

MP C2004 / C2504

Machine Code:

D243 / D244

Field Service Manual

July, 2016

Important Safety Notices

Warnings, Cautions, Notes

In this manual, the following important symbols and notations are used.

WARNING

- A Warning indicates a potentially hazardous situation. Failure to obey a Warning could result in death or serious injury.

CAUTION

- A Caution indicates a potentially hazardous situation. Failure to obey a Caution could result in minor or moderate injury or damage to the machine or other property.

Important

- Obey these guidelines to avoid problems such as misfeeds, damage to originals, loss of valuable data and to prevent damage to the machine.

Note

- This information provides tips and advice about how to best service the machine.

General Safety Instructions

For your safety, please read this manual carefully before you use this product. Keep this manual handy for future reference.

Safety Information

Always obey the following safety precautions when using this product.

Safety During Operation

In this manual, the following important symbols and notations are used.



[A]: ON

[B]: OFF

[C]: Push ON/ Push OFF

[D]: Standby

Switches and Symbols

Where symbols are used on or near switches on machines for Europe and other areas, the meaning of each symbol conforms with IEC60417.

Safety

Prevention of Physical Injury

1. Before disassembling or assembling parts of the machine and peripherals, make sure that the machine and peripheral power cords are unplugged.
2. The plug should be near the machine and easily accessible.
3. Note that some components of the machine and the paper tray unit are supplied with electrical voltage even if the main power switch is turned off.
4. Always unplug the power cord from the power source before you move the product. Before you move the machine, arrange the power cord so it will not fall under the machine.
5. Disconnect all peripheral units (finisher, LCT, etc.) from the mainframe before you move the machine.
6. If any adjustment or operation check has to be made with exterior covers off or open while the main switch is turned on, keep hands away from electrified or mechanically driven components.
7. The machine drives some of its components when it completes the warm-up period. Be careful to keep hands away from the mechanical and electrical components as the machine starts operation.
8. The inside and the metal parts of the fusing unit become extremely hot while the machine is operating. Be careful to avoid touching those components with your bare hands.
9. To prevent a fire or explosion, keep the machine away from flammable liquids, gases, and aerosols.
10. Do not use flammable sprays or solvent in the vicinity of the machine. Also, avoid placing these items in the vicinity of the machine. Doing so could result in fire or electric shock.
11. To avoid fire or explosion, never use an organic cleaner near any part that generates heat.
12. Clean the floor completely after accidental spillage of silicone oil or other materials to prevent slippery surfaces that could cause accidents leading to hand or leg injuries.
13. Never remove any safety device unless it requires replacement. Always replace safety devices immediately.
14. Never do any procedure that defeats the function of any safety device.
15. Modification or removal of a safety device (fuse, switch, etc.) could lead to a fire and personal injury. Always test the operation of the machine to ensure that it is operating normally and safely after removal and replacement of any safety device.

-
16. For replacements use only the correct fuses or circuit breakers rated for use with the machine. Using replacement devices not designed for use with the machine could lead to a fire and personal injuries.
 17. For machines installed with the ADF/ARDF:
When a thick book or three-dimensional original is placed on the exposure glass and the ARDF cover is lowered, the back side of the ARDF rises up to accommodate the original. Therefore, when closing the ARDF, please be sure to keep your hands away from the hinges at the back of the ARDF.
 18. When using a vacuum cleaner around the machine, keep others away from the cleaner, especially small children.
 19. For machines installed with the anti-tip components:
The anti-tip components are necessary for meeting the requirements of IEC60950-1, the international standard for safety. The aim of these components is to prevent the products, which are heavy in weight, from toppling as a result of people running into or leaning onto the products, which can lead to serious accidents such as persons becoming trapped under the product. (U.S.: UL60950-1, Europe: EN60950-1) Therefore, removal of such components must always be with the consent of the customer. Do not remove them at your own judgment.

Health Safety Conditions

1. For the machines installed with the ozone filters:
 - Never operate the machine without the ozone filters installed.
 - Always replace the ozone filters with the specified types at the proper intervals.
2. The machine, which use high voltage power source, can generate ozone gas. High ozone density is harmful to human health. Therefore, locate the machine in a large well ventilated room that has an air turnover rate of more than 50m³/hr/person.
3. Toner and developer are non-toxic, but if you get either of them in your eyes by accident, it may cause temporary eye discomfort. Try to remove with eye drops or flush with water as first aid. If unsuccessful, get medical attention.

Observance of Electrical Safety Standards

1. The machine and its peripherals must be installed and maintained by a customer service representative who has completed the training course on those models with exceptions on some machines where the installation can be handled by the user.

Safety and Ecological Notes for Disposal

1. Do not incinerate toner bottles or used toner. Toner dust may ignite suddenly when exposed to an open flame.

-
2. Dispose of used toner, developer, organic photoconductors, and AIO unit in accordance with local regulations. (These are non-toxic supplies.)
 3. Dispose of replaced parts in accordance with local regulations.
 4. When keeping used lithium batteries in order to dispose of them later, do not put more than 100 batteries per sealed box. Storing larger numbers or not sealing them apart may lead to chemical reactions and heat build-up.
 5. The danger of explosion exists if a battery of this type is incorrectly replaced. Replace only with the same or an equivalent type recommended by the manufacturer. Discard used batteries in accordance with the manufacturer's instructions.

Handling Toner

- Work carefully when removing paper jams or replacing toner bottles or cartridges to avoid spilling toner on clothing or the hands.
- If toner is inhaled, immediately gargle with large amounts of cold water and move to a well-ventilated location. If there are signs of irritation or other problems, seek medical attention.
- If toner gets on the skin, wash immediately with soap and cold running water.
- If toner gets into the eyes, flush the eyes with cold running water or eye wash. If there are signs of irritation or other problems, seek medical attention.
- If toner is swallowed, drink a large amount of cold water to dilute the ingested toner. If there are signs of any problem, seek medical attention.
- If toner spills on clothing, wash the affected area immediately with soap and cold water. Never use hot water! Hot water can cause toner to set and permanently stain fabric.
- Always store toner and developer supplies such as toner and developer packages, cartridges, bottles (including used toner and empty bottles and cartridges), and AIO unit out of the reach of children.
- Always store fresh toner supplies or empty bottles or cartridges in a cool, dry location that is not exposed to direct sunlight.
- Do not use a vacuum cleaner to remove spilled toner (including used toner). Vacuumed toner may cause a fire or explosion due to sparks or electrical contact inside the cleaner. However, it is possible to use a cleaner designed to be dust explosion-proof. If toner is spilled over the floor, sweep up spilled toner slowly and clean up any remaining toner with a wet cloth.

Handling the development unit cooling system

For the machines installed the development cooling system:

1. The development unit cooling system circulates propylene glycol from a sealed tank through hoses that pass behind cooling plates on the sides of each development unit.
2. The coolant tank is located at the bottom of the cooling box on the back of the main machine.

-
3. Always obey local laws and regulations if you need to dispose of a tank or the propylene glycol coolant.
 4. The tank must never be emptied directly into a local drainage system, river, pond, or lake.
 5. Contact a professional industrial waste disposal organization and ask them to dispose of the tank.

Laser Safety

The Center for Devices and Radiological Health (CDRH) prohibits the repair of laser-based optical units in the field. The optical housing unit can only be repaired in a factory or at a location with the requisite equipment. The laser subsystem is replaceable in the field by a qualified Customer Engineer. The laser chassis is not repairable in the field. Customer engineers are therefore directed to return all chassis and laser subsystems to the factory or service depot when replacement of the optical subsystem is required.

WARNING

- Use of controls, or adjustment, or performance of procedures other than those specified in this manual may result in hazardous radiation exposure.

WARNING FOR LASER UNIT

WARNING:

Turn off the main switch before attempting any of the procedures in the Laser Unit section. Laser beams can seriously damage your eyes.



_safe006



_safe007



_safe008

Safety Instructions for the Color Controller

Fuse

The color controller uses a double pole fuse. If this fuse blows, be sure to replace it with an identical fuse.

Batteries







1. Always replace a battery with the same type of battery prescribed for use with the color controller unit. Replacing a battery with any type other than the one prescribed for use could cause an explosion.
2. Never discard used batteries by mixing them with other batteries or other refuse.

-
3. Always remove used batteries from the work site and dispose of them in accordance with local laws and regulations regarding the disposal of such items.

Symbols, Abbreviations and Trademarks

Symbols, Abbreviations

This manual uses several symbols and abbreviations. The meaning of those symbols and abbreviations are as follows:

Symbol	What it means
	Clip ring
	Screw
	Connector
	Clamp
	E-ring
	Flat flexible cable
	Timing belt
SEF	Short edge feed [A]
LEF	Long edge feed [B]
K	Black
C	Cyan
M	Magenta
Y	Yellow
B/W, BW	Black and white
FC	Full color

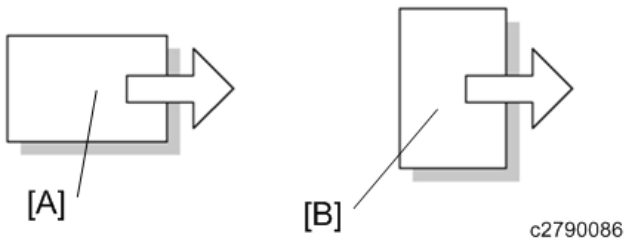

Trademarks

Adobe, Acrobat, PageMaker, PostScript, and PostScript 3 are either registered trademarks or trademarks of Adobe Systems Incorporated in the United States and/or other countries.

The Bluetooth® word mark and logos are registered trademarks owned by Bluetooth SIG, Inc. and any use of such marks by Ricoh Company, Ltd. is under license.

Firefox and Thunderbird are registered trademarks of the Mozilla Foundation.

Google, Android, and Chrome are trademarks of Google Inc.

iOS® is a registered trademark or trademark of Cisco Systems, Inc. and/or its affiliates in the United States and certain other countries.

Java is a registered trademark of Oracle and/or its affiliates.

JAWS® is a registered trademark of Freedom Scientific, Inc., St. Petersburg, Florida and/or other countries.

Kerberos is a trademark of the Massachusetts Institute of Technology (MIT).

Linux is a registered trademark of Linus Torvalds.

Macintosh, OS X, Bonjour, Safari, and TrueType are trademarks of Apple Inc., registered in the U.S. and other countries.

Microsoft, Windows, Windows Server, Windows Vista, Internet Explorer, and Outlook are either registered trademarks or trademarks of Microsoft Corp. in the United States and/or other countries.

PictBridge is a trademark.

QR Code is a registered trademark of DENSO WAVE INCORPORATED in Japan and in other countries.

"Red Hat" is a registered trademark of Red Hat, Inc.

The SD and SD logo are trademarks of SD-3C, LLC.

UNIX is a registered trademark of The Open Group.

UPnP is a trademark of UPnP Implementers Corporation.



This product includes RSA BSAFE® Cryptographic software of EMC Corporation. RSA and BSAFE are registered trademarks or trademarks of EMC Corporation in the United States and other countries.

The proper names of Internet Explorer 6, 7, and 8 are as follows:

- Microsoft® Internet Explorer® 6
- Windows® Internet Explorer® 7
- Windows® Internet Explorer® 8

The proper names of the Windows operating systems are as follows:

- The product names of Windows Vista are as follows:

Microsoft® Windows Vista® Ultimate
Microsoft® Windows Vista® Business
Microsoft® Windows Vista® Home Premium
Microsoft® Windows Vista® Home Basic
Microsoft® Windows Vista® Enterprise

- The product names of Windows 7 are as follows:

Microsoft® Windows® 7 Home Premium
Microsoft® Windows® 7 Professional
Microsoft® Windows® 7 Ultimate
Microsoft® Windows® 7 Enterprise

- The product names of Windows 8 are as follows:

Microsoft® Windows® 8
Microsoft® Windows® 8 Pro
Microsoft® Windows® 8 Enterprise

- The product names of Windows 8.1 are as follows:

Microsoft® Windows® 8.1
Microsoft® Windows® 8.1 Pro
Microsoft® Windows® 8.1 Enterprise

- The product names of Windows 10 are as follows:

Microsoft® Windows® 10 Home Premium

Microsoft® Windows® 10 Pro

Microsoft® Windows® 10 Enterprise

Microsoft® Windows® 10 Education

- The product names of Windows Server 2003 are as follows:

Microsoft® Windows Server® 2003 Standard Edition

Microsoft® Windows Server® 2003 Enterprise Edition

- The product names of Windows Server 2003 R2 are as follows:

Microsoft® Windows Server® 2003 R2 Standard Edition

Microsoft® Windows Server® 2003 R2 Enterprise Edition

- The product names of Windows Server 2008 are as follows:

Microsoft® Windows Server® 2008 Standard

Microsoft® Windows Server® 2008 Enterprise

- The product names of Windows Server 2008 R2 are as follows:

Microsoft® Windows Server® 2008 R2 Standard

Microsoft® Windows Server® 2008 R2 Enterprise

- The product names of Windows Server 2012 are as follows:

Microsoft® Windows Server® 2012 Foundation

Microsoft® Windows Server® 2012 Essentials

Microsoft® Windows Server® 2012 Standard

- The product names of Windows Server 2012 R2 are as follows:

Microsoft® Windows Server® 2012 R2 Foundation

Microsoft® Windows Server® 2012 R2 Essentials

Microsoft® Windows Server® 2012 R2 Standard

Other product names used herein are for identification purposes only and might be trademarks of their respective companies. We disclaim any and all rights to those marks.

Microsoft product screen shots reprinted with permission from Microsoft Corporation.

TABLE OF CONTENTS

Symbols, Abbreviations and Trademarks..... 1

- Symbols, Abbreviations..... 1
- Trademarks..... 2

1. Product Information

Product Overview..... 35

- Component Layout..... 35
- Paper Path..... 37
- Drive Layout..... 40

Machine Codes and Peripherals Configuration..... 42

- Main Machine..... 42
 - 17..... 42
 - 18..... 42
 - 19..... 43
 - 21..... 43
 - 22..... 43
 - 26..... 43
 - 27..... 43
 - 29..... 44
 - 65..... 44
- Options..... 44
- Diagram..... 47

Specifications..... 49

2. Installation

Installation Requirements..... 51

- Environment..... 51
- Machine Level..... 52
- Machine Space Requirements..... 52
- Machine Dimensions..... 53
 - Model -27, -29, -65 (220–240 V)..... 55
 - Model -17, -18 (120–127 V)..... 55
- Power Requirements..... 56
 - Input Voltage Level..... 56

Main Machine Installation..... 57

Important Notice on Security Issues.....	57
Installation Flow Chart.....	59
Accessory Check.....	60
Installation Procedure.....	61
Removal of Packing Materials and Shipping Retainers.....	61
For Machines with preinstalled SPDF: Removal of protective sheet.....	67
Removal of PCDU Seals.....	68
Attaching the Optical Cloth Pocket.....	70
Attaching the Paper Exit Tray Parts.....	70
Checking the Position of the Paper Exit Feeler.....	70
Attaching the Decals.....	71
Toner Bottle Installation and Login Password Setting.....	73
For Machines with Preinstalled ARDF: Fax Stamp Installation (Option).....	76
Image Quality Test/ Settings.....	78
Before Test.....	78
Loading Paper.....	78
ACC Execution and Color Registration Adjustment.....	78
Checking the Copy Image with the Test Chart.....	81
Paper Settings.....	81
Auto Remote Firmware Update Settings.....	82
Enabling the Copy Data Security Function.....	89
HDD Security Function Setting.....	89
Settings Relevant to the Service Contract.....	89
Moving the Machine.....	91
Cautions upon Lashing.....	93
Anti-Condensation Heater (Scanner, PCDU).....	95
Anti-Condensation Heater (Scanner).....	95
Accessory Check.....	95
Installation Procedure.....	97
Anti-Condensation Heater (PCDU).....	108
Accessory Check.....	108
Installation Procedure.....	109
Anti-Condensation Heater for Paper Feed Trays.....	119

Accessory Check.....	119
Connecting to Main Machine Tray.....	120
Connecting to Paper Feed Unit PB3220/PB3210.....	124
Connecting to Paper Feed Unit PB3150.....	126
Paper Feed Unit PB3220 (D787-18, -22)/ PB3210 (D787-17).....	129
Accessory Check.....	129
Installation Procedure.....	129
Paper Feed Unit PB3150 (D694).....	135
Accessory Check.....	135
Installation Procedure.....	135
Caster Table Type M3 (D178).....	140
Accessory Check.....	140
Installation Procedure.....	140
How to Place the MFP on the Caster Table.....	141
How to Place the Paper Feed Unit PB3150 on the Caster Table.....	142
Platen Cover PN2000 (D700).....	143
Accessory Check.....	143
Installation Procedure.....	143
ARDF DF3090 (D779).....	146
Accessory Check.....	146
Installation Procedure.....	146
When Feeding Thin Paper.....	151
SPDF DF3100 (D3B0).....	152
Accessory Check.....	152
Installation Procedure.....	153
Attaching the SPDF.....	153
Adjust SP Settings.....	162
1 Bin Tray BN3110 (D3CQ).....	165
Accessory Check.....	165
Installation Procedure.....	166
Checking the Position of the Paper Exit Feeler.....	172
Internal Shift Tray SH3070 (D691).....	174
Accessory Check.....	174

Installation Procedure.....	174
Checking the Position of the Paper Exit Feeler.....	177
Side Tray Type M3 (D725).....	179
Accessory Check.....	179
Installation Procedure.....	180
Bridge Unit BU3070 (D685).....	187
Accessory Check.....	187
Installation Procedure.....	187
Booklet Finisher SR3220 (D3B9).....	195
Accessory Check.....	195
Installation Procedure.....	196
Attaching the Proof Support Tray.....	204
Punch Unit PU3050.....	205
Accessory Check.....	205
Installation Procedure.....	206
Internal Finisher SR3130 (D690).....	219
Accessory Check.....	219
Installation Procedure.....	220
Punch Unit PU3040 (D716).....	233
Accessory Check.....	233
Installation Procedure.....	234
Internal Finisher SR3180 (D766).....	241
Accessory Check.....	241
Installation Procedure.....	242
Stapleless Stapler Initial Settings.....	258
How to Change the Setting of Staple Method for Stapleless Stapler.....	258
How to set Margin Erase for Stapleless Stapler.....	259
Banner Paper Guide Tray Type M19 (D3BF).....	260
Accessory Check.....	260
Installation Procedure.....	260
Imageable Area Extension Unit Type M19 (D3BR-07).....	265
Accessory Check.....	265
Installation Procedure.....	265

When You Forgot to Change the SP.....	267
External Keyboard Bracket Type M19 (D3BR-10).....	269
Accessory Check.....	269
Installation Procedure.....	269
Internal Options.....	275
List of Slots.....	275
USB Device Server Option Type M19 (D3BC-28,-29).....	276
Accessory Check.....	276
Interface Board Surface.....	277
Installation Procedure.....	278
What Do the LED Indications Mean?.....	282
IP Address Setting.....	283
Extended USB Board Type M19 (D3BS-01).....	285
Accessory Check.....	285
Installation Procedure.....	285
IEEE 1284 Interface Board Type M19 (D3C0).....	287
Accessory Check.....	287
Installation Procedure.....	287
IEEE 802.11 a/g/n Interface Unit Type M19 (D3BR-01).....	289
Accessory Check.....	289
Installation Procedure.....	290
Attaching the Boards.....	290
Attaching the Antenna.....	291
User Tool Settings for IEEE 802.11 a/g/n.....	292
SP Mode Settings for IEEE 802.11 Wireless LAN.....	293
File Format Converter Type M19 (D3BR-04).....	295
Accessory Check.....	295
Installation Procedure.....	295
Bluetooth Interface Unit Type D (D566-01).....	297
Accessory Check.....	297
Installation Procedure.....	297
Memory Unit Type M19 4GB (D3BX-03).....	299
Accessory Check.....	299

Installation Procedure.....	299
Enhanced Security HDD Option Type M12 (D3A6-02).....	302
Accessory Check.....	302
Installation Procedure.....	302
After Installing the HDD.....	306
Optional Counter Interface Unit Type M12 (B870-21).....	308
Accessory Check.....	308
Installation Procedure.....	309
Key Counter Bracket Type M3 (D739-09).....	312
Accessory Check.....	312
Installation Procedure.....	312
Card Reader Bracket Type 3352 (D593-61).....	318
Accessory Check.....	318
Installation Procedure.....	319
NFC Card Reader Type M19 (D3BS-21).....	323
Accessory Check.....	323
Installation Procedure.....	324
Smart Card Reader Built-in Unit Type M19 (D3BS-22).....	331
Accessory Check.....	331
Installation Procedure.....	331
Procedure for Connecting to the Main Machine USB Slot.....	332
Procedure for Connecting to the Operation Panel USB Slot.....	338
SD Card Options.....	345
SD Card Slots.....	345
List of Slots Used.....	345
SD Card Appli Move.....	347
Overview.....	347
Move Exec.....	349
Undo Exec.....	350
PostScript3 Unit Type M19 (D3BD-05, -06, -07).....	352
Accessory Check.....	352
Installation procedure.....	352
Camera Direct Print Card Type M19 (D3BD-13).....	354

Accessory Check.....	354
Installation Procedure.....	354
XPS Direct Print Option Type M19 (D3BC-24, -25, -26).....	356
Accessory Check.....	356
Installation Procedure.....	356
OCR Unit Type M13 (D3AC-23, -24, -25).....	358
Accessory Check.....	358
Searchable PDF Function Outline.....	358
Installation Procedure.....	358
Recovery Procedure.....	360
DataOverwriteSecurity Unit Type M19 (D3BS-03).....	361
Overview.....	361
Accessory Check.....	361
Before You Begin the Procedure.....	362
Seal Check and Removal.....	362
Installation Procedure.....	363
Configuring "Auto Erase Memory" (Performed by the Customer).....	365
@Remote Settings.....	368
Security Settings.....	374
Security Function Installation.....	374
Data Overwrite Security.....	375
Before You Begin the Procedure.....	375
Installation Procedure.....	375
Using Auto Erase Memory.....	376
HDD Encryption.....	378
Before You Begin the Procedure:.....	378
Installation Procedure:.....	379
Enable Encryption Setting.....	379
Check the Encryption Settings.....	382
Backing Up the Encryption Key.....	384
Encryption Key Restoration.....	385

3. Preventive Maintenance

PM Parts Settings.....	389
------------------------	-----

Replacement Procedure of the PM Parts.....	389
Method 1: By SP3701.....	389
Method 2: By [PM Counter / New Unit Set] Menu.....	390
After Installing the New PM Parts.....	392
SP Descriptions.....	392
Preparation before Operation Check.....	393
SP Descriptions.....	393
Operation Check.....	394
PM Parts List.....	395

4. Replacement and Adjustment

Notes on the Main Power Switch.....	397
Push Switch.....	397
Characteristics of the Push Switch (DC Switch).....	397
Shutdown Method.....	398
Forced Shutdown.....	399
Beforehand.....	400
Special Tools.....	401
Exterior Covers.....	402
Overview.....	402
Front and Rear Side Covers.....	402
Right and Left Side Covers.....	403
Paper Exit Covers.....	404
Inner Covers.....	404
Front Cover.....	405
Controller Cover.....	406
Upper Left Cover.....	406
Left Rear Cover.....	407
Left Cover.....	408
Rear Cover.....	411
Rear Lower Cover.....	412
Right Rear Cover.....	412
Right Upper Cover.....	413
Front Upper Cover.....	413

Proximity Sensor (Human Detection Sensor).....	415
Main Power Switch Cover.....	416
Waste Toner Cover.....	417
Inverter Tray.....	418
Paper Exit Tray.....	419
Paper Exit Cover.....	419
Paper Exit Lower Cover.....	419
Paper Exit Front Cover.....	420
Inner Upper Cover.....	421
Inner Lower Cover.....	421
Smart Operation Panel.....	423
Operation Panel Unit.....	423
USB Cable.....	426
ADF.....	429
ADF Removal.....	429
Scanner Unit.....	432
Before You Begin.....	432
Scanner Exterior.....	432
Scanner Front Cover.....	432
Scanner Right Cover.....	433
Scanner Left Cover.....	433
Scanner Upper Cover.....	434
Exposure Glass.....	434
Scanner Carriage.....	436
Cleaning the Scanner Carriage Mirror.....	440
Scanner Motor.....	443
APS Sensor.....	445
Scanner HP Sensor.....	445
ARDF/Platen Cover Sensor.....	446
Scanner FFC.....	447
When Changing the FFC.....	448
Laser Unit.....	452
Laser Unit.....	452

Before Replacement.....	453
Removing.....	453
Installing a New Laser Unit.....	454
Adjustment after Replacing the Laser Unit.....	455
Polygon Mirror Motor.....	456
Adjustment after Replacing the Polygon Mirror Motor.....	457
SP Descriptions.....	457
PCDU.....	459
PCDU.....	459
Adjustment after Replacing the PCDU.....	461
PCU/Development Unit.....	462
Before Replacing a PCU.....	462
Before Replacing a Development Unit.....	464
Replacement.....	464
Notes for Assembling PCU/Development Unit	468
Method for Checking after Replacement.....	468
Adjustment after Replacing the PCU and/or the Development Unit.....	469
Imaging Temperature Sensor (Thermistor).....	469
Waste Toner.....	472
Waste Toner Bottle.....	472
Before Replacing the Waste Toner Bottle.....	472
Replacement.....	472
Image Transfer Unit.....	474
Image Transfer Belt Unit.....	474
What to Do before Replacing the Image Transfer Belt.....	475
Replacement.....	475
Image Transfer Cleaning Unit.....	478
What to Do before Replacing the Image Transfer Cleaning Unit.....	479
Replacement.....	480
Image Transfer Belt.....	483
Attaching the Belt.....	486
Adjustment after replacing the Image transfer belt.....	490
Paper Transfer Roller.....	491

When reinstalling the paper transfer roller.....	492
Paper Transfer Roller Unit.....	495
What to Do before Replacing the Paper Transfer Roller Unit.....	495
Replacement.....	495
Fusing Entrance Sensor.....	498
TM/ID Sensor.....	498
Before Replacing the TM/ID sensor.....	498
Replacement procedure.....	500
Adjustment after Replacing the TM/ID sensor.....	502
Temperature and Humidity Sensor.....	504
ITB Contact and Release Sensor.....	505
Image Transfer Lock Unit.....	506
Installing the Image Transfer Lock Unit.....	508
Drive Unit.....	511
Overview.....	511
Paper Feed Motor.....	512
Transport Motor.....	512
Paper Transfer Contact and Release Motor Unit.....	512
Imaging Drive Unit.....	513
PCU Motor: CMY.....	514
Development Motor: CMY.....	515
Development Solenoid.....	516
PCU motor: Black / ITB Drive Motor.....	517
Registration Motor.....	518
Fusing Motor.....	519
Paper Exit/ Pressure Release Motor.....	520
Duplex Entrance Motor.....	520
Toner Supply Motor.....	521
Sub Hopper.....	522
K.....	523
C.....	525
M.....	526
Y.....	528

Toner End Sensor.....	529
Toner Bottle Drive Motor.....	530
K.....	530
C.....	531
M.....	531
Y.....	532
ID Chip Contact Board.....	532
K.....	532
C.....	533
M.....	533
Y.....	534
Transport Coil Unit.....	535
Y.....	535
M.....	538
C.....	539
K.....	539
Fusing Unit.....	541
Fusing Unit.....	541
Fusing Entrance Guide Plate.....	542
Cleaning the Fusing Entrance Guide Plate.....	543
Fusing Exit Guide Plate.....	543
Cleaning the Fusing Exit Guide Plate.....	544
Fusing Upper Cover.....	544
Fusing Lower Cover.....	545
Fusing Sleeve Belt Unit.....	546
Adjustment before Replacing the Fusing Sleeve Belt Unit.....	547
Replacement.....	547
Pressure Roller.....	550
Adjustment before Replacing the Pressure Roller.....	550
Replacement.....	550
Fusing Sleeve Thermostat Unit.....	552
Non-Contact Thermistor.....	553
Pressure Roller Thermistor.....	554

Thermopile Unit.....	554
Pressure Roller HP Sensor.....	555
Fusing Exit Drive Solenoid.....	556
Paper Exit.....	557
Paper Exit Unit.....	557
Paper Exit Solenoid.....	557
Paper Exit Sensor.....	558
Reverse Sensor.....	560
Reverse Motor.....	561
Fusing Exit Sensor.....	562
Paper Feed.....	564
Paper Feed Unit.....	564
1st Paper Feed Unit.....	564
2nd Paper Feed Unit.....	566
Paper Dust Collection Unit.....	568
Pick-up Roller, Paper Feed Roller, Separation Roller, Torque Limiter.....	568
1st Tray Lift Motor/ 2nd Tray Lift Motor.....	571
Transport Sensor.....	572
Upper Limit Sensor.....	573
Paper End Sensor.....	573
Registration Sensor.....	574
Bypass Tray Unit.....	576
Bypass Tray.....	576
Bypass Paper End Sensor.....	579
Bypass Pick-up Roller.....	581
Bypass Paper Feed Roller.....	581
Bypass Separation Roller/Torque Limiter.....	581
Bypass Width Sensor.....	583
Bypass Length Sensor.....	587
Duplex Unit.....	591
Duplex Unit.....	591
Duplex/Bypass Motor.....	592
Duplex Entrance Sensor.....	593

Duplex Exit Sensor.....	595
Electrical Components.....	597
Overview.....	597
Printed Circuits/Parts inside the Controller Box.....	597
Printed Circuits behind the Controller Box.....	598
Printed Circuit/Parts inside the Power Box.....	599
Printed Circuits behind the Power Box.....	599
Controller Box Cover.....	600
IPU.....	600
BCU.....	601
When installing the new BCU.....	602
Replacing the NVRAM (EEPROM) on the BCU.....	602
Controller Board.....	604
Replacing the NVRAMs on the Controller Board.....	606
HDD.....	613
Adjustment after replacement.....	614
Controller Box.....	614
Imaging IOB.....	615
HVP_TTS.....	617
PSU (AC Controller Board).....	618
PSU (DC Power).....	619
Power Supply Box.....	620
Paper Transport IOB.....	621
HVP-CB.....	622
HVP-CB with Bracket.....	622
Proximity Sensor (Human Detection Sensor) Board.....	624
Fans/Filters.....	625
Ozone filter/Dust filter.....	625
Adjustment before Replacing the Dust Filter.....	625
Replacement.....	625
Deodorization Filter.....	626
Development Intake Fan.....	627
Ozone Exhaust Fan.....	628

Paper Exit Cooling Fan.....	628
Fusing Exhaust Fan.....	629
Toner Supply Cooling Fan.....	630
PSU Cooling Fan.....	631
Controller Box Cooling Fan.....	632
Image Adjustment.....	633
Auto Color Calibration.....	633
Scanning.....	634
Scanner Sub-scan Magnification.....	635
Scanner Leading Edge and Side-to-side Registration.....	635
ARDF.....	636
ARDF Side-to-side, Leading Edge Registration and Trailing Edge.....	636
ARDF Sub-scan Magnification.....	637
Registration.....	637
Image Area.....	637
Leading Edge.....	637
Side to Side.....	637
Adjustment Standard.....	638
Paper Registration Standard.....	638
Adjustment Procedure.....	638
Erase Margin Adjustment.....	638
Adjusting the Tone of the Printed Image.....	639
Adjustment by Changing the Printer Driver Setting.....	640
Opening the Printer Driver's "Color Balance Details" Window.....	640
Color Balance Details Window.....	643
Adjusting the Tone in the "Color Balance Details" Window.....	644
Adjustment Examples.....	646
Adjustment by Changing the Machine's Profile Setting.....	648
Procedure to Change the Profile Setting.....	648
Patterns and Tendency of the Tone for Each Profile.....	649
Printer Gamma Correction.....	650
Color Registration.....	654
Check the Occurrence of Color Registration Errors.....	654

Judgment for Type of Color Registration Error.....	654
--	-----

5. System Maintenance

Service Program Mode.....	665
Entering SP Mode.....	665
Exiting SP Mode.....	666
Types of SP Modes.....	666
SP Mode Button Summary.....	667
Switching Between SP Mode and Copy Mode for Test Printing.....	668
Selecting the Program Number.....	668
Service Mode Lock/Unlock.....	669
Remarks.....	670
Others.....	670
SP Tables.....	672
Firmware Update (SD Card).....	673
Overview.....	673
Firmware Type.....	673
Procedure.....	675
Preparation.....	676
Update procedure.....	676
Error Screens During Updating.....	680
Firmware Update (Remote Firmware Update).....	686
RFU Performable Condition.....	686
Firmware Update (Smart Firmware Update).....	687
Overview.....	687
Immediate Update.....	688
Update at the Next Visit (Reserve).....	691
How to Set the Machine to Download Firmware Later (Reserve).....	691
How to Check if the Firmware Downloaded with Reserve.....	693
How to Install Firmware Downloaded with Reserve.....	695
Update via SD card.....	698
Firmware Update (Auto Remote Firmware Update).....	701
Overview.....	701
Downloading and Updating Process.....	702

Downloads the latest package.....	703
Judgement of ARFU.....	703
Update Process.....	705
Checking the ARFU Result.....	708
Checking the Result Using the Logging Data.....	708
Related SP.....	708
Updating JavaVM.....	713
Creating an SD Card for Updating.....	713
Updating Procedure.....	713
List of Error Messages.....	714
NVRAM Data Upload/Download.....	716
Uploading Content of NVRAM to an SD card.....	716
Downloading an SD Card to NVRAM.....	717
Address Book Upload/Download.....	718
Information List.....	718
Download.....	718
Upload.....	719
Capturing the Device Logs.....	720
Overview.....	720
Security of the Operation Log.....	722
Retrieving the Device Logs via Operation Panel.....	722
Procedure for Retrieving the Device Log with SD Card.....	722
Retrieving the Device Logs via Web Image Monitor.....	725
SMC List Card Save Function.....	729
Overview.....	729
SMC List Card Save.....	729
Procedure.....	729
File Names of the Saved SMC Lists.....	731
Error Messages.....	732
UP/SP Data Import/Export.....	733
UP Data Import/Export.....	733
Data that can be imported and exported.....	733
Data that cannot be imported or exported.....	733

Exporting Device Information.....	734
Importing Device Information.....	735
SP Data Import/Export.....	736
Data that can be imported and exported.....	736
Exporting Device Information.....	737
Importing Device Information.....	738
Possible solutions for import/export problems.....	739
Card Save Function.....	742
Overview.....	742
Card Save:.....	742
Procedure.....	742
Error Messages.....	745

6. Troubleshooting

Self-Diagnostic Mode.....	747
SC Automatic Reboot.....	747
Controller Self-diagnosis Outline.....	750
Controller Self-diagnosis Flowchart.....	751
HDD-related Message.....	754
Service Call Conditions.....	756
Summary.....	756
SC Logging.....	757
List of Automatic Reboot Target SC.....	757
Engine SC.....	757
Controller SC.....	765
SC Code Classification.....	768
Service Call 101-195.....	770
SC100 (Engine: Scanning).....	770
Service Call 202-285.....	784
SC200 (Engine: Image Writing).....	784
Service Call 312-396.....	792
SC300 (Engine: Charge, Development).....	792
Service Call 441-498.....	801
SC400 (Engine: Around the Drum).....	801

Service Call 501-584.....	807
SC500 (Engine: Paper transport 1: Paper Feed, Duplex, Transport).....	807
SC500 (Engine: Fusing).....	819
Fusing Sleeve (Center) Error (SC54*-**).....	822
Fusing Sleeve (Edge) Error (SC55*-**).....	831
Pressure Roller Thermistor (Center) Error (SC56*-**).....	839
Pressure Roller Thermistor (Edge) Error (SC57*-**).....	844
Pressure Roller Thermistor (Full-bleed edge) Error (SC58*-**).....	848
Service Call 620-687.....	853
SC600 (Engine: Communication and Others).....	853
SC600 (Controller).....	877
Service Call 700-792.....	890
SC700 (Engine: Peripherals).....	890
Service Call 816-899.....	915
SC800 (Controller).....	915
Service Call 900-998.....	958
SC900 (Engine: Others).....	958
SC900 (Controller).....	960
Troubleshooting for SC Errors.....	966
When SC285-02 (MUSIC Error) Is Displayed.....	966
Causes.....	966
Solutions.....	967
When SC370 (TM (ID) Sensor Calibration Error) Is Displayed.....	970
Causes.....	970
Solutions.....	970
Recovery Check Procedure.....	971
Adjustment after Recovery.....	971
When SC501, SC502, SC503, or SC504 (Paper Tray Error) Is Displayed.....	972
Solutions.....	972
When SC544-02, SC554-02 (Non-contact Thermistor High Temperature Detection) Is Displayed.....	973
How to Clear SC544-02/SC554-02 with a New Unit Detection Fuse.....	975
Isolation Diagram of SC663, 664, 665, 667, 668, and 670-01.....	976

When SC670 (Engine start up error) is displayed.....	977
Causes.....	977
Solutions.....	977
When SC672 (Controller start up error) Is Displayed.....	978
Symptom.....	978
Causes.....	979
Solutions.....	979
[A]: LEDs on the controller board.....	981
[B]: Abnormal mode: LEDs on the controller board.....	982
[C]: Reconnecting and replacing the USB cable.....	983
[D]: Replacing the Memory.....	985
[E]: CMOS clear.....	986
[F]: Fuse on the IPU.....	986
[G]: Replacing the USB cable and the operation panel.....	987
When Abnormal Noise Occurs.....	993
Procedure of Checking Abnormal Noise of Drive Unit (Peripheral Fusing).....	993
Operation Check Procedures of the Toner Supply Motor/Toner Bottle Drive Motor.....	995
Jam Detection.....	997
Jam Display.....	997
Clearing a Paper Jam.....	997
Paper Jam History.....	998
History Checking Method.....	998
Paper Jam Display.....	998
Jam Codes and Display Codes.....	998
Paper Size Code.....	1006
Sensor Locations.....	1007
Troubleshooting for Transport/Paper Feeding of the Machine.....	1008
Curled Paper.....	1008
Initial Jam.....	1008
Initial Jam: Cause Code 001 / Location Code A.....	1008
Initial Jam: Cause Code 001 / Location Code B.....	1009
Initial Jam: Cause Code 001 / Location Code C.....	1010
Initial Jam: Cause Code 001 / Location Code Z.....	1011

Jam.....	1012
Bypass No Feeding: Cause Code 008.....	1012
Tray 1 Transport Sensor: Late Jam : Cause Code 011.....	1013
Tray 2 Transport Sensor : Late Jam : Cause Code 012.....	1015
Registration Sensor : Late Jam : Cause Code 017.....	1016
Fusing Entrance Sensor : Late Jam : Cause Code 018.....	1016
Fusing Exit Sensor : Late Jam : Cause Code 019.....	1017
Paper Exit Sensor : Late Jam : Cause Code 020.....	1018
Tray 1 Transport Sensor : Lag Jam : Cause Code 051.....	1020
Tray 2 Transport Sensor: Lag Jam: Cause Code 052.....	1022
Registration Sensor: Lag Jam: Cause Code 057.....	1024
Paper Exit Sensor: Lag Jam: Cause Code 060.....	1025
Reverse Sensor: Late Jam: Cause Code 024.....	1026
Reverse Sensor: Lag Jam : Cause Code 064.....	1027
Duplex Exit Sensor: Late Jam: Cause Code 025.....	1028
Duplex Exit Sensor: Lag Jam: Cause Code 065.....	1030
Duplex Entrance Sensor: Late Jam: Cause Code 027.....	1030
Duplex Entrance Sensor: Lag Jam: Cause Code 067.....	1032
Duplex No Feeding: Cause Code 009.....	1033
Bypass Transport Sensor 1: Lag Jam: Cause Code 048.....	1034
Display Error.....	1035
"No paper in Tray 1" is displayed even when the paper is in.....	1035
"No paper in Tray 2" is displayed even when the paper is in.....	1036
"Tray 1 not set" is displayed even when the tray is set.....	1036
"Tray 2 not set" is displayed even when the tray is set.....	1037
Wrong paper size displayed on the operation panel.....	1037
Does not shift to right door open status.....	1038
Others.....	1039
"Replace the waste toner bottle" is displayed even when it is clear that the waste toner bottle is not full.....	1039
Waste toner bottle is never full.....	1040
No waste toner bottle set is displayed on controller board even when it is clear that it is set....	1040
Waste toner bottle is not detected even when it is set.....	1041

Paper transfer unit open/close LED not lit and paper transfer unit open.....	1041
Paper transfer unit open/close LED not lit.....	1041
Paper transfer unit open/close LED always lit.....	1042
Troubleshooting for Finishing Options.....	1044
Finisher Registration Adjustment For Booklet Finisher SR3220 (D3B9).....	1044
Finisher Jogger Problem (For Booklet Finisher SR3220 (D3B9)).....	1047
Early Tray Full Detection Mylar for Internal Finisher SR3130 (D690).....	1047
Pasting the Mylar	1048
Paper Curl Problem for SR3180 (D766).....	1051
Maximum number of sheets for stapling and what happens when the job has too many pages....	1054
Specifications: Maximum sheet capability for staple jobs.....	1054
Behavior: When the number of sheets exceeds the maximum staple capability.....	1055
Select the behavior when the job has more than the maximum of staple capability with SP5199..	1056
.....	1056
Electrical Component Defects.....	1057
Fuses.....	1057
Vertical Streaks on Copies due to Scanning Problems.....	1060
Overview.....	1060
Converting the ARDF DF3090 to Contact Scanning.....	1061
Converting the SPDF3100 to Contact Scanning.....	1064
Image Quality Problems.....	1068
Misjudgment for Auto Color Selection (Copy/Scanner).....	1068
Error Condition.....	1068
Causes.....	1068
Solutions.....	1069
Misjudgment for Auto Color Selection (e.g. When Using Paper Which Has a Strong Blue Component)	1070
.....	1070
When an abnormal image is generated.....	1071
Other Troubleshooting.....	1073
When Fluorescent/ LED Lamps Flicker.....	1073
7. Detailed Descriptions	
Guidance for Those Who are Familiar with Predecessor Products.....	1077
Changes from the Previous Machine.....	1077
Scanner.....	1077

Image Processing.....	1077
Process Control.....	1078
Laser Exposure.....	1078
PCDU (Photo Conductor and Development Unit).....	1078
Waste Toner.....	1079
Image Transfer and Paper Transfer.....	1079
Feed / Transport Part.....	1080
Fusing.....	1081
Electrical Parts.....	1082
Exterior Cover / Air Flows (Fan Control).....	1083
Drive Parts.....	1084
Others.....	1084
Component Layout.....	1086
Scanner Unit.....	1086
Laser Exposure Unit.....	1087
Image Transfer Unit.....	1088
PCDU.....	1089
Toner Supply / Waste Toner Bottle.....	1090
Paper Feed Unit.....	1091
Duplex Unit.....	1092
Bypass Unit.....	1093
Fusing Unit.....	1094
Paper Transfer / Paper Exit.....	1095
Air Flow.....	1096
Drive Unit.....	1097
Board / Switch.....	1098
Scanning.....	1099
Overview.....	1099
Reading System.....	1100
Scanner.....	1100
Mechanism.....	1100
Scanner Drive.....	1100
Operation Flowchart.....	1102

Scanner Carriage Storage Control.....	1103
Document Size Detection.....	1103
Improved Tolerance to Black Lines When Paper Passes through ARDF/SPDF.....	1106
Difference between Non-contact Transport and Contact Transport in DF Scanning.....	1109
Anti-Condensation Heater.....	1110
Image Processing.....	1111
Mechanism.....	1111
SBU.....	1111
IPU.....	1112
Laser Exposure.....	1114
Overview.....	1114
Parts Construction.....	1114
Mechanism.....	1116
LD Drive Board.....	1116
LD Safety Switch.....	1117
Circuit Diagram.....	1117
Line Scanning Mechanism.....	1118
Process Control.....	1119
Mechanism.....	1119
Sensor Construction.....	1119
Outline of the ID Sensors.....	1119
Outline of the TD sensor.....	1119
Process Control.....	1120
Outline.....	1120
Result Code for Executing Process Control.....	1121
The Process Control Procedure.....	1123
Electrified Potential / Development Bias, Vref Correction.....	1124
LD Power Control.....	1125
Toner Supply Control.....	1126
Developer Initial Setting.....	1126
MUSIC (Automatic Color Registration Correction).....	1127
Correction Timing.....	1127
Executing MUSIC Manually	1128

[Color Registration] in User Tools (SP2-111-004)	1128
MUSIC Error Judgment	1129
Real Time Process Control.....	1130
IBACC.....	1131
Outline.....	1131
Operation Timing.....	1131
Patch Pattern.....	1131
SP Descriptions.....	1132
PCDU (Photo Conductor and Development Unit).....	1135
Overview.....	1135
Mechanism (PCU).....	1135
Drum Drive.....	1135
Charge.....	1136
Drum Cleaning.....	1136
Mechanism (Development).....	1137
Development System.....	1137
Agitation System.....	1137
TD Sensor.....	1138
Pressure Release Filter.....	1138
Development Drive.....	1138
Development Bias.....	1139
Toner Supply.....	1140
Overview.....	1140
Mechanism.....	1140
Toner Supply (Toner Cartridge - Sub-hopper).....	1140
Toner Bottle ID Chip.....	1142
Toner Supply (Sub-hopper - Development Unit).....	1142
Drive.....	1143
Toner Near End/ Toner End Detection.....	1143
SP Descriptions.....	1146
Waste Toner.....	1148
Overview.....	1148
Mechanism.....	1148

Waste Toner Bottle Set Detection.....	1148
Waste Toner Drive.....	1148
Waste Toner Recovery Path (PCU/Image Transfer Unit).....	1148
Waste Toner Bottle Full Detection.....	1149
Waste Toner Cover.....	1150
Image Transfer and Paper Transfer.....	1152
Overview.....	1152
Image Transfer Unit.....	1152
Paper Transfer Unit.....	1153
Image Transfer Unit mechanism.....	1153
Drive Mechanism.....	1153
Transfer Bias.....	1154
ITB Contact and Release.....	1154
Image Transfer Belt Drive Control.....	1155
Image Transfer Flow.....	1155
Image Transfer Belt Cleaning Mechanism.....	1155
Paper Transfer Unit Mechanism.....	1156
Paper Transfer Mechanism.....	1156
PTR (Paper Transfer Roller) Drive.....	1156
PTR (Paper Transfer Roller) Contact and Separation.....	1156
Separation.....	1157
TM/ID Sensor.....	1158
Paper Feed/ Transport Section.....	1159
Overview.....	1159
Paper Feed/ Transport Part.....	1159
Tray Base Plate Lift.....	1160
Paper Feed Mechanism.....	1162
Paper Feed Transport Mechanism.....	1164
Paper Size Detection (1st Paper Supply Tray).....	1164
Paper Size Detection (2nd Paper Supply Tray).....	1164
Remaining Paper Detection.....	1166
Paper End Detection.....	1167
Paper Supply Drive.....	1168

Paper Dust Removal Mechanism.....	1170
Bypass Feed Section.....	1172
Bypass Feed Paper/ Separation Mechanism.....	1172
Bypass Feed Paper Size Detection.....	1173
Bypass Feed Paper End Detection.....	1173
Bypass Paper Feeder Drive.....	1173
Duplex Section.....	1174
Transport Inversion Mechanism.....	1174
Duplex Drive.....	1175
Interleave Mechanism.....	1175
Paper Exit Unit.....	1177
Delivery Location Change-over.....	1177
Paper Exit Full/ Paper Exit Jam Detection.....	1179
Drive/Sensor Layout.....	1180
Transport Roller Drive Source.....	1181
Gate/Pick-up Arm Drive Source.....	1182
Inter-Roller Transport Path.....	1182
Sensor Position.....	1183
Paper Exit Driven Roller and Paper Support Guide.....	1184
Removing Wrinkling in the Tray.....	1184
Fusing.....	1187
Overview.....	1187
Mechanism.....	1189
Fusing System.....	1189
Fusing Drive.....	1190
Pressure Release Mechanism.....	1191
Fusing Temperature Control.....	1192
CPM Down Control.....	1193
Curl Correction Mechanism.....	1194
Electrical Parts.....	1199
Block Diagram.....	1199
Board Outline.....	1199
Controller.....	1199

SBU.....	1199
LDB.....	1200
BCU.....	1200
IPU.....	1200
MSENS1 (Proximity Sensor (Human Detection Sensor), MSENS2 (Proximity Sensor (Human Detection Sensor) Board).....	1200
IOB.....	1200
FCU.....	1200
OPU.....	1200
HVP (Composite High-Voltage Power Supply TTS/CB).....	1200
PSU.....	1201
Anti-condensation Heater for Scanner, PCDU, and Paper Feed Tray.....	1201
Circuit Configuration.....	1201
Exterior Cover/ Air Flows (Fan Control).....	1202
Overview.....	1202
Mechanism.....	1205
Cooling of PSU.....	1205
Cooling of Toner Supply Parts.....	1205
Cooling of PCDU parts.....	1205
Cooling of Fusing Parts.....	1205
Cooling in Controller Box.....	1205
Crisis Management When Temperature Rises in the Machine.....	1206
Helmholtz Silencer.....	1207
Energy Save.....	1209
Energy Saver Modes.....	1209
Setting Items that are Related to Energy Saving.....	1209
Recovery Time/ Reduced Electrical Consumption.....	1210
Power States of this Machine.....	1212
Verification of Up Time for each Energy Saving State.....	1215
Checking the Up Time by Device State.....	1215
Recommendation.....	1217
Proximity Sensor (Human Detection Sensor).....	1218
Overview.....	1218

Sensor Operation.....	1219
Operation Modes.....	1219
User Tool.....	1220
Related SC Codes.....	1220
Related SP Code.....	1221



1. Product Information

Product Overview

Component Layout

Note

- For details about electrical components layout, refer to page 1086 "Component Layout".

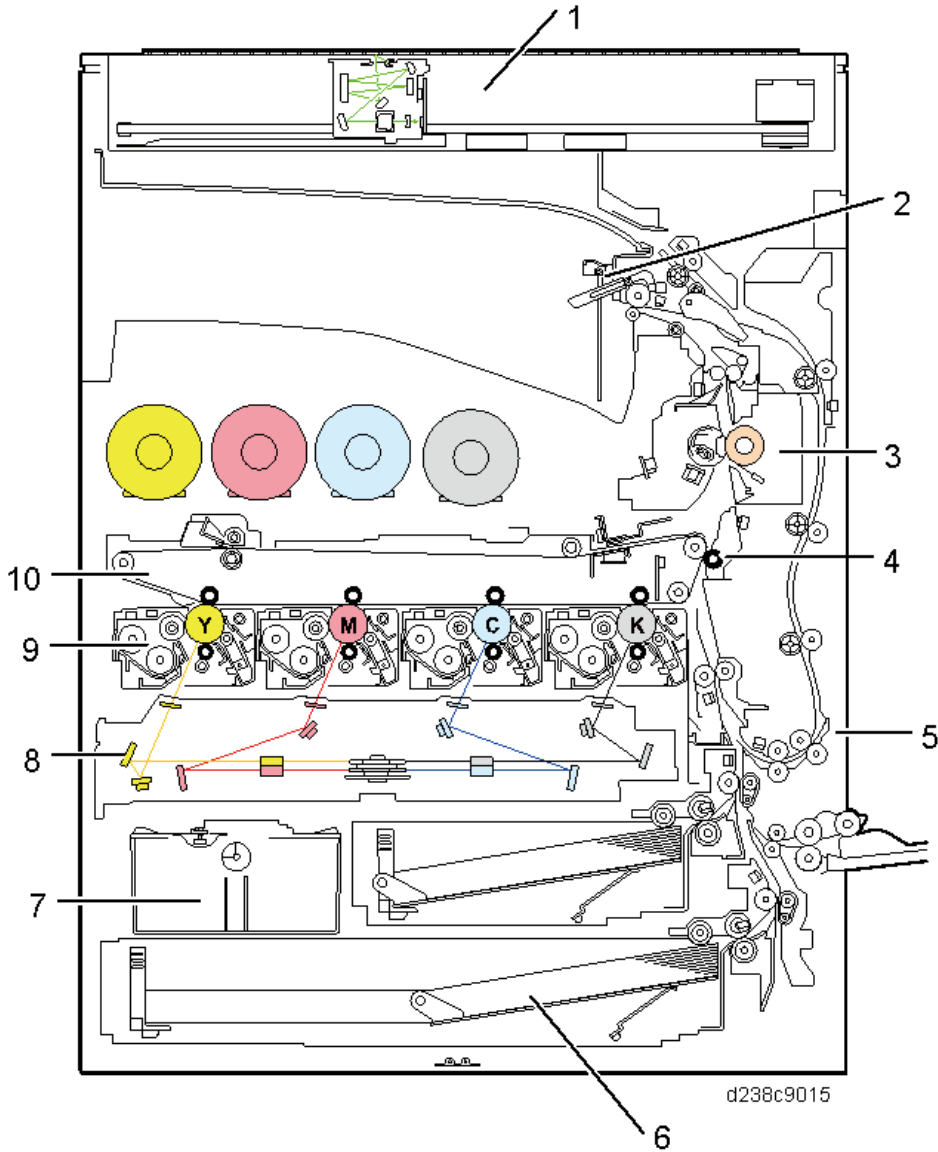

No.	Description	No.	Description
1	Scanner Unit	6	Paper Feed Unit
2	Paper Exit Unit	7	Waste Toner Unit
3	Fusing Unit	8	Laser Exposure Unit
4	Paper Transfer Unit	9	PCDU
5	Duplex Unit	10	Image Transfer Unit

Paper Path

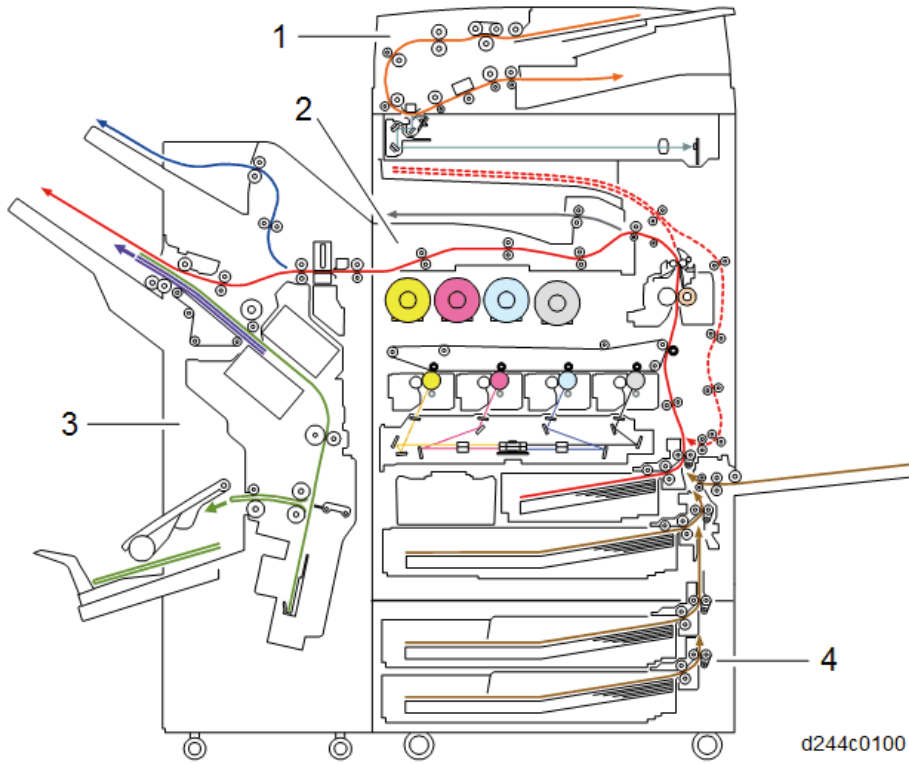

No.	Description	No.	Description
1	SPDF DF3100	3	Booklet Finisher SR3220
2	Bridge Unit BU3070	4	Paper Feed Unit PB3220/PB3210

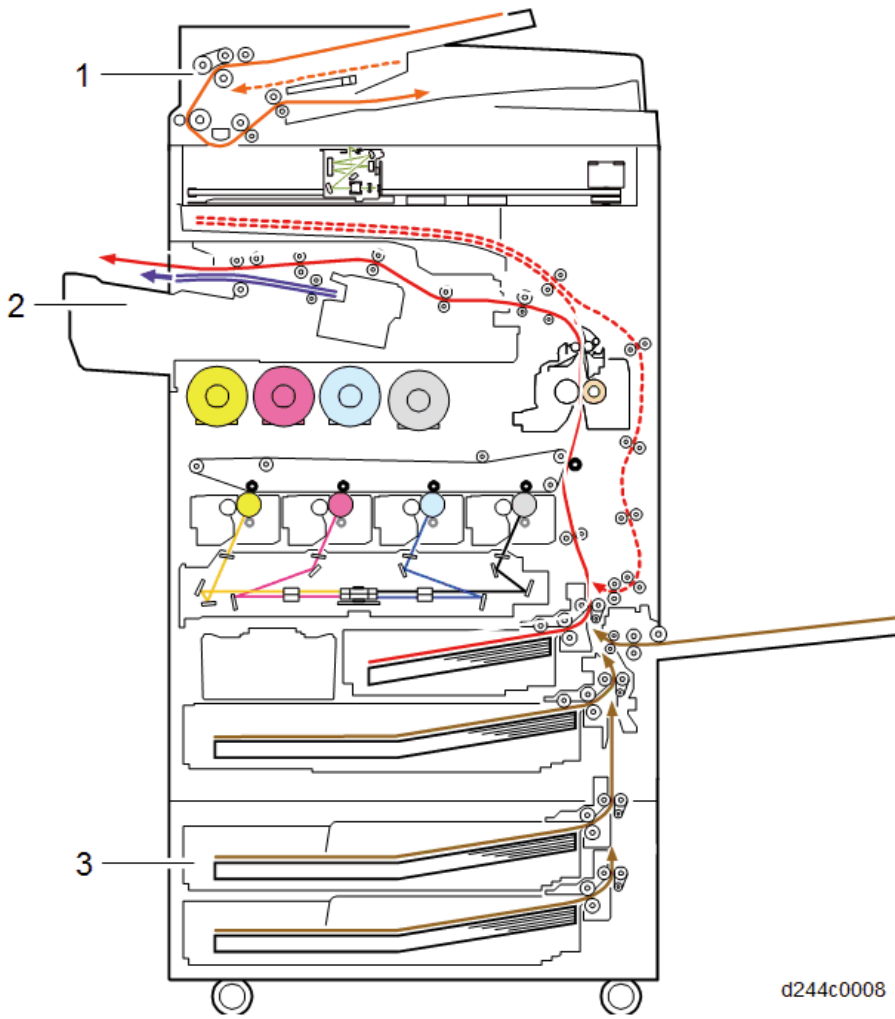

d244c0008

No.	Description	No.	Description
1	ARDF DF3090	3	Paper Feed Unit PB3220/PB3210
2	Internal Finisher SR3130		

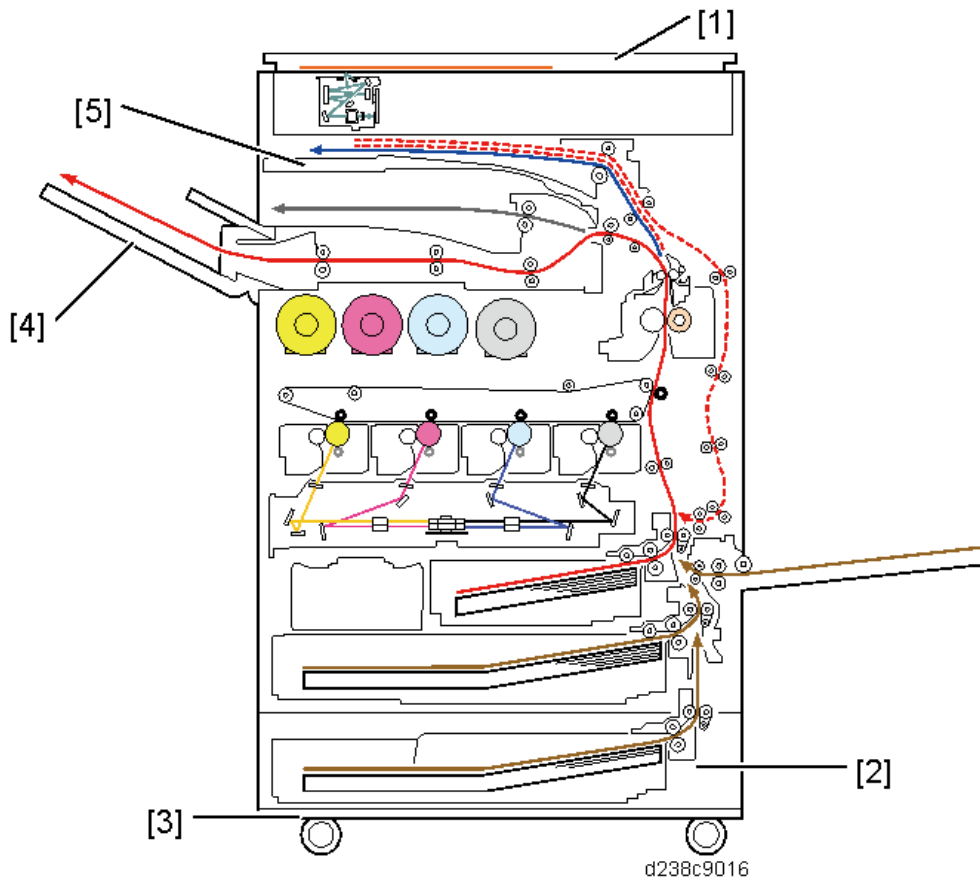

No.	Description	No.	Description
1	Platen Cover PN2000	4	Side Tray Type M3
2	Paper Feed Unit PB3150	5	1 Bin Tray BN3110
3	Caster Table Type M3		

Drive Layout

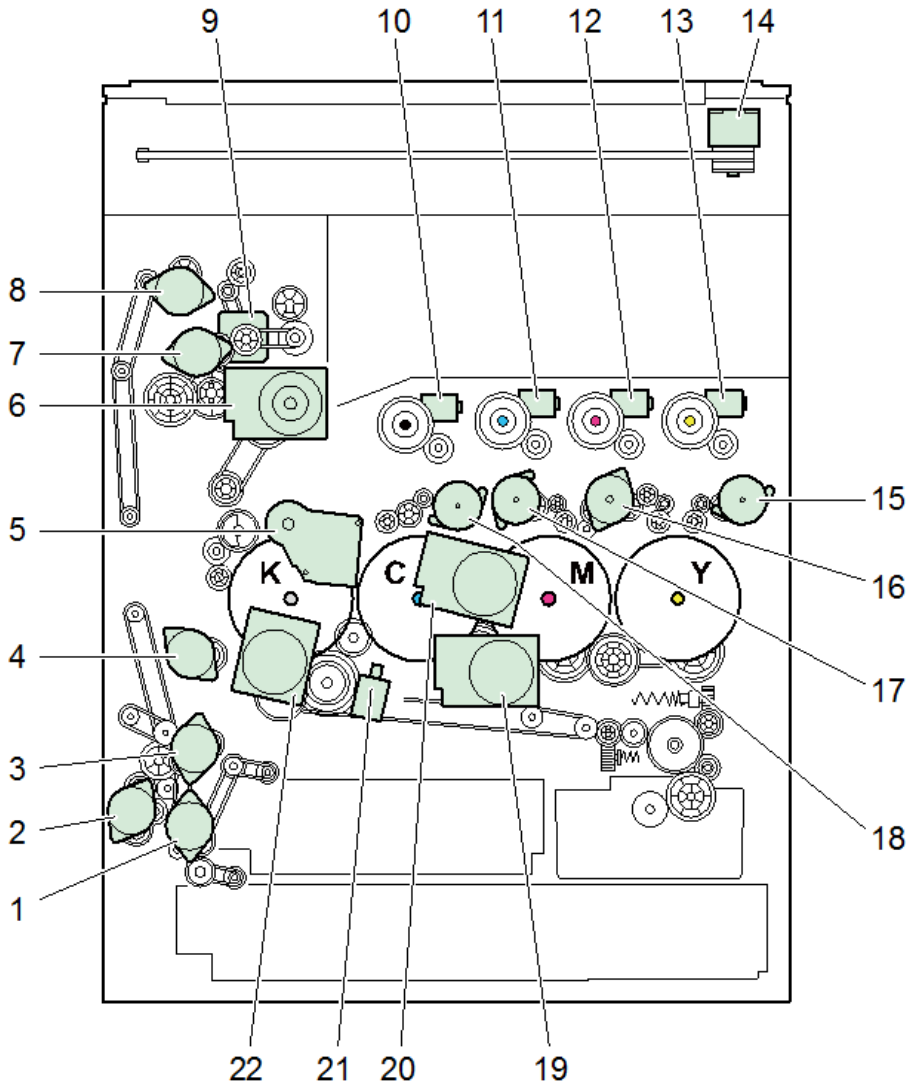

d244c0009

No.	Description	No.	Description
1	Paper feed motor	12	Toner bottle drive motor (M)
2	Duplex/ Bypass motor	13	Toner bottle drive motor (Y)
3	Transport motor	14	Scanner motor
4	Registration motor	15	Toner supply motor (Y)

No.	Description	No.	Description
5	Paper transfer contact and release motor	16	Toner supply motor (M)
6	Fusing motor	17	Toner supply motor (C)
7	Paper exit /Pressure release motor	18	Toner supply motor (Bk)
8	Duplex entrance motor	19	Development motor: CMY
9	Reverse motor	20	PCU Motor: CMY
10	Toner bottle drive motor (Bk)	21	Development solenoid
11	Toner bottle drive motor (C)	22	PCU: Black/ Image transfer motor

Machine Codes and Peripherals Configuration

1

Main Machine

Key	Area	Power
-17	North America/ Central, South America	120V/60Hz
-18	North America GSA models	120V/60Hz
-19	Taiwan	110V/60Hz
-21	China	220-240V/50-60Hz
-22	China	220-240V/50-60Hz
-26	Korea Narajanta model	220V/60Hz
-27	Europe/ Middle, Near East	220-240V/50-60Hz
-29	Korea	220V/60Hz
-29	Asia/Pacific/ Central, South America	220-240V/50-60Hz
-65	Europe/ Middle, Near East	220-240V/50-60Hz

-17

Machine Code	Product Name	DF	CPM
D243	MP C2004SP	ARDF 3090 Std.	FC: 20cpm/BW: 20cpm
D244	MP C2504SP		FC: 25cpm/BW: 25cpm

-18

Machine Code	Product Name	DF	CPM
D243 GSA	MP C2004SPG	ARDF 3090 Std.	FC: 20cpm/BW: 20cpm
D244 GSA	MP C2504SPG		FC: 25cpm/BW: 25cpm

-19

Machine Code	Product Name	DF	CPM
D243	MP C2004SP	ARDF 3090 Std.	FC: 20cpm/BW: 20cpm
D244	MP C2504SP		FC: 25cpm/BW: 25cpm

-21

Machine Code	Product Name	DF	CPM
D243	MP C2004SP	None	FC: 20cpm/BW: 20cpm
D244	MP C2504SP		FC: 25cpm/BW: 25cpm

-22

Machine Code	Product Name	DF	CPM
D243	DSc1220	None	FC: 20cpm/BW: 20cpm
D244	DSc1225		FC: 25cpm/BW: 25cpm

-26

Machine Code	Product Name	DF	CPM
D243	MP C2094SPJ	None	FC: 20cpm/BW: 20cpm
D244	MP C2594SPJ		FC: 25cpm/BW: 25cpm

-27

Machine Code	Product Name	DF	CPM
D243	MP C2004SP	ARDF 3090 Std.	FC: 20cpm/BW: 20cpm
D244	MP C2504SP		FC: 25cpm/BW: 25cpm

-29

Machine Code	Product Name	DF	CPM
D243	MP C2004SP	None	FC: 20cpm/BW: 20cpm
D244	MP C2504SP		FC: 25cpm/BW: 25cpm

-65

Machine Code	Product Name	DF	CPM
D243	MP C2004ASP	SPDF 3100 Std.	FC: 20cpm/BW: 20cpm
D244	MP C2504ASP		FC: 25cpm/BW: 25cpm

Options

Product Name	Code	EU	NA	AA	KOR	TWN	CHN
SPDF DF3100	D3B0	N/A	N/A	-17	-17	-17	-21
Booklet Finisher SR3220	D3B9	-17	-17	-17	-17	-17	-21
1 Bin Tray BN3110	D3CQ	-17	-17	-17	-17	-17	-21
Bridge Unit BU3070	D685	-18	-18	-18	-18	-18	-22
Internal Finisher SR3130	D690	-18	-18	-18	-18	-18	-22
Side Tray Type M3	D725	-18	-18	-18	-18	-18	-22
Internal Finisher SR3180	D766	-18	-18	-18	-18	-18	-22
Banner Paper Guide Tray Type M19	D3BF	-00	-00	-00	-00	-00	-00
IEEE 802.11a/g/n Interface Unit Type M19	D3BR	-01	-01	-01	N/A	N/A	N/A
Memory Unit Type M19 4GB	D3BX	-03	-03	-03	-03	-03	-03
Extended USB Board Type M19	D3BS	-01	-01	-01	-01	-01	-01

Product Name	Code	EU	NA	AA	KOR	TWN	CHN
IEEE 1284 Interface Board Type M19	D3C0	-17	-17	-17	-17	-17	-17
XPS Direct Print Option Type M19	D3BC	-24	-25	-26	-26	-26	-26
USB Device Server Option Type M19	D3BC	-28	-29	-29	-29	N/A	N/A
PostScript3 Unit Type M19	D3BD	-05	06	-07	-07	-07	-07
Camera Direct Print Card Type M19	D3BD	-13	-13	-13	-13	-13	-13
File Format Converter Type M19	D3BR	-04	-04	-04	-04	-04	-04
DataOverwriteSecurity Unit Type M19	D3BS	-03	-03	-03	-03	-03	-03
Fax Option Type M19	D3BV	-01	-02	-03	-03	-04	-05
G3 Interface Unit Type M19	D3BV	-07	-08	-08	-08	12	-08
Fax Memory Unit Type M19 64MB	D3BZ	-17	-17	-17	-17	-17	-17
Fax Connection Unit Type M19	D3BD	-01	-02	-03	-03	-03	-03
NFC Card Reader Type M19	D3BS	-21	-21	-21	-21	-21	-21
Smart Card Reader Built-in Unit Type M19	D3BS	-22	-22	-22	-22	-22	-22
Imageable Area Extension Unit Type M19	D3BR	-07	-07	-07	-07	-07	-07
External Keyboard Bracket Type M19	D3BR	-10	-10	-10	-10	-10	-10
Punch Unit PU3050 NA	D717	-17	-17	-17	-17	-17	N/A
Punch Unit PU3050 EU	D717	-27	-27	-27	-27	-27	-21
Punch Unit PU3050 SC	D717	-28	-28	-28	-28	-28	N/A
Punch Unit PU3040 NA	D716	-17	-17	-17	-17	-17	N/A

Product Name	Code	EU	NA	AA	KOR	TWN	CHN
Punch Unit PU3040 EU	D716	-27	-27	-27	-27	-27	-21
Punch Unit PU3040 SC	D716	-28	-28	-28	-28	-28	N/A
Paper Feed Unit PB3150	D694	-17	-17	-17	-17	-17	-21
Paper Feed Unit PB3220	D787	-18	N/A	-18	-18	-18	-22
Paper Feed Unit PB3210	D787	N/A	-17	N/A	N/A	N/A	N/A
Caster Table Type M3	D178	-02	-02	-02	-02	-02	-02
Internal Shift Tray SH3070	D691	-17	-17	-17	-17	-17	-21
Platen Cover PN2000	D700	N/A	N/A	-01	-01	N/A	-01
ARDF DF3090	D779	N/A	N/A	-17	-17	-17	-21
Handset HS3020	D739	-17	N/A	N/A	N/A	N/A	N/A
Marker Type 30	H903	-02	-02	-02	N/A	-02	N/A
ADF Handle Type C	D593	-81	-81	-81	-81	-81	-81
RICOH e-Sharing Box	D668	-01	-02	-03	-03	-03	-04
SD Card for Fonts Type D	D641	N/A	-54	N/A	N/A	N/A	N/A
Unicode Font Package for SAP(R) 1 License	B869	-01	-01	-01	-01	-01	-01
Unicode Font Package for SAP(R) 10 License	B869	-02	-02	-02	-02	-02	-02
Unicode Font Package for SAP(R) 100 License	B869	-03	-03	-03	-03	-03	-03
Optional Counter Interface Unit Type M12	B870	-21	-21	-21	-21	-21	-21
Key Counter Bracket Type M3	D739	-09	-09	-09	-09	-09	-09
Card Reader Bracket Type 3352	D593	-61	-61	-61	-61	-61	-61
Bluetooth Interface Unit Type D	D566	-01	-01	-01	N/A	N/A	N/A

Product Name	Code	EU	NA	AA	KOR	TWN	CHN
Enhanced Security HDD Option Type M12	D3A6	-02	-02	N/A	N/A	N/A	N/A
OCR Unit Type M13	D3AC	-23	-24	-25	-25	-25	-25

Diagram

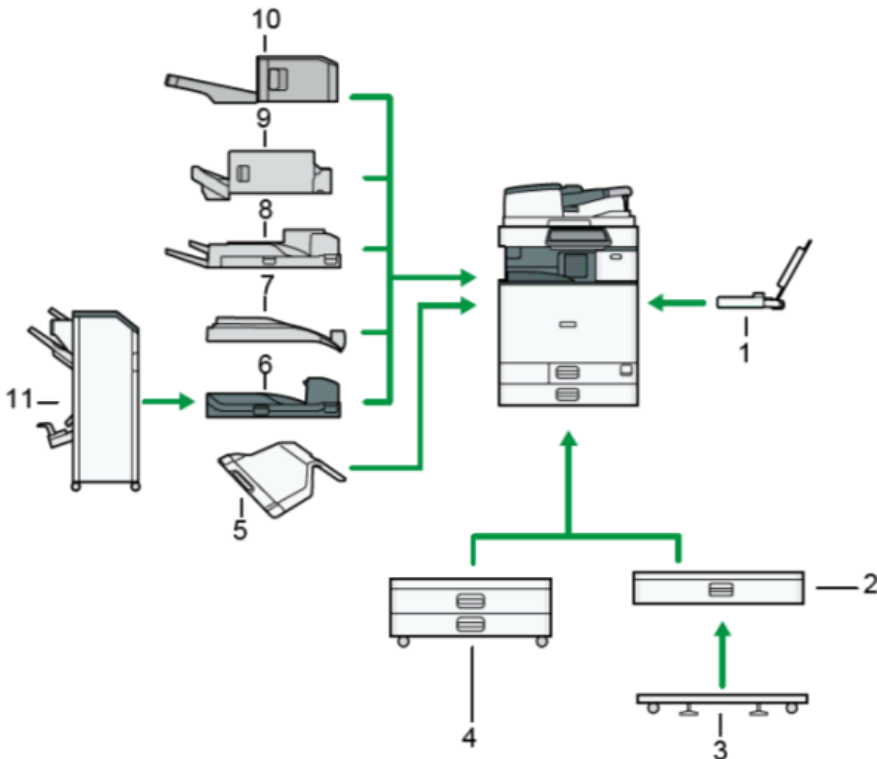

No.	Item	Code	Remarks
1	Banner Paper Guide Tray Type M19	D3BF-00	Common (D238/D239/D240/D241/D242)
2	Paper Feed Unit PB3150	D694-17, -21	
3	Caster Table Type M3	D178-02	

No.	Item	Code	Remarks
4	Paper Feed Unit PB3210 (EU) Paper Feed Unit PB3220 (NA, Asia, KOR, TWN, CHN)	D787-17 D787-18, -22	Common (D176/D177/D237)
5	1 Bin Tray BN3110	D3CQ-17, -21	Common (D238/D239/D240/ D241/D242)
6	Bridge Unit BU3070	D685-18, -22	
7	Internal Shift Tray SH3070	D691-17, -21	
8	Side Tray Type M3	D725-18, -22	
9	Internal Finisher SR3130	D690-18, -22	
10	Internal Finisher SR3180	D766-18, -22	
11	Booklet Finisher SR3220	D3B9-17, -21	
-	Punch Unit PU3050 NA	D717-17	Common (D238/D239/D240/ D241/D242)
-	Punch Unit PU3050 EU	D717-27, -21	
-	Punch Unit PU3050 SC	D717-28	
-	Punch Unit PU3040 NA	D716-17	
-	Punch Unit PU3040 EU	D716-27, -21	
-	Punch Unit PU3040 SC	D716-28	
-	Platen Cover PN2000	D700-01	
-	ARDF DF3090	D779-17, -21	
-	SPDF DF3100	D3B0-17, -21	

Specifications

See "Appendices" for the following information:

- Machine Specifications
- Software Accessories
- Supported Paper Sizes
- Option Specifications

2. Installation

Installation Requirements

Environment

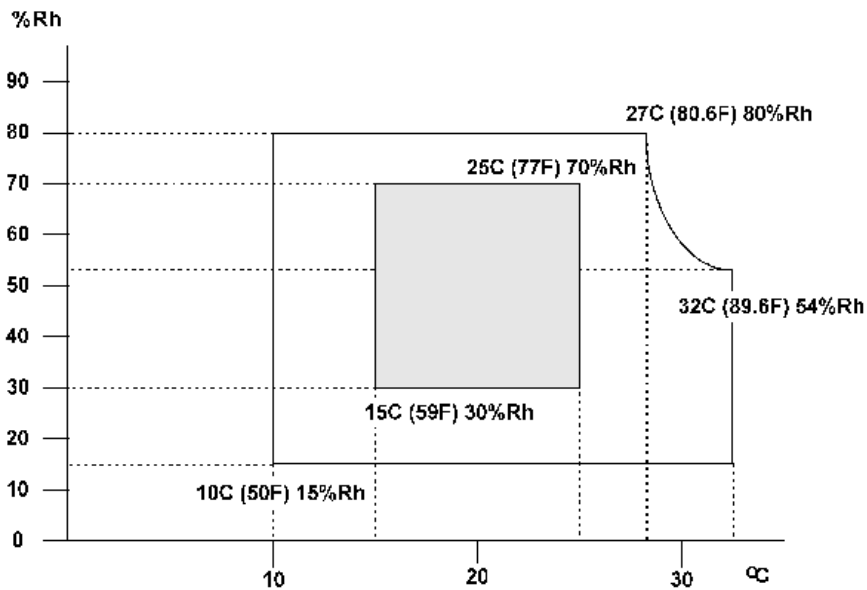

Temperature Range:	10°C to 32°C (50°F to 90°F)
Humidity Range:	15% to 80% RH
Ambient Illumination:	Less than 1,500 lux (do not expose to direct sunlight.)
Ventilation:	Room air should turn over at least 30 m ³ /hr/person

1. Avoid areas exposed to sudden temperature changes:
 - 1) Areas directly exposed to cool air from an air conditioner.
 - 2) Areas directly exposed to heat from a heater.
2. Do not place the machine where it will be exposed to corrosive gases.
3. Do not install the machine at any location over 2,000 m (6,500 ft.) above sea level. (NA model can be installed up to 2,500m (8,202 ft.))
4. Place the main machine on a strong and level base. Inclination on any side should be no more than 5 mm (0.2").
5. Do not place the machine where it may be subjected to strong vibrations.

Machine Level

Front to back: Within 5 mm (0.2")

Right to left: Within 5 mm (0.2")

Machine Space Requirements

Note

- These are the minimum space requirements.

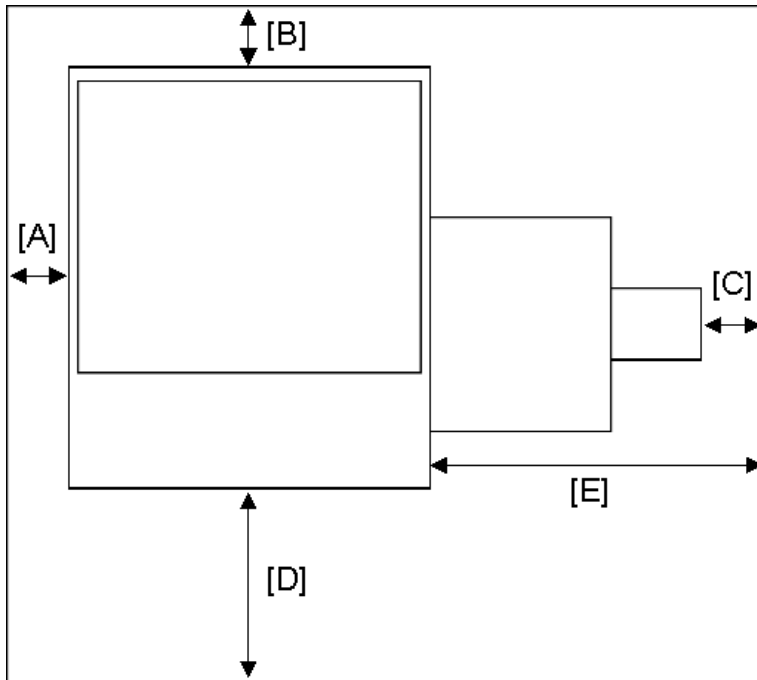

d1462236a

A	Left	Over 100 mm (3.9")
B	Rear	Over 100 mm (3.9")
C	Right with bypass tray	Over 100 mm (3.9")
D	Front	Over 750 mm (29.5")
E	Right	Over 500 mm (19.7")

Put the machine near the power source with the clearance shown above.

↓ Note

- Main Machine Occupation Dimensions (W x D):
1187 mm (46.7") x 1535 mm (60.4")

Machine Dimensions

In the following figure, MP C2504 is equipped with Paper Feed Unit PB3220/PB3210, Bridge Unit BU3070 and Finisher SR3220.

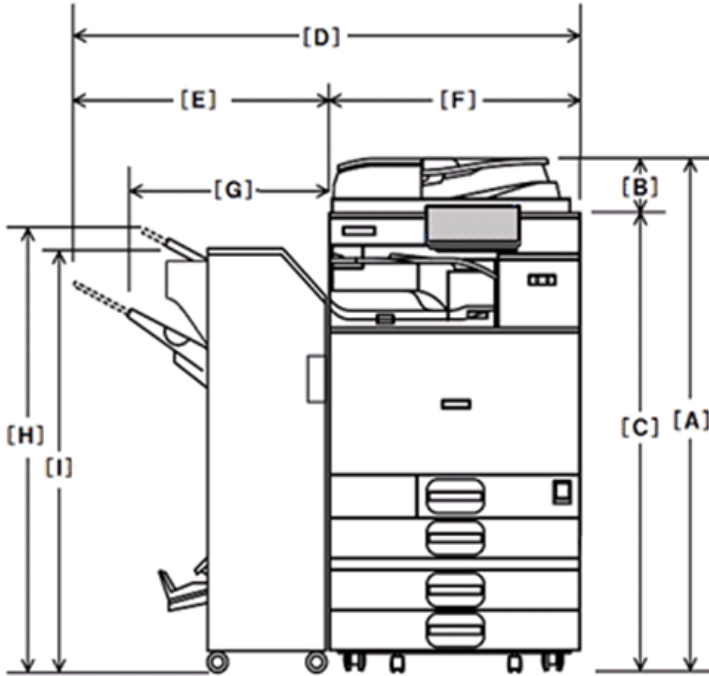

d244c0101

A	1,155 mm / 45.47" (when equipped with ARDF) 1,205 mm / 47.44" (when equipped with SPDF)
B	125 mm / 4.92" (when equipped with ARDF) 175 mm / 6.89" (when equipped with SPDF)
C	1,030 mm / 40.55"
D	1,162 to 1,247 mm / 45.7" to 49.1"
E	575 to 660 mm / 22.63" to 25.98"
F	587 mm / 23.11"
G	575 mm / 22.63"
H	1,045 mm / 41.14"
I	986 mm / 38.81"

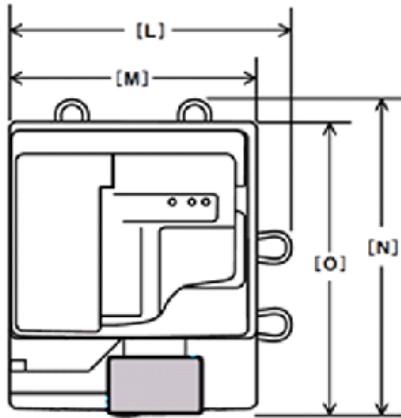

d238m0997

L	668 mm / 26.29"
M	587 mm / 23.11"
N	738 mm / 29.05"
O	685 mm / 26.96"

Model -27, -29, -65 (220–240 V)

Models equipped with the ARDF (W × D × H up to ARDF):

587 × 685 × 913 mm (23.2 × 27.0 × 36.0 inches)

Models equipped with the SPDF (W × D × H up to SPDF):

587 × 685 × 968 mm (23.2 × 27.0 × 38.1 inches)

Models with no ADF (W × D × H up to exposure glass):

587 × 685 × 788 mm (23.2 × 27.0 × 31.1 inches)

Model -17, -18 (120–127 V)

Models equipped with the ARDF (W × D × H up to ARDF):

587 × 685 × 913 mm (23.2 × 27.0 × 36.0 inches)

Power Requirements

CAUTION

- Insert the plug firmly in the outlet.
- Do not use an outlet extension plug or cord.
- Ground the machine.

2

Input Voltage Level

Destination	Power supply voltage	Rated current consumption	Permissible voltage fluctuation
NA	120 to 127 V	12 A or more	Image quality guaranteed: 108 V (120 V - 10%) to 138 V (127 V + 8.66%) Machine operation guaranteed: 102 V (120 V - 15%) to 138 V (127 V + 8.66%)
EU	220 to 240 V	10 A	Image quality guaranteed: 198 V (220 V - 10%) to 264 V (240 V + 10%) Machine operation guaranteed: 187 V (220 V - 15%) to 276 V (240 V + 15%)
AP			
CHN			

Main Machine Installation

Important Notice on Security Issues

In order to increase the security of the MFP, and to ensure that the customer sets the administrator password, an administrator set/change prompt display is shown up at the first power-up.

- The following Program/ Change Administrator screen is displayed at the first power-up.

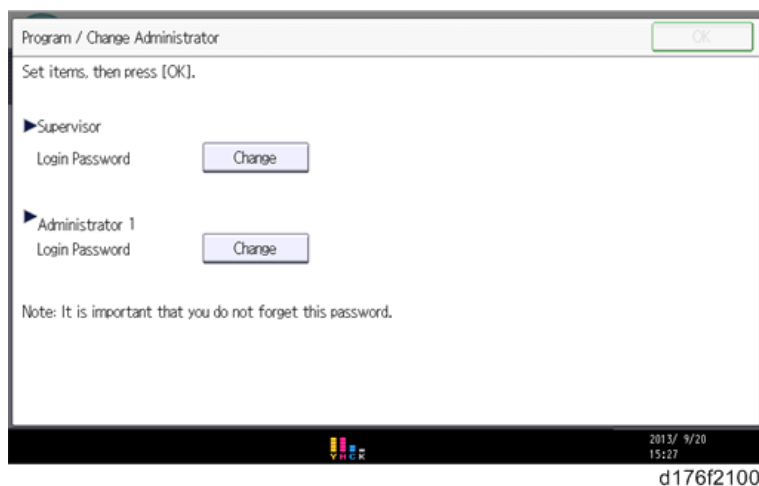

- When the customers set the administrator/supervisor login password, the display disappears and the home display will appear. The customers, however, can erase this screen with the following procedure in the case that they think there is no need to set the password.
 - On the Program/Change Administrator screen, press [Change] next to Supervisor and then press [OK] without inputting any password.
 - Press [OK] again when the Confirm password display shows up.
 - For Administrator 1, do the same procedure as steps 1 and 2.
 - Press the [OK] button, and then turn the power OFF/ON.
- SP5-755-002 (Display Setting: Hide Administrator Password Change Scrn) allows you to skip this screen temporarily and continue the installation procedure without setting an administrator password. However, the Program/Change Administrator screen appears every time you turn the power OFF/ON, if the password is not set.

Note

- For more details about this security issue, see "Notes on Using Multi-Function Printers Safely" supplied with the MFP.
- To enter the SP mode, there are two ways to display the number keyboard on screen;
 - Press the "Document Server" icon.

2. Press and hold the button [A] located at the left side of the operation panel and "Check Status [B]" at the same time.

2



d238m0747



Installation Flow Chart

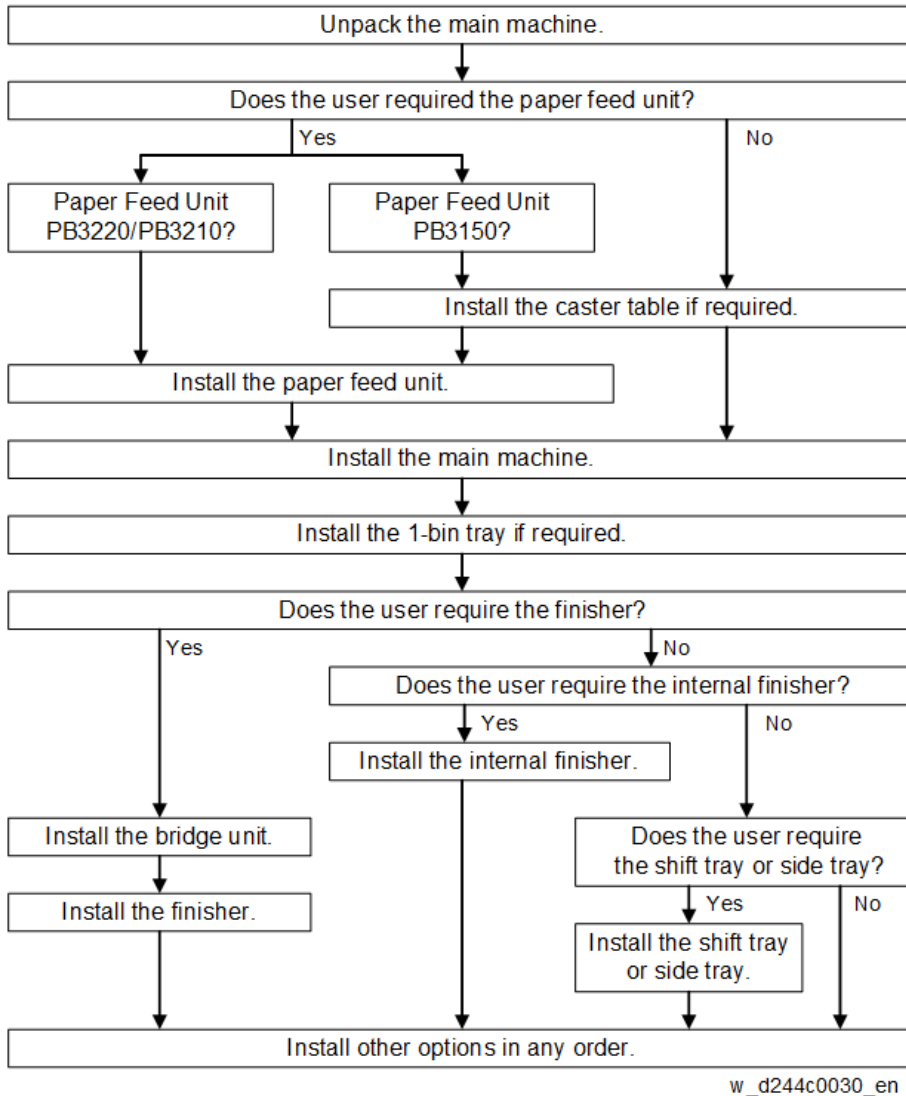

Put the machine on the paper feed tray (1 tray/2 trays) first, then install the machine and other options.

You need **Paper Feed Unit PB3220/PB3210 (D787)** to align the paper transport path if you want to install Booklet Finisher SR3220 (D3B9).

Accessory Check

No.	Description	Q'ty
1	Power Cord	1
2	Cap for scanner lock	2
3	End Fence	1
4	Image Transfer Front Cover	1
5	Decal - Paper Tray	1
6	Decal - Original Table for DF	1
7	Decal - Caution : Original : Multi Language	1
8	Cleaning Cloth	1
9	Cleaning Cloth Holder	1
10	Plate – Logo (Smart Operation Panel)	1
11	Plate – Logo (front cover) (for NA, EU, AA)	1
-	M3x8 Screws for Image Transfer Front Cover	2
-	Sheet: Safety (EU only)	1
-	CD-ROM – OI (AA only)	1
-	CD-ROM - Driver	1
-	Sheet: Exposure glass	1
-	Start Guide	1
-	Read This First	1
-	Sheet: EULA	1
-	Seal: Caution	1
-	Sheet: EMC address (EU only)	1
-	Caution: Smart Operation Panel	1
-	Caution: Smart Operation FCC (NA only)	1

No.	Description	Q'ty
-	Caution: CE (EU only)	1
-	NFC Tag	1
-	Bluetooth decal (for NA, EU, AA)	1



d244c0027

Installation Procedure

⚠ CAUTION

- Remove the tape from the development units before turning the main power ON. The development units can be severely damaged if the tape is still attached.

Removal of Packing Materials and Shipping Retainers

1. Remove the machine from the box, and check the items in the package.

Remove the retainer [A] at the lower front right before lifting up the machine, because the handle for lifting the machine is hidden by the retainer [A].



d1462210

Note

- When you lift the machine, hold the correct parts, as shown in the photo below.
- Do not hold any other parts of the machine when lifting it, because this might deform the machine or break the exterior covers



d1462211

2. Remove the orange tapes and retainers on the outside.
For a basic model



d238m539

For a model on which SPDF DF3100 is preinstalled, remove the orange tapes and retainers on the SPDF.

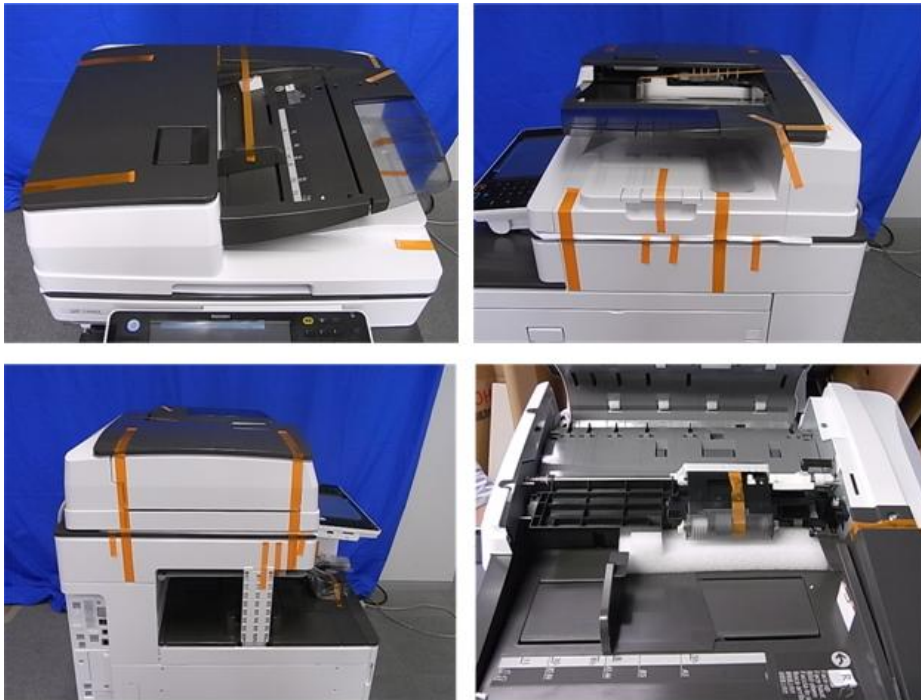

d1462215

For a model on which ARDF DF3090 is preinstalled, remove the orange tapes and retainers on the ARDF.



d244c0032

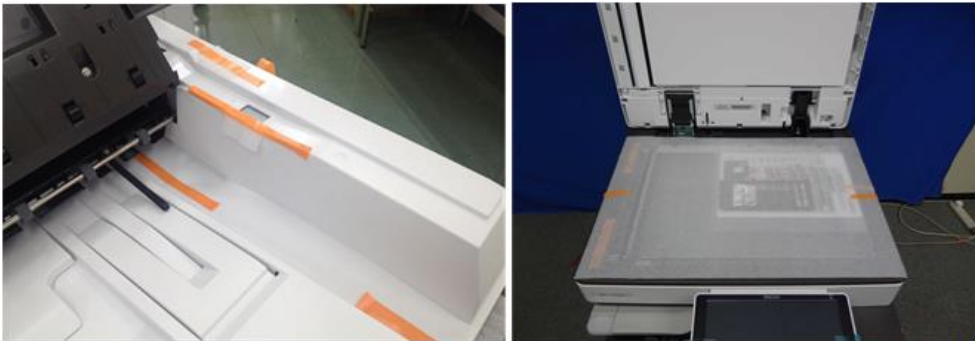

d244c0031

3. Remove the paper size decal [A] on the exposure glass.



d238m526

4. Remove the orange tapes on the scanner shipping locks.

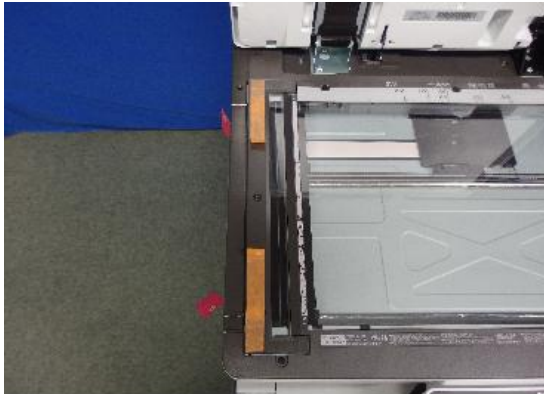

d238m530

5. Remove the two scanner shipping locks [A] by rotating them 90 degrees counter clockwise.

SC120 is displayed when the machine is turned ON with the shipping lock attached.

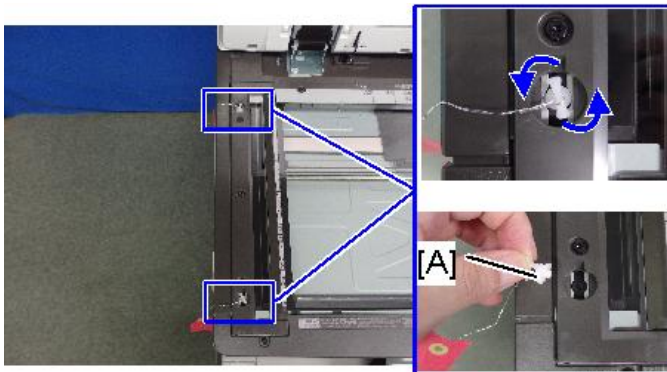

d238m531

Note

- Keep the scanner shipping locks with the machine. They must be used when transporting the machine to another location. (page 91 "Moving the Machine")

6. Attach the two caps [A] provided with the machine.

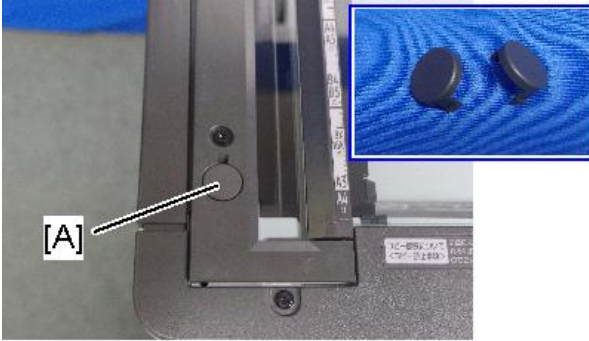

d238m532

7. Pull out the 1st/2nd paper trays, remove the orange tape.



d238m527

8. Remove the scanner support [A].



d1462216

- Open the front cover, and store the scanner support [A] in the storage location.

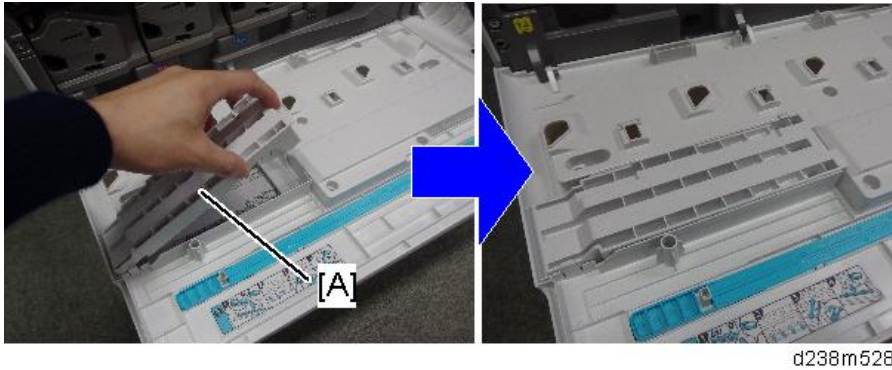

Note

- Underneath the bracket [A] is the storage location for the factory setting sheet.

For Machines with preinstalled SPDF: Removal of protective sheet

- Open the SPDF.
- Release the lever [A], open the pressure plate sheet [B], and pull out the protective sheet [C] slowly.
- Remove the filament tape [D].

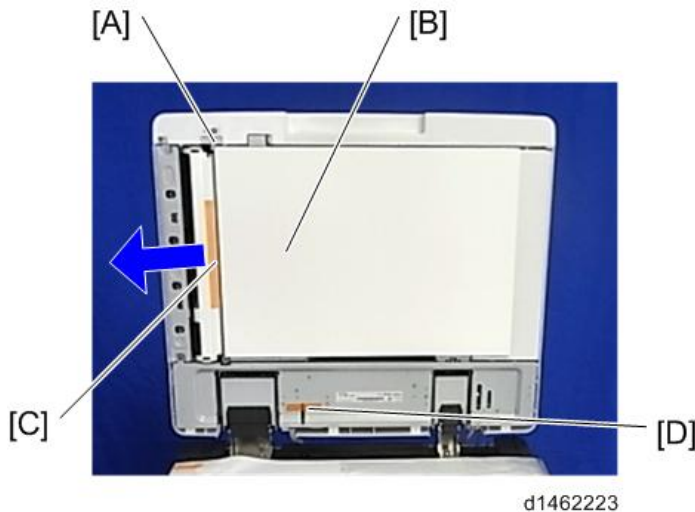

4. Close the pressure plate sheet [A].

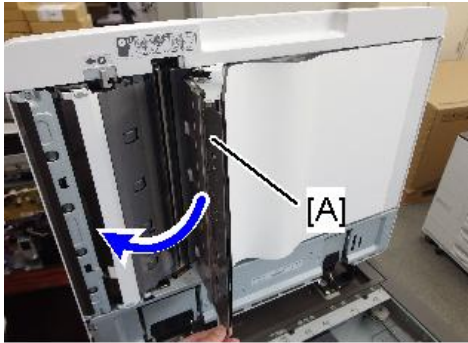

d238m0995b

5. Close the SPDF.

Note

- If the protective sheet remains in the SPDF, a paper jam will be detected.

Removal of PCDU Seals

Note

- Automatic initial adjustment will be done even if the seal was not removed correctly. But toner from a PCDU that still has the seal will not be able to reach the ITB, and will not be transferred to printouts and copies.
- If this happens, remove the PCDU seal and do SP2-111-004 (Forced Line Position Adj. Mode d).
- White stripes may appear in the printed images for the first 20k pages printing continuously in a low humid environment, due to the deviation of toner density adjustment. Except for that, the machine operates normally.
- **SP descriptions**
 - **SP2-111-004 (Forced Line Position Adj. Mode d)**
Executes the fine line position adjustment and rough line position adjustment.

1. Open the front cover.

2. Pull out the seals [A] for Y, M, C, and Bk.

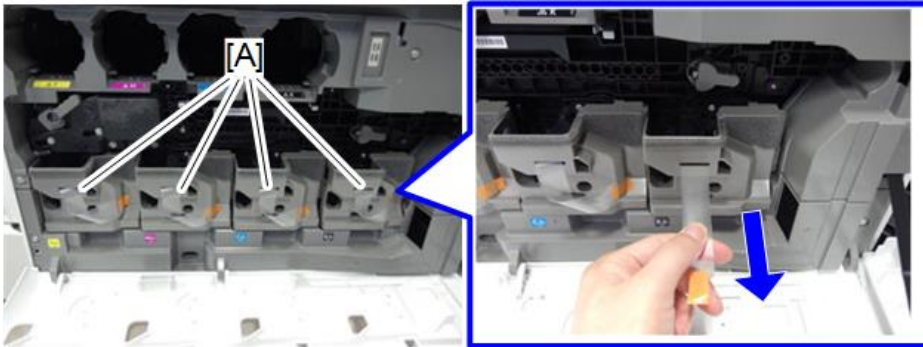

d244c0002

3. Rotate the ITB contact lever [A] clockwise, and set it to the position in the following picture.

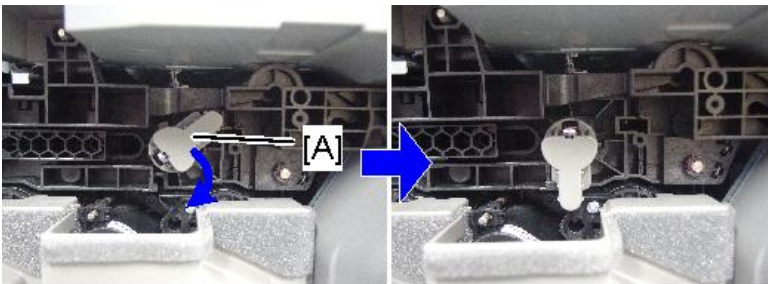

d238m537

4. Attach the image transfer front cover [A] with the two screws (M3×8; provided with the accessories).

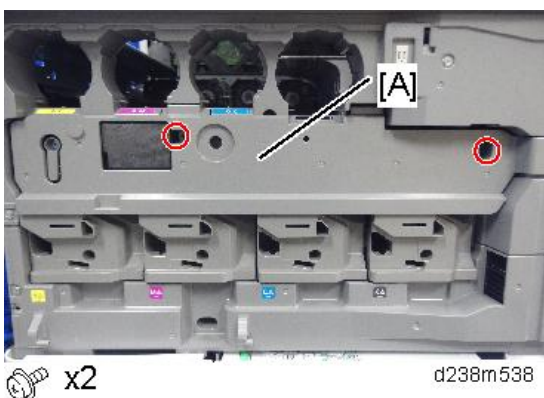
 x2

d238m538

5. Close the front cover.

Attaching the Optical Cloth Pocket

1. Clean the adhesive surface of the optical cloth pocket with an alcohol-soaked cloth.
2. Attach the optical cloth pocket [A] to the left side of the scanner and put the optical cloth into the pocket.

2



d238m533

Attaching the Paper Exit Tray Parts

1. Attach the part [A] to the paper exit tray.
First, insert and attach the front pin (inside the blue circle).

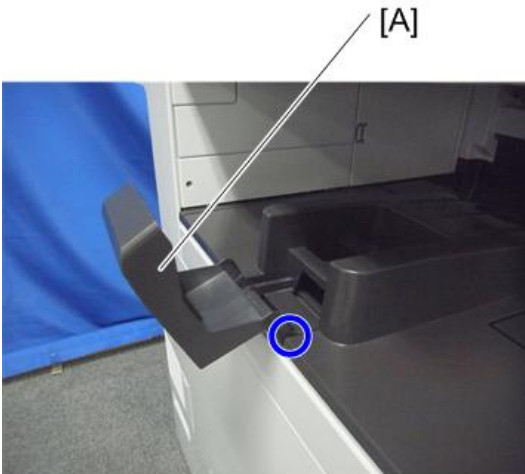

d1462228

Checking the Position of the Paper Exit Feeler

Check the following points for the paper exit feeler [A] installed at the paper exit.

- It can move in line with the ejection of paper.

- It holds contact with the surface of the ejected paper and is still movable.

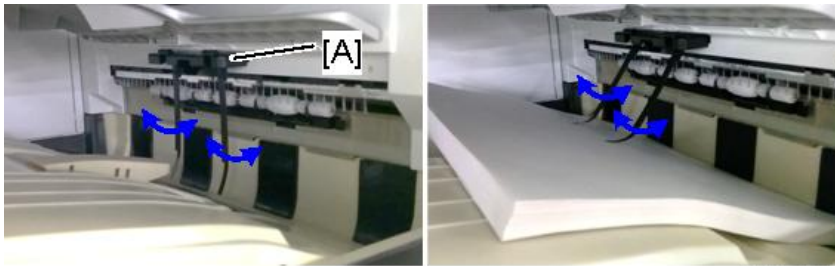

d238m0651

2

Paper will get jammed in the following cases.

- The paper exit feeler does not function due to obstacles (such as cables).
- The paper exit feeler does not function when the paper is pulled out and pushed back again.

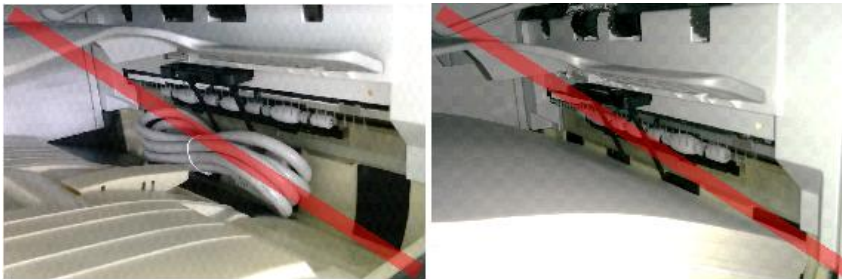

d238m0652

Attaching the Decals

Attach the following decals provided with the machine accessories.

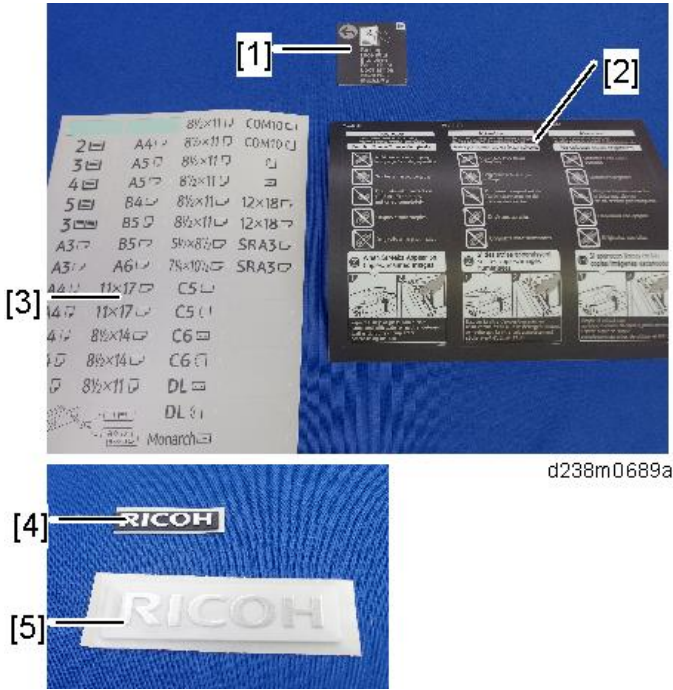

d238m0689a

- 1: Original Set Decal
- 2: ADF Caution Decal
- 3: Paper Size Tray Number Decal
- 4: Brand Logo for Smart Operation Panel
- 5: Brand Logo for Front cover

Location for each decal

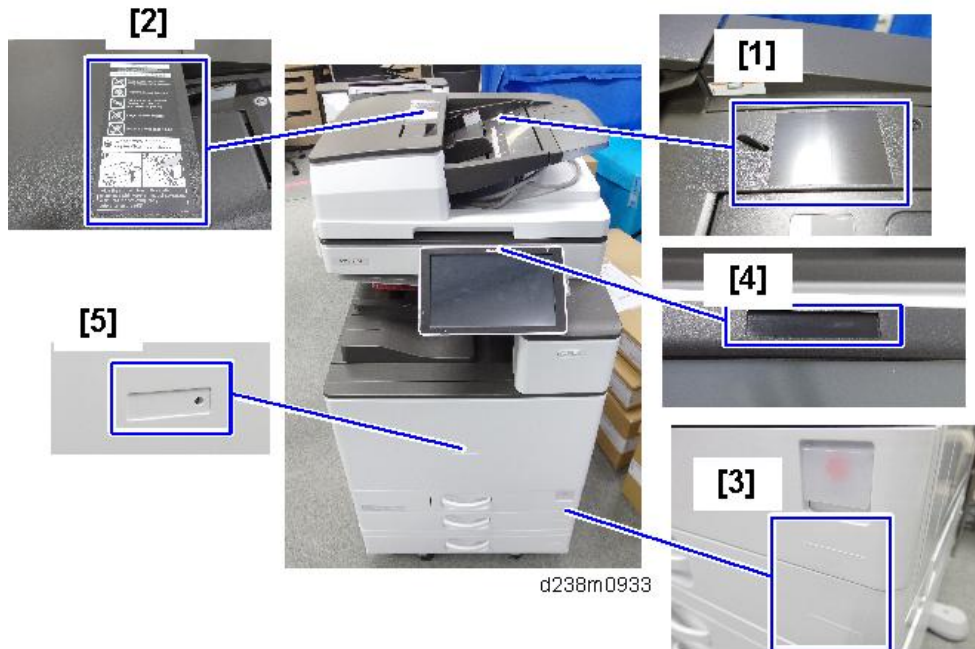

2

Toner Bottle Installation and Login Password Setting

1. Open the front cover.
2. Shake the toner bottle (Bk) 7 to 8 times.

3. Remove the toner bottle protection cap [A].



d1462234

4. Push the toner bottle into the machine slowly.

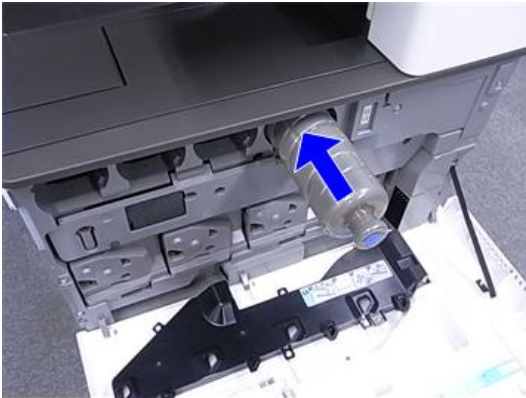

d1462400

5. Set the toner bottles (Y, M, and C) in the same way.
6. Close the front cover.
7. Connect the power cord to the machine.

⚠ CAUTION

- Use the power cord that is provided with the machine. Do not use any other power cord. Also, do not use an extension cord.

8. Turn ON the main power.

- Toner Initialization starts. It takes about 5 minutes to fill the toner up. Be sure to wait long enough. If you do not, Auto Color Calibration (ACC) will take longer.

- Password change display appears. If you want to skip this screen, SP5-755-002 (Display Setting: Hide Administrator Password Change Scrn) allows you to skip it. Refer to page 57 "Important Notice on Security Issues".

★ Important

- When Supervisor/ Administrator 1-4 passwords are configured via network, the "Change Supervisor login password" window will not display.
- The passwords for supervisor or administrator 1 to 4 can be set via "System Settings". But the Program/Change Administrator screen appears every time the power switch is turned ON if the passwords are input this way. So we recommend the customers to set the passwords via network or the Program/Change Administrator screen.

9. Press [Change] and change the supervisor login password.

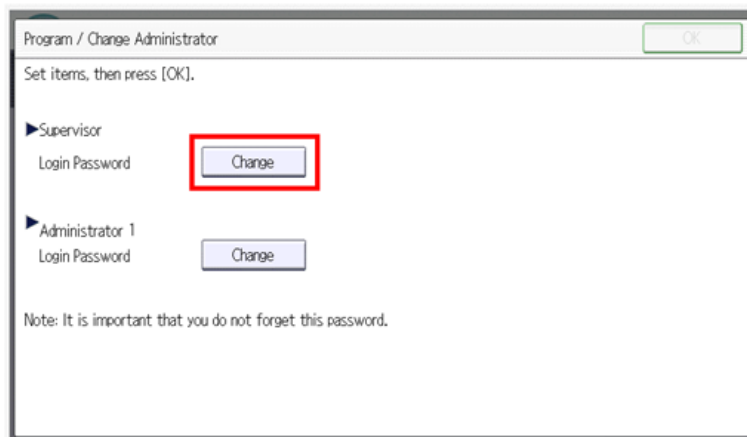

d176f2101

10. Input the password, and then press [OK].

11. Confirm the password, and then press [OK].

12. Change the administrator 1 login password.

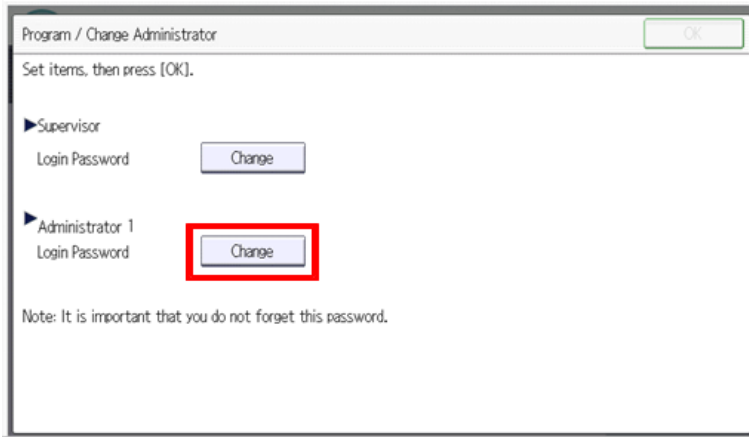

d176f2106

13. Input the password, and then press [OK].

14. Confirm the password, and then press [OK].

15. After the toner initialization is completed, the machine beeps, and the following message is displayed. Turn the machine OFF/ON.

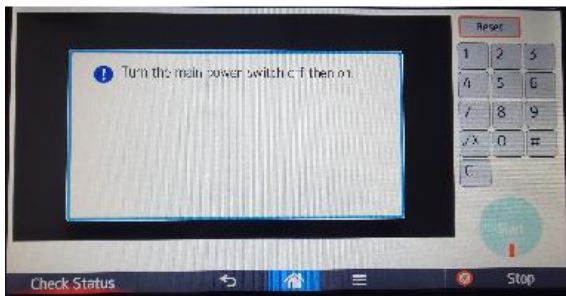

d238m0647

Note

- Even though the control panel display has gone off, the machine may still be on. So when turning the power off and back on, be sure to check that the main power indicator has gone off before turning the power on again.

For Machines with Preinstalled ARDF: Fax Stamp Installation (Option)

This procedure is required for the machine which the fax function is installed as standard.

1. Open the ARDF original cover and stamp holder [A].

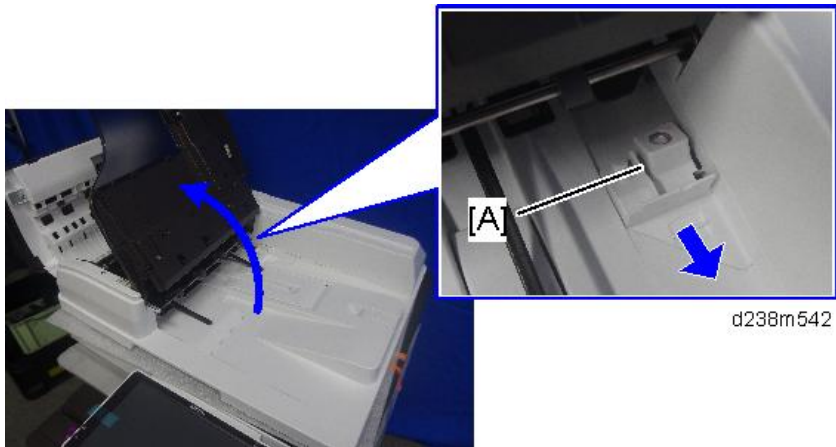

2. Install the fax stamp [A] provided with the machine.

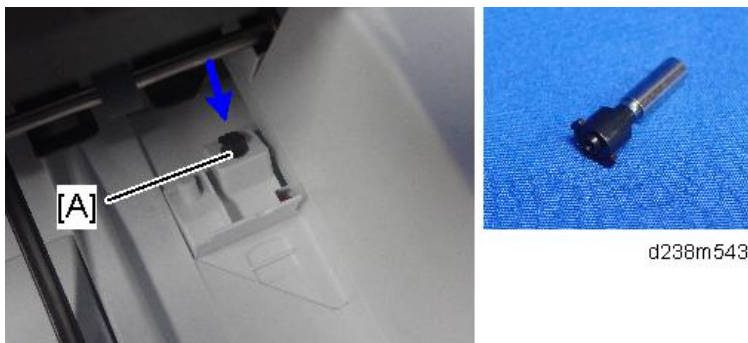

3. Close the holder.

Make sure that it is pushed in to the position where the marks on the holder and the exterior cover face each other. If not, jam detection (001) will occur.

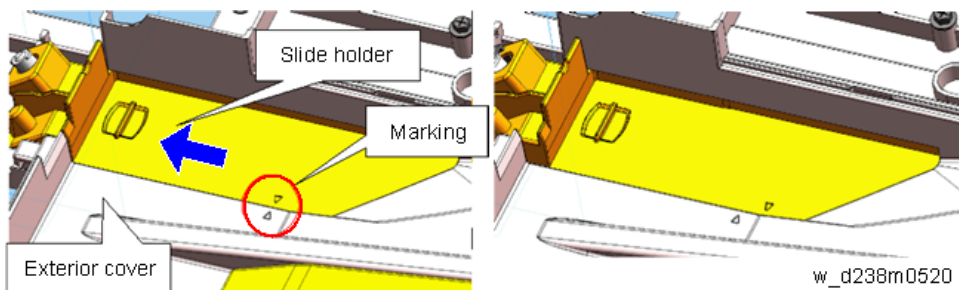

Image Quality Test/ Settings

Before Test

- Perform the image quality test after installing all peripherals
- Confirm that there are no accessories (such as screws and clamps) left inside the main machine and peripherals

Loading Paper

1. Turn ON the main power.
2. Check that the operation panel shows "No Paper" under the "Check Status" screen.
3. The paper size is basically detected automatically.
 1. Pull out the paper feed tray slowly until it stops.
 2. Load the paper.
 3. While pressing the release lever, adjust the side fence to the paper size to be set.
 4. Set the back fence.

ACC Execution and Color Registration Adjustment

Note

- If not transferred to printouts, the PCDU seals will not be removed correctly. Remove the PCDU seals, and then execute SP2-111-004 (Forced Line Position Adj. Mode d).
1. Do the "Automatic Color Calibration (ACC)" for the copier mode & printer mode as follows:
 - Copier mode -
 1. "User Tools" icon > "Machine Features" > "Maintenance" > "Auto Color Calibration" > "Copier Function" > "Start"
 2. Press "Start Printing".
 3. Put the printout on the exposure glass.

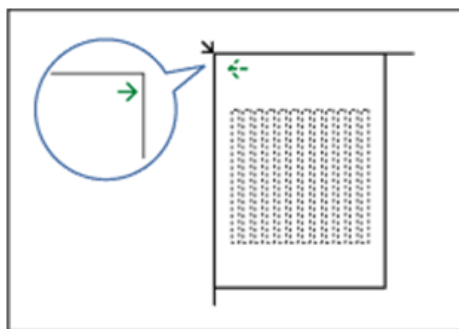

d244c0005

4. Put 10 sheets of white paper on the test chart. This ensures the precise ACC adjustment.
 5. Close the SPDF/ARDF or the platen cover.
 6. Press "Start Scanning" on the LCD. Then, the machine starts the ACC.
- Printer mode -

1. "Printer Function" > "Start"
2. Select a test pattern.

Note

- Print each ACC test pattern. There are 5 test patterns as follows:
 - Test Pattern 1: 600x600 dpi
 - Test Pattern 2: 1800x600 dpi
 - Test Pattern 3: 9000x600 dpi
 - Test Pattern 4: 1200x1200 dpi
 - Test Pattern 5: 3600x1200 dpi
3. Press "Start Printing".
 4. Put the printout on the exposure glass.

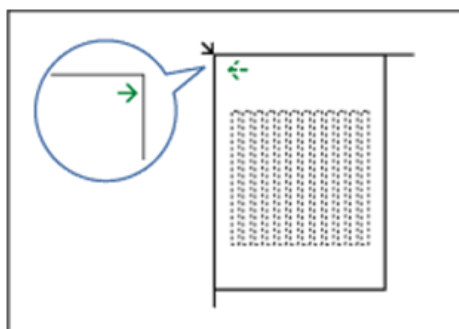

d244c0005

5. Put 10 sheets of white paper on the test chart. This ensures the precise ACC adjustment.
6. Close the SPDF/ARDF or the platen cover.
7. Press "Start Scanning" on the LCD. Then, the machine starts the ACC.

8. Repeat steps 1 to 7 until all the ACC test patterns have been printed.

2. Exit the User Tools mode.

3. Press the "Document Server" icon.

Or press and hold the [A] key and "Check Status [B]" at the same time until the number keyboard screen is displayed.

2



d238m0747



4. Enter the key code for SP mode.



d238m0748

5. Perform line adjustment.

1. Execute SP2-111-004 (Forced Line Position Adj. Mode d)
2. The result can be checked with SP2-194-007 (MUSIC Execution Result)
0: Success, 1: Failure

Note

- If failure, execute SP2-111-004 once more and check the result again.
- Fix the color registration errors, referring to page 654 "Judgment for Type of Color Registration Error".

Also, results for each color can be checked with SP2-194-010 to 013 (MUSIC Execution Result: Error Result C, M, Y, K).

1: Completed successfully

6. Exit the SP mode.

SP descriptions

- **SP2-111-004 (Forced Line Position Adj. Mode d)**
Executes the fine line position adjustment and rough line position adjustment.
- **SP2-194-007 (MUSIC Execution Result: Execution Result)**
Displays the result code of MUSIC adjustment.
0: Success
1: Failure
- **SP2-194-010 to 013 (MUSIC Execution Result: Error Result C,M, Y, K)**
Displays the result code of MUSIC adjustment for each color.
0: Not done
1: Completed successfully
2: Cannot detect patterns
3: Fewer lines on the pattern than the target
4: Out of the adjustment range
5 to 9: Not used

Checking the Copy Image with the Test Chart

Make a copy of a test chart and check the output quality.

Paper Settings

Adjusts the side-to-side registration, refer to the "Image Adjustment" > "Registration" section.

1. Enter SP2-109-003.
2. Print out the test pattern (14: Trimmed area) with SP2-109-003.
3. If necessary, adjust the registration for the paper feed tray.
 - SP1-002-001 (Side-to-Side Registration: By-pass Tray)

- SP1-002-002 (Side-to-Side Registration: Paper Tray 1)
- SP1-002-003 (Side-to-Side Registration: Paper Tray 2)
- SP1-002-006 (Side-to-Side Registration: Duplex)

If optional paper trays is installed, do the following SPs as well:

- SP1-002-004 (Side-to-Side Registration: Paper Tray 3)
- SP1-002-005 (Side-to-Side Registration: Paper Tray 4)

4. If necessary, adjust the registration for ADF.

- SP6-006-001 (ADF Adjustment: Side-to-Side Regist: Front)
- SP6-006-002 (ADF Adjustment: Side-to-Side Regist: Rear)

5. If necessary, adjust the registration for Scanner.

- SP4-803-001 (Home Position Adj Value)
- SP4-011-001 (Main Scan Reg)

↓ Note

• SP descriptions

• SP1-002 (Side-to-Side Registration)

Adjusts the side-to-side registration by changing the laser main scan start position for each mode and tray.

Increasing a value: The image is moved towards the rear edge of the paper.

Decreasing a value: The image is moved towards the front edge of the paper.

• SP2-109-003 (Test Pattern: Pattern Selection)

Selects the test pattern.

Auto Remote Firmware Update Settings

Specify ARFU settings as required.

Operating Conditions:

- Use the machine in an environment where it can be connected to the Internet.

↓ Note

- Auto remote firmware update (ARFU) requires connection to an external network. Be sure to get permission from the customer before setting ARFU up.
- The connection is one-way, so the user's data cannot be accessed from the global server.

Pre-Operation Set Up and Checks

1. Check the network settings (IP address, Subnetmask, Gateway, and Proxy).

2. Check the DNS setting.

How to Check the DNS setting

1. Get the IP address of the DNS server from the customer.
2. Request the customer to check the DNS server.

↓ Note

- How to check the address of the DNS server by the PC (reference).
Check by either of the following methods:
Run "ipconfig / all" at the command prompt on the PC, then check the IP address of the DNS server.
Open the IPv4 properties screen in the PC, check the IP address setting of the DNS server is whether manual or automatic.

★ Important

- If the access to the external server is restricted, request the network administrator (customer) to permit the following FQDN name for communication.
- FQDN: p-rfu-ds2.support.ricoh.com

3. Ask the customer the prohibited time and day of the week of ARFU execution.

4. Check SP5-816-087 (Remote Service: CERT:Macro Ver) and make sure the encryption level is 2048 bit.

[1]: 512 bit / [2]: 2048 bit

★ Important

- If SP5-816-087 is [1]: 512 bit, specify the settings as follows:
 1. Initialize the encryption level by executing SP5-870-003 (Common Key Info Writing: Initialize)
 2. Rewrite as 2048 bit in SP5-870-004 (Common Key Info Writing: Writing 2048 bit).
 3. Turn off and on the main switch.

↓ Note

- ARFU uses the same certificate as @Remote to communicate with the Global Server. This may cause failure in connecting with the Center Server, if the device is to be installed in the following conditions. Make sure to check the conditions before changing the encryption level and do the corresponding workaround.

Conditions

1) Customer uses RC Gate Type BN1.

RC Gate Type BN1 does not support 2048 bit encryption level communication with Ricoh devices (HTTPS Managed device). Therefore, device cannot be registered under RC Gate Type BN 1 in this case.

2) Ricoh device (HTTPS Managed) that supports only 512 bit encryption level is registered as external appliance.

Only one encryption level can be set for an external appliance for its communication with imaging devices. If a 512 bit encryption level Ricoh device (HTTPS Managed) is registered, the external appliance as well as other devices must also use 512 bit encryption level even if 248 bit encryption is supported on those devices.

Workaround

For Condition 1:

Advise your customer to change to the latest appliance that supports 2048 bit encryption level communication.

For Condition 2:

1. Manage the device with embedded RC Gate. (2048 bit)
2. Exclude non-supported devices from the external appliances, and then, change the encryption level of external appliance and all managed devices (from 512 bit to 2048 bit).

Devices excluded to be registered with embedded RC Gate. (512 bit)

Configuration Procedure

1. Do interface settings.

In User Tools > Machine Features > System Settings > Interface Settings, specify the machine's IPv4 address, subnet mask, and gateway IPv4 address.

2. Do DNS settings and check the connection.

In User Tools > Machine Features > System Settings > Interface Settings > DNS Settings

Note

- If the setting of the DNS IP address is automatic, select [Auto-Obtain (DHCP)] at the MFP machine's DNS settings.
- If the setting of the DNS IP address is manual, select [Specify] and specify the DNS server 1 to 3.
- Press [Connection Test] to check the connection with the input address. Make sure that it is connected successfully.

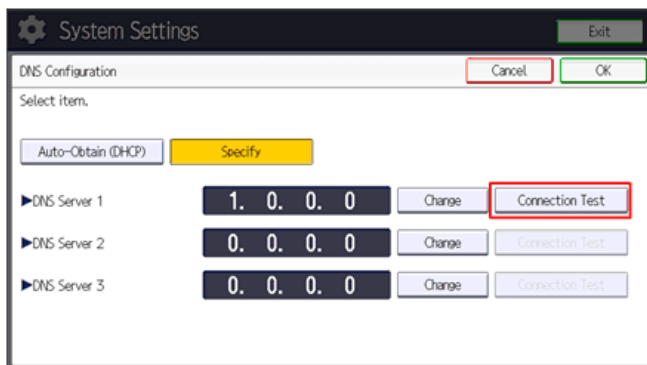

d244c0052

3. Check the user's network environment and, as required, specify the proxy server settings in the following SPs:

- SP5-819-062 (Use Proxy DFU(SSP))
1: Use / 0: Not use
- SP5-816-063 (Use Proxy DFU(SSP))
- SP5-816-064 (Proxy Port Number)
- SP5-816-065 (Proxy User Name)
- SP5-816-066 (Proxy Password)

They can be specified also via Web Image Monitor from Device by logging in with the administrator authorization. Management>Configuration>Device Setting>Auto Firmware Update.

↓ Note

- "Auto Firmware Update" will appear on Web Image Monitor if SP5-886-111 (AutoUpdateSetting) is set to "1 (ON)."

4. Set SP5-886-111 (AutoUpdateSetting) to "1 (ON)."

↓ Note

- To download the firmware only using SFU, and not by ARFU, specify the settings as follows:
 - SP5-886-111 (AutoUpdateSetting) to "0 (OFF)"
 - SP5-886-115 (SfuAutoDownloadSetting) to "1 (ON)"

5. Set the prohibited day of the week, and time, of the auto firmware update.

6. Consider usages of customer's MFP, change the following as needed.

- SP5-886-112 (AutoUpdateProhibitTermSetting)
0: OFF, 1: ON (Default)
- SP5-886-113 (AutoUpdateProhibitStartHour)
Default: 9
- SP5-886-114 (AutoUpdateProhibitEndHour)
Default: 17
- SP5-886-120 (AutoUpdateProhibitDayOfWeekSetting)
Default: 0x00
Set the bits for the days of the week to prohibit updating.
Prohibited (Monday - Sunday): Bit 7
Monday: bit 6
Tuesday: bit 5
Wednesday: bit 4
Thursday: bit 3

Friday: bit 2

Saturday: bit 1

Sunday: bit 0

e.g.) Prohibited on Mon., Fri., Sat., and Sun.: 0x47 (01000111)

They can be specified also via Web Image Monitor logged in as the machine administrator from Device. Management>Configuration>Device Setting>Auto Firmware Update.

↓ Note

- "Auto Firmware Update" will appear on Web Image Monitor if SP5-886-111 (AutoUpdateSetting) is set to "1 (ON)."

7. Use the machine with its main power on and connected to the Internet.

Checking the ARFU Connection

1. Enter the SP mode.
2. Press [Firmware update].
3. Press [Update].
4. Press [Execute update].



d238m0986e

- "Execute update" appears even if @Remote connection has not been established.
- If an error code appears when you click "Execute update", the machine is in the following status.

Error code	Status
E51	The machine in operation for printing, etc.
E71	Network connection error

(Other error, see page 680 "Error Screens During Updating")

5. Check if one of the following messages appears: "Will you download the latest package Ver * and update?" or "The installed package is the latest version."**

- If the message appears, it is possible to execute ARFU.
->Press "No" and close SP mode to complete the configuration.
- If the message does not appear, it is not possible to execute ARFU.
->Check the network settings again.

★ Important

- Update will run immediately if you press "Yes" at the message "Will you download the latest package Ver *** and update?" Update cannot be canceled, as it is run by SFU. (Update can be canceled for ARFU.)
- If the access to the global server is restricted, request the network administrator (customer) to permit the following FQDN name for communication.
- FQDN: p-rfu-ds2.support.ricoh.com

↓ Note

- SP5-886-116 (Auto Update Prohibit Term Setting) displays the scheduled date and time of the next ARFU.
- If the scheduled date and time of the next ARFU coincides with a time and day of the week when ARFU is prohibited, the machine sends an inquiry to the server to check if there is a new firmware package at this time. If there is a new firmware package, it is downloaded in the background, but the package updating is cancelled and executed on the next occasion, 76 hours later, to update the package.

Specifying the Time and Day of the Week to Prohibit Updating via Web Image Monitor

1. Start the Web Image Monitor.
2. Log in as the machine administrator.
3. Point to [Device Management], and then click [Configuration].

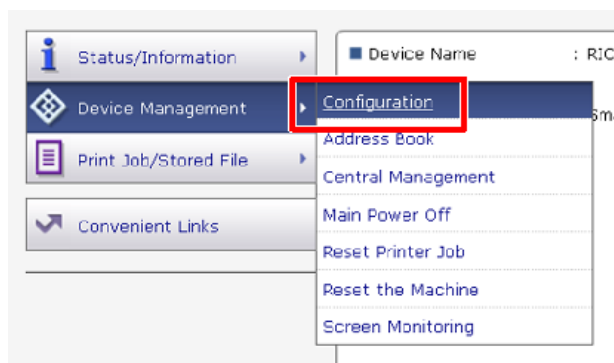

d238m0983e

4. Click "Auto Firmware Update".



Note

- Turn the main power OFF and back ON again after setting SP5-886-111 (AutoUpdateSetting) to "1(ON)". "Auto Firmware Update" will appear in the menu list of the Web Image Monitor.

5. In the applicable items, specify the times and days of the week to prohibit updating.

Select the check boxes of the applicable days of the week to prohibit updating on that day

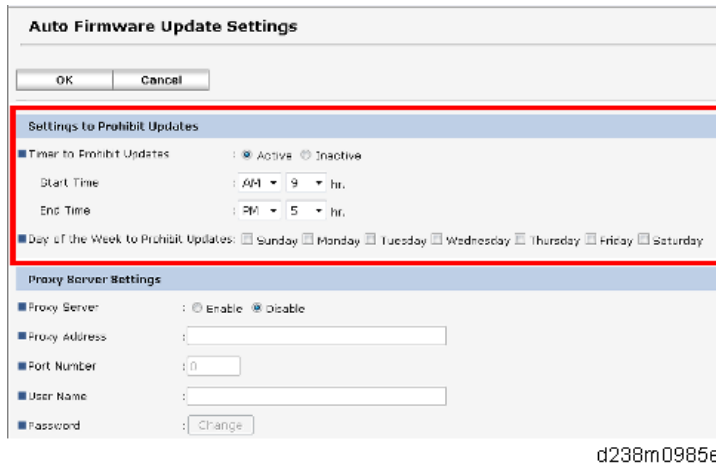

d238m0985e

2

Enabling the Copy Data Security Function

The Copy Data Security function is installed in the IPU as standard for this machine.

Enable this function in User Tools when installing the machine.

1. Press [User Tools] icon on the HOME screen.
2. Select [Machine Features] > [System Settings] > [Administrator Tools] > [Detect Data Security for Copying] > "On".

Copy Data Security Function

If the Unauthorized Copy Prevention function is enabled, embedded text patterns (for instance, a warning message such as "No Copying") are displayed when documents are copied illegally. Accordingly, unauthorized copying can be prevented.

If the Data Security for Copying function is used and settings for special patterns embedded in documents are enabled, copies of documents with embedded patterns are printed with gray overprint. Accordingly, information leakage can be prevented. To protect documents by gray overprint, the Data Security for Copying function must be enabled on the copier or multi-function printer.

HDD Security Function Setting

Perform the encryption and overwrite settings to protect the user information in the HDD as necessary.

Follow the instructions in page 374 "Security Settings".

Settings Relevant to the Service Contract

Change the necessary settings for the following SP modes if the customer has made a service contract.

SP No.	Function	Default
SP5-045-001 Counter method	Specifies if the counting method used in meter charge mode is based on developments, prints, or coverage.	"1": Prints
SP5-104-001 (SSP) A3/DLT double count	Specifies whether the counter is doubled for A3/DLT paper.	"0":Single counting
SP5-812-001 and -002 Service Tel: Telephone / Facsimile	-001: shows or sets the telephone number of the service representative. -002: shows or sets the fax number of the service station. The number is printed on the counter list when the "Meter Click Charge" is enabled. User can send a fax message with the counter list.	

Counter Display Method

There are 3 types (Developments, Prints and Coverage). Display mode can be set by SP5-045-001 (Accounting counter: Counter Method).

Value	Mode	Descriptions
0	Development Count	YMC Development Counter Bk Development Counter
1	Print Count (Default)	Color Copy Counter B&W Copy Counter Color Print Counter B&W Print Counter Color Total Counter B&W Total Counter
2	Coverage Count	Color Total Counter B&W Total Counter Color Coverage Counter 1 Color Coverage Counter 2 Color Coverage Counter 3

Value	Mode	Descriptions
7	Coverage Count (YMC)	Color Total Counter B&W Total Counter Color Coverage Counter 1 (YMC) Color Coverage Counter 2 (YMC) Color Coverage Counter 3 (YMC)

Installation is now completed.

Moving the Machine

This section shows you how to manually move the machine from one floor to another floor. Before turning off the main power, make sure 100% is shown as available memory on the screen if the fax option is installed.

- Turn off the main power.
- Disconnect the power plug from the outlet.
- Close all covers and paper trays, including the front cover and bypass tray.
- Move the scanner carriage to the correct position [A] with SP4-806-001 (**SSP**), and reattach the scanner shipping locks with lock position [B].

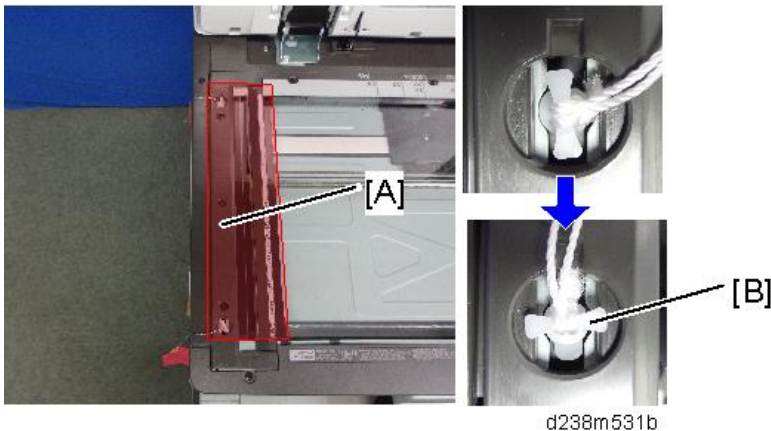

- Keep the machine level and carry it carefully, taking care not to jolt or tip it, and protect the machine from strong shocks.
- When moving the machine, do not press against the ADF.
- Remove the optional feed tray when lifting the main machine for moving it to another floor.

↓ **Note**

• **SP descriptions**

- SP4-806-001 (Scanner carriage storage operation) **(SSP)**

Moves the scanner carriage to the shipping lock position. Attach the scanner shipping locks and fix the scanner carriage after executing SP4-806-001.

★ **Important**

- Do not push the center part of the rear cover. Do not hold the covers of the stabilizers.



d238m0511e

- Do not put hard pressure on the rear cover [A] when moving or picking up the machine as it is fragile. This also applies to the operation panel [C]. Hold part [B] when moving the machine.

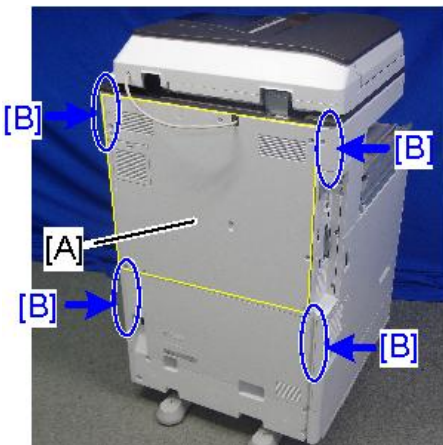

d238m0512

- Hold 4 corners on the bottom base when holding the machine with the optional paper feeding tray joined to the main machine. Do not hold any other parts.

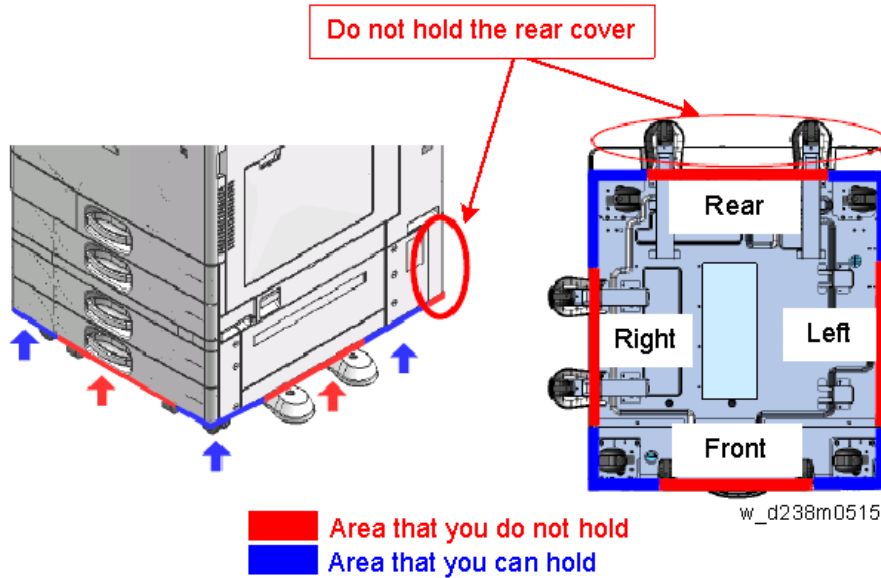

Cautions upon Lashing

1. Position the machine so that its left side faces the wall. Make sure to put cushioning in between.
2. Fasten the belt at the ridge line with cushioning.
3. Make sure that the belt is over the front cover (at 45 – 75 cm height from the ground).

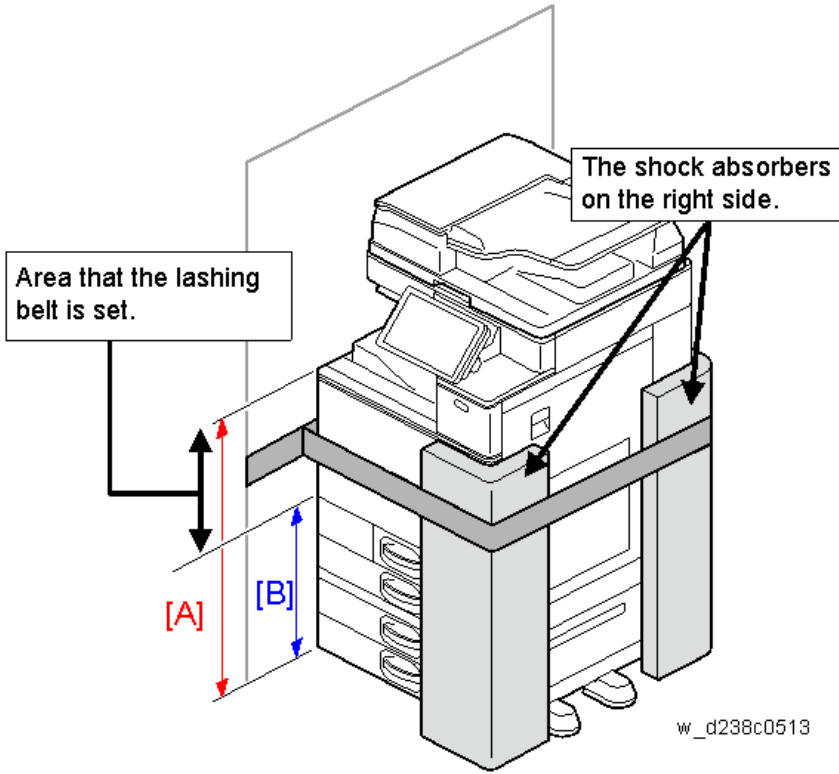

w_d238c0513

[A]: 75 cm/29.5" [B]: 45 cm/17.5"

Anti-Condensation Heater (Scanner, PCDU)

CAUTION

- Unplug the machine power cord before starting the following procedure.
- Do the following procedure not to damage any harnesses.
- Check that harnesses are not damaged or pinched after installation.

2

Anti-Condensation Heater (Scanner)

Note

- This option is provided as a service part.
- If you want to install Anti-Condensation Heater (Scanner), (1) heater for scanner and (2) electrical components should be ordered.

Accessory Check

(1) Heater for Scanner

No.	Description	Q'ty	Remarks
1	COVER: HEATER: SCANNER	2	Parts Number: <ul style="list-style-type: none"> • NA (120V): D2380071 • EU/AA (220/240V): D2380072
2	HEATER:120V:9W HEATER:230V:9W	1	
3	BRACKET HEATER: SCANNER	1	
5	SCREW:POLISHED ROUND/ SPRING:M4x8	1	
6	SCREW M3x3	2	

(2) Electrical components

No.	Description	Q'ty	Remarks
-	TAPPING SCREW M3X6	3	Parts Number: D2386650 Electrical parts set for Scanner and Drum heater is common between NA/EU
4	CLAMP	6	
-	HARNESS: SCANNER/PCU	1	
-	PCB: DHB	1	
-	HARNESS :DC: DHB	1	
-	HARNESS :AC: DHB	1	

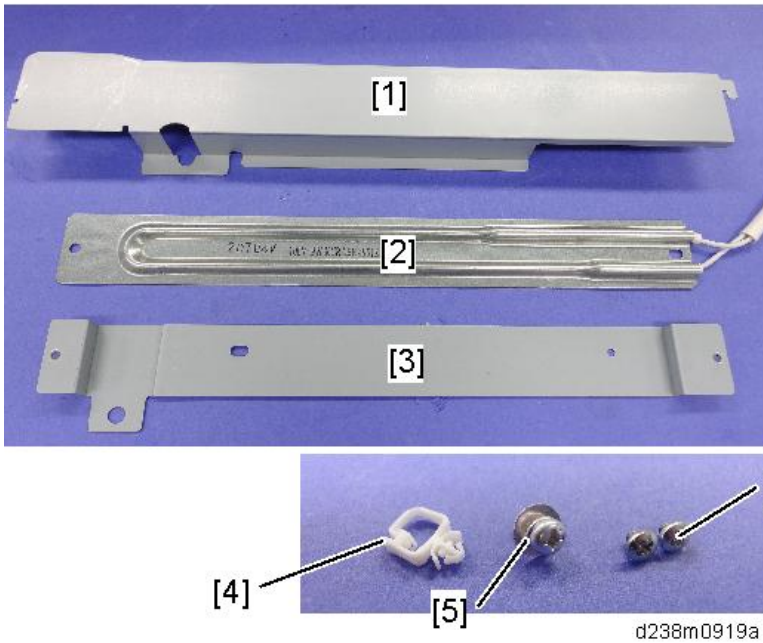

d238m0919a

Installation Procedure

1. Remove the rear cover [A].

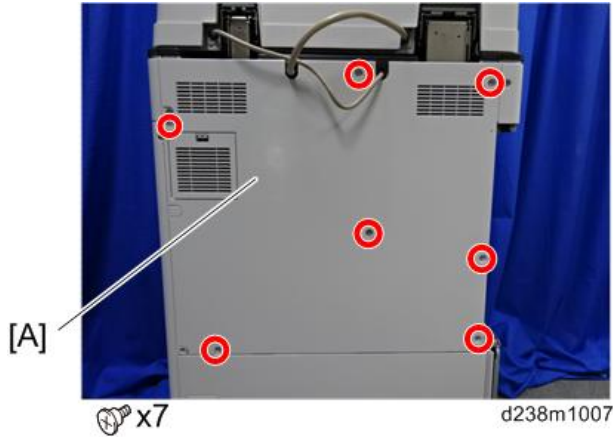

2. Remove the rear lower cover [A].

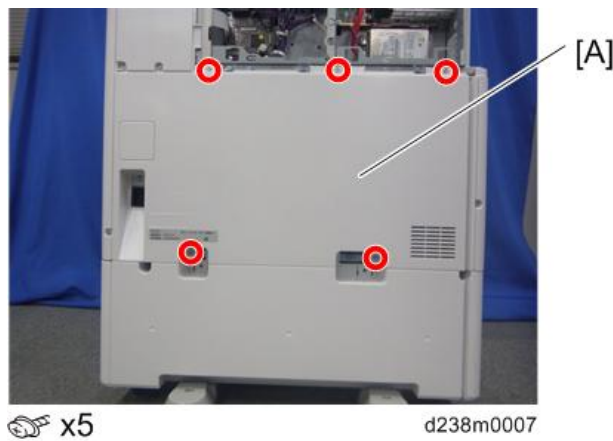

3. Remove the power supply box [A] (🔩 x6, Among them, tapping screw x1)

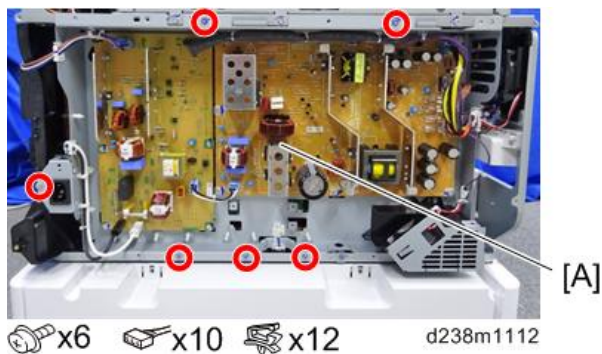

4. Release the 5 clamps.

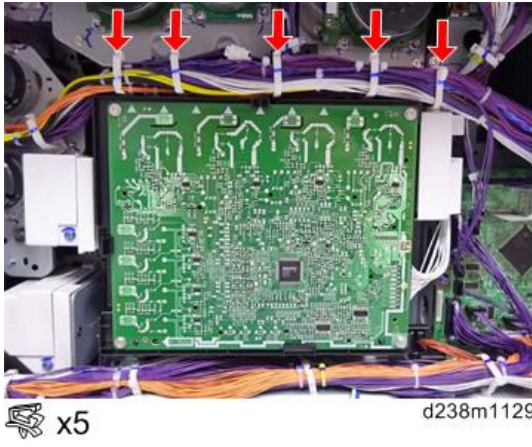

5. Remove the HVP-CB with bracket [A] (Hook x2).

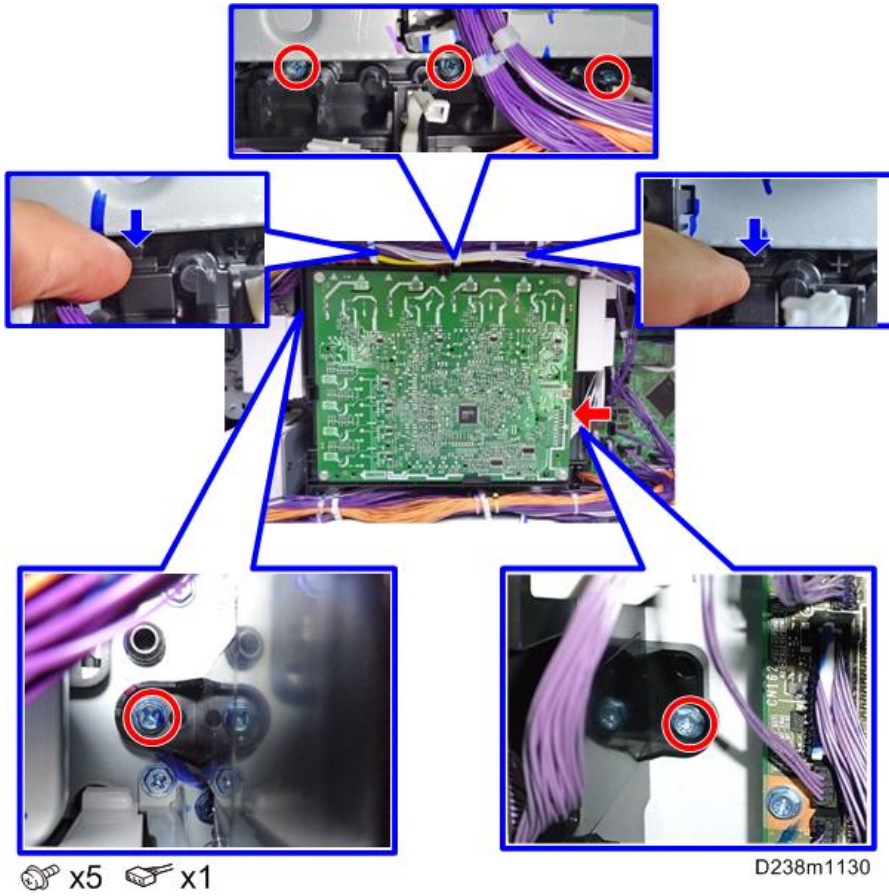

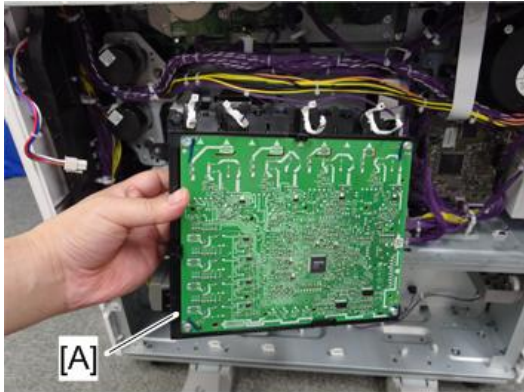

d146z0087

6. Connect the combined Blue/White harness to the back frame [A].

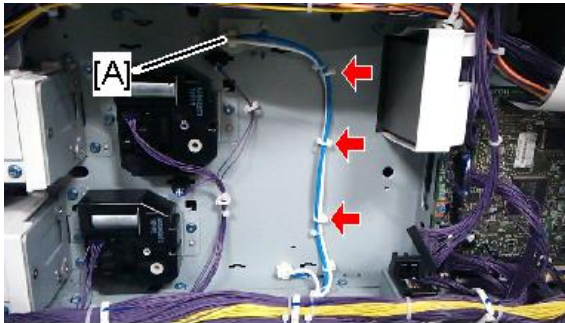

 x3  x1

d146f002b

 **Note**

- The harness will be connected to the relay board. See the details in step 8.

7. Reinstall the HVP-CB unit and power supply box.

8. Secure the relay board to the main machine and connect the Blue/White harness to the socket on the board (🔌 × 1, 🛠 × 3).

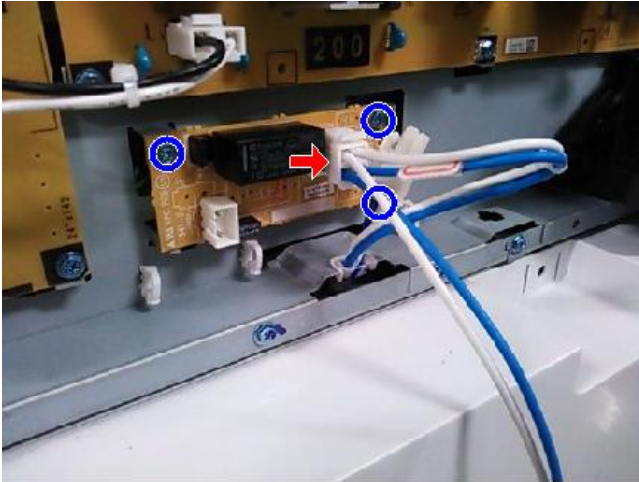

d146f003b

9. Connect the harnesses on the relay board to the sockets on the PSU.

Note

- Two types of harnesses are packed with the heater. Both the Blue/White one [A] and the Gray one [B] must be connected as shown below.

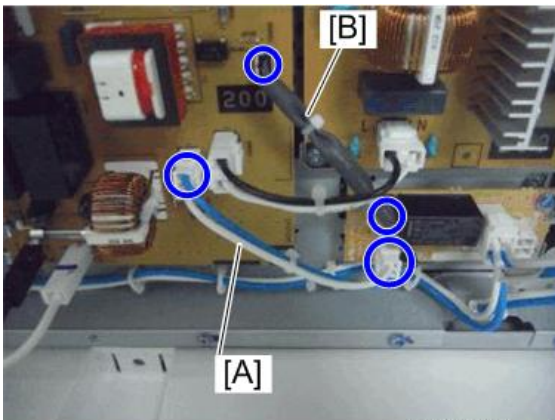

d146f001

10. Remove the right rear cover [A] (🔩 x4, among them, tapping screw x1)

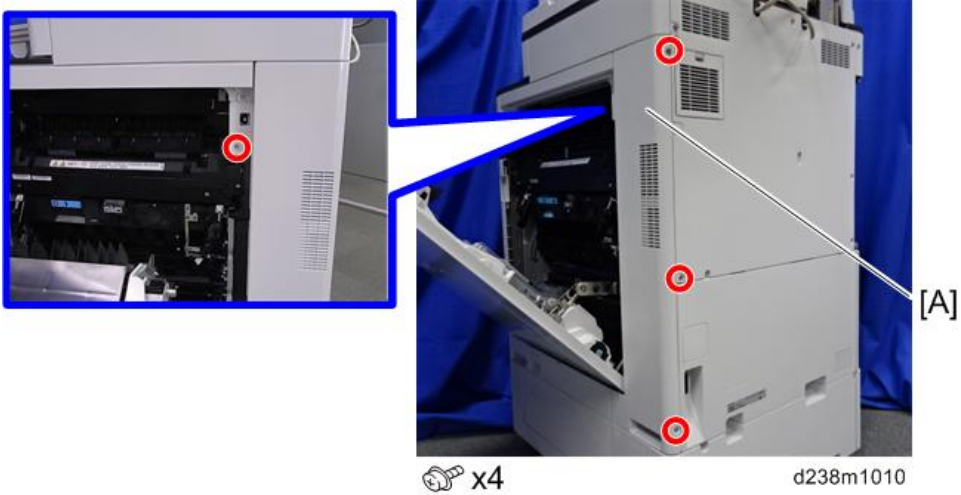

11. Remove a screw.



12. Remove the scanner right cover [A].

Remove the hook at the upper part, and then slide the cover in the rear direction.

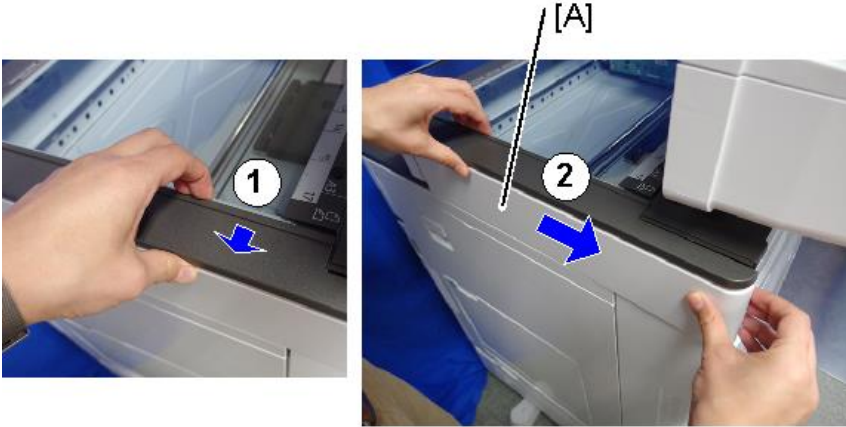

d238m1301

13. Route the harness around the outside of the PSU and pull the harness out of the electrical box through the hole [A] (⚠ x 4).

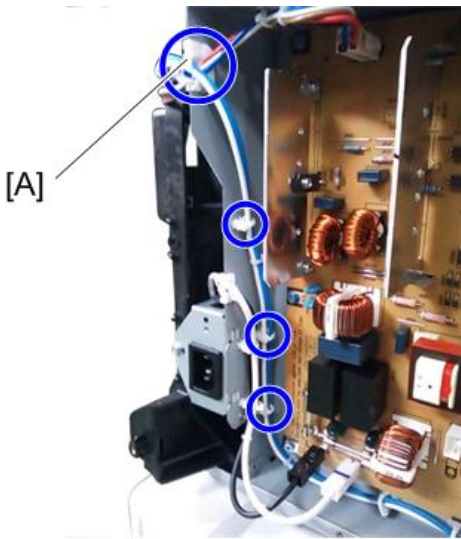

d1463036

14. Route the harness in the direction of the scanner (🔍 x 6).

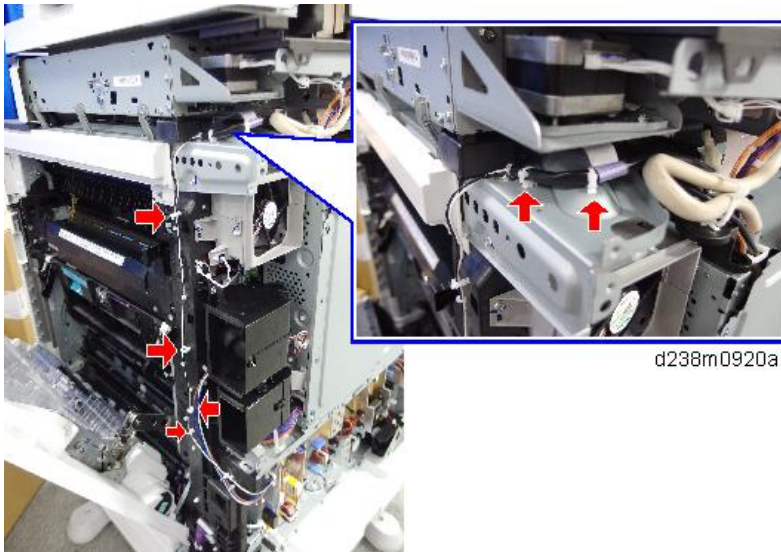

2

★ Important

- Fasten the clamp between the bindings of the harness at the location indicated by the red circle.

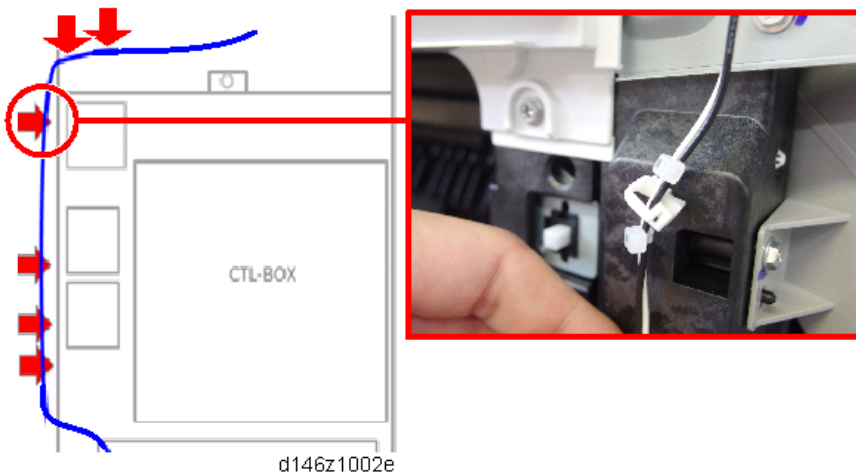

15. Attach the connector to the frame.

Connect it to the heater harness in step 25.

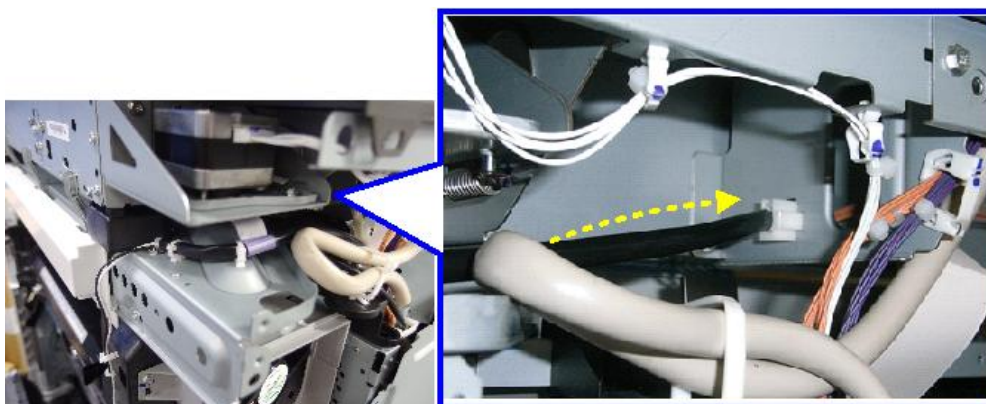

d238m0920b

16. Remove the scale [A]

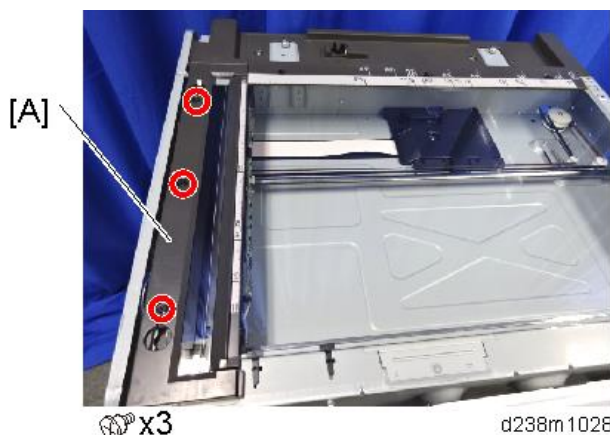

d238m1028

17. Remove the sheet-through exposure glass [A]

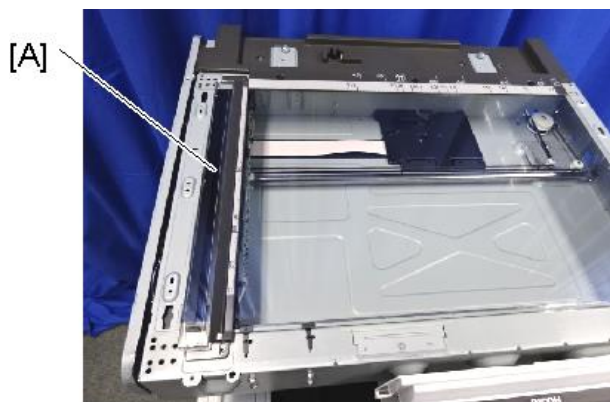

d238m1029

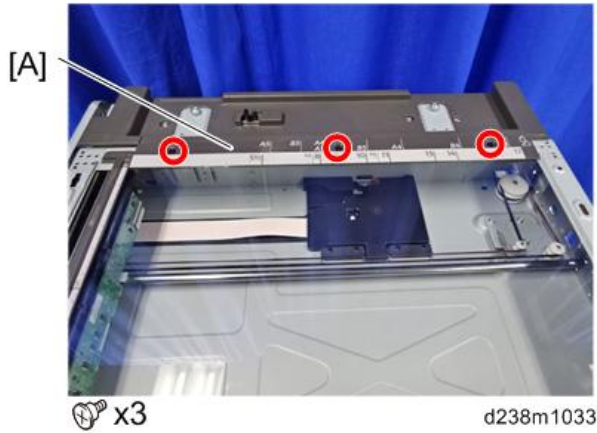
18. Remove the rear scale [A]**19. Remove the left scale and exposure glass [A]****⚠ CAUTION**

- The exposure glass and the left scale are attached with double-sided tape.

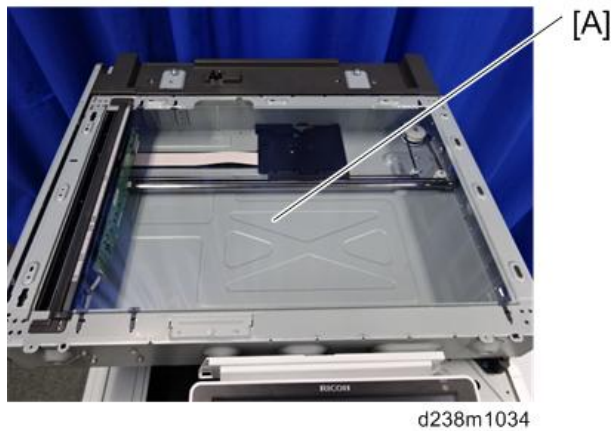
**20. Move the scanner carriage to the right.**

21. Attach the heater [B] to the bracket [A] provided with the accessories (Ⓜ × 2).

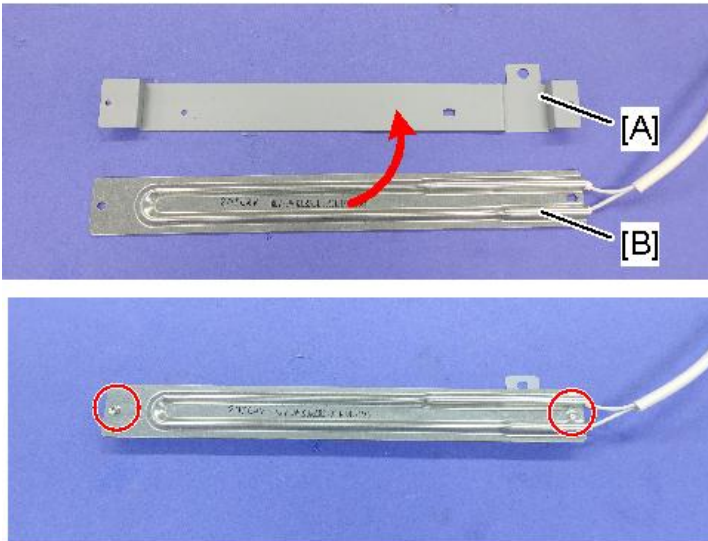

d238m0921a

22. Remove the release paper [A] on the back side of the bracket, and secure the heater [B] with the seal, aligning it with the boss on the frame.

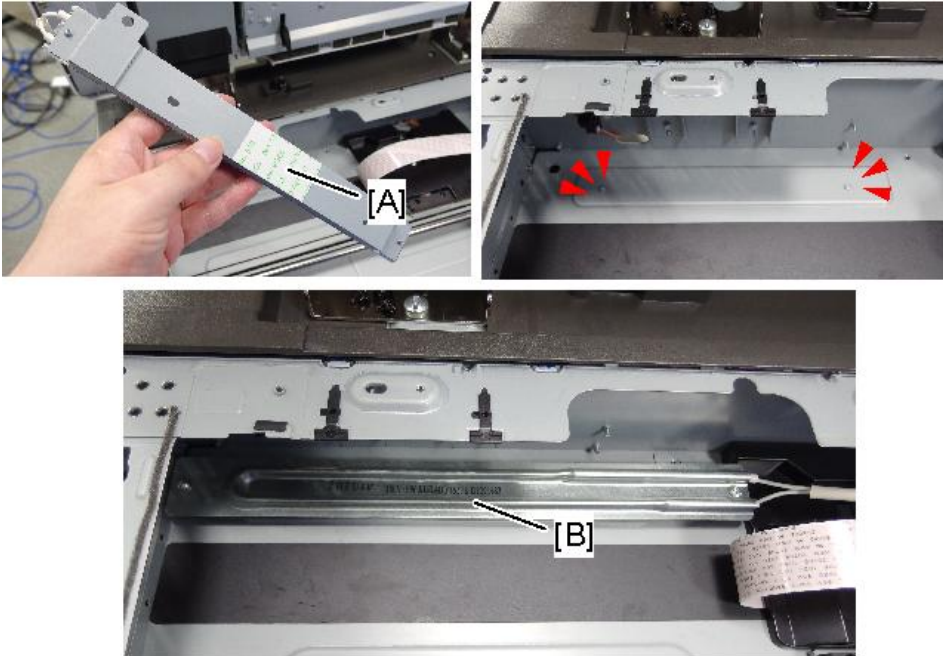

d238m0922a

23. Pull the harness [A] out of the frame hole.
Route the harness into the harness guide.

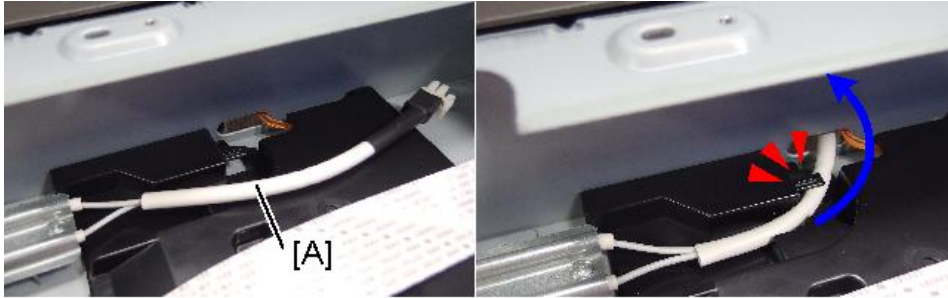

d238m0923a

2

24. Attach the heater cover [A] (🔩 × 1).

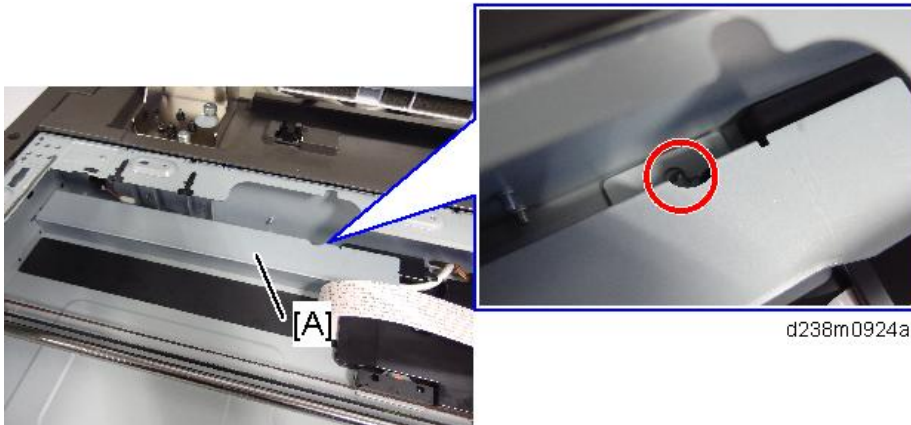

d238m0924a

25. Connect the heater harness that was pulled out of the frame hole to the connector which was mounted in step 15.

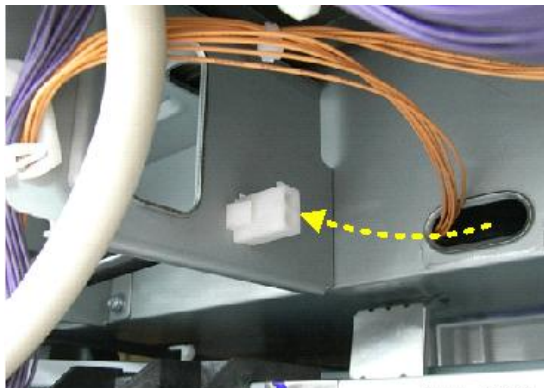

🔌 x1

d238m0925b

26. Reattach all the removed covers.

Anti-Condensation Heater (PCDU)

Note

- This option is provided as a service part.
- If you want to install Anti-Condensation Heater (PCDU), electrical parts (1) and heater for PCDU (2) should be ordered.

2

Accessory Check

(1) Electrical parts

Description	Q'ty	Remarks
TAPPING SCREW M3X6	3	Parts Number: D2386650 Electrical parts set for Scanner and Drum heater is common between NA/EU
CLAMP	6	
HARNESS: SCANNER/PCU	1	
PCB: DHB	1	
HARNESS :DC: DHB	1	
HARNESS :AC: DHB	1	

(2) Heater for PCDU

Description	Q'ty	Remarks
TAPPING SCREW: WASHER M3X8	1	Parts Number: <ul style="list-style-type: none"> • NA (120V): D7390116 • EU/AA (220/240V): D7390117
HEATER: PHOTOCONDUCTOR: EU	1	
HEATER: PHOTOCONDUCTOR: NA	1	
DECAL HIGHT TEMP	1	

Installation Procedure

1. Remove the rear cover [A].

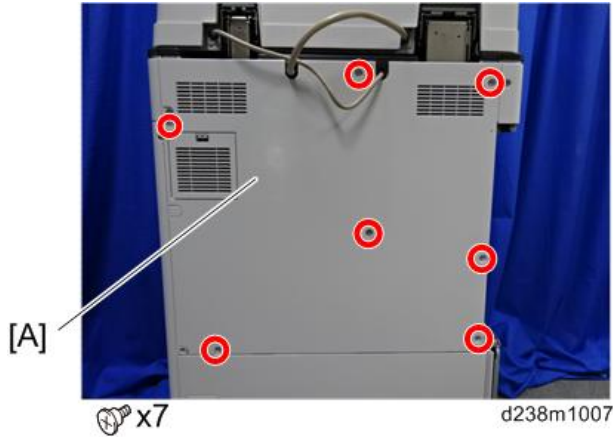

2

2. Remove the rear lower cover [A].

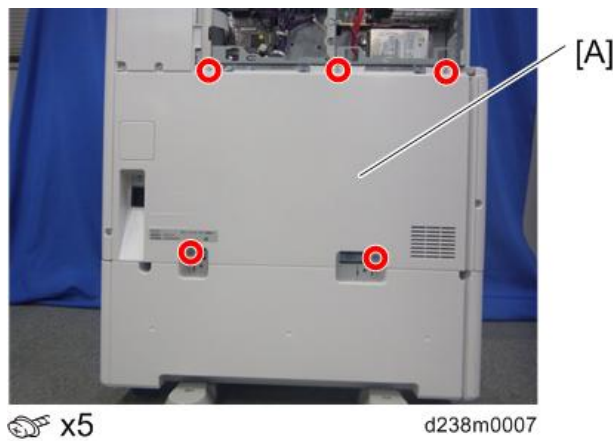

3. Remove the power supply box [A] (🔩 x6, Among them, tapping screw x1)

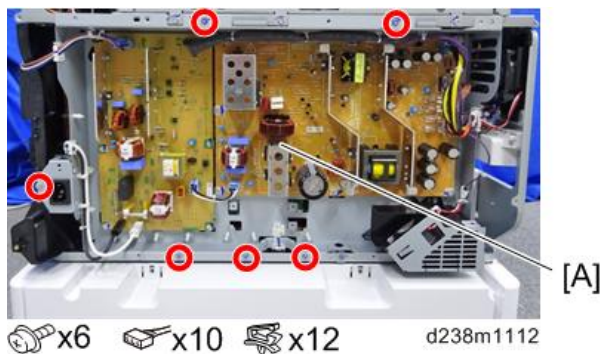

4. Release the 5 clamps.

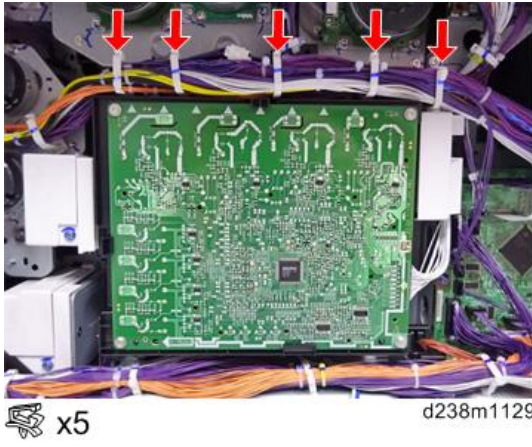

5. Remove the HVP-CB with bracket [A] (Hook x2).

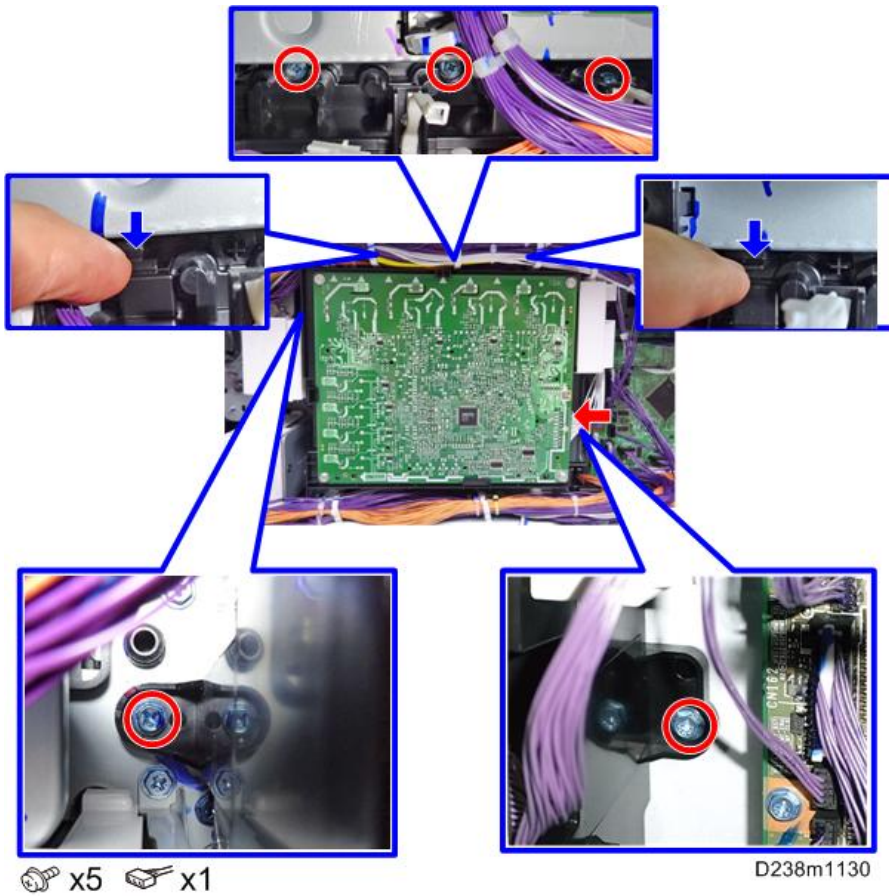

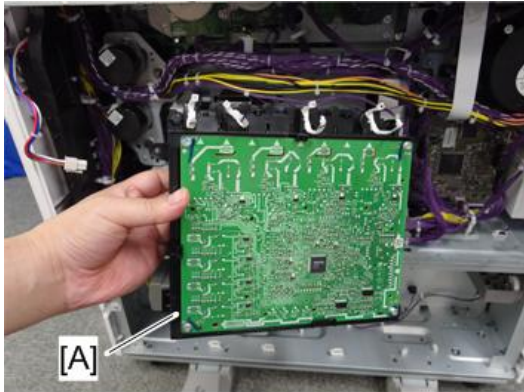

d146z0087

6. Connect the combined Blue/White harness to the back frame [A].

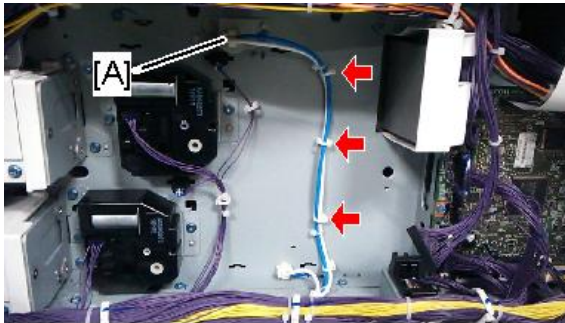

 x3  x1

d146f002b

 **Note**

- The harness will be connected to the relay board. See the details in step 8.

7. Reinstall the HVP-CB unit and power supply box.

8. Secure the relay board to the main machine and connect the Blue/White harness to the socket on the board (🔌 × 1, 🌀 × 3).

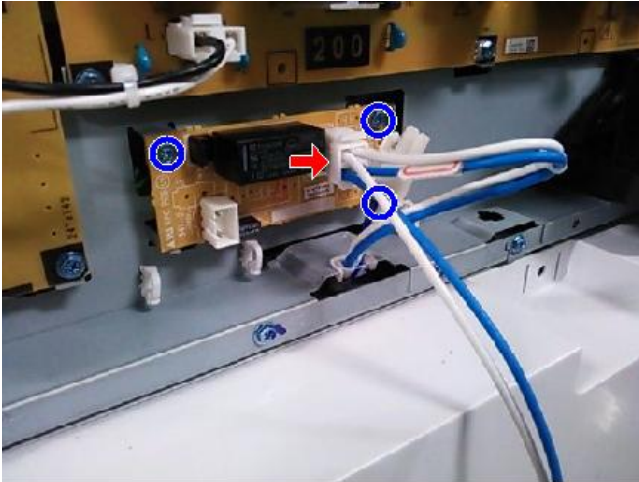

d146f003b

9. Connect the harnesses on the relay board to the sockets on the PSU.

Note

- Two types of harnesses are packed with the heater. Both the Blue/White one [A] and the Gray one [B] must be connected as shown below.

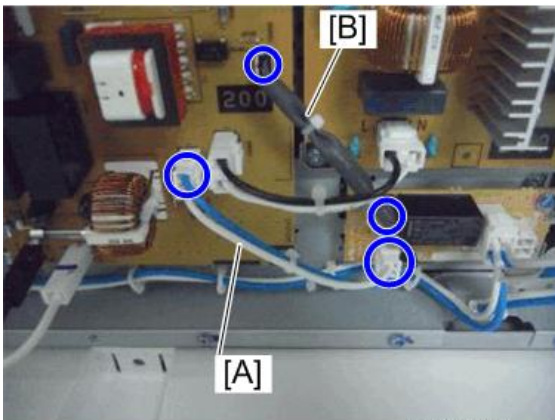

d146f001

10. Remove the right rear cover [A] (🔩 x4, among them, tapping screw x1)

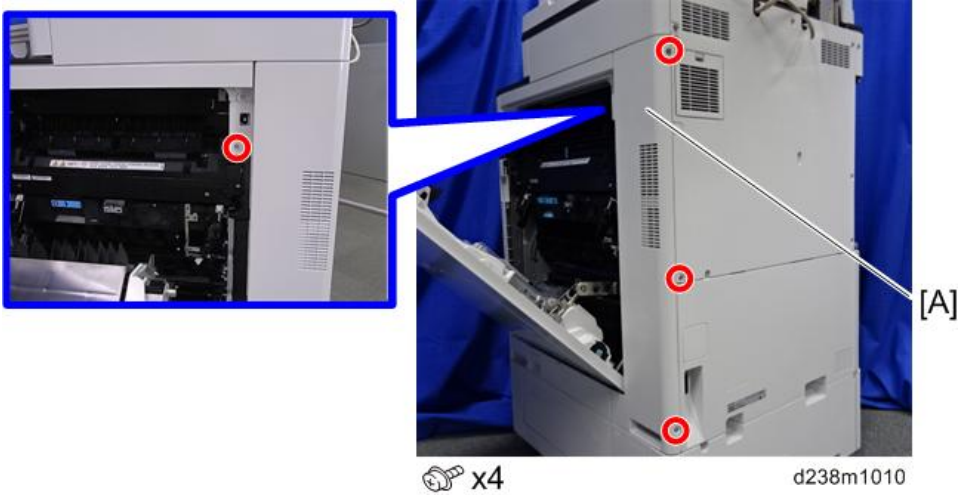

11. Remove a screw.



12. Remove the scanner right cover [A].

Remove the hook at the upper part, and then slide the cover in the rear direction.

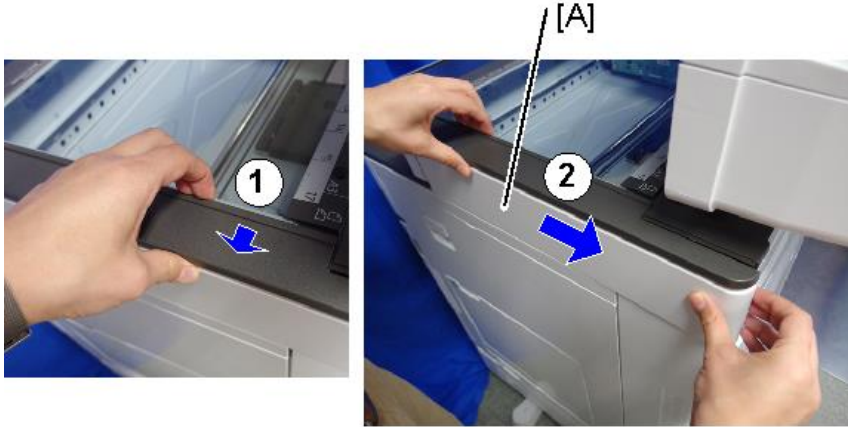

d238m1301

13. Route the harness around the outside of the PSU and pull the harness out of the electrical box through the hole [A] (⚠ x 4).

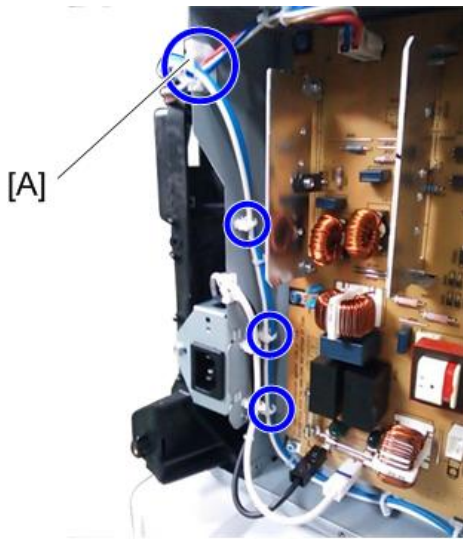

d1463036

14. Route the harness in the direction of the scanner (🔗 x 6).

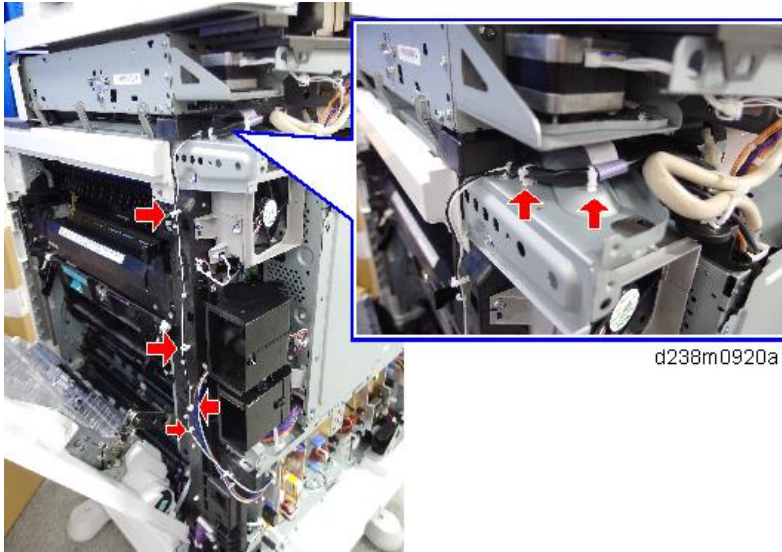

2

★ Important

- Fasten the clamp between the bindings of the harness at the location indicated by the red circle.

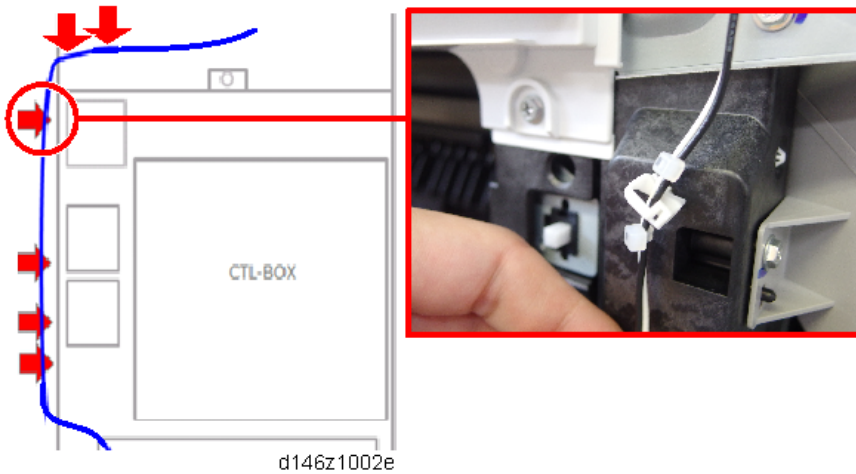

15. Attach the connector to the frame.

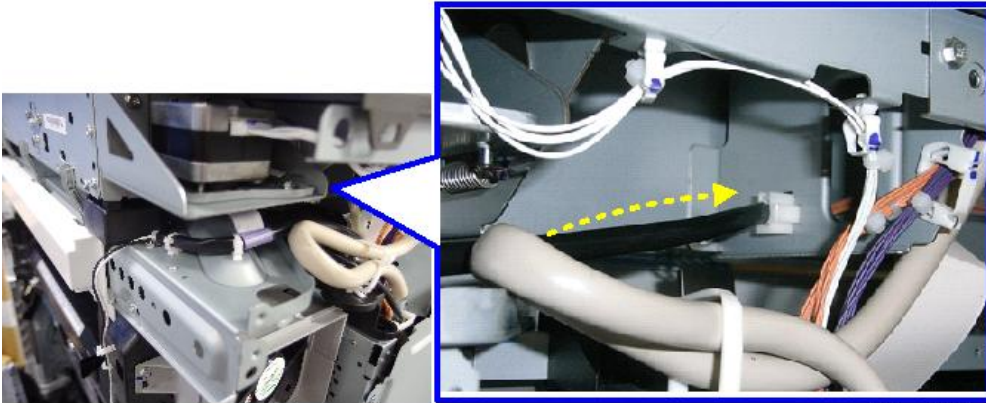

d238m0920b

16. Remove Feed Trays 1 and 2.

17. The connector cover located inside the machine [A] (⊗ × 1).

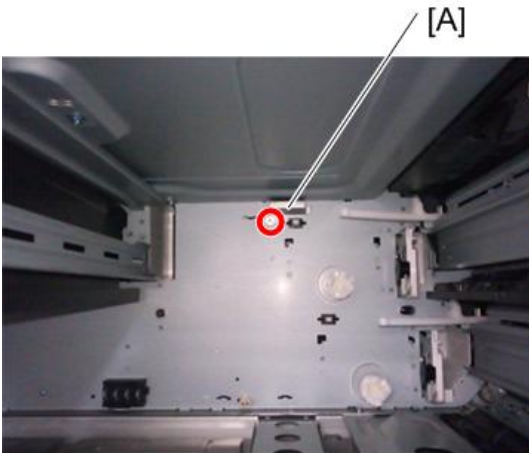

d1463044

18. Temporarily tighten a screw at the top (🔩 M3x8: x1).



d1463045

19. Install the heater [A] by connecting the connector to the inside of the machine, then tighten the screw completely.

↓ Note

- Hold the heater against the inside during final tightening.



d1463046

20. Reinstall the connector cover (🔩 × 1).

21. Attach the warning decal [A].

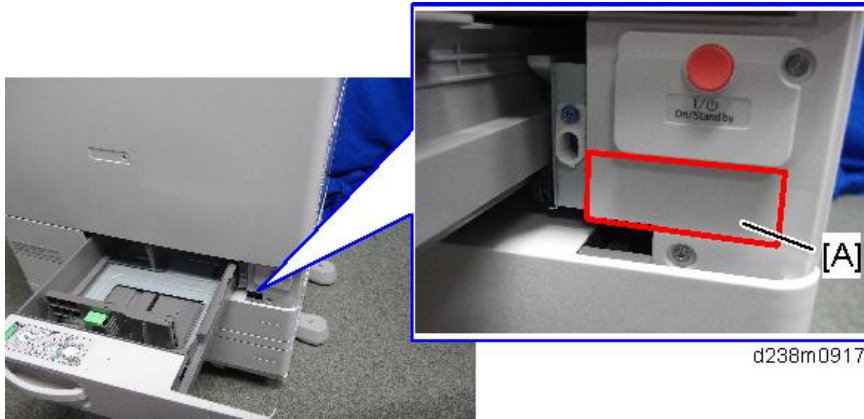

22. Reassemble the machine.

23. Connect the power cord, and then check that the heater is being powered and heated.

Anti-Condensation Heater for Paper Feed Trays

⚠ CAUTION

- Unplug the machine power cord before starting the following procedure.
- Do the following procedure not to damage any harnesses.
- Check that harnesses are not damaged or pinched after installation.

2

Accessory Check

Anti-Condensation Heater (Service Option) for Main Machine

No.	Description	Q'ty	Remarks
1	Tray heater	1	Heater and harness
2	Tapping screw: M3 X 8	2	Parts Number: <ul style="list-style-type: none"> • NA (120V): D2386630 • EU/AA (220/240V): D2386640
3	PCB: DHB	1	Electrical components
4	Harness for tray	1	Parts Number: <ul style="list-style-type: none"> • NA (120V): D2386661, *D2386660 • EU/AA (220/240V): D2386662, *D2386660
5	Harness for DC	1	
6	Harness for AC	1	
7	Tapping screw: M3 X 6	3	

*: Old parts number

Anti-Condensation Heater (Service Option) for Optional Paper Feed Unit

No.	Description	Q'ty	Remarks
1	Tray heater	1	Heater and harness
2	Harness	1	Parts Number: <ul style="list-style-type: none"> • NA (120V): D6931117 • EU/AA (220/240V): D6931127
3	Spring screw: M4 X 10	3	

Connecting to Main Machine Tray

1. Remove the rear cover [A].

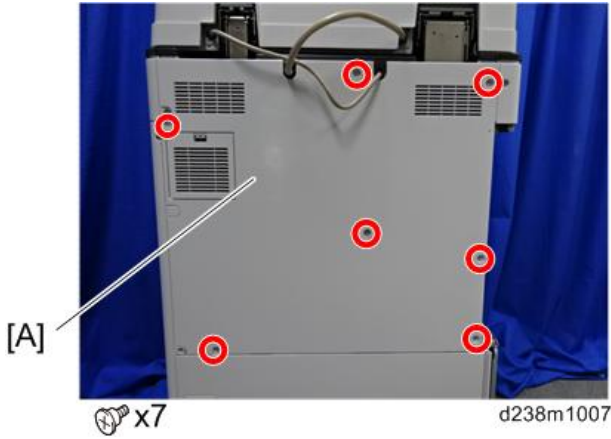

2. Remove the rear lower cover [A].

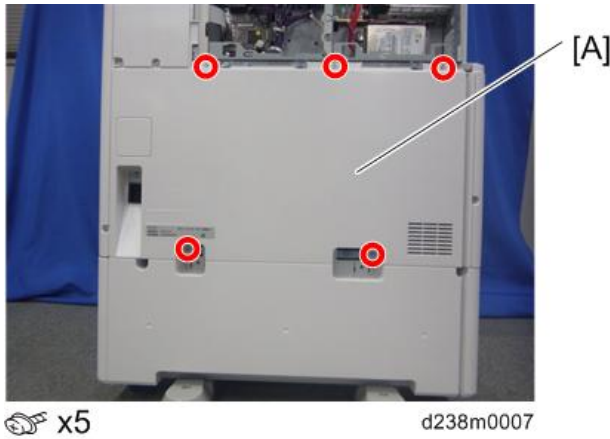

3. Attach PCB: DHB (x 3).



4. Connect the two harnesses between "PCB: DHB" and "PSU".



d1469002

↓ Note

- Red dashed circled cable is only white for NA, red for EU/AA.

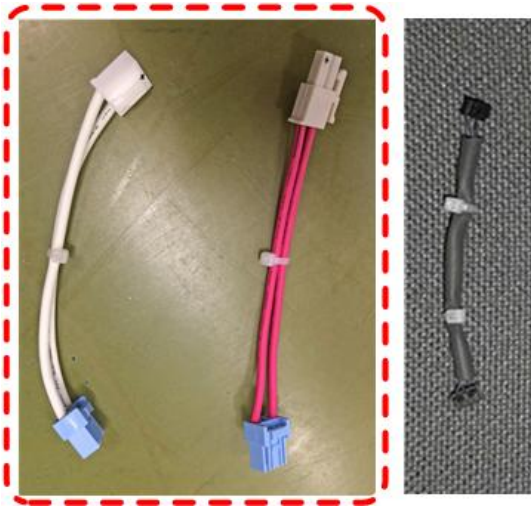

d238m1376

5. Connect connector 1.

6. Connect connector 2 to the harness already attached.

7. Attach connector 3 for the optional paper bank.

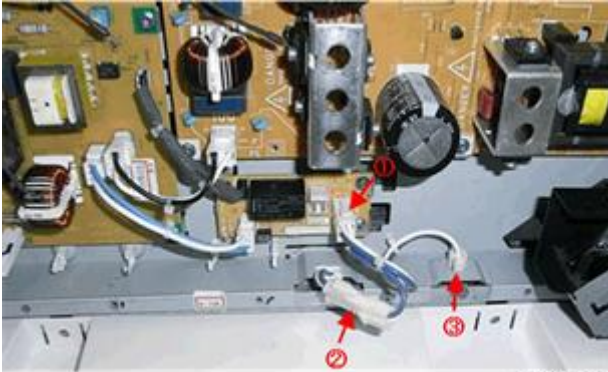

d1469003

Note

- This cable is only white for NA/EU/AA.



d1469008

8. Remove trays 1 and 2 from the machine.



d146f102

9. Connect the connector of the heater to the main machine.



2

d146f103

10. Install the heater inside the machine (🔩 x 1).

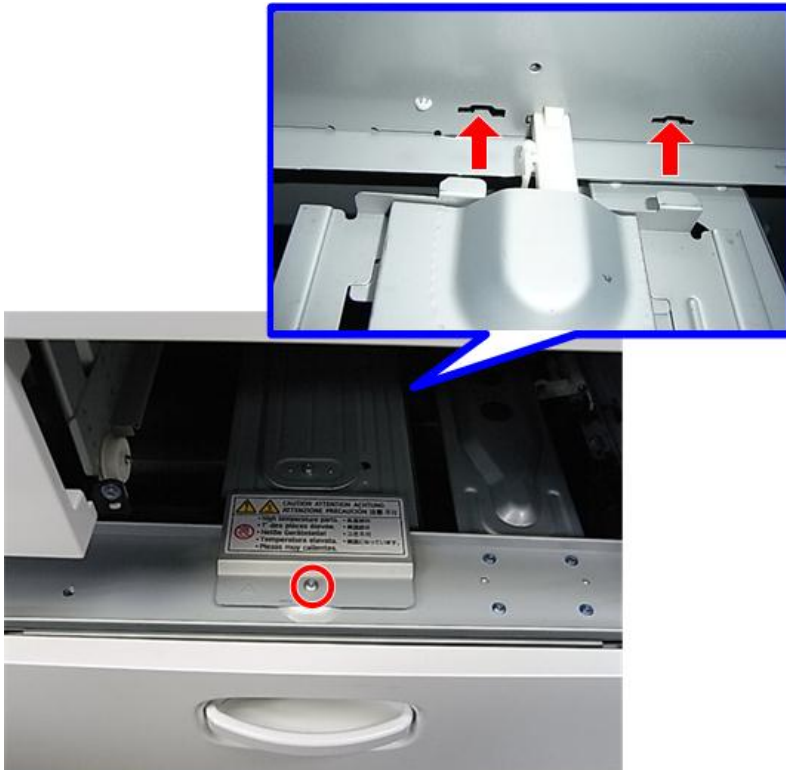

d146f105

11. Reattach trays 1 and 2.

Connecting to Paper Feed Unit PB3220/PB3210

2

1. Perform Steps 1 to 7 of page 120 "Connecting to Main Machine Tray".
2. Pull out the 1st and 2nd paper feed trays of the paper feed unit.
3. Pass the harness of the heater [A] for the optional paper feed unit through the hole in the inner rear frame of the optional paper feed unit, and then attach it (🔩 x1).

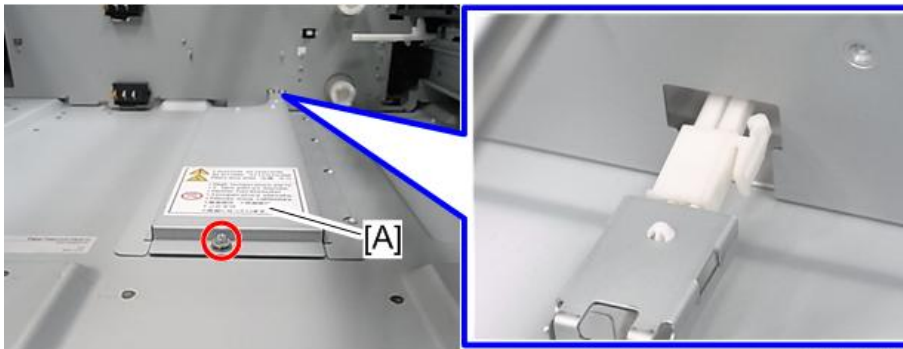

d197z1082

4. Remove the securing brackets [A] of the optional paper feed unit.

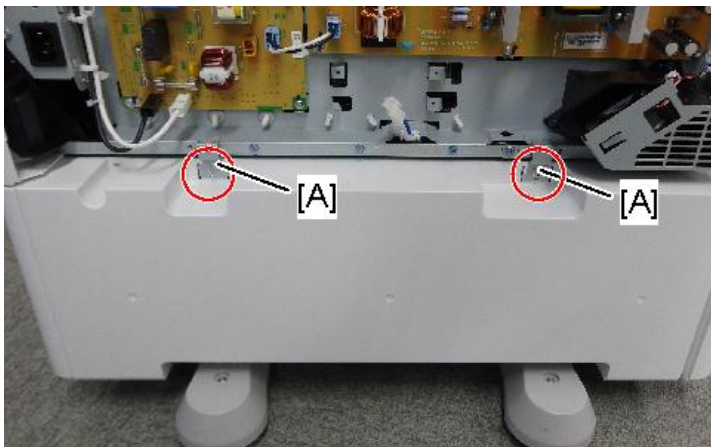

🔩 x2

d238m0836

5. Remove the rear cover [A] of the optional paper feed unit.

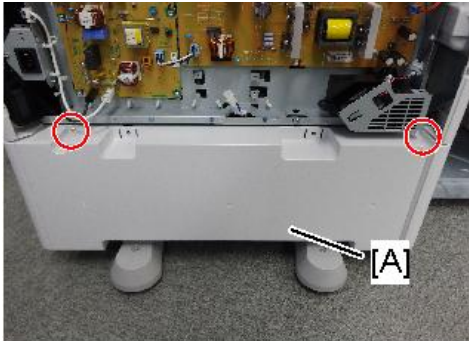

 x2

d238m0837

6. Remove the bracket [A] on the bottom of the main unit ( x1).

The removed bracket can be discarded.

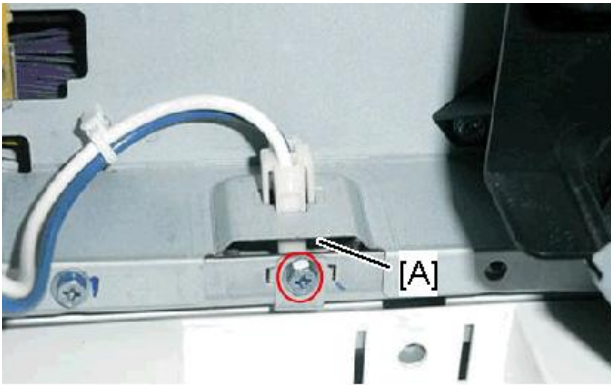

d1469004

7. Connect the PFU harness [A] of the optional paper feed unit to the relay harness [B] of the main unit and the heater harness [C] (⚙️x4).

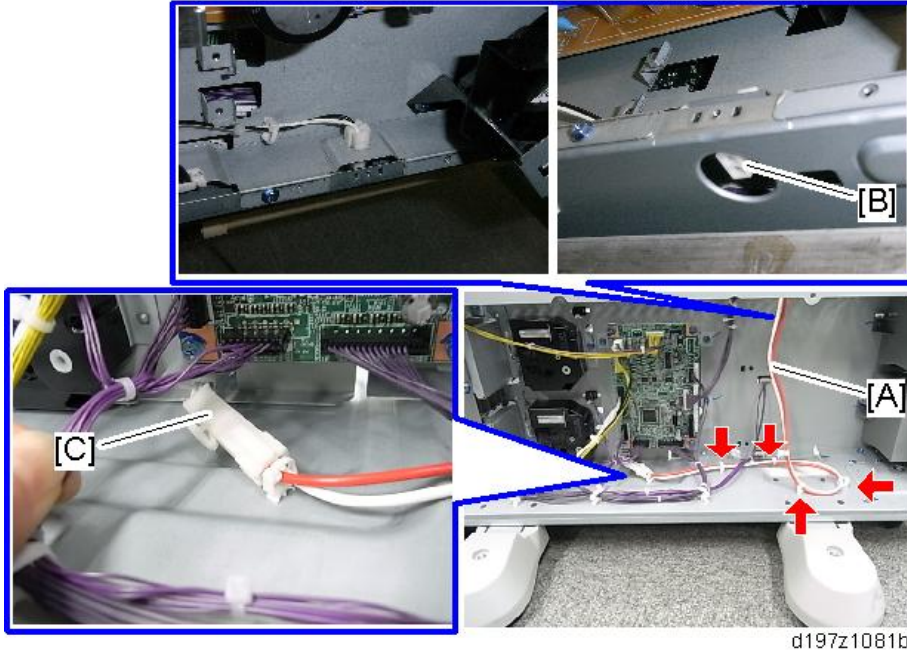

8. Reinstall the removed parts and covers.

9. Connect the power supply cord and turn ON the main power.

Do the following two steps to set the anti-condensation heater to be constantly ON.

1. Set the setting of SP5-805-001 (Anti-Condensation Heater ON/OFF setting) to [1].
2. Manually disconnect the PCU and scanner heaters.

★ Important

- The PCU and scanner heaters must be disabled because the temperature in the machine could become too high, causing problems with toner clogging, or damage to the scanner lamp stabilizer

Connecting to Paper Feed Unit PB3150

1. Perform Steps 1 to 7 of page 120 "Connecting to Main Machine Tray".
2. Pull out the paper feed tray of PB3150.

3. Put the harness of the heater [A] for the optional paper feed unit through the hole at the inner rear frame, and then attach it (🔩 x1).

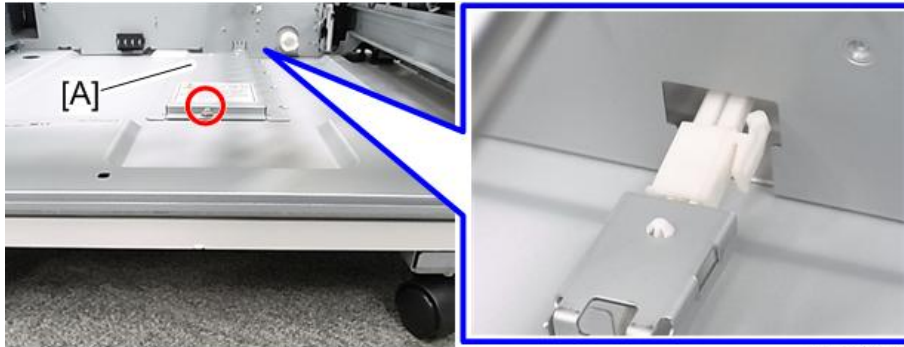

d197z1084

4. Remove the securing brackets [A] of Paper Feed Unit PB3150.

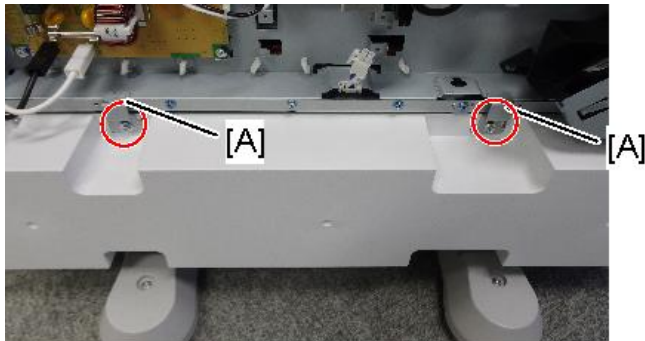

🔩 x2

d238m0838

5. Remove the rear cover [A] of Paper Feed Unit PB3150.

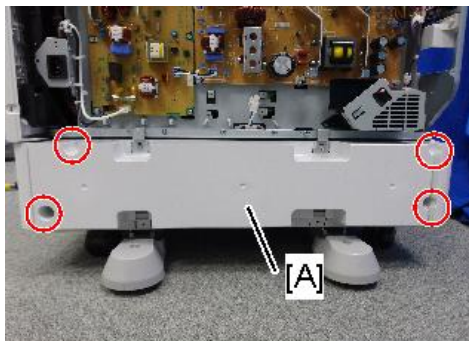

🔩 x4

d238m0839

6. Remove the bracket [A] on the bottom of the main unit (🔩 x1).

The removed bracket can be discarded.

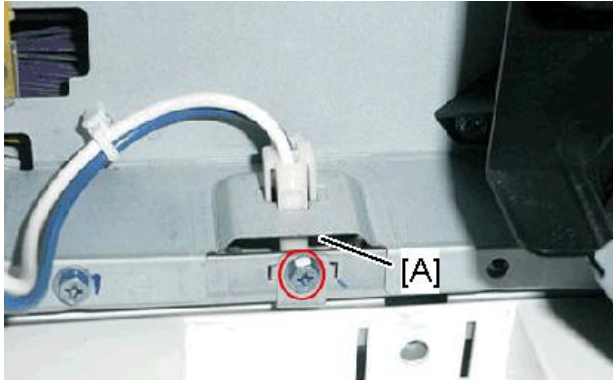

d1469004

7. Connect the PFU harness [A] of the optional paper feed unit to the relay harness [B] of the main unit and the heater harness [C] (x4).

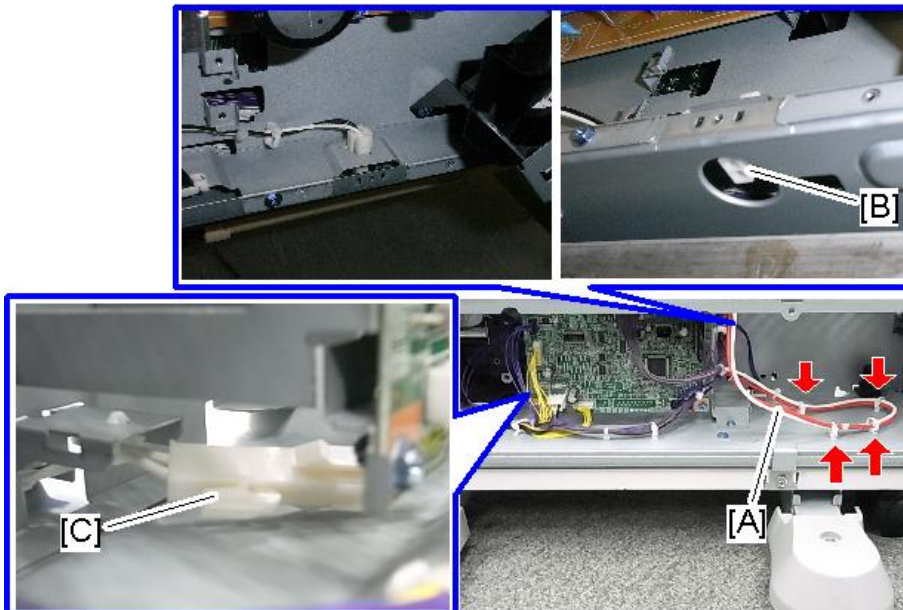

d197z1083b

8. Reinstall the removed parts and covers.
 9. Connect the power supply cord and turn ON the main power.

Do the following two steps to set the anti-condensation heater to be constantly ON.

1. Set the setting of SP5-805-001 (Anti-Condensation Heater ON/OFF setting) to [1].
2. Manually disconnect the PCU and scanner heaters.

★ Important

- The PCU and scanner heaters must be disabled because the temperature in the machine could become too high, causing problems with toner clogging, or damage to the scanner lamp stabilizer

Paper Feed Unit PB3220 (D787-18, -22)/ PB3210 (D787-17)

Accessory Check

2

No.	Description	Q'ty	Remarks
1	Screws (M4 × 10)	2	
2	Screw with Spring Washer (M4 × 10)	1	
3	Securing Bracket	2	

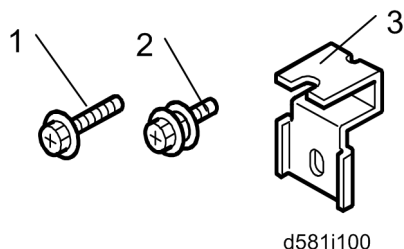

Installation Procedure

⚠ CAUTION

- The main machine weighs approximately 100 kg. Make sure to lift it with the help of at least one more person.
- The machine should be held at the correct locations and lifted gently. If it is lifted without care, handled carelessly or dropped, it may result in an injury.
- When installing this option, turn OFF the main power and unplug the power cord from the wall socket. If installing without turning OFF the main power, an electric shock or a malfunction may occur.
- Be sure to join the machine to the paper feed unit so as to prevent equipment from falling over. If they are not connected, they may move and fall over, resulting in injury.

1. Remove the orange tapes and retainers.

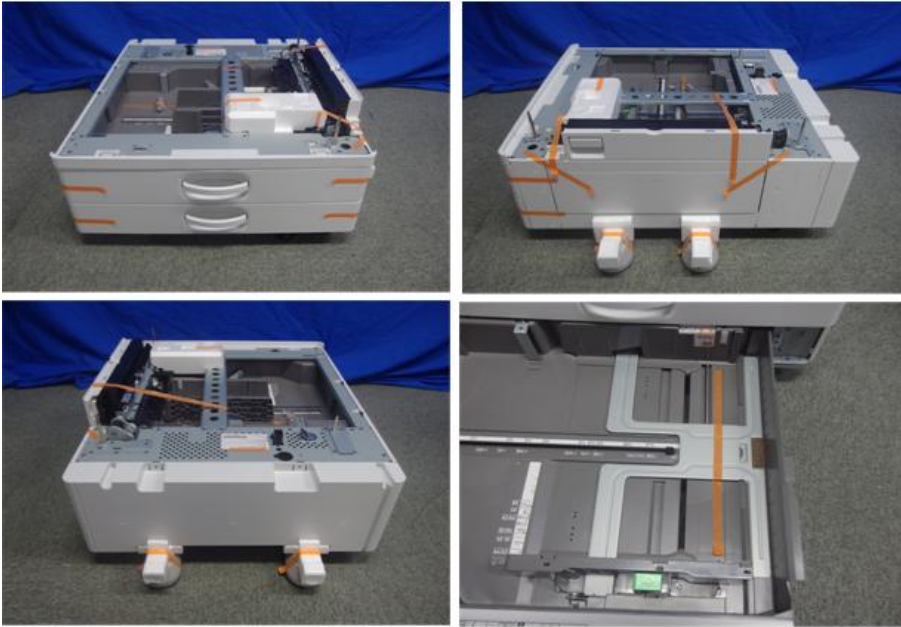

d238m0546

2. Remove the accessories (fixing screws, etc.) (provided with the machine) from the package.
3. Holding the grips on the machine, align the machine with the locating pins [A], and place the machine on the paper feed unit.

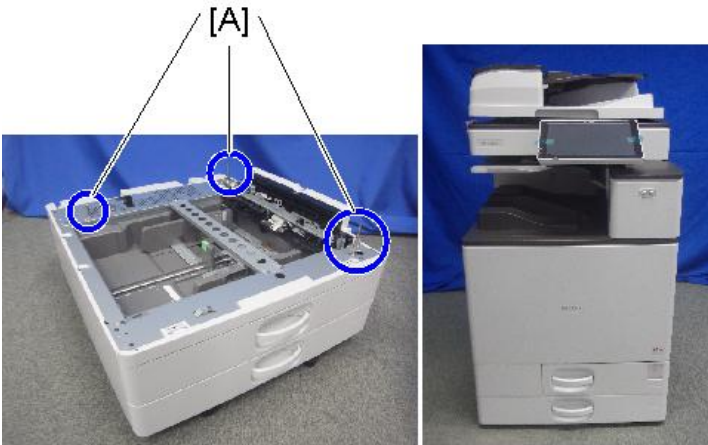

d238m0563

Note

- When you lift the machine, hold the correct locations.



d238m0935

- Do not hold any other parts of the machine when lifting it, because this may cause the machine to deform.
- Do not put the machine down on the paper feed unit as a temporary resting place. This may cause the paper feed unit to deform. Always connect the machine and paper feed unit properly.

4. Pull out the 2nd paper feed tray.

5. Using a securing bracket as a screwdriver, fix the machine to the feed unit (spring washer: screw: M4×10: 1).



d1462443

6. Attach the securing brackets [A] to two positions on the left and right at the rear of the machine (screws: 1 each).

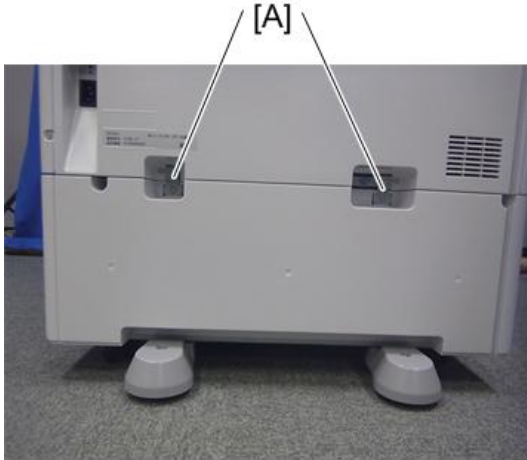

d1462444

7. Reattach the paper feed tray to the machine
8. Attach the decals as shown below.

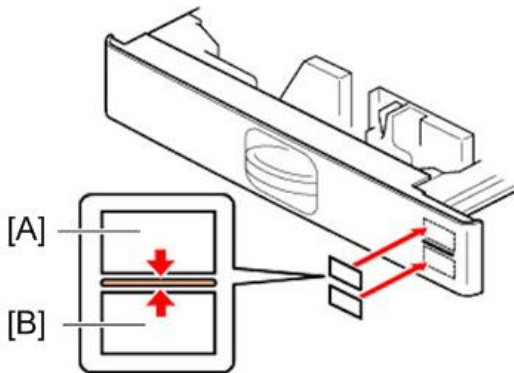

d1462230

[A]: Tray number decal

[B]: Paper size decal

Note

- The tray number decal and paper size decal are packaged together with the machine.

9. Lock the casters of the paper feed unit.

d1462439

10. Connect the power cord to the machine.**Note**

- Stabilizers are attached to the machine when it is shipped. Do not remove them.



d1462468

11. Turn ON the main power.**12. Set the paper, and check that the paper size set in the paper feed tray is displayed on the operation panel.****13. Adjust the registration for the paper feed unit.**

- SP1-002-004 (Side-to-Side Registration Paper Tray 3)
- SP1-002-005 (Side-to-Side Registration Paper Tray 4)

SP descriptions

- **SP1-002 (Side-to-Side Registration)**

Adjusts the side-to-side registration by changing the laser main scan start position for each mode and tray.

Increasing a value: The image is moved towards the rear edge of the paper.

Decreasing a value: The image is moved towards the front edge of the paper.

Paper Feed Unit PB3150 (D694)

Accessory Check

No.	Descriptions	Q'ty	Remarks
1	Securing Bracket	2	
2	Screws - M4 × 10	2	
3	Screw with Spring Washer - M4 × 10	1	

2

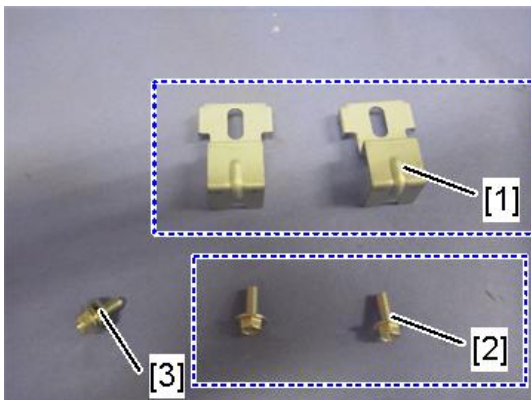

d1462445b

Installation Procedure

⚠ CAUTION

- The main machine weighs approximately 100 kg. Make sure to lift it with the help of at least one more person.
- The machine should be held at the correct locations and lifted gently by two people. If it is lifted without care, handled carelessly or dropped, it may result in injury.
- When installing this option, turn OFF the main power and unplug the power cord from the wall socket. If installing without turning OFF the main power, an electric shock or a malfunction may occur.
- Be sure to join the machine to the paper feed unit so as to prevent equipment from falling over. If they are not connected, they may move and fall over, resulting in injury.

Note

- Paper Feed Unit PB3150 is not supplied with a caster. You can attach the optional page 140 "Caster Table Type M3 (D178)".

1. Remove the orange tapes and retainers.

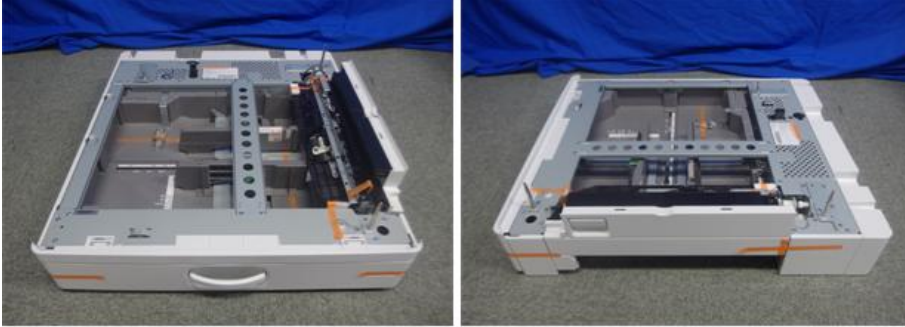

d238m0547

2. Remove the accessories (fixing screws, etc.) (provided with the machine) from the package.

3. Holding the grips on the machine, align the machine with the locating pins [A], and place the machine on the paper feed unit.

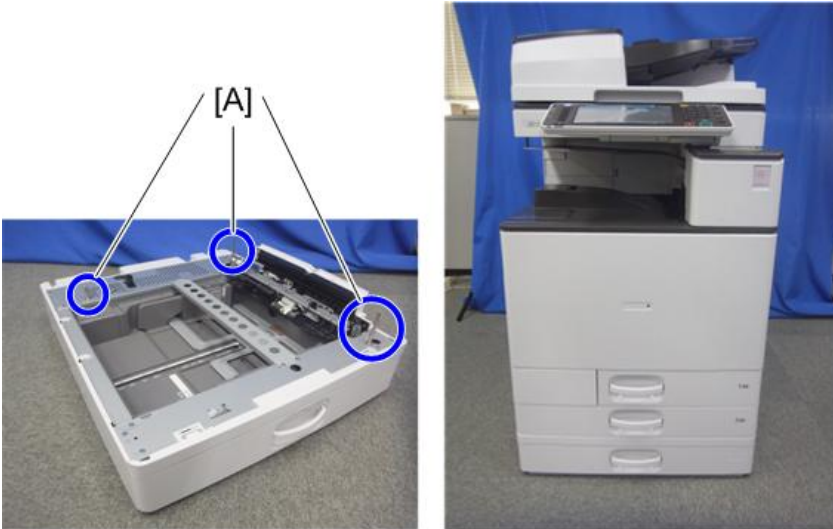

d1462447

Note

- When you lift the machine, hold the correct locations.



d238m0935

- Do not hold any other parts of the machine when lifting it, because this may cause the machine to deform.
- Do not put the machine down on the paper feed unit as a temporary resting place. This may cause the paper feed unit to deform. Always connect the machine and paper feed unit properly.

4. Pull out the 2nd paper feed tray.

- 5. Using a securing bracket as a screwdriver, fix the machine to the feed unit (spring washer: screw: M4×10: 1).**



d1462448

6. Attach the securing brackets [A] to two positions on the left and right at the rear of the machine (screws: 1 each).

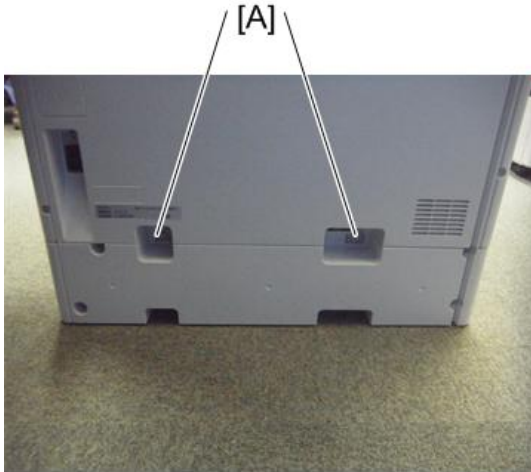

d1462449

7. Reattach the paper feed tray to the machine.
8. Attach the decals as shown below.

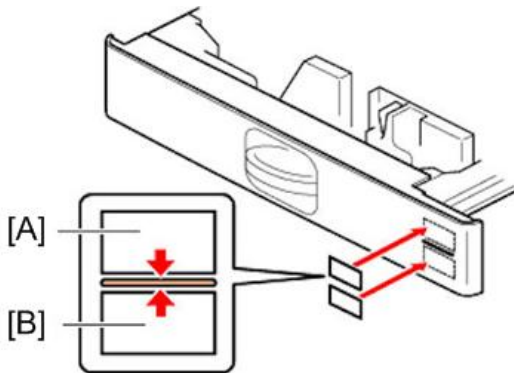

d1462230

[A]: Tray number decal

[B]: Paper size decal

Note

- The tray number decal and paper size decal are packaged together with the machine.

9. Connect the power cord to the machine.
10. Turn ON the main power.
11. Set the paper, and check that the paper size set in the paper feed tray is displayed on the operation panel.

12. Adjust the registration for the paper feed unit.

SP1-002-004 (Side-to-Side Registration Paper Tray 3)

SP descriptions

- **SP1-002 (Side-to-Side Registration)**

Adjusts the side-to-side registration by changing the laser main scan start position for each mode and tray.

Increasing a value: The image is moved towards the rear edge of the paper.

Decreasing a value: The image is moved towards the front edge of the paper.

Caster Table Type M3 (D178)

Accessory Check

No.	Description	Q'ty	Remarks
1	Right Lower Cover	1	Not used when Paper Feed Unit PB3150 is installed.
2	Securing Bracket	2	
3	Screws (M4 × 10)	2	
4	Screw with Spring Washer (M4 × 10)	1	

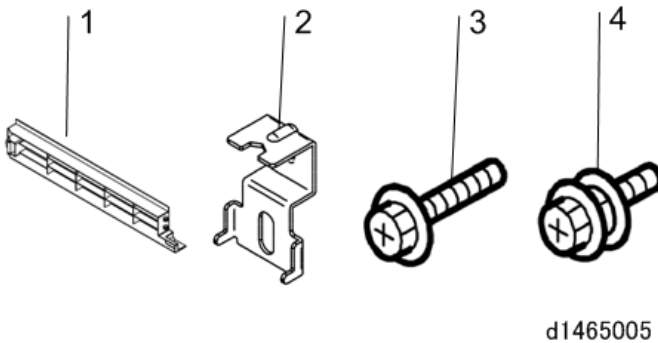

Installation Procedure

⚠ CAUTION

- The main machine weighs approximately 100 kg. Make sure to lift it with the help of at least one more person.
- The machine must be held at the correct locations, and must be lifted slowly. If it is lifted with force, handled carelessly or dropped, it will result in an injury.
- When installing this option, turn OFF the main power and unplug the power cord from the wall socket. If installing without turning OFF the main power, an electric shock or a malfunction may occur.
- Be sure to join the machine and caster table to prevent equipment from falling over. If it is not joined, the machine will move or fall over, which will result in an injury.

How to Place the MFP on the Caster Table

1. Holding the grips on the machine, align the machine with the locating pins, and place the machine on the caster table.

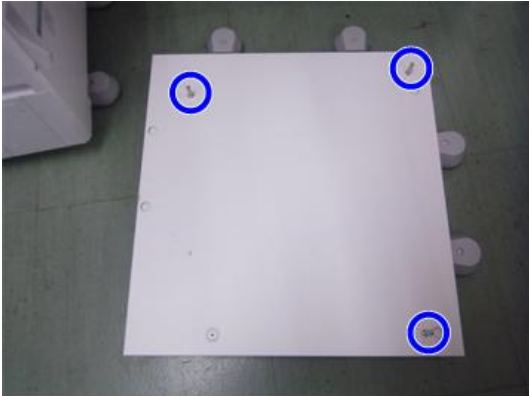

d1463030

Note

- When you lift the machine, hold the lifting handles.



d238m0935

- Do not hold any other parts of the machine when lifting it, because this may cause the machine to deform.
 - Do not put the machine down on the caster table as a temporary resting place. This may cause the machine to deform. Always connect the machine and caster unit properly.
2. Pull out the 2nd paper feed tray.
 3. Using a securing bracket, fix the machine to the paper tray unit (spring washer: screw: M4×10: 1).
 4. Attach the securing brackets at 2 positions to left and right at the rear of the machine (screws: 1 each).
 5. Reattach the 2nd paper feed tray to the machine.

How to Place the Paper Feed Unit PB3150 on the Caster Table

1. Place the paper feed unit [B] on the caster table [A].

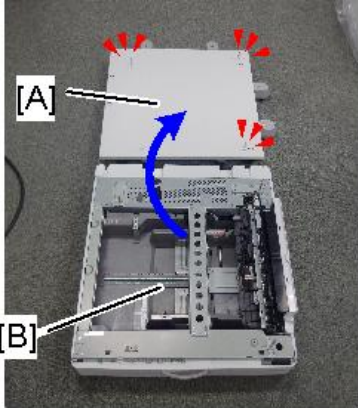

d238m552

2. Pull out the 1st paper feed tray.
3. Using a securing bracket, fix the caster table to the paper tray unit (spring washer: screw: M4×10: 1).
4. Attach the securing brackets at 2 positions to left and right at the rear of the paper tray unit (screws: 1 each).
5. Reattach the paper feed tray.

Platen Cover PN2000 (D700)

Accessory Check

Check that you have the accessories indicated below.

No.	Descriptions	Q'ty	Remarks
1	Platen Cover	1	
2	Platen Sheet	1	
3	Feeler Guide	1	
4	Stepped Screw	2	

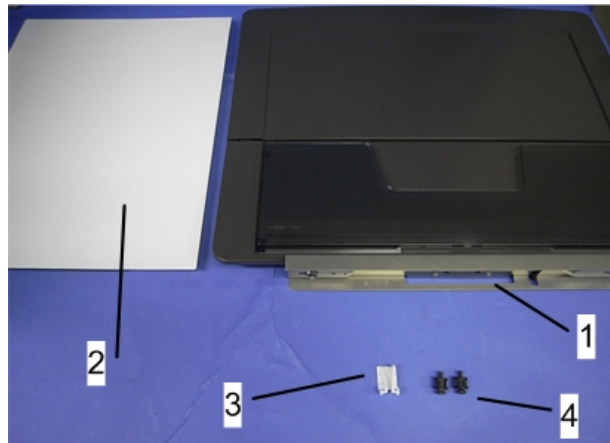

d1582018

Installation Procedure

⚠ CAUTION

- When installing this option, turn OFF the main power and unplug the power cord from the wall socket. If installing without turning OFF the main power, an electric shock or a malfunction may occur.

1. Install the stepped screws (⑤ × 2).

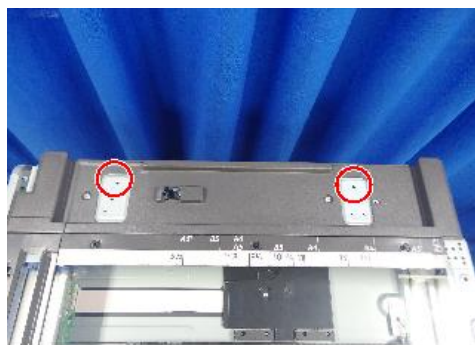

d238m0566

2. Install the feeler guide [A].

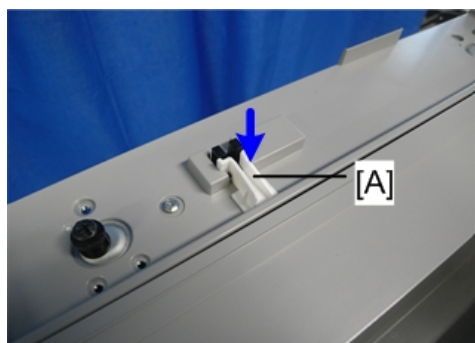

d1582020

3. Install the platen cover [A].

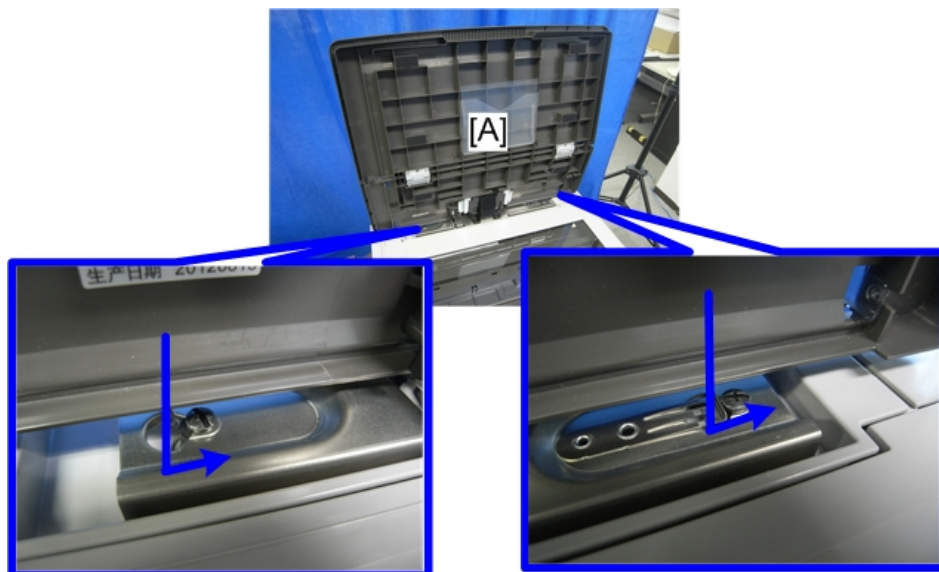

d1582021

4. Place the platen sheet [A] on the exposure glass.
5. Line up the rear left corner of the platen sheet flush against corner [B] on the exposure glass.

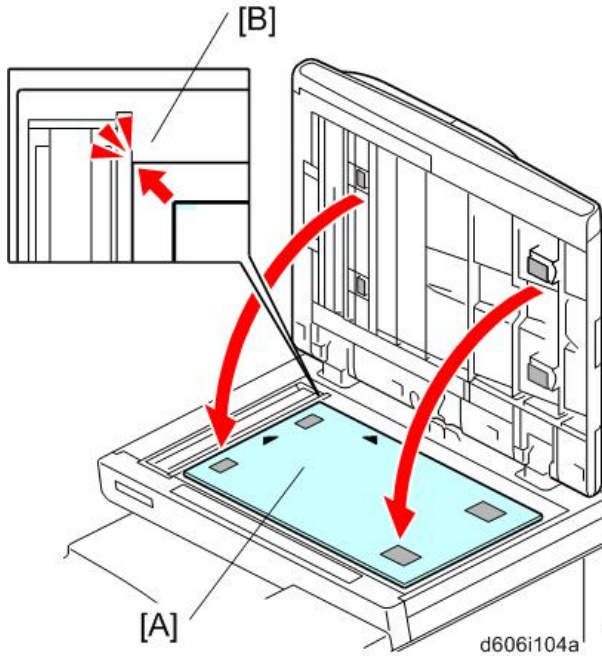

6. Close the platen cover.
7. Open the platen cover.
8. Press the surface of the platen sheet gently to fix it on the platen cover securely.

ARDF DF3090 (D779)

Accessory Check

2

No.	Description	Q'ty	Remarks
1	ARDF	1	
2	Screw	2	
3	Knob Screw	2	
4	Stud Screw (Small)	1	
5	Stud Screw (Large)	1	
6	Attention Decal – Top Cover	1	

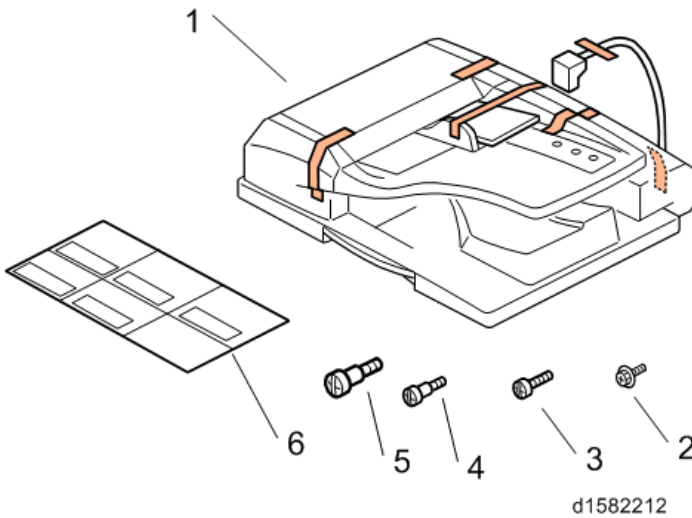

Installation Procedure

⚠ CAUTION

- Turn OFF the main power and unplug the power cord from the wall socket. If installing without turning OFF the main power, an electric shock or a malfunction may occur.

★ Important

- Do not turn the power on until you perform "adjustment after installation," or it may not start normally.
1. Remove all the tapes and shipping retainers.
 2. Insert the two stud screws ([A] is the larger stud, [B] is the smaller stud).

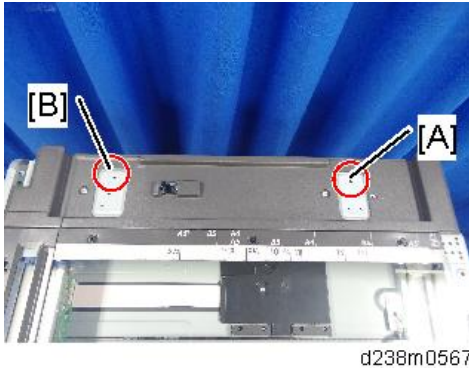

3. Mount the ARDF [A] by aligning the screw keyholes [B] of the ARDF support plate over the stud screws.
4. Slide the ARDF toward the front of the machine.
5. Secure the ARDF with the two knob screws [C].

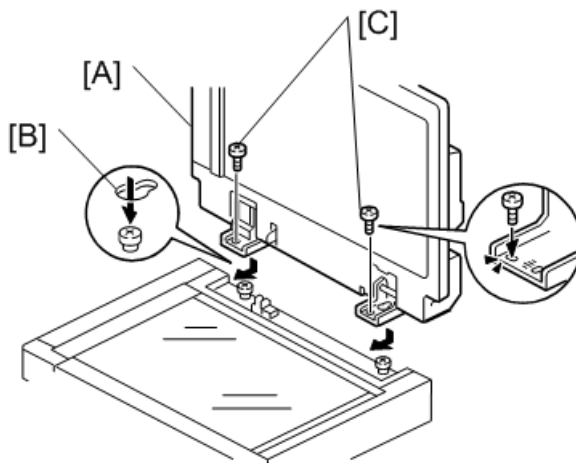

b789i103a

6. Align the rear left corner of the platen sheet [A] with the corner [B] on the exposure glass.
7. Close the ARDF.

8. Open the ARDF and check that the platen sheet is correctly attached.

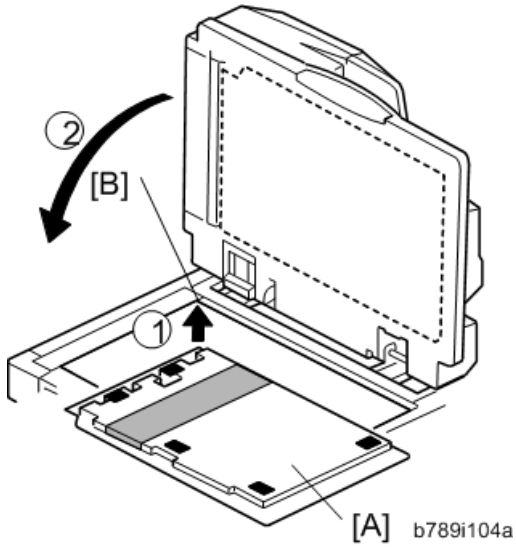

9. Remove the rear cover [A].

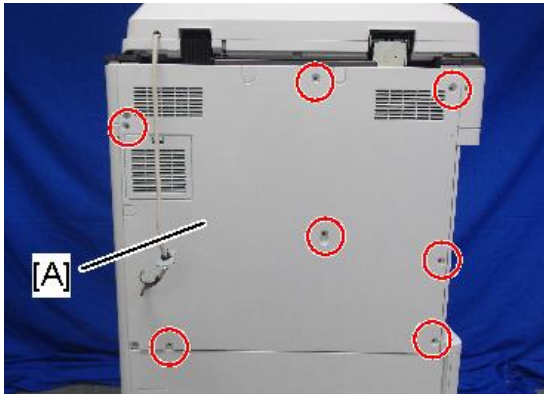

d238m0621

10. Remove the small disposable cover [A] on the rear cover (on the right side).

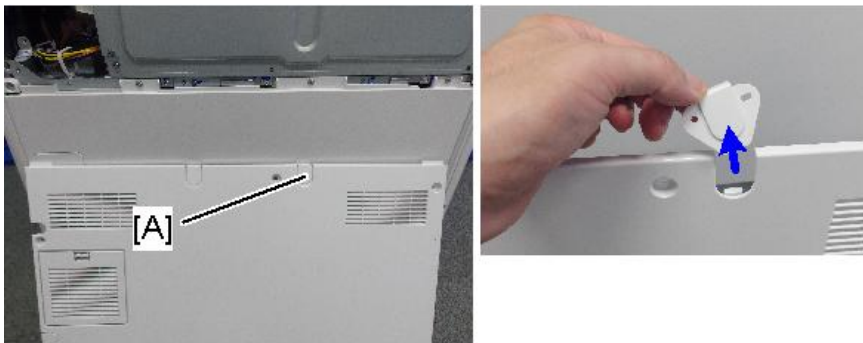

d238m0623

11. Connect the ARDF cable as shown and mount the bracket [A] on the machine's rear frame.

Make sure to connect the grounding wire.

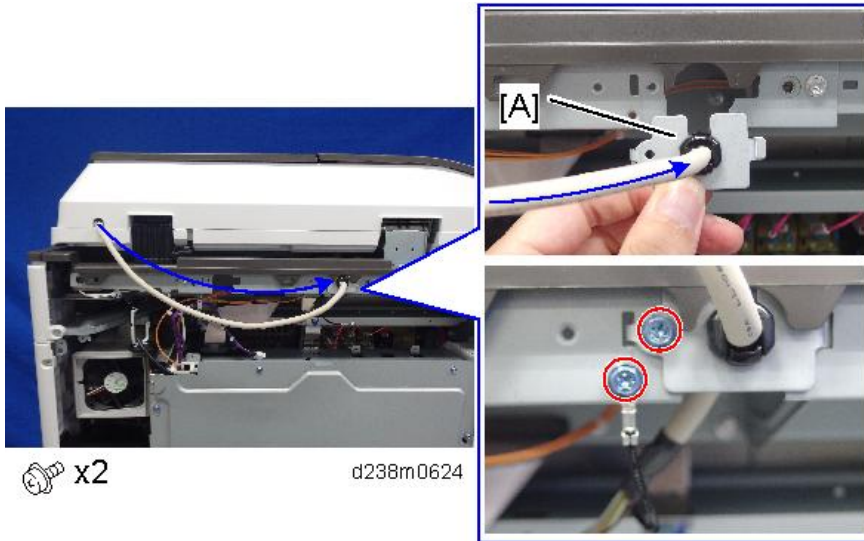

2

12. Connect the scanner cable to the connector at the machine's rear.

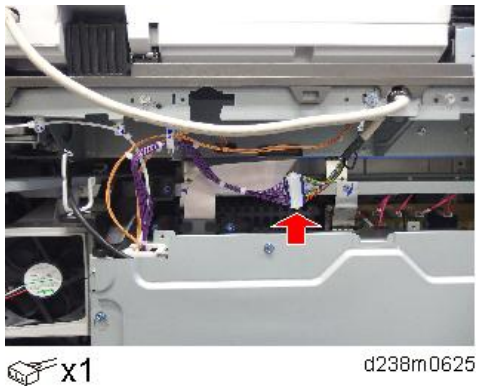

13. Reattach the rear cover.
14. Lift the ARDF original tray.

15. Slide the stamp holder [A] out and install the stamp cartridge in it, if necessary.

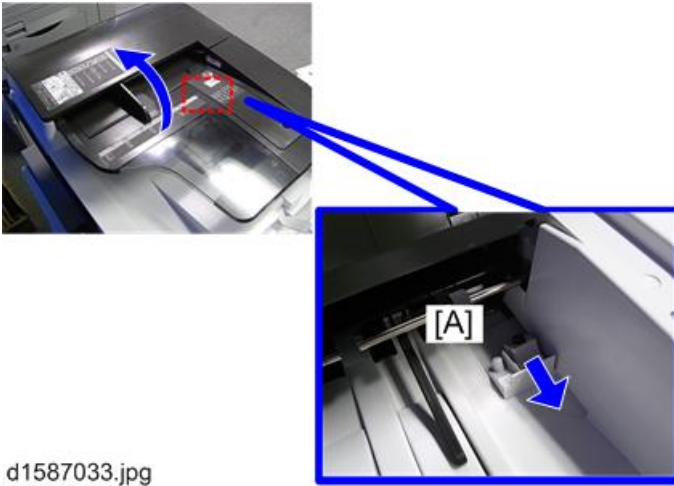

d1587033.jpg

Note

- After the stamp installation, be sure to slide the holder in correctly. Make sure to slide it in thoroughly until the reference marks on the holder and exterior cover are aligned. If it is not mounted correctly, the machine detects a J001 paper jam.

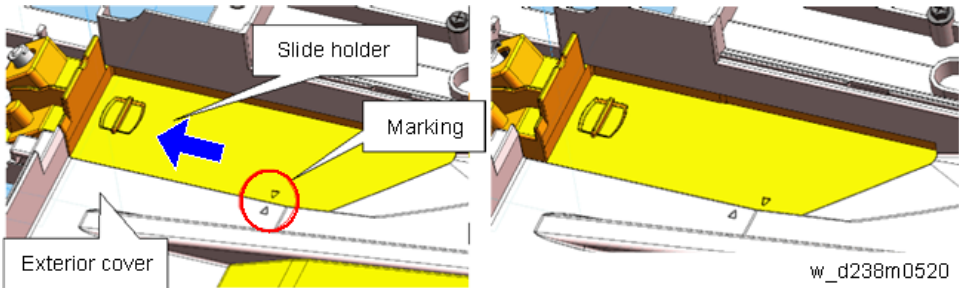

16. Attach the decals [A] [B] to the top cover as shown. Choose the language that you want.

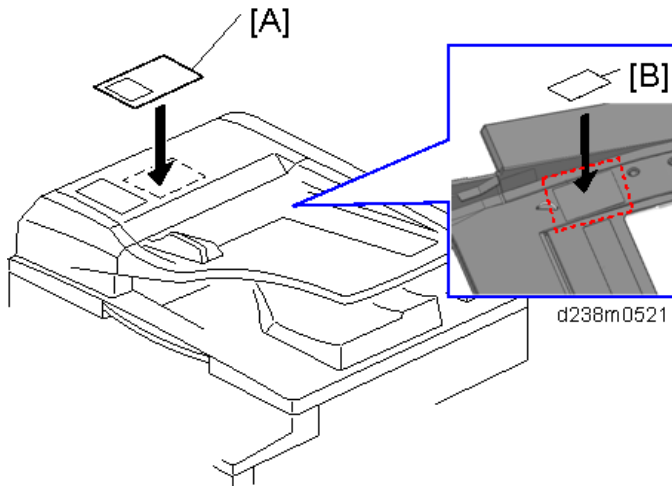

17. Plug in and turn ON the main power.

18. Set SP4-688-001 (DF Density Adjustment ARDF) to "106".

19. Check the ARDF operation, and make a full size copy. Check that the registrations (side-to-side and leading edge) and image skew are correct. If they are not, adjust the registrations and image skew (see page 636 "ARDF").

When Feeding Thin Paper

When feeding thin paper, adjust the sliding tray to the point shown below [A].

When feeding normal paper, adjust the sliding tray to the point shown below [B].

If not, it may cause problems as follows:

- Original jam
- Original curl
- Originals cannot be stacked neatly

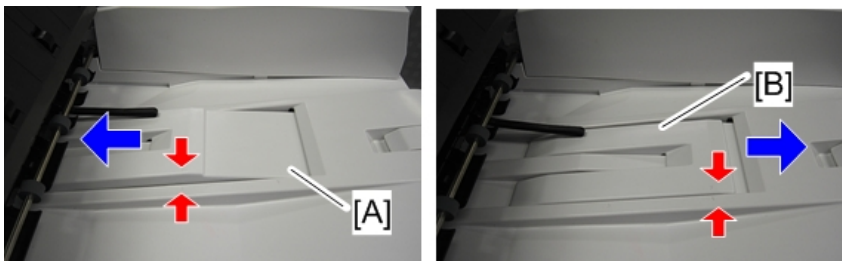

d1585055

SPDF DF3100 (D3B0)

Accessory Check

2

No.	Description	Q'ty	Remarks
1	Attention Decal – Top Cover	1	
2	Ferrite Core (L)	1	
3	Ferrite Core (S)	1	
4	Face-Up Document Decal	1	
5	Knob Screw	2	
6	Stud Screw	2	
7	Screw (3x6)	4	

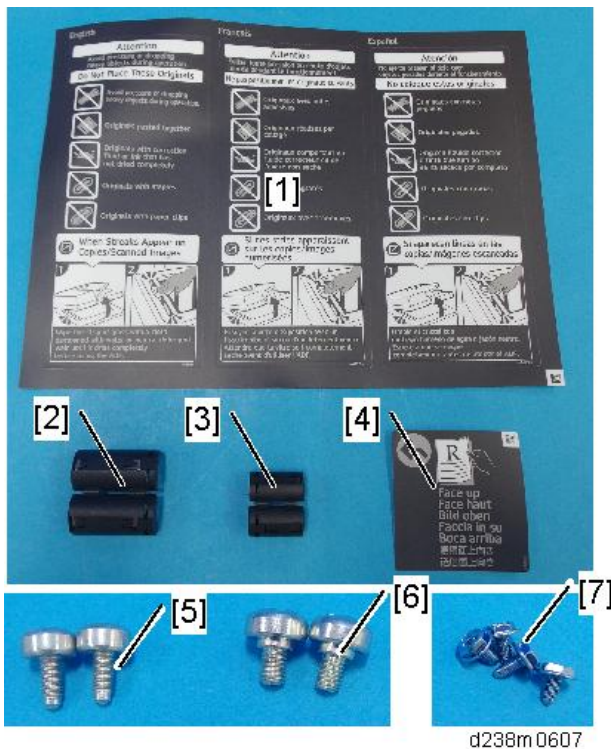

Installation Procedure

⚠ CAUTION

- Turn OFF the main power and unplug the power cord from the wall socket. If installing without turning OFF the main power, an electric shock or a malfunction may occur.

★ Important

- Do not turn the power on until you perform "adjustment after installation," or it may not start normally.

2

Attaching the SPDF

1. When unpacking, hold both sides of the SPDF and take it out of the box.

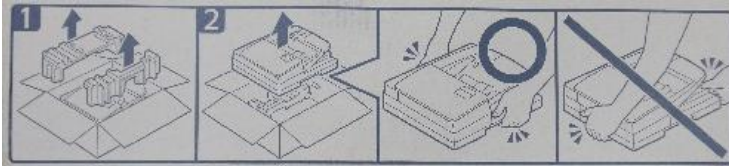

d238m0606

2. Place the unit on the machine temporarily, and remove the orange tapes and shipping retainers.

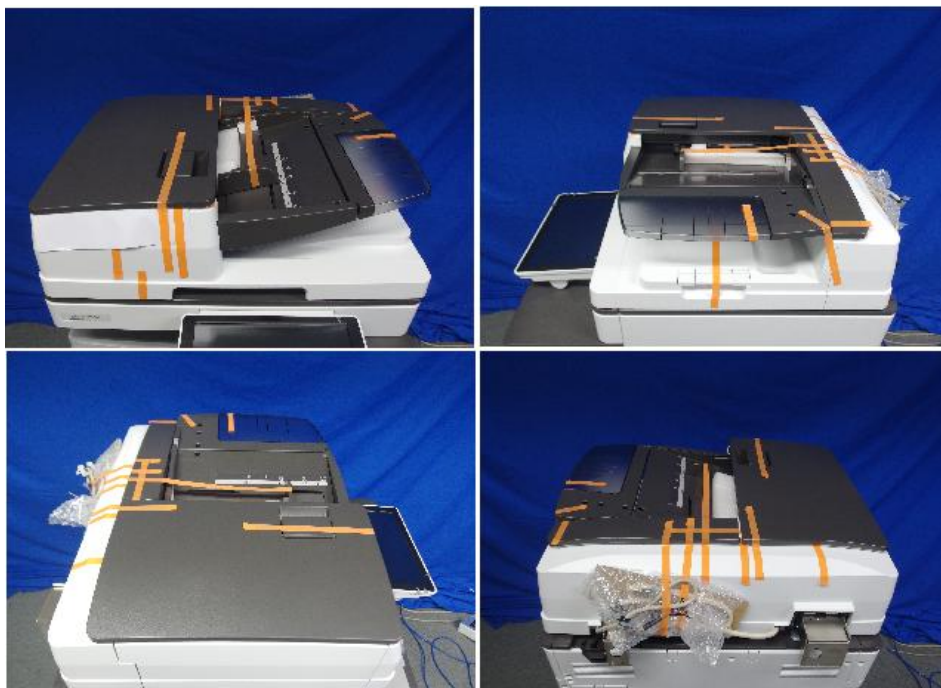

d238m0608

3. Remove the accessories in the package (boards, fixing screws, etc.).
4. Attach the 2 stepped screws to the machine.



 x2

d238m 0609

5. Align the hinges of the SPDF with the stepped screws, and attach them by sliding them in.

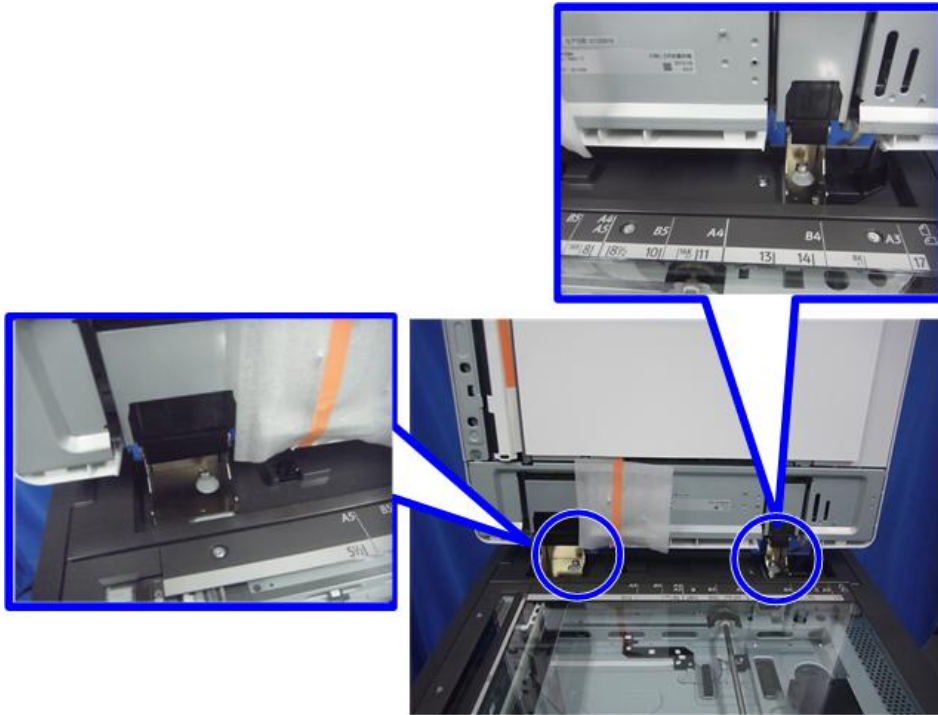

d1462504

6. Fix the SPDF to the machine (coin screws×2)

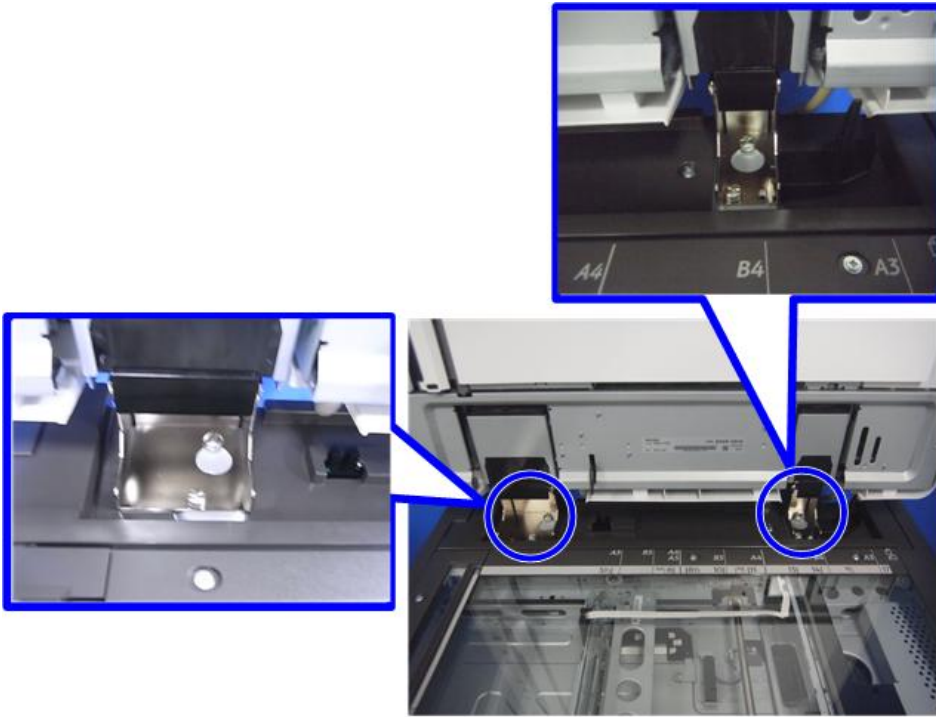

d1462505

7. Release the lever [A], then open the pressure plate sheet [B], and gently remove the protective sheet [C].

8. Remove the filament tape, and shut the pressure plate sheet.

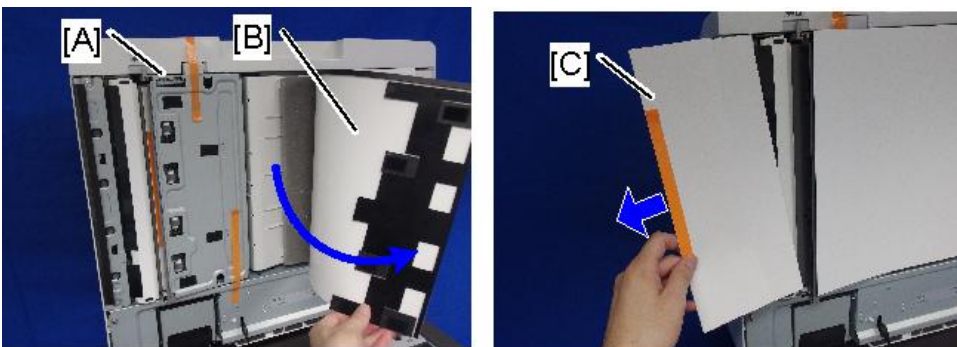

d238m0610

9. Remove the platen sheet [A], and set it on the exposure glass.

Align it with the left scale and rear scale of the printer.

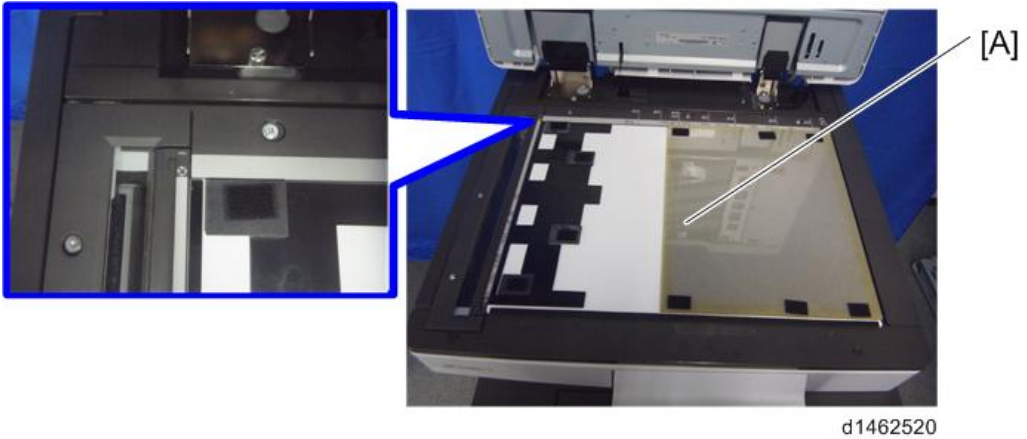

2

10. Close the SPDF slowly, and attach the platen sheet and SPDF.



11. Remove the rear cover [A].

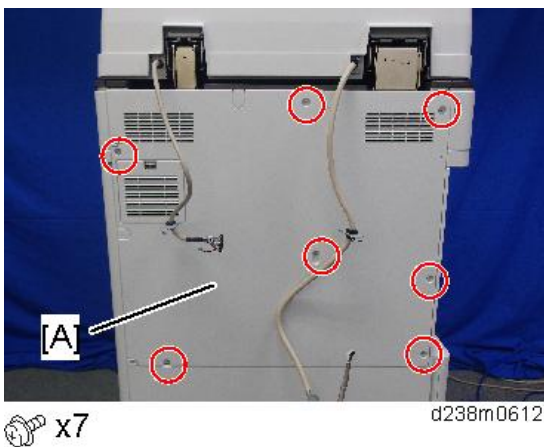

12. Remove the small disposable covers [A] on the rear cover.

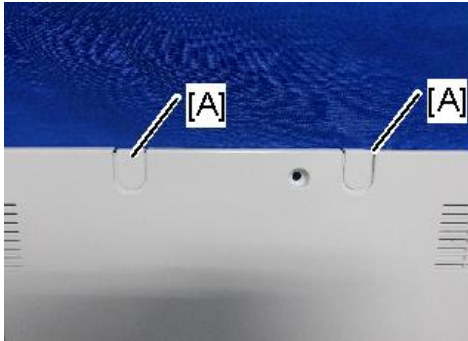

d238m0613

13. Remove the controller box cover [A].

Red Circle: Remove, Blue Circle: Loosen

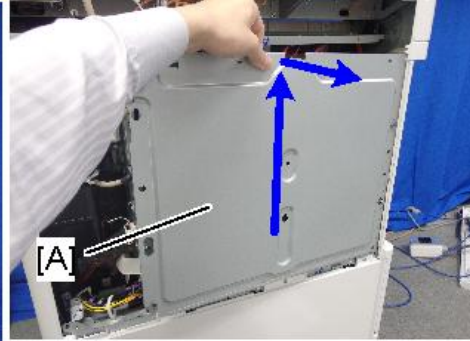
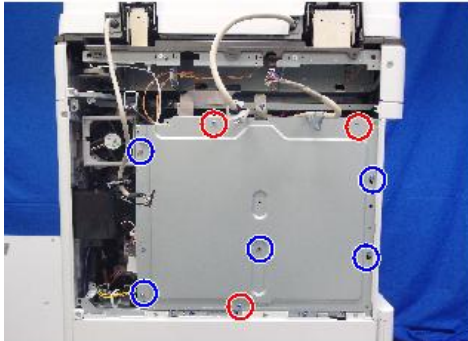

d238m0614

14. Connect the SPDF cable as shown and mount the brackets [A] [B] on the machine's rear frame.

Make sure to connect the grounding wire.

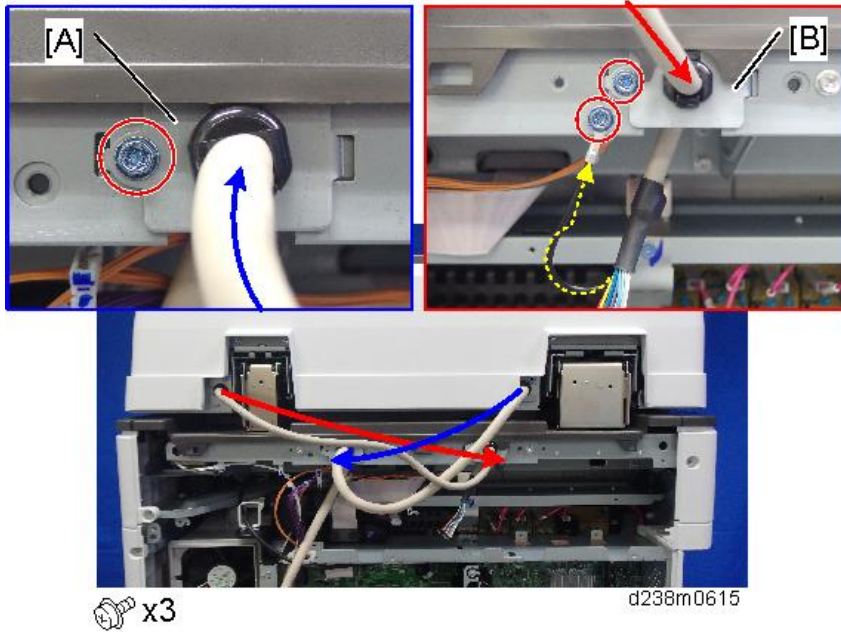

15. Connect the scanner cable to the connector at the machine's rear.

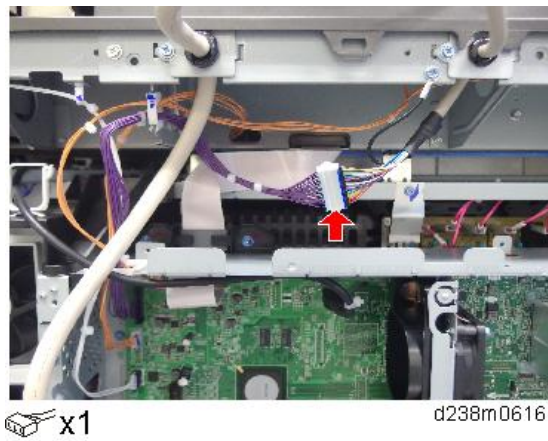

16. Attach the scanner cable [A] with the bracket on the upper frame of the controller box.

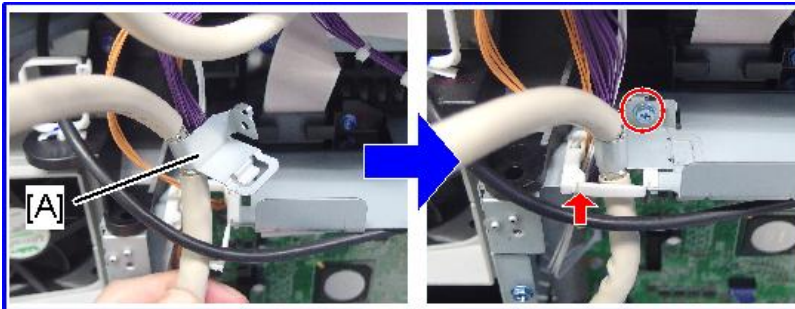

 x1,  x1

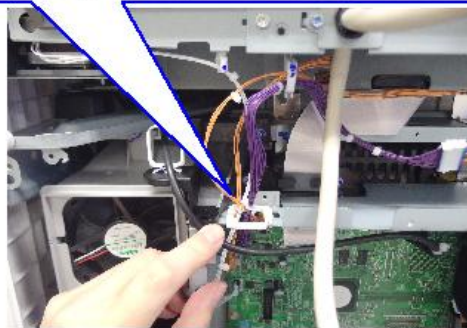

d238m0617

17. Connect the cable to the IPU (CN564).

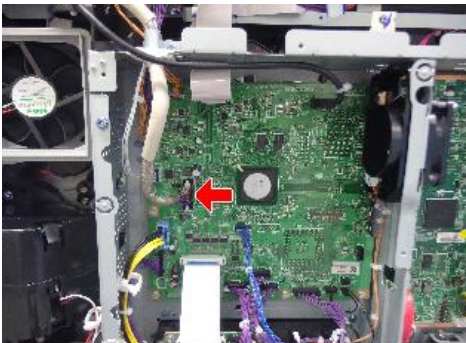

 x1

d238m0618

18. Tuck in the excess length portion of the cable to the back of the machine.

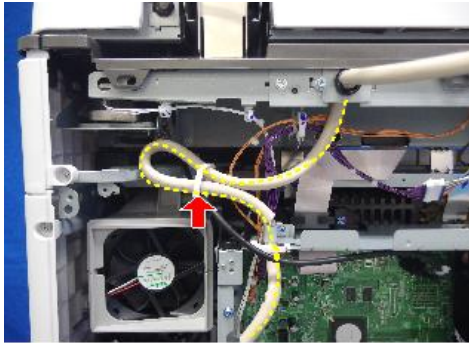

 x1

d238m0619

19. Attach the supplied ferrite core (L) [A] and ferrite core (S) [B].

Attach [A] close to the connector.

Attach [B] in the area near the end of the tube.

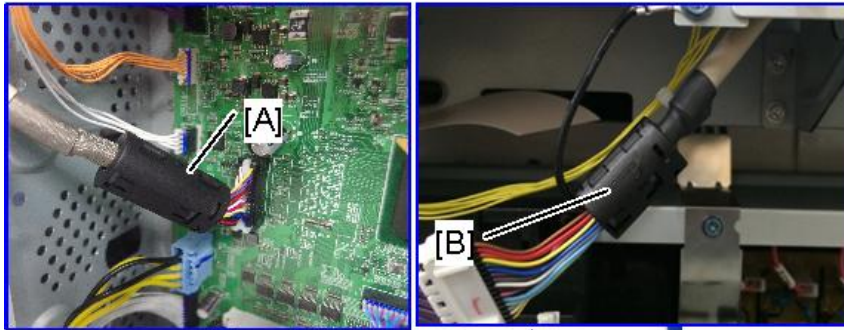

d238m0620

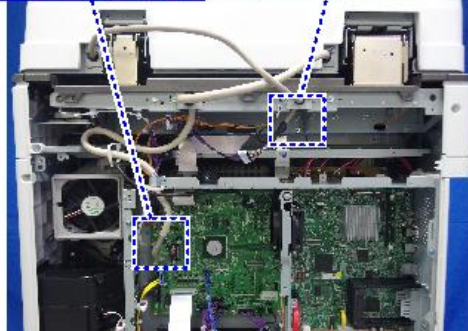

20. Reattach the controller box cover and the rear cover.

21. Attach the decals [A] [B] to the SPDF.

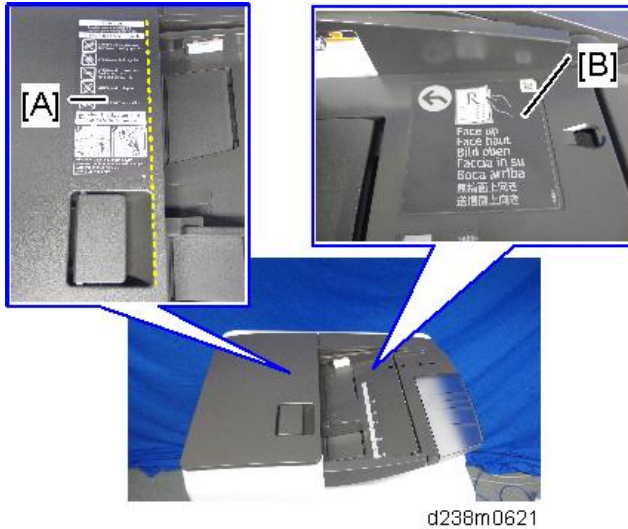

Adjust SP Settings

1. Turn ON the main power.
2. Set SP4-688-002 (Scan Image Density Adjustment 1-pass DF) to "101".
3. Execute SP4-730-002 (FROM Main Factory Setting Execution ON/OFF).
4. Check the vertical registration for the SPDF.
 1. Create an original as shown in the following picture.

The large white arrow indicates the direction of feed.

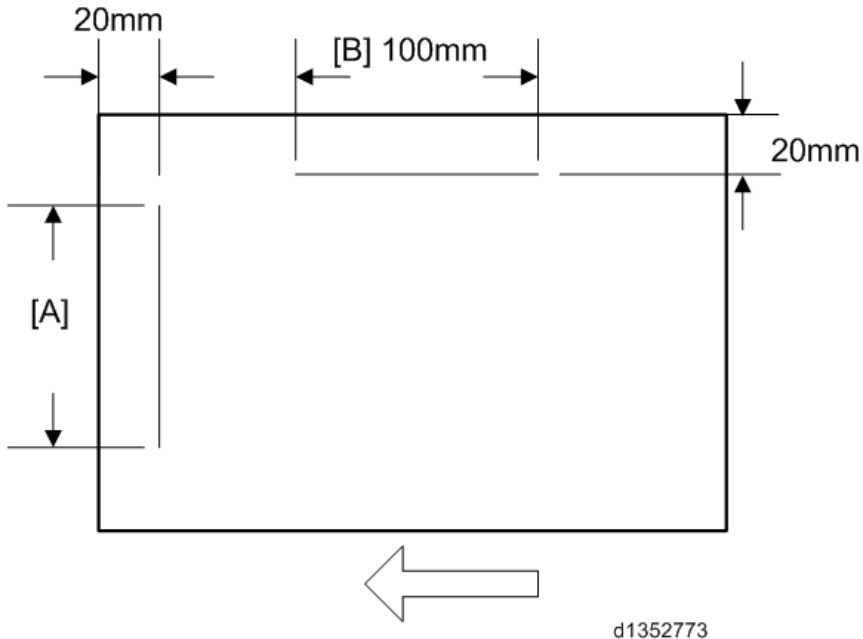

2. Copy the original and make sure that the position of the line [A] is within 0 ± 1 mm
3. If not within the standard, adjust with the SP modes.
 - SP6-006-001 (ADF Adjustment Side-to-Side Regist: Front)
 - SP6-006-002 (ADF Adjustment Side-to-Side Regist: Rear)

5. Check the horizontal registration for the SPDF.

1. Copy the original and make sure that the position of the line [B] that you wrote on the original (see above) is within 0 ± 2 mm.
2. If not within the standard, adjust with the SP modes.
 - SP6-006-010 (ADF Adjustment L-Edge Regist (1-Pass): Front)
 - SP6-006-011 (ADF Adjustment L-Edge Regist (1-Pass): Rear)

6. Check the skew.

1. Make sure that the difference between both end positions of the line [A] that you wrote on the original (see above) is within 0 ± 2 mm.
2. If not within the standard, change the position of the fixing screw [A] to the long hole [B] at the right hinge.

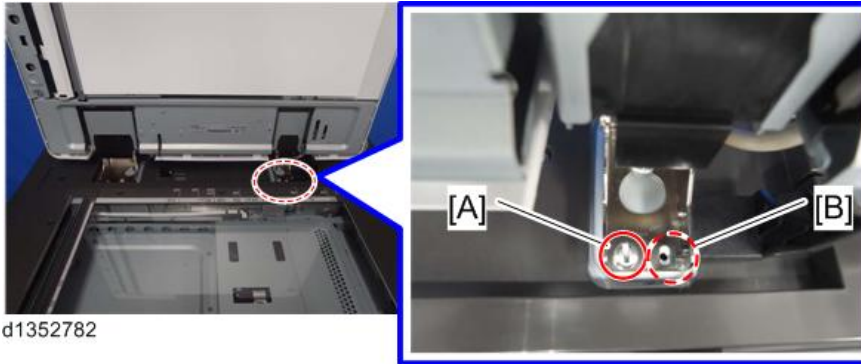

SP descriptions

SP4-688-002 (Scan Image Density Adjustment: 1-pass DF)

Adjusts density difference between Book and ADF. This SP is only for the SPDF models.

SP4-730-002 (FROM Main Factory Setting Execution ON/OFF)

Copies the parameters written in FROM in the SPDF to the engine board in the MFP. This SP is only for the SPDF models.

1 Bin Tray BN3110 (D3CQ)

Accessory Check

No.	Description	Q'ty	Remarks
1	Tray	1	
2	1 Bin Tray Unit	1	
3	Tray support bar	1	
4	Harness	1	
5	Gear	1	
6	Screw: M3 x 8	2	
7	Harness cover	1	
8	Paper support guide	1	Not used for this machine

2

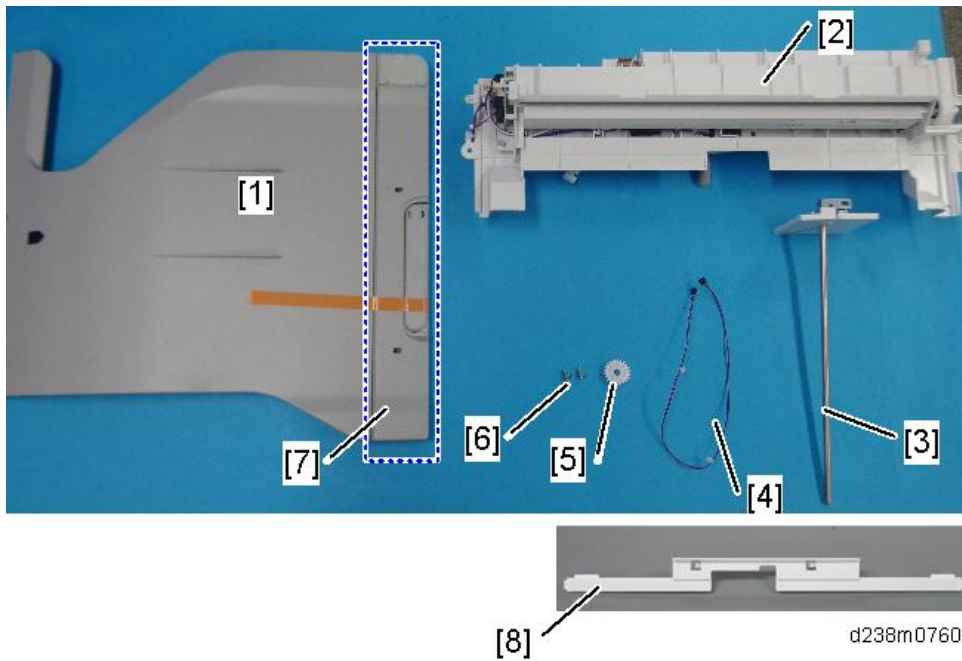

Installation Procedure

⚠ CAUTION

- When installing this option, turn OFF the main power and unplug the power cord from the wall socket. If installing without turning OFF the main power, an electric shock or a malfunction may occur.

★ Important

- When attaching this 1-bin tray unit at the same time as Bridge Unit BU3070 or Side Tray Type M3, attach this tray first. Otherwise, the 1-bin tray's exit tray cannot be attached due to the Bridge Unit BU3070 or Side Tray Type M3.
- To use together with the "Internal Finisher SR3130", first attach the bottom plate of Internal Finisher SR3130, and then install the 1-bin tray.

- Remove the orange tape and shipping retainers.
- Remove the accessories (fixing screws, etc.) provided with the machine.
- Open the right door, and then remove the small cover [A].

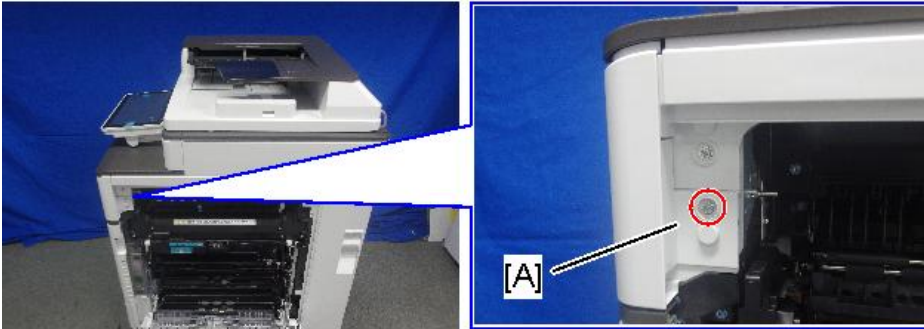



 x1

d238m553

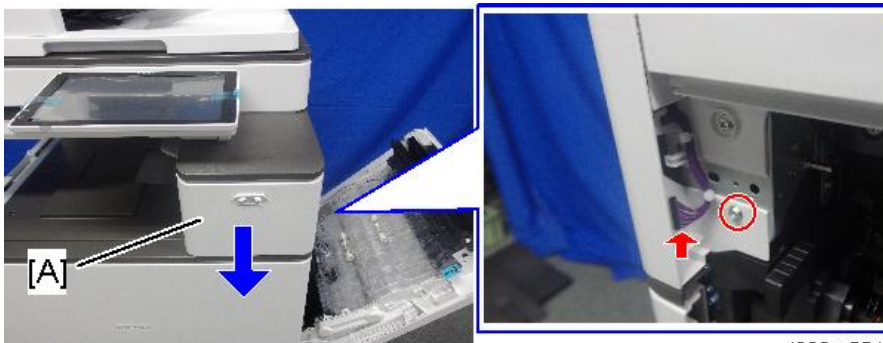
- Remove the screw and connector, and then remove the front upper cover [A].



 x1,  x1

d238m554

Note

- Remember that there are three tabs at the positions of the red arrows.
- Tilt the operation panel [B] upward to a horizontal position, and then remove the front upper cover [A].

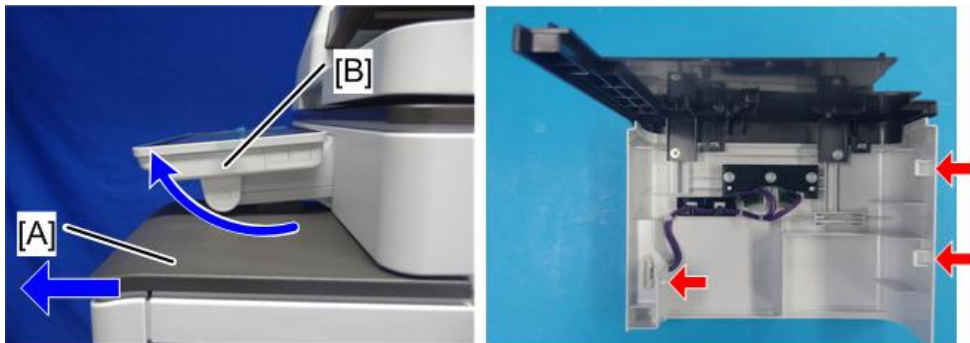

d238m555

5. Remove the paper exit tray [A].



d1462023

6. Remove the paper exit feeler [A].

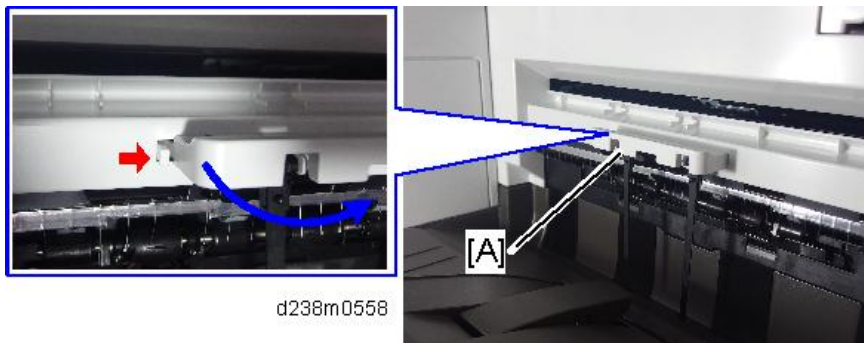

d238m0558

7. Open the front cover, and then remove the upper left cover [A] by pulling it towards the front (🔩×1).

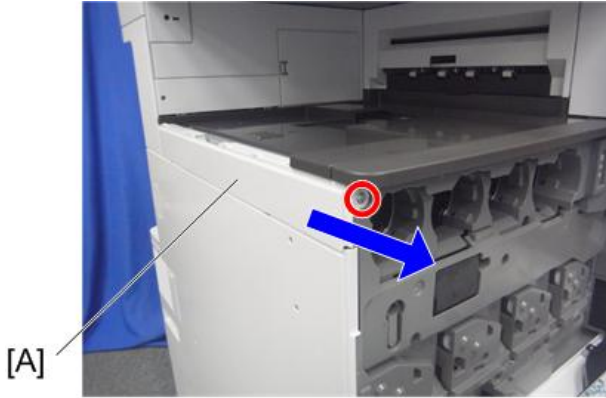

d1462008

8. Remove the left rear cover [A] (🔩×2).

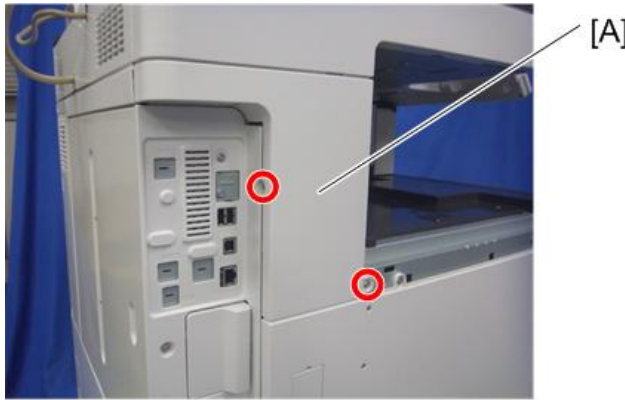

d1462010

9. Remove the inverter tray [A], and tray support rod cover [B] (⚙️ ×1).

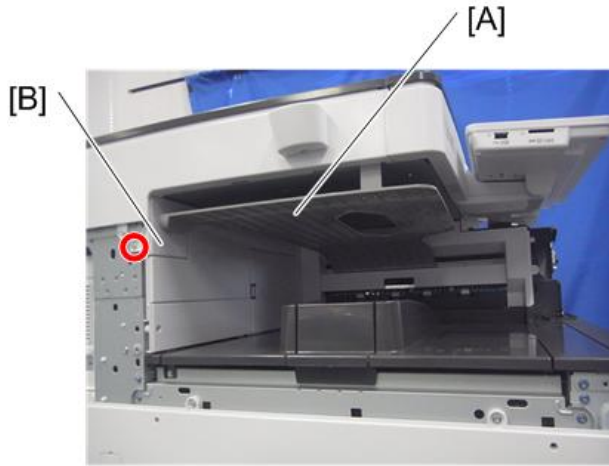

d1462478

10. Remove the paper exit cover [A] (⚙️ ×1).

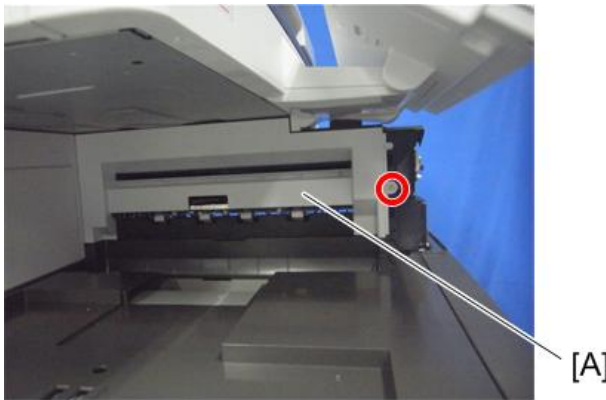

d1462024

11. Attach the gear [A] provided with the accessories.

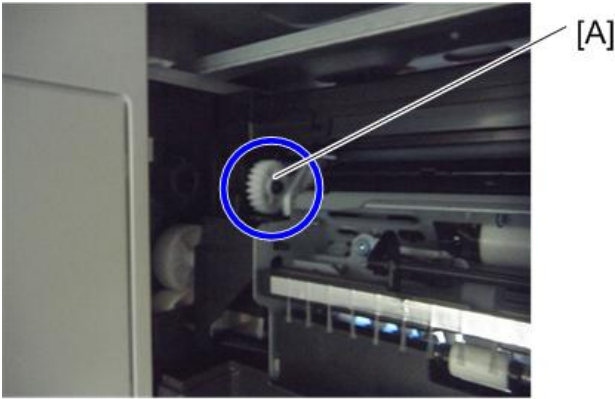

d1462476

12. Attach the 1-bin tray unit [A].

Make sure to engage it with the gear attached in the previous step.

Take care that the harness is not trapped between the 1-bin tray unit and the machine frame.

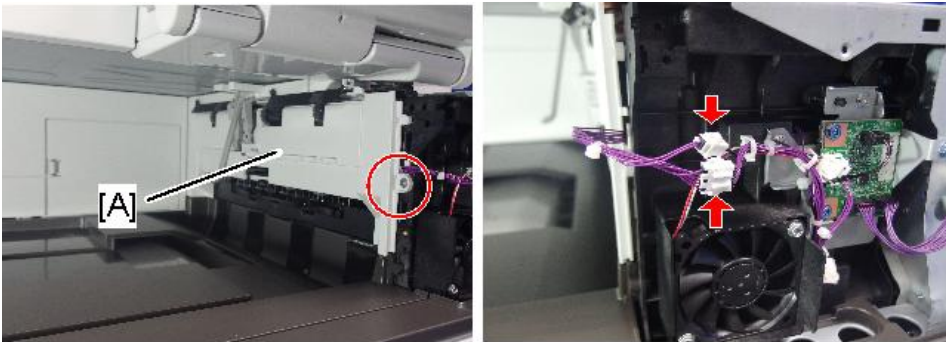

⚙️ x1, 📦 x2

d238m0559

13. Attach the harness provided with the accessories.



d1462479

14. Attach the tray support bar [A] (⑤×1).

When attaching the tray support bar [A], make sure that the harness attached in the previous step goes through the slit in the tray support bar circled in blue and comes outside of it as shown below.

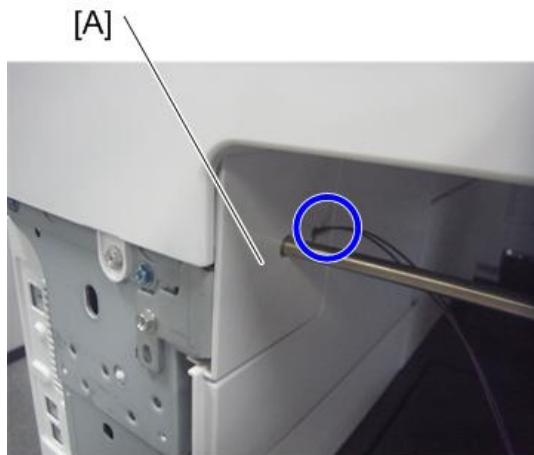

d1462480

15. Hook the 1-bin tray [A] onto the 1-bin tray unit, aligning the positions in the blue circle.

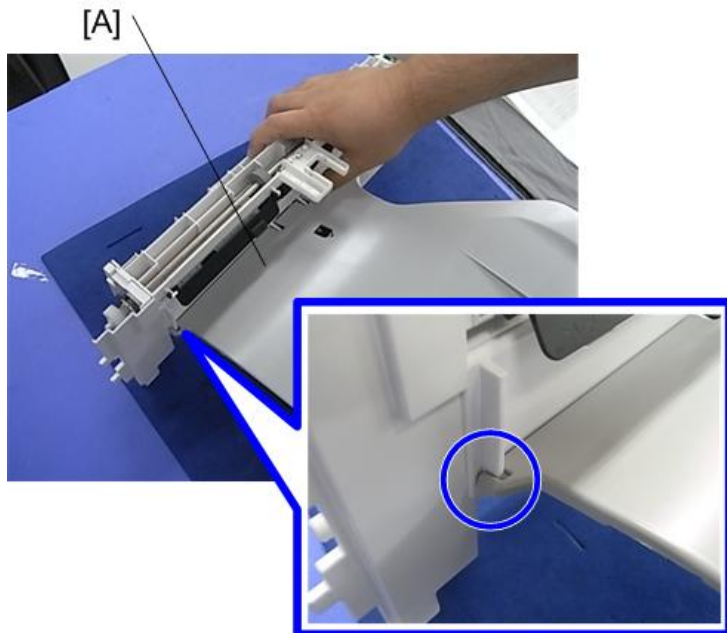

d1465027

16. Connect the harness to the 1-bin tray, and bring it around.



d1462482

17. Insert the tray support bar firmly in the 1-bin tray, and attach the harness cover [A].

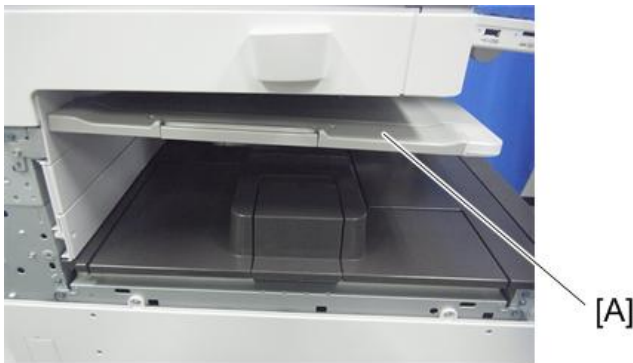

d1462483

18. Reattach the left rear cover, upper left cover and front upper cover, and close the right door.

19. Reattach the paper exit tray and paper exit feeler.

20. Turn ON the main power.

21. Check that output to this tray can be selected on the operation panel, and check operation.

Checking the Position of the Paper Exit Feeler

Check the following points for the paper exit feeler [A] at the paper exit.

- It can move in line with the ejection of paper
- It holds contact with the surface of the ejected paper and is still movable

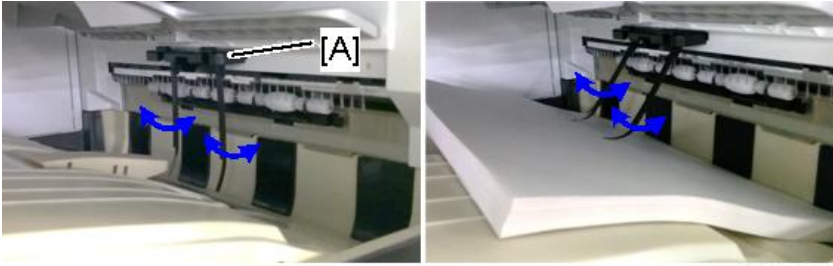

d238m0651

2

Paper will get jammed in the following cases.

- The paper exit feeler does not function due to obstacles (such as cables).
- The paper exit feeler does not function when the paper is pulled out and pushed back again.

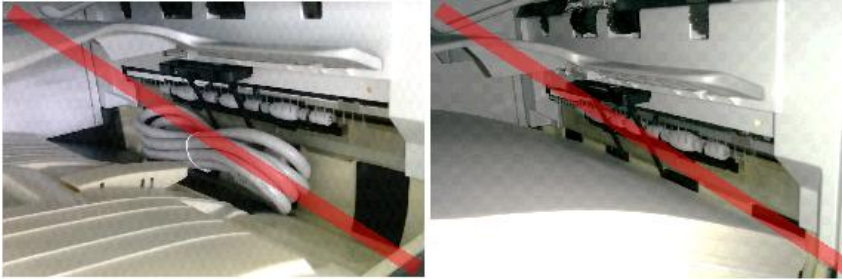

d238m0652

Internal Shift Tray SH3070 (D691)

Accessory Check

No.	Description	Q'ty	
1	Tray Cover	1	
2	Lever	1	Not used for this machine
3	Sheet	2	

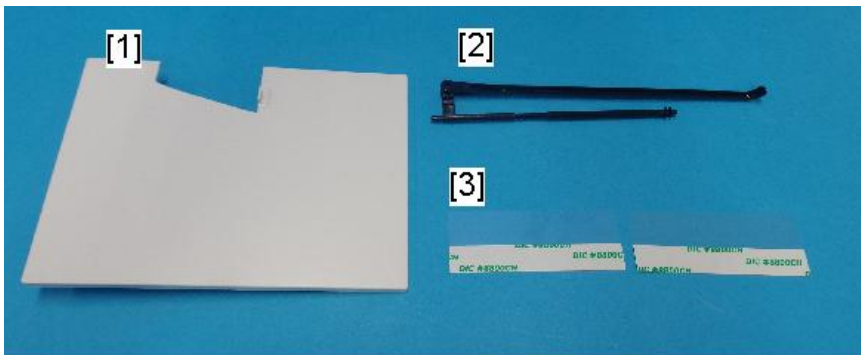

d238m0574

Installation Procedure

⚠ CAUTION

- When installing this option, turn OFF the main power and unplug the power cord from the wall socket. If installing without turning OFF the main power, an electric shock or a malfunction may occur.

↓ Note

- The internal shift tray cannot be used together with the following peripherals:
 - Side Tray Type M3 (D725)
 - Internal Finisher SR 3180 (D766)
 - Internal Finisher SR 3130 (D690)
 - Bridge Unit BU3070 (D685)
- To use together with the "1 Bin Tray BN3110 (D3CQ)", attach the "1 Bin Tray BN3110 (D3CQ)" first before installing the internal shift tray.

1. Remove the orange tapes, shipping retainers, and provided accessories (fixing screws, etc.).

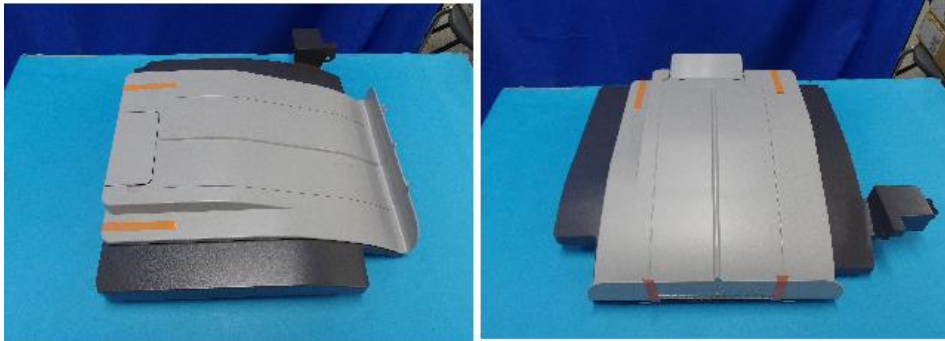

d238m0575

2. Attach the tray cover [B] to the shift tray [A].

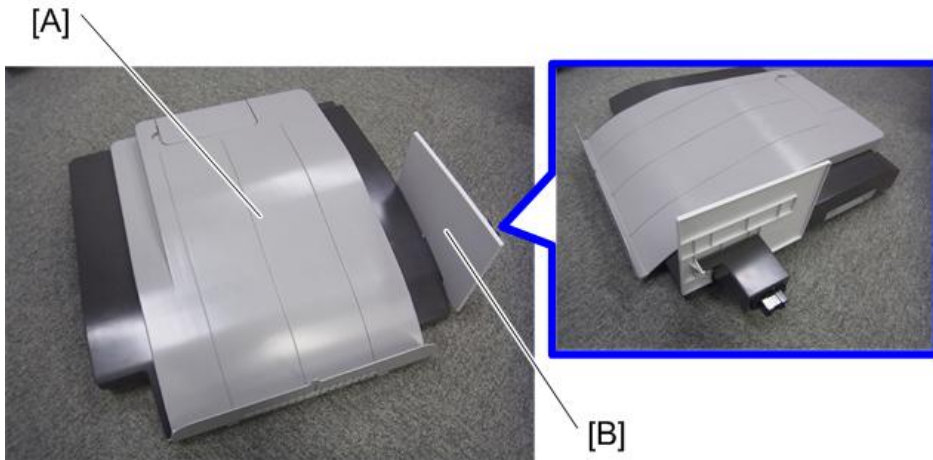

d1462486

3. Remove the paper exit tray [A].



d1462023

4. Remove the connector cover [A].



d1462470

5. Attach the shift tray [A].



d1462487a

6. Remove the paper exit feeler [A] to apply the Mylar sheet properly.

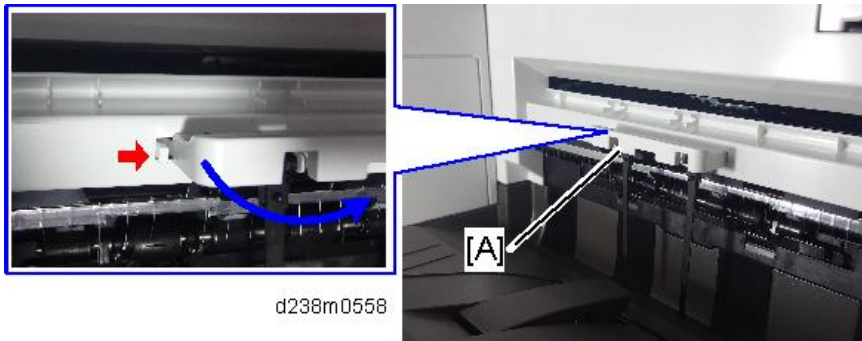

d238m0558

7. Attach the sheets [A] at the edge of the paper exit cover.

★ Important

- Make sure to attach the Mylar as shown in the photo below. This is to prevent curling when the paper lands in the tray.

- The Mylar's top edge should be 0-2.5mm from the top edge of the paper exit cover, i.e. between the two red lines.
- The Mylar's side edge should be flush against the side of the cover, i.e. along the yellow dotted line.

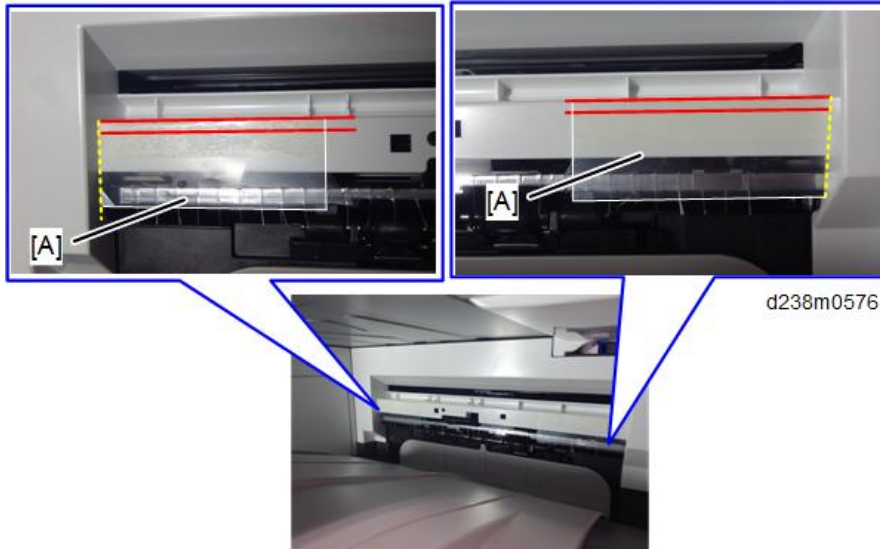

8. Reattach the paper exit tray and close the right door.
9. Reattach the removed paper exit feeler [A].

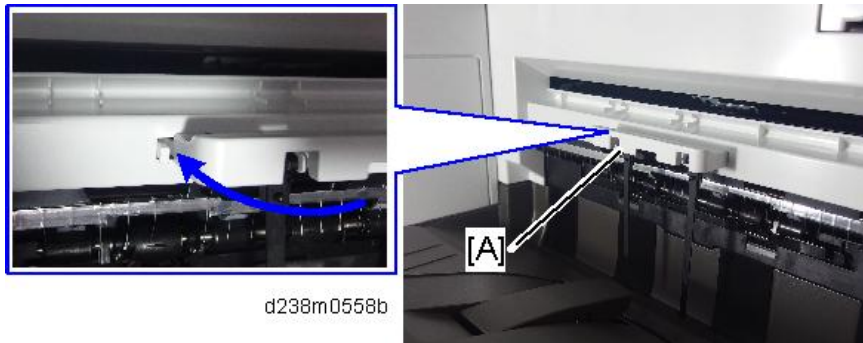

10. Do not use the lever supplied with the optional unit. Doing so may affect the stacking function.
11. Turn ON the main power.
12. Check that paper output to the shift tray can be selected at the operation panel, and check the operation.

Checking the Position of the Paper Exit Feeler

Check the following points for the paper exit feeler [A] at the paper exit.

- It can move in line with the ejection of paper
- It holds contact with the surface of the ejected paper and is still movable

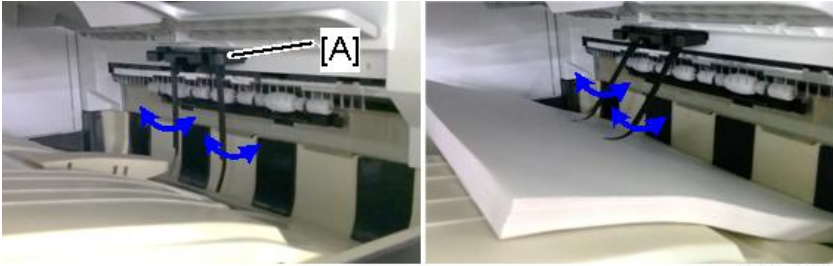

d238m0651

Paper will get jammed in the following cases.

- The paper exit feeler does not function due to obstacles (such as cables).
- The paper exit feeler does not function when the paper is pulled out and pushed back again.

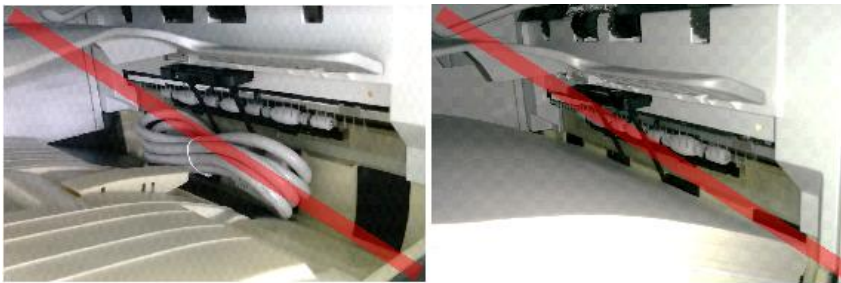

d238m0652

Side Tray Type M3 (D725)

Accessory Check

No.	Description	Q'ty
1	Left Extension Tray	1
2	Upper Extension Tray	1
3	Fixing Plate	1
4	Knob Screw	1
5	Tapping screw - M4 x 14	1
6	Tapping screw - M3 x 8	1
7	Bracket	1
8	Paper Support Guide	1
9	Driven Roller (Flat)	1

2

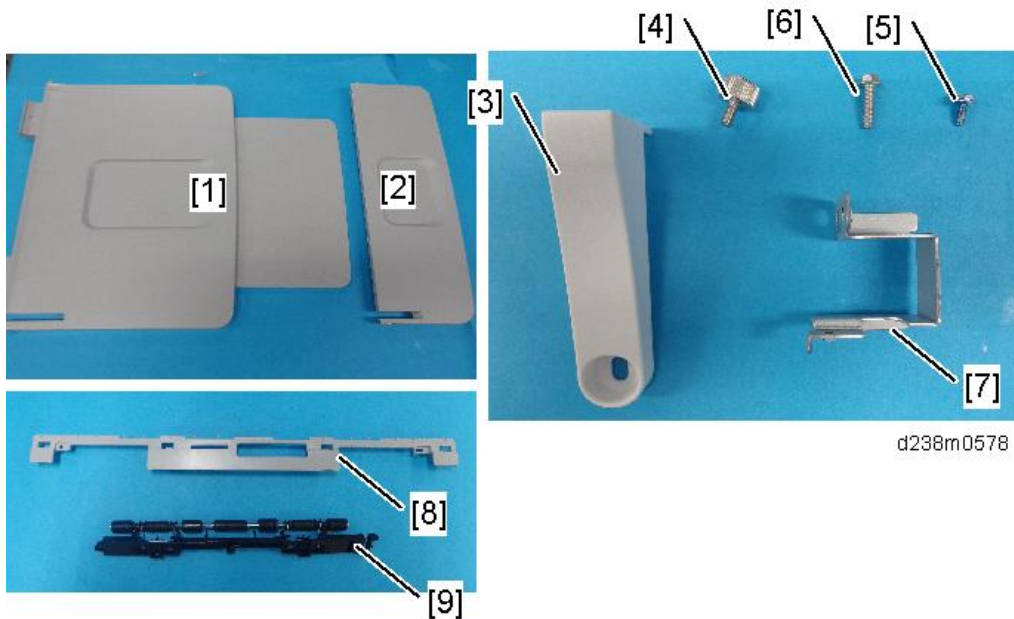

Installation Procedure

CAUTION

- When installing this option, turn OFF the main power and unplug the power cord from the wall socket. If installing without turning OFF the main power, an electric shock or a malfunction may occur.

Note

- The side tray cannot be used together with the following peripherals:
 - Internal Shift Tray SH3070 (D691)
 - Bridge Unit BU3070 (D685)
 - Internal Finisher SR 3180 (D766)
 - Internal Finisher SR 3130 (D690)
- To use together with the "1 Bin Tray BN3110 (D3CQ)", attach the "1 Bin Tray BN3110 (D3CQ)" first before installing the side tray.

1. Remove the orange tapes, shipping retainers, and accessories (fixing screws, etc.).



d238m0579

2. Remove the paper exit tray [A].

d1462023

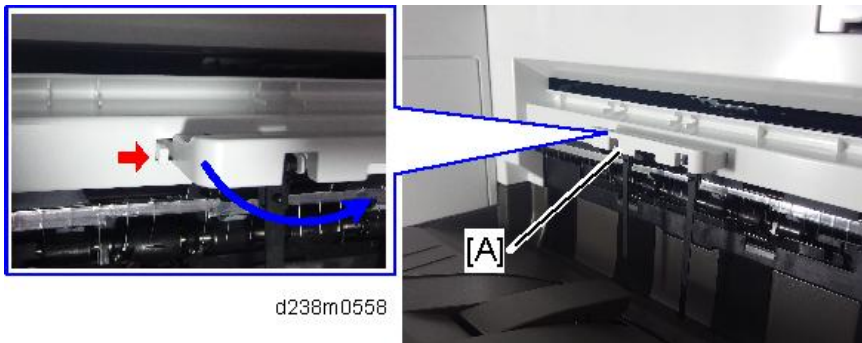
3. Remove the paper exit feeler [A].

d238m0558

4. Remove the driven roller [B] at the machine's exit tray and attach the supplied driven roller [A].

- Insert a flathead screwdriver into the depression in the center, and then, lifting the driven roller, unlock the part indicated by the red arrow.
- When attaching the driven roller, push its center all the way in until it clicks.

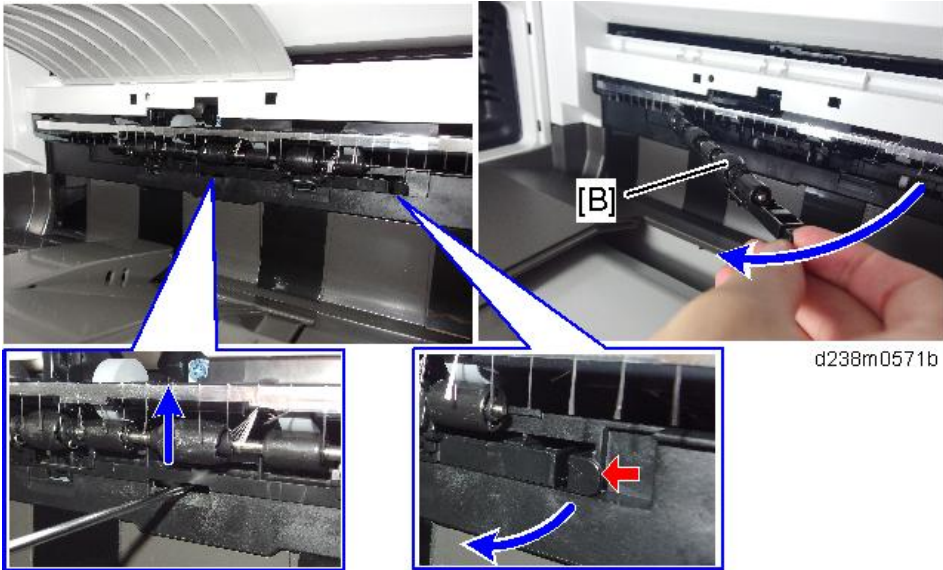

d238m0571b

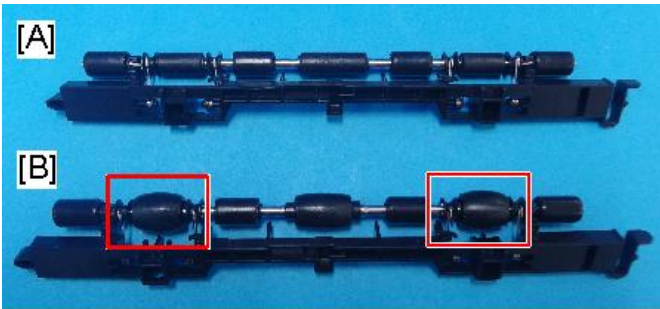

d238m0572

[A]: The supplied driven roller has flat rollers.

[B]: The machine's standard driven roller has drum-type rollers (as indicated by red frames).

5. Attach the paper support guide [A] (Tab x4).

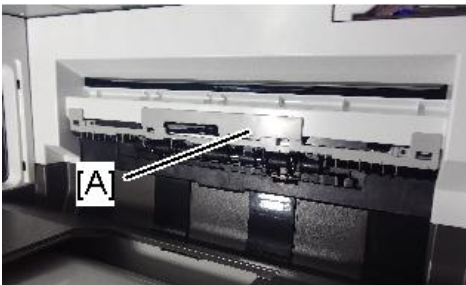

d238m0573b



6. Open the right door, and then remove the small cover [A].

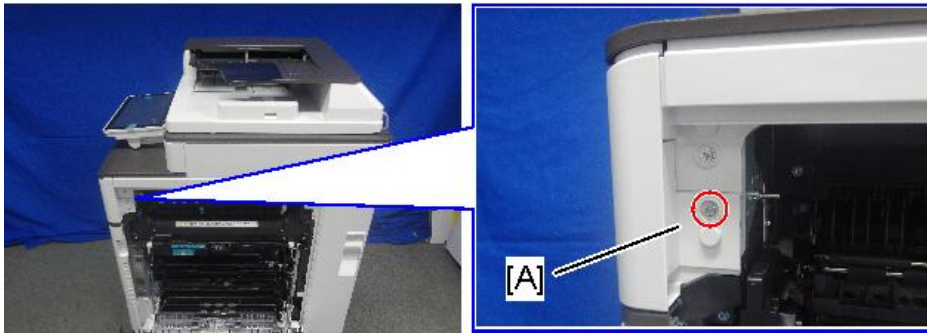



d238m553

 x1

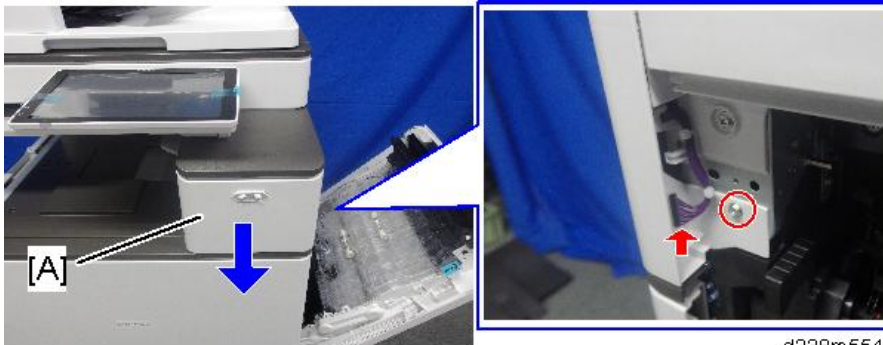
7. Remove the screw and connector, and then remove the front upper cover [A].



d238m554

 x1,  x1

 **Note**

- Remember that there are three tabs at the positions of the red arrows.
- Tilt the operation panel [B] upward to a horizontal position, and then remove the front upper cover [A].

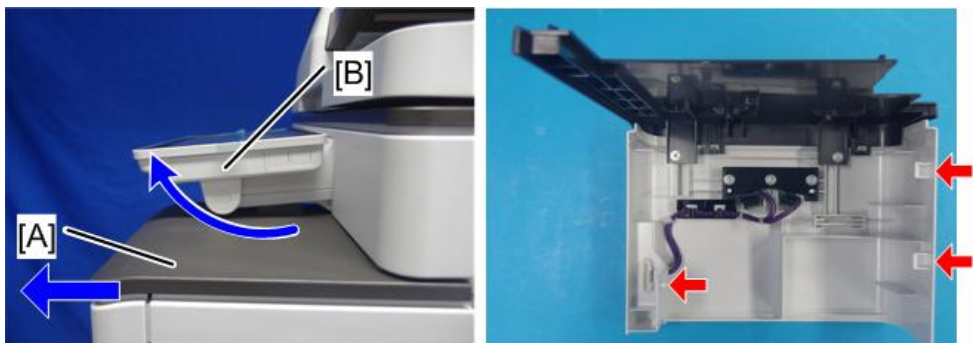

d238m555

8. Attach the bracket [A].

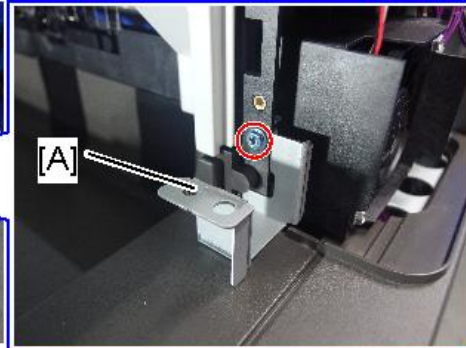
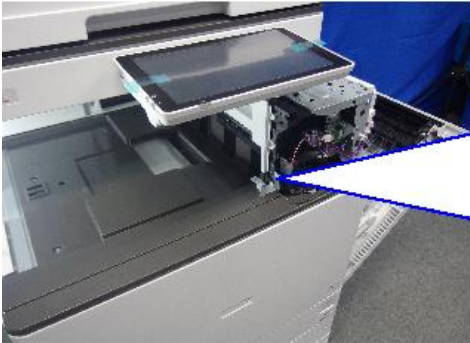

 x1

d238m0556

9. Remove the connector cover [A].



d1462470

10. Attach the bracket [A].

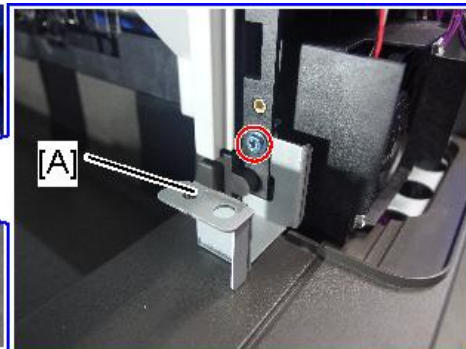
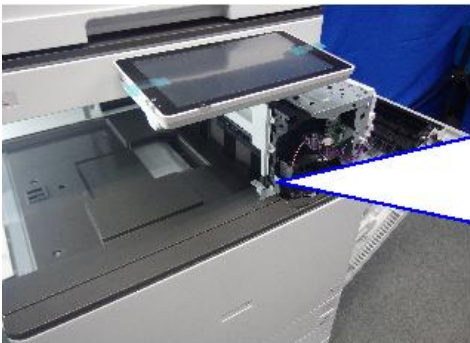



 x1

d238m0556

11. Reattach the front upper cover, and close the right door.

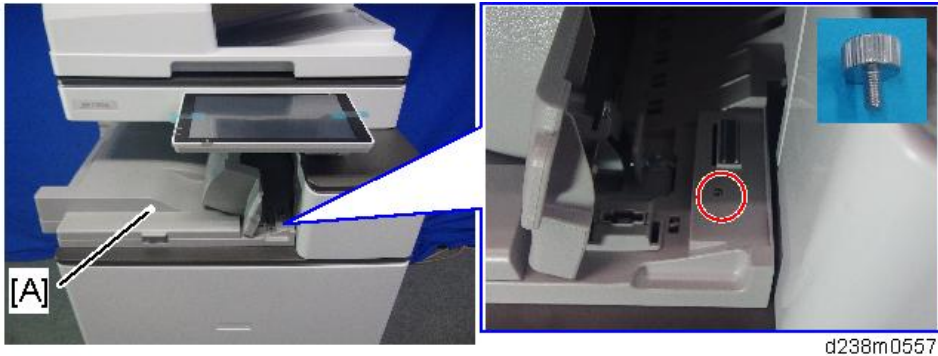
12. Attach the side tray unit [A] to the machine, and fix with a knob screw.



 x1

13. Attach the fixing plate [A] ( x1).



14. Attach the upper extension tray [A] and the left extension tray [B].



15. Turn ON the main power.

- 16. Check that paper output to the side tray can be selected at the operation panel, and check the operation.**

Bridge Unit BU3070 (D685)

Accessory Check

No.	Description	Q'ty
1	Tapping screw- M3 × 8	1
2	Screw - M4	1
3	Knob Screw - M4	1
4	Right Front Bracket	1
5	Upper Left Cover	1
6	Left Front Bracket	1
7	Paper Support Guide	1
8	Driven Roller (Flat)	1

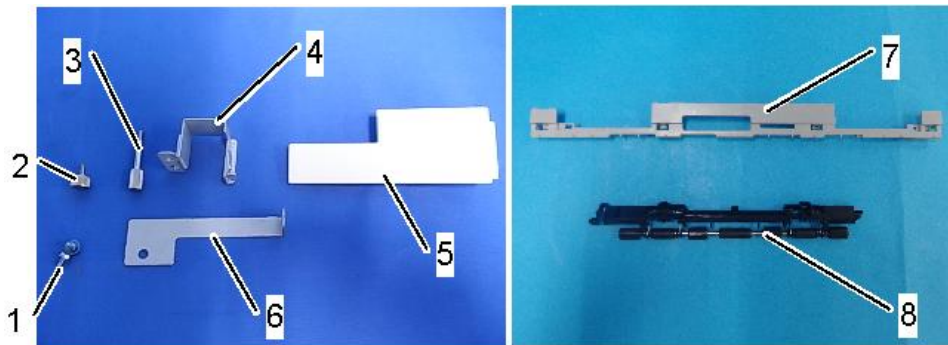

d238m0570

Installation Procedure

⚠ CAUTION

- When installing this option, turn OFF the main power and unplug the power cord from the wall socket. If installing without turning OFF the main power, an electric shock or a malfunction may occur.

↓ Note

- The bridge unit cannot be used together with the following peripherals:

- Internal Shift Tray SH3070 (D691)
- Side Tray Type M3 (D725)
- Internal Finisher SR 3180 (D766)
- Internal Finisher SR 3130 (D690)

- To use together with the "1 Bin Tray BN3110 (D3CQ)", attach the "1 Bin Tray BN3110 (D3CQ)" first before installing the bridge unit.

1. Remove the orange tapes, shipping retainers, and provided accessories (fixing screws, etc.).



d238m0569

2. Remove the interval tray [A].

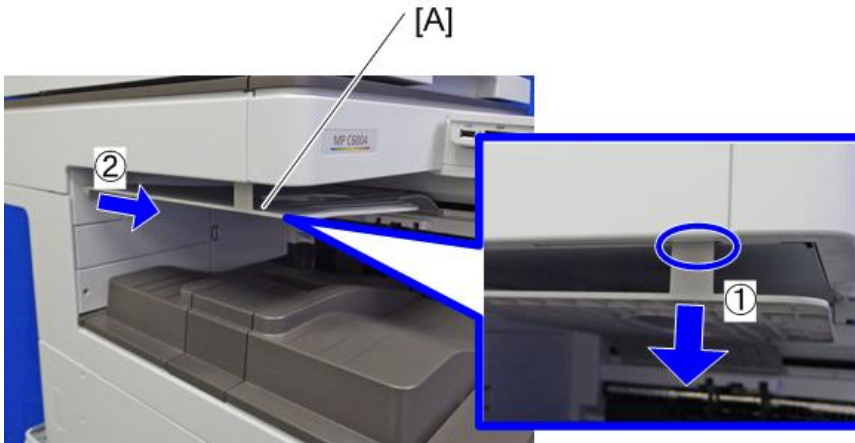

d238m1196

3. Remove the paper exit tray [A].



d1462023

4. Remove the connector cover [A].



d1462470

5. Remove the paper exit feeler [A].

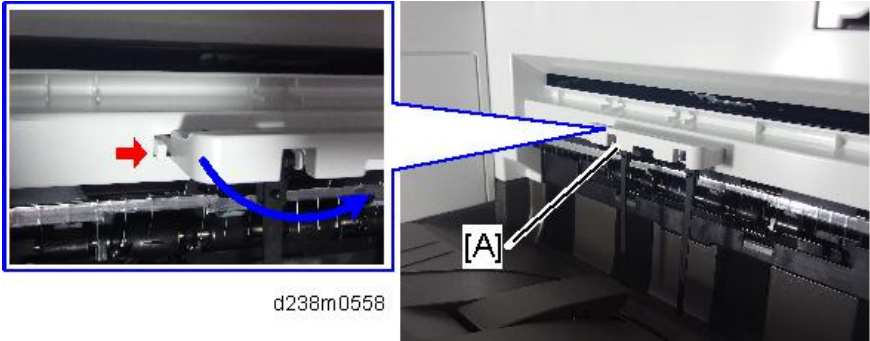

d238m0558

6. Remove the driven roller [B] at the machine's exit tray and attach the supplied driven roller [A].

- Insert a flathead screwdriver into the depression in the center, and then, lifting the driven roller, unlock the part indicated by the red arrow.
- When attaching the driven roller, push its center all the way in until it clicks.

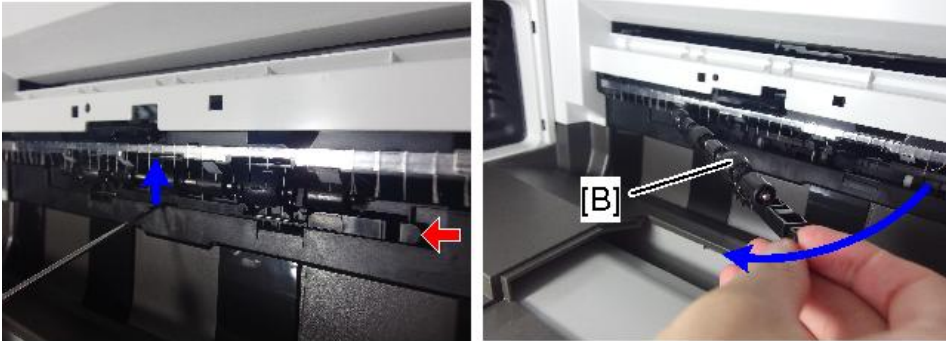

d238m0571

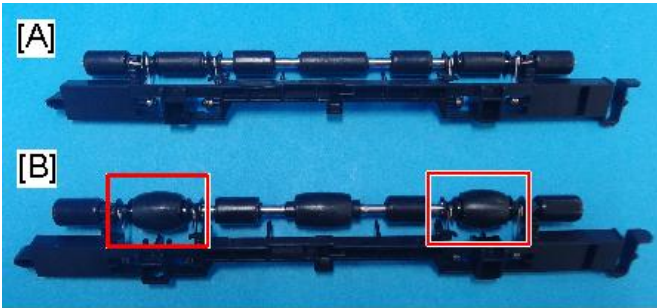

d238m0572

[A]: The supplied driven roller has flat rollers.

[B]: The machine's standard driven roller has drum-type rollers (as indicated by red frames).

7. Attach the paper support guide [A] (Tab x4).



d238m0573b

8. Open the front cover.

9. Remove the upper left cover [A] (⚙️ x1).

⬇️ Note

- The screw removed is used again in step 15.

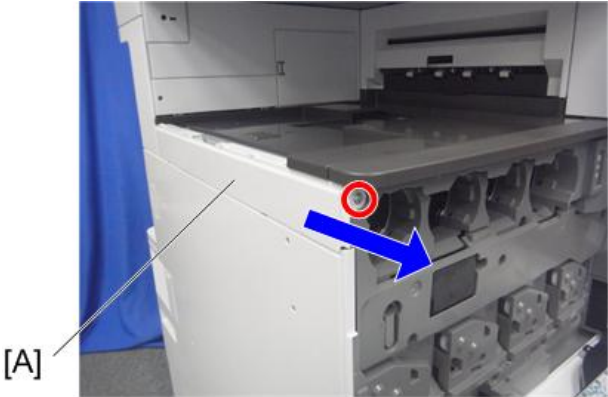

10. Open the right door, and then remove the small cover [A].

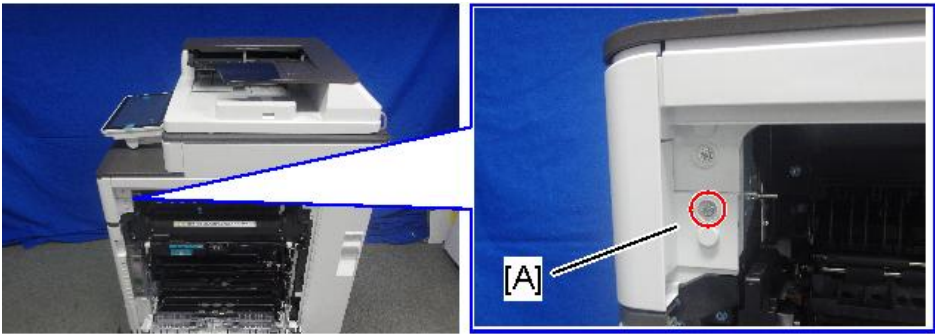

⚙️ x1

11. Remove the screw and connector, and then remove the front upper cover [A].

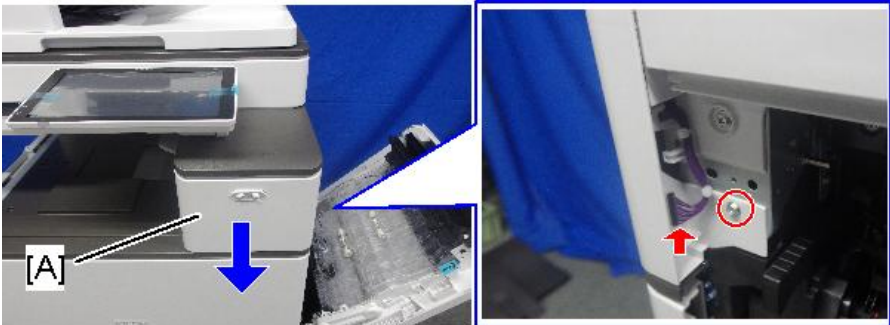

⚙️ x1, 🔌 x1

Note

- Remember that there are three tabs at the positions of the red arrows.
- Tilt the operation panel [B] upward to a horizontal position, and then remove the front upper cover [A].

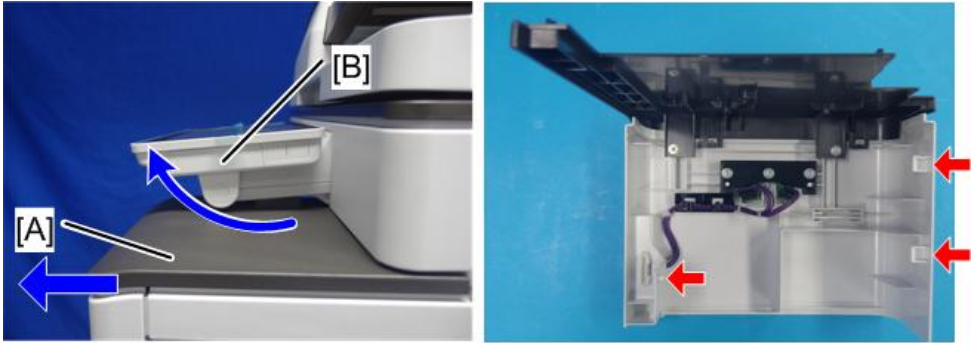

d238m555

12. Attach the right front bracket [A].

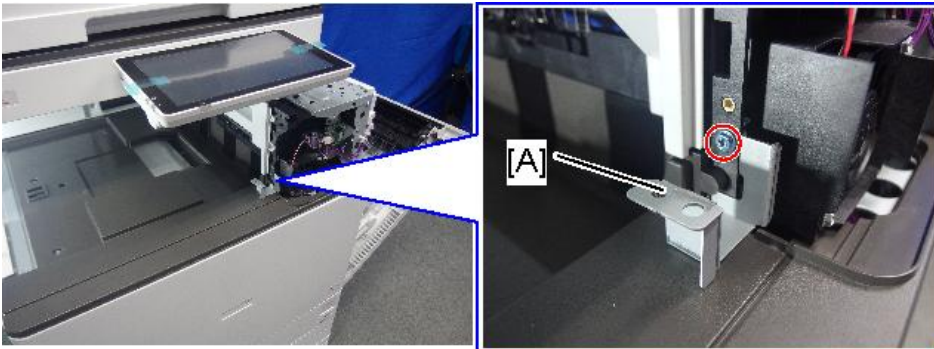

 x1

d238m0556

13. Attach the bridge unit [A] to the machine.

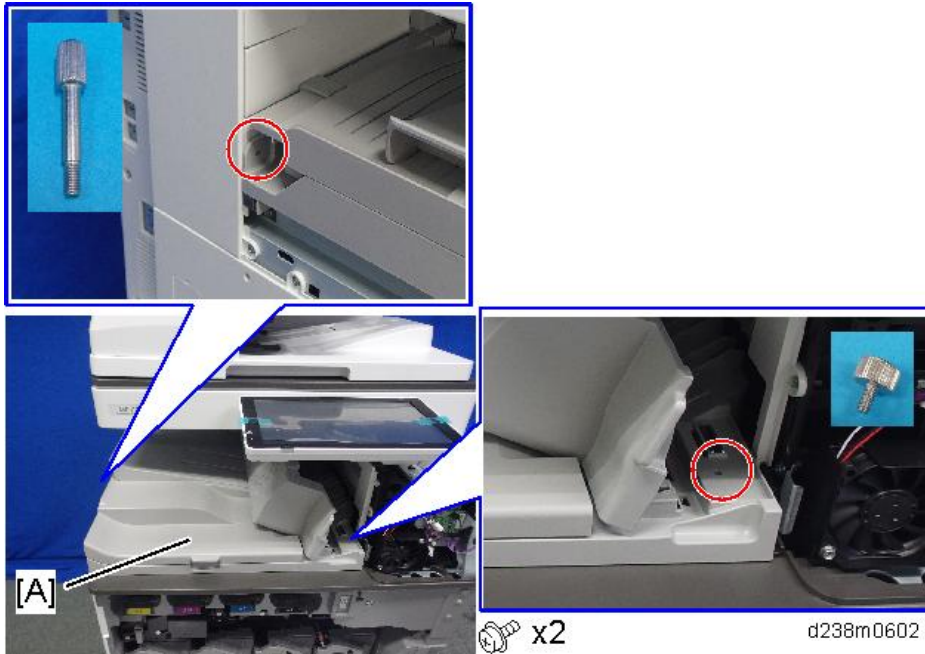

14. Attach the front upper cover, and close the right door.

15. Attach the upper left cover [A] provided with the accessories (⊗×1).

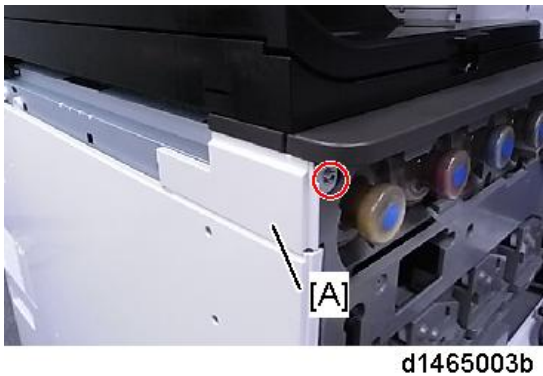

16. Attach the L type connecting bracket [A].

To fix the bridge unit securely on the machine, tighten the finisher's joint bracket [A] and L type connecting bracket [B] together when installing the finisher.

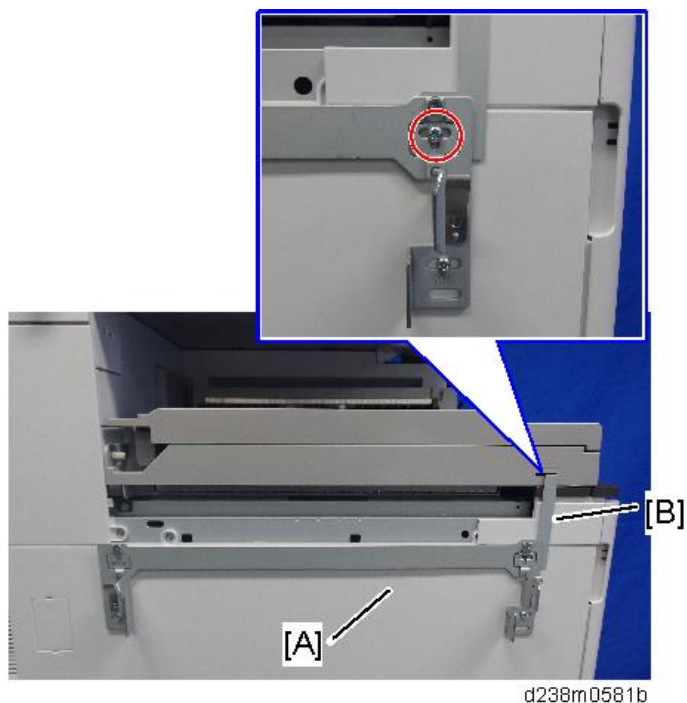

d238m0581b

17. Complete the bridge unit attachment. Refer to the procedure for connecting the optional unit downstream of the bridge unit. page 195 "Booklet Finisher SR3220 (D3B9)"
18. After the finisher is installed, turn ON the main power.
19. Check that the finisher can be selected at the operation panel.

Booklet Finisher SR3220 (D3B9)

★ Important

- To attach this optional unit, the following optional units are required.
 - Bridge Unit BU3070 (D685)
 - Paper Feed Unit PB3220/PB3210 (D787)

2

Accessory Check

No.	Description	Q'ty	Remarks
1	Shift Tray	1	
2	Booklet Tray	1	
3	Joint Bracket	1	
4	Relay Guide Plate	1	
5	Cushion	1	
6	Tapping screws - M3 × 6	4	
7	Tapping screw - M4 × 8	1	
8	Screws - M4 × 12	4	
9	Stabilizer	1	This part must be attached to the finisher just after it is taken out of the shipping box.
10	Ground Plate	1	
11	Proof Support Tray	1	
-	Installation Procedure: Arm	1	

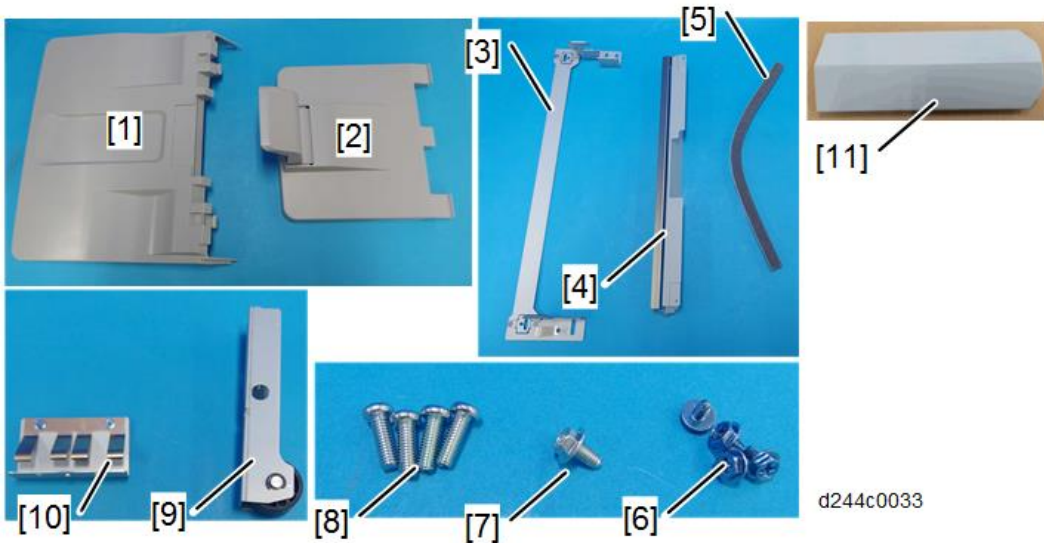

Installation Procedure

⚠ CAUTION

- When installing this option, turn OFF the main power and unplug the power cord from the wall socket. If installing without turning OFF the main power, an electric shock or a malfunction may occur.

↓ Note

- Before installing this option, attach the "Bridge Unit BU3070 (D685)" and "Paper Feed Unit PB3220/PB3210 (D797)".

★ Important

- When you lift the finisher at the time of unpacking, do not hold the part [A]. Doing so may damage the frame.



d238m0601

1. After unpacking, immediately attach the stabilizer [B] to prevent toppling.

Push it in thoroughly along the guide [A] until it clicks.

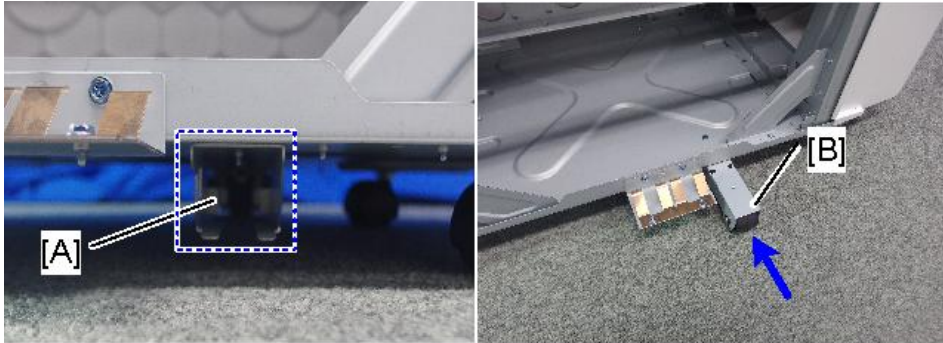

d238m592

2. Attach the ground plate [A] (⌀ × 2).

d1462532

3. Remove the external orange tapes and shipping retainers.

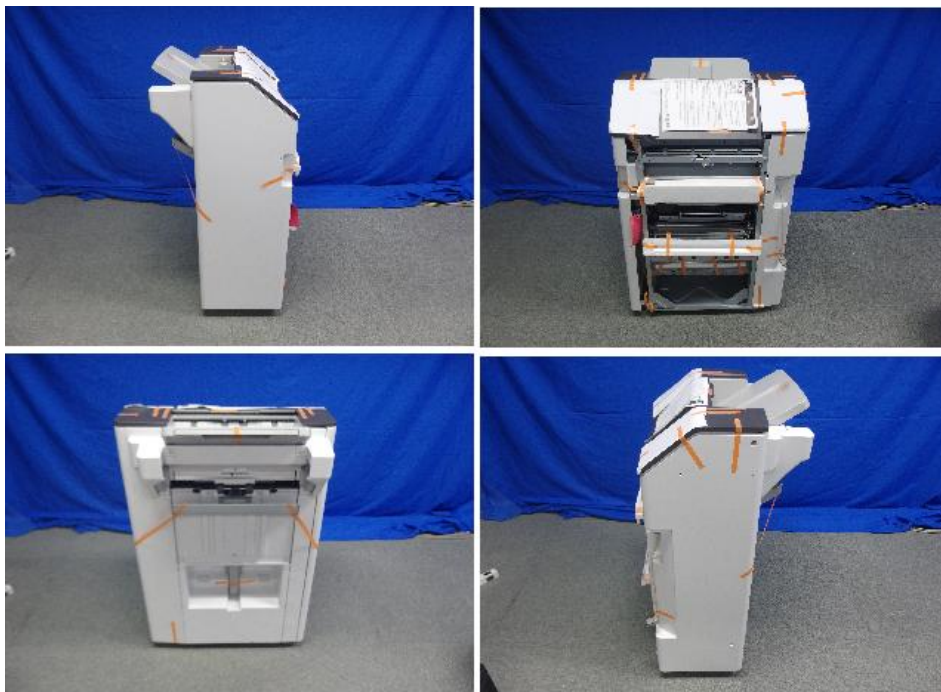

d238m0584

4. Open the front cover, and then remove the filament tape and packing materials.

5. Remove the fixing bracket [A].

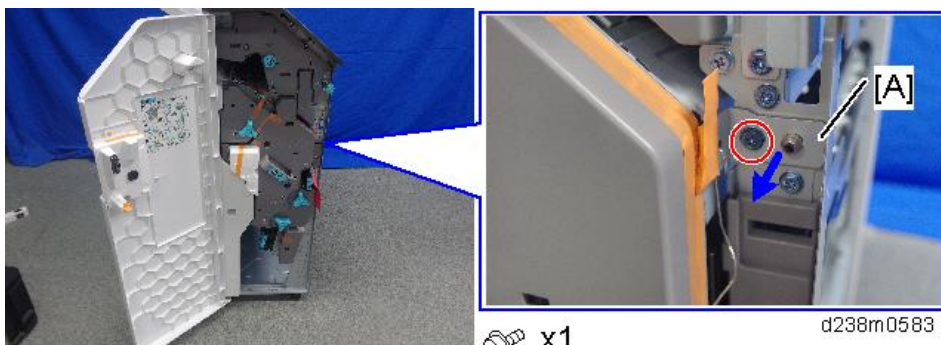

 x1

d238m0583

6. Pull out the saddle stitch unit [A], and remove the filament tape and packing materials.

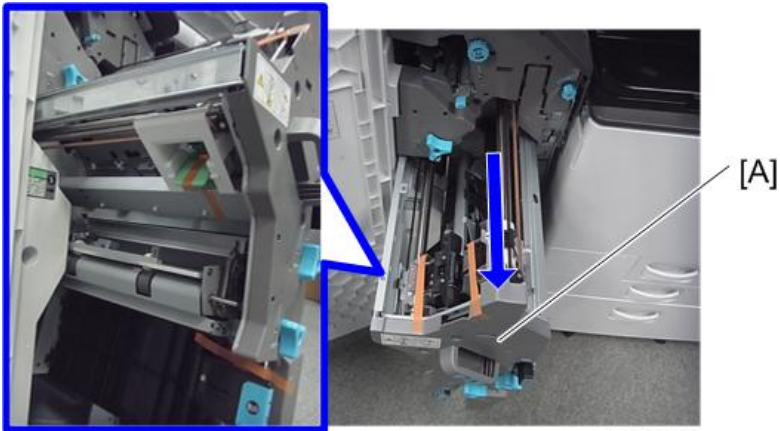

d1462528

7. Remove the accessories in the package (fixing screws, etc.).
8. Attach the shift tray [A] (🔩×1 : M4 × 8).



d1462529

9. Attach the booklet tray [A].

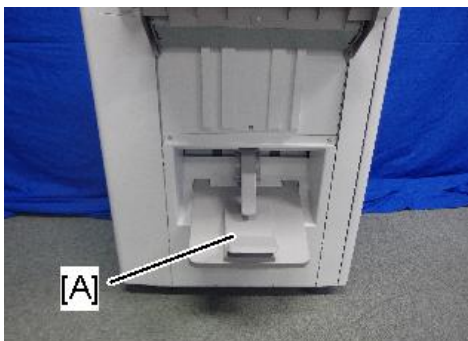

d238m0580

10. Attach the relay guide plate [A] (🔑×2).

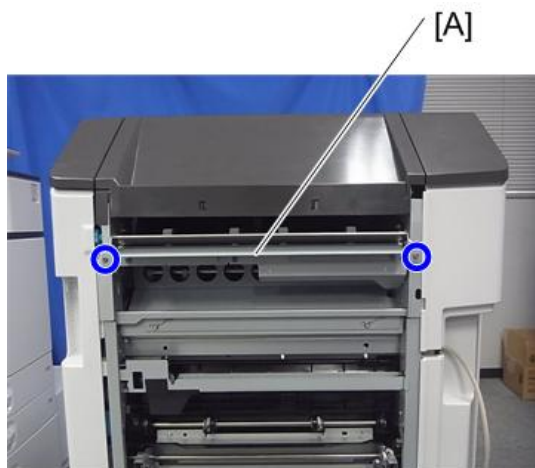

d1462531

11. Clean the right side of the upper cover with a cloth moistened with alcohol, and then attach the cushion to the finisher.

- Make sure that the cushion is aligned with the front-lower edge [A] of the upper cover.

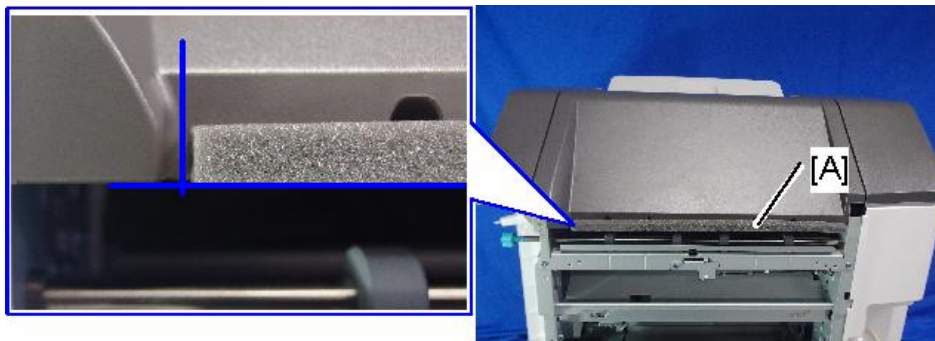

d238m591

12. Remove the connector cover [A] on the rear left side of the main machine.

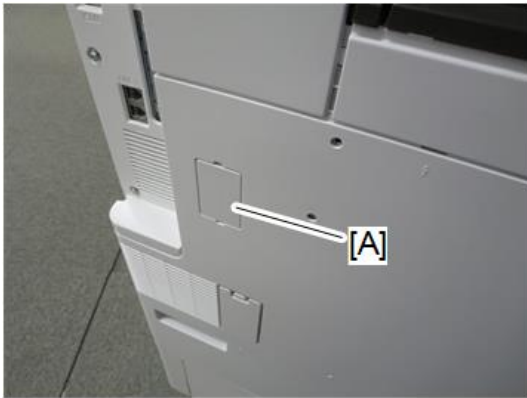

d244c0025

13. Attach the joint bracket [A] to the machine (🔩 ×4 : 4x12).

Tighten the joint bracket [A] and bracket [B] of the bridge unit together.

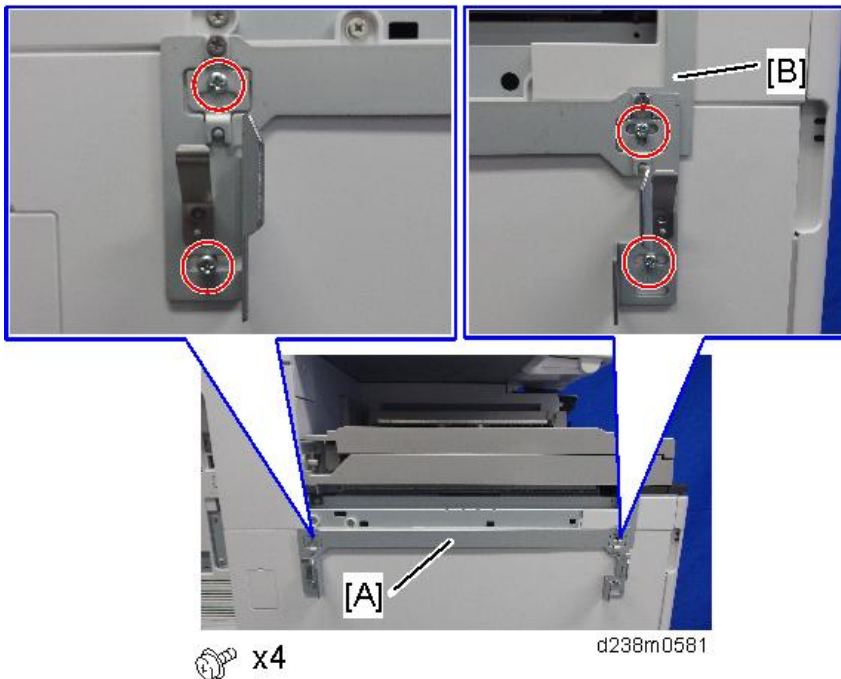

Note

- Attach the screw so that the screw head is at the center of the mark.

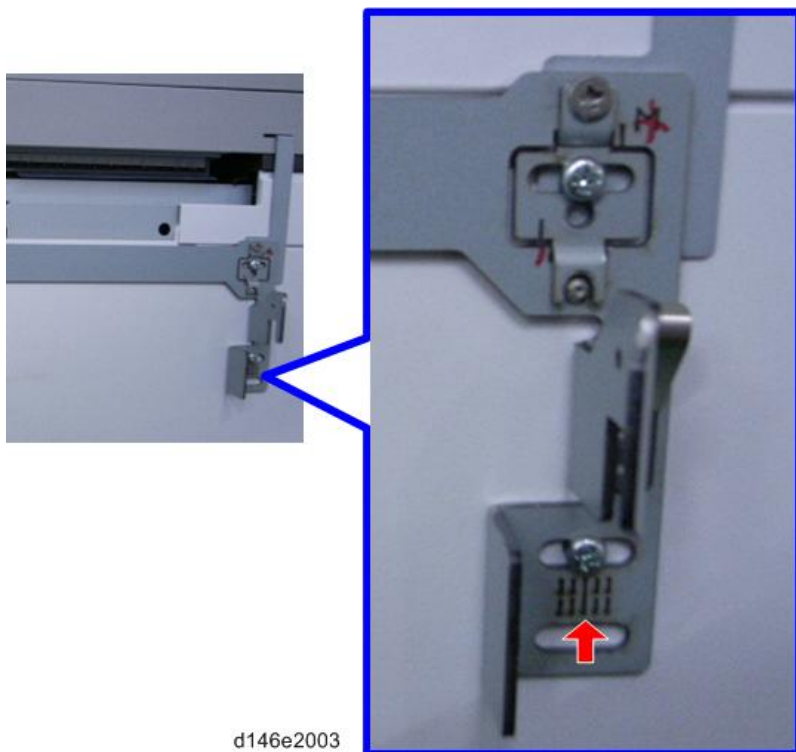

d146e2003

14. Remove the screw on the connection lever [A] and pull the lever.



 x1

d238m0582

15. Connect the finisher to the main unit, and then push in the connection lever [A] to fasten it to the main unit. (Ⓜ x1)

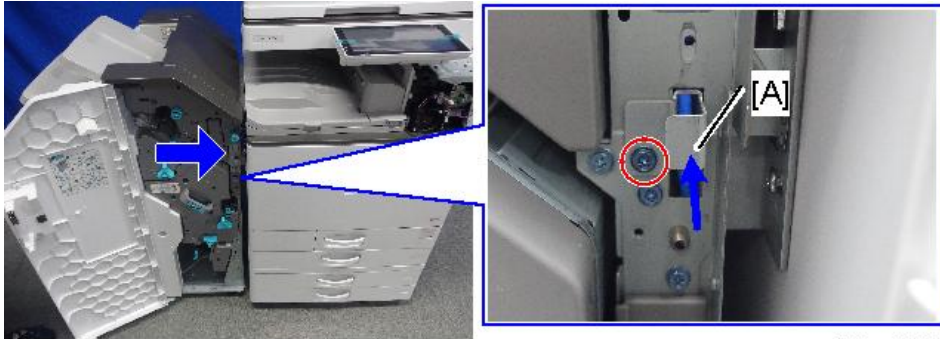

d238m0595

16. Connect the interface cable to the machine.



d1462535

17. Close the front cover.
18. Turn ON the main power.
19. Deliver some A3/DLT paper to the proof tray and check if the vertical registration is correct according to the adjustment scale for A3/DLT paper. [page 1044 "Troubleshooting for Finishing Options"](#)
20. Check that the finisher can be selected on the operation panel, and check the finisher's operation.

Attaching the Proof Support Tray

When using B4, LG or larger paper, or when using limp paper, the sheet may become kinked, resulting in premature full detection.

2



d1826009

This can be solved by attaching the proof support tray [B] on the proof tray [A].

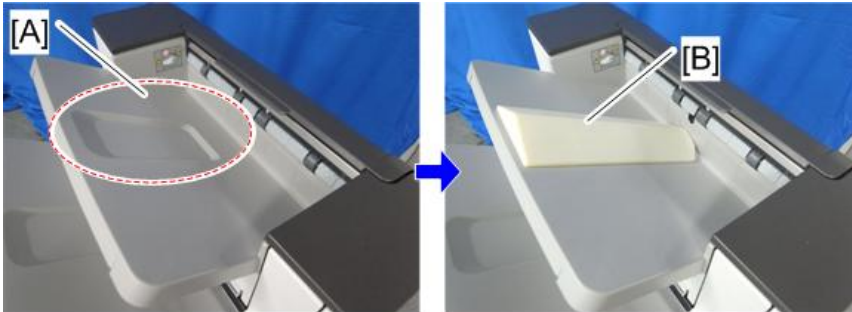

d1826010

Problem that may occur after attaching this support tray:

When printing A4, LT or smaller paper with the support tray, the machine stacks only 200 sheets, which is less than the standard specification of 250 sheets.

When printing B4, LG or larger paper with the support tray, the machine stacks 50 sheets, which is the same as the standard specification.

Punch Unit PU3050

Note

- This Punch Unit is for the Booklet Finisher SR3220 (D3B9).

Accessory Check

2

No.	Description	Q'ty	Remarks
1	Punch unit	1	
2	Cover	1	
3	Stay	1	
4	Hopper	1	
5	Side-to-side detection unit	1	
6	Punch unit movement motor unit	1	
7	Hopper guide plate	1	
8	Guide plate	1	
9	Tapping screws - M3 × 6	16	
10	Harness (Short)	1	
11	Harness (Long)	1	Not used for this machine

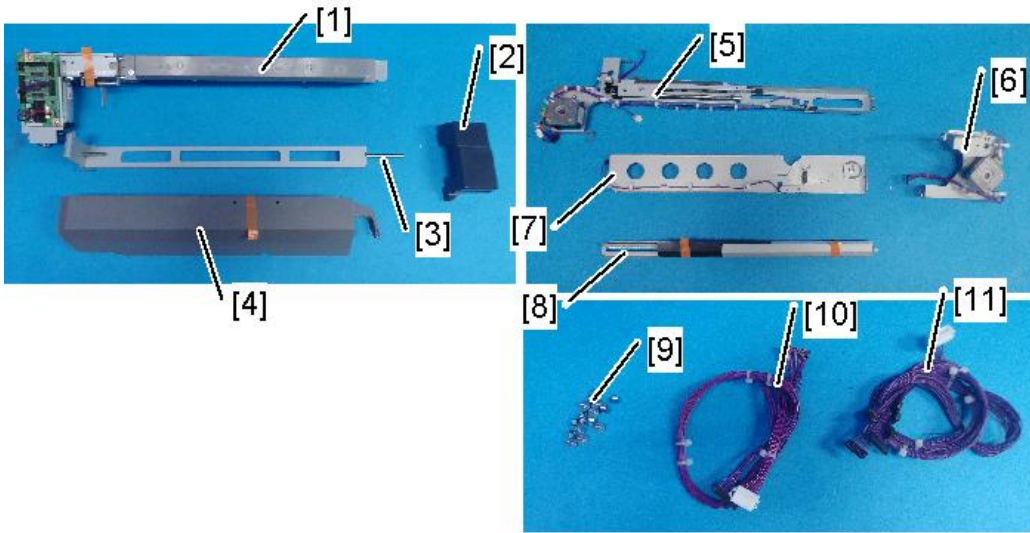

d238m 0768

Installation Procedure

⚠ CAUTION

- When installing this option, turn OFF the main power and unplug the power cord from the wall socket. If installing without turning OFF the main power, an electric shock or a malfunction may occur.

1. Take out of the box, and remove the orange tapes and shipping retainers.
2. Pull out the finisher interface cable, and move it away from the machine.
3. Remove the finisher rear cover [A] (⚙×3).

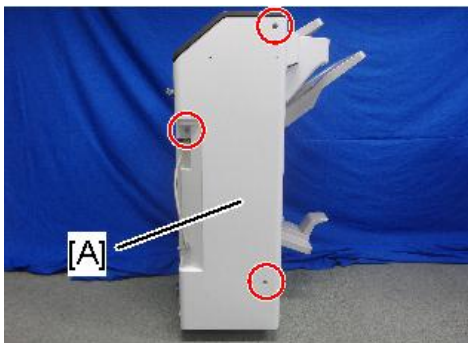

d238m 0769

4. Open the top cover, and then remove the arm [A] (Ⓜ×1).

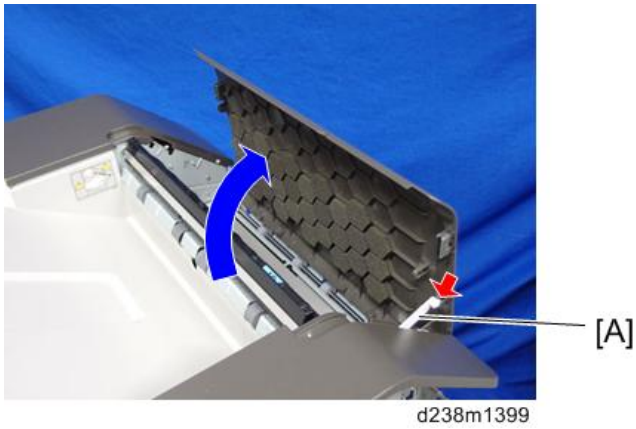

5. Open the finisher front cover, remove the three knobs (Ⓜ×1).

↓ **Note**

- Knobs with a lock mechanism are removed using a knob screwdriver or similar while releasing the lock.

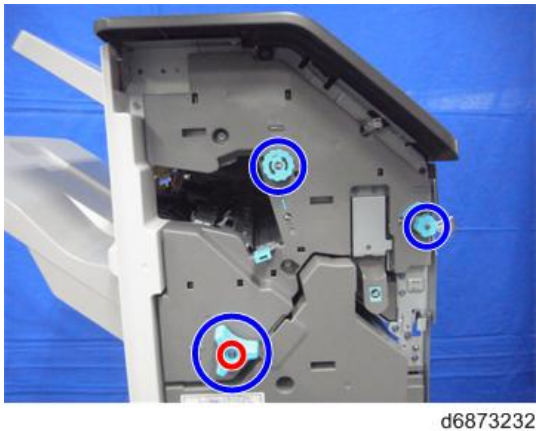

6. Pull the saddle stitch unit [A] or stapling unit.

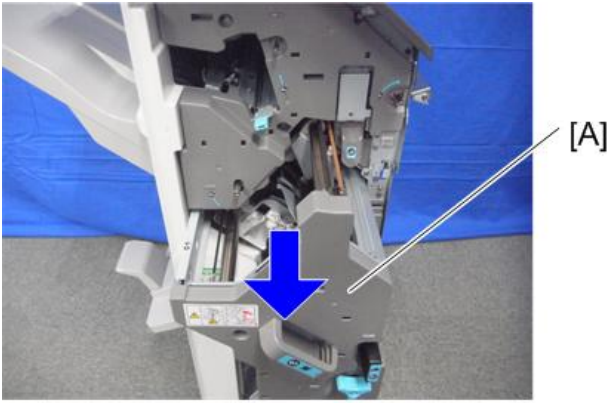

d6873233

7. Remove the finisher inner cover [A] (⊙ x3)

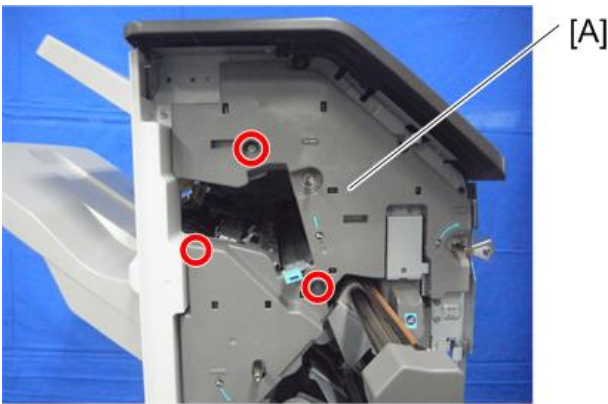

d687z0001

↓ Note

- Remove the connector at the back of the inner cover.



x1

d238m0770

8. Cut off part of the finisher inner cover [A].

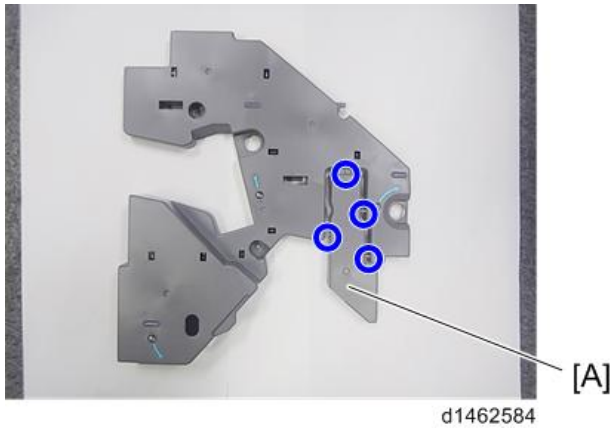

9. Remove the guide plate [A] (⚙️ ×4).

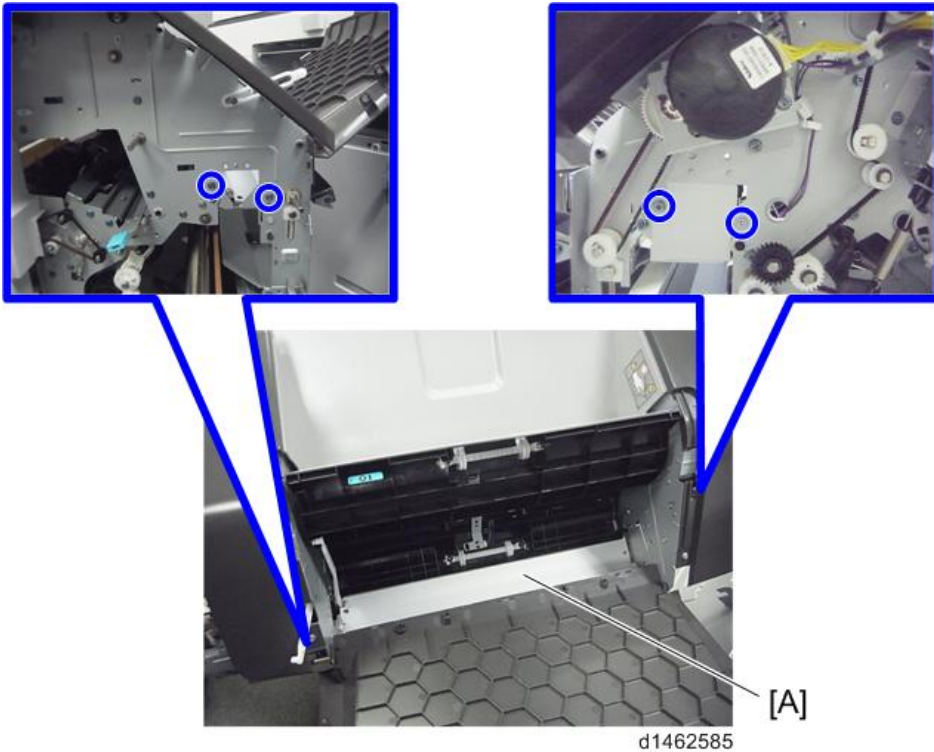

10. Insert and attach the hopper guide plate [A] from the front (⚙️ ×4).
At this time, pass the harness [B] through the clamp [C].

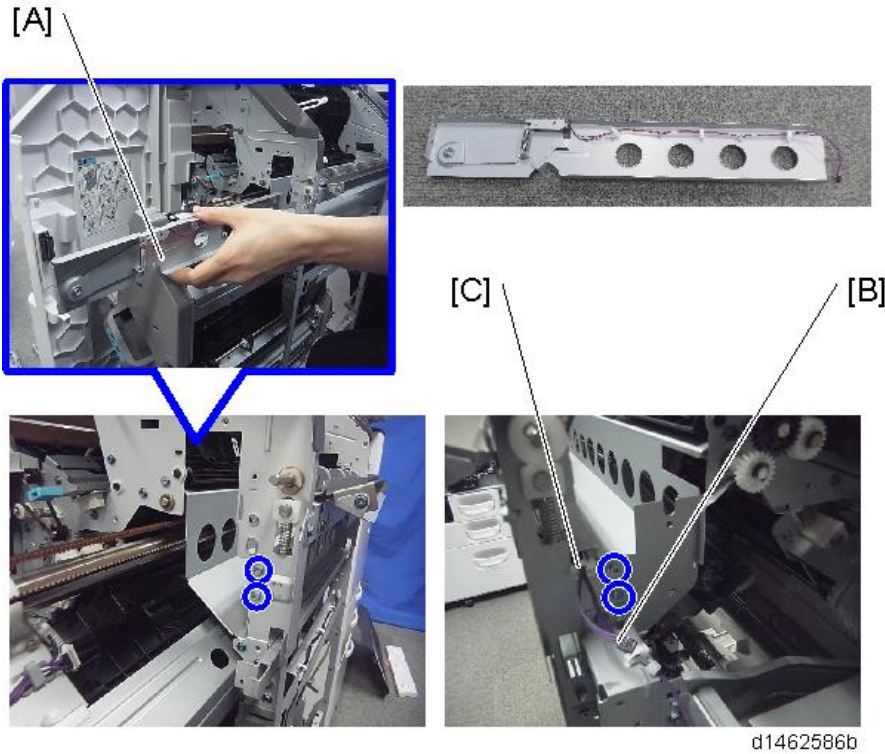

11. Attach the stay [A] (⌀×3).



Front [B]: Insert the holes in the stay over the embossed parts on the finisher.

Rear [C]: Place the axis of the stay through the notch in the finisher.

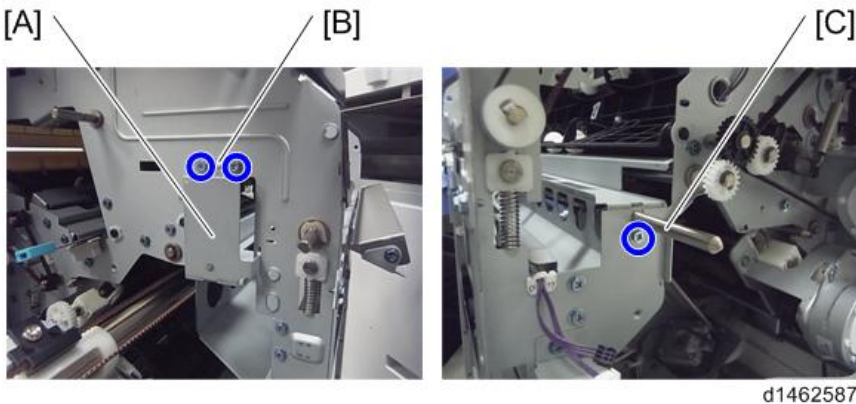

12. Insert and attach the guide plate [A] from the rear (🔩×2).

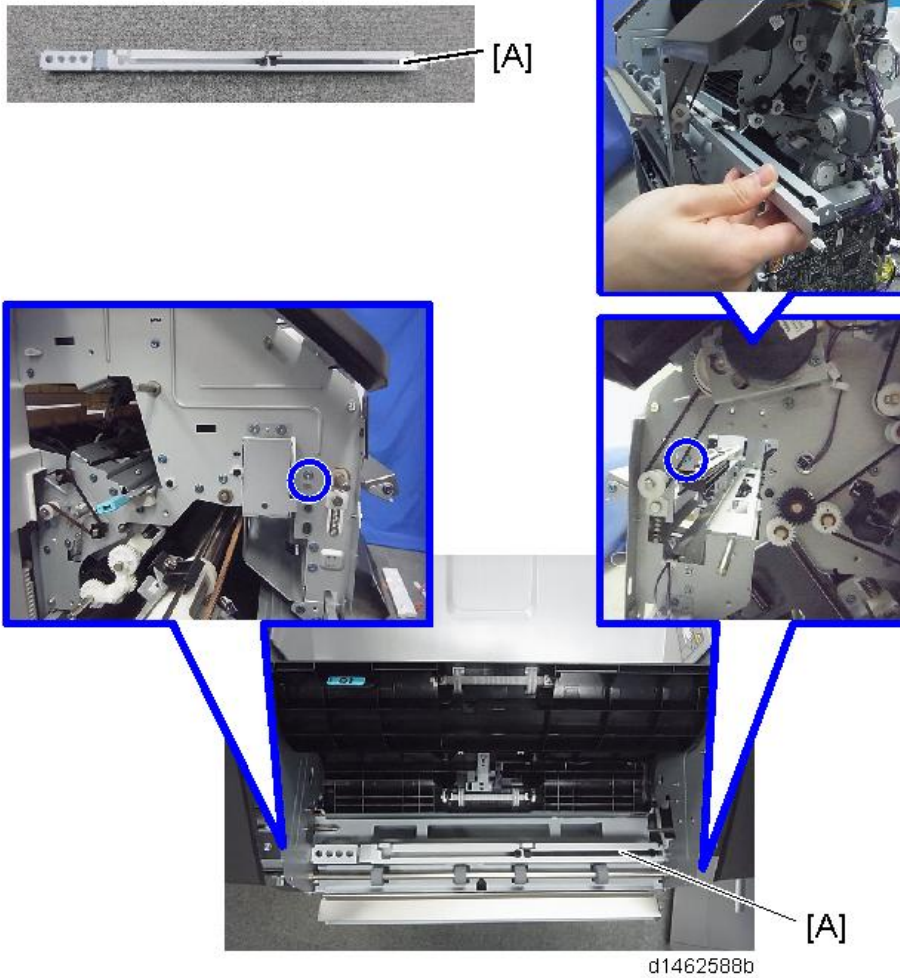

13. Insert and attach the side-to-side detection unit [A] from the rear (🔩×2).

Front: The two shafts of the unit are passed through bearings in the finisher.

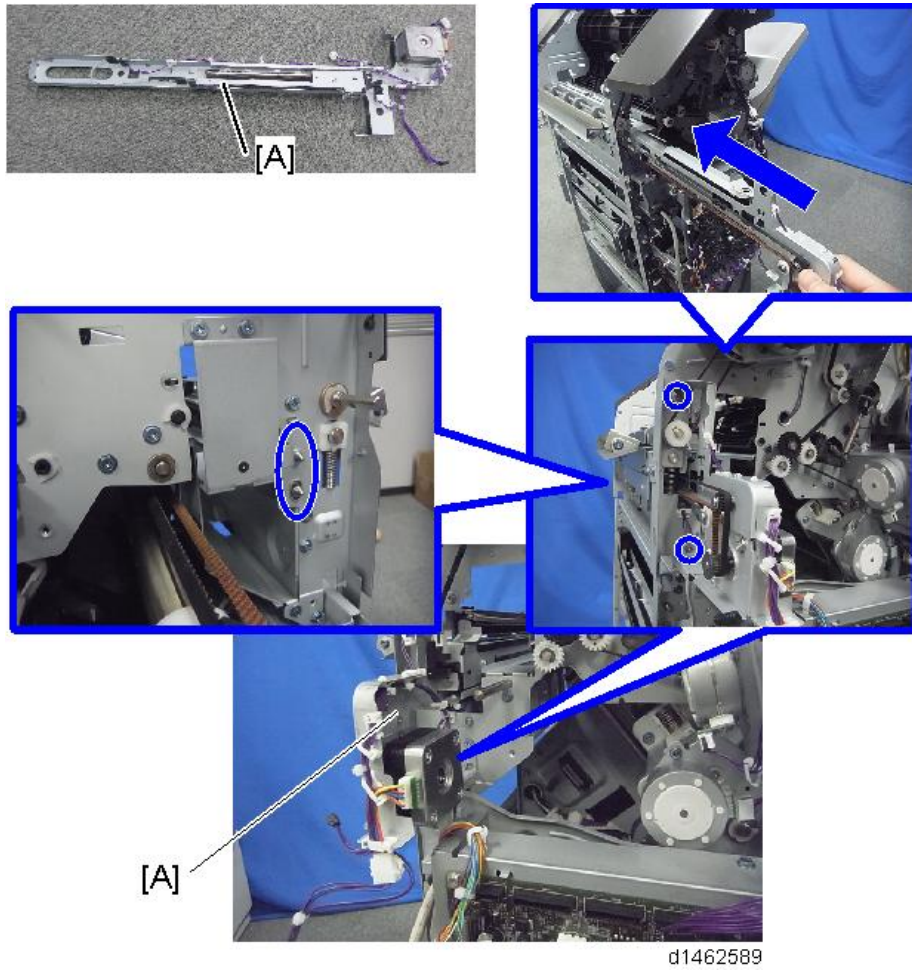

14. Connect the harness [A] of the hopper guide plate to the relay connector [B] of the side-to-side detection unit, and then clamp the harness.

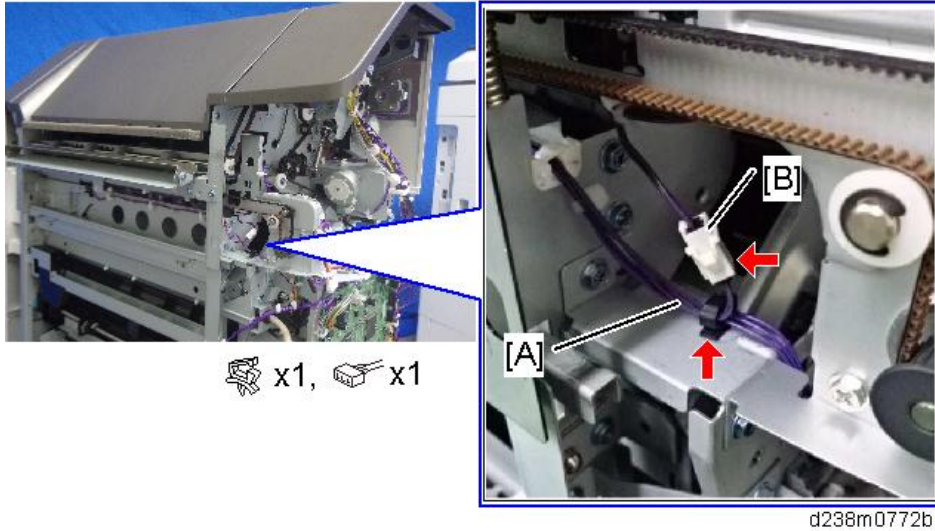

15. Insert and attach the punch unit [A] from the rear.

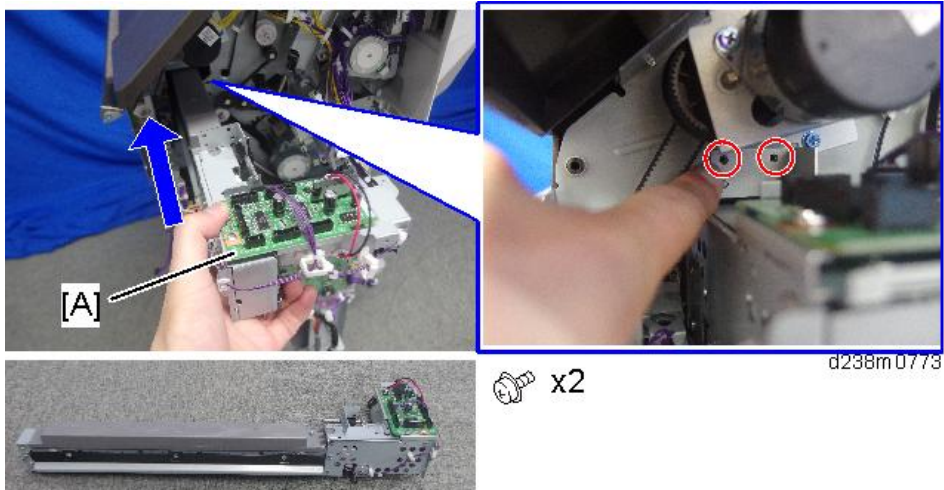

16. Attach the punch unit movement motor unit [A] so that the gear [B] meshes firmly (⚙️×2).

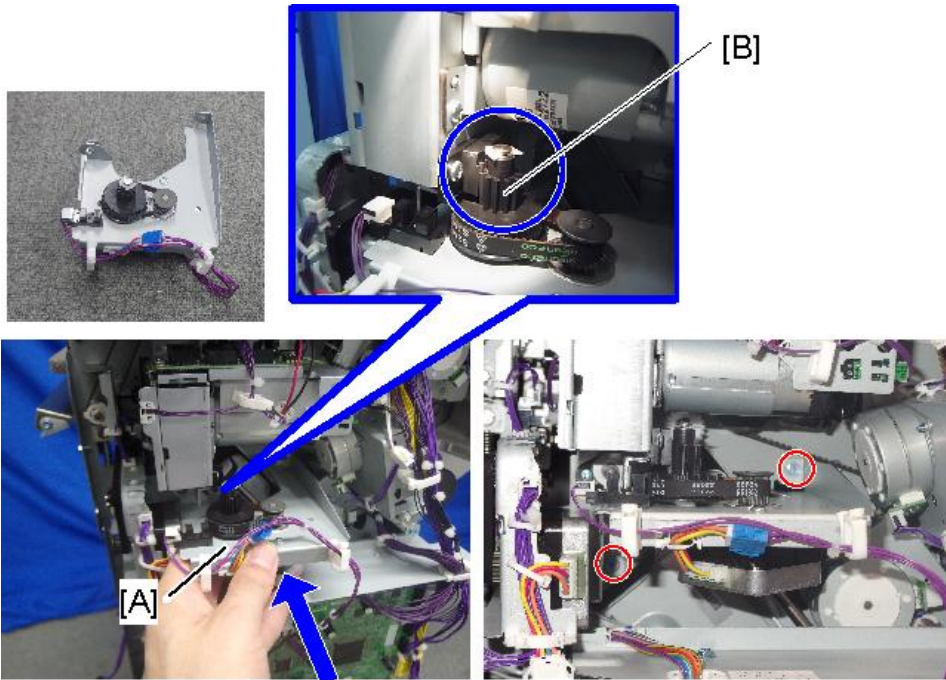

d1462593b

17. Insert the hopper [A].

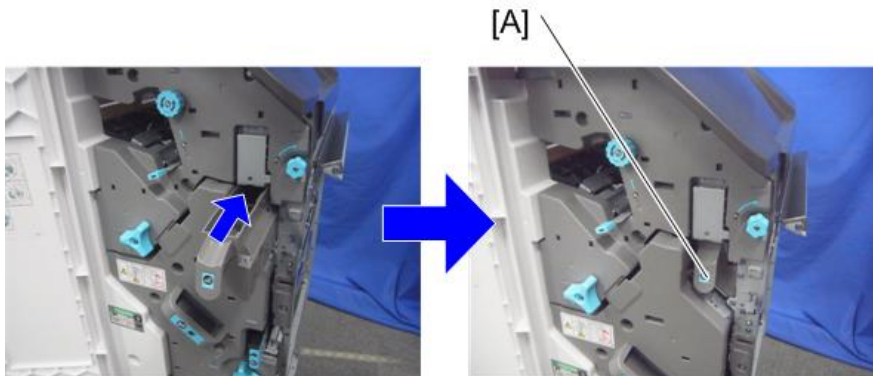

d1462594

18. Connect the provided harness to the punch unit board [A] and the control board [B] of the finisher ( x6).

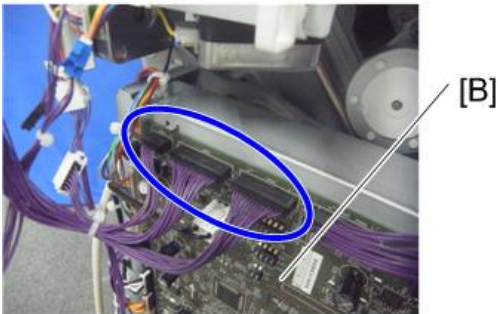

d1462595

19. Remove the harness [A] from the clamp [B], and connect it to the punch unit board [C] (📦 x1).

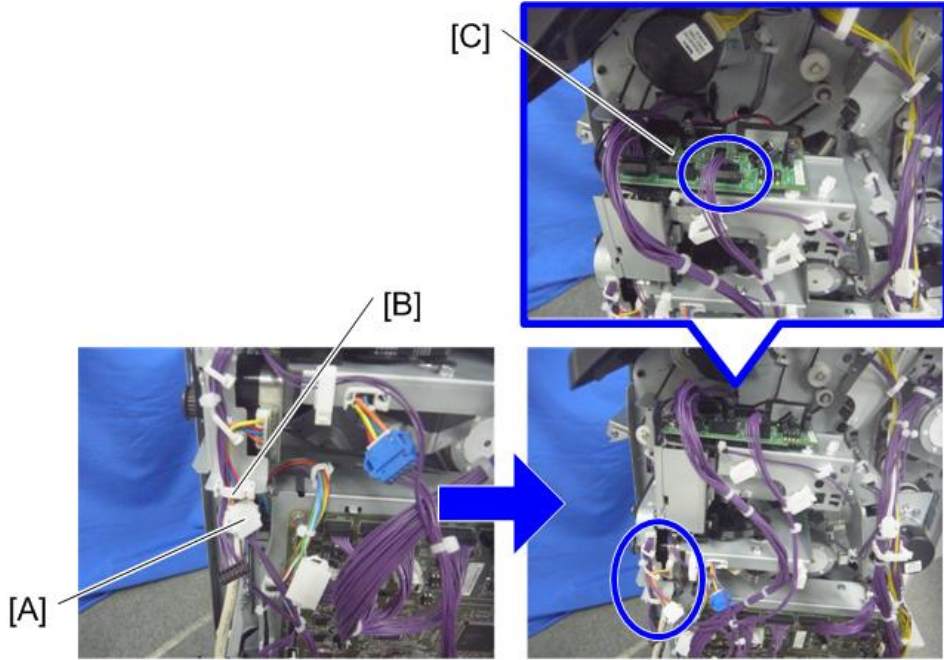

d1462596

20. Connect the harness [A] of the side-to-side detection unit to the relay connector [B] of the harness (📦 x1).

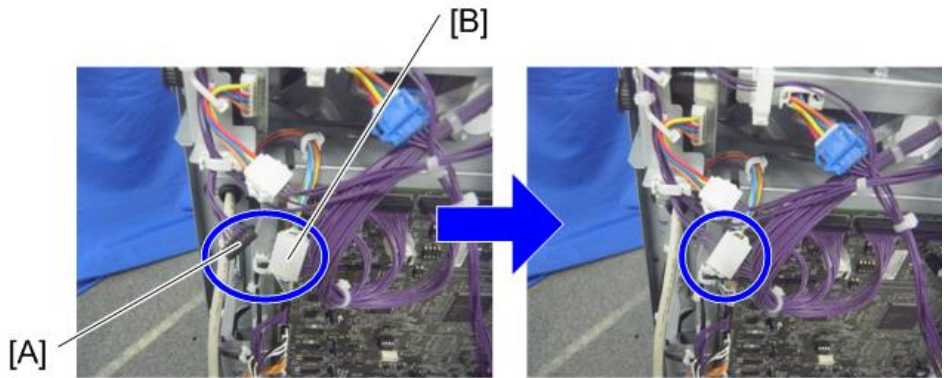

d1462597

21. Connect the harness [A] of the punch unit movement motor unit to the punch unit board [B] ( x1).

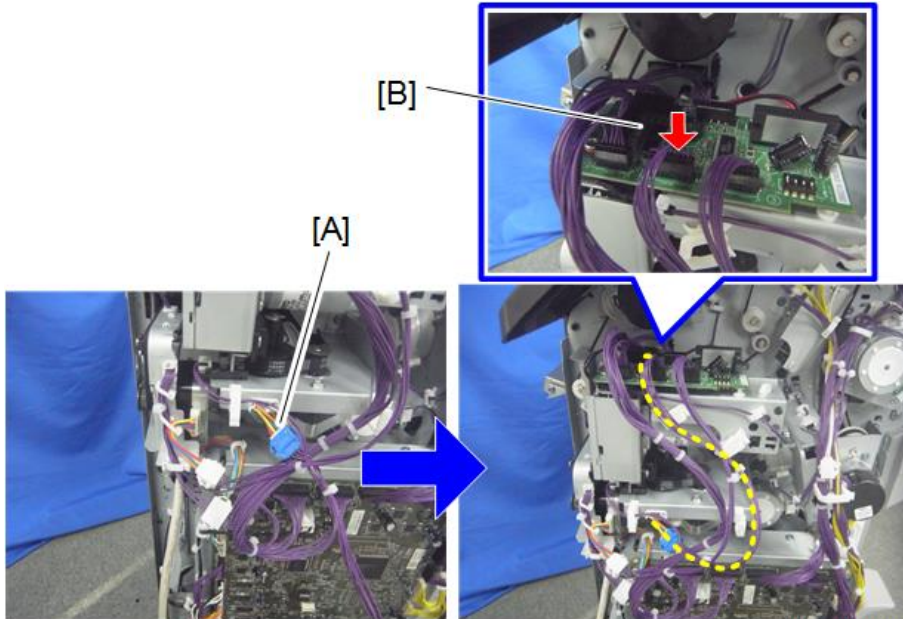

d1462598a

22. Attach the supplied cover [A] to the punch unit board.

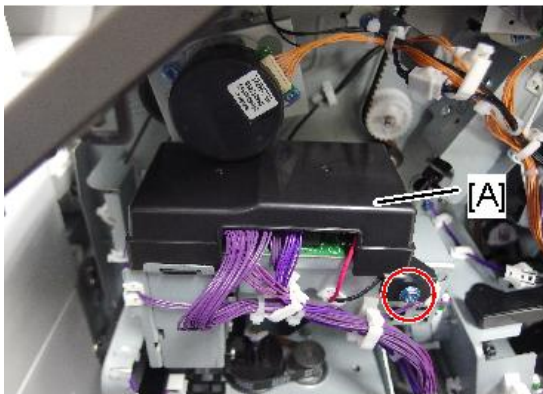
 x1

d238m0814

23. Clamp the harnesses.

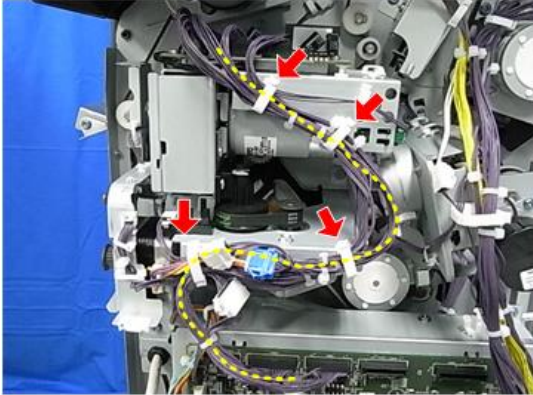

d146z0068a

24. Reattach the finisher rear cover.
25. Reattach the finisher inner cover and three knobs.
26. Close the front cover.
27. Close the top cover.
28. Reconnect the finisher to the machine, and connect the interface cable.
29. Turn ON the main power.
30. Check that the punch can be selected at the operation panel, and check the operation.

Internal Finisher SR3130 (D690)

Accessory Check

No.	Description	Q'ty	Remarks
1	Staple Cartridge	1	
2	Front Right Cover	1	
3	Bottom Plate	1	
4	Left Lower Cover	1	
5	Entrance Guide Plate	1	Not used when the punch unit is attached.
6	Stabilizer	2	
7	Paper Support Guide	1	
8	Driven Roller (Flat)	1	
-	Screw - M3 × 6	6	
-	Tapping Screw – M4 x 6	1	
-	Decal - EMC Address	1	
-	Notes on Installing the Optional Unit	1	

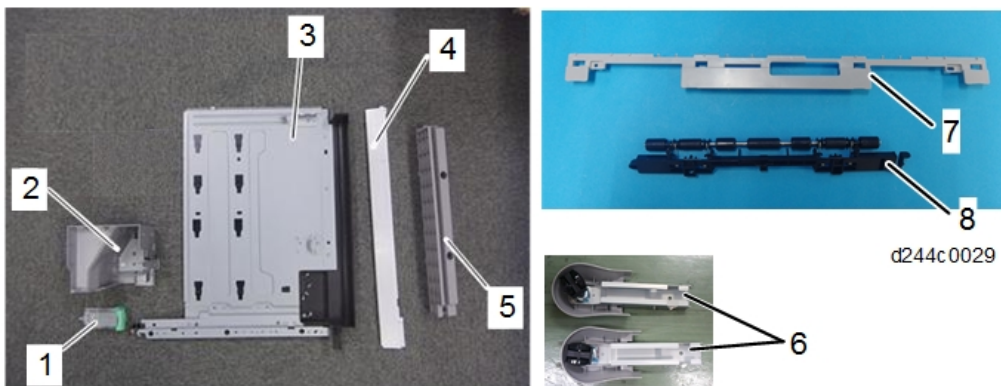

Installation Procedure

⚠ CAUTION

- When installing this option, turn OFF the main power and unplug the power cord from the wall socket. If installing without turning OFF the main power, an electric shock or a malfunction may occur.

↓ Note

- This option cannot be used together with the following peripherals:
 - Internal Shift Tray SH3070 (D691)
 - Side Tray Type M3 (D725)
 - Internal Finisher SR 3180 (D766)
 - Bridge Unit BU3070 (D685)
- To use together with the "1 Bin Tray BN3110 (D3CQ)", after attaching the bottom plate of this option, attach the "1 Bin Tray BN3110 (D3CQ)", and then install this option.
- To use together with the "Punch Unit PU3040 (D716)", first attach the "Punch Unit PU3040 (D716)" before installing this option.

1. Remove the orange tapes and shipping retainers.



d1462556

2. Remove the package accessories (fixing screws, etc.).

3. Remove the paper exit tray [A].



d1462023

4. Remove the paper exit feeler [A].

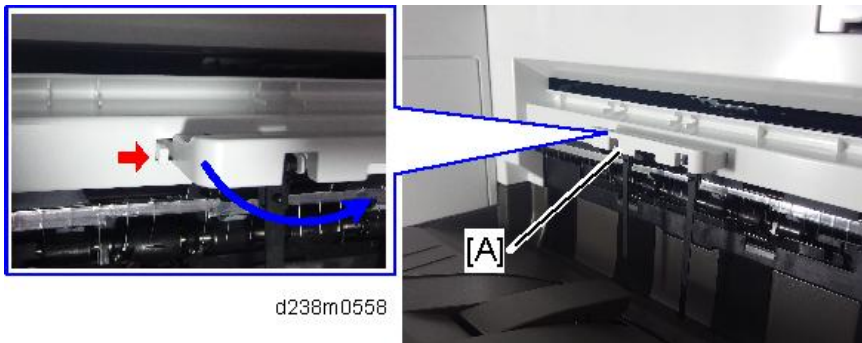

d238m0558

5. Open the front cover, and then remove the upper left cover [A] (⊙ × 1).



d1462008

6. Remove the left rear cover [A] (🔑×2).

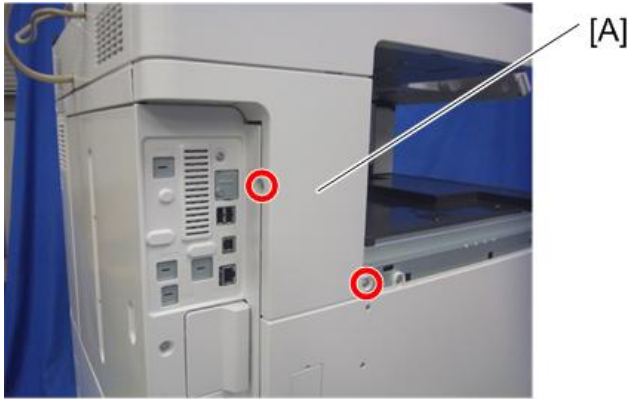

d1462010

7. Remove the inverter tray [A], and tray support plate [B] (🔑×1).

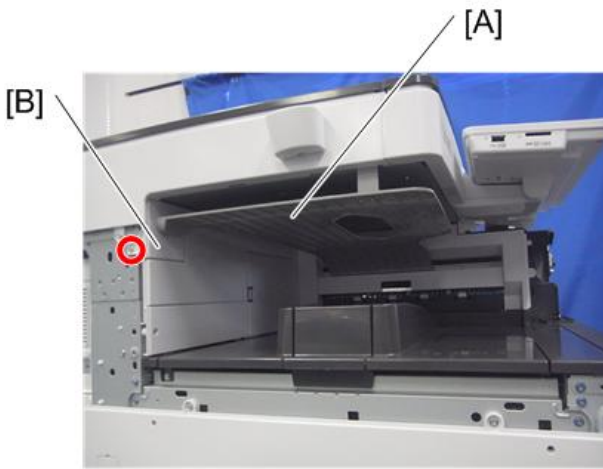

d1462478

8. Open the right door, and then remove the small cover [A].

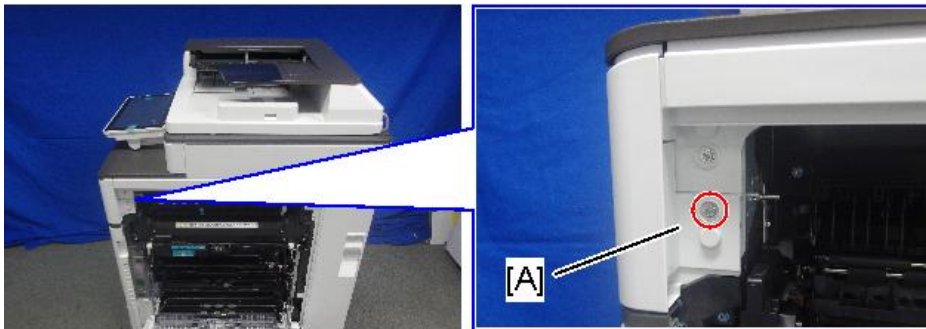



🔑 x1

d238m553

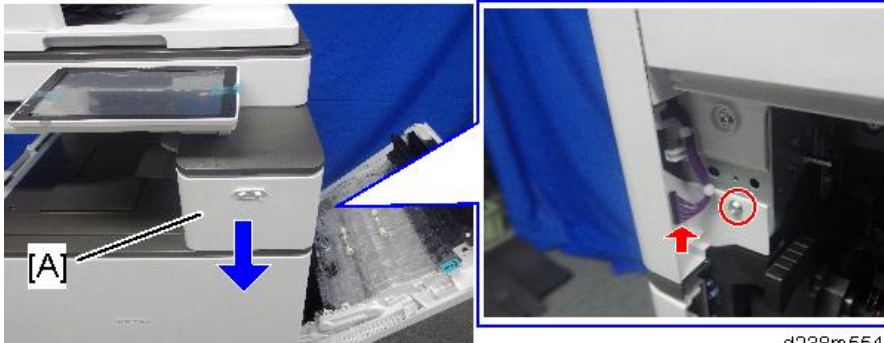
9. Remove the screw and connector, and then remove the front upper cover [A].



d238m554

 x1,  x1

Note

- Remember that there are three tabs at the positions in the red arrows.
- Tilt the operation panel [B] upward to a horizontal position, and then remove the front upper cover [A].

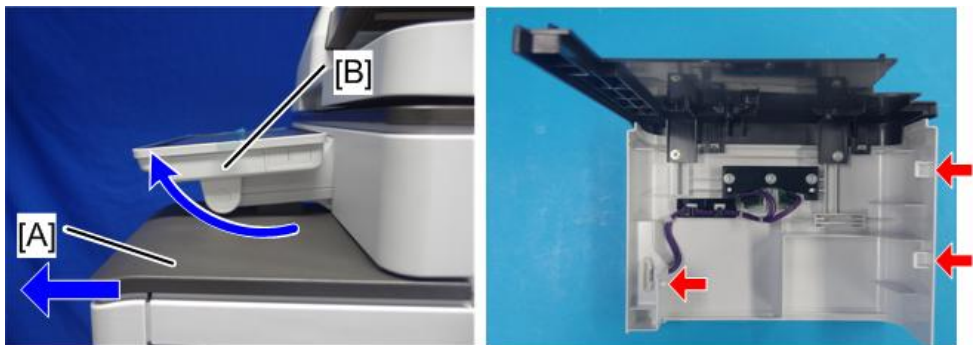

d238m555

10. Remove the paper exit cover [A] ( x1).

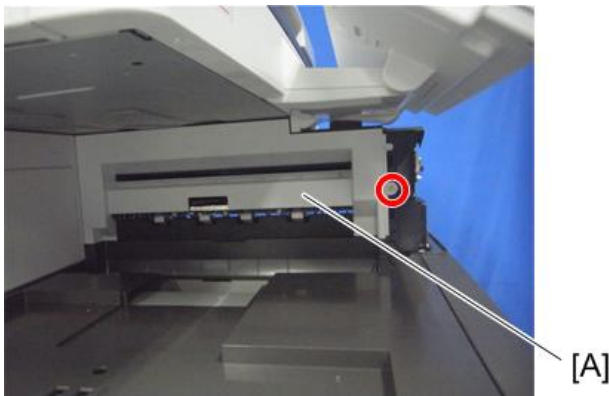

d1462024

11. Remove the connector cover [A].



12. Remove the paper exit lower cover [A].



13. Remove the upper rear inner cover [A] (⚙️ x2)



14. Install a screw removed in step 12.

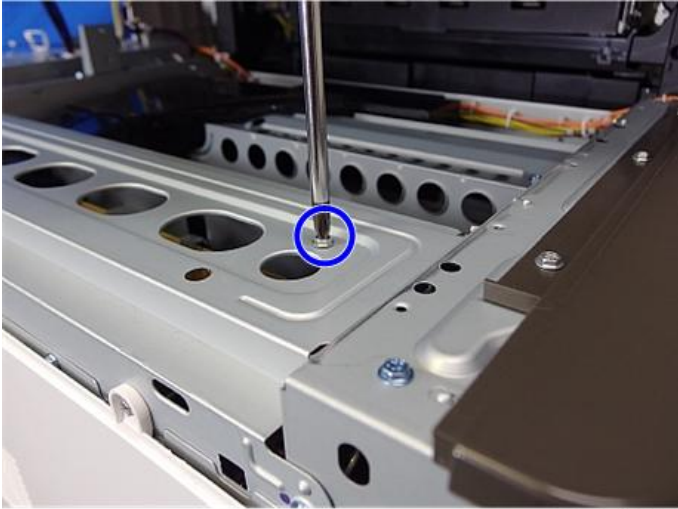

d197f0107

15. While pressing the bottom plate [A] into the area shown by the blue circle [B], insert it into the slot shown by the blue circles [C] [D].

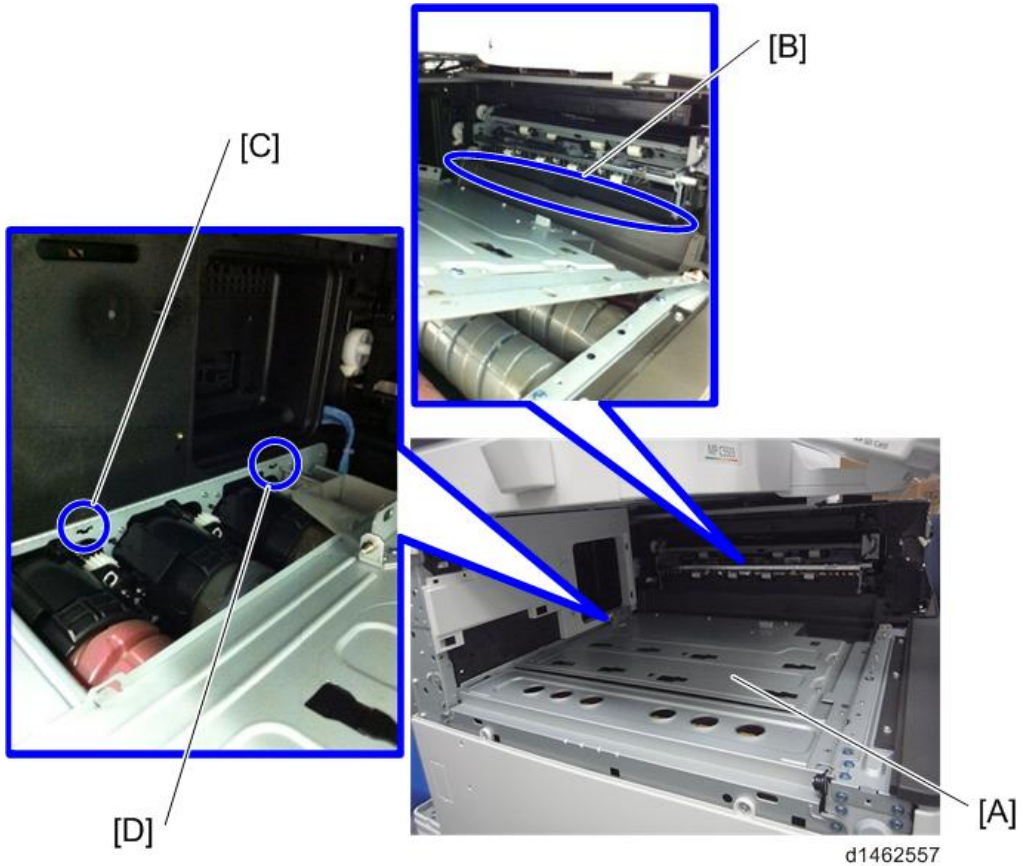

Note

- The following procedure is the easiest way to set this component.
 - 1) Slip the bottom plate [A] into the position in the blue circle [B].
 - 2) Insert the bottom plate [A] into the hole in the blue circle [C].
 - 3) When the bottom plate [A] is picked up (see below), it can be inserted into the hole in the blue circle [D].

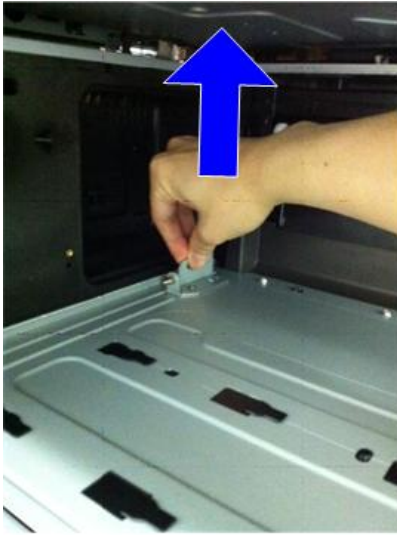

d1462566

16. Attach the bottom plate [A] (⚙️ ×3)

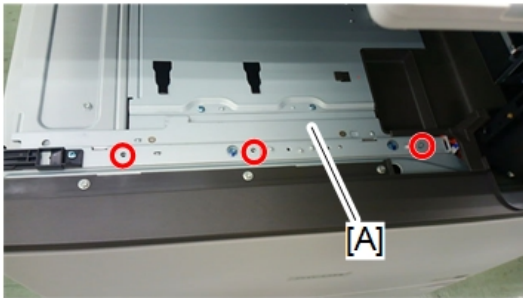

d244c0028

17. Attach the upper rear inner cover.

18. Attach the paper exit cover.

19. Reattach the connector cover, front upper cover, and then close the right door.

20. Remove the driven roller [B] at the machine's exit tray and attach the supplied driven roller [A].

- Insert a flathead screwdriver into the depression in the center, and then, lifting the driven roller, unlock the part indicated by the red arrow.
- When attaching the driven roller, push its center all the way in until it clicks.

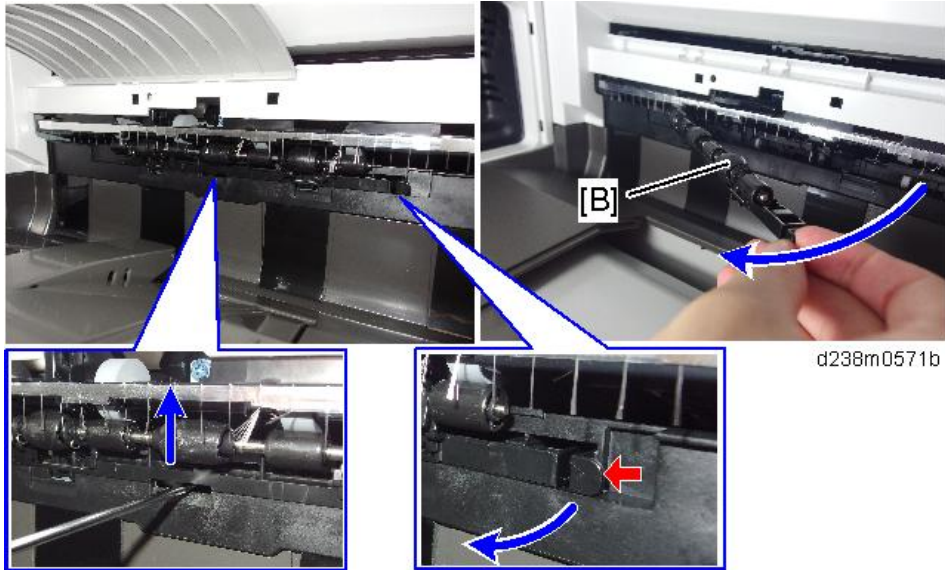

d238m0571b

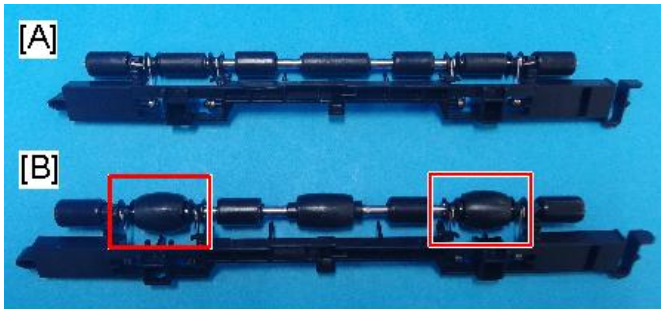

d238m0572

[A]: The supplied driven roller has flat rollers.

[B]: The machine's standard driven roller has drum-type rollers (as indicated by red frames).

21. Attach the paper support guide [A] (Tab x4).

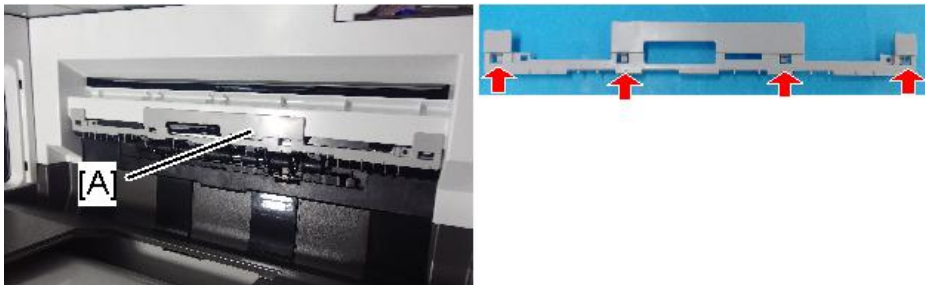

d238m0573b

Note

- Up to this point, the procedure is the same as punch unit installation (for fitting the punch unit, refer to Step 3 and later of the Punch unit installation procedure).

22. Slide the finisher front right cover [A] from left to right to attach it (🔩×1).



d1462558

23. Reattach the inverter tray.

24. Attach the entrance guide plate [B] to the finisher [A] (🔩×2).

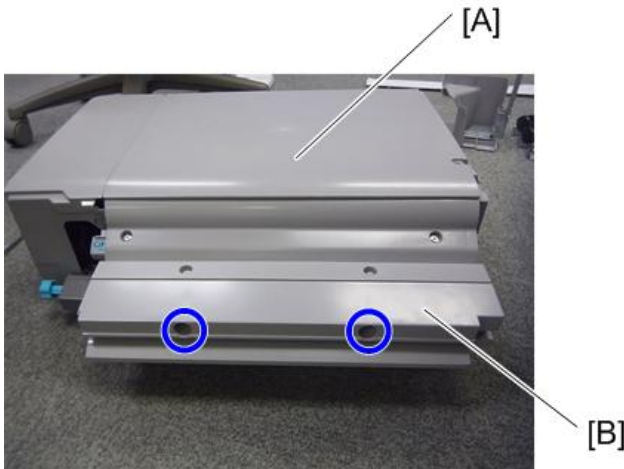

d1462559

25. Slide the finisher [A] along the rail of the bottom plate from the left-hand side of the machine to attach it (⊗×1).



Note

- Hold the front side [A] of the internal finisher as shown below to check if the internal finisher is correctly set in the rail of the bottom plate.



26. Reattach the left rear cover.

27. Insert the upper left cover [A] from the front, and slide it to reattach it.

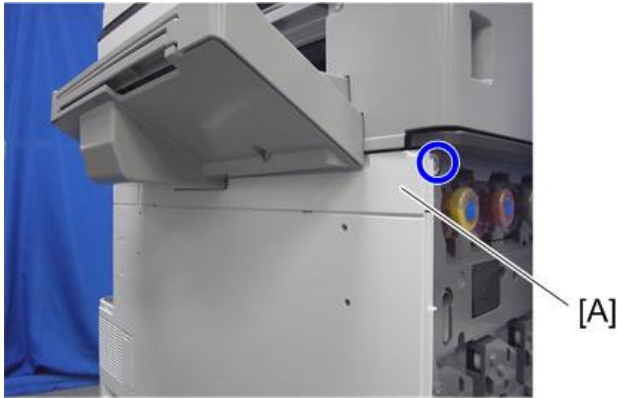

d1462561

28. Attach the stabilizers.

Note

- Because the weight is biased to the right of the machine if the internal finisher is installed, stabilizers are required on the left side. Because they are included with the finisher, install these stabilizers at the same time as you install the internal finisher.



d1462945a

29. Remove the connector cover, then connect the interface cable to the machine.



D1462563

30. Move the stapler unit forward, then set the staple cartridge [A].



d1462564

31. Reinstall the stapler unit, and then turn ON the main power.
32. Check that the finisher can be selected at the operation panel, and check the finisher operation. Also when the punch unit is installed, check the punching operation.

Punch Unit PU3040 (D716)

Note

- Punching unit for the Internal Finisher SR3130 (D690).

Accessory Check

2

No.	Description	Q'ty	Remarks
1	Hopper	1	
2	Punch Unit Cover	1	
3	Lower Front Cover	1	
4	Lower Rear Cover	1	
5	Holder	1	
-	Knob Screw - M4	1	
-	Tapping screws - M3x 6	3	
-	Decal - EMC Address	1	

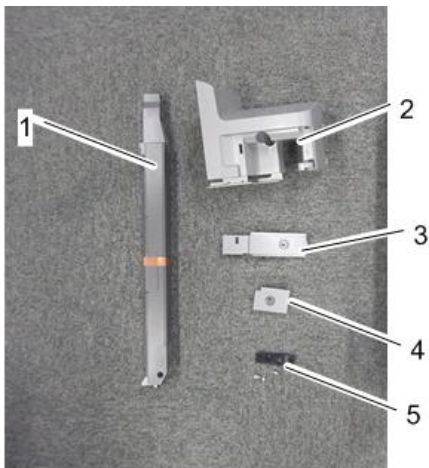

d1462570

Installation Procedure

⚠ CAUTION

- When installing this option, turn OFF the main power and unplug the power cord from the wall socket. If installing without turning OFF the main power, an electric shock or a malfunction may occur.

↓ Note

- When supplied together with the "Internal Finisher SR3130", attach this option before installing the "Internal Finisher SR3130"
- If the "Internal Finisher SR3130" is already attached, attach this option after removing the finisher.

1. Take out from the box, and remove the filament tape and packing material.
2. Remove the finisher and finisher front right cover from the machine.
3. Perform steps 1 to 21 of the installation procedure for the "Internal finisher SR3130".page 219 "Internal Finisher SR3130 (D690)"
4. Change the fixing position of the bracket [A] of the bottom plate (🔩×1).

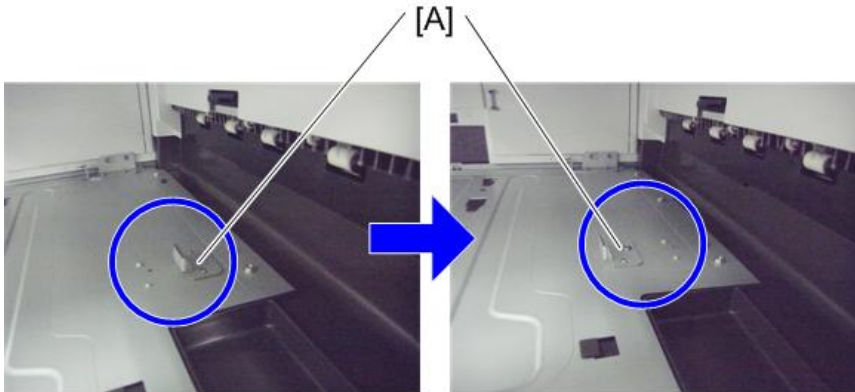

d1462571

5. Replace the lock holder of the bottom plate with the lock holder [A] (🔩×1) provided with the accessories.



d1462572

6. Reattach the front upper cover.
7. Pass the shafts [B] of the punch unit [A] through the bearings [C] of the bottom plate, and attach to the machine (🔩×1, knob screw).

If it is difficult to insert by probing, look from the side while you insert it into the bearings of the bottom plate.

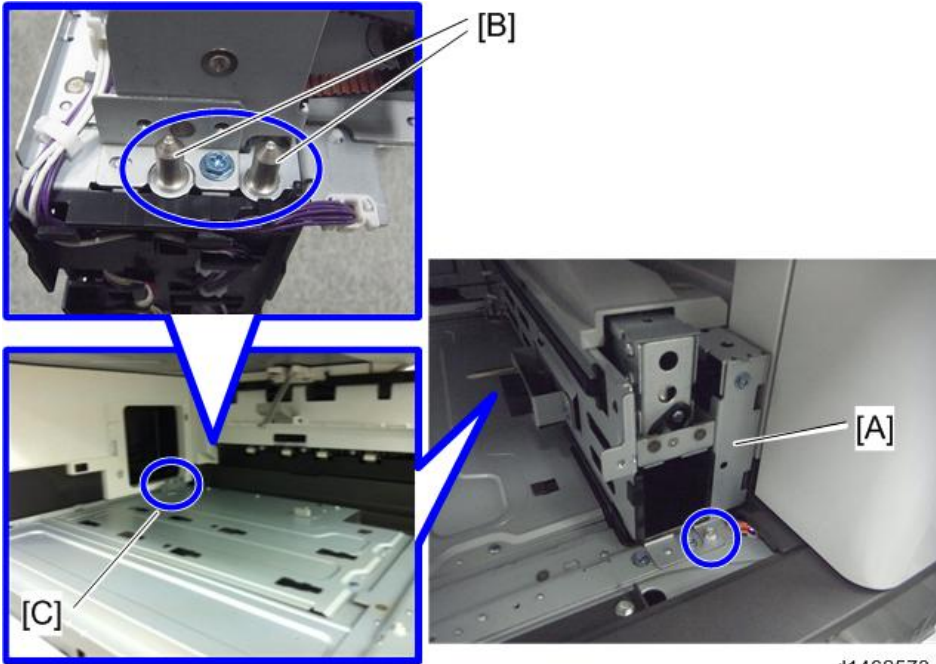

d1462573



d1462579

8. When installing the punch unit in a finisher that is already installed, remove the relay guide plate [A] (Ⓢ×2).

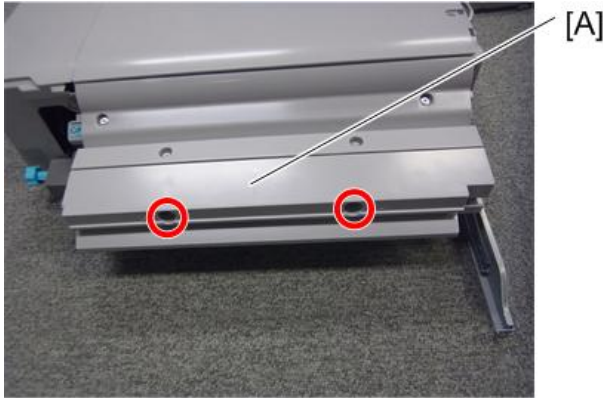

d1462574

↓ Note

- This step is unnecessary when installing the finisher and punch unit at the same time.

9. Attach the punch unit cover [A] provided with the accessories, inserting the tabs (Ⓢ×1).

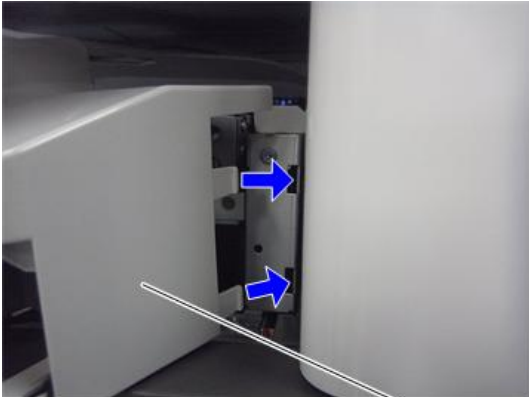

d1462575

10. Insert the hopper [A].

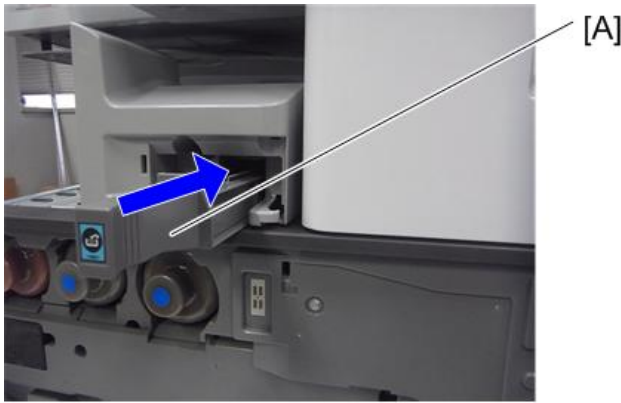

d1462576

11. Slide the finisher [A] along the rail of the bottom plate from the left-hand side of the machine to attach it (⚙️ ×1).



d1462560

12. Attach the components [A] and [B] to the finisher (⚙️ ×2).

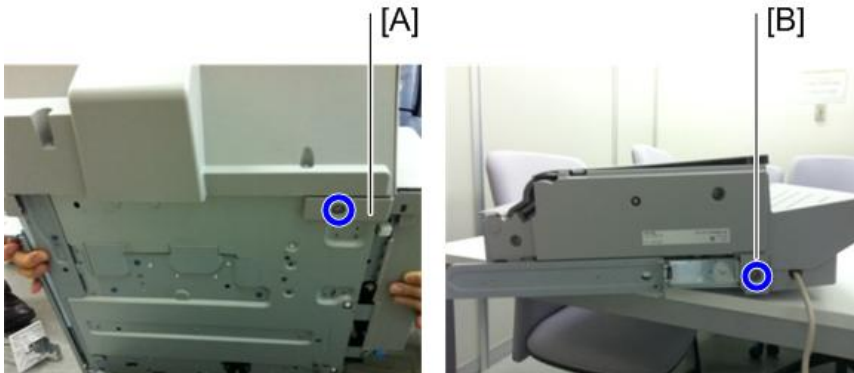

d1462577

13. Attach the left rear cover.

14. Insert the upper left cover [A] from the front, and slide it to attach it.

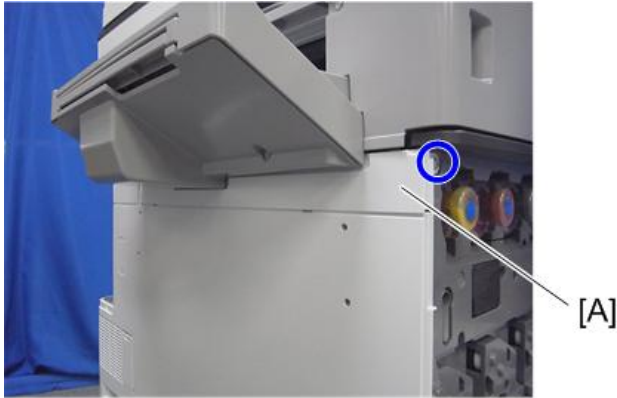

d1462561

15. Attach stabilizers.

Note

- Because the weight is biased to the right of the machine if the internal finisher is installed, stabilizers are required on the left side. Because they are included with the finisher, install these stabilizers at the same time as you install the internal finisher.



d1462945a

16. Remove the connector cover, then connect the interface cable to the machine.



D1462563

17. Move the stapler unit forward, then set the stapler [A].



d1462564

18. Turn ON the main power.
19. Check that the finisher can be selected at the operation panel, and check the finisher and punch operation.

Internal Finisher SR3180 (D766)

Accessory Check

No.	Description	Q'ty	Remarks
1	Bottom Plate	1	
2	Left Lower Cover	1	
3	Paper Exit Tray	1	
4	TAPPING SCREW:3x8	2	
5	TAPPING SCREW:3x8	2	
6	TAPPING SCREW:3x8	2	
7	SCREW:M3x6	3	
8	TAPPING SCREW:3x6	1	
9	TAPPING SCREW:4x8	1	
10	Slide Rail	1	
11	Nylon Clamp	1	
12	Paper Support Guide	1	
13	Driven Roller (Flat)	1	



Installation Procedure

⚠ CAUTION

- When installing this option, turn OFF the main power and unplug the power cord from the wall socket. If installing without turning OFF the main power, an electric shock or a malfunction may occur.

↓ Note

- This option cannot be used together with the following peripherals:
 - Internal Shift Tray SH3070 (D691)
 - Side Tray Type M3 (D725)
 - Internal Finisher SR 3130 (D690)
 - Bridge Unit BU3070 (D685)
- For using this option together with "1 Bin Tray BN3110 (D3CQ)", attach the bottom plate of this option at the beginning, then install the "1 Bin Tray BN3110 (D3CQ)", followed by installing this option.

1. Remove the orange tapes and shipping retainers.



d766z0002

2. Remove the knob screw and red tag [A].

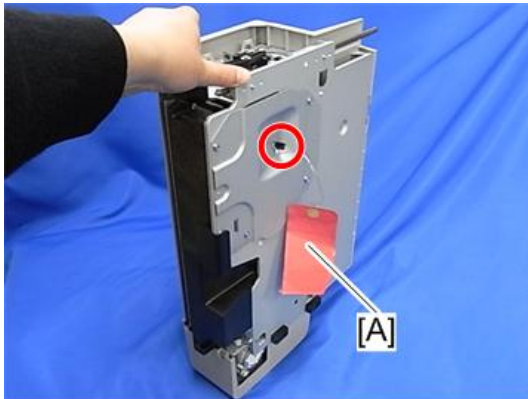

d7662074

3. Remove the shaft [B] from the slide rail [A] (⌚ x 1).

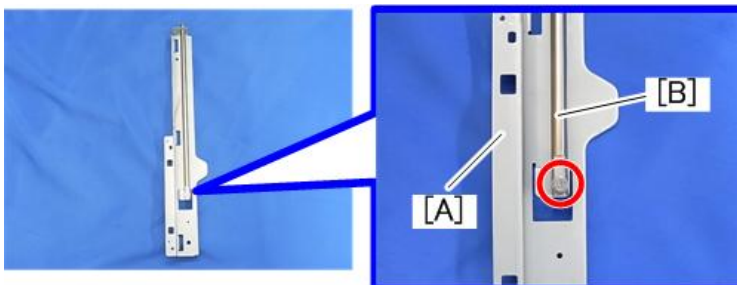

d766z0003

4. Remove the paper exit cover [A] (🔩 x 2).



d766z0004

5. Place the slide rail [A] under the internal finisher [B].

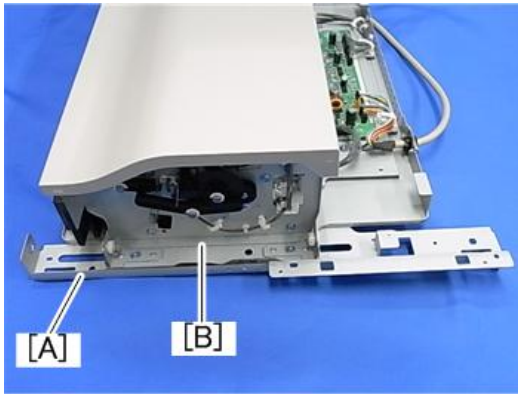

d766z0005

6. Insert the shaft [A] into the holes located in the slide rail and internal finisher, and then fasten with the screw (🔩 x 1).

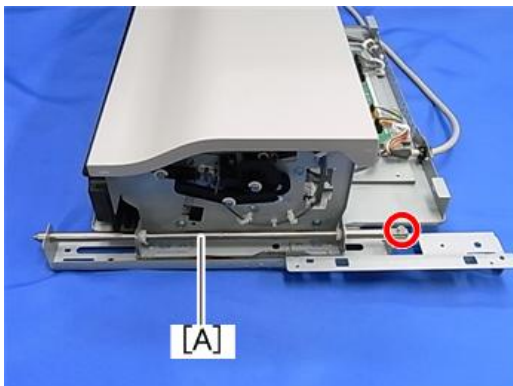

d766z0006

7. Attach the paper exit cover (removed in step 4) [A] (🔩 x 2).

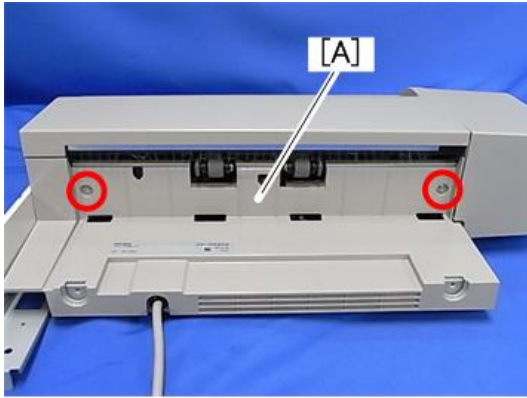

d177z4578

8. Remove the paper exit tray [A].



d1462023

9. Remove the paper exit feeler [A].

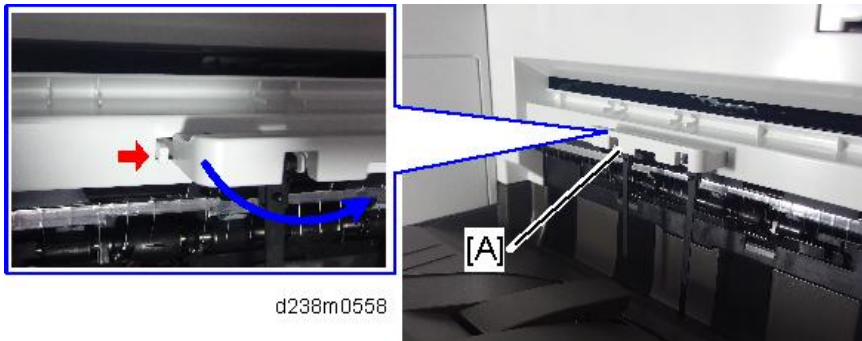

d238m0558

10. Open the front cover, and then remove the left upper cover [A] (⊙ x 1).

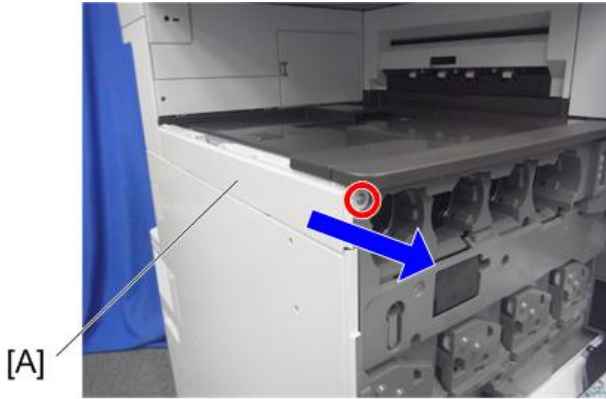

d1462008

11. Remove the left rear cover [A] (⊙ x 2).

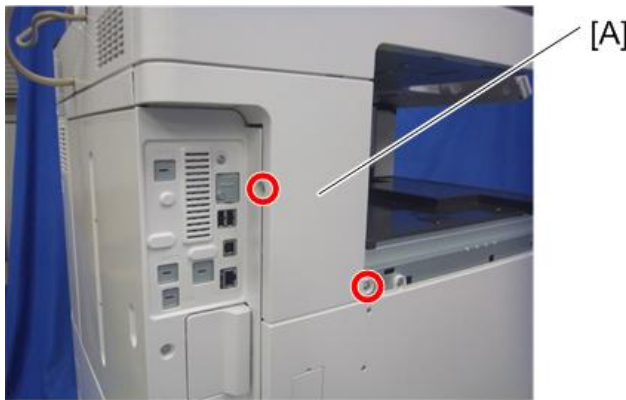

d1462010

12. Remove the inverter tray [A] and tray support plate [B].

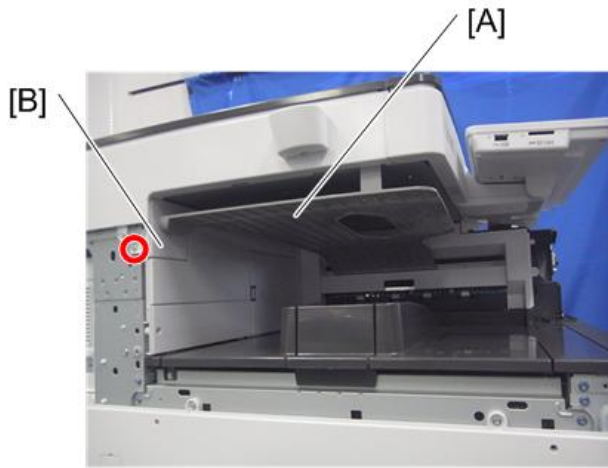

d1462478

13. Open the right door, and then remove the small cover [A].

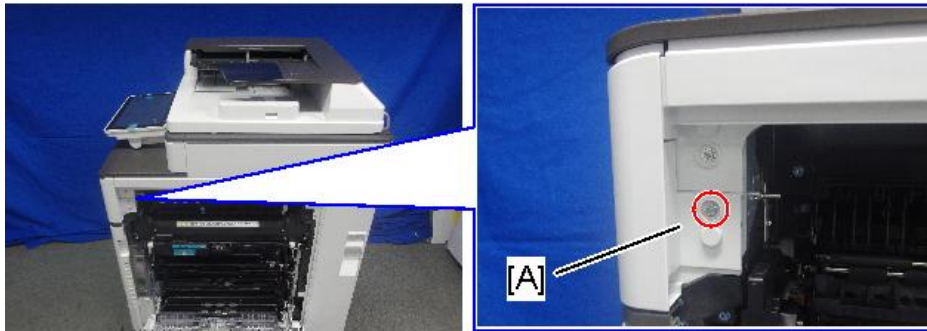



d238m553

 x1

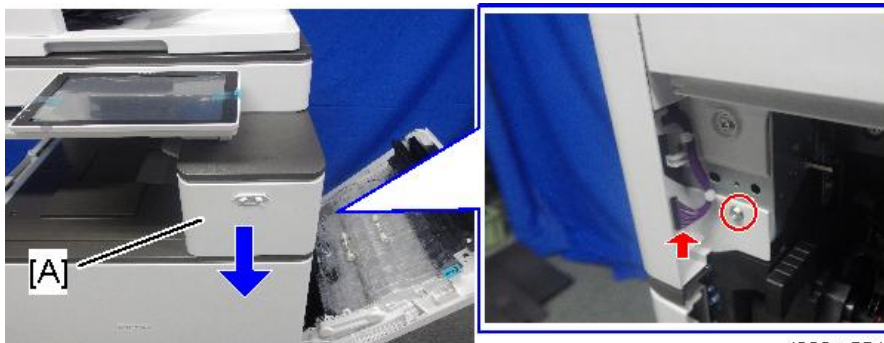
14. Remove the screw and connector, and then remove the front upper cover [A].



d238m554

 x1,  x1

Note

- Remember that there are three tabs at the positions of the red arrows.
- Tilt the operation panel [B] upward to a horizontal position, and then remove the front upper cover [A].

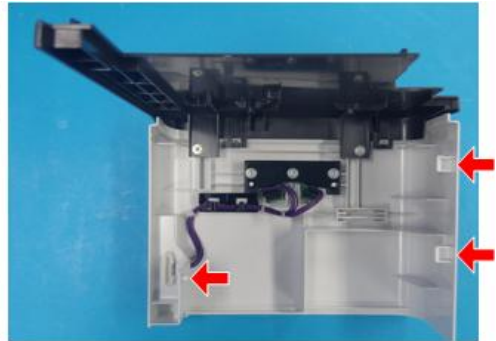
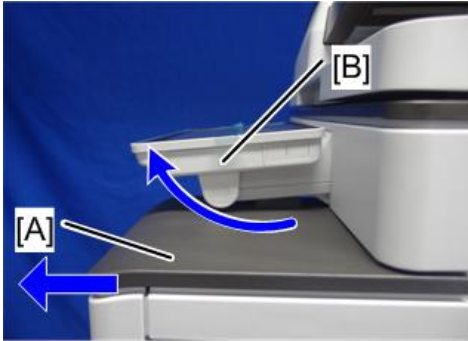

d238m555

15. Remove the paper exit cover [A] (👉 x 1).

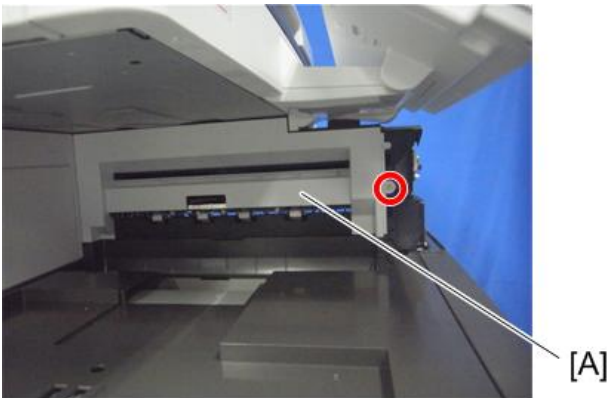

d1462024

16. Remove the connector cover [A].**17. Remove the paper exit lower cover [A].****Note**

- The lower inside cover can be removed together with the paper exit lower cover, since the inside cover is secured on the paper exit lower cover with two screws.



18. Remove the lower inside cover [B] from the paper exit lower cover [A] (⊙ x 2).

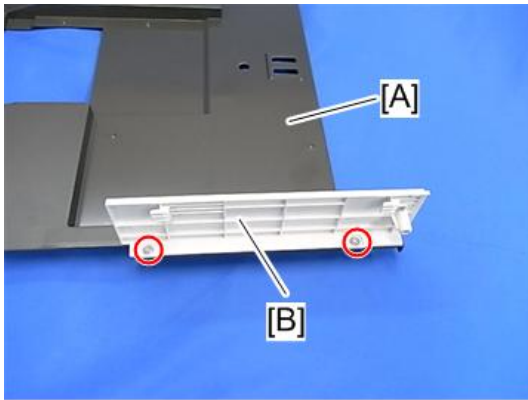

d7662050

19. Remove the upper inside cover [A] (⊙ x 2).

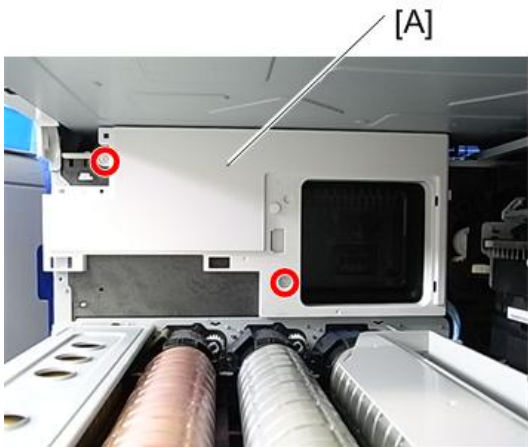

d7662068

20. Insert the bottom plate [A] into the holes.

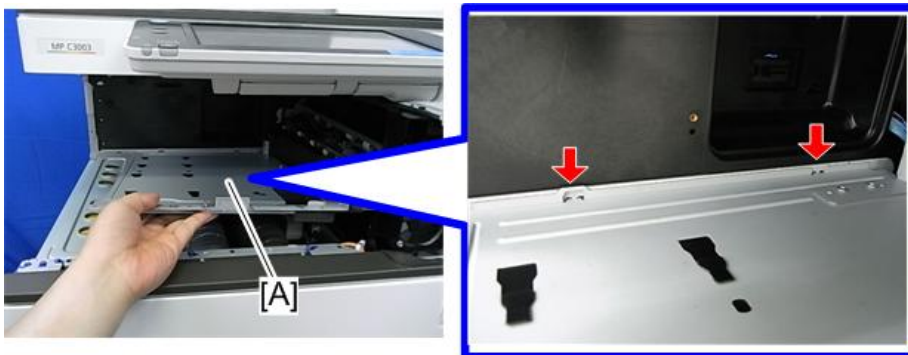

d7662052

21. Install the bottom plate [A] (🔩 x 3, Accessory No. 7).

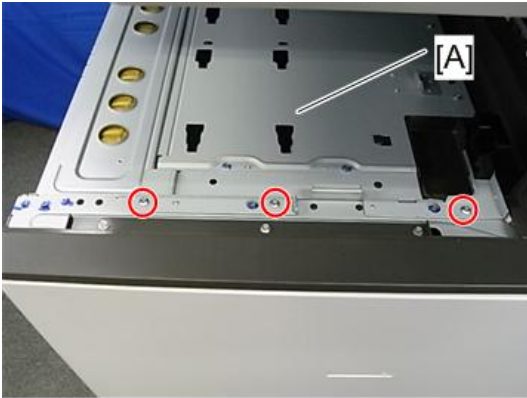

d7662053

22. Install the lower inside cover (removed in step 18) [A] in the finisher (🔩 x 2, Accessory No.5).

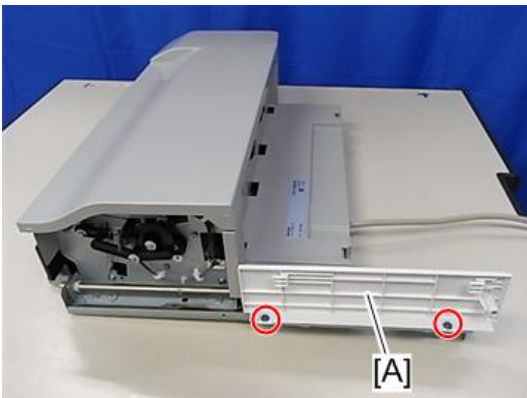

d7662051

23. Reattach the upper inside cover (removed in step 19) [A] (🔩 x 2).

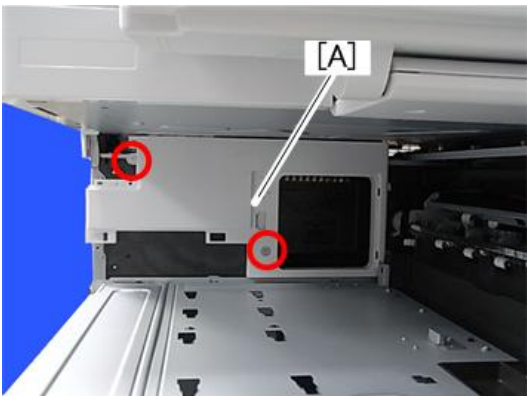

d177z4579

24. Reattach the tray support plate (removed in step 12) [A].

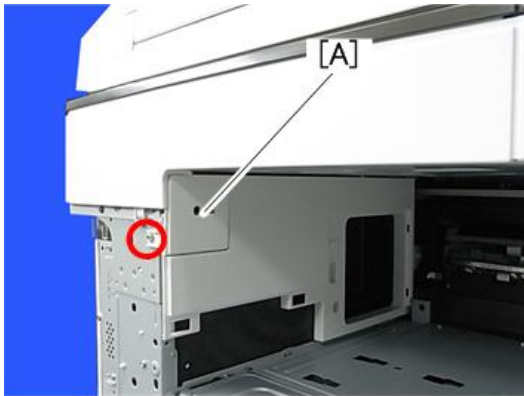

d177z4580

25. Reattach the paper exit cover (removed in step 15 and step 16) [A] and the connector cover [B].

Touching the moving parts inside of the cover can result in an injury. To avoid this, be sure to install the connector cover [B].

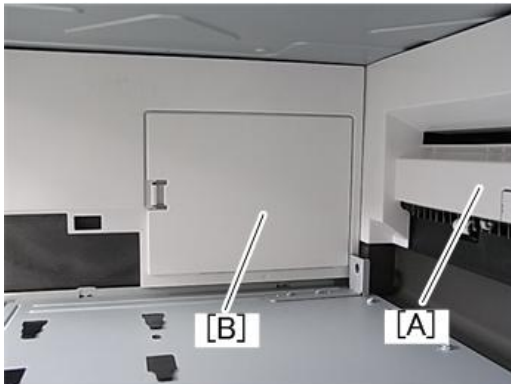

d766z0007

26. Reattach the front upper cover (removed in step 14) and then close the right door.

27. Remove the driven roller [B] at the machine's exit tray and attach the supplied driven roller [A].

- Insert a flathead screwdriver into the depression in the center, and then, lifting the driven roller, unlock the part indicated by the red arrow.
- When attaching the driven roller, push its center all the way in until it clicks.

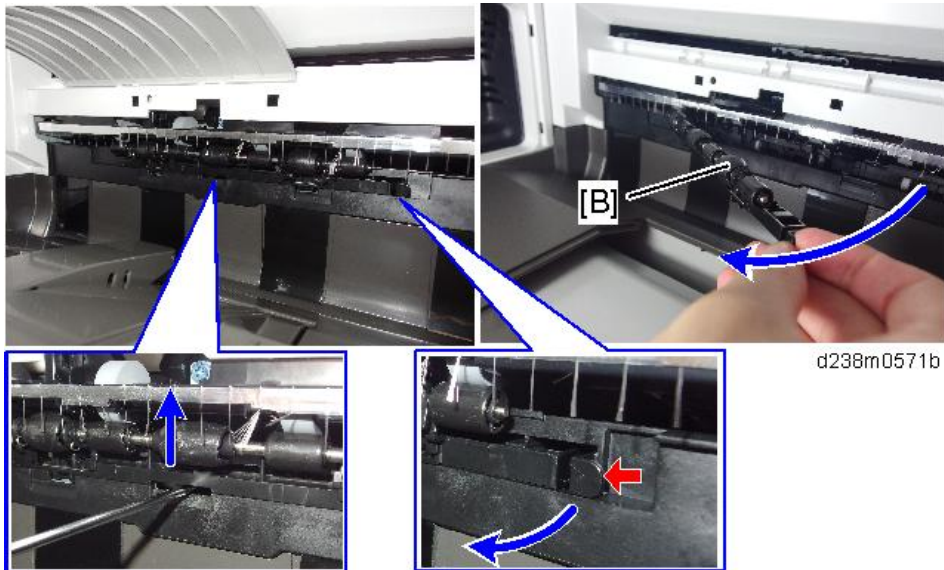

d238m0571b

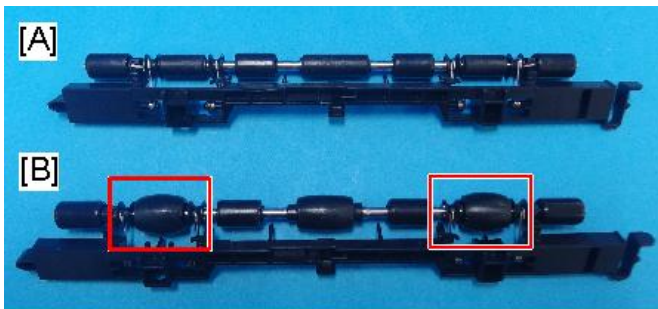

d238m0572

[A]: The supplied driven roller has flat rollers.

[B]: The machine's standard driven roller has drum-type rollers (as indicated by red frames).

28. Attach the paper support guide [A] (Tab x 4).

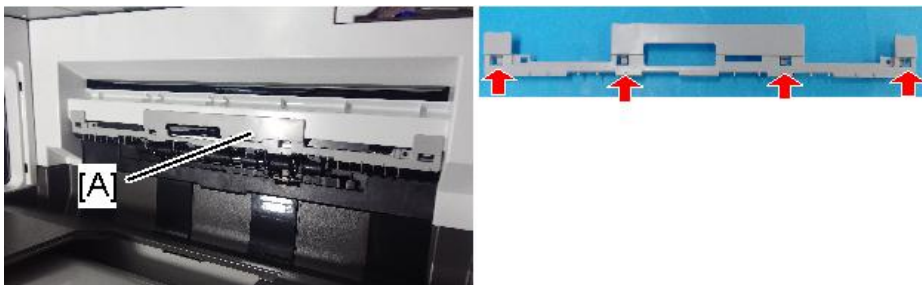

d238m0573b

29. Install the internal finisher [A].

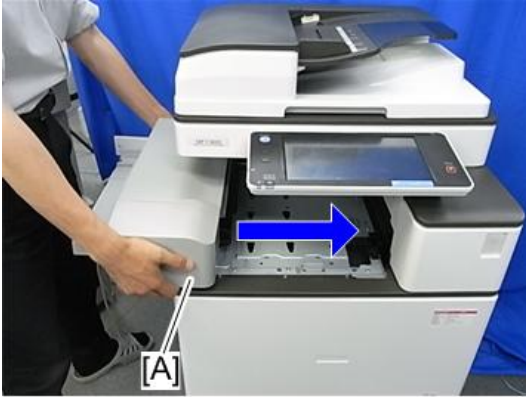

d238m1331

30. Secure the finisher (🔩 x 1, Accessory No.8).



d7662056

31. Reattach the left rear cover [A]



🔩 x2

d238m1006

32. Reattach the left upper cover [A].



33. Attach the left lower cover [A] (☞ x 2, Accessory No.6).



34. Attach the paper exit tray [A] (Ⓢ x 2, Accessory No.4).

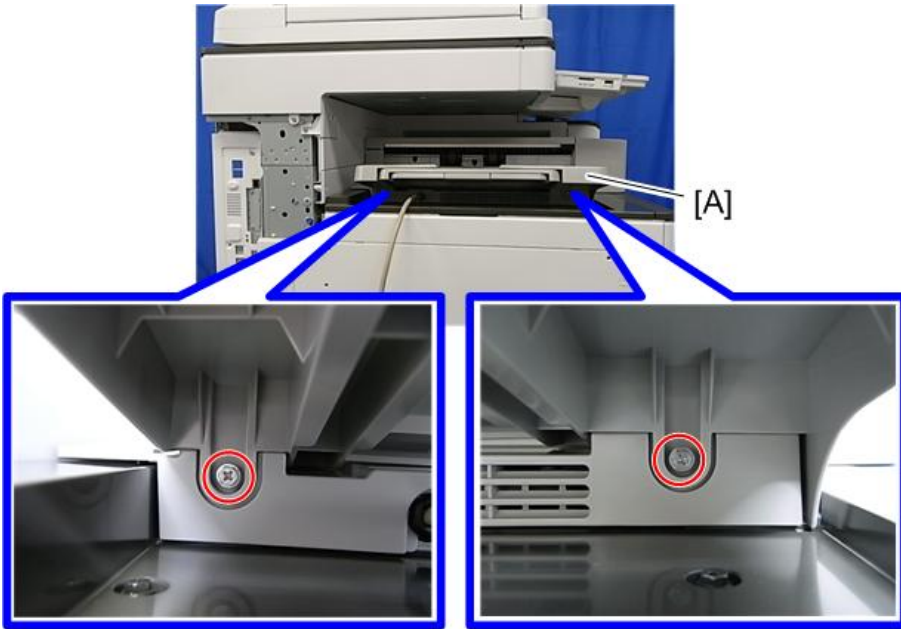

d766z2059

35. Reattach the inverter tray [A] removed in step 12.

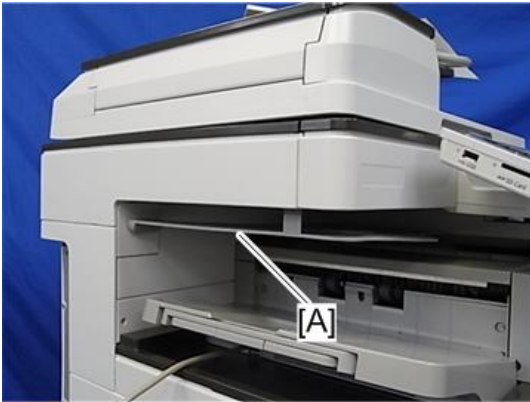

d7662075

36. Remove the connector cover [A] (Release the tab).



d766z0009

37. Connect the interface cable [A].

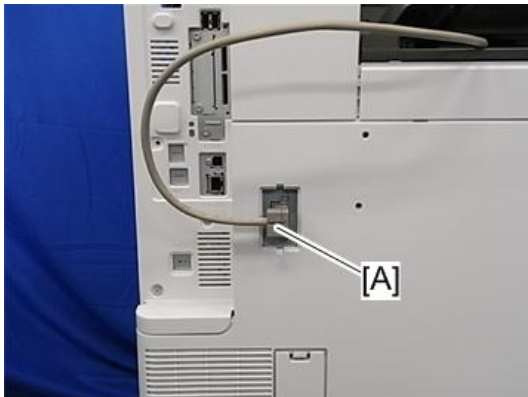

d7662061

38. Attach the nylon clamp [A] as shown below (🔩 x 1, Accessory No.9).

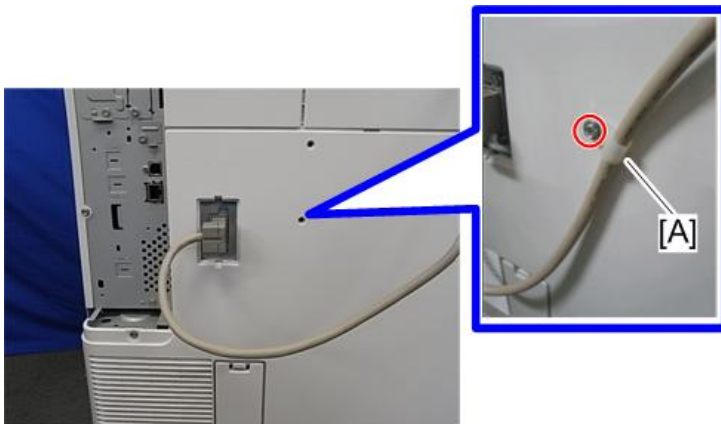

d7662079

39. Turn ON the main power.

40. Ensure that the operation panel displays finisher jobs properly and that it works properly.

Stapleless Stapler Initial Settings

Note

- To adjust the strength of the crimp between sheets of stapled paper, there is a setting to select either single or double stapling.
- The crimp is weakened when there is an image (toner) at the point which is to be stapled. There also is a setting to mask the image on the point for stapling, in order to prevent the crimp from being weakened.
- Depending on users demands, explain the settings/methods of the settings by checking the following instructions.

How to Change the Setting of Staple Method for Stapleless Stapler

Use this procedure to select the type of stapling that is done by the stapleless stapler.

Note that if you change the finisher type from Finisher SR3210 to Internal Finisher SR3180, which has the same type of stapleless staple unit, the current setting in [Stapling Method for Stapleless Stapler] is not carried over, so configure the setting again.

1. Press the [User Tools] icon on Home screen.
2. Press [Machine Features] > [System Setting] > [General Setting] > [Stapling Method for Stapleless Stapler].
3. Select [Double] or [Single].

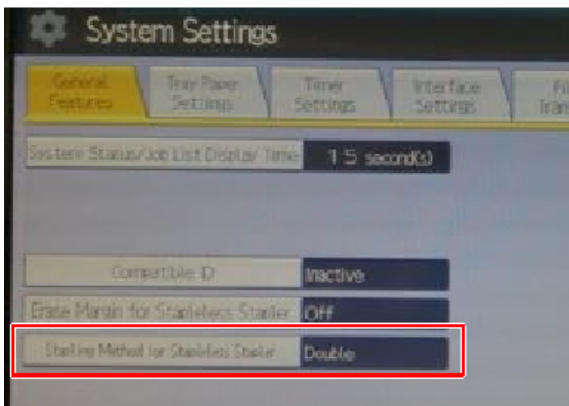

d7665070a

How to set Margin Erase for Stapleless Stapler

1. Press the [User Tools] icon.
2. Press [Machine Features] > [System Setting] > [General Setting].
3. Press [Erase Margin for Stapleless Stapler].

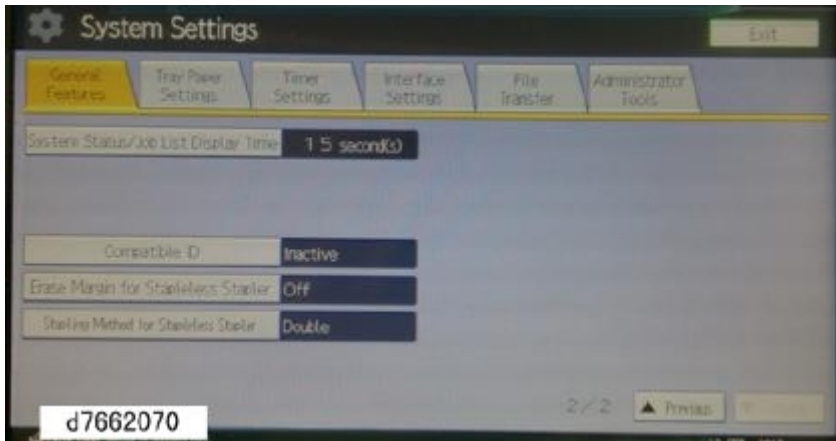

Banner Paper Guide Tray Type M19 (D3BF)

Accessory Check

2

No.	Description	Q'ty	Remarks
1	Main Tray	1	
2	Lock Plate	1	
3	Sub Tray	1	
4	Rivet	2	

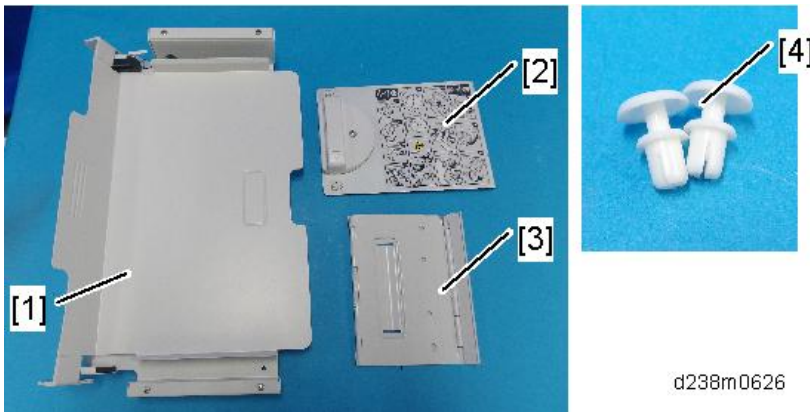

Installation Procedure

⚠ CAUTION

- When installing this option, turn OFF the main power and unplug the power cord from the wall socket. If installing without turning OFF the main power, an electric shock or a malfunction may occur.
- Be careful not to get your finger caught in the area indicated by the red frame (the tray's rotating and insertion part).

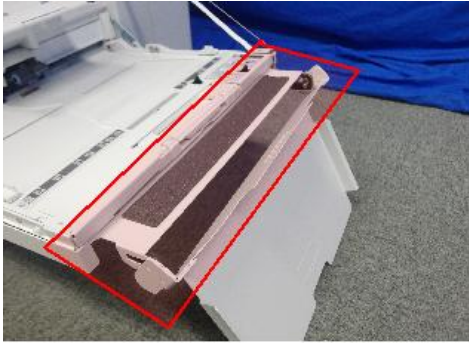

d238m0635

1. Open the bypass tray, and then attach the sub tray [A]. (Rivet x2)



d238m0627

2. Fold the sub-tray.

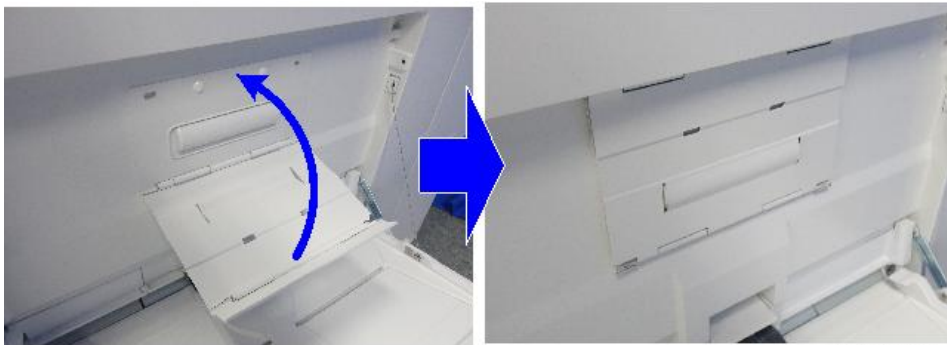

d238m0628

3. While pressing down the feeler [B] on the bypass tray, push the main tray [A] into the bypass tray to attach it.

When you attach the tray, hold it with both hands to make sure that it does not fall.

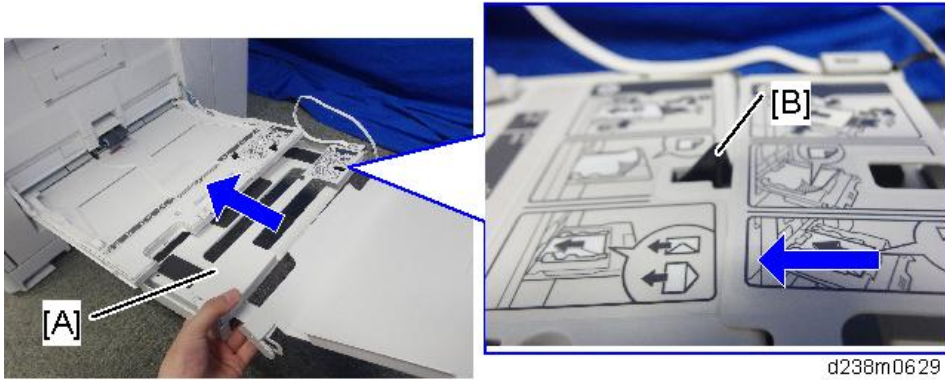

Note

- Check if the locks on the main tray's sides are engaged.

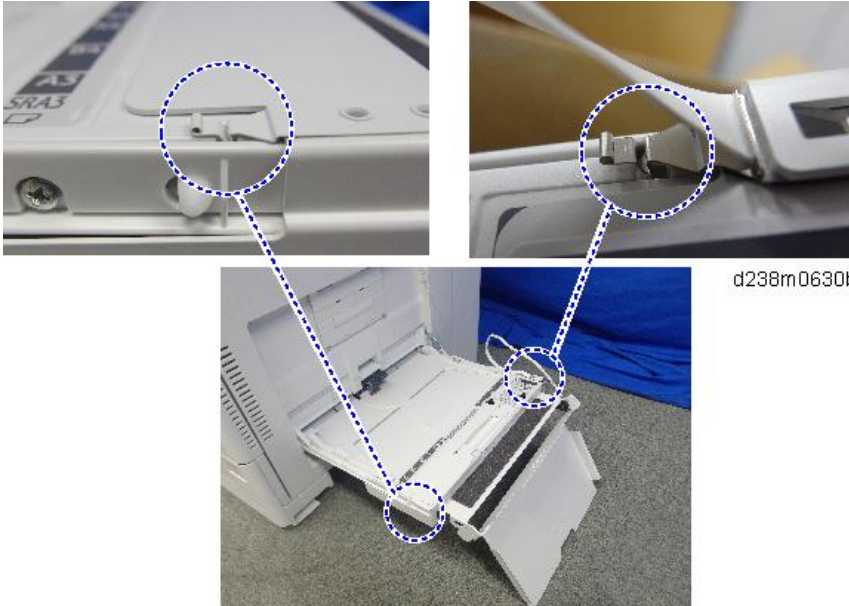

4. Attach the belt by engaging it with the hooks [A].

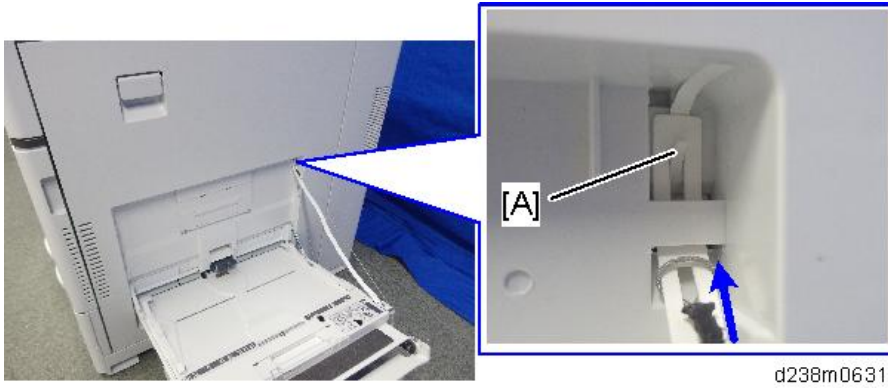

5. Remove the backing paper for the double-sided tapes on the lock plate.



6. Stick the lock plate [B] with its center aligned with the indentation [A] on the right door.

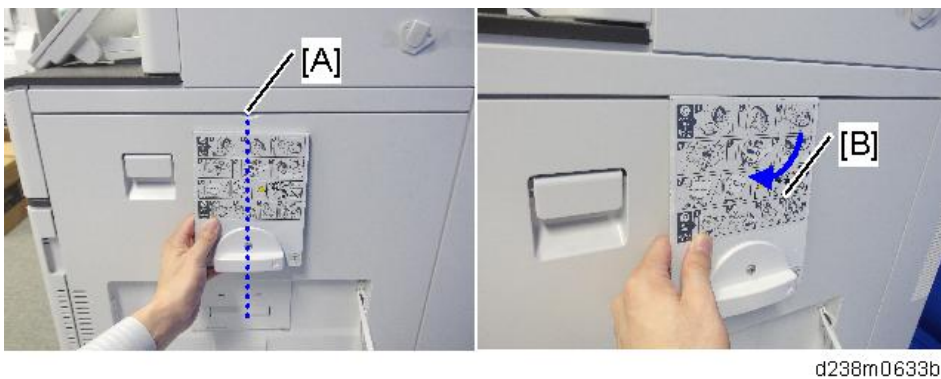

7. Tuck in the banner paper guide tray [A].



↓ **Note**

- The double-sided adhesive tapes stick firmly in about one day.

★ **Important**

- When replacing the parts of the Banner Paper Guide Tray, use the installation procedure above in reverse order as a reference in order to make it easier to disassemble the unit.

Imageable Area Extension Unit Type M19 (D3BR-07)

Accessory Check

2

No.	Description	Q'ty	Remarks
1	Paper transfer roller (Extended)	1	



d238m0677

Installation Procedure

⚠ CAUTION

- When installing this option, turn OFF the main power and unplug the power cord from the wall socket. If installing without turning OFF the main power, an electric shock or a malfunction may occur.

★ Important

- Do not touch the roller surface during replacement. Also, when taking out the unit from the box, be careful not to touch the roller surface [A].

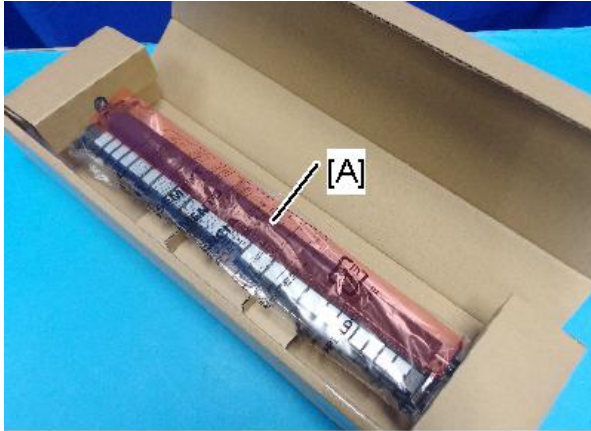

d238m0678

1. Enter the SP mode.
2. Set SP2-400-001 (Paper Transfer Roller Settings Width of Paper Transfer Roller) to "1".

Note

- When SP2-400-001 is changed over, a message is displayed stating "Switch the power OFF/ON".

3. After the SP is changed, turn OFF the main power.
4. Replace the roller [A].

For details about how to replace the roller, refer to page 491 "Paper Transfer Roller".



d238m0680

Note

- During PM replacement, do not install the wrong type of roller.

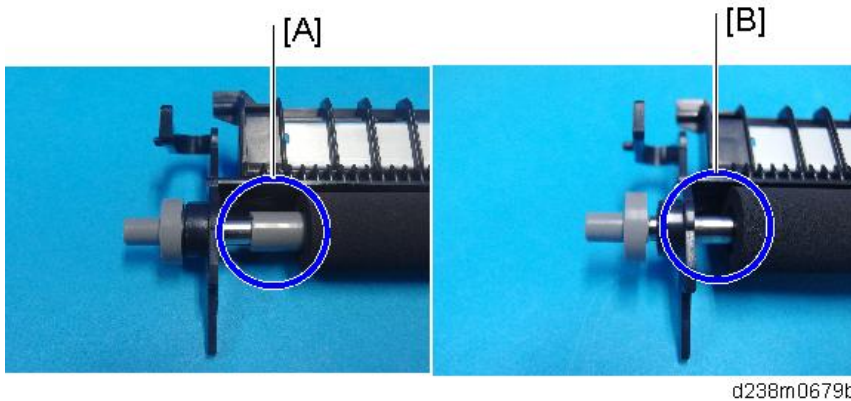

- [A]: The standard roller has a gray collar at its end.
- [B]: Imageable Area Extension Unit Type M19 does not have a collar on it.

5. Turn ON the main power.

6. Using SRA3 paper, check that a full-bleed halftone image is output, and that the image extends to 315 mm in width.

SP descriptions

- **SP2-400-001 (Paper Transfer Roller Settings)**

Specifies the width of the Paper Transfer Roller. This SP must be set to "1" when Imageable Area Extension Unit Type M19 is installed.

0: Default roller

1: Wide roller

When You Forgot to Change the SP

The following problems occur.

When a change-over was made from a standard roller to the imaging range extension option

(If the SP setting is the normal setting (SRA3 paper not supported), but the optional longer paper transfer roller is installed)

- The image cannot be correctly transferred to the SRA3 paper area.
- The MUSIC/program control pattern adheres to the ends of the paper transfer roller (outside the A3 area), and this can transfer to the underside of printouts.
- Real-time process control cannot be performed correctly, and an abnormal image and SC285-00 (MUSIC error) may occur.

When a change-over was made from the imaging range extension option to a standard roller

(If the SP setting is for SRA3, but the paper transfer roller is the normal one (SRA3 paper not supported))

- Real-time process control is not performed, and the interval between process controls becomes short.
- The waiting time for fusing temperature rise is longer than intended.

External Keyboard Bracket Type M19 (D3BR-10)

Accessory Check

2

No.	Description	Q'ty	Remarks
1	Keyboard table bracket	1	
2	Keyboard stand bracket	1	
3	Keyboard stand	2	
4	Screw: M4 x 12	2	
5	Screw: M3 x 8	4	
6	Screw: M3 x 12	1	

Note

- This optional unit is not supplied with a keyboard. Use a commercially available keyboard.

Installation Procedure

CAUTION

- When installing this option, turn OFF the main power and unplug the power cord from the wall socket. If installing without turning OFF the main power, an electric shock or a malfunction may occur.

1. Open the right door, and then remove the small cover [A].

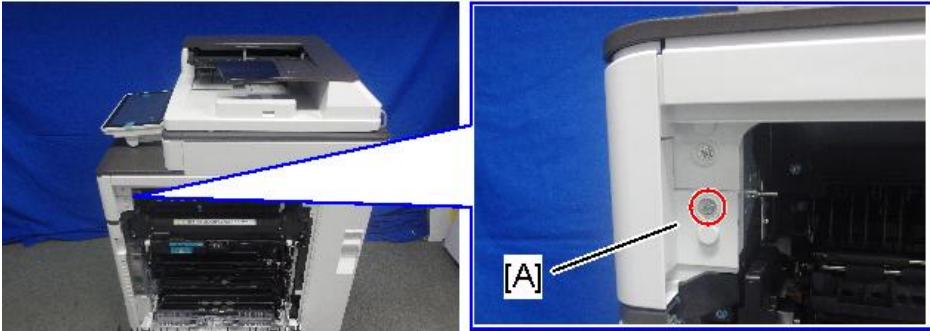



d238m553

 x1

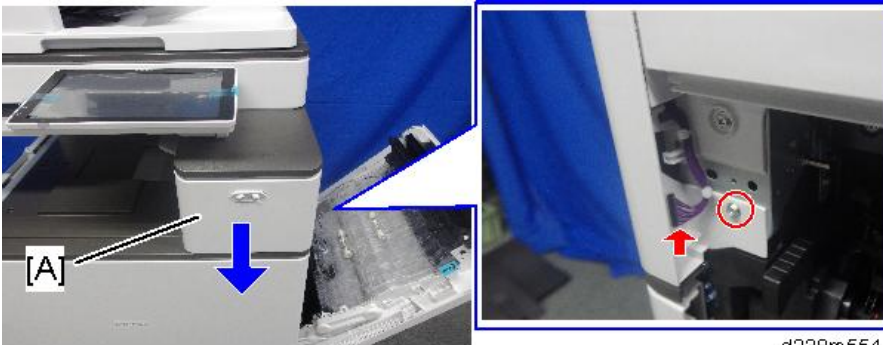
2. Remove the screw and connector, and then remove the front upper cover [A].



d238m554

 x1,  x1

 **Note**

- Remember that there is a tab at the positions of the red arrows.
- Rotate the operation panel [B] upward to a horizontal position, and then detach the front upper cover [A].

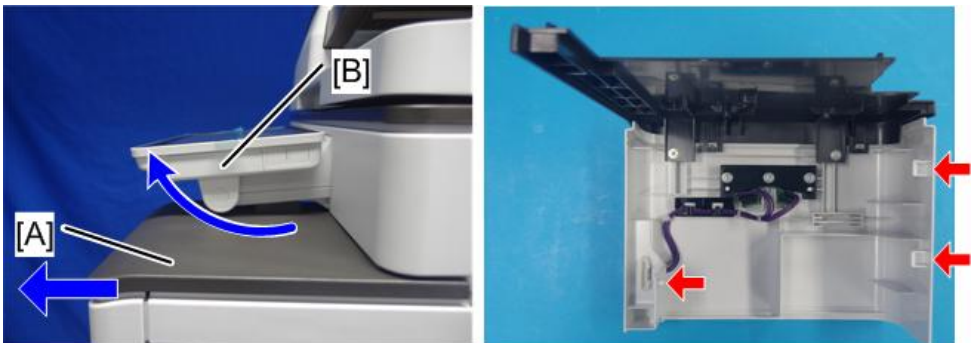

d238m555

3. Remove the screw [A] on the frame of the machine.

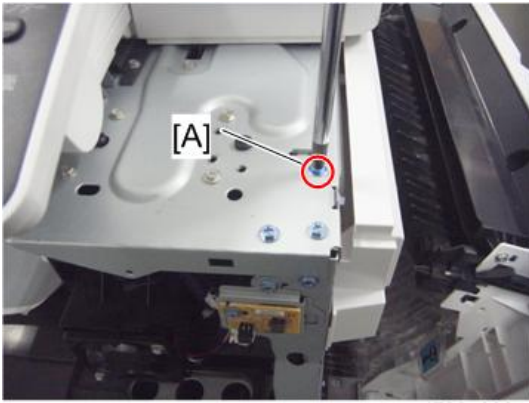

d739z0601

4. Make 3 screw holes in the front upper cover.



d238m0683

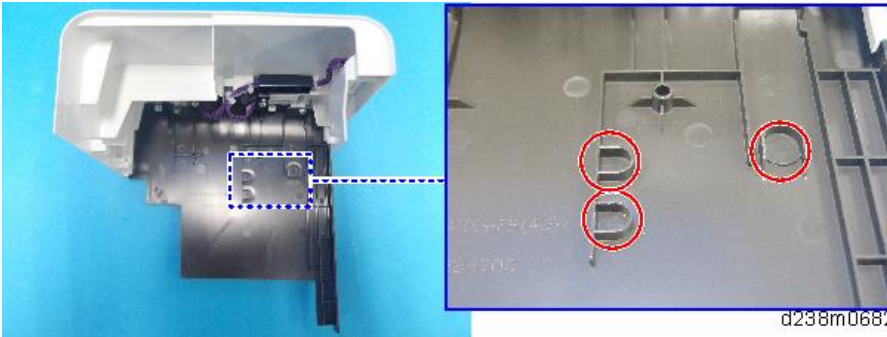

d238m0682

5. Reattach the front upper cover to the machine.

6. Attach the keyboard stand bracket [A] on the front upper cover (⚙️ x3).

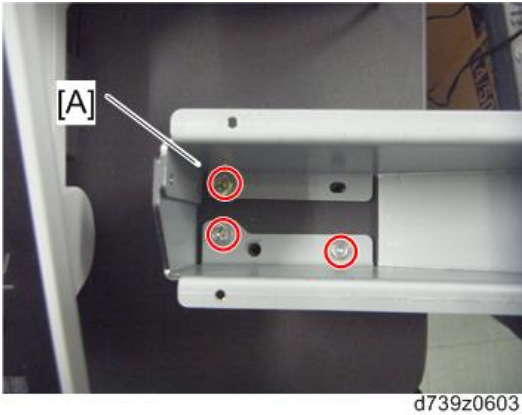

7. Attach the keyboard stand [A] on the keyboard stand bracket (⚙️ x4).

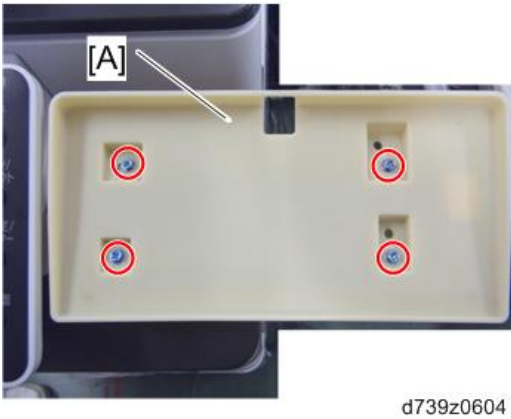

8. Place a keyboard on the keyboard stand, and then pass the keyboard cable through the hole in the keyboard stand.

9. Remove the rear cover [A].

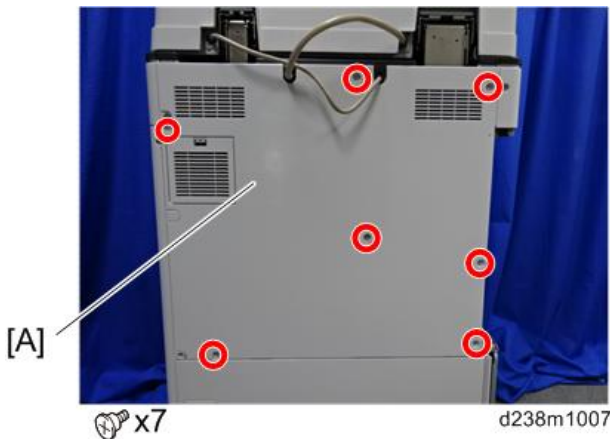

10. Remove the scanner right cover [A] (🔧×1)

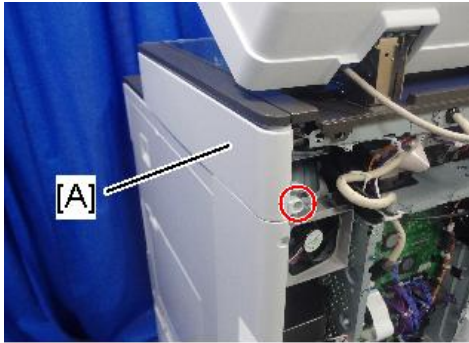

d238m0808

11. Route the keyboard cable [A] along the right side of the scanner unit as shown below.



d739z0508a

12. Route the keyboard cable along the rear side of the scanner unit (🔧×1).

- Adjust the keyboard cable by making loops if the keyboard cable has too much slack.

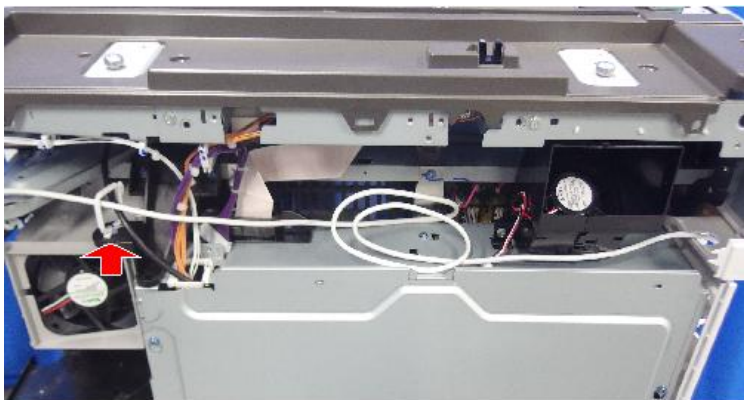

🔧 x1

d238m0702

13. Remove the cutout [A] in the left rear cover to make a cable hole, and then pass the keyboard cable [B] through it.

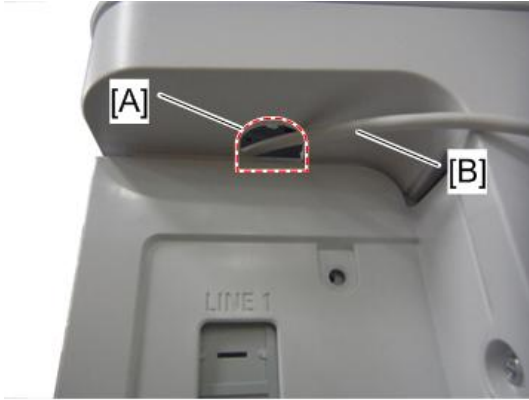

d1463019a

14. Connect the keyboard cable to the USB slot.



d1463020

15. Reattach the scanner right cover, and rear cover.
16. Close the right door.

Internal Options

List of Slots

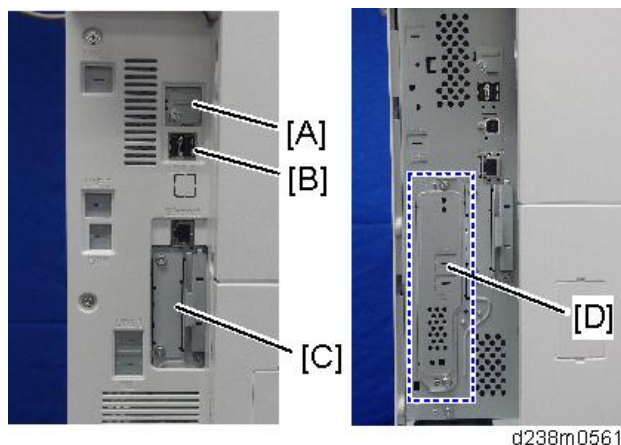

2

Slot		Option
[A]	USB mini	Used for the PictBridge function.
[B]	USB port *2	<ul style="list-style-type: none"> Bluetooth Interface Unit Type D (D566) Smart Card Reader Built-in Unit Type M19 (D3BS-22) NFC Card Reader Type M19 (D3BS-21) External Keyboard Bracket Type M19 (D3BR-10) USB Device Server Option Type M19 (D3BC-28, -29) Extended USB Board Type M19 (D3BS-01)
[C]	I/F slot	<ul style="list-style-type: none"> IEEE 1284 Interface Board Type M19 (D3C0) File Format Converter Type M19 (D3BR-04) IEEE 802.11a/g/n Interface Unit Type M19 (D3BR-01) RC-GATE
[D]	I/F slot *1	Fax Option Type M19 (D3BV-01)

* 1 Dedicated slot for fax unit

* 2 There is no difference between the left and right USB port.

USB Device Server Option Type M19 (D3BC-28,-29)

2

Accessory Check

No	Items	Q'ty	Remarks
1	USB Cable	1	
2	Interface Board	1	
3	Ferrite Core	2	
4	Cable Ties	2	

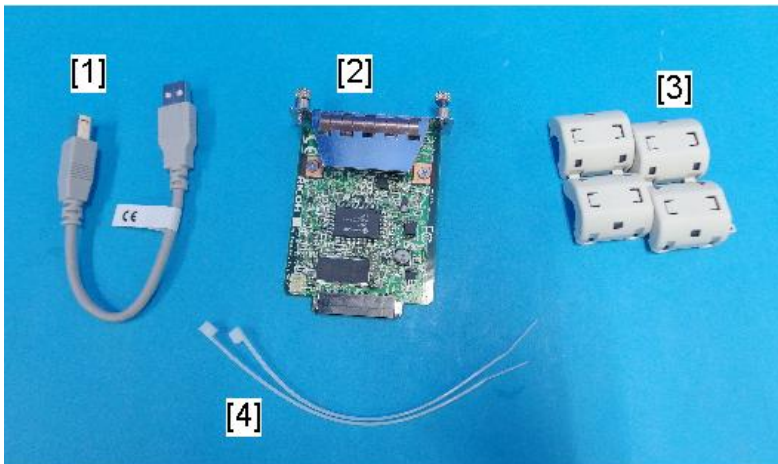

d238m0666

Note

- An Ethernet cable is not packed with this option.

Interface Board Surface

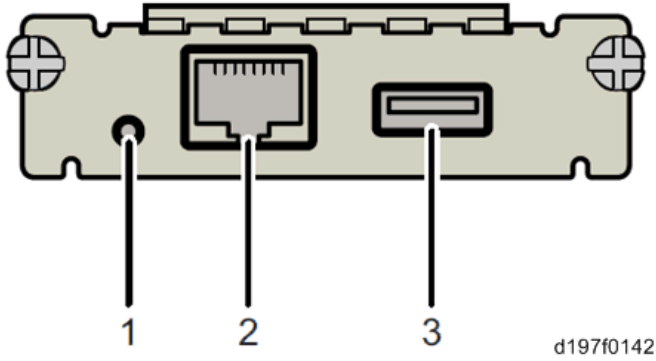

No.	Item	Description
1	Switch	Used to reset to the factory settings.
2	Ethernet port	Used to connect the Ethernet cable.
3	USB port	Used to connect this option to the main machine. Do not use this port with other options.

Note

- When installing the USB device server option, make sure that the labels 'USB-A' and 'Ethernet' are upside down.

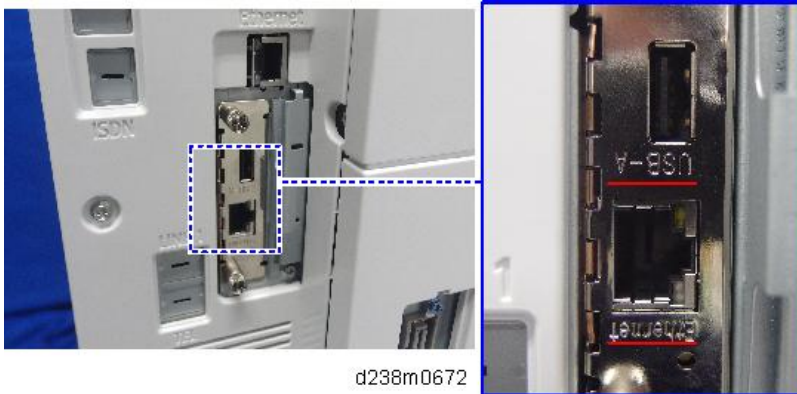

Installation Procedure

⚠ CAUTION

- When installing this option, turn OFF the main power and unplug the power cord from the wall socket. If installing without turning OFF the main power, an electric shock or a malfunction may occur.

★ Important

- The USB device server option has an IP address stored on the PCB. This is different from the machine's IP address. The IP address and other network settings of the USB device server option must be configured after installing this option.

1. Turn OFF the main power of the machine, and unplug the power cord from the wall socket.
2. Remove the slot cover [A].

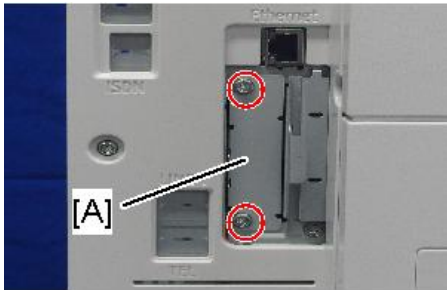

 x2

d238m0657

3. Insert the interface board [A] into the I/F slot.

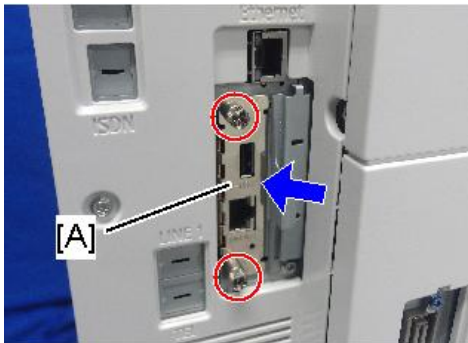

 x2

d238m0671

4. Remove the I/F cover [A].

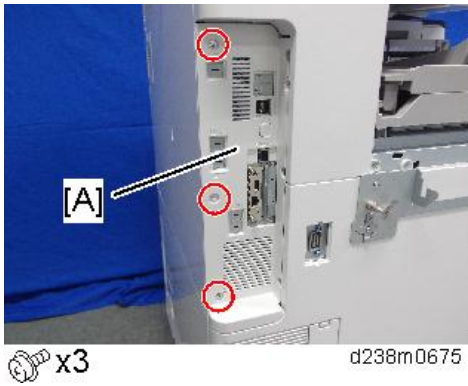

5. Cut off the USB port cover [A] with nippers or other such tool.

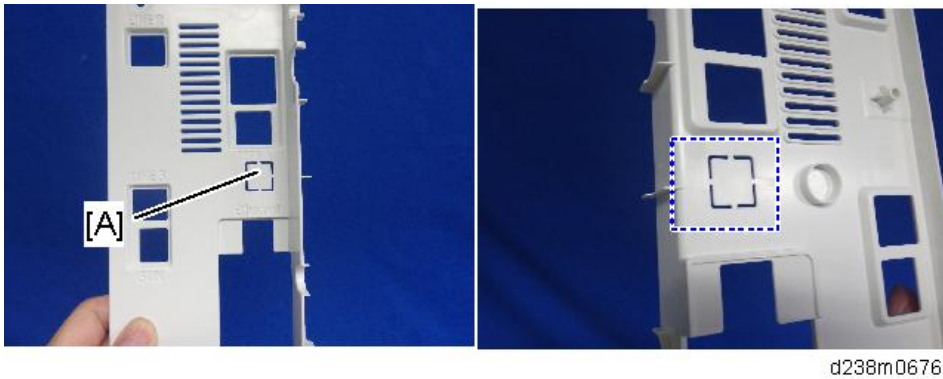

6. Reattach the I/F cover.

7. Insert the USB cable [A] into the USB port (Type A) on the machine I/F.

8. Insert the other side of the USB cable [B] into the USB port (Type B) on this option board.

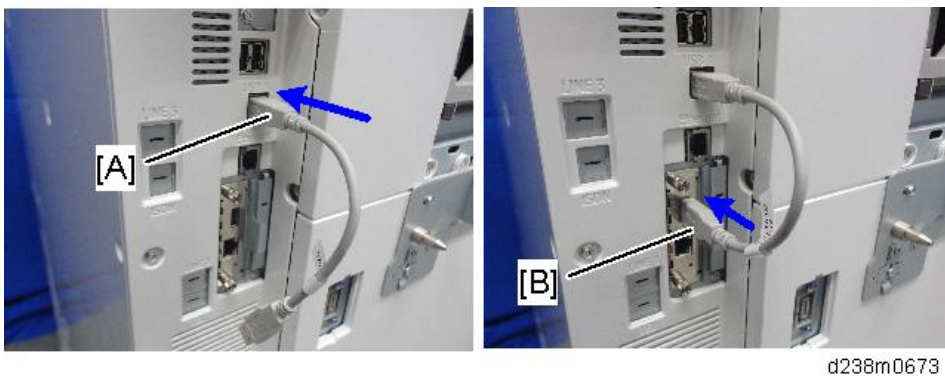

- 9. Attach the ferrite cores to the Ethernet cable, while looping the cable at 3 cm (approx. 1.2 inch) [A] from the each end of the cable.

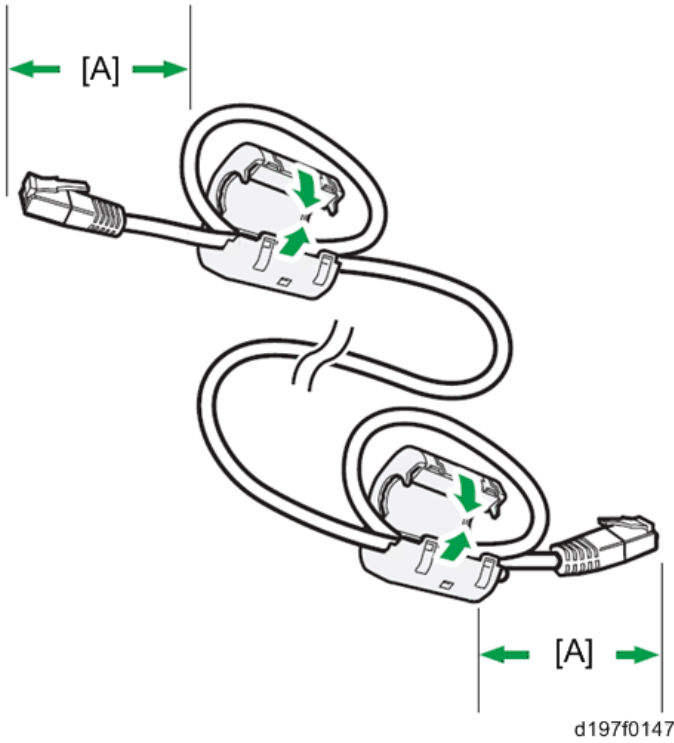

- 10. Only for installing this option in North America, bind both cores with cable ties [A] as shown below.

The two binds are not included in options produced before March, 2015. To bind the cores, use the binds registered as service parts or similar ones.

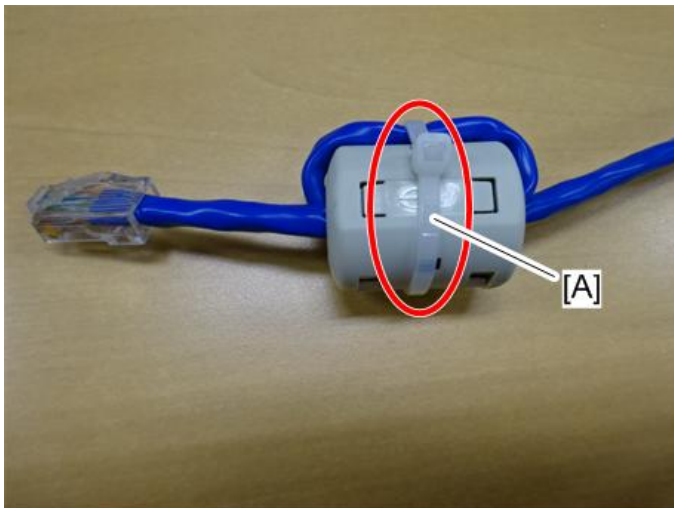

11. Insert the Ethernet cable [A] into the Ethernet port on this option.



d238m0674

12. Insert the other end of the Ethernet cable to a PC for network setting.

13. Plug the power cord into the wall socket and turn on the main power of the machine.

Note

- Do not unplug the USB cable while the machine is recognizing this option. It may take between 30 seconds to 1 minute to finish recognizing it (the LEDs on the Ethernet port of this option light up after recognizing this option; see below). If unplugged, connect the cable again.

14. Make sure that the machine recognizes this option correctly by doing one of the following:

1. Access the option's IP address from a web browser.
2. Ping the option's IP address from a command prompt on a Windows PC in the same network as the mainframe.

If the IP address cannot be found (DHCP server), use the MAC address. This is the number printed on the seal attached to the printed circuit board for the USB server.



d196z2350

3. Use "RX" + the option's MAC address and access a web browser.

Example: <http://RX0080926A3264>



2

4. Ping "RX" + "MAC address" from the command prompt on a windows PC which is on the same network as the mainframe.

```
C:\Users\ >Ping RX0080926A3264
Pinging RX0080926A3264 [192.168.100.100] with 32 bytes of data:
Reply from 192.168.100.100: bytes=32 time<1ms TTL=255
Reply from 192.168.100.100: bytes=32 time<1ms TTL=255
Reply from 192.168.100.100: bytes=32 time<1ms TTL=255
Reply from 192.168.100.100: bytes=32 time<1ms TTL=255

Ping statistics for 192.168.100.100:
    Packets: Sent = 4, Received = 4, Lost = 0 (0% loss),
    Approximate round trip times in milli-seconds:
        Minimum = 0ms, Maximum = 1ms, Average = 0ms
```

Note

- When installing the USB Device Server Option Type M19, the installation status is not shown on the Configuration Page.

Note

- The customer should keep the slot cover which were removed.

What Do the LED Indications Mean?

When this option is properly installed and recognized by the main machine, the LED indicators light up under the following conditions.

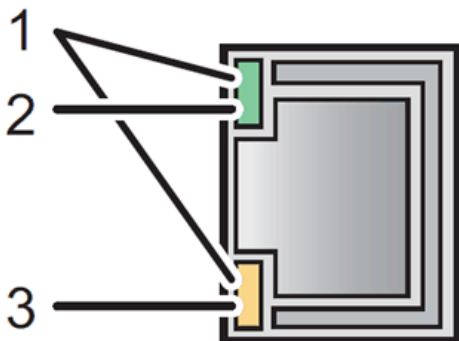

d197f0149

No.	Light Color	Lights Up When:
1	Green and Yellow	1000BASE-T operates
2	Green	10BASE-T operates
3	Yellow	100BASE-TX operates

IP Address Setting

This section describes how to set an IP address on this option manually. Note that you can set an IP address which is not only on the same network segment but also on a different network segment to share a single printer with devices in multiple networks.

★ Important

- You cannot change the IP address for this option from the operation panel of the main machine. The setting must be done from a web browser on your PC.
- The network setting of this option is initially assigned as follows:
IP address: 192.168.100.100 / Subnet mask: 255.255.255.0
- The network setting of your PC must be in the same network segment to change the network setting of this option.

1. Make a note of the current network settings of your PC.
2. Change the IP address on your PC to [192.168.100.xxx (*0 - 255)].
3. Change the subnet mask on your PC to [255.255.255.0].
4. Open a web browser.
5. Type [http://192.168.100.100/] in the address bar.
6. Press the "Enter" key.

↓ Note

- The setting screen for this option appears.

- Click [Network Setting].

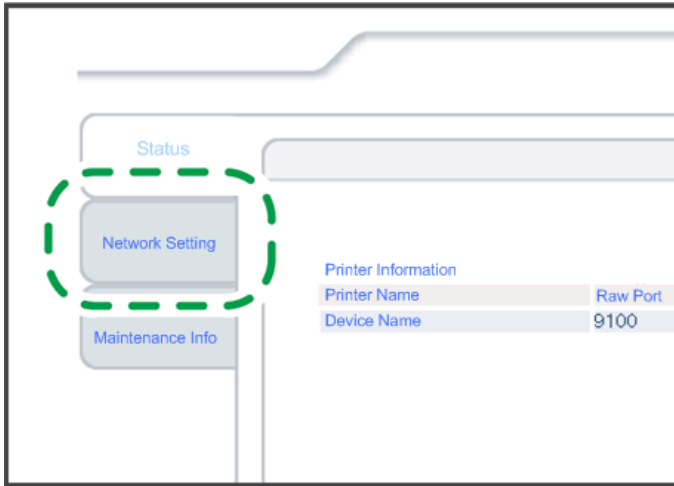

d197f0134

- Type [root] in the user name textbox and click [OK].
- Input [IP Address], [Subnet Mask] and [Default Gateway].

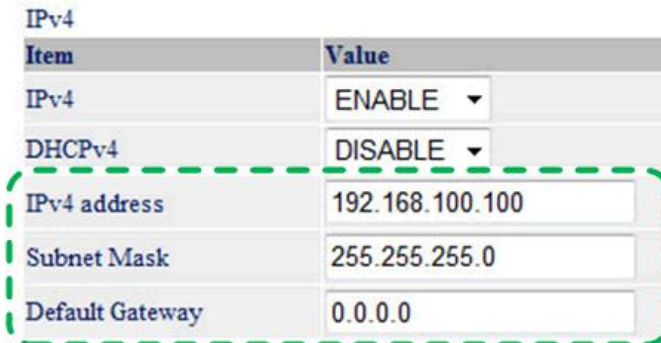

d197f0135a

- Set other items if needed.
- Press [Set]
- Close the web browser.
- Disconnect the Ethernet cable from the PC.
- Connect the Ethernet cable to a network device (e.g. switching hub).
- Set the IP address of this option in the printer driver which you use.

Extended USB Board Type M19 (D3BS-01)

Accessory Check

No	Items	Q'ty	Remarks
1	Extended USB Board	1	

2

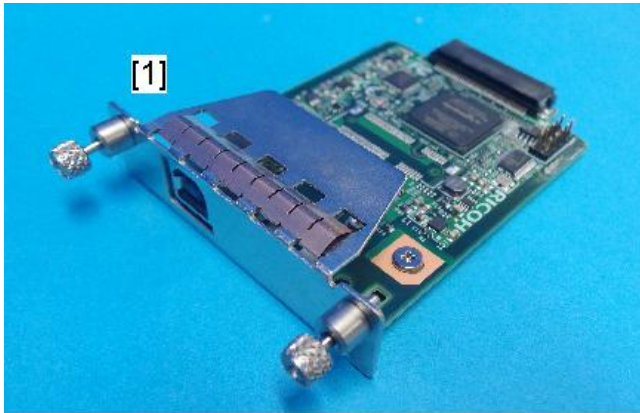

d238m0668

Installation Procedure

⚠ CAUTION

- When installing this option, turn OFF the main power and unplug the power cord from the wall socket. If installing without turning OFF the main power, an electric shock or a malfunction may occur.
- Do not put your hand into the controller box. It will result in a malfunction or injury.
- Before doing any work, touch a metal object to discharge static electricity from the body.

1. Remove the slot cover [A].

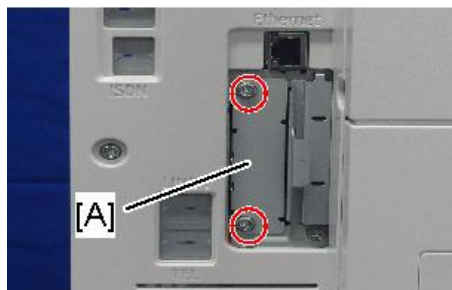

 x2

d238m0657

2. Insert the Extended USB Board into the I/F slot.
3. Turn ON the main power.
4. Check that the system settings list is output, and that the board is recognized correctly.

 **Note**

- The customer should keep the slot cover which were removed.

IEEE 1284 Interface Board Type M19 (D3C0)

Accessory Check

No.	Description	Q'ty	Remarks
1	IEEE 1284 Interface Board	1	
2	FCC document	1	
3	Notes for users	1	

2

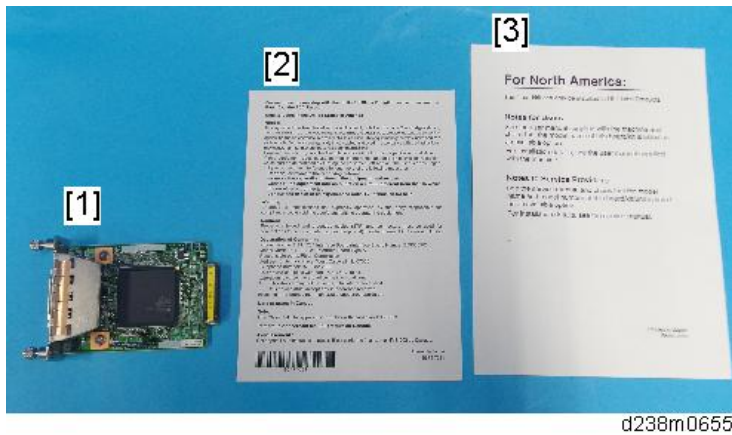

Installation Procedure

⚠ CAUTION

- When installing this option, turn OFF the main power and unplug the power cord from the wall socket. If installing without turning OFF the main power, an electric shock or a malfunction may occur.
- Do not put your hand into the controller box. It will result in a malfunction or injury.
- Before doing any work, touch a metal object to discharge static electricity from the body. There is a possibility that the IEEE 1284 Interface Board may malfunction due to static electricity.

1. Remove the slot cover [A].

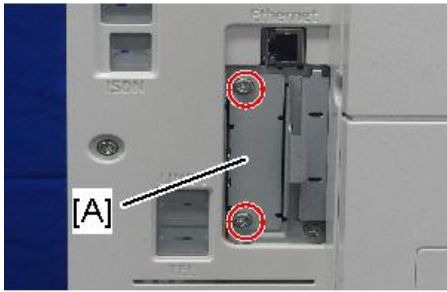

 x2

d238m0657

2. Insert the IEEE 1284 Interface Board into the I/F slot.
3. Turn ON the main power.
4. Check that the system settings list is output, and that the board is recognized correctly.

 **Note**

- The customer should keep the slot cover which were removed.

IEEE 802.11a/g/n Interface Unit Type M19 (D3BR-01)

This option is not available in China, Taiwan, and Korea.

2

Accessory Check

No.	Description	Q'ty
1	IEEE802.11a/g/n Unit	1
2	Clamps	2
3	Velcro Fasteners	8
4	Notes for Users	2

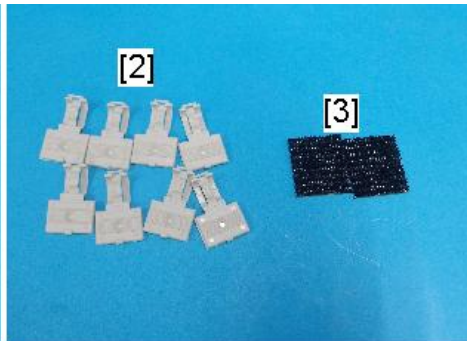

d238m0663

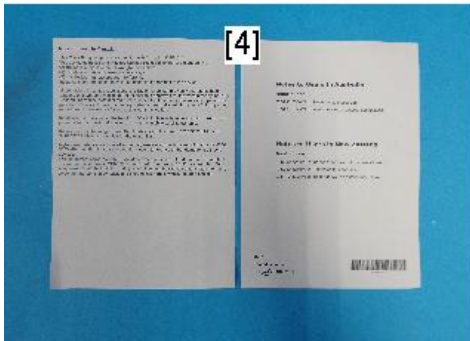

★ Important

- Since disassembly/alteration of a wireless LAN board is illegal, during service replacements, replace the whole PCB assembly.
- Be sure to give the provided leaflet to the customer.

Installation Procedure

⚠ CAUTION

- When installing this option, turn OFF the main power and unplug the power cord from the wall socket. If installing without turning OFF the main power, an electric shock or a malfunction may occur.
- Do not put your hand into the controller box. It will result in a malfunction or injury.
- Before doing any work, touch a metal object to discharge static electricity from the body. There is a possibility that the extension wireless LAN board may malfunction due to static electricity.

★ Important

- When using wireless LAN (IEEE802.11 b/g/n:2.4-GHz band), this radio product uses the 2.4-GHz band. Check that industrial, scientific and medical devices using the same frequency bands, such as a microwave oven or a cordless telephone, are not used nearby.
- If there is interference, communication may become unstable. Check that there are no devices likely to cause interference in the surrounding area.

Attaching the Boards

1. Remove the slot cover [A].

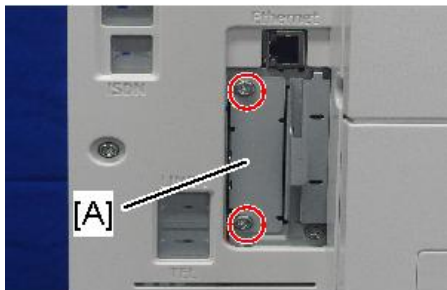

 x2

d238m0657

2. Insert the extended wireless LAN board [A] into the slot (🔑×2)

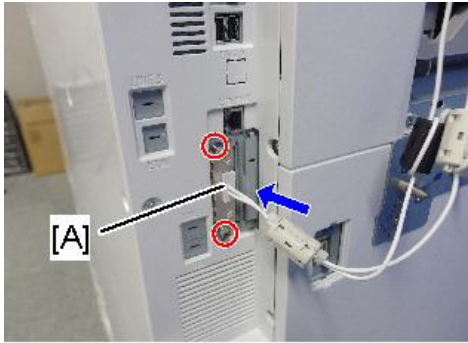

d238m0665

↓ **Note**

- Press the extended wireless LAN board firmly in, and check it is firmly connected.
- The customer should keep the slot cover which were removed.

Attaching the Antenna

1. Attach the velcro fastener [B] (provided with the accessories) on the antenna [A].

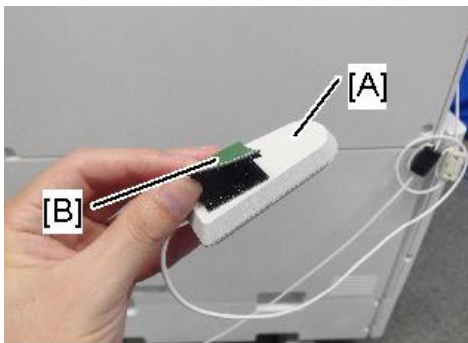

d238m0664

2. Peel the backing paper off the velcro fastener, and attach the antenna on the rear cover and scanner left cover as shown (4x).

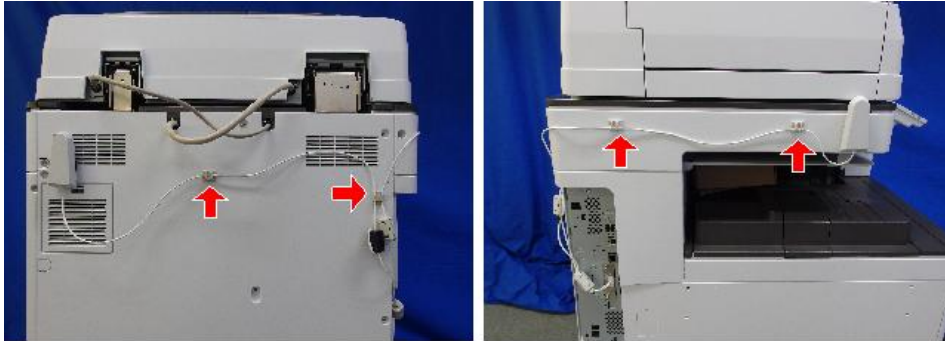

d238m0909

↓ Note

- Take care to loop it around so that it does not interfere with other options or I/F cables.

3. Turn ON the main power.
4. Check that the system settings list is output, and the option is recognized correctly.

User Tool Settings for IEEE 802.11a/g/n

Go into the User Tools mode and do the procedure below. These settings take effect every time the machine is powered on.

↓ Note

- IEEE 802.11a/g/n function is disabled while using Ethernet.

1. Press the "User Tools" icon.
2. Press "Machine Features" > "System Settings".

↓ Note

- Select "Interface Settings"> "Network" > "LAN Type". The "LAN Type" (default: Ethernet) must be set for either Ethernet or wireless LAN.

3. Select "Interface Settings"> "Wireless LAN". Only the wireless LAN options show.
4. Set the "Communication Mode".
5. Enter the "SSID setting". (The setting is case sensitive.)
6. Set the "Ad-hoc Channel". You need this setting when Ad Hoc Mode is selected. The allowed range for the channel settings may vary for different countries.

- For mainly Europe and Asia
2,412 - 2,462 MHz (1 - 11 channels)

5,180 - 5,240 MHz (36, 40, 44 and 48 channels)

(default: 11)

Note

- In some countries, only the following channels are available: 2,412 - 2,462 MHz (1 - 11 channels)

- For mainly North America

2,412 – 2,462 MHz (1 - 11 channels)

5,180 – 5,240 MHz (36, 40, 44 and 48 channels)

(default: 11)

7. Set the "Security Method" to specify the encryption of the Wireless LAN.

- The "WEP" (Wired Equivalent Privacy) setting is designed to protect wireless data transmission. The same WEP key is required on the receiving side in order to unlock encoded data. There are 64 bit and 128 bit WEP keys.

- Range of Allowed Settings:

64 bit: 10 characters

128 bit: 26 characters

- Specify "WPA2" when "Communication Mode" is set to "Infrastructure Mode". Set the "WPA2 Authent. Method".

- WPA2 Authent. Method:

Select either "WPA2-PSK" or "WPA2".

If you select "WPA2-PSK", enter the pre-shared key (PSK) of 8-63 characters in ASCII code.

When "WPA2" is selected, authentication settings and certificate installation settings are required.

8. Press "Wireless LAN Signal" to check the machine's radio wave status using the operation panel.

- Press "Restore Factory Defaults" to initialize the wireless LAN settings.

SP Mode Settings for IEEE 802.11 Wireless LAN

The following SP commands and UP modes can be set for IEEE 802.11

SP No.	Name	Function
SP5-840-006	Channel MAX	Sets the maximum range of the channel settings for the country.

SP No.	Name	Function
SP5-840-007	Channel MIN	Sets the minimum range of the channels settings allowed for your country.
SP5-840-008	Transmission Speed	Sets the transmission speed. Auto, 54 Mbps, 48 Mbps, 36 Mbps, 24 Mbps, 18 Mbps, 12 Mbps, 9 Mbps, 6 Mbps, 11 Mbps, 5.5 Mbps, 2 Mbps, 1 Mbps (default: Auto).
SP5-840-011	WEP Key Select	Used to select the WEP key (Default: 00).
UP mode	Name	Function
	SSID	Used to confirm the current SSID setting.
	WEP Key	Used to confirm the current WEP key setting.
	WEP Mode	Used to show the maximum length of the string that can be used for the WEP Key entry.
	WPA2 Authent. Method	Used to confirm the current WPA authentication setting and preshared key.

File Format Converter Type M19 (D3BR-04)

Accessory Check

No.	Description	Q'ty
1	File Format Converter	1
2	Notes for Users	1

2



Installation Procedure

⚠ CAUTION

- When installing this option, turn OFF the main power and unplug the power cord from the wall socket. If installing without turning OFF the main power, an electric shock or a malfunction may occur.
- Do not put your hand into the controller box. It will result in a malfunction or injury.
- Before doing any work, touch a metal object to discharge static electricity from the body. There is a possibility that the board may malfunction due to static electricity.

1. Remove the slot cover [A].

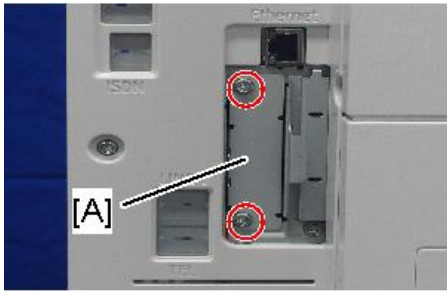

 x2

d238m0657

2. Insert the file format converter board into the I/F slot.
3. Turn ON the main power.
4. Check the system settings list is output, and that the option is recognized correctly.

 **Note**

- The customer should keep the slot cover which were removed.

Bluetooth Interface Unit Type D (D566-01)

Accessory Check

No.	Description	Q'ty
1	Bluetooth Module	1
-	CD-ROM	2

2

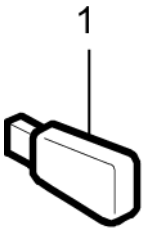

2-5-6_002.jpg

Installation Procedure

⚠ CAUTION

- When installing this option, turn OFF the main power and unplug the power cord from the wall socket. If installing without turning OFF the main power, an electric shock or a malfunction may occur.
- Do not put your hand into the controller box. It will result in a malfunction or injury.

1. Attach the BT wireless interface to the USB-A slot [A].

There is no difference between the left and right USB ports.

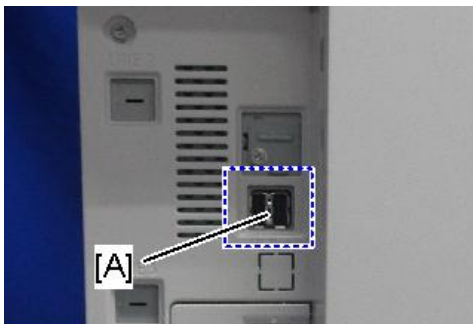

d238m0662

2. Turn ON the main power.

3. Check the system settings list is output, and that the option is recognized correctly.

Memory Unit Type M19 4GB (D3BX-03)

Accessory Check

No.	Description	Q'ty	Remarks
1	Memory Unit (DDR3L-DIMM 4G)	1	

2



d238m0659

Installation Procedure

⚠ CAUTION

- When installing this option, turn OFF the main power and unplug the power cord from the wall socket. If installing without turning OFF the main power, an electric shock or a malfunction may occur.

1. Remove the rear cover [A].

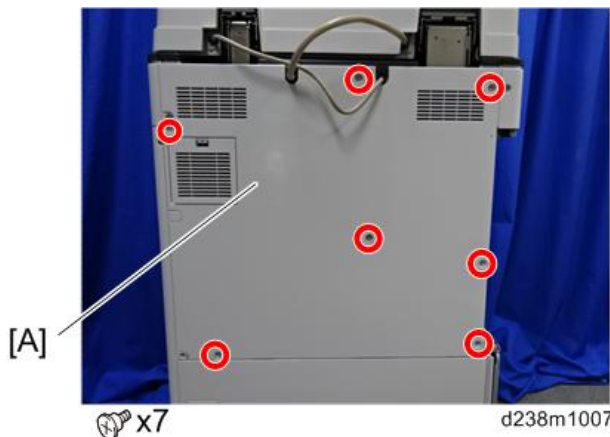

2. Remove the controller box cover [A].

Red Circle: Remove / Blue Circle: Loosen

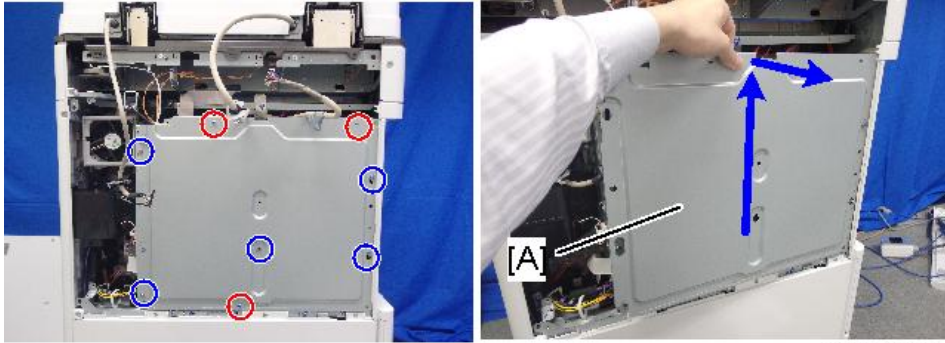

d238m0614

3. Release the latches and remove the standard 2GB DIMM [A].

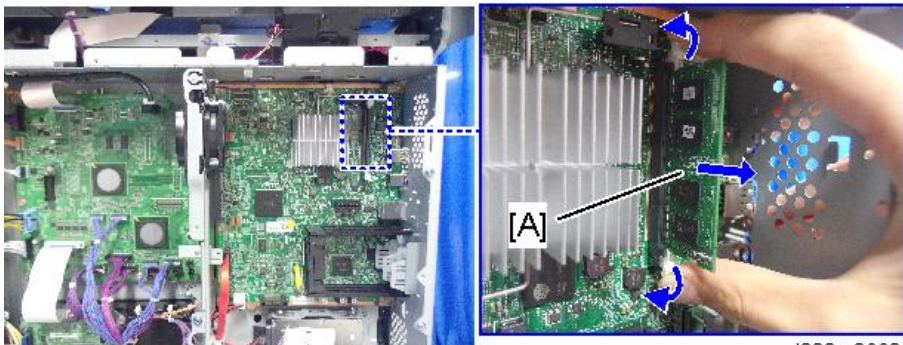

d238m0660

4. Insert the Memory Unit Type M19 4GB [A] into the SDRAM socket.

Push the release latches [B] until they slip into the notch on the edge of the SDRAM.

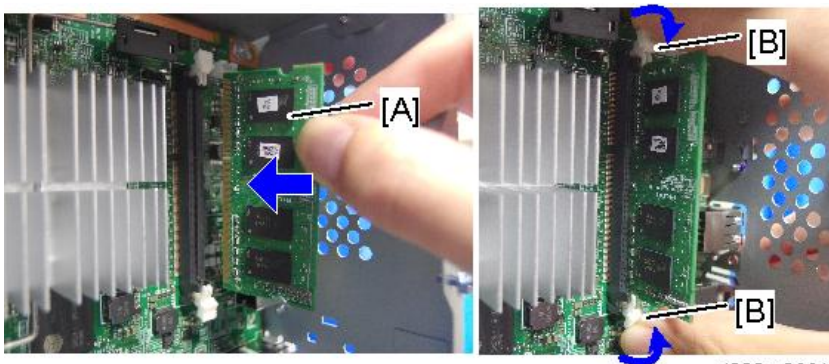

d238m0661

5. Reattach the controller box cover and rear cover.

6. Turn ON the main power.

7. Print out the system setting list to make sure that the memory unit is recognized properly.

Enhanced Security HDD Option Type M12 (D3A6-02)

2

Accessory Check

No.	Description	Q'ty	Remarks
1	Enhanced Security HDD	1	
-	EMC Address	1	



d191b0076

Installation Procedure

⚠ CAUTION

- When installing this option, turn OFF the main power and unplug the power cord from the wall socket. If installing without turning OFF the main power, an electric shock or a malfunction may occur.

1. Remove the rear cover [A].

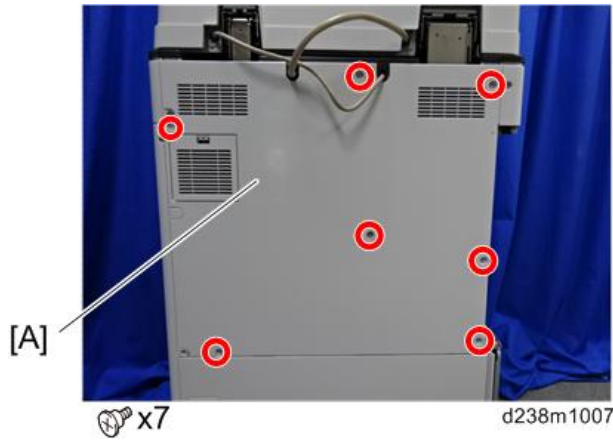

2. Remove the controller box cover [A].

Red Circle: Remove / Blue Circle: Loosen

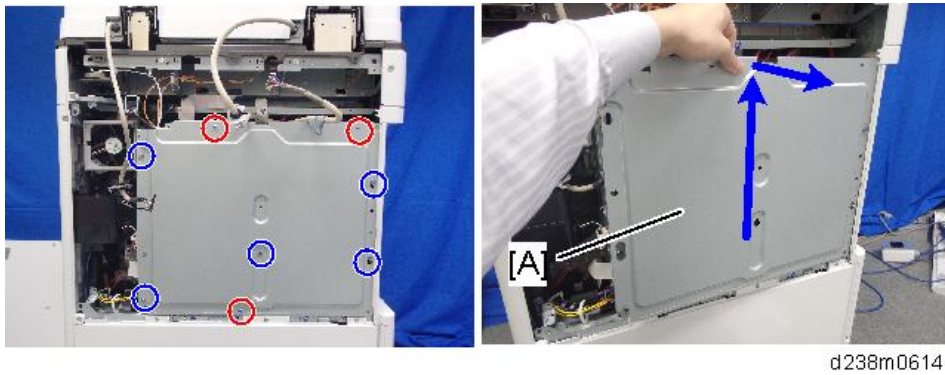

3. Remove the standard HDD [A] installed on the machine.

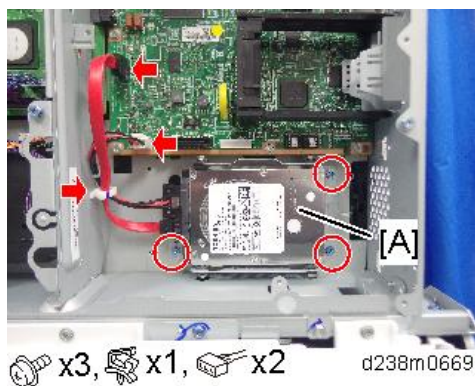

4. Separate the standard HDD from the bracket.

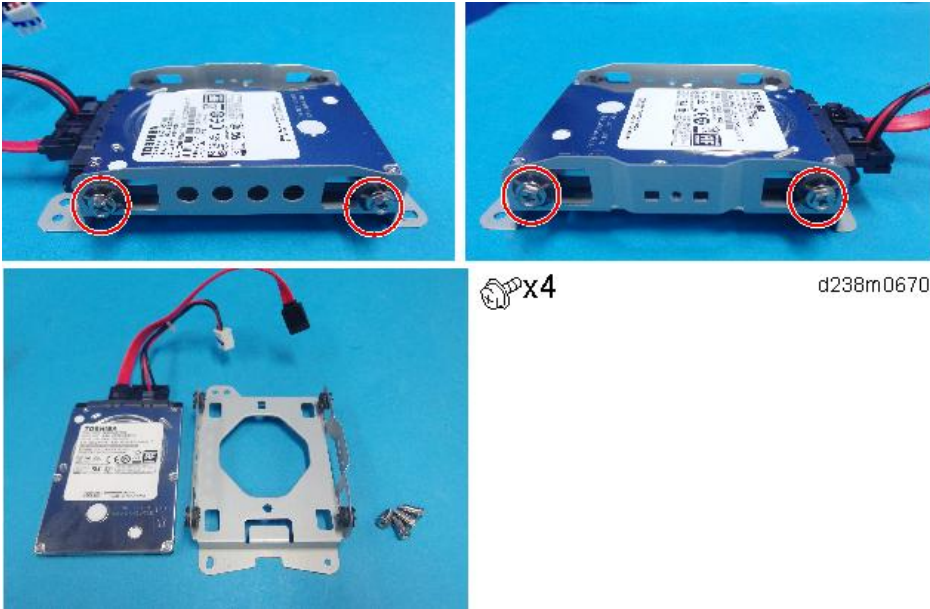

5. Disconnect the cables from the standard HDD. (🔌 x 2)



- Remove the enhanced security HDD from its protective pack.



d191b0078

- Connect the two cables to the enhanced security HDD. (🔌 × 2)



d191b0079

- Fasten the HDD to the bracket. (🔩 × 4)
- Install the HDD bracket in the controller box.
- Reassemble the machine.

After Installing the HDD

1. Connect the power cord and turn the machine on. A message prompts you to format the hard disk.

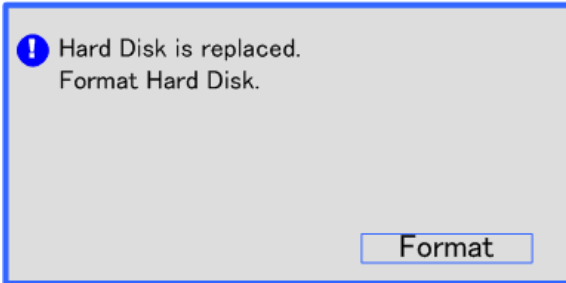

d191b0081

2. Touch [Format].

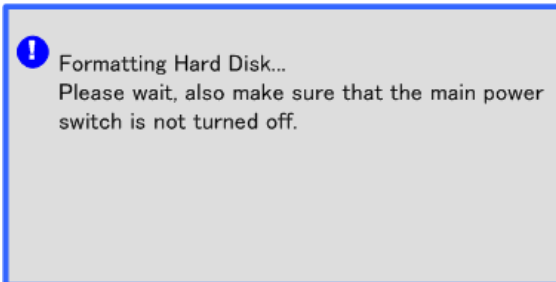

d191b0082

3. Wait for the machine to finish formatting the hard disk.

★ Important

- Do not touch the power switch while the hard disk format is in progress. Wait for the machine to tell you that the formatting is finished.

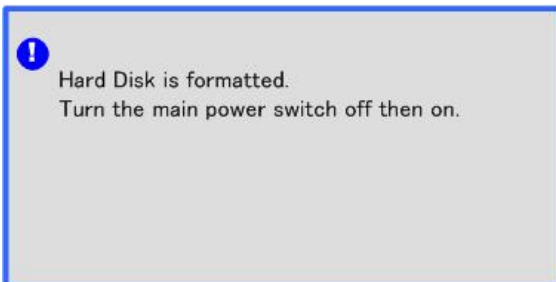

d191b0083

4. Turn the main power OFF and back ON again after the message tells you formatting is finished.
5. Enter the SP mode.

6. Do SP5-846-040 to copy the address book to the hard disk from the controller board.
7. Do SP5-846-041 to let the user get access to the address book.
8. Turn the main power OFF and back ON again.
9. Ask an administrator to register an HDD authentication code in the machine.

★ Important

- If the HDD Authentication Code is not registered, the function of the enhanced security HDD is not activated.

SP descriptions

SP5-846-040	UCS Setting: Addr Book Migration(USB->HDD)
	Copies the address book to the hard disk from the controller board. [Execute]
SP5-846-041	UCS Setting: Fill Addr Acl Info
	This SP must be executed immediately after installation of an HDD unit in a basic machine that previously had no HDD. The first time the machine is powered on with the new HDD installed, the system automatically takes the address book from the NVRAM and writes it onto the new HDD. However, the new address book on the HDD can be accessed only by the system administrator at this stage. Executing this SP by the service technician immediately after power on grants full address book access to all users. [Execute]

Optional Counter Interface Unit Type M12 (B870-21)

2

Accessory Check

No.	Description	Q'ty	For This Model
1	PCB: MKB	1	
2	Harness IOB to MKB	1	Not used
3	Screws M3x8	2	Not used
4	Screws M3x6	4	Not used
5	Standoffs	4	
6	Clamp	1	Not used
7	Wire Band	1	Not used

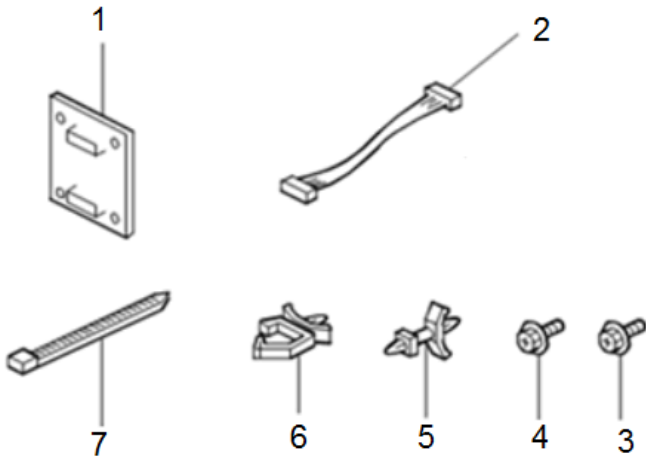

d135d1748a

Installation Procedure

⚠ CAUTION

- When installing this option, turn OFF the main power and unplug the power cord from the wall socket. If installing without turning OFF the main power, an electric shock or a malfunction may occur.

1. Remove the rear cover [A].

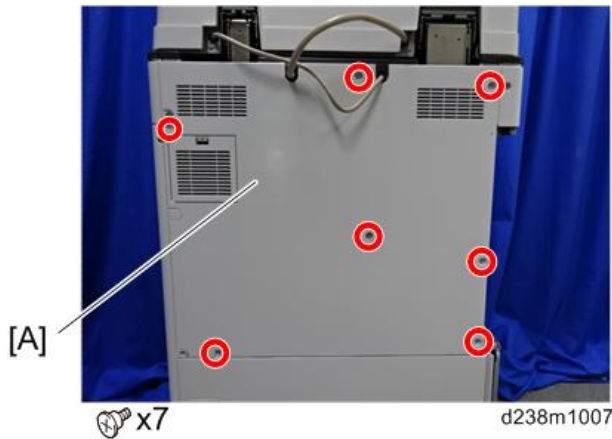

2. Remove the controller box cover [A].

Red Circle: Remove / Blue Circle: Loosen

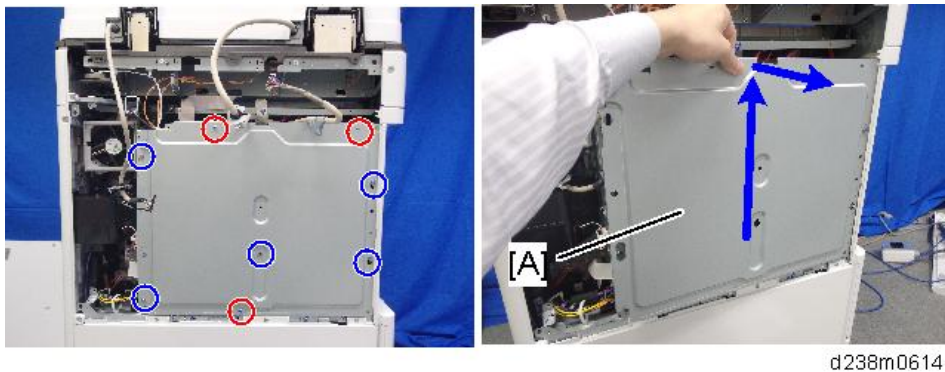

3. Attach the studs provided with the option on the helmholtz silencer (Stud x4).

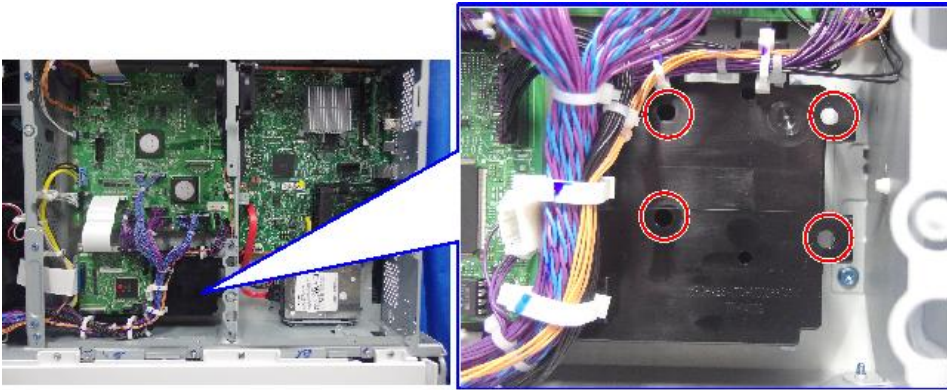

d238m0681

4. Attach the counter interface board [A].

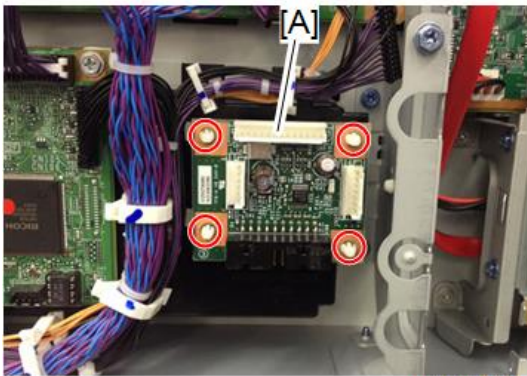

d244c0036

5. Connect the harness [A] of the MFP to the white connector (13 pins) [B].

Note

- Do not use the harness that is provided with the accessories for the interface cable.
- Connect the harness of the optional counter to the black connector [C].

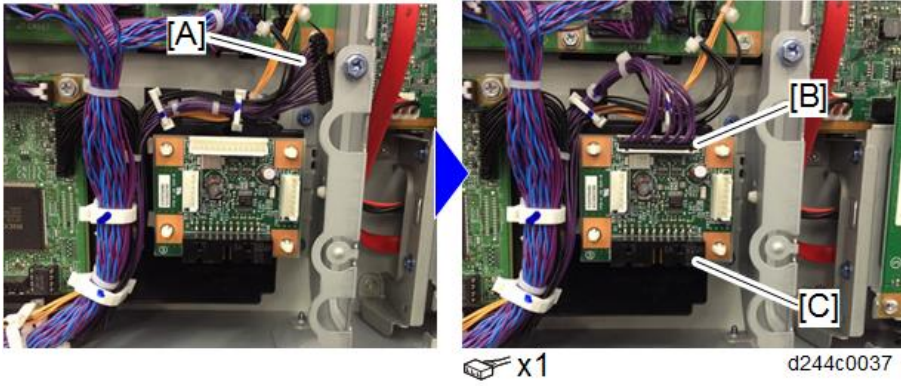

Key Counter Bracket Type M3 (D739-09)

Accessory Check

2

No.	Description	Q'ty	Remarks
-	Screw: M3X8	1	
-	Binding Self-Tapping Screw: M4X8	3	
-	Clamp:LWS-1211Z	2	
-	Clamp:NK-3N	1	
-	Double Sided Tape	2	
-	Key Counter Plate Nut	2	
-	Key Counter Harness	1	

Installation Procedure

CAUTION

- When installing this option, turn OFF the main power and unplug the power cord from the wall socket. If installing without turning OFF the main power, an electric shock or a malfunction may occur.
- Hold the key counter plate nuts [A] on the inside of the key counter bracket [B] and insert the key counter holder [C].
 - Secure the key counter holder to the bracket ( x2).

3. Install the key counter cover [D] (Ⓜ x2).

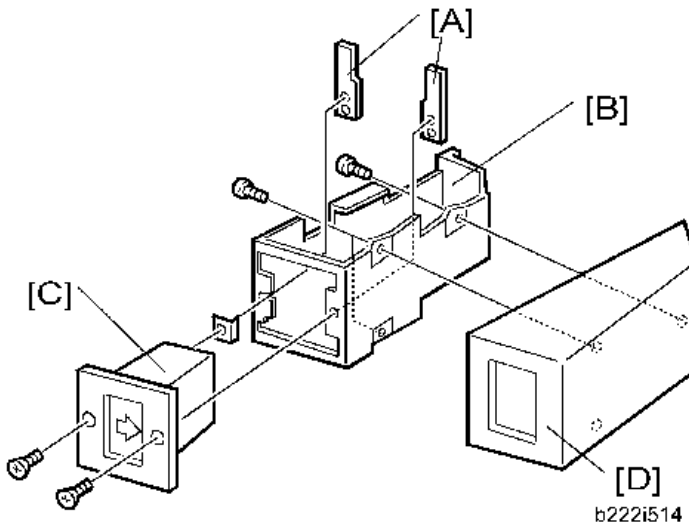

4. Open the right door.

5. Right rear cover [A] (Ⓜ x4, among them, tapping screw x1)

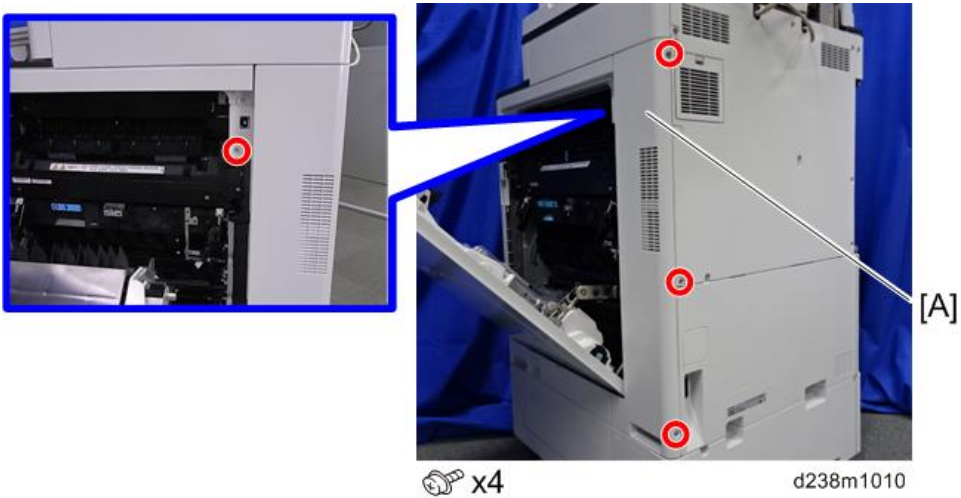

Note

- When installing, insert the projections [A] in the holes [B], taking care not to trap the harness inside.

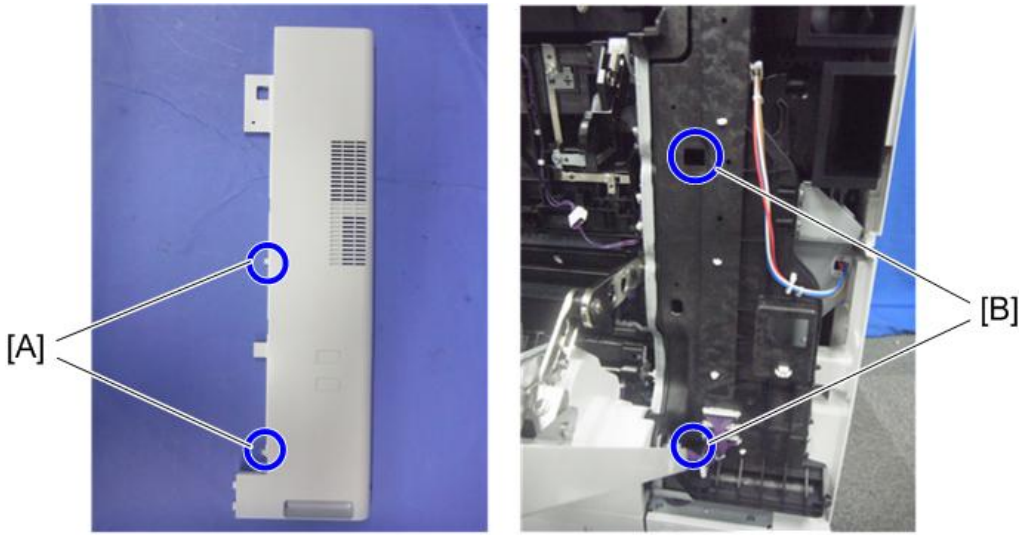

d1462035

6. Remove the rear cover [A].

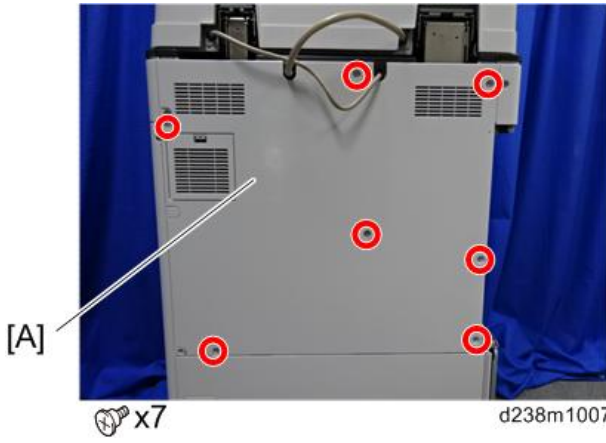

7. Remove the controller box cover [A].

Red Circle: Remove / Blue Circle: Loosen

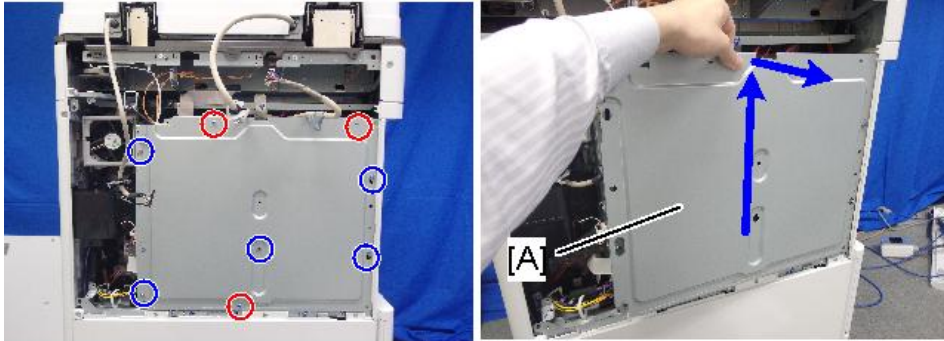

d238m0614

2

8. Route the key counter's cable inside the machine and fasten it using the screw hole [A].

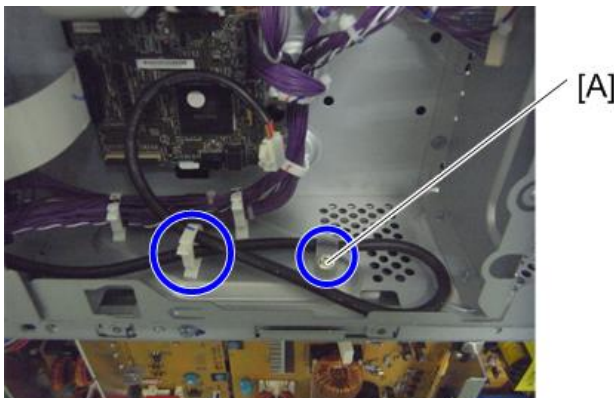

d1463077

9. Connect the key counter's cable to the 4-pin connector [A] on the machine.



d1463078b

10. Attach the supplied clamp [A], and then route the cable as shown.

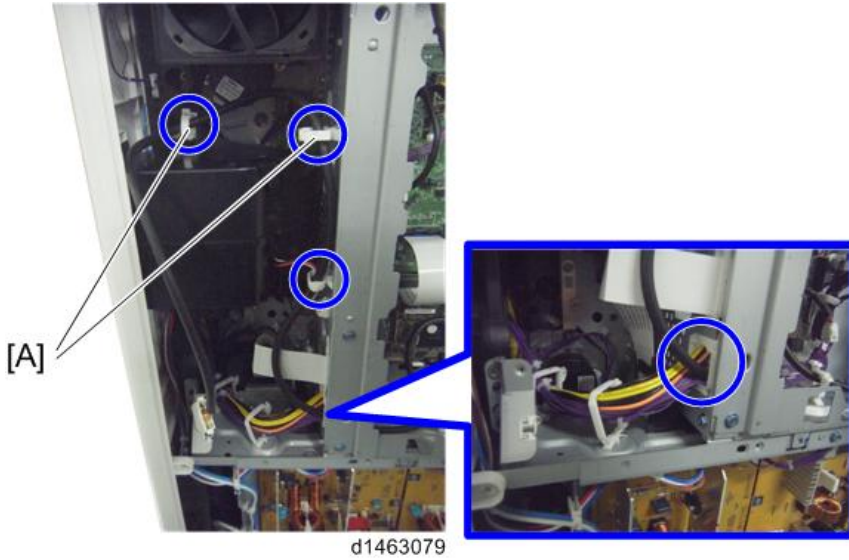

11. Open the slit in the rear cover to put the cable through, and then attach the rear cover while putting the cable through.



12. Connect the key counter and cable.

13. Attach the key counter [A] to the machine's rear right.

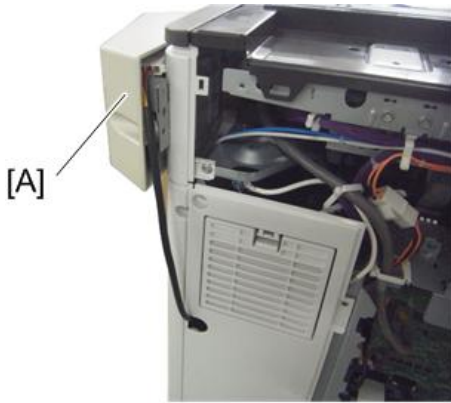

d1463081

14. Reinstall all the covers on the main machine.
15. Peel off double sided tape on the key counter bracket and attach the key counter to the scanner right cover.
16. Reassemble the machine.

Card Reader Bracket Type 3352 (D593-61)

Accessory Check

Check the quantity and condition of the accessories against the following list.

2

No.	Description	Q'ty	For This Model
1	Screw: M3 x 8	2	Yes
2	Screw: M3 x 14	1	Not used
3	Screw: M4 x 25	1	Yes
4	Tapping Screw: M3 x 10	3	Yes
5	Upper Tray	1	Yes
6	Lower Tray	1	Yes
7	Tray Bracket	1	Yes
8	Clamp	5	Yes

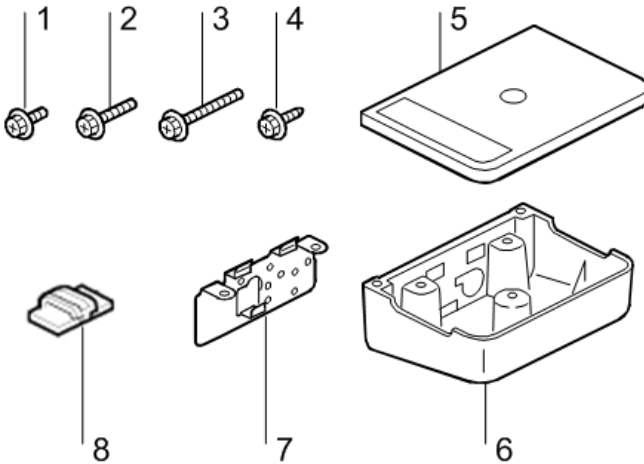

d1822512

Installation Procedure

⚠ CAUTION

- When installing this option, turn OFF the main power and unplug the power cord from the wall socket. If installing without turning OFF the main power, an electric shock or a malfunction may occur.

1. Open the ADF.
2. Remove a screw for the scanner right cover.



 x1

d238m1300

3. Remove the scanner right cover [A].

Remove the hook at the top, and then slide the cover towards the rear.

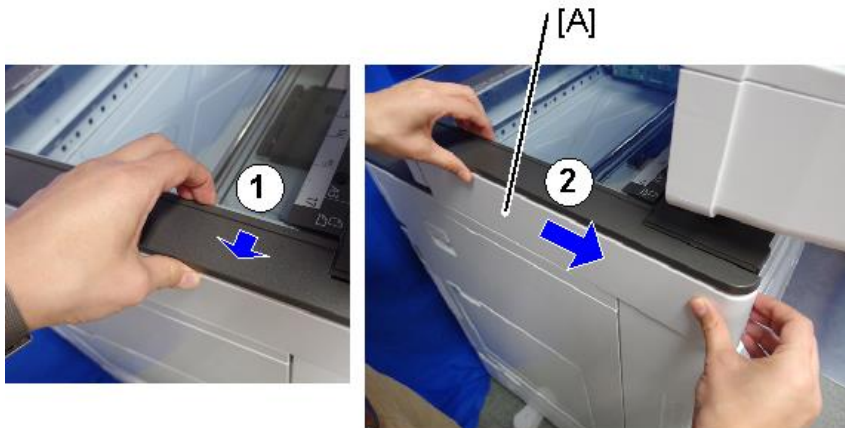

d238m1301

4. Make 2 screw holes in the removed scanner right cover with a screwdriver or drill.

★ Important

- Make the screw holes to be smaller than the screw size.

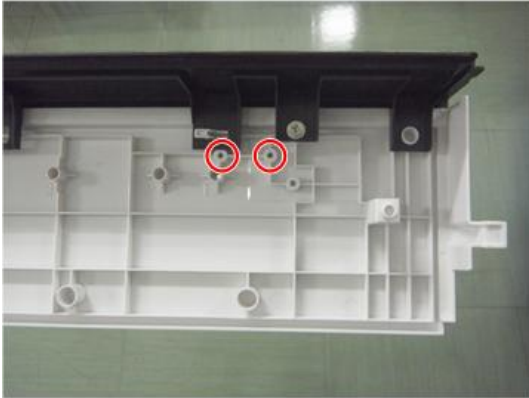

d146z1019

5. Reattach the scanner right cover (⊗ x2).
6. Attach the tray bracket [A] to the scanner right cover (⊗ x2: M3x10 tapping screw).
For this model, use the screw holes marked "3" on the table bracket.

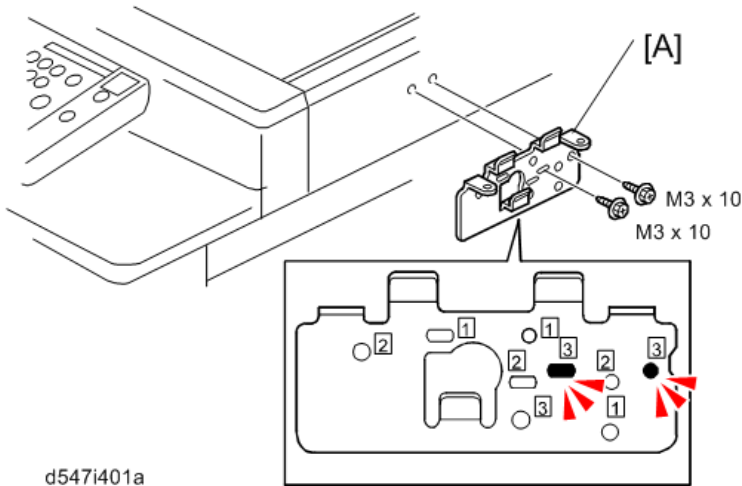

d547i401a

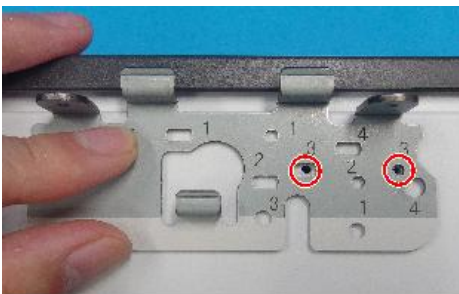

d238m0686

7. Attach the lower tray [A] to the tray bracket (⊗ x2: M3 x 8).

8. Attach the upper tray [B] to the tray bracket (⌀ x1: M3 x 10).

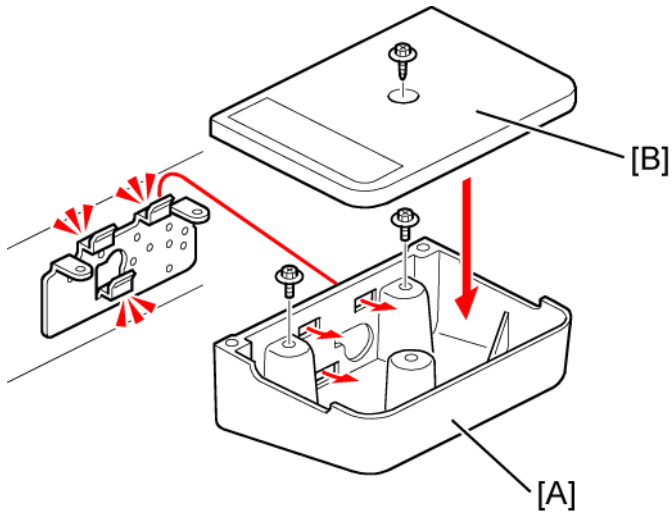

d120i577

9. Attach the clamps ([1] to [5]) and route the harness around the machine as shown.

The USB cable is not supplied. Use a commercially available USB cable.

Scanner Right Cover

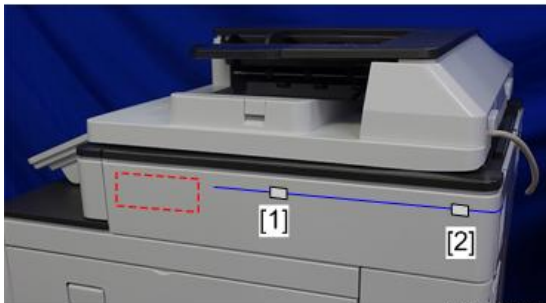

d146z1017

Rear Cover

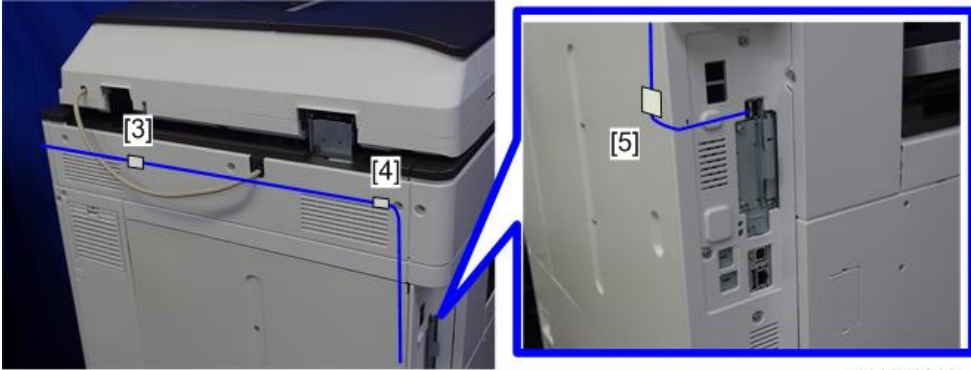

d146z1018

10. Connect the USB cable to the USB A slot.

NFC Card Reader Type M19 (D3BS-21)

Accessory Check

No.	Description	Q'ty	Remarks
1	Corner Cover	1	
2	Reader Spacer	1	
3	Reader Cover	1	
4	Reader	1	
5	Sponge Cushions	2	
6	Ferrite Core (Black)	1	
7	Interface Cable	1	

2



Installation Procedure

⚠ CAUTION

- When installing this option, turn OFF the main power and unplug the power cord from the wall socket. If installing without turning OFF the main power, an electric shock or a malfunction may occur.

1. Open the right door, and then remove the small cover [A].

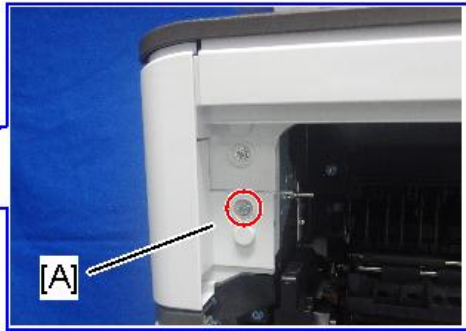



d238m553

 x1

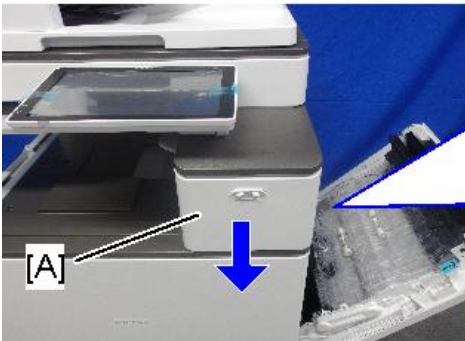
2. Remove the screw and the connector, and then remove the front upper cover [A].



d238m554

 x1,  x1

⚠ Note

- Remember that there is a tab at the positions of the red arrows.
- Rotate the operation panel [B] upward to a horizontal position, and then detach the front upper cover [A].

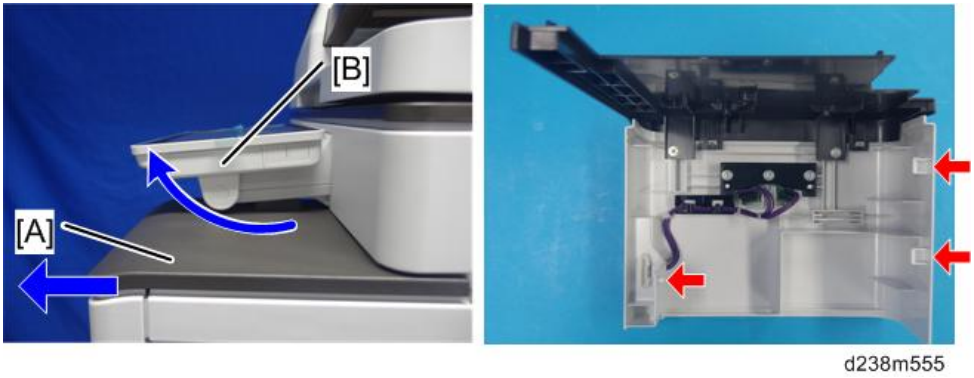

3. Remove the original upper cover [A].

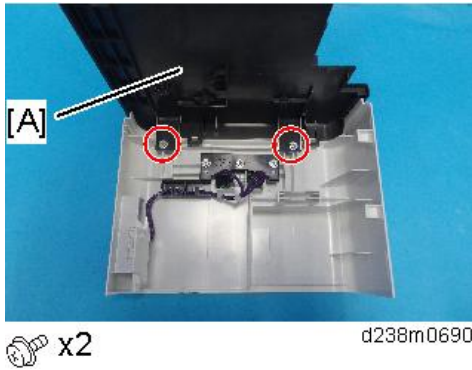

4. Attach the corner cover [A] provided with this option.

Use the screws removed in the previous step.

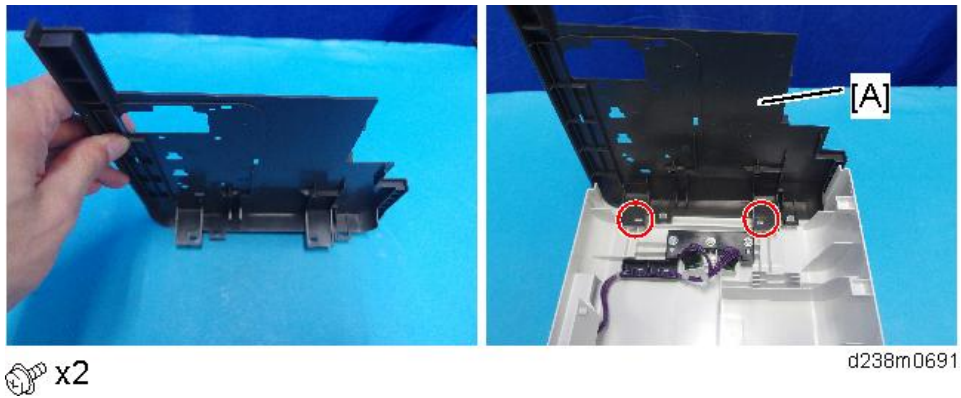

5. Remove the scanner front cover [A].

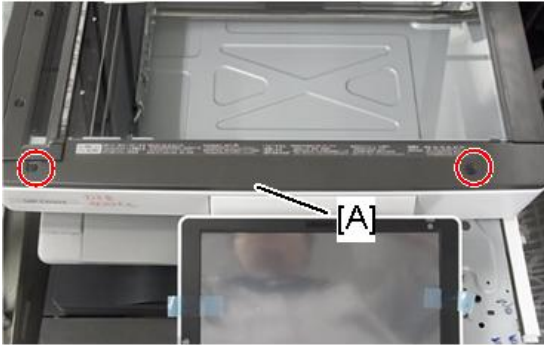

 x2

d238m0852

6. Remove the operation panel upper cover [A].

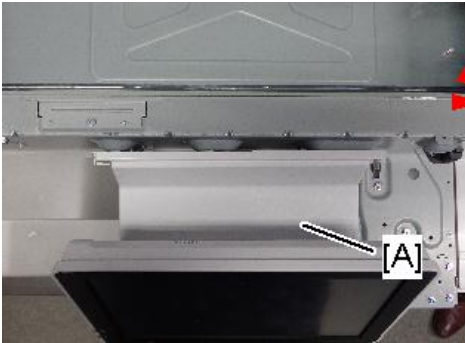

d238m0853

7. Remove the operation panel right cover [A].

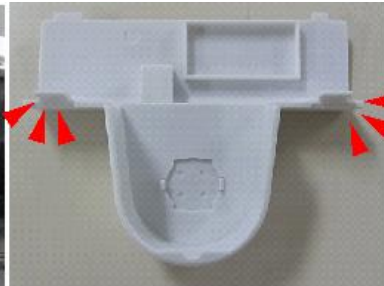
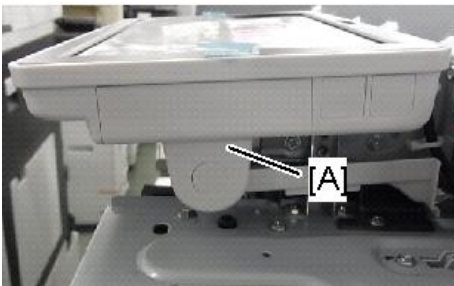

d238m0854

8. Thread the USB cable [B] through the notch in the corner cover [A] and attach the ferrite core [C].

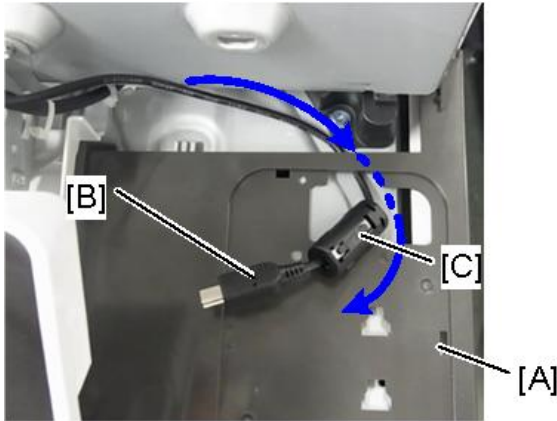

↓ Note

- Attach the ferrite core 6 cm [A] away from the end of the cable.
- By doing so, it becomes easier to put the ferrite core inside the reader cover in step 12.

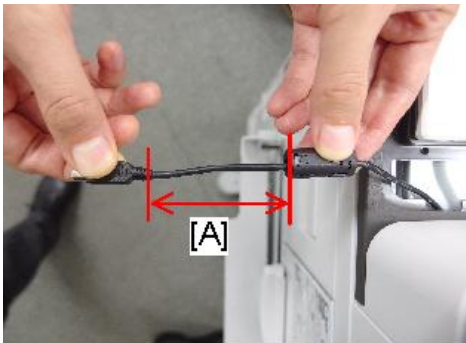

9. Reattach the front upper cover to the machine.

10. Attach the reader spacer [A].

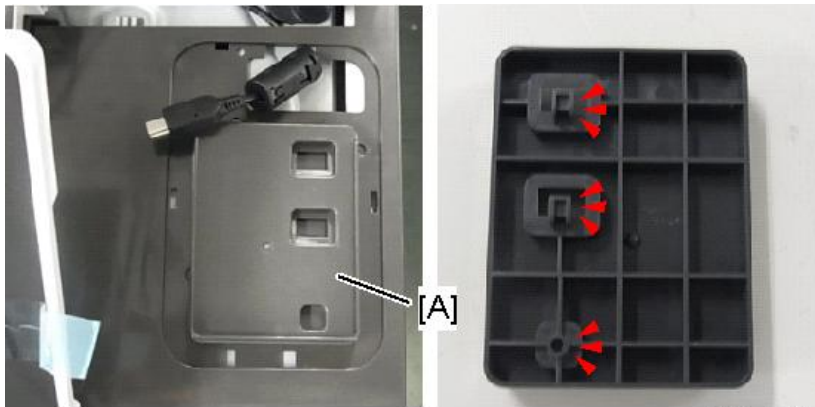

d238m0857

11. Attach the sponge cushions [A] to the reader spacer.

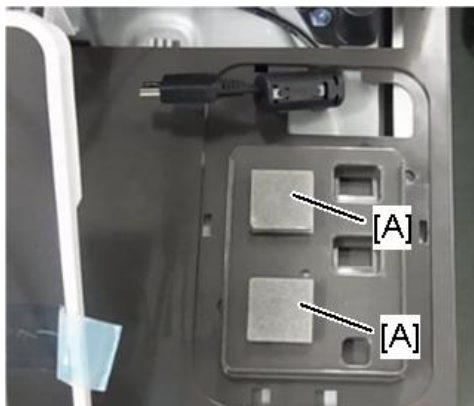

d238m0857

12. Connect the card reader and interface cable.

Make sure to turn the USB cable as shown so that it threads through the notch in the spacer [A].



x1

d238m0858

13. Attach the reader cover [A].

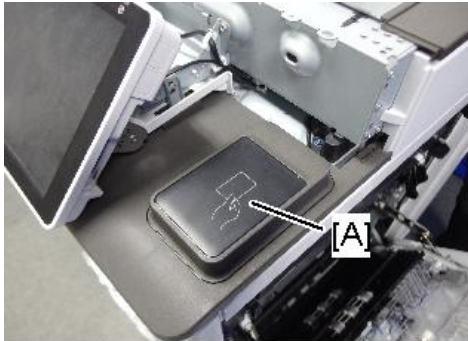

d238m0859

14. Connect the USB cable to the machine's operation panel connector.

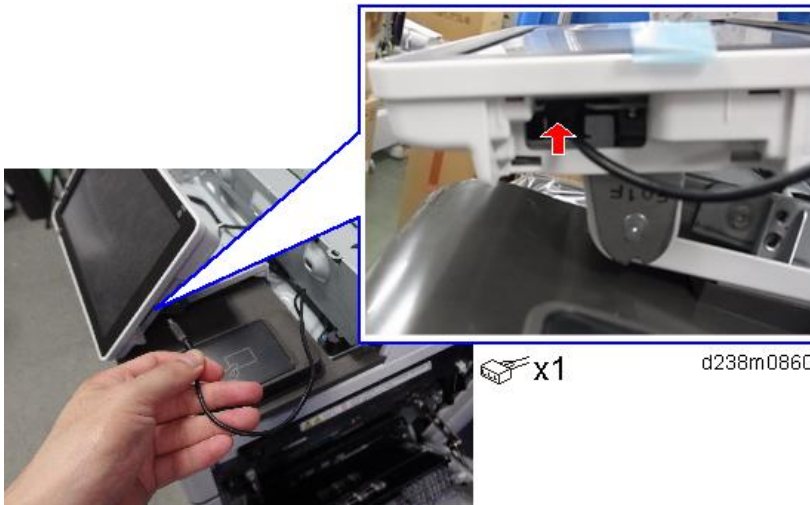

d238m0860

15. Thread the USB cable through the U-shaped groove [A] at the hinge of the operation panel and notch [B] on the cover under the cover.

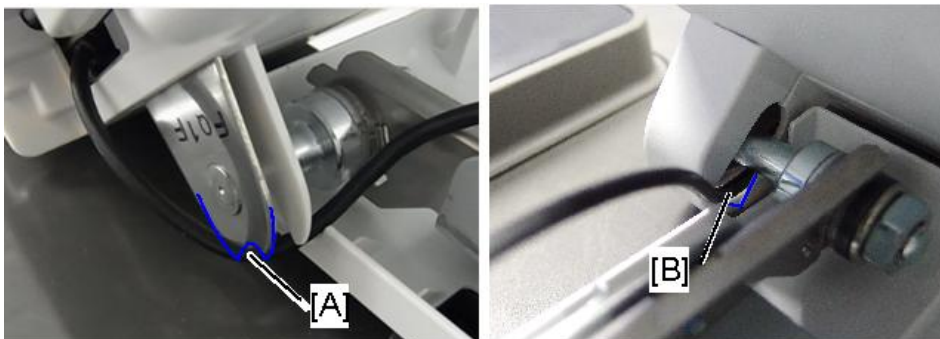

d238m0861

16. Apply the clamp to fasten the USB cable to the machine.

Make sure that the cable is not loose between the connector and hinge [A] and the hinge and clamp [B].

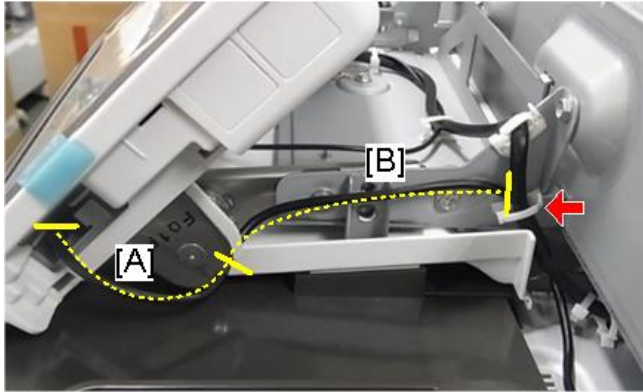

 x1

d238m0862

17. Tuck in the excess length portion of the USB cable in the space under the scanner.

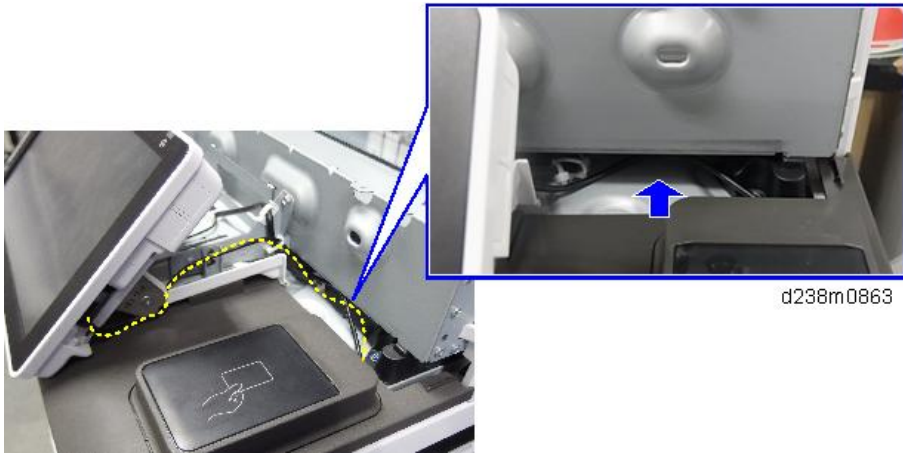

d238m0863

18. Reattach the removed covers.

Smart Card Reader Built-in Unit Type M19 (D3BS-22)

Accessory Check

2

No.	Description	Q'ty	Remarks
1	Corner Cover	1	
2	IC Card Reader Spacer	1	
3	IC Card Reader Table	1	
4	Sponge	2	

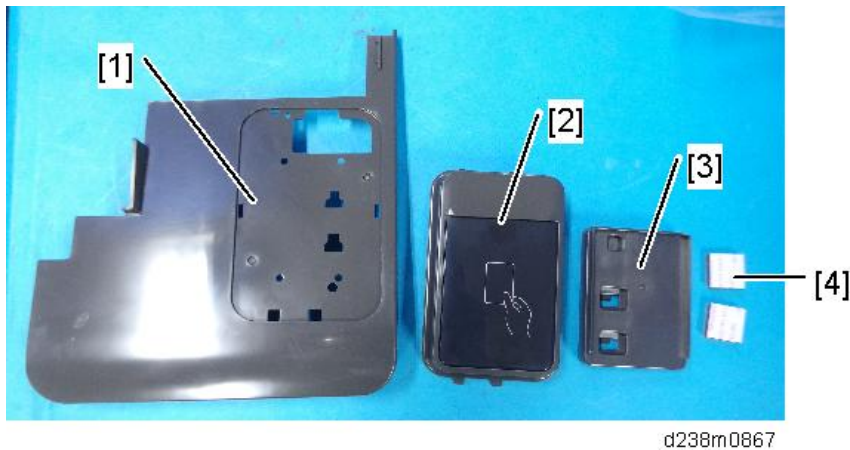

Installation Procedure

⚠ CAUTION

- When installing this option, turn OFF the main power and unplug the power cord from the wall socket. If installing without turning OFF the main power, an electric shock or a malfunction may occur.

An IC card reader and a USB cable are not included with this unit. The customers must obtain these themselves, and the technicians must install them.

There are 2 ways to connect the USB cable of the IC card. One is to the machine USB slot which is the same way as the previous machine, and another is to the smart operation panel USB slot.

Procedure for Connecting to the Main Machine USB Slot

1. Open the right door, and then remove the small cover [A].

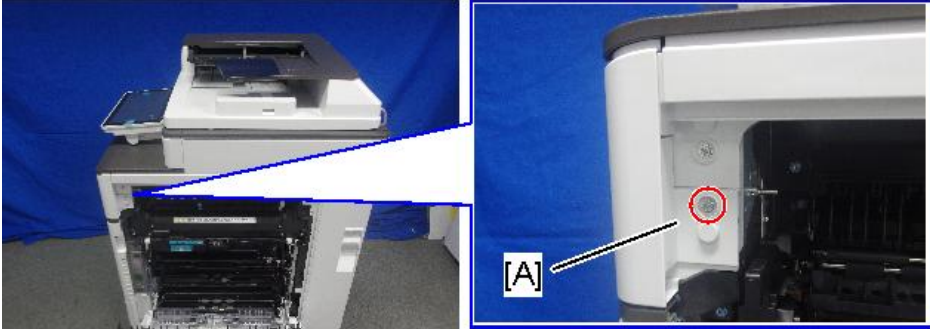



 x1

d238m553

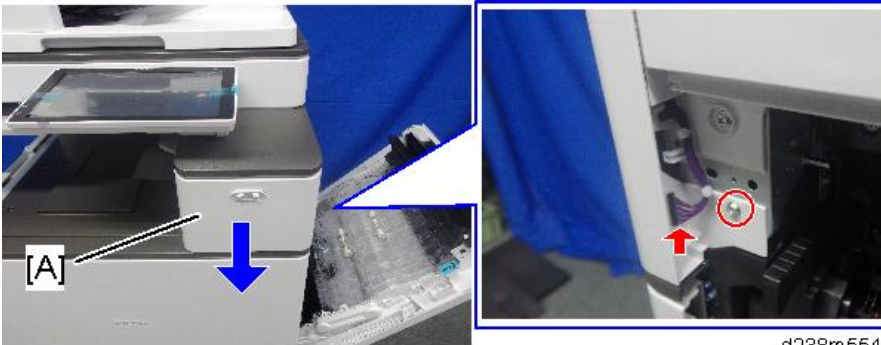
2. Remove the screw and the connector, and then remove the front upper cover [A].



 x1,  x1

d238m554

Note

- Remember that there is a tab at the positions of the red arrows.
- Rotate the operation panel [B] upward to a horizontal position, and then detach the front upper cover [A].

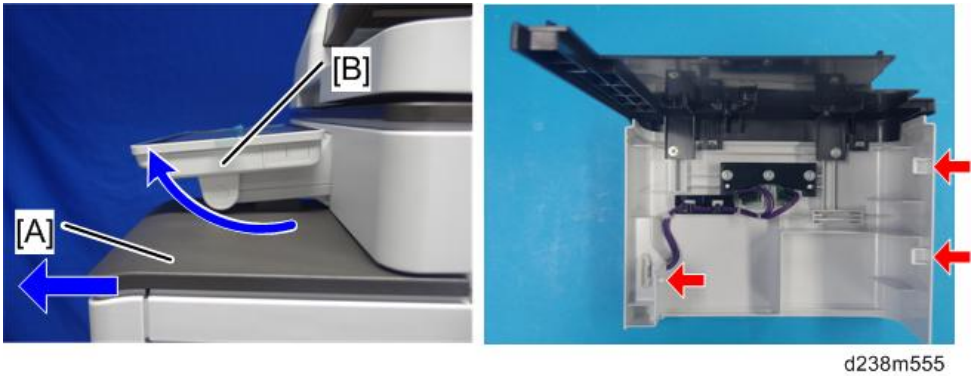

2

3. Remove the original upper cover [A].

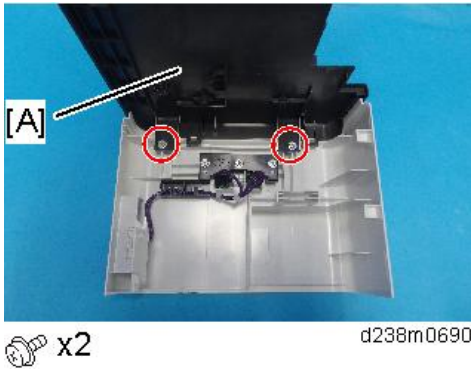

4. Attach the corner cover [A] provided with this option.

Use the screws removed in the previous step.

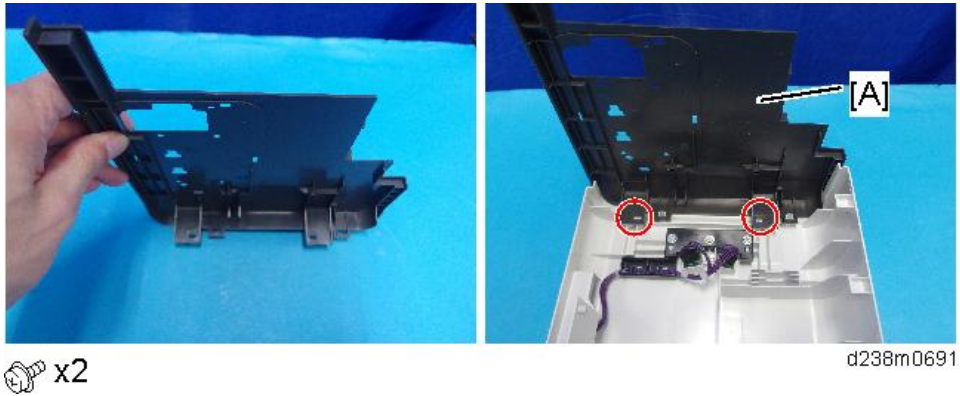

5. Remove the scanner right cover [A].

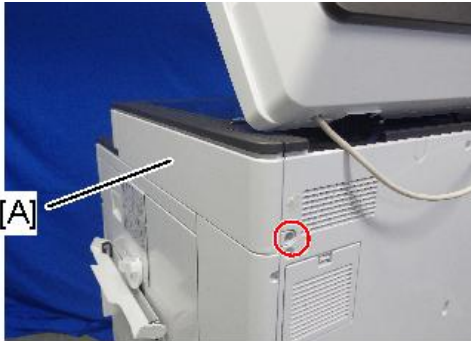

d238m0684

 x1

6. Reattach the front upper cover with corner cover [A] to the main machine.

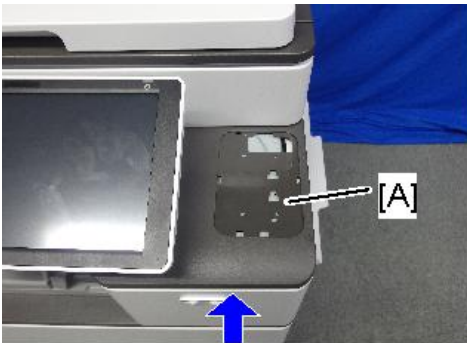

d238m0692

7. Pass the USB cable [A] through the hole.

 **Note**

- This cable is not included in this unit. The user may need to provide it.



d1463011

8. Attach the table [A].**↓ Note**

- There are three ribs on the back side of the table.

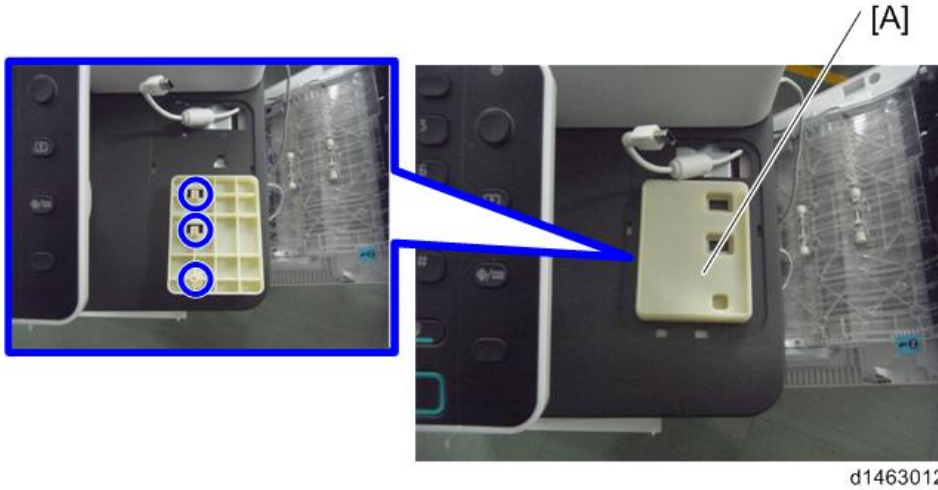

2

9. Attach the sponges [A] with double-sided tape.

10. Connect the cable [B] to the IC reader [A] and attach the reader to the table.

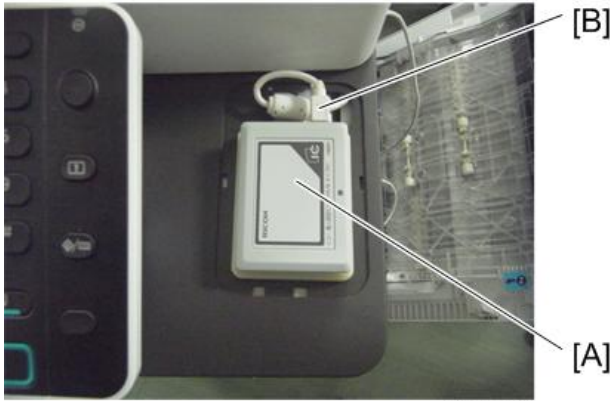

d1463015

Note

- The USB cable should be turned as the following photo shows.



d1463016

11. Attach the IC card reader cover [A].



d1463017

12. Attach the three clamps (🔧x3).



d1463018

13. Remove the cover to make the hole [A] to pass the cable through.



d1463019

14. Connect the USB connector to the USB interface of the controller.



d1463020

15. Route the cable as shown in the following photo.

Tuck in the excess length portion of the cable in the space over the controller box.

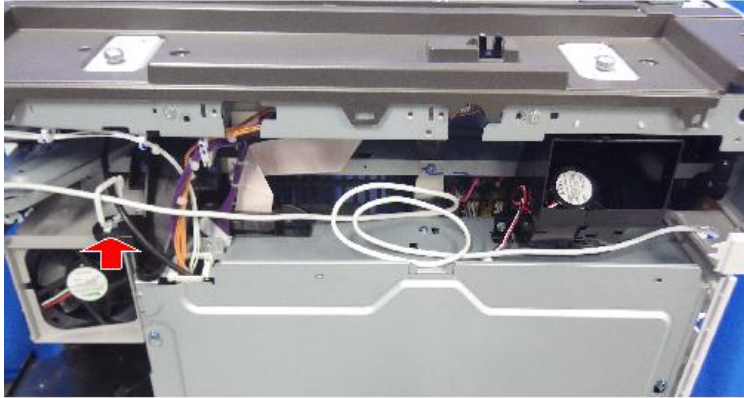

 x1

d238m0702

16. Reattach the exterior covers.

Procedure for Connecting to the Operation Panel USB Slot

1. Open the right door, and then remove the small cover [A].

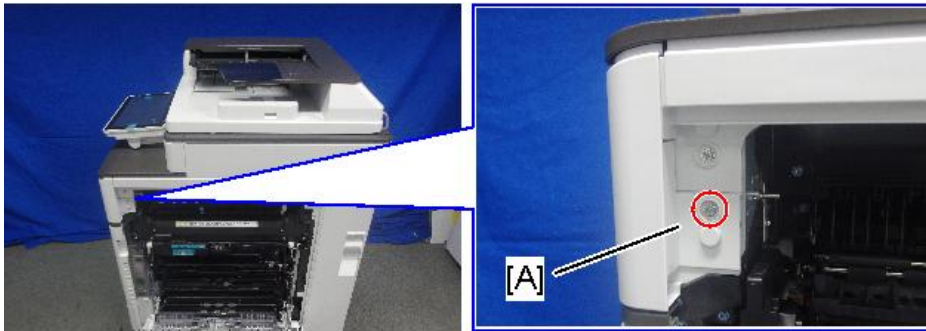



 x1

d238m553

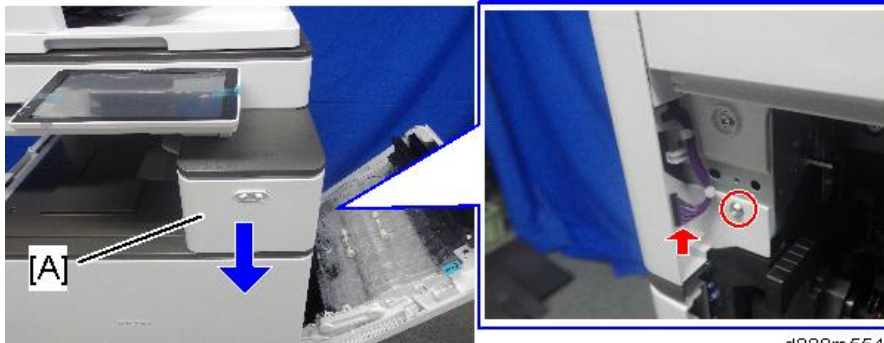
2. Remove the screw and the connector, and then remove the front upper cover [A].



d238m554

 x1,  x1

Note

- Remember that there is a tab at the positions of the red arrows.
- Rotate the operation panel [B] upward to a horizontal position, and then detach the front upper cover [A].

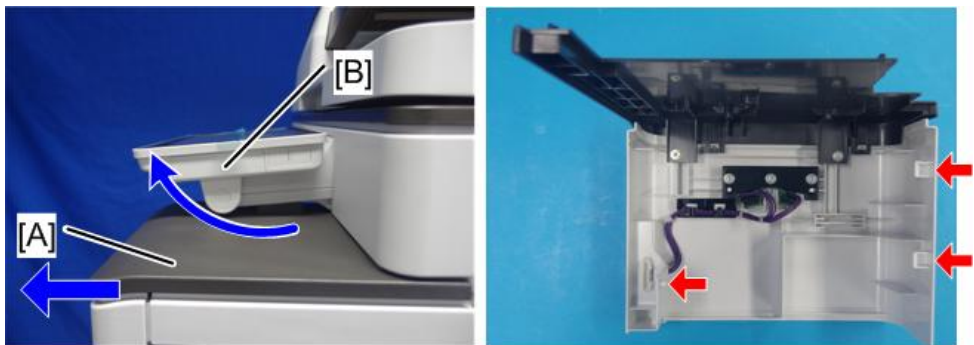

d238m555

3. Remove the original upper cover [A].

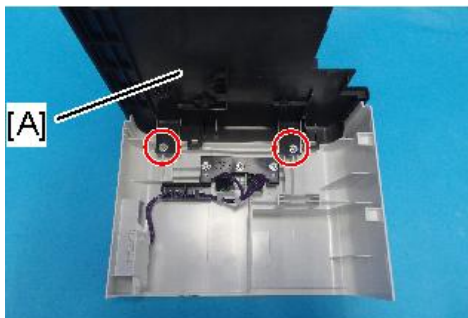

 x2

d238m0690

4. Attach the corner cover [A] provided with this option.

Use the screws removed in the previous step.



 x2

d238m0691

5. Remove the scanner front cover [A].

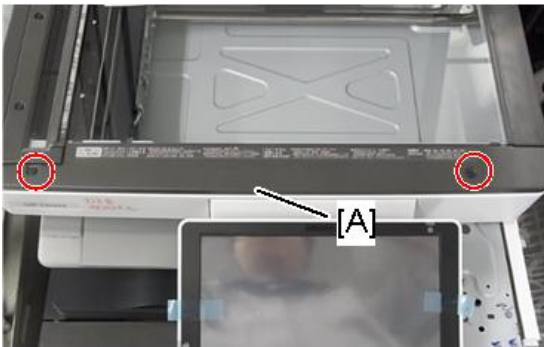

 x2

d238m0852

6. Remove the operation panel upper cover [A].

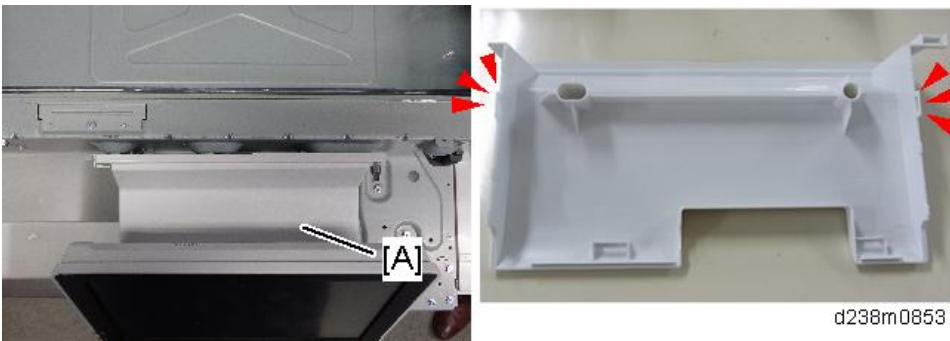

d238m0853

7. Remove the operation panel right cover [A].

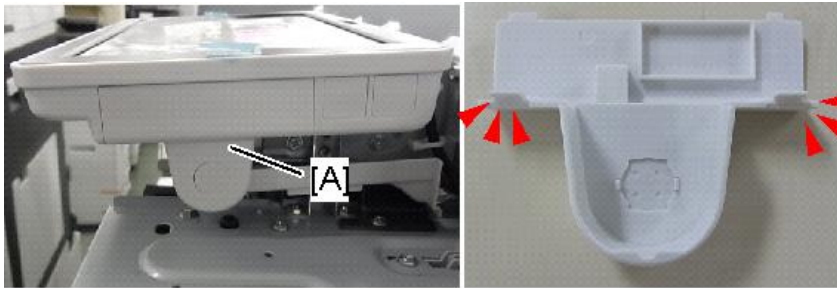

d238m0854

8. Thread the USB cable [B] through the notch in the front upper cover [A] and attach the ferrite core [C].

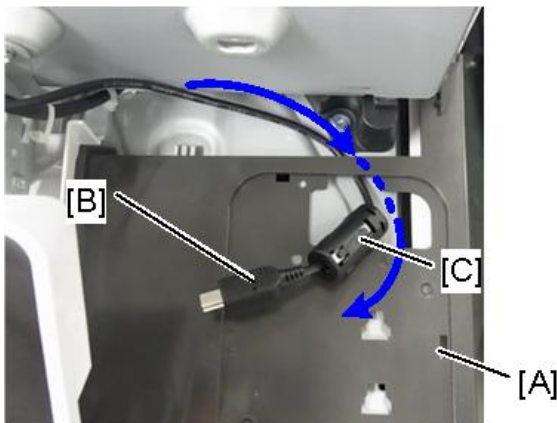

d238m0855

9. Reattach the front upper cover to the main machine.
10. Attach the reader spacer [A].

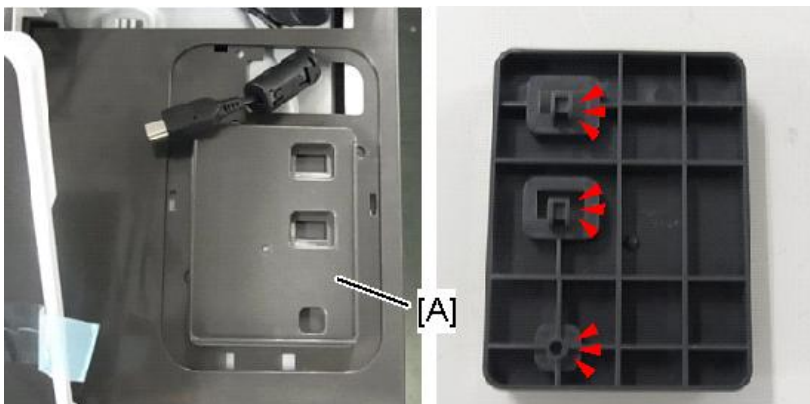

d238m0857

11. Attach the sponge cushions [A] to the reader spacer.

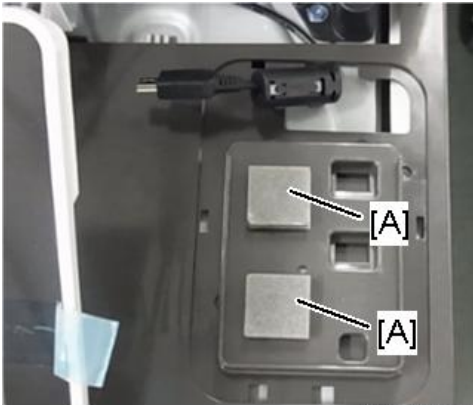

d238m0857

12. Connect the card reader and interface cable.

Make sure to turn the USB cable as shown so that it threads through the notch in the spacer [A].

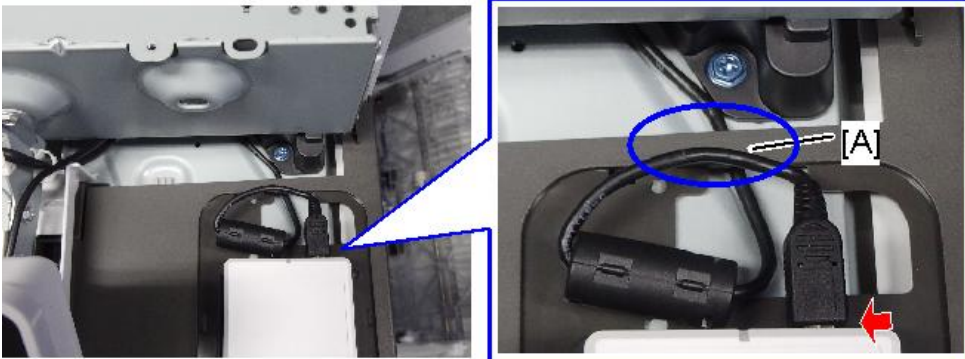

d238m0858

13. Attach the reader cover [A].

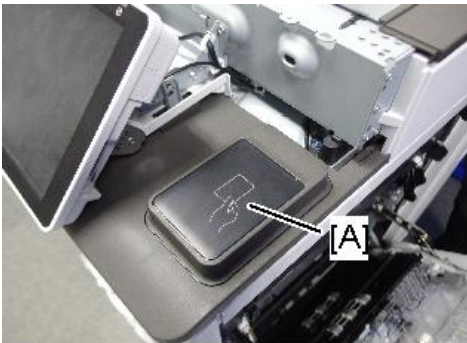

d238m0859

14. Connect the USB cable to the main machine's operation panel connector.

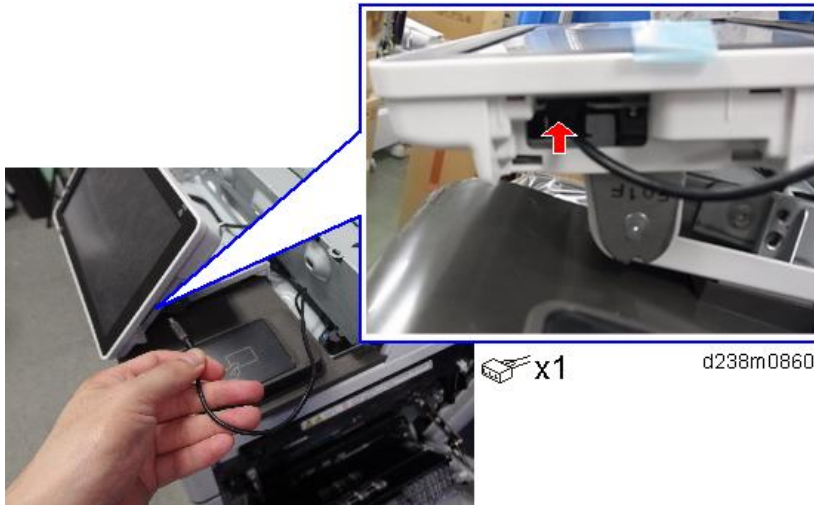

15. Thread the USB cable through the U-shaped groove [A] at the hinge of the operation panel and notch [B] in the cover under the cover.

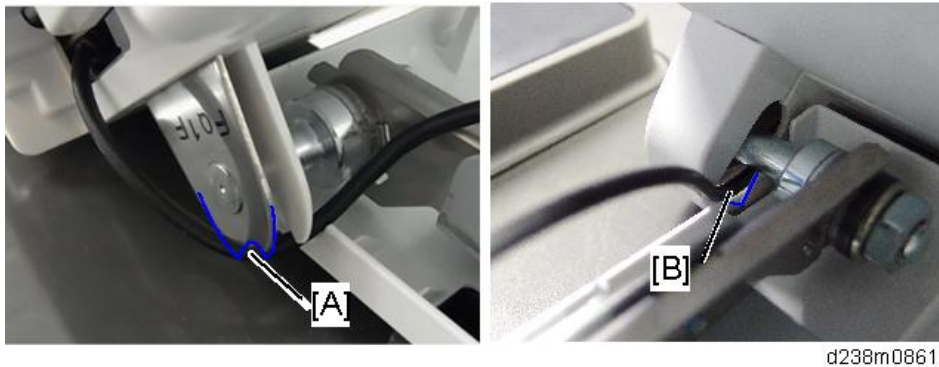

16. Apply the clamp to fasten the USB cable to the main machine.

Make sure that the cable is not loose between the connector and hinge [A] and the hinge and clamp [B].

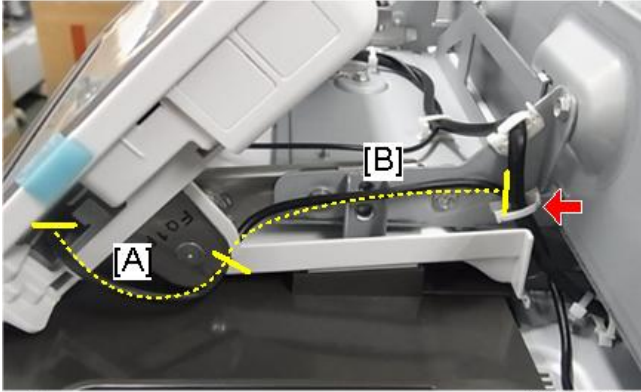

 x1

d238m0862

17. Tuck in the excess length portion of the USB cable in the space under the scanner.

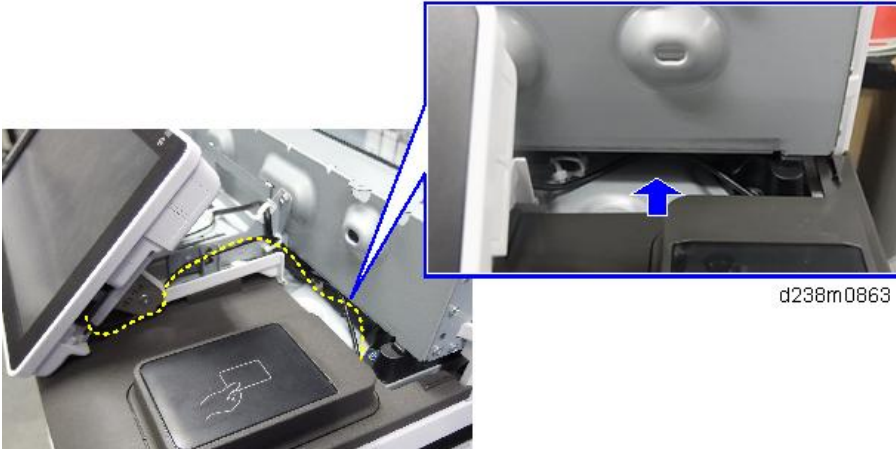

d238m0863

18. Reattach the removed covers.

SD Card Options

SD Card Slots

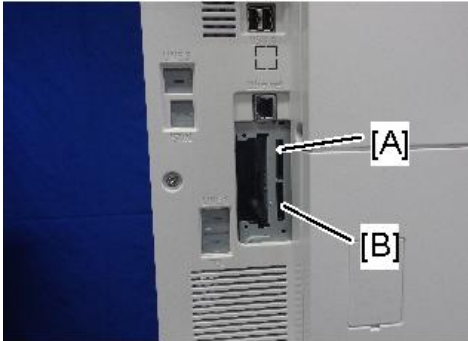

d238m0636

[A]: SD card slot 1 (option slot)

[B]: SD card slot 2 (service slot)

List of Slots Used

Optional SD cards can be set in either slot 1 or slot 2. But slot 2 is the service slot, so we recommend that you use slot 1 to install the SD card options.

SD card options for this machine

- OCR Unit Type M13 (page 358)
- XPS Direct Print Option Type M19 (page 356)
- PostScript3 Unit Type M19 (page 352)
- Camera Direct Print Card Type M19 (page 354)
- DataOverwriteSecurity Unit Type M19 (page 361)
- SD Card for Fonts Type D
- Unicode Font Package for SAP(R) 1 License
- Unicode Font Package for SAP(R) 10 Licenses
- Unicode Font Package for SAP(R) 100 Licenses
- Fax Connection Unit Type M19

↓ Note

- In this machine, it is possible to transfer data from a "Postscript3 Unit" SD card, unlike in earlier models, due to a change in the software licensing (the part of the Postscript software that requires

licensing is now built into the controller, so the portion on the SD card can be moved to another SD card).

SD Card Appli Move

Overview

Since there are only two SD card slots (one of them is a service slot), three or more SD card applications cannot be used simultaneously.

However, if multiple SD card applications are merged, three or more SD card options can be used.

This function is referred to as the "**SD card merge function**".

The "**SD card merge function**" is a function which enables the use of three or more functions within the capacity of two SD cards by physically transferring the function of one SD card to other SD cards (all SD card options can be stored in two SD cards).

However, SD card applications are under license, therefore, since an SD card license after merge is transferred to the target SD card, it cannot be used even if it is moved to the target machine.

Also, a process to prevent illegal copying is performed.

↓ Note

- After merge, store the empty SD card in the location shown below.

1. Open the right door, and then remove the small cover [A].

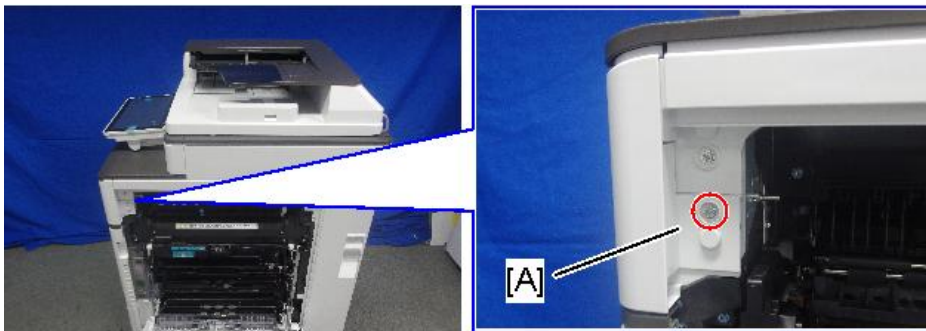

 x1

d238m553

2. Remove the screw and the connector, and then remove the front upper cover [A].

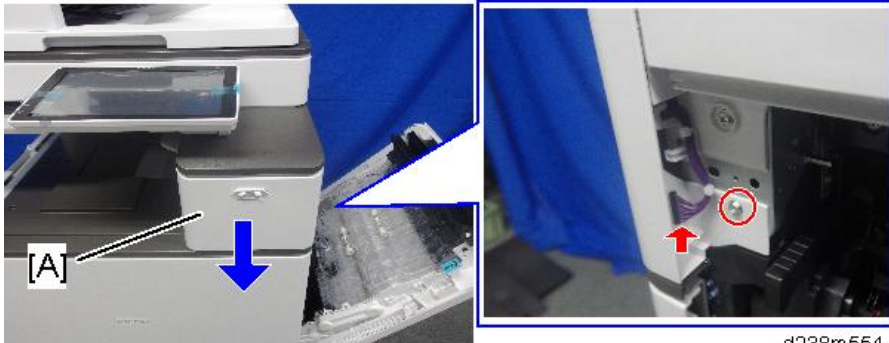

d238m554

x1, x1

Note

- Remember that there is a tab at the positions in the red arrows.
- Rotate the operation panel [B] upward to a horizontal position, and then detach the front upper cover [A].

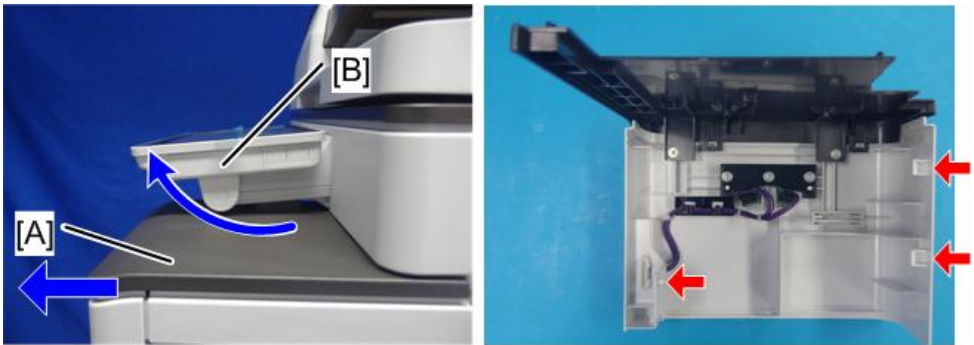

d238m555

3. Insert the SD card in the storage location [A] inside the cover.

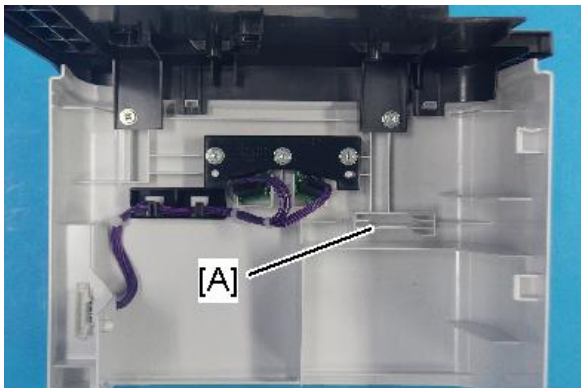

d238m0555b

Move Exec

"Move Exec" (SP5-873-001) lets you move application programs from the original SD card to another SD card.

Note

- The SD card as a destination is not specified.

1. Turn the OFF the main power.
2. Remove the SD card slot cover [A] (🔑 ×1).

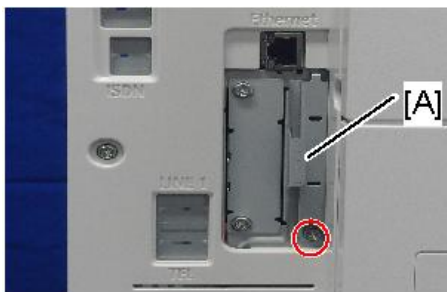

🔑 x1

d238m0641

3. Set the destination SD card (SD card where data is to be stored) in Slot 1 [A], and set the original SD card (SD card from which data is to be transferred) in Slot 2 [B].

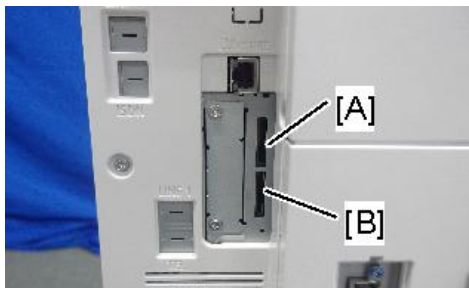

d238m0640j

4. Turn ON the main power, and press [ENTER] in SP5-873-001 (SD Card Appli Move: Move Exec).
5. When a confirmation screen is displayed, press [ENTER] (it takes about 2 - 3 minutes).

Note

- If [CANCEL] is pressed, the display returns to the previous screen.
- Note that if the power supply is turned off, a panel operation is performed, or the cover is opened during merge, it will result in a malfunction.

6. When merge is complete, and the following screen is displayed, press [CLOSE].

Note

- If the process is terminated abnormally, perform the merge in SP mode again.
- If the capacity of the destination SD card is insufficient, the merge operation cannot be performed.

7. Press [END] twice.

8. Turn OFF the main power.

9. Remove the empty SD card after transfer from Slot 2.

10. Reattach the slot cover (🔧 ×1).

11. Turn ON the main power, output the system setting list, and check that the options are recognized correctly.

Undo Exec

"Undo Exec" (SP5-873-002) lets you move back application programs from an SD card in Slot 1 (upper) to the original SD card in Slot 2 (lower). You can use this program when, for example, you have mistakenly copied some programs by using "Move Exec".

1. Turn OFF the main power.

2. Remove the SD card slot cover [A] (🔧 ×1).



🔧 x1

d238m0641

3. Insert the integrated SD card in Slot 1 [A: Upper].



d238m0640

4. Insert the SD card which became empty after integration in Slot 2 (lower slot).
5. Turn On the main power, and press [ENTER] in SP5-873-002 (SD Card Appli Move: Undo Exec).
6. When a confirmation screen is displayed, press [ENTER].

Note

- If [CANCEL] is pressed, the display returns to the previous screen.
- Note that if the power supply is turned off, a panel operation is performed, or the cover is opened during cancellation, it will result in a malfunction.

7. When cancellation is complete, press [CLOSE].
8. Press [END] twice.
9. Turn OFF the main power.
10. Reattach the SD card slot cover (👉 ×1).
11. Turn ON the main power, and check that the application has been deleted.

PostScript3 Unit Type M19 (D3BD-05, -06, -07)

2

Accessory Check

No.	Description	Q'ty
1	SD Card	1
2	PS3 Decal	1

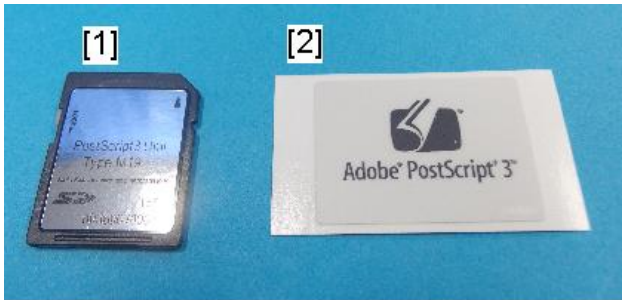

d238m0642

Installation procedure

Note

- When installing more than one SD card, perform the merge operation (page 347 "SD Card Appli Move").

1. Remove the SD card slot cover [A].



x1

d238m0641

2. Insert the PS3 SD card in SD card slot 1 [A: Upper Slot].



d238m0640

3. Reattach the SD card slot cover (🔩 ×1).
4. Stick the "Adobe PostScript3" decal [A] on the front face of the MFP.

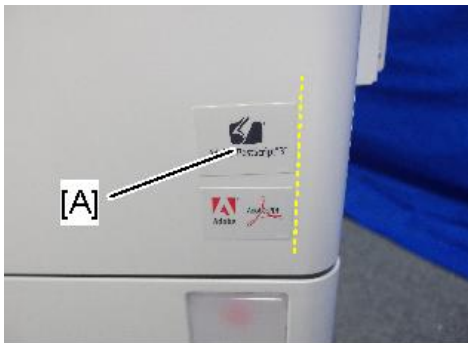

d238m0643

5. Turn ON the main power.
6. Print out the "Configuration Page", and then check if this option is correctly recognized.
 - User Tools > Machine Features > Printer Features > List/Test Page > Configuration Page

↓ Note

- The PDF firmware installed as standard contains a program required to print PS3 data as default. However, this PS3 program is normally disabled.
- The PS3 firmware is a dongle (key) which enables PS3 data printing functions. When the PS3 firmware is installed, the PS3 program in the PDF firmware is enabled. Due to this specification, the self-diagnosis result report shows the ROM part number/software version of the PDF firmware contained in the PS3 program.

Camera Direct Print Card Type M19 (D3BD-13)

Accessory Check

2

No.	Description	Q'ty
1	SD Card	1

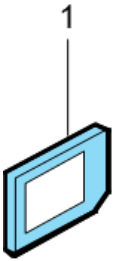

d595i900b

Installation Procedure

Note

- When installing more than one SD card, perform the merge operation (page 347 "SD Card Appli Move").

1. Remove the SD card slot cover [A].

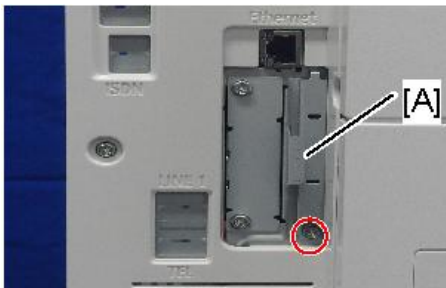

x1

d238m0641

2. Insert the Camera Direct Print Card in SD card slot 1 [A: Upper Slot].



d238m0640

3. Reattach the SD card slot cover. (👉 ×1)
4. Turn ON the main power.
5. Attach the "PictBridge" decal on the front face of the MFP.
6. Print out the "Configuration Page", and then check if this option is correctly recognized.
 - User Tools > Machine Features > Printer Features > List/Test Page > Configuration Page

XPS Direct Print Option Type M19 (D3BC-24, -25, -26)

2

Accessory Check

No.	Description	Qty	Remarks
1	XPS Direct Print SD Card	1	

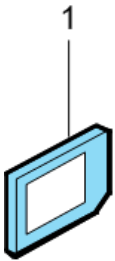

d595i900b

Installation Procedure

↓ Note

- When installing more than one SD card, perform the merge operation (page 347 "SD Card Appli Move").

1. Remove the SD card slot cover [A].

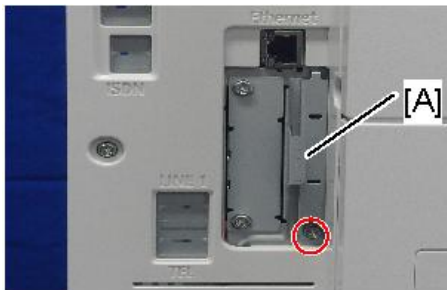

x1

d238m0641

2. Insert the XPS SD card in SD card slot 1 [A: Upper Slot].



d238m0640

3. Reattach the SD card slot cover (🔧 ×1).
4. Turn ON the main power.
5. Print out the "Configuration Page", and then check if this option is correctly recognized.
 - User Tools > Machine Features > Printer Features > List/Test Page > Configuration Page

OCR Unit Type M13 (D3AC-23, -24, -25)

Accessory Check

2

No.	Description	Q'ty
1	SD Card	1

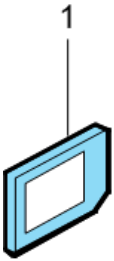

d595i900b

Searchable PDF Function Outline

This option adds a searchable PDF function to the scanning function.

- The searchable PDF function performs OCR by the MFP on a document read with the scanner, and embeds text data in the PDF. This permits PDF text browsing, automatic assignment of filenames, and automatic alignment of document orientation.
- This option is provided with an SD card. By installing an SD card in the MFP, a functional icon is added to the control unit. It is not necessary to install software in a PC.
- If this option is installed, various settings related to the searchable PDF function are available.
- After reading of the document is completed (after it is read by the SPDF/ARDF and output), OCR is performed. Therefore, after reading is completed, documents can be collected from the document glass or SPDF/ARDF.
- Other functions, such as the copy function and printer function, can be used during OCR.

Installation Procedure

↓ Note

- When installing more than one SD card, perform the merge operation (page 347 "SD Card Appli Move").

1. Remove the SD card slot cover [A].



 x1

d238m0641

2. Insert the OCR Unit SD card in SD card slot 1 [A: Upper Slot].



d238m0640

3. Turn ON the main power.

4. Enter the SP mode, and then press "Enter" in SP5-878-004 (Option Setup: OCR Dictionary).

The SD card ID is saved in the NVRAM, and the ID of the MFP is saved on the SD card. The MFP and SD card are thereby linked.

5. When "operation complete" is displayed, press "Close".

↓ Note

- If installation fails, "Failed" is displayed.
- If installation fails, perform the following steps.
 1. Check whether it is a used SD card.
 2. Switch the power OFF, and repeat steps 1-5.

6. Turn the machine OFF and back ON again.

7. Press "Enter" in SP5-878-004 (Option Setup: OCR Dictionary).

Dictionary data is copied to the HDD.

↓ Note

- On the first run, SP5-878-004 links the SD card, and on the second run, copies dictionary data.

8. Turn OFF the main power.

9. Remove the SD card from the SD card slot.

Note

- Keep the SD card in the SD card storage location of the MFP. The original SD card is needed in the event of a HDD malfunction.

10. Reattach the SD card slot cover.

11. Turn ON the main power.

12. Press [File Format / File Name] on the scanner function screen.

13. Check that [OCR setting] is displayed on the "File format / "File Name" screen.

Note

- After installation, the OCR setting can be changed on the "OCR setting" screen.
- When setting OCR, set [OCR setting] to [Yes]. (Default setting: [No])

Recovery Procedure

When this option is installed, a function is saved on the HDD, and ID information on the SD card is saved in the NVRAM. Therefore, when replacing the HDD and NVRAM, this option must be reinstalled.

When storing the original SD card

- When only the HDD is replaced
Reinstall using the original SD card.
- When only the NVRAM is replaced
When performing upload/download of NVRAM data, reinstall using the original SD card.
When not performing upload/download of NVRAM data, order and reinstall a new SD card (service part).
- When the HDD and NVRAM are replaced simultaneously
Reinstall using the original SD card.

If the original SD card is lost

Order and reinstall a new SD card (service part).

DataOverwriteSecurity Unit Type M19 (D3BS-03)

Overview

The machine's hard disk stores all document data from the Copier, Printer, and Scanner functions. It also stores the data of users' Document Server and code counters, and the Address Book. To prevent data on the hard disk being leaked before disposing of the machine, you can overwrite all data stored on the hard disk (Erase All Memory). You can also automatically overwrite temporarily-stored data (Auto Erase Memory).

The function of this option is completely the same as the Data Overwrite Security in Security Functions, which is standard on this machine (page 374 "Security Settings")

This option should be installed only for the customer who requires the **CC certified Data Overwrite Security function**.

Accessory Check

Check the quantity and condition of the accessories in the box against the following list.

No.	Description	Q'ty
1	SD Card	1
-	Comments Sheet	1
-	Operating Instructions CD-ROM	1

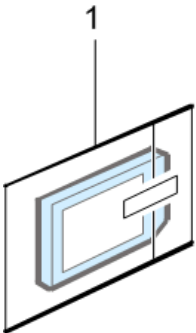

d1351921

Before You Begin the Procedure

1. Confirm that the Data Overwrite Security unit SD card is the correct type for the machine. The correct type for this machine is "Type M19".

★ Important

- If you install any version other than "Type M19" for this machine, you will have to replace the NVRAM and do this installation procedure again.

2. Make sure that the following settings are not at their factory default values:

- Supervisor login password
- Administrator login name
- Administrator login password

If any of these settings is at a factory default value, tell the customer these settings must be changed before you do the installation procedure.

3. Make sure that "Admin. Authentication" is ON.

User Tools > Machine Features > System Settings > Administrator Tools > Administrator Authentication Management > Admin. Authentication

If this setting is OFF, tell the customer this setting must be ON before you do the installation procedure.

4. Make sure that "Administrator Tools" is enabled (selected).

User Tools > Machine Features > System Settings > Administrator Tools > Administrator Authentication Management > Available Settings

If this setting is disabled (not selected), tell the customer this setting must be enabled (selected) before you do the installation procedure.

↓ Note

- See the Operating Instructions (Security Guide) for the factory default values.

Seal Check and Removal

Before opening the corrugated envelope, make sure that the seal has not been broken or peeled off. If the seal has been broken or peeled off (even partially), this is considered an arrival defect. Note that once the seal is peeled off, this will leave a mark on the bag.

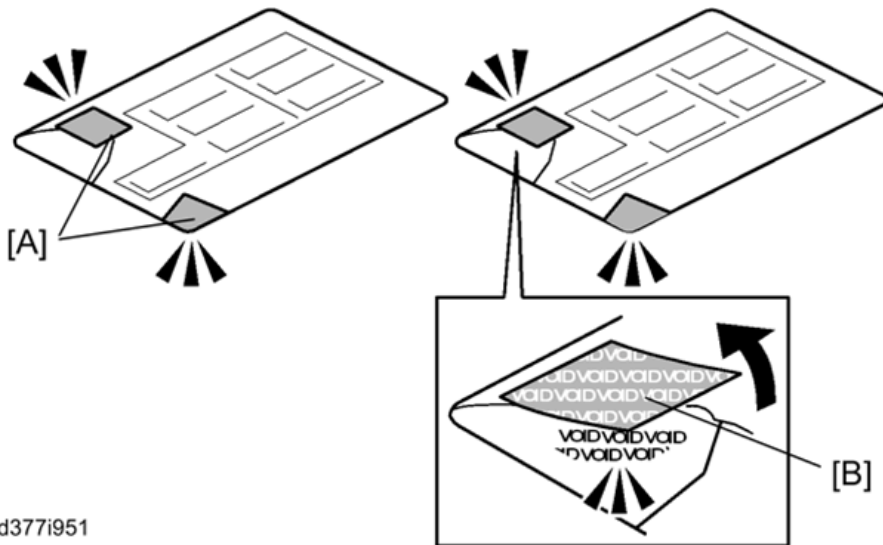

d377i951

⚠ CAUTION

- You must check the box seals to make sure that they were not removed after the items were sealed in the box at the factory before you do the installation.
- 1. Check the box seals [A] on each corner of the box.**
 - Make sure that a tape is attached to each corner.
 - The surfaces of the tapes must be blank. If you see "VOID" on the tapes, do not install the components in the box.
 - 2. If the surfaces of the tapes do not show "VOID", remove them from the corners of the box.**
 - 3. You can see the "VOID" marks [B] when you remove each seal. In this condition, they cannot be attached to the box again.**

Installation Procedure

- 1. Turn the main power off, and then remove the power plug and cables that are connected.**

2. Remove the SD card slot cover [A].

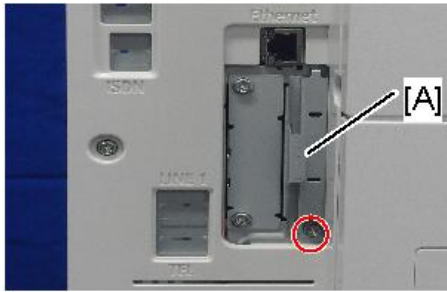

 x1

d238m0641

3. Insert the DataOverwriteSecurity Unit Type M19 SD card in SD card slot 1 [A: Upper Slot].



d238m0640

4. Reattach the SD card slot cover ( x1).

5. Insert the power cord into the outlet and turn ON the main power.

 **Note**

- When installing more than one SD card, perform the merge operation.

6. Enter the SP mode.

7. Do this step only if you are installing the option on a machine that is already in use (not a new machine):

- **If the customer wishes to** continue using the same hard disk, execute all three SP modes below.
 - SP5-801-014 (Clear DCS Setting)
 - SP5-832-001 (HDD Formatting (ALL))
 - SP5-832-002 (HDD Formatting (IMH))
- **If customer wishes to** replace the hard disk with a new one, execute SP5-801-014 only.

 **Note**

- If the customer continues using the same hard disk, the overwriting of the data stored on the disk before the option is installed cannot be guaranteed. It is highly recommended to replace the hard disk with a new one.

8. Set SP5-836-001 (Capture Function (0:Off 1:On)) to a value of 0 (disable).

9. Execute SP5-878-001 ([Option Setup: Data Overwrite Security])

If the installation fails, "Installation failed" is displayed when this SP is executed.

10. Print out the System Settings List and make sure that the option was installed successfully.

11. Reconnect the network cable.

12. Execute SP5-990-005 (SP print mode Diagnostic Report).

Make sure to shut down and reboot the machine once before printing the SMC. Otherwise, the latest settings may not be collected when the SMC is printed.

13. Make sure that ROM number "D3BC5757A" and firmware version "1.02" appear in both of the following areas on the report (they must match):

- "ROM Number / Firmware Version" - "HDD Format Option"
- "Loading Program"

Configuring "Auto Erase Memory" (Performed by the Customer)

1. Press the [User Tools] icon.
2. Press [Machine Features].
3. Press [System Settings].
4. Press [Administrator Tools].
5. Press [Next] three times.
6. Press [Auto Erase Memory Setting].

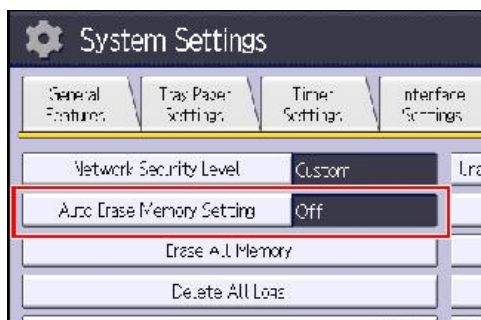

7. Press [On].

8. Select the method of overwriting.

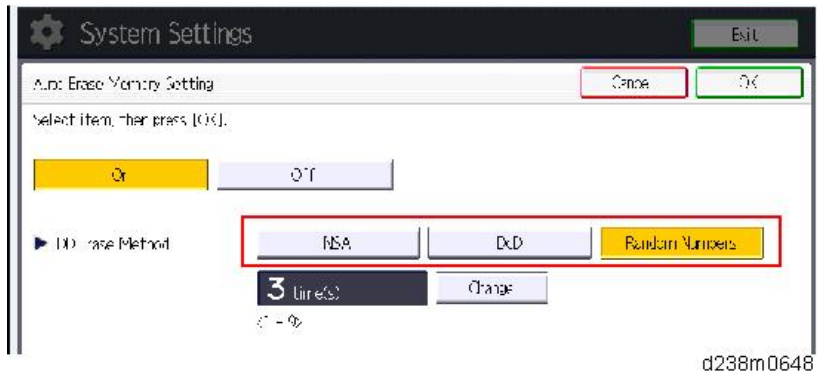

- If you select [NSA] or [DoD], proceed to Step 11.
- If you select [Random Numbers], proceed to Step 9.

9. Press [Change].

10. Enter the number of times that you want to overwrite using the ten keys, and then press [#].



The Random Numbers method overwrites the data using random numbers. You can set the overwrite to be performed anywhere from 1-9 times, with a default of 3 times.

11. Press [OK].



12. Make sure that the Data Overwrite icon is displayed in the bottom right hand corner of the screen.

13. Take a test copy, and then make sure that the Data Overwrite icon changes from "Dirty" (solid) to "Dirty" (blinking), and then to "Clear".

- If the Data Overwrite icon does not change to Clear, check to see if there are any active Sample Print or Locked Print jobs. A Sample Print or Locked Print job can only be overwritten after it has been executed.
- The Dirty icon blinks while an overwrite is in progress.

- If you use your machine for a while with Auto Erase Memory disabled, and then suddenly enable it, the overwrite process may take 10 or more hours depending on HDD usage.

Data Overwrite icon:

	Icon [1]	This icon is lit when there is temporary data to be overwritten, and blinks during overwriting.
	Icon [2]	This icon is lit when there is no temporary data to be overwritten.

SP descriptions

- SP5-801-014 (Memory Clear: Clear DCS Setting)
Initializes the DCS (Delivery Control Service) settings.
- SP5-832-001 (HDD Formatting : HDD Formatting (ALL))
Initializes the hard disk.
- SP5-832-002 (HDD Formatting : HDD Formatting (IMH))
Initializes the hard disk.
- SP5-836-001 (Capture Settings: Capture Function (0:Off 1:On))
With this function disabled, the settings related to the capture feature cannot be initialized, displayed, or selected.
- 5-878-001 (Data Overwrite Security)
Enables the Data Overwrite Security unit. Press "EXECUTE" on the operation panel. Then turn the machine off and on.
- SP5-990-005 (SP Print Mode: Diagnostic Report).
Prints the configuration sheets of the system and user settings : SMC.
Make sure to shut down and reboot the machine once before printing the SMC. Otherwise, the latest settings may not be collected when the SMC is printed.

@Remote Settings

↓ Note

- Prepare and check the following check points before you visit the customer site. For details, ask the @Remote key person.

2

Check points before making @Remote settings

1. The setting of SP5-816-201 in the mainframe must be "0".
2. Print the SMC with SP5-990-002 and then check if a device ID2 (SP5-811-003) must be correctly programmed.
 - 6 spaces must be put between the 3-digit prefix and the following 8-digit number (e.g. xxx____xxxxxxxx).
 - ID2 (SP5-811-003) and the serial number (SP5-811-001) must be the same (e.g. ID2: A01____23456789 = serial No. A0123456789)
 - Make sure to shut down and reboot the machine once before printing the SMC. Otherwise, the latest settings may not be collected when the SMC is printed.
3. The following settings must be correctly programmed.
 - Proxy server IP address (SP5-816-063)
 - Proxy server Port number (SP5-816-064)
 - Proxy User ID (SP5-816-065)
 - Proxy Password (SP5-816-066)

4. Get a Request Number

Execute the @Remote Settings

1. Enter the SP mode.
2. Input the Request number which you have obtained from @Remote Center GUI, and then enter [OK] with SP5-816-202.
3. Confirm the Request number, and then click [EXECUTE] with SP5-816-203.
4. Check the confirmation result with SP5-816-204.

Value	Meaning	Solution/ Workaround
0	Succeeded	-
3	Communication error (proxy enabled)	Check the network condition.
4	Communication error (proxy disabled)	Check the network condition.
5	Proxy error (authentication error)	Check Proxy user name and password.

Value	Meaning	Solution/ Workaround
6	Communication error	Check the network condition.
8	Other error	See "SP5816-208 Error Codes" below this.
9	Request number confirmation executing	Processing... Please wait.
11	Already registered	-
12	Parameter error	-
20	Dial-up authentication error	* These errors occur only in the modems that support @Remote.
21	Answer tone detection error	
22	Carrier detection error	
23	Invalid setting value (modem)	
24	Low power supply current	
25	unplugged modem	
26	Busy line	

5. Make sure that the screen displays the Location Information with SP5-816-205 only when it has been input at the Center GUI.
6. Click [EXECUTE] to execute the registration with SP5-816-206.
7. Check the registration result with SP5-816-207.

Value	Meaning	Solution/ Workaround
0	Succeeded	-
1	Request number error	Check the request number again.
2	Already registered	Check the registration status.
3	Communication error (proxy enabled)	Check the network condition.
4	Communication error (proxy disabled)	Check the network condition.
5	Proxy error (Authentication error)	Check Proxy user name and password.
8	Other error	See "SP5-816-208 Error Codes" below this.

Value	Meaning	Solution/ Workaround
9	Request number confirmation executing	Processing... Please wait.
11	Already registered	-
12	Parameter error	-
20	Dial-up authentication error	* These errors occur only in the modems that support @Remote.
21	Answer tone detection error	
22	Carrier detection error	
23	Invalid setting value (modem)	
24	Low power supply current	
25	unplugged modem	
26	Busy line	

8. Exit the SP mode.

SP5-816-208 Error Codes

Caused by Operation Error, Incorrect Setting

Code	Meaning	Solution/ Workaround
-12002	Inquiry, registration attempted without acquiring Request No.	Obtain a Request Number before attempting the Inquiry or Registration.
-12003	Attempted registration without execution of a confirmation and no previous registration.	Perform Confirmation before attempting the Registration.
-12004	Attempted setting with illegal entries for certification and ID2.	Check ID2 of the mainframe.
-12005	@Remote communication is prohibited. The device has an Embedded RC gate-related problem.	Make sure that "Remote Service" in User Tools is set to "Do not prohibit".
-12006	A confirmation request was made after the confirmation had been already completed.	Execute registration.
-12007	The request number used at registration was different from the one used at confirmation.	Check Request No.

Code	Meaning	Solution/ Workaround
-12008	Update certification failed because mainframe was in use.	Check the mainframe condition. If the mainframe is in use, try again later.
-12009	The ID2 in the NVRAM does not match the ID2 in the individual certification.	Check ID2 of the mainframe.
-12010	The certification area is not initialized.	Initialize the certification area.

Error Caused by Response from GW URL

Code	Meaning	Solution/ Workaround
-2385	Other error	
-2387	Not supported at the Service Center	
-2389	Database out of service	
-2390	Program out of service	
-2391	Two registrations for the same mainframe	Check the registration condition of the mainframe
-2392	Parameter error	
-2393	External RCG not managed	
-2394	Mainframe not managed	
-2395	Box ID for external RCG is illegal.	
-2396	Mainframe ID for external RCG is illegal.	
-2397	Incorrect ID2 format	Check the ID2 of the mainframe.
-2398	Incorrect request number format	Check the Request No.

SP descriptions

- **SP5-816-201 (Remote Service: Regist Status DFU(SSP))**

Displays a number that indicates the status of the @Remote service device.

0: Neither the registered device by the external nor embedded RCG device is set.

1: The embedded RCG device is being set. Only Box registration is completed. In this status, this unit cannot answer a polling request from the external RCG.

2: The embedded RCG device is set. In this status, the external RCG unit cannot answer a polling request.

3: The registered device by the external RCG is being set. In this status the embedded RCG device cannot be set.

4: The registered module by the external RCG has not started.

- **SP5-990-002 (SP Print Mode: SP(Mode Data List))**

Prints the configuration sheets of the system and user settings : SMC.

Make sure to shut down and reboot the machine once before printing the SMC. Otherwise, the latest settings may not be collected when the SMC is printed.

- **SP5-811-003 (Machine No. Setting: ID2 Code Display)**

Sets the ID-2 code used to identify the @remote device at installation.

- **SP5-816-063 (Remote Service: Proxy server IP address)**

This SP sets the address of the proxy server used for communication between the RCG device and the gateway. Use this SP to set up or display the customer proxy server address.

The address is necessary to set up the embedded RCG-N.

The address display is limited to 127 characters. Characters beyond the 127 characters are ignored.

This address is customer information and is not printed in the SMC report.

- **SP5-816-064 (Remote Service: Proxy server Port number)**

This SP sets the port number of the proxy server used for communication between the embedded RCG-N and the gateway. This setting is necessary to set up the embedded RC Gate-N.

This port number is customer information and is not printed in the SMC report.

- **SP5-816-065 (Remote Service: Proxy User ID)**

This SP sets the HTTP proxy certification user name.

The length of the name is limited to 31 characters. Any character beyond the 31st character is ignored.

This name is customer information and is not printed in the SMC report.

- **SP5-816-066 (Remote Service: Proxy Password)**

This SP sets the HTTP proxy certification password.

The length of the password is limited to 31 characters. Any character beyond the 31st character is ignored.

This name is customer information and is not printed in the SMC report.

- **SP5-816-202 (Remote Service: Letter Number DFU(SSP))**

Allows entry of the number of the request needed for the RCG-N device.

- **SP5-816-203 (Remote Service: Confirm Execute)**

Executes the inquiry request to the @Remote GW URL.

- **SP5-816-204 (Remote Service: Confirm Result DFU(SSP))**

Displays a number that indicates the result of the inquiry executed with SP5816203.

- **SP5-816-205 (Remote Service: Confirm Place DFU(SSP))**

Displays the installed section informed from G/W for response of request number inquiry if the section is enrolled on the G/W.

- **SP5-816-206 (Remote Service: Register Execute)**

Executes "Embedded RCG Registration".

- **SP5-816-207 (Remote Service: Register Result DFU(SSP))**

Displays a number that indicates the registration result.

Security Settings

Security Function Installation

The machine contains the Security functions (Data Overwrite Security and HDD Encryption unit) in the controller board.

If you are installing a new machine, it is recommended to activate the Data Overwrite Security and HDD Encryption by selecting "Format All Data" from "System Settings" on the operation panel.

↓ Note

- This method is recommended because there is no user data on the hard drive yet (Address Book data, image data, etc.).

If the customer wishes to activate the Data Overwrite Security and HDD Encryption unit on a machine that is already running, it is recommended to activate the unit by selecting "All Data" from "System Settings" on the operation panel.

★ Important

- **Selecting "All Data" will preserve the data that has already been saved to the HDD. (If "Format All Data" is selected, all user data saved to the HDD up to that point will be erased).**

Immediately after encryption is enabled, the encryption setting process will take several minutes to complete before you can begin using the machine.

↓ Note

- If encryption is enabled after data has been stored on the HDD, or if the encryption key is changed, this process can take up to three and a half hours or more.

The machine cannot be operated while data is being encrypted.

Once the encryption process begins, it cannot be stopped.

Make sure that the machine's main power is not turned off while the encryption process is in progress.

If the machine's main power is turned off while the encryption process is in progress, the HDD will be damaged and all data on it will be unusable.

Print the encryption key and keep the encryption key (which is printed as a paper sheet).

Keep the encryption key in a safe place. If the encryption key is lost and is needed, the controller board, HDD and NVRAM must all be replaced at the same time.

↓ Note

- "NVRAM" mentioned in here means the NVRAM on the Controller Board.
- "NVRAM" or EEPROM on the BCU has nothing to do with this.

Please use the following procedure when the Data Overwrite Security and HDD Encryption are reinstalled.

Data Overwrite Security

Before You Begin the Procedure

1. Make sure that the following settings (1) to (3) are not at their factory default values.

- (1) Supervisor login password
- (2) Administrator login name
- (3) Administrator login password

If any of these settings is at a factory default value, tell the customer these settings must be changed before you do the installation procedure.

2. Make sure that "Admin. Authentication" is on.

[User Tools] icon -> [Machine Features] -> [System Settings] -> [Administrator Tools] -> [Administrator Authentication Management] -> [Admin. Authentication]

If this setting is off, tell the customer this setting must be on before you do the installation procedure.

3. Make sure that "Administrator Tools" is enabled (selected).

[User Tools] icon -> [Machine Features] -> [System Settings] -> [Administrator Tools] -> [Administrator Authentication Management] -> [Available Settings]

If this setting is disabled (not selected), tell the customer this setting must be enabled (selected) before you do the installation procedure.

Installation Procedure

1. Connect the network cable if it needs to be connected.
2. Turn ON the main power.
3. Go into the SP mode and push "EXECUTE" in SP5-878-001.
4. Exit the SP mode and turn off the operation switch. Then turn off the main power switch.
5. Turn on the machine power.
6. Do SP5-990-005 (SP print mode Diagnostic Report).
Make sure to shut down and reboot the machine once before printing the SMC. Otherwise, the latest settings may not be collected when the SMC is printed.
7. Go into the User Tools mode, and select [Machine Features] → [System Settings] → [Administrator Tools] → [Auto Erase Memory Setting] → [On].

8. Exit the User Tools mode.

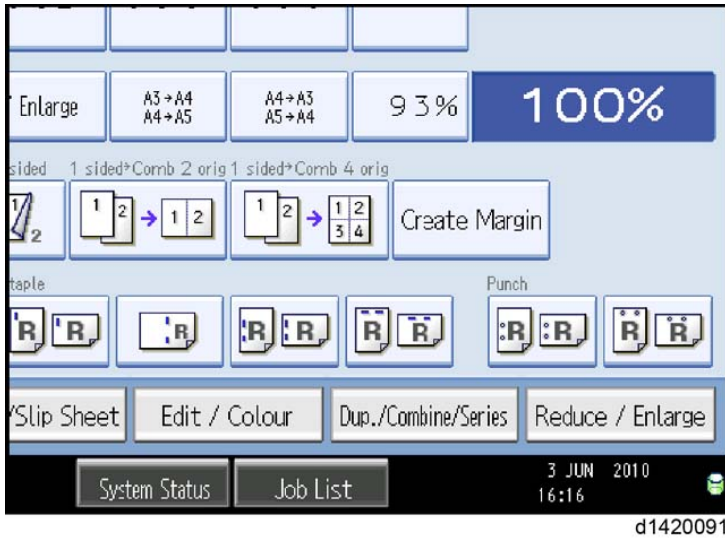

	<p>Icon [1]</p>	<p>This icon is lit when there is temporary data to be overwritten, and blinks during overwriting.</p>
	<p>Icon [2]</p>	<p>This icon is lit when there is no temporary data to be overwritten.</p>

9. Check the display and make sure that the overwrite erase icon appears.

10. Check the overwrite erase icon.

The icon [1] is lit when there is temporary data to be overwritten, and blinks during overwriting.

The icon [2] is lit when there is no temporary data to be overwritten.

Using Auto Erase Memory

The Auto Erase Memory function can be enabled by the following procedure.

1. Log in as the machine administrator from the control panel.
2. Press the [User Tools] icon.
3. Press [Machine Features].
4. Press [System Settings].
5. Press [Administrator Tools].

6. Press [Next] three times.
7. Press [Auto Erase Memory Setting].

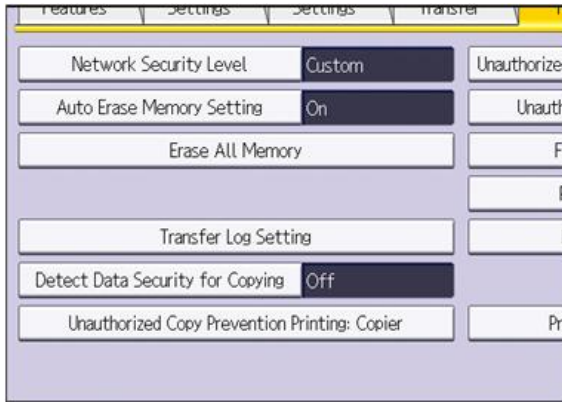

w_d1822517

8. Press [On].
9. Select the method of overwriting.
 - If you select [NSA] or [DoD], proceed to step 12.
 - If you select [Random Numbers], proceed to step 10.
10. Press [Change].
11. Enter the number of times that you want to overwrite using the number keys, and then press [#].
12. Press [OK]. Auto Erase Memory is set.
13. Log out.
14. Check the display and make sure that the overwrite erase icon appears.
15. Check the overwrite erase icon.
 - The icon [1] is lit when there is temporary data to be overwritten, and blinks during overwriting.
 - The icon [2] is lit when there is no temporary data to be overwritten.

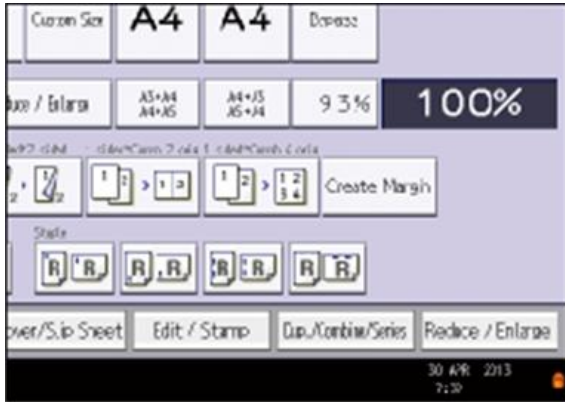

w_d1822516

	<p>Icon [1]</p>	<p>This icon is lit when there is temporary data to be overwritten, and blinks during overwriting.</p>
	<p>Icon [2]</p>	<p>This icon is lit when there is no temporary data to be overwritten.</p>

HDD Encryption

Before You Begin the Procedure:

1. Make sure that the following settings (1) to (3) are not at the factory default settings.

- (1) Supervisor login password
- (2) Administrator login name
- (3) Administrator login password

If any of these settings is at a factory default value, tell the customer these settings must be changed before you do the installation procedure.

2. Confirm that "Admin. Authentication" is on:

[User Tools] icon - [Machine Features] - [System Settings] - [Administrator Tools] - [Administrator Authentication Management] - [Admin. Authentication] - [On]

If this setting is off, tell the customer that this setting must be on before you can do the installation procedure.

3. Confirm that "Administrator Tools" is selected and enabled.

[User Tools] icon - [Machine Features] - [System Settings] - [Administrator Tools] - [Administrator Authentication Management] - [Available Settings]

"Available Settings" is not displayed until step 2 is done.

If this setting is not selected, tell the customer that this setting must be selected before you can do the installation procedure.

Installation Procedure:

1. Turn ON the main power, and then enter the SP mode.
2. Select SP5-878-002, and then press "Execute" on the LCD.
3. Exit the SP mode after "Completed" is displayed on the LCD.
4. Turn OFF the main power.

Enable Encryption Setting

Machine Data Encryption Settings can be enabled by the following procedure.

★ Important

- When setting up encryption, specify whether to start encryption after deleting data (initialize) or encrypt and retain existing data. If data is retained, it may take some time to encrypt it.
1. Turn ON the main power.
 2. Log in as the machine administrator from the control panel.
 3. Press the [User Tools] icon.
 4. Press [Machine Features].
 5. Press [System Settings].
 6. Press [Administrator Tools].
 7. Press [Next] three times.

8. Press [Machine Data Encryption Settings].

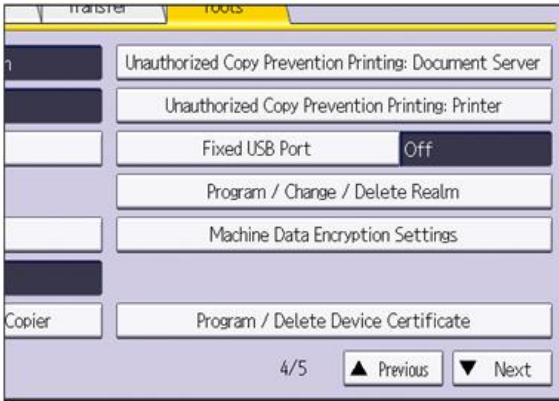

w_d1822518

9. Press [Encrypt].

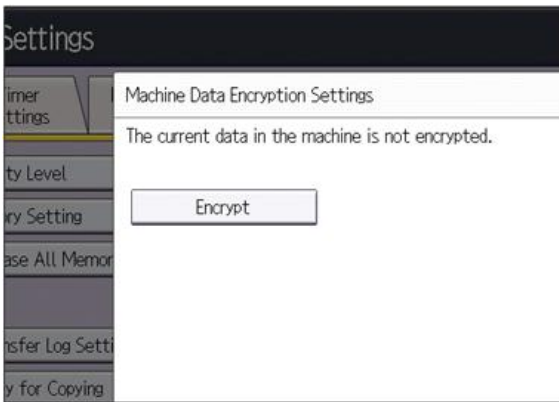

w_d1822519

10. Select the data to be carried over to the HDD and not be reset.

To carry all of the data over to the HDD, select [All Data].

To carry over only the machine settings data, select [File System Data Only].

To reset all of the data, select [Format All Data].

11. Select the backup method.

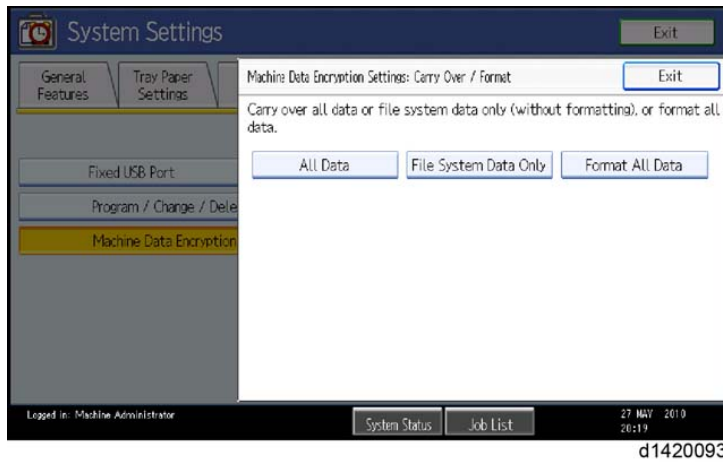

If you have selected [Save to SD Card], load an SD card into the media slot on the side of the control panel and press [OK] to back up the machine's data encryption key.

If you have selected [Print on Paper], press the [Start] key. Print out the machine's data encryption key.

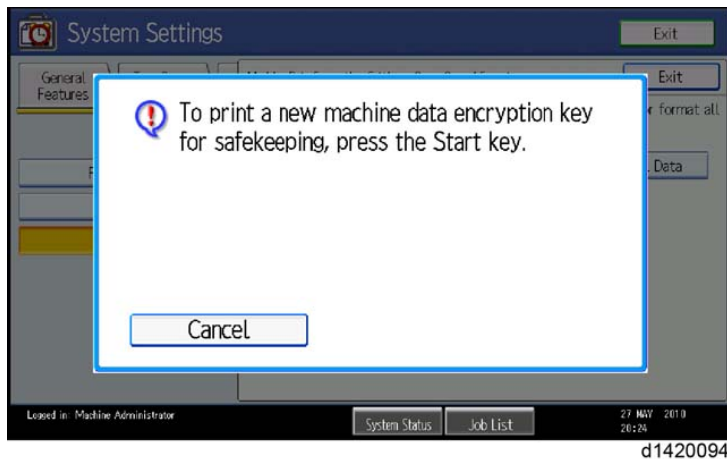

12. Press [OK].

13. Press [Exit].

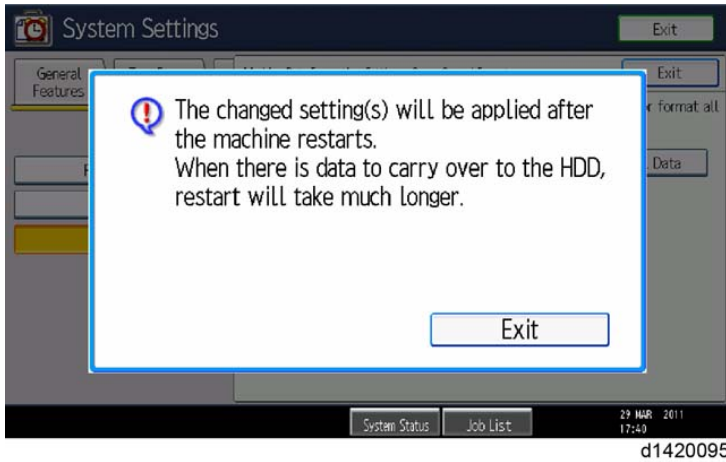

14. Press [Exit].

15. Log out.

16. Turn OFF the main power, and then turn the main power back ON.

The machine will start to convert the data on the memory after you turn on the machine. Wait until the message "Memory conversion complete. Turn the main power switch off." appears, and then turn the main power off again.

Check the Encryption Settings

1. Press the [User Tools] icon.
2. Press [Machine Features].
3. Press [System Settings].
4. Press [Administrator Tools].
5. Press [Machine Data Encryption Settings].

6. Confirm whether the encryption has been completed or not on this display.

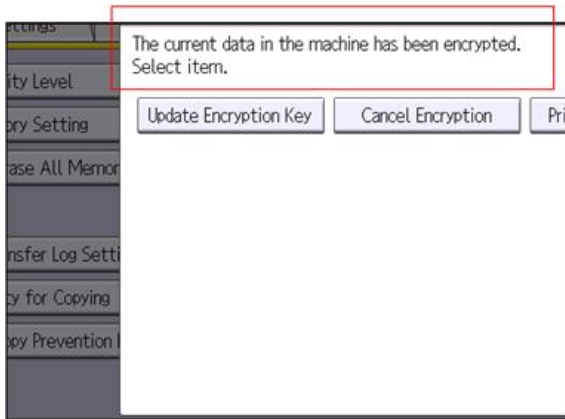

w_d1822520

Print the encryption key

Use the following procedure to print the key again if it has been lost or misplaced.

1. Press the [User Tools] icon.
2. Press [Machine Features].
3. Press [System Settings].
4. Press [Administrator Tools].
5. Press [Machine Data Encryption Settings].

If this item is not visible, press [Next] to display more settings.

6. Press [Print Encryption Key].

Encryption key sample

Machine Data Encryption Key

This is an encryption key which allows you to protect confidential data stored in the machine.
It is essential that the safekeeping and destruction of this encryption key be under your direct responsibility.
Data saved and programmed on the machine (documents, image data, setting values, address book contents etc.) can be encrypted/decrypted with this encryption key. If this machine breaks down, saved and programmed data in the machine can only be restored by entering this encryption key.
(Please note that it may not be possible to restore data in certain machine breakdown cases.)
This machine data encryption key will remain valid as long as the encryption is not cancelled or the encryption key is not changed.
After changing or cancelling the encryption key, please shred this document to destroy confidential data.

Output Date/Time:September 03,2010 08:55:25 AM
Machine Type:Aficio MP C400SR
Machine ID:S7500717004
Machine Data Encryption Key:
6pFIFFGH#EBiYkPafBJz6YE\$wYXk

d1420100

The encryption key is printed out as a sheet of paper like the example shown above. Please instruct the customer to keep it in a safe place.

Backing Up the Encryption Key

The encryption key can be backed up. Select whether to save it to an SD card or to print it.

★ Important

- The encryption key is required for data recovery if the machine malfunctions. Be sure to store the encryption key safely for retrieving backup data.

1. Log in as the machine administrator from the control panel.
2. Press the [User Tools] icon.
3. Press [Machine Features].
4. Press [System Settings].
5. Press [Administrator Tools].
6. Press [Next] three times.
7. Press [Machine Data Encryption Settings].

8. Press [Print Encryption Key].



w_d1822515

9. Select the backup method.

If you have selected [Save to SD Card], load an SD card into the media slot on the side of the control panel and press [OK]; once the machine's data encryption key is backed up, press [Exit].

If you have selected [Print on Paper], press the [Start] key. Print out the machine's data encryption key.

10. Press [Exit].

11. Log out.

Encryption Key Restoration

How to restore the old encryption key to the machine

The following message appears after the controller board is replaced. In such a case, it is necessary to restore the encryption key to the new controller board.

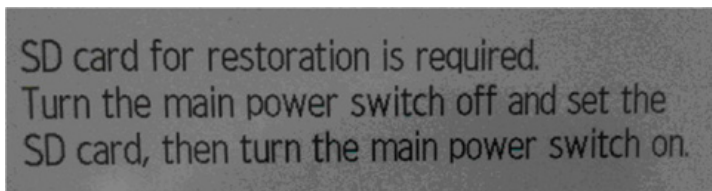

d1420101

To do this, follow the procedure below.

1. Prepare an SD card that has been initialized in FAT16 format.
2. Using a PC, create a folder in the SD card and name it "restore_key".
3. Create a folder in the "restore_key" folder and name it the same as machine's serial number, "xxxxxxxxxxx" (11 digits).

4. Create a text file called "key_XXXXXXXXXX.txt" and save it in the "XXXXXXXXXX" folder. Write the encryption key in the text file.

```
/restore_key/XXXXXXXXXX/key_XXXXXXXXXX.txt
```

Note

- Ask an Administrator to enter the encryption key. The key has already been printed out by the user and may have been saved in the "key_XXXXXXXXXX.txt" file. (The function of back-up the encryption key to the SD card directly is provided 11A products or later.)

5. Turn ON the machine's main power.
6. Confirm that a message is displayed on the LCD telling to insert the SD card that contains the encryption key.
7. Turn OFF the main power.
8. Insert the SD card that contains the encryption key into SD card slot 2 (the lower slot).
9. Turn ON the main power.

Note

- The machine will automatically restore the encryption key to the flash memory on the controller board.

10. Turn OFF the main power when the machine has returned to normal status.
11. Remove the SD card from SD card slot 2.

How to do a forced start up with no encryption key

If the encryption key back-up has been lost, follow the procedure below to do a forced start-up.

Important

- The HDD will be formatted after the forced start-up.
- Encrypted data will be deleted.
- User settings will be cleared.

1. Prepare an SD card.
2. Create a directory named "restore_key" inside the root directory of the SD card. Then, save the "nvram_key.txt" file using the following name:

```
/restore_key/nvram_key.txt
```

3. Create a text file and write "nvclear".

Important

- Write this string at the head of the file.
- Use all lower-case letters.
- Do not use quotation marks or blank spaces.

- It is judged that a forced start has been selected when the content of "nvclear" is executed and the machine shifts to the alternate system (forced start).
4. Confirm that a message is displayed on the LCD telling to insert the SD card that contains the encryption key.
 5. Turn off the main power.
 6. Insert the SD card that contains the encryption key into SD card slot 2 (the lower slot).
 7. Turn ON the main power.
The machine automatically clear the HDD encryption.
 8. Turn OFF the main power when the machine has returned to normal status.
 9. Remove the SD card from SD card Slot 2.
 10. Turn ON the main power.
 11. Memory clear SP5-801-xxx (Exclude SP-5-801-001: All Clear and SP-5-801-002: Engine), and clear SP5-846-046: address book.
 12. Set necessary user settings in User Tools.

SP descriptions

- **SP5-878-002 (Option Setup: HDD Encryption)**
Executes the setup for encryption.
- **SP5-990-005 (SP Print Mode: Diagnostic Report)**
Prints the configuration sheets of the system and user settings : SMC.
Make sure to shut down and reboot the machine once before printing the SMC. Otherwise, the latest settings may not be collected when the SMC is printed.
- **SP5-801-001 (Memory Clear: All Clear)**
Resets all correction data for process control and all software counters, and returns all modes and adjustments to their default values.
- **SP5-801-002 (Memory Clear: Engine)**
Clears non-volatile memory of engine.
- **SP5-846-046 (UCS Setting: Addr Book Media)**
Displays the slot number where an address book data is in.
0: Unconfirmed
1: SD Slot 1
2: SD Slot 2
3: SD Slot 3
4: USB Flash ROM
10: SD Slot 10

20: HDD

30: Nothing

3. Preventive Maintenance

PM Parts Settings

Replacement Procedure of the PM Parts

There are two ways to reset the PM counter for this machine.

"Method 2 By [PM Counter / New Unit Set] Menu" is recommended for its ease of operation.

★ Important

- After the PM counter for the fusing sleeve belt unit reaches its PM life (400K pages or 313,153,000 mm), the machine stops the operation automatically. Replace the fusing sleeve belt unit before the machine stops its operation (stop warning: 415K pages or 302,229,000 mm, stop: 430K pages or 313,153,000 mm).

↓ Note

- For the following units, there is a new unit detection mechanism. It is not necessary to set SPs (New Unit Detection).
 - Fusing unit as a complete unit
 - PCDU as a complete unit
 - Waste Toner Bottle (When the machine stopped because the waste toner bottle was full)

Method 1: By SP3701

1. Enter the SP mode.
2. Output the SMC logging data with SP5-990-004.
Make sure to shut down and reboot the machine once before printing the SMC. Otherwise, the latest settings may not be collected when the SMC is printed.
3. Set the following SPs (New Unit Detection) to "1".

Item	SP
Development unit <ul style="list-style-type: none">• Replacement procedure: page 462	Black: SP3-701-003 Yellow: SP3-701-072 Cyan: SP3-701-026 Magenta: SP3-701-049

Item	SP
PCU <ul style="list-style-type: none"> • Replacement procedure: page 462 	Black: SP3-701-002 Yellow: SP3-701-071 Cyan: SP3-701-025 Magenta: SP3-701-048
Pressure roller <ul style="list-style-type: none"> • Replacement procedure: page 550 Fusing sleeve belt unit <ul style="list-style-type: none"> • Replacement procedure: page 546 (Complete fusing unit is not necessary to set SP3-701.)	Pressure roller: SP3-701-118 Fusing sleeve belt unit: SP3-701-116
Image Transfer Belt Unit <ul style="list-style-type: none"> • Replacement procedure: page 474 	SP3-701-093
Image Transfer Cleaning Unit <ul style="list-style-type: none"> • Replacement procedure: page 478 	SP3-701-102
Paper Transfer Roller Unit <ul style="list-style-type: none"> • Replacement procedure: page 495 	SP3-701-109
Waste Toner Bottle (When the bottle is replaced before the machine detects bottle full and stops) <ul style="list-style-type: none"> • Replacement procedure: page 472 	SP3-701-142
Ozone Filter, Dust Filter <ul style="list-style-type: none"> • Replacement procedure: page 625 	SP3-701-131

4. Turn the main power switch OFF, and disconnect the power cord from the outlet.

5. Replace the PM parts and turn the main power ON.

The machine will reset the PM counters automatically. In the case of the development unit, developer initialization will also be done automatically.

6. Exit the SP mode.

Method 2: By [PM Counter / New Unit Set] Menu

1. Enter the SP mode.

2. Output the SMC logging data with SP5-990-004.

Make sure to shut down and reboot the machine once before printing the SMC. Otherwise, the latest settings may not be collected when the SMC is printed.

3. Press [PM Counter / New Unit Set].

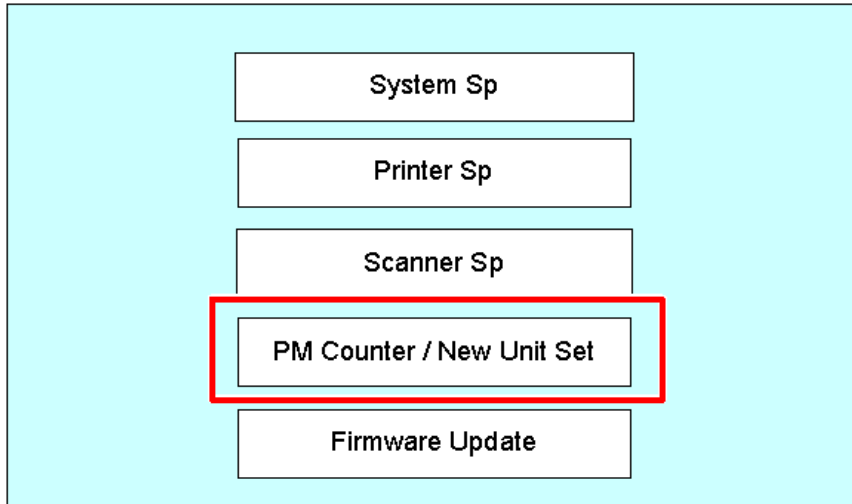

d238m0894

4. Press [All PM Parts List : New Unit Set].

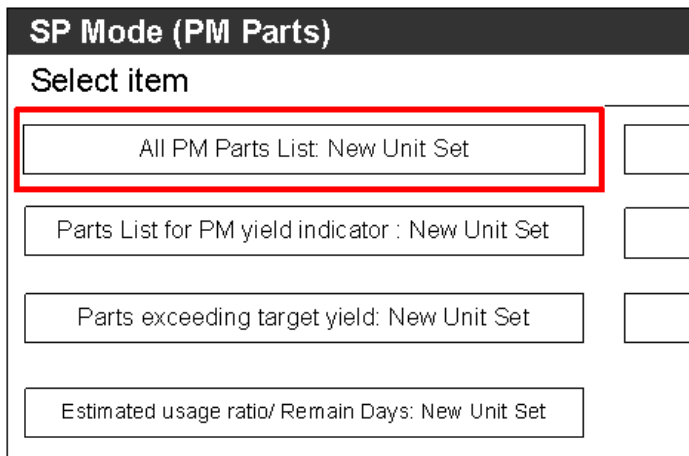

d238m0895

5. Set the PM part that you want to replace to "YES" under "New Unit Set".

After pressing "YES", the [Exit] key will not be available.

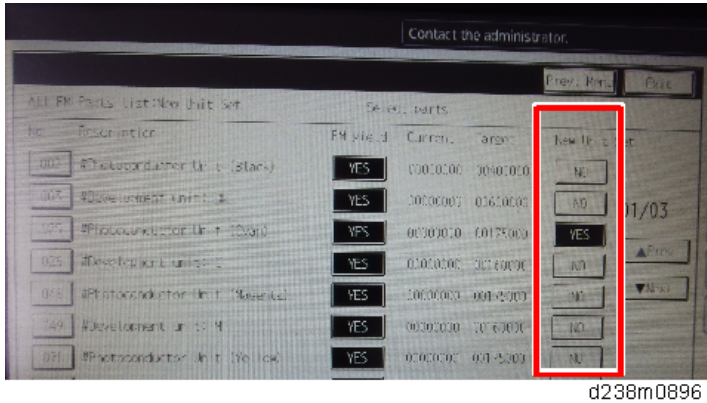

3

6. Turn OFF the main power and unplug the power cord from the wall outlet.
7. Replace the PM parts and turn the main power ON.

The machine will reset the PM counters automatically. In the case of the development unit, developer initialization will also be done automatically.

8. Exit the SP mode.

After Installing the New PM Parts

1. Output the SMC logging data with SP5-990-004 and check the counter values.
Make sure to shut down and reboot the machine once before printing the SMC. Otherwise, the latest settings may not be collected when the SMC is printed.
2. Make sure that the PM counters for the replaced units are "0" with SP7-621, or SP7-944. If the PM counter for a unit was not reset, then execute the new unit detect setting with SP3-701 again and turn the machine OFF/ON.
3. Make sure that the exchange counter counts up with SP7-853.
4. Make sure that the counters for the previous units (SP7-908) on the new SMC logging data list (from step 2 above) are equal to the counters (SP7-621, or SP7-944) for these units on the previous SMC logging data list (the list that was output in the "Before removing the old parts" section).
5. Make sure that the unit replacement date is updated with SP7-950.

SP Descriptions

- SP7-621-001 (PM Counter Display: Paper)

Displays the number of sheets printed for each current maintenance unit.

When a unit is replaced, the machine automatically detects that the new unit is installed.

Then, the current PM counter value is automatically moved to the PM Counter – Previous (SP7-906-1 to 10) and is reset to "0".

- **SP7-853 (Replace Counter)**

Displays the number of times each PM part has been replaced.

- **SP7-908 (Previous Unit Counter: Pages (%))**

Displays the PM counter of the previous PM Part which was replaced last time.

- **SP7-950 (Unit Replacement Date)**

Displays the replacement date of each PM unit.

- **SP5-990 (SP Print Mode)**

Prints the configuration sheets of the system and user settings : SMC.

Make sure to shut down and reboot the machine once before printing the SMC. Otherwise, the latest settings may not be collected when the SMC is printed.

Preparation before Operation Check

1. Clean the exposure glasses (for DF and book scanning).
2. Enter the user tools mode.
3. Do the "Automatic Color Calibration (ACC)" for the copier mode & printer mode as follows:
 - Print the ACC test pattern (User Tools > Maintenance > ACC > Start).
 - Put the printout on the exposure glass.
 - Put 10 sheets of white paper on the test chart. This ensures the precise ACC adjustment.
 - Close the ARDF or the platen cover.
 - Press "Start Scanning" on the LCD. Then, the machine starts the ACC.
4. Exit the User Tools mode, and then enter the SP mode.
5. Perform line adjustment.

SP2-111-004: Forced Line Position Adj. Mode d

The result can be checked with SP2-194-007 (MUSIC Execution Result Execution Result) (0: Success, 1: Failure).

Also, results for each color can be checked with SP2-194-010 to 013.
6. Exit the SP mode.

SP Descriptions

- **SP2-194-007 (MUSIC Execution Result: Execution Result)**

Displays the result code of MUSIC adjustment.

0: Success

1: Failure

- **SP2-194-010 to 013 (MUSIC Execution Result: Error Result C,M, Y, K)**

Displays the result code of MUSIC adjustment for each color.

0: Not done

1: Completed successfully

2: Cannot detect patterns

3: Fewer lines on the pattern than the target

4: Out of the adjustment range

5 to 9: Not used

Operation Check

Check if the sample image has been copied normally.

PM Parts List

See "Appendices" for the following information:

- Preventive Maintenance Items

4. Replacement and Adjustment

Notes on the Main Power Switch

Push Switch

The main power button of this machine has been changed to a push-button switch (push button) from the conventional rocker switch. The push switch has characteristics and specifications different from the rocker switch. Care must be taken when replacing and adjusting parts.

Characteristics of the Push Switch (DC Switch)

Power is supplied to the machine even when the main power switch is turned OFF.

The push switch in this machine uses DC (direct current). Therefore, if the AC power cord is connected to an electrical outlet, power is supplied to the controller board, the operation unit and other modules even when the main power is turned OFF. When replacing the controller board and the operation unit in this state, not only these boards, it will damage other electrical components.

So, when performing maintenance work such as replacing parts, in addition to turning off the main power with the push switch, always unplug the AC power cord.

When you disconnect the power cord from the AC wall outlet, inside the machine there is still residual charge.

When you disconnect the power cord from the AC wall outlet, inside the machine for a while there is still residual charge. Therefore, if you remove boards in this state, it can cause a blown fuse or memory failure.

- How to remove the residual charge inside the machine

After you unplug the power cord from the AC wall outlet, in order to remove the residual charge from inside the machine, be sure to press the main power switch. Thus, the charge remaining in the machine is released, and it is possible to remove boards.

When you reconnect the AC power cord into an AC wall outlet, the machine will start automatically.

In order to remove the residual charge, push the main power switch while you disconnect the AC power cord. At that time, the power ON flag inside the machine is set. Therefore, after you finish work on the machine and reconnect the power cord to the AC, even if you do not press the main power switch, the machine will start automatically and the moving parts will begin to move. When working on moving parts, be careful that fingers or clothes do not get caught.

Note

- Automatic restart deals with cases when you accidentally unplugged the AC power cord or unexpected power outages. By keeping the power flag ON, after the resumption of power, the machine will start up automatically.

In rare cases, when you reconnect the AC power cord to a power outlet, the machine does not start automatically. In this case, the machine has not failed. The cause is due to the timing of releasing the residual charge. If you press the main power switch while the residual charge was already released, the power ON flag will not be set. At this time, start the machine manually by pressing the main power switch.

4

Shutdown Method

1. Press the main power switch [A] on the machine.



d238m1001

2. The shutdown message appears. After the shutdown process, the main power is turned off automatically.

The operation panel and the main power indicator are turned off when the machine completes the shutdown.

Important

- Even after the shutdown message disappears, do not disconnect the power cord while the main power indicator [A] is flashing to indicate that the machine is still shutting down.

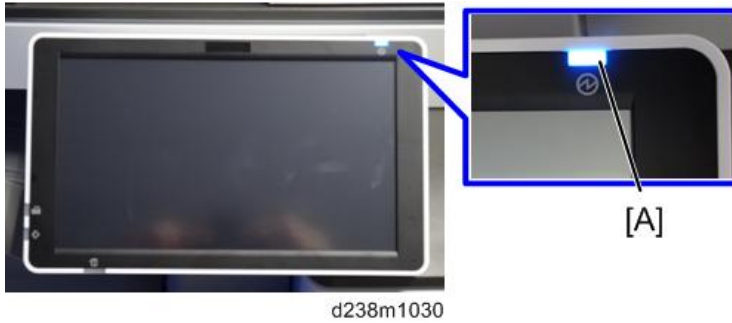

⚠ CAUTION

- Before removing and adjusting electrical boards, do the following procedure. Otherwise, the board can be damaged by the residual charge inside the machine and must be replaced.
1. Take out the power cord after shutdown.
 2. Press the power switch for a second to remove the residual charge inside the machine.

4

Forced Shutdown

In case normal shutdown does not complete for some reason, the machine has a forced shutdown function.

To make a forced shutdown, press and hold the main power switch for 6 seconds.

In general, do not use the forced shutdown.

★ Important

- Forced shutdown may damage the hard disk and memory, and can cause damage to the machine. Use a forced shutdown only if it is unavoidable.

Beforehand

WARNING

- Turn off the main power switch and disconnect the power cord.
- After replacing, make sure that all harnesses that were removed are connected up again and secured in their clamps.

Special Tools

Item	Part Number	Description	Q'ty	Unique or Common
1	A1849501	Scanner Positioning Pin (2pcs/set)	1	C (General)
2	B6455020	SD Card (1GB)	1	C (General)
3	B6455060	SD Card (16GB)	1	C (General)
4	52039502	Silicone Grease G-501	1	C (General)
5	A2579300	Grease Barrierta – S552R	1	C (General)
6	C4019503	20× Magnification Scope	1	C (General)
7	VSSG9002	FLUOTRIBO MG GREASE: 100G	1	C (General)
8	A0929503	C4 Color Test Chart (3 pcs/ set)	1	C (General)

↓ Note

- A PC (Personal Computer) is required for creating the Encryption key file on an SD card when replacing the controller board in which HDD encryption has been enabled.

Exterior Covers

Precaution Concerning Stabilizers

The stabilizers are necessary for meeting the requirements of IEC60950-1, the international standard for safety.

The aim of these stabilizers is to prevent the products, which are heavy, from toppling as a result of people running into or leaning onto the products, which can lead to serious accidents such as persons becoming trapped under the product. (U.S.: UL60950-1, Europe: EN60950-1)

Therefore, removal of such stabilizers must always be with the consent of the customer.

Do not remove them using only your own judgment.

4

Overview

Front and Rear Side Covers



d238m1179a

No.	Cover name
1	Waste toner cover
2	Front upper cover
3	Front cover

No.	Cover name
4	Main power switch cover
5	Rear cover
6	Rear lower cover

Right and Left Side Covers

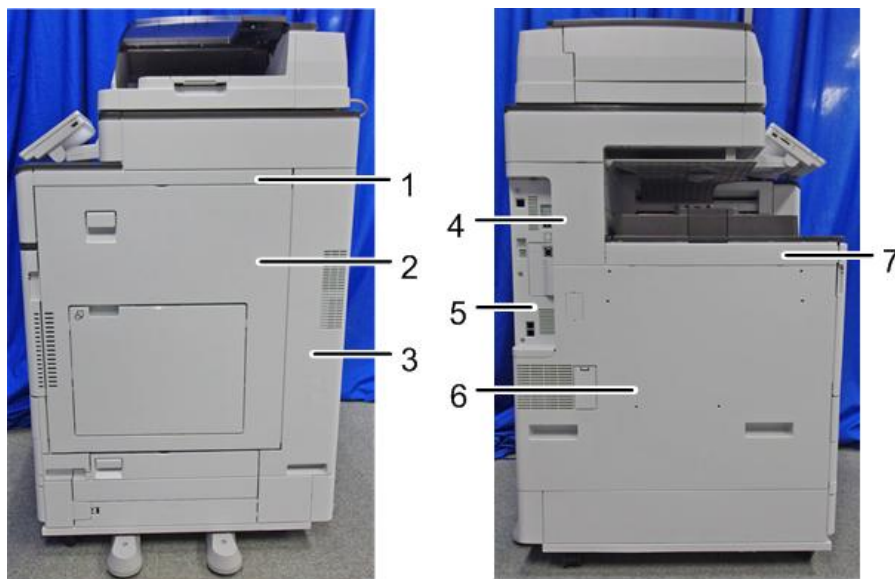

d238m1181a

No.	Cover name
1	Right upper cover
2	Right door
3	Right rear cover
4	Left rear cover
5	Controller cover
6	Left cover
7	Upper left cover

Paper Exit Covers

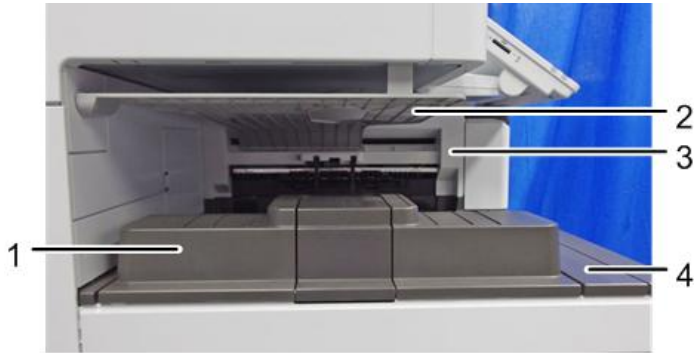

d238m1183

4

No.	Cover name
1	Paper exit tray
2	Inverter tray
3	Paper exit cover
4	Paper exit lower cover

Inner Covers



d238m1184

No.	Cover name
1	Paper exit front cover
2	Inner upper cover

No.	Cover name
3	Inner lower cover

Front Cover

1. Open the front cover [A].



d238m1002

2. Unhook the belt's tip and detach the belt [A].

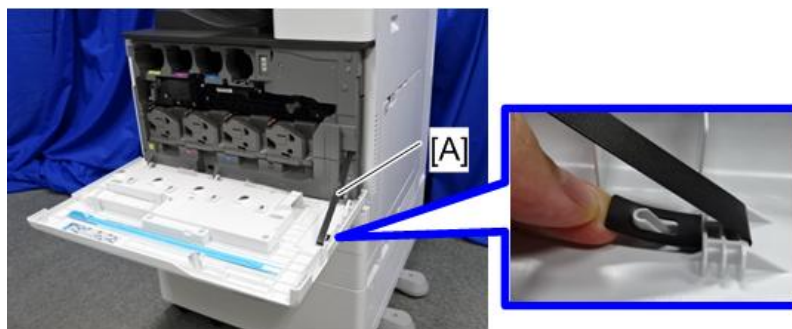

d238m1003

3. Pressing down the stopper, slide the front cover [A] to the right and detach it.

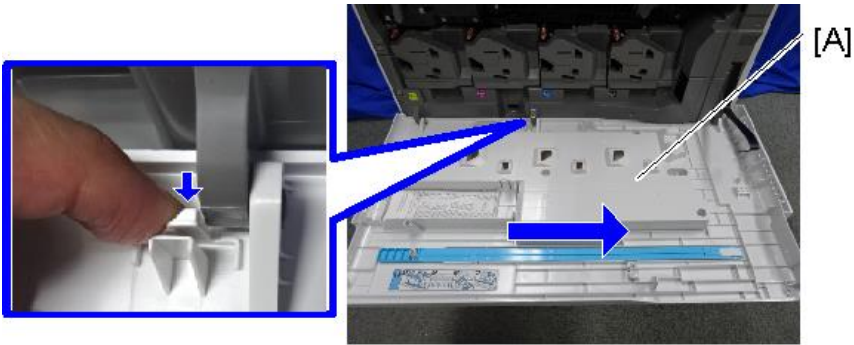

d238m1004

Controller Cover

1. Controller cover [A]



 x3

d238m1005

Upper Left Cover

CAUTION

- Each part enclosed by a blue circle has a tab. Be careful not to damage it when attaching and detaching.

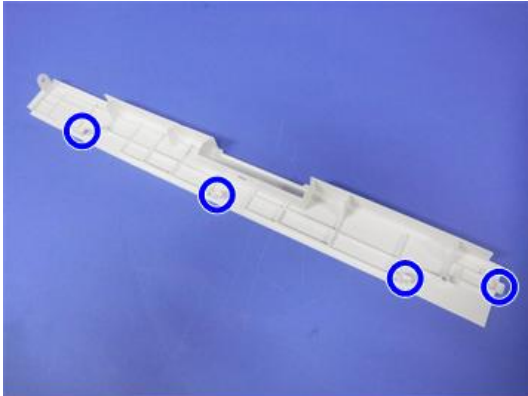

d1462009

1. Open the front cover.
2. Paper exit tray (page 419)
3. Upper left cover [A]

Slide the cover in the direction of the blue arrow.

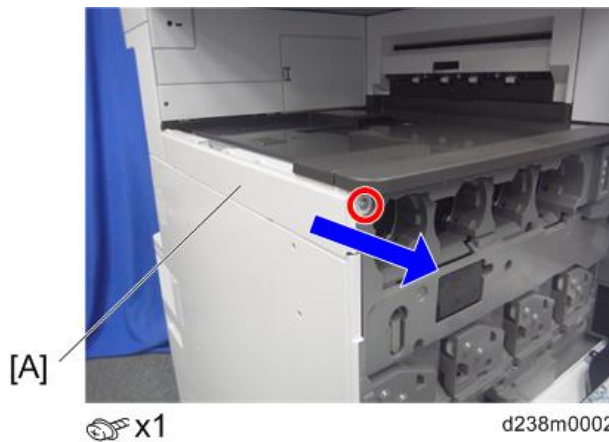

Left Rear Cover

1. Upper left cover (page 406)

2. Left Rear Cover [A]



4

Left Cover

⚠ CAUTION

- Each part enclosed by a blue circle has a tab. Be careful not to damage it when attaching and detaching.

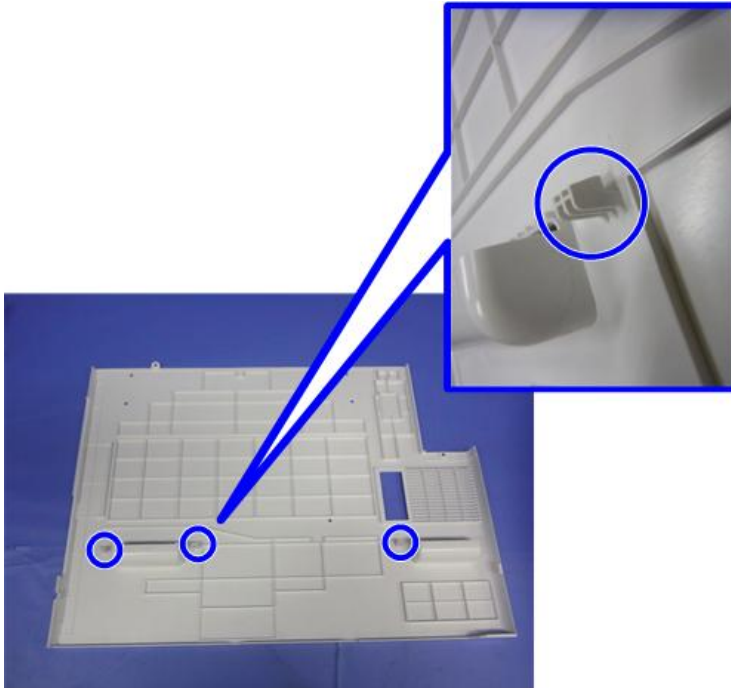

1. Controller cover (page 406)
2. Ozone filter/Dust filter box (page 625)
3. Upper left cover (page 406)
4. Left rear cover (page 407)
5. Open the 2nd paper feed tray slightly.

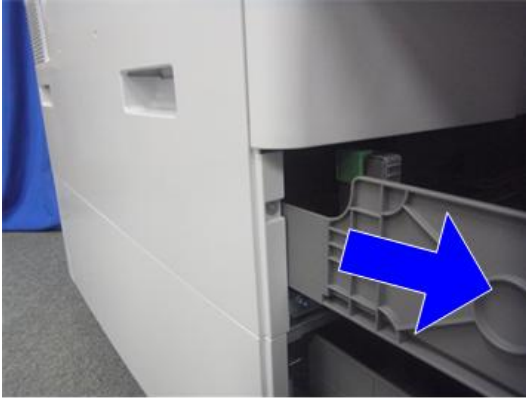

d1462036

6. Left cover [A]

Remove it while pressing down.

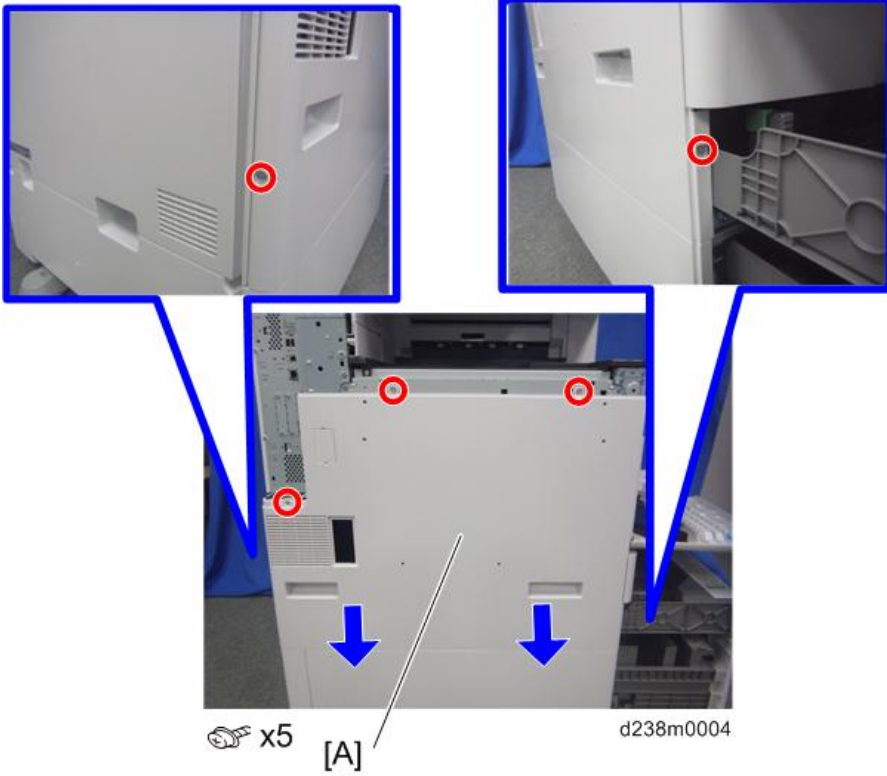

Order to remove

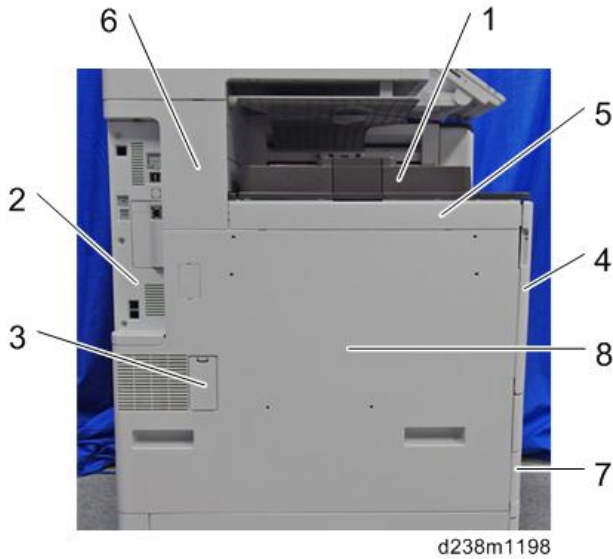

- 1. Paper exit tray
- 2. Controller cover

3. Ozone filter/Dust filter box
4. Front cover
5. Upper left cover
6. Left rear cover
7. 2nd paper feed tray
8. Left cover

Rear Cover

CAUTION

- There are tabs (left-facing) on the back face of the rear cover. When fitting or removing the cover, take care not to damage it.

4

1. Rear cover [A]

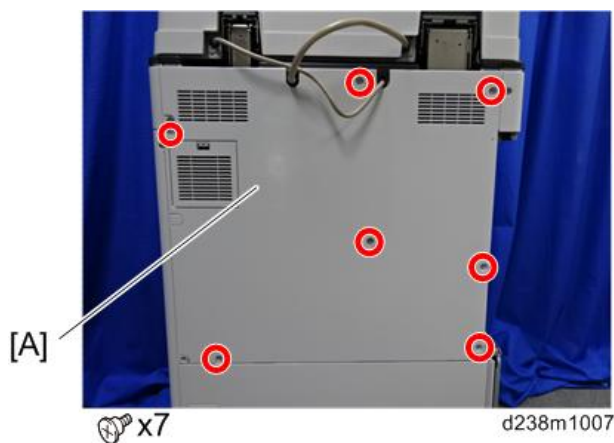

Slightly bend the cover to release the tabs behind the parts indicated by red circles and release the cover.

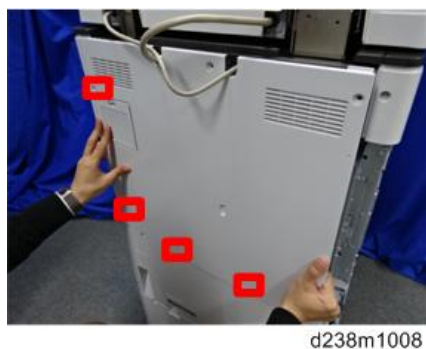

Rear Lower Cover

1. Rear cover (page 411)
2. Rear lower cover [A]

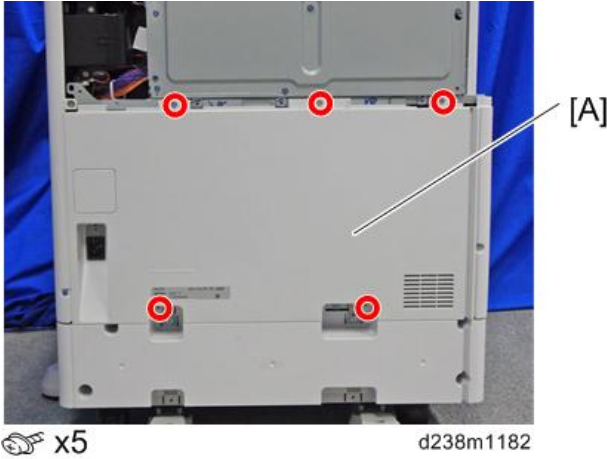

4

Right Rear Cover

1. Open the right door.
2. Right rear cover [A] (screw x4, among them, tapping screw x1)

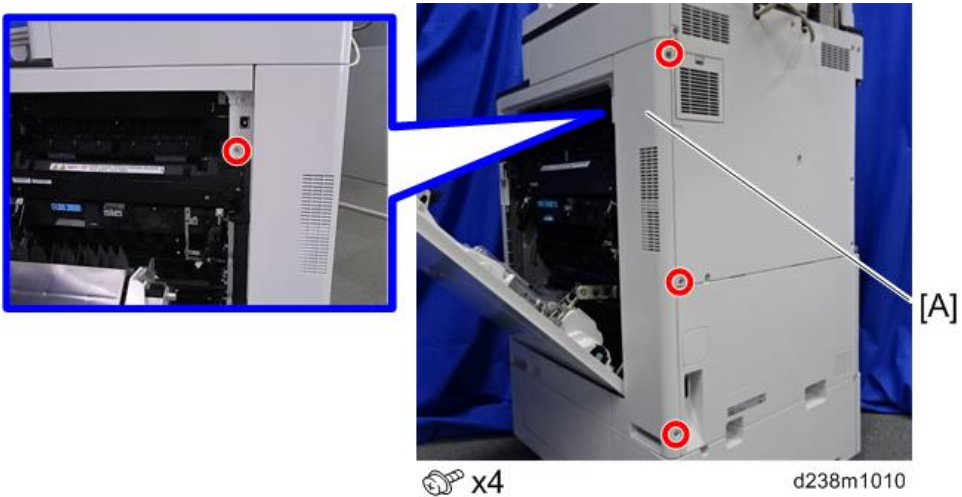

Note

- When installing, insert the projections [A] in the holes [B], taking care not to trap the harness inside.

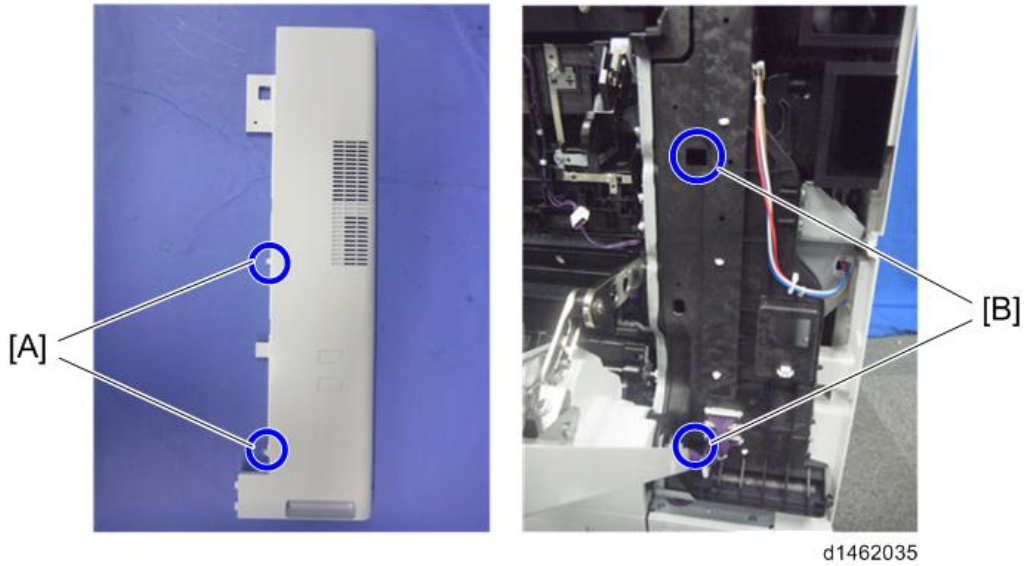

Right Upper Cover

1. Front upper cover (page 413)
2. Right upper cover [A]



Front Upper Cover

1. Open the right door.

2. Small cover [A]

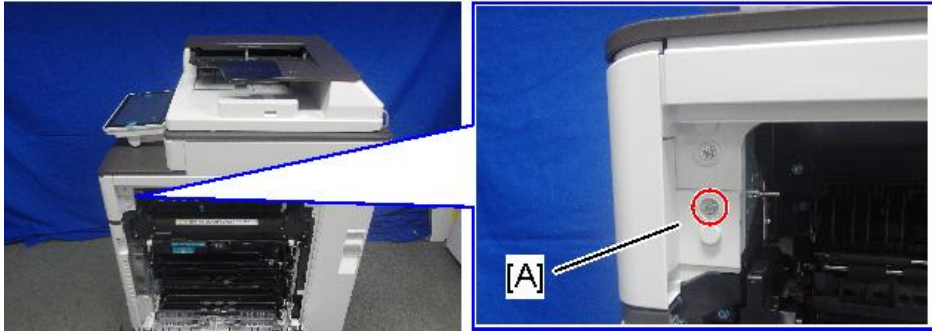



d238m553

 x1

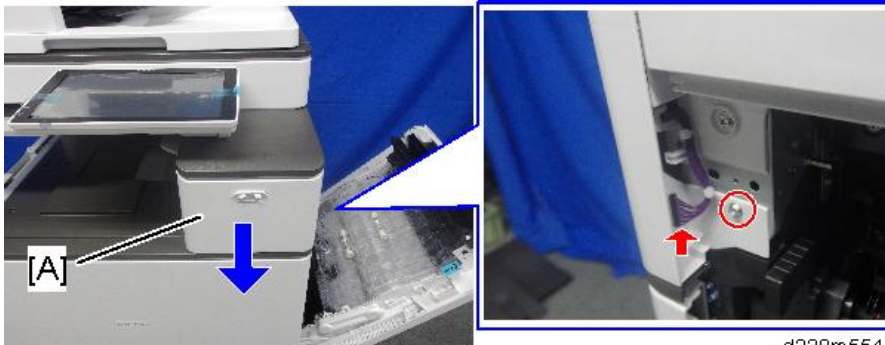
3. Remove the screw and the connector, and then remove the front upper cover [A].



d238m554

 x1,  x1

 **Note**

- Remember that there are three tabs at the positions in the red arrows.
- Tilt the operation panel [B] upward to a horizontal position, and then remove the front upper cover [A].

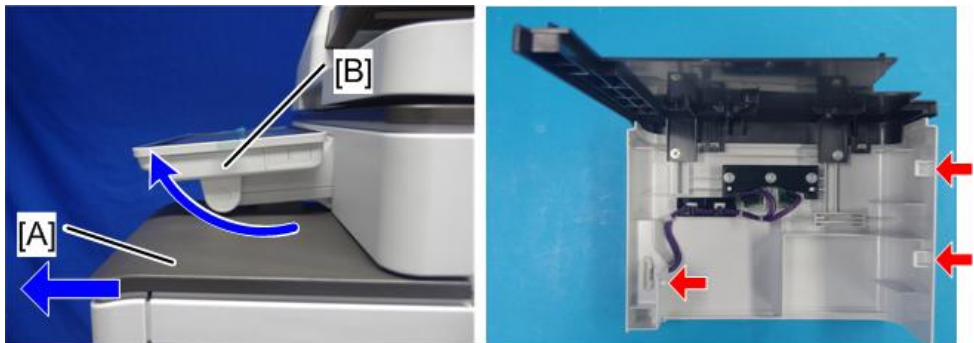

d238m555

Proximity Sensor (Human Detection Sensor)

1. Front upper cover (page 413)
2. Two connectors

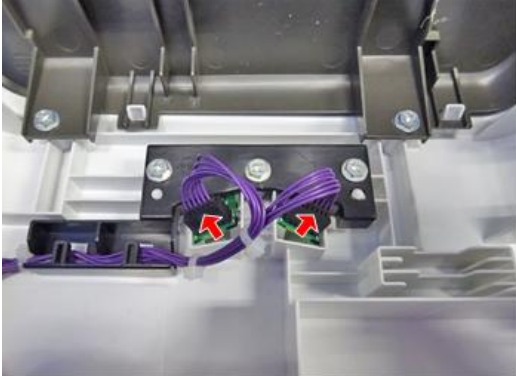

 x2

D238m1147

3. Bracket [A]

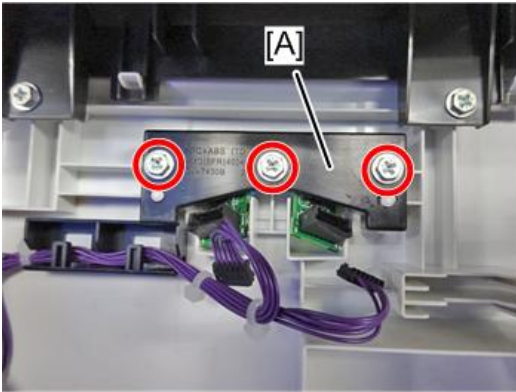

 x3

D238m1148

4. Proximity sensor (Human detection sensor) [A]

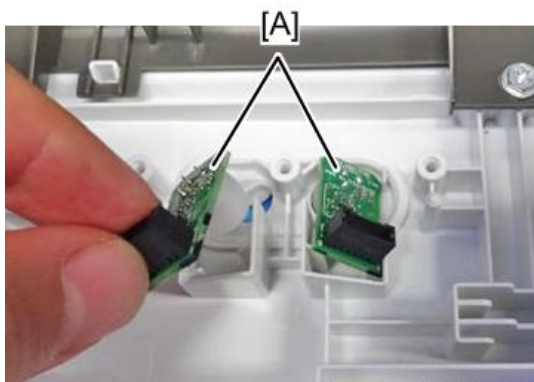

D238m1149

4

Main Power Switch Cover

1. Pull out the paper trays 1 and 2.

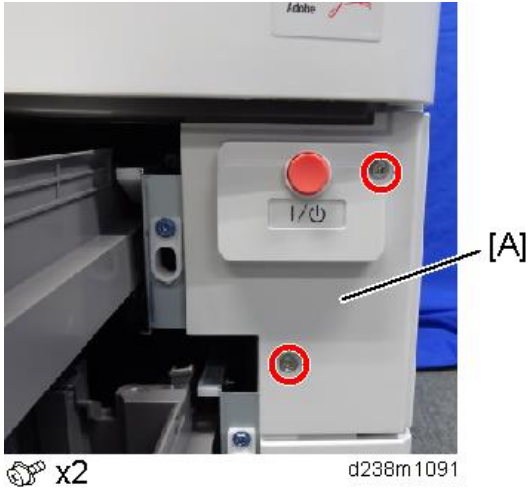

d238m1090

2. Main power switch cover [A].**Waste Toner Cover**

1. Front cover (page 405)
2. Open the waste toner cover [A].



3. Waste Toner Cover [A]

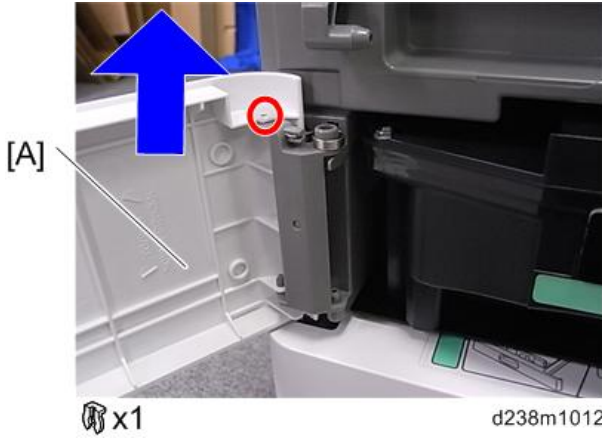

4

Inverter Tray

1. Inverter Tray [A]

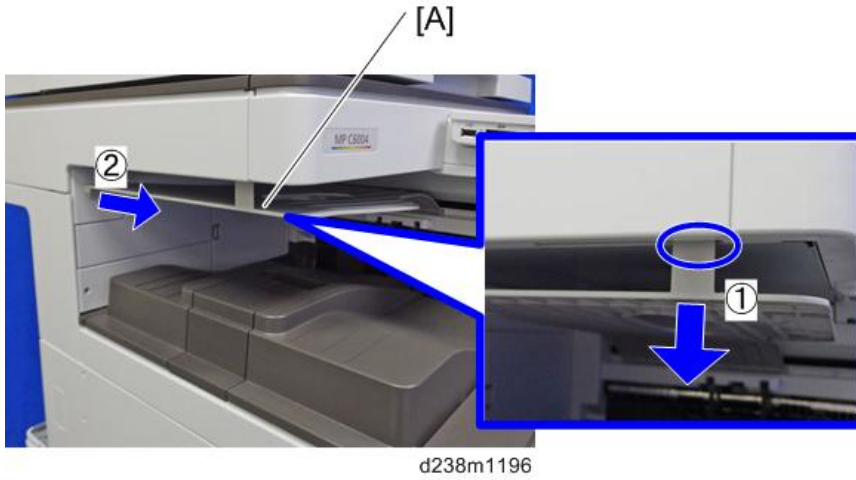

Paper Exit Tray

1. Paper Exit Tray [A]



d238m1197

4

Paper Exit Cover

1. Front upper cover (page 413)
2. Paper exit tray (page 419)
3. Inverter Tray (page 418)
4. Paper exit cover [A]

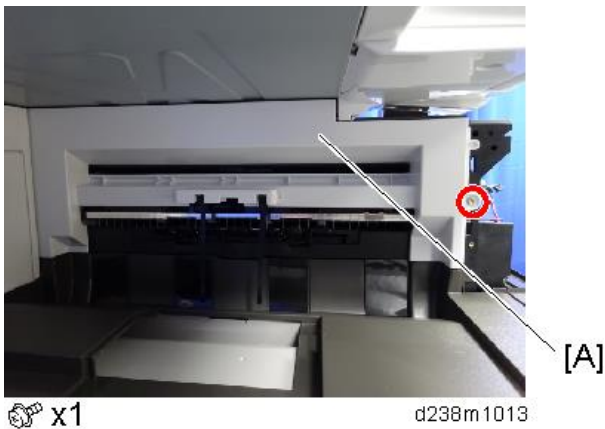

x1

d238m1013

Paper Exit Lower Cover

1. Left rear cover (page 407)
2. Paper exit cover (page 419)

3. Connector cover [A].



d1462090

4

4. Paper exit lower cover [A]

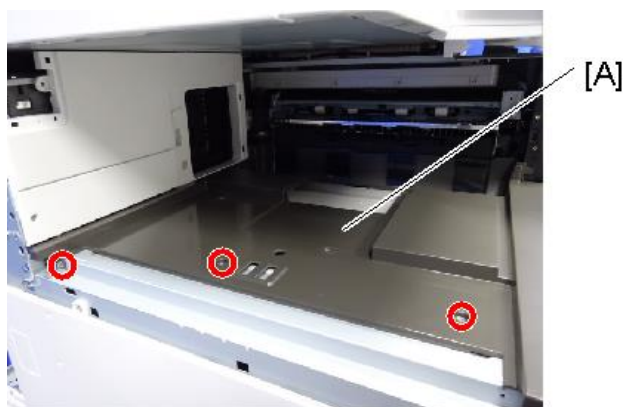

 x3

d238m1016

Paper Exit Front Cover

1. Front upper cover (page 413)
2. Paper exit lower cover (page 419)

3. Paper exit front cover [A]

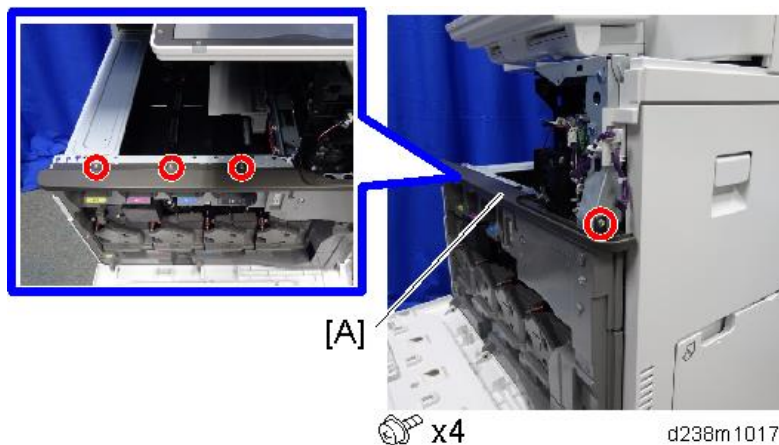

4

Inner Upper Cover

1. Open the front cover, and remove the belt. (page 405)
2. Open the right door.
3. Paper exit front cover (page 420)
4. Image transfer belt unit (page 474)
5. Inner upper cover [A]

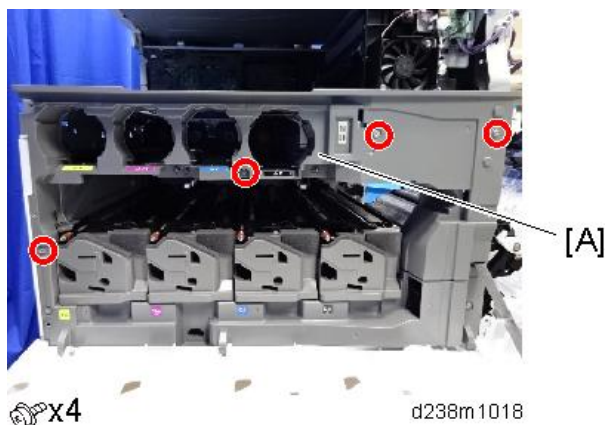

Inner Lower Cover

1. Front cover (page 405)
2. Inner upper cover (page 421)

3. PCDU cover (Y) [A]

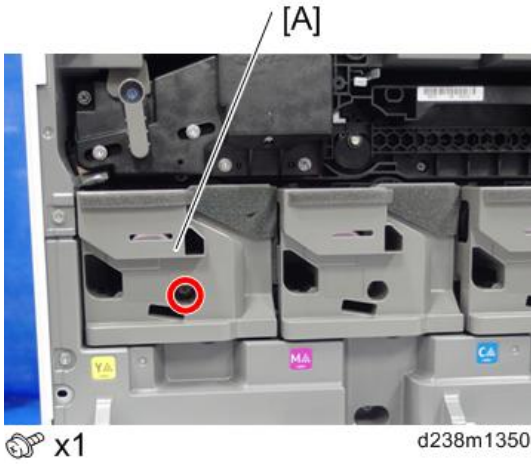

4. Waste toner cover (page 417)

5. Inner lower cover [A]



Smart Operation Panel

This section explains how to remove the Smart Operation Panel from the machine. For details about disassembling the Smart Operation Panel, See the service manual for Smart Operation Panel 2nd Generation.

Operation Panel Unit

1. Scanner front cover (page 432)
2. Holding down both the sides of the operation panel upper cover [A], unhook the tabs (indicated by blue circles) and remove the cover.

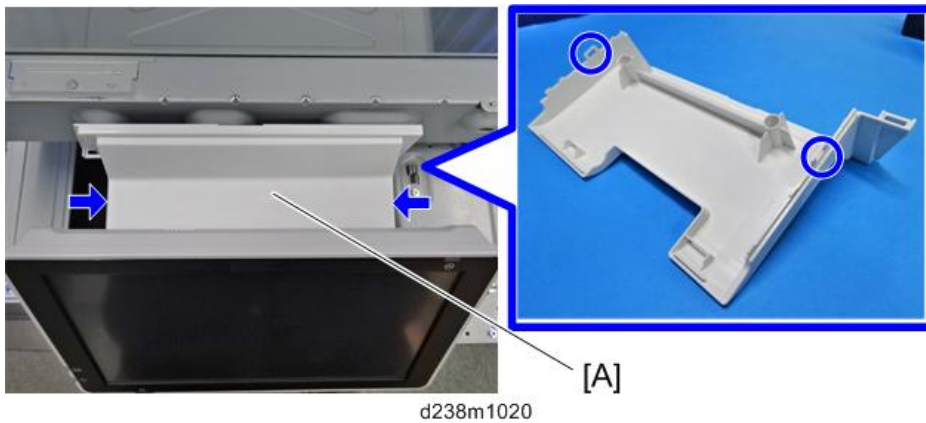

3. Operation panel [A]

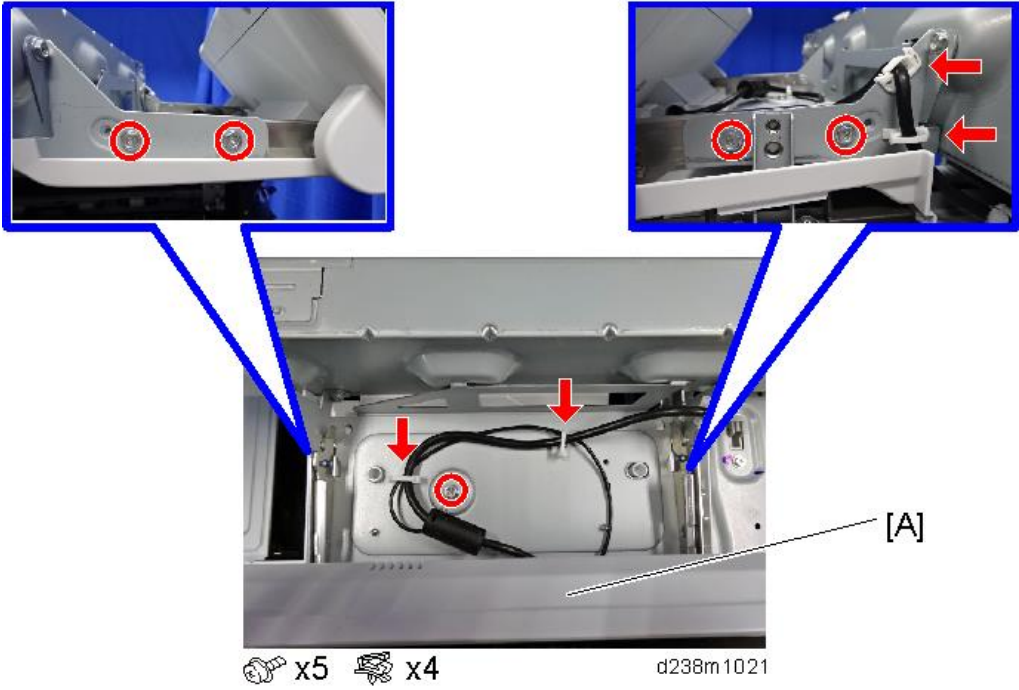

4. Open the platen cover or ADF.

5. Spread a cloth or service mat [A] on the exposure glass to protect the display. Place the operation panel on the exposure glass so that the display faces down.

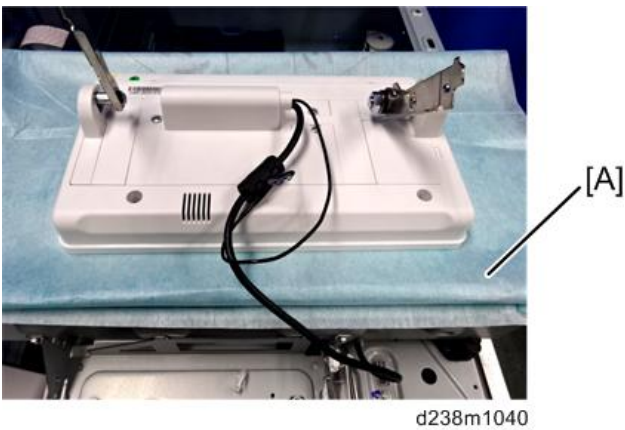

6. Rear center cover [A]

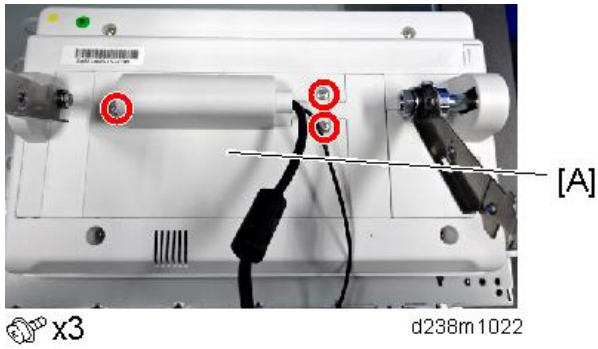

7. Disconnect the USB cable [A].

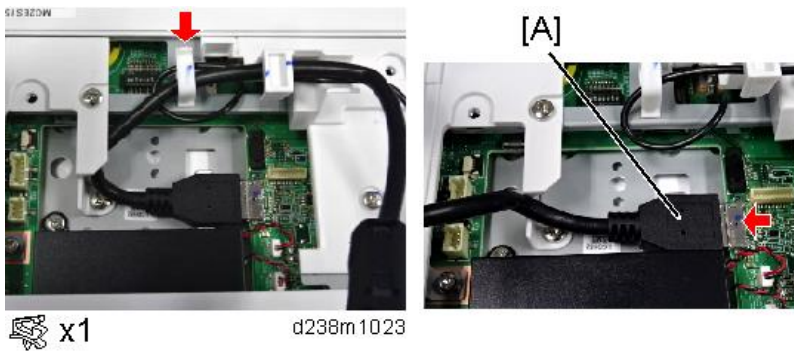

8. Left small cover [A], right small cover [B]

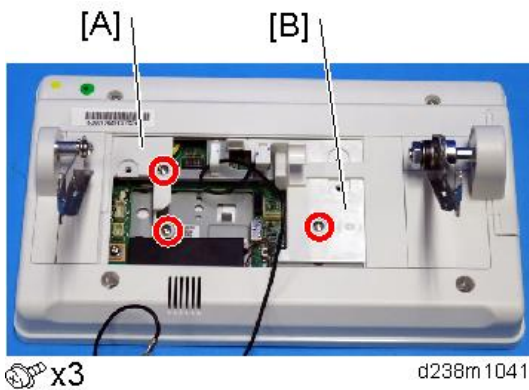

9. Right hinge cover [A] (Hook x 2)



10. Left hinge cover [A], right cover [B]

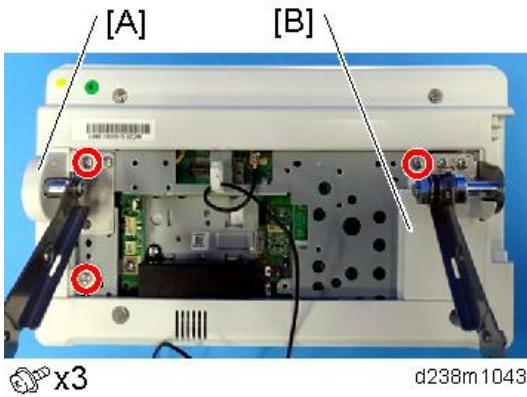

11. Hinges [A] [B]

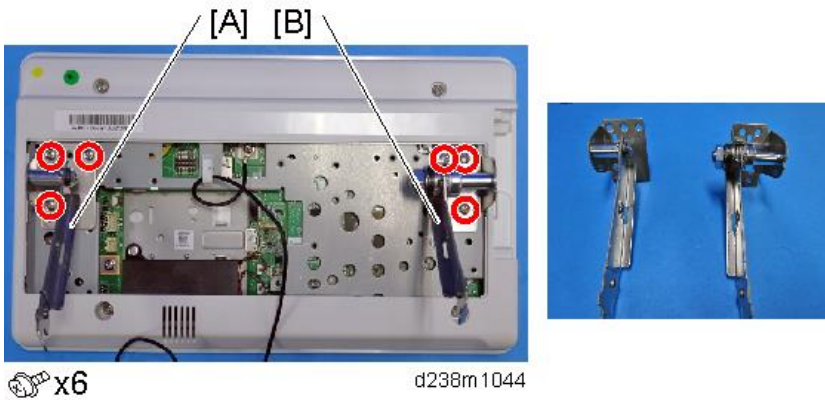

USB Cable

1. Rear cover (page 411)
2. Scanner right cover (page 433)

3. Controller box cover (page 600)

4. Disconnect the USB cable [A]

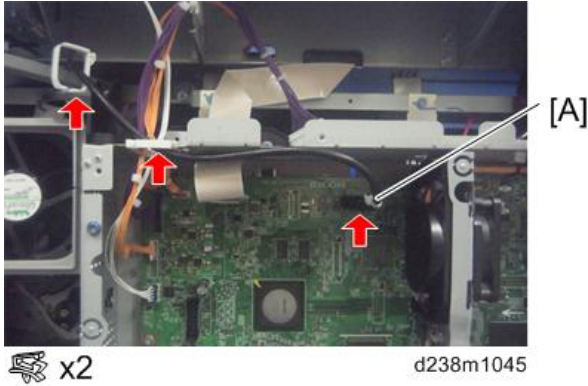

5. Remove the clamps on the cables under the scanner unit.

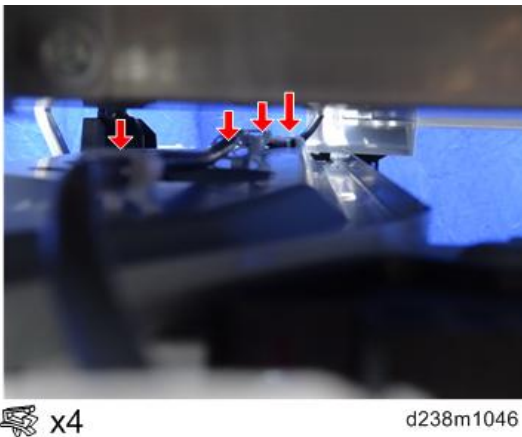

When removing a clamp, insert a long flathead screwdriver or such a tool from the side to remove it.

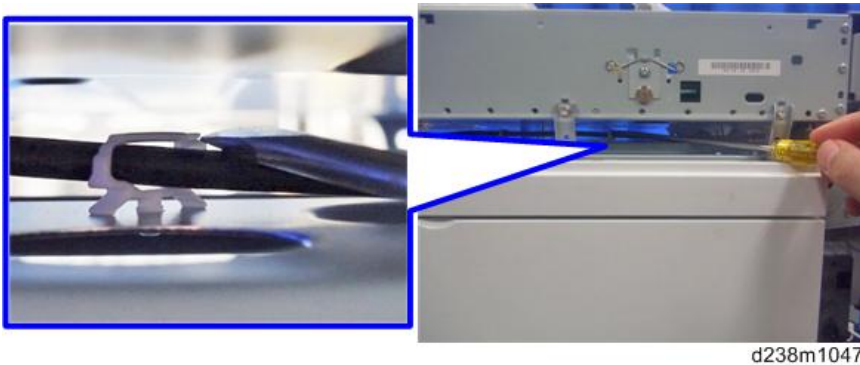



d238m1049

★ Important

- The cable has a set of 2 cable ties. When attaching the cable, position the clamp between the two cable ties.

4

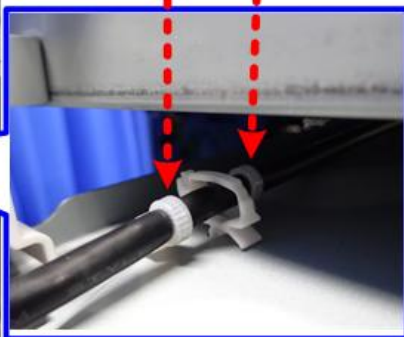
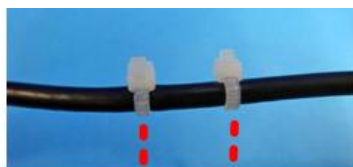
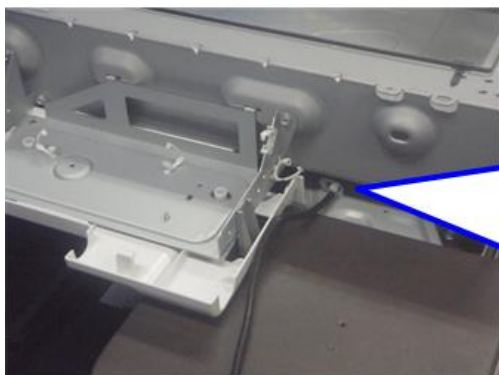

d238m1048

ADF

ADF Removal

1. Rear cover (page 411)
2. Cable bracket and connector

SPDF DF3100

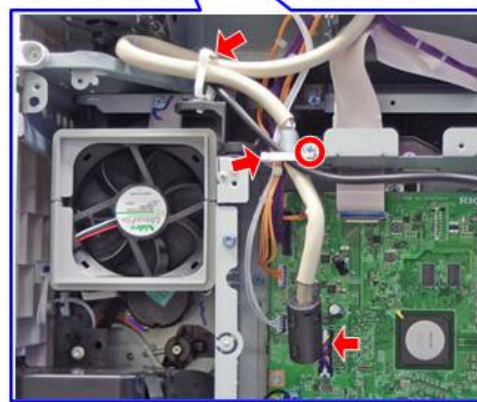
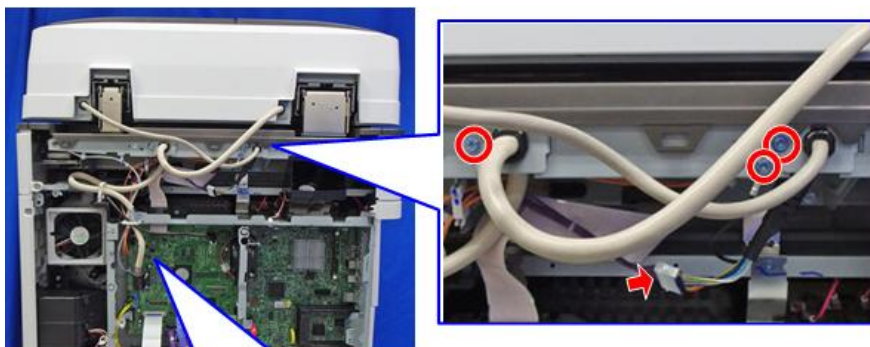

 x4  x2  x2 d238m1171

ARDF DF3090



 x2  x1 d238m1174

4

3. Screws on the ADF base.

SPDF DF3100

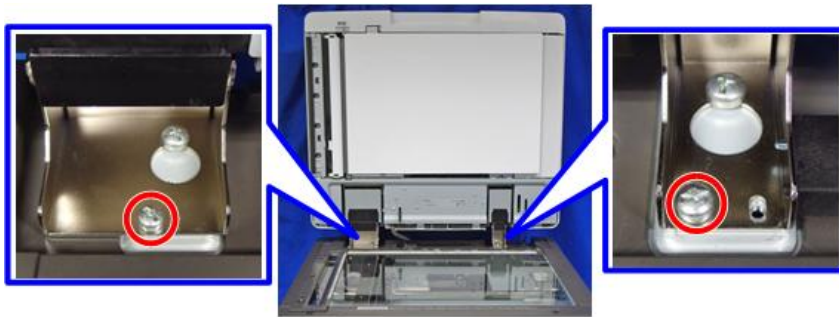

 x2 d238m1173

ARDF DF3090



 x2 d238m1175

4. Slowly and carefully (the ADF is heavy) lift the ADF [A] off the machine.

- Set the ADF on its edge on the floor, and then lean it against a wall [B].

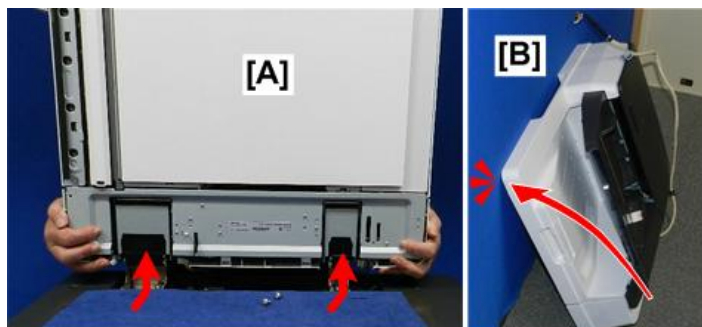

d223c3520

★ Important

- To prevent damage to the fragile feelers [A] of the ADF position sensor, never lay the ADF on a flat surface as shown below.

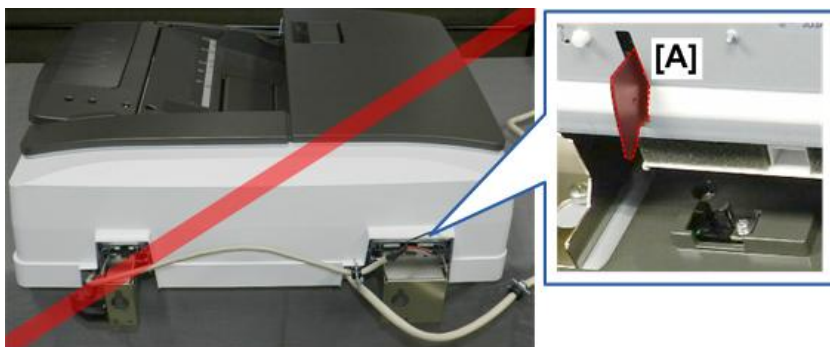

d223c3521

- If the SPDF DF3100 is being replaced, do SP4-730-002 after the new SPDF has been installed.

SP descriptions

- SP4-730-002 (FROM Main Factory Setting Execution ON/OFF)

Copies the parameters written in FROM in the SPDF to the engine board in the MFP. This SP is only for the SPDF models.

Scanner Unit

Before You Begin

There is no SIO (Scanner Interface Board) in this machine. The functions of the SIO of the previous machine are controlled by the IPU. Harnesses of the scanner unit connect directly to the IPU in the controller box on the back of the machine.

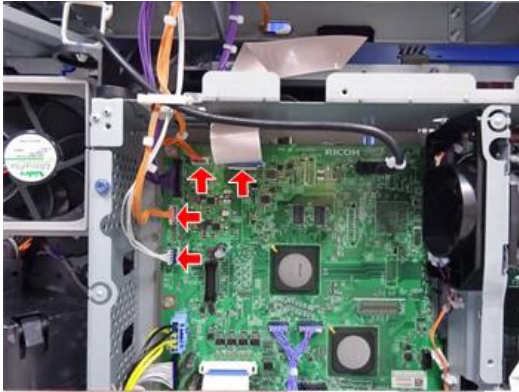

d238m1095

Scanner Exterior

Scanner Front Cover

1. Scanner front cover [A]

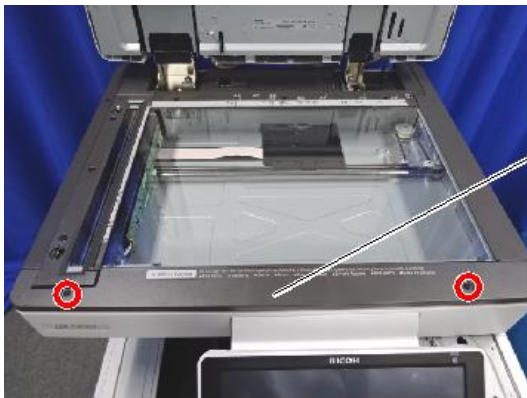

 x2

d238m 1026

Scanner Right Cover

1. Remove the screw.



 x1

d238m1300

2. Scanner right cover [A]

Remove the hook at the top, and then slide the cover towards the rear.

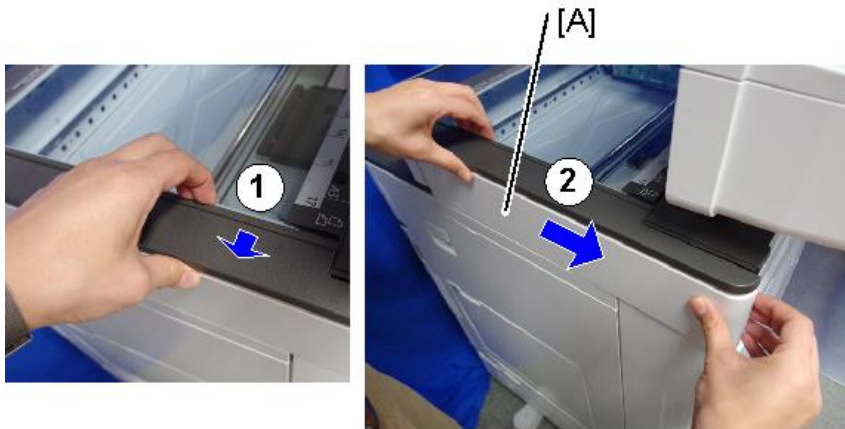

d238m1301

Scanner Left Cover

1. Scanner front cover (page 432)

2. Scanner left cover [A]

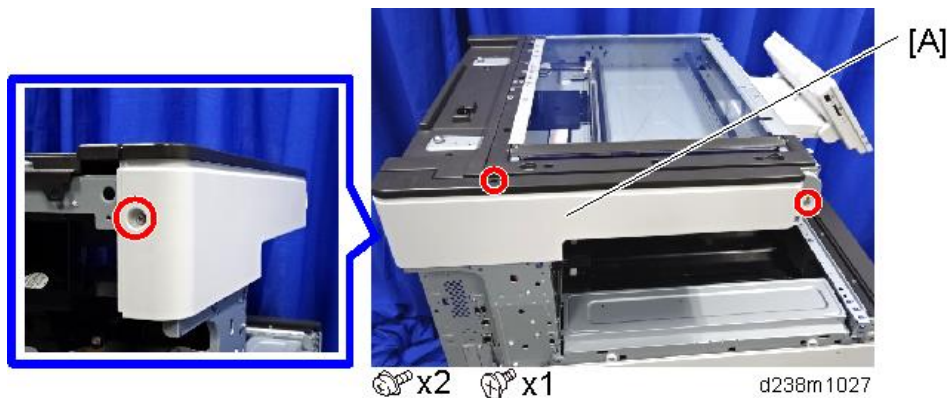

4

Scanner Upper Cover

1. Platen cover or ADF
2. Rear cover (page 411)
3. Scanner Upper Cover [A]

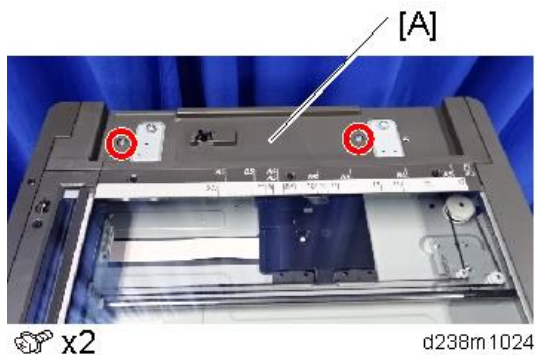

Exposure Glass

1. Open the platen cover or ADF.
2. Scanner right cover (page 433)

3. Scale [A]

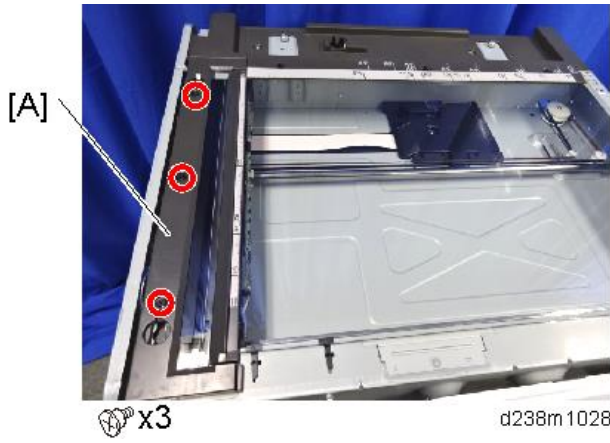

4. Sheet-through exposure glass [A]

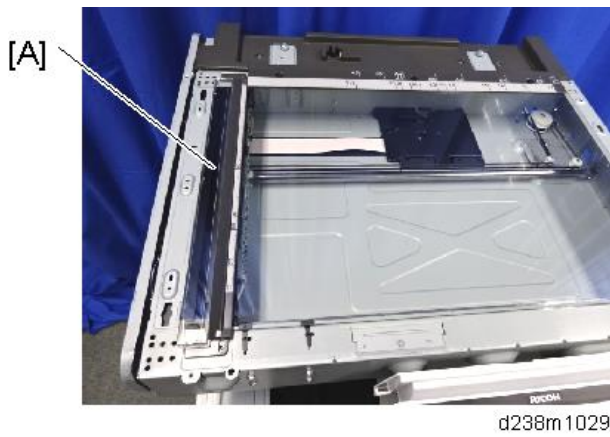

5. Rear scale [A]

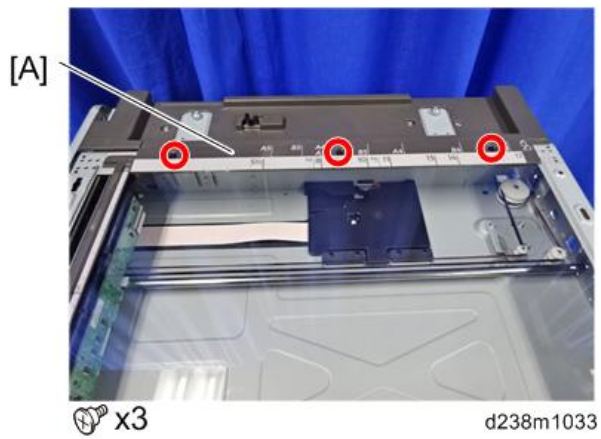

6. Left scale and exposure glass [A]

CAUTION

- The exposure glass and the left scale are attached with double-sided tape.

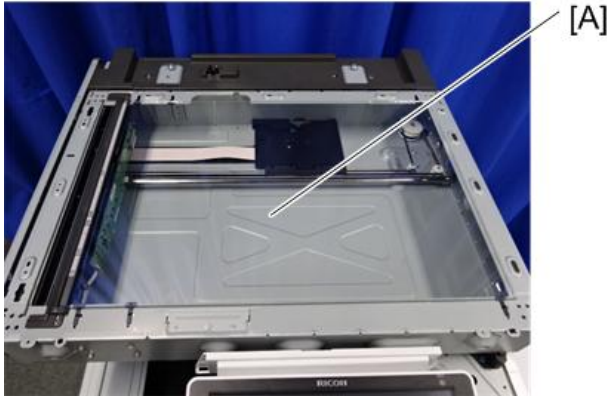

d238m1034

Note

- When installing, please follow the points below:
- Install the sheet-through exposure glass with the mark [A] at the rear left corner.
- Set so that the locating hole of the left scale fits over the locating boss of the front/rear frame.

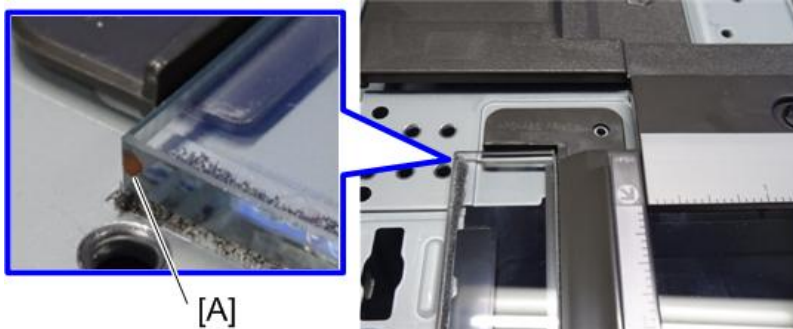

D238m1035

Scanner Carriage

1. Exposure glass (page 434)
2. Scanner front cover (page 432)

3. Scanner carriage front cover [A]

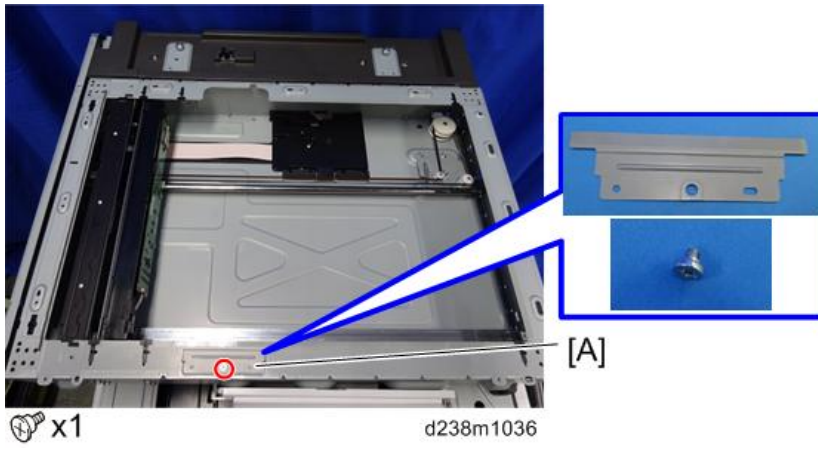

4. Move the scanner carriage [A] to the indicated position as shown.

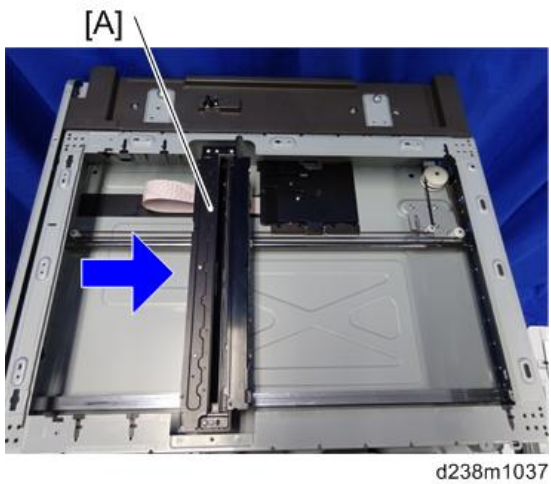

5. Loosen the screw, remove the spring [A], and then remove the belt [B].

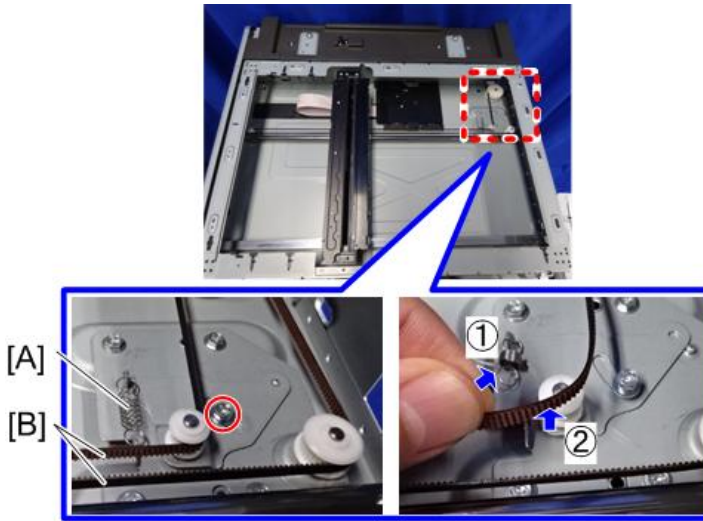

d238m1038

6. Turn the scanner carriage over and place it on the frame [A].



d238m1039

★ Important

- When holding the scanner carriage, be careful not to touch the circuit board [A], lens [B], and mirror [C].

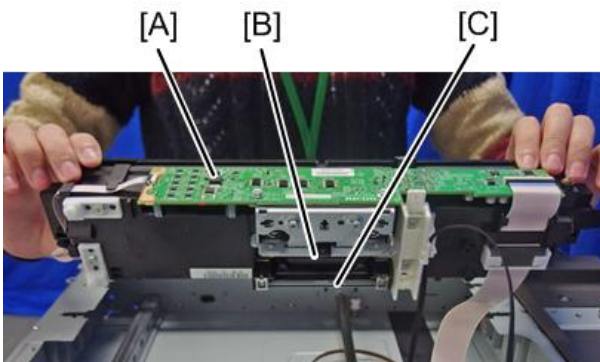

d238m1061

7. Belt [A]



8. Lower the lock lever [A] and disconnect the FFC [B].

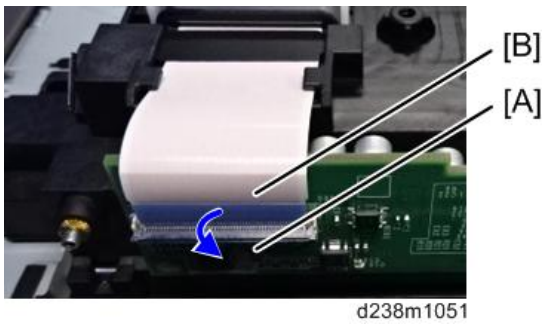

9. Ferrite core [A], Mylar sheet [B] (Hook x 4)

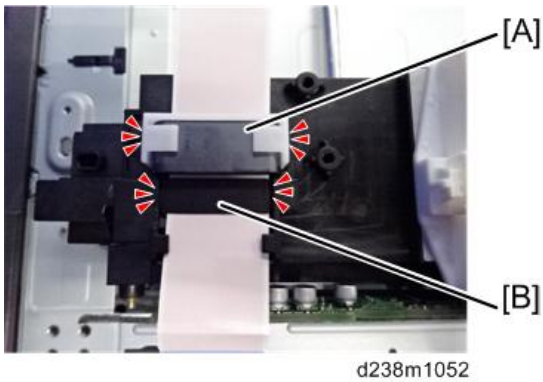

10. Scanner carriage



★ Important

- When attaching the scanner carriage, hold the carriage with the screw [A] loosened and move the carriage back and forth to the sides twice to have the belt stretch evenly. Then, fasten the screw [A].

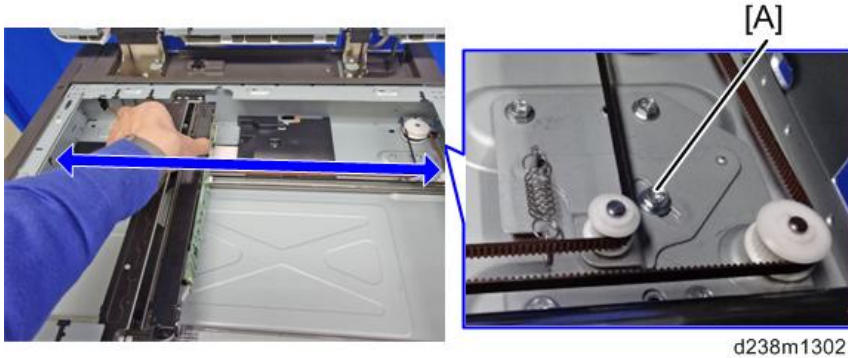

★ Important

- After replacing the scanner carriage, enter the values supplied with the carriage in the following SP
 - SP4-871-002 (Distortion Correction Distortion Initialization)
 - SP4-880-001 (Dot shift amount between R Line and G Line).
 - SP4-880-002 (Dot shift amount between G Line and B Line).To apply the specified settings, turn the power off and then back on.
The specified values are cleared when the NVRAM is initialized, so be sure to keep the supplied sheet showing the values in the machine.

Cleaning the Scanner Carriage Mirror

1. Exposure glass (page 434)
2. Scanner carriage front cover [A]

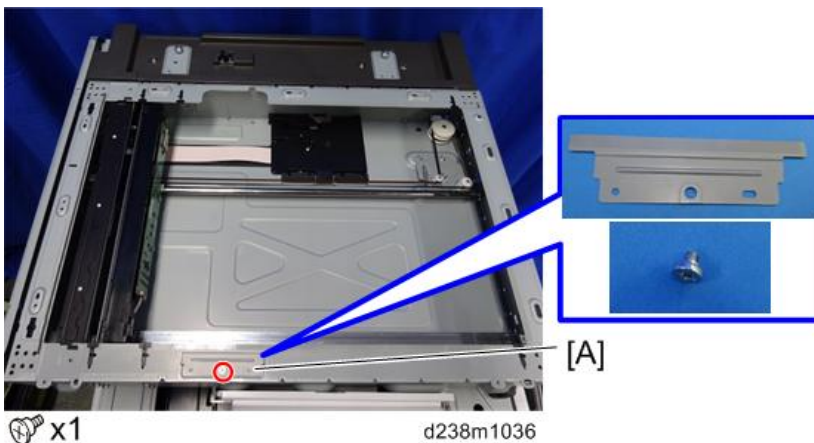

3. Move the scanner carriage [A] to the indicated position as shown.

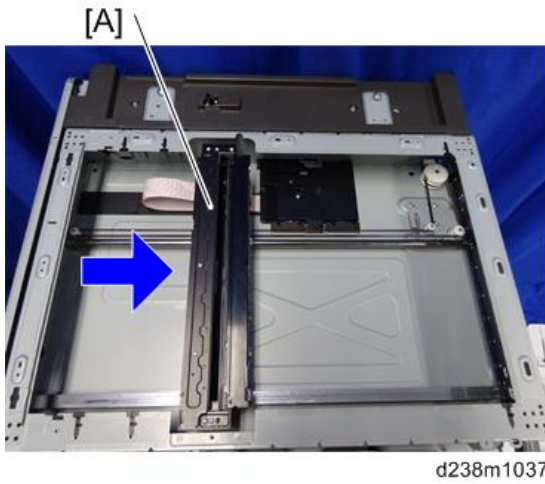

d238m1037

4. Resin cover [A] (Hook x 3)

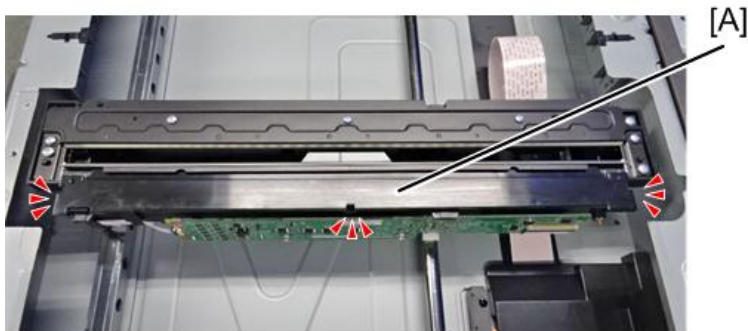

d238m1069

5. Open the metal cover [A]

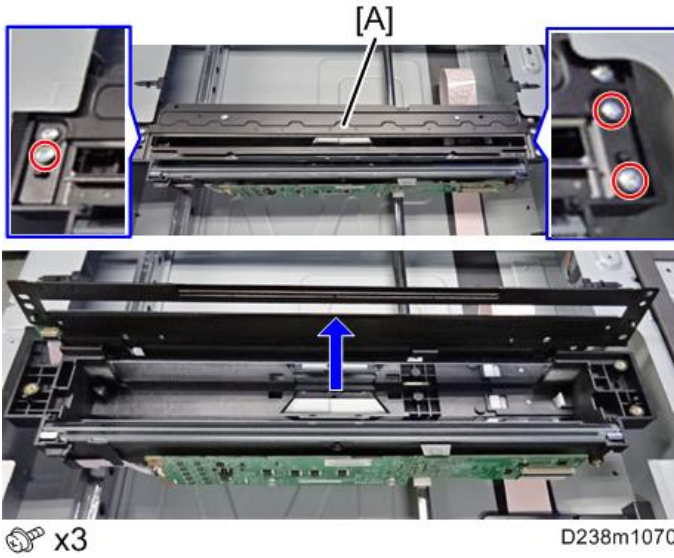

4

6. Wipe clean the mirror with a dry cloth.

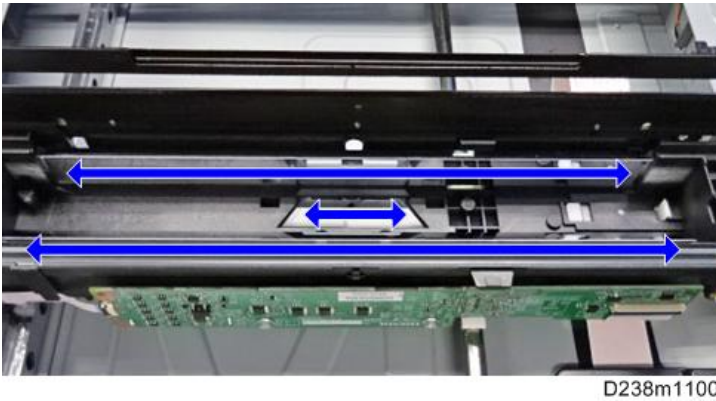

★ Important

- When reattaching the metal cover [A], fasten the screws in the order of "1", "2", and "3".

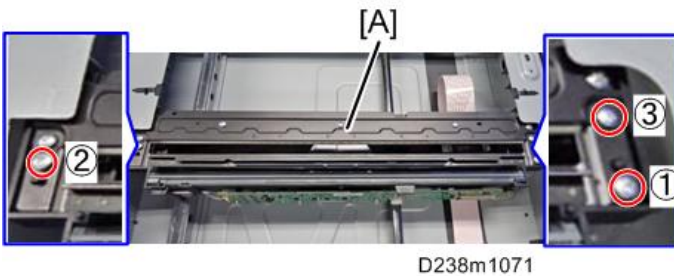

Note

- When attaching the resin cover, insert its tip under the metal frame.



D238m1072

Scanner Motor

1. Scanner upper cover (page 434)
2. Rear cover (page 411)
3. Grounding plate [A]

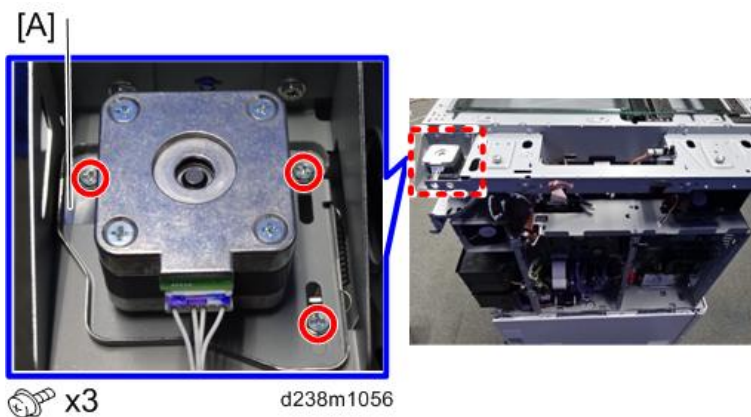

4. Spring [A]

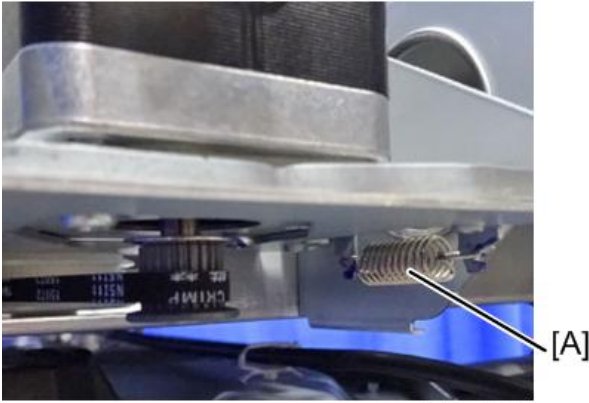

d238m1058

5. Scanner motor with bracket [A]

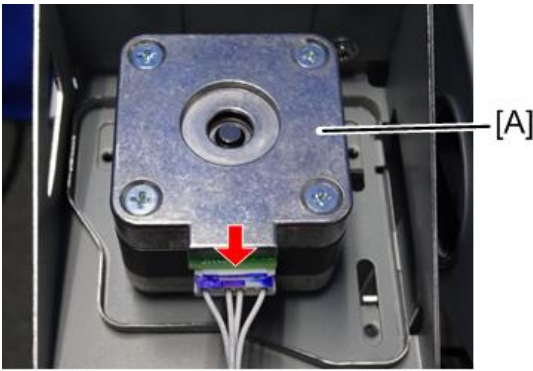

x1

d238m1059

6. Bracket [A]

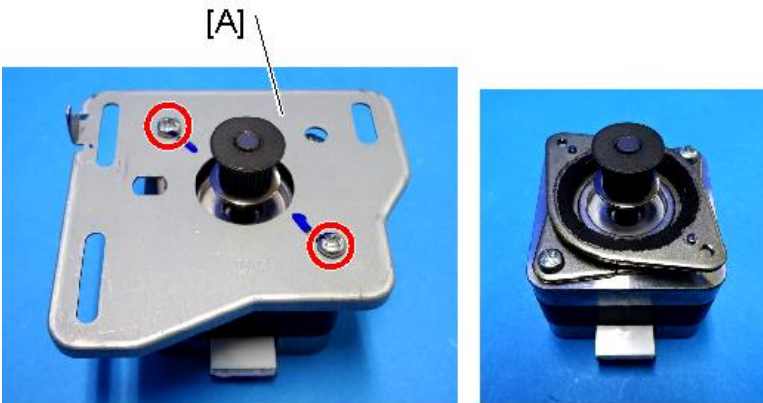

x2

d238m1066

APS Sensor

1. Exposure glass (page 434)
2. APS sensor harness cover [A]

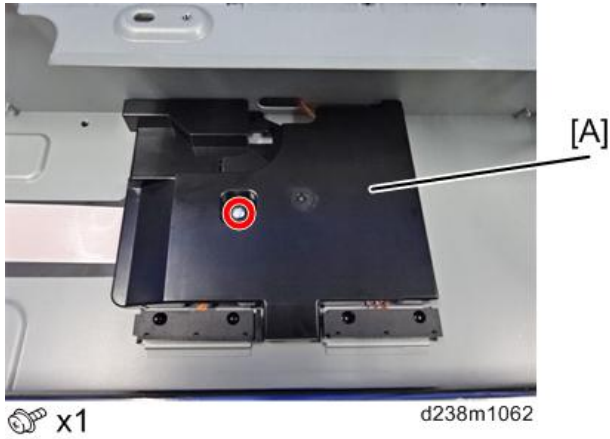

3. APS sensors [A] (Hook x 4)

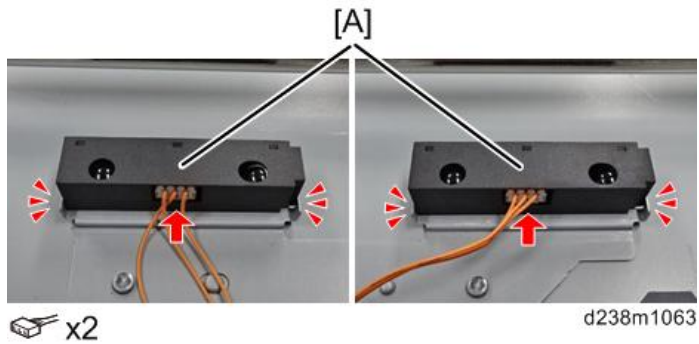

Scanner HP Sensor

1. Exposure glass (page 434)

2. Slide the scanner carriage [A] in the direction of the arrow.

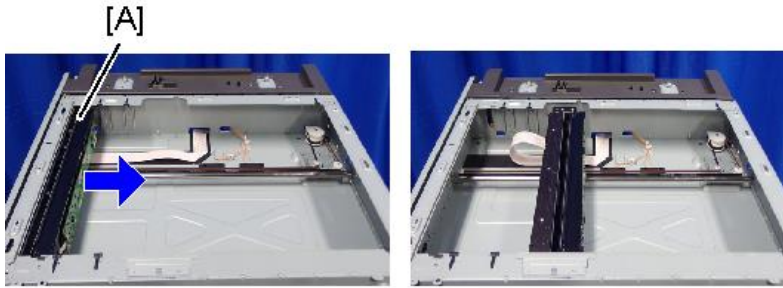

d238m1064

3. Scanner HP Sensor [A] (Hook x 3)

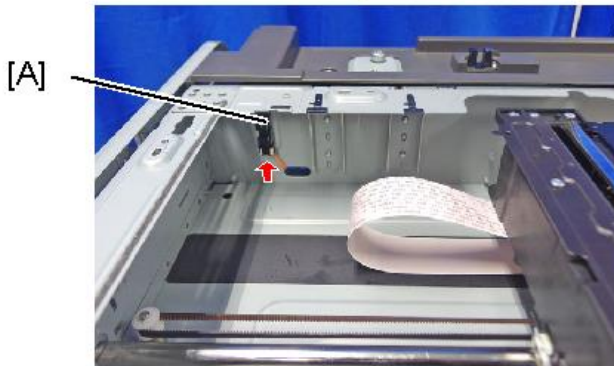
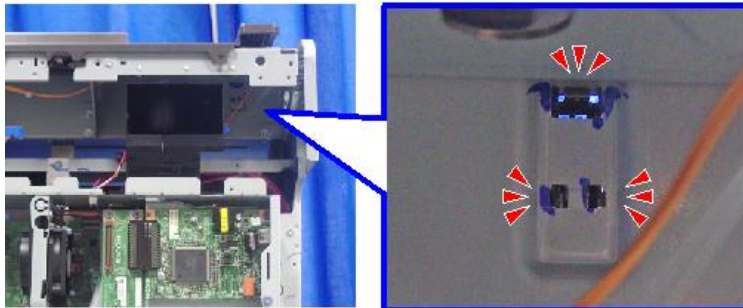

x1

d238m1065

ARDF/Platen Cover Sensor

1. Scanner upper cover (page 434)

2. ARDF/Platen cover sensor [A]

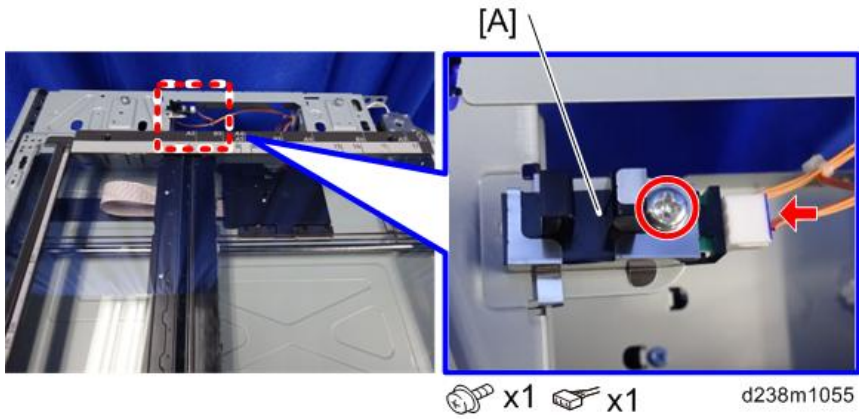

4

Scanner FFC

1. Exposure glass (page 434)
2. Remove the FFC from the scanner carriage (page 436)
3. Original size sensor harness cover [A]

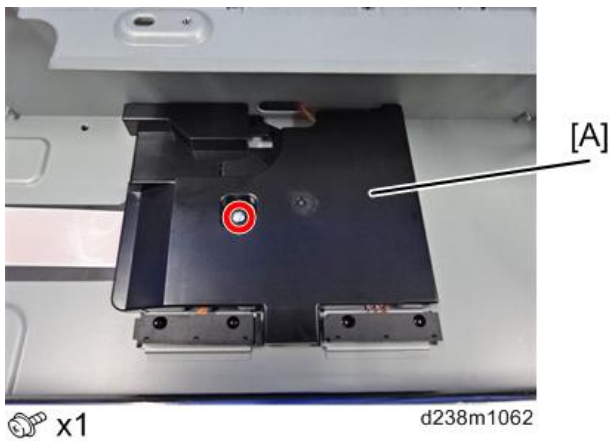

4. Remove the double-sided tape.



d238m1068

4

When reattaching the same part, apply a double-sided tape again.

- 5. Rear cover (page 411)
- 6. Controller box cover (page 600)
- 7. While pressing the lock release lever, pull out the FFC [A].

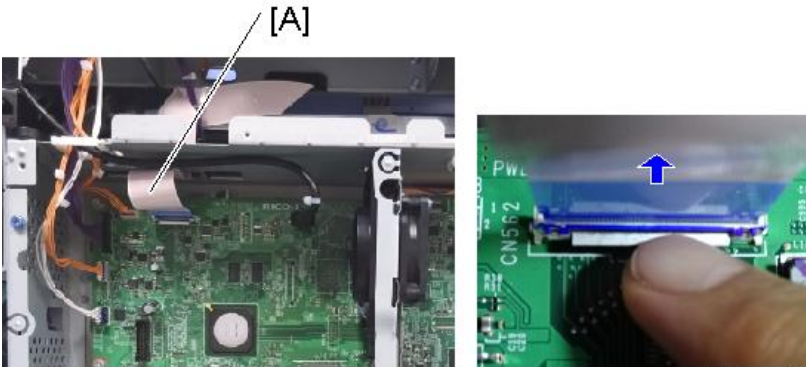

d238m1067

When Changing the FFC

When changing the FFC, stick the Mylar [A] to the new FFC.

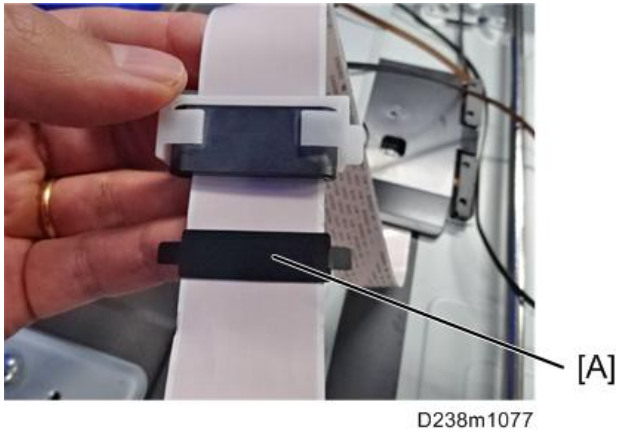

When attaching the Mylar, follow the steps below.

1. Feed the FFC through the ferrite core [A].

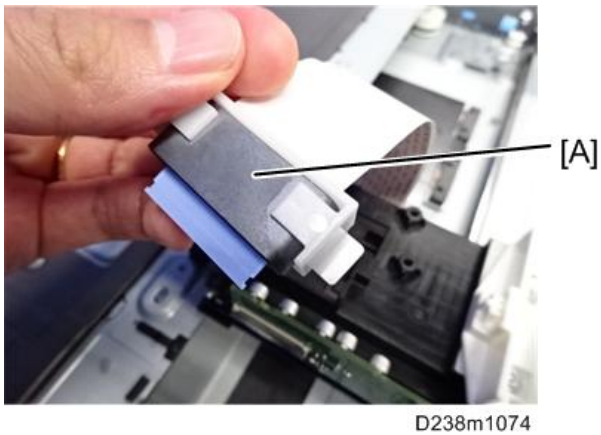

2. Connect the FFC to the scanner carriage's connector, and then lift the lever [A] to lock it.

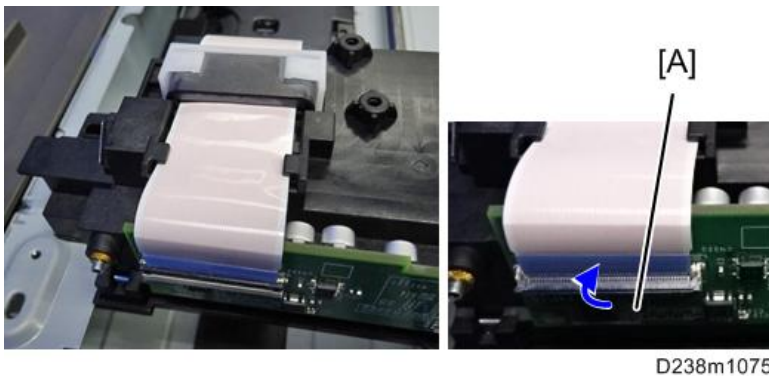

3. Attach the Mylar [A] to the FFC from above, and then insert the tabs at both ends of the Mylar into the gaps in the FFC holder to secure it in position.

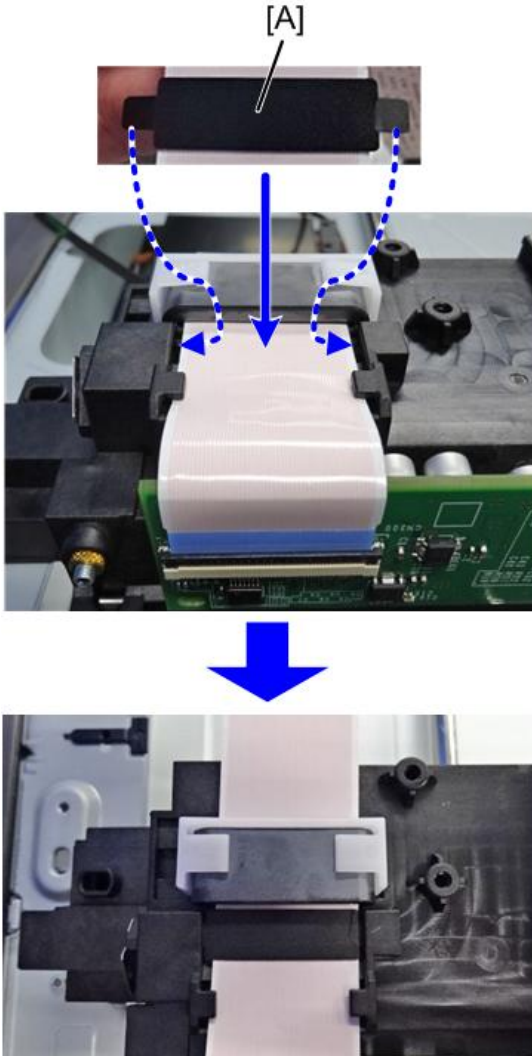

d238m1076a

When applying the Mylar, be sure not to stretch the FFC.

Applying the Mylar while stretching the FFC causes the circuit board to be deformed.

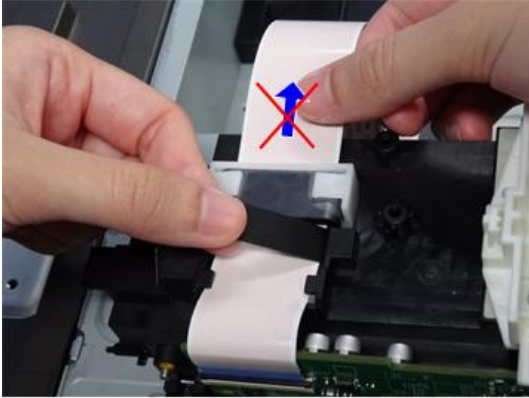

D238m1073

Laser Unit

⚠ WARNING

- Turn off the main power switch and unplug the machine before beginning any of the procedures in this section. Laser beams can cause serious eye injury.
- Caution Decals



d238m 103 1

- Decal Location

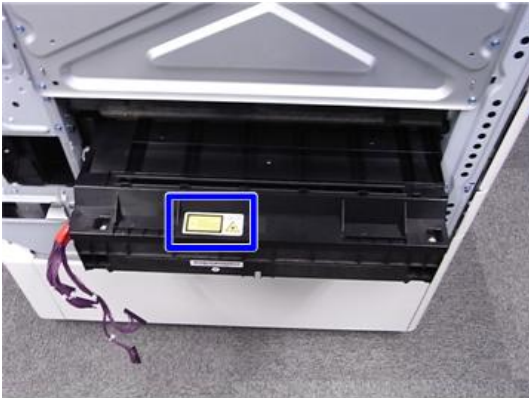

d1462271

Laser Unit

⚠ CAUTION

- A polygon mirror motor protection bracket and a red tag are attached to each new laser unit. Remove these before you install the new unit.

Before Replacement

1. Remove the polygon mirror motor cover [A] from the new laser unit.

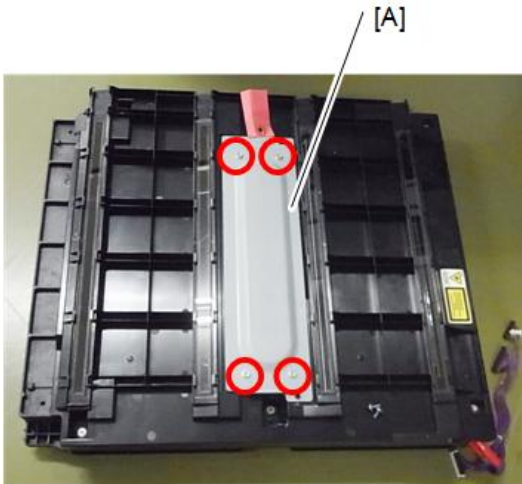

 x4

d238m0059

2. Polygon mirror motor bracket [A], Red tag [B]

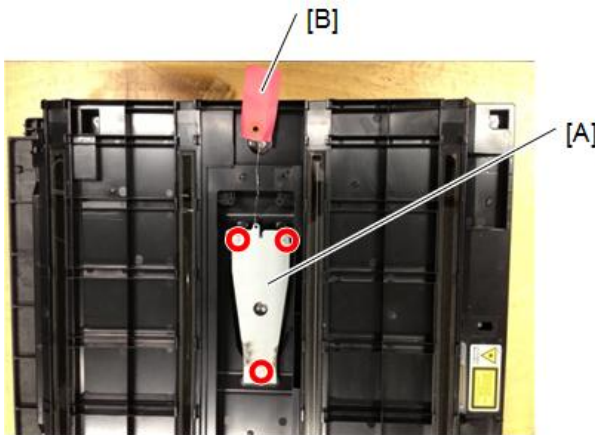

 x3

d238m0060

3. Reattach the polygon mirror motor cover.

Removing

1. Left cover (page 408)
2. Laser unit [A]

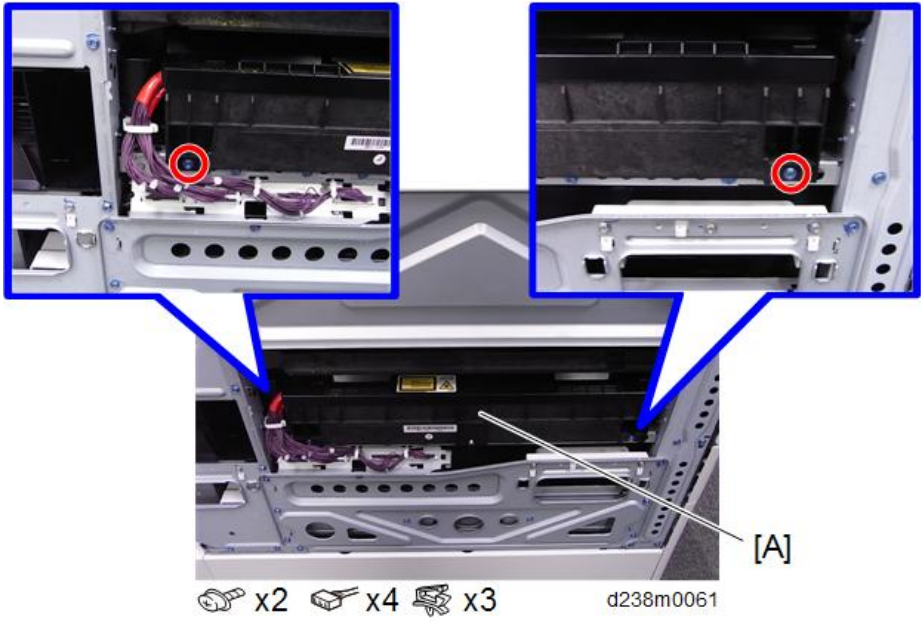

Installing a New Laser Unit

1. Insert the new laser unit in the main body carefully.
2. Connect all harnesses except the laser optics positioning motor harness [A] (2nd from right).

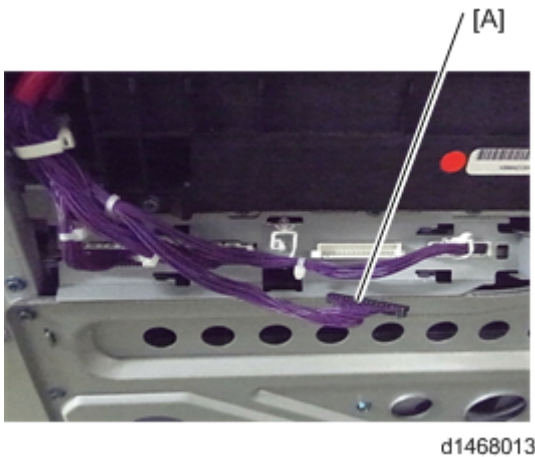

3. Reassemble the machine.

Adjustment after Replacing the Laser Unit

1. Close the front cover and attach the left cover.

⚠ WARNING

- Attach the left cover before turning on the main power switch. Laser beams can seriously damage your eyes.

2. Plug in and turn on the main power switch.
3. Download the data of the new laser unit to the main body with SP2-110-005.
4. Check that SP2-119-001 to 003 is "0."

Note

- If it is not "0", perform SP2-110-005 again.
- If it is not executed correctly, outputs will be abnormal (magnification and color registration errors), and SC 285 may occur.

5. Turn off the main power switch and disconnect the power cord.
6. Remove the left cover and attach the laser optics positioning motor harness [A].

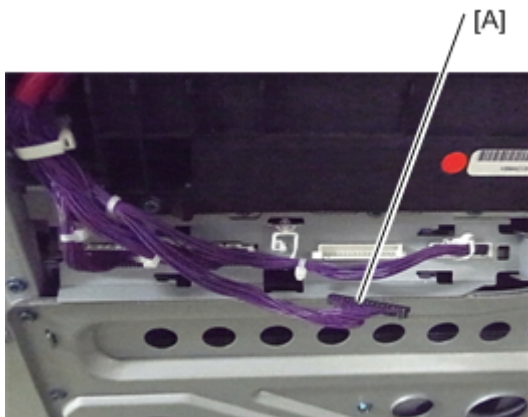

d1468013

7. Close the left cover.
8. Plug in and turn on the main power switch.
9. Select [14: Trimmed area] in SP2-109-003, and then press [OK].
10. Press [Copy Window], and then print the test pattern in the copy screen.
 - Check if the margin on either side on the output (14: Trimmed area) is less than 4 ± 1 mm or not. If it is not within these limits, change the reference value (Bk) of the main scanning magnification adjustment (SP2-102-001 to -003).

Note

- Adjust the values of the main scanning magnification only for Bk (black). It is not necessary to adjust other color's values (cyan, magenta, yellow) because other colors are automatically adjusted in relation to the setting for Bk.
- Input the same value for each SP (SP2-102-001 to -003) even though there are three SPs of the main scanning magnification adjustment for the standard, middle and low line speed which are used for each paper type.
- Check if the margin on the left side on the output (14: Trimmed area) is less than 2 ± 1 mm or not. If it is not within these limits, change the reference value (Bk) of the registration adjustment (SP2-101-001).

4

11. Set SP2-109-003 to "0: None" after adjusting the main scanning magnification and registration.

12. Perform line adjustment.

SP2-111-004: Forced Line Position Adj. Mode d

The result can be checked with SP2-194-007 (MUSIC Execution Result Execution Result) (0: Success, 1: Failure).

Also, results for each color can be checked with SP2-194-010 to 013 (1: Completed successfully).

13. Exit the SP mode.

Polygon Mirror Motor

1. Laser Unit (page 452)
2. Polygon mirror motor cover [A]



 x4

d244c4017

3. Polygon mirror motor holder [A], Polygon mirror motor [B]

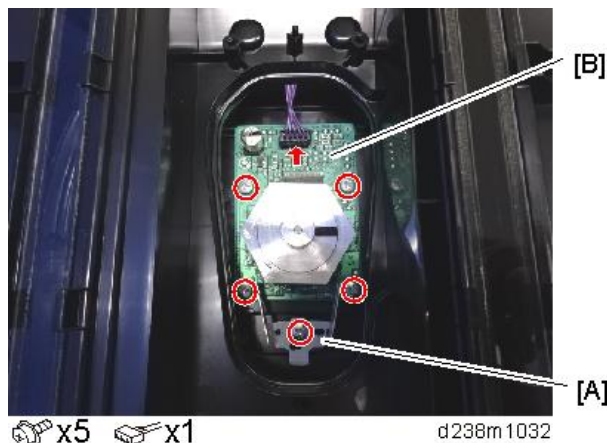

Adjustment after Replacing the Polygon Mirror Motor

SP2-111-004: Forced Line Position Adj. Mode d

The result can be checked with SP2-194-007 (MUSIC Execution Result Execution Result) (0: Success, 1: Failure).

Also, results for each color can be checked with SP2-194-010 to 013.

SP Descriptions

SP2-110-005 (Writing Unit Adj. Transfer)

Execution flag to download adjustment values of laser unit to the main unit's SP.

Must be executed when replacing the laser unit or assembling the main unit.

SP2-119-001 to 003 (Skew Adjustment Display)

Displays the current skew correction value for each color.

SP2-109-003 (Test Pattern: Pattern Selection)

Selects the test pattern.

SP2-102-001 to -003 (Magnification Adjustment: Bk)

Adjusts main scan lower speed scale for BK.

Value increase: image stretches.

Value decrease: image shrinks

CMY color scale will fit to standard BK speed after executing MUSIC; BK color will have a different scale in the image without executing MUSIC after this SP.

SP2-101-001 (Registration Correction: Color Main Dot: Bk)

Adjusts main scan registration for BK.

Value increase: image shifts to the right facing the paper.

Value decrease: image shifts to the left facing the paper.

CMY colors are adjusted to the BK color position if MUSIC is done after this SP.

SP2-111-004 (Forced Line Position Adj. Mode d)

Executes the fine line position adjustment and rough line position adjustment.

SP2-194-007 (MUSIC Execution Result Execution Result)

Displays the result of MUSIC adjustment.

0: Success, 1: Failure

SP2-194-010 to 013 (MUSIC Execution Result: Error Result C, M, Y, K)

Displays the result code of MUSIC adjustment for each color.

Detection Result	Meaning
0	MUSIC not executed
1	Correction Succeeded: Sampling is conducted correctly and the correction is completed
2	Sampling Failed (When the MUSIC pattern failed to be detected)
3	Detection Patterns Lacking (When the number of lines detected is smaller than the fixed number)
4	The sampled data is beyond the correction range. (Calculated correction value is just out of range)
5	The sampled data is beyond the correction range.

PCDU

PCDU

Note

- When installing a complete brand-new PCDU, it is not necessary to set SP3-701: New Development Unit detection

1. Open the front cover [A].



d238m1002

2. Image Transfer front cover [A]

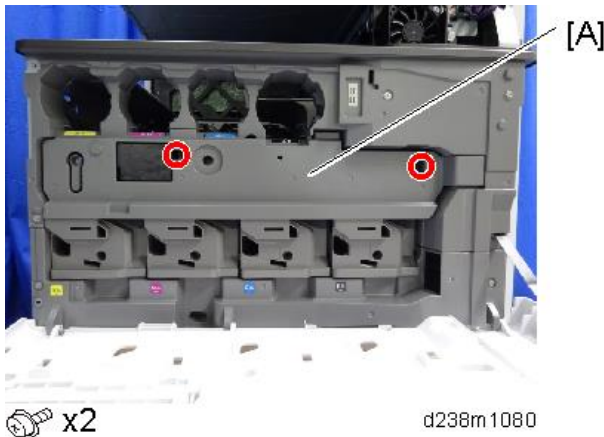



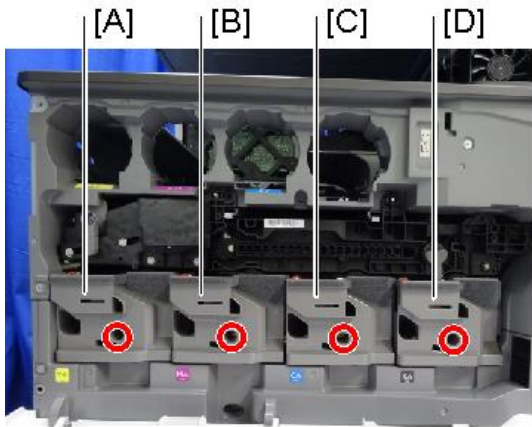

d238m1080

3. PCDU cover.



d238m1081

[A]	Y	 x 1
[B]	M	 x 1
[C]	C	 x 1
[D]	K	 x 1



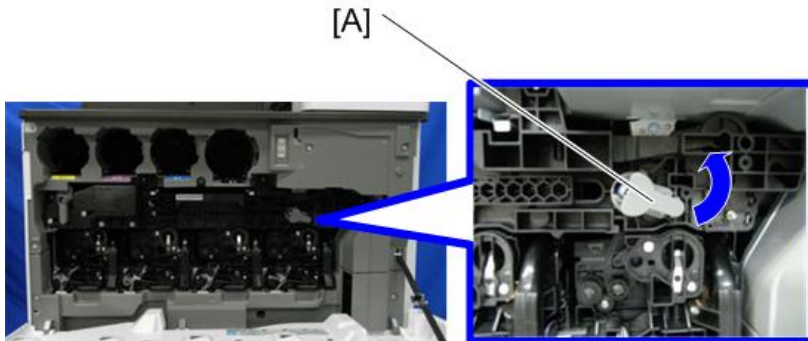





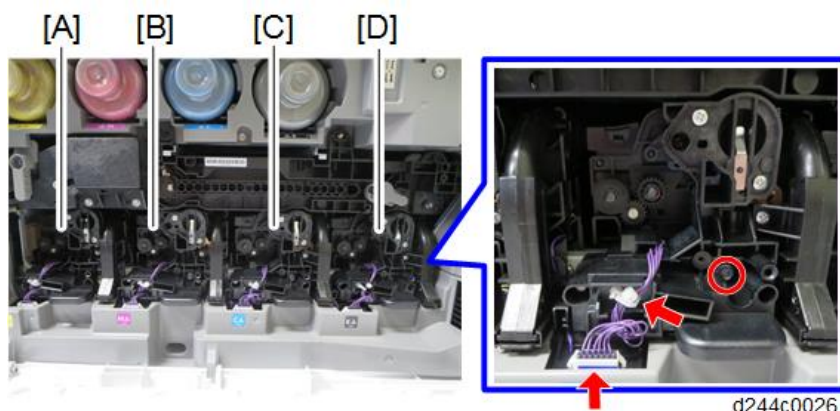



4. Release the lock of the image transfer contact lever [A].



d177z4046

5. PCDU.



[A]	Y	 x 1,  x 1,  x 1
[B]	M	 x 1,  x 1,  x 1
[C]	C	 x 1,  x 1,  x 1
[D]	K	 x 1,  x 1,  x 1

 **Note**

- When attaching the PCDU, clamp the harness so that the bind [A] comes above the clamp.

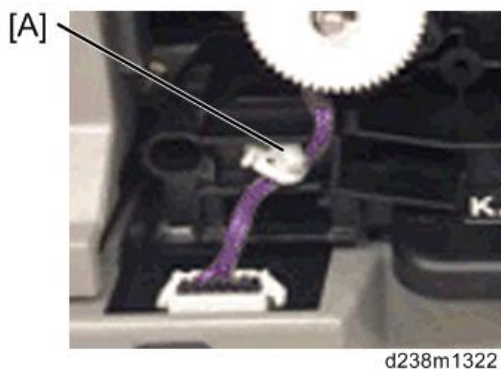

Adjustment after Replacing the PCDU

- Turn ON the main power.
- Do the "Automatic Color Calibration (ACC)" for the copier mode & printer mode as follows:
 - "User Tools" icon > "Machine Features" > "Maintenance" > "Auto Color Calibration" > "Start"

2. Print the ACC test pattern.
3. Put the printout on the exposure glass.
4. Put 10 sheets of white paper on the test chart. This ensures the precise ACC adjustment.
5. Close the SPDF/ARDF or the platen cover.
6. Press "Start Scanning" on the LCD. Then, the machine starts the ACC.

3. Exit the User Tools mode.

PCU/Development Unit

4

Before Replacing a PCU

⚠ CAUTION

- In the PCU for MP C2504/C2004 and the PCU for MP C6004/C5504/C4504/C3504/C3004, the charging method is different. Variations in the charge voltage must be corrected when a PCU is replaced.
- Because of this, before replacing a PCU, do the procedure shown below. The main points are as follows.
 - Input the charge voltage correction value for the new PCU.
 - The machine will optimize SP settings related to imaging using process control, after you input the charge voltage correction value and replace the PCU.

1. Set SP3-701: New PCU detection to "1" before replacing the PCU.

SPs for manual new unit

Item	SP
PCU	Black: SP3-701-002
	Cyan: SP3-701-025
	Magenta: SP3-701-048
	Yellow: SP3-701- 071

0: new unit detection flag OFF, 1: new unit detection flag ON

2. Check the charge voltage correction value printed on the label attached to the new PCU. This value is adjusted for each PCU.

↓ Note

- When installing a complete brand-new PCDU, it is not necessary to input the correction value.



d177z4512

A	Bar code
B	PCU Lot No.
C	Correction value
D	Last three digits of SP number
E	SP No.

- Input the value (located at [C] on the decal as shown above) into SP2-005 as shown below.

SPs for charge voltage correction before replacing PCU

	SP No. (SP name)
K	SP2-005-235 (Correction Coefficient c1: K)
C	SP2-005-236 (Correction Coefficient c1: C)
M	SP2-005-237 (Correction Coefficient c1: M)
Y	SP2-005-238 (Correction Coefficient c1: Y)

- Check SP2-005 to make sure that you have input the correct values. Check that they are the same as the values on the labels in step 2.
- Turn the power OFF.
- Replace the PCU.
- Turn the power ON. (Process control is done automatically.)

Note

- If you replace the PCU without inputting the correction value, do the following procedure:
 - Case 1: When you set SP3-701 to "1"
 - Input the PCU correction value.
 - Execute process control manually with SP3-011-001 in order to adjust the machine settings with the PCU correction value.

- Case 2: When you **did not** set SP3-701 to "1"
 1. Set SP3-701 to "1".
 2. Input the PCU correction value.
 3. Turn the power OFF. Note that process control will start automatically.

Before Replacing a Development Unit

1. Set SP3-701: New unit detection to "1" before replacing the development unit.

SPs for manual new unit

Item	SP
Development unit	Black: SP3-701-003
	Cyan: SP3-701-026
	Magenta: SP3-701-049
	Yellow: SP3-701- 072

0: new unit detection flag OFF, 1: new unit detection flag ON

2. Switch the power OFF. Then replace the development unit and switch the power ON.

CAUTION

- Replacing the development unit resets not only the development unit counter, but also the PCU counter. However, if you change the SP setting (SP3-701) before you replace the development unit, the PM counter of the development unit is reset, but the PM counter of the PCU is not reset.
- Therefore, before you replace the development unit, the manual new unit setting SP3-701 must be done. Doing these in the wrong order will reset the counter of the PCU also.

Replacement

1. PCDU (page 459)

2. Release the connecting part (front) [A] (⚙️ x 2) and harness [B].

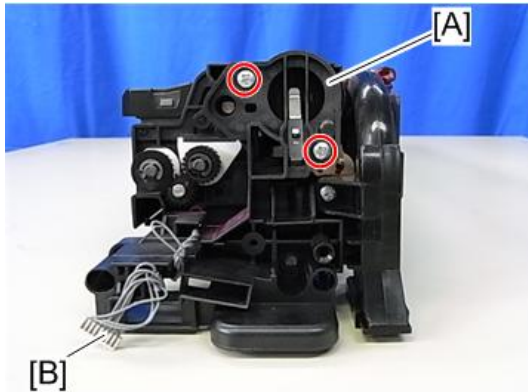

d7662043

3. Cover [A] (⚙️ x 1).

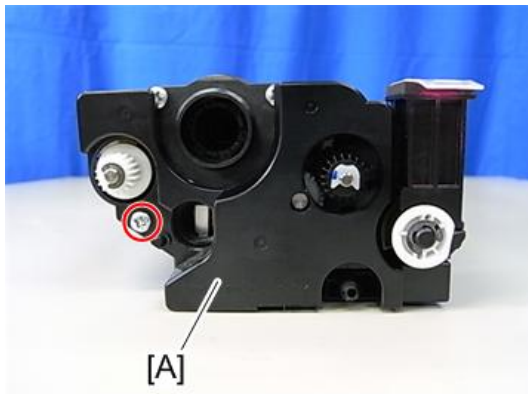

d7662040

⚠️ CAUTION

- Be careful not to break the plate (shown by the red arrow).
- Handle with care to prevent deformation of the plate. Deformation can cause unstable images due to contact failure. Be sure to attach this cover to the PCDU and install the PCDU in the mainframe.



d7662041

4

4. Connecting part (rear) [A] (⌀ x 3).

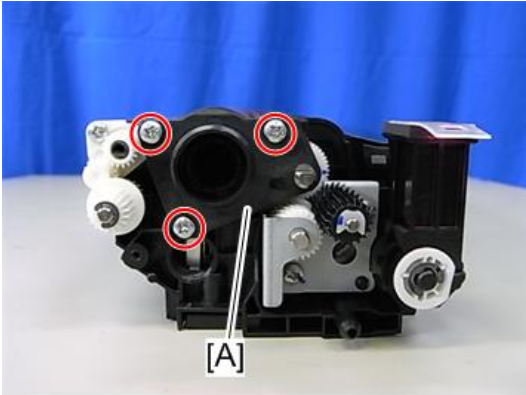

d7662042

5. Separate PCU [A] and development unit [B].

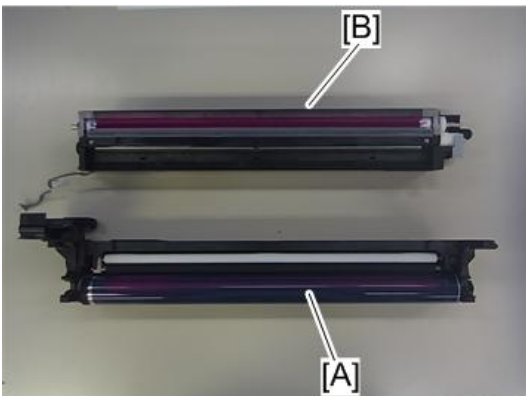

d7662044

⚠ CAUTION

- When holding the development unit, be sure to obey the following three DO NOTs:

- **DO NOT** touch the development roller housing [A]. Doing so will deform the development roller housing, which causes the development roller to be scratched.
- **DO NOT** touch the doctor blade [B]. The doctor blade is an extremely sharp-edged blade, made with a high precision to work properly. So touching the blade causes physical injury as well as deformation of the blade assembly which causes a malfunction of the development unit.
- **DO NOT** touch the development roller. Doing so develops a fingerprint on the paper.

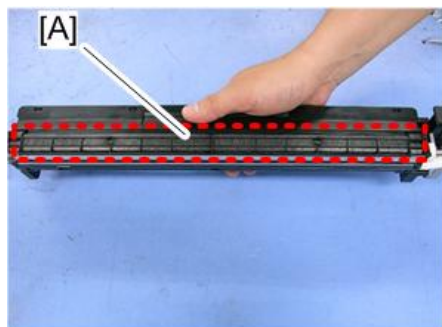

d237z2100

- Hold the development unit as shown below:



d237z2101

↓ Note

- When separating the PCU and development unit, the drum may come off and this could cause a toner spillage. Hold the PCU [A] with the drum side up as shown below to prevent toner spillage.

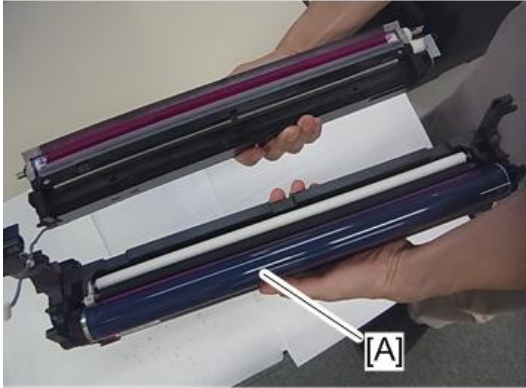

d7662069

4

Notes for Assembling PCU/Development Unit

Pay close attention not to spill any toner on the charge roller when assembling.

Note

- Remove the heat seal [A] after replacing the PCDU.
- Remove the cap [B] pasted on the toner port when replacing the PCDU.

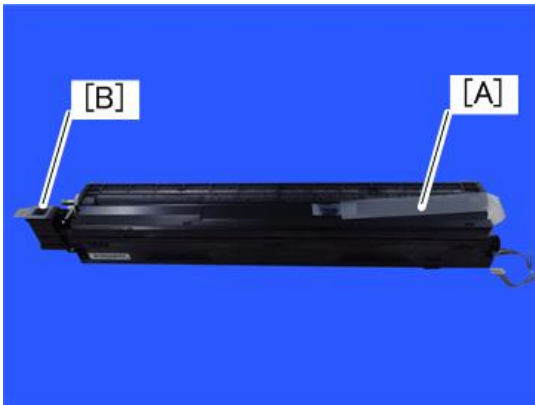

d766z0010

Method for Checking after Replacement

Before installing, rotate the drum in the blue arrow direction, to ensure that toner lines do not occur.



d766z0008

Adjustment after Replacing the PCU and/or the Development Unit

1. Turn ON the main power.
2. Do the "Automatic Color Calibration (ACC)" for the copier mode & printer mode as follows:
 1. "User Tools" icon > "Machine Features" > "Maintenance" > "Auto Color Calibration" > "Start"
 2. Print the ACC test pattern.
 3. Put the printout on the exposure glass.
 4. Put 10 sheets of white paper on the test chart. This ensures the precise ACC adjustment.
 5. Close the SPDF/ARDF or the platen cover.
 6. Press "Start Scanning" on the LCD. Then, the machine starts the ACC.
3. Exit the User Tools mode.

Imaging Temperature Sensor (Thermistor)

1. Toner supply cooling fan unit (page 630)
2. Controller box (page 614)

3. Duct [A]

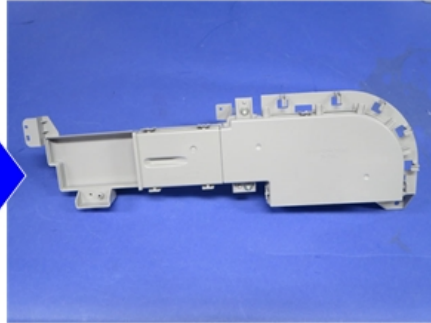
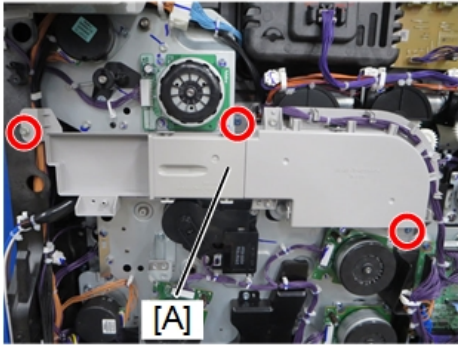

d244c4006

 x3

4

4. Connector [A]

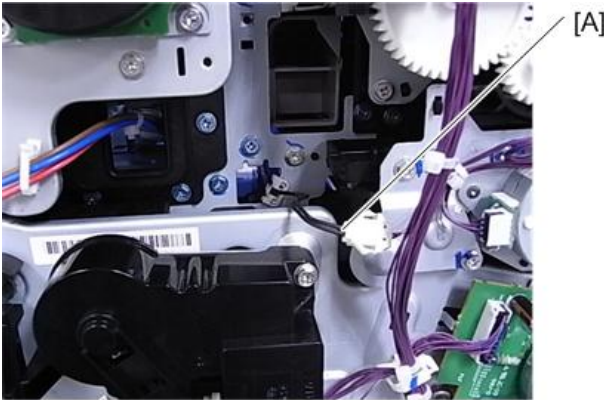

d1462273

5. Image Transfer Belt Unit (page 474)

6. PCDU (K) (page 459)

7. Imaging temperature sensor harness guide [A] and Imaging temperature sensor [B] (👉
x2).

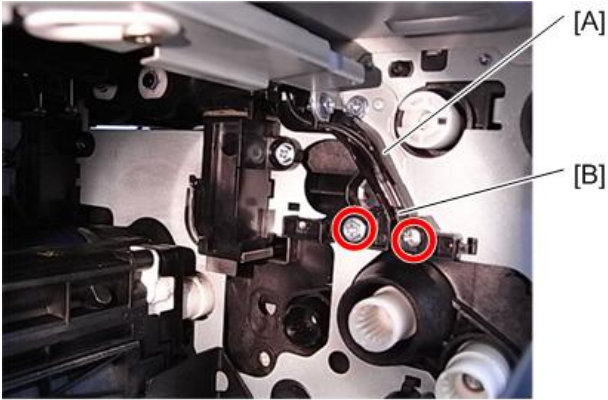

d1462274

Waste Toner

Waste Toner Bottle

Before Replacing the Waste Toner Bottle

When the bottle is replaced after the machine detects that the waste toner bottle is full and stops, the counter for the Waste Toner Bottle is reset automatically.

When the bottle is replaced before the machine stops due to a full bottle, it is necessary to reset the PM counter manually (set SP3-701-142 to "1" before replacing the bottle, then switch the power off).

4

SP3-701 (Manual New Unit Set)

This SP is the new unit detection flag.

0: new unit detection flag OFF, 1: new unit detection flag ON

Item	SP
Waste toner bottle	SP3-701-142

Replacement

1. Open the waste toner cover [A].



d238m1054

2. Pull out the waste toner bottle [A].



3. Replace the waste toner bottle.

Image Transfer Unit

Image Transfer Belt Unit

CAUTION

- Note that if the two levers [A] [B] are not pointing up, the image transfer belt unit cannot be inserted.

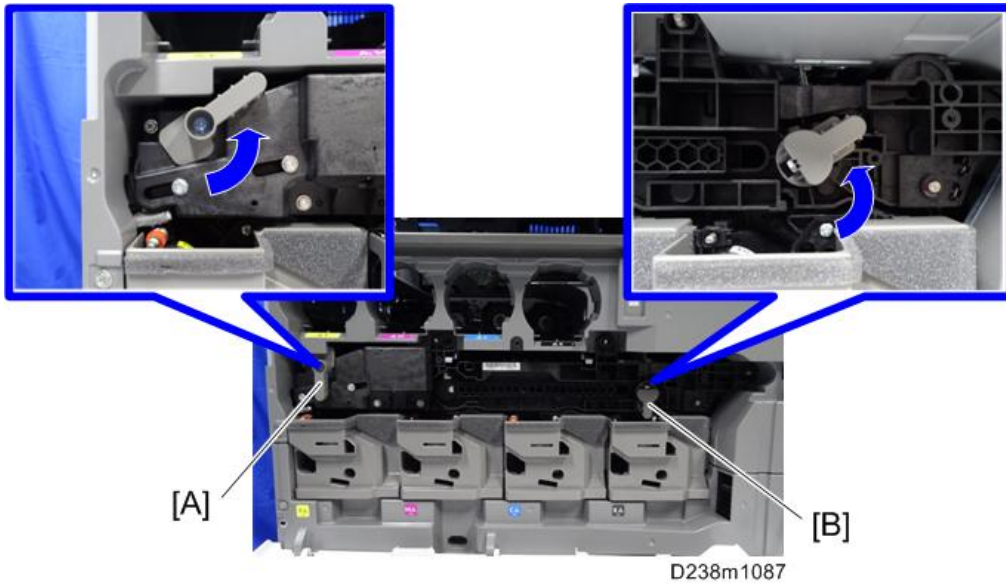

- Before you remove or attach the image transfer belt unit, open the right door and the paper transfer unit.
- Do not touch the rollers but hold the upper/lower resin parts [A] when you lift the Image Transfer Unit. Touching the rollers may cause poor image quality.

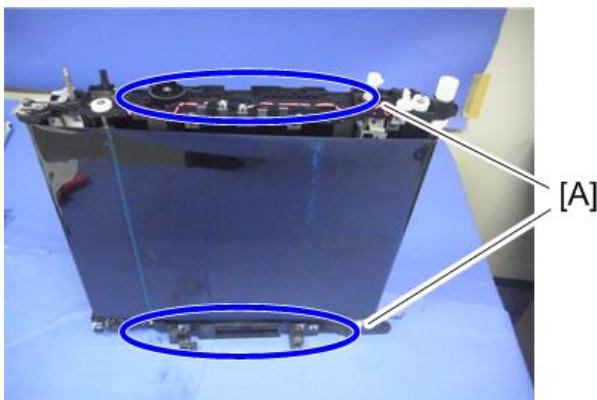

d1464005

⚠ CAUTION

- **Precautions when attaching the image transfer belt unit:**
 - Slowly push the unit until it is inserted all the way, and then give a final strong push one more time. Then lock the ITB lock lever and ITB contact lever.
- If the ITB contact lever is locked with the image transfer belt unit not fully inserted into the machine, the paper transfer roller is not set in the correct position when the paper transfer roller unit is closed. This causes shadows on the image or paper jam, and the paper transfer roller unit may not open.



d146e2101

4

What to Do before Replacing the Image Transfer Belt

Before replacing the Image Transfer Belt unit, set SP3-701-093 to "1" and switch the power OFF. Then replace the Image Transfer Belt unit and switch the power ON.

SP3-701 (Manual New Unit Set)

This SP is the new unit detection flag.

0: new unit detection flag OFF, 1: new unit detection flag ON

Item	SP
Image Transfer Belt Unit	SP3-701-093

Replacement

1. Open the front cover.

2. Image transfer front cover [A]

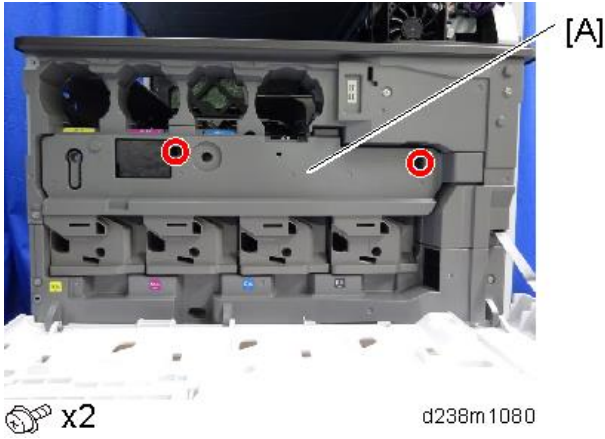

3. Release the lock [A] and open the right door [B].

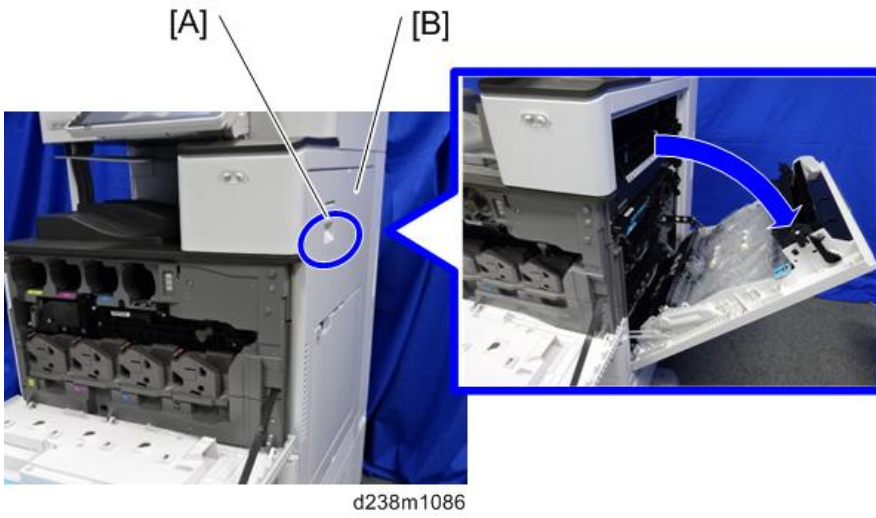

4. Pull the handle [A] and open the paper transfer unit [B].

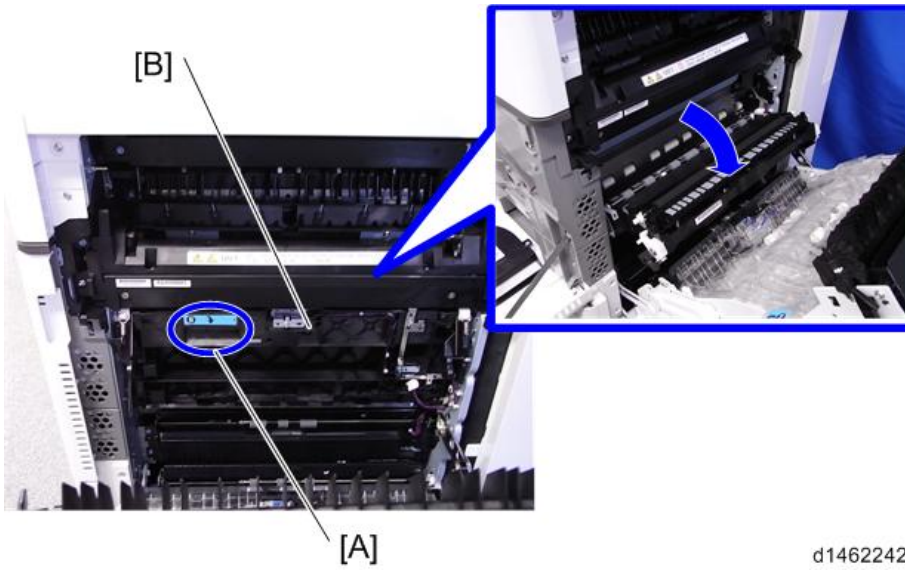

4

d1462242

5. Release the ITB lock lever [A] and ITB contact lever [B].

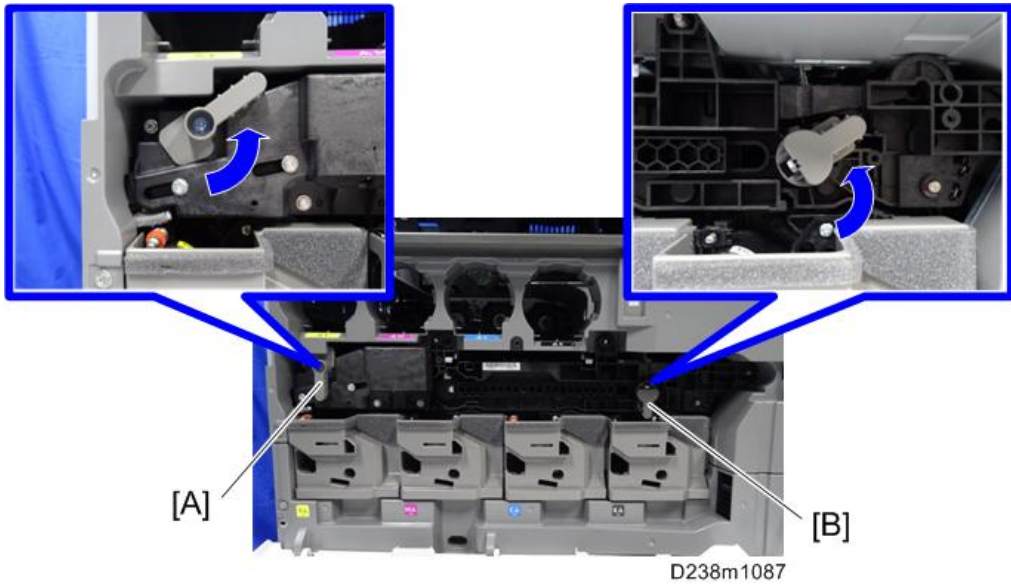

D238m1087

6. Pull out the image transfer belt unit fully [A].

7. Lift the handle [B] to release the lock, and remove the image transfer belt unit.

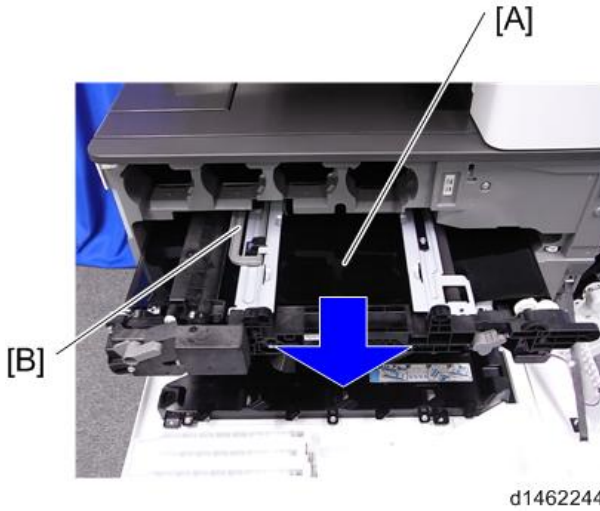

Locking mechanism by handle



Image Transfer Cleaning Unit

⚠ CAUTION

- Before removing the image transfer cleaning unit [A], turn the assembly upside down (as shown on the right), so that the image transfer cleaning unit [A] is underneath the image transfer belt unit [B]. This prevents scattering of toner.

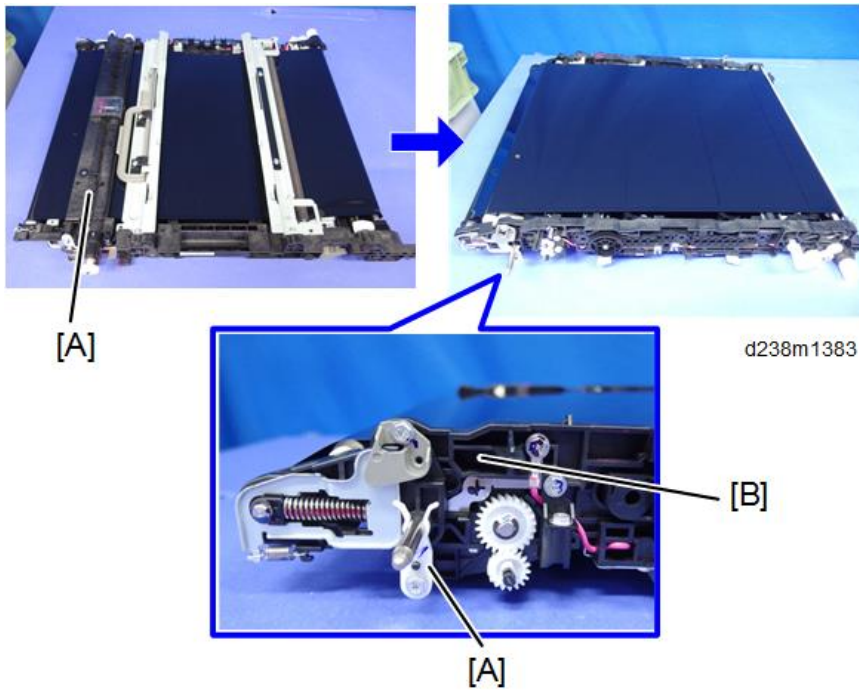

★ Important

- When replacing the Image Transfer Cleaning Unit, do not touch the cleaning blade edge.

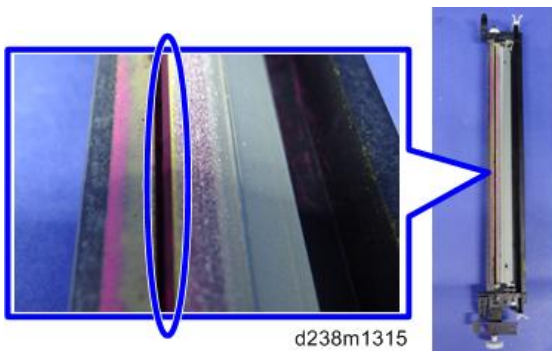

What to Do before Replacing the Image Transfer Cleaning Unit

Before replacing the Image Transfer Belt Cleaning, set SP3-701-102 to "1" and switch the power OFF. Then replace the Image Transfer Belt Cleaning and switch the power ON.

SP3-701 (Manual New Unit Set)

This SP is the new unit detection flag.

0: new unit detection flag OFF, 1: new unit detection flag ON

Item	SP
Image Transfer Cleaning Unit	SP3-701-102

Replacement

1. Image transfer belt unit (page 474)
2. Image transfer lock unit [A]

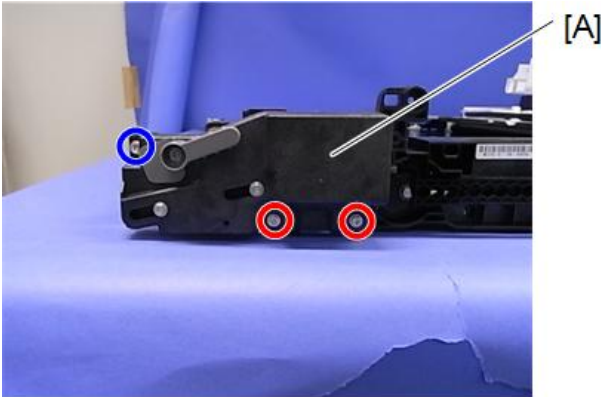

 x2  x1

d238m0072

3. Remove the screws above the image transfer cleaning unit [A].



 x2

d238m0073

- Turn the whole image transfer belt unit over, and remove the screws below the image transfer cleaning unit.

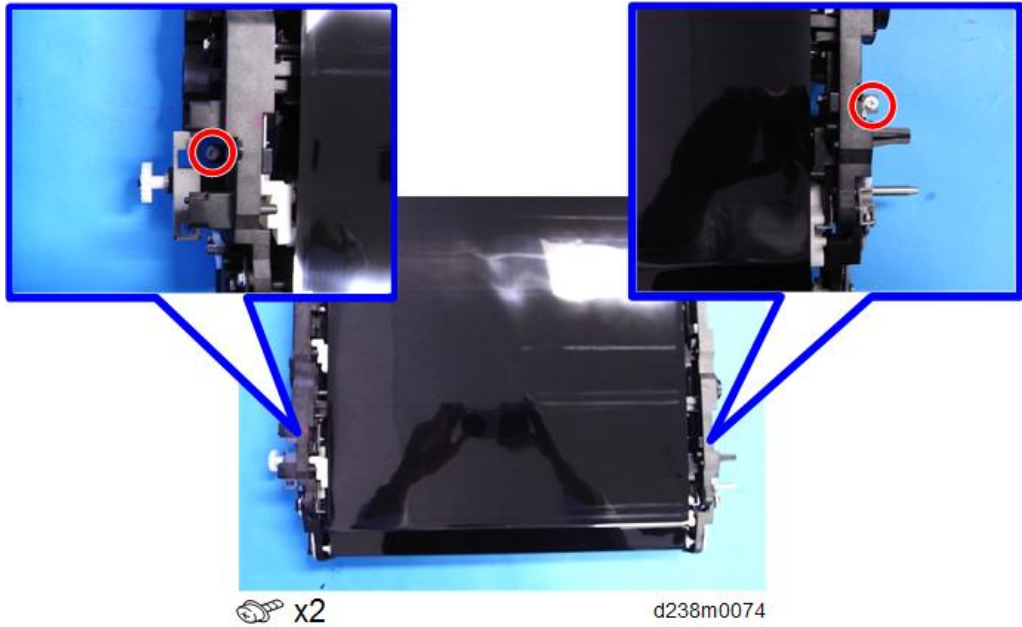

4

- While releasing the hook, lift the image transfer belt unit gently, and remove the image transfer cleaning unit.

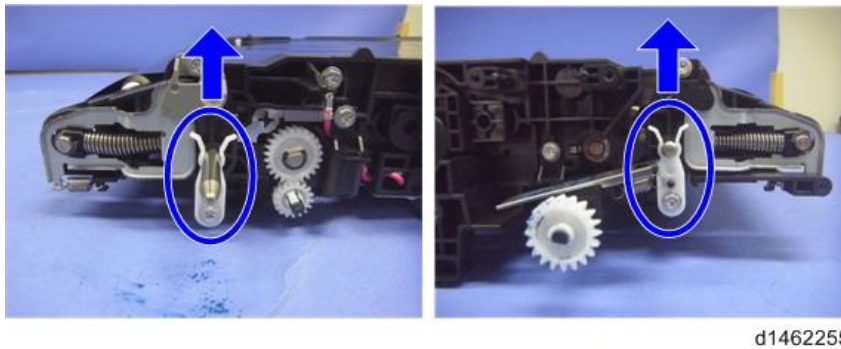

6. Put toner on the image transfer belt.

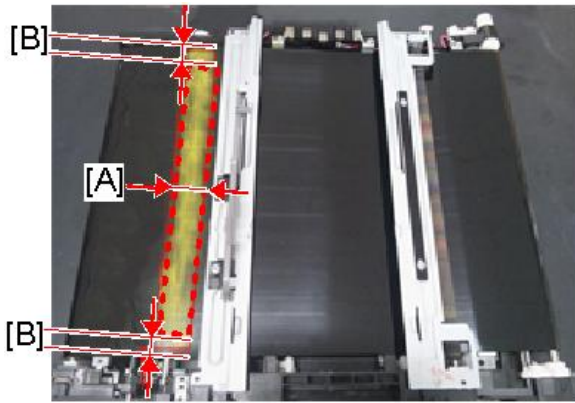

d238z2176

[A]: 20mm or more

[B]: About 5mm

Note

- It is not necessary to specify the color of the toner, though yellow toner is used in the above example.

7. Attach the image transfer cleaning unit.

8. Rotate the image transfer belt about 10mm [A] in the reverse direction, then turn it forward one complete turn [B].

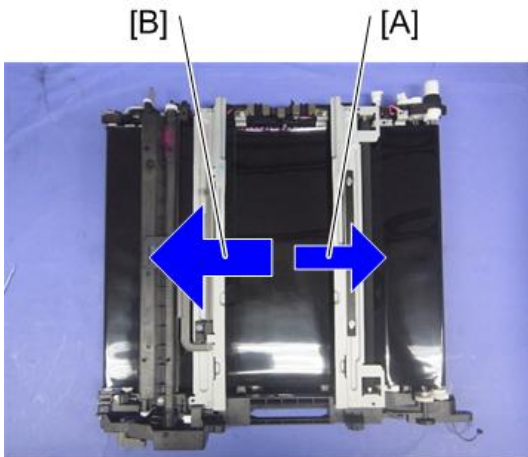

d1462175

Image Transfer Belt

⚠ CAUTION

- Do not touch the rollers but hold the upper/lower resin part [A] when you lift the Image Transfer Unit. Touching the rollers may cause poor image quality.

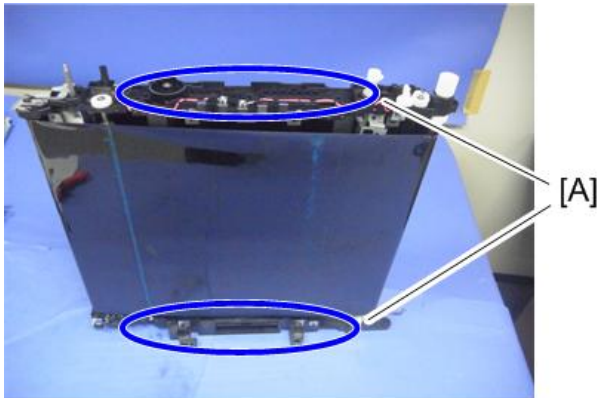

d1464005

1. Image transfer belt unit (page 474)
2. Bracket [A]

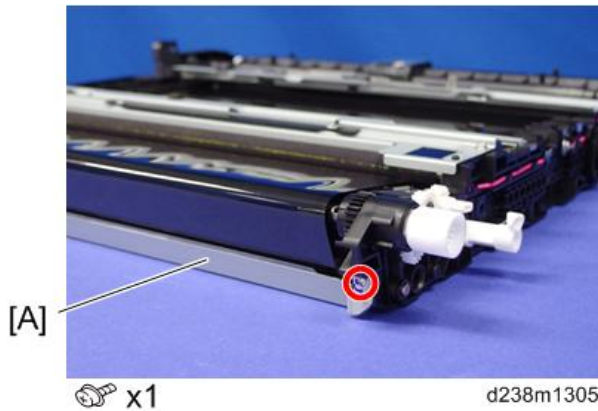
 x1

d238m1305

3. Brackets [A] [B]

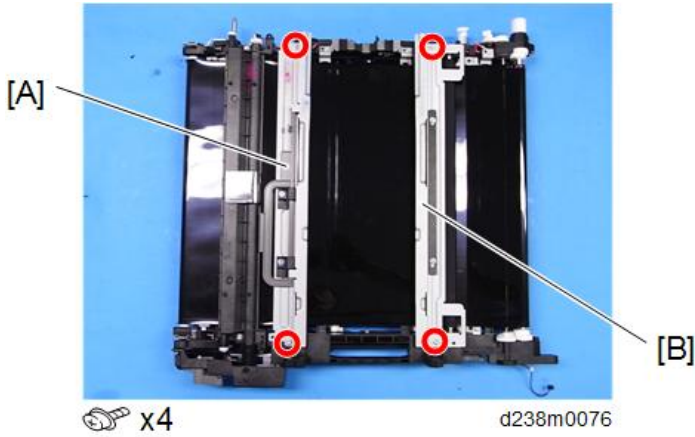

4. Image transfer cleaning unit (page 478)

5. Remove the tension fixing frames [A] and [B] (front side: black, rear side: gray).

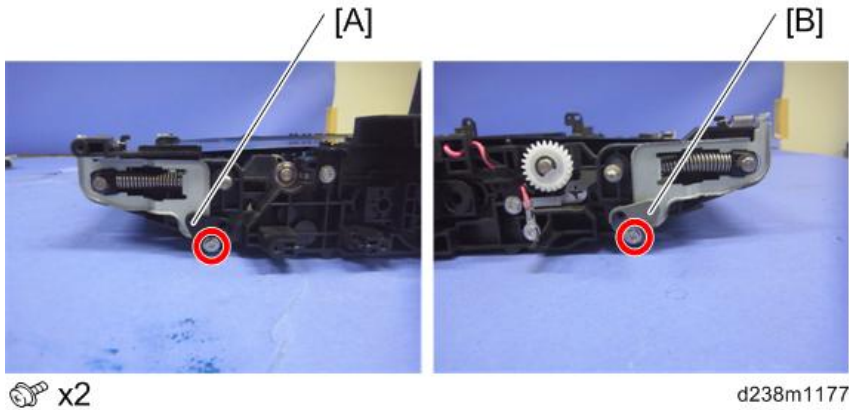

6. Position the image transfer unit with the front side underneath.



7. Rotate the gear [A] to change to the OPEN position.

The part in the red circle opens.

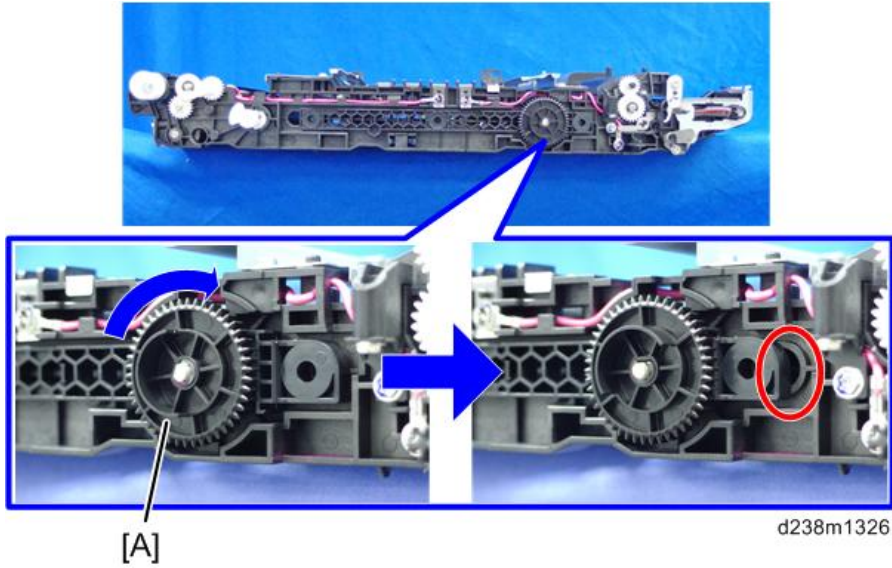

4

8. Release the tension, and remove the belt.

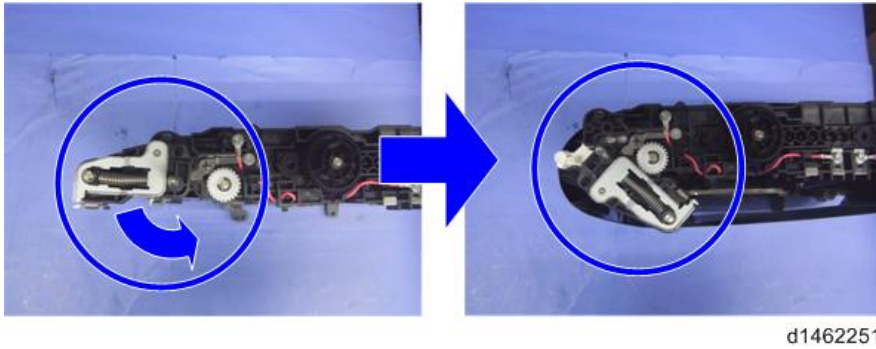

d1462252

Attaching the Belt

★ Important

- When attaching the belt, make sure that there is no foreign material on it.
 - Make sure to attach the belt with the edge with markings (2 white dots) at the unit's rear.
 - Be careful not to bend or scratch the belt.
1. Place the image transfer unit upright with its front face down, and then attach the belt from the top.

Make sure to have the belt's edge with markings (2 white dots) positioned at the top (unit's rear).

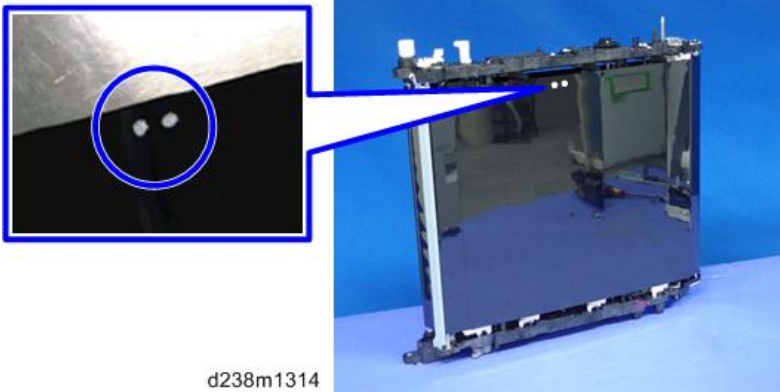

2. Holding the resin parts on the top and bottom, place the unit on its side.
3. Adjust the belt position according to the following two points:
 - The belt must be attached between the flanges [A] at both ends of the tension roller.
 - The belt's edge must be between the two lines [B] on the frame.

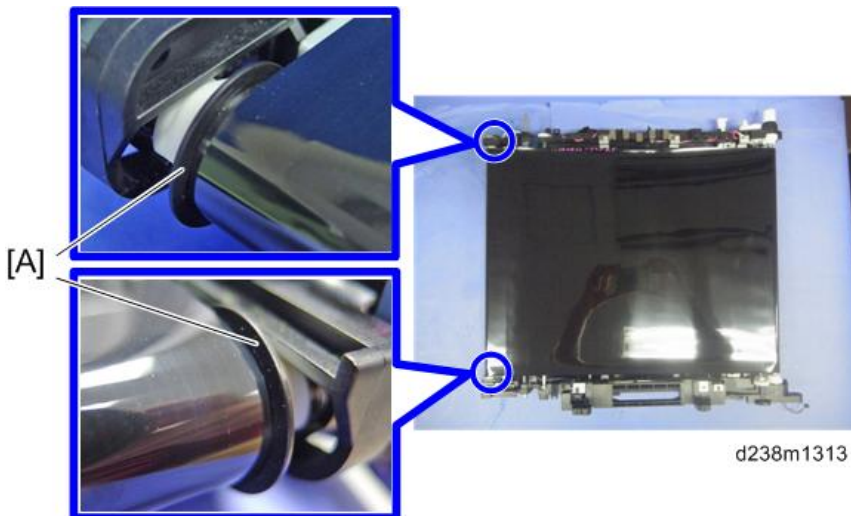

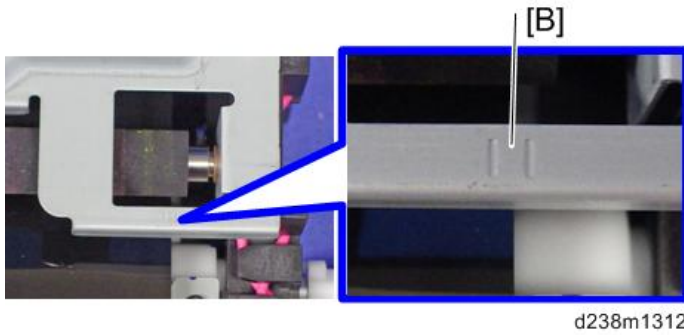

4. Apply tension back to normal.

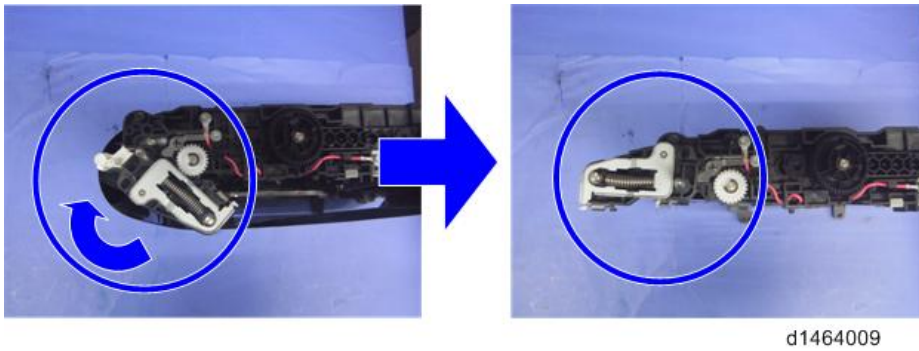

5. Rotate the gear [A] to change to the CLOSED position.

The part in the red circle closes.

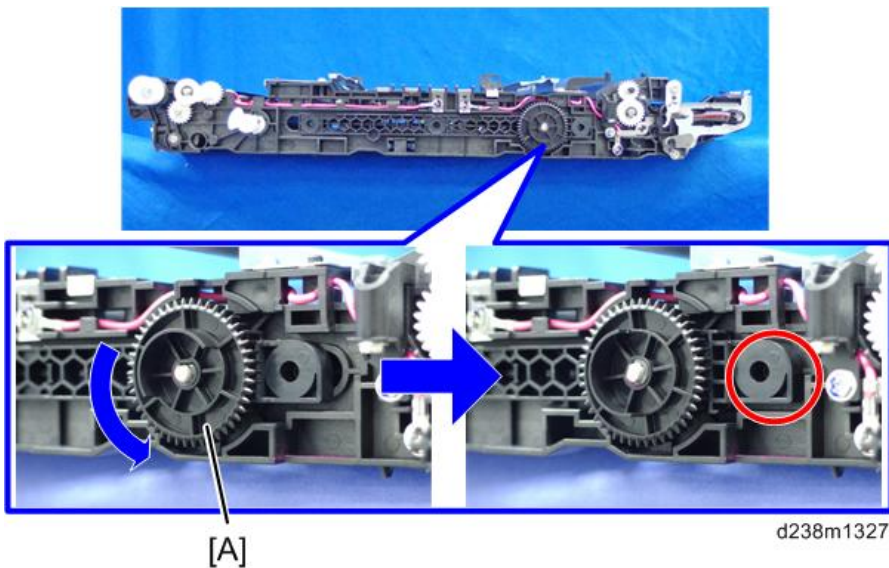

6. Attach the tension fixing frames [A] and [B] (front side: black, rear side: gray).

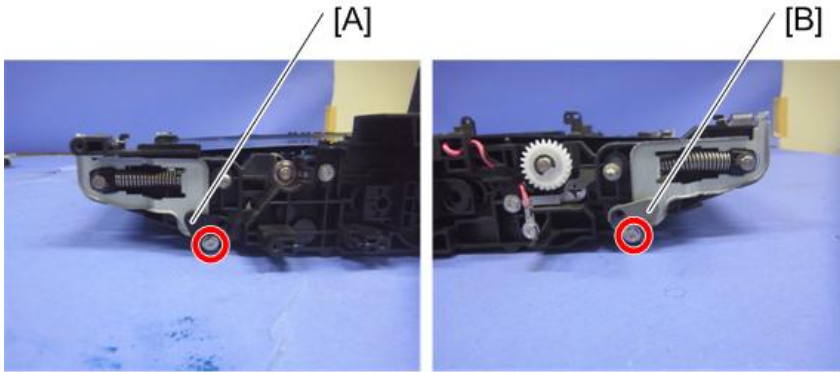

 x2

d238m1177

4

7. Put toner on the image transfer belt.

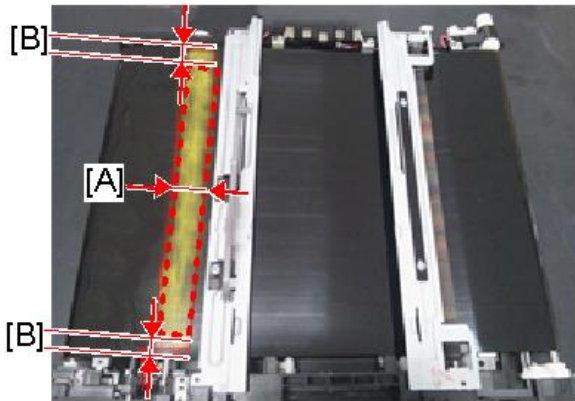

d238z2176

[A]: 20mm or more

[B]: About 5mm

 **Note**

- It is not necessary to specify the color of the toner, though yellow toner is used in the example above.

8. Attach the image transfer cleaning unit. (Refer to page 478)

9. Rotate the image transfer belt about 10mm [A] in the reverse direction, then turn it forward one complete turn [B].

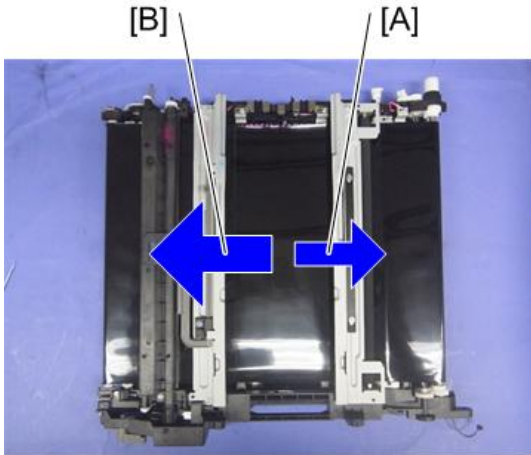

d1462175

10. Attach the brackets [A] [B]

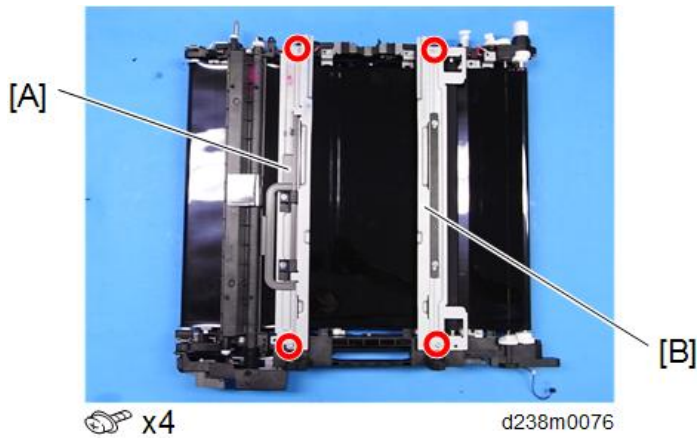

x4

d238m0076

11. Attach the bracket [A]

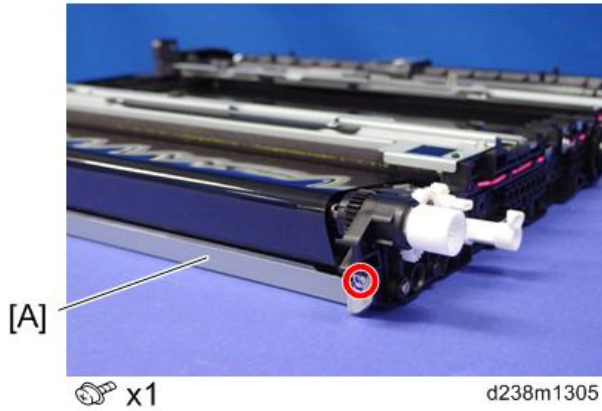

4

12. Attach the image transfer lock unit [A].

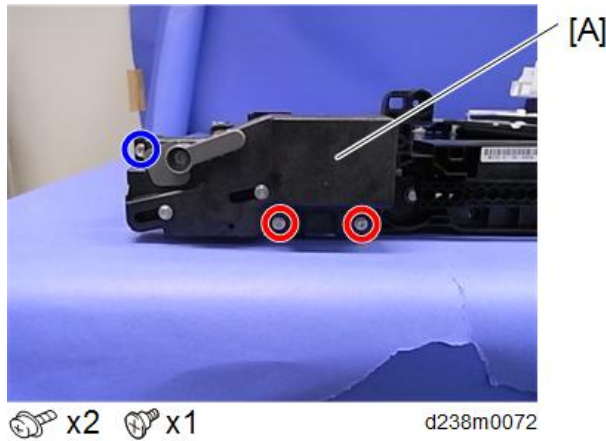

13. Install the image transfer unit on the machine.

Adjustment after replacing the Image transfer belt

After replacing the image transfer belt, to prevent twisting of the belt, pass the belt round once in the direction of the arrow.



d1462254

Paper Transfer Roller

1. Open the right door.
2. Pull the handle [A] and open the paper transfer unit [B].

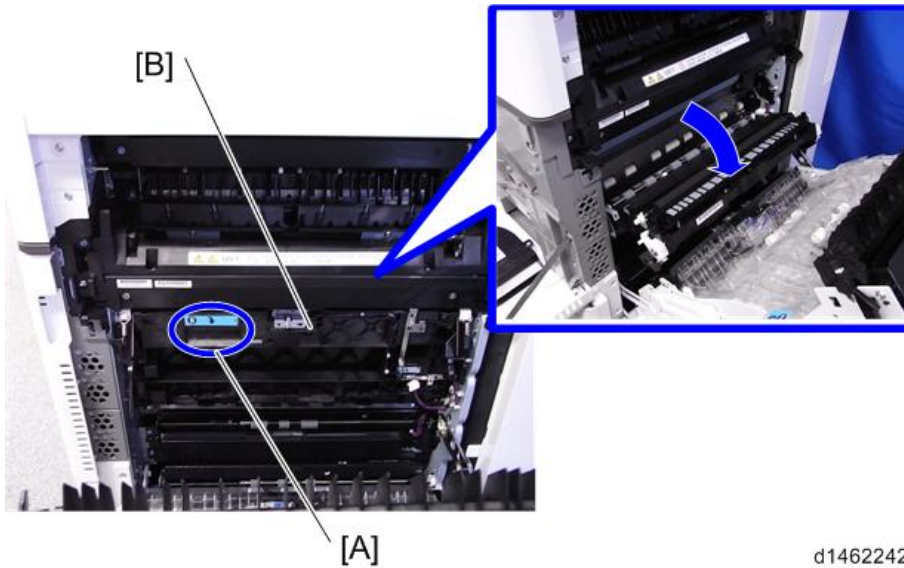

d1462242

3. Paper transfer roller [A]

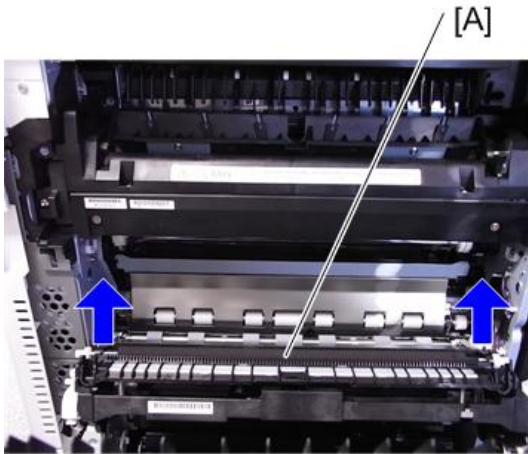

d1462260

4

When reinstalling the paper transfer roller

When reinstalling the paper transfer roller, do not install the wrong type of roller.

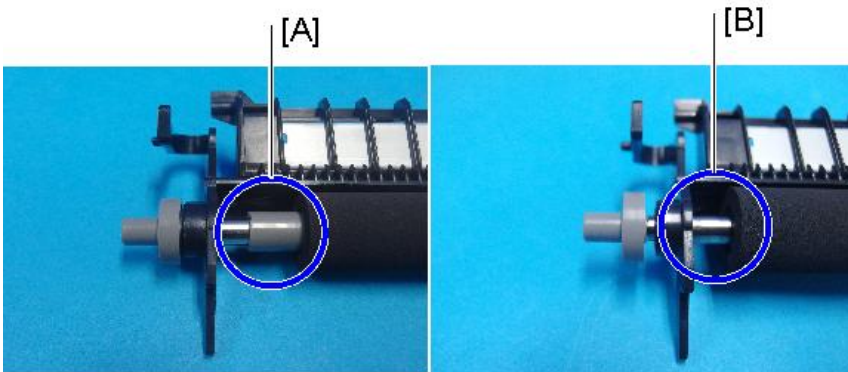

d238m0679b

[A]: Standard roller

[B]: Imageable Area Extension Unit Type M19

When attaching the paper transfer roller, make sure that the roller is set in the correct position while referring to the three points described below.

⚠ CAUTION

- If the paper transfer roller is set incorrectly, the following problems may occur.
 - Damage to the image transfer belt
 - Roller detachment when opening and closing the paper transfer roller unit to remove a paper jam

- The paper transfer roller unit does not open

1. Check that the claw [A] on the roller holder is under the guide plate [B].

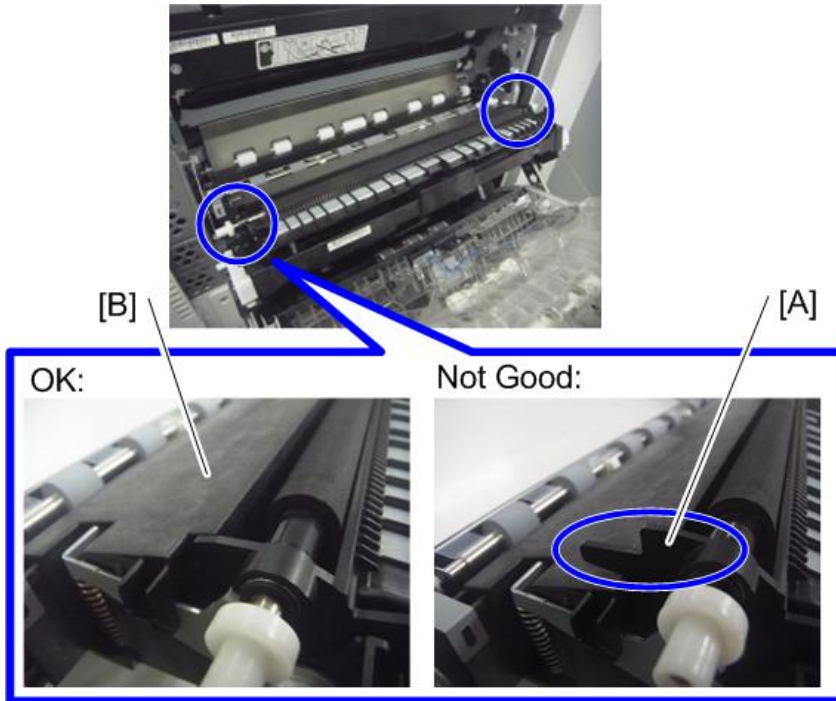

d146e2102

2. Check that the pin [A] on either end of the paper transfer roller is inserted correctly.

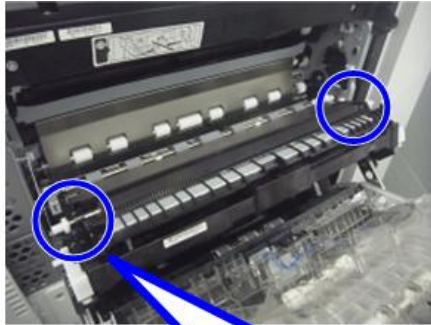

[A]

OK:



Not Good:



d146e2103

3. Check that the spring [A] at either end of the paper transfer roller unit is in the correct position at each end.

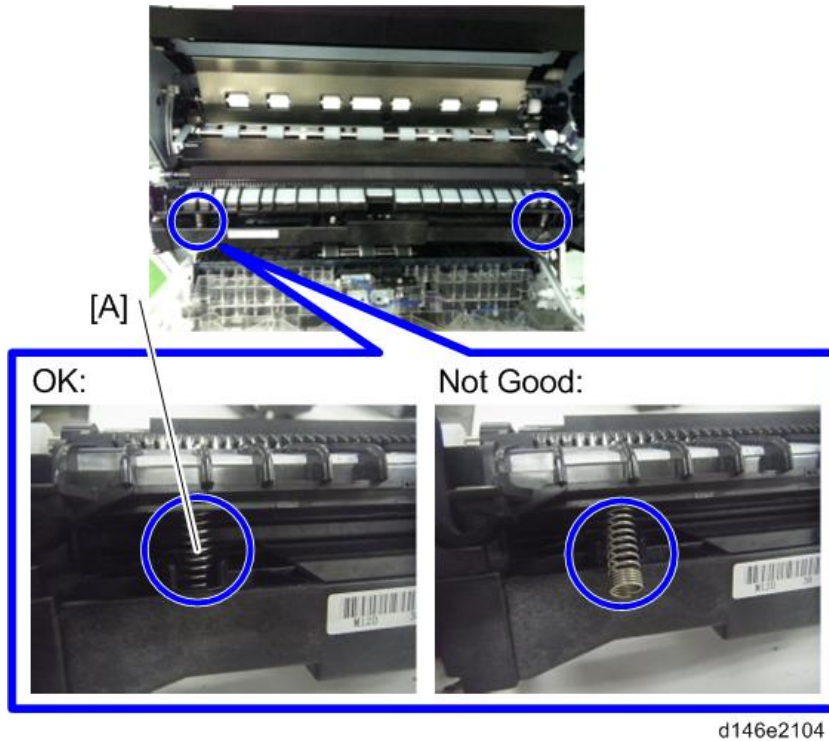

Paper Transfer Roller Unit

What to Do before Replacing the Paper Transfer Roller Unit

Before replacing the Image Paper Transfer Roller Unit, set SP3-701-109 to "1" and switch the power OFF. Then replace the Image Paper Transfer Roller Unit and switch the power ON.

SP3-701 (Manual New Unit Set)

This SP is the new unit detection flag.

0: new unit detection flag OFF, 1: new unit detection flag ON

Item	SP
Paper Transfer Roller Unit	SP3-701-109

Replacement

1. Open the right door.

2. Remove the right clip ring and connector on the rear side.

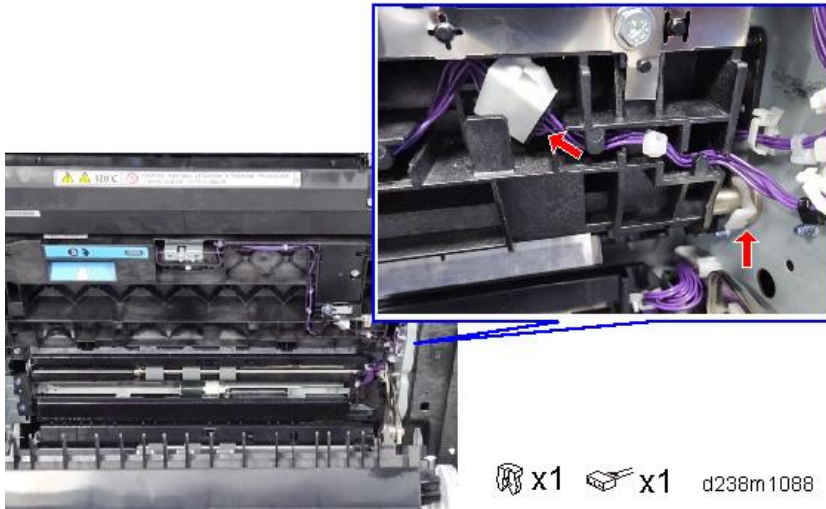

3. Pull the handle [A] and open the paper transfer unit [B].

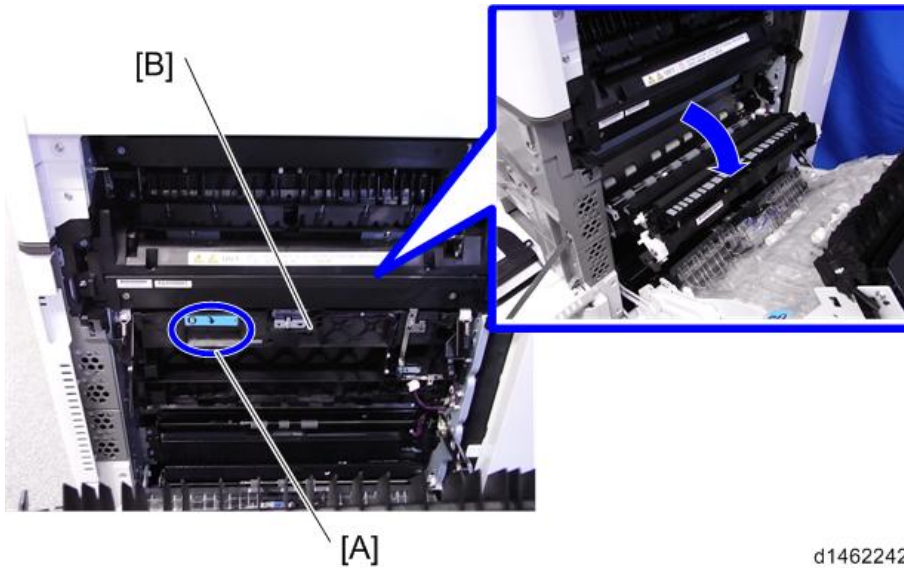

4. Remove the left clip ring at the front side, and remove the paper transfer roller unit [A].

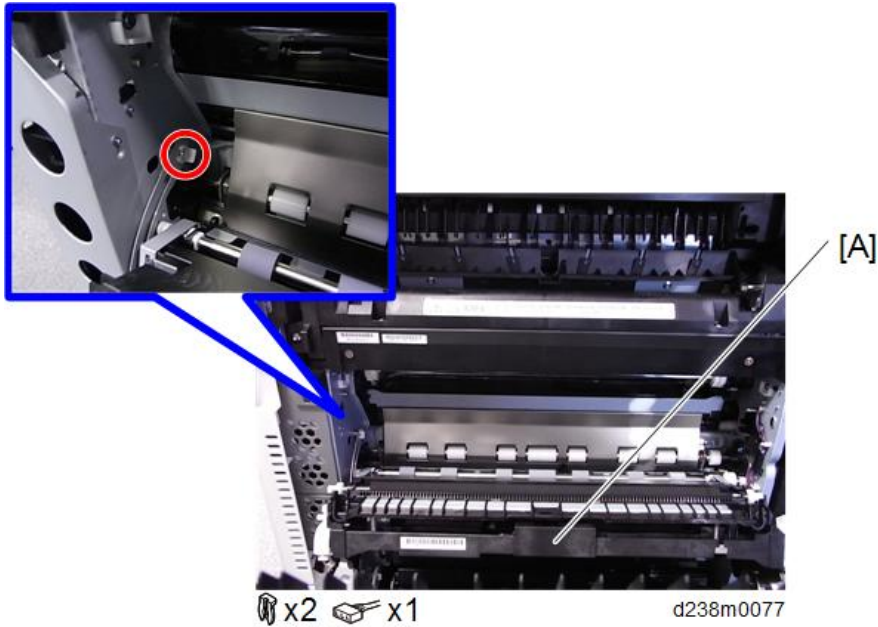

↓ Note

- Note that the sizes of the clip ring differ on the left and right.
- When attaching a paper transfer roller unit, first attach the bushings [A] to the paper transfer roller unit.

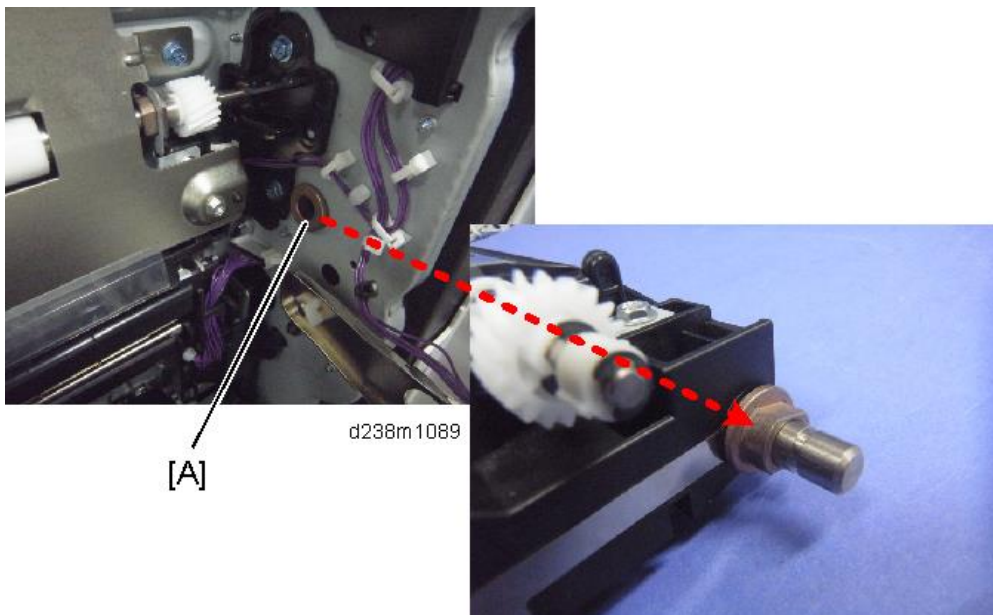

Fusing Entrance Sensor

1. Open the right door.
2. Fusing entrance sensor unit [A]

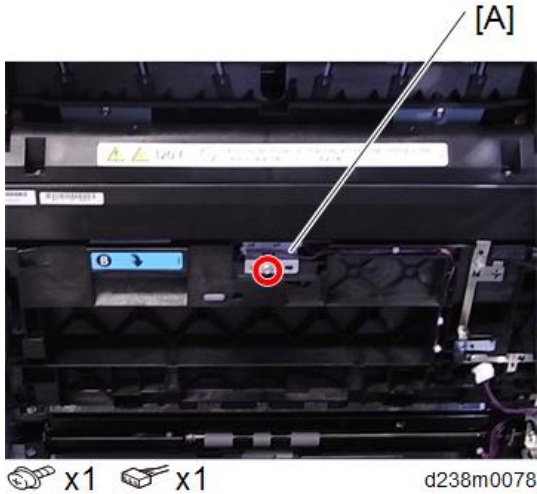

3. Fusing entrance sensor [A]

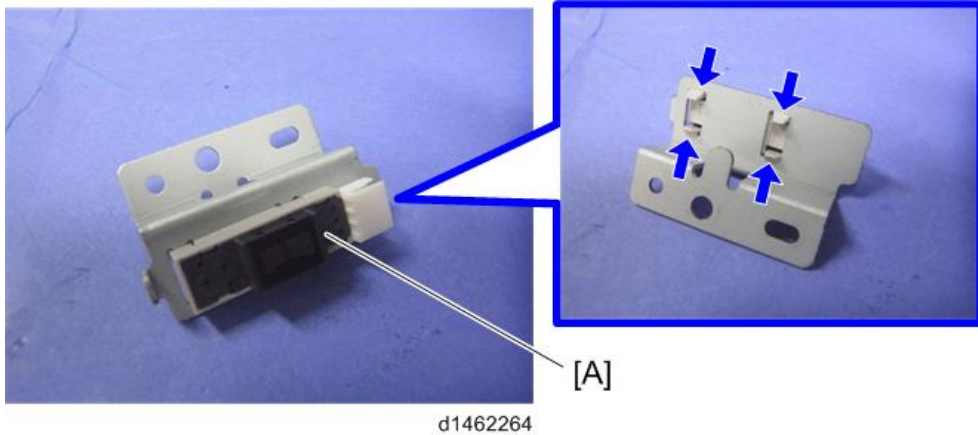

TM/ID Sensor

Before Replacing the TM/ID sensor

Each sensor assembly has a list of characteristic values attached to it. Before you replace the TM/ID sensor, you must do the following procedure, or process control/MUSIC will not be done correctly after power is switched on (it will use the values for the old sensor).

Note

- The characteristic values attached to the service part must be entered before replacement. It is recommended that in case Process control/MUSIC after replacement is not completed successfully, take a note of values of SP3-333, SP3-334 and SP3-335.

1. Note the characteristic values that are listed on the bar code label.



d1462268

Note

- TM/ID Sensor (front): F, TM/ID Sensor (center): C, TM/ID Sensor (rear): R, be careful.

2. Turn on the main power switch, and then go into the SP mode.

3. Input the characteristic values.

Input data for TM/ID Sensor: F into SP3-333. Input data for TM/ID sensor: C into SP3-334. Input data for TM/ID sensor: R into SP3-335.

SP No.	Classification 1	Classification 2	Value
3-333-001	ID.Sens TestVal:F	K2: Check	TM/ID sensor: F, value of [1]
3-333-002	ID.Sens TestVal:F	Diffuse Corr	TM/ID sensor: F, value of [2]
3-333-003	ID.Sens TestVal:F	Vct_reg Check:Slope	TM/ID sensor: F, value of [3]
3-333-004	ID.Sens TestVal:F	Vct_reg Check:Xint	TM/ID sensor: F, value of [4]
3-333-005	ID.Sens TestVal:F	Vct_dif Check:Slope	TM/ID sensor: F, value of [5]
3-333-006	ID.Sens TestVal:F	Vct_dif Check:Xint	TM/ID sensor: F, value of [6]
3-334-001	ID.Sens TestVal:C	K2: Check	TM/ID sensor: C, value of [1]
3-334-002	ID.Sens TestVal:C	Diffuse Corr	TM/ID sensor: C, value of [2]
3-334-003	ID.Sens TestVal:C	Vct_reg Check:Slope	TM/ID sensor: C, value of [3]
3-334-004	ID.Sens TestVal:C	Vct_reg Check:Xint	TM/ID sensor: C, value of [4]
3-334-005	ID.Sens TestVal:C	Vct_dif Check:Slope	TM/ID sensor: C, value of [5]

SP No.	Classification 1	Classification 2	Value
3-334-006	ID.Sens TestVal:C	Vct_dif Check:Xint	TM/ID sensor: C, value of [6]
3-335-001	ID.Sens TestVal:R	K2: Check	TM/ID sensor: R, value of [1]
3-335-002	ID.Sens TestVal:R	Diffuse Corr	TM/ID sensor: R, value of [2]
3-335-003	ID.Sens TestVal:R	Vct_reg Check:Slope	TM/ID sensor: R, value of [3]
3-335-004	ID.Sens TestVal:R	Vct_reg Check:Xint	TM/ID sensor: R, value of [4]
3-335-005	ID.Sens TestVal:R	Vct_dif Check:Slope	TM/ID sensor: R, value of [5]
3-335-006	ID.Sens TestVal:R	Vct_dif Check:Xint	TM/ID sensor: R, value of [6]

Replacement procedure

1. Image transfer belt unit (page 474)
2. Paper transfer roller unit (page 495)
3. Fusing unit (page 541)
4. TM/ID sensor unit [A]

CAUTION

- When installing the TM/ID sensor unit.
 1. Attach the screw of the front side [B]
 2. Attach the screw of the back side [C]
- When installed in reverse order, an SC may occur because the sensor position has shifted.

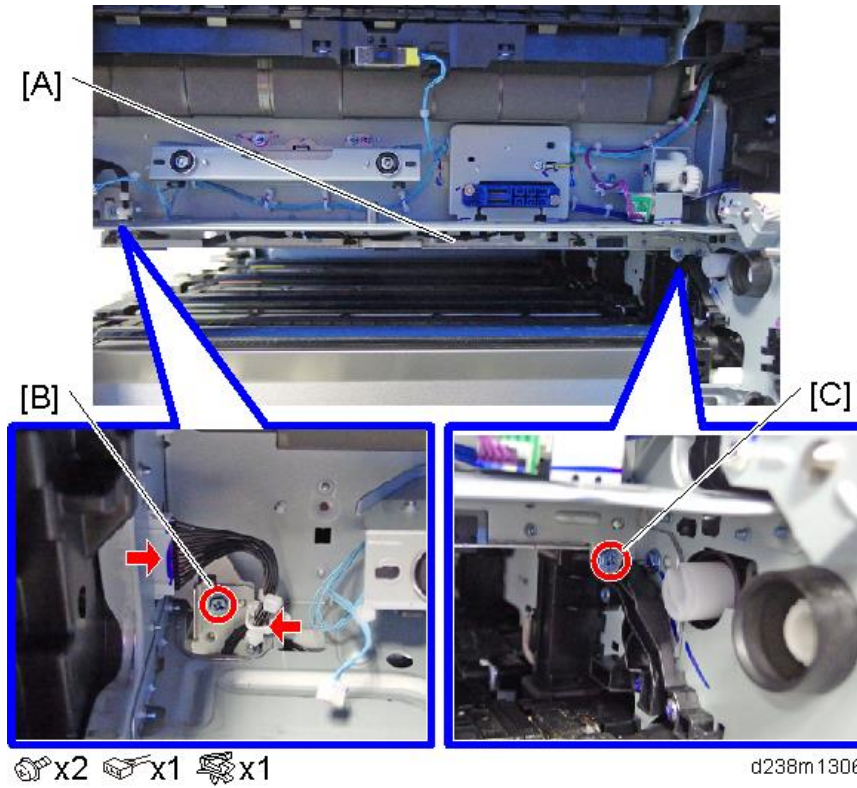

5. Disconnect the connectors.

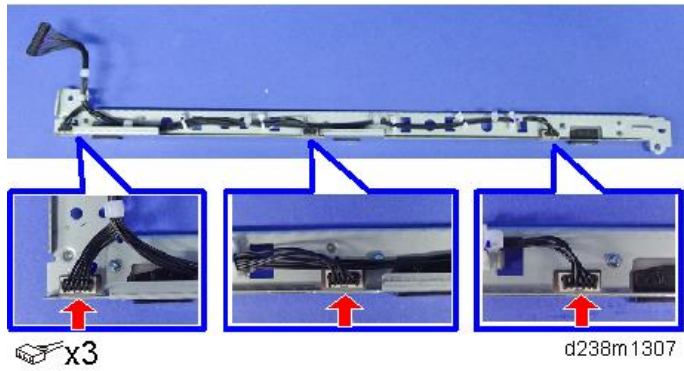

6. TM/ID sensor [A]

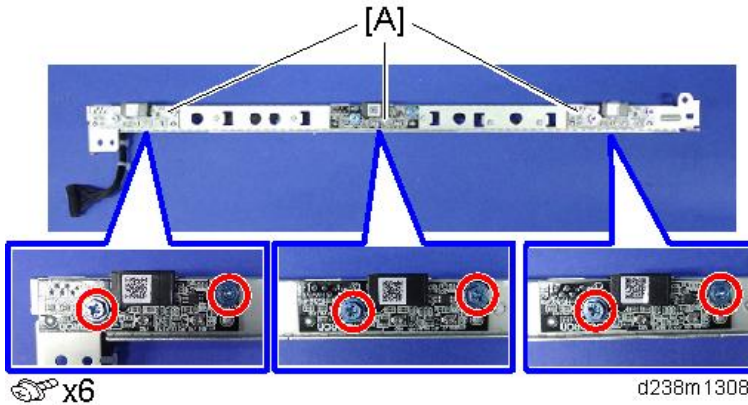

4

Adjustment after Replacing the TM/ID sensor

1. Turn on the main power switch, and then go into the SP mode.
2. Run SP3-011-004 (Manual Procon: Exe Full MUSIC).

Note

- If the SP3-011-004 can't finish successfully, make sure you are entering the correct value into the SP.

Related SPs

- SP3-011-004 (Manual ProCon :Exe: Full MUSIC)
Executes Process Control and full MUSIC.
- SP3-012-001 to 010 (ProCon OK?: Front)
Displays the past 10 Process Control result codes detected by the front TM/ID sensor. The code is 2 digits per color from the left, in the order of YMCK.
- SP3-012-011 to 020 (ProCon OK?: Center)
Displays the past 10 Process Control result codes detected by the center TM/ID sensor. The code is 2 digits per color from the left, in the order of YMCK.
- SP3-012-021 to 030 (ProCon OK?: Rear)
Displays the past 10 Process Control result codes detected by the rear TM/ID sensor. The code is 2 digits per color from left, in the order of YMCK.

ProCon results code

Category	Code	Result name	Description
00 and larger	00	Not executed	Factory default setting (SP default)

Category	Code	Result name	Description
10 and larger Result (Normal)	11	Succeeded	-
40 and larger ID Sensor	41	ID sensor output error (Max)	Vt > Max
	42	ID sensor output error (Min)	Vt < Min
	43	ID Sensor error (Max)	Development gamma is in target, but Vt value is less than upper limit.
	44	ID Sensor error (Min)	Development gamma is in target, but Vt value is less than lower limit.
45 and larger ID Pattern detection	45	ID Pattern extract error	Cannot detect ID Pattern
	50	Vmin_Bk/K2 error (Max)	K:Vmin_Bk / CMY:K2 > Max
	51	Vmin_Bk/K2 error (Min)	K:Vmin_Bk / CMY:K2 < Min
	52	K5 error (Max)	K5 > Max
	53	K5 error (Min)	K5 < Min
	54	K5 calculated approximate point error	K5 calculated approximate point < Min
	55	Development gamma error (Max)	Development gamma > Max
	56	Development gamma error (Min)	Development gamma < Min
	57	Start developing voltage: V _k error(Max)	Start developing voltage: V _k > Max
	58	Start developing voltage: V _k error(Min)	Start developing voltage: V _k < Min
59	Not enough valid data	Adhesion amount data for development gamma calculation point is under 2.	

Category	Code	Result name	Description
90 and larger Result(End)	90	Potential not adjusted	Potential control method is set as [0:FIX].
	99	Stopped	Stopped by door open, power off, error. (Set when execute.)

Note

- Execution result example (In order of YMCK from left)
- Factory default (SP default): [00,00,00,00]
- Starting adjust: [99,99,99,99]
- Fail Vsg adjust(Y): [21,99,99,99]
- Error of Development gamma Max(C): [99,99,55,99]
- Succeeded: [11,11,11,11]

4

Temperature and Humidity Sensor

1. Remove the 1st and 2nd paper tray.
2. Main power switch cover [A]



3. Insert a screwdriver through the hole in the frame, and detach the temperature and humidity sensor together with its bracket [A].

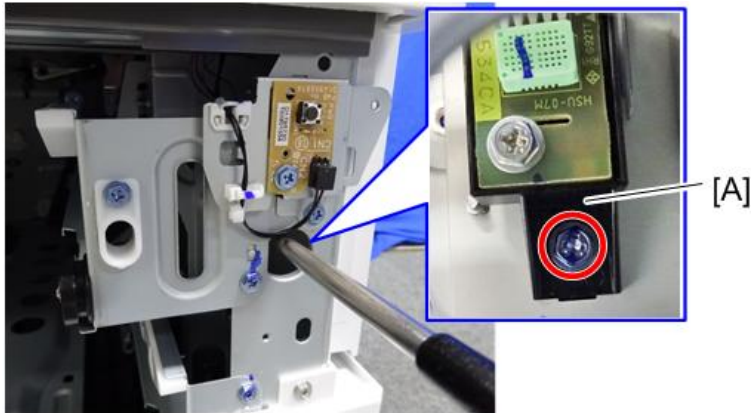

 x1

d238m1093

4. Temperature and humidity sensor [A]

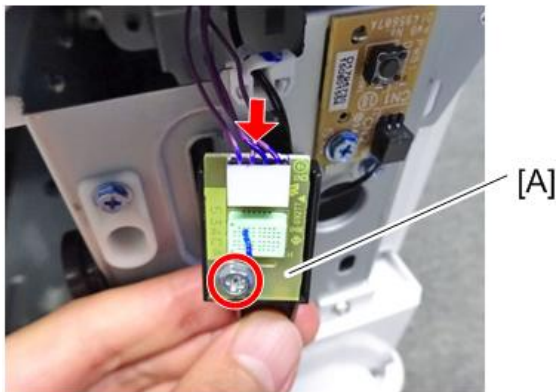

 x1  x1

d238m1094

ITB Contact and Release Sensor

1. Image transfer belt unit (page 474)
2. PCDUs (page 459)

3. ITB contact and release sensor bracket [A]

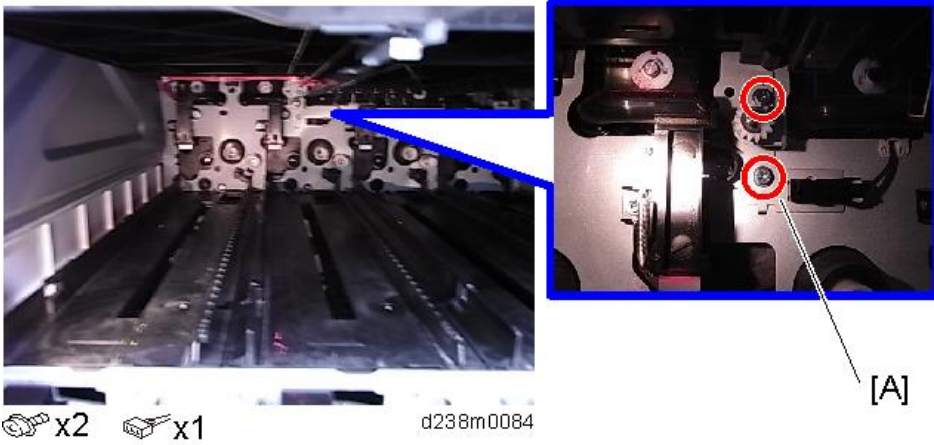

4. ITB contact and release sensor [A]

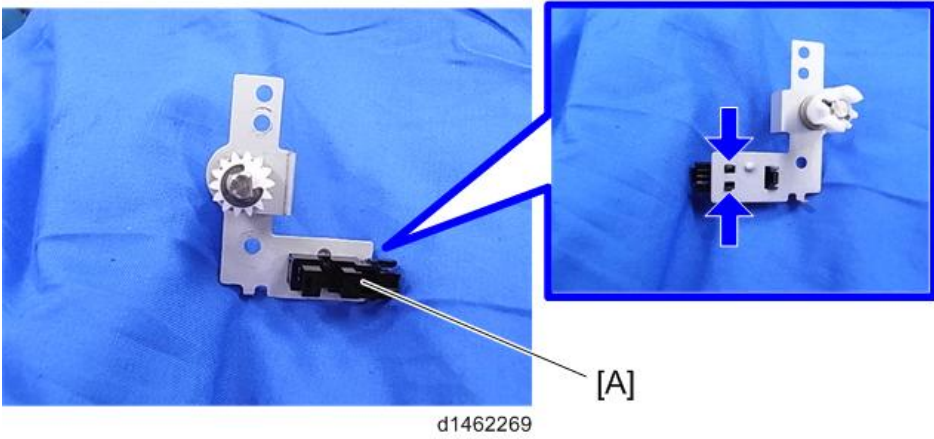
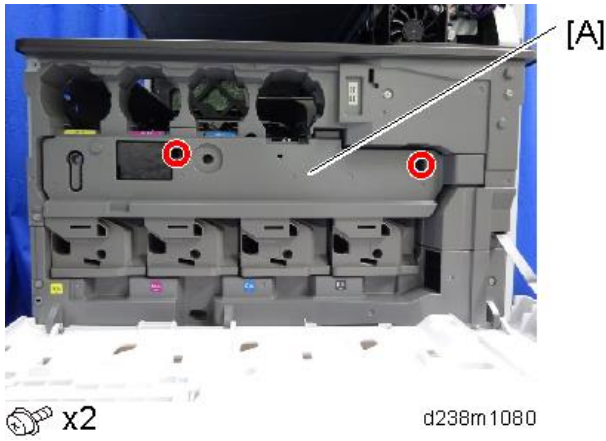

Image Transfer Lock Unit

1. Open the front cover.

2. Image transfer front cover [A]



3. Release the ITB lock lever [A].

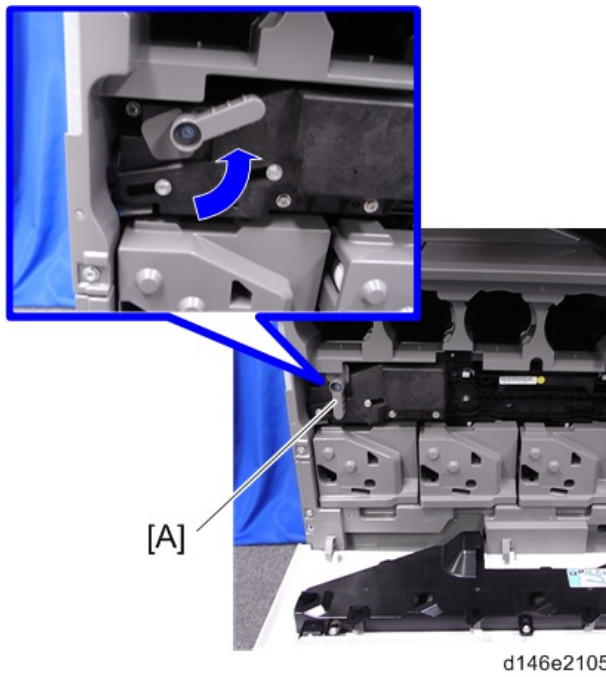

4. Image transfer lock unit [A]

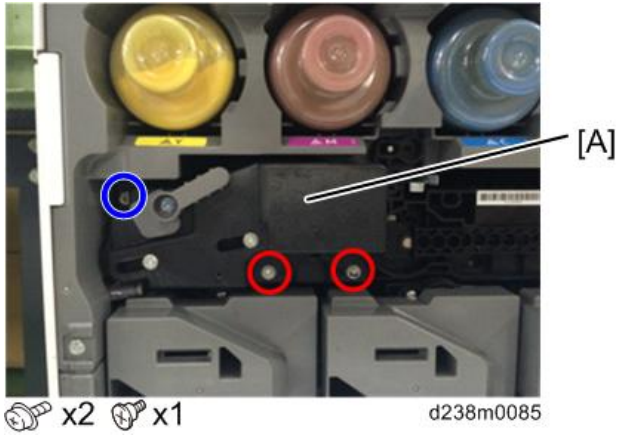

4

Installing the Image Transfer Lock Unit

⚠ CAUTION

- When installing the image transfer lock unit, release the ITB lock lever and follow the procedures below, taking care to avoid deformation of the pin inside the unit (circled in red below). If the pin is deformed, the shutter on the waste toner recovery path may not open and waste toner may clog the cleaning unit.

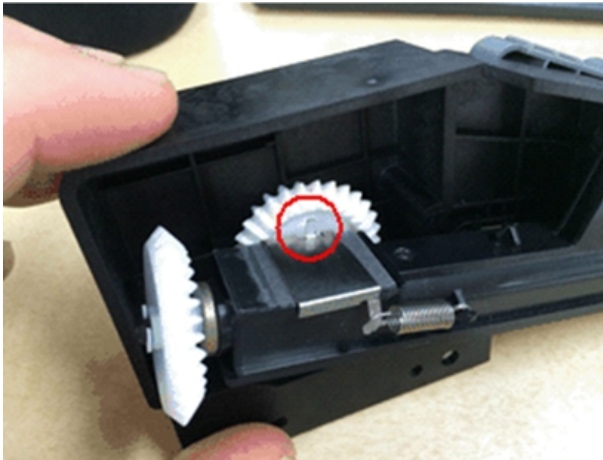

1. Before installing, check that the lever on the image transfer lock unit is in the unlocked position.

Unlocked position:



d146e2108

4

2. Install the image transfer lock unit [A] so that the gear [B] on the image transfer unit side fits into the space in the image transfer lock unit circled in blue below.

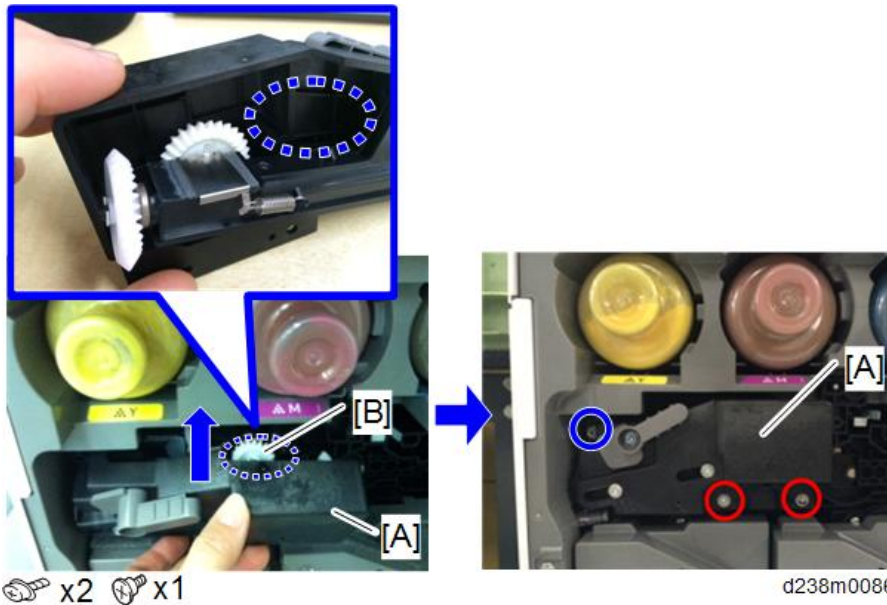

d238m0086

3. Return the ITB lock lever [A] to the locked position.

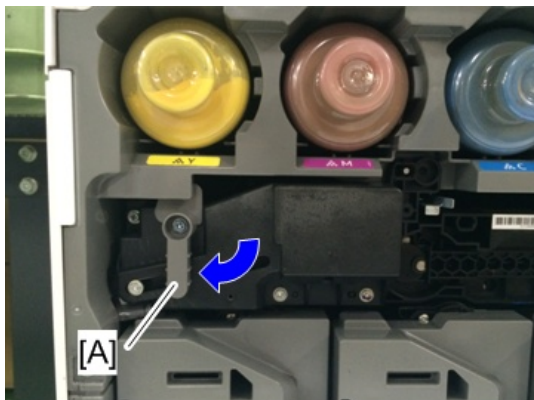

d146e2110

Drive Unit

Overview

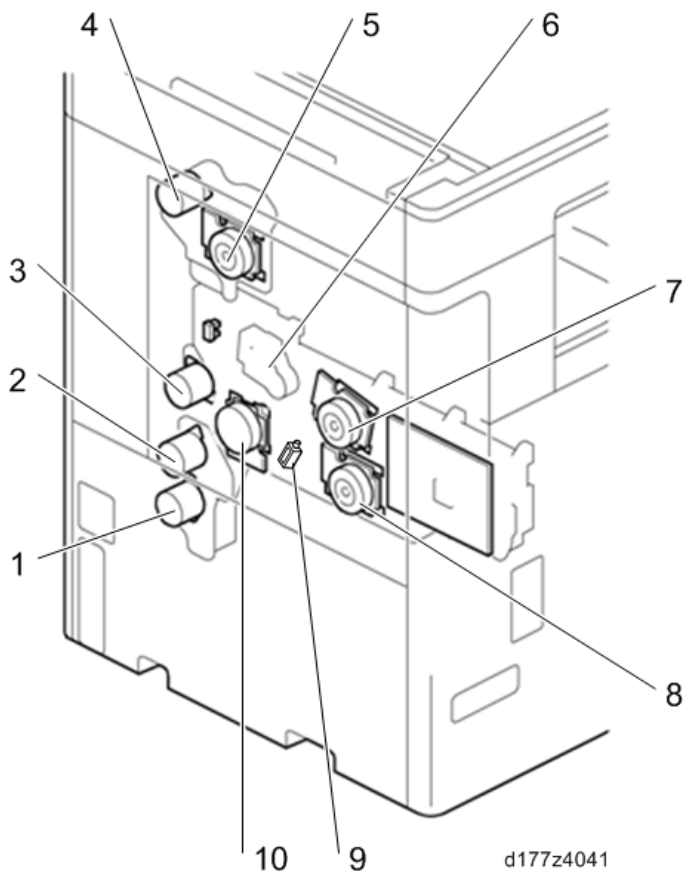

No.	Description	No.	Description
1	Paper feed motor	6	Paper transfer contact and release motor
2	Transport motor	7	PCU motor: CMY
3	Registration motor	8	Development motor: CMY
4	Paper exit/ Pressure release motor	9	Development solenoid
5	Fusing motor	10	PCU motor: Black/ ITB drive motor

Paper Feed Motor

1. Power supply box (page 620)
2. Paper Feed Motor [A]

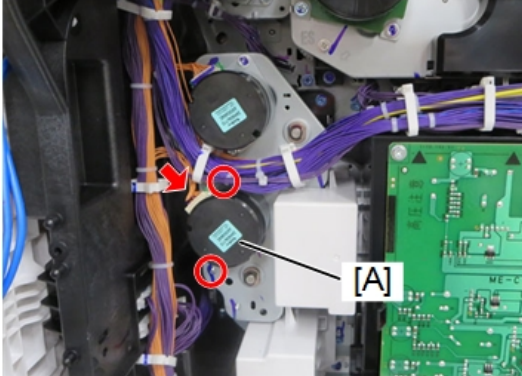

 x2  x1

d244c4002

Transport Motor

1. Power supply box (page 620)
2. Transport motor [A]

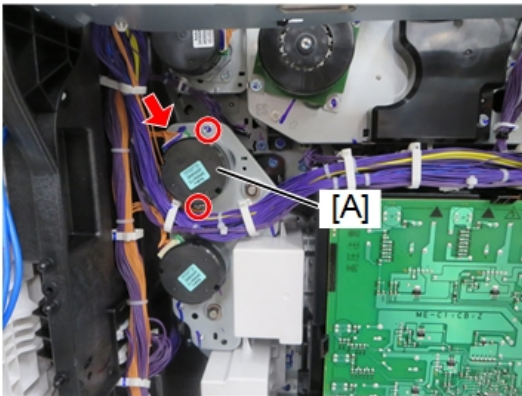

 x2  x1

d244c4001

Paper Transfer Contact and Release Motor Unit

1. Controller box (page 614)

2. Paper transfer contact and release motor unit [A]

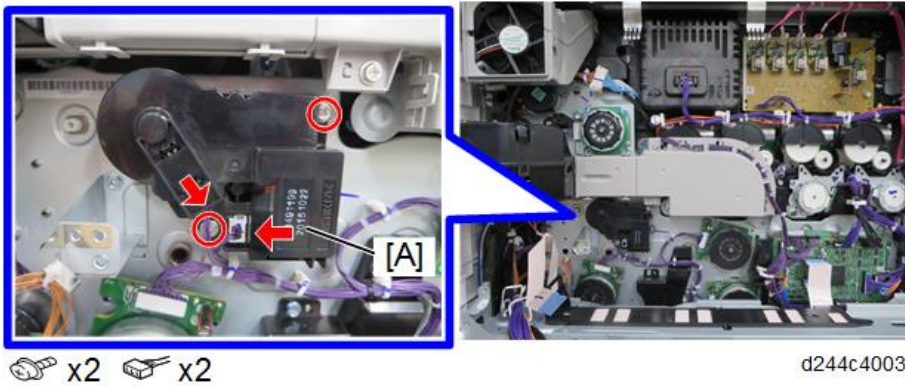

Imaging Drive Unit

1. Controller box (page 614)
2. Power supply box (page 620)
3. Right rear cover (page 412)
4. Bracket [A]

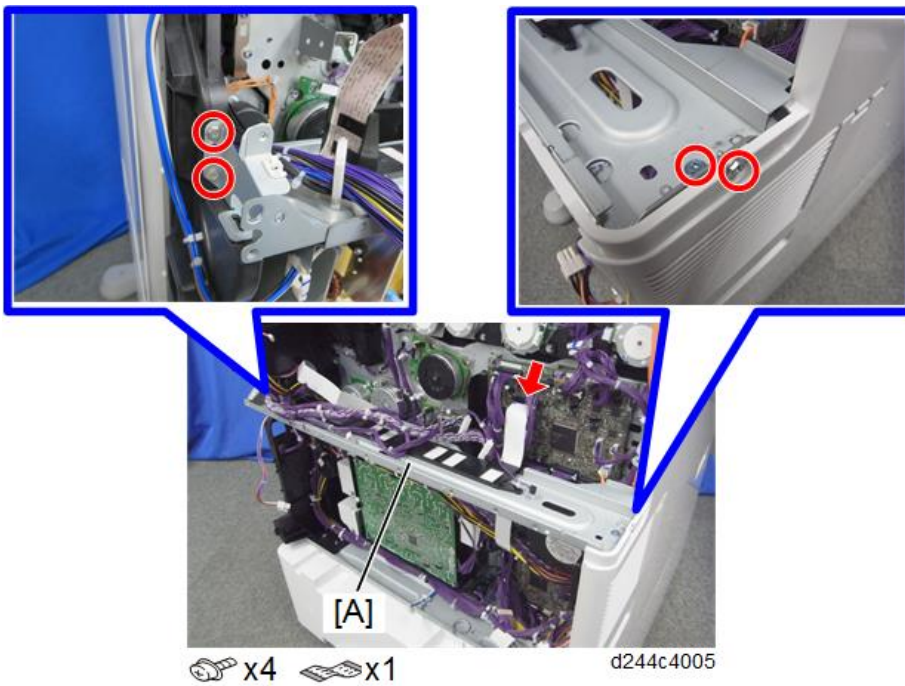

5. Toner supply cooling fan unit (page 630)

6. Duct [A]

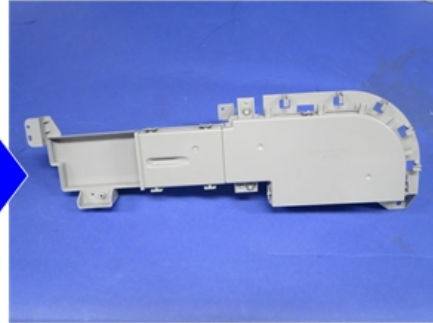
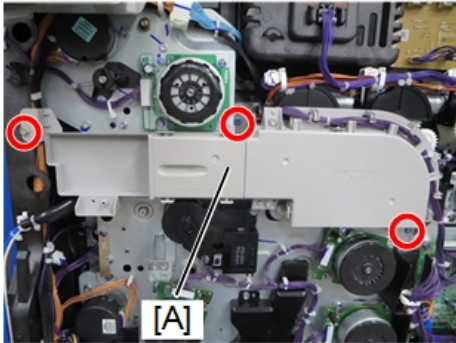

d244c4006

 x3

4

7. Imaging drive unit [A]

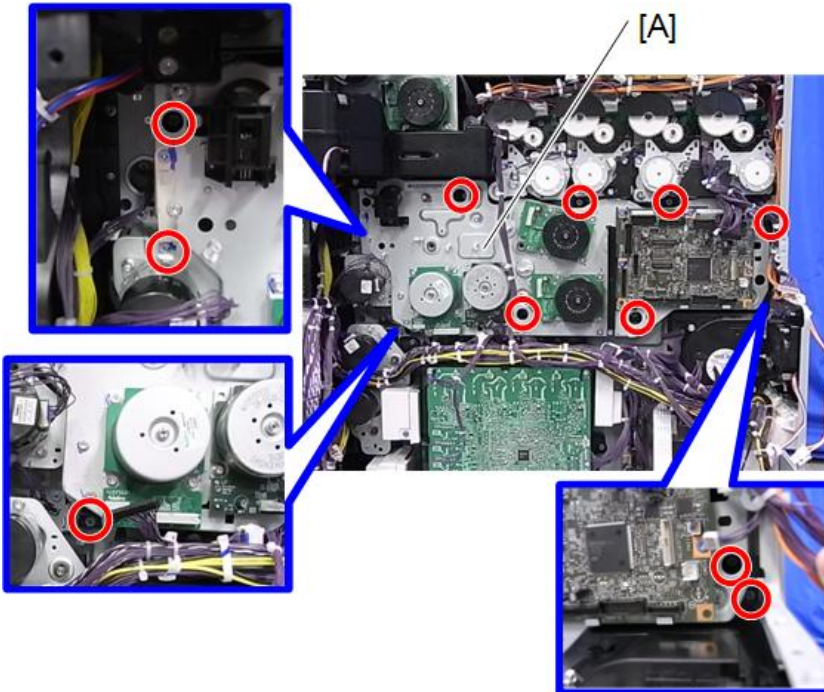

 x11 d238m0094

PCU Motor: CMY

1. Controller box (page 614)

2. PCU Motor: CMY [A]

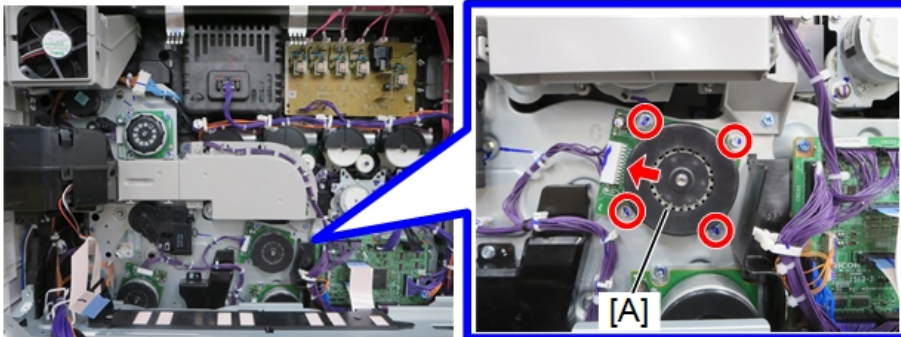

 x4  x1

d244c4007

Development Motor: CMY

1. Controller box (page 614)
2. Power supply box (page 620)
3. Right rear cover (page 412)
4. Bracket [A]

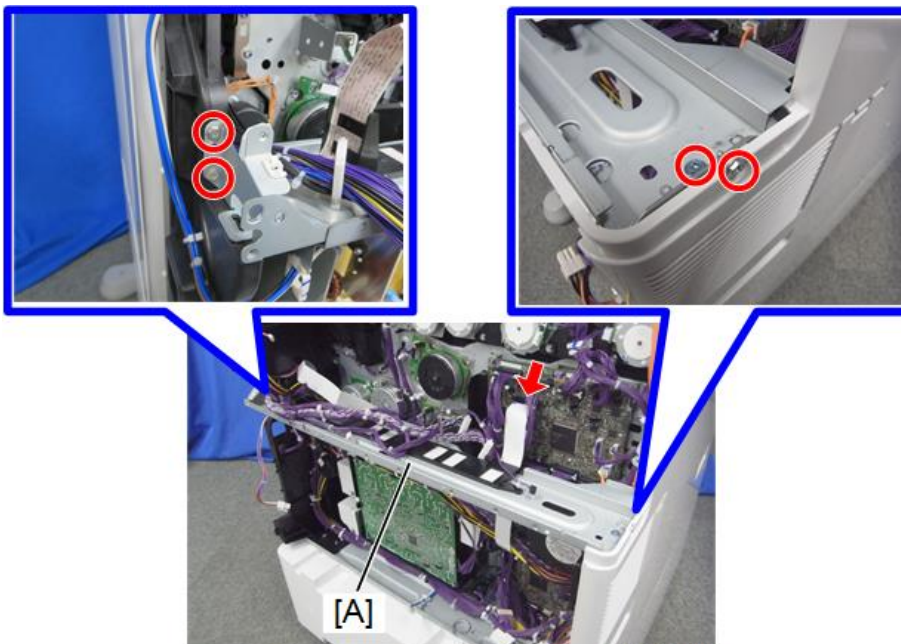

 x4  x1

d244c4005

5. Development Motor: CMY [A]

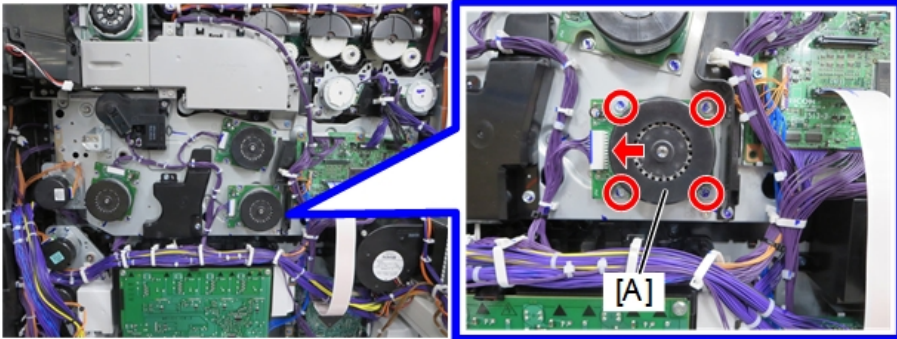

 x4  x1

d244c4008

4

Development Solenoid

1. Controller box (page 614)
2. Power supply box (page 620)
3. Right rear cover (page 412)
4. Bracket [A]

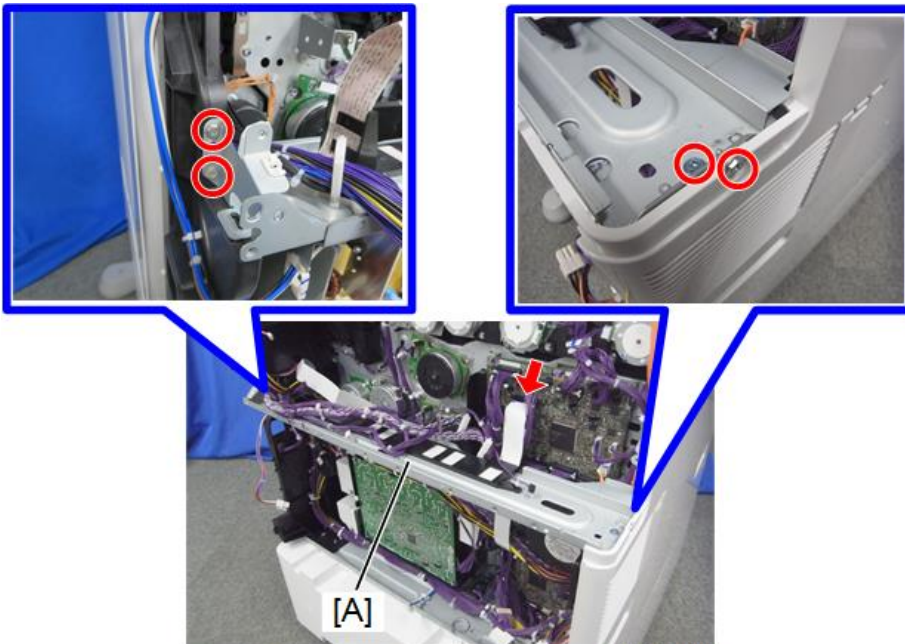

 x4  x1

d244c4005

5. Development solenoid cover [A]

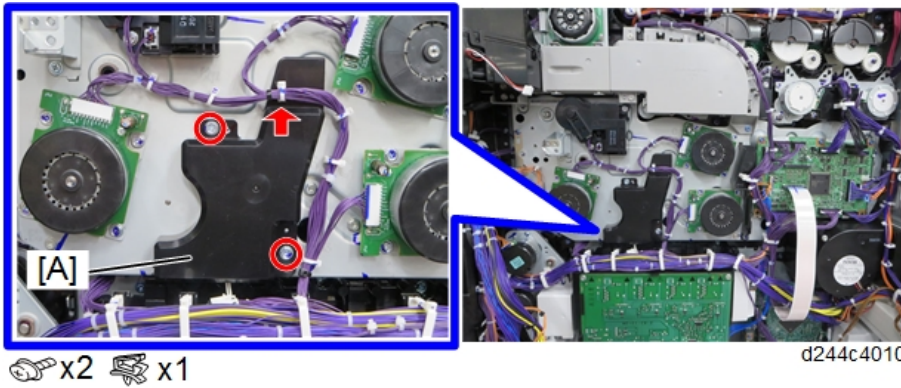

6. Development solenoid [A]

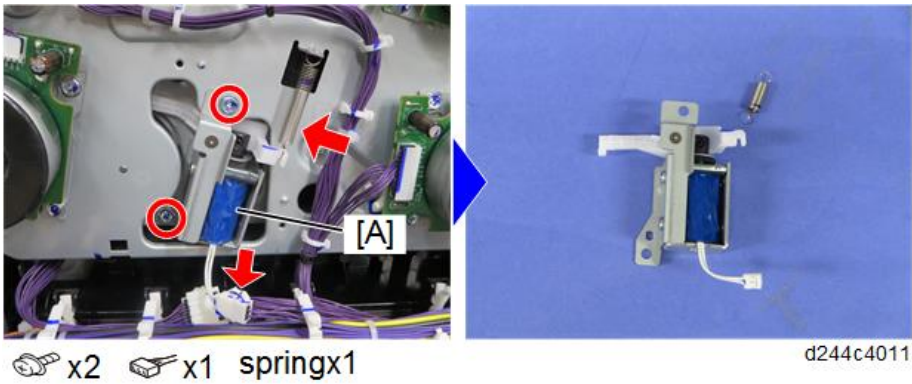

4

PCU motor: Black / ITB Drive Motor

1. Controller box (page 614)
2. Power supply box (page 620)
3. Right rear cover (page 412)

4. Bracket [A]

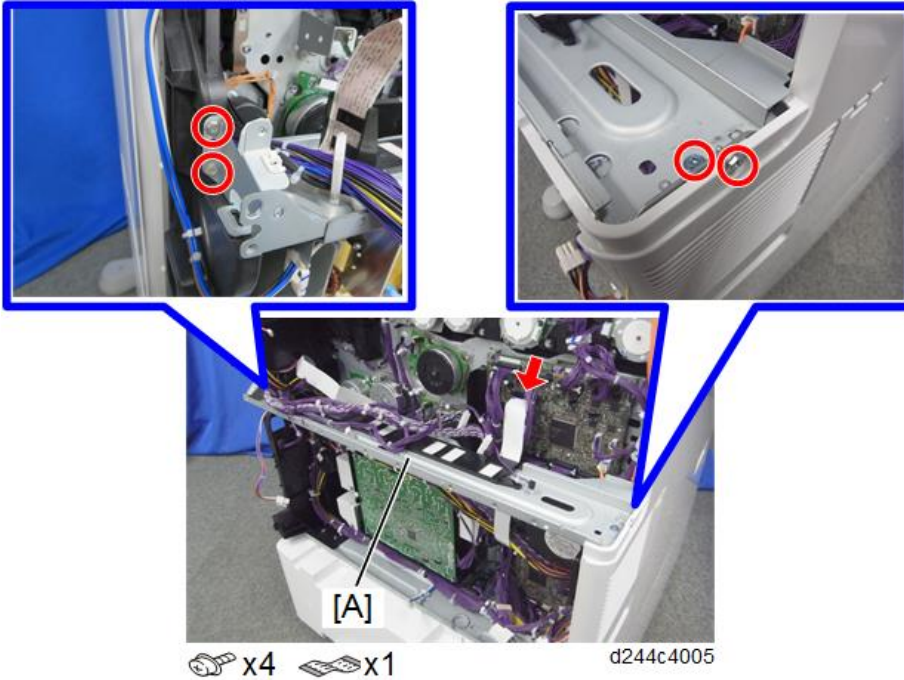

4

5. PCU motor: Black / ITB drive motor [A]

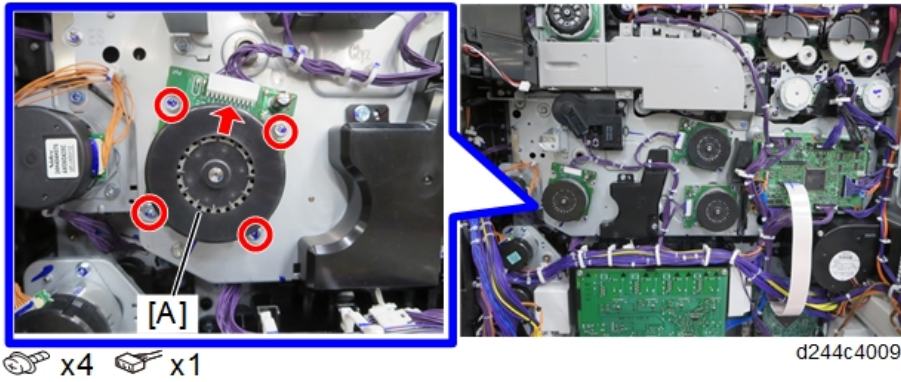

Registration Motor

1. Controller box (page 614)
2. Power supply box (page 620)
3. Right rear cover (page 412)

4. Bracket [A]

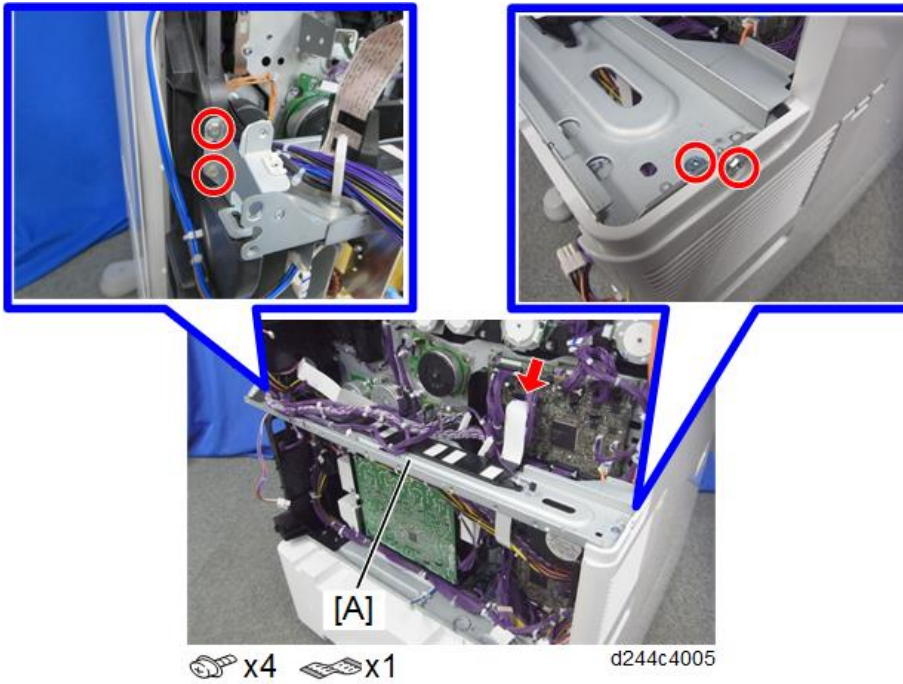

4

5. Registration motor [A]

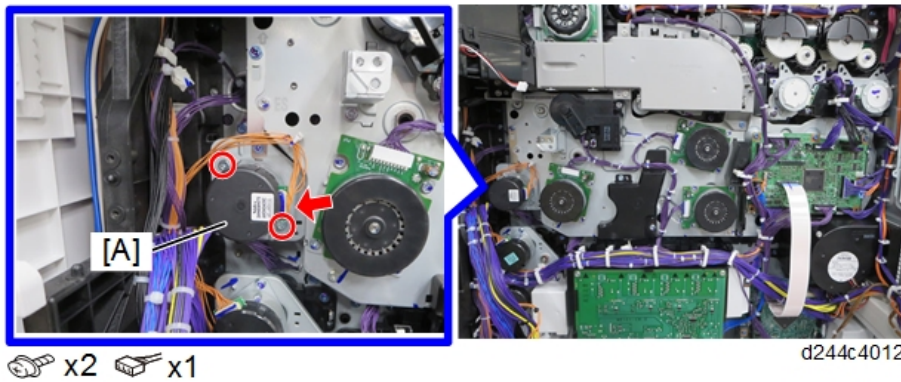

Fusing Motor

1. Controller box (page 614)

2. Fusing motor [A]

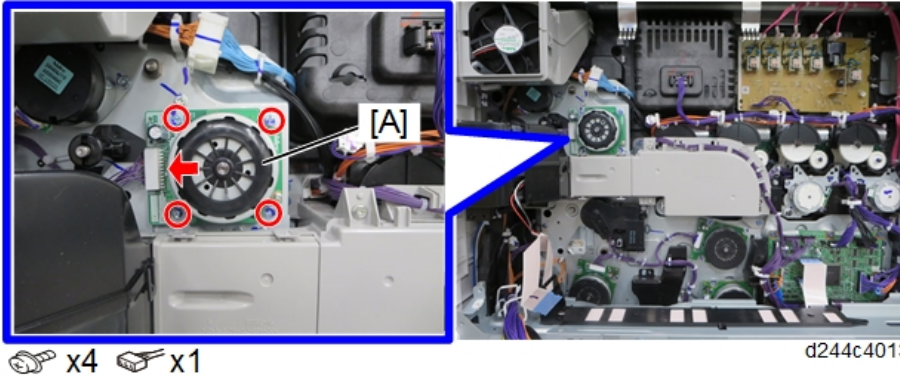

4

Paper Exit/ Pressure Release Motor

1. Fusing exhaust fan unit (page 629)
2. Paper exit / Pressure release motor [A]

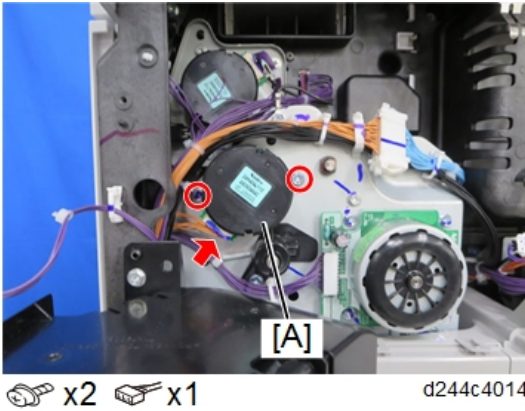

Duplex Entrance Motor

1. Paper exit unit (page 557)
2. Fusing exhaust fan unit (page 629)

3. Duplex entrance motor unit [A]

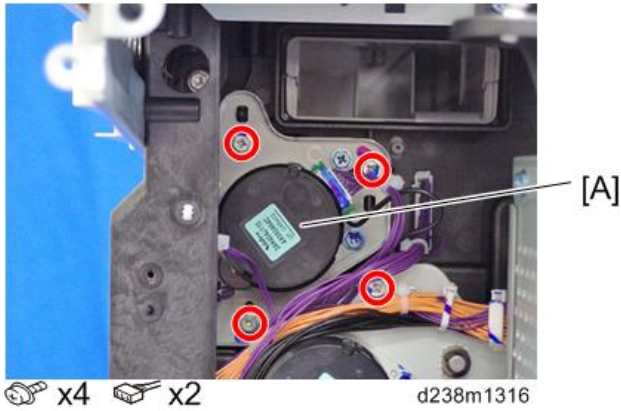

4. Duplex entrance motor [A]



Toner Supply Motor

1. Controller box (page 614)
2. Toner supply cooling fan unit (page 630)

3. Duct [A]

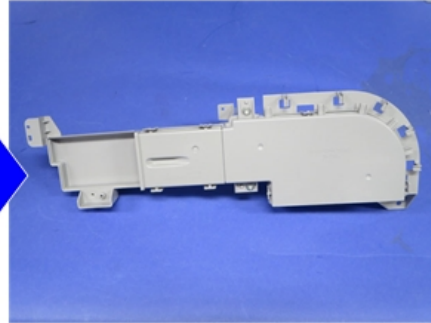
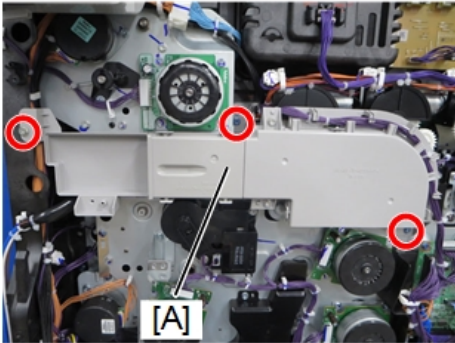

d244c4006







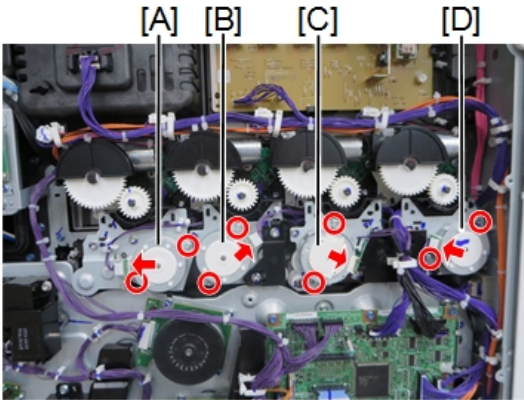

 x3

4

4. Toner supply motor



d244c4015

[A]	K	 x2,  x1
[B]	C	 x2,  x1
[C]	M	 x2,  x1
[D]	Y	 x2,  x1

Sub Hopper

★ Important

- When removing the sub hopper, be careful not to tilt it to avoid spilling the toner inside the hopper.

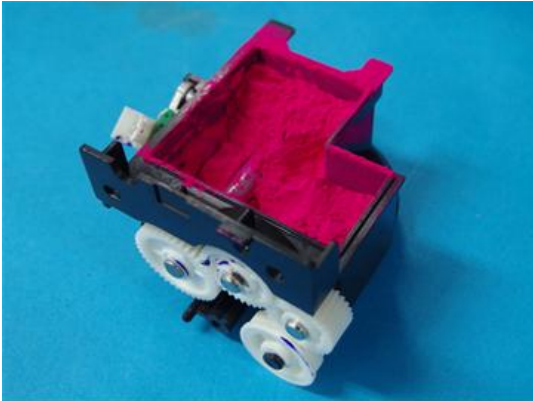

m0ajm1258

- When replacing the sub hopper because of clogged toner, replace the toner duct[A], too.

4

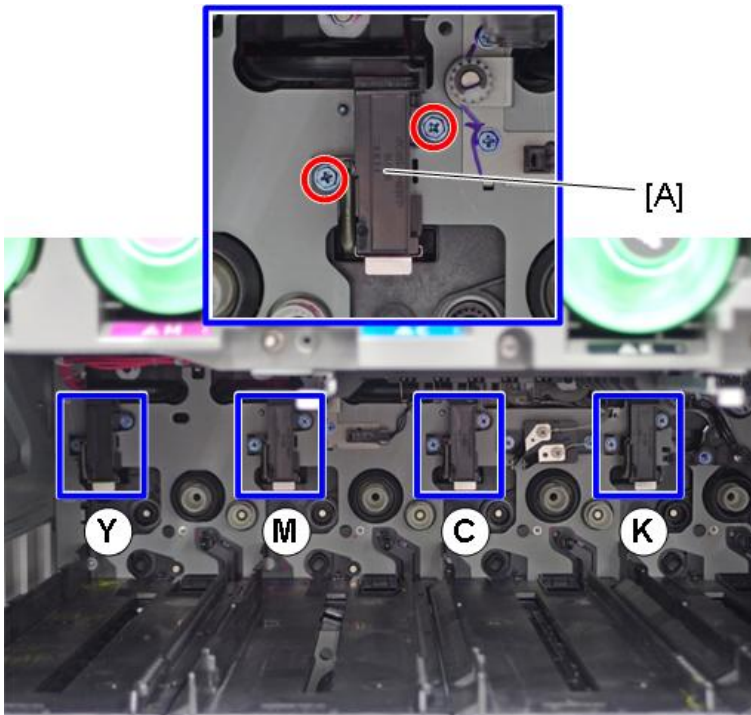

m0ajm1259

K

1. Pull out the image transfer belt unit about 5cm.
2. Controller box (page 614)
3. Toner supply cooling fan unit (page 630)

4. Duct [A]

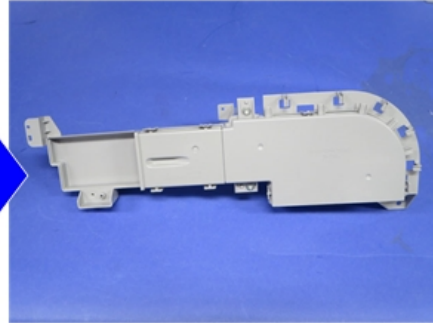
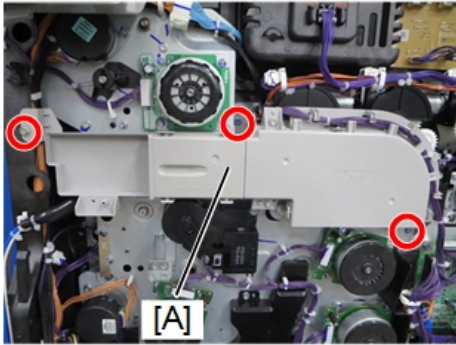

d244c4006



 x3

4

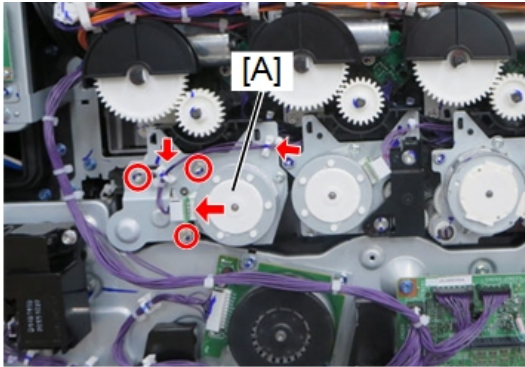
5. Toner supply motor unit (K) [A]



d244c4016

 x3  x1  x2

6. Sub hopper (K) [A]

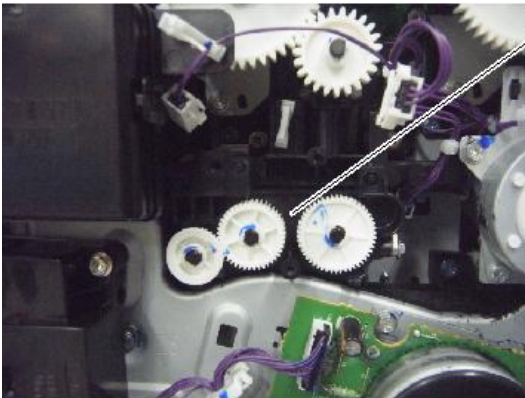



d1462125a

 x1

C

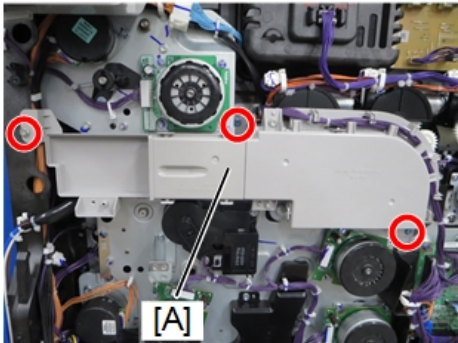
1. Pull out the image transfer belt unit about 5cm.
2. Controller box (page 614)
3. Toner supply cooling fan unit (page 630)
4. Duct [A]



 x3

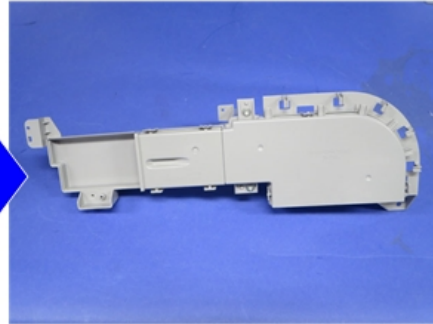

d244c4006

5. Harness guide [A]

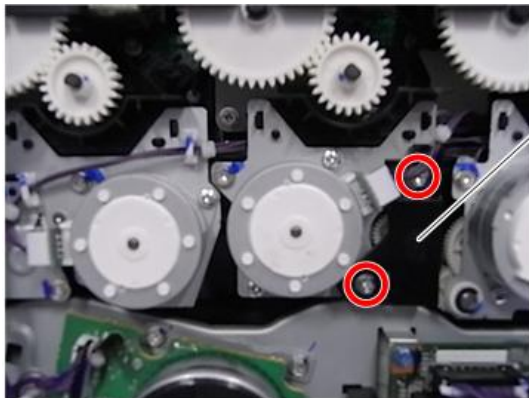

 x2

d238m0105

6. Toner supply motor unit (C) [A]

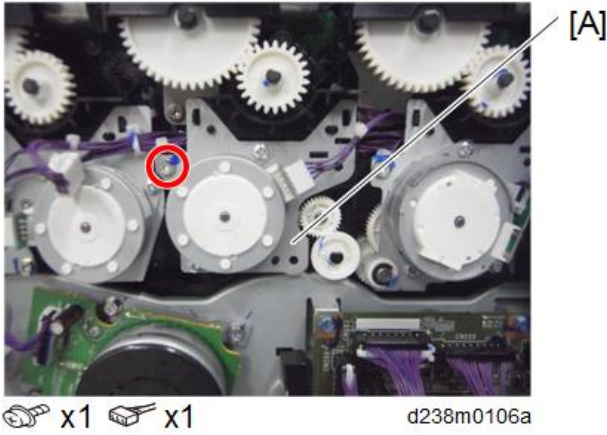

7. Sub hopper (C) [A]



M

1. Controller box (page 614)

2. Harness guide [A]

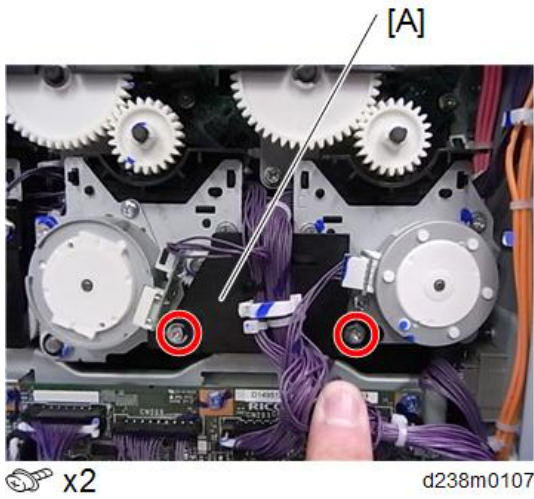

3. Toner supply motor unit (M) [A]

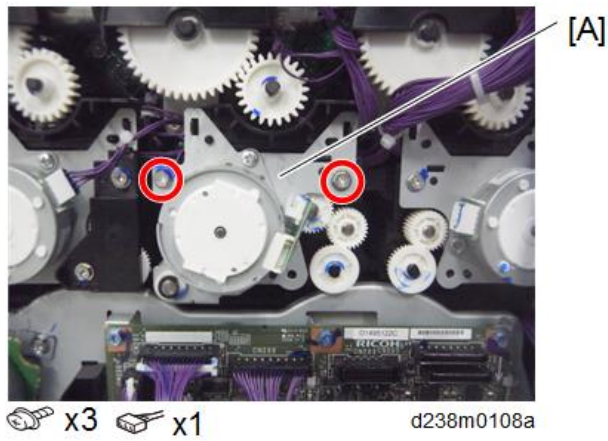

4. Sub hopper (M) [A]

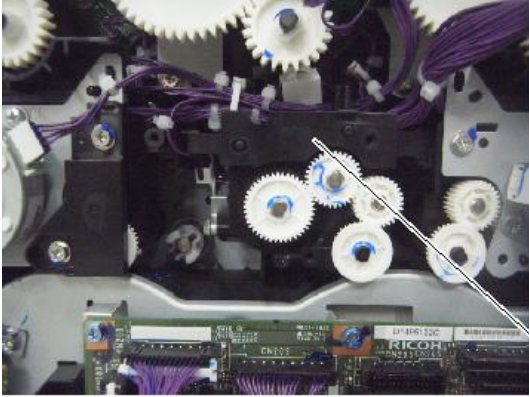

[A]

 x1

d1462131a

4

Y

1. Controller box (page 614)
2. Harness guide [A]

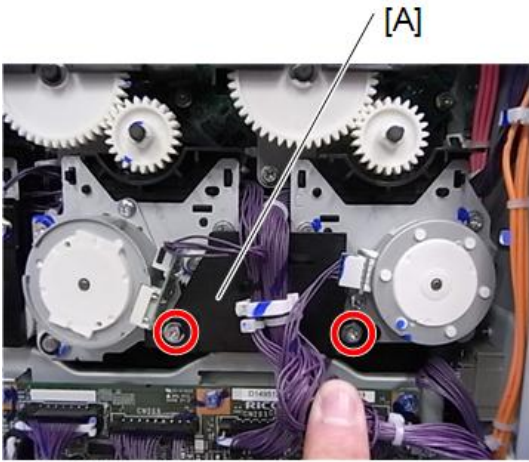

[A]

 x2

d238m0107

3. Toner supply motor unit (Y) [A]

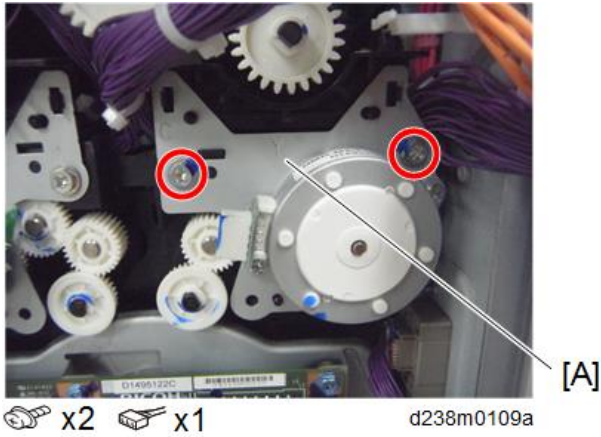

4. Sub hopper (Y) [A]



Toner End Sensor

1. Sub Hopper (page 522)

2. Toner end sensor [A]

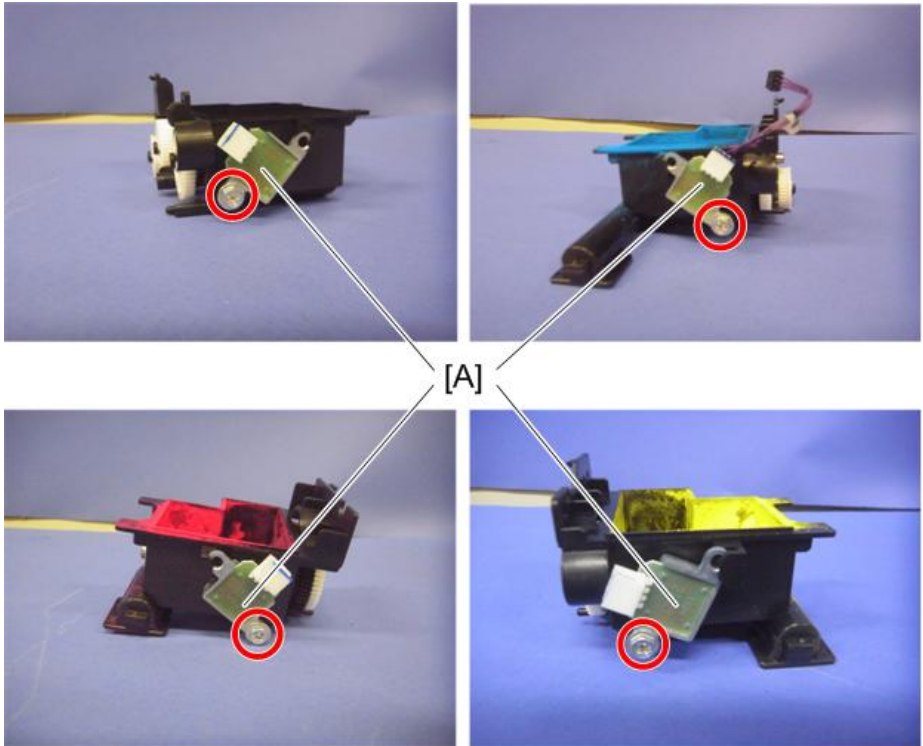

d1462134

Note

- The toner end sensors are the same for each color.

Toner Bottle Drive Motor

K

1. Toner supply motor/K (page 521)

2. Toner bottle drive motor/K [A]

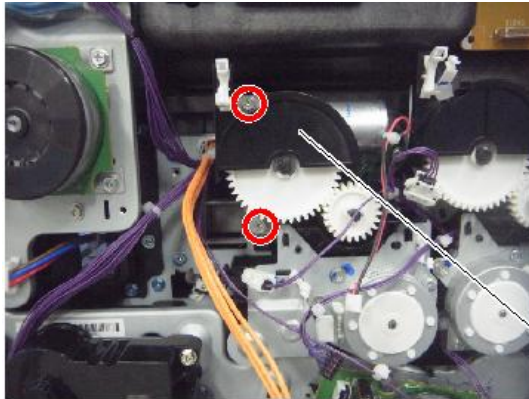

 x2  x1

d238m0110a

[A]

4

C

1. Toner supply motor/C (page 521)

2. Toner bottle drive motor/C [A]

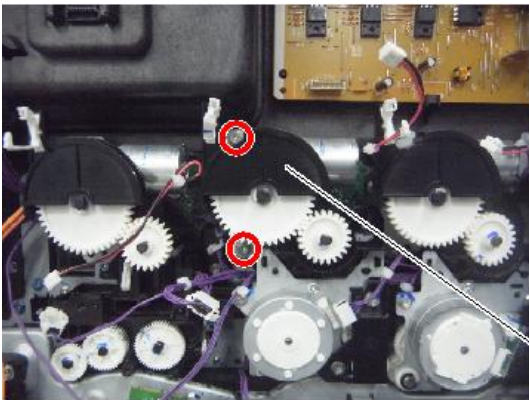

 x2  x1

d238m0111a

[A]

M

1. Toner supply motor/M (page 521)

2. Toner bottle drive motor/M [A]

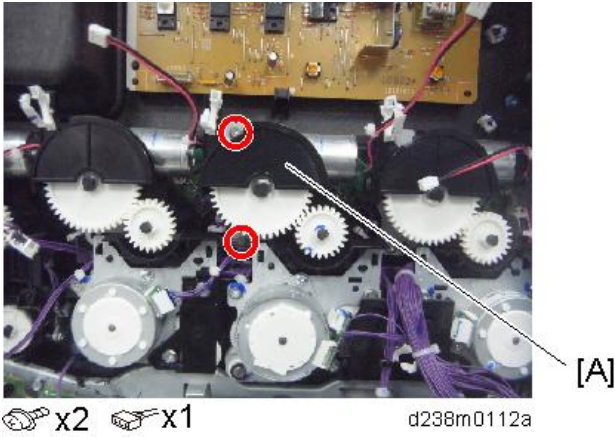

4

Y

1. Toner supply motor/Y (page 521)
2. Toner bottle drive motor/Y [A]

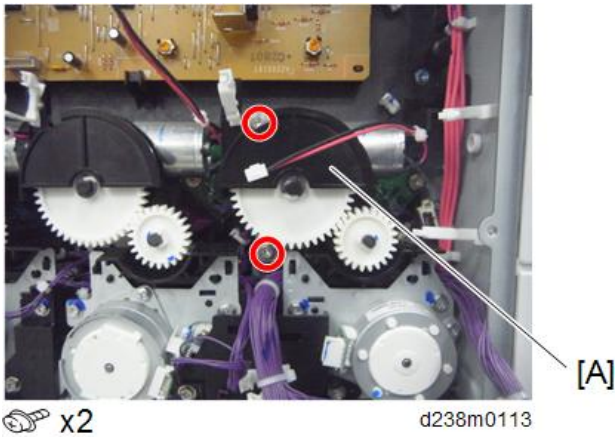

ID Chip Contact Board

K

1. Toner bottle drive motor/K (page 530)
2. Toner bottle drive motor/C (page 531)

3. ID chip contact board (K) [A]

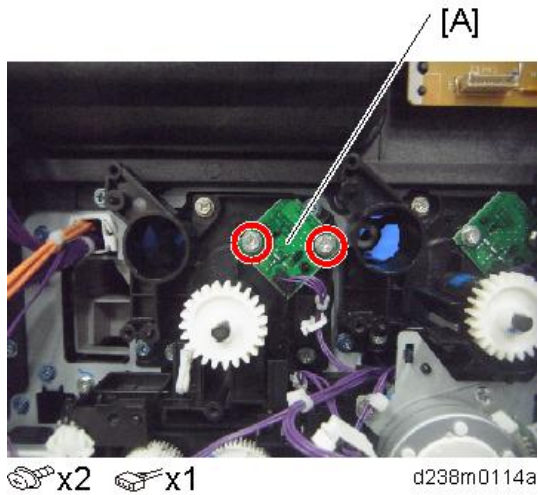

4

C

1. Toner bottle drive motor/C (page 531)
2. Toner bottle drive motor/M (page 531)
3. ID chip contact board (C) [A]

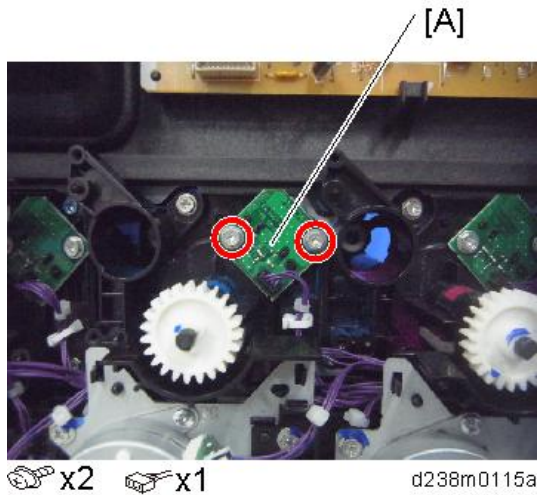

M

1. Toner bottle drive motor/M (page 531)
2. Toner bottle drive motor/Y (page 532)

3. ID chip contact board (M) [A]

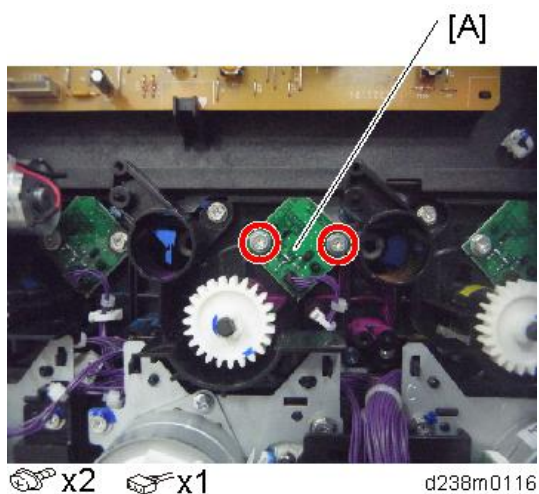

4

Y

1. Toner bottle drive motor/Y (page 532)

2. ID chip contact board (Y) [A]

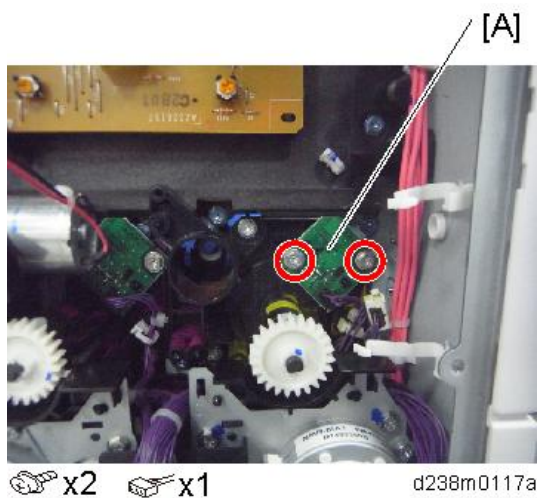

Transport Coil Unit

Y

1. Image transfer belt unit (page 474)
2. PCPU (page 459)
3. Toner bottle drive motor (page 530)
4. Sub hopper (page 522)
5. ID chip contact board (page 532)
6. Put a piece of disposable paper [A] on the inside of the machine to avoid damage due to toner spillage.

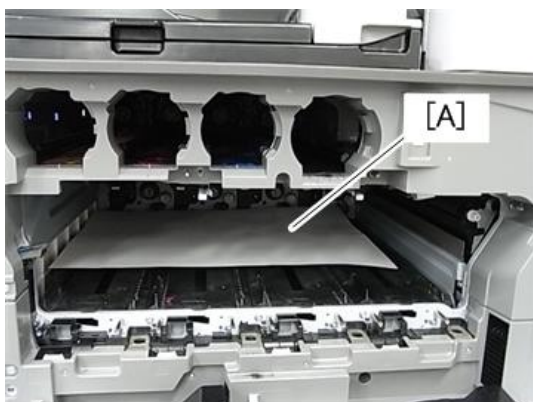

d177z4551

7. Put a piece of disposable paper [A] under the transport coil to avoid damage due to toner spillage.

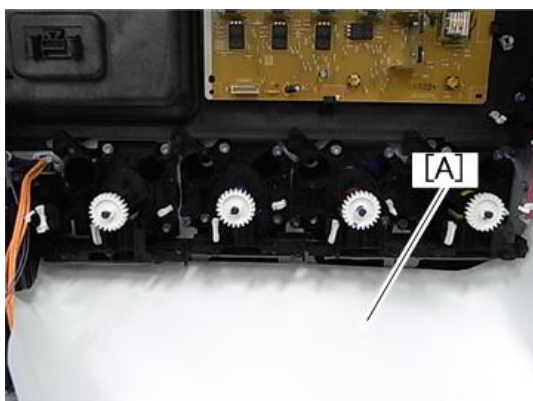

d177z4563

8. Remove all the harnesses connecting to the transport coil unit (⚡×8).

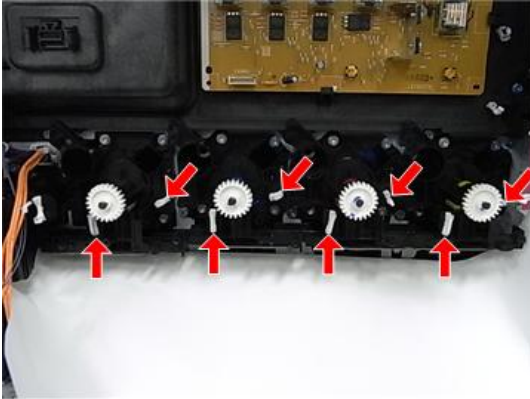

d177z4561

9. Remove the screws fixing the transport coil units [A] (⚙×5, each color).

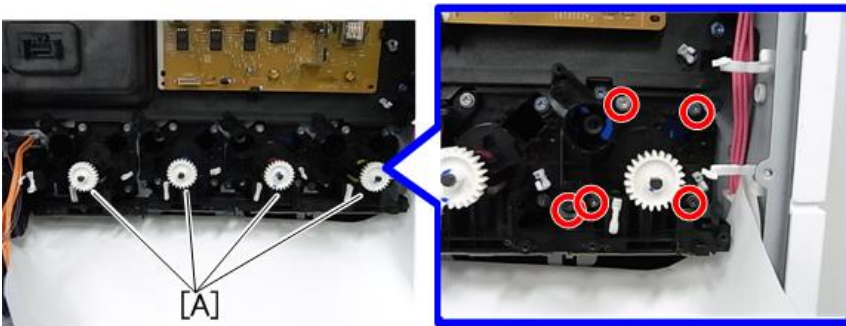

d177z4552

10. Release the claws for the transport coil units [A] (claw ×1, each color).

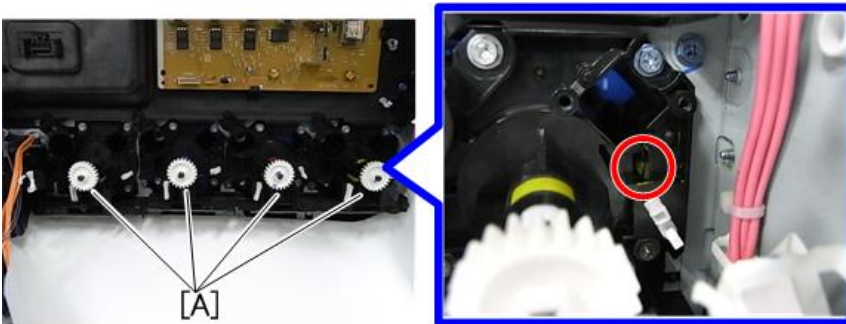

d177z4553

11. Remove the screws securing the bracket [A] (⑤ ×2).

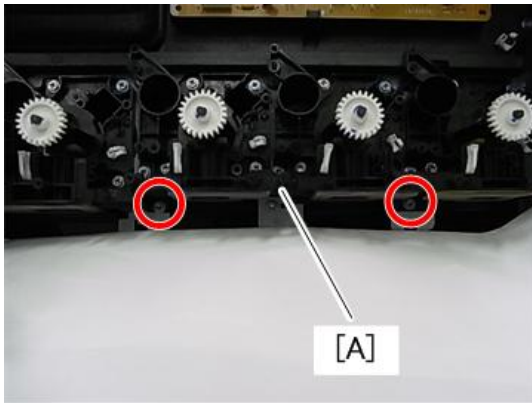

d177z4554

12. Put a piece of disposable paper on the floor because toner can spill when you put the transport coil unit down.
13. Pull out the whole transport coil unit [A] together with the bracket [B].

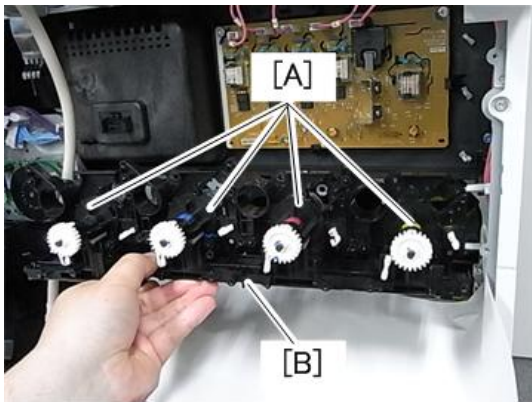

d177z4555

Note

- Be sure to put a piece of disposable paper on the floor because toner can spill when you put the transport coil unit down.

14. Transport coil unit for (Y) [A] (tab×1).

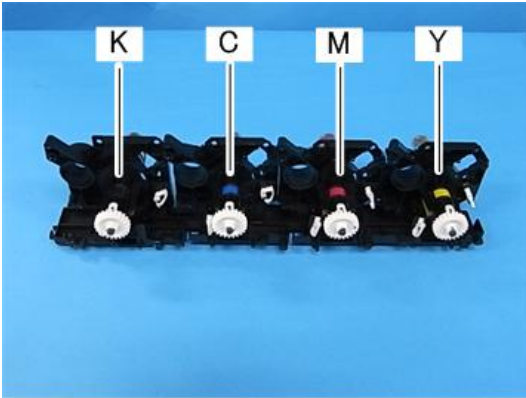

d177z4557

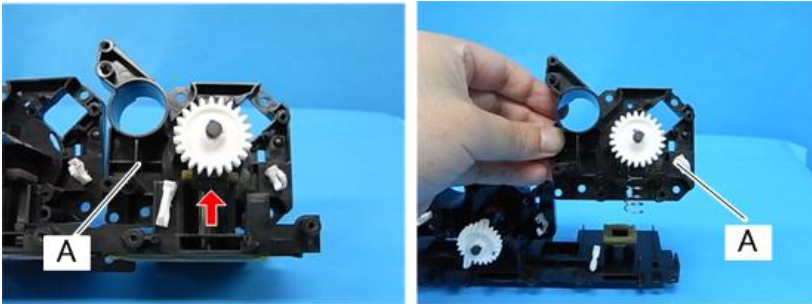

d177z4556

M

1. See steps 1 to 13 in the transport coil replacement procedure for "Y". (page 535)
2. Transport coil unit for (M) [A] (tab×1).

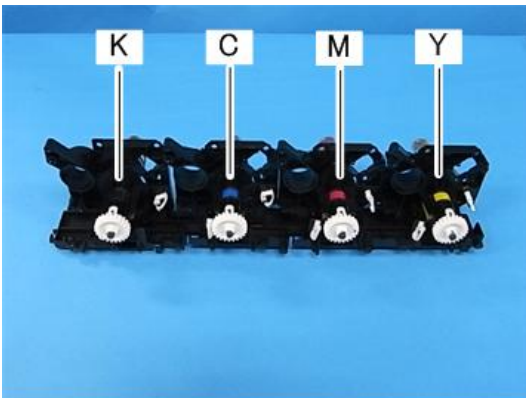

d177z4557

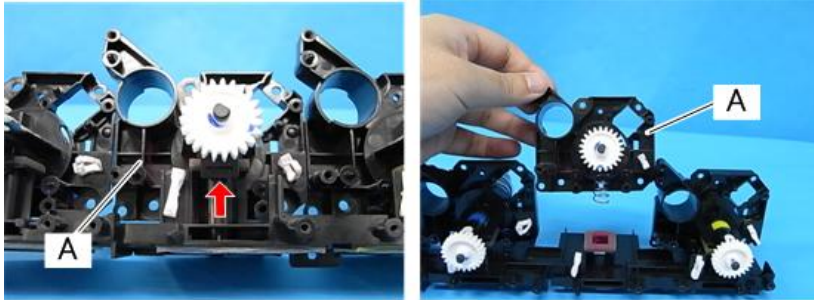

d177z4558

C

1. See steps 1 to 13 in the transport coil replacement procedure for "Y". (page 535)
2. Transport coil unit for (C) [A] (tab×1).

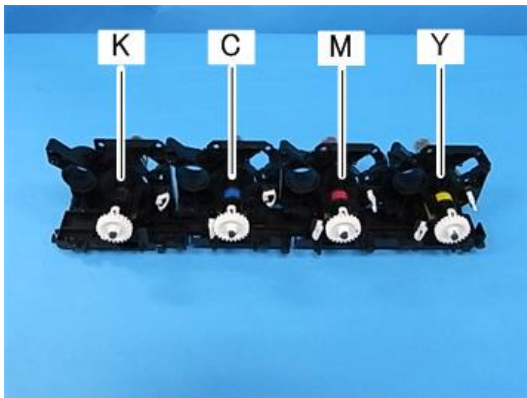

d177z4557

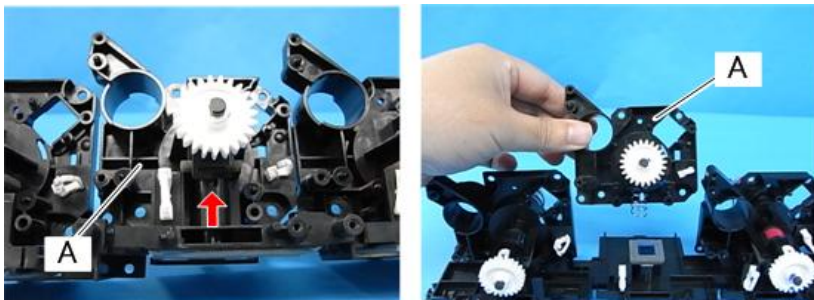

d177z4559

K

1. See steps 1 to 13 in the transport coil replacement procedure for "Y". (page 535)

2. Transport coil unit for (K) [A] (tab×1).

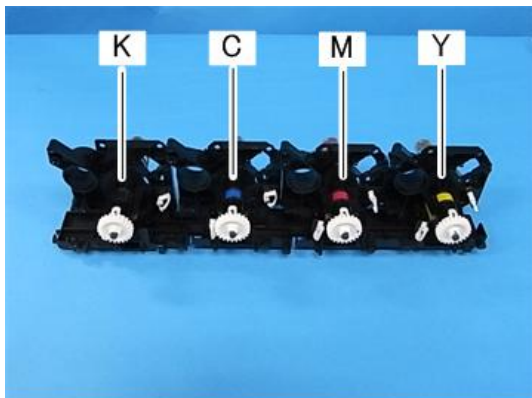

d177z4557

Fusing Unit

Fusing Unit

⚠ CAUTION

- Because there is a danger of burns on contact with hot parts of the fusing unit, start work when the temperature drops to a low enough temperature.
- To clear SC544-02 or SC554-02, replacing the fusing unit or installing a fuse (provided in the fusing sleeve belt unit) in the fusing unit must be required. Refer to page 973 "When SC544-02, SC554-02 (Non-contact Thermistor High Temperature Detection) Is Displayed".

↓ Note

- Fusing unit has a new unit detection mechanism, so it is not necessary to set SPs (New Unit Detection).
- When the fusing unit is used past its target yield (400k), the fusing unit may break, causing a service call. Therefore, the machine displays a warning on the operation panel at 415k pages and stops at 430k pages.

1. Open the right door.
2. Pull the handle [A] and open the paper transfer unit [B].

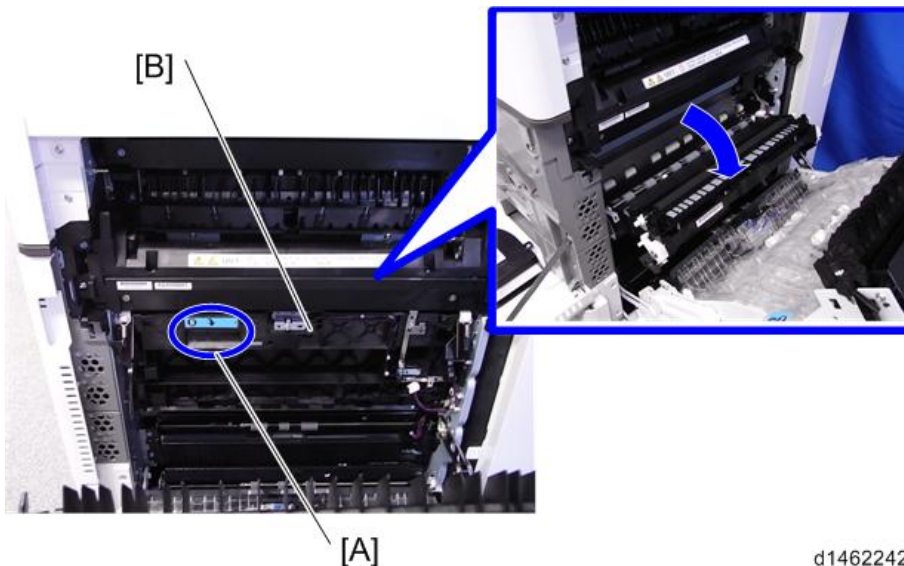

d1462242

3. Fusing unit [A]

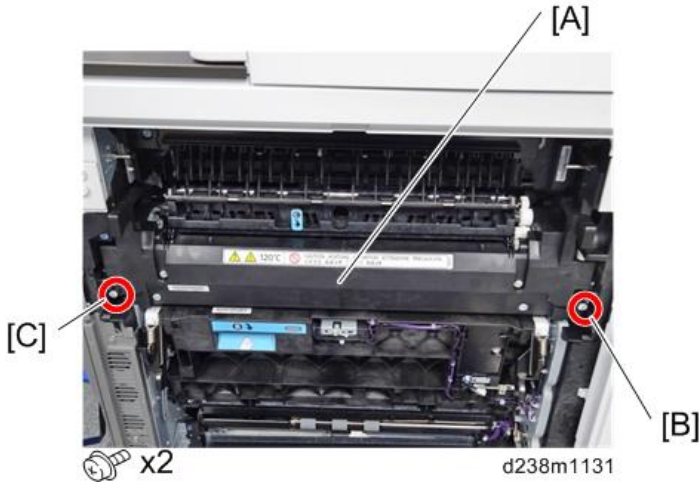

↓ Note

- To attach the fusing unit, fasten the screws in the order [B] (rear), [C] (front).

Fusing Entrance Guide Plate

1. Fusing unit (page 541)
2. Fusing entrance guide plate [A].

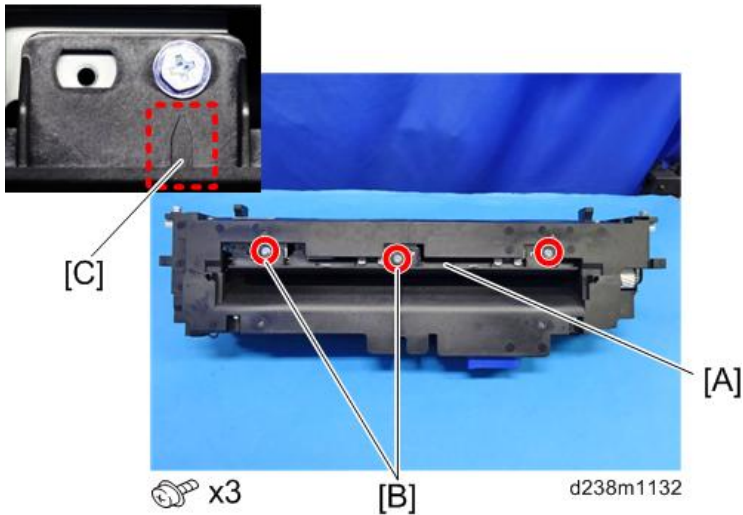

↓ Note

- The screws [B] are threaded screws. When you assemble the unit, take care not to use the wrong screws.

- Fasten the screw in the marked screw hole [C].

Cleaning the Fusing Entrance Guide Plate

Carefully remove adhering toner as shown in the diagram below with a dry cloth. Then, wipe with a cloth moistened with alcohol.



d088r374

4

Fusing Exit Guide Plate

1. Fusing unit (page 541)
2. Fusing upper cover (page 544)
3. Fusing exit guide plate [A]

Remove the clip ring, and then slide this part to the right to remove it.

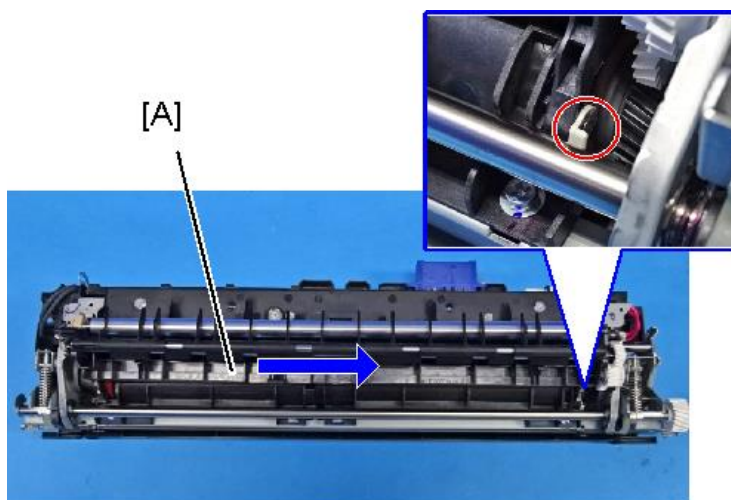

 x1

d238m1135



d238m1136

Cleaning the Fusing Exit Guide Plate

1. Open the fusing exit guide plate [A].

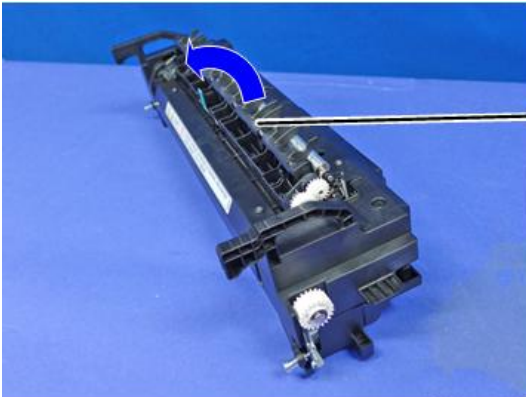

d238m1310

2. Wipe clean with a dry cloth. Then wipe clean with a cloth dampened with alcohol.



d238m1311

Fusing Upper Cover

1. Fusing unit (page 541)

2. Fusing upper cover [A]

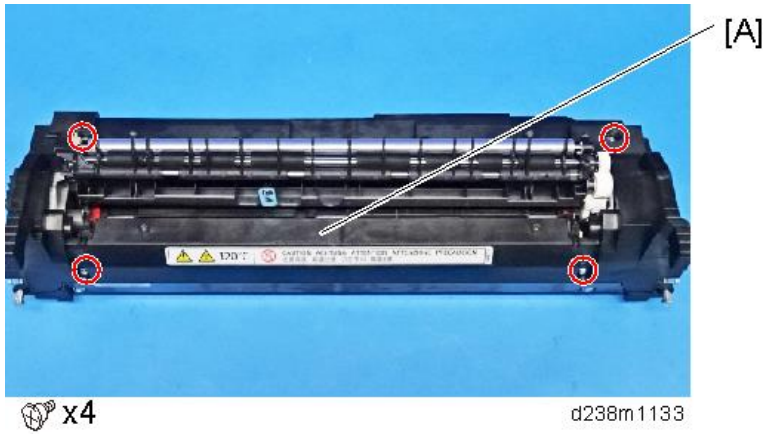

4

Fusing Lower Cover

1. Fusing unit (page 541)
2. Remove 4 screws on the front and rear sides.



3. Lift the fusing unit to remove the fusing lower cover [A].

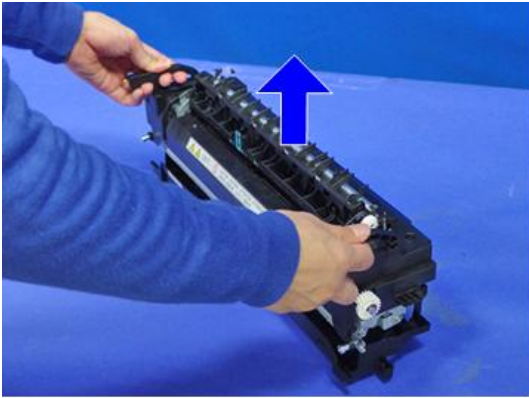

d238m1304

4

Fusing Sleeve Belt Unit

⚠ CAUTION

- The fusing sleeve belt unit is designed with a highly soft material. Do not touch the sleeve belt unit with your hands to prevent dents during replacement. If you have touched it and a dent has been made, the dent will gradually become larger during operation and it can cause a fusing malfunction or sleeve belt breakage.

★ Important

- To cancel SC544-02/SC554-02, it is necessary to replace the fusing unit or install an intact new unit detection fuse. Refer to page 973 "When SC544-02, SC554-02 (Non-contact Thermistor High Temperature Detection) Is Displayed".
- If you are replacing the fusing sleeve belt unit for PM or any reason other than canceling SC544-02/SC554-02, you can discard the fuse that is packed with the new fusing sleeve belt unit.

Adjustment before Replacing the Fusing Sleeve Belt Unit

Before replacing the fusing sleeve belt unit, set SP3-701-116 to "1" and switch the power OFF. Then replace the fusing sleeve belt unit and switch the power ON.

SP3-701 (Manual New Unit Set)

This SP is the new unit detection flag.

0: new unit detection flag OFF, 1: new unit detection flag ON

Item	SP
Fusing sleeve belt unit	SP3-701-116

Replacement

4

1. Fusing upper cover (page 544)
2. Fusing lower cover (page 545)
3. Left frame [A]

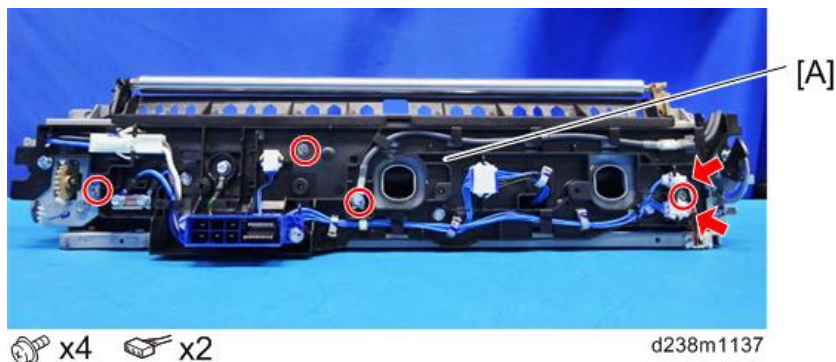

4. Exit guide plate (left) unit [A]



5. Fusing exit driven roller [A]

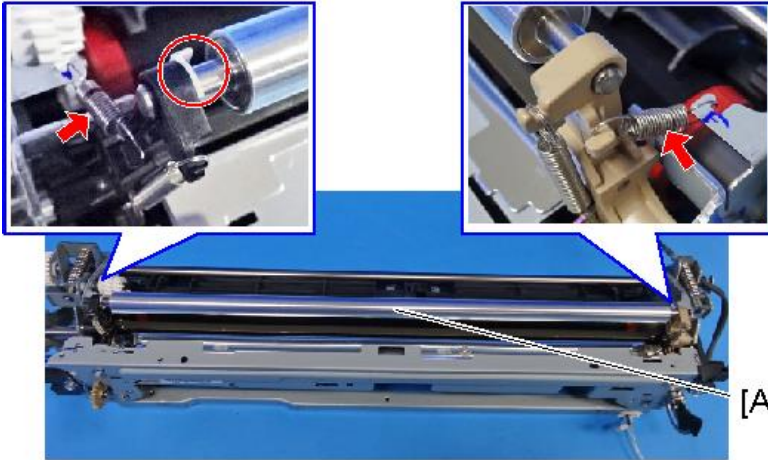

 x1  x2

d238m1139

6. Side plate [A]

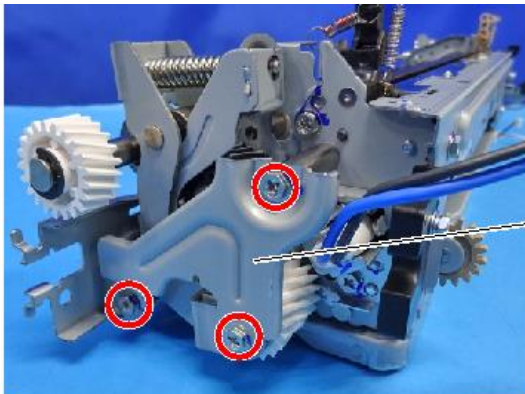

 x3

d238m1140

7. Two screws.

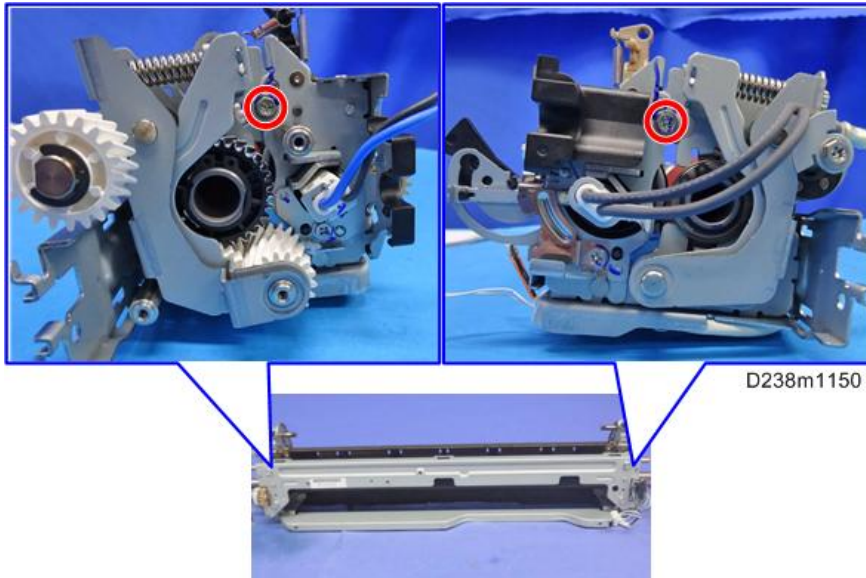

8. Release the boss caps on both sides, and then detach the fusing sleeve belt unit [A].

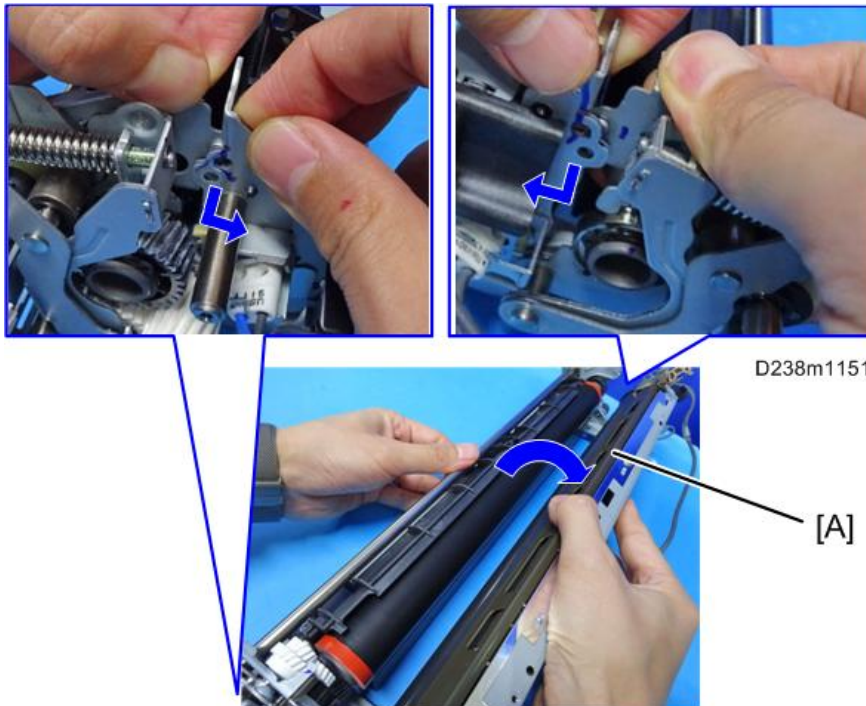

9. Remove the spring, and then remove the separation plate [A] and supports [B].

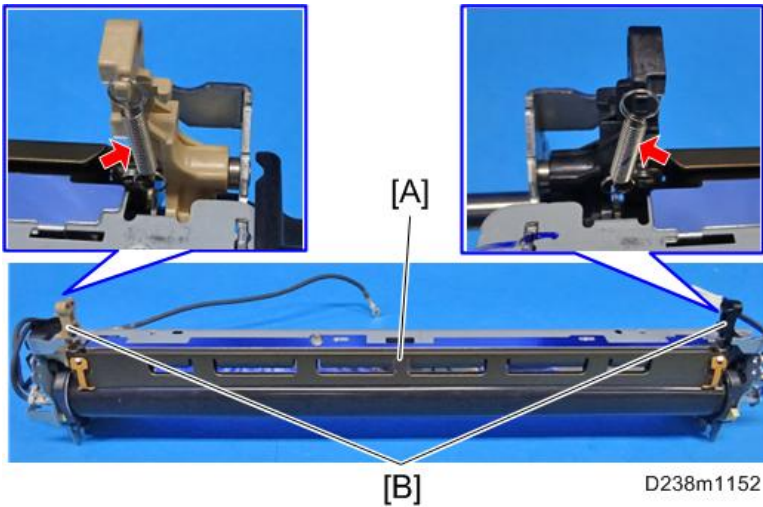

Pressure Roller

Adjustment before Replacing the Pressure Roller

Before replacing the Pressure Roller, set SP3-701-118 to "1" and switch the power OFF. Then replace the pressure roller and switch the power ON.

SP3-701 (Manual New Unit Set)

This SP is the new unit detection flag.

0: new unit detection flag OFF, 1: new unit detection flag ON

Item	SP
Pressure Roller	SP3-701-118

Replacement

⚠ CAUTION

- Do not remove or adjust the pressure adjusting screws [A] when replacing the pressure roller.
- The fusing unit is adjusted in the factory to match the hardness of the pressure roller, so that the nip width will be correct.

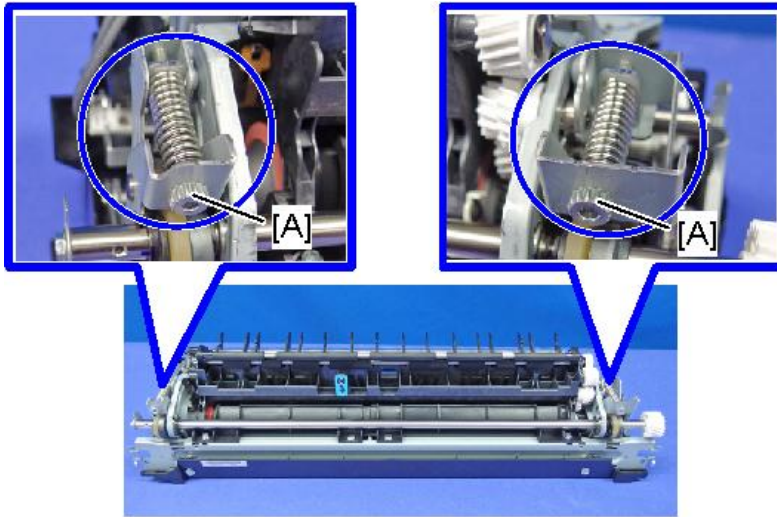

d238m1309

- Do not move the pressure roller to another fusing unit.

1. Fusing sleeve belt unit (page 546)

2. Pressure roller [A]



x2

d238m0128

3. Apply the grease (FLUOTRIBO MG GREASE) to the rear shaft of the pressure roller at 5-7mm from the cut edge.

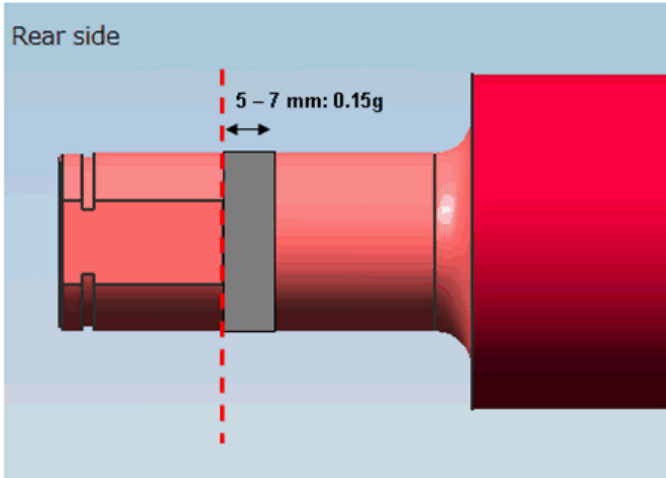

W_d1465020

4. Apply the grease (FLUOTRIBO MG GREASE) to the front shaft of the pressure roller at 5-7mm from the C-ring notch.

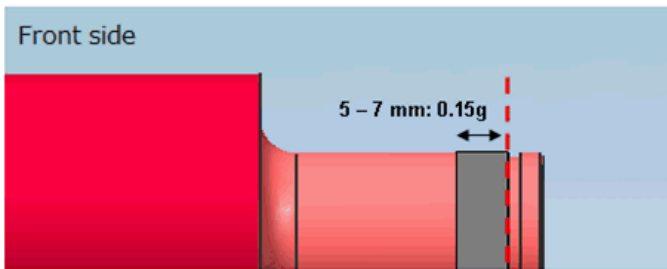

W_d1465021

Fusing Sleeve Thermostat Unit

1. Fusing upper cover (page 544)
2. Fusing lower cover (page 545)

3. Left frame [A]

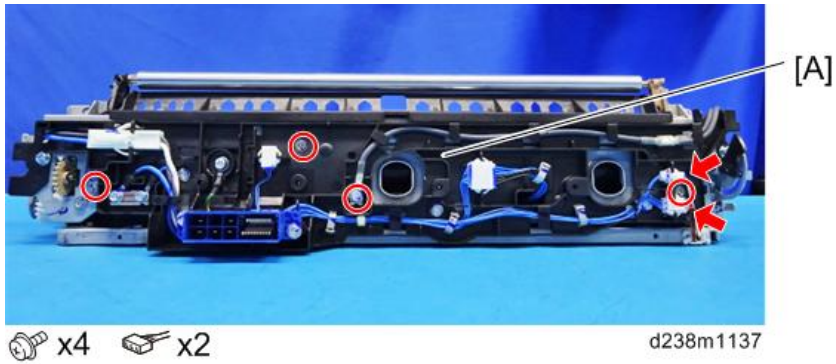

4. Fusing sleeve thermostat unit [A]



Non-Contact Thermistor

1. Fusing upper cover (page 544)
2. Fusing lower cover (page 545)
3. Left frame [A]

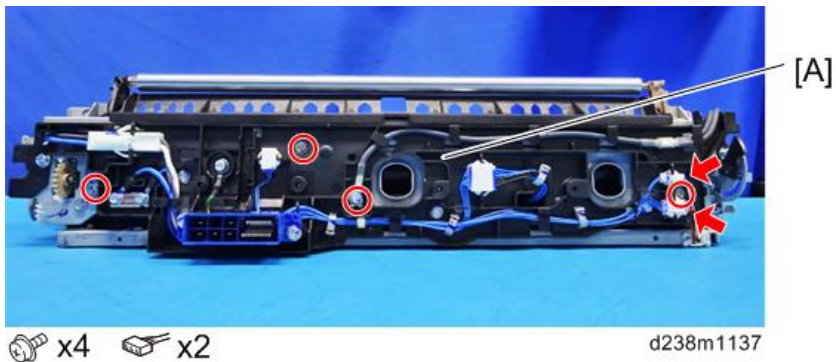

4. Non-contact thermistor unit [A]

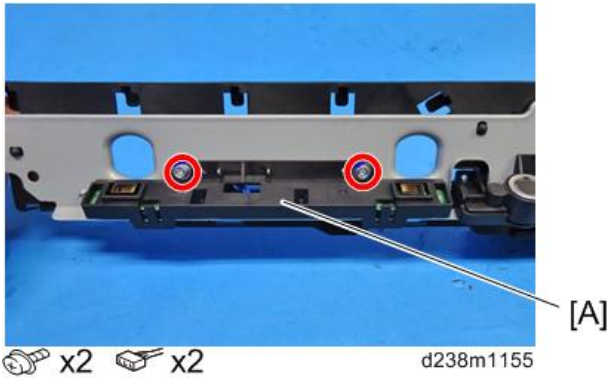

4

Pressure Roller Thermistor

1. Fusing entrance guide plate (page 542)
2. Fusing upper cover (page 544)
3. Fusing lower cover (page 545)
4. Pressure roller thermistor [A].

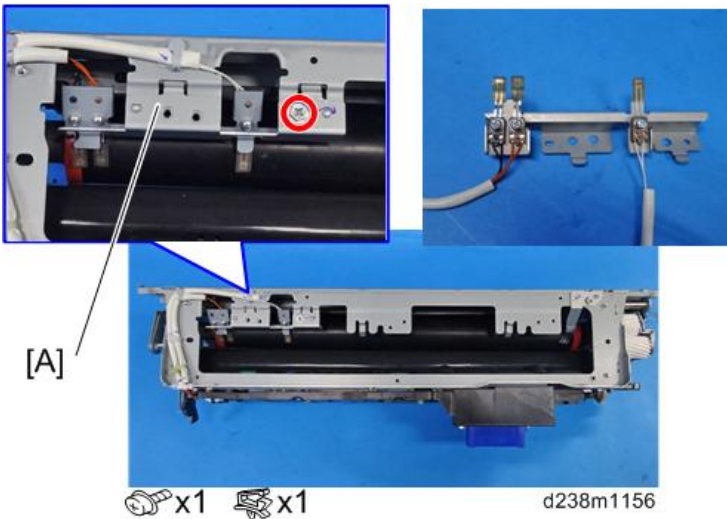

Thermopile Unit

1. Fusing unit (page 541)

2. Thermopile unit [A]

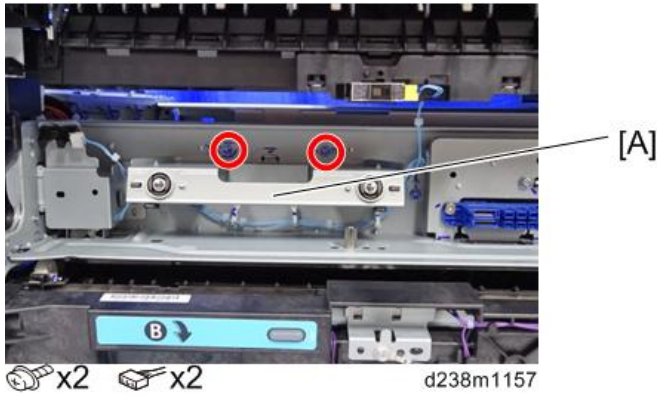

4

Pressure Roller HP Sensor

1. Fusing unit (page 541)
2. Pressure roller HP sensor unit [A]

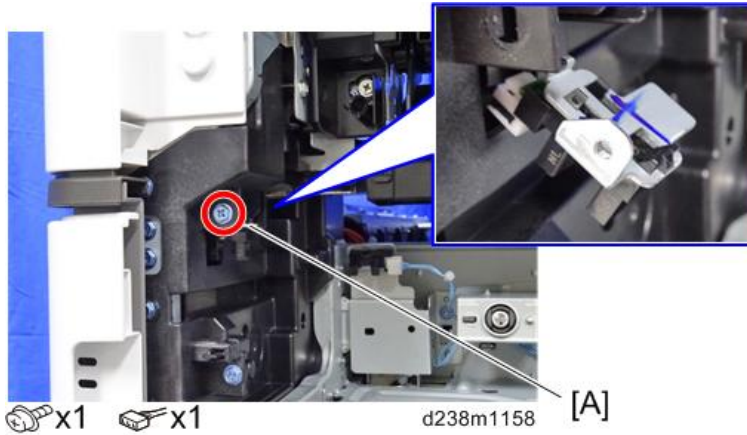

3. Pressure roller HP sensor [A]

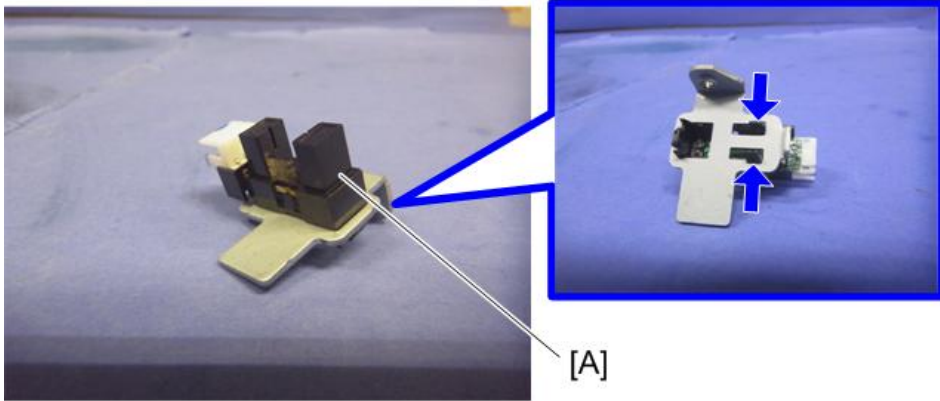

d1462359

Fusing Exit Drive Solenoid

1. Paper exit unit (page 557)
2. Fusing exit drive solenoid [A].

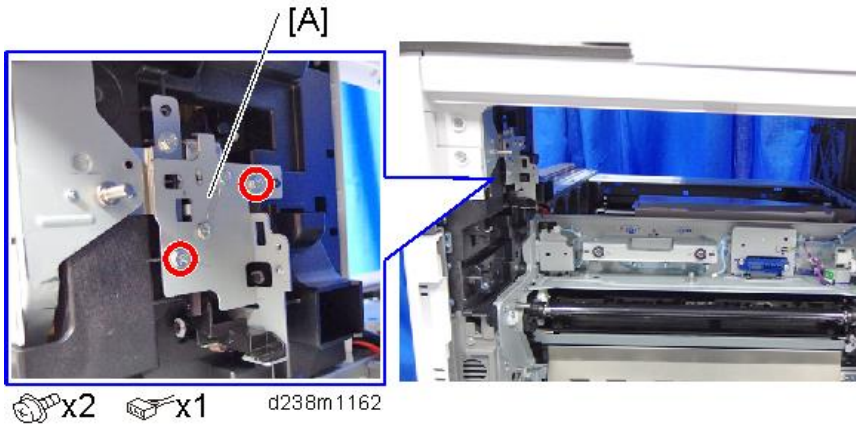

d238m1162



d238m1163

Paper Exit

Paper Exit Unit

1. Fusing unit (page 541)
2. Inner cover [A]

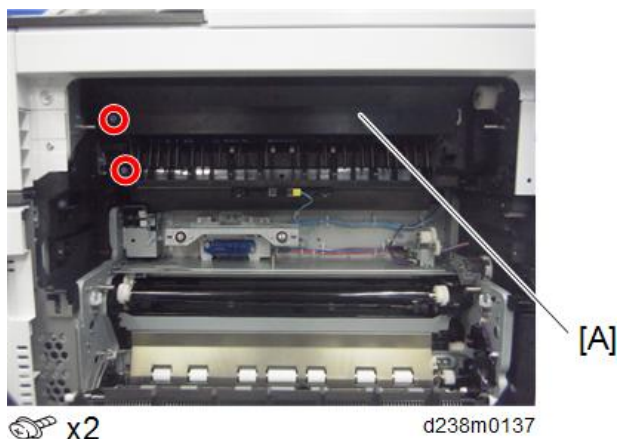

3. Paper exit unit [A]

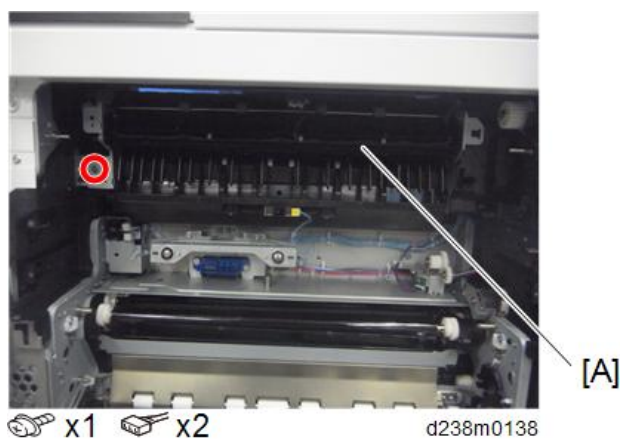

Paper Exit Solenoid

1. Paper exit unit (page 557)

2. Paper exit solenoid [A]

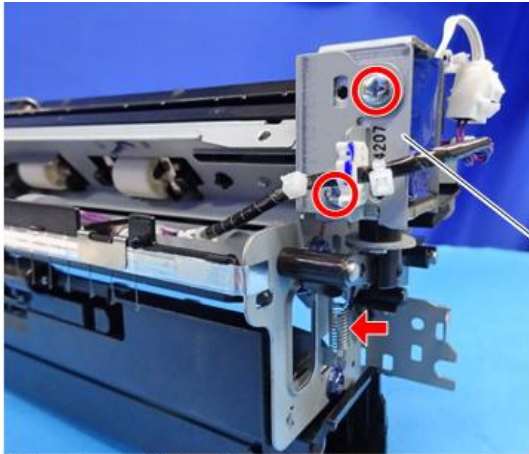

 x2  x1  x1 d238m1164

Paper Exit Sensor

1. Paper exit unit (page 557)
2. Feeler [A]

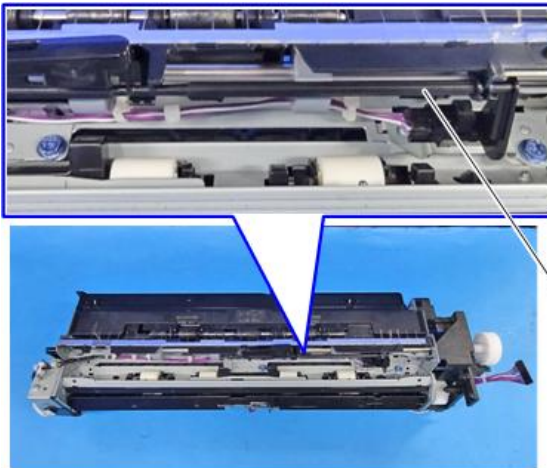

d238m1165

3. Harness [A]

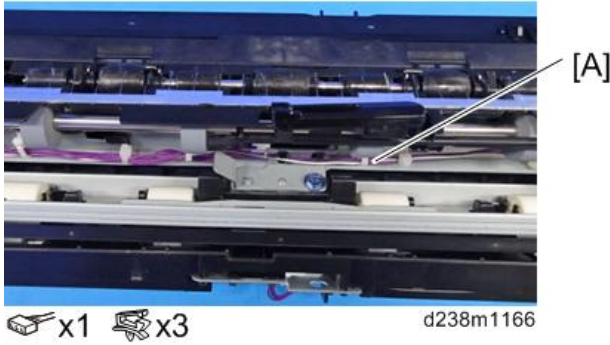

4. Paper exit sensor unit [A]

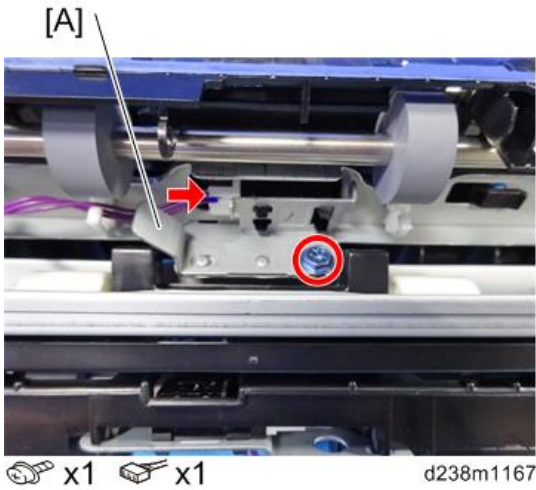

5. Paper exit sensor [A]

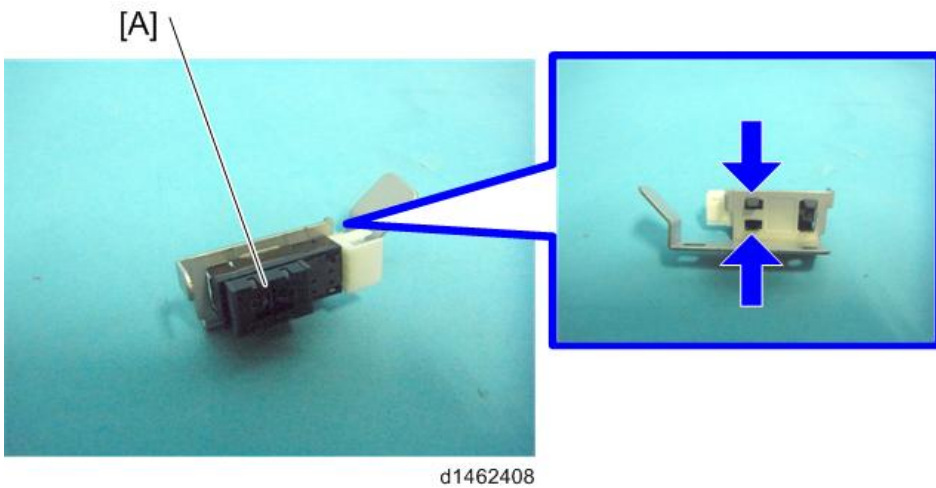

Reverse Sensor

1. Paper exit unit (page 557)
2. Reverse sensor unit [A]

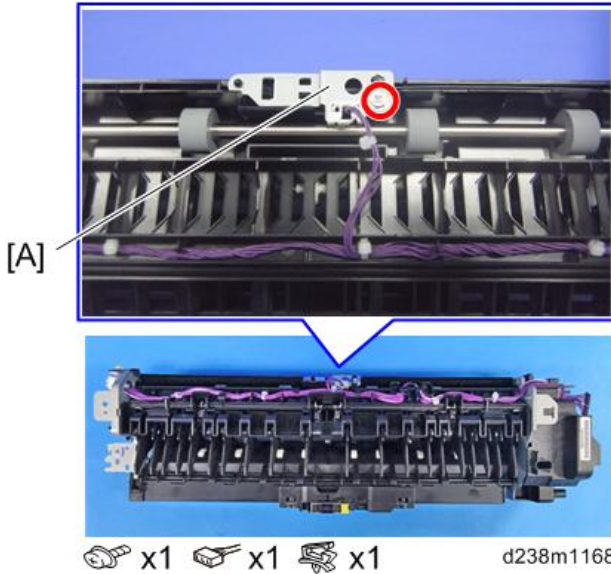

When attaching the reverse sensor, if you screw too tightly in the direction of the blue arrow, it may cause the gap between the guide plates [A] to be too narrow, resulting in paper jams. Make sure that there is a gap [A] of 3mm or more after you fasten the screw.

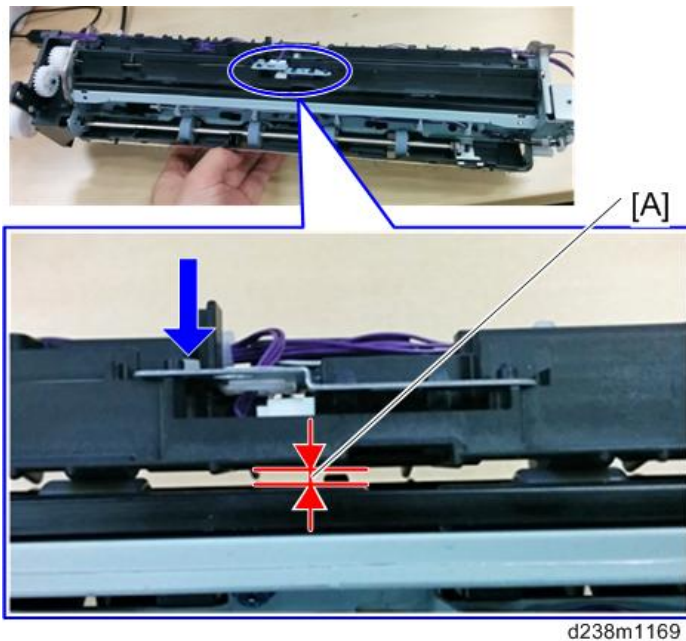

3. Reverse sensor [A]

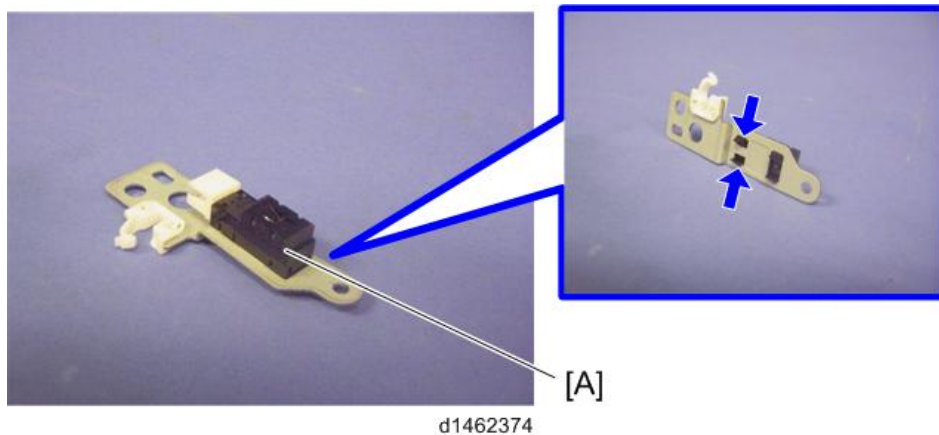

Reverse Motor

1. Paper exit unit (page 557)
2. Gear [A] (Tab x1)

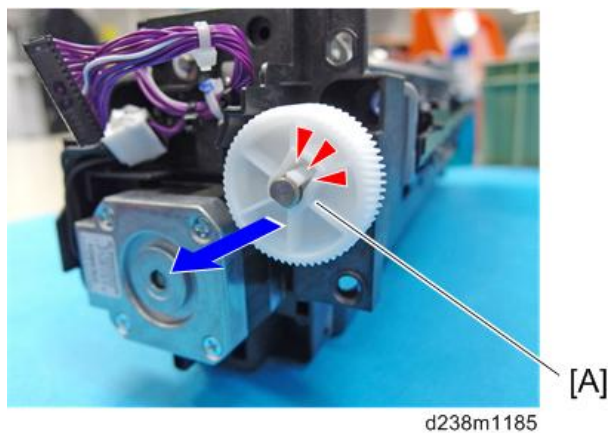

3. Reverse motor unit [A]

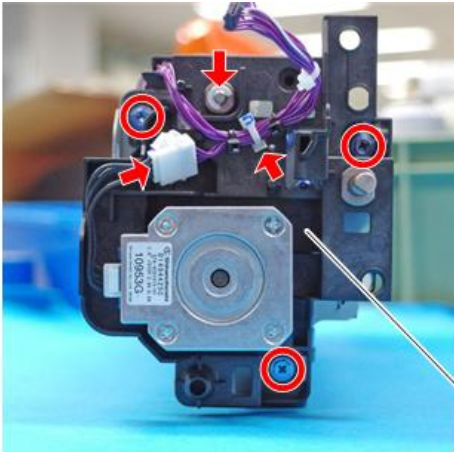

4

[A]

⚙️ x3 🗝️ x1 📄 x1 🛠️ x1 d238m1186

4. Reverse motor [A]

[A]

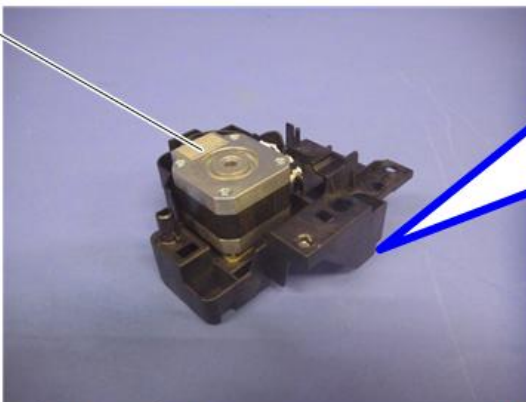

⚙️ x2 🗝️ x1

d238m0145

Fusing Exit Sensor

1. Paper exit unit (page 557)

2. Fusing exit sensor unit [A]

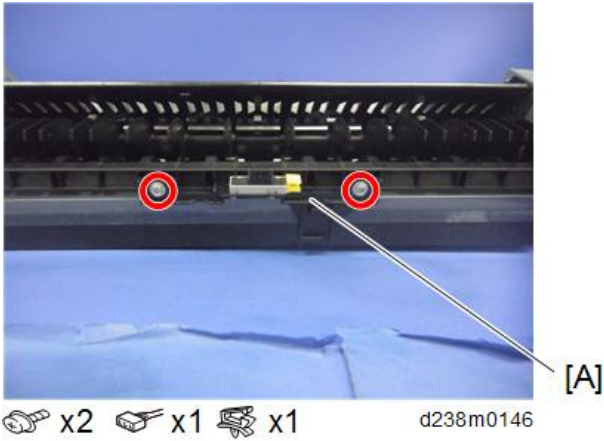

3. Fusing exit sensor [A]

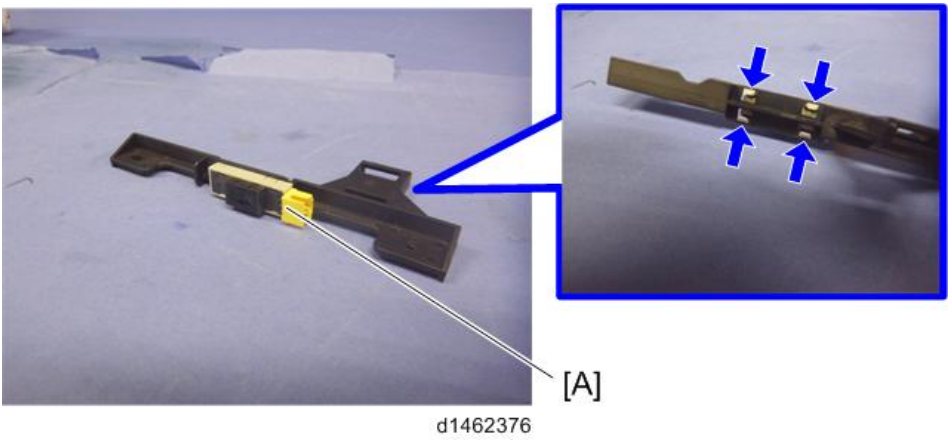

Paper Feed

Note

- The 1st paper feed unit can be removed without removing the duplex unit (just open the right door), and you can remove the paper feed unit after pulling out the paper tray.
- The 1st paper feed unit and 2nd paper feed unit are not interchangeable.

Paper Feed Unit

4

1st Paper Feed Unit

1. Open the right door.
2. Arms [A] [B]

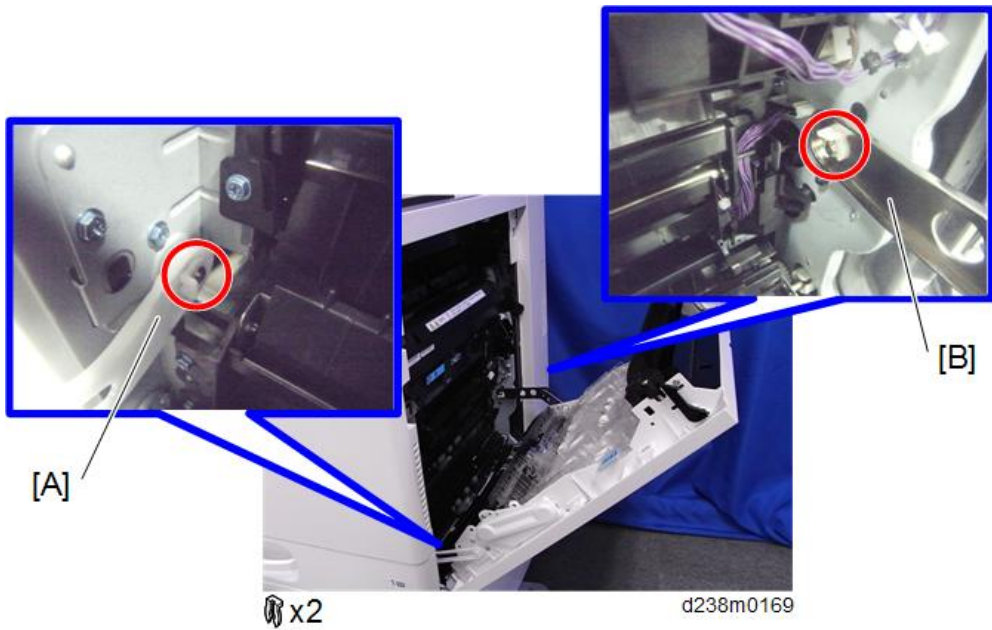

3. Open the right door wide.

4. Pull out the 1st paper tray [A].



d1462181

5. Press the left tab to release the lock, and remove the paper feed guide plate [A].

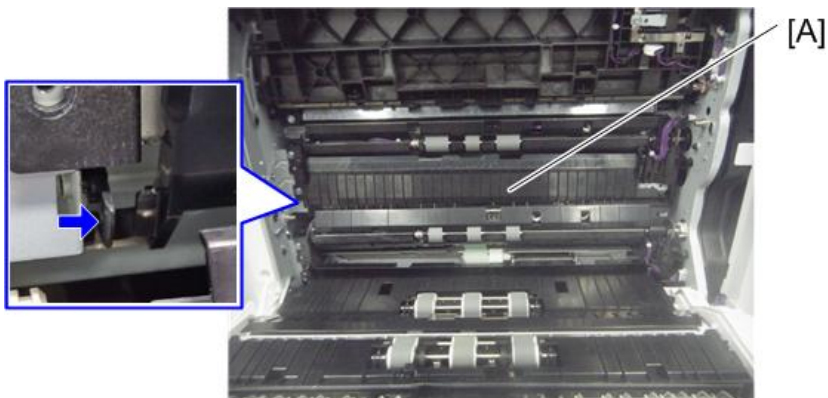

d238m1141

6. 1st paper feed unit [A]

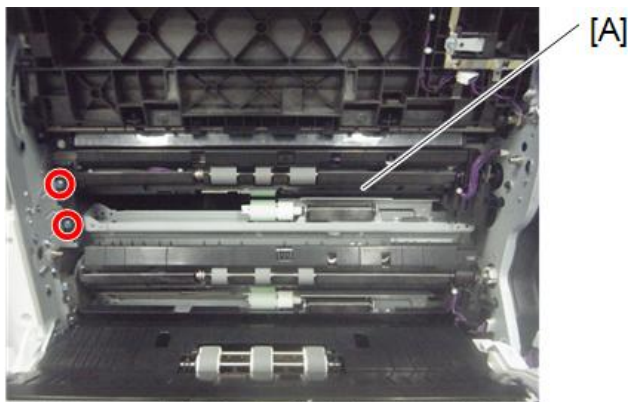

 x2  x1

d238m0148

2nd Paper Feed Unit

1. Duplex unit (page 591)
2. Pull out the 2nd paper tray [A].

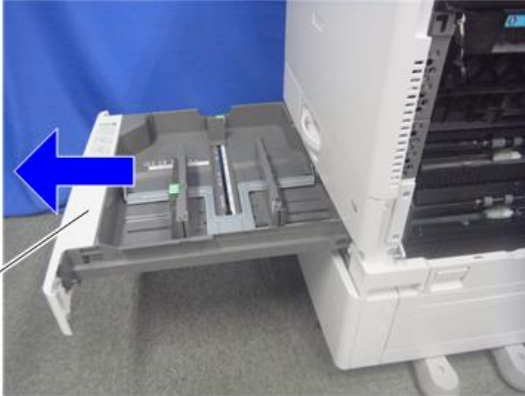

d1462184

3. Transport guide [A]

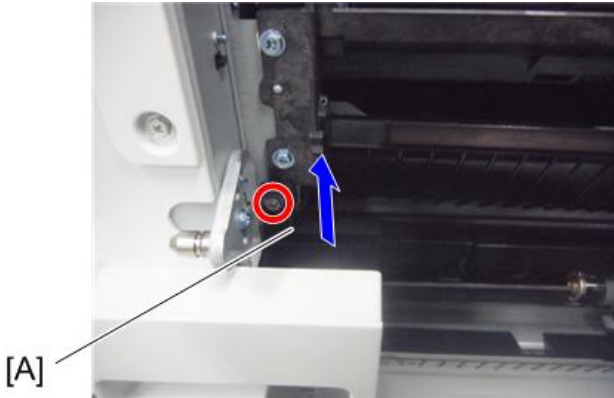

 x1

d238m0149

4. Harness guide [A] (Hook x 1)

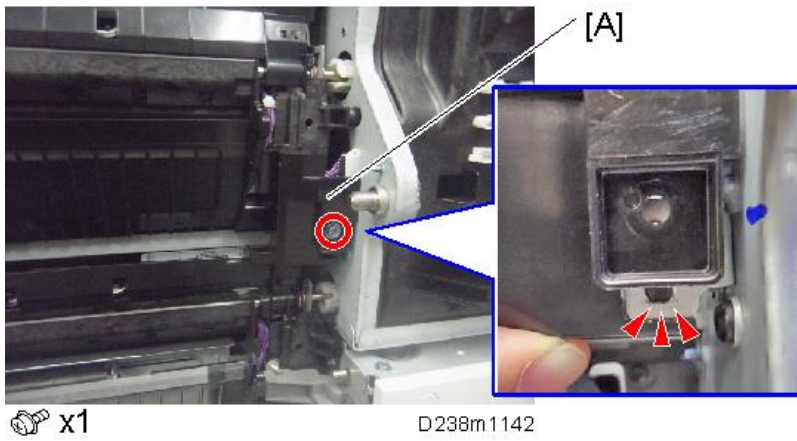

4

5. Press the left tab to release the lock, and remove the paper feed guide plate [A].

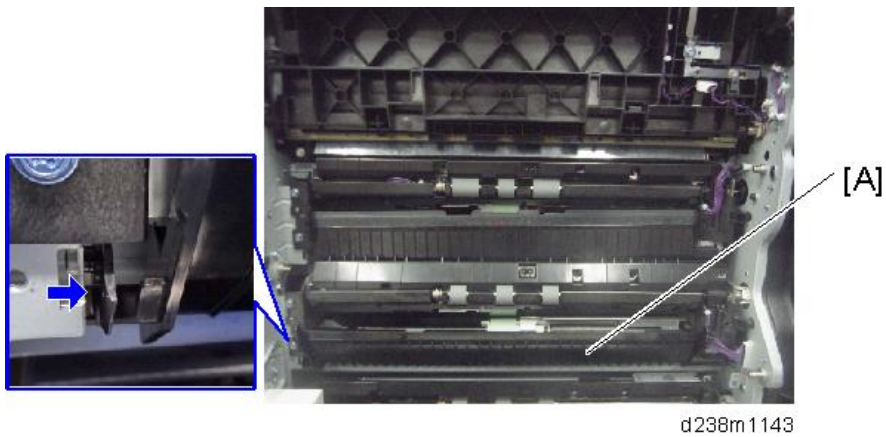

6. 2nd paper feed unit [A]

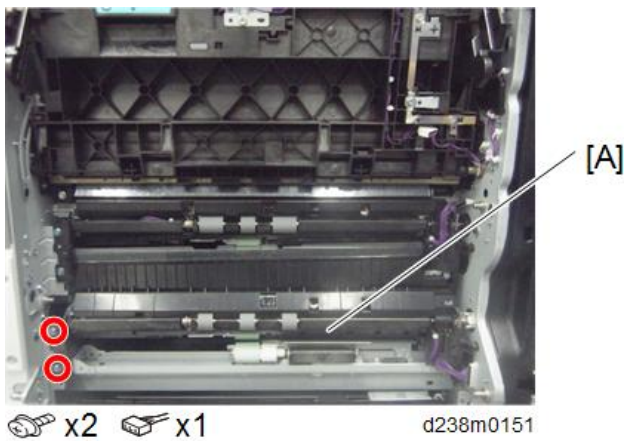

Paper Dust Collection Unit

1. Open the right door.
2. Arms [A] [B]

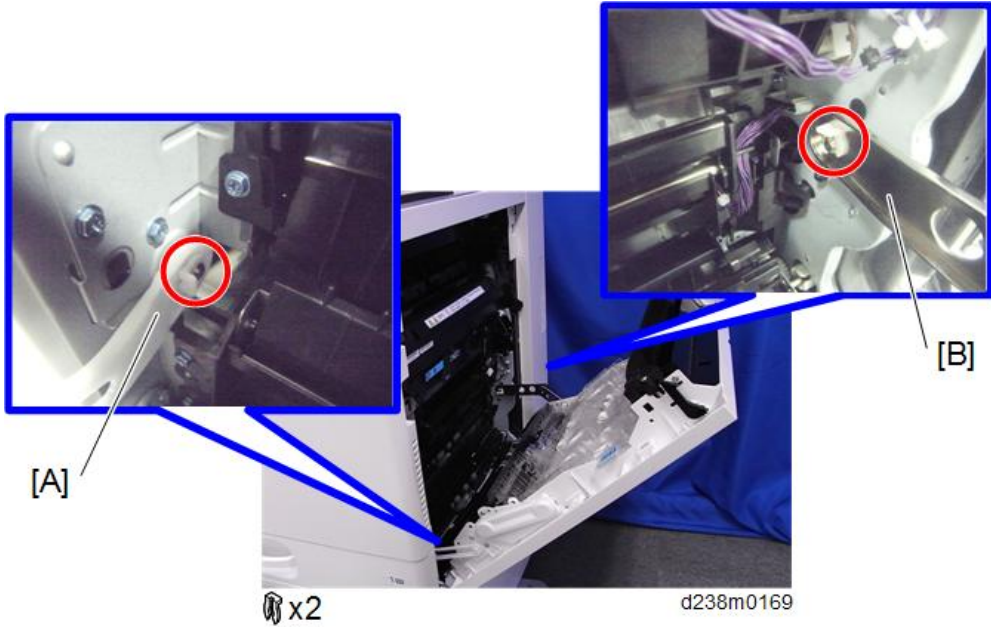

3. Open the right door wide.
4. Paper dust collection unit [A]

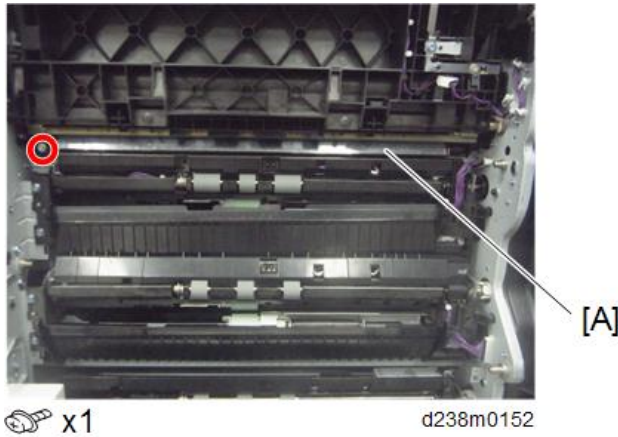

Pick-up Roller, Paper Feed Roller, Separation Roller, Torque Limiter

1. Paper feed unit (page 564)

2. Retainer [A]

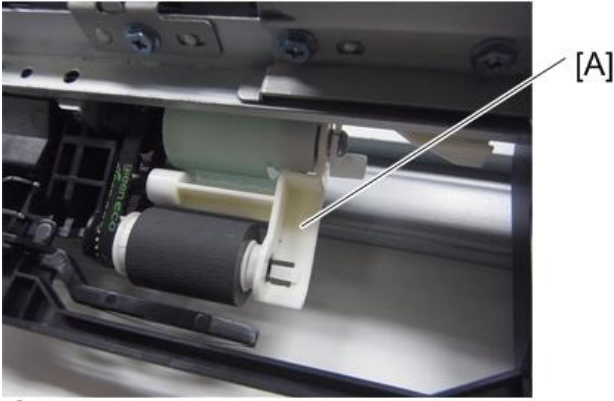

 x1

d238m1145

3. Pick-up Roller [A]

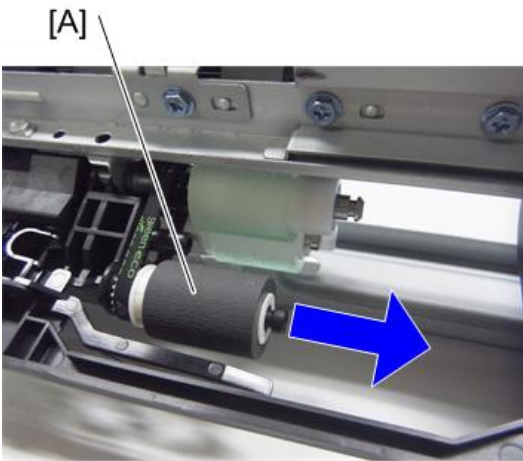

d1462189

4. Paper Feed Roller [A]

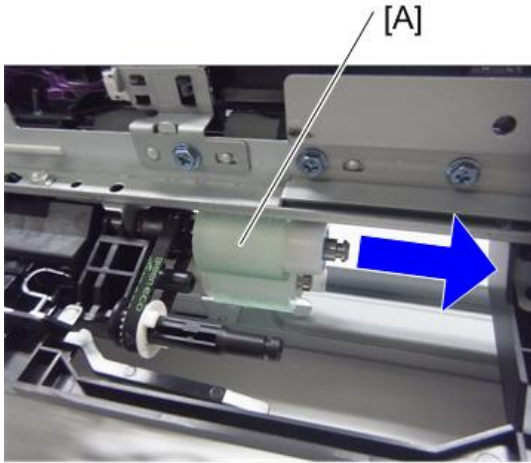

d1462190

5. Separation Roller [A]

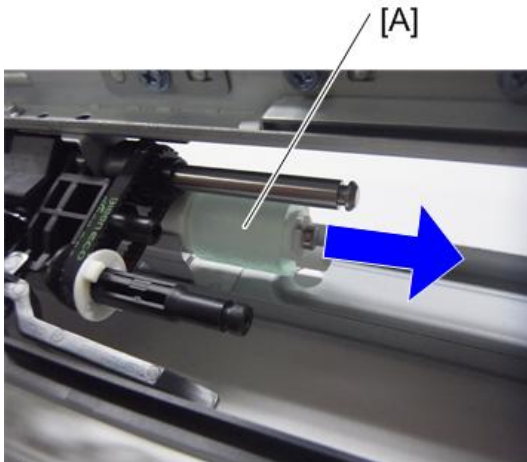

 x1

D238m1146

6. Torque Limiter [A]

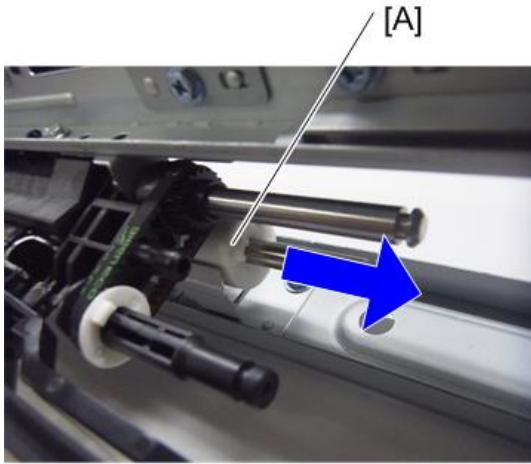

d1462192

4

1st Tray Lift Motor/ 2nd Tray Lift Motor

1. HVP-CB with bracket (page 622)
2. 1st Tray Lift Motor [A]

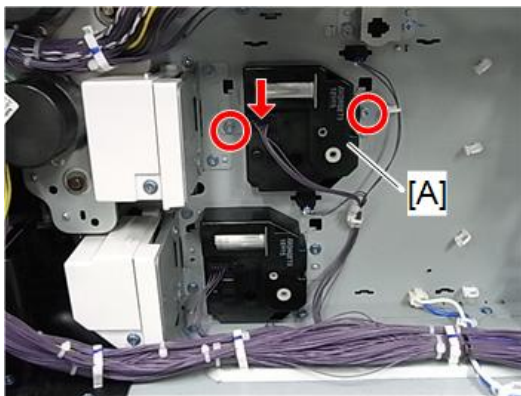

x2 x1

d238m0155

3. 2nd Tray Lift Motor [A]

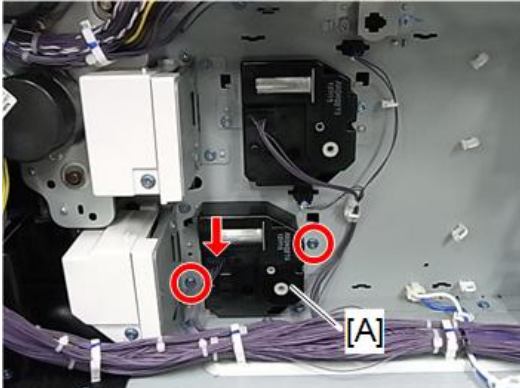

 x2  x1

d238m0156

4

Transport Sensor

1. Paper feed unit (page 564)
2. Transport sensor unit [A]

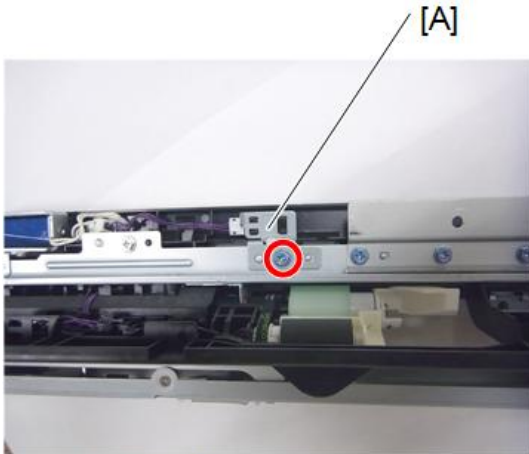

 x1  x1

d238m0159

3. Transport sensor [A]

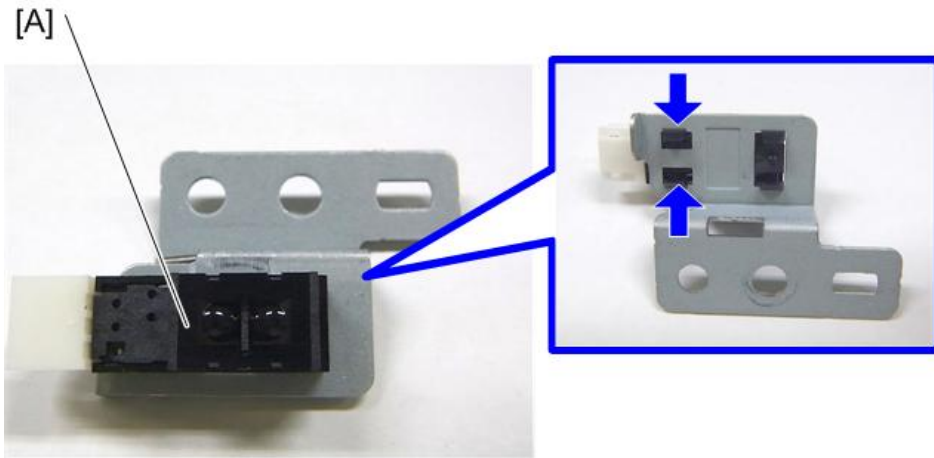

d1462197

4

Upper Limit Sensor

1. Paper feed unit (page 564)
2. Upper limit sensor [A]

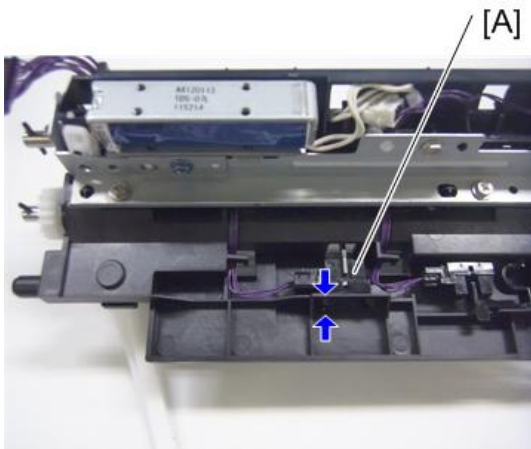

d1462198

Paper End Sensor

1. Paper feed unit (page 564)

2. While pressing the tab enclosed by the blue circle, remove the paper end sensor [A] (Harness*1).

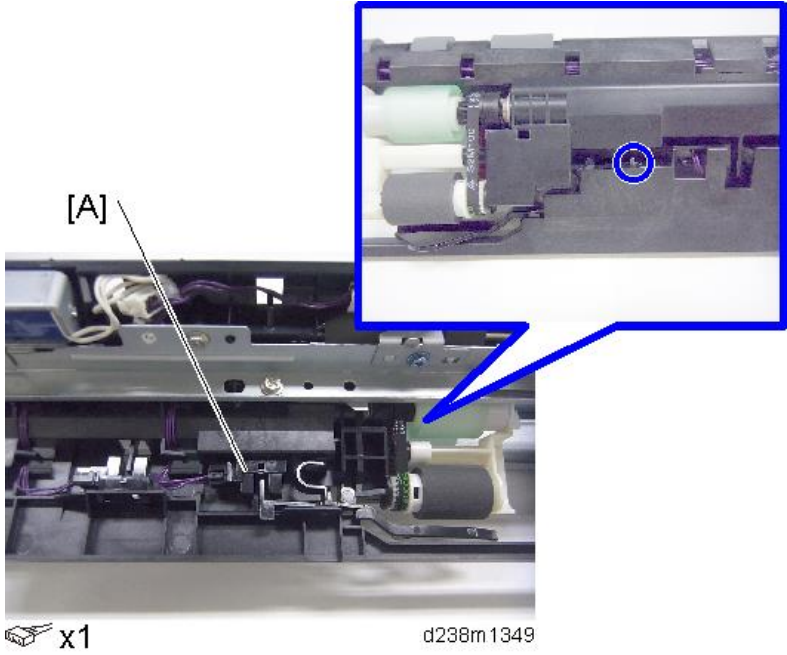

Registration Sensor

1. Open the right door.
2. Paper transfer roller unit (page 495)
3. Inner bracket [A]

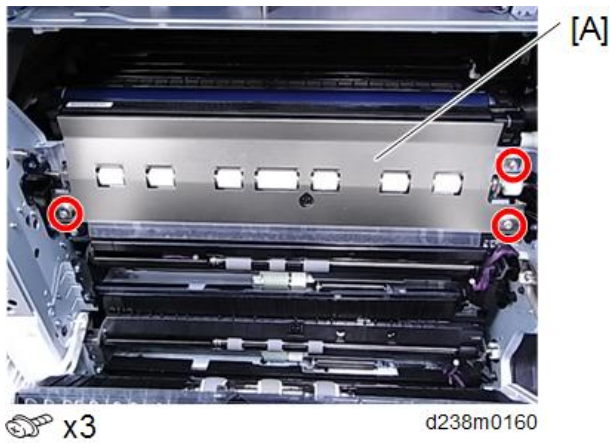

4. Remove two screws, then release the tab by inserting a flathead driver behind the registration sensor [A].

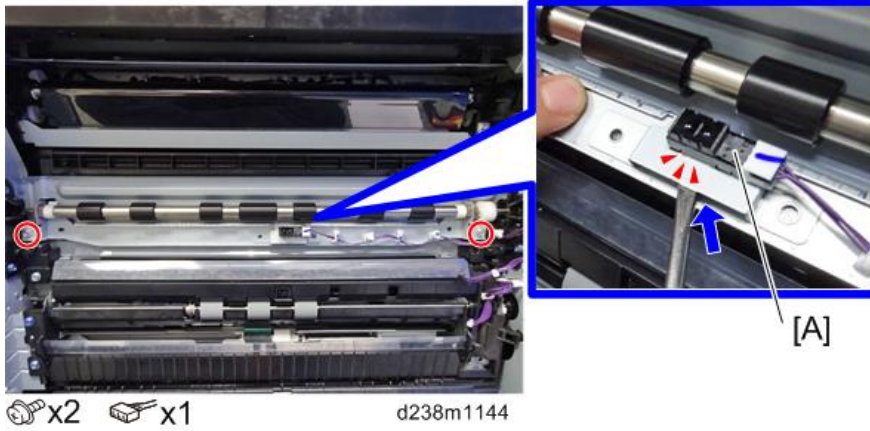

Bypass Tray Unit

Bypass Tray

1. Open the right door.
2. Arm [A][B]

4

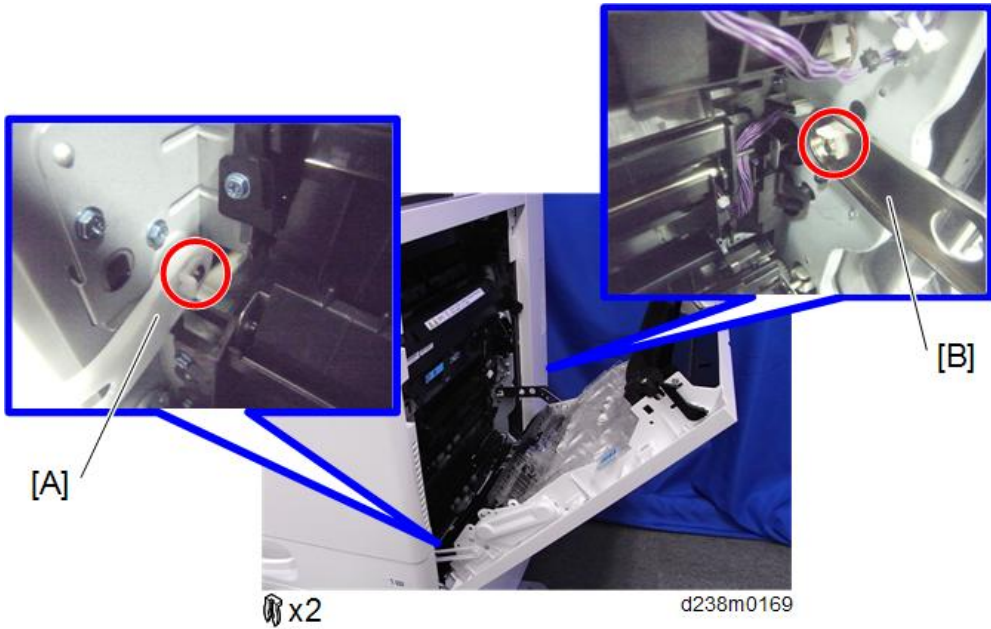

3. Open the right door wide.

4. Paper transport guide [A]

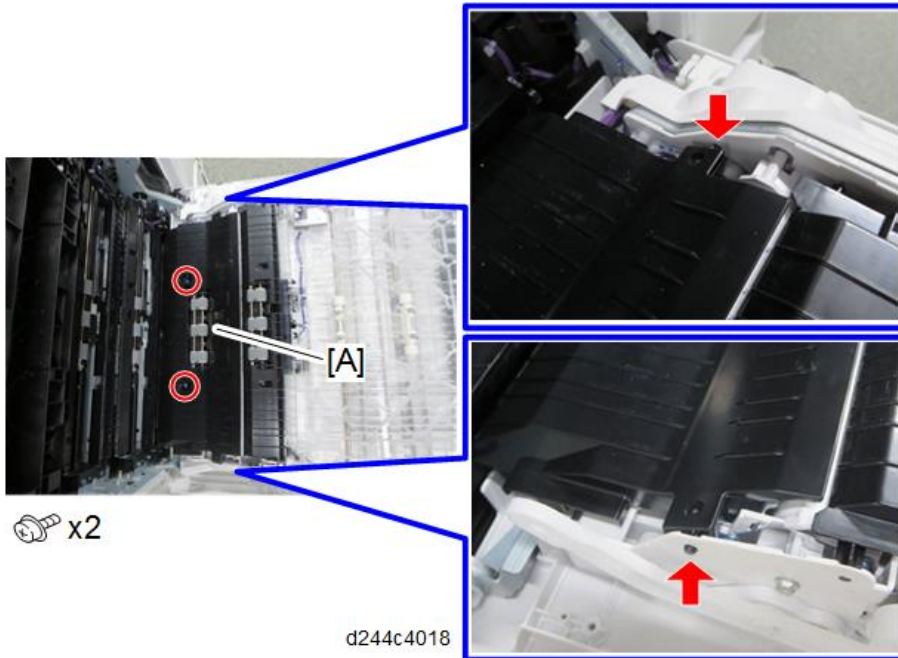

5. Harness

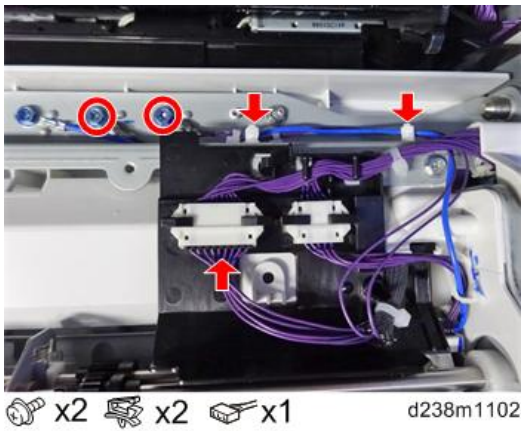

6. Release the tab and loosen the harness bracket [A].

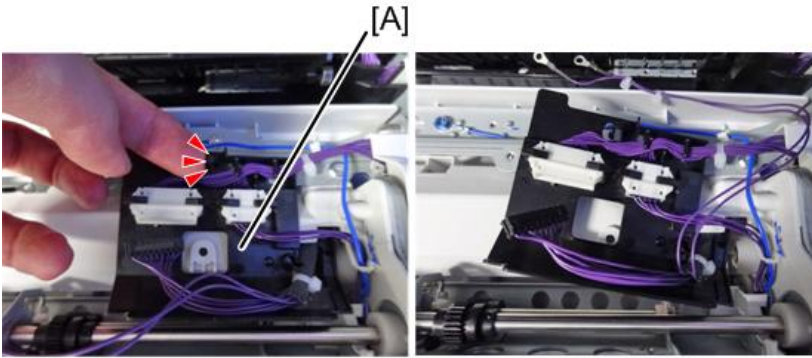

d238m1103

4

7. Bypass tray [A]

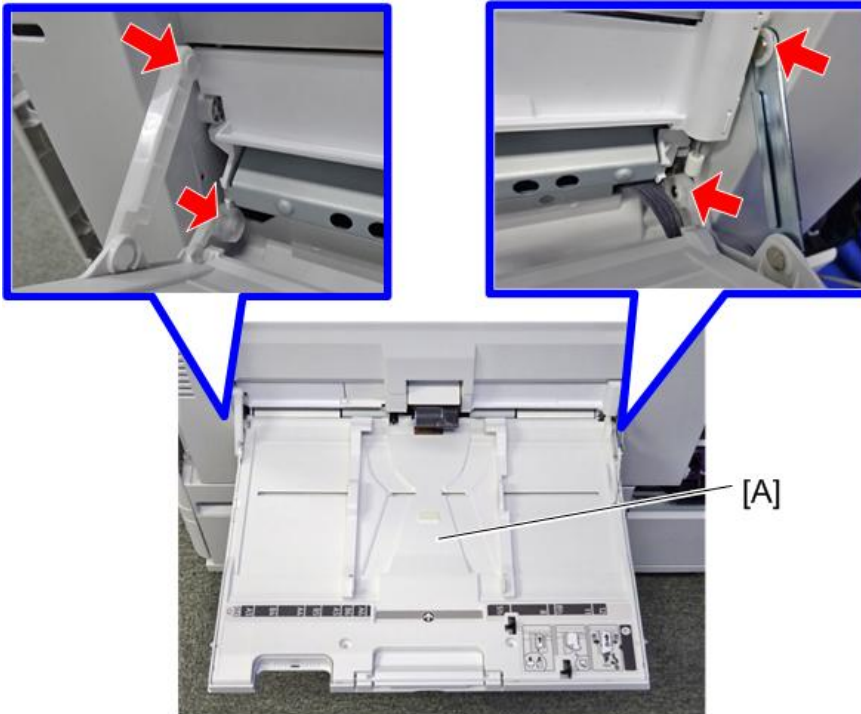

x4

d238m1104

Note

- When attaching the bypass tray, pass the harness through the indicated position as shown.



d238m1116

Bypass Paper End Sensor

1. Open the bypass tray [A].

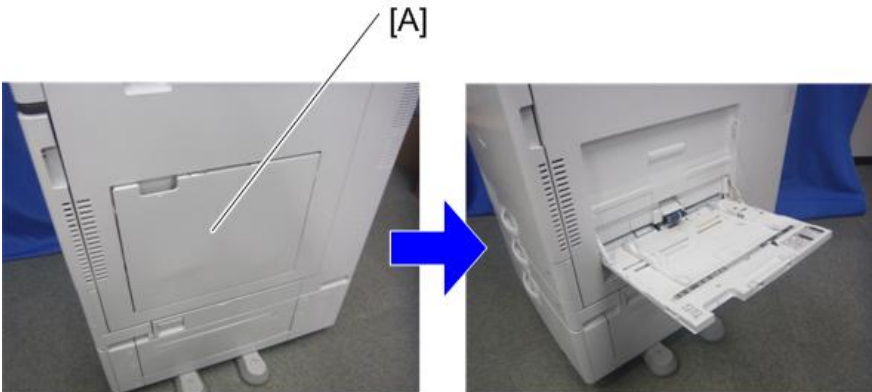

d1462416

2. Bypass paper end sensor cover [A]

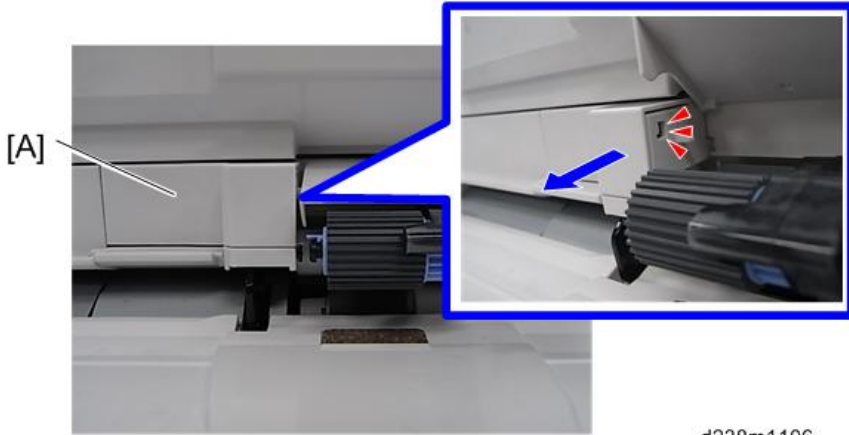

d238m1106

3. Bypass paper end sensor unit [A]

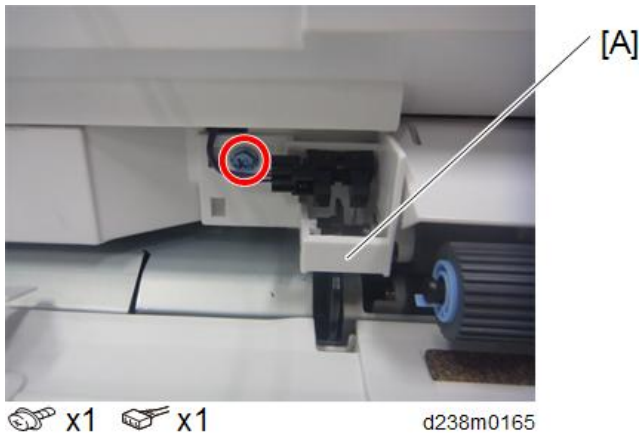

d238m0165

4. Bypass paper end sensor [A]

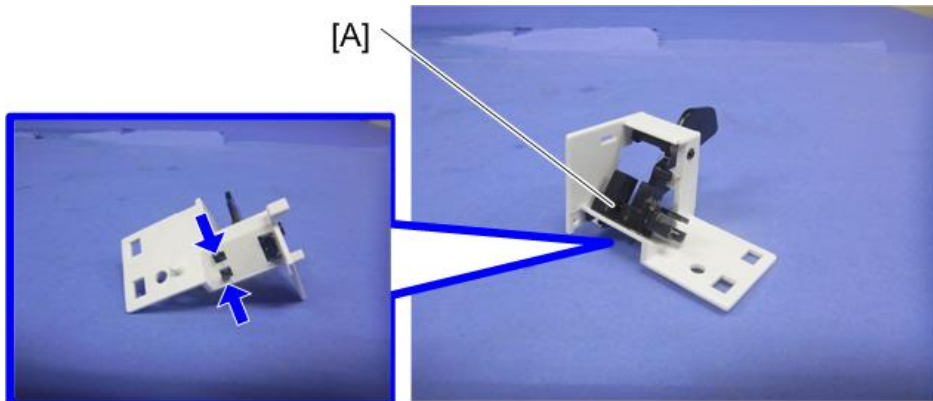

d1462415

Bypass Pick-up Roller

1. Open the bypass tray.
2. Bypass pick-up roller [A]

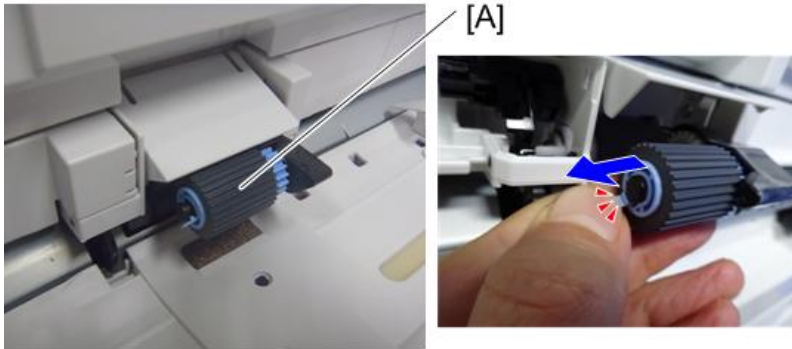

d238m1105

4

Bypass Paper Feed Roller

1. Bypass paper end sensor unit (page 579)
2. Bypass paper feed roller [A]

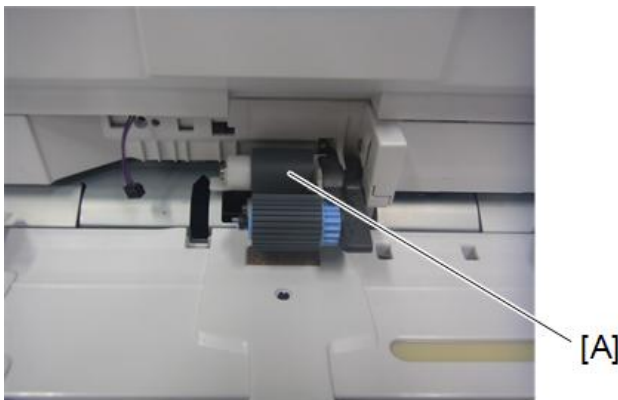

x1

d238m0167

Bypass Separation Roller/Torque Limiter

1. Open the right door.

2. Arm [A][B]

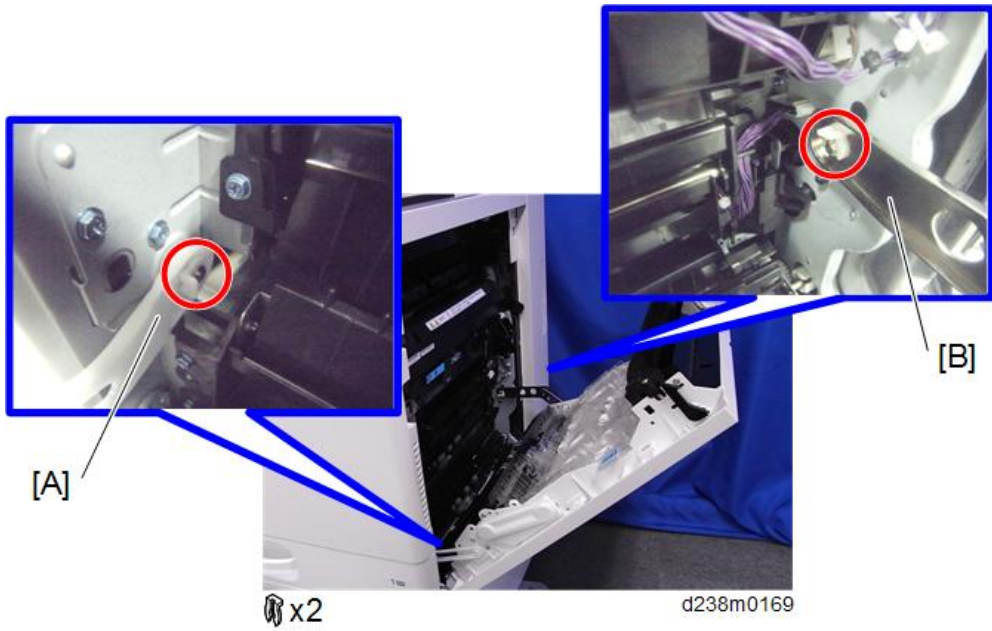

3. Open the right door wide.

4. Paper transport guide [A]

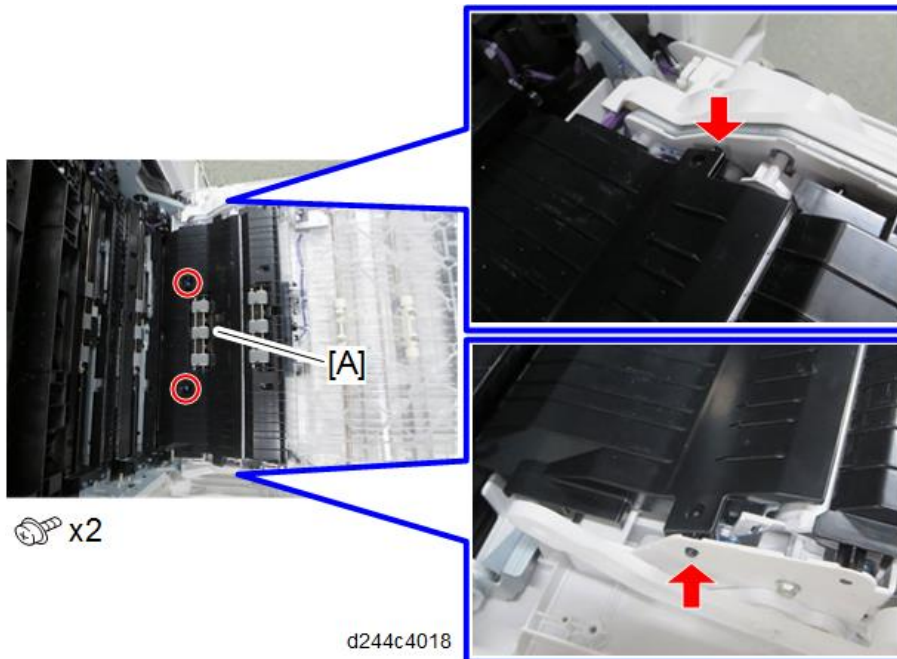

5. Bypass separation roller [A]



 x1

d238m0168

4

6. Torque limiter [A]

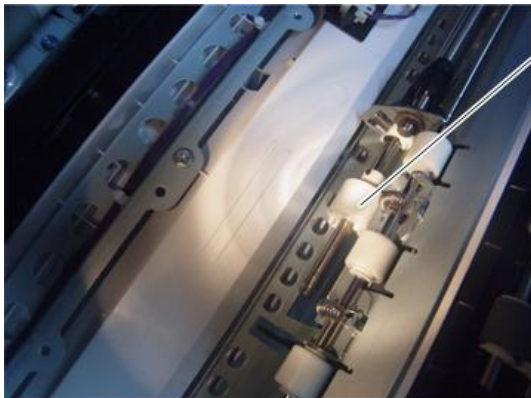

d1462420

Bypass Width Sensor

1. Bypass tray (page 576)

2. Six screws on the bypass tray [A] (Ⓜ×6).

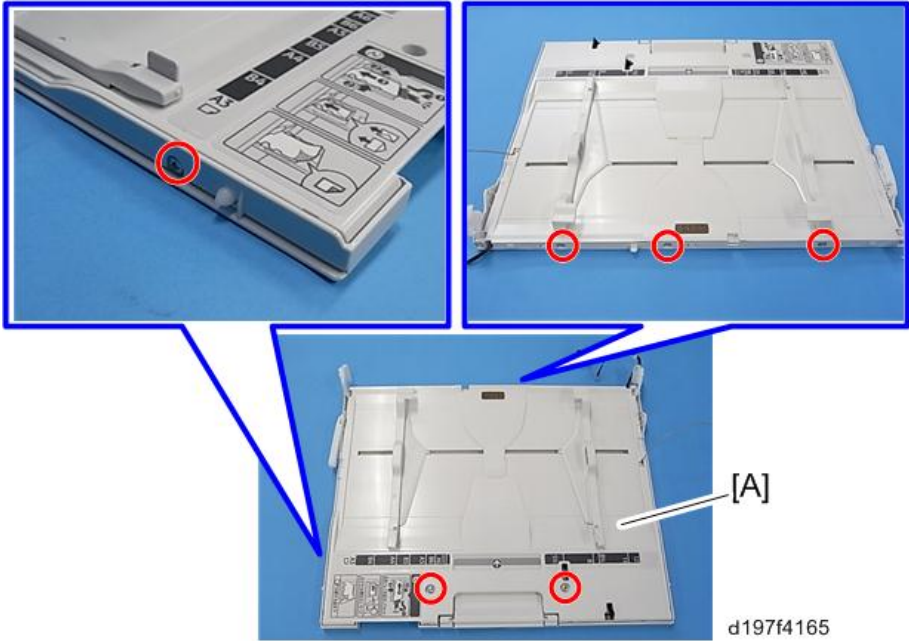

4

3. Release the hooks around the bypass tray [A].

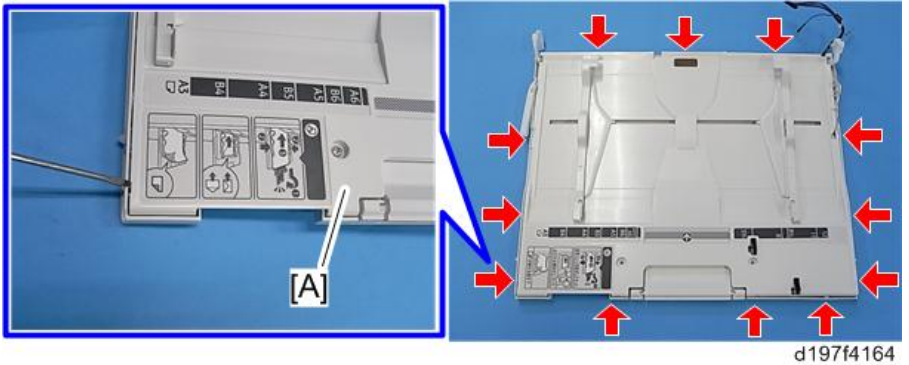

↓ Note

- There is a hook in the tray cover. Be careful not to damage it during removal or installation.

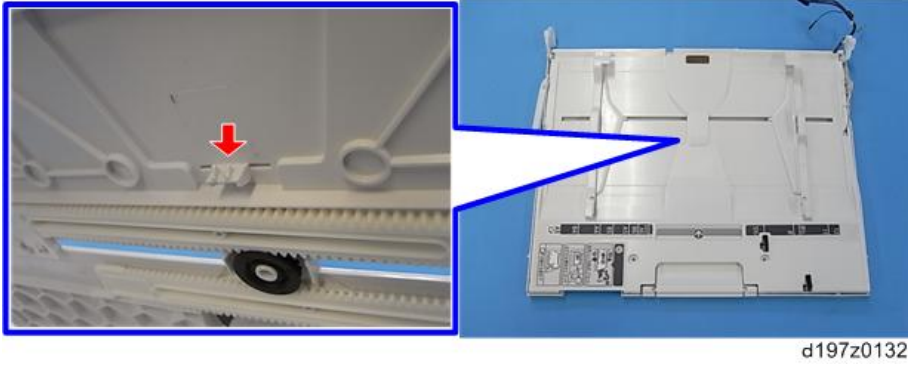

4. Release the links.

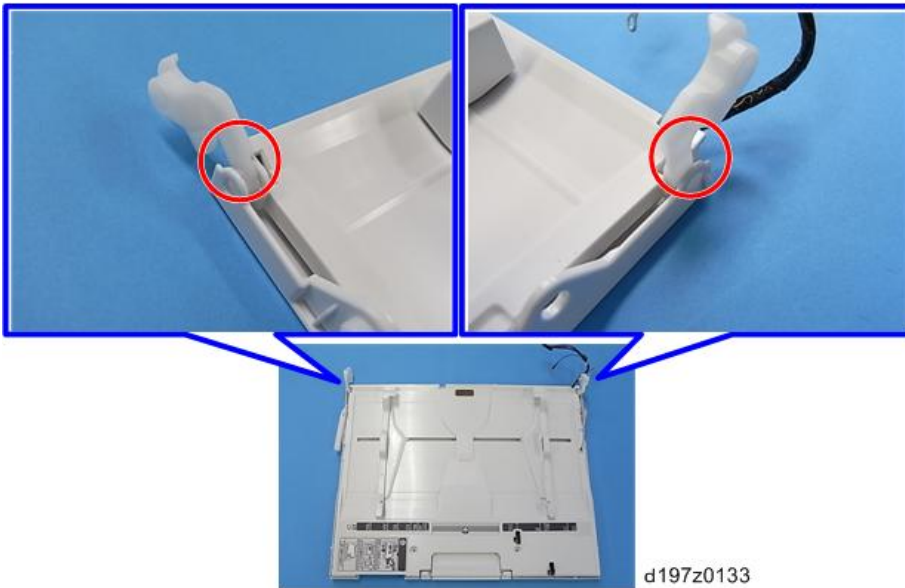

5. Bypass tray upper cover [A] (pin x 1,  x1)

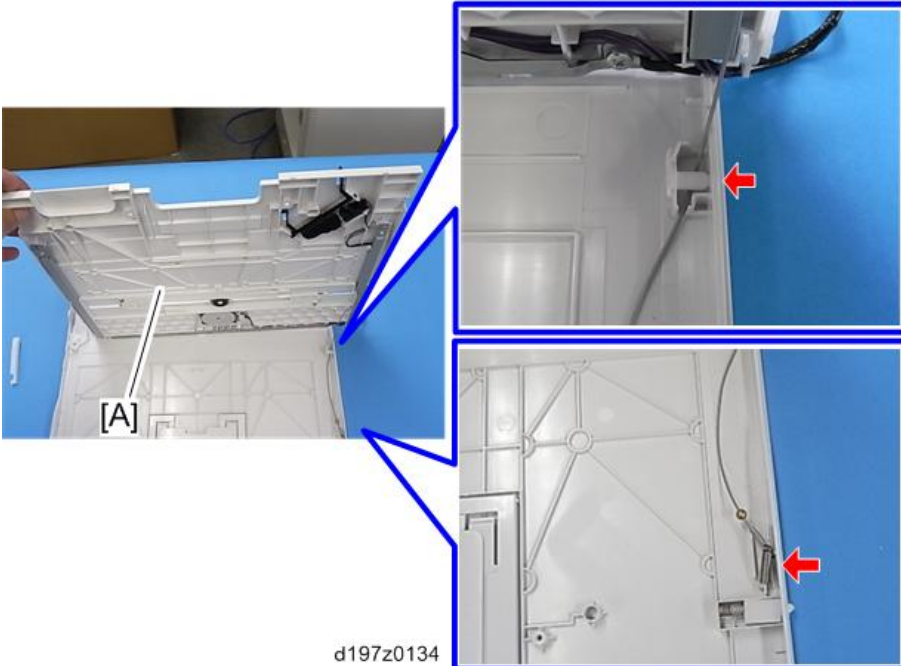

6. Bypass width sensor [A] ( x1, hook x2)

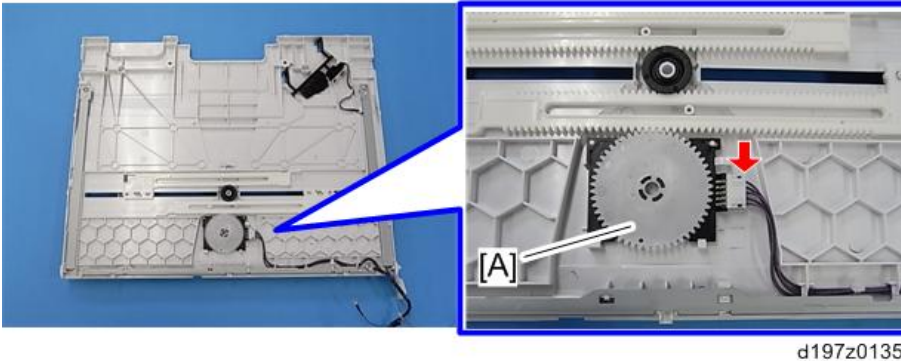

 **Note**

- When installing, the holes must align as shown below.

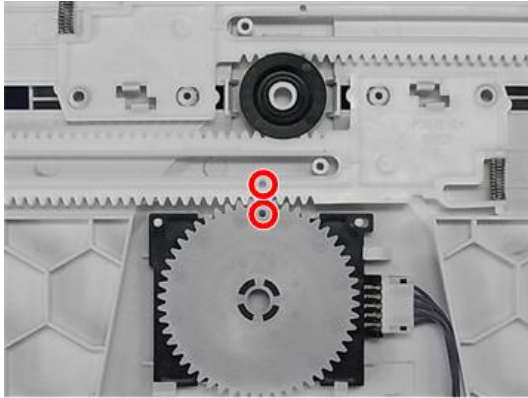

d197z0449

4

Bypass Length Sensor

1. Bypass tray (page 576)
2. Six screws on the bypass tray [A] (Ⓜ×6).

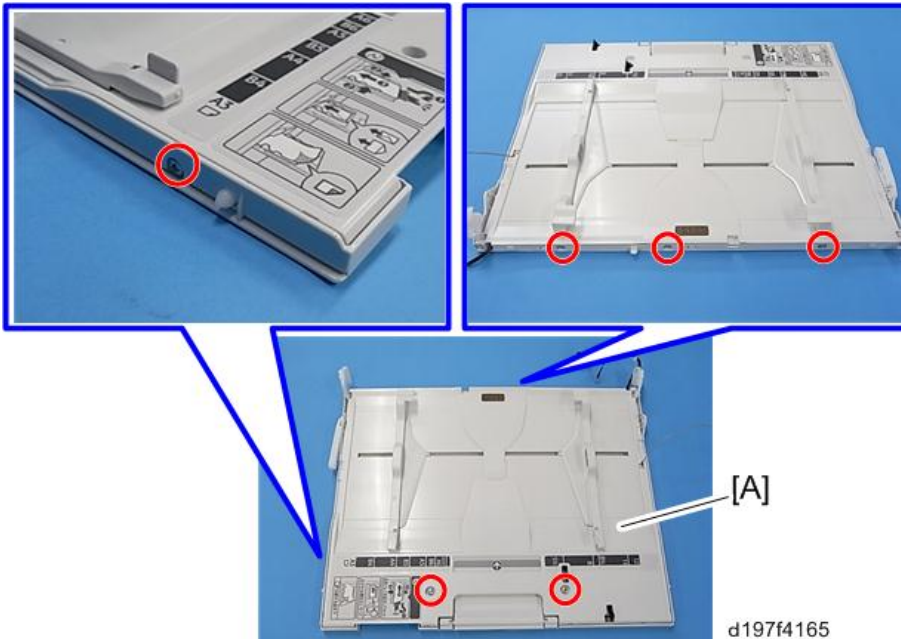

d197f4165

3. Release the hooks around the bypass tray [A].

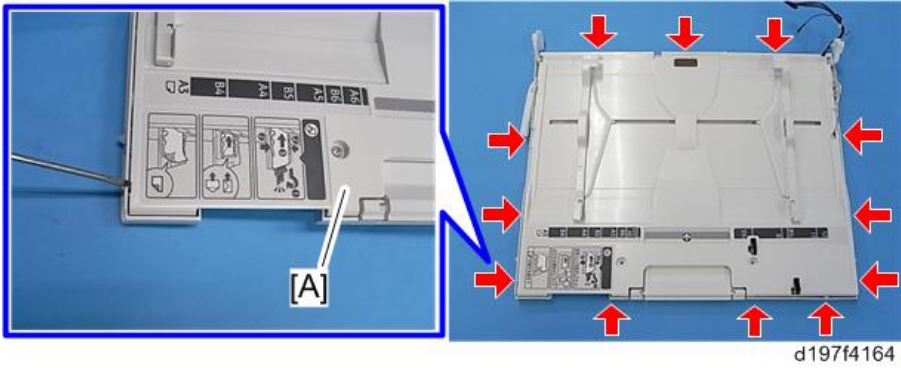

4

Note

- There is a hook in the tray cover. Be careful not to damage it during removal or installation.

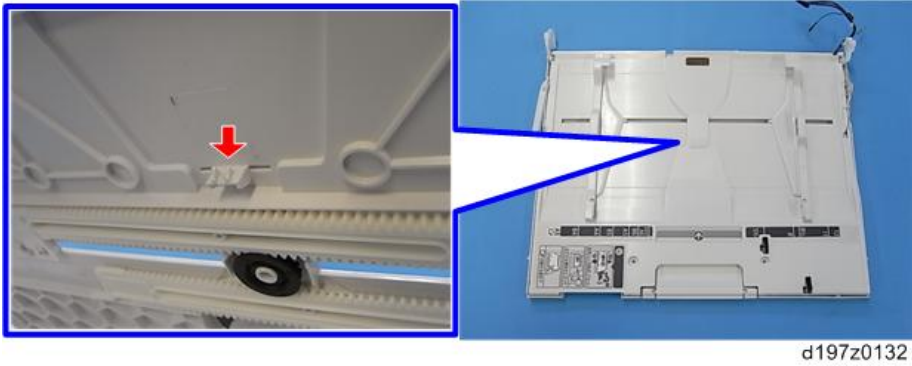

4. Release the links.

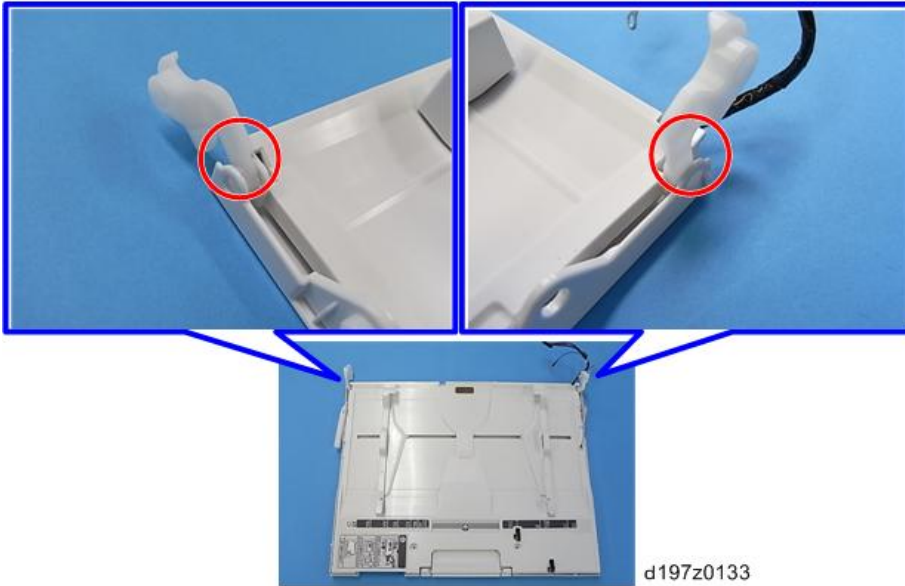

5. Bypass tray upper cover [A] (pin x 1,  x1)

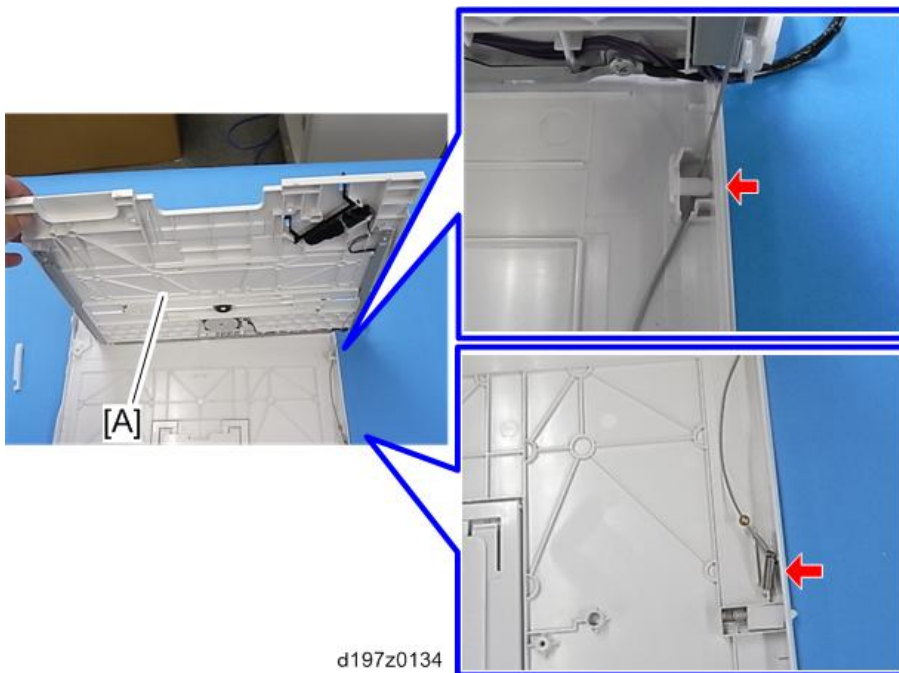

6. Bypass length sensor [A] (📦 ×1, hooks)



d197z0136

Duplex Unit

Duplex Unit

1. Unlock the lever [A], and then open the right door [B].

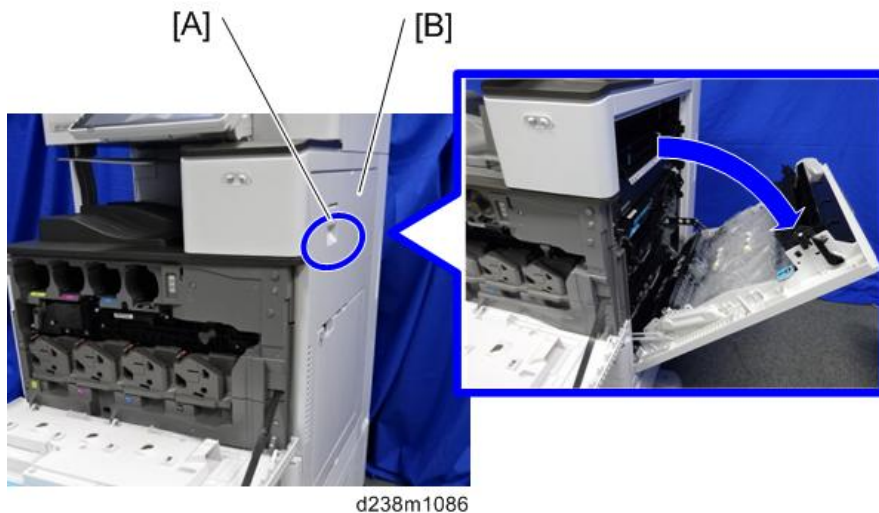

4

2. Arms [A] [B]

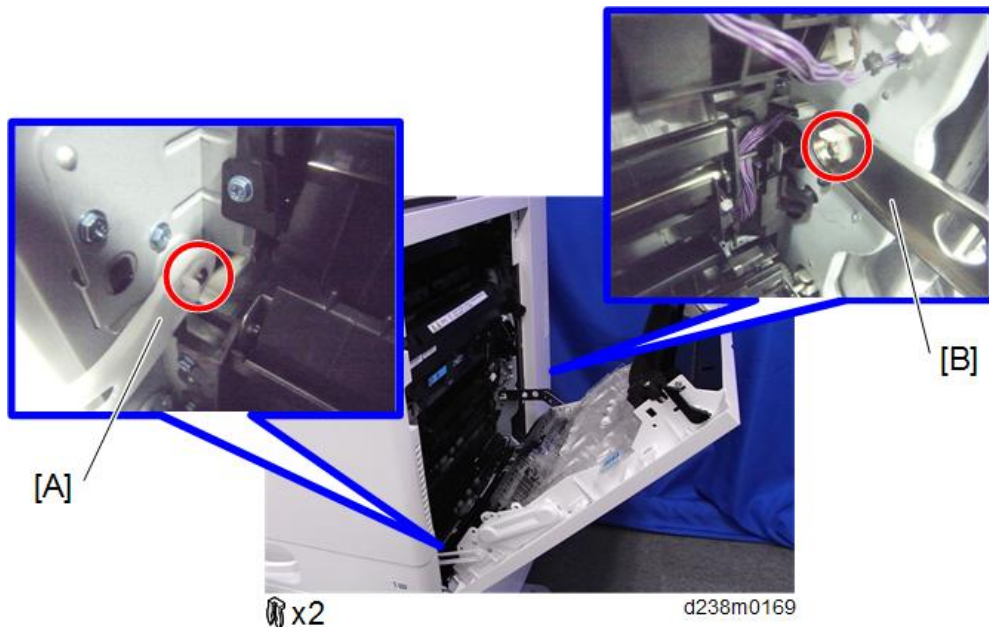

3. Right rear cover (page 412)

4. Main power switch cover (page 416)

5. Duplex unit [A]

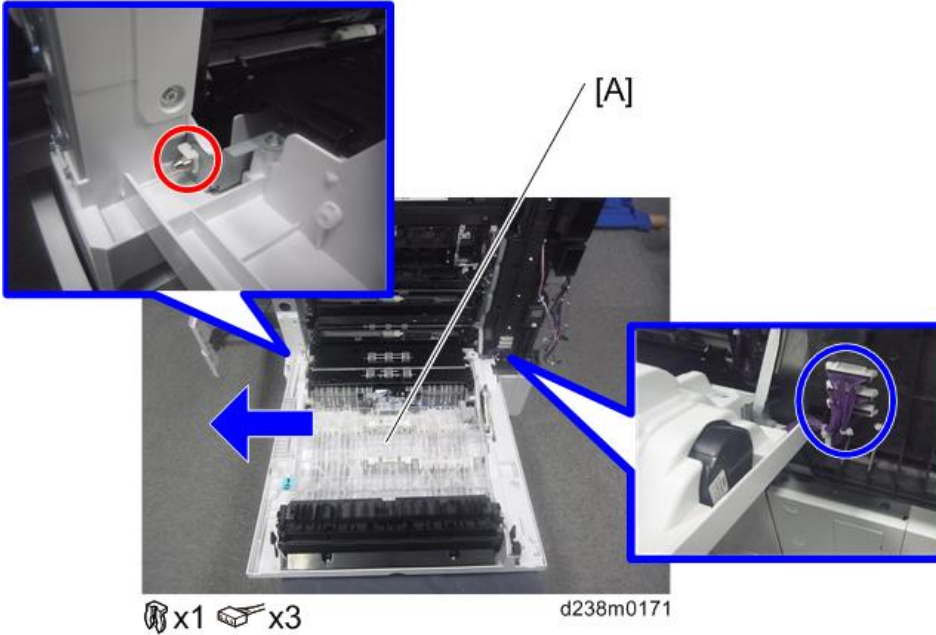

4

Duplex/Bypass Motor

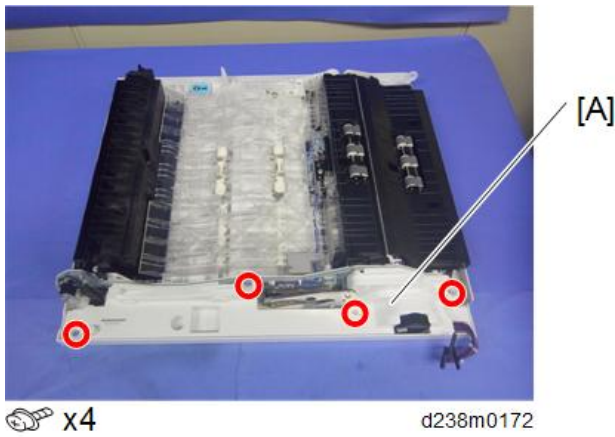

1. Duplex unit (page 591)

2. Harness guide [A]

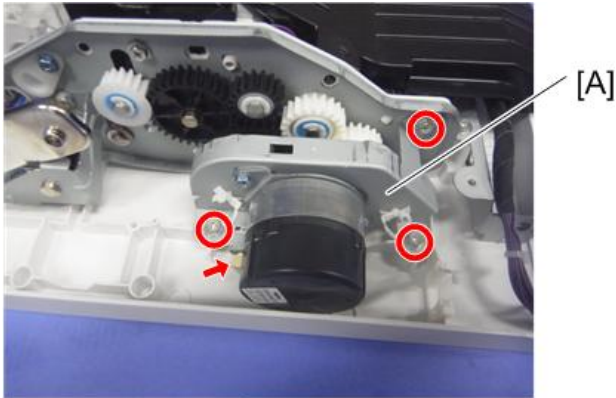

3. Duplex/Bypass motor unit [A]



 x3
  x1
  x3
 d238m0173

4

4. Duplex/Bypass Motor [A]

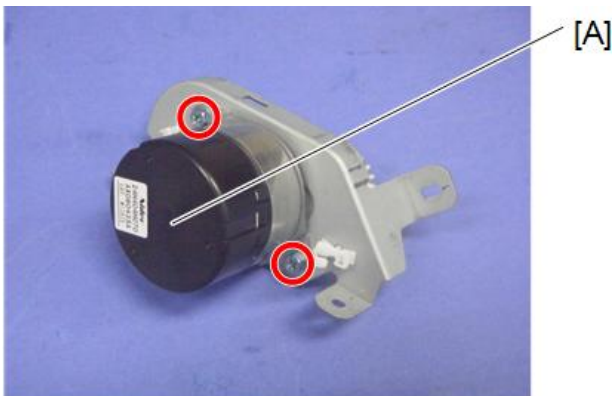

 x2
 d238m0174

Duplex Entrance Sensor

1. Remove two tabs, and remove the transport guide [A].

Note

- Make sure to release the tab on the right [C] first.
- When you reattach this part, make sure to attach it from the tab on the left [B] first.

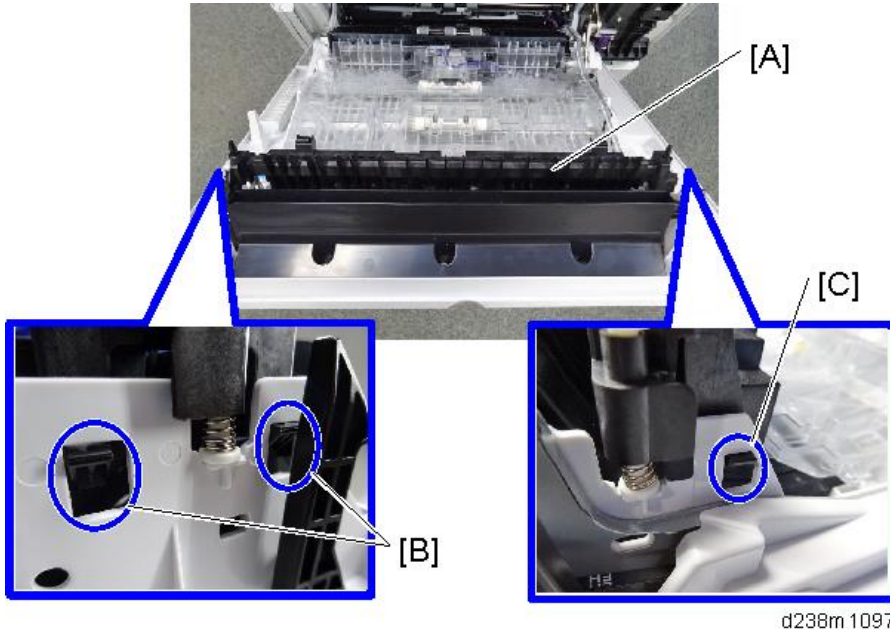

2. Duplex entrance unit [A]

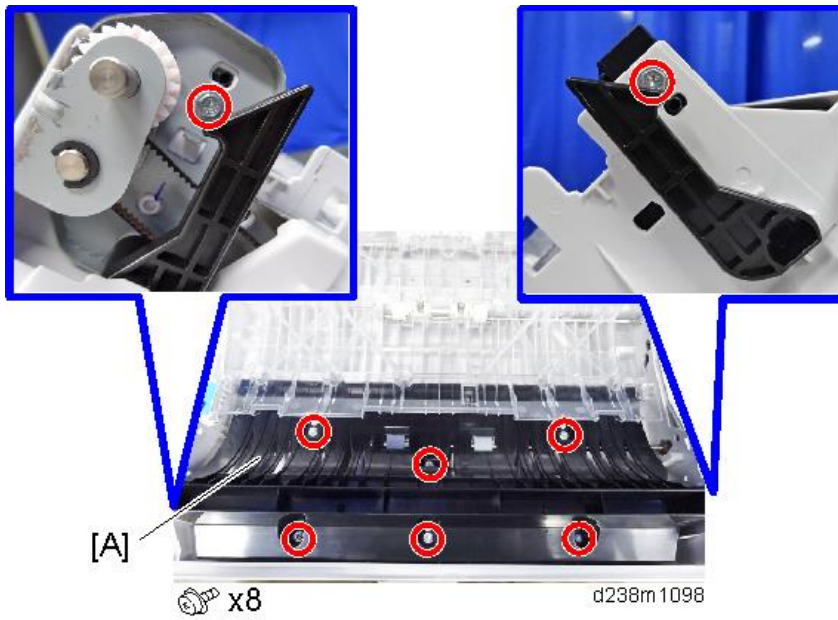

3. Duplex entrance sensor unit [A]

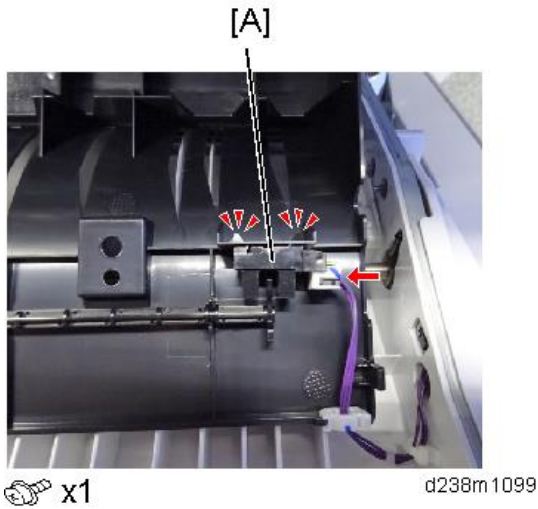

4

Duplex Exit Sensor

1. Duplex unit (page 591)
2. Harness guide [A]

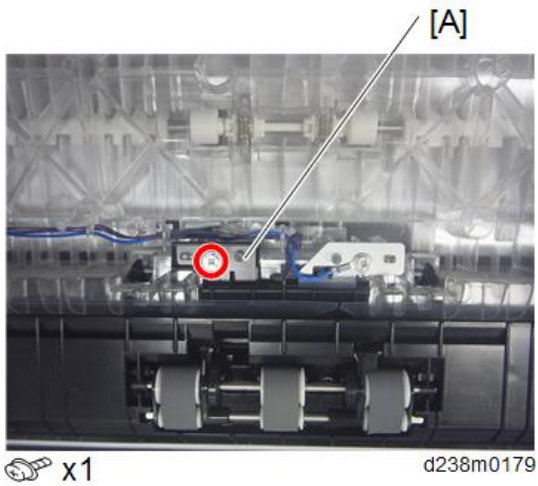

3. Duplex exit sensor unit [A]

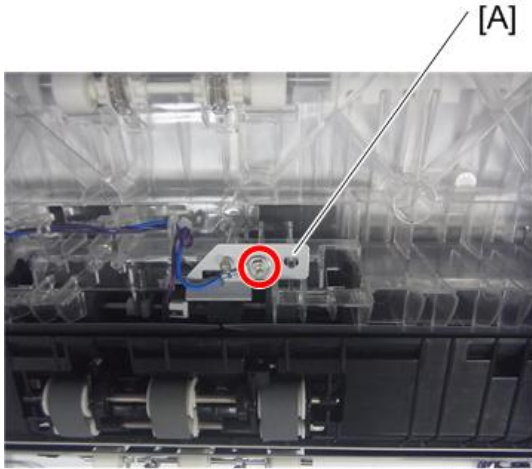

 x1  x1

d238m0180

4. Duplex exit sensor [A]

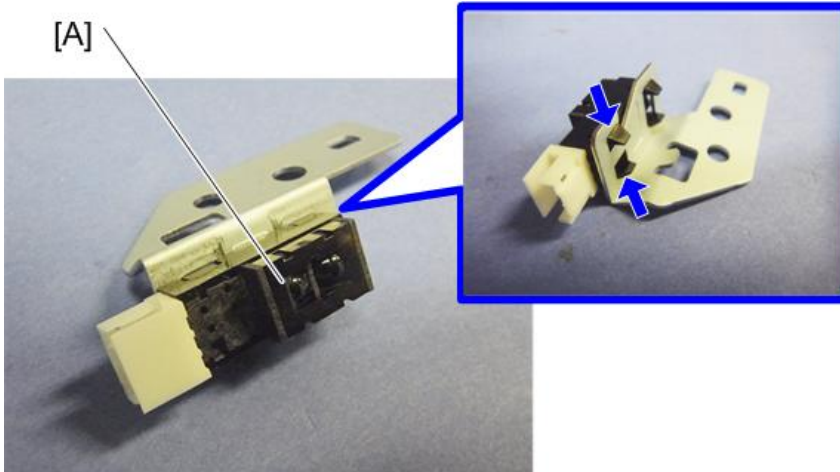

d238m0181

Electrical Components

⚠ CAUTION

- Before doing any work, touch a metal object to discharge static electricity from the body. There is a possibility that the electrical components may malfunction due to static electricity.
- When disconnecting the FFC, release the lock.
- [A]: Disconnect the scanner FFC for the IPU while pressing the lock release button.
- [B]: Disconnect the other FFC while pressing the lock release levers on its sides.

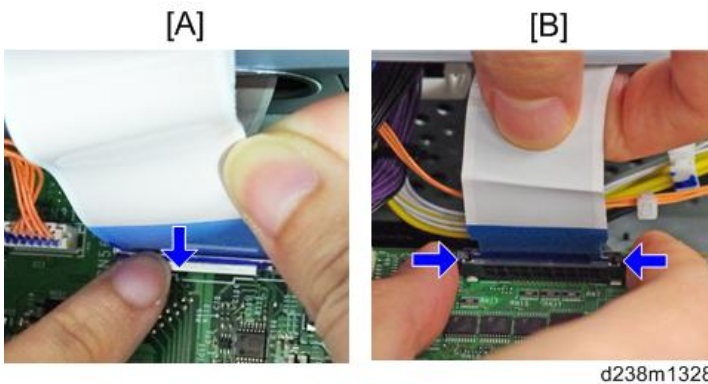

Overview

Printed Circuits/Parts inside the Controller Box

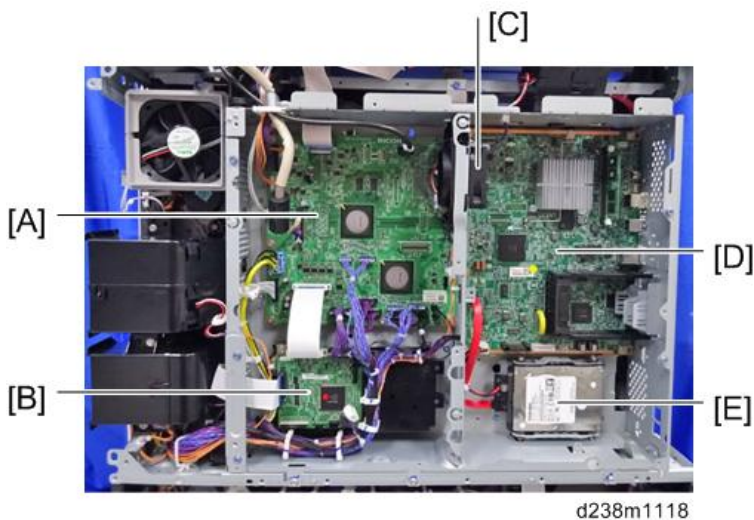

[A]	IPU
[B]	BCU
[C]	Controller Box Cooling Fan
[D]	Controller Board
[E]	HDD

Printed Circuits behind the Controller Box

4

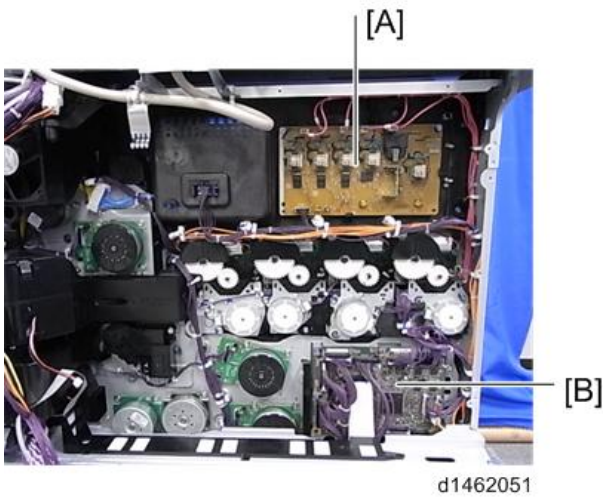

[A]	HVP_TTS
[B]	Imaging IOB

Printed Circuit/Parts inside the Power Box

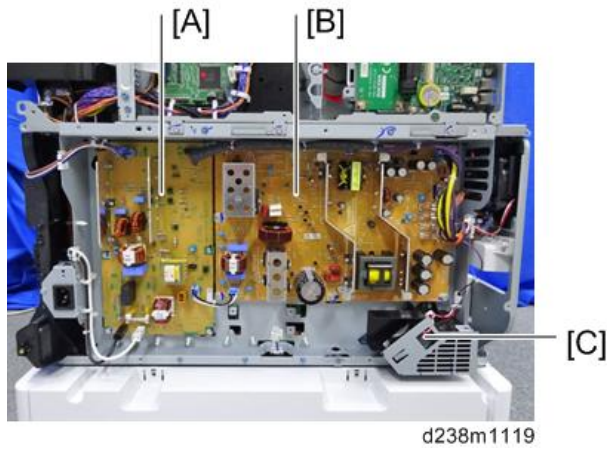

[A]	PSU (AC controller board)
[B]	PSU (DC Power)
[C]	PSU Cooling Fan

Printed Circuits behind the Power Box

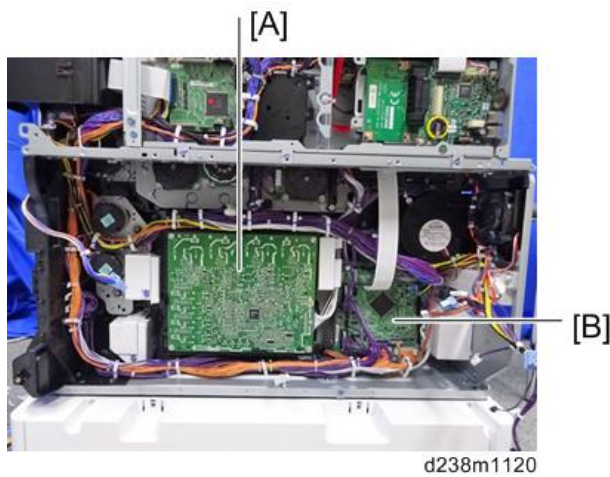

[A]	HVP_CB
[B]	Paper Transport IOB

Controller Box Cover

1. Rear cover (page 411)
2. Controller box cover [A].

Red circles: Remove / Blue circles: Loosen

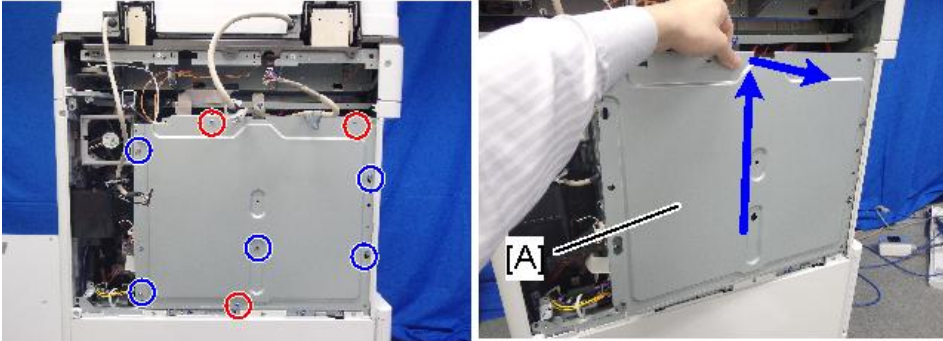

d238m0614

IPU

CAUTION

- The FFC connector has a lock mechanism. Do not use force to pull it out.

1. Controller box cover (page 600)
2. IPU [A]

Disconnect the upper FFC (scanner) while pressing the lock release button.

Disconnect the lower FFC while pressing the lock release levers on its sides.

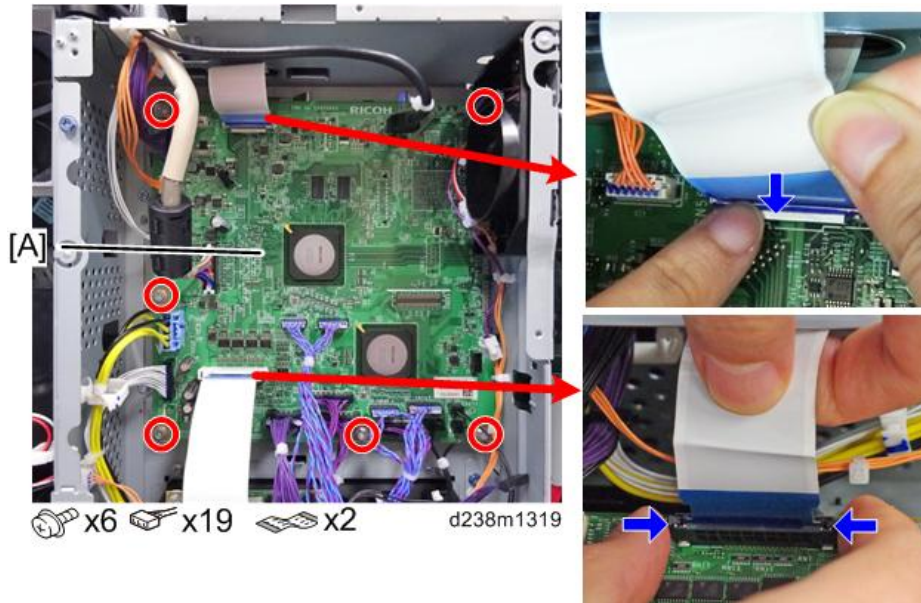

BCU

⚠ CAUTION

- The FFC connector has a lock mechanism. Do not use force to pull it out.

1. Controller box cover (page 600)
2. BCU [A]

Disconnect the FFCs while pressing the lock release levers on its sides. Disconnecting the FFC without releasing the lock may cause the FFC or connector to be damaged, resulting in an SC670 error.

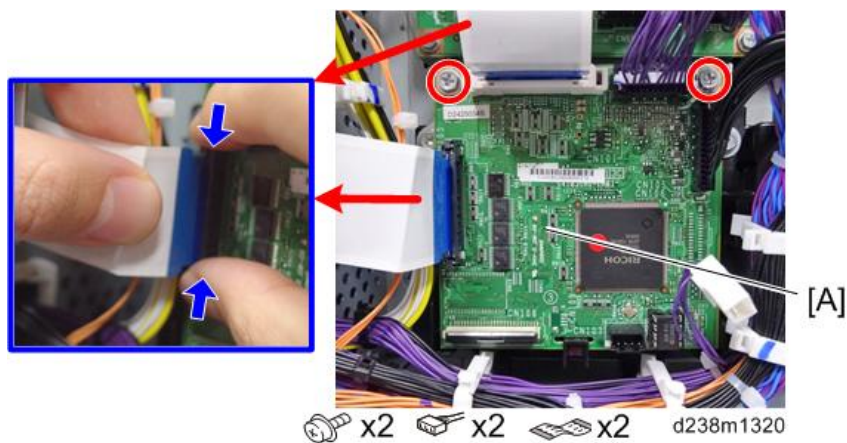

When installing the new BCU

Remove the NVRAM (EEPROM) [A] from the old BCU. Then install it on the new BCU after you replace the BCU.

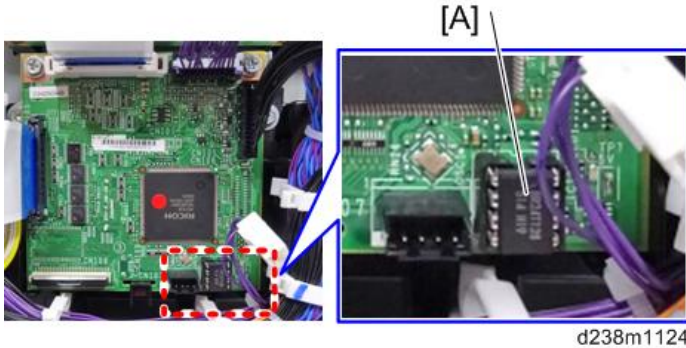

Replace the NVRAM (page 602) if the NVRAM on the old BCU is defective.

Note

- Make sure you print out the SMC reports ("SP Mode Data" and "Logging Data") before you replace the NVRAM (EEPROM).

CAUTION

- Keep NVRAMs (EEPROM) away from any objects that can cause static electricity. Static electricity can damage NVRAM data.
- Make sure the serial number is input in the machine for the NVRAM data with SP5-811-004, if not, SC995-001 occurs

Replacing the NVRAM (EEPROM) on the BCU

1. Make sure that you have the SMC report (factory settings). This report comes with the machine.
2. Output the SMC data ("ALL") using SP5-990-001/SP5-992-001.
Make sure to shut down and reboot the machine once before printing/exporting the SMC. Otherwise, the latest settings may not be collected when the SMC is printed/exported.
3. Turn OFF the main power switch.
4. Insert a blank SD card in the SD slot #2, and then turn ON the main power switch.
5. Use SP5-824-001 to upload the NVRAM data from the BCU.
6. Turn off the main power switch and unplug the power cord.
7. Replace the NVRAM on the BCU with a new one.

8. Plug in, and then turn on the main power switch.**Note**

- When the power is turned ON, SC195-00 appears, but continue with the following steps.

9. Select the destination setting. (SP5-131-001) (JPN: 0, NA: 1, EU/AA/TWN/CHN: 2)**10. Set the following SP, Machine Serial Set (SP5-811-001), Area Selection (SP5-807-001), and CPM Set (SP5-882-001).****Note**

- For information on how to configure this SP, contact the supervisor in your branch office.

11. Turn off the machine, and then turn it back on.**12. Use SP5-801-002 "Memory Clear Engine".****Important**

- After changing the EEPROM, Some SPs do not have appropriate initial values. Because of this, steps 10 to 12 are done.

13. Turn off the machine, and then turn it back on.**14. From the SD card where you saved the NV-RAM data in step 5, download the NV-RAM data (SP5-825-001).****15. Turn off the machine, and then remove the SD card from slot #2.****16. Turn on the main power switch.****17. Check the factory setting sheet and the SMC data printout from step 2, and set the user tool and SP settings so they are the same as before.****18. Do ACC (Copier function and Printer function).**

SP descriptions

- **SP5-811-004 (MachineSerial Set)**
Displays/Enters serial number of BCU EEPROM.
- **SP5-131-001 (Paper Size Type Selection)**
Sets the region setting for paper size/type.
(0: Japan, 1: NA, 2: EU/AA/TWN/CHN)
- **SP5-811-001 (MachineSerial)**
Displays machine serial number.
- **SP5-807-001 (Area Selection)**
Sets the machine destination.
(1: Japan, 2: NA, 3: EU, 4: Taiwan, 5: Asia, 6: China, 7: Korea)
- **SP5-801-002 (Memory Clear: Engine)**
Clears non-volatile memory of engine.

- **SP5-824-001 (NV-RAM Data Upload)**
Uploads the NVRAM data to an SD card.
- **SP5-825-001 (NV-RAM Data Download)**
Downloads data from an SD card to the NVRAM in the machine.

Controller Board

Note

- Keep NVRAMs away from any objects that can cause static electricity. Static electricity can damage NVRAM data.

1. **Controller cover (page 406)**
2. **Controller box cover (page 600)**
3. **Controller bracket [A]**

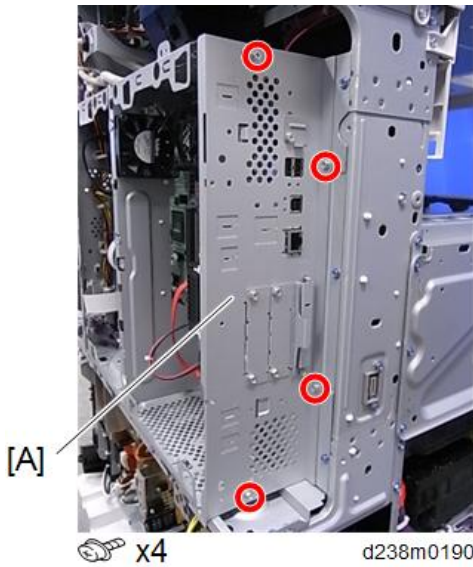

4. Controller Board [A]

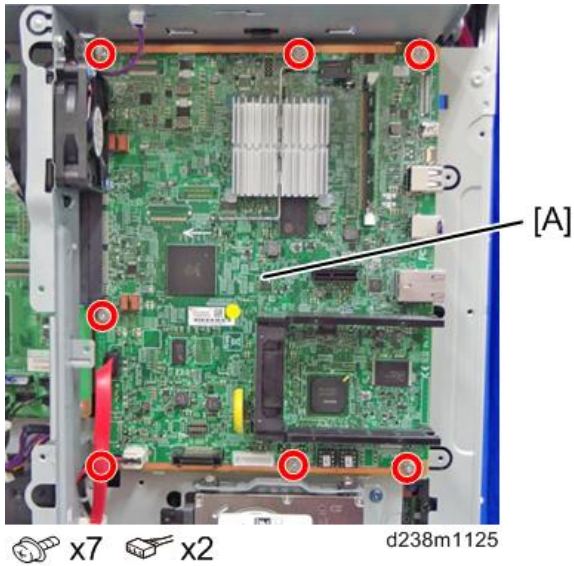

5. DIMM [A]

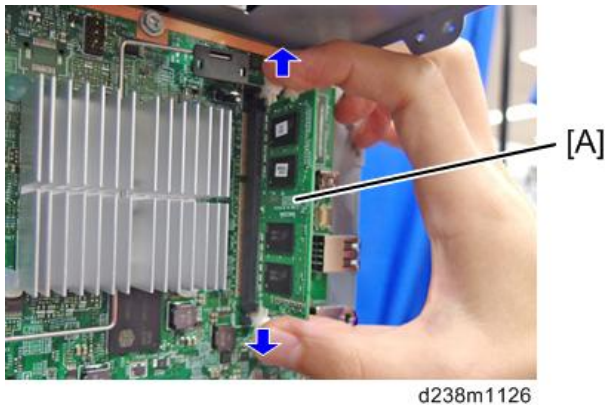

6. Remove the two used NVRAMs from the old controller board and install them on the new controller board.

⚠ CAUTION

- Make sure that the FRAM 1 and FRAM2 are placed at the right position and orientation when attaching to the new board.
- Incorrect installation of the NVRAM will damage both the controller board and NVRAM.

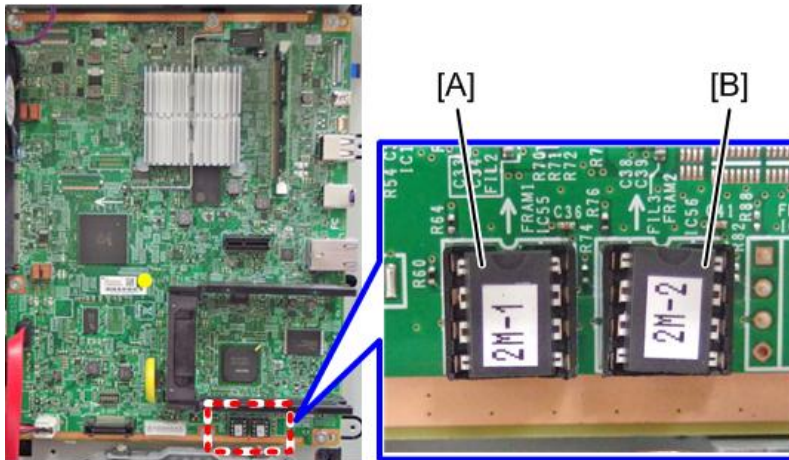

d238m1382

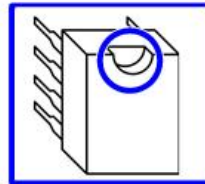

	Position	Label on the board	Label on the NVRAM
[A]	Left	FRAM1	2M-1
[B]	Right	FRAM2	2M-2

- When replacing the controller board, first, check which SDK applications have been installed. After replacing the controller board, re-install the SDK applications by following the installation instructions for each application.
- After reinstalling the SDK applications, print the SMC (SP-5-990-024/025 (SMC: SDK/ Application Info)). Then open the front upper cover. Store the SMC sheet and the SD card(s) that was used to install the SDK application(s).

Replacing the NVRAMs on the Controller Board

CAUTION

- Referring to the following procedure, be sure that there are no mistakes in the mounting position and orientation of the NVRAMs.
Incorrect installation of the NVRAM will damage both the controller board and NVRAM.
- SC195 (Machine serial number error) will be displayed if you forget to attach the NVRAM.
- Passwords for the Supervisor and Administrator 1 will be discarded later in this procedure.
- Installing a new NVRAM initializes SPs and issues an SC. Reset the SC with the procedure below.

Mounting position and orientation of the NVRAMs

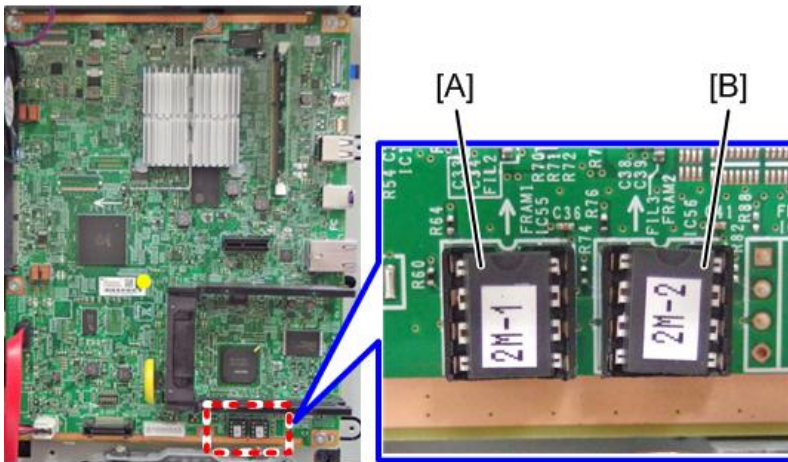

d238m1382

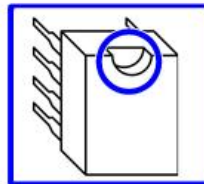

	Position	Label on the board	Label on the NVRAM
[A]	Left	FRAM1	2M-1
[B]	Right	FRAM2	2M-2

1. Make sure that you have the SMC report (factory settings). This report comes with the machine.
2. Output all the SMC data using SP5-990-001 (SP Print Mode: All (Data List)), or download the SMC data to an SD card using SP5-992-001 (SP Text mode: ALL (Data List))
Make sure to shut down and reboot the machine once before printing/exporting the SMC. Otherwise, the latest settings may not be collected when the SMC is printed/exported.
3. Turn the main power switch OFF.
4. Insert an SD card into Slot 2 and turn the main power switch ON.
5. Upload the NV-RAM data on the controller board to the SD card using SP5-824-001 (NV-RAM Data Upload).

6. Make sure that the customer has backed up their Address Book data. If they have not, save the Address Book data to an SD card using SP5-846-051 (Backup All Addr Book).

★ Important

- The address data stored in the machine will be discarded later during this procedure. So be sure to obtain a backup of the customer's address book data.
- Note that the counters for the user will be reset when doing the backup/restore of the address book data.
- If they have a backup of the address book data, use their own backup data for restoring. This is because there is a risk that the data cannot be backed up properly depending on the NV-RAM condition.

7. Do the following steps if the machine has the fax unit. If not, skip this step:

1. Print the Box List with the User Tools/Counter.
 - [User Tools/Counter] - [Facsimile Features] - [General Settings] - [Box Setting: Print List]
2. Print the Special Sender List by pressing these buttons in the following order.
 - [User Tools/Counter] - [Facsimile Features] - [Reception Settings] - [Program Special Sender: Print List]
3. Write down the following fax settings.
 - [Receiver] in [User Tools/Counter] - [Facsimile Features] - [Reception Settings] - [Reception File Settings] - [Forwarding].
 - [Notify Destination] in [User Tools/Counter] - [Facsimile Features] - [Reception Settings] - [Reception File Settings] - [Store].
 - [Specify User] in [User Tools/Counter] - [Facsimile Features] - [Reception Settings] - [Stored Reception File User Setting].
 - [Notify Destination] in [User Tools/Counter] - [Facsimile Features] - [Reception Settings] - [Folder Transfer Result Report].
 - Specified folder in [User Tools/Counter] - [Facsimile Features] - [Send Settings] - [Backup File TX Setting].
 - [Receiver] in [User Tools/Counter] - [Facsimile Features] - [Reception Settings] - [Reception File Settings] - [Output Mode Switch Timer].
 - [Store: Notify Destination] in [User Tools/Counter] - [Facsimile Features] - [Reception Settings] - [Output Mode Switch Timer].
 - All the destination information shown on the display.

↓ Note

- In the fax settings, address book data is stored with entry IDs, which the system internally assigns to each data. The entry IDs may be changed due to re-assigning in backup/restore operations.

4. Make sure that there is no transmission standby file. If any standby file exists, ask the customer to delete it or complete the transmission.

8. Turn the power OFF and unplug the power supply cord.

9. Push the power switch ON again to discharge the residual charge.

10. Replace the NV-RAM with a brand-new one.

11. Turn the power ON with the SD card to which the NV-RAM data has been uploaded in Slot 2.

Note

- SC673 appears at start-up, but this is normal behavior. This is because the controller and the smart operation panel cannot communicate with each other due to changing the SP settings for the operation panel.

12. Change the SP settings for the operation panel.

If you switch the screen to enter the SP mode, SC995-02 is displayed. However, continue the following steps.

- SP5-748-101: (OpePanel Setting: Op Type Action Setting): Change bit 0 from 0 to 1.
- SP5-748-201: (OpePanel Setting: Cheetah Panel Connect Setting): Change the value from 0 to 1.

13. Change the Flair API SP values.

- SP5-752-001 (Copy FlairAPIFunction Setting): Change bit 0 from 0 to 1.
- SP1-041-001 (Scan:FlairAPI Setting): Change bit 0 from 0 to 1.
- SP3-301-001 (FAX:FlairAPI Setting) Change bit 0 from 0 to 1.

14. Cycle the power OFF/ON.

Note

- The model information is written on the NVRAM (Novita), so SC995-02 does not occur.
- Program/Change Administrator will be displayed in Japanese, but this is normal.

15. Enter the SP mode and specify the following settings manually.

- a. SP5-985-001 (Device Setting: On Board NIC) Change the value from 0 to 1.
- b. SP5-985-002 (Device Setting: On Board USB) Change the value from 0 to 1.

16. Turn OFF the main power, and then turn ON the main power with the SD card to which the NV-RAM data has been uploaded in Slot 2.

17. Download the NV-RAM data stored in the SD card to the brand-new NV-RAM using SP5-825-001 (NV-RAM Data Download).

Note

- The download will take a couple of minutes.

18. Turn the power OFF and remove the SD card from slot 2.

19. Turn the power ON.

The screen "Program/Change Administrator" will be displayed in the language that is the same language as the time when the data was uploaded to the SD card in step 5.

20. Execute SP5-755-002 (Hide Administrator Password Change Scrn).

After you execute this SP and exit SP mode, the Home screen is displayed and user functions can be used.

21. Check that the fax and scanner icons are displayed, and then change the following SP settings.

- a. SP5-193-001 (External Controller Info. Settings) Change the value from 0 to 1.
- b. SP5-895-001 (Application invalidation: Printer) Change the value from 0 to 1.
- c. SP5-895-002 (Application invalidation: Scanner) Change the value from 0 to 1.

22. If the security functions (e.g. Stored file encryption/ Auto Erase Memory Setting) were applied, set the functions again.**23. Ask the customer to restore their address book. Or restore the address book data using SP5-846-052 (UCS Setting: Restore All Addr Book), and ask the customer to ensure the address book data has been restored properly.****★ Important**

- If you obtained the backup of the customer's address book data in step 3, delete the backup immediately after the NV-RAM replacement to avoid accidentally taking out the customer's data.

24. Output all the SMC data with SP5-990-001 and make sure all the SP/UP settings except for counter information are properly restored, by checking the SMC data obtained in step 2.**↓ Note**

- The counters will be reset.

25. When equipped with fax, make sure that the list printed in steps 7-1 to 7-2 are the same as the sender information that you wrote down in step 7-3.

If the setting is different from the original setting after the replacement of the NVRAM, then set it again to the original setting.

26. Execute the process control (SP3-011-001).**27. Execute the ACC (Copy).****28. Execute the ACC (Printer).****29. Cycle the power OFF/ON.****★ Important**

- If you cannot execute SP5-824-001 or SP5-825-001 for some reason, try all the following things.

- Check the changed SP value on the SMC which was output in step 2 and set it manually. Especially, ensure that the values of the following SPs are same as the setting before the replacement.
 - a. SP5-045-001 (Accounting counter: Counter Method)
 - b. SP5-302-002 (Set Time: Time Difference)
- Because the PM counters have been reset during NV-RAM replacement, it is necessary to replace all the PM parts for proper PM management.

↓ Note

- If a message tells you need a SD card to restore displays after the NV-RAM replacement, create a "SD card for restoration" and restore with the SD card.

SP descriptions

- **5-846-051 (UCS Setting: Backup All Addr Book)**
Uploads all directory information to the SD card.
- **SP5-748-101 (OpePanel Setting: Op Type Action Setting)**
Sets the operation panel type.
0: Normal operation panel
1: Smart operation panel
- **SP5-748-201 (OpePanel Setting: Cheetah Panel Connect Setting)**
0: OFF
1: ON
- **SP5-752-001 (Copy: FlairAPIFunction Setting)**
Sets Copy FlairAPI Function enable / disable.
- **SP1-041-001 (Scan: FlairAPI Setting)**
Sets Scanner FlairAPI Function enable / disable.
- **SP3-301-001 (FAX: FlairAPI Setting)**
Sets Fax FlairAPI Function enable / disable.

Bit Switches for FlairAPI Settings

Bit	Item	0	1	Description	Initial value
0	Flair API Server Boot	Disabled	Enabled	Specifies whether to start the HTTP server for Flair API. "0" disables all the Flair API functions (Remote UI).	0

Bit	Item	0	1	Description	Initial value
1	Access Permission	Enabled	Disabled	Setting this value to "0" permits only internal access in the machine (MFP browser). Setting this value to "1" permits to access from external devices such as PC, Remote UI, IT-BOX.	0
2	Select IPv6/IPv4	IPv6	IPv4	Setting this value to "0" permits only accessing with IPv6. Setting this value to "1" permits accessing with IPv4 or IPv6.	0
3	Remote UI	Not use	Use	Sets whether to use the Remote UI.	0
4	Reserved	-	-	N/A	N/A
5	Reserved	-	-	N/A	N/A
6	Reserved	-	-	N/A	N/A
7	Reserved	-	-	N/A	N/A

- **SP5-985-001/002 (Device Setting: On Board NIC/On Board USB)**

The NIC and USB support features are built into the GW controller. Use this SP to enable and disable these features. In order to use the NIC and USB functions built into the controller board, these SP codes must be set to "1".

- **SP5-824-001 (NV-RAM Data Upload)**

Uploads the NVRAM data to an SD card.

- **SP5-825-001 (NV-RAM Data Download)**

Downloads data from an SD card to the NVRAM in the machine.

- **SP5-755-002 (Hide Administrator Password Change Scrn)**

Hides the input screen of the administrator password temporarily.

- **SP5-193-001 (External Controller Info. Settings)**

Sets the model of the external controller connected to the main unit.

0: External Controller is not installed

1: EFI

2: Ratio

3: Egret

4: GJ

5: Creo

6: QX-100

7: Kurofune

8 to 10: Reserved

- **SP5-846-052 (UCS Setting: Restore All Addr Book)**

Downloads all directory information from the SD card.

- **SP3-011-001 (Manual ProCon :Exe: Normal ProCon)**

Executes Process control.

- **SP5-045-001 (Accounting counter: Counter Method)**

Sets the counter methods as follows; Developments, Prints or Coverage.

- **SP5-302-002 (Set Time: Time Difference)**

Adjusts the RTC (real time clock) time setting for the local time zone.

Examples: For Japan (+9 GMT), enter 540 (9 hours x 60 min.)

Japan: +540 (Tokyo)

NA: -300 (New York)

EU: + 60 (Paris)

CHN: +480 (Beijing)

TWN: +480 (Taipei)

AA: +480 (Hong Kong)

KO: +540 (Korea)

HDD

↓ Note

- Before replacing the HDD, copy the address book data to an SD card with SP5846-051 if possible.
- If the customer is using the Data Overwrite Security, the Data Encryption feature or OCR Scanned PDF, these applications must be installed again.

1. Controller box cover (page 600)

2. HDD [A]

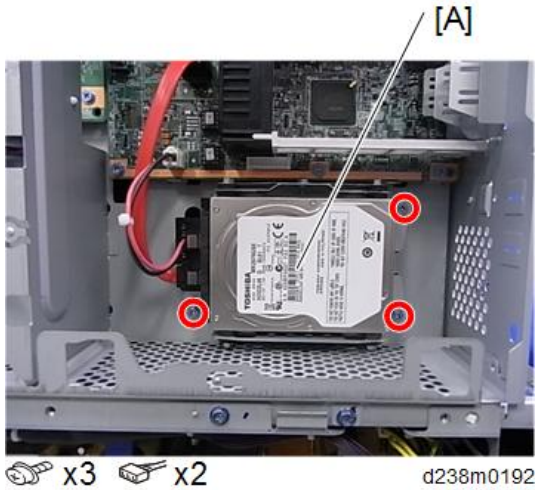

Adjustment after replacement

1. Run SP5-832-001, to initialize the hard disk.
Even if you use an HDD that is already formatted, it is recommended that you re-initialize.
2. Run SP5-853-001, to install the fixed stamps.
3. Run SP5-846-052, to copy the address book from the SD card to the HDD.
4. Turn off the machine, and then turn it back on.

SP descriptions

- **SP5-832-001 (HDD Formatting: HDD Formatting (ALL))**
Initializes the hard disk.
- **SP5-853-001 (Stamp Date Download)**
Downloads the fixed stamp data from the machine ROM onto the hard disk. Then these stamps can be used by the User Tools menu. If this is not done, the user will not have access to the fixed stamps ("Confidential", "Secret", etc.).
You must always execute this SP after replacing the HDD or after formatting the HDD.
- **SP5-846-052 (UCS Setting: Restore All Addr Book)**
Downloads all directory information from the SD card.

Controller Box

1. Controller cover (page 406)

2. Controller box cover (page 600)

3. Bracket [A]

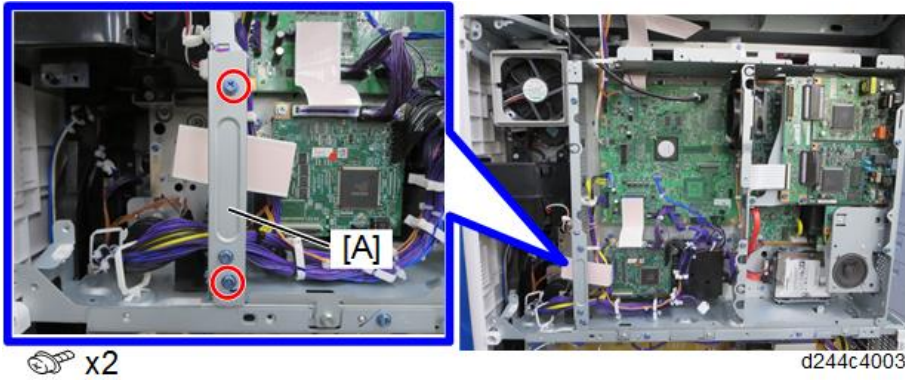

 x2

d244c4003

4. Controller box [A]

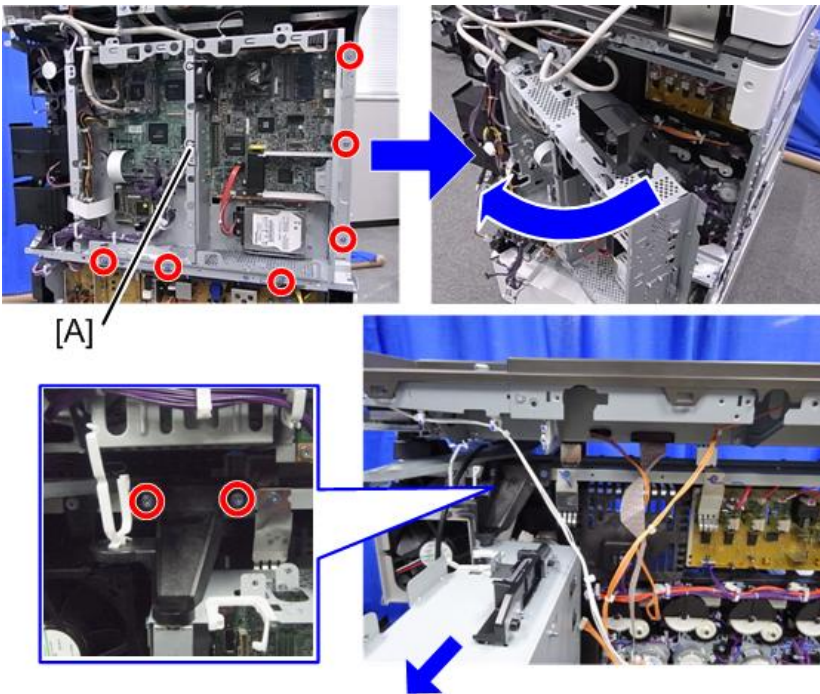

[A]

 x8  x21  x12  x2

d238m1108

Imaging IOB

1. Controller cover (page 406)

2. Controller box cover (page 600)

3. Disconnect the FFC [A] between IPU-Scanner Unit while pressing the lock release button.

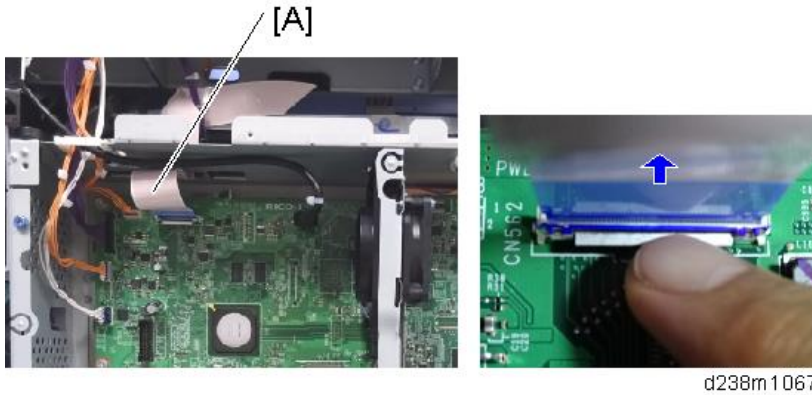

4

4. Open the controller box [A].

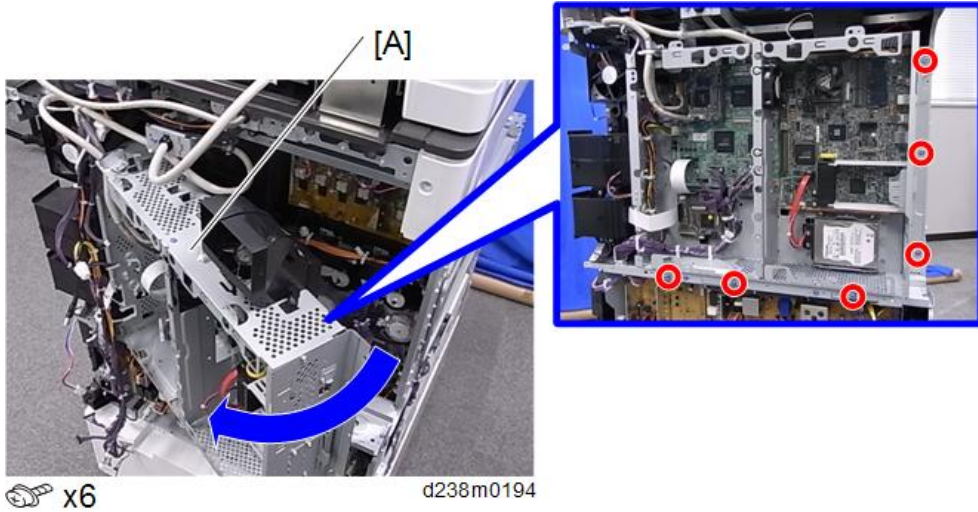

5. Imaging IOB [A]

Disconnect the FFC while pressing the lock release levers on its sides. Disconnecting the FFC without releasing the lock may cause the FFC or connector to be damaged, resulting in an SC670 error.

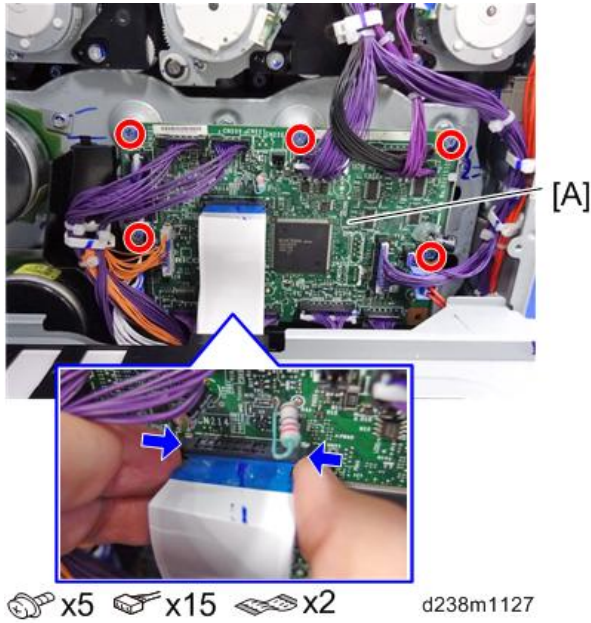

HVP_TTS

1. Controller cover (page 406)
2. Controller box cover (page 600)
3. Disconnect the FFC [A] between IPU-Scanner Unit while pressing the lock release button.

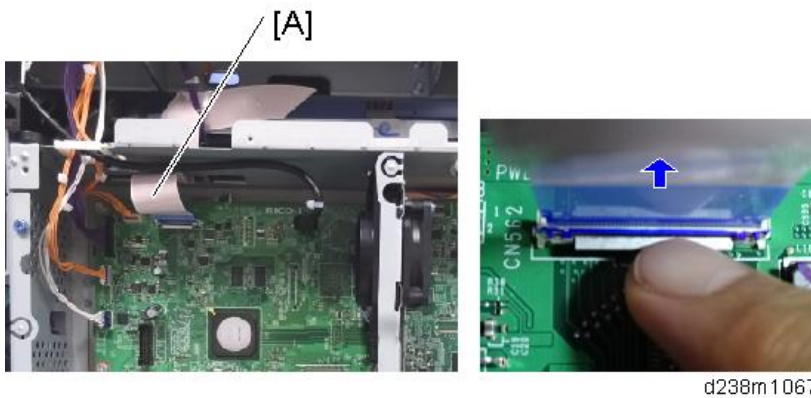

4. Open the controller box [A].

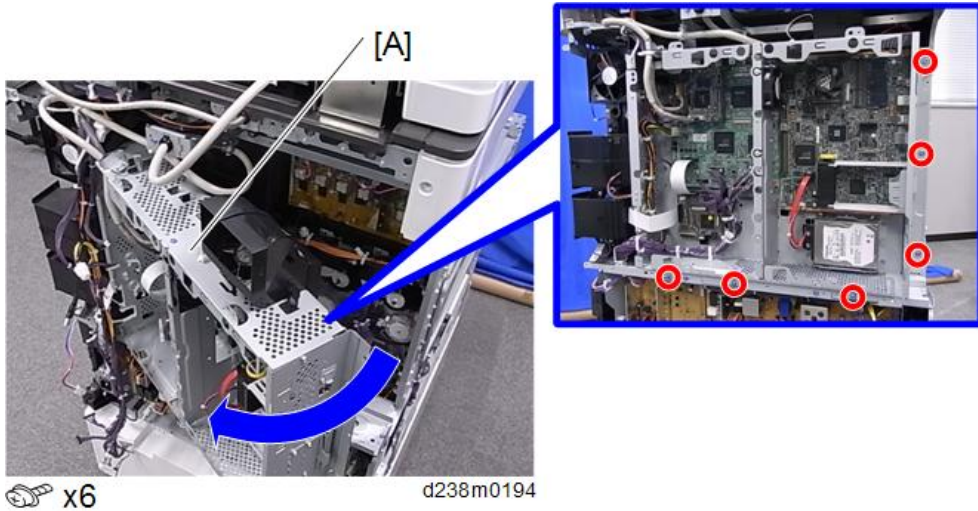

5. HVP_TTS [A]

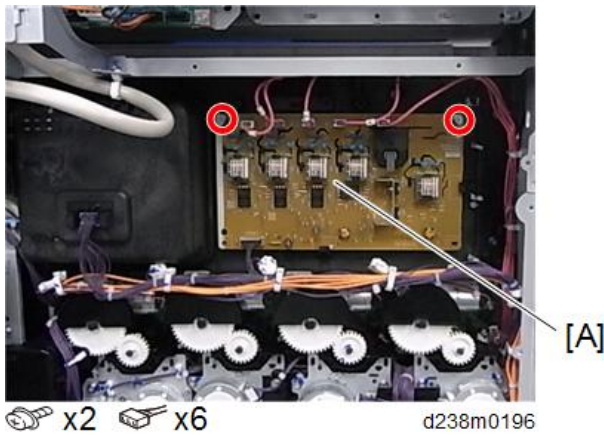

PSU (AC Controller Board)

⚠ CAUTION

- Turn off the main power switch and unplug the power cord before replacing the PSU.
- Do not touch the areas outlined in red in the following diagrams when replacing the PSU. Residual charge on the board may cause electric shock.

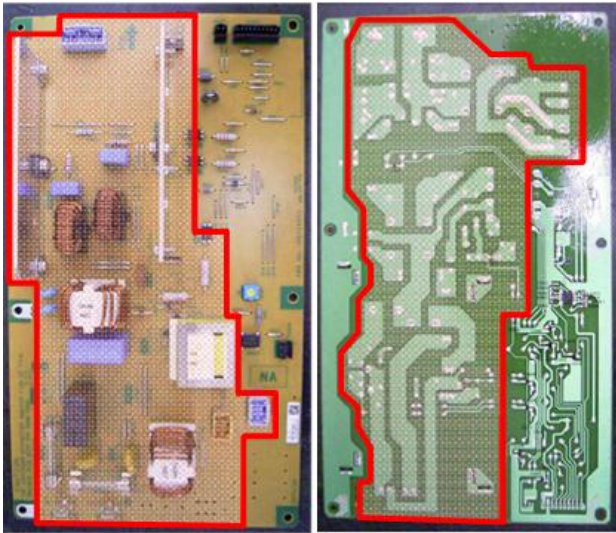

d238m1190

1. Rear lower cover (page 412)
2. PSU (AC Controller Board) [A]

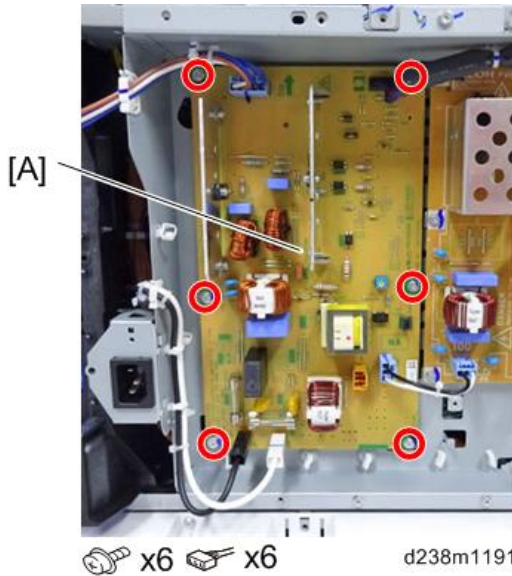

d238m1191

PSU (DC Power)

⚠ CAUTION

- Turn OFF the main power switch and unplug the power cord before replacing the PSU.

- Do not touch the areas outlined in red in the following diagrams when replacing the PSU. Residual charge on the board may cause electric shock.

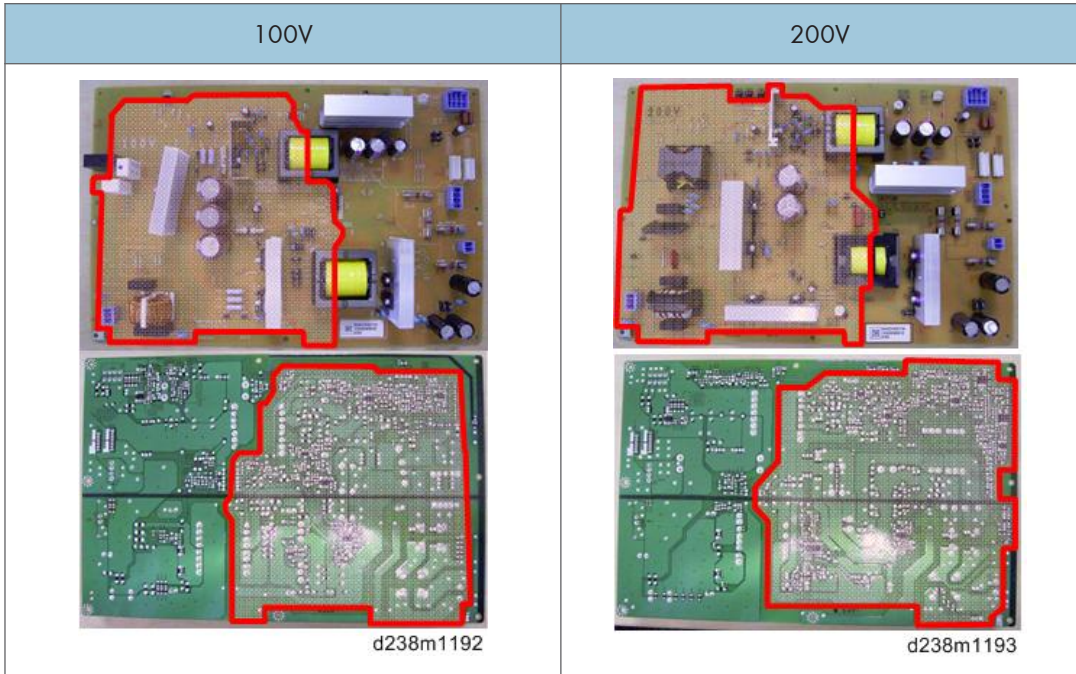

1. Rear lower cover (page 412)

2. PSU (DC Power) [A]

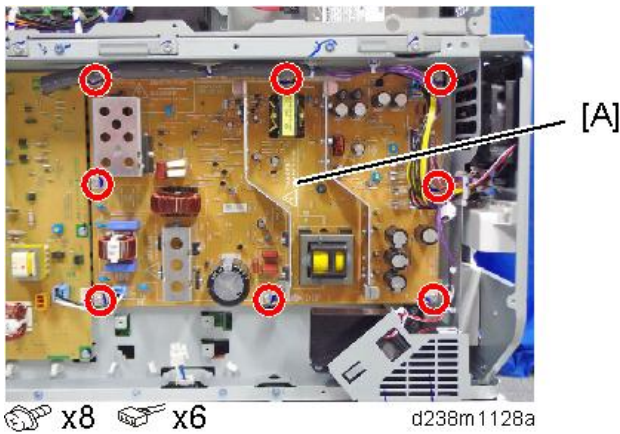

Power Supply Box

1. Rear lower cover (page 412)

2. Power supply box [A] (⚙️ x6, Among them, tapping screw x1)

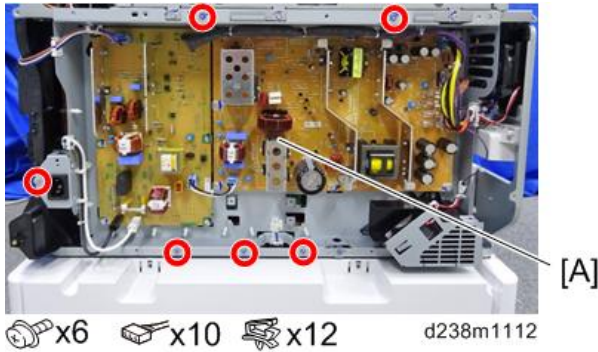

⬇️ Note

- You can hang the power box [A] on the machine by using 3 tabs.

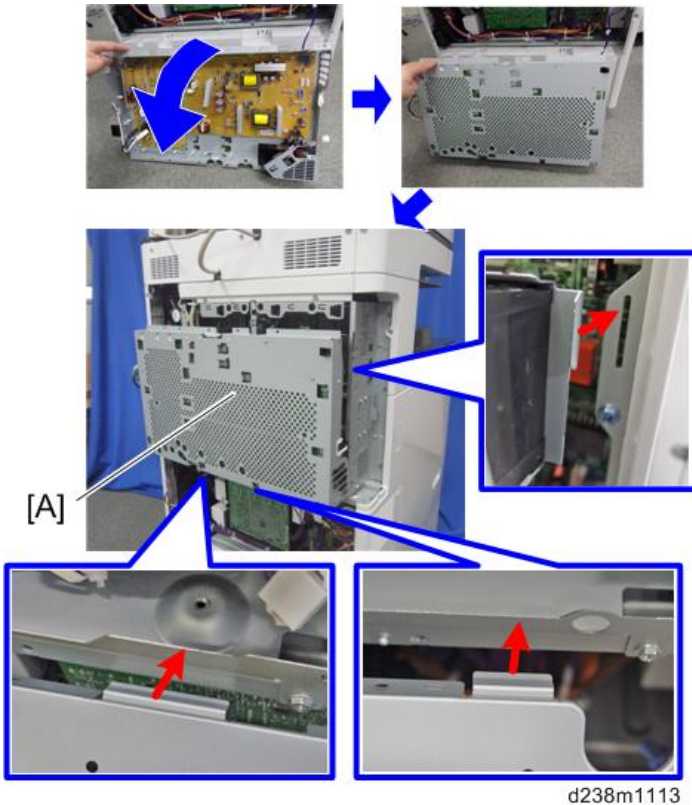

Paper Transport IOB

1. Power supply box (page 620)

2. Paper transport IOB [A]

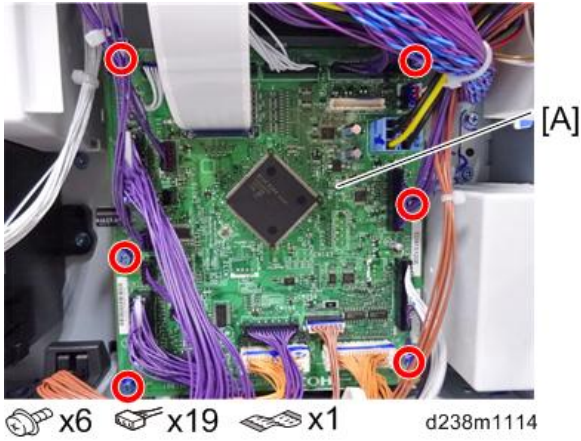

4

HVP-CB

1. Power supply box (page 620)
2. HVP_CB [A]

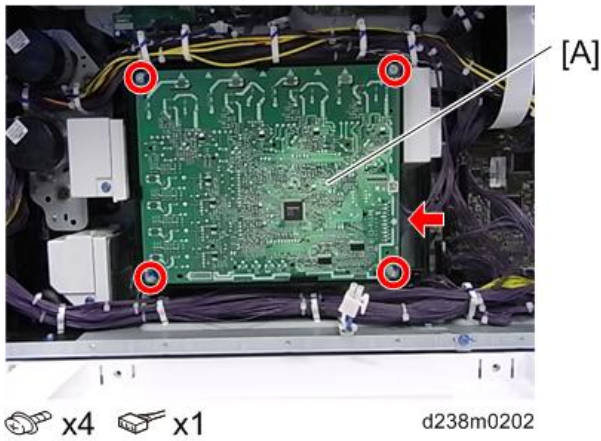

HVP-CB with Bracket

1. Power supply box (page 620)

2. Release the 5 clamps.

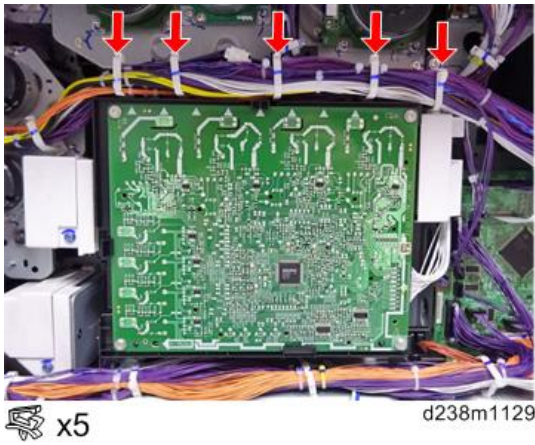

3. Remove the HVP-CB with bracket [A] (Tab x2)

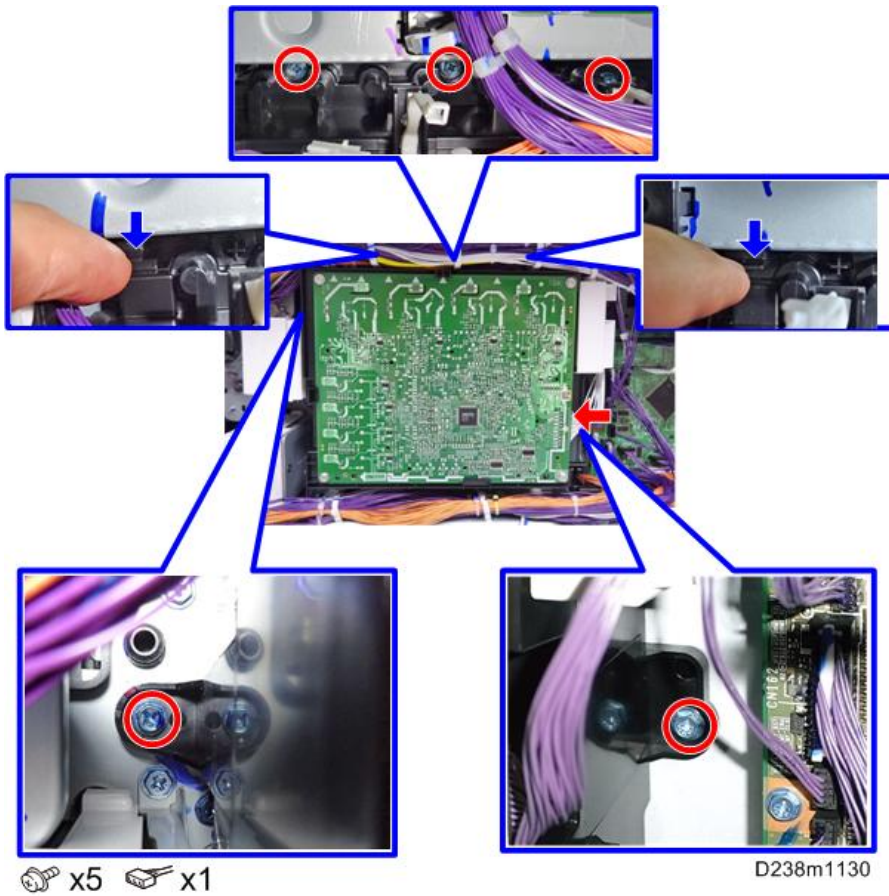

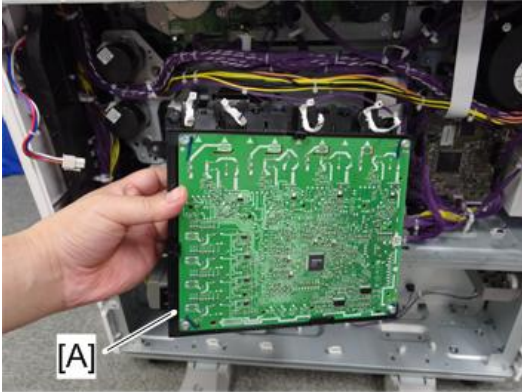



d146z0087

4

Proximity Sensor (Human Detection Sensor) Board

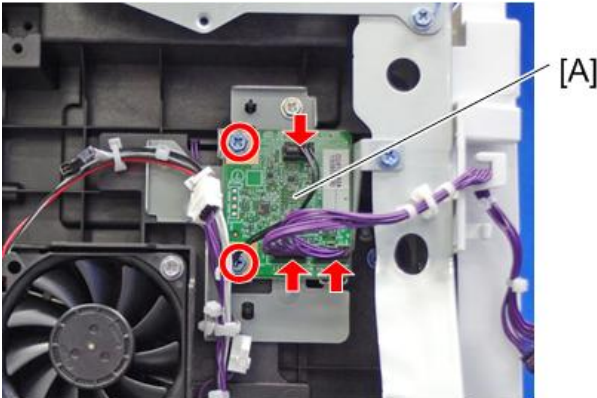
1. Front upper cover (page 413)
2. Proximity sensor (Human detection sensor) board [A].



 x2  x3

d238m1197

Fans/ Filters

Ozone filter/Dust filter

Adjustment before Replacing the Dust Filter

Before replacing the Dust filter, set SP3-701-132 to "1" and switch the power OFF. Then replace the Dust filter and switch the power ON.

Replacement

4

1. Pull out the ozone filter and dust filter box [A].

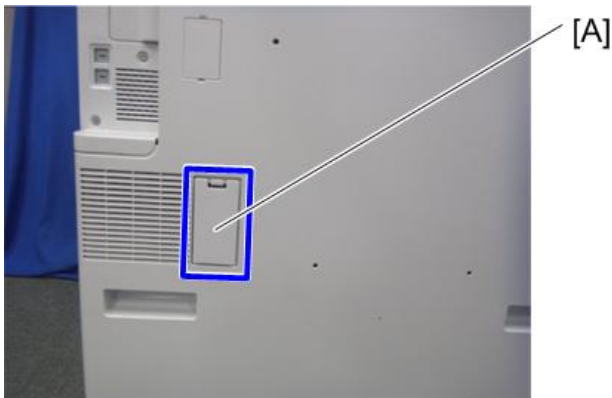

d1462031

2. Ozone filter [A], Dust filter [B]

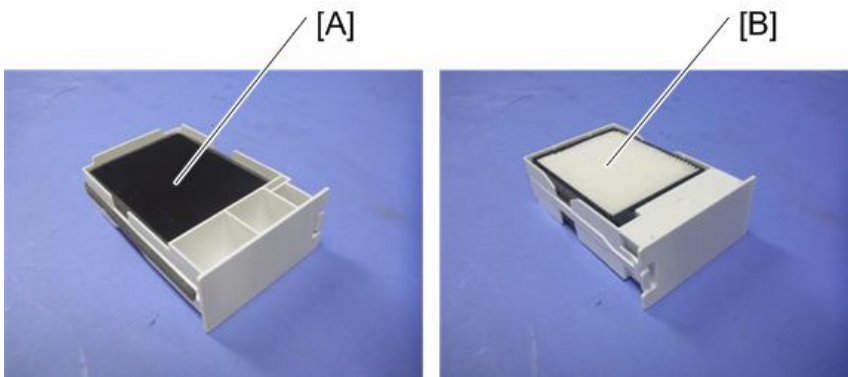

d1462032

★ Important

- When attaching the ozone filter and dust filter unit to the machine, attach it by pressing the area below its center [A]. Attaching it by pressing the area above the center may cause incomplete attachment.

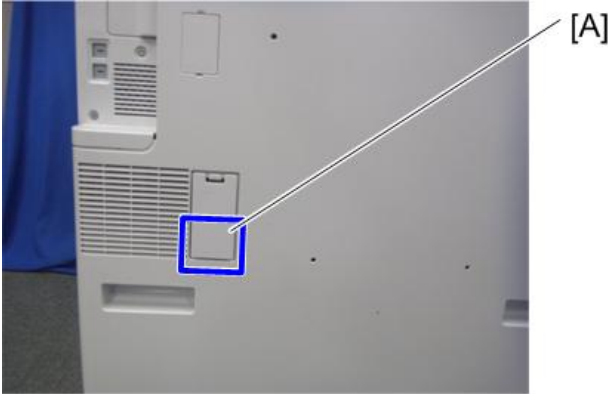

d1464011

Deodorization Filter

1. Deodorization filter box [A]

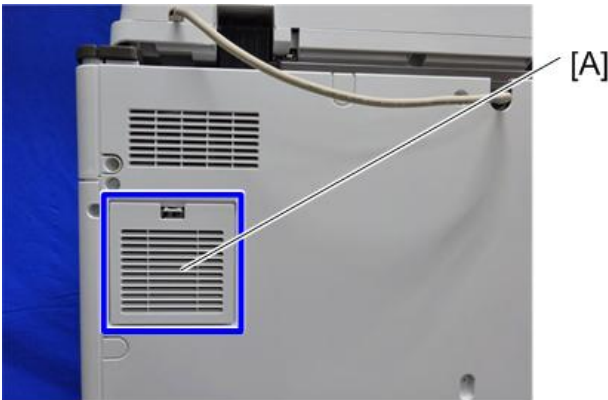

d238m1115

2. Deodorization filter [A]

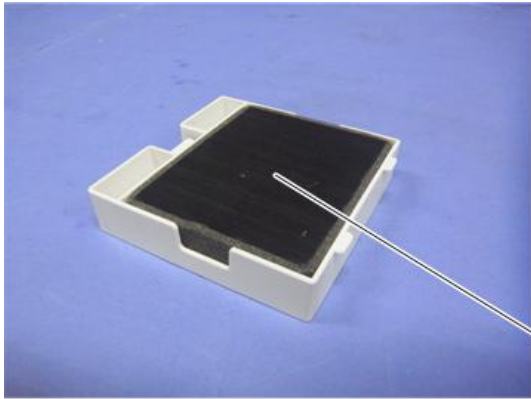

[A]

d1462034

4

Development Intake Fan

1. Inner lower cover (page 421)
2. Development intake fan unit [A]

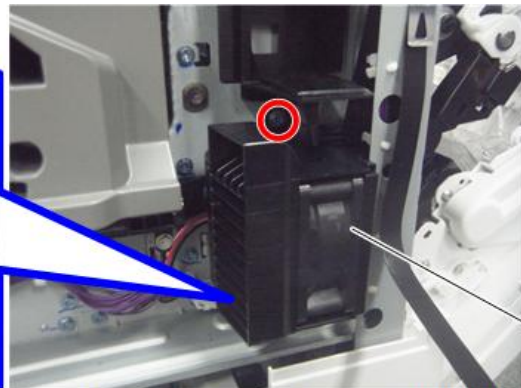

[A]

 x2  x1  x1

d238m0203

3. Development intake fan [A]

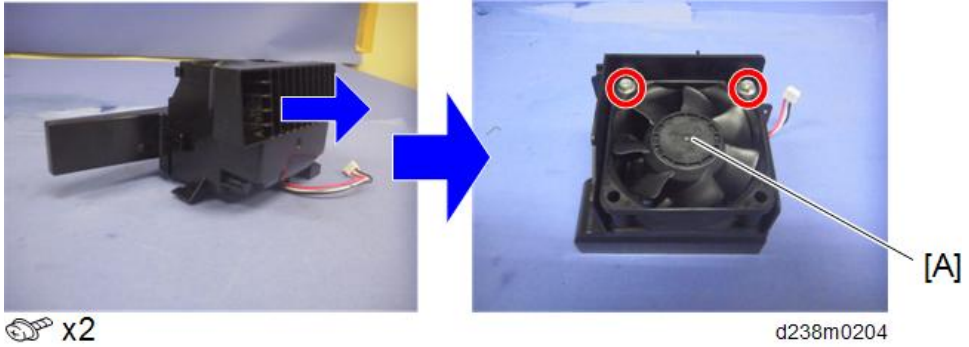

Ozone Exhaust Fan

1. Power supply box (page 620)
2. Ozone exhaust fan [A]

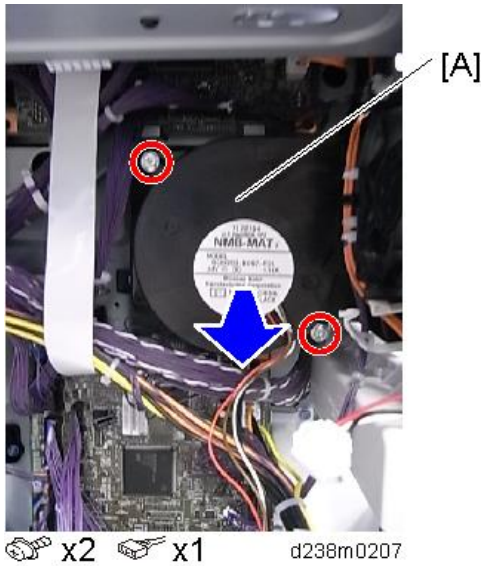



Paper Exit Cooling Fan

1. Front upper cover (page 413)

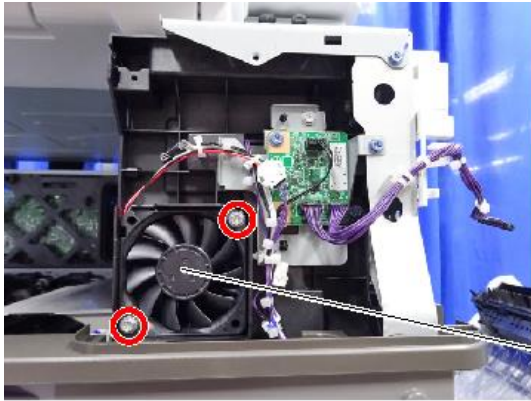
2. Paper exit cooling fan [A]



 x2
  x1
  x2

d238m1117

[A]

4

Fusing Exhaust Fan

1. Rear cover (page 411)
2. Right rear cover (page 412)
3. Fusing exhaust fan unit [A]

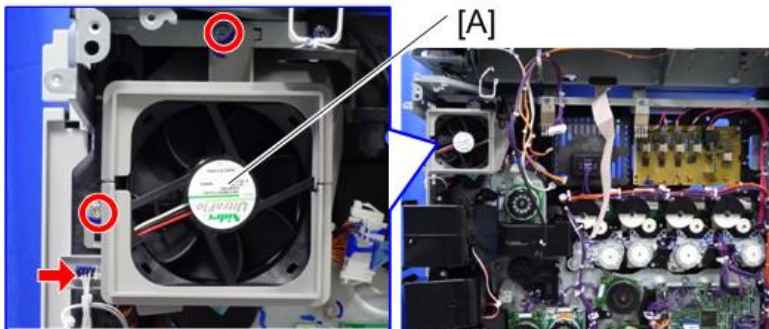

 x2
  x1

d238m1110

[A]

4. Fusing exhaust fan [A]

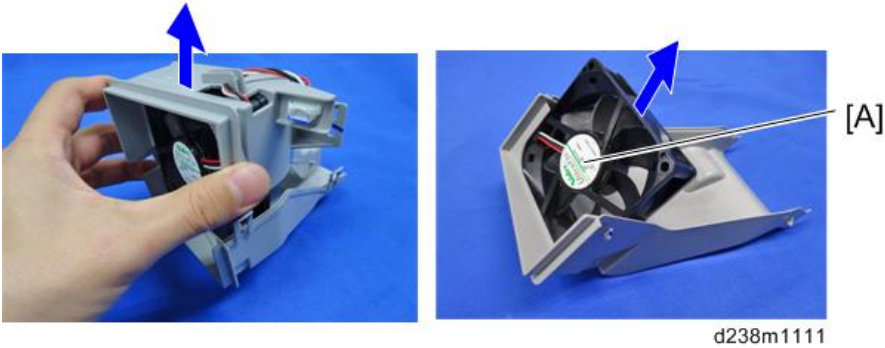

4

Toner Supply Cooling Fan

1. Rear cover (page 411)
2. Right rear cover (page 412)
3. Toner supply cooling fan unit [A]

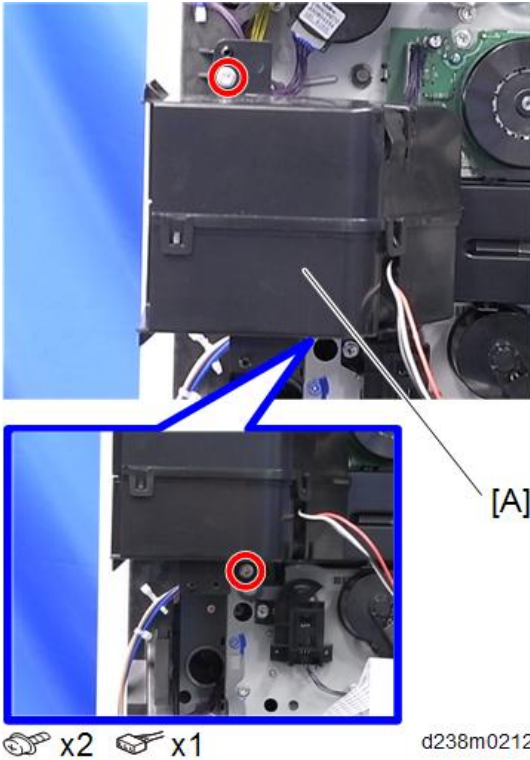

4. Toner supply cooling fan [A]

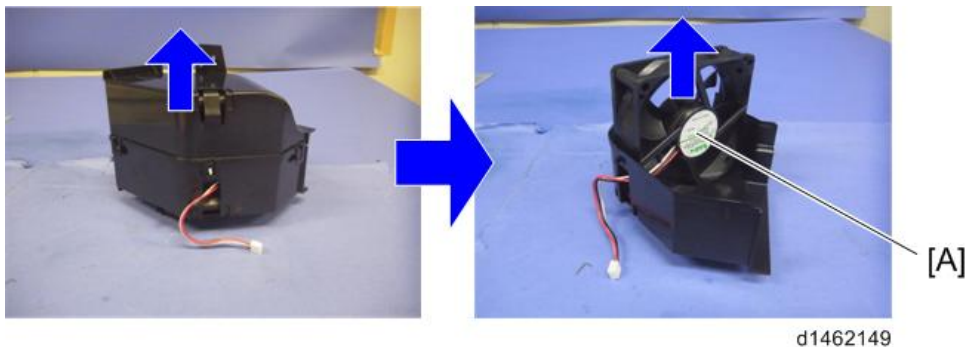

PSU Cooling Fan

4

1. Rear lower cover (page 412)
2. PSU cooling fan unit [A]

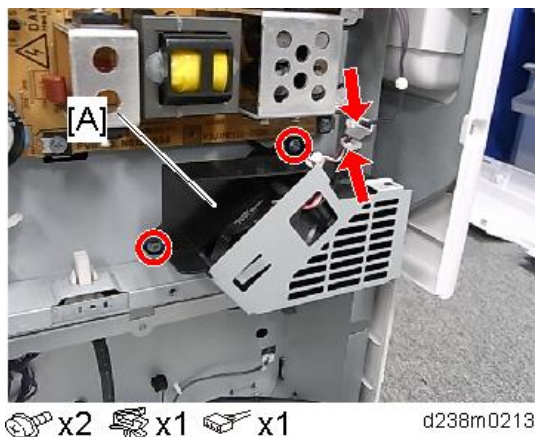

3. PSU cooling fan [A]

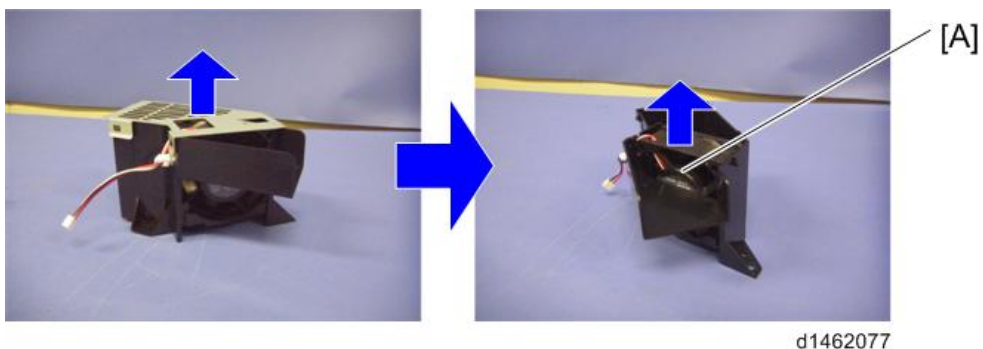

Controller Box Cooling Fan

1. Controller box cover (page 600)
2. Controller box cooling fan [A]

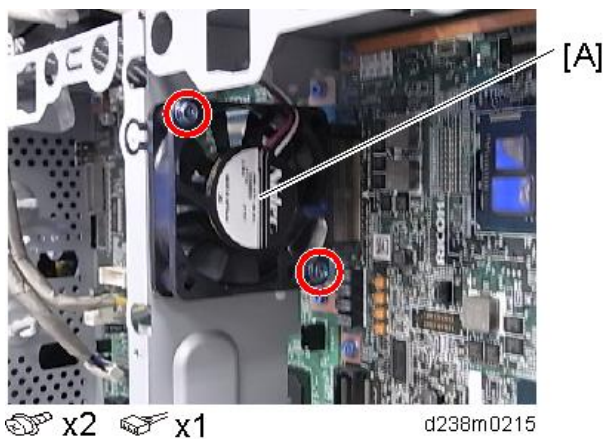

Image Adjustment

Auto Color Calibration

For the best image quality, this is done during installation, and should be done periodically by the customer. It is accessed with the user tools as follows.

User Tools -> Machine Features -> Maintenance -> Auto Color Calibration

Note

- When you set the adjustment sheet on the exposure glass, put about 10 pieces of white paper on the adjustment sheet in order for the original to contact the exposure glass sufficiently. Instruct the customer to periodically execute the ACC.

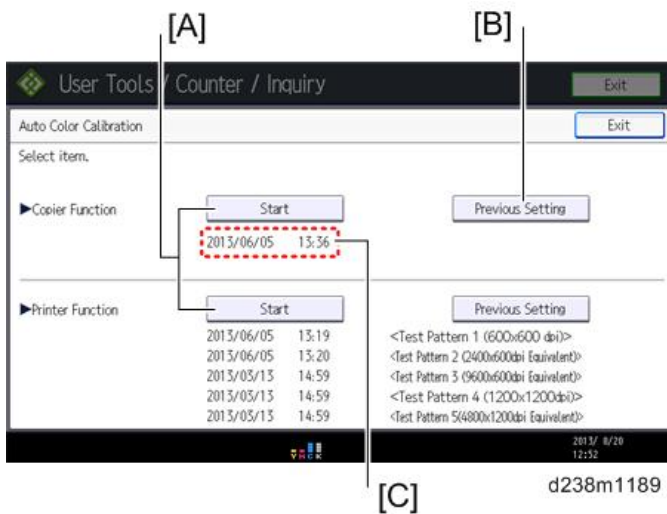

	Description
[A]	Output adjustment sheets. You must execute both for copy and printer functions.
[B]	Roll back to the previous value.
[C]	Displays the last date/time ACC was executed.

About the printer ACC

It is difficult to keep constant printing density due to the environment of the machine, individual differences between devices, and the passage of time. The printer ACC reads the current printing density using the scanner, and then compares the result with the time when it was in a normal state, and makes the printing density close to the normal state.

Issues possibly solved by the printer ACC

- When the printed image looks strongly red, blue, or yellow because the density of the cyan, magenta, and yellow are not balanced.



Image on the monitor

The color of the printed image is unbalanced.

d238m1354

- When the printed image looks too dark or light.



Image on the monitor

The printed image is too dark.

The printed image is too light.

d238m1355

Issues cannot be solved by the printer ACC

The tone differences from other types of machine or machines of other manufactures cannot be solved by the printer ACC. The tone differences from the machines of other manufactures occur due to the differences in color reproduction caused by the difference in the engine and color profile specifications so it may not be solved even after performing the printer ACC.

Refer to page 648 "Adjustment by Changing the Machine's Profile Setting" for the color tone differences from the other types of the machine.

Scanning

Check the printing registration/side-to-side adjustment and the blank margin adjustment before you do the following scanner adjustments.

Note

- Use a C4 test chart to do the following adjustments.

Scanner Sub-scan Magnification

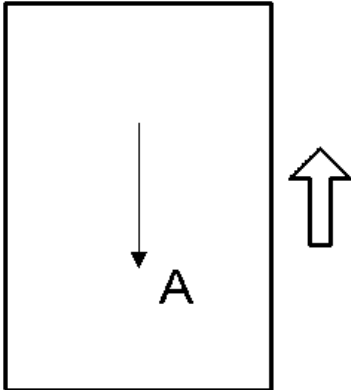

4

A: Sub-scan magnification

1. Put the test chart on the exposure glass. Then make a copy from one of the feed stations.
2. Check the magnification ratio. Adjust with SP4-008 if necessary.
Standard: $\pm 1.0\%$.

Scanner Leading Edge and Side-to-side Registration

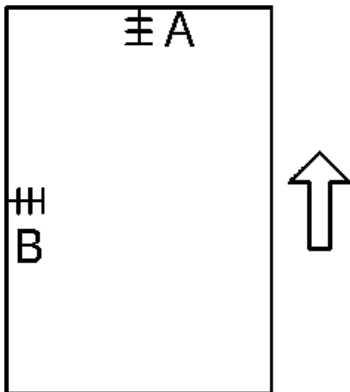

A: Leading Edge Registration

1. Put the test chart on the exposure glass. Then make a copy from one of the feed stations.
2. Check the leading edge and side-to-side registration. Adjust the following SP modes if necessary.
Standard: $0 \pm 2\text{mm}$ for the leading edge registration, $0 \pm 2.5\text{mm}$ for the side-to-side registration.

What It Does	SP code
Leading edge registration (Home Position Adj Value)	SP4-803-001
Side-to-Side Registration (Main Scan Reg)	SP4-011-001

ARDF

ARDF Side-to-side, Leading Edge Registration and Trailing Edge

4

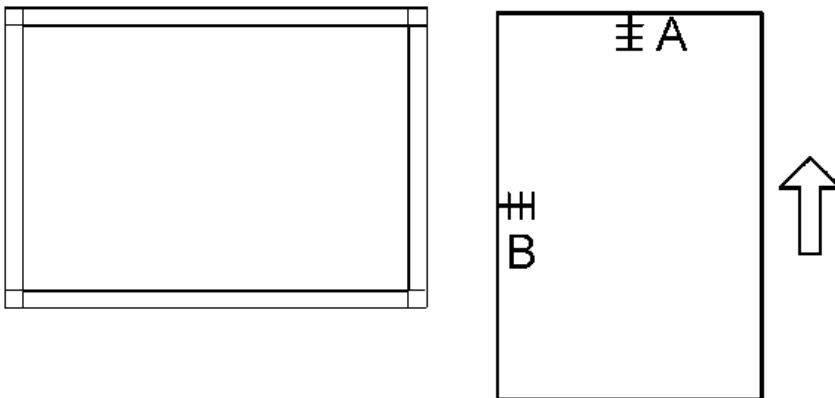

A: Leading edge registration

Use A3/DLT paper to make a temporary test chart as shown above.

1. Put the temporary test chart on the ARDF. Then make a copy from one of the feed stations.
2. Check the registration. Check the leading edge and side-to-side registration. Adjust the following SP modes if necessary.

Standard: 4.2 ± 2 mm for the leading edge registration, 2 ± 1 mm for the side-to-side registration. Use the following SP modes to adjust if necessary.

SP Code	What It Does	Adjustment Range
SP6-006-001	Side-to-Side Regist: Front	± 3.0 mm
SP6-006-003	Leading Edge Registration	± 5.0 mm
SP6-006-005	Buckle: Duplex Front	± 3.0 mm
SP6-006-006	Buckle: Duplex Rear	± 2.5 mm
SP6-006-007	Rear Edge Erase (Trailing Edge)	± 10.0 mm

ARDF Sub-scan Magnification

1. Put the temporary test chart on the ARDF. Then make a copy from one of the feed stations.
2. Check the magnification ratio. Adjust with SP6-017-001 if necessary.
 - Standard: $\pm 5.0\%$
 - Reduction mode: $\pm 1.0\%$
 - Enlargement mode: $\pm 1.0\%$

Registration

Image Area

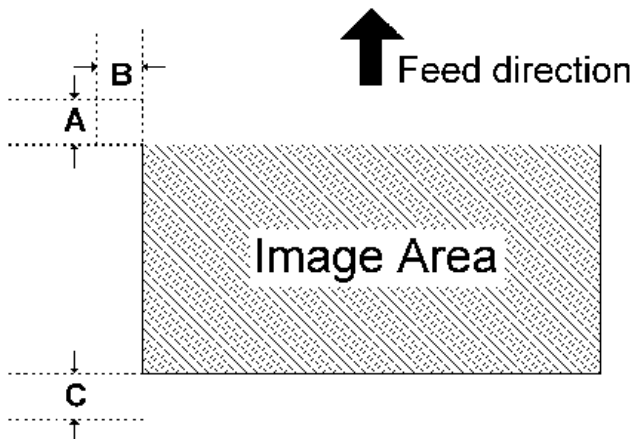

$A = C = 5.2 \text{ mm (0.2")}$, $B = 2.0 \text{ mm}$

Make sure that the registration is adjusted within the adjustment standard range as shown below.

Leading Edge

Adjusts the leading edge registration for each paper type and process line speed.

Side to Side

Adjusts the side-to-side registration for each paper feed station. Use SP mode (SP1-002) to adjust the side-to-side registration for the optional paper feed unit, LCT, and duplex unit.

Adjustment Standard

- Leading edge (sub-scan direction): 5.2 ± 2 mm
- Side to side (main-scan direction): 2 ± 1 mm

Paper Registration Standard

The registration in both main- and sub-scan directions can change within the following tolerance.

- Sub-scan direction: 0 ± 9 mm
- Main-scan direction: 0 ± 4 mm

4

Adjustment Procedure

1. Enter SP2-109-003.
2. Print out the test pattern (14: Trimmed area) with SP2-109-003.

↓ Note

- Registration can change slightly as shown on the previous page. Print some pages of the "14: Trimmed area" for step 3 and 4. Then average the leading edge and side-to-side registration values, and adjust each SP mode.
3. Do the leading edge registration adjustment.
 - 1) Check the leading edge registration and adjust it with SP1-001.
 - 2) Select the adjustment conditions (paper type and process line speed).
 - 3) Input the value. Then press the \oplus key.
 - 4) Generate a trim pattern to check the leading edge adjustment.
 4. Do the side-to-side registration adjustment.
 - 1) Check the side-to-side registration and adjust it with SP1-002.
 - 2) Select the adjustment conditions (paper feed station).
 - 3) Input the value. Then press the \oplus key.
 - 4) Generate a trim pattern to check the leading edge adjustment.

Erase Margin Adjustment

↓ Note

- Adjust the erase margin C and D only if the registration (main scan and sub scan) cannot be adjusted within the standard values. Do the registration adjustment after adjusting the erase margin C and D, and then adjust the erase margin A and B.

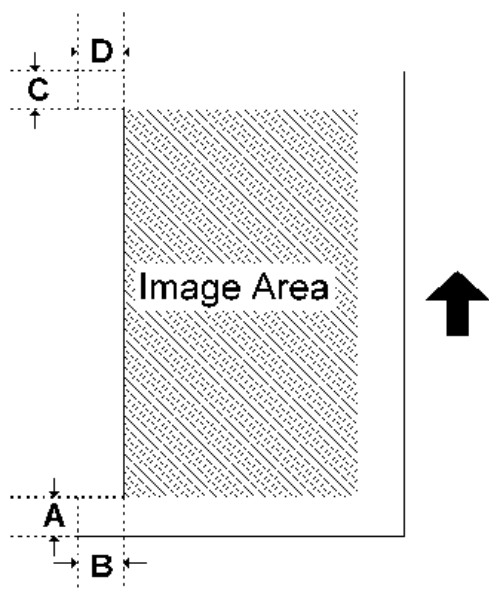

1. Enter SP2-109-003.
2. Print out the test pattern (14: Trimmed area) with SP2-109-003.
3. Check the erase margin A and B. Adjust them with SP2-103-001 to -015 if necessary.
 - Leading edge: 0.0 to 9.0 mm (default: 4.2 mm)
 - Side-to-side: 0.0 to 9.0 mm (default: 2.0 mm)
 - Trailing edge: 0.0 to 9.0 mm (default: 4.2 mm)

Adjusting the Tone of the Printed Image

If a customer wishes to have the tone of the printed image corrected, you can adjust it as follows.

For details about the adjustment procedures, see the corresponding sections.

Adjustment Method	Outline
Adjustment by Changing the Printer Driver Setting (page 640)	Perform this to adjust the tone for each print job. This can be adjusted by the user.
Adjustment by Changing the Machine's Profile Setting (page 648)	Perform this to make the tone similar to that of another model. Doing this changes the tone of all images printed by the machine's printer function.

Adjustment Method	Outline
Adjustment by Printer Gamma Correction (page 650)	Basically, we recommend the default setting. Doing this changes the tone of all images printed by the machine's printer function.

Adjustment by Changing the Printer Driver Setting

Using the printer driver, you can change the color balance for each print job as follows.

1. Open the printer driver's "Color Balance Details" window. (page 640)
2. Adjust the tone (color gamut). (page 644)

4

Opening the Printer Driver's "Color Balance Details" Window

PCL6 driver / PS driver

1. Click [Detailed Setting] tab -> [Print Quality].
2. Click [Details...] in "Color Balance".

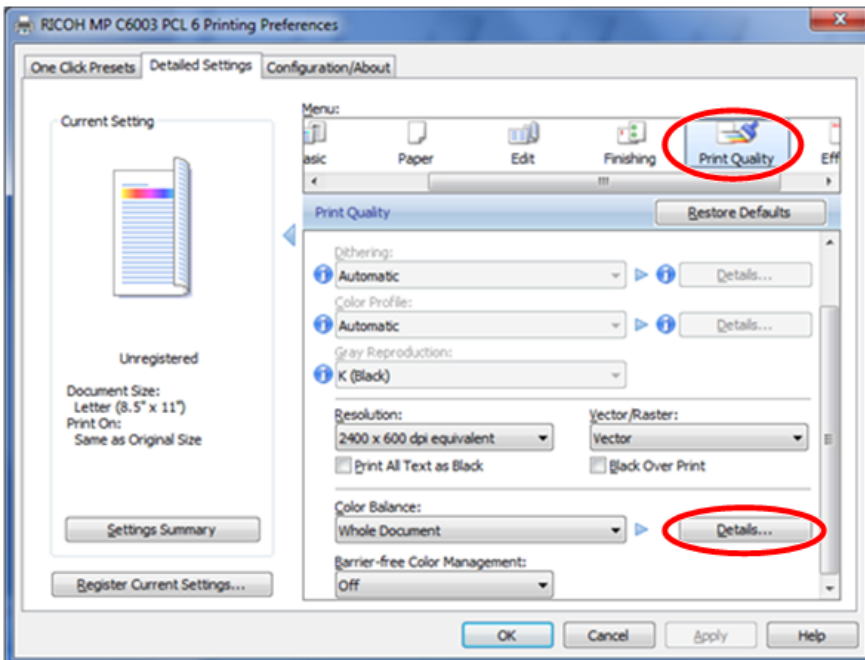

d238m1332

3. "Color Balance Details" window appears. (page 643)

PCL6 Universal driver / PS Universal driver

1. Click [Detailed Setting] tab -> [Print Quality:Advanced].
2. Click [Details...] in "Color Balance".

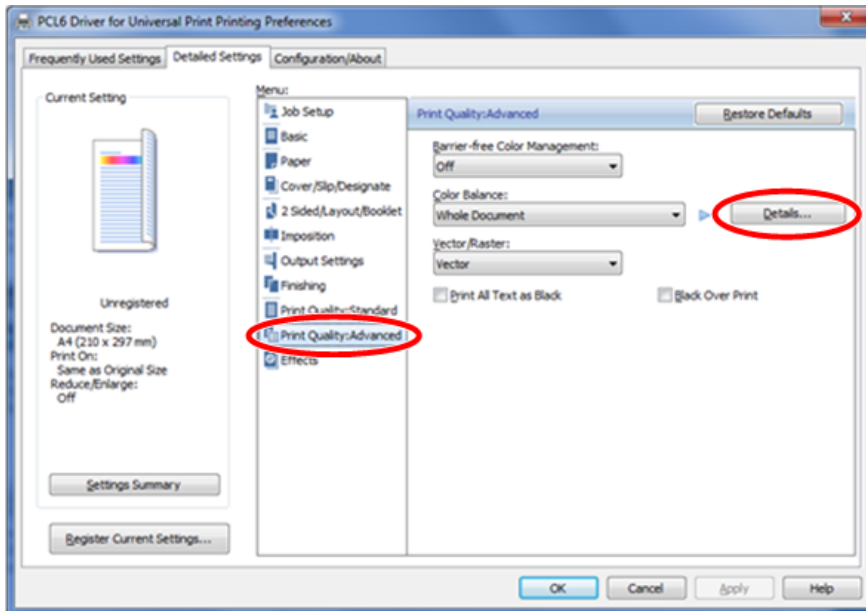

d238m1333

3. "Color Balance Details" window appears. (page 643)

Mac PS driver

1. On the print dialog box, open the context menu (right click menu), then select [Color Balance Details].

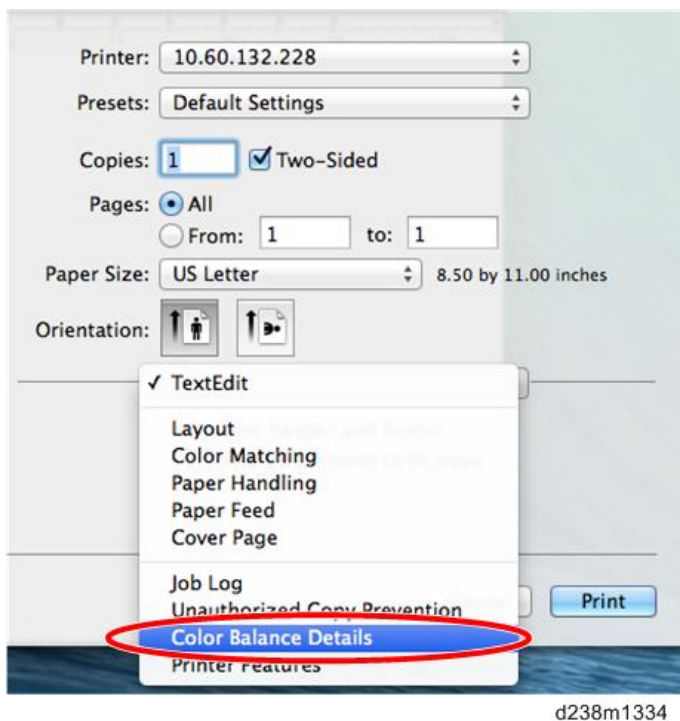

4

2. "Color Balance Details" window appears. (page 643)

Color Balance Details Window

PCL driver

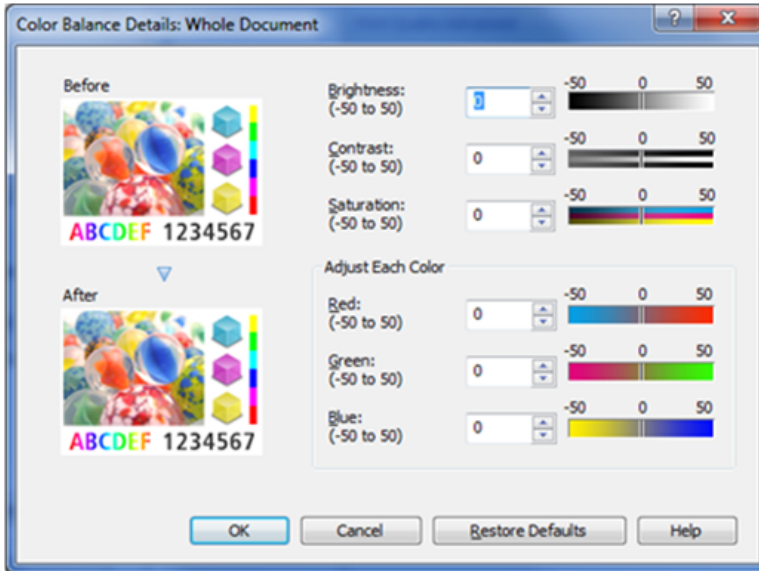

d238m1340

PS driver

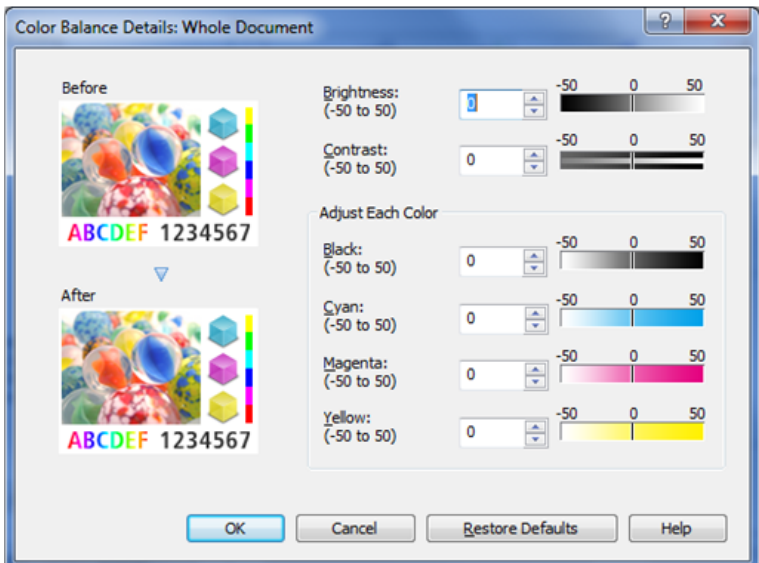

d238m1341

Mac PS driver

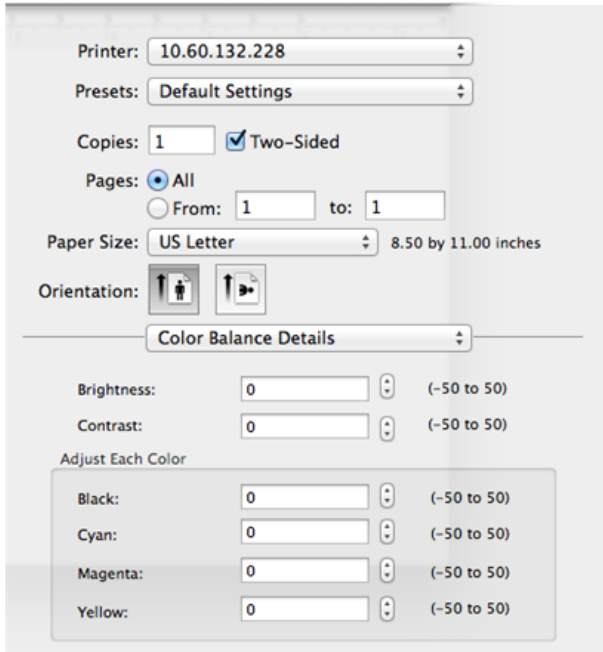

d238m1342

4

Adjusting the Tone in the "Color Balance Details" Window

Brightness

- Decreasing the brightness makes the printed image darker and increasing it makes the printed image fainter.
- Decrease the value to make the printed image darker and increase it to make the printed image fainter.
- If you increase the value too much, overexposure of bright areas may occur.
- If you decrease the value too much, underexposure of dark areas may occur
- Can be specified using the PCL/PS drivers.



w_d238m1335

Contrast

- Increasing the contrast makes bright areas brighter and dark areas darker.
- Decreasing the contrast makes bright areas darker and dark areas brighter.

- Increase the value to make the printed image clearer and decrease it to prevent overexposure of bright areas and underexposure of dark areas.
- If you increase the value too much, overexposure of bright areas and underexposure of dark areas may occur.
- If you decrease the value too much, the printed image may become unclear.
- Can be specified using the PCL/PS drivers.



Saturation

- Increasing the saturation makes the printed image more vivid.
- Decreasing the saturation makes the printed image closer to the neutral color (gray).
- If you increase the value too much, it may lower the gradation, resulting in a difficulty to distinguish colors.
- The printer's color gamut is limited, so even if you increase the value, it may not make any difference.
- Can be specified using the PCL driver only.

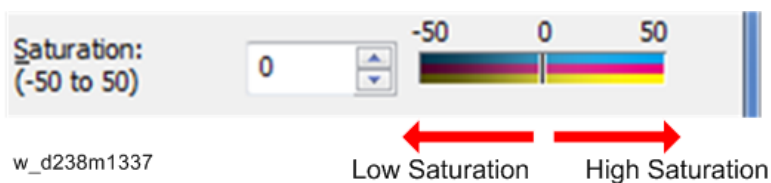

RGB Adjustment (Adjust Each Color)

When using the PCL driver, adjust the tone (color gamut) by this method.

- Increasing "Red" makes "M" and "Y" more vivid and "C" less so.
- Decreasing "Red" makes "M" and "Y" less vivid and "C" more so.
- Increasing "Green" makes "C" and "Y" more vivid and "M" less so.
- Decreasing "Green" makes "C" and "Y" less vivid and "M" more so.
- Increasing "Blue" makes "C" and "M" more vivid and "Y" less so.
- Decreasing "Blue" makes "C" and "M" less vivid and "Y" more so.

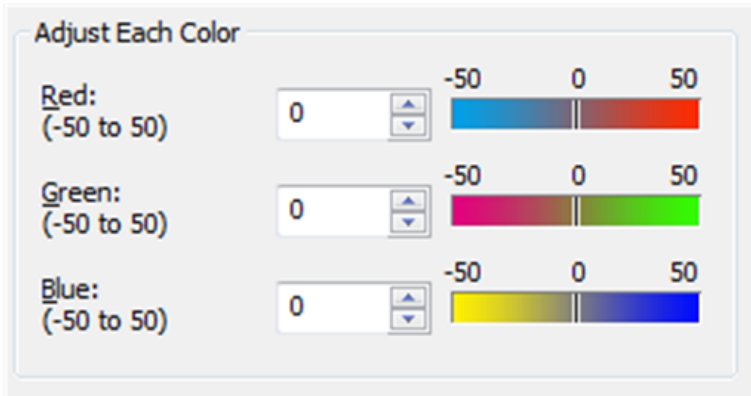

4

CMYK Adjustment (Adjust Each Color)

When using the PS driver, adjust the tone (color gamut) by this method.

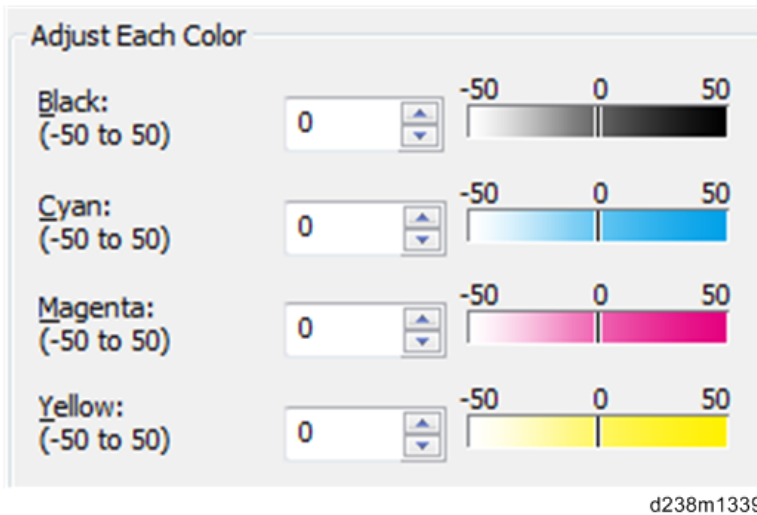

Adjustment Examples

The following shows adjustment examples. Be sure to check the printed image when changing values.

If the printed image is dark:

Increase the brightness by 20.



d238m1343

If the printed image is faint:

Decrease the brightness by 20.



d238m1344

If the printed image is too bluish:

Increase "Red" or "Magenta" by 20.



d238m1345

If the printed image is too reddish:

Increase "Blue" or "Cyan" by 20.



d238m1346

If the printed image is unclear:

Increase the contrast by 15.

4



d238m1347

Adjustment by Changing the Machine's Profile Setting

You can change the printer's profile setting by specifying a bit switch in SP mode.

★ Important

- By changing the profile setting, you can change the tone of all images printed by the machine's printer function.
- By changing the profile setting, you can make the tone (image gamut) of the printed image similar to that of another model. However, due to factors such as the image gamut difference between different models, individual differences, and ageing of components, you may not achieve exactly the same tone.

Procedure to Change the Profile Setting

1. Enter the printer SP mode.

2. Change the values of bit switches with the following SP numbers.

Desired tone (color gamut)	SP to change	Value to select
2009 Spring model or those before it	SP1-001-002	00000001 [01H]
2009 Autumn to 2011 Spring model		00010000 [10H]
2011 Autumn model or later		00000000 [00H]
Fuji Xerox product	SP1-001-001	10000000 [80H]

3. Turn the machine's power off and then back on.

The specified setting is applied.

Patterns and Tendency of the Tone for Each Profile

Model with the desired tone	Image (Photo)	Graphic (Chart)	Text
2009 Spring model or earlier	Color A	Color A	Color A
2009 Autumn to 2011 Spring model	Color B	Color B	Color B
2011 Autumn model or later	Color B	Color C	Color C
Fuji Xerox product	Color D	Color D	Color D

Color A

Standard profile for MP C2030/C2050/C2030/C2530/C2800/C3300/C4000/C5000 and their preceding models

Color B

Standard profile for MP C2051/C2551/C3001/C3501/C4501/C5501.

Compared to Color A, following changes have been applied:

- Yellow tint of the skin color is reduced.

- Redness is enhanced to prevent it from appearing like vermilion.
- Green and blue-green appear darker.
- Uses the pure cyan toner on graphics to prevent muddiness.
- Pink in the printed image appears darker.

Color C

Standard profile for MP C3002/C3502/C4502/C5502 up to the present model.

Compared to Color B, the difference between colors have become more recognizable. On the other hand, the printed image has become slightly less vivid.

If you receive a comment that the printed image is less vivid compared to that of a Color B-standard model, we recommend changing the setting to Color B.

Color D

Profile with a tone similar to that of the prints by the FX products.

- Bluish colors appear slightly purplish. (Image of the sky appears with a slight tint of red.)
- Pink in the printed image appears with a tint of magenta.

Printer Gamma Correction

★ Important

- We recommend that you keep the printer gamma correction values at the default values.
- The values adjusted/saved in the printer SP mode are applied after the machine's power is turned off and then back on.
- After adjusting/saving the values in the printer SP mode, make sure not to perform the printer's Auto Color Calibration (ACC). Doing so will reset the values.
- To change multiple resolutions, perform this procedure for each resolution.

1. Select the mode you want to change in the printer SP1102-001: Resolution Setting.

1102	[Resolution Setting]
	Selects the printing mode (resolution) for the printer gamma adjustment.

001	Resolution Setting	CTL	[0 to 9 / 0 / 1/step] 0: 1200x1200 Photo (2bit/4col) 1: 1200x1200 Photo (1bit/4col) 2: 600x600 Photo (4bit/4col) 3: 600x600 Photo (2bit/4col) 4: 600x600 Photo (1bit/4col) 5: 1200x1200 Text (2bit/4col) 6: 1200x1200 Text (1bit/4col) 7: 600x600 Text (4bit/4col) 8: 600x600 Text (2bit/4col) 9: 600x600 Text (1bit/4col)
-----	--------------------	-----	---

2. Change the gamma correction value for each color in the printer SP1104: Gamma Adjustment.

↓ Note

- When adjusting the value, be sure to follow the sequence: I (IDmax) → M (Middle) → S (Shadow) → H (Highlight).
- To lower the print density, reduce and save the H/M/S/I value for each color.
- To heighten the print density, increase and save the H/M/S/I value for each color.

1104	[Gamma Adjustment]
	Adjusts the printer gamma for the mode selected in the "Mode Selection" menu.

001	Black: Highlight	CTL	[0 to 30 / 00 / 1/step]
002	Black: Shadow	CTL	
003	Black: Middle	CTL	
004	Black: IDmax	CTL	
021	Cyan: Highlight	CTL	
022	Cyan: Shadow	CTL	
023	Cyan: Middle	CTL	
024	Cyan: IDmax	CTL	
041	Magenta: Highlight	CTL	
042	Magenta: Shadow	CTL	
043	Magenta: Middle	CTL	
044	Magenta: IDmax	CTL	
061	Yellow: Highlight	CTL	
062	Yellow: Shadow	CTL	
063	Yellow: Middle	CTL	
064	Yellow: IDmax	CTL	

Gamma Correction Sheet

600×600 dpi 1 bit Photo(1)									
					Color	Highlight	Shadow	Middle	ID
1	1	1	1	1	Black	15	15	15	15
2	2	2	2	2	Cyan	15	15	15	15
3	3	3	3	3	Magenta	15	15	15	15
4	4	4	4	4	Yellow	15	15	15	15
5	5	5	5	5					
6	6	6	6	6					
7	7	7	7	7					
8	8	8	8	8					
9	9	9	9	9					
10	10	10	10	10					
11	11	11	11	11					
12	12	12	12	12					
13	13	13	13	13					
14	14	14	14	14					
15	15	15	15	15					
16	16	16	16	16					
3C	K	C	M	Y					

w_d146e2005

4

Range where each value affects

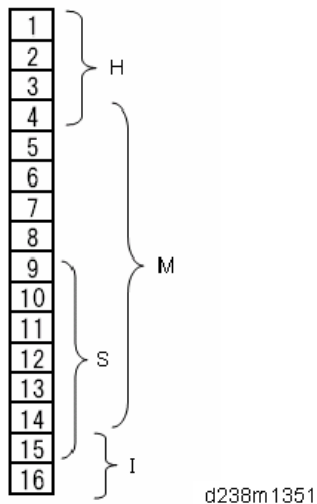

3. Execute the SP1105-001: Save Tone Control Value.

Note

- If you exit the SP mode without saving the values, any changes made in the printer SP1104: Gamma Adjustment will be lost.
- You can check the color balance before and after the gamma adjustment in the printer SP1103-001: Test Page - Color Gray Scale.

4. Turn the machine's power off and then back on.

The changed gamma correction setting is applied.

5. Check the output image and repeat steps 1 - 4 until the desired image is obtained.

Color Registration

Adjust color registration with the following procedure when color registration errors occurred.

Check the Occurrence of Color Registration Errors

Prepare some A3 sheets.

1. Execute SP2-111-004 (Forced line Position Adj.: Mode d)

2. Make sure that execution completed successfully with using SP2-194-007 (MUSIC).

If the value of SP2-194-007 is "0", it indicates that the result of SP2-111-004 was successful.

If the value of SP2-194-007 is "1", it indicates that the result of SP2-111-004 was a failure, which you need to fix the color registration errors (See "Ways to fix color registration errors" (page 654))

3. Execute SP2-109-003 (Test Pattern: Pattern Selection)

4. With a loupe, check the details of the color registration errors on the printed test pattern. (page 654)

- Specification: Main/Sub is smaller than 180.0um
- No color registration errors: Adjustment completed.
- Color registration errors occurred: Adjust the color registration errors (See "Ways to fix color registration errors" (page 654))

Judgment for Type of Color Registration Error

In the following diagrams, solid lines represent "K" and dotted lines indicate any of "C", "M" or "Y".

1. Pattern 1

This is a case in which there is a shift in the sub-scan direction at the leading edge of the paper. The following diagram shows "C", "M" or "Y" lines closer to the leading edge than "K" lines.

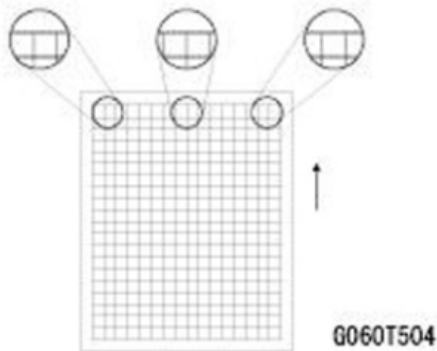

2. Pattern 2

This is a case in which there is a shift in the sub-scan direction at the trailing edge of the paper. The following diagram shows "C", "M" or "Y" lines farther away from the leading edge than "K" lines.

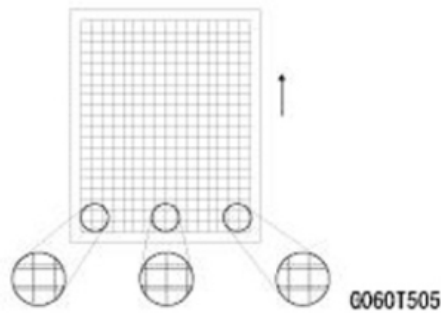

3. Pattern 3

This is a case in which a color registration error is found in the main-scan direction and size of the error is the same at the left, center and right.

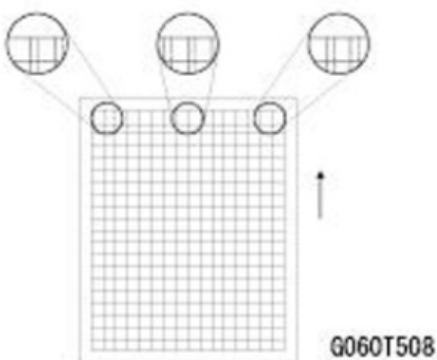

4. Pattern 4

This is a case in which a color registration error is found in the main-scan direction and the size of the error is different at the left, center and right. For "M", the largest error will be at the right,

followed by the center and then the left. For "C" or "Y", the order will be reversed. This is because the writing direction of the laser beam for "K" and "M" is different from "C" and "Y".

Case "M"

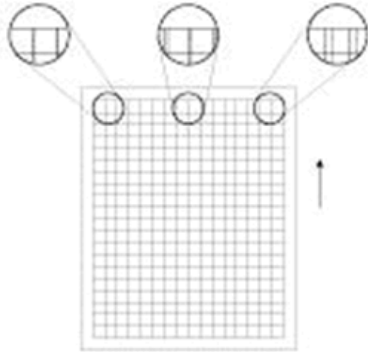

d1772001

Case "C" or "Y"

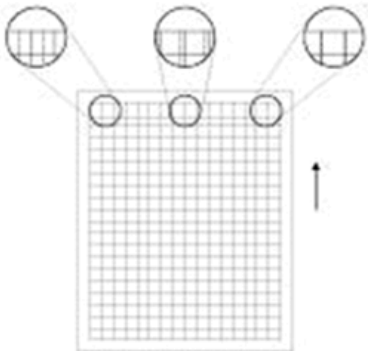

d1772002

5. Pattern 5

This is a case in which a color registration error is found in the sub-scan direction, but it is not the same as the Pattern 1 or 2. The error appears and disappears at intervals down the page.

Ways to fix color registration errors

SP2-111-004 (Forced Line Position Adj. : Mode D) Execution

Result: Failed Case: SP2-194-007: 1 (Failed)

SP2-194-010, 011, 012 shows "2" or "3"	Result of Check	Blank image, abnormal image, low image density
	Causes	<ol style="list-style-type: none"> 1. Image processing failure 2. Pattern density low 3. BCU(IPU) failure
	Solution	<ol style="list-style-type: none"> 1. Replace PCU, image transfer belt, power pack 2. Execute process control, supply toner 3. Replace BCU(IPU)
	Pattern	-
Failed to read the pattern of Line position Adj.	Result of Check	Normal (but color registration errors occur)
	Causes	<ol style="list-style-type: none"> 1. ID sensor shutter failure 2. ID sensor failure 3. BCU(IPU) failure
	Solution	<ol style="list-style-type: none"> 1. Replace ID sensor shutter 2. Replace ID sensor 3. Replace BCU(IPU)
	Pattern	-

Any of SP2-194-010 or 011 or 012 shows "5"	Result of Check	Image density low
	Causes	Pattern density low
	Solution	Execute the process control Supply toner
	Pattern	-
	Result of Check	Leading edge registration for "M", "C", and/or "Y" shifts over ± 1.4 mm from that of "K".
	Causes	1. Normal 2. Laser unit failure 3. BCU(IPU) failure
	Solution	1. Execute SP2-111-003 (Forced Line Position Adj.: Mode c) 2. Replace laser unit 3. Replace BCU(IPU)
	Pattern	3

Out of line position correction range	Result of Check	Leading edge registration of "M", "C", and/or "Y" shifts over ± 1.4 mm from that of "K".
	Causes	<ol style="list-style-type: none"> 1. Normal 2. Image transfer belt failure 3. Drive section failure 4. BCU(IPU) failure
	Solution	<ol style="list-style-type: none"> 1. Execute SP2-1 1 1-003 (Forced Line Position Adj.: Mode c) 2. Replace image transfer belt 3. Replace PCU/ PCU motor 4. Replace BCU(IPU)
	Pattern	1, 2
	Result of Check	The main scan magnification is OK, but the color registration in the center of the image shifts over 0.66 mm.
	Causes	<ol style="list-style-type: none"> 1. ID Sensor(Center) failure 2. Significant movement of image transfer belt (Center) 3. BCU(IPU) failure
	Solution	<ol style="list-style-type: none"> 1. Replace ID Sensor 2. Replace image transfer belt 3. Replace BCU(IPU)
	Pattern	-

Out of line position correction range	Result of Check	Skew of "M", "C", and/or "Y" shifts over $\pm 0.75\text{mm}$ against that of "K"
	Causes	1. PCU installation failure 2. Laser Unit failure 3. BCU(IPU) failure
	Solution	1. Reset/Replace PCU 2. Replace laser unit 3. Replace BCU(IPU)
	Pattern	-
	Result of Check	Other
	Causes	1. The upper skew correction value is abnormal 2. BCU(IPU) failure
	Solution	1. Reset skew correction value (* 1) 2. Replace BCU(IPU)
	Pattern	-

* 1 Method for resetting the skew correction value.

1. Turn the power OFF.
2. Remove the left cover (page 408)
3. Remove the harness of the laser optics positioning motor attached to the laser unit (15-pin).

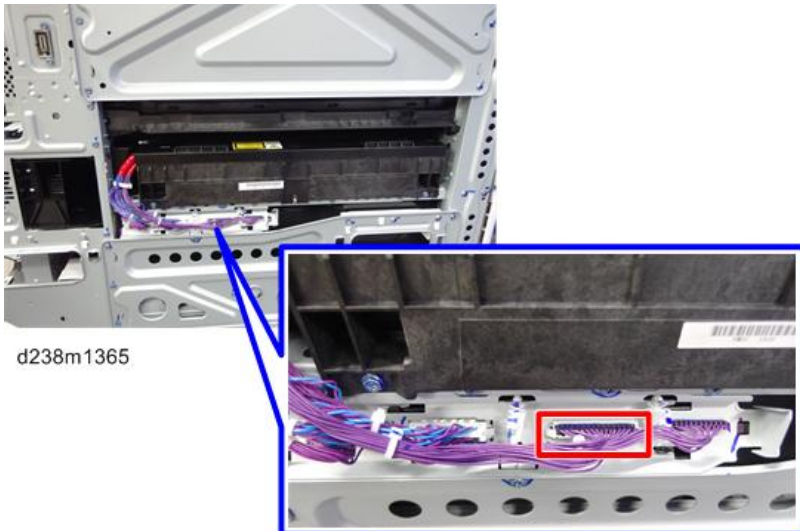

4. Turn the power ON, and then execute the following SPs to set the skew correction mechanism to the origin.
 - SP2-220-001 (Skew Origin Set M: Skew Motor)
 - SP2-220-002 (Skew Origin Set C: Skew Motor)
 - SP2-220-003 (Skew Origin Set Y: Skew Motor)
5. Turn the power OFF.
6. Connect the harness of the laser optics positioning motor to the laser unit.
7. Turn the power ON

SP2-111-001 (Forced Line Position Adj.: Mode A) execution (or Color Registration via the Maintenance menu in User Tools)		
Result: OK Case: SP2-194-007: 0 (Success)		
No color registration errors	Result of Check	Side-to-side registration for K shifted
	Causes	Abnormal SP value of main scan color registration (K)
	Solution	Adjust SP2-101-001
	Pattern	-
Color registration errors found	Result of Check	Image density low
	Causes	Pattern density low
	Solution	Execute process control, Supply toner
	Pattern	-
Color registration errors found	Result of Check	The main scan magnification of "M", "C" and/or "Y" is not correct.
	Causes	1. Laser unit failure 2. ID sensor failure 3. BCU(IPU) failure 4. Normal
	Solution	1. Replace laser unit 2. Replace ID sensor 3. Replace BCU(IPU)
	Pattern	4

Color registration errors found	Result of Check	Although main scan magnification is OK, the color registration in the center of the image is shifted
	Causes	<ol style="list-style-type: none"> 1. Significant movement of image transfer belt (Center) 2. ID sensor (Center) failure 3. BCU(IPU) failure
	Solution	<ol style="list-style-type: none"> 1. Replace image transfer belt 2. Replace ID sensor 3. Replace BCU(IPU)
	Pattern	-
Color registration errors found	Result of Check	The side-to-side registration of "M", "C", and/or "Y" is not correct.
	Causes	<ol style="list-style-type: none"> 1.ID sensor(Center) failure 2. Significant movement of Image transfer belt (Center) 3.BCU(IPU) failure
	Solution	<ol style="list-style-type: none"> 1. Replace laser unit 2. Replace ID sensor 3. Replace BCU(IPU)
	Pattern	3

Color registration errors found	Result of Check	The leading edge registration of "M", "C" and/or "Y" is not correct.
	Causes	<ol style="list-style-type: none"> 1. Image transfer belt failure 2. Drive section failure 3. ID sensor failure 4. BCU(IPU) failure 5. Normal
	Solution	<ol style="list-style-type: none"> 1. Replace Image transfer belt 2. Replace PCU, drum motor 3. Replace ID sensor 4. Replace BCU(IPU)
	Pattern	1, 2
Color registration errors found	Result of Check	The skew of "M", "C" and/or "Y" is not correct.
	Causes	<ol style="list-style-type: none"> 1. PCU installation failure 2. Laser unit failure 3. IOB failure
	Solution	<ol style="list-style-type: none"> 1. Reset/Replace PCU 2. Replace laser unit 3. Replace IOB
	Pattern	-
Color registration errors found	Result of Check	Shifted Drum phase.
	Causes	<ol style="list-style-type: none"> 1. PCU installation failure 2. Drive section failure 3. Phase adjustment failure
	Solution	<ol style="list-style-type: none"> 1. Reset/Replace PCU 2. Check/Replace drive section 3. Execute SP1-902-001
	Pattern	5

5. System Maintenance

Service Program Mode

⚠ CAUTION

- Make sure that the data-in LED (🔌) is not on before you go into the SP mode. This LED indicates that some data is coming to the machine. When the LED is on, wait for the copier to process the data.

📌 Note

- The Service Program Mode is for use by service representatives only. If this mode is used by anyone other than service representatives for any reason, data might be deleted or settings might be changed. In such case, product quality cannot be guaranteed any more.

Entering SP Mode

If there are no Classic Application (copy//printer//scanner//fax) icons on the HOME screen, follow the procedure below to display the number keyboard.

1. Press and hold the button [A] located at the left side of the operation panel and "Check Status [B]" at the same time, until the number keyboard is displayed.



d238m0747



2. Enter the key code for SP mode.



d238m0748

For details of the key code to enter the SP mode, ask your supervisor.

Exiting SP Mode

5

Press "Exit" on the LCD twice to return to the copy window.

Types of SP Modes

- System SP: SP modes related to the engine functions
- Printer SP: SP modes related to the controller functions
- Scanner SP: SP modes related to the scanner functions
- Fax SP: SP modes related to the fax functions

Select one of the Service Program modes (System, Printer, Scanner, or Fax) from the touch panel as shown in the diagram below after you access the SP mode. This section explains the functions of the System/Printer/Scanner SP modes. Refer to the Fax service manual for the Fax SP modes.



SP Mode Button Summary

Here is a short summary of the touch-panel buttons.

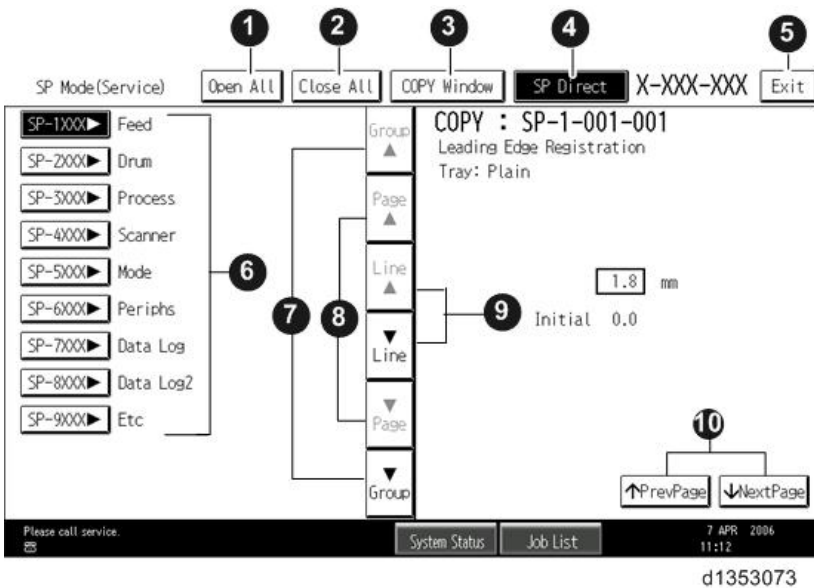

1	Opens all SP groups and sublevels.
2	Closes all open groups and sublevels and restores the initial SP mode display.

3	Opens the copy window (copy mode) so you can make test copies. Press SP Mode (highlighted) in the copy window to return to the SP mode screen,
4	Enter the SP code directly with the number keys if you know the SP number. Then press [#]. The required SP Mode number will be highlighted when pressing [#]. If not, just press the required SP Mode number.)
5	Press two times to leave the SP mode and return to the copy window to resume normal operation.
6	Press any Class 1 number to open a list of Class 2 SP modes.
7	Press to scroll the show to the previous or next group.
8	Press to scroll to the previous or next display in segments the size of the screen display (page).
9	Press to scroll the show the previous or next line (line by line).
10	Press to move the highlight on the left to the previous or next selection in the list.

Switching Between SP Mode and Copy Mode for Test Printing

1. In the SP mode, select the test print. Then press "Copy Window".
2. Use the copy window (copier mode), to select the appropriate settings (paper size, etc.) for the test print.
3. Press [Start] key to start the test print.
4. Press SP Mode (highlighted) to return to the SP mode screen and repeat from step 1.

Selecting the Program Number

Program numbers have two or three levels.

1. Refer to the Service Tables to find the SP that you want to adjust before you begin.
2. Press the Group number on the left side SP Mode window that contains the SP that you want to adjust.
3. Use the scrolling buttons in the center of the SP mode window to show the SP number that you want to open. Then press that number to expand the list.
4. Use the center touch-panel buttons to scroll to the number and title of the item that you want to set and press it. The small entry box on the right activates and shows the below default or the current settings.

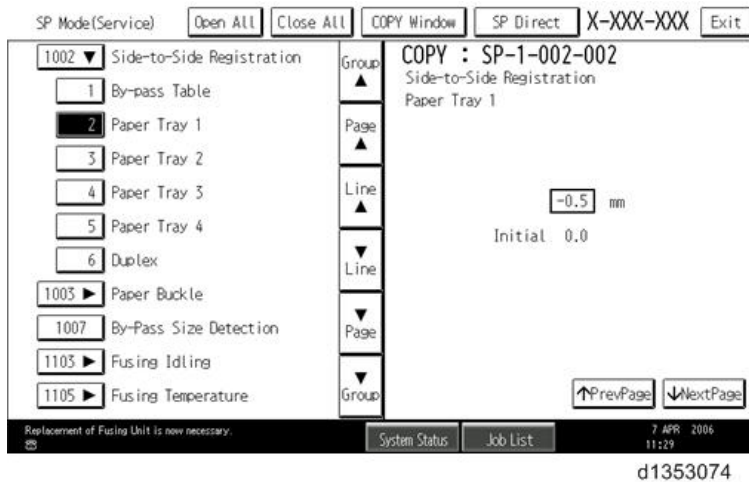

Note

- Refer to the Service Tables for the range of allowed settings.
5. Do this procedure to enter a setting:
 - Press \ominus to toggle between plus and minus and use the keypad to enter the appropriate number. The number you enter writes over the previous setting.
 - Press [#] to enter the setting. (The value is not registered if you enter a number that is out of range.)
 - Press "Yes" when you are prompted to complete the selection.
 6. If you need to perform a test print, press Copy Window to open the copy window and select the settings for the test print. Press [Start] key and then press SP Mode (highlighted) in the copy window to return to the SP mode display.
 7. Press Exit two times to return to the copy window when you are finished.

Service Mode Lock/Unlock

At locations where the machine contains sensitive data, the customer engineer cannot operate the machine until the Administrator turns the service mode lock off. This function makes sure that work on the machine is always done with the permission of the Administrator.

1. If you cannot go into the SP mode, ask the Administrator to log in with the User Tool and then set "Service Mode Lock" to OFF after he or she logs in:

User Tools > Machine Features > System Settings > Administrator Tools > Service Mode Lock > OFF

 - This unlocks the machine and lets you get access to all the SP codes.
 - The CE can service the machine and turn OFF then ON the machine power. It is not necessary to ask the Administrator to log in again each time the main power is turned ON.
2. Go into the SP mode and set SP5-169 to "1" if you must use the printer bit switches.

3. After machine servicing is completed:

- Change SP5-169 from "1" to "0".
- Turn OFF then ON the machine power. Tell the administrator that you have completed servicing the machine.
- The Administrator will then set the "Service Mode Lock" to ON.

Remarks

The maximum number of characters which can show on the control panel screen is limited to 30 characters. For this reason, some of the SP modes shown on the screen need to be abbreviated. The following are abbreviations used for the SP modes for which the full description is over 20 characters.

Item	Description
Paper Weight	Thin paper: 52-59 g/m ² , 14-15lb. Bond Plain Paper1: 60-74 g/m ² , 16-20lb. Bond Plain Paper2: 75-81 g/m ² , 20lb. Bond Middle Thick: 82-105 g/m ² , 20-28lb. Bond Thick Paper1: 106-169 g/m ² , 28lb. Bond-90lb. Index Thick Paper2: 170-220 g/m ² , 65-80lb. Cover Thick Paper3: 221-256 g/m ² , 80lb. Cover-140lb. Index Thick Paper4: 257-300 g/m ² , 140lb. Index-110lb. Cover
Paper Type	N: Normal paper MTH: Middle thick paper TH: Thick paper
Paper Feed Station	P: Paper tray B: Bypass tray
Print Mode	S: Simplex D: Duplex

Others

The settings of each SP mode are explained in the right-hand column of the SP table in the following way.

[Adjustable range / **Default setting** / Step] Alphanumeric

 **Note**

- If "Alphanumeric" is written to the right of the bracket as shown above, the setting of the SP mode shows on the screen using alphanumeric characters instead of only numbers. However, the settings in the bracket in the SP mode table are explained by using only the numbers.

The following symbols are used in the SP mode tables.

Notation	What it means
ENG	Engine SP
CTL	Controller SP
FA	Factory setting: Data may be adjusted from the default setting at the factory. Refer to the factory setting sheets enclosed. You can find it in the front cover.
DFU	Design/Factory Use only: Do not touch these SP modes in the field.
*	<p>An asterisk (*) to the left side of ENG/CTL column means that this mode is stored in the NVRAM. If you do a RAM clear, this SP mode will be reset to the default value. "ENG" and "CTL" show which NVRAM contains the data.</p> <ul style="list-style-type: none"> • *ENG: NVRAM on the BCU board • *CTL: NVRAM on the controller board
SSP	This denotes a "Special Service Program" mode setting.

SP Tables

See "Appendices" for the following information:

- Engine SP Tables - SP1000
- Engine SP Tables - SP2000
- Engine SP Tables - SP3000
- Engine SP Tables - SP4000
- Engine SP Tables - SP5000
- Engine SP Tables - SP6000
- Engine SP Tables - SP7000
- Input Check
- Output Check
- Controller SP Tables - SP5000
- Controller SP Tables - SP7000
- Controller SP Tables - SP8000
- Printer Service Menu
- Scanner Service Menu

Firmware Update (SD Card)

Overview

In order to update the firmware of this machine, it is necessary to download the latest version of firmware on an SD card.

Insert the SD card into SD card slot 2 beside the rear left of the controller box.

Types of firmware update files, supported update methods:

	SFU	SD Card	RFU	ARFU
Individual firmware	N/A	Available	Available	N/A
Package firmware	Available	Available	Available	Available

5

Firmware Type

Firmware type	Firmware location
System/Copy	Controller Board
Engine	BCU
Operation Panel	Smart Operation Panel
ADF	ADF
Finisher 1	Finisher
Bank	Bank
FCU	FCU
Network Support	Smart Operation Panel – CPU board
Bank2	Bank
BIOS	BCU
HDD format option	Controller Board
RPCS	Controller Board
PS	Controller Board

Firmware type	Firmware location
RPDL	Controller Board
R98	Controller Board
R16	Controller Board
RPGL	Controller Board
R55	Controller Board
RTIFF	Controller Board
PCL	Controller Board
PCLXL	Controller Board
MSIS	Controller Board
PDF	Controller Board
PictBridge	Controller Board
PJL	Controller Board
MediaPrint: JPEG	Controller Board
MeidaPrint: TIFF	Controller Board
XPS	Controller Board
FONT	Controller Board
FONT1	Controller Board
FONT2	Controller Board
Copy apl	Smart Operation Panel – CPU board
NetworkDocBox	Smart Operation Panel – CPU board
Fax apl	Smart Operation Panel – CPU board
Printer apl	Smart Operation Panel – CPU board
Scanner apl	Smart Operation Panel – CPU board
Remote Fax apl	Smart Operation Panel – CPU board
MIB	Smart Operation Panel – CPU board

Firmware type	Firmware location
Websupport	Smart Operation Panel – CPU board
WebUapl	Smart Operation Panel – CPU board
CSPF	Smart Operation Panel – CPU board

What is Included in the Firmware Package

Modules included in the firmware package are indicated by ticks (✓).

Firmware not included in the package require updating by SD cards, etc.

Included	Firmware
-	aics
✓	animation
✓	Application Site
✓	BluetoothService
✓	CheetahSystem
-	CSPF
-	Data Erase Onb
-	EcoInfoWidget
✓	Engine
-	External Auth
✓	Fax
-	FaxInfoWidget
✓	GWFCU3.8-9(WW)

Procedure

★ Important

- An SD card is a precision device, so when you handle an SD card, respect the following.
- When the power is switched ON, do not insert or remove a card.

- During installation, do not switch the power OFF.
- Since the card is manufactured to high precision, do not store it in a hot or humid location, or in direct sunlight.
- Do not bend the card, scratch it, or give it a strong shock.
- Before downloading firmware to an SD card, check whether write-protection of the SD card is canceled. If write-protection is enabled, an error code (error code 44, etc.) will be displayed during download, and the download will fail.
- Before updating firmware, remove the network cable from this machine.
- If SC818 is generated during software update, switch the power OFF -> ON, and complete the update which was interrupted.
- During software update, disconnect network cables and interface cables, remove wireless boards, etc., (so that they are not accessed during the update).

5

Preparation

- If the SD card is blank, copy the entire "romdata" folder onto the SD card.
- If the card already contains the "romdata" folder, copy the "D244" folder onto the card.
- If the card already contains folders up to "D244", copy the necessary firmware files (e.g. D244xxxx.fwu) into this folder.

↓ Note

- Do not put multiple machine firmware programs on the same SD card. Copy the only model firmware you want.

Update procedure

1. First download the new firmware to the SD card.
2. Turn OFF the main power.
3. Remove the SD card slot cover [A].

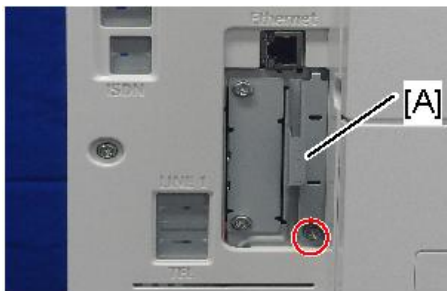

 x1

d238m0641

4. Insert the SD card into SD card slot 1 [A: Lower Slot].



d238m0640b

↓ Note

- Check whether the card is properly in the SD card slot. When a SD card is inserted, a click is heard, and it is locked.
- To remove the card, release by pressing once.

5. Turn ON the main power.

6. Wait until the update screen starts (about 45 seconds).

When it appears, "Please Wait" is displayed.

7. Check whether a program installation screen is displayed. (English display) When the SD card contains two or more software modules, they are displayed as follows.

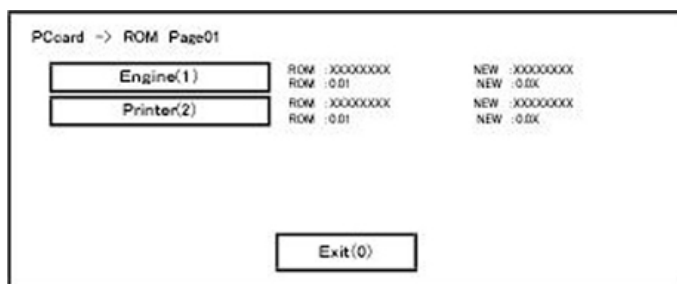

<<When two or more software names are displayed>>

1. Press the module selection button or [1] - [5] on the 10-key pad.
2. Choose the appropriate module. (If already selected, cancel the selection)

Operation of keys or buttons

Keys or buttons to press	Contents
[Exit] or 10-key pad [0]	Returns to normal screen.
[Start] Key	Select all modules.
[Clear/Stop] key	Cancel all selections.

Display contents

On the above screen, two programs, i.e., engine firmware and printer application are displayed. (The screen may change depending on the firmware or application).

The display contents are as follows:

Display	Contents
ROM:	Display installed module number / version information.
NEW:	Display module number / version information in the card.

The upper row corresponds to the module name, the lower row corresponds to the version number.

- Select the module with the module selection button or 10 key pad operation. The selected module is highlighted, and [Verify] and [Update] are displayed.**

5

Note

- Depending on the combination of modules to update, it may not be possible to select all of them simultaneously.

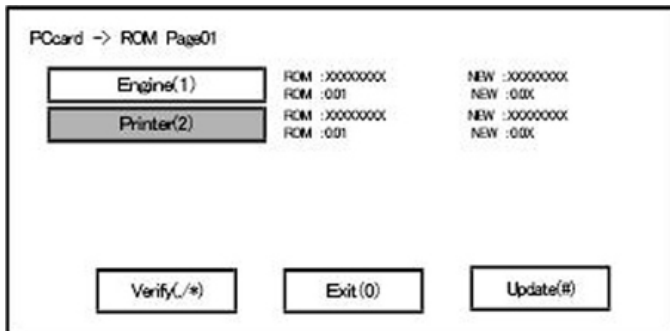

<<Key or button operations>>

Keys or buttons to press	Contents
[Update] or [#] key	Update the ROM of the selected module.
[Verify] button or [./*] key	Perform verification of the selected module.

- Press the [Update] or [#] key, and perform software update.**

10. During firmware update, a "firmware update/ verification progress screen" is displayed. When firmware update is complete, a "firmware update end screen" is displayed.

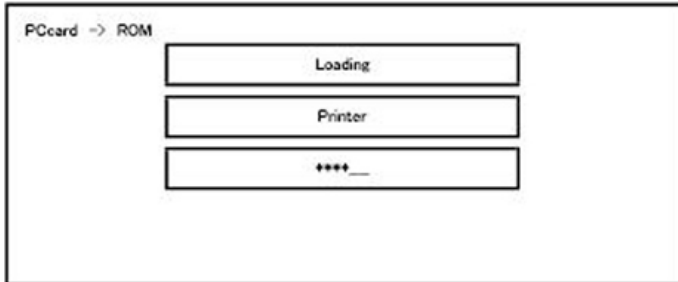

- In the middle row, the name of the module currently being updated is displayed. (in this case, the printer module is being updated)
- In the lower row, a progress bar is displayed in ten steps. (The more *, the more the progress.)

<<Firmware update end screen>>

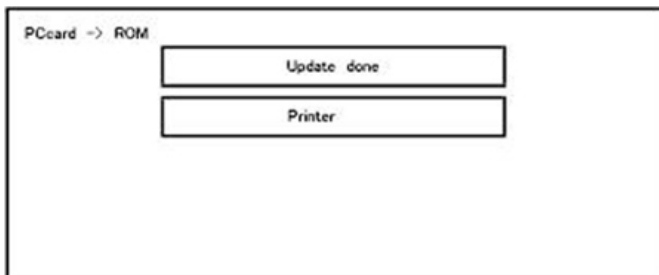

- This screen is displayed when all selected firmware modules are to be updated. "Printer" in the second row shows that the module updated last is the printer. (When more than one were updated simultaneously, only the module that was updated last is displayed.)
- When Verify has completed normally, the Update done display of the above screen is "Verify done." If "Verify Error" is displayed, reinstall the software of the application displayed in the lower row.

11. After turning the main power OFF, remove the SD card.
12. Turn the main power ON again, and check whether the machine is operating normally.
13. Return the SD card slot cover to the original position.

Note

- When the power supply is switched OFF during firmware update, update is interrupted, and the power is switched ON again, normal operation cannot be guaranteed.
- To guarantee operation, an update error continues to be displayed until update is successful.
- In this case, insert the SD card again, switch the power ON, and continue download of firmware from the SD card automatically.

- The PS3 firmware program is included in the preinstalled PDF firmware. In the default state, although the PS3 firmware program is hidden in the disabled state, the function is enabled by installing the PS3 card. (The program installed in the PS3 card is a dongle (key) for enabling the PS3 function).
- Due to the above specification, the self-diagnosis result report shows the ROM module number / software version of the PDF firmware at the PS location.

Error Screens During Updating

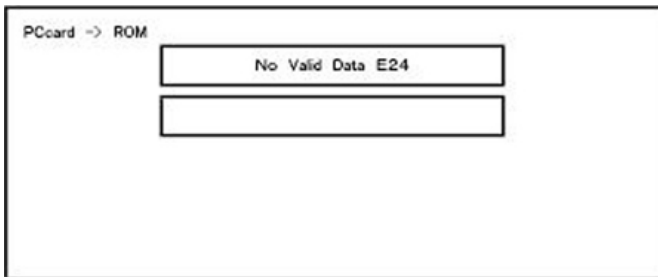

5

E24 shows an error code.

For error codes, refer to the following table:

Error Code List

Code	Contents	Solutions
20	Physical address mapping cannot be performed.	<ul style="list-style-type: none"> • Switch the main power supply off and on to try again. • Re-insert the SD card to reboot it. • Replace the controller board if the above solutions do not solve the problem.
21	Insufficient memory for the download	<ul style="list-style-type: none"> • Switch the main power supply off and on to try again. • Replace the controller board if the updating cannot be done by switching the power off and on.
22	Decompression of compressed data failed.	<ul style="list-style-type: none"> • Switch the main power supply off and on to try again. • Replace the SD card used for the update. • Replace the controller board if the above solutions do not solve the problem.

Code	Contents	Solutions
24	SD card access error	<ul style="list-style-type: none"> • Re-insert the SD card. • Switch the main power supply off and on to try again. • Replace the SD card used for the update. • Replace the controller board if the above solutions do not solve the problem.
32	<p>The SD card used after download suspension is incorrect.</p> <p>SD cards are different between the one which was inserted before power interruption and the one which was inserted after power interruption.</p>	<ul style="list-style-type: none"> • Insert the SD card containing the same program as when the firmware update was suspended, and then switch the main power supply off and on to try again. • There is a possibility that the SD card is damaged if the update cannot be done after the correct SD card has been inserted. In this case, try again with a different SD card. • Replace the controller board if the above solutions do not solve the problem. Replace all relevant boards if the update is done for the BCU and FCU. Replace the operation panel unit if the update is done for the operation panel.
33	<p>Card version error.</p> <p>The wrong card version is downloaded.</p>	<ul style="list-style-type: none"> • Install the correct ROM update data for each version in the SD card.
34	<p>Destination error.</p> <p>A card for the wrong destination is inserted.</p>	<ul style="list-style-type: none"> • Install the correct ROM update data for each destination (JPN/ EXP/ OEM) in the SD card.
35	<p>Model error.</p> <p>A card for the wrong model is inserted.</p>	<ul style="list-style-type: none"> • Install the correct ROM update data for each model in the SD card.

Code	Contents	Solutions
36	<p>Module error.</p> <p>The program to be downloaded does not exist on the main unit.</p> <p>The download destination specified by the card does not match up to the destination for the main unit's program.</p>	<ul style="list-style-type: none"> • Install the program to be updated in advance. • There is a possibility that the SD card containing the program to be updated has not been mounted. Check to confirm that the SD card has been correctly mounted. • The SD card is incorrect if the program to be updated has been correctly installed. In this case, insert the correct SC card.
38	<p>The version of the downloaded program has not been authorized for the update.</p>	<ul style="list-style-type: none"> • Make sure that the program to be overwritten is the specified version.
40	<p>Engine download fails.</p>	<ul style="list-style-type: none"> • Switch the main power supply off and on to try again. • If the download fails again, replace the controller board and the BCU.
41	<p>Fax download fails.</p>	<ul style="list-style-type: none"> • Switch the main power supply off and on to try again. • If the download fails again, replace the controller board and the FCU board.
42	<p>Control panel / language download fails.</p>	<ul style="list-style-type: none"> • Switch the main power supply off and on to try again. • If the download fails again, replace the controller board and the operation panel unit.
43	<p>Printing download fails.</p>	<ul style="list-style-type: none"> • Switch the main power supply off and on to try again. • The SD card is damaged if the update fails again. Replace the SD card.

Code	Contents	Solutions
44	The data to be overwritten cannot be accessed when controller-related programs are downloaded.	<ul style="list-style-type: none"> Switch the main power supply off and on to try again. Install the correct ROM update data in the SD card. Replace the controller board if the data to be overwritten is contained on the controller board.
49	Firmware updates are currently prohibited.	<ul style="list-style-type: none"> The setting of Update Firmware in the Administrator Tools has been set to [Prohibit] by an administrator. Amend the setting to [Do not Prohibit] and try again.
50	The results of the electronic authorization check have rejected the update data.	<ul style="list-style-type: none"> Install the correct ROM update data in the SD card.
57	@Remote is not connected at the date/time reserved for receiving the package firmware update from the network.	<ul style="list-style-type: none"> Check the @Remote connection.
58	Update cannot be done due to a reception route problem.	<ul style="list-style-type: none"> Check the @Remote connection.
59	HDD is not mounted.	<ul style="list-style-type: none"> Check the HDD connection.
60	HDD could not be used during the package firmware update.	<ul style="list-style-type: none"> Try again. Replace the HDD if the download fails again.
61	The module ID for the package firmware update is incorrect.	<ul style="list-style-type: none"> Prepare the correct package files.
62	The configuration of the package firmware update files is incorrect.	<ul style="list-style-type: none"> Prepare the correct package files.
63	Reception fails due to the power off at the reserved date/time of the remote firmware update from the network.	<ul style="list-style-type: none"> Update is to be done automatically when the next reception time has elapsed.

Code	Contents	Solutions
64	Reception fails due to the power off at the reserved date/time of the package firmware update from the network.	<ul style="list-style-type: none"> Reset the reservation date/time for the remote update.
65	Reception fails due to the status error of the machine at the reserved date/time of the remote firmware update from the network.	<ul style="list-style-type: none"> Update is to be done automatically when the next reception time has elapsed.
66	Reception failed due to the status error of the machine at the reserved date/time of the package firmware update from the network.	<ul style="list-style-type: none"> Reset the reservation date/time for the remote update.
67	Acquisition of the latest version information from the Gateway fails at the reserved date/time of the remote firmware update from the network.	<ul style="list-style-type: none"> Check that the network is connected correctly.
68	Acquisition of the latest version information from the Gateway fails.	<ul style="list-style-type: none"> Check that the network is connected correctly.
69	Download fails at the reserved date/time of the remote firmware update from the network.	<ul style="list-style-type: none"> Check that the network is connected correctly.
70	Package firmware download from the network fails.	<ul style="list-style-type: none"> Check that the network is connected correctly.
71	Network communication error occurs at the reserved date/time of the package firmware update from the network.	<ul style="list-style-type: none"> Check that the network is connected correctly.
72	The setting of @Remote is invalid at the reserved date/time of the package firmware update from the network.	<ul style="list-style-type: none"> Set the setting of @Remote Service in the Administrator Tools to [Do not Prohibit].

Note

- The PDF firmware installed as standard contains the program required to print PS3 data by default. However, this PS3 program is normally disabled.
- The PS3 firmware is a dongle (key) which enables PS3 data printing functions. When the PS3 firmware is installed, the PS3 program in the PDF firmware is enabled. Due to this specification, the self-diagnosis result report shows the ROM part number/software version of the PDF firmware contained in the PS3 program.

Firmware Update (Remote Firmware Update)

In this machine, software can be updated by remote control using @Remote.

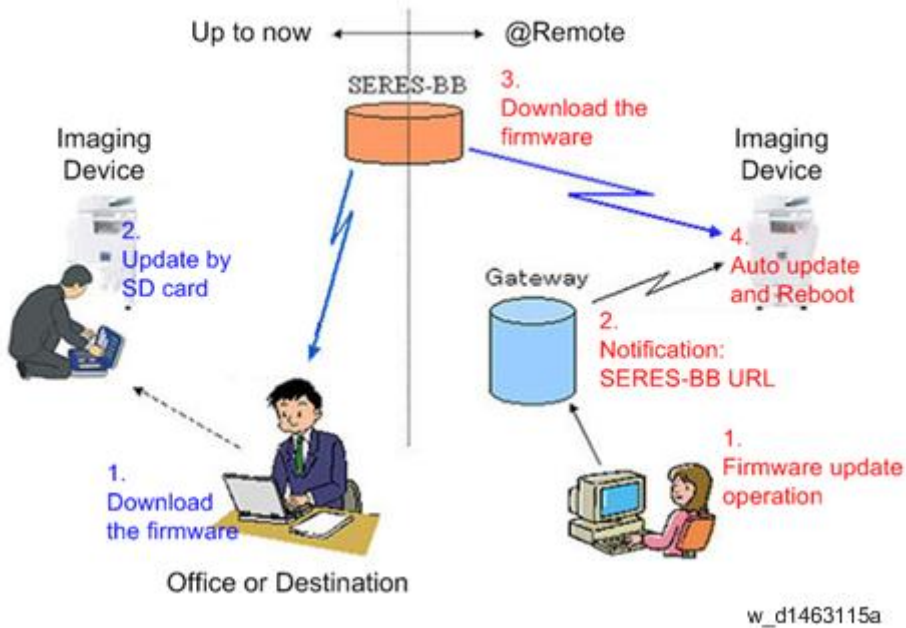

5

w_d1463115a

Types of firmware update files, supported update methods:

	SFU	SD	RFU	ARFU
Individual firmware	N/A	Available	Available	N/A
Package firmware	Available	Available	Available	Available

RFU Performable Condition

RFU is performable for a device which meets the following conditions.

1. The customer consents to the use of RFU.
2. The device is connected to a network via TCP/IP for @Remote.

Firmware Update (Smart Firmware Update)

⚠ CAUTION

- A HDD unit must be installed on the machine to enable the SFU or the package firmware update via SD card.

Overview

Each firmware module (such as System/Copy, Engine, etc.) used to be updated individually. However, an all-inclusive firmware package (package_ALL) is now available.

There are two ways to update using the firmware package.

- Package firmware update via a network: SFU (Smart Firmware Update)
- Package firmware update with an SD card

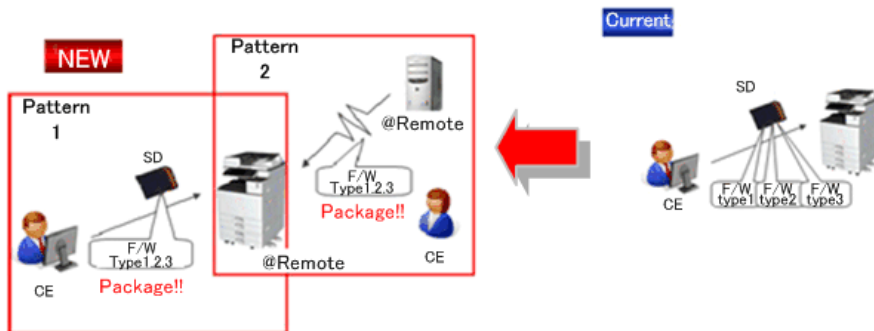

w_d176f2130

Package firmware update via a network: SFU (Smart Firmware Update)

- There are two methods for SFU.
 - Immediate Update: To update the firmware when visiting
 - Update at the next visit: To set the date and time for downloading. The firmware will be automatically downloaded beforehand and updated at the following visit.
- "Update at the next visit" is recommended since firmware download may take some minutes due to the network condition.

↓ Note

- SFU requires the connection to @Remote via a device which has the embedded @Remote communicating function. When a machine is connected to @Remote via an intermediate device (RC Gate), the SFU function is disabled.

Package firmware update via an SD card

Package firmware update can also be performed using the conventional SD card method by writing the package firmware directly to the SD card.

Types of firmware update files, supported update methods:

	SFU	SD Card	RFU	ARFU
Individual firmware	N/A	Available	Available	N/A
Package firmware	Available	Available	Available	Available

Immediate Update

Enter the [Firmware Update] menu in the SP mode and update the package firmware.

Note

- The [Firmware Update] button will appear even when a machine is connected to @Remote with a device which does not have an embedded @Remote communicating function.
- If an error code is displayed, refer to page 680 "Error Screens During Updating".

5

1. Enter the SP mode.
2. Press [Firmware Update].

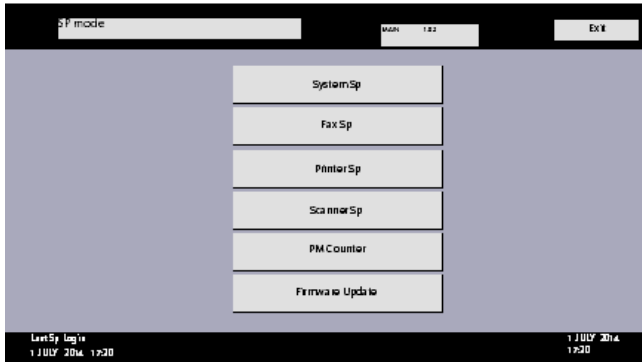

d197f0507

3. Press [Update].

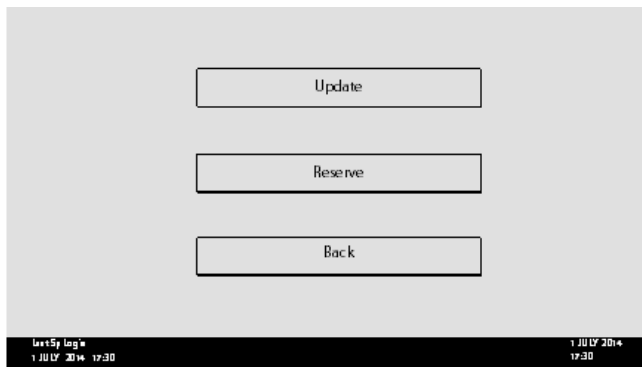

d197f0508

4. Press [Execute Update].

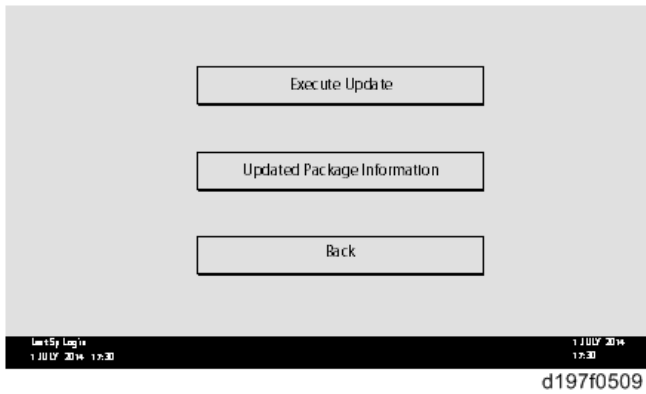

5. Press [YES].

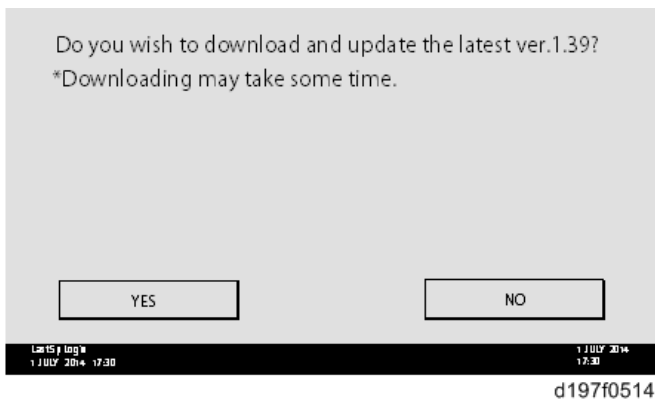

6. The following will be displayed.

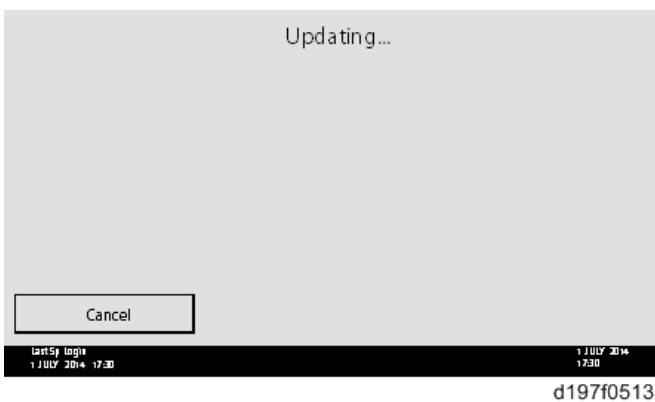

Note

- If the error code E66, which indicates that the download of the firmware has failed, is displayed, go back to step 1.

- Update will be started automatically after the download is finished.
- When the machine is in the update mode, the automatic update is suspended if a print job is started. After the print job is finished, press [YES] on the display shown below to restart updating.

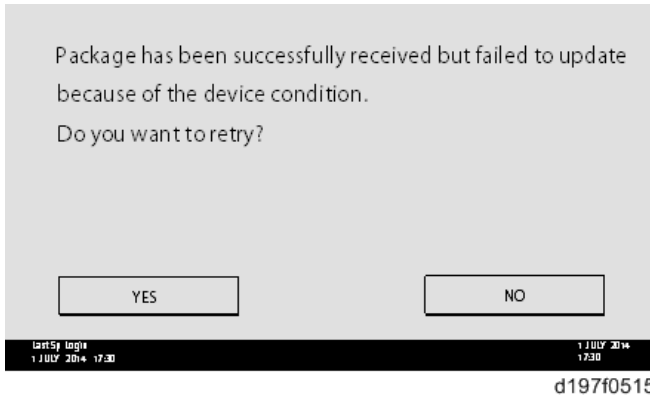

5

7. [Update done] is displayed.

- The machine will automatically reboot itself.

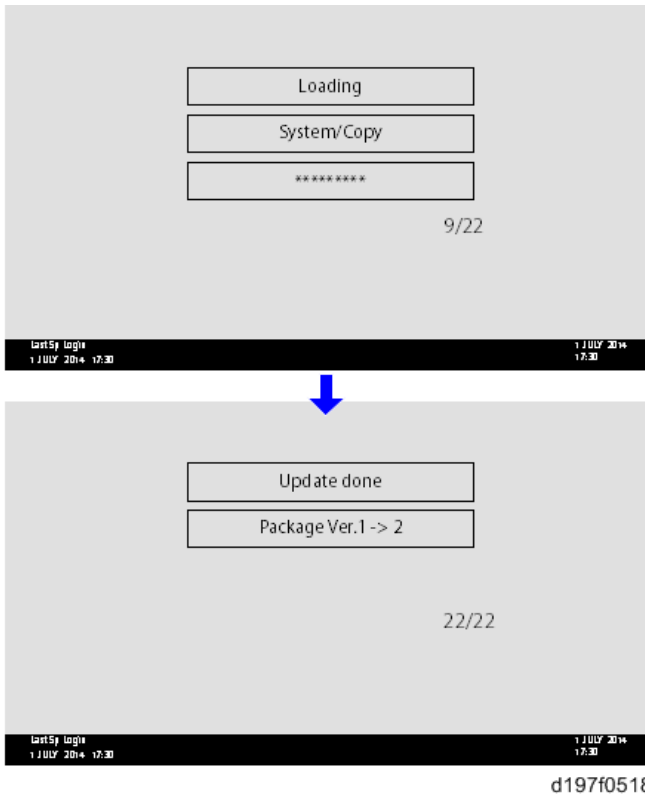

Note

- The figures at the lower right of the display indicate "Number of updated items/ All items to be updated".

Update at the Next Visit (Reserve)

It is possible to set the machine to download the package firmware which is necessary for SFU in advance, and then perform the actual installation at the next service visit. This saves waiting time for the firmware to download at the service visit.

How to Set the Machine to Download Firmware Later (Reserve)

Enter the [Firmware Update] menu in the SP mode and update the package firmware.

Note

- The [Firmware Update] button will appear even when a machine is connected to @Remote with a device which does not have an embedded @Remote communicating function. If an error code is displayed, refer to page 680 "Error Screens During Updating".

1. Enter the SP mode.
2. Press [Firmware Update].

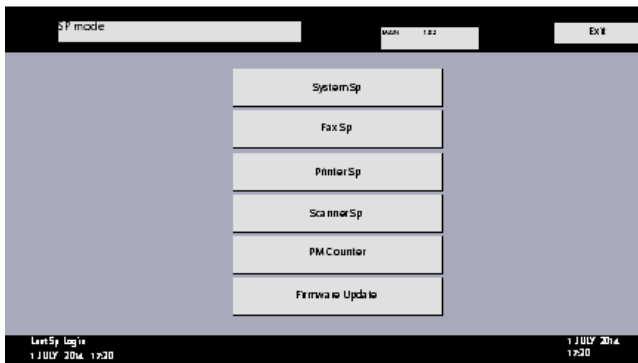

d197f0507

3. Press [Reserve].

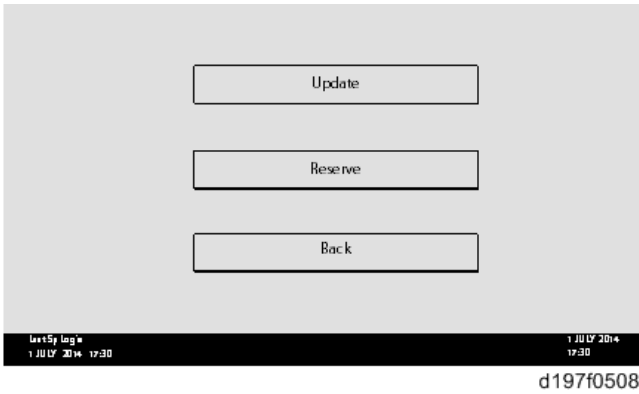

4. Press [Reservation setting].

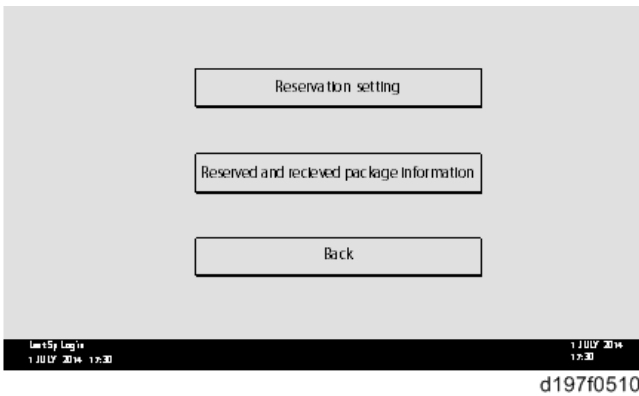

5. Enter the dates and times of the next visit and the start of receiving data.

- "Next time to visit this customer": The package firmware will be automatically downloaded by this time/date.
- "When to receive? (1-7)": The download of the package firmware will begin this number of days before the next visit.

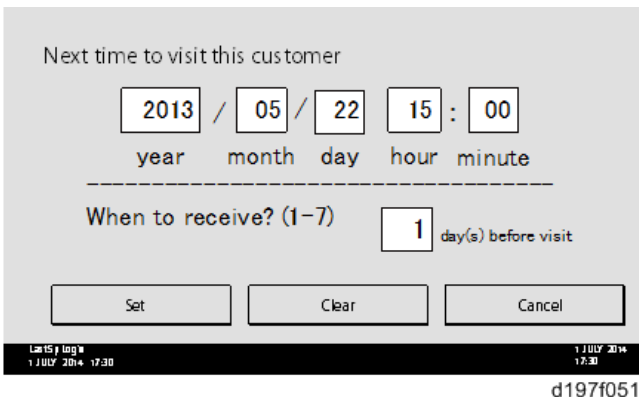

Successful Download

In the two diagrams below, the firmware is set to be downloaded by the day before the next scheduled visit. In the first diagram, the download is successful on the first try. In the second diagram, the download fails three times and is successful on the fourth try.

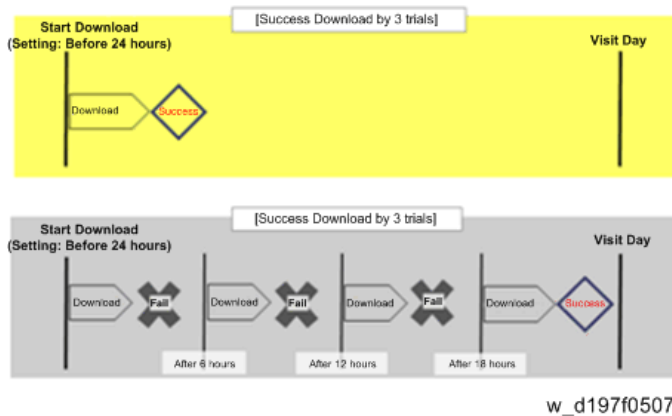

- If the firmware download fails or cannot be completed due to the network settings/condition, no power to the machine, or other reason, the machine will continue retrying every six hours until the scheduled deadline (up to a maximum of four tries). For example, if the download is set for the day before the next visit, the machine will attempt the download at 24 hours before the visit, and then continue trying every six hours (max. four tries total).
- The retry is only performed in cases when the firmware download has failed.
- If the machine is in Energy Saver mode when the download is scheduled to begin, the download will be performed in the background and the machine/panel will stay in Energy Saver mode.
- The download will continue uninterrupted even if the customer initiates a print job, copy job, fax receiving or other operation while the download is in progress.
- The download will be terminated if the customer turns the power off while the download is in progress.
- If the download cannot be completed successfully by the time of the next scheduled visit, the machine will stop trying to download the firmware.

How to Check if the Firmware Downloaded with Reserve

1. Enter the SP mode.

2. Press [Firmware Update].

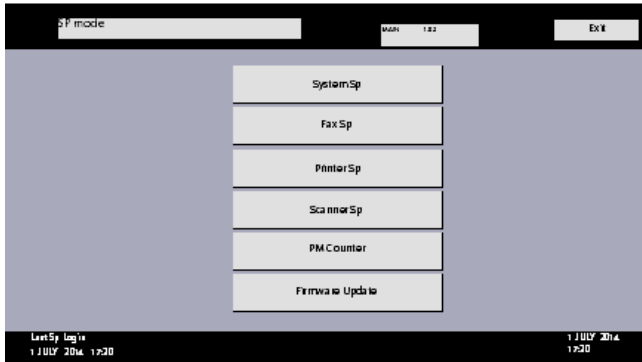

d197f0507

3. Press [Reserve].

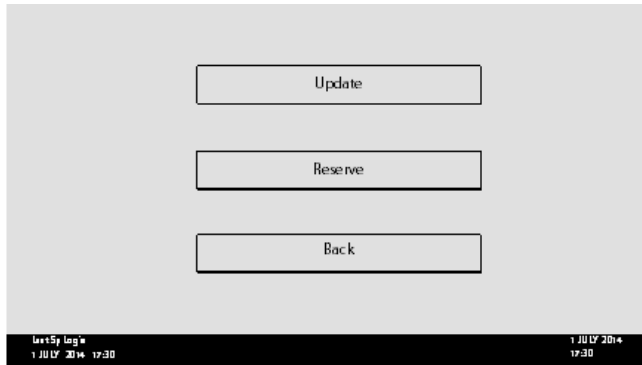

d197f0508

4. Press [Reserve and received package information].

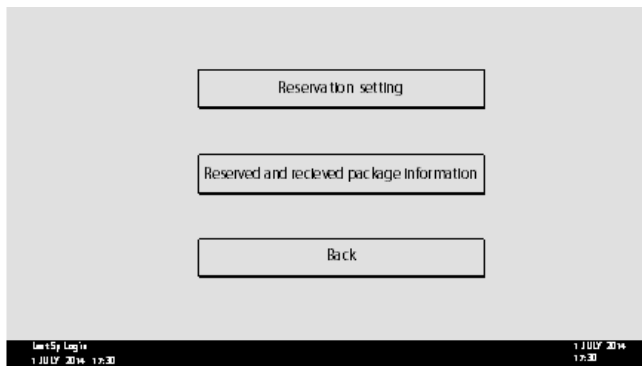

d197f0510

5. Check the information displayed.

When the package firmware was downloaded successfully, the details of the download result are displayed as the following picture shows.

Reservation reception result	Success
Part number of reserved and received package	D1234567
Version of reserved and received package	1.35
Package received date	2014/05/22
Reservation reception has succeeded. You may start the update.	Back

Lenovo Logo 1 JULY 2014 17:30 1 JULY 2014 17:30

d197f0511

↓ Note

- This information will only be displayed if the reserved firmware has already been downloaded. If not, all the data items are indicated with "-".

5

How to Install Firmware Downloaded with Reserve

1. Enter the SP mode.
2. Press [Firmware Update].

The screenshot shows a menu titled "SP mode" with a "Back" button at the top right. The menu contains the following options: System Sp, Fax Sp, Printer Sp, Scanner Sp, PM Counter, and Firmware Update. At the bottom, there is a status bar with "Lenovo Logo", "1 JULY 2014 17:30", and "1 JULY 2014 17:30".

d197f0507

3. Press [Update].

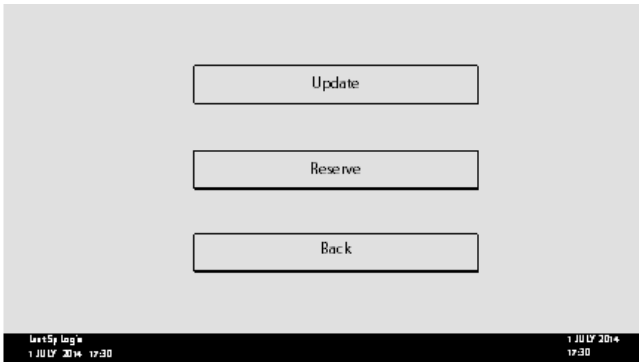

d197f0508

4. Press [Execute Update].

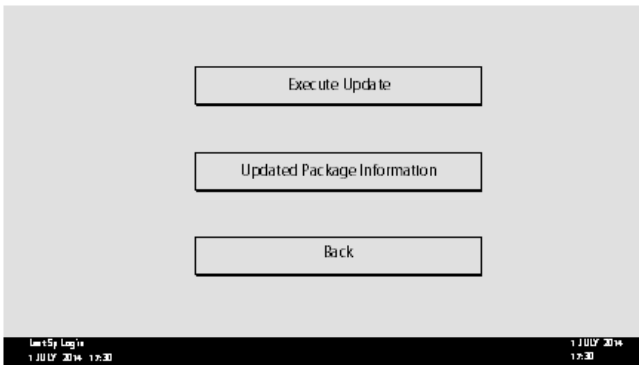

d197f0509

5. Check the version of the received package firmware, and then press [YES].

- Update is started.

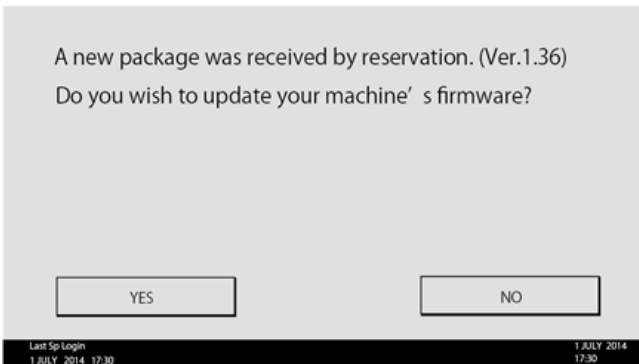

d197f0516

Note

- If the version of the reserved package in the HDD is older than the latest version, the messages shown in the following picture are displayed.

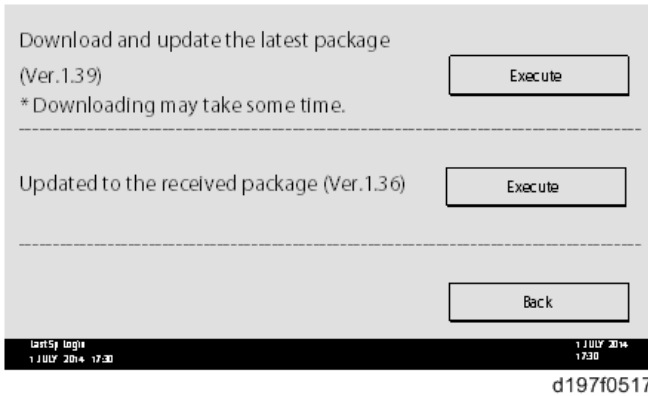

- If you wish to download the latest version, press [Execute] beside the message "Download and update the latest package." Then update of the package firmware will be started.
- If you wish to update using the firmware in the HDD (old version), press [Execute] beside the message "Update to the received package."

6. [Update done] is displayed.

- The machine will automatically reboot itself.

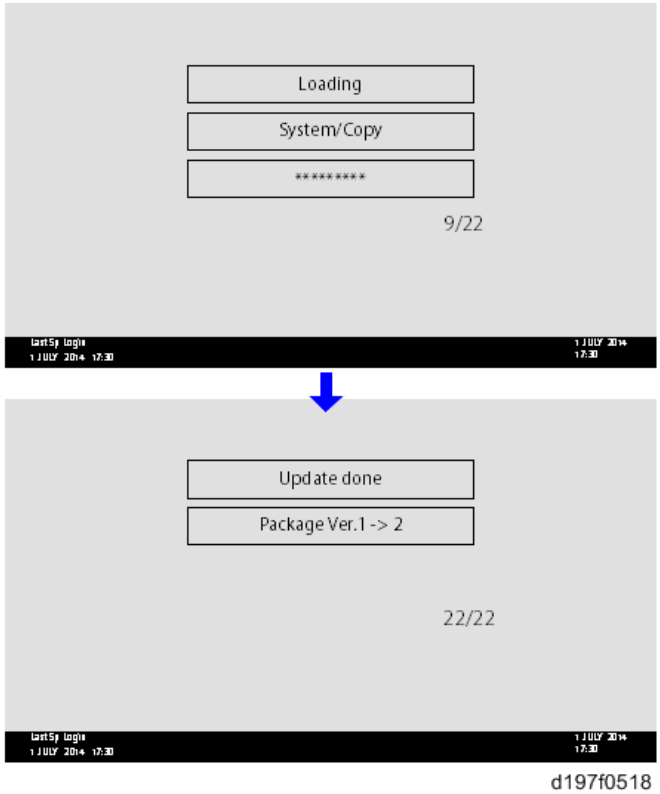

Note

- The figures at the lower right of the display indicate "Number of updated items/ All items to be updated".

Update via SD card

Update with an SD card, which is the conventional method, is available if you write the package firmware to the SD card.

Note

- If an error code is displayed, refer to page 680 "Error Screens During Updating".
1. Create a new folder in the SD card, and then name it "package".

2. Copy the package firmware (xxxxxxx.pkg) to this folder.

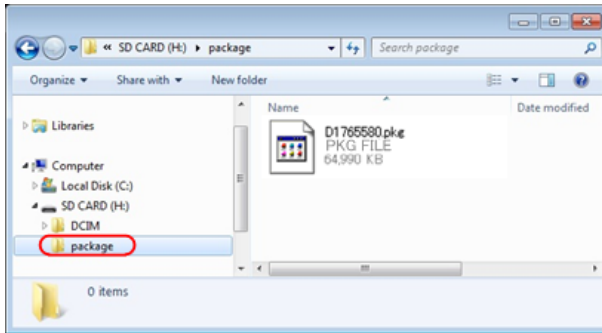

d197f0504

★ Important

- If you copy the package firmware into the conventional "romdata" folder, the update will not work.
- Only one version of the package firmware should be copied into the folder. If you copy multiple versions of package firmware to the SD card, the machine will select only one version of the firmware randomly.

3. Turn the power OFF.

4. Insert the SD card which contains the package into SD card slot 2 (for service).

5. Turn the power ON and press [Update].

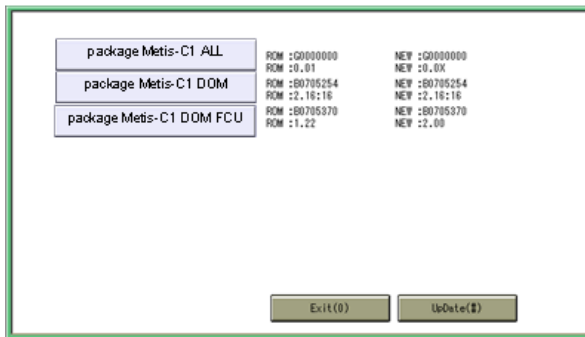

d176f2127

↓ Note

- When the SD card contains both a firmware package and one or more modules, the following display may show up. Select [Package] and press [OK] to move to step 5 above.

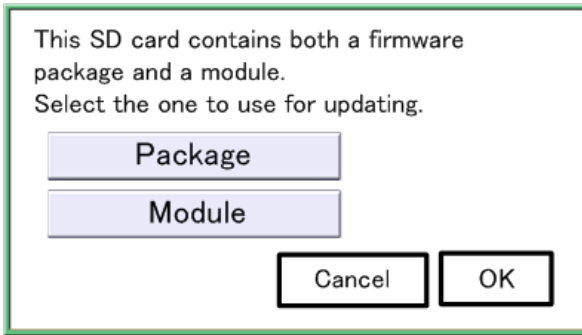

d176f2128

- Update is started automatically after the package firmware download to the HDD has been completed.
- When update is completed, "Update done" is displayed.

5

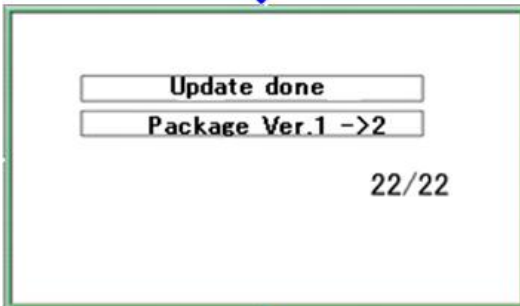
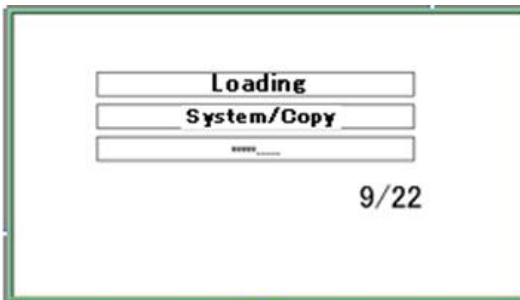

w_d177z0021a

Note

- The figures at the lower right of the display indicate "Number of updated items/ All items to be updated".

- Turn the main power switch OFF, and then pull out the SD card from SD card slot 2.
- Turn the power ON.

Firmware Update (Auto Remote Firmware Update)

Note

- Auto remote firmware update (ARFU) requires connection to the Internet. Be sure to get permission from the customer before setting.

Overview

By Auto Remote Firmware Update (ARFU), the firmware is updated by checking the global server every 76 hours and downloading the latest package if it is newer than the one installed on the machine.

Function Overview

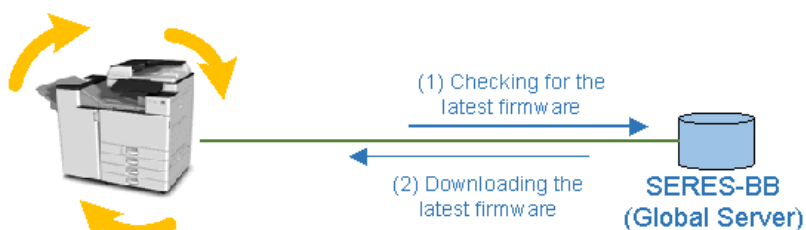

(3) Automatic firmware update

w_d238z5023e

Types of firmware update files, supported update methods:

	SFU	SD Card	RFU	ARFU
Individual firmware	N/A	Available	Available	N/A
Package firmware	Available	Available	Available	Available

What is Included in the Firmware Package

Modules included in the firmware package are indicated by ticks (✓) in the firmware download web site.

Firmware not included in the package require updating by SD cards, etc.

Included	Firmware
-	aics
✓	animation
✓	Application Site

Included	Firmware
✓	BluetoothService
✓	CheetahSystem
-	CSPF
-	Data Erase Onb
-	EcoInfoWidget
✓	Engine
-	External Auth
✓	Fax
-	FaxInfoWidget
✓	GWFCU3.8-9(WW)

Downloading and Updating Process

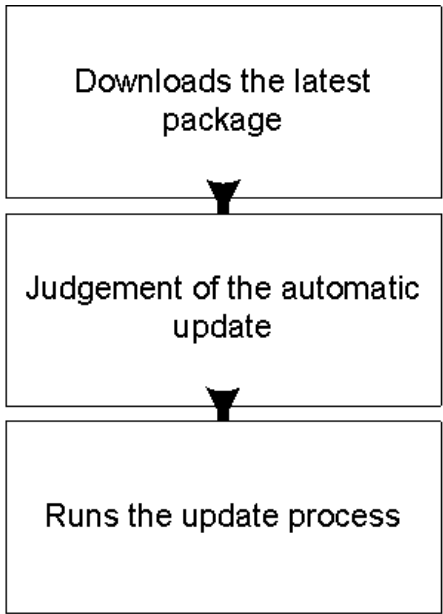

w_d238z5024e

Downloads the latest package

The machine checks the server for the latest package version.

If the version of the package on the global server is later than that of the package installed on the machine, or if the machine has not downloaded the firmware package, the machine downloads the latest package in the background even when the customer is using the machine.

If download fails, the machine will retry downloading 76 hours later.

The downloaded package can also be used with SFU (Smart Firmware Update). A package downloaded with SFU (Smart Firmware Update) can be used with ARFU (Auto Remote Firmware Update) and vice versa.

When replacing the hard disk, the firmware package data becomes lost from the hard disk. Even if the latest firmware is on the new hard disk, be sure to receive the latest package data.

When the machine connects to the server where the package files are stored, the DNS settings and the name solution by DNS are needed. The machine will still try to download the package even if the name cannot be resolved, but will fail as the name is not resolved.

The time and date to send the next inquiry to the global server can be checked with SP5-886-1 16 (Farm Update Setting: Auto Update Next Date).

The auto remote firmware update is executed every 76 hours.

Judgement of ARFU

Update judgement is done when the latest update package is successfully downloaded, or the package has already been downloaded.

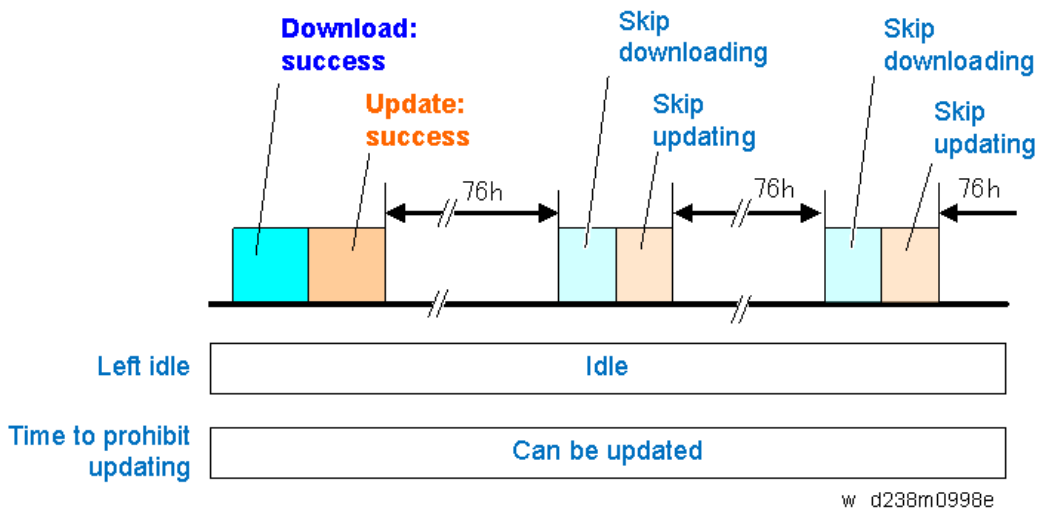

w_d238m0998e

If the judgement timing is in the range of the update prohibited time or day set with SP or WIM, the machine will retry the update after 76 hours.

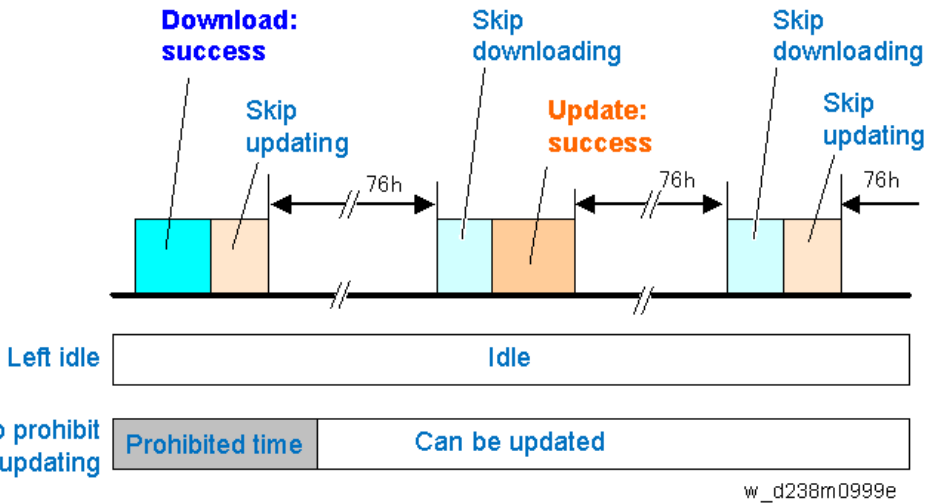

w_d238m0999e

5

If the machine is in use when the judgement process runs, the process is retried. Retry is done up to three times every hour (can be changed with SP) and if the machine is in use for all three retries, the machine will retry the update after 76 hours

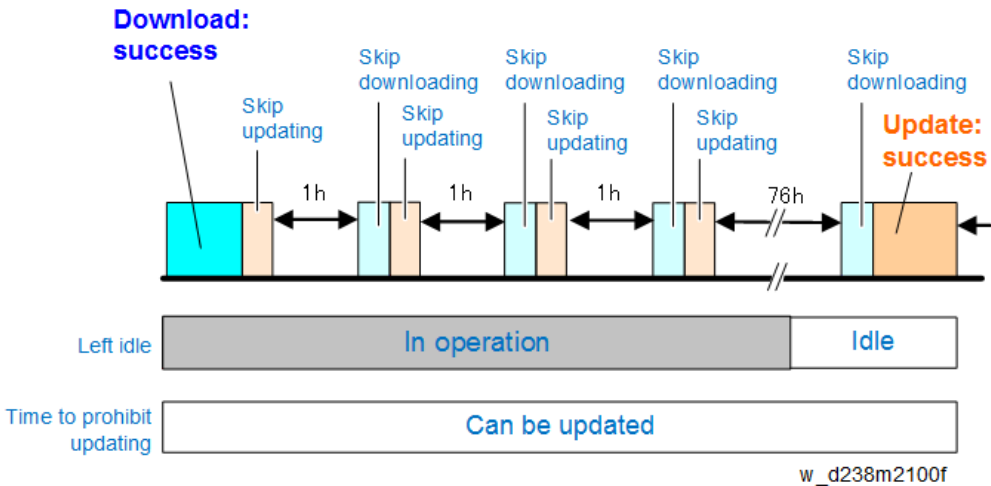

w_d238m2100f

Situations judged as machine in use

No.	Situations judged as machine in use
1	When the control panel is used within 30 seconds
2	During firmware update
3	While firmware update is disabled
4	While printing (copy, printer, fax, re-printing via network)

No.	Situations judged as machine in use
5	While scanning (copy, scanner, fax)
6	Retrieving image data via network
7	While initial setting (User Tools settings) or SP is being set
8	While fax is transferring data
9	During on hook / on handset
10	During the PC-FAX process (from PC to machine data transfer to the end of the job)
11	While shifting to/from the energy server mode
12	When not being able to run firmware update due to the modules that are running e.g.) Waiting for DCS transfer (refer to appendix), accessing devices such as HDD/SD card, etc.
13	While displaying a preview
14	While the document server function is in use
15	Connecting to TWAIN
16	During the interrupt copy process
17	While displaying the printer menu
18	While updating the display for the document server function via WIM or for stored fax documents
19	While writing log information
20	While accessing the address book
21	During SC

Update Process

When the machine has decided to run the auto firmware update, the following message is displayed.

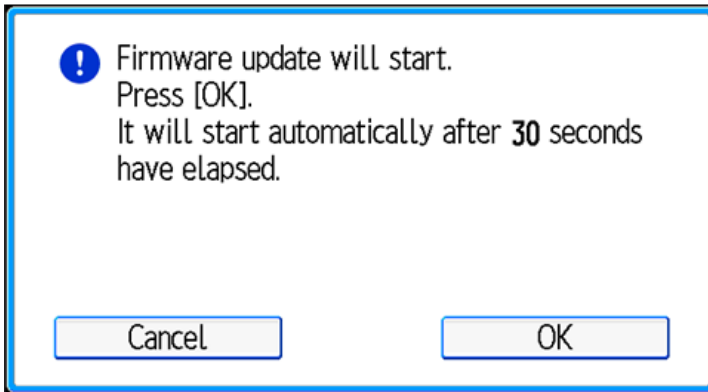

d238m2106

The popup will have "Cancel" and "OK" buttons and the update process will start either when the "OK" button is selected or 30 seconds has passed.

5

When the "Cancel" button is selected, the machine will run the "Retry update" process.

When the device update and three retries in recovery mode both fail, it is determined as a device defect and will display an SC for the defective device. If such an SC appears, replace the indicated board. In the case of SC845, the SC cannot be reported to the call center.

Device and corresponding SC number.

Device name	SC number
Engine board	SC845-01
Controller board	SC845-02
Operation panel (normal panel)	SC845-03
Operation panel (smart panel)	SC845-04
FCU	SC845-05

Canceling the update

It is possible to cancel the Auto Remote Firmware Update (ARFU) or update in recovery mode from the operation panel.

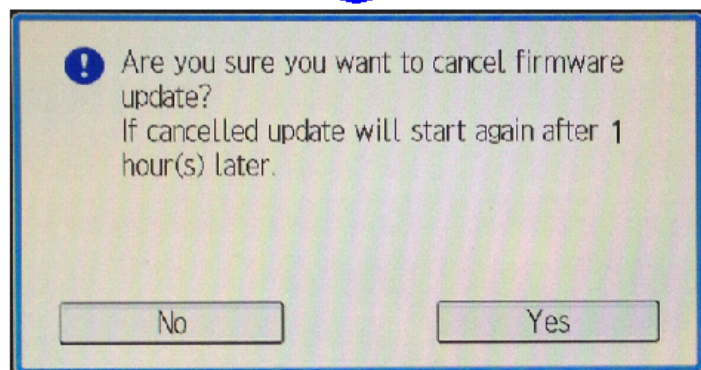
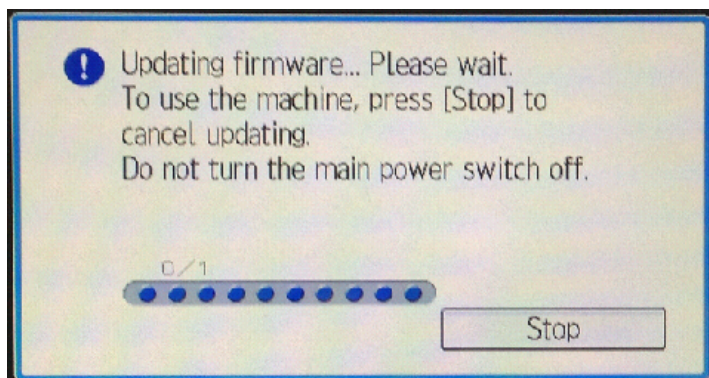

d238m2107

But this is not possible while updating the operation panel itself. On the other hand, the update for the operation panel will run at the final stage of the update. Thus canceling the update at that stage has no real effect.

When the update is cancelled, the machine will reboot when updates for all modules of one of the following devices is done.

1. Engine Board
2. FCU
3. Controller Board
4. Operation Panel

For example, when the update process is cancelled while updating the first module of the operation panel, the machine will reboot when all modules in the operation panel have been updated.

The firmware contents included in the package can be referred to in the release note in SERES release of the package.

The next update will run 76 hours after the cancellation. The old (cancelled) package will be discarded if the package downloaded 76 hours later is the latest.

Checking the ARFU Result

1. Enter the SP mode.
2. Press [Firmware update].
3. Press [Update].
4. Press [Update Package Information].
5. If the firmware package is the same as the one on the global server, the update was completed successfully. Otherwise, check the result using the logging date.

In SP7-520-041 to -045 (Update Log: Auto:Version), you can check the versions of the packages updated by ARFU. (-041 displays the latest result. It is also printed on the SMC sheet.)

Checking the Result Using the Logging Data

5

1. Enter the SP mode.
2. Press [System/Copy].
3. Check the results for ARFU by SP7-520-051 to 060 (Update Log: Auto:Result)

"-051" is the latest update result. For details about the number of each result log, see next section "Related SP."

Related SP

SP Number	Selection Def.	Overview
SP5-886-111	0: OFF 1: ON	Sets auto update ON/OFF by ARFU.
SP5-886-112	0: OFF 1: ON	Will not run the update when update prohibited time setting is ON and the current time is in the range of the time set. <ul style="list-style-type: none"> • Start time < End time: Prohibited time is from the start time to the end time on the same day. • Start time > End time: Prohibited time is from the start time to the end time on the next day. • Start time == End time: Prohibited time setting is disabled. (Update will not be prohibited.)
SP5-886-113	0 to 23 9	
SP5-886-114	0 to 23 17	

SP Number	Selection Def.	Overview
SP5-886-115	0: OFF 1: ON	Even when the update function is disabled, downloading the package is allowed. The downloaded package can be used with SFU.
SP5-886-116	Display only	Displays when the latest package check will run.
SP5-886-117	1 to 24 1	Set time for the next version check after retry.
SP5-886-120	0x00	Update will not run if the corresponding bit for each day below is set to 1. <ul style="list-style-type: none"> • prohibited: bit 7 • Monday: bit 6 • Tuesday: bit 5 • Wednesday: bit 4 • Thursday: bit 3 • Friday: bit 2 • Saturday: bit 1 • Sunday: bit 0 This setting is not affected by the prohibited time setting. e.g.) Prohibited on Mon., Fri., Sat., and Sun. : 0x47 (01000111)
SP7-520-011 to 015	Display only	History of date and time when update has started. The five most recent are recorded, the lowest number being most recent. If the last update failed, this is not recorded.
SP7-520-021 to 025	Display only	History of date and time when update has finished. The five most recent are recorded, the lowest number being most recent. The record is created when the update has successfully finished. When the update is cancelled, no record is created.

SP Number	Selection Def.	Overview
SP7-520-031 to 035	Display only	<p>History of the package number (including suffix) for which update has completed.</p> <p>The five most recent are recorded, the lowest number being most recent.</p> <p>The record is created when the update has successfully finished.</p> <p>When the update is cancelled, no record is created.</p>
SP7-520-041 to 045	Display only	<p>History of the package version for which update has completed.</p> <p>The five most recent are recorded, the lowest number being most recent.</p> <p>The record is created when the update has successfully finished.</p> <p>When the update is cancelled, no record is created.</p>
SP7-520-051 to 060	Display only	<p>History of the result of the download and the update.</p> <p>Refer below for the numbers set.</p>

Numbers set for the result history for SP7-520-051 to 060

No.	Result	Description
1	Downloading with SFU	Cannot download or update as the machine is now downloading the package for SFU.
2	HDD uninstalled	Cannot download or update as the machine has no HDD.
3	Updating with SFU	Cannot download or update as the machine is being updated with SFU.
4	HDD error	Cannot download or update as the HDD cannot be used.
5	Version information obtain error	Cannot download or update as the version information cannot be obtained.
6	Update download error	<p>Cannot download or update as the update download failed.</p> <p>In non @Remote method, this shows that the download failed because there was no proxy set.</p>

No.	Result	Description
7	Name resolution error	Cannot download or update as the name cannot be resolved upon downloading the update.
8	Auto update setting disabled	The package has been downloaded but will not run the update as SP5-886-111 (auto update setting) is disabled and SP5-886-115 (auto download setting for SFU) is enabled.
9	Update prohibited time	Cannot start to update as the auto update prohibited time setting (SP5-886-112) is enabled and the time update initiated was in the range of prohibited time (SP5-886-113 to 114). Or the day which update was initiated was a day for which update was prohibited (SP5-886-120).
10	Update postponed due to machine in use	Cannot start update due to the following conditions when update was initiated. <ul style="list-style-type: none"> • The machine is in use by a user (the panel was used within 30 seconds) • Machine offline for other reasons • Operation prohibited • Displaying SP/UP menu • Firmware update is running with another method • Configuration change prohibited • Verifying the operation panel (smart panel)
11	Update cancelled by user	Update was cancelled because a user selected "Cancel" in the popup shown before starting the update.
12	Offline failed	Cannot start to update as the machine is offline for other reasons.
13	Update successful	Update was started and successfully completed.
14	Update failed	Update was started but failed.

No.	Result	Description
15	Update deemed completed	Update was cancelled after the process was initiated because a user selected "Cancel". There is no need to resume the update due to one of the following reasons: <ul style="list-style-type: none"> • A newer update has been released and received. • When retrying ARFU, the update has already been completed by another method.
16	Update cancelled by user after update initiated	Update was cancelled after the process initiated because a user selected "Cancel" during the update.
17	Version information obtain error (communication error occurred for hostname)	Cannot download or update as the name cannot be resolved when obtaining version information.
18	Version information obtain error (proxy verification failure)	Cannot download or update as the proxy verification failed with proxy settings when obtaining version information.
19	Version information obtain error (other than proxy verification failure when proxy is set)	Cannot download or update as an error other than proxy verification with proxy settings occurred when obtaining version information.
20	Update download error (proxy verification failure)	Cannot download or update as the proxy verification failed with proxy settings when downloading the package.
21	Update download error (other than proxy verification failure when proxy is set)	Cannot download or update as an error other than proxy verification with proxy settings occurred when downloading the package.
22	Update by retry successful	After power failure, unsuccessful update, or rebooting, update by retry is executed successfully. However, this does not apply to the case where the update was cancelled after the process was initiated because a user selected "Cancel". In this case, the update is "successful" if the retry is not executed between the start and completion of the next update (76 hours after the cancellation).

Updating JavaVM

Creating an SD Card for Updating

1. Download the update modules from Firmware Download Center. As one of the model modules, "Java VM v11 UpdateTool" is available for download. (The version differs depending on the model.)
2. Unzip the downloaded file. Copy the whole "sdk" folder to the root of the SD card directly below.

Note

- When unzipping the downloaded file, two subfolders ("update" and "sdk") exist in the "sdk" folder. Rather than just copying the subfolder "sdk", copy the whole folder "sdk".

Updating Procedure

CAUTION

- SD card can be inserted with the machine power off.
 - During the updating process, do not turn off the power.
 - If you turn off the power during the updating, the machine performance is not guaranteed. (There is a possibility that an SC and boot failure occurs.)
 - If you accidentally turn off the power during the updating, retry the updating procedure from the beginning. (If the update fails again, you will need to replace the controller board.)
1. If the boot priority application is set to the ESA application, switch to the copy application. ([System Settings]-[General Features]-[Function Priority])
 2. Take a note of the current Heap size. ([Extended Feature Settings] – [Administrator Tools] – [Heap/Stack Size Settings])
The Heap size setting is changed to the initial setting when updating.
 3. Turn OFF the main power.
 4. Insert the SD card for update into the service slot.
 5. Turn ON the main power.
 6. After booting Java VM, update of the application is started. "Updating SDK/J" appears in the banner message of the touch panel display. (Estimated time: about 2 minutes)

- After completing the update and starting the Java VM, "Update SDK / J done SUCCESS" appear in the banner message of the touch panel display. After turning off the power, remove the SD card from the slot.

When you fail to update, "Update SDK/J done FAIL" is displayed. You can confirm the cause of the error message below.

- Turn ON the main power.
- Reconfigure the Heap size. ([Extended Feature Settings]-[Administrator Tools]-[Heap/ Stack Size Settings]).

See the manual for the ESA application to know what value to set for the heap size.

- Return to the previous setting for the boot priority application.

List of Error Messages

5

Update results are output as a text file on the SD card called "sdkjversionup.log" in the "\sdk \update" folder.

Result	File contents	Description of the output
Success	script file = /mnt/sd0/sdk/update/bootscrip 2012/08/22 17:57:47 start 2012/08/22 17:59:47 end SUCCESS	Boot script path Boot scripts processing start time End time boot script processing, the results
Failure	script file = /mnt/sd0/sdk/update/bootscrip 2012/08/22 17:57:47 start XXXX Error 2012/08/22 17:57:57 end FAIL	Boot script path Boot scripts processing start time Error message (Possibly multiple) End time boot script processing, the results

Error Message	Cause	Remedy
PIECEMARK Error,machine=XXXXX	Applied the wrong updating tool (Using the updating tool of a different model)	Use the correct updating tool for this model.
pasePut() - error : The file of the copy origin is not found Put Error!	Inadequacy with the SD card for updating (Files are missing in the updating tool)	Re-create the SD card for updating.

Error Message	Cause	Remedy
<p>paseCopy() - error : The file of the copy origin is not found.</p> <p>Copy Error!</p>	<p>Inadequacy SD card for updating</p> <p>(Files in the updating tool are missing)</p>	<p>Inadequacy SD card for updating</p> <p>(Files in the updating tool are missing)</p>
<p>[file name: XX] error, No space left on device</p> <p>pasePut() - error : The destination directory cannot be made.</p> <p>pasePut() - error : fileCopy Error.</p> <p>Put Error!</p>	<p>Writing destination is full. (The NAND flash memory on the controller board is full.)</p>	<p>Uninstall the unnecessary SDK applications.</p> <p>If you can not uninstall it, implement escalation, stating the "model name, application configuration, SMC sheet (SP5-990-006/024/025), and error file."</p>
<p>[file name: XX] error, No space left on device</p> <p>paseCopy() - error : The destination directory cannot be made.</p> <p>paseCopy() - error : fileCopy Error.</p> <p>Copy Error!</p>	<p>Writing destination is full. (The NAND flash memory on the controller board is full.)</p>	<p>Uninstall the unnecessary SDK applications.</p> <p>If you can not uninstall it, implement escalation stating the "model name, application configuration, SMC sheet (SP5-990-006/024/025), and error file."</p>
<p>Put Error! * 1</p> <p>Copy Error! * 1</p> <p>Delete Error!</p> <p>[XXXXX] is an unsupported command.</p> <p>Version Error</p>	<p>Error, not normally expected to occur</p>	<p>If you cannot uninstall it, implement escalation stating the "model name, application configuration, SMC sheet (SP5-990-006/024/025), and error file."</p> <p>* 1</p> <p>Without the foregoing error message, only "Put Error / Copy Error" will be displayed</p>

NVRAM Data Upload/Download

Uploading Content of NVRAM to an SD card

Do the following procedure to upload SP code settings from NVRAM to an SD card.

↓ Note

- This data should always be uploaded to an SD card before the NVRAM is replaced.
 - Make sure that the write protection of an SD card is unlocked.
1. Do SP5-990-001 (SP Print Mode: All(Data List)) before you switch the machine off. You will need a record of the NVRAM settings if the upload fails.

Make sure to shut down and reboot the machine once before printing the SMC. Otherwise, the latest settings may not be collected when the SMC is printed.

2. Turn OFF the main power.
3. Remove the SD card slot cover [A].

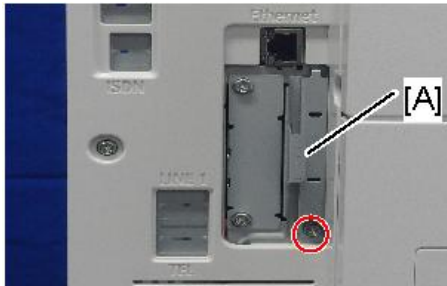

 x1

d238m0641

4. Insert the SD card in Service Slot [A: Lower Slot].



d238m0640b

5. Turn ON the main power.
6. Execute SP5-824-001 (NVRAM Data Upload) and then press the "Execute" key.

7. The following files are copied to an NVRAM folder on the SD card when the upload procedure is finished. The file is saved to the path and the following filename:

NVRAM\`<serial number>`.NV

Here is an example with Serial Number "K5000017114":

NVRAM\K5000017114.NV

8. In order to prevent an error during the download, be sure to mark the SD card that holds the uploaded data with the number of the machine from which the data was uploaded.

Note

- You can upload NVRAM data from more than one machine to the same SD card.

Downloading an SD Card to NVRAM

Do the following procedure to download SP data from an SD card to the NVRAM in the machine.

- The NVRAM data download may fail if the SD card with the NVRAM data is damaged, or if the connection between the controller and BCU is defective.
- Do the download procedure again if the download fails.
- Do the following procedure if the second attempt fails:
- Enter the NVRAM data manually using the SMC print you created before uploading the NVRAM data.

- Turn OFF the main power.
- Remove the SD slot cover.
- Insert the SD card with the NVRAM data into SD Card Slot 2 (lower).
- Switch ON the main power.
- Do SP5-825-001 (NVRAM Data Download) and press the "Execute" key.

Note

- The serial number of the file on the SD card must match the serial number of the machine for the NVRAM data to download successfully. The download fails if the serial numbers do not match.

This procedure does not download the following data to the NVRAM:

- Total Count
- C/O, P/O Count

Address Book Upload/Download

Information List

The following information is possible to be uploaded and downloaded.

Information	
<ul style="list-style-type: none"> • Registration No. • User Code • E-mail • Protection Code • Fax Destination • Fax Option • Group Name • Key Display 	<ul style="list-style-type: none"> • Select Title • Folder • Local Authentication • Folder Authentication • Account ACL • New Document Initial ACL • LDAP Authentication

5

Download

1. Prepare a formatted SD card.
2. Make sure that the write-protection on the SD card is off.
3. Turn OFF the main power.
4. Remove the SD card slot cover [A].

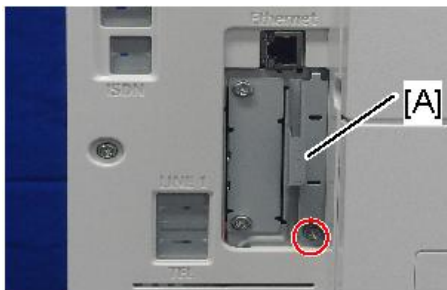

 x1

d238m0641

5. Insert the SD card in Service Slot [A: Lower Slot].



d238m0640b

6. Enter the SP mode.
7. Do SP5-846-051 (Backup All Addr Book).
8. Exit the SP mode, and then turn OFF the main power switch.
9. Remove the SD card from the SD card slot 2 (lower).
10. Install the SD slot cover.

Note

- If the capacity of SD card is not enough to store the local user information, an error message is displayed.
- Carefully handle the SD card, which contains user information. Do not take it back to your location.

Upload

1. Turn OFF the main power.
2. Remove the SD slot cover at the left rear side of the machine.
3. Install the SD card, which has already been uploaded, into the SD card slot 2 (lower).
4. Turn ON the main power.
5. Enter the SP mode.
6. Do SP5-846-052 (Restore All Addr Book).
7. Exit the SP mode, and then turn OFF the main power switch.
8. Remove the SD card from the SD card slot 2 (lower).
9. Install the SD slot cover.

Note

- The counter in the user code information is initialized after uploading.
- The information of an administrator and supervisor cannot be downloaded nor uploaded.
- If there is no data of address book information in the SD card, an error message is displayed.

Capturing the Device Logs

Overview

With this feature, you can save device logs that are stored in the machine (HDD or operation panel) or an SD card. It allows the Customer Engineer to save and retrieve error information for analysis.

The Capturing Log feature saves device logs for the following four.

- Controller device log including operation log
- Engine device log
- FCU device log
- Operation panel log

★ Important

- In older models, a technician enabled the logging tool after a problem occurred. After that, when the problem had been reproduced, the technician was able to retrieve the device log.
- However, this new feature saves the device logs at the time that problems occur. Then you can copy the logs to an SD card.
- You can retrieve the device logs using a SD card without a network.
- Analysis of the device log is effective for problems caused by the software. Analysis of the device log is not valid for the selection of defective parts or problems caused by hardware.
- Make sure to shut down and reboot the machine once before retrieving the Debug Logs. Otherwise, the latest settings may not be collected when the debug logs are retrieved.

Types of device logs that can be saved

Type	Storage Timing	Destination (maximum storage capacity)
Controller device log including operation log	<ul style="list-style-type: none"> • Saved at all times 	HDD (4 GB) or SD card connected to the service slot. When the data gets over 4.0 GB, the older data is deleted.
Engine device log	<ul style="list-style-type: none"> • When an engine SC occurs • When paper feeding/output stop because of a jam • When the machine doors are opened during normal operation 	HDD or SD card connected to the service slot (Up to 300 times)

Type	Storage Timing	Destination (maximum storage capacity)
FCU device log	<ul style="list-style-type: none"> When a specified amount of FCU device log is stored in the FCU. If fax application is unavailable (e.g. not installed), the machine does not transfer the log. 	HDD or SD card connected to the service slot
Operation panel log	<ul style="list-style-type: none"> When an error related to the operation panel occurs. 	Memory in the operation panel.

↓ Note

- **Device logs are not saved in the following conditions:**
- While erasing all memory
- While data encryption equipment is installed
- While changing the firmware configuration
- Forced power OFF (accidentally disconnecting the outlet)
- Engine device log while the machine is shutting down
- When the power supply to the HDD is off because of energy saving (engine OFF mode/STR mode)
- When one of the following SCs occurs: SC672, SC816, SC819, SC878, SC899, SC859, SC860, SC861, SC863, or SC864

↓ Note

- **The following logs are not saved:**
- Logs related to the energy saver mode (Engine-off, suspend-mode, or other cases)
 - Network communication log
 - Logs related to NRS
 - IP-FAX log
 - Access log for unauthorized users (guests)
- HTTP session timeout log
- Auto log-out log
- IC card related log
- Authorization for Fax

↓ Note

- The default save destination is the HDD. Except when it cannot be saved to the HDD for some reason, there is no need to change from the HDD to an SD card.

- If you want to change the save destination to an SD card, do the following.
 1. Set SP5-858-002 (Collect Machine Info: Save To) to "1 (SD)"
 2. Execute SP5-858-003 (Collect Machine Info: Make Log Trace Dir) to make a folder for the log in the SD card.
 3. Turn the power switch OFF and ON.
- It is recommended to use the SD card (8 GB) provided as a service part. The part number of the SD card that is registered as a service part is "B6455040".

Security of the Operation Log

The following operation logs related to security are not saved.

- User ID
- Password
- IP address
- Telephone number
- Encryption key
- Transition to SP mode

Retrieving the Device Logs via Operation Panel

★ Important

- Retrieve device logs to identify the date of occurrence of the problems and to find details of the problems
- e.g.: At around 8:00 am on March 10, an engine stall occurred. The operation panel does not respond. Turn the main power supply off / on.
- Analysis of the device log is effective for problems caused by the software. Analysis of the device log is not valid for the selection of defective parts or problems caused by hardware.

Procedure for Retrieving the Device Log with SD Card

1. Insert the SD card into the slot on the side of the operation panel or the service slot.

★ Important

- It is recommended to use the SD card (2 GBs* or 8 GBs**) provided as a service part. This is because the log data can be acquired much faster than when using commercially available SD cards.
- Format the SD card by using SD Formatter from Panasonic before copying the logs: https://www.sdcard.org/downloads/formatter_3/ (free software)

- Insert the SD card into the machine's service slot instead of the SD slot on the side of the operation panel.

* The part number of the SD card with 2 GBs that is registered as a service part is "B6455030".

** The part number of the SD card with 8 GBs that is registered as a service part is "B6455040".

2. Turn ON the main power.

3. Enter SP mode.

4. Specify the date that the problem occurred in SP5-858-101 (Start Date) by setting it to the year-month-day calendar format.

- For example, if a problem occurred on February 1, 2015, the date should be set to "20150201", as shown above.
- Be sure to confirm the date when the problem occurred before obtaining the logs.

5. Specify the number of days to collect the logs in SP5-858-102 (Days of Tracing).

- "2" is set by default, which is the minimum needed for investigating the problem.
- A value of "1" to "180" can be set.

6. Execute SP5-858-111 (Acquire All Info & Logs) to copy all of the log types to an SD card.

It is possible to obtain the logs separately by the following SPs.

SP	Collectable Information and/or Logs
SP5-858-111	All of the information and logs that are collected by executing the SPs from SP5-858-121 to SP5-858-145, and SMC.
SP5-858-121	Configuration page
SP5-858-122	Font page
SP5-858-123	Print settings list
SP5-858-124	Print Error log
SP5-858-131	Fax information (whether the fax destinations are included or not depends on the setting of SP5-858-103.)
SP5-858-141	Controller log, engine log, operation panel log, FCU, and SMC.
SP5-858-142	Controller log
SP5-858-143	Engine log
SP5-858-144	Operation panel log
SP5-858-145	FCU log

SP	Collectable Information and/or Logs
SP5-992-001	SMC

7. After executing the SP for copying the information and/or logs, a confirmation screen will appear. To proceed with obtaining the information and/or logs, tap "Execute"

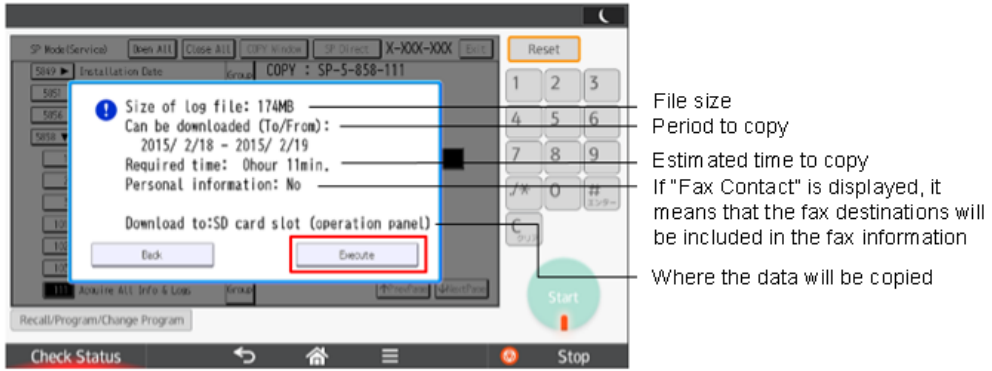

w_d238m0748

Note

- The approximate time it takes to transfer the debug log is as follows. Transfer time may be affected by the type or format of the SD card.
 Controller device log (GW device log): 2 - 20 minutes
 Engine device log: 2 minutes
 Operation panel device log: 2 - 20 minutes

If the estimated time is not calculated due to an error, an error code will be displayed.

Error Code	Description
-1	Other.
-2	No SD card is inserted in the service slot or in the SD slot on the side of the operation panel. In this case, insert an SD card into either of the SD slots.

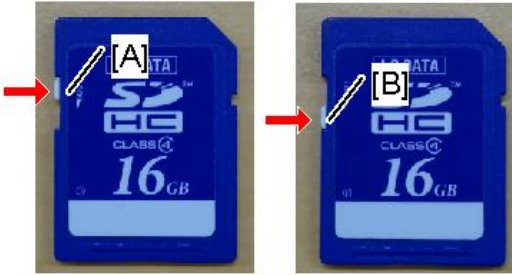
Error Code	Description
-3	<p>The SD card is locked. In this case, unlock the SD card, as shown below.</p>  <p>[A]: Unlocked, [B]: Locked</p>

8. Wait for the information and/or logs to be copied to the SD card.

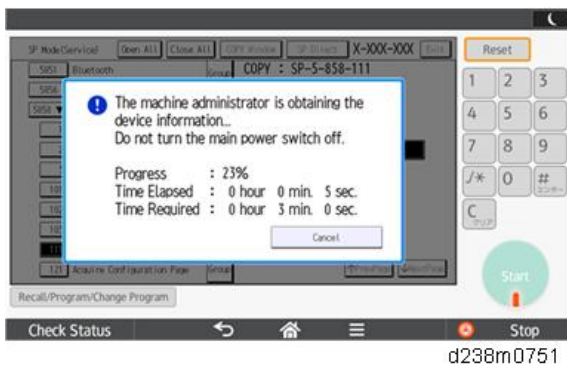

9. After a message stating that the process has completed appears on the operation panel, confirm that the LED light next to the SD card slot is not flashing and then remove the SD card.

10. Make sure that the SD card access LED is off, then remove the SD card.

Note

- The process of obtaining logs fails in the following cases:
 - When the size of the logs to obtain exceeds the amount of space available on the SD card.
 - When the SD card is removed while the logs are being copied to it.
 - When the SD card is not formatted.
- If 'failed' appears on the touch panel display, turn the power off, and then recover from step 1 again.

Retrieving the Device Logs via Web Image Monitor

The device logs can be retrieved via the Web Image Monitor.

1. Access the following URL and logon as an administrator:

http://[IP address or host name]/web/entry/df/websys/direct/getSysInfo.cgi



d238m0884

2. Specify the date that the problem occurred and the number of days to download the logs. If the fax destinations need to be included in the fax information, set "On" as "Obtain Fax Destination(s) Information". Then click "Download".

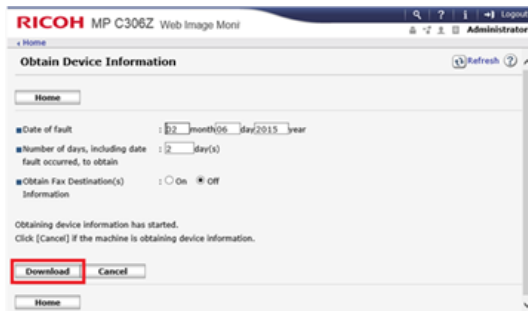

d238m0885

5

Note

- "3" is set by default for "Number of days, including date fault occurred, to obtain". However "2", which is the minimum needed for investigating the problems, is recommended for reducing the downloading time.
- "Obtain Fax Destination(s) Information" is set to "Off" by default.

- The confirmation screen will appear and the information and/or logs will start downloading. To proceed to download the information and/or logs, wait for the open-or-save dialog to appear.



d238m0886

Note

- To cancel downloading, click "Cancel".
- To reconfigure some settings, click "Download again".
- Operation panel when downloading the logs:

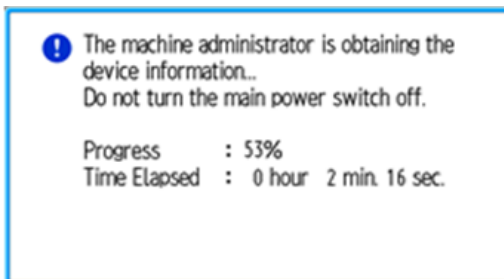

d238m0887

- After a while, the open-or-save dialog will appear. Specify where to download and save the file.



d238m0888

Note

- The debug logs are saved with the following file names. These names are the same as the files downloaded with SD card.

The device logs are saved with the following file names.

Controller log (mmesg)	/LogTrace/[the model number]/watching/[yyyymmdd_hhmmss]_[a unique value].gz
Engine device log	/LogTrace/[Machine Serial]/engine/[yyyymmdd_hhmmss].gz
Operation panel log	/LogTrace/[the model number]/opepanel/[yyyymmdd_hhmmss].tar.gz
SMC	/LogTrace/[the model number]/smc/[the model number]_[5992XXX]_[yyyymmdd]_[hhmmss].csv
Configuration page	/LogTrace/[the model number]/gps/ConfigurationPage/ConfigurationPage_[yyyymmdd_hhmmss].csv
Font page	<ul style="list-style-type: none"> • /LogTrace/[the model number]/gps/FontPage/FontPage_PCL_[the page number]_[yyyymmdd_hhmmss].jpg • /LogTrace/[the model number]/gps/FontPage/FontPage_PDF_[the page number]_[yyyymmdd_hhmmss].jpg • /LogTrace/[the model number]/gps/FontPage/FontPage_PS_[the page number]_[yyyymmdd_hhmmss].jpg
Print settings list	<ul style="list-style-type: none"> • /LogTrace/[the model number]/gps/PrintSettingList/PrintSettingList_RPGL_[yyyymmdd_hhmmss].txt • /LogTrace/[the model number]/gps/PrintSettingList/PrintSettingList_RTIFFF_[yyyymmdd_hhmmss].csv
Error log	/LogTrace/[the model number]/gps/ErrorLog/[yyyymmdd_hhmmss].csv
Fax information	/LogTrace/[the model number]/faxreport/[yyyymmdd_hhmmss].csv
FCU debug log	/LogTrace/[Machine Serial]/fcu-log/[yyyymmdd_hhmmss].gz

SMC List Card Save Function

Overview

SMC List Card Save

The SMC List Card Save (SP Text Mode) function is used to save the SMC list as CSV files to the SD-card inserted into the operation panel SD-card slot.

★ Important

- Make sure to shut down and reboot the machine once before exporting the SMC sheet data. Otherwise, the latest settings may not be collected when the SMC is exported.

Procedure

5

1. Turn OFF the main power.
2. Insert the SD card into the operation panel SD-card slot, and then turn OFF the main power.
3. Enter SP mode.
4. Select "System SP".

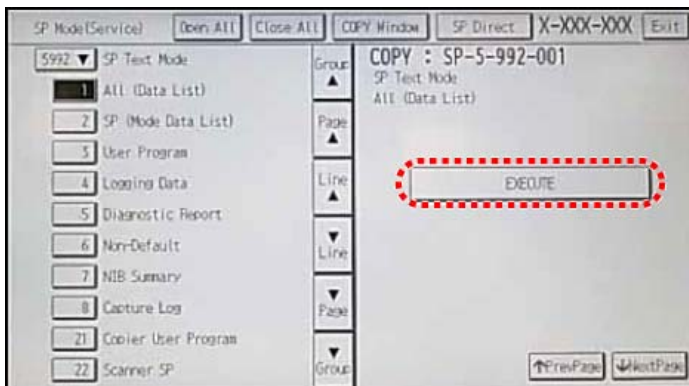

d1440127

5. Select SP5-992-001 (SP Text Mode).
6. Select a detail SP number shown below to save data on the SD card.
SP5-992-xxx (SP Text Mode)

Detail No.	SMC Categories to Save
001	All (Data List)
002	SP (Mode Data List)
003	User Program
004	Logging Data
005	Diagnostic Report
006	Non-Default
007	NIB Summary
008	Capture Log
021	Copier User Program
022	Scanner SP
023	Scanner User Program
024	SDK/J Summary
025	SDK/J Application Info
026	Printer SP
027	Smart Operation Panel SP
028	Smart Operation Panel UP

7. Press [EXECUTE].

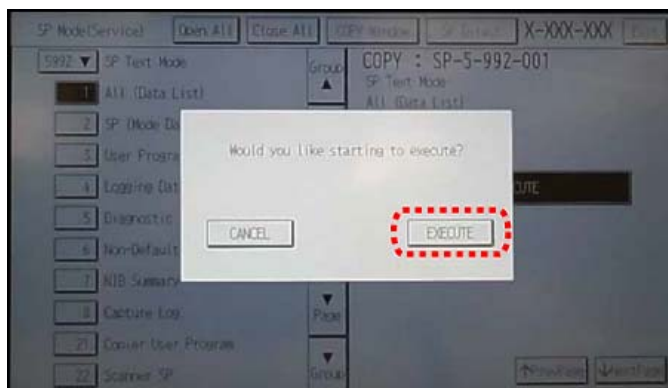

d1440128

8. Press [EXECUTE] again to start. Press [CANCEL] to cancel the saving.



d1440130

9. "It is executing it" is shown on the screen while executing.

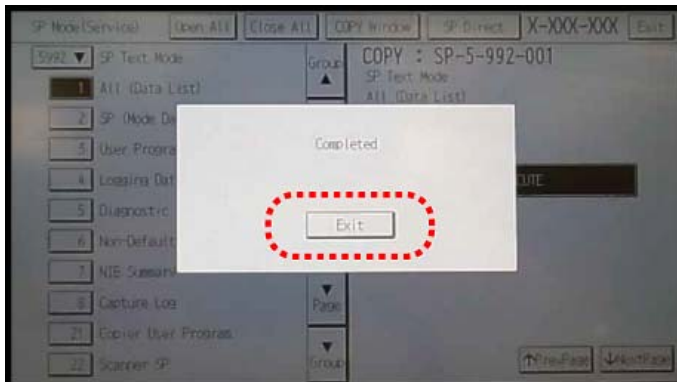

d1440129

10. Wait for 2 to 3 minutes until "Completed" is shown.

Note

- The SMC list saving may take from 2 to 3 minutes to complete.
- Press [CANCEL] to abort executing.

11. Press [Exit] to exit from SP mode.

File Names of the Saved SMC Lists

The SMC list data saved on the SD-card will be named automatically. The file naming rules are as follows.

Example:

W801P999017_59921_20111011_53954.csv



d1440131a

A:

Machine serial number (fixed for each machine)

B:

SP number saved in this file.

First four digits (5992) in this part are fixed. The other one or two digits are the detail SP number(s). In this case, it is one digit. Therefore, this file is of SP5-992-001 (All data list). See the upper SP table for the correspondence between SP detail numbers and the contents.

C:

File creation date

Year/Month/Day ("Zero" will be omitted if each is one digit.)

D:

File creation time

Hour/Minute/Second ("Zero" will be omitted if each is one digit.)

E:

File Extension CSV (Comma Separated Value)

This part is fixed.

Note

- A folder named by the machine serial number will be created on the SD card when this function is executed.
- This function can save the SMC list data only to an SD card inserted into the operation panel SD card slot.

Error Messages

SMC List Card Save error message:

- **Failed:**
FACTOR: Read-only file system, No space left on device.

If an error occurs, pressing "Exit" will cause the device to discard the job and return to the ready state.

UP/SP Data Import/Export

UP Data Import/Export

Data that can be imported and exported

- Copier / Document Server Features
- Printer Features
- Scanner Features
- Facsimile Features
- Browser Features
- Extended Feature Settings
- Program (Document Server)
- Program (Copier)
- Program (Scanner)
- Web Image Monitor Setting
- Web Service Settings
- System Settings

5

Data that cannot be imported or exported

- Some System Settings *1 *2
 - *1 The setting for the date, settings that require the device certificate, and settings that need to be adjusted for each machine (for example, image adjustment settings) cannot be imported or exported.
 - *2 Settings only for executing functions and settings only for viewing cannot be imported or exported.
- Extended Feature Settings
- Address book
- Programs (fax function)
- Programs (printer function)
- User stamp in Copier / Document Server Features
- Settings that can be specified via telnet
- @Remote-related data

- Counters
- EFI printer unit settings
- Settings that can only be specified via Web Image Monitor or Web Service (for example, Bonjour, SSDP setting)

Exporting Device Information

This can be exported / imported by an administrator with all privileges.

When exporting SP device information from the control panel, the data is saved on an SD card.

1. Insert an SD card into the media slot on the side of the control panel.
2. Log in from the control panel as an administrator with all privileges.
3. Press [User Tools] icon > [Machine Features] > [System Settings].
4. Press [Administrator Tools].
5. Press [Device Setting Information: Export (Memry Strge Devc)].

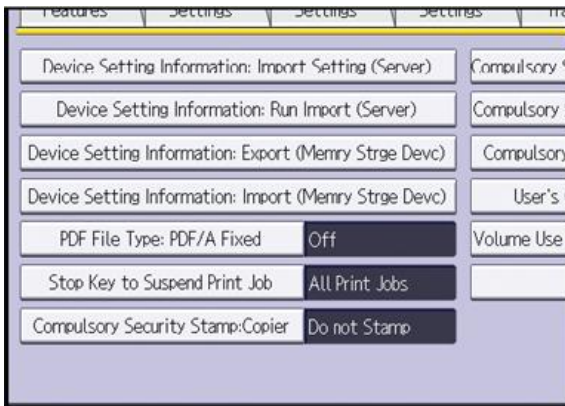

w_d1825501

6. Set the export conditions.

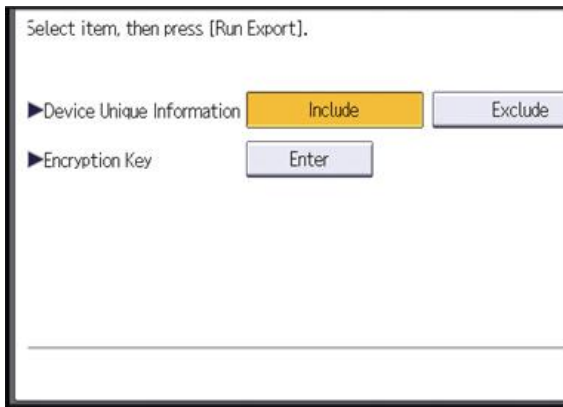

w_d1825502

- Specify whether to [Include] or [Exclude] the "Device Unique Information". "Device Unique Information" includes the IP address, host name, fax number, etc.
- Specify an encryption key.

7. Press [Run Export].

8. Press [OK].

9. Press [Exit].

10. Log out.

⬇ Note

- If data export fails, the details of the error can be viewed in the log.
- When device Information is periodically imported, it is necessary to create the device setting information file with special software and store it on the web server.

Importing Device Information

This can be exported / imported by an administrator with all privileges.

Import device information saved on an SD card.

1. Insert an SD card into the media slot on the side of the control panel.
2. Log in from the control panel as an administrator with all privileges.
3. Press [User Tools] icon > [Machine Features] > [System Settings].
4. Press [Administrator Tools].
5. Press [Device Setting Information: Import (Memory Storage Device)].

6. Configure the import conditions.

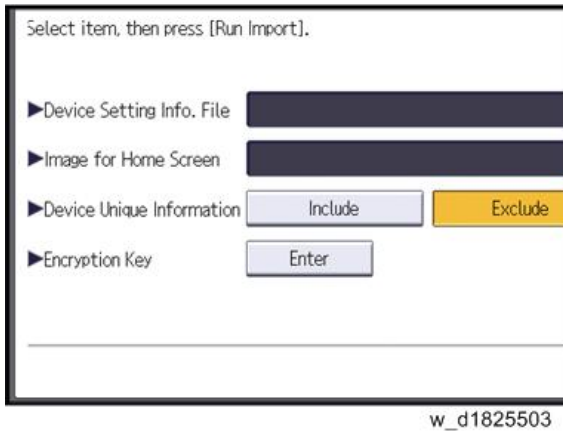

- Press [Select] of the "Device Setting Info. File" to select the file(s) to import.
- When inserting a file into a home screen, press [Select] for the Image for Home screen and select the file. You cannot use this setting when using the Smart Operation Panel.
- Specify whether to [Include] or [Exclude] the "Device Unique Information". "Device Unique Information" includes the IP address, host name, fax number, etc.
- Enter the encryption key that was specified when the file was exported.

7. Press [Run Import].

8. Press [OK].

9. Press [Exit].

The machine restarts.

⬇ Note

- If data export fails, the details of the error can be viewed in the log.

SP Data Import/Export

Data that can be imported and exported

- System SP
- Printer SP
- Fax SP
- Scanner SP

Exporting Device Information

When exporting SP device information from the control panel, the data is saved on an SD card.

1. Insert an SD card into the media slot on the side of the control panel.
2. Enter SP mode.
3. Press SP5-749-001 (Import/Export: Export)
4. Select "Target" SP settings (System/Printer/Fax/Scanner/Smart Operation Panel) to be exported.
5. Select "Option" settings (Unique/Secret).

Item	Specification	Note
Unique	Unique information of the machine is included in the exported file if you select "Unique" setting.	<p>Unique information that can be updated</p> <p>#1. Items that are to be used to identify the machine. Example: Network Information/ Host name / Information related to fax number /Mail address assigned to the machine</p> <p>#2. Items for specifying the options equipped on the machine. Example: Lot number for developer</p> <p>Unique information that cannot be updated</p> <p>#1. Items that may cause a problem if imported Example: Serial number / Information related to @Remote</p> <p>#2. Items for managing the history of the machine Example: Time and date / Counter information / Installation date</p> <p>#3. Setting values for the Engine</p>

Item	Specification	Note
Secret	Secret information is exported if you select "Secret" setting.	<p>Secret information</p> <p>#1. Data that cannot be exported without being encrypted. (Exported data is encrypted.) Example: Password / Encryption key / PIN code</p> <p>#2. Confidential information for the customer Example: User name / User ID / Department code / Mail address / Phone number</p> <p>#3. Personal information Example: Document name / Image data</p> <p>#4. Sensitive information for the customer Example: MAC address / Network parameters</p>

* The IP address is exported when both 'Unique' and 'Secret' are selected.

6. Select "Crpt config" setting (Encryption).

Encryption	<p>Select whether to encrypt or not when exporting.</p> <p>If you push the "Encryption" key, you can export secret information.</p>	<p>If the encryption function is used, setting of an encryption key is required by direct input.</p> <ul style="list-style-type: none"> Type the arbitrary password using the soft keyboard Can enter up to 32 characters
------------	---	---

7. Press [Execute].

8. Press [OK].

↓ Note

- If data export fails, the details of the error can be viewed in the log.

Importing Device Information

Import device information saved on an SD card.

1. Insert an SD card into the media slot on the side of the control panel.
2. Enter SP mode.
3. Press SP5-749-101 (Import/Export: Import)
4. Select a unique setting.
5. Press [Encryption Key], if the encryption key was created when the file was exported.

6. Select an encryption setting.

Unique	If you want to apply the unique information to the target machine, select the "Unique" key.	Refer to the above information.
Encryption	If an encrypted file is selected as the import file, this setting is required.	

7. Press [Execute].

8. Press [OK].

↓ Note

- If data export fails, the details of the error can be viewed in the log.

Possible solutions for import/export problems

5

The access log file is created when export/import is executed. The file is stored in the same location as the exported device setting information file.

If an error occurs, check the log's result code in the access log file first. Values other than 0 indicate that an error occurred.

The result code will appear in the circled area illustrated below.

- Example of a log file

```
*1.0.0*
*ExecType*, *Date*, *SerialNo*, *PnP*, *Model*, *Destination*, *IP*, *Host*, *Storage*, *FileName*
*FileID*, *TotalItem*, *NumOfOkItem*, *ResultCode*, *ResultName*, *Identifier*
*IMPORT*
*2012-07-05T15:29:16+09:00*
*3C35-7M0014*
*Brand Name*
*Product Name*
*0*
*10*
*10.250.155.125*
*RNP00267332582D*
*SD*
*201207051519563C35-710220.csv*
*201207051519563C35-710220*
* 0*
* 2*
*INVALID REQUEST*
*TargetID*, *ModuleID*, *PrefID*, *Item*, *NgCode*, *NgName*
w_d1825500
```

If you cannot solve the problem or do not know how to solve it after checking the code, note down the error log entry, then contact your supervisor.

Result Code	Cause	Solutions
2 (INVALID REQUEST)	A file import was attempted between different models or machines with different device configurations.	Import files exported from the same model with the same device configurations.
4 (INVALID OUTPUT DIR)	Failed to write the device information to the destination device.	Check whether the destination device is operating normally.
7 (MODULE ERROR)	An unexpected error occurred during import or export.	Switch the power off and then back on, and then try the operation again. If the error persists, contact your supervisor.
8 (DISK FULL)	The available storage space on the external medium is insufficient.	Execute the operation again after making sure there is enough storage space.
9 (DEVICE ERROR)	Failed to write or read the log file.	Check whether the path to the folder for storing the file or the folder in which the file is stored is missing.
10 (LOG ERROR)	The hard disk is faulty.	Contact your supervisor.

Result Code	Cause	Solutions
20 (PART FAILED)	Failed to import some settings.	<p>The reason for the failure is logged in "NgCode". Check the code.</p> <p>Reason for the Error (Ng-Name)</p> <p>2. INVALID VALUE The specified value exceeds the allowable range.</p> <p>3. PERMISSION ERROR The permission to edit the setting is missing.</p> <p>4. NOT EXIST The setting does not exist in the system.</p> <p>5. INTERLOCK ERROR The setting cannot be changed because of the system status or interlocking with other specified settings.</p> <p>6. OTHER ERROR The setting cannot be changed for some other reason.</p>
21 (INVALID FILE)	Failed to import the file because it is in the wrong format in the external medium.	<p>Check whether the file format is correct.</p> <p>The import file should be a CSV file.</p>
22 (INVALID KEY)	The encryption key is not valid.	Use the correct encryption key.

Note

- When exporting device information from the control panel, the data can be saved only on an SD card.
- The file format for exports is CSV.

Card Save Function

Overview

Card Save:

- The Card Save function is used to save print jobs received by the printer on an SD card with no print output. Card Save mode is toggled using printer Bit Switch #1 bit number 4. Card Save will remain enabled until the SD card becomes full, or until all file names have been used.
- Captures are stored on the SD card in the folder /prt/cardsave. File names are assigned sequentially from PRT00000.prn to PRT99999.prn. An additional file PRT.CTL will be created. This file contains a list of all files created on the card by the card save function.
- Previously stored files on the SD card can be overwritten or left intact. Card Save SD has "Add" and "New" menu items.
 - **Card Save (Add):** Appends files to the SD Card. Does not overwrite existing files. If the card becomes full or if all file names are used, an error will be displayed on the operation panel. Subsequent jobs will not be stored.
 - **Card Save (New):** Overwrites files in the card's /prt/cardsave directory.

Limitation:

- Card Save cannot be used with PjL Status Readback commands. PjL Status Readbacks will not work. In addition they will cause the Card Save to fail.

Procedure

1. Turn OFF the main power.
2. Insert the SD card into slot 2 (lower), then turn ON the main power.
3. Enter SP mode.
4. Select the "Printer SP".

5. Select SP-1001 "Bit Switch".

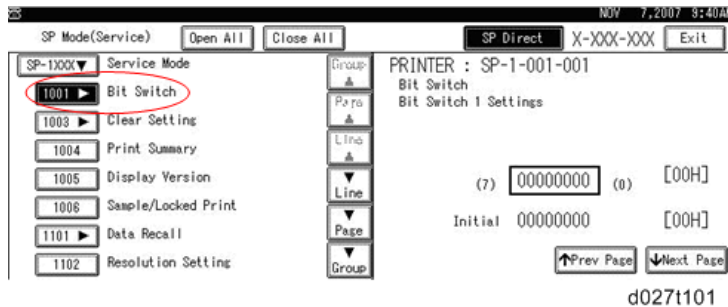

6. Select "Bit Switch 1 Settings" and use the numeric keypad to turn bit 4 ON and then press the "#" to register the change. The result should look like: 00010000. By doing this, Card Save option will appear in the "List/Test Print" menu.

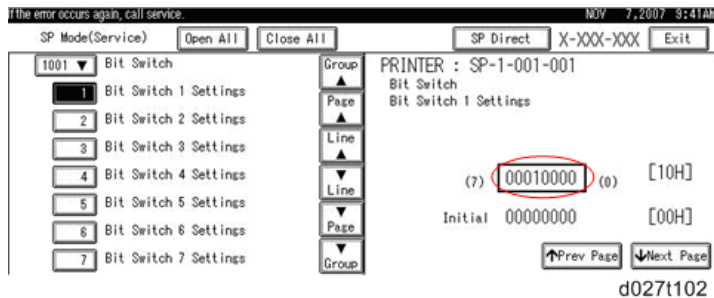

7. Press "Exit" to exit SP Mode.
8. Press the "User Tools" icon > "Machine Features".
9. Select "Printer Features".

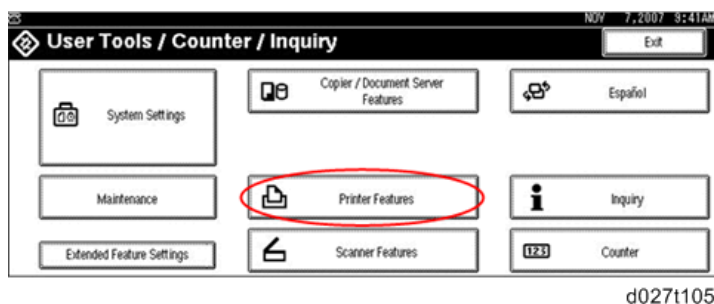

- 10. Card Save (Add) and Card Save (New) should be displayed on the screen. Select Card Save (Add) or Card Save (New).

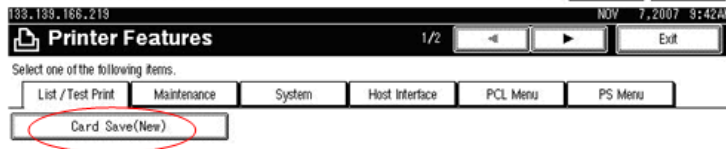
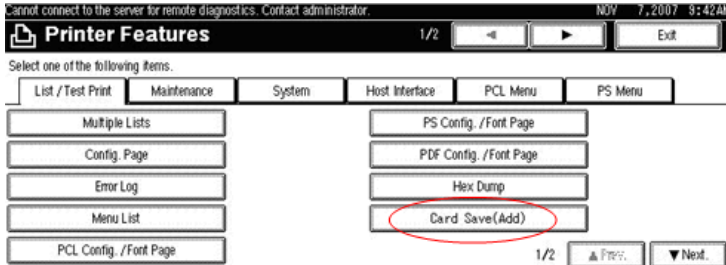

5

2/2 ▲ Prev. ▼ Next
d0271106

- 11. Press "OK" and then return to Home screen.

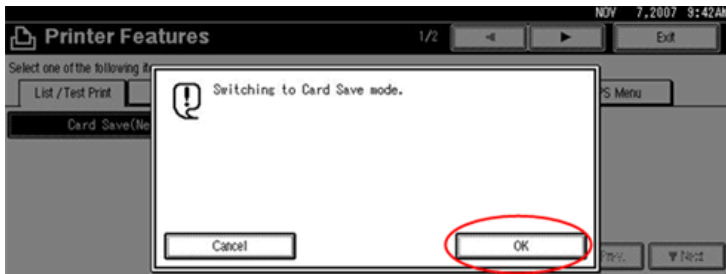

d0271107

- 12. Press the "Printer (Classic)" icon.

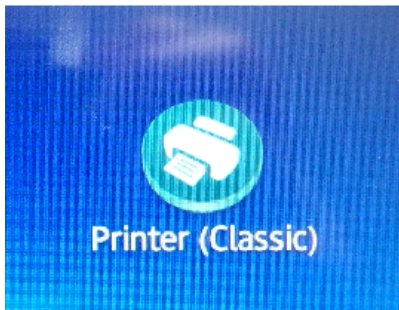

d238m0937

13. "Hex Dump Mode" is displayed in the top left of the display panel.

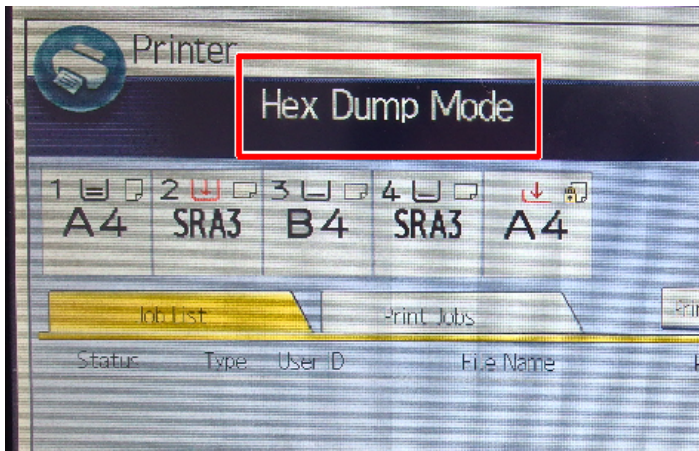

d238m0936

14. Send a job to the printer. The Communicating light should start blinking.
15. As soon as the printer receives the data, it will be stored on the SD card automatically with no print output.

Nothing is displayed on the screen, indicating that a Card Save operation was successful.

16. Press "Reset" to exit Card Save mode.

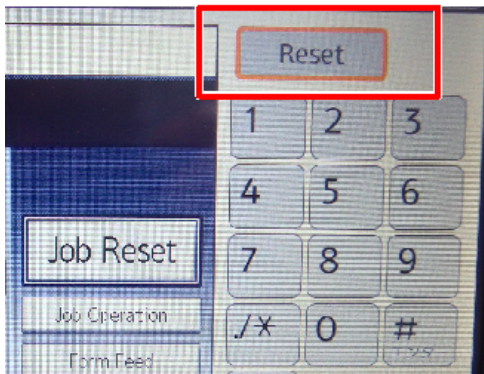

d238m0938

17. Change the Bit Switch Settings back to the default 00000000, then press the "#" in the numeric keypad to register the changes.
18. Remove the SD card after the main power switch is turned OFF.

Error Messages

Card Save error messages:

- **Init error:** A card save process (e.g. card detection, change to kernel mode) failed to initialize.

- **Card not found:** Card cannot be detected in the slot.
- **No memory:** Insufficient working memory to process the job.
- **Write error:** Failed to write to the card.
- **Other error:** An unknown error occurred.

If an error occurs, pressing "OK" will cause the device to discard the job and return to the ready state.

6. Troubleshooting

Self-Diagnostic Mode

SC Automatic Reboot

When an ordinary SC (pattern D) is generated, automatically reboot is performed. Automatic reboot or reboot by user operation can be set by SP5-875-001 (SC automatic reboot setting out) (default value: 0 "Automatic reboot").

When a type D occurs, automatic reboot is done or the machine display asks the customer if it can reboot. However, when the SC occurs twice in a short time, the machine sends a report to the @Remote server without rebooting. This is because just rebooting may not be a good solution if an SC occurs twice.

When an automatic reboot is performed, a confirmation screen is displayed after reboot. The confirmation screen can be cancelled by pressing the [OK] key (display is not cancelled only when the main power switch is switched OFF to ON).

Screen display during reboot

- Status display on the current screen
 - Post-processing Post-processing during printing, etc.
 - Automatic reboot After operation end

Post-processing
 ■ ■ □ □ □ □ □ □ □ □

Until automatic reboot
 □ □ □ □ □ □ □ □ □ □

- Reset key (Reboot key)
 Key to perform reboot
 # Cancel key is not displayed.
- Turn on spanner LED (same as when an SC is generated).

Operation during SC reboot

- Timing of SC reboot

When @Remote is enabled, and when a NRS alarm* 1 is not generated, the corresponding SC is the object of an automatic reboot.

* 1 NRS alarm: Issued when an ordinary SC (type D) is generated twice while the total counter counts 10 times.

- Time to automatic reboot

Reboot is performed 30 seconds after an engine reboot is possible, after the end of post-processing during printing, etc.

At that time, a reboot is performed even if the MFP is operating. The engine does not start process control when a reboot is possible.

- Automatic reboot

See the flowchart below.

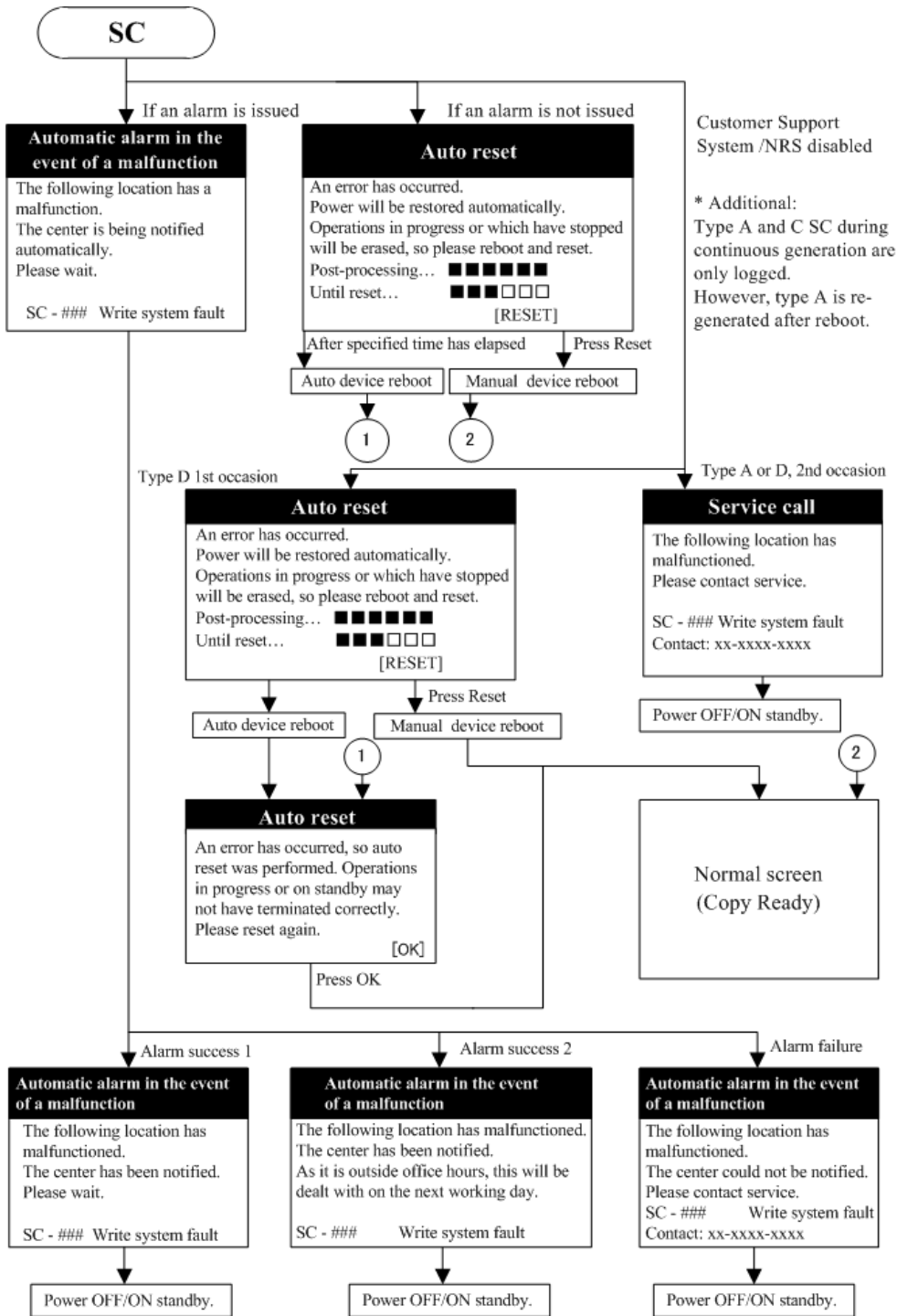

w_d1462643

Note

- For the SC list of automatic reboot, refer to page 757 "List of Automatic Reboot Target SC".

Controller Self-diagnosis Outline

Controller self-diagnosis includes 3 types, i.e., "ordinary self-diagnosis", "detailed self-diagnosis", and "SC detection". "Ordinary self-diagnosis" is diagnosis performed for every power ON, and "detailed self-diagnosis" is diagnosis treated as part of the service tools. "SC detection" detects mechanical faults when power is switched on or when the machine is operating.

Detailed self-diagnosis – Method

1. After attaching the option "IEEE 1284 board" to the controller board, connect the provided conversion connector.
2. Set a loop back connector in the reference Centronics I/F.
3. Press the main power supply switch while simultaneously pressing the "#" and "./* key. The display changes to the following screen, and self-diagnosis starts.



4. After the end of detailed self-diagnosis, a "Self-diagnosis results report" is automatically printed.

Note

- If a Centronics loopback connector is not fitted, a Centronics diagnosis error (SC 835) is generated.

Controller Self-diagnosis Flowchart

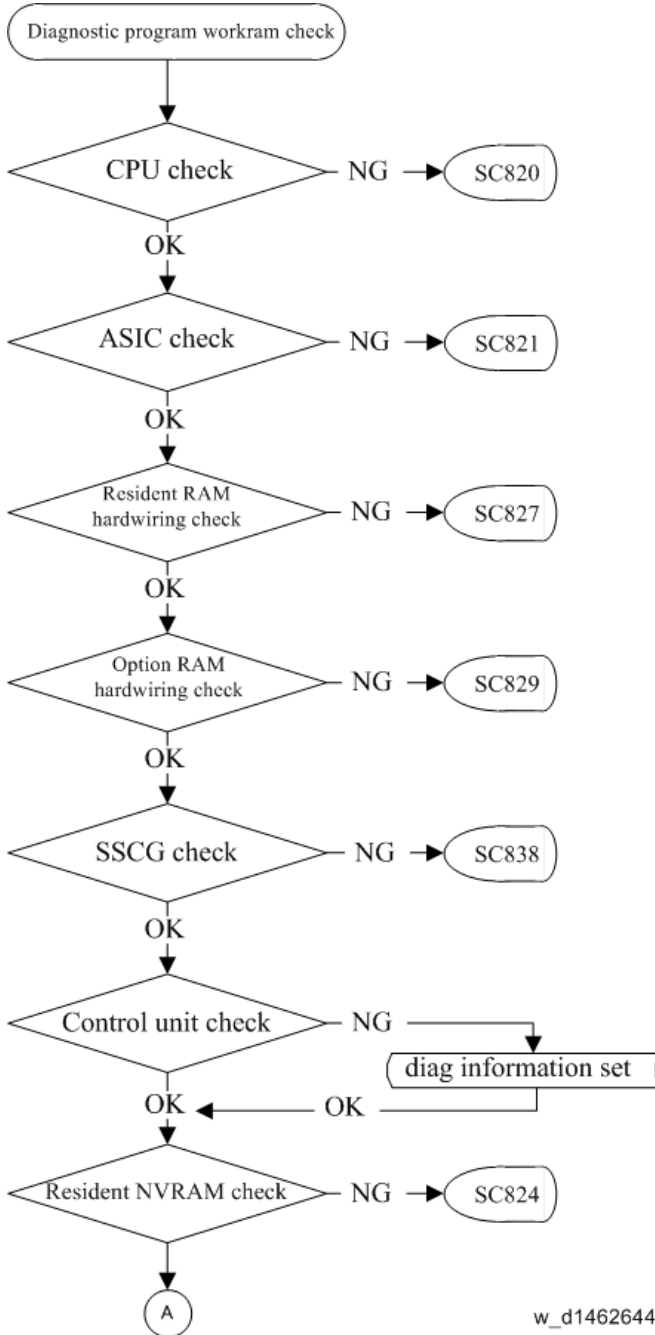

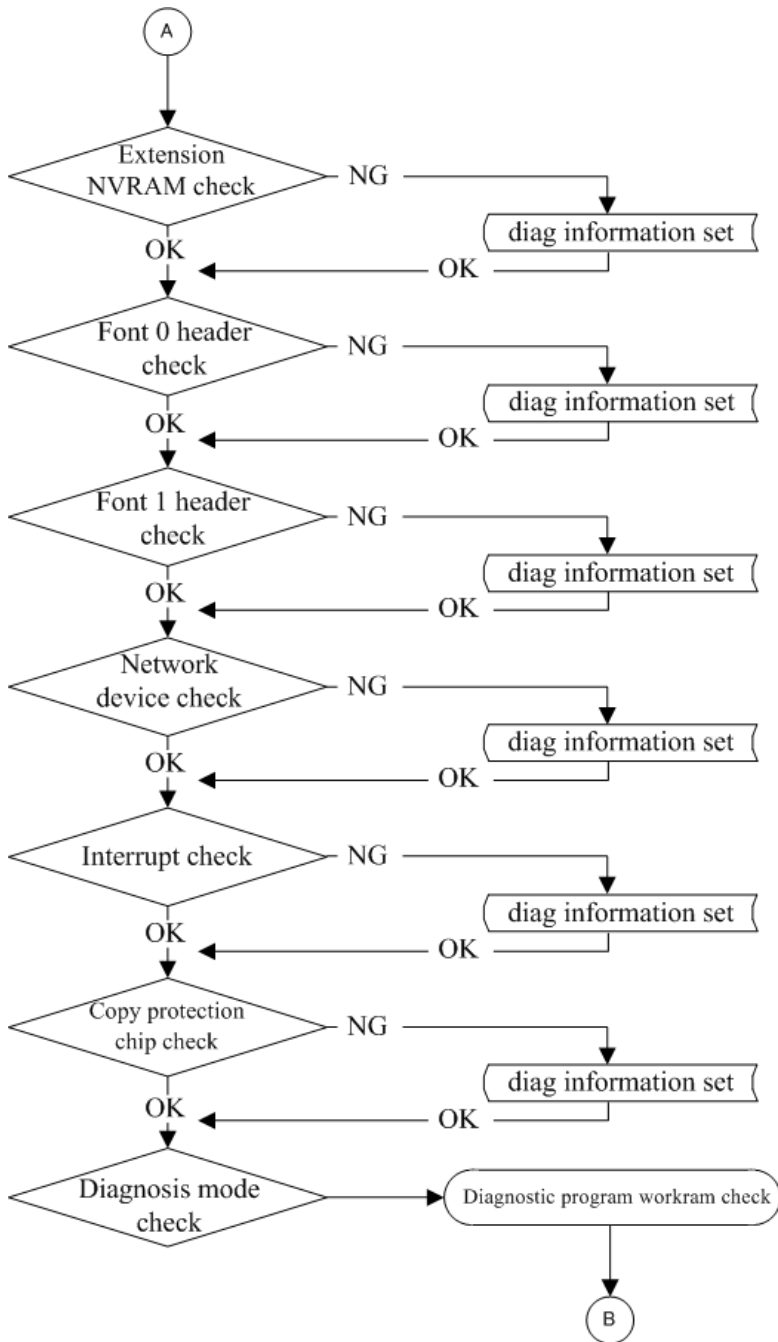

w_d1462645

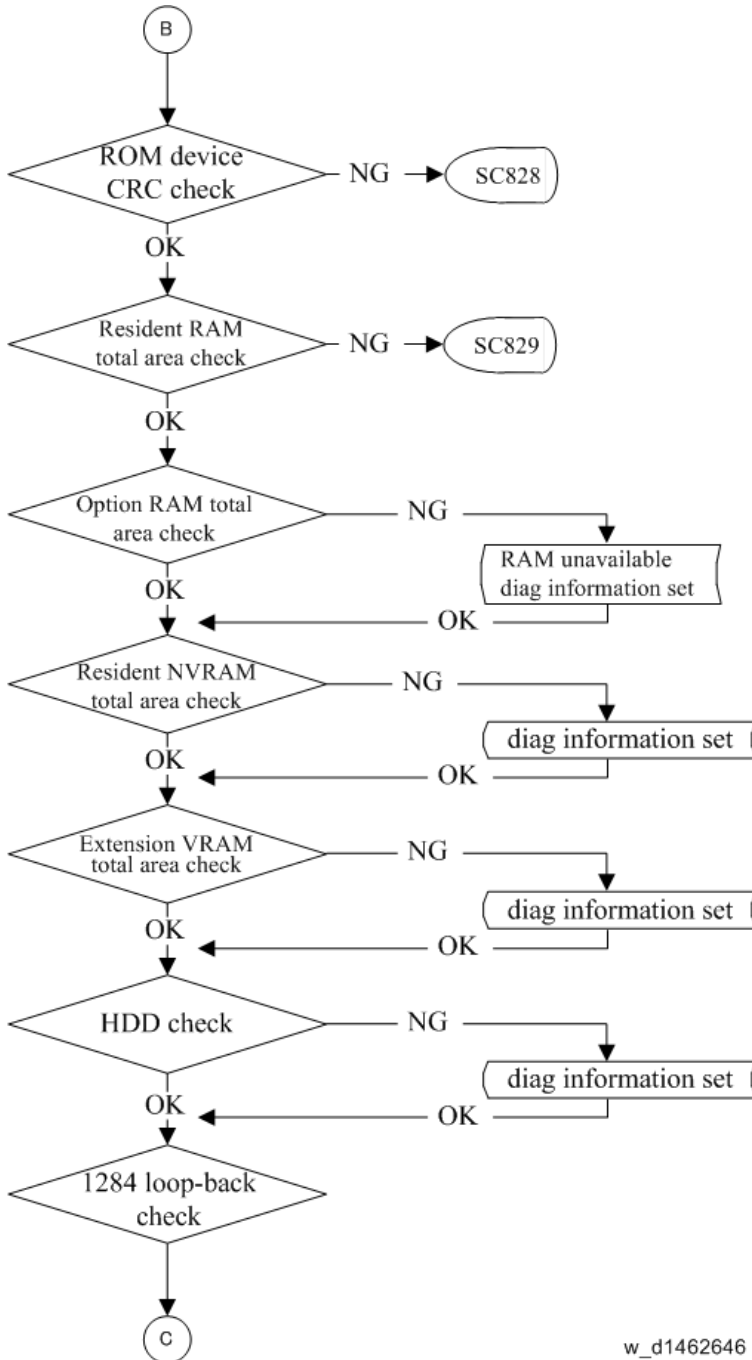

w_d1462646

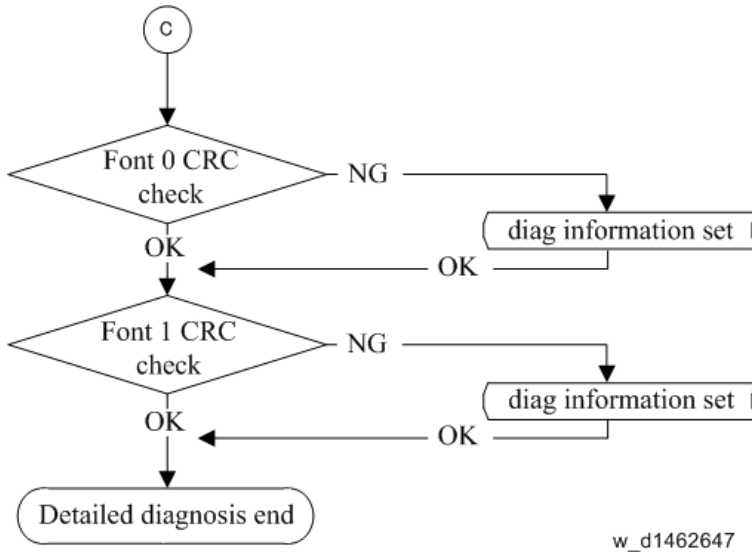

6

HDD-related Message

When an error occurs to the HDD, the HDD abnormality message appears on the operation panel and the screen for formatting is displayed. Also when replacing the HDD, a message "Hard Disk is replaced." appears on the operation panel and the screen for formatting is displayed.

Refer to the table shown below for the conditions of the message display.

Even when replacing the controller board, a banner "Hard Disk is replaced." appears. It is because the machine recognizes HDD has been replaced when the controller board that does not hold the HDD identification information is attached.

Message list

Message	Display Type	Normal/ Abnormal	Error Condition/ Major Cause/ Solution
SC870	banner	abnormal	The HDD cannot be accessed at power-on.
			NVRAM defective
			Turn the main power off/on to initialize the machine. *When replacing the NVRAM, if possible, back up the address book before replacing the NVRAM and restore it after replacing the NVRAM.

Message	Display Type	Normal/Abnormal	Error Condition/ Major Cause/ Solution
Hard Disk will be formatted due to problem with Hard Disk.	pop-up formatting button	abnormal	Management file on the HDD can not be read. Or the file system can not be mounted.
			HDD defective
			Replace the HDD.
Problem with the Encryption Key for Hard Disk. Format Hard Disk.	pop-up formatting button	abnormal	The encryption key for the HDD is abnormal.
			HDD defective
			Replace the HDD.
Hard Disk is replaced. Format Hard Disk.	pop-up formatting button	normal	A new HDD is attached.
			A new HDD attached
			Push the formatting button.
Hard Disk is replaced.	banner	abnormal	The HDD is replaced (Data can be read).
			<ul style="list-style-type: none"> • Controller board replaced • After starting the machine without an HDD, a new HDD is attached to the machine and then restart the machine.
			Turn the main power off/on.
Formatting Hard Disk... Please wait, also make sure the main power switch is not turned off.	pop-up	abnormal	Pushing the formatting button.
			Formatting the HDD
			-
Hard Disk is formatted. Turn main power switch off then on.	pop-up	abnormal	Formatting the HDD is finished.
			Formatting the HDD
			Turn the main power off/on.

Service Call Conditions

Summary

The 'SC Table' section shows the SC codes for controller errors and other errors. The latter are put into four types. The type is determined by their reset procedures. The table shows the classification of the SC codes.

Type	Display	How to reset
A	<p>The SC is immediately displayed on the operation panel when SC occurs.</p> <p>The error involves the fusing unit. The machine operation is disabled. The user cannot reset the error.</p> <p>★ Important</p> <ul style="list-style-type: none"> When canceling a fusing unit SC, (SC544-00/ SC554-00/ SC564-00/ SC574-00), perform part replacement in accordance with the above procedure. 	<p>Reset the SC (set SP5-810-1) and then cycle the main power off and on.</p>
B	<p>When a function is selected, the SC is displayed on the operation panel.</p> <p>The machine cannot be used (down-time mitigation).</p>	<p>Turn the operation switch off and on.</p>
C	<p>No display on the operation panel.</p> <p>The machine operates as usual.</p>	<p>Only the SC history is updated.</p>
D	<p>The SC is displayed on the operation panel.</p> <p>The machine cannot be used (machine-error SC).</p>	<p>Turn the main n power switch off and on.</p>

↓ Note

- When an ordinary SC (type D) is generated, an automatic reboot is performed. When an event is reported by the customer support system, even in the event of an ordinary SC, reboot is not performed. During automatic reboot, a confirmation screen is displayed after the reboot.
- When automatic reboot occurs twice continuously, an SC is displayed without rebooting, and logging count is performed. Also, when an SMC print is output, an * mark is added alongside the SC number for clarity.
- Automatic reboot can be enabled or disabled with SP5-875-001 (SC automatic reboot setting) (default value: ON).

SP descriptions

- **SP5-875-001 (SC automatic reboot: Reboot Setting)**

Enables or disables the automatic reboot function when an SC error occurs.

0: The machine reboots automatically when the machine issues an SC error and logs the SC error code. If the same SC occurs again, the machine does not reboot.

1: The machine does not reboot when an SC error occurs.

The reboot is not executed for the pattern A or C.

SC Logging

When an SC is generated, the "total count value when the SC is generated" and the "SC code" are logged. However, if the total count value during the SC is the same as last time, logging is not performed.

Logged data can be checked by outputting an administrative report (SMC print). The SC history is logged up to the last 10 entries, and if there are more than 10 entries, data are progressively deleted starting from the oldest.

List of Automatic Reboot Target SC

Engine SC

Automatic reboot target SC is as follows. For details of Automatic reboot, refer to page 747 "SC Automatic Reboot".

SC code	Name
101-01	Lamp Error (Scanning)
101-02	Lamp Error (LED illumination adjustment)
102-00	LED Illumination Adjustment Error
120-00	Scanner Home Position Error 1
121-00	Scanner Home Position Error 2
141-00	Black level detection error
142-00	White level detection error
144-00	SBU Communication Error

SC code	Name
151-00	Black Level Error: Side 2
152-00	White Level Error: Side 2
154-00	Scanner Communication Error: Side 2
161-02	IPU error (Lsync Error: Side 2)
161-20	IPU error (DRAM initialization failure)
202-00	Polygon Motor: ON Timeout Error
203-00	Polygon Motor: OFF Timeout Error
204-00	Polygon Motor: XSCRDY Signal Error
220-01	Leading Edge: LD1 synchronization detection error: Bk
220-04	Leading Edge: LD1 synchronization detection error: Ye
230-01	FGATE ON error: Bk
230-02	FGATE ON error: Cy
230-03	FGATE ON error: Ma
230-04	FGATE ON error: Ye
231-01	FGATE OFF error: Bk
231-02	FGATE OFF error: Cy
231-03	FGATE OFF error: Ma
231-04	FGATE OFF error: Ye
240-01	LD error: Bk
240-02	LD error: Cy
240-03	LD error: Ma
240-04	LD error: Ye
272-01	LD driver communication error: Bk
272-02	LD driver communication error: Cy
272-03	LD driver communication error: Ma

SC code	Name
272-04	LD driver communication error: Ye
272-10	LD driver communication error: Other
312-01	Charge Roller HVP_CB Output Error (K)
312-02	Charge Roller HVP_CB Output Error (C)
312-03	Charge Roller HVP_CB Output Error (M)
312-04	Charge Roller HVP_CB Output Error (Y)
324-05	Development motor: CMY: Lock
360-01	TD sensor adjustment error (K)
360-02	TD sensor adjustment error (C)
360-03	TD sensor adjustment error (M)
360-04	TD sensor adjustment error (Y)
396-05	Drum motor (CMY) Lock
441-00	Drum transfer motor: Lock
442-00	ITB Lift Error
452-00	Paper transfer contact motor error
491-00	High voltage power source: charge/development: output error
531-01	Development Intake Fan/Right Lock
531-03	Drive Cooling Fan Lock
533-03	PSU Cooling Fan Lock
533-04	Controller Box Cooling Fan Lock
534-01	Main Exhaust Fan Lock
534-02	Toner Supply Cooling Fan Lock
534-03	Ozone Exhaust Fan Lock
535-00	Paper Exit Cooling Fan Lock
540-00	Fusing Motor: Lock

SC code	Name
542-05	Thermopile (Center) does not reload (Low Power)
542-06	Thermopile (Center) does not reload (Low Power)
545-05	Fusing Central Lamp Continuously Heat (Low Power)
547-01	Zero cross error (relay-contact soldering)
547-02	Zero cross error (relay contact error)
547-03	Zero cross error (low-frequency error)
552-05	Thermopile (Center) Does Not Reload (Low Power)
552-06	Thermopile (Center) Does Not Reload (Low Power)
561-05	Pressure Roller Thermistor (Center) Disconnection (Low Power)
562-05	Pressure Roller Thermistor (Center) Does Not Reload (Low Power)
569-00	Paper Exit/ Pressure Release Motor Error Detection
571-05	Pressure Roller Thermistor (Edge) Disconnection
572-05	Pressure Roller Thermistor (Edge) Does Not Reload (Low Power)
581-05	Pressure Roller Thermistor (Full-Bleed Edge) Disconnection (Low Power)
582-05	Pressure Roller Thermistor (Full-Bleed Edge) Does Not Reload (Low Power)
620-01	ADF Communication error 1
620-02	ADF Communication error 2
620-03	ADF Communication error 3
621-00	Finisher communication error
622-01	Paper bank 1 communication error for Paper Feed Unit PB3150 (D694)
622-11	Paper bank 1 communication error for Paper Feed Unit PB3220/PB3210 (D787)
663-01	Reset Detection: Imaging IOB: Software hangup occurs
663-02	Reset Detection: Imaging IOB: Power ON reset occurs
663-03	Reset Detection: Imaging IOB: Software reset occurs
663-11	Reset Detection: Paper Transport IOB: Software hangup occurs

SC code	Name
663-12	Reset Detection: Paper Transport IOB: Power ON reset occurs
663-13	Reset Detection: Paper Transport IOB: Software reset occurs
664-01	VODKA1 (Paper Transport Vodka) access permission error to VODKA SRAM
669-01	EEPROM OPEN: ID error
669-02	EEPROM OPEN: Channel error
669-03	EEPROM OPEN: Device error
669-04	EEPROM OPEN: Communication abort error
669-05	EEPROM OPEN: Communication timeout error
669-06	EEPROM OPEN: Operation stopped error
669-07	EEPROM OPEN: Buffer full
669-08	EEPROM OPEN: No error code
669-09	EEPROM CLOSE: ID error
669-10	EEPROM CLOSE: No error code
669-11	EEPROM Data write: ID error
669-12	EEPROM Data write: Channel error
669-13	EEPROM Data write: Device error
669-14	EEPROM Data write: Communication abort error
669-15	EEPROM Data write: Communication timeout error
669-16	EEPROM Data write: Operation stopped error
669-17	EEPROM Data write: Buffer full
669-18	EEPROM Data write: No error code
669-19	EEPROM Data read: ID error
669-20	EEPROM Data read: Channel error
669-21	EEPROM Data read: Device error
669-22	EEPROM Data read: Communication abort error

SC code	Name
669-23	EEPROM Data read: Communication timeout error
669-24	EEPROM Data read: Operation stopped error
669-25	EEPROM Data read: Buffer full
669-26	EEPROM Data read: No error code
669-36	Verification error
669-37	Error Detection
681-01	Toner bottle: IDChip Communication error: Invalid device ID :K
681-02	Toner bottle: IDChip Communication error: Invalid device ID :M
681-03	Toner bottle: IDChip Communication error: Invalid device ID :C
681-04	Toner bottle: IDChip Communication error: Invalid device ID :Y
681-06	Toner bottle: IDChip Communication error: Channel error :K
681-07	Toner bottle: IDChip Communication error: Channel error :M
681-08	Toner bottle: IDChip Communication error: Channel error :C
681-09	Toner bottle: IDChip Communication error: Channel error :Y
681-11	Toner bottle: IDChip Communication error: Device Error :K
681-12	Toner bottle: IDChip Communication error: Device Error :M
681-13	Toner bottle: IDChip Communication error: Device Error :C
681-14	Toner bottle: IDChip Communication error: Device Error :Y
681-16	Toner bottle: IDChip Communication error: Communication error (interrupted) :K
681-17	Toner bottle: IDChip Communication error: Communication error (interrupted) :M
681-18	Toner bottle: IDChip Communication error: Communication error (interrupted) :C
681-19	Toner bottle: IDChip Communication error: Communication error (interrupted) :Y
681-21	Toner bottle: IDChip Communication error: Communication timeout :K
681-22	Toner bottle: IDChip Communication error: Communication timeout :M
681-23	Toner bottle: IDChip Communication error: Communication timeout :C

SC code	Name
681-24	Toner bottle: IDChip Communication error: Communication timeout :Y
681-26	Toner bottle: IDChip Communication error: Device stops (logically) :K
681-27	Toner bottle: IDChip Communication error: Device stops (logically) :M
681-28	Toner bottle: IDChip Communication error: Device stops (logically) :C
681-29	Toner bottle: IDChip Communication error: Device stops (logically) :Y
681-31	Toner bottle: IDChip Communication error: Full of buffer (request) :K
681-32	Toner bottle: IDChip Communication error: Full of buffer (request) :M
681-33	Toner bottle: IDChip Communication error: Full of buffer (request) :C
681-34	Toner bottle: IDChip Communication error: Full of buffer (request) :Y
681-36	Toner bottle: IDChip Communication error: Verification error:K
681-37	Toner bottle: IDChip Communication error: Verification error:M
681-38	Toner bottle: IDChip Communication error: Verification error:C
681-39	Toner bottle: IDChip Communication error: Verification error:Y
682-01	TD sensor communication error: Invalid device ID :K
682-02	TD sensor communication error: Invalid device ID :M
682-03	TD sensor communication error: Invalid device ID :C
682-04	TD sensor communication error: Invalid device ID :Y
682-06	TD sensor communication error: Channel error :K
682-07	TD sensor communication error: Channel error :M
682-08	TD sensor communication error: Channel error :C
682-09	TD sensor communication error: Channel error :Y
682-11	TD sensor communication error: Device Error :K
682-12	TD sensor communication error: Device Error :M
682-13	TD sensor communication error: Device Error :C
682-14	TD sensor communication error: Device Error :Y

SC code	Name
682-16	TD sensor communication error: Communication error (interrupted) :K
682-17	TD sensor communication error: Communication error (interrupted) :M
682-18	TD sensor communication error: Communication error (interrupted) :C
682-19	TD sensor communication error: Communication error (interrupted) :Y
682-21	TD sensor communication error: Communication timeout :K
682-22	TD sensor communication error: Communication timeout :M
682-23	TD sensor communication error: Communication timeout :C
682-24	TD sensor communication error: Communication timeout :Y
682-26	TD sensor communication error: Device stops (logically) :K
682-27	TD sensor communication error: Device stops (logically) :M
682-28	TD sensor communication error: Device stops (logically) :C
682-29	TD sensor communication error: Device stops (logically) :Y
682-31	TD sensor communication error: Full of buffer (request) :K
682-32	TD sensor communication error: Full of buffer (request) :M
682-33	TD sensor communication error: Full of buffer (request) :C
682-34	TD sensor communication error: Full of buffer (request) :Y
682-36	TD sensor communication error: Verification error:K
682-37	TD sensor communication error: Verification error:M
682-38	TD sensor communication error: Verification error:C
682-39	TD sensor communication error: Verification error:Y
687-00	PER Not Received Error
700-01	SPDF: Base Plate Lift Motor Error
700-02	SPDF: Original Pick-up Error
700-04	SPDF: Paper Feed Motor Error
700-05	SPDF: Pullout Motor Error

SC code	Name
700-06	SPDF: Intermediate Motor Error
700-07	SPDF: Scanning Motor Error
700-09	SPDF: Paper Exit Motor Error
701-03	SPDF: Paper Feed Motor Driver Error
701-08	SPDF: Paper Exit Motor Driver Error
702-01	ARDF: Protection Device Intercept Error 1
702-02	ARDF: Protection Device Intercept Error 2
702-03	ARDF: Protection Device Intercept Error 3
702-04	SPDF: Protection Device Intercept Error 4
702-05	SPDF: Protection Device Intercept Error 5
780-01	Bank 1 (Upper optional paper tray) Protection Device Intercept Error
781-01	Bank 2 (Lower optional paper tray) Protection Device Intercept Error
791-00	No bridge unit when finisher is present
995-01	CPM setting error 1
995-02	CPM setting error 2
995-03	CPM setting error 3
995-04	CPM setting error 4

Controller SC

Automatic reboot target SC is as follows. For details of Automatic reboot, refer to page 747 "SC Automatic Reboot".

SC code	Name
632-00	Counter device error 1
633-00	Counter device error 2
634-00	Counter device error 3

SC code	Name
635-00	Counter device error 4
636-01	IC Card Error (Expanded authentication module error)
636-02	IC Card Error (Version error)
637-01	Tracking Information Notification Error (Tracking application error)
637-02	Tracking Information Notification Error (Management server error)
641-00	Communication error between BCU and Controller board
641-01	Communication error between BCU and Controller board: Timeout
641-02	Communication error between BCU and Controller board: retry over
641-03	Communication error between BCU and Controller board: download error
641-04	Communication error between BCU and Controller board: UART error
670-01	Engine does not start up during the starting up
670-02	Engine does not start up after the starting up
670-03	IPU power does not start up
670-04	Communication is not linked up
816-00	Energy save I/O subsystem error
816-01	Subsystem error
816-02	Sysarch (LPUX_GET_PORT_INFO) error
816-03	Transition to STR was denied.
816-04	Interrupt in kernel communication driver
816-05	Preparation for transition to STR failed.
816-07	Sysarch (LPUX_GET_PORT_INFO) error
816-08	Sysarch (LPUX_ENGINE_TIMERCTRL) error
816-09	Sysarch (LPUX_RETURN_FACTOR_STR) error
816-10 to 12	Sysarch (LPUX_GET_PORT_INFO) error
816-13	open() error

SC code	Name
816-14	Memory address error
816-15 to 18	open() error
816-19	Double open() error
816-20	open() error
816-22	Parameter error
816-23	read() error
816-24	read() error
816-25	write () error
816-26	write() communication retry error
816-27	write() communication retry error
816-28	write() communication retry error
816-29	read() communication retry error
816-30	read() communication retry error
816-35	read() error
816-36 to 94	Subsystem error
818-00	Watchdog timer error
821-00	Self-diagnostics error: ASIC
823-00	Self-diagnostics error: NIC
827-00	Self-diagnostics error: RAM
828-00	Self-diagnostics error: ROM
829-00	Self-diagnostics error: Optional Serial
833-00	Self-diagnostic error: Engine I/F ASIC
839-00	Self-diagnostic Error: Serial Flash
840-00	EEPROM access error
841-00	EEPROM read data error

SC code	Name
850-00	Network I/F Error
862-00	Number of the defective sector reaches the maximum count
863-00 to 23	HDD data read failure
864-00 to 23	HD data CRC error
865-00 to 23	HDD access error
865-50 to 73	HDD time-out error
868-00 to 02	SD card authentication error
871-01	FCU error
875-01	Delete all error (HDD erasure) (hddcheck -i error)
875-02	Delete all error (HDD erasure) (Data deletion failure)
875-03	Delete all error (HDD erasure)
880-00	MLB error
899-00	Software performance error (signal reception end)
919-00	External controller down
990-00	Software operation error
992-00	Undefined SC issued.
997-00	Application function selection error
998-00	Application start error

SC Code Classification

The table shows the classification of the SC codes:

Class	Section
SC1xx	Scanning
SC2xx	Exposure

Class	Section
SC3xx	Image Processing 1
SC4xx	Image Processing 2
SC5xx	Paper feed and Fusing
SC6xx	Communication
SC7xx	Peripherals
SC8xx	Overall System
SC9xx	Others

Service Call 101-195

SC100 (Engine: Scanning)

SC No.	Type	Error Name/Error Condition/Major Cause/Solution
SC101-01	D	LED Error (Scanning)
		The white level peak did not reach the prescribed threshold when the white guide plate was scanned.
		<ul style="list-style-type: none"> • Scanner Carriage defective • BCU defective • Connector defective (disconnected, loose) • Harness defective • IPU defective • Condensation in scanner unit • White Reference Seal dirty or installed incorrectly (sheet-through exposure glass) • White Guide Plate, or White Roller dirty or installed incorrectly (SPDF/ARDF)

SC No.	Type	Error Name/Error Condition/Major Cause/Solution
		<p>Check if the SC occurs by turning the power OFF then ON. If the SC occurs again, do the following steps. Check if the SC reoccurs by cycling the power after each step.</p> <ol style="list-style-type: none"> 1. Clean the white guide plate, or white roller (SPDF/ARDF). 2. Reconnect the following connectors; <ul style="list-style-type: none"> • Scanner Carriage - IPU harness (FFC) • SBU - LEDB harness (FFC) • IPU- BCU harness 3. Check the white reference seal that attached back of sheet-through exposure glass. Replace the sheet-through exposure glass, if dirty or damaged. 4. Replace the white guide plate, or white roller (SPDF/ARDF). 5. Replace the Scanner Carriage. 6. Replace the IPU. 7. Replace the following harnesses; <ul style="list-style-type: none"> • Scanner Carriage - IPU harness (FFC) • IPU - BCU harness 8. Replace the BCU.
SC101-02	D	<p>LED Error (LED illumination adjustment)</p> <p>LED error was detected.</p> <ul style="list-style-type: none"> • Connector defective (disconnected, loose) • Scanner Carriage defective • IPU defective • Harness defective • BCU defective

SC No.	Type	Error Name/Error Condition/Major Cause/Solution
		<p>Check if the SC occurs by turning the power OFF then ON. If the SC occurs again, do the following steps. Check if the SC reoccurs by cycling the power after each step.</p> <ol style="list-style-type: none"> 1. Reconnect the following connectors; <ul style="list-style-type: none"> • Scanner Carriage - IPU harness (FFC) • SBU - LEDB harness (FFC) • IPU- BCU harness 2. Check the white reference seal that attached back of sheet-through exposure glass. Replace the sheet-through exposure glass, if dirty or damaged. 3. Replace the Scanner Carriage. 4. Replace the IPU. 5. Replace the following harnesses; <ul style="list-style-type: none"> • Scanner Carriage - IPU harness (FFC) • IPU - BCU harness 6. Replace the BCU.

SC No.	Type	Error Name/Error Condition/Major Cause/Solution
SC102-00	D	LED Illumination Adjustment Error
		The white level peak reached the prescribed threshold when the white plate was scanned after a specified number of adjustments.
		<ul style="list-style-type: none"> • LED defective • IDB (LED driver) defective • SBU defective • IPU defective • Power/signal harness defective
		<p>Check if the SC occurs by turning the power OFF then ON. If the SC occurs again, do the following steps. Check if the SC reoccurs by cycling the power after each step.</p> <ol style="list-style-type: none"> 1. Reconnect the power/signal harness. 2. Replace the following parts: <ul style="list-style-type: none"> • Replace the Scanner Carriage. • Replace the IPU board. • Replace the power/signal harness.

SC No.	Type	Error Name/Error Condition/Major Cause/Solution
SC120-00	D	Scanner Home Position Error 1
		<p>The scanner home position sensor does not go OFF.</p> <p>Details:</p> <p>Error detection timing</p> <ul style="list-style-type: none"> • During homing (when the machine is turned ON or when it returns from energy save mode) • During an automatic adjustment (when the machine is turned ON or when it returns from energy save mode) • During a scan from the ADF/ARDF or exposure glass.
		<ul style="list-style-type: none"> • Scanner motor driver defective • Scanner motor defective • Scanner HP sensor defective • Harness defective • Timing belt, pulley, wire, or carriage not installed correctly
		<p>Check if the SC occurs by turning the power OFF then ON. If the SC occurs again, do the following steps.</p> <p>1. Replace the following parts:</p> <ul style="list-style-type: none"> • Replace the HP sensor • Replace the scanner motor • Replace the harness.

SC No.	Type	Error Name/Error Condition/Major Cause/Solution
SC121-00	D	Scanner Home Position Error 2
		<p>The scanner home position sensor does not go ON.</p> <p>Details:</p> <p>Error detection timing</p> <ul style="list-style-type: none"> • During homing • During an automatic adjustment • During a scan from the ADF/ARDF or exposure glass.
		<ul style="list-style-type: none"> • Scanner motor driver defective • Scanner motor defective • Scanner HP sensor defective • Harness defective • Timing belt, pulley, wire, or carriage not installed correctly
		<p>Check if the SC occurs by turning the power OFF then ON. If the SC occurs again, do the following steps.</p> <p>1. Replace the following parts:</p> <ul style="list-style-type: none"> • Replace the home position sensor • Replace the scanner motor • Replace the harness.

SC No.	Type	Error Name/Error Condition/Major Cause/Solution
SC141-00	D	Black level detection error
		The black level cannot be adjusted within the target during auto gain control.
		<ul style="list-style-type: none"> • Scanner Carriage defective • IPU defective • Harness defective • BCU defective
		<p>Check if the SC occurs by turning the power OFF then ON. If the SC occurs again, do the following steps. Check if the SC reoccurs by cycling the power after each step.</p> <ol style="list-style-type: none"> 1. Reconnect the following connectors; <ul style="list-style-type: none"> • Scanner Carriage - IPU harness (FFC) • IPU- BCU harness 2. Replace the Scanner Carriage. 3. Replace the IPU. 4. Replace the following harnesses; <ul style="list-style-type: none"> • Scanner Carriage - IPU harness (FFC) • IPU - BCU harness 5. Replace the BCU.

SC No.	Type	Error Name/Error Condition/Major Cause/Solution
SC142-00	D	White level detection error
		The white level cannot be adjusted to the second target level within the target during auto gain control.
		<ul style="list-style-type: none"> • Scanner Carriage defective • IPU defective • Harness defective • Connector defective (disconnected, loose) • Condensation in scanner unit • White plate dirty or installed incorrectly
		<p>Check if the SC occurs by turning the power OFF then ON. If the SC occurs again, do the following steps. Check if the SC reoccurs by cycling the power after each step.</p> <ol style="list-style-type: none"> 1. Reconnect the following connectors; <ul style="list-style-type: none"> • Scanner Carriage - IPU harness (FFC) • SBU - LEDB harness (FFC) • IPU- BCU harness 2. Check the white reference seal that attached back of sheet-through exposure glass. Replace the sheet-through exposure glass, if dirty or damaged. 3. Replace the scanner carriage. 4. Replace the IPU. 5. Replace the following harnesses; <ul style="list-style-type: none"> • Scanner Carriage - IPU harness (FFC) • IPU - BCU harness 6. Replace the BCU.

SC No.	Type	Error Name/Error Condition/Major Cause/Solution
SC144-00	D	SBU Communication Error
		<ul style="list-style-type: none"> • The machine cannot detect that the Scanner Carriage is connected. • The machine cannot communicate with the Scanner Carriage. • The communication data is incorrect.
		<ul style="list-style-type: none"> • Scanner Carriage defective • IPU defective • BCU defective • Harness defective
		<p>Check if the SC occurs by turning the power OFF then ON. If the SC occurs again, do the following steps. Check if the SC reoccurs by cycling the power after each step.</p> <ol style="list-style-type: none"> 1. Reconnect the following connectors; <ul style="list-style-type: none"> • Scanner Carriage - IPU harness (FFC) • IPU- BCU harness 2. Replace the Scanner Carriage. 3. Replace the IPU. 4. Replace the BCU. 5. Replace the following harnesses; <ul style="list-style-type: none"> • Scanner Carriage - IPU harness (FFC) • IPU - BCU harness

SC No.	Type	Error Name/Error Condition/Major Cause/Solution
SC151-00	D	Black Level Error: Side 2
		The black level scanned is not specified range.
		<ul style="list-style-type: none"> • CIS for SPDF defective • SPDF main board defective • Harness defective
		<p>Check if the SC occurs by turning the power OFF then ON. If the SC occurs again, do the following steps. Check if the SC reoccurs by cycling the power after each step.</p> <ol style="list-style-type: none"> 1. Reconnect the SPDF main board - CIS connectors if they are disconnected, or loose. 2. Replace the CIS for SPDF 3. Replace the following harnesses; <ul style="list-style-type: none"> • SPDF main board - CIS • IPU -SPDF main board 4. Replace the SPDF main board.

SC No.	Type	Error Name/Error Condition/Major Cause/Solution
SC152-00	D	White Level Error: Side 2
		<ul style="list-style-type: none"> • The shading data peak value read out from the CIS is not specified range from the target value.
		<ul style="list-style-type: none"> • CIS defective • White roller defective • SPDF main board defective • Harness defective
		<p>Check if the SC occurs by turning the power OFF then ON. If the SC occurs again, do the following steps. Check if the SC reoccurs by cycling the power after each step.</p> <ol style="list-style-type: none"> 1. Reconnect the SPDF main board - CIS connectors if they are disconnected, or loose. 2. Replace the CIS for SPDF 3. Replace the following harnesses; <ul style="list-style-type: none"> • SPDF main board - CIS • IPU -SPDF main board 4. Replace the SPDF main board.

SC No.	Type	Error Name/Error Condition/Major Cause/Solution
SC154-00	D	Scanner Communication Error: Side 2
		The value read out from the ASIC and FROM area inside the CIS is different from the expected value.
		<ul style="list-style-type: none"> • CIS defective • "FROM" area error • SPDF main board defective • Connector defective (loose, broken)
		<p>Check if the SC occurs by turning the power OFF then ON. If the SC occurs again, do the following steps. Check if the SC reoccurs by cycling the power after each step.</p> <ol style="list-style-type: none"> 1. Reconnect the SPDF main board - CIS connectors if they are disconnected, or loose. 2. Replace the CIS for SPDF 3. Replace the following harnesses; <ul style="list-style-type: none"> • SPDF main board - CIS • IPU -SPDF main board 4. Replace the SPDF main board.

SC No.	Type	Error Name/Error Condition/Major Cause/Solution
SC161-02	D	IPU error (Lsync Error: Side 2)
		The machine detects the error from the results of self-diagnostic test before scanning the side 2.
		<ul style="list-style-type: none"> • harness defective between CIS and IPU (disconnected, loose) • CIS defective • IPU defective (ASIC: Macaron error)
		<p>Check if the SC occurs by turning the power OFF then ON. If the SC occurs again, do the following steps. Check if the SC reoccurs by cycling the power after each step.</p> <ol style="list-style-type: none"> 1. Reconnect the IPU - CIS connectors if they are disconnected, or loose. 2. Replace the CIS for SPDF. 3. Replace the IPU - CIS harness. 4. Replace the IPU.

SC No.	Type	Error Name/Error Condition/Major Cause/Solution
SC161-20	D	IPU error (DRAM initialization failure)
		An error occurred during performed every time the machine is turned on, or returns to full operation from energy save mode.
		<ul style="list-style-type: none"> • IPU defective (Macaron/ DRAM device connection error) • DRAM device defective
		<p>Check if the SC occurs by turning the power OFF then ON. If the SC occurs again, do the following steps. Check if the SC reoccurs by cycling the power after each step.</p> <ol style="list-style-type: none"> 1. Reconnect the all connectors on IPU board if they are disconnected, or loose. 2. Replace the IPU, and BCU.

SC No.	Type	Error Name/Error Condition/Major Cause/Solution
SC195-00	D	Machine serial number error
		Comparison of the product identification code in the machine serial number (11 digits).
		The product identification code in the machine serial number (11 digits) does not match.
		Re-enter the machine serial number.

Service Call 202-285

SC200 (Engine: Image Writing)

SC No.	Type	Error Name/Error Condition/Major Cause/Solution
SC202-00	D	Polygon Motor: ON Timeout Error
		After the polygon motor turned on, or within the specified time (sec.) after the rpm's changed, the motor did not enter READY status.
		<ul style="list-style-type: none"> • The interface harness to the polygon motor driver damaged or not connected correctly. • Polygon motor or polygon motor driver defective • Polygon motor drive pulse cannot be output correctly. (Polygon controller) • XSCRDY signal observation failing (Polygon controller)
		<ol style="list-style-type: none"> 1. Turn the main power OFF/ON. 2. Reconnect the connectors between LD unit and IPU. 3. Check CN586 (a connector with 1 pin) for the polygon mirror motor from the PSU. 4. Replace the LD unit (Polygon mirror motor). 5. Replace the harness between the LD unit and IPU. 6. Replace the IPU. 7. Replace the PSU (or fuses on PSU).

SC No.	Type	Error Name/Error Condition/Major Cause/Solution
SC203-00	D	Polygon Motor: OFF Timeout Error
		The XSCRDY signal (polygon ready) never becomes inactive (H) within 3 sec. after the polygon motor went OFF.
		<ul style="list-style-type: none"> • The interface harness to the polygon motor driver damaged or not connected correctly. • Polygon motor or polygon motor driver defective • Polygon motor drive pulse cannot be output correctly. (Polygon controller) • XSCRDY signal observation failing (Polygon controller)
		<ol style="list-style-type: none"> 1. Turn the main power OFF/ON. 2. Reconnect the harness between LD unit and IPU. 3. Check CN586 (a connector with 1 pin) for the polygon mirror motor from the PSU. 4. Replace the LD unit (Polygon mirror motor). 5. Replace the harness between the LD unit and IPU. 6. Replace the IPU. 7. Replace the PSU (or fuses on PSU).

SC No.	Type	Error Name/Error Condition/Major Cause/Solution
SC204-00	D	Polygon Motor: XSCRDY Signal Error
		During polygon motor rotation, the XSCRDY signal was inactive (H) for longer than one rotation of the polygon.
		<ul style="list-style-type: none"> The interface harness to the polygon motor driver damaged or not connected correctly. Polygon motor or polygon motor driver defective
		<ol style="list-style-type: none"> Turn the main power OFF/ON. Reconnect the connectors between LD unit and IPU. Check CN586 (a connector with 1 pin) for the polygon mirror motor from the PSU. Replace the LD unit (Polygon mirror motor). Replace the harness between the LD unit and IPU. Replace the IPU. Replace the PSU (or fuses on PSU).

SC No.	Type	Error Name/Error Condition/Major Cause/Solution
SC220-01	D	Leading Edge: LD1 synchronization detection error: Bk
SC220-04	D	Leading Edge: LD1 synchronization detection error: Ye

SC No.	Type	Error Name/Error Condition/Major Cause/Solution
		<p>The leading edge LDO synchronization detection signal of the corresponding color was not output within the specified time (sec.) while the polygon mirror motor was operating at normal speed.</p> <ul style="list-style-type: none"> • The interface harness to the synchronization detection unit damaged or not connected correctly. • Synchronization detection board defective • Beam does not enter photo detector. • Abnormality around GAVD • LDB defective <ol style="list-style-type: none"> 1. Turn the main power OFF/ON. 2. Check for condensation on the LDB. 3. Reconnect the connectors between LDB (Synchronizing detector board) and IPU. 4. Replace the LD unit. 5. Replace the IPU 6. Replace the harness between LDB (Synchronizing detector board) and IPU.

SC No.	Type	Error Name/Error Condition/Major Cause/Solution
SC230-01	D	FGATE ON error: Bk
SC230-02	D	FGATE ON error: Cy
SC230-03	D	FGATE ON error: Ma
SC230-04	D	FGATE ON error: Ye
		<p>The FGATE signal did not turn ON within the specified time (sec.) after the writing process of the corresponding color started.</p> <ul style="list-style-type: none"> • Image processing ASIC defective on IPU • Harness between IPU and LDB defective <ol style="list-style-type: none"> 1. Turn the main power OFF/ON. 2. Reconnect the connectors between IPU and controller board. 3. Replace the IPU.

SC No.	Type	Error Name/Error Condition/Major Cause/Solution
SC231-01	D	FGATE OFF error: Bk
SC231-02	D	FGATE OFF error: Cy
SC231-03	D	FGATE OFF error: Ma
SC231-04	D	FGATE OFF error: Ye
		<ul style="list-style-type: none"> • The FGATE signal did not turn OFF within the specified time (sec.) after the writing process of the corresponding color ended. • The FGATE signal did not turn OFF when the next job of the corresponding color started.
		<ul style="list-style-type: none"> • Image processing ASIC defective on IPU • Harness between IPU and LDB defective
		<ol style="list-style-type: none"> 1. Turn the main power OFF/ON. 2. Reconnect the connectors between IPU and controller board. 3. Replace the IPU.

SC No.	Type	Error Name/Error Condition/Major Cause/Solution
SC240-01	D	LD error: Bk
SC240-02	D	LD error: Cy
SC240-03	D	LD error: Ma
SC240-04	D	LD error: Ye

SC No.	Type	Error Name/Error Condition/Major Cause/Solution
		<ul style="list-style-type: none"> If LD error terminal of LD driver of corresponding color is asserted after LD initialization. If an error is detected during initialization of LD driver which detects lth/leta of LD of corresponding color.
		<ul style="list-style-type: none"> LD degradation (LD broken, shift of output characteristics etc.) The interface harness damaged or not connected correctly. LD driver defective
		<ol style="list-style-type: none"> Turn the main power OFF/ON. Check the value in SP2-110-001 to 004 (LD Driver), the default is "0h". <ul style="list-style-type: none"> If current value is "0", perform step 4. If current value is "1", perform steps 3 and 5. Reconnect the connectors between LDB and IPU. Replace the LD unit Replace the harness between LDB to IPU.

SC No.	Type	Error Name/Error Condition/Major Cause/Solution
SC272-01	D	LD driver communication error: Bk
SC272-02	D	LD driver communication error: Cy
SC272-03	D	LD driver communication error: Ma
SC272-04	D	LD driver communication error: Ye

SC No.	Type	Error Name/Error Condition/Major Cause/Solution
		In view of parity, 3 retries were performed
		<ul style="list-style-type: none"> • BCU defective • Harness defective • LDB defective
		<ol style="list-style-type: none"> 1. Turn the main power OFF/ON. 2. Reconnect the following connectors; <ul style="list-style-type: none"> • LDB-IPU harness • IPU-BCU harness 3. Replace the LD unit. 4. Replace the BCU. 5. Replace the following harnesses; <ul style="list-style-type: none"> • LDB-IPU harness • IPU-BCU harness

SC No.	Type	Error Name/Error Condition/Major Cause/Solution
SC272-10	D	LD driver communication error: Other
		LD voltage does not satisfy the specified voltage (5 V).
		<ul style="list-style-type: none"> • BCU defective (LD5V Power error) • LDB defective (LD drive error) • LDB connector defective (loose, broken) • Interlock switch defective
		<ol style="list-style-type: none"> 1. Turn the main power OFF/ON. 2. Reconnect the connectors between LDB and IPU. 3. Replace the IPU. 4. Replace the LD unit. 5. Replace the harness between LDB and IPU. 6. Replace the interlock switch.

SC No.	Type	Error Name/Error Condition/Major Cause/Solution
SC285-01	C	Laser optics positioning motor (in LD unit) :Power control error
		The power supply from PSU is not supplied to the laser optics positioning motors.
		<ul style="list-style-type: none"> • Software error • Imaging IOB defective • BCU defective
		<ol style="list-style-type: none"> 1. Turn the main power OFF/ON. 2. Update the firmware. 3. Replace the imaging IOB. 4. Replace the BCU.

SC No.	Type	Error Name/Error Condition/Major Cause/Solution
SC285-02	C	MUSIC error
		The results of MUSIC pattern reading failed 4 times. (even if mode e (real time MUSIC) fails, the error count is not incremented (+1))
		For details about cause and solution, refer to page 966 "When SC285-02 (MUSIC Error) Is Displayed".

Service Call 312-396

SC300 (Engine: Charge, Development)

SC No.	Type	Error Name/Error Condition/Major Cause/Solution
SC312-01	D	Charge Roller HVP_CB Output Error (K)
SC312-02	D	Charge Roller HVP_CB Output Error (C)
SC312-03	D	Charge Roller HVP_CB Output Error (M)
SC312-04	D	Charge Roller HVP_CB Output Error (Y)
		<p>Charging AC is set to ON at the standard speed, and the FB voltage of the charging AC of each color is monitored for 200 ms at 20ms intervals (10 times) after 80ms of charge AC_ON, and below 0.3V is detected continuously for 200ms (10 times), the SC of the corresponding color lights up, and machine operation is suspended.</p> <ul style="list-style-type: none"> • High voltage harness defective or shorted. • PCU setting fault or damage • HVP_CB fault • Connector disconnected • Harness broken

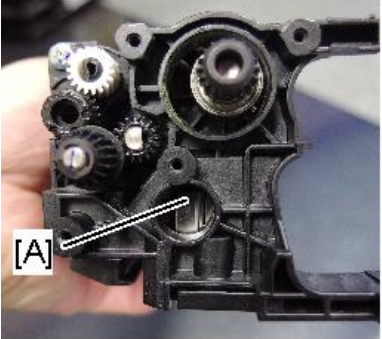
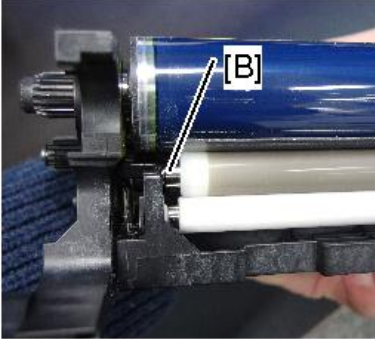
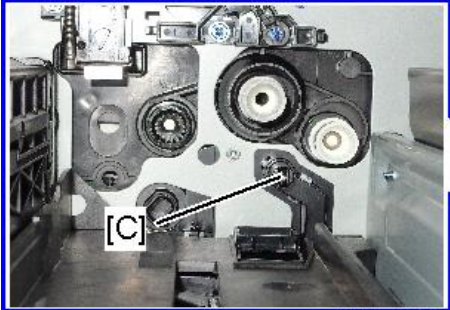
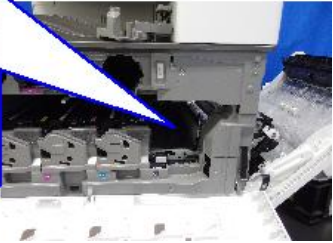
SC No.	Type	Error Name/Error Condition/Major Cause/Solution
<p>Check if the SC occurs by turning the power OFF then ON. If the SC occurs again, do the following steps. Check if the SC reoccurs by cycling the power after each step.</p>		
<p>1. Check the PCU for the following points and recover or replace the PCU if there are any defects.</p>		
<ul style="list-style-type: none"> • Checking contaminants on the Charge Roller terminal [A] • Checking damage or deformation of the Charge Roller terminal [A] • Checking continuity to the Charge Roller terminal core bar [B] 		
<div style="display: flex; justify-content: space-around;">   </div> <p style="text-align: right; margin-right: 50px;">d238m0900</p>		
<p>2. Check if all connectors related to PCDU are connected securely. Replace the connectors if they are disconnected, or loose.</p>		
<p>3. Recover or replace the parts of the main machine if there are any defects after checking the following points.</p>		
<ul style="list-style-type: none"> • Checking contaminants on the charged power supplying plate [C] • Checking damage or deformation of the charged power supplying plate [C] • Checking continuity between the Charge Roller terminal core bar and the HVP (CB) 		
<div style="display: flex; justify-content: space-around;">   </div> <p style="text-align: right; margin-right: 50px;">d238m0901</p>		
<p>4. Replace the HVP (CB).</p>		
<p>5. If SC occurs again, replace the BCU.</p>		

SC No.	Type	Error Name/Error Condition/Major Cause/Solution
SC324-01	D	Development motor: Bk: Lock
		Motor status is observed at 100ms intervals during motor ON, and the unlock status is detected at least 20 times
		<ul style="list-style-type: none"> • Motor defective • Connector disconnected • Harness broken • IOB defective • Development unit torque increased
		<ul style="list-style-type: none"> • Replace the motor • Reconnect the connector • Replace the harness • Replace the Imaging IOB. • Replace the development unit

SC No.	Type	Error Name/Error Condition/Major Cause/Solution
SC324-05	D	Development motor: CMY: Lock
		Motor status is observed at 100ms intervals during motor ON, and the unlock status is detected at least 20 times.
		<ul style="list-style-type: none"> • Motor defective • Connector disconnected • Harness broken • IOB defective • Development unit torque increased
		<ul style="list-style-type: none"> • Replace the motor • Reconnect the connector • Replace the harness • Replace the Imaging IOB. • Replace the development unit

SC No.	Type	Error Name/Error Condition/Major Cause/Solution
SC360-01	D	TD sensor adjustment error (K)
SC360-02	D	TD sensor adjustment error (C)
SC360-03	D	TD sensor adjustment error (M)
SC360-04	D	TD sensor adjustment error (Y)
		<ol style="list-style-type: none"> Mu count is higher than the threshold which detects no developer. Mu count is lower than the upper/lower target thresholds three consecutive times. <ul style="list-style-type: none"> TD sensor defective Loose connection Harness broken Developer toner density differs from initial developer
		<p>Check if the SC occurs by turning the power OFF then ON. If the SC occurs again, do the following steps. Check if the SC reoccurs by cycling the power after each step.</p> <ol style="list-style-type: none"> Check if all connectors related to TD sensor are connected securely. Replace the connectors if they are disconnected, or loose. Check the Development Unit for the following points and recover or replace it if there are any defects. <ul style="list-style-type: none"> Gear came off PCDU seal was not removed Not initial developer Check the TD sensor and recover or replace it if there are any defects. Check the harness for TD sensor. Replace the harness if it is disconnected, or damaged. Replace the BCU if the SC cannot be recovered even after executing steps 1 to 4.

SC No.	Type	Error Name/Error Condition/Major Cause/Solution
SC361-01	D	TD sensor output error: Upper Limit (K)
SC361-02	D	TD sensor output error: Upper Limit (C)

SC No.	Type	Error Name/Error Condition/Major Cause/Solution
SC361-03	D	TD sensor output error: Upper Limit (M)
SC361-04	D	TD sensor output error: Upper Limit (Y)
		TD sensor output: V_t (SP3-210-001 to 004) > output upper limit error threshold (SP3-211-002) continuously exceeded the upper limit occurrence threshold value (SP3-211-003).
		TD sensor connector dropout (connection fault)

SC No.	Type	Error Name/Error Condition/Major Cause/Solution
		<p>Check if the SC occurs by turning the power OFF then ON. If the SC occurs again, do the following steps. Check if the SC reoccurs by cycling the power after each step.</p> <ol style="list-style-type: none"> 1. Check if all connectors related to TD sensor are connected securely. Replace the connectors if they are disconnected, or loose. 2. Check the Development Unit for the following points and recover or replace it if there are any defects. <ul style="list-style-type: none"> • Gear comes off • Development unit is not installed correctly 3. Check the TD sensor and recover or replace it if there are any defects. 4. Check the values of SP3-030-061 to 064 (Init TD Sensor :Exe Initial mu count). If they are initial, perform the TD sensor adjustment (SP3-030-001 to 006). 5. Check the Toner Supply Unit and recover or replace it if there are any defects. (When the image density is excessively low, the supply unit may have a possibility of abnormality) <ul style="list-style-type: none"> • Toner bottle is empty • Toner bottle drive error • Clogging in the supplying path 6. Check the harness for TD sensor. Replace the harness if it is disconnected, or damaged. 7. Replace the BCU if the SC cannot be recovered even after executing steps 1 to 6. <p>Recovery Confirmation Procedure</p> <ol style="list-style-type: none"> 1. Turn ON the main power, and then print a sheet. 2. Execute SP3-320-*** (TD.Sens:\Vt :Disp: Current: CMYK) to check the output value of the TD sensor. 3. Execute SP3-211-004 (Vt Limits Err :Disp Lower Threshold) to check the lower limit value. <ul style="list-style-type: none"> • Abnormal if the TD sensor output value is lower than the lower limit value • Normal if the TD sensor output value is equal to or larger than the lower limit value

SC No.	Type	Error Name/Error Condition/Major Cause/Solution
SC362-01	D	TD sensor output error: Lower limit (K)
SC362-02	D	TD sensor output error: Lower limit (C)
SC362-03	D	TD sensor output error: Lower limit (M)
SC362-04	D	TD sensor output error: Lower limit (Y)
		TD sensor output: Vt (SP3-210-001 to 004) < output lower limit error threshold (SP3-211-004) is continuously below the lower limit occurrence threshold value (SP3-211-005)
		TD sensor connector missing/dropout

SC No.	Type	Error Name/Error Condition/Major Cause/Solution
		<p>Check if the SC occurs by turning the power OFF then ON. If the SC occurs again, do the following steps. Check if the SC reoccurs by cycling the power after each step.</p> <ol style="list-style-type: none"> 1. Check if all connectors related to TD sensor are connected securely. Replace the connectors if they are disconnected, or loose. 2. Check the Development Unit for the following points and recover or replace it if there are any defects. <ul style="list-style-type: none"> • Gear comes off • Development unit is not installed correctly 3. Check the TD sensor and recover or replace it if there are any defects. 4. Check the values of SP3-030-061 to 064 (Init TD Sensor :Exe Initial mu count). If they are initial, perform the TD sensor adjustment (SP3-030-001 to 006). 5. Check the Toner Supply Unit and recover or replace it if there are any defects. <ul style="list-style-type: none"> • Toner bottle driving error (left rotating) 6. Check the harness for TD sensor. Replace the harness if it is disconnected, or damaged. 7. Replace the BCU if the SC cannot be recovered even after executing steps 1 to 6. <p>Recovery Confirmation Procedure</p> <ol style="list-style-type: none"> 1. Turn ON the main power, and then print a sheet. 2. Execute SP3-320-*** (TD.Sens:Vt :Disp: Current: CMYK) to check the output value of the TD sensor. 3. Execute SP3-211-004 (Vt Limits Err :Disp Lower Threshold) to check the lower limit value. <ul style="list-style-type: none"> • Abnormal if the TD sensor output value is lower than the lower limit value • Normal if the TD sensor output value is equal to or larger than the lower limit value

SC No.	Type	Error Name/Error Condition/Major Cause/Solution
SC370-01	D	TM (ID) sensor calibration error (F)

SC No.	Type	Error Name/Error Condition/Major Cause/Solution
SC370-02	D	TM (ID) sensor calibration error (C)
SC370-03	D	TM (ID) sensor calibration error (R)
		<p>Regular reflection optical output voltage of the Front or Center or Rear TM (ID) sensor: Vsg_reg cannot be adjusted to within target range.</p> <p>Upper limit (SP3-320-013: initial value 4.5V)</p> <p>Lower limit (SP3-320-014: initial value 3.5V)</p>
		For details about cause and solution, refer to page 970 "When SC370 (TM (ID) Sensor Calibration Error) Is Displayed".

SC No.	Type	Error Name/Error Condition/Major Cause/Solution
SC396-05	D	Drum motor (CMY) Lock
		Motor status is observed at 100ms intervals during motor ON, and the unlock status is detected at least 20 times
		<ul style="list-style-type: none"> • Motor defective • Connector disconnected • Harness broken • IOB defective • Unit torque increased.
		<ul style="list-style-type: none"> • Replace the motor • Reconnect the connector • Replace the harness • Replace the Imaging IOB. • Replace the PCDU

Service Call 441-498

SC400 (Engine: Around the Drum)

SC No.	Level	Error Name/Error Condition/Major Cause/Solution
SC441-00	D	Drum transfer motor: Lock
		Motor status is observed at 100ms intervals during motor ON, and the unlock status is detected at least 20 times.
		<ul style="list-style-type: none"> • Motor defective • Connector disconnected • Harness broken • IOB defective • Unit torque increased.
		<ul style="list-style-type: none"> • Replace the motor • Reconnect the connector • Replace the harness • Replace the Imaging IOB. • Check the load on the motor (PCDU, Image transfer unit, Paper transfer unit, Waste toner bottle). • Replace the PCDU, Image transfer unit, Paper transfer unit or Waste toner bottle.

SC No.	Level	Error Name/Error Condition/Major Cause/Solution
SC442-00	D	ITB Lift Error
		<p>Even though the ITB contact and release motor (also Toner supply motor (M)) rotates, the ITB contact and release sensor failed to detect the specified sensor feeler status within specified time.</p> <ul style="list-style-type: none"> • Contact/separation operation: If not detected in 2000msec • Home position operation: If not detected in 5000msec • Signal detection sampling period: 10msec
		<ul style="list-style-type: none"> • Image transfer unit not set/faulty setting • Sensor dirt • Sensor defective • Motor defective • Unit load large
		<ol style="list-style-type: none"> 1. Reset the Image transfer unit properly. 2. Clean the ITB contact and release sensor 3. Check the harness (disconnected, loose connectors) 4. Replace the ITB contact and release sensor 5. Replace the image transfer unit 6. Replace the contact and release drive unit

SC No.	Level	Error Name/Error Condition/Major Cause/Solution
SC452-00	D	Paper transfer contact motor error
		<p>Paper transfer contact motor: position sensor cannot detect the sensor filler state within the predetermined time (see below) even if the paper transfer contact and release motor is rotated.</p> <ul style="list-style-type: none"> • Contact operation: If not detected in 2000msec • Home position operation: If not detected in 5000msec • Signal detection sampling period: 10msec
		<ul style="list-style-type: none"> • Sensor dirt • Sensor defection • Motor defection • Unit load large
		<ul style="list-style-type: none"> • Replace the contact drive unit • Replace the image transfer unit • Check the harness

SC No.	Level	Error Name/Error Condition/Major Cause/Solution
SC491-00	D	<p>High voltage power source: charge/development: output error</p> <p>SC detection signal (charge/development) is L (abnormal) for 200 ms consecutively during high voltage (charge/development) output.</p> <p>H/W error</p> <ul style="list-style-type: none"> • Output contact setting fault • Controller connector set fault • Ground fault of output high voltage path • Surface/air clearance insufficient (arc discharge) • Controller harness disconnection, short-circuit • PCU setting fault • Control board _IOB error (related signal error) • HVP_CB error <p>Load error</p> <ul style="list-style-type: none"> • Grounding fault of charging output, short-circuit with other outputs • Surface/air clearance insufficient in charging output path (including distance from other outputs) • Abnormal deterioration of drum, and over current due to pinholes • Drum vs charge roller gap error (PCU error). • Over current due to drum surface condensation • Grounding fault of developing output, short-circuit with other outputs • Surface/air clearance insufficient in developing output path (including distance from other outputs) • Other
		<ul style="list-style-type: none"> • Turn the main power OFF/ON. • Reset or replace the harness of high voltage power supply feed path • Reset or replace the harness between IOB-HVP_CB • Reset or replace the PCU • Check the operation of the contact mechanism • Replace the HVP_CB • Replace the Imaging IOB.

SC No.	Level	Error Name/Error Condition/Major Cause/Solution
SC492-00	C	High voltage power source: image transfer/paper transfer: output error
		SC detection signal (transfer) is L (abnormal) for 200 ms consecutively during high voltage (transfer) output.
		<p>H/W error</p> <ul style="list-style-type: none"> • Output power connector setting fault • Controller connector setting fault • Output high voltage Harness disconnection • Controller harness disconnection, short-circuit • Transfer unit setting fault • Control board_ IOB error (related signal error) • HVP_TTS error <p>Load error</p> <ul style="list-style-type: none"> • Increase in paper transfer roller impedance (low temperature environment/impedance rise/impedance rise due to dirt) • Operation fault of paper transfer contact mechanism • Increase in image transfer belt impedance • Opening in load power supply path <ul style="list-style-type: none"> • Reset or replacement the harness of high voltage power supply feed path • Reset or replace the harness between IOB-HVP_TTS • Reset or replace the transfer unit • Check operation of the contact mechanism • Replace the HVP_TTS • Replace the Imaging IOB.

SC No.	Level	Error Name/Error Condition/Major Cause/Solution
SC497-00	C	Machine temperature detection thermistor error
		Temperature sensor output error: Below 0.56V, or above 3.0V
		<ul style="list-style-type: none"> • Connector disconnection or broken • Sensor (Thermistor) defective
		<p>Check if the SC occurs by turning the power OFF then ON. If the SC occurs again, do the following steps. Check if the SC reoccurs by cycling the power after each step.</p> <ol style="list-style-type: none"> 1. Check if all connectors related to the Imaging Temperature Sensor (Thermistor) are connected securely. Reconnect the connectors if they are disconnected, or loose. 2. Replace the Imaging Temperature Sensor (Thermistor).

SC No.	Level	Error Name/Error Condition/Major Cause/Solution
SC498-00	C	Temperature and humidity sensor error
		Temperature sensor output error: Below 0.76V, or above 2.90V, or Moisture sensor output error: more than 2.4V
		<ul style="list-style-type: none"> • Sensor not setting (disconnection or broken) • Sensor defective
		<p>Check if the SC occurs by turning the power OFF then ON. If the SC occurs again, do the following steps. Check if the SC reoccurs by cycling the power after each step.</p> <ol style="list-style-type: none"> 1. Check if all connectors related to the Temperature and Humidity Sensor are connected securely. Reconnect the connectors if they are disconnected, or loose. 2. Replace the Temperature and Humidity Sensor.

Service Call 501-584

SC500 (Engine: Paper transport 1: Paper Feed, Duplex, Transport)

SC No.	Type	Error Name/Error Condition/Major Cause/Solution
SC501-01	B	1st Tray Lift Error (Main Machine)
		The 1st tray lift motor error detection count reaches 3 times. (Up to 2 times, reset instruction is displayed)
		<ul style="list-style-type: none"> • 1st tray upper limit sensor connector missing, malfunction, dirt • 1st tray lift motor connector missing, disconnection, malfunction. • Foreign object, such as paper scrap, is caught between the paper feed tray and the tray lift motor. • Paper set incorrectly
		<ul style="list-style-type: none"> • Reload the paper. • Remove the foreign object. <p>1st tray upper limit sensor, 1st tray lift motor</p> <ul style="list-style-type: none"> • Check the harness. • Reset the connector. • Replace <p>1st paper feed unit, 1st tray</p> <ul style="list-style-type: none"> • Replace <p>Paper transport IOB</p> <ul style="list-style-type: none"> • Replace

SC No.	Type	Error Name/Error Condition/Major Cause/Solution
SC501-02	B	1st Tray Descent Error (Main Frame)
		The 1st tray descent motor error detection count reaches 5. (Up to 4, reset instruction is displayed.)
		<ul style="list-style-type: none"> • 1st tray upper limit sensor connector missing, malfunction, dirt • 1st tray lift motor connector missing, disconnection, malfunction • Foreign object, such as paper scrap, is caught between the paper feed tray and the tray lift motor. • Paper set incorrectly • Paper overload
		<ul style="list-style-type: none"> • Reset the paper. • Remove the foreign object. <p>1st tray upper limit sensor, 1st tray lift motor</p> <ul style="list-style-type: none"> • Check the harness. • Reset the connector. • Replace <p>1st paper feed unit, 1st tray</p> <ul style="list-style-type: none"> • Replace <p>Paper transport IOB</p> <ul style="list-style-type: none"> • Replace

SC No.	Type	Error Name/Error Condition/Major Cause/Solution
SC502-01	B	2nd Tray Lift Error (Main Frame)
		The 2nd tray lift motor error detection count reaches 3. (Up to 2, reset is displayed.)
		<ul style="list-style-type: none"> • 2nd tray upper limit sensor connector missing, malfunction, dirt • 2nd tray lift motor connector missing, disconnection, malfunction • Foreign object, such as paper scrap, is caught between the paper feed tray and the tray lift motor • Paper set incorrectly
		<ul style="list-style-type: none"> • Reset the paper. • Remove the foreign object. <p>2nd tray upper limit sensor, 2nd tray lift motor</p> <ul style="list-style-type: none"> • Check the harness. • Reset the connector. • Replace <p>2nd paper feed unit, 2nd tray</p> <ul style="list-style-type: none"> • Replace <p>Paper transport IOB</p> <ul style="list-style-type: none"> • Replace

SC No.	Type	Error Name/Error Condition/Major Cause/Solution
SC502-02	B	2nd Tray Descent Error (Main Frame)
		The detection count of 2nd tray descent motor descent errors reaches a total of 5. (Up to 4, reset is displayed.)
		<ul style="list-style-type: none"> • 2nd tray upper limit sensor connector missing, malfunction, and dirt • 2nd tray lift motor connector missing, disconnection, malfunction • Foreign object, such as paper scrap, is caught between the paper feed tray and the tray lift motor • Paper set incorrectly • Paper overload
		<ul style="list-style-type: none"> • Reset the paper. • Remove the foreign object. <p>2nd tray upper limit sensor, 2nd tray lift motor</p> <ul style="list-style-type: none"> • Check the harness. • Reset the connector. • Replace <p>2nd paper feed unit, 2nd tray</p> <ul style="list-style-type: none"> • Replace <p>Paper transport IOB</p> <ul style="list-style-type: none"> • Replace

SC No.	Type	Error Name/Error Condition/Major Cause/Solution
SC503-01	B	3rd Tray Lift Error (Paper Feed Unit PB3150 (D694))
		<ul style="list-style-type: none"> • Lift motor ascent error detection <p>During tray initialization (upper limit not detected/lower limit detection), the tray base plate is raised to check the tray base plate position, and the upper limit sensor is not detected although a predetermined time elapsed, for 3 times consecutively.</p> <p>(Up to 2 times consecutively, the bank transmits a "tray set incorrectly" to the main machine.)</p>
		<ul style="list-style-type: none"> • Lift motor error/connector missing • Upper limit sensor error/connector missing • Harness broken • Bank control board defective • Foreign object, such as paper scrap, is caught between the paper feed tray and the tray lift motor • Paper set incorrectly
		<p>Remove the jammed paper or slip of paper from the tray, and check if the SC occurs by turning the main power OFF then ON. If the SC occurs again, do the following steps. Check if the SC reoccurs by cycling the power after each step.</p> <ol style="list-style-type: none"> 1. Check if all connectors in Tray 3 are connected securely. Reconnect the connectors if they are disconnected, or loose. 2. Check the harness in Tray 3. Replace the harnesses if it is disconnected, or damaged. 3. Check if the motor runs, sensors turn OFF/ON, has no overloads, and is properly driven. Replace the parts if there are any defects. 4. Check if there are any signs of a short circuit. Replace the parts if there are any defects.

SC No.	Type	Error Name/Error Condition/Major Cause/Solution
SC503-02	B	<p data-bbox="454 309 1048 341">3rd Tray Descent Error (Paper Feed Unit PB3150 (D694))</p> <ul data-bbox="477 374 1199 981" style="list-style-type: none"> <li data-bbox="477 374 842 399">• Lift motor descent error detection During tray initialization, the tray base plate is lowered to check the tray base plate position, and the upper limit sensor is detected although a predetermined time elapsed, for 3 times consecutively. (Up to 2 times consecutively, the bank transmits a "tray set incorrectly" to the main machine.) <li data-bbox="477 635 852 660">• Lift motor error/connector missing <li data-bbox="477 680 943 705">• Upper limit sensor error/connector missing <li data-bbox="477 725 666 750">• Harness broken <li data-bbox="477 770 801 795">• Bank control board defective <li data-bbox="477 815 666 840">• Paper overload <li data-bbox="477 860 1181 929">• Foreign object, such as paper scrap, is caught between the paper feed tray and the tray lift motor <li data-bbox="477 948 714 974">• Paper set incorrectly
		<p data-bbox="454 1011 1204 1144">Remove the jammed paper or slip of paper from the tray, and check if the SC occurs by turning the main power OFF then ON. If the SC occurs again, do the following steps. Check if the SC reoccurs by cycling the power after each step.</p> <ol data-bbox="471 1164 1199 1477" style="list-style-type: none"> <li data-bbox="471 1164 1199 1232">1. Check if all connectors in Tray 3 are connected securely. Reconnect the connectors if they are disconnected, or loose. <li data-bbox="471 1252 1085 1321">2. Check the harness in Tray 3. Replace the harnesses if it is disconnected, or damaged. <li data-bbox="471 1340 1177 1409">3. Check if the motor runs, sensors turn OFF/ON, has no overloads, and is properly driven. Replace the parts if there are any defects. <li data-bbox="471 1428 1167 1477">4. Check if there are any signs of a short circuit. Replace the parts if there are any defects.

SC No.	Type	Error Name/Error Condition/Major Cause/Solution
SC503-11	B	<p data-bbox="450 305 1136 374">3rd Tray Lift Error (Upper Tray: Paper Feed Unit PB3220/PB3210 (D787))</p> <ul data-bbox="477 407 828 433" style="list-style-type: none"> <li data-bbox="477 407 828 433">• Lift motor ascent error detection <p data-bbox="504 452 1195 589">During tray initialization (upper limit not detected/lower limit detection), the tray base plate is raised to check the tray base plate position, and the upper limit sensor is not detected although a predetermined time elapsed, for 3 times consecutively.</p> <p data-bbox="504 609 1098 668">(Up to 2 times consecutively, the bank transmits a "tray set incorrectly" to the main machine.)</p> <ul data-bbox="477 701 1181 1001" style="list-style-type: none"> <li data-bbox="477 701 852 727">• Lift motor error/connector missing <li data-bbox="477 746 943 772">• Upper limit sensor error/connector missing <li data-bbox="477 791 669 817">• Harness broken <li data-bbox="477 836 801 862">• Bank control board defective <li data-bbox="477 882 1181 940">• Foreign object, such as paper scrap, is caught between the paper feed tray and the tray lift motor <li data-bbox="477 960 714 985">• Paper set incorrectly
		<p data-bbox="450 1027 1204 1164">Remove the jammed paper or slip of paper from the tray, and check if the SC occurs by turning the main power OFF then ON. If the SC occurs again, do the following steps. Check if the SC reoccurs by cycling the power after each step.</p> <ol data-bbox="477 1183 1204 1491" style="list-style-type: none"> <li data-bbox="477 1183 1204 1242">1. Check if all connectors in Tray 3 are connected securely. Reconnect the connectors if they are disconnected, or loose. <li data-bbox="477 1262 1085 1321">2. Check the harness in Tray 3. Replace the harnesses if it is disconnected, or damaged. <li data-bbox="477 1340 1177 1399">3. Check if the motor runs, sensors turn OFF/ON, has no overloads, and is properly driven. Replace the parts if there are any defects. <li data-bbox="477 1419 1167 1477">4. Check if there are any signs of a short circuit. Replace the parts if there are any defects.

SC No.	Type	Error Name/Error Condition/Major Cause/Solution
SC503-12	B	<p data-bbox="454 309 1190 378">3rd Tray Descent Error(Upper Tray: Paper Feed Unit PB3220/PB3210 (D787))</p> <ul data-bbox="477 407 842 437" style="list-style-type: none"> <li data-bbox="477 407 842 437">• Lift motor descent error detection <p data-bbox="454 456 1190 554">During tray initialization, the tray base plate is lowered to check the tray base plate position; the upper limit sensor is detected although a predetermined time elapsed, for 3 times consecutively.</p> <p data-bbox="454 574 1190 642">(Up to 2 times consecutively, the bank transmits a "tray set incorrectly" to the main machine.)</p> <ul data-bbox="477 672 1190 1015" style="list-style-type: none"> <li data-bbox="477 672 854 701">• Lift motor error/connector missing <li data-bbox="477 721 943 750">• Upper limit sensor error/connector missing <li data-bbox="477 770 669 799">• Harness broken <li data-bbox="477 819 806 848">• Bank control board defective <li data-bbox="477 868 669 897">• Paper overload <li data-bbox="477 917 1190 976">• Foreign object, such as paper scrap, is caught between the paper feed tray and the tray lift motor <li data-bbox="477 995 717 1015">• Paper set incorrectly
		<p data-bbox="454 1044 1204 1181">Remove the jammed paper or slip of paper from the tray, and check if the SC occurs by turning the main power OFF then ON. If the SC occurs again, do the following steps. Check if the SC reoccurs by cycling the power after each step.</p> <ol data-bbox="477 1201 1204 1511" style="list-style-type: none"> <li data-bbox="477 1201 1204 1270">1. Check if all connectors in Tray 3 are connected securely. Reconnect the connectors if they are disconnected, or loose. <li data-bbox="477 1289 1087 1358">2. Check the harness in Tray 3. Replace the harnesses if it is disconnected, or damaged. <li data-bbox="477 1377 1190 1446">3. Check if the motor runs, sensors turn OFF/ON, has no overloads, and is properly driven. Replace the parts if there are any defects. <li data-bbox="477 1466 1170 1511">4. Check if there are any signs of a short circuit. Replace the parts if there are any defects.

SC No.	Type	Error Name/Error Condition/Major Cause/Solution
SC504-21	B	<p data-bbox="450 309 1126 378">4th Tray Lift Error (Lower Tray: Paper Feed Unit PB3220/PB3210 (D787))</p> <ul data-bbox="477 407 828 437" style="list-style-type: none"> <li data-bbox="477 407 828 437">• Lift motor ascent error detection <p data-bbox="504 456 1195 593">During tray initialization (upper limit not detected/lower limit detection), the tray base plate is raised to check the tray base plate position, but the upper limit sensor is not detected although a predetermined time elapsed, for 3 times consecutively.</p> <p data-bbox="504 613 1098 672">(Up to 2 times consecutively, the bank transmits a "tray set incorrectly" to the main machine.)</p> <ul data-bbox="477 711 1181 1001" style="list-style-type: none"> <li data-bbox="477 711 852 740">• Lift motor error/connector missing <li data-bbox="477 750 943 780">• Upper limit sensor error/connector missing <li data-bbox="477 799 669 829">• Harness broken <li data-bbox="477 848 806 878">• Bank control board defective <li data-bbox="477 897 1181 956">• Foreign object, such as paper scrap, is caught between the paper feed tray and the tray lift motor <li data-bbox="477 976 714 1005">• Paper set incorrectly
		<p data-bbox="450 1034 1204 1172">Remove the jammed paper or slip of paper from the tray, and check if the SC occurs by turning the main power OFF then ON. If the SC occurs again, do the following steps. Check if the SC reoccurs by cycling the power after each step.</p> <ol data-bbox="477 1191 1204 1505" style="list-style-type: none"> <li data-bbox="477 1191 1204 1250">1. Check if all connectors in Tray 4 are connected securely. Reconnect the connectors if they are disconnected, or loose. <li data-bbox="477 1270 1085 1328">2. Check the harness in Tray 4. Replace the harnesses if it is disconnected, or damaged. <li data-bbox="477 1348 1177 1407">3. Check if the motor runs, sensors turn OFF/ON, has no overloads, and is properly driven. Replace the parts if there are any defects. <li data-bbox="477 1426 1167 1505">4. Check if there are any signs of a short circuit. Replace the parts if there are any defects.

SC No.	Type	Error Name/Error Condition/Major Cause/Solution
SC504-22	B	4th Tray Descent Error (Lower Tray: Paper Feed Unit PB3220/PB3210 (D787))
		<ul style="list-style-type: none"> • Lift motor descent error detection <p>During tray initialization, the tray base plate is lowered to check the tray base plate position, but the upper limit sensor is detected although a predetermined time elapsed, for 3 times consecutively. (Up to 2 times consecutively, the bank transmits a "tray set incorrectly" to the main machine.)</p> <ul style="list-style-type: none"> • Lift motor error/connector missing • Upper limit sensor error/connector missing • Harness broken • Bank control board defective • Paper overload • Foreign object, such as paper scrap, is caught between the paper feed tray and the tray lift motor • Paper set incorrectly
		<p>Remove the jammed paper or slip of paper from the tray, and check if the SC occurs by turning the main power OFF then ON. If the SC occurs again, do the following steps. Check if the SC reoccurs by cycling the power after each step.</p> <ol style="list-style-type: none"> 1. Check if all connectors in Tray 4 are connected securely. Reconnect the connectors if they are disconnected, or loose. 2. Check the harness in Tray 4. Replace the harnesses if it is disconnected, or damaged. 3. Check if the motor runs, sensors turn OFF/ON, has no overloads, and is properly driven. Replace the parts if there are any defects. 4. Check if there are any signs of a short circuit. Replace the parts if there are any defects.

SC No.	Type	Error Name/Error Condition/Major Cause/Solution
SC508-00	B	Bypass Tray Size Detection Error
		The paper size detected on the bypass tray is different from any of the pattern of automatic size detection.
		<ul style="list-style-type: none"> • Bypass length sensor or bypass width sensor malfunction • Bypass length sensor or bypass width sensor harness disconnected
		<ol style="list-style-type: none"> 1. Replace the Bypass Length Sensor, or Bypass Width Sensor. 2. Replace the harness for bypass length sensor, or bypass width sensor.

SC No.	Type	Error Name/Error Condition/Major Cause/Solution
SC520-01	C	Registration Motor: Lock
SC520-02	C	Paper feed Motor: Lock
SC520-03	C	Transport Motor: Lock
		<p>During motor ON, after checking the motor error notification registers (err_velo and err_posi) for 0.5 sec, the error state of either register was detected at least 5 times.</p> <ul style="list-style-type: none"> • Motor defective • Connector disconnected • Harness broken • IOB defective • Encoder defective <ul style="list-style-type: none"> • Replace the motor. • Reset the connector. • Replace the harness. • Replace the paper transport IOB.

SC No.	Type	Error Name/Error Condition/Major Cause/Solution
SC521-01	C	Duplex Entrance Motor: Lock
SC521-02	C	Duplex Bypass Motor: Lock

SC No.	Type	Error Name/Error Condition/Major Cause/Solution
		<p>During motor ON, after checking the motor error notification registers (err_velo and err_posi) for 0.5 sec, the error state of either register was detected at least 5 times.</p> <ul style="list-style-type: none"> • Motor defective • Connector disconnected • Harness broken • IOB defective • Encoder defective <ul style="list-style-type: none"> • Replace the motor. • Reset the connector. • Replace the harness. • Replace the paper transport IOB.

SC No.	Type	Error Name/Error Condition/Major Cause/Solution
SC522-00	C	<p>Paper Exit Motor: Lock</p> <p>During motor ON, after checking the motor error notification registers (err_velo and err_posi) for 0.5 sec, the error state of either register was detected at least 5 times.</p> <ul style="list-style-type: none"> • Motor defective • Connector disconnected • Harness broken • IOB defective • Encoder defective <ul style="list-style-type: none"> • Replace the motor. • Reset the connector. • Replace the harness. • Replace the paper transport IOB.

SC500 (Engine: Fusing)

SC No.	Type	Error Name/Error Condition/Major Cause/Solution
SC530-00	D	Fusing Exhaust Fan Lock
		In the motor ON state, the value of the lock sensor is checked every 0.1 sec. If a lock signal is not obtained for 50 times consecutively.
		<ul style="list-style-type: none"> • Motor defective • Connector disconnected • Harness broken • IOB defective
		<ul style="list-style-type: none"> • Replace the fusing exhaust fan. • Reconnect the connector. • Replace the harness. • Replace the paper transport IOB.

SC No.	Type	Error Name/Error Condition/Major Cause/Solution
SC531-01	D	Development Intake Fan/Right Lock
SC531-03	D	Drive Cooling Fan Lock
		In the motor ON state, the value of the lock sensor is checked every 0.1 sec. If a lock signal is not obtained for 50 times consecutively.
		<ul style="list-style-type: none"> • Motor defective • Connector disconnected • Harness broken • IOB defective
		<ul style="list-style-type: none"> • Replace the development intake fan/right for SC531-01, or drive cooling fan for SC531-03. • Reconnect the connector. • Replace the harness. • Replace the imaging IOB.

SC No.	Type	Error Name/Error Condition/Major Cause/Solution
SC533-03	D	PSU Cooling Fan Lock
SC533-04	D	Controller Box Cooling Fan Lock
		<p>In the motor ON state, the value of the lock sensor is checked every 0.1 sec.</p> <p>If a lock signal is not obtained for 50 times consecutively.</p> <ul style="list-style-type: none"> • Motor defective • Connector disconnected • Harness broken • IOB defective <ul style="list-style-type: none"> • Replace the PSU exhaust fan for SC533-01, PSU cooling fan for SC533-04 or controller box cooling fan for SC533-04. • Reconnect the connector. • Replace the harness. • Replace the paper transport IOB (for SC533-01, -03). • Replace the imaging IOB (for SC533-04).

SC No.	Type	Error Name/Error Condition/Major Cause/Solution
SC534-01	D	Main Exhaust Fan Lock
SC534-02	D	Toner Supply Cooling Fan Lock
SC534-03	D	Ozone Exhaust Fan Lock

SC No.	Type	Error Name/Error Condition/Major Cause/Solution
		<p>In the motor ON state, the value of the lock sensor is checked every 0.1 sec.</p> <p>If a lock signal is not obtained for 50 times consecutively.</p> <ul style="list-style-type: none"> • Motor defective • Connector disconnected • Harness broken • IOB defective
		<ul style="list-style-type: none"> • Replace the development intake fan/right for SC534-01, or drive cooling fan for SC534-03. • Reconnect the connector. • Replace the harness. • Replace the imaging IOB (SC534-01, -02). • Replace the paper transport IOB (for SC534-03).

SC No.	Type	Error Name/Error Condition/Major Cause/Solution
SC535-00	D	<p>Paper Exit Cooling Fan Lock</p> <p>In the motor ON state, the value of the lock sensor is checked every 0.1 sec.</p> <p>If a lock signal is not obtained for 50 times consecutively.</p> <ul style="list-style-type: none"> • Motor defective • Connector disconnected • Harness broken • IOB defective
		<ul style="list-style-type: none"> • Replace the paper exit cooling fan. • Reconnect the connector. • Replace the harness. • Replace the imaging IOB.

SC No.	Type	Error Name/Error Condition/Major Cause/Solution
SC540-00	D	Fusing Motor: Lock
		Motor status is observed at 0.1 sec intervals during motor ON, and the unlock status is detected at least 20 times.
		<ul style="list-style-type: none"> • Motor defective • Connector disconnected • Harness broken • IOB defective • Unit torque increased
		<ul style="list-style-type: none"> • Replace the fusing motor. • Reconnect the connector. • Replace the harness. • Replace the paper transport IOB.

Fusing Sleeve (Center) Error (SC54* - **)

SC No.	Type	Error Name/Error Condition/Major Cause/Solution
SC541-01	A	Thermopile (Center) Disconnection
		Below -50 degrees C (or below CB) is detected for 0.1 sec continuously.
		<ul style="list-style-type: none"> • Thermopile disconnection • Connector disconnected • Harness disconnection between the fusing unit and the BCU • BCU defective
		<ol style="list-style-type: none"> 1. Reconnect the connectors (main machine side, BCU side). 2. Replace the thermopile (center). 3. Replace the harness between the fusing unit and the BCU. 4. Replace the BCU.

SC No.	Type	Error Name/Error Condition/Major Cause/Solution
SC541-02	A	Non-contact Thermistor (Center) Disconnection
		Above 3F6 is detected for 1 sec. continuously (NC sensor center: detection & compensation NC sensor edge: detection & compensation). Detection period: 0.1 sec, detection frequency: 10 times or more.
		<ul style="list-style-type: none"> • Non-contact thermistor disconnection • Connector disconnected • Harness disconnection in the fusing unit • Harness disconnection between the fusing unit and the BCU • BCU defective
		<ol style="list-style-type: none"> 1. Reconnect the connectors (between the fusing unit and the BCU). 2. Replace the non-contact thermistor with the harness. 3. Replace the fusing unit. 4. Replace the harness between the fusing unit and the BCU. 5. Replace the BCU.
SC541-03	A	Non-contact Thermistor (Center) short-circuit
		Below AD value: 8 is detected for 1 sec. continuously. Detection period: 0.1 sec, detection frequency: 10 times or more.
		<ul style="list-style-type: none"> • Non-contact thermistor short-circuit • Connector disconnected • Harness disconnection in the fusing unit • Harness disconnection between the fusing unit and the BCU • BCU defective
		<ol style="list-style-type: none"> 1. Reconnect the connectors (between the fusing unit and the BCU). 2. Replace the non-contact thermistor with the harness. 3. Replace the fusing unit. 4. Replace the harness between the fusing unit and the BCU. 5. Replace the BCU.

SC No.	Type	Error Name/Error Condition/Major Cause/Solution
SC542-02	A	Thermopile (Center) does not reload
		65 degrees C not reached after fusing lamp 1 ON for 10 sec continuously.
SC542-03	A	Thermopile (Center) does not reload
		Heating central reload permission temperature not reached after fusing lamp 1 ON for 35 sec continuously.
SC542-05	D	Thermopile (Center) does not reload (Low Power)
		65 degrees C not reached after fusing lamp 1 ON for 10 sec continuously.
SC542-06	D	Thermopile (Center) does not reload (Low Power)
		Heating central reload permission temperature not reached after fusing lamp 1 ON for 35 sec continuously.

SC No.	Type	Error Name/Error Condition/Major Cause/Solution
		<ul style="list-style-type: none"> • Outside input voltage guarantee • Jammed paper between the thermopile and fusing unit • Thermopile lens dirt • Thermopile modification/float • After excessive temperature rise prevention unit operation • Fusing lamp disconnection • Harness disconnection between the fusing unit and the BCU or the PSU (AC controller board) • BCU defective • AC controller board defective <hr/> <ol style="list-style-type: none"> 1. Check the power supply voltage and reconnect the cable to the outlet. 2. Remove the jammed paper between the thermopile and fusing unit. 3. Clean or replace the thermopile (center). 4. Replace the fusing sleeve thermostat 5. Replace the fusing sleeve belt unit. 6. Reconnect or replace the harness between the fusing unit and the BCU or the PSU (AC controller board). 7. Replace the BCU. 8. Replace the PSU (AC controller board).

SC No.	Type	Error Name/Error Condition/Major Cause/Solution
SC543-00	A	Thermopile (Center) high temperature detection (software)
		Above 240 degrees C detected for 1 sec continuously. Detection period: 0.1 sec, detection count: 10 times or more.
		<ul style="list-style-type: none"> • Fusing sleeve belt defective • Paper setting misdetection • Incorrect paper position in the paper feed tray • Gear abrasion • Thermopile failure • Harness disconnection between the fusing unit and the BCU or the PSU (AC controller board) • Triac defective (short-circuit) • BCU failure • AC controller board failure
		<ol style="list-style-type: none"> 1. Inspect the fusing sleeve belt unit, and replace if damaged. 2. Check the paper settings. 3. Check the paper position in the paper feed tray. 4. Reconnect the connectors (main machine side, BCU side). 5. Inspect or replace the gears in the fusing unit or main machine. 6. Replace the thermopile (center). 7. Replace the harness between the fusing unit and the BCU or the PSU (AC controller board). 8. Replace the BCU. 9. Replace the PSU (AC controller board). <p>If the problem cannot be solved after performing the above steps, replace the fusing unit.</p>

SC No.	Type	Error Name/Error Condition/Major Cause/Solution
SC544-01	A	Thermopile (Center) high temperature detection (hardware)
		In the event of an error
		<ul style="list-style-type: none"> • Fusing sleeve belt defective • Paper setting misdetection • Incorrect paper position in the paper feed tray • Gear abrasion • Pressure roller HP sensor disconnected • Thermopile failure • Harness disconnection between the fusing unit and the BCU or the PSU (AC controller board) • Triac defective (short-circuit) • BCU failure • AC controller board failure
		<ol style="list-style-type: none"> 1. Inspect the fusing sleeve belt unit, and replace if damaged. 2. Check the paper settings. 3. Check the paper position in the paper feed tray. 4. Reconnect the connectors (main machine side, BCU side). 5. Inspect or replace the gears in the fusing unit or main machine. 6. Inspect the pressure roller HP sensor with SP5-803-047. 7. Replace the thermopile (center). 8. Replace the harness between the fusing unit and the BCU or the PSU (AC controller board). 9. Replace the BCU. 10. Replace the PSU (AC controller board). <p>If the problem cannot be solved after performing the above steps, replace the fusing unit.</p>

SC No.	Type	Error Name/Error Condition/Major Cause/Solution
SC544-02	A	Non-contact Thermistor (Center) high temperature detection (hardware)
		In the event of an error
		<ul style="list-style-type: none"> • Fusing sleeve belt defective • Paper setting misdetection • Incorrect paper position in the paper feed tray • Jammed paper between the thermopile and fusing unit • Thermopile lens dirt • Thermopile modification/float • Pressure roller HP sensor disconnected • Harness disconnection between the fusing unit and the BCU or the PSU (AC controller board) • Triac defective (short-circuit) • BCU failure • AC controller board failure
		<ol style="list-style-type: none"> 1. Inspect the fusing sleeve belt unit, and replace if damaged. 2. Check the paper settings. 3. Check the paper position in the paper feed tray. 4. Reconnect the connectors (main machine side, BCU side). 5. Remove the jammed paper between the thermopile and fusing unit. 6. Clean or replace the thermopile (center). 7. Replace the fusing unit. 8. Inspect the pressure roller HP sensor with SP5-803-047. 9. Replace the harness between the fusing unit and the BCU or the PSU (AC controller board). 10. Replace the BCU. 11. Replace the PSU (AC controller board).

SC No.	Type	Error Name/Error Condition/Major Cause/Solution
SC545-01	A	Fusing Central Lamp Continuously Heat

SC No.	Type	Error Name/Error Condition/Major Cause/Solution
SC545-05	D	Fusing Central Lamp Continuously Heat (Low Power)
		<p>After waiting for full power for more than 5 sec continuously.</p> <ul style="list-style-type: none"> • Definition of fusing lamp full power Continuously heating rate set point (maximum heating rate) • Measurement start point After reload (after fusing lamp extinguished, after rotation complete) below the standby temperature (target temperature), measurement starts after a fusing lamp heat-up request is issued. • Measurement stop condition Rotation started due to a print signal during measurement or other. • Maximum heat-up duty (SP interlinked value) 0% is excluded.
		<ul style="list-style-type: none"> • Outside input voltage guarantee • Jammed paper between the thermopile and fusing unit • Thermopile lens dirt • Thermopile modification/float • After excessive temperature rise prevention unit operation • Fusing lamp disconnection • Harness disconnection between the fusing unit and the BCU or the PSU (AC controller board) • BCU defective • AC controller board defective
<ol style="list-style-type: none"> 1. Check the power supply voltage and reconnect the cable to the outlet. 2. Remove the jammed paper between the thermopile and fusing unit. 3. Clean or replace the thermopile (center). 4. Replace the fusing sleeve thermostat. 5. Replace the fusing sleeve belt unit. 6. Reconnect or replace the harness between the fusing unit and the BCU or the PSU (AC controller board). 7. Replace the BCU. 8. Replace the PSU (AC controller board). 		

SC No.	Type	Error Name/Error Condition/Major Cause/Solution
SC547-01	D	Zero cross error (relay-contact soldering)
		Zero-cross signal is detected while the fusing relay is OFF.
		<ul style="list-style-type: none"> Fusing relay defective (contact soldering) Fusing relay drive circuit error
		<ol style="list-style-type: none"> Reconnect the connectors between PSU (AC controller board) and paper transport IOB. Replace the PSU (AC controller board). Replace the paper transport IOB.
SC547-02	D	Zero cross error (relay contact error)
		Zero-cross signal is not detected while the fusing relay is ON.
		<ul style="list-style-type: none"> Fusing relay damage (contact open) Fusing relay drive circuit error PSU fuse (24 VS) blowout
		<ol style="list-style-type: none"> Reconnect the connectors between PSU (AC controller board) and Paper transport IOB. Replace the PSU (AC controller board). Replace the paper transport IOB. Replace the harness between PSU (AC controller board) and paper transport IOB.
SC547-03	D	Zero cross error (low-frequency error)
		Mains power supply frequency is determined to be 44 Hz or lower.
		Frequency instability of mains power supply
		<ol style="list-style-type: none"> Check that the mains power supply frequency is higher than 44 Hz. If it is equal to or lower than 44 Hz, infrastructure may have defects to be dealt with. Replace the PSU (AC controller board).

Fusing Sleeve (Edge) Error (SC55* - **)

SC No.	Type	Error Name/Error Condition/Major Cause/Solution
SC551-01	A	Thermopile (Edge) Disconnection
		Below -50 degrees C (or below CB) is detected for 0.1 sec continuously.
		<ul style="list-style-type: none"> • Thermopile disconnection • Connector disconnected • Harness disconnection between the fusing unit and the BCU • BCU defective
		<ol style="list-style-type: none"> 1. Reconnect the connectors (main machine side, BCU side). 2. Replace the thermopile (edge). 3. Replace the harness between the fusing unit and the BCU. 4. Replace the BCU.
SC551-02	A	Non-contact Thermistor (Edge) Disconnection
		Above 3F6 is detected for 1 sec continuously (NC sensor center: detection & compensation NC sensor edge: detection & compensation). Detection period: 0.1 sec, detection frequency: 10 times or more.
		<ul style="list-style-type: none"> • Non-contact thermistor disconnection • Connector disconnected • Harness disconnection in the fusing unit • Harness disconnection between the fusing unit and the BCU • BCU defective
		<ol style="list-style-type: none"> 1. Reconnect the connectors (between the fusing unit and the BCU). 2. Replace the non-contact thermistor with the harness. 3. Replace the fusing unit. 4. Replace the harness between the fusing unit and the BCU. 5. Replace the BCU.

SC No.	Type	Error Name/Error Condition/Major Cause/Solution
SC551-03	A	Non-contact Thermistor (Edge) Short-circuit
		Below AD value: 8 is detected for 1 sec. continuously. Detection period: 0.1 sec, detection frequency: 10 times or more.
		<ul style="list-style-type: none"> • Non-contact thermistor short-circuit • Connector disconnected • Harness disconnection in the fusing unit • Harness disconnection between the fusing unit and the BCU • BCU defective
		<ol style="list-style-type: none"> 1. Reconnect the connectors (between the fusing unit and the BCU). 2. Replace the non-contact thermistor with the harness. 3. Replace the fusing unit. 4. Replace the harness between the fusing unit and the BCU. 5. Replace the BCU.

SC No.	Type	Error Name/Error Condition/Major Cause/Solution
SC552-02	A	Thermopile (Edge) Does Not Reload
		65 degrees C not reached after fusing lamp 1 ON for 14 sec continuously.
SC552-03	A	Thermopile (Edge) Does Not Reload
		Heating edge reload permission temperature not reached after fusing lamp 1 ON for 28 sec continuously.
SC552-05	D	Thermopile (Edge) Does Not Reload (Low Power)
		65 degrees C not reached after fusing lamp 1 ON for 14 sec continuously.
SC552-06	D	Thermopile (Edge) Does Not Reload (Low Power)
		Heating edge reload permission temperature not reached after fusing lamp 1 ON for 28 sec continuously.

SC No.	Type	Error Name/Error Condition/Major Cause/Solution
		<ul style="list-style-type: none"> • Outside input voltage guarantee • Jammed paper between the thermopile and fusing unit • Thermopile lens dirt • Thermopile modification/float • After excessive temperature rise prevention unit operation • Fusing lamp disconnection • Harness disconnection between the fusing unit and BCU or the PSU (AC controller board) • BCU defective • AC controller board defective <hr/> <ol style="list-style-type: none"> 1. Check the power supply voltage and reconnect the cable to the outlet. 2. Remove the jammed paper between the thermopile and fusing unit. 3. Clean or replace the thermopile (edge). 4. Replace the fusing sleeve thermostat. 5. Reconnect the fusing sleeve belt unit. 6. Reconnect or replace the harness between the fusing unit and the BCU or the PSU (AC controller board). 7. Replace the BCU. 8. Replace the PSU (AC controller board).

SC No.	Type	Error Name/Error Condition/Major Cause/Solution
SC553-00	A	Thermopile (Edge) High Temperature Detection (software)
		Above 240 degrees C detected for 1 sec continuously. Detection period: 0.1 sec, detection count: 10 times or more.
		<ul style="list-style-type: none"> • Fusing sleeve belt defective • Paper setting misdetection • Incorrect paper position in the paper feed tray • Gear abrasion • Thermopile failure • Harness disconnection between the fusing unit and the BCU or the PSU (AC controller board) • Triac defective (short-circuit) • BCU failure • AC controller board failure
		<ol style="list-style-type: none"> 1. Inspect the fusing sleeve belt unit, and replace if damaged. 2. Check the paper settings. 3. Check the paper position in the paper feed tray. 4. Reconnect the connectors (main machine side, BCU side). 5. Inspect or replace the gears in the fusing unit or main machine. 6. Replace the thermopile (edge). 7. Replace the harness between the fusing unit and the BCU or the PSU (AC controller board). 8. Replace the BCU. 9. Replace the PSU (AC controller board). <p>If the problem cannot be solved after performing the above steps, replace the fusing unit.</p>

SC No.	Type	Error Name/Error Condition/Major Cause/Solution
SC554-01	A	Thermopile (Edge) high temperature detection (hardware)
		In the event of an error
		<ul style="list-style-type: none"> • Fusing sleeve belt defective • Paper setting misdetection • Incorrect paper position in the paper feed tray • Gear abrasion • Pressure roller HP sensor disconnected • Thermopile failure • Harness disconnection between the fusing unit and the BCU • Triac defective (short-circuit) • BCU failure • AC controller board failure <ol style="list-style-type: none"> 1. Inspect the fusing sleeve belt unit, and replace if damaged. 2. Check the paper settings. 3. Check the paper position in the paper feed tray. 4. Reconnect the connectors (main machine side, BCU side). 5. Inspect or replace the gears in the fusing unit or main machine. 6. Inspect the pressure roller HP sensor with SP5-803-047. 7. Replace the thermopile (edge). 8. Replace the harness between the fusing unit and the BCU or the PSU (AC controller board). 9. Replace the BCU. 10. Replace the PSU (AC controller board). <p>If the problem cannot be solved after performing the above steps, replace the fusing unit.</p>

SC No.	Type	Error Name/Error Condition/Major Cause/Solution
SC554-02	A	Non-contact Thermistor (Edge) high temperature detection (hardware)
		In the event of an error
		<ul style="list-style-type: none"> • Fusing sleeve belt defective • Paper setting misdetection • Incorrect paper position in the paper feed tray • Jammed paper between the thermopile and fusing unit • Thermopile lens dirt • Thermopile modification/float • Pressure roller HP sensor disconnected • Harness disconnection between the fusing unit and the BCU or the PSU (AC controller board) • Triac defective (short-circuit) • BCU failure • AC controller board failure
		<ol style="list-style-type: none"> 1. Inspect the fusing sleeve belt unit, and replace if damaged. 2. Check the paper settings. 3. Check the paper position in the paper feed tray. 4. Reconnect the connectors (main machine side, BCU side). 5. Remove the jammed paper between the thermopile and fusing unit. 6. Clean or replace the thermopile (edge). 7. Replace the fusing unit. 8. Inspect the pressure roller HP sensor with SP5-803-047. 9. Replace the harness between the fusing unit and the BCU or the PSU (AC controller board). 10. Replace the BCU. 11. Replace the PSU (AC controller board).

SC No.	Type	Error Name/Error Condition/Major Cause/Solution
SC555-01	A	Fusing Edge Lamp Continuously Heat
SC555-05	D	Fusing Edge Lamp Continuously Heat (Low Power)

SC No.	Type	Error Name/Error Condition/Major Cause/Solution
		<p>After waiting for full power for more than 5 sec continuously.</p> <ul style="list-style-type: none"> • Definition of fusing lamp full power Continuously heating rate set point (maximum heating rate) • Measurement start point After reload (after fusing lamp extinguished, after rotation complete) below the standby temperature (target temperature), measurement starts after a fusing lamp heat-up request is issued. • Measurement stop condition Rotation started due to a print signal during measurement or other • Maximum heat-up Duty (SP interlinked value) 0% is excluded <ul style="list-style-type: none"> • Outside input voltage guarantee • Jammed paper between the thermopile and fusing unit • Thermopile lens dirt • Thermopile modification/float • After excessive temperature rise prevention unit operation • Fusing lamp disconnection • Harness disconnection between the fusing unit and the BCU • BCU defective • AC controller board defective <ol style="list-style-type: none"> 1. Check the power supply voltage and reconnect the cable to the outlet. 2. Remove the jammed paper between the thermopile and fusing unit. 3. Clean or replace the thermopile (edge). 4. Replace the fusing sleeve thermostat. 5. Replace the fusing sleeve belt unit. 6. Reconnect or replace the harness between the fusing unit and the BCU or the PSU (AC controller board). 7. Replace the BCU. 8. Replace the PSU (AC controller board).

SC No.	Type	Error Name/Error Condition/Major Cause/Solution
SC557-00	C	Zero Cross Frequency Exceeded
		In the event of an error
		Frequency instability of mains power supply /Noise
		-

SC No.	Type	Error Name/Error Condition/Major Cause/Solution
SC558-01	C	Low Input Voltage
		Input voltage below the specification is detected on the mains power supply
		Low input of mains power supply
		-

SC No.	Type	Error Name/Error Condition/Major Cause/Solution
SC559-00	A	Fusing Jam Detected for 3 Times Consecutively
		<p>Fusing jam (does not reach fusing exit sensor) is detected for 3 times consecutively.</p> <ul style="list-style-type: none"> • Detection conditions Displays the SC559-00 at the time of integrating the counter each time fusing jam occurs, became fusing jam counter value = 3. The counter value is retained without fusing jam also reset by OFF/ON the power supply. • Control ON/OFF And enables ON / OFF is this SC, the default is set to OFF, then ON at the time of customer requirements. SP1-142-001 0: OFF (default), 1: ON (Set at the time of customer requirements) • Counter reset condition occurs fusing jam <ol style="list-style-type: none"> 1. Normal paper exit has been done during this continuous fusing jam, fusing jam counter is reset. 2. When "1" is changed to "0" SP1-142-001, to reset the (SP9-912-001) fusing jam counter. 3. When after displaying SC559, SC release is made, reset the (SP9912-001) fusing jam counter.
		<ul style="list-style-type: none"> • Stripper plate float/ mounting failure • Gear abrasion • Fusing motor failure <ol style="list-style-type: none"> 1. Inspect or replace the stripper plate. 2. Replace the gears in the fusing unit or main machine. 3. Replace the fusing motor. 4. Replace the fusing unit.

Pressure Roller Thermistor (Center) Error (SC56*-**)

SC No.	Type	Error Name/Error Condition/Major Cause/Solution
SC561-01	A	Pressure Roller Thermistor (Center) Disconnection

SC No.	Type	Error Name/Error Condition/Major Cause/Solution
SC561-05	D	Pressure Roller Thermistor (Center) Disconnection (Low Power)
		<p>Below 0 degree C detected for 20 sec continuously. Detection period 0.1 sec, detection count: 10 times or more.</p> <ul style="list-style-type: none"> • Non-contact thermistor disconnection • Connector disconnected • Harness disconnection in the fusing unit • Harness disconnection between the fusing unit and the BCU or the PSU (AC controller board) • BCU defective • Fusing lamp defective • AC controller board defective <ol style="list-style-type: none"> 1. Check the power supply voltage and reconnect the cable to the outlet. (-05 only) 2. Reconnect the connectors (between the fusing unit and the BCU). 3. Replace the thermistor. 4. Replace the fusing unit. 5. Replace the harness between the fusing unit and the BCU or the PSU (AC controller board). 6. Replace the BCU. 7. Replace the fusing sleeve belt unit. 8. Replace the PSU (AC controller board).

SC No.	Type	Error Name/Error Condition/Major Cause/Solution
SC562-02	A	Pressure Roller Thermistor (Center) Does Not Reload
SC562-05	D	Pressure Roller Thermistor (Center) Does Not Reload (Low Power)

SC No.	Type	Error Name/Error Condition/Major Cause/Solution
		<p data-bbox="450 309 1105 341">Does not reach 40 degree C after fusing lamp 1ON for 12 sec.</p> <ul data-bbox="477 374 1181 805" style="list-style-type: none"> • Outside input voltage guarantee • Thermistor dirt • Thermistor modification/float • After excessive temperature rise prevention unit operation • Fusing lamp disconnection • Harness disconnection between the fusing unit and the BCU or the PSU (AC controller board) • Thermopile defective • BCU defective • AC controller board defective <ol data-bbox="467 844 1204 1266" style="list-style-type: none"> 1. Check the power supply voltage and reconnect the cable to the outlet. 2. Clean or replace the thermistor. 3. Replace the fusing sleeve thermostat. 4. Replace the fusing sleeve belt unit. 5. Replace the harness between the fusing unit and the BCU or the PSU (AC controller board). 6. Replace the thermopile (center). 7. Replace the BCU. 8. Replace the PSU (AC controller board).

SC No.	Type	Error Name/Error Condition/Major Cause/Solution
SC563-00	A	Pressure Roller Thermistor (Center) High Temperature Detection (software)
		Above 230 degrees C detected for 1 sec continuously. Detection period: 0.1 sec, detection count: 10 times or more.
		<ul style="list-style-type: none"> • Paper setting misdetection • Incorrect paper position in the paper feed tray • Jammed paper between the center thermopile and fusing unit • Thermopile lens dirt • Thermopile modification/float • Harness disconnection between the fusing unit and the BCU or the PSU (AC controller board) • Triac defective (short-circuit) • BCU failure • AC controller board failure
		<ol style="list-style-type: none"> 1. Check the paper settings. 2. Check the paper position in the paper feed tray. 3. Reconnect the connectors (main machine side, BCU side). 4. Remove the jammed paper between the center thermopile and fusing unit. 5. Clean or replace the thermopile (center). 6. Replace the harness between the fusing unit and the BCU or the PSU (AC controller board). 7. Replace the BCU. 8. Replace the PSU (AC controller board). <p>If the problem cannot be solved after performing the above steps, replace the fusing unit.</p>

SC No.	Type	Error Name/Error Condition/Major Cause/Solution
SC564-00	A	Pressure Roller Thermistor (Center) High Temperature Detection (Hardware)
		Above 240 degrees C detected.
		<ul style="list-style-type: none"> • Paper setting misdetection • Incorrect paper position in the paper feed tray • Jammed paper between the center thermopile and fusing unit • Thermopile lens dirt • Thermopile modification/float • Pressure roller HP sensor disconnected • Harness disconnection between the fusing unit and the BCU or the PSU (AC controller board) • Triac defective (short-circuit) • BCU failure • AC controller board failure
		<ol style="list-style-type: none"> 1. Check the paper settings. 2. Check the paper position in the paper feed tray. 3. Reconnect the connectors (main machine side, BCU side). 4. Remove the jammed paper between the center thermopile and fusing unit. 5. Clean or replace the thermopile (center). 6. Inspect the pressure roller HP sensor with SP5-803-047. 7. Replace the harness between the fusing unit and the BCU or the PSU (AC controller board). 8. Replace the BCU. 9. Replace the PSU (AC controller board). <p>If the problem cannot be solved after performing the above steps, replace the fusing unit.</p>

SC No.	Type	Error Name/Error Condition/Major Cause/Solution
SC569-00	D	Paper Exit/ Pressure Release Motor Error Detection
		Retry operation fails 3 times consecutively.
		<ul style="list-style-type: none"> • Pressure roller HP sensor disconnected • Pressure release encoder modification • Fusing unit defective • Paper exit/ pressure release motor disconnected
		<p>Inspect the pressure roller HP sensor with SP5-803-047.</p> <p>If no response from the sensor, perform steps 1 and 2.</p> <ol style="list-style-type: none"> 1. Check the connection of the pressure roller HP sensor. 2. Inspect the pressure roller HP sensor. 3. Inspect the pressure release encoder. 4. Replace the fusing unit. 5. Check the connectors of the paper exit/ pressure release motor.

Pressure Roller Thermistor (Edge) Error (SC57* - **)

SC No.	Type	Error Name/Error Condition/Major Cause/Solution
SC571-01	A	Pressure Roller Thermistor (Edge) Disconnection
SC571-05	D	Pressure Roller Thermistor (Edge) Disconnection (Low Power)

SC No.	Type	Error Name/Error Condition/Major Cause/Solution
		<p>Below 0 degree C detected for 40 sec. continuously. Detection period: 0.1 sec, detection counts: 10 times or more.</p> <ul style="list-style-type: none"> • Thermistor disconnection • Connector disconnected • Harness disconnection in the fusing unit • Harness disconnection between the fusing unit and the BCU or the PSU (AC controller board) • BCU defective • Fusing lamp defective • AC controller board defective <ol style="list-style-type: none"> 1. Check the power supply voltage and reconnect the cable to the outlet. (-05 only) 2. Reconnect the connectors (between the fusing unit and the BCU or the PSU (AC controller board). 3. Replace the thermistor. 4. Replace the fusing unit. 5. Replace the harness between the fusing unit and the BCU or the PSU (AC controller board). 6. Replace the BCU. 7. Replace the fusing sleeve belt unit. 8. Replace the PSU (AC controller board).

SC No.	Type	Error Name/Error Condition/Major Cause/Solution
SC572-04	A	Pressure Roller Thermistor (Edge) Does Not Reload
SC572-05	D	Pressure Roller Thermistor (Edge) Does Not Reload (Low Power)

SC No.	Type	Error Name/Error Condition/Major Cause/Solution
		<p data-bbox="450 309 1185 378">After starting continuous job with paper width of 257mm or more, does not reach 0 degrees C after 100 sec.</p> <ul data-bbox="477 407 1185 844" style="list-style-type: none"> • Outside input voltage guarantee • Thermistor dirt • Thermistor modification/float • After excessive temperature rise prevention unit operation • Fusing lamp disconnection • Harness disconnection between the fusing unit and the BCU or the PSU (AC controller board) • Thermopile defective • BCU defective • AC controller board defective <ol data-bbox="467 878 1174 1305" style="list-style-type: none"> 1. Check the power supply voltage and reconnect the cable to the outlet. 2. Clean or replace the thermistor. 3. Replace the fusing sleeve thermostat. 4. Replace the fusing sleeve belt unit. 5. Reconnect or replace the harness between the fusing unit and the BCU or the PSU (AC controller board). 6. Replace the thermopile (edge). 7. Replace the BCU. 8. Replace the PSU (AC controller board).

SC No.	Type	Error Name/Error Condition/Major Cause/Solution
SC573-00	A	Pressure Roller Thermistor (Edge) High Temperature Detection (software)
		Above 230 degrees C detected for 1 sec continuously. Detection period: 0.1 sec, detection count: 10 times or more.
		<ul style="list-style-type: none"> • Paper setting misdetection • Incorrect paper position in the paper feed tray • Jammed paper between the thermopile and fusing unit • Thermopile lens dirt • Thermopile modification/float • Harness disconnection between the fusing unit and the BCU or the PSU (AC controller board) • Triac defective (short-circuit) • BCU failure • AC controller board failure
		<ol style="list-style-type: none"> 1. Check the paper settings. 2. Check the paper position in the paper feed tray. 3. Reconnect the connectors (main machine side, BCU side). 4. Remove the jammed paper between the thermopile and fusing unit. 5. Clean or replace the thermopile (edge). 6. Replace the harness between the fusing unit and the BCU or the PSU (AC controller board). 7. Replace the BCU. 8. Replace the PSU (AC controller board). <p>If the problem cannot be solved after performing the above steps, replace the fusing unit.</p>

SC No.	Type	Error Name/Error Condition/Major Cause/Solution
SC574-00	A	Pressure Roller Thermistor (edge) High Temperature Detection (hardware)
		Above 240 degrees C detected
		<ul style="list-style-type: none"> • Paper setting misdetection • Incorrect paper position in the paper feed tray • Jammed paper between the thermopile and fusing unit • Thermopile lens dirt • Thermopile modification/float • Pressure roller HP sensor disconnected • Harness disconnection between the fusing unit and the BCU or the PSU (AC controller board) • Triac defective (short-circuit) • BCU failure • AC controller board failure
		<ol style="list-style-type: none"> 1. Check the paper settings. 2. Check the paper position in the paper feed tray. 3. Reconnect the connector. 4. Remove the jammed paper between the thermopile and fusing unit. 5. Clean or replace the thermopile (edge). 6. Inspect the pressure roller HP sensor with SP5-803-047. 7. Replace the harness between the fusing unit and the BCU or the PSU (AC controller board). 8. Replace the BCU. 9. Replace the PSU (AC controller board). <p>If the problem cannot be solved after performing the above steps, replace the fusing unit.</p>

Pressure Roller Thermistor (Full-bleed edge) Error (SC58* - **)

SC No.	Type	Error Name/Error Condition/Major Cause/Solution
SC581-01	A	Pressure Roller Thermistor (Full-bleed edge) Thermistor Disconnection
SC581-05	D	Pressure Roller Thermistor (Full-bleed edge) Disconnection (Low Power)

SC No.	Type	Error Name/Error Condition/Major Cause/Solution
		<p>Below 0 degree C detected for 40 sec. continuously. Detection period: 0.1 sec, detection count: 10 times or more.</p> <ul style="list-style-type: none"> • Thermistor disconnection • Connector disconnected • Harness disconnection in the fusing unit • Harness disconnection between the fusing unit and the BCU or the PSU (AC controller board) • BCU defective • Fusing lamp defective • AC controller board defective <ol style="list-style-type: none"> 1. Check the power supply voltage and reconnect the cable to the outlet. (-05 only) 2. Reconnect the connectors (between the fusing unit and the BCU or the PSU (AC controller board). 3. Replace the thermistor. 4. Replace the fusing unit. 5. Replace the harness between the fusing unit and the BCU or the PSU (AC controller board). 6. Replace the BCU. 7. Replace the fusing sleeve belt unit. 8. Replace the PSU (AC controller board).

SC No.	Type	Error Name/Error Condition/Major Cause/Solution
SC582-04	A	Pressure Roller Thermistor (Full-bleed edge) Does Not Reload
SC582-05	D	Pressure Roller Thermistor (Full-bleed edge) Does Not Reload (Low Power)

SC No.	Type	Error Name/Error Condition/Major Cause/Solution
		<p data-bbox="450 309 1190 378">After starting continuous job with paper width of 257 mm or more, does not reach 0 degrees C after 100 sec.</p> <ul data-bbox="477 407 1181 844" style="list-style-type: none"> • Outside input voltage guarantee • Thermistor dirt • Thermistor modification/float • After excessive temperature rise prevention unit operation • Fusing lamp disconnection • Harness disconnection between the fusing unit and the BCU or the PSU (AC controller board) • Thermopile defective • BCU defective • AC controller board defective <ol data-bbox="467 878 1204 1305" style="list-style-type: none"> 1. Check the power supply voltage and reconnect the cable to the outlet. 2. Clean or replace the thermistor. 3. Replace the fusing sleeve thermostat. 4. Replace the fusing sleeve belt unit. 5. Replace the harness between the fusing unit and the BCU or the PSU (AC controller board). 6. Replace the thermopile (edge). 7. Replace the BCU. 8. Replace the PSU (AC controller board).

SC No.	Type	Error Name/Error Condition/Major Cause/Solution
SC583-00	A	Pressure Roller Thermistor (Full-bleed edge) High Temperature Detection (software)
		Above 230 degrees C detected for 1 sec continuously. Detection period: 0.1 sec, detection count: 10 times or more.
		<ul style="list-style-type: none"> • Paper setting misdetection • Incorrect paper position in the paper feed tray • Jammed paper between the thermopile and fusing unit • Thermopile lens dirt. • Thermopile modification/float • Harness disconnection between the fusing unit and the BCU or the PSU (AC controller board) • Triac defective (short-circuit) • BCU failure • AC controller board failure
		<ol style="list-style-type: none"> 1. Check the paper settings. 2. Check the paper position in the paper feed tray. 3. Reconnect the connectors (main machine side, BCU side). 4. Remove the jammed paper between the thermopile and fusing unit. 5. Clean or replace the thermopile (edge). 6. Replace the harness between the fusing unit and the BCU or the PSU (AC controller board). 7. Replace the BCU. 8. Replace the PSU (AC controller board). <p>If the problem cannot be solved after performing the above steps, replace the fusing unit.</p>

SC No.	Type	Error Name/Error Condition/Major Cause/Solution
SC584-00	A	Pressure Roller Thermistor (Full-bleed edge) High Temperature Detection (hardware)
		Above 240 degrees C detected
		<ul style="list-style-type: none"> • Paper setting misdetection • Incorrect paper position in the paper feed tray • Jammed paper between the thermopile and fusing unit • Thermopile lens dirt • Thermopile modification/float • Pressure roller HP sensor disconnected • Harness disconnection between the fusing unit and the BCU or the PSU (AC controller board) • Triac defective (short-circuit) • BCU failure • AC controller board failure
		<ol style="list-style-type: none"> 1. Check the paper settings. 2. Check the paper position in the paper feed tray. 3. Reconnect the connectors (main machine side, BCU side). 4. Remove the jammed paper between the thermopile and fusing unit. 5. Clean or replace the thermopile (edge). 6. Inspect the pressure roller HP sensor with SP5-803-047. 7. Replace the harness between the fusing unit and the BCU or the PSU (AC controller board). 8. Replace the BCU. 9. Replace the PSU (AC controller board). <p>If the problem cannot be solved after performing the above steps, replace the fusing unit.</p>

Service Call 620-687

SC600 (Engine: Communication and Others)

SC No.	Type	Error Name/Error Condition/Major Cause/Solution
SC620-01	D	ADF Communication error 1 (DF3090 (D779)/ DF3100 (D3B0))
		After ADF connection was recognized on startup, an error is detected. (disconnection detection)
		<ul style="list-style-type: none"> • ADF connection error • ADF deflection • IPU board deflection • Noise contamination
		<p>Check if the SC occurs by turning the main power OFF then ON. If the SC occurs again, do the following steps. Check if the SC reoccurs by cycling the power after each step.</p> <ol style="list-style-type: none"> 1. Check if all connectors related to SPDF/ARDF are connected securely. Reconnect the connectors if they are disconnected, or loose. 2. Check the machine and ADF firmware version. <ul style="list-style-type: none"> • Proceed to Step 3 if there is no new firmware released. • Run the firmware update when there is a new firmware released. 3. Check the harness. Replace the harness if it is disconnected, or damaged. 4. Replace the IPU. 5. Check if there are any signs of a short circuit on the SPDF/ARDF Main Board. If there are any defects, replace the board.

SC No.	Type	Error Name/Error Condition/Major Cause/Solution
SC620-02	D	ADF Communication error 2 (DF3090 (D779)/ DF3100 (D3B0))
		After ADF connection was recognized on startup, an error is detected. (Retry out due to communication error)
		<ul style="list-style-type: none"> • ADF connection error • ADF defection • IPU board defection • Noise contamination
		Follow the solution for SC620-01.

SC No.	Type	Error Name/Error Condition/Major Cause/Solution
SC620-03	D	ADF Communication error 3 (DF3100 (D3B0))
		SC is displayed when CIS initialization complete command is not received for certain time.
		<ul style="list-style-type: none"> • ADF connection error • ADF defection • IPU board defection • Noise contamination • Unsupported ADF is connected
		<p>Check if the SC occurs by turning the main power OFF then ON. If the SC occurs again, do the following steps. Check if the SC reoccurs by cycling the power after each step.</p> <ol style="list-style-type: none"> 1. Check if all connectors related to SPDF/ARDF are connected securely. Reconnect the connectors if they are disconnected, or loose. 2. Check the harness. Replace the harness if it is disconnected, or damaged. 3. Check if there are any signs of a short circuit on the SPDF Main Board. If there are any defects, replace the board.

SC No.	Type	Error Name/Error Condition/Major Cause/Solution
SC621-00	D	Finisher communication error
		<ul style="list-style-type: none"> • Detected an error when connecting the communication line. • Received a communication error notification from the URAT.
		<ul style="list-style-type: none"> • Finisher control board defective. • BCU defective • IOB defective • Connection error between finisher and main machine.
		<ul style="list-style-type: none"> • Reconnect the Finisher interface cable. • Replace the BCU. • Replace the Imaging IOB. • Replace the finisher. • Turn the power off/on.

SC No.	Type	Error Name/Error Condition/Major Cause/Solution
SC622-01	D	Paper bank 1 communication error for Paper Feed Unit PB3150 (D694)
SC622-11	D	Paper bank 1 communication error for Paper Feed Unit PB3220/ PB3210 (D787)

SC No.	Type	Error Name/Error Condition/Major Cause/Solution
		<ul style="list-style-type: none"> • Detected an error when connecting the communication line. • Received a communication error notification from the URAT.
		<ul style="list-style-type: none"> • Paper bank control board defective • BCU defective • IOB defective • Paper bank-main machine connection error
		<p>Check if the SC occurs by turning the main power OFF then ON. If the SC occurs again, do the following steps. Check if the SC reoccurs by cycling the power after each step.</p> <ol style="list-style-type: none"> 1. Check if all connectors in tray 1, 2, and optional paper tray are connected securely. Reconnect the connectors if they are disconnected, or loose. 2. Check the harness in tray 1, 2, and optional paper tray. Replace the harness if it is disconnected, or damaged. 3. Check if there are any signs of a short circuit on the Bank Main Board. If there are any defects, replace the board.

SC No.	Type	Error Name/Error Condition/Major Cause/Solution
SC663-01	D	Reset Detection: Imaging IOB: Software hang-up occurs
SC663-02	D	Reset Detection: Imaging IOB: Power ON reset occurs
SC663-03	D	Reset Detection: Imaging IOB: Software reset occurs
SC663-11	D	Reset Detection: Paper Transport IOB: Software hang-up occurs
SC663-12	D	Reset Detection: Paper Transport IOB: Power ON reset occurs
SC663-13	D	Reset Detection: Paper Transport IOB: Software reset occurs

SC No.	Type	Error Name/Error Condition/Major Cause/Solution
		<p>SC is displayed when unexpected reset from Imaging IOB/Paper Transport IOB is detected while standby/operation.</p> <ul style="list-style-type: none"> • Unexpected noise from inside the machine gets into Paper Transport IOB. • Parts defect and implementation defect of Imaging IOB/ Paper Transport IOB. • Software ran reset to ASIC when there was a bug in the software or unexpected signal was input (-03/-13 only). <ol style="list-style-type: none"> 1. Turn the main power OFF/ON. 2. Replace the Paper Transport IOB (-01 to -03) 3. Replace the Imaging IOB (-11 to -13)

SC No.	Type	Error Name/Error Condition/Major Cause/Solution
SC664-01	D	VODKA1 (Paper Transport Vodka) access permission error to VODKA SRAM
SC664-02	D	VODKA1 (Paper Transport Vodka) write error to VODKA SRAM
SC664-03	D	VODKA1 (Paper Transport Vodka) VODKA program launch error
SC664-11	D	VODKA2 (Imaging Vodka) access permission error to VODKA SRAM
SC664-12	D	VODKA2 (Imaging Vodka) write error to VODKA SRAM
SC664-13	D	VODKA2 (Imaging Vodka) VODKA program launch error

SC No.	Type	Error Name/Error Condition/Major Cause/Solution
		<p>The machine detects the communication error between VODKA and SRAM when starting up, or recovery from energy saver mode.</p> <p>The following board defects (Parts implementation defect, solder scrap, implemented parts defect, etc.);</p> <ul style="list-style-type: none"> • BCU • Imaging IOB • Paper Transport IOB <p>-01 to 03</p> <ol style="list-style-type: none"> 1. Turn the main power OFF/ON. 2. Replace the Paper Transport IOB. 3. Replace the BCU. 4. Replace the Imaging IOB. <p>-11 to 13</p> <ol style="list-style-type: none"> 1. Turn the main power OFF/ON. 2. Replace the Imaging IOB. 3. Replace the BCU.

SC No.	Type	Error Name/Error Condition/Major Cause/Solution
SC665-01	D	<p>Connection Error (BCU - IPU)</p> <p>The machine detects the communication error between BCU and IPU (No FFC connection) when starting up, or recovery from energy saver mode.</p> <ul style="list-style-type: none"> • FFC connection error • FFC defective (disconnected, foreign object, etc.) • The following board defects (Parts implementation defect, solder scrap, implemented parts defect, etc.); <ul style="list-style-type: none"> • BCU • IPU <ol style="list-style-type: none"> 1. Reconnect the FFC between BCU and IPU. 2. Replace the FFC between BCU and IPU. 3. Replace the BCU. 4. Replace the IPU.

SC No.	Type	Error Name/Error Condition/Major Cause/Solution
SC665-02	D	Connection Error (BCU – Imaging IOB)
		The machine detects the communication error between BCU and Imaging IOB (No connection) when starting up, or recovery from energy saver mode.
		<ul style="list-style-type: none"> • FFC connection error • FFC defective (disconnected, foreign object, etc.) • The following board defects (Parts implementation defect, solder scrap, implemented parts defect, etc.); <ul style="list-style-type: none"> • BCU • Imaging IOB
		<ol style="list-style-type: none"> 1. Reconnect the FFC between BCU and Imaging IOB. 2. Replace the FFC between BCU and Imaging IOB. 3. Replace the BCU. 4. Replace the Imaging IOB.

SC No.	Type	Error Name/Error Condition/Major Cause/Solution
SC665-03	D	Connection Error (Paper Transport IOB – Imaging IOB)
		The machine detects the communication error between Imaging IOB and Paper Transport IOB (No connection) when starting up, or recovery from energy saver mode.
		<ul style="list-style-type: none"> • FFC connection error • FFC defective (disconnected, foreign object, etc.) • The following board defects (Parts implementation defect, solder scrap, implemented parts defect, etc.); <ul style="list-style-type: none"> • Paper Transport IOB. • Imaging IOB.
		<ol style="list-style-type: none"> 1. Reconnect the FFC between Paper Transport IOB and Imaging IOB. 2. Replace the FFC between Paper Transport IOB and Imaging IOB. 3. Replace the Imaging IOB. 4. Replace the Paper Transport IOB.

SC No.	Type	Error Name/Error Condition/Major Cause/Solution
SC665-04	D	IOB does not start up
		The IOB does not start up when starting up, or recovery from energy saver mode.
		<ul style="list-style-type: none"> • Connector disconnected • Harness disconnected • The following board defects (Parts implementation defect, solder scrap, implemented parts defect, etc.) <ul style="list-style-type: none"> • BCU • Imaging IOB • Paper Transport IOB
		<ol style="list-style-type: none"> 1. Turn the main power OFF/ON. 2. Reconnect the following FFC; <ul style="list-style-type: none"> • BCU - Imagine IOB • Imaging IOB - Paper Transport IOB 3. Replace the following FFC; <ul style="list-style-type: none"> • BCU - Imagine IOB • Imaging IOB - Paper Transport IOB 4. Replace the BCU. 5. Replace the Imaging IOB. 6. Replace the Paper Transport IOB.

SC No.	Type	Error Name/Error Condition/Major Cause/Solution
SC665-05	D	<p data-bbox="450 309 828 339">Master Device Communication Error</p> <p data-bbox="450 370 1188 437">The machine detects the communication error between CPU and Slave 1 when starting up, or recovery from energy saver mode.</p> <ul data-bbox="477 468 1167 811" style="list-style-type: none"> <li data-bbox="477 468 721 497">• FFC connection error <li data-bbox="477 515 1007 544">• FFC defective (disconnected, foreign object, etc.) <li data-bbox="477 562 1167 811">• The following board defects (Parts implementation defect, solder scrap, implemented parts defect, etc.); <ul data-bbox="529 642 776 811" style="list-style-type: none"> <li data-bbox="529 642 605 672">• BCU <li data-bbox="529 689 595 719">• IPU <li data-bbox="529 736 691 766">• Imaging IOB <li data-bbox="529 784 776 811">• Paper Transport IOB.
		<ol data-bbox="470 844 924 1291" style="list-style-type: none"> <li data-bbox="470 844 828 874">1. Turn the main power OFF/ON. <li data-bbox="470 891 924 1015">2. Reconnect the following FFC; <ul data-bbox="529 938 924 1015" style="list-style-type: none"> <li data-bbox="529 938 760 968">• BCU - Imagine IOB <li data-bbox="529 985 924 1015">• Imaging IOB - Paper Transport IOB <li data-bbox="470 1032 924 1156">3. Replace the following FFC; <ul data-bbox="529 1079 924 1156" style="list-style-type: none"> <li data-bbox="529 1079 760 1109">• BCU - Imagine IOB <li data-bbox="529 1127 924 1156">• Imaging IOB - Paper Transport IOB <li data-bbox="470 1174 687 1203">4. Replace the BCU. <li data-bbox="470 1221 773 1250">5. Replace the Imaging IOB. <li data-bbox="470 1268 852 1297">6. Replace the Paper Transport IOB.

SC No.	Type	Error Name/Error Condition/Major Cause/Solution
SC665-06	D	IPU and IOB signal Communication Error
		<p>The machine detects the communication error between CPU and Slave 1 when starting up, or recovery from energy saver mode.</p> <ul style="list-style-type: none"> • FFC connection error • FFC defective (disconnected, foreign object, etc.) • The following board defects (Parts implementation defect, solder scrap, implemented parts defect, etc.); <ul style="list-style-type: none"> • BCU • IPU • Imaging IOB • Paper Transport IOB.
		<ol style="list-style-type: none"> 1. Turn the main power OFF/ON. 2. Reconnect the following FFC; <ul style="list-style-type: none"> • BCU - Imagine IOB • Imaging IOB - Paper Transport IOB 3. Replace the following FFC; <ul style="list-style-type: none"> • BCU - Imagine IOB • Imaging IOB - Paper Transport IOB 4. Replace the BCU. 5. Replace the IPU. 6. Replace the Imaging IOB. 7. Replace the Paper Transport IOB.

SC No.	Type	Error Name/Error Condition/Major Cause/Solution
SC665-07	D	IPU signal Communication Error
		The machine detects the communication error between CPU and Slave device when starting up, or recovery from energy saver mode.
		<ul style="list-style-type: none"> • FFC connection error • FFC defective (disconnected, foreign object, etc.) • The following board defects (Parts implementation defect, solder scrap, implemented parts defect, etc.); <ul style="list-style-type: none"> • BCU • IPU
		<ol style="list-style-type: none"> 1. Turn the main power OFF/ON. 2. Reconnect the following FFC; <ul style="list-style-type: none"> • BCU - Imagine IOB • Imaging IOB - Paper Transport IOB 3. Replace the following FFC; <ul style="list-style-type: none"> • BCU - Imagine IOB • Imaging IOB - Paper Transport IOB 4. Replace the BCU. 5. Replace the IPU.

SC No.	Type	Error Name/Error Condition/Major Cause/Solution
SC665-08	D	IOB signal Communication Error
		The machine detects the communication error between CPU and Slave 1 when starting up, or recovery from energy saver mode.
		<ul style="list-style-type: none"> • FFC connection error • FFC defective (disconnected, foreign object, etc.) • The following board defects (Parts implementation defect, solder scrap, implemented parts defect, etc.); <ul style="list-style-type: none"> • BCU • Imaging IOB • Paper Transport IOB. <ol style="list-style-type: none"> 1. Turn the main power OFF/ON. 2. Reconnect the following FFC; <ul style="list-style-type: none"> • BCU - Imagine IOB • Imaging IOB - Paper Transport IOB 3. Replace the following FFC; <ul style="list-style-type: none"> • BCU - Imagine IOB • Imaging IOB - Paper Transport IOB 4. Replace the BCU. 5. Replace the Imaging IOB. 6. Replace the Paper Transport IOB.

SC No.	Type	Error Name/Error Condition/Major Cause/Solution
SC665-11	D	Vodka1 Communication Error
		The machine detects the communication error between CPU and Vodka1 when starting up, or recovery from energy saver mode.
		<ul style="list-style-type: none"> • FFC connection error • FFC defective (disconnected, foreign object, etc.) • The following board defects (Parts implementation defect, solder scrap, implemented parts defect, etc.); <ul style="list-style-type: none"> • BCU • Paper Transport IOB.
		<ol style="list-style-type: none"> 1. Turn the main power OFF/ON. 2. Reconnect the FFC between Imaging IOB and Paper Transport IOB. 3. Replace the harness between Imaging IOB and Paper Transport IOB. 4. Replace the Imaging IOB. 5. Replace the Paper Transport IOB. 6. Reconnect the FFC between BCU and Imaging IOB. 7. Replace the FFC between BCU and Imaging IOB 8. Replace the BCU.

SC No.	Type	Error Name/Error Condition/Major Cause/Solution
SC665-12	D	Vodka2 Communication Error
		The machine detects the communication error between CPU and Vodka2 when starting up, or recovery from energy saver mode.
		<ul style="list-style-type: none"> • FFC connection error • FFC defective (disconnected, foreign object, etc.) • The following board defects (Parts implementation defect, solder scrap, implemented parts defect, etc.); <ul style="list-style-type: none"> • BCU • Imaging IOB.
		<ol style="list-style-type: none"> 1. Turn the main power OFF/ON. 2. Reconnect the FFC between BCU and Imaging IOB. 3. Replace the FFC between BCU and Imaging IOB 4. Replace the BCU. 5. Replace the Imaging IOB. 6. Pull out all the PCUs and check if the SC reoccurs or not. If SC message disappears, replace the PCU. 7. Pull out all the toner bottles and check if the SC reoccurs or not. If SC message disappears, replace the toner bottle.

SC No.	Type	Error Name/Error Condition/Major Cause/Solution
SC665-41	D	Macaron1 Communication Error
		The machine detects the communication error between CPU and Macaron1 when starting up, or recovery from energy saver mode.
		<ul style="list-style-type: none"> • FFC connection error • FFC defective (disconnected, foreign object, etc.) • The following board defects (Parts implementation defect, solder scrap, implemented parts defect, etc.); <ul style="list-style-type: none"> • BCU • IPU
		<ol style="list-style-type: none"> 1. Turn the main power OFF/ON. 2. Replace the IPU. 3. Reconnect the FFC between BCU and IPU. 4. Replace the FFC between BCU and IPU. 5. Replace the BCU.

SC No.	Type	Error Name/Error Condition/Major Cause/Solution
SC665-42	D	Macaron2 Communication Error
		The machine detects the communication error between CPU and Macaron2 when starting up, or recovery from energy saver mode.
		<ul style="list-style-type: none"> • FFC connection error • FFC defective (disconnected, foreign object, etc.) • The following board defects (Parts implementation defect, solder scrap, implemented parts defect, etc.); <ul style="list-style-type: none"> • BCU • IPU
		<ol style="list-style-type: none"> 1. Turn the main power OFF/ON. 2. Replace the IPU. 3. Reconnect the FFC between BCU and IPU. 4. Replace the FFC between BCU and IPU. 5. Replace the BCU.

SC No.	Type	Error Name/Error Condition/Major Cause/Solution
SC667-01	D	Master Device Mode Setting Error
		The machine detects the CPU mode error when starting up, or recovery from energy saver mode.
		The following board defects (Parts implementation defect, solder scrap, implemented parts defect, etc.); <ul style="list-style-type: none"> • BCU
		<ol style="list-style-type: none"> 1. Turn the main power OFF/ON. 2. Replace the BCU.

SC No.	Type	Error Name/Error Condition/Major Cause/Solution
SC667-10	D	Slave1 Device Mode Setting Error
		The machine detects the Slave1 mode error when starting up, or recovery from energy saver mode.
		The following board defects (Parts implementation defect, solder scrap, implemented parts defect, etc.); <ul style="list-style-type: none"> • BCU • Paper Transport IOB
		<ol style="list-style-type: none"> 1. Turn the main power OFF/ON. 2. Replace the Paper Transport IOB. 3. Reconnect the FFC between Imaging IOB and Paper Transport IOB. 4. Replace the harness between Imaging IOB and Paper Transport IOB. 5. Replace the Imaging IOB. 6. Reconnect the harness between BCU and Imaging IOB. 7. Replace the harness between BCU and Imaging IOB. 8. Replace the BCU.

SC No.	Type	Error Name/Error Condition/Major Cause/Solution
SC667-11	D	Slave2 Device Mode Setting Error
		The machine detects the Slave2 mode error when starting up, or recovery from energy saver mode.
		The following board defects (Parts implementation defect, solder scrap, implemented parts defect, etc.); <ul style="list-style-type: none"> • BCU • Paper Transport IOB
		<ol style="list-style-type: none"> 1. Turn the main power OFF/ON. 2. Replace the Imaging IOB. 3. Reconnect the harness between BCU and Imaging IOB. 4. Replace the harness between BCU and Imaging IOB. 5. Replace the BCU.

SC No.	Type	Error Name/Error Condition/Major Cause/Solution
SC667-40	D	Macaron1 Mode Setting Error
		The machine detects the Macaron1 mode error when starting up, or recovery from energy saver mode.
		The following board defects (Parts implementation defect, solder scrap, implemented parts defect, etc.); <ul style="list-style-type: none"> • BCU • IPU
		<ol style="list-style-type: none"> 1. Turn the main power OFF/ON. 2. Replace the IPU. 3. Reconnect the harness between BCU and IPU. 4. Replace the harness between BCU and IPU. 5. Replace the BCU.

SC No.	Type	Error Name/Error Condition/Major Cause/Solution
SC667-41	D	Macaron2 Mode Setting Error
		The machine detects the Macaron2 mode error when starting up, or recovery from energy saver mode.
		The following board defects (Parts implementation defect, solder scrap, implemented parts defect, etc.); <ul style="list-style-type: none"> • BCU • IPU
		<ol style="list-style-type: none"> 1. Turn the main power OFF/ON. 2. Replace the IPU. 3. Reconnect the harness between BCU and IPU. 4. Replace the harness between BCU and IPU. 5. Replace the BCU.

SC No.	Type	Error Name/Error Condition/Major Cause/Solution
SC668-01	D	Vodka1 Version Setting Error
		The machine detects the version settings error in Vodka 1 when starting up, or recovery from energy saver mode.
		The following board defects (Parts implementation defect, solder scrap, implemented parts defect, etc.); <ul style="list-style-type: none"> • BCU • Paper Transport IOB
		<ol style="list-style-type: none"> 1. Turn the main power OFF/ON. 2. Replace the Paper Transport IOB. 3. Replace the BCU.

SC No.	Type	Error Name/Error Condition/Major Cause/Solution
SC668-02	D	Vodka2 Version Setting Error
		The machine detects the version settings error in Vodka2 when starting up, or recovery from energy saver mode.
		The following board defects (Parts implementation defect, solder scrap, implemented parts defect, etc.); <ul style="list-style-type: none"> • BCU • Imaging IOB
		<ol style="list-style-type: none"> 1. Turn the main power OFF/ON. 2. Replace the Imaging IOB. 3. Replace the BCU.

SC No.	Type	Error Name/Error Condition/Major Cause/Solution
SC668-03	D	Vodka 1,2 Version Setting Error
		The machine detects the version settings error in both Vodka 1 and Vodka2 when starting up, or recovery from energy saver mode.
		The following board defects (Parts implementation defect, solder scrap, implemented parts defect, etc.); <ul style="list-style-type: none"> • BCU • Imaging IOB • Paper Transport IOB
		<ol style="list-style-type: none"> 1. Turn the main power OFF/ON. 2. Replace the BCU. 3. Replace the Imaging IOB. 4. Replace the Paper Transport IOB.

SC No.	Type	Error Name/Error Condition/Major Cause/Solution
SC669-**		EEPROM Communication Error
SC669-01	D	EEPROM OPEN: ID error
SC669-02	D	EEPROM OPEN: Channel error

SC No.	Type	Error Name/Error Condition/Major Cause/Solution
SC669-03	D	EEPROM OPEN: Device error
SC669-04	D	EEPROM OPEN: Communication abort error
SC669-05	D	EEPROM OPEN: Communication timeout error
SC669-06	D	EEPROM OPEN: Operation stopped error
SC669-07	D	EEPROM OPEN: Buffer full
SC669-08	D	EEPROM OPEN: No error code
SC669-09	D	EEPROM CLOSE: ID error
SC669-10	D	EEPROM CLOSE: No error code
SC669-11	D	EEPROM Data write: ID error
SC669-12	D	EEPROM Data write: Channel error
SC669-13	D	EEPROM Data write: Device error
SC669-14	D	EEPROM Data write: Communication abort error
SC669-15	D	EEPROM Data write: Communication timeout error
SC669-16	D	EEPROM Data write: Operation stopped error
SC669-17	D	EEPROM Data write: Buffer full
SC669-18	D	EEPROM Data write: No error code
SC669-19	D	EEPROM Data read: ID error
SC669-20	D	EEPROM Data read: Channel error
SC669-21	D	EEPROM Data read: Device error
SC669-22	D	EEPROM Data read: Communication abort error
SC669-23	D	EEPROM Data read: Communication timeout error
SC669-24	D	EEPROM Data read: Operation stopped error
SC669-25	D	EEPROM Data read: Buffer full
SC669-26	D	EEPROM Data read: No error code
SC669-36	D	Verification error

SC No.	Type	Error Name/Error Condition/Major Cause/Solution
SC669-37	D	Error Detection
		<p>The TD sensor cannot be recovered after retrying N*1 times for EEPROM communication error. (* 1 SC669-01 to 26: 3, SC669-36: 2, SC669-37: 1)</p> <ul style="list-style-type: none"> • Electrical noise • EEPROM not connected fully • EEPROM not installed • EEPROM damaged • BCU damaged <ol style="list-style-type: none"> 1. Turn the main power OFF/ON. 2. Reconnect the EEPROM. 3. Replace the EEPROM. 4. Replace the BCU.

SC No.	Type	Error Name/Error Condition/Major Cause/Solution
681-**	D	Toner bottle: ID Chip Communication error
		When error notification was received during communication with the tag and operation is not resumed after N*1 retries. * 1 See the detailed table below.
		<ul style="list-style-type: none"> • Corrupted ID data • Disconnected ID chip • No ID chip • Noise
		<p>Turn the main power off, and then do the following.</p> <ol style="list-style-type: none"> 1. Clean ID chip connections inside the toner bottle, and check if any of the ID Chip Contact Board connector pins have snapped. If there are any snapped pin, follow step 5. 2. Reconnect the connectors between Imaging IOB and ID Chip Contact Board. 3. Reconnect the FFC between Imaging IOB and BCU. 4. Replace the ID Chip Contact Board. 5. Reconnect the harness between Imaging IOB and ID Chip Contact Board. 6. Replace the FFC between Imaging IOB and BCU. 7. Replace the Imaging IOB. 8. Replace the BCU.

SC681 Details

No.	Detail	Causes	Retry
01 - 04	Invalid device ID	Noise, Incorrect connection, Malfunction	3
06 - 09	Channel error	Noise, Incorrect connection, Malfunction	3
11 - 14	Device Error	Noise, Incorrect connection	3
16 - 19	Communication error (interrupted)	Noise, Incorrect connection	3
21 - 24	Communication timeout	Noise, Incorrect connection, Malfunction	3

No.	Detail	Causes	Retry
26 - 29	Device stops (logically)	Noise, Incorrect connection, Malfunction	3
31 - 34	Full of buffer (request)	Noise, Incorrect connection, Malfunction	3
36 - 39	Verification error	Noise, Incorrect connection	2

Note

- If the last digit of the SC's branch number (-**) is:
 - 1 or 6, then do the above steps for K
 - 2 or 7, then do the above steps for M
 - 3 or 8, then do the above steps for C
 - 4 or 9, then do the above steps for Y

No.	Type	Error Name/Error Condition/Major Cause/Solution
SC682-**	D	TD sensor communication error
		TD sensor cannot be recovered after retrying N*1 times for an ID chip communication error. * 1 See the detailed table below.
		<ul style="list-style-type: none"> • Corrupted ID data • Disconnected ID chip • No ID chip • Noise
		<p>Turn the main power off, and then do the following.</p> <ol style="list-style-type: none"> 1. Reinstall the PCU. 2. Reconnect the connectors between Imaging IOB and TD sensor. 3. Reconnect the FFC between Imaging IOB and BCU. 4. Replace the PCU. 5. Reconnect the harness between Imaging IOB and TD sensor. 6. Replace the FFC between Imaging IOB and BCU. 7. Replace the Imaging IOB. 8. Replace the BCU. <p>Note</p> <ul style="list-style-type: none"> • If the last digit of the SC's branch number (-**) is: <ol style="list-style-type: none"> 1 or 6, then do the above steps for K 2 or 7, then do the above steps for M 3 or 8, then do the above steps for C 4 or 9, then do the above steps for Y

SC682 Details

No.	Description	Cause	Retry
01 - 04	Invalid device ID	Noise, Incorrect connection, Malfunction	3
06 - 09	Channel error	Noise, Incorrect connection, Malfunction	3
11 - 14	Device Error	Noise, Incorrect connection	3

No.	Description	Cause	Retry
16 - 19	Communication error (interrupted)	Noise, Incorrect connection	3
21 - 24	Communication timeout	Noise, Incorrect connection, Malfunction	3
26 - 29	Device stops (logically)	Noise, Incorrect connection, Malfunction	3
31 - 34	Full of buffer (request)	Noise, Incorrect connection, Malfunction	3
36 - 39	Verification error	Noise, Incorrect connection	2

SC No.	Type	Error Name/Error Condition/Major Cause/Solution
SC687-00	D	PER Not Received Error
		Unable to receive the PER command from the controller.
		Communication error
		Replace the BCU.

SC600 (Controller)

SC No.	Type	Error Name/Error Condition/Major Cause/Solution
SC632-00	D	Counter device error 1
		After 3 attempts to send a data frame to the optional counter device via the serial communication line, no ACK signal was received within 100 ms.
		Serial line between the optional counter device, the relay board and copier control board is disconnected or damaged.
		<ul style="list-style-type: none"> • Turn the main power off/on. • Check the serial communication line.

SC No.	Type	Error Name/Error Condition/Major Cause/Solution
SC633-00	D	Counter device error 2
		After communication was established, the controller received the brake signal from the accounting device.
		Serial line between the optional counter device, the relay board and copier control board is disconnected or damaged.
		<ul style="list-style-type: none"> • Turn the main power off/on. • Check the serial communication line.

SC No.	Type	Error Name/Error Condition/Major Cause/Solution
SC634-00	D	Counter device error 3
		A backup RAM error was returned by the counter device.
		Counter device control board or the backup battery of counter device defective
		<ul style="list-style-type: none"> • Replace the counter device control board. • Replace the backup battery.

SC No.	Type	Error Name/Error Condition/Major Cause/Solution
SC635-00	D	Counter device error 4
		A backup battery error was returned by the counter device.
		Counter device control board or the backup battery of counter device defective
		<ul style="list-style-type: none"> • Replace the counter device control board. • Replace the backup battery.

SC No.	Type	Error Name/Error Condition/Major Cause/Solution
SC636-01	D	IC Card Error (Expanded authentication module error)
		Issued when expanded authentication management is set to "ON" but either of the following occur. <ul style="list-style-type: none"> • There is no expanded authentication module in the machine. • The SD card or the file of the expanded authentication module is broken. • There is no DESS module in the machine.
		<ul style="list-style-type: none"> • There is no DESS module in the machine (models on which the function is optional). • There is no expanded authentication module in the machine. • The SD card or the file of the expanded authentication module is broken.
		<ul style="list-style-type: none"> • Set a working SD card/expanded authentication module file. • Install the DESS module. • In the SSP mode set SP5-401-160 to "0". • In the SSP mode, set SP5-401-161 to "0". • Replace the NVRAM.

SC No.	Type	Error Name/Error Condition/Major Cause/Solution
SC636-02	D	IC Card Error (Version error)
		The version of the expanded authentication module is not correct.
		Incorrect module version
		Install the correct file of the expanded authentication module.

SC No.	Type	Error Name/Error Condition/Major Cause/Solution
SC637-01	D	Tracking Information Notification Error (Tracking application error)
		Tracking information was lost.
		<ul style="list-style-type: none"> Tracking SDK application error Internal notification error
		Turn the main power off/on.

SC No.	Type	Error Name/Error Condition/Major Cause/Solution
SC637-02	D	Tracking Information Notification Error (Management server error)
		Tracking information was lost.
		Communication with tracking management server failed. <ul style="list-style-type: none"> Network error tracking management server error Tracking SDK application error
		Turn the main power off/on.

SC No.	Type	Details (Symptom, Possible Cause, Troubleshooting Procedures)
SC641-00	D	Communication error between BCU and Controller board.
		Controller board does not respond after BCU tries to communicate three times.
		<ul style="list-style-type: none"> Controller board software error Connect error between BCU and Controller board Engine board software error
		<ul style="list-style-type: none"> Check connections between Controller board and BCU. Turn the main switch off and on.

SC No.	Type	Error Name/Error Condition/Major Cause/Solution
SC650-01	C	Remote Service Modem Communication Error (Dialup authentication failure)
		<ul style="list-style-type: none"> An error related to communication (dialup connection, modem board etc.) using the RC Gate Type M was detected or an error that prevents RC Gate operation was detected at power on. Displayed only when an error is detected while RC Gate is operating. SC is not issued if an error occurs during RC Gate installation (because it can be referenced using SP).
		Dialup authentication failure
		Check the following SPs. <ul style="list-style-type: none"> SP5-816-156 SP5-816-157

SC No.	Type	Error Name/Error Condition/Major Cause/Solution
SC650-04	C	Remote Service Modem Communication Error (dialup failing because of incorrect modem configuration)
		<ul style="list-style-type: none"> An error related to communication (dialup connection, modem board etc.) using the RC Gate Type M was detected or an error that prevents RC Gate operation was detected at power on. Displayed only when an error is detected while RC Gate is operating. SC is not issued if an error occurs during RC Gate installation (because it can be referenced using SP).
		Dialup failing because of incorrect modem configuration
		Check if the setting of SP5-816-160 is correct. If it is correct, then there is a software bug.

SC No.	Type	Error Name/Error Condition/Major Cause/Solution
SC650-05	C	Remote Service Modem Communication Error (insufficient current or connection error)
		<ul style="list-style-type: none"> An error related to communication (dialup connection, modem board etc.) using the RC Gate Type M was detected or an error that prevents RC Gate operation was detected at power on. Displayed only when an error is detected while RC Gate is operating. SC is not issued if an error occurs during RC Gate installation (because it can be referenced using SP).
		Insufficient current or connection error
		The line is not supported and nothing can be done.

SC No.	Type	Error Name/Error Condition/Major Cause/Solution
SC650-13	C	Remote Service Modem Communication Error (RC Gate Type M was installed but modem is not present (detected during operation))
		<ul style="list-style-type: none"> An error related to communication (dialup connection, modem board etc.) using the RC Gate Type M was detected or an error that prevents RC Gate operation was detected at power on. Displayed only when an error is detected while RC Gate is operating. SC is not issued if an error occurs during RC Gate installation (because it can be referenced using SP).
		RC Gate Type M was installed but modem is not present (detected during operation)
		<ul style="list-style-type: none"> If a modem board is not installed, install it. Check again if the modem driver configurations (SP5-816-160, SP5-816-165 to 171) are correct. If the problem is not solved, replace the modem.

SC No.	Type	Error Name/Error Condition/Major Cause/Solution
SC650-14	C	Remote Service Modem Communication Error (RC Gate Type N was installed but modem is present or wired/wireless LAN is not working correctly)
		<ul style="list-style-type: none"> • An error related to communication (dialup connection, modem board etc.) using the RC Gate was detected or an error that prevents RC Gate operation was detected at power on. • Displayed only when an error is detected while RC Gate is operating. • SC is not issued if an error occurs during RC Gate installation (because it can be referenced using SP).
		RC Gate Type N was installed but modem is present or wired/wireless LAN is not working correctly
		<ul style="list-style-type: none"> • If a modem board is attached, remove it. • Check if wired/wireless LAN works.

SC No.	Type	Error Name/Error Condition/Major Cause/Solution
SC651-01	C	Illegal Remote Service Dial-up (Chat program parameter error)
		An unexpected error occurred when RC Gate Type M dialed up the NRS Center.
		Software bug
		Logging only.

SC No.	Type	Error Name/Error Condition/Major Cause/Solution
SC651-02	C	Illegal Remote Service Dial-up (Chat program execution error)
		An unexpected error occurred when RC Gate dialed up the NRS Center.
		Software bug
		Logging only.

SC No.	Type	Error Name/Error Condition/Major Cause/Solution
SC652-00	A	Remote service ID2 mismatching
		There was an authentication mismatch between ID2 for @Remote, the controller board, and NVRAM.
		<ul style="list-style-type: none"> • Used controller board installed • Used NVRAM installed (such action is not allowed.)
		<ul style="list-style-type: none"> • If this occurs during RC Gate installation: Check the validity of the certificate and the NVRAM, check the machine serial number, write the common certificate, and then begin installation again. • If this occurs after RC Gate installation: Clear the RC Gate install status, check the validity of the certificate and the NVRAM, check the machine serial number, write the common certificate, and then begin installation again.

SC No.	Type	Error Name/Error Condition/Major Cause/Solution
SC653-00	A	Incorrect remote service ID2
		ID2 stored in the NVRAM has either of the following problems. <ul style="list-style-type: none"> • Number of characters is not 17. • Includes a character that cannot be printed. • All spaces • NULL
		Replace the NVRAM.
		Clear the RC Gate install status, write the common certificate, and then begin installation again.

SC No.	Type	Error Name/Error Condition/Major Cause/Solution
SC670-01	D	Engine start up error when the machine boots up
		<ul style="list-style-type: none"> • /ENGRDY signal was not asserted when the machine was turned on. • PCI I/F is not linked up when the machine returns from energy saver mode. • /IPURDY signal was not asserted when the machine was turned on or returned from energy saver mode. • EC/PC/SC response was not received within specified time from power on. • Writing to Rapi driver failed (the other party not found through PCI). • Connection defect between controller board and IPU. • IPU is down / unstable • BCU is down / unstable
		Engine board does not start up.
		Refer to page 977 "When SC670 (Engine start up error) is displayed".

SC No.	Type	Error Name/Error Condition/Major Cause/Solution
SC670-02	D	Engine start up error when the machine is in operation
		<ul style="list-style-type: none"> • CPU reset by software • CPU reset by anomaly CPU • CPU reset by hardware defect / noise • Hardware defect
		Engine board reset unexpectedly.
		Refer to page 977 "When SC670 (Engine start up error) is displayed".

SC No.	Type	Error Name/Error Condition/Major Cause/Solution
SC670-03	D	IPU start up error when the machine boots up
		VDET_EPCI signal was not asserted when the machine was turned on.
		<ul style="list-style-type: none"> • IPU, PSU, and/or CTL defective • Incorrect connection between CTL and IPU. • Harness of IPU disconnected
		Refer to page 977 "When SC670 (Engine start up error) is displayed".

SC No.	Type	Error Name/Error Condition/Major Cause/Solution
SC670-04	D	Communication error between the engine and controller
		Communication could not linked up.
		<ul style="list-style-type: none"> • IPU and/or CTL defective • Incorrect connection between CTL and IPU.
		Refer to page 977 "When SC670 (Engine start up error) is displayed".

SC No.	Type	Error Name/Error Condition/Major Cause/Solution
SC672-10	D	Controller start up error
		After the machine was powered on, communication between the controller and the operation panel was not established.
		<ul style="list-style-type: none"> • Controller stalled • Board installed incorrectly • Controller board defective • Operation panel connector loose, broken, or defective • Controller late
		Refer to page 978 "When SC672 (Controller start up error) Is Displayed".

SC No.	Type	Error Name/Error Condition/Major Cause/Solution
SC672-11	D	Controller start up error
		After the machine was powered on, communication between the controller and the operation panel was not established, or communication with controller was interrupted after a normal startup.
		<ul style="list-style-type: none"> • Controller stalled • Board installed incorrectly • Controller board defective • Operation panel connector loose, broken, or defective • Controller late
		Refer to page 978 "When SC672 (Controller start up error) Is Displayed".

SC No.	Type	Error Name/Error Condition/Major Cause/Solution
SC672-12	D	Controller start up error
		Communication with controller was interrupted after a normal startup.
		<ul style="list-style-type: none"> • Controller stalled • Board installed incorrectly • Controller board defective • Operation panel connector loose, broken, or defective • Controller late
		Refer to page 978 "When SC672 (Controller start up error) Is Displayed".

SC No.	Type	Error Name/Error Condition/Major Cause/Solution
SC672-13	D	Controller start up error
		The operation panel detects that the controller is down due to other reason shown in SC672-10, SC672-11, and SC672-12.
		<ul style="list-style-type: none"> • Controller stalled • Board installed incorrectly • Controller board defective • Operation panel connector loose, broken, or defective • Controller late
		Refer to page 978 "When SC672 (Controller start up error) Is Displayed".

SC No.	Type	Error Name/Error Condition/Major Cause/Solution
SC672-99	D	Controller start up error
		The operation panel software ended abnormally.
		<ul style="list-style-type: none"> • Controller stalled • Board installed incorrectly • Controller board defective • Operation panel connector loose, broken, or defective • Controller late
		Refer to page 978 "When SC672 (Controller start up error) Is Displayed".

SC No.	Type	Error Name/Error Condition/Major Cause/Solution
SC673-10	D	Operation panel Flair communication error (Smart Operation Panel)
		<p>This SC is issued only for the machine that has the Smart Operation Panel installed.</p> <ul style="list-style-type: none"> • Communication between Smart Operation Panel and main machine (this is called "Flair communication") is not sent to Smart Operation Panel. • SP setting (SP5-748-201) for Smart Operation Panel is not activated.
		<p>The CATS module (controller) did not see the response to notification of monitoring service module (operation panel).</p>
		<ul style="list-style-type: none"> • Turn the main power OFF/ON. • Set SP5-748-201 (OpePanel Setting: Cheetah Panel Connect Setting) to "1: Connect" if the value is "0: Not connect".

Service Call 700-792

SC700 (Engine: Peripherals)

SC No.	Type	Error Name/Error Condition/Major Cause/Solution
SC700		SPDF DF3100 (D3B0) Error
SC700-01	D	ADF bottom plate lift motor error
SC700-02	D	ADF pick-up roller lift motor
SC700-04	D	ADF feed motor error
SC700-05	D	ADF entrance motor error
SC700-06	D	ADF transport motor error
SC700-07	D	ADF scanning motor error
SC700-09	D	ADF exit motor error
		<p>-01</p> <p>Even if the base plate motor is rotated in the base plate ascent direction, the base plate paper feed correct position sensor does not detect.</p> <p>Even if the base plate motor is rotated in the base plate descent direction, the base plate home position sensor does not detect.</p> <p>-02</p> <p>Even if the pickup arm motor is rotated, the pickup arm home position sensor does not detect.</p> <p>-04, 05, 06, 07, 09</p> <p>When an error notification signal is detected during the motor drive period.</p>

SC No.	Type	Error Name/Error Condition/Major Cause/Solution
		<p>-01</p> <ul style="list-style-type: none"> • Base plate paper feed correct position sensor error (output error) • Base plate home position sensor error (output error) • Base plate motor error (does not rotate) • Controller error <p>-02</p> <ul style="list-style-type: none"> • Pick-up home position sensor error (output error) • Pick-up motor error (does not rotate) • Controller error <p>-04, 05, 06, 07, 09</p> <ul style="list-style-type: none"> • Motor defective • Connector disconnected • Harness broken • Overload
		<p>Check if the SC occurs by turning the main power OFF then ON, opening/closing covers, and input/output check. If the SC occurs again, do the following steps. Check if the SC reoccurs by cycling the power after each step.</p> <p>The target parts that need to be checked are as follows;</p> <ul style="list-style-type: none"> • -01: all motors, and Pick-up Roller HP Sensor • -02: all motors, and Bottom Plate Lift Sensor, Bottom Plate HP Sensor • -03, 04, 05, 06, 07, 09: all parts in ADF. <ol style="list-style-type: none"> 1. Check if the connector of the target part is connected securely. Reconnect the connector if it is disconnected, or loose. 2. Check the harness for the target part. Replace the harness if it is disconnected, or damaged. 3. Check if the motor runs, sensors turn OFF/ON, has no overloads, and is properly driven. Replace the parts if there are any defects. 4. Check if there are any signs of a short circuit. Replace the parts if there are any defects.

SC No.	Type	Error Name/Error Condition/Major Cause/Solution
SC701		ARDF DF3090 (D779) Error

SC No.	Type	Error Name/Error Condition/Major Cause/Solution
SC701-03	D	Paper Feed Motor Driver Error
		Detection of error signal from motor driver
SC701-08	D	Paper Exit Motor Driver Error
		Detection of error signal from motor driver.
		<ul style="list-style-type: none"> • Encoder disconnection • Encoder connector dropout • Encoder defective • Overload • Motor deterioration <p>Check if the SC occurs by turning the main power OFF then ON, opening/closing covers, and input/output check. If the SC occurs again, do the following steps. Check if the SC reoccurs by cycling the power after each step.</p> <ul style="list-style-type: none"> • The target parts that need to be checked are all motors, all solenoids, all clutches, and all sensors. <ol style="list-style-type: none"> 1. Check if the connector of the target part is connected securely. Reconnect the connector if it is disconnected, or loose. 2. Check the harness for the target part. Replace the harness if it is disconnected, or damaged. 3. Check if the motor runs, sensors turn OFF/ON, has no overloads, and is properly driven. Replace the parts if there are any defects. 4. Check if there are any signs of a short circuit. Replace the parts if there are any defects.

SC No.	Type	Error Name/Error Condition/Major Cause/Solution
SC702		ARDF DF3090 (D779) Error

SC No.	Type	Error Name/Error Condition/Major Cause/Solution
SC702-01	D	Protection Device Intercept Error
		When original source 5V power supply is ON, protection device intercept of 24V power supply system is detected.
		Any of feed motor, transport motor, reverse solenoid, paper feed solenoid, paper feed clutch and FAN motor defective, a harness short-circuit occurs, and the protection device of the 24V power supply system intercepts.
		<p>Check if the SC occurs by turning the main power OFF then ON, opening/closing covers, and input/output check. If the SC occurs again, do the following steps. Check if the SC reoccurs by cycling the power after each step.</p> <ul style="list-style-type: none"> • The target parts that need to be checked are all motors, all solenoids, and all clutches. <ol style="list-style-type: none"> 1. Check if the connector of the target part is connected securely. Reconnect the connector if it is disconnected, or loose. 2. Check the harness for the target part. Replace the harness if it is disconnected, or damaged. 3. Check if the specific part runs (OUTPUT Check), has no overloads, and is properly driven. Replace the part if there are any defects. 4. Check if there are any signs of a short circuit. Replace the parts if there are any defects.

SC No.	Type	Error Name/Error Condition/Major Cause/Solution
SC702-02	D	Protection Device Intercept Error 2
		When original source 5V power supply is ON, protection device intercept of 24V OUT power supply system is detected.
		Solenoid defective or harness short-circuit occurs in 24VOUT power supply system.
		<p>Check if the SC occurs by turning the main power OFF then ON, opening/closing covers, and input/output check. If the SC occurs again, do the following steps. Check if the SC reoccurs by cycling the power after each step.</p> <ul style="list-style-type: none"> • The target parts that need to be checked are all motors, all solenoids, and all clutches. <ol style="list-style-type: none"> 1. Check if the connector of the target part is connected securely. Reconnect the connector if it is disconnected, or loose. 2. Check the harness for the target part. Replace the harness if it is disconnected, or damaged. 3. Check if the specific part runs (OUTPUT Check), has no overloads, and is properly driven. Replace the part if there are any defects. 4. Check if there are any signs of a short circuit. Replace the parts if there are any defects.

SC No.	Type	Error Name/Error Condition/Major Cause/Solution
SC702-03	D	Protection Device Intercept Error 3
		When original source 5V power supply is ON, protection device intercept of 5VE power supply system is detected.
		Sensor defective or a harness short-circuit occur in 5VE power supply system.
		<p>Check if the SC occurs by turning the main power OFF then ON, opening/closing covers, and input/output check. If the SC occurs again, do the following steps. Check if the SC reoccurs by cycling the power after each step.</p> <ol style="list-style-type: none"> 1. Check if the connector for Original Set Sensor is connected securely. Reconnect the connector if it is disconnected, or loose. 2. Check the harness for Original Set Sensor. Replace the harness if it is disconnected, or damaged. 3. Check if the Original Set Sensor turns OFF/ON (INPUT Check). Replace the part if there are any defects. 4. Check if there are any signs of a short circuit. Replace the parts if there are any defects.

SC No.	Type	Error Name/Error Condition/Major Cause/Solution
SC702		ARDF/SPDF Error

SC No.	Type	Error Name/Error Condition/Major Cause/Solution
SC702-04	D	Protection Device Intercept Error 4
		Motor defective in any of the pickup motor, completion stamp, base plate motor or FAN motor, or a harness short-circuit occurs, and the protection device of the non-interlocking power supply system intercepts.
		Motor defective or a harness short-circuit occurs in the non-interlocking power supply system.
		<p>Check if the SC occurs by turning the main power OFF then ON, opening/closing covers, and input/output check. If the SC occurs again, do the following steps. Check if the SC reoccurs by cycling the power after each step.</p> <ul style="list-style-type: none"> • The target parts that need to be checked are the Pick-up Roller Lift Motor, Stamp Solenoid, Feed Motor, and Cooling Fan Motor. <ol style="list-style-type: none"> 1. Check if the connector of the target part is connected securely. Reconnect the connector if it is disconnected, or loose. 2. Check the harness for the target part. Replace the harness if it is disconnected, or damaged. 3. Check if the motor runs, has no overloads, and is properly driven. Replace the parts if there are any defects. 4. Check if there are any signs of a short circuit. Replace the parts if there are any defects.
SC702-05	D	Protection Device Intercept Error 5

SC No.	Type	Error Name/Error Condition/Major Cause/Solution
		Motor defective in the paper feed motor, pullout motor, intermediate motor, scanner motor or paper exit motor, or a harness short-circuit occurs, and the protection device of the interlocking power supply system intercepts.
		Motor defective or a harness short-circuit occurs in the interlocking power supply system.
		<p>Check if the SC occurs by turning the main power OFF then ON, opening/closing covers, and input/output check. If the SC occurs again, do the following steps. Check if the SC reoccurs by cycling the power after each step.</p> <ul style="list-style-type: none"> • The target parts that need to be checked are the Feed Motor, Pick-up Roller Lift Motor, Relay Motor, Transport Motor, and Exit Motor. <ol style="list-style-type: none"> 1. Check if the connector of the target part is connected securely. Reconnect the connector if it is disconnected, or loose. 2. Check the harness for the target part. Replace the harness if it is disconnected, or damaged. 3. Check if the motor runs, has no overloads, and is properly driven. Replace the parts if there are any defects. 4. Check if there are any signs of a short circuit. Replace the parts if there are any defects.

SC No.	Type	Error Name/Error Condition/Major Cause/Solution
SC721		Booklet Finisher SR3220 (D3B9) Error
SC721-03	B	Protection Device Intercept Error 1
		Fuse blowout is detected
SC721-06	C	See the descriptions next table below.
SC721-10	B	Transport Motor 1 Error
		Motor driver detects an error state (DC motor control error) (1st time is jam notification, 2nd time is SC notification).
SC721-11	B	Transport Motor 2 Error
		Motor driver detects an error state (DC motor control error) (1st time is jam notification, 2nd time is SC notification).

SC No.	Type	Error Name/Error Condition/Major Cause/Solution
SC721-17	B	Paper Eject Motor 2 Error
		Motor driver detects an error state (DC motor control error) (1st time is jam notification, 2nd time is SC notification).
SC721-24	B	Paper Exit Guide Plate Open/Close motor Error
		<ul style="list-style-type: none"> • During movement to home, the home position could not be detected within a predetermined pulse (1st time is jam notification, 2nd time is SC notification). • During movement from home, the home position was detected for longer than a predetermined pulse (1st time is jam notification, 2nd time is SC notification).
SC721-25	B	Punch Drive Motor Error
		<ul style="list-style-type: none"> • During movement to home, the home position could not be detected within a predetermined time (1st time is jam notification, 2nd time is SC notification). • During movement from home, the home position was detected even after a predetermined time elapsed (1st time is jam notification, 2nd time is SC notification). • Output from the encoder could not be counted for a predetermined number of times within a predetermined time (1st time is jam notification, 2nd time is SC notification).
SC721-27	B	Punch Movement Motor Error
SC721-28	B	Punch Horizontal Registration Detection Error
SC721-30	B	Jogger Motor 1 Error
SC721-33	B	Positioning Roller Motor Error
SC721-41	B	Release Motor Error
		<ul style="list-style-type: none"> • During movement to home, the home position could not be detected within a predetermined pulse (1st time is jam notification, 2nd time is SC notification). • During movement from home, the home position was detected even after a predetermined pulse elapsed (1st time is jam notification, 2nd time is SC notification).

SC No.	Type	Error Name/Error Condition/Major Cause/Solution
SC721-42	B	Stapler Retreat Motor Error
		<ul style="list-style-type: none"> • During movement to home, the home position could not be detected within a predetermined pulse (1st time is jam notification, 2nd time is SC notification). • During movement from home, the home position was detected even after a predetermined pulse elapsed (1st time is jam notification, 2nd time is SC notification). • During movement from home, retreat sensor ON could not be detected even after a predetermined pulse elapsed (1st time is jam notification, 2nd time is SC notification). • During initialization, retreat sensor ON was detected simultaneously when the home position is detected (1st time is jam notification, 2nd time is SC notification).
SC721-44	B	Stapler Motor Error
		<ul style="list-style-type: none"> • During movement to home, the home position could not be detected even after a predetermined time elapsed (1st time is jam notification, 2nd time is SC notification). • During movement from home, the home position was detected even after a predetermined time elapsed (1st time is jam notification, 2nd time is SC notification). • During motor drive, the output from the encoder could not be counted for a predetermined number of times within a predetermined time (1st time is jam notification, 2nd time is SC notification).
SC721-52	B	Folding Plate Drive Motor Error
		<ul style="list-style-type: none"> • Motor driver detects an error (short-circuit and overheating) (1st time is SC). • During movement to home, the home position could not be detected within a predetermined pulse (1st time is jam notification, 2nd time is SC notification). • During movement from home, the home position was detected for longer than a predetermined pulse (1st time is jam notification, 2nd time is SC notification).

SC No.	Type	Error Name/Error Condition/Major Cause/Solution
SC721-53	B	Rear End Fence Displacement Motor Error
		<ul style="list-style-type: none"> • During movement to home, the home position could not be detected within a predetermined pulse (1st time is jam notification, 2nd time is SC notification). • During movement from home, the home position was detected for longer than a predetermined pulse (1st time is jam notification, 2nd time is SC notification).
SC721-58	B	Bundle Transport 1 Release Motor Error
SC721-59	B	Bundle Transport 2 Release Motor Error
		<ul style="list-style-type: none"> • During movement to home, the home position could not be detected within a predetermined pulse (1st time is jam notification, 2nd time is SC notification). • During movement from home, the home position was detected for longer than a predetermined pulse (1st time is jam notification, 2nd time is SC notification).
SC721-80	B	Folding Transport Motor Error
		<ul style="list-style-type: none"> • Motor driver detects an error (short-circuit or overheating) (1st time is SC)
SC721-70	B	Tray 1 Lift Motor Error
		<ul style="list-style-type: none"> • Motor driver detects an error (short-circuit or overheating) (1st time is SC). • During descent, the paper surface sensor still detects paper even after a predetermined time elapses (1st time is jam notification, 2nd time is SC notification). • During ascent, the paper surface sensor could not detect the paper surface even after a predetermined time elapses (1st time is jam notification, 2nd time is SC notification).

SC No.	Type	Error Name/Error Condition/Major Cause/Solution
SC721-71	B	<p data-bbox="450 309 646 339">Shift Motor 1 Error</p> <ul data-bbox="477 374 1204 589" style="list-style-type: none"> <li data-bbox="477 374 1204 472">• During movement to home, the home position could not be detected within a predetermined pulse (1st time is jam notification, 2nd time is SC notification). <li data-bbox="477 491 1204 589">• During movement from home, the home position was detected for longer than a predetermined pulse (1st time is jam notification, 2nd time is SC notification).
SC721-81	B	<p data-bbox="450 619 773 648">Paper Guide Drive Motor Error</p> <ul data-bbox="477 684 1204 899" style="list-style-type: none"> <li data-bbox="477 684 1204 782">• During movement to home, the home position could not be detected within a predetermined pulse (1st time is jam notification, 2nd time is SC notification). <li data-bbox="477 801 1204 899">• During movement from home, the home position was detected for longer than a predetermined pulse (1st time is jam notification, 2nd time is SC notification).

SC No.	Type	Error Name/Error Condition/Major Cause/Solution
		<ul style="list-style-type: none"> • Overcurrent (-03 only) • Staple jam (-44 only) • Encoder error (-11, -11, -25, -44) • Motor defective • Connector disconnected, or loose • Motor overload • HP sensor defective • Paper surface sensor defective (-70 only)
		<p>Check if the SC occurs by opening/closing covers, and input/output check. If the SC occurs again, do the following steps. Check if the SC reoccurs by cycling the power after each step.</p> <ul style="list-style-type: none"> • The target parts are the motor and related HP sensor that SC occurred. <ol style="list-style-type: none"> 1. Check if the connector of the target part is connected securely. Reconnect the connector if it is disconnected, or loose. 2. Check the harness for the target part. Replace the harness if it is disconnected, or damaged. 3. Check if the motor runs, sensors turn OFF/ON, has no overloads, and is properly driven. Replace the parts if there are any defects. 4. Check if there are any signs of a short circuit. Replace the parts if there are any defects.

SC No.	Type	Error Name/Error Condition/Major Cause/Solution
SC721		Booklet Finisher SR3220 (D3B9) Error
SC721-06	C	Access error to NVRAM
		Error occurs when accessing NV memory.
		Connection failure or malfunction of NV memory
		<p>Check if the SC occurs by turning the main power OFF then ON. If the SC occurs again, do the following steps.</p> <ol style="list-style-type: none"> 1. Pull out and reinsert the NV memory to check if the NV memory is correctly inserted into the IC socket. If the SC cannot be recovered, replace the main board.

SC No.	Type	Error Name/Error Condition/Major Cause/Solution
SC723		Internal Finisher SR3180 (D766) Error
SC723-03	B	Power Supply Error
		When original source 24V power supply is ON, protection device intercept of non-interlock power supply system is detected.
		A motor failure or harness short-circuit occur in the non-interlock power supply system.
		<ul style="list-style-type: none"> • Replace the short-circuited harnesses • Replace the protection devices
SC723-10	B	Transport Motor Error
		The DCM driver error detection is started after reset, and the error signal is detected for 0.2 sec. This SC will be issued when the above phenomenon repeated 2 times.
		<ul style="list-style-type: none"> • Transport Motor failure • Harness short-circuit • Circuit board failure • Over current • Abnormal temperature
		<ul style="list-style-type: none"> • Replace the motor • Replace the harness • Replace the circuit board.

SC No.	Type	Error Name/Error Condition/Major Cause/Solution
SC723-20	B	Junction Gate Motor Error
		When the junction gate HP sensor was not turned off for 0.1 sec. applied to the junction gate motor with the HP sensor turned on. When the junction gate HP sensor was not turned on for 0.6 sec. applied to the junction gate motor with the HP sensor turned off. This SC will be issued when the above phenomenon repeated 2 times.
		<ul style="list-style-type: none"> • Junction Gate Motor failure • Connector disconnected • Over load • Junction gate HP sensor error
		<ul style="list-style-type: none"> • Check the connection • Replace the motor/sensor • Replace the harness
SC723-24	B	Exit Paper Pressure Motor Error
		When the exit paper pressure HP sensor was not turned off for 0.15 sec. applied to the exit pressure release motor with the HP sensor turned on. When paper output pressure HP sensor was not turned on for 0.7 sec. applied to the exit pressure release motor with the HP sensor turned off. This SC will be issued when the above phenomenon repeated 2 times.
		<ul style="list-style-type: none"> • Exit Pressure Release Motor failure • Connector disconnected • Over load • Exit pressure release HP sensor error
		<ul style="list-style-type: none"> • Check the connection • Replace the motor/sensor • Replace the harness

SC No.	Type	Error Name/Error Condition/Major Cause/Solution
SC723-44	B	Stapler Motor Error
		<p>When the stapler drive HP sensor was not turned off for 0.6 sec. applied to the stapler motor with the HP sensor turned on.</p>
		<p>When stapler drive HP sensor was not turned on for 9 sec. applied to the stapler motor with the HP sensor turned off.</p>
		<p>The STM driver error detection is started after reset, and the signal is detected for 0.2 sec.</p> <p>This SC will be issued when the above phenomenon repeated 2 times.</p>
<ul style="list-style-type: none"> • Stapler Motor failure • Connector disconnected • Stapler Motor overload • Stapler HP sensor error • Harness short-circuit • Circuit board failure • Excess current • Abnormal temperature 		
<ul style="list-style-type: none"> • Check the connection • Replace the motor/sensor • Replace the harness • Replace the circuit board 		

SC No.	Type	Error Name/Error Condition/Major Cause/Solution
SC723-71	B	Shift Motor Error
		When the shift HP sensor was not turned off for 0.15 sec. applied to the shift motor with the HP sensor turned on. When shift HP sensor was not turned on for 1.1 sec. applied to the shift motor with the HP sensor turned off. The STM driver error detection is started after reset, and the error signal is detected for 0.2 sec. This SC will be issued when the above phenomenon repeated 2 times.
		<ul style="list-style-type: none"> • Shift Motor failure • Connector disconnected • Shift Motor overload • Shift HP sensor error • Harness short-circuit • Circuit board failure • Excess current • Abnormal temperature
		<p>Check if the SC occurs by opening/closing covers, and input/output check. If the SC occurs again, do the following steps. Check if the SC reoccurs by cycling the power after each step.</p> <ul style="list-style-type: none"> • The target parts are the motor and related HP sensor that SC occurred. <ol style="list-style-type: none"> 1. Check if the connector of the target part is connected securely. Reconnect the connector if it is disconnected, or loose. 2. Check the harness for the target part. Replace the harness if it is disconnected, or damaged. 3. Check if the motor runs, sensors turn OFF/ON, has no overloads, and is properly driven. Replace the parts if there are any defects. 4. Check if there are any signs of a short circuit. Replace the parts if there are any defects.

SC No.	Type	Error Name/Error Condition/Major Cause/Solution
SC724		Internal Finisher SR3130 (D690) Error

SC No.	Type	Error Name/Error Condition/Major Cause/Solution
SC724-24	B	Paper Exit Guide Plate Open/Close Motor Error
		<ul style="list-style-type: none"> When paper exit guide plate open/close motor is driven for 0.15 sec. after paper exit guide plate HP sensor ON, the HP sensor does not switch OFF (1st time is jam notification, 2nd time is SC notification). When paper exit guide plate open/close motor is driven for 0.15 sec. after paper exit guide plate HP sensor OFF, the HP sensor does not switch ON (1st time is jam notification, 2nd time is SC notification).
SC724-25	B	Punch Motor Error
		<ul style="list-style-type: none"> When punch motor is driven for 0.05 sec. after punch HP sensor ON, the HP sensor does not switch OFF (1st time is jam notification, 2nd time is SC notification). When punch motor is driven for 0.15 sec after punch HP sensor OFF, the HP sensor does not switch ON (1st time is jam notification, 2nd time is SC notification).
SC724-27	B	Punch Displacement Motor Error
		<ul style="list-style-type: none"> When punch displacement motor is driven for 0.166 sec. when punch displacement HP sensor is ON, the HP sensor does not switch OFF (1st time is jam notification, 2nd time is SC notification). When punch displacement motor is driven for 0.832 sec. when punch displacement HP sensor is OFF, the HP sensor does not switch ON (1st time is jam notification, 2nd time is SC notification).
SC724-28	B	Punch Horizontal Registration Detection Motor Error
		<ul style="list-style-type: none"> When horizontal registration displacement motor is driven for 0.428 sec. when horizontal registration displacement HP sensor is ON, the HP sensor does not switch OFF (1st time is jam notification, 2nd time is SC notification). When horizontal registration displacement motor is driven for 1.81 sec. when horizontal registration displacement HP sensor is OFF, the HP sensor does not switch ON (1st time is jam notification, 2nd time is SC notification).

SC No.	Type	Error Name/Error Condition/Major Cause/Solution
SC724-31	B	Jogger Front Motor Error
		<ul style="list-style-type: none"> When front jogger motor is driven for 0.114 sec. when front jogger HP sensor is ON, the HP sensor does not switch OFF (1st time is jam notification, 2nd time is SC notification). When front jogger motor is driven for 0.6 sec. when front jogger HP sensor is OFF, the HP sensor does not switch ON (1st time is jam notification, 2nd time is SC notification).
SC724-32	B	Jogger Rear Motor Error
		<ul style="list-style-type: none"> When rear jogger motor is driven for 0.114 sec. when rear jogger HP sensor is ON, the HP sensor does not switch OFF (1st time is jam notification, 2nd time is SC notification). When rear jogger motor is driven for 0.6 sec. when rear jogger HP sensor is OFF, the HP sensor does not switch ON (1st time is jam notification, 2nd time is SC notification).
SC724-33	B	Positioning Roller Motor Error
		<ul style="list-style-type: none"> During initialization/positioning roller descent, even when the positioning roller motor is driven for 0.357 sec. when the positioning roller HP sensor is ON, the HP sensor does not switch OFF (1st time is jam notification, 2nd time is SC notification). During initialization, even when the positioning roller motor is driven for 0.714 sec. when the positioning roller HP sensor is OFF, the HP sensor does not switch ON (1st time is jam notification, 2nd time is SC notification). When the positioning roller is lifted from the press position, even when driven for 0.714 sec., the HP sensor does not switch ON (1st time is jam notification, 2nd time is SC notification).
SC724-38	B	Paper Press Motor Error
		<ul style="list-style-type: none"> When the paper press HP sensor is ON and the paper press motor is driven for 0.1 sec., the HP sensor does not switch OFF (1st time is jam notification, 2nd time is SC notification). When the paper press HP sensor is OFF and the paper press motor is driven for 0.1 sec., the HP sensor does not switch ON (1st time is jam notification, 2nd time is SC notification).

SC No.	Type	Error Name/Error Condition/Major Cause/Solution
SC724-42	B	Stapler Displacement Movable Motor Error
		<ul style="list-style-type: none"> • Sifter stapler displacement HP sensor ON, even when the stapler retreat motor is driven for 0.25 sec., the HP sensor does not switch OFF (1st time is jam notification, 2nd time is SC notification). • After stapler displacement HP sensor OFF, even when the stapler retreat motor is driven for 4.5 sec. the HP sensor does not switch ON (1st time is jam notification, 2nd time is SC notification).
SC724-70	B	Shift Tray Ascent/Descent Motor Error
		<ul style="list-style-type: none"> • During ascent from paper surface sensor ON, even after 2 sec. elapses, the paper surface sensor does not switch OFF (1st time is jam notification, 2nd time is SC notification). • During descent from paper surface sensor OFF, the paper surface sensor does not switch ON even after 2 sec. elapses (1st time is jam notification, 2nd time is SC notification). • During descent to the packing position, the full sensor does not switch ON even if 2 sec. elapses.
SC724-71	B	Shift Motor Error
		The level of shift sensor output does not change when the shift motor is driven for 1.86 sec. after the motor is turned ON.

SC No.	Type	Error Name/Error Condition/Major Cause/Solution
		<ul style="list-style-type: none"> • Motor defective • Connector disconnected • Motor overload • Home position sensor error • Paper surface sensor error (* SC724-38, 70 only) <p>Check if the SC occurs by opening/closing covers, and input/output check. If the SC occurs again, do the following steps. Check if the SC reoccurs by cycling the power after each step.</p> <ul style="list-style-type: none"> • The target parts are the motor and related HP sensor that SC occurred. <ol style="list-style-type: none"> 1. Check if the connector of the target part is connected securely. Reconnect the connector if it is disconnected, or loose. 2. Check the harness for the target part. Replace the harness if it is disconnected, or damaged. 3. Check if the motor runs, sensors turn OFF/ON, has no overloads, and is properly driven. Replace the parts if there are any defects. 4. Check if there are any signs of a short circuit. Replace the parts if there are any defects.

SC No.	Type	Error Name/Error Condition/Major Cause/Solution
SC724		Internal Finisher SR3130 (D690) Error
SC724-80	B	<p>Shift Motor Error</p> <ul style="list-style-type: none"> • When the shift roller HP sensor is ON, the HP sensor does not switch OFF even when the shift roller motor is driven for 0.567 sec. 1st time is jam notification, 2nd time is SC notification. • When the shift roller HP sensor is OFF, the HP sensor does not switch ON even when the shift roller motor is driven for 1.417 sec. 1st time is jam notification, 2nd time is SC notification.

SC No.	Type	Error Name/Error Condition/Major Cause/Solution
SC724-86	B	<p>Stapler Motor Error</p> <ul style="list-style-type: none"> • HP sensor does not switch OFF even when the stapler motor is driven for 0.6 sec. after the stapler HP sensor switches ON (1st time is jam notification, 2nd time is SC notification). • HP sensor does not switch ON even when the stapler motor is driven for 0.6 sec. after the stapler HP sensor switches OFF (1st time is jam notification, 2nd time is SC notification).
		<ul style="list-style-type: none"> • Motor defective • Connector disconnected • Motor overload • Home position sensor error • Staple jam (*SC724-86 only) <p>Check if the SC occurs by opening/closing covers, and input/output check. If the SC occurs again, do the following steps. Check if the SC reoccurs by cycling the power after each step.</p> <ul style="list-style-type: none"> • The target parts are the motor and related HP sensor that SC occurred. <ol style="list-style-type: none"> 1. Check if the connector of the target part is connected securely. Reconnect the connector if it is disconnected, or loose. 2. Check the harness for the target part. Replace the harness if it is disconnected, or damaged. 3. Check if the motor runs, sensors turn OFF/ON, has no overloads, and is properly driven. Replace the parts if there are any defects. 4. Check if there are any signs of a short circuit. Replace the parts if there are any defects.

SC No.	Type	Error Name/Error Condition/Major Cause/Solution
SC761		Bridge Unit BU3070 (D685) or Side Tray Type M3 (D725) Error
SC761-03	B	Protection Device Intercept Error 5V
SC761-04	B	Protection Device Intercept Error 24V

SC No.	Type	Error Name/Error Condition/Major Cause/Solution
		Fuse blowout occurs due to over current during power injection (output detected for longer than 2 seconds).
		<ul style="list-style-type: none"> • Over current of bridge unit motor • Over current due to short-circuit in PCB
		<ul style="list-style-type: none"> • Replace the bridge unit or side tray • Replace the PCB of bridge unit or side tray

SC No.	Type	Error Name/Error Condition/Major Cause/Solution
SC780-01	D	Bank 1 (Upper optional paper tray) Protection Device Intercept Error
		When original source of 5V power supply is ON, protection device intercept of 24V power system is detected.
		<p>In 24V power supply system:</p> <ul style="list-style-type: none"> • Motor defective • Solenoid defective • Harness short- circuit
		<p>Remove the jammed paper or slip of paper from the tray, and check if the SC occurs by turning the main power OFF then ON. If the SC occurs again, do the following steps. Check if the SC reoccurs by cycling the power after each step.</p> <ol style="list-style-type: none"> 1. Check if all connectors in tray 1, 2, and optional upper tray are connected securely. Reconnect the connectors if they are disconnected, or loose. 2. Check the harness in tray 1, 2, and optional upper tray. Replace the harness if it is disconnected, or damaged. 3. Check if the motor runs, has no overloads, and is properly driven. Replace the parts if there are any defects. 4. Check if there are any signs of a short circuit. Replace the parts if there are any defects.

SC No.	Type	Error Name/Error Condition/Major Cause/Solution
SC781-01	D	Bank 2 (Lower optional paper tray) Protection Device Intercept Error
		When original source of 5V power supply is ON, protection device intercept of 24V power system is detected.
		In 24V power supply system: <ul style="list-style-type: none"> • Motor defective • Solenoid defective • Harness short- circuit
		Remove the jammed paper or slip of paper from the tray, and check if the SC occurs by turning the main power OFF then ON. If the SC occurs again, do the following steps. Check if the SC reoccurs by cycling the power after each step. <ol style="list-style-type: none"> 1. Check if all connectors in tray 1, 2, and optional upper/lower trays are connected securely. Reconnect the connectors if they are disconnected, or loose. 2. Check the harness in tray 1, 2, and optional upper/lower trays. Replace the harness if it is disconnected, or damaged. 3. Check if the motor runs, has no overloads, and is properly driven. Replace the parts if there are any defects. 4. Check if there are any signs of a short circuit. Replace the parts if there are any defects.

SC No.	Type	Error Name/Error Condition/Major Cause/Solution
SC791-00	D	No bridge unit when finisher is present
		When power supply is switched on or paper is fed, finisher set is detected but bridge unit set is not detected. (during internal finisher connection, not detected)
		<ul style="list-style-type: none"> • Bridge unit not attached • Bridge unit defective
		<ul style="list-style-type: none"> • Reset the bridge unit • Turn the main power OFF/ON.

SC No.	Type	Error Name/Error Condition/Major Cause/Solution
SC792-00	B	No finisher, bridge unit provided
		When power supply is switched on, it is recognized there is no finisher, and a bridge unit is fitted.
		<ul style="list-style-type: none"> • Finisher connector set incorrectly • In a machine which has a bridge unit connected, a finisher is not fitted • Finisher defective
		Connect finisher or disconnect bridge unit, and turn the main power OFF/ON.

Service Call 816-899

SC800 (Controller)

No.	Type	Error Name/Error Condition/Major Cause/Solution
SC816-**	[0x0000]	Energy save I/O subsystem error
SC816-01	D	Subsystem error
SC816-02	D	Sysarch (LPUX_GET_PORT_INFO) error
SC816-03	D	Transition to STR was denied.
SC816-04	D	Interrupt in kernel communication driver
SC816-05 , 06	D	Preparation for transition to STR failed.
SC816-07	D	Sysarch (LPUX_GET_PORT_INFO) error
SC816-08	D	Sysarch (LPUX_ENGINE_TIMERCTRL) error
SC816-09	D	Sysarch (LPUX_RETURN_FACTOR_STR) error
SC816-10 to 12	D	Sysarch (LPUX_GET_PORT_INFO) error
SC816-13	D	open() error
SC816-14	D	Memory address error
SC816-15 to 18	D	open() error
SC816-19	D	Double open() error
SC816-20	D	open() error
SC816-22	D	Parameter error
SC816-23 , 24	D	read() error
SC816-25	D	write () error

No.	Type	Error Name/Error Condition/Major Cause/Solution
SC816-26 to 28	D	write() communication retry error
SC816-29, 30	D	read() communication retry error
SC816-35	D	read() error
SC816-36 to 96, 99	D	Subsystem error
		<p>Energy save I/O subsystem detected some abnormality.</p> <ul style="list-style-type: none"> • Energy save I/O subsystem defective • Energy save I/O subsystem detected a controller board error (non-response). • Error was detected during preparation for transition to STR. • SC816-99 occurs as a subsystem error except any error from -06 to 96. <p>Check if the SC occurs by turning the power OFF then ON. If the SC occurs again, do the following steps. Check if the SC reoccurs by cycling the power after each step.</p> <ol style="list-style-type: none"> 1. Update the "System/Copy" firmware and the other system firmware modules to the latest version. 2. Disable the STR shift function by SP5-191-001 (Power Str Set). 3. Replace the controller board.

No.	Type	Error Name/Error Condition/Major Cause/Solution
SC817-00	D	Monitor error: File detection / Digital signature error
		<ul style="list-style-type: none"> • Bootloader cannot read any of diagnostic module, kernel, or root filesystem. • In a bootloader SD card, the digital signature checking for any of diagnostic module, kernel, or root filesystem is failed.
		<ul style="list-style-type: none"> • Any of the following items does not exist or is broken OS Flash ROM, Diagnostic module in SD card, Kernel, Root filesystem • Any of the following items is revised fraudulently: Diagnostic module in SD card, Kernel, Root filesystem
		<ul style="list-style-type: none"> • ROM update for controller system • Use another booting SD card having a valid digital signature

No.	Type	Error Name/Error Condition/Major Cause/Solution
SC818-00	D	Watchdog timer error
		The system program fell into a bus-hold state or an endless loop of the program interruption occurred, causing other process to stop.
		<ul style="list-style-type: none"> • System program defective • Controller board defective • Optional board defective
		<ul style="list-style-type: none"> • Turn the main power OFF/ON. • Replace the controller board.

No.	Type	Error Name/Error Condition/Major Cause/Solution
SC819-00	D	Kernel halt error [xxxx]: Detailed error code
		Due to a control error, a RAM overflow occurred during system processing. One of the following messages was displayed on the operation panel.

No.	Type	Error Name/Error Condition/Major Cause/Solution
	[0x5032]	HAIC-P2 error
		HAIC-P2 decompression error (An error occurred in the ASIC compression/decompression module.)
		<ul style="list-style-type: none"> • The code data saved in the HDD was broken for an unexpected reason. (HDD device defective) • The code data saved to memory was broken for an unexpected reason. (Memory device defective) • ASIC defective • Data other than code data was unzipped due to a software malfunction.
		<ul style="list-style-type: none"> • Turn the main power OFF/ON. • Replace the HDD. • Replace the memory • Replace the controller board. • Fix the software
	[0x5245]	Link up error
		Link up transaction between Engine ASIC and Veena was not completed within 100 ms.
		<p>Either one of following message appears on console if Link up error occurs.</p> <p>RESUME:PCI-Express bus ROOT_DL status error</p> <p>RESUME:PCI-Express bus DETUP status error</p> <p>"0x53554D45" -> Link up error</p> <p>Also, error code "0x5245" and detail code ""0x53554D45" -> Link up error" appears on operation panel.</p>
		<ul style="list-style-type: none"> • Turn the main power OFF/ON. • Replace the controller board or the engine board (IPU, BCU)

No.	Type	Error Name/Error Condition/Major Cause/Solution
	[0x5355]	<p>L2 status time out</p> <p>L2 status register between Engine ASIC and Veena was not reached the target value within 1 sec.</p> <p>Engine ASIC during operation was rebooted or shifted to energy saving mode.</p> <p>Machine reboots when SC23x, SC30x occurs.</p> <p>If Engine ASIC is working when rebooting (or shifting to the energy saving mode), L2 status value is not on target.</p> <p>The following message appears on console.</p> <p>SUSPEND:PCI-Express L2 Status Check Error SUSPEND:PCI-Express L2 Status Check Error</p> <p>Also, error code "0x5355" and detail code ""0x5350454E44" -> L2 status time out" appears on operation panel.</p> <ul style="list-style-type: none"> • Turn the main power OFF/ON. • Replace the controller board or the engine board (IPU, BCU)
	[0x6261]	<p>HDD defective</p> <p>Received file system data was broken even if the initialization succeeds and there was no error reply from the HDD.</p> <p>Power supply disconnection during data writing to the HDD.</p> <p>Replace the HDD.</p> <p>This SC may occur when turning on the machine for the first time with a new HDD. In this case, turn the main power off/on.</p>
	[0x696e]	<p>gwinit processing end</p> <p>If the SCS process is ended for some reason</p> <p>If an unexpected error occurs at SCS processing end, gwinit processing also halts (this result is judged a kernel stop error, by gwinit specification)</p> <p>"0x69742064" -> "init died"</p> <p>Turn the main power OFF/ON.</p>

No.	Type	Error Name/Error Condition/Major Cause/Solution
	[0x766d]	VM full error
		Occurs when too much RAM is used during system processing
		"vm_pageout: VM is full"
		Turn the main power OFF/ON.
	Console string	Other error (characters on operation panel)
		System detected internal mismatch error
		<ul style="list-style-type: none"> • Software defective • Insufficient memory • Hardware driver defective (RAM, flash memory)
		<ul style="list-style-type: none"> • Replace with a larger capacity RAM, or flash memory. • Replace the controller board. • Replace the connected controller option with a new one.

No.	Type	Error Name/Error Condition/Major Cause/Solution
SC820-00	C	Self-diagnostics error: CPU [XXXX]: Detailed error code
	[0612]	ASIC interrupt error
		Interrupt occurs in an ASIC.
		<ul style="list-style-type: none"> • ASIC device error • Peripherals device error
		<ul style="list-style-type: none"> • Replace the controller board • Replace the connected controller option with a new one.

No.	Type	Error Name/Error Condition/Major Cause/Solution
SC821-00	D	Self-diagnostics error: ASIC [xxxx]: Detailed error code
		[0B00]
	[0B06]	ASIC detection error
		Error in the I/O ASIC for system control detection
		<ul style="list-style-type: none"> • Defective ASIC • Defective North Bridge and PCII/F
		Replace the controller board.

No.	Type	Error Name/Error Condition/Major Cause/Solution
	[0D05]	Comparison error of CPU and ASIC timer
		The CPU checks if the ASIC timer works correctly compared with the CPU timer. If the ASIC timer does not function in the specified range, this SC code is displayed.
		<ul style="list-style-type: none"> • Defective ASIC timer device • Defective CPU device
		Replace the controller board.
	[50A1]	Video bridge device detection error
		Video bridge device is not detected.
		<ul style="list-style-type: none"> • Video bridge device ASIC (HARP or KLAVIER) defective. • Connection error between PCI I / F of the controller ASIC and video bridge device ASIC.
		Replace the controller board
	[50A2]	Video bridge device (ASIC) register error
		The CPU detects the video bridge device, but detects error data from the video bridge device.
		Defective I/F between the video bridge device and the controller
		Replace the controller board.

No.	Type	Details (Symptom, Possible Cause, Troubleshooting Procedures)
SC822-00	D	Self-diagnostic error: HDD [xxxx]: Detailed error code
		[3003]
	HDD timeout	
	Check performed only when HDD is installed:	
	<ul style="list-style-type: none"> • HDD device busy for over 31sec. • After a diagnostic command is set for the HDD, but the device remains busy for over 6sec. 	
	<ul style="list-style-type: none"> • HDD defective • HDD harness disconnected, defective • Controller board defective 	
	<ul style="list-style-type: none"> • Replace the HDD. • Replace the HDD connector. • Replace the controller board. 	
	[3004]	
Diagnostic command error		
No response to the self-diagnostic command from the ASIC to the HDD.		
HDD defective		
Replace the HDD.		

No.	Type	Details (Symptom, Possible Cause, Troubleshooting Procedures)
	[3013]	HDD timeout (first machine)
		HDD device busy for over 31 seconds. A diagnostic command is set for the HDD, but the device remains busy for over 6 seconds.
		<ul style="list-style-type: none"> • Defective HDD device • Defective HDD connector • Defective ASIC device
		<ul style="list-style-type: none"> • Replace or remove the HDD device. • Replace the HDD connector • Replace the controller board
	[3014]	Diagnostics command error (First machine)
		Result of the issuance of diagnostic command is error.
		Defective HDD device
		Replace the HDD device.

No.	Type	Error Name/Error Condition/Major Cause/Solution
SC823-00	B	Self-diagnostics error: NIC [XXXX]: Detailed error code
		[6101]
		MAC address check sum error
		The result of the MAC address check sum does not match the check sum stored in ROM.
		<ul style="list-style-type: none"> Defective SEEP ROM Defective I2C bus (connection)
		Replace the controller board.
	[6104]	PHY IC error
		The PHY IC on the controller cannot be correctly recognized.
		<ul style="list-style-type: none"> Defective PHY chip Defective ASIC MII I/F
		Replace the controller board.
	[6105]	PHY IC loop-back error
		An error occurred during the loop-back test for the PHY IC on the controller.
	<ul style="list-style-type: none"> PHY chip Defective MAC of ASIC (SIMAC/COMIC/CELLO) Defective I/F with the PHY board Defective solder on the PHY board 	
	Replace the controller board.	

No.	Type	Error Name/Error Condition/Major Cause/Solution
SC824-00	C	Self-diagnostics error: NVRAM (resident) [XXXX]: Detailed error code
	[1401]	NVRAM verify error
		NVRAM device is missing or NVRAM device is damaged.
		<ul style="list-style-type: none"> • The NVRAM device is missing. • The NVRAM device is damaged. • NVRAM backup battery exhausted • NVRAM socket damaged
	Replace the NVRAM device.	

No.	Type	Error Name/Error Condition/Major Cause/Solution
SC833-00	D	Self-diagnostic error: Engine I/F ASIC [XXXX]: Detailed error code
	[0F30]	Engine I/F ASIC detection error
		ASIC (Mandolin) for engine control could not be detected.
		ASIC (Mandolin) error
		Replace the Engine I/F board (mother board).
	[50B1]	Video device: clock generator detection error
		Could not initialize or read the bus connection.
		<ul style="list-style-type: none"> • Defective connection bus • Defective SSCG
		Replace the Engine I/F board (mother board).
	[50B2]	Video device: clock generator verify error
Value of the SSCG register is incorrect.		
<ul style="list-style-type: none"> • Defective connection bus • Defective SSCG 		
Replace the Engine I/F board (mother board).		

No.	Type	Error Name/Error Condition/Major Cause/Solution
SC834-00	D	Self-diagnostic error: Optional memory
	[5101]	Engine I/F optional memory verify error
		An error occurs after write/verify check for optional RAM on the engine I/F board (mother board).
		Defective memory device
	Replace the Engine I/F board (mother board).	

No.	Type	Error Name/Error Condition/Major Cause/Solution
SC835-00	B	Self-diagnostic error: Centronic device [xxxx]: Detailed error code
		[1102]
		Verify error
		The loopback connector is connected but check results is an error.
		<ul style="list-style-type: none"> • IEEE1284 connector error • Centronic loopback connector defective
		Replace the controller board.
	[110C]	DMA verify error
		The loopback connector is connected but check results is an error.
		<ul style="list-style-type: none"> • ASIC device error • IEEE1284 connector error • Centronic loopback connector is defective
		Replace the controller board.
	[1120]	Loopback connector not detected
		Centronic loopback connector is not connected for detailed self-diagnostic test.
	<ul style="list-style-type: none"> • Centronic loopback connector not connected correctly • Centronic loopback connector is defective • ASIC device is defective 	
	<ul style="list-style-type: none"> • Connect the centronic loopback connector • Replace the centronic loopback connector • Replace the controller board. 	

No.	Type	Error Name/Error Condition/Major Cause/Solution
SC838-00	C	Self-diagnostic Error: Clock Generator [xxxx]: Detailed error code
	[2701]	Verify error
		A verify error occurred when setting data was read from the clock generator via the I2C bus.
		<ul style="list-style-type: none"> Defective clock generator Defective I2C bus Defective I2C port on the CPU
	Replace the controller board.	

No.	Type	Error Name/Error Condition/Major Cause/Solution
SC839-00	D	Self-diagnostic Error: Serial Flash [xxxx]: Detailed error code
	[9001]	Serial Flash access error
		USB NAND Flash ROM cannot be read.
		Defective controller board
	Replace the controller board.	

No.	Type	Error Name/Error Condition/Major Cause/Solution
SC840-00	D	EEPROM access error
		<ul style="list-style-type: none"> During the I/O processing, a reading error occurred. The 3rd reading failure causes this SC code. During the I/O processing, a writing error occurred.
		<ul style="list-style-type: none"> Defective EEPROM
		-

No.	Type	Error Name/Error Condition/Major Cause/Solution
SC841-00	D	EEPROM read data error
		Mirrored data of the EEPROM is different from the original data in EEPROM.
		Data in the EEPROM is overwritten for some reason.
		-

No.	Type	Error Name/Error Condition/Major Cause/Solution
SC842-00	C	Nand-Flash updating verification error
		SCS write error (verify error) occurred at the Nand-Flash module when remote ROM or main ROM was updated.
		Nand-Flash defective
		Turn the main power OFF/ON.

No.	Type	Error Name/Error Condition/Major Cause/Solution
SC842-01	C	Insufficient Nand-Flash blocks (threshold exceeded)
		At startup, or when machine returned from low power mode, the Nand-Flash status was read and judged that the number of unusable blocks had exceeded threshold, and then SCS generated the SC code.
		Number of unusable blocks exceeded threshold for Nand-Flash
		Replace the controller board.

No.	Type	Error Name/Error Condition/Major Cause/Solution
SC842-02	C	Number of Nand-Flash block deletions exceeded
		At startup, or when the machined returned from low power mode, the Nand-Flash was read and judged that the number of deleted blocks had exceeded threshold, and then SCS generated this SC code.
		Number of blocks deleted exceeded threshold for Nand-Flash
		Replace the controller board.

No.	Type	Error Name/Error Condition/Major Cause/Solution
SC845		Hardware Error Detected when the automatic firmware update
SC845-01	D	Engine Board
SC845-02	D	Controller Board
SC845-03	D	Operation Panel (Normal)
SC845-04	D	Operation Panel (Smart Panel)
SC845-05	D	FCU
		When updating the firmware automatically (ARFU), the firmware cannot be read or written normally, and the firmware update cannot be completed even by 3 retries.
		Hardware abnormality of the target board
		Replacing the target board For SC845-02, HDD and memory may cause the problem. Replace the HDD or memory if the SC cannot be recovered by replacing the controller board.

No.	Type	Error Name/Error Condition/Major Cause/Solution
SC853-00	B	Bluetooth device connection error
		The Bluetooth hardware (USB type) was connected after the machine was turned on.
		The Bluetooth hardware (USB type) was connected after the machine was turned on.
		Always connect the Bluetooth device (USB type) before the machine is turned on.

No.	Type	Error Name/Error Condition/Major Cause/Solution
SC854-00	B	Bluetooth device disconnected
		The Bluetooth hardware (USB type) was disconnected after the machine was turned on.
		The Bluetooth hardware (USB type) was disconnected after the machine was turned on.
		Never remove Bluetooth (USB type) after machine starts

No.	Type	Error Name/Error Condition/Major Cause/Solution
SC855-01	B	Wireless LAN board error (driver attachment failure)
		Wireless LAN board error (wireless LAN card: 802.11 is covered)
		<ul style="list-style-type: none"> • Defective wireless LAN board • Loose connection
		<ul style="list-style-type: none"> • Turn the main power OFF/ON. • Replace wireless LAN board

No.	Type	Error Name/Error Condition/Major Cause/Solution
SC855-02	B	Wireless LAN board error (driver initialization failure)
		Wireless LAN board error (wireless LAN card: 802.11 is covered)
		<ul style="list-style-type: none"> • Defective wireless LAN board • Loose connection
		<ul style="list-style-type: none"> • Turn the main power OFF/ON. • Replace wireless LAN board

No.	Type	Error Name/Error Condition/Major Cause/Solution
SC857-00	B	USB I/F Error
		The USB interface is unusable because of a driver error.
		USB driver error (There are three causes of USB error: RX error/CRC error/STALL. SC is issued only in the case of STALL.)
		<ul style="list-style-type: none"> • Check USB connection. • Replace the controller board.

No.	Type	Error Name/Error Condition/Major Cause/Solution
SC858-00	A	Data encryption conversion error (Key Setting Error)
		A serious error occurred during an attempt to update the encryption key.
		<ul style="list-style-type: none"> • USB Flash, other data, corrupted • Communication error caused by electrostatic noise • Controller board defective
		Replace the controller board.

No.	Type	Error Name/Error Condition/Major Cause/Solution
SC858-01	A	Data encryption conversion error (HDD Key Setting Error)
		A serious error occurred during an attempt to update the encryption key.
		<ul style="list-style-type: none"> • USB Flash, other data, corrupted • Communication error caused by electrostatic noise • Controller board defective
		<ul style="list-style-type: none"> • Turn the main power OFF/ON. • If the error persists, replace the controller board.

No.	Type	Error Name/Error Condition/Major Cause/Solution
SC858-02	A	Data encryption conversion error (NVRAM Read/Write Error)
		A serious error occurred after data conversion during an attempt to update the encryption key.
		NVRAM defective
		<ul style="list-style-type: none"> • Replace the NVRAM. • Replace the controller board.

No.	Type	Error Name/Error Condition/Major Cause/Solution
SC858-30	A	Data encryption conversion error (NVRAM Before Replace Error)
		A serious error occurred after data conversion during an attempt to update the encryption key.
		Software error such as conversion parameters being invalid.
		<ul style="list-style-type: none"> • Turn the main power OFF/ON. • If the error persists, replace the controller board.

No.	Type	Error Name/Error Condition/Major Cause/Solution
SC858-31	A	Data encryption conversion error (Other Error)
		A serious error occurred after data conversion during an attempt to update the encryption key.
		Controller board defective
		Replace the controller board.

No.	Type	Error Name/Error Condition/Major Cause/Solution
SC859-00	B	Data encryption conversion HDD conversion error
		When the data encryption key was updated, HDD data was converted, but not correctly. Image displayed at conversion only (this SC is not displayed), but SC is displayed after machine is cycled off/on.
		<ul style="list-style-type: none"> • HDD conversion was set with the data encryption key update function, but the HDD was removed. • Machine lost power during data encryption key update • Electrostatic noise, or an HDD error occurred, during data encryption key update, and data was not encrypted.
		<ul style="list-style-type: none"> • Check HDD connection. • Format the HDD (SP5-832: HDD formatting). • If there is a problem with the HDD, it has to be replaced.

No.	Type	Error Name/Error Condition/Major Cause/Solution
SC859-01	B	Data encryption conversion HDD conversion error (HDD check error)
		When the data encryption key was updated, HDD data was converted, but not correctly. Image displayed at conversion only (this SC is not displayed), but SC is displayed after machine is cycled off/on.
		<ul style="list-style-type: none"> • HDD conversion was set with the data encryption key update function, but the HDD was removed. • Machine lost power during data encryption key update • Electrostatic noise, or an HDD error occurred, during data encryption key update, and data was not encrypted.
		<ul style="list-style-type: none"> • Check HDD connection. • Format the HDD (SP5-832: HDD formatting). • If there is a problem with the HDD, it has to be replaced.

No.	Type	Error Name/Error Condition/Major Cause/Solution
SC859-02	B	Data encryption conversion HDD conversion error (Power failure during conversion)
		When the data encryption key was updated, HDD data was converted, but not correctly. Image displayed at conversion only (this SC is not displayed), but SC is displayed after machine is cycled off/on. Details: NVRAM/HDD conversion is incomplete.
		Power failure occurred during encryption key update.
		None The display after restart instructs the user to format the HDD.

No.	Type	Error Name/Error Condition/Major Cause/Solution
SC859-10	B	Data encryption conversion HDD conversion error (Data read/write command error)
		When the data encryption key was updated, HDD data was converted, but not correctly. Image displayed at conversion only (this SC is not displayed), but SC is displayed after machine is cycled off/on. Details: Abnormal DMAC return value has been received two or more times (DMAC timeout, serial communication error etc.)
		HDD was not successfully converted during encryption key update due to HDD errors or cable noises.
		<ul style="list-style-type: none"> • Check HDD connection. • Format the HDD (SP5-832: HDD formatting). • If there is a problem with the HDD, it has to be replaced.

No.	Type	Error Name/Error Condition/Major Cause/Solution
SC860-00	B	<p data-bbox="444 309 943 339">HDD startup error at main power on (HDD error)</p> <ul style="list-style-type: none"> <li data-bbox="467 374 1171 403">• The HDD is connected but the driver detected the following errors. <li data-bbox="467 419 1108 448">• SS_NO.T_READY:/* (-2)HDD does not become READY*/ <li data-bbox="467 464 989 493">• SS_BAD_LABEL:/* (-4)Wrong partition type*/ <li data-bbox="467 509 1188 576">• SS_READ_ERROR:/* (-5)Error occurred while reading or checking the label*/ <li data-bbox="467 591 1188 658">• SS_WRITE_ERROR:/* (-6)Error occurred while writing or checking the label*/ <li data-bbox="467 674 1057 703">• SS_FS_ERROR:/* (-7)Failed to repair the filesystem*/ <li data-bbox="467 719 1126 748">• SS_MOUNT_ERROR:/* (-8)Failed to mount the filesystem*/ <li data-bbox="467 764 1085 831">• SS_COMMAND_ERROR:/* (-9)Drive not responding to command*/ <li data-bbox="467 846 1037 876">• SS_KERNEL_ERROR:/* (-10)Internal kernel error*/ <li data-bbox="467 891 996 921">• SS_SIZE_ERROR:/* (-11)Drive size too small*/ <li data-bbox="467 936 1133 1003">• SS_NO._PARTITION:/* (-12)The specified partition does not exist*/ <li data-bbox="467 1019 1016 1048">• SS_NO._FILE:/* (-13)Device file does not exist*/ <li data-bbox="467 1064 1157 1130">• Attempted to acquire HDD status through the driver but there has been no response for 30 seconds or more. <ul style="list-style-type: none"> <li data-bbox="467 1174 683 1203">• Unformatted HDD <li data-bbox="467 1219 712 1248">• Label data corrupted <li data-bbox="467 1264 646 1293">• HDD defective <p data-bbox="444 1324 1085 1354">Format the HDD (SP5-832: HDD formatting) through SP mode.</p>

No.	Type	Error Name/Error Condition/Major Cause/Solution
SC862-00	D	Number of the defective sector reaches the maximum count
		101 defective sectors are generated at the image storage area in the HDD.
		SC863 occurs during the HDD reading and defective sectors are registered up to 101.
		<ul style="list-style-type: none"> • Format the HDD with SPSP5-832. • Replace the HDD.

No.	Type	Error Name/Error Condition/Major Cause/Solution
SC863-01	D	HDD data read failure
		The data written to the HDD cannot be read normally.
		Bad sectors were generated during operation. (An error occurred in an area that does not belong to a partition, such as the disk label area.)
		<p>Guide for when to replace the HDD</p> <ol style="list-style-type: none"> 1. When SC863 has occurred ten times or more <ul style="list-style-type: none"> • The interval is short. • Repeatedly occurs in the same situation (At power-on, etc.). • Startup takes a long time when the main power is turned on. 2. It takes a long time after main power on for the operation panel to become ready. <p>HDD access may be consuming time. Normal HDD access time after main power on is about 5 seconds. If the machine is not waiting for the engine to be ready and it still takes 20 to 30 seconds or more, the HDD may be the cause. If there is a problem with the HDD, HDD-related SCs such as SC860 and SC863 will occur frequently. Print the SC log data and check them.</p>

No.	Type	Error Name/Error Condition/Major Cause/Solution
SC863-02 to 23	D	HDD data read failure
		The data written to the HDD cannot be read normally.
		Bad sectors were generated during operation. (An error occurred in partition "a" (SC863-02) to partition "v" (SC863-23)).
		<p>Guide for when to replace the HDD</p> <ol style="list-style-type: none"> When SC863 has occurred ten times or more <ul style="list-style-type: none"> The interval is short. Repeatedly occurs in the same situation (At power-on, etc.). Startup takes a long time when the main power is turned on. It takes a long time after main power on for the operation panel to become ready. <p>HDD access may be consuming time. Normal HDD access time after main power on is about 5 seconds. If the machine is not waiting for the engine to be ready and it still takes 20 to 30 seconds or more, the HDD may be the cause. If there is a problem with the HDD, HDD-related SCs such as SC860 and SC863 will occur frequently. Print the SC log data and check them.</p>

No.	Type	Error Name/Error Condition/Major Cause/Solution
SC864-00	D	HD data CRC error
		During HD operation, the HD cannot respond to a CRC error query. Data transfer did not execute normally while data was being written to the HD.
		HD defective
		-

No.	Type	Error Name/Error Condition/Major Cause/Solution
SC864-01	D	HDD data CRC error
		During HDD operation, the HDD cannot respond to a CRC error query. Data transfer did not execute normally while data was being written to the HDD.
		Bad sectors were generated during operation. (An error occurred in an area that does not belong to a partition, such as the disk label area.)
		<ul style="list-style-type: none"> • Format the HDD. • Replace the HDD.

No.	Type	Error Name/Error Condition/Major Cause/Solution
SC864-02 to 23	D	HDD data CRC error
		During HDD operation, the HDD cannot respond to a CRC error query. Data transfer did not execute normally while data was being written to the HDD.
		Bad sectors were generated during operation. (An error occurred in partition "a" (SC864-02) to partition "v" (SC864-23)).
		<ul style="list-style-type: none"> • Format the HDD. • Replace the HDD.

No.	Type	Error Name/Error Condition/Major Cause/Solution
SC865-00	D	HD access error
		During HDD operation, the HDD returned an error.
		The HDD returned an error that does not constitute SC863 (bad sector) or SC864 (CRC error).
		Replace the HDD.

No.	Type	Error Name/Error Condition/Major Cause/Solution
SC865-01	D	HDD access error
		During HDD operation, the HDD returned an error.
		The HDD returned an error that does not constitute SC863 (bad sector) or SC864 (CRC error). (An error occurred in an area that does not belong to a partition, such as the disk label area.)
		Replace the HDD.

No.	Type	Error Name/Error Condition/Major Cause/Solution
SC865-02 to 23	D	HDD access error
		During HDD operation, the HDD returned an error.
		The HDD returned an error that does not constitute SC863 (bad sector) or SC864 (CRC error). (An error occurred in partition "a" (SC865-02) to partition "v" (SC865-23)).
		Replace the HDD.

No.	Type	Error Name/Error Condition/Major Cause/Solution
SC865-50 to 73	D	HDD time-out error
		The machine does not detect a reply from the HDD during the HDD operation.
		The HDD does not respond to the read/ write command from the machine.
		<ul style="list-style-type: none"> • Check the harness connections between the controller board and HDD. • Replace the HDD.

No.	Type	Error Name/Error Condition/Major Cause/Solution
SC866-00	B	SD card authentication error
		A license error of an application that is started from the SD card was detected.
		Invalid program data is stored on the SD card.
		Store a valid program data on the SD card.

No.	Type	Error Name/Error Condition/Major Cause/Solution
SC867-00	C	SD card removed
		The SD card was removed while the machine is on.
		An application SD card has been removed from the slot (mount point of /mnt/sd0).
		Turn the main power OFF/ON.

No.	Type	Error Name/Error Condition/Major Cause/Solution
SC867-01	C	SD card removed
		The SD card was removed while the machine is on.
		An application SD card has been removed from the slot (mount point of /mnt/sd1).
		Turn the main power OFF/ON.

No.	Type	Error Name/Error Condition/Major Cause/Solution
SC867-02	C	SD card removed
		The SD card was removed while the machine is on.
		An application SD card has been removed from the slot (mount point of /mnt/sd2).
		Turn the main power OFF/ON.

No.	Type	Error Name/Error Condition/Major Cause/Solution
SC868-**		SD card access error
SC868-00	D	The SD controller returned an error during operation. (An error occurred at the mount point of /mnt/sd0)
SC868-01	D	The SD controller returned an error during operation. (An error occurred at the mount point of /mnt/sd1)
SC868-02	D	The SD controller returned an error during operation. (An error occurred at the mount point of /mnt/sd2)

No.	Type	Error Name/Error Condition/Major Cause/Solution
		<ul style="list-style-type: none"> • SD card defective • SD controller defective
		<p>Slot number is displayed on the sub code.</p> <p>Detail code is described in SMC print can confirm the details of the error.</p> <ul style="list-style-type: none"> • -13 to -3: File system check error • Otherwise (no code, -2) : Device access error
		<p>SD card that starts an application</p> <ol style="list-style-type: none"> 1. Turn the main power off and check the SD card insertion status. 2. If no problem is found, insert the SD card and turn the main power on. 3. If an error occurs, replace the SD card. 4. If the error persists even after replacing the SD card, replace the controller board. <p>SD card for users</p> <ol style="list-style-type: none"> 1. In case of a file system error, reformat the SD card (using the "SD Formatter" made by Panasonic).* <p>In case of a device access error</p> <ol style="list-style-type: none"> 1. Turn the main power off and check the SD card insertion status. 2. If no problem is found, insert the SD card and turn the main power on. 3. If an error occurs, use another SD card. 4. If the error persists even after replacing the SD card, replace the controller board.

* Do not format an SD card supplied with the main machine or sold as an option. You may only format SD cards used for firmware update by a customer engineer.

No.	Type	Error Name/Error Condition/Major Cause/Solution
SC869-**		Malfunction of the proximity sensor (human detection sensor) is detected

No.	Type	Error Name/Error Condition/Major Cause/Solution
SC869-01	C	Continuously detecting malfunction
		The proximity sensor (human detection sensor) keeps in a detection state and accumulated time exceeds 24 hours.
		The proximity sensor (human detection sensor) is disabled and is in the detection state at all times.
SC869-02	C	Continuously non-detecting malfunction
		In the non-detection state, the following operations are detected 20 times continuously. <ul style="list-style-type: none"> • Pressing "energy saver" key or touching the operation panel • Opening/closing the plate cover or ADF • Setting the original • Opening the front cover • Opening the paper feed tray
		The proximity sensor (human detection sensor) is disabled and is in the non-detection state at all times.

No.	Type	Error Name/Error Condition/Major Cause/Solution
		<ol style="list-style-type: none"> 1. Go to the SP5-102-203 (AutoDetect: HumanDetectSetting). 2. Cover the sensor with 10 sheets of plain paper, and then execute the SP. Make sure that it becomes "0". (Do not place your hand near the sensor, even over the paper, when covering the sensor) 3. Remove the paper from the sensor and make sure that it becomes "1". 4. If the sensor reacts normally in step 2 and 3, check if there are any other possible factors around the machine that may cause the temperature change such as a heater or a fan. (Deal with the issue as necessary) 5. Replace the proximity sensors (human detection sensors) and proximity sensor (human detection sensor) board if an abnormal value is detected during steps 2 and 3. 6. Turn on the main power on and perform steps 1, 2, and 3 again. 7. If the SC is not solved, turn the main power off and replace the harness which connects the proximity sensors (human detection sensors) and the proximity sensor (human detection sensor) board. 8. If the SC is still not solved, there is a possibility that other parts of the machine such as the connector at the controller side or the harness between proximity sensor (human detection sensor) board and IPU are broken.

No.	Type	Error Name/Error Condition/Major Cause/Solution
SC870-00	B	Address Book data error (Anytime: Address Book Error.)
SC870-01	B	Address Book data error (On startup: Media required for storing the Address Book is missing.)
SC870-02	B	Address Book data error (On startup: encryption is configured but the module required for encryption (DESS) is missing.)
SC870-03	B	Address Book data error (Initialization: Failed to generate a file to store internal Address Book.)
SC870-04	B	Address Book data error (Initialization: Failed to generate a file to store delivery sender.)
SC870-05	B	Address Book data error (Initialization: Failed to generate a file to store delivery destination.)

No.	Type	Error Name/Error Condition/Major Cause/Solution
SC870-06	B	Address Book data error (Initialization: Failed to generate a file to store information required for LDAP search.)
SC870-07	B	Address Book data error (Initialization: Failed to initialize entries required for machine operation.)
SC870-08	B	Address Book data error (Machine configuration: HDD is present but the space for storing the Address Book is unusable.)
SC870-09	B	Address Book data error (Machine configuration: Inconsistency in the NVRAM area used for storing settings required for Address Book configuration.)
SC870-10	B	Address Book data error (Machine configuration: Cannot make a directory for storing the Address Book in the SD/USB FlashROM.)
SC870-11	B	Address Book data error (On startup: Inconsistency in Address Book entry number.)
SC870-20	B	Address Book data error (File I/O: Failed to initialize file.)
SC870-21	B	Address Book data error (File I/O: Failed to generate file.)
SC870-22	B	Address Book data error (File I/O: Failed to open file.)
SC870-23	B	Address Book data error (File I/O: Failed to write to file.)
SC870-24	B	Address Book data error (File I/O: Failed to read file.)
SC870-25	B	Address Book data error (File I/O: Failed to check file size.)
SC870-26	B	Address Book data error (File I/O: Failed to delete data.)
SC870-27	B	Address Book data error (File I/O: Failed to add data.)
SC870-30	B	Address Book data error (Search: Failed to obtain data from cache when searching in the machine Address Book. delivery destination/sender.)
SC870-31	B	Address Book data error (Search: Failed to obtain data from cache during LDAP search.)
SC870-32	B	Address Book data error (Search: Failed to obtain data from cache while searching the WS-Scanner Address Book.)
SC870-41	B	Address Book data error (Cache: failed to obtain data from cache.)

No.	Type	Error Name/Error Condition/Major Cause/Solution
SC870-50	B	Address Book data error (On startup: Detected abnormality of the Address Book encryption status.)
SC870-51	B	Address Book data error (Encryption settings: Failed to create directory required for conversion between plaintext and encrypted text.)
SC870-52	B	Address Book data error (Encryption settings: Failed to convert from plaintext to encrypted text.)
SC870-53	B	Address Book data error (Encryption settings: Failed to convert from encrypted text to plaintext.)
SC870-54	B	Address Book data error (Encryption settings: Detected data inconsistency when reading the encrypted Address Book.)
SC870-55	B	Address Book data error (Encryption settings: Failed to delete file when changing encryption setting.)
SC870-56	B	Address Book data error (Encryption settings: Failed to erase the file that records the encryption key during an attempt to change the encryption setting.)
SC870-57	B	Address Book data error (Encryption settings: Failed to move a file during an attempt to change the encryption setting.)
SC870-58	B	Address Book data error (Encryption settings: Failed to delete a directory during an attempt to change the encryption setting.)
SC870-59	B	Address Book data error (Encryption settings: Detected a resource shortage during an attempt to change the encryption setting.)
SC870-60	B	Address Book data error (Unable to obtain the on/off setting for administrator authentication (06A and later).)

No.	Type	Error Name/Error Condition/Major Cause/Solution
		<p>When an error related to the Address Book is detected during startup or operation.</p> <ul style="list-style-type: none"> • Software bug • Inconsistency of Address Book source location (machine/delivery server/LDAP server) • Inconsistency of Address Book encryption setting or encryption key (NVRAM or HDD was replaced individually without formatting the Address Book) • Address Book storage device (SD/HDD) was temporarily removed or hardware configuration does not match the application configuration. • Address Book data corruption was detected. <p>Install the device that contains address book information properly, and turn the main power off/on. If SC occurs again, do the following steps.</p> <ol style="list-style-type: none"> 1. After installing the HDD, or SD/USB ROM, execute SP5-846-046 (UCS Setting). 2. Wait more than 3 seconds, then execute SP5-832 (HDD Formatting). 3. Turn the main power OFF/ON. <p>Procedure after SC870 is cleared</p> <ol style="list-style-type: none"> 1. If there is backup data in SD card or Web Image Monitor, restore the address book data. (To restore from SD card, enter the encryption password which is the same as when you enter to backup.)

No.	Type	Error Name/Error Condition/Major Cause/Solution
SC871-00	D	FCU error
		An error occurred when FCS detects FCU defective.
		<ul style="list-style-type: none"> • Time-out error • Abnormal Parameter
		<ul style="list-style-type: none"> • Turn the main power OFF/ON. • Update the firmware if more recent firmware was released.

No.	Type	Error Name/Error Condition/Major Cause/Solution
SC872-00	B	HDD mail reception error
		An error was detected on the HDD immediately after the machine was turned on.
		<ul style="list-style-type: none"> • HDD defective • Power was turned off while the machine used the HDD.
		<ul style="list-style-type: none"> • Format the HDD (SP5-832-007: HDD Formatting: Mail RX Data).) • Replace the HDD. <p>When you do the above, the following information will be initialized.</p> <ul style="list-style-type: none"> • Partly received partial mail messages. • Already-read statuses of POP3-received messages (All messages on the mail server are handled as new messages).

No.	Type	Error Name/Error Condition/Major Cause/Solution
SC873-00	B	HDD mail reception error
		An error was detected on the HDD immediately after the machine was turned on.
		<ul style="list-style-type: none"> • HDD defective • Power was turned off while the machine used the HDD.
		<ul style="list-style-type: none"> • Format the HDD (SP5-832-007 : HDD Formatting: Mail RX Data). • Replace the HDD. <p>When you do the above, the following information will be initialized.</p> <ul style="list-style-type: none"> • Sender's mail text • Default sender name/password (SMB/FTP/NCP) • Administrator mail address • Scanner delivery history

No.	Type	Error Name/Error Condition/Major Cause/Solution
SC874-05	D	Delete all error (Delete data area) : Read error
SC874-06	D	Delete all error (Delete data area) : Write error

No.	Type	Error Name/Error Condition/Major Cause/Solution
SC874-09	D	Delete all error (Delete data area) : No response from HDD
SC874-10	D	Delete all error (Delete data area) : Error in Kernel
SC874-12	D	Delete all error (Delete data area) : No designated partition
SC874-13	D	Delete all error (Delete data area) : No device file
SC874-14	D	Delete all error (Delete data area) : Start option error
SC874-15	D	Delete all error (Delete data area) : No designated sector number
SC874-16	D	Delete all error (Delete data area) : failure in performing hdderase
SC874-41	D	Delete all error (Delete data area) : Other fatal errors
SC874-42	D	Delete all error (Delete data area) : End by cancellation
SC874-61 to -65	D	Delete all error (Delete data area) : library error
SC874-66	D	Delete all error (Delete data area) : Unavailable
SC874-67	D	Delete all error (Delete data area) : Erasing not finished
SC874-68	D	Delete all error (Delete data area) : HDD format failure (Normal)
SC874-69	D	Delete all error (Delete data area) : HDD format failure (Abnormal)
SC874-70	D	Delete all error (Delete data area) : Unauthorized library
SC874-99	D	Delete all error (Delete data area) : other errors
		<p>An error occurred while data was being erased on HDD or NVRAM.</p> <ul style="list-style-type: none"> • Error detected in HDD data delete program • Error detected in NVRAM data delete program • The "Delete All" option was not set <ul style="list-style-type: none"> • Turn the main power switch off and back on, and then execute "Erase All Memory" under UP mode again. (However, if there is a defective sector or other problem with the hard disk, the error will persist even after trying the above.) • If the "Delete All" option is not installed when this error occurs, install the option.

No.	Type	Error Name/Error Condition/Major Cause/Solution
SC875-01	D	Delete all error (HDD erasure) (hddchack -i error)
SC875-02	D	Delete all error (HDD erasure) (Data deletion failure)
		An error was detected before HDD/data erasure starts. (Failed to erase data/failed to logically format HDD)
		<ul style="list-style-type: none"> • HDD logical formatting failed. • The modules failed to erase data.
		Turn the main power OFF/ON.

No.	Type	Error Name/Error Condition/Major Cause/Solution
SC876-00	D	Log Data Error
		An error was detected in the handling of the log data at power on or during machine operation.
		<ul style="list-style-type: none"> • Damaged log data file. • Log encryption is enabled but encryption module is not installed. • Inconsistency of encryption key between NV-RAM and HDD. • Software bug.
		<p>Try the SC876-01 to -99 solutions listed below. If it is not solved, do the following steps (for when only an HDD is replaced):</p> <ol style="list-style-type: none"> 1. Disconnect the HDD and turn ON the main power. 2. Execute SP5-801-019 (Memory Clear: LCS Memory Clr) to Initialize the LCS settings. 3. Turn OFF the main power. 4. Connect the HDD and turn ON the main power. 5. Execute SP5-832-004 (HDD Formatting (Job Log)). 6. Turn OFF the main power. <ul style="list-style-type: none"> * The following step is to configure the logging/encryption setting again. 7. Turn ON the main power.

No.	Type	Error Name/Error Condition/Major Cause/Solution
SC876-01	D	Log Data Error 1
		An error was detected in the handling of the log data at power on or during machine operation.
		Damaged log data file
		Initialize the HDD (SP5-832-004).

No.	Type	Error Name/Error Condition/Major Cause/Solution
SC876-02	D	Log Data Error 2
		An error was detected in the handling of the log data at power on or during machine operation.
		Log encryption is enabled but encryption module is not installed.
		<ul style="list-style-type: none"> • Replace or set again the encryption module. • Disable the log encryption setting.

No.	Type	Error Name/Error Condition/Major Cause/Solution
SC876-03	D	Log Data Error 3
		An error was detected in the handling of the log data at power on or during machine operation.
		Inconsistency of encryption key between NV-RAM and HDD.
		<ul style="list-style-type: none"> • Disable the log encryption setting. • Initialize LCS memory (SP5801-019). • Initialize the HDD (SP5-832-004).

No.	Type	Error Name/Error Condition/Major Cause/Solution
SC876-04	D	Log Data Error 4
		An error was detected in the handling of the log data at power on or during machine operation.
		<ul style="list-style-type: none"> Log encryption key is disabled but the log data file is encrypted. (NVRAM data corruption) Log encryption key is enabled but the log data file is not encrypted. (NVRAM data corruption)
		Initialize the HDD (SP5-832-004).

No.	Type	Error Name/Error Condition/Major Cause/Solution
SC876-05	D	Log Data Error 5
		An error was detected in the handling of the log data at power on or during machine operation.
		<ul style="list-style-type: none"> Only the NV-RAM has been replaced with one previously used in another machine. Only the HDD has been replaced with one previously used in another machine.
		<ul style="list-style-type: none"> Attach the original NV-RAM. Attach the original HDD. With the configuration that caused the SC, initialize the HDD (SP5-832-004).

No.	Type	Error Name/Error Condition/Major Cause/Solution
SC876-99	D	Log Data Error 99
		An error was detected in the handling of the log data at power on or during machine operation.
		Other causes
		-

No.	Type	Error Name/Error Condition/Major Cause/Solution
SC877-00	B	Data Overwrite Security card error
		The "Auto Erase Memory" function of the Data Overwrite Security is set to on but it cannot be done.
		<ul style="list-style-type: none"> Data Overwrite Security option SD card is broken. Data Overwrite Security option SD card has been removed.
		<ul style="list-style-type: none"> If the SD card is broken, prepare a new Data Overwrite Security option SD card and replace the NVRAM. If the SD card has been removed, turn the main power off and reinstall a working Data Overwrite Security option SD card.

No.	Type	Error Name/Error Condition/Major Cause/Solution
SC878-00	D	TPM authentication error
		TPM electronic recognition failure
		<ul style="list-style-type: none"> Update of system module attempted without correct update path USB flash memory not operating correctly
		Replace the controller board.

Trusted Platform Module

- In computing, Trusted Platform Module (TPM) is both the name of a published specification detailing a secure crypto processor that can store cryptographic keys that protect information, as well as the general name of implementations of that specification often called the "TPM chip" or "TPM Security Device" (as designated in certain Dell BIOS settings).

No.	Type	Error Name/Error Condition/Major Cause/Solution
SC878-01	D	USB flash error
		There is a problem in the file system of the USB flash memory.
		USB Flash system files corrupted
		Replace the controller board.

No.	Type	Error Name/Error Condition/Major Cause/Solution
SC878-02	D	TPM error
		An error occurred in either TPM or the TPM driver
		TPM not operating correctly
		Replace the controller board.

No.	Type	Error Name/Error Condition/Major Cause/Solution
SC878-03	D	TCSD error
		An error occurred in the TPM software stack.
		<ul style="list-style-type: none"> • TPM, TPM software cannot start • A file required by TPM is missing
		Replace the controller board.

No.	Type	Error Name/Error Condition/Major Cause/Solution
SC878-20	D	Random number test error
		An error was detected when a random number table was generated during a self-test. The random number table is generated by TPM (Trusted Platform Module). The table generated by TPM failed the test.
		<p>Note</p> <ul style="list-style-type: none"> • TPM (Trusted Platform Module) is a computer chip that can securely store information used to authenticate the platform. This information can include passwords, certificates, and encryption keys.
		<p>TPM is defective</p> <ul style="list-style-type: none"> • Turn the main power OFF/ON. • Replace the controller board.

No.	Type	Error Name/Error Condition/Major Cause/Solution
SC880-00	D	MLB error
		Reply to MLB access was not returned within a specified time.
		MLB defective
		<ul style="list-style-type: none"> • Replace the MLB. • Remove the MLB.

No.	Type	Error Name/Error Condition/Major Cause/Solution
SC881-01	D	Management area error
		<ul style="list-style-type: none"> • A problem was detected in the software • This error may even occur is an IC card option is not installed.
		<ul style="list-style-type: none"> • This is caused by accumulation of abnormal authentication information in the software. (User operation will not directly cause it.) • At login Example: When a job is sent to the printer/when logged on from the operation panel/when logged on from a Web browser
		Turn the main power OFF/ON.

No.	Type	Error Name/Error Condition/Major Cause/Solution
SC899-00	D	Software performance error (signal reception end)
		Unknown software error occurred.
		Occurs when an internal program behaves abnormally.
		<p>In the case of a hardware defect</p> <ul style="list-style-type: none"> • Replace the hardware. <p>In the case of a software error</p> <ul style="list-style-type: none"> • Turn the main power OFF/ON. • Try updating the firmware.

Service Call 900-998

SC900 (Engine: Others)

SC No.	Type	Error Name/Error Condition/Major Cause/Solution
SC995-01	D	CPM setting error 1
		Comparison of machine serial number (11 digits) and machine identification code. Details: <ul style="list-style-type: none"> Machine serial number cannot be identified because of BICU replacement or malfunctioning. Machine serial number cannot be identified because of NV-RAM replacement
		Machine serial number (11 digits) or machine identification code does not match.
		<ul style="list-style-type: none"> Enter the machine serial number using SP5-811 (MachineSerial), and then turn the power on/off. Attach the NV-RAM that was installed previously.

SC No.	Type	Error Name/Error Condition/Major Cause/Solution
SC995-02	D	CPM setting error 2
		Comparison of machine serial number (11 digits) and machine identification code. Details: <p>Machine serial number cannot be identified because of NV-RAM replacement or malfunctioning.</p>
		Machine serial number (11 digits) or machine identification code does not match.
		<ul style="list-style-type: none"> Attach the NV-RAM that was installed previously. Download data on the NV-RAM using SP5-825 (NV-RAM Data Download).

SC No.	Type	Error Name/Error Condition/Major Cause/Solution
SC995-03	D	CPM setting error 3
		Comparison of machine serial number (11 digits) and machine identification code. Details: Unable to recognize machine identification code because the controller was replaced incorrectly or is malfunctioning.
		Machine serial number (11 digits) or machine identification code does not match.
		Replace it with a specified controller.

SC No.	Type	Error Name/Error Condition/Major Cause/Solution
SC995-04	D	CPM setting error 4
		Comparison of machine serial number (11 digits) and machine identification code. Machine serial number (11 digits) or machine identification code does not match.
		Return the parts to the original configuration, and then replace them according to the manual.

SC900 (Controller)

SC No.	Type	Error Name/Error Condition/Major Cause/Solution
SC900-00	A	Electric counter error
		The electric total counter value is out of specification. Error is detected when increasing the total counter.
		<ul style="list-style-type: none"> • Unexpected NV-RAM is attached. • NV-RAM defective • NV-RAM data corrupted. • Data written to unexpected area because of external factor etc. • The count requested by the SRM on receiving PRT is not completed.
		Replace the NV-RAM.

SC No.	Type	Error Name/Error Condition/Major Cause/Solution
SC910-01	C	External controller error 1
SC910-02	C	External controller error 2
SC910-03	C	External controller error 3
		<p>-01 The external controller receives the unexpected command from the engine side.</p> <p>-02 The external controller wrongly receives the command from the engine side.</p> <p>-03 The external controller receives the engine status out of specification.</p> <p>Refer to the instructions for the external controller</p> <p>Turn the main power OFF/ON.</p>

SC No.	Type	Error Name/Error Condition/Major Cause/Solution
SC910-10	C	External controller error 1
		The external controller error is detected due to other reason shown in SC910-01 to -03.
		Refer to the instructions for the external controller
		Turn the main power OFF/ON.

SC No.	Type	Error Name/Error Condition/Major Cause/Solution
SC919-00	D	External controller down
		While EAC (External Application Converter), the conversion module, was operating normally, the receipt of a power line interrupt signal from the FLUTE serial driver was detected, of BREAK signal from the other station was detected.
		External controller and the machine had been operating correctly (*) but the external controller was turned off or rebooted, or the video bus was disconnected. * Printing or scanning using the external controller.
		Turn the main power OFF/ON.

SC No.	Type	Error Name/Error Condition/Major Cause/Solution
SC920-02	B	Printer application error (WORK memory cannot be acquired)
SC920-04	B	Printer application error (Filter process ended abnormally)
		An error was detected in the application, and no further operation is possible.
		<ul style="list-style-type: none"> • There is a bug in the software. • The hardware configuration is not as planned (for example, insufficient memory).
		<ul style="list-style-type: none"> • Turn the main power OFF/ON. • Increase the memory storage capacity.

SC No.	Type	Error Name/Error Condition/Major Cause/Solution
SC921-00	B	Printer application error (Resident font not found)
		The resident fonts cannot be found at printer startup.
		The resident font file is missing.
		Turn the main power off/on.

SC No.	Type	Error Name/Error Condition/Major Cause/Solution
SC925-00	B	NetFile function error
SC925-01	B	NetFile function error
		<p>The NetFile file management on the HDD cannot be used, or a NetFile management file is corrupted and operation cannot continue.</p> <ul style="list-style-type: none"> • HDD defective • HDD inconsistency caused by power failure during HDD access, etc. • Software bug

SC No.	Type	Error Name/Error Condition/Major Cause/Solution
		<p>If another SC related to HDD errors (SC860 to SC865) is issued at the same time, the HDD is the cause. Solve the other SC.</p> <ul style="list-style-type: none"> If SC860 to SC865 is not issued <ul style="list-style-type: none"> Turn the main power off/on. If this does not work, initialize the HDD NetFile partition (SP5-832-011: HDD Formatting (Ridoc I/F)). Approval by the customer is required because received fax message waiting to be delivered and documents waiting to be captured will be lost. <p>Procedure:</p> <ol style="list-style-type: none"> Go into the User Tools mode and do "Delivery Settings" to print all received fax documents that are scheduled for delivery. Then erase them. In the User Tools mode, do Document Management> Batch Delete Transfer Documents. Do SP5-832-011, then turn the machine power off and on. <ul style="list-style-type: none"> If this does not solve the problem, initialize all partitions of the HDD (SP5-832-001: HDD Formatting (ALL)), then turn the machine power off and on. <p>Approval by the customer is required because documents and Address Book information in the HDD will be lost. Received fax messages stored are protected but the order may be changed.</p> <ul style="list-style-type: none"> If this does not solve the problem, replace the HDD.

SC No.	Type	Error Name/Error Condition/Major Cause/Solution
SC990-00	D	Software operation error
		Software attempted an unexpected operation.
		<ul style="list-style-type: none"> Parameter error Internal parameter error Insufficient work memory Operation error caused by abnormalities that are normally undetectable.
		<ul style="list-style-type: none"> Turn the main power off/on. Reinstall the software of the controller and BCU board.

SC No.	Type	Error Name/Error Condition/Major Cause/Solution
SC991-00	C	Recoverable software operation error
		Software attempted an unexpected operation. SC991 covers recoverable errors as opposed to CS990.
		<ul style="list-style-type: none"> • Parameter error • Internal parameter error • Insufficient work memory • Operation error caused by abnormalities that are normally undetectable.
		Logging only

SC No.	Type	Error Name/Error Condition/Major Cause/Solution
SC992-00	D	Undefined SC issued.
		An SC, that is not controlled by the system, occurred.
		<ul style="list-style-type: none"> • An SC for the previous model was used mistakenly, etc. • Basically a software bug.
		Turn the main power OFF/ON.

SC No.	Type	Error Name/Error Condition/Major Cause/Solution
SC994-00	C	Operation error caused by abnormalities that are normally undetectable.
		An error occurred because the number of records exceeded the limit for images managed in the service layer of the firmware.
		This can occur if there are too many application screens open on the operation panel.
		Logging only.

SC No.	Type	Error Name/Error Condition/Major Cause/Solution
SC997-00	D	Application function selection error
		The application selected by the operation panel key operated abnormally (No response, abnormal ending).
		Software bug (mainly the application)
		<ul style="list-style-type: none"> • Check the optional RAM, DIMM, boards required by the application program. • Check if the combination of downloaded programs are correct.

SC No.	Type	Error Name/Error Condition/Major Cause/Solution
SC998-00	D	Application start error
		<ul style="list-style-type: none"> • No application was registered to system within a specified time after the main power was turned on. (No application starts/All applications have been terminated abnormally) • Application started but cannot be drawn now for some reason.
		<ul style="list-style-type: none"> • Software bug (mainly the application) • The optional RAM, DIMM, boards required by the application program. Are not installed correctly.
		<ul style="list-style-type: none"> • Turn the main power OFF/ON. • Check the optional RAM, DIMM, boards • Check the combination of programs • Replace the controller board.

Troubleshooting for SC Errors

When SC285-02 (MUSIC Error) Is Displayed

Causes

- The ID sensor cannot detect the MUSIC pattern
- Color registration error is larger than the specified value

[Assumed Cause]

1. Large drifting

"Large drifting" is the state where the color registration error is larger than the specified value.

In the "Large drifting" state, the MUSIC pattern is shifted a long distance in the main scan direction (side to side), and is moved to the position where the MUSIC Sensor (TM/ID sensor) cannot be detected, or each pattern cannot be detected due to the pattern overlapping.

2. MUSIC pattern density error

Pattern with the lower density

3. Defective Image transfer belt/Image transfer unit

- Belt scratched
- Belt corrugation, belt skew
- Cleaning failure
- Background stains
- Filming

"Filming" is a phenomenon where surface properties change over time.

Glossiness is one of the surface properties. In the "Filming" state, the whole or part (belt shaped) of the Image Transfer Belt surface becomes foggy. "Filming" changes reflected light, and the MUSIC Sensor (TM/ID sensor) may detect the input wrongly, which causes an error.

4. MUSIC sensor (TM/ID sensor) defective

- Connector/ harness disconnected
- Sensor surface dirty
- Sensor malfunction
- BCU malfunction

5. Paper transfer contact/release mechanism defective

- Connector/ harness disconnected
- Motor/ sensor malfunction

- Imaging IOB malfunction
6. **Laser optics positioning motor in laser unit defective**
- Connector/ harness disconnected
 - Motor malfunction
 - Imaging IOB malfunction

Solutions

As SC285-02 is a logging SC (SC Type C), it is not displayed at once when an error occurs. Though the equipment can be operated, check the SC history and perform a recovery operation if the SC has occurred.

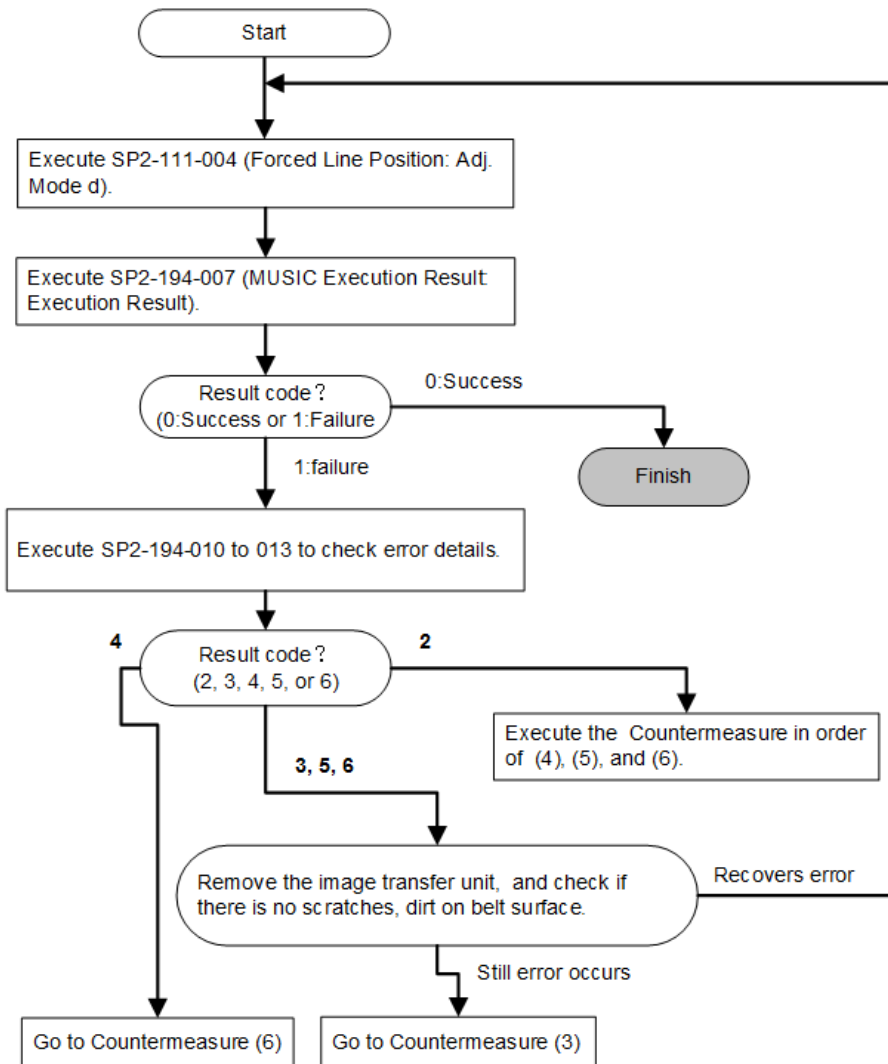

If a MUSIC fail cannot be cleared, perform counter measures from (2) to (6) in this order.
If SC370 occurs when operating MUSIC, refer to the recovery procedure for the SC370.

w_d238m0753b_en

Countermeasure (1): Large drifting

An abnormal value may be contained in the SP where the MUSIC corrected result is saved.

1. Execute SP2-180-001 (Line Pos. Adj.: Clear Color Regist.).
2. Execute SP2-111-004 (Forced Line Position: Adj. Mode d.).
3. Execute SP2-194-007 (MUSIC Execution Result: Execution Result).

Countermeasure (2): MUSIC pattern density Error

Execute MUSIC and check the result.

1. Execute SP3-011-001 (Manual ProCon :Exe : Normal ProCon).
2. Execute SP2-111-004 (Forced Line Position: Adj. Mode d).
3. Execute SP2-194-007 (MUSIC Execution Result: Execution Result).

Countermeasure (3): Image transfer belt/ Image transfer unit defective

1. Execute SP2-112-001 (TM/ID Sensor Check Execute).
2. Check SP2-112-010 (TM/ID Sensor Test General:FCR).
 - Normal If the result is "111"
 - >Execute other countermeasures.
 - Vsg adjustment is failed if the result is "2xx", "x2x", or "xx2"
 - >Execute recovery operation for SC370
 - There is a high probability that contaminants, scars, or irregularities may exist on the belt if the result is "3xx", "x3x", or "xx3"
 - >Execute the following procedure;
 1. Remove the image transfer unit, and check for abnormalities such as contaminants or scars, and set it after cleaning.
 2. Execute SP2-111-004 (Forced Line Position: Adj. Mode d).
 3. Execute SP2-194-007 (MUSIC Execution Result: Execution Result).
 4. If it fails, replace the image transfer belt/ Image transfer unit.
 - There is a high probability that contaminants or curls may exist on the belt if the result is "5xx", "6xx", "7xx", "8xx", "x5x", "x6x", "x7x", "x8x", "xx5", "xx6", "xx7", or "xx8".
 - > Execute the following procedure
 1. Remove the Image Transfer Unit, and check for abnormalities such as contaminants or scars, and set it after cleaning.
 2. Execute SP2-111-004 (Forced Line Position: Adj. Mode d).
 3. Execute SP2-194-007 (MUSIC Execution Result: Execution Result).
 4. If it fails, replace the image transfer belt/ Image transfer unit.

Countermeasure (4): TM/ID sensor defective

Follow the next step if executing SP2-111-004 (Forced Line Position: Adj. Mode d) and SP2-194-007 (MUSIC Execution Result: Execution Result) fails.

1. Clean the TM/ID Sensor.
2. Check the harness and connector for TM/ID sensor.
3. Replace the TM/ID sensor.
4. Replace the BCU.

Countermeasure (5): Paper transfer contact/release mechanism defective

Check if the MUSIC/ProCon Pattern is attached on the Paper Transfer Roller. If it is attached, separating may be defective.

1. Execute SP5-804-255 (OUTPUT Check: Paper Transfer Contact Operation) to operate the paper transfer contact and release motor to check the separating operation of the paper transfer roller.
2. Check for a broken harness or connector disconnection.
3. If the problem cannot be solved, replace the Imaging IOB.

Countermeasure (6): Laser optics positioning motor in laser unit error

1. Check the operation of the laser optics positioning motor and check for a broken harness or connector disconnection. If an abnormality is detected, replace the Laser Unit.
2. If the problem cannot be solved, replace the Imaging IOB.

When SC370 (TM (ID) Sensor Calibration Error) Is Displayed

6

Causes

- TM (ID) sensor connector missing/connection error
- TM (ID) sensor detection window dirt
- TM (ID) sensor malfunction
- Undulation in the ITB, or belt slippage

Solutions

Check if the SC occurs by turning the power OFF then ON. If the SC occurs again, do the following steps.

1. Check if all connectors related to TM/ID sensor are connected securely. Reconnect the connectors if they are disconnected, or loose.
2. If TM/ID sensor is contaminated, clean it with damp cloth (never use a dry cloth or alcohol).
3. Check if there is an abnormality on the image transfer belt surface.
4. If any abnormalities are found on the image transfer belt surface, replace the image transfer belt.
 - Belt scratched
 - Belt corrugation, belt skew
 - Cleaning failure
 - Background stains
 - Filming

5. Check the TM/ID sensor for malfunctions, and recover or replace it if there are any defects.
6. Check the harness. Replace the harness if it is disconnected, or damaged.
7. If the SC is not cleared even after performing steps 1 to 6, replace the BCU

Recovery Check Procedure

1. Execute Vsg adjustment with SP3-320-001 (Vsg Adj: Execute :P Sensor).
2. Check the result with SP3-323-001 (Vsg Adj OK?: Latest).
 - If code is "1": Recovered
 - If code is not "1": Not recovered

Adjustment after Recovery

After performing recovery on SC370, execute the following adjustment procedures.

1. Execute SP2-111-004 (Forced Line Position: Adj. Mode d).
2. Execute the following SPs and check the results:
 - SP2-194-007 (Execution Result)
 - SP2-194-010 (Error Result: C)
 - SP2-194-011 (Error Result: M)
 - SP2-194-012 (Error Result: Y)

Execute result sample
 Factory default: 0
 Success: 1
3. Execute SP3-011-001 (Manual ProCon :Exe).
4. Execute the following SPs and check the results.
 - SP3-012-001 to 010 (Front)
 - SP3-012-011 to 020 (Center)
 - SP3-012-021 to 030 (Rear)

Execute result sample (In order of YMCK from left)

 - Factory default:[00,00,00,00]
 - Starting adjust:[99,99,99,99]
 - Fail Vsg adjust(Y):[21,99,99,99]
 - Error of Development gamma Max(C):[99,99,55,99]
 - Succeed:[11,11,11,11]

When SC501, SC502, SC503, or SC504 (Paper Tray Error) Is Displayed

SC501, SC502, SC503, or SC504 occurs.

Solutions

1. Pull out the paper feed tray [A] on which the SC has occurred, and then, lifting the front part of the tray, pull it out all the way through (The photograph shows Tray 1.)

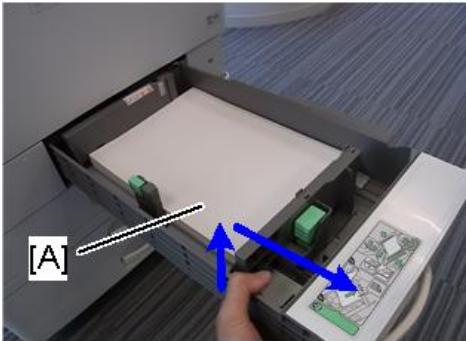

d238m0902

2. Check if there is any paper jammed in the machine, and remove it if there is.



d238m0903

3. If the sheets exceed the stackable limit, reduce the number of sheets.



d238m0904

4. Reattach the tray. Lift the tray slightly when you attach it.

When SC544-02, SC554-02 (Non-contact Thermistor High Temperature Detection) Is Displayed

When SC544-02 or SC554-02 is displayed, the unit is probably damaged. Therefore replace a fusing unit or fusing sleeve belt unit in accordance with the following procedure.

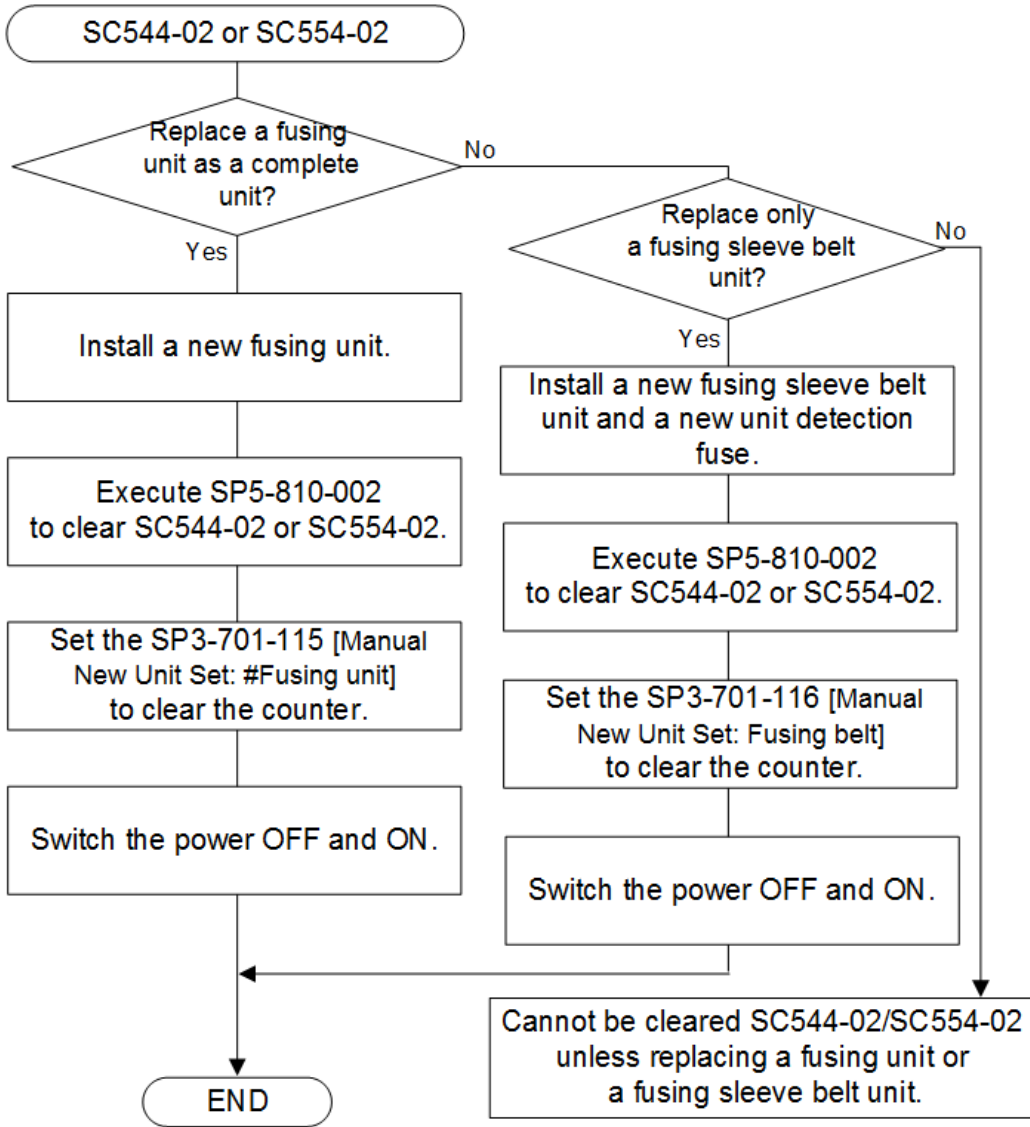

w_d244c6008_en

To clear SC544-02 or SC554-02, replacing the fusing unit or installing an intact new unit detection fuse in the fusing unit must be required. The intact new unit detection fuse is provided in the fusing sleeve belt unit.

When replacing the fusing sleeve belt unit, follow the procedure below.

SP descriptions

- SP5-810-002 [SC Reset: Hard High Temp. Detection]
Clears the fusing hardware SC.
- SP3-701-115 [Manual New Unit Set: #Fusing Unit]

Sets the new unit detection flag ON/OFF.

- SP3-701-116 [Manual New Unit Set: Fusing Belt]

Sets the new unit detection flag ON/OFF.

How to Clear SC544-02/SC554-02 with a New Unit Detection Fuse

1. Install a new fusing sleeve belt unit. (page 547)
2. There is a new unit detection fuse packed with the new fusing sleeve belt unit.

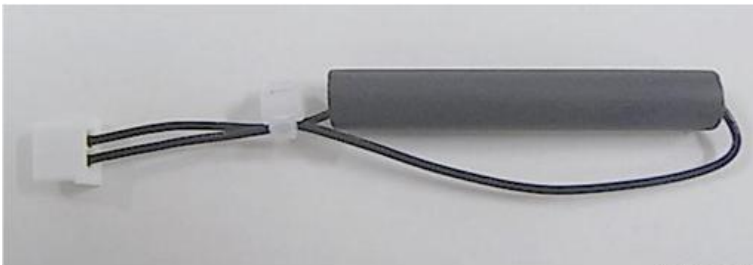

d146f00007

3. Connect the new unit detection fuse to the connector [A], and place the fuse in the empty space [B].

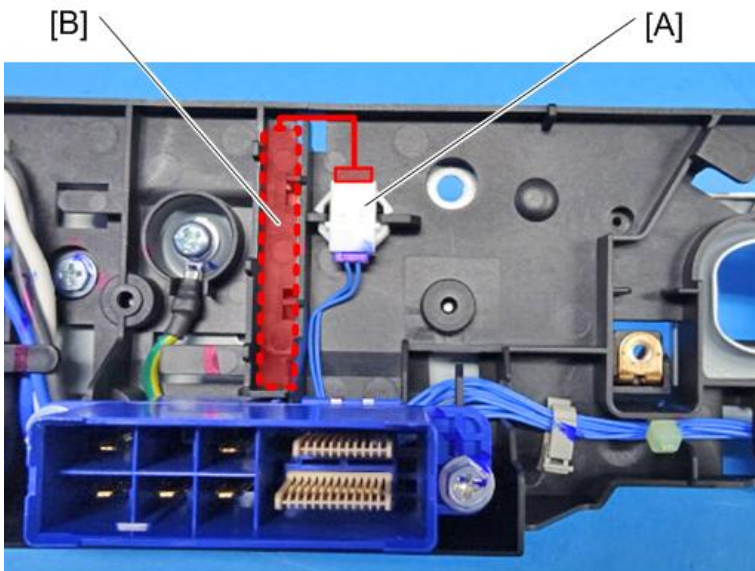

D238m1153

4. Reattach the fusing unit.
5. Switch the power ON.
6. Execute SP5-810-002 [SC Reset: Hard High Temp. Detection].
7. Set SP3-701-116 [Manual New Unit Set: Fusing Belt] to "1".

8. Switch the power OFF and ON.

Isolation Diagram of SC663, 664, 665, 667, 668, and 670-01

The modules considered to be the cause of SC663, 664, 665, 667, 668 and 670-01 are as follows.

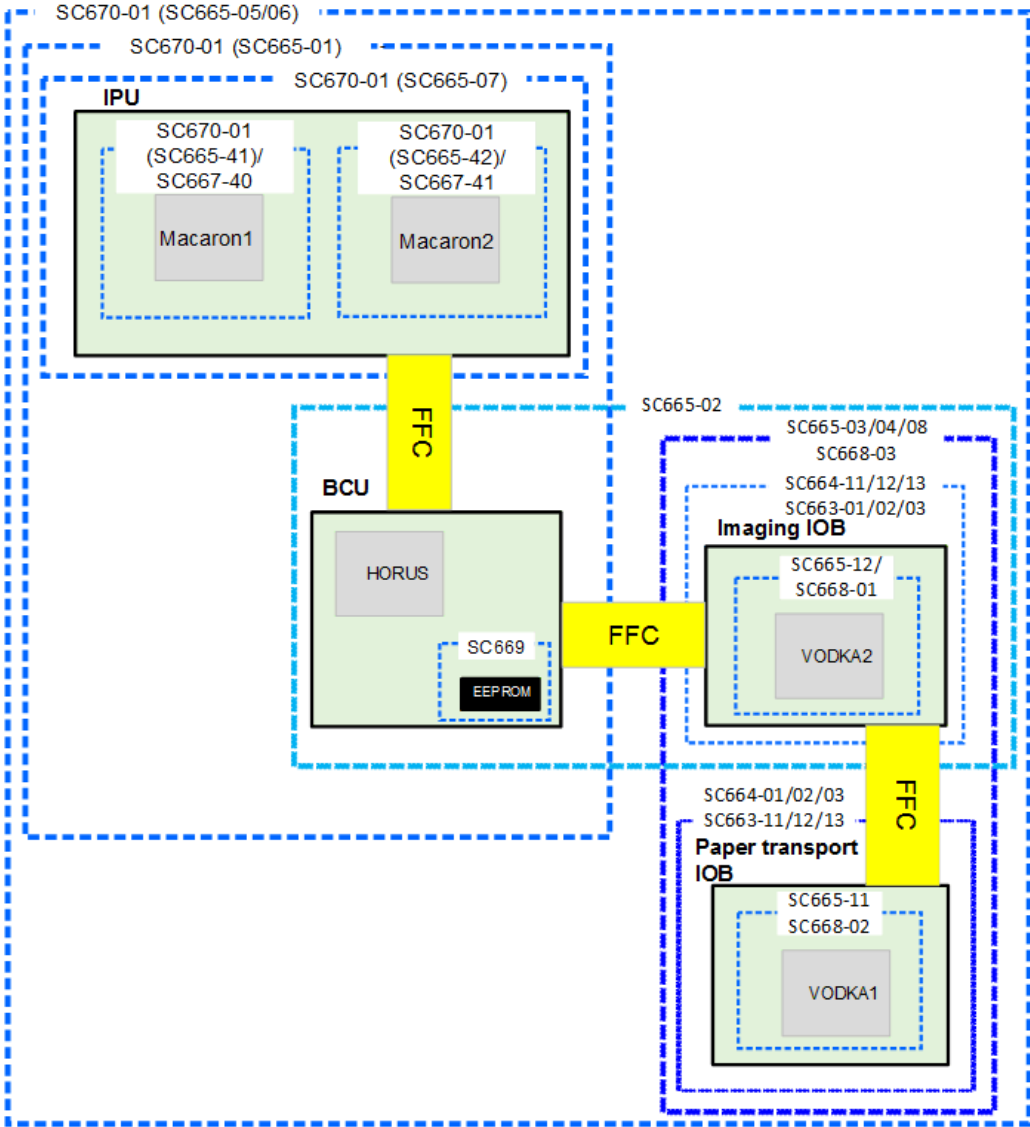

w_d238m2108a_en

When SC670 (Engine start up error) is displayed

Causes

The engine board resets at an unexpected time, and does not start up again.

Solutions

Note: CTL = Controller

SC670-01

Engine start up error when the machine boots up

If the symptom occurs, use the following chart to decide the best course of action.

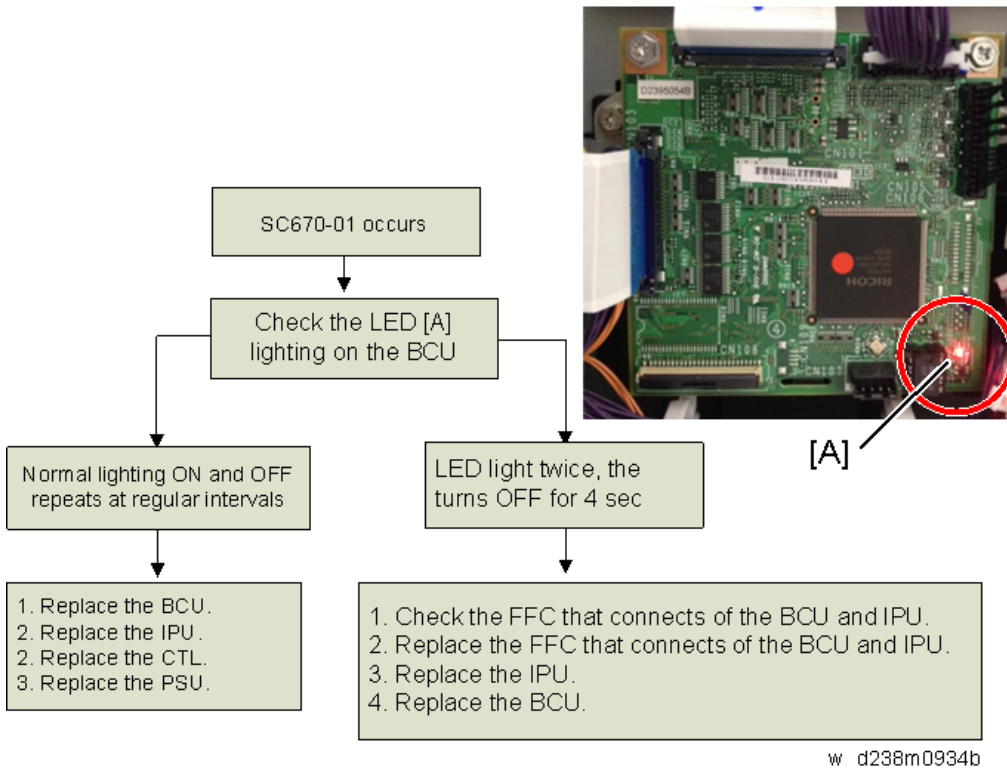

SC670-02

Engine start up error when the machine is in operation.

Replace the part in order of precedence stated below (since there is a high possibility that those parts are broken and causing the error).

1. Replace BCU

2. Replace IPU
3. Replace CTL
4. Replace PSU

SC670-03

IPU start up error when the machine boots up.

Replace the part in order of precedence stated below (since there is a high possibility that those parts are broken and causing the error).

1. Replace IPU
2. Replace CTL
3. Replace PSU
4. Replace BCU.

SC670-04

Communication error between the engine and controller.

Replace the part in order of precedence stated below (since there is a high possibility that those parts are broken and causing the error).

1. Replace IPU
2. Replace BCU
3. Replace CTL
4. Replace PSU

When SC672 (Controller start up error) Is Displayed

Symptom

Note: CTL = Controller

The following occur:

SC672-00	Communication error between operation panel and CTL after machine is powered on.
SC672-10	Communication error (receive) between operation panel and CTL after machine is powered on.
SC672-11	Communication error (send) between operation panel and CTL after machine is powered on.
SC672-12	Communication error between operation panel and CTL after normal start-up.

SC672-13	Communication error between operation panel and CTL after normal start-up; Operation panel not detected.
----------	---

Note

- SC672 does not appear on the SMC report, as it is not logged.
- The Smart Operation Panel communicates with the controller via a USB cable and IPU. SC672 is triggered when the panel cannot communicate with the controller.

Causes

Possible causes of SC672 include:

- USB communication path failure (USB cable, IPU)
- CTL boot up error and/or operation panel boot up error due to abnormal break in operations of CTL.

Possible causes of operation panel cannot light include:

- USB communication path failure (USB cable, IPU)
- Operation panel cannot communicate with CTL due to CTL boot-up error

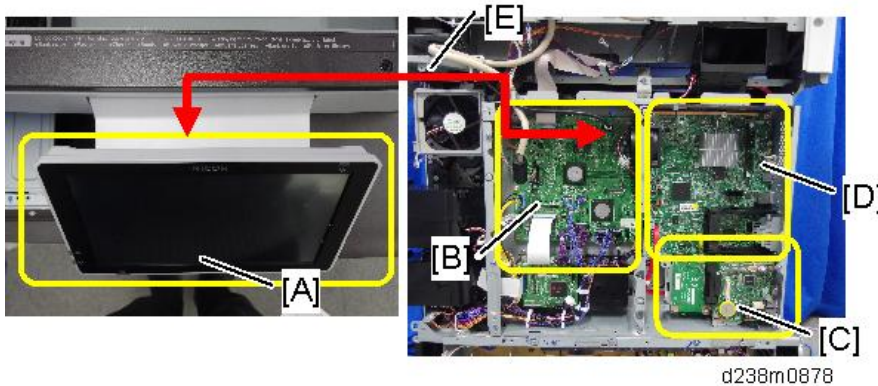

- [A]: Operation Panel
- [B]: IPU
- [C]: FCU
- [D]: Controller
- [E]: USB cable

Solutions

Do the following.

1. Turn the machine power OFF/ON.
2. Do the action in the flowchart below to determine the cause and best course of action when SC672 occurs.

Note

- If the SC recurs after you do the action in this flowchart, do the following.
 - If SC819 (cache error) appears in the SC history, replace the controller board.
 - If SC991 (SCS: scs time count level c') appears in the SC history, replace the controller board and USB cable.

Flowchart to determine parts to replace when SC672 occurs

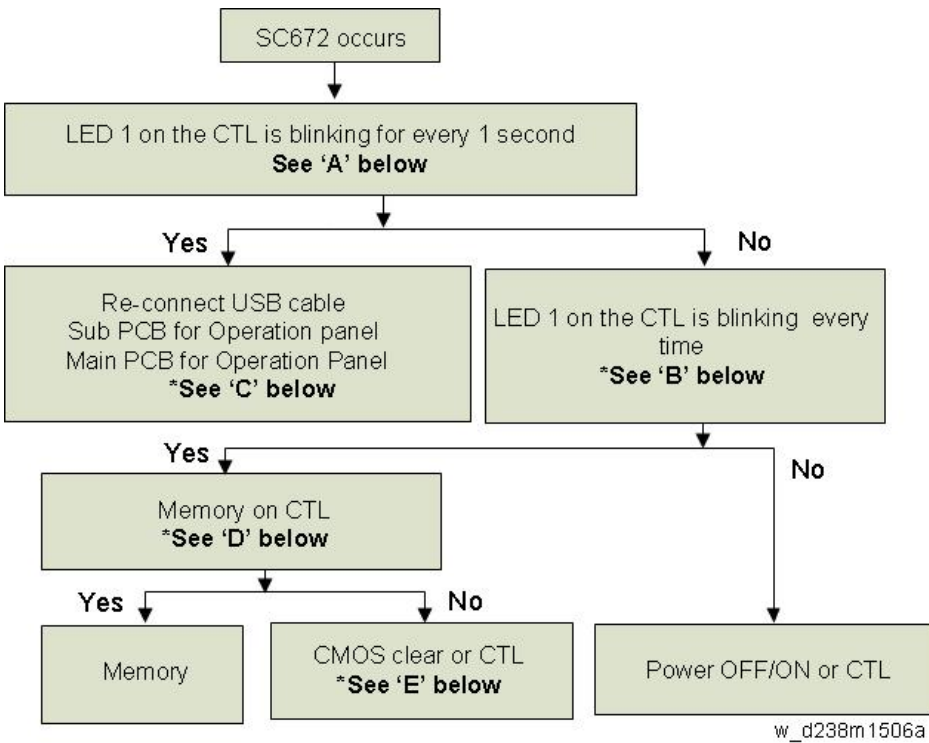

Parts	How to determine the cause
USB cable	LED on CTL blinks for 1 second
Operation panel	LED on CTL blinks for 1 second
CTL	LEDs on CTL blink constantly
Memory	LEDs on CTL blink constantly

Flowchart to determine parts to replace when no display on operation panel

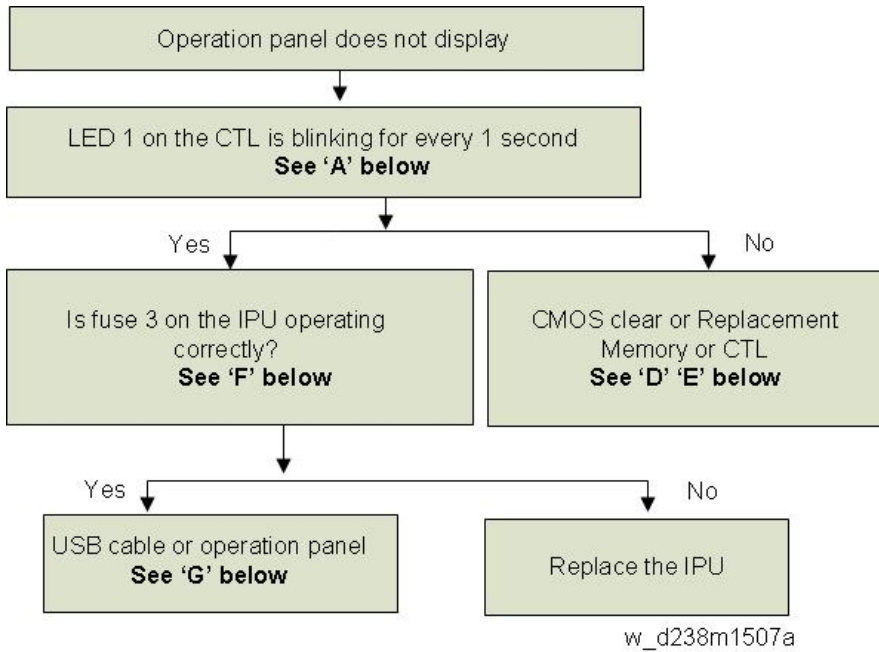

Parts	How to determine the cause
USB cable	LED on CTL blinks for 1 second
Operation panel	LED on CTL blinks for 1 second
IPU	Fuse 3 on the IPU
CTL	LED on CTL does not blink
Memory	LED on CTL does not blink

[A]: LEDs on the controller board

Check the condition (lit, off, blinking) of the LED on the CTL.

LED /POSTCODE AREA on the CTL

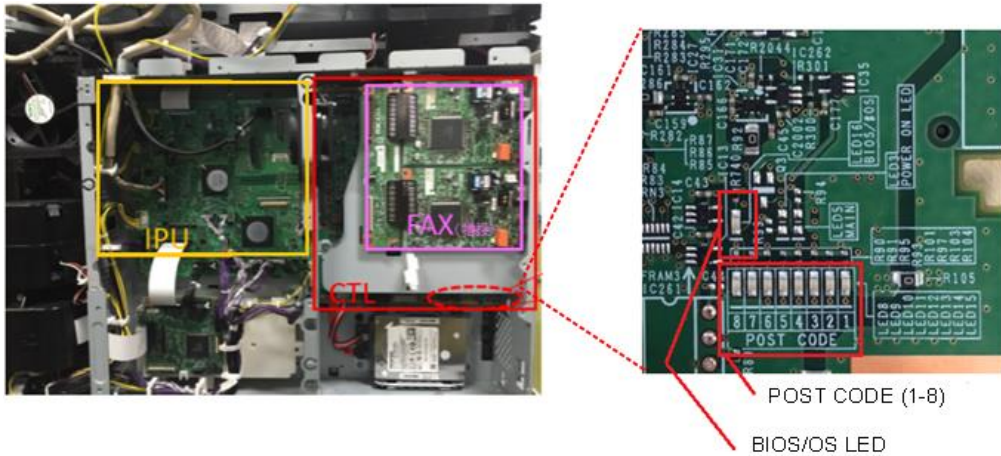

w_d238m1508a

Normal situation: POSTCODE LED 8 and BIOS LED blinking for 1 second

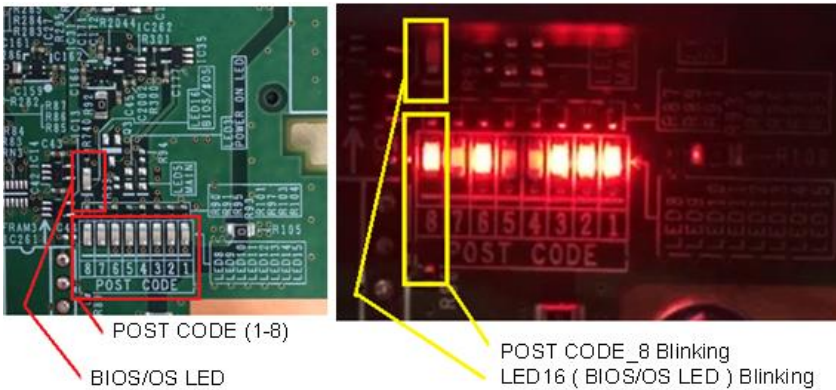

w_d238m1509a

No.	Note
LED	For CPU - POSTCODE 8 and LED16 blink when the CPU is operating normally. - POSTCODE 8 and LED16 is lit or off when there is a problem with the CPU.

[B]: Abnormal mode: LEDs on the controller board

LEDs 1 to 8 blink constantly



d238m1510a

No.	Note
POSTCOD E 1-8	1. For self-diagnosis code (BIOS). 2. After the BIOS starts up, LEDs 4,5,7 turn off and LEDs 1,2,3 ,6 turn on and LED 8 blinks . LED 8 is lit or off when there is a problem with the CPU.
LED 16	- LED is lit when the BIOS is running. - LED blinks when the OS is running.

[C]: Reconnecting and replacing the USB cable

1. Re-connect the USB cable between IPU board and operation panel.

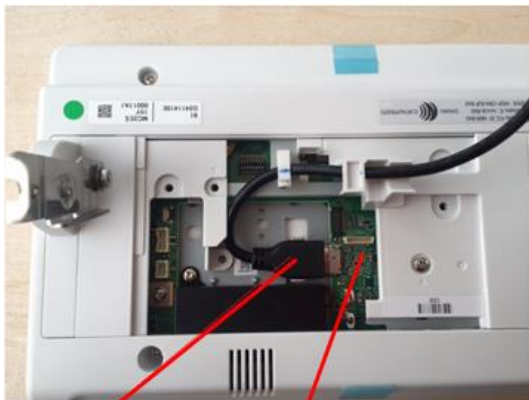

CABLE: OPERATION
SUB-UNIT:USB3.0

PCB:SUB:PROGRAM:ASS'Y

w_d238m1511a

When connecting the cable, hold the molded part of the cable as shown below so as not to apply excessive force on the connector part. Applying excessive force toward the upper direction on the connector may cause connection failure.

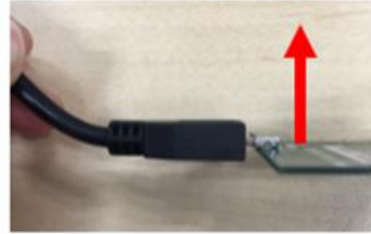

d238m0927a

Applied to machines built in October 2016 and later:

A bracket [A] which covers the upper part of the cable will be added.

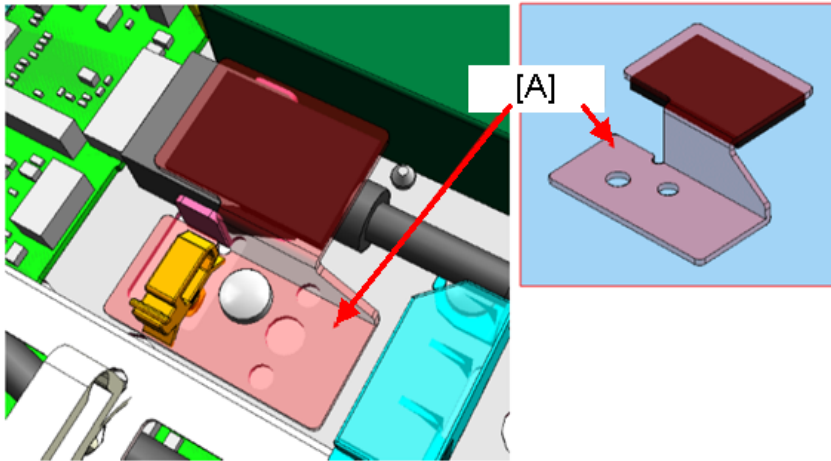

d238m0928a

PCB for the operation panel

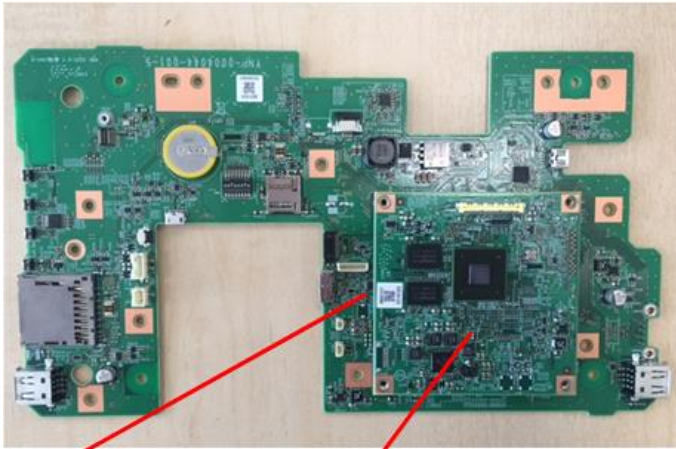

PCB:SUB:PROGRAM:ASS'Y PCB:MAIN:PROGRAM:ASS'Y
w_d238m1512a

USB connector [B] (IPU)

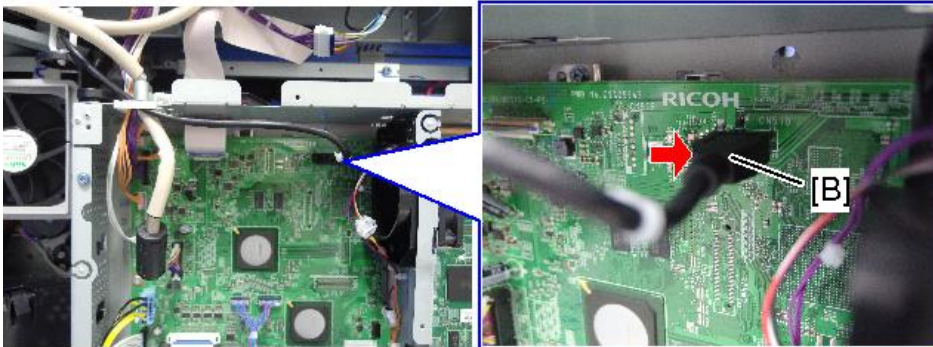

d238m0879

[D]: Replacing the Memory

1. Turn the machine power OFF.
2. Attach the memory on the CTL as shown (in a vertical orientation).



d238m1513a

3. Lock the hook.



d238m1514a

[E]: CMOS clear

1. Turn the machine power OFF.
2. Turn Dip switch 1-3 ON for 10 seconds
3. Turn Dip switch 1-3 OFF
4. Turn the machine power ON.

6

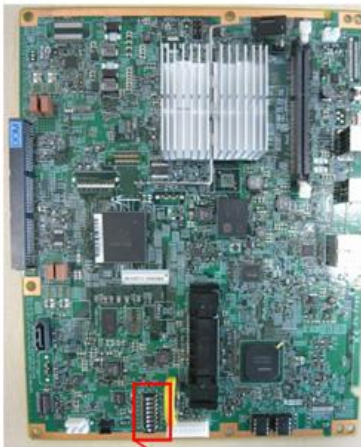

DipSW1

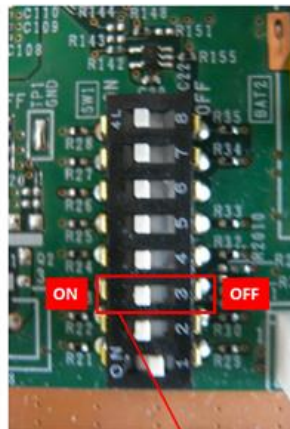

DipSW1-3 for CMOS CLEAR

w_d238m1515a

[F]: Fuse on the IPU

Fuse on the IPU



d238m1517a

[G]: Replacing the USB cable and the operation panel

1. Remove the Platen Cover, or ARDF/SPDF. (page 429)
2. Remove a screw at the scanner right cover.



 x1

d238m1300

3. Remove the scanner right cover [A]

Remove the hook at the upper part, and then slide the cover in the rear direction.

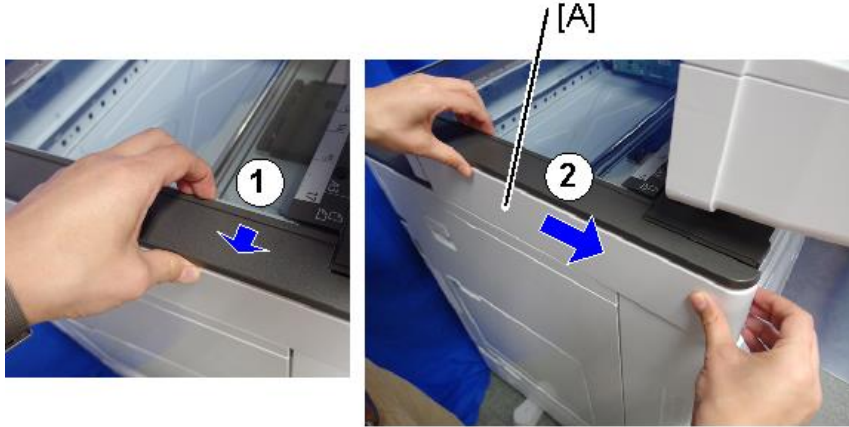

d238m 1301

4. Remove the scanner front cover [A]

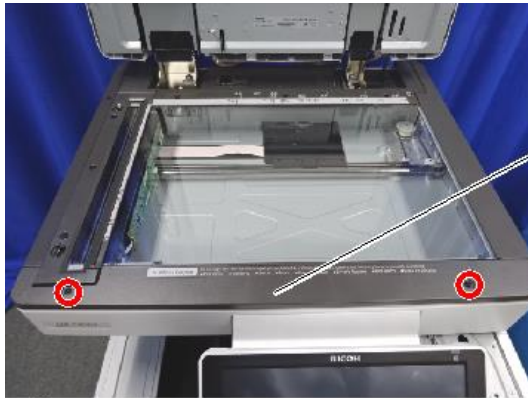

 x2

d238m 1026

5. Remove the scanner left cover [A]

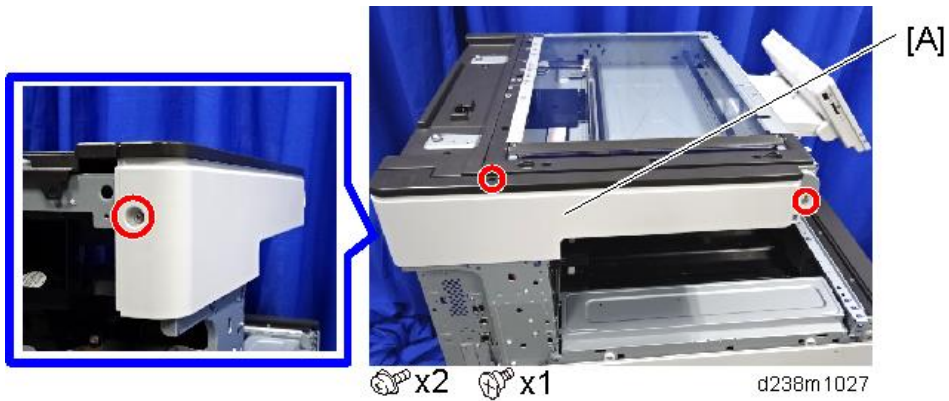

 x2  x1

d238m 1027

6. Holding down both the sides of the operation panel upper cover [A], unhook the tabs (indicated by blue circles) and remove the cover.

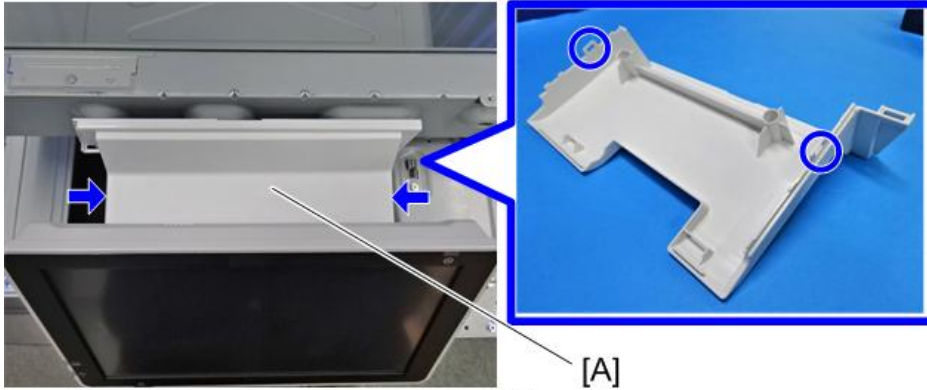

d238m1020

7. Remove the USB cable connector [A] (🔩 x1, 🛠️ x2).

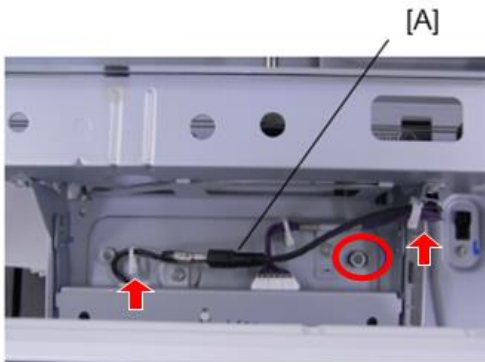

d238m1518a

8. Remove the two screws (🔩 x2).

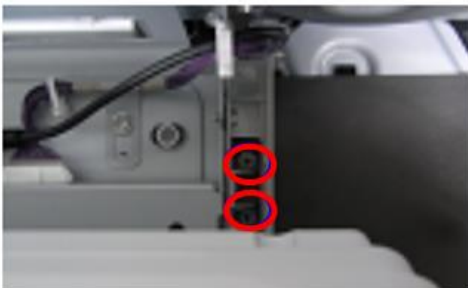

d238m1519a

9. Remove the two connectors (🔌 x2).

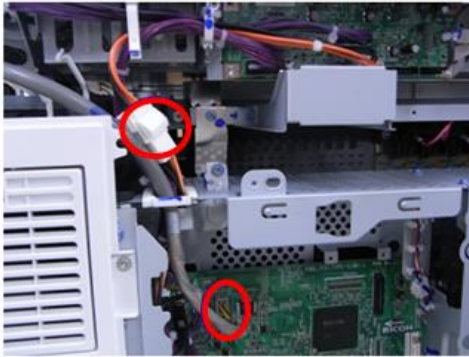

d238m1520a

10. Remove the scanner unit [A] (🔧 x11).

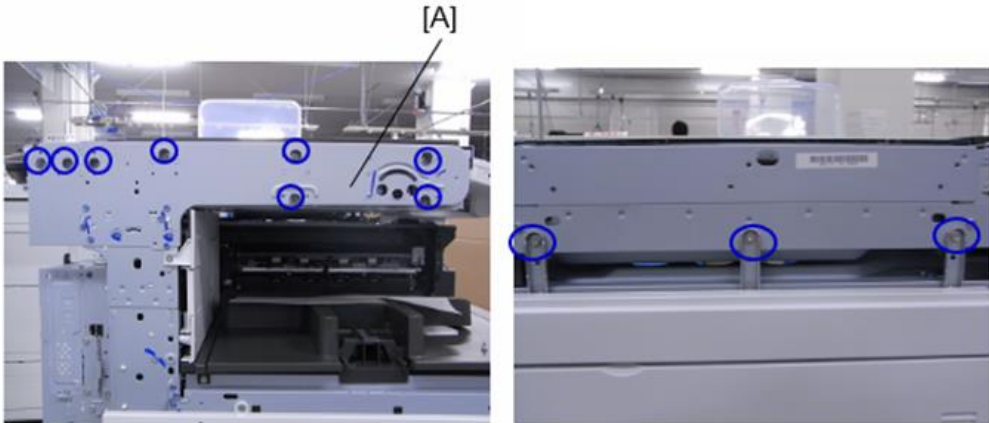

d238m1505a

↓ **Note**

- **Never loosen or remove** the following screw when you remove or re-attach the unit. This screw fixes the scanner cam in place. If the position of the scanner cam changes, the scanner will be misaligned. This will result in image skew and other image alignment issues.

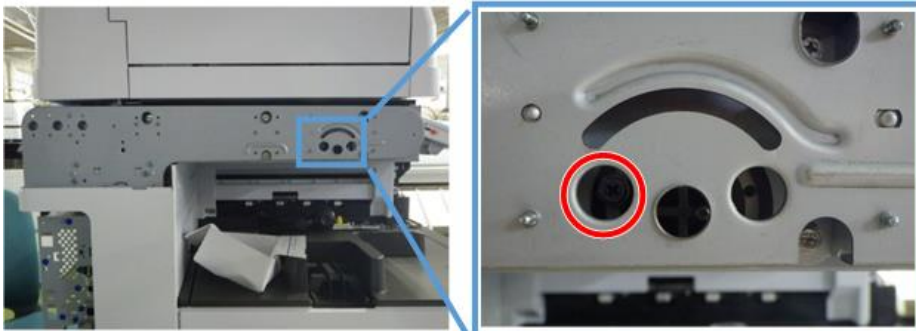

d238m1503a

11. Remove the USB cable (5x5)

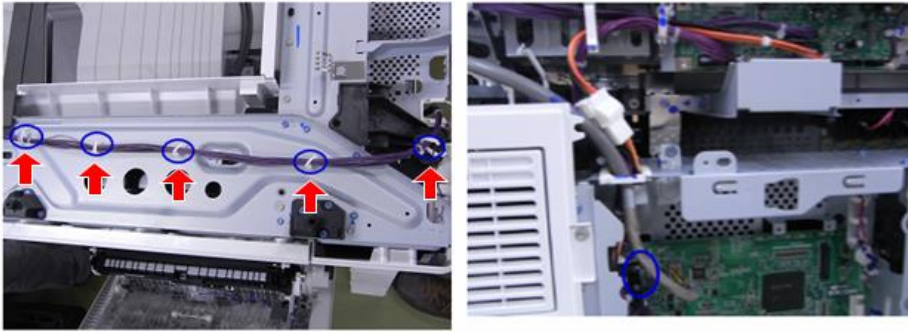

d238m1502a

Applied to machines built in May 2016 and later:

A clamp on the IPU [A] will be added.



d238m0929a

↓ Note

- Make sure that there is no space between the machine frame and the following three areas of the scanner unit when you re-attach the scanner unit.

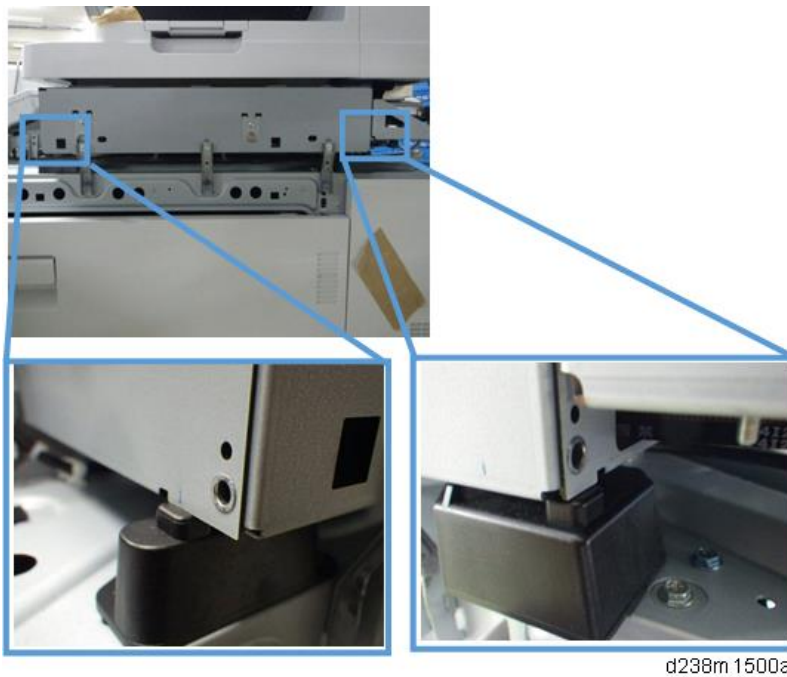
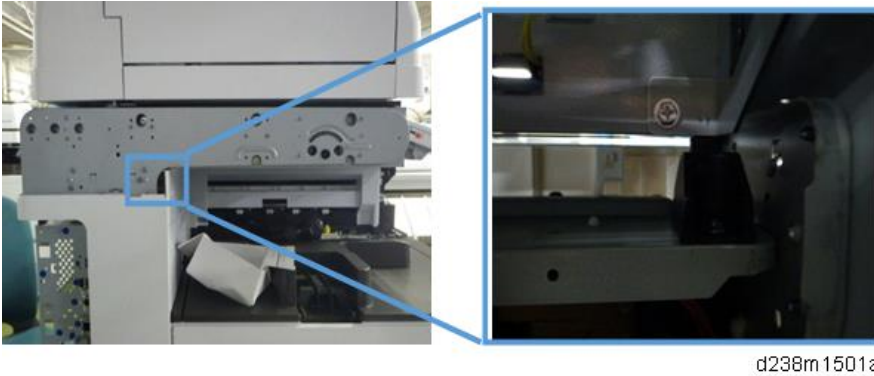

If the symptom is not resolved, escalate the issue using the normal process, together with the following information for further investigation.

- SC sub code (SC672-10 or 99)
- Date/time of problem occurrence
- Factor(s) that trigger the problem (ex. SC672-11 occurred 3 minutes after tuning ON the main power switch.)
- Occurrence frequency (ex. One out of ten times when turning ON the main power switch)
- Parts replaced
- Date/time when parts were replaced

When Abnormal Noise Occurs

When abnormal noise occurs during machine operating, identify the occurrence location, by using various OUTPUT Check. However, about the following two modules, follow the checking procedure flow.

- Check the abnormal noise of the drive unit (peripheral fusing)
- Check the abnormal noise when the toner is supplied or the bottle motor is driving

CAUTION

- Because the damage or contamination of parts can lead to secondary failure, always follow the procedure.
- Take particular care not to be caught in the rotating parts of the motors and/or gears.

Procedure of Checking Abnormal Noise of Drive Unit (Peripheral Fusing)

When the abnormal noise of drive unit (peripheral fusing) has occurred, follow the following flow, and check whether the fusing unit is the cause, by using SP1-153 (Abnormal Noise Confirmation).

If the fusing unit is the cause, replace the fusing unit. If the drive module is the cause, in addition perform the operation check of various motors by using OUTPUT Check, to identify which motor is the cause.

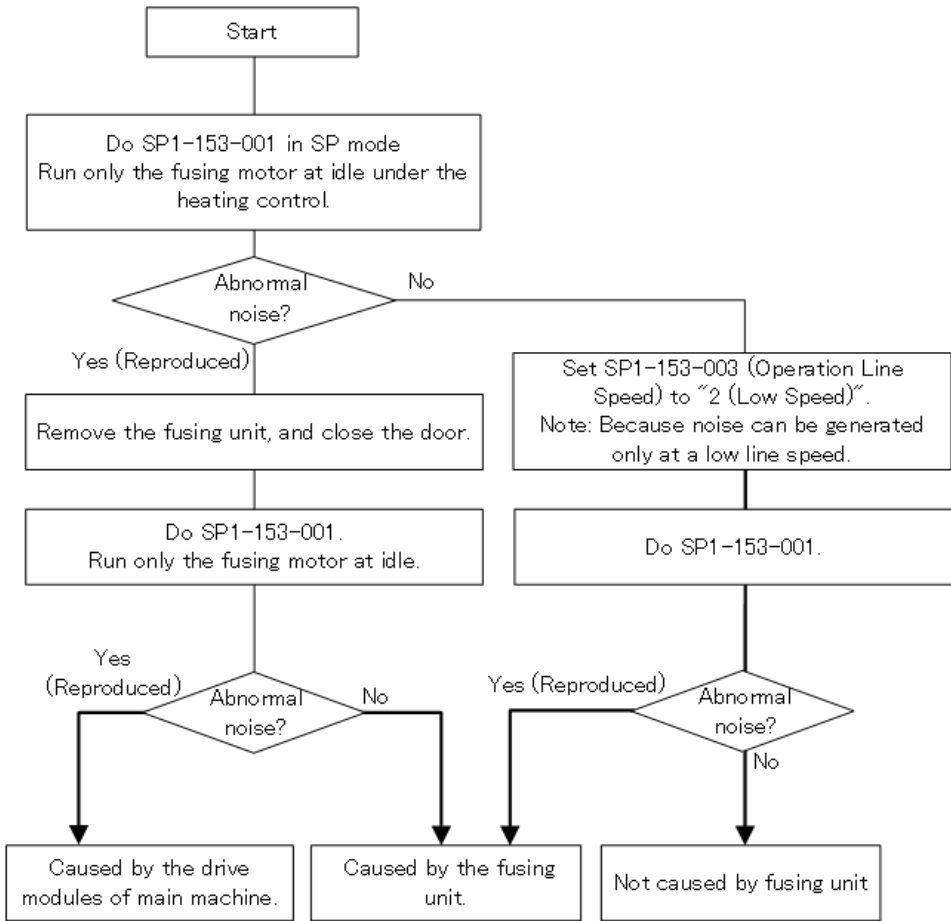

w_m0ajm0104_en

About the setting value of the operation line speed in SP1-153-003

During warming-up or operating on the operation panel, the motors rotate at low line speeds. At the time, if noise occurs, start checking from [2: Low Speed]. Middle speed is for only thick paper 1 printing, so use middle speed if abnormal noise occurs when thick paper 1 is supplied.

Related SP

SP No.	SP Name	Function	Description
SP1-153-001	Abnormal Noise Confirmation: Unit: Execute	The fusing motor rotates with the heating control.	Fails if the fusing unit is not installed or the cover is open
SP1-153-002	Abnormal Noise Confirmation: No Unit: Execute	The fusing motor rotates without the fusing unit.	Fails if the fusing unit is installed or the cover is open

SP No.	SP Name	Function	Description
SP1-153-003	Abnormal Noise Confirmation: Operation Line Speed	Line speed at the time of rotation 0: Standard speed 1: Middle speed 2: Low speed	
SP1-153-004	Abnormal Noise Confirmation: Operation Time	Rotates during this time. Initial value: 60 sec.	
SP1-153-005	Abnormal Noise Confirmation: Heat Center Target Temp	Temperature setting for SP1-153-001 (Unit: Execute)	Do not change
SP1-153-006	Abnormal Noise Confirmation: Heat End Target Temp	Temperature setting for SP1-153-001 (Unit: Execute)	
SP1-153-007	Abnormal Noise Confirmation: Press Target Temp	Temperature setting for SP1-153-001 (Unit: Execute)	

Operation Check Procedures of the Toner Supply Motor/Toner Bottle Drive Motor

The operation check of the toner supply motor and/or toner bottle drive motor, is performed by a forced toner supply, not OUTPUT Check.

CAUTION

- Operation other than the following procedures may occur the abnormal density, toner scattering, scumming, and cleaning failure at the image transfer unit.

1. Do [Force Tnr Supply :Exe (SP3-050-003 to 006)] for the applicable color twice. If there is enough toner in the toner supply unit, the toner bottle drive motor will not work.

SP No.	SP Name
SP3-050-003	Force Tnr Supply :Exe Execute: K
SP3-050-004	Force Tnr Supply :Exe Execute: C
SP3-050-005	Force Tnr Supply :Exe Execute: M

SP No.	SP Name
SP3-050-006	Force Tnr Supply :Exe Execute: Y

2. Do [Manual ProCon :Exe Density Adjustment (SP3-011-002)] once.

 **Note**

- If the operation of the toner bottle drive motor could not be checked, do step1 again after the manual execution of density adjustment.

Jam Detection

Jam Display

When a jam occurs, the cause position will blink.

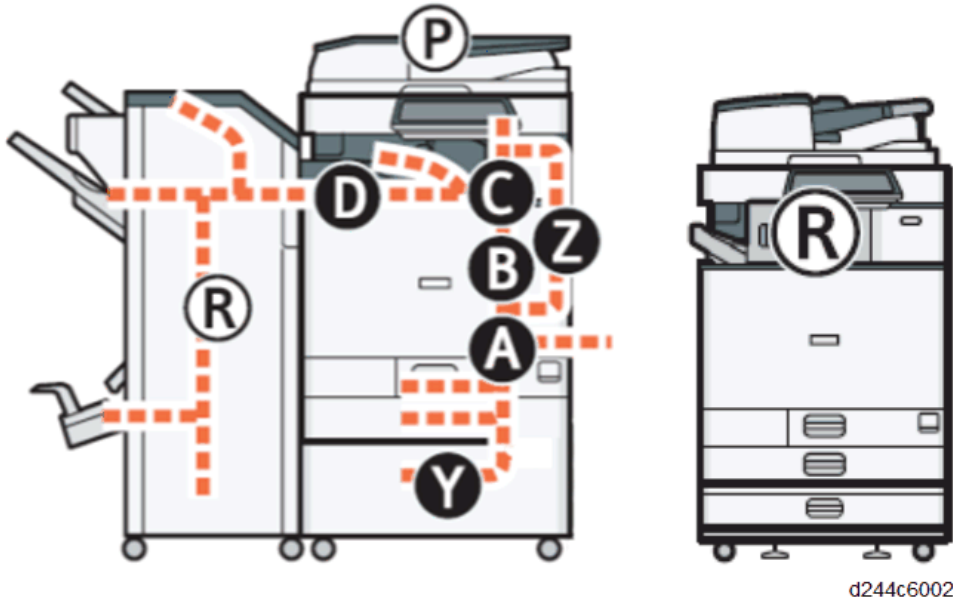

Clearing a Paper Jam

⚠ CAUTION

- Do not touch any components except the specified parts for removing jammed paper. Some parts can burn you because they become hot during operation.

↓ Note

- Do not turn the power off during removal of jammed paper. If you turned the power off, functions or values that were previously set will be deleted.
- Be sure not to tear paper up, and that you remove all pieces. Remaining scraps of paper in the machine could cause another paper jam or machine failure.
- If there are multiple jam locations, check all the locations that are displayed at the same time.

See the decals on the machine for how to remove jammed paper.

Paper Jam History

History Checking Method

Plotter (print engine) jam history can be displayed using SP7-507.

- SP7-507-001 "Plotter Jam: History Latest"
- SP7-507-002 "Plotter Jam: History Latest1"
- SP7-507-003 "Plotter Jam: History Latest2"
- SP7-507-004 "Plotter Jam: History Latest3"
- SP7-507-005 "Plotter Jam: History Latest4"
- SP7-507-006 "Plotter Jam: History Latest5"
- SP7-507-007 "Plotter Jam: History Latest6"
- SP7-507-008 "Plotter Jam: History Latest7"
- SP7-507-009 "Plotter Jam: History Latest8"
- SP7-507-010 "Plotter Jam: History Latest9"

Paper Jam Display

CODE	:	011
SIZE	:	005
TOTAL	:	0000334
DATE	:	Mon Jan 21 11:44:50 2008

- CODE: Indicates the jam code.
- SIZE: Indicates the paper size code.
- TOTAL: Indicates the total counter (SP7-502-001).
- DATE: Indicates the date when the jam occurred.

↓ Note

- The jam history of the 10 latest jams is displayed.
- The first jam is not included in the history record.

Jam Codes and Display Codes

↓ Note

- Cause code: Jam cause code displayed by log data

- Display code: Jam position displayed on control panel

Late jam

The paper has failed to arrive within the prescribed time due to a jam that has occurred upstream of the referenced sensor.

Lag jam

The paper has failed to leave the location of the referenced sensor within the prescribed time due to a jam downstream of the referenced sensor.

Stay jam

The paper is within the location of the referenced sensor.

ARDF DF3090

Cause code	Cause of jam	Late Jam	Lag Jam	Stay Jam	Display code
014	Skew Correction Sensor	✓			P
064	Skew Correction Sensor		✓		P
016	Registration Sensor	✓			P
066	Registration Sensor		✓		P
017	Exit Sensor	✓			P
067	Exit Sensor		✓		P
239	Misfeed: Original Removed			✓	P

SPDF DF3100

Cause code	Cause of jam	Late Jam	Lag Jam	Stay Jam	Display code
013	Separation Sensor	✓			P
063	Separation Sensor		✓		P
014	Skew Correction Sensor	✓			P
064	Skew Correction Sensor		✓		P
015	Pre-Scanning Entrance Sensor	✓			P
065	Pre-Scanning Entrance Sensor		✓		P

Cause code	Cause of jam	Late Jam	Lag Jam	Stay Jam	Display code
016	Registration Sensor	✓			P
066	Registration Sensor		✓		P
017	Exit Sensor	✓			P
067	Exit Sensor		✓		P
239	Misfeed: Original Removed			✓	P
001	Initial jam	✓			P
001	Overload jam	✓			P

Main Machine

Cause code	Cause of jam	Late Jam	Lag Jam	Stay Jam	Display code
001	Transport Sensor 1			✓	A
001	Transport Sensor 2			✓	A
001	Registration Sensor			✓	B
001	Fusing Entrance Sensor			✓	C
001	Fusing Exit Sensor			✓	C
001	Paper Exit Sensor			✓	C
001	Reverse Sensor			✓	C
001	Duplex Exit Sensor			✓	Z
001	Duplex Entrance Sensor			✓	Z
003	Paper not fed from tray 1	✓			A1
004	Paper not fed from tray 2	✓			A2
008	Paper not fed from bypass tray	✓			A
009	Paper not transported to duplex unit	✓			Z

Cause code	Cause of jam	Late Jam	Lag Jam	Stay Jam	Display code
096	Disappearance of the detection Timing Only remaining paper position information displayed				
011	Transport Sensor 1	✓			A
012	Transport Sensor 2	✓			A
017	Registration Sensor	✓			A
018	Fusing Entrance Sensor	✓			B
019	Fusing Exit Sensor	✓			C
020	Paper Exit Sensor	✓			C
051	Transport Sensor 1 (when paper not fed from Tray 1)		✓		A
052	Transport Sensor 2		✓		A
048	Transport Sensor 1 (when paper not fed from Bypass Tray)		✓		A
057	Registration Sensor		✓		B
060	Paper Exit Sensor		✓		C
024	Reverse Sensor	✓			C
064	Reverse Sensor		✓		C
025	Duplex Exit Sensor	✓			Z
025	Duplex Exit Sensor & No Paper at Duplex Entrance Sensor	✓			Z
065	Duplex Exit Sensor		✓		Z
027	Duplex Entrance Sensor	✓			C
027	Duplex Entrance Sensor & No Paper at Reverse Sensor	✓			Z
067	Duplex Entrance Sensor		✓		A

Paper Feed Unit PB3150

Cause code	Cause of jam	Late Jam	Lag Jam	Stay Jam	Display code
005	Paper not fed from tray 3	✓			Y1
013	Vertical Transport Sensor (Tray 3)	✓			Y
053	Vertical Transport Sensor (Tray 3)		✓		Y
001	Vertical Transport Sensor (Tray 3)			✓	Y

Paper Feed Unit PB3220/PB3210

Cause code	Cause of jam	Late Jam	Lag Jam	Stay Jam	Display code
005	Paper not fed from tray 3	✓			Y1
013	Vertical Transport Sensor (Tray 3)	✓			Y
053	Vertical Transport Sensor (Tray 3)		✓		Y
001	Vertical Transport Sensor (Tray 3)			✓	Y
006	Paper not fed from tray 4	✓			Y2
014	Vertical Transport Sensor (Tray 4)	✓			Y
054	Vertical Transport Sensor (Tray 4)		✓		Y
001	Vertical Transport Sensor (Tray 4)			✓	Y

Bridge Unit BU3070

Cause code	Cause of jam	Late Jam	Lag Jam	Stay Jam	Display code
021	Paper Exit Sensor (Bridge Unit)	✓			D
022	Relay Transport Sensor (Bridge Unit)	✓			D
061	Paper Exit Sensor (Bridge Unit)		✓		D
062	Relay Transport Sensor (Bridge Unit)		✓		D

Internal Finisher SR3130

Cause code	Cause of jam	Late Jam	Lag Jam	Stay Jam	Display code
100	Inlet Sensor	✓			R1-R2
101	Inlet Sensor		✓		R1-R2
102	Transport sensor	✓			R1-R2
103	Transport sensor		✓		R1-R2
104	Paper Exit Unit		✓		R1-R2
105	Jogger fence motor (front)			✓	R1-R2
106	Jogger fence motor (rear)			✓	R1-R2
107	Shift Roller Motor			✓	R1-R2
108	Positioning Roller Motor			✓	R1-R2
109	Paper Exit Guide Plate Open/Close Motor			✓	R1-R2
110	Stapler Retreat Motor			✓	R1-R2
111	Shift Tray Ascent/Descent Motor			✓	R1-R2
112	Stapler Motor			✓	R1-R2
113	Paper Press Motor			✓	R1-R2
114	Punch Motor			✓	R1-R2
115	Punch Displacement Motor			✓	R1-R2
116	Horizontal Registration Displacement Motor			✓	R1-R2
148	Paper exit end not responding			✓	R1-R2
149	Main instruction data defect			✓	R1-R2

Booklet Finisher SR3220

Cause code	Cause of jam	Late Jam	Lag Jam	Stay Jam	Display code
200	Paper Entrance	✓			R1-R4

Cause code	Cause of jam	Late Jam	Lag Jam	Stay Jam	Display code
201	Paper Entrance		✓		R1-R4
202	Proof Exit	✓			R1-R4
203	Proof Exit		✓		R1-R4
204	Intermediate transport (right)	✓			R1-R4
205	Intermediate transport (left)	✓			R1-R4
206	Intermediate transport (left)		✓		R1-R4
207	Shift Exit	✓			R1-R4
208	Shift Exit		✓		R1-R4
209	Stack Transport	✓			R5-R10
210	Rear Edge Stopper Transport	✓			R5-R10
211	Rear Edge Stopper Transport		✓		R5-R10
212	Paper did not reach middle folding exit	✓			R5-R10
213	Middle Folding exit		✓		R5-R10
220	Jam in inlet transport motor	✓	✓	✓	R1-R4
221	Jam in proof transport motor	✓	✓	✓	R1-R4
222	Jam in exit transport/positioning/approach roller motor	✓	✓	✓	R1-R4
223	Jam in shift motor	✓	✓	✓	R1-R4
224	Jam in jogger motor	✓	✓	✓	R1-R4
225	Jam in exit guide plate open/close motor	✓	✓	✓	R1-R4
226	Jam release motor	✓	✓	✓	R1-R4
227	Jam in tray ascent/descent motor	✓	✓	✓	R1-R4
228	Jam in positioning roller motor	✓	✓	✓	R1-R4
229	Jam in stapler retreat motor	✓	✓	✓	R1-R4

Cause code	Cause of jam	Late Jam	Lag Jam	Stay Jam	Display code
230	Jam in stapler motor	✓	✓	✓	R1-R4
231	Jam in punch system motor	✓	✓	✓	R1-R4
232	Jam in stack transport motor	✓	✓	✓	R5-R10
233	Jam in rear edge stopper motor	✓	✓	✓	R5-R10
234	Jam in folding brade motor	✓	✓	✓	R5-R10
235	Jam in paper exit guide drive motor	✓	✓	✓	R1-R4
236	Jam in stapleless stapler transfer motor	✓	✓	✓	R1-R4
237	Jam in staple motor (stapleless)	✓	✓	✓	R1-R4
238	Jam in paper guide motor	✓	✓	✓	R1-R4
248	Paper exit end is not responding	✓	✓	✓	R1-R4
249	Main instruction data defect	✓	✓	✓	R1-R4

Internal Finisher SR3180

Cause code	Cause of jam	Late Jam	Lag Jam	Stay Jam	Display code
300	Entrance sensor	✓			R
301	Entrance sensor		✓		R
302	Paper exit sensor	✓			R
303	Paper exit sensor		✓		R
304	Shift motor			✓	R
305	Junction gate motor			✓	R
306	Paper exit pressure release motor			✓	R
307	Stapler motor			✓	R
348	Paper exit end not responding			✓	R

Paper Size Code

Size Code	Paper Size	Size Code	Paper Size
005	A4 LEF	141	B4 SEF
006	A5 LEF	142	B5 SEF
014	B5 LEF	160	DLT SEF
038	LT LEF	164	LG SEF
044	HLT LEF	166	LT SEF
132	A3 SEF	172	HLT SEF
133	A4 SEF	255	Others
134	A5 SEF		

Sensor Locations

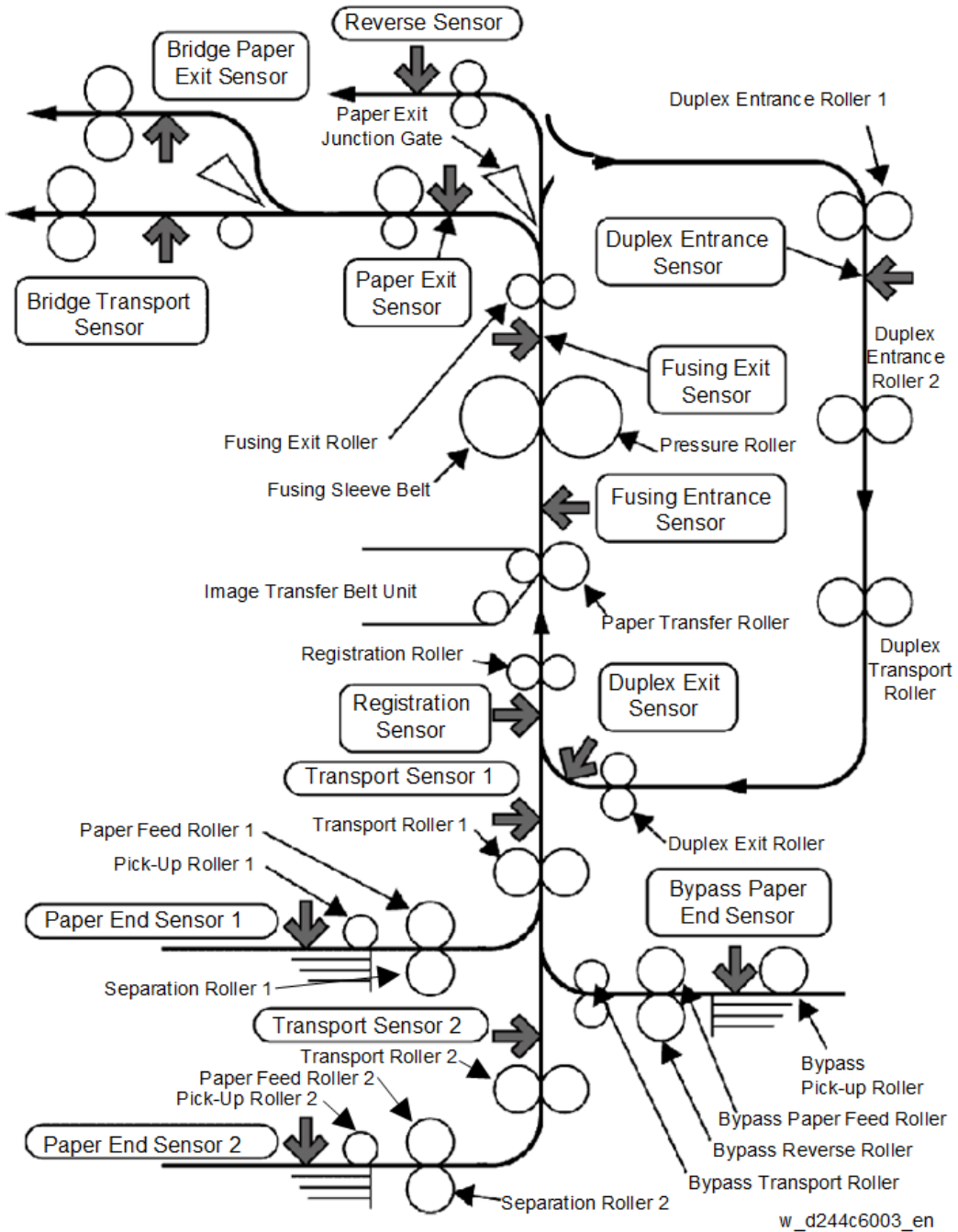

Troubleshooting for Transport/Paper Feeding of the Machine

Curled Paper

Make sure that the following SPs are set to their default values, and keep them at these values at all time.

- **SP1-113-001 (Curl Correction): Keep at default value of 0 (OFF)**
This is because printing productivity drops to about 65 to 80% when this SP is ON. It is not effective in reducing curl on these models.
- **SP1-115-xxx (Print Target Temp): Keep at default value.**
This is because fusing offset may occur when the fusing temperature is reduced. This SP is not effective for improving image quality on these models.

Solution:

Installing the tray heaters for the mainframe paper bank and optional paper banks. (page 119 "Anti-Condensation Heater for Paper Feed Trays")

6

Initial Jam

If the error occurs periodically, do the following steps. If the result is as shown in the "Problem Judgement" column, follow the solutions.

Initial Jam: Cause Code 001 / Location Code A

Target Part/SP No.: Transport Sensor (1st Feed Tray) / SP5-803-003 (Transport Sensor 1)

Cause verification	Problem Judgement
Execute an INPUT check when there is no paper at the position of the referenced sensor.	0: Paper detected
Execute an INPUT check when there is paper at the position of the referenced sensor.	1: Paper not detected

Solution:

- Clean the sensor.
- Reconnect the connector.
- Replace the sensor.

- Replace the Paper Transport IOB.
- Replace the harness.

Target Part/SP No.: Transport Sensor (2nd Feed Tray) / SP5-803-005 (Transport Sensor 2)

Cause verification	Problem Judgement
Execute an INPUT check when there is no paper at the position of the referenced sensor.	0: Paper detected
Execute an INPUT check when there is paper at the position of the referenced sensor.	1: Paper not detected

Solution:

- Clean the sensor.
- Reconnect the connector.
- Replace the sensor.
- Replace the Paper Transport IOB.
- Replace the harness.

Initial Jam: Cause Code 001 / Location Code B

Target Part/SP No.: Registration Sensor / SP5-803-001

Cause verification	Problem Judgement
Execute an INPUT check when there is no paper at the position of the referenced sensor.	0: Paper detected
Execute an INPUT check when there is paper at the position of the referenced sensor.	1: Paper not detected

Solution:

- Clean the sensor.
- Reconnect the connector.
- Replace the sensor.
- Replace the Paper Transport IOB.
- Replace the harness.

Initial Jam: Cause Code 001 / Location Code C

Target Part/SP No.: Fusing Entrance Sensor / SP5-803-006

Cause verification	Problem Judgement
Execute an INPUT check when there is no paper at the position of the referenced sensor.	0: Paper detected
Execute an INPUT check when there is paper at the position of the referenced sensor.	1: Paper not detected

Solution:

- Clean the sensor.
- Reconnect the connector.
- Replace the sensor.
- Replace the Paper Transport IOB.
- Replace the harness.

Target Part/SP No.: Fusing Exit Sensor / SP5-803-007

Cause verification	Problem Judgement
Execute an INPUT check when there is no paper at the position of the referenced sensor.	0: Paper detected
Execute an INPUT check when there is paper at the position of the referenced sensor.	1: Paper not detected

Solution:

- Clean the sensor.
- Reconnect the connector.
- Replace the sensor.
- Replace the Paper Transport IOB.
- Replace the harness.

Target Part/SP No.: Paper Exit Sensor / SP5-803-008

Cause verification	Problem Judgement
Execute an INPUT check when there is no paper at the position of the referenced sensor.	0: Paper detected

Execute an INPUT check when there is paper at the position of the referenced sensor.	1: Paper not detected
--	-----------------------

Solution:

- Clean the sensor.
- Reconnect the connector.
- Replace the sensor.
- Replace the Paper Transport IOB.
- Replace the harness.

Target Part/SP No.: Reverse Sensor / SP5-803-009 (Inverter Sensor)

Cause verification	Problem Judgement
Execute an INPUT check when there is no paper at the position of the referenced sensor.	0: Paper detected
Execute an INPUT check when there is paper at the position of the referenced sensor.	1: Paper not detected

Solution:

- Clean the sensor.
- Reconnect the connector.
- Replace the sensor.
- Replace the Paper Transport IOB.
- Replace the harness.

Initial Jam: Cause Code 001 / Location Code Z

Target Part/SP No.: Duplex Entrance Sensor / SP5-803-011

Cause verification	Problem Judgement
Execute an INPUT check when there is no paper at the position of the referenced sensor.	0: Paper detected
Execute an INPUT check when there is paper at the position of the referenced sensor.	1: Paper not detected

Solution:

- Clean the sensor.

- Reconnect the connector.
- Replace the sensor.
- Replace the Paper Transport IOB.
- Replace the harness.

Target Part/SP No.: Duplex Exit Sensor / SP5-803-010

Cause verification	Problem Judgement
Execute an INPUT check when there is no paper at the position of the referenced sensor.	0: Paper detected
Execute an INPUT check when there is paper at the position of the referenced sensor.	1: Paper not detected

Solution:

- Clean the sensor.
- Reconnect the connector.
- Replace the sensor.
- Replace the Paper Transport IOB.
- Replace the harness.

Jam

If the error occurs periodically, do the following steps. If the result is as shown in the "Problem Judgement" column, follow the solutions.

Bypass No Feeding: Cause Code 008

Target Part/SP No.:Bypass/Duplex motor / SP5-804-071 (Duplex Bypass Motor: CW: Standard Speed)

Cause verification	Problem Judgement
Turn the referenced motor OFF with OUTPUT	Drive sound heard
Turn the referenced motor ON with OUTPUT	Drive sound not heard

Solution:

- Reconnect the connector.
- Replace the motor.

- Replace the Paper Transport IOB.
- Replace the harness.
- Replace the harness.

Checking paper status, pick-up roller, feed roller, and friction roller for bypass tray

Check the paper position (Check whether or not the leading edge of the paper, side paper guide, and end paper guide are positioned according to the manual.)	<ul style="list-style-type: none"> • Check the paper orientation. • Turn the paper in the feed tray upside down.
Check if the paper has reached the maximum stackable limit of the side paper guide.	Reduce the paper to below the stackable limit.
Check if the sheets are stuck to each other due to edge roughness, coating, stain, or temperature.	Fan the paper
Check if extra thin paper or thick paper exceeding the supported paper thickness is being used.	Use a supported paper type.
Check if the paper thickness and size are detected correctly.	Set the paper thickness and size to the correct value.
Check if the paper being used produces a lot of paper dust.	Change the paper type (if possible).
Check if the paper roller is stained with paper dust.	Clean the pick-up roller, feed roller, and friction roller for bypass tray.

Tray 1 Transport Sensor: Late Jam : Cause Code 011

Target Part/SP No.:Transport Sensor (1st Feed Tray) / SP5-803-003 (Transport Sensor 1)

Cause verification	Problem Judgement
Execute an INPUT check when there is no paper at the position of the referenced sensor.	0: Paper detected
Execute an INPUT check when there is paper at the position of the referenced sensor.	1: Paper not detected

Solution:

- Clean the sensor.
- Reconnect the connector.
- Replace the sensor.
- Replace the Paper Transport IOB.

- Replace the harness.

Target Part/SP No.:Bypass pick-up Solenoid / SP5-803-016 (Bypass Pickup Solenoid)

Cause verification	Problem Judgement
Turn the referenced solenoid OFF with OUTPUT check	Drive sound heard
Turn the referenced solenoid ON with OUTPUT check	Drive sound not heard

Solution:

- Reconnect the connector.
- Replace the solenoid.
- Replace the Paper Transport IOB.
- Replace the harness.

Checking paper status, pick-up roller, feed roller, and friction roller for 1st feed tray

Check the paper position (Check whether or not the leading edge of the paper, side paper guide, and end paper guide are positioned according to the manual.)	<ul style="list-style-type: none"> • Check the paper orientation. • Turn the paper in the feed tray upside down.
Check if the paper has reached the maximum stackable limit of the side paper guide.	Reduce the paper to below the stackable limit.
Check if the sheets are stuck to each other due to edge roughness, coating, stain, or temperature.	Fan the paper
Check if extra thin paper or thick paper exceeding the supported paper thickness is being used.	Use a supported paper type.
Check if the paper thickness and size are detected correctly.	Set the paper thickness and size to the correct value.
Check if the paper being used produces a lot of paper dust.	Change the paper type (if possible).
Check if the paper roller is not stained with paper dust.	Clean the pick-up roller, feed roller, and friction roller for 1st feed tray.

Tray 2 Transport Sensor : Late Jam : Cause Code 012

Target Part/SP No.:Transport Sensor (2nd Feed Tray) / SP5-803-005 (Transport Sensor 2)

Cause verification	Problem Judgement
Execute an INPUT check when there is no paper at the position of the referenced sensor.	0 :Paper detected
Execute an INPUT check when there is paper at the position of the referenced sensor.	1: Paper not detected

Solution:

- Clean the sensor.
- Reconnect the connector.
- Replace the sensor.
- Replace the Paper Transport IOB.
- Replace the harness.

Checking paper status, pick-up roller, feed roller, and friction roller for 2nd feed tray

Check the paper position (Check whether or not the leading edge of the paper, side paper guide, and end paper guide are positioned according to the manual.)	<ul style="list-style-type: none"> • Check the paper orientation. • Turn the paper in the feed tray upside down.
Check if the paper has reached the maximum stackable limit of the side paper guide.	Reduce the paper to below the stackable limit.
Check if the sheets are stuck to each other due to edge roughness, coating, stain, or temperature.	Fan the paper.
Check if extra thin paper or thick paper exceeding the supported paper thickness is being used.	Use a supported paper type.
Check if the paper thickness and size are detected correctly.	Set the paper thickness and size to the correct value.
Check if the paper being used produces a lot of paper dust.	Change the paper type (if possible).
Check if the paper roller is not stained with paper dust.	Clean the pick-up roller, feed roller, and friction roller for 2nd feed tray.

Registration Sensor : Late Jam : Cause Code 017

Target Part/SP No.:Registration Sensor / SP5-803-001

Cause verification	Problem Judgement
Execute an INPUT check when there is no paper at the position of the referenced sensor.	0 :Paper detected
Execute an INPUT check when there is paper at the position of the referenced sensor.	1 : Paper not detected

Solution:

- Clean the sensor.
- Reconnect the connector.
- Replace the sensor.
- Replace the Paper Transport IOB.
- Replace the harness.

6

Checking paper status, or 1st paper transport roller.

Check if extra thin paper or thick paper exceeding the supported paper thickness is being used.	Use a supported paper type.
Check if the paper thickness and size are detected correctly.	Set the paper thickness and size to the correct value.
Check if the paper feed tray is not stained with a lot of paper dust.	Clean the 1st transport roller.

Fusing Entrance Sensor : Late Jam : Cause Code 018

Target Part/SP No.:Fusing Entrance Sensor / SP5-803-011

Cause verification	Problem Judgement
Execute an INPUT check when there is no paper at the position of the referenced sensor.	0 :Paper detected
Execute an INPUT check when there is paper at the position of the referenced sensor.	1 : Paper not detected

Solution:

- Clean the sensor.

- Reconnect the connector.
- Replace the sensor.
- Replace the Paper Transport IOB.
- Replace the harness.

Target Part/SP No.: PCU Motor: Black / ITB Drive Motor / SP5-804-136 (Transfer Drum Motor K: Standard Speed)

Cause verification	Problem Judgement
Turn the referenced motor OFF with OUTPUT check	Drive sound heard
Turn the referenced motor ON with OUTPUT check	Drive sound not heard

Solution:

- Reconnect the connector.
- Replace the motor.
- Replace the Imaging IOB.
- Replace the harness.

Checking paper jam, or paper transfer unit

Check if there is no double feeding.	Fan the paper.
Check the edges of the discharge plate to see if it is deformed or broken.	Reattach or replace the discharge plate.

Fusing Exit Sensor : Late Jam : Cause Code 019

Target Part/SP No.:Fusing Exit Sensor / SP5-803-011 (Duplex Entrance Sensor)

Cause verification	Problem Judgement
Execute an INPUT check when there is no paper at the position of the referenced sensor.	0 :Paper detected
Execute an INPUT check when there is paper at the position of the referenced sensor.	1: Paper not detected

Solution:

- Clean the sensor.
- Reconnect the connector.
- Replace the sensor.

- Replace the Paper Transport IOB.
- Replace the harness.

Target Part/SP No.: Fusing Motor / SP5-804-092 (Fusing Motor: CW: Standard Speed)

Cause verification	Problem Judgement
Turn the referenced motor OFF with OUTPUT check	Drive sound heard
Turn the referenced motor ON with OUTPUT check	Drive sound not heard

Solution:

- Reconnect the connector.
- Replace the motor.
- Replace the Imaging IOB.
- Replace the harness.

Checking paper jam, or paper transfer unit

Check if there is double feeding.	Fan the paper.
Check if the margin of the leading edge of paper is too narrow.	Adjust the margin at the leading edge of paper with SPs.
Check if the paper is a non-recommended type, e.g., inkjet paper.	Replace the paper.
Check if the gap between the fusing stripper plate and fusing belt is too wide, caused by deformation of the plate.	Replace the fusing stripper plate.
Check if there is toner and/or paper dust on the surfaces of the fusing belt and pressure roller.	Clean the fusing belt.
Check if the setting values, e.g. fusing temperature, are higher than the initial values.	Reset the SP values to the initial values.

Paper Exit Sensor : Late Jam : Cause Code 020
Target Part/SP No.: Paper Exit Sensor / SP5-803-008

Cause verification	Problem Judgement
Execute an INPUT check when there is no paper at the position of the referenced sensor.	0 :Paper detected
Execute an INPUT check when there is paper at the position of the referenced sensor.	1: Paper not detected

Solution:

- Clean the sensor.
- Reconnect the connector.
- Replace the sensor.
- Replace the Paper Transport IOB.
- Replace the harness.

Target Part/SP No.:Paper Exit Solenoid / SP5-804-004 (Exit Junction Solenoid)

Cause verification	Problem Judgement
Turn the referenced solenoid OFF with OUTPUT check	Drive sound heard
Turn the referenced solenoid ON with OUTPUT check	Drive sound not heard

Solution:

- Reconnect the connector.
- Replace the solenoid.
- Replace the Paper Transport IOB.
- Replace the harness.

Checking paper jam, or paper status

Check if the leading edge of the paper and the paper feed guide are wet.	If condensation has occurred inside the machine, leave the machine idle for a few minutes to remove condensation.
Check if the paper is curled too much.	If the paper is curled too much, switch on the anti-condensation heater for paper tray.
Check if extra thin paper or thick paper exceeding the supported paper thickness is being used.	Use a supported paper type.
Check if the paper thickness and size are detected correctly.	Set the paper thickness and size to the correct value.

Tray 1 Transport Sensor : Lag Jam : Cause Code 051

Target Part/SP No.:Transport Sensor (1st Feed Tray) / SP5-803-003 (Transport Sensor 1)

Cause verification	Problem Judgement
Execute an INPUT check when there is no paper at the position of the referenced sensor.	0 :Paper detected
Execute an INPUT check when there is paper at the position of the referenced sensor.	1: Paper not detected

Solution:

- Clean the sensor.
- Reconnect the connector.
- Replace the sensor.
- Replace the Paper Transport IOB.
- Replace the harness.

Target Part/SP No.:Paper Feed Motor / SP5-804-016 (Feed Motor:CW:Standard Speed)

Cause verification	Problem Judgement
Turn the referenced motor OFF with OUTPUT check	Drive sound heard
Turn the referenced motor ON with OUTPUT check	Drive sound not heard

Solution:

- Reconnect the connector.
- Replace the motor.
- Replace the Paper Transport IOB.
- Replace the harness.

Target Part/SP No.: Transport Motor / SP5-804-028

Cause verification	Problem Judgement
Turn the referenced motor OFF with OUTPUT check	Drive sound heard
Turn the referenced motor ON with OUTPUT check	Drive sound not heard

Solution:

- Reconnect the connector.
- Replace the motor.

- Replace the Paper Transport IOB.
- Replace the harness.

Target Part/SP No.:Reverse Motor / SP5-804-047 (Inverter Motor: CW:Standard Speed)

Cause verification	Problem Judgement
Turn the referenced motor OFF with OUTPUT check	Drive sound heard
Turn the referenced motor ON with OUTPUT check	Drive sound not heard

Solution:

- Reconnect the connector.
- Replace the motor.
- Replace the Paper Transport IOB.
- Replace the harness.

Target Part/SP No.:Bypass Length Sensor / SP5-803-024 (By-pass: Sub Scan Length Sensor)

Cause verification	Problem Judgement
Execute an INPUT check when there is no paper at the position of the referenced sensor.	1: Paper detected
Execute an INPUT check when there is paper at the position of the referenced sensor.	0: Paper not detected

Solution:

- Clean the sensor.
- Reconnect the connector.
- Replace the sensor.
- Replace the Paper Transport IOB.
- Replace the harness.

Checking paper jam, or paper status

Check the paper position (Check whether or not the leading edge of the paper, side paper guide, and end paper guide are positioned according to the manual.)	<ul style="list-style-type: none"> • Check the paper orientation. • Turn the paper in the feed tray upside down.
Check if the paper has reached the maximum stackable limit of the side paper guide.	Reduce the paper to below the stackable limit.

Check if extra thin paper or thick paper exceeding the supported paper thickness is being used.	Use a supported paper type.
Check if the paper thickness and size are detected correctly.	Set the paper thickness and size to the correct value.
Check if the paper being used produces a lot of paper dust.	Change the paper type (if possible).
Check if there is no double feeding.	Fan the paper.
Check if the paper feed tray is not stained with a lot of paper dust.	Clean the paper feed tray.
Check if the paper roller is not stained with paper dust.	Clean the pick-up roller, feed roller, and friction roller for 1st feed tray.

Tray 2 Transport Sensor: Lag Jam: Cause Code 052

6

Target Part/SP No.: Transport Sensor (2nd Feed Tray) / SP5-803-005 (Transport Sensor 2)

Cause verification	Problem Judgement
Execute an INPUT check when there is no paper at the position of the referenced sensor.	0 : Paper detected
Execute an INPUT check when there is paper at the position of the referenced sensor.	1 : Paper not detected

Solution:

- Clean the sensor.
- Reconnect the connector.
- Replace the sensor.
- Replace the Paper Transport IOB.
- Replace the harness.

Target Part/SP No.: Paper Feed Motor / SP5-804-016 (Feed Motor: CW: Standard Speed)

Cause Verification	Problem Judgement
Turn the referenced motor OFF with OUTPUT check	Drive sound heard
Turn the referenced motor ON with OUTPUT check	Drive sound not heard

Solution:

- Clean the sensor.
- Reconnect the connector.
- Replace the sensor.
- Replace the Paper Transport IOB.
- Replace the harness.

Target Part/SP No.: Transport Motor / SP5-804-028

Cause verification	Problem Judgement
Turn the referenced motor OFF with OUTPUT check	Drive sound heard
Turn the referenced motor ON with OUTPUT check	Drive sound not heard

Solution:

- Reconnect the connector.
- Replace the motor.
- Replace the Paper Transport IOB.
- Replace the harness.

Checking paper jam, or paper status

Check the paper position (Check whether or not the leading edge of the paper, side paper guide, and end paper guide are positioned according to the manual.)	<ul style="list-style-type: none"> • Check the paper orientation. • Turn the paper in the feed tray upside down.
Check if the paper has reached the maximum stackable limit of the side paper guide.	Reduce the paper to below the stackable limit.
Check if extra thin paper or thick paper exceeding the supported paper thickness is being used.	Use a supported paper type.
Check if the paper thickness and size are detected correctly.	Set the paper thickness and size to the correct value.
Check if the paper being used produces a lot of paper dust.	Change the paper type (if possible).
Check if there is no double feeding.	Fan the paper.
Check if the paper feed tray is not stained with a lot of paper dust.	Clean the paper feed tray.
Check if the paper roller is not stained with paper dust.	Clean the pick-up roller, feed roller, and friction roller for 2nd feed tray.

Registration Sensor: Lag Jam: Cause Code 057

Target Part/SP No.:Registration Sensor / SP5-803-001

Cause verification	Problem Judgement
Execute an INPUT check when there is no paper at the position of the referenced sensor.	0 :Paper detected
Execute an INPUT check when there is paper at the position of the referenced sensor.	1 : Paper not detected

Solution:

- Clean the sensor.
- Reconnect the connector.
- Replace the sensor.
- Replace the Paper Transport IOB.
- Replace the harness.

Target Part/SP No.: Bypass/Duplex Motor / SP5-804-071 (Duplex Bypass Motor: CW: Standard Speed)

Cause verification	Problem Judgement
Turn the referenced motor OFF with OUTPUT check	Drive sound heard
Turn the referenced motor ON with OUTPUT check	Drive sound not heard

Solution:

- Reconnect the connector.
- Replace the motor.
- Replace the Paper Transport IOB.
- Replace the harness.

Target Part/SP No.:Reverse Motor / SP5-804-047 (Inverter Motor: CW: Standard Speed)

Cause verification	Problem Judgement
Turn the referenced motor OFF with OUTPUT check	Drive sound heard
Turn the referenced motor ON with OUTPUT check	Drive sound not heard

Solution:

- Reconnect the connector.

- Replace the motor.
- Replace the Paper Transport IOB.
- Replace the harness.

Checking paper jam, or paper status

Check if there is no double feeding.	Fan the paper.
--------------------------------------	----------------

Paper Exit Sensor: Lag Jam: Cause Code 060

Target Part/SP No.: Paper Exit Sensor / SP5-803-008

Cause verification	Problem Judgement
Execute an INPUT check when there is no paper at the position of the referenced sensor.	0 :Paper detected
Execute an INPUT check when there is paper at the position of the referenced sensor.	1 : Paper not detected

Solution:

- Clean the sensor.
- Reconnect the connector.
- Replace the sensor.
- Replace the Paper Transport IOB.
- Replace the harness.

Checking paper jam, or paper status

Check if the leading edge of the paper and the paper feed guide are wet.	If condensation has occurred inside the machine, leave the machine idle for a few minutes to remove condensation.
Check if there is no double feeding.	Fan the paper.
Check if the paper is curled too much.	If the paper is curled too much, switch on the anti-condensation heater for paper tray.
Check if extra thin paper or thick paper exceeding the supported paper thickness is being used.	Use a supported paper type.

Check if the paper thickness and size are detected correctly.	Set the paper thickness and size to the correct value.
---	--

Reverse Sensor: Late Jam: Cause Code 024

Target Part/SP No.:Reverse Sensor / SP5-803-009 (Inverter Sensor)

Cause verification	Problem Judgement
Execute an INPUT check when there is no paper at the position of the referenced sensor.	0 :Paper detected
Execute an INPUT check when there is paper at the position of the referenced sensor.	1: Paper not detected

Solution:

- Clean the sensor.
- Reconnect the connector.
- Replace the sensor.
- Replace the Paper Transport IOB.
- Replace the harness.

Target Part/SP No.: Reverse Motor / SP5-804-047 (Inverter Motor:CW:Standard Speed)

Cause verification	Problem Judgement
Turn the referenced motor OFF with OUTPUT check	Drive sound heard
Turn the referenced motor ON with OUTPUT check	Drive sound not heard

Solution:

- Reconnect the connector.
- Replace the motor.
- Replace the Paper Transport IOB.
- Replace the harness.

Target Part/SP No.:Paper Exit Solenoid / SP5-804-004 (Exit Junction Solenoid)

Cause verification	Problem Judgement
Turn the referenced solenoid OFF with OUTPUT check	Drive sound heard
Turn the referenced solenoid ON with OUTPUT check	Drive sound not heard

Solution:

- Reconnect the connector.
- Replace the solenoid.
- Replace the Paper Transport IOB.
- Replace the harness.

Checking paper jam, or paper status

Check if the leading edge of the paper and the paper feed guide are wet.	If condensation has occurred inside the machine, leave the machine idle for a few minutes to remove condensation.
Check if there is no double feeding.	Fan the paper.
Check if the paper is curled too much.	If the paper is curled too much, switch on the anti-condensation heater for paper tray.
Check if extra thin paper or thick paper exceeding the supported paper thickness is being used.	Use a supported paper type.
Check if the paper thickness and size are detected correctly.	Set the paper thickness and size to the correct value.

Reverse Sensor: Lag Jam : Cause Code 064

Target Part/SP No.:Reverse Sensor / SP5-803-009 (Inverter Sensor)

Cause verification	Problem Judgement
Execute an INPUT check when there is no paper at the position of the referenced sensor.	0 :Paper detected
Execute an INPUT check when there is paper at the position of the referenced sensor.	1: Paper not detected

Solution:

- Clean the sensor.
- Reconnect the connector.
- Replace the sensor.
- Replace the Paper Transport IOB.
- Replace the harness.

Target Part/SP No.:Duplex Entrance Motor / SP5-804-065 (Duplex Entrance Motor: CW: Standard Speed)

Cause verification	Problem Judgement
Turn the referenced motor OFF with OUTPUT check	Drive sound heard
Turn the referenced motor ON with OUTPUT check	Drive sound not heard

Solution:

- Clean the sensor.
- Reconnect the connector.
- Replace the sensor.
- Replace the Paper Transport IOB.
- Replace the harness.

Checking paper jam, or paper status

Check if the leading edge of the paper and the paper feed guide are wet.	If condensation has occurred inside the machine, leave the machine idle for a few minutes to remove condensation.
Check if there is no double feeding.	Fan the paper.
Check if the paper is curled too much.	If the paper is curled too much, switch on the anti-condensation heater for paper tray.
Check if extra thin paper or thick paper exceeding the supported paper thickness is being used.	Use a supported paper type.
Check if the paper thickness and size are detected correctly.	Set the paper thickness and size to the correct value.

Duplex Exit Sensor: Late Jam: Cause Code 025

Target Part/SP No.:Duplex Exit Sensor / SP5-803-010

Cause verification	Problem Judgement
Execute an INPUT check when there is no paper at the position of the referenced sensor.	0 :Paper detected

Cause verification	Problem Judgement
Execute an INPUT check when there is paper at the position of the referenced sensor.	1: Paper not detected

Solution:

- Clean the sensor.
- Reconnect the connector.
- Replace the sensor.
- Replace the Paper Transport IOB.
- Replace the harness.

Target Part/SP No.: Bypass/Duplex Motor / SP5-804-071 (Duplex Bypass Motor: CW: Standard Speed)

Cause verification	Problem Judgement
Turn the referenced motor OFF with OUTPUT check	Drive sound heard
Turn the referenced motor ON with OUTPUT check	Drive sound not heard

Solution:

- Reconnect the connector.
- Replace the motor.
- Replace the Paper Transport IOB.
- Replace the harness.

Checking paper jam, or paper status

Check if there is no double feeding.	Fan the paper.
Check if the paper is curled too much.	If the paper is curled too much, switch on the anti-condensation heater for paper tray.
Check if extra thin paper or thick paper exceeding the supported paper thickness is being used.	Use a supported paper type.
Check if the paper thickness and size are detected correctly.	Set the paper thickness and size to the correct value.

Duplex Exit Sensor: Lag Jam: Cause Code 065

Target Part/SP No.:Duplex Exit Sensor / SP5-803-010

Cause verification	Problem Judgement
Execute an INPUT check when there is no paper at the position of the referenced sensor.	0 :Paper detected
Execute an INPUT check when there is paper at the position of the referenced sensor.	1 : Paper not detected

Solution:

- Clean the sensor.
- Reconnect the connector.
- Replace the sensor.
- Replace the Paper Transport IOB.
- Replace the harness.

Checking paper jam, or paper status

Check if there is no double feeding.	Fan the paper.
Check if the paper is curled too much.	If the paper is curled too much, switch on the anti-condensation heater for paper tray.
Check if extra thin paper or thick paper exceeding the supported paper thickness is being used.	Use a supported paper type.
Check if the paper thickness and size are detected correctly.	Set the paper thickness and size to the correct value.

Duplex Entrance Sensor: Late Jam: Cause Code 027

Target Part/SP No.:Duplex Entrance Sensor / SP5-803-011

Cause verification	Problem Judgement
Execute an INPUT check when there is no paper at the position of the referenced sensor.	0 :Paper detected
Execute an INPUT check when there is paper at the position of the referenced sensor.	1 : Paper not detected

Solution:

- Clean the sensor.
- Reconnect the connector.
- Replace the sensor.
- Replace the Paper Transport IOB.
- Replace the harness.

Target Part/SP No.:Duplex Entrance Motor / SP5-804-065 (Duplex Entrance Motor: CW: Standard Speed)

Cause verification	Problem Judgement
Turn the referenced motor OFF with OUTPUT check	Drive sound heard
Turn the referenced motor ON with OUTPUT check	Drive sound not heard

Solution:

- Clean the sensor.
- Reconnect the connector.
- Replace the sensor.
- Replace the Paper Transport IOB.
- Replace the harness.

Target Part/SP No.:Paper Exit Solenoid / SP5-804-004 (Exit Junction Solenoid)

Cause verification	Problem Judgement
Turn the referenced solenoid OFF with OUTPUT check	Drive sound heard
Turn the referenced solenoid ON with OUTPUT check	Drive sound not heard

Solution:

- Reconnect the connector.
- Replace the solenoid.
- Replace the Paper Transport IOB.
- Replace the harness.

Checking paper jam, or paper status

Check if there is no double feeding.	Fan the paper.
--------------------------------------	----------------

Check if the paper is curled too much.	If the paper is curled too much, switch on the anti-condensation heater for paper tray.
Check if extra thin paper or thick paper exceeding the supported paper thickness is being used.	Use a supported paper type.
Check if the paper thickness and size are detected correctly.	Set the paper thickness and size to the correct value.

Duplex Entrance Sensor: Lag Jam: Cause Code 067

Target Part/SP No.:Duplex Entrance Sensor / SP5-803-011

Cause verification	Problem Judgement
Execute an INPUT check when there is no paper at the position of the referenced sensor.	0 :Paper detected
Execute an INPUT check when there is paper at the position of the referenced sensor.	1 : Paper not detected

Solution:

- Clean the sensor.
- Reconnect the connector.
- Replace the sensor.
- Replace the Paper Transport IOB.
- Replace the harness.

Target Part/SP No.:Duplex Entrance Motor/ SP5-804-065 (Duplex Entrance Motor: CW: Standard Speed)

Cause verification	Problem Judgement
Turn the referenced motor OFF with OUTPUT check	Drive sound heard
Turn the referenced motor ON with OUTPUT check	Drive sound not heard

Solution:

- Reconnect the connector.
- Replace the sensor.
- Replace the Paper Transport IOB.

- Replace the harness.

Target Part/SP No.:Duplex/ Bypass Motor / SP5-804-071 (Duplex Bypass Motor: CW: Standard Speed)

Cause verification	Problem Judgement
Turn the referenced motor OFF with OUTPUT check	Drive sound heard
Turn the referenced motor ON with OUTPUT check	Drive sound not heard

Solution:

- Reconnect the connector.
- Replace the sensor.
- Replace the Paper Transport IOB.
- Replace the harness.

Checking paper jam, or paper status

Check if there is no double feeding.	Fan the paper.
Check if the paper is curled too much.	If the paper is curled too much, switch on the anti-condensation heater for paper tray.
Check if extra thin paper or thick paper exceeding the supported paper thickness is being used.	Use a supported paper type.
Check if the paper thickness and size are detected correctly.	Set the paper thickness and size to the correct value.

Duplex No Feeding: Cause Code 009

Target Part/SP No.:Registration Sensor / SP5-803-001 (Registration Sensor)

Cause verification	Problem Judgement
Execute an INPUT check when there is no paper at the position of the referenced sensor.	0 : Paper detected
Execute an INPUT check when there is paper at the position of the referenced sensor.	1 : Paper not detected

Solution:

- Clean the sensor.

- Reconnect the connector.
- Replace the sensor.
- Replace the Paper Transport IOB.
- Replace the harness.

Checking paper jam, or paper status

Check if there is no double feeding.	Fan the paper.
Check if the paper is curled too much.	If the paper is curled too much, switch on the anti-condensation heater for the paper tray.
Check if extra thin paper or thick paper exceeding the supported paper thickness is being used.	Use a supported paper type.
Check if the paper thickness and size are detected correctly.	Set the paper thickness and size to the correct value.

Bypass Transport Sensor 1: Lag Jam: Cause Code 048

Target Part/SP No.:Transport Sensor (1st Feed Tray) / SP5-803-003 (Transport Sensor 1)

Cause verification	Problem Judgement
Execute an INPUT check when there is no paper at the position of the referenced sensor.	0 :Paper detected
Execute an INPUT check when there is paper at the position of the referenced sensor.	1: Paper not detected

Solution:

- Clean the sensor.
- Reconnect the connector.
- Replace the sensor.
- Replace the Paper Transport IOB.
- Replace the harness.

Target Part/SP No.: Transport Motor / SP5-804-028 (Bypass V-Transport Motor: CW: Std Speed)

Cause verification	Problem Judgement
Turn the referenced motor OFF with OUTPUT check	Drive sound heard

Cause verification	Problem Judgement
Turn the referenced motor ON with OUTPUT check	Drive sound not heard

Solution:

- Reconnect the connector.
- Replace the motor.
- Replace the Paper Transport IOB.
- Replace the harness.

Display Error

"No paper in Tray 1" is displayed even when the paper is in

Target Part/SP No.:Paper End Sensor (1st Feed Tray) / SP5-803-015 (Tray 1: Paper End Detection)

Cause verification	Problem Judgement
Execute an INPUT check when there is no paper at the position of the referenced sensor.	1: Paper detected
Execute an INPUT check when there is paper at the position of the referenced sensor.	0: Paper not detected

Solution:

- Reconnect the connector.
- Replace the sensor.
- Replace the Paper Transport IOB.
- Replace the harness.

Feeler for 1st paper end sensor

Cause verification	Problem Judgement
Check if the feeler for 1st paper end sensor is unfastened.	Feeler is unfastened.

Solution:

- Reinstall the feeler.
- Check if there are any defects in the 1st paper feed unit.

"No paper in Tray 2" is displayed even when the paper is in

Target Part/SP No.:Paper End Sensor (2nd Feed Tray) / SP5-803-019 (Tray 2: Paper End Detection)

Cause verification	Problem Judgement
Execute an INPUT check when there is no paper at the position of the referenced sensor.	1: Paper detected
Execute an INPUT check when there is paper at the position of the referenced sensor.	0: Paper not detected

Solution:

- Reconnect the connector.
- Replace the sensor.
- Replace the Paper Transport IOB.
- Replace the harness.

Feeler for 2nd paper end sensor

Cause verification	Problem Judgement
Check if the feeler for 2nd paper end sensor is unfastened.	Feeler is unfastened.

Solution:

- Reinstall the feeler.
- Check if there are any defects in the 2nd paper feed unit.

"Tray 1 not set" is displayed even when the tray is set

Target Part/SP No.:Tray Set Switch (1st Feed Tray) / SP5-803-016 (Tray 1: Set Sensor)

Cause verification	Problem Judgement
Manually press the referenced switch (Done after detaching paper feeding tray 1 from the machine.)	1: Not set
Pull out paper feed tray 1 from the machine.	0: Set

Solution:

- Reconnect the connector.
- Replace the sensor.

- Replace the Paper Transport IOB.
- Replace the harness.

1st Paper Feed Tray

Replace the 1st paper feed tray.	Replace the 1st paper feed tray.
----------------------------------	----------------------------------

"Tray 2 not set" is displayed even when the tray is set

Target Part/SP No.:Tray Set Switch (2nd Feed Tray) / SP5-803-020 (Tray 2: Set Sensor)

Cause verification	Problem Judgement
Manually press the referenced switch (Done after detaching paper feeding tray 2 from the machine.)	1: Not set
Pull out paper feed tray 2 from the machine.	0: Set

Solution:

- Reconnect the connector.
- Replace the sensor.
- Replace the Paper Transport IOB.
- Replace the harness.

2nd Paper Feed Tray

Check the 2nd tray set sensor to see if there are any defects.	Replace the 2nd paper feed tray.
--	----------------------------------

Wrong paper size displayed on the operation panel

Target Part/SP No.:Size Switch (2nd Feed Tray) / SP5-803-021 (Tray 2: Size Sensor)

Cause verification	Problem Judgement
Press the 1st switch from the right on the size switch of paper feed tray 2 when seen from the front of the machine (Done after detaching paper feed tray 2)	Parameter other than 00000111
Press the 2nd switch from the right on the size switch of paper feed tray 2 when seen from the front of the machine (Done after detaching paper feed tray 2)	Parameter other than 00001011

Cause verification	Problem Judgement
Press the 3rd switch from the right on the size switch of paper feed tray 2 when seen from the front of the machine (Done after detaching paper feed tray 2)	Parameter other than 00001101
Press the 4th switch from the right on the size switch of paper feed tray 2 when seen from the front of the machine (Done after detaching paper feed tray 2)	Parameter other than 00001110
Pull out paper feed tray 2 from the machine.	Parameter other than 00001111

Solution:

- Reconnect the connector.
- Replace the sensor.
- Replace the Paper Transport IOB.
- Replace the harness.

2nd Paper Feed Tray

Check the 2nd tray set sensor to see if there are any defects.	Replace the switch for the pick-up arm.
--	---

Does not shift to right door open status

Target Part/SP No.:Right Door Open/Close Switch / SP5-803-026 (Right Door Open/Close Sensor)

Cause verification	Problem Judgement
Manually press the referenced switch (Done after opening the right door)	1: Open
Open the right door	0: Close

Solution:

- Reconnect the connector.
- Replace the sensor.
- Replace the Paper Transport IOB.
- Replace the harness.

Target Part/SP No.:Duplex Unit Open/Close Sensor / SP5-803-027 (Tray Full Exit Sensor)

Cause verification	Problem Judgement
Manually press the referenced switch (Done after opening the duplex guide plate)	1: Open
Open the duplex guide plate.	0: Close

Solution:

- Reconnect the connector.
- Replace the sensor.
- Replace the Paper Transport IOB.
- Replace the harness.

Pick-up Arm

Check the switch for the pick-up arm to see if there are any defects.	Replace the 2nd paper feed tray.
---	----------------------------------

Others

If the error occurs periodically, do the following steps. If the result is as shown in the "Problem Judgement" column, follow the solutions.

"Replace the waste toner bottle" is displayed even when it is clear that the waste toner bottle is not full

Target Part/SP No.: Waste Toner Bottle Full Sensor / SP5-803-032 (Toner Collection Full Sensor)

Cause verification	Problem Judgement
Execute an INPUT check with no feeler in the sensor detection range (Done after detaching the waste toner bottle)	1: Full

Solution:

- Clean the sensor.
- Reconnect the connector.
- Replace the sensor.
- Replace the Imaging IOB.
- Replace the harness.

Waste toner bottle is never full

Target Part/SP No.: Waste Toner Bottle Full Sensor / SP5-803-032 (Toner Collection Full Sensor)

Cause verification	Problem Judgement
Execute an INPUT check with feeler within the sensor detection range (Done after removing the waste toner bottle)	0: Not full

Solution:

- Clean the sensor.
- Reconnect the connector.
- Replace the sensor.
- Replace the Imaging IOB.
- Replace the harness.

6

No waste toner bottle set is displayed on controller board even when it is clear that is set

Target Part/SP No.:Waste Toner Bottle Set Sensor / SP5-803-033 (Toner Collection Bottle Set Sensor)

Cause verification	Problem Judgement
Execute an INPUT check with the feeler within the sensor detection range (Done after removing the waste toner bottle)	1: Not set

Solution:

- Reconnect the connector.
- Replace the sensor.
- Replace the Imaging IOB.
- Replace the harness.

Waste toner bottle is not detected even when it is set

Target Part/SP No.:Waste Toner Bottle Set Sensor / SP5-803-033 (Toner Collection Bottle Set Sensor)

Cause verification	Problem Judgement
Detach the waste toner bottle from the machine.	0: Set

Solution:

- Reconnect the connector.
- Replace the sensor.
- Replace the Imaging IOB.
- Replace the harness.

Paper transfer unit open/close LED not lit and paper transfer unit open

Target Part/SP No.:PTR Open/Close Sensor / SP5-803-028 (PTR Open/Close Sensor)

Cause verification	Problem Judgement
Execute an INPUT check with an object (e.g. paper) placed within the sensor detection range.	1: Close
Execute an INPUT check without an object (e.g. paper) placed within the sensor detection range.	0: Open

Solution:

- Clean the sensor.
- Reconnect the connector.
- Replace the sensor.
- Replace the Paper Transport IOB.
- Replace the harness.

Paper transfer unit open/close LED not lit

Target Part/SP No.:Paper Transfer Unit Open/Close LED / SP5-804-206 (PTR Open/Close LED)

Cause verification	Problem Judgement
Turn ON the paper transfer unit open/close LED with OUTPUT check	1: Close

Cause verification	Problem Judgement
Execute an OUTPUT check without an object (e.g. paper) placed within the sensor detection range.	0: Open

Solution:

- Clean the LED.
- Reconnect the connector.
- Replace the LED.
- Replace the Paper Transport IOB.
- Replace the harness.

Paper transfer unit open/close LED always lit

Target Part/SP No.:PTR Open/Close Sensor / SP5-803-028 (PTR Open/Close Sensor)

Cause verification	Problem Judgement
Execute an INPUT check with an object (e.g. paper) placed within the sensor detection range	1: Close
Execute an INPUT check without an object (e.g. paper) placed within the sensor detection range	0: Open

Solution:

- Clean the sensor.
- Reconnect the connector.
- Replace the sensor.
- Replace the Paper Transport IOB.
- Replace the harness.

Target Part/SP No.:Paper Transfer Unit Open/Close LED / SP5-804-206 (PTR Open/Close LED)

Cause verification	Problem Judgement
Turn OFF the paper transfer unit open/close LED with OUTPUT check	LED lit

Solution:

- Clean the LED.
- Reconnect the connector.

- Replace the LED.
- Replace the Paper Transport IOB.
- Replace the harness.

Troubleshooting for Finishing Options

Finisher Registration Adjustment For Booklet Finisher SR3220 (D3B9)

Side-to-side registration can be adjusted by the docking bracket for SR3220 [A] (and the docking bracket screw [B]).

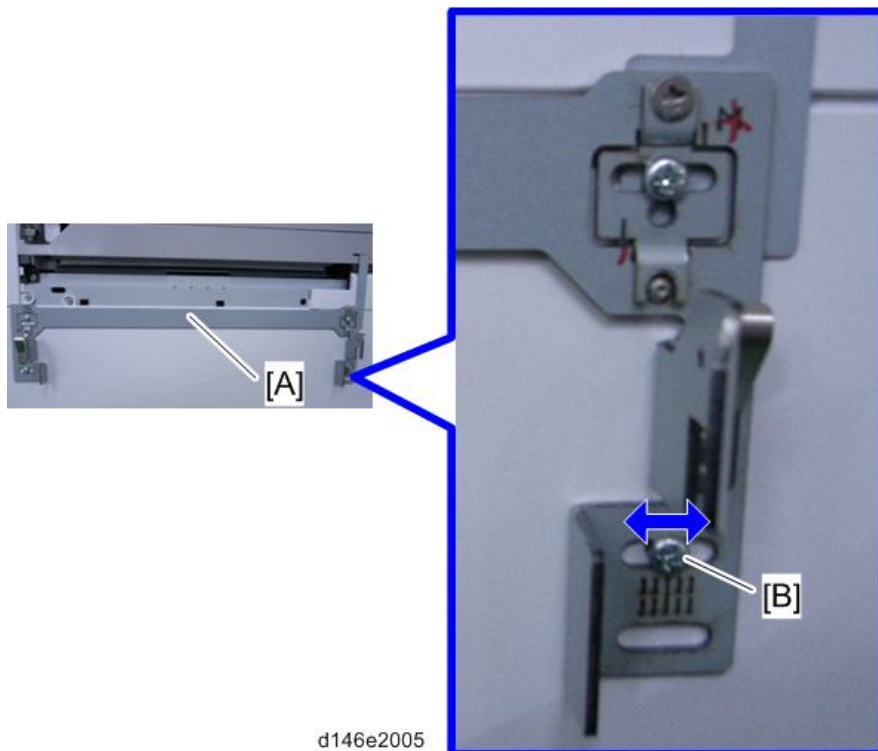

d146e2005

1. Eject a sheet of A4(LEF) or A3 paper to the proof tray and check for how many divisions of the scale the edge of the paper has shifted from the center.

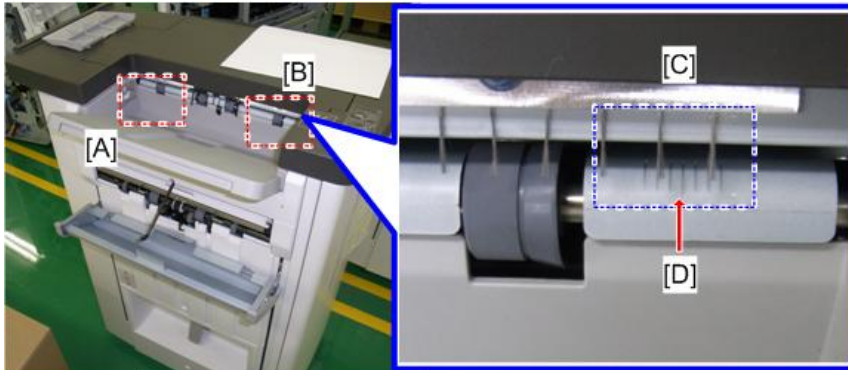

d135a3121

- [A]: Scale marks for DLT
- [B]: Scale marks for A3
- [C]: 7 scale marks in 2mm intervals
- [D]: Center mark

2. Change the position of the standard bracket by rotating it 180 degrees as shown below. This makes the docking bracket easier to slide horizontally. Then reattach the docking bracket to the mainframe.

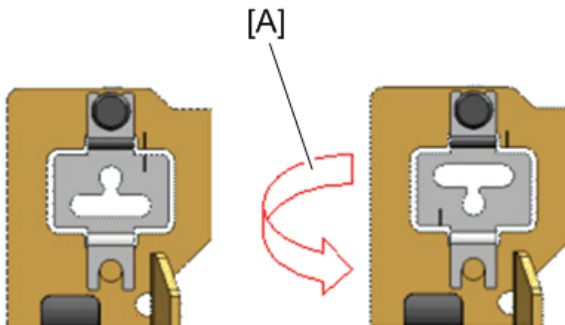

d197f0210

- [A]: Reverse

If the paper shifts towards the front

Slide the docking bracket towards the front side by the amount of shift, to move the finisher in the same direction.

e.g.: When the paper has shifted by 2 mm towards the front from the center mark (2 mm/division of the scale), move the docking bracket towards the front by 2 mm (2 divisions). The divisions move towards the rear.

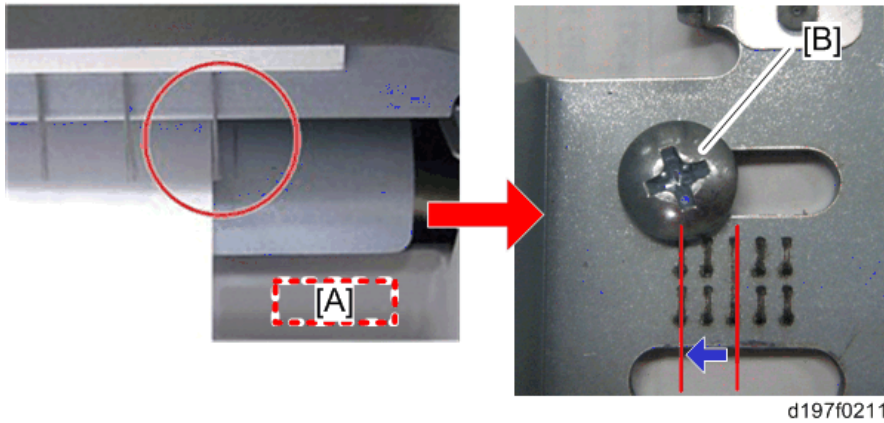

[A]: Proof Tray

[B]: Docking Bracket Screw

If the paper shifts towards the rear

Slide the docking bracket towards the rear by the amount of shift, to move the finisher in the same direction.

e.g.: When the paper has shifted by 2 mm towards the rear from the center mark (2 mm/division of the scale), move the docking bracket towards the rear by 2 mm (2 divisions). The divisions move towards the front.

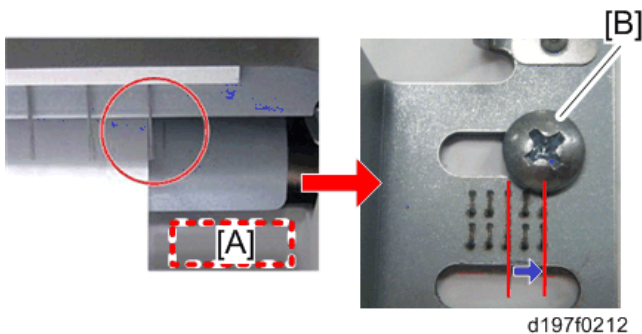

[A]: Proof Tray

[B]: Docking Bracket Screw

↓ Note

- After the adjustment, check the side-to-side registration by feeding paper out to the proof tray. If the shift has not been solved, adjust the docking bracket (screw for the docking bracket) slightly again.

Finisher Jogger Problem (For Booklet Finisher SR3220 (D3B9))

If a paper alignment problem occurs as shown below, do the following procedure to adjust the jogger width.

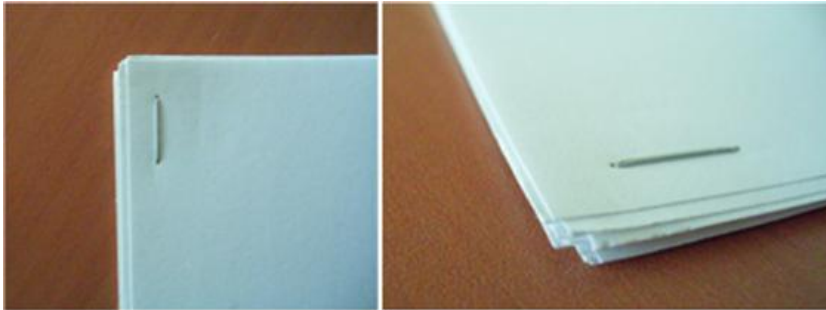

d146z0091

Cause

Depending on the type of paper or the manufacturer, the paper may not be the correct size. In this case, the paper may not align properly even when the jogger is used.

Solution

Adjust the jogger width with SP6-143 (adjustable threshold: -1.5 to +1.5 mm for each paper size).

- SP6-143 (Jogger Pos Adj:1K FIN)

Note

- Adjust the jogger width to be slightly narrower (approximately -0.5 mm) than the paper width.

Early Tray Full Detection Mylar for Internal Finisher SR3130 (D690)

Paper curl may occur when output gets to near full. Paste the Mylar to the full detection feeler to detect tray full early before paper curl occurs.

Pasting the Mylar

1. Pull the finisher [A]

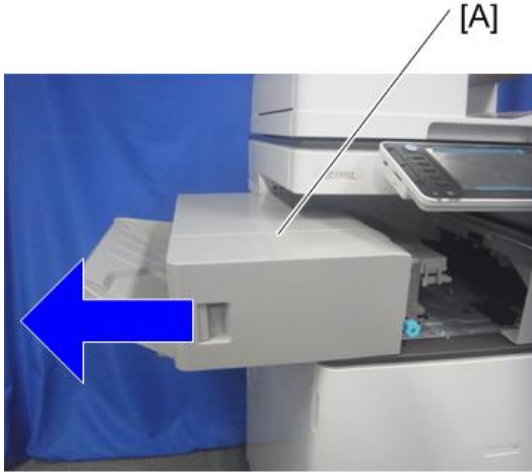

d1462876

6

2. Remove the finisher front cover [A] (⊗ x2)

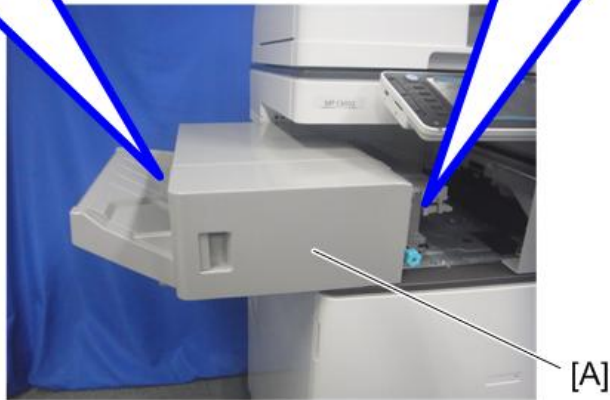

d1462877

3. Remove the left lower cover [A] (⚙️ x2)

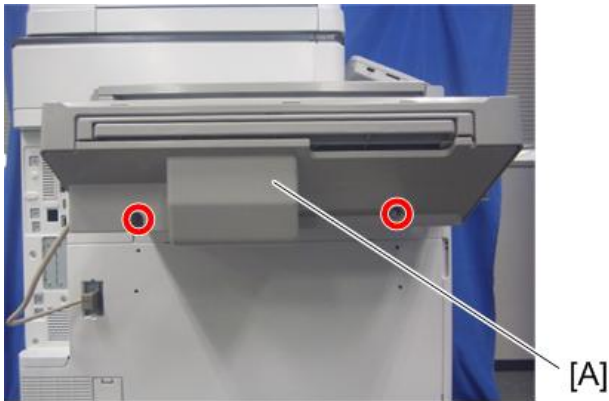

d1462879

4. Rotate the gear [A] to lift down the movable tray [B].

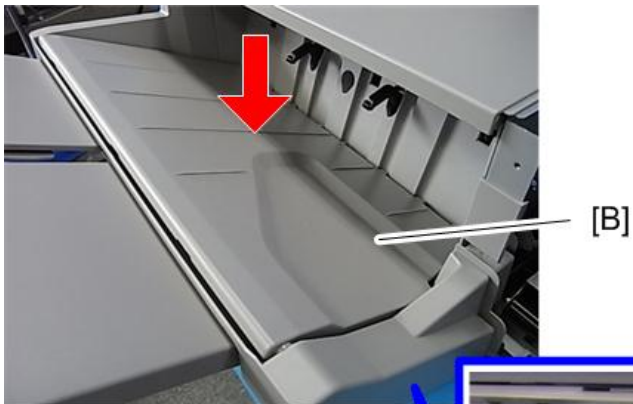

d197f0614

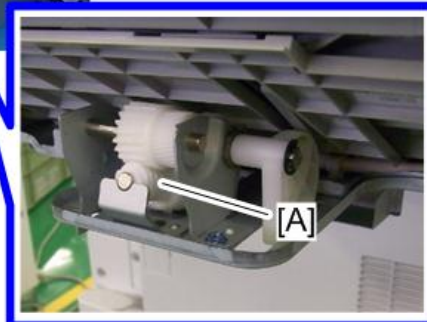

5. Remove the paper exit tray [A] (🔧 x2)

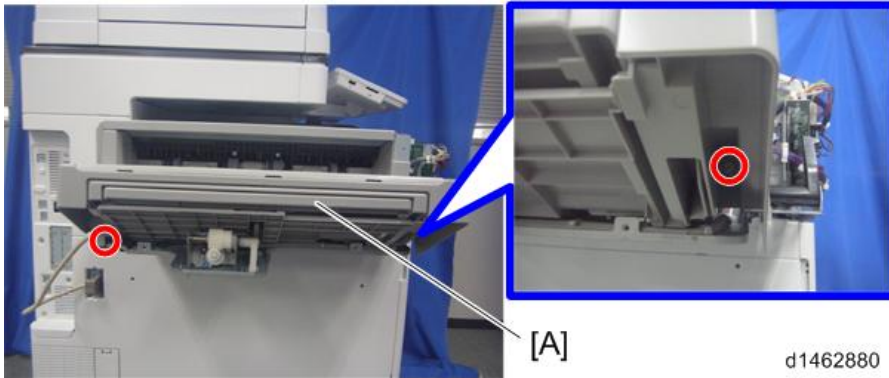

6. Paste the Mylar [A] on the full detection feeler [B].

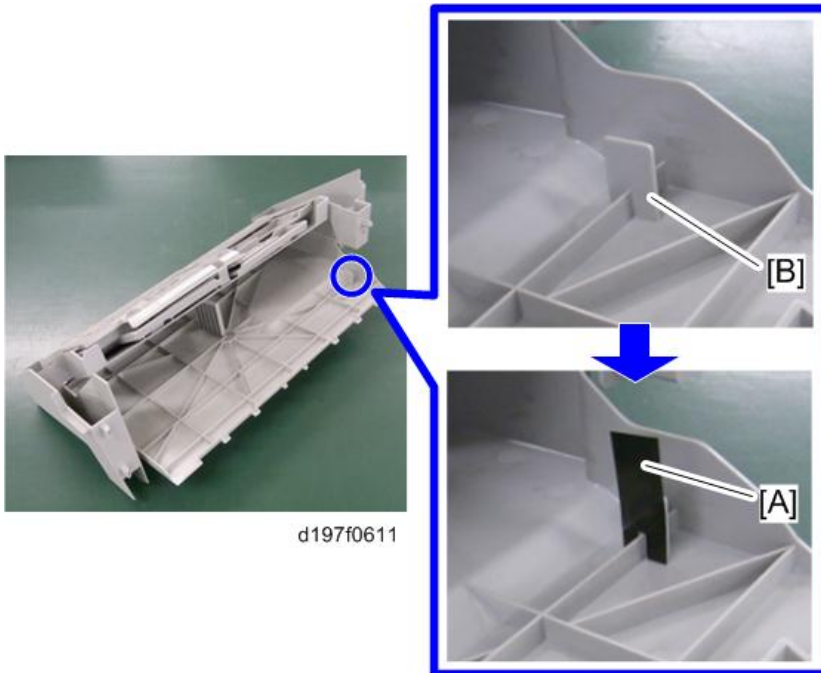

7. Re-attach the paper exit tray (🔧 x2)

8. Move the movable tray [A] up and down to check that the Mylar does go through the sensor properly.

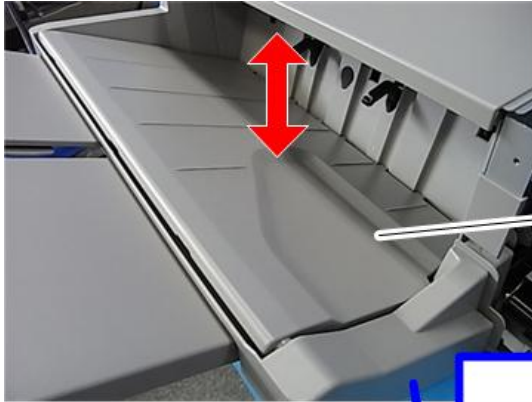

d197f0613

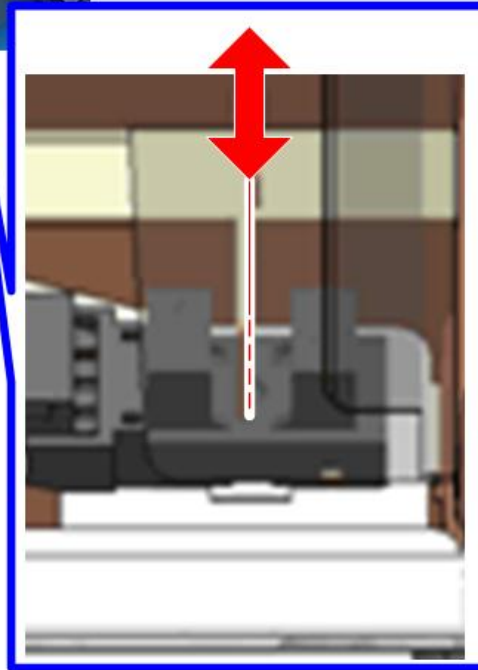

9. Re-attach the left lower cover (🔩 x2)
10. Re-attach the finisher front cover (🔩 x2)

Paper Curl Problem for SR3180 (D766)

When using the mixed mode, duplex (curls towards the lower side) over the simplex (curl towards the upper side) and paper curl occurs, attach the auxiliary tray (D7667010), disable the paper exit full sensor, and paste the Mylar.

1. Remove the paper exit cover [A] (🔪×2)

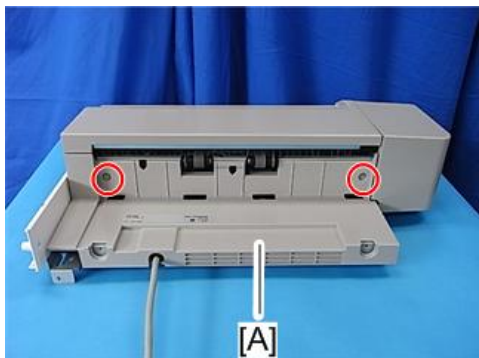

d197z0499

2. Release the clamp and disconnect the harness of the paper exit full sensor 1 [A].

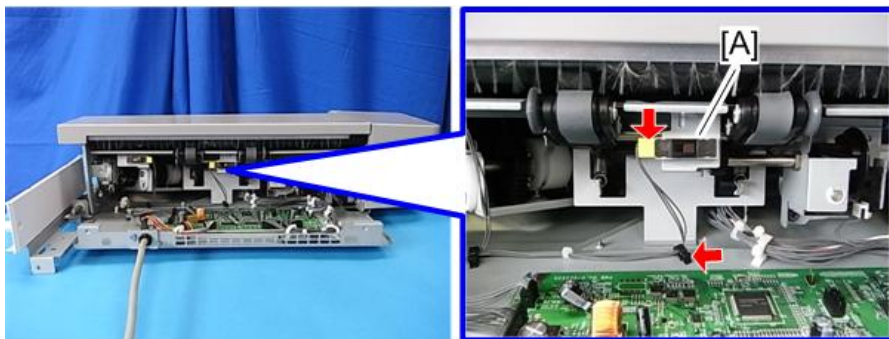

d197z0500

3. Loop and clamp the harness [A] as shown.

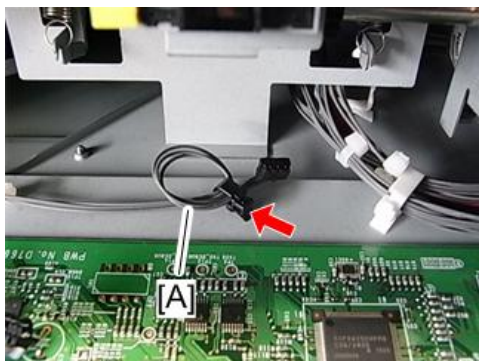

d197z0501

4. Release the clamp and disconnect the harness of the paper exit full sensor 2 (Staple) [A].

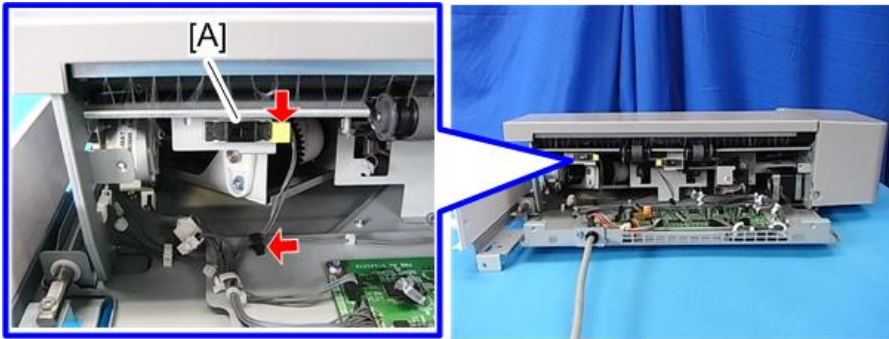

d197z0502

5. Loop and clamp the harness [A] as shown.

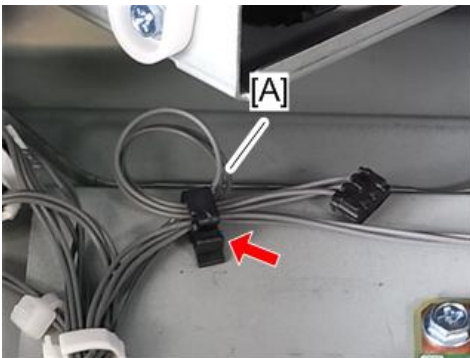

d197z0503

Note

- If the harness cable [A] is short to loop, clamp the harness without looping.



d197z0504

6. Re-attach the paper exit cover (🔩×2)

7. Attach the auxiliary tray (D7667010) [B] to the paper exit tray [A]

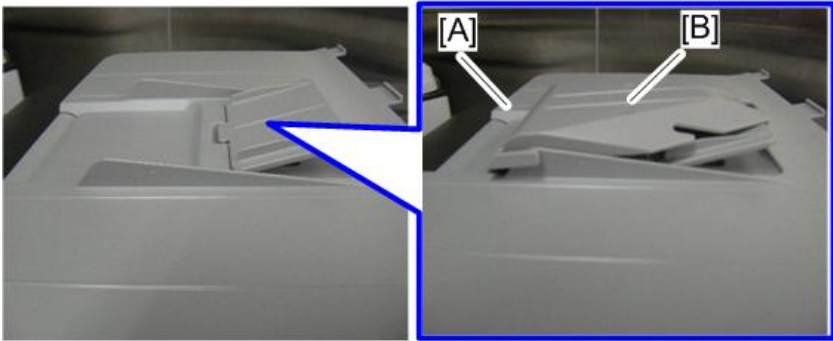

d197z0505

8. Paste the Mylars [A] on the frame of the finisher.

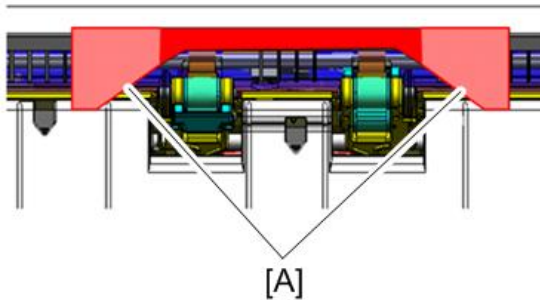

d197z0506

Maximum number of sheets for stapling and what happens when the job has too many pages

Specifications: Maximum sheet capability for staple jobs

Model	Corner Staple	Booklet Staple
Booklet Finisher SR3220	50 sheets	15 sheets
Internal Finisher SR3130	50 sheets	-

Behavior: When the number of sheets exceeds the maximum staple capability

When corner stapling

Sheets are fed out without being stapled. First, the maximum number of sheets (50) is stacked in the staple tray and fed out. Following this, any remaining sheets that exceed this maximum are also stacked and fed out without being stapled, in the same way.

Example:

If 60 sheets are set to be stapled, the first 50 are stacked in the staple tray and then fed out without being stapled. The remaining 10 are then stacked in the tray and fed out without being stapled.

When the maximum number of originals for a stapled set has been scanned, "Stapling capacity exceeded" is displayed on the LCD.

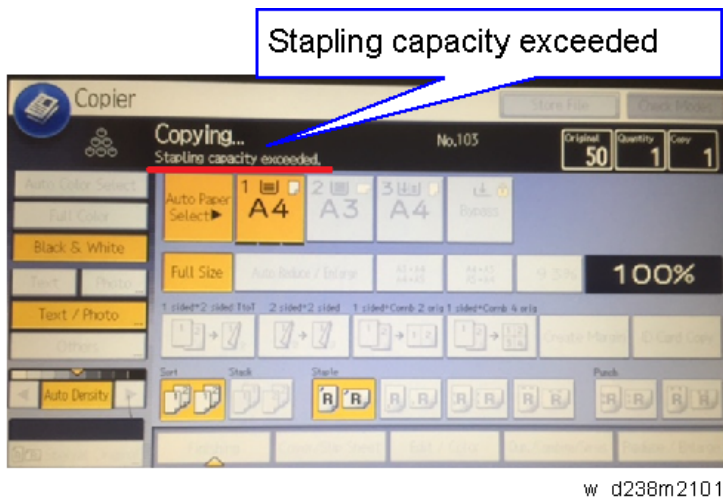

w_d238m2101

There is no message displayed prompting the user to cancel or continue with the 51st original.

When booklet stapling

The following dialog is displayed when the maximum number of sheets in a stapled set is reached during the scanning of the originals. The user is prompted before printing begins.

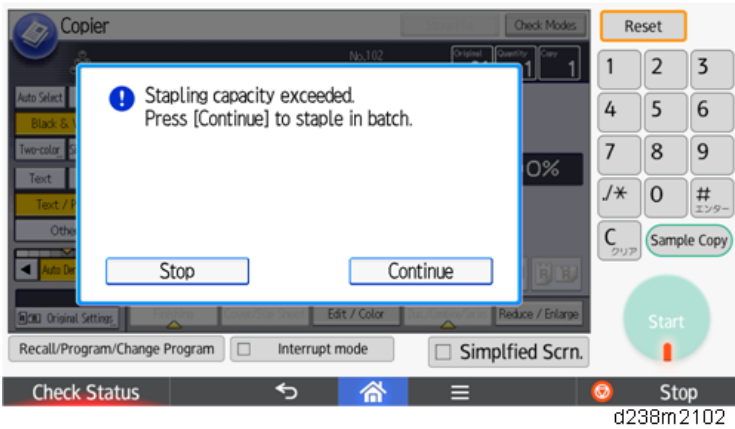

[Stop] The job is canceled (no further scanning, no printing)

[Continue] Sets are stapled at maximum capacity in batch and fed out.

Example:

The machine stops scanning after 20 out of 30 originals are scanned.

The message shown above is displayed.

If [Continue] is selected, printing starts and sheets are stapled in batches of 20 sheets and 10 sheets.

Select the behavior when the job has more than the maximum of staple capability with SP5199

SP5-199 sets whether to staple sheets stacked in the staple tray or finisher before feeding out.

0 (default): Behavior depends on the finisher attached.

1: Sheets are fed out without being stapled.

2: Sheets are stapled and fed out.

Electrical Component Defects

Fuses

Name	Output connector	Capacity	Part number	Market exchange possible
		Voltage	Part name	Remarks
FU101	CN985 (Fusing center lamp) CN986 (Fusing edge lamp)	15A (NA) 8A	11071241(NA) 11071366	Yes
		AC	TLC-15A-N4 (NA) FIH 250V 8A(EM)8A	Installed on AC control board
FU102	CN988 (DC power supply)	15A(NA) 8A	11071241(NA) 11071366	Yes
		AC	TLC-15A-N4 (NA) FIH 250V 8A(EM)8A	Installed on AC control board
FU110	CN921(Heater for Tray 1, 2, and optional trays) CN922 (Heater for Scanner and PCU)	2A	11071225	NO
		AC	SLT 250V 2A	Installed on Heater Board (Service Part)
FU105	None	2A	11071362	NO
		AC	SCT2A	Installed on AC control board
FU1	CN911(IOB)	5A	11071229	NO
		5V	SLT 250V 5A	Installed on DC power supply

Name	Output connector	Capacity	Part number	Market exchange possible
		Voltage	Part name	Remarks
FU2	CN911(IPU)	5A	11071229	NO
		5V	SLT 250V 5A	Installed on DC power supply
FU3	CN912(IOB)	8A		NO
		24V	51MS(P)080L	Installed on DC power supply
FU4	CN917 (Interlock switch [IOB])	8A		NO
		24V	51MS(P)080L	Installed on DC power supply
FU5	CN917 (Interlock switch [IOB])	8A		NO
		24V	51MS(P)080L	Installed on DC power supply
FU7	CN913(FIN) CN914(BANK)	8A		NO
		24V	51MS(P)080L	Installed on DC power supply

Fuse position



d244c0022



Vertical Streaks on Copies due to Scanning Problems

Overview

Marks on prints and copies are mostly due to dirt on the DF exposure glass [A], generally caused by adhesive contaminants (such as ball point pen ink and correction fluid).

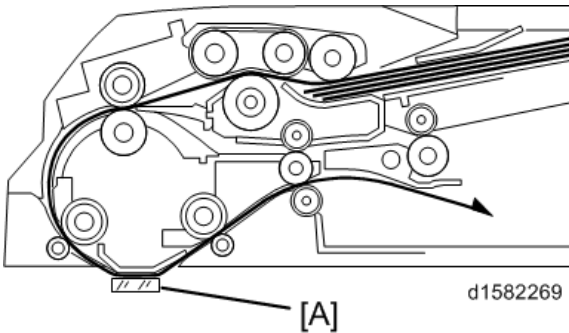

6

Compared to non-adhesive contaminants (such as paper fragments and eraser dust), adhesive contaminants are more likely to lead to complaints from customers because of the following:

- Vertical streaks caused by adhesive contaminants are more visible in terms of image quality.
- Unless removed by cleaning, adhesive contaminants continue to produce vertical streaks, while non-adhesive contaminants stop producing streaks after they are dislodged.
- Many adhesive contaminants are difficult to remove by cleaning.

The ARDF DF3090 / SPDF DF3100 features a system (non-contact scanning) to reduce vertical streaks caused by adhesive contaminants.

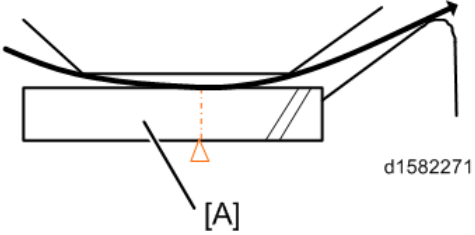
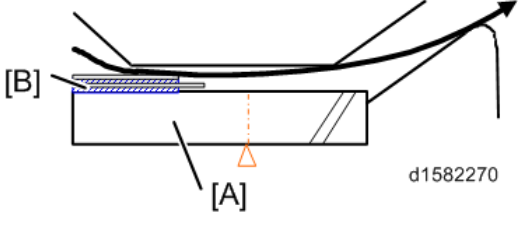
Contact scanning: Other ADFs/ARDFs	Non-contact scanning: DF3090 / DF3100
<p>In contact scanning, the whole of the original comes into contact with the DF exposure glass [A] so that non-adhesive contaminants can be removed.</p> 	<p>By means of the Mylar sheet [B], originals are kept slightly above the DF exposure glass [A], preventing adhesive contaminants from adhering to the glass.</p> 

The ARDF DF3090 / SPDF DF3100 can be converted from non-contact scanning to contact scanning for users who wish to reduce vertical streaks caused by non-adhesive contaminants.

SP No.	Contact scanning	Non-contact scanning
SP4-688-001 (for ARDF3090)	103%	106%
SP4-688-002 (for SPDF3100)	96%	101%
SP4-871-003 (both ARDF and SPDF)	0.00%	0.11%

Converting the ARDF DF3090 to Contact Scanning

1. Unplug the machine power cord before starting the following procedure.
2. Remove the ARDF front cover [A] (🔧 x1).

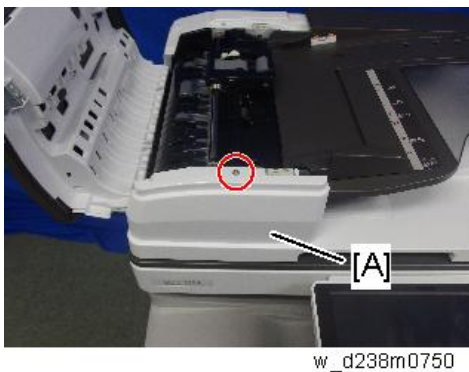

3. Remove the Scanning guide plate [B] (🔧 [A]x1).

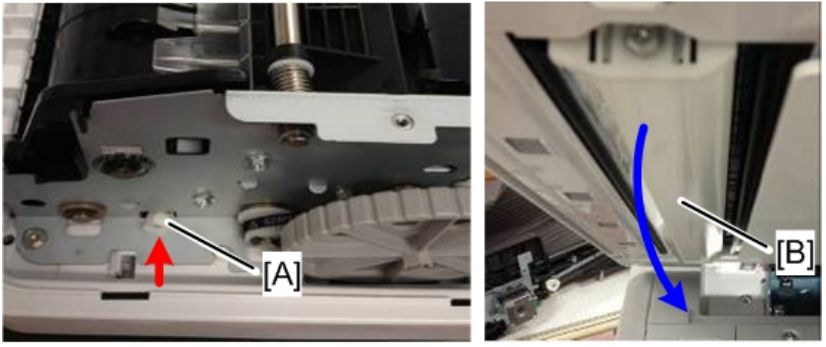

d1582263

4. Remove the plastic guides [A] on the sides of the scanning guide plate (🔧 x1).

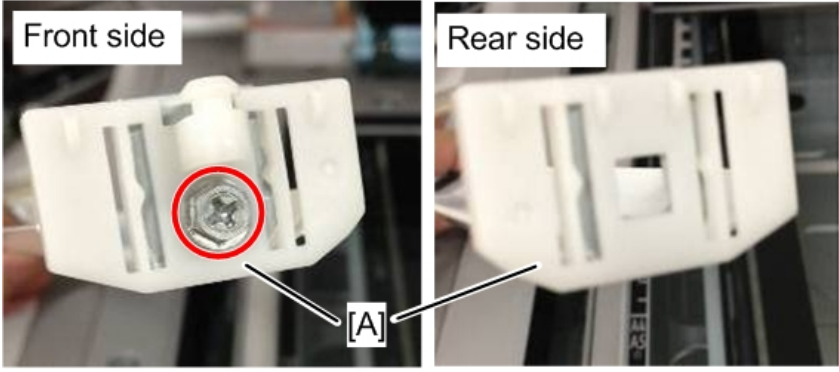

w_d1582264

5. Attach the guides for contact scanning. Each guide has a hole [B].

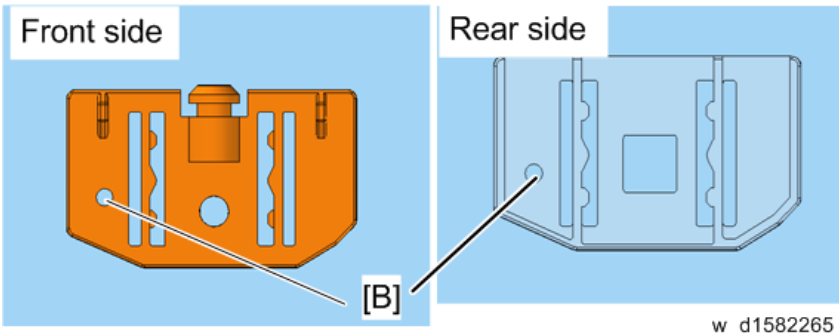

w_d1582265

6. Mount the scanning guide plate, taking care not to damage the sheet [A].

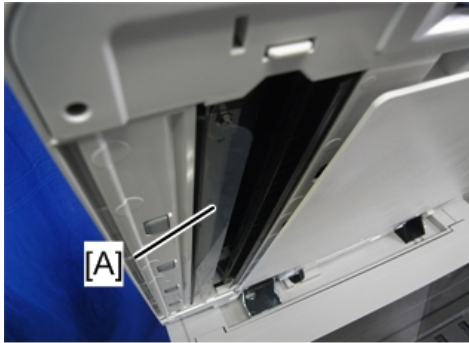

d1582266

7. Peel off the gap sheet [A] from the DF exposure glass with your hands.



d238m0752

8. Clean the DF exposure glass [A] with alcohol.

To avoid paper jams, make sure adhesive is completely removed.

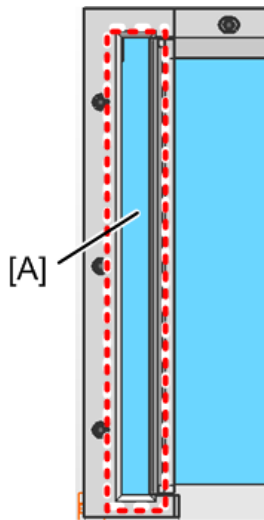

d1582268

9. Turn the main switch on.
10. Start the SP mode.
11. Select SP4-688-001 (DF Density Adjustment ARDF) and change the setting from "106" to "103" for the contact scanning.
12. Change the DF magnification (SP4-871-003) from [0.11%] to [0.00%].

Note

- When returning the setting back to non-contact scanning, return the SP values also.

Converting the SPDF3100 to Contact Scanning

1. Open the SPDF and exchange the entrance lower guide unit [A] to a non-contact type part.

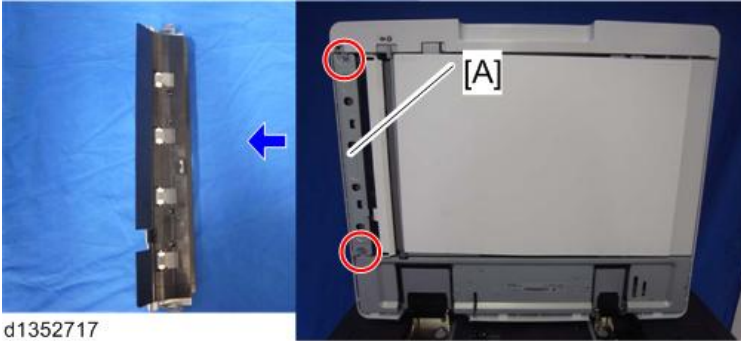

- Entrance lower guide unit for non-contact transport: The following areas are black [A].
- Entrance lower guide unit for contact transport: The following areas are clear and colorless [B].

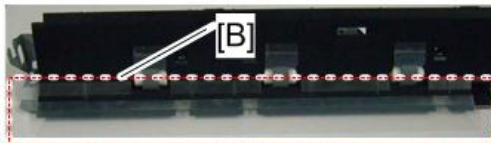

d1352723

2. Exchange the scanning guide plate [A] to a non-contact type part (hook x 1).



d1352718

- [A] : The color of the marker of the non-contact type scanning guide plate for this machine is gray.
- [B]: The color of the marker of the contact type scanning guide plate for this machine is white.
- [C]: The color of the marker of the non-contact type scanning guide plate for previous machine is black.

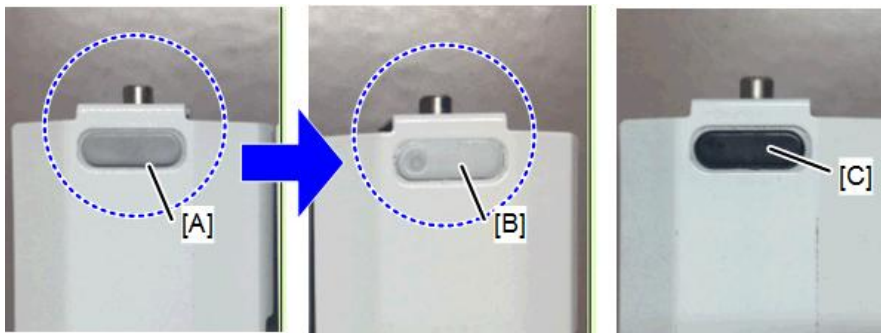

d238m0797

3. Attach the scanning guide plate for contact transport [A] (hook x 1).

4. Attach the entrance lower guide unit for contact transport [B] (Ⓢ x 2).

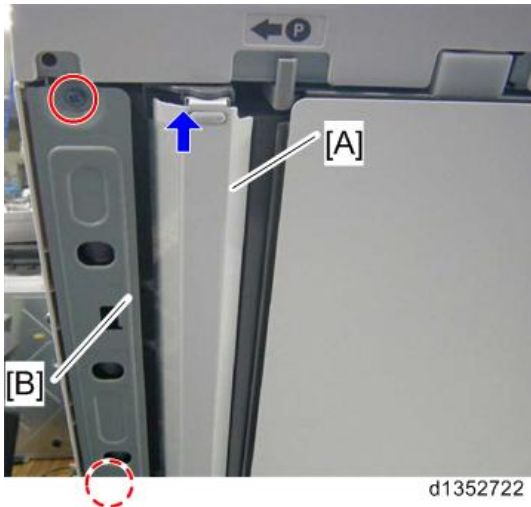

5. Peel off the gap sheet [A] from the DF exposure glass with your hands.

6



6. Clean the DF exposure glass [A] with alcohol.

To avoid paper jams, make sure adhesive is completely removed.

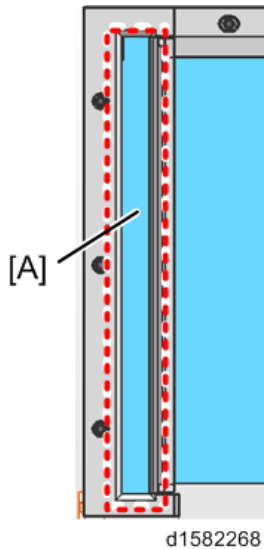

7. Enter the SP mode.
8. Change SP4-688-002 (Scan Image Density Adjustment 1-pass) from "101" to "96".
9. Change the DF magnification (SP4-871-003) from [0.11%] to [0.00%].

Note

- When returning the setting back to non-contact scanning, return the SP values also.

Image Quality Problems

Misjudgment for Auto Color Selection (Copy/Scanner)

In the Auto Color Selection (hereafter called ACS) mode, if copying or scanning an original on which color is printed only on the edge, the original will be misjudged as monochrome. If so, color is not printed on the output.

Error Condition

Copy Application

The misjudgment occurs when copying an original which has color at the edge, and that color is printed on the output 10 mm from the edge in the ACS mode.

When using the copy application, if the original is judged as monochrome, color on the document may not be printed on the output. When printing the standard 10 colors used in Microsoft Office Word 2013 (an example is shown below), the following colors with the "x" mark will disappear if the document is judged as monochrome in the ACS mode.

Note

- Colors with the "x" mark will not be printed if the document is judged as monochrome. The result may differ depending on the equipment status or environment.



D238m0891

Scanner Application

The misjudgment occurs when scanning an original which has color only 15 mm from the edge (using the original as a standard) in the ACS mode.

Causes

In the ACS mode, the edge of the original is excluded from the judgment. Only the center part of the original document is the target area to judge color or monochrome (in order to prevent misjudgment due to noise).

When copying in the ACS mode, ACS judgment and the image processing equivalent to full color is performed simultaneously. If judged as monochrome in the ACS judgment, color without a K component will not be printed.

Solutions

Change the ACS area excluded from judgment with the following SP settings.

The smaller the value, the smaller the ACS area excluded from judgment becomes, which enables the document to be judged as color.

SP No.	SP Name	Def.	Max.	Min.
4-938-001	ACS:Edge Mask Copy:Sub LEdge	10	0	31
4-938-002	ACS:Edge Mask Copy:Sub TEdge	10	0	31
4-938-003	ACS:Edge Mask Copy:Main LEdge	10	0	31
4-938-004	ACS:Edge Mask Copy:Main TEdge	10	0	31
4-938-005	ACS:Edge Mask Scan:Sub LEdge	15	0	31
4-938-006	ACS:Edge Mask Scan:Sub TEdge	15	0	31
4-938-007	ACS:Edge Mask Scan:Main LEdge	15	0	31
4-938-008	ACS:Edge Mask Scan:Main TEdge	15	0	31

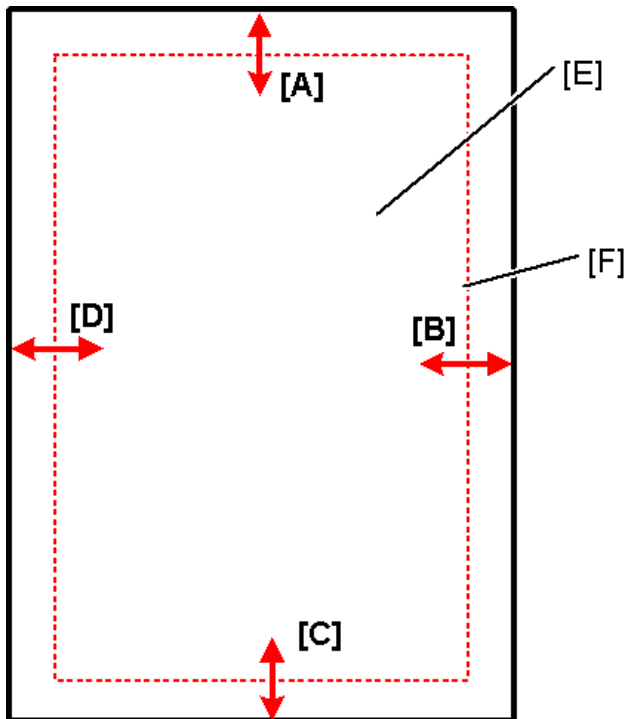

d238m0893

[A]: Sub scan direction: leading edge (left)

[B]: Main scan direction (front)

[C]: Sub scan direction: leading edge (right)

[D]: Main scan direction (rear)

[E]: Paper

[F]: ACS area excluded from judgment

↓ Note

- Because the edge of the original is subject to noise, color misjudgment may occur after setting these SPs smaller than the defaults. In this case, in order to avoid complaints concerning extra cost, be sure to ask the customer for permission before changing these SP settings.

Misjudgment for Auto Color Selection (e.g. When Using Paper Which Has a Strong Blue Component)

Causes

The strong blue component of the paper causes the difference in RGB values to be relatively large. As a result, ACS mistakenly judges that the paper is blue.

↓ Note

- ACS makes this judgment based on the RGB thresholds set in SP mode.

Solutions

Change the setting of SP4-939-001 (ACS:Color Range) until ACS works correctly.

↓ Note

- Change the value of the SP to “-1” or “-2” when a black and white document is misjudged as a color document.

When an abnormal image is generated

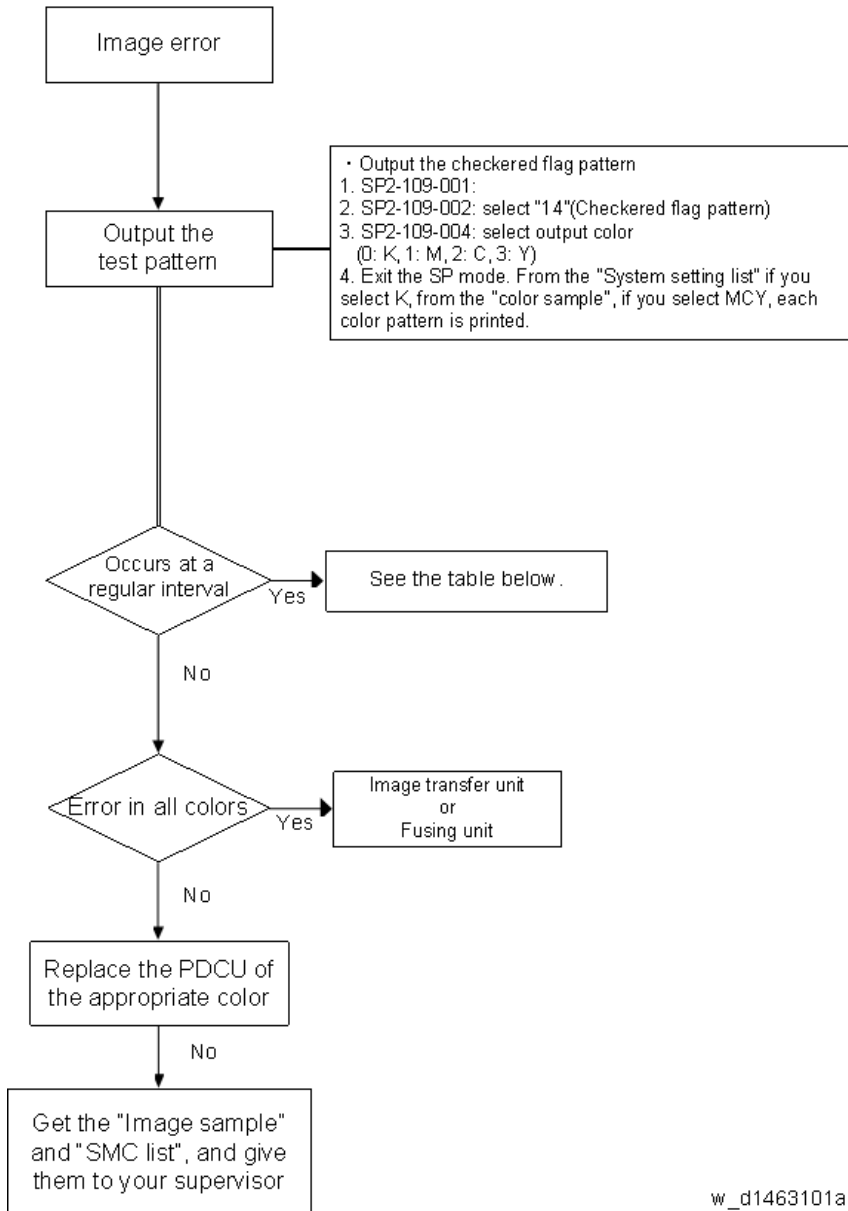

Interval	Target part	Replacement part
31.4mm	Charge roller cleaner	PCU
34.6mm	Development roller	Development unit
37.7mm	Charge roller	PCU
48.7mm	Paper transfer roller	Paper transfer roller unit
54.8mm	Image transfer drive roller	Image transfer unit
94.2mm	Drum	PCU
94.2mm	Fusing sleeve belt	Fusing sleeve belt unit/ Fusing unit
100.5mm	Pressure roller	Pressure roller/ Fusing unit
963.8mm	Image transfer belt	Image transfer belt/ Image transfer unit

Other Troubleshooting

When Fluorescent/ LED Lamps Flicker

Problem

Under the usage environment of this machine, at the placement location, fluorescent and/or LED lamps flicker.

Causes

As a result of the voltage drop occurs, when the fusing lamp is applied an electrical current. It depends on the electrical power environment, at the customer's placement location.

Solutions

The procedure varies by the flicker occurrence timing. So check the occurrence timing, and do the procedure that matches the timing.

Occurrence Timing

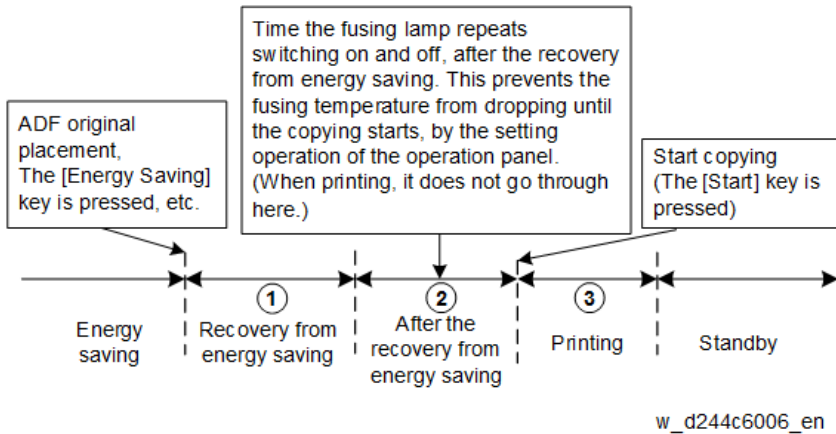

Timing	Solutions	Side effect
① Recovery from energy saving	Set SP1-135-001 (Inrush Control) to "1 (ON)".	Recovery time from energy saving becomes slower approx. 0.4 sec..

Timing	Solutions	Side effect
<p>② After the recovery from energy saving</p>	<p>Set SP1-135-001 (Inrush Control) to "1 (ON)".</p> <p>Set SP1-135-002 (Flicker Control) to "1 (ON)".</p>	<ul style="list-style-type: none"> • Recovery time from energy saving becomes slower approx. 0.4 sec.. • In the case of the adhesion amount of an image is large, an offset may occur. • In the case of a fusing offset occurs, in the related SP to fusing offsets, setting values must be changed.
	<p>If it has not been improved in the above, do the following procedures in addition;</p> <ul style="list-style-type: none"> • Stop the lighting of the fusing lamp after the warm-up. Set SP1-121-001 (Switch:Rotation Start/ Stop:Time:After Reload) to "0 sec". 	<ul style="list-style-type: none"> • The fusing temperature drops during the operation. After copying starts, the fusing temperature is raised up to a printable temperature. Because of that, copying completion time becomes slower (approx. 1-2 sec.).
<p>③ Printing</p>	<p>Set SP1-135-002 (Flicker Control) to "1 (ON)".</p>	<ul style="list-style-type: none"> • In the case of the adhesion amount of an image is large, an offset may occur. • In the case of a fusing offset occurs, in the related SP to fusing offsets, setting values must be changed.

Related SP to Fusing Offsets

SP Name	SP No.	Value
Print Target Temp.:Plain1:FC:Center	SP1-105-001	As initial values + 10 °C are the upper limits, change values to improve offsets.
Print Target Temp.:Plain1:BW:Center	SP1-105-003	
Print Target Temp.:Plain2:FC:Center	SP1-105-005	
Print Target Temp.:Plain2:BW:Center	SP1-105-007	
Print Target Temp.: Thin:FC:Center	SP1-105-009	
Print Target Temp.: Thin:BW:Center	SP1-105-011	
Print Target Temp.: M-thick:FC:Center	SP1-105-013	
Print Target Temp.: M-thick:BW:Center	SP1-105-015	

7. Detailed Descriptions

Guidance for Those Who are Familiar with Predecessor Products

Changes from the Previous Machine

Scanner

Items	MP C2003/C2503 /C2011	MP C6004/C5504/C4504 /C3504/C3004	MP C2004/C2504
Scanner type	-	Short focus scanner For distortion correction: After replacing the scanner carriage, the correction value specified on the supplied sheet in the SP code must be entered. For details, see page 436 "Scanner Carriage".	
Scanner carriage storage upon shipping	None	The scanner carriage must be moved to the lock position to lock the carriage to the scanner frame before shipping.	
Main scanning magnification adjustment	Not available	Magnification adjustment is available for the main scanning direction with SP4-871-003, -004.	

7

Image Processing

Items	MP C2003/C2503 /C2011	MP C6004/C5504/C4504 /C3504/C3004	MP C2004/C2504
SIO	Available	Not available The functions of this old board are built into the IPU.	
Copy data security function	Available by option	Available by default on the IPU	

Process Control

Items	MP C2003/C2503 /C2011	MP C6004/C5504/C4504 /C3504/C3004	MP C2004/C2504
MUSIC	Executing rough adjustment -> fine adjustment only	<p>Process upon execution of SP2-111-004 (Forced Line Position Adj.: mode d) and [Color Registration] in the User Tools have been changed.</p> <ul style="list-style-type: none"> • Normal Operation: rough adjustment -> fine adjustment -> contact MUSIC (new process) • With Imageable Area Extension Unit: rough adjustment -> fine adjustment 	

Laser Exposure

Items	MP C2003/C2503 /C2011	MP C6004/C5504/C4504 /C3504/C3004	MP C2004/C2504
Laser unit	LD 1 beam	<p>MPC4504/C5504/C6004: LD 4 beams</p> <p>MP C3004/C3504: LD 1 beam</p>	LD 1 beam

PCDU (Photo Conductor and Development Unit)

Items	MP C2003/C2503 /C2011	MP C6004/C5504/C4504 /C3504/C3004	MP C2004/C2504
Removal of PCDU seal	The seals must be pulled out for all colors.	<p>MPC4504/C5504/C6004: The seals for all colors must be wound up.</p> <p>MP C3004/C3504: The seal for K must be wound up with a special tool, and the seals for CMY must be pulled out</p>	The seals must be pulled out for all colors.

Items	MP C2003/C2503 /C2011	MP C6004/C5504/C4504 /C3504/C3004	MP C2004/C2504
PCU	DC charge roller (Contact type) Correction SP value must be input when PCU is replaced No lubricant bar Discharge lamp is in the main frame	AC charge roller (No contact type) Lubricant bar No discharge lamp	DC charge roller (Contact type) Correction SP value must be input when PCU is replaced No lubricant bar Discharge lamp is in the main frame
Development unit	Two mixing coils, two- way circulation	MPC4504/C5504/C6004: OD (One-way circulation of developer) system MP C3004/C3504: K: OD (One-way circulation of developer) system CMY: Two mixing coils, one way circulation	Two mixing coils, two-way circulation

Waste Toner

Items	MP C2003/C2503 /C2011	MP C6004/C5504/C4504 /C3504/C3004	MP C2004/C2504
Waste toner cover	With latch	Without latch	

Image Transfer and Paper Transfer

Items	MP C2003/C2503 /C2011	MP C6004/C5504/C4504 /C3504/C3004	MP C2004/C2504
TM/ID sensor shutter	Available	Not Available	

Feed / Transport Part

Items	MP C2003/C2503 /C2011	MP C6004/C5504/C4504 /C3504/C3004	MP C2004/C2504
Bypass tray / Main machine jam code	-	The following codes are used to isolate the cause: <ul style="list-style-type: none"> • JAM048: Transport Sensor Lag Jam from Bypass Tray • JAM051: Transport Sensor Lag Jam from 1st Feed Tray 	
Main tray paper exit	-	<ul style="list-style-type: none"> • Improved stacking performance after feedout by adding resilience to the paper with the paper exit driven roller (drum shape). • To prevent paper jam when the paper is delivered from the machine’s paper exit to the internal exit peripherals, attach the paper support guide (supplied with the peripherals). • Replaced the paper exit driven roller to a flat type roller to prevent jamming when paper is fed to the internal exit peripherals. 	
Tray draw-in mechanism	Not Available	Available	Not Available
Paper feed sensor/ Paper exit full sensor	Not Available	Available	Not Available
Paper thickness (Duplex)	52 - 169 g/m ²	52 - 256 g/m ²	52 - 169 g/m ²
Removing wrinkle in tray	Screwed with L-shaped sheet metal	Support component and decal are provided User installable	

Fusing

Items	MP C2003/C2503 /C2011	MP C6004/C5504/C4504 /C3504/C3004	MP C2004/C2504
Curl correction	Not Available	Equipped with a curl correction mechanism at the fusing exit.	
Fusing shield plate	Available	MP C6004/C5504/ C4504: Available MP C3004/C3504: Not Available	Not Available
Fusing shield plate position sensor	2	MP C6004/C5504/ C4504: 1 MP C3004/C3504: -	-
Heat conduction plate	Not Available	Available	
Others	-	Changed the drawer connector location	

- Changed the drawer connector location:

[A]: MP C6004/C5504/C4504/C3504/C2504/C2004

[B]: MP C2003/C2503/C2011

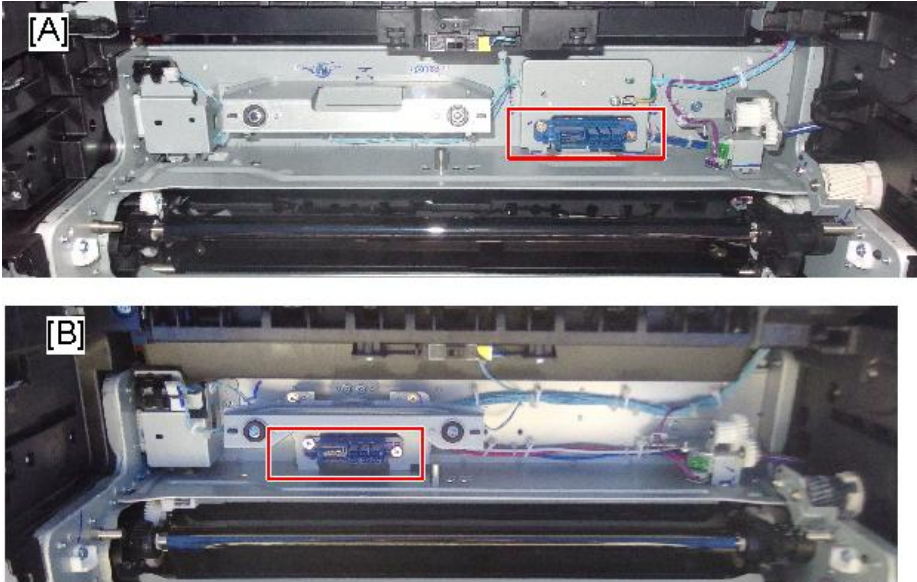

d238m0803

Electrical Parts

7

Items	MP C2003/C2503 /C2011	MP C6004/C5504/C4504 /C3504/C3004	MP C2004/C2504
SIO	Available	Not available The functions for this old board are included on the IPU	
Human detection (Proximity sensor)	Not Available	Available Equipped with the proximity sensor (human detection sensor).	
OPU	1st generation Smart Operation Panel	2nd generation Smart Operation Panel	

Exterior Cover / Air Flows (Fan Control)

Items	MP C2003/C2503 /C2011	MP C6004/C5504/C4504 /C3504/C3004	MP C2004/C2504
Air flow	8 fans	MP C6004/C5504/ C4504: 10 fans MP C3004/C3504: 7 fans	7 fans
Duct	-	Increased the rigidity of the duct Changed the duct shape	
Noise control	-	<ul style="list-style-type: none"> Equipped with a Helmholtz silencer Labyrinth structure of the exterior 	

↓ Note

- Labyrinth structure of the exterior:
- Exterior parts engage with each other to reduce the leaking of the driving noise.

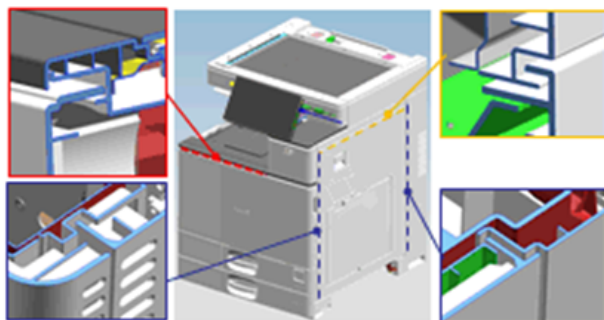

d238m1386

Drive Parts

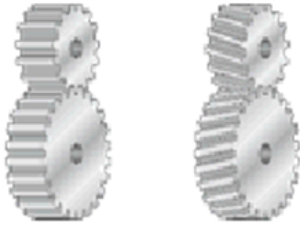
Items	MP C2003/C2503 /C2011	MP C6004/C5504/C4504 /C3504/C3004	MP C2004/C2504
Noise control	-	<p data-bbox="651 427 1186 564">From the usual non-helical gears [A], we increased the use of helical gears [B] to increase the efficiency of engagement. This has also reduced the rattling noise due to the increased gear engagement.</p> <div data-bbox="655 589 1016 913" style="border: 1px solid black; padding: 5px; text-align: center;">  <p data-bbox="732 854 769 887">[A]</p> <p data-bbox="920 854 957 887">[B]</p> </div> <p data-bbox="913 919 1016 942">d238m1387</p>	
Silencing grease for the drive parts	-	<p data-bbox="651 981 1200 1040">Grease is applied to over 100 parts, including gears, shafts, and bearings, to reduce the driving noise.</p>	

Others

Changing the Default Value for the Binding Margin

Until the last model, the default value for the binding margin was “5 mm on the right (on the back of the sheet)” when copying on both sides, in order to align the prints on both sides when punching. This has occasionally caused the paper edges to appear on the printed copies.

Thus, in this series, the default value for the binding margin is changed to “0 mm on the right (on the back of the sheet)” and the default value to mask the paper edge (SP mode) is also changed to reduce the chance of the black streak appearing.

Binding Margin Setting

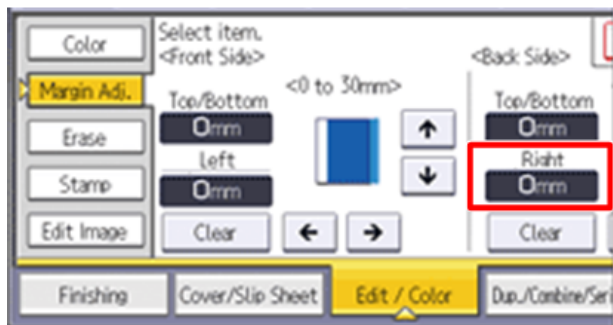

d238m1398

Changed Default Values in the SP mode

SP4-012-001 (Set Scale Mask Book:Sub Ledge) 0 -> 1mm

SP4-012-003 (Set Scale Mask Book:Main:Ledge) 0 -> 1mm

SP6-006-007 (ADF Adjustment Rear Edge Erase Front) 0 -> -2.3mm

SP6-006-014 (ADF Adjustment T-Edge Erase (1-Pass): Front) -1.5 -> -3.0mm

SP6-006-015 (ADF Adjustment T-Edge Erase (1-Pass): Front) -1.5 -> -2.5mm

Component Layout

Scanner Unit

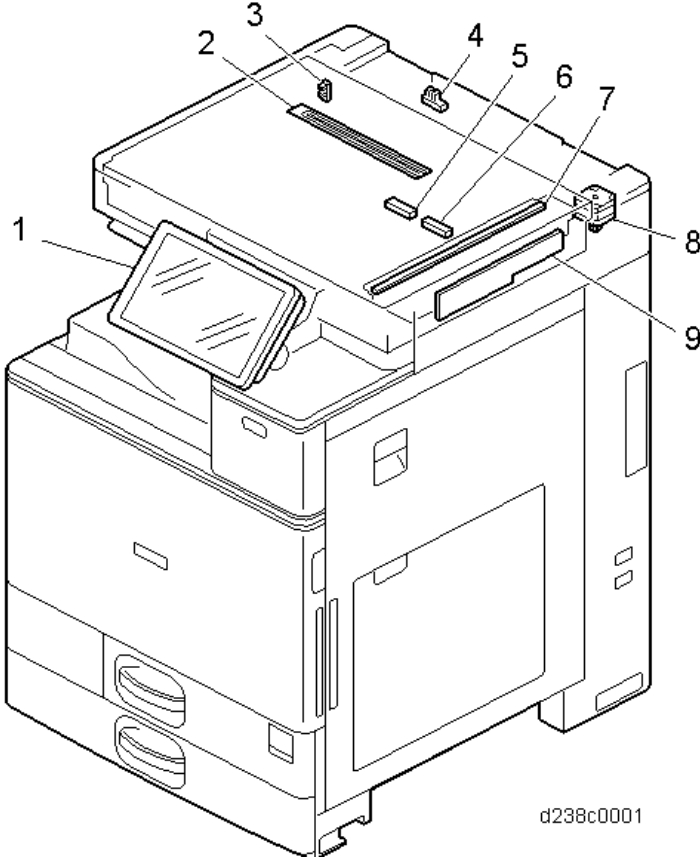

d238c0001

No.	Description	No.	Description
1	Operation panel	6	Auto paper size (APS) sensor
2	Anti-condensation heater (Scanner heater) *1	7	Scanner lamp unit (LED)
3	Scanner HP sensor	8	Scanner motor
4	ARDF/Platen cover sensor	9	Sensor board unit (SBU)
5	Auto paper size (APS) sensor		

* Service part

Laser Exposure Unit

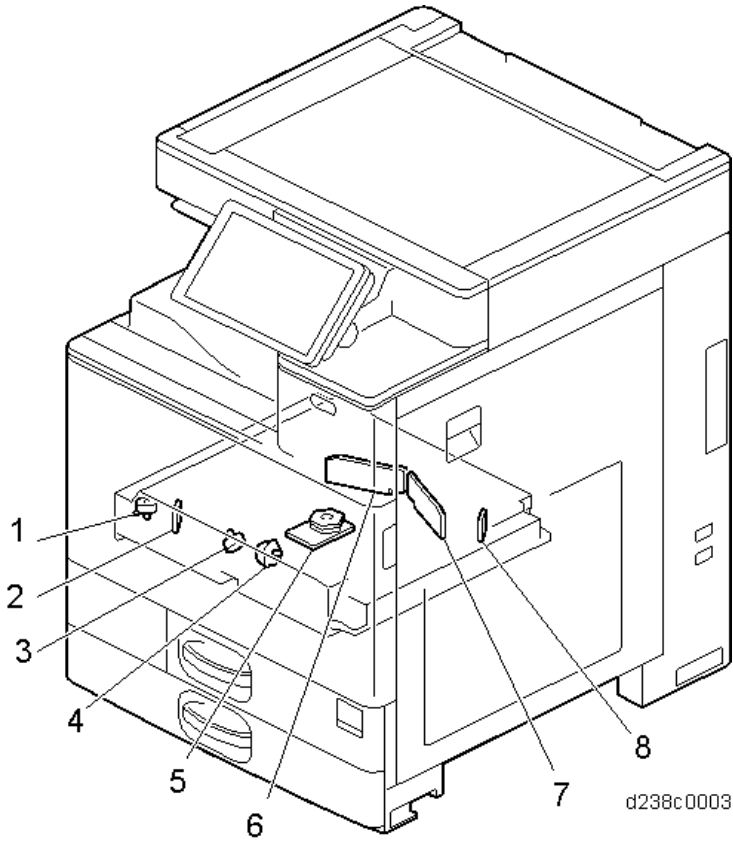

7

No.	Description	No.	Description
1	Laser optics positioning motor (Y)	5	Polygon mirror motor
2	Synchronizing detector board: M/Y-S	6	LD drive board (M/Y)
3	Laser optics positioning motor (M)	7	LD drive board (Bk/C)
4	Laser optics positioning motor (C)	8	Synchronizing detector board: Bk/C-S

Image Transfer Unit

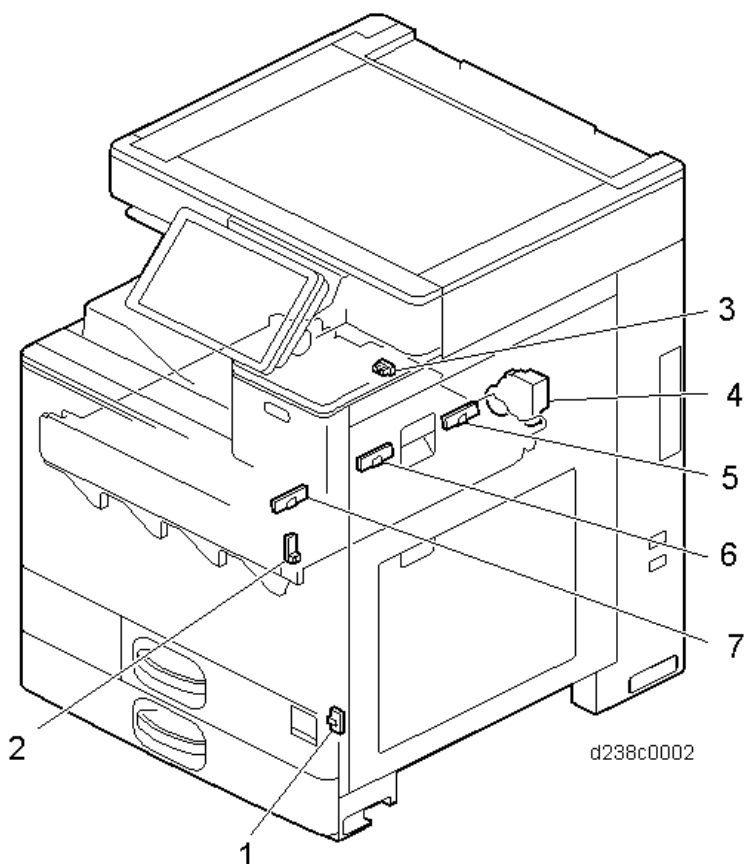

No.	Description
1	Temperature and humidity sensor
2	Interlock switch: right door
3	ITB contact and release sensor
4	Paper transfer contact and release motor
5	TM/ID sensor (rear)
6	TM/ID sensor (center)
7	TM/ID sensor (front)

PCDU

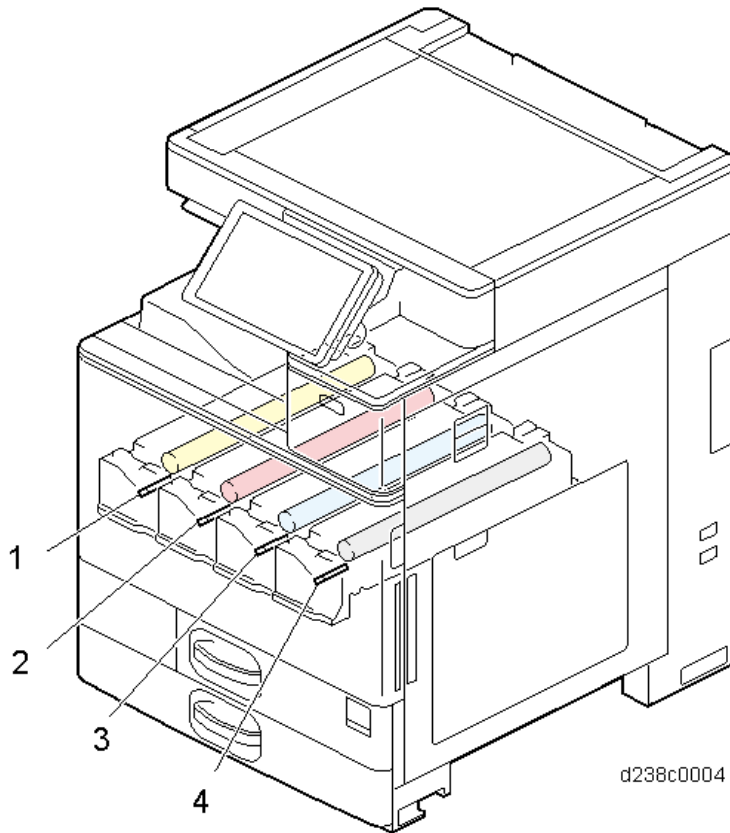

No.	Description	No.	Description
1	PCDU (Y)	3	PCDU (C)
2	PCDU (M)	4	PCDU (Bk)

Toner Supply / Waste Toner Bottle

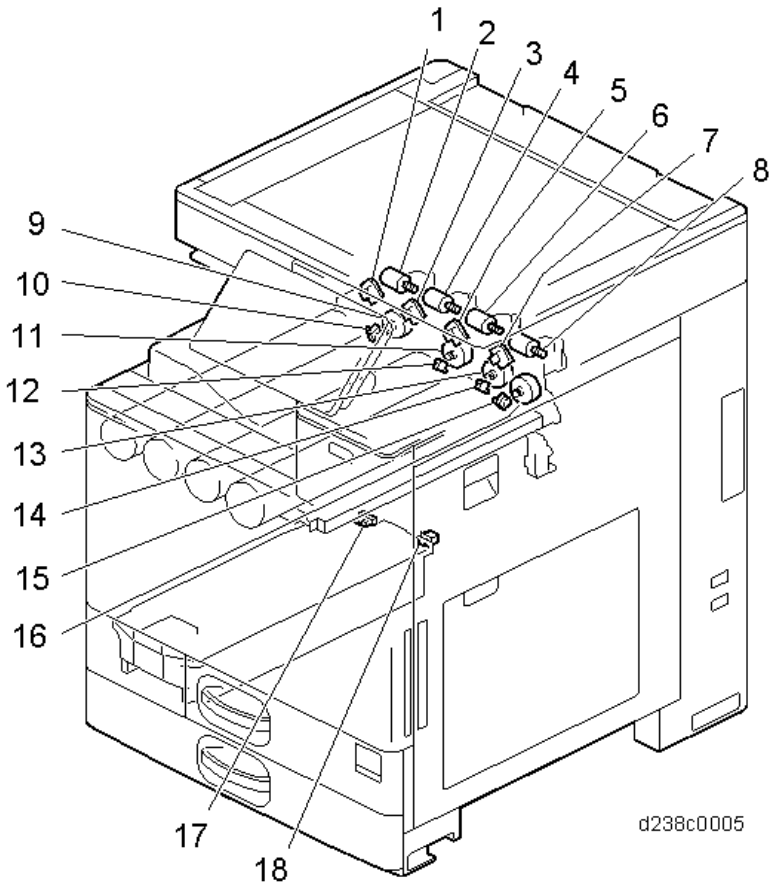

d238c0005

7

No.	Description	No.	Description
1	ID chip contact board (Y)	10	Toner end sensor (Y)
2	Toner bottle drive motor (Y)	11	Toner supply motor (M)
3	ID chip contact board (M)	12	Toner end sensor (M)
4	Toner bottle drive motor (M)	13	Toner supply motor (C)
5	ID chip contact board (C)	14	Toner end sensor (C)
6	Toner bottle drive motor (C)	15	Toner end sensor (Bk)
7	ID chip contact board (Bk)	16	Toner supply motor (Bk)
8	Toner bottle drive motor (Bk)	17	Waste toner bottle full sensor

No.	Description	No.	Description
9	Toner supply motor (Y)	18	Waste toner bottle set sensor

Paper Feed Unit

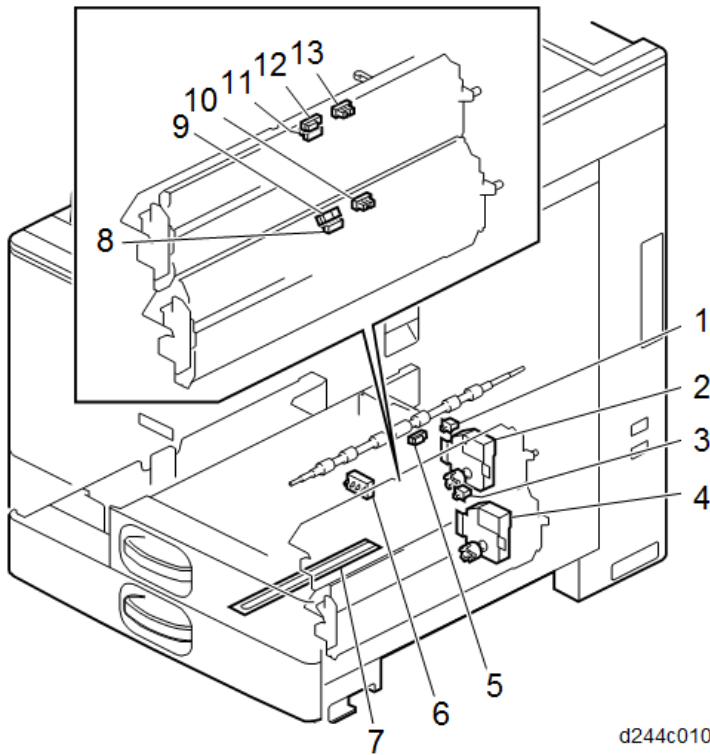

No.	Description	No.	Description
1	Tray set switch (1st feed tray)	8	Transport sensor (2nd Feed Tray)
2	Lift motor (1st feed tray)	9	Paper end sensor (2nd feed tray)
3	Tray set switch (2nd feed tray)	10	Upper limit sensor (2nd feed tray)
4	Lift motor (2nd feed tray)	11	Transport sensor (1st feed tray)
5	Registration sensor	12	Paper end sensor (1st feed tray)
6	Paper size switch (2nd Feed Tray)	13	Upper limit sensor (1st feed tray)
7	Anti-condensation heater		

Duplex Unit

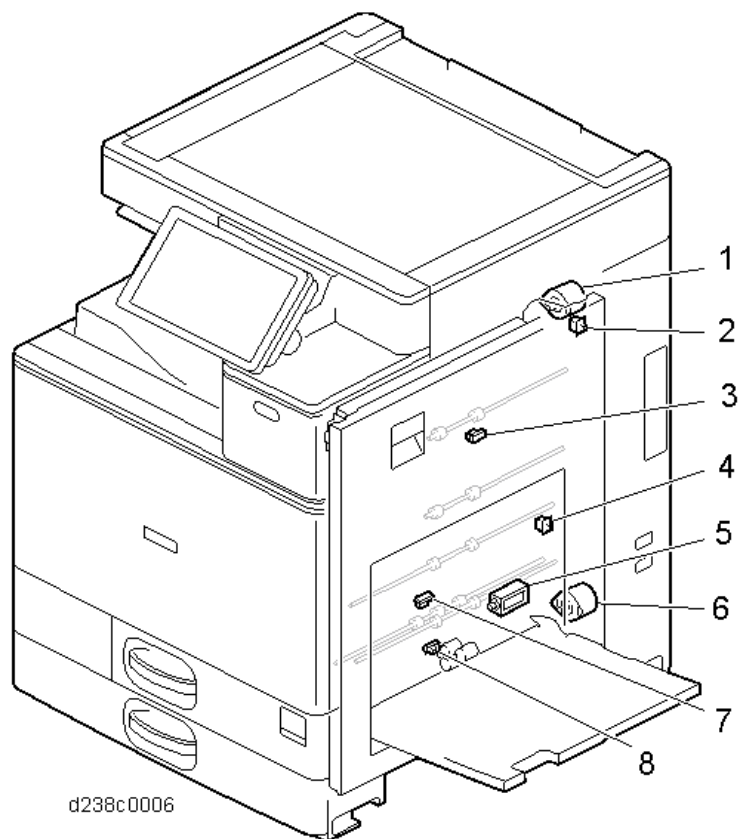

d238c0006

No.	Description	No.	Description
1	Duplex entrance motor	5	Bypass pick-up solenoid
2	Right door open/close sensor	6	Bypass / Duplex motor
3	Duplex entrance sensor	7	Duplex exit sensor
4	Duplex guide plate open/close sensor	8	Bypass paper end sensor

Bypass Unit

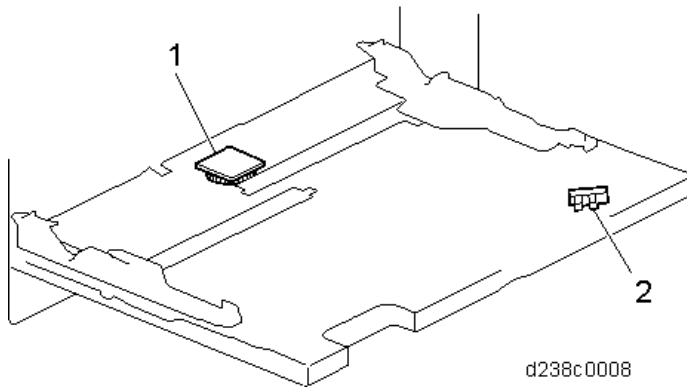

No.	Description
1	Bypass width sensor
2	Bypass length sensor

Fusing Unit

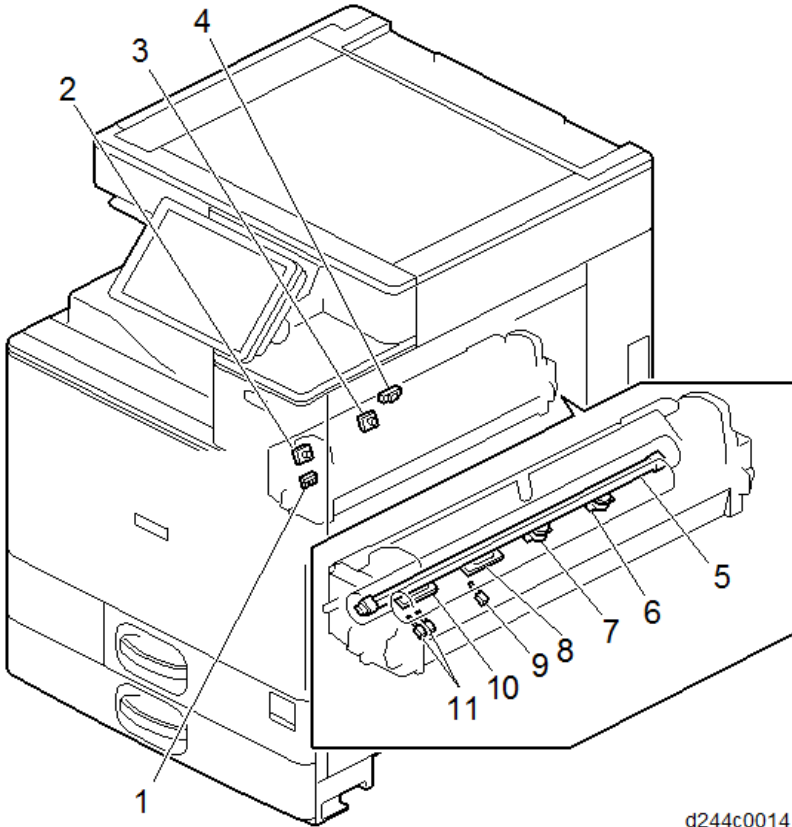

d244c0014

No.	Description	No.	Description
1	Pressure roller HP sensor	7	Fusing sleeve thermostat (center)
2	Thermopile (edge)	8	Non-contact thermistor (center)
3	Thermopile (center)	9	Pressure roller thermistor (center)
4	Fusing exit sensor	10	Non-contact thermistor (edge)
5	Fusing lamp	11	Pressure roller thermistors (edge, full-bleed edge)
6	Fusing sleeve thermostat (edge)		

Paper Transfer / Paper Exit

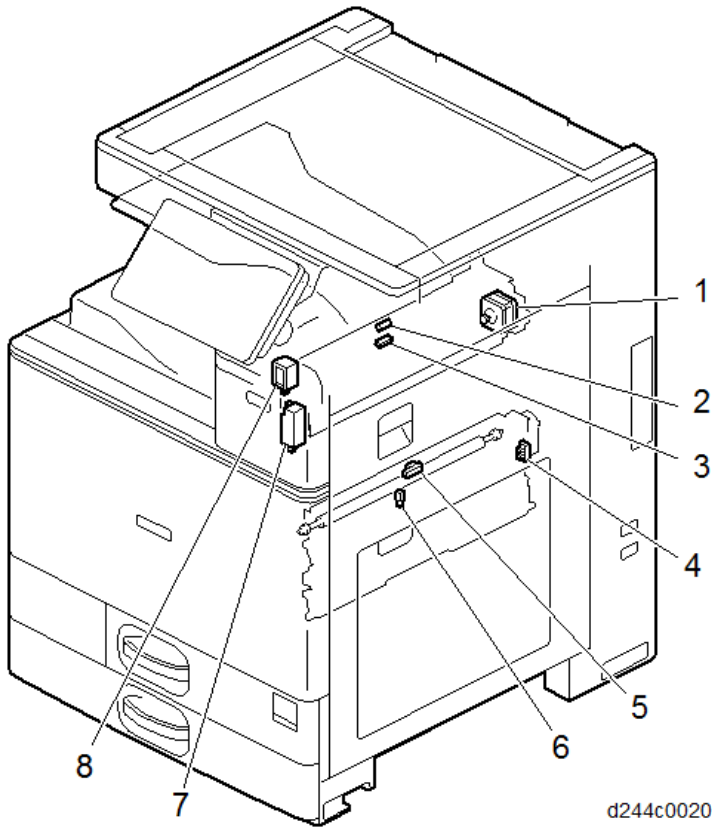

d244c0020

No.	Description	No.	Description
1	Reverse motor	5	Fusing entrance sensor
2	Reverse sensor	6	Fusing exit sensor
3	Paper exit sensor	7	Fusing exit drive solenoid (installed on the main machine)
4	PTR open/close sensor	8	Paper exit solenoid

Air Flow

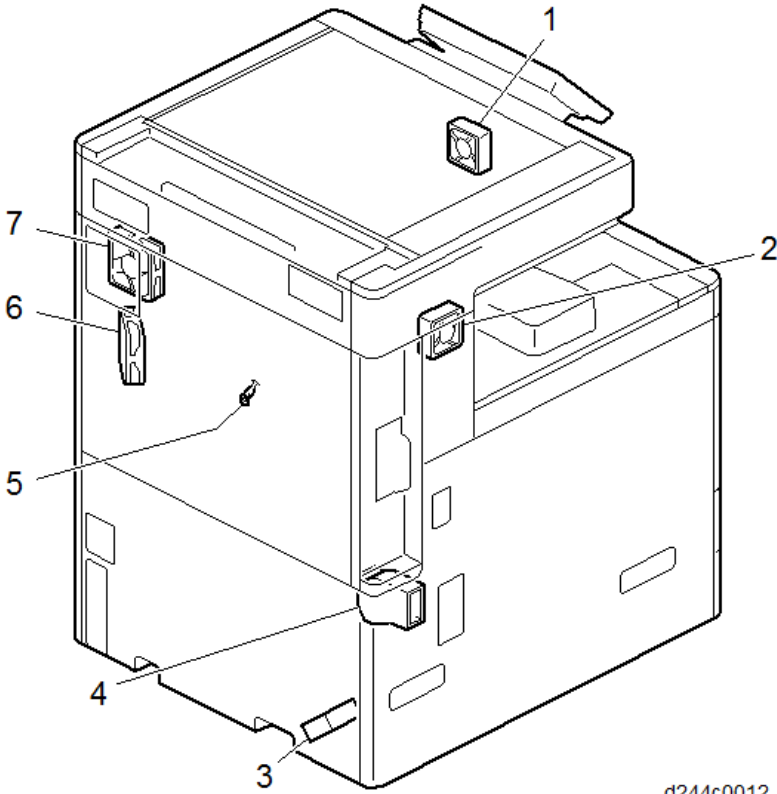

d244c0012

No.	Description	No.	Description
1	Paper exit cooling fan	5	Imaging temperature sensor (Thermistor)
2	Development intake fan	6	Toner supply cooling fan
3	PSU cooling fan	7	Fusing exhaust fan
4	Ozone exhaust fan		

Drive Unit

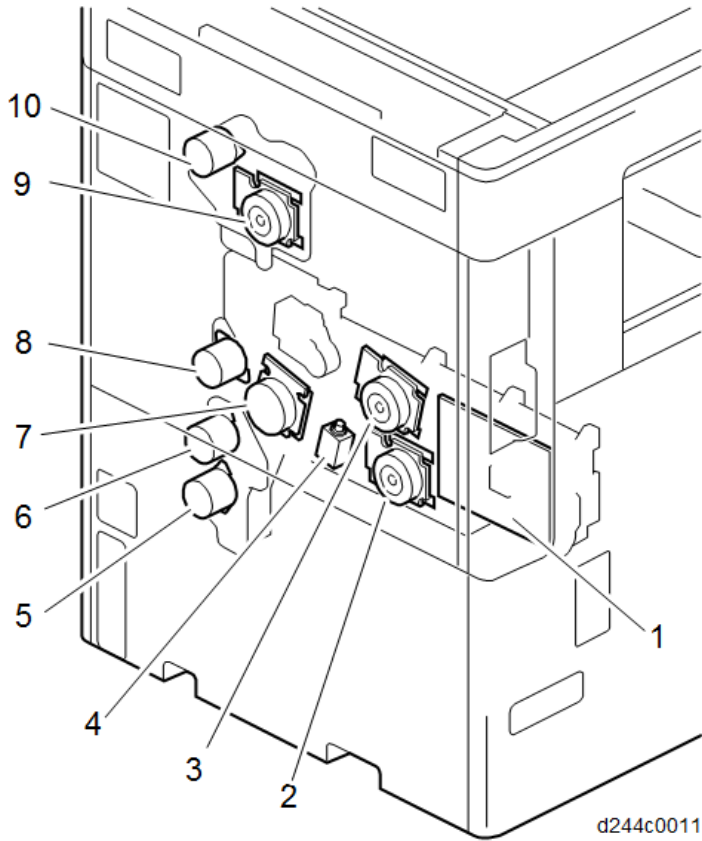

No.	Description	No.	Description
1	Imaging IOB	6	Transport motor
2	Development motor: CMY	7	PCU motor: Black / ITB drive motor
3	PCU motor: CMY	8	Registration motor
4	Development Solenoid	9	Fusing motor
5	Paper feed motor	10	Paper exit / Pressure release motor

Board / Switch

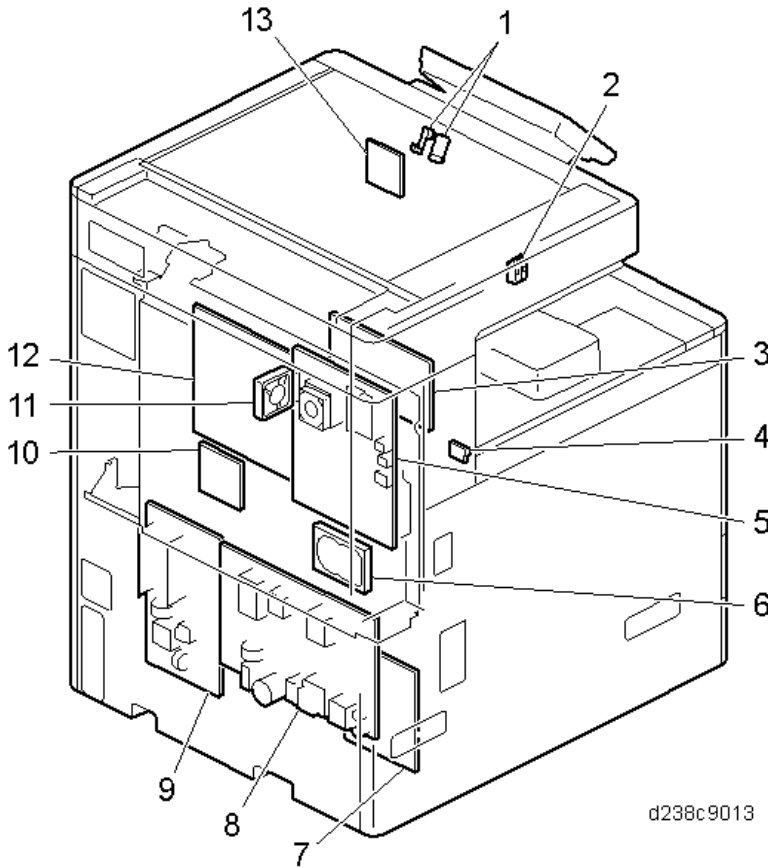

d238c9013

No.	Description	No.	Description
1	Proximity sensor (Human detection sensor)	8	PSU (DC power)
2	Interlock switch: front cover	9	PSU (AC controller board)
3	HVP_TTS	10	BCU
4	Main power switch	11	Controller box cooling fan
5	Control board	12	IPU
6	HDD	13	Proximity sensor (Human detection sensor) board
7	Paper transport IOB		

Scanning

Overview

The short focus scanner is realized by implementing a lens block (SBU, CCD, and Lens) on the carriage.

After the scanner lamp unit emits the light to the document, the light goes through route shown below and reaches the CCD.

Scanner lamp unit (LED) -> Original -> 1st mirror (13) -> 2nd mirror (3) -> 3rd mirror (6) -> 2nd mirror (3) -> 4th mirror (5) -> 5th mirror (14) -> lens -> pre-sensor lens -> CCD

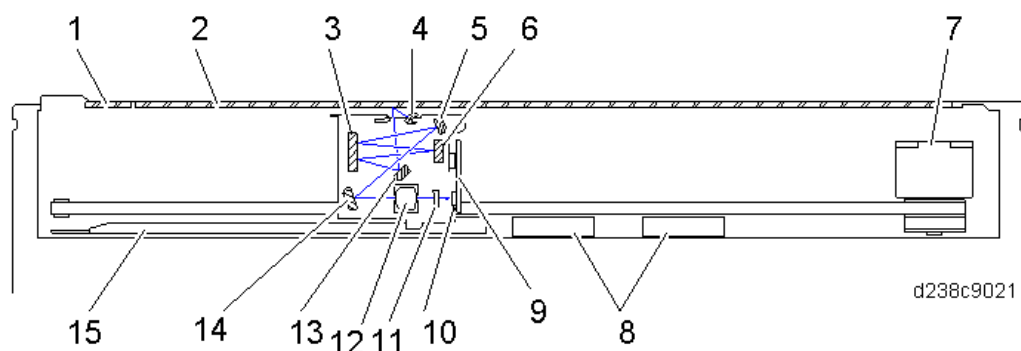

No.	Description	No.	Description
1	Sheet-through exposure glass	9	Sensor board unit (SBU)
2	Exposure glass	10	CCD
3	2nd mirror	11	Pre-sensor lens
4	Scanner lamp unit (LED)	12	Lens
5	4th mirror	13	1st mirror
6	3rd mirror	14	5th mirror
7	Scanner motor	15	Anti-condensation heater* (Scanner heater)
8	APS sensors		

*Service part

Reading System

Two scan modes are available: book mode (platen mode) and ADF mode (sheet-through method).

In book mode (platen mode), the scanner scans the document from left to right.

When the ADF is used (ADF mode), the scanner is fixed in the home position on the left side, and the document is transported and read (sheet-through method).

Scanner

Scanner lamp

The light source is an LED. The LED emits little heat (low power consumption), and has excellent light output rise characteristics.

CCD

The 3 line color CCD converts shade in the document to 3 color (B, G, and R) electrical signals. The use of a 4.7 μm image CCD achieves low-cost and compactness.

Reflection plate (reflector)

The reflection plate reflects light from the scanner lamp, and collects light for the document read unit. The light which illuminates the document is adjusted to be the same on the left and right so as not to cast any shadow on the document.

White reference seal

A white reference seal for shading correction is affixed to the underside of the scale on the left of the MFP. This is read by the scanner and CCD when the power is ON. The data read are temporarily stored in a RAM, and used for correction of document image data.

Mechanism

Scanner Drive

The scanner is driven by the scanner motor [D] via the timing belt [C]. For each mode, reading is completed in one pass.

Position control of the scanner carriage [B] is based on the scanner HP sensor [A].

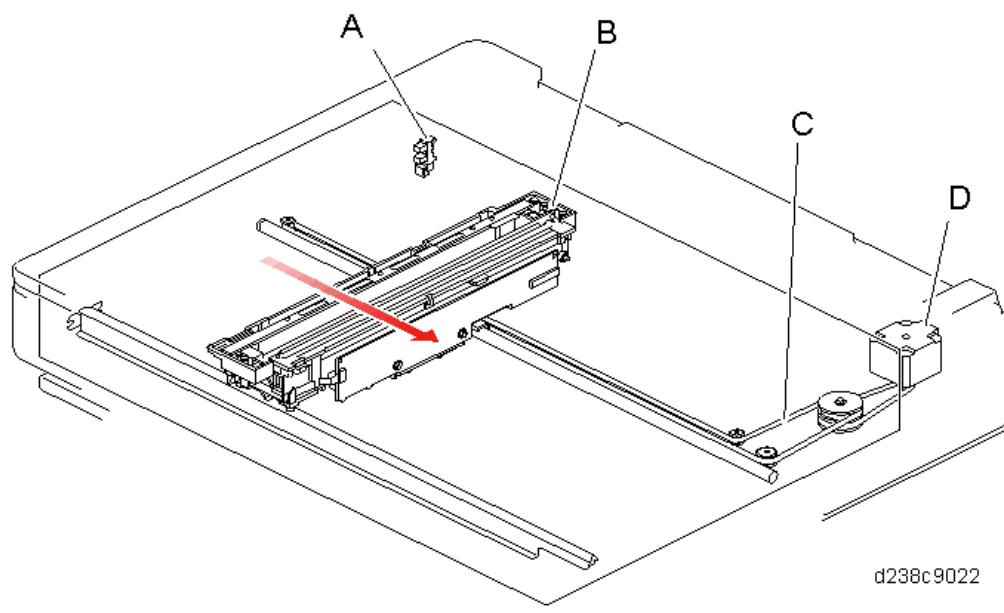

Operation Flowchart

Overall Flowchart

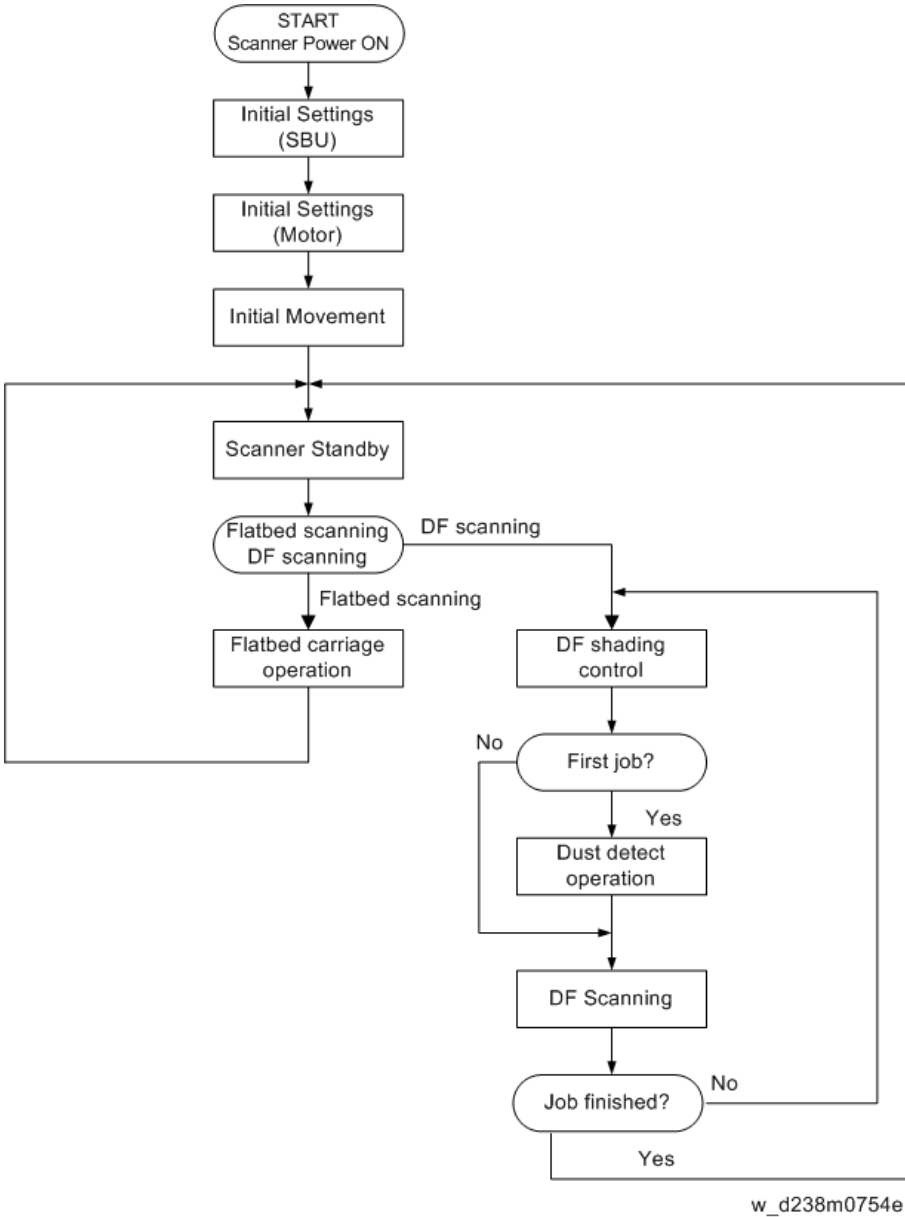

Scanner Carriage Storage Control

To protect the scanner carriage, the carriage must be locked to the scanner frame before shipping. The scanner can be moved to the shipping lock position with SP4-806-001 (Scanner carriage storage operation).

If pre-shipping check is required, make sure to move the scanner carriage to the right position with SP4-806-001 and mount the locking parts.

SC121-00 will occur when the power is turned on or scanning takes place while the carriage is locked.

Document Size Detection

In this MFP, for document size detection, two reflecting sensors are used for the sub scanning direction, and a CCD is used for the main scanning direction.

Sub scanning direction

The document size is detected by ON/OFF of the sensor. The pressure plate open/close sensor is used for document size detection timing. When the pressure plate open/close sensor has changed from "no cover" to "cover," the size is detected.

Main scanning direction

RGB color densities at 3 locations (S1, S2, S3) are detected by a CCD, and when any of the RGB densities is 12 digits or more, it is determined that a document is present.

The pressure plate open/close sensor is used for document size detection timing. When the pressure plate open/close sensor detects "no cover," the scanner lamp is moved to the right; when it detects "cover," the scanner lamp is moved to home position while lit, and during this time, the size is read.

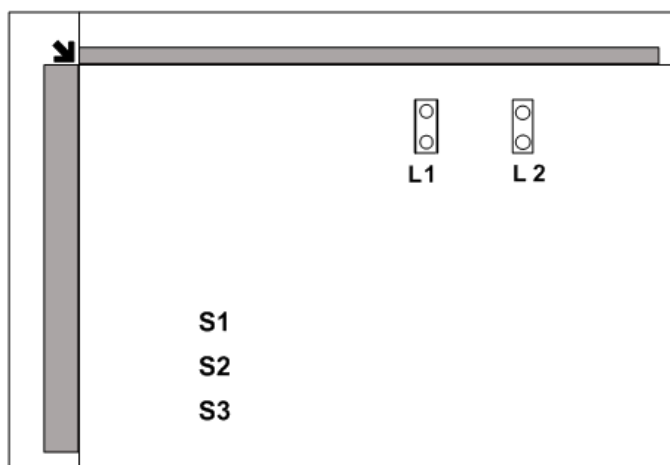

d088d514a

Document size			Sensor response				
Size	Direction	Dimensions (main × sub)	S1	S2	S3	L1	L2
A3	SEF	297×420	-	-	⊙	⊙	⊙
B4	SEF	257×364	-	⊙	-	⊙	⊙
A4	SEF	210×297	⊙	-	-	⊙	-
A4	LEF	297×210	-	-	⊙	-	-
B5	SEF	182×257	-	-	-	⊙	-
B5	LEF	257×182		⊙	-	-	-
A5	SEF	148×210	-	-	-	-	-
A5	LEF	210×148	⊙	-	-	-	-
B6	SEF	128×182	-	-	-	-	-
B6	LEF	182×128	-	-	-	-	-
DLT	SEF	11"×17"	-	-	⊙	-	⊙
10×15	SEF	10"×15"	-	⊙	-	-	⊙
USB4	SEF	10"×14"	-	⊙	-	-	⊙
LG	SEF	8 1/2"×14"	⊙	-	-	-	⊙
Oficio	SEF	8 1/2"×13.4"	⊙	-	-	-	⊙
Foolscap	SEF	8 1/2"×13"	⊙	-	-	-	⊙
Folio	SEF	8 1/4"×13"	⊙	-	-	-	⊙
F	SEF	8"×13"	⊙	-	-	-	⊙
LT	SEF	8 1/2"×11"	⊙	-	-	⊙	-
LT	LEF	11"×8 1/2"	-	-	⊙	-	-
8×10	SEF	8"×10"	⊙	-	-	⊙	-
10×8	LEF	10"×8"	-	⊙	-	-	-

Document size			Sensor response				
Executive	SEF	7 1/4"×10 1/2"	-	-	-	⊙	-
HLT	SEF	5 1/2"×8 1/2"	-	-	-	-	-
HLT	LEF	8 1/2"×5 1/2"	⊙	-	-	-	-
8kai	SEF	267×388	-	⊙	-	-	⊙
16kai	SEF	194×267	-	-	-	⊙	-
16kai	LEF	267×194	-	⊙	-	-	-

↓ Note

- The document width (main scanning direction) is detected by the sensor indicated with '⊙'.

How to check the sensor state

- SP4-301 (Operation Check APS Sensor)

How to read the screen

(7)00000000(0)

0: no document

1: document present

When the sensor responds, bit 0 is displayed as "1."

- SP4-310 (Scan Size Detect Value)

Viewed from the control panel, labeling positions from rear to front S1-S3 in that order, the RGB density at each position is displayed in digit units (the value just before scan is displayed).

Other

- SP4-303 (Min Size for APS)

Sets the display when non-standard (small size) size original is detected.

0: Display message "Original size unknown".

1: Operate assuming the original size is A5 LEF (HLT LEF for inches).

- SP4-305-001 (8K/16K Detection)

By changing this SP, you can change between A4 size/letter size or Chinese paper size (8×16).

0: Normal setting. (Default)

- 1: When detecting A4/LT size -> Assume that it is A4 when SEF, LT when LEF.
- 2: When detecting A4/LT size -> Assume that it is LT when SEF, A4 when LEF.
- 3: Change to 8K/16K settings.

A3, B4 -> 8K LEF

A4 LEF, B4 LEF, A5 LEF -> 16K LEF

A4 SEF, B4 SEF, A5 SEF -> 16K SEF

- SP5-126 (Set F-size Document)

Selects the paper size for the F-size original.

0: When detecting Foolscap -> Assume that the size is 8 1/2"x13". (Default)

1: When detecting Folio -> Assume that the size is 8 1/4"x13".

2: When detecting F -> Assume that the size is 8"/13".

- SP4-308 (Scan Size Detection)

Sets CCD original size detection and APS original size detection.

0: Disable: Not detect original size

1: Enable: Detect original size by the CCD unit

2: APS: APS sensor is used for detecting original size.

- SP4-309-004 (Scan Size Detect:Setting LED PWM Duty)

If the user specifies that the pre-scan lamp is too bright, the brightness pre-scan can be reduced by decreasing the value of SP4-309-004 (Scan Size Detect:Setting LED PWM Duty). However, if the lamp brightness is reduced, size detection for a document with a large number of solid images will be less accurate.

- SP5-135 (LG_Oficio Change)

1: When detecting LG size -> Assume that the size is 8 1/2"x14".

2: When detecting Oficio size -> Assume that the size is 8 1/2"x13.4". (Default)

Improved Tolerance to Black Lines When Paper Passes through ARDF/SPDF

The original document does not come in contact with the sheet-through exposure glass, which prevents adhesive dirt (ball pen ink) on the document from adhering to the sheet-through exposure glass.

ADF cross-section diagram, non-contact scanning

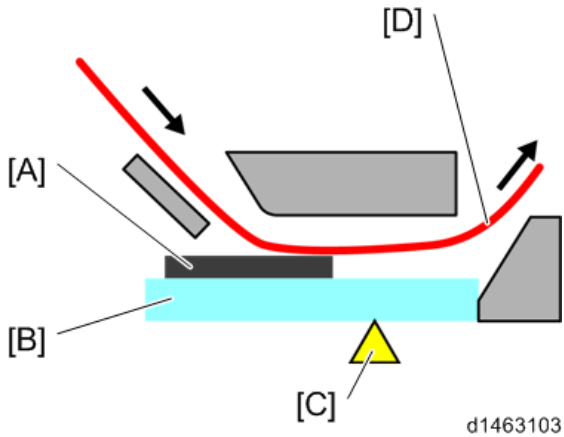

[A]: Sheet

[B]: Sheet-through exposure glass

[C]: Read position

[D]: Document

- Contact scanning

As the document comes in contact with the sheet-through exposure glass this is useful for dealing with adhesion of free dirt particles (paper scraps, etc.). (Self-cleaning mechanism using paper)

On the other hand, sticky dirt adhering to the document sticks to the sheet-through exposure glass, and may give rise to the appearance of black lines.

ADF cross-section diagram, contact scanning

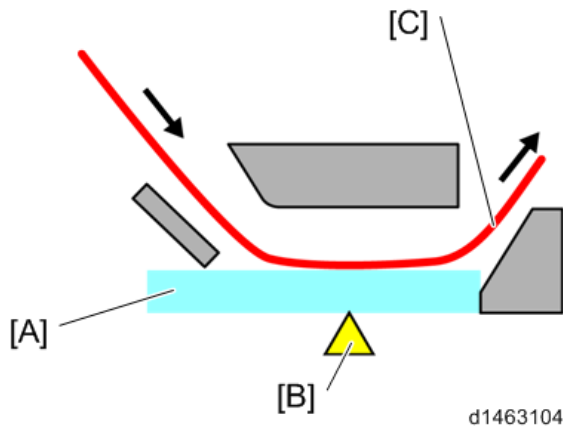

[A]: Sheet-through exposure glass

[B]: Read position

[C]: Document

If black lines due to free dirt particles appear within a short time, such as when users have documents with large amounts of paper scraps, you can change from the non-contact scanning system to the contact scanning system with the procedure in Troubleshooting - Vertical Streaks on Copies due to Scanning Problems.

- Reference (reading position correction)

By changing SP4-020-001 (Dust Check Dust Detect:On/Off), when dirt is detected at the reading position, the reading position may be changed to avoid the dirt.

(If it cannot be avoided, an alert is displayed on the control panel advising the user to perform target glass cleaning).

Image diagram

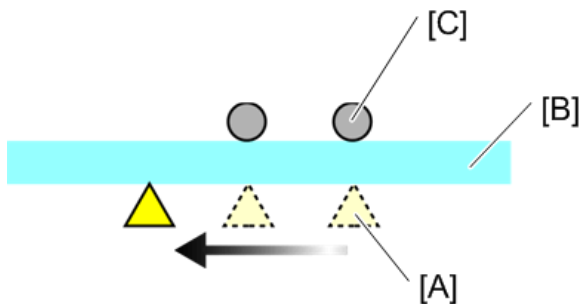

d1463105

[A]: Read position

[B]: Sheet-through exposure glass

[C]: Dirt

Note

- Dirt is detected when a document passes through, so the alert will not disappear until reading of the next document begins, even after the sheet-through exposure glass cleaning is performed.
- If dirt is detected not on the sheet-through exposure glass but on the background guide plate, the alert will not disappear even if the glass is wiped.
- The time required for the first copy is slightly (almost imperceptibly) longer.
- The detection threshold value can be changed using SP4-020-002 (Dust Check Dust Detect:Lvl). (The larger the value is, the smaller the dirt particles that can be detected become.)
- It is prohibited to change the setting of SP4-020-003 (Dust Check Lvl Dust Reject:Lvl).

Difference between Non-contact Transport and Contact Transport in DF Scanning

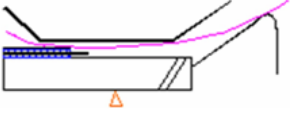
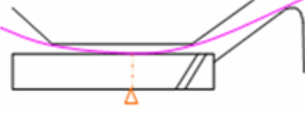
Transport Method	Non-contact Transport	Contact Transport
Descriptions	 <p>Because of the film attached to the glass, the original doesn't contact the glass.</p>	 <p>While passing, the original contacts the glass.</p>
Merit	<p>It almost never causes stripes on the image that arise from foreign substances transferring from the original to the glass.</p>	<p>It almost never causes stripes on the image that arise from dust on the glass, because the glass is cleaned by contact with the transported original.</p>
Demerit	<p>Compared with the contact method, stripes on the image caused by dust occur more often.</p>	<p>Compared with the non-contact method, stripes on the image caused by foreign substances transferred from the surface of an original to the glass occur more often.</p>
Aim	<p>To improve prevention of stripes in the image caused by sticky foreign substances.</p>	<p>Considering the target users of this machine, it's important to improve prevention of stripes caused by dust in the path</p>
Note	<ol style="list-style-type: none"> 1. Be sure to replace the sheet-through glass with the film attached on the glass. 2. When you attach the film on the glass, you need to keep the left scale attached on the glass in order to fix the location of the film.* 1 3. You can change the method (contact method to non-contact, or vice versa) by replacing some parts.* 1 	<p>-</p>

* 1: For details, page 1060 "Vertical Streaks on Copies due to Scanning Problems".

Anti-Condensation Heater

Under low temperature conditions, condensation may appear on optical parts (such as mirrors). This will cause image deletion, blacked out images, and gray images. As a countermeasure, there is an anti-condensation heater [A] that is an optional service part. This heater turns on automatically when the power source turns off.

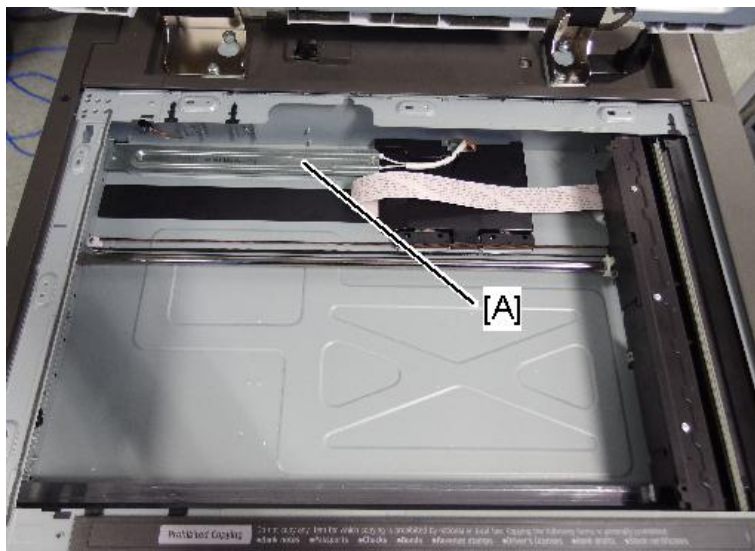

d238m0926a

7

A	Anti-condensation heater
---	--------------------------

Image Processing

Mechanism

SBU

Functions

Performs Black level correction and White level correction, Creating the SBU test pattern, and A/D conversion.

This machine is equipped with a short focus scanner and the SBU is located on the scanner carriage.

Operation overview

Samples 2 analog signals (ODD, EVEN) from RGB output from the 3-line CCD, and converts them to digital signals by an A/D converter. The digital signals are output to the IPU.

SP correction value storage

The SBU correction value is stored in an EEPROM on the BCU.

Execute the following SP settings when the scanner carriage is replaced. (Lens block is located on the scanner carriage.)

- SP4-871-002 (Distortion Correction Distortion Initialization)
- SP4-880-001 (Dot shift amount between R Line and G Line).
- SP4-880-002 (Dot shift amount between G Line and B Line).

SBU Test Mode

There is an SP code to create a test pattern which can be used as a diagnostic tool to troubleshoot problems in the SBU:

- SP4-699-001 (SBU Test Pattern Change)

Pattern 1: fixed value

Pattern 2: main scanning gradation pattern

Pattern 3: width scanning gradation pattern

Pattern 4: main scanning/width scanning lattice pattern

SBU has a function to generate four test patterns.

IPU

Image processing function overview

The image signals from the SBU are subjected to various image processing, and output to the controller (memory). The image signals from the controller (memory) are received, and output to the LDB (the LDB is provided in the write unit).

Image processing overview (copy application)

Digital signal data output from the SBU is subjected to shading correction and line interval correction, as well as image processing, which are performed by the IPU. Finally, the data is sent to the machine as digital signals-4 bit/pixels.

Image processing items	Details
Shading correction	Corrects for uneven scanner lamp lighting, and scatter in CCD light receiving sensitivity.
Line interval correction	Line shift during subscanning magnification/reduction by scanner. Corrects integer part.
Dot correction	Line shift during subscanning magnification/reduction by scanner. Corrects below decimal point.
Vertical line correction	Corrects a vertical striped image during sheet-through ADF.
Image area separation	Determines text parts and photo parts of image.
Scanner gamma correction	Corrects scatter of image data relative to exposure amount. From reflectivity linear to density linear.
Filter	Performs image sharpness adjustment and removes moire.
ADS	Performs natural complexion removal in full color mode.
Color compensation preprocessing	Determines hue in masking mode, and improves chromaticity.
Color compensation	Converts RGB data to density value CMYK data of color materials.
Image magnification change	Arbitrarily changes main scanning magnification, subscanning fixed image reduction and magnification of scanner image.
Image shift function	Shifts image data in the main scanning or subscanning directions.
Image binarization function	In scanner mode, outputs a binary signal.

Image processing items	Details
Image mask	Masks an area outside a frame of an arbitrary region in scanner or printer data.
Image compression/ expansion	Compresses or expands an image.
Printer gamma correction	Adjusts exposure amount of photosensitive body relative to image density.
Gradation processing	Applies 600dpi, 4bit 16 value gradation processing.

Laser Exposure

Overview

Four stations (one for each color).

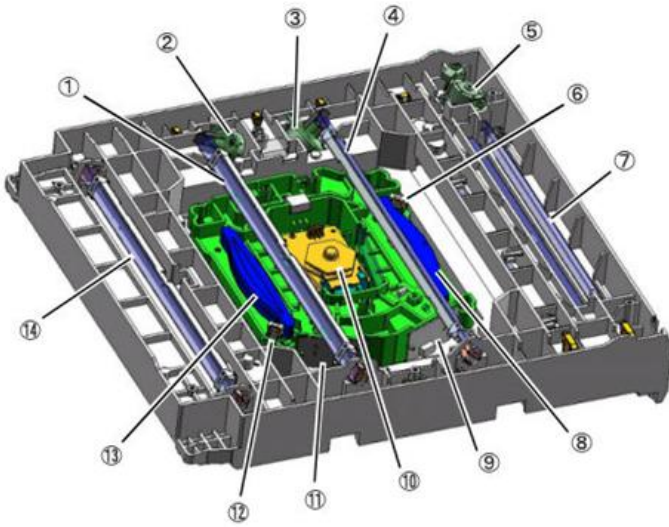

d1462690

No.	Description	No.	Description
1	2nd mirror	8	F-theta lens-M/Y
2	Laser optics positioning motor (C)	9	LD drive board
3	Laser optics positioning motor (M)	10	Polygon mirror motor
4	2nd mirror	11	LD drive board
5	Laser optics positioning motor (Y)	12	Cylinder lens
6	Cylinder lens	13	F-theta lens-Bk/C
7	1st mirror	14	2nd mirror

Parts Construction

The write unit comprises a housing and the following main parts:

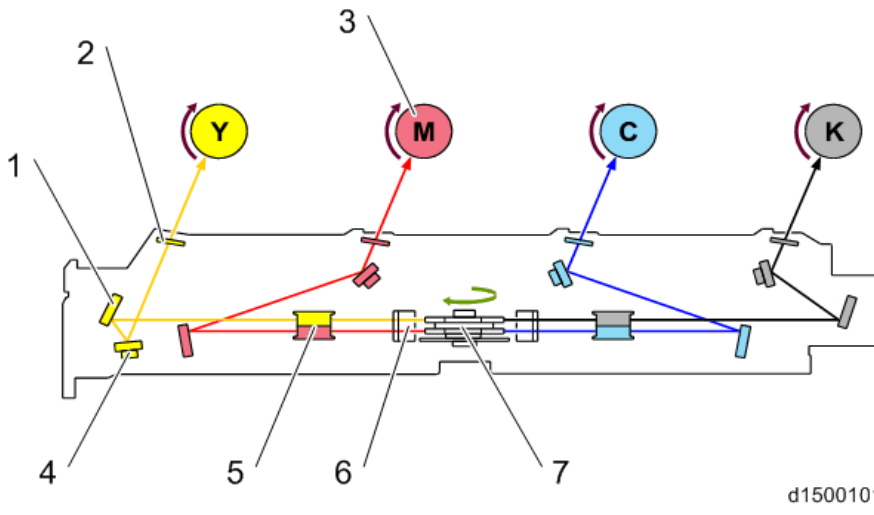

No.	Description	No.	Description
1	1st mirror	5	F-theta lens
2	Dust shield glass	6	Soundproof glass
3	PCU (Y, M, C, K)	7	Polygon mirror motor
4	2nd mirror		

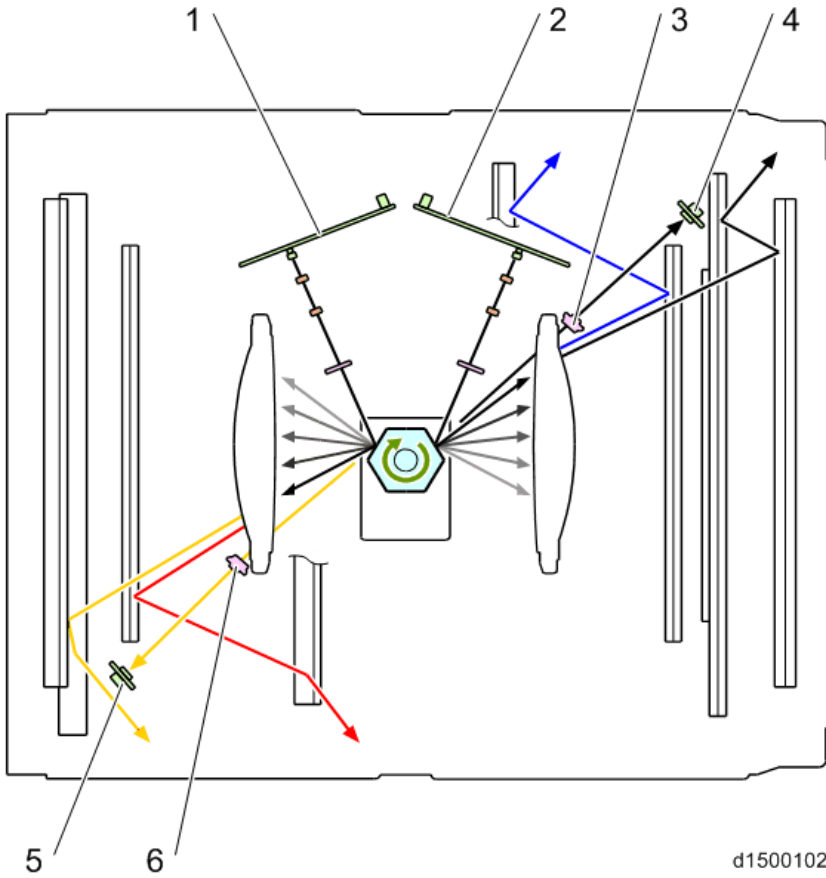

No.	Description	No.	Description
1	LD drive board (M/Y)	4	Synchronizing detector board: Bk/C-S
2	LD drive board (Bk/C)	5	Synchronizing detector board: M/Y-S
3	Cylinder lens (Bk/C)	6	Cylinder lens (M/Y)

Mechanism

LD Drive Board

The LD Unit is provided with two LD drive board. The beam system is a 1 beam type.

The LD drive board comprises an LD (laser diode), PD (photodiode) and LD control unit.

- The LD outputs the laser light to the PCU.
- The PD continuously detects laser light from LD, and outputs it to the LD control unit.

- The LD control unit adjusts the light amount of the LD based on the output signal of the PD.

LD control board adjustment is not required in the field.

LD Safety Switch

To prevent the laser beam from turning on when the front cover or right door is open, the 5V supply to the LD drive board is interrupted when the interlock switch is open.

Circuit Diagram

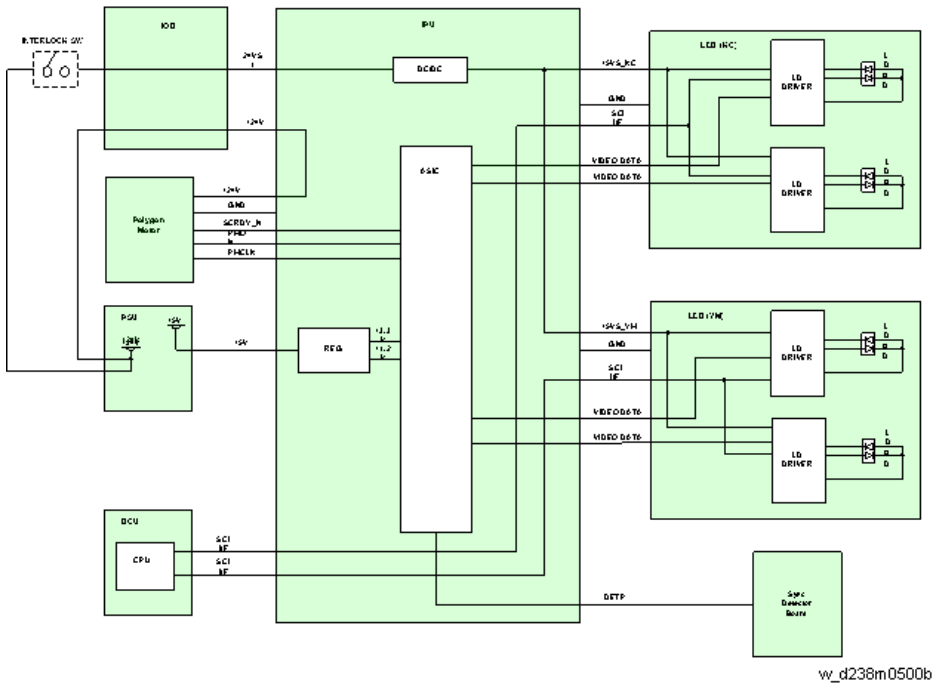

Line Scanning Mechanism

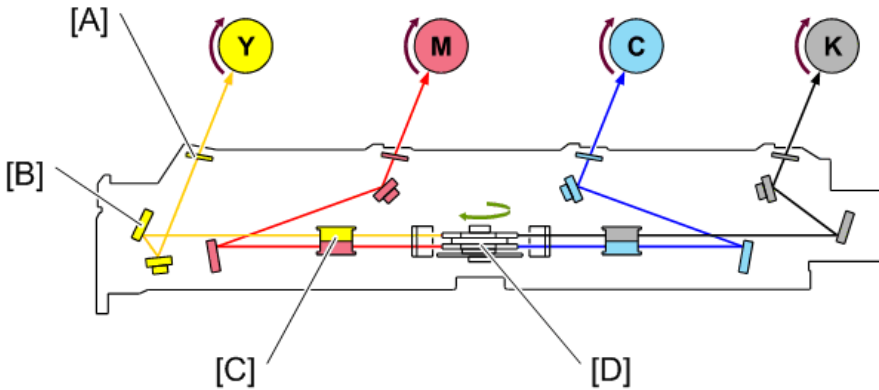

d1462614

[A]: Dust shield glass

[B]: 1st mirror

[C]: F-theta lens

[D]: Polygon mirror motor

1. Mirror, lens

Laser diodes of each color emit light to match the paper transport timing. After passing through the cylinder lens (laser beam width correction), polygon mirror motor (main scanning line scan), F-theta lens (dot position correction and optical face angle error correction), it reaches the drums of each color.

The F-theta lens has a two-stage integrated construction, and 2 color beam correction is performed with one lens.

2. Polygon mirror motor

The polygon mirror motor comprises two (upper and lower) 6-faced mirrors formed in an integral construction (these are combined in one unit).

In this MFP, 4 color simultaneous write is performed by the LD irradiating a polygon mirror.

* The rotation speed of the polygon mirror motor is controlled by LD/ Polygon mirror motor.

3. Synchronization sensor

There are two synchronization sensors, i.e., one on the K-C side, and one on the M-Y side. Each sensor detects light from one color, and synchronization for two colors is calculated from this.

There is only one sensor for each color. The sensor at the leading edge of the main scan line has been removed.

4. Scan line inclination and automatic adjustment mechanism

The laser optics positioning motor installed on the 2nd mirror adjusts the scan line inclination.

This is done during automatic image position correction.

Process Control

Mechanism

Sensor Construction

The ID Sensors (also called the TM/ID sensors) are used to measure the amount of toner on the transfer belt and to correct any errors in color registration.

The TD sensor (also called the μ sensor) is used to measure the toner density in the developer.

Outline of the ID Sensors

The ID sensors are fixed onto the main frame, against the surface of the transfer belt. Color registration is checked by all three sensors; the front [A], center [B], and rear [C].

The center sensor [B] acts as an ID sensor and a MUSIC sensor.

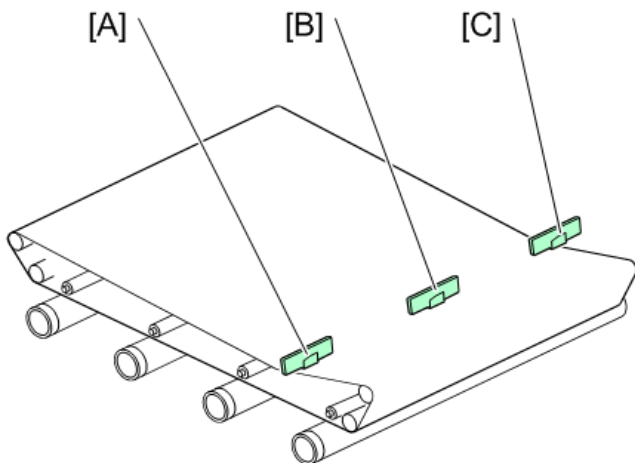

d1500305

Outline of the TD sensor

In this model, a non-contact toner density (TD) sensor, which we also call a μ (μ) sensor, is used for toner density control.

The TD sensor is attached on the lower side of the development unit. Unlike a HST sensor, the board of the TD sensor is exposed. So there is a cover around the sensor to protect it and to maintain a good contact between the sensor and development unit.

The TD sensor measures the permeability of the developer without contacting it, from the outside of the case, and converts the measured value to the toner density.

According to the toner density measured by this sensor, the proper amount of toner is supplied to the developer.

A counter corresponding to the frequency is used as the unit of TD sensor output. Thus, unlike a HST sensor which directly detects V_t , the TD sensor output is converted into V_t for toner supply control.

In the TD sensor, there is an ID chip storing the machine identification information, the running distance information of development unit and PCU, and other information used by image density control.

Process Control

Outline

Process control adjusts the condition of the imaging hardware to maintain a constant image density. Process control is executed at the following times.

	Process Control	Operative Condition	Related SPs
1	PowerON ProCon :Set	When a certain time has passed after the previous job end (Except when recovering from an SC or jam)	SP3-530-001 SP3-530-002 SP3-530-003 SP3-530-004 SP3-530-005 SP3-530-006 SP3-530-007 SP3-530-008
2	JobEnd ProCon :Set	When the value of the job end counter becomes more than the threshold (At job end)	SP3-534-001 to 004 SP3-534-011 to 014
3	Interrupt ProCon :Set	When the value of the job interrupt counter becomes more than the threshold	SP3-533-001 to 004 SP3-533-011 to 014
4	Non-useTime Procon :Set	When the value of the non-use time counter becomes more than the threshold	SP3-531-001 to 004
5	Manual ProCon :Exe	When SP 3-011 is used	SP3-011-001 to 005
6	Toner End Recovery	After the Toner End Status is cleared (Recovery is NOT done in the near end status)	-

	Process Control	Operative Condition	Related SPs
7	Initial Developer Setting Process Control	When the machine detects a new PCU or development unit	-

Result Code for Executing Process Control

Check the following SPs.

- SP3-012-001 to 010 (Front)
- SP3-012-011 to 020 (Center)
- SP3-012-021 to 030 (Rear)

Category	Code	Result name	Description
00 and larger	00	Not executed	Factory default setting (SP default)
10 and larger Result (Normal)	11	Succeeded	-
40 and larger ID Sensor	41	ID sensor output error (Max)	Vt > Max
	42	ID sensor output error (Min)	Vt < Min
	43	ID Sensor error (Max)	Development gamma is in target, but Vt value is less than upper limit.
	44	ID Sensor error (Min)	Development gamma is in target, but Vt value is less than lower limit.

Category	Code	Result name	Description
45 and larger ID Pattern detection	45	ID Pattern extract error	Cannot detect ID Pattern
	50	Vmin_Bk/K2 error (Max)	K:Vmin_Bk / CMY:K2 > Max
	51	Vmin_Bk/K2 error (Min)	K:Vmin_Bk / CMY:K2 < Min
	52	K5 error (Max)	K5 > Max
	53	K5 error (Min)	K5 < Min
	54	K5 calculated approximate point error	K5 calculated approximate point < Min
	55	Development gamma error (Max)	Development gamma > Max
	56	Development gamma error (Min)	Development gamma < Min
	57	Start developing voltage: V _k error(Max)	Start developing voltage: V _k > Max
	58	Start developing voltage: V _k error(Min)	Start developing voltage: V _k < Min
	59	Not enough valid data	Adhesion amount data for development gamma calculation point is under 2.
90 and larger Result(End)	90	Potential not adjusted	Potential control method is set as [0:FIX].
	99	Stopped	Stopped by door open, power off, error. (Set when execute.)

Note

- Execution result example (In order of YMCK from left)
- Factory default (SP default): [00,00,00,00]
- Starting adjust: [99,99,99,99]
- Fail V_{sg} adjust(Y): [21,99,99,99]
- Error of Development gamma Max(C): [99,99,55,99]
- Succeeded: [11,11,11,11]

The Process Control Procedure

The potential of the unexposed drum is called the electrified potential (V_d), whereas the potential when toner starts to adhere to the drum is called the development bias (V_b).

Toner starts to adhere to the drum in proportion to the potential when the value of potential becomes more than V_b . The value (coefficient) which shows the relation between the potential and the amount of adhesion is called development gamma.

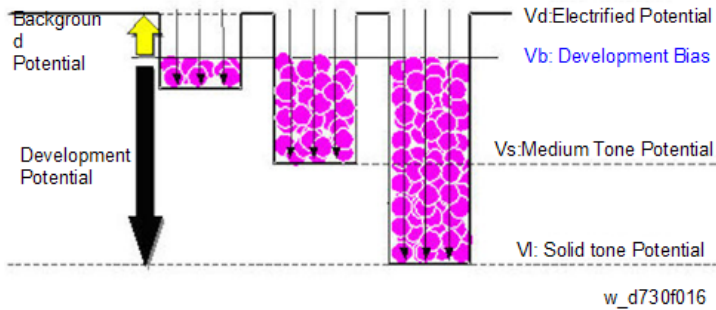

In addition to the development gamma and the potential, the toner density in the developer needs to be controlled. This is done to maintain the proper toner density (the amount of toner adhesion).

The target figure for the toner density in the developer is called V_{ref} .

Process control is done as shown in the following chart, which includes development gamma determination, V_{ref} correction, and LD power control.

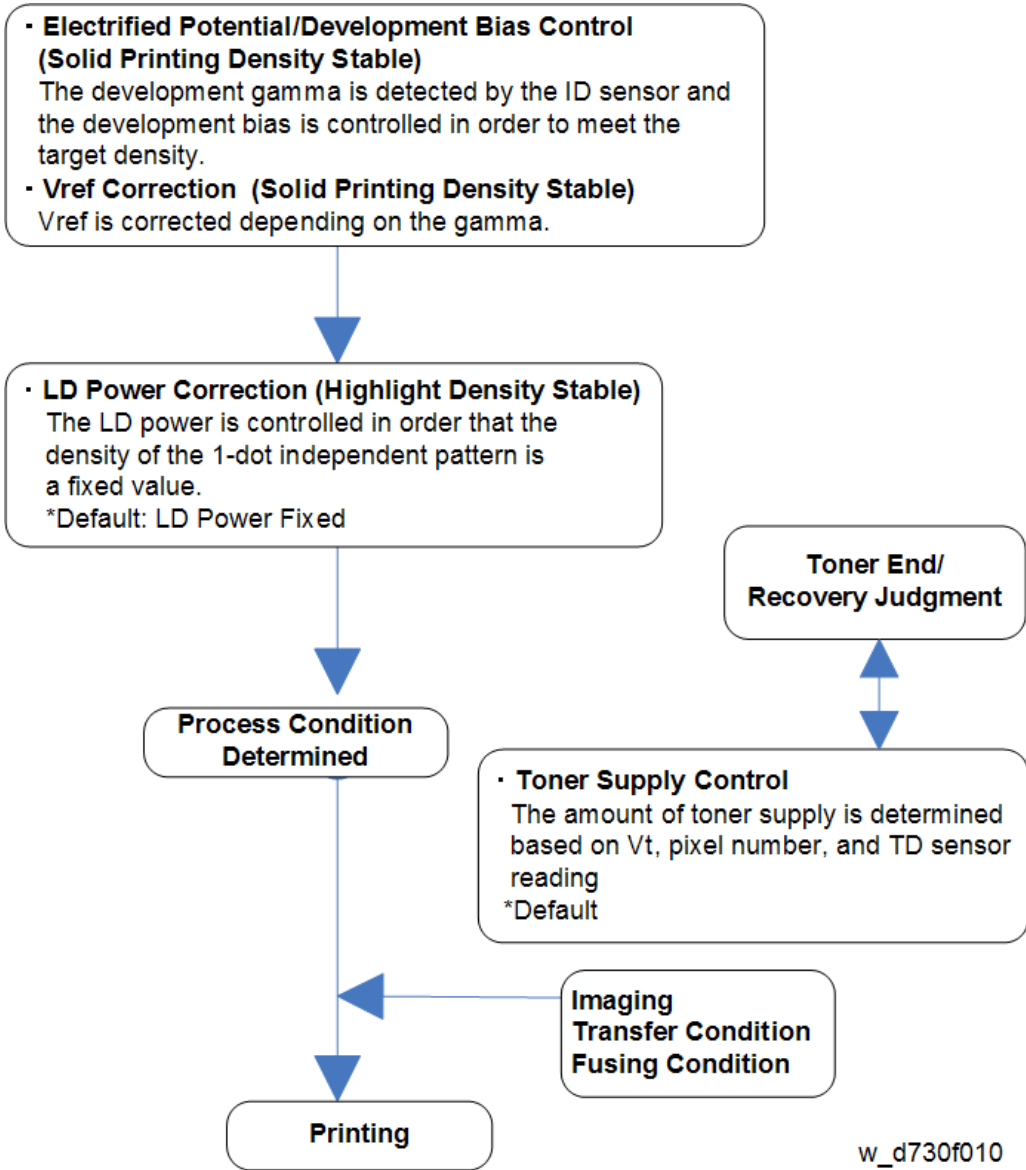

Electrified Potential / Development Bias, Vref Correction

Electrified Potential/ Development Bias and Vref Correction are done with the following method.

The operation time differs depending on the line speed.

1. Adjusting the ID sensor Vsg

The machine adjusts the LED strength of the ID sensor so that the value of Vsg (the charge which is detected from the background on the Transfer Belt) will be in the range of $4.0V \pm 0.5V$. When Vsg is detected as not within the target range three times, SC370 (ID sensor error) will be detected.

↓ **Note**

- SP3-320-031/032/033 (V_{sg} Error Counter)
- SP3-320-013 (V_{sg} Upper Threshold)
- SP3-320-014 (V_{sg} Lower Threshold)

2. **Agitating the Developer (5 seconds)**

The machine agitates the developer and reads the TD sensor output.

↓ **Note**

- SP3-539-001 (Dev Agitating Time :Set)

3. **Creating patterns, detecting the density**

5 patterns are created on the transfer belt and detected by each ID sensor, with the Charge/ Development Bias adjusted for each pattern.

The ID sensor contains an LED [B] and two types of photo detector. The sensor detects the reflection from the LED with the positive photo detector (REG) [A] and the diffusion photo detector (DIF) [C].

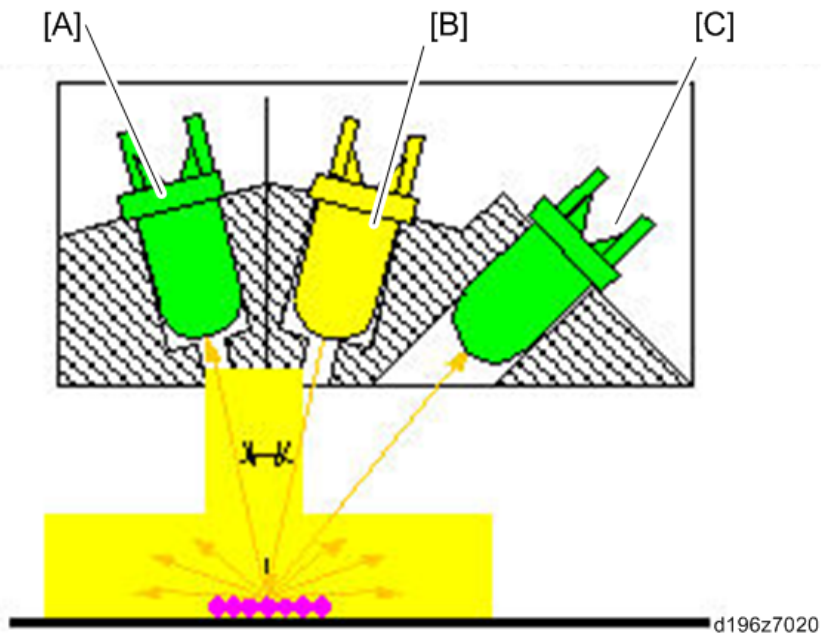

4. **Determining V_{tref} from the Development Gamma**

This decides the charge voltage and development bias

LD Power Control

LD Control is set with SP3-600-002(Process Control/ Select ProCon: LD Control).

- **To use a fixed LD Power**

Change the SP setting to [Fixed]. LD strength is fixed with SP2-221-001 to 004.

- **To control LD Power by Process Control (Default)**
 - The LD power is determined by process control.
 - The LD strength is adjusted based on a table which is determined by the Development Bias Control and Vref Correction.

Toner Supply Control

The Toner Supply Type can be selected with SP3-400-001 to 004 (Toner Supply Type).

- **0: Fixed (Fixed supply method)**

The toner supply time is calculated based on the supply rate of SP3-440-001 to 004 (Fixed Supply Mode: Fixed Rate).
- **2: PID (Proportion Integral Differential)**

The amount of toner supply is calculated based on the pixel information and TD sensor information.
- **4: DANC (Divided Active Noise Control) (Default)**

Conventional PID method + active noise control. It controls the timing to supply the developer to minimize uneven developer density in the development unit.

Developer Initial Setting

When a new PCDU is set in the machine, the machine automatically detects it and enters the developer initial setting mode. The machine then detects the μ count which is an output from the TD sensor. The developer initial setting is done as follows.

1. Starting the developer initial setting mode

The new unit detection mechanism triggers the developer initial setting mode.

2. Agitating the developer

The machine rotates the development roller and transport coil to agitate the developer for 30 seconds.

3. Detecting the μ count (Initial value)

While agitating the developer, the machine detects the output from the TD sensor, and stores this output as the initial μ count.

4. Calculating V_t

The machine calculates V_t using the difference of the current μ count while referring to the initial μ count through SP.

5. Forced toner supply (only when newly installing the machine)

This step is required only when the machine is newly installed because there is no toner in the toner transport route.

When the developer initial setting is successfully completed, the machine stores the calculated V_t as V_{tref} . The V_{tref} is used as a reference the next time the machine performs an initial developer setting.

SC360-01 through -04 appears if the results of step 3 are as follows:

- The μ count is equal or exceeds the threshold (6480 [counts]).
- The μ count does not match the target threshold (5800 – 6380 [counts]) three times consecutively.

Process Control and MUSIC are forcibly done after developer initial setting when a PCDU is replaced.

MUSIC (Automatic Color Registration Correction)

Correction Timing

The machine creates correction patterns, measures the image position by reading the correction patterns, and corrects the writing position.

	Operative Condition	Notes
1	Power switch just turned on, or recovering from the energy save mode	Mode b or Mode a is done See notes *1 and *2 below.
2	When printing (when the temperature has changed by a certain amount since the previous job ended, or when the number of pages printed becomes more than a set number)	Mode b is done
3	End of printing (when the temperature has changed by a certain amount since the previous job ended, or when the number of pages printed becomes more than a set number)	Mode b is done
4	Front cover opening/ closing (when the temperature has changed by a certain amount since the previous job ended)	Mode b is done

	Operative Condition	Notes
5	Waiting (when the temperature has changed by a certain amount since the previous job ended, and when the number of pages printed becomes more than a set number)	Mode b is done
6	When the machine detects a new PCDU, and/or image transfer belt	Mode a is done

* 1 Mode **a**: adjusted two times

* 2 Mode **b**: adjusted once

Executing MUSIC Manually

To operate modes a, b, and c manually, use the following SPs.

- SP2-111-001 (Mode a)
- SP2-111-002 (Mode b)
- SP2-111-003 (Mode c)

Do this SP after the laser unit is changed.

- SP2-111-004 (Mode d)
Mode d is the same as doing mode c then mode a.
Normally in the field, we should only use mode d.

Note

- Color registration errors can be corrected only by the mode d when the error is large.

[Color Registration] in User Tools (SP2-111-004)

Correction with higher accuracy can be performed by contacting the image transfer roller and executing MUSIC in a condition that is almost the same as during actual printing. This process is called 'contact MUSIC'.

Contact MUSIC can be done manually by executing HOME screen -> User Tools icon -> Machine Features -> Maintenance -> Color Registration (SP2-111-004).

When the Imageable Area Extension Unit is installed, the MUSIC sensor is in the printing area. Therefore, the image transfer roller cannot be contacted and execution of MUSIC becomes the same as the previous machine.

Items	MP C2003/C2503/C2011	MP C2004/C2504
Normal Operation	rough adjustment -> fine adjustment only	rough adjustment -> fine adjustment -> contact MUSIC
With Imageable Area Extension Unit	rough adjustment -> fine adjustment only	rough adjustment -> fine * Same as the previous machine

Execution time varies from model to model.

Items	MP C2003/C2503/C2011	MP C2004/C2504
Execution time	About 22 sec.	About 29 sec.

MUSIC Error Judgment

When MUSIC is done, the results must be checked for each color. SP2-194-007 shows whether MUSIC was OK or NG, and SP2-194-010 to 012 show the details of the result.

- SP2-194-007 (Execution Result)

Detection Result	Meaning
0	Success
1	Failure

- SP2-194-010 (Error Result: C)
- SP2-194-011 (Error Result: M)
- SP2-194-012 (Error Result: Y)

Detection Result	Meaning
0	MUSIC not executed
1	Correction Succeeded: Sampling is conducted correctly and the correction is completed
2	Sampling Failed (When the MUSIC pattern failed to be detected)
3	Detection Patterns Lack (When the number of lines detected is smaller than the fixed number)
4	The sampled data is beyond the correction range. (Calculated correction value is just out of range)

Detection Result	Meaning
5	The sampled data is beyond the correction range.

Correction Operation Outline

1. The machine corrects the ID sensor output by Vsg adjustment
2. The machine creates the MUSIC pattern on the transfer belt with toner of each color.
3. The machine reads the MUSIC pattern on the transfer belt and detects the positions of the line patterns.
4. The machine calculates the amount of color registration or skew from the detected positions.
5. The machine determines the correction for the color registration, by calculating the required main scan magnification shift, main scan magnification deviation, main scan registration shift, skew correction value, and sub scan registration shift from the detected positions.

Real Time Process Control

During printing, 5 mm patterns are created outside the normal imaging area on the transfer belt, and the image density is corrected in the real time, to improve printing of solid areas. However, note that if the optional Imageable Area Extension Unit is installed, this process is disabled.

7

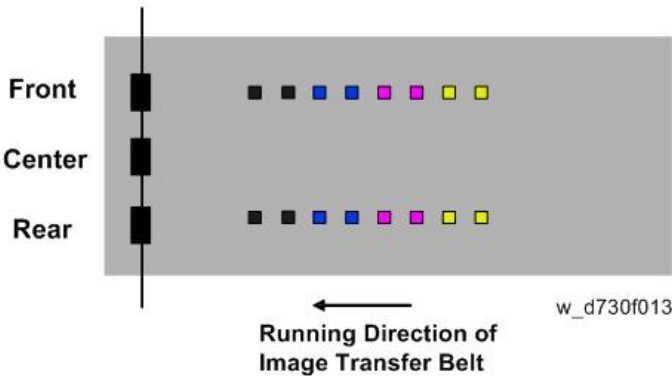

Normally, the real time control is done once every 10 sheets, but it could be done once every 5 sheets depending on the density detection level.

The frequency depends on the following SPs.

- SP3-301-001: RTP Pattern:Set:Create Intrvl:BW
- SP3-301-002: RTP Pattern:Set:Create Intrvl:FC

To see the latest result, check the following SPs. If there is an error, the result will not be updated.

- SP3-300-001 to 004 RTP Pattern:Disp:M/A(Latest):Each Color

- SP3-300-001 to 004 RTP Pattern:Disp:M/A(Target):Each Color

IBACC

Outline

IBACC (Image transfer belt type of inner ACC) maintains the quality of gradation in the images. To do this, the machine makes a gradation pattern on the transfer belt, and measures variations in density between the middle to the highlight tone, which solid printing control cannot correct perfectly. The machine feeds back variations in the density to the image-processing parameters (the digital gamma correction table).

Operation Timing

IBACC must be done in the shortest time possible, in cooperation with process control. This is because the process requires time to adjust. If the ON/OFF setting of IBACC operation (SP3-600-030) is ON, IBACC is done at the time of normal process control. If the setting is OFF, the IBACC is not done.

Before the IBACC procedure, the machine determines whether IBACC can be done, based on the engine condition. If there is an error in the latest process control, the following IBACC is considered to be unnecessary.

Patch Pattern

16x16 patterns are created. The order of the tones depends on the image processing layout. There are patterns for 600 dpi and 1200 dpi.

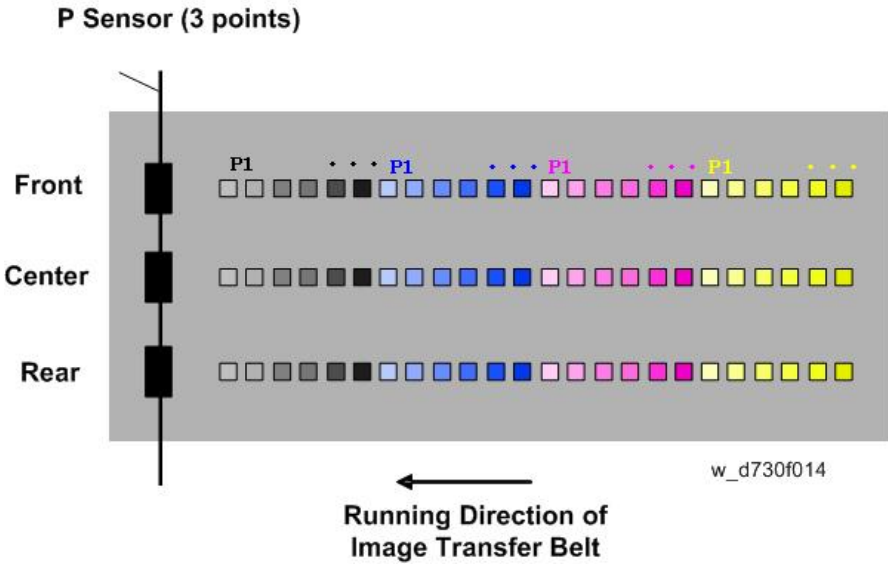

SP Descriptions

- **SP2-111-001 (Forced Line Position Adj.: Mode a)**
Executes MUSIC mode a (fine-tune x 2)
- **SP2-111-002 (Forced Line Position Adj.: Mode b)**
Executes MUSIC mode b (fine-tune x 1)
- **SP2-111-003 (Forced Line Position Adj.: Mode c)**
Executes MUSIC mode c (rough-tune x 1)
- **SP2-111-004 (Forced Line Position Adj.: Mode d)**
Executes MUSIC mode d (rough-tune then fine-tune)
- **SP2-194-007 (MUSIC Execution Result: Execution Result)**
Displays the execution results of MUSIC.
0: Completed successfully, 1: Failed
- **SP2-194-010,-011, and -012 (MUSIC Execution Result:Error Result: C, M, Y)**
Displays the details of MUSIC results for each color.
- **SP3-011-001 (Manual ProCon :Exe: Normal ProCon)**
Executes Pro-Con.
- **SP3-011-002 (Manual ProCon :Exe: Density Adjustment)**
Executes toner density adjusting Pro-Con.
- **SP3-011-003 (Manual ProCon :Exe: ACC RunTime ProCon)**

Executes pre-ACC Pro-Con.

- **SP3-011-004 (Manual ProCon :Exe: Full MUSIC)**

Executes Pro-Con / full MUSIC.

- **SP3-011-005 (Manual ProCon :Exe: Normal MUSIC)**

Executes Pro-Con / normal MUSIC.

- **SP3-012-001 to 010 (ProCon OK?: Front)**

Displays the history for past 10 times of ProCon results code detected by the front TM/ID sensor. The code is 2 digits per color from left, in the order of YMCK.

- **SP3-012-011 to 020 (ProCon OK?: Center)**

Displays the history for past 10 times of ProCon results code detected by the center TM/ID sensor. The code is 2 digits per color from left, in the order of YMCK.

- **SP3-012-021 to 030 (ProCon OK?: Rear)**

Displays the history for past 10 times of ProCon results code detected by the rear TM/ID sensor. The code is 2 digits per color from left, in the order of YMCK.

- **SP3-400-001 to 004 (Toner Supply Type: Select; Bk, C, M, Y)**

Selects the toner supply mode.

0: FIXED, 2: PID, 4: DANK

- **SP3-530-001 to 008 (PowerON ProCon :Set)**

Specifies the non-use time setting, temperature, relative humidity, absolute humidity or page interval as the threshold of process control execution determination at power on.

- **SP3-531-001 to 004 (Non-useTime Procon :Set)**

Specifies the non-use time setting, temperature, relative humidity, absolute humidity or page interval as the threshold of process control execution determination for during the standby-mode.

- **SP3-533-001 (Interrupt ProCon :Set: Interval:Set:BW)**

Specifies the number of sheets interval for Interrupt Pro-Con (BW).

- **SP3-533-002 (Interrupt ProCon :Set: Interval:Disp:BW)**

Displays the number of sheets interval for Interrupt Pro-Con (BW).

- **SP3-533-003 (Interrupt ProCon :Set: Corr(Short):BW)**

Specifies the correcting coefficient (Short) of number of sheets interval for Interrupt Pro-Con (BW).

- **SP3-533-004 (Interrupt ProCon :Set: Corr(Mid):BW)**

Specifies the correcting coefficient (Mid) of number of sheets interval for Interrupt Pro-Con (BW).

- **SP3-533-011 (Interrupt ProCon :Set: Interval:Set:FC)**

Specifies the number of sheets interval for Interrupt Pro-Con (FC).

- **SP3-533-012 (Interrupt ProCon :Set: nterval:Disp:FC)**

Displays the number of sheets interval for Interrupt Pro-Con (FC).

- **SP3-533-013 (Interrupt ProCon :Set: Corr(Short):FC)**

Specifies the correcting coefficient (Short) of number of sheets interval for Interrupt Pro-Con (FC).

- **SP3-533-014 (Interrupt ProCon :Set: Corr(Mid):FC)**

Specifies the correcting coefficient (Mid) of number of sheets interval for Interrupt Pro-Con (FC).

- **SP3-534-001 (JobEnd ProCon :Set: Interval:Set:BW)**

Specifies the number of sheets interval for Job end Pro-Con (BW).

- **SP3-534-002 (JobEnd ProCon :Set: Interval:Disp:BW)**

Displays the number of sheets interval for Job end Pro-Con (BW).

- **SP3-534-003 (JobEnd ProCon :Set: Corr(Short):BW)**

Specifies the correcting coefficient (Short) of number of sheets interval for Job end Pro-Con (BW).

- **SP3-534-004 (JobEnd ProCon :Set: Corr(Mid):BW)**

Specifies the correcting coefficient (Mid) of number of sheets interval for Job end Pro-Con (BW).

- **SP3-534-011 (JobEnd ProCon :Set: Interval:Set:FC)**

Specifies the number of sheets interval for Job end Pro-Con (FC).

- **SP3-534-012 (JobEnd ProCon :Set: Interval:Disp:FC)**

Displays the number of sheets interval for Job end Pro-Con (FC).

- **SP3-534-013 (JobEnd ProCon :Set: Corr(Short):FC)**

Specifies the correcting coefficient (Short) of number of sheets interval for Job end Pro-Con (FC).

- **SP3-534-014 (JobEnd ProCon :Set: Corr(Mid):FC)**

Specifies the correcting coefficient (Mid) of number of sheets interval for Job end Pro-Con (BW).

- **SP3-539-001 (Dev Agitating Time :Set: Time)**

Specifies the developer agitating time.

- **SP3-600-002 (Select ProCon: LD Control)**

Specifies the LD control mode.

0:OFF, 1:ON

- **SP3-600-030 (Select ProCon: IBACC:ON/OFF)**

Specifies ON/OFF of IBACC.

0: OFF, 1: ON

PCDU (Photo Conductor and Development Unit)

Overview

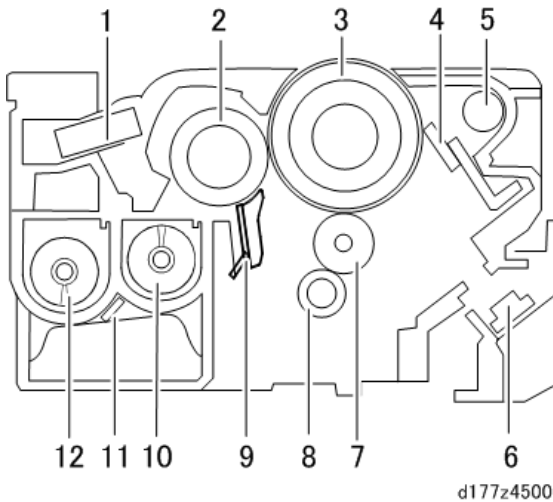

No.	Description	No.	Description
1	Inner pressure adjustment filter	7	Charge roller
2	Development roller	8	Cleaning roller (charge roller)
3	OPC drum	9	Doctor blade
4	Cleaning blade	10	Developer supply coil
5	Toner collection coil	11	TD sensor
6	Discharge lamp (installed on the main machine)	12	Developer collection coil

Mechanism (PCU)

Drum Drive

Bk and CMY are both driven by motor.

PCU	Drive source
Bk	PCU motor: Black / ITB drive motor*
CMY	PCU motor: CMY

* The PCU motor: Black / ITB drive motor is used to drive both the image transfer unit and the waste toner bottle.

Charge

This device uses a charge roller [B] for all four colors to reduce generation of ozone.

The charge roller, which is a rubber-covered roller that has a metal shaft, rotates in the forward direction contacting the drum [A], and applies a charge to the drum surface uniformly.

When the charge roller is dirty, an uneven charge is generated, so a cleaning roller [C] always contacts the charge roller.

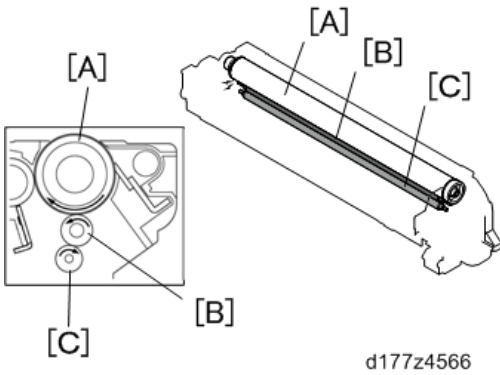

Drum Cleaning

Residual toner on the drums after image transfer is recovered by a cleaning blade [A]. The cleaning blade is installed counter to the drum rotation in contact with the drum, and scrapes toner off.

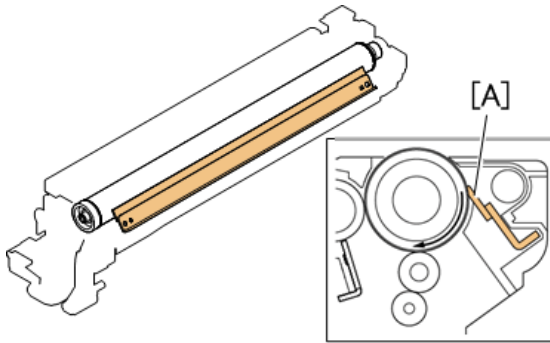

d177z4565

Mechanism (Development)

Development System

A dry two-component magnetic brush development system is used.

The dry two-component magnetic brush development system gives a suitable electrostatic charge to the toner using magnetic particles called carriers which form a magnetic brush due to their magnetism, and cause toner to adhere electrostatically to the drum surface.

7

Agitation System

This device uses a double-coil agitation system (twin-shaft environment development system).

Toner transported from the toner cartridge to the development unit will be agitated with the developer by two toner transport coils [A] and will be delivered to the development roller.

The amount of developer adhering to the development roller is controlled by a doctor blade [B], and supplies toner to the surface of the photoconductor unit.

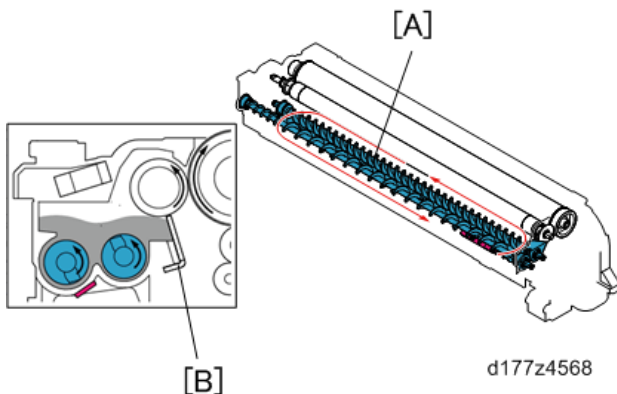

d177z4568

TD Sensor

In the TD sensor (also called the  sensor), there is an ID chip storing the machine identification information, the running distance information of Development unit and PCU, and other information used by image density control.

ID chip

PCDU replacement information and toner density information are stored.

In the ID chip, the following data is stored.

- Model series ID
- New PCDU information
- Color information
- Developer replacement information
- PCU replacement information
- TD sensor serial no., date of manufacture
- Date of unit installation
- Unit total counter at installation (no. of sheets, travel distance)
- Date of unit operation
- Unit total counter during operation (no. of sheets, travel distance)
- Unit parts information
- Total counter
- Total color counter

Pressure Release Filter

To prevent scattering of toner, the air pressure in the development unit is released via a filter.

Development Drive

A gear for developer coil rotation is provided on the front side of the unit (downstream side).

Drive source for Bk	Drive source for C, M, Y
PCU motor: Black / ITB drive motor	Development motor: CMY

The PCU motor: Black / ITB drive motor is also used for the image transfer unit and waste toner bottle. Drive is switched by the development solenoid.

Development Bias

Applied from the development power pack via a plate spring on the front cover of the PCDU.

Toner Supply

Overview

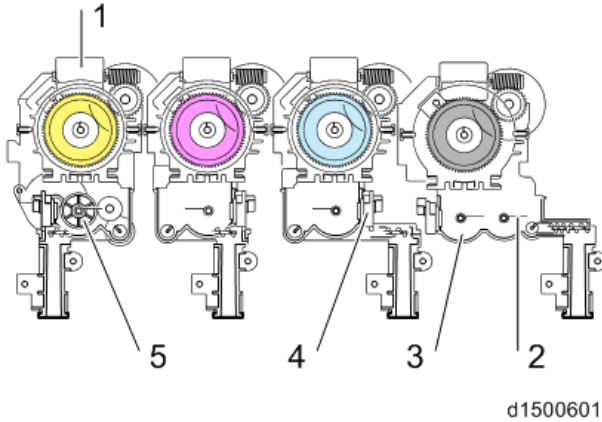

No.	Description	No.	Description
1	Toner bottle drive motor	4	Toner end sensor
2	Agitator	5	Toner supply motor
3	Sub-hopper		

Toner is supplied by a Hi-Act (High Accuracy and Clean Toner) cartridge + sub-hopper.

Mechanism

Toner Supply (Toner Cartridge - Sub-hopper)

When the toner cartridge is set, the transport nozzle on the side of the unit is inserted into the bottle (Hi-Act system).

When the toner supply motor drives and the piezoelectric sensor in the sub-hopper detects there is no toner, the bottle drive motor rotates. The rotation of the bottle drive motor is transmitted to a transport coil via a drive gear, and toner in the bottle is transported horizontally. Due to the coil transport, stable toner supply/enhanced supply precision/reduction of residual toner are achieved.

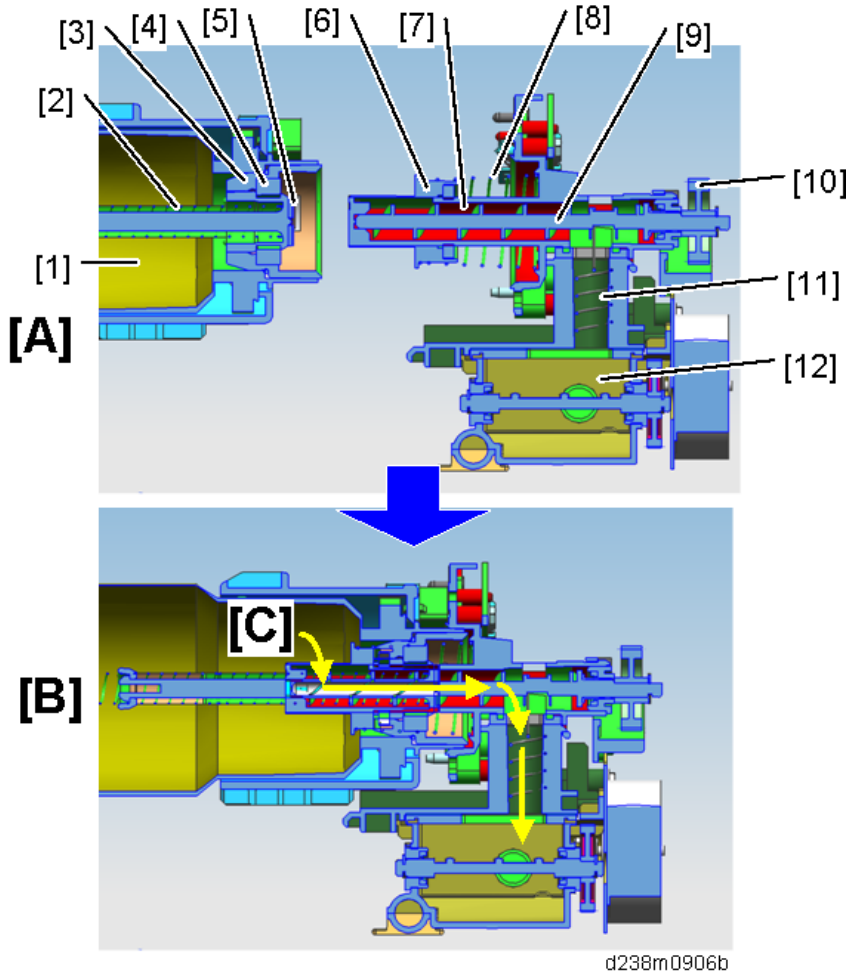

[A]: Before setting

[B]: After setting

[C]: Toner path

No.	Description	No.	Description
1	Toner bottle	7	Transport nozzle
2	Coil spring	8	Coil spring
3	Shutter holder	9	Toner transport coil
4	Seal	10	Drive gear
5	Shutter	11	Rocking spring

No.	Description	No.	Description
6	Shutter	12	sub-hopper

Toner transported by the coil falls directly into the sub-hopper via the transport pipe.

To prevent toner from remaining, the rocking spring in the transport pipe moves up and down together with the coil.

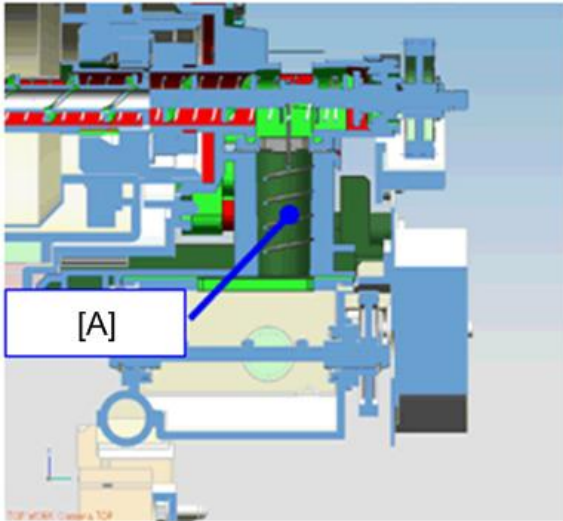

d1462631

[A]: Rocking spring

Toner Bottle ID Chip

A contact type ID chip is provided in each toner bottle which stores residual toner and various toner counters, toner end history, and model serial number.

Data read and write to the ID chip contact board is performed by contact with the ID chip contact board installed in the machine.

Toner Supply (Sub-hopper - Development Unit)

The sub-hopper can hold Bk: 24.7 cc (equivalent to 230 sheets of 5% chart), or Color: 19.3 cc (equivalent to 150 sheets of 5% chart) of toner.

Toner which has fallen into the sub-hopper is homogenized by an agitator (Mylar sheet: 2 for BK, 1 for each color).

After being horizontally transported by the coil, toner in the sub-hopper falls directly into the development unit.

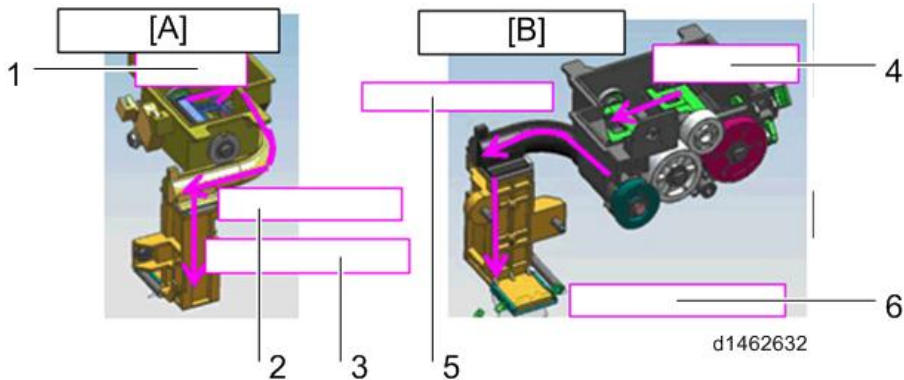

[A]: Sub-hopper: CMY

[B]: Sub-hopper: Bk

1. Transport by the Mylar sheet
2. Transport horizontally by the coil
3. Vertical drop to the development unit
4. Transport by the Mylar sheet
5. Transport horizontally by the coil
6. Vertical drop to the development unit

Drive

To shorten the recovery time after bottle replacement, the toner cartridge and sub-hopper are driven separately.

The sub-hopper is driven by a stepping motor to reduce supply variations.

Toner Near End/ Toner End Detection

In this device, there are two types of toner near end status.

The detection conditions and detection operation for each status are shown in the following table.

Control overview

Status	Control panel message	Detection conditions
Estimated toner end SP3-101-001 to 004="2"	Control panel banner display: <Toner Cartridge is almost empty. Prepare toner cartridge replacement(s).>	If the residual amount in the toner cartridge falls below SP3-110-001 to 004 (Near End Thresh) (Default: K 65g, CMY 45g) The lesser of the "toner residual amount computed from the toner supply motor drive time" and the "toner residual amount computed from the pixel count" is taken as the toner residual amount.
Definite toner near end SP3-101-001 to 004="1"	Control panel banner display: <Toner Cartridge is empty. Printing will be suspended soon. Replace the cartridge.>	If "the toner cartridge residual amount falls below specification" and "the toner end sensor in the sub-hopper has detected toner end" Remarks: When toner end is detected, to use up all the toner in the cartridge, the toner cartridge is rotated for 5 seconds (full use control). After no toner is detected again, the status becomes definite toner near end.
Toner end	Control panel pop-up display (alert screen): <Toner has been depleted. Replace Toner Cartridge.>	Toner end is defined by the following conditions (1) or (2): (1) Determination by number of sheets and pixel count (After definite toner near end, count is begun). (2) Determination by Vt output (not related to definite toner near end)

Control details

Estimated toner near end

- The toner residual amount Z (SP3-102-021 to 024) is taken as the lesser of the toner residual amount Z1 computed from the toner supply motor drive time (SP3-102-001 to 004) and the toner residual amount Z2 computed from the pixel count (SP3-102-011 to 014).

- If the condition, toner residual amount Z (SP3-102-021 to 024) < near end residual amount threshold value (SP3-110-001 to 004) is satisfied, this is taken as the estimated toner near end.

Definite toner near end

Preconditions

- The toner residual amount Z (SP3-102-021 to 024) is taken as the lesser of the toner residual amount Z1 computed from the toner supply motor drive time (SP3-102-001 to 004) and the toner residual amount Z2 computed from the pixel count (SP3-102-011 to 014).
- If the condition, toner residual amount Z (SP3-102-021 to 024) < sensor near end residual amount threshold value (SP3-120-001 to 004) is satisfied, toner end sensor detection is begun to determine the definite end. (When the toner residual amount is more than the threshold value, determination by the toner end sensor is not performed).

Sensor detection

- The toner end sensor detects the sensor output every 200 ms while the polygon motor is ON, and determines whether toner is present or not from the latest 10 counts.
- The determination result is stored in the "no toner counter (SP3-121-001 to 004)".
To prevent clearing due to erroneous detection, the counter is reset if the toner end sensor detects "toner remaining" 4 times in a row.
- If the condition "no toner counter (SP3-121-001 to 004) > sensor near end determination threshold value (SP3-122-001 to 004) is satisfied, full use control which rotates the toner bottle for a certain time (SP3-163-001) is performed, and toner presence/absence determination by the toner end sensor is performed again.
- If no toner is detected after full use control determination, it is taken as definite toner near end.

Operation after changing the status to definite toner near end

- After changing the status to definite toner near end, sheet counter and pixel counter increment is begun to detect toner end.

SP3-133-011 to 014 (TE Detect :Set Page Cnt:K, C, M, Y)

SP3-133-031 to 034 (TE Detect :Set Pxl Cnt:K, C, M, Y)

Operation during definite toner near end

- When the toner supply motor drives and the toner end sensor detects no toner, the toner bottle motor drives for 2 seconds.
- If "toner remaining" is detected 4 times in a row, according to the ID chip data on the toner bottle SP3-101-001 to 004 (Toner Status :Disp) display "10" or "2" (estimated toner end).
- When it comes under the condition of Toner end pattern (1) and (2) (mentioned below), the status becomes toner end.
- After the toner bottle is replaced during definite toner near end, the machine does not execute the toner end judgement until the toner bottle motor drives for 40 or more seconds totally.

Toner end

Pattern (1): Determination by paper sheet counter/pixel counter

The total sheet counter and pixel counter values after definite toner near end are compared with the threshold values.

If the following "(evaluation method A=TRUE) and (evaluation method B=TRUE) or (evaluation method C=TRUE)" is satisfied, it is determined as toner end.

- Determination method A: Sheet counter (SP3-133-011 to 014) > Sheet counter threshold value (min)
- Determination method B: Sheet counter (SP3-133-011 to 014) > Sheet counter threshold value (max)
- Determination method C: Pixel counter (SP3-133-031 to 034) > Pixel counter threshold value

Pattern (2): Determination by Vt output

When the deviation between the TD sensor output value and TD sensor target value has become large, it is taken as toner end.

- After definite toner end has been determined

The difference between the output of the TD sensor (Vt: SP3-210-001 to 004) and the target value of the TD sensor (Vtref: SP3-230-001 to 004) is computed as the delta Vt, and values of the delta Vt larger than the threshold value (SP3-131-001) are integrated as "sigma delta Vt" (SP3-132-001 to 004).

If the integration value of "sigma delta Vt" is larger than the threshold value (SP3-132-002), it is determined to be toner end.

- Before definite toner near end is determined (bottle full or estimated toner near end)

The computation is done in the same way as for definite toner near end, but separate values for the delta Vt threshold value and "sigma delta Vt" threshold value are used.

- Delta Vt threshold value before toner near end: SP3-131-011
- Sigma delta Vt threshold value before toner near end: SP3-131-012

SP Descriptions

- **SP3-101-001 to 004 (Toner Status :Disp)**

Displays the amount of toner remaining for each color. Uses a descending 10-step scale: 10: Full, 2: Estimated toner near end, 1: Definite toner end, 0: Toner end

- **SP3-110-001 to 004 (Near End Thresh)**

Sets the threshold amount of judging near-toner end.

- **SP3-102-001 to 004 (Toner Remain:Disp: Bottle Motor Bk, C, M, Y)**

Displays the remaining toner calculated from the motor running time.

- **SP3-102-011 to 014 (Toner Remain:Disp: Pixel Bk, C, M, Y)**
Displays the remaining toner calculated from imaging size.
- **SP3-102-021 to 024 (Toner Remaining: Display: Fill Amount Bk, C, M, Y)**
Display the filler content of new bottle.
- **SP3-120-001 to 004 (TE Sn Detect Thresh: Bk, C, M, Y)**
Sets the starting threshold of the near-toner end detection by the toner end sensor.
- **SP3-121-001 to 004 (TE Counter: Disp: Bk, C, M, Y)**
Displays the number of times the toner end sensor detected toner end.
- **SP3-122-001 to 004 (TE Sn NE Thresh: Bk, C, M, Y)**
Sets the number of toner end detection to start near-toner end detection.
- **SP3-163-001 (Bottle Drive: Set Rotation Time at Toner End)**
Sets the empty turn time[ms] at almost toner-end.
- **SP3-133-011 to 014 (TE Detect :Set Page Cnt:K, C, M, Y)**
Displays the amount of sheets printed after toner near end is fixed.
- **SP3-133-031 to 034 (TE Detect :Set Pxl Cnt:K, C, M, Y)**
Displays the amount of toner used in cm² after toner near-end is fixed.
- **SP3-210-001 to 004 (TD.Sens:Vt :Disp: Current: K, C, M, Y)**
Displays the latest TD sensor output.
- **SP3-131-001 (Vt TE Thresh: Delta Vt Thresh)**
Specifies the threshold to start adding the delta Vt after toner Near End.
- **SP3-132-001 to 004 (Delta Vt Sum: Bk, C, M, Y)**
Displays the integrated value of delta Vt.
- **SP3-131-011 (Delta Vt Thresh BF NE)**
Specifies the threshold to start integrating delta Vt before toner Near End.
- **SP3-131-012 (Delta Vt Sum Thresh BF NE)**
Specifies the threshold of delta Vt to check Toner End before toner Near End.

Waste Toner

Overview

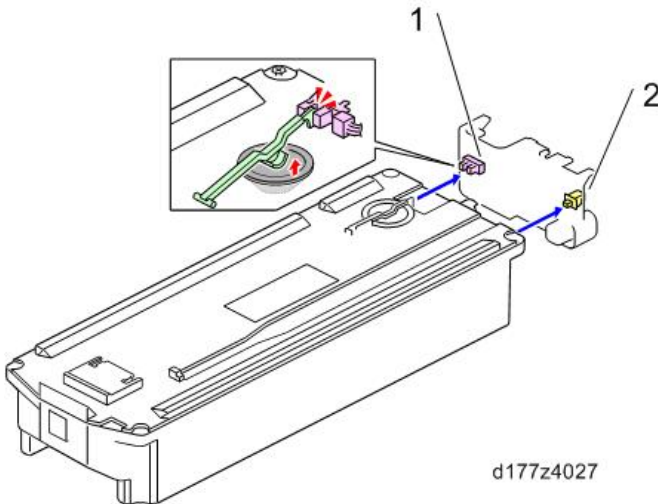

7

No.	Description	No.	Description
1	Waste toner bottle full sensor	2	Waste toner bottle set sensor

Mechanism

Waste Toner Bottle Set Detection

The waste toner bottle set sensor is at the rear of the waste toner bottle.

If the waste toner bottle is not set, this switch is OFF, so imaging is prohibited, and "Waste toner bottle is not set. Please contact service department." is displayed on the control panel.

Waste Toner Drive

Driven by the "PCU motor: Black / ITB drive motor".

Waste Toner Recovery Path (PCU/Image Transfer Unit)

Waste toner from the PCU and Image transfer unit is collected in the transport path at the front of the machine, and arrives at the entrance to the waste toner tank.

PCU waste toner transport path

Waste toner recovered by the cleaning blade is transported from the rear of the PCU to the transport path at the front of the machine by the waste toner transport coil.

Image transfer unit waste toner transport path

Waste toner recovered by the Image transfer cleaning unit is transported from the rear of the Image transfer cleaning unit to the transport path at the front of the machine by the waste toner transport coil.

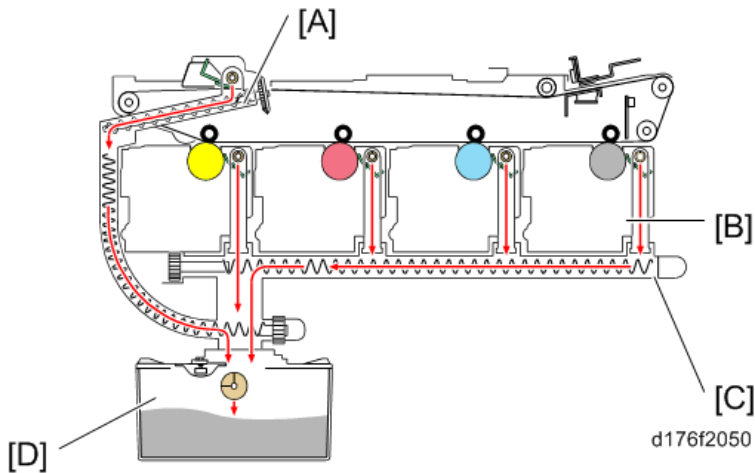

[A]: Image transfer unit waste toner transport path

[B]: PCDU

[C]: PCU waste toner transport path

[D]: Waste toner bottle

Waste Toner Bottle Full Detection

The waste toner bottle full sensor is at the top of the waste toner bottle. When the waste toner in the bottle has reached approximately 90%, the sensor lifts up a feeler, and an actuator blocks the waste toner bottle full sensor. After sensor detection, the remaining number of days of use is decremented from 18 by the pixel counter.

Full detection flow

1. When waste toner reaches approximately 90% of the bottle capacity, the full sensor switches ON.
2. When the waste capacity sensor switches ON, the days remaining counter is decremented from 18.
3. Days remaining counter: At 15 days to go, a @Remote warning is given (only in models with @Remote connection).

4. Days remaining counter: At 5 days to go, a control panel message (Waste toner bottle is nearly full. Please contact service department.) is displayed. (Nearly full)
5. Days remaining counter: At 0 days to go, a control panel warning is displayed, and the machine stops.

↓ Note

- After the full sensor switches ON, before nearly full, if the waste toner bottle full sensor has been switched OFF, it is determined that the waste toner bottle has not been replaced, and countdown of the days remaining counter continues.
- The days remaining counter starts computing when a new bottle is detected, and displays the days remaining, whose upper limit is 255 and lower limit is 18, until the waste toner bottle full sensor is first switched ON.
- After the full sensor was first switched ON, the days remaining which is computed from when the sensor switched ON is displayed (upper limit is 18)
- When the bottle is replaced before the machine detects a full waste toner bottle and stops printing, it is necessary to reset PM counters manually (SP3-701-142).
- When the bottle is replaced after the machine stopped due to detecting a full waste toner bottle, it is not necessary to reset PM counters. If the counters are reset, the replace counter will count up twice.

7

SP descriptions

- **SP3-701-142 (Manual New Unit Set: Waste Toner Bottle)**

Enables/disables the new unit detection function. When this function is ON, the machine automatically resets the PM counter when a new unit is detected.

Waste Toner Cover

The latch which existed with the previous machine has been removed for this machine.

The waste toner cover is opened by pulling the 1st paper tray, and inserting a finger into the gap (red circle) shown below.

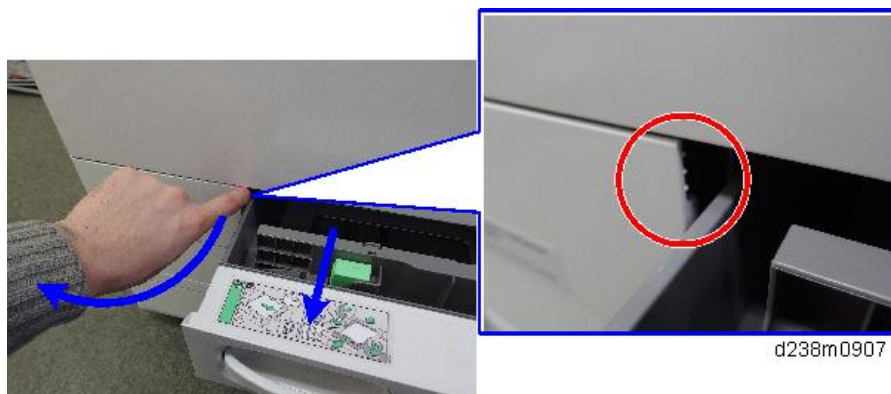

The waste toner cover of the previous machine (MP C2003/C2503/C2011) is opened by pressing it with your fingers.

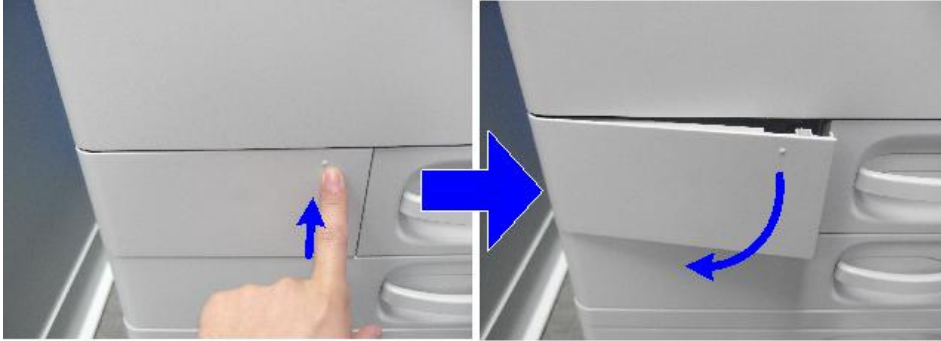

d238m0779

Image Transfer and Paper Transfer

Overview

Image Transfer Unit

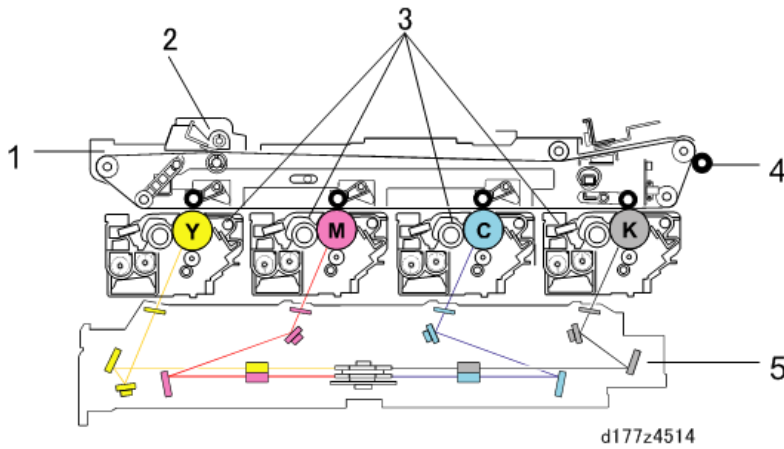

7

No.	Description	No.	Description
1	Image transfer unit	4	Paper transfer roller
2	Image transfer belt cleaning unit	5	Laser exposure unit
3	PCDU		

Paper Transfer Unit

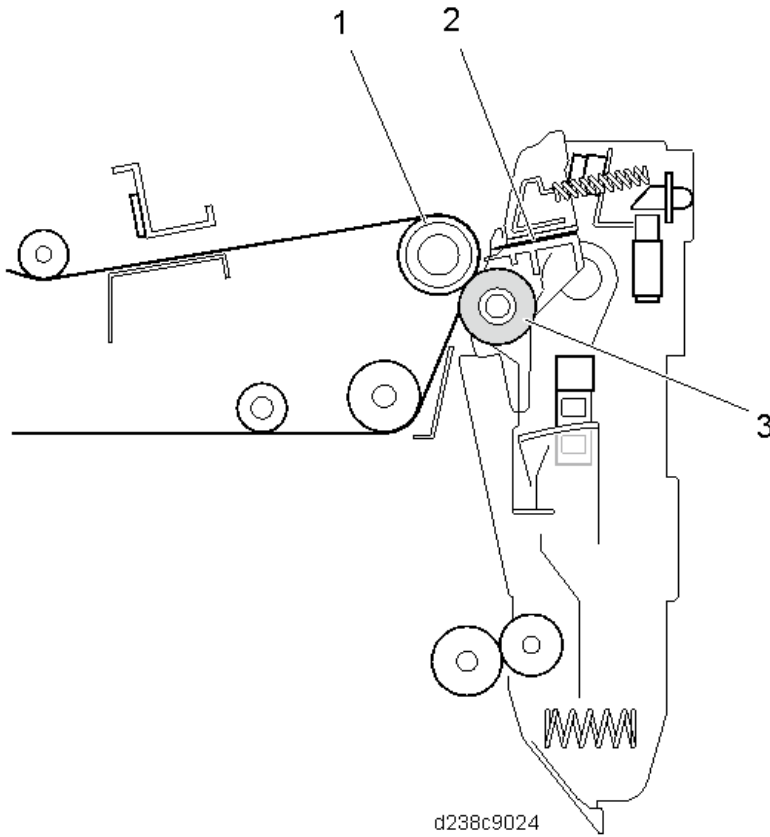

7

No.	Description	No.	Description
1	ITB drive roller	3	Paper transfer roller
2	Discharge plate		

Image Transfer Unit mechanism

Drive Mechanism

The image transfer belt is driven by the "PCU motor: Black/ ITB drive motor" via the gear and the ITB drive roller.

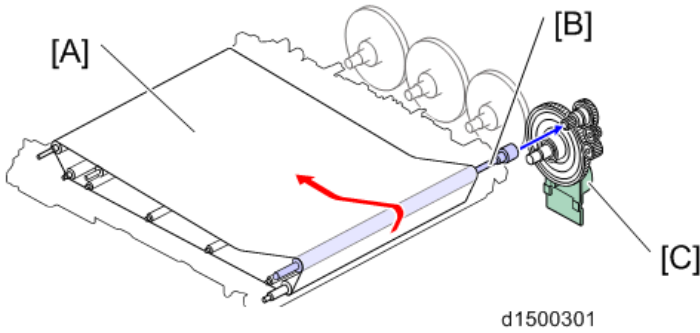

- [A]: Image transfer belt
- [B]: ITB drive roller
- [C]: PCU motor: Black/ ITB drive motor

Transfer Bias

The bias to the Image transfer belt is applied to the image transfer roller of each color from the transfer power pack.

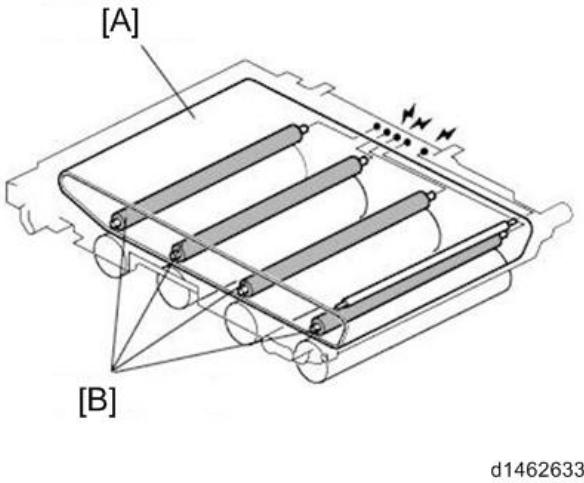

- [A]: Image transfer belt
- [B]: Image transfer roller

The 5 springs, in order from the right (double-side unit), consist of "C (cyan), secondary transfer, BK (black), Y (yellow) and M (magenta)" transfer bias terminals.

ITB Contact and Release

To prevent early deterioration of the color photosensitive drum, the Image transfer belt unit is provided with a contact/separation mechanism and, during monochrome printing, separation of the image

transfer belt from the color photosensitive drum is controlled. Contact/separation of the image transfer belt unit is performed via a gear from an ITB contact and release motor (also used as a magenta toner supply motor). Separation or contact is detected by the ITB contact and release sensor.

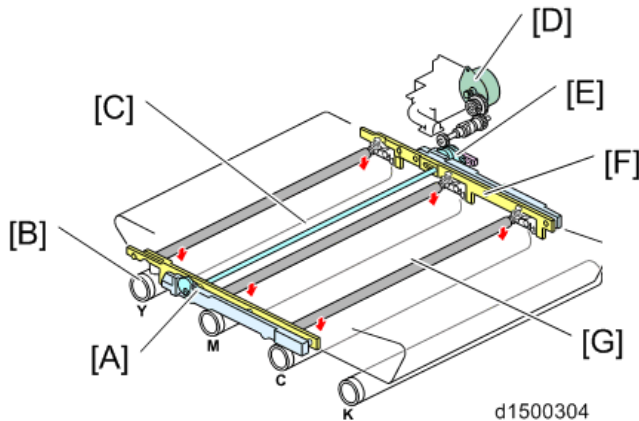

[A]: Slider

[B]: Drum

[C]: Contact and release cam

[D]: ITB contact and release motor (also used as a magenta toner supply motor)

[E]: ITB contact and release sensor

[F]: Guide

[G]: Image transfer roller

Image Transfer Belt Drive Control

FG Control is performed (Frequency Generator control: ensures precision of motor operation)

Image Transfer Flow

By arranging the imaging sequence in the order $Y > M > C > Bk$, cyan is laid on top of magenta, which increases tolerance to image blurring and image reddening when dark blue is output, and improves image quality.

Image Transfer Belt Cleaning Mechanism

Image transfer cleaning is performed by a cleaning blade (counter method).

Due to downsizing of machine width, the cleaning unit is installed on top of the image transfer unit. Therefore, to replace the cleaning unit, replacement must be performed after taking out the Image transfer unit and inverting it.

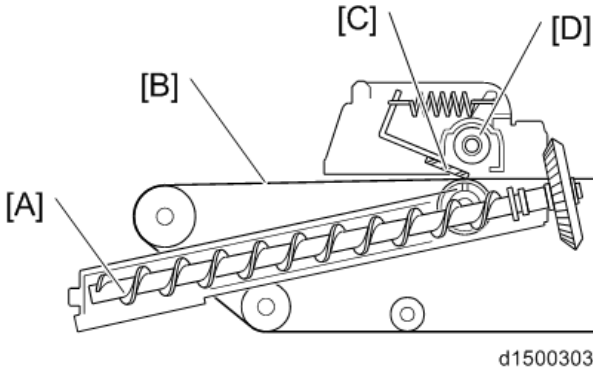

- [A]: Toner collection coil
- [B]: Image transfer belt
- [C]: Image transfer cleaning blade
- [D]: Toner collection coil

Paper Transfer Unit Mechanism

7

Paper Transfer Mechanism

A bias is applied to the ITB drive roller to transfer the image on the image transfer belt to the paper (repulsion transfer). As there is no paper between the image transfer roller and toner image, this method is not easily affected by paper conditioning.

Also, toner adsorption on the paper is facilitated by the static charge eliminator of the paper transfer unit (no charge is applied).

PTR (Paper Transfer Roller) Drive

The rotation of the paper transfer roller follows that of the ITB drive roller.

PTR (Paper Transfer Roller) Contact and Separation

If the paper transfer roller is permanently in contact with the image transfer belt, toner on the Image transfer belt moves to the roller and soils the underside of the paper surface, therefore the Paper transfer roller is separated during process control or MUSIC control (it is not separated during real-time process control).

Separation of the paper transfer roller is achieved by transmitting the drive of the paper transfer contact motor via the ITB unit joint.

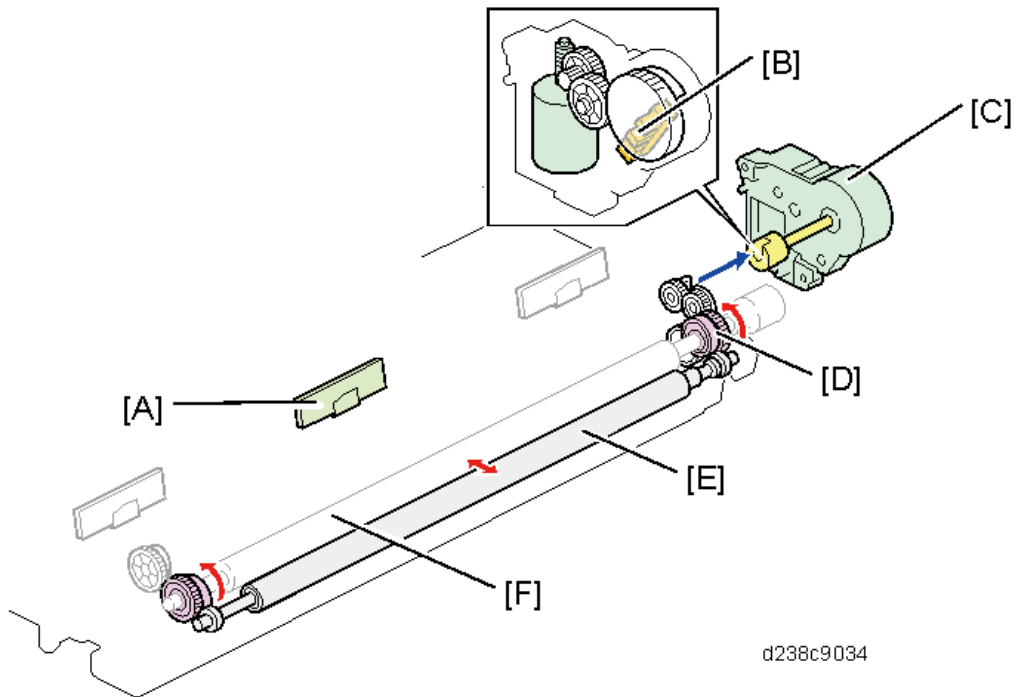

d238c9034

- [A]: TM/ID sensor (center)
- [B]: Paper transfer roller HP sensor
- [C]: Paper transfer contact and release motor
- [D]: Cam
- [E]: Paper transfer roller
- [F]: ITB drive roller

Separation

To achieve paper separation, a curvature separation method which separates the paper transfer roller and Image transfer belt is employed.

TM/ID Sensor

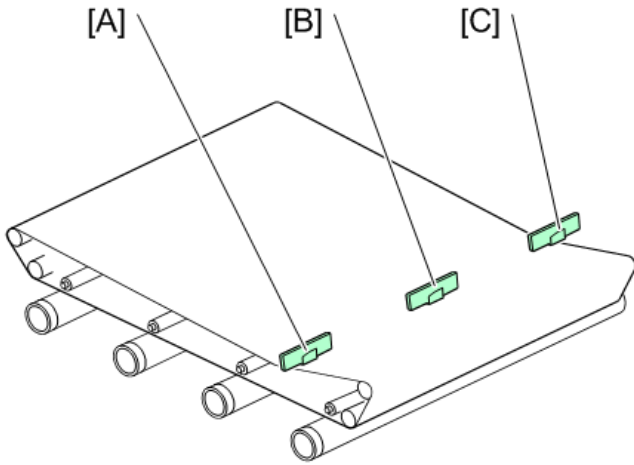

d1500305

[A]: TM/ID sensor (front)

[B]: TM/ID sensor (center)

[C]: TM/ID sensor (rear)

7

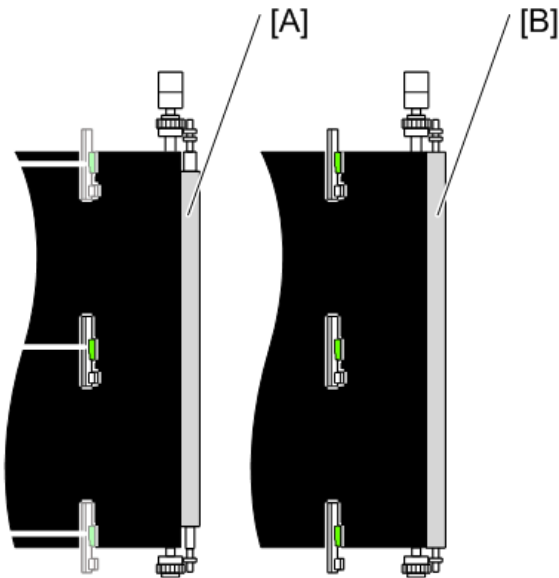

d1500308

[A]: Paper transfer roller (standard roller)

[B]: Paper transfer roller (Imageable Area Extension Unit Type M19)

When Imageable Area Extension Unit (316mm) is equipped, 316mm width printing is done instead of Real Time Process Control at margin.

Paper Feed/ Transport Section

Overview

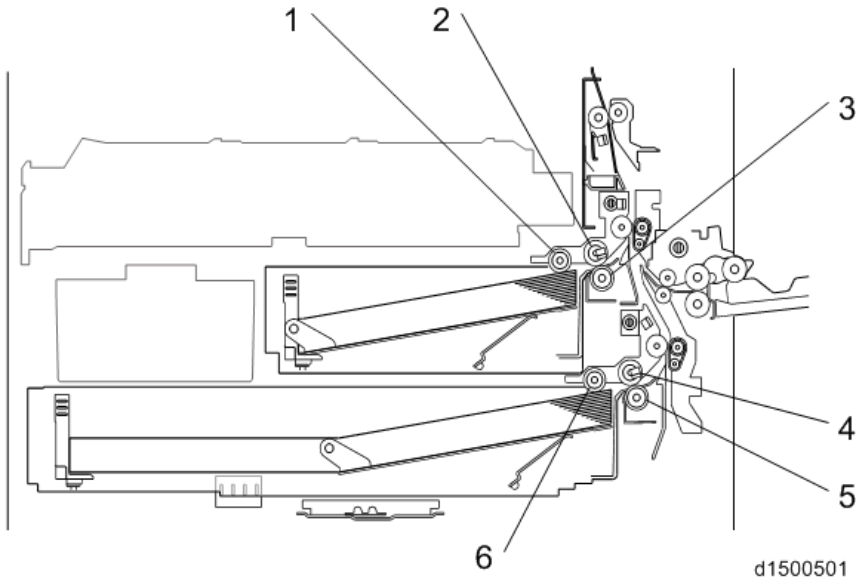

No.	Description	No.	Description
1	Pick-up roller (1st paper tray)	4	Paper feed roller (2nd paper tray)
2	Paper feed roller (1st paper tray)	5	Friction roller (2nd paper tray)
3	Friction roller (1st paper tray)	6	Pick-up roller (2nd paper tray)

In this machine, an RF paper feed system is employed, and the paper feed roller, friction roller and pick-up roller are high durability rollers.

Paper Feed/ Transport Part

The paper feed tray consists of 2 units, i.e., a main double tray and a bypass feed tray. By using the 1st tray as a fixed tray, and the 2nd tray as a universal tray, a space-saving two-step feed is enabled.

Tray	Paper size	Loading number of sheets	Corresponding paper thickness
1st paper tray	A4 landscape - A5 landscape	550 sheets	60 to 300 g/m ²
2nd paper tray	SRA3 - postcard	550 sheets	60 to 300 g/m ²
Bypass feed tray	SRA3 - postcard	100 sheets	60 to 300 g/m ²
Duplex unit	SRA3 - A6 portrait	Interleave	60 to 169 g/m ²

Tray Base Plate Lift

When the paper feed tray is set in the machine, the set switch at the rear of the tray switches ON, and it is detected that the tray is set.

The coupling between the shaft at the rear of the tray and the lift motor then engages, the motor rotates, and the tray base plate is lifted. The tray base plate lifts until the paper surface pushes the pick-up roller up, the upper limit sensor switches OFF (interrupt), and the machine enters paper feed standby mode.

When the tray is removed, the coupling is released, and the base plate moves down. The lift motor then rotates until the coupling returns to the home position.

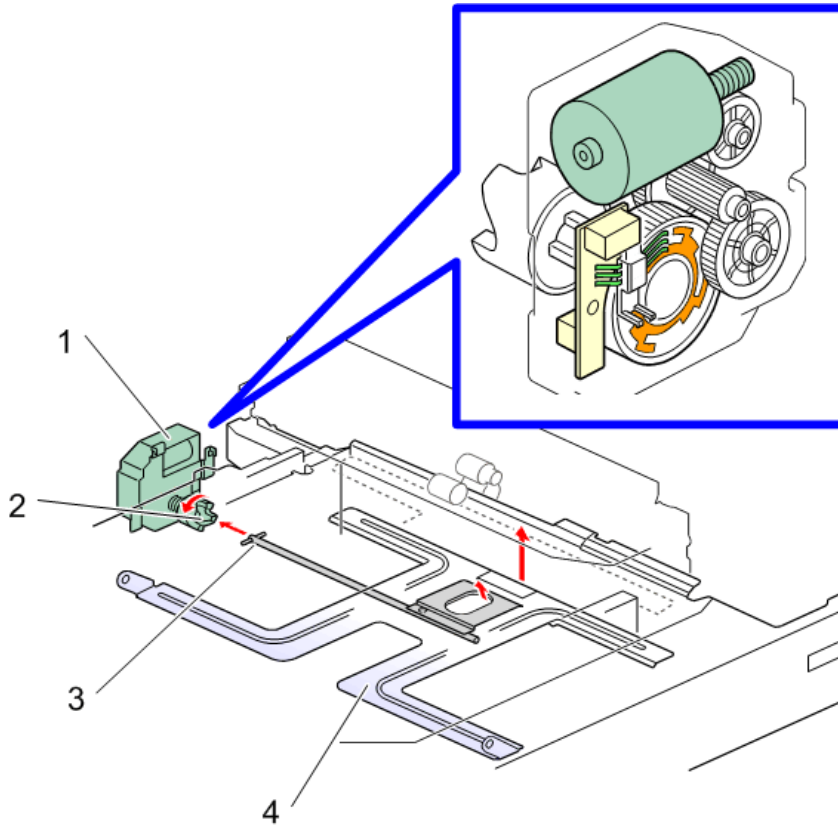

d1462611

No.	Description	No.	Description
1	Lift motor	3	Tray rear shaft
2	Coupling	4	Tray bottom plate

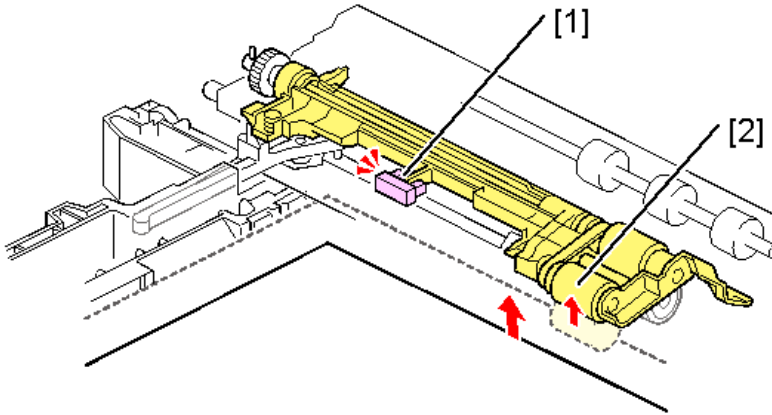

d238c9035

No.	Description	No.	Description
1	Upper limit sensor	2	Pick-up roller

Paper Feed Mechanism

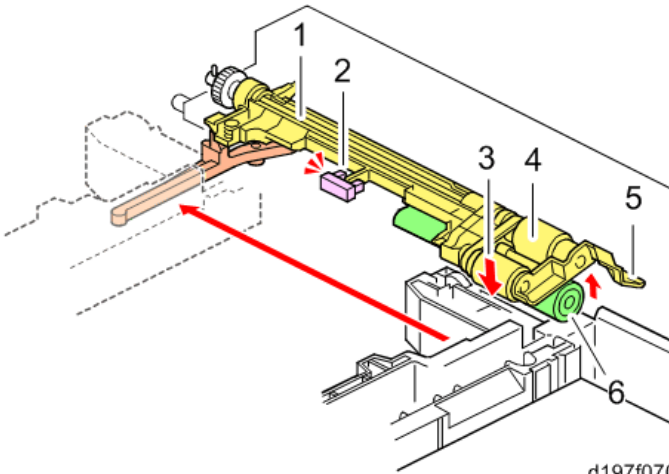

d197f0705

No.	Description	No.	Description
1	Pick-up arm	4	Paper feed roller
2	Upper limit sensor	5	Feed guide
3	Pick-up roller	6	Friction roller

The paper feed unit employs an RF system.

In a conventional FRR system, transport of 2 sheets at a time is prevented by reverse rotation of the separating roller, but in the RF system, paper separation is assisted by the resistance of a separating roller with a torque limiter (reverse drive is not performed).

When the paper feed tray is set in the machine, the pressure release lever is pressed, the Friction roller comes in contact with the paper feed roller, and the pick-up roller contacts the top of the paper (to prevent paper remaining, when the paper feed tray is withdrawn, the arm returns and contact with the rollers is released).

The machine enters paper supply standby mode when the tray bottom plate moves up. When the paper feed motor is switched ON, the rollers rotate and paper is supplied.

The roller holder functions as a paper guide and roller clip ring. The roller holder prevents the paper from winding up.

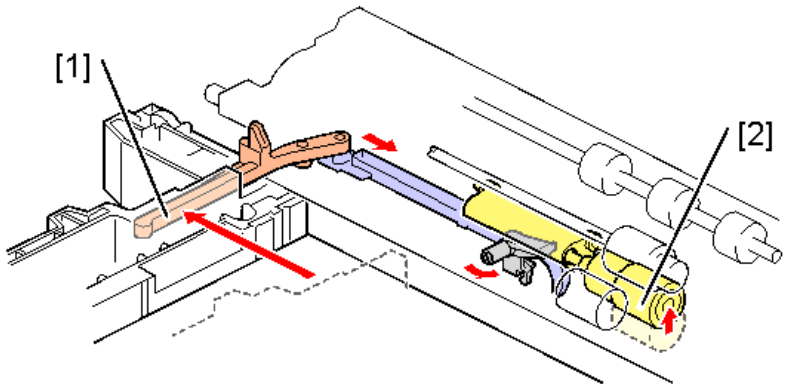

d238c9036

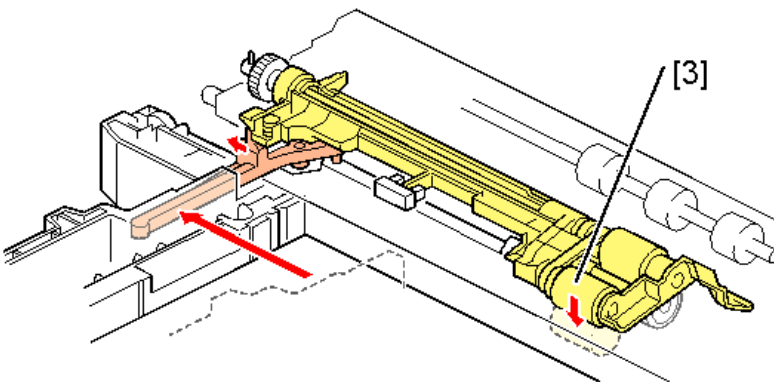

d238c9037

No.	Description	No.	Description
1	Pressure release lever	3	Pick-up roller
2	Friction roller		

Paper Feed Transport Mechanism

In this machine, to maintain the paper gap constant, switching the paper feed roller ON/OFF adjusts the paper feed timing.

1. The paper feed motor is switched ON, and the first sheet is supplied.
2. Just before the rear edge of the first sheet leaves the paper feed roller, the paper feed motor switches OFF.
3. When the first sheet is fed a predetermined distance by the downstream transport roller, the paper feed motor switches ON to supply the second sheet of paper.

Paper Size Detection (1st Paper Supply Tray)

Size cannot be detected only with set detection.

- 1st tray settings:
A4 LEF, LT LEF, B5 LEF, and A5 LEF (select with UP mode, default is A4 LEF)

Paper Size Detection (2nd Paper Supply Tray)

The end fence interlocking rotation detection plate is an automatic detection system which recognizes patterns by a 4-position push switch.

Size is detected by the detection patterns of knobs 1, 2, 3, and 4. Tray set is detected by another switch.

If there has been a change in the pattern, "MFP tray automatic size detection" control is performed continuously.

If the paper size is selected manually by user setting, the automatic size detection is overridden.

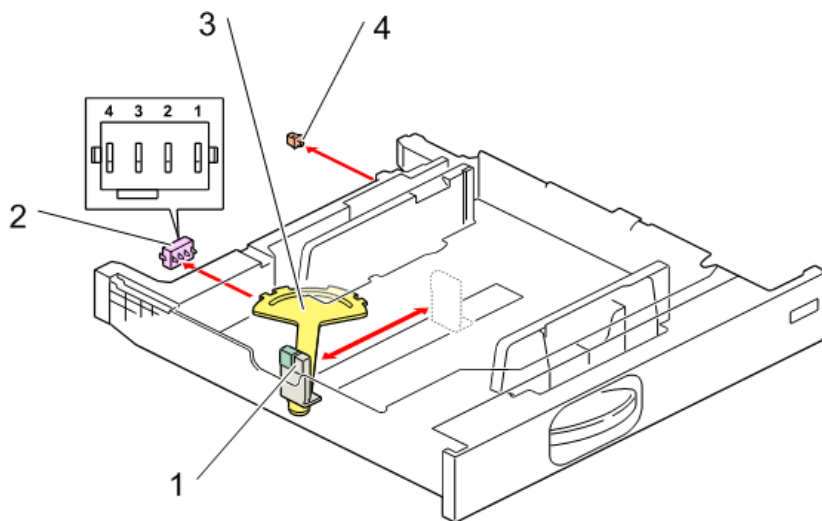

d1359620

No.	Description	No.	Description
1	End fence	3	Size detection actuator
2	Paper size switch	4	Tray set switch

2nd tray detection sizes:

SRA3, A3, B4, A4 SEF, LT SEF, B5 SEF, A4 LEF, B5 LEF, and A5 LEF

2nd tray size detection patterns:

Size	Knob			
	4	3	2	1
SRA3(12"×18")	1	0	1	0
A3(DLT)	0	1	0	0
B4(LG)	0	0	1	1
	0	1	1	1
A4 portrait	1	1	1	0
LT portrait	1	1	0	0
B5 portrait	1	0	0	0
A4 landscape(LT landscape)	0	0	0	1

Size	Knob			
	4	3	2	1
B5 landscape(Exe landscape)	0	0	1	0
A5 landscape	0	1	0	1

* "0" is switch ON (PUSH), "1" is switch OFF.

* The figures in parentheses are automatic paper size switch can be switched over in SP mode (for SP settings, see "SP mode (paper supply transport)": SP5-181-002 to 006).

* SRA3=320×450mm(12.6"×17.7")

* Exe LEF=10.5"×7.25"

* If a pattern other than the above is detected, a blank is displayed on the control panel.

Remaining Paper Detection

When the lift motor rotates, the remaining paper sensors 1, 2 [A] built into the motor switch ON (unblocked) or OFF (blocked). Paper remaining in the paper feed tray is detected by the combination of ON/OFF for the two sensors.

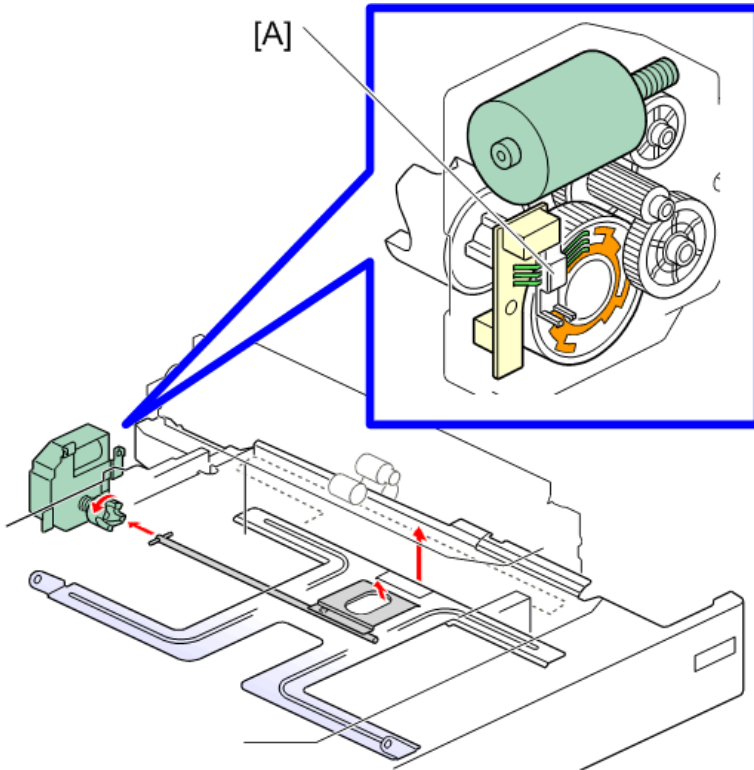

d1462629

There are the following 4 remaining paper detection levels:

Remaining paper status	100%	70%	30%	10%
Remaining paper status sensor 1	ON	OFF	OFF	ON
Remaining paper status sensor 2	ON	ON	OFF	OFF
Control panel remaining paper display	Bar 4	Bar 3	Bar 2	Bar 1

Paper End Detection

When there is no more paper in the paper feed tray, the leading edge of the paper end feeler falls into a notch in the base plate, and the paper end sensor at the rear edge of the end filler switches ON (pass).

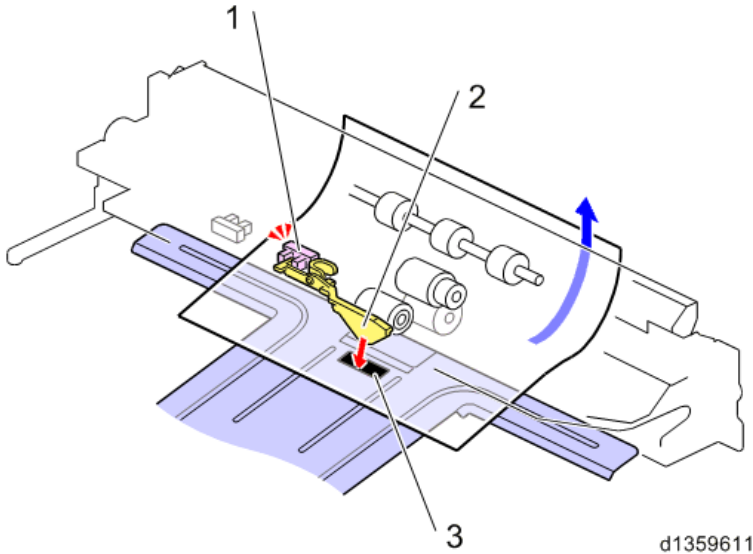

No.	Description	No.	Description
1	Paper end sensor	3	Notch
2	End feeler		

Paper Supply Drive

The 1st/2nd pick-up rollers and 1st/2nd paper feed rollers are driven by the paper feed motor. The 1st/2nd separation rollers are driven by the transport motor.

The bypass transport roller is driven by the bypass/duplex motor, and the registration roller is driven by the registration motor.

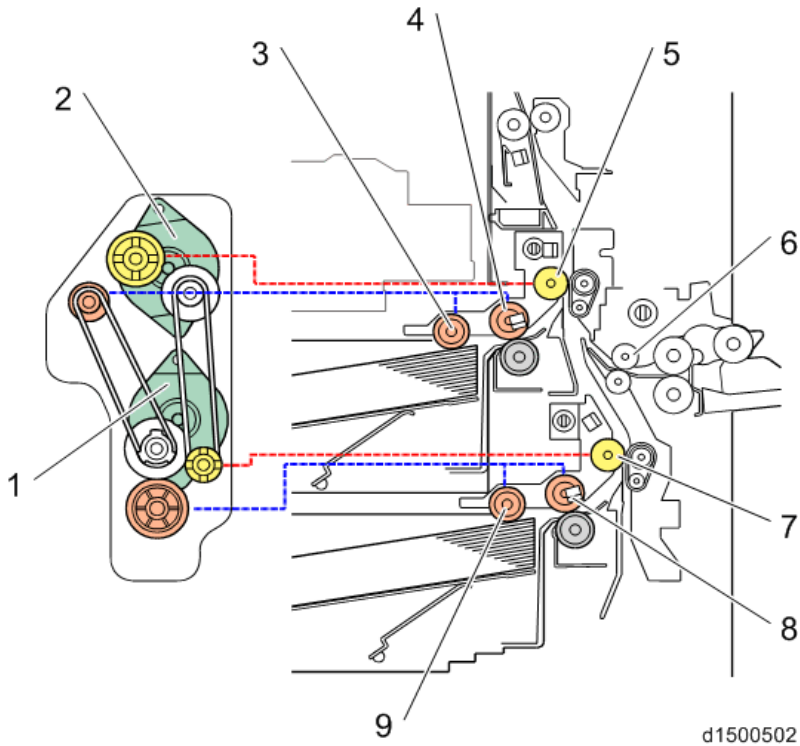

No.	Description	No.	Description
1	Paper feed motor	6	Bypass transport roller
2	Transport motor	7	Transport roller (2nd tray)
3	Pick-up roller (1st tray)	8	Paper feed roller (2nd tray)
4	Paper feed roller (1st tray)	9	Pick-up roller (2nd tray)
5	Transport roller (1st tray)		

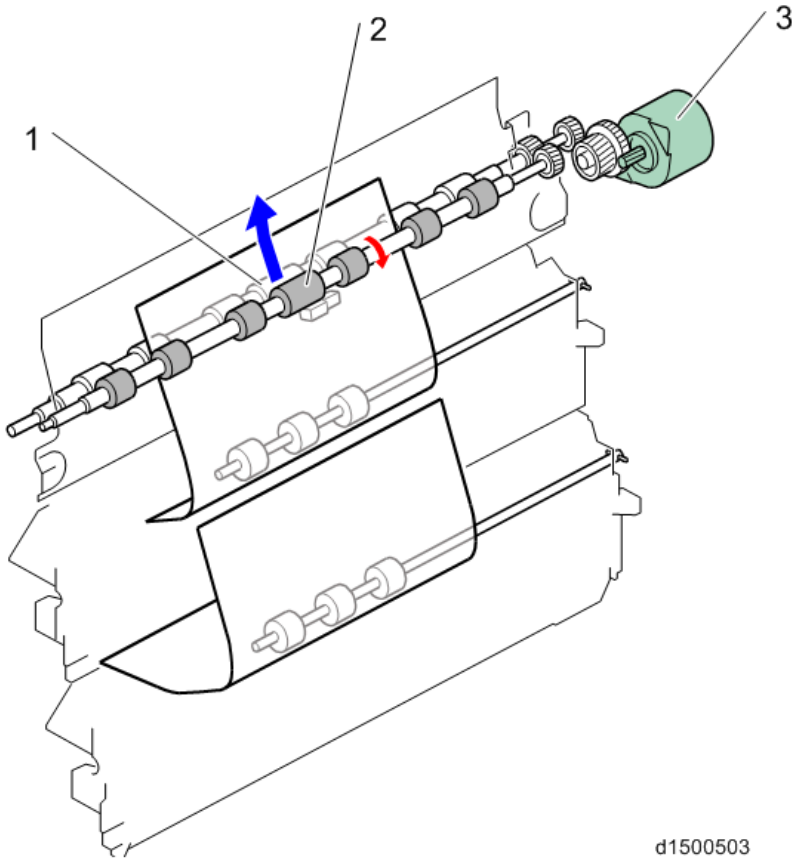

d1500503

No.	Description	No.	Description
1	Registration roller (Driven)	3	Registration motor
2	Registration roller (Drive)		

Paper Dust Removal Mechanism

The registration mechanism removes paper scraps using the paper removal Mylar in contact with the driven roller (resin). Paper scraps removed by the paper removal Mylar are collected in the paper dust container.

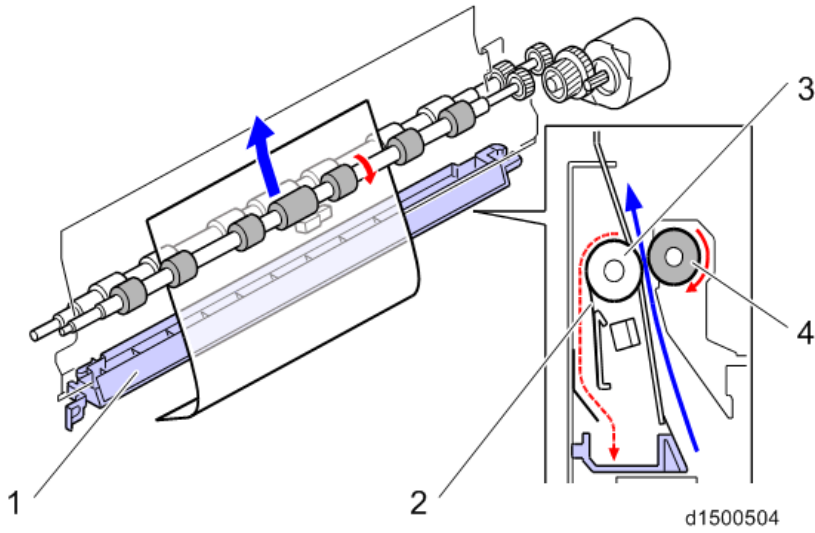

No.	Description	No.	Description
1	Paper dust container	3	Registration roller (Driven)
2	Paper dust removal Mylar	4	Registration roller (Drive)

Bypass Feed Section

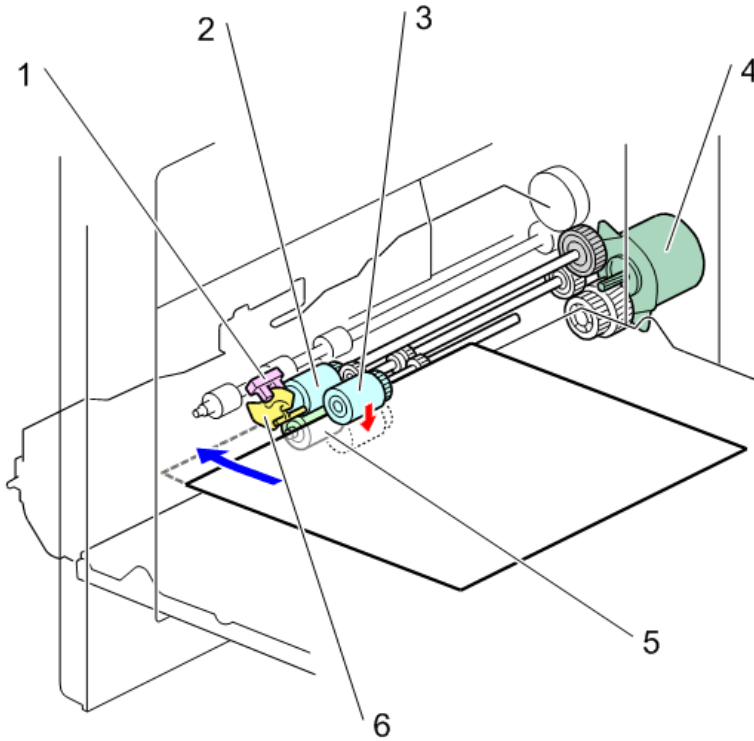

d1500505

No.	Description	No.	Description
1	Manual feed lever end sensor	4	Bypass/Duplex motor
2	Bypass paper feed roller	5	Bypass/Reverse roller
3	Bypass pick-up roller	6	Paper detection filler

Bypass Feed Paper/ Separation Mechanism

The bypass paper feed mechanism employs an FRR system. The bypass paper feed unit comprises a paper feed roller, reverse roller and pick-up roller.

When the paper feed tray is selected and the machine is started, the bypass pick-up solenoid is switched OFF, and paper is supplied by the bypass/duplex motor (CCW).

In standby mode, the bypass pick-up roller is not in contact with the paper surface. This is opposite to the paper feed tray.

Bypass Feed Paper Size Detection

Paper size width detection is performed by the bypass width sensor (rotary switch).

The bypass feed size switch has a rotation plate which rotates together with the side fence of the bypass feed table, and detects the paper size.

Paper portrait/landscape is determined by the length sensor.

Two feelers [A] for the bypass length sensor [B] are added to the rear of the tray to prevent false detection of paper length caused by floating at the rear of paper when long paper is set without pulling out the bypass tray extension.

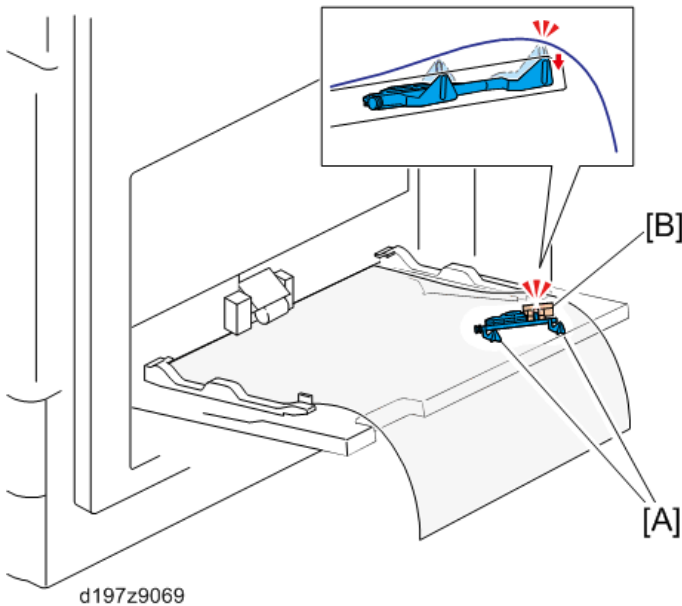

Bypass Feed Paper End Detection

To detect bypass feed paper end, a paper detection feeler and bypass feed paper end sensor are provided.

When the paper is set, the bypass feed paper end sensor switches ON (interrupt), and paper set is detected.

When there is no more paper, the detection feeler falls into a hole in the bypass feed table, the bypass feed paper end sensor switches OFF (pass), and paper end is detected.

Bypass Paper Feeder Drive

The paper feed roller, Reverse roller and pick-up roller are driven by the bypass/duplex motor.

Duplex Section

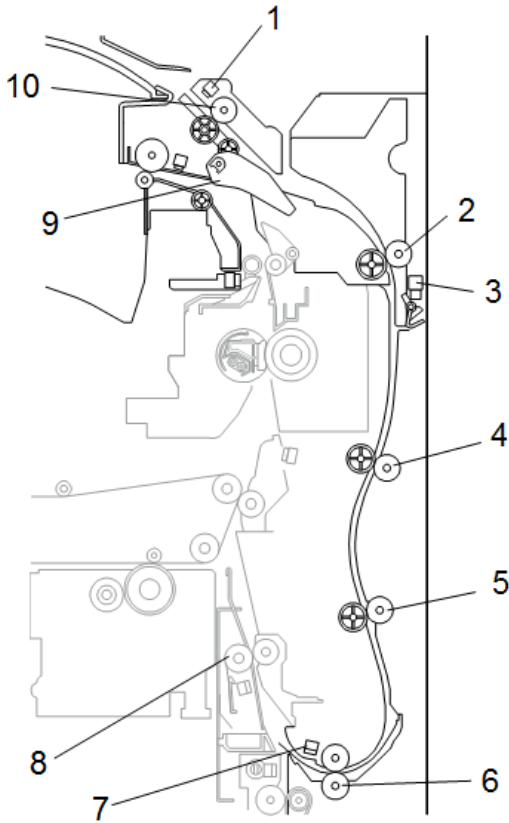

d244c0024

No.	Description	No.	Description
1	Reverse sensor	6	Duplex exit roller
2	Duplex entrance roller 1	7	Duplex exit sensor
3	Duplex entrance sensor	8	Registration roller
4	Duplex entrance roller 2	9	Paper exit junction gate
5	Duplex transport roller	10	Reverse roller

Transport Inversion Mechanism

The paper passes through the junction gate, and is fed to the duplex unit past reverse rotation sensor and reverse rotation roller.

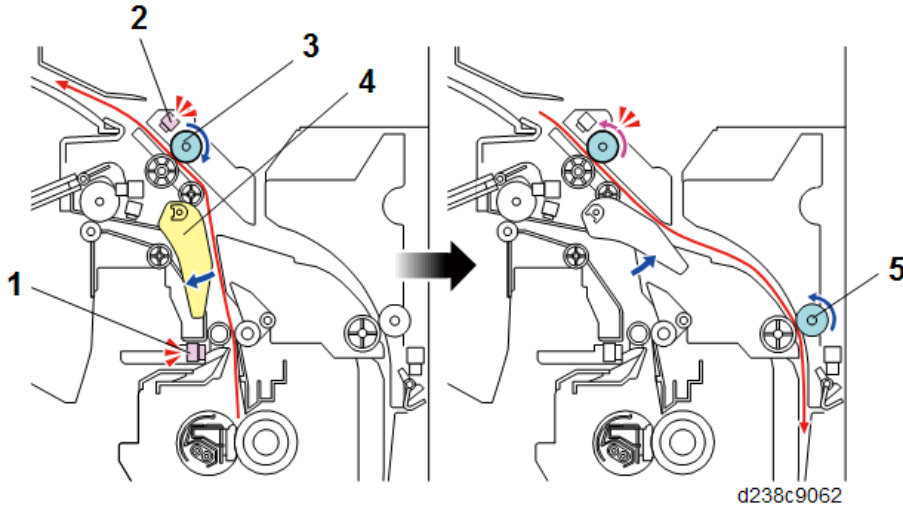

No.	Description	No.	Description
1	Fusing exit sensor	4	Paper exit junction gate
2	Reverse sensor	5	Duplex entrance roller 1
3	Reverse roller		

Duplex Drive

The rollers are driven by the following motors:

Rollers	Drive sources
Reverse roller	Reverse motor
Duplex entrance roller 1	Duplex entrance motor
Duplex entrance roller 2	Duplex entrance motor
Duplex transport roller	Bypass/ Duplex motor
Duplex exit roller	Bypass/ Duplex motor

Interleave Mechanism

The duplex unit, in order to reduce the overall duplex copying time, performs interleaving.

Paper exit from main machine

Length	No. of interleaves
Less than 216 mm	3
216-432 mm	2
432-457.2 mm	1

1-bin tray exit from main machine

Length	No. of interleaves
Less than 216 mm	2
216-432 mm	1

- 3 sheet interleave
 1 sheet undersurface -> 2 sheet undersurface -> 3 sheet undersurface -> 1 sheet top surface -> 4 sheet undersurface -> 2 sheet top surface
- 2 sheet interleave
 1 sheet undersurface -> 2 sheet undersurface -> 1 sheet top surface -> 3 sheet undersurface -> 2 sheet top surface -> 4 sheet undersurface

3-sheet interleaving

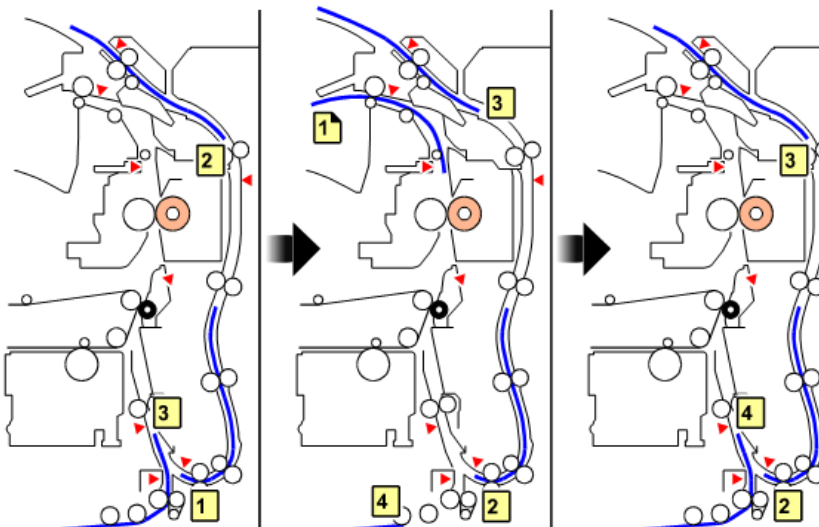

d1500804

Paper Exit Unit

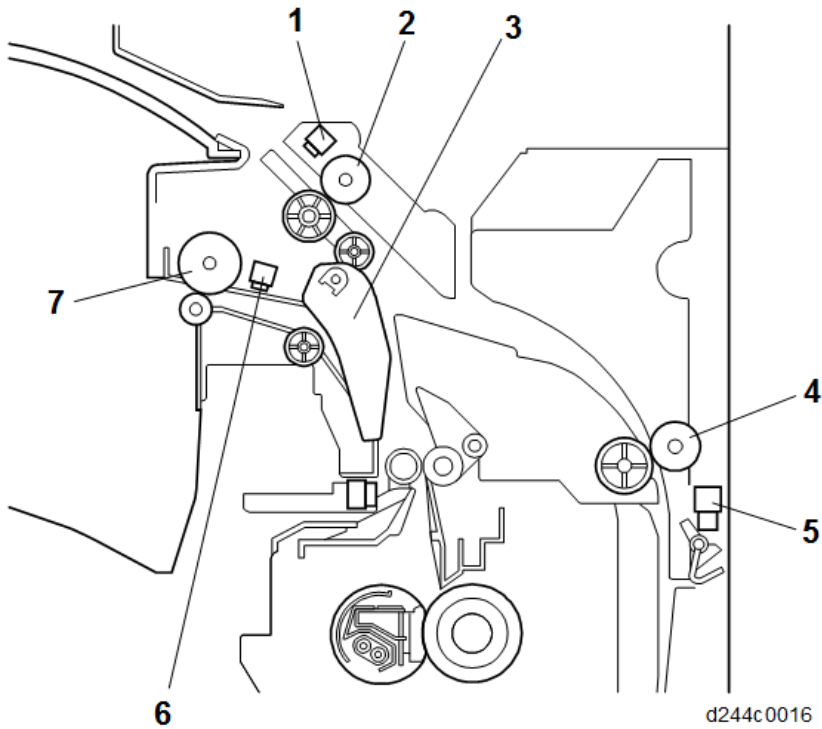

7

No.	Description	No.	Description
1	Reverse sensor	5	Duplex entrance sensor
2	Reverse roller	6	Paper exit sensor
3	Paper exit junction gate	7	Paper exit roller
4	Duplex entrance roller 1		

Delivery Location Change-over

The paper fed from the fusing unit is changed over by the junction gate in the "Paper exit/bridge unit" direction or the "duplex unit/1-bin tray" direction.

Machine paper exit/bridge unit direction

1. The registration sensor switches ON.
2. The paper exit/pressure release motor switches ON (CCW).

- When the rear edge of the paper leaves the paper exit roller, the paper exit/pressure release motor switches OFF.

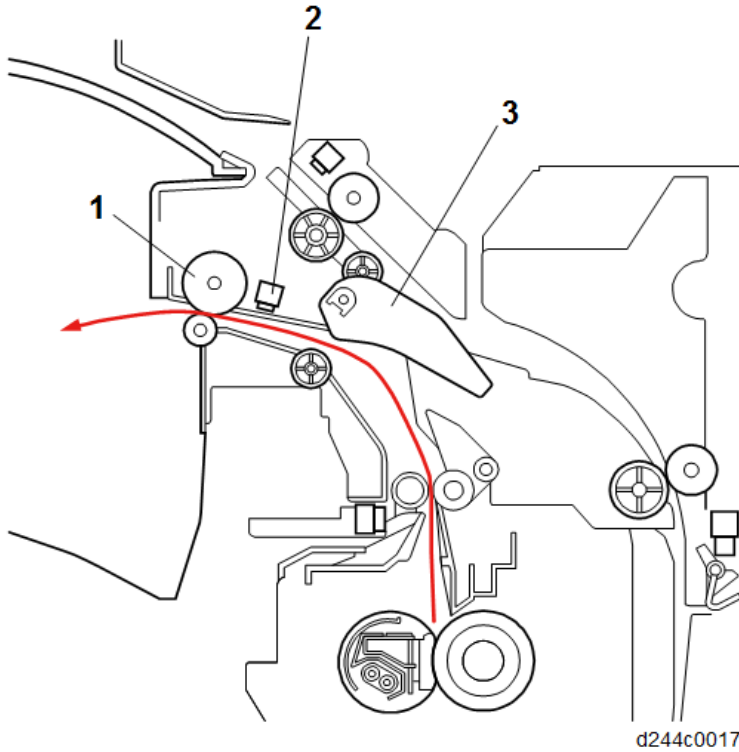

No.	Description
1	Paper exit roller
2	Paper exit sensor
3	Paper exit junction gate

Duplex unit/1-bin tray direction

- Registration sensor switches ON.
- The reverse motor switches ON (CCW).
- Before the leading edge of the paper reaches the paper exit junction gate, the junction gate moves to the duplex unit/1-bin tray direction.
 - * If the gate is in the duplex unit/1-bin tray direction, the gate is not changed over.
- Before reversing the paper, the paper exit solenoid switches OFF.
- When the rear edge of the paper leaves the reverse roller, the reverse motor switches OFF.

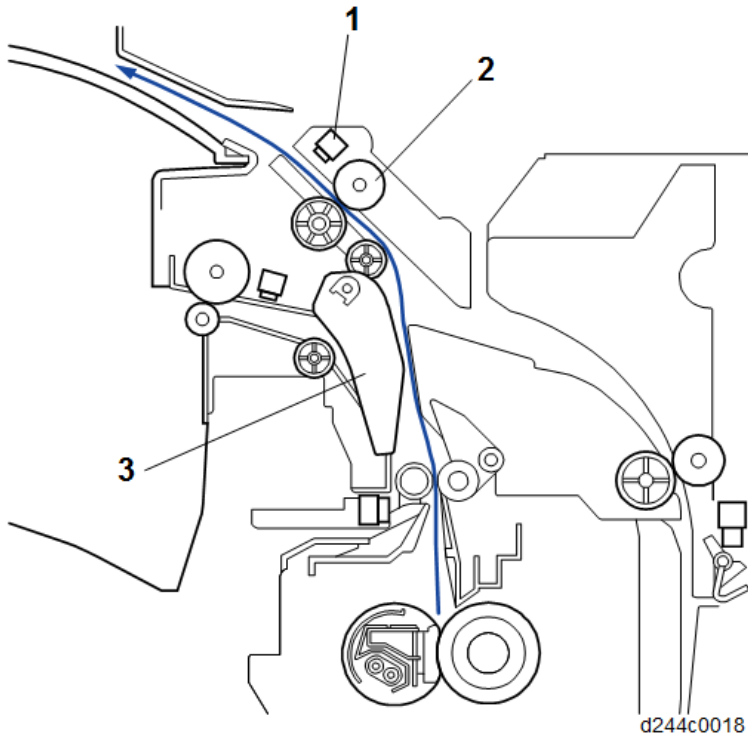

d244c0018

7

No.	Description
1	Reverse sensor
2	Reverse roller
3	Paper exit junction gate

Paper Exit Full/ Paper Exit Jam Detection

Paper exit full detection

This machine has no paper exit full sensor.

Paper exit jam detection

Paper exit jam is detected by the paper exit sensor.

Drive/Sensor Layout

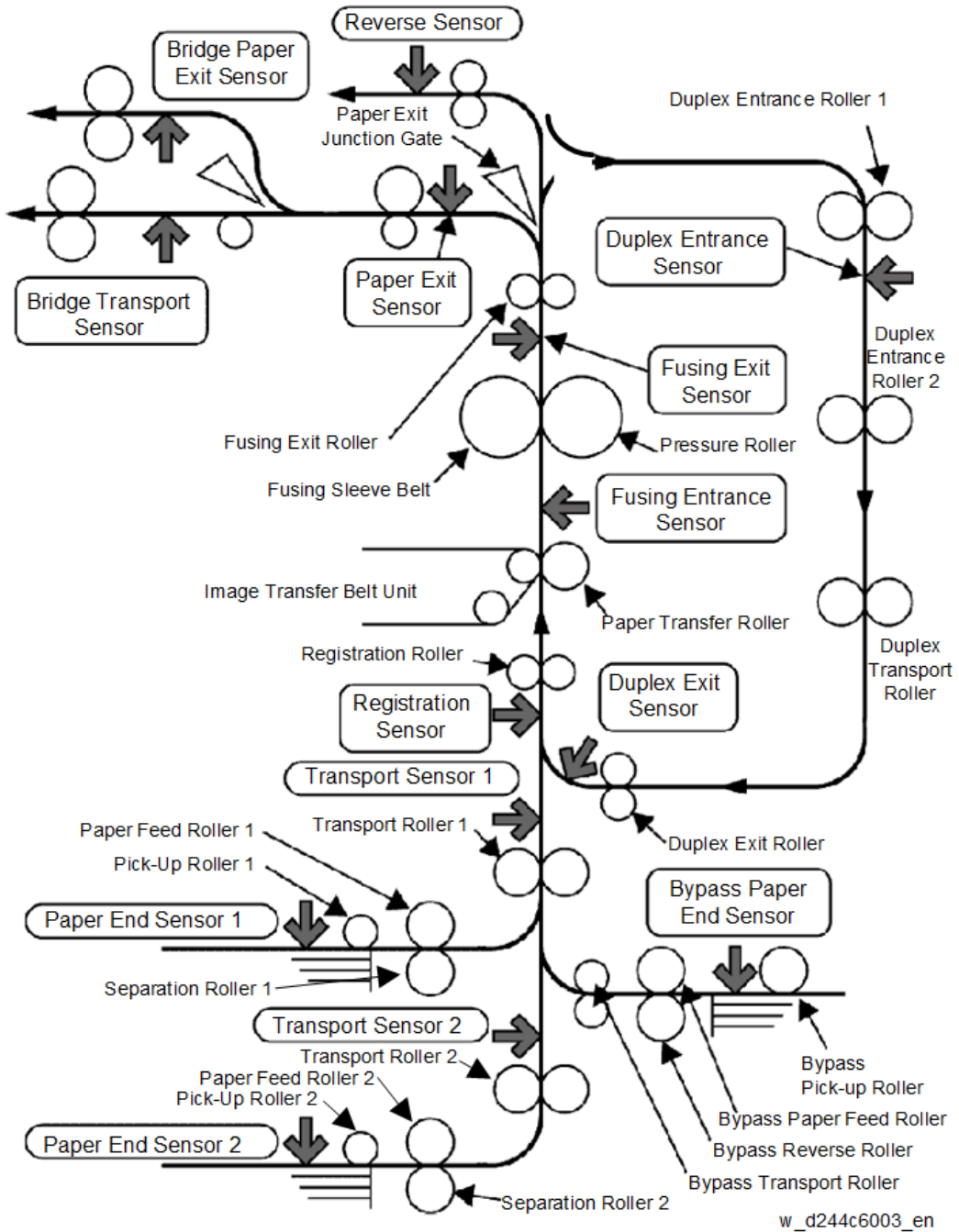

Transport Roller Drive Source

Output	Drive source
Pick-up roller 1	Paper feed motor
Paper feed roller 1	
Pick-up roller 2	
Paper feed roller 2	
Transport roller 1	Transport motor
Transport roller 2	
Registration roller	Registration motor
Paper exit roller	Paper exit/ Pressure release motor
Reverse roller	Reverse motor
Duplex entrance roller 1	Duplex entrance motor
Duplex entrance roller 2	
Duplex transport roller	Bypass/Duplex motor
Duplex exit roller	
Bypass feed transport roller	
Bypass pick-up roller	
Bypass paper feed roller	
Bypass reverse roller	
ITB drive roller (belt)	ITB drive motor
Paper transfer roller	ITB drive roller (Follows rotation of image transfer belt)
Fusing drive roller	Fusing motor

Gate/Pick-up Arm Drive Source

Output	Drive source	Default position	Application
1st tray pick-up roller	Paper feed motor	Pressure contact when OFF	Loaded paper contact and release change-over
2nd tray pick-up roller	Paper feed motor	Pressure contact when OFF	Loaded paper contact and release change-over
Paper exit junction gate	Paper exit solenoid	Paper exit path open when OFF	Paper exit/ bridge unit or 1-bin/duplex path change-over
Bypass pick-up roller	Bypass pick-up solenoid	Clearance when OFF	Loaded paper contact and release change-over

7

Inter-Roller Transport Path

Distance units: mm

Md.	From	To	Distance
1st tray paper feed	Pick-up roller 1	Paper feed roller 1	30.0
	Paper feed roller 1	Transport roller 1	43.0
2nd tray paper feed	Pick-up roller 2	Paper feed roller 2	30.0
	Paper feed roller 2	Transport roller 2	43.0
	Transport roller 2	Transport roller 1	96.9
Registration	Transport roller 1	Registration roller	86.8
	Registration roller	Paper transfer roller (image transfer position)	95.5
Fusing	Paper transfer roller (nip)	Fusing roller (nip)	85.0
	Fusing roller (nip)	Fusing exit roller	55.7
Paper exit	Fusing roller (nip)	Paper exit roller	143.6

Md.	From	To	Distance
Two-way distribution	Fusing roller (nip)	Reverse roller	143.6
	Reverse roller	Duplex entrance roller 1	131.3
Duplex re-supply	Duplex entrance roller 1	Duplex entrance roller 2	120.4
	Duplex entrance roller 2	Duplex transport roller	90.9
	Duplex transport roller	Duplex exit roller	110.2
	Duplex exit roller	Registration roller	94.7
Bypass feed	Bypass pick-up roller	Bypass paper feed roller	30.0
	Bypass paper feed roller	Bypass transport roller	24.5
	Bypass transport roller	First transport roller	56.0

Sensor Position

Distance units: mm

Md.	From	To	Distance
1st tray paper feed	Transport roller 1	Transport sensor 1	16.8
2nd tray paper feed	Transport roller 2	Transport sensor 2	24.3
	Transport sensor 2	Transport sensor 1	88.7
Registration	Registration sensor	Registration roller	17.2
Paper exit	Paper exit sensor	Paper exit roller	17.0
Two-way distribution	Reverse roller	Reverse sensor	14.0
Duplex	Duplex entrance roller	Duplex entrance sensor	25.0
	Duplex exit roller	Duplex exit sensor	15.0
1-bin	Reverse sensor	1-bin paper exit roller	-

Paper Exit Driven Roller and Paper Support Guide

Paper Exit Driven Roller

The standard paper exit driven roller [B] is drum-shaped and improves the stacking performance of the main machine exit tray by adding stiffness to the paper. However, if the paper has too much stiffness, it may jam as it enters the optional paper path when the internal peripheral is connected. Therefore, a flat type driven roller [A] is used to reduce the stiffness when transporting the paper.

The following options use the flat type driven roller:

- Internal Finisher SR3130
- Bridge Unit BU3070
- Internal Finisher SR3180
- Side Tray Type M3

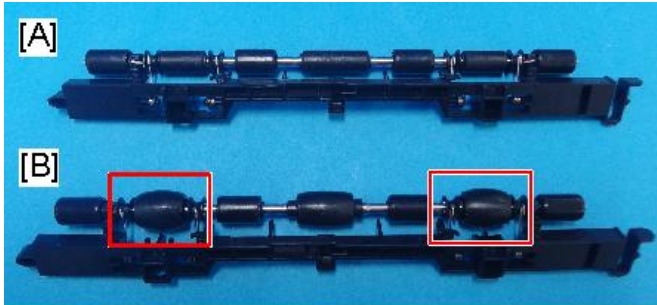

d238m0572

Paper Support Guide

To prevent paper jam when the paper is delivered from the machine's paper exit to the internal exit peripherals, attach the paper support guide [C] (supplied with the peripherals).

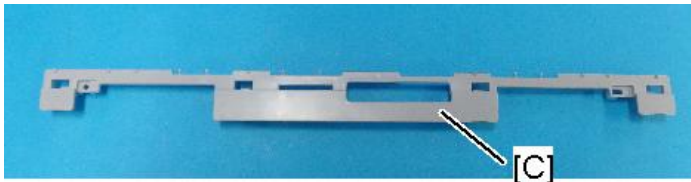

d238m0578b

Removing Wrinkling in the Tray

When paper larger than A3 is set, wrinkles may appear at the end of the paper. As a countermeasure, the previous machine used an L-shaped sheet metal [B].



In this machine, the support components [A] and a decal are attached, which are also available to the end-user.

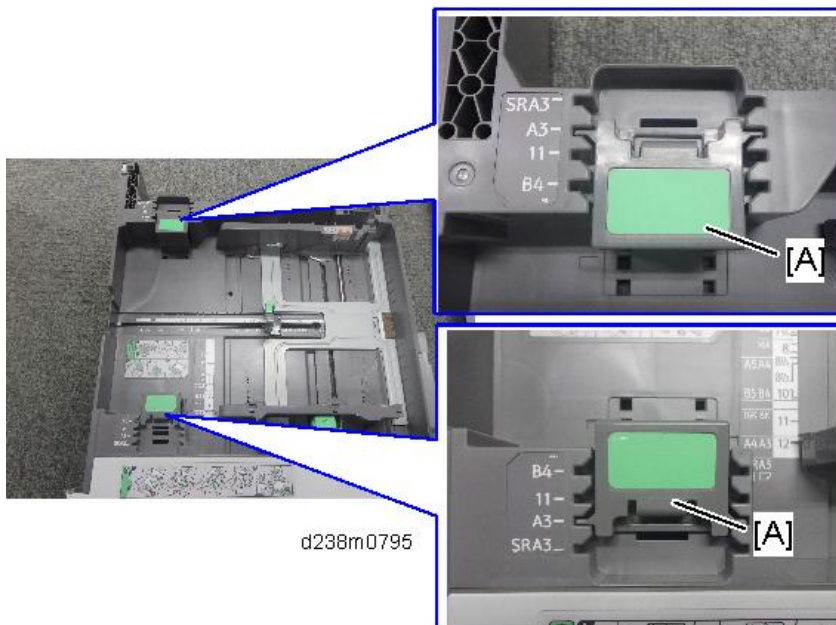

For small size paper, the side fences [B] are sufficient because the paper is light, but paper larger than A3 must be set at the position indicated by the decal.

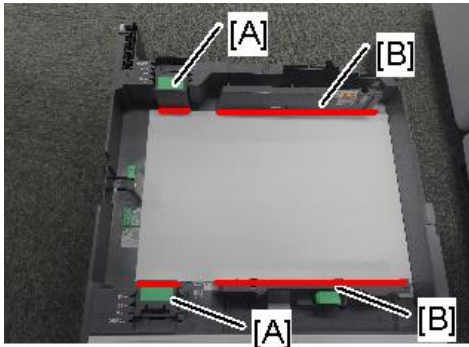

d238m0796

Tray 2, Paper Feed Unit PB3220/PB3210 (D787), and Paper Feed Unit PB3150 (D694) are also changed from L-shaped sheet metal to support component.

Factory Default:

- Tray 2: A3 (11 inches for NA only)
- Optional Paper Tray: A3 for all regions

Fusing

Overview

This machine employs a QSU fusing system wherein a lamp emits light to heat a sleeve belt.

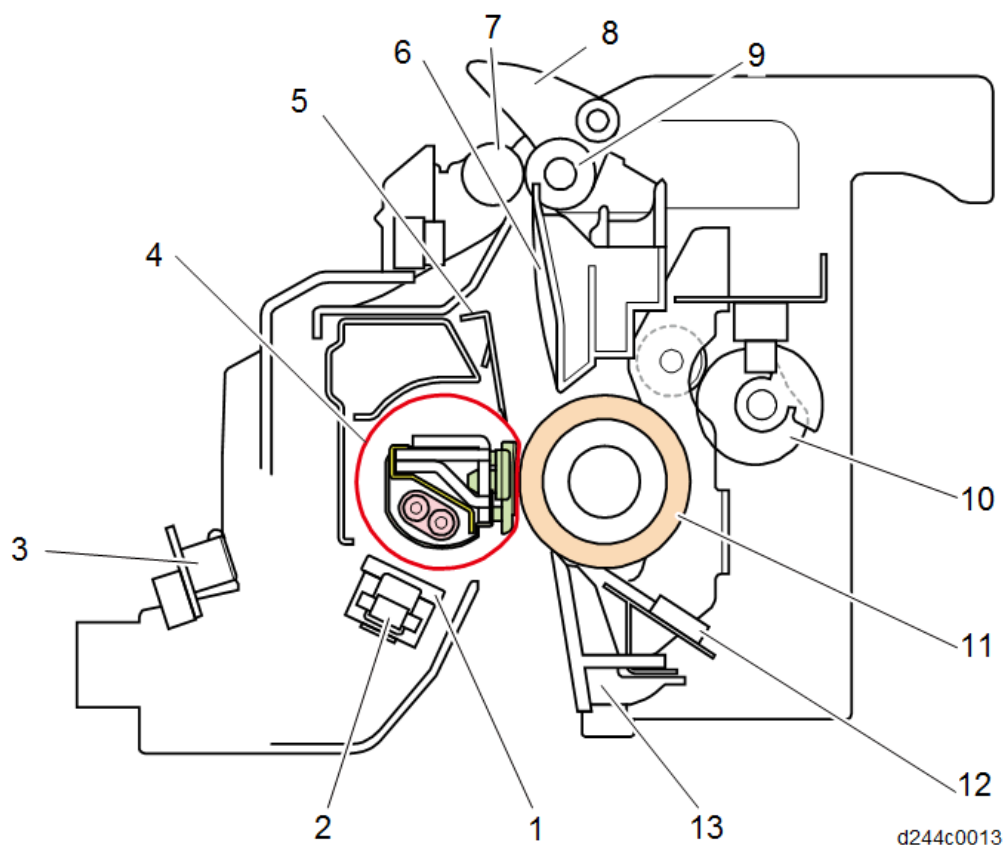

No.	Description	No.	Description
1	Fusing sleeve thermostats	8	Fusing junction gate
2	Non-contact thermistor	9	Fusing exit roller (drive)
3	Thermopile	10	Pressure roller drive cam
4	Fusing sleeve belt	11	Pressure roller
5	Stripper Plate	12	Pressure roller thermistors: Center, Edge, and Full-bleed edge

No.	Description	No.	Description
6	Fusing exit guide plate	13	Fusing entrance guide plate
7	Fusing exit roller (driven)		

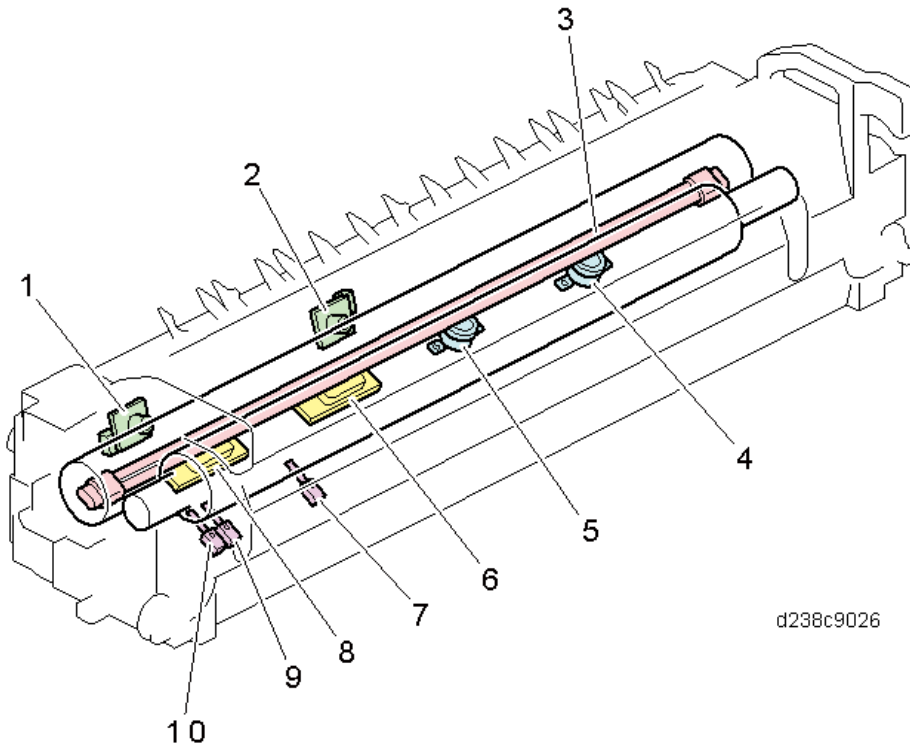

d238c9026

No.	Description	No.	Description
1	Thermopile (edge)	6	Non-contact thermistor (center)
2	Thermopile (center)	7	Pressure roller thermistor (center)
3	Fusing lamp	8	Non-contact thermistor (edge)
4	Fusing sleeve thermostat (edge)	9	Pressure roller thermistor (edge)
5	Fusing sleeve thermostat (center)	10	Pressure roller thermistor (Full-bleed edge)

Mechanism

Fusing System

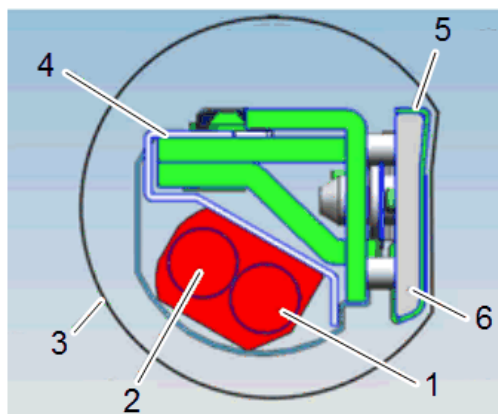

d244c0015

No.	Description	No.	Description
1	Fusing lamp (center)	4	Reflector
2	Fusing lamp (edge)	5	Heat conduction plate
3	Fusing sleeve belt	6	Nip pad

7

E-QSU (Enhanced-Quick Start Up) fusing

This fusing unit has the heat conduction plate added to the pressure pad on the fusing nip and removed the shield plate control.

The model of 35 cpm or below require little amount of heat, so it controls the temperature by the heat conduction plate and lamp control at the edges and center.

The heat conduction plate on the nip (on the surface of the pressure pad) disperses the temperature deviation between the front and rear parts of the fusing sleeve belt, so as to even out the temperature.

A fusing sleeve belt is driven by drag rotation following a pressure roller, and presses a nip pad against the pressure roller to fix toner on the paper.

The fusing lamp heats the fusing sleeve belt, and the area of the belt which is heated moves in an anticlockwise direction so that heat is transmitted up to the contact point with the pressure roller.

Lamps

There are two lamps.

Lamp power:

	NA/TWN	EU/AA/CHN
Center	647 W	700 W
Edge	344 W	527 W

Nip pad

Presses against the pressure roller to form a fusing nip. The top surface is covered with a slippery sheet.

Reflector

Transmits heat efficiently to the fusing sleeve belt.

Flanges

Situated on both ends of the fusing sleeve belt. They maintain the shape of the belt.

Heat conduction plate

Disperses the temperature deviation between the front and rear edges of the fusing sleeve belt to make the temperature uniform.

7

Fusing Drive

The pressure roller [B] is driven by the fusing motor [A].

The fusing sleeve belt [C] is driven by the pressure roller (drag rotation).

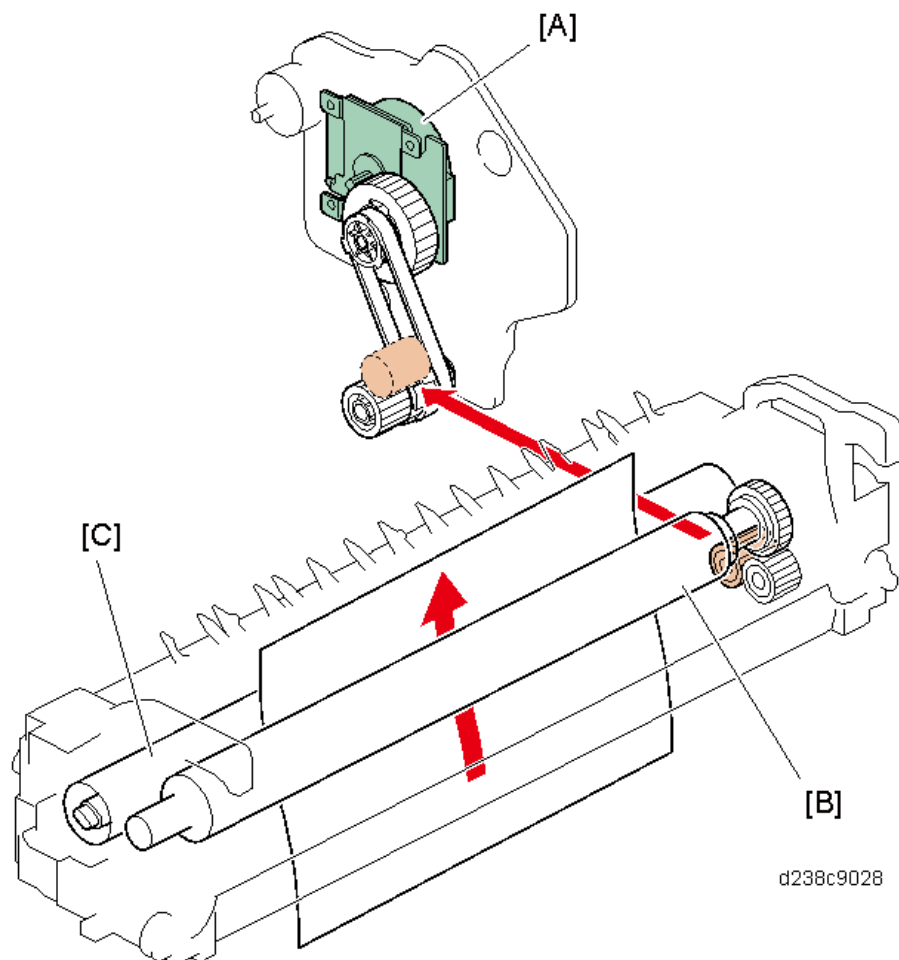

Pressure Release Mechanism

The pressure release mechanism helps the user to remove paper jams from the fusing unit more easily. A pressure lever [C] is released by the drive of the paper exit/pressure release motor [A], and the pressure roller [D] separates from the fusing sleeve belt.

The pressure roller HP sensor [E] detects the encoder [B], and determines the position of the pressure roller.

After replacing the pressure roller, if the sensor does not detect the encoder for 3 times continuously after a job is completed, SC569-00 (Paper Exit/ Pressure Release Motor Error Detection) is generated.

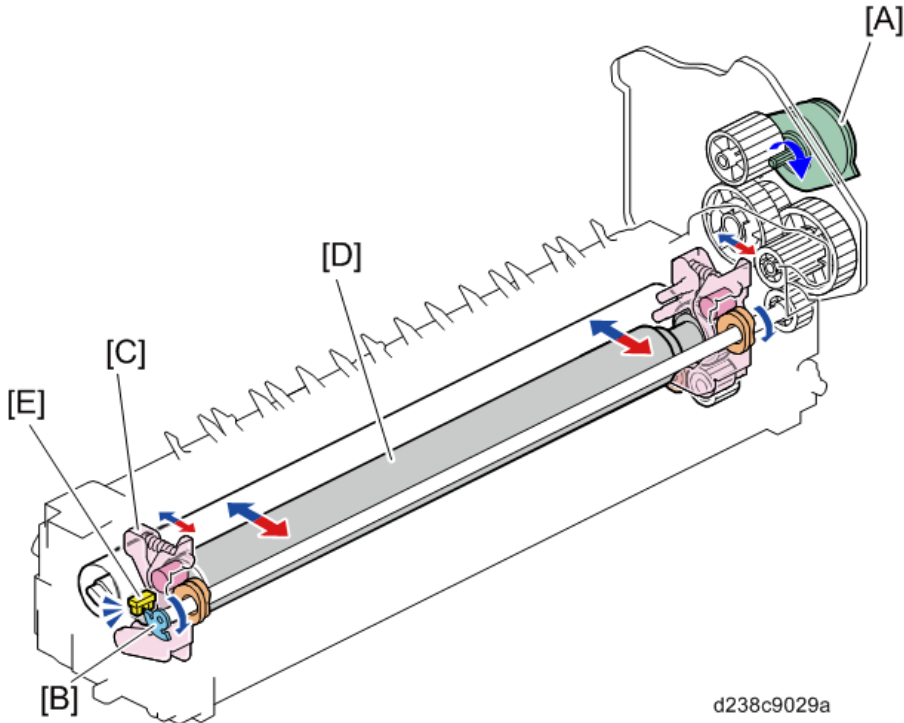

Fusing Temperature Control

Warm-up mode

After power ON, fusing warm-up begins. The fusing motor is switched ON, the halogen lamp is energized, and the fusing temperature is increased to the "reload target temperature."

When fusing warm-up is completed, the fusing motor stays ON for a certain time, and the fusing temperature is maintained at the "reload target temperature."

Standby mode

After fusing reload, when a certain time has elapsed, power supply to the halogen lamp is switched OFF, and the fusing motor is switched OFF. At the same time, the temperature is maintained at the "standby target temperature (SP1-107-001)" by the halogen lamp.

In standby mode, the Fusing motor rotates once every 60 minutes.

The operation interval of the Fusing motor can be changed by SP1-122-001 (Standby Rotation Setting Rotation Interval) but the change may cause the uneven glossiness on the image.

Printing ready mode

After returning to standby mode, the halogen lamp is re-energized, and the fusing temperature is raised to the "printing ready target temperature." If printing is not required, the machine again enters the standby mode after a certain time has elapsed.

If printing is required in standby mode during return, the halogen lamp is energized, the fusing temperature is increased to "target temperature after reload/after paper feed," and the print job starts.

CPM Down Control

To maintain image quality and machine quality, this machine has a low-temperature CPM mode and high-temperature CPM mode, and implements 3 levels of CPM down according to the usage situation and machine state.

Low-temperature CPM mode

In a low-temperature environment, the fusing lamp cannot keep up, and it may be difficult to maintain the fusing target temperature. To handle this, the detection temperature of the fusing center thermopile is checked every few seconds, and if the detection temperature during the check is below a threshold value, the CPM is decreased by 1 level.

This low temperature CPM reduction is performed in the following 3 levels:

CPM down level

Mode	Level
Normal CPM	100%
CPM down 1	80%
CPM down 2	65%
CPM down 3	50%

Hot CPM mode

To shorten warm-up time and reduce the TEC value, this machine employs a fusing unit with a low heat capacity.

For this reason, the temperature of those parts of the fusing sleeve belt where paper does not pass easily increases, and the outside of the paper width may get extremely hot. In order to prevent the belt breakage due to this excessive temperature rise, CPM down is implemented depending on the usage conditions. CPM down can be implemented in the following 3 levels depending on the detection temperature of the temperature sensor, or the paper passage time.

Note

- The down level % is a value for the case where a typical paper (Normal paper: A4 or smaller paper sizes) passes through the SEF at normal speed. There may be some differences depending on paper size/paper thickness.

CPM down level

Mode	Level
Normal CPM	100%
CPM down 1	80%
CPM down 2	50%
CPM down 3	30%

CPM down determination using a temperature sensor

The temperature sensor is checked at given intervals, and if the detection temperature is above a threshold value, the CPM is decreased by 1 level.

Since the points at which temperature tends to increase depend on the paper size, the sensor used is changed depending on the paper size.

7

Paper width (length)	Check sensor
A3/DTL/B4	Pressure roller thermistor (edge)
LT/A4	Thermopile (edge)
B5/A5/B6/A6	Pressure roller thermistor (center)

CPM down determination using paper passage time

Depending on the paper size, it may not be possible to determine the points on the fusing sleeve belt which tend to rise in temperature by a sensor.

Therefore, time conditions are also used to determine CPM down, and if continuous paper passage time is above a threshold value, CPM is decreased by 1 level.

(When CPM down is performed by time conditions, CPM does not increase thereafter.)

Curl Correction Mechanism

This machine provides a curl reduction mechanism on the fusing exit.

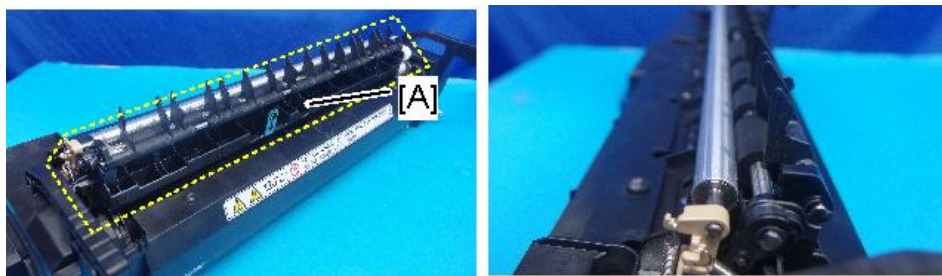

d238m0798

Curling is reduced by bending in the reverse direction of the curl created at the fuser nip and forcibly adding resilience using the fusing exit roller [B], fuser exit driven roller [C], and fusing junction gate [A], located at the fuser nip exit.

The fusing junction gate is retracted for duplex printing/thick paper to prevent image smearing.

Curl correction position

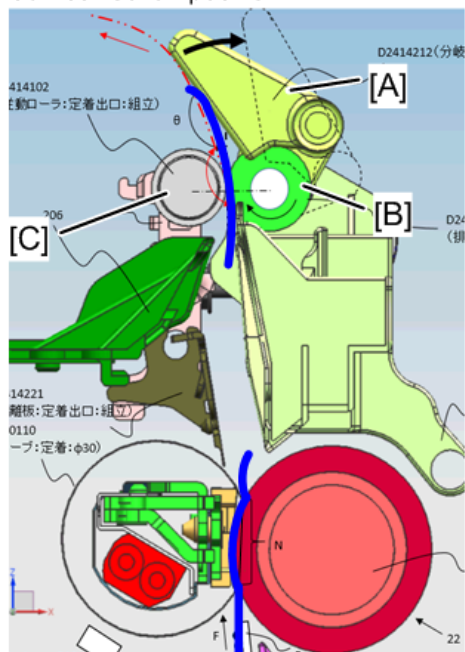

Position for no curl correction

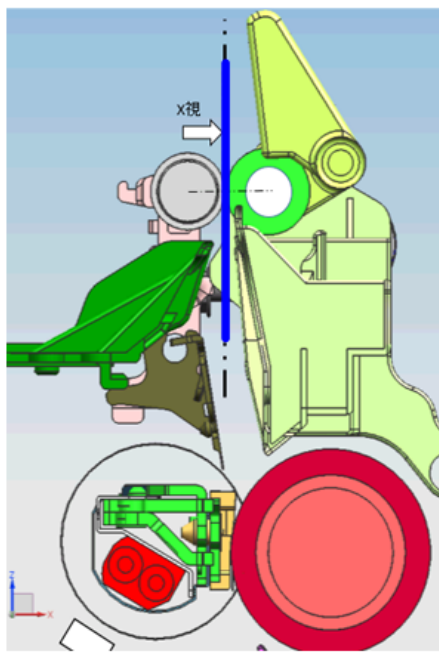

w_d238m0799e

Drive

The fusing junction gate [C] is rotated via the arm [B] by turning ON the fusing exit drive solenoid [A] located on the main machine side.

When the solenoid is ON, the fusing junction gate is at no curl correction position.

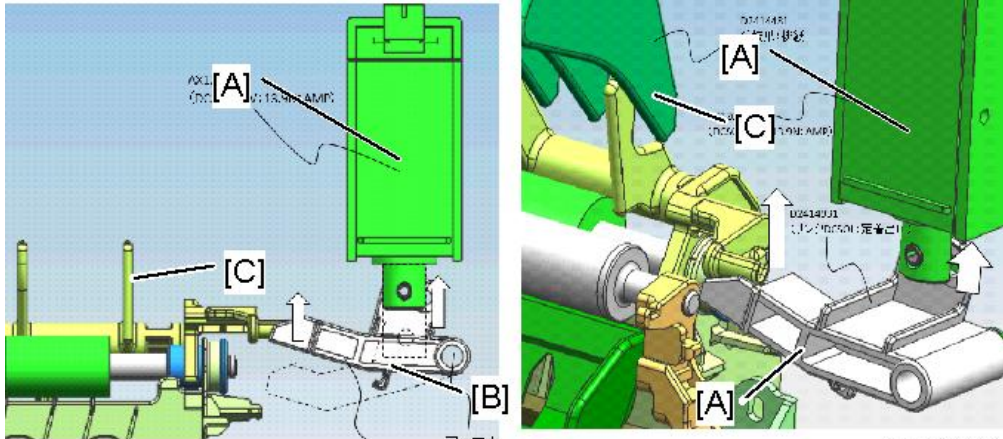

d238m0800

When the solenoid is OFF, it is put in the continuous curl correction position by spring [A].

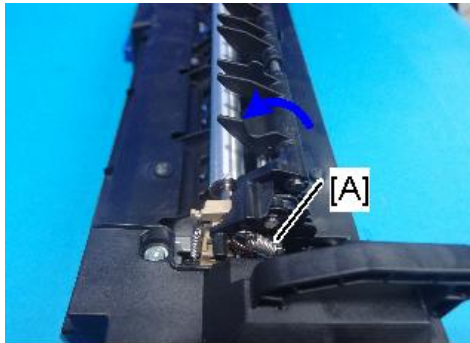

d238m0801

Availability of curl correction by print mode

For duplex printing, or using thick paper, the fusing junction gate is retracted to prevent image smearing.

✓: Curl corrected (one-side printing only)

-: Curl not corrected

	Thin Paper	Plain Paper 1	Plain Paper 2	Middle Thick	Thick Paper 1	Thick Paper 2	Thick Paper 3	Thick Paper 4
Normal Paper	✓	✓	✓	-	-	-	-	-
Recycled Paper	✓	✓	✓	-	-	-	-	-
Color Paper	✓	✓	✓	-	-	-	-	-
Special Paper 1	✓	✓	✓	-	-	-	-	-

	Thin Paper	Plain Paper 1	Plain Paper 2	Middle Thick	Thick Paper 1	Thick Paper 2	Thick Paper 3	Thick Paper 4
Special Paper 2	✓	✓	✓	-	-	-	-	-
Special Paper 3	✓	✓	✓	-	-	-	-	-
Letterhead	✓	✓	✓	-	-	-	-	-
Preprinted Paper	✓	✓	✓	-	-	-	-	-
Bond Paper	✓	✓	✓	-	-	-	-	-
Cardstock	✓	✓	✓	-	-	-	-	-
OHP (Transparency)	-	-	-	-	-	-	-	-
Label Paper	✓	✓	✓	-	-	-	-	-
Coated: Matte	-	-	-	-	-	-	-	-
Envelope	-	-	-	-	-	-	-	-
Coated: Glossy	-	-	-	-	-	-	-	-

SP1-907-096 (Operation Setting: Fusing Exit SOL Setting)

By changing SP1-907-096, the curl correction mechanism can be enabled regardless of the paper setting.

If the fusing exit drive solenoid is ON, the curl correction function is OFF.

If the fusing exit drive solenoid is OFF, the curl correction function is ON.

SP value	Curl Correction	
	Tray	Bypass
0	Normal Operation	
1	Normal Operation	Always OFF
2	Always OFF	Normal Operation
3	Always OFF	Always OFF
4	Normal Operation	Always ON

SP value	Curl Correction	
	Tray	Bypass
5	Always ON	Normal Operation
6	Always ON	Always ON

For duplex printing, or printing to 1-bin tray, always **no** curl correction regardless of the SP setting, because the fusing junction gate would interfere with the transfer path.

Electrical Parts

Block Diagram

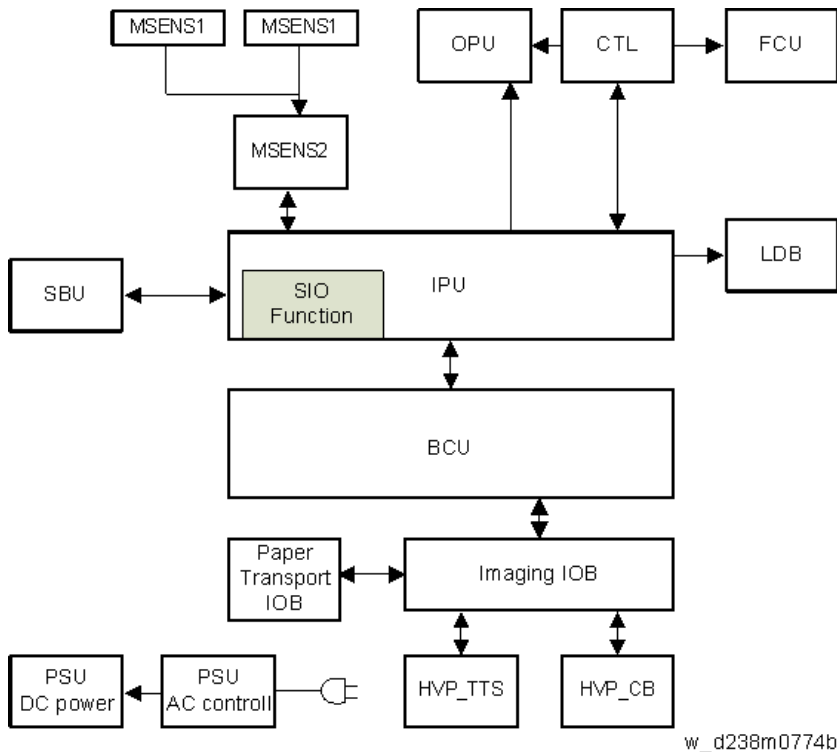

Board Outline

Controller

Controls the MFP system overall. Comprises an x86CPU, controller ASIC, IO control ASIC, and RAM.

SBU

Scanning control circuit which performs analog signal processing and AD image conversion of the CCD scanned image.

It also has an IPU I/F, and controls scanner input output signals according to CPU commands.

LDB

LD control circuit which drives the laser diode with a universal driver.

BCU

Controls the engine.

IPU

Processes digital signals.

The SIO functions are included in the IPU for this machine. Thus the SIO board is removed.

SIO Function

Circuit which controls generation of SBU power, scanner internal sensor I/F, carriage drive stepping motor and LED drive.

MSENS1 (Proximity Sensor (Human Detection Sensor), MSENS2 (Proximity Sensor (Human Detection Sensor) Board)

Proximity sensors (human detection sensors) and proximity sensor (human detection sensor) board are equipped.

People are detected by IR sensors which sense the temperature difference between the human body and the temperature of the machine location.

IOB

Controls the MFP engine sensor, motor and solenoid.

FCU

Controls the fax program.

OPU

Controls the control panel.

HVP (Composite High-Voltage Power Supply TTS/CB)

Generates the high-voltage power required for process control. Divided into two units, i.e., transfer (TTS) and electrostatic/developing (CB).

PSU

Generates DC power from a commercial AC power supply, and supplies it to each control circuit. Comprises an A/C drive circuit for controlling the fixing heater.

Anti-condensation Heater for Scanner, PCDU, and Paper Feed Tray

Circuit Configuration

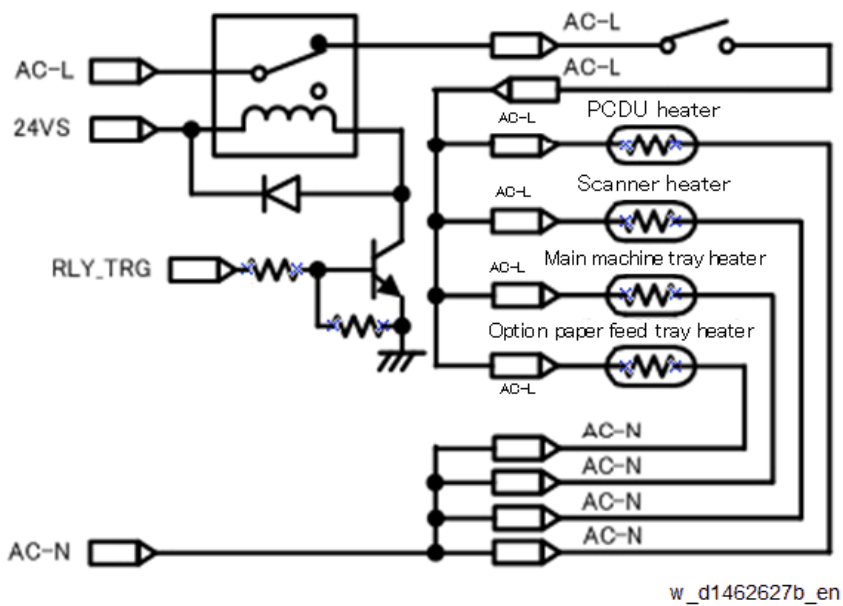

The power circuit of the anti-condensation heaters for scanner and PCDU is linked to the switch of the paper feed tray heater. Therefore, when the paper feed tray heater power is turned OFF, all heaters are de-energized. In addition, the operation during printing is controlled so as not to exceed the maximum power.

The behavior of the heaters when the machine is in standby mode is controlled by SP5-805-001 (Anti-Condensation Heater OFF/ON).

Heater	SP5-805-001	Plug-in	Energy saving	Standby	Printing
- Scanner heater	OFF(0)	ON	ON	OFF	OFF
- PCDU heater	ON(1)			ON	
- Main machine tray heater		ON	ON		
- Optional paper feed tray heater		ON	ON		

Exterior Cover/ Air Flows (Fan Control)

Overview

Imaging system (front)

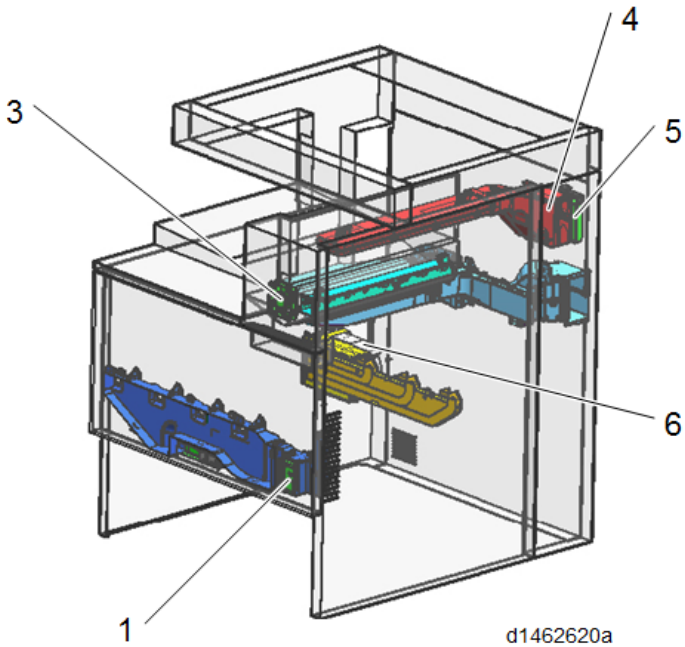

Imaging system (rear)

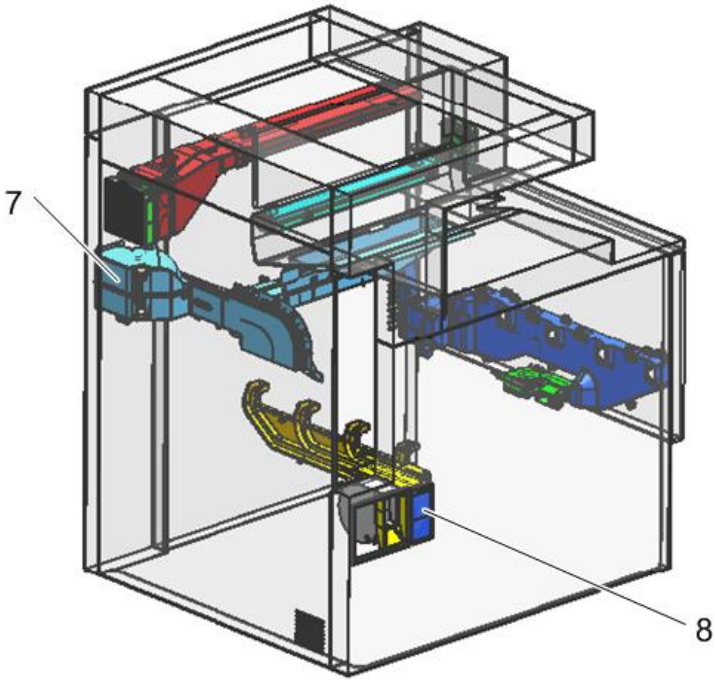

d1462621

Electric system

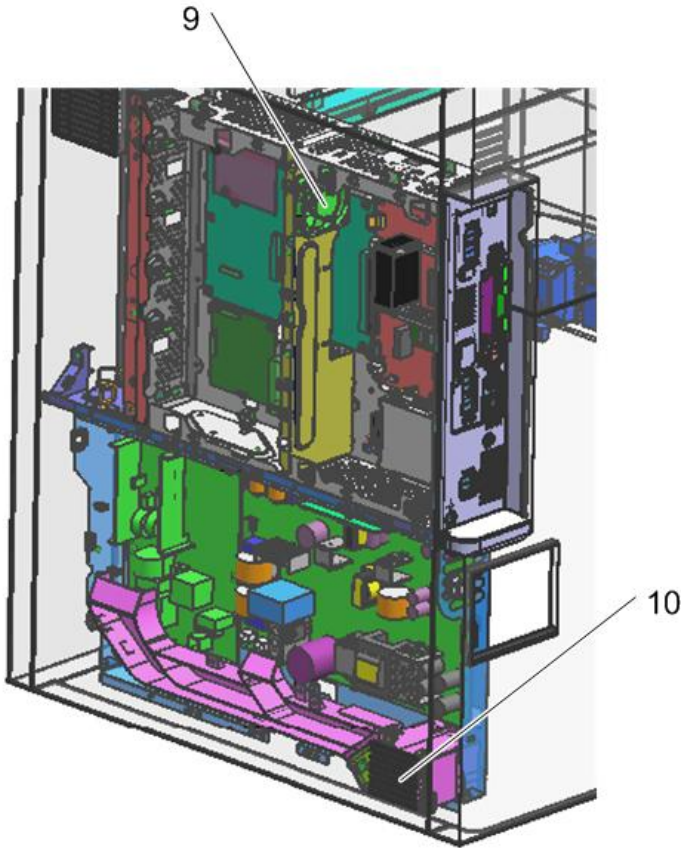

d1462622

No.	Part name
1	Development intake fan
3	Paper exit cooling fan
4	Fusing exhaust fan
5	Deodorization filter
6	Ozone exhaust fan
7	Toner supply cooling fan
8	Ozone filter/Dust filter
9	Controller box cooling fan

No.	Part name
10	PSU cooling fan

Mechanism

By installing the duct corresponding to each fan, the air flow is efficiently controlled to a cooling target. Moreover, improvement in quietness and energy-saving efficiency is achieved by performing stepwise operation of the fan according to the imaging temperature.

Cooling of PSU

Air taken in by the PSU cooling fan is guided near the cooling target by the duct, and is efficiently cooled.

Cooling of Toner Supply Parts

Air taken in with the toner supply cooling fan is guided to circulate around the toner bottle, and is discharged from the side of the delivery tray to outside the machine. It is aimed to achieve heat insulation from the stack of paper to the toner bottle by reducing the melting point of the toner.

Cooling of PCDU parts

By discharging air taken in from the development intake fan at the front, from the ozone exhaust fan at the rear, a uniform air flow is attained and efficient cooling is realized. Discharge of ozone and scattering of toner are prevented by installing an ozone filter and a dust filter in front of the ozone exhaust fan.

Cooling of Fusing Parts

Air taken in from the paper discharge cooling fan at the front is discharged from the fusing heat discharge fan at the rear to outside the machine. By cooling the paper immediately after fusing, not only cooling of the fusing exit sensor but also reduction of stored heat of the stacked paper and reduction of curl are realized. This also serves to prevent condensation on the paper discharge guide sheet. As a measure against odor, a deodorization filter is installed downstream from the fusing exhaust fan.

Cooling in Controller Box

Air is circulated by the controller box cooling fan installed in the controller box, preventing temperature rise in the controller box.

Crisis Management When Temperature Rises in the Machine

In order to suppress excessive temperature rise in the machine and maintain equipment quality, a temperature sensor (imaging temperature sensor (thermistor)) [A] is installed in the machine. The imaging temperature sensor (thermistor) detects the temperature environment in the machine, and controls cooling operation.



Overview of cooling operation in the machine

The temperature in the machine is detected during output and after output, and the interior of the machine is cooled by fan operation (stepwise operation of fan, prolonged fan rotation after paper has passed through) according to the temperature inside the machine.

However, if the temperature inside the machine rises significantly due to passing a large volume of paper, in addition to fan operation, the CPM is specified to control the temperature in the machine.

Cooling operation during output

Perform cooling operation under the following conditions.

Imaging temperature	Less than 34	34	35	36	37	38	40 ^{*1}
Fusing exhaust fan	ON	ON	ON	ON	ON	ON	ON
Ozone exhaust fan	20%	20%	30%	30%	40%	40%	40%
Toner supply cooling fan	-	-	-	ON	ON	ON	ON
Development intake fan ^{*3}	-	-	-	ON	ON	ON	ON
PSU cooling fan ^{*2}	ON	ON	ON	ON	ON	ON	ON

The operation start temperature can be modified by SP.

- *1 If the imaging temperature reaches 41°C each fan will continue operating until it falls by 2°C.
- *2 Operating condition:
When the time interval from the previous job is less than 10 minutes. Or, when the time interval from the previous job is more than 10 minutes, and 5 minutes have elapsed from start of machine.
- *3 Operating condition:
For 36°C or above, full speed rotation at 24V
For less than 36°C, rotated at low speed with voltage reduced to 13V (rotating speed approximately 50%)
Changes from low speed rotation to full speed rotation when printing continues for more than 5 minutes while the temperature inside the machine is 36°C or lower

Cooling operation after output

Usually, after output, fan operation is suspended.

If the temperature in the machine after output is high, fan rotation is continued after output to cool the interior of the machine.

Helmholtz Silencer

The Helmholtz silencer applies the resonance phenomenon called the "Helmholtz resonance" to emit a sound having reverse phase of the motor frequency by resonance and cancel the motor noise.

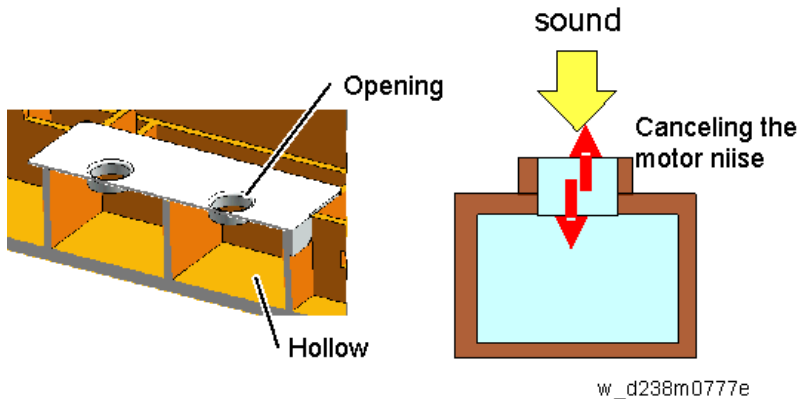

On this machine, it is located on the controller box side to reduce the noise. The BCU [B] is mounted on the mold [A] of the Helmholtz silencer.

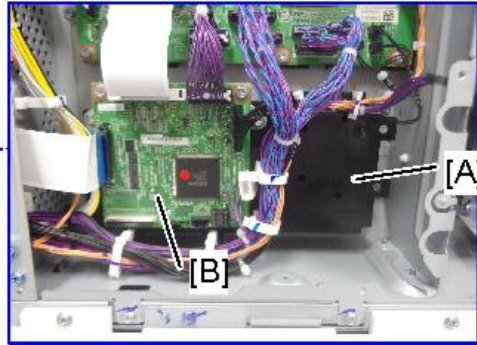
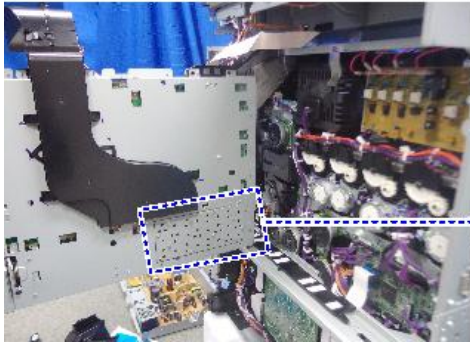
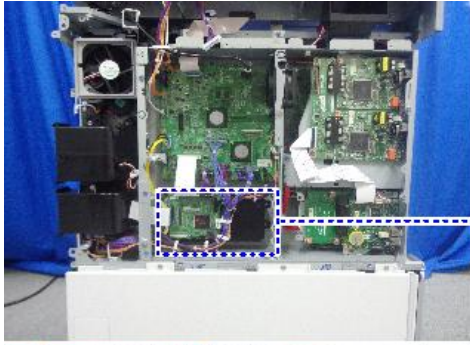

d238m0775

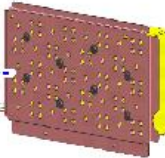

Energy Save

Energy Saver Modes

Customers should use energy saver modes properly, to save energy and protect the environment.

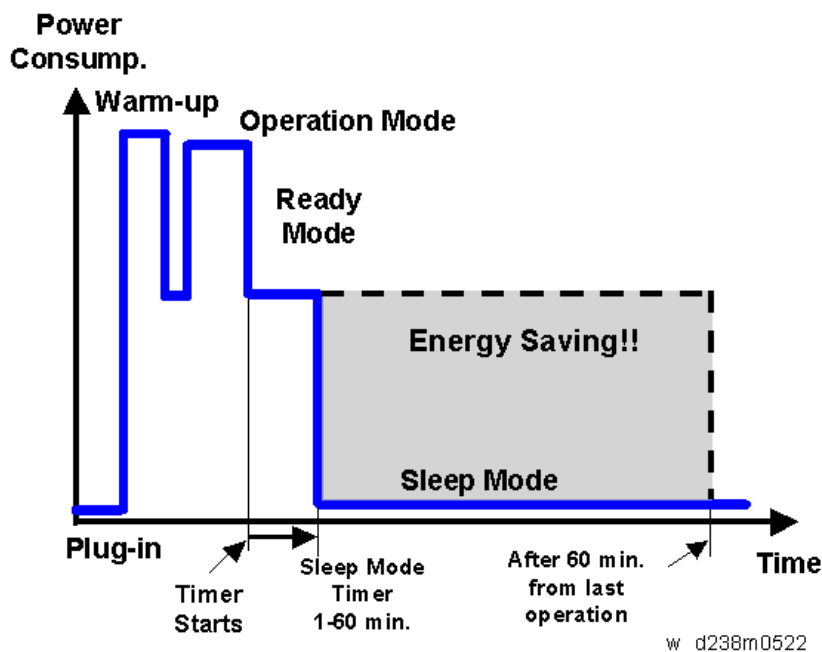

7

The area shaded grey in this diagram represents the amount of energy that is saved when the timers are at the default settings. If the timers are changed, then the energy saved will be different. For example, if the timers are all set to 60 min., the grey area will disappear, and no energy is saved before 60 min. expires.

Setting Items that are Related to Energy Saving

The user can set these timers with User Tools (Machine Features > System Settings > Timer Settings)

Sleep Mode Timer

User Tools (Machine Features > System Settings > Timer Settings)

After a specified period has passed, or [Energy Saver] is pressed, the machine enters Sleep mode in order to conserve energy. Specify the time to elapse before Sleep mode.

Default: [1 minute(s)]

Sleep mode timer may not work when error messages appear.

Depending on which embedded software architecture application is installed on it, the machine might take longer than indicated to enter Sleep mode.

Fusing Unit Off Mode (Energy Saving) On/Off

User Tools (Machine Features > System Settings > Timer Settings)

Specifies whether Fusing Unit Off mode is enabled or not.

When Fusing Unit Off mode is enabled, the display is on but the fusing unit is off to save energy.

The machine requires roughly the same time as warm-up time to recover from Fusing Unit Off mode.

Default: [Off]

If [Fusing Unit Off Mode (Energy Saving) On/Off] is set to [On], you can specify when to exit Fusing Unit Off mode and the time to elapse before entering Fusing Unit Off mode.

If [Exit Fusing Unit Off Mode] is set to [On Printing], the machine exits Fusing Unit Off mode when printing is performed.

If [Exit Fusing Unit Off Mode] is set to [On Operating Control Panel], the machine exits Fusing Unit Off mode when a key other than the copy function key is pressed on the control panel of the machine.

If printing is performed with the copy function or a key in the copy function is pressed on the control panel of the machine, the machine exits Fusing Unit Off mode regardless of this setting. If the timer is set to [On], you can set the time from 10 seconds to 240 minutes, using the number keys.

7

Energy Saving Recvry. for Business Application.

User Tools (Machine Features > System settings > General Settings)

Specify whether or not to enable low-energy recovery from Sleep mode to use applications independent of the machine, such as Address Book Management or Browser.

Default: [Off]

If [On (Energy Saving)] is selected, it takes longer than usual to be ready to use the machine.

Recovery Time/ Reduced Electrical Consumption

Reduced electrical consumption in Sleep mode:

MP C2004	MP C2504
NA: 0.85 W	NA: 0.85 W
EU: 1.00 W	EU: 1.00 W

Recovery time from Sleep mode

MP C2004	MP C2504
6.0 sec.	6.0 sec.

Power States of this Machine

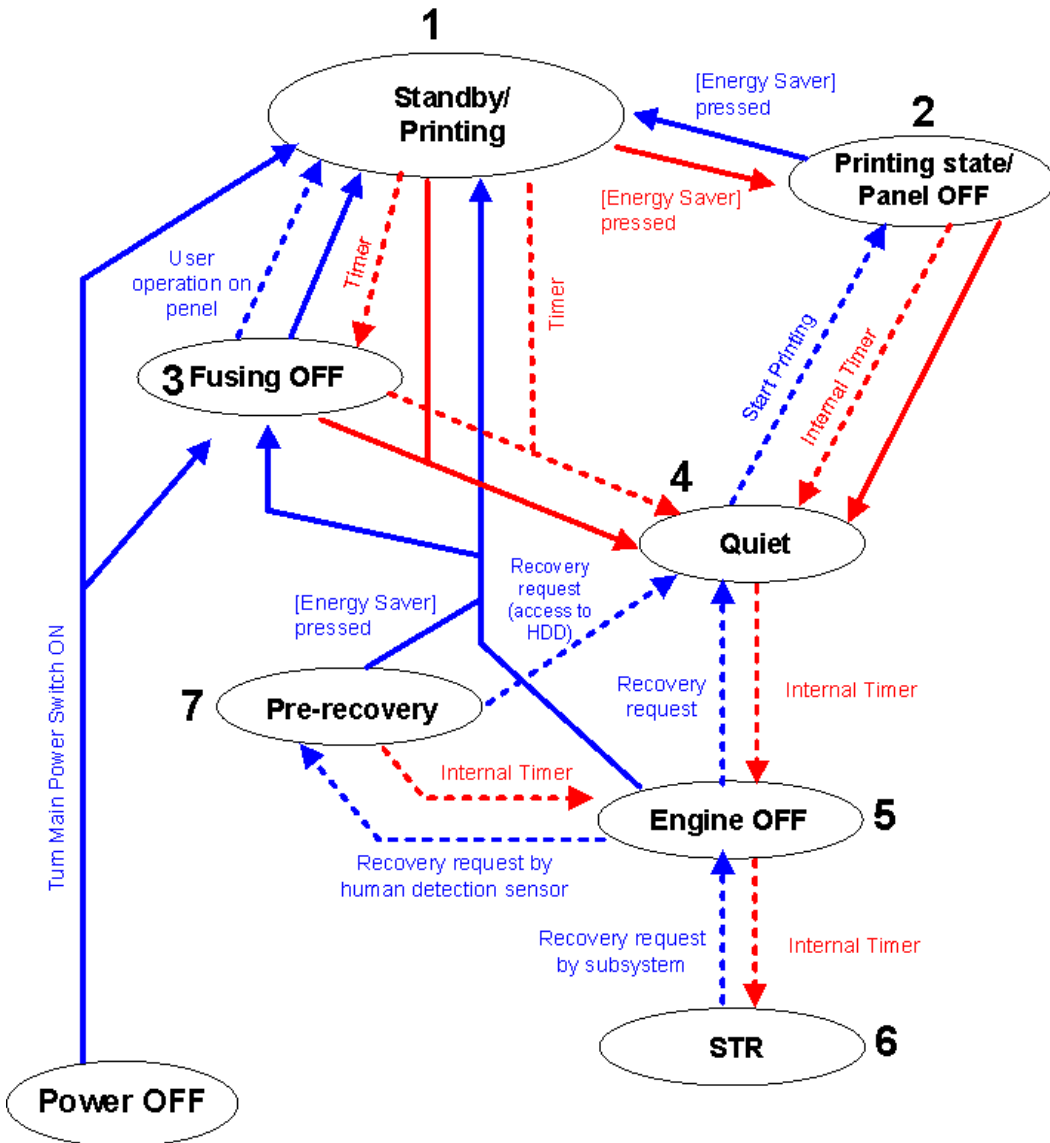

- ← "Energy Saver" key is pressed, main power ON, or ADF / platen cover open/close
- ←···· Request from other factor
- ← "Energy Saver" key is pressed, or request via the external device
- ←···· Automatic internal timer

w_d238m0523e

	State	Description
1	Standby/Printing	<ul style="list-style-type: none"> State where normal operation is possible after warm-up State during printing
2	Printing state/ Panel OFF	State when printing with the backlight of the operation panel turned off
3	Fusing OFF	<p>State where the Standby Fusing OFF state is entered when the time set with the "Fusing Unit Off Mode (Energy Saving) On/Off" setting of the User Tools has elapsed.</p> <ul style="list-style-type: none"> State where the operation panel is flashing and the fusing lamp is OFF. The bottom plate of the paper feed tray is raised.
4	Quiet state	<p>Quiet state is entered when the Energy Saving key is pressed or the time set with the "Sleep Mode Timer" of the User Tools has elapsed. This is a temporary energy saving state before entering sleep mode.</p> <ul style="list-style-type: none"> Basically, no homing (initialization) of peripheral devices is performed. The bottom plate of the paper feed tray is raised. The fusing lamp is turned OFF.
5	Engine OFF (Sleep mode)	<p>Entered from Quiet state with internal timer.</p> <ul style="list-style-type: none"> The relevant power systems (24V, 12V, 5V) are turned OFF at the same time as the fusing lamp. When receiving a fax or printing is performed in engine OFF state, warm-up is started and printing is performed while the backlight of the operation panel is turned OFF.
6	STR state (Sleep mode)	Supplying of power and clock to the CPU and peripheral chips on the controller board is stopped.
7	Pre-recovery	<p>The Pre-recovery state is entered from STR state when the proximity sensor (human detection sensor) detects presence of a person.</p> <p>This is the Energy Saving state where the power of the operation panel and HDD is ON and the power of the engine is OFF, but the backlight of the operation panel LCD is off.</p>

Device state for each Energy Saving state

State	Energy Saving LED	Operation panel LCD	Engine (Printer/Scanner)	HDD	CTL
Standby/Printing	ON	ON	ON	ON	ON
Printing state/Panel OFF	ON	OFF	ON (Only scanner is in Quiet state)	ON	ON
fusing OFF	ON	ON	ON (Both printer/scanner are in Quiet state)	ON	ON
Quiet state	ON	OFF ON* 1	ON (Both printer/scanner are in Quiet state)	ON	ON
Engine OFF	Blinking gradually ON* 1	Sleep OFF or ON* 1	OFF	OFF ON* 1	ON
STR state	Blinking gradually	Sleep	OFF	OFF	STR
Pre-recovery	ON	OFF ON* 1	OFF	ON	ON

* 1 When [Energy Saving Recvry. for Business Applicatn.] is [On (Energy Saving)], ON/OFF is determined by the internal timer of the Smart Operation Panel.

Transition of operation panel to Energy Saving when [Energy Saving Recvry. for Business Applicatn.] is [On (Energy Saving)]

Normally, the Energy Saving state of the operation panel LCD changes in step with the energy saving state of the MFP/LP main unit, but to support the scenario where an application that does not use the engine (printer/scanner) is executed from the operation panel, the Energy Saving state of the operation panel is transitioned through the three states ON, OFF, and Sleep with its internal timer when [Energy Saving Recvry. for Business Applicatn.] is [On (Energy Saving)].

Verification of Up Time for each Energy Saving State

The up time for each power state of the machine can be checked with SP8-961 (Electricity Status). It is also output on the SMC sheet.

SP	Name	Description
SP8-961-001	Ctrl Standby Time	Cumulative time of Engine OFF mode, Quiet mode, and Standby mode
SP8-961-002	STR Time	Cumulative time of STR mode
SP8-961-003	Main Power Off Time	Cumulative time of state in which the power plug is connected to the outlet but the main power is off
SP8-961-004	Reading and Printing Time	Cumulative time of state in which both the plotter engine and scanner engine are running or warming up
SP8-961-005	Printing Time	Cumulative time of the state in which the plotter engine is running
SP8-961-006	Reading Time	Cumulative time of the state in which the scanner engine is running
SP8-961-007	Eng Waiting Time	Cumulative time of state in which the power state of the engine is Standby state
SP8-961-008	Low Power State Time	Not used for this machine
SP8-961-009	Quiet State Time	Cumulative time of the state in which the power state of the engine is Quiet state
SP8-961-010	Heater Off State Time	Cumulative time of the state in which the power state of the engine is fusing OFF state
SP8-961-011	LCD on Time	Cumulative time of the state in which the backlight of the LCD is on.

Checking the Up Time by Device State

SP8-941 (Machine Status) keeps a record of the amount of time that the machine spends in each mode.

SP	Name	Description
SP8-941-001	Operation Time	Cumulative time of the state in which the engine state notification is enabled. The state in which the engine is not running (such as when storing to HD only with the controller) is excluded from the running state.
SP8-941-002	Standby Time	Cumulative time of the state in which the engine state is not running.
SP8-941-003	Low Power Time	Not used for this machine
SP8-941-004	Sleep mode time	Cumulative time in Sleep Mode state.
SP8-941-005	Off Mode Time	Cumulative time in which the Energy Saving state of the device is engine OFF state.
SP8-941-006 to 009	Down time	Cumulative time in which the device is disabled because itself or its component is in the following state. <ul style="list-style-type: none"> • SP8-941-006: SC (excluding mode SC) • SP8-941-007: Jam (plotter) • SP8-941-008: Jam (scanner) • SP8-941-009: Supply/PM unit end

7

With this data, and the power consumption values from the specifications, we can estimate the amount of energy that is used by the machine.

This should only be used as a reference value, because the power consumption specifications are measured in a controlled environment with a constant power supply.

To get an exact measurement at the customer’s site, a watt meter must be used to measure the actual energy consumed.

To use SP8-941 to calculate the energy consumed:

- At the start of the measurement period, read the values of SP8-941-001 to 005.
- At the end of the measurement period, read the values of SP8-941-001 to 005 again.
- Find the amount of time spent in each mode (subtract the earlier measurement from the later measurement).
- Multiply this by the power consumption spec for each mode.
- Convert the result to kWh (kilowatt hours)

Recommendation

We recommend that the default settings related to energy saving should be kept.

- If the customer requests that these settings should be changed, please explain that their energy costs could increase, and that they should consider the effects on the environment of extra energy use.

Proximity Sensor (Human Detection Sensor)

Overview

The proximity sensor (human detection sensor) is located on the right upper corner of the main machine.



When the machine has been idle for a long period and the proximity sensor (human detection sensor) detects the presence of anyone in front of the machine, it signals the machine to prepare itself for quick recovery to operation status by shortening the time required for the machine to recover full operation (pre-recovery mode) before the operator even touches the machine or operation panel. The proximity sensor (human detection sensor) employs infrared and can detect the presence of the operator within an arc of 150° out to 1.8 m (6 ft.) away from the front of the machine.

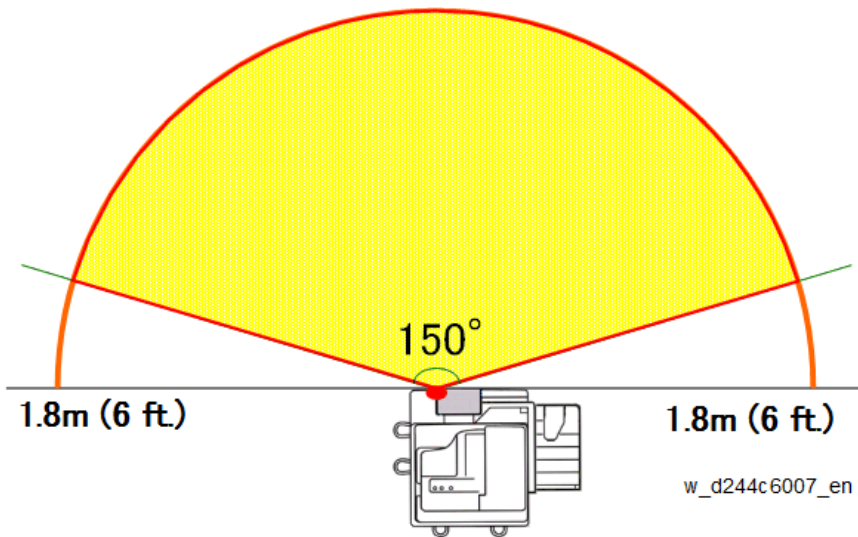

Sensor Operation

There are three phases in the operation of the proximity sensor (human detection sensor):

- First, the sensor detects the presence of the operator within the arc in front of the machine, and then signals the machine to leave the STR mode (or Engine OFF mode) and enter the Pre-recovery mode.
- Second, as soon as the machine enters the Pre-recovery mode it resets the Engine Off mode timer for 5 min. If the operator does not touch the machine for 5 minutes, the machine slips back into the Engine Off mode. If the operator touches the LCD, or opens and closes the ADF or front cover, etc., the machine shifts to Standby mode.
- Third, once the machine enters Standby mode, if the operator does nothing to start operation, the machine will gradually step down from Standby mode to Lower Energy mode, Quiet mode, Engine Off mode, and then finally to STR mode.

Operation Modes

Here are more details about these operation mode levels.

- **STR mode.** Suspend-to-RAM mode. The power supply to the CPU, adjacent chips, and the clock on the controller board is shut down.
- **Engine Off mode.** The fusing lamps and other engine components remain off. The operation panel backlight is off, but there is power supplied to the operation panel and the controller boards.
- **Pre-recovery mode.** The operation panel and HDD are on but the engine components remain off (Energy Save mode). However, the operation backlight still remains off, so there is no change on

the operation panel to indicate that the machine has shifted from STR mode, through Engine Off mode, and into Pre-recovery mode.

- **Quiet mode.** Fusing lamps still remain off, but the HDD and SD cards are accessible so the machine can receive jobs (Data In) and incoming faxes.
- **Lower Power mode.** Finally, power is restored to the fusing lamps but maintained at low temperature.
- **Standby mode.** The machine is ready to operate.

User Tool

The operation of the proximity sensor (human detection sensor) can be switched off and on with a User Tool setting.

1. Press "User Tools" on the operation panel.
2. Select Machine features > System Settings > General Settings > Human Detection Sensor
3. You can switch the sensor off/on by selected Disabled/Enabled. The default setting is "Enabled".

Related SC Codes

One of two SC codes is issued if the proximity sensor (human detection sensor) fails.

SC869-01 Proximity sensor (human detection sensor) failure: Error 1

The sensor remained on for over 24 hours.

- Cycling the machine off/on does not cancel this error.
- When this error occurs the machine enters sensor failure mode and ignores subsequent input from the proximity sensor (human detection sensor).
- Even though the sensor is on, the machine does not enter Pre-recovery mode, and the Engine Off timer setting is not affected and continues to operate normally.
- To cancel the error, switch off the proximity sensor (human detection sensor) with the User Tool setting described above.
- The sensor and its components require replacement.

SC869-02 Proximity sensor (human detection sensor) failure: Error 2

The sensor remained off, even after the operator performed 20 actions with the machine operation panel, opening and closing the front cover, ADF, etc. The machine will issue this error code after every 20 events in operation of the machine.

- Cycling the machine off/on does not cancel this error.
- To cancel the error, switch off the proximity sensor (human detection sensor) with the User Tool setting described above.

- The sensor and its components require replacement.

Related SP Code

There is one proximity sensor (human detection sensor) related SP code: SP5102-203 Auto Detect: human detection check. This is an on/off check.

- Enter "0" to switch the sensor off.
- Enter "1" to switch the sensor on.

This SP is used to check the operation of the sensor. It confirms that the sensor can be switched off and on normally. (Default: On). This check can be used regardless of the User Tool setting. Even if the sensor is switched off with the User Tool setting, a check can be done with this SP code.

MEMO

MEMO

MEMO

MP C2004 / C2504

Machine Code:

D243 / D244

Appendices

July, 2016

Symbols, Abbreviations and Trademarks

Abbreviations

This manual uses several symbols and abbreviations. The meaning of those symbols and abbreviations are as follows:

Abbreviations	What it means
SEF	Short Edge Feed [A]
LEF	Long Edge Feed [B]
K	Black
C	Cyan
M	Magenta
Y	Yellow
B/W, BW	Black and White
FC	Full color

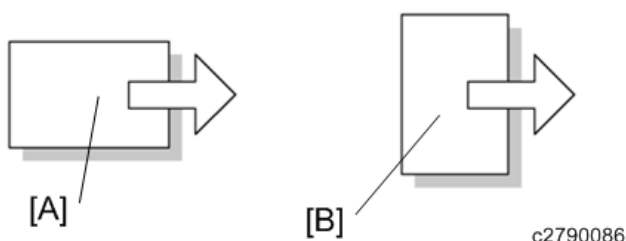

Trademarks

Adobe, Acrobat, PageMaker, PostScript, and PostScript 3 are either registered trademarks or trademarks of Adobe Systems Incorporated in the United States and/or other countries.

The Bluetooth® word mark and logos are registered trademarks owned by Bluetooth SIG, Inc. and any use of such marks by Ricoh Company, Ltd. is under license.

Firefox and Thunderbird are registered trademarks of the Mozilla Foundation.

Google, Android, and Chrome are trademarks of Google Inc.

iOS® is a registered trademark or trademark of Cisco Systems, Inc. and/or its affiliates in the United States and certain other countries.

Java is a registered trademark of Oracle and/or its affiliates.

JAWS® is a registered trademark of Freedom Scientific, Inc., St. Petersburg, Florida and/or other countries.

Kerberos is a trademark of the Massachusetts Institute of Technology (MIT).

Linux is a registered trademark of Linus Torvalds.

Macintosh, OS X, Bonjour, Safari, and TrueType are trademarks of Apple Inc., registered in the U.S. and other countries.

Microsoft, Windows, Windows Server, Windows Vista, Internet Explorer, and Outlook are either registered trademarks or trademarks of Microsoft Corp. in the United States and/or other countries.

PictBridge is a trademark.

QR Code is a registered trademark of DENSO WAVE INCORPORATED in Japan and in other countries.

"Red Hat" is a registered trademark of Red Hat, Inc.

The SD and SD logo are trademarks of SD-3C, LLC.

UNIX is a registered trademark of The Open Group.

UPnP is a trademark of UPnP Implementers Corporation.



This product includes RSA BSAFE® Cryptographic software of EMC Corporation. RSA and BSAFE are registered trademarks or trademarks of EMC Corporation in the United States and other countries.

The proper names of Internet Explorer 6, 7, and 8 are as follows:

- Microsoft® Internet Explorer® 6
- Windows® Internet Explorer® 7
- Windows® Internet Explorer® 8

The proper names of the Windows operating systems are as follows:

- The product names of Windows Vista are as follows:
 - Microsoft® Windows Vista® Ultimate
 - Microsoft® Windows Vista® Business

Microsoft® Windows Vista® Home Premium

Microsoft® Windows Vista® Home Basic

Microsoft® Windows Vista® Enterprise

- The product names of Windows 7 are as follows:

Microsoft® Windows® 7 Home Premium

Microsoft® Windows® 7 Professional

Microsoft® Windows® 7 Ultimate

Microsoft® Windows® 7 Enterprise

- The product names of Windows 8 are as follows:

Microsoft® Windows® 8

Microsoft® Windows® 8 Pro

Microsoft® Windows® 8 Enterprise

- The product names of Windows 8.1 are as follows:

Microsoft® Windows® 8.1

Microsoft® Windows® 8.1 Pro

Microsoft® Windows® 8.1 Enterprise

- The product names of Windows 10 are as follows:

Microsoft® Windows® 10 Home Premium

Microsoft® Windows® 10 Pro

Microsoft® Windows® 10 Enterprise

Microsoft® Windows® 10 Education

- The product names of Windows Server 2003 are as follows:

Microsoft® Windows Server® 2003 Standard Edition

Microsoft® Windows Server® 2003 Enterprise Edition

- The product names of Windows Server 2003 R2 are as follows:

Microsoft® Windows Server® 2003 R2 Standard Edition

Microsoft® Windows Server® 2003 R2 Enterprise Edition

- The product names of Windows Server 2008 are as follows:

Microsoft® Windows Server® 2008 Standard

Microsoft® Windows Server® 2008 Enterprise

- The product names of Windows Server 2008 R2 are as follows:

Microsoft® Windows Server® 2008 R2 Standard

Microsoft® Windows Server® 2008 R2 Enterprise

-
- The product names of Windows Server 2012 are as follows:

Microsoft® Windows Server® 2012 Foundation

Microsoft® Windows Server® 2012 Essentials

Microsoft® Windows Server® 2012 Standard

- The product names of Windows Server 2012 R2 are as follows:

Microsoft® Windows Server® 2012 R2 Foundation

Microsoft® Windows Server® 2012 R2 Essentials

Microsoft® Windows Server® 2012 R2 Standard

Other product names used herein are for identification purposes only and might be trademarks of their respective companies. We disclaim any and all rights to those marks.

Microsoft product screen shots reprinted with permission from Microsoft Corporation.

TABLE OF CONTENTS

Symbols, Abbreviations and Trademarks.....	1
Abbreviations.....	1
Trademarks.....	1
1. Specifications	
Machine Specifications.....	9
General Specifications.....	9
Printer Specifications.....	11
Scan Specifications.....	13
Other Specifications.....	15
HDD Specifications.....	15
Speed Specifications.....	16
OFF/ Sleep Mode Shift Time.....	17
OFF/ Sleep mode Watts, Recovering Time.....	17
Noise (Sound Power Level).....	17
Software Accessories.....	18
Printer Drivers.....	18
Scanner and LAN Fax Drivers.....	19
Supported Paper Sizes.....	20
Original Size Detection	20
Paper Feed.....	22
Tray 1 to 4.....	22
Bypass Tray.....	25
Paper Exit	29
Main unit tray, 1 bin tray, Inner shit tray, Side tray.....	29
Internal Finisher SR3130.....	32
Booklet Finisher SR3220.....	35
Bridge Unit.....	39
Option Specifications.....	43
Paper Feed Unit PB3150 (D694).....	43
Paper Feed Unit PB3220/PB3210 (D787).....	43
ARDF DF3090 (D779-17, -21).....	44
SPDF DF3100 (D3B0-17, -21).....	44
Side Tray Type M3 (D725).....	46

Internal Shift Tray SH3070 (D691).....	46
1 Bin Tray BN3110 (D3CQ).....	47
Bridge Unit BU3070 (D685).....	48
Internal Finisher SR3130 (D690).....	48
Finisher part specifications.....	50
Stapler unit specifications.....	50
Punch Unit PU3040 NA/EU/SC (D716).....	51
Internal Finisher SR3180 (D766).....	52
Finisher part specifications.....	53
Stapler unit specifications.....	54
Booklet Finisher SR3220 (D3B9).....	54
Punch Unit PU3050 NA/EU/SC (D717).....	57
Banner Paper Guide Tray Type M19 (D3BF).....	58

2. Preventive Maintenance

Preventive Maintenance.....	61
Preventive Maintenance Items.....	61
Mainframe.....	61
ARDF DF3090.....	65
SPDF DF3100.....	65
Paper Feed Unit PB3220/PB3210.....	66
1 Bin Tray BN3110.....	66
Bridge Unit BU3070.....	66
Internal Shift Tray SH3070.....	67
Side Tray Type M3.....	67
Booklet Finisher SR3220/Punch Unit PU3050.....	67
Internal Finisher SR3130.....	68
Internal Finisher SR3180.....	68

3. Engine SP Mode Tables

Engine SP Tables - SP1000-1.....	69
SP1-XXX (Feed).....	69
SP1-XXX (Fusing).....	74
Engine SP Tables - SP1000-2.....	141
SP1-XXX (Drive, Fan).....	141

Engine SP Tables - SP2000-1.....	157
SP2-XXX (Drum).....	157
Engine SP Tables - SP2000-2.....	229
SP2-XXX (Drum).....	229
Engine SP Tables - SP3000.....	317
SP3-XXX (Process).....	317
Engine SP Tables - SP4000.....	366
SP4-XXX (Scanner).....	366
Engine SP Tables - SP5000.....	394
SP5-XXX (Mode).....	394
Engine SP Tables - SP6000.....	400
SP6-XXX (Peripherals).....	400
Engine SP Tables - SP7000.....	415
SP7-XXX (Data Log).....	415
Input and Output Check.....	448
Input Check Table.....	448
Main Machine, Paper Feed Tray.....	448
ADF.....	462
Finisher.....	465
Output Check Table.....	475
Main Machine, Paper Feed Tray.....	475
ADF.....	486
Finisher.....	488
Test Pattern Printing.....	495

4. Controller SP Mode Tables

Controller SP Tables - SP5000.....	497
SP5-XXX (Mode).....	497
Controller SP Tables - SP7000.....	569
SP7-XXX (Data Log).....	569
Controller SP Tables - SP8000.....	595
SP8-XXX (Data Log 2).....	595
Keys and abbreviations in Data Log 2.....	596
Printer Service Menu.....	652

SP1-XXX (Service Mode).....	652
Scanner Service Menu.....	670
SP1-XXX (System and Others).....	670
SP2-XXX (Scanning-image quality).....	672

5. Software Configuration

Printing Features.....	675
Auto PDL Detection Function.....	675
Overview.....	675
Conditions for Detection of the PDL.....	675
PDL Detection by the Printer System, PCL Interpreter and PS Interpreter.....	675
PDL Selection and Switching.....	676
Triggers.....	678
Some Possible Problems.....	679
Printer Bit Switch Description.....	679
Print Image Rotation.....	680
Printer Bit Switch Description.....	680
PJL USTATUS.....	681
Printer Bit Switch Description.....	681
Scanner Features.....	684
Display Settings of Recently Used Scan Destination.....	684
The Setting of SMTP Authentication in Scan to Email.....	685
Typical Example.....	685
The Qualification Switching of Scan to Folder.....	687

1. Specifications

Machine Specifications

1

General Specifications

Item	Specification
Configuration:	Desk top
CPU:	Intel Atom Processor Bay Trail 1.33GHz
RAM:	2GB
Color Support:	Full color
Photoconductor Type:	OPC drum
Copy System:	Laser beam scanning and electro-photographic printing
Develop System:	Dry two-component magnetic brush development system
Fusing System:	Direct heating (DH) fusing
First copy time* 1:	Black & White: 5.5 sec. Color: 7.7 sec.
Copy Speed (A4/LT: LEF):	MP C2004: Color 20 sheets/min., Black & White 20 sheets/min. MP C2504: Color 25 sheets/min., Black & White 25 sheets/min.
Warm-Up-Time: (Normal Temperature 20C/68F, NRP)	26 sec.
Originals:	Sheet/Book
Maximum original size:	A3 SEF (297 x 420mm), 11 x 17 SEF (279 x 432mm): A3/DLT full size

Item	Specification
Paper Size:	Main unit upper tray (1 st tray): A4 LEF/LT LEF Main unit lower tray (2 nd tray): 12.6"x17.7"/12"x18" to A6 SEF Bypass tray: 12.6"x17.7"/12"x18"/320x457mm to A6 SEF Custom size Width: 90 to 320 mm (Bypass) Length: 148 to 600 mm
Paper Thickness:	<ul style="list-style-type: none"> • Tray 1: 60 to 300 g/m² • Tray 2: 60 to 300 g/m² • Bypass tray: 52 to 300 g/m² • Duplex: 52 to 169 g/m²
Mask image area:	<ul style="list-style-type: none"> • Leading edge: 4.2 ± 1.5 mm (0.17 ± 0.06") • Left/Right: 0.5 to 4.0 mm (0.02 to 0.16") • Trailing edge: 0.5 to 6.0 mm (0.02 to 0.24")
Copy Scale (Zoom):	25 to 400% (1% steps)
Resolution (Scanning):	600 dpi x 600 dpi
Resolution(Writing):	600 dpi x 600 dpi
Gradation:	256
Feeding System / Paper Capacity:	<ul style="list-style-type: none"> • 550 x 2 + 550 x 2 + 100 sheets (4 drawers paper feed model)
Continuous Copy:	1 to 999 Sheets
Power Source:	NA: 120-127V, 60Hz EU, AA, CHN, KOR: 220-240V, 50/60Hz TWN: 110V, 60Hz
Power consumption:	1.85 kW or less
Dimensions (W x D x H):	<ul style="list-style-type: none"> • 587 x 685 x 788 mm (23.1 x 27.0 x 31.0 inches) (Main Unit) • 587 x 685 x 913 mm (23.1 x 27.0 x 35.9 inches) (Equipped with the ARDF) • 587 x 685 x 968 mm (23.1 x 27.0 x 38.1 inches) (Equipped with the SPDF)

Item	Specification
Unit Occupation Dimensions (W x D):	Main Unit: 1,149 x 1,236 mm (45.2 x 48.7 inches) (With the bypass table opened, the bypass extension tray opened, the right door opened, and the paper tray pulled)
Weight:	Approx. 83.3 kg (183.6 lb.)

* 1 A4 LEF, 1st paper feed tray, with book scanner.

Printer Specifications

Item	Specification
Print Size:	Fixed size: Max. A3 SEF (297 x 420 mm), 12 x 18 SEF (304.8 x 457.2 mm) Custom: Max. 320 x 600 mm (bypass tray)
Print Speed (A4/LT: LEF):	<ul style="list-style-type: none"> • MP C2004: Color 20 sheets/min., Black & White 20 sheets/min. • MP C2504: Color 25 sheets/min., Black & White 25 sheets/min.
Resolution:	1200 x 1200 dpi, 600 x 600 dpi, 400 x 400 dpi, 300 x 300 dpi, 200 x 200 dpi
PDL:	<ul style="list-style-type: none"> • Standard: PDF Direct, MediaPrint: JPEG, MediaPrint: TIFF • Optional: PS3, IPDS, PictBridge

Item	Specification
Interface:	<ul style="list-style-type: none"> • Standard: <ul style="list-style-type: none"> USB2.0 Type A SD Slot Ethernet (1000BASE-T/100BASE-TX/10BASE-T) • Optional: <ul style="list-style-type: none"> Wireless LAN (IEEE802.11a/b/g/n) IEEE1284 Gigabit Ethernet (Optional for EFI) Bluetooth Ver2.0+EDR
Protocol:	<ul style="list-style-type: none"> • Standard: <ul style="list-style-type: none"> TCP/IP (IPv4/IPv6), SMB, IPP, FTP, Bonjour, RSH, LPD, DIPRINT, NetBIOS, WSD (Device/Printer/Scanner), UDP, ICMP, SSL, TLS, IPsec, HTTP, SMTP, POP3, IMAP4, SNMP v1/v2/v3, DNS, Dynamic DNS, LDAP, DHCP, RCP, SNTTP, IEEE802.1X, HTTPS, RHPP, NTLM, Kerberos, LLTD, TELNET, WINS, sftp, ssh, SSDP (UpnP)
USB Interface (Standard):	<ul style="list-style-type: none"> • Available Operating Systems: <ul style="list-style-type: none"> Windows 2000/XP/Vista/7/8/8.1/10, Windows Server 2003/2003 R2/2008/2008 R2/2012/2012 R2, Mac OS 10.7 or later. • Communication mode: <ul style="list-style-type: none"> Corresponding to USB2.0 Standard • Connecting mode: <ul style="list-style-type: none"> Devices corresponding to USB2.0 Standard
Built-in Fonts:	<ul style="list-style-type: none"> • PCL 5c/6: 45 fonts + International fonts 13 fonts • PDF: 136 fonts • PS 3: 136 fonts • IPDS: 108 fonts (Option)
Scale:	25% to 400%

Scan Specifications

Item	Specification
Originals:	Sheet, Book, Object
Available Original Size for Scanning:	Minimum length: 10 mm, Maximum length: 432 mm Minimum width: 10 mm, Maximum width: 297 mm
Auto Detectable Size for Originals Set to Book scanner:	A3 SEF, B4 JIS SEF, A4 SEF/LEF, B5 JIS SEF/LEF, A5 SEF/LEF, 11 x 17SEF, 8 ¹ / ₂ " x 14" SEF, 8 1/2 x 13 2/5 SEF, 8 ¹ / ₂ " x 11" SEF/LEF, 5 1/2 x 8 1/2 SEF/LEF
Auto Detectable Size for Originals Set to ADF:	A3 SEF, B4 JIS SEF, A4 SEF/LEF, B5 JIS SEF/LEF, A5 SEF/LEF, B6 JIS SEF/LEF, 11 x 17SEF, 8 ¹ / ₂ " x 14" SEF, 8 1/2 x 13 2/5 SEF, 8 ¹ / ₂ " x 11" SEF/LEF, 7 1/4 x 10 1/2 SEF/LEF, 5 1/2 x 8 1/2 SEF/LEF, 10 x 14 SEF
Original Scanning Speed (A4/LT: LEF):	<p>When using E-mail, Scan to Folder, WSD (Push Type), or Scan to Removable device (Original size: A4 LEF, Resolution: 200 dpi/300 dpi), Original scanning speed will be as following:</p> <p>Black & White:</p> <ul style="list-style-type: none"> ARDF DF3090: 80 sheets/min (Simplex) SPDF DF3100: 110 sheets/min (Simplex), 180 sheets/min (Duplex) <p>(Original Type: B & W: Text/ Line Art, Compression (Black & White): MMR, ITU-T No1 Chart)</p> <p>Color:</p> <ul style="list-style-type: none"> ARDF DF3090: 80 sheets/min (Simplex) SPDF DF3100: 110 sheets/min (Simplex), 180 sheets/min (Duplex) <p>(Original type: Full Color: Text/ Photo, Compression (Gray Scale/ Full Color): Default, Original chart)</p> <p>Depending on: machine operating conditions, PC use environment, scanning conditions, original content, the scan speed might change.</p>
Gradation:	Black & White: 2 Color/Gray scale: 256
Basic Scanning Resolution:	200 dpi

Item	Specification
Compress Format for Binary B&W Image:	MH/MR/MMR/JBIG2
Compress Format for Gray Scale / Full Color:	JPEG
Interface:	<ul style="list-style-type: none"> • Ethernet (1000BASE-T/100BASE-TX/10BASE-T) • Wireless LAN (IEEE802.11a/b/g/n) • USB2.0 Type A • SD Card Slot
Protocol for Network Connection:	TCP/IP
Scanning Resolution for Sending email:	100dpi, 200dpi, 300dpi, 400dpi, 600 dpi
Available Protocol for Sending email:	POP, SMTP, IMAP4
Output Format for Sending email* 1:	TIFF, JPEG, PDF, High Compression PDF, Searchable PDF, PDF/A
Scanning Resolution for Scan to Folder:	100 dpi, 200 dpi, 300 dpi, 400 dpi, 600 dpi
Available Protocol for Send to Folder:	SMB, FTP
Output Format for Send to Folder* 1:	TIFF, JPEG, PDF, High Compression PDF, Searchable PDF, PDF/A
Available Protocol for WSD Scanner Sending:	Web Services on Devices for Scanning
Scan Resolution for Network TWAIN Scanner:	100 to 1200 dpi
Available Protocol for Network TWAIN Scanner:	TCP/IP

Item	Specification
Available Operating Systems for Network TWAIN Scanner:	Windows Vista/7/8/8.1/10, Windows Server 2003/2008/2008 R2/2012/2012 R2 (TWAIN scanner runs in 32-bit compatible mode on a 64-bit operating system, so TWAIN scanner is not compatible with 64-bit applications. Use it with 32-bit applications.)
Scanning Resolution for Scan to Network (Main Scan x Sub Scan):	100 dpi, 200 dpi, 300 dpi, 400 dpi, 600 dpi
Scan Resolution for when Using WIA Scanner (main Scan x Sub Scan):	100 to 1200dpi
Available Protocol for when Using WIA Scanner:	TCP/IP
Available Operating Systems for WIA Scanner:	Windows Vista (SP1 or later) /7/8/8.1/10, Windows Server 2008 /2008 R2 (WIA scanner can function under both 32- and 64-bit operating systems.)

Other Specifications

HDD Specifications

Item	Spec.
Capacity for Document Server:	Approx. 73 GB Max. Pages per file: 2,000 pages Max.: 9,000 Pages (Storable pages of all storage) Stored File retention period: 1 to 180 days, or unlimited Max. Folders: 200
Document Server Manageable File numbers:	Max. 3,000 files

Item	Spec.
Memory Sortable Pages:	Max. 2,000 pages Copy/ B&W/ A4 original: Approx. 2,000 pages Printer/ B&W/ A4/ When 600 dpi 2bit: Approx. 2,000 pages (With printer sort, depends on printing image)

Speed Specifications

Copy Speed: Simplex (Standard Mode, A4 / LT LEF)

MP C2004	MP C2504
BW: 20 cpm	BW: 25 cpm
FC: 20 cpm	FC: 25 cpm

ARDF 1 to 1 Speed: Single Sided Original (Standard Mode, A4 / LT LEF)

MP C2004	MP C2504
BW: 20 cpm	BW: 25 cpm
FC: 20 cpm	FC: 25 cpm

Copy Speed: Duplex (Standard Mode, A4 / LT LEF)

MP C2004	MP C2504
BW: 20 cpm	BW: 25 cpm
FC: 20 cpm	FC: 25 cpm

ARDF 1 to 1 Speed: Double Sided Original (Standard Mode, A4 / LT LEF)

MP C2004	MP C2504
BW: 20 cpm	BW: 25 cpm
FC: 20 cpm	FC: 25 cpm

Electric Sort Copy Speed: Duplex Single sided to Double Sided (A4 / LT LEF)

MP C2004	MP C2504
BW: 20 cpm	BW: 25 cpm
FC: 20 cpm	FC: 25 cpm

OFF/ Sleep Mode Shift Time

Item	Spec.
Off/ Sleep mode shift time:	Standard: 1 min., With initial setting 1 to 60 min. (1 min. per step)
System all reset time:	Standard: 60 sec., 10 to 999 Sec. (1 sec. per step), or "Do not clear" can be selected.

OFF/ Sleep mode Watts, Recovering Time

Item	Watts	Recovering time
Off / Sleep mode:	NA: 0.85 W or less EU: 1.00 W or less	6.0 sec.

Note

- Depending on operating environment and usage status, power consumption in OFF/Sleep mode might change.
(Such cases as power change for fusing unit temperature control when in a low temperature environment, or network environment obstructs switching to STR mode.)

Noise (Sound Power Level)

Running:

Models	MP C2004	MP C2504
Mainframe only:	58.4 dB	58.7 dB
Full system:	67.5 dB	67.5 dB

Standby:

Models	MP C2004	MP C2504
Mainframe / Full system	35.0 dB	35.0 dB

Software Accessories

The printer drivers and utility software are provided on one CD-ROM. An auto-run installer allows you to select which components to install.

1

Printer Drivers

Operating System ^{*1}	Printer Language		
	PCL 5c	PCL 6	PostScript 3
Windows Vista ^{*2}	Supported	Supported	Supported
Windows 7 ^{*3}	Supported	Supported	Supported
Windows 8 ^{*4}	Supported	Supported	Supported
Windows 8.1 ^{*5}	Supported	Supported	Supported
Windows 10 ^{*6}	Supported	Supported	Supported
Windows Server 2003 ^{*7}	Supported	Supported	Supported
Windows Server 2008 ^{*8}	Supported	Supported	Supported
Windows Server 2012 ^{*9}	Supported	Supported	Supported
OS X ^{*10}	Not available	Not available	Supported

*1 Windows operating system supports both versions (32/64 bit).

*2 Microsoft Windows Vista Ultimate/Microsoft Windows Vista Enterprise/Microsoft Windows Vista Business/Microsoft Windows Vista Home Premium/Microsoft Windows Vista Home Basic

*3 Microsoft Windows 7 Home Premium/Microsoft Windows 7 Professional/Microsoft Windows 7 Ultimate/Microsoft Windows 7 Enterprise

*4 Microsoft Windows 8/Microsoft Windows 8 Pro/Microsoft Windows 8 Enterprise

*5 Microsoft Windows 8.1/Microsoft Windows 8.1 Pro/Microsoft Windows 8.1 Enterprise

*6 Microsoft Windows 10 Home/Microsoft Windows 10 Pro/Microsoft Windows 10 Enterprise/Microsoft Windows 10 Education

*7 Microsoft Windows Server 2003 Standard Edition/Microsoft Windows Server 2003 Enterprise Edition/Microsoft Windows Server 2003 R2 Standard Edition/Microsoft Windows Server 2003 R2 Enterprise Edition

*8 Microsoft Windows Server 2008 Standard/Microsoft Windows Server 2008 Enterprise/Microsoft Windows Server 2008 R2 Standard/Microsoft Windows Server 2008 R2 Enterprise

*9 Microsoft Windows Server 2012 Foundation/Microsoft Windows Server 2012 Essentials/Microsoft Windows Server 2012 Standard/Microsoft Windows Server 2012 R2 Foundation/Microsoft Windows Server 2012 R2 Essentials/Microsoft Windows Server 2012 R2 Standard

*10 OS X 10.7 or later

↓ Note

- Some applications may require installation of the PCL 5c printer driver. In this case, you can install PCL 5c without having to install PCL 6.
- Adobe PostScript printer driver allows the computer to communicate with the printer using a printer language. PPD files allow the printer driver to enable specific printer functions.

Scanner and LAN Fax Drivers

Operating System	TWAIN* ¹	PC-FAX
Windows Vista	Supported	Supported
Windows 7	Supported	Supported
Windows 8	Supported	Supported
Windows 8.1	Supported	Supported
Windows 10	Supported	Supported
Windows Server 2003/2003 R2	Supported	Supported
Windows Server 2008/2008 R2	Supported	Supported
Windows Server 2012/2012 R2	Supported	Supported
OS X	Not available	Not available

*1 TWAIN scanner runs on a 64-bit operating system, but is not compatible with 64-bit applications. Use it with 32-bit applications.

Supported Paper Sizes

1

Original Size Detection

Size (W x L) [mm]	NA		EU/AP	
	Book	ADF	Book	ADF
A3 SEF (297 x 420)	-	Y	Y*4	Y
B4 SEF (257 x 364)	-	-	Y*4	Y
A4 SEF (210 x 297)	Y*5	Y	Y*4, 5	Y
A4 LEF (297 x 210)	Y*5	Y	Y*4, 5	Y
B5 SEF (182 x 257)	-	-	Y*4	Y
B5 LEF (257 x 182)	-	-	Y*4	Y
A5 SEF (148 x 210)	-	-	Y*2, 4	Y
A5 LEF (210 x 148)	-	-	Y*4	Y
B6 SEF (128 x 182)	-	-	-	Y
B6 LEF (182 x 128)	-	-	-	Y
DLT SEF (11" x 17")	Y	Y*Db	-	Y*Df
LG SEF (8 ¹ / ₂ " x 14")	Y	Y*Dc	-	-
LT SEF (8 ¹ / ₂ " x 11")	Y*5	Y*Dd	Y*5	Y*Di
LT LEF (11" x 8 ¹ / ₂ ")	Y*5	Y*De	Y*5	Y*Dg
HLT SEF (5 ¹ / ₂ " x 8 ¹ / ₂ ")	Y*2	Y	-	-
HLT LEF (8 ¹ / ₂ " x 5 ¹ / ₂ ")	Y	Y	-	-
F SEF (8" x 13")	-	-	Y*S3	Y*S3
Foolscap SEF (8 ¹ / ₂ " x 13")	-	Y*Sc	Y*D3	Y*D3
Folio SEF (8 ¹ / ₄ " x 13")	-	-	Y*S3	Y*S3
Folio SEF (11" x 15")	-	Y*Sb	-	-

Size (W x L) [mm]	NA		EU/AP	
	Book	ADF	Book	ADF
Folio SEF (10" x 14")	-	Y	-	-
Folio SEF (8" x 10")	-	Y*Sd	-	-
US EXE SEF (7 ¹ / ₄ " x 10 ¹ / ₂ "	-	Y	-	-
US EXE LEF (10 ¹ / ₂ " x 7 ¹ / ₄ "	-	Y*Se	-	-
8K SEF (267 x 390)	-	-	Y*4	Y*Sf
16K SEF (195 x 267)	-	-	Y*4	Y*Si
16K LEF (267 x 195)	-	-	Y*4v	Y*Sg

Sizes with letters (a, b, c) means only either size with the corresponding letter can be selected for size detection. "D" is for default set sizes, and when setting "S" sizes for size detection from SP mode, "D" sizes can no longer be detected.

(*2)For detected originals smaller than A5 size, with SP mode either "detect as A5" or "Detect as Unknown" can be selected. (Default is "Detect as unknown")

(*3)F Sizes (8.5" x 13" SEF, 8.25" x 13" SEF, 8" x 13" SEF) will be available by SP mode settings.

(*4)Switch Book scanner original detection between "K" series and "A/B" series from SP mode.

(Can not set both to detect, but 8K/16K detect can be set from SO mode)

8K SEF -> Switch between A3, B4 SEF

16K SEF -> Switch between A4, A5, B5 SEF

16K LEF -> Switch between A4, A5, B5 LEF *Can not switch only either size.

(*5)Can be selected with switching A4/LT from SP mode:

- Standard detect (default)
- When placing A4/LT size LEF, detect as A4 LEF. When placing SEF, detect as LT SEF.
- When placing A4/LT size LEF, detect as LT LEF. When placing SEF, detect as A4 SEF.

Remarks:

Y	Yes; available
-	Not available

Paper Feed

Tray 1 to 4

Size (W x L) [mm]	Tray 1		Tray 2		Tray 3/4 1 drawer /2 drawers bank		
	Region (EU/AA)	NA	EU/AA	NA	EU/AA	NA	EU/AA
A3 SEF (297 x 420)	-	-	G2	A2	G2	A2	
A4 SEF (210 x 297)	-	-	A	A	A	A	
A4 LEF (297 x 210)	K	H	G1	A1	G1	A1	
A5 SEF (148 x 210)	-	-	B	B			
A5 LEF (210 x 148)	K	K	A	A	A	A	
A6 SEF (105 x 148)	-	-	B	B			
B4 SEF (257 x 364)	-	-	G3	A3	G3	A3	
B5 SEF (182 x 257)	-	-	A	A	A	A	
B5 LEF (257 x 182)	K	K	G4	A4	G4	A4	
B6 SEF (128 x 182)	-	-	B	B			
DLT SEF (11" x 17")	-	-	A2	G2	A2	G2	
Legal SEF (8 ¹ / ₂ " x 14")	-	-	A3	G3	A3	G3	
Foolscap SEF (8 ¹ / ₂ " x 13")	-	-	B	B	B	B	
LT SEF (8 ¹ / ₂ " x 11")	-	-	A	A	A	A	
LT LEF (11" x 8 ¹ / ₂ ")	H	K	A1	G1	A1	G1	
Gov. LG SEF (8 ¹ / ₄ " x 14")	-	-	B	B	B	B	
Folio SEF (8 ¹ / ₄ " x 13")	-	-	B	B	B	B	
F/GL SEF (8" x 13")	-	-	B	B	B	B	
GLT SEF (8" x 10 ¹ / ₂ ")	-	-	-	-			

Size (W x L) [mm]	Tray 1		Tray 2		Tray 3/4 1 drawer /2 drawers bank	
Region (EU/AA)	NA	EU/AA	NA	EU/AA	NA	EU/AA
GLT LEF (10 ¹ / ₂ " x 8")	-	-	-	-		
Eng Quatro SEF (8" x 10")	-	-	B	B	B	B
Eng Quatro LEF (10" x 8")	-	-	-	-		-
Executive SEF (7 ¹ / ₄ " x 10 ¹ / ₂ "	-	-	B	B	B	B
Executive LEF (10 ¹ / ₂ " x 7 ¹ / ₄ "	-	-	A4	G4	A4	G4
HLT SEF (5 ¹ / ₂ " x 8 ¹ / ₂ "	-	-	B	B	-	-
HLT LEF (8 ¹ / ₂ " x 5 ¹ / ₂ "	-	-	-	-	-	-
SRA3 SEF (420 x 320)	-	-	G5	A5	G5	A5
SRA4 SEF	-	-	-	-	-	-
SRA4 LEF	-	-	-	-	-	-
Line slider 1 SEF	-	-	-	-	-	-
Line slider 1 LEF	-	-	-	-	-	-
Line slider 2 SEF	-	-	-	-	-	-
Line slider 2 LEF	-	-	-	-	-	-
Com10 SEF (104.8 x 241.3)	-	-	B	B	-	-
Com10 LEF (241.3 x 104.8)	-	-	B	B	B	B
Monarch SEF (98.4 x 190.5)	-	-	B	B	-	-
Monarch LEF (190.5 x 98.4)	-	-	-	-	-	-
C5 SEF (162 x 229)	-	-	B	B	B	B
C5 LEF (229 x 162)	-	-	B	B	B	B
C6 SEF (114 x 162)	-	-	B	B	B	B
C6LEF (162 x 114)		-	B	B	B	B

Size (W x L) [mm]	Tray 1		Tray 2		Tray 3/4 1 drawer /2 drawers bank	
	Region (EU/AA)	NA	EU/AA	NA	EU/AA	NA
DL Env SEF (110 x 220)	-	-	B	B	B	B
DL Env LEF (220 x 110)	-	-	B	B	B	B
8K SEF (267 x 390)	-	-	B	B	B	B
16K SEF (195 x 267)	-	-	B	B	B	B
16K LEF (267 x 195)	-	-	B	B	B	B
13" x 19.2" SEF	-	-	-	-	-	-
13" x 19" SEF	-	-	-	-	-	-
13" x 18" SEF	-	-	-	-	-	-
12.6" x 19.2 SEF	-	-	-	-	-	-
12.6" x 18.5" SEF	-	-	-	-	-	-
12" x 18" SEF	-	-	A5	G5	A5	G5
12" x 18" LEF	-	-	-	-	-	-
11" x 15" SEF	-	-	B	B	B	B
11" x 14" SEF	-	-	-	-	-	-
10" x 15" SEF	-	-	-	-	-	-
10" x 14" SEF	-	-	B	B	B	B
8.5" x 13.4" SEF	-	-	A3	B	A3	B

Remarks:

A	Auto detectable. Also can be selected with size button of initial setting.
B	Can be selected with size button from initial setting.
C	Select this size by setting the dial.
D	Set dial to "***", then select with size button from initial setting.

E	<Bypass setting> Copy window/Bypass/Standard size/Size select or select with the print bypass paper size/size button from initial setting.
F	Select with SP from preset paper sizes. Cannot be selected from printer driver.
G	Switches which size to set as auto detect with SP. *Example: The combination of A1-G1. G (When not auto detectable) will be as same as B. Combinations are only made from same region same tray. *Example: The combination of G1 and J1. G (When not auto detectable) will be as same as E. Combinations are only made from same region same tray.
H	Size fixed when shipping.
I	<Bypass setting> With bypass tray, after 1 st sheet trailing edge goes through, auto detects size, then fixed to size detected from the 2 nd sheet.
J	<Bypass setting> Auto detect of Copy window/Bypass/Standard size/Select with size button.
K	Select with SP from preset paper sizes. Can be selected from printer driver.
-	Not available

Bypass Tray

Size (W x L) [mm]	Bypass	
	NA	EU/AA
A3 SEF (297 x 420)	E	J
A4 SEF (210 x 297)	E	J
A4 LEF (297 x 210)	E	J
A5 SEF (148 x 210)	E	J

Size (W x L) [mm]	Bypass	
Region (EU/AA)	NA	EU/AA
A5 LEF (210 x 148)	J	J
A6 SEF (105 x 148)	E	J
B4 SEF (257 x 364)	E	J
B5 SEF (182 x 257)	J	J
B5 LEF (257 x 182)	E	J
B6 SEF (128 x 182)	E	J
DLT SEF (11" x 17")	J	E
Legal SEF (8 ¹ / ₂ " x 14")	G1	E
Foolscap SEF (8 ¹ / ₂ " x 13")	E	E
LT SEF (8 ¹ / ₂ " x 11")	J1	E
LT LEF (11" x 8 ¹ / ₂ ")	J	E
Gov. LG SEF (8 ¹ / ₄ " x 14")	E	E
Folio SEF (8 ¹ / ₄ " x 13")	E	E
F/GL SEF (8" x 13")	E	E
GLT SEF (8" x 10 ¹ / ₂ ")	-	-
GLT LEF (10 ¹ / ₂ " x 8")	-	-
Eng Quatro SEF (8" x 10")	E	E
Eng Quatro LEF (10" x 8")	-	-
Executive SEF (7 ¹ / ₄ " x 10 ¹ / ₂ ")	E	E
Executive LEF (10 ¹ / ₂ " x 7 ¹ / ₄ ")	E	E
HLT SEF (5 ¹ / ₂ " x 8 ¹ / ₂ ")	J	E
HLT LEF (8 ¹ / ₂ " x 5 ¹ / ₂ ")	-	-
SRA3 SEF (420 x 320)	J	J
SRA4 SEF	E	E

Size (W x L) [mm]	Bypass	
	NA	EU/AA
SRA4 LEF	E	E
Line slider 1 SEF	-	-
Line slider 1 LEF	-	-
Line slider 2 SEF	-	-
Line slider 2 LEF	-	-
Com10 SEF (104.8 x 241.3)	E*1	E*1
Com10 LEF (241.3 x 104.8)	E*1	E*1
Monarch SEF (98.4 x 190.5)	E*1	E*1
Monarch LEF (190.5 x 98.4)	E*1	E*1
C5 SEF (162 x 229)	E*1	E*1
C5 LEF (229 x 162)	E*1	E*1
C6 SEF (114 x 162)	E*1	E*1
C6LEF (162 x 114)	E*1	E*1
DL Env SEF (110 x 220)	E*1	E*1
DL Env LEF (220 x 110)	E*1	E*1
8K SEF (267 x 390)	E	E
16K SEF (195 x 267)	E	E
16K LEF (267 x 195)	E	E
13" x 19.2" SEF	-	-
13" x 19" SEF	-	-
13" x 18" SEF	-	-
12.6" x 19.2 SEF	-	-
12.6" x 18.5" SEF	-	-
12" x 18" SEF	J	E

Size (W x L) [mm]	Bypass	
Region (EU/AA)	NA	EU/AA
12" x 18" LEF	-	-
11" x 15" SEF	E	E
11" x 14" SEF	-	-
10" x 15" SEF	-	-
10" x 14" SEF	E	E
8.5" x 13.4" SEF	E	E

Remarks:

A	Auto detectable. Also can be selected with size button of initial setting.
B	Can be selected with size button from initial setting.
C	Select this size by setting the dial.
D	Set dial to " * ", then select with size button from initial setting.
E	<Bypass setting> Copy window/Bypass/Standard size/Size select or select with the print bypass paper size/size button from initial setting.
F	Select with SP from preset paper sizes. Cannot be selected from printer driver.
G	Switches which size to set as auto detect with SP. *Example: The combination of A1-G1. G (When not auto detectable) will be as same as B. Combinations are only made from same region same tray. *Example: The combination of G1 and J1. G (When not auto detectable) will be as same as E. Combinations are only made from same region same tray.
H	Size fixed when shipping.

I	<Bypass setting> With bypass tray, after 1 st sheet trailing edge goes through, auto detects size, then fixed to size detected from the 2 nd sheet.
J	<Bypass setting> Auto detect of Copy window/Bypass/Standard size/Select with size button.
K	Select with SP from preset paper sizes. Can be selected from printer driver.
-	Not available

* 1	Even the paper size is in the range or available sizes for duplex, envelopes can not be done so.
-----	--

Paper Exit

Main unit tray, 1 bin tray, Inner shit tray, Side tray

Size (W x L) [mm]	Main unit tray	1 bin tray	Inner shit tray		Side Tray	
	Main unit tray	Upper tray	shift	shifting	Bridge upper exit	Side tray
A3 SEF (297 x 420)	A	A	A	A	A	A
A4 SEF (210 x 297)	A	A	A	A	A	A
A4 LEF (297 x 210)	A	A	A	A	A	A
A5 SEF (148 x 210)	A	A	A	A	A	A
A5 LEF (210 x 148)	A	A	A	A	A	A
A6 SEF (105 x 148)	A	A ^{*1}	A	B	A	A
B4 SEF (257 x 364)	A	A	A	A	A	A
B5 SEF (182 x 257)	A	A	A	A	A	A
B5 LEF (257 x 182)	A	A	A	A	A	A

Size (W x L) [mm]	Main unit tray	1 bin tray	Inner shit tray		Side Tray	
	Main unit tray	Upper tray	shift	shifting	Bridge upper exit	Side tray
B6 SEF (128 x 182)	A	A*1	A	B	A	A
DLT SEF (11" x 17")	A	A	A	A	A	A
Legal SEF (8 ¹ / ₂ " x 14")	A	A	A	A	A	A
Foolscap SEF (8 ¹ / ₂ " x 13")	A	A	A	A	A	A
LT SEF (8 ¹ / ₂ " x 11")	A	A	A	A	A	A
LT LEF (11" x 8 ¹ / ₂ ")	A	A	A	A	A	A
Gov. LG SEF (8 ¹ / ₄ " x 14")	A	A	A	A	A	A
Folio SEF (8 ¹ / ₄ " x 13")	A	A	A	A	A	A
F/GL SEF (8" x 13")	A	A	A	A	A	A
GLT SEF (8" x 10 ¹ / ₂ ")	-	-	-	-	-	-
GLT LEF (10 ¹ / ₂ " x 8")	-	-	-	-	-	-
Eng Quatro SEF (8" x 10")	A	A	A	A	A	A
Eng Quatro LEF (10" x 8")	-	-	-	-	-	-
Executive SEF (7 ¹ / ₄ " x 10 ¹ / ₂ ")	A	A	A	A	A	A
Executive LEF (10 ¹ / ₂ " x 7 ¹ / ₄ ")	A	A	A	A	A	A
HLT SEF (5 ¹ / ₂ " x 8 ¹ / ₂ ")	A	A	A	A	A	A
HLT LEF (8 ¹ / ₂ " x 5 ¹ / ₂ ")						
SRA3 SEF (420 x 320)	A	A	A*1	B	A	A
SRA4 SEF	A	A	A	A	A	A
SRA4 LEF	A	A	A	B	A	A
Line slider 1 SEF	-	-	-	-	-	-

Size (W x L) [mm]	Main unit tray	1 bin tray	Inner shit tray		Side Tray	
	Main unit tray	Upper tray	shift	shifting	Bridge upper exit	Side tray
Line slider 1 LEF	-	-	-	-	-	-
Line slider 2 SEF	-	-	-	-	-	-
Line slider 2 LEF	-	-	-	-	-	-
Com10 SEF (104.8 x 241.3)	A	B	A ^{*1}	B	A ^{*1}	B
Com10 LEF (241.3 x 104.8)	A	B	A ^{*1}	B	A ^{*1}	-
Monarch SEF (98.4 x 190.5)	A	B	A ^{*1}	B	A ^{*1}	B
Monarch LEF (190.5 x 98.4)	A	B	A ^{*1}	B	A ^{*1}	-
C5 SEF (162 x 229)	A	B	A ^{*1}	B	A ^{*1}	B
C5 LEF (229 x 162)	A	B	A ^{*1}	B	A ^{*1}	B
C6 SEF (114 x 162)	A	B	A ^{*1}	B	A ^{*1}	B
C6LEF (162 x 114)	A	B	A ^{*1}	B	A ^{*1}	-
DL Env SEF (110 x 220)	A	B	A ^{*1}	B	A ^{*1}	B
DL Env LEF (220 x 110)	A	B	A ^{*1}	B	A ^{*1}	-
8K SEF (267 x 390)	A	A	A	A	A	A
16K SEF (195 x 267)	A	A	A	A	A	A
16K LEF (267 x 195)	A	A	A	A	A	A
13" x 19.2" SEF	-	-	-	-	-	-
13" x 19" SEF	-	-	-	-	-	-
13" x 18" SEF	-	-	-	-	-	-
12.6" x 19.2 SEF	-	-	-	-	-	-
12.6" x 18.5" SEF	-	-	-	-	-	-
12" x 18" SEF	-	-	-	-	-	-

Size (W x L) [mm]	Main unit tray	1 bin tray	Inner shit tray		Side Tray	
	Main unit tray	Upper tray	shift	shifting	Bridge upper exit	Side tray
12" x 18" LEF	A	A	A*1	B	A	A
11" x 15" SEF	A	A	A	A	A	A
11" x 14" SEF	-	-	-	-	-	-
10" x 15" SEF	-	-	-	-	-	-
10" x 14" SEF	A	A	A	A	A	A
8.5" x 13.4" SEF	A	A	A	A	A	A

Internal Finisher SR3130

Size (W x L) [mm]	Paper exit		Staple		Punch		
	Shift	Shifting	Single/Double size	Stapling amount	EU 2 SC 4 Holes	NA 3 EU 4 Holes	NA 2 Holes
A3 SEF (297 x 420)	A	A	A	30	A	A	A
A4 SEF (210 x 297)	A	A	A	50	A	-	B
A4 LEF (297 x 210)	A	A	A	50	A	A	A
A5 SEF (148 x 210)	A*1	A*1	-	-	-	-	-
A5 LEF (210 x 148)	A*1	A*1	-	-	-	-	-
A6 SEF (105 x 148)	A*1	-	-	-	-	-	-
B4 SEF (257 x 364)	A	A	A	30	A	-	-
B5 SEF (182 x 257)	A	A	A	50	A	-	-
B5 LEF (257 x 182)	A	A	A	50	A	-	-
B6 SEF (128 x 182)	A*1	-	-	-	-	-	-

Size (W x L) [mm]	Paper exit		Staple		Punch		
	Shift	Shifting	Single/ Double size	Staplin g amount	EU 2 SC 4 Holes	NA 3 EU 4 Holes	NA 2 Holes
DLT SEF (11" x 17")	A	A	A	30	A	A	A
Legal SEF (8 ¹ / ₂ " x 14")	A	A	A	30	A	-	A
Foolscap SEF (8 ¹ / ₂ " x 13")	A	A	A	30	A	-	A
LT SEF (8 ¹ / ₂ " x 11")	A	A	A	50	A	-	A
LT LEF (11" x 8 ¹ / ₂ ")	A	A	A	50	A	A	A
Gov. LG SEF (8 ¹ / ₄ " x 14")	A	A	A	30	-	-	-
Folio SEF (8 ¹ / ₄ " x 13")	A	A	A	30	-	-	-
F/GL SEF (8" x 13")	A	A ^{*1}	-	-	-	-	-
GLT SEF (8" x 10 ¹ / ₂ ")	-	-	-	-	-	-	-
GLT LEF (10 ¹ / ₂ " x 8")	-	-	-	-	-	-	-
Eng Quatro SEF (8" x 10")	A	A ^{*1}	-	-	-	-	-
Eng Quatro LEF (10" x 8")	-	-	-	-	-	-	-
Executive SEF (7 ¹ / ₄ " x 10 ¹ / ₂ ")	A	A	A	50	A	-	A
Executive LEF (10 ¹ / ₂ " x 7 ¹ / ₄ ")	A	A	A	50	-	-	-
HLT SEF (5 ¹ / ₂ " x 8 ¹ / ₂ ")	A ^{*1}	-	-	-	-	-	-
HLT LEF (8 ¹ / ₂ " x 5 ¹ / ₂ ")	-	-	-	-	-	-	-
SRA3 SEF (420 x 320)	A ^{*1}	-	-	-	-	-	-
SRA4 SEF	A ^{*1}	A	-	-	-	-	-
SRA4 LEF	A ^{*1}	-	-	-	-	-	-
Line slider 1 SEF	-	-	-	-	-	-	-
Line slider 1 LEF	-	-	-	-	-	-	-

Size (W x L) [mm]	Paper exit		Staple		Punch		
	Shift	Shifting	Single/ Double size	Staplin g amount	EU 2 SC 4 Holes	NA 3 EU 4 Holes	NA 2 Holes
Line slider 2 SEF	-	-	-	-	-	-	-
Line slider 2 LEF	-	-	-	-	-	-	-
Com10 SEF (104.8 x 241.3)	A ^{*1}	-	-	-	-	-	-
Com10 LEF (241.3 x 104.8)	A ^{*1,3,4}	-	-	-	-	-	-
Monarch SEF (98.4 x 190.5)	A ^{*1}	-	-	-	-	-	-
Monarch LEF (190.5 x 98.4)	A ^{*1,3,4}	-	-	-	-	-	-
C5 SEF (162 x 229)	A ^{*1}	A ^{*1}	-	-	-	-	-
C5 LEF (229 x 162)	A ^{*1}	A ^{*1}	-	-	-	-	-
C6 SEF (114 x 162)	A ^{*1}	-	-	-	-	-	-
C6LEF (162 x 114)	A ^{*1,3,4}	-	-	-	-	-	-
DL Env SEF (110 x 220)	A ^{*1}	-	-	-	-	-	-
DL Env LEF (220 x 110)	A ^{*1,3,4}	-	-	-	-	-	-
8K SEF (267 x 390)	A	A	A	30	A	-	-
16K SEF (195 x 267)	A	A	A	50	A	-	-
16K LEF (267 x 195)	A	A	A	50	A	-	-
13" x 19.2" SEF	-	-	-	-	-	-	-
13" x 19" SEF	-	-	-	-	-	-	-
13" x 18" SEF	-	-	-	-	-	-	-
12.6" x 19.2 SEF	-	-	-	-	-	-	-
12.6" x 18.5" SEF	-	-	-	-	-	-	-
12" x 18" SEF	-	-	-	-	-	-	-
12" x 18" LEF	A ^{*1}	-	-	-	-	-	-

Size (W x L) [mm]	Paper exit		Staple		Punch		
	Shift	Shifting	Single/ Double size	Staplin g amount	EU 2 SC 4 Holes	NA 3 EU 4 Holes	NA 2 Holes
11" x 15" SEF	A*1	A	-	-	-	-	-
11" x 14" SEF	-	-	-	-	-	-	-
10" x 15" SEF	-	-	-	-	-	-	-
10" x 14" SEF	A*1	A	-	-	-	-	-
8.5" x 13.4" SEF	-	-	A	30	A	-	A

Booklet Finisher SR3220

Size (W x L) [mm]	Paper exit				Hal f fold	Staple				Punch		
	Pro of	Shi ft	Shi ftin g	Sa ddl e stitch	Mi ddl e fold	Single/ Do ubl e stitch	Sta ple am oun t	Sa ddl e stitch	Sa ddl e stitch am oun t	EU 2 SC 4 Ho les	N A 2 Ho les	NA 3 EU 4 Ho les
A3 SEF (297 x 420)	A	A	A	A	A*5	A	30	A	15	A	A	A
A4 SEF (210 x 297)	A	A	A	A	A*5	A	50	A	15	A	B	-
A4 LEF (297 x 210)	A	A	A	-	-	A	50	-	-	A	A	A
A5 SEF (148 x 210)	A	B	B	-	-	-	-	-	-	A	A	-
A5 LEF (210 x 148)	A	A	A	-	-	-	-	-	-	A	B	-
A6 SEF (105 x 148)	A	B	-	-	-	-	-	-	-	-	-	-
B4 SEF (257 x 364)	A	A	A	A	A*5	A	30	A	15	A	A	A

Size (W x L) [mm]	Paper exit				Half fold	Staple				Punch		
	Proof	Shift	Shifting	Saddle stitch		Middle fold	Single/Double stitch	Staple amount	Saddle stitch	Saddle stitch amount	EU 2 SC 4 Holes	NA 2 Holes
B5 SEF (182 x 257)	A	B	B	A	A*5	A	50	A	15	A	A	-
B5 LEF (257 x 182)	A	A	A	-	-	A	50	-	-	A	A	A
B6 SEF (128 x 182)	A	B	A	-	-	-	-	-	-	-	-	-
DLT SEF (11" x 17")	A	A	A	A	A*5	A	30	A	15	A	A	A
Legal SEF (8 ¹ / ₂ " x 14")	A	A	A	A	A*5	A	30	A	15	A	A	-
Foolscap SEF (8 ¹ / ₂ " x 13")	A	A	A	-	-	A	30	-	-	A	A	-
LT SEF (8 ¹ / ₂ " x 11")	A	A	A	A	A*5	A	50	A	15	A	A	-
LT LEF (11" x 8 ¹ / ₂ "	A	A	A	-	-	A	50	-	-	A	A	A
Gov. LG SEF (8 ¹ / ₄ " x 14")	A	A	A	-	-	A	30	-	-	A	A	-
Folio SEF (8 ¹ / ₄ " x 13")	A	A	A	-	-	A	30	-	-	A	A	-
F/GL SEF (8" x 13")	A	A	A	-	-	A	30	-	-	A	A	-
GLT SEF (8" x 10 ¹ / ₂ "	-	-	-	-	-	-	-	-	-	-	-	-
GLT LEF (10 ¹ / ₂ " x 8")	-	-	-	-	-	-	-	-	-	-	-	-
Eng Quatro SEF (8" x 10")	A	A	A	-	-	A	50	-	-	A	A	-
Eng Quatro LEF (10" x 8")	-	-	-	-	-	-	-	-	-	-	-	-
Executive SEF (7 ¹ / ₄ " x 10 ¹ / ₂ "	A	A	A	-	-	A	50	-	-	A	A	-
Executive LEF (10 ¹ / ₂ " x 7 ¹ / ₄ "	A	A	A	-	-	A	50	-	-	A	A	A

Size (W x L) [mm]	Paper exit				Half fold	Staple				Punch		
	Proof	Shift	Shifting	Saddle stitch	Middle fold	Single/Double stitch	Staple amount	Saddle stitch	Saddle stitch amount	EU 2 SC 4 Holes	NA 2 Holes	NA 3 EU 4 Holes
HLT SEF (5 ¹ / ₂ " x 8 ¹ / ₂ "	A	B	B	-	-	-	-	-	-	A	A	-
HLT LEF (8 ¹ / ₂ " x 5 ¹ / ₂ "	-	-	-	-	-	-	-	-	-	-	-	-
SRA3 SEF (420 x 320)	A	A	-	-	-	-	-	-	-	-	-	-
SRA4 SEF	A	A	A	-	-	A	30	-	-	-	-	-
SRA4 LEF	A	A	-	-	-	-	-	-	-	-	-	-
Line slider 1 SEF	-	-	-	-	-	-	-	-	-	-	-	-
Line slider 1 LEF	-	-	-	-	-	-	-	-	-	-	-	-
Line slider 2 SEF	-	-	-	-	-	-	-	-	-	-	-	-
Line slider 2 LEF	-	-	-	-	-	-	-	-	-	-	-	-
Com10 SEF (104.8 x 241.3)	-	-	-	-	-	-	-	-	-	-	-	-
Com10 LEF (241.3 x 104.8)	-	-	-	-	-	-	-	-	-	-	-	-
Monarch SEF (98.4 x 190.5)	-	-	-	-	-	-	-	-	-	-	-	-
Monarch LEF (190.5 x 98.4)	-	-	-	-	-	-	-	-	-	-	-	-
C5 SEF (162 x 229)	-	-	-	-	-	-	-	-	-	-	-	-
C5 LEF (229 x 162)	-	-	-	-	-	-	-	-	-	-	-	-
C6 SEF (114 x 162)	-	-	-	-	-	-	-	-	-	-	-	-
C6LEF (162 x 114)	-	-	-	-	-	-	-	-	-	-	-	-
DL Env SEF (110 x 220)	-	-	-	-	-	-	-	-	-	-	-	-

Size (W x L) [mm]	Paper exit				Half fold	Staple				Punch		
	Proof	Shift	Shifting	Saddle stitch	Middle fold	Single/Double stitch	Staple amount	Saddle stitch	Saddle stitch amount	EU 2 SC 4 Holes	NA 2 Holes	NA 3 EU 4 Holes
DL Env LEF (220 x 110)	-	-	-	-	-	-	-	-	-	-	-	-
8K SEF (267 x 390)	A	A	A	-	-	A	30	-	-	A	A	A
16K SEF (195 x 267)	A	A	A	-	-	A	50	-	-	A	A	-
16K LEF (267 x 195)	A	A	A	-	-	A	50	-	-	A	A	A
13" x 19.2" SEF	-	-	-	-	-	-	-	-	-	-	-	-
13" x 19" SEF	-	-	-	-	-	-	-	-	-	-	-	-
13" x 18" SEF	-	-	-	-	-	-	-	-	-	-	-	-
12.6" x 19.2 SEF	-	-	-	-	-	-	-	-	-	-	-	-
12.6" x 18.5" SEF	-	-	-	-	-	-	-	-	-	-	-	-
12" x 18" SEF	A	A	A	A	A ^{*5}	A	50	A	15	-	-	-
12" x 18" LEF	-	-	-	-	-	-	-	-	-	-	-	-
11" x 15" SEF	A	A	A	-	-	A	50	-	-	A	A	A
11" x 14" SEF	-	-	-	-	-	-	-	-	-	-	-	-
10" x 15" SEF	-	-	-	-	-	-	-	-	-	-	-	-
10" x 14" SEF	A	A	A	-	-	A	50	-	-	A	A	A
8.5" x 13.4" SEF	A	A	A	A	A ^{*5}	A	30	-	-	A	A	-

Bridge Unit

Size (W x L) [mm]	Paper exit	Bridge
	Bridge upper paper exit	Finisher Bridge
A3 SEF (297 x 420)	A	A
A4 SEF (210 x 297)	A	A
A4 LEF (297 x 210)	A	A
A5 SEF (148 x 210)	A	A
A5 LEF (210 x 148)	A	A
A6 SEF (105 x 148)	A	A
B4 SEF (257 x 364)	A	A
B5 SEF (182 x 257)	A	A
B5 LEF (257 x 182)	A	A
B6 SEF (128 x 182)	A	A
DLT SEF (11" x 17")	A	A
Legal SEF (8 ¹ / ₂ " x 14")	A	A
Foolscap SEF (8 ¹ / ₂ " x 13")	A	A
LT SEF (8 ¹ / ₂ " x 11")	A	A
LT LEF (11" x 8 ¹ / ₂ ")	A	A
Gov. LG SEF (8 ¹ / ₄ " x 14")	A	A
Folio SEF (8 ¹ / ₄ " x 13")	A	A
F/GL SEF (8" x 13")	A	A
GLT SEF (8" x 10 ¹ / ₂ ")	-	-
GLT LEF (10 ¹ / ₂ " x 8")	-	-
Eng Quatro SEF (8" x 10")	A	A
Eng Quatro LEF (10" x 8")	-	-

Size (W x L) [mm]	Paper exit	Bridge
	Bridge upper paper exit	Finisher Bridge
Executive SEF (7 ¹ / ₄ " x 10 ¹ / ₂ ")	A	A
Executive LEF (10 ¹ / ₂ " x 7 ¹ / ₄ ")	A	A
HLT SEF (5 ¹ / ₂ " x 8 ¹ / ₂ ")	A	A
HLT LEF (8 ¹ / ₂ " x 5 ¹ / ₂ ")	-	-
SRA3 SEF (420 x 320)	A	A
SRA4 SEF	A	A
SRA4 LEF	A	A
Line slider 1 SEF	-	-
Line slider 1 LEF	-	-
Line slider 2 SEF	-	-
Line slider 2 LEF	-	-
Com10 SEF (104.8 x 241.3)	A ^{*1}	-
Com10 LEF (241.3 x 104.8)	A ^{*1}	-
Monarch SEF (98.4 x 190.5)	A ^{*1}	-
Monarch LEF (190.5 x 98.4)	A ^{*1}	-
C5 SEF (162 x 229)	A ^{*1}	-
C5 LEF (229 x 162)	A ^{*1}	-
C6 SEF (114 x 162)	A ^{*1}	-
C6LEF (162 x 114)	A ^{*1}	-
DL Env SEF (110 x 220)	A ^{*1}	-
DL Env LEF (220 x 110)	A ^{*1}	-
8K SEF (267 x 390)	A	A

Size (W x L) [mm]	Paper exit	Bridge
	Bridge upper paper exit	Finisher Bridge
16K SEF (195 x 267)	A	A
16K LEF (267 x 195)	A	A
13" x 19.2" SEF	-	-
13" x 19" SEF	-	-
13" x 18" SEF	-	-
12.6" x 19.2 SEF	-	-
12.6" x 18.5" SEF	-	-
12" x 18" SEF	-	-
12" x 18" LEF	A	A
11" x 15" SEF	A	A
11" x 14" SEF	-	-
10" x 15" SEF	-	-
10" x 14" SEF	A	A
8.5" x 13.4" SEF	A	A

Remarks:

A	Paper through, paper exit available.
B	Will not guarantee, but paper can go through or exit.
-	Not available.

*1	Out of the true up precision guarantee.
*2	Multi folding can be done up to 5 sheets.
*3	Envelopes can only go through each at a time.
*4	Except envelopes with triangle flap.

*5

Only one sheet can be half folded with saddle stitch mode.
Therefore, multi sheets/sets must be paginated and exit one at a time.

Option Specifications

Paper Feed Unit PB3150 (D694)

Item	Specification
Paper size:	A3 SEF, A4 SEF/LEF, A5 SEF, B4 JIS SEF, B5 JIS SEF/LEF, A6 LEF, 11 × 17 SEF, 8 1/2 × 14 SEF, 8 1/2 × 13 LEF, 8 1/2 × 11 SEF/LEF, 8 1/4 × 14 SEF, 8 1/4 × 13 SEF, 8 × 13 SEF, 8 × 10 SEF, 7 1/4 × 10 1/2 SEF/LEF, 8K SEF, 16K SEF/LEF, 12 × 18 SEF, 11 × 15 SEF, 10 × 14 SEF, 4 1/8 × 9 1/2 SEF, C5 Env SEF, SRA3 SEF, custom size
Paper weight:	52–300 g/m ² (14 lb. Bond–110 lb. Cover)
Paper capacity (80 g/m ² , 20 lb. Bond):	550 sheets × 1 tray
Power consumption:	19 W or less (Power is supplied from the main unit.)
Dimensions (W × D × H):	587 × 685 × 120 mm (23.2 × 27.0 × 4.8 inches)
Weight:	Approx. 11 kg (24.3 lb.)

Paper Feed Unit PB3220/PB3210 (D787)

Item	Specification
Paper size:	A3 SEF, A4 SEF/LEF, A5 LEF, B4 JIS SEF, B5 JIS SEF/LEF, 11 × 17 SEF, 8 1/2 × 14 SEF, 8 1/2 × 13 LEF, 8 1/2 × 11 SEF/LEF, 8 1/4 × 14 SEF, 8 1/4 × 13 SEF, 8 × 13 SEF, 8 × 10 SEF, 7 1/4 × 10 1/2 SEF/LEF, 8K SEF, 16K SEF/LEF, 12 × 18 SEF, 11 × 15 SEF, 10 × 14 SEF, 4 1/8 × 9 1/2 SEF, C5 Env SEF, SRA3 SEF, custom size
Paper weight:	60–300 g/m ² (16 lb. Bond–110 lb. Cover)
Paper capacity (80 g/m ² , 20 lb. Bond):	550 sheets × 2 trays
Power consumption:	21 W or less (Power is supplied from the main unit.)
Dimensions (W × D × H):	587 × 685 × 247 mm (23.2 × 27.0 × 9.8 inches)

Item	Specification
Weight:	Approx. 22.0 kg (48.5 lb.)

ARDF DF3090 (D779-17, -21)

Item	Specification
Mode:	Batch mode, SADF mode, Mixed Sizes mode, Original Orientation mode, and Custom Size originals mode
Original Size:	EU/AA <ul style="list-style-type: none"> • One-sided originals: A3 SEF-B6 JIS SEF/LEF, 11 × 17 SEF-8 1/2 × 11 SEF/LEF • Two-sided originals: A3 SEF-A5 SEF/LEF, 11 × 17 SEF-8 1/2 × 11 SEF/LEF NA <ul style="list-style-type: none"> • One-sided originals: 11 × 17 SEF-5 1/2 × 8 1/2 SEF/LEF, A3 SEF-A4 SEF/LEF • Two-sided originals: 11 × 17 SEF-5 1/2 × 8 1/2 SEF/LEF, A3 SEF-A4 SEF/LEF
Original weight:	<ul style="list-style-type: none"> • One-sided originals: 40-128 g/m² (11-34 lb. Bond) • Two-sided originals: 52-128 g/m² (14-34 lb. Bond)
Number of originals to be set (81 g/m ² , 20 lb. Bond):	100 sheets
Power consumption:	42 W or less (Power is supplied from the main unit.)
Dimensions (W × D × H):	565 × 500 × 125 mm (22.3 × 19.7 × 5.0 inches)
Weight:	Approx. 9 kg (19.9 lb.)

SPDF DF3100 (D3B0-17, -21)

Item	Specification
Configuration:	Automatic document feed duple ^x scanner (one pass two-side scanning)

Item	Specification
Mode:	Batch mode, SADF mode, Mixed Sizes mode, Original Orientation mode, and Custom Size originals mode
Original size	EU/AA <ul style="list-style-type: none"> • One-sided originals: A3 SEF-B6 JIS SEF/LEF, 11 × 17 SEF-8 1/2 × 11 SEF/LEF • Two-sided originals: A3 SEF-A5 SEF/LEF, 11 × 17 SEF-8 1/2 × 11 SEF/LEF NA <ul style="list-style-type: none"> • One-sided originals: 11 × 17 SEF-5 1/2 × 8 1/2 SEF/LEF, A3 SEF-A4 SEF/LEF • Two-sided originals: 11 × 17 SEF-5 1/2 × 8 1/2 SEF/LEF, A3 SEF-A4 SEF/LEF
Scanning origin point:	Origin at rear upper left corner
Original setting:	Face-up on original tray
Original feed:	Feeds from top of stack on original tray
Original separation:	Feed belt and reverse roller separation by friction
Original scanning method:	Through-sheet method (Front: White platen plate, Back: Color CIS and white roller)
Original tray capacity:	220 sheets (80 g/m ² , 20 lb. Bond)
Power consumption:	55 W or less (Power is supplied from the main unit.)
Dimensions (W × D × H):	587 × 520 × 175 mm (23.2 × 20.5 × 6.9 in.)
Weight:	Approx. 14 kg (30.9 lb.)

Side Tray Type M3 (D725)

Item	Specification
Paper size:	A3 SEF, A4 SEF/LEF, A5 SEF/LEF, A6 SEF, B4 JIS SEF, B5 JIS SEF/LEF, B6 JIS SEF, 11 × 17 SEF, 8 1/2 × 14 SEF, 8 1/2 × 13 LEF, 8 1/2 × 11 SEF/LEF, 8 1/4 × 14 SEF, 8 1/4 × 13 SEF, 8 × 13 SEF, 8 × 10 SEF, 7 1/4 × 10 1/2 SEF/LEF, 5 1/2 × 8 1/2 SEF, 4 1/8 × 9 1/2 SEF/LEF, 3 7/8 × 7 1/2 SEF/LEF, C5 Env SEF/LEF, C6 Env SEF/LEF, DL Env SEF/LEF, 8K SEF, 16K SEF/LEF, 12 × 18 SEF, 11 × 15 SEF, 10 × 14 SEF, SRA3 SEF, SRA4 SEF/LEF, custom size
Paper weight:	52–300 g/m ² (14 lb. Bond–110 lb. Cover)
Paper capacity (80 g/m ² , 20 lb. Bond):	<ul style="list-style-type: none"> Internal tray 1: 250 sheets: A4, 8 1/2 × 11 or smaller 125 sheets: B4 JIS, 8 1/2 × 14 or larger External tray: 125 sheets
Power consumption:	12 W (Power is supplied from the main unit.)
Dimensions (W × D × H):	800 × 549 × 156 mm (31.5 × 21.7 × 6.2 inches)
Weight:	Approx. 4 kg (8.9 lb.)

Internal Shift Tray SH3070 (D691)

Item	Specification
Paper size:	A3 SEF, A4 SEF/LEF, A5 SEF/LEF, A6 SEF, B4 JIS SEF, B5 JIS SEF/LEF, B6 JIS SEF, 11 × 17 SEF, 8 1/2 × 14 SEF, 8 1/2 × 13 LEF, 8 1/2 × 11 SEF/LEF, 8 1/4 × 14 SEF, 8 1/4 × 13 SEF, 8 × 13 SEF, 8 × 10 SEF, 7 1/4 × 10 1/2 SEF/LEF, 5 1/2 × 8 1/2 SEF, 4 1/8 × 9 1/2 SEF/LEF, 3 7/8 × 7 1/2 SEF/LEF, C5 Env SEF/LEF, C6 Env SEF/LEF, DL Env SEF/LEF, 8K SEF, 16K SEF/LEF, 12 × 18 SEF, 11 × 15 SEF, 10 × 14 SEF, SRA3 SEF, SRA4 SEF/LEF, custom size
Paper weight:	60–300 g/m ² (16 lb. Bond–110 lb. Cover)

Item	Specification
Paper sizes that can be shifted:	A3 SEF, A4 SEF/LEF, A5 SEF/LEF, A6 SEF, B4 JIS SEF, B5 JIS SEF/LEF, B6 JIS SEF, 11 × 17 SEF, 8 1/2 × 14 SEF, 8 1/2 × 13 LEF, 8 1/2 × 11 SEF/LEF, 8 1/4 × 14 SEF, 8 1/4 × 13 SEF, 8 × 13 SEF, 8 × 10 SEF, 7 1/4 × 10 1/2 SEF/LEF, 5 1/2 × 8 1/2 SEF, 4 1/8 × 9 1/2 SEF/LEF, 3 7/8 × 7 1/2 SEF/LEF, C5 Env SEF/LEF, C6 Env SEF/LEF, DL Env SEF/LEF, 8K SEF, 16K SEF/LEF, 12 × 18 SEF, 11 × 15 SEF, 10 × 14 SEF, SRA3 SEF, SRA4 SEF/LEF, custom size
Paper weight that can be shifted:	60–300 g/m ² (16 lb. Bond–110 lb. Cover)
Stack capacity (80 g/m ² , 20 lb. Bond):	<ul style="list-style-type: none"> • 250 sheets: A4, 8 1/2 × 11 or smaller • 125 sheets: B4 JIS, 8 1/2 × 14 or larger
Power consumption:	4.3 W (Power is supplied from the main unit.)
Dimensions (W × D × H):	420 × 489 × 107 mm (16.6 × 19.3 × 4.3 inches)
Weight:	Approx. 2 kg (4.5 lb.)

1 Bin Tray BN3110 (D3CQ)

Item	Specification
Number of bins:	1
Paper size:	A3 SEF A4 SEF/LEF, A5 SEF/LEF, B4 JIS SEF B5 JIS SEF/LEF, 11 × 17 SEF, 8 1/2 × 14 SEF, 8 1/2 × 13 LEF, 8 1/2 × 11 SEF/LEF, 8 1/4 × 14 SEF, 8 1/4 × 13 SEF, 8 × 13 SEF, 8 × 10 SEF, 7 1/4 × 10 1/2 SEF/LEF, 5 1/2 × 8 1/2 SEF, 8K SEF, 16K SEF/LEF, 11 × 15 SEF, 10 × 14 SEF, SRA3 SEF, SRA4 SEF/LEF, custom size
Paper weight:	52–300 g/m ² (14 lb. Bond–110 lb. Cover)
Paper capacity (80 g/m ² , 20 lb. Bond):	125 sheets
Power consumption:	1 W or less (Power is supplied from the main unit.)
Dimensions (W × D × H):	444 × 450 × 150 mm (17.5 × 17.8 × 6.0 inches)
Weight:	Approx. 2 kg (4.5 lb.)

Bridge Unit BU3070 (D685)

Item	Specification
Stack capacity (80 g/m ² , 20 lb. Bond):	<ul style="list-style-type: none"> • 250 sheets: A4, 8 1/2 × 11 or smaller • 125 sheets: B4 JIS, 8 1/2 × 14 or larger
Power consumption:	15 W (Power is supplied from the main unit.)
Dimensions (W × D × H):	412 × 466 × 143 mm (16.3 × 18.4 × 5.7 inches)
Weight:	Approx. 4 kg (8.9 lb.)

Internal Finisher SR3130 (D690)

Item	Specification
Paper size:	A3 SEF, A4 SEF/LEF, A5 SEF/LEF, A6 SEF, B4 JIS SEF, B5 JIS SEF/LEF, B6 JIS SEF, 11 × 17 SEF, 8 1/2 × 14 SEF, 8 1/2 × 13 LEF, 8 1/2 × 11 SEF/LEF, 8 1/4 × 14 SEF, 8 1/4 × 13 SEF, 8 × 13 SEF, 8 × 10 SEF, 7 1/4 × 10 1/2 SEF/LEF, 5 1/2 × 8 1/2 SEF, 4 1/8 × 9 1/2 SEF/LEF, 3 7/8 × 7 1/2 SEF/LEF, C5 Env SEF/LEF, C6 Env SEF/LEF, DL Env SEF/LEF, 8K SEF, 16K SEF/LEF, 12 × 18 SEF, 11 × 15 SEF, 10 × 14 SEF, SRA3 SEF, SRA4 SEF/LEF, custom size
Paper weight:	60–300 g/m ² (16 lb. Bond–110 lb. Cover)
Paper sizes that can be shifted:	A3 SEF, A4 SEF/LEF, A5 SEF/LEF, B4 JIS SEF, B5 JIS SEF/LEF, 11 × 17 SEF, 8 1/2 × 14 SEF, 8 1/2 × 13 LEF, 8 1/2 × 11 SEF/LEF, 8 1/4 × 14 SEF, 8 1/4 × 13 SEF, 8 × 13 SEF, 8 × 10 SEF, 7 1/4 × 10 1/2 SEF/LEF, C5 Env SEF/LEF, 8K SEF, 16K SEF/LEF, 11 × 15 SEF, 10 × 14 SEF, SRA4 LEF, custom size
Paper weight that can be shifted:	64–105 g/m ² (17–28 lb. Bond)
Stack capacity (80 g/m ² , 20 lb. Bond):	<ul style="list-style-type: none"> • 500 sheets: A4, 8 1/2 × 11 or smaller • 250 sheets: B4 JIS, 8 1/2 × 14 or larger
Staple paper size:	A3 SEF, A4 SEF/LEF, B4 JIS SEF, B5 JIS SEF/LEF, 11 × 17 SEF, 8 1/2 × 14 SEF, 8 1/2 × 13 LEF, 8 1/2 × 11 SEF/LEF, 8 1/4 × 14 SEF, 8 1/4 × 13 SEF, 7 1/4 × 10 1/2 SEF/LEF, 8K SEF, 16K SEF/LEF

Item	Specification
Staple paper weight:	64–105 g/m ² (17–28 lb. Bond)
Staple capacity (80 g/m ² , 20 lb. Bond):	<ul style="list-style-type: none"> • Without Mixed Size: 30 sheets: A3 SEF, B4 JIS SEF, 11 × 17 SEF, 8 1/2 × 14 SEF, 8 1/2 × 13 LEF, 8 1/4 × 14 SEF, 8 1/4 × 13 SEF, 8K SEF 50 sheets: A4 SEF/LEF, B5 JIS SEF/LEF, 8 1/2 × 11 SEF/LEF, 7 1/4 × 10 1/2 SEF/LEF, 16K SEF/LEF • With Mixed Size: 30 sheets: A3 SEF/ A4 LEF, B4 JIS SEF/ B5 JIS SEF, 11 × 17 SEF/8 1/2 × 11 SEF
Stack capacity after stapling (80 g/m ² , 20 lb. Bond):	<ul style="list-style-type: none"> • 2–9 sheets: 55–46 sets (A4 LEF, B5 JIS LEF, 8 1/2 × 11 LEF) • 10–50 sheets: 45–10 sets (A4 LEF, B5 JIS LEF, 8 1/2 × 11 LEF) • 2–9 sheets: 55–27 sets (A4 SEF, B5 JIS SEF, 8 1/2 × 11 SEF) • 10– 50 sheets: 25–8 sets (A4 SEF, B5 JIS SEF, 8 1/2 × 11 SEF) • 2–9 sheets: 55–27 sets (A3 SEF, B4 JIS SEF, 11 × 17 SEF, 8 1/2 × 14 SEF) • 10–30 sheets: 25–8 sets (A3 SEF, B4 JIS SEF, 11 × 17 SEF, 8 1/2 × 14 SEF)
Staple position:	Top 1, Bottom 1, Left 2, Top 2
Power consumption:	<ul style="list-style-type: none"> • 50 W or less (without punch unit) (Power is supplied from the main unit.) • 60 W or less (with punch unit) (Power is supplied from the main unit.)
Dimensions (W × D × H):	546 × 523 × 170 mm (21.5 × 20.6 × 6.7 inches)
Weight:	<p>Approx. 13 kg (28.7 lb.) (without punch unit)</p> <p>Approx. 17 kg (37.5 lb.) (with punch unit)</p>

Finisher part specifications

Item	Specification
Type	Case system
Shift tray	Yes
No. of sheets which can be accommodated	A4, 8 ¹ / ₂ ×11 or smaller: 500 / height: lower than 57mm B4, 8 ¹ / ₂ ×14 or larger: 250 / height: lower than 28.5mm
Paper thicknesses which can be handled	52g/m ² -300g/m ²
Up/down shift function	No
Left/right shift function	Yes
Stapling function	Yes
Punching function	Option
Remainder detection	No
Full-load detection	Yes
Paper detection	No
Power consumption	Less than 47W (24V DC /2A)
Power source	24V DC (supplied from main printer), 5V SC (generated by FIN board), SELV (super-low voltage secondary power supply)

Stapler unit specifications

Item	Specification
No. of sheets which can be stitched	A3 SEF, B4 SEF, 11"×17" SEF, 8 ¹ / ₂ "×14" SEF, 8 ¹ / ₂ "×13" SEF, 8 ¹ / ₄ "×14" SEF, 8 ¹ / ₄ "×13" SEF: 30 A4 LEF / SEF, B5 LEF / SEF, 8 ¹ / ₂ "×11" LEF / SEF, 7 ¹ / ₄ "×10 ¹ / ₂ " LEF / SEF: 50 When loading mixed widths: 30

Item	Specification
Sizes which can be stitched	A3 SEF, B4 SEF, 11"×17" SEF, 8 ¹ / ₂ "×14" SEF, 8 ¹ / ₂ "×13" SEF, 8 ¹ / ₄ "×14" SEF, 8 ¹ / ₄ "×13" SEF A4 LEF / SEF, B5 LEF / SEF, 8 ¹ / ₂ "×11" LEF / SEF, 7 ¹ / ₄ "×10 ¹ / ₂ " LEF / SEF
Thicknesses which can be stitched	52g/m ² - 105g/m ² The quality for sheets of paper which are thinner than 64g/m ² is not guaranteed. No. of sheets to be stitched decreases when sheets of paper are thicker than 64g/m ² , depending on the weight.
Stitching position	Top, bottom, 2 positions on the left, 2 positions on the top
Staple supply	Refill charge to dedicated staple cartridge
Stitching capacity	5000 / cartridge

Punch Unit PU3040 NA/EU/SC (D716)

Paper size:

Punch unit type	Paper size
2 & 4 holes type: 2 holes	SEF: A3, A4, B4 JIS, B5 JIS, 11 × 17, 8 1/2 × 14, 8 1/2 × 13, 8 1/2 × 11, 7 1/4 × 10 1/2, 8K, 16K
2 & 4 holes type: 2 holes	LEF: A4, B5 JIS, 8 1/2 × 11, 16K
2 & 4 holes type: 4 holes	SEF: A3, 11 × 17
2 & 4 holes type: 4 holes	LEF: A4, 8 1/2 × 11
4 holes type: 4 holes	SEF: A3, A4, B4 JIS, B5 JIS, 11 × 17, 8 1/2 × 14, 8 1/2 × 13, 8 1/2 × 11, 7 1/4 × 10 1/2
4 holes type: 4 holes	LEF: A4, B5 JIS, 8 1/2 × 11
2 & 3 holes type: 2 holes	SEF: A3, 11 × 17, 8 1/2 × 14, 8 1/2 × 13, 8 1/2 × 11, 7 1/4 × 10 1/2
2 & 3 holes type: 2 holes	LEF: A4, 8 1/2 × 11
2 & 3 holes type: 3 holes	SEF: A3, 11 × 17

Punch unit type	Paper size
2 & 3 holes type: 3 holes	LEF: A4, 8 1/2 × 11

Paper weight:

60–169 g/m² (16 lb. Bond –90 lb. Index)

Internal Finisher SR3180 (D766)

Item	Specification
Paper size:	A3 SEF, A4 LEF/SEF, B4 JIS SEF, B5 JIS LEF/SEF, 11 × 17 SEF, 8 1/2 × 14 SEF, 8 1/2 × 13 SEF, 8 1/2 × 11 LEF/SEF, 8 1/4 × 14 SEF, 8 1/4 × 13 SEF, 7 1/4 × 10 1/2 LEF/SEF, 8K SEF, 16K LEF/SEF, custom size
Paper weight:	50–300 g/m ² (14 lb. Bond–110 lb. Cover)
Paper sizes that can be shifted:	A3 SEF, A4 LEF/SEF, B4 JIS SEF, B5 JIS LEF/SEF, 11 × 17 SEF, 8 1/2 × 14 SEF, 8 1/2 × 13 SEF, 8 1/2 × 11 LEF/SEF, 8 1/4 × 14 SEF, 8 1/4 × 13 SEF, 7 1/4 × 10 1/2 LEF/SEF, 8K SEF, 16K LEF/SEF, custom size
Paper weight that can be shifted:	64–80 g/m ² (17–20 lb. Bond)
Stack capacity (80 g/m ² , 20 lb. Bond):	<ul style="list-style-type: none"> 250 sheets or more: A4 LEF, B5 JIS LEF/SEF, 8 1/2 × 11 LEF/SEF 125 sheets: A3 SEF to A4 SEF, B4 JIS SEF, 8 1/2 × 14 SEF, 11 × 17 SEF
Stapling paper size:	A3 SEF, A4 LEF/SEF, B4 JIS SEF, B5 JIS LEF/SEF, 11 × 17 SEF, 8 1/2 × 14 SEF, 8 1/2 × 13 SEF, 8 1/2 × 11 LEF/SEF, 8 1/4 × 14 SEF, 8 1/4 × 13 SEF, 7 1/4 × 10 1/2 LEF/SEF, 8K SEF, 16K LEF/SEF
Stapling paper weight:	64–80 g/m ² (17–20 lb. Bond)
Stapling capacity (80 g/m ² , 20 lb. Bond):	<p>5 sheets:</p> <p>A3 SEF, A4 LEF/SEF, B4 JIS LEF/SEF, B5JIS LEF/SEF, 11×17 SEF, 8 1/2×14 SEF, 8 1/2×13 SEF 8 1/2×11 LEF/SEF, 8 4/1×14SEF, 8 1/4×13 SEF, 7 1/4×10 1/2 LEF/ SEF, 8K SEF, 16K LEF SEF</p>

Item	Specification
Stack capacity after stapling (80 g/m ² , 20 lb. Bond):	<ul style="list-style-type: none"> • 30 sets or more (A4 LEF, 8 1/2 × 11 LEF) • 20 sets or more (B5 JIS LEF/SEF) • 15 sets or more (A3 SEF- A4 SEF, B4 JIS SEF, 11 × 17 SEF, 8 1/2 × 11 SEF)
Staple position:	Bottom Slant
Power consumption:	30 W or less
Dimensions (W × D × H):	435 × 515 × 150 mm (17.2 × 20.3 × 6.0 inches)
Weight:	Approx. 10 kg (22.1 lb.)

Finisher part specifications

Item	Specification
Type	Case system
Shift tray	Yes
No. of sheets which can be accommodated	A4, 8 1/2×11 or smaller: 250 B4, 8 1/2×14 or larger: 125
Paper thicknesses which can be handled	52g/m ² -300g/m ²
Up/down shift function	No
Left/right shift function	Yes
Stapling function	Yes
Punching function	No
Remainder detection	No
Full-load detection	Yes
Paper detection	No
Power consumption	Less than 30W

Item	Specification
Power source	24V DC (supplied from main frame), 5V SC (generated by FIN board), SELV (super-low voltage secondary power supply)

Stapler unit specifications

Item	Specification
No. of sheets which can be stitched	2 to 5 sheets
Sizes which can be stitched	A3 SEF - B5 SEF / DLT SEF - LT SEF
Thicknesses which can be stitched	54g/m ² -80g/m ²
Stitching position	1 position (Top Slant)
Staple supply	No
Stitching capacity	No
Weight	Less than 1.4 kg (not including packaging materials and other items in package)
Service life	1200k sheets or 5 years

* 1 80g/m² or less (paper exceeding 80g/m² is calculated by weight)

* 2 Up to 1280 mm in SP mode.

Booklet Finisher SR3220 (D3B9)

Item	Specification
Paper size for the finisher upper tray	A3 SEF, B4 JIS SEF, A4 SEF/LEF B5 JIS SEF/LEF, A5 SEF/LEF, B6 JIS SEF, A6 SEF, 12 × 18 SEF, 11 × 17 SEF, 11 × 15 SEF, 10 × 14 SEF, 8 1/2 × 14 SEF, 8 1/2 × 13 LEF, 8 1/2 × 11 SEF/LEF, 8 1/4 × 14 SEF, 8 1/4 × 13 SEF, 8 × 13 SEF, 8 × 10 SEF, 5 1/2 × 8 1/2 SEF, 7 1/4 × 10 1/2 SEF/LEF, 8K SEF, 16K SEF/LEF, SRA3 SEF, SRA4 SEF/LEF, 8 1/2 × 13 2/5 LEF, custom size

Item	Specification
Paper weight for the finisher upper tray:	52–169 g/m ² (14 lb. Bond–90 lb. Index)
Stack capacity for the finisher upper tray (80 g/m ² , 20 lb. Bond):	250 sheets: A4, 8 1/2 × 11 or smaller 50 sheets: B4 JIS, 8 1/2 × 14 or larger
Paper size for the finisher shift tray:	A3 SEF, B4 JIS SEF, A4 SEF/LEF, B5 JIS/LEF, A5 SEF/LEF, B6 JIS SEF, A6 SEF, 12 × 18 SEF, 11 × 17 SEF, 11 × 15 SEF, 10 × 14 SEF, 8 1/2 × 14 SEF, 8 1/2 × 13 LEF, 8 1/2 × 11 SEF/LEF, 8 1/4 × 14 SEF, 8 1/4 × 13 SEF, 8 × 13 SEF, 8 × 10 SEF, 7 1/4 × 10 1/2 SEF/LEF, 5 1/2 × 8 1/2 SEF, 8K SEF, 16K SEF/LEF, SRA3 SEF, SRA4 SEF/LEF, 8 1/2 × 13 2/5 LEF, custom size
Paper weight for the finisher shift tray:	52–300 g/m ² (14 lb. Bond–110 lb. Cover)
Paper sizes that can be shifted when delivered to the finisher shift tray:	A3 SEF, A4 SEF/LEF, A5 SEF, B4 JIS SEF, B5 JIS SEF, B6 JIS SEF, 12 × 18 SEF, 11 × 17 SEF, 11 × 15 SEF, 10 × 14 SEF, 8 1/2 × 14 SEF, 8 1/2 × 13 LEF, 8 1/2 × 11 SEF/LEF, 8 1/4 × 14 SEF, 8 1/4 × 13 SEF, 8 × 13 SEF, 8 × 10 SEF, 7 1/4 × 10 1/2 SEF/LEF, 5 1/2 × 8 1/2 SEF, 8K SEF, 16K SEF/LEF SRA4 LEF, 8 1/2 × 13 2/5 LEF
Paper weight that can be shifted when delivered to the finisher shift tray:	52–300 g/m ² (14 lb. Bond–110 lb. Cover)
Stack capacity for the finisher shift tray (80 g/m ² , 20 lb. Bond):	1,000 sheets: A4, 8 1/2 × 14 or smaller 500 sheets: B4 JIS, 8 1/2 × 14 or larger
Staple paper size:	A3 SEF, B4 JIS SEF, A4 SEF/LEF, B5 JIS SEF/LEF, 11 × 17 SEF, 11 × 15 SEF, 10 × 14 SEF, 8 1/2 × 14 SEF, 8 1/2 × 11 SEF/LEF, 7 1/4 × 10 1/2 SEF/LEF, 8 × 13 SEF, 8B 1/2 × 13 LEF, 8 1/4 × 14 SEF, 8 1/4 × 13 SEF, 8 × 10 SEF, 12 × 18 SEF, 8K SEF, 16K SEF/LEF, 8 1/2 × 13 2/5 LEF, custom size
Staple paper weight:	52–105 g/m ² (14–28 lb. Bond) You can use two sheets of paper weighing up to 216 g/m ² (80 lb. Cover) per set as cover sheets.

Item	Specification
Staple capacity (80 g/m ² , 20 lb. Bond):	<ul style="list-style-type: none"> • Without Mixed Size: <ul style="list-style-type: none"> 30 sheets: A3 SEF, B4 JIS SEF, 11 × 17 SEF, 8 1/2 × 14 SEF, 8 × 13 SEF, 8 1/2 × 13 LEF, 8 1/4 × 14 SEF, 8 1/4 × 13 SEF, 11 × 15 SEF, 10 × 14 SEF, 8K SEF, 12 × 18 SEF, 8 1/2 × 13 2/5 LEF 50 sheets: A4 SEF/LEF, B5 JIS SEF/LEF, 8 1/2 × 11 SEF/LEF, 8 × 10 SEF, 7 1/4 × 10 1/2 SEF/LEF, 16K SEF/LEF • With Mixed Size: <ul style="list-style-type: none"> 22 sheets: A3 SEF/A4 LEF, B4 JIS SEF/B5 JIS SEF, 11 × 17 SEF/8 1/2 × 11 SEF
Stack capacity after stapling (80 g/m ² , 20 lb. Bond):	<ul style="list-style-type: none"> • Without Mixed Size: <ul style="list-style-type: none"> • 2–9 sheets: 100 sets (A4 LEF, B5 JIS LEF, 8 1/2 × 11 LEF) • 10–50 sheets: 100–20 sets (A4 LEF, B5 JIS LEF, 8 1/2 × 11 LEF) • 10–50 sheets: 50–10 sets (A4 SEF, B5 JIS SEF, 8 1/2 × 11 SEF) • 2–9 sheets: 50 sets (A3 SEF, A4 SEF, B4 JIS SEF, B5 JIS SEF, 11 × 17 SEF, 8 1/2 × 14 SEF, 8 1/2 × 11 SEF) • 10–30 sheets: 50–10 sets (A3 SEF, B4 JIS SEF, 11 × 17 SEF, 8 1/2 × 14 SEF) • With Mixed Size: <ul style="list-style-type: none"> • 2–22 sheets: 22 sets (A3 SEF/ A4 LEF, B4 JIS SEF/B5 JIS SEF, 11 × 17 SEF/8 1/2 × 11 SEF)
Staple position:	3 positions (Top, Bottom, 2 Staples)
Saddle stitch paper size:	A3 SEF, A4 LEF, B4 JIS SEF, B5 JIS LEF, 11 × 17 SEF, 8 1/2 × 14 SEF, 8 1/2 × 11 LEF, 12 × 18 SEF
Saddle stitch paper weight:	52–105 g/m ² (14–28 lb. Bond)
Saddle stitch capacity (80 g/m ² , 20 lb. Bond):	1 set (15 sheets)

Item	Specification
Stack capacity after saddle stitching (80 g/m ² , 20 lb. Bond):	2–5 sheets: Approx. 20 sets 6–10 sheets: Approx. 10 sets 11–15 sheets: Approx. 7 sets
Saddle stitch position:	Center 2 positions
Types of folds:	Half Fold
Half fold paper size:	A3 SEF, A4 LEF, B4 JIS SEF, B5 JIS LEF, 11 × 17 SEF, 8 1/2 × 14 SEF, 8 1/2 × 11 LEF, 12 × 18 SEF, 8 1/2 × 13 2/5 LEF
Half fold paper weight:	52–105 g/m ² (14–28 lb. Bond)
Power consumption:	35.4 W (Power is supplied from the main unit.)
Dimensions (W × D × H):	<ul style="list-style-type: none"> Tray is folded: 575 × 620 × 960 mm (22.6 × 24.5 × 37.8 inches) Tray is extended: 658 × 620 × 960 mm (25.9 × 24.5 × 37.8 inches)
Weight:	Approx. 42 kg (92.6 lb.)

Punch Unit PU3050 NA/EU/SC (D717)

Paper size:

Punch unit type	Paper size
2 & 4 holes type: 2 holes	SEF: A3, B4 JIS, A4, B5 JIS, A5, 11 × 17, 8 1/2 × 14, 8 1/2 × 11, 5 1/2 × 8 1/2, 7 1/4 × 10 1/2, 8 × 13, 8 1/2 × 13, 8 1/4 × 13, 8K, 16K, 8 1/4 × 14, 8 × 10, 11 × 15, 10 × 14
2 & 4 holes type: 2 holes	LEF: A4, B5 JIS, A5, 8 1/2 × 11, 7 1/4 × 10 1/2, 16K
2 & 4 holes type: 4 holes	SEF: A3, B4 JIS, 11 × 17, 11 × 15, 8K
2 & 4 holes type: 4 holes	LEF: A4, B5 JIS, 8 1/2 × 11, 7 1/4 × 10 1/2, 16K
4 holes type: 4 holes	SEF: A3, B4 JIS, A4, B5 JIS, A5, 11 × 17, 8 1/2 × 14, 8 1/2 × 11, 5 1/2 × 8 1/2, 7 1/4 × 10 1/2, 8 × 13, 8 1/2 × 13, 8 1/4 × 13, 8K, 16K, 8 1/4 × 14, 8 × 10, 11 × 15, 10 × 14

Punch unit type	Paper size
4 holes type: 4 holes	LEF: A4, B5 JIS, A5, 8 1/2 × 11, 7 1/4 × 10 1/2, 16K
2 & 3 holes type: 2 holes	SEF: A3, B4 JIS, B5 JIS, A5, 11 × 17, 8 1/2 × 14, 8 1/2 × 11, 5 1/2 × 8 1/2, 7 1/4 × 10 1/2, 8 × 13, 8 1/2 × 13, 8 1/4 × 13, 8K, 16K, 8 1/4 × 14, 8 × 10, 11 × 15, 10 × 14
2 & 3 holes type: 2 holes	LEF: A4, B5 JIS, 8 1/2 × 11, 7 1/4 × 10 1/2, 16K
2 & 3 holes type: 3 holes	SEF: A3, B4 JIS, 11 × 17, 11 × 15, 10 × 14, 8K
2 & 3 holes type: 3 holes	LEF: A4, B5 JIS, 8 1/2 × 11, 7 1/4 × 10 1/2, 16K

Paper weight:52–256 g/m² (14 lb. Bond–140 lb. Index)**Banner Paper Guide Tray Type M19 (D3BF)**

Item	Specification
Dimensions (W × D × H):	<p>Main Tray</p> <p>Tray is folded: 370 × 250 × 70 mm (14.6 × 9.8 × 2.8 inches)</p> <p>Tray is expanded: 370 × 250 × 250 mm (14.6 × 9.8 × 9.8 inches)</p> <p>Sub Tray</p> <p>Tray is folded: 150 × 110 × 15 mm (5.9 × 4.3 × 0.6 inches)</p> <p>Tray is expanded: 150 × 110 × 100 mm (5.9 × 4.3 × 3.9 inches)</p> <p>Lock Plate</p> <p>Locked: 135 × 150 × 25 mm (5.3 × 5.9 × 1.0 inches)</p> <p>Unlocked: 135 × 220 × 25 mm (5.3 × 8.7 × 1.0 inches)</p>

Item	Specification
Weight:	Main Tray: 942 g (2.0 lb.) Sub Tray: 245 g (0.5 lb.) Lock Plate: 280 g (0.6 lb.)

2. Preventive Maintenance

Preventive Maintenance

Preventive Maintenance Items

Note

- **Yield Parts:**
Some of the parts mentioned in these tables have a target yield. However, the total copy/print volume made by the machine will not reach the target yield within the machine's targeted lifetime if the machine is used under the target usage conditions (ACV, color ratio, P/J, and C/O). So, these parts are categorized not as PM parts but as yield parts (EM parts).

Chart: A4 (LT)/5% image coverage ratio

Mode: 2 copies/original (prints/job)

Color ratio: 20%

Environment: Normal temperature and humidity

Yield may change depending on circumstances and print conditions.

Symbol keys: C: Clean, R: Replace, L: Lubricant, I: Inspect

Mainframe

The PM count for the following items is based on sheets of copy paper:

Item	PM Parts	Cycle	EM	Remarks
Scanner				
Exposure glass	-	C 300K	C	Clean with a cleaning cloth. Do not clean with alcohol. Doing so may leave a whitish trace that affects image scanning.
Sheet-through exposure glass	-	C 300K	C	Clean with a cleaning cloth. Do not clean with alcohol. Doing so may leave a whitish trace that affects image scanning.
PCDU				

Item	PM Parts	Cycle	EM	Remarks
PCU(K)	✓	R 60K	-	
PCU(C,M,Y)	-	R 48K	-	
Development unit (K)	✓	R 180K	-	PM parts: only for MP C2504
Development unit (C,M,Y)	-	R 120K	-	
Waste toner bottle	✓	R 100K	-	Target yield (number of sheets) is only a guide and it is possible to collect up to 1,200,000 mg of waste toner. Full detection is a mechanical detection by a feeler. Replace when waste toner bottle full is detected.
Transfer				
Image transfer cleaning unit	-	R 240K	-	
Image transfer belt unit	-	R 240K	-	
Paper transfer roller unit	-	R 240K	-	
Fusing				
Fusing sleeve belt unit	-	R 240K	-	
Fusing entrance guide plate	-	-	C	Remove toner deposits
Fusing exit guide plate	-	-	C	Remove toner deposits
Stripper plate	-	-	C	Remove toner deposits

Item	PM Parts	Cycle	EM	Remarks
Pressure roller	-	R 240K	-	
Bearing: Pressure roller	-	R/L 240K	-	Lubricate with FLUTORIBO MG GREASE: 100G
Thermopile	-	C 400K	C	Dry cloth
Pressure roller gears	-	-	R	Replace if worn out
Idler gear	-	-	R	Replace if worn out
Fusing exit roller	-	-	C	Damp cloth
Miscellaneous				
Ozone filter/Dust filter	-	R 300K	-	
Dust shield glass	-	-	C	Damp cloth
TM/ID sensor	-	-	C	Damp cloth Do not use a dry cloth that can cause static electricity.
Paper feed				
Registration roller	-	-	C	Damp cloth
Registration sensor	-	-	C	Remove toner and paper dust, Dry cloth
Paper dust collection unit	-	-	C	Remove toner and paper dust
Transport roller	-	-	C	Damp cloth
Transport sensor	-	-	C	Remove toner and paper dust, Dry cloth
Feed roller	-	-	C	Remove toner and paper dust, Dry cloth

Item	PM Parts	Cycle	EM	Remarks
Separation roller	-	-	C	Remove toner and paper dust, Dry cloth
Pick-up roller	-	-	C	Remove toner and paper dust, Dry cloth
Duplex/Bypass/Exit				
Duplex entrance sensor	-	-	C	Remove toner and paper dust, Dry cloth
Duplex exit sensor	-	-	C	Remove toner and paper dust, Dry cloth
Duplex transport roller	-	-	C	Damp cloth
Duplex exit roller	-	-	C	Damp cloth
Duplex entrance roller 1, 2	-	-	C	Damp cloth
Bypass paper feed roller	-	-	C	Damp cloth
Bypass separation roller	-	-	C	Damp cloth
Bypass pick-up roller	-	-	C	Damp cloth
Bypass transport roller	-	-	C	Damp cloth
Reverse roller	-	-	C	Damp cloth
Reverse sensor	-	-	C	Remove toner and paper dust, Dry cloth
Paper exit roller	-	-	C	Damp cloth
Paper exit sensor	-	-	C	Remove toner and paper dust, Dry cloth

ARDF DF3090

Item	Cycle	EM	Remarks
Pick-up roller	R 120K	C	Wipe with a cloth dampened with ethyl alcohol.
Feed belt	R 120K	C	Wipe with a cloth dampened with ethyl alcohol or water.
Separation roller	R 120K	C	Wipe with a cloth dampened with ethyl alcohol.
Sensors	-	C	Clean with a blower brush.
Platen sheet	-	C	Wipe with a cloth dampened with ethyl alcohol.
Other rollers	-	C	
Scanner guide plate	-	C	

SPDF DF3100

Item	Cycle	EM	Remarks
Pick-up roller	R 120K	C	Wipe with a cloth dampened with ethyl alcohol.
Feed belt	R 120K	C	Wipe with a cloth dampened with ethyl alcohol or water.
Separation roller	R 120K	C	Wipe with a cloth dampened with ethyl alcohol.
CIS (Glass area)	-	C	Clean with a cleaning cloth. Do not clean with alcohol. Doing so may leave a whitish trace that affects image scanning.
Sensors	-	C	Clean with a blower brush.
Gears	-	L	Lubricate with Silicone Grease G-501 when noise occurred.

Item	Cycle	EM	Remarks
Platen sheet	-	C	Wipe with a cloth dampened with ethyl alcohol.
Other rollers	-	C	
Scanner guide plate	-	C	

Paper Feed Unit PB3220/PB3210

Item	EM	Remarks
Paper feed roller	C	Wipe with a cloth dampened with ethyl alcohol.
Pick-up roller	C	Wipe with a cloth dampened with ethyl alcohol.
Separation roller	C	Wipe with a cloth dampened with ethyl alcohol.
Relay rollers	C	Wipe with a cloth dampened with ethyl alcohol.
Bottom plate pad	C	Remove dust with a dry cloth.
Sensors	C	Remove dust with a dry cloth.

1 Bin Tray BN3110

Item	EM	Remarks
Rollers	C	Wipe with a cloth dampened with ethyl alcohol.
Copy tray	C	Clean with a damp cloth, and then wipe with a dry cloth.
Sensors	C	Clean with a blower brush.

Bridge Unit BU3070

Item	EM	Remarks
Rollers	C	Wipe with a cloth dampened with ethyl alcohol.

Internal Shift Tray SH3070

Item	EM	Remarks
Exit Tray	C	Clean with a damp cloth, and then wipe with a dry cloth.

Side Tray Type M3

Item	EM	Remarks
Rollers	C	Wipe with a cloth dampened with ethyl alcohol.
Sensors	C	Remove dust with a dry cloth.

Booklet Finisher SR3220/Punch Unit PU3050

Item	Cycle	EM	Remarks
Rollers	-	C	Wipe with a cloth dampened with ethyl alcohol.
Quenching brush	-	C	Clean with a dry cloth if dirt adheres to it.
Sensors	-	C	Clean with a blower brush.
Stapler (Corner)	R 4000K	C	Replace when the staple counter in the logging data reaches 500k. Staple a few times for a test after replacement.
Booklet Stapler	R 4000K	C	Replace when the staple counter in the logging data reaches 200k.
Punch	R 3000K	C	Remove paper dust in the transport unit.
Punch waste	C 300K	C	Discard punch waste when hopper full is detected.

Internal Finisher SR3130

Item	EM	Remarks
Rollers	C	Wipe with a cloth dampened with ethyl alcohol.
Sensors	C	Clean with a blower brush.
Stapler	R	Replace when the staple counter in the logging data reaches 200k.

Internal Finisher SR3180

Item	EM	Remarks
Rollers	C	Wipe with a cloth dampened with ethyl alcohol.
Sensors	C	Clean with a blower brush.
Stapler	R	Replace when the staple counter in the logging data reaches 200k.

3. Engine SP Mode Tables

Engine SP Tables - SP1000-1

SP1-XXX (Feed)

1001	[Leading Edge Registration]		
1-001-001	Tray1: Thin	*ENG	[-9 to 9 / 0 / 0.1 mm/step]
1-001-002	Tray1: Plain	*ENG	[-9 to 9 / 0 / 0.1 mm/step]
1-001-003	Tray1: Mid-thick	*ENG	[-9 to 9 / 0 / 0.1 mm/step]
1-001-004	Tray1: Thick 1	*ENG	[-9 to 9 / 0 / 0.1 mm/step]
1-001-005	Tray1: Thick 2	*ENG	[-9 to 9 / 0 / 0.1 mm/step]
1-001-006	Tray1: Thick 3	*ENG	[-9 to 9 / 0 / 0.1 mm/step]
1-001-007	Tray1: Thick 4	*ENG	[-9 to 9 / 0 / 0.1 mm/step]
1-001-008	Tray2/3/4/5/LCT: Thin	*ENG	[-9 to 9 / 0 / 0.1 mm/step]
1-001-009	Tray2/3/4/5/LCT: Plain	*ENG	[-9 to 9 / 0 / 0.1 mm/step]
1-001-010	Tray2/3/4/5/LCT: Mid-thick	*ENG	[-9 to 9 / 0 / 0.1 mm/step]
1-001-011	Tray2/3/4/5/LCT: Thick 1	*ENG	[-9 to 9 / 0 / 0.1 mm/step]
1-001-012	Tray2/3/4/5/LCT: Thick 2	*ENG	[-9 to 9 / 0 / 0.1 mm/step]
1-001-013	Tray2/3/4/5/LCT: Thick 3	*ENG	[-9 to 9 / 0 / 0.1 mm/step]
1-001-014	Tray2/3/4/5/LCT: Thick 4	*ENG	[-9 to 9 / 0 / 0.1 mm/step]
1-001-015	By-pass: Thin	*ENG	[-9 to 9 / 0 / 0.1 mm/step]
1-001-016	By-pass: Plain	*ENG	[-9 to 9 / 0 / 0.1 mm/step]
1-001-017	By-pass: Mid-thick	*ENG	[-9 to 9 / 0 / 0.1 mm/step]
1-001-018	By-pass: Thick 1	*ENG	[-9 to 9 / 0 / 0.1 mm/step]
1-001-019	By-pass: Thick 2	*ENG	[-9 to 9 / 0 / 0.1 mm/step]
1-001-020	By-pass: Thick 3	*ENG	[-9 to 9 / 0 / 0.1 mm/step]

1-001-021	By-pass: Thick 4	*ENG	[-9 to 9 / 0 / 0.1 mm/step]
1-001-022	Duplex: Thin	*ENG	[-9 to 9 / 0 / 0.1 mm/step]
1-001-023	Duplex: Plain	*ENG	[-9 to 9 / 0 / 0.1 mm/step]
1-001-024	Duplex: Mid-thick	*ENG	[-9 to 9 / 0 / 0.1 mm/step]
1-001-025	Duplex: Thick 1	*ENG	[-9 to 9 / 0 / 0.1 mm/step]
1-001-026	Duplex: Thick 2	*ENG	[-9 to 9 / 0 / 0.1 mm/step]
1-001-027	Duplex: Thick 3	*ENG	[-9 to 9 / 0 / 0.1 mm/step]
1-001-028	Tray1: Thin:1200	*ENG	[-9 to 9 / 0 / 0.1 mm/step]
1-001-029	Tray1: Plain:1200	*ENG	[-9 to 9 / 0 / 0.1 mm/step]
1-001-030	Tray1: Mid-thick:1200	*ENG	[-9 to 9 / 0 / 0.1 mm/step]
1-001-031	Tray1: Thick 1:1200	*ENG	[-9 to 9 / 0 / 0.1 mm/step]
1-001-032	Tray1: Thick 2:1200	*ENG	[-9 to 9 / 0 / 0.1 mm/step]
1-001-033	Tray1: Thick 3:1200	*ENG	[-9 to 9 / 0 / 0.1 mm/step]
1-001-034	Tray1: Thick 4:1200	*ENG	[-9 to 9 / 0 / 0.1 mm/step]
1-001-035	Tray2/3/4/5/LCT: Thin:1200	*ENG	[-9 to 9 / 0 / 0.1 mm/step]
1-001-036	Tray2/3/4/5/LCT: Plain:1200	*ENG	[-9 to 9 / 0 / 0.1 mm/step]
1-001-037	Tray2/3/4/5/LCT: Mid-thick: 1200	*ENG	[-9 to 9 / 0 / 0.1 mm/step]
1-001-038	Tray2/3/4/5/LCT: Thick 1:1200	*ENG	[-9 to 9 / 0 / 0.1 mm/step]
1-001-039	Tray2/3/4/5/LCT: Thick 2:1200	*ENG	[-9 to 9 / 0 / 0.1 mm/step]
1-001-040	Tray2/3/4/5/LCT: Thick 3:1200	*ENG	[-9 to 9 / 0 / 0.1 mm/step]
1-001-041	Tray2/3/4/5/LCT: Thick 4:1200	*ENG	[-9 to 9 / 0 / 0.1 mm/step]
1-001-042	By-pass: Thin:1200	*ENG	[-9 to 9 / 0 / 0.1 mm/step]
1-001-043	By-pass: Plain:1200	*ENG	[-9 to 9 / 0 / 0.1 mm/step]
1-001-044	By-pass: Mid-thick:1200	*ENG	[-9 to 9 / 0 / 0.1 mm/step]
1-001-045	By-pass: Thick 1:1200	*ENG	[-9 to 9 / 0 / 0.1 mm/step]

1-001-046	By-pass: Thick 2:1200	*ENG	[-9 to 9 / 0 / 0.1 mm/step]
1-001-047	By-pass: Thick 3:1200	*ENG	[-9 to 9 / 0 / 0.1 mm/step]
1-001-048	By-pass: Thick 4:1200	*ENG	[-9 to 9 / 0 / 0.1 mm/step]
1-001-049	Duplex: Thin:1200	*ENG	[-9 to 9 / 0 / 0.1 mm/step]
1-001-050	Duplex: Plain:1200	*ENG	[-9 to 9 / 0 / 0.1 mm/step]
1-001-051	Duplex: Mid-thick:1200	*ENG	[-9 to 9 / 0 / 0.1 mm/step]
1-001-052	Duplex: Thick 1:1200	*ENG	[-9 to 9 / 0 / 0.1 mm/step]
1-001-053	Duplex: Thick 2:1200	*ENG	[-9 to 9 / 0 / 0.1 mm/step]
1-001-054	Duplex: Thick 3:1200	*ENG	[-9 to 9 / 0 / 0.1 mm/step]

1002	[Side-to-Side Registration]		
1-002-001	By-pass Tray	ENG	[-4 to 4 / 0 / 0.1 mm/step]
1-002-002	Paper Tray 1	ENG	[-4 to 4 / 0 / 0.1 mm/step]
1-002-003	Paper Tray 2	ENG	[-4 to 4 / 0 / 0.1 mm/step]
1-002-004	Paper Tray 3	ENG	[-4 to 4 / 0 / 0.1 mm/step]
1-002-005	Paper Tray 4	ENG	[-4 to 4 / 0 / 0.1 mm/step]
1-002-006	Duplex	*ENG	[-4 to 4 / 0 / 0.1 mm/step]
1-002-007	Large Capacity Tray	*ENG	[-4 to 4 / 0 / 0.1 mm/step]

1003	[Paper Buckle]		
1-003-001	Paper Tray 1: Thin	*ENG	[-4 to 5 / 0 / 0.1 mm/step]
1-003-002	Paper Tray 1: Plain	*ENG	[-4 to 5 / 0 / 0.1 mm/step]
1-003-003	Paper Tray 1: Mid-thick	*ENG	[-4 to 5 / 0 / 0.1 mm/step]
1-003-004	Paper Tray 1: Thick 1	*ENG	[-4 to 5 / -3.5 / 0.1 mm/step]
1-003-005	Tray 2/3/4/5/LCT: Thin	*ENG	[-4 to 5 / 0 / 0.1 mm/step]
1-003-006	Tray 2/3/4/5/LCT: Plain	*ENG	[-4 to 5 / 0 / 0.1 mm/step]
1-003-007	Tray 2/3/4/5/LCT: Mid-thick	*ENG	[-4 to 5 / 0 / 0.1 mm/step]

1-003-008	Tray2/3/4/5/LCT: Thick 1	*ENG	[-4 to 5 / -3.5 / 0.1mm/step]
1-003-009	By-pass: Thin	*ENG	[-4 to 5 / 0 / 0.1mm/step]
1-003-010	By-pass: Plain	*ENG	[-4 to 5 / 0 / 0.1mm/step]
1-003-011	By-pass: Mid-thick	*ENG	[-4 to 5 / 0 / 0.1mm/step]
1-003-012	By-pass:Thick1	*ENG	[-4 to 5 / -3 / 0.1mm/step]
1-003-013	Duplex:Thin	*ENG	[-4 to 5 / -1.5 / 0.1mm/step]
1-003-014	Duplex:Plain	*ENG	[-4 to 5 / -1.5 / 0.1mm/step]
1-003-015	Duplex: Mid-thick	*ENG	[-4 to 5 / -1.5 / 0.1mm/step]
1-003-016	Duplex:Thick1	*ENG	[-4 to 5 / -3.5 / 0.1mm/step]
1-003-017	Paper Tray 1: Thin:1200	*ENG	[-4 to 5 / 0 / 0.1mm/step]
1-003-018	Paper Tray 1: Plain:1200	*ENG	[-4 to 5 / 0 / 0.1mm/step]
1-003-019	Paper Tray 1: Mid-thick:1200	*ENG	[-4 to 5 / 0 / 0.1mm/step]
1-003-020	Paper Tray 1: Thick1:1200	*ENG	[-4 to 5 / -3.5 / 0.1mm/step]
1-003-021	Tray2/3/4/5/LCT: Thin:1200	*ENG	[-4 to 5 / 0 / 0.1mm/step]
1-003-022	Tray2/3/4/5/LCT: Plain: 1200	*ENG	[-4 to 5 / 0 / 0.1mm/step]
1-003-023	Tray2/3/4/5/LCT: Mid:1200	*ENG	[-4 to 5 / 0 / 0.1mm/step]
1-003-024	Tray2/3/4/5/LCT: Thick 1:1200	*ENG	[-4 to 5 / -3.5 / 0.1mm/step]
1-003-025	By-pass: Thin:1200	*ENG	[-4 to 5 / 0 / 0.1mm/step]
1-003-026	By-pass: Plain:1200	*ENG	[-4 to 5 / 0 / 0.1mm/step]
1-003-027	By-pass: Mid-thick:1200	*ENG	[-4 to 5 / 0 / 0.1mm/step]
1-003-028	By-pass:Thick1:1200	*ENG	[-4 to 5 / -3 / 0.1mm/step]
1-003-029	Duplex:Thin:1200	*ENG	[-4 to 5 / -1.5 / 0.1mm/step]
1-003-030	Duplex:Plain:1200	*ENG	[-4 to 5 / -1.5 / 0.1mm/step]
1-003-031	Duplex: Mid-thick:1200	*ENG	[-4 to 5 / -1.5 / 0.1mm/step]

1-003-032	Duplex:Thick1:1200	*ENG	[-4 to 5 / -3.5 / 0.1mm/step]
-----------	--------------------	------	-------------------------------

1007	[By-Pass Size Detection]		
1-007-001	Switch LT SEF/LG SEF	*ENG	[0 or 1 / 0 / 1/step] 0:OFF 1:ON
1-007-002	By-Pass Jam Detection Set	*ENG	[0 or 1 / 0 / 1/step] 0: Normal Detection 1: Simple Detection

1009	[Initial Operation Setting]		
1-009-001	Registration Gear Backlash Cut	*ENG	[0 to 1 / 0 / 1/step]
1009	[Operation Setting]		
1-009-002	Paper Exit Speed	*ENG	[0 to 1 / 1 / 1/step]
1009	[Pickup SOL Separate Setting]		
1-009-003	Paper Tray1: Thin	*ENG	[0 to 1 / 1 / 1/step]
1-009-004	Paper Tray1: Plain	*ENG	[0 to 1 / 1 / 1/step]
1-009-005	Paper Tray1: Thick	*ENG	[0 to 1 / 1 / 1/step]
1-009-006	Paper Tray2: Thin	*ENG	[0 to 1 / 1 / 1/step]
1-009-007	Paper Tray2: Plain	*ENG	[0 to 1 / 1 / 1/step]
1-009-008	Paper Tray2: Thick	*ENG	[0 to 1 / 1 / 1/step]
1-009-009	Paper Tray3: Thin	*ENG	[0 to 1 / 1 / 1/step]
1-009-010	Paper Tray3: Plain	*ENG	[0 to 1 / 1 / 1/step]
1-009-011	Paper Tray3: Thick	*ENG	[0 to 1 / 1 / 1/step]
1-009-012	Paper Tray4: Thin	*ENG	[0 to 1 / 1 / 1/step]
1-009-013	Paper Tray4: Plain	*ENG	[0 to 1 / 1 / 1/step]
1-009-014	Paper Tray4: Thick	*ENG	[0 to 1 / 1 / 1/step]

1-009-015	Paper LCT: Thin	*ENG	[0 to 1 / 1 / 1/step]
1-009-016	Paper LCT: Plain	*ENG	[0 to 1 / 1 / 1/step]
1-009-017	Paper LCT: Thick	*ENG	[0 to 1 / 1 / 1/step]

1101	[Operation Setting]		
1-009-018	Pre-rotation Start Temp.	*ENG	[0 to 3 / 1 / 1/step]

SP1-XXX (Fusing)

1101	[Reload Permit Setting]		
1-101-001	Pre-rotation Start Temp.	*ENG	[0 to 200 / 0 / 1deg/step]
1-101-002	Reload Target Temp.:Center	*ENG	[0 to 190 / 114 / 1deg/step]
1-101-003	Reload Target Temp.:Press	*ENG	[0 to 200 / 120 / 1deg/step]
1-101-004	Temp.:Delta:Cold:Center	*ENG	[4 to 200 / * / 1deg/step] *NA: 27, EU: 31, Asia: 31, CHN: 31, TWN: 27, KOR: 31
1-101-005	Temp.:Delta:Cold:End	*ENG	[4 to 200 / * / 1deg/step] *NA: 27, EU: 31, Asia: 31, CHN: 31, TWN 27, KOR: 31
1-101-006	Temp.:Delta:Cold:Press	*ENG	[4 to 200 / 110 / 1deg/step]
1-101-007	Forced Reload Time:Cold	*ENG	[0 to 100 / 15 / 0.1sec/step]
1-101-008	Temp.:Delta:Low Power:Center	*ENG	[4 to 200 / 6 / 1deg/step]
1-101-009	Temp.:Delta:Low Power:End	*ENG	[4 to 200 / 6 / 1deg/step]
1-101-010	Temp.:Delta:Low Power:Press	*ENG	[4 to 200 / 110 / 1deg/step]
1-101-011	Forced Reload Time:Low Power	*ENG	[0 to 100 / 15 / 0.1sec/step]
1-101-012	Temp.:Delta:Hot:Center	*ENG	[4 to 200 / 6 / 1deg/step]
1-101-013	Temp.:Delta:Hot:End	*ENG	[4 to 200 / 6 / 1deg/step]
1-101-014	Temp.:Delta:Hot:Press	*ENG	[4 to 200 / 110 / 1deg/step]

1-101-015	Forced Reload Time:Hot	*ENG	[0 to 100 / 15 / 0.1sec/step]
1-101-016	Temp.:Delta:Cold:BW1/2:Center	*ENG	[4 to 200 / * / 1deg/step] *NA: 42, EU: 46, Asia: 46, CHN: 46, TWN: 42, KOR: 46
1-101-017	Temp.:Delta:Cold:BW1/2:End	*ENG	[4 to 200 / * / 1deg/step] *NA: 42, EU: 46, Asia: 46, CHN: 46, TWN: 42, KOR: 46
1-101-018	Temp.:Delta:Cold:BW1/2:Press	*ENG	[4 to 200 / 110 / 1deg/step]
1-101-019	Forced Reload Time:Cold:BW1/2	*ENG	[0 to 100 / 15 / 0.1sec/step]
1-101-101	Reload Target Temp.:Center:Energy Saving	*ENG	[0 to 200 / * / 1deg/step] *NA: 116, EU: 114, Asia: 114, CHN: 114, TWN: 116, KOR: 114
1-101-102	Reload Target Temp.:Press:Energy Saving	*ENG	[0 to 200 / 120 / 1deg/step]
1-101-103	Temp.:Delta:Cold:Energy Saving:Center	*ENG	[0 to 200 / * / 1deg/step] *NA: 34, EU: 42, Asia: 42, CHN: 42, TWN: 34, KOR: 42
1-101-104	Temp.:Delta:Cold:Energy Saving:End	*ENG	[0 to 200 / * / 1deg/step] *NA: 34, EU: 42, Asia: 42, CHN: 42, TWN: 34, KOR: 42
1-101-105	Temp.:Delta:Cold:Energy Saving:Press	*ENG	[4 to 200 / 100 / 1deg/step]
1-101-106	Forced Reload Time:Cold:Energy Saving	*ENG	[0 to 100 / 30 / 0.1sec/step]
1-101-151	Temp.:Delta:Low Temp.:Center	*ENG	[4 to 200 / 6 / 1deg/step]
1-101-152	Temp.:Delta:Low Temp.:End	*ENG	[4 to 200 / 6 / 1deg/step]
1-101-153	Temp.:Delta:Low Temp.:Press	*ENG	[4 to 200 / 70 / 1deg/step]
1-101-154	Forced Reload Time:Low Temp.	*ENG	[0 to 100 / 35 / 0.1sec/step]

1-101-201	Temp.:Delta:Cold:Center:FIN-less/ADF-less	*ENG	[4 to 200 / * / 1deg/step] *NA: 30, EU: 34, Asia: 34, CHN: 34, TWN: 30, KOR: 34
1-101-202	Temp.:Delta:Cold:End:FIN-less/ADF-less	*ENG	[4 to 200 / * / 1deg/step] *NA: 30, EU: 34, Asia: 34, CHN: 34, TWN: 30, KOR: 34
1-101-203	Temp.:Delta:Cold:Press:FIN-less/ADF-less	*ENG	[4 to 200 / 110 / 1deg/step]
1-101-204	Forced Reload Time:Cold:FIN-less/ADF-less	*ENG	[0 to 100 / 15 / 0.1sec/step]
1-101-211	Temp:Delta:Cold:Center:FIN-less/ADF-attached	*ENG	[4 to 200 / * / 1deg/step] *NA: 30, EU: 34, Asia: 34, CHN: 34, TWN: 30, KOR: 34
1-101-212	Temp.:Delta:Cold:End:FIN-less/ADF-attached	*ENG	[4 to 200 / * / 1deg/step] *NA: 30, EU: 34, Asia: 34, CHN: 34, TWN: 30, KOR: 34
1-101-213	Temp.:Delta:Cold:Press:FIN-less/ADF-attached	*ENG	[4 to 200 / 110 / 1deg/step]
1-101-214	ForcedReloadTime:Cold:FIN-less/ADF-attached	*ENG	[0 to 100 / 15 / 0.1sec/step]

1102	[Feed Permit Setting]		
1-102-001	Temp.:Lower Delta:Center	*ENG	[0 to 200 / * / 1deg/step] *NA: 33, EU: 38, Asia: 38, CHN: 38, TWN: 33, KOR: 38
1-102-002	Temp.:Lower Delta:End	*ENG	[0 to 200 / * / 1deg/step] *NA: 33, EU: 38, Asia: 38, CHN: 38, TWN: 33, KOR: 38
1-102-003	Temp.:Upper Delta:Center	*ENG	[0 to 200 / 40 / 1deg/step]
1-102-004	Temp.:Upper Delta:End	*ENG	[0 to 200 / 40 / 1deg/step]
1-102-005	Temp.:Lower Delta:Press	*ENG	[0 to 200 / 90 / 1deg/step]

1-102-006	Rotation Time	*ENG	[0 to 100 / 0.65 / 0.01 sec/step]
1-102-007	Temp.:Lower Delta:Center:Sp.1	*ENG	[0 to 200 / 5 / 1 deg/step]
1-102-008	Temp.:Lower Delta:End:Sp.1	*ENG	[0 to 200 / 5 / 1 deg/step]
1-102-009	Temp.:Upper Delta:Center:Sp.1	*ENG	[0 to 200 / 30 / 1 deg/step]
1-102-010	Temp.:Upper Delta:End:Sp.1	*ENG	[0 to 200 / 30 / 1 deg/step]
1-102-011	Temp.:Lower Delta:Press:Sp.1	*ENG	[0 to 200 / 45 / 1 deg/step]
1-102-012	Rotation Time:Sp.1	*ENG	[0 to 200 / 0.65 / 0.01 sec/step]
1-102-013	Temp.:Lower Delta:Center:Sp.2	*ENG	[0 to 100 / 0 / 0.01 sec/step]
1-102-014	Temp.:Lower Delta:End:Sp.2	*ENG	[0 to 200 / 5 / 1 deg/step]
1-102-015	Temp.:Upper Delta:Center:Sp.2	*ENG	[0 to 200 / 15 / 1 deg/step]
1-102-016	Temp.:Upper Delta:End:Sp.2	*ENG	[0 to 200 / 15 / 1 deg/step]
1-102-017	Temp.:Lower Delta:Press:Sp.2	*ENG	[0 to 200 / 100 / 1 deg/step]
1-102-018	Rotation Time:Sp2	*ENG	[0 to 100 / 0.65 / 0.01 sec/step]
1-102-019	Feed Permit Time	*ENG	[0 to 200 / 60 / 1 sec/step]
1-102-020	Temp.:Lower Delta:Center	*ENG	[0 to 200 / 40 / 1 deg/step]
1-102-021	Temp.:Lower Delta:End	*ENG	[0 to 200 / 40 / 1 deg/step]
1-102-022	Temp.:Upper Delta:Center	*ENG	[0 to 200 / 30 / 1 deg/step]
1-102-023	Temp.:Upper Delta:End	*ENG	[0 to 200 / 30 / 1 deg/step]
1-102-024	Temp.:Lower Delta:Press	*ENG	[0 to 200 / 38 / 1 deg/step]
1-102-025	Temp.:Lower Delta:Press	*ENG	[0 to 200 / 53 / 1 deg/step]
1-102-026	Rotation Time	*ENG	[0 to 100 / 0.65 / 0.01 sec/step]
1-102-027	Temp.:Lower Delta:Center	*ENG	[0 to 200 / 5 / 1 deg/step]
1-102-028	Temp.:Lower Delta:End	*ENG	[0 to 200 / 5 / 1 deg/step]
1-102-029	Temp.:Upper Delta:Center	*ENG	[0 to 200 / 30 / 1 deg/step]
1-102-030	Temp.:Upper Delta:End	*ENG	[0 to 200 / 30 / 1 deg/step]
1-102-031	Temp.:Lower Delta:Press	*ENG	[0 to 200 / 34 / 1 deg/step]

1-102-032	Temp.:Lower Delta:Press	*ENG	[0 to 200 / 49 / 1deg/step]
1-102-033	Rotation Time	*ENG	[0 to 100 / 0.65 / 0.01 sec/step]
1-102-034	Temp.:Lower Delta:Center	*ENG	[0 to 200 / 5 / 1deg/step]
1-102-035	Temp.:Lower Delta:End	*ENG	[0 to 200 / 5 / 1deg/step]
1-102-036	Temp.:Upper Delta:Center	*ENG	[0 to 200 / 15 / 1deg/step]
1-102-037	Temp.:Upper Delta:End	*ENG	[0 to 200 / 15 / 1deg/step]
1-102-038	Temp.:Lower Delta:Press	*ENG	[0 to 200 / 100 / 1deg/step]
1-102-039	Temp.:Lower Delta:Press	*ENG	[0 to 200 / 100 / 1deg/step]
1-102-040	Rotation Time	*ENG	[0 to 100 / 0.65 / 0.01 sec/step]
1-102-041	Judgment Power A	*ENG	[0 to 2000 / * / 1W/step] *NA: 1304, EU: 1429, Asia: 1429, CHN: 1429, TWN: 1304, KOR: 1429
1-102-042	Temp.:Lower Delta:Center:Power A	*ENG	[0 to 200 / 49 / 1deg/step]
1-102-043	Temp.:Lower Delta::Power A	*ENG	[0 to 200 / 49 / 1deg/step]
1-102-044	Temp.:Upper Delta:Center:Power A	*ENG	[0 to 200 / 40 / 1deg/step]
1-102-045	Temp.:Upper Delta:End:Power A	*ENG	[0 to 200 / 40 / 1deg/step]
1-102-046	Temp.:Lower Delta:Press:Power A	*ENG	[0 to 200 / 90 / 1deg/step]
1-102-047	Rotation Time:Power A	*ENG	[0 to 100 / 0.65 / 0.01 sec/step]
1-102-051	Judgment Power B	*ENG	[0 to 2000 / * / 1W/step] *NA: 1284, EU: 1409, Asia: 1409, CHN: 1409, TWN: 1284, KOR: 1409
1-102-052	Temp.:Lower Delta:Center:Power B	*ENG	[0 to 200 / 49 / 1deg/step]
1-102-053	Temp.:Lower Delta:End:Power B	*ENG	[0 to 200 / 49 / 1deg/step]

1-102-054	Temp.:Upper Delta:Center:Power B	*ENG	[0 to 200 / 40 / 1deg/step]
1-102-055	Temp.:Upper Delta:End:Power B	*ENG	[0 to 200 / 40 / 1deg/step]
1-102-056	Temp.:Lower Delta:Press:Power B	*ENG	[0 to 200 / 90 / 1deg/step]
1-102-057	Rotation Time:Power B	*ENG	[0 to 100 / 0.65 / 0.01 sec/step]
1-102-060	Waiting Time: Stabilize Temp.	*ENG	[0 to 10000 / 0 / 1msec/step]
1-102-070	Timeout: Cold: Normal	*ENG	[0 to 20000 / 4000 / 1msec/step]
1-102-071	Timeout: Hot: Normal	*ENG	[0 to 20000 / 4000 / 1msec/step]
1-102-072	Timeout: Cold: Power 1	*ENG	[0 to 20000 / 4000 / 1msec/step]
1-102-073	Timeout: Hot: Power 1	*ENG	[0 to 20000 / 4000 / 1msec/step]
1-102-074	Timeout: Cold: Power 2	*ENG	[0 to 20000 / 4000 / 1msec/step]
1-102-075	Timeout: Hot: Power 2	*ENG	[0 to 20000 / 4000 / 1msec/step]
1-102-076	Timeout: 10sec: 11	*ENG	[0 to 20000 / 4000 / 1msec/step]
1-102-077	Timeout: 10sec: 15	*ENG	[0 to 20000 / 4000 / 1msec/step]
1-102-078	Timeout: 10sec: 16	*ENG	[0 to 20000 / 4000 / 1msec/step]
1-102-101	Temp.:Lower Delta:Press0	*ENG	[0 to 200 / 0 / 1deg/step]
1-102-102	Temp.:Lower Delta:Press10	*ENG	[0 to 200 / 0 / 1deg/step]
1-102-103	Temp.:Lower Delta:Press1	*ENG	[0 to 200 / 0 / 1deg/step]
1-102-104	Temp.:Lower Delta:Press2	*ENG	[0 to 200 / 0 / 1deg/step]
1-102-105	Temp.:Lower Delta:Press3	*ENG	[0 to 200 / 0 / 1deg/step]
1-102-106	Temp.:Lower Delta:Press13	*ENG	[0 to 200 / 0 / 1deg/step]
1-102-107	Temp.:Lower Delta:Press4	*ENG	[0 to 200 / 0 / 1deg/step]
1-102-108	Temp.:Lower Delta:Press14	*ENG	[0 to 200 / 0 / 1deg/step]
1-102-109	Temp.:Lower Delta:Press5	*ENG	[0 to 200 / 17 / 1deg/step]
1-102-110	Temp.:Lower Delta:Press6	*ENG	[0 to 200 / 17 / 1deg/step]

1-102-111	Temp.:Lower Delta:Press7	*ENG	[0 to 200 / 13 / 1deg/step]
1-102-112	Temp.:Lower Delta:Press11	*ENG	[0 to 200 / 0 / 1deg/step]
1-102-113	Temp.:Lower Delta:Press15	*ENG	[0 to 200 / 0 / 1deg/step]
1-102-114	Temp.:Lower Delta:Press16	*ENG	[0 to 200 / 0 / 1deg/step]
1-102-121	Timeout:Press0	*ENG	[0 to 200 / 0 / 1deg/step]
1-102-122	Timeout:Press10	*ENG	[0 to 200 / 0 / 1deg/step]
1-102-123	Timeout:Press1	*ENG	[0 to 200 / 0 / 1deg/step]
1-102-124	Timeout:Press2	*ENG	[0 to 200 / 0 / 1deg/step]
1-102-125	Timeout:Press3	*ENG	[0 to 200 / 0 / 1deg/step]
1-102-126	Timeout:Press13	*ENG	[0 to 200 / 0 / 1deg/step]
1-102-127	Timeout:Press4	*ENG	[0 to 200 / 0 / 1deg/step]
1-102-128	Timeout:Press14	*ENG	[0 to 200 / 0 / 1deg/step]
1-102-129	Timeout:Press5	*ENG	[0 to 60000 / 5000 / 1msec/step]
1-102-130	Timeout:Press6	*ENG	[0 to 60000 / 5000 / 1msec/step]
1-102-131	Timeout:Press7	*ENG	[0 to 60000 / 3000 / 1msec/step]
1-102-132	Timeout: Press: 11	*ENG	[0 to 60000 / 0 / 1msec/step]
1-102-133	Timeout: Press: 15	*ENG	[0 to 60000 / 0 / 1msec/step]
1-102-134	Timeout: Press: 16	*ENG	[0 to 60000 / 0 / 1msec/step]

1105	[Print Target Temp.]		
1-105-001	Plain1:FC:Center	*ENG	[100 to 180 / * / 1deg/step] *MP C2004: 126 *MP C2504: 123
1-105-002	Plain1:FC:Press	*ENG	[0 to 200 / 122 / 1deg/step]
1-105-003	Plain1:BW:Center	*ENG	[100 to 180 / * / 1deg/step] *MP C2004: 123 *MP C2504: 120

1-105-004	Plain1:BW:Press	*ENG	[0 to 200 / 122 / 1deg/step]
1-105-005	Plain2:FC:Center	*ENG	[100 to 180 / * / 1deg/step] *MP C2004: 128 *MP C2504: 122
1-105-006	Plain2:FC:Press	*ENG	[0 to 200 / 122 / 1deg/step]
1-105-007	Plain2:BW:Center	*ENG	[100 to 180 / * / 1deg/step] *MP C2004: 128 *MP C2504: 122
1-105-008	Plain2:BW:Press	*ENG	[0 to 200 / 122 / 1deg/step]
1-105-009	Thin:FC:Center	*ENG	[100 to 180 / * / 1deg/step] *MP C2004: 121 *MP C2504: 118
1-105-010	Thin:FC:Press	*ENG	[0 to 200 / 121 / 1deg/step]
1-105-011	Thin:BW:Center	*ENG	[100 to 180 / * / 1deg/step] *MP C2004: 121 *MP C2504: 118
1-105-012	Thin:BW:Press	*ENG	[0 to 200 / 121 / 1deg/step]
1-105-013	M-thick:FC:Center	*ENG	[100 to 180 / 136 / 1deg/step]
1-105-014	M-thick:FC:Press	*ENG	[0 to 200 / 118 / 1deg/step]
1-105-015	M-thick:BW:Center	*ENG	[100 to 180 / 136 / 1deg/step]
1-105-016	M-thick:BW:Press	*ENG	[0 to 200 / 118 / 1deg/step]
1-105-017	Thick1:FC:Center	*ENG	[100 to 180 / 127 / 1deg/step]
1-105-018	Thick1:FC:Press	*ENG	[0 to 200 / 120 / 1deg/step]
1-105-019	Thick1:BW:Center	*ENG	[100 to 180 / 127 / 1deg/step]
1-105-020	Thick1:BW:Press	*ENG	[0 to 200 / 120 / 1deg/step]
1-105-021	Thick2:FC:Center	*ENG	[100 to 180 / 132 / 1deg/step]
1-105-022	Thick2:FC:Press	*ENG	[0 to 200 / 120 / 1deg/step]

1-105-023	Thick2:BW:Center	*ENG	[100 to 180 / 132 / 1deg/step]
1-105-024	Thick2:BW:Press	*ENG	[0 to 200 / 120 / 1deg/step]
1-105-025	Thick3:FC:Center	*ENG	[100 to 180 / 137 / 1deg/step]
1-105-026	Thick3:FC:Press	*ENG	[0 to 200 / 120 / 1deg/step]
1-105-027	Thick3:BW:Center	*ENG	[100 to 180 / 137 / 1deg/step]
1-105-028	Thick3:BW:Press	*ENG	[0 to 200 / 120 / 1deg/step]
1-105-029	Special1:FC:Center	*ENG	[100 to 180 / * / 1deg/step] *MP C2004: 126 *MP C2504: 123
1-105-030	Special1:FC:Press	*ENG	[0 to 200 / 117 / 1deg/step]
1-105-031	Special1:BW:Center	*ENG	[100 to 180 / * / 1deg/step] *MP C2004: 123 *MP C2504: 120
1-105-032	Special1:BW:Press	*ENG	[0 to 200 / 117 / 1deg/step]
1-105-033	Special2:FC:Center	*ENG	[100 to 180 / * / 1deg/step] *MP C2004: 131 *MP C2504: 128
1-105-034	Special2:FC:Press	*ENG	[0 to 200 / 122 / 1deg/step]
1-105-035	Special2:BW:Center	*ENG	[100 to 180 / * / 1deg/step] *MP C2004: 128 *MP C2504: 125
1-105-036	Special2:BW:Press	*ENG	[0 to 200 / 122 / 1deg/step]
1-105-037	Special3:FC:Center	*ENG	[100 to 180 / 136 / 1deg/step]
1-105-038	Special3:FC:Press	*ENG	[0 to 200 / 118 / 1deg/step]
1-105-039	Special3:BW:Center	*ENG	[100 to 180 / 136 / 1deg/step]
1-105-040	Special3:BW:Press	*ENG	[0 to 200 / 118 / 1deg/step]
1-105-041	Envelop:Center	*ENG	[100 to 180 / 142 / 1deg/step]

1-105-042	Envelop:Press	*ENG	[0 to 200 / 118 / 1deg/step]
1-105-051	Special1:FC:Center:Middle Speed	*ENG	[100 to 180 / 122 / 1deg/step]
1-105-052	Special1:FC:Press:Middle Speed	*ENG	[0 to 200 / 120 / 1deg/step]
1-105-053	Special1:BW:Center:Middle Speed	*ENG	[100 to 180 / 122 / 1deg/step]
1-105-054	Special1:BW:Press:Middle Speed	*ENG	[0 to 200 / 120 / 1deg/step]
1-105-055	Special2:FC:Center:Middle Speed	*ENG	[100 to 180 / 127 / 1deg/step]
1-105-056	Special2:FC:Press:Middle Speed	*ENG	[0 to 200 / 120 / 1deg/step]
1-105-057	Special2:BW:Center:Middle Speed	*ENG	[100 to 180 / 127 / 1deg/step]
1-105-058	Special2:BW:Press:Middle Speed	*ENG	[0 to 200 / 120 / 1deg/step]
1-105-059	Special3:FC:Center:Middle Speed	*ENG	[100 to 180 / 132 / 1deg/step]
1-105-060	Special3:FC:Press:Middle Speed	*ENG	[0 to 200 / 120 / 1deg/step]
1-105-061	Special3:BW:Center:Middle Speed	*ENG	[100 to 180 / 132 / 1deg/step]
1-105-062	Special3:BW:Press:Middle Speed	*ENG	[0 to 200 / 120 / 1deg/step]
1-105-101	Plain1:FC:Center:Low Speed	*ENG	[100 to 180 / 115 / 1deg/step]
1-105-102	Plain1:FC:Press:Low Speed	*ENG	[0 to 200 / 118 / 1deg/step]
1-105-103	Plain1:BW:Center:Low Speed	*ENG	[100 to 180 / 115 / 1deg/step]
1-105-104	Plain1:BW:Press:Low Speed	*ENG	[0 to 200 / 118 / 1deg/step]
1-105-105	Plain2:FC:Center:Low Speed	*ENG	[100 to 180 / 120 / 1deg/step]

1-105-106	Plain2:FC:Press:Low Speed	*ENG	[0 to 200 / 118 / 1deg/step]
1-105-107	Plain2:BW:Center:Low Speed	*ENG	[100 to 180 / 120 / 1deg/step]
1-105-108	Plain2:BW:Press:Low Speed	*ENG	[0 to 200 / 118 / 1deg/step]
1-105-109	M-thick:FC:Center:Low Speed	*ENG	[100 to 180 / 122 / 1deg/step]
1-105-110	M-thick:FC:Press:Low Speed	*ENG	[0 to 200 / 118 / 1deg/step]
1-105-111	M-thick:BW:Center:Low Speed	*ENG	[100 to 180 / 122 / 1deg/step]
1-105-112	M-thick:BW:Press:Low Speed	*ENG	[0 to 200 / 118 / 1deg/step]
1-105-113	Thick1:FC:Center:Low Speed	*ENG	[100 to 180 / 127 / 1deg/step]
1-105-114	Thick1:FC:Press:Low Speed	*ENG	[0 to 200 / 118 / 1deg/step]
1-105-115	Thick1:BW:Center:Low Speed	*ENG	[100 to 180 / 127 / 1deg/step]
1-105-116	Thick1:BW:Press:Low Speed	*ENG	[0 to 200 / 118 / 1deg/step]
1-105-117	Special1:FC:Center:Low Speed	*ENG	[100 to 180 / 122 / 1deg/step]
1-105-118	Special1:FC:Press:Low Speed	*ENG	[0 to 200 / 118 / 1deg/step]
1-105-119	Special1:BW:Center:Low Speed	*ENG	[100 to 180 / 122 / 1deg/step]
1-105-120	Special1:BW:Press:Low Speed	*ENG	[0 to 200 / 118 / 1deg/step]
1-105-121	Special2:FC:Center:Low Speed	*ENG	[100 to 180 / 132 / 1deg/step]
1-105-122	Special2:FC:Press:Low Speed	*ENG	[0 to 200 / 120 / 1deg/step]
1-105-123	Special2:BW:Center:Low Speed	*ENG	[100 to 180 / 132 / 1deg/step]
1-105-124	Special2:BW:Press:Low Speed	*ENG	[0 to 200 / 120 / 1deg/step]
1-105-125	Plain1:Glossy:Center	*ENG	[100 to 180 / 132 / 1deg/step]
1-105-126	Plain1:Glossy:Press	*ENG	[0 to 200 / 118 / 1deg/step]
1-105-127	Plain2:Glossy:Center	*ENG	[100 to 180 / 137 / 1deg/step]
1-105-128	Plain2:Glossy:Press	*ENG	[0 to 200 / 118 / 1deg/step]
1-105-129	M-thick:Glossy:Center	*ENG	[100 to 180 / 142 / 1deg/step]

1-105-130	M-thick:Glossy:Press	*ENG	[0 to 200 / 118 / 1deg/step]
1-105-131	OHP:Center	*ENG	[100 to 180 / 160 / 1deg/step]
1-105-132	OHP:Press	*ENG	[0 to 200 / 118 / 1deg/step]
1-105-133	Envelop:Center:Low Speed	*ENG	[100 to 180 / 135 / 1deg/step]
1-105-134	Envelop:Press:Low Speed	*ENG	[0 to 200 / 118 / 1deg/step]
1-105-135	Thin:FC:Center:Low Speed	*ENG	[100 to 180 / 110 / 1deg/step]
1-105-136	Thin:FC:Press:Low Speed	*ENG	[0 to 200 / 118 / 1deg/step]
1-105-137	Thin:BW:Center:Low Speed	*ENG	[100 to 180 / 110 / 1deg/step]
1-105-138	Thin:BW:Press:Low Speed	*ENG	[0 to 200 / 118 / 1deg/step]
1-105-139	Thick4:FC:Center	*ENG	[100 to 180 / 142 / 1deg/step]
1-105-140	Thick4:FC:Press	*ENG	[0 to 200 / 118 / 1deg/step]
1-105-141	Thick4:BW:Center	*ENG	[100 to 180 / 142 / 1deg/step]
1-105-142	Thick4:BW:Press	*ENG	[0 to 200 / 118 / 1deg/step]
1-105-143	Postcard:Center	*ENG	[100 to 180 / 124 / 1deg/step]
1-105-144	Postcard:Press	*ENG	[0 to 200 / 118 / 1deg/step]
1-105-145	Special3:FC:Center:Middle Speed	*ENG	[100 to 180 / 142 / 1deg/step]
1-105-146	Special3:FC:Press:Middle Speed	*ENG	[0 to 200 / 118 / 1deg/step]
1-105-147	Special3:BW:Center:Middle Speed	*ENG	[100 to 180 / 142 / 1deg/step]
1-105-148	Special3:BW:Press:Middle Speed	*ENG	[0 to 200 / 118 / 1deg/step]
1-105-149	Mid Thick:Matte:Center	*ENG	[100 to 180 / 136 / 1deg/step]
1-105-150	Mid Thick:Matte:Press	*ENG	[0 to 200 / 118 / 1deg/step]
1-105-151	Thick1:Matte:Center	*ENG	[100 to 180 / 127 / 1deg/step]
1-105-152	Thick1:Matte:Press	*ENG	[0 to 200 / 120 / 1deg/step]

1-105-153	Thick2:Matte:Center	*ENG	[100 to 180 / 132 / 1deg/step]
1-105-154	Thick2:Matte:Press	*ENG	[0 to 200 / 120 / 1deg/step]
1-105-155	Thick3:Matte:Center	*ENG	[100 to 180 / 137 / 1deg/step]
1-105-156	Thick3:Matte:Press	*ENG	[0 to 200 / 120 / 1deg/step]
1-105-157	Thick4:Matte:Center	*ENG	[100 to 180 / 142 / 1deg/step]
1-105-158	Thick4:Matte:Press	*ENG	[0 to 200 / 118 / 1deg/step]
1-105-159	Mid Thick:Matte:Center:Low Speed	*ENG	[100 to 180 / 122 / 1deg/step]
1-105-160	Mid Thick:Matte:Press:Low Speed	*ENG	[0 to 200 / 118 / 1deg/step]
1-105-161	Thick1:Matte:Center:Low Speed	*ENG	[100 to 180 / 127 / 1deg/step]
1-105-162	Thick1:Matte:Press:Low Speed	*ENG	[0 to 200 / 118 / 1deg/step]
1-105-163	Mid Thick:Glossy:Center	*ENG	[100 to 180 / 136 / 1deg/step]
1-105-164	Mid Thick:Glossy:Press	*ENG	[0 to 200 / 118 / 1deg/step]
1-105-165	Thick1:Glossy:Center	*ENG	[100 to 180 / 127 / 1deg/step]
1-105-166	Thick1:Glossy:Press	*ENG	[0 to 200 / 120 / 1deg/step]
1-105-167	Thick2:Glossy:Center	*ENG	[100 to 180 / 132 / 1deg/step]
1-105-168	Thick2:Glossy:Press	*ENG	[0 to 200 / 120 / 1deg/step]
1-105-169	Thick3:Glossy:Center	*ENG	[100 to 180 / 137 / 1deg/step]
1-105-170	Thick3:Glossy:Press	*ENG	[0 to 200 / 120 / 1deg/step]
1-105-171	Thick4:Glossy:Center	*ENG	[100 to 180 / 142 / 1deg/step]
1-105-172	Thick4:Glossy:Press	*ENG	[0 to 200 / 118 / 1deg/step]
1-105-173	Mid Thick:Glossy:Center:Low Speed	*ENG	[100 to 180 / 122 / 1deg/step]
1-105-174	Mid Thick:Glossy:Press:Low Speed	*ENG	[0 to 200 / 118 / 1deg/step]

1-105-175	Thick1:Glossy:Center:Low Speed	*ENG	[100 to 180 / 127 / 1deg/step]
1-105-176	Thick1:Glossy:Press:Low Speed	*ENG	[0 to 200 / 118 / 1deg/step]

1106	[Fusing Temp. Display]		
1-106-001	Heat Center	ENG	[-10 to 250 / 0 / 1deg/step]
1-106-002	Heat End	ENG	[-10 to 250 / 0 / 1deg/step]
1-106-003	Press Center	ENG	[-10 to 250 / 0 / 1deg/step]
1-106-004	Press End	ENG	[-10 to 250 / 0 / 1deg/step]
1-106-005	Press End	ENG	[-10 to 250 / 0 / 1deg/step]

1107	[Standby Target Temp. Setting]		
1-107-001	Stanby/Preheat1:Center	*ENG	[0 to 125 / 90 / 1deg/step]
1-107-003	Preheat2:Center	*ENG	[0 to 200 / 90 / 1deg/step]
1-107-005	Low Power:Center	*ENG	[0 to 125 / 60 / 1deg/step]
1-107-007	Print Ready:Center	*ENG	[85 to 180 / * / 1deg/step] *MP C2004: 121 *MP C2504: 118
1-107-008	Print Ready:Press	*ENG	[0 to 200 / 120 / 1deg/step]
1-107-011	Standby Heater Off Time	*ENG	[0 to 100 / 0 / 1sec/step]

1108	[After Reload/Job Target Temp.]		
1-108-001	Center	*ENG	[85 to 200 / * / 1deg/step] *MP C2004: 121 *MP C2504: 118
1-108-002	Press	*ENG	[0 to 200 / 120 / 1deg/step]
1-108-011	Center:Energy Saving	*ENG	[85 to 200 / * / 1deg/step] *NA: 116, EU: 114, Asia: 114, CHN: 114, TWN: 116, KOR: 114

1-108-012	Press:Energy Saving	*ENG	[0 to 200 / 120 / 1deg/step]
-----------	---------------------	------	-------------------------------------

1111	[Environment Correction:Fusing]		
1-111-001	Temp.: Threshold: Low	*ENG	[0 to 100 / 15 / 1deg/step]
1-111-002	Temp.: Threshold: High	*ENG	[0 to 100 / 30 / 1deg/step]
1-111-003	Low Temp. Correction	*ENG	[0 to 15 / 3 / 1deg/step]
1-111-004	High Temp. Correction	*ENG	[0 to 15 / 0 / 1deg/step]
1-111-005	Job Low Temp. Correction	*ENG	[0 to 10 / 0.6 / 0.1deg/step]
1-111-006	Job High Temp. Correction	*ENG	[0 to 100 / 0 / 0.1deg/step]
1-111-007	Job Low Temp. Correction:Sp.	*ENG	[0 to 10 / 0.7 / 0.1deg/step]
1-111-008	Job High Temp. Correction:Sp.	*ENG	[0 to 100 / 0 / 0.1deg/step]
1-111-011	Standard Environment Temp.	*ENG	[10 to 30 / 23 / 1deg/step]

1112	[Image Processing Temp. Correct]		
1-112-001	Temp.:Plain:Center:Level1/2	*ENG	[-20 to 20 / 0 / 1deg/step]
1-112-002	Temp.:Plain:Center:Energy Saving	*ENG	[-30 to 20 / * / 1deg/step] *MP C2004: *NA: -12, EU: -14, Asia: -14, CHN: -14, TWN: -12, KOR: -14 *MP C2504: *NA: -9, EU: -11, Asia: -11, CHN: -11, TWN: -9, KOR: -11

1113	[Curl Correction]		
1-113-001	Execute Pattern	*ENG	[0 to 2 / 0 / 1/step] 0: OFF 1: ON(No Decurl) 2: ON
1-113-002	Humidity:Threshold:M-humid	*ENG	[0 to 100 / 1 / 1%/step]

1-113-003	Humidity:Threshold:H-humid	*ENG	[0 to 100 / 65 / 1%/step]
1-113-004	Permit Temp.:Delta:Press:M-humid	*ENG	[0 to 200 / 60 / 1deg/step]
1-113-005	Permit Temp.:Delta:Press:H-humid	*ENG	[0 to 200 / 50 / 1deg/step]
1-113-006	Permit Temp.:Delta:Press:M-humid:No Decurl	*ENG	[0 to 200 / 50 / 1deg/step]
1-113-007	Permit Temp.:Delta:Press:H-humid:No Decurl	*ENG	[0 to 200 / 40 / 1deg/step]
1-113-008	CPM:M-humid	*ENG	[0 to 100 / 80 / 1%/step]
1-113-009	CPM:H-humid	*ENG	[0 to 100 / 65 / 1%/step]
1-113-010	CPM:M-humid:No Decurl	*ENG	[0 to 100 / 80 / 1%/step]
1-113-011	CPM:H-humid:No Decurl	*ENG	[0 to 100 / 65 / 1%/step]

1114	[Heat Storage Status]		
1-114-001	Temp.:Threshold:Press	*ENG	[0 to 200 / 80 / 1deg/step]
1-114-002	Temp.Threshold:Atmosphere	*ENG	[0 to 200 / 40 / 1deg/step]
1-114-003	Temp.:Threshold:CPM Down	*ENG	[0 to 200 / 60 / 1deg/step]
1-114-004	Temp.:Threshold:Voltage Detection	*ENG	[0 to 200 / 40 / 1deg/step]

1115	[Target Temp. Correction]		
1-115-001	Temp.:Delta:End	*ENG	[-100 to 100 / 0 / 1deg/step]

1116	[Heat Storage FB Control]		
1-116-001	Execution mode	*ENG	[0 to 2 / 2 / 1/step]
1-116-002	Correction Formula Judge Temp	*ENG	[0 to 200 / 97 / 1deg/step]
1-116-003	Heat Gap Correction Temp	*ENG	[0 to 200 / 0 / 1deg/step]

1-116-011	Time Out	*ENG	[0 to 500 / 10 / 1sec/step]
1-116-012	Time Out:Energy Saving	*ENG	[0 to 500 / 10 / 1sec/step]
1-116-021	Delay:Standard Speed:FC:1	*ENG	[0 to 20000 / 3590 / 1msec/step]
1-116-022	Delay:Standard Speed:BW:1	*ENG	[0 to 20000 / 1320 / 1msec/step]
1-116-023	Delay:Mid. Speed:FC:1	*ENG	[0 to 20000 / 3590 / 1msec/step]
1-116-024	Delay:Mid. Speed:BW:1	*ENG	[0 to 20000 / 1320 / 1msec/step]
1-116-025	Delay:Low Speed:FC:1	*ENG	[0 to 20000 / 7180 / 1msec/step]
1-116-026	Delay:Low Speed:BW:1	*ENG	[0 to 20000 / 2640 / 1msec/step]
1-116-031	Delay:Standard Speed:FC:2	*ENG	[0 to 20000 / 3590 / 1msec/step]
1-116-032	Delay:Standard Speed:BW:2	*ENG	[0 to 20000 / 1320 / 1msec/step]
1-116-033	Delay:Mid. Speed:FC:2	*ENG	[0 to 20000 / 3590 / 1msec/step]
1-116-034	Delay:Mid. Speed:BW:2	*ENG	[0 to 20000 / 1320 / 1msec/step]
1-116-035	Delay:Low Speed:FC:2	*ENG	[0 to 20000 / 7180 / 1msec/step]
1-116-036	Delay:Low Speed:BW:2	*ENG	[0 to 20000 / 2640 / 1msec/step]
1-116-041	Press Reference Temp.	*ENG	[0 to 200 / 86 / 1deg/step]
1-116-042	Temp. Correction Lower Limit	*ENG	[-30 to 0 / 0 / 1deg/step]
1-116-043	Temp. Correction Upper Limit	*ENG	[0 to 30 / 4 / 1deg/step]
1-116-044	Press Reference Temp.:Energy Saving	*ENG	[0 to 200 / 75 / 1deg/step]
1-116-045	Temp. Corr. Lower Limit:Energy Saving	*ENG	[-30 to 0 / -1 / 1deg/step]
1-116-046	Temp. Corr. Upper Limit:Energy Saving	*ENG	[0 to 30 / 0 / 1deg/step]
1-116-051	Paper Thickness Coefficient:Plain 1	*ENG	[-100 to 100 / * / 1/step] *MP C2004: -20 *MP C2504: -30
1-116-052	Paper Thickness Coefficient:Plain2	*ENG	[-100 to 100 / -40 / 1/step]

1-116-053	Paper Thickness Coeff.:Thin	*ENG	[-100 to 100 / * / 1/step] *MP C2004: -20 *MP C2504: -40
1-116-054	Paper Thickness Coeff.:M-thick	*ENG	[-100 to 100 / * / 1/step] *MP C2004: -60 *MP C2504: -50
1-116-073	Paper Thickness Coeff.:Low Speed	*ENG	[-100 to 100 / 0 / 1/step]
1-116-074	Paper Thickness Coeff.:Plain 1/2:Energy Save	*ENG	[-100 to 100 / 30 / 1/step]

1117	[Repeat Temp. Correction] DFU		
1-117-001	Control Time 1:A3	*ENG	[0 to 300 / 0 / 1sec/step]
1-117-002	Control Time 2:A3	*ENG	[0 to 300 / 4 / 1sec/step]
1-117-003	Temp.:Center:1:A3	*ENG	[-30 to 30 / 0 / 1deg/step]
1-117-004	Temp.:End:1:A3	*ENG	[-30 to 30 / 5 / 1deg/step]
1-117-005	Temp.:Center:2:A3	*ENG	[-30 to 30 / 0 / 1deg/step]
1-117-006	Temp.:End:2:A3	*ENG	[-30 to 30 / 0 / 1deg/step]
1-117-011	Control Time 1:DLT	*ENG	[0 to 300 / 0 / 1sec/step]
1-117-012	Control Time 2:DLT	*ENG	[0 to 300 / 0 / 1sec/step]
1-117-013	Temp.:Center:1:DLT	*ENG	[-30 to 30 / 0 / 1deg/step]
1-117-014	Temp.:End:1:DLT	*ENG	[-30 to 30 / 0 / 1deg/step]
1-117-015	Temp.:Center:2:DLT	*ENG	[-30 to 30 / 0 / 1deg/step]
1-117-016	Temp.:End:2:DLT	*ENG	[-30 to 30 / 0 / 1deg/step]
1-117-021	Control Time 1:B4	*ENG	[0 to 300 / 0 / 1sec/step]
1-117-022	Control Time 2:B4	*ENG	[0 to 300 / 10 / 1sec/step]
1-117-023	Temp.:Center:1:B4	*ENG	[-30 to 30 / 0 / 1deg/step]
1-117-024	Temp.:End:1:B4	*ENG	[-30 to 30 / 25 / 1deg/step]

1-117-025	Temp.:Center:2:B4	*ENG	[-30 to 30 / 0 / 1deg/step]
1-117-026	Temp.:End:2:B4	*ENG	[-30 to 30 / 25 / 1deg/step]
1-117-031	Control Time 1:LT	*ENG	[0 to 300 / 0 / 1sec/step]
1-117-032	Control Time 2:LT	*ENG	[0 to 300 / 0 / 1sec/step]
1-117-033	Temp.:Center:1:LT	*ENG	[-30 to 30 / 6 / 1deg/step]
1-117-034	Temp.:End:1:LT	*ENG	[-30 to 30 / 21 / 1deg/step]
1-117-035	Temp.:Center:2:LT	*ENG	[-30 to 30 / 6 / 1deg/step]
1-117-036	Temp.:End:2:LT	*ENG	[-30 to 30 / 21 / 1deg/step]
1-117-041	Control Time 1:Energy Saving	*ENG	[0 to 300 / 0 / 1sec/step]
1-117-042	Control Time 2:Energy Saving	*ENG	[0 to 300 / 40 / 1sec/step]
1-117-043	Temp.:Center:1:Energy Saving	*ENG	[-30 to 30 / 0 / 1deg/step]
1-117-044	Temp.:End:1:Energy Saving	*ENG	[-30 to 30 / * / 1deg/step] *NA: 1, EU: 3, Asia: 1, CHN: 1, TWN: 3, KOR: 1
1-117-045	Temp.:Center:2:Energy Saving	*ENG	[-30 to 30 / 9 / 1deg/step]
1-117-046	Temp.:End:2:Energy Saving	*ENG	[-30 to 30 / 11 / 1deg/step]
1-117-051	Control Time 1:A4	*ENG	[0 to 300 / 0 / 1sec/step]
1-117-052	Control Time 2:A4	*ENG	[0 to 300 / 120 / 1sec/step]
1-117-053	Temp.:Center:1:A4	*ENG	[-30 to 30 / 0 / 1deg/step]
1-117-054	Temp.:End:1:A4	*ENG	[-30 to 30 / 21 / 1deg/step]
1-117-055	Temp.:Center:2:A4	*ENG	[-30 to 30 / * / 1deg/step] *NA: 6, EU: 0, Asia: 0, CHN: 0, TWN: 6, KOR: 0
1-117-056	Temp.:End:2:A4	*ENG	[-30 to 30 / -30 / 1deg/step]
1-117-061	Control Time 1:A3:M-thick	*ENG	[0 to 300 / 0 / 1sec/step]
1-117-062	Control Time 2:A3:M-thick	*ENG	[0 to 300 / 0 / 1sec/step]
1-117-063	Temp.:Center:1:A3:M-thick	*ENG	[-30 to 30 / 0 / 1deg/step]

1-117-064	Temp.:End:1:A3:M-thick	*ENG	[-30 to 30 / 0 / 1deg/step]
1-117-065	Temp.:Center:2:A3:M-thick	*ENG	[-30 to 30 / 0 / 1deg/step]
1-117-066	Temp.:End:2:A3:M-thick	*ENG	[-30 to 30 / 0 / 1deg/step]
1-117-071	Control Time 1:DLT:M-thick	*ENG	[0 to 300 / 0 / 1sec/step]
1-117-072	Control Time 2:DLT:M-thick	*ENG	[0 to 300 / 0 / 1sec/step]
1-117-073	Temp.:Center:1:DLT:M-thick	*ENG	[-30 to 30 / 0 / 1deg/step]
1-117-074	Temp.:End:1:DLT:M-thick	*ENG	[-30 to 30 / 0 / 1deg/step]
1-117-075	Temp.:Center:2:DLT:M-thick	*ENG	[-30 to 30 / 0 / 1deg/step]
1-117-076	Temp.:End:2:DLT:M-thick	*ENG	[-30 to 30 / 0 / 1deg/step]
1-117-081	Control Time 1:Envelope:Long	*ENG	[0 to 300 / 0 / 1sec/step]
1-117-082	Control Time 2:Envelope:Long	*ENG	[0 to 300 / 0 / 1sec/step]
1-117-083	Temp.:Center:1:Envelope:Long	*ENG	[-30 to 30 / 0 / 1deg/step]
1-117-084	Temp.:End:1:Envelope:Long	*ENG	[-30 to 30 / 10 / 1deg/step]
1-117-085	Temp.:Center:2:Envelope:Long	*ENG	[-30 to 30 / 0 / 1deg/step]
1-117-086	Temp.:End:2:Envelope:Long	*ENG	[-30 to 30 / 10 / 1deg/step]
1-117-091	Control Time 1:Envelope:Short	*ENG	[0 to 300 / 0 / 1sec/step]
1-117-092	Control Time 2:Envelope:Short	*ENG	[0 to 300 / 0 / 1sec/step]
1-117-093	Temp.:Center:1:Envelope:Short	*ENG	[-30 to 30 / 0 / 1deg/step]
1-117-094	Temp.:End:1:Envelope:Short	*ENG	[-30 to 30 / 0 / 1deg/step]
1-117-095	Temp.:Center:2:Envelope:Short	*ENG	[-30 to 30 / 0 / 1deg/step]
1-117-096	Temp.:End:2:Envelope:Short	*ENG	[-30 to 30 / 0 / 1deg/step]
1-117-101	Control Time 1:B5	*ENG	[0 to 300 / 0 / 1sec/step]
1-117-102	Control Time 2:B5	*ENG	[0 to 300 / 0 / 1sec/step]
1-117-103	Temp.:Center:1:B5	*ENG	[-30 to 30 / 0 / 1deg/step]
1-117-104	Temp.:End:1:B5	*ENG	[-125 to 30 / -125 / 1deg/step]
1-117-105	Temp.:Center:2:B5	*ENG	[-30 to 30 / 0 / 1deg/step]

1-117-106	Temp.:End:2:B5	*ENG	[-125 to 30 / -125 / 1deg/step]
1-117-111	Control Time 1:12inch	*ENG	[0 to 300 / 0 / 1sec/step]
1-117-112	Control Time 2:12inch	*ENG	[0 to 300 / 0 / 1sec/step]
1-117-113	Temp.:Center:1:12inch	*ENG	[-30 to 30 / -2 / 1deg/step]
1-117-114	Temp.:End:1:12inch	*ENG	[-30 to 30 / -1 / 1deg/step]
1-117-115	Temp.:Center:2:12inch	*ENG	[-30 to 30 / -2 / 1deg/step]
1-117-116	Temp.:End:2:12inch	*ENG	[-30 to 30 / -1 / 1deg/step]
1-117-121	Control Time 1:12inch:M-thick	*ENG	[0 to 300 / 0 / 1sec/step]
1-117-122	Control Time 2:12inch:M-thick	*ENG	[0 to 300 / 0 / 1sec/step]
1-117-123	Temp.:Center:1:12inch:M-thick	*ENG	[-30 to 30 / 0 / 1deg/step]
1-117-124	Temp.:End:1:12inch:M-thick	*ENG	[-30 to 30 / 4 / 1deg/step]
1-117-125	Temp.:Center:2:12inch:M-thick	*ENG	[-30 to 30 / 0 / 1deg/step]
1-117-126	Temp.:End:2:12inch:M-thick	*ENG	[-30 to 30 / 4 / 1deg/step]
1-117-131	Control Time 1:SRA3	*ENG	[0 to 300 / 0 / 1sec/step]
1-117-132	Control Time 2:SRA3	*ENG	[0 to 300 / 11 / 1sec/step]
1-117-133	Temp.:Center:1:SRA3	*ENG	[-30 to 30 / 0 / 1deg/step]
1-117-134	Temp.:End:1:SRA3	*ENG	[-30 to 30 / 30 / 1 / deg
1-117-135	Temp.:Center:2:SRA3	*ENG	[-30 to 30 / 0 / 1deg/step]
1-117-136	Temp.:End:2:SRA3	*ENG	[-30 to 30 / 17 / 1deg/step]
1-117-141	Control Time 1:SRA3:M-thick	*ENG	[0 to 300 / 0 / 1sec/step]
1-117-142	Control Time 2:SRA3:M-thick	*ENG	[0 to 300 / 11 / 1sec/step]
1-117-143	Temp.:Center:1:SRA3:M-thick	*ENG	[-30 to 30 / 0 / 1deg/step]
1-117-144	Temp.:End:1:SRA3:M-thick	*ENG	[-30 to 30 / 6 / 1deg/step]
1-117-145	Temp.:Center:2:SRA3:M-thick	*ENG	[-30 to 30 / 5 / 1deg/step]
1-117-146	Temp.:End:2:SRA3:M-thick	*ENG	[-30 to 30 / 8 / 1deg/step]
1-117-151	Control Time 1:A3:Low	*ENG	[0 to 300 / 0 / 1sec/step]

1-117-152	Control Time 2:A3:Low	*ENG	[0 to 300 / 0 / 1sec/step]
1-117-153	Temp.:Center:1:A3:Low	*ENG	[-30 to 30 / 0 / 1deg/step]
1-117-154	Temp.:End:1:A3:Low	*ENG	[-30 to 30 / 0 / 1deg/step]
1-117-155	Temp.:Center:2:A3:Low	*ENG	[-30 to 30 / 0 / 1deg/step]
1-117-156	Temp.:End:2:A3:Low	*ENG	[-30 to 30 / 0 / 1deg/step]
1-117-161	Control Time 1:DLT:Low	*ENG	[0 to 300 / 0 / 1sec/step]
1-117-162	Control Time 2:DLT:Low	*ENG	[0 to 300 / 0 / 1sec/step]
1-117-163	Temp.:Center:1:DLT:Low	*ENG	[-30 to 30 / 0 / 1deg/step]
1-117-164	Temp.:End:1:DLT:Low	*ENG	[-30 to 30 / 0 / 1deg/step]
1-117-165	Temp.:Center:2:DLT:Low	*ENG	[-30 to 30 / 0 / 1deg/step]
1-117-166	Temp.:End:2:DLT:Low	*ENG	[-30 to 30 / 0 / 1deg/step]
1-117-171	Control Time 1:A4LEF	*ENG	[0 to 300 / 0 / 1sec/step]
1-117-172	Control Time 2:A4LEF	*ENG	[0 to 300 / 0 / 1sec/step]
1-117-173	Temp.:Center:1:A4LEF	*ENG	[-30 to 30 / 0 / 1deg/step]
1-117-174	Temp.:End:1:A4LEF	*ENG	[-30 to 30 / 0 / 1deg/step]
1-117-175	Temp.:Center:2:A4LEF	*ENG	[-30 to 30 / 0 / 1deg/step]
1-117-176	Temp.:End:2:A4LEF	*ENG	[-30 to 30 / 0 / 1deg/step]

1118	[Before Job Temp. Correct]		
1-118-001	Temp.:Center:12inch	*ENG	[-30 to 30 / 0 / 1deg/step]
1-118-002	Temp.:End:12inch	*ENG	[-30 to 30 / 0 / 1deg/step]
1-118-003	Temp.:Center:A3	*ENG	[-30 to 30 / 0 / 1deg/step]
1-118-004	Temp.:End:A3	*ENG	[-30 to 30 / 0 / 1deg/step]
1-118-005	Temp.:Center:DLT	*ENG	[-30 to 30 / 0 / 1deg/step]
1-118-006	Temp.:End:DLT	*ENG	[-30 to 30 / 0 / 1deg/step]
1-118-007	Temp.:Center:SRA3	*ENG	[-30 to 30 / 0 / 1deg/step]

1-118-008	Temp.:End:SRA3	*ENG	[-30 to 30 / 17 / 1 deg/step]
1-118-011	Temp.:Center:12inch:M-thick	*ENG	[-30 to 30 / 0 / 1 deg/step]
1-118-012	Temp.:End:12inch:M-thick	*ENG	[-30 to 30 / 0 / 1 deg/step]
1-118-013	Temp.:Center:A3:M-thick	*ENG	[-30 to 30 / 0 / 1 deg/step]
1-118-014	Temp.:End:A3:M-thick	*ENG	[-30 to 30 / 0 / 1 deg/step]
1-118-015	Temp.:Center:DLT:M-thick	*ENG	[-30 to 30 / 0 / 1 deg/step]
1-118-016	Temp.:End:DLT:M-thick	*ENG	[-30 to 30 / 0 / 1 deg/step]
1-118-017	Temp.:Center:SRA3:M-thick	*ENG	[-30 to 30 / 3 / 1 deg/step]
1-118-018	Temp.:End:SRA3:M-thick	*ENG	[-30 to 30 / 6 / 1 deg/step]
1-118-021	Temp.:Center:12inch:Thick	*ENG	[-30 to 30 / 0 / 1 deg/step]
1-118-022	Temp.:End:12inch:Thick	*ENG	[-30 to 30 / 0 / 1 deg/step]
1-118-023	Temp.:Center:A3:Thick	*ENG	[-30 to 30 / 0 / 1 deg/step]
1-118-024	Temp.:End:A3:Thick	*ENG	[-30 to 30 / 0 / 1 deg/step]
1-118-025	Temp.:Center:DLT:Thick	*ENG	[-30 to 30 / 0 / 1 deg/step]
1-118-026	Temp.:End:DLT:Thick	*ENG	[-30 to 30 / 0 / 1 deg/step]
1-118-027	Temp.:Center:SRA3:Thick	*ENG	[-30 to 30 / 0 / 1 deg/step]
1-118-028	Temp.:End:SRA3:Thick	*ENG	[-30 to 30 / 20 / 1 deg/step]

1120	[Reserve SP]		
1-120-001	Recovery mode SW:Low Temp	*ENG	[0 to 1 / 0 / 1 deg/step]
1-120-002	Recovery mode SW:Voltage:Low	*ENG	[0 to 1 / 0 / 1 deg/step]
1-120-003	UC3	*ENG	[0 to 255 / 0 / 1 deg/step]
1-120-004	UC4	*ENG	[0 to 255 / 0 / 1 deg/step]
1-120-005	Ini. CPM Down Time:High Power	*ENG	[0 to 255 / 2 / 1 sec/step]

1-120-006	Ini. CPM Down Time:Mid.Power	*ENG	[0 to 255 / 2 / 1sec/step]
1-120-007	Ini. CPM Down Time:Voltage:Low	*ENG	[0 to 255 / 2 / 1sec/step]
1-120-008	Ini. CPM Down Time:Low Temp	*ENG	[0 to 255 / 2 / 1sec/step]
1-120-009	Temp.:Center: 3:DLT:Voltage:Low	*ENG	[0 to 30 / 0 / 1deg/step]
1-120-010	Temp.:End:3:DLT:Voltage:Low	*ENG	[0 to 30 / 0 / 1deg/step]
1-120-011	Control Time 1:DLT:Voltage:Low	*ENG	[0 to 300 / 0 / 1sec/step]
1-120-012	Control Time 2:DLT:Voltage:Low	*ENG	[0 to 300 / 0 / 1sec/step]
1-120-013	Control Time 3:DLT:Voltage:Low	*ENG	[0 to 300 / 0 / 1sec/step]
1-120-014	Control Time 1:DLT:Voltage:Low	*ENG	[0 to 300 / 0 / 1sec/step]
1-120-015	Control Time 2:DLT:Voltage:Low	*ENG	[0 to 300 / 0 / 1sec/step]
1-120-016	Control Time 3:DLT:Voltage:Low	*ENG	[0 to 300 / 0 / 1sec/step]
1-120-017	UW7	*ENG	[0 to 60000 / 0 / 1msec/step]
1-120-018	UW8	*ENG	[0 to 60000 / 0 / 1msec/step]
1-120-019	Temp.:End:2:DLT:Voltage:Low	*ENG	[0 to 100.00 / 0 / 0.01sec/step]
1-120-020	Temp.:Center: 3:DLT:Voltage:Low	*ENG	[0 to 100.00 / 0 / 0.01sec/step]
1-120-021	Temp.:Center: 1:DLT:Voltage:Low	*ENG	[-30 to 30 / 0 / 1deg/step]
1-120-022	Temp.:End:1:DLT:Voltage:Low	*ENG	[-30 to 30 / 0 / 1deg/step]
1-120-023	Temp.:Center: 2:DLT:Voltage:Low	*ENG	[-30 to 30 / 0 / 1deg/step]

1-120-024	Temp.:End:2:DLT:Voltage:Low	*ENG	[-30 to 30 / 0 / 1 deg/step]
1-120-025	Temp.:Center: 3:DLT:Voltage:Low	*ENG	[-30 to 30 / 0 / 1 deg/step]
1-120-026	Temp.:End:3:DLT:Voltage:Low	*ENG	[-30 to 30 / 0 / 1 deg/step]
1-120-027	Temp.:Center: 1:DLT:Voltage:Low	*ENG	[-30 to 30 / 0 / 1 deg/step]
1-120-028	Temp.:End:1:DLT:Voltage:Low	*ENG	[-30 to 30 / 0 / 1 deg/step]
1-120-029	Temp.:Center: 2:DLT:Voltage:Low	*ENG	[-30 to 30 / 0 / 1 deg/step]
1-120-030	Temp.:End:2:DLT:Voltage:Low	*ENG	[-30 to 30 / 0 / 1 deg/step]

1121	[Switch:Rotation Start/Stop]		
1-121-001	Time:After Reload	*ENG	[0 to 100 / 30 / 1sec/step]
1-121-002	Time:After Recovery	*ENG	[0 to 100 / 15 / 1sec/step]
1-121-004	Press Temp.:After Reload	*ENG	[0 to 160 / 160 / 1deg/step]
1-121-005	End Temp.:After Job:SRA3	*ENG	[100 to 250 / 200 / 1deg/step]
1-121-006	ShiftTemp:After Job:PressEdge:A3	*ENG	[100 to 250 / 200 / 1deg/step]
1-121-007	ShiftTemp:After Job:PressEdge:DLT	*ENG	[100 to 250 / 200 / 1deg/step]
1-121-008	Overshoot Prevent Temp.	*ENG	[0 to 250 / 185 / 1deg/step]
1-121-009	Overshoot Prevent Time	*ENG	[0 to 100 / 10 / 1sec/step]
1-121-010	End Temp.:After Job:B4	*ENG	[100 to 250 / 143 / 1deg/step]
1-121-011	End Temp.:After Job:LT	*ENG	[100 to 250 / * / 1deg/step] *NA: 210, EU: 153, Asia: 153, CHN: 153, TWN: 210, KOR: 153
1-121-012	End Temp.:After Job:B5	*ENG	[100 to 250 / 155 / 1deg/step]
1-121-013	End Temp.:After Job:A5	*ENG	[100 to 250 / 155 / 1deg/step]
1-121-014	End Temp.:After Job:B6	*ENG	[100 to 250 / 145 / 1deg/step]

1-121-015	ShiftTemp:FC:After Job:PressCenter:A6	*ENG	[100 to 250 / 160 / 1deg/step]
1-121-016	ShiftTemp:Bk:After Job:PressFl- B_Edge:SRA3	*ENG	[100 to 250 / 200 / 1deg/step]
1-121-017	ShiftTemp:Bk:After Job:PressEdge:A3	*ENG	[100 to 250 / 200 / 1deg/step]
1-121-018	ShiftTemp:Bk:After Job:PressEdge:DLT	*ENG	[100 to 250 / 200 / 1deg/step]
1-121-019	ShiftTemp:Bk:After Job:PressEdge:B4	*ENG	[100 to 250 / 148 / 1deg/step]
1-121-020	ShiftTemp:Bk:After Job:FusingEdge:LT	*ENG	[100 to 250 / * / 1deg/step] *NA: 215, EU: 153, Asia: 153, CHN: 153, TWN: 215, KOR: 153
1-121-021	Time:After Main Switch On	*ENG	[0 to 100 / 30 / 1sec/step]
1-121-022	ShiftTemp:Bk:After Job:PressCenter:B5	*ENG	[100 to 250 / 160 / 1deg/step]
1-121-023	ShiftTemp:Bk:After Job:PressCenter:A5	*ENG	[100 to 250 / 160 / 1deg/step]
1-121-024	ShiftTemp:Bk:After Job:PressCenter:B6	*ENG	[100 to 250 / 150 / 1deg/step]
1-121-025	ShiftTemp:Bk:After Job:PressCenter:A6	*ENG	[100 to 250 / 150 / 1deg/step]
1-121-031	Pre Job Paper Feed Time:FC:A3	*ENG	[0 to 10000 / 10000 / 1sec/step]
1-121-032	Soaking Rotary Time:FC:A3	*ENG	[0 to 100 / 0 / 1sec/step]
1-121-033	Pre Job Paper Feed Time:FC:DLT	*ENG	[0 to 10000 / 10000 / 1sec/step]
1-121-034	Soaking Rotary Time:FC:DLT	*ENG	[0 to 100 / 0 / 1sec/step]
1-121-035	Pre Job Paper Feed Time:FC:B4	*ENG	[0 to 10000 / 235 / 1sec/step]
1-121-036	Soaking Rotary Time:FC:B4	*ENG	[0 to 100 / 15 / 1sec/step]
1-121-037	Pre Job Paper Feed Time:FC:LT	*ENG	[0 to 10000 / 250 / 1sec/step]

1-121-038	Soaking Rotary Time:FC:LT	*ENG	[0 to 100 / 10 / 1sec/step]
1-121-039	Pre Job Paper Feed Time:FC:B5	*ENG	[0 to 10000 / 180 / 1sec/step]
1-121-040	Soaking Rotary Time:FC:B5	*ENG	[0 to 100 / 15 / 1sec/step]
1-121-041	Pre Job Paper Feed Time:FC:A5	*ENG	[0 to 10000 / 31 / 1sec/step]
1-121-042	Soaking Rotary Time:FC:A5	*ENG	[0 to 100 / 20 / 1sec/step]
1-121-043	Pre Job Paper Feed Time:FC:B6	*ENG	[0 to 10000 / 27 / 1sec/step]
1-121-044	Soaking Rotary Time:FC:B6	*ENG	[0 to 100 / 25 / 1sec/step]
1-121-045	Pre Job Paper Feed Time:FC:A6	*ENG	[0 to 10000 / * / 1sec/step] *NA: 70, EU: 40, Asia: 40, CHN: 40, TWN: 70, KOR: 40
1-121-046	Soaking Rotary Time:FC:A6	*ENG	[0 to 100 / 60 / 1sec/step]
1-121-051	Pre Job Paper Feed Time:Bk:A3	*ENG	[0 to 10000 / 10000 / 1sec/step]
1-121-052	Soaking Rotary Time:Bk:A3	*ENG	[0 to 100 / 0 / 1sec/step]
1-121-053	Pre Job Paper Feed Time:Bk:DLT	*ENG	[0 to 10000 / 10000 / 1sec/step]
1-121-054	Soaking Rotary Time:Bk:DLT	*ENG	[0 to 100 / 0 / 1sec/step]
1-121-055	Pre Job Paper Feed Time:Bk:B4	*ENG	[0 to 10000 / 235 / 1sec/step]
1-121-056	Soaking Rotary Time:Bk:B4	*ENG	[0 to 100 / 10 / 1sec/step]
1-121-057	Pre Job Paper Feed Time:Bk:LT	*ENG	[0 to 10000 / 250 / 1sec/step]
1-121-058	Soaking Rotary Time:Bk:LT	*ENG	[0 to 100 / 5 / 1sec/step]
1-121-059	Pre Job Paper Feed Time:Bk:B5	*ENG	[0 to 10000 / 180 / 1sec/step]
1-121-060	Soaking Rotary Time:Bk:B5	*ENG	[0 to 100 / 10 / 1sec/step]
1-121-061	Pre Job Paper Feed Time:Bk:A5	*ENG	[0 to 10000 / 31 / 1sec/step]
1-121-062	Soaking Rotary Time:Bk:A5	*ENG	[0 to 100 / 20 / 1sec/step]
1-121-063	Pre Job Paper Feed Time:Bk:B6	*ENG	[0 to 10000 / 27 / 1sec/step]
1-121-064	Soaking Rotary Time:Bk:B6	*ENG	[0 to 100 / 20 / 1sec/step]
1-121-065	Pre Job Paper Feed Time:Bk:A6	*ENG	[0 to 10000 / 80 / 1sec/step]

1-121-066	Soaking Rotary Time:Bk:A6	*ENG	[0 to 100 / 5 / 1sec/step]
1-121-080	Shift Time: AfterReload: LineSpd Dwn	*ENG	[0 to 60 / 10 / 0.1sec/step]
1-121-101	Heat Off Time:Start:Warm Up	*ENG	[0 to 60000 / 0 / 1msec/step]
1-121-102	Heat Off Time:Start:End of A Control	*ENG	[0 to 600000 / 100000 / 1msec/ step]
1-121-103	Time After Feeler Edge Detect	*ENG	[0 to 200 / 0 / 1sec/step]
1-121-114	Relay ON Temp.:Warm Up	*ENG	[0 to 250 / 200 / 1deg/step]
1-121-120	ShiftTemp:Press_Full-Bd Edge:SRA3	*ENG	[100 to 250 / 220 / 1deg/step]
1-121-121	ShiftTemp:PressEdge:A3	*ENG	[100 to 250 / 215 / 1deg/step]
1-121-122	ShiftTemp:PressEdge:DLT	*ENG	[100 to 250 / 205 / 1deg/step]
1-121-123	ShiftTemp:PressEdge:B4	*ENG	[100 to 250 / 215 / 1deg/step]
1-121-124	ShiftTemp:FusingEdge:LT	*ENG	[100 to 250 / 225 / 1deg/step]
1-121-125	ShiftTemp:PressCenter:B5	*ENG	[100 to 250 / 220 / 1deg/step]
1-121-126	ShiftTemp:PressCenter:A5	*ENG	[100 to 250 / 210 / 1deg/step]
1-121-127	ShiftTemp:PressCenter:B6	*ENG	[100 to 250 / 210 / 1deg/step]
1-121-128	ShiftTemp:PressCenter:A6	*ENG	[100 to 250 / 210 / 1deg/step]
1-121-141	Pre Job Paper Feed Time:A3	*ENG	[0 to 10000 / 10000 / 1sec/step]
1-121-142	Soaking Rotary Time:A3	*ENG	[0 to 100 / 10 / 1sec/step]
1-121-143	Pre Job Paper Feed Time:DLT	*ENG	[0 to 10000 / 10000 / 1sec/step]
1-121-144	Soaking Rotary Time:DLT	*ENG	[0 to 100 / 10 / 1sec/step]
1-121-145	Pre Job Paper Feed Time:B4	*ENG	[0 to 10000 / 10000 / 1sec/step]
1-121-146	Soaking Rotary Time:B4	*ENG	[0 to 100 / 10 / 1sec/step]
1-121-147	Pre Job Paper Feed Time:LT	*ENG	[0 to 10000 / 10000 / 1sec/step]
1-121-148	Soaking Rotary Time:LT	*ENG	[0 to 100 / 10 / 1sec/step]
1-121-149	Pre Job Paper Feed Time:B5	*ENG	[0 to 10000 / 10000 / 1sec/step]

1-121-150	Soaking Rotary Time:B5	*ENG	[0 to 100 / 10 / 1sec/step]
1-121-151	Pre Job Paper Feed Time:A5	*ENG	[0 to 10000 / 10000 / 1sec/step]
1-121-152	Soaking Rotary Time:A5	*ENG	[0 to 100 / 10 / 1sec/step]
1-121-153	Pre Job Paper Feed Time:B6	*ENG	[0 to 10000 / 10000 / 1sec/step]
1-121-154	Soaking Rotary Time:B6	*ENG	[0 to 100 / 10 / 1sec/step]
1-121-155	Pre Job Paper Feed Time:A6	*ENG	[0 to 10000 / 10000 / 1sec/step]
1-121-156	Soaking Rotary Time:A6	*ENG	[0 to 100 / 10 / 1sec/step]

1122	[Standby Rotation Setting]		
1-122-001	Rotation Interval	*ENG	[0 to 240 / 60 / 1min/step]
1-122-002	Rotation Time	*ENG	[0.0 to 60.0 / 8.0 / 0.1sec/step]

1123	[Paper Jam Rotation Setting]		
1-123-001	Normal Rotation Distance	*ENG	[0 to 10000 / 75 / 1mm/step]
1-123-002	Reverse Rotation Distance	*ENG	[0 to 10000 / 25 / 1mm/step]

1124	[CPM Down Setting] DFU		
1-124-001	High:Down Temp.	*ENG	[-50 to 0 / -30 / 1deg/step]
1-124-002	High:Up Temp.	*ENG	[-50 to 0 / -15 / 1deg/step]
1-124-003	Low :1st CPM	*ENG	[10 to 100 / 80 / 1%/step]
1-124-004	Low :2nd CPM	*ENG	[10 to 100 / 65 / 1%/step]
1-124-005	Low :3rd CPM	*ENG	[10 to 100 / 50 / 1%/step]
1-124-007	High:2nd CPM	*ENG	[10 to 100 / 50 / 1%/step]
1-124-008	High:3rd CPM	*ENG	[10 to 100 / 30 / 1%/step]
1-124-009	High:1st CPM Down Temp.:A3:Press End	*ENG	[100 to 250 / 205 / 1deg/step]
1-124-010	High:2nd CPM Down Temp.:A3:Press End	*ENG	[100 to 250 / 210 / 1deg/step]

1-124-011	High:3rd CPM Down Temp.:A3:Press End	*ENG	[100 to 250 / 215 / 1deg/step]
1-124-012	High:1st CPM Down Temp.:DLT:Press End	*ENG	[100 to 250 / 205 / 1deg/step]
1-124-013	High:2nd CPM Down Temp.:DLT:Press End	*ENG	[100 to 250 / 210 / 1deg/step]
1-124-014	High:3rd CPM Down Temp.:DLT:Press End	*ENG	[100 to 250 / 215 / 1deg/step]
1-124-015	High:1st CPM Down Temp.:B4:Press End	*ENG	[100 to 250 / 200 / 1deg/step]
1-124-016	High:2nd CPM Down Temp.:B4:Press End	*ENG	[100 to 250 / 210 / 1deg/step]
1-124-017	High:3rd CPM Down Temp.:B4:Press End	*ENG	[100 to 250 / 215 / 1deg/step]
1-124-018	High:1st CPM Down Temp.:LT:Fuser End	*ENG	[100 to 250 / 215 / 1deg/step]
1-124-019	High:2nd CPM Down Temp.:LT:Fuser End	*ENG	[100 to 250 / 220 / 1deg/step]
1-124-020	High:3rd CPM Down Temp.:LT:Fuser End	*ENG	[100 to 250 / 225 / 1deg/step]
1-124-021	High:1st CPM Down Temp.:A4:Fuser End	*ENG	[100 to 250 / 215 / 1deg/step]
1-124-022	High:2nd CPM Down Temp.:A4:Fuser End	*ENG	[100 to 250 / 220 / 1deg/step]
1-124-023	High:3rd CPM Down Temp.:A4:Fuser End	*ENG	[100 to 250 / 225 / 1deg/step]
1-124-024	High:1st CPM Down Temp.:B5:Press Center	*ENG	[100 to 250 / 205 / 1deg/step]
1-124-025	High:2nd CPM Down Temp.:B5:Press Center	*ENG	[100 to 250 / 210 / 1deg/step]
1-124-026	High:3rd CPM Down Temp.:B5:Press Center	*ENG	[100 to 250 / 215 / 1deg/step]

1-124-027	High:1st CPM Down Temp.:A5:Press Center	*ENG	[100 to 250 / * / 1deg/step] *NA: 170, EU: 204, Asia: 204, CHN: 204, TWN: 170, KOR: 204
1-124-028	High:2nd CPM Down Temp.:A5:Press Center	*ENG	[100 to 250 / 209 / 1deg/step]
1-124-029	High:3rd CPM Down Temp.:A5:Press Center	*ENG	[100 to 250 / 217 / 1deg/step]
1-124-030	High:1st CPM Down Temp.:B6:Press Center	*ENG	[100 to 250 / * / 1deg/step] *NA: 180, EU: 209, Asia: 209, CHN: 209, TWN: 180, KOR: 209
1-124-031	High:2nd CPM Down Temp.:B6:Press Center	*ENG	[100 to 250 / * / 1deg/step] *NA: 185, EU: 214, Asia: 214, CHN: 214, TWN: 185, KOR: 214
1-124-032	High:3rd CPM Down Temp.:B6:Press Center	*ENG	[100 to 250 / * / 1deg/step] *NA: 192, EU: 219, Asia: 219, CHN: 29, TWN: 192, KOR: 219
1-124-033	High:1st CPM Down Temp.:A6:Press Center	*ENG	[100 to 250 / * / 1deg/step] *NA: 180, EU: 209, Asia: 209, CHN: 209, TWN: 180, KOR: 209
1-124-034	High:2nd CPM Down Temp.:A6:Press Center	*ENG	[100 to 250 / * / 1deg/step] *NA: 185, EU: 214, Asia: 214, CHN: 214, TWN: 185, KOR: 214
1-124-035	High:3rd CPM Down Temp.:A6:Press Center	*ENG	[100 to 250 / * / 1deg/step] *NA: 192, EU: 219, Asia: 219, CHN: 29, TWN: 192, KOR: 219
1-124-036	High:1st CPM Down Temp.:SRA3:Press End	*ENG	[100 to 250 / 210 / 1deg/step]
1-124-037	High:2nd CPM Down Temp.:SRA3:Press End	*ENG	[100 to 250 / 215 / 1deg/step]
1-124-038	High:3rd CPM Down Temp.:SRA3:Press End	*ENG	[100 to 250 / 220 / 1deg/step]
1-124-040	Low Temp.:1st CPM_2	*ENG	[10 to 100 / 80 / 1%/step]

1-124-041	Low Temp.:2nd CPM_2	*ENG	[10 to 100 / 65 / 1%/step]
1-124-042	Low Temp.:1st CPM_3	*ENG	[10 to 100 / 80 / 1%/step]
1-124-043	Low Temp.:2nd CPM_3	*ENG	[10 to 100 / 65 / 1%/step]
1-124-051	Judging Interval	*ENG	[1 to 250 / 4 / 1sec/step]
1-124-060	Ini. CPM Down Time	*ENG	[0 to 255 / 2 / 1sec/step]
1-124-061	Ini. CPM Down Time 10sec recovery	*ENG	[0 to 255 / 2 / 1sec/step]
1-124-071	L:High:1st Temp.:DLT:Press End	*ENG	[100 to 250 / 205 / 1deg/step]
1-124-072	L:High:2nd Temp.:DLT:Press End	*ENG	[100 to 250 / 210 / 1deg/step]
1-124-073	L:High:3rd Temp.:DLT:Press End	*ENG	[100 to 250 / 215 / 1deg/step]
1-124-074	L:High:4th Temp.:DLT:Press End	*ENG	[100 to 250 / 215 / 1deg/step]
1-124-075	L:High:1st Temp.:B4:Press End	*ENG	[100 to 250 / 180 / 1deg/step]
1-124-076	L:High:2nd Temp.:B4:Press End	*ENG	[100 to 250 / 180 / 1deg/step]
1-124-077	L:High:3rd Temp.:B4:Press End	*ENG	[100 to 250 / 215 / 1deg/step]
1-124-078	L:High:4th Temp.:B4:Press End	*ENG	[100 to 250 / 215 / 1deg/step]
1-124-079	L:High:1st Temp.:B5:Press Center	*ENG	[100 to 250 / * / 1deg/step] *NA: 155, EU: 193, Asia: 193, CHN: 193, TWN: 205, KOR: 193
1-124-080	L:High:2nd Temp.:B5:Press Center	*ENG	[100 to 250 / * / 1deg/step] *NA: 160, EU: 199, Asia: 199, CHN: 199, TWN: 210, KOR: 199
1-124-081	L:High:3rd Temp.:B5:Press Center	*ENG	[100 to 250 / * / 1deg/step] *NA: 165, EU: 205, Asia: 205, CHN: 205, TWN: 165, KOR: 205
1-124-082	L:High:4th Temp.:B5:Press Center	*ENG	[100 to 250 / * / 1deg/step] *NA: 200, EU: 205, Asia: 205, CHN: 205, TWN: 200, KOR: 205

1-124-083	L:High:1st Temp.:A5:Press Center	*ENG	[100 to 250 / * / 1deg/step] *NA: 160, EU: 193, Asia: 193, CHN: 193, TWN: 160, KOR: 193
1-124-084	L:High:2nd Temp.:A5:Press Center	*ENG	[100 to 250 / * / 1deg/step] *NA: 170, EU: 199, Asia: 199, CHN: 199, TWN: 170, KOR: 199
1-124-085	L:High:3rd Temp.:A5:Press Center	*ENG	[100 to 250 / * / 1deg/step] *NA: 190, EU: 205, Asia: 205, CHN: 205, TWN: 190, KOR: 205
1-124-086	L:High:4th Temp.:A5:Press Center	*ENG	[100 to 250 / * / 1deg/step] *NA: 200, EU: 205, Asia: 205, CHN: 205, TWN: 200, KOR: 205
1-124-087	L:High:1st Temp.:B6:Press Center	*ENG	[100 to 250 / * / 1deg/step] *NA: 155, EU: 191, Asia: 191, CHN: 191, TWN: 155, KOR: 191
1-124-088	L:High:2nd Temp.:B6:Press Center	*ENG	[100 to 250 / * / 1deg/step] *NA: 178, EU: 196, Asia: 196, CHN: 196, TWN: 178, KOR: 196
1-124-089	L:High:3rd Temp.:B6:Press Center	*ENG	[100 to 250 / * / 1deg/step] *NA: 192, EU: 201, Asia: 201, CHN: 201, TWN: 192, KOR: 201
1-124-090	L:High:4th Temp.:B6:Press Center	*ENG	[100 to 250 / * / 1deg/step] *NA: 192, EU: 201, Asia: 201, CHN: 201, TWN: 192, KOR: 201
1-124-091	L:High:1st Temp.:A6:Press Center	*ENG	[100 to 250 / * / 1deg/step] *NA: 155, EU: 191, Asia: 191, CHN: 191, TWN: 155, KOR: 191
1-124-092	L:High:2nd Temp.:A6:Press Center	*ENG	[100 to 250 / * / 1deg/step] *NA: 178, EU: 196, Asia: 196, CHN: 196, TWN: 178, KOR: 196

1-124-093	L:High:3rd Temp.:A6:Press Center	*ENG	[100 to 250 / * / 1deg/step] *NA: 192, EU: 201, Asia: 201, CHN: 201, TWN: 192, KOR: 201
1-124-094	L:High:4th Temp.:A6:Press Center	*ENG	[100 to 250 / * / 1deg/step] *NA: 192, EU: 201, Asia: 201, CHN: 201, TWN: 192, KOR: 201
1-124-101	High:1st CPM Down Time:A3	*ENG	[0 to 10000 / 10000 / 1sec/step]
1-124-102	High:2nd CPM Down Time:A3	*ENG	[0 to 10000 / 10000 / 1sec/step]
1-124-103	High:3rd CPM Down Time:A3	*ENG	[0 to 10000 / 10000 / 1sec/step]
1-124-104	High:1st CPM Down Time:DLT	*ENG	[0 to 10000 / 10000 / 1sec/step]
1-124-105	High:2nd CPM Down Time:DLT	*ENG	[0 to 10000 / 10000 / 1sec/step]
1-124-106	High:3rd CPM Down Time:DLT	*ENG	[0 to 10000 / 10000 / 1sec/step]
1-124-107	High:1st CPM Down Time:B4	*ENG	[0 to 10000 / 10000 / 1sec/step]
1-124-108	High:2nd CPM Down Time:B4	*ENG	[0 to 10000 / 10000 / 1sec/step]
1-124-109	High:3rd CPM Down Time:B4	*ENG	[0 to 10000 / 10000 / 1sec/step]
1-124-110	High:1st CPM Down Time:LT	*ENG	[0 to 10000 / 10000 / 1sec/step]
1-124-111	High:2nd CPM Down Time:LT	*ENG	[0 to 10000 / 10000 / 1sec/step]
1-124-112	High:3rd CPM Down Time:LT	*ENG	[0 to 10000 / 10000 / 1sec/step]
1-124-113	High:1st CPM Down Time:A4	*ENG	[0 to 10000 / 10000 / 1sec/step]
1-124-114	High:2nd CPM Down Time:A4	*ENG	[0 to 10000 / 10000 / 1sec/step]
1-124-115	High:3rd CPM Down Time:A4	*ENG	[0 to 10000 / 10000 / 1sec/step]
1-124-116	High:1st CPM Down Time:B5	*ENG	[0 to 10000 / 10000 / 1sec/step]
1-124-117	High:2nd CPM Down Time:B5	*ENG	[0 to 10000 / 10000 / 1sec/step]
1-124-118	High:3rd CPM Down Time:B5	*ENG	[0 to 10000 / 10000 / 1sec/step]
1-124-119	High:1st CPM Down Time:A5	*ENG	[0 to 10000 / 10000 / 1sec/step]
1-124-120	High:2nd CPM Down Time:A5	*ENG	[0 to 10000 / 10000 / 1sec/step]
1-124-121	High:3rd CPM Down Time:A5	*ENG	[0 to 10000 / 10000 / 1sec/step]

1-124-122	High:1st CPM Down Time:B6	*ENG	[0 to 10000 / 10000 / 1sec/step]
1-124-123	High:2nd CPM Down Time:B6	*ENG	[0 to 10000 / 10000 / 1sec/step]
1-124-124	High:3rd CPM Down Time:B6	*ENG	[0 to 10000 / 10000 / 1sec/step]
1-124-125	High:1st CPM Down Time:A6	*ENG	[0 to 10000 / 10000 / 1sec/step]
1-124-126	High:2nd CPM Down Time:A6	*ENG	[0 to 10000 / 10000 / 1sec/step]
1-124-127	High:3rd CPM Down Time:A6	*ENG	[0 to 10000 / 10000 / 1sec/step]
1-124-128	High:1st CPM Down Time:SRA3	*ENG	[0 to 10000 / 10000 / 1sec/step]
1-124-129	High:2nd CPM Down Time:SRA3	*ENG	[0 to 10000 / 10000 / 1sec/step]
1-124-130	High:3rd CPM Down Time:SRA3	*ENG	[0 to 10000 / 10000 / 1sec/step]
1-124-151	High:1st CPM Down Time:A3:Low Speed	*ENG	[0 to 10000 / 10000 / 1sec/step]
1-124-152	High:2nd CPM Down Time:A3:Low Speed	*ENG	[0 to 10000 / 10000 / 1sec/step]
1-124-153	High:3rd CPM Down Time:A3:Low Speed	*ENG	[0 to 10000 / 10000 / 1sec/step]
1-124-154	High:1st CPM Down Time:DLT:Low Speed	*ENG	[0 to 10000 / 10000 / 1sec/step]
1-124-155	High:2nd CPM Down Time:DLT:Low Speed	*ENG	[0 to 10000 / 10000 / 1sec/step]
1-124-156	High:3rd CPM Down Time:DLT:Low Speed	*ENG	[0 to 10000 / 10000 / 1sec/step]
1-124-157	High:1st CPM Down Time:B4:Low Speed	*ENG	[0 to 10000 / 10000 / 1sec/step]
1-124-158	High:2nd CPM Down Time:B4:Low Speed	*ENG	[0 to 10000 / 10000 / 1sec/step]
1-124-159	High:3rd CPM Down Time:B4:Low Speed	*ENG	[0 to 10000 / 10000 / 1sec/step]

1-124-160	High:1st CPM Down Time:LT:Low Speed	*ENG	[0 to 10000 / 10000 / 1sec/step]
1-124-161	High:2nd CPM Down Time:LT:Low Speed	*ENG	[0 to 10000 / 10000 / 1sec/step]
1-124-162	High:3rd CPM Down Time:LT:Low Speed	*ENG	[0 to 10000 / 10000 / 1sec/step]
1-124-163	High:1st CPM Down Time:A4:Low Speed	*ENG	[0 to 10000 / 10000 / 1sec/step]
1-124-164	High:2nd CPM Down Time:A4:Low Speed	*ENG	[0 to 10000 / 10000 / 1sec/step]
1-124-165	High:3rd CPM Down Time:A4:Low Speed	*ENG	[0 to 10000 / 10000 / 1sec/step]
1-124-166	High:1st CPM Down Time:B5:Low Speed	*ENG	[0 to 10000 / 10000 / 1sec/step]
1-124-167	High:2nd CPM Down Time:B5:Low Speed	*ENG	[0 to 10000 / 10000 / 1sec/step]
1-124-168	High:3rd CPM Down Time:B5:Low Speed	*ENG	[0 to 10000 / 10000 / 1sec/step]
1-124-169	High:1st CPM Down Time:A5:Low Speed	*ENG	[0 to 10000 / 10000 / 1sec/step]
1-124-170	High:2nd CPM Down Time:A5:Low Speed	*ENG	[0 to 10000 / 10000 / 1sec/step]
1-124-171	High:3rd CPM Down Time:A5:Low Speed	*ENG	[0 to 10000 / 10000 / 1sec/step]
1-124-172	High:1st CPM Down Time:B6:Low Speed	*ENG	[0 to 10000 / 60 / 1sec/step]
1-124-173	High:2nd CPM Down Time:B6:Low Speed	*ENG	[0 to 10000 / 10000 / 1sec/step]
1-124-174	High:3rd CPM Down Time:B6:Low Speed	*ENG	[0 to 10000 / 10000 / 1sec/step]
1-124-175	High:1st CPM Down Time:A6:Low Speed	*ENG	[0 to 10000 / 60 / 1sec/step]

1-124-176	High:2nd CPM Down Time:A6:Low Speed	*ENG	[0 to 10000 / 10000 / 1sec/step]
1-124-177	High:3rd CPM Down Time:A6:Low Speed	*ENG	[0 to 10000 / 10000 / 1sec/step]
1-124-178	High:1st CPM Down Time:SRA3:Low Speed	*ENG	[0 to 10000 / 10000 / 1sec/step]
1-124-179	High:2nd CPM Down Time:SRA3:Low Speed	*ENG	[0 to 10000 / 10000 / 1sec/step]
1-124-180	High:3rd CPM Down Time:SRA3:Low Speed	*ENG	[0 to 10000 / 10000 / 1sec/step]
1-124-190	NC:1st CPM:Decreased Temp.	*ENG	[80 to 250 / 123 / 1deg/step]
1-124-191	NC:2nd CPM:Decreased Temp.	*ENG	[80 to 250 / 124 / 1deg/step]
1-124-192	NC:3rd CPM:Decreased Temp.	*ENG	[80 to 250 / 125 / 1deg/step]
1-124-193	NC:1st CPM:Decreased Ratio	*ENG	[10 to 100 / 50 / 1%/step]
1-124-194	NC:2nd CPM:Decreased Ratio	*ENG	[10 to 100 / 30 / 1%/step]
1-124-195	NC:3rd CPM:Decreased Ratio	*ENG	[10 to 100 / 10 / 1%/step]
1-124-201	Low:Down Temp.	*ENG	[-50 to 0 / -30 / 1deg/step]
1-124-202	Low:Up Temp.	*ENG	[-50 to 0 / -15 / 1deg/step]
1-124-203	High Temp: Decreased Temp: Mid-Low Spd	*ENG	[-50 to 0 / -20 / 1deg/step]
1-124-204	High Temp: Increased Temp: Mid-Low Spd	*ENG	[-50 to 0 / -15 / 1deg/step]
1-124-205	Low Temp: Decreased Temp: Mid-Low Spd	*ENG	[-50 to 0 / -20 / 1deg/step]
1-124-206	Low Temp: Increased Temp: Mid-Low Spd	*ENG	[-50 to 0 / -15 / 1deg/step]
1-124-210	Temp.:Threshold::Low Power	*ENG	[0 to 200 / 0 / 1deg/step]
1-124-211	CPM Level 2: Judge:Low Power	*ENG	[0 to 200 / 110 / 1deg/step]

1-124-212	Temp.:Threshold:Judge:Mid. Power	*ENG	[0 to 200 / 0 / 1deg/step]
1-124-213	CPM Level 2: Judge:Mid. Power	*ENG	[0 to 200 / 110 / 1deg/step]
1-124-214	Temp.:Threshold:Judge:High Power	*ENG	[0 to 200 / 0 / 1deg/step]
1-124-215	CPM Level 2: Judge:High Power	*ENG	[0 to 200 / 110 / 1deg/step]
1-124-220	Ini.: HighTemp: DownTemp	*ENG	[-50 to 0 / -30 / 1deg/step]
1-124-221	Ini.: HighTemp: UpTemp	*ENG	[-50 to 50 / -15 / 1deg/step]
1-124-222	Ini.: LowTemp: DownTemp	*ENG	[-50 to 0 / -30 / 1deg/step]
1-124-223	Ini.: LowTemp: UpTemp	*ENG	[-50 to 50 / -15 / 1deg/step]
1-124-224	Ini.: HighTemp: DownTemp: Mid-Low Spd	*ENG	[-50 to 0 / -20 / 1deg/step]
1-124-225	Ini.: HighTemp: UpTemp: Mid- Low Spd	*ENG	[-50 to 50 / -15 / 1deg/step]
1-124-226	Ini.: LowTemp: DownTemp: Mid-Low Spd	*ENG	[-50 to 0 / -20 / 1deg/step]
1-124-227	Ini.: LowTemp: UpTemp: Mid- Low Spd	*ENG	[-50 to 50 / -15 / 1deg/step]
1-124-241	L:High:3rd Temp.:SRA3:Press End	*ENG	[100 to 250 / 220 / 1deg/step]
1-124-242	L:High:3rd Temp.:A3:Press End	*ENG	[100 to 250 / 215 / 1deg/step]
1-124-243	L:High:3rd Temp.:DLT:Press End	*ENG	[100 to 250 / 215 / 1deg/step]
1-124-244	L:High:3rd Temp.:B4:Press End	*ENG	[100 to 250 / 215 / 1deg/step]
1-124-245	L:High:3rd Temp.:LT:Fuser End	*ENG	[100 to 250 / 225 / 1deg/step]
1-124-246	L:High:3rd Temp.:A4:Fuser End	*ENG	[100 to 250 / 225 / 1deg/step]
1-124-247	L:High:3rd Temp.:B5:Press Center	*ENG	[100 to 250 / 215 / 1deg/step]

1-124-248	L:High:3rd Temp.:A5:Press Center	*ENG	[100 to 250 / 217 / 1deg/step]
1-124-249	L:High:3rd Temp.:B6:Press Center	*ENG	[100 to 250 / * / 1deg/step] *NA: 192, EU: 219, Asia: 219, CHN: 219, TWN: 192, KOR: 219
1-124-250	L:High:3rd Temp.:A6:Press Center	*ENG	[100 to 250 / * / 1deg/step] *NA: 192, EU: 219, Asia: 219, CHN: 219, TWN: 192, KOR: 219

1125	[CPM Down Setting]		
1-125-001	High:1st CPM:A3:Large Size:Normal Speed	*ENG	[0 to 100 / 80 / 1%/step]
1-125-002	High:2nd CPM:A3:Large Size:Normal Speed	*ENG	[0 to 100 / 50 / 1%/step]
1-125-003	High:3rd CPM:A3:Large Size:Normal Speed	*ENG	[0 to 100 / 30 / 1%/step]
1-125-004	High:1st CPM:A3:Small Size:Normal Speed	*ENG	[0 to 100 / 80 / 1%/step]
1-125-005	High:2nd CPM:A3:Small Size:Normal Speed	*ENG	[0 to 100 / 50 / 1%/step]
1-125-006	High:3rd CPM:A3:Small Size:Normal Speed	*ENG	[0 to 100 / 30 / 1%/step]
1-125-007	High:1st CPM:DLT:Large Size:Normal Speed	*ENG	[0 to 100 / 80 / 1%/step]
1-125-008	High:2nd CPM:DLT:Large Size:Normal Speed	*ENG	[0 to 100 / 50 / 1%/step]
1-125-009	High:3rd CPM:DLT:Large Size:Normal Speed	*ENG	[0 to 100 / 30 / 1%/step]
1-125-010	High:1st CPM:DLT:Small Size:Normal Speed	*ENG	[0 to 100 / 80 / 1%/step]
1-125-011	High:2nd CPM:DLT:Small Size:Normal Speed	*ENG	[0 to 100 / 50 / 1%/step]

1-125-012	High:3rd CPM:DLT:Small Size:Normal Speed	*ENG	[0 to 100 / 30 / 1%/step]
1-125-013	High:1st CPM:B4:Large Size:Normal Speed	*ENG	[0 to 100 / 80 / 1%/step]
1-125-014	High:2nd CPM:B4:Large Size:Normal Speed	*ENG	[0 to 100 / 50 / 1%/step]
1-125-015	High:3rd CPM:B4:Large Size:Normal Speed	*ENG	[0 to 100 / 30 / 1%/step]
1-125-016	High:1st CPM:B4:Small Size:Normal Speed	*ENG	[0 to 100 / 80 / 1%/step]
1-125-017	High:2nd CPM:B4:Small Size:Normal Speed	*ENG	[0 to 100 / 50 / 1%/step]
1-125-018	High:3rd CPM:B4:Small Size:Normal Speed	*ENG	[0 to 100 / 30 / 1%/step]
1-125-019	High:1st CPM:LT:Large Size:Normal Speed	*ENG	[0 to 100 / 80 / 1%/step]
1-125-020	High:2nd CPM:LT:Large Size:Normal Speed	*ENG	[0 to 100 / 50 / 1%/step]
1-125-021	High:3rd CPM:LT:Large Size:Normal Speed	*ENG	[0 to 100 / 30 / 1%/step]
1-125-022	High:1st CPM:LT:Small Size:Normal Speed	*ENG	[0 to 100 / 80 / 1%/step]
1-125-023	High:2nd CPM:LT:Small Size:Normal Speed	*ENG	[0 to 100 / 50 / 1%/step]
1-125-024	High:3rd CPM:LT:Small Size:Normal Speed	*ENG	[0 to 100 / 30 / 1%/step]
1-125-025	High:1st CPM:A4:Large Size:Normal Speed	*ENG	[0 to 100 / 80 / 1%/step]
1-125-026	High:2nd CPM:A4:Large Size:Normal Speed	*ENG	[0 to 100 / 50 / 1%/step]
1-125-027	High:3rd CPM:A4:Large Size:Normal Speed	*ENG	[0 to 100 / 30 / 1%/step]

1-125-028	High:1st CPM:A4:Small Size:Normal Speed	*ENG	[0 to 100 / 80 / 1%/step]
1-125-029	High:2nd CPM:A4:Small Size:Normal Speed	*ENG	[0 to 100 / 50 / 1%/step]
1-125-030	High:3rd CPM:A4:Small Size:Normal Speed	*ENG	[0 to 100 / 30 / 1%/step]
1-125-031	High:1st CPM:B5:Large Size:Normal Speed	*ENG	[0 to 100 / 80 / 1%/step]
1-125-032	High:2nd CPM:B5:Large Size:Normal Speed	*ENG	[0 to 100 / 50 / 1%/step]
1-125-033	High:3rd CPM:B5:Large Size:Normal Speed	*ENG	[0 to 100 / 30 / 1%/step]
1-125-034	High:1st CPM:B5:Small Size:Normal Speed	*ENG	[0 to 100 / 80 / 1%/step]
1-125-035	High:2nd CPM:B5:Small Size:Normal Speed	*ENG	[0 to 100 / 50 / 1%/step]
1-125-036	High:3rd CPM:B5:Small Size:Normal Speed	*ENG	[0 to 100 / 30 / 1%/step]
1-125-037	High:1st CPM:A5:Normal Speed	*ENG	[0 to 100 / 80 / 1%/step]
1-125-038	High:2nd CPM:A5:Normal Speed	*ENG	[0 to 100 / 50 / 1%/step]
1-125-039	High:3rd CPM:A5:Normal Speed	*ENG	[0 to 100 / 30 / 1%/step]
1-125-040	High:1st CPM:B6:Normal Speed	*ENG	[0 to 100 / 80 / 1%/step]
1-125-041	High:2nd CPM:B6:Normal Speed	*ENG	[0 to 100 / 50 / 1%/step]
1-125-042	High:3rd CPM:B6:Normal Speed	*ENG	[0 to 100 / 30 / 1%/step]
1-125-043	High:1st CPM:A6:Normal Speed	*ENG	[0 to 100 / 80 / 1%/step]

1-125-044	High:2nd CPM:A6:Normal Speed	*ENG	[0 to 100 / 50 / 1%/step]
1-125-045	High:3rd CPM:A6:Normal Speed	*ENG	[0 to 100 / 30 / 1%/step]
1-125-046	High:1st CPM:SRA3:Large Size:Normal Speed	*ENG	[0 to 100 / 80 / 1%/step]
1-125-047	High:2nd CPM:SRA3:Large Size:Normal Speed	*ENG	[0 to 100 / 50 / 1%/step]
1-125-048	High:3rd CPM:SRA3:Large Size:Normal Speed	*ENG	[0 to 100 / 30 / 1%/step]
1-125-049	High:1st CPM:SRA3:Small Size:Normal Speed	*ENG	[0 to 100 / 80 / 1%/step]
1-125-050	High:2nd CPM:SRA3:Small Size:Normal Speed	*ENG	[0 to 100 / 50 / 1%/step]
1-125-051	High:3rd CPM:SRA3:Small Size:Normal Speed	*ENG	[0 to 100 / 30 / 1%/step]
1-125-101	High:1st CPM:A3:Large Size:Middle Speed	*ENG	[0 to 100 / 80 / 1%/step]
1-125-102	High:2nd CPM:A3:Large Size:Middle Speed	*ENG	[0 to 100 / 50 / 1%/step]
1-125-104	High:1st CPM:A3:Small Size:Middle Speed	*ENG	[0 to 100 / 80 / 1%/step]
1-125-105	High:2nd CPM:A3:Small Size:Middle Speed	*ENG	[0 to 100 / 50 / 1%/step]
1-125-107	High:1st CPM:DLT:Large Size:Middle Speed	*ENG	[0 to 100 / 80 / 1%/step]
1-125-108	High:2nd CPM:DLT:Large Size:Middle Speed	*ENG	[0 to 100 / 50 / 1%/step]
1-125-110	High:1st CPM:DLT:Small Size:Middle Speed	*ENG	[0 to 100 / 80 / 1%/step]
1-125-111	High:2nd CPM:DLT:Small Size:Middle Speed	*ENG	[0 to 100 / 50 / 1%/step]

1-125-113	High:1st CPM:B4:Large Size:Middle Speed	*ENG	[0 to 100 / 80 / 1%/step]
1-125-114	High:2nd CPM:B4:Large Size:Middle Speed	*ENG	[0 to 100 / 50 / 1%/step]
1-125-116	High:1st CPM:B4:Small Size:Middle Speed	*ENG	[0 to 100 / 80 / 1%/step]
1-125-117	High:2nd CPM:B4:Small Size:Middle Speed	*ENG	[0 to 100 / 50 / 1%/step]
1-125-119	High:1st CPM:LT:Large Size:Middle Speed	*ENG	[0 to 100 / 80 / 1%/step]
1-125-120	High:2nd CPM:LT:Large Size:Middle Speed	*ENG	[0 to 100 / 50 / 1%/step]
1-125-122	High:1st CPM:LT:Small Size:Middle Speed	*ENG	[0 to 100 / 80 / 1%/step]
1-125-123	High:2nd CPM:LT:Small Size:Middle Speed	*ENG	[0 to 100 / 50 / 1%/step]
1-125-125	High:1st CPM:A4:Large Size:Middle Speed	*ENG	[0 to 100 / 80 / 1%/step]
1-125-126	High:2nd CPM:A4:Large Size:Middle Speed	*ENG	[0 to 100 / 50 / 1%/step]
1-125-128	High:1st CPM:A4:Small Size:Middle Speed	*ENG	[0 to 100 / 80 / 1%/step]
1-125-129	High:2nd CPM:A4:Small Size:Middle Speed	*ENG	[0 to 100 / 50 / 1%/step]
1-125-131	High:1st CPM:B5:Large Size:Middle Speed	*ENG	[0 to 100 / 80 / 1%/step]
1-125-132	High:2nd CPM:B5:Large Size:Middle Speed	*ENG	[0 to 100 / 50 / 1%/step]
1-125-134	High:1st CPM:B5:Small Size:Middle Speed	*ENG	[0 to 100 / 80 / 1%/step]
1-125-135	High:2nd CPM:B5:Small Size:Middle Speed	*ENG	[0 to 100 / 50 / 1%/step]

1-125-137	High:1st CPM:A5:Middle Speed	*ENG	[0 to 100 / 80 / 1%/step]
1-125-138	High:2nd CPM:A5:Middle Speed	*ENG	[0 to 100 / 50 / 1%/step]
1-125-140	High:1st CPM:B6:Middle Speed	*ENG	[0 to 100 / 60 / 1%/step]
1-125-141	High:2nd CPM:B6:Middle Speed	*ENG	[0 to 100 / 50 / 1%/step]
1-125-143	High:1st CPM:A6:Middle Speed	*ENG	[0 to 100 / 80 / 1%/step]
1-125-144	High:2nd CPM:A6:Middle Speed	*ENG	[0 to 100 / 50 / 1%/step]
1-125-145	High:1st CPM:SRA3:Large Size:Middle Speed	*ENG	[0 to 100 / 80 / 1%/step]
1-125-146	High:2nd CPM:SRA3:Large Size:Middle Speed	*ENG	[0 to 100 / 50 / 1%/step]
1-125-147	High:1st CPM:SRA3:Small Size:Middle Speed	*ENG	[0 to 100 / 80 / 1%/step]
1-125-148	High:2nd CPM:SRA3:Small Size:Middle Speed	*ENG	[0 to 100 / 50 / 1%/step]
1-125-201	High:1st CPM:A3:Large Size:Low Speed	*ENG	[0 to 100 / 80 / 1%/step]
1-125-204	High:1st CPM:A3:Small Size:Low Speed	*ENG	[0 to 100 / 80 / 1%/step]
1-125-207	High:1st CPM:DLT:Large Size:Low Speed	*ENG	[0 to 100 / 80 / 1%/step]
1-125-210	High:1st CPM:DLT:Small Size:Low Speed	*ENG	[0 to 100 / 80 / 1%/step]
1-125-213	High:1st CPM:B4:Large Size:Low Speed	*ENG	[0 to 100 / 80 / 1%/step]
1-125-216	High:1st CPM:B4:Small Size:Low Speed	*ENG	[0 to 100 / 80 / 1%/step]

1-125-219	High:1st CPM:LT:Large Size:Low Speed	*ENG	[0 to 100 / 80 / 1%/step]
1-125-222	High:1st CPM:LT:Small Size:Low Speed	*ENG	[0 to 100 / 80 / 1%/step]
1-125-225	High:1st CPM:A4:Large Size:Low Speed	*ENG	[0 to 100 / 80 / 1%/step]
1-125-228	High:1st CPM:A4:Small Size:Low Speed	*ENG	[0 to 100 / 80 / 1%/step]
1-125-231	High:1st CPM:B5:Large Size:Low Speed	*ENG	[0 to 100 / 80 / 1%/step]
1-125-234	High:1st CPM:B5:Small Size:Low Speed	*ENG	[0 to 100 / 80 / 1%/step]
1-125-237	High:1st CPM:A5:Low Speed	*ENG	[0 to 100 / 80 / 1%/step]
1-125-240	High:1st CPM:B6:Low Speed	*ENG	[0 to 100 / 83 / 1%/step]
1-125-243	High:1st CPM:A6:Low Speed	*ENG	[0 to 100 / 93 / 1%/step]
1-125-244	High:1st CPM:SRA3:Large Size:Low Speed	*ENG	[0 to 100 / 80 / 1%/step]
1-125-245	High:1st CPM:SRA3:Small Size:Low Speed	*ENG	[0 to 100 / 80 / 1%/step]

1126	[Heating Start Delay]		
1-126-001	Judgement Temp 1	*ENG	[0 to 180 / 30 / 1deg/step]
1-126-002	Judgement Temp 2	*ENG	[0 to 180 / 32 / 1deg/step]
1-126-003	Judgement Temp 3	*ENG	[0 to 180 / 45 / 1deg/step]
1-126-011	Set TimeA: Div 1	*ENG	[0 to 10000 / * / 1msec/step] *NA: 1100, EU: 1500, Asia: 1500, CHN: 1500, TWN: 1100, KOR: 1500
1-126-012	Set TimeA: Div 2	*ENG	[0 to 10000 / * / 1msec/step] *NA: 1600, EU: 2200, Asia: 2200, CHN: 2200, TWN: 1600, KOR: 2200

1-126-013	Set TimeA: Div 3	*ENG	[0 to 10000 / * / 1msec/step] *NA: 1900, EU: 2500, Asia: 2500, CHN: 2500, TWN: 1900, KOR: 2500
1-126-014	Set TimeA: Div 4	*ENG	[0 to 10000 / * / 1msec/step] *NA: 1100, EU: 1500, Asia: 1500, CHN: 1500, TWN: 1100, KOR: 1500
1-126-021	Delay Time: Div 1	*ENG	[0 to 10000 / * / 1msec/step] *NA: 1100, EU: 1500, Asia: 1500, CHN: 1500, TWN: 1100, KOR: 1500
1-126-022	Delay Time: Div 2	*ENG	[0 to 10000 / * / 1msec/step] *NA: 1600, EU: 2200, Asia: 2200, CHN: 2200, TWN: 1600, KOR: 2200
1-126-023	Delay Time: Div 3	*ENG	[0 to 10000 / * / 1msec/step] *NA: 1900, EU: 2500, Asia: 2500, CHN: 2500, TWN: 1900, KOR: 2500
1-126-024	Delay Time: Div 4	*ENG	[0 to 10000 / * / 1msec/step] *NA: 1100, EU: 1500, Asia: 1500, CHN: 1500, TWN: 1100, KOR: 1500

1127	[Energy Saving PprFeed Judgment]		
1-127-001	Judging Method Change	ENG	[0 to 2 / 1 / 1/step]
1-127-002	Temp.: Threshold: Press	ENG	[0 to 200 / 50 / 1deg/step]
1-127-003	Temp.: Threshold: Atmosphere	ENG	[0 to 200 / 60 / 1deg/step]
1-127-004	Power Supply Voltage: Lower	ENG	[0 to 300 / * / 1V/step] *NA: 108, EU: 206, Asia: 206, CHN: 206, TWN: 102, KOR: 206
1-127-005	Power Supply Voltage: Upper	ENG	[0 to 300 / * / 1V/step] *NA: 134, EU: 252, Asia: 252, CHN: 252, TWN: 121, KOR: 252
1-127-006	Judgment Time-Out	ENG	[0 to 10.0 / 10.0 / 0.1sec/step]

1131	[Continuous Print Mode Switch]		
1-131-001	Feed Permit Condition	*ENG	[0 to 2 / 1 / 1/step] 0: Productivity Mode 1: Fusing Quality Mode 2: Fusing Quality Mode 2

1132	[Maximum Duty Switch]		
1-132-001	Control Method Switch	*ENG	[0 or 1 / 1 / 1/step] 0: Fixed Duty 1: AutoOffstCtl

1133	[Voltage Detection]		
1-133-001	Heater ON	*ENG	[0 to 350.0 / * / 0.1V/step] *NA: 116.0, EU: 223.0, Asia: 223.0, CHN: 223.0, TWN: 107.0 , KOR: 223.0
1-133-002	Max	*ENG	[0 to 350.0 / 0 / 0.1V/step]
1-133-003	Min	*ENG	[0 to 350.0 / 350.0 / 0.1V/step]
1-133-004	Last	*ENG	[0 to 350.0 / 0 / 0.1V/step]
1-133-005	SC	*ENG	[0 to 350.0 / 0 / 0.1V/step]
1-133-006	Threshold Voltage	*ENG	[0 to 255 / * / 1V/step] *NA: 96, EU: 178, Asia: 178, CHN: 178, TWN: 88 , KOR: 178

1134	[Effective Duty Adjustment]		
1-134-001	Control Method Switch	*ENG	[0 or 1 / 1 / 1/step] 0: OFF 1: ON

1135	[Inrush Control]		
-------------	-------------------------	--	--

1-135-001	Inrush Control	*ENG	[0 or 1 / 0 / 1/step] 0: Normal (Do not) 1: Inrush current suppress (Do)
1135	[Inrush Control]		
1-135-002	Flicker Control	*ENG	[0 or 1 / 0 / 1/step]

1141	[Fusing SC Error Time Info]		
1-141-001	SC Number	*ENG	[0 to 99999 / 0 / 1/step]
1-141-101	Htg Roller: Ctr Det1	*ENG	[-100 to 300 / 0 / 1 deg/step]
1-141-102	Htg Roller: End Det1	*ENG	[-100 to 300 / 0 / 1 deg/step]
1-141-103	Press Roller: Ctr Det1	*ENG	[-100 to 300 / 0 / 1 deg/step]
1-141-104	Press Roller: End Det1	*ENG	[-100 to 300 / 0 / 1 deg/step]
1-141-105	NC Sensor: Center Atmosphere Temp 1	*ENG	[-100 to 300 / 0 / 1 deg/step]
1-141-106	NC Sensor: End Atmosphere Temp 1	*ENG	[-100 to 300 / 0 / 1 deg/step]
1-141-151	Htg Roller: Ctr Det2	*ENG	[-100 to 300 / 0 / 1 deg/step]
1-141-152	Htg Roller: End Det2	*ENG	[-100 to 300 / 0 / 1 deg/step]
1-141-153	Press Roller: Ctr Det2	*ENG	[-100 to 300 / 0 / 1 deg/step]
1-141-154	Press Roller: End Det2	*ENG	[-100 to 300 / 0 / 1 deg/step]
1-141-155	NC Sensor: Center Atmosphere Temp 2	*ENG	[-100 to 300 / 0 / 1 deg/step]
1-141-156	NC Sensor: End Atmosphere Temp 2	*ENG	[-100 to 300 / 0 / 1 deg/step]
1-141-201	Htg Roller: Ctr Det3	*ENG	[-100 to 300 / 0 / 1 deg/step]
1-141-202	Htg Roller: End Det3	*ENG	[-100 to 300 / 0 / 1 deg/step]
1-141-203	Press Roller: Ctr Det3	*ENG	[-100 to 300 / 0 / 1 deg/step]
1-141-204	Press Roller: End Det3	*ENG	[-100 to 300 / 0 / 1 deg/step]

1-141-205	NC Sensor: Center Atmosphere Temp 3	*ENG	[-100 to 300 / 0 / 1deg/step]
1-141-206	NC Sensor: End Atmosphere Temp 3	*ENG	[-100 to 300 / 0 / 1deg/step]

1142	[Fusing Jam Detection]		
1-142-001	SC Display	*ENG	[0 or 1 / 0 / 1/step] 0: OFF 1: ON

1151	[Pressure Setting]		
1-151-001	Pressure Change ON/OFF	*ENG	[0 or 1 / 1 / 1/step] 0: OFF 1: ON
1-151-002	Pressure Time1	*ENG	[0 to 10000 / 70 / 10msec/step]
1-151-003	Pressure Time2	*ENG	[0 to 10000 / 70 / 10msec/step]
1-151-005	Depressure Time	*ENG	[0 to 10000 / 0 / 10msec/step]
1-151-010	Shift Time:Energy Saving	*ENG	[0 to 3600 / 0 / 1sec/step]
1-151-011	Shift Time	*ENG	[0 to 3600 / 60 / 1sec/step]
1-151-051	Rotary speed	*ENG	[-12.8 to 12.7 / 0 / 0.1%/step]
1-151-101	Pressure:Plain1/2	*ENG	[0 to 3 / 2 / 1/step]
1-151-102	Pressure:Thin	*ENG	[0 to 3 / 2 / 1/step]
1-151-103	Pressure:M-thick	*ENG	[0 to 3 / 2 / 1/step]
1-151-104	Pressure:Thick1	*ENG	[0 to 3 / 2 / 1/step]
1-151-105	Pressure:Thick2	*ENG	[0 to 3 / 2 / 1/step]
1-151-106	Pressure:Thick3	*ENG	[0 to 3 / 2 / 1/step]
1-151-107	Pressure:Special1	*ENG	[0 to 3 / 2 / 1/step]
1-151-108	Pressure:Special2	*ENG	[0 to 3 / 2 / 1/step]

1-151-109	Pressure:Special3	*ENG	[0 to 3 / 2 / 1/step]
1-151-110	Pressure:Envelope	*ENG	[0 to 3 / 2 / 1/step]
1-151-151	Pressure:Plain1/2:Low Speed	*ENG	[0 to 3 / 2 / 1/step]
1-151-152	Pressure:M-thick:Low Speed	*ENG	[0 to 3 / 2 / 1/step]
1-151-153	Pressure:Thick1:Low Speed	*ENG	[0 to 3 / 2 / 1/step]
1-151-154	Pressure:Special1:Low Speed	*ENG	[0 to 3 / 2 / 1/step]
1-151-157	Pressure:M-thick:Glossy	*ENG	[0 to 3 / 2 / 1/step]
1-151-158	Pressure:OHP	*ENG	[0 to 3 / 2 / 1/step]
1-151-159	Pressure:Envelope:Low Speed	*ENG	[0 to 3 / 2 / 1/step]
1-151-160	Pressure:Thin:Low Speed	*ENG	[0 to 3 / 2 / 1/step]
1-151-161	Pressure:Thick4	*ENG	[0 to 3 / 2 / 1/step]
1-151-162	Pressure:Postcard	*ENG	[0 to 3 / 2 / 1/step]

1152	[Fusing Nip Band Check]		
1-152-001	Execute	ENG	[0 or 1 / 0 / 1/step]
1-152-002	Pre-idling Time	*ENG	[0 to 999 / 300 / 1sec/step]
1-152-003	Stop Time	*ENG	[0 to 100 / 20 / 1sec/step]
1-152-004	Pressure Position	*ENG	[1 to 2 / 2 / 1/step]

1153	[Abnormal Noise Confirmation]		
1-153-001	Unit: Execute	ENG	[0 or 1 / 0 / 1/step]
1-153-002	No Unit: Execute	ENG	[0 or 1 / 0 / 1/step]
1-153-003	Operation Line Speed	ENG	[0 to 2 / 0 / 1/step] 0: Std Speed 1: Mid Speed 2: Low Speed
1-153-004	Operation Time	ENG	[0 to 240 / 60 / 1sec/step]

1-153-005	Heat Center Target Temp	ENG	[100 to 180 / 130 / 1deg/step]
1-153-006	Heat End Target Temp	ENG	[100 to 180 / 130 / 1deg/step]
1-153-007	Press Target Temp	ENG	[0 to 200 / 0 / 1deg/step]

1154	[Switch:Rotation Start/Stop]		
1-154-001	Judging Method Change	*ENG	[0 or 1 / 0 / 1/step] 0: On 1: Off
1-154-005	Heater ON Timing	*ENG	[0 to 250 / 50 / 1 / 10msec/step]
1-154-006	Overshoot Prevent Temp.:SC	*ENG	[0 to 250 / 180 / 1deg/step]

1155	[Small Size Paper Control]		
1-155-001	Print Width	*ENG	[0 to 300 / 0 / 1mm/step]

1157	[Overshoot Prevent Control]		
1-157-001	Decision Time	*ENG	[0 to 100 / 5 / 1sec/step]
1-157-002	Decision Temp.	*ENG	[0 to 250 / 185 / 1deg/step]
1-157-003	-	*ENG	[0 to 300 / 15 / 1sec/step]
1-157-004	Timeout	*ENG	[0 to 300 / 300 / 1sec/step]

1161	[Shading Plate Control]		
1-161-001	Judgment Temp A	ENG	[0 to 250 / 250 / 1deg/step]
1-161-002	Judgment Temp B	ENG	[0 to 250 / 250 / 1deg/step]
1-161-003	Position Transition Time	ENG	[0 to 10000 / 1000 / 1msec/step]
1-161-004	After Transition Time Out	ENG	[0 to 20000 / 0 / 1msec/step]
1-161-005	Shading Plate Retry Volume	*ENG	[0 to 100 / 60 / 1pulse/step]

1162	[Shading Plate Control]		
-------------	--------------------------------	--	--

1-162-001	Shading Position Temp: 1 2inch: 1	ENG	[0 to 250 / 250 / 1 deg/step]
1-162-002	Shading Position Temp: 1 2inch: 2	ENG	[0 to 250 / 250 / 1 deg/step]
1-162-003	Shading Position Temp: 1 2inch: 3	ENG	[0 to 250 / 250 / 1 deg/step]
1-162-004	Shading Position Temp: A3: 1	ENG	[0 to 250 / 250 / 1 deg/step]
1-162-005	Shading Position Temp: A3: 2	ENG	[0 to 250 / 250 / 1 deg/step]
1-162-006	Shading Position Temp: A3: 3	ENG	[0 to 250 / 250 / 1 deg/step]
1-162-007	Shading Position Temp: DLT: 1	ENG	[0 to 250 / 250 / 1 deg/step]
1-162-008	Shading Position Temp: DLT: 2	ENG	[0 to 250 / 250 / 1 deg/step]
1-162-009	Shading Position Temp: DLT: 3	ENG	[0 to 250 / 250 / 1 deg/step]
1-162-010	Shading Position Temp: B4: 1	ENG	[0 to 250 / 250 / 1 deg/step]
1-162-011	Shading Position Temp: B4: 2	ENG	[0 to 250 / 250 / 1 deg/step]
1-162-012	Shading Position Temp: B4: 3	ENG	[0 to 250 / 250 / 1 deg/step]
1-162-013	Shading Position Temp: LT: 1	ENG	[0 to 250 / 250 / 1 deg/step]
1-162-014	Shading Position Temp: LT: 2	ENG	[0 to 250 / 250 / 1 deg/step]
1-162-015	Shading Position Temp: LT: 3	ENG	[0 to 250 / 250 / 1 deg/step]
1-162-016	Shading Position Temp: A4: 1	ENG	[0 to 250 / 250 / 1 deg/step]
1-162-017	Shading Position Temp: A4: 2	ENG	[0 to 250 / 250 / 1 deg/step]
1-162-018	Shading Position Temp: A4: 3	ENG	[0 to 250 / 250 / 1 deg/step]
1-162-019	Shading Position Temp: B5: 1	ENG	[0 to 250 / 250 / 1 deg/step]
1-162-020	Shading Position Temp: B5: 2	ENG	[0 to 250 / 250 / 1 deg/step]
1-162-021	Shading Position Temp: B5: 3	ENG	[0 to 250 / 250 / 1 deg/step]
1-162-022	Shading Position Temp: A5: 1	ENG	[0 to 250 / 250 / 1 deg/step]
1-162-023	Shading Position Temp: A5: 2	ENG	[0 to 250 / 250 / 1 deg/step]
1-162-024	Shading Position Temp: A5: 3	ENG	[0 to 250 / 250 / 1 deg/step]

1-162-025	Shading Position Temp: B6: 1	ENG	[0 to 250 / 250 / 1 deg/step]
1-162-026	Shading Position Temp: B6: 2	ENG	[0 to 250 / 250 / 1 deg/step]
1-162-027	Shading Position Temp: B6: 3	ENG	[0 to 250 / 250 / 1 deg/step]
1-162-028	Shading Position Temp: DLEnv: 1	ENG	[0 to 250 / 250 / 1 deg/step]
1-162-029	Shading Position Temp: DLEnv: 2	ENG	[0 to 250 / 250 / 1 deg/step]
1-162-030	Shading Position Temp: DLEnv: 3	ENG	[0 to 250 / 250 / 1 deg/step]
1-162-031	Shading Position Temp: COM10: 1	ENG	[0 to 250 / 250 / 1 deg/step]
1-162-032	Shading Position Temp: COM10: 2	ENG	[0 to 250 / 250 / 1 deg/step]
1-162-033	Shading Position Temp: COM10: 3	ENG	[0 to 250 / 250 / 1 deg/step]
1-162-034	Shading Position Temp: Postcard: 1	ENG	[0 to 250 / 250 / 1 deg/step]
1-162-035	Shading Position Temp: Postcard: 2	ENG	[0 to 250 / 250 / 1 deg/step]
1-162-036	Shading Position Temp: Postcard: 3	ENG	[0 to 250 / 250 / 1 deg/step]
1-162-037	Shading Position Temp: 12inch: 4	ENG	[0 to 250 / 250 / 1 deg/step]
1-162-038	Shading Position Temp: 12inch: 5	ENG	[0 to 250 / 250 / 1 deg/step]
1-162-039	Shading Position Temp: 12inch: 6	ENG	[0 to 250 / 250 / 1 deg/step]
1-162-040	Shading Position Temp: 12inch: 7	ENG	[0 to 250 / 250 / 1 deg/step]
1-162-041	Shading Position Temp: 12inch: 8	ENG	[0 to 250 / 250 / 1 deg/step]

1-162-042	Shading Position Temp: A3: 4	ENG	[0 to 250 / 250 / 1 deg/step]
1-162-043	Shading Position Temp: A3: 5	ENG	[0 to 250 / 250 / 1 deg/step]
1-162-044	Shading Position Temp: A3: 6	ENG	[0 to 250 / 250 / 1 deg/step]
1-162-045	Shading Position Temp: A3: 7	ENG	[0 to 250 / 250 / 1 deg/step]
1-162-046	Shading Position Temp: A3: 8	ENG	[0 to 250 / 250 / 1 deg/step]
1-162-047	Shading Position Temp: DLT: 4	ENG	[0 to 250 / 250 / 1 deg/step]
1-162-048	Shading Position Temp: DLT: 5	ENG	[0 to 250 / 250 / 1 deg/step]
1-162-049	Shading Position Temp: DLT: 6	ENG	[0 to 250 / 250 / 1 deg/step]
1-162-050	Shading Position Temp: DLT: 7	ENG	[0 to 250 / 250 / 1 deg/step]
1-162-051	Shading Position Temp: DLT: 8	ENG	[0 to 250 / 250 / 1 deg/step]
1-162-052	Shading Position Temp: B4: 4	ENG	[0 to 250 / 250 / 1 deg/step]
1-162-053	Shading Position Temp: B4: 5	ENG	[0 to 250 / 250 / 1 deg/step]
1-162-054	Shading Position Temp: B4: 6	ENG	[0 to 250 / 250 / 1 deg/step]
1-162-055	Shading Position Temp: B4: 7	ENG	[0 to 250 / 250 / 1 deg/step]
1-162-056	Shading Position Temp: B4: 8	ENG	[0 to 250 / 250 / 1 deg/step]
1-162-057	Shading Position Temp: LT: 4	ENG	[0 to 250 / 250 / 1 deg/step]
1-162-058	Shading Position Temp: LT: 5	ENG	[0 to 250 / 250 / 1 deg/step]
1-162-059	Shading Position Temp: LT: 6	ENG	[0 to 250 / 250 / 1 deg/step]
1-162-060	Shading Position Temp: LT: 7	ENG	[0 to 250 / 250 / 1 deg/step]
1-162-061	Shading Position Temp: LT: 8	ENG	[0 to 250 / 250 / 1 deg/step]
1-162-062	Shading Position Temp: A4: 4	ENG	[0 to 250 / 250 / 1 deg/step]
1-162-063	Shading Position Temp: A4: 5	ENG	[0 to 250 / 250 / 1 deg/step]
1-162-064	Shading Position Temp: A4: 6	ENG	[0 to 250 / 250 / 1 deg/step]
1-162-065	Shading Position Temp: A4: 7	ENG	[0 to 250 / 250 / 1 deg/step]
1-162-066	Shading Position Temp: A4: 8	ENG	[0 to 250 / 250 / 1 deg/step]
1-162-067	Shading Position Temp: B5: 4	ENG	[0 to 250 / 250 / 1 deg/step]

1-162-068	Shading Position Temp: B5: 5	ENG	[0 to 250 / 250 / 1 deg/step]
1-162-069	Shading Position Temp: B5: 6	ENG	[0 to 250 / 250 / 1 deg/step]
1-162-070	Shading Position Temp: B5: 7	ENG	[0 to 250 / 250 / 1 deg/step]
1-162-071	Shading Position Temp: B5: 8	ENG	[0 to 250 / 250 / 1 deg/step]
1-162-072	Shading Position Temp: A5: 4	ENG	[0 to 250 / 250 / 1 deg/step]
1-162-073	Shading Position Temp: A5: 5	ENG	[0 to 250 / 250 / 1 deg/step]
1-162-074	Shading Position Temp: A5: 6	ENG	[0 to 250 / 250 / 1 deg/step]
1-162-075	Shading Position Temp: A5: 7	ENG	[0 to 250 / 250 / 1 deg/step]
1-162-076	Shading Position Temp: A5: 8	ENG	[0 to 250 / 250 / 1 deg/step]
1-162-077	Shading Position Temp: B6: 4	ENG	[0 to 250 / 250 / 1 deg/step]
1-162-078	Shading Position Temp: B6: 5	ENG	[0 to 250 / 250 / 1 deg/step]
1-162-079	Shading Position Temp: B6: 6	ENG	[0 to 250 / 250 / 1 deg/step]
1-162-080	Shading Position Temp: B6: 7	ENG	[0 to 250 / 250 / 1 deg/step]
1-162-081	Shading Position Temp: B6: 8	ENG	[0 to 250 / 250 / 1 deg/step]
1-162-082	Shading Position Temp: DLEnv: 4	ENG	[0 to 250 / 250 / 1 deg/step]
1-162-083	Shading Position Temp: DLEnv: 5	ENG	[0 to 250 / 250 / 1 deg/step]
1-162-084	Shading Position Temp: DLEnv: 6	ENG	[0 to 250 / 250 / 1 deg/step]
1-162-085	Shading Position Temp: DLEnv: 7	ENG	[0 to 250 / 250 / 1 deg/step]
1-162-086	Shading Position Temp: DLEnv: 8	ENG	[0 to 250 / 250 / 1 deg/step]
1-162-087	Shading Position Temp: COM10: 4	ENG	[0 to 250 / 250 / 1 deg/step]
1-162-088	Shading Position Temp: COM10: 5	ENG	[0 to 250 / 250 / 1 deg/step]

1-162-089	Shading Position Temp: COM10: 6	ENG	[0 to 250 / 250 / 1 deg/step]
1-162-090	Shading Position Temp: COM10: 7	ENG	[0 to 250 / 250 / 1 deg/step]
1-162-091	Shading Position Temp: COM10: 8	ENG	[0 to 250 / 250 / 1 deg/step]
1-162-092	Shading Position Temp: Postcard: 4	ENG	[0 to 250 / 250 / 1 deg/step]
1-162-093	Shading Position Temp: Postcard: 5	ENG	[0 to 250 / 250 / 1 deg/step]
1-162-094	Shading Position Temp: Postcard: 6	ENG	[0 to 250 / 250 / 1 deg/step]
1-162-095	Shading Position Temp: Postcard: 7	ENG	[0 to 250 / 250 / 1 deg/step]
1-162-096	Shading Position Temp: Postcard: 8	ENG	[0 to 250 / 250 / 1 deg/step]
1-162-121	Shading Position Temp: SRA3: 1	ENG	[0 to 250 / 250 / 1 deg/step]
1-162-122	Shading Position Temp: SRA3: 2	ENG	[0 to 250 / 250 / 1 deg/step]
1-162-123	Shading Position Temp: SRA3: 3	ENG	[0 to 250 / 250 / 1 deg/step]
1-162-124	Shading Position Temp: SRA3: 4	ENG	[0 to 250 / 250 / 1 deg/step]
1-162-125	Shading Position Temp: SRA3: 5	ENG	[0 to 250 / 250 / 1 deg/step]
1-162-126	Shading Position Temp: SRA3: 6	ENG	[0 to 250 / 250 / 1 deg/step]
1-162-127	Shading Position Temp: SRA3: 7	ENG	[0 to 250 / 250 / 1 deg/step]
1-162-128	Shading Position Temp: SRA3: 8	ENG	[0 to 250 / 250 / 1 deg/step]

1-162-201	Shading Position Temp: 12inch: Clear	ENG	[0 to 250 / 0 / 1deg/step]
1-162-202	Shading Position Temp: A3: Clear	ENG	[0 to 250 / 0 / 1deg/step]
1-162-203	Shading Position Temp: DLT: Clear	ENG	[0 to 250 / 0 / 1deg/step]
1-162-204	Shading Position Temp: B4: Clear	ENG	[0 to 250 / 0 / 1deg/step]
1-162-205	Shading Position Temp: LT: Clear	ENG	[0 to 250 / 0 / 1deg/step]
1-162-206	Shading Position Temp: A4: Clear	ENG	[0 to 250 / 0 / 1deg/step]
1-162-207	Shading Position Temp: B5: Clear	ENG	[0 to 250 / 0 / 1deg/step]
1-162-208	Shading Position Temp: A5: Clear	ENG	[0 to 250 / 0 / 1deg/step]
1-162-209	Shading Position Temp: B6: Clear	ENG	[0 to 250 / 0 / 1deg/step]
1-162-210	Shading Position Temp: DLEnv: Clear	ENG	[0 to 250 / 0 / 1deg/step]
1-162-211	Shading Position Temp: COM10: Clear	ENG	[0 to 250 / 0 / 1deg/step]
1-162-212	Shading Position Temp: Postcard: Clear	ENG	[0 to 250 / 0 / 1deg/step]
1-162-213	Shading Position Temp: SRA3: Clear	ENG	[0 to 250 / 0 / 1deg/step]

1163	[Shading Plate Control]		
1-163-001	Shading Position Time: 12inch: 1	ENG	[0 to 10000 / 10000 / 1sec/step]
1-163-002	Shading Position Time: 12inch: 2	ENG	[0 to 10000 / 10000 / 1sec/step]

1-163-003	Shading Position Time: 12inch: 3	ENG	[0 to 10000 / 10000 / 1 sec/step]
1-163-004	Shading Position Time: A3: 1	ENG	[0 to 10000 / 10000 / 1 sec/step]
1-163-005	Shading Position Time: A3: 2	ENG	[0 to 10000 / 10000 / 1 sec/step]
1-163-006	Shading Position Time: A3: 3	ENG	[0 to 10000 / 10000 / 1 sec/step]
1-163-007	Shading Position Time: DLT: 1	ENG	[0 to 10000 / 10000 / 1 sec/step]
1-163-008	Shading Position Time: DLT: 2	ENG	[0 to 10000 / 10000 / 1 sec/step]
1-163-009	Shading Position Time: DLT: 3	ENG	[0 to 10000 / 10000 / 1 sec/step]
1-163-010	Shading Position Time: B4: 1	ENG	[0 to 10000 / 10000 / 1 sec/step]
1-163-011	Shading Position Time: B4: 2	ENG	[0 to 10000 / 10000 / 1 sec/step]
1-163-012	Shading Position Time: B4: 3	ENG	[0 to 10000 / 10000 / 1 sec/step]
1-163-013	Shading Position Time: LT: 1	ENG	[0 to 10000 / 10000 / 1 sec/step]
1-163-014	Shading Position Time: LT: 2	ENG	[0 to 10000 / 10000 / 1 sec/step]
1-163-015	Shading Position Time: LT: 3	ENG	[0 to 10000 / 10000 / 1 sec/step]
1-163-016	Shading Position Time: A4: 1	ENG	[0 to 10000 / 10000 / 1 sec/step]
1-163-017	Shading Position Time: A4: 2	ENG	[0 to 10000 / 10000 / 1 sec/step]
1-163-018	Shading Position Time: A4: 3	ENG	[0 to 10000 / 10000 / 1 sec/step]
1-163-019	Shading Position Time: B5: 1	ENG	[0 to 10000 / 10000 / 1 sec/step]
1-163-020	Shading Position Time: B5: 2	ENG	[0 to 10000 / 10000 / 1 sec/step]
1-163-021	Shading Position Time: B5: 3	ENG	[0 to 10000 / 10000 / 1 sec/step]
1-163-022	Shading Position Time: A5: 1	ENG	[0 to 10000 / 10000 / 1 sec/step]
1-163-023	Shading Position Time: A5: 2	ENG	[0 to 10000 / 10000 / 1 sec/step]
1-163-024	Shading Position Time: A5: 3	ENG	[0 to 10000 / 10000 / 1 sec/step]
1-163-025	Shading Position Time: B6: 1	ENG	[0 to 10000 / 10000 / 1 sec/step]
1-163-026	Shading Position Time: B6: 2	ENG	[0 to 10000 / 10000 / 1 sec/step]
1-163-027	Shading Position Time: B6: 3	ENG	[0 to 10000 / 10000 / 1 sec/step]

1-163-028	Shading Position Time: DLEnv: 1	ENG	[0 to 10000 / 10000 / 1 sec/step]
1-163-029	Shading Position Time: DLEnv: 2	ENG	[0 to 10000 / 10000 / 1 sec/step]
1-163-030	Shading Position Time: DLEnv: 3	ENG	[0 to 10000 / 10000 / 1 sec/step]
1-163-031	Shading Position Time: COM10: 1	ENG	[0 to 10000 / 10000 / 1 sec/step]
1-163-032	Shading Position Time: COM10: 2	ENG	[0 to 10000 / 10000 / 1 sec/step]
1-163-033	Shading Position Time: COM10: 3	ENG	[0 to 10000 / 10000 / 1 sec/step]
1-163-034	Shading Position Time: Postcard: 1	ENG	[0 to 10000 / 10000 / 1 sec/step]
1-163-035	Shading Position Time: Postcard: 2	ENG	[0 to 10000 / 10000 / 1 sec/step]
1-163-036	Shading Position Time: Postcard: 3	ENG	[0 to 10000 / 10000 / 1 sec/step]
1-163-037	Shading Position Time: 12inch: 4	ENG	[0 to 10000 / 10000 / 1 sec/step]
1-163-038	Shading Position Time: 12inch: 5	ENG	[0 to 10000 / 10000 / 1 sec/step]
1-163-039	Shading Position Time: 12inch: 6	ENG	[0 to 10000 / 10000 / 1 sec/step]
1-163-040	Shading Position Time: 12inch: 7	ENG	[0 to 10000 / 10000 / 1 sec/step]
1-163-041	Shading Position Time: 12inch: 8	ENG	[0 to 10000 / 10000 / 1 sec/step]
1-163-042	Shading Position Time: A3: 4	ENG	[0 to 10000 / 10000 / 1 sec/step]
1-163-043	Shading Position Time: A3: 5	ENG	[0 to 10000 / 10000 / 1 sec/step]
1-163-044	Shading Position Time: A3: 6	ENG	[0 to 10000 / 10000 / 1 sec/step]

1-163-045	Shading Position Time: A3: 7	ENG	[0 to 10000 / 10000 / 1 sec/step]
1-163-046	Shading Position Time: A3: 8	ENG	[0 to 10000 / 10000 / 1 sec/step]
1-163-047	Shading Position Time: DLT: 4	ENG	[0 to 10000 / 10000 / 1 sec/step]
1-163-048	Shading Position Time: DLT: 5	ENG	[0 to 10000 / 10000 / 1 sec/step]
1-163-049	Shading Position Time: DLT: 6	ENG	[0 to 10000 / 10000 / 1 sec/step]
1-163-050	Shading Position Time: DLT: 7	ENG	[0 to 10000 / 10000 / 1 sec/step]
1-163-051	Shading Position Time: DLT: 8	ENG	[0 to 10000 / 10000 / 1 sec/step]
1-163-052	Shading Position Time: B4: 4	ENG	[0 to 10000 / 10000 / 1 sec/step]
1-163-053	Shading Position Time: B4: 5	ENG	[0 to 10000 / 10000 / 1 sec/step]
1-163-054	Shading Position Time: B4: 6	ENG	[0 to 10000 / 10000 / 1 sec/step]
1-163-055	Shading Position Time: B4: 7	ENG	[0 to 10000 / 10000 / 1 sec/step]
1-163-056	Shading Position Time: B4: 8	ENG	[0 to 10000 / 10000 / 1 sec/step]
1-163-057	Shading Position Time: LT: 4	ENG	[0 to 10000 / 10000 / 1 sec/step]
1-163-058	Shading Position Time: LT: 5	ENG	[0 to 10000 / 10000 / 1 sec/step]
1-163-059	Shading Position Time: LT: 6	ENG	[0 to 10000 / 10000 / 1 sec/step]
1-163-060	Shading Position Time: LT: 7	ENG	[0 to 10000 / 10000 / 1 sec/step]
1-163-061	Shading Position Time: LT: 8	ENG	[0 to 10000 / 10000 / 1 sec/step]
1-163-062	Shading Position Time: A4: 4	ENG	[0 to 10000 / 10000 / 1 sec/step]
1-163-063	Shading Position Time: A4: 5	ENG	[0 to 10000 / 10000 / 1 sec/step]
1-163-064	Shading Position Time: A4: 6	ENG	[0 to 10000 / 10000 / 1 sec/step]
1-163-065	Shading Position Time: A4: 7	ENG	[0 to 10000 / 10000 / 1 sec/step]
1-163-066	Shading Position Time: A4: 8	ENG	[0 to 10000 / 10000 / 1 sec/step]
1-163-067	Shading Position Time: B5: 4	ENG	[0 to 10000 / 10000 / 1 sec/step]
1-163-068	Shading Position Time: B5: 5	ENG	[0 to 10000 / 10000 / 1 sec/step]
1-163-069	Shading Position Time: B5: 6	ENG	[0 to 10000 / 10000 / 1 sec/step]
1-163-070	Shading Position Time: B5: 7	ENG	[0 to 10000 / 10000 / 1 sec/step]

1-163-071	Shading Position Time: B5: 8	ENG	[0 to 10000 / 10000 / 1 sec/step]
1-163-072	Shading Position Time: A5: 4	ENG	[0 to 10000 / 10000 / 1 sec/step]
1-163-073	Shading Position Time: A5: 5	ENG	[0 to 10000 / 10000 / 1 sec/step]
1-163-074	Shading Position Time: A5: 6	ENG	[0 to 10000 / 10000 / 1 sec/step]
1-163-075	Shading Position Time: A5: 7	ENG	[0 to 10000 / 10000 / 1 sec/step]
1-163-076	Shading Position Time: A5: 8	ENG	[0 to 10000 / 10000 / 1 sec/step]
1-163-077	Shading Position Time: B6: 4	ENG	[0 to 10000 / 10000 / 1 sec/step]
1-163-078	Shading Position Time: B6: 5	ENG	[0 to 10000 / 10000 / 1 sec/step]
1-163-079	Shading Position Time: B6: 6	ENG	[0 to 10000 / 10000 / 1 sec/step]
1-163-080	Shading Position Time: B6: 7	ENG	[0 to 10000 / 10000 / 1 sec/step]
1-163-081	Shading Position Time: B6: 8	ENG	[0 to 10000 / 10000 / 1 sec/step]
1-163-082	Shading Position Time: DLEnv: 4	ENG	[0 to 10000 / 10000 / 1 sec/step]
1-163-083	Shading Position Time: DLEnv: 5	ENG	[0 to 10000 / 10000 / 1 sec/step]
1-163-084	Shading Position Time: DLEnv: 6	ENG	[0 to 10000 / 10000 / 1 sec/step]
1-163-085	Shading Position Time: DLEnv: 7	ENG	[0 to 10000 / 10000 / 1 sec/step]
1-163-086	Shading Position Time: DLEnv: 8	ENG	[0 to 10000 / 10000 / 1 sec/step]
1-163-087	Shading Position Time: COM10: 4	ENG	[0 to 10000 / 10000 / 1 sec/step]
1-163-088	Shading Position Time: COM10: 5	ENG	[0 to 10000 / 10000 / 1 sec/step]
1-163-089	Shading Position Time: COM10: 6	ENG	[0 to 10000 / 10000 / 1 sec/step]
1-163-090	Shading Position Time: COM10: 7	ENG	[0 to 10000 / 10000 / 1 sec/step]

1-163-091	Shading Position Time: COM10: 8	ENG	[0 to 10000 / 10000 / 1 sec/step]
1-163-092	Shading Position Time: Postcard: 4	ENG	[0 to 10000 / 10000 / 1 sec/step]
1-163-093	Shading Position Time: Postcard: 5	ENG	[0 to 10000 / 10000 / 1 sec/step]
1-163-094	Shading Position Time: Postcard: 6	ENG	[0 to 10000 / 10000 / 1 sec/step]
1-163-095	Shading Position Time: Postcard: 7	ENG	[0 to 10000 / 10000 / 1 sec/step]
1-163-096	Shading Position Time: Postcard: 8	ENG	[0 to 10000 / 10000 / 1 sec/step]
1-163-121	Shading Position Time: SRA3: 1	ENG	[0 to 10000 / 10000 / 1 sec/step]
1-163-122	Shading Position Time: SRA3: 2	ENG	[0 to 10000 / 10000 / 1 sec/step]
1-163-123	Shading Position Time: SRA3: 3	ENG	[0 to 10000 / 10000 / 1 sec/step]
1-163-124	Shading Position Time: SRA3: 4	ENG	[0 to 10000 / 10000 / 1 sec/step]
1-163-125	Shading Position Time: SRA3: 5	ENG	[0 to 10000 / 10000 / 1 sec/step]
1-163-126	Shading Position Time: SRA3: 6	ENG	[0 to 10000 / 10000 / 1 sec/step]
1-163-127	Shading Position Time: SRA3: 7	ENG	[0 to 10000 / 10000 / 1 sec/step]
1-163-128	Shading Position Time: SRA3: 8	ENG	[0 to 10000 / 10000 / 1 sec/step]
1-163-131	Shading Position Time: ECO: 1	ENG	[0 to 10000 / 10000 / 1 sec/step]
1-163-132	Shading Position Time: ECO: 2	ENG	[0 to 10000 / 10000 / 1 sec/step]
1-163-133	Shading Position Time: ECO: 3	ENG	[0 to 10000 / 10000 / 1 sec/step]
1-163-134	Shading Position Time: ECO: 4	ENG	[0 to 10000 / 10000 / 1 sec/step]
1-163-135	Shading Position Time: ECO: 5	ENG	[0 to 10000 / 10000 / 1 sec/step]
1-163-136	Shading Position Time: ECO: 6	ENG	[0 to 10000 / 10000 / 1 sec/step]
1-163-137	Shading Position Time: ECO: 7	ENG	[0 to 10000 / 10000 / 1 sec/step]
1-163-138	Shading Position Time: ECO: 8	ENG	[0 to 10000 / 10000 / 1 sec/step]

1164	[Shading Plate Control]		
1-164-001	Shading Position: 12inch: 1	ENG	[0 to 1000 / 0 / 1pluse/step]
1-164-002	Shading Position: 12inch: 2	ENG	[0 to 1000 / 0 / 1pluse/step]
1-164-003	Shading Position: 12inch: 3	ENG	[0 to 1000 / 0 / 1pluse/step]
1-164-004	Shading Position: A3: 1	ENG	[0 to 1000 / 0 / 1pluse/step]
1-164-005	Shading Position: A3: 2	ENG	[0 to 1000 / 0 / 1pluse/step]
1-164-006	Shading Position: A3: 3	ENG	[0 to 1000 / 0 / 1pluse/step]
1-164-007	Shading Position: DLT: 1	ENG	[0 to 1000 / 0 / 1pluse/step]
1-164-008	Shading Position: DLT: 2	ENG	[0 to 1000 / 0 / 1pluse/step]
1-164-009	Shading Position: DLT: 3	ENG	[0 to 1000 / 0 / 1pluse/step]
1-164-010	Shading Position: B4: 1	ENG	[0 to 1000 / 0 / 1pluse/step]
1-164-011	Shading Position: B4: 2	ENG	[0 to 1000 / 0 / 1pluse/step]
1-164-012	Shading Position: B4: 3	ENG	[0 to 1000 / 0 / 1pluse/step]
1-164-013	Shading Position: LT: 1	ENG	[0 to 1000 / 0 / 1pluse/step]
1-164-014	Shading Position: LT: 2	ENG	[0 to 1000 / 0 / 1pluse/step]
1-164-015	Shading Position: LT: 3	ENG	[0 to 1000 / 0 / 1pluse/step]
1-164-016	Shading Position: A4: 1	ENG	[0 to 1000 / 0 / 1pluse/step]
1-164-017	Shading Position: A4: 2	ENG	[0 to 1000 / 0 / 1pluse/step]
1-164-018	Shading Position: A4: 3	ENG	[0 to 1000 / 0 / 1pluse/step]
1-164-019	Shading Position: B5: 1	ENG	[0 to 1000 / 0 / 1pluse/step]
1-164-020	Shading Position: B5: 2	ENG	[0 to 1000 / 0 / 1pluse/step]
1-164-021	Shading Position: B5: 3	ENG	[0 to 1000 / 0 / 1pluse/step]
1-164-022	Shading Position: A5: 1	ENG	[0 to 1000 / 0 / 1pluse/step]
1-164-023	Shading Position: A5: 2	ENG	[0 to 1000 / 0 / 1pluse/step]
1-164-024	Shading Position: A5: 3	ENG	[0 to 1000 / 0 / 1pluse/step]
1-164-025	Shading Position: B6: 1	ENG	[0 to 1000 / 0 / 1pluse/step]

1-164-026	Shading Position: B6: 2	ENG	[0 to 1000 / 0 / 1pulse/step]
1-164-027	Shading Position: B6: 3	ENG	[0 to 1000 / 0 / 1pulse/step]
1-164-028	Shading Position: DLEnv: 1	ENG	[0 to 1000 / 0 / 1pulse/step]
1-164-029	Shading Position: DLEnv: 2	ENG	[0 to 1000 / 0 / 1pulse/step]
1-164-030	Shading Position: DLEnv: 3	ENG	[0 to 1000 / 0 / 1pulse/step]
1-164-031	Shading Position: COM10: 1	ENG	[0 to 1000 / 0 / 1pulse/step]
1-164-032	Shading Position: COM10: 2	ENG	[0 to 1000 / 0 / 1pulse/step]
1-164-033	Shading Position: COM10: 3	ENG	[0 to 1000 / 0 / 1pulse/step]
1-164-034	Shading Position: Postcard: 1	ENG	[0 to 1000 / 0 / 1pulse/step]
1-164-035	Shading Position: Postcard: 2	ENG	[0 to 1000 / 0 / 1pulse/step]
1-164-036	Shading Position: Postcard: 3	ENG	[0 to 1000 / 0 / 1pulse/step]
1-164-037	Shading Position: 12inch: 4	ENG	[0 to 1000 / 0 / 1pulse/step]
1-164-038	Shading Position: 12inch: 5	ENG	[0 to 1000 / 0 / 1pulse/step]
1-164-039	Shading Position: 12inch: 6	ENG	[0 to 1000 / 0 / 1pulse/step]
1-164-040	Shading Position: 12inch: 7	ENG	[0 to 1000 / 0 / 1pulse/step]
1-164-041	Shading Position: 12inch: 8	ENG	[0 to 1000 / 0 / 1pulse/step]
1-164-042	Shading Position: A3: 4	ENG	[0 to 1000 / 0 / 1pulse/step]
1-164-043	Shading Position: A3: 5	ENG	[0 to 1000 / 0 / 1pulse/step]
1-164-044	Shading Position: A3: 6	ENG	[0 to 1000 / 0 / 1pulse/step]
1-164-045	Shading Position: A3: 7	ENG	[0 to 1000 / 0 / 1pulse/step]
1-164-046	Shading Position: A3: 8	ENG	[0 to 1000 / 0 / 1pulse/step]
1-164-047	Shading Position: DLT: 4	ENG	[0 to 1000 / 0 / 1pulse/step]
1-164-048	Shading Position: DLT: 5	ENG	[0 to 1000 / 0 / 1pulse/step]
1-164-049	Shading Position: DLT: 6	ENG	[0 to 1000 / 0 / 1pulse/step]
1-164-050	Shading Position: DLT: 7	ENG	[0 to 1000 / 0 / 1pulse/step]
1-164-051	Shading Position: DLT: 8	ENG	[0 to 1000 / 0 / 1pulse/step]

1-164-052	Shading Position: B4: 4	ENG	[0 to 1000 / 0 / 1pluse/step]
1-164-053	Shading Position: B4: 5	ENG	[0 to 1000 / 0 / 1pluse/step]
1-164-054	Shading Position: B4: 6	ENG	[0 to 1000 / 0 / 1pluse/step]
1-164-055	Shading Position: B4: 7	ENG	[0 to 1000 / 0 / 1pluse/step]
1-164-056	Shading Position: B4: 8	ENG	[0 to 1000 / 0 / 1pluse/step]
1-164-057	Shading Position: LT: 4	ENG	[0 to 1000 / 0 / 1pluse/step]
1-164-058	Shading Position: LT: 5	ENG	[0 to 1000 / 0 / 1pluse/step]
1-164-059	Shading Position: LT: 6	ENG	[0 to 1000 / 0 / 1pluse/step]
1-164-060	Shading Position: LT: 7	ENG	[0 to 1000 / 0 / 1pluse/step]
1-164-061	Shading Position: LT: 8	ENG	[0 to 1000 / 0 / 1pluse/step]
1-164-062	Shading Position: A4: 4	ENG	[0 to 1000 / 0 / 1pluse/step]
1-164-063	Shading Position: A4: 5	ENG	[0 to 1000 / 0 / 1pluse/step]
1-164-064	Shading Position: A4: 6	ENG	[0 to 1000 / 0 / 1pluse/step]
1-164-065	Shading Position: A4: 7	ENG	[0 to 1000 / 0 / 1pluse/step]
1-164-066	Shading Position: A4: 8	ENG	[0 to 1000 / 0 / 1pluse/step]
1-164-067	Shading Position: B5: 4	ENG	[0 to 1000 / 0 / 1pluse/step]
1-164-068	Shading Position: B5: 5	ENG	[0 to 1000 / 0 / 1pluse/step]
1-164-069	Shading Position: B5: 6	ENG	[0 to 1000 / 0 / 1pluse/step]
1-164-070	Shading Position: B5: 7	ENG	[0 to 1000 / 0 / 1pluse/step]
1-164-071	Shading Position: B5: 8	ENG	[0 to 1000 / 0 / 1pluse/step]
1-164-072	Shading Position: A5: 4	ENG	[0 to 1000 / 0 / 1pluse/step]
1-164-073	Shading Position: A5: 5	ENG	[0 to 1000 / 0 / 1pluse/step]
1-164-074	Shading Position: A5: 6	ENG	[0 to 1000 / 0 / 1pluse/step]
1-164-075	Shading Position: A5: 7	ENG	[0 to 1000 / 0 / 1pluse/step]
1-164-076	Shading Position: A5: 8	ENG	[0 to 1000 / 0 / 1pluse/step]
1-164-077	Shading Position: B6: 4	ENG	[0 to 1000 / 0 / 1pluse/step]

1-164-078	Shading Position: B6: 5	ENG	[0 to 1000 / 0 / 1pluse/step]
1-164-079	Shading Position: B6: 6	ENG	[0 to 1000 / 0 / 1pluse/step]
1-164-080	Shading Position: B6: 7	ENG	[0 to 1000 / 0 / 1pluse/step]
1-164-081	Shading Position: B6: 8	ENG	[0 to 1000 / 0 / 1pluse/step]
1-164-082	Shading Position: DLEnv: 4	ENG	[0 to 1000 / 0 / 1pluse/step]
1-164-083	Shading Position: DLEnv: 5	ENG	[0 to 1000 / 0 / 1pluse/step]
1-164-084	Shading Position: DLEnv: 6	ENG	[0 to 1000 / 0 / 1pluse/step]
1-164-085	Shading Position: DLEnv: 7	ENG	[0 to 1000 / 0 / 1pluse/step]
1-164-086	Shading Position: DLEnv: 8	ENG	[0 to 1000 / 0 / 1pluse/step]
1-164-087	Shading Position: COM10: 4	ENG	[0 to 1000 / 0 / 1pluse/step]
1-164-088	Shading Position: COM10: 5	ENG	[0 to 1000 / 0 / 1pluse/step]
1-164-089	Shading Position: COM10: 6	ENG	[0 to 1000 / 0 / 1pluse/step]
1-164-090	Shading Position: COM10: 7	ENG	[0 to 1000 / 0 / 1pluse/step]
1-164-091	Shading Position: COM10: 8	ENG	[0 to 1000 / 0 / 1pluse/step]
1-164-092	Shading Position: Postcard: 4	ENG	[0 to 1000 / 0 / 1pluse/step]
1-164-093	Shading Position: Postcard: 5	ENG	[0 to 1000 / 0 / 1pluse/step]
1-164-094	Shading Position: Postcard: 6	ENG	[0 to 1000 / 0 / 1pluse/step]
1-164-095	Shading Position: Postcard: 7	ENG	[0 to 1000 / 0 / 1pluse/step]
1-164-096	Shading Position: Postcard: 8	ENG	[0 to 1000 / 0 / 1pluse/step]
1-164-121	Shading Position: SRA3: 1	ENG	[0 to 1000 / 0 / 1pluse/step]
1-164-122	Shading Position: SRA3: 2	ENG	[0 to 1000 / 0 / 1pluse/step]
1-164-123	Shading Position: SRA3: 3	ENG	[0 to 1000 / 0 / 1pluse/step]
1-164-124	Shading Position: SRA3: 4	ENG	[0 to 1000 / 0 / 1pluse/step]
1-164-125	Shading Position: SRA3: 5	ENG	[0 to 1000 / 0 / 1pluse/step]
1-164-126	Shading Position: SRA3: 6	ENG	[0 to 1000 / 0 / 1pluse/step]
1-164-127	Shading Position: SRA3: 7	ENG	[0 to 1000 / 0 / 1pluse/step]

1-164-128	Shading Position: SRA3: 8	ENG	[0 to 1000 / 0 / 1pluse/step]
-----------	---------------------------	-----	-------------------------------

1165	[Shading Plate Control]		
1-165-001	Execution Judgement	*ENG	[0 or 1 / 0 / 1/step] 0: ON 1: OFF
1-165-101	Continuous Error Times	*ENG	[0 to 10 / 0 / 1/step]

Engine SP Tables - SP1000-2

SP1-XXX (Drive, Fan)

1801	[Relay Motor Speed Adjust]		
1-801-001	Feed CCW:Plain:Low	*ENG	[-2 to 2 / 0.9 / 0.1%/step]
1-801-002	Feed CCW:Plain:Std	*ENG	[-2 to 2 / 0.9 / 0.1%/step]
1-801-003	Feed CCW:Mid-thick:Low	*ENG	[-2 to 2 / 1.1 / 0.1%/step]
1-801-004	Feed CCW:Mid-thick:Std	*ENG	[-2 to 2 / 1.1 / 0.1%/step]
1-801-005	Feed CCW:Thick 1:Low	*ENG	[-2 to 2 / 1.2 / 0.1%/step]
1-801-006	Feed CCW:Thick 1:Mid	*ENG	[-2 to 2 / 1.2 / 0.1%/step]
1-801-007	Feed CCW:Thick 2:Low	*ENG	[-2 to 2 / 1.2 / 0.1%/step]
1-801-008	Feed CCW:Thick 3:Low	*ENG	[-2 to 2 / 0.9 / 0.1%/step]
1-801-009	Feed CCW:Thick 4:Low	*ENG	[-2 to 2 / 0.9 / 0.1%/step]
1-801-010	Feed CW:Plain:Low	*ENG	[-2 to 2 / 0.9 / 0.1%/step]
1-801-011	Feed CW:Plain:Std	*ENG	[-2 to 2 / 0.9 / 0.1%/step]
1-801-012	Feed CW:Mid-thick:Low	*ENG	[-2 to 2 / 1.1 / 0.1%/step]
1-801-013	Feed CW:Mid-thick:Std	*ENG	[-2 to 2 / 1.1 / 0.1%/step]
1-801-014	Feed CW:Thick 1:Low	*ENG	[-2 to 2 / 1.2 / 0.1%/step]
1-801-015	Feed CW:Thick 1:Mid	*ENG	[-2 to 2 / 1.2 / 0.1%/step]
1-801-016	Feed CW:Thick 2:Low	*ENG	[-2 to 2 / 1.2 / 0.1%/step]
1-801-017	Feed CW:Thick 3:Low	*ENG	[-2 to 2 / 0.9 / 0.1%/step]
1-801-018	Feed CW:Thick 4:Low	*ENG	[-2 to 2 / 0.9 / 0.1%/step]
1-801-019	Vertical Feed:Plain:Low	*ENG	[-2 to 2 / 0.9 / 0.1%/step]
1-801-020	Vertical Feed:Plain:Std	*ENG	[-2 to 2 / 0.9 / 0.1%/step]
1-801-021	Vertical Feed:Mid-thick:Low	*ENG	[-2 to 2 / 1.1 / 0.1%/step]

1-801-022	Vertical Feed:Mid-thick:Std	*ENG	[-2 to 2 / 1.1 / 0.1%/step]
1-801-023	Vertical Feed:Thick 1:Low	*ENG	[-2 to 2 / 1.2 / 0.1%/step]
1-801-024	Vertical Feed:Thick 1:Mid	*ENG	[-2 to 2 / 1.2 / 0.1%/step]
1-801-025	Vertical Feed:Thick 2:Low	*ENG	[-2 to 2 / 1.2 / 0.1%/step]
1-801-026	Vertical Feed:Thick 3:Low	*ENG	[-2 to 2 / 0.9 / 0.1%/step]
1-801-027	Vertical Feed:Thick 4:Low	*ENG	[-2 to 2 / 0.9 / 0.1%/step]
1-801-028	Registration:Plain:Low	*ENG	[-2 to 2 / 0.3 / 0.1%/step]
1-801-029	Registration:Plain:Std	*ENG	[-2 to 2 / 0.3 / 0.1%/step]
1-801-030	Registration:Mid-thick:Low	*ENG	[-2 to 2 / 0.3 / 0.1%/step]
1-801-031	Registration:Mid-thick:Std	*ENG	[-2 to 2 / 0.3 / 0.1%/step]
1-801-032	Registration:Thick 1:Low	*ENG	[-2 to 2 / 0.4 / 0.1%/step]
1-801-033	Registration:Thick 1:Mid	*ENG	[-2 to 2 / 0.4 / 0.1%/step]
1-801-034	Registration:Thick 2:Low	*ENG	[-2 to 2 / 0.4 / 0.1%/step]
1-801-035	Registration:Thick 3:Low	*ENG	[-2 to 2 / 0.3 / 0.1%/step]
1-801-036	Registration:Thick 4:Low	*ENG	[-2 to 2 / 0.3 / 0.1%/step]
1-801-037	Exit CCW:Plain:Low	*ENG	[-4 to 4 / -0.8 / 0.1%/step]
1-801-038	Exit CCW:Plain:Std	*ENG	[-4 to 4 / -0.8 / 0.1%/step]
1-801-039	Exit CCW:Mid-thick:Low	*ENG	[-4 to 4 / -0.8 / 0.1%/step]
1-801-040	Exit CCW:Mid-thick:Std	*ENG	[-4 to 4 / -0.8 / 0.1%/step]
1-801-041	Exit CCW:Thick 1:Low	*ENG	[-4 to 4 / -0.8 / 0.1%/step]
1-801-042	Exit CCW:Thick 1:Mid	*ENG	[-4 to 4 / -0.6 / 0.1%/step]
1-801-043	Exit CCW:Thick 2:Low	*ENG	[-4 to 4 / -0.9 / 0.1%/step]
1-801-044	Exit CCW:Thick 3:Low	*ENG	[-4 to 4 / -0.9 / 0.1%/step]
1-801-045	Exit CCW:Thick 4:Low	*ENG	[-4 to 4 / -0.4 / 0.1%/step]
1-801-046	Reverse CW:Plain:Low	*ENG	[-4 to 4 / 0.7 / 0.1%/step]
1-801-047	Reverse CW:Plain:Std	*ENG	[-4 to 4 / 0.7 / 0.1%/step]

1-801-048	Reverse CW:Mid-thick:Low	*ENG	[-4 to 4 / 0.5 / 0.1%/step]
1-801-049	Reverse CW:Mid-thick:Std	*ENG	[-4 to 4 / 0.5 / 0.1%/step]
1-801-050	Reverse CW:Thick1:Low	*ENG	[-4 to 4 / 0.7 / 0.1%/step]
1-801-051	Reverse CW:Thick1:Mid	*ENG	[-4 to 4 / 0.7 / 0.1%/step]
1-801-052	Reverse CW:Thick2:Low	*ENG	[-4 to 4 / 0.8 / 0.1%/step]
1-801-053	Reverse CW:Thick3:Low	*ENG	[-4 to 4 / 0.7 / 0.1%/step]
1-801-054	Reverse CW:Thick4:Low	*ENG	[-4 to 4 / 0.7 / 0.1%/step]
1-801-055	Reverse CCW:Plain:Low	*ENG	[-4 to 4 / -0.8 / 0.1%/step]
1-801-056	Reverse CCW:Plain:Std	*ENG	[-4 to 4 / -0.8 / 0.1%/step]
1-801-057	Reverse CCW:Mid-thick:Low	*ENG	[-4 to 4 / -0.8 / 0.1%/step]
1-801-058	Reverse CCW:Mid-thick:Std	*ENG	[-4 to 4 / -0.8 / 0.1%/step]
1-801-059	Reverse CCW:Thick1:Low	*ENG	[-4 to 4 / -0.8 / 0.1%/step]
1-801-060	Reverse CCW:Thick1:Mid	*ENG	[-4 to 4 / -0.6 / 0.1%/step]
1-801-061	Reverse CCW:Thick2:Low	*ENG	[-4 to 4 / -0.9 / 0.1%/step]
1-801-062	Reverse CCW:Thick3:Low	*ENG	[-4 to 4 / -0.9 / 0.1%/step]
1-801-063	Reverse CCW:Thick4:Low	*ENG	[-4 to 4 / -0.4 / 0.1%/step]
1-801-064	Duplex Enter CW:Plain:Low	*ENG	[-4 to 4 / 1.4 / 0.1%/step]
1-801-065	Duplex Enter CW:Plain:Std	*ENG	[-4 to 4 / 1.4 / 0.1%/step]
1-801-066	Duplex Enter CW:Mid-thick:Low	*ENG	[-4 to 4 / 1.2 / 0.1%/step]
1-801-067	Duplex Enter CW:Mid-thick:Std	*ENG	[-4 to 4 / 1.2 / 0.1%/step]
1-801-068	Duplex Enter CW:Thick1:Low	*ENG	[-4 to 4 / 1.5 / 0.1%/step]
1-801-069	Duplex Enter CW:Thick1:Mid	*ENG	[-4 to 4 / 1.5 / 0.1%/step]
1-801-070	Duplex Enter CW:Thick2:Low	*ENG	[-4 to 4 / 1.5 / 0.1%/step]
1-801-071	Duplex Enter CW:Thick3:Low	*ENG	[-4 to 4 / 1.4 / 0.1%/step]
1-801-072	Duplex CW:Plain:Low	*ENG	[-4 to 4 / 0.7 / 0.1%/step]

1-801-073	Duplex CW:Plain:Std	*ENG	[-4 to 4 / 0.7 / 0.1%/step]
1-801-074	Duplex CW:Mid-thick:Low	*ENG	[-4 to 4 / 0.5 / 0.1%/step]
1-801-075	Duplex CW:Mid-thick:Std	*ENG	[-4 to 4 / 0.5 / 0.1%/step]
1-801-076	Duplex CW:Thick1:Low	*ENG	[-4 to 4 / 0.8 / 0.1%/step]
1-801-077	Duplex CW:Thick1:Mid	*ENG	[-4 to 4 / 0.8 / 0.1%/step]
1-801-078	Duplex CW:Thick2:Low	*ENG	[-4 to 4 / 0.8 / 0.1%/step]
1-801-079	Duplex CW:Thick3:Low	*ENG	[-4 to 4 / 0.7 / 0.1%/step]
1-801-080	Duplex CCW:Plain:Low	*ENG	[-4 to 4 / 0.9 / 0.1%/step]
1-801-081	Duplex CCW:Plain:Std	*ENG	[-4 to 4 / 0.9 / 0.1%/step]
1-801-082	Duplex CCW:Mid-thick:Low	*ENG	[-4 to 4 / 1.1 / 0.1%/step]
1-801-083	Duplex CCW:Mid-thick:Std	*ENG	[-4 to 4 / 1.1 / 0.1%/step]
1-801-084	Duplex CCW:Thick1:Low	*ENG	[-4 to 4 / 1.2 / 0.1%/step]
1-801-085	Duplex CCW:Thick1:Mid	*ENG	[-4 to 4 / 1.2 / 0.1%/step]
1-801-086	Duplex CCW:Thick2:Low	*ENG	[-4 to 4 / 1.2 / 0.1%/step]
1-801-087	Duplex CCW:Thick3:Low	*ENG	[-4 to 4 / 0.9 / 0.1%/step]
1-801-088	Duplex CCW:Thick4:Low	*ENG	[-4 to 4 / 0.9 / 0.1%/step]
1-801-089	Relay Motor Speed Adjust:Low	*ENG	[-4 to 4 / 0 / 0.1%/step]
1-801-090	Relay Motor Speed Adjust:Mid	*ENG	[-4 to 4 / 0 / 0.1%/step]
1-801-091	Relay Motor Speed Adjust:Standard	*ENG	[-4 to 4 / 0 / 0.1%/step]
1-801-100	Drum Adjust	*ENG	[0 or 1 / 1 / 1/step]
1-801-101	Offset:ColorOpcMot:Standard	*ENG	[-10 to 10 / 0 / 0.01Hz/step]
1-801-102	Offset:ColorOpcMot:Mid	*ENG	[-10 to 10 / 0 / 0.01Hz/step]
1-801-103	Offset:ColorOpcMot:Low	*ENG	[-10 to 10 / 0 / 0.01Hz/step]
1-801-106	ColorOpcMot:Standard	*ENG	[-10 to 10 / 0 / 0.01Hz/step]
1-801-107	ColorOpcMot:Mid	*ENG	[-10 to 10 / 0 / 0.01Hz/step]

1-801-108	ColorOpcMot:Low	*ENG	[-10 to 10 / 0 / 0.01Hz/step]
1-801-109	BkDevMot:Standard	*ENG	[-20 to 20 / 0 / 0.1%/step]
1-801-110	BkDevMot:Mid	*ENG	[-20 to 20 / 0 / 0.1%/step]
1-801-111	BkDevMot:Low	*ENG	[-20 to 20 / 0 / 0.1%/step]
1-801-115	ColorDevMot:Standard	*ENG	[-20 to 20 / 0 / 0.1%/step]
1-801-116	ColorDevMot:Mid	*ENG	[-20 to 20 / 0 / 0.1%/step]
1-801-117	ColorDevMot:Low	*ENG	[-20 to 20 / 0 / 0.1%/step]
1-801-118	Fusing:Standard	*ENG	[-10 to 10 / -1.4 / 0.1%/step]
1-801-119	Fusing:Mid	*ENG	[-10 to 10 / -1.0 / 0.1%/step]
1-801-120	Fusing:Low	*ENG	[-10 to 10 / -1.0 / 0.1%/step]
1-801-121	Fusing:Low:1200:Plain	*ENG	[-10 to 10 / -1.4 / 0.1%/step]
1-801-122	OPCTransferMot:Standard	*ENG	[-10 to 10 / 0.2 / 0.1%/step]
1-801-123	OPCTransferMot:Mid	*ENG	[-10 to 10 / 0.2 / 0.1%/step]
1-801-124	OPCTransferMot:Low	*ENG	[-10 to 10 / 0.2 / 0.1%/step]
1-801-125	Fusing:Low:Thick 4	*ENG	[-10 to 10 / -0.5 / 0.1%/step]
1-801-133	ColorOpcMot:Standard:independence	*ENG	[-10 to 10 / -0.2 / 0.1%/step]
1-801-134	ColorOpcMot:Mid:independence	*ENG	[-10 to 10 / -0.2 / 0.1%/step]
1-801-135	ColorOpcMot:Low:independence	*ENG	[-10 to 10 / -0.2 / 0.1%/step]
1-801-140	Long:Registration:Plain:Low	*ENG	[-2 to 2 / 0.3 / 0.1%/step]
1-801-141	Long:Registration:Plain:High	*ENG	[-2 to 2 / 0.3 / 0.1%/step]
1-801-142	Long:Registration:Middle Thick:Low	*ENG	[-2 to 2 / 0.3 / 0.1%/step]
1-801-143	Long:Registration:Middle Thick:High	*ENG	[-2 to 2 / 0.3 / 0.1%/step]
1-801-144	Long:Registration:Thick 1:Low	*ENG	[-2 to 2 / 0.4 / 0.1%/step]

1-801-145	Long:Registration:Thick 1:Middle	*ENG	[-2 to 2 / 0.4 / 0.1%/step]
1-801-146	Long:Registration:Thick 2:Low	*ENG	[-2 to 2 / 0.4 / 0.1%/step]
1-801-147	Long:Registration:Thick 3:Low	*ENG	[-2 to 2 / 0.3 / 0.1%/step]
1-801-148	Long:Registration:Thick 4:Low	*ENG	[-2 to 2 / 0.3 / 0.1%/step]
1-801-160	Long:Fusing:Plain:Low	*ENG	[-10 to 10 / -1.2 / 0.01%/step]
1-801-161	Long:Fusing:Plain:High	*ENG	[-10 to 10 / -1.4 / 0.01%/step]
1-801-162	Long:Fusing:Middle Thick:Low	*ENG	[-10 to 10 / -0.8 / 0.01%/step]
1-801-163	Long:Fusing:Middle Thick:High	*ENG	[-10 to 10 / -1.4 / 0.01%/step]
1-801-164	Long:Fusing:Thick 1:Low	*ENG	[-10 to 10 / -0.8 / 0.01%/step]
1-801-165	Long:Fusing:Thick 1:Middle	*ENG	[-10 to 10 / -0.8 / 0.01%/step]
1-801-166	Long:Fusing:Thick 2:Low	*ENG	[-10 to 10 / -0.8 / 0.01%/step]
1-801-167	Long:Fusing:Thick 3:Low	*ENG	[-10 to 10 / -0.8 / 0.01%/step]
1-801-168	Long:Fusing:Thick 4:Low	*ENG	[-10 to 10 / -0.8 / 0.01%/step]
1-801-180	Long:Exit CCW:Plain:Low	*ENG	[-4 to 4 / -0.8 / 0.1%/step]
1-801-181	Long:Exit CCW:Plain:High	*ENG	[-4 to 4 / -0.8 / 0.1%/step]
1-801-182	Long:Exit CCW:Middle Thick:Low	*ENG	[-4 to 4 / -0.8 / 0.1%/step]
1-801-183	Long:Exit CCW:Middle Thick:High	*ENG	[-4 to 4 / -0.8 / 0.1%/step]
1-801-184	Long:Exit CCW:Thick 1:Low	*ENG	[-4 to 4 / -0.8 / 0.1%/step]
1-801-185	Long:Exit CCW:Thick 1:Middle	*ENG	[-4 to 4 / -0.6 / 0.1%/step]
1-801-186	Long:Exit CCW:Thick 2:Low	*ENG	[-4 to 4 / -0.9 / 0.1%/step]
1-801-187	Long:Exit CCW:Thick 3:Low	*ENG	[-4 to 4 / -0.9 / 0.1%/step]
1-801-188	Long:Exit CCW:Thick 4:Low	*ENG	[-4 to 4 / -0.9 / 0.1%/step]

1805	[Motor Gain Adj.]
------	-------------------

1-805-050	DuplexInM:Speed Detective Gain	*ENG	[0 to 200 / 100 / 0.01%/step]
1-805-051	DuplexInM:Position Loop Gain	*ENG	[0 to 200 / 50 / 0.01%/step]
1-805-052	DuplexInM:Proportio *NAI Gain:PID	*ENG	[0 to 200 / 50 / 0.01%/step]
1-805-053	DuplexInM:Integral Gain:PID	*ENG	[0 to 200 / 50 / 0.01%/step]
1-805-054	DuplexInM:Derivative Gain:PID	*ENG	[0 to 200 / 50 / 0.01%/step]
1-805-055	DuplexInM:Derivative Gain:FF	*ENG	[0 to 200 / 100 / 0.01%/step]
1-805-056	DuplexInM:Proportio *NAI Gain:FF	*ENG	[0 to 200 / 100 / 0.01%/step]
1-805-057	DuplexInM:Offset:FF	*ENG	[0 to 200 / 100 / 0.01%/step]
1-805-058	DuplexInM:Numerator Coefficient:LPF:B0	*ENG	[0 to 200 / 100 / 0.01%/step]
1-805-059	DuplexInM:Denomi *NAI Coefficient:LPF:A1	*ENG	[0 to 200 / 100 / 0.01%/step]
1-805-060	DuplexInM:Denomi *NAI Coefficient:LPF:A2	*ENG	[0 to 200 / 100 / 0.01%/step]
1-805-061	DuplexM:Speed Detective Gain	*ENG	[0 to 200 / 100 / 0.01%/step]
1-805-062	DuplexM:Position Loop Gain	*ENG	[0 to 200 / 50 / 0.01%/step]
1-805-063	DuplexM:Proportio *NAI Gain:PID	*ENG	[0 to 200 / 50 / 0.01%/step]
1-805-064	DuplexM:Integral Gain:PID	*ENG	[0 to 200 / 50 / 0.01%/step]
1-805-065	DuplexM:Derivative Gain:PID	*ENG	[0 to 200 / 50 / 0.01%/step]
1-805-066	DuplexM:Derivative Gain:FF	*ENG	[0 to 200 / 100 / 0.01%/step]
1-805-067	DuplexM:Proportio *NAI Gain:FF	*ENG	[0 to 200 / 100 / 0.01%/step]
1-805-068	DuplexM:Offset:FF	*ENG	[0 to 200 / 100 / 0.01%/step]
1-805-069	DuplexM:Numerator Coefficient:LPF:B0	*ENG	[0 to 200 / 100 / 0.01%/step]

1-805-070	DuplexM:Denomi*NAtor Coefficient:LPF:A1	*ENG	[0 to 200 / 100 / 0.01%/step]
1-805-071	DuplexM:Denomi*NAtor Coefficient:LPF:A2	*ENG	[0 to 200 / 100 / 0.01%/step]
1-805-072	DuplexM:Speed Detective Gain	*ENG	[0 to 200 / 100 / 0.01%/step]
1-805-073	DuplexM:Position Loop Gain	*ENG	[0 to 200 / 50 / 0.01%/step]
1-805-074	DuplexM:Proportio*NAI Gain:PID	*ENG	[0 to 200 / 50 / 0.01%/step]
1-805-075	DuplexM:Integral Gain:PID	*ENG	[0 to 200 / 50 / 0.01%/step]
1-805-076	DuplexM:Derivative Gain:PID	*ENG	[0 to 200 / 50 / 0.01%/step]
1-805-077	DuplexM:Derivative Gain:FF	*ENG	[0 to 200 / 100 / 0.01%/step]
1-805-078	DuplexM:Proportio*NAI Gain:FF	*ENG	[0 to 200 / 100 / 0.01%/step]
1-805-079	DuplexM:Offset:FF	*ENG	[0 to 200 / 100 / 0.01%/step]
1-805-080	DuplexM:Numerator Coefficient:LPF:B0	*ENG	[0 to 200 / 100 / 0.01%/step]
1-805-081	DuplexM:Denomi*NAtor Coefficient:LPF:A1	*ENG	[0 to 200 / 100 / 0.01%/step]
1-805-082	DuplexM:Denomi*NAtor Coefficient:LPF:A2	*ENG	[0 to 200 / 100 / 0.01%/step]
1-805-115	DuplexInM:Proportio*NAI Gain:PID	*ENG	[0 to 200 / 100 / 0.01%/step]
1-805-116	DuplexInM:Integral Gain:PID	*ENG	[0 to 200 / 100 / 0.01%/step]
1-805-117	DuplexInM:Derivative Gain:PID	*ENG	[0 to 200 / 100 / 0.01%/step]
1-805-118	DuplexM:Proportio*NAI Gain:PID	*ENG	[0 to 200 / 100 / 0.01%/step]
1-805-119	DuplexM:Integral Gain:PID	*ENG	[0 to 200 / 100 / 0.01%/step]
1-805-120	DuplexM:Derivative Gain:PID	*ENG	[0 to 200 / 100 / 0.01%/step]

1-805-121	DuplexM:Proportio*NAI Gain:PID	*ENG	[0 to 200 / 100 / 0.01%/step]
1-805-122	DuplexM:Integral Gain:PID	*ENG	[0 to 200 / 100 / 0.01%/step]
1-805-123	DuplexM:Derivative Gain:PID	*ENG	[0 to 200 / 100 / 0.01%/step]

1806	[Motor Speed Profile]		
1-806-020	DuplexInM:Acceleration1	*ENG	[0 to 200 / 100 / 0.01%/step]
1-806-021	DuplexInM:Deceleration1	*ENG	[0 to 200 / 100 / 0.01%/step]
1-806-022	DuplexInM:Acceleration2	*ENG	[0 to 200 / 100 / 0.01%/step]
1-806-023	DuplexInM:Deceleration2	*ENG	[0 to 200 / 100 / 0.01%/step]
1-806-024	DuplexM:Acceleration1	*ENG	[0 to 200 / 100 / 0.01%/step]
1-806-025	DuplexM:Deceleration1	*ENG	[0 to 200 / 100 / 0.01%/step]
1-806-026	DuplexM:Acceleration2	*ENG	[0 to 200 / 100 / 0.01%/step]
1-806-027	DuplexM:Deceleration2	*ENG	[0 to 200 / 100 / 0.01%/step]
1-806-028	DuplexM:Acceleration1	*ENG	[0 to 200 / 100 / 0.01%/step]
1-806-029	DuplexM:Deceleration1	*ENG	[0 to 200 / 100 / 0.01%/step]
1-806-030	DuplexM:Acceleration2	*ENG	[0 to 200 / 100 / 0.01%/step]
1-806-031	DuplexM:Deceleration2	*ENG	[0 to 200 / 100 / 0.01%/step]

1902	[Drum Phase Adj.]		
1-902-001	Execute	ENG	[0 or 1 / 0 / 1/step]

1907	[Paper Feed Timing Adj.]		
1-907-001	Feed Solenoid ON:Tray1:Plain	*ENG	[-20 to 20 / 0 / 1mm/step]
1-907-002	Feed Solenoid ON:Tray1:Thick	*ENG	[-20 to 20 / 0 / 1mm/step]
1-907-003	Feed Solenoid ON:Tray2:Plain	*ENG	[-20 to 20 / 0 / 1mm/step]
1-907-004	Feed Solenoid ON:Tray2:Thick	*ENG	[-20 to 20 / 0 / 1mm/step]

1-907-005	Feed DCM OFF:Tray1:Plain	*ENG	[-20 to 20 / 0 / 1 mm/step]
1-907-006	Feed DCM OFF:Tray1:Thick	*ENG	[-20 to 20 / 0 / 1 mm/step]
1-907-007	Feed DCM OFF:Tray2:Plain	*ENG	[-20 to 20 / 0 / 1 mm/step]
1-907-008	Feed DCM OFF:Tray2:Thick	*ENG	[-20 to 20 / 0 / 1 mm/step]
1-907-009	Feed Solenoid OFF:Tray1:Plain	*ENG	[-20 to 20 / 0 / 1 mm/step]
1-907-010	Feed Solenoid OFF:Tray1:Thick	*ENG	[-20 to 20 / 0 / 1 mm/step]
1-907-011	Feed Solenoid OFF:Tray2:Plain	*ENG	[-20 to 20 / 0 / 1 mm/step]
1-907-012	Feed Solenoid OFF:Tray2:Thick	*ENG	[-20 to 20 / 0 / 1 mm/step]
1-907-013	Feed Start:Tray1:Plain	*ENG	[-20 to 20 / 0 / 1 mm/step]
1-907-014	Feed Start:Tray1:Thick	*ENG	[-20 to 20 / 0 / 1 mm/step]
1-907-015	Feed Start:Tray2:Plain	*ENG	[-20 to 20 / 0 / 1 mm/step]
1-907-016	Feed Start:Tray2:Thick	*ENG	[-20 to 20 / 0 / 1 mm/step]
1-907-017	Feed Re-Start:Tray1:Plain	*ENG	[-20 to 20 / 0 / 1 mm/step]
1-907-018	Feed Re-Start:Tray1:Thick	*ENG	[-20 to 20 / 0 / 1 mm/step]
1-907-019	Feed Re-Start:Tray2:Plain	*ENG	[-20 to 20 / 0 / 1 mm/step]
1-907-020	Feed Re-Start:Tray2:Thick	*ENG	[-20 to 20 / 0 / 1 mm/step]
1-907-021	Feed Re2-Start:Tray2:Plain	*ENG	[-20 to 20 / 0 / 1 mm/step]
1-907-022	Feed Re2-Start:Tray2:Thick	*ENG	[-20 to 20 / 0 / 1 mm/step]
1-907-023	Registration DCM OFF:Plain	*ENG	[-5 to 5 / 0 / 0.1 mm/step]
1-907-024	Registration DCM OFF:Thick	*ENG	[-5 to 5 / 0 / 0.1 mm/step]
1-907-025	By-pass Solenoid ON:Low	*ENG	[0 to 40 / 0 / 1 mm/step]
1-907-026	By-pass Solenoid ON:Mid	*ENG	[0 to 40 / 0 / 1 mm/step]
1-907-027	By-pass Solenoid ON:Std	ENG	[0 to 40 / 0 / 1 mm/step]
1-907-028	By-pass Solenoid OFF	*ENG	[0 to 40 / 0 / 1 mm/step]
1-907-029	By-pass Size Decision Timing	*ENG	[1 to 3 / 3 / 1/step]
1-907-030	Duplex DCM OFF:Low	*ENG	[-10 to 10 / 0 / 1 mm/step]

1-907-031	Duplex DCM OFF:Mid	*ENG	[-10 to 10 / 0 / 1 mm/step]
1-907-032	Duplex DCM OFF:Std	ENG	[-10 to 10 / 0 / 1 mm/step]
1-907-033	ExitPaperJunction SOL ON:Low	*ENG	[-10 to 10 / 0 / 1 mm/step]
1-907-034	ExitPaperJunction SOL ON:Mid	*ENG	[-10 to 10 / 0 / 1 mm/step]
1-907-035	ExitPaperJunction SOL ON:Std	ENG	[-10 to 10 / 0 / 1 mm/step]
1-907-036	ExitPaperJunction SOL OFF:Low	*ENG	[-10 to 10 / 0 / 1 mm/step]
1-907-037	ExitPaperJunction SOL OFF:Mid	*ENG	[-10 to 10 / 0 / 1 mm/step]
1-907-038	ExitPaperJunction SOL OFF:Std	ENG	[-10 to 10 / 0 / 1 mm/step]
1-907-039	Reverse Position:Plain	*ENG	[-10 to 10 / 0 / 1 mm/step]
1-907-040	Reverse Position:Thick	*ENG	[-10 to 10 / 0 / 1 mm/step]
1-907-041	Duplex Enter Position:Plain	ENG	[-10 to 10 / 0 / 1 mm/step]
1-907-042	Duplex Enter Position:Thick	ENG	[-10 to 10 / 0 / 1 mm/step]
1-907-043	Duplex Re-Feed Position:Plain	*ENG	[-10 to 10 / 0 / 1 mm/step]
1-907-044	Duplex Re-Feed Position:Thick	*ENG	[-10 to 10 / 0 / 1 mm/step]
1-907-045	ExitM:Accelerate Position:Normal Speed	ENG	[-5 to 15 / 0 / 1 mm/step]
1-907-046	ExitM:Accelerate Position:Middle Speed	ENG	[-5 to 15 / 0 / 1 mm/step]
1-907-047	ExitM:Accelerate Position:Low Speed	ENG	[-5 to 15 / 0 / 1 mm/step]
1-907-048	ExitM:Accelerate Position:Low: 1200:Plain	ENG	[-5 to 15 / 0 / 1 mm/step]
1-907-061	Feed Solenoid ON:Tray3:Plain	ENG	[-20 to 20 / 0 / 1 mm/step]
1-907-062	Feed Solenoid ON:Tray3:Thick	ENG	[-20 to 20 / 0 / 1 mm/step]
1-907-063	Feed Solenoid ON:Tray4:Plain	ENG	[-20 to 20 / 0 / 1 mm/step]
1-907-064	Feed Solenoid ON:Tray4:Thick	ENG	[-20 to 20 / 0 / 1 mm/step]

1-907-065	Feed Solenoid ON:Tray5(LCT):Plain	ENG	[-20 to 20 / 0 / 1 mm/step]
1-907-066	Feed Solenoid ON:Tray5(LCT):Thick	ENG	[-20 to 20 / 0 / 1 mm/step]
1-907-067	Feed DCM OFF:Tray3:Plain	ENG	[-20 to 20 / 0 / 1 mm/step]
1-907-068	Feed DCM OFF:Tray3:Thick	ENG	[-20 to 20 / 0 / 1 mm/step]
1-907-069	Feed DCM OFF:Tray4:Plain	ENG	[-20 to 20 / 0 / 1 mm/step]
1-907-070	Feed DCM OFF:Tray4:Thick	ENG	[-20 to 20 / 0 / 1 mm/step]
1-907-071	Feed DCM OFF:Tray5(LCT):Plain	ENG	[-20 to 20 / 0 / 1 mm/step]
1-907-072	Feed DCM OFF:Tray5(LCT):Thick	ENG	[-20 to 20 / 0 / 1 mm/step]
1-907-073	Feed Solenoid OFF:Tray3:Plain	ENG	[-20 to 20 / 0 / 1 mm/step]
1-907-074	Feed Solenoid OFF:Tray3:Thick	ENG	[-20 to 20 / 0 / 1 mm/step]
1-907-075	Feed Solenoid OFF:Tray4:Plain	ENG	[-20 to 20 / 0 / 1 mm/step]
1-907-076	Feed Solenoid OFF:Tray4:Thick	ENG	[-20 to 20 / 0 / 1 mm/step]
1-907-077	Feed Solenoid OFF:Tray5(LCT):Plain	ENG	[-20 to 20 / 0 / 1 mm/step]
1-907-078	Feed Solenoid OFF:Tray5(LCT):Thick	ENG	[-20 to 20 / 0 / 1 mm/step]
1-907-079	Feed Start:Tray3:Plain	ENG	[-20 to 20 / 0 / 1 mm/step]
1-907-080	Feed Start:Tray3:Thick	ENG	[-20 to 20 / 0 / 1 mm/step]
1-907-081	Feed Start:Tray4:Plain	ENG	[-20 to 20 / 0 / 1 mm/step]
1-907-082	Feed Start:Tray4:Thick	ENG	[-20 to 20 / 0 / 1 mm/step]
1-907-083	Feed Start:Tray5(LCT):Plain	ENG	[-20 to 20 / 0 / 1 mm/step]
1-907-084	Feed Start:Tray5(LCT):Thick	ENG	[-20 to 20 / 0 / 1 mm/step]
1-907-085	ExitLineSpdUp EndPos:StdSpd	*ENG	[-30 to 15 / 0 / 1 mm/step]
1-907-086	ExitLineSpdUp EndPos:MidSpd	*ENG	[-30 to 15 / 0 / 1 mm/step]

1-907-087	ExitLineSpdUp EndPos:LowSpd	*ENG	[-30 to 15 / 0 / 1 mm/step]
1-907-088	ExitLineSpdUp EndPos:LowSpd: 1200:Plain	*ENG	[-30 to 15 / 0 / 1 mm/step]
1-907-090	Fusing Exit SOL ON: LowSpd	*ENG	[-15 to 15 / 0 / 1 mm/step]
1-907-091	Fusing Exit SOL ON: MidSpd	*ENG	[-15 to 15 / 0 / 1 mm/step]
1-907-092	Fusing Exit SOL ON: StdSpd	*ENG	[-15 to 15 / 0 / 1 mm/step]
1-907-093	Fusing Exit SOL OFF: LowSpd	*ENG	[-15 to 15 / 0 / 1 mm/step]
1-907-094	Fusing Exit SOL OFF: MidSpd	*ENG	[-15 to 15 / 0 / 1 mm/step]
1-907-095	Fusing Exit SOL OFF: StdSpd	*ENG	[-15 to 15 / 0 / 1 mm/step]

1907	[Operating Setting]		
1-907-096	Fusing Exit SOL Setting	*ENG	[0 to 6 / 0 / 1/step]

1907	[Paper Feed Timing Adj.]		
1-907-097	Feed Re-Start:Tray3:Plain	*ENG	[-20 to 20 / 0 / 1 mm/step]
1-907-098	Feed Re-Start:Tray3:Thick	*ENG	[-20 to 20 / 0 / 1 mm/step]
1-907-099	Feed Re-Start:Tray4:Plain	*ENG	[-20 to 20 / 0 / 1 mm/step]
1-907-100	Feed Re-Start:Tray4:Thick	*ENG	[-20 to 20 / 0 / 1 mm/step]
1-907-101	Feed Re-Start:Tray5(LCT):Plain	*ENG	[-20 to 20 / 0 / 1 mm/step]
1-907-102	Feed Re-Start:Tray5(LCT):Thick	*ENG	[-20 to 20 / 0 / 1 mm/step]
1-907-103	Feed Re2-Start:Tray3:Plain	*ENG	[-20 to 20 / 0 / 1 mm/step]
1-907-104	Feed Re2-Start:Tray3:Thick	*ENG	[-20 to 20 / 0 / 1 mm/step]
1-907-105	Feed Re2-Start:Tray4:Plain	*ENG	[-20 to 20 / 0 / 1 mm/step]
1-907-106	Feed Re2-Start:Tray4:Thick	*ENG	[-20 to 20 / 0 / 1 mm/step]
1-907-107	Feed Re2- Start:Tray5(LCT):Plain	*ENG	[-20 to 20 / 0 / 1 mm/step]
1-907-108	Feed Re2- Start:Tray5(LCT):Thick	*ENG	[-20 to 20 / 0 / 1 mm/step]

1-907-109	Manual Feed Regist. Stop Timing: Env	ENG	[0 to 40 / 0 / 1mm/step]
-----------	---	-----	--------------------------

1908	[Paper Feed Length]		
1-908-001	Feed Solenoid ON:Tray1:Plain	ENG	[-99 to 99 / 0 / 1mm/step]
1-908-002	Feed Solenoid ON:Tray1:Thick	ENG	[-99 to 99 / 0 / 1mm/step]
1-908-003	Feed Solenoid ON:Tray2:Plain	ENG	[-99 to 99 / 0 / 1mm/step]
1-908-004	Feed Solenoid ON:Tray2:Thick	ENG	[-99 to 99 / 0 / 1mm/step]
1-908-005	Feed DCM OFF:Tray1:Plain	ENG	[-99 to 99 / 0 / 1mm/step]
1-908-006	Feed DCM OFF:Tray1:Thick	ENG	[-99 to 99 / 0 / 1mm/step]
1-908-007	Feed DCM OFF:Tray2:Plain	ENG	[-99 to 99 / 0 / 1mm/step]
1-908-008	Feed DCM OFF:Tray2:Thick	ENG	[-99 to 99 / 0 / 1mm/step]
1-908-009	Feed Solenoid OFF:Tray1:Plain	ENG	[-99 to 99 / 0 / 1mm/step]
1-908-010	Feed Solenoid OFF:Tray1:Thick	ENG	[-99 to 99 / 0 / 1mm/step]

1950	[Fan Cooling Time Set]		
1-950-003	Dev Cooling Fan	*ENG	[0 to 120 / 0 / 1min/step]
1-950-005	Ozone Fan	*ENG	
1-950-006	Fusing Fan	*ENG	
1-950-007	Paper Exit Cooling Fan	*ENG	
1-950-011	PSU Cooling Fan	*ENG	
1-950-051	Dev Suction Fan: Right	*ENG	

1951	[Fan Start Time Set]		
1-951-003	Dev Cooling Fan	*ENG	[0 to 900 / 120 / 1sec/step]
1-951-005	Ozone Fan	*ENG	[0 to 900 / 0 / 1sec/step]
1-951-006	Fusing Fan	*ENG	[0 to 900 / 120 / 1sec/step]

1-951-007	Paper Exit Cooling Fan	*ENG	[0 to 900 / 120 / 1 sec/step]
1-951-011	PSU Cooling Fan	*ENG	[0 to 900 / 120 / 1 sec/step]
1-951-051	Dev Suction Fan: Right	*ENG	[0 to 900 / 0 / 1 sec/step]

1952	[Fan Control Off Mode Time Set]		
1-952-001	-	*ENG	[0 to 60 / 10 / 1 min/step]

1953	[Extra Fan Control]		
1-953-001	Extra Fan Cooling State	*ENG	[0 or 1 / 0 / 1/step] 0: Disable 1: enable
1-953-002	Execution Temp. Threshold	*ENG	[0 to 100 / 38.5 / 0.1deg/step]
1-953-003	Cancellation Temp. Threshold	*ENG	[0 to 100 / 2 / 0.1deg/step]
1-953-004	Extra Fan Operation ON/OFF Setting	*ENG	[0 or 1 / 1 / 1/step] 0: disable 1: enable

1955	[Fan Control]		
1-955-004	Dev Cooling Fan Op Sw Temp	*ENG	[0 to 100 / 36 / 0.1deg/step]
1-955-006	Paper Exit Cooling Fan Op Sw Temp	*ENG	[0 to 100 / 12 / 0.1deg/step]
1-955-007	Fusing Fan Op Sw Temp	*ENG	[0 to 100 / 0 / 0.1deg/step]
1-955-009	Ozone Fan Low Speed Op Sw Temp	*ENG	[0 to 100 / 35 / 0.1deg/step]
1-955-010	Ozone Fan Middle Speed Op Sw Temp	*ENG	[0 to 100 / 37 / 0.1deg/step]
1-955-011	Ozone Fan High Speed Op Sw Temp	*ENG	[0 to 100 / 40 / 0.1deg/step]
1-955-012	Ozone Fan Low Noise Op DUTY	*ENG	[0 to 100 / 20 / 1%/step]

1-955-013	Ozone Fan Low Speed Op DUTY	*ENG	[0 to 100 / 30 / 1%/step]
1-955-014	Ozone Fan Middle Speed Op DUTY	*ENG	[0 to 100 / 40 / 1%/step]
1-955-015	Ozone Fan High Speed Op DUTY	*ENG	[0 to 100 / 40 / 1%/step]
1-955-016	Paper Exit Cooling Fan Op Start Time A	*ENG	[0 to 900 / 300 / 1sec/step]
1-955-017	PSU Cooling Fan Op Start Time A	*ENG	[0 to 900 / 300 / 1sec/step]
1-955-018	Fan Op Sw Temp Thers	*ENG	[0 to 100 / 2 / 0.1deg/step]
1-955-019	Paper Exit Cooling Fan Control Off Mode Time	*ENG	[0 to 3600 / 600 / 1sec/step]
1-955-020	PSU Cooling Fan Control Off Mode Time	*ENG	[0 to 3600 / 600 / 1sec/step]
1-955-051	Dev Suction Fan: Right Op Sw Temp	*ENG	[0 to 100 / 36 / 0.1deg/step]
1-955-062	Dev Suction Fan: Right Op Start Time	*ENG	[0 to 900 / 300 / 1sec/step]
1-955-063	Paper Exit Cooling Fan Op Start Time B	*ENG	[0 to 900 / 300 / 1sec/step]
1-955-064	PSU Cooling Fan Op Start Time B	*ENG	[0 to 900 / 300 / 1sec/step]
1-955-065	PSU Cooling Fan Op Start Time C	*ENG	[0 to 900 / * / 1sec/step] *NA: 300, EU: 120, Asia: 120, CHN: 120, TWN: 300, KOR: 120
1-955-066	PSU Cooling Fan Op Start Time D	*ENG	[0 to 900 / * / 1sec/step] *NA: 300, EU: 120, Asia: 120, CHN: 120, TWN: 300, KOR: 120
1-955-071	Ozone Fan Extra Op DUTY	*ENG	[0 to 100 / 20 / 1%/step]

Engine SP Tables - SP2000-1

SP2-XXX (Drum)

2005	[Charge DC Voltage: Fixed]		
2-005-001	Standard Speed: K	*ENG	[0 to 2000 / 1350 / 10-V/step]
2-005-002	Standard Speed: C	*ENG	[0 to 2000 / 1350 / 10-V/step]
2-005-003	Standard Speed: M	*ENG	[0 to 2000 / 1350 / 10-V/step]
2-005-004	Standard Speed: Y	*ENG	[0 to 2000 / 1350 / 10-V/step]
2-005-005	Middle Speed: K	*ENG	[0 to 2000 / 1350 / 10-V/step]
2-005-006	Middle Speed: C	*ENG	[0 to 2000 / 1350 / 10-V/step]
2-005-007	Middle Speed: M	*ENG	[0 to 2000 / 1350 / 10-V/step]
2-005-008	Middle Speed: Y	*ENG	[0 to 2000 / 1350 / 10-V/step]
2-005-009	Low Speed: K	*ENG	[0 to 2000 / 1350 / 10-V/step]
2-005-010	Low Speed: C	*ENG	[0 to 2000 / 1350 / 10-V/step]
2-005-011	Low Speed: M	*ENG	[0 to 2000 / 1350 / 10-V/step]
2-005-012	Low Speed: Y	*ENG	[0 to 2000 / 1350 / 10-V/step]
2005	[Charge DC Voltage: Correction]		
2-005-013	PCU: Standard Speed	*ENG	[-100 to 100 / 0 / 1-V/step]
2-005-014	PCU: Middle Speed	*ENG	[-100 to 100 / 0 / 1-V/step]
2-005-015	PCU: Low Speed	*ENG	[-100 to 100 / 0 / 1-V/step]
2-005-018	Correction Coefficient a: K	*ENG	[0 to 2 / 1 / 0.001/step]
2-005-019	Correction Coefficient a: C	*ENG	[0 to 2 / 1 / 0.001/step]
2-005-020	Correction Coefficient a: M	*ENG	[0 to 2 / 1 / 0.001/step]
2-005-021	Correction Coefficient a: Y	*ENG	[0 to 2 / 1 / 0.001/step]
2-005-022	Correction Coefficient b: K	*ENG	[0 to 2000 / 700 / 1-V/step]

2-005-023	Correction Coefficient b: C	*ENG	[0 to 2000 / 700 / 1-V/step]
2-005-024	Correction Coefficient b: M	*ENG	[0 to 2000 / 700 / 1-V/step]
2-005-025	Correction Coefficient b: Y	*ENG	[0 to 2000 / 700 / 1-V/step]
2-005-026	Correction Coefficient c: K	*ENG	[0 to 100 / 0 / 1-V/step]
2-005-027	Correction Coefficient c: C	*ENG	[0 to 100 / 0 / 1-V/step]
2-005-028	Correction Coefficient c: M	*ENG	[0 to 100 / 0 / 1-V/step]
2-005-029	Correction Coefficient c: Y	*ENG	[0 to 100 / 0 / 1-V/step]
2-005-030	Temperature Threshold L: K	*ENG	[0 to 99 / 15 / 1deg/step]
2-005-031	Temperature Threshold L: C	*ENG	[0 to 99 / 15 / 1deg/step]
2-005-032	Temperature Threshold L: M	*ENG	[0 to 99 / 16 / 1deg/step]
2-005-033	Temperature Threshold L: Y	*ENG	[0 to 99 / 16 / 1deg/step]
2-005-034	Temperature Threshold M: K	*ENG	[0 to 99 / 22 / 1deg/step]
2-005-035	Temperature Threshold M: C	*ENG	[0 to 99 / 22 / 1deg/step]
2-005-036	Temperature Threshold M: M	*ENG	[0 to 99 / 23 / 1deg/step]
2-005-037	Temperature Threshold M: Y	*ENG	[0 to 99 / 23 / 1deg/step]
2-005-038	Temperature Threshold H: K	*ENG	[0 to 99 / 28 / 1deg/step]
2-005-039	Temperature Threshold H: C	*ENG	[0 to 99 / 28 / 1deg/step]
2-005-040	Temperature Threshold H: M	*ENG	[0 to 99 / 29 / 1deg/step]
2-005-041	Temperature Threshold H: Y	*ENG	[0 to 99 / 29 / 1deg/step]
2-005-043	DC Bias Fixed Value Set	*ENG	[0 or 1 / 0 / 1/step]
2-005-044	Correction Coefficient a: Fixed K	*ENG	[0 to 2 / 1 / 0.001/step]
2-005-045	Correction Coefficient a: Fixed C	*ENG	[0 to 2 / 1 / 0.001/step]
2-005-046	Correction Coefficient a: Fixed M	*ENG	[0 to 2 / 1 / 0.001/step]
2-005-047	Correction Coefficient a: Fixed Y	*ENG	[0 to 2 / 1 / 0.001/step]
2-005-048	Correction Coefficient b: Fixed K	*ENG	[0 to 2000 / 700 / 1-V/step]
2-005-049	Correction Coefficient b: Fixed C	*ENG	[0 to 2000 / 700 / 1-V/step]

2-005-050	Correction Coefficient b: Fixed M	*ENG	[0 to 2000 / 700 / 1-V/step]
2-005-051	Correction Coefficient b: Fixed Y	*ENG	[0 to 2000 / 700 / 1-V/step]
2-005-052	Correction Coefficient c: Fixed K	*ENG	[0 to 100 / 0 / 1-V/step]
2-005-053	Correction Coefficient c: Fixed C	*ENG	[0 to 100 / 0 / 1-V/step]
2-005-054	Correction Coefficient c: Fixed M	*ENG	[0 to 100 / 0 / 1-V/step]
2-005-055	Correction Coefficient c: Fixed Y	*ENG	[0 to 100 / 0 / 1-V/step]
2-005-056	Correction Rotation : Charge R: K	*ENG	[0 to 999999999 / 0 / 1mm/step]
2-005-057	Correction Rotation : Charge R: C	*ENG	[0 to 999999999 / 0 / 1mm/step]
2-005-058	Correction Rotation : Charge R: M	*ENG	[0 to 999999999 / 0 / 1mm/step]
2-005-059	Correction Rotation : Charge R: Y	*ENG	[0 to 999999999 / 0 / 1mm/step]
2-005-060	Correction Rotation : OPC R: K	*ENG	[0 to 999999999 / 0 / 1mm/step]
2-005-061	Correction Rotation : OPC R: C	*ENG	[0 to 999999999 / 0 / 1mm/step]
2-005-062	Correction Rotation : OPC R: M	*ENG	[0 to 999999999 / 0 / 1mm/step]
2-005-063	Correction Rotation : OPC R: Y	*ENG	[0 to 999999999 / 0 / 1mm/step]
2-005-064	Correction Coefficient Cd	*ENG	[-125 to 125 / 10 / 1-V/step]
2-005-065	Correction Coefficient Ce	*ENG	[-125 to 125 / 13 / 1-V/step]
2-005-066	Correction Coefficient Cf	*ENG	[-125 to 125 / 16 / 1-V/step]
2-005-067	Correction Coefficient Cg	*ENG	[-125 to 125 / 0 / 1-V/step]
2-005-068	Correction Coefficient Ch	*ENG	[-125 to 125 / 0 / 1-V/step]
2-005-069	Correction Coefficient Ci	*ENG	[-125 to 125 / 10 / 1-V/step]
2-005-070	Correction Coefficient Cj	*ENG	[-125 to 125 / 13 / 1-V/step]
2-005-071	Correction Coefficient Ck	*ENG	[-125 to 125 / 16 / 1-V/step]
2-005-072	Correction Coefficient Cl	*ENG	[-125 to 125 / 0 / 1-V/step]
2-005-073	Correction Coefficient Cm	*ENG	[-125 to 125 / 0 / 1-V/step]
2-005-074	Correction Coefficient Cn	*ENG	[-125 to 125 / 10 / 1-V/step]
2-005-075	Correction Coefficient Co	*ENG	[-125 to 125 / 13 / 1-V/step]

2-005-076	Correction Coefficient Cp	*ENG	[-125 to 125 / 16 / 1-V/step]
2-005-077	Correction Coefficient Cq	*ENG	[-125 to 125 / 0 / 1-V/step]
2-005-078	Correction Coefficient Cr	*ENG	[-125 to 125 / 0 / 1-V/step]
2-005-079	Correction Coefficient Cs	*ENG	[-125 to 125 / 10 / 1-V/step]
2-005-080	Correction Coefficient Ct	*ENG	[-125 to 125 / 13 / 1-V/step]
2-005-081	Correction Coefficient Cu	*ENG	[-125 to 125 / 16 / 1-V/step]
2-005-082	Correction Coefficient Cv	*ENG	[-125 to 125 / 0 / 1-V/step]
2-005-083	Correction Coefficient Cw	*ENG	[-125 to 125 / 0 / 1-V/step]
2-005-084	Correction Coefficient Cx	*ENG	[-125 to 125 / 10 / 1-V/step]
2-005-085	Correction Coefficient Cy	*ENG	[-125 to 125 / 13 / 1-V/step]
2-005-086	Correction Coefficient Cz	*ENG	[-125 to 125 / 16 / 1-V/step]
2-005-087	Correction Coefficient CAA	*ENG	[-125 to 125 / 0 / 1-V/step]
2-005-088	Correction Coefficient CAB	*ENG	[-125 to 125 / 0 / 1-V/step]
2-005-089	Correction Coefficient Cd	*ENG	[-125 to 125 / 0 / 1-V/step]
2-005-090	Correction Coefficient Ce	*ENG	[-125 to 125 / 0 / 1-V/step]
2-005-091	Correction Coefficient Cf	*ENG	[-125 to 125 / 0 / 1-V/step]
2-005-092	Correction Coefficient Cg	*ENG	[-125 to 125 / 0 / 1-V/step]
2-005-093	Correction Coefficient Ch	*ENG	[-125 to 125 / 0 / 1-V/step]
2-005-094	Correction Coefficient Ci	*ENG	[-125 to 125 / 0 / 1-V/step]
2-005-095	Correction Coefficient Cj	*ENG	[-125 to 125 / 0 / 1-V/step]
2-005-096	Correction Coefficient Ck	*ENG	[-125 to 125 / 0 / 1-V/step]
2-005-097	Correction Coefficient Cl	*ENG	[-125 to 125 / 0 / 1-V/step]
2-005-098	Correction Coefficient Cm	*ENG	[-125 to 125 / 0 / 1-V/step]
2-005-099	Correction Coefficient Cn	*ENG	[-125 to 125 / 0 / 1-V/step]
2-005-100	Correction Coefficient Co	*ENG	[-125 to 125 / 0 / 1-V/step]
2-005-101	Correction Coefficient Cp	*ENG	[-125 to 125 / 0 / 1-V/step]

2-005-102	Correction Coefficient Cq	*ENG	[-125 to 125 / 0 / 1-V/step]
2-005-103	Correction Coefficient Cr	*ENG	[-125 to 125 / 0 / 1-V/step]
2-005-104	Correction Coefficient Cs	*ENG	[-125 to 125 / 0 / 1-V/step]
2-005-105	Correction Coefficient Ct	*ENG	[-125 to 125 / 0 / 1-V/step]
2-005-106	Correction Coefficient Cu	*ENG	[-125 to 125 / 0 / 1-V/step]
2-005-107	Correction Coefficient Cv	*ENG	[-125 to 125 / 0 / 1-V/step]
2-005-108	Correction Coefficient Cw	*ENG	[-125 to 125 / 0 / 1-V/step]
2-005-109	Correction Coefficient Cx	*ENG	[-125 to 125 / 0 / 1-V/step]
2-005-110	Correction Coefficient Cy	*ENG	[-125 to 125 / 0 / 1-V/step]
2-005-111	Correction Coefficient Cz	*ENG	[-125 to 125 / 0 / 1-V/step]
2-005-112	Correction Coefficient CAA	*ENG	[-125 to 125 / 0 / 1-V/step]
2-005-113	Correction Coefficient CAB	*ENG	[-125 to 125 / 0 / 1-V/step]
2-005-114	Correction Coefficient Md	*ENG	[-125 to 125 / 0 / 1-V/step]
2-005-115	Correction Coefficient Me	*ENG	[-125 to 125 / 0 / 1-V/step]
2-005-116	Correction Coefficient Mf	*ENG	[-125 to 125 / 0 / 1-V/step]
2-005-117	Correction Coefficient Mg	*ENG	[-125 to 125 / 0 / 1-V/step]
2-005-118	Correction Coefficient Mh	*ENG	[-125 to 125 / 0 / 1-V/step]
2-005-119	Correction Coefficient Mi	*ENG	[-125 to 125 / 0 / 1-V/step]
2-005-120	Correction Coefficient Mj	*ENG	[-125 to 125 / 0 / 1-V/step]
2-005-121	Correction Coefficient Mk	*ENG	[-125 to 125 / 0 / 1-V/step]
2-005-122	Correction Coefficient Ml	*ENG	[-125 to 125 / 0 / 1-V/step]
2-005-123	Correction Coefficient Mm	*ENG	[-125 to 125 / 0 / 1-V/step]
2-005-124	Correction Coefficient Mn	*ENG	[-125 to 125 / 0 / 1-V/step]
2-005-125	Correction Coefficient Mo	*ENG	[-125 to 125 / 0 / 1-V/step]
2-005-126	Correction Coefficient Mp	*ENG	[-125 to 125 / 0 / 1-V/step]
2-005-127	Correction Coefficient Mq	*ENG	[-125 to 125 / 0 / 1-V/step]

2-005-128	Correction Coefficient Mr	*ENG	[-125 to 125 / 0 / 1-V/step]
2-005-129	Correction Coefficient Ms	*ENG	[-125 to 125 / 0 / 1-V/step]
2-005-130	Correction Coefficient Mt	*ENG	[-125 to 125 / 0 / 1-V/step]
2-005-131	Correction Coefficient Mu	*ENG	[-125 to 125 / 0 / 1-V/step]
2-005-132	Correction Coefficient Mv	*ENG	[-125 to 125 / 0 / 1-V/step]
2-005-133	Correction Coefficient Mw	*ENG	[-125 to 125 / 0 / 1-V/step]
2-005-134	Correction Coefficient Mx	*ENG	[-125 to 125 / 0 / 1-V/step]
2-005-135	Correction Coefficient My	*ENG	[-125 to 125 / 0 / 1-V/step]
2-005-136	Correction Coefficient Mz	*ENG	[-125 to 125 / 0 / 1-V/step]
2-005-137	Correction Coefficient MAA	*ENG	[-125 to 125 / 0 / 1-V/step]
2-005-138	Correction Coefficient MAB	*ENG	[-125 to 125 / 0 / 1-V/step]
2-005-139	Correction Coefficient Yd	*ENG	[-125 to 125 / 0 / 1-V/step]
2-005-140	Correction Coefficient Ye	*ENG	[-125 to 125 / 0 / 1-V/step]
2-005-141	Correction Coefficient Yf	*ENG	[-125 to 125 / 0 / 1-V/step]
2-005-142	Correction Coefficient Yg	*ENG	[-125 to 125 / 0 / 1-V/step]
2-005-143	Correction Coefficient Yh	*ENG	[-125 to 125 / 0 / 1-V/step]
2-005-144	Correction Coefficient Yi	*ENG	[-125 to 125 / 0 / 1-V/step]
2-005-145	Correction Coefficient Yj	*ENG	[-125 to 125 / 0 / 1-V/step]
2-005-146	Correction Coefficient Yk	*ENG	[-125 to 125 / 0 / 1-V/step]
2-005-147	Correction Coefficient Yl	*ENG	[-125 to 125 / 0 / 1-V/step]
2-005-148	Correction Coefficient Ym	*ENG	[-125 to 125 / 0 / 1-V/step]
2-005-149	Correction Coefficient Yn	*ENG	[-125 to 125 / 0 / 1-V/step]
2-005-150	Correction Coefficient Yo	*ENG	[-125 to 125 / 0 / 1-V/step]
2-005-151	Correction Coefficient Yp	*ENG	[-125 to 125 / 0 / 1-V/step]
2-005-152	Correction Coefficient Yq	*ENG	[-125 to 125 / 0 / 1-V/step]
2-005-153	Correction Coefficient Yr	*ENG	[-125 to 125 / 0 / 1-V/step]

2-005-154	Correction Coefficient Ys	*ENG	[-125 to 125 / 0 / 1-V/step]
2-005-155	Correction Coefficient Yt	*ENG	[-125 to 125 / 0 / 1-V/step]
2-005-156	Correction Coefficient Yu	*ENG	[-125 to 125 / 0 / 1-V/step]
2-005-157	Correction Coefficient Yv	*ENG	[-125 to 125 / 0 / 1-V/step]
2-005-158	Correction Coefficient Yw	*ENG	[-125 to 125 / 0 / 1-V/step]
2-005-159	Correction Coefficient Yx	*ENG	[-125 to 125 / 0 / 1-V/step]
2-005-160	Correction Coefficient Yy	*ENG	[-125 to 125 / 0 / 1-V/step]
2-005-161	Correction Coefficient Yz	*ENG	[-125 to 125 / 0 / 1-V/step]
2-005-162	Correction Coefficient YAA	*ENG	[-125 to 125 / 0 / 1-V/step]
2-005-163	Correction Coefficient YAB	*ENG	[-125 to 125 / 0 / 1-V/step]
2-005-164	Correction Coefficient b1: K	*ENG	[-300 to 300 / 0 / 1/step]
2-005-165	Correction Coefficient b1: C	*ENG	[-300 to 300 / 0 / 1/step]
2-005-166	Correction Coefficient b1: M	*ENG	[-300 to 300 / 0 / 1/step]
2-005-167	Correction Coefficient b1: Y	*ENG	[-300 to 300 / 0 / 1/step]
2-005-168	Temperature Threshold	*ENG	[1 to 99 / 20 / 1/step]
2-005-169	Environmental Target Temperature	*ENG	[-100 to 700 / 200 / 0.1/step]
2-005-170	Temp PCU: K	*ENG	[-100 to 700 / 200 / 0.1/step]
2-005-171	Temp PCU: C	*ENG	[-100 to 700 / 200 / 0.1/step]
2-005-172	Temp PCU: M	*ENG	[-100 to 700 / 200 / 0.1/step]
2-005-173	Temp PCU: Y	*ENG	[-100 to 700 / 200 / 0.1/step]
2-005-174	Temp Charge R: K	*ENG	[0 to 9999 / 0 / 1/step]
2-005-175	Temp Charge R: C	*ENG	[0 to 9999 / 0 / 1/step]
2-005-176	Temp Charge R: M	*ENG	[0 to 9999 / 0 / 1/step]
2-005-177	Temp Charge R: Y	*ENG	[0 to 9999 / 0 / 1/step]
2-005-178	Correction Temp Charge R: K	*ENG	[-99 to 99 / 0 / 1-V/step]
2-005-179	Correction Temp Charge R: C	*ENG	[-99 to 99 / 0 / 1-V/step]

2-005-180	Correction Temp Charge R: M	*ENG	[-99 to 99 / 0 / 1-V/step]
2-005-181	Correction Temp Charge R: Y	*ENG	[-99 to 99 / 0 / 1-V/step]
2-005-182	Correction Coefficient bb: K	*ENG	[0 to 1000 / 100 / 0.001/step]
2-005-183	Correction Coefficient bb: C	*ENG	[0 to 1000 / 100 / 0.001/step]
2-005-184	Correction Coefficient bb: M	*ENG	[0 to 1000 / 100 / 0.001/step]
2-005-185	Correction Coefficient bb: Y	*ENG	[0 to 1000 / 100 / 0.001/step]
2-005-186	Correction Coefficient dd1	*ENG	[0 to 200 / 100 / 0.01/step]
2-005-187	Correction Coefficient dd1	*ENG	[0 to 200 / 100 / 0.01/step]
2-005-188	Correction Coefficient dd3	*ENG	[0 to 200 / 100 / 0.01/step]
2-005-189	Correction Coefficient dd4	*ENG	[0 to 200 / 100 / 0.01/step]
2-005-190	JOB DotCoverage:K	*ENG	[0 to 10000 / 0 / 0.01%/step]
2-005-191	JOB DotCoverage:C	*ENG	[0 to 10000 / 0 / 0.01%/step]
2-005-192	JOB DotCoverage:M	*ENG	[0 to 10000 / 0 / 0.01%/step]
2-005-193	JOB DotCoverage:Y	*ENG	[0 to 10000 / 0 / 0.01%/step]
2-005-194	Correction Coefficient cc: K	*ENG	[0 to 900 / 80 / 0.01/step]
2-005-195	Correction Coefficient cc: C	*ENG	[0 to 900 / 80 / 0.01/step]
2-005-196	Correction Coefficient cc: M	*ENG	[0 to 900 / 80 / 0.01/step]
2-005-197	Correction Coefficient cc: Y	*ENG	[0 to 900 / 80 / 0.01/step]
2-005-198	Temp Difference	*ENG	[-800 to 800 / 0 / 0.1/step]
2-005-199	Correction Coefficient b2: K	*ENG	[-99 to 99 / 0 / 1-V/step]
2-005-200	Correction Coefficient b2: C	*ENG	[-99 to 99 / 0 / 1-V/step]
2-005-201	Correction Coefficient b2: M	*ENG	[-99 to 99 / 0 / 1-V/step]
2-005-202	Correction Coefficient b2: Y	*ENG	[-99 to 99 / 0 / 1-V/step]
2-005-203	Correction Coefficient ee: K	*ENG	[0 to 100 / 38 / 0.1/step]
2-005-204	Correction Coefficient ee: C	*ENG	[0 to 100 / 38 / 0.1/step]
2-005-205	Correction Coefficient ee: M	*ENG	[0 to 100 / 38 / 0.1/step]

2-005-206	Correction Coefficient ee: Y	*ENG	[0 to 100 / 38 / 0.1/step]
2-005-207	Correction Coefficient b3: K	*ENG	[-99 to 99 / 0 / 1-V/step]
2-005-208	Correction Coefficient b3: C	*ENG	[-99 to 99 / 0 / 1-V/step]
2-005-209	Correction Coefficient b3: M	*ENG	[-99 to 99 / 0 / 1-V/step]
2-005-210	Correction Coefficient b3: Y	*ENG	[-99 to 99 / 0 / 1-V/step]
2-005-211	Correction Coefficient gg: K	*ENG	[0 to 900 / 130 / 0.01/step]
2-005-212	Correction Coefficient gg: C	*ENG	[0 to 900 / 130 / 0.01/step]
2-005-213	Correction Coefficient gg: M	*ENG	[0 to 900 / 130 / 0.01/step]
2-005-214	Correction Coefficient gg: Y	*ENG	[0 to 900 / 130 / 0.01/step]
2-005-215	Correction Coefficient hh1: K	*ENG	[0 to 900 / 100 / 0.01/step]
2-005-216	Correction Coefficient hh1: C	*ENG	[0 to 900 / 100 / 0.01/step]
2-005-217	Correction Coefficient hh1: M	*ENG	[0 to 900 / 100 / 0.01/step]
2-005-218	Correction Coefficient hh1: Y	*ENG	[0 to 900 / 100 / 0.01/step]
2-005-219	Correction Coefficient hh2: K	*ENG	[0 to 900 / 100 / 0.01/step]
2-005-220	Correction Coefficient hh2: C	*ENG	[0 to 900 / 100 / 0.01/step]
2-005-221	Correction Coefficient hh2: M	*ENG	[0 to 900 / 100 / 0.01/step]
2-005-222	Correction Coefficient hh2: Y	*ENG	[0 to 900 / 100 / 0.01/step]
2-005-223	Correction Coefficient hh3: K	*ENG	[0 to 900 / 100 / 0.01/step]
2-005-224	Correction Coefficient hh3: C	*ENG	[0 to 900 / 100 / 0.01/step]
2-005-225	Correction Coefficient hh3: M	*ENG	[0 to 900 / 100 / 0.01/step]
2-005-226	Correction Coefficient hh3: Y	*ENG	[0 to 900 / 100 / 0.01/step]
2-005-227	Correction Coefficient hh4: K	*ENG	[0 to 900 / 100 / 0.01/step]
2-005-228	Correction Coefficient hh4: C	*ENG	[0 to 900 / 100 / 0.01/step]
2-005-229	Correction Coefficient hh4: M	*ENG	[0 to 900 / 100 / 0.01/step]
2-005-230	Correction Coefficient hh4: Y	*ENG	[0 to 900 / 100 / 0.01/step]
2-005-231	Correction Coefficient b0: K	*ENG	[0 to 2000 / 714 / 1/step]

2-005-232	Correction Coefficient b0: C	*ENG	[0 to 2000 / 714 / 1/step]
2-005-233	Correction Coefficient b0: M	*ENG	[0 to 2000 / 714 / 1/step]
2-005-234	Correction Coefficient b0: Y	*ENG	[0 to 2000 / 714 / 1/step]
2-005-235	Correction Coefficient c1: K	*ENG	[-80 to 80 / 0 / 1/step]
2-005-236	Correction Coefficient c1: C	*ENG	[-80 to 80 / 0 / 1/step]
2-005-237	Correction Coefficient c1: M	*ENG	[-80 to 80 / 0 / 1/step]
2-005-238	Correction Coefficient c1: Y	*ENG	[-80 to 80 / 0 / 1/step]
2-005-239	Correction Coefficient c2: K	*ENG	[-20 to 20 / 0 / 1/step]
2-005-240	Correction Coefficient c2: C	*ENG	[-20 to 20 / 0 / 1/step]
2-005-241	Correction Coefficient c2: M	*ENG	[-20 to 20 / 0 / 1/step]
2-005-242	Correction Coefficient c2: Y	*ENG	[-20 to 20 / 0 / 1/step]
2-005-243	Rotation At Prev Correction: VdVc: Bk	*ENG	[0 to 999999999 / 0 / 1 mm/step]
2-005-244	Rotation At Prev Correction: VdVc: C	*ENG	[0 to 999999999 / 0 / 1 mm/step]
2-005-245	Rotation At Prev Correction: VdVc: M	*ENG	[0 to 999999999 / 0 / 1 mm/step]
2-005-246	Rotation At Prev Correction: VdVc: Y	*ENG	[0 to 999999999 / 0 / 1 mm/step]
2-005-247	Correction Coefficient b2: Fixed K	*ENG	[-99 to 99 / 37 / 1-V/step]
2-005-248	Correction Coefficient b2: Fixed C	*ENG	[-99 to 99 / 37 / 1-V/step]
2-005-249	Correction Coefficient b2: Fixed M	*ENG	[-99 to 99 / 37 / 1-V/step]
2-005-250	Correction Coefficient b2: Fixed Y	*ENG	[-99 to 99 / 37 / 1-V/step]

2006	[Charge AC Voltage: Fixed]
-------------	-----------------------------------

2-006-001	Standard Speed: K	*ENG	[0 to 3 / 2.2 / 0.01kV/step]
2-006-002	Standard Speed: C	*ENG	
2-006-003	Standard Speed: M	*ENG	
2-006-004	Standard Speed: Y	*ENG	
2-006-005	Middle Speed: K	*ENG	
2-006-006	Middle Speed: C	*ENG	
2-006-007	Middle Speed: M	*ENG	
2-006-008	Middle Speed: Y	*ENG	
2-006-009	Low Speed: K	*ENG	
2-006-010	Low Speed: C	*ENG	
2-006-011	Low Speed: M	*ENG	
2-006-012	Low Speed: Y	*ENG	

2007	[Charge AC Current: LL]		
2-007-001	Environmental Target: Bk	*ENG	[0 to 3 / 0.81 / 0.01mA/step]
2-007-002	Environmental Target: C	*ENG	
2-007-003	Environmental Target: M	*ENG	
2-007-004	Environmental Target: Y	*ENG	

2008	[Charge AC Current: ML]		
2-008-001	Environmental Target: Bk	*ENG	[0 to 3 / 0.81 / 0.01mA/step]
2-008-002	Environmental Target: C	*ENG	
2-008-003	Environmental Target: M	*ENG	
2-008-004	Environmental Target: Y	*ENG	

2009	[Charge AC Current: MM]		
-------------	--------------------------------	--	--

2-009-001	Environmental Target: Bk	*ENG	[0 to 3 / 0.81 / 0.01mA/step]
2-009-002	Environmental Target: C	*ENG	
2-009-003	Environmental Target: M	*ENG	
2-009-004	Environmental Target: Y	*ENG	

2010	[Charge AC Current: MH]		
2-010-001	Environmental Target: Bk	*ENG	[0 to 3 / 0.83 / 0.01mA/step]
2-010-002	Environmental Target: C	*ENG	
2-010-003	Environmental Target: M	*ENG	
2-010-004	Environmental Target: Y	*ENG	

2011	[Charge AC Current: HH]		
2-011-001	Environmental Target: Bk	*ENG	[0 to 3 / 0.86 / 0.01mA/step]
2-011-002	Environmental Target: C	*ENG	
2-011-003	Environmental Target: M	*ENG	
2-011-004	Environmental Target: Y	*ENG	

2012	[Charge Output Control]		
2-012-001	AC Voltage	*ENG	[0 or 1 / 0 / 1/step] 0: Set to environment correction value used when FB . 1: Electrify AC voltage of SP: Set to fixed setting value.

2013	[Environmental Correction: PCU]		
2-013-001	Current Environmental FC : Display	*ENG	[0 to 0 / 0 / 1/step]
2-013-002	Forced Setting	*ENG	[0 to 5 / 0 / 1/step]
2-013-003	Absolute Humidity: Threshold 1	*ENG	[0 to 100 / 3 / 0.01g/m ³ /step]
2-013-004	Absolute Humidity: Threshold 2	*ENG	[0 to 100 / 8 / 0.01g/m ³ /step]

2-013-005	Absolute Humidity: Threshold 3	*ENG	[0 to 100 / 15 / 0.01g/m ³ /step]
2-013-006	Absolute Humidity: Threshold 4	*ENG	[0 to 100 / 22 / 0.01g/m ³ /step]
2-013-007	Temp FC: Display	*ENG	[0 to 100 / 0 / 1deg/step]
2-013-008	Relative Humidity FC : Display	*ENG	[0 to 100 / 0 / 1%RH/step]
2-013-009	Absolute Humidity FC : Display	*ENG	[0 to 100 / 0 / 0.01g/m ³ /step]
2-013-010	Environmental Bk: Display	*ENG	[0 to 0 / 0 / 1/step]
2-013-011	Temp Bk.: Display	*ENG	[0 to 100 / 0 / 1deg/step]
2-013-012	Relative Humidity Bk : Display	*ENG	[0 to 100 / 0 / 1%RH/step]
2-013-013	Absolute Humidity Bk : Display	*ENG	[0 to 100 / 0 / 0.01g/m ³ /step]

2014	[Charge AC Control: Setting]		
2-014-001	Exec Interval: Power ON	*ENG	[0 to 2000 / 500 / 1 page/step]
2-014-002	Exec Interval: Print	*ENG	[0 to 2000 / 0 / 1 page/step]
2-014-003	Page Interval	*ENG	[0 to 500 / 10 / 1 page/step]
2-014-004	Temperature	*ENG	[0 to 99 / 35 / 1deg/step]
2-014-005	Relative Humidity	*ENG	[0 to 99 / 50 / 1%RH/step]
2-014-006	Absolute Humidity	*ENG	[0 to 99 / 12 / 1g/m ³ /step]
2-014-007	Temp Threshold M	*ENG	[0 to 99 / 10 / 1deg/step]
2-014-008	RH Threshold M	*ENG	[0 to 99 / 50 / 1%RH/step]
2-014-009	AH Threshold M	*ENG	[0 to 99 / 6 / 1g/m ³ /step]
2-014-010	Temp Threshold S	*ENG	[0 to 20 / 1 / 0.1deg/step]
2-014-011	RH Threshold S	*ENG	[0 to 50 / 5 / 1%RH/step]
2-014-012	AH Threshold S	*ENG	[0 to 20 / 1 / 0.1g/m ³ /step]
2-014-013	Non-use Time	*ENG	[0 to 1440 / 360 / 10min/step]
2-014-014	AC Current Error Detection	*ENG	[0 or 1 / 0 / 1/step]

2015	[Charge AC Adj: Result]		
-------------	--------------------------------	--	--

2-015-001	Bk	*ENG	[0 to 9 / 0 / 1/step]
2-015-002	C	*ENG	[0 to 9 / 0 / 1/step]
2-015-003	M	*ENG	[0 to 9 / 0 / 1/step]
2-015-004	Y	*ENG	[0 to 9 / 0 / 1/step]

2020	[Background Pot Corr. Set]		
2-020-001	Temp. Condition	*ENG	[0 to 19 / 15 / 1deg/step]
2-020-002	Absolute Humidity	*ENG	[0 to 99 / 6 / 1g/m ³ /step]
2-020-003	Print Page Counter After Corr.	*ENG	[0 to 999 / 0 / 1page/step]
2-020-004	Print Pages Threshold After Corr.	*ENG	[0 to 999 / 10 / 1page/step]
2-020-005	Temp. Thresh	*ENG	[20 to 99 / 20 / 1deg/step]
2-020-011	Coeff. a: K	*ENG	[0 to 1 / 0.06 / 0.01/step]
2-020-012	Coeff. a: C	*ENG	[0 to 1 / 0.06 / 0.01/step]
2-020-013	Coeff. a: M	*ENG	[0 to 1 / 0.06 / 0.01/step]
2-020-014	Coeff. a: Y	*ENG	[0 to 1 / 0.06 / 0.01/step]
2-020-015	Coeff. b: K	*ENG	[0 to 9 / 0.5 / 0.01/step]
2-020-016	Coeff. b: C	*ENG	[0 to 9 / 0.5 / 0.01/step]
2-020-017	Coeff. b: M	*ENG	[0 to 9 / 0.5 / 0.01/step]
2-020-018	Coeff. b: Y	*ENG	[0 to 9 / 0.5 / 0.01/step]

2021	[Background Pot Corr.]		
2-021-002	Display: C	*ENG	[0 to 90 / 0 / 1-V/step]
2-021-003	Display: M	*ENG	[0 to 90 / 0 / 1-V/step]
2-021-004	Display: Y	*ENG	[0 to 90 / 0 / 1-V/step]
2-021-005	Setting 1: K	*ENG	[0 to 90 / 0 / 10-V/step]
2-021-006	Setting 1: C	*ENG	[0 to 90 / 0 / 10-V/step]
2-021-007	Setting 1: M	*ENG	[0 to 90 / 0 / 10-V/step]

2-021-008	Setting 1: Y	*ENG	[0 to 90 / 0 / 10-V/step]
2-021-009	Setting 2: K	*ENG	[0 to 90 / 0 / 10-V/step]
2-021-010	Setting 2: C	*ENG	[0 to 90 / 0 / 10-V/step]
2-021-011	Setting 2: M	*ENG	[0 to 90 / 0 / 10-V/step]
2-021-012	Setting 2: Y	*ENG	[0 to 90 / 0 / 10-V/step]
2-021-013	Setting 3: K	*ENG	[0 to 90 / 0 / 5-V/step]
2-021-014	Setting 3: C	*ENG	[0 to 90 / 0 / 5-V/step]
2-021-015	Setting 3: M	*ENG	[0 to 90 / 0 / 5-V/step]
2-021-016	Setting 3: Y	*ENG	[0 to 90 / 0 / 5-V/step]
2-021-017	Setting 4: K	*ENG	[0 to 90 / 0 / 5-V/step]
2-021-018	Setting 4: C	*ENG	[0 to 90 / 0 / 5-V/step]
2-021-019	Setting 4: M	*ENG	[0 to 90 / 0 / 5-V/step]
2-021-020	Setting 4: Y	*ENG	[0 to 90 / 0 / 5-V/step]
2-021-021	Setting 5: K	*ENG	[0 to 90 / 0 / 1-V/step]
2-021-022	Setting 5: C	*ENG	[0 to 90 / 0 / 1-V/step]
2-021-023	Setting 5: M	*ENG	[0 to 90 / 0 / 1-V/step]
2-021-024	Setting 5: Y	*ENG	[0 to 90 / 0 / 1-V/step]
2-021-025	Setting 6: K	*ENG	[-90 to 90 / 2 / 1-V/step]
2-021-026	Setting 6: C	*ENG	[-90 to 90 / 2 / 1-V/step]
2-021-027	Setting 6: M	*ENG	[-90 to 90 / 2 / 1-V/step]
2-021-028	Setting 6: Y	*ENG	[-90 to 90 / 2 / 1-V/step]
2-021-029	Display: Energized: K	*ENG	[0 to 90 / 0 / 1-V/step]
2-021-030	Display: Energized: C	*ENG	[0 to 90 / 0 / 1-V/step]
2-021-031	Display: Energized: M	*ENG	[0 to 90 / 0 / 1-V/step]
2-021-032	Display: Energized: Y	*ENG	[0 to 90 / 0 / 1-V/step]
2-021-033	Display: Total Rotation: K	*ENG	[0 to 90 / 0 / 1-V/step]

2-021-034	Display: Total Rotation: C	*ENG	[0 to 90 / 0 / 1-V/step]
2-021-035	Display: Total Rotation: M	*ENG	[0 to 90 / 0 / 1-V/step]
2-021-036	Display: Total Rotation: Y	*ENG	[0 to 90 / 0 / 1-V/step]
2-021-037	Split Number n: K	*ENG	[1 to 99 / 12 / 1/step]
2-021-038	Split Number n: C	*ENG	[1 to 99 / 12 / 1/step]
2-021-039	Split Number n: M	*ENG	[1 to 99 / 12 / 1/step]
2-021-040	Split Number n: Y	*ENG	[1 to 99 / 12 / 1/step]
2-021-041	Display:Energized for Target Value:K	*ENG	[0 to 90 / 0 / 1-V/step]
2-021-042	Display:Energized for Target Value:C	*ENG	[0 to 90 / 0 / 1-V/step]
2-021-043	Display:Energized for Target Value:M	*ENG	[0 to 90 / 0 / 1-V/step]
2-021-044	Display:Energized for Target Value:Y	*ENG	[0 to 90 / 0 / 1-V/step]
2-021-045	Setting 7: K	*ENG	[0 to 50 / 24 / 1-V/step]
2-021-046	Setting 7: C	*ENG	[0 to 50 / 24 / 1-V/step]
2-021-047	Setting 7: M	*ENG	[0 to 50 / 24 / 1-V/step]
2-021-048	Setting 7: Y	*ENG	[0 to 50 / 24 / 1-V/step]

2022	[Charge R Running Par]		
2-022-001	Display:K	*ENG	[0 to 999999 / 0 / 1/step]
2-022-002	Display:C	*ENG	[0 to 999999 / 0 / 1/step]
2-022-003	Display:M	*ENG	[0 to 999999 / 0 / 1/step]
2-022-004	Display:Y	*ENG	[0 to 999999 / 0 / 1/step]
2-022-005	PCU Rotation Time After Correction: K	*ENG	[0 to 9999999 / 0 / 1/step]

2-022-006	PCU Rotation Time After Correction: C	*ENG	[0 to 9999999 / 0 / 1/step]
2-022-007	PCU Rotation Time After Correction: M	*ENG	[0 to 9999999 / 0 / 1/step]
2-022-008	PCU Rotation Time After Correction: Y	*ENG	[0 to 9999999 / 0 / 1/step]
2-022-009	Threshold1:K	*ENG	[0 to 4000 / 30 / 1/step]
2-022-010	Threshold1:C	*ENG	[0 to 4000 / 30 / 1/step]
2-022-011	Threshold1:M	*ENG	[0 to 4000 / 30 / 1/step]
2-022-012	Threshold1:Y	*ENG	[0 to 4000 / 30 / 1/step]
2-022-013	Threshold2:K	*ENG	[0 to 4000 / 70 / 1/step]
2-022-014	Threshold2:C	*ENG	[0 to 4000 / 70 / 1/step]
2-022-015	Threshold2:M	*ENG	[0 to 4000 / 70 / 1/step]
2-022-016	Threshold2:Y	*ENG	[0 to 4000 / 70 / 1/step]
2-022-017	Threshold3:K	*ENG	[0 to 4000 / 150 / 1/step]
2-022-018	Threshold3:C	*ENG	[0 to 4000 / 150 / 1/step]
2-022-019	Threshold3:M	*ENG	[0 to 4000 / 150 / 1/step]
2-022-020	Threshold3:Y	*ENG	[0 to 4000 / 150 / 1/step]
2-022-021	Threshold4:K	*ENG	[0 to 4000 / 250 / 1/step]
2-022-022	Threshold4:C	*ENG	[0 to 4000 / 250 / 1/step]
2-022-023	Threshold4:M	*ENG	[0 to 4000 / 250 / 1/step]
2-022-024	Threshold4:Y	*ENG	[0 to 4000 / 250 / 1/step]
2-022-025	Prev Correction Calculation Bk:Year	*ENG	[0 to 99 / 0 / 1year/step]
2-022-026	Prev Correction Calculation Bk:Month	*ENG	[1 to 12 / 1 / 1 month] /step]
2-022-027	Prev Correction Calculation Bk:Day	*ENG	[1 to 31 / 1 / 1 day/step]

2-022-028	Prev Correction Calculation Bk:Hour	*ENG	[0 to 23 / 0 / 1 hour/step]
2-022-029	Prev Correction Calculation Bk:Minute	*ENG	[0 to 59 / 0 / 1 minute/step]
2-022-030	Rotation At Prev Correction: PCU: Bk	*ENG	[0 to 999999999 / 0 / 1 mm/step]
2-022-031	Rotation At Prev Correction: PCU: C	*ENG	[0 to 999999999 / 0 / 1 mm/step]
2-022-032	Rotation At Prev Correction: PCU: M	*ENG	[0 to 999999999 / 0 / 1 mm/step]
2-022-033	Rotation At Prev Correction: PCU: Y	*ENG	[0 to 999999999 / 0 / 1 mm/step]

2101	[Registration Correction]		
2-101-001	Color Main Dot: Bk	*ENG	[-512 to 511 / 0 / 1 dot/step]
2-101-002	Color Main Dot: Ma	*ENG	[-512 to 511 / 0 / 1 dot/step]
2-101-003	Color Main Dot: Cy	*ENG	[-512 to 511 / 0 / 1 dot/step]
2-101-004	Color Main Dot: Ye	*ENG	[-512 to 511 / 0 / 1 dot/step]
2-101-005	Color Sub Line: Bk	*ENG	[-16384 to 16383 / 0 / 1 line/step]
2-101-006	Color Sub Line: Ma	*ENG	[-16384 to 16383 / 0 / 1 line/step]
2-101-007	Color Sub Line: Cy	*ENG	[-16384 to 16383 / 0 / 1 line/step]
2-101-008	Color Sub Line: Ye	*ENG	[-16384 to 16383 / 0 / 1 line/step]

2102	[Magnification Adjustment]		
2-102-001	Main Mag.: Standard Speed: Bk	*ENG	[-2 to 2 / 0 / 0.001%/step]
2-102-002	Main Mag.: Middle Speed: Bk	*ENG	[-2 to 2 / 0 / 0.001%/step]
2-102-003	Main Mag.: Low Speed: Bk	*ENG	[-2 to 2 / 0 / 0.001%/step]
2-102-004	Main Mag.: Standard Speed: Ma	*ENG	[-2 to 2 / 0 / 0.001%/step]
2-102-005	Main Mag.: Middle Speed: Ma	*ENG	[-2 to 2 / 0 / 0.001%/step]

2-102-006	Main Mag.: Low Speed: Ma	*ENG	[-2 to 2 / 0 / 0.001%/step]
2-102-007	Main Mag.: Standard Speed: Cy	*ENG	[-2 to 2 / 0 / 0.001%/step]
2-102-008	Main Mag.: Middle Speed: Cy	*ENG	[-2 to 2 / 0 / 0.001%/step]
2-102-009	Main Mag.: Low Speed: Cy	*ENG	[-2 to 2 / 0 / 0.001%/step]
2-102-010	Main Mag.: Standard Speed: Ye	*ENG	[-2 to 2 / 0 / 0.001%/step]
2-102-011	Main Mag.: Middle Speed: Ye	*ENG	[-2 to 2 / 0 / 0.001%/step]
2-102-012	Main Mag.: Low Speed: Ye	*ENG	[-2 to 2 / 0 / 0.001%/step]
2-102-028	Color Main Mag.: High Speed: Ma	*ENG	[-2 to 2 / 0 / 0.001%/step]
2-102-031	Color Main Mag.: High Speed: Cy	*ENG	[-2 to 2 / 0 / 0.001%/step]
2-102-034	Color Main Mag.: High Speed: Ye	*ENG	[-2 to 2 / 0 / 0.001%/step]
2102	[Main Scan Beam Pitch Adj.]		
2-102-037	Bk: 1st-2nd	*ENG	[0 to 100 / 9.61 / 0.01dot/step]
2-102-038	Bk: 1st-3rd	*ENG	[0 to 100 / 19.22 / 0.01dot/step]
2-102-039	Bk: 1st-4th	*ENG	[0 to 100 / 28.83 / 0.01dot/step]
2-102-040	Ma: 1st-2nd	*ENG	[0 to 100 / 9.61 / 0.01dot/step]
2-102-041	Ma: 1st-3rd	*ENG	[0 to 100 / 19.22 / 0.01dot/step]
2-102-042	Ma: 1st-4th	*ENG	[0 to 100 / 28.83 / 0.01dot/step]
2-102-043	Cy: 1st-2nd	*ENG	[0 to 100 / 9.61 / 0.01dot/step]
2-102-044	Cy: 1st-3rd	*ENG	[0 to 100 / 19.22 / 0.01dot/step]
2-102-045	Cy: 1st-4th	*ENG	[0 to 100 / 28.83 / 0.01dot/step]
2-102-046	Ye: 1st-2nd	*ENG	[0 to 100 / 9.61 / 0.01dot/step]
2-102-047	Ye: 1st-3rd	*ENG	[0 to 100 / 19.22 / 0.01dot/step]
2-102-048	Ye: 1st-4th	*ENG	[0 to 100 / 28.83 / 0.01dot/step]
2103	[Erase Margin Adjustment]		

2-103-001	Lead Edge Width	ENG	[0 to 9.9 / 4.2 / 0.1 mm/step]
2-103-002	Trail. Edge Width	ENG	[0 to 9.9 / 4.2 / 0.1 mm/step]
2-103-003	Left	ENG	[0 to 9.9 / 2 / 0.1 mm/step]
2-103-004	Right	ENG	[0 to 9.9 / 2 / 0.1 mm/step]
2-103-006	Duplex Trail. L Size	ENG	[-4 to 4 / 0.8 / 0.1 mm/step]
2-103-007	Duplex Trail. M Size	ENG	[-4 to 4 / 0.8 / 0.1 mm/step]
2-103-008	Duplex Trail. S Size	ENG	[-4 to 4 / 0.6 / 0.1 mm/step]
2-103-009	Duplex Left Edge	ENG	[0 to 1.5 / 0.3 / 0.1 mm/step]
2-103-010	Duplex Right Edge	ENG	[0 to 1.5 / 0.3 / 0.1 mm/step]
2-103-011	Duplex Trail. L Size:Thick	ENG	[-4 to 4 / 0.8 / 0.1 mm/step]
2-103-012	Duplex Trail. M Size:Thick	ENG	[-4 to 4 / 0.8 / 0.1 mm/step]
2-103-013	Duplex Trail. S Size:Thick	ENG	[-4 to 4 / 0.6 / 0.1 mm/step]
2-103-014	Duplex Left Edge:Thick	ENG	[0 to 1.5 / 0.3 / 0.1 mm/step]
2-103-015	Duplex Right Edge:Thick	ENG	[0 to 1.5 / 0.3 / 0.1 mm/step]
2-103-016	Duplex Trail. L Size:Thin	ENG	[-4 to 4 / 0.8 / 0.1 mm/step]
2-103-017	Duplex Trail. M Size:Thin	ENG	[-4 to 4 / 0.8 / 0.1 mm/step]
2-103-018	Duplex Trail. S Size:Thin	ENG	[-4 to 4 / 0.6 / 0.1 mm/step]
2-103-019	Lead Edge Width:Thin	ENG	[0 to 9.9 / 4.2 / 0.1 mm/step]
2-103-020	Trail. Edge Width:Thin	ENG	[0 to 9.9 / 4.2 / 0.1 mm/step]

2106	[Polygon Rotation Time]		
2-106-001	Warming-Up	*ENG	[0 to 60 / 10 / 1 sec/step]
2-106-002	Job End	*ENG	[0 to 60 / 0.1 / 0.1 sec/step]

2107	[Image Parameter]		
2-107-001	Image Gamma Flag	ENG	[0 or 1 / 1 / 1/step]
2-107-002	Shading Correction Flag	*ENG	[0 or 1 / 0 / 1/step]

2109		[Test Pattern]	
2-109-003	Pattern Selection		ENG [0 to 23 / 0 / 1/step]
	0	None	12 Independent Pattern (2dot)
	1	Vertical Line (1 dot)	13 Independent Pattern (4dot)
	2	Vertical Line (2dot)	14 Trimming Area
	3	Horizontal Line (1 dot)	15 Hound's Tooth Check (Vertical)
	4	Horizontal Line (2dot)	16 Hound's Tooth Check (Horizontal)
	5	Grid Vertical Line	17 Band (Horizontal)
	6	Grid Horizontal Line	18 Band (Vertical)
	7	Grid Pattern Small	19 Checker Flag Pattern
	8	Grid Pattern Large	20 Grayscale (Vertical Margin)
	9	Argyle Pattern Small	21 Grayscale (Horizontal Margin)
	10	Argyle Pattern Large	22 Wormy Pattern
11	Independent Pattern (1 dot)	23 Full Dot Pattern	
2-109-005	Color Selection		ENG [1 to 4 / 1 / 1/step] 1: All Color 2: Ma 3: Ye 4: Cy
2-109-006	Density: Bk	ENG	[0 to 15 / 15 / 1/step]
2-109-007	Density: Ma	ENG	[0 to 15 / 15 / 1/step]
2-109-008	Density: Cy	ENG	[0 to 15 / 15 / 1/step]
2-109-009	Density: Ye	ENG	[0 to 15 / 15 / 1/step]
2110		[LD Driver]	
2-110-001	Error Bk	ENG	[0x0000 to 0xFFFF / 0x0000 / 1/step]

2-110-002	Error Ma	ENG	[0x0000 to 0xFFFF / 0x0000 / 1/step]
2-110-003	Error Cy	ENG	[0x0000 to 0xFFFF / 0x0000 / 1/step]
2-110-004	Error Ye	ENG	[0x0000 to 0xFFFF / 0x0000 / 1/step]
2-110-005	Writing Unit Adj. Transfer	ENG	[0 or 1 / 0 / 1/step]

2111	[Forced Line Position Adj.]		
2-111-001	Mode a	ENG	[0 or 1 / 0 / 1/step]
2-111-002	Mode b	ENG	[0 or 1 / 0 / 1/step]
2-111-003	Mode c	ENG	[0 or 1 / 0 / 1/step]
2-111-004	Mode d	ENG	[0 or 1 / 0 / 1/step]

2112	[TM/ID Sensor Check]		
2-112-001	Execute	ENG	[0 or 1 / 0 / 1/step]
2112	[TM/ID Sensor Test]		
2-112-010	General:FCR	*ENG	[0 to 999 / 0 / 1/step]
2-112-020	Threshold Setting	*ENG	[0 to 3.5 / 1.9 / 0.01-V/step]

2117	[Skew Adjustment]		
2-117-001	Pulse: M	*ENG	[-75 to 75 / 0 / 1pulse/step]
2-117-002	Pulse: C	*ENG	[-75 to 75 / 0 / 1pulse/step]
2-117-003	Pulse: Y	*ENG	[-99 to 99 / 0 / 1pulse/step]

2118	[Skew Adjustment]		
2-118-001	Execute: M	ENG	[0 or 1 / - / 1/step]
2-118-002	Execute: C	ENG	[0 or 1 / - / 1/step]
2-118-003	Execute: Y	ENG	[0 or 1 / - / 1/step]

2119	[Skew Adjustment Display]		
2-119-001	M	*ENG	[-75 to 75 / 0 / 1pulse/step]
2-119-002	C	*ENG	[-75 to 75 / 0 / 1pulse/step]
2-119-003	Y	*ENG	[-99 to 99 / 0 / 1pulse/step]

2120	[Skew Adj Changing Line Speed]		
2-120-001	On/Off	*ENG	[0 or 1 / 0 / 1/step]

2121	[Skew Adjust Coefficient]		
2-121-001	Coefficient	*ENG	[0 to 2 / 0 / 1/step]

2140	[TM/ID Sensor Check Result]		
2-140-005	PWM: Front	ENG	[0 to 1023 / 0 / 1/step]
2-140-006	PWM: Center	*ENG	[0 to 1023 / 0 / 1/step]
2-140-007	PWM: Rear	*ENG	[0 to 1023 / 0 / 1/step]

2141	[TM/ID Sensor Check Result]		
2-141-005	Average: Front	*ENG	[0 to 5.5 / 0 / 0.01-V/step]
2-141-006	Average: Center	*ENG	[0 to 5.5 / 0 / 0.01-V/step]
2-141-007	Average: Rear	*ENG	[0 to 5.5 / 0 / 0.01-V/step]

2142	[TM/ID Sensor Check Result]		
2-142-005	Maximum: Front	*ENG	[0 to 5.5 / 0 / 0.01-V/step]
2-142-006	Maximum: Center	*ENG	[0 to 5.5 / 0 / 0.01-V/step]
2-142-007	Maximum: Rear	*ENG	[0 to 5.5 / 0 / 0.01-V/step]

2143	[TM/ID Sensor Check Result]		
2-143-005	Minimum: Front	*ENG	[0 to 5.5 / 0 / 0.01-V/step]

2-143-006	Minimum: Center	*ENG	[0 to 5.5 / 0 / 0.01-V/step]
2-143-007	Minimum: Rear	*ENG	[0 to 5.5 / 0 / 0.01-V/step]

2144	[TM/ID Sensor Check Result]		
2-144-005	Maximum 2: Front	*ENG	[0 to 5.5 / 0 / 0.01-V/step]
2-144-006	Maximum 2: Center	*ENG	[0 to 5.5 / 0 / 0.01-V/step]
2-144-007	Maximum 2: Rear	*ENG	[0 to 5.5 / 0 / 0.01-V/step]

2145	[TM/ID Sensor Check Result]		
2-145-005	Minimum 2: Front	*ENG	[0 to 5.5 / 0 / 0.01-V/step]
2-145-006	Minimum 2: Center	*ENG	[0 to 5.5 / 0 / 0.01-V/step]
2-145-007	Minimum 2: Rear	*ENG	[0 to 5.5 / 0 / 0.01-V/step]

2146	[TM-Sensor Test]		
2-146-005	Number of Edge Detection:Front	*ENG	[0 to 16 / 0 / 1/step]
2-146-006	Number of Edge Detection:Center	*ENG	[0 to 16 / 0 / 1/step]
2-146-007	Number of Edge Detection:Rear	*ENG	[0 to 16 / 0 / 1/step]

2150	[Area Mag. Correction]		
2-150-027	Area 0: Bk	*ENG	[-16 to 16 / 0 / 0.01dot/step]
2-150-028	Area 1: Bk	*ENG	[-16 to 16 / 0 / 0.01dot/step]
2-150-029	Area 2: Bk	*ENG	[-16 to 16 / 0 / 0.01dot/step]
2-150-030	Area 3: Bk	*ENG	[-16 to 16 / 0 / 0.01dot/step]
2-150-031	Area 4: Bk	*ENG	[-16 to 16 / 0 / 0.01dot/step]
2-150-032	Area 5: Bk	*ENG	[-16 to 16 / 0 / 0.01dot/step]
2-150-033	Area 6: Bk	*ENG	[-16 to 16 / 0 / 0.01dot/step]
2-150-034	Area 7: Bk	*ENG	[-16 to 16 / 0 / 0.01dot/step]

2-150-035	Area 8: Bk	*ENG	[-16 to 16 / 0 / 0.01 dot/step]
2-150-036	Area 9: Bk	*ENG	[-16 to 16 / 0 / 0.01 dot/step]
2-150-037	Area 10: Bk	*ENG	[-16 to 16 / 0 / 0.01 dot/step]
2-150-038	Area 11: Bk	*ENG	[-16 to 16 / 0 / 0.01 dot/step]
2-150-039	Area 12: Bk	*ENG	[-16 to 16 / 0 / 0.01 dot/step]
2-150-079	Area 0: Ma	*ENG	[-16 to 16 / 0 / 0.01 dot/step]
2-150-080	Area 1: Ma	*ENG	[-16 to 16 / 0 / 0.01 dot/step]
2-150-081	Area 2: Ma	*ENG	[-16 to 16 / 0 / 0.01 dot/step]
2-150-082	Area 3: Ma	*ENG	[-16 to 16 / 0 / 0.01 dot/step]
2-150-083	Area 4: Ma	*ENG	[-16 to 16 / 0 / 0.01 dot/step]
2-150-084	Area 5: Ma	*ENG	[-16 to 16 / 0 / 0.01 dot/step]
2-150-085	Area 6: Ma	*ENG	[-16 to 16 / 0 / 0.01 dot/step]
2-150-086	Area 7: Ma	*ENG	[-16 to 16 / 0 / 0.01 dot/step]
2-150-087	Area 8: Ma	*ENG	[-16 to 16 / 0 / 0.01 dot/step]
2-150-088	Area 9: Ma	*ENG	[-16 to 16 / 0 / 0.01 dot/step]
2-150-089	Area 10: Ma	*ENG	[-16 to 16 / 0 / 0.01 dot/step]
2-150-090	Area 11: Ma	*ENG	[-16 to 16 / 0 / 0.01 dot/step]
2-150-091	Area 12: Ma	*ENG	[-16 to 16 / 0 / 0.01 dot/step]
2-150-131	Area 0: Cy	*ENG	[-16 to 16 / 0 / 0.01 dot/step]
2-150-132	Area 1: Cy	*ENG	[-16 to 16 / 0 / 0.01 dot/step]
2-150-133	Area 2: Cy	*ENG	[-16 to 16 / 0 / 0.01 dot/step]
2-150-134	Area 3: Cy	*ENG	[-16 to 16 / 0 / 0.01 dot/step]
2-150-135	Area 4: Cy	*ENG	[-16 to 16 / 0 / 0.01 dot/step]
2-150-136	Area 5: Cy	*ENG	[-16 to 16 / 0 / 0.01 dot/step]
2-150-137	Area 6: Cy	*ENG	[-16 to 16 / 0 / 0.01 dot/step]
2-150-138	Area 7: Cy	*ENG	[-16 to 16 / 0 / 0.01 dot/step]

2-150-139	Area 8: Cy	*ENG	[-16 to 16 / 0 / 0.01 dot/step]
2-150-140	Area 9: Cy	*ENG	[-16 to 16 / 0 / 0.01 dot/step]
2-150-141	Area 10: Cy	*ENG	[-16 to 16 / 0 / 0.01 dot/step]
2-150-142	Area 11: Cy	*ENG	[-16 to 16 / 0 / 0.01 dot/step]
2-150-143	Area 12: Cy	*ENG	[-16 to 16 / 0 / 0.01 dot/step]
2-150-183	Area 0: Ye	*ENG	[-16 to 16 / 0 / 0.01 dot/step]
2-150-184	Area 1: Ye	*ENG	[-16 to 16 / 0 / 0.01 dot/step]
2-150-185	Area 2: Ye	*ENG	[-16 to 16 / 0 / 0.01 dot/step]
2-150-186	Area 3: Ye	*ENG	[-16 to 16 / 0 / 0.01 dot/step]
2-150-187	Area 4: Ye	*ENG	[-16 to 16 / 0 / 0.01 dot/step]
2-150-188	Area 5: Ye	*ENG	[-16 to 16 / 0 / 0.01 dot/step]
2-150-189	Area 6: Ye	*ENG	[-16 to 16 / 0 / 0.01 dot/step]
2-150-190	Area 7: Ye	*ENG	[-16 to 16 / 0 / 0.01 dot/step]
2-150-191	Area 8: Ye	*ENG	[-16 to 16 / 0 / 0.01 dot/step]
2-150-192	Area 9: Ye	*ENG	[-16 to 16 / 0 / 0.01 dot/step]
2-150-193	Area 10: Ye	*ENG	[-16 to 16 / 0 / 0.01 dot/step]
2-150-194	Area 11: Ye	*ENG	[-16 to 16 / 0 / 0.01 dot/step]
2-150-195	Area 12: Ye	*ENG	[-16 to 16 / 0 / 0.01 dot/step]

2152	[Shad. Correct Setting]		
2-152-001	Standard Speed: Bk	*ENG	[50 to 120 / 100 / 0.1%/step]
2-152-002	Standard Speed: Ma	*ENG	[50 to 120 / 100 / 0.1%/step]
2-152-003	Standard Speed: Cy	*ENG	[50 to 120 / 100 / 0.1%/step]
2-152-004	Standard Speed: Ye	*ENG	[50 to 120 / 100 / 0.1%/step]
2-152-005	Middle Speed: Bk	*ENG	[50 to 120 / 100 / 0.1%/step]
2-152-006	Middle Speed: Ma	*ENG	[50 to 120 / 100 / 0.1%/step]

2-152-007	Middle Speed: Cy	*ENG	[50 to 120 / 100 / 0.1%/step]
2-152-008	Middle Speed: Ye	*ENG	[50 to 120 / 100 / 0.1%/step]
2-152-009	Low Speed: Bk	*ENG	[50 to 120 / 100 / 0.1%/step]
2-152-010	Low Speed: Ma	*ENG	[50 to 120 / 100 / 0.1%/step]
2-152-011	Low Speed: Cy	*ENG	[50 to 120 / 100 / 0.1%/step]
2-152-012	Low Speed: Ye	*ENG	[50 to 120 / 100 / 0.1%/step]

2154	[Shad. Correct Setting]		
2-154-002	Front End Area: Bk: LD1	*ENG	[50 to 150 / 100 / 0.1%/step]
2-154-003	Front End Area: Bk: LD2	*ENG	[50 to 150 / 100 / 0.1%/step]
2-154-004	Front End Area: Bk: LD3	*ENG	[50 to 150 / 100 / 0.1%/step]
2-154-005	Front End Area: Bk: LD4	*ENG	[50 to 150 / 100 / 0.1%/step]
2-154-007	Front End Area: Ma: LD1	*ENG	[50 to 150 / 100 / 0.1%/step]
2-154-008	Front End Area: Ma: LD2	*ENG	[50 to 150 / 100 / 0.1%/step]
2-154-009	Front End Area: Ma: LD3	*ENG	[50 to 150 / 100 / 0.1%/step]
2-154-010	Front End Area: Ma: LD4	*ENG	[50 to 150 / 100 / 0.1%/step]
2-154-012	Front End Area: Cy: LD1	*ENG	[50 to 150 / 100 / 0.1%/step]
2-154-013	Front End Area: Cy: LD2	*ENG	[50 to 150 / 100 / 0.1%/step]
2-154-014	Front End Area: Cy: LD3	*ENG	[50 to 150 / 100 / 0.1%/step]
2-154-015	Front End Area: Cy: LD4	*ENG	[50 to 150 / 100 / 0.1%/step]
2-154-017	Front End Area: Ye: LD1	*ENG	[50 to 150 / 100 / 0.1%/step]
2-154-018	Front End Area: Ye: LD2	*ENG	[50 to 150 / 100 / 0.1%/step]
2-154-019	Front End Area: Ye: LD3	*ENG	[50 to 150 / 100 / 0.1%/step]
2-154-020	Front End Area: Ye: LD4	*ENG	[50 to 150 / 100 / 0.1%/step]

2160	[Vertical Line Width]		
2-160-001	600dpi:Bk	*ENG	[10 to 15 / 15 / 1/step]

2-160-002	600dpi:Ma	*ENG	[10 to 15 / 15 / 1/step]
2-160-003	600dpi:Cy	*ENG	[10 to 15 / 15 / 1/step]
2-160-004	600dpi:Ye	*ENG	[10 to 15 / 15 / 1/step]
2-160-005	1200dpi:Bk	*ENG	[10 to 15 / 15 / 1/step]
2-160-006	1200dpi:Ma	*ENG	[10 to 15 / 15 / 1/step]
2-160-007	1200dpi:Cy	*ENG	[10 to 15 / 15 / 1/step]
2-160-008	1200dpi:Ye	*ENG	[10 to 15 / 15 / 1/step]
2-160-009	600dpi:Indet.:Bk	*ENG	[10 to 15 / 14 / 1/step]
2-160-010	1200dpi:Indet.:Bk	*ENG	[10 to 15 / 15 / 1/step]

2180	[Line Pos. Adj. Clear]		
2-180-001	Color Regist.	ENG	[0 or 1 / 0 / 1/step]
2-180-002	Main Scan Length Detection	ENG	[0 or 1 / 0 / 1/step]
2-180-003	MUSIC Result	ENG	[0 or 1 / 0 / 1/step]
2-180-004	Area Magnification Correction	ENG	[0 or 1 / 0 / 1/step]

2181	[Line Position Adj. Result]		
2-181-003	Skew: M	*ENG	[-5000 to 5000 / 0 / 0.001um/step]
2-181-011	M. Cor.: Dot: M	*ENG	[-512 to 511 / 0 / 1dot/step]
2-181-012	M. Cor.: Subdot: M	*ENG	[-1 to 1 / 0 / 0.01dot/step]
2-181-013	S. Cor.: 1200 Line: Middle: M	*ENG	[-16384 to 16383 / 0 / 1line/step]
2-181-014	S. Cor.: 1200 Sub: Middle: M	*ENG	[-2 to 2 / 0 / 0.001line/step]
2-181-015	M. Left Mag.: Subdot: M	*ENG	[-32 to 32 / 0 / 0.01dot/step]
2-181-016	M. Right Mag.: Subdot: M	*ENG	[-32 to 32 / 0 / 0.01dot/step]
2-181-017	S. Cor.: 1200 Line: Standard: M	*ENG	[-16384 to 16383 / 0 / 1line/step]
2-181-018	S. Cor.: 1200 Sub: Standard: M	*ENG	[-2 to 2 / 0 / 0.001line/step]

2-181-019	S. Cor.: 1200 Line: Low: M	*ENG	[-16384 to 16383 / 0 / 1line/step]
2-181-020	S. Cor.: 1200 Sub: Low: M	*ENG	[-2 to 2 / 0 / 0.001line/step]
2-181-021	Skew: C	*ENG	[-5000 to 5000 / 0 / 0.001 / um]
2-181-029	M. Cor.: Dot: C	*ENG	[-512 to 511 / 0 / 1dot/step]
2-181-030	M. Cor.: Subdot: C	*ENG	[-1 to 1 / 0 / 0.01dot/step]
2-181-031	S. Cor.: 1200 Line: Middle: C	*ENG	[-16384 to 16383 / 0 / 1line/step]
2-181-032	S. Cor.: 1200 Sub: Middle: C	*ENG	[-2 to 2 / 0 / 0.001line/step]
2-181-033	C. Left Mag.: Subdot: M	*ENG	[-32 to 32 / 0 / 0.01dot/step]
2-181-034	C. Right Mag.: Subdot: M	*ENG	[-32 to 32 / 0 / 0.01dot/step]
2-181-035	S. Cor.: 1200 Line: Standard: C	*ENG	[-16384 to 16383 / 0 / 1line/step]
2-181-036	S. Cor.: 1200 Sub: Standard: C	*ENG	[-2 to 2 / 0 / 0.001line/step]
2-181-037	S. Cor.: 1200 Line: Low: C	*ENG	[-16384 to 16383 / 0 / 1line/step]
2-181-038	S. Cor.: 1200 Sub: Low: C	*ENG	[-2 to 2 / 0 / 0.001line/step]
2-181-039	Skew: Y	*ENG	[-5000 to 5000 / 0 / 0.001um/ step]
2-181-047	M. Cor.: Dot: Y	*ENG	[-512 to 511 / 0 / 1dot/step]
2-181-048	M. Cor.: Subdot: Y	*ENG	[-1 to 1 / 0 / 0.01dot/step]
2-181-049	S. Cor.: 1200 Line: Middle: Y	*ENG	[-16384 to 16383 / 0 / 1line/step]
2-181-050	S. Cor.: 1200 Sub: Middle: Y	*ENG	[-2 to 2 / 0 / 0.001line/step]
2-181-051	Y. Left Mag.: Subdot: M	*ENG	[-32 to 32 / 0 / 0.01dot/step]
2-181-052	Y. Right Mag.: Subdot: M	*ENG	[-32 to 32 / 0 / 0.01dot/step]
2-181-053	S. Cor.: 1200 Line: Standard: Y	*ENG	[-16384 to 16383 / 0 / 1line/step]
2-181-054	S. Cor.: 1200 Sub: Standard: Y	*ENG	[-2 to 2 / 0 / 0.001line/step]
2-181-055	S. Cor.: 1200 Line: Low: Y	*ENG	[-16384 to 16383 / 0 / 1line/step]
2-181-056	S. Cor.: 1200 Sub: Low: Y	*ENG	[-2 to 2 / 0 / 0.001line/step]
2-181-057	S. Cor.: 600 Sub	*ENG	[-1 to 1 / 0 / 0.001line/step]

2-181-059	S. Cor.: 1200 Sub :High	*ENG	[-2 to 2 / 0 / 0.001line/step]
2-181-060	S. Cor.: 1200 Sub :Low	*ENG	[-2 to 2 / 0 / 0.001line/step]
2-181-061	S. Cor.: 1200 Sub :Middle	*ENG	[-2 to 2 / 0 / 0.001line/step]
2-181-064	M. Cor.: Dot: K	*ENG	[-512 to 511 / 0 / 1dot/step]
2-181-072	LineSift: StandardSpeed: M	*ENG	[0 to 3 / 0 / 1line/step]
2-181-073	LineSift: MidSpeed: M	*ENG	[0 to 1 / 0 / 1line/step]
2-181-074	LineSift: StandardSpeed: C	*ENG	[0 to 3 / 0 / 1line/step]
2-181-075	LineSift: MidSpeed: C	*ENG	[0 to 1 / 0 / 1line/step]
2-181-076	LineSift: StandardSpeed: Y	*ENG	[0 to 3 / 0 / 1line/step]
2-181-077	LineSift: MidSpeed: Y	*ENG	[0 to 1 / 0 / 1line/step]
2-181-080	Detect Diff.: M	*ENG	[-1000 to 1000 / 0 / 0.1/step]
2-181-081	Detect Diff.: C	*ENG	[-1000 to 1000 / 0 / 0.1/step]
2-181-082	Detect Diff.: Y	*ENG	[-1000 to 1000 / 0 / 0.1/step]

2182	[Line Position Adj. Offset]		
2-182-004	M. Scan: Standard: Dot: M	*ENG	[-512 to 511 / 0 / 1dot/step]
2-182-005	M. Scan: Standard: Subdot: M	*ENG	[-1 to 1 / 0 / 0.01dot/step]
2-182-006	M. Scan: Middle: Dot: M	*ENG	[-512 to 511 / 0 / 1dot/step]
2-182-007	M. Scan: Middle: Subdot: M	*ENG	[-1 to 1 / 0 / 0.01dot/step]
2-182-008	M. Scan: Low: Dot: M	*ENG	[-512 to 511 / 0 / 1dot/step]
2-182-009	M. Scan: Low: Subdot: M	*ENG	[-1 to 1 / 0 / 0.01dot/step]
2-182-010	M. Scan: Standard: Dot: C	*ENG	[-512 to 511 / 0 / 1dot/step]
2-182-011	M. Scan: Standard: Subdot: C	*ENG	[-1 to 1 / 0 / 0.01dot/step]
2-182-012	M. Scan: Middle: Dot: C	*ENG	[-512 to 511 / 0 / 1dot/step]
2-182-013	M. Scan: Middle: Subdot: C	*ENG	[-1 to 1 / 0 / 0.01dot/step]
2-182-014	M. Scan: Low: Dot: C	*ENG	[-512 to 511 / 0 / 1dot/step]

2-182-015	M. Scan: Low: Subdot: C	*ENG	[-1 to 1 / 0 / 0.01 dot/step]
2-182-016	M. Scan: Standard: Dot: Y	*ENG	[-512 to 511 / 0 / 1 dot/step]
2-182-017	M. Scan: Standard: Subdot: Y	*ENG	[-1 to 1 / 0 / 0.01 dot/step]
2-182-018	M. Scan: Middle: Dot: Y	*ENG	[-512 to 511 / 0 / 1 dot/step]
2-182-019	M. Scan: Middle: Subdot: Y	*ENG	[-1 to 1 / 0 / 0.01 dot/step]
2-182-020	M. Scan: Low: Dot: Y	*ENG	[-512 to 511 / 0 / 1 dot/step]
2-182-021	M. Scan: Low: Subdot: Y	*ENG	[-1 to 1 / 0 / 0.01 dot/step]
2-182-022	S. Scan: Standard: Line: M	*ENG	[-16384 to 16383 / 0 / 1 line/step]
2-182-023	S. Scan: Standard: Subline: M	*ENG	[-1 to 1 / 0 / 0.01 line/step]
2-182-024	S. Scan: Middle: Line: M	*ENG	[-16384 to 16383 / 0 / 1 line/step]
2-182-025	S. Scan: Middle: Subline: M	*ENG	[-1 to 1 / 0 / 0.01 line/step]
2-182-026	S. Scan: Low: Line: M	*ENG	[-16384 to 16383 / 0 / 1 line/step]
2-182-027	S. Scan: Low: Subline: M	*ENG	[-1 to 1 / 0 / 0.01 line/step]
2-182-028	S. Scan: Standard: Line: C	*ENG	[-16384 to 16383 / 0 / 1 line/step]
2-182-029	S. Scan: Standard: Subline: C	*ENG	[-1 to 1 / 0 / 0.01 line/step]
2-182-030	S. Scan: Middle: Line: C	*ENG	[-16384 to 16383 / 0 / 1 line/step]
2-182-031	S. Scan: Middle: Subline: C	*ENG	[-1 to 1 / 0 / 0.01 line/step]
2-182-032	S. Scan: Low: Line: C	*ENG	[-16384 to 16383 / 0 / 1 line/step]
2-182-033	S. Scan: Low: Subline: C	*ENG	[-1 to 1 / 0 / 0.01 line/step]
2-182-034	S. Scan: Standard: Line: Y	*ENG	[-16384 to 16383 / 0 / 1 line/step]
2-182-035	S. Scan: Standard: Subline: Y	*ENG	[-1 to 1 / 0 / 0.01 line/step]
2-182-036	S. Scan: Middle: Line: Y	*ENG	[-16384 to 16383 / 0 / 1 line/step]
2-182-037	S. Scan: Middle: Subline: Y	*ENG	[-1 to 1 / 0 / 0.01 line/step]
2-182-038	S. Scan: Low: Line: Y	*ENG	[-16384 to 16383 / 0 / 1 line/step]
2-182-039	S. Scan: Low: Subline: Y	*ENG	[-1 to 1 / 0 / 0.01 line/step]
2-182-040	M. Scan: Dot: K	*ENG	[-512 to 511 / 0 / 1 dot/step]

2187	[Method Select]		
2-187-002	MUSIC Pattern Length Adj.	*ENG	[-300 to 300 / 0 / 1dot/step]
2-187-003	Pattern Width Adj.	*ENG	[-512 to 511 / 0 / 1dot/step]
2-187-004	Pattern Interval Adj.	*ENG	[-512 to 511 / 0 / 1dot/step]

2190	[Line Position Adj.]		
2-190-012	SnSErr Range	*ENG	[0 to 3500 / 200 / 1um/step]

2193	[MUSIC Condition Set]		
2-193-002	Page: Job End: BW+FC	*ENG	[0 to 999 / 500 / 1 page/step]
2-193-003	Page: Job End: FC	*ENG	[0 to 999 / 200 / 1 page/step]
2-193-004	Page: Interrupt: BW+FC	*ENG	[0 to 999 / 200 / 1 page/step]
2-193-005	Page: Interrupt: FC	*ENG	[0 to 999 / 200 / 1 page/step]
2-193-006	Page: Stand-By: BW	*ENG	[0 to 999 / 100 / 1 page/step]
2-193-007	Page: Stand-By: FC	*ENG	[0 to 999 / 100 / 1 page/step]
2-193-008	Temp.	*ENG	[0 to 100 / 5 / 1deg/step]
2-193-011	Temp. 2	*ENG	[0 to 100 / 5 / 1deg/step]
2-193-013	Temp. 3	*ENG	[0 to 100 / 10 / 1deg/step]
2-193-016	Page: Power ON:BW+FC	*ENG	[0 to 999 / 200 / 1 page/step]
2-193-017	Skew	*ENG	[0 to 999 / 50 / 1um/step]
2-193-018	Page: Low Speed: BW+FC	*ENG	[0 to 999 / 50 / 1 page/step]
2-193-019	Page: Low Speed: FC	*ENG	[0 to 999 / 50 / 1 page/step]

2194	[MUSIC Execution Result]		
2-194-001	Year	*ENG	[0 to 99 / 0 / 1year/step]
2-194-002	Month	*ENG	[1 to 12 / 1 / 1month/step]
2-194-003	Day	*ENG	[1 to 31 / 1 / 1day/step]

2-194-004	Hour	*ENG	[0 to 23 / 0 / 1 hour/step]
2-194-005	Minute	*ENG	[0 to 59 / 0 / 1 minute/step]
2-194-006	Temperature	*ENG	[0 to 100 / 0 / 1 deg/step]
2-194-007	Execution Result	*ENG	[0 or 1 / 0 / 1/step]
2-194-008	Number of Execution	*ENG	[0 to 999999 / 0 / 1 time/step]
2-194-009	Number of Failure	*ENG	[0 to 999999 / 0 / 1 time/step]
2-194-010	Error Result: C	*ENG	[0 to 9 / 0 / 1/step]
2-194-011	Error Result: M	*ENG	[0 to 9 / 0 / 1/step]
2-194-012	Error Result: Y	*ENG	[0 to 9 / 0 / 1/step]
2-194-013	Error Result: K	*ENG	[0 to 9 / 0 / 1/step]
2-194-014	Temperature 2	*ENG	[-10 to 100 / 0 / 1 deg/step]

2195	[Realtime MUSIC Condition Set]		
2-195-001	ON/OFF	*ENG	[0 or 1 / 1 / 1/step] 0: OFF 1: ON
2-195-002	Page: Interrupt: BW+FC	*ENG	[0 to 999 / 50 / 1 page/step]
2-195-003	Page: Interrupt: FC	*ENG	[0 to 999 / 50 / 1 page/step]
2-195-004	Temperature 4	*ENG	[0 to 100 / 1 / 1 deg/step]
2-195-005	Temperature 5	*ENG	[0 to 100 / 1 / 1 deg/step]

2220	[Skew Origin Set]		
2-220-001	M: Skew Motor	ENG	[0 or 1 / 0 / 1/step]
2-220-002	C: Skew Motor	ENG	[0 or 1 / 0 / 1/step]
2-220-003	Y: Skew Motor	ENG	[0 or 1 / 0 / 1/step]

2221	[LD Power: Fixed]		
-------------	--------------------------	--	--

2-221-001	K	*ENG	[0 to 217 / 100 / 1%/step]
2-221-002	C	*ENG	
2-221-003	M	*ENG	
2-221-004	Y	*ENG	

2229	[Develop DC Bias]		
2-229-001	Standard Speed: Bk	*ENG	[0 to 800 / 550 / 1-V/step]
2-229-002	Standard Speed: C	*ENG	[0 to 800 / 550 / 1-V/step]
2-229-003	Standard Speed: M	*ENG	[0 to 800 / 550 / 1-V/step]
2-229-004	Standard Speed: Y	*ENG	[0 to 800 / 550 / 1-V/step]
2-229-005	Middle Speed Bk	*ENG	[0 to 800 / 550 / 1-V/step]
2-229-006	Middle Speed C	*ENG	[0 to 800 / 550 / 1-V/step]
2-229-007	Middle Speed M	*ENG	[0 to 800 / 550 / 1-V/step]
2-229-008	Middle Speed Y	*ENG	[0 to 800 / 550 / 1-V/step]
2-229-009	Low Speed: Bk	*ENG	[0 to 800 / 550 / 1-V/step]
2-229-010	Low Speed: C	*ENG	[0 to 800 / 550 / 1-V/step]
2-229-011	Low Speed: M	*ENG	[0 to 800 / 550 / 1-V/step]
2-229-012	Low Speed: Y	*ENG	[0 to 800 / 550 / 1-V/step]

2230	[QL Power Setting]		
2-230-001	Standard Speed	*ENG	[0 to 100 / 26 / 1%/step]
2-230-002	Middle Speed	*ENG	[0 to 100 / 13 / 1%/step]
2-230-003	Low Speed	*ENG	[0 to 100 / 13 / 1%/step]

2241	[Temperature/Humidity: Display]		
2-241-003	Exec Interval: Extra Fan Control	*ENG	[1 to 3600 / 10 / 1 sec/step]
2241	[AIT Temperature]		

2-241-004	AIT Temperature	ENG	[0 to 70 / 0 / 0.1deg/step]
-----------	-----------------	-----	-----------------------------

2242	[TS Operation Env. Log]		
2-242-001	TS<=A-3	ENG	[0 to 99999999 / 0 / 1mm/step]
2-242-002	A-3<TS<=A	ENG	[0 to 99999999 / 0 / 1mm/step]
2-242-003	A<TS<=A+3	ENG	[0 to 99999999 / 0 / 1mm/step]
2-242-004	A+3<TS	ENG	[0 to 99999999 / 0 / 1mm/step]
2-242-100	Log Clear	ENG	[0 or 1 / 0 / 1/step]

2250	[Interval Downmode]		
2-250-001	ON/OFF Setting	ENG	[0 or 1 / 1 / 1/step]

2302	[Environmental Correction:Trans]		
2-302-001	Current Environmental Display	ENG	[0 to 0 / 0 / 0/step]
2-302-002	Forced Setting	*ENG	[0 to 6 / 0 / 1/step] 0: Sensor detect 1: LL 2: ML 3: MM 4: HM 5: HH 6: SLL
2-302-003	Absolute Humidity:Threshold 1	*ENG	[0 to 100 / 4 / 0.01g/m ³ /step]
2-302-004	Absolute Humidity:Threshold 2	*ENG	[0 to 100 / 8 / 0.01g/m ³ /step]
2-302-005	Absolute Humidity:Threshold 3	*ENG	[0 to 100 / 16 / 0.01g/m ³ /step]
2-302-006	Absolute Humidity:Threshold 4	*ENG	[0 to 100 / 24 / 0.01g/m ³ /step]
2-302-007	Temperature:Threshold	*ENG	[-5 to 30 / 5 / 1deg/step]

2303	[Time-Lapse Correction]		
-------------	--------------------------------	--	--

2-303-001	Current Div K	*ENG	[0 to 3 / 0 / 1/step]
2-303-002	Current Div C	*ENG	[0 to 3 / 0 / 1/step]
2-303-003	Current Div M	*ENG	[0 to 3 / 0 / 1/step]
2-303-004	Current Div Y	*ENG	[0 to 3 / 0 / 1/step]
2-303-005	Correction Threshold 1_Bk	*ENG	[0 to 600000 / 5000 / 10page/step]
2-303-006	Correction Threshold 1_Color	*ENG	[0 to 600000 / 5000 / 10page/step]
2-303-007	Correction Threshold 2_Bk	*ENG	[0 to 600000 / 20000 / 10page/step]
2-303-008	Correction Threshold 2_Color	*ENG	[0 to 600000 / 20000 / 10page/step]
2-303-009	Correction Threshold 3_Bk	*ENG	[0 to 600000 / 50000 / 10page/step]
2-303-010	Correction Threshold 3_Color	*ENG	[0 to 600000 / 50000 / 10page/step]

2308	[Paper Size Correction]		
2-308-001	Threshold 1	*ENG	[0 to 350 / 297 / 1 mm/step]
2-308-002	Threshold 2	*ENG	[0 to 350 / 257 / 1 mm/step]
2-308-003	Threshold 3	*ENG	[0 to 350 / 210 / 1 mm/step]
2-308-004	Threshold 4	*ENG	[0 to 350 / 148 / 1 mm/step]
2-308-005	Threshold 1	*ENG	[0 to 350 / 297 / 1 mm/step]
2-308-006	Threshold 2	*ENG	[0 to 350 / 257 / 1 mm/step]
2-308-007	Threshold 3	*ENG	[0 to 350 / 210 / 1 mm/step]
2-308-008	Threshold 4	*ENG	[0 to 350 / 148 / 1 mm/step]

2311	[Non Image Area:Bias]		
2-311-001	Image Transfer	*ENG	[10 to 250 / 100 / 5%/step]

2-311-002	Paper Transfer	*ENG	[0 to 230 / 0 / 1-uA/step]
2-311-003	Paper Transfer	*ENG	[0 to 2100 / 500 / 10V/step]

2316	[Power ON:Bias]		
2-316-001	Image Transfer	*ENG	[0 to 80 / 5 / 1uA/step]

2326	[Transfer Roller CL:Bias]		
2-326-001	Positive:befor and after JOB	*ENG	[0 to 2100 / 250 / 10V/step]
2-326-002	Negative:befor and after JOB	*ENG	[10 to 995 / 100 / 10%/step]
2-326-003	Positive:befor and afterProcon	*ENG	[0 to 2100 / 2000 / 10V/step]
2-326-004	Negative:befor and afterProcon	*ENG	[10 to 995 / 100 / 10%/step]
2-326-005	Positive:prevention	*ENG	[0 to 2100 / 500 / 10-V/step]
2326	[Transfer Roller CL:Env]		
2-326-011	Positive:befor and after JOB	*ENG	[1 to 110 / 100 / 1/step]
2-326-013	Positive:befor and afterProcon	*ENG	[1 to 110 / 100 / 1/step]
2-326-015	Positive:prevention	*ENG	[1 to 110 / 100 / 1/step]

2351	[Common:BW:Bias]		
2-351-001	Image Transfer:standard	*ENG	[0 to 60 / 28 / 1uA/step]
2-351-002	Image Transfer:Middle	ENG	[0 to 60 / 24 / 1uA/step]
2-351-003	Image Transfer:low	ENG	[0 to 60 / 13 / 1uA/step]

2357	[Common:FC:Bias]		
2-357-001	ImageTransfer:standard:Bk	*ENG	[0 to 60 / 28 / 1uA/step]
2-357-002	ImageTransfer:standard:C	*ENG	[0 to 60 / 27 / 1uA/step]
2-357-003	ImageTransfer:standard:M	*ENG	[0 to 60 / 27 / 1uA/step]
2-357-004	ImageTransfer:standard:Y	*ENG	[0 to 60 / 28 / 1uA/step]

2-357-005	ImageTransfer:Middle:Bk	ENG	[0 to 60 / 24 / 1 uA/step]
2-357-006	ImageTransfer:Middle:C	ENG	[0 to 60 / 24 / 1 uA/step]
2-357-007	ImageTransfer:Middle:M	ENG	[0 to 60 / 26 / 1 uA/step]
2-357-008	ImageTransfer:Middle:Y	ENG	[0 to 60 / 28 / 1 uA/step]
2-357-009	Image Transfer:low:Bk	ENG	[0 to 60 / 12 / 1 uA/step]
2-357-010	Image Transfer:low:C	ENG	[0 to 60 / 11 / 1 uA/step]
2-357-011	Image Transfer:low:M	ENG	[0 to 60 / 11 / 1 uA/step]
2-357-012	Image Transfer:low:Y	ENG	[0 to 60 / 12 / 1 uA/step]

2358	[TC adjust Process Control:Bias]		
2-358-001	ImageTransfer:standard:FC:Bk	*ENG	[0 to 60 / 28 / 1 uA/step]
2-358-002	ImageTransfer:standard:FC:C	*ENG	[0 to 60 / 27 / 1 uA/step]
2-358-003	ImageTransfer:standard:FC:M	*ENG	[0 to 60 / 27 / 1 uA/step]
2-358-004	ImageTransfer:standard:FC:Y	*ENG	[0 to 60 / 28 / 1 uA/step]
2-358-005	ImageTransfer:standard:Bk:Bk	*ENG	[0 to 60 / 28 / 1 uA/step]

2360	[Common:BW:Env.CorrectionTable]		
2-360-001	Image Transfer:standard	*ENG	[1 to 110 / 13 / 1/step]
2-360-002	Image Transfer:Middle	ENG	[1 to 110 / 2 / 1/step]
2-360-003	Image Transfer:low	ENG	[1 to 110 / 54 / 1/step]
2-360-004	ImageTransfer:standard:Bk	*ENG	[1 to 110 / 13 / 1/step]
2-360-005	ImageTransfer:standard:C	*ENG	[1 to 110 / 54 / 1/step]
2-360-006	ImageTransfer:standard:M	*ENG	[1 to 110 / 54 / 1/step]
2-360-007	ImageTransfer:standard:Y	*ENG	[1 to 110 / 55 / 1/step]
2-360-008	ImageTransfer:Middle:Bk	ENG	[1 to 110 / 1 / 1/step]
2-360-009	ImageTransfer:Middle:C	ENG	[1 to 110 / 2 / 1/step]
2-360-010	ImageTransfer:Middle:M	ENG	[1 to 110 / 3 / 1/step]

2-360-011	ImageTransfer:Middle:Y	ENG	[1 to 110 / 4 / 1/step]
2-360-012	Image Transfer:low:Bk	ENG	[1 to 110 / 15 / 1/step]
2-360-013	Image Transfer:low:C	ENG	[1 to 110 / 55 / 1/step]
2-360-014	Image Transfer:low:M	ENG	[1 to 110 / 56 / 1/step]
2-360-015	Image Transfer:low:Y	ENG	[1 to 110 / 56 / 1/step]

2361	[Time-Lapse Correction: Div 1]		
2-361-001	Standard Speed: Bk	*ENG	[1 to 60 / 2 / 1/step]
2-361-002	Mid Speed: Bk	ENG	
2-361-003	Low Speed: Bk	ENG	
2-361-004	Standard Speed: FC: K	*ENG	[1 to 60 / 1 / 1/step]
2-361-005	Standard Speed: FC: C	*ENG	
2-361-006	Standard Speed: FC: M	*ENG	
2-361-007	Standard Speed: FC: Y	*ENG	
2-361-008	Mid Speed: FC: K	ENG	
2-361-009	Mid Speed: FC: C	ENG	
2-361-010	Mid Speed: FC: M	ENG	
2-361-011	Mid Speed: FC: Y	ENG	
2-361-012	Low Speed: FC: K	ENG	
2-361-013	Low Speed: FC: C	ENG	
2-361-014	Low Speed: FC: M	ENG	
2-361-015	Low Speed: FC: Y	ENG	

2362	[Time-Lapse Correction: Div 2]		
2-362-001	Standard Speed: Bk	*ENG	[1 to 60 / 3 / 1/step]
2-362-002	Mid Speed: Bk	ENG	
2-362-003	Low Speed: Bk	ENG	

2-362-004	Standard Speed: FC: K	*ENG	[1 to 60 / 1 / 1/step]
2-362-005	Standard Speed: FC: C	*ENG	
2-362-006	Standard Speed: FC: M	*ENG	
2-362-007	Standard Speed: FC: Y	*ENG	
2-362-008	Mid Speed: FC: K	ENG	
2-362-009	Mid Speed: FC: C	ENG	
2-362-010	Mid Speed: FC: M	ENG	
2-362-011	Mid Speed: FC: Y	ENG	
2-362-012	Low Speed: FC: K	ENG	
2-362-013	Low Speed: FC: C	ENG	
2-362-014	Low Speed: FC: M	ENG	
2-362-015	Low Speed: FC: Y	ENG	

2363	[Time-Lapse Correction: Div 3]		
2-363-001	Standard Speed: Bk	*ENG	[1 to 60 / 4 / 1/step]
2-363-002	Mid Speed: Bk	ENG	
2-363-003	Low Speed: Bk	ENG	

2-363-004	Standard Speed: FC: K	*ENG	[1 to 60 / 1 / 1/step]
2-363-005	Standard Speed: FC: C	*ENG	
2-363-006	Standard Speed: FC: M	*ENG	
2-363-007	Standard Speed: FC: Y	*ENG	
2-363-008	Mid Speed: FC: K	ENG	
2-363-009	Mid Speed: FC: C	ENG	
2-363-010	Mid Speed: FC: M	ENG	
2-363-011	Mid Speed: FC: Y	ENG	
2-363-012	Low Speed: FC: K	ENG	
2-363-013	Low Speed: FC: C	ENG	
2-363-014	Low Speed: FC: M	ENG	
2-363-015	Low Speed: FC: Y	ENG	

2400	[Paper Transfer Roller Settings]		
2-400-001	Width of Paper Transfer Roller	*ENG	[0 or 1 / 0 / 1/step] 0: Default roller 1: Wide roller
2-400-002	Detach timing in waiting	ENG	[0 to 600 / 240 / 1 min/step]

2403	[Plain 1: Bias: BW]		
2-403-001	PaperTransfer:standard:1side	ENG	[0 to 200 / 22 / 1-uA/step]
2-403-002	PaperTransfer:standard:2side	ENG	[0 to 200 / 22 / 1-uA/step]
2-403-003	PaperTransfer:low:1side	ENG	[0 to 200 / 11 / 1-uA/step]
2-403-004	PaperTransfer:low:2side	ENG	[0 to 200 / 11 / 1-uA/step]

2407	[Plain 1: Bias: FC]		
2-407-001	PaperTransfer:standard:1side	*ENG	[0 to 200 / 29 / 1-uA/step]

2-407-002	PaperTransfer:standard:2side	ENG	[0 to 200 / 29 / 1-uA/step]
2-407-003	PaperTransfer:low:1side	ENG	[0 to 200 / 14 / 1-uA/step]
2-407-004	PaperTransfer:low:2side	ENG	[0 to 200 / 14 / 1-uA/step]

2411	[Plain1:SizeCorrection:BW]		
2-411-001	PaperTransfer:Standard:1Sid:S1	ENG	[100 to 995 / 100 / 1%/step]
2-411-002	PaperTransfer:Standard:2Sid:S1	ENG	[100 to 995 / 100 / 1%/step]
2-411-003	PaperTransfer:Low:1Side:S1	ENG	[100 to 995 / 100 / 1%/step]
2-411-004	PaperTransfer:Low:2Side:S1	ENG	[100 to 995 / 100 / 1%/step]
2-411-005	PaperTransfer:Standard:1Sid:S2	ENG	[100 to 995 / 100 / 1%/step]
2-411-006	PaperTransfer:Standard:2Sid:S2	ENG	[100 to 995 / 105 / 1%/step]
2-411-007	PaperTransfer:Low:1Side:S2	ENG	[100 to 995 / 100 / 1%/step]
2-411-008	PaperTransfer:Low:2Side:S2	ENG	[100 to 995 / 105 / 1%/step]
2-411-009	PaperTransfer:Standard:1Sid:S3	ENG	[100 to 995 / 105 / 1%/step]
2-411-010	PaperTransfer:Standard:2Sid:S3	ENG	[100 to 995 / 118 / 1%/step]
2-411-011	PaperTransfer:Low:1Side:S3	ENG	[100 to 995 / 105 / 1%/step]
2-411-012	PaperTransfer:Low:2Side:S3	ENG	[100 to 995 / 118 / 1%/step]
2-411-013	PaperTransfer:Standard:1Sid:S4	ENG	[100 to 995 / 118 / 1%/step]

2-411-014	PaperTransfer:Standard:2Sid:S4	ENG	[100 to 995 / 131 / 1%/step]
2-411-015	PaperTransfer:Low:1Side:S4	ENG	[100 to 995 / 118 / 1%/step]
2-411-016	PaperTransfer:Low:2Side:S4	ENG	[100 to 995 / 131 / 1%/step]
2-411-017	PaperTransfer:Standard:1Sid:S5	ENG	[100 to 995 / 132 / 1%/step]
2-411-018	PaperTransfer:Standard:2Sid:S5	ENG	[100 to 995 / 184 / 1%/step]
2-411-019	PaperTransfer:Low:1Side:S5	ENG	[100 to 995 / 132 / 1%/step]
2-411-020	PaperTransfer:Low:2Side:S5	ENG	[100 to 995 / 184 / 1%/step]
2-411-021	Wide Roller:PaperTransfer:Standard:1Sid:S1	ENG	[100 to 995 / 100 / 1%/step]
2-411-022	Wide Roller:PaperTransfer:Standard:2Sid:S1	ENG	[100 to 995 / 100 / 1%/step]
2-411-023	Wide Roller:PaperTransfer:Low:1Side:S1	ENG	[100 to 995 / 100 / 1%/step]
2-411-024	Wide Roller:PaperTransfer:Low:2Side:S1	ENG	[100 to 995 / 100 / 1%/step]
2-411-025	Wide Roller:PaperTransfer:Standard:1Sid:S2	ENG	[100 to 995 / 100 / 1%/step]
2-411-026	Wide Roller:PaperTransfer:Standard:2Sid:S2	ENG	[100 to 995 / 105 / 1%/step]
2-411-027	Wide Roller:PaperTransfer:Low:1Side:S2	ENG	[100 to 995 / 100 / 1%/step]
2-411-028	Wide Roller:PaperTransfer:Low:2Side:S2	ENG	[100 to 995 / 105 / 1%/step]
2-411-029	Wide Roller:PaperTransfer:Standard:1Sid:S3	ENG	[100 to 995 / 105 / 1%/step]

2-411-030	Wide Roller:PaperTransfer:Standard: 2Sid:S3	ENG	[100 to 995 / 118 / 1%/ step]
2-411-031	Wide Roller:PaperTransfer:Low:1 Side:S3	ENG	[100 to 995 / 105 / 1%/ step]
2-411-032	Wide Roller:PaperTransfer:Low:2Side:S3	ENG	[100 to 995 / 118 / 1%/ step]
2-411-033	Wide Roller:PaperTransfer:Standard: 1Sid:S4	ENG	[100 to 995 / 118 / 1%/ step]
2-411-034	Wide Roller:PaperTransfer:Standard: 2Sid:S4	ENG	[100 to 995 / 131 / 1%/ step]
2-411-035	Wide Roller:PaperTransfer:Low:1 Side:S4	ENG	[100 to 995 / 118 / 1%/ step]
2-411-036	Wide Roller:PaperTransfer:Low:2Side:S4	ENG	[100 to 995 / 131 / 1%/ step]
2-411-037	Wide Roller:PaperTransfer:Standard: 1Sid:S5	ENG	[100 to 995 / 132 / 1%/ step]
2-411-038	Wide Roller:PaperTransfer:Standard: 2Sid:S5	ENG	[100 to 995 / 184 / 1%/ step]
2-411-039	Wide Roller:PaperTransfer:Low:1 Side:S5	ENG	[100 to 995 / 132 / 1%/ step]
2-411-040	Wide Roller:PaperTransfer:Low:2Side:S5	ENG	[100 to 995 / 184 / 1%/ step]

2412	[Plain1:SizeCorrection:FC]		
2-412-001	PaperTransfer:Standard:1Sid:S1	ENG	[100 to 995 / 100 / 1%/ step]
2-412-002	PaperTransfer:Standard:2Sid:S1	ENG	[100 to 995 / 100 / 1%/ step]
2-412-003	PaperTransfer:Low:1 Side:S1	ENG	[100 to 995 / 100 / 1%/ step]
2-412-004	PaperTransfer:Low:2Side:S1	ENG	[100 to 995 / 100 / 1%/ step]

2-412-005	PaperTransfer:Standard:1Sid:S2	ENG	[100 to 995 / 120 / 1%/step]
2-412-006	PaperTransfer:Standard:2Sid:S2	ENG	[100 to 995 / 140 / 1%/step]
2-412-007	PaperTransfer:Low:1Side:S2	ENG	[100 to 995 / 120 / 1%/step]
2-412-008	PaperTransfer:Low:2Side:S2	ENG	[100 to 995 / 140 / 1%/step]
2-412-009	PaperTransfer:Standard:1Sid:S3	ENG	[100 to 995 / 118 / 1%/step]
2-412-010	PaperTransfer:Standard:2Sid:S3	ENG	[100 to 995 / 180 / 1%/step]
2-412-011	PaperTransfer:Low:1Side:S3	ENG	[100 to 995 / 118 / 1%/step]
2-412-012	PaperTransfer:Low:2Side:S3	ENG	[100 to 995 / 180 / 1%/step]
2-412-013	PaperTransfer:Standard:1Sid:S4	ENG	[100 to 995 / 130 / 1%/step]
2-412-014	PaperTransfer:Standard:2Sid:S4	ENG	[100 to 995 / 200 / 1%/step]
2-412-015	PaperTransfer:Low:1Side:S4	ENG	[100 to 995 / 130 / 1%/step]
2-412-016	PaperTransfer:Low:2Side:S4	ENG	[100 to 995 / 200 / 1%/step]
2-412-017	PaperTransfer:Standard:1Sid:S5	ENG	[100 to 995 / 140 / 1%/step]
2-412-018	PaperTransfer:Standard:2Sid:S5	ENG	[100 to 995 / 240 / 1%/step]
2-412-019	PaperTransfer:Low:1Side:S5	ENG	[100 to 995 / 140 / 1%/step]
2-412-020	PaperTransfer:Low:2Side:S5	ENG	[100 to 995 / 240 / 1%/step]

2-412-021	Wide Roller:PaperTransfer:Standard: 1Sid:S1	ENG	[100 to 995 / 100 / 1%/ step]
2-412-022	Wide Roller:PaperTransfer:Standard: 2Sid:S1	ENG	[100 to 995 / 100 / 1%/ step]
2-412-023	Wide Roller:PaperTransfer:Low: 1 Side:S1	ENG	[100 to 995 / 100 / 1%/ step]
2-412-024	Wide Roller:PaperTransfer:Low:2Side:S1	ENG	[100 to 995 / 100 / 1%/ step]
2-412-025	Wide Roller:PaperTransfer:Standard: 1Sid:S2	ENG	[100 to 995 / 120 / 1%/ step]
2-412-026	Wide Roller:PaperTransfer:Standard: 2Sid:S2	ENG	[100 to 995 / 140 / 1%/ step]
2-412-027	Wide Roller:PaperTransfer:Low: 1 Side:S2	ENG	[100 to 995 / 120 / 1%/ step]
2-412-028	Wide Roller:PaperTransfer:Low:2Side:S2	ENG	[100 to 995 / 140 / 1%/ step]
2-412-029	Wide Roller:PaperTransfer:Standard: 1Sid:S3	ENG	[100 to 995 / 118 / 1%/ step]
2-412-030	Wide Roller:PaperTransfer:Standard: 2Sid:S3	ENG	[100 to 995 / 180 / 1%/ step]
2-412-031	Wide Roller:PaperTransfer:Low: 1 Side:S3	ENG	[100 to 995 / 118 / 1%/ step]
2-412-032	Wide Roller:PaperTransfer:Low:2Side:S3	ENG	[100 to 995 / 180 / 1%/ step]
2-412-033	Wide Roller:PaperTransfer:Standard: 1Sid:S4	ENG	[100 to 995 / 130 / 1%/ step]
2-412-034	Wide Roller:PaperTransfer:Standard: 2Sid:S4	ENG	[100 to 995 / 200 / 1%/ step]
2-412-035	Wide Roller:PaperTransfer:Low: 1 Side:S4	ENG	[100 to 995 / 130 / 1%/ step]
2-412-036	Wide Roller:PaperTransfer:Low:2Side:S4	ENG	[100 to 995 / 200 / 1%/ step]

2-412-037	Wide Roller:PaperTransfer:Standard: 1Sid:S5	ENG	[100 to 995 / 140 / 1%/ step]
2-412-038	Wide Roller:PaperTransfer:Standard: 2Sid:S5	ENG	[100 to 995 / 240 / 1%/ step]
2-412-039	Wide Roller:PaperTransfer:Low:1 Side:S5	ENG	[100 to 995 / 140 / 1%/ step]
2-412-040	Wide Roller:PaperTransfer:Low:2Side:S5	ENG	[100 to 995 / 240 / 1%/ step]

2413	[Plain1:Size-Env.Correct:BW]		
2-413-001	PaperTransfer:Standard:1Sid:S1	ENG	[1 to 110 / 10 / 1/step]
2-413-002	PaperTransfer:Standard:2Sid:S1	ENG	[1 to 110 / 15 / 1/step]
2-413-003	PaperTransfer:Low:1 Side:S1	ENG	[1 to 110 / 10 / 1/step]
2-413-004	PaperTransfer:Low:2Side:S1	ENG	[1 to 110 / 15 / 1/step]
2-413-005	PaperTransfer:Standard:1Sid:S2	ENG	[1 to 110 / 11 / 1/step]
2-413-006	PaperTransfer:Standard:2Sid:S2	ENG	[1 to 110 / 16 / 1/step]
2-413-007	PaperTransfer:Low:1 Side:S2	ENG	[1 to 110 / 11 / 1/step]
2-413-008	PaperTransfer:Low:2Side:S2	ENG	[1 to 110 / 16 / 1/step]
2-413-009	PaperTransfer:Standard:1Sid:S3	ENG	[1 to 110 / 12 / 1/step]
2-413-010	PaperTransfer:Standard:2Sid:S3	ENG	[1 to 110 / 17 / 1/step]
2-413-011	PaperTransfer:Low:1 Side:S3	ENG	[1 to 110 / 12 / 1/step]
2-413-012	PaperTransfer:Low:2Side:S3	ENG	[1 to 110 / 17 / 1/step]
2-413-013	PaperTransfer:Standard:1Sid:S4	ENG	[1 to 110 / 13 / 1/step]
2-413-014	PaperTransfer:Standard:2Sid:S4	ENG	[1 to 110 / 18 / 1/step]
2-413-015	PaperTransfer:Low:1 Side:S4	ENG	[1 to 110 / 13 / 1/step]
2-413-016	PaperTransfer:Low:2Side:S4	ENG	[1 to 110 / 18 / 1/step]
2-413-017	PaperTransfer:Standard:1Sid:S5	ENG	[1 to 110 / 14 / 1/step]
2-413-018	PaperTransfer:Standard:2Sid:S5	ENG	[1 to 110 / 19 / 1/step]

2-413-019	PaperTransfer:Low:1Side:S5	ENG	[1 to 110 / 14 / 1/step]
2-413-020	PaperTransfer:Low:2Side:S5	ENG	[1 to 110 / 19 / 1/step]
2-413-021	Wide Roller:PaperTransfer:Standard: 1Sid:S1	ENG	[1 to 110 / 10 / 1/step]
2-413-022	Wide Roller:PaperTransfer:Standard: 2Sid:S1	ENG	[1 to 110 / 15 / 1/step]
2-413-023	Wide Roller:PaperTransfer:Low:1Side:S1	ENG	[1 to 110 / 10 / 1/step]
2-413-024	Wide Roller:PaperTransfer:Low:2Side:S1	ENG	[1 to 110 / 15 / 1/step]
2-413-025	Wide Roller:PaperTransfer:Standard: 1Sid:S2	ENG	[1 to 110 / 11 / 1/step]
2-413-026	Wide Roller:PaperTransfer:Standard: 2Sid:S2	ENG	[1 to 110 / 16 / 1/step]
2-413-027	Wide Roller:PaperTransfer:Low:1Side:S2	ENG	[1 to 110 / 11 / 1/step]
2-413-028	Wide Roller:PaperTransfer:Low:2Side:S2	ENG	[1 to 110 / 16 / 1/step]
2-413-029	Wide Roller:PaperTransfer:Standard: 1Sid:S3	ENG	[1 to 110 / 12 / 1/step]
2-413-030	Wide Roller:PaperTransfer:Standard: 2Sid:S3	ENG	[1 to 110 / 17 / 1/step]
2-413-031	Wide Roller:PaperTransfer:Low:1Side:S3	ENG	[1 to 110 / 12 / 1/step]
2-413-032	Wide Roller:PaperTransfer:Low:2Side:S3	ENG	[1 to 110 / 17 / 1/step]
2-413-033	Wide Roller:PaperTransfer:Standard: 1Sid:S4	ENG	[1 to 110 / 13 / 1/step]
2-413-034	Wide Roller:PaperTransfer:Standard: 2Sid:S4	ENG	[1 to 110 / 18 / 1/step]
2-413-035	Wide Roller:PaperTransfer:Low:1Side:S4	ENG	[1 to 110 / 13 / 1/step]
2-413-036	Wide Roller:PaperTransfer:Low:2Side:S4	ENG	[1 to 110 / 18 / 1/step]
2-413-037	Wide Roller:PaperTransfer:Standard: 1Sid:S5	ENG	[1 to 110 / 14 / 1/step]
2-413-038	Wide Roller:PaperTransfer:Standard: 2Sid:S5	ENG	[1 to 110 / 19 / 1/step]

2-413-039	Wide Roller:PaperTransfer:Low:1Side:S5	ENG	[1 to 110 / 14 / 1/step]
2-413-040	Wide Roller:PaperTransfer:Low:2Side:S5	ENG	[1 to 110 / 19 / 1/step]

2414	[Plain 1:Size-Env.Correct:FC]		
2-414-001	PaperTransfer:Standard:1Sid:S1	*ENG	[1 to 110 / 20 / 1/step]
2-414-002	PaperTransfer:Standard:2Sid:S1	ENG	[1 to 110 / 25 / 1/step]
2-414-003	PaperTransfer:Low:1Side:S1	ENG	[1 to 110 / 20 / 1/step]
2-414-004	PaperTransfer:Low:2Side:S1	ENG	[1 to 110 / 25 / 1/step]
2-414-005	PaperTransfer:Standard:1Sid:S2	ENG	[1 to 110 / 21 / 1/step]
2-414-006	PaperTransfer:Standard:2Sid:S2	ENG	[1 to 110 / 26 / 1/step]
2-414-007	PaperTransfer:Low:1Side:S2	ENG	[1 to 110 / 21 / 1/step]
2-414-008	PaperTransfer:Low:2Side:S2	ENG	[1 to 110 / 26 / 1/step]
2-414-009	PaperTransfer:Standard:1Sid:S3	ENG	[1 to 110 / 22 / 1/step]
2-414-010	PaperTransfer:Standard:2Sid:S3	ENG	[1 to 110 / 27 / 1/step]
2-414-011	PaperTransfer:Low:1Side:S3	ENG	[1 to 110 / 22 / 1/step]
2-414-012	PaperTransfer:Low:2Side:S3	ENG	[1 to 110 / 27 / 1/step]
2-414-013	PaperTransfer:Standard:1Sid:S4	ENG	[1 to 110 / 23 / 1/step]
2-414-014	PaperTransfer:Standard:2Sid:S4	ENG	[1 to 110 / 28 / 1/step]
2-414-015	PaperTransfer:Low:1Side:S4	ENG	[1 to 110 / 23 / 1/step]
2-414-016	PaperTransfer:Low:2Side:S4	ENG	[1 to 110 / 28 / 1/step]
2-414-017	PaperTransfer:Standard:1Sid:S5	ENG	[1 to 110 / 24 / 1/step]
2-414-018	PaperTransfer:Standard:2Sid:S5	ENG	[1 to 110 / 29 / 1/step]
2-414-019	PaperTransfer:Low:1Side:S5	ENG	[1 to 110 / 24 / 1/step]
2-414-020	PaperTransfer:Low:2Side:S5	ENG	[1 to 110 / 29 / 1/step]
2-414-021	Wide Roller:PaperTransfer:Standard: 1Sid:S1	*ENG	[1 to 110 / 20 / 1/step]

2-414-022	Wide Roller:PaperTransfer:Standard: 2Sid:S1	ENG	[1 to 110 / 25 / 1/step]
2-414-023	Wide Roller:PaperTransfer:Low: 1 Side:S1	ENG	[1 to 110 / 20 / 1/step]
2-414-024	Wide Roller:PaperTransfer:Low:2Side:S1	ENG	[1 to 110 / 25 / 1/step]
2-414-025	Wide Roller:PaperTransfer:Standard: 1Sid:S2	ENG	[1 to 110 / 21 / 1/step]
2-414-026	Wide Roller:PaperTransfer:Standard: 2Sid:S2	ENG	[1 to 110 / 26 / 1/step]
2-414-027	Wide Roller:PaperTransfer:Low: 1 Side:S2	ENG	[1 to 110 / 21 / 1/step]
2-414-028	Wide Roller:PaperTransfer:Low:2Side:S2	ENG	[1 to 110 / 26 / 1/step]
2-414-029	Wide Roller:PaperTransfer:Standard: 1Sid:S3	ENG	[1 to 110 / 22 / 1/step]
2-414-030	Wide Roller:PaperTransfer:Standard: 2Sid:S3	ENG	[1 to 110 / 27 / 1/step]
2-414-031	Wide Roller:PaperTransfer:Low: 1 Side:S3	ENG	[1 to 110 / 22 / 1/step]
2-414-032	Wide Roller:PaperTransfer:Low:2Side:S3	ENG	[1 to 110 / 27 / 1/step]
2-414-033	Wide Roller:PaperTransfer:Standard: 1Sid:S4	ENG	[1 to 110 / 23 / 1/step]
2-414-034	Wide Roller:PaperTransfer:Standard: 2Sid:S4	ENG	[1 to 110 / 28 / 1/step]
2-414-035	Wide Roller:PaperTransfer:Low: 1 Side:S4	ENG	[1 to 110 / 23 / 1/step]
2-414-036	Wide Roller:PaperTransfer:Low:2Side:S4	ENG	[1 to 110 / 28 / 1/step]
2-414-037	Wide Roller:PaperTransfer:Standard: 1Sid:S5	ENG	[1 to 110 / 24 / 1/step]
2-414-038	Wide Roller:PaperTransfer:Standard: 2Sid:S5	ENG	[1 to 110 / 29 / 1/step]
2-414-039	Wide Roller:PaperTransfer:Low: 1 Side:S5	ENG	[1 to 110 / 24 / 1/step]
2-414-040	Wide Roller:PaperTransfer:Low:2Side:S5	ENG	[1 to 110 / 29 / 1/step]

2415**[Plain1:LeadingEdgeCorrection]**

2-415-001	PaperTransfer:Standard:1Side	ENG	[0 to 995 / 100 / 5%/step]
2-415-002	PaperTransfer:Standard:2Side	ENG	[0 to 995 / 100 / 5%/step]
2-415-003	Paper Transfer:Low:1side	ENG	[0 to 995 / 100 / 5%/step]
2-415-004	Paper Transfer:Low:2side	ENG	[0 to 995 / 100 / 5%/step]

2416	[Plain1:SwitchTimingLeadEdge]		
2-416-001	PaperTransfer:Standard:1side	ENG	[0 to 50 / 0 / 2mm/step]
2-416-002	PaperTransfer:Standard:2side	ENG	[0 to 50 / 0 / 2mm/step]
2-416-003	Paper Transfer:Low:1side	ENG	[0 to 50 / 0 / 2mm/step]
2-416-004	Paper Transfer:Low:2side	ENG	[0 to 50 / 0 / 2mm/step]

2417	[Plain1:TrailEdgeCorrection]		
2-417-001	PaperTransfer:Standard:1Side	ENG	[0 to 995 / 100 / 5%/step]
2-417-002	PaperTransfer:Standard:2Side	ENG	[0 to 995 / 100 / 5%/step]
2-417-003	Paper Transfer:Low:1side	ENG	[0 to 995 / 100 / 5%/step]
2-417-004	Paper Transfer:Low:2side	ENG	[0 to 995 / 100 / 5%/step]

2418	[Plain1:SwitchTimingTrailEdge]		
2-418-001	PaperTransfer:Standard:1side	ENG	[0 to 50 / 0 / 2mm/step]
2-418-002	PaperTransfer:Standard:2side	ENG	[0 to 50 / 0 / 2mm/step]
2-418-003	Paper Transfer:Low:1side	ENG	[0 to 50 / 0 / 2mm/step]
2-418-004	Paper Transfer:Low:2side	ENG	[0 to 50 / 0 / 2mm/step]

2423	[Plain2:Bias:BW]		
2-423-001	PaperTransfer:standard:1side	ENG	[0 to 200 / 22 / 1-uA/step]
2-423-002	PaperTransfer:standard:2side	ENG	[0 to 200 / 22 / 1-uA/step]
2-423-003	PaperTransfer:low:1side	ENG	[0 to 200 / 11 / 1-uA/step]

2-423-004	PaperTransfer:low:2side	ENG	[0 to 200 / 11 / 1-uA/step]
-----------	-------------------------	-----	-----------------------------

2425	[Hhsmall:LeadEdgeCorrection]		
2-425-001	PaperTransfer:1side	ENG	[0 to 995 / 100 / 5%/step]
2-425-002	PaperTransfer:2stSide	ENG	[0 to 995 / 100 / 5%/step]

2427	[Plain2:Bias:FC]		
2-427-001	PaperTransfer:standard:1side	ENG	[0 to 200 / 29 / 1-uA/step]
2-427-002	PaperTransfer:standard:2side	ENG	[0 to 200 / 29 / 1-uA/step]
2-427-003	PaperTransfer:low:1side	ENG	[0 to 200 / 14 / 1-uA/step]
2-427-004	PaperTransfer:low:2side	ENG	[0 to 200 / 14 / 1-uA/step]

2431	[Plain2:SizeCorrection:BW]		
2-431-001	PaperTransfer:Standard:1Sid:S1	ENG	[100 to 995 / 100 / 1%/step]
2-431-002	PaperTransfer:Standard:2Sid:S1	ENG	[100 to 995 / 100 / 1%/step]
2-431-003	PaperTransfer:Low:1Side:S1	ENG	[100 to 995 / 100 / 1%/step]
2-431-004	PaperTransfer:Low:2Side:S1	ENG	[100 to 995 / 100 / 1%/step]
2-431-005	PaperTransfer:Standard:1Sid:S2	ENG	[100 to 995 / 100 / 1%/step]
2-431-006	PaperTransfer:Standard:2Sid:S2	ENG	[100 to 995 / 105 / 1%/step]
2-431-007	PaperTransfer:Low:1Side:S2	ENG	[100 to 995 / 100 / 1%/step]
2-431-008	PaperTransfer:Low:2Side:S2	ENG	[100 to 995 / 105 / 1%/step]
2-431-009	PaperTransfer:Standard:1Sid:S3	ENG	[100 to 995 / 105 / 1%/step]

2-431-010	PaperTransfer:Standard:2Sid:S3	ENG	[100 to 995 / 118 / 1%/step]
2-431-011	PaperTransfer:Low:1Side:S3	ENG	[100 to 995 / 105 / 1%/step]
2-431-012	PaperTransfer:Low:2Side:S3	ENG	[100 to 995 / 118 / 1%/step]
2-431-013	PaperTransfer:Standard:1Sid:S4	ENG	[100 to 995 / 118 / 1%/step]
2-431-014	PaperTransfer:Standard:2Sid:S4	ENG	[100 to 995 / 131 / 1%/step]
2-431-015	PaperTransfer:Low:1Side:S4	ENG	[100 to 995 / 118 / 1%/step]
2-431-016	PaperTransfer:Low:2Side:S4	ENG	[100 to 995 / 131 / 1%/step]
2-431-017	PaperTransfer:Standard:1Sid:S5	ENG	[100 to 995 / 132 / 1%/step]
2-431-018	PaperTransfer:Standard:2Sid:S5	ENG	[100 to 995 / 184 / 1%/step]
2-431-019	PaperTransfer:Low:1Side:S5	ENG	[100 to 995 / 132 / 1%/step]
2-431-020	PaperTransfer:Low:2Side:S5	ENG	[100 to 995 / 184 / 1%/step]
2-431-021	Wide Roller:PaperTransfer:Standard:1Sid:S1	ENG	[100 to 995 / 100 / 1%/step]
2-431-022	Wide Roller:PaperTransfer:Standard:2Sid:S1	ENG	[100 to 995 / 100 / 1%/step]
2-431-023	Wide Roller:PaperTransfer:Low:1Side:S1	ENG	[100 to 995 / 100 / 1%/step]
2-431-024	Wide Roller:PaperTransfer:Low:2Side:S1	ENG	[100 to 995 / 100 / 1%/step]
2-431-025	Wide Roller:PaperTransfer:Standard:1Sid:S2	ENG	[100 to 995 / 100 / 1%/step]

2-431-026	Wide Roller:PaperTransfer:Standard: 2Sid:S2	ENG	[100 to 995 / 105 / 1%/ step]
2-431-027	Wide Roller:PaperTransfer:Low: 1 Side:S2	ENG	[100 to 995 / 100 / 1%/ step]
2-431-028	Wide Roller:PaperTransfer:Low:2Side:S2	ENG	[100 to 995 / 105 / 1%/ step]
2-431-029	Wide Roller:PaperTransfer:Standard: 1Sid:S3	ENG	[100 to 995 / 105 / 1%/ step]
2-431-030	Wide Roller:PaperTransfer:Standard: 2Sid:S3	ENG	[100 to 995 / 118 / 1%/ step]
2-431-031	Wide Roller:PaperTransfer:Low: 1 Side:S3	ENG	[100 to 995 / 105 / 1%/ step]
2-431-032	Wide Roller:PaperTransfer:Low:2Side:S3	ENG	[100 to 995 / 118 / 1%/ step]
2-431-033	Wide Roller:PaperTransfer:Standard: 1Sid:S4	ENG	[100 to 995 / 118 / 1%/ step]
2-431-034	Wide Roller:PaperTransfer:Standard: 2Sid:S4	ENG	[100 to 995 / 131 / 1%/ step]
2-431-035	Wide Roller:PaperTransfer:Low: 1 Side:S4	ENG	[100 to 995 / 118 / 1%/ step]
2-431-036	Wide Roller:PaperTransfer:Low:2Side:S4	ENG	[100 to 995 / 131 / 1%/ step]
2-431-037	Wide Roller:PaperTransfer:Standard: 1Sid:S5	ENG	[100 to 995 / 132 / 1%/ step]
2-431-038	Wide Roller:PaperTransfer:Standard: 2Sid:S5	ENG	[100 to 995 / 184 / 1%/ step]
2-431-039	Wide Roller:PaperTransfer:Low: 1 Side:S5	ENG	[100 to 995 / 132 / 1%/ step]
2-431-040	Wide Roller:PaperTransfer:Low:2Side:S5	ENG	[100 to 995 / 184 / 1%/ step]

2432	[Plain2:SizeCorrection:FC]
-------------	----------------------------

2-432-001	PaperTransfer:Standard:1Sid:S1	ENG	[100 to 995 / 100 / 1%/step]
2-432-002	PaperTransfer:Standard:2Sid:S1	ENG	[100 to 995 / 100 / 1%/step]
2-432-003	PaperTransfer:Low:1Side:S1	ENG	[100 to 995 / 100 / 1%/step]
2-432-004	PaperTransfer:Low:2Side:S1	ENG	[100 to 995 / 100 / 1%/step]
2-432-005	PaperTransfer:Standard:1Sid:S2	ENG	[100 to 995 / 120 / 1%/step]
2-432-006	PaperTransfer:Standard:2Sid:S2	ENG	[100 to 995 / 140 / 1%/step]
2-432-007	PaperTransfer:Low:1Side:S2	ENG	[100 to 995 / 120 / 1%/step]
2-432-008	PaperTransfer:Low:2Side:S2	ENG	[100 to 995 / 140 / 1%/step]
2-432-009	PaperTransfer:Standard:1Sid:S3	ENG	[100 to 995 / 118 / 1%/step]
2-432-010	PaperTransfer:Standard:2Sid:S3	ENG	[100 to 995 / 180 / 1%/step]
2-432-011	PaperTransfer:Low:1Side:S3	ENG	[100 to 995 / 118 / 1%/step]
2-432-012	PaperTransfer:Low:2Side:S3	ENG	[100 to 995 / 180 / 1%/step]
2-432-013	PaperTransfer:Standard:1Sid:S4	ENG	[100 to 995 / 130 / 1%/step]
2-432-014	PaperTransfer:Standard:2Sid:S4	ENG	[100 to 995 / 200 / 1%/step]
2-432-015	PaperTransfer:Low:1Side:S4	ENG	[100 to 995 / 130 / 1%/step]
2-432-016	PaperTransfer:Low:2Side:S4	ENG	[100 to 995 / 200 / 1%/step]

2-432-017	PaperTransfer:Standard:1Sid:S5	ENG	[100 to 995 / 140 / 1%/step]
2-432-018	PaperTransfer:Standard:2Sid:S5	ENG	[100 to 995 / 240 / 1%/step]
2-432-019	PaperTransfer:Low:1Side:S5	ENG	[100 to 995 / 140 / 1%/step]
2-432-020	PaperTransfer:Low:2Side:S5	ENG	[100 to 995 / 240 / 1%/step]
2-432-021	Wide Roller:PaperTransfer:Standard:1Sid:S1	ENG	[100 to 995 / 100 / 1%/step]
2-432-022	Wide Roller:PaperTransfer:Standard:2Sid:S1	ENG	[100 to 995 / 100 / 1%/step]
2-432-023	Wide Roller:PaperTransfer:Low:1Side:S1	ENG	[100 to 995 / 100 / 1%/step]
2-432-024	Wide Roller:PaperTransfer:Low:2Side:S1	ENG	[100 to 995 / 100 / 1%/step]
2-432-025	Wide Roller:PaperTransfer:Standard:1Sid:S2	ENG	[100 to 995 / 120 / 1%/step]
2-432-026	Wide Roller:PaperTransfer:Standard:2Sid:S2	ENG	[100 to 995 / 140 / 1%/step]
2-432-027	Wide Roller:PaperTransfer:Low:1Side:S2	ENG	[100 to 995 / 120 / 1%/step]
2-432-028	Wide Roller:PaperTransfer:Low:2Side:S2	ENG	[100 to 995 / 140 / 1%/step]
2-432-029	Wide Roller:PaperTransfer:Standard:1Sid:S3	ENG	[100 to 995 / 118 / 1%/step]
2-432-030	Wide Roller:PaperTransfer:Standard:2Sid:S3	ENG	[100 to 995 / 180 / 1%/step]
2-432-031	Wide Roller:PaperTransfer:Low:1Side:S3	ENG	[100 to 995 / 118 / 1%/step]
2-432-032	Wide Roller:PaperTransfer:Low:2Side:S3	ENG	[100 to 995 / 180 / 1%/step]

2-432-033	Wide Roller:PaperTransfer:Standard: 1Sid:S4	ENG	[100 to 995 / 130 / 1%/ step]
2-432-034	Wide Roller:PaperTransfer:Standard: 2Sid:S4	ENG	[100 to 995 / 200 / 1%/ step]
2-432-035	Wide Roller:PaperTransfer:Low: 1 Side:S4	ENG	[100 to 995 / 130 / 1%/ step]
2-432-036	Wide Roller:PaperTransfer:Low:2Side:S4	ENG	[100 to 995 / 200 / 1%/ step]
2-432-037	Wide Roller:PaperTransfer:Standard: 1Sid:S5	ENG	[100 to 995 / 140 / 1%/ step]
2-432-038	Wide Roller:PaperTransfer:Standard: 2Sid:S5	ENG	[100 to 995 / 240 / 1%/ step]
2-432-039	Wide Roller:PaperTransfer:Low: 1 Side:S5	ENG	[100 to 995 / 140 / 1%/ step]
2-432-040	Wide Roller:PaperTransfer:Low:2Side:S5	ENG	[100 to 995 / 240 / 1%/ step]

2433	[Plain2:Size-Env.Correct:BW]		
2-433-001	PaperTransfer:Standard:1Sid:S1	ENG	[1 to 110 / 10 / 1/step]
2-433-002	PaperTransfer:Standard:2Sid:S1	ENG	[1 to 110 / 15 / 1/step]
2-433-003	PaperTransfer:Low: 1 Side:S 1	ENG	[1 to 110 / 10 / 1/step]
2-433-004	PaperTransfer:Low:2Side:S 1	ENG	[1 to 110 / 15 / 1/step]
2-433-005	PaperTransfer:Standard:1Sid:S2	ENG	[1 to 110 / 11 / 1/step]
2-433-006	PaperTransfer:Standard:2Sid:S2	ENG	[1 to 110 / 16 / 1/step]
2-433-007	PaperTransfer:Low: 1 Side:S2	ENG	[1 to 110 / 11 / 1/step]
2-433-008	PaperTransfer:Low:2Side:S2	ENG	[1 to 110 / 16 / 1/step]
2-433-009	PaperTransfer:Standard:1Sid:S3	ENG	[1 to 110 / 12 / 1/step]
2-433-010	PaperTransfer:Standard:2Sid:S3	ENG	[1 to 110 / 17 / 1/step]
2-433-011	PaperTransfer:Low: 1 Side:S3	ENG	[1 to 110 / 12 / 1/step]

2-433-012	PaperTransfer:Low:2Side:S3	ENG	[1 to 110 / 17 / 1/step]
2-433-013	PaperTransfer:Standard:1Sid:S4	ENG	[1 to 110 / 13 / 1/step]
2-433-014	PaperTransfer:Standard:2Sid:S4	ENG	[1 to 110 / 18 / 1/step]
2-433-015	PaperTransfer:Low:1Side:S4	ENG	[1 to 110 / 13 / 1/step]
2-433-016	PaperTransfer:Low:2Side:S4	ENG	[1 to 110 / 18 / 1/step]
2-433-017	PaperTransfer:Standard:1Sid:S5	ENG	[1 to 110 / 14 / 1/step]
2-433-018	PaperTransfer:Standard:2Sid:S5	ENG	[1 to 110 / 19 / 1/step]
2-433-019	PaperTransfer:Low:1Side:S5	ENG	[1 to 110 / 14 / 1/step]
2-433-020	PaperTransfer:Low:2Side:S5	ENG	[1 to 110 / 19 / 1/step]
2-433-021	Wide Roller:PaperTransfer:Standard: 1Sid:S1	ENG	[1 to 110 / 10 / 1/step]
2-433-022	Wide Roller:PaperTransfer:Standard: 2Sid:S1	ENG	[1 to 110 / 15 / 1/step]
2-433-023	Wide Roller:PaperTransfer:Low:1Side:S1	ENG	[1 to 110 / 10 / 1/step]
2-433-024	Wide Roller:PaperTransfer:Low:2Side:S1	ENG	[1 to 110 / 15 / 1/step]
2-433-025	Wide Roller:PaperTransfer:Standard: 1Sid:S2	ENG	[1 to 110 / 11 / 1/step]
2-433-026	Wide Roller:PaperTransfer:Standard: 2Sid:S2	ENG	[1 to 110 / 16 / 1/step]
2-433-027	Wide Roller:PaperTransfer:Low:1Side:S2	ENG	[1 to 110 / 11 / 1/step]
2-433-028	Wide Roller:PaperTransfer:Low:2Side:S2	ENG	[1 to 110 / 16 / 1/step]
2-433-029	Wide Roller:PaperTransfer:Standard: 1Sid:S3	ENG	[1 to 110 / 12 / 1/step]
2-433-030	Wide Roller:PaperTransfer:Standard: 2Sid:S3	ENG	[1 to 110 / 17 / 1/step]
2-433-031	Wide Roller:PaperTransfer:Low:1Side:S3	ENG	[1 to 110 / 12 / 1/step]
2-433-032	Wide Roller:PaperTransfer:Low:2Side:S3	ENG	[1 to 110 / 17 / 1/step]

2-433-033	Wide Roller:PaperTransfer:Standard: 1Sid:S4	ENG	[1 to 110 / 13 / 1/step]
2-433-034	Wide Roller:PaperTransfer:Standard: 2Sid:S4	ENG	[1 to 110 / 18 / 1/step]
2-433-035	Wide Roller:PaperTransfer:Low: 1 Side:S4	ENG	[1 to 110 / 13 / 1/step]
2-433-036	Wide Roller:PaperTransfer:Low:2Side:S4	ENG	[1 to 110 / 18 / 1/step]
2-433-037	Wide Roller:PaperTransfer:Standard: 1Sid:S5	ENG	[1 to 110 / 14 / 1/step]
2-433-038	Wide Roller:PaperTransfer:Standard: 2Sid:S5	ENG	[1 to 110 / 19 / 1/step]
2-433-039	Wide Roller:PaperTransfer:Low: 1 Side:S5	ENG	[1 to 110 / 14 / 1/step]
2-433-040	Wide Roller:PaperTransfer:Low:2Side:S5	ENG	[1 to 110 / 19 / 1/step]

2434	[Plain2:Size-Env.Correct:FC]		
2-434-001	PaperTransfer:Standard:1Sid:S1	ENG	[1 to 110 / 20 / 1/step]
2-434-002	PaperTransfer:Standard:2Sid:S1	ENG	[1 to 110 / 25 / 1/step]
2-434-003	PaperTransfer:Low: 1 Side:S 1	ENG	[1 to 110 / 20 / 1/step]
2-434-004	PaperTransfer:Low:2Side:S 1	ENG	[1 to 110 / 25 / 1/step]
2-434-005	PaperTransfer:Standard:1Sid:S2	ENG	[1 to 110 / 21 / 1/step]
2-434-006	PaperTransfer:Standard:2Sid:S2	ENG	[1 to 110 / 26 / 1/step]
2-434-007	PaperTransfer:Low: 1 Side:S2	ENG	[1 to 110 / 21 / 1/step]
2-434-008	PaperTransfer:Low:2Side:S2	ENG	[1 to 110 / 26 / 1/step]
2-434-009	PaperTransfer:Standard:1Sid:S3	ENG	[1 to 110 / 22 / 1/step]
2-434-010	PaperTransfer:Standard:2Sid:S3	ENG	[1 to 110 / 27 / 1/step]
2-434-011	PaperTransfer:Low: 1 Side:S3	ENG	[1 to 110 / 22 / 1/step]
2-434-012	PaperTransfer:Low:2Side:S3	ENG	[1 to 110 / 27 / 1/step]
2-434-013	PaperTransfer:Standard:1Sid:S4	ENG	[1 to 110 / 23 / 1/step]
2-434-014	PaperTransfer:Standard:2Sid:S4	ENG	[1 to 110 / 28 / 1/step]

2-434-015	PaperTransfer:Low:1Side:S4	ENG	[1 to 110 / 23 / 1/step]
2-434-016	PaperTransfer:Low:2Side:S4	ENG	[1 to 110 / 28 / 1/step]
2-434-017	PaperTransfer:Standard:1Sid:S5	ENG	[1 to 110 / 24 / 1/step]
2-434-018	PaperTransfer:Standard:2Sid:S5	ENG	[1 to 110 / 29 / 1/step]
2-434-019	PaperTransfer:Low:1Side:S5	ENG	[1 to 110 / 24 / 1/step]
2-434-020	PaperTransfer:Low:2Side:S5	ENG	[1 to 110 / 29 / 1/step]
2-434-021	Wide Roller:PaperTransfer:Standard: 1Sid:S1	ENG	[1 to 110 / 20 / 1/step]
2-434-022	Wide Roller:PaperTransfer:Standard: 2Sid:S1	ENG	[1 to 110 / 25 / 1/step]
2-434-023	Wide Roller:PaperTransfer:Low:1Side:S1	ENG	[1 to 110 / 20 / 1/step]
2-434-024	Wide Roller:PaperTransfer:Low:2Side:S1	ENG	[1 to 110 / 25 / 1/step]
2-434-025	Wide Roller:PaperTransfer:Standard: 1Sid:S2	ENG	[1 to 110 / 21 / 1/step]
2-434-026	Wide Roller:PaperTransfer:Standard: 2Sid:S2	ENG	[1 to 110 / 26 / 1/step]
2-434-027	Wide Roller:PaperTransfer:Low:1Side:S2	ENG	[1 to 110 / 21 / 1/step]
2-434-028	Wide Roller:PaperTransfer:Low:2Side:S2	ENG	[1 to 110 / 26 / 1/step]
2-434-029	Wide Roller:PaperTransfer:Standard: 1Sid:S3	ENG	[1 to 110 / 22 / 1/step]
2-434-030	Wide Roller:PaperTransfer:Standard: 2Sid:S3	ENG	[1 to 110 / 27 / 1/step]
2-434-031	Wide Roller:PaperTransfer:Low:1Side:S3	ENG	[1 to 110 / 22 / 1/step]
2-434-032	Wide Roller:PaperTransfer:Low:2Side:S3	ENG	[1 to 110 / 27 / 1/step]
2-434-033	Wide Roller:PaperTransfer:Standard: 1Sid:S4	ENG	[1 to 110 / 23 / 1/step]
2-434-034	Wide Roller:PaperTransfer:Standard: 2Sid:S4	ENG	[1 to 110 / 28 / 1/step]
2-434-035	Wide Roller:PaperTransfer:Low:1Side:S4	ENG	[1 to 110 / 23 / 1/step]

2-434-036	Wide Roller:PaperTransfer:Low:2Side:S4	ENG	[1 to 110 / 28 / 1/step]
2-434-037	Wide Roller:PaperTransfer:Standard:1Sid:S5	ENG	[1 to 110 / 24 / 1/step]
2-434-038	Wide Roller:PaperTransfer:Standard:2Sid:S5	ENG	[1 to 110 / 29 / 1/step]
2-434-039	Wide Roller:PaperTransfer:Low:1Side:S5	ENG	[1 to 110 / 24 / 1/step]
2-434-040	Wide Roller:PaperTransfer:Low:2Side:S5	ENG	[1 to 110 / 29 / 1/step]

2435	[Plain2:LeadingEdgeCorrection]		
2-435-001	PaperTransfer:Standard:1Side	ENG	[0 to 995 / 100 / 5%/step]
2-435-002	PaperTransfer:Standard:2Side	ENG	[0 to 995 / 100 / 5%/step]
2-435-003	Paper Transfer:Low:1side	ENG	[0 to 995 / 100 / 5%/step]
2-435-004	Paper Transfer:Low:2side	ENG	[0 to 995 / 100 / 5%/step]

2436	[Plain2:SwitchTimingLeadEdge]		
2-436-001	PaperTransfer:Standard:1side	ENG	[0 to 50 / 0 / 2mm/step]
2-436-002	PaperTransfer:Standard:2side	ENG	[0 to 50 / 0 / 2mm/step]
2-436-003	Paper Transfer:Low:1side	ENG	[0 to 50 / 0 / 2mm/step]
2-436-004	Paper Transfer:Low:2side	ENG	[0 to 50 / 0 / 2mm/step]

2437	[Plain2:TrailEdgeCorrection]		
2-437-001	PaperTransfer:Standard:1Side	ENG	[0 to 995 / 100 / 5%/step]
2-437-002	PaperTransfer:Standard:2Side	ENG	[0 to 995 / 100 / 5%/step]
2-437-003	Paper Transfer:Low:1side	ENG	[0 to 995 / 100 / 5%/step]
2-437-004	Paper Transfer:Low:2side	ENG	[0 to 995 / 100 / 5%/step]

2438	[Plain2:SwitchTimingTrailEdge]		
2-438-001	PaperTransfer:Standard:1side	ENG	[0 to 50 / 0 / 2mm/step]

2-438-002	PaperTransfer:Standard:2side	ENG	[0 to 50 / 0 / 2mm/step]
2-438-003	Paper Transfer:Low:1 side	ENG	[0 to 50 / 0 / 2mm/step]
2-438-004	Paper Transfer:Low:2side	ENG	[0 to 50 / 0 / 2mm/step]

2443	[Middle:Bias:BW]		
2-443-001	PaperTransfer:standard:1 side	ENG	[0 to 200 / 22 / 1-uA/step]
2-443-002	PaperTransfer:standard:2side	ENG	[0 to 200 / 22 / 1-uA/step]
2-443-003	PaperTransfer:low:1 side	ENG	[0 to 200 / 11 / 1-uA/step]
2-443-004	PaperTransfer:low:2side	ENG	[0 to 200 / 11 / 1-uA/step]

2447	[Middle:Bias:FC]		
2-447-001	PaperTransfer:standard:1 side	ENG	[0 to 200 / 29 / 1-uA/step]
2-447-002	PaperTransfer:standard:2side	ENG	[0 to 200 / 29 / 1-uA/step]
2-447-003	PaperTransfer:low:1 side	ENG	[0 to 200 / 14 / 1-uA/step]
2-447-004	PaperTransfer:low:2side	ENG	[0 to 200 / 14 / 1-uA/step]

2451	[Middle:SizeCorrection:BW]		
2-451-001	PaperTransfer:Standard:1Sid:S1	ENG	[100 to 995 / 100 / 1%/step]
2-451-002	PaperTransfer:Standard:2Sid:S1	ENG	[100 to 995 / 100 / 1%/step]
2-451-003	PaperTransfer:Low:1 Side:S1	ENG	[100 to 995 / 100 / 1%/step]
2-451-004	PaperTransfer:Low:2Side:S1	ENG	[100 to 995 / 100 / 1%/step]
2-451-005	PaperTransfer:Standard:1Sid:S2	ENG	[100 to 995 / 100 / 1%/step]
2-451-006	PaperTransfer:Standard:2Sid:S2	ENG	[100 to 995 / 106 / 1%/step]

2-451-007	PaperTransfer:Low:1Side:S2	ENG	[100 to 995 / 100 / 1%/step]
2-451-008	PaperTransfer:Low:2Side:S2	ENG	[100 to 995 / 106 / 1%/step]
2-451-009	PaperTransfer:Standard:1Sid:S3	ENG	[100 to 995 / 105 / 1%/step]
2-451-010	PaperTransfer:Standard:2Sid:S3	ENG	[100 to 995 / 110 / 1%/step]
2-451-011	PaperTransfer:Low:1Side:S3	ENG	[100 to 995 / 105 / 1%/step]
2-451-012	PaperTransfer:Low:2Side:S3	ENG	[100 to 995 / 110 / 1%/step]
2-451-013	PaperTransfer:Standard:1Sid:S4	ENG	[100 to 995 / 113 / 1%/step]
2-451-014	PaperTransfer:Standard:2Sid:S4	ENG	[100 to 995 / 120 / 1%/step]
2-451-015	PaperTransfer:Low:1Side:S4	ENG	[100 to 995 / 113 / 1%/step]
2-451-016	PaperTransfer:Low:2Side:S4	ENG	[100 to 995 / 120 / 1%/step]
2-451-017	PaperTransfer:Standard:1Sid:S5	ENG	[100 to 995 / 118 / 1%/step]
2-451-018	PaperTransfer:Standard:2Sid:S5	ENG	[100 to 995 / 140 / 1%/step]
2-451-019	PaperTransfer:Low:1Side:S5	ENG	[100 to 995 / 118 / 1%/step]
2-451-020	PaperTransfer:Low:2Side:S5	ENG	[100 to 995 / 140 / 1%/step]
2-451-021	Wide Roller:PaperTransfer:Standard:1Sid:S1	ENG	[100 to 995 / 100 / 1%/step]
2-451-022	Wide Roller:PaperTransfer:Standard:2Sid:S1	ENG	[100 to 995 / 100 / 1%/step]

2-451-023	Wide Roller:PaperTransfer:Low:1 Side:S1	ENG	[100 to 995 / 100 / 1%/step]
2-451-024	Wide Roller:PaperTransfer:Low:2Side:S1	ENG	[100 to 995 / 100 / 1%/step]
2-451-025	Wide Roller:PaperTransfer:Standard:1Sid:S2	ENG	[100 to 995 / 100 / 1%/step]
2-451-026	Wide Roller:PaperTransfer:Standard:2Sid:S2	ENG	[100 to 995 / 106 / 1%/step]
2-451-027	Wide Roller:PaperTransfer:Low:1 Side:S2	ENG	[100 to 995 / 100 / 1%/step]
2-451-028	Wide Roller:PaperTransfer:Low:2Side:S2	ENG	[100 to 995 / 106 / 1%/step]
2-451-029	Wide Roller:PaperTransfer:Standard:1Sid:S3	ENG	[100 to 995 / 105 / 1%/step]
2-451-030	Wide Roller:PaperTransfer:Standard:2Sid:S3	ENG	[100 to 995 / 110 / 1%/step]
2-451-031	Wide Roller:PaperTransfer:Low:1 Side:S3	ENG	[100 to 995 / 105 / 1%/step]
2-451-032	Wide Roller:PaperTransfer:Low:2Side:S3	ENG	[100 to 995 / 110 / 1%/step]
2-451-033	Wide Roller:PaperTransfer:Standard:1Sid:S4	ENG	[100 to 995 / 113 / 1%/step]
2-451-034	Wide Roller:PaperTransfer:Standard:2Sid:S4	ENG	[100 to 995 / 120 / 1%/step]
2-451-035	Wide Roller:PaperTransfer:Low:1 Side:S4	ENG	[100 to 995 / 113 / 1%/step]
2-451-036	Wide Roller:PaperTransfer:Low:2Side:S4	ENG	[100 to 995 / 120 / 1%/step]
2-451-037	Wide Roller:PaperTransfer:Standard:1Sid:S5	ENG	[100 to 995 / 118 / 1%/step]
2-451-038	Wide Roller:PaperTransfer:Standard:2Sid:S5	ENG	[100 to 995 / 140 / 1%/step]

2-451-039	Wide Roller:PaperTransfer:Low:1Side:S5	ENG	[100 to 995 / 118 / 1%/step]
2-451-040	Wide Roller:PaperTransfer:Low:2Side:S5	ENG	[100 to 995 / 140 / 1%/step]

2452	[Middle:SizeCorrection:FC]		
2-452-001	PaperTransfer:Standard:1Sid:S1	ENG	[100 to 995 / 100 / 1%/step]
2-452-002	PaperTransfer:Standard:2Sid:S1	ENG	[100 to 995 / 100 / 1%/step]
2-452-003	PaperTransfer:Low:1Side:S1	ENG	[100 to 995 / 100 / 1%/step]
2-452-004	PaperTransfer:Low:2Side:S1	ENG	[100 to 995 / 100 / 1%/step]
2-452-005	PaperTransfer:Standard:1Sid:S2	ENG	[100 to 995 / 106 / 1%/step]
2-452-006	PaperTransfer:Standard:2Sid:S2	ENG	[100 to 995 / 132 / 1%/step]
2-452-007	PaperTransfer:Low:1Side:S2	ENG	[100 to 995 / 106 / 1%/step]
2-452-008	PaperTransfer:Low:2Side:S2	ENG	[100 to 995 / 132 / 1%/step]
2-452-009	PaperTransfer:Standard:1Sid:S3	ENG	[100 to 995 / 110 / 1%/step]
2-452-010	PaperTransfer:Standard:2Sid:S3	ENG	[100 to 995 / 170 / 1%/step]
2-452-011	PaperTransfer:Low:1Side:S3	ENG	[100 to 995 / 110 / 1%/step]
2-452-012	PaperTransfer:Low:2Side:S3	ENG	[100 to 995 / 170 / 1%/step]
2-452-013	PaperTransfer:Standard:1Sid:S4	ENG	[100 to 995 / 120 / 1%/step]

2-452-014	PaperTransfer:Standard:2Sid:S4	ENG	[100 to 995 / 189 / 1%/step]
2-452-015	PaperTransfer:Low:1Side:S4	ENG	[100 to 995 / 120 / 1%/step]
2-452-016	PaperTransfer:Low:2Side:S4	ENG	[100 to 995 / 189 / 1%/step]
2-452-017	PaperTransfer:Standard:1Sid:S5	ENG	[100 to 995 / 140 / 1%/step]
2-452-018	PaperTransfer:Standard:2Sid:S5	ENG	[100 to 995 / 245 / 1%/step]
2-452-019	PaperTransfer:Low:1Side:S5	ENG	[100 to 995 / 140 / 1%/step]
2-452-020	PaperTransfer:Low:2Side:S5	ENG	[100 to 995 / 245 / 1%/step]
2-452-001	PaperTransfer:Standard:1Sid:S1	ENG	[100 to 995 / 100 / 1%/step]
2-452-022	Wide Roller:PaperTransfer:Standard:2Sid:S1	ENG	[100 to 995 / 100 / 1%/step]
2-452-023	Wide Roller:PaperTransfer:Low:1Side:S1	ENG	[100 to 995 / 100 / 1%/step]
2-452-024	Wide Roller:PaperTransfer:Low:2Side:S1	ENG	[100 to 995 / 100 / 1%/step]
2-452-025	Wide Roller:PaperTransfer:Standard:1Sid:S2	ENG	[100 to 995 / 106 / 1%/step]
2-452-026	Wide Roller:PaperTransfer:Standard:2Sid:S2	ENG	[100 to 995 / 132 / 1%/step]
2-452-027	Wide Roller:PaperTransfer:Low:1Side:S2	ENG	[100 to 995 / 106 / 1%/step]
2-452-028	Wide Roller:PaperTransfer:Low:2Side:S2	ENG	[100 to 995 / 132 / 1%/step]
2-452-029	Wide Roller:PaperTransfer:Standard:1Sid:S3	ENG	[100 to 995 / 110 / 1%/step]

2-452-030	Wide Roller:PaperTransfer:Standard: 2Sid:S3	ENG	[100 to 995 / 170 / 1%/ step]
2-452-031	Wide Roller:PaperTransfer:Low: 1 Side:S3	ENG	[100 to 995 / 110 / 1%/ step]
2-452-032	Wide Roller:PaperTransfer:Low:2Side:S3	ENG	[100 to 995 / 170 / 1%/ step]
2-452-033	Wide Roller:PaperTransfer:Standard: 1Sid:S4	ENG	[100 to 995 / 120 / 1%/ step]
2-452-034	Wide Roller:PaperTransfer:Standard: 2Sid:S4	ENG	[100 to 995 / 189 / 1%/ step]
2-452-035	Wide Roller:PaperTransfer:Low: 1 Side:S4	ENG	[100 to 995 / 120 / 1%/ step]
2-452-036	Wide Roller:PaperTransfer:Low:2Side:S4	ENG	[100 to 995 / 189 / 1%/ step]
2-452-037	Wide Roller:PaperTransfer:Standard: 1Sid:S5	ENG	[100 to 995 / 140 / 1%/ step]
2-452-038	Wide Roller:PaperTransfer:Standard: 2Sid:S5	ENG	[100 to 995 / 245 / 1%/ step]
2-452-039	Wide Roller:PaperTransfer:Low: 1 Side:S5	ENG	[100 to 995 / 140 / 1%/ step]
2-452-040	Wide Roller:PaperTransfer:Low:2Side:S5	ENG	[100 to 995 / 245 / 1%/ step]

2453	[Middle:Size-Env.Correct:BW]		
2-453-001	PaperTransfer:Standard:1Sid:S1	ENG	[1 to 110 / 10 / 1/step]
2-453-002	PaperTransfer:Standard:2Sid:S1	ENG	[1 to 110 / 41 / 1/step]
2-453-003	PaperTransfer:Low: 1 Side:S1	ENG	[1 to 110 / 10 / 1/step]
2-453-004	PaperTransfer:Low:2Side:S1	ENG	[1 to 110 / 41 / 1/step]
2-453-005	PaperTransfer:Standard:1Sid:S2	ENG	[1 to 110 / 39 / 1/step]
2-453-006	PaperTransfer:Standard:2Sid:S2	ENG	[1 to 110 / 42 / 1/step]

2-453-007	PaperTransfer:Low:1Side:S2	ENG	[1 to 110 / 39 / 1/step]
2-453-008	PaperTransfer:Low:2Side:S2	ENG	[1 to 110 / 42 / 1/step]
2-453-009	PaperTransfer:Standard:1Sid:S3	ENG	[1 to 110 / 40 / 1/step]
2-453-010	PaperTransfer:Standard:2Sid:S3	ENG	[1 to 110 / 43 / 1/step]
2-453-011	PaperTransfer:Low:1Side:S3	ENG	[1 to 110 / 40 / 1/step]
2-453-012	PaperTransfer:Low:2Side:S3	ENG	[1 to 110 / 43 / 1/step]
2-453-013	PaperTransfer:Standard:1Sid:S4	ENG	[1 to 110 / 40 / 1/step]
2-453-014	PaperTransfer:Standard:2Sid:S4	ENG	[1 to 110 / 44 / 1/step]
2-453-015	PaperTransfer:Low:1Side:S4	ENG	[1 to 110 / 40 / 1/step]
2-453-016	PaperTransfer:Low:2Side:S4	ENG	[1 to 110 / 44 / 1/step]
2-453-017	PaperTransfer:Standard:1Sid:S5	ENG	[1 to 110 / 40 / 1/step]
2-453-018	PaperTransfer:Standard:2Sid:S5	ENG	[1 to 110 / 45 / 1/step]
2-453-019	PaperTransfer:Low:1Side:S5	ENG	[1 to 110 / 40 / 1/step]
2-453-020	PaperTransfer:Low:2Side:S5	ENG	[1 to 110 / 45 / 1/step]
2-453-021	Wide Roller:PaperTransfer:Standard: 1Sid:S1	ENG	[1 to 110 / 10 / 1/step]
2-453-022	Wide Roller:PaperTransfer:Standard: 2Sid:S1	ENG	[1 to 110 / 41 / 1/step]
2-453-023	Wide Roller:PaperTransfer:Low:1Side:S1	ENG	[1 to 110 / 10 / 1/step]
2-453-024	Wide Roller:PaperTransfer:Low:2Side:S1	ENG	[1 to 110 / 41 / 1/step]
2-453-025	Wide Roller:PaperTransfer:Standard: 1Sid:S2	ENG	[1 to 110 / 39 / 1/step]
2-453-026	Wide Roller:PaperTransfer:Standard: 2Sid:S2	ENG	[1 to 110 / 42 / 1/step]
2-453-027	Wide Roller:PaperTransfer:Low:1Side:S2	ENG	[1 to 110 / 39 / 1/step]
2-453-028	Wide Roller:PaperTransfer:Low:2Side:S2	ENG	[1 to 110 / 42 / 1/step]
2-453-029	Wide Roller:PaperTransfer:Standard: 1Sid:S3	ENG	[1 to 110 / 40 / 1/step]

2-453-030	Wide Roller:PaperTransfer:Standard: 2Sid:S3	ENG	[1 to 110 / 43 / 1/step]
2-453-031	Wide Roller:PaperTransfer:Low: 1 Side:S3	ENG	[1 to 110 / 40 / 1/step]
2-453-032	Wide Roller:PaperTransfer:Low:2Side:S3	ENG	[1 to 110 / 43 / 1/step]
2-453-033	Wide Roller:PaperTransfer:Standard: 1Sid:S4	ENG	[1 to 110 / 40 / 1/step]
2-453-034	Wide Roller:PaperTransfer:Standard: 2Sid:S4	ENG	[1 to 110 / 44 / 1/step]
2-453-035	Wide Roller:PaperTransfer:Low: 1 Side:S4	ENG	[1 to 110 / 40 / 1/step]
2-453-036	Wide Roller:PaperTransfer:Low:2Side:S4	ENG	[1 to 110 / 44 / 1/step]
2-453-037	Wide Roller:PaperTransfer:Standard: 1Sid:S5	ENG	[1 to 110 / 40 / 1/step]
2-453-038	Wide Roller:PaperTransfer:Standard: 2Sid:S5	ENG	[1 to 110 / 45 / 1/step]
2-453-039	Wide Roller:PaperTransfer:Low: 1 Side:S5	ENG	[1 to 110 / 40 / 1/step]
2-453-040	Wide Roller:PaperTransfer:Low:2Side:S5	ENG	[1 to 110 / 45 / 1/step]

2454	[Middle:Size-Env.Correct:FC]		
2-454-001	PaperTransfer:Standard:1Sid:S1	ENG	[1 to 110 / 20 / 1/step]
2-454-002	PaperTransfer:Standard:2Sid:S1	ENG	[1 to 110 / 49 / 1/step]
2-454-003	PaperTransfer:Low: 1 Side:S 1	ENG	[1 to 110 / 20 / 1/step]
2-454-004	PaperTransfer:Low:2Side:S 1	ENG	[1 to 110 / 49 / 1/step]
2-454-005	PaperTransfer:Standard:1Sid:S2	ENG	[1 to 110 / 46 / 1/step]
2-454-006	PaperTransfer:Standard:2Sid:S2	ENG	[1 to 110 / 50 / 1/step]
2-454-007	PaperTransfer:Low: 1 Side:S2	ENG	[1 to 110 / 46 / 1/step]
2-454-008	PaperTransfer:Low:2Side:S2	ENG	[1 to 110 / 50 / 1/step]
2-454-009	PaperTransfer:Standard:1Sid:S3	ENG	[1 to 110 / 47 / 1/step]
2-454-010	PaperTransfer:Standard:2Sid:S3	ENG	[1 to 110 / 51 / 1/step]

2-454-011	PaperTransfer:Low:1Side:S3	ENG	[1 to 110 / 47 / 1/step]
2-454-012	PaperTransfer:Low:2Side:S3	ENG	[1 to 110 / 51 / 1/step]
2-454-013	PaperTransfer:Standard:1Sid:S4	ENG	[1 to 110 / 48 / 1/step]
2-454-014	PaperTransfer:Standard:2Sid:S4	ENG	[1 to 110 / 52 / 1/step]
2-454-015	PaperTransfer:Low:1Side:S4	ENG	[1 to 110 / 48 / 1/step]
2-454-016	PaperTransfer:Low:2Side:S4	ENG	[1 to 110 / 52 / 1/step]
2-454-017	PaperTransfer:Standard:1Sid:S5	ENG	[1 to 110 / 48 / 1/step]
2-454-018	PaperTransfer:Standard:2Sid:S5	ENG	[1 to 110 / 53 / 1/step]
2-454-019	PaperTransfer:Low:1Side:S5	ENG	[1 to 110 / 48 / 1/step]
2-454-020	PaperTransfer:Low:2Side:S5	ENG	[1 to 110 / 53 / 1/step]
2-454-021	Wide Roller:PaperTransfer:Standard: 1Sid:S1	ENG	[1 to 110 / 20 / 1/step]
2-454-022	Wide Roller:PaperTransfer:Standard: 2Sid:S1	ENG	[1 to 110 / 49 / 1/step]
2-454-023	Wide Roller:PaperTransfer:Low:1Side:S1	ENG	[1 to 110 / 20 / 1/step]
2-454-024	Wide Roller:PaperTransfer:Low:2Side:S1	ENG	[1 to 110 / 49 / 1/step]
2-454-025	Wide Roller:PaperTransfer:Standard: 1Sid:S2	ENG	[1 to 110 / 46 / 1/step]
2-454-026	Wide Roller:PaperTransfer:Standard: 2Sid:S2	ENG	[1 to 110 / 50 / 1/step]
2-454-027	Wide Roller:PaperTransfer:Low:1Side:S2	ENG	[1 to 110 / 46 / 1/step]
2-454-028	Wide Roller:PaperTransfer:Low:2Side:S2	ENG	[1 to 110 / 50 / 1/step]
2-454-029	Wide Roller:PaperTransfer:Standard: 1Sid:S3	ENG	[1 to 110 / 47 / 1/step]
2-454-030	Wide Roller:PaperTransfer:Standard: 2Sid:S3	ENG	[1 to 110 / 51 / 1/step]
2-454-031	Wide Roller:PaperTransfer:Low:1Side:S3	ENG	[1 to 110 / 47 / 1/step]
2-454-032	Wide Roller:PaperTransfer:Low:2Side:S3	ENG	[1 to 110 / 51 / 1/step]

2-454-033	Wide Roller:PaperTransfer:Standard: 1Sid:S4	ENG	[1 to 110 / 48 / 1/step]
2-454-034	Wide Roller:PaperTransfer:Standard: 2Sid:S4	ENG	[1 to 110 / 52 / 1/step]
2-454-035	Wide Roller:PaperTransfer:Low: 1 Side:S4	ENG	[1 to 110 / 48 / 1/step]
2-454-036	Wide Roller:PaperTransfer:Low:2Side:S4	ENG	[1 to 110 / 52 / 1/step]
2-454-037	Wide Roller:PaperTransfer:Standard: 1Sid:S5	ENG	[1 to 110 / 48 / 1/step]
2-454-038	Wide Roller:PaperTransfer:Standard: 2Sid:S5	ENG	[1 to 110 / 53 / 1/step]
2-454-039	Wide Roller:PaperTransfer:Low: 1 Side:S5	ENG	[1 to 110 / 48 / 1/step]
2-454-040	Wide Roller:PaperTransfer:Low:2Side:S5	ENG	[1 to 110 / 53 / 1/step]

2455	[Middle:LeadingEdgeCorrection]		
2-455-001	PaperTransfer:Standard:1Side	ENG	[0 to 995 / 100 / 5%/step]
2-455-002	PaperTransfer:Standard:2Side	ENG	[0 to 995 / 100 / 5%/step]
2-455-003	Paper Transfer:Low:1 side	ENG	[0 to 995 / 100 / 5%/step]
2-455-004	Paper Transfer:Low:2side	ENG	[0 to 995 / 100 / 5%/step]

2456	[Middle:SwitchTimingLeadEdge]		
2-456-001	PaperTransfer:Standard:1 side	ENG	[0 to 50 / 0 / 2mm/step]
2-456-002	PaperTransfer:Standard:2side	ENG	[0 to 50 / 0 / 2mm/step]
2-456-003	Paper Transfer:Low:1 side	ENG	[0 to 50 / 0 / 2mm/step]
2-456-004	Paper Transfer:Low:2side	ENG	[0 to 50 / 0 / 2mm/step]

2457	[Middle:TrailEdgeCorrection]		
2-457-001	PaperTransfer:Standard:1Side	ENG	[0 to 995 / 100 / 5%/step]
2-457-002	PaperTransfer:Standard:2Side	ENG	[0 to 995 / 100 / 5%/step]
2-457-003	Paper Transfer:Low:1 side	ENG	[0 to 995 / 100 / 5%/step]

2-457-004	Paper Transfer:Low:2side	ENG	[0 to 995 / 100 / 5%/step]
-----------	--------------------------	-----	----------------------------

2458	[Middle:SwitchTimingTrailEdge]		
2-458-001	PaperTransfer:Standard:1side	ENG	[0 to 50 / 0 / 2mm/step]
2-458-002	PaperTransfer:Standard:2side	ENG	[0 to 50 / 0 / 2mm/step]
2-458-003	Paper Transfer:Low:1side	ENG	[0 to 50 / 0 / 2mm/step]
2-458-004	Paper Transfer:Low:2side	ENG	[0 to 50 / 0 / 2mm/step]

Engine SP Tables - SP2000-2

SP2-XXX (Drum)

2463	[Thin:Bias:BW]		
2-463-001	PaperTransfer:Standard:1Sid	ENG	[0 to 200 / 22 / 1-uA/step]
2-463-002	PaperTransfer:Standard:2Sid	ENG	[0 to 200 / 22 / 1-uA/step]
2-463-003	Paper Transfer:Low:1side	ENG	[0 to 200 / 11 / 1-uA/step]
2-463-004	Paper Transfer:Low:2side	ENG	[0 to 200 / 11 / 1-uA/step]

2467	[Thin:Bias:FC]		
2-467-001	PaperTransfer:Standard:1Sid	ENG	[0 to 200 / 29 / 1-uA/step]
2-467-002	PaperTransfer:Standard:2Sid	ENG	[0 to 200 / 29 / 1-uA/step]
2-467-003	Paper Transfer:Low:1side	ENG	[0 to 200 / 14 / 1-uA/step]
2-467-004	Paper Transfer:Low:2side	ENG	[0 to 200 / 14 / 1-uA/step]

2471	[Thin:SizeCorrection:BW]		
2-471-001	PaperTransfer:Standard:1Sid:S1	ENG	[100 to 995 / 100 / 1%/step]
2-471-002	PaperTransfer:Standard:2Sid:S1	ENG	[100 to 995 / 100 / 1%/step]
2-471-003	PaperTransfer:Low:1Side:S1	ENG	[100 to 995 / 100 / 1%/step]
2-471-004	PaperTransfer:Low:2Side:S1	ENG	[100 to 995 / 100 / 1%/step]
2-471-005	PaperTransfer:Standard:1Sid:S2	ENG	[100 to 995 / 100 / 1%/step]
2-471-006	PaperTransfer:Standard:2Sid:S2	ENG	[100 to 995 / 105 / 1%/step]

2-471-007	PaperTransfer:Low:1Side:S2	ENG	[100 to 995 / 100 / 1%/step]
2-471-008	PaperTransfer:Low:2Side:S2	ENG	[100 to 995 / 105 / 1%/step]
2-471-009	PaperTransfer:Standard:1Sid:S3	ENG	[100 to 995 / 111 / 1%/step]
2-471-010	PaperTransfer:Standard:2Sid:S3	ENG	[100 to 995 / 140 / 1%/step]
2-471-011	PaperTransfer:Low:1Side:S3	ENG	[100 to 995 / 111 / 1%/step]
2-471-012	PaperTransfer:Low:2Side:S3	ENG	[100 to 995 / 140 / 1%/step]
2-471-013	PaperTransfer:Standard:1Sid:S4	ENG	[100 to 995 / 121 / 1%/step]
2-471-014	PaperTransfer:Standard:2Sid:S4	ENG	[100 to 995 / 175 / 1%/step]
2-471-015	PaperTransfer:Low:1Side:S4	ENG	[100 to 995 / 121 / 1%/step]
2-471-016	PaperTransfer:Low:2Side:S4	ENG	[100 to 995 / 175 / 1%/step]
2-471-017	PaperTransfer:Standard:1Sid:S5	ENG	[100 to 995 / 132 / 1%/step]
2-471-018	PaperTransfer:Standard:2Sid:S5	ENG	[100 to 995 / 211 / 1%/step]
2-471-019	PaperTransfer:Low:1Side:S5	ENG	[100 to 995 / 132 / 1%/step]
2-471-020	PaperTransfer:Low:2Side:S5	ENG	[100 to 995 / 211 / 1%/step]
2-471-021	Wide Roller:PaperTransfer:Standard:1Sid:S1	ENG	[100 to 995 / 100 / 1%/step]
2-471-022	Wide Roller:PaperTransfer:Standard:2Sid:S1	ENG	[100 to 995 / 100 / 1%/step]

2-471-023	Wide Roller:PaperTransfer:Low:1Side:S1	ENG	[100 to 995 / 100 / 1%/step]
2-471-024	Wide Roller:PaperTransfer:Low:2Side:S1	ENG	[100 to 995 / 100 / 1%/step]
2-471-025	Wide Roller:PaperTransfer:Standard:1Sid:S2	ENG	[100 to 995 / 100 / 1%/step]
2-471-026	Wide Roller:PaperTransfer:Standard:2Sid:S2	ENG	[100 to 995 / 105 / 1%/step]
2-471-027	Wide Roller:PaperTransfer:Low:1Side:S2	ENG	[100 to 995 / 100 / 1%/step]
2-471-028	Wide Roller:PaperTransfer:Low:2Side:S2	ENG	[100 to 995 / 105 / 1%/step]
2-471-029	Wide Roller:PaperTransfer:Standard:1Sid:S3	ENG	[100 to 995 / 111 / 1%/step]
2-471-030	Wide Roller:PaperTransfer:Standard:2Sid:S3	ENG	[100 to 995 / 140 / 1%/step]
2-471-031	Wide Roller:PaperTransfer:Low:1Side:S3	ENG	[100 to 995 / 111 / 1%/step]
2-471-032	Wide Roller:PaperTransfer:Low:2Side:S3	ENG	[100 to 995 / 140 / 1%/step]
2-471-033	Wide Roller:PaperTransfer:Standard:1Sid:S4	ENG	[100 to 995 / 121 / 1%/step]
2-471-034	Wide Roller:PaperTransfer:Standard:2Sid:S4	ENG	[100 to 995 / 175 / 1%/step]
2-471-035	Wide Roller:PaperTransfer:Low:1Side:S4	ENG	[100 to 995 / 121 / 1%/step]
2-471-036	Wide Roller:PaperTransfer:Low:2Side:S4	ENG	[100 to 995 / 175 / 1%/step]
2-471-037	Wide Roller:PaperTransfer:Standard:1Sid:S5	ENG	[100 to 995 / 132 / 1%/step]
2-471-038	Wide Roller:PaperTransfer:Standard:2Sid:S5	ENG	[100 to 995 / 211 / 1%/step]

2-471-039	Wide Roller:PaperTransfer:Low:1 Side:S5	ENG	[100 to 995 / 132 / 1%/step]
2-471-040	Wide Roller:PaperTransfer:Low:2Side:S5	ENG	[100 to 995 / 211 / 1%/step]

2472	[Thin:SizeCorrection:FC]		
2-472-001	PaperTransfer:Standard:1Sid:S1	ENG	[100 to 995 / 100 / 1%/step]
2-472-002	PaperTransfer:Standard:1Sid:S1	ENG	[100 to 995 / 100 / 1%/step]
2-472-003	PaperTransfer:Low:1 Side:S1	ENG	[100 to 995 / 100 / 1%/step]
2-472-004	PaperTransfer:Low:1 Side:S1	ENG	[100 to 995 / 100 / 1%/step]
2-472-005	PaperTransfer:Standard:1Sid:S2	ENG	[100 to 995 / 106 / 1%/step]
2-472-006	PaperTransfer:Standard:1Sid:S2	ENG	[100 to 995 / 130 / 1%/step]
2-472-007	PaperTransfer:Low:1 Side:S2	ENG	[100 to 995 / 106 / 1%/step]
2-472-008	PaperTransfer:Low:1 Side:S2	ENG	[100 to 995 / 130 / 1%/step]
2-472-009	PaperTransfer:Standard:1Sid:S3	ENG	[100 to 995 / 117 / 1%/step]
2-472-010	PaperTransfer:Standard:1Sid:S3	ENG	[100 to 995 / 153 / 1%/step]
2-472-011	PaperTransfer:Low:1 Side:S3	ENG	[100 to 995 / 117 / 1%/step]
2-472-012	PaperTransfer:Low:1 Side:S3	ENG	[100 to 995 / 153 / 1%/step]
2-472-013	PaperTransfer:Standard:1Sid:S4	ENG	[100 to 995 / 128 / 1%/step]

2-472-014	PaperTransfer:Standard:1Sid:S4	ENG	[100 to 995 / 177 / 1%/step]
2-472-015	PaperTransfer:Low:1Side:S4	ENG	[100 to 995 / 128 / 1%/step]
2-472-016	PaperTransfer:Low:1Side:S4	ENG	[100 to 995 / 177 / 1%/step]
2-472-017	PaperTransfer:Standard:1Sid:S5	ENG	[100 to 995 / 140 / 1%/step]
2-472-018	PaperTransfer:Standard:2Sid:S5	ENG	[100 to 995 / 200 / 1%/step]
2-472-019	PaperTransfer:Low:1Side:S5	ENG	[100 to 995 / 140 / 1%/step]
2-472-020	PaperTransfer:Low:2Side:S5	ENG	[100 to 995 / 200 / 1%/step]
2-472-021	Wide Roller:PaperTransfer:Standard:1Sid:S1	ENG	[100 to 995 / 100 / 1%/step]
2-472-022	Wide Roller:PaperTransfer:Standard:2Sid:S1	ENG	[100 to 995 / 100 / 1%/step]
2-472-023	Wide Roller:PaperTransfer:Low:1Side:S1	ENG	[100 to 995 / 100 / 1%/step]
2-472-024	Wide Roller:PaperTransfer:Low:2Side:S1	ENG	[100 to 995 / 100 / 1%/step]
2-472-025	Wide Roller:PaperTransfer:Standard:1Sid:S2	ENG	[100 to 995 / 106 / 1%/step]
2-472-026	Wide Roller:PaperTransfer:Standard:2Sid:S2	ENG	[100 to 995 / 130 / 1%/step]
2-472-027	Wide Roller:PaperTransfer:Low:1Side:S2	ENG	[100 to 995 / 106 / 1%/step]
2-472-028	Wide Roller:PaperTransfer:Low:2Side:S2	ENG	[100 to 995 / 130 / 1%/step]
2-472-029	Wide Roller:PaperTransfer:Standard:1Sid:S3	ENG	[100 to 995 / 117 / 1%/step]

2-472-030	Wide Roller:PaperTransfer:Standard: 2Sid:S3	ENG	[100 to 995 / 153 / 1%/ step]
2-472-031	Wide Roller:PaperTransfer:Low: 1 Side:S3	ENG	[100 to 995 / 117 / 1%/ step]
2-472-032	Wide Roller:PaperTransfer:Low:2Side:S3	ENG	[100 to 995 / 153 / 1%/ step]
2-472-033	Wide Roller:PaperTransfer:Standard: 1Sid:S4	ENG	[100 to 995 / 128 / 1%/ step]
2-472-034	Wide Roller:PaperTransfer:Standard: 2Sid:S4	ENG	[100 to 995 / 177 / 1%/ step]
2-472-035	Wide Roller:PaperTransfer:Low: 1 Side:S4	ENG	[100 to 995 / 128 / 1%/ step]
2-472-036	Wide Roller:PaperTransfer:Low:2Side:S4	ENG	[100 to 995 / 177 / 1%/ step]
2-472-037	Wide Roller:PaperTransfer:Standard: 1Sid:S5	ENG	[100 to 995 / 140 / 1%/ step]
2-472-038	Wide Roller:PaperTransfer:Standard: 2Sid:S5	ENG	[100 to 995 / 200 / 1%/ step]
2-472-039	Wide Roller:PaperTransfer:Low: 1 Side:S5	ENG	[100 to 995 / 140 / 1%/ step]
2-472-040	Wide Roller:PaperTransfer:Low:2Side:S5	ENG	[100 to 995 / 200 / 1%/ step]

2473	[Thin:Size-Env.Correct:BW]		
2-473-001	PaperTransfer:Standard:1Sid:S1	ENG	[1 to 110 / 10 / 1/step]
2-473-002	PaperTransfer:Standard:1Sid:S1	ENG	[1 to 110 / 15 / 1/step]
2-473-003	PaperTransfer:Low: 1 Side:S1	ENG	[1 to 110 / 10 / 1/step]
2-473-004	PaperTransfer:Low: 1 Side:S1	ENG	[1 to 110 / 15 / 1/step]
2-473-005	PaperTransfer:Standard:1Sid:S2	ENG	[1 to 110 / 11 / 1/step]
2-473-006	PaperTransfer:Standard:1Sid:S2	ENG	[1 to 110 / 16 / 1/step]

2-473-007	PaperTransfer:Low: 1 Side:S2	ENG	[1 to 110 / 11 / 1/step]
2-473-008	PaperTransfer:Low: 1 Side:S2	ENG	[1 to 110 / 16 / 1/step]
2-473-009	PaperTransfer:Standard: 1 Sid:S3	ENG	[1 to 110 / 12 / 1/step]
2-473-010	PaperTransfer:Standard: 1 Sid:S3	ENG	[1 to 110 / 30 / 1/step]
2-473-011	PaperTransfer:Low: 1 Side:S3	ENG	[1 to 110 / 12 / 1/step]
2-473-012	PaperTransfer:Low: 1 Side:S3	ENG	[1 to 110 / 30 / 1/step]
2-473-013	PaperTransfer:Standard: 1 Sid:S4	ENG	[1 to 110 / 13 / 1/step]
2-473-014	PaperTransfer:Standard: 1 Sid:S4	ENG	[1 to 110 / 31 / 1/step]
2-473-015	PaperTransfer:Low: 1 Side:S4	ENG	[1 to 110 / 13 / 1/step]
2-473-016	PaperTransfer:Low: 1 Side:S4	ENG	[1 to 110 / 31 / 1/step]
2-473-017	PaperTransfer:Standard: 1 Sid:S5	ENG	[1 to 110 / 14 / 1/step]
2-473-018	PaperTransfer:Standard: 2 Sid:S5	ENG	[1 to 110 / 32 / 1/step]
2-473-019	PaperTransfer:Low: 1 Side:S5	ENG	[1 to 110 / 14 / 1/step]
2-473-020	PaperTransfer:Low: 2 Side:S5	ENG	[1 to 110 / 32 / 1/step]
2-473-021	Wide Roller:PaperTransfer:Standard: 1 Sid:S1	ENG	[1 to 110 / 10 / 1/step]
2-473-022	Wide Roller:PaperTransfer:Standard: 2 Sid:S1	ENG	[1 to 110 / 15 / 1/step]
2-473-023	Wide Roller:PaperTransfer:Low: 1 Side:S1	ENG	[1 to 110 / 10 / 1/step]
2-473-024	Wide Roller:PaperTransfer:Low: 2 Side:S1	ENG	[1 to 110 / 15 / 1/step]
2-473-025	Wide Roller:PaperTransfer:Standard: 1 Sid:S2	ENG	[1 to 110 / 11 / 1/step]
2-473-026	Wide Roller:PaperTransfer:Standard: 2 Sid:S2	ENG	[1 to 110 / 16 / 1/step]
2-473-027	Wide Roller:PaperTransfer:Low: 1 Side:S2	ENG	[1 to 110 / 11 / 1/step]
2-473-028	Wide Roller:PaperTransfer:Low: 2 Side:S2	ENG	[1 to 110 / 16 / 1/step]
2-473-029	Wide Roller:PaperTransfer:Standard: 1 Sid:S3	ENG	[1 to 110 / 12 / 1/step]

2-473-030	Wide Roller:PaperTransfer:Standard: 2Sid:S3	ENG	[1 to 110 / 30 / 1/step]
2-473-031	Wide Roller:PaperTransfer:Low: 1 Side:S3	ENG	[1 to 110 / 12 / 1/step]
2-473-032	Wide Roller:PaperTransfer:Low:2Side:S3	ENG	[1 to 110 / 30 / 1/step]
2-473-033	Wide Roller:PaperTransfer:Standard: 1Sid:S4	ENG	[1 to 110 / 13 / 1/step]
2-473-034	Wide Roller:PaperTransfer:Standard: 2Sid:S4	ENG	[1 to 110 / 31 / 1/step]
2-473-035	Wide Roller:PaperTransfer:Low: 1 Side:S4	ENG	[1 to 110 / 13 / 1/step]
2-473-036	Wide Roller:PaperTransfer:Low:2Side:S4	ENG	[1 to 110 / 31 / 1/step]
2-473-037	Wide Roller:PaperTransfer:Standard: 1Sid:S5	ENG	[1 to 110 / 14 / 1/step]
2-473-038	Wide Roller:PaperTransfer:Standard: 2Sid:S5	ENG	[1 to 110 / 32 / 1/step]
2-473-039	Wide Roller:PaperTransfer:Low: 1 Side:S5	ENG	[1 to 110 / 14 / 1/step]
2-473-040	Wide Roller:PaperTransfer:Low:2Side:S5	ENG	[1 to 110 / 32 / 1/step]

2474	[Thin:Size-Env.Correct:FC]		
2-474-001	PaperTransfer:Standard:1Sid:S1	ENG	[1 to 110 / 20 / 1/step]
2-474-002	PaperTransfer:Standard:1Sid:S1	ENG	[1 to 110 / 25 / 1/step]
2-474-003	PaperTransfer:Low: 1 Side:S 1	ENG	[1 to 110 / 20 / 1/step]
2-474-004	PaperTransfer:Low: 1 Side:S 1	ENG	[1 to 110 / 25 / 1/step]
2-474-005	PaperTransfer:Standard:1Sid:S2	ENG	[1 to 110 / 21 / 1/step]
2-474-006	PaperTransfer:Standard:1Sid:S2	ENG	[1 to 110 / 35 / 1/step]
2-474-007	PaperTransfer:Low: 1 Side:S2	ENG	[1 to 110 / 21 / 1/step]
2-474-008	PaperTransfer:Low: 1 Side:S2	ENG	[1 to 110 / 35 / 1/step]
2-474-009	PaperTransfer:Standard:1Sid:S3	ENG	[1 to 110 / 33 / 1/step]
2-474-010	PaperTransfer:Standard:1Sid:S3	ENG	[1 to 110 / 36 / 1/step]

2-474-011	PaperTransfer:Low:1Side:S3	ENG	[1 to 110 / 33 / 1/step]
2-474-012	PaperTransfer:Low:1Side:S3	ENG	[1 to 110 / 36 / 1/step]
2-474-013	PaperTransfer:Standard:1Sid:S4	ENG	[1 to 110 / 34 / 1/step]
2-474-014	PaperTransfer:Standard:1Sid:S4	ENG	[1 to 110 / 37 / 1/step]
2-474-015	PaperTransfer:Low:1Side:S4	ENG	[1 to 110 / 34 / 1/step]
2-474-016	PaperTransfer:Low:1Side:S4	ENG	[1 to 110 / 37 / 1/step]
2-474-017	PaperTransfer:Standard:1Sid:S5	ENG	[1 to 110 / 24 / 1/step]
2-474-018	PaperTransfer:Standard:2Sid:S5	ENG	[1 to 110 / 38 / 1/step]
2-474-019	PaperTransfer:Low:1Side:S5	ENG	[1 to 110 / 24 / 1/step]
2-474-020	PaperTransfer:Low:2Side:S5	ENG	[1 to 110 / 38 / 1/step]
2-474-021	Wide Roller:PaperTransfer:Standard: 1Sid:S1	ENG	[1 to 110 / 20 / 1/step]
2-474-022	Wide Roller:PaperTransfer:Standard: 2Sid:S1	ENG	[1 to 110 / 25 / 1/step]
2-474-023	Wide Roller:PaperTransfer:Low:1Side:S1	ENG	[1 to 110 / 20 / 1/step]
2-474-024	Wide Roller:PaperTransfer:Low:2Side:S1	ENG	[1 to 110 / 25 / 1/step]
2-474-025	Wide Roller:PaperTransfer:Standard: 1Sid:S2	ENG	[1 to 110 / 21 / 1/step]
2-474-026	Wide Roller:PaperTransfer:Standard: 2Sid:S2	ENG	[1 to 110 / 35 / 1/step]
2-474-027	Wide Roller:PaperTransfer:Low:1Side:S2	ENG	[1 to 110 / 21 / 1/step]
2-474-028	Wide Roller:PaperTransfer:Low:2Side:S2	ENG	[1 to 110 / 35 / 1/step]
2-474-029	Wide Roller:PaperTransfer:Standard: 1Sid:S3	ENG	[1 to 110 / 33 / 1/step]
2-474-030	Wide Roller:PaperTransfer:Standard: 2Sid:S3	ENG	[1 to 110 / 36 / 1/step]
2-474-031	Wide Roller:PaperTransfer:Low:1Side:S3	ENG	[1 to 110 / 33 / 1/step]
2-474-032	Wide Roller:PaperTransfer:Low:2Side:S3	ENG	[1 to 110 / 36 / 1/step]

2-474-033	Wide Roller:PaperTransfer:Standard: 1Sid:S4	ENG	[1 to 110 / 34 / 1/step]
2-474-034	Wide Roller:PaperTransfer:Standard: 2Sid:S4	ENG	[1 to 110 / 37 / 1/step]
2-474-035	Wide Roller:PaperTransfer:Low: 1 Side:S4	ENG	[1 to 110 / 34 / 1/step]
2-474-036	Wide Roller:PaperTransfer:Low:2Side:S4	ENG	[1 to 110 / 37 / 1/step]
2-474-037	Wide Roller:PaperTransfer:Standard: 1Sid:S5	ENG	[1 to 110 / 24 / 1/step]
2-474-038	Wide Roller:PaperTransfer:Standard: 2Sid:S5	ENG	[1 to 110 / 38 / 1/step]
2-474-039	Wide Roller:PaperTransfer:Low: 1 Side:S5	ENG	[1 to 110 / 24 / 1/step]
2-474-040	Wide Roller:PaperTransfer:Low:2Side:S5	ENG	[1 to 110 / 38 / 1/step]

2475	[Thin:LeadingEdgeCorrection]		
2-475-001	PaperTransfer:Standard:1Side	ENG	[0 to 995 / 100 / 5%/step]
2-475-002	PaperTransfer:Standard:2Side	ENG	[0 to 995 / 100 / 5%/step]
2-475-003	Paper Transfer:Low:1 side	ENG	[0 to 995 / 100 / 5%/step]
2-475-004	Paper Transfer:Low:2side	ENG	[0 to 995 / 100 / 5%/step]

2476	[Thin:SwitchTimingLeadEdge]		
2-476-001	PaperTransfer:Standard:1 side	ENG	[0 to 50 / 0 / 2mm/step]
2-476-002	PaperTransfer:Standard:2side	ENG	[0 to 50 / 0 / 2mm/step]
2-476-003	Paper Transfer:Low:1 side	ENG	[0 to 50 / 0 / 2mm/step]
2-476-004	Paper Transfer:Low:2side	ENG	[0 to 50 / 0 / 2mm/step]

2477	[Thin:TrailEdgeCorrection]		
2-477-001	PaperTransfer:Standard:1Side	ENG	[0 to 995 / 100 / 5%/step]
2-477-002	PaperTransfer:Standard:2Side	ENG	[0 to 995 / 100 / 5%/step]
2-477-003	Paper Transfer:Low:1 side	ENG	[0 to 995 / 100 / 5%/step]

2-477-004	Paper Transfer:Low:2side	ENG	[0 to 995 / 100 / 5%/step]
-----------	--------------------------	-----	----------------------------

2478	[Thin:SwitchTimingTrailEdge]		
2-478-001	PaperTransfer:Standard:1side	ENG	[0 to 50 / 0 / 2mm/step]
2-478-002	PaperTransfer:Standard:2side	ENG	[0 to 50 / 0 / 2mm/step]
2-478-003	Paper Transfer:Low:1side	ENG	[0 to 50 / 0 / 2mm/step]
2-478-004	Paper Transfer:Low:2side	ENG	[0 to 50 / 0 / 2mm/step]

2483	[Thick1:Bias:BW]		
2-483-001	PaperTransfer:middle:1side	ENG	[0 to 200 / 16 / 1-uA/step]
2-483-002	PaperTransfer:middle:2side	ENG	[0 to 200 / 13 / 1-uA/step]
2-483-003	PaperTransfer:low:1side	ENG	[0 to 200 / 11 / 1-uA/step]
2-483-004	PaperTransfer:low:2side	ENG	[0 to 200 / 9 / 1-uA/step]

2487	[Thick1:Bias:FC]		
2-487-001	PaperTransfer:middle:1side	ENG	[0 to 200 / 23 / 1-uA/step]
2-487-002	PaperTransfer:middle:2side	ENG	[0 to 200 / 26 / 1-uA/step]
2-487-003	PaperTransfer:low:1side	ENG	[0 to 200 / 16 / 1-uA/step]
2-487-004	PaperTransfer:low:2side	ENG	[0 to 200 / 18 / 1-uA/step]

2491	[Thick1:SizeCorrection:BW]		
2-491-001	PaperTransfer:middle:1Sid:S1	ENG	[100 to 995 / 100 / 1%/step]
2-491-002	PaperTransfer:middle:1Sid:S1	ENG	[100 to 995 / 100 / 1%/step]
2-491-003	PaperTransfer:Low:1Side:S1	ENG	[100 to 995 / 100 / 1%/step]
2-491-004	PaperTransfer:Low:1Side:S1	ENG	[100 to 995 / 100 / 1%/step]

2-491-005	PaperTransfer:middle:1Sid:S2	ENG	[100 to 995 / 100 / 1%/step]
2-491-006	PaperTransfer:middle:1Sid:S2	ENG	[100 to 995 / 177 / 1%/step]
2-491-007	PaperTransfer:Low:1Side:S2	ENG	[100 to 995 / 100 / 1%/step]
2-491-008	PaperTransfer:Low:1Side:S2	ENG	[100 to 995 / 177 / 1%/step]
2-491-009	PaperTransfer:middle:1Sid:S3	ENG	[100 to 995 / 100 / 1%/step]
2-491-010	PaperTransfer:middle:1Sid:S3	ENG	[100 to 995 / 231 / 1%/step]
2-491-011	PaperTransfer:Low:1Side:S3	ENG	[100 to 995 / 100 / 1%/step]
2-491-012	PaperTransfer:Low:1Side:S3	ENG	[100 to 995 / 231 / 1%/step]
2-491-013	PaperTransfer:middle:1Sid:S4	ENG	[100 to 995 / 100 / 1%/step]
2-491-014	PaperTransfer:middle:1Sid:S4	ENG	[100 to 995 / 270 / 1%/step]
2-491-015	PaperTransfer:Low:1Side:S4	ENG	[100 to 995 / 100 / 1%/step]
2-491-016	PaperTransfer:Low:1Side:S4	ENG	[100 to 995 / 270 / 1%/step]
2-491-017	PaperTransfer:middle:1Sid:S5	ENG	[100 to 995 / 100 / 1%/step]
2-491-018	PaperTransfer:middle:2Sid:S5	ENG	[100 to 995 / 308 / 1%/step]
2-491-019	PaperTransfer:Low:1Side:S5	ENG	[100 to 995 / 100 / 1%/step]
2-491-020	PaperTransfer:Low:2Side:S5	ENG	[100 to 995 / 308 / 1%/step]

2-491-021	Wide Roller:PaperTransfer:middle: 1Sid:S1	ENG	[100 to 995 / 100 / 1%/ step]
2-491-022	Wide Roller:PaperTransfer:middle: 2Sid:S1	ENG	[100 to 995 / 100 / 1%/ step]
2-491-023	Wide Roller:PaperTransfer:Low:1 Side:S1	ENG	[100 to 995 / 100 / 1%/ step]
2-491-024	Wide Roller:PaperTransfer:Low:2Side:S1	ENG	[100 to 995 / 100 / 1%/ step]
2-491-025	Wide Roller:PaperTransfer:middle: 1Sid:S2	ENG	[100 to 995 / 100 / 1%/ step]
2-491-026	Wide Roller:PaperTransfer:middle: 2Sid:S2	ENG	[100 to 995 / 177 / 1%/ step]
2-491-027	Wide Roller:PaperTransfer:Low:1 Side:S2	ENG	[100 to 995 / 100 / 1%/ step]
2-491-028	Wide Roller:PaperTransfer:Low:2Side:S2	ENG	[100 to 995 / 177 / 1%/ step]
2-491-029	Wide Roller:PaperTransfer:middle: 1Sid:S3	ENG	[100 to 995 / 100 / 1%/ step]
2-491-030	Wide Roller:PaperTransfer:middle: 2Sid:S3	ENG	[100 to 995 / 231 / 1%/ step]
2-491-031	Wide Roller:PaperTransfer:Low:1 Side:S3	ENG	[100 to 995 / 100 / 1%/ step]
2-491-032	Wide Roller:PaperTransfer:Low:2Side:S3	ENG	[100 to 995 / 231 / 1%/ step]
2-491-033	Wide Roller:PaperTransfer:middle: 1Sid:S4	ENG	[100 to 995 / 100 / 1%/ step]
2-491-034	Wide Roller:PaperTransfer:middle: 2Sid:S4	ENG	[100 to 995 / 270 / 1%/ step]
2-491-035	Wide Roller:PaperTransfer:Low:1 Side:S4	ENG	[100 to 995 / 100 / 1%/ step]
2-491-036	Wide Roller:PaperTransfer:Low:2Side:S4	ENG	[100 to 995 / 270 / 1%/ step]

2-491-037	Wide Roller:PaperTransfer:middle: 1Sid:S5	ENG	[100 to 995 / 100 / 1%/ step]
2-491-038	Wide Roller:PaperTransfer:middle: 2Sid:S5	ENG	[100 to 995 / 308 / 1%/ step]
2-491-039	Wide Roller:PaperTransfer:Low: 1 Side:S5	ENG	[100 to 995 / 100 / 1%/ step]
2-491-040	Wide Roller:PaperTransfer:Low:2Side:S5	ENG	[100 to 995 / 308 / 1%/ step]

2492	[Thick1:SizeCorrection:FC]		
2-492-001	PaperTransfer:middle: 1 Sid:S1	ENG	[100 to 995 / 100 / 1%/ step]
2-492-002	PaperTransfer:middle: 1 Sid:S1	ENG	[100 to 995 / 100 / 1%/ step]
2-492-003	PaperTransfer:Low: 1 Side:S1	ENG	[100 to 995 / 100 / 1%/ step]
2-492-004	PaperTransfer:Low: 1 Side:S1	ENG	[100 to 995 / 100 / 1%/ step]
2-492-005	PaperTransfer:middle: 1 Sid:S2	ENG	[100 to 995 / 100 / 1%/ step]
2-492-006	PaperTransfer:middle: 1 Sid:S2	ENG	[100 to 995 / 173 / 1%/ step]
2-492-007	PaperTransfer:Low: 1 Side:S2	ENG	[100 to 995 / 100 / 1%/ step]
2-492-008	PaperTransfer:Low: 1 Side:S2	ENG	[100 to 995 / 173 / 1%/ step]
2-492-009	PaperTransfer:middle: 1 Sid:S3	ENG	[100 to 995 / 100 / 1%/ step]
2-492-010	PaperTransfer:middle: 1 Sid:S3	ENG	[100 to 995 / 250 / 1%/ step]
2-492-011	PaperTransfer:Low: 1 Side:S3	ENG	[100 to 995 / 100 / 1%/ step]

2-492-012	PaperTransfer:Low:1Side:S3	ENG	[100 to 995 / 250 / 1%/step]
2-492-013	PaperTransfer:middle:1Sid:S4	ENG	[100 to 995 / 100 / 1%/step]
2-492-014	PaperTransfer:middle:1Sid:S4	ENG	[100 to 995 / 308 / 1%/step]
2-492-015	PaperTransfer:Low:1Side:S4	ENG	[100 to 995 / 100 / 1%/step]
2-492-016	PaperTransfer:Low:1Side:S4	ENG	[100 to 995 / 308 / 1%/step]
2-492-017	PaperTransfer:middle:1Sid:S5	ENG	[100 to 995 / 100 / 1%/step]
2-492-018	PaperTransfer:middle:2Sid:S5	ENG	[100 to 995 / 385 / 1%/step]
2-492-019	PaperTransfer:Low:1Side:S5	ENG	[100 to 995 / 100 / 1%/step]
2-492-020	PaperTransfer:Low:2Side:S5	ENG	[100 to 995 / 385 / 1%/step]
2-492-021	Wide Roller:PaperTransfer:middle:1Sid:S1	ENG	[100 to 995 / 100 / 1%/step]
2-492-022	Wide Roller:PaperTransfer:middle:2Sid:S1	ENG	[100 to 995 / 100 / 1%/step]
2-492-023	Wide Roller:PaperTransfer:Low:1Side:S1	ENG	[100 to 995 / 100 / 1%/step]
2-492-024	Wide Roller:PaperTransfer:Low:2Side:S1	ENG	[100 to 995 / 100 / 1%/step]
2-492-025	Wide Roller:PaperTransfer:middle:1Sid:S2	ENG	[100 to 995 / 100 / 1%/step]
2-492-026	Wide Roller:PaperTransfer:middle:2Sid:S2	ENG	[100 to 995 / 173 / 1%/step]
2-492-027	Wide Roller:PaperTransfer:Low:1Side:S2	ENG	[100 to 995 / 100 / 1%/step]

2-492-028	Wide Roller:PaperTransfer:Low:2Side:S2	ENG	[100 to 995 / 173 / 1%/step]
2-492-029	Wide Roller:PaperTransfer:middle:1Sid:S3	ENG	[100 to 995 / 100 / 1%/step]
2-492-030	Wide Roller:PaperTransfer:middle:2Sid:S3	ENG	[100 to 995 / 250 / 1%/step]
2-492-031	Wide Roller:PaperTransfer:Low:1 Side:S3	ENG	[100 to 995 / 100 / 1%/step]
2-492-032	Wide Roller:PaperTransfer:Low:2Side:S3	ENG	[100 to 995 / 250 / 1%/step]
2-492-033	Wide Roller:PaperTransfer:middle:1Sid:S4	ENG	[100 to 995 / 100 / 1%/step]
2-492-034	Wide Roller:PaperTransfer:middle:2Sid:S4	ENG	[100 to 995 / 308 / 1%/step]
2-492-035	Wide Roller:PaperTransfer:Low:1 Side:S4	ENG	[100 to 995 / 100 / 1%/step]
2-492-036	Wide Roller:PaperTransfer:Low:2Side:S4	ENG	[100 to 995 / 308 / 1%/step]
2-492-037	Wide Roller:PaperTransfer:middle:1Sid:S5	ENG	[100 to 995 / 100 / 1%/step]
2-492-038	Wide Roller:PaperTransfer:middle:2Sid:S5	ENG	[100 to 995 / 385 / 1%/step]
2-492-039	Wide Roller:PaperTransfer:Low:1 Side:S5	ENG	[100 to 995 / 100 / 1%/step]
2-492-040	Wide Roller:PaperTransfer:Low:2Side:S5	ENG	[100 to 995 / 385 / 1%/step]

2493	[Thick1:Size-Env.Correct:BW]		
2-493-001	PaperTransfer:middle:1 Sid:S1	ENG	[1 to 110 / 54 / 1/step]
2-493-002	PaperTransfer:middle:1 Sid:S1	ENG	[1 to 110 / 57 / 1/step]
2-493-003	PaperTransfer:Low:1 Side:S1	ENG	[1 to 110 / 54 / 1/step]

2-493-004	PaperTransfer:Low:1 Side:S1	ENG	[1 to 110 / 57 / 1/step]
2-493-005	PaperTransfer:middle:1 Sid:S2	ENG	[1 to 110 / 55 / 1/step]
2-493-006	PaperTransfer:middle:1 Sid:S2	ENG	[1 to 110 / 58 / 1/step]
2-493-007	PaperTransfer:Low:1 Side:S2	ENG	[1 to 110 / 55 / 1/step]
2-493-008	PaperTransfer:Low:1 Side:S2	ENG	[1 to 110 / 58 / 1/step]
2-493-009	PaperTransfer:middle:1 Sid:S3	ENG	[1 to 110 / 56 / 1/step]
2-493-010	PaperTransfer:middle:1 Sid:S3	ENG	[1 to 110 / 59 / 1/step]
2-493-011	PaperTransfer:Low:1 Side:S3	ENG	[1 to 110 / 56 / 1/step]
2-493-012	PaperTransfer:Low:1 Side:S3	ENG	[1 to 110 / 59 / 1/step]
2-493-013	PaperTransfer:middle:1 Sid:S4	ENG	[1 to 110 / 56 / 1/step]
2-493-014	PaperTransfer:middle:1 Sid:S4	ENG	[1 to 110 / 60 / 1/step]
2-493-015	PaperTransfer:Low:1 Side:S4	ENG	[1 to 110 / 56 / 1/step]
2-493-016	PaperTransfer:Low:1 Side:S4	ENG	[1 to 110 / 60 / 1/step]
2-493-017	PaperTransfer:middle:1 Sid:S5	ENG	[1 to 110 / 56 / 1/step]
2-493-018	PaperTransfer:middle:2Sid:S5	ENG	[1 to 110 / 61 / 1/step]
2-493-019	PaperTransfer:Low:1 Side:S5	ENG	[1 to 110 / 56 / 1/step]
2-493-020	PaperTransfer:Low:2Side:S5	ENG	[1 to 110 / 61 / 1/step]
2-493-021	Wide Roller:PaperTransfer:middle: 1Sid:S1	ENG	[1 to 110 / 54 / 1/step]
2-493-022	Wide Roller:PaperTransfer:middle: 2Sid:S1	ENG	[1 to 110 / 57 / 1/step]
2-493-023	Wide Roller:PaperTransfer:Low:1 Side:S1	ENG	[1 to 110 / 54 / 1/step]
2-493-024	Wide Roller:PaperTransfer:Low:2Side:S1	ENG	[1 to 110 / 57 / 1/step]
2-493-025	Wide Roller:PaperTransfer:middle: 1Sid:S2	ENG	[1 to 110 / 55 / 1/step]
2-493-026	Wide Roller:PaperTransfer:middle: 2Sid:S2	ENG	[1 to 110 / 58 / 1/step]

2-493-027	Wide Roller:PaperTransfer:Low:1 Side:S2	ENG	[1 to 110 / 55 / 1/step]
2-493-028	Wide Roller:PaperTransfer:Low:2Side:S2	ENG	[1 to 110 / 58 / 1/step]
2-493-029	Wide Roller:PaperTransfer:middle: 1Sid:S3	ENG	[1 to 110 / 56 / 1/step]
2-493-030	Wide Roller:PaperTransfer:middle: 2Sid:S3	ENG	[1 to 110 / 59 / 1/step]
2-493-031	Wide Roller:PaperTransfer:Low:1 Side:S3	ENG	[1 to 110 / 56 / 1/step]
2-493-032	Wide Roller:PaperTransfer:Low:2Side:S3	ENG	[1 to 110 / 59 / 1/step]
2-493-033	Wide Roller:PaperTransfer:middle: 1Sid:S4	ENG	[1 to 110 / 56 / 1/step]
2-493-034	Wide Roller:PaperTransfer:middle: 2Sid:S4	ENG	[1 to 110 / 60 / 1/step]
2-493-035	Wide Roller:PaperTransfer:Low:1 Side:S4	ENG	[1 to 110 / 56 / 1/step]
2-493-036	Wide Roller:PaperTransfer:Low:2Side:S4	ENG	[1 to 110 / 60 / 1/step]
2-493-037	Wide Roller:PaperTransfer:middle: 1Sid:S5	ENG	[1 to 110 / 56 / 1/step]
2-493-038	Wide Roller:PaperTransfer:middle: 2Sid:S5	ENG	[1 to 110 / 61 / 1/step]
2-493-039	Wide Roller:PaperTransfer:Low:1 Side:S5	ENG	[1 to 110 / 56 / 1/step]
2-493-040	Wide Roller:PaperTransfer:Low:2Side:S5	ENG	[1 to 110 / 61 / 1/step]

2494	[Thick1:Size-Env.Correct:FC]		
2-494-001	PaperTransfer:middle:1 Sid:S1	ENG	[1 to 110 / 13 / 1/step]
2-494-002	PaperTransfer:middle:1 Sid:S1	ENG	[1 to 110 / 65 / 1/step]
2-494-003	PaperTransfer:Low:1 Side:S1	ENG	[1 to 110 / 13 / 1/step]
2-494-004	PaperTransfer:Low:1 Side:S1	ENG	[1 to 110 / 65 / 1/step]
2-494-005	PaperTransfer:middle:1 Sid:S2	ENG	[1 to 110 / 63 / 1/step]
2-494-006	PaperTransfer:middle:1 Sid:S2	ENG	[1 to 110 / 66 / 1/step]

2-494-007	PaperTransfer:Low: 1 Side:S2	ENG	[1 to 110 / 63 / 1/step]
2-494-008	PaperTransfer:Low: 1 Side:S2	ENG	[1 to 110 / 66 / 1/step]
2-494-009	PaperTransfer:middle: 1 Sid:S3	ENG	[1 to 110 / 63 / 1/step]
2-494-010	PaperTransfer:middle: 1 Sid:S3	ENG	[1 to 110 / 67 / 1/step]
2-494-011	PaperTransfer:Low: 1 Side:S3	ENG	[1 to 110 / 63 / 1/step]
2-494-012	PaperTransfer:Low: 1 Side:S3	ENG	[1 to 110 / 67 / 1/step]
2-494-013	PaperTransfer:middle: 1 Sid:S4	ENG	[1 to 110 / 64 / 1/step]
2-494-014	PaperTransfer:middle: 1 Sid:S4	ENG	[1 to 110 / 68 / 1/step]
2-494-015	PaperTransfer:Low: 1 Side:S4	ENG	[1 to 110 / 64 / 1/step]
2-494-016	PaperTransfer:Low: 1 Side:S4	ENG	[1 to 110 / 68 / 1/step]
2-494-017	PaperTransfer:middle: 1 Sid:S5	ENG	[1 to 110 / 64 / 1/step]
2-494-018	PaperTransfer:middle:2Sid:S5	ENG	[1 to 110 / 69 / 1/step]
2-494-019	PaperTransfer:Low: 1 Side:S5	ENG	[1 to 110 / 64 / 1/step]
2-494-020	PaperTransfer:Low:2Side:S5	ENG	[1 to 110 / 69 / 1/step]
2-494-021	Wide Roller:PaperTransfer:middle: 1 Sid:S1	ENG	[1 to 110 / 13 / 1/step]
2-494-022	Wide Roller:PaperTransfer:middle: 2Sid:S1	ENG	[1 to 110 / 65 / 1/step]
2-494-023	Wide Roller:PaperTransfer:Low: 1 Side:S1	ENG	[1 to 110 / 13 / 1/step]
2-494-024	Wide Roller:PaperTransfer:Low:2Side:S1	ENG	[1 to 110 / 65 / 1/step]
2-494-025	Wide Roller:PaperTransfer:middle: 1 Sid:S2	ENG	[1 to 110 / 63 / 1/step]
2-494-026	Wide Roller:PaperTransfer:middle: 2Sid:S2	ENG	[1 to 110 / 66 / 1/step]
2-494-027	Wide Roller:PaperTransfer:Low: 1 Side:S2	ENG	[1 to 110 / 63 / 1/step]
2-494-028	Wide Roller:PaperTransfer:Low:2Side:S2	ENG	[1 to 110 / 66 / 1/step]
2-494-029	Wide Roller:PaperTransfer:middle: 1 Sid:S3	ENG	[1 to 110 / 63 / 1/step]

2-494-030	Wide Roller:PaperTransfer:middle: 2Sid:S3	ENG	[1 to 110 / 67 / 1/step]
2-494-031	Wide Roller:PaperTransfer:Low: 1 Side:S3	ENG	[1 to 110 / 63 / 1/step]
2-494-032	Wide Roller:PaperTransfer:Low:2Side:S3	ENG	[1 to 110 / 67 / 1/step]
2-494-033	Wide Roller:PaperTransfer:middle: 1Sid:S4	ENG	[1 to 110 / 64 / 1/step]
2-494-034	Wide Roller:PaperTransfer:middle: 2Sid:S4	ENG	[1 to 110 / 68 / 1/step]
2-494-035	Wide Roller:PaperTransfer:Low: 1 Side:S4	ENG	[1 to 110 / 64 / 1/step]
2-494-036	Wide Roller:PaperTransfer:Low:2Side:S4	ENG	[1 to 110 / 68 / 1/step]
2-494-037	Wide Roller:PaperTransfer:middle: 1Sid:S5	ENG	[1 to 110 / 64 / 1/step]
2-494-038	Wide Roller:PaperTransfer:middle: 2Sid:S5	ENG	[1 to 110 / 69 / 1/step]
2-494-039	Wide Roller:PaperTransfer:Low: 1 Side:S5	ENG	[1 to 110 / 64 / 1/step]
2-494-040	Wide Roller:PaperTransfer:Low:2Side:S5	ENG	[1 to 110 / 69 / 1/step]

2495	[Thick1:LeadingEdgeCorrection]		
2-495-001	PaperTransfer:middle: 1 Side	ENG	[0 to 995 / 100 / 5%/step]
2-495-002	PaperTransfer:middle:2Side	ENG	[0 to 995 / 100 / 5%/step]
2-495-003	Paper Transfer:Low: 1 side	ENG	[0 to 995 / 100 / 5%/step]
2-495-004	Paper Transfer:Low:2side	ENG	[0 to 995 / 100 / 5%/step]

2496	[Thick1:SwitchTimingLeadEdge]		
2-496-001	PaperTransfer:middle: 1 side	ENG	[0 to 50 / 0 / 2mm/step]
2-496-002	PaperTransfer:middle:2side	ENG	[0 to 50 / 0 / 2mm/step]
2-496-003	Paper Transfer:Low: 1 side	ENG	[0 to 50 / 0 / 2mm/step]
2-496-004	Paper Transfer:Low:2side	ENG	[0 to 50 / 0 / 2mm/step]

2497	[Thick1:TrailEdgeCorrection]		
2-497-001	PaperTransfer:middle:1Side	ENG	[0 to 995 / 100 / 5%/step]
2-497-002	PaperTransfer:middle:2Side	ENG	[0 to 995 / 100 / 5%/step]
2-497-003	Paper Transfer:Low:1side	ENG	[0 to 995 / 100 / 5%/step]
2-497-004	Paper Transfer:Low:2side	ENG	[0 to 995 / 100 / 5%/step]

2498	[Thick1:SwitchTimingTrailEdge]		
2-498-001	PaperTransfer:middle:1Side	ENG	[0 to 50 / 0 / 2mm/step]
2-498-002	PaperTransfer:middle:2Side	ENG	[0 to 50 / 0 / 2mm/step]
2-498-003	Paper Transfer:Low:1side	ENG	[0 to 50 / 0 / 2mm/step]
2-498-004	Paper Transfer:Low:2side	ENG	[0 to 50 / 0 / 2mm/step]

2503	[Thick2:Bias:BW]		
2-503-003	PaperTransfer:1side	ENG	[0 to 200 / 11 / 1-uA/step]
2-503-004	PaperTransfer:2side	ENG	[0 to 200 / 15 / 1-uA/step]

2507	[Thick2:Bias:FC]		
2-507-003	PaperTransfer:1side	ENG	[0 to 200 / 19 / 1-uA/step]
2-507-004	PaperTransfer:2side	ENG	[0 to 200 / 21 / 1-uA/step]

2511	[Thick2:SizeCorrection:BW]		
2-511-003	PaperTransfer:1Side:S1	ENG	[100 to 995 / 100 / 1%/step]
2-511-004	PaperTransfer:2Side:S1	ENG	[100 to 995 / 100 / 1%/step]
2-511-007	PaperTransfer:1Side:S2	ENG	[100 to 995 / 100 / 1%/step]
2-511-008	PaperTransfer:2Side:S2	ENG	[100 to 995 / 133 / 1%/step]

2-511-011	PaperTransfer:1Side:S3	ENG	[100 to 995 / 100 / 1%/step]
2-511-012	PaperTransfer:2Side:S3	ENG	[100 to 995 / 167 / 1%/step]
2-511-015	PaperTransfer:1Side:S4	ENG	[100 to 995 / 100 / 1%/step]
2-511-016	PaperTransfer:2Side:S4	ENG	[100 to 995 / 233 / 1%/step]
2-511-019	PaperTransfer:1Side:S5	ENG	[100 to 995 / 100 / 1%/step]
2-511-020	PaperTransfer:2Side:S5	ENG	[100 to 995 / 267 / 1%/step]
2-511-023	Wide Roller:PaperTransfer:1Side:S1	ENG	[100 to 995 / 100 / 1%/step]
2-511-024	Wide Roller:PaperTransfer:2Side:S1	ENG	[100 to 995 / 100 / 1%/step]
2-511-027	Wide Roller:PaperTransfer:1Side:S2	ENG	[100 to 995 / 100 / 1%/step]
2-511-028	Wide Roller:PaperTransfer:2Side:S2	ENG	[100 to 995 / 133 / 1%/step]
2-511-031	Wide Roller:PaperTransfer:1Side:S3	ENG	[100 to 995 / 100 / 1%/step]
2-511-032	Wide Roller:PaperTransfer:2Side:S3	ENG	[100 to 995 / 167 / 1%/step]
2-511-035	Wide Roller:PaperTransfer:1Side:S4	ENG	[100 to 995 / 100 / 1%/step]
2-511-036	Wide Roller:PaperTransfer:2Side:S4	ENG	[100 to 995 / 233 / 1%/step]
2-511-039	Wide Roller:PaperTransfer:1Side:S5	ENG	[100 to 995 / 100 / 1%/step]
2-511-040	Wide Roller:PaperTransfer:2Side:S5	ENG	[100 to 995 / 267 / 1%/step]

2512	[Thick2:SizeCorrection:FC]		
2-512-003	PaperTransfer:1Side:S1	ENG	[100 to 995 / 100 / 1%/step]
2-512-004	PaperTransfer:2Side:S1	ENG	[100 to 995 / 100 / 1%/step]
2-512-007	PaperTransfer:1Side:S2	ENG	[100 to 995 / 100 / 1%/step]
2-512-008	PaperTransfer:2Side:S2	ENG	[100 to 995 / 181 / 1%/step]
2-512-011	PaperTransfer:1Side:S3	ENG	[100 to 995 / 100 / 1%/step]
2-512-012	PaperTransfer:2Side:S3	ENG	[100 to 995 / 229 / 1%/step]
2-512-015	PaperTransfer:1Side:S4	ENG	[100 to 995 / 100 / 1%/step]
2-512-016	PaperTransfer:2Side:S4	ENG	[100 to 995 / 286 / 1%/step]
2-512-019	PaperTransfer:1Side:S5	ENG	[100 to 995 / 100 / 1%/step]
2-512-020	PaperTransfer:2Side:S5	ENG	[100 to 995 / 381 / 1%/step]
2-512-023	Wide Roller:PaperTransfer:1Side:S1	ENG	[100 to 995 / 100 / 1%/step]
2-512-024	Wide Roller:PaperTransfer:2Side:S1	ENG	[100 to 995 / 100 / 1%/step]
2-512-027	Wide Roller:PaperTransfer:1Side:S2	ENG	[100 to 995 / 100 / 1%/step]
2-512-028	Wide Roller:PaperTransfer:2Side:S2	ENG	[100 to 995 / 181 / 1%/step]
2-512-031	Wide Roller:PaperTransfer:1Side:S3	ENG	[100 to 995 / 100 / 1%/step]

2-512-032	Wide Roller:PaperTransfer:2Side:S3	ENG	[100 to 995 / 229 / 1%/step]
2-512-035	Wide Roller:PaperTransfer:1 Side:S4	ENG	[100 to 995 / 100 / 1%/step]
2-512-036	Wide Roller:PaperTransfer:2Side:S4	ENG	[100 to 995 / 286 / 1%/step]
2-512-039	Wide Roller:PaperTransfer:1 Side:S5	ENG	[100 to 995 / 100 / 1%/step]
2-512-040	Wide Roller:PaperTransfer:2Side:S5	ENG	[100 to 995 / 381 / 1%/step]

2513	[Thick2:Size-Env.Correct:BW]		
2-513-003	PaperTransfer:1 Side:S1	ENG	[1 to 110 / 70 / 1/step]
2-513-004	PaperTransfer:2Side:S1	ENG	[1 to 110 / 72 / 1/step]
2-513-007	PaperTransfer:1 Side:S2	ENG	[1 to 110 / 71 / 1/step]
2-513-008	PaperTransfer:2Side:S2	ENG	[1 to 110 / 73 / 1/step]
2-513-011	PaperTransfer:1 Side:S3	ENG	[1 to 110 / 71 / 1/step]
2-513-012	PaperTransfer:2Side:S3	ENG	[1 to 110 / 74 / 1/step]
2-513-015	PaperTransfer:1 Side:S4	ENG	[1 to 110 / 71 / 1/step]
2-513-016	PaperTransfer:2Side:S4	ENG	[1 to 110 / 75 / 1/step]
2-513-019	PaperTransfer:1 Side:S5	ENG	[1 to 110 / 71 / 1/step]
2-513-020	PaperTransfer:2Side:S5	ENG	[1 to 110 / 76 / 1/step]
2-513-023	Wide Roller:PaperTransfer:1 Side:S1	ENG	[1 to 110 / 70 / 1/step]
2-513-024	Wide Roller:PaperTransfer:2Side:S1	ENG	[1 to 110 / 72 / 1/step]
2-513-027	Wide Roller:PaperTransfer:1 Side:S2	ENG	[1 to 110 / 71 / 1/step]
2-513-028	Wide Roller:PaperTransfer:2Side:S2	ENG	[1 to 110 / 73 / 1/step]
2-513-031	Wide Roller:PaperTransfer:1 Side:S3	ENG	[1 to 110 / 71 / 1/step]
2-513-032	Wide Roller:PaperTransfer:2Side:S3	ENG	[1 to 110 / 74 / 1/step]

2-513-035	Wide Roller:PaperTransfer:1Side:S4	ENG	[1 to 110 / 71 / 1/step]
2-513-036	Wide Roller:PaperTransfer:2Side:S4	ENG	[1 to 110 / 75 / 1/step]
2-513-039	Wide Roller:PaperTransfer:1Side:S5	ENG	[1 to 110 / 71 / 1/step]
2-513-040	Wide Roller:PaperTransfer:2Side:S5	ENG	[1 to 110 / 76 / 1/step]

2514	[Thick2:Size-Env.Correct:FC]		
2-514-003	PaperTransfer:1Side:S1	ENG	[1 to 110 / 77 / 1/step]
2-514-004	PaperTransfer:2Side:S1	ENG	[1 to 110 / 80 / 1/step]
2-514-007	PaperTransfer:1Side:S2	ENG	[1 to 110 / 78 / 1/step]
2-514-008	PaperTransfer:2Side:S2	ENG	[1 to 110 / 81 / 1/step]
2-514-011	PaperTransfer:1Side:S3	ENG	[1 to 110 / 79 / 1/step]
2-514-012	PaperTransfer:2Side:S3	ENG	[1 to 110 / 82 / 1/step]
2-514-015	PaperTransfer:1Side:S4	ENG	[1 to 110 / 79 / 1/step]
2-514-016	PaperTransfer:2Side:S4	ENG	[1 to 110 / 83 / 1/step]
2-514-019	PaperTransfer:1Side:S5	ENG	[1 to 110 / 79 / 1/step]
2-514-020	PaperTransfer:2Side:S5	ENG	[1 to 110 / 84 / 1/step]
2-514-023	Wide Roller:PaperTransfer:1Side:S1	ENG	[1 to 110 / 77 / 1/step]
2-514-024	Wide Roller:PaperTransfer:2Side:S1	ENG	[1 to 110 / 80 / 1/step]
2-514-027	Wide Roller:PaperTransfer:1Side:S2	ENG	[1 to 110 / 78 / 1/step]
2-514-028	Wide Roller:PaperTransfer:2Side:S2	ENG	[1 to 110 / 81 / 1/step]
2-514-031	Wide Roller:PaperTransfer:1Side:S3	ENG	[1 to 110 / 79 / 1/step]
2-514-032	Wide Roller:PaperTransfer:2Side:S3	ENG	[1 to 110 / 82 / 1/step]
2-514-035	Wide Roller:PaperTransfer:1Side:S4	ENG	[1 to 110 / 79 / 1/step]
2-514-036	Wide Roller:PaperTransfer:2Side:S4	ENG	[1 to 110 / 83 / 1/step]
2-514-039	Wide Roller:PaperTransfer:1Side:S5	ENG	[1 to 110 / 79 / 1/step]
2-514-040	Wide Roller:PaperTransfer:2Side:S5	ENG	[1 to 110 / 84 / 1/step]

2515	[Thick2:LeadingEdgeCorrection]		
2-515-003	Paper Transfer:1side	ENG	[0 to 995 / 100 / 5%/step]
2-515-004	Paper Transfer:2side	ENG	[0 to 995 / 100 / 5%/step]

2516	[Thick2:SwitchTimingLeadEdge]		
2-516-003	Paper Transfer:1side	ENG	[0 to 50 / 0 / 2mm/step]
2-516-004	Paper Transfer:2side	ENG	[0 to 50 / 0 / 2mm/step]

2517	[Thick2:TrailEdgeCorrection]		
2-517-003	Paper Transfer:1side	ENG	[0 to 995 / 100 / 5%/step]
2-517-004	Paper Transfer:2side	ENG	[0 to 995 / 100 / 5%/step]

2518	[Thick2:SwitchTimingTrailEdge]		
2-518-003	Paper Transfer:1side	ENG	[0 to 50 / 0 / 2mm/step]
2-518-004	Paper Transfer:2side	ENG	[0 to 50 / 0 / 2mm/step]

2523	[Thick3:Bias:BW]		
2-523-003	PaperTransfer:1side	ENG	[0 to 200 / 11 / 1-uA/step]
2-523-004	PaperTransfer:2side	ENG	[0 to 200 / 15 / 1-uA/step]

2527	[Thick3:Bias:FC]		
2-527-003	PaperTransfer:1side	ENG	[0 to 200 / 19 / 1-uA/step]
2-527-004	PaperTransfer:2side	ENG	[0 to 200 / 21 / 1-uA/step]

2531	[Thick3:SizeCorrection:BW]		
2-531-003	PaperTransfer:1Side:S1	ENG	[100 to 995 / 100 / 1%/step]
2-531-004	PaperTransfer:2Side:S1	ENG	[100 to 995 / 100 / 1%/step]

2-531-007	PaperTransfer:1Side:S2	ENG	[100 to 995 / 100 / 1%/step]
2-531-008	PaperTransfer:2Side:S2	ENG	[100 to 995 / 133 / 1%/step]
2-531-011	PaperTransfer:1Side:S3	ENG	[100 to 995 / 100 / 1%/step]
2-531-012	PaperTransfer:2Side:S3	ENG	[100 to 995 / 167 / 1%/step]
2-531-015	PaperTransfer:1Side:S4	ENG	[100 to 995 / 100 / 1%/step]
2-531-016	PaperTransfer:2Side:S4	ENG	[100 to 995 / 233 / 1%/step]
2-531-019	PaperTransfer:1Side:S5	ENG	[100 to 995 / 100 / 1%/step]
2-531-020	PaperTransfer:2Side:S5	ENG	[100 to 995 / 267 / 1%/step]
2-531-023	Wide Roller:PaperTransfer:1Side:S1	ENG	[100 to 995 / 100 / 1%/step]
2-531-024	Wide Roller:PaperTransfer:2Side:S1	ENG	[100 to 995 / 100 / 1%/step]
2-531-027	Wide Roller:PaperTransfer:1Side:S2	ENG	[100 to 995 / 100 / 1%/step]
2-531-028	Wide Roller:PaperTransfer:2Side:S2	ENG	[100 to 995 / 133 / 1%/step]
2-531-031	Wide Roller:PaperTransfer:1Side:S3	ENG	[100 to 995 / 100 / 1%/step]
2-531-032	Wide Roller:PaperTransfer:2Side:S3	ENG	[100 to 995 / 167 / 1%/step]
2-531-035	Wide Roller:PaperTransfer:1Side:S4	ENG	[100 to 995 / 100 / 1%/step]
2-531-036	Wide Roller:PaperTransfer:2Side:S4	ENG	[100 to 995 / 233 / 1%/step]

2-531-039	Wide Roller:PaperTransfer:1Side:S5	ENG	[100 to 995 / 100 / 1%/step]
2-531-040	Wide Roller:PaperTransfer:2Side:S5	ENG	[100 to 995 / 267 / 1%/step]

2532	[Thick3:SizeCorrection:FC]		
2-532-003	PaperTransfer:1Side:S1	ENG	[100 to 995 / 100 / 1%/step]
2-532-004	PaperTransfer:2Side:S1	ENG	[100 to 995 / 100 / 1%/step]
2-532-007	PaperTransfer:1Side:S2	ENG	[100 to 995 / 100 / 1%/step]
2-532-008	PaperTransfer:2Side:S2	ENG	[100 to 995 / 181 / 1%/step]
2-532-011	PaperTransfer:1Side:S3	ENG	[100 to 995 / 100 / 1%/step]
2-532-012	PaperTransfer:2Side:S3	ENG	[100 to 995 / 229 / 1%/step]
2-532-015	PaperTransfer:1Side:S4	ENG	[100 to 995 / 100 / 1%/step]
2-532-016	PaperTransfer:2Side:S4	ENG	[100 to 995 / 286 / 1%/step]
2-532-019	PaperTransfer:1Side:S5	ENG	[100 to 995 / 100 / 1%/step]
2-532-020	PaperTransfer:2Side:S5	ENG	[100 to 995 / 381 / 1%/step]
2-532-023	Wide Roller:PaperTransfer:1Side:S1	ENG	[100 to 995 / 100 / 1%/step]
2-532-024	Wide Roller:PaperTransfer:2Side:S1	ENG	[100 to 995 / 100 / 1%/step]
2-532-027	Wide Roller:PaperTransfer:1Side:S2	ENG	[100 to 995 / 100 / 1%/step]

2-532-028	Wide Roller:PaperTransfer:2Side:S2	ENG	[100 to 995 / 181 / 1%/step]
2-532-031	Wide Roller:PaperTransfer:1Side:S3	ENG	[100 to 995 / 100 / 1%/step]
2-532-032	Wide Roller:PaperTransfer:2Side:S3	ENG	[100 to 995 / 229 / 1%/step]
2-532-035	Wide Roller:PaperTransfer:1Side:S4	ENG	[100 to 995 / 100 / 1%/step]
2-532-036	Wide Roller:PaperTransfer:2Side:S4	ENG	[100 to 995 / 286 / 1%/step]
2-532-039	Wide Roller:PaperTransfer:1Side:S5	ENG	[100 to 995 / 100 / 1%/step]
2-532-040	Wide Roller:PaperTransfer:2Side:S5	ENG	[100 to 995 / 381 / 1%/step]

2533	[Thick3:Size-Env.Correct:BW]		
2-533-003	PaperTransfer:1Side:S1	ENG	[1 to 110 / 85 / 1/step]
2-533-004	PaperTransfer:2Side:S1	ENG	[1 to 110 / 87 / 1/step]
2-533-007	PaperTransfer:1Side:S2	ENG	[1 to 110 / 86 / 1/step]
2-533-008	PaperTransfer:2Side:S2	ENG	[1 to 110 / 88 / 1/step]
2-533-011	PaperTransfer:1Side:S3	ENG	[1 to 110 / 86 / 1/step]
2-533-012	PaperTransfer:2Side:S3	ENG	[1 to 110 / 89 / 1/step]
2-533-015	PaperTransfer:1Side:S4	ENG	[1 to 110 / 86 / 1/step]
2-533-016	PaperTransfer:2Side:S4	ENG	[1 to 110 / 90 / 1/step]
2-533-019	PaperTransfer:1Side:S5	ENG	[1 to 110 / 86 / 1/step]
2-533-020	PaperTransfer:2Side:S5	ENG	[1 to 110 / 91 / 1/step]
2-533-023	Wide Roller:PaperTransfer:1Side:S1	ENG	[1 to 110 / 85 / 1/step]
2-533-024	Wide Roller:PaperTransfer:2Side:S1	ENG	[1 to 110 / 87 / 1/step]
2-533-027	Wide Roller:PaperTransfer:1Side:S2	ENG	[1 to 110 / 86 / 1/step]

2-533-028	Wide Roller:PaperTransfer:2Side:S2	ENG	[1 to 110 / 88 / 1/step]
2-533-031	Wide Roller:PaperTransfer:1Side:S3	ENG	[1 to 110 / 86 / 1/step]
2-533-032	Wide Roller:PaperTransfer:2Side:S3	ENG	[1 to 110 / 89 / 1/step]
2-533-035	Wide Roller:PaperTransfer:1Side:S4	ENG	[1 to 110 / 86 / 1/step]
2-533-036	Wide Roller:PaperTransfer:2Side:S4	ENG	[1 to 110 / 90 / 1/step]
2-533-039	Wide Roller:PaperTransfer:1Side:S5	ENG	[1 to 110 / 86 / 1/step]
2-533-040	Wide Roller:PaperTransfer:2Side:S5	ENG	[1 to 110 / 91 / 1/step]

2534	[Thick3:Size-Env.Correct:FC]		
2-534-003	PaperTransfer:1Side:S1	ENG	[1 to 110 / 77 / 1/step]
2-534-004	PaperTransfer:2Side:S1	ENG	[1 to 110 / 92 / 1/step]
2-534-007	PaperTransfer:1Side:S2	ENG	[1 to 110 / 78 / 1/step]
2-534-008	PaperTransfer:2Side:S2	ENG	[1 to 110 / 93 / 1/step]
2-534-011	PaperTransfer:1Side:S3	ENG	[1 to 110 / 79 / 1/step]
2-534-012	PaperTransfer:2Side:S3	ENG	[1 to 110 / 94 / 1/step]
2-534-015	PaperTransfer:1Side:S4	ENG	[1 to 110 / 79 / 1/step]
2-534-016	PaperTransfer:2Side:S4	ENG	[1 to 110 / 95 / 1/step]
2-534-019	PaperTransfer:1Side:S5	ENG	[1 to 110 / 79 / 1/step]
2-534-020	PaperTransfer:2Side:S5	ENG	[1 to 110 / 96 / 1/step]
2-534-023	Wide Roller:PaperTransfer:1Side:S1	ENG	[1 to 110 / 77 / 1/step]
2-534-024	Wide Roller:PaperTransfer:2Side:S1	ENG	[1 to 110 / 92 / 1/step]
2-534-027	Wide Roller:PaperTransfer:1Side:S2	ENG	[1 to 110 / 78 / 1/step]
2-534-028	Wide Roller:PaperTransfer:2Side:S2	ENG	[1 to 110 / 93 / 1/step]
2-534-031	Wide Roller:PaperTransfer:1Side:S3	ENG	[1 to 110 / 79 / 1/step]
2-534-032	Wide Roller:PaperTransfer:2Side:S3	ENG	[1 to 110 / 94 / 1/step]
2-534-035	Wide Roller:PaperTransfer:1Side:S4	ENG	[1 to 110 / 79 / 1/step]

2-534-036	Wide Roller:PaperTransfer:2Side:S4	ENG	[1 to 110 / 95 / 1/step]
2-534-039	Wide Roller:PaperTransfer:1Side:S5	ENG	[1 to 110 / 79 / 1/step]
2-534-040	Wide Roller:PaperTransfer:2Side:S5	ENG	[1 to 110 / 96 / 1/step]

2535	[Thick3:LeadingEdgeCorrection]		
2-535-003	Paper Transfer:1side	ENG	[0 to 995 / 100 / 5%/step]
2-535-004	Paper Transfer:2side	ENG	[0 to 995 / 100 / 5%/step]

2536	[Thick3:SwitchTimingLeadEdge]		
2-536-003	Paper Transfer:1side	ENG	[0 to 50 / 0 / 2mm/step]
2-536-004	Paper Transfer:2side	ENG	[0 to 50 / 0 / 2mm/step]

2537	[Thick3:TrailEdgeCorrection]		
2-537-003	Paper Transfer:1side	ENG	[0 to 995 / 100 / 5%/step]
2-537-004	Paper Transfer:2side	ENG	[0 to 995 / 100 / 5%/step]

2538	[Thick3:SwitchTimingTrailEdge]		
2-538-003	Paper Transfer:1side	ENG	[0 to 50 / 0 / 2mm/step]
2-538-004	Paper Transfer:2side	ENG	[0 to 50 / 0 / 2mm/step]

2543	[OHP:Bias:BW]		
2-543-003	PaperTransfer	ENG	[0 to 200 / 11 / 1-uA/step]

2547	[OHP:Bias:FC]		
2-547-003	PaperTransfer	ENG	[0 to 200 / 19 / 1-uA/step]

2551	[OHP:SizeCorrection:BW]		
2-551-003	PaperTransfer:S1	ENG	[100 to 995 / 100 / 1%/step]

2-551-007	PaperTransfer:S2	ENG	[100 to 995 / 100 / 1%/step]
2-551-011	PaperTransfer:S3	ENG	[100 to 995 / 100 / 1%/step]
2-551-015	PaperTransfer:S4	ENG	[100 to 995 / 100 / 1%/step]
2-551-019	PaperTransfer:S5	ENG	[100 to 995 / 100 / 1%/step]
2-551-023	Wide Roller:PaperTransfer:S1	ENG	[100 to 995 / 100 / 1%/step]
2-551-027	Wide Roller:PaperTransfer:S2	ENG	[100 to 995 / 100 / 1%/step]
2-551-031	Wide Roller:PaperTransfer:S3	ENG	[100 to 995 / 100 / 1%/step]
2-551-035	Wide Roller:PaperTransfer:S4	ENG	[100 to 995 / 100 / 1%/step]
2-551-039	Wide Roller:PaperTransfer:S5	ENG	[100 to 995 / 100 / 1%/step]

2552	[OHP:SizeCorrection:FC]		
2-552-003	PaperTransfer:S1	ENG	[100 to 995 / 100 / 1%/step]
2-552-007	PaperTransfer:S2	ENG	[100 to 995 / 181 / 1%/step]
2-552-011	PaperTransfer:S3	ENG	[100 to 995 / 229 / 1%/step]
2-552-015	PaperTransfer:S4	ENG	[100 to 995 / 286 / 1%/step]
2-552-019	PaperTransfer:S5	ENG	[100 to 995 / 381 / 1%/step]
2-552-023	Wide Roller:PaperTransfer:S1	ENG	[100 to 995 / 100 / 1%/step]

2-552-027	Wide Roller:PaperTransfer:S2	ENG	[100 to 995 / 181 / 1%/step]
2-552-031	Wide Roller:PaperTransfer:S3	ENG	[100 to 995 / 229 / 1%/step]
2-552-035	Wide Roller:PaperTransfer:S4	ENG	[100 to 995 / 286 / 1%/step]
2-552-039	Wide Roller:PaperTransfer:S5	ENG	[100 to 995 / 381 / 1%/step]

2553	[OHP:Size-Env.Correct:BW]		
2-553-003	PaperTransfer:S1	ENG	[1 to 110 / 70 / 1/step]
2-553-007	PaperTransfer:S2	ENG	[1 to 110 / 71 / 1/step]
2-553-011	PaperTransfer:S3	ENG	[1 to 110 / 72 / 1/step]
2-553-015	PaperTransfer:S4	ENG	[1 to 110 / 72 / 1/step]
2-553-019	PaperTransfer:S5	ENG	[1 to 110 / 72 / 1/step]
2-553-023	Wide Roller:PaperTransfer:S1	ENG	[1 to 110 / 70 / 1/step]
2-553-027	Wide Roller:PaperTransfer:S2	ENG	[1 to 110 / 71 / 1/step]
2-553-031	Wide Roller:PaperTransfer:S3	ENG	[1 to 110 / 72 / 1/step]
2-553-035	Wide Roller:PaperTransfer:S4	ENG	[1 to 110 / 72 / 1/step]
2-553-039	Wide Roller:PaperTransfer:S5	ENG	[1 to 110 / 72 / 1/step]

2554	[OHP:Size-Env.Correct:FC]		
2-554-003	PaperTransfer:S1	ENG	[1 to 110 / 77 / 1/step]
2-554-007	PaperTransfer:S2	ENG	[1 to 110 / 78 / 1/step]
2-554-011	PaperTransfer:S3	ENG	[1 to 110 / 79 / 1/step]
2-554-015	PaperTransfer:S4	ENG	[1 to 110 / 79 / 1/step]
2-554-019	PaperTransfer:S5	ENG	[1 to 110 / 79 / 1/step]
2-554-023	Wide Roller:PaperTransfer:S1	ENG	[1 to 110 / 77 / 1/step]

2-554-027	Wide Roller:PaperTransfer:S2	ENG	[1 to 110 / 78 / 1/step]
2-554-031	Wide Roller:PaperTransfer:S3	ENG	[1 to 110 / 79 / 1/step]
2-554-035	Wide Roller:PaperTransfer:S4	ENG	[1 to 110 / 79 / 1/step]
2-554-039	Wide Roller:PaperTransfer:S5	ENG	[1 to 110 / 79 / 1/step]

2555 [OHP:LeadingEdgeCorrection]

2-555-003	Paper Transfer	ENG	[0 to 995 / 100 / 5%/step]
-----------	----------------	-----	-----------------------------------

2556 [OHP:SwitchTimingLeadEdge]

2-556-003	Paper Transfer	ENG	[0 to 50 / 0 / 2mm/step]
-----------	----------------	-----	---------------------------------

2557 [OHP:TrailEdgeCorrection]

2-557-003	Paper Transfer	ENG	[0 to 995 / 100 / 5%/step]
-----------	----------------	-----	-----------------------------------

2558 [OHP:SwitchTimingTrailEdge]

2-558-003	Paper Transfer	ENG	[0 to 50 / 0 / 2mm/step]
-----------	----------------	-----	---------------------------------

2563 [Special 1 :Bias:BW]

2-563-001	PaperTransfer:standard:1side	ENG	[0 to 200 / 22 / 1-uA/step]
2-563-002	PaperTransfer:standard:2side	ENG	[0 to 200 / 22 / 1-uA/step]
2-563-003	PaperTransfer:low:1side	ENG	[0 to 200 / 11 / 1-uA/step]
2-563-004	PaperTransfer:low:2side	ENG	[0 to 200 / 11 / 1-uA/step]

2567 [Special 1 :Bias:FC]

2-567-001	PaperTransfer:standard:1side	ENG	[0 to 200 / 29 / 1-uA/step]
2-567-002	PaperTransfer:standard:2side	ENG	[0 to 200 / 29 / 1-uA/step]
2-567-003	PaperTransfer:low:1side	ENG	[0 to 200 / 14 / 1-uA/step]
2-567-004	PaperTransfer:low:2side	ENG	[0 to 200 / 14 / 1-uA/step]

2571	[Special 1:SizeCorrection:BW]		
2-571-001	PaperTransfer:Standard:1Sid:S1	ENG	[100 to 995 / 100 / 1%/step]
2-571-002	PaperTransfer:Standard:2Sid:S1	ENG	[100 to 995 / 100 / 1%/step]
2-571-003	PaperTransfer:Low:1Side:S1	ENG	[100 to 995 / 100 / 1%/step]
2-571-004	PaperTransfer:Low:2Side:S1	ENG	[100 to 995 / 100 / 1%/step]
2-571-005	PaperTransfer:Standard:1Sid:S2	ENG	[100 to 995 / 100 / 1%/step]
2-571-006	PaperTransfer:Standard:2Sid:S2	ENG	[100 to 995 / 105 / 1%/step]
2-571-007	PaperTransfer:Low:1Side:S2	ENG	[100 to 995 / 100 / 1%/step]
2-571-008	PaperTransfer:Low:2Side:S2	ENG	[100 to 995 / 105 / 1%/step]
2-571-009	PaperTransfer:Standard:1Sid:S3	ENG	[100 to 995 / 105 / 1%/step]
2-571-010	PaperTransfer:Standard:2Sid:S3	ENG	[100 to 995 / 118 / 1%/step]
2-571-011	PaperTransfer:Low:1Side:S3	ENG	[100 to 995 / 105 / 1%/step]
2-571-012	PaperTransfer:Low:2Side:S3	ENG	[100 to 995 / 118 / 1%/step]
2-571-013	PaperTransfer:Standard:1Sid:S4	ENG	[100 to 995 / 118 / 1%/step]
2-571-014	PaperTransfer:Standard:2Sid:S4	ENG	[100 to 995 / 131 / 1%/step]
2-571-015	PaperTransfer:Low:1Side:S4	ENG	[100 to 995 / 118 / 1%/step]

2-571-016	PaperTransfer:Low:2Side:S4	ENG	[100 to 995 / 131 / 1%/step]
2-571-017	PaperTransfer:Standard:1Sid:S5	ENG	[100 to 995 / 132 / 1%/step]
2-571-018	PaperTransfer:Standard:2Sid:S5	ENG	[100 to 995 / 184 / 1%/step]
2-571-019	PaperTransfer:Low:1 Side:S5	ENG	[100 to 995 / 132 / 1%/step]
2-571-020	PaperTransfer:Low:2Side:S5	ENG	[100 to 995 / 184 / 1%/step]
2-571-021	Wide Roller:PaperTransfer:Standard:1Sid:S1	ENG	[100 to 995 / 100 / 1%/step]
2-571-022	Wide Roller:PaperTransfer:Standard:2Sid:S1	ENG	[100 to 995 / 100 / 1%/step]
2-571-023	Wide Roller:PaperTransfer:Low:1 Side:S1	ENG	[100 to 995 / 100 / 1%/step]
2-571-024	Wide Roller:PaperTransfer:Low:2Side:S1	ENG	[100 to 995 / 100 / 1%/step]
2-571-025	Wide Roller:PaperTransfer:Standard:1Sid:S2	ENG	[100 to 995 / 100 / 1%/step]
2-571-026	Wide Roller:PaperTransfer:Standard:2Sid:S2	ENG	[100 to 995 / 105 / 1%/step]
2-571-027	Wide Roller:PaperTransfer:Low:1 Side:S2	ENG	[100 to 995 / 100 / 1%/step]
2-571-028	Wide Roller:PaperTransfer:Low:2Side:S2	ENG	[100 to 995 / 105 / 1%/step]
2-571-029	Wide Roller:PaperTransfer:Standard:1Sid:S3	ENG	[100 to 995 / 105 / 1%/step]
2-571-030	Wide Roller:PaperTransfer:Standard:2Sid:S3	ENG	[100 to 995 / 118 / 1%/step]
2-571-031	Wide Roller:PaperTransfer:Low:1 Side:S3	ENG	[100 to 995 / 105 / 1%/step]

2-571-032	Wide Roller:PaperTransfer:Low:2Side:S3	ENG	[100 to 995 / 118 / 1%/step]
2-571-033	Wide Roller:PaperTransfer:Standard:1Sid:S4	ENG	[100 to 995 / 118 / 1%/step]
2-571-034	Wide Roller:PaperTransfer:Standard:2Sid:S4	ENG	[100 to 995 / 131 / 1%/step]
2-571-035	Wide Roller:PaperTransfer:Low:1 Side:S4	ENG	[100 to 995 / 118 / 1%/step]
2-571-036	Wide Roller:PaperTransfer:Low:2Side:S4	ENG	[100 to 995 / 131 / 1%/step]
2-571-037	Wide Roller:PaperTransfer:Standard:1Sid:S5	ENG	[100 to 995 / 132 / 1%/step]
2-571-038	Wide Roller:PaperTransfer:Standard:2Sid:S5	ENG	[100 to 995 / 184 / 1%/step]
2-571-039	Wide Roller:PaperTransfer:Low:1 Side:S5	ENG	[100 to 995 / 132 / 1%/step]
2-571-040	Wide Roller:PaperTransfer:Low:2Side:S5	ENG	[100 to 995 / 184 / 1%/step]

2572	[Special 1:SizeCorrection:FC]		
2-572-001	PaperTransfer:Standard:1Sid:S1	ENG	[100 to 995 / 100 / 1%/step]
2-572-002	PaperTransfer:Standard:2Sid:S1	ENG	[100 to 995 / 100 / 1%/step]
2-572-003	PaperTransfer:Low:1 Side:S 1	ENG	[100 to 995 / 100 / 1%/step]
2-572-004	PaperTransfer:Low:2Side:S 1	ENG	[100 to 995 / 100 / 1%/step]
2-572-005	PaperTransfer:Standard:1Sid:S2	ENG	[100 to 995 / 120 / 1%/step]
2-572-006	PaperTransfer:Standard:2Sid:S2	ENG	[100 to 995 / 140 / 1%/step]

2-572-007	PaperTransfer:Low:1Side:S2	ENG	[100 to 995 / 120 / 1%/step]
2-572-008	PaperTransfer:Low:2Side:S2	ENG	[100 to 995 / 140 / 1%/step]
2-572-009	PaperTransfer:Standard:1Sid:S3	ENG	[100 to 995 / 118 / 1%/step]
2-572-010	PaperTransfer:Standard:2Sid:S3	ENG	[100 to 995 / 180 / 1%/step]
2-572-011	PaperTransfer:Low:1Side:S3	ENG	[100 to 995 / 118 / 1%/step]
2-572-012	PaperTransfer:Low:2Side:S3	ENG	[100 to 995 / 180 / 1%/step]
2-572-013	PaperTransfer:Standard:1Sid:S4	ENG	[100 to 995 / 130 / 1%/step]
2-572-014	PaperTransfer:Standard:2Sid:S4	ENG	[100 to 995 / 200 / 1%/step]
2-572-015	PaperTransfer:Low:1Side:S4	ENG	[100 to 995 / 130 / 1%/step]
2-572-016	PaperTransfer:Low:2Side:S4	ENG	[100 to 995 / 200 / 1%/step]
2-572-017	PaperTransfer:Standard:1Sid:S5	ENG	[100 to 995 / 140 / 1%/step]
2-572-018	PaperTransfer:Standard:2Sid:S5	ENG	[100 to 995 / 240 / 1%/step]
2-572-019	PaperTransfer:Low:1Side:S5	ENG	[100 to 995 / 140 / 1%/step]
2-572-020	PaperTransfer:Low:2Side:S5	ENG	[100 to 995 / 240 / 1%/step]
2-572-021	Wide Roller:PaperTransfer:Standard:1Sid:S1	ENG	[100 to 995 / 100 / 1%/step]
2-572-022	Wide Roller:PaperTransfer:Standard:2Sid:S1	ENG	[100 to 995 / 100 / 1%/step]

2-572-023	Wide Roller:PaperTransfer:Low:1 Side:S1	ENG	[100 to 995 / 100 / 1%/step]
2-572-024	Wide Roller:PaperTransfer:Low:2Side:S1	ENG	[100 to 995 / 100 / 1%/step]
2-572-025	Wide Roller:PaperTransfer:Standard:1Sid:S2	ENG	[100 to 995 / 120 / 1%/step]
2-572-026	Wide Roller:PaperTransfer:Standard:2Sid:S2	ENG	[100 to 995 / 140 / 1%/step]
2-572-027	Wide Roller:PaperTransfer:Low:1 Side:S2	ENG	[100 to 995 / 120 / 1%/step]
2-572-028	Wide Roller:PaperTransfer:Low:2Side:S2	ENG	[100 to 995 / 140 / 1%/step]
2-572-029	Wide Roller:PaperTransfer:Standard:1Sid:S3	ENG	[100 to 995 / 118 / 1%/step]
2-572-030	Wide Roller:PaperTransfer:Standard:2Sid:S3	ENG	[100 to 995 / 180 / 1%/step]
2-572-031	Wide Roller:PaperTransfer:Low:1 Side:S3	ENG	[100 to 995 / 118 / 1%/step]
2-572-032	Wide Roller:PaperTransfer:Low:2Side:S3	ENG	[100 to 995 / 180 / 1%/step]
2-572-033	Wide Roller:PaperTransfer:Standard:1Sid:S4	ENG	[100 to 995 / 130 / 1%/step]
2-572-034	Wide Roller:PaperTransfer:Standard:2Sid:S4	ENG	[100 to 995 / 200 / 1%/step]
2-572-035	Wide Roller:PaperTransfer:Low:1 Side:S4	ENG	[100 to 995 / 130 / 1%/step]
2-572-036	Wide Roller:PaperTransfer:Low:2Side:S4	ENG	[100 to 995 / 200 / 1%/step]
2-572-037	Wide Roller:PaperTransfer:Standard:1Sid:S5	ENG	[100 to 995 / 140 / 1%/step]
2-572-038	Wide Roller:PaperTransfer:Standard:2Sid:S5	ENG	[100 to 995 / 240 / 1%/step]

2-572-039	Wide Roller:PaperTransfer:Low:1 Side:S5	ENG	[100 to 995 / 140 / 1%/step]
2-572-040	Wide Roller:PaperTransfer:Low:2Side:S5	ENG	[100 to 995 / 240 / 1%/step]

2573	[Special 1:Size-Env.Correct:BW]		
2-573-001	PaperTransfer:Standard:1Sid:S1	ENG	[1 to 110 / 10 / 1/step]
2-573-002	PaperTransfer:Standard:2Sid:S1	ENG	[1 to 110 / 15 / 1/step]
2-573-003	PaperTransfer:Low:1 Side:S1	ENG	[1 to 110 / 10 / 1/step]
2-573-004	PaperTransfer:Low:2Side:S1	ENG	[1 to 110 / 15 / 1/step]
2-573-005	PaperTransfer:Standard:1Sid:S2	ENG	[1 to 110 / 11 / 1/step]
2-573-006	PaperTransfer:Standard:2Sid:S2	ENG	[1 to 110 / 16 / 1/step]
2-573-007	PaperTransfer:Low:1 Side:S2	ENG	[1 to 110 / 11 / 1/step]
2-573-008	PaperTransfer:Low:2Side:S2	ENG	[1 to 110 / 16 / 1/step]
2-573-009	PaperTransfer:Standard:1Sid:S3	ENG	[1 to 110 / 12 / 1/step]
2-573-010	PaperTransfer:Standard:2Sid:S3	ENG	[1 to 110 / 17 / 1/step]
2-573-011	PaperTransfer:Low:1 Side:S3	ENG	[1 to 110 / 12 / 1/step]
2-573-012	PaperTransfer:Low:2Side:S3	ENG	[1 to 110 / 17 / 1/step]
2-573-013	PaperTransfer:Standard:1Sid:S4	ENG	[1 to 110 / 13 / 1/step]
2-573-014	PaperTransfer:Standard:2Sid:S4	ENG	[1 to 110 / 18 / 1/step]
2-573-015	PaperTransfer:Low:1 Side:S4	ENG	[1 to 110 / 13 / 1/step]
2-573-016	PaperTransfer:Low:2Side:S4	ENG	[1 to 110 / 18 / 1/step]
2-573-017	PaperTransfer:Standard:1Sid:S5	ENG	[1 to 110 / 14 / 1/step]
2-573-018	PaperTransfer:Standard:2Sid:S5	ENG	[1 to 110 / 19 / 1/step]
2-573-019	PaperTransfer:Low:1 Side:S5	ENG	[1 to 110 / 14 / 1/step]
2-573-020	PaperTransfer:Low:2Side:S5	ENG	[1 to 110 / 19 / 1/step]

2-573-021	Wide Roller:PaperTransfer:Standard: 1Sid:S1	ENG	[1 to 110 / 10 / 1/step]
2-573-022	Wide Roller:PaperTransfer:Standard: 2Sid:S1	ENG	[1 to 110 / 15 / 1/step]
2-573-023	Wide Roller:PaperTransfer:Low:1 Side:S1	ENG	[1 to 110 / 10 / 1/step]
2-573-024	Wide Roller:PaperTransfer:Low:2Side:S1	ENG	[1 to 110 / 15 / 1/step]
2-573-025	Wide Roller:PaperTransfer:Standard: 1Sid:S2	ENG	[1 to 110 / 11 / 1/step]
2-573-026	Wide Roller:PaperTransfer:Standard: 2Sid:S2	ENG	[1 to 110 / 16 / 1/step]
2-573-027	Wide Roller:PaperTransfer:Low:1 Side:S2	ENG	[1 to 110 / 11 / 1/step]
2-573-028	Wide Roller:PaperTransfer:Low:2Side:S2	ENG	[1 to 110 / 16 / 1/step]
2-573-029	Wide Roller:PaperTransfer:Standard: 1Sid:S3	ENG	[1 to 110 / 12 / 1/step]
2-573-030	Wide Roller:PaperTransfer:Standard: 2Sid:S3	ENG	[1 to 110 / 17 / 1/step]
2-573-031	Wide Roller:PaperTransfer:Low:1 Side:S3	ENG	[1 to 110 / 12 / 1/step]
2-573-032	Wide Roller:PaperTransfer:Low:2Side:S3	ENG	[1 to 110 / 17 / 1/step]
2-573-033	Wide Roller:PaperTransfer:Standard: 1Sid:S4	ENG	[1 to 110 / 13 / 1/step]
2-573-034	Wide Roller:PaperTransfer:Standard: 2Sid:S4	ENG	[1 to 110 / 18 / 1/step]
2-573-035	Wide Roller:PaperTransfer:Low:1 Side:S4	ENG	[1 to 110 / 13 / 1/step]
2-573-036	Wide Roller:PaperTransfer:Low:2Side:S4	ENG	[1 to 110 / 18 / 1/step]
2-573-037	Wide Roller:PaperTransfer:Standard: 1Sid:S5	ENG	[1 to 110 / 14 / 1/step]
2-573-038	Wide Roller:PaperTransfer:Standard: 2Sid:S5	ENG	[1 to 110 / 19 / 1/step]
2-573-039	Wide Roller:PaperTransfer:Low:1 Side:S5	ENG	[1 to 110 / 14 / 1/step]
2-573-040	Wide Roller:PaperTransfer:Low:2Side:S5	ENG	[1 to 110 / 19 / 1/step]

2574	[Special 1:Size-Env.Correct:FC]		
2-574-001	PaperTransfer:Standard:1Sid:S1	ENG	[1 to 110 / 20 / 1/step]
2-574-002	PaperTransfer:Standard:2Sid:S1	ENG	[1 to 110 / 25 / 1/step]
2-574-003	PaperTransfer:Low:1Side:S1	ENG	[1 to 110 / 20 / 1/step]
2-574-004	PaperTransfer:Low:2Side:S1	ENG	[1 to 110 / 25 / 1/step]
2-574-005	PaperTransfer:Standard:1Sid:S2	ENG	[1 to 110 / 21 / 1/step]
2-574-006	PaperTransfer:Standard:2Sid:S2	ENG	[1 to 110 / 26 / 1/step]
2-574-007	PaperTransfer:Low:1Side:S2	ENG	[1 to 110 / 21 / 1/step]
2-574-008	PaperTransfer:Low:2Side:S2	ENG	[1 to 110 / 26 / 1/step]
2-574-009	PaperTransfer:Standard:1Sid:S3	ENG	[1 to 110 / 22 / 1/step]
2-574-010	PaperTransfer:Standard:2Sid:S3	ENG	[1 to 110 / 27 / 1/step]
2-574-011	PaperTransfer:Low:1Side:S3	ENG	[1 to 110 / 22 / 1/step]
2-574-012	PaperTransfer:Low:2Side:S3	ENG	[1 to 110 / 27 / 1/step]
2-574-013	PaperTransfer:Standard:1Sid:S4	ENG	[1 to 110 / 23 / 1/step]
2-574-014	PaperTransfer:Standard:2Sid:S4	ENG	[1 to 110 / 28 / 1/step]
2-574-015	PaperTransfer:Low:1Side:S4	ENG	[1 to 110 / 23 / 1/step]
2-574-016	PaperTransfer:Low:2Side:S4	ENG	[1 to 110 / 28 / 1/step]
2-574-017	PaperTransfer:Standard:1Sid:S5	ENG	[1 to 110 / 24 / 1/step]
2-574-018	PaperTransfer:Standard:2Sid:S5	ENG	[1 to 110 / 29 / 1/step]
2-574-019	PaperTransfer:Low:1Side:S5	ENG	[1 to 110 / 24 / 1/step]
2-574-020	PaperTransfer:Low:2Side:S5	ENG	[1 to 110 / 29 / 1/step]
2-574-021	Wide Roller:PaperTransfer:Standard: 1Sid:S1	ENG	[1 to 110 / 20 / 1/step]
2-574-022	Wide Roller:PaperTransfer:Standard: 2Sid:S1	ENG	[1 to 110 / 25 / 1/step]
2-574-023	Wide Roller:PaperTransfer:Low:1Side:S1	ENG	[1 to 110 / 20 / 1/step]

2-574-024	Wide Roller:PaperTransfer:Low:2Side:S1	ENG	[1 to 110 / 25 / 1/step]
2-574-025	Wide Roller:PaperTransfer:Standard:1Sid:S2	ENG	[1 to 110 / 21 / 1/step]
2-574-026	Wide Roller:PaperTransfer:Standard:2Sid:S2	ENG	[1 to 110 / 26 / 1/step]
2-574-027	Wide Roller:PaperTransfer:Low:1Side:S2	ENG	[1 to 110 / 21 / 1/step]
2-574-028	Wide Roller:PaperTransfer:Low:2Side:S2	ENG	[1 to 110 / 26 / 1/step]
2-574-029	Wide Roller:PaperTransfer:Standard:1Sid:S3	ENG	[1 to 110 / 22 / 1/step]
2-574-030	Wide Roller:PaperTransfer:Standard:2Sid:S3	ENG	[1 to 110 / 27 / 1/step]
2-574-031	Wide Roller:PaperTransfer:Low:1Side:S3	ENG	[1 to 110 / 22 / 1/step]
2-574-032	Wide Roller:PaperTransfer:Low:2Side:S3	ENG	[1 to 110 / 27 / 1/step]
2-574-033	Wide Roller:PaperTransfer:Standard:1Sid:S4	ENG	[1 to 110 / 23 / 1/step]
2-574-034	Wide Roller:PaperTransfer:Standard:2Sid:S4	ENG	[1 to 110 / 28 / 1/step]
2-574-035	Wide Roller:PaperTransfer:Low:1Side:S4	ENG	[1 to 110 / 23 / 1/step]
2-574-036	Wide Roller:PaperTransfer:Low:2Side:S4	ENG	[1 to 110 / 28 / 1/step]
2-574-037	Wide Roller:PaperTransfer:Standard:1Sid:S5	ENG	[1 to 110 / 24 / 1/step]
2-574-038	Wide Roller:PaperTransfer:Standard:2Sid:S5	ENG	[1 to 110 / 29 / 1/step]
2-574-039	Wide Roller:PaperTransfer:Low:1Side:S5	ENG	[1 to 110 / 24 / 1/step]
2-574-040	Wide Roller:PaperTransfer:Low:2Side:S5	ENG	[1 to 110 / 29 / 1/step]

2575	[Special 1:LeadingEdgeCorrection]		
2-575-001	PaperTransfer:Standard:1Side	ENG	[0 to 995 / 100 / 5%/step]
2-575-002	PaperTransfer:Standard:2Side	ENG	[0 to 995 / 100 / 5%/step]

2-575-003	Paper Transfer:Low:1 side	ENG	[0 to 995 / 100 / 5%/step]
2-575-004	Paper Transfer:Low:2side	ENG	[0 to 995 / 100 / 5%/step]

2576	[Special 1:SwitchTimingLeadEdge]		
2-576-001	PaperTransfer:Standard:1 side	ENG	[0 to 50 / 0 / 2mm/step]
2-576-002	PaperTransfer:Standard:2side	ENG	[0 to 50 / 0 / 2mm/step]
2-576-003	Paper Transfer:Low:1 side	ENG	[0 to 50 / 0 / 2mm/step]
2-576-004	Paper Transfer:Low:2side	ENG	[0 to 50 / 0 / 2mm/step]

2577	[Special 1:TrailEdgeCorrection]		
2-577-001	PaperTransfer:Standard:1Side	ENG	[0 to 995 / 100 / 5%/step]
2-577-002	PaperTransfer:Standard:2Side	ENG	[0 to 995 / 100 / 5%/step]
2-577-003	Paper Transfer:Low:1 side	ENG	[0 to 995 / 100 / 5%/step]
2-577-004	Paper Transfer:Low:2side	ENG	[0 to 995 / 100 / 5%/step]

2578	[Special 1:SwitchTimingTrailEdge]		
2-578-001	PaperTransfer:Standard:1 side	ENG	[0 to 50 / 0 / 2mm/step]
2-578-002	PaperTransfer:Standard:2side	ENG	[0 to 50 / 0 / 2mm/step]
2-578-003	Paper Transfer:Low:1 side	ENG	[0 to 50 / 0 / 2mm/step]
2-578-004	Paper Transfer:Low:2side	ENG	[0 to 50 / 0 / 2mm/step]

2583	[Special 2:Bias:BW]		
2-583-001	PaperTransfer:standard:1 side	ENG	[0 to 200 / 22 / 1-uA/step]
2-583-002	PaperTransfer:standard:2side	ENG	[0 to 200 / 22 / 1-uA/step]
2-583-003	PaperTransfer:low:1 side	ENG	[0 to 200 / 11 / 1-uA/step]
2-583-004	PaperTransfer:low:2side	ENG	[0 to 200 / 11 / 1-uA/step]

2587	[Special 2:Bias:FC]		
-------------	----------------------------	--	--

2-587-001	PaperTransfer:standard:1side	ENG	[0 to 200 / 29 / 1-uA/step]
2-587-002	PaperTransfer:standard:2side	ENG	[0 to 200 / 29 / 1-uA/step]
2-587-003	PaperTransfer:low:1side	ENG	[0 to 200 / 14 / 1-uA/step]
2-587-004	PaperTransfer:low:2side	ENG	[0 to 200 / 14 / 1-uA/step]

2591	[Special2:SizeCorrection:BW]		
2-591-001	PaperTransfer:standard:1Sid:S1	ENG	[100 to 995 / 100 / 1%/step]
2-591-002	PaperTransfer:standard:2Sid:S1	ENG	[100 to 995 / 100 / 1%/step]
2-591-003	PaperTransfer:Low:1Side:S1	ENG	[100 to 995 / 100 / 1%/step]
2-591-004	PaperTransfer:Low:2Side:S1	ENG	[100 to 995 / 100 / 1%/step]
2-591-005	PaperTransfer:standard:1Sid:S2	ENG	[100 to 995 / 100 / 1%/step]
2-591-006	PaperTransfer:standard:2Sid:S2	ENG	[100 to 995 / 105 / 1%/step]
2-591-007	PaperTransfer:Low:1Side:S2	ENG	[100 to 995 / 100 / 1%/step]
2-591-008	PaperTransfer:Low:2Side:S2	ENG	[100 to 995 / 105 / 1%/step]
2-591-009	PaperTransfer:standard:1Sid:S3	ENG	[100 to 995 / 105 / 1%/step]
2-591-010	PaperTransfer:standard:2Sid:S3	ENG	[100 to 995 / 118 / 1%/step]
2-591-011	PaperTransfer:Low:1Side:S3	ENG	[100 to 995 / 105 / 1%/step]
2-591-012	PaperTransfer:Low:2Side:S3	ENG	[100 to 995 / 118 / 1%/step]

2-591-013	PaperTransfer:standard:1Sid:S4	ENG	[100 to 995 / 118 / 1%/step]
2-591-014	PaperTransfer:standard:2Sid:S4	ENG	[100 to 995 / 131 / 1%/step]
2-591-015	PaperTransfer:Low:1Side:S4	ENG	[100 to 995 / 118 / 1%/step]
2-591-016	PaperTransfer:Low:2Side:S4	ENG	[100 to 995 / 131 / 1%/step]
2-591-017	PaperTransfer:Standard:1Sid:S5	ENG	[100 to 995 / 132 / 1%/step]
2-591-018	PaperTransfer:Standard:2Sid:S5	ENG	[100 to 995 / 184 / 1%/step]
2-591-019	PaperTransfer:Low:1Side:S5	ENG	[100 to 995 / 132 / 1%/step]
2-591-020	PaperTransfer:Low:2Side:S5	ENG	[100 to 995 / 184 / 1%/step]
2-591-021	Wide Roller:PaperTransfer:Standard:1Sid:S1	ENG	[100 to 995 / 100 / 1%/step]
2-591-022	Wide Roller:PaperTransfer:Standard:2Sid:S1	ENG	[100 to 995 / 100 / 1%/step]
2-591-023	Wide Roller:PaperTransfer:Low:1Side:S1	ENG	[100 to 995 / 100 / 1%/step]
2-591-024	Wide Roller:PaperTransfer:Low:2Side:S1	ENG	[100 to 995 / 100 / 1%/step]
2-591-025	Wide Roller:PaperTransfer:Standard:1Sid:S2	ENG	[100 to 995 / 100 / 1%/step]
2-591-026	Wide Roller:PaperTransfer:Standard:2Sid:S2	ENG	[100 to 995 / 105 / 1%/step]
2-591-027	Wide Roller:PaperTransfer:Low:1Side:S2	ENG	[100 to 995 / 100 / 1%/step]
2-591-028	Wide Roller:PaperTransfer:Low:2Side:S2	ENG	[100 to 995 / 105 / 1%/step]

2-591-029	Wide Roller:PaperTransfer:Standard: 1Sid:S3	ENG	[100 to 995 / 105 / 1%/ step]
2-591-030	Wide Roller:PaperTransfer:Standard: 2Sid:S3	ENG	[100 to 995 / 118 / 1%/ step]
2-591-031	Wide Roller:PaperTransfer:Low: 1 Side:S3	ENG	[100 to 995 / 105 / 1%/ step]
2-591-032	Wide Roller:PaperTransfer:Low:2Side:S3	ENG	[100 to 995 / 118 / 1%/ step]
2-591-033	Wide Roller:PaperTransfer:Standard: 1Sid:S4	ENG	[100 to 995 / 118 / 1%/ step]
2-591-034	Wide Roller:PaperTransfer:Standard: 2Sid:S4	ENG	[100 to 995 / 131 / 1%/ step]
2-591-035	Wide Roller:PaperTransfer:Low: 1 Side:S4	ENG	[100 to 995 / 118 / 1%/ step]
2-591-036	Wide Roller:PaperTransfer:Low:2Side:S4	ENG	[100 to 995 / 131 / 1%/ step]
2-591-037	Wide Roller:PaperTransfer:Standard: 1Sid:S5	ENG	[100 to 995 / 132 / 1%/ step]
2-591-038	Wide Roller:PaperTransfer:Standard: 2Sid:S5	ENG	[100 to 995 / 184 / 1%/ step]
2-591-039	Wide Roller:PaperTransfer:Low: 1 Side:S5	ENG	[100 to 995 / 132 / 1%/ step]
2-591-040	Wide Roller:PaperTransfer:Low:2Side:S5	ENG	[100 to 995 / 184 / 1%/ step]

2592	[Special2:SizeCorrection:FC]		
2-592-001	PaperTransfer:standard: 1 Sid:S1	ENG	[100 to 995 / 100 / 1%/ step]
2-592-002	PaperTransfer:standard:2Sid:S1	ENG	[100 to 995 / 100 / 1%/ step]
2-592-003	PaperTransfer:Low: 1 Side:S1	ENG	[100 to 995 / 100 / 1%/ step]

2-592-004	PaperTransfer:Low:2Side:S1	ENG	[100 to 995 / 100 / 1%/step]
2-592-005	PaperTransfer:standard:1Sid:S2	ENG	[100 to 995 / 120 / 1%/step]
2-592-006	PaperTransfer:standard:2Sid:S2	ENG	[100 to 995 / 140 / 1%/step]
2-592-007	PaperTransfer:Low:1Side:S2	ENG	[100 to 995 / 120 / 1%/step]
2-592-008	PaperTransfer:Low:2Side:S2	ENG	[100 to 995 / 140 / 1%/step]
2-592-009	PaperTransfer:standard:1Sid:S3	ENG	[100 to 995 / 118 / 1%/step]
2-592-010	PaperTransfer:standard:2Sid:S3	ENG	[100 to 995 / 180 / 1%/step]
2-592-011	PaperTransfer:Low:1Side:S3	ENG	[100 to 995 / 118 / 1%/step]
2-592-012	PaperTransfer:Low:2Side:S3	ENG	[100 to 995 / 180 / 1%/step]
2-592-013	PaperTransfer:standard:1Sid:S4	ENG	[100 to 995 / 130 / 1%/step]
2-592-014	PaperTransfer:standard:2Sid:S4	ENG	[100 to 995 / 200 / 1%/step]
2-592-015	PaperTransfer:Low:1Side:S4	ENG	[100 to 995 / 130 / 1%/step]
2-592-016	PaperTransfer:Low:2Side:S4	ENG	[100 to 995 / 200 / 1%/step]
2-592-017	PaperTransfer:Standard:1Sid:S5	ENG	[100 to 995 / 140 / 1%/step]
2-592-018	PaperTransfer:Standard:2Sid:S5	ENG	[100 to 995 / 240 / 1%/step]
2-592-019	PaperTransfer:Low:1Side:S5	ENG	[100 to 995 / 140 / 1%/step]

2-592-020	PaperTransfer:Low:2Side:S5	ENG	[100 to 995 / 240 / 1%/step]
2-592-021	Wide Roller:PaperTransfer:Standard:1Sid:S1	ENG	[100 to 995 / 100 / 1%/step]
2-592-022	Wide Roller:PaperTransfer:Standard:2Sid:S1	ENG	[100 to 995 / 100 / 1%/step]
2-592-023	Wide Roller:PaperTransfer:Low:1 Side:S1	ENG	[100 to 995 / 100 / 1%/step]
2-592-024	Wide Roller:PaperTransfer:Low:2Side:S1	ENG	[100 to 995 / 100 / 1%/step]
2-592-025	Wide Roller:PaperTransfer:Standard:1Sid:S2	ENG	[100 to 995 / 120 / 1%/step]
2-592-026	Wide Roller:PaperTransfer:Standard:2Sid:S2	ENG	[100 to 995 / 140 / 1%/step]
2-592-027	Wide Roller:PaperTransfer:Low:1 Side:S2	ENG	[100 to 995 / 120 / 1%/step]
2-592-028	Wide Roller:PaperTransfer:Low:2Side:S2	ENG	[100 to 995 / 140 / 1%/step]
2-592-029	Wide Roller:PaperTransfer:Standard:1Sid:S3	ENG	[100 to 995 / 118 / 1%/step]
2-592-030	Wide Roller:PaperTransfer:Standard:2Sid:S3	ENG	[100 to 995 / 180 / 1%/step]
2-592-031	Wide Roller:PaperTransfer:Low:1 Side:S3	ENG	[100 to 995 / 118 / 1%/step]
2-592-032	Wide Roller:PaperTransfer:Low:2Side:S3	ENG	[100 to 995 / 180 / 1%/step]
2-592-033	Wide Roller:PaperTransfer:Standard:1Sid:S4	ENG	[100 to 995 / 130 / 1%/step]
2-592-034	Wide Roller:PaperTransfer:Standard:2Sid:S4	ENG	[100 to 995 / 200 / 1%/step]
2-592-035	Wide Roller:PaperTransfer:Low:1 Side:S4	ENG	[100 to 995 / 130 / 1%/step]

2-592-036	Wide Roller:PaperTransfer:Low:2Side:S4	ENG	[100 to 995 / 200 / 1%/step]
2-592-037	Wide Roller:PaperTransfer:Standard:1Sid:S5	ENG	[100 to 995 / 140 / 1%/step]
2-592-038	Wide Roller:PaperTransfer:Standard:2Sid:S5	ENG	[100 to 995 / 240 / 1%/step]
2-592-039	Wide Roller:PaperTransfer:Low:1 Side:S5	ENG	[100 to 995 / 140 / 1%/step]
2-592-040	Wide Roller:PaperTransfer:Low:2Side:S5	ENG	[100 to 995 / 240 / 1%/step]

2593	[Special2:Size-Env.Correct:BW]		
2-593-001	PaperTransfer:standard:1Sid:S1	ENG	[1 to 110 / 10 / 1/step]
2-593-002	PaperTransfer:standard:2Sid:S1	ENG	[1 to 110 / 15 / 1/step]
2-593-003	PaperTransfer:Low:1 Side:S1	ENG	[1 to 110 / 10 / 1/step]
2-593-004	PaperTransfer:Low:2Side:S1	ENG	[1 to 110 / 15 / 1/step]
2-593-005	PaperTransfer:standard:1Sid:S2	ENG	[1 to 110 / 11 / 1/step]
2-593-006	PaperTransfer:standard:2Sid:S2	ENG	[1 to 110 / 16 / 1/step]
2-593-007	PaperTransfer:Low:1 Side:S2	ENG	[1 to 110 / 11 / 1/step]
2-593-008	PaperTransfer:Low:2Side:S2	ENG	[1 to 110 / 16 / 1/step]
2-593-009	PaperTransfer:standard:1Sid:S3	ENG	[1 to 110 / 12 / 1/step]
2-593-010	PaperTransfer:standard:2Sid:S3	ENG	[1 to 110 / 17 / 1/step]
2-593-011	PaperTransfer:Low:1 Side:S3	ENG	[1 to 110 / 12 / 1/step]
2-593-012	PaperTransfer:Low:2Side:S3	ENG	[1 to 110 / 17 / 1/step]
2-593-013	PaperTransfer:standard:1Sid:S4	ENG	[1 to 110 / 13 / 1/step]
2-593-014	PaperTransfer:standard:2Sid:S4	ENG	[1 to 110 / 18 / 1/step]
2-593-015	PaperTransfer:Low:1 Side:S4	ENG	[1 to 110 / 13 / 1/step]
2-593-016	PaperTransfer:Low:2Side:S4	ENG	[1 to 110 / 18 / 1/step]

2-593-017	PaperTransfer:Standard:1Sid:S5	ENG	[1 to 110 / 14 / 1/step]
2-593-018	PaperTransfer:Standard:2Sid:S5	ENG	[1 to 110 / 19 / 1/step]
2-593-019	PaperTransfer:Low:1Side:S5	ENG	[1 to 110 / 14 / 1/step]
2-593-020	PaperTransfer:Low:2Side:S5	ENG	[1 to 110 / 19 / 1/step]
2-593-021	Wide Roller:PaperTransfer:Standard: 1Sid:S1	ENG	[1 to 110 / 10 / 1/step]
2-593-022	Wide Roller:PaperTransfer:Standard: 2Sid:S1	ENG	[1 to 110 / 15 / 1/step]
2-593-023	Wide Roller:PaperTransfer:Low:1Side:S1	ENG	[1 to 110 / 10 / 1/step]
2-593-024	Wide Roller:PaperTransfer:Low:2Side:S1	ENG	[1 to 110 / 15 / 1/step]
2-593-025	Wide Roller:PaperTransfer:Standard: 1Sid:S2	ENG	[1 to 110 / 11 / 1/step]
2-593-026	Wide Roller:PaperTransfer:Standard: 2Sid:S2	ENG	[1 to 110 / 16 / 1/step]
2-593-027	Wide Roller:PaperTransfer:Low:1Side:S2	ENG	[1 to 110 / 11 / 1/step]
2-593-028	Wide Roller:PaperTransfer:Low:2Side:S2	ENG	[1 to 110 / 16 / 1/step]
2-593-029	Wide Roller:PaperTransfer:Standard: 1Sid:S3	ENG	[1 to 110 / 12 / 1/step]
2-593-030	Wide Roller:PaperTransfer:Standard: 2Sid:S3	ENG	[1 to 110 / 17 / 1/step]
2-593-031	Wide Roller:PaperTransfer:Low:1Side:S3	ENG	[1 to 110 / 12 / 1/step]
2-593-032	Wide Roller:PaperTransfer:Low:2Side:S3	ENG	[1 to 110 / 17 / 1/step]
2-593-033	Wide Roller:PaperTransfer:Standard: 1Sid:S4	ENG	[1 to 110 / 13 / 1/step]
2-593-034	Wide Roller:PaperTransfer:Standard: 2Sid:S4	ENG	[1 to 110 / 18 / 1/step]
2-593-035	Wide Roller:PaperTransfer:Low:1Side:S4	ENG	[1 to 110 / 13 / 1/step]
2-593-036	Wide Roller:PaperTransfer:Low:2Side:S4	ENG	[1 to 110 / 18 / 1/step]

2-593-037	Wide Roller:PaperTransfer:Standard:1Sid:S5	ENG	[1 to 110 / 14 / 1/step]
2-593-038	Wide Roller:PaperTransfer:Standard:2Sid:S5	ENG	[1 to 110 / 19 / 1/step]
2-593-039	Wide Roller:PaperTransfer:Low:1 Side:S5	ENG	[1 to 110 / 14 / 1/step]
2-593-040	Wide Roller:PaperTransfer:Low:2Side:S5	ENG	[1 to 110 / 19 / 1/step]

3

2594	[Special2:Size-Env.Correct:FC]		
2-594-001	PaperTransfer:standard:1Sid:S1	ENG	[1 to 110 / 20 / 1/step]
2-594-002	PaperTransfer:standard:2Sid:S1	ENG	[1 to 110 / 25 / 1/step]
2-594-003	PaperTransfer:Low:1 Side:S1	ENG	[1 to 110 / 20 / 1/step]
2-594-004	PaperTransfer:Low:2Side:S1	ENG	[1 to 110 / 25 / 1/step]
2-594-005	PaperTransfer:standard:1Sid:S2	ENG	[1 to 110 / 21 / 1/step]
2-594-006	PaperTransfer:standard:2Sid:S2	ENG	[1 to 110 / 26 / 1/step]
2-594-007	PaperTransfer:Low:1 Side:S2	ENG	[1 to 110 / 21 / 1/step]
2-594-008	PaperTransfer:Low:2Side:S2	ENG	[1 to 110 / 26 / 1/step]
2-594-009	PaperTransfer:standard:1Sid:S3	ENG	[1 to 110 / 22 / 1/step]
2-594-010	PaperTransfer:standard:2Sid:S3	ENG	[1 to 110 / 27 / 1/step]
2-594-011	PaperTransfer:Low:1 Side:S3	ENG	[1 to 110 / 22 / 1/step]
2-594-012	PaperTransfer:Low:2Side:S3	ENG	[1 to 110 / 27 / 1/step]
2-594-013	PaperTransfer:standard:1Sid:S4	ENG	[1 to 110 / 23 / 1/step]
2-594-014	PaperTransfer:standard:2Sid:S4	ENG	[1 to 110 / 28 / 1/step]
2-594-015	PaperTransfer:Low:1 Side:S4	ENG	[1 to 110 / 23 / 1/step]
2-594-016	PaperTransfer:Low:2Side:S4	ENG	[1 to 110 / 28 / 1/step]
2-594-017	PaperTransfer:Standard:1Sid:S5	ENG	[1 to 110 / 24 / 1/step]
2-594-018	PaperTransfer:Standard:2Sid:S5	ENG	[1 to 110 / 29 / 1/step]
2-594-019	PaperTransfer:Low:1 Side:S5	ENG	[1 to 110 / 24 / 1/step]

2-594-020	PaperTransfer:Low:2Side:S5	ENG	[1 to 110 / 29 / 1/step]
2-594-021	Wide Roller:PaperTransfer:Standard: 1Sid:S1	ENG	[1 to 110 / 20 / 1/step]
2-594-022	Wide Roller:PaperTransfer:Standard: 2Sid:S1	ENG	[1 to 110 / 25 / 1/step]
2-594-023	Wide Roller:PaperTransfer:Low: 1 Side:S1	ENG	[1 to 110 / 20 / 1/step]
2-594-024	Wide Roller:PaperTransfer:Low:2Side:S1	ENG	[1 to 110 / 25 / 1/step]
2-594-025	Wide Roller:PaperTransfer:Standard: 1Sid:S2	ENG	[1 to 110 / 21 / 1/step]
2-594-026	Wide Roller:PaperTransfer:Standard: 2Sid:S2	ENG	[1 to 110 / 26 / 1/step]
2-594-027	Wide Roller:PaperTransfer:Low: 1 Side:S2	ENG	[1 to 110 / 21 / 1/step]
2-594-028	Wide Roller:PaperTransfer:Low:2Side:S2	ENG	[1 to 110 / 26 / 1/step]
2-594-029	Wide Roller:PaperTransfer:Standard: 1Sid:S3	ENG	[1 to 110 / 22 / 1/step]
2-594-030	Wide Roller:PaperTransfer:Standard: 2Sid:S3	ENG	[1 to 110 / 27 / 1/step]
2-594-031	Wide Roller:PaperTransfer:Low: 1 Side:S3	ENG	[1 to 110 / 22 / 1/step]
2-594-032	Wide Roller:PaperTransfer:Low:2Side:S3	ENG	[1 to 110 / 27 / 1/step]
2-594-033	Wide Roller:PaperTransfer:Standard: 1Sid:S4	ENG	[1 to 110 / 23 / 1/step]
2-594-034	Wide Roller:PaperTransfer:Standard: 2Sid:S4	ENG	[1 to 110 / 28 / 1/step]
2-594-035	Wide Roller:PaperTransfer:Low: 1 Side:S4	ENG	[1 to 110 / 23 / 1/step]
2-594-036	Wide Roller:PaperTransfer:Low:2Side:S4	ENG	[1 to 110 / 28 / 1/step]
2-594-037	Wide Roller:PaperTransfer:Standard: 1Sid:S5	ENG	[1 to 110 / 24 / 1/step]
2-594-038	Wide Roller:PaperTransfer:Standard: 2Sid:S5	ENG	[1 to 110 / 29 / 1/step]
2-594-039	Wide Roller:PaperTransfer:Low: 1 Side:S5	ENG	[1 to 110 / 24 / 1/step]

2-594-040	Wide Roller:PaperTransfer:Low:2Side:S5	ENG	[1 to 110 / 29 / 1/step]
-----------	--	-----	--------------------------

2595	[Special2:LeadingEdgeCorrection]		
2-595-001	PaperTransfer:standard:1Side	ENG	[0 to 995 / 100 / 5%/step]
2-595-002	PaperTransfer:standard:2Side	ENG	[0 to 995 / 100 / 5%/step]
2-595-003	Paper Transfer:Low:1side	ENG	[0 to 995 / 100 / 5%/step]
2-595-004	Paper Transfer:Low:2side	ENG	[0 to 995 / 100 / 5%/step]

2596	[Special2:SwitchTimingLeadEdge]		
2-596-001	PaperTransfer:standard:1side	ENG	[0 to 50 / 0 / 2mm/step]
2-596-002	PaperTransfer:standard:2side	ENG	[0 to 50 / 0 / 2mm/step]
2-596-003	Paper Transfer:Low:1side	ENG	[0 to 50 / 0 / 2mm/step]
2-596-004	Paper Transfer:Low:2side	ENG	[0 to 50 / 0 / 2mm/step]

2597	[Special2:TrailEdgeCorrection]		
2-597-001	PaperTransfer:standard:1Side	ENG	[0 to 995 / 100 / 5%/step]
2-597-002	PaperTransfer:standard:2Side	ENG	[0 to 995 / 100 / 5%/step]
2-597-003	Paper Transfer:Low:1side	ENG	[0 to 995 / 100 / 5%/step]
2-597-004	Paper Transfer:Low:2side	ENG	[0 to 995 / 100 / 5%/step]

2598	[Special2:SwitchTimingTrailEdge]		
2-598-001	PaperTransfer:standard:1side	ENG	[0 to 50 / 0 / 2mm/step]
2-598-002	PaperTransfer:standard:2side	ENG	[0 to 50 / 0 / 2mm/step]
2-598-003	Paper Transfer:Low:1side	ENG	[0 to 50 / 0 / 2mm/step]
2-598-004	Paper Transfer:Low:2side	ENG	[0 to 50 / 0 / 2mm/step]

2603	[Special3:Bias:BW]		
2-603-001	PaperTransfer:standard:1side	ENG	[0 to 200 / 22 / 1-uA/step]

2-603-002	PaperTransfer:standard:2side	ENG	[0 to 200 / 22 / 1-uA/step]
2-603-003	PaperTransfer:low:1side	ENG	[0 to 200 / 11 / 1-uA/step]
2-603-004	PaperTransfer:low:2side	ENG	[0 to 200 / 11 / 1-uA/step]

2607	[Special3:Bias:FC]		
2-607-001	PaperTransfer:standard:1side	ENG	[0 to 200 / 29 / 1-uA/step]
2-607-002	PaperTransfer:standard:2side	ENG	[0 to 200 / 29 / 1-uA/step]
2-607-003	PaperTransfer:low:1side	ENG	[0 to 200 / 14 / 1-uA/step]
2-607-004	PaperTransfer:low:2side	ENG	[0 to 200 / 14 / 1-uA/step]

2611	[Special3:SizeCorrection:BW]		
2-611-001	PaperTransfer:standard:1Sid:S1	ENG	[100 to 995 / 100 / 1%/step]
2-611-002	PaperTransfer:standard:2Sid:S1	ENG	[100 to 995 / 100 / 1%/step]
2-611-003	PaperTransfer:Low:1Side:S1	ENG	[100 to 995 / 100 / 1%/step]
2-611-004	PaperTransfer:Low:2Side:S1	ENG	[100 to 995 / 100 / 1%/step]
2-611-005	PaperTransfer:standard:1Sid:S2	ENG	[100 to 995 / 100 / 1%/step]
2-611-006	PaperTransfer:standard:2Sid:S2	ENG	[100 to 995 / 105 / 1%/step]
2-611-007	PaperTransfer:Low:1Side:S2	ENG	[100 to 995 / 100 / 1%/step]
2-611-008	PaperTransfer:Low:2Side:S2	ENG	[100 to 995 / 105 / 1%/step]
2-611-009	PaperTransfer:standard:1Sid:S3	ENG	[100 to 995 / 105 / 1%/step]
2-611-010	PaperTransfer:standard:2Sid:S3	ENG	[100 to 995 / 118 / 1%/step]

2-611-011	PaperTransfer:Low:1Side:S3	ENG	[100 to 995 / 105 / 1%/step]
2-611-012	PaperTransfer:Low:2Side:S3	ENG	[100 to 995 / 118 / 1%/step]
2-611-013	PaperTransfer:standard:1Sid:S4	ENG	[100 to 995 / 118 / 1%/step]
2-611-014	PaperTransfer:standard:2Sid:S4	ENG	[100 to 995 / 131 / 1%/step]
2-611-015	PaperTransfer:Low:1Side:S4	ENG	[100 to 995 / 118 / 1%/step]
2-611-016	PaperTransfer:Low:2Side:S4	ENG	[100 to 995 / 131 / 1%/step]
2-611-017	PaperTransfer:Standard:1Sid:S5	ENG	[100 to 995 / 132 / 1%/step]
2-611-018	PaperTransfer:Standard:2Sid:S5	ENG	[100 to 995 / 184 / 1%/step]
2-611-019	PaperTransfer:Low:1Side:S5	ENG	[100 to 995 / 132 / 1%/step]
2-611-020	PaperTransfer:Low:2Side:S5	ENG	[100 to 995 / 184 / 1%/step]
2-611-021	Wide Roller:PaperTransfer:Standard:1Sid:S1	ENG	[100 to 995 / 100 / 1%/step]
2-611-022	Wide Roller:PaperTransfer:Standard:2Sid:S1	ENG	[100 to 995 / 100 / 1%/step]
2-611-023	Wide Roller:PaperTransfer:Low:1Side:S1	ENG	[100 to 995 / 100 / 1%/step]
2-611-024	Wide Roller:PaperTransfer:Low:2Side:S1	ENG	[100 to 995 / 100 / 1%/step]
2-611-025	Wide Roller:PaperTransfer:Standard:1Sid:S2	ENG	[100 to 995 / 100 / 1%/step]
2-611-026	Wide Roller:PaperTransfer:Standard:2Sid:S2	ENG	[100 to 995 / 105 / 1%/step]

2-611-027	Wide Roller:PaperTransfer:Low:1Side:S2	ENG	[100 to 995 / 100 / 1%/step]
2-611-028	Wide Roller:PaperTransfer:Low:2Side:S2	ENG	[100 to 995 / 105 / 1%/step]
2-611-029	Wide Roller:PaperTransfer:Standard:1Sid:S3	ENG	[100 to 995 / 105 / 1%/step]
2-611-030	Wide Roller:PaperTransfer:Standard:2Sid:S3	ENG	[100 to 995 / 118 / 1%/step]
2-611-031	Wide Roller:PaperTransfer:Low:1Side:S3	ENG	[100 to 995 / 105 / 1%/step]
2-611-032	Wide Roller:PaperTransfer:Low:2Side:S3	ENG	[100 to 995 / 118 / 1%/step]
2-611-033	Wide Roller:PaperTransfer:Standard:1Sid:S4	ENG	[100 to 995 / 118 / 1%/step]
2-611-034	Wide Roller:PaperTransfer:Standard:2Sid:S4	ENG	[100 to 995 / 131 / 1%/step]
2-611-035	Wide Roller:PaperTransfer:Low:1Side:S4	ENG	[100 to 995 / 118 / 1%/step]
2-611-036	Wide Roller:PaperTransfer:Low:2Side:S4	ENG	[100 to 995 / 131 / 1%/step]
2-611-037	Wide Roller:PaperTransfer:Standard:1Sid:S5	ENG	[100 to 995 / 132 / 1%/step]
2-611-038	Wide Roller:PaperTransfer:Standard:2Sid:S5	ENG	[100 to 995 / 184 / 1%/step]
2-611-039	Wide Roller:PaperTransfer:Low:1Side:S5	ENG	[100 to 995 / 132 / 1%/step]
2-611-040	Wide Roller:PaperTransfer:Low:2Side:S5	ENG	[100 to 995 / 184 / 1%/step]

2612	[Special3:SizeCorrection:FC]		
2-612-002	PaperTransfer:standard:2Sid:S1	ENG	[100 to 995 / 100 / 1%/step]

2-612-003	PaperTransfer:Low:1Side:S1	ENG	[100 to 995 / 100 / 1%/step]
2-612-004	PaperTransfer:Low:2Side:S1	ENG	[100 to 995 / 100 / 1%/step]
2-612-005	PaperTransfer:standard:1Sid:S2	ENG	[100 to 995 / 120 / 1%/step]
2-612-006	PaperTransfer:standard:2Sid:S2	ENG	[100 to 995 / 140 / 1%/step]
2-612-007	PaperTransfer:Low:1Side:S2	ENG	[100 to 995 / 120 / 1%/step]
2-612-008	PaperTransfer:Low:2Side:S2	ENG	[100 to 995 / 140 / 1%/step]
2-612-009	PaperTransfer:standard:1Sid:S3	ENG	[100 to 995 / 118 / 1%/step]
2-612-010	PaperTransfer:standard:2Sid:S3	ENG	[100 to 995 / 180 / 1%/step]
2-612-011	PaperTransfer:Low:1Side:S3	ENG	[100 to 995 / 118 / 1%/step]
2-612-012	PaperTransfer:Low:2Side:S3	ENG	[100 to 995 / 180 / 1%/step]
2-612-013	PaperTransfer:standard:1Sid:S4	ENG	[100 to 995 / 130 / 1%/step]
2-612-014	PaperTransfer:standard:2Sid:S4	ENG	[100 to 995 / 200 / 1%/step]
2-612-015	PaperTransfer:Low:1Side:S4	ENG	[100 to 995 / 130 / 1%/step]
2-612-016	PaperTransfer:Low:2Side:S4	ENG	[100 to 995 / 200 / 1%/step]
2-612-017	PaperTransfer:Standard:1Sid:S5	ENG	[100 to 995 / 140 / 1%/step]
2-612-018	PaperTransfer:Standard:2Sid:S5	ENG	[100 to 995 / 240 / 1%/step]

2-612-019	PaperTransfer:Low:1Side:S5	ENG	[100 to 995 / 140 / 1%/step]
2-612-020	PaperTransfer:Low:2Side:S5	ENG	[100 to 995 / 240 / 1%/step]
2-612-021	Wide Roller:PaperTransfer:Standard:1Sid:S1	ENG	[100 to 995 / 100 / 1%/step]
2-612-022	Wide Roller:PaperTransfer:Standard:2Sid:S1	ENG	[100 to 995 / 100 / 1%/step]
2-612-023	Wide Roller:PaperTransfer:Low:1Side:S1	ENG	[100 to 995 / 100 / 1%/step]
2-612-024	Wide Roller:PaperTransfer:Low:2Side:S1	ENG	[100 to 995 / 100 / 1%/step]
2-612-025	Wide Roller:PaperTransfer:Standard:1Sid:S2	ENG	[100 to 995 / 120 / 1%/step]
2-612-026	Wide Roller:PaperTransfer:Standard:2Sid:S2	ENG	[100 to 995 / 140 / 1%/step]
2-612-027	Wide Roller:PaperTransfer:Low:1Side:S2	ENG	[100 to 995 / 120 / 1%/step]
2-612-028	Wide Roller:PaperTransfer:Low:2Side:S2	ENG	[100 to 995 / 140 / 1%/step]
2-612-029	Wide Roller:PaperTransfer:Standard:1Sid:S3	ENG	[100 to 995 / 118 / 1%/step]
2-612-030	Wide Roller:PaperTransfer:Standard:2Sid:S3	ENG	[100 to 995 / 180 / 1%/step]
2-612-031	Wide Roller:PaperTransfer:Low:1Side:S3	ENG	[100 to 995 / 118 / 1%/step]
2-612-032	Wide Roller:PaperTransfer:Low:2Side:S3	ENG	[100 to 995 / 180 / 1%/step]
2-612-033	Wide Roller:PaperTransfer:Standard:1Sid:S4	ENG	[100 to 995 / 130 / 1%/step]
2-612-034	Wide Roller:PaperTransfer:Standard:2Sid:S4	ENG	[100 to 995 / 200 / 1%/step]

2-612-035	Wide Roller:PaperTransfer:Low:1Side:S4	ENG	[100 to 995 / 130 / 1%/step]
2-612-036	Wide Roller:PaperTransfer:Low:2Side:S4	ENG	[100 to 995 / 200 / 1%/step]
2-612-037	Wide Roller:PaperTransfer:Standard:1Sid:S5	ENG	[100 to 995 / 140 / 1%/step]
2-612-038	Wide Roller:PaperTransfer:Standard:2Sid:S5	ENG	[100 to 995 / 240 / 1%/step]
2-612-039	Wide Roller:PaperTransfer:Low:1Side:S5	ENG	[100 to 995 / 140 / 1%/step]
2-612-040	Wide Roller:PaperTransfer:Low:2Side:S5	ENG	[100 to 995 / 240 / 1%/step]

2613	[Special3:Size-Env.Correct:BW]		
2-613-001	PaperTransfer:standard:1Sid:S1	ENG	[1 to 110 / 10 / 1/step]
2-613-002	PaperTransfer:standard:2Sid:S1	ENG	[1 to 110 / 15 / 1/step]
2-613-003	PaperTransfer:Low:1Side:S1	ENG	[1 to 110 / 10 / 1/step]
2-613-004	PaperTransfer:Low:2Side:S1	ENG	[1 to 110 / 15 / 1/step]
2-613-005	PaperTransfer:standard:1Sid:S2	ENG	[1 to 110 / 11 / 1/step]
2-613-006	PaperTransfer:standard:2Sid:S2	ENG	[1 to 110 / 16 / 1/step]
2-613-007	PaperTransfer:Low:1Side:S2	ENG	[1 to 110 / 11 / 1/step]
2-613-008	PaperTransfer:Low:2Side:S2	ENG	[1 to 110 / 16 / 1/step]
2-613-009	PaperTransfer:standard:1Sid:S3	ENG	[1 to 110 / 12 / 1/step]
2-613-010	PaperTransfer:standard:2Sid:S3	ENG	[1 to 110 / 17 / 1/step]
2-613-011	PaperTransfer:Low:1Side:S3	ENG	[1 to 110 / 12 / 1/step]
2-613-012	PaperTransfer:Low:2Side:S3	ENG	[1 to 110 / 17 / 1/step]
2-613-013	PaperTransfer:standard:1Sid:S4	ENG	[1 to 110 / 13 / 1/step]
2-613-014	PaperTransfer:standard:2Sid:S4	ENG	[1 to 110 / 18 / 1/step]

2-613-015	PaperTransfer:Low:1Side:S4	ENG	[1 to 110 / 13 / 1/step]
2-613-016	PaperTransfer:Low:2Side:S4	ENG	[1 to 110 / 18 / 1/step]
2-613-017	PaperTransfer:Standard:1Sid:S5	ENG	[1 to 110 / 14 / 1/step]
2-613-018	PaperTransfer:Standard:2Sid:S5	ENG	[1 to 110 / 19 / 1/step]
2-613-019	PaperTransfer:Low:1Side:S5	ENG	[1 to 110 / 14 / 1/step]
2-613-020	PaperTransfer:Low:2Side:S5	ENG	[1 to 110 / 19 / 1/step]
2-613-021	Wide Roller:PaperTransfer:Standard: 1Sid:S1	ENG	[1 to 110 / 10 / 1/step]
2-613-022	Wide Roller:PaperTransfer:Standard: 2Sid:S1	ENG	[1 to 110 / 15 / 1/step]
2-613-023	Wide Roller:PaperTransfer:Low:1Side:S1	ENG	[1 to 110 / 10 / 1/step]
2-613-024	Wide Roller:PaperTransfer:Low:2Side:S1	ENG	[1 to 110 / 15 / 1/step]
2-613-025	Wide Roller:PaperTransfer:Standard: 1Sid:S2	ENG	[1 to 110 / 11 / 1/step]
2-613-026	Wide Roller:PaperTransfer:Standard: 2Sid:S2	ENG	[1 to 110 / 16 / 1/step]
2-613-027	Wide Roller:PaperTransfer:Low:1Side:S2	ENG	[1 to 110 / 11 / 1/step]
2-613-028	Wide Roller:PaperTransfer:Low:2Side:S2	ENG	[1 to 110 / 16 / 1/step]
2-613-029	Wide Roller:PaperTransfer:Standard: 1Sid:S3	ENG	[1 to 110 / 12 / 1/step]
2-613-030	Wide Roller:PaperTransfer:Standard: 2Sid:S3	ENG	[1 to 110 / 17 / 1/step]
2-613-031	Wide Roller:PaperTransfer:Low:1Side:S3	ENG	[1 to 110 / 12 / 1/step]
2-613-032	Wide Roller:PaperTransfer:Low:2Side:S3	ENG	[1 to 110 / 17 / 1/step]
2-613-033	Wide Roller:PaperTransfer:Standard: 1Sid:S4	ENG	[1 to 110 / 13 / 1/step]
2-613-034	Wide Roller:PaperTransfer:Standard: 2Sid:S4	ENG	[1 to 110 / 18 / 1/step]
2-613-035	Wide Roller:PaperTransfer:Low:1Side:S4	ENG	[1 to 110 / 13 / 1/step]

2-613-036	Wide Roller:PaperTransfer:Low:2Side:S4	ENG	[1 to 110 / 18 / 1/step]
2-613-037	Wide Roller:PaperTransfer:Standard:1Sid:S5	ENG	[1 to 110 / 14 / 1/step]
2-613-038	Wide Roller:PaperTransfer:Standard:2Sid:S5	ENG	[1 to 110 / 19 / 1/step]
2-613-039	Wide Roller:PaperTransfer:Low:1Side:S5	ENG	[1 to 110 / 14 / 1/step]
2-613-040	Wide Roller:PaperTransfer:Low:2Side:S5	ENG	[1 to 110 / 19 / 1/step]

2614	[Special3:Size-Env.Correct:FC]		
2-614-001	PaperTransfer:standard:1Sid:S1	ENG	[1 to 110 / 20 / 1/step]
2-614-002	PaperTransfer:standard:2Sid:S1	ENG	[1 to 110 / 25 / 1/step]
2-614-003	PaperTransfer:Low:1Side:S1	ENG	[1 to 110 / 20 / 1/step]
2-614-004	PaperTransfer:Low:2Side:S1	ENG	[1 to 110 / 25 / 1/step]
2-614-005	PaperTransfer:standard:1Sid:S2	ENG	[1 to 110 / 21 / 1/step]
2-614-006	PaperTransfer:standard:2Sid:S2	ENG	[1 to 110 / 26 / 1/step]
2-614-007	PaperTransfer:Low:1Side:S2	ENG	[1 to 110 / 21 / 1/step]
2-614-008	PaperTransfer:Low:2Side:S2	ENG	[1 to 110 / 26 / 1/step]
2-614-009	PaperTransfer:standard:1Sid:S3	ENG	[1 to 110 / 22 / 1/step]
2-614-010	PaperTransfer:standard:2Sid:S3	ENG	[1 to 110 / 27 / 1/step]
2-614-011	PaperTransfer:Low:1Side:S3	ENG	[1 to 110 / 22 / 1/step]
2-614-012	PaperTransfer:Low:2Side:S3	ENG	[1 to 110 / 27 / 1/step]
2-614-013	PaperTransfer:standard:1Sid:S4	ENG	[1 to 110 / 23 / 1/step]
2-614-014	PaperTransfer:standard:2Sid:S4	ENG	[1 to 110 / 28 / 1/step]
2-614-015	PaperTransfer:Low:1Side:S4	ENG	[1 to 110 / 23 / 1/step]
2-614-016	PaperTransfer:Low:2Side:S4	ENG	[1 to 110 / 28 / 1/step]
2-614-017	PaperTransfer:Standard:1Sid:S5	ENG	[1 to 110 / 24 / 1/step]
2-614-018	PaperTransfer:Standard:2Sid:S5	ENG	[1 to 110 / 29 / 1/step]

2-614-019	PaperTransfer:Low:1Side:S5	ENG	[1 to 110 / 24 / 1/step]
2-614-020	PaperTransfer:Low:2Side:S5	ENG	[1 to 110 / 29 / 1/step]
2-614-021	Wide Roller:PaperTransfer:Standard: 1Sid:S1	ENG	[1 to 110 / 20 / 1/step]
2-614-022	Wide Roller:PaperTransfer:Standard: 2Sid:S1	ENG	[1 to 110 / 25 / 1/step]
2-614-023	Wide Roller:PaperTransfer:Low:1Side:S1	ENG	[1 to 110 / 20 / 1/step]
2-614-024	Wide Roller:PaperTransfer:Low:2Side:S1	ENG	[1 to 110 / 25 / 1/step]
2-614-025	Wide Roller:PaperTransfer:Standard: 1Sid:S2	ENG	[1 to 110 / 21 / 1/step]
2-614-026	Wide Roller:PaperTransfer:Standard: 2Sid:S2	ENG	[1 to 110 / 26 / 1/step]
2-614-027	Wide Roller:PaperTransfer:Low:1Side:S2	ENG	[1 to 110 / 21 / 1/step]
2-614-028	Wide Roller:PaperTransfer:Low:2Side:S2	ENG	[1 to 110 / 26 / 1/step]
2-614-029	Wide Roller:PaperTransfer:Standard: 1Sid:S3	ENG	[1 to 110 / 22 / 1/step]
2-614-030	Wide Roller:PaperTransfer:Standard: 2Sid:S3	ENG	[1 to 110 / 27 / 1/step]
2-614-031	Wide Roller:PaperTransfer:Low:1Side:S3	ENG	[1 to 110 / 22 / 1/step]
2-614-032	Wide Roller:PaperTransfer:Low:2Side:S3	ENG	[1 to 110 / 27 / 1/step]
2-614-033	Wide Roller:PaperTransfer:Standard: 1Sid:S4	ENG	[1 to 110 / 23 / 1/step]
2-614-034	Wide Roller:PaperTransfer:Standard: 2Sid:S4	ENG	[1 to 110 / 28 / 1/step]
2-614-035	Wide Roller:PaperTransfer:Low:1Side:S4	ENG	[1 to 110 / 23 / 1/step]
2-614-036	Wide Roller:PaperTransfer:Low:2Side:S4	ENG	[1 to 110 / 28 / 1/step]
2-614-037	Wide Roller:PaperTransfer:Standard: 1Sid:S5	ENG	[1 to 110 / 24 / 1/step]
2-614-038	Wide Roller:PaperTransfer:Standard: 2Sid:S5	ENG	[1 to 110 / 29 / 1/step]

2-614-039	Wide Roller:PaperTransfer:Low:1Side:S5	ENG	[1 to 110 / 24 / 1/step]
2-614-040	Wide Roller:PaperTransfer:Low:2Side:S5	ENG	[1 to 110 / 29 / 1/step]

2615	[Special3:LeadingEdgeCorrection]		
2-615-001	Paper Transfer:standard:1side	ENG	[0 to 995 / 100 / 5%/step]
2-615-002	Paper Transfer:standard:2side	ENG	[0 to 995 / 100 / 5%/step]
2-615-003	Paper Transfer:Low:1side	ENG	[0 to 995 / 100 / 5%/step]
2-615-004	Paper Transfer:Low:2side	ENG	[0 to 995 / 100 / 5%/step]

2616	[Special3:SwitchTimingLeadEdge]		
2-616-001	Paper Transfer:standard:1side	ENG	[0 to 50 / 0 / 2mm/step]
2-616-002	Paper Transfer:standard:2side	ENG	[0 to 50 / 0 / 2mm/step]
2-616-003	Paper Transfer:Low:1side	ENG	[0 to 50 / 0 / 2mm/step]
2-616-004	Paper Transfer:Low:2side	ENG	[0 to 50 / 0 / 2mm/step]

2617	[Special3:TrailEdgeCorrection]		
2-617-001	Paper Transfer:standard:1side	ENG	[0 to 995 / 100 / 5%/step]
2-617-002	Paper Transfer:standard:2side	ENG	[0 to 995 / 100 / 5%/step]
2-617-003	Paper Transfer:Low:1side	ENG	[0 to 995 / 100 / 5%/step]
2-617-004	Paper Transfer:Low:2side	ENG	[0 to 995 / 100 / 5%/step]

2618	[Special3:SwitchTimingTrailEdge]		
2-618-001	Paper Transfer:standard:1side	ENG	[0 to 50 / 0 / 2mm/step]
2-618-002	Paper Transfer:standard:2side	ENG	[0 to 50 / 0 / 2mm/step]
2-618-003	Paper Transfer:Low:1side	ENG	[0 to 50 / 0 / 2mm/step]
2-618-004	Paper Transfer:Low:2side	ENG	[0 to 50 / 0 / 2mm/step]

2623	[Special1 Thick:Bias:BW]		
-------------	---------------------------------	--	--

2-623-003	PaperTransfer: 1 side	ENG	[0 to 200 / 11 / 1-uA/step]
2-623-004	PaperTransfer:2side	ENG	[0 to 200 / 15 / 1-uA/step]

2627	[Special1 Thick:Bias:FC]		
2-627-003	PaperTransfer: 1 side	ENG	[0 to 200 / 19 / 1-uA/step]
2-627-004	PaperTransfer:2side	ENG	[0 to 200 / 21 / 1-uA/step]

2631	[Special1 Thick:PaperSizeCorr:BW]		
2-631-003	PaperTransfer: 1 Side:S1	ENG	[100 to 995 / 100 / 1%/step]
2-631-004	PaperTransfer:2Side:S1	ENG	[100 to 995 / 100 / 1%/step]
2-631-007	PaperTransfer: 1 Side:S2	ENG	[100 to 995 / 100 / 1%/step]
2-631-008	PaperTransfer:2Side:S2	ENG	[100 to 995 / 133 / 1%/step]
2-631-011	PaperTransfer: 1 Side:S3	ENG	[100 to 995 / 100 / 1%/step]
2-631-012	PaperTransfer:2Side:S3	ENG	[100 to 995 / 167 / 1%/step]
2-631-015	PaperTransfer: 1 Side:S4	ENG	[100 to 995 / 100 / 1%/step]
2-631-016	PaperTransfer:2Side:S4	ENG	[100 to 995 / 233 / 1%/step]
2-631-019	PaperTransfer: 1 Side:S5	ENG	[100 to 995 / 100 / 1%/step]
2-631-020	PaperTransfer:2Side:S5	ENG	[100 to 995 / 267 / 1%/step]
2-631-023	Wide Roller:PaperTransfer: 1 Side:S1	ENG	[100 to 995 / 100 / 1%/step]

2-631-024	Wide Roller:PaperTransfer:2Side:S1	ENG	[100 to 995 / 100 / 1%/step]
2-631-027	Wide Roller:PaperTransfer:1Side:S2	ENG	[100 to 995 / 100 / 1%/step]
2-631-028	Wide Roller:PaperTransfer:2Side:S2	ENG	[100 to 995 / 133 / 1%/step]
2-631-031	Wide Roller:PaperTransfer:1Side:S3	ENG	[100 to 995 / 100 / 1%/step]
2-631-032	Wide Roller:PaperTransfer:2Side:S3	ENG	[100 to 995 / 167 / 1%/step]
2-631-035	Wide Roller:PaperTransfer:1Side:S4	ENG	[100 to 995 / 100 / 1%/step]
2-631-036	Wide Roller:PaperTransfer:2Side:S4	ENG	[100 to 995 / 233 / 1%/step]
2-631-039	Wide Roller:PaperTransfer:1Side:S5	ENG	[100 to 995 / 100 / 1%/step]
2-631-040	Wide Roller:PaperTransfer:2Side:S5	ENG	[100 to 995 / 267 / 1%/step]

2632	[Special 1 Thick:PaperSizeCorr:FC]		
2-632-003	PaperTransfer:1Side:S1	ENG	[100 to 995 / 100 / 1%/step]
2-632-004	PaperTransfer:2Side:S1	ENG	[100 to 995 / 100 / 1%/step]
2-632-007	PaperTransfer:1Side:S2	ENG	[100 to 995 / 100 / 1%/step]
2-632-008	PaperTransfer:2Side:S2	ENG	[100 to 995 / 181 / 1%/step]
2-632-011	PaperTransfer:1Side:S3	ENG	[100 to 995 / 100 / 1%/step]
2-632-012	PaperTransfer:2Side:S3	ENG	[100 to 995 / 229 / 1%/step]

2-632-015	PaperTransfer:1Side:S4	ENG	[100 to 995 / 100 / 1%/step]
2-632-016	PaperTransfer:2Side:S4	ENG	[100 to 995 / 286 / 1%/step]
2-632-019	PaperTransfer:1Side:S5	ENG	[100 to 995 / 100 / 1%/step]
2-632-020	PaperTransfer:2Side:S5	ENG	[100 to 995 / 381 / 1%/step]
2-632-023	Wide Roller:PaperTransfer:1Side:S1	ENG	[100 to 995 / 100 / 1%/step]
2-632-024	Wide Roller:PaperTransfer:2Side:S1	ENG	[100 to 995 / 100 / 1%/step]
2-632-027	Wide Roller:PaperTransfer:1Side:S2	ENG	[100 to 995 / 100 / 1%/step]
2-632-028	Wide Roller:PaperTransfer:2Side:S2	ENG	[100 to 995 / 181 / 1%/step]
2-632-031	Wide Roller:PaperTransfer:1Side:S3	ENG	[100 to 995 / 100 / 1%/step]
2-632-032	Wide Roller:PaperTransfer:2Side:S3	ENG	[100 to 995 / 229 / 1%/step]
2-632-035	Wide Roller:PaperTransfer:1Side:S4	ENG	[100 to 995 / 100 / 1%/step]
2-632-036	Wide Roller:PaperTransfer:2Side:S4	ENG	[100 to 995 / 286 / 1%/step]
2-632-039	Wide Roller:PaperTransfer:1Side:S5	ENG	[100 to 995 / 100 / 1%/step]
2-632-040	Wide Roller:PaperTransfer:2Side:S5	ENG	[100 to 995 / 381 / 1%/step]

2633	[Sp1Thick:PaperSizeEnvCorr:BW]		
2-633-003	PaperTransfer:1Side:S1	ENG	[1 to 110 / 85 / 1/step]
2-633-004	PaperTransfer:2Side:S1	ENG	[1 to 110 / 87 / 1/step]

2-633-007	PaperTransfer: 1 Side:S2	ENG	[1 to 110 / 86 / 1/step]
2-633-008	PaperTransfer:2Side:S2	ENG	[1 to 110 / 88 / 1/step]
2-633-011	PaperTransfer: 1 Side:S3	ENG	[1 to 110 / 86 / 1/step]
2-633-012	PaperTransfer:2Side:S3	ENG	[1 to 110 / 89 / 1/step]
2-633-015	PaperTransfer: 1 Side:S4	ENG	[1 to 110 / 86 / 1/step]
2-633-016	PaperTransfer:2Side:S4	ENG	[1 to 110 / 90 / 1/step]
2-633-019	PaperTransfer: 1 Side:S5	ENG	[1 to 110 / 86 / 1/step]
2-633-020	PaperTransfer:2Side:S5	ENG	[1 to 110 / 91 / 1/step]
2-633-023	Wide Roller:PaperTransfer: 1 Side:S1	ENG	[1 to 110 / 85 / 1/step]
2-633-024	Wide Roller:PaperTransfer:2Side:S1	ENG	[1 to 110 / 87 / 1/step]
2-633-027	Wide Roller:PaperTransfer: 1 Side:S2	ENG	[1 to 110 / 86 / 1/step]
2-633-028	Wide Roller:PaperTransfer:2Side:S2	ENG	[1 to 110 / 88 / 1/step]
2-633-031	Wide Roller:PaperTransfer: 1 Side:S3	ENG	[1 to 110 / 86 / 1/step]
2-633-032	Wide Roller:PaperTransfer:2Side:S3	ENG	[1 to 110 / 89 / 1/step]
2-633-035	Wide Roller:PaperTransfer: 1 Side:S4	ENG	[1 to 110 / 86 / 1/step]
2-633-036	Wide Roller:PaperTransfer:2Side:S4	ENG	[1 to 110 / 90 / 1/step]
2-633-039	Wide Roller:PaperTransfer: 1 Side:S5	ENG	[1 to 110 / 86 / 1/step]
2-633-040	Wide Roller:PaperTransfer:2Side:S5	ENG	[1 to 110 / 91 / 1/step]

2634	[Sp 1 Thick:PaperSizeEnvCorr:FC]		
2-634-003	PaperTransfer: 1 Side:S1	ENG	[1 to 110 / 77 / 1/step]
2-634-004	PaperTransfer:2Side:S1	ENG	[1 to 110 / 92 / 1/step]
2-634-007	PaperTransfer: 1 Side:S2	ENG	[1 to 110 / 78 / 1/step]
2-634-008	PaperTransfer:2Side:S2	ENG	[1 to 110 / 93 / 1/step]
2-634-011	PaperTransfer: 1 Side:S3	ENG	[1 to 110 / 79 / 1/step]
2-634-012	PaperTransfer:2Side:S3	ENG	[1 to 110 / 94 / 1/step]

2-634-015	PaperTransfer:1Side:S4	ENG	[1 to 110 / 79 / 1/step]
2-634-016	PaperTransfer:2Side:S4	ENG	[1 to 110 / 95 / 1/step]
2-634-019	PaperTransfer:1Side:S5	ENG	[1 to 110 / 79 / 1/step]
2-634-020	PaperTransfer:2Side:S5	ENG	[1 to 110 / 96 / 1/step]
2-634-023	Wide Roller:PaperTransfer:1Side:S1	ENG	[1 to 110 / 77 / 1/step]
2-634-024	Wide Roller:PaperTransfer:2Side:S1	ENG	[1 to 110 / 92 / 1/step]
2-634-027	Wide Roller:PaperTransfer:1Side:S2	ENG	[1 to 110 / 78 / 1/step]
2-634-028	Wide Roller:PaperTransfer:2Side:S2	ENG	[1 to 110 / 93 / 1/step]
2-634-031	Wide Roller:PaperTransfer:1Side:S3	ENG	[1 to 110 / 79 / 1/step]
2-634-032	Wide Roller:PaperTransfer:2Side:S3	ENG	[1 to 110 / 94 / 1/step]
2-634-035	Wide Roller:PaperTransfer:1Side:S4	ENG	[1 to 110 / 79 / 1/step]
2-634-036	Wide Roller:PaperTransfer:2Side:S4	ENG	[1 to 110 / 95 / 1/step]
2-634-039	Wide Roller:PaperTransfer:1Side:S5	ENG	[1 to 110 / 79 / 1/step]
2-634-040	Wide Roller:PaperTransfer:2Side:S5	ENG	[1 to 110 / 96 / 1/step]

2635	[Sp1Thick:LeadingEdgeCorrection]		
2-635-003	Paper Transfer:1side	ENG	[0 to 995 / 100 / 5%/step]
2-635-004	Paper Transfer:2side	ENG	[0 to 995 / 100 / 5%/step]

2636	[Sp1Thick:SwitchTimingLeadEdge]		
2-636-003	Paper Transfer:1side	ENG	[0 to 50 / 0 / 2mm/step]
2-636-004	Paper Transfer:2side	ENG	[0 to 50 / 0 / 2mm/step]

2637	[Sp1Thick:TrailEdgeCorrection]		
2-637-003	Paper Transfer:1side	ENG	[0 to 995 / 100 / 5%/step]
2-637-004	Paper Transfer:2side	ENG	[0 to 995 / 100 / 5%/step]

2638	[Sp 1 Thick:SwitchTimingTrailEdge]		
2-638-003	Paper Transfer: 1 side	ENG	[0 to 50 / 0 / 2mm/step]
2-638-004	Paper Transfer: 2 side	ENG	[0 to 50 / 0 / 2mm/step]

2643	[Special2 Thick:Bias:BW]		
2-643-003	PaperTransfer: 1 side	ENG	[0 to 200 / 11 / 1-uA/step]
2-643-004	PaperTransfer: 2 side	ENG	[0 to 200 / 15 / 1-uA/step]

2647	[Special2 Thick:Bias:FC]		
2-647-003	PaperTransfer: 1 side	ENG	[0 to 200 / 19 / 1-uA/step]
2-647-004	PaperTransfer: 2 side	ENG	[0 to 200 / 21 / 1-uA/step]

2651	[Special2Thick:PaperSizeCorr:BW]		
2-651-003	PaperTransfer: 1 Side:S1	ENG	[100 to 995 / 100 / 1%/step]
2-651-004	PaperTransfer: 2 Side:S1	ENG	[100 to 995 / 100 / 1%/step]
2-651-007	PaperTransfer: 1 Side:S2	ENG	[100 to 995 / 100 / 1%/step]
2-651-008	PaperTransfer: 2 Side:S2	ENG	[100 to 995 / 133 / 1%/step]
2-651-011	PaperTransfer: 1 Side:S3	ENG	[100 to 995 / 100 / 1%/step]
2-651-012	PaperTransfer: 2 Side:S3	ENG	[100 to 995 / 167 / 1%/step]
2-651-015	PaperTransfer: 1 Side:S4	ENG	[100 to 995 / 100 / 1%/step]
2-651-016	PaperTransfer: 2 Side:S4	ENG	[100 to 995 / 233 / 1%/step]
2-651-019	PaperTransfer: 1 Side:S5	ENG	[100 to 995 / 100 / 1%/step]

2-651-020	PaperTransfer:2Side:S5	ENG	[100 to 995 / 267 / 1%/step]
2-651-023	Wide Roller:PaperTransfer:1Side:S1	ENG	[100 to 995 / 100 / 1%/step]
2-651-024	Wide Roller:PaperTransfer:2Side:S1	ENG	[100 to 995 / 100 / 1%/step]
2-651-027	Wide Roller:PaperTransfer:1Side:S2	ENG	[100 to 995 / 100 / 1%/step]
2-651-028	Wide Roller:PaperTransfer:2Side:S2	ENG	[100 to 995 / 133 / 1%/step]
2-651-031	Wide Roller:PaperTransfer:1Side:S3	ENG	[100 to 995 / 100 / 1%/step]
2-651-032	Wide Roller:PaperTransfer:2Side:S3	ENG	[100 to 995 / 167 / 1%/step]
2-651-035	Wide Roller:PaperTransfer:1Side:S4	ENG	[100 to 995 / 100 / 1%/step]
2-651-036	Wide Roller:PaperTransfer:2Side:S4	ENG	[100 to 995 / 233 / 1%/step]
2-651-039	Wide Roller:PaperTransfer:1Side:S5	ENG	[100 to 995 / 100 / 1%/step]
2-651-040	Wide Roller:PaperTransfer:2Side:S5	ENG	[100 to 995 / 267 / 1%/step]

2652	[Special2Thick:PaperSizeCorr:FC]		
2-652-003	PaperTransfer:1Side:S1	ENG	[100 to 995 / 100 / 1%/step]
2-652-004	PaperTransfer:2Side:S1	ENG	[100 to 995 / 100 / 1%/step]
2-652-007	PaperTransfer:1Side:S2	ENG	[100 to 995 / 100 / 1%/step]
2-652-008	PaperTransfer:2Side:S2	ENG	[100 to 995 / 181 / 1%/step]

2-652-011	PaperTransfer:1Side:S3	ENG	[100 to 995 / 100 / 1%/step]
2-652-012	PaperTransfer:2Side:S3	ENG	[100 to 995 / 229 / 1%/step]
2-652-015	PaperTransfer:1Side:S4	ENG	[100 to 995 / 100 / 1%/step]
2-652-016	PaperTransfer:2Side:S4	ENG	[100 to 995 / 286 / 1%/step]
2-652-019	PaperTransfer:1Side:S5	ENG	[100 to 995 / 100 / 1%/step]
2-652-020	PaperTransfer:2Side:S5	ENG	[100 to 995 / 381 / 1%/step]
2-652-023	Wide Roller:PaperTransfer:1Side:S1	ENG	[100 to 995 / 100 / 1%/step]
2-652-024	Wide Roller:PaperTransfer:2Side:S1	ENG	[100 to 995 / 100 / 1%/step]
2-652-027	Wide Roller:PaperTransfer:1Side:S2	ENG	[100 to 995 / 100 / 1%/step]
2-652-028	Wide Roller:PaperTransfer:2Side:S2	ENG	[100 to 995 / 181 / 1%/step]
2-652-031	Wide Roller:PaperTransfer:1Side:S3	ENG	[100 to 995 / 100 / 1%/step]
2-652-032	Wide Roller:PaperTransfer:2Side:S3	ENG	[100 to 995 / 229 / 1%/step]
2-652-035	Wide Roller:PaperTransfer:1Side:S4	ENG	[100 to 995 / 100 / 1%/step]
2-652-036	Wide Roller:PaperTransfer:2Side:S4	ENG	[100 to 995 / 286 / 1%/step]
2-652-039	Wide Roller:PaperTransfer:1Side:S5	ENG	[100 to 995 / 100 / 1%/step]
2-652-040	Wide Roller:PaperTransfer:2Side:S5	ENG	[100 to 995 / 381 / 1%/step]

2653	[Sp2Thick:PaperSizeEnvCorr:BW]		
2-653-003	PaperTransfer:1Side:S1	ENG	[1 to 110 / 70 / 1/step]
2-653-004	PaperTransfer:2Side:S1	ENG	[1 to 110 / 72 / 1/step]
2-653-007	PaperTransfer:1Side:S2	ENG	[1 to 110 / 71 / 1/step]
2-653-008	PaperTransfer:2Side:S2	ENG	[1 to 110 / 73 / 1/step]
2-653-011	PaperTransfer:1Side:S3	ENG	[1 to 110 / 72 / 1/step]
2-653-012	PaperTransfer:2Side:S3	ENG	[1 to 110 / 74 / 1/step]
2-653-015	PaperTransfer:1Side:S4	ENG	[1 to 110 / 72 / 1/step]
2-653-016	PaperTransfer:2Side:S4	ENG	[1 to 110 / 75 / 1/step]
2-653-019	PaperTransfer:1Side:S5	ENG	[1 to 110 / 72 / 1/step]
2-653-020	PaperTransfer:2Side:S5	ENG	[1 to 110 / 76 / 1/step]
2-653-023	Wide Roller:PaperTransfer:1Side:S1	ENG	[1 to 110 / 70 / 1/step]
2-653-024	Wide Roller:PaperTransfer:2Side:S1	ENG	[1 to 110 / 72 / 1/step]
2-653-027	Wide Roller:PaperTransfer:1Side:S2	ENG	[1 to 110 / 71 / 1/step]
2-653-028	Wide Roller:PaperTransfer:2Side:S2	ENG	[1 to 110 / 73 / 1/step]
2-653-031	Wide Roller:PaperTransfer:1Side:S3	ENG	[1 to 110 / 72 / 1/step]
2-653-032	Wide Roller:PaperTransfer:2Side:S3	ENG	[1 to 110 / 74 / 1/step]
2-653-035	Wide Roller:PaperTransfer:1Side:S4	ENG	[1 to 110 / 72 / 1/step]
2-653-036	Wide Roller:PaperTransfer:2Side:S4	ENG	[1 to 110 / 75 / 1/step]
2-653-039	Wide Roller:PaperTransfer:1Side:S5	ENG	[1 to 110 / 72 / 1/step]
2-653-040	Wide Roller:PaperTransfer:2Side:S5	ENG	[1 to 110 / 76 / 1/step]

2654	[Sp2Thick:PaperSizeEnvCorr:FC]		
2-654-003	PaperTransfer:1Side:S1	ENG	[1 to 110 / 77 / 1/step]
2-654-004	PaperTransfer:2Side:S1	ENG	[1 to 110 / 80 / 1/step]
2-654-007	PaperTransfer:1Side:S2	ENG	[1 to 110 / 78 / 1/step]

2-654-008	PaperTransfer:2Side:S2	ENG	[1 to 110 / 81 / 1/step]
2-654-011	PaperTransfer:1Side:S3	ENG	[1 to 110 / 79 / 1/step]
2-654-012	PaperTransfer:2Side:S3	ENG	[1 to 110 / 82 / 1/step]
2-654-015	PaperTransfer:1Side:S4	ENG	[1 to 110 / 79 / 1/step]
2-654-016	PaperTransfer:2Side:S4	ENG	[1 to 110 / 83 / 1/step]
2-654-019	PaperTransfer:1Side:S5	ENG	[1 to 110 / 79 / 1/step]
2-654-020	PaperTransfer:2Side:S5	ENG	[1 to 110 / 84 / 1/step]
2-654-023	Wide Roller:PaperTransfer:1Side:S1	ENG	[1 to 110 / 77 / 1/step]
2-654-024	Wide Roller:PaperTransfer:2Side:S1	ENG	[1 to 110 / 80 / 1/step]
2-654-027	Wide Roller:PaperTransfer:1Side:S2	ENG	[1 to 110 / 78 / 1/step]
2-654-028	Wide Roller:PaperTransfer:2Side:S2	ENG	[1 to 110 / 81 / 1/step]
2-654-031	Wide Roller:PaperTransfer:1Side:S3	ENG	[1 to 110 / 79 / 1/step]
2-654-032	Wide Roller:PaperTransfer:2Side:S3	ENG	[1 to 110 / 82 / 1/step]
2-654-035	Wide Roller:PaperTransfer:1Side:S4	ENG	[1 to 110 / 79 / 1/step]
2-654-036	Wide Roller:PaperTransfer:2Side:S4	ENG	[1 to 110 / 83 / 1/step]
2-654-039	Wide Roller:PaperTransfer:1Side:S5	ENG	[1 to 110 / 79 / 1/step]
2-654-040	Wide Roller:PaperTransfer:2Side:S5	ENG	[1 to 110 / 84 / 1/step]

2655	[Sp2Thick:LeadingEdgeCorrection]		
2-655-003	Paper Transfer:1side	ENG	[0 to 995 / 100 / 5%/step]
2-655-004	Paper Transfer:2side	ENG	[0 to 995 / 100 / 5%/step]

2656	[Sp2Thick:SwitchTimingLeadEdge]		
2-656-003	Paper Transfer:1side	ENG	[0 to 50 / 0 / 2mm/step]
2-656-004	Paper Transfer:2side	ENG	[0 to 50 / 0 / 2mm/step]

2657	[Sp2Thick:TrailEdgeCorrection]		
-------------	---------------------------------------	--	--

2-657-003	Paper Transfer:1 side	ENG	[0 to 995 / 100 / 5%/step]
2-657-004	Paper Transfer:2side	ENG	[0 to 995 / 100 / 5%/step]

2658	[Sp2Thick:SwitchTimingTrailEdge]		
2-658-003	Paper Transfer:1 side	ENG	[0 to 50 / 0 / 2mm/step]
2-658-004	Paper Transfer:2side	ENG	[0 to 50 / 0 / 2mm/step]

2663	[Special3 Thick:Bias:BW]		
2-663-003	PaperTransfer:1 side	ENG	[0 to 200 / 11 / 1-uA/step]
2-663-004	PaperTransfer:2side	ENG	[0 to 200 / 15 / 1-uA/step]

2667	[Special3 Thick:Bias:FC]		
2-667-003	PaperTransfer:1 side	ENG	[0 to 200 / 19 / 1-uA/step]
2-667-004	PaperTransfer:2side	ENG	[0 to 200 / 21 / 1-uA/step]

2671	[Special3Thick:PaperSizeCorr:BW]		
2-671-003	PaperTransfer:1 Side:S1	ENG	[100 to 995 / 100 / 5%/step]
2-671-004	PaperTransfer:2Side:S1	ENG	[100 to 995 / 100 / 5%/step]
2-671-007	PaperTransfer:1 Side:S2	ENG	[100 to 995 / 100 / 5%/step]
2-671-008	PaperTransfer:2Side:S2	ENG	[100 to 995 / 133 / 5%/step]
2-671-011	PaperTransfer:1 Side:S3	ENG	[100 to 995 / 100 / 5%/step]
2-671-012	PaperTransfer:2Side:S3	ENG	[100 to 995 / 167 / 5%/step]
2-671-015	PaperTransfer:1 Side:S4	ENG	[100 to 995 / 100 / 5%/step]

2-671-016	PaperTransfer:2Side:S4	ENG	[100 to 995 / 233 / 5%/step]
2-671-019	PaperTransfer:1Side:S5	ENG	[100 to 995 / 100 / 5%/step]
2-671-020	PaperTransfer:2Side:S5	ENG	[100 to 995 / 267 / 5%/step]
2-671-023	Wide Roller:PaperTransfer:1Side:S1	ENG	[100 to 995 / 100 / 5%/step]
2-671-024	Wide Roller:PaperTransfer:2Side:S1	ENG	[100 to 995 / 100 / 5%/step]
2-671-027	Wide Roller:PaperTransfer:1Side:S2	ENG	[100 to 995 / 100 / 5%/step]
2-671-028	Wide Roller:PaperTransfer:2Side:S2	ENG	[100 to 995 / 133 / 5%/step]
2-671-031	Wide Roller:PaperTransfer:1Side:S3	ENG	[100 to 995 / 100 / 5%/step]
2-671-032	Wide Roller:PaperTransfer:2Side:S3	ENG	[100 to 995 / 167 / 5%/step]
2-671-035	Wide Roller:PaperTransfer:1Side:S4	ENG	[100 to 995 / 100 / 5%/step]
2-671-036	Wide Roller:PaperTransfer:2Side:S4	ENG	[100 to 995 / 233 / 5%/step]
2-671-039	Wide Roller:PaperTransfer:1Side:S5	ENG	[100 to 995 / 100 / 5%/step]
2-671-040	Wide Roller:PaperTransfer:2Side:S5	ENG	[100 to 995 / 267 / 5%/step]

2672	[Special3Thick:PaperSizeCorr:FC]		
2-672-003	PaperTransfer:1Side:S1	ENG	[100 to 995 / 100 / 5%/step]
2-672-004	PaperTransfer:2Side:S1	ENG	[100 to 995 / 100 / 5%/step]

2-672-007	PaperTransfer:1Side:S2	ENG	[100 to 995 / 100 / 5%/step]
2-672-008	PaperTransfer:2Side:S2	ENG	[100 to 995 / 181 / 5%/step]
2-672-011	PaperTransfer:1Side:S3	ENG	[100 to 995 / 100 / 5%/step]
2-672-012	PaperTransfer:2Side:S3	ENG	[100 to 995 / 229 / 5%/step]
2-672-015	PaperTransfer:1Side:S4	ENG	[100 to 995 / 100 / 5%/step]
2-672-016	PaperTransfer:2Side:S4	ENG	[100 to 995 / 286 / 5%/step]
2-672-019	PaperTransfer:1Side:S5	ENG	[100 to 995 / 100 / 5%/step]
2-672-020	PaperTransfer:2Side:S5	ENG	[100 to 995 / 381 / 5%/step]
2-672-023	Wide Roller:PaperTransfer:1Side:S1	ENG	[100 to 995 / 100 / 5%/step]
2-672-024	Wide Roller:PaperTransfer:2Side:S1	ENG	[100 to 995 / 100 / 5%/step]
2-672-027	Wide Roller:PaperTransfer:1Side:S2	ENG	[100 to 995 / 100 / 5%/step]
2-672-028	Wide Roller:PaperTransfer:2Side:S2	ENG	[100 to 995 / 181 / 5%/step]
2-672-031	Wide Roller:PaperTransfer:1Side:S3	ENG	[100 to 995 / 100 / 5%/step]
2-672-032	Wide Roller:PaperTransfer:2Side:S3	ENG	[100 to 995 / 229 / 5%/step]
2-672-035	Wide Roller:PaperTransfer:1Side:S4	ENG	[100 to 995 / 100 / 5%/step]
2-672-036	Wide Roller:PaperTransfer:2Side:S4	ENG	[100 to 995 / 286 / 5%/step]

2-672-039	Wide Roller:PaperTransfer:1Side:S5	ENG	[100 to 995 / 100 / 5%/step]
2-672-040	Wide Roller:PaperTransfer:2Side:S5	ENG	[100 to 995 / 381 / 5%/step]

2673	[Sp3Thick:PaperSizeEnvCorr:BW]		
2-673-003	PaperTransfer:1Side:S1	ENG	[1 to 110 / 70 / 1/step]
2-673-004	PaperTransfer:2Side:S1	ENG	[1 to 110 / 72 / 1/step]
2-673-007	PaperTransfer:1Side:S2	ENG	[1 to 110 / 71 / 1/step]
2-673-008	PaperTransfer:2Side:S2	ENG	[1 to 110 / 73 / 1/step]
2-673-011	PaperTransfer:1Side:S3	ENG	[1 to 110 / 72 / 1/step]
2-673-012	PaperTransfer:2Side:S3	ENG	[1 to 110 / 74 / 1/step]
2-673-015	PaperTransfer:1Side:S4	ENG	[1 to 110 / 72 / 1/step]
2-673-016	PaperTransfer:2Side:S4	ENG	[1 to 110 / 75 / 1/step]
2-673-019	PaperTransfer:1Side:S5	ENG	[1 to 110 / 72 / 1/step]
2-673-020	PaperTransfer:2Side:S5	ENG	[1 to 110 / 76 / 1/step]
2-673-023	Wide Roller:PaperTransfer:1Side:S1	ENG	[1 to 110 / 70 / 1/step]
2-673-024	Wide Roller:PaperTransfer:2Side:S1	ENG	[1 to 110 / 72 / 1/step]
2-673-027	Wide Roller:PaperTransfer:1Side:S2	ENG	[1 to 110 / 71 / 1/step]
2-673-028	Wide Roller:PaperTransfer:2Side:S2	ENG	[1 to 110 / 73 / 1/step]
2-673-031	Wide Roller:PaperTransfer:1Side:S3	ENG	[1 to 110 / 72 / 1/step]
2-673-032	Wide Roller:PaperTransfer:2Side:S3	ENG	[1 to 110 / 74 / 1/step]
2-673-035	Wide Roller:PaperTransfer:1Side:S4	ENG	[1 to 110 / 72 / 1/step]
2-673-036	Wide Roller:PaperTransfer:2Side:S4	ENG	[1 to 110 / 75 / 1/step]
2-673-039	Wide Roller:PaperTransfer:1Side:S5	ENG	[1 to 110 / 72 / 1/step]
2-673-040	Wide Roller:PaperTransfer:2Side:S5	ENG	[1 to 110 / 76 / 1/step]

2674	[Sp3Thick:PaperSizeEnvCorr:FC]		
2-674-003	PaperTransfer:1Side:S1	ENG	[1 to 110 / 77 / 1/step]
2-674-004	PaperTransfer:2Side:S1	ENG	[1 to 110 / 80 / 1/step]
2-674-007	PaperTransfer:1Side:S2	ENG	[1 to 110 / 78 / 1/step]
2-674-008	PaperTransfer:2Side:S2	ENG	[1 to 110 / 81 / 1/step]
2-674-011	PaperTransfer:1Side:S3	ENG	[1 to 110 / 79 / 1/step]
2-674-012	PaperTransfer:2Side:S3	ENG	[1 to 110 / 82 / 1/step]
2-674-015	PaperTransfer:1Side:S4	ENG	[1 to 110 / 79 / 1/step]
2-674-016	PaperTransfer:2Side:S4	ENG	[1 to 110 / 83 / 1/step]
2-674-019	PaperTransfer:1Side:S5	ENG	[1 to 110 / 79 / 1/step]
2-674-020	PaperTransfer:2Side:S5	ENG	[1 to 110 / 84 / 1/step]
2-674-023	Wide Roller:PaperTransfer:1Side:S1	ENG	[1 to 110 / 77 / 1/step]
2-674-024	Wide Roller:PaperTransfer:2Side:S1	ENG	[1 to 110 / 80 / 1/step]
2-674-027	Wide Roller:PaperTransfer:1Side:S2	ENG	[1 to 110 / 78 / 1/step]
2-674-028	Wide Roller:PaperTransfer:2Side:S2	ENG	[1 to 110 / 81 / 1/step]
2-674-031	Wide Roller:PaperTransfer:1Side:S3	ENG	[1 to 110 / 79 / 1/step]
2-674-032	Wide Roller:PaperTransfer:2Side:S3	ENG	[1 to 110 / 82 / 1/step]
2-674-035	Wide Roller:PaperTransfer:1Side:S4	ENG	[1 to 110 / 79 / 1/step]
2-674-036	Wide Roller:PaperTransfer:2Side:S4	ENG	[1 to 110 / 83 / 1/step]
2-674-039	Wide Roller:PaperTransfer:1Side:S5	ENG	[1 to 110 / 79 / 1/step]
2-674-040	Wide Roller:PaperTransfer:2Side:S5	ENG	[1 to 110 / 84 / 1/step]

2675	[Sp3Thick:LeadingEdgeCorrection]		
2-675-003	Paper Transfer:1side	ENG	[0 to 995 / 100 / 5%/step]
2-675-004	Paper Transfer:2side	ENG	[0 to 995 / 100 / 5%/step]
2676	[Sp3Thick:SwitchTimingLeadEdge]		

2-675-003	Paper Transfer:1 side	ENG	[0 to 995 / 100 / 5%/step]
2-675-004	Paper Transfer:2side	ENG	[0 to 995 / 100 / 5%/step]
2677	[Sp3Thick:TrailEdgeCorrection]		
2-675-003	Paper Transfer:1 side	ENG	[0 to 995 / 100 / 5%/step]
2-675-004	Paper Transfer:2side	ENG	[0 to 995 / 100 / 5%/step]

3

2678	[Sp3Thick:SwitchTimingTrailEdge]		
2-678-003	Paper Transfer:1 side	ENG	[0 to 50 / 0 / 2mm/step]
2-678-004	Paper Transfer:2side	ENG	[0 to 50 / 0 / 2mm/step]

2690	[ITB Contact Setting]		
2-690-001	Thick1	ENG	[0 or 1 / 0 / 1/step]
2-690-002	Thick2	ENG	[0 or 1 / 0 / 1/step]
2-690-003	Thick3	ENG	[0 or 1 / 0 / 1/step]
2-690-004	Thick4	ENG	[0 or 1 / 0 / 1/step]
2-690-014	Special1Thick1234	ENG	[0 or 1 / 0 / 1/step]
2-690-015	Special2Thick1234	ENG	[0 or 1 / 0 / 1/step]
2-690-016	Special3Thick1234	ENG	[0 or 1 / 0 / 1/step]

2703	[Thick4:Bias:BW]		
2-703-003	PaperTransfer:1 side	ENG	[0 to 200 / 11 / 1-uA/step]
2-703-004	PaperTransfer:2side	ENG	[0 to 200 / 15 / 1-uA/step]

2707	[Thick4:Bias:FC]		
2-707-003	PaperTransfer:1 side	ENG	[0 to 200 / 19 / 1-uA/step]
2-707-004	PaperTransfer:2side	ENG	[0 to 200 / 21 / 1-uA/step]

2711	[Thick4:SizeCorrection:BW]		
-------------	-----------------------------------	--	--

2-711-003	PaperTransfer:1Side:S1	ENG	[100 to 995 / 100 / 1%/step]
2-711-004	PaperTransfer:2Side:S1	ENG	[100 to 995 / 100 / 1%/step]
2-711-007	PaperTransfer:1Side:S2	ENG	[100 to 995 / 100 / 1%/step]
2-711-008	PaperTransfer:2Side:S2	ENG	[100 to 995 / 133 / 1%/step]
2-711-011	PaperTransfer:1Side:S3	ENG	[100 to 995 / 100 / 1%/step]
2-711-012	PaperTransfer:2Side:S3	ENG	[100 to 995 / 167 / 1%/step]
2-711-015	PaperTransfer:1Side:S4	ENG	[100 to 995 / 100 / 1%/step]
2-711-016	PaperTransfer:2Side:S4	ENG	[100 to 995 / 233 / 1%/step]
2-711-019	PaperTransfer:1Side:S5	ENG	[100 to 995 / 100 / 1%/step]
2-711-020	PaperTransfer:2Side:S5	ENG	[100 to 995 / 267 / 1%/step]
2-711-023	Wide Roller:PaperTransfer:1Side:S1	ENG	[100 to 995 / 100 / 1%/step]
2-711-024	Wide Roller:PaperTransfer:2Side:S1	ENG	[100 to 995 / 100 / 1%/step]
2-711-027	Wide Roller:PaperTransfer:1Side:S2	ENG	[100 to 995 / 100 / 1%/step]
2-711-028	Wide Roller:PaperTransfer:2Side:S2	ENG	[100 to 995 / 133 / 1%/step]
2-711-031	Wide Roller:PaperTransfer:1Side:S3	ENG	[100 to 995 / 100 / 1%/step]
2-711-032	Wide Roller:PaperTransfer:2Side:S3	ENG	[100 to 995 / 167 / 1%/step]

2-711-035	Wide Roller:PaperTransfer:1Side:S4	ENG	[100 to 995 / 100 / 1%/step]
2-711-036	Wide Roller:PaperTransfer:2Side:S4	ENG	[100 to 995 / 233 / 1%/step]
2-711-039	Wide Roller:PaperTransfer:1Side:S5	ENG	[100 to 995 / 100 / 1%/step]
2-711-040	Wide Roller:PaperTransfer:2Side:S5	ENG	[100 to 995 / 267 / 1%/step]

3

2712	[Thick4:SizeCorrection:FC]		
2-712-003	PaperTransfer:1Side:S1	ENG	[100 to 995 / 100 / 1%/step]
2-712-004	PaperTransfer:2Side:S1	ENG	[100 to 995 / 100 / 1%/step]
2-712-007	PaperTransfer:1Side:S2	ENG	[100 to 995 / 100 / 1%/step]
2-712-008	PaperTransfer:2Side:S2	ENG	[100 to 995 / 181 / 1%/step]
2-712-011	PaperTransfer:1Side:S3	ENG	[100 to 995 / 100 / 1%/step]
2-712-012	PaperTransfer:2Side:S3	ENG	[100 to 995 / 229 / 1%/step]
2-712-015	PaperTransfer:1Side:S4	ENG	[100 to 995 / 100 / 1%/step]
2-712-016	PaperTransfer:2Side:S4	ENG	[100 to 995 / 286 / 1%/step]
2-712-019	PaperTransfer:1Side:S5	ENG	[100 to 995 / 100 / 1%/step]
2-712-020	PaperTransfer:2Side:S5	ENG	[100 to 995 / 381 / 1%/step]
2-712-023	Wide Roller:PaperTransfer:1Side:S1	ENG	[100 to 995 / 100 / 1%/step]

2-712-024	Wide Roller:PaperTransfer:2Side:S1	ENG	[100 to 995 / 100 / 1%/step]
2-712-027	Wide Roller:PaperTransfer:1Side:S2	ENG	[100 to 995 / 100 / 1%/step]
2-712-028	Wide Roller:PaperTransfer:2Side:S2	ENG	[100 to 995 / 181 / 1%/step]
2-712-031	Wide Roller:PaperTransfer:1Side:S3	ENG	[100 to 995 / 100 / 1%/step]
2-712-032	Wide Roller:PaperTransfer:2Side:S3	ENG	[100 to 995 / 229 / 1%/step]
2-712-035	Wide Roller:PaperTransfer:1Side:S4	ENG	[100 to 995 / 100 / 1%/step]
2-712-036	Wide Roller:PaperTransfer:2Side:S4	ENG	[100 to 995 / 286 / 1%/step]
2-712-039	Wide Roller:PaperTransfer:1Side:S5	ENG	[100 to 995 / 100 / 1%/step]
2-712-040	Wide Roller:PaperTransfer:2Side:S5	ENG	[100 to 995 / 381 / 1%/step]

2713	[Thick4:Size-Env.Correct:BW]		
2-713-003	PaperTransfer:1Side:S1	ENG	[1 to 110 / 70 / 1/step]
2-713-004	PaperTransfer:2Side:S1	ENG	[1 to 110 / 72 / 1/step]
2-713-007	PaperTransfer:1Side:S2	ENG	[1 to 110 / 71 / 1/step]
2-713-008	PaperTransfer:2Side:S2	ENG	[1 to 110 / 73 / 1/step]
2-713-011	PaperTransfer:1Side:S3	ENG	[1 to 110 / 72 / 1/step]
2-713-012	PaperTransfer:2Side:S3	ENG	[1 to 110 / 74 / 1/step]
2-713-015	PaperTransfer:1Side:S4	ENG	[1 to 110 / 72 / 1/step]
2-713-016	PaperTransfer:2Side:S4	ENG	[1 to 110 / 75 / 1/step]
2-713-019	PaperTransfer:1Side:S5	ENG	[1 to 110 / 72 / 1/step]
2-713-020	PaperTransfer:2Side:S5	ENG	[1 to 110 / 76 / 1/step]

2-713-023	Wide Roller:PaperTransfer:1 Side:S1	ENG	[1 to 110 / 70 / 1/step]
2-713-024	Wide Roller:PaperTransfer:2Side:S1	ENG	[1 to 110 / 72 / 1/step]
2-713-027	Wide Roller:PaperTransfer:1 Side:S2	ENG	[1 to 110 / 71 / 1/step]
2-713-028	Wide Roller:PaperTransfer:2Side:S2	ENG	[1 to 110 / 73 / 1/step]
2-713-031	Wide Roller:PaperTransfer:1 Side:S3	ENG	[1 to 110 / 72 / 1/step]
2-713-032	Wide Roller:PaperTransfer:2Side:S3	ENG	[1 to 110 / 74 / 1/step]
2-713-035	Wide Roller:PaperTransfer:1 Side:S4	ENG	[1 to 110 / 72 / 1/step]
2-713-036	Wide Roller:PaperTransfer:2Side:S4	ENG	[1 to 110 / 75 / 1/step]
2-713-039	Wide Roller:PaperTransfer:1 Side:S5	ENG	[1 to 110 / 72 / 1/step]
2-713-040	Wide Roller:PaperTransfer:2Side:S5	ENG	[1 to 110 / 76 / 1/step]

2714	[Thick4:Size-Env.Correct:FC]		
2-714-003	PaperTransfer:1 Side:S1	ENG	[1 to 110 / 77 / 1/step]
2-714-004	PaperTransfer:2Side:S1	ENG	[1 to 110 / 80 / 1/step]
2-714-007	PaperTransfer:1 Side:S2	ENG	[1 to 110 / 78 / 1/step]
2-714-008	PaperTransfer:2Side:S2	ENG	[1 to 110 / 81 / 1/step]
2-714-011	PaperTransfer:1 Side:S3	ENG	[1 to 110 / 79 / 1/step]
2-714-012	PaperTransfer:2Side:S3	ENG	[1 to 110 / 82 / 1/step]
2-714-015	PaperTransfer:1 Side:S4	ENG	[1 to 110 / 79 / 1/step]
2-714-016	PaperTransfer:2Side:S4	ENG	[1 to 110 / 83 / 1/step]
2-714-019	PaperTransfer:1 Side:S5	ENG	[1 to 110 / 79 / 1/step]
2-714-020	PaperTransfer:2Side:S5	ENG	[1 to 110 / 84 / 1/step]
2-714-023	Wide Roller:PaperTransfer:1 Side:S1	ENG	[1 to 110 / 77 / 1/step]
2-714-024	Wide Roller:PaperTransfer:2Side:S1	ENG	[1 to 110 / 80 / 1/step]
2-714-027	Wide Roller:PaperTransfer:1 Side:S2	ENG	[1 to 110 / 78 / 1/step]
2-714-028	Wide Roller:PaperTransfer:2Side:S2	ENG	[1 to 110 / 81 / 1/step]

2-714-031	Wide Roller:PaperTransfer:1Side:S3	ENG	[1 to 110 / 79 / 1/step]
2-714-032	Wide Roller:PaperTransfer:2Side:S3	ENG	[1 to 110 / 82 / 1/step]
2-714-035	Wide Roller:PaperTransfer:1Side:S4	ENG	[1 to 110 / 79 / 1/step]
2-714-036	Wide Roller:PaperTransfer:2Side:S4	ENG	[1 to 110 / 83 / 1/step]
2-714-039	Wide Roller:PaperTransfer:1Side:S5	ENG	[1 to 110 / 79 / 1/step]
2-714-040	Wide Roller:PaperTransfer:2Side:S5	ENG	[1 to 110 / 84 / 1/step]

2715	[Thick4:LeadingEdgeCorrection]		
2-715-003	Paper Transfer:1side	ENG	[0 to 995 / 100 / 5%/step]
2-715-004	Paper Transfer:2side	ENG	[0 to 995 / 100 / 5%/step]

2716	[Thick4:SwitchTimingLeadEdge]		
2-716-003	Paper Transfer:1side	ENG	[0 to 50 / 0 / 2mm/step]
2-716-004	Paper Transfer:2side	ENG	[0 to 50 / 0 / 2mm/step]

2717	[Thick4:TrailEdgeCorrection]		
2-717-003	Paper Transfer:1side	ENG	[0 to 995 / 100 / 5%/step]
2-717-004	Paper Transfer:2side	ENG	[0 to 995 / 100 / 5%/step]

2718	[Thick4:SwitchTimingTrailEdge]		
2-718-003	Paper Transfer:1side	ENG	[0 to 50 / 0 / 2mm/step]
2-718-004	Paper Transfer:2side	ENG	[0 to 50 / 0 / 2mm/step]

2901	[OPC Drum Brake Time]		
2-901-001	All	*ENG	[50 to 240000 / 50 / 10msec/step]

2902	[OPC Drum Reverse Time]		
2-902-001	All: BW	*ENG	[0 to 200 / 40 / 10msec/step]

2-902-002	All: FC	*ENG	[0 to 200 / 40 / 10msec/step]
2903	[Image Transfer Brake Time]		
2-903-003	All	*ENG	[50 to 240000 / 50 / 10msec/step]
2905	[Dev Rvs Time]		
2-905-003	K	*ENG	[0 to 200 / 70 / 10msec/step]
2-905-004	Cl	*ENG	[0 to 200 / 90 / 10msec/step]
2905	[Dev Rvs Threshold Counter]		
2-905-005	ALL	*ENG	[0 to 400000 / 4000 / 10mm/step]
2905	[Dev Rvs Counter]		
2-905-006	K	*ENG	[0 to 4294967295 / 0 / 1mm/step]
2-905-007	Cl	*ENG	[0 to 4294967295 / 0 / 1mm/step]
2907	[ACS Setting (FC to Bk)]		
2-907-001	Continuous Bk Pages	*ENG	[0 to 10 / 0 / 1sheet/step]
2930	[Transfer:Bias Limiter]		
2-930-001	Bias	*ENG	[0 to 7000 / 6000 / 10-V/step]
2960	[Process Interval]		
2-960-001	Additional Time	*ENG	[0 to 10 / 0 / 1sec/step]
2972	[B/W Image Request Timing]		
2-972-001	T14:standard speed	*ENG	[0 to 4000 / 0 / 10msec/step]
2-972-003	T14:low speed	*ENG	
2974	[Trans. Contact Fgate Timing: Y]		

2-974-001	Fwait:Y std	*ENG	[0 to 3000 / 0 / 10msec/step]
2-974-002	Fwait:Y mid	*ENG	
2-974-003	Fwait:Y low	*ENG	

2980	[LubricantApplication Operation]		
2-980-001	Lubricant Application Setting	*ENG	[0 to 300 / 0 / 10pages/step]
2-980-002	Idle Time: BK	*ENG	[0 to 600 / 1 / 1sec/step]
2-980-003	Idle Time: FC	*ENG	[0 to 600 / 1 / 1sec/step]

2990	[Print Duty Control]		
2-990-001	Duty Control State	*ENG	[0 or 1 / 0 / 1/step] 0: Non restricted 1: Restricted
2-990-002	Exec Interval: Duty Control	*ENG	[60 to 3600 / 60 / 10sec/step]
2-990-004	Forced CPM Down Thresh: No Duty Control	*ENG	[0 to 5000 / 0 / 1page/step]
2-990-005	Down-time_BW: No Duty Control	*ENG	[0 to 20000 / 0 / 10msec/step]
2-990-006	Down-time_FC: No Duty Control	*ENG	[0 to 20000 / 0 / 10msec/step]
2-990-007	Forced CPM Down Thresh: Duty Control	*ENG	[0 to 5000 / 20 / 1page/step]
2-990-008	Down-time_BW: Duty Control	*ENG	[0 to 240000 / 60000 / 10msec/step]
2-990-009	Down-time_FC: Duty Control	*ENG	[0 to 240000 / 60000 / 10msec/step]
2-990-010	Ambient Temp Correction Coeff	*ENG	[-1 to 1 / 0 / 0.1/step]
2-990-011	Execution Temp. Threshold	*ENG	[20 to 70 / 38.5 / 0.1 deg/step]
2-990-012	Cancellation Temp. Threshold	*ENG	[0.1 to 20 / 0.1 / 0.1 deg/step]

2-990-013	ON/OFF Setting	*ENG	[0 or 1 / 1 / 1/step]
2-990-014	Duty Control_Down-time_BW	*ENG	[0 to 240000 / 0 / 10msec/step]
2-990-015	Duty Control_Down-time_FC	*ENG	[0 to 240000 / 0 / 10msec/step]

Engine SP Tables - SP3000

SP3-XXX (Process)

3011	[Manual ProCon :Exe]		
3-011-001	Normal ProCon	ENG	[0 or 1 / 0 / 1/step] [Execute]
3-011-002	Density Adjustment	ENG	[0 or 1 / 0 / 1/step] [Execute]
3-011-003	ACC RunTime ProCon	ENG	[0 or 1 / 0 / 1/step] [Execute]
3-011-004	Full MUSIC	ENG	[0 or 1 / 0 / 1/step] [Execute]
3-011-005	Normal MUSIC	ENG	[0 or 1 / 0 / 1/step] [Execute]

3012	[ProCon OK?]		
3-012-001	History:Last(Front)	*ENG	[0 to 99999999 / 0 / 1/step]
3-012-002	History:Last 2(Front)	*ENG	[0 to 99999999 / 0 / 1/step]
3-012-003	History:Last 3(Front)	*ENG	[0 to 99999999 / 0 / 1/step]
3-012-004	History:Last 4(Front)	*ENG	[0 to 99999999 / 0 / 1/step]
3-012-005	History:Last 5(Front)	*ENG	[0 to 99999999 / 0 / 1/step]
3-012-006	History:Last 6(Front)	*ENG	[0 to 99999999 / 0 / 1/step]
3-012-007	History:Last 7(Front)	*ENG	[0 to 99999999 / 0 / 1/step]
3-012-008	History:Last 8(Front)	*ENG	[0 to 99999999 / 0 / 1/step]
3-012-009	History:Last 9(Front)	*ENG	[0 to 99999999 / 0 / 1/step]
3-012-010	History:Last 10(Front)	*ENG	[0 to 99999999 / 0 / 1/step]
3-012-011	History:Last(Center)	*ENG	[0 to 99999999 / 0 / 1/step]

3-012-012	History:Last 2(Center)	*ENG	[0 to 99999999 / 0 / 1/step]
3-012-013	History:Last 3(Center)	*ENG	[0 to 99999999 / 0 / 1/step]
3-012-014	History:Last 4(Center)	*ENG	[0 to 99999999 / 0 / 1/step]
3-012-015	History:Last 5(Center)	*ENG	[0 to 99999999 / 0 / 1/step]
3-012-016	History:Last 6(Center)	*ENG	[0 to 99999999 / 0 / 1/step]
3-012-017	History:Last 7(Center)	*ENG	[0 to 99999999 / 0 / 1/step]
3-012-018	History:Last 8(Center)	*ENG	[0 to 99999999 / 0 / 1/step]
3-012-019	History:Last 9(Center)	*ENG	[0 to 99999999 / 0 / 1/step]
3-012-020	History:Last 10(Center)	*ENG	[0 to 99999999 / 0 / 1/step]
3-012-021	History:Last(Rear)	*ENG	[0 to 99999999 / 0 / 1/step]
3-012-022	History:Last 2(Rear)	*ENG	[0 to 99999999 / 0 / 1/step]
3-012-023	History:Last 3(Rear)	*ENG	[0 to 99999999 / 0 / 1/step]
3-012-024	History:Last 4(Rear)	*ENG	[0 to 99999999 / 0 / 1/step]
3-012-025	History:Last 5(Rear)	*ENG	[0 to 99999999 / 0 / 1/step]
3-012-026	History:Last 6(Rear)	*ENG	[0 to 99999999 / 0 / 1/step]
3-012-027	History:Last 7(Rear)	*ENG	[0 to 99999999 / 0 / 1/step]
3-012-028	History:Last 8(Rear)	*ENG	[0 to 99999999 / 0 / 1/step]
3-012-029	History:Last 9(Rear)	*ENG	[0 to 99999999 / 0 / 1/step]
3-012-030	History:Last 10(Rear)	*ENG	[0 to 99999999 / 0 / 1/step]

***SP3-012 Display result detail**

Category	Code	Result name	Description
00 and larger	00	Not executed	Factory default setting (SP default)
10 and larger Result (Normal)	11	Succeeded	-

Category	Code	Result name	Description
40 and larger ID Sensor	41	ID sensor output error (Max)	Vt > Max
	42	ID sensor output error (Min)	Vt < Min
	43	ID Sensor error (Max)	Development gamma is in target, but Vt value is less than upper limit.
	44	ID Sensor error (Min)	Development gamma is in target, but Vt value is less than lower limit.
45 and larger ID Pattern detection	45	ID Pattern extract error	Cannot detect ID Pattern
	50	Vmin_Bk/K2 error (Max)	K:Vmin_Bk / CMY:K2 > Max
	51	Vmin_Bk/K2 error (Min)	K:Vmin_Bk / CMY:K2 < Min
	52	K5 error (Max)	K5 > Max
	53	K5 error (Min)	K5 < Min
	54	K5 calculated approximate point error	K5 calculated approximate point < Min
	55	Development gamma error (Max)	Development gamma > Max
	56	Development gamma error (Min)	Development gamma < Min
	57	Start developing voltage: Vk error(Max)	Start developing voltage: Vk > Max
	58	Start developing voltage: Vk error(Min)	Start developing voltage: Vk < Min
59	Not enough valid data	Adhesion amount data for development gamma calculation point is under 2	
90 and larger Result(End)	90	Potential not adjusted	Potential control method is set as [0:FIX]
	99	Stopped	Stopped by door open, power off, error. (Set when execute.)

Note

- Execute result sample (In order of YMCK from left)
- Factory default(SP default):[00,00,00,00]
- Starting adjust:[99,99,99,99]
- Fail Vsg adjust(Y):[21,99,99,99]
- Error of Develop gamma Max(C):[99,99,55,99]
- Succeed:[11,11,11,11]

3

3014	[IBACC OK?]		
3-014-001	History:Last	*ENG	[0 to 9999 / 0 / 1/step]
3-014-002	History:Last 2	*ENG	
3-014-003	History:Last 3	*ENG	
3-014-004	History:Last 4	*ENG	
3-014-005	History:Last 5	*ENG	
3-014-006	History:Last 6	*ENG	
3-014-007	History:Last 7	*ENG	
3-014-008	History:Last 8	*ENG	
3-014-009	History:Last 9	*ENG	
3-014-010	History:Last 10	*ENG	

3015	[Background Pot ProCon OK?]		
3-015-001	History:Front:Latest	*ENG	[0 to 9999 / 0 / 1/step]
3-015-002	History:Front:Last 2	*ENG	[0 to 9999 / 0 / 1/step]
3-015-003	History:Front:Last 3	*ENG	[0 to 9999 / 0 / 1/step]
3-015-004	History:Front:Last 4	*ENG	[0 to 9999 / 0 / 1/step]
3-015-005	History:Front:Last 5	*ENG	[0 to 9999 / 0 / 1/step]
3-015-006	history:Center:Latest	*ENG	[0 to 9999 / 0 / 1/step]
3-015-007	History:Center:Last 2	*ENG	[0 to 9999 / 0 / 1/step]

3-015-008	History:Center:Last 3	*ENG	[0 to 9999 / 0 / 1/step]
3-015-009	History:Center:Last 4	*ENG	[0 to 9999 / 0 / 1/step]
3-015-010	History:Center:Last 5	*ENG	[0 to 9999 / 0 / 1/step]
3-015-011	history:Rear:Latest	*ENG	[0 to 9999 / 0 / 1/step]
3-015-012	History:Rear:Last 2	*ENG	[0 to 9999 / 0 / 1/step]
3-015-013	History:Rear:Last 3	*ENG	[0 to 9999 / 0 / 1/step]
3-015-014	History:Rear:Last 4	*ENG	[0 to 9999 / 0 / 1/step]
3-015-015	History:Rear:Last 5	*ENG	[0 to 9999 / 0 / 1/step]

3030	[Init TD Sensor :Exe]		
3-030-001	Execute: ALL	ENG	[0 or 1 / 0 / 1/step] [Execute]
3-030-002	Execute: Col	ENG	[0 or 1 / 0 / 1/step] [Execute]
3-030-003	Execute: K	ENG	[0 or 1 / 0 / 1/step] [Execute]
3-030-004	Execute: C	ENG	[0 or 1 / 0 / 1/step] [Execute]
3-030-005	Execute: M	ENG	[0 or 1 / 0 / 1/step] [Execute]
3-030-006	Execute: Y	ENG	[0 or 1 / 0 / 1/step] [Execute]
3-030-071	Init Temp: K	*ENG	[-100 to 100 / 23 / 0.1 deg/step]
3-030-072	Init Temp: C	*ENG	[-100 to 100 / 23 / 0.1 deg/step]
3-030-073	Init Temp: M	*ENG	[-100 to 100 / 23 / 0.1 deg/step]
3-030-074	Init Temp: Y	*ENG	[-100 to 100 / 23 / 0.1 deg/step]
3-030-081	Init Rel Hum: K	*ENG	[0 to 100 / 50 / 0.1%RH/step]

3-030-082	Init Rel Hum: C	*ENG	[0 to 100 / 50 / 0.1%RH/step]
3-030-083	Init Rel Hum: M	*ENG	[0 to 100 / 50 / 0.1%RH/step]
3-030-084	Init Rel Hum: Y	*ENG	[0 to 100 / 50 / 0.1%RH/step]
3-030-091	Init Abs Hum: K	*ENG	[0 to 100 / 10.3 / 0.01g/m ³ /step]
3-030-092	Init Abs Hum: C	*ENG	[0 to 100 / 10.3 / 0.01g/m ³ /step]
3-030-093	Init Abs Hum: M	*ENG	[0 to 100 / 10.3 / 0.01g/m ³ /step]
3-030-094	Init Abs Hum: Y	*ENG	[0 to 100 / 10.3 / 0.01g/m ³ /step]

3031	[TD Sens Init OK?]		
3-031-001	From Left:YMCK	ENG	[0 to 9999 / 0 / 1/step]

3050	[Force Tnr Supply :Exe]		
3-050-001	Execute: ALL	ENG	[0 or 1 / 0 / 1/step] [Execute]
3-050-002	Execute: Col	ENG	[0 or 1 / 0 / 1/step] [Execute]
3-050-003	Execute: K	ENG	[0 or 1 / 0 / 1/step] [Execute]
3-050-004	Execute: C	ENG	[0 or 1 / 0 / 1/step] [Execute]
3-050-005	Execute: M	ENG	[0 or 1 / 0 / 1/step] [Execute]
3-050-006	Execute: Y	ENG	[0 or 1 / 0 / 1/step] [Execute]
3-050-021	Supply Quantity:K	*ENG	[0 to 5 / 0.5 / 0.1wt%/step]
3-050-022	Supply Quantity:C	*ENG	[0 to 5 / 0.5 / 0.1wt%/step]
3-050-023	Supply Quantity:M	*ENG	[0 to 5 / 0.5 / 0.1wt%/step]
3-050-024	Supply Quantity:Y	*ENG	[0 to 5 / 0.5 / 0.1wt%/step]

3-050-033	RepeatCount	*ENG	[0 to 255 / 8 / 1count/step]
-----------	-------------	------	-------------------------------------

3072	[T Sensor: Check]		
3-072-001	Execute Check	ENG	[0 or 1 / 0 / 1/step] [Execute]

3073	[T Sensor Measurement Value:]		
3-073-001	mu count:K	*ENG	[0 to 65535 / 0 / 1/step]
3-073-002	mu count:C	*ENG	
3-073-003	mu count:M	*ENG	
3-073-004	mu count:Y	*ENG	

3100	[Toner End Detection: Set]		
3-100-001	ON/OFF	*ENG	[0 or 1 / 0 / 1/step] Whether to decide NE/TE. 0: Enable 1: Disable
3-100-002	NE Detection	*ENG	[0 or 1 / 0 / 1/step] NE decision method. 0: Counter & Toner End Sensor 1: Toner End Sensor Only

3101	[Toner Status :Disp]		
3-101-001	K	ENG	[0 to 10 / 10 / 1/step] 10: Full 1: Near end 0: Toner end
3-101-002	C	ENG	
3-101-003	M	ENG	
3-101-004	Y	ENG	

3102	[Toner Remain:Disp]		
-------------	----------------------------	--	--

3-102-001	Bottle Motor: Bk	*ENG	[0.000 to 700.000 / 560.000 / 0.001g/step]
3-102-002	Bottle Motor: C	*ENG	[0.000 to 700.000 / 440.000 / 0.001g/step]
3-102-003	Bottle Motor: M	*ENG	
3-102-004	Bottle Motor: Y	*ENG	
3-102-011	Pixel: Bk	*ENG	[0.000 to 700.000 / 560.000 / 0.001g/step]
3-102-012	Pixel: C	*ENG	[0.000 to 700.000 / 440.000 / 0.001g/step]
3-102-013	Pixel: M	*ENG	
3-102-014	Pixel: Y	*ENG	
3102	[Toner Remaining: Display]		
3-102-021	Fill Amount: Bk	*ENG	[0 to 600 / 560 / 1g/step]
3-102-022	Fill Amount: C	*ENG	[0 to 600 / 440 / 1g/step]
3-102-023	Fill Amount: M	*ENG	
3-102-024	Fill Amount: Y	*ENG	
3102	[Toner Remain:Disp]		

3-102-031	Pixel: Toner Consumption x 2: Bk	*ENG	[0.000 to 1000.000 / 0.000 / 0.001g/step]
3-102-032	Pixel: Toner Consumption x 2: C	*ENG	
3-102-033	Pixel: Toner Consumption x 2: M	*ENG	
3-102-034	Pixel: Toner Consumption x 2: Y	*ENG	
3-102-041	Drive Motor: Toner Consumption x 1: Bk	*ENG	
3-102-042	Drive Motor: Toner Consumption x 1: C	*ENG	
3-102-043	Drive Motor: Toner Consumption x 1: M	*ENG	
3-102-044	Drive Motor: Toner Consumption x 1: Y	*ENG	

3104	[Flag: Display]		
3-104-001	NE Toner: Bk	*ENG	[0 or 1 / 0 / 1/step]
3-104-002	NE Toner: C	*ENG	
3-104-003	NE Toner: M	*ENG	
3-104-004	NE Toner: Y	*ENG	
3-104-011	Vt end:Bk	*ENG	[0 or 1 / 0 / 1/step]
3-104-012	Vt end:C	*ENG	
3-104-013	Vt end:M	*ENG	
3-104-014	Vt end:Y	*ENG	

3110	[Near End Thresh]		
3-110-001	Bk	*ENG	[0 to 500 / 65 / 1g/step]

3-110-002	C	*ENG	[0 to 500 / 45 / 1g/step]
3-110-003	M	*ENG	
3-110-004	Y	*ENG	

3121	[TE Counter: Disp]		
3-121-001	Bk	*ENG	[0 to 99 / 0 / 1count/step]
3-121-002	C	*ENG	
3-121-003	M	*ENG	
3-121-004	Y	*ENG	

3121	[TE Counter: Clearcount]		
3-121-011	Bk	*ENG	[0 to 99 / 0 / 1count/step]
3-121-012	C	*ENG	
3-121-013	M	*ENG	
3-121-014	Y	*ENG	

3131	[Vt TE Thresh]		
3-131-001	Delta Vt Thresh	*ENG	[0 to 5 / 0.5 / 0.01V/step]
3-131-002	Delta Vt Sum Thresh	*ENG	[0 to 99 / 10 / 1V/step]
3-131-011	Delta Vt Thresh BF NE	*ENG	[0 to 5 / 0.5 / 0.01V/step]
3-131-012	Delta Vt Sum Thresh BF NE	*ENG	[0 to 99 / 10 / 1V/step]

3132	[Delta Vt Sum]		
3-132-001	Bk	*ENG	[0 to 99 / 0 / 0.01V/step]
3-132-002	C	*ENG	
3-132-003	M	*ENG	
3-132-004	Y	*ENG	

3133	[TE Detect :Set]		
3-133-001	Set Sheets(Min)	*ENG	[0 to 50 / 10 / 1 sheet/step]
3-133-002	Set Sheets(Max)	*ENG	[0 to 5000 / 1000 / 1 sheet/step]
3-133-011	Page Cnt:K	*ENG	[0 to 5000 / 0 / 1 sheet/step]
3-133-012	Page Cnt:C	*ENG	[0 to 5000 / 0 / 1 sheet/step]
3-133-013	Page Cnt:M	*ENG	[0 to 5000 / 0 / 1 sheet/step]
3-133-014	Page Cnt:Y	*ENG	[0 to 5000 / 0 / 1 sheet/step]
3-133-021	Set Pxl Cnt	*ENG	[0 to 1000000 / 7000 / 1 cm ² /step]
3-133-031	Pxl Cnt:K	*ENG	[0 to 1000000 / 0 / 1 cm ² /step]
3-133-032	Pxl Cnt:C	*ENG	[0 to 1000000 / 0 / 1 cm ² /step]
3-133-033	Pxl Cnt:M	*ENG	[0 to 1000000 / 0 / 1 cm ² /step]
3-133-034	Pxl Cnt:Y	*ENG	[0 to 1000000 / 0 / 1 cm ² /step]

3150	[TE Sensor :Set]		
3-150-001	SamplingCount	*ENG	[4 to 20 / 10 / 1 count/step]
3-150-002	Judge:p	*ENG	[0.2 to 1 / 0.8 / 0.1/step]
3-150-003	result:K	*ENG	[0.0 to 1 / 0.5 / 0.1/step]
3-150-004	result:C	*ENG	
3-150-005	result:M	*ENG	
3-150-006	result:Y	*ENG	

3160	[Bottle Drive :Set]		
3-160-001	Bottle Drive System	*ENG	[0 or 1 / 0 / 1/step] 0: TE Sensor Control 1: TonerSupplyMotor Track Control

3200	[TnrDensity]		
-------------	---------------------	--	--

3-200-001	K	*ENG	[0 to 25.5 / 0.0 / 0.1wt%/step]
3-200-002	C	*ENG	
3-200-003	M	*ENG	
3-200-004	Y	*ENG	

3201	[TnrDensity]		
3-201-001	Upper TC	*ENG	[1.0 to 15.0 / 9.0 / 0.1wt%/step]
3-201-002	Lower TC	*ENG	[-1.0 to 15.0 / 2.0 / 0.1wt%/step]

3205	[TD.Sens Sensitivity]		
3-205-051	Mu Cnv Coef:K	*ENG	[0.001 to 0.1 / 0.014 / 0.001V/count/step]
3-205-052	Mu Cnv Coef:C	*ENG	[0.001 to 0.1 / 0.016 / 0.001V/count/step]
3-205-053	Mu Cnv Coef:M	*ENG	[0.001 to 0.1 / 0.016 / 0.001V/count/step]
3-205-054	Mu Cnv Coef:Y	*ENG	[0.001 to 0.1 / 0.016 / 0.001V/count/step]
3-205-101	Bulk Density: K	*ENG	[-5 to 5 / 0.00 / 0.01V/step]
3-205-102	Bulk Density: C	*ENG	
3-205-103	Bulk Density: M	*ENG	
3-205-104	Bulk Density: Y	*ENG	

3210	[TD.Sens:Vt :Disp]		
3-210-001	Current: K	*ENG	[0.00 to 5.50 / 0.00 / 0.01V/step]
3-210-002	Current: C	*ENG	
3-210-003	Current: M	*ENG	
3-210-004	Current: Y	*ENG	

3212	[Vt Shift :Set]		
3-212-101	TC Cor.(ON/OFF)	*ENG	[-0.5 to 0.5 / 0 / 0.01V/step]

3-212-111	TC Mid Spd:K	*ENG	[-0.5 to 0.5 / 0 / 0.01V/step]
3-212-112	TC Mid Spd:C	*ENG	[-0.5 to 0.5 / 0 / 0.01V/step]
3-212-113	TC Mid Spd:M	*ENG	[-0.5 to 0.5 / 0 / 0.01V/step]
3-212-114	TC Mid Spd:Y	*ENG	[-0.5 to 0.5 / 0 / 0.01V/step]
3-212-121	TC Low Spd:K	*ENG	[-0.5 to 0.5 / 0 / 0.01V/step]
3-212-122	TC Low Spd:C	*ENG	[-0.5 to 0.5 / 0 / 0.01V/step]
3-212-123	TC Low Spd:M	*ENG	[-0.5 to 0.5 / 0 / 0.01V/step]
3-212-124	TC Low Spd:Y	*ENG	[-0.5 to 0.5 / 0 / 0.01V/step]

3214	[Vt Save :Set]		
3-214-001	Coverage Thresh	*ENG	[0 to 100 / 20 / 1 %/step]

3230	[Vtref :Disp/Set]		
3-230-001	Current: K	*ENG	[0 to 5 / 1.8 / 0.01V/step]
3-230-002	Current: C	*ENG	[0 to 5 / 1.8 / 0.01V/step]
3-230-003	Current: M	*ENG	[0 to 5 / 1.8 / 0.01V/step]
3-230-004	Current: Y	*ENG	[0 to 5 / 1.8 / 0.01V/step]

3232	[Vtref Correct:Pixel]		
3-232-001	ON/OFF	*ENG	[0 or 1 / 1 / 1/step]
3-232-011	Low Coverage Coef:K	*ENG	[0 to 5 / 1 / 0.1/step]
3-232-012	Low Coverage Coef:C	*ENG	[0 to 5 / 1 / 0.1/step]
3-232-013	Low Coverage Coef:M	*ENG	[0 to 5 / 1 / 0.1/step]
3-232-014	Low Coverage Coef:Y	*ENG	[0 to 5 / 1 / 0.1/step]
3-232-021	High Coverage Coef:K	*ENG	[0 to 5 / 0.5 / 0.1/step]
3-232-022	High Coverage Coef:C	*ENG	[0 to 5 / 1.0 / 0.1/step]
3-232-023	High Coverage Coef:M	*ENG	[0 to 5 / 1.0 / 0.1/step]

3-232-024	High Coverage Coeff:Y	*ENG	[0 to 5 / 1.0 / 0.1/step]
3-232-040	Initial ProCon Thresh	*ENG	[0 to 255 / 100 / 1count/step]
3-232-041	High Coverage Thresh:H	*ENG	[0 to 100 / 100 / 1%/step]
3-232-050	ProCon Thresh	*ENG	[0 to 255 / 100 / 1count/step]
3-232-060	Low Coverage Thresh	*ENG	[0 to 20 / 3 / 0.1%/step]
3-232-070	TC Upper Limit Correction	*ENG	[0 to 5 / 0.5 / 0.1wt%/step]
3-232-071	TC Upper Limit:Display:Bk	*ENG	[1 to 15 / 9 / 0.1wt%/step]
3-232-072	TC Upper Limit:Display:C	*ENG	[1 to 15 / 9 / 0.1wt%/step]
3-232-073	TC Upper Limit:Display:M	*ENG	[1 to 15 / 9 / 0.1wt%/step]
3-232-074	TC Upper Limit:Display:Y	*ENG	[1 to 15 / 9 / 0.1wt%/step]

3233	[RTP Vtref Corr :Disp/Set]		
3-233-001	ON/OFF	*ENG	[0 to 1 / 1 / 1/step]
3-233-011	Corr Amt(+):K	*ENG	[0 to 1 / 0.03 / 0.01V/step]
3-233-012	Corr Amt(+):C	*ENG	[0 to 1 / 0.03 / 0.01V/step]
3-233-013	Corr Amt(+):M	*ENG	[0 to 1 / 0.03 / 0.01V/step]
3-233-014	Corr Amt(+):Y	*ENG	[0 to 1 / 0.03 / 0.01V/step]
3-233-021	Corr Amt(-):K	*ENG	[0 to 1 / 0.03 / 0.01V/step]
3-233-022	Corr Amt(-):C	*ENG	[0 to 1 / 0.03 / 0.01V/step]
3-233-023	Corr Amt(-):M	*ENG	[0 to 1 / 0.03 / 0.01V/step]
3-233-024	Corr Amt(-):Y	*ENG	[0 to 1 / 0.03 / 0.01V/step]
3-233-031	Corr Thresh:K	*ENG	[0 to 0.1 / 0.005 / 0.001mg/cm ² /step]
3-233-032	Corr Thresh:C	*ENG	[0 to 0.1 / 0.01 / 0.001mg/cm ² /step]
3-233-033	Corr Thresh:M	*ENG	[0 to 0.1 / 0.01 / 0.001mg/cm ² /step]
3-233-034	Corr Thresh:Y	*ENG	[0 to 0.1 / 0.01 / 0.001mg/cm ² /step]

3-233-041	Vtavg Weight Coeff (H)	*ENG	[0 to 100 / 30 / 1%/step]
3-233-051	Vtavg Weight Coeff (M)	*ENG	[0 to 100 / 0 / 1%/step]
3-233-061	Vtavg Weight Coeff (L)	*ENG	[0 to 100 / 5 / 1%/step]

3234	[Vtref Corr :Disp/Set]		
3-234-001	ON/OFF	*ENG	[0 to 1 / 1 / 1/step]
3-234-011	Corr Amt(+):K	*ENG	[0 to 1 / 0.01 / 0.01V/step]
3-234-012	Corr Amt(+):C	*ENG	[0 to 1 / 0.01 / 0.01V/step]
3-234-013	Corr Amt(+):M	*ENG	[0 to 1 / 0.01 / 0.01V/step]
3-234-014	Corr Amt(+):Y	*ENG	[0 to 1 / 0.01 / 0.01V/step]
3-234-021	Corr Amt(-):K	*ENG	[0 to 1 / 0.01 / 0.01V/step]
3-234-022	Corr Amt(-):C	*ENG	[0 to 1 / 0.01 / 0.01V/step]
3-234-023	Corr Amt(-):M	*ENG	[0 to 1 / 0.01 / 0.01V/step]
3-234-024	Corr Amt(-):Y	*ENG	[0 to 1 / 0.01 / 0.01V/step]
3-234-031	P Rank 1 Threshold	*ENG	[0 to 2 / 0.15 / 0.01/step]
3-234-032	P Rank 2 Threshold	*ENG	[0 to 2 / 0.05 / 0.01/step]
3-234-033	P Rank 3 Threshold	*ENG	[-2 to 0 / -0.05 / 0.01/step]
3-234-034	P Rank 4 Threshold	*ENG	[-2 to 0 / -0.15 / 0.01/step]
3-234-041	T Rank 1 Threshold	*ENG	[-1 to 0 / -0.2 / 0.01V/step]
3-234-042	T Rank 2 Threshold	*ENG	[0 to 1 / 0.2 / 0.01V/step]
3-234-050	Correction Coefficient	*ENG	[1 to 10 / 10 / 0.1/step]

3250	[ImgArea :Disp]		
3-250-001	ImgArea:K	*ENG	[0 to 9999 / 0 / 1 cm ² /step]
3-250-002	ImgArea:C	*ENG	
3-250-003	ImgArea:M	*ENG	
3-250-004	ImgArea:Y	*ENG	

3251	[DotCoverage :Disp]		
3-251-001	DotCoverage:K	*ENG	[0 to 100 / 0 / 0.01%/step]
3-251-002	DotCoverage:C	*ENG	[0 to 100 / 0 / 0.01%/step]
3-251-003	DotCoverage:M	*ENG	[0 to 100 / 0 / 0.01%/step]
3-251-004	DotCoverage:Y	*ENG	[0 to 100 / 0 / 0.01%/step]
3-251-011	DC Avg.:S:K	*ENG	[0 to 100 / 5 / 0.01%/step]
3-251-012	DC Avg.:S:C	*ENG	[0 to 100 / 5 / 0.01%/step]
3-251-013	DC Avg.:S:M	*ENG	[0 to 100 / 5 / 0.01%/step]
3-251-014	DC Avg.:S:Y	*ENG	[0 to 100 / 5 / 0.01%/step]
3-251-021	DC Avg.:M:K	*ENG	[0 to 100 / 5 / 0.01%/step]
3-251-022	DC Avg.:M:C	*ENG	[0 to 100 / 5 / 0.01%/step]
3-251-023	DC Avg.:M:M	*ENG	[0 to 100 / 5 / 0.01%/step]
3-251-024	DC Avg.:M:Y	*ENG	[0 to 100 / 5 / 0.01%/step]
3-251-031	DC Avg.:L:K	*ENG	[0 to 100 / 5 / 0.01%/step]
3-251-032	DC Avg.:L:C	*ENG	[0 to 100 / 5 / 0.01%/step]
3-251-033	DC Avg.:L:M	*ENG	[0 to 100 / 5 / 0.01%/step]
3-251-034	DC Avg.:L:Y	*ENG	[0 to 100 / 5 / 0.01%/step]
3-251-041	TotalPage:S:Set	*ENG	[1 to 255 / 50 / 1count/step]
3-251-042	TotalPage:S:Set	*ENG	[1 to 500 / 50 / 1count/step]
3-251-043	TotalPage:S:Set	*ENG	[1 to 999 / 250 / 1count/step]
3-251-051	TotalPage:S:Set	*ENG	[1 to 255 / 100 / 1count/step]
3-251-052	TotalPage:S:Set	*ENG	[1 to 500 / 50 / 1count/step]
3-251-053	TotalPage:S:Set	*ENG	[1 to 999 / 250 / 1count/step]
3-251-151	Total DC: Dev: K	*ENG	[0 to 100 / 0 / 0.01%/step]
3-251-152	Total DC: Dev: C	*ENG	[0 to 100 / 0 / 0.01%/step]
3-251-153	Total DC: Dev: M	*ENG	[0 to 100 / 0 / 0.01%/step]

3-251-154	Total DC: Dev: Y	*ENG	[0 to 100 / 0 / 0.01%/step]
-----------	------------------	------	-----------------------------

3252	[AccumlmgArea :Disp]		
3-252-001	DotCoverage:K	*ENG	[0 to 65535 / 0 / 1cm ² /step]
3-252-002	DotCoverage:C	*ENG	[0 to 65535 / 0 / 1cm ² /step]
3-252-003	DotCoverage:M	*ENG	[0 to 65535 / 0 / 1cm ² /step]
3-252-004	DotCoverage:Y	*ENG	[0 to 65535 / 0 / 1cm ² /step]
3-252-011	DC Avg.:S:K	*ENG	[0 to 4294967295 / 0 / 1cm ² /step]
3-252-012	DC Avg.:S:C	*ENG	[0 to 4294967295 / 0 / 1cm ² /step]
3-252-013	DC Avg.:S:M	*ENG	[0 to 4294967295 / 0 / 1cm ² /step]
3-252-014	DC Avg.:S:Y	*ENG	[0 to 4294967295 / 0 / 1cm ² /step]

3260	[Temperature/Humidity: Display]		
3-260-001	Temperature	ENG	[-5 to 45 / 0 / 0.1deg/step]
3-260-002	Relative Humidity	ENG	[0 to 100 / 0 / 0.1%RH/step]
3-260-003	Absolute Humidity	ENG	[0 to 100 / 0 / 0.01g/m ³ /step]

3300	[RTP Pattern :Disp]		
3-300-001	M/A(Latest):K	*ENG	[0 to 1 / 0 / 0.001mg/cm ² /step]
3-300-002	M/A(Latest):C	*ENG	[0 to 2 / 0 / 0.001mg/cm ² /step]
3-300-003	M/A(Latest):M	*ENG	[0 to 2 / 0 / 0.001mg/cm ² /step]
3-300-004	M/A(Latest):Y	*ENG	[0 to 2 / 0 / 0.001mg/cm ² /step]
3-300-011	M/A(Target):K	*ENG	[0 to 1 / 0.225 / 0.001mg/cm ² /step]
3-300-012	M/A(Target):C	*ENG	[0 to 1 / 0.4 / 0.001mg/cm ² /step]
3-300-013	M/A(Target):M	*ENG	[0 to 1 / 0.45 / 0.001mg/cm ² /step]
3-300-014	M/A(Target):Y	*ENG	[0 to 1 / 0.4 / 0.001mg/cm ² /step]

3301	[RTP Pattern :Set]		
3-301-001	Create Intrvl:BW	*ENG	[0 to 200 / 10 / 1 page/step]
3-301-002	Create Intrvl:FC	*ENG	[0 to 200 / 10 / 1 page/step]
3-301-011	Page Cnt:BW	*ENG	[0 to 200 / 0 / 1 page/step]
3-301-012	Page Cnt:FC	*ENG	[0 to 200 / 0 / 1 page/step]
3-301-021	M/A UppErr:K	*ENG	[0 to 1 / 0.6 / 0.001mg/cm ² /step]
3-301-022	M/A UppErr:Col	*ENG	[0 to 2 / 1.2 / 0.001mg/cm ² /step]
3-301-023	M/A LowErr:K	*ENG	[0 to 1 / 0.1 / 0.001mg/cm ² /step]
3-301-024	M/A LowErr:Col	*ENG	[0 to 1 / 0.2 / 0.001mg/cm ² /step]
3-301-031	Feed Cnt :Set	*ENG	[0 to 99999999 / 50000 / 1msec/step]
3-301-041	Feed Cnt :K	*ENG	[0 to 99999999 / 0 / 1msec/step]
3-301-042	Feed Cnt :C	*ENG	[0 to 99999999 / 0 / 1msec/step]
3-301-043	Feed Cnt :M	*ENG	[0 to 99999999 / 0 / 1msec/step]
3-301-044	Feed Cnt :Y	*ENG	[0 to 99999999 / 0 / 1msec/step]
3-301-081	M/A(RTP)_Std	*ENG	[0 to 1 / 0.196 / 0.001 mg/cm ² /step]
3-301-091	M/A Thresh_Upp:K	*ENG	[0 to 1 / 0.086 / 0.001mg/cm ² /step]
3-301-092	M/A Thresh_Upp:C	*ENG	[0 to 1 / 0.05 / 0.001mg/cm ² /step]
3-301-093	M/A Thresh_Upp:M	*ENG	[0 to 1 / 0.05 / 0.001mg/cm ² /step]
3-301-094	M/A Thresh_Upp:Y	*ENG	[0 to 1 / 0.05 / 0.001mg/cm ² /step]
3-301-101	M/A Thresh_Low:K	*ENG	[0 to 1 / 0.086 / 0.001mg/cm ² /step]
3-301-102	M/A Thresh_Low:C	*ENG	[0 to 1 / 0.1 / 0.001mg/cm ² /step]
3-301-103	M/A Thresh_Low:M	*ENG	[0 to 1 / 0.1 / 0.001mg/cm ² /step]
3-301-104	M/A Thresh_Low:Y	*ENG	[0 to 1 / 0.1 / 0.001mg/cm ² /step]
3-301-111	Weight Coeff:K	*ENG	[1 to 10 / 1 / 1/step]
3-301-112	Weight Coeff:Col	*ENG	[1 to 10 / 1 / 1/step]

3310	[ID.Sens :Voffset]		
3-310-001	Voffset reg (Front)	*ENG	[0 to 5.5 / 0 / 0.01V/step]
3-310-002	Voffset reg (Center)	*ENG	[0 to 5.5 / 0 / 0.01V/step]
3-310-003	Voffset reg (Rear)	*ENG	[0 to 5.5 / 0 / 0.01V/step]
3-310-011	Voffset dif (Front)	*ENG	[0 to 5.5 / 0 / 0.01V/step]
3-310-012	Voffset dif (Center)	*ENG	[0 to 5.5 / 0 / 0.01V/step]
3-310-013	Voffset dif (Rear)	*ENG	[0 to 5.5 / 0 / 0.01V/step]
3-310-021	Voffset TM(Front)	*ENG	[0 to 5.5 / 0 / 0.01V/step]
3-310-022	Voffset TM(Center)	*ENG	[0 to 5.5 / 0 / 0.01V/step]
3-310-023	Voffset TM(Rear)	*ENG	[0 to 5.5 / 0 / 0.01V/step]

3311	[ID.Sens :Vmin]		
3-311-001	Vmin_K(Front)	*ENG	[0 to 5 / 0 / 0.001V/step]
3-311-002	Vmin_K(Center)	*ENG	
3-311-003	Vmin_K(Rear)	*ENG	

3312	[ID.Sens :Vct]		
3-312-001	Vct_reg(Front)	*ENG	[0 to 5 / 0 / 0.001V/step]
3-312-002	Vct_reg(Center)	*ENG	
3-312-003	Vct_reg(Rear)	*ENG	
3-312-011	Vct_dif(Front)	*ENG	
3-312-012	Vct_dif(Center)	*ENG	
3-312-013	Vct_dif(Rear)	*ENG	

3320	[Vsg Adj: Execute]		
3-320-001	P Sensor	ENG	[0 or 1 / 0 / 1/step]
3-320-031	Vsg Error Counter (Front)	*ENG	[0 to 99 / 0 / 1count/step]

3-320-032	Vsg Error Counter (Center)	*ENG	[0 to 99 / 0 / 1count/step]
3-320-033	Vsg Error Counter (Rear)	*ENG	[0 to 99 / 0 / 1count/step]

3321	[Adjusted Vsg]		
3-321-001	Vsg reg (Front)	*ENG	[0 to 5.5 / 4 / 0.01V/step]
3-321-002	Vsg reg (Center)	*ENG	[0 to 5.5 / 4 / 0.01V/step]
3-321-003	Vsg reg (Rear)	*ENG	[0 to 5.5 / 4 / 0.01V/step]
3-321-011	Vsg dif (Front)	*ENG	[0 to 5.5 / 0 / 0.01V/step]
3-321-012	Vsg dif (Center)	*ENG	[0 to 5.5 / 0 / 0.01V/step]
3-321-013	Vsg dif (Rear)	*ENG	[0 to 5.5 / 0 / 0.01V/step]
3-321-041	Vsg TM(Front)	*ENG	[0 to 5.5 / 4 / 0.01V/step]
3-321-042	Vsg TM(Center)	*ENG	[0 to 5.5 / 4 / 0.01V/step]
3-321-043	Vsg TM(Rear)	*ENG	[0 to 5.5 / 4 / 0.01V/step]

3322	[Adjusted Ifsg]		
3-322-001	Ifsg RTP (Front)	*ENG	[0 to 50 / 10 / 0.001mA/step]
3-322-002	Ifsg RTP (Center)	*ENG	[0 to 50 / 10 / 0.001mA/step]
3-322-003	Ifsg RTP (Rear)	*ENG	[0 to 50 / 10 / 0.001mA/step]
3-322-011	Ifsg Min (Front)	*ENG	[0 to 50 / 27 / 0.001mA/step]
3-322-012	Ifsg Min (Center)	*ENG	[0 to 50 / 27 / 0.001mA/step]
3-322-013	Ifsg Min (Rear)	*ENG	[0 to 50 / 27 / 0.001mA/step]
3-322-021	Ifsg: TM(Front)	*ENG	[0 to 50 / 10 / 0.001mA/step]
3-322-022	Ifsg: TM(Center)	*ENG	[0 to 50 / 10 / 0.001mA/step]
3-322-023	Ifsg: TM(Rear)	*ENG	[0 to 50 / 10 / 0.001mA/step]

3323	[Vsg Adj OK?]		
-------------	----------------------	--	--

	Code	Result	detail
	0	Did not EXEC.	(SP default)
	1	Succeed	-
	2	ID sensor proofread error	Out of range from $V_{sg} = V_{sg_reg}(\text{target value}) \pm x.x[V/\text{step}]$
	4	LED Ampere Max. error.	$I_{fsg} > \text{Max.}$
	5	ID sensor output error.	$V_{sg} < V_{sg_reg}(\text{error})$
	9	Kill	Kill by error of door open, power off.
3-323-001	Latest	*ENG	[0 to 999 / 0 / 1/step]
3-323-002	Latest 2	*ENG	
3-323-003	Latest 3	*ENG	
3-323-004	Latest 4	*ENG	
3-323-005	Latest 5	*ENG	
3-323-006	Latest 6	*ENG	
3-323-007	Latest 7	*ENG	
3-323-008	Latest 8	*ENG	
3-323-009	Latest 9	*ENG	
3-323-010	Latest 10	*ENG	

3330	[ID.Sens Coef :Disp]		
3-330-001	K2(Latest) (Front)	*ENG	[0 to 5 / 0 / 0.0001/step]
3-330-002	K2(Latest) (Center)	*ENG	[0 to 5 / 0 / 0.0001/step]
3-330-003	K2(Latest) (Rear)	*ENG	[0 to 5 / 0 / 0.0001 /step]
3-330-011	K5(Latest) (Front)	*ENG	[0 to 10 / 5 / 0.0001/step]
3-330-012	K5(Latest) (Center)	*ENG	[0 to 10 / 5 / 0.0001/step]
3-330-013	K5(Latest) (Rear)	*ENG	[0 to 10 / 5 / 0.0001/step]

3331	[ID.Sens TestVal:F]		
3-333-001	K2: Check	*ENG	[0 to 1 / 0.516 / 0.001/step]
3-333-002	Diffuse Corr	*ENG	[0.75 to 1.35 / 1.00 / 0.01/step]
3-333-003	Vct_reg Check:Slope	*ENG	[0 to 200 / 0.0 / 0.1mV/mA/step]
3-333-004	Vct_reg Check:Xint	*ENG	[0 to 25.5 / 0.0 / 0.1mA/step]
3-333-005	Vct_dif Check:Slope	*ENG	[0 to 200 / 0.0 / 0.1mV/mA/step]
3-333-006	Vct_dif Check:Xint	*ENG	[0 to 25.5 / 0.0 / 0.1mA/step]

3334	[ID.Sens TestVal:C]		
3-334-001	K2: Check	*ENG	[0 to 1 / 0.516 / 0.001/step]
3-334-002	Diffuse Corr	*ENG	[0.75 to 1.35 / 1.00 / 0.01/step]
3-334-003	Vct_reg Check:Slope	*ENG	[0 to 200 / 0.0 / 0.1mV/mA/step]
3-334-004	Vct_reg Check:Xint	*ENG	[0 to 25.5 / 0.0 / 0.1mA/step]
3-334-005	Vct_dif Check:Slope	*ENG	[0 to 200 / 0.0 / 0.1mV/mA/step]
3-334-006	Vct_dif Check:Xint	*ENG	[0 to 25.5 / 0.0 / 0.1mA/step]

3335	[ID.Sens TestVal:R]		
3-335-001	K2: Check	*ENG	[0 to 1 / 0.516 / 0.001/step]
3-335-002	Diffuse Corr	*ENG	[0.75 to 1.35 / 1.00 / 0.01/step]
3-335-003	Vct_reg Check:Slope	*ENG	[0 to 200 / 0.0 / 0.1mV/mA/step]
3-335-004	Vct_reg Check:Xint	*ENG	[0 to 25.5 / 0.0 / 0.1mA/step]
3-335-005	Vct_dif Check:Slope	*ENG	[0 to 200 / 0.0 / 0.1mV/mA/step]
3-335-006	Vct_dif Check:Xint	*ENG	[0 to 25.5 / 0.0 / 0.1mA/step]

3400	[Toner Supply Type]		
-------------	----------------------------	--	--

3-400-001	K	*ENG	[0 to 4 / 4 / 1/step] 0: Fixed 2: PID 4: DANC
3-400-002	C	*ENG	
3-400-003	M	*ENG	
3-400-004	Y	*ENG	

3411	[Toner Supply Qty]		
3-411-001	K	ENG	[0 to 40000 / 0 / 0.1mg/step]
3-411-002	C	ENG	
3-411-003	M	ENG	
3-411-004	Y	ENG	

3420	[DeveloperWeight]		
3-420-001	Total_Weight:K	*ENG	[50 to 2000 / 240 / 1g/step]
3-420-002	Total_Weight:CMY	*ENG	

3421	[TnrSplyAbility]		
3-421-001	K	*ENG	[0.001 to 2 / 0.71 / 0.001mg/msec/step]
3-421-002	C	*ENG	[0.001 to 2 / 0.71 / 0.001mg/msec/step]
3-421-003	M	*ENG	[0.001 to 2 / 0.71 / 0.001mg/msec/step]
3-421-004	Y	*ENG	[0.001 to 2 / 0.71 / 0.001mg/msec/step]
3-421-011	TnrSplyAbilityCoef1	*ENG	[0.5 to 2 / 1.12 / 0.01/step]
3-421-012	TnrSplyAbilityCoef2	*ENG	[0.5 to 2 / 1.12 / 0.01/step]
3-421-013	TnrSplyAbilityCoef3	*ENG	[0.5 to 2 / 1.10 / 0.01/step]
3-421-014	TnrSplyAbilityCoef4	*ENG	[0.5 to 2 / 1.06 / 0.01/step]
3-421-015	TnrSplyAbilityCoef5	*ENG	[0.5 to 2 / 1.00 / 0.01/step]

3-421-016	TnrSplyAbilityCoef6	*ENG	[0.5 to 2 / 0.99 / 0.01/step]
3-421-017	TnrSplyAbilityCoef7	*ENG	[0.5 to 2 / 0.98 / 0.01/step]
3-421-018	TnrSplyAbilityCoef8	*ENG	[0.5 to 2 / 0.95 / 0.01/step]
3-421-019	TnrSplyAbilityCoef9	*ENG	[0.5 to 2 / 0.95 / 0.01/step]
3-421-020	TnrSplyAbilityCoef10	*ENG	[0.5 to 2 / 0.95 / 0.01/step]
3-421-031	AbsHum Threshold:1	*ENG	[0 to 65 / 6.0 / 0.1g/m ³ /step]
3-421-032	AbsHum Threshold:2	*ENG	[0 to 65 / 12.0 / 0.1g/m ³ /step]
3-421-033	AbsHum Threshold:3	*ENG	[0 to 65 / 24.0 / 0.1g/m ³ /step]
3-421-041	Environ Coef1	*ENG	[0.5 to 2 / 1.00 / 0.01/step]
3-421-042	Environ Coef2	*ENG	[0.5 to 2 / 1.00 / 0.01/step]
3-421-043	Environ Coef3	*ENG	[0.5 to 2 / 1.00 / 0.01/step]
3-421-044	Environ Coef4	*ENG	[0.5 to 2 / 1.00 / 0.01/step]

3422	[Tnr Supply Limits :Set]		
3-422-001	Max Supply Rate:K	*ENG	[0 to 255 / 87 / 1%/step]
3-422-002	Max Supply Rate:C	*ENG	[0 to 255 / 87 / 1%/step]
3-422-003	Max Supply Rate:M	*ENG	[0 to 255 / 87 / 1%/step]
3-422-004	Max Supply Rate:Y	*ENG	[0 to 255 / 87 / 1%/step]
3-422-011	Min Supply Time: K	*ENG	[0 to 255 / 100 / 1msec/step]
3-422-012	Min Supply Time: C	*ENG	[0 to 255 / 100 / 1msec/step]
3-422-013	Min Supply Time: M	*ENG	[0 to 255 / 100 / 1msec/step]
3-422-014	Min Supply Time: Y	*ENG	[0 to 255 / 100 / 1msec/step]

3428	[TnrSplyDelay : Setting]		
3-428-001	Delay	*ENG	[0 to 255 / 0 / 1msec/step]

3440	[Fixed Supply Mode]		
-------------	----------------------------	--	--

3-440-001	Fixed Rate: K	*ENG	[0 to 100 / 10 / 1%/step]
3-440-002	Fixed Rate: C	*ENG	
3-440-003	Fixed Rate: M	*ENG	
3-440-004	Fixed Rate: Y	*ENG	

3460	[TonerSupply :DANC]		
3-460-011	Time_Min	*ENG	[0 to 250 / 0 / 1msec/step]
3-460-012	Time_Max	*ENG	[0 to 1000 / 200 / 1msec/step]
3-460-022	SMITH_Weight:K	*ENG	[1 to 500 / 71 / 1mg/step]
3-460-023	SMITH_Weight:CMY	*ENG	[1 to 500 / 140 / 1mg/step]
3-460-111	Rev_Fix:K	*ENG	[1 to 1.5 / 1 / 0.01/step]
3-460-112	Rev_Fix:C	*ENG	[1 to 1.5 / 1 / 0.01/step]
3-460-113	Rev_Fix:M	*ENG	[1 to 1.5 / 1 / 0.01/step]
3-460-114	Rev_Fix:Y	*ENG	[1 to 1.5 / 1 / 0.01/step]

3461	[TonerSupply :DANC]		
3-461-001	Pl:Power	*ENG	[5 to 200 / 100 / 1%/step]
3-461-011	Pl:P Gain:K	*ENG	[0 to 1 / 0.001 / 0.0001/step]
3-461-012	Pl:P Limits:Up:K	*ENG	[0 to 1 / 0.1 / 0.01/step]
3-461-013	Pl:P Limits:Low:K	*ENG	[0 to 1 / 0.1 / 0.01/step]
3-461-021	Pl:I Gain:K	*ENG	[0 to 0.1 / 0.005 / 0.0001/step]
3-461-022	Pl:I Limits:Up:K	*ENG	[0 to 1 / 0.2 / 0.01/step]
3-461-023	Pl:I Limits:Low:K	*ENG	[0 to 1 / 0.2 / 0.01/step]
3-461-031	Pl:P Gain:CMY	*ENG	[0 to 1 / 0.01 / 0.0001/step]
3-461-032	Pl:P Limits:Up:CMY	*ENG	[0 to 1 / 0.1 / 0.01/step]
3-461-033	Pl:P Limits:Low:CMY	*ENG	[0 to 1 / 0.1 / 0.01/step]
3-461-041	Pl:I Gain:CMY	*ENG	[0 to 0.1 / 0.001 / 0.0001/step]

3-461-042	Pl:I Limits:Up:CMY	*ENG	[0 to 1 / 0.1 / 0.01/step]
3-461-043	Pl:I Limits:Low:CMY	*ENG	[0 to 1 / 0.1 / 0.01/step]
3-461-052	AW:AWIpn:K	*ENG	[0 to 2000 / 100 / 1/step]
3-461-062	AW:AWIpn:CMY	*ENG	[0 to 2000 / 1000 / 1/step]
3-461-102	Pl:LineSpdCoef:MidSpd:K	*ENG	[0.05 to 1 / 0.5 / 0.01/step]
3-461-103	Pl:LineSpdCoef:LowSpd:K	*ENG	[0.05 to 1 / 0.5 / 0.01/step]
3-461-112	Pl:LineSpdCoef:StdSpd:CMY	*ENG	[0.05 to 1 / 0.5 / 0.01/step]
3-461-113	Pl:LineSpdCoef:LowSpd:CMY	*ENG	[0.05 to 1 / 0.5 / 0.01/step]
3-461-121	SMITH:Gain:K	*ENG	[0 to 2 / 1 / 0.01/step]
3-461-122	SMITH:MidSpd:K	*ENG	[0 to 1 / 1 / 0.01/step]
3-461-123	SMITH:LowSpd:K	*ENG	[0 to 1 / 1 / 0.01/step]
3-461-131	SMITH:Gain:CMY	*ENG	[0 to 2 / 1 / 0.01/step]
3-461-132	SMITH:MidSpd:CMY	*ENG	[0 to 1 / 1 / 0.01/step]
3-461-133	SMITH:LowSpd:CMY	*ENG	[0 to 1 / 1 / 0.01/step]

3462	[TonerSupply :DANC]		
3-462-001	ANC:Power	*ENG	[0 to 200 / 100 / 1%/step]
3-462-101	ANC:Gain:K	*ENG	[0 to 2 / 1 / 0.01/step]
3-462-102	ANC:MidSpd:K	*ENG	[0.05 to 1 / 1 / 0.01/step]
3-462-103	ANC:LowSpd:K	*ENG	[0.05 to 1 / 1 / 0.01/step]
3-462-111	ANC:Gain:CMY	*ENG	[0 to 2 / 1 / 0.01/step]
3-462-112	ANC:MidSpd:CMY	*ENG	[0.05 to 1 / 1 / 0.01/step]
3-462-113	ANC:LowSpd:CMY	*ENG	[0.05 to 1 / 1 / 0.01/step]

3463	[TonerSupply :DANC]		
-------------	----------------------------	--	--

3-463-101	Int:I:K	*ENG	[-1000.0000 to 1000.0000 / 0.0000 / 0.0001/step]
3-463-102	Int:I:C	*ENG	
3-463-103	Int:I:M	*ENG	
3-463-104	Int:I:Y	*ENG	
3-463-111	ANC:ref Sum:K	*ENG	[-1000.0000 to 1000.0000 / 0.0000 / 0.0001/step]
3-463-112	ANC:ref Sum:C	*ENG	
3-463-113	ANC:ref Sum:M	*ENG	
3-463-114	ANC:ref Sum:Y	*ENG	
3-463-201	ImgArea:K	*ENG	[0 to 9999 / 0 / 1cm ² /step]
3-463-202	ImgArea:C	*ENG	
3-463-203	ImgArea:M	*ENG	
3-463-204	ImgArea:Y	*ENG	

3500	[ImgQtyAdj :ON/OFF]		
3-500-001	ALL	*ENG	[0 or 1 / 1 / 1/step]
3-500-002	ProCon	*ENG	[0 or 1 / 1 / 1/step]
3-500-003	MUSIC Condition:Auto Exe	*ENG	[0 or 1 / 1 / 1/step]
3-500-004	Init TD Sensor	*ENG	[0 or 1 / 1 / 1/step]
3-500-006	PresetSealWindup Exe	*ENG	[0 or 1 / 0 / 1/step]

3509	[ImgQtyAdj :ModeSelect]		
3-509-011	ImgQtyAdj Mode Setting	*ENG	[0 to 2 / 0 / 1/step]

3510	[ImgQtyAdj :ExeFlag]		
-------------	-----------------------------	--	--

3-510-024	MUSIC	*ENG	[0 to 3 / 0 / 1/step] 0: OFF 1: Mode:b 2: Mode:a 3: Mode:e
-----------	-------	------	--

3520	[ImgQtyAdj :Interval]		
3-520-001	During Job	*ENG	[0 to 100 / 30 / 1page/step]
3-520-002	During Stand-by	*ENG	[0 to 100 / 5 / 1minute/step]

3521	[Drum Stop Time :Disp]		
3-521-001	Year	*ENG	[0 to 99 / 0 / 1year/step]
3-521-002	Month	*ENG	[1 to 12 / 1 / 1month/step]
3-521-003	Day	*ENG	[1 to 31 / 1 / 1day/step]
3-521-004	Hour	*ENG	[0 to 23 / 0 / 1hour/step]
3-521-005	Minute	*ENG	[0 to 59 / 0 / 1minute/step]
3-521-011	Year:Col	*ENG	[0 to 99 / 0 / 1year/step]
3-521-012	Month:Col	*ENG	[1 to 12 / 1 / 1month/step]
3-521-013	Day:Col	*ENG	[1 to 31 / 1 / 1day/step]
3-521-014	Hour:Col	*ENG	[0 to 23 / 0 / 1hour/step]
3-521-015	Minute:Col	*ENG	[0 to 59 / 0 / 1minute/step]

3522	[Drum Stop Environ :Disp]		
3-522-001	Temperature	*ENG	[-1280 to 1270 / 0 / 0.1deg/step]
3-522-002	Rel Humidity	*ENG	[0 to 1000 / 0 / 0.1%RH/step]
3-522-003	Abs Humidity	*ENG	[0 to 1000 / 0 / 0.1g/m ³ /step]
3-522-011	Temperature:Col	*ENG	[-1280 to 1270 / 0 / 0.1deg/step]
3-522-012	Rel Humidity:Col	*ENG	[0 to 1000 / 0 / 0.1%RH/step]

3-522-013	Abs Humidity:Col	*ENG	[0 to 1000 / 0 / 0.1g/m ³ /step]
-----------	------------------	------	---

3529	[ProCon Interval Control :Set]		
3-529-001	Gamma Corr	*ENG	[0 or 1 / 1 / 1/step] 0: OFF 1: ON
3-529-002	Environ Corr	*ENG	[0 or 1 / 1 / 1/step] 0: OFF 1: ON
3-529-003	AbsHum Threshold	*ENG	[0 to 99 / 4.3 / 0.1g/m ³ /step]
3-529-004	Max Cnt Threshold	*ENG	[0 to 99 / 2 / 1count/step]
3-529-005	Exe Cnt	ENG	[0 to 255 / 0 / 1count/step]
3-529-006	Page Cnt:BW	*ENG	[0 to 5000 / 0 / 1sheet/step]
3-529-007	Page Cnt:FC	*ENG	[0 to 5000 / 0 / 1sheet/step]

3530	[PowerON ProCon :Set]		
3-530-001	Non-use Time Setting	*ENG	[0 to 1440 / 360 / 1minute/step]
3-530-002	Temperature Range	*ENG	[0 to 99 / 10 / 1deg/step]
3-530-003	Relative Humidity Range	*ENG	[0 to 99 / 50 / 1%RH/step]
3-530-004	Absolute Humidity Range	*ENG	[0 to 99 / 6 / 1g/m ³ /step]
3-530-005	Interval:BW	*ENG	[0 to 5000 / 250 / 1sheet/step]
3-530-006	Interval:FC	*ENG	[0 to 5000 / 100 / 1sheet/step]
3-530-007	Page Cnt:BW	*ENG	[0 to 5000 / 0 / 1sheet/step]
3-530-008	Page Cnt:FC	*ENG	[0 to 5000 / 0 / 1sheet/step]

3531	[Non-useTime Procon :Set]		
3-531-001	Non-use Time Setting	*ENG	[0 to 1440 / 360 / 1minute/step]
3-531-002	Temperature Range	*ENG	[0 to 99 / 10 / 1deg/step]

3-531-003	Relative Humidity Range	*ENG	[0 to 99 / 50 / 1%RH/step]
3-531-004	Absolute Humidity Range	*ENG	[0 to 99 / 6 / 1g/m ³ /step]
3-531-005	Maximum Execution Number	*ENG	[0 to 99 / 10 / 1count/step]

3532	[Prediction Control :Set]		
3-532-001	Prediction ControlON/OFF	*ENG	[0 to 1 / 0 / 1/step]

3533	[Interrupt ProCon :Set]		
3-533-001	Interval:Set:BW	*ENG	[0 to 5000 / 500 / 1sheet/step]
3-533-002	Interval:Disp:BW	*ENG	[0 to 5000 / 500 / 1sheet/step]
3-533-003	Corr(Short):BW	*ENG	[0 to 1 / 1 / 0.01/step]
3-533-004	Corr(Mid):BW	*ENG	[0 to 1 / 1 / 0.01/step]
3-533-011	Interval:Set:FC	*ENG	[0 to 5000 / 200 / 1sheet/step]
3-533-012	Interval:Disp:FC	*ENG	[0 to 5000 / 200 / 1sheet/step]
3-533-013	Corr(Short):FC	*ENG	[0 to 1 / 1 / 0.01/step]
3-533-014	Corr(Mid):FC	*ENG	[0 to 1 / 1 / 0.01/step]

3534	[JobEnd ProCon :Set]		
3-534-001	Interval:Set:BW	*ENG	[0 to 5000 / 500 / 1sheet/step]
3-534-002	Interval:Disp:BW	*ENG	[0 to 5000 / 500 / 1sheet/step]
3-534-003	Corr(Short):BW	*ENG	[0 to 1 / 1 / 0.01/step]
3-534-004	Corr(Mid):BW	*ENG	[0 to 1 / 1 / 0.01/step]
3-534-011	Interval:Set:FC	*ENG	[0 to 1000 / 200 / 1sheet/step]
3-534-012	Interval:Disp:FC	*ENG	[0 to 5000 / 200 / 1sheet/step]
3-534-013	Corr(Short):FC	*ENG	[0 to 1 / 1 / 0.01/step]
3-534-014	Corr(Mid):FC	*ENG	[0 to 1 / 1 / 0.01/step]

3539	[Dev Agitating Time :Set]		
3-539-001	Time	*ENG	[0 to 3000 / 10 / 1 sec/step]
3-539-010	ON/OFF(by AbsHum)	*ENG	[0 or 1 / 1 / 1/step]
3-539-011	by AbsHum:1	*ENG	[0 to 3000 / 0 / 1 sec/step]
3-539-012	by AbsHum:2	*ENG	[0 to 3000 / 5 / 1 sec/step]
3-539-013	by AbsHum:3	*ENG	[0 to 3000 / 5 / 1 sec/step]
3-539-014	by AbsHum:4	*ENG	[0 to 3000 / 5 / 1 sec/step]
3-539-015	by AbsHum:5	*ENG	[0 to 3000 / 5 / 1 sec/step]
3-539-016	by AbsHum:6	*ENG	[0 to 3000 / 5 / 1 sec/step]
3-539-021	AbsHum Threshold:1	*ENG	[0 to 100 / 4 / 1g/cm ³ /step]
3-539-022	AbsHum Threshold:2	*ENG	[0 to 100 / 8 / 1g/cm ³ /step]
3-539-023	AbsHum Threshold:3	*ENG	[0 to 100 / 12 / 1g/cm ³ /step]
3-539-024	AbsHum Threshold:4	*ENG	[0 to 100 / 16 / 1g/cm ³ /step]
3-539-025	AbsHum Threshold:5	*ENG	[0 to 100 / 24 / 1g/cm ³ /step]
3-539-030	ON/OFF(by Non-use Time)	*ENG	[0 or 1 / 1 / 1/step]
3-539-050	ON/OFF(by Non-use Time)	*ENG	[0 or 1 / 1 / 1/step]
3-539-051	by DotCoverage :1	*ENG	[0 to 3000 / 0 / 1 sec/step]
3-539-052	by DotCoverage :2	*ENG	[0 to 3000 / 0 / 1 sec/step]
3-539-053	by DotCoverage :3	*ENG	[0 to 3000 / 5 / 1 sec/step]
3-539-054	by DotCoverage :4	*ENG	[0 to 3000 / 5 / 1 sec/step]
3-539-055	by DotCoverage :5	*ENG	[0 to 3000 / 5 / 1 sec/step]
3-539-056	by DotCoverage :6	*ENG	[0 to 3000 / 5 / 1 sec/step]
3-539-061	DotCoverage Threshhold:1	*ENG	[0 to 5000 / 10 / 1%/step]
3-539-062	DotCoverage Threshhold:2	*ENG	[0 to 5000 / 20 / 1%/step]
3-539-063	DotCoverage Threshhold:3	*ENG	[0 to 5000 / 30 / 1%/step]
3-539-064	DotCoverage Threshhold:4	*ENG	[0 to 5000 / 40 / 1%/step]

3-539-065	DotCoverage Threshold:5	*ENG	[0 to 5000 / 50 / 1%/step]
3-539-099	UpperLimit	*ENG	[0 to 3600 / 30 / 1 sec/step]

3541	[Music Interval :Set]		
3-541-001	Page Cnt:BW	*ENG	[0 to 5000 / 0 / 1 sheet/step]
3-541-002	Page Cnt:FC	*ENG	

3550	[Refresh Mode]		
3-550-001	Required Area: K	*ENG	[0 to 65535 / 0 / 1 cm ² /step]
3-550-002	Required Area: C	*ENG	[0 to 65535 / 0 / 1 cm ² /step]
3-550-003	Required Area: M	*ENG	[0 to 65535 / 0 / 1 cm ² /step]
3-550-004	Required Area: Y	*ENG	[0 to 65535 / 0 / 1 cm ² /step]
3-550-011	Dev. Unit Rotation: Display: Bk	*ENG	[0 to 1000 / 0 / 0.1m/step]
3-550-012	Dev. Unit Rotation: Display: C	*ENG	[0 to 1000 / 0 / 0.1m/step]
3-550-013	Dev. Unit Rotation: Display: M	*ENG	[0 to 1000 / 0 / 0.1m/step]
3-550-014	Dev. Unit Rotation: Display: Y	*ENG	[0 to 1000 / 0 / 0.1m/step]
3-550-031	Reflesh Threshold: Bk	*ENG	[0 to 255 / * / 1 cm ² /step] *MP C2004: 75 *MP C2504: 84
3-550-032	Reflesh Threshold: C	*ENG	[0 to 255 / * / 1 cm ² /step] *MP C2004: 52 *MP C2504: 56
3-550-033	Reflesh Threshold: M	*ENG	[0 to 255 / * / 1 cm ² /step] *MP C2004: 52 *MP C2504: 56
3-550-034	Reflesh Threshold: Y	*ENG	[0 to 255 / * / 1 cm ² /step] *MP C2004: 52 *MP C2504: 56

3-550-041	Job End Area Coefficient:K	*ENG	[0.1 to 25.5 / * / 0.1/step] *MP C2004: 44 *MP C2504: 49
3-550-042	Job End Vb Coefficient:K	*ENG	[0 to 100 / 40 / 1%/step]
3-550-043	Job End Length:K	*ENG	[0 to 255 / 10 / 1mm/step]
3-550-044	Job End Supply	*ENG	[0 to 1 / 0 / 0.001mg/cm ² /step]
3-550-045	Job End Area Coefficient:YMC	*ENG	[0.1 to 25.5 / * / 0.1/step] *MP C2004: 31 *MP C2504: 33
3-550-046	Job End Vb Coefficient:YMC	*ENG	[0 to 100 / 40 / 1%/step]
3-550-047	Job End Length:YMC	*ENG	[0 to 255 / 10 / 1mm/step]
3-550-050	Threshold	*ENG	[0 to 65535 / * / 1cm ² /step] *MP C2004: 56 *MP C2504: 62
3-550-081	TC Adj. Consume(Upp Limit)	*ENG	[0 to 255 / 0 / 1count/step]

3553	[Transfer belt cleaning]		
3-553-001	TransferIdleTime Temperature:H	*ENG	[0 to 3 / 0 / 0.1 revolution/step]
3-553-002	TransferIdleTime Temperature:M	*ENG	[0 to 3 / 0 / 0.1 revolution/step]
3-553-003	TransferIdleTime Temperature:L	*ENG	[0 to 3 / 0 / 0.1 revolution/step]
3-553-004	TransferIdleTime Temperature:L:ON	*ENG	[0 to 3 / 0 / 0.1 revolution/step]
3-553-005	Temperature Threshold:T2	*ENG	[20 to 30 / 25 / 1deg/step]
3-553-006	Temperature Threshold:T1	*ENG	[0 to 15 / 15 / 1deg/step]
3-553-007	Temperature Threshold:T3	*ENG	[0 to 30 / 5 / 1deg/step]
3-553-008	TransferIdleTime Rotation :Initial	*ENG	[0 to 3 / 0 / 0.1 revolution/step]
3-553-009	TransferIdleTime Rotation :Middle	*ENG	[0 to 3 / 0 / 0.1 revolution/step]

3-553-010	TransferIdleTime Rotation :End	*ENG	[0 to 3 / 0 / 0.1 revolution/step]
3-553-011	Transfer Rotation Threshold:L1	*ENG	[0 to 999999999 / 24000000 / 1mm/step]
3-553-012	Transfer Rotation Threshold:L2	*ENG	[0 to 999999999 / 96000000 / 1mm/step]

3555	[ImageQuality Adj. Counter:Disp]		
3-555-001	Charge AC Control	*ENG	[0 to 2000 / 0 / 1page/step]

3600	[Select ProCon]		
3-600-001	Potential Control	*ENG	[0 or 1 / 1 / 1/step]
3-600-002	LD Control	*ENG	[0 to 3 / 1 / 1/step]
3-600-003	TC Adj. Mode	*ENG	[0 to 4 / 4 / 1/step]
3-600-004	ACC Before ProCon	*ENG	[0 to 3 / 2 / 1/step]
3-600-010	ActivePotentialControl	*ENG	[0 or 1 / 1 / 1/step]
3-600-030	IBACC:ON/OFF	*ENG	[0 or 1 / 1 / 1/step]
3-600-060	Vsg ITB Internal Circumference Correction	*ENG	[0 or 1 / 1 / 1/step]
3-600-080	Background Pot ProCon:ON/OFF setting	*ENG	[0 or 1 / 1 / 1/step]

3610	[Chrg AC Control]		
3-610-001	Std Speed: K	*ENG	[0 to 3 / 2.2 / 0.01kV/step]
3-610-002	Std Speed: C	*ENG	
3-610-003	Std Speed: M	*ENG	
3-610-004	Std Speed: Y	*ENG	

3611	[Chrg DC Control]		
3-611-001	Std Speed: K	*ENG	[300 to 1000 / 690 / 1-V/step]

3-611-002	Std Speed: C	*ENG	[300 to 1000 / 690 / 1-V/step]
3-611-003	Std Speed: M	*ENG	[300 to 1000 / 690 / 1-V/step]
3-611-004	Std Speed: Y	*ENG	[300 to 1000 / 690 / 1-V/step]
3-611-011	Mid Speed: K	*ENG	[300 to 1000 / 690 / 1-V/step]
3-611-012	Mid Speed: C	*ENG	[300 to 1000 / 690 / 1-V/step]
3-611-013	Mid Speed: M	*ENG	[300 to 1000 / 690 / 1-V/step]
3-611-014	Mid Speed: Y	*ENG	[300 to 1000 / 690 / 1-V/step]
3-611-021	Low Speed: K	*ENG	[300 to 1000 / 690 / 1-V/step]
3-611-022	Low Speed: C	*ENG	[300 to 1000 / 690 / 1-V/step]
3-611-023	Low Speed: M	*ENG	[300 to 1000 / 690 / 1-V/step]
3-611-024	Low Speed: Y	*ENG	[300 to 1000 / 690 / 1-V/step]
3-611-201	Now:Std Speed: K	*ENG	[300 to 1000 / 690 / 1-V/step]
3-611-202	Now:Std Speed: C	*ENG	[300 to 1000 / 690 / 1-V/step]
3-611-203	Now:Std Speed: M	*ENG	[300 to 1000 / 690 / 1-V/step]
3-611-204	Now:Std Speed: Y	*ENG	[300 to 1000 / 690 / 1-V/step]
3-611-211	Now:Mid Speed: K	*ENG	[300 to 1000 / 690 / 1-V/step]
3-611-212	Now:Mid Speed: C	*ENG	[300 to 1000 / 690 / 1-V/step]
3-611-213	Now:Mid Speed: M	*ENG	[300 to 1000 / 690 / 1-V/step]
3-611-214	Now:Mid Speed: Y	*ENG	[300 to 1000 / 690 / 1-V/step]
3-611-221	Now:Low Speed: K	*ENG	[300 to 1000 / 690 / 1-V/step]
3-611-222	Now:Low Speed: C	*ENG	[300 to 1000 / 690 / 1-V/step]
3-611-223	Now:Low Speed: M	*ENG	[300 to 1000 / 690 / 1-V/step]
3-611-224	Now:Low Speed: Y	*ENG	[300 to 1000 / 690 / 1-V/step]

3612	[Dev DC Control]		
3-612-001	Std Speed: K	*ENG	[200 to 800 / 550 / 1-V/step]

3-612-002	Std Speed: C	*ENG	[200 to 800 / 550 / 1-V/step]
3-612-003	Std Speed: M	*ENG	[200 to 800 / 550 / 1-V/step]
3-612-004	Std Speed: Y	*ENG	[200 to 800 / 550 / 1-V/step]
3-612-011	Mid Speed: K	*ENG	[200 to 800 / 550 / 1-V/step]
3-612-012	Mid Speed: C	*ENG	[200 to 800 / 550 / 1-V/step]
3-612-013	Mid Speed: M	*ENG	[200 to 800 / 550 / 1-V/step]
3-612-014	Mid Speed: Y	*ENG	[200 to 800 / 550 / 1-V/step]
3-612-021	Low Speed: K	*ENG	[200 to 800 / 550 / 1-V/step]
3-612-022	Low Speed: C	*ENG	[200 to 800 / 550 / 1-V/step]
3-612-023	Low Speed: M	*ENG	[200 to 800 / 550 / 1-V/step]
3-612-024	Low Speed: Y	*ENG	[200 to 800 / 550 / 1-V/step]
3-612-120	Set:Vb Limit	*ENG	[0 to 500 / 50 / 1V/step]
3-612-121	Set:Limit TC1	*ENG	[1 to 15 / 6.5 / 0.1wt%/step]
3-612-122	Set:Limit TC2	*ENG	[1 to 15 / 7 / 0.1wt%/step]
3-612-123	Set:Page Thresh	*ENG	[0 to 999999 / 35000 / 1page/step]
3-612-131	Set:Upper Vb Current:K	*ENG	[0 to 800 / 600 / 1V/step]
3-612-132	Set:Upper Vb Current:C	*ENG	[0 to 800 / 600 / 1V/step]
3-612-133	Set:Upper Vb Current:M	*ENG	[0 to 800 / 600 / 1V/step]
3-612-134	Set:Upper Vb Current:Y	*ENG	[0 to 800 / 600 / 1V/step]
3-612-201	Now:Std Speed: K	*ENG	[200 to 800 / 690 / 1-V/step]
3-612-202	Now:Std Speed: C	*ENG	[200 to 800 / 690 / 1-V/step]
3-612-203	Now:Std Speed: M	*ENG	[200 to 800 / 690 / 1-V/step]
3-612-204	Now:Std Speed: Y	*ENG	[200 to 800 / 690 / 1-V/step]
3-612-211	Now:Mid Speed: K	*ENG	[200 to 800 / 690 / 1-V/step]
3-612-212	Now:Mid Speed: C	*ENG	[200 to 800 / 690 / 1-V/step]
3-612-213	Now:Mid Speed: M	*ENG	[200 to 800 / 690 / 1-V/step]

3-612-214	Now:Mid Speed: Y	*ENG	[200 to 800 / 690 / 1-V/step]
3-612-221	Now:Low Speed: K	*ENG	[200 to 800 / 690 / 1-V/step]
3-612-222	Now:Low Speed: C	*ENG	[200 to 800 / 690 / 1-V/step]
3-612-223	Now:Low Speed: M	*ENG	[200 to 800 / 690 / 1-V/step]
3-612-224	Now:Low Speed: Y	*ENG	[200 to 800 / 690 / 1-V/step]

3613	[LD Power Control]		
3-613-001	Std Speed: K	*ENG	[0 to 200 / 100 / 1%/step]
3-613-002	Std Speed: C	*ENG	[0 to 200 / 100 / 1%/step]
3-613-003	Std Speed: M	*ENG	[0 to 200 / 100 / 1%/step]
3-613-004	Std Speed: Y	*ENG	[0 to 200 / 100 / 1%/step]
3-613-011	Mid Speed: K	*ENG	[0 to 200 / 100 / 1%/step]
3-613-012	Mid Speed: C	*ENG	[0 to 200 / 100 / 1%/step]
3-613-013	Mid Speed: M	*ENG	[0 to 200 / 100 / 1%/step]
3-613-014	Mid Speed: Y	*ENG	[0 to 200 / 100 / 1%/step]
3-613-021	Low Speed: K	*ENG	[0 to 200 / 100 / 1%/step]
3-613-022	Low Speed: C	*ENG	[0 to 200 / 100 / 1%/step]
3-613-023	Low Speed: M	*ENG	[0 to 200 / 100 / 1%/step]
3-613-024	Low Speed: Y	*ENG	[0 to 200 / 100 / 1%/step]
3-613-101	PrcsCntrlCorrect:K	*ENG	[0 to 200 / 100 / 1%/step]
3-613-102	PrcsCntrlCorrect:C	*ENG	[0 to 200 / 100 / 1%/step]
3-613-103	PrcsCntrlCorrect:M	*ENG	[0 to 200 / 100 / 1%/step]
3-613-104	PrcsCntrlCorrect:Y	*ENG	[0 to 200 / 100 / 1%/step]
3-613-201	Now:Std Speed: K	*ENG	[0 to 200 / 100 / 1%/step]
3-613-202	Now:Std Speed: C	*ENG	[0 to 200 / 100 / 1%/step]
3-613-203	Now:Std Speed: M	*ENG	[0 to 200 / 100 / 1%/step]

3-613-204	Now:Std Speed: Y	*ENG	[0 to 200 / 100 / 1%/step]
3-613-211	Now:Mid Speed: K	*ENG	[0 to 200 / 100 / 1%/step]
3-613-212	Now:Mid Speed: C	*ENG	[0 to 200 / 100 / 1%/step]
3-613-213	Now:Mid Speed: M	*ENG	[0 to 200 / 100 / 1%/step]
3-613-214	Now:Mid Speed: Y	*ENG	[0 to 200 / 100 / 1%/step]
3-613-221	Now:Low Speed: K	*ENG	[0 to 200 / 100 / 1%/step]
3-613-222	Now:Low Speed: C	*ENG	[0 to 200 / 100 / 1%/step]
3-613-223	Now:Low Speed: M	*ENG	[0 to 200 / 100 / 1%/step]
3-613-224	Now:Low Speed: Y	*ENG	[0 to 200 / 100 / 1%/step]

3619	[Bias:Spd Corr]		
3-619-011	VbCoef:Mid Spd: K	*ENG	[0.5 to 1.5 / 1 / 0.01/step]
3-619-012	VbCoef:Mid Spd: C	*ENG	[0.5 to 1.5 / 1 / 0.01/step]
3-619-013	VbCoef:Mid Spd: M	*ENG	[0.5 to 1.5 / 1 / 0.01/step]
3-619-014	VbCoef:Mid Spd: Y	*ENG	[0.5 to 1.5 / 1 / 0.01/step]
3-619-021	VbCoef:Low Spd: K	*ENG	[0.5 to 1.5 / 1 / 0.01/step]
3-619-022	VbCoef:Low Spd: C	*ENG	[0.5 to 1.5 / 1 / 0.01/step]
3-619-023	VbCoef:Low Spd: M	*ENG	[0.5 to 1.5 / 1 / 0.01/step]
3-619-024	VbCoef:Low Spd: Y	*ENG	[0.5 to 1.5 / 1 / 0.01/step]
3-619-051	Offset: Std Spd: K	*ENG	[-128 to 127 / 39 / 1V/step]
3-619-052	Offset: Std Spd: C	*ENG	[-128 to 127 / 2 / 1V/step]
3-619-053	Offset: Std Spd: M	*ENG	[-128 to 127 / 2 / 1V/step]
3-619-054	Offset: Std Spd: Y	*ENG	[-128 to 127 / 2 / 1V/step]
3-619-061	Offset: Mid Spd: K	*ENG	[-128 to 127 / 2 / 1V/step]
3-619-062	Offset: Mid Spd: C	*ENG	[-128 to 127 / 2 / 1V/step]
3-619-063	Offset: Mid Spd: M	*ENG	[-128 to 127 / 2 / 1V/step]

3-619-064	Offset: Mid Spd: Y	*ENG	[-128 to 127 / 2 / 1V/step]
3-619-071	Offset: Low Spd: K	*ENG	[-128 to 127 / 2 / 1V/step]
3-619-072	Offset: Low Spd: C	*ENG	[-128 to 127 / 2 / 1V/step]
3-619-073	Offset: Low Spd: M	*ENG	[-128 to 127 / 2 / 1V/step]
3-619-074	Offset: Low Spd: Y	*ENG	[-128 to 127 / 2 / 1V/step]

3620	[ProCon Target M/A]		
3-620-001	Maximum M/A:K	*ENG	[0.25 to 0.75 / 0.37 / 0.001mg/cm ² /step]
3-620-002	Maximum M/A:C	*ENG	[0.25 to 0.75 / 0.4 / 0.001mg/cm ² /step]
3-620-003	Maximum M/A:M	*ENG	[0.25 to 0.75 / 0.45 / 0.001mg/cm ² /step]
3-620-004	Maximum M/A:Y	*ENG	[0.25 to 0.75 / 0.4 / 0.001mg/cm ² /step]

3622	[Dev Pot :Set]		
3-622-001	Current:K	*ENG	[0 to 800 / 0 / 1V/step]
3-622-002	Current:C	*ENG	[0 to 800 / 0 / 1V/step]
3-622-003	Current:M	*ENG	[0 to 800 / 0 / 1V/step]
3-622-004	Current:Y	*ENG	[0 to 800 / 0 / 1V/step]
3-622-011	Current:F_K	*ENG	[0 to 800 / 0 / 1V/step]
3-622-012	Current:F_C	*ENG	[0 to 800 / 0 / 1V/step]
3-622-013	Current:F_M	*ENG	[0 to 800 / 0 / 1V/step]
3-622-014	Current:F_Y	*ENG	[0 to 800 / 0 / 1V/step]
3-622-021	Current:C_K	ENG	[0 to 800 / 0 / 1V/step]
3-622-022	Current:C_C	ENG	[0 to 800 / 0 / 1V/step]
3-622-023	Current:C_M	ENG	[0 to 800 / 0 / 1V/step]

3-622-024	Current:C_Y	ENG	[0 to 800 / 0 / 1V/step]
3-622-031	Current:R_K	ENG	[0 to 800 / 0 / 1V/step]
3-622-032	Current:R_C	ENG	[0 to 800 / 0 / 1V/step]
3-622-033	Current:R_M	ENG	[0 to 800 / 0 / 1V/step]
3-622-034	Current:R_Y	ENG	[0 to 800 / 0 / 1V/step]
3-622-051	UpperLimit	*ENG	[400 to 800 / 700 / 1V/step]
3-622-052	UpperLimit	*ENG	[400 to 800 / 700 / 1V/step]
3-622-053	UpperLimit	*ENG	[400 to 800 / 700 / 1V/step]
3-622-054	UpperLimit	*ENG	[400 to 800 / 700 / 1V/step]
3-622-061	LowerLimit	*ENG	[0 to 400 / 200 / 1V/step]
3-622-062	LowerLimit	*ENG	[0 to 400 / 200 / 1V/step]
3-622-063	LowerLimit	*ENG	[0 to 400 / 200 / 1V/step]
3-622-064	LowerLimit	*ENG	[0 to 400 / 200 / 1V/step]
3-622-101	Target:K	*ENG	[0 to 800 / 0 / 1V/step]
3-622-102	Target:C	*ENG	[0 to 800 / 0 / 1V/step]
3-622-103	Target:M	*ENG	[0 to 800 / 0 / 1V/step]
3-622-104	Target:Y	*ENG	[0 to 800 / 0 / 1V/step]
3-622-111	Target Corr:K	*ENG	[-128 to 127 / 0 / 1/step]
3-622-112	Target Corr:C	*ENG	[-128 to 127 / 0 / 1/step]
3-622-113	Target Corr:M	*ENG	[-128 to 127 / 0 / 1/step]
3-622-114	Target Corr:Y	*ENG	[-128 to 127 / 0 / 1/step]
3-622-121	Vk:Upper_K	*ENG	[0 to 255 / 30 / 1-V/step]
3-622-122	Vk:Upper_Col	*ENG	[0 to 255 / 30 / 1-V/step]
3-622-123	Vk:Lower_K	*ENG	[-128 to 0 / -90 / 1-V/step]
3-622-124	Vk:Lower_Col	*ENG	[-128 to 0 / -60 / 1-V/step]

3623	[LD Power :Set]		
3-623-001	Std Speed Slope:K	*ENG	[-1000 to 1000 / 133 / 1/step]
3-623-002	Std Speed Slope:C	*ENG	[-1000 to 1000 / 133 / 1/step]
3-623-003	Std Speed Slope:M	*ENG	[-1000 to 1000 / 133 / 1/step]
3-623-004	Std Speed Slope:Y	*ENG	[-1000 to 1000 / 133 / 1/step]
3-623-011	Std Speed intercept:K	*ENG	[-1000 to 1000 / 31 / 1/step]
3-623-012	Std Speed intercept:C	*ENG	[-1000 to 1000 / 31 / 1/step]
3-623-013	Std Speed intercept:M	*ENG	[-1000 to 1000 / 31 / 1/step]
3-623-014	Std Speed intercept:Y	*ENG	[-1000 to 1000 / 31 / 1/step]
3-623-021	Mid Speed Slope:K	ENG	[-1000 to 1000 / 133 / 1/step]
3-623-022	Mid Speed Slope:C	ENG	[-1000 to 1000 / 133 / 1/step]
3-623-023	Mid Speed Slope:M	ENG	[-1000 to 1000 / 133 / 1/step]
3-623-024	Mid Speed Slope:Y	ENG	[-1000 to 1000 / 133 / 1/step]
3-623-031	Mid Speed intercept:K	ENG	[-1000 to 1000 / 31 / 1/step]
3-623-032	Mid Speed intercept:C	ENG	[-1000 to 1000 / 31 / 1/step]
3-623-033	Mid Speed intercept:M	ENG	[-1000 to 1000 / 31 / 1/step]
3-623-034	Mid Speed intercept:Y	ENG	[-1000 to 1000 / 31 / 1/step]
3-623-041	Low Speed Slope:K	*ENG	[-1000 to 1000 / 133 / 1/step]
3-623-042	Low Speed Slope:C	*ENG	[-1000 to 1000 / 133 / 1/step]
3-623-043	Low Speed Slope:M	*ENG	[-1000 to 1000 / 133 / 1/step]
3-623-044	Low Speed Slope:Y	*ENG	[-1000 to 1000 / 133 / 1/step]
3-623-051	Low Speed intercept:K	*ENG	[-1000 to 1000 / 18 / 1/step]
3-623-052	Low Speed intercept:C	*ENG	[-1000 to 1000 / 18 / 1/step]
3-623-053	Low Speed intercept:M	*ENG	[-1000 to 1000 / 18 / 1/step]
3-623-054	Low Speed intercept:Y	*ENG	[-1000 to 1000 / 18 / 1/step]

3624	[TC Adj. Mode]		
3-624-001	Target(Upp Limit)	* ENG	[0 to 1 / 0.10 / 0.01mg/cm ² /-kV/step]
3-624-002	Target(Lwr Limit)	* ENG	[-1 to 0 / -0.12 / 0.01mg/cm ² /-kV/step]
3-624-021	Consumption Pat: DUTY: K	* ENG	[0 to 15 / 15 / 1/step]
3-624-022	Consumption Pat: DUTY: C	* ENG	[0 to 15 / 15 / 1/step]
3-624-023	Consumption Pat: DUTY: M	* ENG	[0 to 15 / 15 / 1/step]
3-624-024	Consumption Pat: DUTY: Y	* ENG	[0 to 15 / 15 / 1/step]
3-624-031	Max Counts:PowerON	* ENG	[0 to 10 / 1 / 1/step]
3-624-032	Max Counts:Job In	* ENG	[0 to 10 / 0 / 1/step]
3-624-033	Max Counts:Printing	* ENG	[0 to 10 / 0 / 1/step]
3-624-034	Max Counts:Job End	* ENG	[0 to 10 / 1 / 1/step]
3-624-035	Max Counts:ACC	* ENG	[0 to 10 / 2 / 1/step]
3-624-036	Max Counts:Initial Setting	* ENG	[0 to 10 / 3 / 1/step]
3-624-037	Max Counts:Replenishment	* ENG	[0 to 10 / 3 / 1/step]
3-624-038	Max Counts:Recovery	* ENG	[0 to 10 / 3 / 1/step]
3-624-071	AbsHumThresh(Upp)	* ENG	[0 to 100 / 18 / 0.01g/m ³ /step]
3-624-072	AbsHumThresh(Low)	* ENG	[0 to 100 / 4 / 0.01g/m ³ /step]
3-624-073	AbsHumThresh(Range)	* ENG	[0 to 100 / 12 / 0.01g/m ³ /step]
3-624-101	AbsHum: Threshold 2	* ENG	[0 to 10000 / 1500 / 0.01g/m ³ /step]
3-624-102	Delta AbsHum: Threshold 2	* ENG	[0 to 10000 / 550 / 0.01g/m ³ /step]
3-624-111	Development DC Division Table	* ENG	[0 to 99 / 11 / 1/step]
3-624-112	Consumption Coefficient	* ENG	[0 to 10 / 0 / 0.1/step]
3-624-113	Consumption: Threshold 1	* ENG	[0 to 10000 / 150 / 1mg/step]
3-624-114	Consumption: Threshold 2	* ENG	[0 to 10000 / 300 / 1 mg/step]

3-624-115	Consumption: Threshold 3	* ENG	[0 to 10000 / 450 / 1 mg/step]
3-624-116	Consumption: Threshold 4	* ENG	[0 to 10000 / 600 / 1 mg/step]
3-624-117	Consumption: Threshold 5	* ENG	[0 to 10000 / 750 / 1 mg/step]
3-624-118	Consumption: Threshold 6	* ENG	[0 to 10000 / 900 / 1 mg/step]
3-624-121	Consumption: Threshold (Upp)	* ENG	[0 to 10000 / 150 / 1 mg/step]

3627	[P Pattern Extraction :Set]		
3-627-001	Edge Detection Threshold :K	* ENG	[0 to 5 / 2 / 0.1V/step]
3-627-002	Edge Detection Threshold :C	* ENG	[0 to 5 / 2.5 / 0.1V/step]
3-627-003	Edge Detection Threshold :M	* ENG	[0 to 5 / 2.5 / 0.1V/step]
3-627-004	Edge Detection Threshold :Y	* ENG	[0 to 5 / 2.5 / 0.1V/step]
3-627-011	Edge Upper Limit:Potential Control	* ENG	[7 to 10 / 9 / 0.1mm/step]
3-627-012	Edge Upper Limit:IBACC	* ENG	[10 to 13 / 12 / 0.1mm/step]
3-627-013	Edge Upper Limit:RTP	* ENG	[5 to 8 / 7 / 0.1mm/step]
3-627-021	Edge Lower Limit:Potential Control	* ENG	[4 to 7 / 5 / 0.1mm/step]
3-627-022	Edge Lower Limit:IBACC	* ENG	[7 to 10 / 8 / 0.1mm/step]
3-627-023	Edge Lower Limit:RTP	* ENG	[2 to 5 / 3 / 0.1mm/step]

3628	[ID Pattern Timing :Set]		
3-628-001	Scan: YCMK	* ENG	[-500 to 500 / 0 / 0.1mm/step]
3-628-002	Detection Delay Time	* ENG	[0 to 2500 / 0 / 1msec/step]
3-628-003	Delay Time	* ENG	[0 to 2500 / 778 / 1msec/step]
3-628-004	MUSIC Delay Time	* ENG	[0 to 2500 / 150 / 1msec/step]

3630	[Dev gamma :Disp/Set]		
3-630-001	Current:K	* ENG	[0.1 to 6 / 0.84 / 0.01mg/cm ² /-kV/step]

3-630-002	Current:C	* ENG	[0.1 to 6 / 0.88 / 0.01mg/cm ² /-kV/step]
3-630-003	Current:M	* ENG	[0.1 to 6 / 0.79 / 0.01mg/cm ² /-kV/step]
3-630-004	Current:Y	* ENG	[0.1 to 6 / 0.92 / 0.01mg/cm ² /-kV/step]
3-630-011	Target:K	* ENG	[0.5 to 2.55 / 0.84 / 0.01mg/cm ² /-kV/step]
3-630-012	Target:C	* ENG	[0.5 to 2.55 / 0.88 / 0.01mg/cm ² /-kV/step]
3-630-013	Target:M	* ENG	[0.5 to 2.55 / 0.79 / 0.01mg/cm ² /-kV/step]
3-630-014	Target:Y	* ENG	[0.5 to 2.55 / 0.92 / 0.01mg/cm ² /-kV/step]
3-630-061	TnrDensity:K	* ENG	[0 to 25.5 / 0 / 0.1 wt%/step]
3-630-062	TnrDensity:C	* ENG	[0 to 25.5 / 0 / 0.1 wt%/step]
3-630-063	TnrDensity:M	* ENG	[0 to 25.5 / 0 / 0.1 wt%/step]
3-630-064	TnrDensity:Y	* ENG	[0 to 25.5 / 0 / 0.1 wt%/step]
3-630-111	Current:F_K	* ENG	[0.1 to 6 / 0.9 / 0.01mg/cm ² /-kV/step]
3-630-112	Current:F_C	* ENG	[0.1 to 6 / 0.8 / 0.01mg/cm ² /-kV/step]
3-630-113	Current:F_M	* ENG	[0.1 to 6 / 0.8 / 0.01mg/cm ² /-kV/step]
3-630-114	Current:F_Y	* ENG	[0.1 to 6 / 0.8 / 0.01mg/cm ² /-kV/step]
3-630-121	Current:C_K	* ENG	[0.1 to 6 / 0.9 / 0.01mg/cm ² /-kV/step]
3-630-122	Current:C_C	* ENG	[0.1 to 6 / 0.8 / 0.01mg/cm ² /-kV/step]
3-630-123	Current:C_M	* ENG	[0.1 to 6 / 0.8 / 0.01mg/cm ² /-kV/step]
3-630-124	Current:C_Y	* ENG	[0.1 to 6 / 0.8 / 0.01mg/cm ² /-kV/step]
3-630-131	Current:R_K	* ENG	[0.1 to 6 / 0.9 / 0.01mg/cm ² /-kV/step]
3-630-132	Current:R_C	* ENG	[0.1 to 6 / 0.8 / 0.01mg/cm ² /-kV/step]
3-630-133	Current:R_M	* ENG	[0.1 to 6 / 0.8 / 0.01mg/cm ² /-kV/step]
3-630-134	Current:R_Y	* ENG	[0.1 to 6 / 0.8 / 0.01mg/cm ² /-kV/step]
3-630-141	Range M/A Upp:K	* ENG	[0.2 to 1 / 0.4 / 0.01mg/cm ² /step]
3-630-142	Range M/A Low:K	* ENG	[0 to 0.2 / 0.05 / 0.01mg/cm ² /step]
3-630-143	Range M/A Upp:Col	* ENG	[0.2 to 1 / 0.5 / 0.01mg/cm ² /step]

3-630-144	Range M/A Low:Col	*ENG	[0 to 0.2 / 0.05 / 0.01mg/cm ² /step]
-----------	-------------------	------	---

3631	[Vk :Disp]		
3-631-001	Current:K	*ENG	[-300 to 300 / 0 / 1-V/step]
3-631-002	Current:C	*ENG	[-300 to 300 / 0 / 1-V/step]
3-631-003	Current:M	*ENG	[-300 to 300 / 0 / 1-V/step]
3-631-004	Current:Y	*ENG	[-300 to 300 / 0 / 1-V/step]
3-631-111	Current:F_K	*ENG	[-300 to 300 / 0 / 1-V/step]
3-631-112	Current:F_C	*ENG	[-300 to 300 / 0 / 1-V/step]
3-631-113	Current:F_M	*ENG	[-300 to 300 / 0 / 1-V/step]
3-631-114	Current:F_Y	*ENG	[-300 to 300 / 0 / 1-V/step]
3-631-121	Current:C_K	*ENG	[-300 to 300 / 0 / 1-V/step]
3-631-122	Current:C_C	*ENG	[-300 to 300 / 0 / 1-V/step]
3-631-123	Current:C_M	*ENG	[-300 to 300 / 0 / 1-V/step]
3-631-124	Current:C_Y	*ENG	[-300 to 300 / 0 / 1-V/step]
3-631-131	Current:R_K	*ENG	[-300 to 300 / 0 / 1-V/step]
3-631-132	Current:R_C	*ENG	[-300 to 300 / 0 / 1-V/step]
3-631-133	Current:R_M	*ENG	[-300 to 300 / 0 / 1-V/step]
3-631-134	Current:R_Y	*ENG	[-300 to 300 / 0 / 1-V/step]

3680	[Shading Compensation]		
3-680-001	Plus Image Quantity: K	*ENG	[-20 to 16 / 0 / 1/step]
3-680-002	Plus Image Quantity: C	*ENG	[-20 to 16 / 0 / 1/step]
3-680-003	Plus Image Quantity: M	*ENG	[-20 to 16 / 0 / 1/step]
3-680-004	Plus Image Quantity: Y	*ENG	[-20 to 16 / 0 / 1/step]
3-680-011	Minus Image Quantity: K	*ENG	[-20 to 16 / 0 / 1/step]
3-680-012	Minus Image Quantity: C	*ENG	[-20 to 16 / 0 / 1/step]

3-680-013	Minus Image Quantity: M	*ENG	[-20 to 16 / 0 / 1/step]
3-680-014	Minus Image Quantity: Y	*ENG	[-20 to 16 / 0 / 1/step]

3690	[Background Pot ProCon]		
3-690-001	Correction Coefficient h:Disp: K	*ENG	[-100 to 100 / 0 / 1-V/step]
3-690-002	Correction Coefficient h:Disp: C	*ENG	[-100 to 100 / 0 / 1-V/step]
3-690-003	Correction Coefficient h:Disp: M	*ENG	[-100 to 100 / 0 / 1-V/step]
3-690-004	Correction Coefficient h:Disp: Y	*ENG	[-100 to 100 / 0 / 1-V/step]
3-690-011	Correction Coefficient h ₁ : K	*ENG	[-100 to 100 / 0 / 1-V/step]
3-690-012	Correction Coefficient h ₁ : C	*ENG	[-100 to 100 / 0 / 1-V/step]
3-690-013	Correction Coefficient h ₁ : M	*ENG	[-100 to 100 / 0 / 1-V/step]
3-690-014	Correction Coefficient h ₁ : Y	*ENG	[-100 to 100 / 0 / 1-V/step]
3-690-021	Correction Coefficient h ₁ :Upper	*ENG	[-100 to 100 / 50 / 1-V/step]
3-690-022	Correction Coefficient h ₁ :Lower	*ENG	[-100 to 100 / 0 / 1-V/step]
3-690-025	h ₁ Coefficient	*ENG	[0 to 255 / 50 / 0.01 / -]
3-690-031	Dev gamma h ₁ :Disp:K	*ENG	[0 to 600 / 0 / 0.01mg/cm ² /-kV/step]
3-690-032	Dev gamma h ₁ :Disp:C	*ENG	[0 to 600 / 0 / 0.01mg/cm ² /-kV/step]
3-690-033	Dev gamma h ₁ :Disp:M	*ENG	[0 to 600 / 0 / 0.01mg/cm ² /-kV/step]
3-690-034	Dev gamma h ₁ :Disp:Y	*ENG	[0 to 600 / 0 / 0.01mg/cm ² /-kV/step]
3-690-051	Vkh ₁ :Disp:K	*ENG	[-300 to 300 / 0 / 1-V/step]
3-690-052	Vkh ₁ :Disp:C	*ENG	[-300 to 300 / 0 / 1-V/step]
3-690-053	Vkh ₁ :Disp:M	*ENG	[-300 to 300 / 0 / 1-V/step]
3-690-054	Vkh ₁ :Disp:Y	*ENG	[-300 to 300 / 0 / 1-V/step]
3-690-101	Threshold:Correction Coefficient h	*ENG	[0 to 255 / 10 / 1-V/step]

3-690-102	Threshold:Temperature	*ENG	[0 to 990 / 100 / 0.1deg/step]
3-690-103	Threshold:AbsoluteHumidity:Low	*ENG	[0 to 100 / 50 / 0.1g/m ³ /step]
3-690-104	Threshold:AbsoluteHumidity:Hi	*ENG	[100 to 990 / 160 / 0.1g/m ³ /step]
3-690-105	Temperature At Prev Correction	*ENG	[-990 to 990 / 0 / 0.1deg/step]
3-690-106	Threshold: Temperature change	*ENG	[0 to 990 / 100 / 0.1deg/step]
3-690-107	AbsoluteHumidity At Prev Correction	*ENG	[0 to 990 / 0 / 0.1g/m ³ /step]
3-690-108	Threshold:Humidity change	*ENG	[0 to 990 / 50 / 0.1g/m ³ /step]
3-690-109	Count:Disp:Pages	*ENG	[0 to 999 / 0 / 1 / page]
3-690-110	Threshold:Interval	*ENG	[0 to 999 / 0 / 1 / page]
3-690-111	Max: Correction Coefficient change	*ENG	[0 to 255 / 0 / 1-V/step]
3-690-112	Threshold: Correction Coefficient change	*ENG	[0 to 255 / 0 / 1-V/step]
3-690-113	Threshold:Correction Coefficient h:JobEnd	*ENG	[0 to 255 / 0 / 1-V/step]
3-690-141	Vk Offset:Low Humidity:K	*ENG	[0 to 255 / 100 / 1-V/step]
3-690-142	Vk Offset:Low Humidity:CMY	*ENG	[0 to 255 / 100 / 1-V/step]
3-690-143	Vk Offset:Std Humidity:K	*ENG	[0 to 255 / 100 / 1-V/step]
3-690-144	Vk Offset:Std Humidity:CMY	*ENG	[0 to 255 / 100 / 1-V/step]
3-690-145	Vk Offset:Hi Humidity:K	*ENG	[0 to 255 / 100 / 1-V/step]
3-690-146	Vk Offset:Hi Humidity:CMY	*ENG	[0 to 255 / 100 / 1-V/step]

3700	[New Unit Detection]		
3-700-001	ON/OFF Setting	*ENG	[0 or 1 / 1 / 1/step]

3701	[Manual New Unit Set]		
3-701-002	# PCU:K	*ENG	[0 or 1 / 0 / 1/step]

3-701-003	# Dev Unit:K	*ENG	[0 or 1 / 0 / 1/step]
3-701-025	# PCU:C	*ENG	[0 or 1 / 0 / 1/step]
3-701-026	# Dev Unit:C	*ENG	[0 or 1 / 0 / 1/step]
3-701-048	# PCU:M	*ENG	[0 or 1 / 0 / 1/step]
3-701-049	# Dev Unit:M	*ENG	[0 or 1 / 0 / 1/step]
3-701-071	# PCU:Y	*ENG	[0 or 1 / 0 / 1/step]
3-701-072	# Dev Unit:Y	*ENG	[0 or 1 / 0 / 1/step]
3-701-093	# ITB Unit	*ENG	[0 or 1 / 0 / 1/step]
3-701-102	# ITB Cleaning Unit	*ENG	[0 or 1 / 0 / 1/step]
3-701-109	# PTR Unit	*ENG	[0 or 1 / 0 / 1/step]
3-701-115	# Fusing Unit	*ENG	[0 or 1 / 0 / 1/step]
3-701-116	Fusing Belt	*ENG	[0 or 1 / 0 / 1/step]
3-701-118	Pressure Roller	*ENG	[0 or 1 / 0 / 1/step]
3-701-131	Dust Filter	*ENG	[0 or 1 / 0 / 1/step]
3-701-142	Waste Toner Bottle	*ENG	[0 or 1 / 0 / 1/step]
3-701-206	ADF Pick-up Roller	*ENG	[0 or 1 / 0 / 1/step]
3-701-207	ADF Supply Belt	*ENG	[0 or 1 / 0 / 1/step]
3-701-208	ADF Reverse Roller	*ENG	[0 or 1 / 0 / 1/step]

3704	[PCU Voltage Correction]		
3-704-001	ON/OFF Setting	*ENG	[0 or 1 / 1 / 1/step]

3800	[Waste Toner Full Detection]		
3-800-001	Condition	*ENG	[0 to 4 / 0 / 1/step]
3-800-002	Page Count 1 After Near Full	*ENG	[0 to 1000000 / 0 / 1 sheet/step]
3-800-003	Volume Count 1 After Near Full	*ENG	[0 to 10000000 / 0 / 0.1 mg/step]
3-800-004	Volume Count 1 After Replacement	*ENG	[0 to 10000000 / 0 / 0.1 mg/step]

3-800-005	Volume Count 2 After Replacement	*ENG	[0 to 10000000 / 0 / 0.1 mg/step]
3-800-006	Page Count 2 After Near Full	*ENG	[0 to 1000000 / 0 / 1 sheet/step]
3-800-007	Volume Count 2 After Near Full	*ENG	[0 to 10000000 / 0 / 0.1 mg/step]
3-800-014	Threshold : Remainder days	*ENG	[1 to 255 / 15 / 1 day/step]
3-800-024	Date of detection for near full	*ENG	[0 or 1 / 0 / 1/step]

3905	[Recycled Parts: New/Old Flag]		
3-905-001	OPC:K	*ENG	[0 or 1 / 0 / 1/step]
3-905-002	OPC:C	*ENG	
3-905-003	OPC:M	*ENG	
3-905-004	OPC:Y	*ENG	

3990	[Abs Temp.:Get Charge Load]		
3-990-001	Temperature: Display	*ENG	[0 to 70 / 0 / 0.1 deg/step]
3990	[Abs Humidity:Get Charge Load]		
3-990-002	Abs Humidity: Display	*ENG	[0 to 100 / 0 / 0.01g/m ³ /step]

Engine SP Tables - SP4000

SP4-XXX (Scanner)

4008	[Sub Scan Magnification Adj]		
4-008-001	-	*ENG	[-1.0 to 1.0 / 0 / 0.1%/step]

4010	[Sub Scan Registration Adj]		
4-010-001	-	*ENG	[-2.0 to 2.0 / 0 / 0.1mm/step]

4011	[Main Scan Reg]		
4-011-001	-	*ENG	[-2.5 to 2.5 / 0 / 0.1mm/step]

4012	[Set Scale Mask]		
4-012-001	Book:Sub LEdge	ENG	[0.0 to 3.0 / 1 / 0.1mm/step]
4-012-002	Book:Sub TEdge	ENG	[0.0 to 3.0 / 0 / 0.1mm/step]
4-012-003	Book:Main:LEdge	ENG	[0.0 to 3.0 / 1 / 0.1mm/step]
4-012-004	Book:Main:TEdge	ENG	[0.0 to 3.0 / 0 / 0.1mm/step]
4-012-005	ADF: Leading Edge	*ENG	[0.0 to 3.0 / 0 / 0.1mm/step]
4-012-007	ADF: Right	*ENG	[0.0 to 3.0 / 0 / 0.1mm/step]
4-012-008	ADF: left	*ENG	[0.0 to 3.0 / 0 / 0.1mm/step]

4013	[Scanner Free Run]		
4-013-001	Book mode :Lamp Off	ENG	[0 or 1 / 0 / 1/step] 0: OFF 1: ON
4-013-002	Book mode :Lamp On	ENG	[0 or 1 / 0 / 1/step] 0: OFF 1: ON

4020	[Dust Check]		
4-020-001	Dust Detect:On/Off	ENG	[0 or 1 / 0 / 1/step] 0: OFF, 1: ON
4-020-002	Dust Detect:Lvl	ENG	[0 to 8 / 4 / 1/step] 0: lowest detection level 8: highest detection level
4020	[Dust Check Lvl]		
4-020-003	Dust Reject:Lvl	ENG	[0 to 4 / 0 / 1/step]
4020	[DF Dust Check]		
4-020-011	Dust Detect Level:Rear	ENG	[0 or 1 / 0 / 1/step] 0: OFF, 1: ON
4-020-012	Correction Level:Rear	ENG	[0 to 8 / 4 / 1/step] 0:Lowest level 8:Highest level

4201	[LoCPP edge level:K]		
4-201-001	600dpi 2bit edge1	*ENG	[0 to 15 / 15 / 1/step]
4-201-002	600dpi 2bit edge2	*ENG	[0 to 15 / 15 / 1/step]
4-201-003	600dpi 4bit edge1	*ENG	[0 to 15 / 15 / 1/step]
4-201-004	600dpi 4bit edge2	*ENG	[0 to 15 / 15 / 1/step]
4-201-005	600dpi 1bit edge1	*ENG	[0 to 15 / 15 / 1/step]
4-201-006	600dpi 1bit edge2	*ENG	[0 to 15 / 15 / 1/step]
4-201-011	1200dpi1bit edge12	*ENG	[0 to 15 / 15 / 1/step]
4-201-012	1200dpi1bit edge34	*ENG	[0 to 15 / 15 / 1/step]
4-201-013	1200dpi2bit edge12	*ENG	[0 to 15 / 15 / 1/step]
4-201-014	1200dpi2bit edge34	*ENG	[0 to 15 / 15 / 1/step]

4202	[LoCPP edge level:C]		
-------------	-----------------------------	--	--

4-202-001	600dpi 2bit edge1	*ENG	[0 to 15 / 15 / 1/step]
4-202-002	600dpi 2bit edge2	*ENG	[0 to 15 / 15 / 1/step]
4-202-003	600dpi 4bit edge1	*ENG	[0 to 15 / 15 / 1/step]
4-202-004	600dpi 4bit edge2	*ENG	[0 to 15 / 15 / 1/step]
4-202-005	600dpi 1bit edge1	*ENG	[0 to 15 / 15 / 1/step]
4-202-006	600dpi 1bit edge2	*ENG	[0 to 15 / 15 / 1/step]
4-202-011	1200dpi 1bit edge12	*ENG	[0 to 15 / 15 / 1/step]
4-202-012	1200dpi 1bit edge34	*ENG	[0 to 15 / 15 / 1/step]
4-202-013	1200dpi 2bit edge12	*ENG	[0 to 15 / 15 / 1/step]
4-202-014	1200dpi 2bit edge34	*ENG	[0 to 15 / 15 / 1/step]

4203	[LoCPP edge level:M]		
4-203-001	600dpi 2bit edge1	*ENG	[0 to 15 / 15 / 1/step]
4-203-002	600dpi 2bit edge2	*ENG	[0 to 15 / 15 / 1/step]
4-203-003	600dpi 4bit edge1	*ENG	[0 to 15 / 15 / 1/step]
4-203-004	600dpi 4bit edge2	*ENG	[0 to 15 / 15 / 1/step]
4-203-005	600dpi 1bit edge1	*ENG	[0 to 15 / 15 / 1/step]
4-203-006	600dpi 1bit edge2	*ENG	[0 to 15 / 15 / 1/step]
4-203-011	1200dpi 1bit edge12	*ENG	[0 to 15 / 15 / 1/step]
4-203-012	1200dpi 1bit edge34	*ENG	[0 to 15 / 15 / 1/step]
4-203-013	1200dpi 2bit edge12	*ENG	[0 to 15 / 15 / 1/step]
4-203-014	1200dpi 2bit edge34	*ENG	[0 to 15 / 15 / 1/step]

4204	[LoCPP edge level:Y]		
4-204-001	600dpi 2bit edge1	*ENG	[0 to 15 / 15 / 1/step]
4-204-002	600dpi 2bit edge2	*ENG	[0 to 15 / 15 / 1/step]
4-204-003	600dpi 4bit edge1	*ENG	[0 to 15 / 15 / 1/step]

4-204-004	600dpi 4bit edge2	*ENG	[0 to 15 / 15 / 1/step]
4-204-005	600dpi 1bit edge1	*ENG	[0 to 15 / 15 / 1/step]
4-204-006	600dpi 1bit edge2	*ENG	[0 to 15 / 15 / 1/step]
4-204-011	1200dpi 1bit edge12	*ENG	[0 to 15 / 15 / 1/step]
4-204-012	1200dpi 1bit edge34	*ENG	[0 to 15 / 15 / 1/step]
4-204-013	1200dpi 2bit edge12	*ENG	[0 to 15 / 15 / 1/step]
4-204-014	1200dpi 2bit edge34	*ENG	[0 to 15 / 15 / 1/step]

4301	[Operation Check APS Sensor]		
4-301-001	-	*ENG	[0 to 255 / 0 / 1/step] 0: Not detected 1: Detected

4303	[Min Size for APS]		
4-303-001	-	*ENG	[0 or 1 / 0 / 1/step] 0: No Original 1: A5-Lengthwise

4305	[8K/16K Detection]		
4-305-001	-	*ENG	[0 to 3 / 0 / 1/step] 0: Normal Detection 1: A4-Sideways LT-Lengthwise 2: LT-Sideways A4-Lengthwise 3: 8K 16K

4308	[Scan Size Detection]		
4-308-001	Detection ON/OFF	*ENG	[0 to 2 / 1 / 1/step] 0: OFF 1: ON 2: APS

4309	[Scan Size Detect:Setting]		
4-309-001	Original Density Thresh	*ENG	[0 to 2 / 1 / 1/step]
4-309-002	Detection Time	*ENG	[0 to 255 / 26 / 1 digit/step]
4-309-003	Lamp ON:Delay Time	*ENG	[20 to 100 / 60 / 20msec/step]
4-309-004	LED PWM Duty	*ENG	[40 to 200 / 40 / 10msec/step]

3

4310	[Scan Size Detect Value]		
4-310-001	S1:R	ENG	[0 to 255 / 0 / 1 digit/step]
4-310-002	S1:G	ENG	
4-310-003	S1:B	ENG	
4-310-004	S2:R	ENG	
4-310-005	S2:G	ENG	
4-310-006	S2:B	ENG	
4-310-007	S3:R	ENG	
4-310-008	S3:G	ENG	
4-310-009	S3:B	ENG	

4400	[Org Edge Mask]		
4-400-001	Book:Sub:LEdge(Left)	*ENG	[0.0 to 3.0 / 0 / 0.1mm/step]
4-400-002	Book:Sub:TEdge(Right)	*ENG	[0.0 to 3.0 / 0 / 0.1mm/step]
4-400-003	Book:Main:LEdge(Rear)	*ENG	[0.0 to 3.0 / 0 / 0.1mm/step]
4-400-004	Book:Main:Tedge(Front)	*ENG	[0.0 to 3.0 / 0 / 0.1mm/step]
4-400-005	ADF: Leading Edge	*ENG	[0.0 to 3.0 / 0 / 0.1mm/step]
4-400-007	ADF: Right	*ENG	[0.0 to 3.0 / 0 / 0.1mm/step]
4-400-008	ADF: left	*ENG	[0.0 to 3.0 / 0 / 0.1mm/step]

4417	[IPU Test Pattern]		
-------------	---------------------------	--	--

4-417-001	Test Pattern	ENG	[0 to 8 / 0 / 1/step] 0: Scanned image 1: Gradation main scan A 2: Patch 16C 3: Grid pattern A 4: Slant grid pattern B 5: Slant grid pattern C 6: Slant grid pattern D 7: Scanned+Slant Grid C 8: Scanned+Slant Grid D
-----------	--------------	-----	---

4429	[Select Copy Data Security]		
4-429-001	Copying	*ENG	[0 to 3 / 3 / 1/step]
4-429-002	Scanning	*ENG	[0 to 3 / 3 / 1/step]
4-429-003	Fax Operation	*ENG	[0 to 3 / 3 / 1/step]

4460	[Digital AE]		
4-460-001	Low Limit Value	*ENG	[0 to 1023 / 364 / 1/step]
4-460-002	Background level	*ENG	[512 to 1535 / 932 / 1/step]

4501	[ACC Target Den]		
4-501-001	Copy:K:Text	*ENG	[0 to 10 / 5 / 1/step]
4-501-002	Copy:C:Text	*ENG	[0 to 10 / 5 / 1/step]
4-501-003	Copy:M:Text	*ENG	[0 to 10 / 5 / 1/step]
4-501-004	Copy:Y:Text	*ENG	[0 to 10 / 5 / 1/step]
4-501-005	Copy:K:Photo	*ENG	[0 to 10 / 5 / 1/step]
4-501-006	Copy:C:Photo	*ENG	[0 to 10 / 5 / 1/step]
4-501-007	Copy:M:Photo	*ENG	[0 to 10 / 5 / 1/step]
4-501-008	Copy:Y:Photo	*ENG	[0 to 10 / 5 / 1/step]

4505	[ACC Cor:Bright]		
4-505-001	Master:K	* ENG	[-128 to 127 / 0 / 1/step]
4-505-002	Master:C	* ENG	[-128 to 127 / 0 / 1/step]
4-505-003	Master:M	* ENG	[-128 to 127 / 0 / 1/step]
4-505-004	Master:Y	* ENG	[-128 to 127 / 0 / 1/step]
4-505-005	Slave:K	* ENG	[-128 to 127 / 0 / 1/step]
4-505-006	Slave:C	* ENG	[-128 to 127 / 0 / 1/step]
4-505-007	Slave:M	* ENG	[-128 to 127 / 0 / 1/step]
4-505-008	Slave:Y	* ENG	[-128 to 127 / 0 / 1/step]

4506	[ACC Cor:Dark]		
4-506-001	Master:K	* ENG	[-128 to 127 / 0 / 1/step]
4-506-002	Master:C	* ENG	[-128 to 127 / 0 / 1/step]
4-506-003	Master:M	* ENG	[-128 to 127 / 0 / 1/step]
4-506-004	Master:Y	* ENG	[-128 to 127 / 0 / 1/step]
4-506-005	Slave:K	* ENG	[-128 to 127 / 0 / 1/step]
4-506-006	Slave:C	* ENG	[-128 to 127 / 0 / 1/step]
4-506-007	Slave:M	* ENG	[-128 to 127 / 0 / 1/step]
4-506-008	Slave:Y	* ENG	[-128 to 127 / 0 / 1/step]

4520	[IBACC:DetectedValue]		
-------------	------------------------------	--	--

4-520-001	Latest:K_P1	*ENG	[0 to 1023 / 0 / 1/step]
4-520-002	Latest:K_P2	*ENG	
4-520-003	Latest:K_P3	*ENG	
4-520-004	Latest:K_P4	*ENG	
4-520-005	Latest:K_P5	*ENG	
4-520-006	Latest:K_P6	*ENG	
4-520-007	Latest:K_P6	*ENG	
4-520-008	Latest:K_P6	*ENG	
4-520-021	Latest:C_P1	*ENG	
4-520-022	Latest:C_P2	*ENG	
4-520-023	Latest:C_P3	*ENG	
4-520-024	Latest:C_P4	*ENG	
4-520-025	Latest:C_P5	*ENG	
4-520-026	Latest:C_P6	*ENG	
4-520-027	Latest:C_P6	*ENG	
4-520-028	Latest:C_P6	*ENG	

4-520-041	Latest:M_P1	*ENG	[0 to 1023 / 0 / 1/step]
4-520-042	Latest:M_P2	*ENG	
4-520-043	Latest:M_P3	*ENG	
4-520-044	Latest:M_P4	*ENG	
4-520-045	Latest:M_P5	*ENG	
4-520-046	Latest:M_P6	*ENG	
4-520-047	Latest:M_P6	*ENG	
4-520-048	Latest:M_P6	*ENG	
4-520-061	Latest:Y_P1	*ENG	
4-520-062	Latest:Y_P2	*ENG	
4-520-063	Latest:Y_P3	*ENG	
4-520-064	Latest:Y_P4	*ENG	
4-520-065	Latest:Y_P5	*ENG	
4-520-066	Latest:Y_P6	*ENG	
4-520-067	Latest:Y_P6	*ENG	
4-520-068	Latest:Y_P6	*ENG	

4-520-102	Previous:K_P2	*ENG	[0 to 1023 / 0 / 1/step]
4-520-103	Previous:K_P3	*ENG	
4-520-104	Previous:K_P4	*ENG	
4-520-105	Previous:K_P5	*ENG	
4-520-106	Previous:K_P6	*ENG	
4-520-107	Previous:K_P6	*ENG	
4-520-108	Previous:K_P6	*ENG	
4-520-121	Previous:C_P1	*ENG	
4-520-122	Previous:C_P2	*ENG	
4-520-123	Previous:C_P3	*ENG	
4-520-124	Previous:C_P4	*ENG	
4-520-125	Previous:C_P5	*ENG	
4-520-126	Previous:C_P6	*ENG	
4-520-127	Previous:C_P6	*ENG	
4-520-128	Previous:C_P6	*ENG	

4-520-141	Previous:M_P1	*ENG	[0 to 1023 / 0 / 1/step]
4-520-142	Previous:M_P2	*ENG	
4-520-143	Previous:M_P3	*ENG	
4-520-144	Previous:M_P4	*ENG	
4-520-145	Previous:M_P5	*ENG	
4-520-146	Previous:M_P6	*ENG	
4-520-147	Previous:M_P6	*ENG	
4-520-148	Previous:M_P6	*ENG	
4-520-161	Previous:Y_P1	*ENG	
4-520-162	Previous:Y_P2	*ENG	
4-520-163	Previous:Y_P3	*ENG	
4-520-164	Previous:Y_P4	*ENG	
4-520-165	Previous:Y_P5	*ENG	
4-520-166	Previous:Y_P6	*ENG	
4-520-167	Previous:Y_P6	*ENG	
4-520-168	Previous:Y_P6	*ENG	

4540	[Print Coverage]		
4-540-001	RY Phase: Option	ENG	[0 to 255 / 0 / 1/step] 0:OFF 1:ON
4-540-002	RY Phase: R	ENG	[-256 to 255 / 0 / 1/step]
4-540-003	RY Phase: G	ENG	[-256 to 255 / 0 / 1/step]
4-540-004	RY Phase: B	ENG	[-256 to 255 / 0 / 1/step]
4-540-005	YR Phase: Option	ENG	[0 to 255 / 0 / 1/step] 0:OFF 1:ON

4-540-006	YR Phase: R	ENG	[-256 to 255 / 0 / 1/step]
4-540-007	YR Phase: G	ENG	[-256 to 255 / 0 / 1/step]
4-540-008	YR Phase: B	ENG	[-256 to 255 / 0 / 1/step]
4-540-009	YG Phase: Option	ENG	[0 to 255 / 0 / 1/step] 0:OFF 1:ON
4-540-010	YG Phase: R	ENG	[-256 to 255 / 0 / 1/step]
4-540-011	YG Phase: G	ENG	[-256 to 255 / 0 / 1/step]
4-540-012	YG Phase: B	ENG	[-256 to 255 / 0 / 1/step]
4-540-013	GY Phase: Option	ENG	[0 to 255 / 0 / 1/step] 0:OFF 1:ON
4-540-014	GY Phase: R	ENG	[-256 to 255 / 0 / 1/step]
4-540-015	GY Phase: G	ENG	[-256 to 255 / 0 / 1/step]
4-540-016	GY Phase: B	ENG	[-256 to 255 / 0 / 1/step]
4-540-017	GC Phase: Option	ENG	[0 to 255 / 0 / 1/step] 0:OFF 1:ON
4-540-018	GC Phase: R	ENG	[-256 to 255 / 0 / 1/step]
4-540-019	GC Phase: G	ENG	[-256 to 255 / 0 / 1/step]
4-540-020	GC Phase: B	ENG	[-256 to 255 / 0 / 1/step]
4-540-021	CG Phase: Option	ENG	[0 to 255 / 0 / 1/step] 0:OFF 1:ON
4-540-022	CG Phase: R	ENG	[-256 to 255 / 0 / 1/step]
4-540-023	CG Phase: G	ENG	[-256 to 255 / 0 / 1/step]
4-540-024	CG Phase: B	ENG	[-256 to 255 / 0 / 1/step]

4-540-025	CB Phase: Option	ENG	[0 to 255 / 0 / 1/step] 0:OFF 1:ON
4-540-026	CB Phase: R	ENG	[-256 to 255 / 0 / 1/step]
4-540-027	CB Phase: G	ENG	[-256 to 255 / 0 / 1/step]
4-540-028	CB Phase: B	ENG	[-256 to 255 / 0 / 1/step]
4-540-029	BC Phase: Option	ENG	[0 to 255 / 0 / 1/step] 0:OFF 1:ON
4-540-030	BC Phase: R	ENG	[-256 to 255 / 0 / 1/step]
4-540-031	BC Phase: G	ENG	[-256 to 255 / 0 / 1/step]
4-540-032	BC Phase: B	ENG	[-256 to 255 / 0 / 1/step]
4-540-033	BM Phase: Option	ENG	[0 to 255 / 0 / 1/step] 0:OFF 1:ON
4-540-034	BM Phase: R	ENG	[-256 to 255 / 0 / 1/step]
4-540-035	BM Phase: G	ENG	[-256 to 255 / 0 / 1/step]
4-540-036	BM Phase: B	ENG	[-256 to 255 / 0 / 1/step]
4-540-037	MB Phase: Option	ENG	[0 to 255 / 0 / 1/step] 0:OFF 1:ON
4-540-038	MB Phase: R	ENG	[-256 to 255 / 0 / 1/step]
4-540-039	MB Phase: G	ENG	[-256 to 255 / 0 / 1/step]
4-540-040	MB Phase: B	ENG	[-256 to 255 / 0 / 1/step]
4-540-041	MR Phase: Option	ENG	[0 to 255 / 0 / 1/step] 0:OFF 1:ON
4-540-042	MR Phase: R	ENG	[-256 to 255 / 0 / 1/step]

4-540-043	MR Phase: G	ENG	[-256 to 255 / 0 / 1/step]
4-540-044	MR Phase: B	ENG	[-256 to 255 / 0 / 1/step]
4-540-045	RM Phase: Option	ENG	[0 to 255 / 0 / 1/step] 0:OFF 1:ON
4-540-046	RM Phase: R	ENG	[-256 to 255 / 0 / 1/step]
4-540-047	RM Phase: G	ENG	[-256 to 255 / 0 / 1/step]
4-540-048	RM Phase: B	ENG	[-256 to 255 / 0 / 1/step]
4-540-049	WHITE: Option	ENG	[0 to 255 / 0 / 1/step] 0:OFF 1:ON
4-540-050	WHITE:R	ENG	[-256 to 255 / 0 / 1/step]
4-540-051	WHITE:G	ENG	[-256 to 255 / 0 / 1/step]
4-540-052	WHITE:B	ENG	[-256 to 255 / 0 / 1/step]
4-540-053	BLACK: Option	ENG	[0 to 255 / 0 / 1/step] 0:OFF 1:ON
4-540-054	BLACK:R	ENG	[-256 to 255 / 0 / 1/step]
4-540-055	BLACK:G	ENG	[-256 to 255 / 0 / 1/step]
4-540-056	BLACK:B	ENG	[-256 to 255 / 0 / 1/step]

4541	[Photo Correction]		
4-541-001	Copied Photo	ENG	[0 to 1 / 0 / 1/step]

4550	[Scan Apli:Txt/Print]		
4-550-005	MTF: 0(Off) 1-15 (Weak-Strong)	*ENG	[0 to 15 / 8 / 1/step]
4-550-006	Smoothing: 0(x1) 1-7 (Weak-Strong)	*ENG	[0 to 7 / 4 / 1/step]

4-550-007	Brightness: 1-255	*ENG	[1 to 255 / 128 / 1/step]
4-550-008	Contrast: 1-255	*ENG	[1 to 255 / 128 / 1/step]
4-550-009	Ind Dot Erase: 0(Off) 1-7 (Weak-Strong)	*ENG	[0 to 7 / 0 / 1/step]

4551	[Scan Apli:Txt]		
4-551-005	MTF: 0(Off) 1-15 (Weak-Strong)	*ENG	[0 to 15 / 8 / 1/step]
4-551-006	Smoothing: 0(x1) 1-7 (Weak-Strong)	*ENG	[0 to 7 / 4 / 1/step]
4-551-007	Brightness: 1-255	*ENG	[1 to 255 / 128 / 1/step]
4-551-008	Contrast: 1-255	*ENG	[1 to 255 / 128 / 1/step]
4-551-009	Ind Dot Erase: 0(Off) 1-7 (Weak-Strong)	*ENG	[0 to 7 / 0 / 1/step]

4552	[Scan Apli:Txt Dropout]		
4-552-005	MTF: 0(Off) 1-15 (Weak-Strong)	*ENG	[0 to 15 / 8 / 1/step]
4-552-006	Smoothing: 0(x1) 1-7 (Weak-Strong)	*ENG	[0 to 7 / 4 / 1/step]
4-552-007	Brightness: 1-255	*ENG	[1 to 255 / 128 / 1/step]
4-552-008	Contrast: 1-255	*ENG	[1 to 255 / 128 / 1/step]
4-552-009	Ind Dot Erase: 0(Off) 1-7 (Weak-Strong)	*ENG	[0 to 7 / 0 / 1/step]

4553	[Scan Apli:Txt/Photo]		
4-553-005	MTF: 0(Off) 1-15 (Weak-Strong)	*ENG	[0 to 15 / 8 / 1/step]
4-553-006	Smoothing: 0(x1) 1-7 (Weak-Strong)	*ENG	[0 to 7 / 4 / 1/step]
4-553-007	Brightness: 1-255	*ENG	[1 to 255 / 128 / 1/step]

4-553-008	Contrast: 1-255	*ENG	[1 to 255 / 128 / 1/step]
4-553-009	Ind Dot Erase: 0(Off) 1-7 (Weak-Strong)	*ENG	[0 to 7 / 0 / 1/step]

4554	[Scan Apli:Photo]		
4-554-005	MTF: 0(Off) 1-15 (Weak-Strong)	*ENG	[0 to 15 / 8 / 1/step]
4-554-006	Smoothing: 0(x1) 1-7 (Weak-Strong)	*ENG	[0 to 7 / 4 / 1/step]
4-554-007	Brightness: 1-255	*ENG	[1 to 255 / 128 / 1/step]
4-554-008	Contrast: 1-255	*ENG	[1 to 255 / 128 / 1/step]
4-554-009	Ind Dot Erase: 0(Off) 1-7 (Weak-Strong)	*ENG	[0 to 7 / 0 / 1/step]

4565	[Scan Apli:GrayScale]		
4-565-005	MTF: 0(Off) 1-15 (Weak-Strong)	*ENG	[0 to 15 / 8 / 1/step]
4-565-006	Smoothing: 0(x1) 1-7 (Weak-Strong)	*ENG	[0 to 7 / 4 / 1/step]
4-565-007	Brightness: 1-255	*ENG	[1 to 255 / 128 / 1/step]
4-565-008	Contrast: 1-255	*ENG	[1 to 255 / 128 / 1/step]
4-565-009	Ind Dot Erase: 0(Off) 1-7 (Weak-Strong)	*ENG	[0 to 7 / 0 / 1/step]

4570	[Scan Apli:Col Txt/Photo]		
4-570-005	MTF: 0(Off) 1-15 (Weak-Strong)	*ENG	[0 to 15 / 8 / 1/step]
4-570-006	Smoothing: 0(x1) 1-7 (Weak-Strong)	*ENG	[0 to 7 / 4 / 1/step]
4-570-007	Brightness: 1-255	*ENG	[1 to 255 / 128 / 1/step]
4-570-008	Contrast: 1-255	*ENG	[1 to 255 / 128 / 1/step]

4-570-009	Ind Dot Erase: 0(Off) 1-7 (Weak-Strong)	*ENG	[0 to 7 / 0 / 1/step]
-----------	--	------	-----------------------

4571	[Scan Apli:Col Gloss Photo]		
4-571-005	MTF: 0(Off) 1-15 (Weak-Strong)	*ENG	[0 to 15 / 8 / 1/step]
4-571-006	Smoothing: 0(x1) 1-7 (Weak-Strong)	*ENG	[0 to 7 / 4 / 1/step]
4-571-007	Brightness: 1-255	*ENG	[1 to 255 / 128 / 1/step]
4-571-008	Contrast: 1-255	*ENG	[1 to 255 / 128 / 1/step]
4-571-009	Ind Dot Erase: 0(Off) 1-7 (Weak-Strong)	*ENG	[0 to 7 / 0 / 1/step]

4572	[Scan Apli:AutoCol]		
4-572-005	MTF: 0(Off) 1-15 (Weak-Strong)	*ENG	[0 to 15 / 8 / 1/step]
4-572-006	Smoothing: 0(x1) 1-7 (Weak-Strong)	*ENG	[0 to 7 / 4 / 1/step]
4-572-007	Brightness: 1-255	*ENG	[1 to 255 / 128 / 1/step]
4-572-008	Contrast: 1-255	*ENG	[1 to 255 / 128 / 1/step]
4-572-009	Ind Dot Erase: 0(Off) 1-7 (Weak-Strong)	*ENG	[0 to 7 / 0 / 1/step]

4580	[Fax Apli:Txt/Chart]		
4-580-005	MTF: 0(Off) 1-15 (Weak-Strong)	*ENG	[0 to 15 / 8 / 1/step]
4-580-006	Smoothing: 0(x1) 1-7 (Weak-Strong)	*ENG	[0 to 7 / 4 / 1/step]
4-580-007	Brightness: 1-255	*ENG	[1 to 255 / 128 / 1/step]
4-580-008	Contrast: 1-255	*ENG	[1 to 255 / 128 / 1/step]

4-580-009	Ind Dot Erase: 0(Off) 1-7 (Weak-Strong)	*ENG	[0 to 7 / 0 / 1/step]
4-580-010	Texture Erase: 0	*ENG	[0 to 2 / 0 / 1/step]

4581	[Fax Apli:Txt]		
4-581-005	MTF: 0(Off) 1-15 (Weak-Strong)	*ENG	[0 to 15 / 8 / 1/step]
4-581-006	Smoothing: 0(x1) 1-7 (Weak-Strong)	*ENG	[0 to 7 / 4 / 1/step]
4-581-007	Brightness: 1-255	*ENG	[1 to 255 / 128 / 1/step]
4-581-008	Contrast: 1-255	*ENG	[1 to 255 / 128 / 1/step]
4-581-009	Ind Dot Erase: 0(Off) 1-7 (Weak-Strong)	*ENG	[0 to 7 / 0 / 1/step]

4582	[Fax Apli:Txt/Photo]		
4-582-005	MTF: 0(Off) 1-15 (Weak-Strong)	*ENG	[0 to 15 / 8 / 1/step]
4-582-006	Smoothing: 0(x1) 1-7 (Weak-Strong)	*ENG	[0 to 7 / 4 / 1/step]
4-582-007	Brightness: 1-255	*ENG	[1 to 255 / 128 / 1/step]
4-582-008	Contrast: 1-255	*ENG	[1 to 255 / 128 / 1/step]
4-582-009	Ind Dot Erase: 0(Off) 1-7 (Weak-Strong)	*ENG	[0 to 7 / 0 / 1/step]
4-582-010	Texture Erase: 0	*ENG	[0 to 2 / 0 / 1/step]

4583	[Fax Apli:Photo]		
4-583-005	MTF: 0(Off) 1-15 (Weak-Strong)	*ENG	[0 to 15 / 8 / 1/step]
4-583-006	Smoothing: 0(x1) 1-7 (Weak-Strong)	*ENG	[0 to 7 / 4 / 1/step]
4-583-007	Brightness: 1-255	*ENG	[1 to 255 / 128 / 1/step]

4-583-008	Contrast: 1-255	*ENG	[1 to 255 / 128 / 1/step]
4-583-009	Ind Dot Erase: 0(Off) 1-7 (Weak-Strong)	*ENG	[0 to 7 / 0 / 1/step]
4-583-010	Texture Erase: 0	*ENG	[0 to 2 / 0 / 1/step]

4584**[Fax Apli:Original 1]**

4-584-005	MTF: 0(Off) 1-15 (Weak-Strong)	*ENG	[0 to 15 / 8 / 1/step]
4-584-006	Smoothing: 0(x1) 1-7 (Weak-Strong)	*ENG	[0 to 7 / 4 / 1/step]
4-584-007	Brightness: 1-255	*ENG	[1 to 255 / 128 / 1/step]
4-584-008	Contrast: 1-255	*ENG	[1 to 255 / 128 / 1/step]
4-584-009	Ind Dot Erase: 0(Off) 1-7 (Weak-Strong)	*ENG	[0 to 7 / 0 / 1/step]

4585**[Fax Apli:Original 2]**

4-585-005	MTF: 0(Off) 1-15 (Weak-Strong)	*ENG	[0 to 15 / 8 / 1/step]
4-585-006	Smoothing: 0(x1) 1-7 (Weak-Strong)	*ENG	[0 to 7 / 4 / 1/step]
4-585-007	Brightness: 1-255	*ENG	[1 to 255 / 128 / 1/step]
4-585-008	Contrast: 1-255	*ENG	[1 to 255 / 128 / 1/step]
4-585-009	Independent Dot Erase (0)/ 1-7 (Strong)	*ENG	[0 to 7 / 0 / 1/step]

4600**[SBU Version Display]**

4-600-001	SBU ID	ENG	[0x00 to 0xFF / 0 / 1/step]
-----------	--------	-----	------------------------------------

4609**[Gray Balance Set: R]**

4-609-001	Book Scan	*ENG	[-384 to 255 / -100 / 1 digit/step]
-----------	-----------	------	--

4-609-002	DF Scan	*ENG	[-384 to 255 / -100 / 1 digit/step]
4610	[Gray Balance Set: G]		
4-610-001	Book Scan	*ENG	[-384 to 255 / -100 / 1 digit/step]
4-610-002	DF Scan	*ENG	[-384 to 255 / -100 / 1 digit/step]
4611	[Gray Balance Set: B]		
4-611-001	Book Scan	*ENG	[-384 to 255 / -100 / 1 digit/step]
4-611-002	DF Scan	*ENG	[-384 to 255 / -100 / 1 digit/step]
4635	[SSCG Correction Set]		
4-635-001	Mode Selection	*ENG	[0 to 3 / 1 / 1/step] 0: Do not noise correct SSCG. 1: Only adjust analog (initial value) 2: Only adjust digital 3: Adjust both analog/digital
4646	[Scan Adjust Error]		

4-646-001	White level	ENG	<p>[0 to 65535 / 0 / 1/step]</p> <p>Bit15:Unused</p> <p>Bit14: Unused</p> <p>Bit13:White level abnormal (F side/RED/EVEN pixel)</p> <p>Bit12: White level abnormal (F side /RED/ODD pixel)</p> <p>Bit11: White level abnormal (F side /GREEN/EVEN pixel)</p> <p>Bit10: White level abnormal (F side /GREEN/ODD pixel)</p> <p>Bit9: White level abnormal (F side /BLUE/EVEN pixel)</p> <p>Bit8:White level abnormal (F side /BLUE/ODD pixel)</p> <p>Bit7: Unused</p> <p>Bit6: Unused</p> <p>Bit5:gain abnormal (F side /RED/EVEN pixel)</p> <p>Bit4: gain abnormal (F side /RED/ODD pixel)</p> <p>Bit3: gain abnormal (F side /GREEN/EVEN pixel)</p> <p>Bit2: gain abnormal (F side /GREEN/ODD pixel)</p> <p>Bit1: gain abnormal (F side /BLUE/EVEN pixel)</p> <p>Bit0: gain abnormal (F side /BLUE/ODD pixel)</p>
4-646-002	Black level	ENG	<p>[0 to 65535 / 0 / 1/step]</p> <p>Bit7: Unused</p> <p>Bit6: Unused</p> <p>Bit5: Black level abnormal (F side/RED/EVEN Pixel)</p> <p>Bit4: Black level abnormal (F side /RED/ODD Pixel)</p> <p>Bit3: Black level abnormal (F side /GREEN/EVEN Pixel)</p> <p>Bit2: Black level abnormal (F side /GREEN/ODD Pixel)</p> <p>Bit1: Black level abnormal (F side /BLUE/EVEN Pixel)</p> <p>Bit0: Black level abnormal (F side /BLUE/ODD Pixel)</p>

4-646-003	SSCG Correction	ENG	<p>[0 to 65535 / 0 / 1/step]</p> <p>Bit7: Unused</p> <p>Bit6: Unused</p> <p>Bit5: SSCG correction error (Fside/RED/EVEN Pixel)</p> <p>Bit4: SSCG correction error (Fside/RED/ODD Pixel)</p> <p>Bit3: SSCG correction error (Fside/GREEN/EVEN Pixel)</p> <p>Bit2: SSCG correction error (Fside/GREEN/ODD Pixel)</p> <p>Bit1: SSCG correction error (Fside/BLUE/EVEN Pixel)</p> <p>Bit0: SSCG correction error (Fside/BLUE/ODD Pixel)</p>
-----------	-----------------	-----	---

4647	[Scanner Hard Error]		
4-647-001	Power-ON	ENG	<p>[0 to 65535 / 0 / 1/step]</p> <p>Bit15: Unused</p> <p>Bit14:SBU hardware error (Power ON/un-reset error)</p> <p>Bit13:SBU hardware error (Serial communication error: F side)</p> <p>Bit12:SBU hardware error (Reset error: F side)</p> <p>Bit11: Unused</p> <p>Bit10: Unused</p> <p>Bit9:SBU hardware error (Version error)</p> <p>Bit8: Unused</p> <p>Bit7: Unused</p> <p>Bit6: Unused</p> <p>Bit5:SBU hardware error (Serial communication error: L side)</p> <p>Bit4:SBU hardware error (Reset error:Lside)</p> <p>Bit3: Unused</p> <p>Bit2: Unused</p> <p>Bit1: Unused</p>

4688	[DF Density Adjustment]		
4-688-001	ARDF	*ENG	[80 to 120 / 106 / 1%/step]

4688	[Scan Image Density Adjustment]		
4-688-002	1-pass DF	*ENG	[[80 to 120 / 101 / 1%/step]
4699	[SBU Test Pattern Change]		
4-699-001	-	ENG	[0 to 255 / 0 / 1/step]
4700	[CIS ID Display]		
4-700-001	-	ENG	[0x00 to 0xFF / 0 / 1/step]
4712	[CIS GB Adj. Value: R]		
4-712-001	-	*ENG	[0 to 2048 / 1023 / 1 digit/step]
4713	[CIS GB Adj. Value: G]		
4-713-001	-	*ENG	[0 to 2048 / 1023 / 1 digit/step]
4714	[CIS GB Adj. Value: B]		
4-714-001	-	*ENG	[0 to 2048 / 1023 / 1 digit/step]
4730	[FROM ADF Factory Setting]		
4-730-001	CIS Parameter	ENG	[0 or 1 / 0 / 0/step]
4730	[FROM Main Factory Setting]		
4-730-002	Execution ON/OFF	ENG	[0 or 1 / 0 / 0/step]
4-730-003	Execution Flag	*ENG	[0 or 1 / 0 / 1/step]
4730	[FROM Data Update]		
4-730-004	-	ENG	[0 to 1 / 0 / 0/step]
4745	[CIS Image Level Error Flag]		
4-745-001	-	ENG	[0 to 65535 / 0 / 1/step]

4746	[CIS GB Adj Error Flag]		
4-746-001	-	ENG	[0 to 7 / 0 / 1/step]

4747	[CIS Hard Error Flag]		
4-747-001	-	ENG	[0 to 15 / 0 / 1/step]

4796	[Low Density Color Correction]		
4-796-001	Front Side	*ENG	[0 to 3 / 0 / 1/step] 0: OFF 1: WEAK 2: MEDIUM 3: STRONG
4-796-002	Rear Side	*ENG	[0 to 3 / 0 / 1/step] 0: OFF 1: WEAK 2: MEDIUM 3: STRONG

4797	[Rear Side: Digital AE]		
4-797-001	Low Limit Setting	*ENG	[0 to 1023 / 364 / 1/step]
4-797-002	Background Erase Level	*ENG	[512 to 1535 / 932 / 1/step]

4799	[CIS TEST Pattern]		
4-799-001	select	ENG	[0 to 5 / 0 / 1/step] Sets CIS test pattern output. 0: Scanned Image 1: Fixed Value Pattern 2: EO Fixed Value Pattern 3: Main Scan Gradation 4: Sub Scan Gradation 5: Grid Pattern

4-799-002	Even Output Level Setting	ENG	[0 to 1023 / 0 / 1 digit/step]
4-799-003	Odd Output Level Setting	ENG	[0 to 1023 / 0 / 1 digit/step]

4803	[Home Position Adj Value]		
4-803-001	-	ENG	[-2.0 to 2.0 / 0 / 0.1mm/step]

4853	[Partial LED ON]		
4-853-001	ON/OFF(Scan)	*ENG	[0 or 1 / 1 / 1/step]
4-853-002	ON/OFF(Size Detection)	*ENG	[0 or 1 / 1 / 1/step]

4871	[Distortion Corr.]		
4-871-001	Distortion Corr. ON/OFF	*ENG	[0 or 1 / 1 / 1/step]
4-871-002	Distortion Initialization	*ENG	[0 to 3 / 0 / 1/step]
4-871-003	Magnification Adjust(DF)	*ENG	[-0.35 to 0.35 / 0.11 / 0.01%/step]
4-871-004	Magnification Adjust(FB)	*ENG	[-0.35 to 0.35 / 0 / 0.01%/step]

4902	[Disp ACC Data]		
4-902-001	R_DATA1	*ENG	[0 to 255 / 0 / 1/step]
4-902-002	G_DATA1	*ENG	[0 to 255 / 0 / 1/step]
4-902-003	B_DATA1	*ENG	[0 to 255 / 0 / 1/step]
4-902-004	R_DATA2	*ENG	[0 to 255 / 0 / 1/step]
4-902-005	G_DATA2	*ENG	[0 to 255 / 0 / 1/step]
4-902-006	B_DATA2	*ENG	[0 to 255 / 0 / 1/step]

4903	[Filter Setting]		
4-903-001	Ind Dot Erase: Text	*ENG	[0 to 7 / 0 / 1/step]
4-903-002	Ind Dot Erase: Generation Copy	*ENG	[0 to 7 / 0 / 1/step]

4905	[Select Gradation Level]		
4-905-001	-	*ENG	[0 to 255 / 0 / 1/step]

4918	[Man Gamma Adj]		
4-918-009	-	ENG	[- / - / -]

4930	[Coverage Ctrl: Text]		
4-930-001	Copy: Full Color 1	ENG	[0 to 400 / 200 / 1/step]
4-930-002	Copy: Full Color 2	ENG	[0 to 400 / 200 / 1/step]
4-930-003	Copy: Single Color	ENG	[0 to 400 / 100 / 1/step]
4-930-004	Copy: Color Conversion	ENG	[0 to 400 / 180 / 1/step]
4-930-005	Coverage Ctrl OFF	ENG	[0 to 400 / 400 / 1/step]

4931	[Coverage Ctrl: Photo]		
4-931-001	Copy: Full Color 1	ENG	[0 to 400 / 240 / 1/step]
4-931-002	Copy: Full Color 2	ENG	[0 to 400 / 260 / 1/step]
4-931-003	Copy: Single Color	ENG	[0 to 400 / 100 / 1/step]
4-931-004	Copy: Color Conversion	ENG	[0 to 400 / 200 / 1/step]
4-931-005	Coverage Ctrl OFF	ENG	[0 to 400 / 400 / 1/step]

4938	[ACS:Edge Mask]		
4-938-001	Copy:Sub LEdge	*ENG	[0 to 31 / 10 / 1mm/step]
4-938-002	Copy:Sub TEdge	*ENG	[0 to 31 / 10 / 1mm/step]
4-938-003	Copy:Main LEdge	*ENG	[0 to 31 / 10 / 1mm/step]
4-938-004	Copy:Main TEdge	*ENG	[0 to 31 / 10 / 1mm/step]
4-938-005	Scan:Sub LEdge	*ENG	[0 to 31 / 15 / 1mm/step]
4-938-006	Scan:Sub TEdge	*ENG	[0 to 31 / 15 / 1mm/step]

4-938-007	Scan:Main LEdge	*ENG	[0 to 31 / 15 / 1mm/step]
4-938-008	Scan:Main TEdge	*ENG	[0 to 31 / 15 / 1mm/step]

4939	[ACS:Color Range]		
4-939-001	-	*ENG	[-2 to 2 / 0 / 1/step] Change the value of this SP to negative ("-1" or "-2") when a black and white document is misjudged as a color document.

4954	[Restore Test Chart]		
4-954-005	Chromaticity Rank	ENG	[0 to 255 / 0 / 1/step]

4958	[Restore Test Chart: Rear]		
4-958-005	Chromaticity Rank	ENG	[0 to 255 / 0 / 1/step]

4984	[IBACC Target Den]		
4-984-001	IBACC notch K	*ENG	[0 to 10 / 5 / 1/step]
4-984-002	IBACC notch C	*ENG	
4-984-003	IBACC notch M	*ENG	
4-984-004	IBACC notch Y	*ENG	

4993	[High Light Correction]		
4-993-001	Sensitivity Selection	ENG	[0 to 9 / 4 / 1/step] 0: Weak 9: Strong
4-993-002	Range Selection	ENG	[0 to 9 / 4 / 1/step] 0: Weak 9: Strong

4994	[Adj Txt/Photo Recog Level]		
-------------	------------------------------------	--	--

4-994-001	High Compression PDF	ENG	[0 to 2 / 1 / 1/step]
4996	[White Paper Detection Level]		
4-996-001	-	ENG	[0 to 6 / 3 / 1/step]

Engine SP Tables - SP5000

SP5-XXX (Mode)

5126	[Set F-size Document]		
5-126-001	-	ENG	[0 to 2 / 0 / 1/step] 0: 8 1/2 x13 1: 8 1/4 x13 2: 8 x13

5131	[Paper Size Type Selection]		
5-131-001	-	*ENG	[0 to 2 / * / 1/step] *NA: 1, EU: 2, Asia: 2, CHN: 2, TWN: 2 , KOR: 2 --- 0: JP (Japan) 1: NA 2: EU

5135	[LG_Oficio Change]		
5-135-001	-	*ENG	[0 or 1 / 0 / 1/step]

5181	[Size Adjust]		
5-181-001	TRAY 1	*ENG	[0 to 3 / * / 1/step] *NA: 1, EU: 0, Asia: 0, CHN: 0, TWN: 0 , KOR: 0 0: A4 LEF 1: LT LEF 2: B5 LEF 3: A5 LEF

5-181-002	TRAY 2: 1	*ENG	[0 or 1 / * / 1/step] *NA: 1, EU: 0, Asia: 0, CHN: 0, TWN: 0 , KOR: 0 0: A4 LEF 1: LT LEF
5-181-003	TRAY 2: 2	*ENG	[0 or 1 / * / 1/step] *NA: 1, EU: 0, Asia: 0, CHN: 0, TWN: 0 , KOR: 0 0: A3 1: DLT
5-181-004	TRAY 2: 3	*ENG	[0 or 1 / * / 1/step] *NA: 1, EU: 0, Asia: 0, CHN: 0, TWN: 0 , KOR: 0 0: B4 1: LG
5-181-005	TRAY 2: 4	*ENG	[0 or 1 / * / 1/step] *NA: 1, EU: 0, Asia: 0, CHN: 0, TWN: 0 , KOR: 0 0: B5LEF 1: ExeLEF
5-181-006	TRAY 2: 5	*ENG	[0 or 1 / * / 1/step] *NA: 1, EU: 0, Asia: 0, CHN: 0, TWN: 0 , KOR: 0 0: SRA3 1: 12X18
5-181-007	TRAY 3/T-LCT: 1	*ENG	[0 or 1 / * / 1/step] *NA: 1, EU: 0, Asia: 0, CHN: 0, TWN: 0 , KOR: 0 0: A4LEF 1: LTLEF

5-181-008	TRAY 3: 2	*ENG	[0 or 1 / * / 1/step] *NA: 1, EU: 0, Asia: 0, CHN: 0, TWN: 0 , KOR: 0 0: A3 1: DLT
5-181-009	TRAY 3: 3	*ENG	[0 or 1 / * / 1/step] *NA: 1, EU: 0, Asia: 0, CHN: 0, TWN: 0 , KOR: 0 0: B4 1: LG
5-181-010	TRAY 3: 4	*ENG	[0 or 1 / * / 1/step] *NA: 1, EU: 0, Asia: 0, CHN: 0, TWN: 0 , KOR: 0 0: B5LEF 1: ExeLEF
5-181-011	TRAY 3: 5	*ENG	[0 or 1 / * / 1/step] *NA: 1, EU: 0, Asia: 0, CHN: 0, TWN: 0 , KOR: 0 0: 12.6X17.7 1: 12X18
5-181-012	TRAY 4: 1	*ENG	[0 or 1 / * / 1/step] *NA: 1, EU: 0, Asia: 0, CHN: 0, TWN: 0 , KOR: 0 0: A4LEF 1: LTLEF
5-181-013	TRAY 4: 2	*ENG	[0 or 1 / * / 1/step] *NA: 1, EU: 0, Asia: 0, CHN: 0, TWN: 0 , KOR: 0 0: A3 1: DLT

5-181-014	TRAY 4: 3	*ENG	[0 or 1 / * / 1/step] NA: 1, EU: 0, Asia: 0, CHN: 0, TWN: 0 , KOR: 0 0: B4 1: LG
5-181-015	TRAY 4: 4	*ENG	[0 or 1 / * / 1/step] *NA: 1, EU: 0, Asia: 0, CHN: 0, TWN: 0 , KOR: 0 0: B5LEF 1: ExeLEF
5-181-016	TRAY 4: 5	*ENG	[0 or 1 / * / 1/step] *NA: 1, EU: 0, Asia: 0, CHN: 0, TWN: 0 , KOR: 0 0: 12.6X17.7 1: 12X18
5-181-017	LCT	*ENG	[0 to 2 / * / 1/step] *NA: 1, EU: 0, Asia: 0, CHN: 0, TWN: 0 , KOR: 0 0: A4LEF 1: LTLEF 2: B5LEF

5186	[RK4]		
5-186-001	-	*ENG	[0 or 1 / 0 / 1/step]

5610	[Base Gamma Ctrl Pt:Execute]		
5-610-004	Get Factory Default	ENG	[0 or 1 / 0 / 1/step]
5-610-005	Set Factory Default	ENG	[0 or 1 / 0 / 1/step]
5-610-006	Restore Orginal Value	ENG	[0 or 1 / 0 / 1/step]

5611	[Toner Color in 2C]		
-------------	----------------------------	--	--

5-611-001	B-C	*ENG	[0 to 128 / 100 / 1/step]
5-611-002	B-M	*ENG	[0 to 128 / 100 / 1/step]
5-611-003	G-C	*ENG	[0 to 128 / 100 / 1/step]
5-611-004	G-Y	*ENG	[0 to 128 / 100 / 1/step]
5-611-005	R-M	*ENG	[0 to 128 / 100 / 1/step]
5-611-006	R-Y	*ENG	[0 to 128 / 100 / 1/step]

5801	[Memory Clear]		
5-801-002	Engine	ENG	[- / - / -] [Execute]

5803	[INPUT Check]		
See page 448 "Input Check Table"			

5804	[OUTPUT Check]		
See page 475 "Output Check Table"			

5805	[Anti-Condensation Heater]		
5-805-001	0:OFF / 1:ON	*ENG	[0 or 1 / 0 / 1/step] 0: OFF... Switches OFF when standby (default setting) 1: ON... Switches ON when standby

5810	[SC Reset]		
5-810-001	Fusing SC Reset	ENG	Clears the fusing SC.
5-810-002	Hard High Temp. Detection	ENG	Clears the fusing hardware SC.

5811	[MachineSerial]		
5-811-002	Display	*ENG	[0 to 255 / 0 / 1/step]

5811	[MachineSerial Set]		
5-811-004	BCU	*ENG	[0 to 255 / 0 / 1/step]
5811	[Machine Serial: Update Date]		
5-811-021	Latest	*ENG	[0 or 1 / 0 / 1/step]
5-811-022	Previous	*ENG	[0 or 1 / 0 / 1/step]
5811	[MachineSerial]		
5-811-023	Previous	*ENG	[0 to 255 / 0 / 1/step]
5811	[Machine Serial: Update Date]		
5-811-024	Latest (BCU)	*ENG	[0 or 1 / 0 / 1/step]
5-811-025	Previous (BCU)	*ENG	[0 or 1 / 0 / 1/step]
5811	[MachineSerial]		
5-811-026	Previous (BCU)	*ENG	[0 to 255 / 0 / 1/step]
5894	[External Mech Count Setting]		
5-894-001	Mech Counter Switch Setting	*ENG	[0 to 2 / 0 / 1/step]
5900	[Engine Log Upload]		
5-900-001	Pattern	*ENG	[0 to 4 / 0 / 1/step]
5-900-002	Trigger	*ENG	[0 to 3 / 0 / 1/step]
5998	[Fusing Warm UP]		
5-998-001	Warm Up In Advance ON/OFF	*ENG	[0 or 1 / 0 / 1/step]

Engine SP Tables - SP6000

SP6-XXX (Peripherals)

6006	[ADF Adjustment]		
6-006-001	Side-to-Side Regist: Front	*ENG	[-3.0 to 3.0 / 0 / 0.1 mm/step]
6-006-002	Side-to-Side Regist: Rear	*ENG	[-3.0 to 3.0 / 0 / 0.1 mm/step]
6-006-003	Leading Edge Registration: Front	*ENG	[-5.0 to 5.0 / 0 / 0.1 mm/step]
6-006-004	Leading Edge Registration: Rear	*ENG	[-5.0 to 5.0 / 0 / 0.1 mm/step]
6-006-005	Buckle: Duplex Front	*ENG	[-5.0 to 5.0 / 0 / 0.1 mm/step]
6-006-006	Buckle: Duplex Rear	*ENG	[-5.0 to 5.0 / 0 / 0.1 mm/step]
6-006-007	Rear Edge Erase Front	*ENG	[-10.0 to 10.0 / -2.3 / 0.1 mm/step]
6-006-008	Rear Edge Erase Rear	*ENG	[-10.0 to 10.0 / -2.3 / 0.1 mm/step]
6-006-010	L-Edge Regist (1-Pass): Front	*ENG	[-5.0 to 5.0 / 0 / 0.1 mm/step]
6-006-011	L-Edge Regist (1-Pass): Rear	*ENG	[-5.0 to 5.0 / 0 / 0.1 mm/step]
6-006-012	1st Buckle (1-Pass)	*ENG	[-3.0 to 3.0 / 0 / 0.1 mm/step]
6-006-013	2nd Buckle (1-Pass)	*ENG	[-2.0 to 3.0 / 0 / 0.1 mm/step]
6-006-014	T-Edge Erase (1-Pass): Front	*ENG	[-5.0 to 5.0 / -3.0 / 0.1 mm/step]
6-006-015	T-Edge Erase (1-Pass): Rear	*ENG	[-5.0 to 5.0 / -2.5 / 0.1 mm/step]

6007	[ADF INPUT Check]		
	See page 448 "Input Check Table"		

6008	[ADF OUTPUT Check]		
	See page 475 "Output Check Table"		

6009	[ADF FreeRun]		
6-009-001	Free Run Simplex Motion	ENG	[0 or 1 / 0 / 1/step]
6-009-002	Free Run Duplex Motion	ENG	[0 or 1 / 0 / 1/step]
6-009-003	Free Run Stamp Motion	ENG	[0 or 1 / 0 / 1/step]
6-009-004	Free Run Simplex Motion(low speed)	ENG	[0 or 1 / 0 / 1/step]
6-009-005	Free Run Simplex Motion(high speed)	ENG	[0 or 1 / 0 / 1/step]
6-009-006	Free Run Duplex Motion(low speed)	ENG	[0 or 1 / 0 / 1/step]
6-009-007	Free Run Duplex Motion(high speed)	ENG	[0 or 1 / 0 / 1/step]

6010	[Stamp Position Adj.]		
6-010-001	-	*ENG	[-5.0 to 5.0 / 0 / 0.1mm/step]

6011	[1-Pass ADF INPUT Check]		
See page 448 "Input Check Table"			

6012	[1-Pass ADF OUTPUT Check]		
See page 475 "Output Check Table"			

6016	[Original Size Detect Setting]		
6-016-001	-	*ENG	[0 to 255 / 0 / 1/step]

6017	[DF Magnification Adj.]		
6-017-001	-	*ENG	[-5 to 5 / 0 / 0.1%/step]

6020	[Skew Correction Moving Setting]		
6-020-001	-	*ENG	[0 or 1 / 0 / 1/step]

6121	[NV Adj. Data Mod.]		
6-121-001	Jogger Pos. Factory Adj.	ENG	[-3 to 3 / 0 / 0.5mm/step]
6-121-002	Folding Pos. Factory Adj.	ENG	[-1.4 to 1.4 / 0 / 0.2mm/step]

6125	[Use Paper Guide(Big Size)]		
6-125-001	All Size	ENG	[0 or 1 / 0 / 1/step]

6126	[Use Paper Guide(Small Size)]		
6-126-001	All Size	ENG	[0 or 1 / 0 / 1/step]

6130	[Sub-scan PunchPosAdj:FrontFIN]		
6-130-001	Domestic 2Hole(Europe 2Hole)	ENG	[-7.5 to 7.5 / 0 / 0.5mm/step]
6-130-002	North America 3Hole	ENG	
6-130-003	Europe 4Hole	ENG	
6-130-004	North Europe 4Hole	ENG	
6-130-005	North America 2Hole	ENG	

6131	[Main-scan PunchPosAdj:FrontFIN]		
6-131-001	Domestic 2Hole(Europe 2Hole)	ENG	[-2 to 2 / 0 / 0.4mm/step]
6-131-002	North America 3Hole	ENG	
6-131-003	Europe 4Hole	ENG	
6-131-004	North Europe 4Hole	ENG	
6-131-005	North America 2Hole	ENG	

6132	[Jogger Fence Fine Adj:FrontFIN]		
6-132-001	A3T	ENG	[-1.5 to 1.5 / 0 / 0.5mm/step]
6-132-002	B4T	ENG	[-3 to 3 / 0 / 0.5mm/step]
6-132-003	A4T	ENG	[-3 to 3 / 0 / 0.5mm/step]

6-132-004	A4Y	ENG	[-1.5 to 1.5 / 0 / 0.5mm/step]
6-132-005	B5T	ENG	[-3 to 3 / 0 / 0.5mm/step]
6-132-006	B5Y	ENG	[-3 to 3 / 0 / 0.5mm/step]
6-132-007	DLT-T	ENG	[-3 to 3 / 0 / 0.5mm/step]
6-132-008	LG-T	ENG	[-3 to 3 / 0 / 0.5mm/step]
6-132-009	Oficio-T	ENG	[-3 to 3 / 0 / 0.5mm/step]
6-132-010	LT-T	ENG	[-3 to 3 / 0 / 0.5mm/step]
6-132-011	LT-Y	ENG	[-3 to 3 / 0 / 0.5mm/step]
6-132-012	8K-T	ENG	[-3 to 3 / 0 / 0.5mm/step]
6-132-013	16K-T	ENG	[-3 to 3 / 0 / 0.5mm/step]
6-132-014	16K-Y	ENG	[-3 to 3 / 0 / 0.5mm/step]
6-132-015	Other	ENG	[-3 to 3 / 0 / 0.5mm/step]

6133	[Staple Position Adj: FrontFIN]		
6-133-001	Finisher1	ENG	[-2 to 2 / 0 / 0.5mm/step]

6134	[Finisher Free Run: FrontFIN]		
6-134-001	Free Run1	ENG	[0 or 1 / 0 / 1/step]
6-134-002	Free Run2	ENG	[0 or 1 / 0 / 1/step]
6-134-003	Free Run3	ENG	[0 or 1 / 0 / 1/step]
6-134-004	Free Run4	ENG	[0 or 1 / 0 / 1/step]

6135	[INPUT Check: FrontFIN]		
	See page 448 "Input Check Table"		

6136	[OUTPUT Check: FrontFIN]		
	See page 475 "Output Check Table"		

6140	[Staple Position Adj: 1K FIN]		
6-140-001	-	ENG	[-3.5 to 3.5 / 0 / 0.5mm/step]
6-140-002	-	ENG	[-3 to 3 / 0 / 0.3mm/step]

6141	[Booklet Stapler Pos Adj:1K FIN]		
6-141-001	A3 SEF	ENG	[-3 to 3 / 0 / 0.2mm/step]
6-141-002	B4 SEF	ENG	[-3 to 3 / 0 / 0.2mm/step]
6-141-003	A4 SEF	ENG	[-3 to 3 / 0 / 0.2mm/step]
6-141-004	B5 SEF	ENG	[-3 to 3 / 0 / 0.2mm/step]
6-141-005	DLT SEF	ENG	[-3 to 3 / 0 / 0.2mm/step]
6-141-006	LG SEF	ENG	[-3 to 3 / 0 / 0.2mm/step]
6-141-007	Oficio SEF	ENG	[-3 to 3 / 0 / 0.2mm/step]
6-141-008	LT SEF	ENG	[-3 to 3 / 0 / 0.2mm/step]
6-141-009	12"x18"	ENG	[-3 to 3 / 0 / 0.2mm/step]

6142	[Sub-scan Punch Pos Adj:1K FIN]		
6-142-001	JPN/EU: 2-Hole	ENG	[-7.5 to 7.5 / 0 / 0.5mm/step]
6-142-002	NA: 3-Hole	ENG	
6-142-003	Europe: 4-Hole	ENG	
6-142-004	NEU: 4-Hole	ENG	
6-142-005	NA: 2-Hole	ENG	

6143	[Jogger Pos Adj:1K FIN]		
-------------	--------------------------------	--	--

6-143-001	A3 SEF	ENG	[-1.5 to 1.5 / 0 / 0.5mm/step]
6-143-002	B4 SEF	ENG	
6-143-003	A4 SEF	ENG	
6-143-004	A4 LEF	ENG	
6-143-005	B5 SEF	ENG	
6-143-006	B5 LEF	ENG	[-1.5 to 1.5 / 0 / 0.5mm/step]
6-143-007	DLT SEF	ENG	
6-143-008	LG SEF	ENG	
6-143-009	Oficio SEF	ENG	
6-143-010	LT SEF	ENG	
6-143-011	LT LEF	ENG	
6-143-012	12"x18"	ENG	
6-143-013	8K SEF	ENG	[-1.5 to 1.5 / 0 / 0.5mm/step]
6-143-014	16K SEF	ENG	
6-143-015	16K LEF	ENG	
6-143-016	Other	ENG	

6144	[Main-scan Punch Pos Adj: 1K FIN]		
6-144-001	JPN/EU: 2-Hole	ENG	[-2 to 2 / 0 / 0.4mm/step]
6-144-002	NA: 3-Hole	ENG	
6-144-003	Europe: 4-Hole	ENG	
6-144-004	NEU: 4-Hole	ENG	
6-144-005	NA: 2-Hole	ENG	

6145	[Skew Correct Buckle Adj: 1K FIN]		
-------------	--	--	--

6-145-001	A3 SEF	ENG	[-5 to 5 / 0 / 0.2mm/step]
6-145-002	B4 SEF	ENG	
6-145-003	A4 SEF	ENG	
6-145-004	A4 LEF	ENG	
6-145-005	B5 SEF	ENG	
6-145-006	B5 LEF	ENG	[-5 to 5 / 0 / 0.2mm/step]
6-145-007	A5 LEF	ENG	
6-145-008	DLT SEF	ENG	
6-145-009	LG SEF	ENG	
6-145-010	Oficio SEF	ENG	
6-145-011	LT SEF	ENG	[-5 to 5 / 0 / 0.2mm/step]
6-145-012	LT LEF	ENG	
6-145-013	HLT LEF	ENG	
6-145-014	12"x18"	ENG	
6-145-015	8K SEF	ENG	
6-145-016	16K SEF	ENG	
6-145-017	16K LEF	ENG	
6-145-018	Other	ENG	[-5 to 5 / 0 / 0.2mm/step]

6146	[Skew Correct Ctrl SW:1K FIN]		
6-146-001	A3 SEF	ENG	[0 or 1 / 0 / 1/step] 0: enable 1: disable
6-146-002	B4 SEF	ENG	[0 or 1 / 0 / 1/step] 0: enable 1: disable

6-146-003	A4 SEF	ENG	[0 or 1 / 0 / 1/step] 0: enable 1: disable
6-146-004	A4 LEF	ENG	[0 or 1 / 0 / 1/step] 0: enable 1: disable
6-146-005	B5 SEF	ENG	[0 or 1 / 0 / 1/step] 0: enable 1: disable
6-146-006	B5 LEF	ENG	[0 or 1 / 0 / 1/step] 0: enable 1: disable
6-146-007	A5 LEF	ENG	[0 or 1 / 0 / 1/step] 0: enable 1: disable
6-146-008	DLT SEF	ENG	[0 or 1 / 0 / 1/step] 0: enable 1: disable
6-146-009	LG SEF	ENG	[0 or 1 / 0 / 1/step] 0: enable 1: disable
6-146-010	Oficio SEF	ENG	[0 or 1 / 0 / 1/step] 0: enable 1: disable
6-146-011	LT SEF	ENG	[0 or 1 / 0 / 1/step] 0: enable 1: disable
6-146-012	LT LEF	ENG	[0 or 1 / 0 / 1/step] 0: enable 1: disable

6-146-013	HLT LEF	ENG	[0 or 1 / 0 / 1/step] 0: enable 1: disable
6-146-014	12"x18"	ENG	[0 or 1 / 0 / 1/step] 0: enable 1: disable
6-146-015	8K SEF	ENG	[0 or 1 / 0 / 1/step] 0: enable 1: disable
6-146-016	16K SEF	ENG	[0 or 1 / 0 / 1/step] 0: enable 1: disable
6-146-017	16K LEF	ENG	[0 or 1 / 0 / 1/step] 0: enable 1: disable
6-146-018	Other	ENG	[0 or 1 / 0 / 1/step] 0: enable 1: disable

6147	[Booklet Folder Pos Adj:1K FIN]		
6-147-001	A3 SEF	ENG	[-3 to 3 / 0 / 0.2mm/step]
6-147-002	B4 SEF	ENG	[-3 to 3 / 0 / 0.2mm/step]
6-147-003	A4 SEF	ENG	[-3 to 3 / 0 / 0.2mm/step]
6-147-004	B5 SEF	ENG	[-3 to 3 / 0 / 0.2mm/step]
6-147-005	DLT SEF	ENG	[-3 to 3 / 0 / 0.2mm/step]
6-147-006	LG SEF	ENG	[-3 to 3 / 0 / 0.2mm/step]
6-147-007	Oficio SEF	ENG	[-3 to 3 / 0 / 0.2mm/step]
6-147-008	LT SEF	ENG	[-3 to 3 / 0 / 0.2mm/step]
6-147-009	12"x18"	ENG	[-3 to 3 / 0 / 0.2mm/step]

6-147-010	A3 SEF(1-5)	ENG	[-3 to 3 / 0 / 0.2mm/step]
6-147-011	A3 SEF(6-10)	ENG	[-3 to 3 / 0 / 0.2mm/step]
6-147-012	A3 SEF(11-over)	ENG	[-3 to 3 / 0 / 0.2mm/step]
6-147-013	B4 SEF(1-5)	ENG	[-3 to 3 / 0 / 0.2mm/step]
6-147-014	B4 SEF(6-10)	ENG	[-3 to 3 / 0 / 0.2mm/step]
6-147-015	B4 SEF(11-over)	ENG	[-3 to 3 / 0 / 0.2mm/step]
6-147-016	A4 SEF(1-5)	ENG	[-3 to 3 / 0 / 0.2mm/step]
6-147-017	A4 SEF(6-10)	ENG	[-3 to 3 / 0 / 0.2mm/step]
6-147-018	A4 SEF(11-over)	ENG	[-3 to 3 / 0 / 0.2mm/step]
6-147-019	B5 SEF(1-5)	ENG	[-3 to 3 / 0 / 0.2mm/step]
6-147-020	B5 SEF(6-10)	ENG	[-3 to 3 / 0 / 0.2mm/step]
6-147-021	B5 SEF(11-over)	ENG	[-3 to 3 / 0 / 0.2mm/step]
6-147-022	DLT SEF(1-5)	ENG	[-3 to 3 / 0 / 0.2mm/step]
6-147-023	DLT SEF(6-10)	ENG	[-3 to 3 / 0 / 0.2mm/step]
6-147-024	DLT SEF(11-over)	ENG	[-3 to 3 / 0 / 0.2mm/step]
6-147-025	LG SEF(1-5)	ENG	[-3 to 3 / 0 / 0.2mm/step]
6-147-026	LG SEF(6-10)	ENG	[-3 to 3 / 0 / 0.2mm/step]
6-147-027	LG SEF(11-over)	ENG	[-3 to 3 / 0 / 0.2mm/step]
6-147-028	Oficio SEF(1-5)	ENG	[-3 to 3 / 0 / 0.2mm/step]
6-147-029	Oficio SEF(6-10)	ENG	[-3 to 3 / 0 / 0.2mm/step]
6-147-030	Oficio SEF(11-over)	ENG	[-3 to 3 / 0 / 0.2mm/step]
6-147-031	LT SEF(1-5)	ENG	[-3 to 3 / 0 / 0.2mm/step]
6-147-032	LT SEF(6-10)	ENG	[-3 to 3 / 0 / 0.2mm/step]
6-147-033	LT SEF(11-over)	ENG	[-3 to 3 / 0 / 0.2mm/step]
6-147-034	12"x18"(1-5)	ENG	[-3 to 3 / 0 / 0.2mm/step]
6-147-035	12"x18"(6-10)	ENG	[-3 to 3 / 0 / 0.2mm/step]

6-147-036	12"x18"(11-over)	ENG	[-3 to 3 / 0 / 0.2mm/step]
-----------	------------------	-----	----------------------------

6148	[Fold Times Adj: 1K FIN]		
6-148-001	-	ENG	[0 to 29 / 0 / 1sec/step]

6149	[Last Paper Pos Time Adj: 1K FIN]		
6-149-001	-	*ENG	[0 to 1 / 0 / 1time/step]

6150	[PositioningStrtTimingAdj: 1KFIN]		
6-150-001	A3 SEF	ENG	[-100 to 100 / 0 / 10msec/step]
6-150-002	B4 SEF	ENG	
6-150-003	A4 SEF	ENG	
6-150-004	A4 LEF	ENG	
6-150-005	B5 SEF	ENG	
6-150-006	B5 LEF	ENG	
6-150-007	DLT SEF	ENG	
6-150-008	LG SEF	ENG	
6-150-009	Oficio SEF	ENG	
6-150-010	LT SEF	ENG	
6-150-011	LT LEF	ENG	
6-150-012	12"x18"	ENG	
6-150-013	8K SEF	ENG	
6-150-014	16K SEF	ENG	
6-150-015	16K LEF	ENG	
6-150-016	Other	ENG	

6151	[PosTimeAdj(LstPr2ndTime): 1KFIN]		
-------------	--	--	--

6-151-001	-	ENG	[-100 to 100 / 0 / 10msec/step]
-----------	---	-----	---------------------------------

6152	[PosTiAdj(ExcLstPr3rdTi):1KFIN]		
6-152-001	A3 SEF	ENG	[-100 to 100 / 0 / 10msec/step]
6-152-002	B4 SEF	ENG	
6-152-003	A4 SEF	ENG	
6-152-004	A4 LEF	ENG	
6-152-005	B5 SEF	ENG	
6-152-006	B5 LEF	ENG	
6-152-007	DLT SEF	ENG	
6-152-008	LG SEF	ENG	
6-152-009	Oficio SEF	ENG	
6-152-010	LT SEF	ENG	
6-152-011	LT LEF	ENG	
6-152-012	12"x18"	ENG	
6-152-013	8K SEF	ENG	
6-152-014	16K SEF	ENG	
6-152-015	16K LEF	ENG	
6-152-016	Other	ENG	

6154	[Pos Time Adj By Sheet: 1K FIN]		
6-154-001	1 - 10 Sheets	ENG	[-100 to 100 / 0 / 10msec/step]
6-154-002	11 - 20 Sheets	ENG	
6-154-003	21 - 30 Sheets	ENG	
6-154-004	31 - 40 Sheets	ENG	
6-154-005	41 - 50 Sheets	ENG	

6155	[Paper Guide Poss Adj: 1K FIN]		
6-155-001	-	ENG	[-10 to 10 / 0 / 1mm/step]

6156	[Paper Guide Retra Adj: 1K FIN]		
6-156-001	-	ENG	[-50 to 50 / 0 / 5mm/step]

6157	[Paper Guide Accept Adj: 1K FIN]		
6-157-001	-	ENG	[-50 to 50 / 0 / 5msec/step]

6160	[Finisher Free Run: 1K FIN]		
6-160-001	Free Run 1	ENG	[0 or 1 / 0 / 1/step]
6-160-002	Free Run 2	ENG	[0 or 1 / 0 / 1/step]
6-160-003	Free Run 3	ENG	[0 or 1 / 0 / 1/step]
6-160-004	Free Run 4	ENG	[0 or 1 / 0 / 1/step]

6161	[FIN (1K FIN) INPUT Check]		
	See page 448 "Input Check Table"		

6162	[FIN (1K FIN) OUTPUT Check]		
	See page 475 "Output Check Table"		

6163	[Use Paper Guide]		
6-163-001	Big Size	ENG	[0 or 1 / 1 / 1/step]
6-163-002	Small Size	ENG	[0 or 1 / 0 / 1/step]

6164	[NV Adj. Data Mod. 1KShfFIN]		
6-164-001	Jogger Pos. Factory Adj.	ENG	[-1.5 to 1.5 / 0 / 0.5mm/step]
6-164-002	Stapling Pos. Factory Adj.	ENG	[-2 to 2 / 0 / 0.5mm/step]
6164	[NV Adj. Data Mod. 1KShfFIN HY]		

6-164-003	Stapling Pos. Factory Adj. (HY)	ENG	[-2.1 to 2.1 / 0 / 0.3mm/step]
6-164-004	Stapleless Stapling Pos. Factory Adj.	ENG	[-2.1 to 2.1 / 0 / 0.3mm/step]
6164	[NV Adj. Data Mod. 1KShrFIN]		
6-164-005	Folding Pos. Factory Adj.	ENG	[-2 to 2 / 0 / 0.1mm/step]

6180	[M-ScanBindPosAdj:NoStplBindFIN]		
6-180-001	-	ENG	[-1 to 1 / 0 / 0.5mm/step]

6181	[BindSpeedSetting:NoStplBindFIN]		
6-181-001	-	ENG	[1 to 3 / 3 / 2/step]

6182	[ExitSpeedSwitch:NoStplBindFIN]		
6-182-001	PaperLength: 297.0-457.2mm,Thick(106-300g/m ²)	ENG	[1 to 5 / 2 / 1/step]
6-182-002	PaperLength: 297.0-457.2mm,Plain(60-105g/m ²)	ENG	[1 to 5 / 2 / 1/step]
6-182-003	PaperLength:297.0-457.2mm,Thin(52-59g/m ²)	ENG	[1 to 5 / 4 / 1/step]
6-182-004	PaperLength: 210.0-296.9mm,Thick(106-300g/m ²)	ENG	[1 to 5 / 2 / 1/step]
6-182-005	PaperLength: 210.0-296.9mm,Plain(60-105g/m ²)	ENG	[1 to 5 / 2 / 1/step]
6-182-006	PaperLength:210.0-296.9mm,Thin(52-59g/m ²)	ENG	[1 to 5 / 4 / 1/step]
6-182-007	PaperLength: 148.0-209.9mm,Thick(106-300g/m ²)	ENG	[1 to 5 / 2 / 1/step]
6-182-008	PaperLength: 148.0-209.9mm,Plain(60-105g/m ²)	ENG	[1 to 5 / 2 / 1/step]
6-182-009	PaperLength:148.0-209.9mm,Thin(52-59g/m ²)	ENG	[1 to 5 / 4 / 1/step]

6183	[FinisherFreeRun:NoStplBindFIN]		
-------------	--	--	--

6-183-001	Free Run 1	ENG	[0 or 1 / 0 / 0/step]
6-183-002	Free Run 2	ENG	[0 or 1 / 0 / 0/step]
6-183-003	Free Run 3	ENG	[0 or 1 / 0 / 0/step]

6184	[Input Check:NoStplBindFIN]		
	See page 448 "Input Check Table"		

6185	[Output Check:NoStplBindFIN]		
	See page 475 "Output Check Table"		

6186	[BindTimes NoStplBindFIN]		
6-186-001	-	*ENG	[1 to 2 / 2 / 1/step]

6801	[1-pass Stamp Unit]		
6-801-001	-	*ENG	[0 or 1 / 0 / 1/step] 0: NO 1: YES

6900	[ADF Bottom Plate Setting]		
6-900-001	-	*ENG	[0 or 1 / 0 / 1/step]

6901	[ADF Operation Setting]		
	Setting to give priority to stackability.		
6-901-001	-	ENG	[0 or 1 / 0 / 1/step] 0: Higher quietness 1: Higher throughput
6-901-002	-	ENG	[0 or 1 / 0 / 1/step] 0: Normal 1: Higher stackability

Engine SP Tables - SP7000

SP7-XXX (Data Log)

7621	[PM Counter Display: Pages]		
7-621-002	# PCU:K	ENG	[0 to 99999999 / 0 / 1 page/step]
7-621-003	# Dev Unit:K	*ENG	[0 to 99999999 / 0 / 1 page/step]
7-621-004	Developer:K	ENG	[0 to 99999999 / 0 / 1 page/step]
7-621-025	# PCU:C	ENG	[0 to 99999999 / 0 / 1 page/step]
7-621-026	# Dev Unit:C	*ENG	[0 to 99999999 / 0 / 1 page/step]
7-621-027	Developer:C	ENG	[0 to 99999999 / 0 / 1 page/step]
7-621-048	# PCU:M	ENG	[0 to 99999999 / 0 / 1 page/step]
7-621-049	# Dev Unit:M	*ENG	[0 to 99999999 / 0 / 1 page/step]
7-621-050	Developer:M	ENG	[0 to 99999999 / 0 / 1 page/step]
7-621-071	# PCU:Y	ENG	[0 to 99999999 / 0 / 1 page/step]
7-621-072	# Dev Unit:Y	*ENG	[0 to 99999999 / 0 / 1 page/step]
7-621-073	Developer:Y	ENG	[0 to 99999999 / 0 / 1 page/step]
7-621-093	# ITB Unit	ENG	[0 to 99999999 / 0 / 1 page/step]
7-621-102	# ITB Cleaning Unit	ENG	[0 to 99999999 / 0 / 1 page/step]
7-621-109	# PTR Unit	ENG	[0 to 99999999 / 0 / 1 page/step]
7-621-115	# Fusing Unit	ENG	[0 to 99999999 / 0 / 1 page/step]
7-621-116	Fusing Belt	ENG	[0 to 99999999 / 0 / 1 page/step]
7-621-118	Pressure Roller	ENG	[0 to 99999999 / 0 / 1 page/step]
7-621-131	Dust Filter	ENG	[0 to 99999999 / 0 / 1 page/step]
7-621-142	Waste Toner Bottle	ENG	[0 to 999999999 / 0 / 1 mg/step]
7-621-206	ADF Pick-up Roller	ENG	[0 to 999999999 / 0 / 1 page/step]

7-621-207	ADF Supply Belt	ENG	[0 to 999999999 / 0 / 1 page/step]
7-621-208	ADF Reverse Roller	ENG	[0 to 999999999 / 0 / 1 page/step]

7622	[PM Counter Reset]		
7-622-002	# PCU:K	ENG	[0 or 1 / 0 / 1/step]
7-622-003	# Dev Unit:K	ENG	[0 or 1 / 0 / 1/step]
7-622-004	Developer:K	ENG	[0 or 1 / 0 / 1/step]
7-622-025	# PCU:C	ENG	[0 or 1 / 0 / 1/step]
7-622-026	# Dev Unit:C	ENG	[0 or 1 / 0 / 1/step]
7-622-027	Developer:C	ENG	[0 or 1 / 0 / 1/step]
7-622-048	# PCU:M	ENG	[0 or 1 / 0 / 1/step]
7-622-049	# Dev Unit:M	ENG	[0 or 1 / 0 / 1/step]
7-622-050	Developer:M	ENG	[0 or 1 / 0 / 1/step]
7-622-071	# PCU:Y	ENG	[0 or 1 / 0 / 1/step]
7-622-072	# Dev Unit:Y	ENG	[0 or 1 / 0 / 1/step]
7-622-073	Developer:Y	ENG	[0 or 1 / 0 / 1/step]
7-622-093	# ITB Unit	ENG	[0 or 1 / 0 / 1/step]
7-622-102	# ITB Cleaning Unit	ENG	[0 or 1 / 0 / 1/step]
7-622-109	# PTR Unit	ENG	[0 or 1 / 0 / 1/step]
7-622-115	# Fusing Unit	ENG	[0 or 1 / 0 / 1/step]
7-622-116	Fusing Belt	ENG	[0 or 1 / 0 / 1/step]
7-622-118	Pressure Roller	ENG	[0 or 1 / 0 / 1/step]
7-622-131	Dust Filter	ENG	[0 or 1 / 0 / 1/step]
7-622-206	ADF Pick-up Roller	ENG	[0 or 1 / 0 / 1/step]
7-622-207	ADF Supply Belt	ENG	[0 or 1 / 0 / 1/step]
7-622-208	ADF Reverse Roller	ENG	[0 or 1 / 0 / 1/step]

7-622-245	PCU:All Colors	ENG	[0 or 1 / 0 / 1/step]
7-622-246	Development Unit:All Colors	ENG	[0 or 1 / 0 / 1/step]
7-622-247	Developer:All Colors	ENG	[0 or 1 / 0 / 1/step]
7-622-250	SCS	ENG	[0 or 1 / 0 / 1/step]

7623	[PM Value Setting: Life Pages]		
7-623-002	# PCU:K	ENG	[0 to 99999999 / 0 / 1 page/step]
7-623-003	# Dev Unit:K	ENG	[0 to 99999999 / 0 / 1 page/step]
7-623-004	Developer:K	ENG	[0 to 99999999 / 0 / 1 page/step]
7-623-025	# PCU:C	ENG	[0 to 99999999 / 0 / 1 page/step]
7-623-026	# Dev Unit:C	ENG	[0 to 99999999 / 0 / 1 page/step]
7-623-027	Developer:C	ENG	[0 to 99999999 / 0 / 1 page/step]
7-623-048	# PCU:M	ENG	[0 to 99999999 / 0 / 1 page/step]
7-623-049	# Dev Unit:M	ENG	[0 to 99999999 / 0 / 1 page/step]
7-623-050	Developer:M	ENG	[0 to 99999999 / 0 / 1 page/step]
7-623-071	# PCU:Y	ENG	[0 to 99999999 / 0 / 1 page/step]
7-623-072	# Dev Unit:Y	ENG	[0 to 99999999 / 0 / 1 page/step]
7-623-073	Developer:Y	ENG	[0 to 99999999 / 0 / 1 page/step]
7-623-093	# ITB Unit	ENG	[0 to 99999999 / 240000 / 1 page/step]
7-623-102	# ITB Cleaning Unit	ENG	[0 to 99999999 / 240000 / 1 page/step]
7-623-109	# PTR Unit	ENG	[0 to 99999999 / 240000 / 1 page/step]
7-623-115	# Fusing Unit	ENG	[0 to 99999999 / 240000 / 1 page/step]
7-623-116	Fusing Belt	ENG	[0 to 99999999 / 240000 / 1 page/step]

7-623-118	Pressure Roller	ENG	[0 to 99999999 / 240000 / 1 page/step]
7-623-131	Dust Filter	ENG	[0 to 99999999 / 300000 / 1 page/step]
7-623-142	Waste Toner Bottle	ENG	[0 to 999999999 / 1200000 / 1 mg/step]
7-623-206	ADF Pick-up Roller	ENG	[0 to 99999999 / 120000 / 1 page/step]
7-623-207	ADF Supply Belt	ENG	[0 to 99999999 / 120000 / 1 page/step]
7-623-208	ADF Reverse Roller	ENG	[0 to 99999999 / 120000 / 1 page/step]

7625	[Previous Unit Counter: Pages]		
7-625-002	# PCU:K	ENG	[0 to 99999999 / 0 / 1 page/step]
7-625-003	# Dev Unit:K	ENG	[0 to 99999999 / 0 / 1 page/step]
7-625-004	Developer:K	ENG	[0 to 99999999 / 0 / 1 page/step]
7-625-025	# PCU:C	ENG	[0 to 99999999 / 0 / 1 page/step]
7-625-026	# Dev Unit:C	ENG	[0 to 99999999 / 0 / 1 page/step]
7-625-027	Developer:C	ENG	[0 to 99999999 / 0 / 1 page/step]
7-625-048	# PCU:M	ENG	[0 to 99999999 / 0 / 1 page/step]
7-625-049	# Dev Unit:M	ENG	[0 to 99999999 / 0 / 1 page/step]
7-625-050	Developer:M	ENG	[0 to 99999999 / 0 / 1 page/step]
7-625-071	# PCU:Y	ENG	[0 to 99999999 / 0 / 1 page/step]
7-625-072	# Dev Unit:Y	ENG	[0 to 99999999 / 0 / 1 page/step]
7-625-073	Developer:Y	ENG	[0 to 99999999 / 0 / 1 page/step]
7-625-093	# ITB Unit	ENG	[0 to 99999999 / 0 / 1 page/step]
7-625-102	# ITB Cleaning Unit	ENG	[0 to 99999999 / 0 / 1 page/step]

7-625-109	# PTR Unit	ENG	[0 to 99999999 / 0 / 1 page/step]
7-625-115	# Fusing Unit	ENG	[0 to 99999999 / 0 / 1 page/step]
7-625-116	Fusing Belt	ENG	[0 to 99999999 / 0 / 1 page/step]
7-625-118	Pressure Roller	ENG	[0 to 99999999 / 0 / 1 page/step]
7-625-131	Dust Filter	ENG	[0 to 99999999 / 0 / 1 page/step]
7-625-142	Waste Toner Bottle	ENG	[0 to 99999999 / 0 / 1 page/step]
7-625-206	ADF Pick-up Roller	ENG	[0 to 99999999 / 0 / 1 page/step]
7-625-207	ADF Supply Belt	ENG	[0 to 99999999 / 0 / 1 page/step]
7-625-208	ADF Reverse Roller	ENG	[0 to 99999999 / 0 / 1 page/step]

7626	[Previous Unit Counter2: Pages]		
7-626-002	# PCU:K	ENG	[0 to 99999999 / 0 / 1 page/step]
7-626-003	# Dev Unit:K	ENG	[0 to 99999999 / 0 / 1 page/step]
7-626-004	Developer:K	ENG	[0 to 99999999 / 0 / 1 page/step]
7-626-025	# PCU:C	ENG	[0 to 99999999 / 0 / 1 page/step]
7-626-026	# Dev Unit:C	ENG	[0 to 99999999 / 0 / 1 page/step]
7-626-027	Developer:C	ENG	[0 to 99999999 / 0 / 1 page/step]
7-626-048	# PCU:M	ENG	[0 to 99999999 / 0 / 1 page/step]
7-626-049	# Dev Unit:M	ENG	[0 to 99999999 / 0 / 1 page/step]
7-626-050	Developer:M	ENG	[0 to 99999999 / 0 / 1 page/step]
7-626-071	# PCU:Y	ENG	[0 to 99999999 / 0 / 1 page/step]
7-626-072	# Dev Unit:Y	ENG	[0 to 99999999 / 0 / 1 page/step]
7-626-073	Developer:Y	ENG	[0 to 99999999 / 0 / 1 page/step]
7-626-093	# ITB Unit	ENG	[0 to 99999999 / 0 / 1 page/step]
7-626-102	# ITB Cleaning Unit	ENG	[0 to 99999999 / 0 / 1 page/step]
7-626-109	# PTR Unit	ENG	[0 to 99999999 / 0 / 1 page/step]

7-626-115	# Fusing Unit	ENG	[0 to 999999999 / 0 / 1 page/step]
7-626-116	Fusing Belt	ENG	[0 to 999999999 / 0 / 1 page/step]
7-626-118	Pressure Roller	ENG	[0 to 999999999 / 0 / 1 page/step]
7-626-131	Dust Filter	ENG	[0 to 999999999 / 0 / 1 page/step]
7-626-142	Waste Toner Bottle	ENG	[0 to 999999999 / 0 / 1 mg/step]
7-626-206	ADF Pick-up Roller	ENG	[0 to 999999999 / 0 / 1 page/step]
7-626-207	ADF Supply Belt	ENG	[0 to 999999999 / 0 / 1 page/step]
7-626-208	ADF Reverse Roller	ENG	[0 to 999999999 / 0 / 1 page/step]

7628	[PM Counter Reset]		
7-628-002	SCS	ENG	[0 or 1 / 0 / 1/step]

7720	[Ave. Cvrg for Eng.]		
7-720-001	K	*ENG	[0 to 100 / 0 / 0.01%/step]
7-720-002	C	*ENG	[0 to 100 / 0 / 0.01%/step]
7-720-003	M	*ENG	[0 to 100 / 0 / 0.01%/step]
7-720-004	Y	*ENG	[0 to 100 / 0 / 0.01%/step]

7801	[ROM No.]		
7-801-002	Engine	ENG	[- / - / -]
7-801-005	ADF	ENG	[- / - / -]
7-801-007	Finisher	ENG	[- / - / -]
7-801-009	PTU	ENG	[- / - / -]
7-801-010	LCT	ENG	[- / - / -]
7-801-019	PTU2	ENG	[- / - / -]
7801	[ROM No./ Firmware Version]		
7-801-102	Engine	ENG	[- / - / -]

7-801-105	ADF	ENG	[- / - / -]
7-801-107	Finisher	ENG	[- / - / -]
7-801-109	PTU	ENG	[- / - / -]
7-801-110	LCT	ENG	[- / - / -]

7852	[DF Glass Dust Check]		
7-852-001	Dust Detection Counter	*ENG	[0 to 65535 / 0 / 1/step]
7-852-002	Dust Counter Clear Counter	*ENG	[0 to 65535 / 0 / 1/step]
7-852-003	Dust Detection Counter: Back	*ENG	[0 to 65535 / 0 / 1/step]

7853	[Replace Counter]		
7-853-002	# PCU:K	ENG	[0 to 255 / 0 / 1/step]
7-853-003	# Dev Unit:K	ENG	[0 to 255 / 0 / 1/step]
7-853-004	Developer:K	ENG	[0 to 255 / 0 / 1/step]
7-853-025	# PCU:C	ENG	[0 to 255 / 0 / 1/step]
7-853-026	# Dev Unit:C	ENG	[0 to 255 / 0 / 1/step]
7-853-027	Developer:C	ENG	[0 to 255 / 0 / 1/step]
7-853-048	# PCU:M	ENG	[0 to 255 / 0 / 1/step]
7-853-049	# Dev Unit:M	ENG	[0 to 255 / 0 / 1/step]
7-853-050	Developer:M	ENG	[0 to 255 / 0 / 1/step]
7-853-071	# PCU:Y	ENG	[0 to 255 / 0 / 1/step]
7-853-072	# Dev Unit:Y	ENG	[0 to 255 / 0 / 1/step]
7-853-073	Developer:Y	ENG	[0 to 255 / 0 / 1/step]
7-853-093	# ITB Unit	ENG	[0 to 255 / 0 / 1/step]
7-853-102	# ITB Cleaning Unit	ENG	[0 to 255 / 0 / 1/step]
7-853-109	# PTR Unit	ENG	[0 to 255 / 0 / 1/step]
7-853-115	# Fusing Unit	ENG	[0 to 255 / 0 / 1/step]

7-853-116	Fusing Belt	ENG	[0 to 255 / 0 / 1/step]
7-853-118	Pressure Roller	ENG	[0 to 255 / 0 / 1/step]
7-853-131	Dust Filter	ENG	[0 to 255 / 0 / 1/step]
7-853-142	Waste Toner Bottle	ENG	[0 to 255 / 0 / 1/step]
7-853-206	ADF Pick-up Roller	ENG	[0 to 255 / 0 / 1/step]
7-853-207	ADF Supply Belt	ENG	[0 to 255 / 0 / 1/step]
7-853-208	ADF Reverse Roller	ENG	[0 to 255 / 0 / 1/step]

7906	[Previous Unit Counter:Distance]		
7-906-002	# PCU:K	ENG	[0 to 4294967295 / 0 / 1mm/step]
7-906-003	# Dev Unit:K	ENG	[0 to 4294967295 / 0 / 1mm/step]
7-906-004	Developer:K	ENG	[0 to 4294967295 / 0 / 1mm/step]
7-906-025	# PCU:C	ENG	[0 to 4294967295 / 0 / 1mm/step]
7-906-026	# Dev Unit:C	ENG	[0 to 4294967295 / 0 / 1mm/step]
7-906-027	Developer: C	ENG	[0 to 4294967295 / 0 / 1mm/step]
7-906-048	# PCU:M	ENG	[0 to 4294967295 / 0 / 1mm/step]
7-906-049	# Dev Unit:M	ENG	[0 to 4294967295 / 0 / 1mm/step]
7-906-050	Developer: M	ENG	[0 to 4294967295 / 0 / 1mm/step]
7-906-071	# PCU:Y	ENG	[0 to 4294967295 / 0 / 1mm/step]
7-906-072	# Dev Unit:Y	ENG	[0 to 4294967295 / 0 / 1mm/step]
7-906-073	Developer: Y	ENG	[0 to 4294967295 / 0 / 1mm/step]
7-906-093	# ITB Unit	ENG	[0 to 4294967295 / 0 / 1mm/step]
7-906-102	# ITB Cleaning Unit	ENG	[0 to 4294967295 / 0 / 1mm/step]
7-906-109	# PTR Unit	ENG	[0 to 4294967295 / 0 / 1mm/step]
7-906-115	# Fusing Unit	ENG	[0 to 4294967295 / 0 / 1mm/step]
7-906-116	Fusing Belt	ENG	[0 to 4294967295 / 0 / 1mm/step]

7-906-118	Pressure Roller	ENG	[0 to 4294967295 / 0 / 1mm/step]
7-906-230	Low Speed: # PCU:K	ENG	[0 to 4294967295 / 0 / 1mm/step]
7-906-231	Low Speed: # PCU:C	ENG	[0 to 4294967295 / 0 / 1mm/step]
7-906-232	Low Speed: # PCU:M	ENG	[0 to 4294967295 / 0 / 1mm/step]
7-906-233	Low Speed: # PCU:Y	ENG	[0 to 4294967295 / 0 / 1mm/step]
7-906-234	Middle Speed: # PCU:K	ENG	[0 to 4294967295 / 0 / 1mm/step]
7-906-235	Middle Speed: # PCU:C	ENG	[0 to 4294967295 / 0 / 1mm/step]
7-906-236	Middle Speed: # PCU:M	ENG	[0 to 4294967295 / 0 / 1mm/step]
7-906-237	Middle Speed: # PCU:Y	ENG	[0 to 4294967295 / 0 / 1mm/step]

7907	[Previous Unit Cntr:Distance(%)]		
7-907-002	# PCU:K	ENG	[0 to 255 / 0 / 1%/step]
7-907-003	# Dev Unit:K	ENG	[0 to 255 / 0 / 1%/step]
7-907-004	Developer:K	ENG	[0 to 255 / 0 / 1%/step]
7-907-025	# PCU:C	ENG	[0 to 255 / 0 / 1%/step]
7-907-026	# Dev Unit:C	ENG	[0 to 255 / 0 / 1%/step]
7-907-027	Developer:C	ENG	[0 to 255 / 0 / 1%/step]
7-907-048	# PCU:M	ENG	[0 to 255 / 0 / 1%/step]
7-907-049	# Dev Unit:M	ENG	[0 to 255 / 0 / 1%/step]
7-907-050	Developer:M	ENG	[0 to 255 / 0 / 1%/step]
7-907-071	# PCU:Y	ENG	[0 to 255 / 0 / 1%/step]
7-907-072	# Dev Unit:Y	ENG	[0 to 255 / 0 / 1%/step]
7-907-073	Developer:Y	ENG	[0 to 255 / 0 / 1%/step]
7-907-093	# ITB Unit	ENG	[0 to 255 / 0 / 1%/step]
7-907-102	# ITB Cleaning Unit	ENG	[0 to 255 / 0 / 1%/step]
7-907-109	# PTR Unit	ENG	[0 to 255 / 0 / 1%/step]

7-907-115	# Fusing Unit	ENG	[0 to 255 / 0 / 1%/step]
7-907-116	Fusing Belt	ENG	[0 to 255 / 0 / 1%/step]
7-907-118	Pressure Roller	ENG	[0 to 255 / 0 / 1%/step]

7908	[Previous Unit Counter:Pages(%)]		
7-908-002	# PCU:K	ENG	[0 to 255 / 0 / 1%/step]
7-908-003	# Dev Unit:K	ENG	[0 to 255 / 0 / 1%/step]
7-908-004	Developer:K	ENG	[0 to 255 / 0 / 1%/step]
7-908-025	# PCU:C	ENG	[0 to 255 / 0 / 1%/step]
7-908-026	# Dev Unit:C	ENG	[0 to 255 / 0 / 1%/step]
7-908-027	Developer:C	ENG	[0 to 255 / 0 / 1%/step]
7-908-048	# PCU:M	ENG	[0 to 255 / 0 / 1%/step]
7-908-049	# Dev Unit:M	ENG	[0 to 255 / 0 / 1%/step]
7-908-050	Developer:M	ENG	[0 to 255 / 0 / 1%/step]
7-908-071	# PCU:Y	ENG	[0 to 255 / 0 / 1%/step]
7-908-072	# Dev Unit:Y	ENG	[0 to 255 / 0 / 1%/step]
7-908-073	Developer:Y	ENG	[0 to 255 / 0 / 1%/step]
7-908-093	# ITB Unit	ENG	[0 to 255 / 0 / 1%/step]
7-908-102	# ITB Cleaning Unit	ENG	[0 to 255 / 0 / 1%/step]
7-908-109	# PTR Unit	ENG	[0 to 255 / 0 / 1%/step]
7-908-115	# Fusing Unit	ENG	[0 to 255 / 0 / 1%/step]
7-908-116	Fusing Belt	ENG	[0 to 255 / 0 / 1%/step]
7-908-118	Pressure Roller	ENG	[0 to 255 / 0 / 1%/step]
7-908-131	Dust Filter	ENG	[0 to 255 / 0 / 1%/step]
7-908-142	Waste Toner Bottle	ENG	[0 to 255 / 0 / 1%/step]
7-908-206	ADF Pick-up Roller	ENG	[0 to 255 / 0 / 1%/step]

7-908-207	ADF Supply Belt	ENG	[0 to 255 / 0 / 1%/step]
7-908-208	ADF Reverse Roller	ENG	[0 to 255 / 0 / 1%/step]

7931	[Toner Bottle Bk]		
7-931-001	Machine Serial ID	*ENG	[0 to 255 / 0 / 1/step]
7-931-002	Cartridge Ver	*ENG	[0 to 255 / 0 / 1/step]
7-931-003	Brand ID	*ENG	[0 to 255 / 0 / 1/step]
7-931-004	Area ID	*ENG	[0 to 255 / 0 / 1/step]
7-931-005	Product ID	*ENG	[0 to 255 / 0 / 1/step]
7-931-006	Color ID	*ENG	[0 to 255 / 0 / 1/step]
7-931-007	Maintenance ID	*ENG	[0 to 255 / 0 / 1/step]
7-931-008	New Product Information	*ENG	[0 to 255 / 0 / 1/step]
7-931-009	Recycle Counter	*ENG	[0 to 255 / 0 / 1/step]
7-931-010	Date	*ENG	[0 to 1 / 0 / 1/step]
7-931-011	SerialNo.	*ENG	[0 to 1 / 0 / 1/step]
7-931-012	Toner Remaining	*ENG	[0 to 100 / 100 / 1%/step]
7-931-013	EDP Code	*ENG	[0 to 1 / 0 / 1/step]
7-931-014	End History	*ENG	[0 to 1 / 0 / 1/step]
7-931-015	Refill Information	*ENG	[0 to 1 / 0 / 1/step]
7-931-016	Attachment: Total Counter	*ENG	[0 to 99999999 / 0 / 1/step]
7-931-017	Attachment: Color Counter	*ENG	[0 to 99999999 / 0 / 1/step]
7-931-018	End: Total Counter	*ENG	[0 to 99999999 / 0 / 1/step]
7-931-019	End: Color Counter	*ENG	[0 to 99999999 / 0 / 1/step]
7-931-020	Attachment Date	*ENG	[0 to 1 / 0 / 1/step]
7-931-021	End Date	*ENG	[0 to 1 / 0 / 1/step]

7932	[Toner Bottle M]		
-------------	-------------------------	--	--

7-932-001	Machine Serial ID	*ENG	[0 to 255 / 0 / 1/step]
7-932-002	Cartridge Ver	*ENG	[0 to 255 / 0 / 1/step]
7-932-003	Brand ID	*ENG	[0 to 255 / 0 / 1/step]
7-932-004	Area ID	*ENG	[0 to 255 / 0 / 1/step]
7-932-005	Product ID	*ENG	[0 to 255 / 0 / 1/step]
7-932-006	Color ID	*ENG	[0 to 255 / 0 / 1/step]
7-932-007	Maintenance ID	*ENG	[0 to 255 / 0 / 1/step]
7-932-008	New Product Information	*ENG	[0 to 255 / 0 / 1/step]
7-932-009	Recycle Counter	*ENG	[0 to 255 / 0 / 1/step]
7-932-010	Date	*ENG	[0 to 1 / 0 / 1/step]
7-932-011	SerialNo.	*ENG	[0 to 1 / 0 / 1/step]
7-932-012	Toner Remaining	*ENG	[0 to 100 / 100 / 1%/step]
7-932-013	EDP Code	*ENG	[0 to 1 / 0 / 1/step]
7-932-014	End History	*ENG	[0 to 1 / 0 / 1/step]
7-932-015	Refill Information	*ENG	[0 to 1 / 0 / 1/step]
7-932-016	Attachment: Total Counter	*ENG	[0 to 99999999 / 0 / 1/step]
7-932-017	Attachment: Color Counter	*ENG	[0 to 99999999 / 0 / 1/step]
7-932-018	End: Total Counter	*ENG	[0 to 99999999 / 0 / 1/step]
7-932-019	End: Color Counter	*ENG	[0 to 99999999 / 0 / 1/step]
7-932-020	Attachment Date	*ENG	[0 to 1 / 0 / 1/step]
7-932-021	End Date	*ENG	[0 to 1 / 0 / 1/step]

7933	[Toner Bottle C]		
7-933-001	MachineSerialID	*ENG	[0 to 255 / 0 / 1/step]
7-933-002	Cartridge Ver	*ENG	[0 to 255 / 0 / 1/step]
7-933-003	Brand ID	*ENG	[0 to 255 / 0 / 1/step]

7-933-004	Area ID	*ENG	[0 to 255 / 0 / 1/step]
7-933-005	Product ID	*ENG	[0 to 255 / 0 / 1/step]
7-933-006	Color ID	*ENG	[0 to 255 / 0 / 1/step]
7-933-007	Maintenance ID	*ENG	[0 to 255 / 0 / 1/step]
7-933-008	New Product Information	*ENG	[0 to 255 / 0 / 1/step]
7-933-009	Recycle Counter	*ENG	[0 to 255 / 0 / 1/step]
7-933-010	Date	*ENG	[0 to 1 / 0 / 1/step]
7-933-011	SerialNo.	*ENG	[0 to 1 / 0 / 1/step]
7-933-012	Toner Remaining	*ENG	[0 to 100 / 100 / 1%/step]
7-933-013	EDP Code	*ENG	[0 to 1 / 0 / 1/step]
7-933-014	End History	*ENG	[0 to 1 / 0 / 1/step]
7-933-015	Refill Information	*ENG	[0 to 1 / 0 / 1/step]
7-933-016	Attachment: Total Counter	*ENG	[0 to 99999999 / 0 / 1/step]
7-933-017	Attachment: Color Counter	*ENG	[0 to 99999999 / 0 / 1/step]
7-933-018	End: Total Counter	*ENG	[0 to 99999999 / 0 / 1/step]
7-933-019	End: Color Counter	*ENG	[0 to 99999999 / 0 / 1/step]
7-933-020	Attachment Date	*ENG	[0 to 1 / 0 / 1/step]
7-933-021	End Date	*ENG	[0 to 1 / 0 / 1/step]

7934	[Toner Bottle Y]		
7-934-001	MachineSerialID	*ENG	[0 to 255 / 0 / 1/step]
7-934-002	Cartridge Ver	*ENG	[0 to 255 / 0 / 1/step]
7-934-003	Brand ID	*ENG	[0 to 255 / 0 / 1/step]
7-934-004	Area ID	*ENG	[0 to 255 / 0 / 1/step]
7-934-005	Product ID	*ENG	[0 to 255 / 0 / 1/step]
7-934-006	Color ID	*ENG	[0 to 255 / 0 / 1/step]

7-934-007	Maintenance ID	*ENG	[0 to 255 / 0 / 1/step]
7-934-008	New Product Information	*ENG	[0 to 255 / 0 / 1/step]
7-934-009	Recycle Counter	*ENG	[0 to 255 / 0 / 1/step]
7-934-010	Date	*ENG	[0 to 1 / 0 / 1/step]
7-934-011	SerialNo.	*ENG	[0 to 1 / 0 / 1/step]
7-934-012	Toner Remaining	*ENG	[0 to 100 / 100 / 1%/step]
7-934-013	EDP Code	*ENG	[0 to 1 / 0 / 1/step]
7-934-014	End History	*ENG	[0 to 1 / 0 / 1/step]
7-934-015	Refill Information	*ENG	[0 to 1 / 0 / 1/step]
7-934-016	Attachment: Total Counter	*ENG	[0 to 99999999 / 0 / 1/step]
7-934-017	Attachment: Color Counter	*ENG	[0 to 99999999 / 0 / 1/step]
7-934-018	End: Total Counter	*ENG	[0 to 99999999 / 0 / 1/step]
7-934-019	End: Color Counter	*ENG	[0 to 99999999 / 0 / 1/step]
7-934-020	Attachment Date	*ENG	[0 to 1 / 0 / 1/step]
7-934-021	End Date	*ENG	[0 to 1 / 0 / 1/step]

7935	[Toner Bottle Log 1: Bk]		
7-935-001	SerialNo.	ENG	[0 or 1 / 0 / 1/step]
7-935-002	Attachment Date	ENG	[0 or 1 / 0 / 1/step]
7-935-003	Attachment: Total Counter	ENG	[0 to 99999999 / 0 / 1/step]
7-935-004	Refill Information	*ENG	[0 or 1 / 0 / 1/step]
7935	[Toner Bottle Log 2: Bk]		
7-935-011	SerialNo.	ENG	[0 or 1 / 0 / 1/step]
7-935-012	Attachment Date	ENG	[0 or 1 / 0 / 1/step]
7-935-013	Attachment: Total Counter	ENG	[0 to 99999999 / 0 / 1/step]
7-935-014	Refill Information	*ENG	[0 or 1 / 0 / 1/step]

7935	[Toner Bottle Log 3: Bk]		
7-935-021	SerialNo.	ENG	[0 or 1 / 0 / 1/step]
7-935-022	Attachment Date	ENG	[0 or 1 / 0 / 1/step]
7-935-023	Attachment: Total Counter	ENG	[0 to 99999999 / 0 / 1/step]
7-935-024	Refill Information	*ENG	[0 or 1 / 0 / 1/step]
7935	[Toner Bottle Log 4: Bk]		
7-935-031	SerialNo.	ENG	[0 or 1 / 0 / 1/step]
7-935-032	Attachment Date	ENG	[0 or 1 / 0 / 1/step]
7-935-033	Attachment: Total Counter	ENG	[0 to 99999999 / 0 / 1/step]
7-935-034	Refill Information	*ENG	[0 or 1 / 0 / 1/step]
7935	[Toner Bottle Log 5: Bk]		
7-935-041	SerialNo.	ENG	[0 or 1 / 0 / 1/step]
7-935-042	Attachment Date	ENG	[0 or 1 / 0 / 1/step]
7-935-043	Attachment: Total Counter	ENG	[0 to 99999999 / 0 / 1/step]
7-935-044	Refill Information	*ENG	[0 or 1 / 0 / 1/step]

7936	[Toner Bottle Log 1: M]		
7-936-001	SerialNo.	ENG	[0 or 1 / 0 / 1/step]
7-936-002	Attachment Date	ENG	[0 or 1 / 0 / 1/step]
7-936-003	Attachment: Total Counter	ENG	[0 to 99999999 / 0 / 1/step]
7-936-004	Refill Information	*ENG	[0 or 1 / 0 / 1/step]
7936	[Toner Bottle Log 2: M]		
7-936-011	SerialNo.	ENG	[0 or 1 / 0 / 1/step]
7-936-012	Attachment Date	ENG	[0 or 1 / 0 / 1/step]
7-936-013	Attachment: Total Counter	ENG	[0 to 99999999 / 0 / 1/step]
7-936-014	Refill Information	*ENG	[0 or 1 / 0 / 1/step]

7936	[Toner Bottle Log 3: M]		
7-936-021	SerialNo.	ENG	[0 or 1 / 0 / 1/step]
7-936-022	Attachment Date	ENG	[0 or 1 / 0 / 1/step]
7-936-023	Attachment: Total Counter	ENG	[0 to 99999999 / 0 / 1/step]
7-936-024	Refill Information	*ENG	[0 or 1 / 0 / 1/step]
7936	[Toner Bottle Log 4: M]		
7-936-031	SerialNo.	ENG	[0 or 1 / 0 / 1/step]
7-936-032	Attachment Date	ENG	[0 or 1 / 0 / 1/step]
7-936-033	Attachment: Total Counter	ENG	[0 to 99999999 / 0 / 1/step]
7-936-034	Refill Information	*ENG	[0 or 1 / 0 / 1/step]
7936	[Toner Bottle Log 5: M]		
7-936-041	SerialNo.	ENG	[0 or 1 / 0 / 1/step]
7-936-042	Attachment Date	ENG	[0 or 1 / 0 / 1/step]
7-936-043	Attachment: Total Counter	ENG	[0 to 99999999 / 0 / 1/step]
7-936-044	Refill Information	*ENG	[0 or 1 / 0 / 1/step]

7937	[Toner Bottle Log 1: C]		
7-937-001	SerialNo.	ENG	[0 or 1 / 0 / 1/step]
7-937-002	Attachment Date	ENG	[0 or 1 / 0 / 1/step]
7-937-003	Attachment: Total Counter	ENG	[0 to 99999999 / 0 / 1/step]
7-937-004	Refill Information	*ENG	[0 or 1 / 0 / 1/step]
7937	[Toner Bottle Log 2: C]		
7-937-011	SerialNo.	ENG	[0 or 1 / 0 / 1/step]
7-937-012	Attachment Date	ENG	[0 or 1 / 0 / 1/step]
7-937-013	Attachment: Total Counter	ENG	[0 to 99999999 / 0 / 1/step]
7-937-014	Refill Information	*ENG	[0 or 1 / 0 / 1/step]

7937	[Toner Bottle Log 3: C]		
7-937-021	SerialNo.	ENG	[0 or 1 / 0 / 1/step]
7-937-022	Attachment Date	ENG	[0 or 1 / 0 / 1/step]
7-937-023	Attachment: Total Counter	ENG	[0 to 99999999 / 0 / 1/step]
7-937-024	Refill Information	*ENG	[0 or 1 / 0 / 1/step]
7937	[Toner Bottle Log 4: C]		
7-937-031	SerialNo.	ENG	[0 or 1 / 0 / 1/step]
7-937-032	Attachment Date	ENG	[0 or 1 / 0 / 1/step]
7-937-033	Attachment: Total Counter	ENG	[0 to 99999999 / 0 / 1/step]
7-937-034	Refill Information	*ENG	[0 or 1 / 0 / 1/step]
7937	[Toner Bottle Log 5: C]		
7-937-041	SerialNo.	ENG	[0 or 1 / 0 / 1/step]
7-937-042	Attachment Date	ENG	[0 or 1 / 0 / 1/step]
7-937-043	Attachment: Total Counter	ENG	[0 to 99999999 / 0 / 1/step]
7-937-044	Refill Information	*ENG	[0 or 1 / 0 / 1/step]
7938	[Toner Bottle Log 1: Y]		
7-938-001	SerialNo.	ENG	[0 or 1 / 0 / 1/step]
7-938-002	Attachment Date	ENG	[0 or 1 / 0 / 1/step]
7-938-003	Attachment: Total Counter	ENG	[0 to 99999999 / 0 / 1/step]
7-938-004	Refill Information	*ENG	[0 or 1 / 0 / 1/step]
7938	[Toner Bottle Log 2: Y]		
7-938-011	SerialNo.	ENG	[0 or 1 / 0 / 1/step]
7-938-012	Attachment Date	ENG	[0 or 1 / 0 / 1/step]
7-938-013	Attachment: Total Counter	ENG	[0 to 99999999 / 0 / 1/step]
7-938-014	Refill Information	*ENG	[0 or 1 / 0 / 1/step]
7938	[Toner Bottle Log 3: Y]		

7-938-021	SerialNo.	ENG	[0 or 1 / 0 / 1/step]
7-938-022	Attachment Date	ENG	[0 or 1 / 0 / 1/step]
7-938-023	Attachment: Total Counter	ENG	[0 to 99999999 / 0 / 1/step]
7-938-024	Refill Information	*ENG	[0 or 1 / 0 / 1/step]
7938	[Toner Bottle Log 4: Y]		
7-938-031	SerialNo.	ENG	[0 or 1 / 0 / 1/step]
7-938-032	Attachment Date	ENG	[0 or 1 / 0 / 1/step]
7-938-033	Attachment: Total Counter	ENG	[0 to 99999999 / 0 / 1/step]
7-938-034	Refill Information	*ENG	[0 or 1 / 0 / 1/step]
7938	[Toner Bottle Log 5: Y]		
7-938-041	SerialNo.	ENG	[0 or 1 / 0 / 1/step]
7-938-042	Attachment Date	ENG	[0 or 1 / 0 / 1/step]
7-938-043	Attachment: Total Counter	ENG	[0 to 99999999 / 0 / 1/step]
7-938-044	Refill Information	*ENG	[0 or 1 / 0 / 1/step]

7940	[PM Value Setting:Life Distance]		
7-940-002	# PCU:K	ENG	[0 to 999999999 / 0 / 1mm/step]
7-940-003	# Dev Unit:K	ENG	[0 to 999999999 / 0 / 1mm/step]
7-940-004	Developer:K	ENG	[0 to 999999999 / 0 / 1mm/step]
7-940-025	# PCU:C	ENG	[0 to 999999999 / 0 / 1mm/step]
7-940-026	# Dev Unit:C	ENG	[0 to 999999999 / 0 / 1mm/step]
7-940-027	Developer:C	ENG	[0 to 999999999 / 0 / 1mm/step]
7-940-048	# PCU:M	ENG	[0 to 999999999 / 0 / 1mm/step]
7-940-049	# Dev Unit:M	ENG	[0 to 999999999 / 0 / 1mm/step]
7-940-050	Developer:M	ENG	[0 to 999999999 / 0 / 1mm/step]
7-940-071	# PCU:Y	ENG	[0 to 999999999 / 0 / 1mm/step]

7-940-072	# Dev Unit:Y	ENG	[0 to 999999999 / 0 / 1mm/step]
7-940-073	Developer:Y	ENG	[0 to 999999999 / 0 / 1mm/step]
7-940-093	# ITB Unit	ENG	[0 to 999999999 / 128410397 / 1mm/step]
7-940-102	# ITB Cleaning Unit	ENG	[0 to 999999999 / 128410397 / 1mm/step]
7-940-109	# PTR Unit	ENG	[0 to 999999999 / 128410397 / 1mm/step]
7-940-115	# Fusing Unit	ENG	[0 to 999999999 / 291305000 / 1mm/step]
7-940-116	Fusing Belt	ENG	[0 to 999999999 / 291305000 / 1mm/step]
7-940-118	Pressure Roller	ENG	[0 to 999999999 / 291305000 / 1mm/step]

7942	[PM Counter Display:Distance(%)]		
7-942-002	# PCU:K	ENG	[0 to 255 / 0 / 1%/step]
7-942-003	# Dev Unit:K	ENG	[0 to 255 / 0 / 1%/step]
7-942-004	Developer:K	ENG	[0 to 255 / 0 / 1%/step]
7-942-025	# PCU:C	ENG	[0 to 255 / 0 / 1%/step]
7-942-026	# Dev Unit:C	ENG	[0 to 255 / 0 / 1%/step]
7-942-027	Developer:C	ENG	[0 to 255 / 0 / 1%/step]
7-942-048	# PCU:M	ENG	[0 to 255 / 0 / 1%/step]
7-942-049	# Dev Unit:M	ENG	[0 to 255 / 0 / 1%/step]
7-942-050	Developer:M	ENG	[0 to 255 / 0 / 1%/step]
7-942-071	# PCU:Y	ENG	[0 to 255 / 0 / 1%/step]
7-942-072	# Dev Unit:Y	ENG	[0 to 255 / 0 / 1%/step]
7-942-073	Developer:Y	ENG	[0 to 255 / 0 / 1%/step]

7-942-093	# ITB Unit	ENG	[0 to 255 / 0 / 1%/step]
7-942-102	# ITB Cleaning Unit	ENG	[0 to 255 / 0 / 1%/step]
7-942-109	# PTR Unit	ENG	[0 to 255 / 0 / 1%/step]
7-942-115	# Fusing Unit	ENG	[0 to 255 / 0 / 1%/step]
7-942-116	Fusing Belt	ENG	[0 to 255 / 0 / 1%/step]
7-942-118	Pressure Roller	ENG	[0 to 255 / 0 / 1%/step]

7944	[PM Counter Display: Distance]		
7-944-002	# PCU:K	*ENG	[0 to 4294967295 / 0 / 1mm/step]
7-944-003	# Dev Unit:K	*ENG	[0 to 4294967295 / 0 / 1mm/step]
7-944-004	Developer:K	*ENG	[0 to 4294967295 / 0 / 1mm/step]
7-944-025	# PCU:C	*ENG	[0 to 4294967295 / 0 / 1mm/step]
7-944-026	# Dev Unit:C	*ENG	[0 to 4294967295 / 0 / 1mm/step]
7-944-027	Developer:C	*ENG	[0 to 4294967295 / 0 / 1mm/step]
7-944-048	# PCU:M	*ENG	[0 to 4294967295 / 0 / 1mm/step]
7-944-049	# Dev Unit:M	*ENG	[0 to 4294967295 / 0 / 1mm/step]
7-944-050	Developer:M	*ENG	[0 to 4294967295 / 0 / 1mm/step]
7-944-071	# PCU:Y	*ENG	[0 to 4294967295 / 0 / 1mm/step]
7-944-072	# Dev Unit:Y	*ENG	[0 to 4294967295 / 0 / 1mm/step]
7-944-073	Developer:Y	*ENG	[0 to 4294967295 / 0 / 1mm/step]
7-944-093	# ITB Unit	*ENG	[0 to 4294967295 / 0 / 1mm/step]
7-944-102	# ITB Cleaning Unit	ENG	[0 to 4294967295 / 0 / 1mm/step]
7-944-109	# PTR Unit	ENG	[0 to 4294967295 / 0 / 1mm/step]
7-944-115	# Fusing Unit	ENG	[0 to 4294967295 / 0 / 1mm/step]
7-944-116	Fusing Belt	ENG	[0 to 4294967295 / 0 / 1mm/step]
7-944-118	Pressure Roller	ENG	[0 to 4294967295 / 0 / 1mm/step]

7-944-230	Low Speed: # PCU:K	ENG	[0 to 4294967295 / 0 / 1mm/step]
7-944-231	Low Speed: # PCU:C	ENG	[0 to 4294967295 / 0 / 1mm/step]
7-944-232	Low Speed: # PCU:M	ENG	[0 to 4294967295 / 0 / 1mm/step]
7-944-233	Low Speed: # PCU:Y	ENG	[0 to 4294967295 / 0 / 1mm/step]
7-944-234	Middle Speed: # PCU:K	ENG	[0 to 4294967295 / 0 / 1mm/step]
7-944-235	Middle Speed: # PCU:C	ENG	[0 to 4294967295 / 0 / 1mm/step]
7-944-236	Middle Speed: # PCU:M	ENG	[0 to 4294967295 / 0 / 1mm/step]
7-944-237	Middle Speed: # PCU:Y	ENG	[0 to 4294967295 / 0 / 1mm/step]
7950	[Unit Replacement Date]		
7-950-002	# PCU:K	*ENG	[- / 0 / -]
7-950-003	# Dev Unit:K	*ENG	[- / 0 / -]
7-950-004	Developer:K	*ENG	[- / 0 / -]
7-950-025	# PCU:C	*ENG	[- / 0 / -]
7-950-026	# Dev Unit:C	*ENG	[- / 0 / -]
7-950-027	Developer:C	*ENG	[- / 0 / -]
7-950-048	# PCU:M	*ENG	[- / 0 / -]
7-950-049	# Dev Unit:M	*ENG	[- / 0 / -]
7-950-050	Developer:M	*ENG	[- / 0 / -]
7-950-071	# PCU:Y	*ENG	[- / 0 / -]
7-950-072	# Dev Unit:Y	*ENG	[- / 0 / -]
7-950-073	Developer:Y	*ENG	[- / 0 / -]
7-950-093	# ITB Unit	*ENG	[- / 0 / -]
7-950-102	# ITB Cleaning Unit	*ENG	[- / 0 / -]
7-950-109	# PTR Unit	*ENG	[- / 0 / -]
7-950-115	# Fusing Unit	*ENG	[- / 0 / -]
7-950-116	Fusing Belt	*ENG	[- / 0 / -]

7-950-118	Pressure Roller	*ENG	[- / 0 / -]
7-950-131	Dust Filter	*ENG	[- / 0 / -]
7-950-142	Waste Toner Bottle	*ENG	[- / 0 / -]
7-950-206	ADF Pick-up Roller	*ENG	[- / 0 / -]
7-950-207	ADF Supply Belt	*ENG	[- / 0 / -]
7-950-208	ADF Reverse Roller	*ENG	[- / 0 / -]

7951	[Remain Day Counter: Pages]		
7-951-002	# PCU:K	ENG	[0 to 255 / 255 / 1 day/step]
7-951-003	# Dev Unit:K	ENG	[0 to 255 / 255 / 1 day/step]
7-951-004	Developer:K	ENG	[0 to 255 / 255 / 1 day/step]
7-951-025	# PCU:C	ENG	[0 to 255 / 255 / 1 day/step]
7-951-026	# Dev Unit:C	ENG	[0 to 255 / 255 / 1 day/step]
7-951-027	Developer:C	ENG	[0 to 255 / 255 / 1 day/step]
7-951-048	# PCU:M	ENG	[0 to 255 / 255 / 1 day/step]
7-951-049	# Dev Unit:M	ENG	[0 to 255 / 255 / 1 day/step]
7-951-050	Developer:M	ENG	[0 to 255 / 255 / 1 day/step]
7-951-071	# PCU:Y	ENG	[0 to 255 / 255 / 1 day/step]
7-951-072	# Dev Unit:Y	ENG	[0 to 255 / 255 / 1 day/step]
7-951-073	Developer:Y	ENG	[0 to 255 / 255 / 1 day/step]
7-951-093	# ITB Unit	ENG	[0 to 255 / 255 / 1 day/step]
7-951-102	# ITB Cleaning Unit	ENG	[0 to 255 / 255 / 1 day/step]
7-951-109	# PTR Unit	ENG	[0 to 255 / 255 / 1 day/step]
7-951-115	# Fusing Unit	ENG	[0 to 255 / 255 / 1 day/step]
7-951-116	Fusing Belt	ENG	[0 to 255 / 255 / 1 day/step]
7-951-118	Pressure Roller	ENG	[0 to 255 / 255 / 1 day/step]

7-951-131	Dust Filter	ENG	[0 to 255 / 255 / 1 day/step]
7-951-142	Waste Toner Bottle	ENG	[0 to 255 / 255 / 1 day/step]
7-951-206	ADF Pick-up Roller	ENG	[0 to 255 / 255 / 1 day/step]
7-951-207	ADF Supply Belt	ENG	[0 to 255 / 255 / 1 day/step]
7-951-208	ADF Reverse Roller	ENG	[0 to 255 / 255 / 1 day/step]

7952	[Remain Day Counter: Distance]		
7-952-002	# PCU:K	ENG	[0 to 255 / 255 / 1 day/step]
7-952-003	# Dev Unit:K	ENG	[0 to 255 / 255 / 1 day/step]
7-952-004	Developer:K	ENG	[0 to 255 / 255 / 1 day/step]
7-952-025	# PCU:C	ENG	[0 to 255 / 255 / 1 day/step]
7-952-026	# Dev Unit:C	ENG	[0 to 255 / 255 / 1 day/step]
7-952-027	Developer:C	ENG	[0 to 255 / 255 / 1 day/step]
7-952-048	# PCU:M	ENG	[0 to 255 / 255 / 1 day/step]
7-952-049	# Dev Unit:M	ENG	[0 to 255 / 255 / 1 day/step]
7-952-050	Developer:M	ENG	[0 to 255 / 255 / 1 day/step]
7-952-071	# PCU:Y	ENG	[0 to 255 / 255 / 1 day/step]
7-952-072	# Dev Unit:Y	ENG	[0 to 255 / 255 / 1 day/step]
7-952-073	Developer:Y	ENG	[0 to 255 / 255 / 1 day/step]
7-952-093	# ITB Unit	ENG	[0 to 255 / 255 / 1 day/step]
7-952-102	# ITB Cleaning Unit	ENG	[0 to 255 / 255 / 1 day/step]
7-952-109	# PTR Unit	ENG	[0 to 255 / 255 / 1 day/step]
7-952-115	# Fusing Unit	ENG	[0 to 255 / 255 / 1 day/step]
7-952-116	Fusing Belt	ENG	[0 to 255 / 255 / 1 day/step]
7-952-118	Pressure Roller	ENG	[0 to 255 / 255 / 1 day/step]

7953	[Operation Env. Log: PCU: K]		
-------------	-------------------------------------	--	--

7-953-001	T<=0	ENG	[0 to 999999999 / 0 / 1mm/step]
7-953-002	0<T<=5:0<=H<30	ENG	[0 to 999999999 / 0 / 1mm/step]
7-953-003	0<T<=5:30<=H<70	ENG	[0 to 999999999 / 0 / 1mm/step]
7-953-004	0<T<=5:70<=H<=100	ENG	[0 to 999999999 / 0 / 1mm/step]
7-953-005	5<T<15:0<=H<30	ENG	[0 to 999999999 / 0 / 1mm/step]
7-953-006	5<T<15:30<=H<55	ENG	[0 to 999999999 / 0 / 1mm/step]
7-953-007	5<T<15:55<=H<80	ENG	[0 to 999999999 / 0 / 1mm/step]
7-953-008	5<T<15:80<=H<=100	ENG	[0 to 999999999 / 0 / 1mm/step]
7-953-009	15<=T<25:0<=H<30	ENG	[0 to 999999999 / 0 / 1mm/step]
7-953-010	15<=T<25:30<=H<55	ENG	[0 to 999999999 / 0 / 1mm/step]
7-953-011	15<=T<25:55<=H<80	ENG	[0 to 999999999 / 0 / 1mm/step]
7-953-012	15<=T<25:80<=H<=100	ENG	[0 to 999999999 / 0 / 1mm/step]
7-953-013	25<=T<30:0<=H<30	ENG	[0 to 999999999 / 0 / 1mm/step]
7-953-014	25<=T<30:30<=H<55	ENG	[0 to 999999999 / 0 / 1mm/step]
7-953-015	25<=T<30:55<=H<80	ENG	[0 to 999999999 / 0 / 1mm/step]
7-953-016	25<=T<30:80<=H<=100	ENG	[0 to 999999999 / 0 / 1mm/step]
7-953-017	30<=T:0<=H<30	ENG	[0 to 999999999 / 0 / 1mm/step]
7-953-018	30<=T:30<=H<55	ENG	[0 to 999999999 / 0 / 1mm/step]
7-953-019	30<=T:55<=H<80	ENG	[0 to 999999999 / 0 / 1mm/step]
7-953-020	30<=T:80<=H<=100	ENG	[0 to 999999999 / 0 / 1mm/step]
7-953-021	35<=T:0<=H<=100	ENG	[0 to 999999999 / 0 / 1mm/step]
7953	[Operation Env. Log Clear]		
7-953-100		ENG	[0 to 1 / 0 / 1/step]

7954	[PM Counter Display: Pages (%)]		
7-954-002	# PCU:K	ENG	[0 to 255 / 0 / 1%/step]

7-954-003	# Dev Unit:K	ENG	[0 to 255 / 0 / 1%/step]
7-954-004	Developer:K	ENG	[0 to 255 / 0 / 1%/step]
7-954-025	# PCU:C	ENG	[0 to 255 / 0 / 1%/step]
7-954-026	# Dev Unit:C	ENG	[0 to 255 / 0 / 1%/step]
7-954-027	Developer:C	ENG	[0 to 255 / 0 / 1%/step]
7-954-048	# PCU:M	ENG	[0 to 255 / 0 / 1%/step]
7-954-049	# Dev Unit:M	ENG	[0 to 255 / 0 / 1%/step]
7-954-050	Developer:M	ENG	[0 to 255 / 0 / 1%/step]
7-954-071	# PCU:Y	ENG	[0 to 255 / 0 / 1%/step]
7-954-072	# Dev Unit:Y	ENG	[0 to 255 / 0 / 1%/step]
7-954-073	Developer:Y	ENG	[0 to 255 / 0 / 1%/step]
7-954-093	# ITB Unit	ENG	[0 to 255 / 0 / 1%/step]
7-954-102	# ITB Cleaning Unit	ENG	[0 to 255 / 0 / 1%/step]
7-954-109	# PTR Unit	ENG	[0 to 255 / 0 / 1%/step]
7-954-115	# Fusing Unit	ENG	[0 to 255 / 0 / 1%/step]
7-954-116	Fusing Belt	ENG	[0 to 255 / 0 / 1%/step]
7-954-118	Pressure Roller	ENG	[0 to 255 / 0 / 1%/step]
7-954-131	Dust Filter	ENG	[0 to 255 / 0 / 1%/step]
7-954-142	Waste Toner Bottle	ENG	[0 to 255 / 0 / 1%/step]
7-954-206	ADF Pick-up Roller	ENG	[0 to 255 / 0 / 1%/step]
7-954-207	ADF Supply Belt	ENG	[0 to 255 / 0 / 1%/step]
7-954-208	ADF Reverse Roller	ENG	[0 to 255 / 0 / 1%/step]

7955	[Estimated Remain Pages]		
7-955-002	# PCU:K	ENG	[0 to 9999999 / 0 / 1 page/step]
7-955-003	# Dev Unit:K	ENG	[0 to 9999999 / 0 / 1 page/step]

7-955-004	Developer:K	ENG	[0 to 9999999 / 0 / 1 page/step]
7-955-025	# PCU:C	ENG	[0 to 9999999 / 0 / 1 page/step]
7-955-026	# Dev Unit:C	ENG	[0 to 9999999 / 0 / 1 page/step]
7-955-027	Developer:C	ENG	[0 to 9999999 / 0 / 1 page/step]
7-955-048	# PCU:M	ENG	[0 to 9999999 / 0 / 1 page/step]
7-955-049	# Dev Unit:M	ENG	[0 to 9999999 / 0 / 1 page/step]
7-955-050	Developer:M	ENG	[0 to 9999999 / 0 / 1 page/step]
7-955-071	# PCU:Y	ENG	[0 to 9999999 / 0 / 1 page/step]
7-955-072	# Dev Unit:Y	ENG	[0 to 9999999 / 0 / 1 page/step]
7-955-073	Developer:Y	ENG	[0 to 9999999 / 0 / 1 page/step]
7-955-093	# ITB Unit	ENG	[0 to 9999999 / 0 / 1 page/step]
7-955-102	# ITB Cleaning Unit	ENG	[0 to 9999999 / 0 / 1 page/step]
7-955-109	# PTR Unit	ENG	[0 to 9999999 / 0 / 1 page/step]
7-955-115	# Fusing Unit	ENG	[0 to 9999999 / 0 / 1 page/step]
7-955-116	Fusing Belt	ENG	[0 to 9999999 / 0 / 1 page/step]
7-955-118	Pressure Roller	ENG	[0 to 9999999 / 0 / 1 page/step]

7956	[Estimated Remain Days]		
7-956-002	# PCU:K	ENG	[0 to 255 / 255 / 1 day/step]
7-956-003	# Dev Unit:K	ENG	[0 to 255 / 255 / 1 day/step]
7-956-004	Developer:K	ENG	[0 to 255 / 255 / 1 day/step]
7-956-025	# PCU:C	ENG	[0 to 255 / 255 / 1 day/step]
7-956-026	# Dev Unit:C	ENG	[0 to 255 / 255 / 1 day/step]
7-956-027	Developer:C	ENG	[0 to 255 / 255 / 1 day/step]
7-956-048	# PCU:M	ENG	[0 to 255 / 255 / 1 day/step]
7-956-049	# Dev Unit:M	ENG	[0 to 255 / 255 / 1 day/step]

7-956-050	Developer:M	ENG	[0 to 255 / 255 / 1 day/step]
7-956-071	# PCU:Y	ENG	[0 to 255 / 255 / 1 day/step]
7-956-072	# Dev Unit:Y	ENG	[0 to 255 / 255 / 1 day/step]
7-956-073	Developer:Y	ENG	[0 to 255 / 255 / 1 day/step]
7-956-093	# ITB Unit	ENG	[0 to 255 / 255 / 1 day/step]
7-956-102	# ITB Cleaning Unit	ENG	[0 to 255 / 255 / 1 day/step]
7-956-109	# PTR Unit	ENG	[0 to 255 / 255 / 1 day/step]
7-956-115	# Fusing Unit	ENG	[0 to 255 / 255 / 1 day/step]
7-956-116	Fusing Belt	ENG	[0 to 255 / 255 / 1 day/step]
7-956-118	Pressure Roller	ENG	[0 to 255 / 255 / 1 day/step]
7-956-131	Dust Filter	ENG	[0 to 255 / 255 / 1 day/step]
7-956-142	Waste Toner Bottle	ENG	[0 to 255 / 255 / 1 day/step]
7-956-206	ADF Pick-up Roller	ENG	[0 to 255 / 255 / 1 day/step]
7-956-207	ADF Supply Belt	ENG	[0 to 255 / 255 / 1 day/step]
7-956-208	ADF Reverse Roller	ENG	[0 to 255 / 255 / 1 day/step]

7957	[Monthly Average Pages]		
7-957-002	# PCU:K	ENG	[0 to 9999999 / 0 / 1 page/step]
7-957-003	# Dev Unit:K	ENG	[0 to 9999999 / 0 / 1 page/step]
7-957-004	Developer:K	ENG	[0 to 9999999 / 0 / 1 page/step]
7-957-025	# PCU:C	ENG	[0 to 9999999 / 0 / 1 page/step]
7-957-026	# Dev Unit:C	ENG	[0 to 9999999 / 0 / 1 page/step]
7-957-027	Developer:C	ENG	[0 to 9999999 / 0 / 1 page/step]
7-957-048	# PCU:M	ENG	[0 to 9999999 / 0 / 1 page/step]
7-957-049	# Dev Unit:M	ENG	[0 to 9999999 / 0 / 1 page/step]
7-957-050	Developer:M	ENG	[0 to 9999999 / 0 / 1 page/step]

7-957-071	# PCU:Y	ENG	[0 to 9999999 / 0 / 1 page/step]
7-957-072	# Dev Unit:Y	ENG	[0 to 9999999 / 0 / 1 page/step]
7-957-073	Developer:Y	ENG	[0 to 9999999 / 0 / 1 page/step]
7-957-093	# ITB Unit	ENG	[0 to 9999999 / 0 / 1 page/step]
7-957-102	# ITB Cleaning Unit	ENG	[0 to 9999999 / 0 / 1 page/step]
7-957-109	# PTR Unit	ENG	[0 to 9999999 / 0 / 1 page/step]
7-957-115	# Fusing Unit	ENG	[0 to 9999999 / 0 / 1 page/step]
7-957-116	Fusing Belt	ENG	[0 to 9999999 / 0 / 1 page/step]
7-957-118	Pressure Roller	ENG	[0 to 9999999 / 0 / 1 page/step]

7958	[PM Value Setting:DaysThreshold]		
7-958-002	# PCU:K	ENG	[1 to 30 / 15 / 1 day/step]
7-958-003	# Dev Unit:K	ENG	[1 to 30 / 15 / 1 day/step]
7-958-004	Developer:K	ENG	[1 to 30 / 15 / 1 day/step]
7-958-025	# PCU:C	ENG	[1 to 30 / 15 / 1 day/step]
7-958-026	# Dev Unit:C	ENG	[1 to 30 / 15 / 1 day/step]
7-958-027	Developer:C	ENG	[1 to 30 / 15 / 1 day/step]
7-958-048	# PCU:M	ENG	[1 to 30 / 15 / 1 day/step]
7-958-049	# Dev Unit:M	ENG	[1 to 30 / 15 / 1 day/step]
7-958-050	Developer:M	ENG	[1 to 30 / 15 / 1 day/step]
7-958-071	# PCU:Y	ENG	[1 to 30 / 15 / 1 day/step]
7-958-072	# Dev Unit:Y	ENG	[1 to 30 / 15 / 1 day/step]
7-958-073	Developer:Y	ENG	[1 to 30 / 15 / 1 day/step]
7-958-093	# ITB Unit	ENG	[1 to 30 / 15 / 1 day/step]
7-958-102	# ITB Cleaning Unit	ENG	[1 to 30 / 15 / 1 day/step]
7-958-109	# PTR Unit	ENG	[1 to 30 / 15 / 1 day/step]

7-958-115	# Fusing Unit	ENG	[1 to 30 / 15 / 1 day/step]
7-958-116	Fusing Belt	ENG	[1 to 30 / 15 / 1 day/step]
7-958-118	Pressure Roller	ENG	[1 to 30 / 15 / 1 day/step]
7-958-131	Dust Filter	ENG	[1 to 30 / 15 / 1 day/step]
7-958-142	Waste Toner Bottle	ENG	[1 to 30 / 15 / 1 day/step]
7-958-206	ADF Pick-up Roller	ENG	[1 to 30 / 15 / 1 day/step]
7-958-207	ADF Supply Belt	ENG	[1 to 30 / 15 / 1 day/step]
7-958-208	ADF Reverse Roller	ENG	[1 to 30 / 15 / 1 day/step]

7959	[Fusing: Stop]		
7-959-001	Near End: Page	ENG	[0 to 999999999 / 244000 / 1 page/step]
7-959-002	End: Page	ENG	[0 to 999999999 / 248000 / 1 page/step]
7-959-003	Near End: Rotation	ENG	[0 to 999999999 / 302229000 / 1 mm/step]
7-959-004	End: Rotation	ENG	[0 to 999999999 / 313153000 / 1 mm/step]

7960	[Estimated Usage Rate]		
7-960-002	# PCU:K	ENG	[0 to 255 / 0 / 1%/step]
7-960-003	# Dev Unit:K	ENG	[0 to 255 / 0 / 1%/step]
7-960-004	Developer:K	ENG	[0 to 255 / 0 / 1%/step]
7-960-025	# PCU:C	ENG	[0 to 255 / 0 / 1%/step]
7-960-026	# Dev Unit:C	ENG	[0 to 255 / 0 / 1%/step]
7-960-027	Developer:C	ENG	[0 to 255 / 0 / 1%/step]
7-960-048	# PCU:M	ENG	[0 to 255 / 0 / 1%/step]
7-960-049	# Dev Unit:M	ENG	[0 to 255 / 0 / 1%/step]

7-960-050	Developer:M	ENG	[0 to 255 / 0 / 1%/step]
7-960-071	# PCU:Y	ENG	[0 to 255 / 0 / 1%/step]
7-960-072	# Dev Unit:Y	ENG	[0 to 255 / 0 / 1%/step]
7-960-073	Developer:Y	ENG	[0 to 255 / 0 / 1%/step]
7-960-093	# ITB Unit	ENG	[0 to 255 / 0 / 1%/step]
7-960-102	# ITB Cleaning Unit	ENG	[0 to 255 / 0 / 1%/step]
7-960-109	# PTR Unit	ENG	[0 to 255 / 0 / 1%/step]
7-960-115	# Fusing Unit	ENG	[0 to 255 / 0 / 1%/step]
7-960-116	Fusing Belt	ENG	[0 to 255 / 0 / 1%/step]
7-960-118	Pressure Roller	ENG	[0 to 255 / 0 / 1%/step]
7-960-131	Dust Filter	ENG	[0 to 255 / 0 / 1%/step]
7-960-142	Waste Toner Bottle	ENG	[0 to 255 / 0 / 1%/step]
7-960-206	ADF Pick-up Roller	ENG	[0 to 255 / 0 / 1%/step]
7-960-207	ADF Supply Belt	ENG	[0 to 255 / 0 / 1%/step]
7-960-208	ADF Reverse Roller	ENG	[0 to 255 / 0 / 1%/step]

7979	[ENG Reset Log]		
7-979-001	Data1	* ENG	[0x00 to 0xFF / 0x00 / 1/step]
7-979-002	Data2	* ENG	[0x0000 to 0xFFFF / 0x0000 / 1/step]
7-979-003	Data3	* ENG	[0x0000 to 0xFFFF / 0x0000 / 1/step]
7-979-004	Data4	* ENG	[0x0000 to 0xFFFF / 0x0000 / 1/step]
7-979-005	Data5	* ENG	[0x0000 to 0xFFFF / 0x0000 / 1/step]
7-979-006	Data6	* ENG	[0x0000 to 0xFFFF / 0x0000 / 1/step]
7-979-007	Data7	* ENG	[0x0000 to 0xFFFF / 0x0000 / 1/step]
7-979-008	Data8	* ENG	[0x0000 to 0xFFFF / 0x0000 / 1/step]
7-979-009	Data9	* ENG	[0x0000 to 0xFFFF / 0x0000 / 1/step]

7-979-010	Data10	* ENG	[0x0000 to 0xFFFF / 0x0000 / 1/step]
7-979-011	Data11	* ENG	[0x0000 to 0xFFFF / 0x0000 / 1/step]
7-979-012	Data12	* ENG	[0x0000 to 0xFFFF / 0x0000 / 1/step]
7-979-013	Data13	* ENG	[0x0000 to 0xFFFF / 0x0000 / 1/step]
7-979-014	Data14	* ENG	[0x0000 to 0xFFFF / 0x0000 / 1/step]
7-979-015	Data15	* ENG	[0x0000 to 0xFFFF / 0x0000 / 1/step]
7-979-016	Data16	* ENG	[0x0000 to 0xFFFF / 0x0000 / 1/step]
7-979-017	Data17	* ENG	[0x0000 to 0xFFFF / 0x0000 / 1/step]
7-979-018	Data18	* ENG	[0x0000 to 0xFFFF / 0x0000 / 1/step]
7-979-019	Data19	* ENG	[0x0000 to 0xFFFF / 0x0000 / 1/step]
7-979-020	Data20	* ENG	[0x0000 to 0xFFFF / 0x0000 / 1/step]
7-979-021	Data21	* ENG	[0x0000 to 0xFFFF / 0x0000 / 1/step]

7980	[Current for Torque Calculation]		
7-980-001	OPCTransferMotor	* ENG	[0 to 9.999 / 0 / 0.001A/step]
7-980-002	BkDevMotor	* ENG	[0 to 9.999 / 0 / 0.001A/step]
7-980-003	ColorOpcMotor	* ENG	[0 to 9.999 / 0 / 0.001A/step]
7-980-004	ColorDevMotor	* ENG	[0 to 9.999 / 0 / 0.001A/step]
7-980-005	FusingMotor	* ENG	[0 to 9.999 / 0 / 0.001A/step]

7981	[Edict:OffsetValueForTorqCalcu]		
7-981-001	ManualExe	ENG	[0 or 1 / 0 / 1/step]

7982	[OffsetValueForTorqCalculation]		
7-982-001	OPCTransferMotor	* ENG	[0 to 655.35 / 0 / 0.01/step]
7-982-002	BkDevMotor	* ENG	[0 to 655.35 / 0 / 0.01/step]
7-982-003	ColorOpcMotor	* ENG	[0 to 655.35 / 0 / 0.01/step]

7-982-004	ColorDevMotor	*ENG	[0 to 655.35 / 0 / 0.01/step]
7-982-005	FusingMotor	*ENG	[0 to 655.35 / 0 / 0.01/step]

7983	[OutputLevel1CountNo.]		
7-983-001	OPCTransferMotor	*ENG	[0 to 65535 / 0 / 1count/step]
7-983-002	BkDevMotor	*ENG	[0 to 65535 / 0 / 1count/step]
7-983-003	ColorOpcMotor	*ENG	[0 to 65535 / 0 / 1count/step]
7-983-004	ColorDevMotor	*ENG	[0 to 65535 / 0 / 1count/step]
7-983-005	FusingMotor	*ENG	[0 to 65535 / 0 / 1count/step]

7984	[OutputLevel2CountNo.]		
7-984-001	OPCTransferMotor	*ENG	[0 to 65535 / 0 / 1count/step]
7-984-002	BkDevMotor	*ENG	[0 to 65535 / 0 / 1count/step]
7-984-003	ColorOpcMotor	*ENG	[0 to 65535 / 0 / 1count/step]
7-984-004	ColorDevMotor	*ENG	[0 to 65535 / 0 / 1count/step]
7-984-005	FusingMotor	*ENG	[0 to 65535 / 0 / 1count/step]

7985	[OutputLevel3CountNo.]		
7-985-001	OPCTransferMotor	*ENG	[0 to 65535 / 0 / 1count/step]
7-985-002	BkDevMotor	*ENG	[0 to 65535 / 0 / 1count/step]
7-985-003	ColorOpcMotor	*ENG	[0 to 65535 / 0 / 1count/step]
7-985-004	ColorDevMotor	*ENG	[0 to 65535 / 0 / 1count/step]
7-985-005	FusingMotor	*ENG	[0 to 65535 / 0 / 1count/step]

7986	[VelocityErr.CountNo.]		
7-986-001	OPCTransferMotor	*ENG	[0 to 65535 / 0 / 1count/step]
7-986-002	BkDevMotor	*ENG	[0 to 65535 / 0 / 1count/step]

7-986-003	ColorOpcMotor	*ENG	[0 to 65535 / 0 / 1 count/step]
7-986-004	ColorDevMotor	*ENG	[0 to 65535 / 0 / 1 count/step]
7-986-005	FusingMotor	*ENG	[0 to 65535 / 0 / 1 count/step]

Input and Output Check

Input Check Table

Main Machine, Paper Feed Tray

3

5803	[INPUT Check]		
5-803-001	Registration Sensor	ENG	[0 or 1 / 0 / 1/step] 0: paper exist 1: paper non exist
	Responds to paper existence on register sensor position. (0: paper exist, 1: paper non exist)		
5-803-002	Paper Feed Sensor 1 This setting is not available for MP C2004/MP C2504.	ENG	[0 or 1 / 0 / 1/step] 0: paper exist 1: paper non exist
	Responds to paper existence on 1st paper feed sensor position. (0: paper exist, 1: paper non exist)		
5-803-003	Transport Sensor 1	ENG	[0 or 1 / 0 / 1/step] 0: paper exist 1: paper non exist
	Responds to paper existence on 1st carry sensor position. (0: paper exist, 1: paper non exist)		
5-803-004	Paper Feed Sensor 2 This setting is not available for MP C2004/MP C2504.	ENG	[0 or 1 / 0 / 1/step] 0: paper exist 1: paper non exist
	Responds to paper existence on 2nd paper feed sensor position. (0: paper exist, 1: paper non exist)		

5-803-005	Transport Sensor 2	ENG	[0 or 1 / 0 / 1/step] 0: paper exist 1: paper non exist
	Responds to paper existence on 2nd carry sensor position. (0: paper exist, 1: paper non exist)		
5-803-006	Fusing Entrance Sensor	ENG	[0 or 1 / 0 / 1/step] 0: paper exist 1: paper non exist
	Responds to paper existence on fusing entrance sensor position. (0: paper exist, 1: paper non exist)		
5-803-007	Fusing Exit Sensor	ENG	[0 or 1 / 0 / 1/step] 0: paper exist 1: paper non exist
	Responds to paper existence on fusing exit sensor position. (0: paper exist, 1: paper non exist)		
5-803-008	Paper Exit Sensor	ENG	[0 or 1 / 0 / 1/step] 0: paper exist 1: paper non exist
	Responds to paper existence on paper exit sensor position. (0: paper exist, 1: paper non exist)		
5-803-009	Inverter Sensor	ENG	[0 or 1 / 0 / 1/step] 0: paper exist 1: paper non exist
	Responds to paper existence on reverse sensor position. (0: paper exist, 1: paper non exist)		
5-803-010	Duplex Exit Sensor	ENG	[0 or 1 / 0 / 1/step] 0: paper exist 1: paper non exist
	Responds to paper existence on duplex exit sensor position. (0: paper exist, 1: paper non exist)		

5-803-011	Duplex Entrance Sensor	ENG	[0 or 1 / 0 / 1/step] 0: paper exist 1: paper non exist
	Responds to paper existence on duplex entrance sensor position. (0: paper exist, 1: paper non exist)		
5-803-012	Tray Full Exit Sensor This setting is not available for MP C2004/MP C2504.	ENG	[0 or 1 / 0 / 1/step] 0: Not full 1: full
	Detects paper full of main unit paper exit tray. (0: Not full, 1: full)		
5-803-013	Tray 1: Paper Height Sensor	ENG	[0 to 3 / 0 / 1/step] When full is 100%, 11: 71 to 100% 01: 31 to 70% 00: 11 to 30% 10: 1 to 10%
	Detects remaining paper amount of 1st paper feed tray. (When full is 100%, 11: 71 to 100%, 01: 31 to 70%, 00: 11 to 30%, 10: 1 to 10%) *Check SP5-803-015 for paper end.		
5-803-014	Tray 1: Upper Limit Sensor	ENG	[0 or 1 / 0 / 1/step] 0: less then limit 1: high then limit
	Detects the height of paper loaded in 1st paper feed tray. (0: less then limit, 1: high then limit) * As long as you do not press the white bar of the machine side in the tray back, not output.		

5-803-015	Tray 1: Paper End Detection	ENG	[0 or 1 / 0 / 1/step] 0: No paper 1: paper remaining
	Detects paper is running out on 1st paper feed tray. (0: No paper, 1: paper remaining)		
5-803-016	Tray 1: Set Sensor	ENG	[0 or 1 / 0 / 1/step] 0: set 1: not set
	Detects that 1st paper feed tray is set to main unit. (0: set, 1: not set)		
5-803-017	Tray 2: Paper Height Sensor	ENG	[0 to 3 / 0 / 1/step] When full is 100%, 11: 71 to 100% 01: 31 to 70% 00: 11 to 30% 10: 1 to 10%
	Detects remaining paper amount of 2nd paper feed tray. (When full is 100%, 11: 71 to 100%, 01: 31 to 70%, 00: 11 to 30%, 10: 1 to 10%) *Check SP5-803-019 for paper end.		
5-803-018	Tray 2: Paper End Sensor	ENG	[0 or 1 / 0 / 1/step] 0: less then limit 1: high then limit
	Detects the height of paper loaded in 2nd paper feed tray. (0: less then limit, 1: high then limit) * As long as you do not press the white bar of the machine side in the tray back, not output.		

5-803-019	Tray 2: Paper End Detection	ENG	[0 or 1 / 0 / 1/step] 0: No paper 1: paper remaining
	Detects paper running out of 2nd paper feed tray. (0: No paper, 1: paper remaining)		
5-803-020	Tray 2: Set Sensor	ENG	[0 or 1 / 0 / 1/step] 0: set 1: not set
	Detects that 2nd paper feed tray is set to main unit. (0: set, 1: not set)		
5-803-021	Tray 2: Size Sensor	ENG	[0 to 15 / 0 / 1/step]
	Value changes depending on paper size (fence position) set to 2nd paper feed tray.		
5-803-022	By-pass: Paper End Sensor	ENG	[0 or 1 / 0 / 1/step] 0: No paper 1: paper remaining
	Detects paper is running out on bypass tray. (0: No paper, 1: paper remaining)		
5-803-023	By-pass: Main Scan Length Sensor	ENG	[0 to 31 / 0 / 1/step]
	Value changes depending on main scan direction of paper set to bypass tray.		
5-803-024	By-pass: Sub Scan Length Sensor	ENG	[0 or 1 / 0 / 1/step]
	Value changes depending on sub scan direction of paper set to bypass tray.		
5-803-025	Interlock Release Detection	ENG	[0 to 1 / 0 / 1/step] 00: Unlocked 11: Locked
	Detects open/close of interlock switch (front cover/right cover). (00: Unlocked, 11: Locked)		

5-803-026	Right Door Open/Close Sensor	ENG	[0 or 1 / 0 / 1/step] 0: close 1: open
	Detects right door status. (0: close, 1: open)		
5-803-027	Duplex Guide Plate Open/Close Sensor	ENG	[0 or 1 / 0 / 1/step] 0: close 1: open
	Detects duplex guide plate status. (0: close, 1: open)		
5-803-028	PTR Open/Close Sensor	ENG	[0 or 1 / 0 / 1/step] 0: open 1: close
	Detects paper transfer unit status. (0: open, 1: close)		
5-803-029	ITB Contact Sensor	ENG	[0 or 1 / 0 / 1/step] 0: Abutting 1: Alienate
	Detects image transfer roller (Y, M, and C) and photoreceptors distance. (0: Abutting, 1: Alienate)		
5-803-030	PTR Contact Sensor	ENG	[0 or 1 / 0 / 1/step] 0: Abutting 1: Alienate
	Detects image transfer belt and paper transfer rollers distance. (0: Abutting, 1: Alienate)		
5-803-031	New ITB Unit Detection	ENG	[0 or 1 / 0 / 1/step]
	Not available with C1		

5-803-032	Toner Collection Full Sensor	ENG	[0 or 1 / 0 / 1/step] 0: Not full 1: full
	Detects full of waste toner bottle. (0: Not full, 1: full)		
5-803-033	Toner Collection Bottle Set Sensor	ENG	[0 or 1 / 0 / 1/step] 0: set 1: not set
	Detects that waste toner bottle is set to main unit. (0: set, 1: not set)		
5-803-034	Toner End Sensor:Y	ENG	[0 or 1 / 0 / 1/step] 0: End 1: Not End
	Detects remaining toner amount. *Power with SP5-804-173 before checking. (0: End, 1: Not End)		
5-803-035	Toner End Sensor:M	ENG	[0 or 1 / 0 / 1/step] 0: End 1: Not End
	Detects remaining toner amount. *Power with SP5-804-173 before checking. (0: End, 1: Not End)		
5-803-036	Toner End Sensor:C	ENG	[0 or 1 / 0 / 1/step] 0: End 1: Not End
	Detects remaining toner amount. *Power with SP5-804-173 before checking. (0: End, 1: Not End)		

5-803-037	Toner End Sensor:K	ENG	[0 or 1 / 0 / 1/step] 0: End 1: Not End
	Detects remaining toner amount. *Power with SP5-804-172 before checking. (0: End, 1: Not End)		
5-803-038	Fusing:Area Detection	ENG	[0 to 15 / 0 / 1/step] 01:200V system 10:100V System 00, 01:unit set error
	Detects region of fusing unit. (0111: 200V system, 1011: 100V System)		
5-803-039	Fusing:New Unit Detection	ENG	[0 or 1 / 0 / 1/step] 0: New 1: Old
	Detects New/Old of fusing unit. (0: New, 1: Old)		
5-803-040	Fusing Temp Detect	ENG	[0 or 1 / 0 / 1/step] 0: Normal 1: High temperature
	Detects whether high temperature is detected from fusing unit. (0: Normal, 1: High temperature)		
5-803-041	NC Sensor Temp Detection/ 2	ENG	[0 or 1 / 0 / 1/step] 0: Normal 1: High temperature
	Detects whether high temperature is detected from fusing unit. (0: Normal, 1: High temperature)		

5-803-042	NC Sensor Temp Detection/ 1	ENG	[0 or 1 / 0 / 1/step] 0: Normal 1: High temperature
	Detects whether high temperature is detected from fusing unit. (0: Normal, 1: High temperature)		
5-803-047	Nip Pres. Release Home Position Sensor	ENG	[0 or 1 / 0 / 1/step] 0: Pressured 1: Not pressured
	Detects state of fusing nip pressure. (0: Pressured , 1: Not pressured)		
5-803-048	Fusing Fan: Lock	ENG	[0 or 1 / 0 / 1/step] 0: Running 1: Stopped, or locked
	Detects locking of fusing exhaust heat fan. (0: Running, 1: Stopped, or locked)		
5-803-049	Dev Fan: Right: Lock	ENG	[0 or 1 / 0 / 1/step] 0: Running 1: Stopped, or locked
	Detects locking of developer air intake fan (right). (0: Running, 1: Stopped, or locked)		
5-803-051	PSU Cooling Fan: Lock	ENG	[0 or 1 / 0 / 1/step] 0: Running 1: Stopped, or locked
	Detects locking of PSU cooling fan. (0: Running, 1: Stopped, or locked)		
5-803-052	Ozone Fan: Lock	ENG	[0 or 1 / 0 / 1/step] 0: Running 1: Stopped, or locked
	Detects locking of ozone exhaust air fan. (0: Running, 1: Stopped, or locked)		

5-803-054	PSU Fan: Lock	ENG	[0 or 1 / 0 / 1/step] 0: Running 1: Stopped, or locked
	Detects locking of PSU exhaust heat fan. (0: Running, 1: Stopped, or locked)		
5-803-055	PCB Box Cooling Fan: Lock	ENG	[0 or 1 / 0 / 1/step] 0: Running 1: Stopped, or locked
	Detects locking of electric box cooling fan. (0: Running, 1: Stopped, or locked)		
5-803-058	Paper Exit Cooling Fan: Lock	ENG	[0 or 1 / 0 / 1/step] 0: Running 1: Stopped, or locked
	Detects locking of paper exit cooling fan. (0: Running, 1: Stopped, or locked)		
5-803-060	Toner Supply Cooling Fan: Lock	ENG	[0 or 1 / 0 / 1/step] 0: Running 1: Stopped, or locked
	Detects locking of toner supply cooling fan. (0: Running, 1: Stopped, or locked)		
5-803-063	Development Motor FC: Lock	ENG	[0 or 1 / 0 / 1/step] 0: Stopped, or locked 1: Running
	Detects locking of developer motor (FC). (0: Running, 1: Stopped, or locked)		
5-803-064	Drum Motor FC: Lock	ENG	[0 or 1 / 0 / 1/step] 0: Stopped, or locked 1: Running
	Detects locking of drum motor (FC). (0: Running, 1: Stopped, or locked)		

5-803-065	Fusing Motor: Lock	ENG	[0 or 1 / 0 / 1/step] 0: Stopped, or locked 1: Running
	Detects locking of fusing motor. (0: Running, 1: Stopped, or locked)		
5-803-066	Transfer Drum Motor K: Lock	ENG	[0 or 1 / 0 / 1/step] 0: Stopped, or locked 1: Running
	Detects locking of transfer drum motor K. (0: Running, 1: Stopped, or locked)		
5-803-068	PP:CB:SC Detection	ENG	[0 or 1 / 0 / 1/step] 0: SC detected 1: Normal
	Detects SC of HVP (electrify/develop). (0: SC detected, 1: Normal)		
5-803-069	PP:TTS:SC Detection	ENG	[0 or 1 / 0 / 1/step] 0: SC detected 1: Normal
	Detects SC of HVP (transfer). (0: SC detected, 1: Normal)		
5-803-072	Key Counter: Set 1	ENG	[0 or 1 / 0 / 1/step] 0: set 1:unset
	Detects setting of key counter. (0: set, 1:unset) (key counter: set 1=0, 2=1 for set, others for unset)		

5-803-073	Key Counter: Set 2	ENG	[0 or 1 / 0 / 1/step] 0: unset 1:set
	Detects setting of key counter. (0: unset, 1:set) (key counter: set 1=0, 2=1 for set, others for unset)		
5-803-074	Key Card Set	ENG	[0 or 1 / 0 / 1/step] 0: set 1: not set
	Detects that key card is set to main unit. (0: set, 1:not set)		
5-803-075	1 Bin Tray: Paper Sensor	ENG	[0 or 1 / 0 / 1/step] 0: paper exist 1: paper non exist
	Detects that paper is left upon the tray. (0: paper exist, 1: paper non exist)		
5-803-076	1 Bin Tray: Set Detection System	ENG	[0 or 1 / 0 / 1/step] 0: paper exist 1: paper non exist
	Detects that tray is set to main unit. (0: set, 1:not set)		
5-803-077	Bridge Relay Sensor	ENG	[0 or 1 / 0 / 1/step] 0: paper exist 1: paper non exist
	Responds to paper existence on carry sensor position or bridge unit. (0: paper exist, 1: paper non exist)		

5-803-078	Bridge Exit Sensor	ENG	[0 or 1 / 0 / 1/step] 0: Paper exist 1: Paper do not exist
	Responds to paper existence on paper exit sensor position or bridge unit. (0: paper exist, 1: paper non exist)		
5-803-079	Bridge Set Detection System	ENG	[0 or 1 / 0 / 1/step] 10: set 11: not set
	Detects that bridge unit is set to main unit. (10: set, 11: not set)		
5-803-082	Bridge Relay/Left Exit Cover Sensor	ENG	[0 or 1 / 0 / 1/step] 0: close 1: open
	Detects open/close of the left carry cover open/close sensor (left paper exit tray) and the relay carry cover open/close sensor (bridge unit). (0: close, 1: open)		
5-803-083	Bridge Exit/Upper Exit Cover Sensor	ENG	[0 or 1 / 0 / 1/step] 0: close 1: open
	Detects open/close of the upper carry cover open/close sensor (left paper exit tray) and the relay paper exit cover open/close sensor (bridge unit). (0: close, 1: open)		
5-803-084	Shift Tray: Set Detection System	ENG	[0 or 1 / 0 / 1/step] 01: set 11: not set
	Detects that shift tray is set to main unit. (01: set, 11: not set)		

5-803-085	Shift Tray: Position Sensor 1	ENG	[0 or 1 / 0 / 1/step] 0: Stop on this side. during moving towards inner 1: Stop on inner side. during moving towards this side
	Detects shift tray position. (0: Stop on this side. during moving towards inner, 1: Stop on inner side. during moving towards this side)		
5-803-086	Shift Tray: Position Sensor 2	ENG	[0 or 1 / 0 / 1/step]
	* It is a backup sensor with this machine, so "1" is always displayed)		
5-803-094	GAVD Open/Close Detection	ENG	[0 or 1 / 0 / 1/step]
	For checking door open/close during process. No need to operate.		
5-803-095	Bridge 24V Fuse Detection	ENG	[0 or 1 / 0 / 1/step] 0: Not cut 1: Cut
	Detects state of 24V fuse on the bridge unit. (0: Not cut, 1: Cut)		
5-803-096	Bridge 5V Fuse Detection	ENG	[0 or 1 / 0 / 1/step] 0: Not cut 1: Cut
	Detects state of 5V fuse on the bridge unit. (0: Not cut, 1: Cut)		
5-803-200	HP Sensor	ENG	[0 or 1 / 0 / 1/step]
	Tests the scanner HP sensor.		
5-803-201	Platen Cover Sensor	ENG	[0 or 1 / 0 / 1/step]
	Tests the book open/close sensor.		
5803	[INPUT Check]		
	Gets information of specified sensor.		

5-803-211	Bank: Tray3: Feed Sensor	ENG	[0 or 1 / 0 / 1/step]
5-803-212	Bank: Tray4: Feed Sensor	ENG	0: paper not detected 1: paper detected.
5-803-213	Bank: Tray5: Feed Sensor	ENG	
5-803-214	Bank: Tray3: Transport Sensor	ENG	
5-803-215	Bank: Tray4: Transport Sensor	ENG	
5-803-216	Bank: Tray5: Transport Sensor	ENG	
5-803-217	Bank: Feed Cover Open Detection 1	ENG	[0 or 1 / 0 / 1/step]
5-803-218	Bank: Feed Cover Open Detection 2	ENG	0: cover open 1: cover closed
5-803-219	LCT Paper Supply Open/Close	ENG	
5-803-220	LCT Slide Open/Close	ENG	[0 or 1 / 0 / 1/step] 0: slide open 1: slide closed

ADF

6007	[ADF INPUT Check]		
	Gets sensor information from ADF. Displays signal level of sensor as it is.		
6-007-001	Original Length 1 (B5 Detection Sensor)	ENG	[0 or 1 / 0 / 1/step]
6-007-002	Original Length 2 (A4 Detection Sensor)	ENG	[0 or 1 / 0 / 1/step]
6-007-003	Original Length 3 (LG Detection Sensor)	ENG	[0 or 1 / 0 / 1/step]
6-007-004	Original Width 1	ENG	[0 or 1 / 0 / 1/step]
6-007-005	Original Width 2	ENG	[0 or 1 / 0 / 1/step]
6-007-006	Original Width 3	ENG	[0 or 1 / 0 / 1/step]
6-007-007	Original Width 4	ENG	[0 or 1 / 0 / 1/step]

6-007-008	Original Width 5	ENG	[0 or 1 / 0 / 1/step]
6-007-009	Original Detection	ENG	[0 or 1 / 0 / 1/step]
6-007-011	Skew Correction	ENG	[0 or 1 / 0 / 1/step]
6-007-013	Registration Sensor	ENG	[0 or 1 / 0 / 1/step]
6-007-014	Exit Sensor	ENG	[0 or 1 / 0 / 1/step]
6-007-015	Feed Cover Sensor	ENG	[0 or 1 / 0 / 1/step]
6-007-016	Lift Up Sensor	ENG	[0 or 1 / 0 / 1/step]
6-007-023	Rear Edge Detection	ENG	[0 or 1 / 0 / 1/step]

6011	[1-Pass ADF INPUT Check]		
	For Single-Pass simultaneous duplex models only.		
6-011-001	Original Length 1 (B5 Sensor)	ENG	[0 or 1 / 0 / 1/step]
	Gets sensor information from ADF. Gives 1 when there is a paper at sensor area.		
6-011-002	Original Length 2 (A4 Sensor)	ENG	[0 or 1 / 0 / 1/step]
	Gets sensor information from ADF. Gives 1 when there is a paper at sensor area.		
6-011-003	Original Length 3 (LG Sensor)	ENG	[0 or 1 / 0 / 1/step]
	Gets sensor information from ADF. Gives 1 when there is a paper at sensor area.		
6-011-004	Original Width 1	ENG	[0 or 1 / 0 / 1/step]
	Gets sensor information from ADF. Gives 1 when there is a paper at sensor area.		
6-011-005	Original Width 2	ENG	[0 or 1 / 0 / 1/step]
	Gets sensor information from ADF. Gives 1 when there is a paper at sensor area.		
6-011-006	Original Width 3	ENG	[0 or 1 / 0 / 1/step]
	Gets sensor information from ADF. Gives 1 when there is a paper at sensor area.		
6-011-007	Original Width 4	ENG	[0 or 1 / 0 / 1/step]
	Gets sensor information from ADF. Gives 1 when there is a paper at sensor area.		

6-011-008	Original Width 5	ENG	[0 or 1 / 0 / 1/step]
	Gets sensor information from ADF. Gives 1 when there is a paper at sensor area.		
6-011-009	Original Detection	ENG	[0 or 1 / 0 / 1/step]
	Gets sensor information from ADF. Gives 1 when original is set.		
6-011-010	Separation Sensor	ENG	[0 or 1 / 0 / 1/step]
	Gets sensor information from ADF. Gives 1 when there is a paper at sensor area.		
6-011-011	Skew Correction	ENG	[0 or 1 / 0 / 1/step]
	Gets sensor information from ADF. Gives 1 when there is a paper at sensor area.		
6-011-012	Scan Entrance Sensor	ENG	[0 or 1 / 0 / 1/step]
	Gets sensor information from ADF. Gives 1 when there is a paper at sensor area.		
6-011-013	Registration Sensor	ENG	[0 or 1 / 0 / 1/step]
	Gets sensor information from ADF. Gives 1 when there is a paper at sensor area.		
6-011-014	Exit Sensor	ENG	[0 or 1 / 0 / 1/step]
	Gets sensor information from ADF. Gives 1 when there is a paper at sensor area.		
6-011-015	Feed Cover Sensor	ENG	[0 or 1 / 0 / 1/step]
	Gets sensor information from ADF. Gives 1 when cover is open.		
6-011-016	Lift Up Sensor	ENG	[0 or 1 / 0 / 1/step]
	Gets sensor information from ADF. Gives 1 when lift up.		
6-011-018	Pick-Up Roller HP Sensor	ENG	[0 or 1 / 0 / 1/step]
	Gets sensor information from ADF. Gives 1 when pick up roller is not in home position.		
6-011-021	Bottom Plate HP Sensor	ENG	[0 or 1 / 0 / 1/step]
	Gets sensor information from ADF. Gives 1 when bottom plate is not in home position.		
6-011-022	Bottom Plate Position Sensor	ENG	[0 or 1 / 0 / 1/step]
	Gets sensor information from ADF. Gives 1 when pick up roller is not in the correct position.		

6-011-023	Original Length 4 (LT/A4 Tail Sensor)	ENG	[0 or 1 / 0 / 1/step]
Gets sensor information from ADF. Gives 1 when there is a paper at sensor area.			

Finisher

6123	[INPUT Check: 2K/3K FIN]		
6-123-001	Entrance Sensor	ENG	[0 or 1 / 0 / 1/step]
Gets information of specified sensor. Displays signal level of sensor as it is.			
6-123-002	Horizontal Transport Sensor	ENG	[0 or 1 / 0 / 1/step]
Gets information of specified sensor. Displays signal level of sensor as it is.			
6-123-003	Switchback Transport Sensor	ENG	[0 or 1 / 0 / 1/step]
Gets information of specified sensor. Displays signal level of sensor as it is.			
6-123-004	Proof Tray Exit Sensor	ENG	[0 or 1 / 0 / 1/step]
Gets information of specified sensor. Displays signal level of sensor as it is.			
6-123-005	Shift Tray Exit Sensor	ENG	[0 or 1 / 0 / 1/step]
Gets information of specified sensor. Displays signal level of sensor as it is.			
6-123-006	Booklet Stapler Exit Sensor	ENG	[0 or 1 / 0 / 1/step]
Gets information of specified sensor. Displays signal level of sensor as it is.			
6-123-007	Paper Exit Open/Close Guide HP Sensor	ENG	[0 or 1 / 0 / 1/step]
Gets information of specified sensor. Displays signal level of sensor as it is.			
6-123-008	Punch HP Sensor	ENG	[0 or 1 / 0 / 1/step]
Gets information of specified sensor. Displays signal level of sensor as it is.			
6-123-009	Punch Move HP Sensor	ENG	[0 or 1 / 0 / 1/step]
Gets information of specified sensor. Displays signal level of sensor as it is.			

6-123-010	S-to-S Registration Detection HP Sensor	ENG	[0 or 1 / 0 / 1/step]
	Gets information of specified sensor. Displays signal level of sensor as it is.		
6-123-011	Lower Junction Solenoid HP Sensor	ENG	[0 or 1 / 0 / 1/step]
	Gets information of specified sensor. Displays signal level of sensor as it is.		
6-123-012	Jogger HP Sensor	ENG	[0 or 1 / 0 / 1/step]
	Gets information of specified sensor. Displays signal level of sensor as it is.		
6-123-013	Positioning Roller HP Sensor	ENG	[0 or 1 / 0 / 1/step]
	Gets information of specified sensor. Displays signal level of sensor as it is.		
6-123-014	Feed-out HP Sensor	ENG	[0 or 1 / 0 / 1/step]
	Gets information of specified sensor. Displays signal level of sensor as it is.		
6-123-015	Stapler Moving HP Sensor	ENG	[0 or 1 / 0 / 1/step]
	Gets information of specified sensor. Displays signal level of sensor as it is.		
6-123-016	Booklet Stapler HP Sensor	ENG	[0 or 1 / 0 / 1/step]
	Gets information of specified sensor. Displays signal level of sensor as it is.		
6-123-017	Booklet Jogger HP Sensor	ENG	[0 or 1 / 0 / 1/step]
	Gets information of specified sensor. Displays signal level of sensor as it is.		
6-123-018	Booklet Jog Solenoid HP Sensor	ENG	[0 or 1 / 0 / 1/step]
	Gets information of specified sensor. Displays signal level of sensor as it is.		
6-123-019	Booklet Standard Fence HP Sensor	ENG	[0 or 1 / 0 / 1/step]
	Gets information of specified sensor. Displays signal level of sensor as it is.		
6-123-020	Booklet Stapler HP Sensor	ENG	[0 or 1 / 0 / 1/step]
	Gets information of specified sensor. Displays signal level of sensor as it is.		
6-123-022	Folder Blade Cam HP Sensor	ENG	[0 or 1 / 0 / 1/step]
	Gets information of specified sensor. Displays signal level of sensor as it is.		

6-123-023	Folder Blade HP Sensor	ENG	[0 or 1 / 0 / 1/step]
	Gets information of specified sensor. Displays signal level of sensor as it is.		
6-123-024	Shift Roller HP Sensor	ENG	[0 or 1 / 0 / 1/step]
	Gets information of specified sensor. Displays signal level of sensor as it is.		
6-123-028	Drag Roller Vibrating HP Sensor	ENG	[0 or 1 / 0 / 1/step]
	Gets information of specified sensor. Displays signal level of sensor as it is.		
6-123-029	LE Guide HP Sensor	ENG	[0 or 1 / 0 / 1/step]
	Gets information of specified sensor. Displays signal level of sensor as it is.		
6-123-030	TE Stack Plate HP Sensor	ENG	[0 or 1 / 0 / 1/step]
	Gets information of specified sensor. Displays signal level of sensor as it is.		
6-123-031	Staple Tray Paper Sensor	ENG	[0 or 1 / 0 / 1/step]
	Gets information of specified sensor. Displays signal level of sensor as it is.		
6-123-032	ITB Paper Sensor	ENG	[0 or 1 / 0 / 1/step]
	Gets information of specified sensor. Displays signal level of sensor as it is.		
6-123-033	Booklet Stapler Transport Paper Sn: Upper	ENG	[0 or 1 / 0 / 1/step]
	Gets information of specified sensor. Displays signal level of sensor as it is.		
6-123-034	Booklet Stapler Transport Paper Sn: Lower	ENG	[0 or 1 / 0 / 1/step]
	Gets information of specified sensor. Displays signal level of sensor as it is.		
6-123-035	Paper Height Sensor: Shift	ENG	[0 or 1 / 0 / 1/step]
	Gets information of specified sensor. Displays signal level of sensor as it is.		
6-123-036	Corner Stapler Paper Height Sensor 1	ENG	[0 or 1 / 0 / 1/step]
	Gets information of specified sensor. Displays signal level of sensor as it is.		

6-123-037	Corner Stapler Paper Height Sensor 2	ENG	[0 or 1 / 0 / 1/step]
	Gets information of specified sensor. Displays signal level of sensor as it is.		
6-123-038	Proof Tray Full Sensor	ENG	[0 or 1 / 0 / 1/step]
	Gets information of specified sensor. Displays signal level of sensor as it is.		
6-123-039	Booklet Stapler Full Sensor 1	ENG	[0 or 1 / 0 / 1/step]
	Gets information of specified sensor. Displays signal level of sensor as it is.		
6-123-040	Booklet Stapler Full Sensor 2	ENG	[0 or 1 / 0 / 1/step]
	Gets information of specified sensor. Displays signal level of sensor as it is.		
6-123-041	S-to-S Registration Detection Sensor	ENG	[0 or 1 / 0 / 1/step]
	Gets information of specified sensor. Displays signal level of sensor as it is.		
6-123-042	Punch RPS Sensor	ENG	[0 or 1 / 0 / 1/step]
	Gets information of specified sensor. Displays signal level of sensor as it is.		
6-123-043	Corner Stapler Leading Edge Detection Sensor	ENG	[0 or 1 / 0 / 1/step]
	Gets information of specified sensor. Displays signal level of sensor as it is.		
6-123-044	Corner Stapler Staple End Sensor	ENG	[0 or 1 / 0 / 1/step]
	Gets information of specified sensor. Displays signal level of sensor as it is.		
6-123-045	Booklet Stapler Staple End Sensor: Front	ENG	[0 or 1 / 0 / 1/step]
	Gets information of specified sensor. Displays signal level of sensor as it is.		
6-123-046	Booklet Stapler Staple End Sensor: Rear	ENG	[0 or 1 / 0 / 1/step]
	Gets information of specified sensor. Displays signal level of sensor as it is.		
6-123-047	Shift Tray Lower Limit Sensor 1	ENG	[0 or 1 / 0 / 1/step]
	Gets information of specified sensor. Displays signal level of sensor as it is.		

6-123-048	Shift Tray Lower Limit Sensor 2	ENG	[0 or 1 / 0 / 1/step]
	Gets information of specified sensor. Displays signal level of sensor as it is.		
6-123-049	Shift Tray Lower Limit Sensor 3	ENG	[0 or 1 / 0 / 1/step]
	Gets information of specified sensor. Displays signal level of sensor as it is.		
6-123-050	Shift Tray Lower Limit Sensor 4	ENG	[0 or 1 / 0 / 1/step]
	Gets information of specified sensor. Displays signal level of sensor as it is.		
6-123-051	Shift Tray Lower Limit Sensor 5	ENG	[0 or 1 / 0 / 1/step]
	Gets information of specified sensor. Displays signal level of sensor as it is.		
6-123-052	Punch Chad Full Sensor	ENG	[0 or 1 / 0 / 1/step]
	Gets information of specified sensor. Displays signal level of sensor as it is.		
6-123-053	Punch Set Detection	ENG	[0 or 1 / 0 / 1/step] 0: connected 1: not connected
	Gets connection status of punch unit.		
6-123-054	Shift Jogger Set Detection	ENG	[0 or 1 / 0 / 1/step] 0: connected 1: not connected
	Gets connection status of setting jogger unit. * Not use: currently, VOLGA-B does not have setting jogger in system configuration.		
6-123-055	Booklet Stapler Set Detection	ENG	[0 or 1 / 0 / 1/step] 0: not connected 1: connected
	Gets connection status of saddle stitch unit.		
6-123-056	Front Door SW	ENG	[0 or 1 / 0 / 1/step]
	Gets information of specified switch. Displays signal level of switch as it is.		
6-123-057	Dynamic Roller Open/Close Guide Plate Sensor	ENG	[0 or 1 / 0 / 1/step]
	Gets information of specified switch. Displays signal level of switch as it is.		

6-123-058	Tray Upper Limit SW	ENG	[0 or 1 / 0 / 1/step]
	Gets information of specified switch. Displays signal level of switch as it is.		
6-123-059	Paper Exit Open/Close Guide Plate Limit SW	ENG	[0 or 1 / 0 / 1/step]
	Gets information of specified switch. Displays signal level of switch as it is.		
6-123-060	Punch Selection DIPSW 1	ENG	[0 or 1 / 0 / 1/step]
	Gets information of specified switch. Displays signal level of switch as it is.		
6-123-061	Punch Selection DIPSW 2	ENG	[0 or 1 / 0 / 1/step]
	Gets information of specified switch. Displays signal level of switch as it is.		
6-123-065	Paper Guide HP Sensor	ENG	[0 or 1 / 0 / 1/step]
	Gets information of specified switch. Displays signal level of switch as it is.		
6-123-066	Shift Jogger HP Sensor: Front	ENG	[0 or 1 / 0 / 1/step]
	Gets information of specified switch. Displays signal level of switch as it is.		
6-123-067	Shift Jogger HP Sensor: Rear	ENG	[0 or 1 / 0 / 1/step]
	Gets information of specified switch. Displays signal level of switch as it is.		
6-123-068	Shift Jogger Retraction HP Sensor: Upper	ENG	[0 or 1 / 0 / 1/step]
	Gets information of specified switch. Displays signal level of switch as it is.		
6-123-069	Shift Jogger Retraction HP Sensor: Lower	ENG	[0 or 1 / 0 / 1/step]
	Gets information of specified switch. Displays signal level of switch as it is.		

6135	[INPUT Check: FrontFIN]		
	Gets information of specified sensor. Displays signal level of sensor as it is.		
6-135-001	Entrance Sensor	*ENG	[0 or 1 / 0 / 1/step]
6-135-002	Carry Sensor	*ENG	[0 or 1 / 0 / 1/step]
6-135-003	Exit Sensor	*ENG	[0 or 1 / 0 / 1/step]

6-135-004	Staple Tray Paper Sensor	*ENG	[0 or 1 / 0 / 1/step]
6-135-005	Front Jogger HP Sensor	*ENG	[0 or 1 / 0 / 1/step]
6-135-006	Rear Jogger HP Sensor	*ENG	[0 or 1 / 0 / 1/step]
6-135-007	Sft Roller HP Sensor	*ENG	[0 or 1 / 0 / 1/step]
6-135-008	Hitroll HP Sensor	*ENG	[0 or 1 / 0 / 1/step]
6-135-009	Ext Guide Plate HP Sensor	*ENG	[0 or 1 / 0 / 1/step]
6-135-010	Staple Moving HP Sensor	ENG	[0 or 1 / 0 / 1/step]
6-135-011	Shift Tray Paper Sensor	ENG	[0 or 1 / 0 / 1/step]
6-135-012	Shift Tray Limit Sensor	ENG	[0 or 1 / 0 / 1/step]
6-135-013	Staple Rotation Sensor	ENG	[0 or 1 / 0 / 1/step]
6-135-014	Staple Near End Sensor	ENG	[0 or 1 / 0 / 1/step]
6-135-015	Self Priming Sensor	ENG	[0 or 1 / 0 / 1/step]
6-135-016	Stopper HP Sensor	ENG	[0 or 1 / 0 / 1/step]
6-135-017	Punch HP Sensor	ENG	[0 or 1 / 0 / 1/step]
6-135-018	Punch Pluse Count Sensor	ENG	[0 or 1 / 0 / 1/step]
6-135-019	Punch Chad Full Sensor	ENG	[0 or 1 / 0 / 1/step]
6-135-020	Punch Moving HP Sensor	ENG	[0 or 1 / 0 / 1/step]
6-135-021	Punch Registration Detection HP Sensor	ENG	[0 or 1 / 0 / 1/step]
6-135-022	Punch Registration Detection Sensor	ENG	[0 or 1 / 0 / 1/step]
6135	[INPUT Check: FrontFIN]		
	Gets information of specified switch. Displays signal level of switch as it is.		
6-135-023	Slide Door SW	ENG	[0 or 1 / 0 / 1/step]
6-135-024	Shift Tray Upper Limit SW	ENG	[0 or 1 / 0 / 1/step]

6161	[FIN (1K FIN) INPUT Check]		
	Gets information of specified sensor. Displays signal level of sensor as it is.		
6-161-001	Entrance Sensor	ENG	[0 or 1 / 0 / 1/step]
6-161-002	Upper Cover Open/Close Sensor	ENG	[0 or 1 / 0 / 1/step]
6-161-003	Proof Tray Exit Sensor	ENG	[0 or 1 / 0 / 1/step]
6-161-004	Proof Tray Full Sensor	ENG	[0 or 1 / 0 / 1/step]
6-161-005	Shift HP Sensor	ENG	[0 or 1 / 0 / 1/step]
6-161-006	Exit Guide Plate Open/Close HP Sensor	ENG	[0 or 1 / 0 / 1/step]
6-161-007	Shift Paper Exit (Lift Tray Exit) Sensor	ENG	[0 or 1 / 0 / 1/step]
6-161-008	Positioning Roller HP Sensor	ENG	[0 or 1 / 0 / 1/step]
6-161-009	Lift Tray Paper Sensor	ENG	[0 or 1 / 0 / 1/step]
6-161-010	Jogger HP Sensor	ENG	[0 or 1 / 0 / 1/step]
6-161-011	Feed Out HP Sensor	ENG	[0 or 1 / 0 / 1/step]
6-161-012	Lift Tray Lower Limit Sensor (Upper)	ENG	[0 or 1 / 0 / 1/step]
6-161-013	Lift Tray Lower Limit Sensor (Lower)	ENG	[0 or 1 / 0 / 1/step]
6-161-014	Staple Tray Paper Sensor	ENG	[0 or 1 / 0 / 1/step]
6-161-015	Stapler Moving HP Sensor	ENG	[0 or 1 / 0 / 1/step]
6-161-016	Near End Sensor (Common: Corner/Bklt Stplr)	ENG	[0 or 1 / 0 / 1/step]
6-161-017	Self Priming Sensor (Common:Crnr/Bklt Stplr)	ENG	[0 or 1 / 0 / 1/step]
6-161-018	Driver HP Sensor (Corner/Booklet Stapler)	ENG	[0 or 1 / 0 / 1/step]

6-161-020	Clincher HP Sensor (Corner/ Booklet Stapler)	ENG	[0 or 1 / 0 / 1/step]
6-161-022	Stapler Retraction Sensor	ENG	[0 or 1 / 0 / 1/step]
6-161-023	Untitled	ENG	[0 or 1 / 0 / 1/step]
6-161-024	Untitled	ENG	[0 or 1 / 0 / 1/step]
6-161-025	Untitled	ENG	[0 or 1 / 0 / 1/step]
6-161-026	Punch HP Sensor	ENG	[0 or 1 / 0 / 1/step]
6-161-027	Punch RP Sensor	ENG	[0 or 1 / 0 / 1/step]
6-161-028	Punch Hopper Full Sensor	ENG	[0 or 1 / 0 / 1/step]
6-161-029	Punch Move HP Sensor	ENG	[0 or 1 / 0 / 1/step]
6-161-030	S-to-S Registration Detection HP Sensor	ENG	[0 or 1 / 0 / 1/step]
6-161-031	S-to-S Registration Detection Sensor	ENG	[0 or 1 / 0 / 1/step]
6161	[FIN (1K FIN) INPUT Check]		
	Gets information of specified switch. Displays signal level of switch as it is.		
6-161-032	Punch Selection DIPSW 1	ENG	[0 or 1 / 0 / 1/step]
6-161-033	Punch Selection DIPSW 2	ENG	[0 or 1 / 0 / 1/step]
6161	[FIN (1K FIN) INPUT Check]		
	Gets information of specified sensor. Displays signal level of sensor as it is.		
6-161-034	ITB Transport Sensor: Right	ENG	[0 or 1 / 0 / 1/step]
6-161-035	ITB Transport Sensor: Left	ENG	[0 or 1 / 0 / 1/step]
6-161-036	Stack Transport Sensor	ENG	[0 or 1 / 0 / 1/step]
6-161-037	Stack Trans Upper Pressure Release HP Sensor	ENG	[0 or 1 / 0 / 1/step]
6-161-038	Stack Trans Lower Pressure Release HP Sensor	ENG	[0 or 1 / 0 / 1/step]
6-161-039	Fold Blade HP Sensor	ENG	[0 or 1 / 0 / 1/step]

6-161-040	Fold Cam HP Sensor	ENG	[0 or 1 / 0 / 1/step]
6-161-041	TE Stopper Transport Sensor	ENG	[0 or 1 / 0 / 1/step]
6-161-042	TE Stopper HP Sensor	ENG	[0 or 1 / 0 / 1/step]
6-161-043	Booklet Folder Exit Sensor	ENG	[0 or 1 / 0 / 1/step]
6-161-044	Booklet Folder Tray Full Sensor: Upper	ENG	[0 or 1 / 0 / 1/step]
6-161-045	Booklet Folder Tray Full Sensor: Lower	ENG	[0 or 1 / 0 / 1/step]
6161	[FIN (1K FIN) INPUT Check]		
	Gets information of specified switch. Displays signal level of switch as it is.		
6-161-046	Door Open/Close SW	ENG	[0 or 1 / 0 / 1/step]
6-161-047	Lift Tray Upper Limit SW	ENG	[0 or 1 / 0 / 1/step]
6161	[FIN (1K FIN) INPUT Check]		
	Gets information of specified sensor. Displays signal level of sensor as it is.		
6-161-048	Paper Guide HP Sensor	ENG	[0 or 1 / 0 / 1/step]

6184	[Input Check: NoStplBindFIN]		
6-184-001	Entrance Sensor	ENG	[0 or 1 / 0 / 1/step]
	Gets the entrance sensor information of non staple finisher. (0: Sensor Off, 1: Sensor On)		
6-184-002	Exit Sensor	ENG	[0 or 1 / 0 / 1/step]
	Gets the paper exit sensor information of non staple finisher. (0: Sensor Off, 1: Sensor On)		
6-184-003	Horizontal Registration Detection Sensor	ENG	[0 or 1 / 0 / 1/step]
	Gets the horizontal registration sensor information of non staple finisher. (0: Sensor Off, 1: Sensor On)		

6-184-004	Shift HP Sensor	ENG	[0 or 1 / 0 / 1/step]
	Gets the shift HP sensor information of non staple finisher. (0: Sensor Off, 1: Sensor On)		
6-184-005	Junction Solenoid HP Sensor	ENG	[0 or 1 / 0 / 1/step]
	Gets the junction solenoid HP sensor information of non staple finisher. (0: Sensor Off, 1: Sensor On, "0" appears if sensor detects home position)		
6-184-006	Exit Pressure Release HP Sensor	ENG	[0 or 1 / 0 / 1/step]
	Gets the exit pressure release HP sensor information of non staple finisher. (0: Sensor Off, 1: Sensor On)		
6-184-007	Stapler HP Sensor	ENG	[0 or 1 / 0 / 1/step]
	Gets the stapler HP sensor information of non staple finisher. (0: Sensor On, "0" appears if sensor detects home position)		
6-184-008	Tray Full Detection Sensor 1	ENG	[0 or 1 / 0 / 1/step]
	Gets the tray full detection sensor 1 information of non staple finisher. (0: Paper overflow)		
6-184-009	Tray Full Detection Sensor 2	ENG	[0 or 1 / 0 / 1/step]
	Gets the tray full detection sensor 2 information of non staple finisher. (0: Paper overflow)		
6-184-010	Slide Door Open/Close Door SW	ENG	[0 or 1 / 0 / 1/step]
	Gets the slide door switch information of non staple finisher. (0: Close, 1: Open)		

Output Check Table

Main Machine, Paper Feed Tray

5804	[OUTPUT Check]
------	----------------

5-804-001	Feed Pickup Solenoid 1 This setting is not available for MP C2004/MP C2504.	ENG	[0 or 1 / 0 / 1/step]
	Moves 1st paper feed tray pick up solenoid.		
5-804-002	Feed Pickup Solenoid 2 This setting is not available for MP C2004/MP C2504.	ENG	[0 or 1 / 0 / 1/step]
	Moves 2nd paper feed tray pick up solenoid.		
5-804-003	Bypass Pickup Solenoid	ENG	[0 or 1 / 0 / 1/step]
	Moves bypass pick up solenoid.		
5-804-004	Exit Junction Solenoid	ENG	[0 or 1 / 0 / 1/step]
	Moves output paper divide solenoid.		
5804	[OUTPUT Check]		
	Moves paper feed tray rising motor. * Do not execute SP 5-804-006/008 without removing the paper tray. Otherwise, the tray might be damaged.		
5-804-005	Tray 1 Lift Motor: CW	ENG	[0 or 1 / 0 / 1/step]
5-804-006	Tray 1 Lift Motor: CCW	ENG	
5-804-007	Tray 2 Lift Motor: CW	ENG	
5-804-008	Tray 2 Lift Motor: CCW	ENG	
5804	[OUTPUT Check]		
	Moves register motor.		
5-804-009	Regist Motor: CCW: Standard Speed	ENG	[0 or 1 / 0 / 1/step]
5-804-011	Regist Motor: CCW: Low Speed	ENG	
5804	[OUTPUT Check]		

5-804-015	Regist Motor:Position Hold	ENG	[0 or 1 / 0 / 1/step]
	Holds position of register motor.		
5804	[OUTPUT Check]		
	Moves paper feed motor. * It is fed if there is paper in the paper tray.		
5-804-016	Feed Motor: CW: Standard Speed	ENG	[0 or 1 / 0 / 1/step]
5-804-018	Feed Motor: CW: Low Speed	ENG	
5-804-022	Feed Motor: CCW: Standard Speed	ENG	
5-804-024	Feed Motor: CCW: Low Speed	ENG	
5804	[OUTPUT Check]		
	Moves transport motor.		
5-804-028	Bypass V-Transport Motor: CW: Std Speed	ENG	[0 or 1 / 0 / 1/step]
5-804-030	Bypass V-Transport Motor: CW: Low Speed	ENG	
5804	[OUTPUT Check]		
5-804-034	Bypass V-Transport Motor: Position Hold	ENG	[0 or 1 / 0 / 1/step]
	Holds position of transport motor.		
5-804-037	Exit Motor: CW: Fusing Pressure Release	ENG	[0 or 1 / 0 / 1/step]
	Moves fusing dis-pressure. * If driving this motor while attaching the fusing unit, be sure to stop it less than 5 seconds. Otherwise, the unit might be damaged.		
5804	[OUTPUT Check]		
	Moves paper exit motor.		

5-804-041	Exit Motor:CCW:Standard Speed	ENG	[0 or 1 / 0 / 1/step]
5-804-043	Exit Motor:CCW:Low Speed	ENG	
5804	[OUTPUT Check]		
	Moves reverse motor.		
5-804-047	Inverter Motor:CW:Standard Speed	ENG	[0 or 1 / 0 / 1/step]
5-804-049	Inverter Motor:CW:Low Speed	ENG	
5-804-052	Inverter Mt: CW: Normal Speed: Duplex	ENG	
5-804-054	Inverter Mt: CW: Low Speed: Duplex	ENG	
5-804-056	Inverter Motor:CCW:Standard Speed	ENG	
5-804-058	Inverter Motor:CCW:Low Speed	ENG	
5-804-061	Inverter Mt: CCW: Normal Speed: Inc Speed	ENG	
5804	[OUTPUT Check]		
	Moves duplex entrance motor.		
5-804-065	Duplex Entrance Motor:CW:Standard Speed	ENG	[0 or 1 / 0 / 1/step]
5-804-067	Duplex Entrance Motor:CW:Low Speed	ENG	
5-804-068	Duplex Entrance Motor: Normal Speed: Duplex	ENG	
5-804-069	Duplex Entrance Motor: Low Speed: Duplex	ENG	
5804	[OUTPUT Check]		
	Moves bypass/duplex motor.		

5-804-071	Duplex Bypass Motor: CW: Standard Speed	ENG	[0 or 1 / 0 / 1/step]
5-804-073	Duplex Bypass Motor: CW: Low Speed	ENG	
5-804-074	Duplex Bypass Motor: CW: Normal Speed: Dup	ENG	
5-804-075	Duplex Bypass Motor: CW: Low Speed: Duplex	ENG	
5-804-077	Duplex Bypass Motor: CCW: Standard Speed	ENG	
5-804-079	Duplex Bypass Motor: CCW: Low Speed	ENG	
5804	[OUTPUT Check]		
5-804-083	Duplex Bypass Motor: Position Hold	ENG	[0 or 1 / 0 / 1/step]
	Holds position of bypass/duplex motor.		
5804	[OUTPUT Check]		
	Moves fusing motor. *See Important below		
5-804-092	Fusing Motor: CW: Standard Speed	ENG	[0 or 1 / 0 / 1/step]
5-804-094	Fusing Motor: CW: Low Speed	ENG	
5-804-098	Fusing Motor: CCW: Low Speed	ENG	

Important: Use the procedure below to do the output checks for the fusing exit motor. If you do not follow this procedure, a kink will form in the fusing belt sleeve, and the fusing sleeve belt unit will need to be replaced.

1. Do one of the following:
 - Open the right cover of the paper bank
 - Remove one of the toner bottles
 - Pull out the waste toner bottle half-way
 - Remove the fusing unit
2. Enter SP mode.
3. Do the following out output checks:
 - SP5-804-092 (Fusing Motor: CW: Standard Speed)
 - SP5-804-094 (Fusing Motor: CW: Low Speed)
 - SP5-804-098 (Fusing Motor: CCW: Low Speed)

4. Without exiting SP mode, turn the main power switch off and then on again.

Important: If you exit SP mode before you turn the main power switch off, the fusing exit motor will stay off when the machine warms up. Heat will be concentrated in one area of the fusing belt sleeve and cause a kink to form. If this happens, you will need to replace the fusing sleeve belt unit.

5. Do the reverse of what you did in step 1 (for example, reattach the fusing unit).

5804	[OUTPUT Check]		
5-804-104	Polygon Motor: L	ENG	[0 or 1 / 0 / 1/step]
	Runs motor with 21969 rpm.		
5-804-105	Polygon Motor: M	ENG	[0 or 1 / 0 / 1/step]
	Runs motor with 25512 rpm.		
5-804-106	Polygon Motor: H	ENG	[0 or 1 / 0 / 1/step]
	Runs motor with 30236 rpm.		
5-804-107	Polygon Motor: HH	ENG	[0 or 1 / 0 / 1/step]
	Runs motor with 34488 rpm.		
5-804-110	Fusing Fan: Full Speed	ENG	[0 or 1 / 0 / 1/step]
	Moves fusing exhaust fan.		

5-804-111	Fusing Fan: Half Speed	ENG	[0 or 1 / 0 / 1/step]
	Moves fusing exhaust fan.		
5-804-113	PSU Cooling/Exhaust Heat Fan	ENG	[0 or 1 / 0 / 1/step]
	Moves PSU cooling fan and PSU exhaust fan (not included in this machine).		
5-804-114	Ozone Fan	ENG	[0 or 1 / 0 / 1/step]
	Moves ozone exhaust heat fan.		
5-804-115	PCB Box Cooling Fan/ Exhaust Cooling Fan	ENG	[0 or 1 / 0 / 1/step]
	Moves controller box cooling fan and exhaust cooling fan.		
5-804-116	Development: Right: Half Speed	ENG	[0 or 1 / 0 / 1/step]
	Moves development intake fan.		
5-804-117	Drive Cooling/ Main/ Toner Supply Cooling Fan	ENG	[0 or 1 / 0 / 1/step]
	Moves drive cooling fan (not included in this machine), main exhaust fan (not included in this machine), and toner supply cooling fan.		
5-804-118	Development: Right	ENG	[0 or 1 / 0 / 1/step]
	Moves development intake fan.		
5-804-119	Development Solenoid	ENG	[0 or 1 / 0 / 1/step]
	Moves development solenoid.		
5804	[OUTPUT Check]		
	Moves development motor.		
5-804-128	Development Motor FC: Standard Speed	ENG	[0 or 1 / 0 / 1/step]
5-804-130	Development Motor FC: Low Speed	ENG	

5804	[OUTPUT Check]		
	Moves/Stops PCU motor :CMY. * Execute this SP after correcting the cam position so that ITB contact/separation lever of the color station is released.		
5-804-132	Drum Motor FC: Standard Speed	ENG	[0 or 1 / 0 / 1/step]
5-804-134	Drum Motor FC: Low Speed	ENG	
5804	[OUTPUT Check]		
	Moves/Stops PCU motor: Black/ ITB drive motor. * Execute this SP after correcting the cam position so that ITB contact/separation lever of the color station is released.		
5-804-136	Transfer Drum Motor K: Standard Speed	ENG	[0 or 1 / 0 / 1/step]
5-804-138	Transfer Drum Motor K: Low Speed	ENG	
5804	[OUTPUT Check]		
	Moves paper transfer contact and release motor.		
5-804-140	PTR Contact Motor: CW	ENG	[0 or 1 / 0 / 1/step]
5-804-141	PTR Contact Motor: CCW	ENG	
5804	[OUTPUT Check]		
	Moves ITB contact and release motor (reverse to toner supply motor M). * Execute this SP after correcting the cam position so that ITB contact/separation lever of the color station is released.		
5-804-150	Toner Supply Motor M: CW: (ITB Contact)	ENG	[0 or 1 / 0 / 1/step]
5804	[OUTPUT Check]		
	Moves relay carry motor (bridge unit)/left paper exit carry motor (left paper exit tray).		

5-804-163	Bridge Relay/Left Exit Motor: Normal Speed	ENG	[0 or 1 / 0 / 1/step]
5-804-165	Bridge Relay/Left Exit Motor: Low Speed	ENG	
5-804-166	Bridge Relay/Left Ex Mt: Normal Speed Upper	ENG	
5804	[OUTPUT Check]		
5-804-169	Bridge Junction/Left Exit Junction Solenoid	ENG	[0 or 1 / 0 / 1/step]
	Moves relay divide solenoid (bridge unit)/left paper exit divide solenoid (left paper exit tray).		
5-804-170	Shift Tray Motor: CW	ENG	[0 or 1 / 0 / 1/step]
	Moves shift tray motor.		
5-804-171	Shift Tray Motor: CCW	ENG	[0 or 1 / 0 / 1/step]
	Moves shift tray motor.		
5-804-172	Toner End Sensor: K Power	ENG	[0 or 1 / 0 / 1/step]
	Supplies power to toner end sensor (K).		
5-804-173	Toner End Sensor: FC Power	ENG	[0 or 1 / 0 / 1/step]
	Supplies power to toner end sensor (FC).		
5-804-174	Drum PCL: K	ENG	[0 or 1 / 0 / 1/step]
	<p>Lights (PWM drive) the drum PCL (K).</p> <p>* Continuing the OPC's exposure, it might accumulate damage due to electrostatic locally.</p> <ul style="list-style-type: none"> • If operating QL without rotation, be sure to stop it within 10 seconds. • Do rotate the OPC drum when QL is turned on. 		

5-804-175	Drum PCL: FC	ENG	[0 or 1 / 0 / 1/step]
	Lights (PWM drive) the drum PCL (FC). * Continuing the OPC's exposure, it might accumulate damage due to electrostatic locally. <ul style="list-style-type: none"> • If operating QL without rotation, be sure to stop it within 10 seconds. • Do rotate the OPC drum when QL is turned on. 		
5804	[OUTPUT Check]		
	Outputs PWM for electrify HVP (DC/AC:Y/M/C/K).		
5-804-176	PP: Charge DC: Y	ENG	[0 or 1 / 0 / 1/step]
5-804-177	PP: Charge DC: M	ENG	
5-804-178	PP: Charge DC: C	ENG	
5-804-179	PP: Charge DC: K	ENG	
5-804-180	PP: Charge AC: Y	ENG	
5-804-181	PP: Charge AC: M	ENG	[0 or 1 / 0 / 1/step] This setting is not available for MP C2004/MP C2504
5-804-182	PP: Charge AC: C	ENG	
5-804-183	PP: Charge AC: K	ENG	
5804	[OUTPUT Check]		
	Outputs PWM for develop HVP.		
5-804-184	PP: Development: Y	ENG	[0 or 1 / 0 / 1/step]
5-804-185	PP: Development: M	ENG	
5-804-186	PP: Development: C	ENG	
5-804-187	PP: Development: K	ENG	
5804	[OUTPUT Check]		
	Outputs PWM for transfer HVP (image transfer: Y/M/C/K).		

5-804-195	PP: ITB: Y	ENG	[0 or 1 / 0 / 1/step]
5-804-196	PP: ITB: M	ENG	
5-804-197	PP: ITB: C	ENG	
5-804-198	PP: ITB: K	ENG	
5804	[OUTPUT Check]		
	Outputs PWM for transfer HVP (paper transfer: +/-).		
5-804-199	PP: PTR: +	ENG	[0 or 1 / 0 / 1/step]
5-804-200	PP: PTR: -	ENG	
5804	[OUTPUT Check]		
5-804-202	Scanner Lamp	ENG	[0 or 1 / 0 / 1/step]
	Checks output of scanner lamp. Use to check light source malfunction when SC101-01, SC101-02, SC102-00, SC142-00 occurs.		
5-804-206	PTR Open/Close LED	ENG	[0 or 1 / 0 / 1/step]
	Lights paper transfer open/close LED.		
5-804-208	TM/P Sensor: F	ENG	[0 or 1 / 0 / 1/step]
	Lights TM/P sensor: Front glowing part.		
5-804-209	TM/P Sensor: C	ENG	[0 or 1 / 0 / 1/step]
	Lights TM/P sensor: Center glowing part.		
5-804-210	TM/P Sensor: R	ENG	[0 or 1 / 0 / 1/step]
	Lights TM/P sensor: Rear glowing part.		
5-804-211	Toner Sensor Power	ENG	[0 or 1 / 0 / 1/step]
5-804-232	Toner IDTAG Power	ENG	[0 or 1 / 0 / 1/step]
5804	[OUTPUT Check]		
5-804-239	Fusing Exit Drive Solenoid	ENG	[0 or 1 / 0 / 1/step]

5804	[OUTPUT Check]		
	Continuously drives specified motor for operation test.		
5-804-241	Bank: Tray3: Feed Mt: Standard Speed	ENG	[0 or 1 / 0 / 1/step]
5-804-242	Bank: Tray4: Feed Mt: Standard Speed	ENG	
5-804-243	Bank: Tray5: Feed Mt: Standard Speed	ENG	
5-804-244	Bank: Tray3: Transport Mt: Standard Speed	ENG	
5-804-245	Bank: Tray4: Transport Mt: Standard Speed	ENG	
5-804-246	Bank: Tray5: Transport Mt: Standard Speed	ENG	
5804	[OUTPUT Check]		
	Drives specified motor for a certain period of time to test operation.		
5-804-247	Bank: Tray3: PU Solenoid	ENG	[0 or 1 / 0 / 1/step]
5-804-248	Bank: Tray4: PU Solenoid	ENG	
5-804-249	Bank: Tray5: PU Solenoid	ENG	

ADF

6008	[ADF OUTPUT Check]		
	Checks operation of the load of ADF.		
6-008-003	Feed Motor Forward	ENG	[0 or 1 / 0 / 1/step]
	Rotates paper feed motor forward.		
6-008-004	Feed Motor Reverse	ENG	[0 or 1 / 0 / 1/step]
	Rotates paper feed motor backward.		

6-008-005	Relay Motor Forward	ENG	[0 or 1 / 0 / 1/step]
	Rotates carry motor forward.		
6-008-006	Relay Motor Reverse	ENG	[0 or 1 / 0 / 1/step]
	Rotates carry motor backward.		
6-008-011	Inverter Solenoid	ENG	[0 or 1 / 0 / 1/step]
	Interval drives reverse solenoid.		
6-008-012	Stamp	ENG	[0 or 1 / 0 / 1/step]
	Interval drives DONE stamp.		
6-008-013	Fan Motor	ENG	[0 or 1 / 0 / 1/step]
	Interval drives FAN motor.		
6-008-014	Feed Clutch	ENG	[0 or 1 / 0 / 1/step]
	Interval drives paper feed clutch.		
6-008-015	Feed Solenoid	ENG	[0 or 1 / 0 / 1/step]
	Interval drives paper feed solenoid.		

6012	[1-Pass ADF OUTPUT Check]		
	For Single-Pass simultaneous duplex models only.		
6-012-001	Pick-Up Motor Forward	ENG	[0 or 1 / 0 / 1/step] 0:Off 1:On
	Forwardly rotates ADF pick up motor.		
6-012-003	Feed Motor Forward	ENG	[0 or 1 / 0 / 1/step] 0:Off 1:On
	Forwardly rotates ADF paper feed motor.		

6-012-005	Relay Motor Forward	ENG	[0 or 1 / 0 / 1/step] 0:Off 1:On
	Forwardly rotates ADF paper carry motor.		
6-012-009	Exit Motor Forward	ENG	[0 or 1 / 0 / 1/step] 0:Off 1:On
	Forwardly rotates ADF paper exit motor.		
6-012-010	Bottom Plate Motor For/Rev	ENG	[0 or 1 / 0 / 1/step] 0:Off 1:On
	Moves up/down the bottom plate by driving the ADF bottom plate motor forward, backward.		
6-012-012	Stamp	ENG	[0 or 1 / 0 / 1/step] 0:Off 1:On
	Stamps the DONE stamp.		
6-012-015	Pull-Out Motor Forward	ENG	[0 or 1 / 0 / 1/step] 0:Off 1:On
	Forwardly rotates ADF pull out motor.		
6-012-016	Middle Motor Forward	ENG	[0 or 1 / 0 / 1/step] 0:Off 1:On
	Forwardly rotates ADF middle motor.		

Finisher

6124	[OUTPUT Check: 2K/3K FIN]
------	---------------------------

6-124-001	Entrance Transport Motor	ENG	[0 or 1 / 0 / 1/step]
	Drives specified motor for a certain period of time to test operation.		
6-124-002	Horizontal Transport Motor	ENG	[0 or 1 / 0 / 1/step]
	Drives specified motor for a certain period of time to test operation.		
6-124-003	Pre-Stack Transport Motor	ENG	[0 or 1 / 0 / 1/step]
	Drives specified motor for a certain period of time to test operation.		
6-124-004	ITB Transport Motor	ENG	[0 or 1 / 0 / 1/step]
	Drives specified motor for a certain period of time to test operation.		
6-124-005	Paper Exit Motor	ENG	[0 or 1 / 0 / 1/step]
	Drives specified motor for a certain period of time to test operation.		
6-124-006	Upper Junction Solenoid	ENG	[0 or 1 / 0 / 1/step]
	Turns NO/OFF specified solenoid for validation.		
6-124-007	TE Stack Plate Motor	ENG	[0 or 1 / 0 / 1/step]
	Drives specified motor for a certain period of time to test operation.		
6-124-008	Paper Exit Open/Close Guide Plate Motor	ENG	[0 or 1 / 0 / 1/step]
	Drives specified motor for a certain period of time to test operation.		
6-124-009	Punching Motor	ENG	[0 or 1 / 0 / 1/step]
	Drives specified motor for a certain period of time to test operation.		
6-124-010	Punch Move Motor	ENG	[0 or 1 / 0 / 1/step]
	Drives specified motor for a certain period of time to test operation.		
6-124-011	S-to-S Registration Detection Move Motor	ENG	[0 or 1 / 0 / 1/step]
	Drives specified motor for a certain period of time to test operation.		
6-124-012	Lower Junction Solenoid Motor	ENG	[0 or 1 / 0 / 1/step]
	Drives specified motor for a certain period of time to test operation.		

6-124-013	Jogger Motor	ENG	[0 or 1 / 0 / 1/step]
	Drives specified motor for a certain period of time to test operation.		
6-124-014	Positioning Roller Rotation Motor	ENG	[0 or 1 / 0 / 1/step]
	Drives specified motor for a certain period of time to test operation.		
6-124-015	Feed-out Motor	ENG	[0 or 1 / 0 / 1/step]
	Drives specified motor for a certain period of time to test operation.		
6-124-016	Booklet Stapler Move Motor	ENG	[0 or 1 / 0 / 1/step]
	Drives specified motor for a certain period of time to test operation.		
6-124-017	Corner Stapler Motor	ENG	[0 or 1 / 0 / 1/step]
	Drives specified motor for a certain period of time to test operation.		
6-124-018	Booklet Stapler Jogger Motor	ENG	[0 or 1 / 0 / 1/step]
	Drives specified motor for a certain period of time to test operation.		
6-124-019	Booklet Stapler Jog Solenoid Move Motor	ENG	[0 or 1 / 0 / 1/step]
	Drives specified motor for a certain period of time to test operation.		
6-124-020	Booklet Stapler Standard Fence Motor	ENG	[0 or 1 / 0 / 1/step]
	Drives specified motor for a certain period of time to test operation.		
6-124-021	Booklet Stapler Motor	ENG	[0 or 1 / 0 / 1/step]
	Drives specified motor for a certain period of time to test operation.		
6-124-022	Dynamic Roller Transport Motor	ENG	[0 or 1 / 0 / 1/step]
	Drives specified motor for a certain period of time to test operation.		
6-124-023	Folder Transport Motor	ENG	[0 or 1 / 0 / 1/step]
	Drives specified motor for a certain period of time to test operation.		

6-124-025	Press-fold Motor	ENG	[0 or 1 / 0 / 1/step]
	Drives specified motor for a certain period of time to test operation.		
6-124-026	Tray Lift Motor	ENG	[0 or 1 / 0 / 1/step]
	Drives specified motor for a certain period of time to test operation.		
6-124-027	Shift Motor	ENG	[0 or 1 / 0 / 1/step]
	Drives specified motor for a certain period of time to test operation.		
6-124-028	Front Shift Jogger Motor	ENG	[0 or 1 / 0 / 1/step]
	Drives specified motor for a certain period of time to test operation. * Not use: currently, VOLGA-B does not have setting jogger in system configuration.		
6-124-029	Rear Shift Jogger Motor	ENG	[0 or 1 / 0 / 1/step]
	Drives specified motor for a certain period of time to test operation. * Not use: currently, VOLGA-B does not have setting jogger in system configuration.		
6-124-030	Shift Jogger Retraction Motor	ENG	[0 or 1 / 0 / 1/step]
	Drives specified motor for a certain period of time to test operation. * Not use: currently, VOLGA-B does not have setting jogger in system configuration.		
6-124-031	Drag Roller Vibrating Motor	ENG	[0 or 1 / 0 / 1/step]
	Drives specified motor for a certain period of time to test operation.		
6-124-032	LE Guide Motor	ENG	[0 or 1 / 0 / 1/step]
	Drives specified motor for a certain period of time to test operation.		
6-124-033	Navigation LED (All)	ENG	[0 or 1 / 0 / 1/step]
	Lights all guide LED.		
6-124-037	Positioning Roller Transport Motor	ENG	[0 or 1 / 0 / 1/step]
	Drives specified motor for a certain period of time to test operation.		
6-124-038	Paper Guide Motor	ENG	[0 or 1 / 0 / 1/step]
	Drives specified motor for a certain period of time to test operation.		

6136	[OUTPUT Check: FrontFIN]		
	Continuously drives specified motor for operation test.		
6-136-001	Entrance Motor	*ENG	[0 or 1 / 0 / 1/step]
6-136-002	Carry Motor	ENG	[0 or 1 / 0 / 1/step]
6-136-003	Exit Motor	ENG	[0 or 1 / 0 / 1/step]
6136	[OUTPUT Check: FrontFIN]		
	Drives specified motor for a certain period of time to test operation.		
6-136-004	Front Jogger Motor	ENG	[0 or 1 / 0 / 1/step]
6-136-005	Rear Jogger Motor	ENG	[0 or 1 / 0 / 1/step]
6-136-006	Shift Motor	ENG	[0 or 1 / 0 / 1/step]
6-136-007	Hitroll Motor	ENG	[0 or 1 / 0 / 1/step]
6-136-008	Exit Guide Plate Motor	ENG	[0 or 1 / 0 / 1/step]
6-136-009	Staple Moving Motor	ENG	[0 or 1 / 0 / 1/step]
6-136-010	Tray Motor	ENG	[0 or 1 / 0 / 1/step]
6-136-011	Staple Motor	ENG	[0 or 1 / 0 / 1/step]
6-136-012	Stopper Motor	ENG	[0 or 1 / 0 / 1/step]
6-136-013	Punch Motor	ENG	[0 or 1 / 0 / 1/step]
6-136-014	Punch Moving Motor	ENG	[0 or 1 / 0 / 1/step]
6-136-015	Punch Registration Moving Motor	ENG	[0 or 1 / 0 / 1/step]

6162	[FIN (1K FIN) OUTPUT Check]		
	Continuously runs specified motor for operation test.		
6-162-001	Entrance Transport Motor	ENG	[0 or 1 / 0 / 1/step]
6-162-002	Proof Transport Motor	ENG	[0 or 1 / 0 / 1/step]
6-162-003	Paper Feed/Positioning & Move Roller Motor	ENG	[0 or 1 / 0 / 1/step]

6162	[FIN (1K FIN) OUTPUT Check]		
	Drives specified motor for a certain period of time to test operation.		
6-162-004	Junction Solenoid	ENG	[0 or 1 / 0 / 1/step]
6-162-005	Shift Motor	ENG	[0 or 1 / 0 / 1/step]
6-162-006	Jogger Motor	ENG	[0 or 1 / 0 / 1/step]
6-162-007	Exit Guide Plate Open/ Close Motor	ENG	[0 or 1 / 0 / 1/step]
6-162-008	Feed-out Motor	ENG	[0 or 1 / 0 / 1/step]
6-162-009	Tray Lift Motor	ENG	[0 or 1 / 0 / 1/step]
6-162-011	Positioning Roller Motor	ENG	[0 or 1 / 0 / 1/step]
6-162-012	Stapler Shift Motor	ENG	[0 or 1 / 0 / 1/step]
6-162-013	Stapler Motor	ENG	[0 or 1 / 0 / 1/step]
6-162-014	Untitled	ENG	[0 or 1 / 0 / 1/step]
6-162-015	Untitled	ENG	[0 or 1 / 0 / 1/step]
6-162-016	Untitled	ENG	[0 or 1 / 0 / 1/step]
6-162-017	Punch Motor	ENG	[0 or 1 / 0 / 1/step]
6-162-018	Punch Move Motor	ENG	[0 or 1 / 0 / 1/step]
6-162-019	S-to-S Registration Detection Move Motor	ENG	[0 or 1 / 0 / 1/step]
6-162-020	Stack Transport Motor: Upper	ENG	[0 or 1 / 0 / 1/step]
6-162-021	Stck Trns Uppr Prss Rls/ Stndrd Fence Rtrct M	ENG	[0 or 1 / 0 / 1/step]
6-162-022	Stack Lower Pressure Release Motor	ENG	[0 or 1 / 0 / 1/step]
6162	[FIN (1K FIN) OUTPUT Check]		
	Continuously runs specified motor for operation test.		
6-162-023	Folder Transport Motor	ENG	[0 or 1 / 0 / 1/step]

6162	[FIN (1K FIN) OUTPUT Check]		
	Drives specified motor for a certain period of time to test operation.		
6-162-024	TE Stopper Motor	ENG	[0 or 1 / 0 / 1/step]
6-162-025	Folder Blade Motor	ENG	[0 or 1 / 0 / 1/step]
6162	[FIN (1K FIN) OUTPUT Check]		
	Lights all guide LED.		
6-162-026	Navigation LED (All)	ENG	[0 or 1 / 0 / 1/step]

6185	[Output Check: NoStplBindFIN]		
	Checks the transport motor's movement of non staple finisher.		
6-185-001	Transport Motor	ENG	[0 or 1 / 0 / 1/step]
6-185-002	Shift Motor	ENG	[0 or 1 / 0 / 1/step]
	Checks the shift motor's movement of non staple finisher.		
6-185-003	Junction Solenoid Motor	ENG	[0 or 1 / 0 / 1/step]
	Checks the junction solenoid motor's movement of non staple finisher.		
6-185-004	Exit Pressure Release Motor	ENG	[0 or 1 / 0 / 1/step]
	Checks the exit pressure release motor's movement of non staple finisher.		
6-185-005	Stapler Motor	ENG	[0 or 1 / 0 / 1/step]
	Checks the stapler motor's movement of non staple finisher.		

Test Pattern Printing

Printing Test pattern: SP2-109

Some of these test patterns are used for copy image adjustments but most are used primarily for design testing.

↓ Note

- Do not operate the machine until the test pattern is printed out completely. Otherwise, SC will occur.
1. Enter the SP mode then select **SP2-109-003**.
 2. Select test pattern for print from the list then press [OK].
 3. When selecting color for Printing; Full Color or either CMYK, go to SP2-109-005 (1: Full Color, 2: Cyan, 3: Magenta, 4: Yellow, 5: Black) to select.
 4. When changing density of test pattern, select density with SP2-109-006 through 009 for each color.

↓ Note

- If select "0" with SP2-109-006 through 009, the color adjusted so will not show up in the test pattern.
5. To Print, Touch "Copy Window", then set settings within the following window for test print (paper size etc...).

↓ Note

- When using black and white printing, touch "Black & White" on the LCD. When using color printing, touch "Full Color" on the LCD.
6. Press "Start" key to start test print.
 7. After checking test pattern, touch "SP Mode" on the LCD to return to SP mode display.
 8. Reset all settings to default values.
 9. Exit SP mode.

No.	Pattern	No.	Pattern
0	Copy image	12	Independent Pattern (2dot)
1	Vertical Line (1 dot)	13	Independent Pattern (4dot)
2	Vertical Line (2dot)	14	Trimming Area
3	Horizontal Line (1 dot)	15	Hound's Tooth Check (Vertical)
4	Horizontal Line (2dot)	16	Hound's Tooth Check (Horizontal)

No.	Pattern	No.	Pattern
5	Grid Vertical Line	17	Band (Horizontal)
6	Grid Horizontal Line	18	Band (Vertical)
7	Grid Pattern Small	19	Checker Flag Pattern
8	Grid Pattern Large	20	Grayscale (Vertical Margin)
9	Argyle Pattern Small	21	Grayscale (Horizontal Margin)
10	Argyle Pattern Large	22	Wormy Pattern
11	Independent Pattern (1 dot)	23	Full Dot Pattern

4. Controller SP Mode Tables

Controller SP Tables - SP5000

SP5-XXX (Mode)

5009	[Add Display Language]		
	<p>Adds language available in user choice. (Only the languages registered in the machine)</p> <p>Refer to the displayed language list to set in the way showed below.</p> <p>List Number Assigned Bit Switch</p> <p>No.1 to 8 BIT1 to 8 (SP5-009-201)</p> <p>No.9 to 16 BIT1 to 8 (SP5-009-202)</p> <p>No.17 to 24 BIT1 to 8 (SP5-009-203)</p> <p>No.25 to 32 BIT1 to 8 (SP5-009-204)</p> <p>No.33 to 40 BIT1 to 8 (SP5-009-205)</p> <p>No.41 to 48 BIT1 to 8 (SP5-009-206)</p> <p>No.49 to 56 BIT1 to 8 (SP5-009-207)</p> <p>Example: To add American(No.3 in the list) or Czech (No.15)</p> <p>Turn Bit 3 of "SP5-009-201" 0 to 1 for American.</p> <p>Turn Bit 7 of "SP5-009-202" 0 to 1 for Czech.</p> <p>After setting, turn the main power switch off and on to make the setting valid.</p>		
5-009-201	1-8	*CTL	[1 to 255 / 0 / 1]
5-009-202	9-16	*CTL	[1 to 255 / 0 / 1]
5-009-203	17-24	*CTL	[1 to 255 / 0 / 1]
5-009-204	25-32	*CTL	[1 to 255 / 0 / 1]
5-009-205	33-40	*CTL	[1 to 255 / 0 / 1]
5-009-206	41-48	*CTL	[1 to 255 / 0 / 1]
5-009-207	49-56	*CTL	[1 to 255 / 0 / 1]

5024	[mm/inch Display Selection]		
	Display units (mm or inch) for custom paper sizes.		
5-024-001	0:mm 1:inch	*CTL	[0 or 1 / 1(USA), 0(Others) / 1] 0: mm 1: inch

5045	[Accounting counter]		
5-045-001	Counter Method	*CTL	[0 to 7 / 1 / step] 0: Developments 1: Prints 2: Coverage 7: Coverage (YMC)

5047	[Paper Display]		
5-047-001	Backing Paper	*CTL	[0 or 1 / 0 / 1] 0: OFF 1: ON

5051	[TonerRefillDetectionDisplay]		
5-051-001	-	*CTL	[0 or 1 / 0 / 1] 0: ON 1: OFF

5055	[Display IP Address]		
5-055-001	-	*CTL	[0 or 1 / 0 / 1] 0: OFF 1: ON

5061	[Toner Remaining Icon Display Change]		
-------------	--	--	--

5-061-001	-	*CTL	[0 or 1 / 0 / 1] 0: Not display 1: Display
-----------	---	------	--

5062	[Parts Replacement Alert Display]		
5-062-002	#Photoconductor Unit (Black)	*CTL	[0 or 1 / 0 / 1] 0: Not display 1: Display
5-062-003	#Development unit: Bk	*CTL	[0 or 1 / 0 / 1] 0: Not display 1: Display
5-062-025	#Photoconductor Unit (Cyan)	*CTL	[0 or 1 / 0 / 1] 0: Not display 1: Display
5-062-026	#Development unit: C	*CTL	[0 or 1 / 0 / 1] 0: Not display 1: Display
5-062-048	#Photoconductor Unit (Magenta)	*CTL	[0 or 1 / 0 / 1] 0: Not display 1: Display
5-062-049	#Development unit: M	*CTL	[0 or 1 / 0 / 1] 0: Not display 1: Display
5-062-071	#Photoconductor Unit (Yellow)	*CTL	[0 or 1 / 0 / 1] 0: Not display 1: Display
5-062-072	#Development unit: Y	*CTL	[0 or 1 / 0 / 1] 0: Not display 1: Display

5-062-093	#Intermediate Transfer Unit	*CTL	[0 or 1 / 0 / 1] 0: Not display 1: Display
5-062-102	#ITB Cleaning Unit	*CTL	[0 or 1 / 0 / 1] 0: Not display 1: Display
5-062-109	#Paper Transfer Unit	*CTL	[0 or 1 / 0 / 1] 0: Not display 1: Display
5-062-115	#Fuser Unit	*CTL	[0 or 1 / 0 / 1] 0: Not display 1: Display
5-062-116	Fuser Unit: Belt	*CTL	[0 or 1 / 0 / 1] 0: Not display 1: Display
5-062-118	Fuser Unit: Pressure Roller	*CTL	[0 or 1 / 0 / 1] 0: Not display 1: Display
5-062-131	#Dust Filter	*CTL	[0 or 1 / 0 / 1] 0: Not display 1: Display
5-062-142	#Wast Toner bottle	*CTL	[0 or 1 / 0 / 1] 0: Not display 1: Display
5-062-206	#ADF Pick-up Roller	*CTL	[0 or 1 / 0 / 1] 0: Not display 1: Display
5-062-207	#ADF Paper Supply Belt	*CTL	[0 or 1 / 0 / 1] 0: Not display 1: Display

5-062-208	#ADF Separate Roller	*CTL	[0 or 1 / 0 / 1] 0: Not display 1: Display
-----------	----------------------	------	--

5066	[PM Parts Display]		
5-066-001	-	*CTL	[0 or 1 / 0 / 1] 0: Not display 1: Display

5067	[Part Replacement Operation Type]		
5-067-002	#Photoconductor Unit (Black)	*CTL	[0 or 1 / 0 / 1] 0: Service 1: User
5-067-003	#Development unit: Bk	*CTL	[0 or 1 / 0 / 1] 0: Service 1: User
5-067-025	#Photoconductor Unit (Cyan)	*CTL	[0 or 1 / 0 / 1] 0: Service 1: User
5-067-026	#Development unit: C	*CTL	[0 or 1 / 0 / 1] 0: Service 1: User
5-067-048	#Photoconductor Unit (Magenta)	*CTL	[0 or 1 / 0 / 1] 0: Service 1: User
5-067-049	#Development unit: M	*CTL	[0 or 1 / 0 / 1] 0: Service 1: User
5-067-071	#Photoconductor Unit (Yellow)	*CTL	[0 or 1 / 0 / 1] 0: Service 1: User

5-067-072	#Development unit: Y	*CTL	[0 or 1 / 0 / 1] 0: Service 1: User
5-067-093	#Intermediate Transfer Unit	*CTL	[0 or 1 / 0 / 1] 0: Service 1: User
5-067-102	#ITB Cleaning Unit	*CTL	[0 or 1 / 0 / 1] 0: Service 1: User
5-067-109	#Paper Transfer Unit	*CTL	[0 or 1 / 0 / 1] 0: Service 1: User
5-067-115	#Fuser Unit	*CTL	[0 or 1 / 0 / 1] 0: Service 1: User
5-067-116	Fuser Unit: Belt	*CTL	[0 or 1 / 0 / 1] 0: Service 1: User
5-067-118	Fuser Unit: Pressure Roller	*CTL	[0 or 1 / 0 / 1] 0: Service 1: User
5-067-131	#Dust Filter	*CTL	[0 or 1 / 0 / 1] 0: Service 1: User
5-067-142	#Wast Toner bottle	*CTL	[0 or 1 / 0 / 1] 0: Service 1: User
5-067-206	#ADF Pick-up Roller	*CTL	[0 or 1 / 0 / 1] 0: Service 1: User

5-067-207	#ADF Paper Supply Belt	*CTL	[0 or 1 / 0 / 1] 0: Service 1: User
5-067-208	#ADF Separate Roller	*CTL	[0 or 1 / 0 / 1] 0: Service 1: User

5071	[Set Bypass Paper Size Display]		
5-071-001	-	CTL	[0 or 1 / 0 / 1] 0: Off 1: On

5073	[Supply Part Replacement Operation Type]		
5-073-001	Waste Toner Bottle	*CTL	[0 or 1 / 0 / 1] 0:No Display 1:Display

5074	[Home Screen Login]		
5-074-002	Login Setting	*CTL	[0 to 255 / 0 / 1]
5-074-050	Show Home Edit Menu	*CTL	[0 to 2 / 0 / 1]
5-074-091	Function Setting	*CTL	[0 to 2 / 0 / 1] 0: Function disable 1: SDK application 2: Legacy application (reserved)
5-074-092	Product ID	*CTL	[0x00 to 0xffff / - / 1]
5-074-093	Application Screen ID	*CTL	[0 to 255 / 0 / 1]

5075	[USB Keyboard]		
-------------	-----------------------	--	--

5-075-003	Display setting	*CTL	[0 or 1 / 0 / 1] 0: Disable 1: Enable
5081	[ServiceSP Entry Code Setting]		
	DFU		
5-081-001	ServiceSP Entry Code Setting	-	-
5083	[LED Light Switch Setting]		
	5-083-001	Toner Near End	*CTL [0 or 1 / 0 / 1] 0: OFF 1: ON
	5-083-002	Waste Toner Near End	*CTL [0 or 1 / 0 / 1]
5102	[AutoDetect]		
	5-102-203	HumanDetectSetting	*CTL [0 or 1 / 0 / 1]
5114	[Optional Counter I/F]		
	5-114-001	MF Key Card Extension	*CTL [0 or 1 / 0 / 1] 0: Not installed 1: Installed (scanning accounting)
5118	[Disable Copying]		
	5-118-001	-	*CTL [0 or 1 / 0 / 1] 0: Not disabled 1: Disabled
5120	[Mode Clear Opt. Counter Removal]		

5-120-001	0:Yes 1:StandBy 2:No	*CTL	[0 to 2 / 0 / 1] 0: Yes (removed) 1: Standby (installed but not used) 2: No (not removed)
-----------	----------------------	------	--

5121	[Counter Up Timing]		
5-121-001	0:Feed 1:Exit	*CTL	[0 or 1 / 0 / 1] 0: Feed 1: Exit

5127	[APS Mode]		
5-127-001	-	*CTL	[0 or 1 / 0 / 1] 0: Not disabled 1: Disabled

5148	[Size Detection Off]		
5-148-002	Tray 1	*CTL	[0 or 1 / 0 / 1]

5150	[Length Setting]		
5-150-001	Bypass(0:OFF 1:Long)	CTL	[0 or 1 / 0 / 1] 0: OFF 1: ON

5162	[App. Switch Method]		
5-162-001	-	*CTL	[0 or 1 / 0 / 1] 0: Soft Key Set 1: Hard Key Set

5167	[Fax Printing Mode at Optional Counter Off]		
-------------	--	--	--

5-167-001	-	*CTL	[0 or 1 / 0 / 1] 0: Automatic printing 1: No automatic printing
5169	[CE Login]		
5-169-001		*CTL	[0 or 1 / 0 / 1] 0: Disabled 1: Enabled
5188	[Copy Nv Version]		
5-188-001	-	*CTL	[- / - / -]
5191	[Mode Set]		
5-191-001	Power Str Set	*CTL	[0 or 1 / 1 / 1] 0: OFF 1: ON
5193	[External Controller Info. Settings]		
5-193-001	-	CTL	[0 to 10 / 0 / 1] 0: External Controller is not installed 1: EFI 2: Ratio 3: Egret 4: GJ 5: Creo 6: QX-100 7: Kurofune 8 to 10: Reserved
5195	[Limitless SW]		

5-195-001	-	*CTL	[0 or 1 / 0 / 1] 0: Productivity Precede 1: Use paper up
-----------	---	------	--

5196	[Copier Vendor Mode]		
5-196-001	90 deg. Rotation	CTL	[0 or 1 / 0 / 1]
5-196-002	Color and Tray Selection	CTL	[0 or 1 / 0 / 1]

5199	[Paper Exit After Staple End]		
5-199-001	Staple(1:Without 2:After 0:Auto)	CTL	[0 to 2 / 0 / 1]
5-199-002	Saddle(1:Without 2:After 0:Auto)	CTL	[0 to 2 / 0 / 1]
5-199-003	Stapless(1:Without 2:After 0:Auto)	CTL	[0 to 2 / 0 / 1]

5212	[Page Numbering]		
5-212-003	Duplex Printout Left/Right Position of Left/Right Facing	*CTL	[-10 to 10 / 0 / 0.01mm/step]
5-212-004	Duplex Printout Top/Bottom Position of Left/Right Facing	*CTL	[-10 to 10 / 0 / 0.01mm/step]
5-212-018	Duplex Printout Left/Right Position of Top/Bottom Facing	*CTL	[-10 to 10 / 0 / 0.01mm/step]
5-212-019	Duplex Printout Top/Bottom Position of Top/Bottom Facing	*CTL	[-10 to 10 / 0 / 0.01mm/step]

5227	[Page numbering]		
5-227-201	Allow Page No. Entry	*CTL	[2 to 9 / 9 / 1]
5-227-202	Zero Surplus Stting	*CTL	[0 or 1 / 0 / 1] 0:OFF 1:ON

5302	[Set Time]		
	<p>Adjusts the RTC (real time clock) time setting for the local time zone. Examples: For Japan (+9 GMT), enter 540 (9 hours x 60 min.) DOM: +540 (Tokyo) NA: -300 (New York) EU: + 60 (Paris) CH: +480 (Beijing) TW: +480 (Taipei) AS: +480 (Hong Kong)</p>		
5-302-002	Time Difference	*CTL	[-1440 to 1440 / - / 1min/step]

5305	[Auto Off Set]		
5-305-101	Auto Off Limit Set	*CTL	[0 or 1 / 1 / 1]

5307	[Daylight Saving Time]		
5-307-001	Setting	*CTL	[0 to 1 / - / 1] 0: Disabled 1: Enabled (Default) 1: NA and EUR 0: ASIA and others
	Enables or disables the summer time mode. Note <ul style="list-style-type: none"> Make sure that both SP5-307-3 and -4 are correctly set. Otherwise, this SP is not activated even if this SP is set to "1". 		

5-307-003	Rule Set (Start)	*CTL	[0 to 0xffffffff / - / 1hex] (Default) NA: 0x111100200 EUR: 0x10500100 ASIA: 0x03100000 Other: 0x00000000
<p>Specifies the start setting for the summer time mode.</p> <p>There are 8 digits in this SP. For months 1 to 9, the "0" cannot be input in the first digit, so the eight-digit setting for -2 or -3 becomes a seven-digit setting.</p> <p>1st and 2nd digits: The month. [1 to 12]</p> <p>3rd digit: The week of the month. [1 to 5]</p> <p>4th digit: The day of the week. [0 to 6 = Sunday to Saturday]</p> <p>5th and 6th digits: The hour. [00 to 23]</p> <p>7th digit: The length of the advanced time. [0 to 9 / 1 hour]</p> <p>8th digit: The length of the advanced time. [0 to 5 / 10 minutes]</p> <ul style="list-style-type: none"> • The digits are counted from the left. • Make sure that SP5-307-1 is set to "1". 			
5-307-004	Rule Set (End)	*CTL	[0 to 0xffffffff / - / 1hex]
<p>Specifies the end setting for the summer time mode.</p> <p>There are 8 digits in this SP.</p> <p>1st and 2nd digits: The month. [1 to 12]</p> <p>3rd digit: The week of the month. [0 to 5]</p> <p>4th digit: The day of the week. [0 to 7 = Sunday to Saturday]</p> <p>5th and 6th digits: The hour. [00 to 23]</p> <p>The 7th and 8 digits must be set to "00".</p> <ul style="list-style-type: none"> • The digits are counted from the left. • Make sure that SP5-307-1 is set to "1". 			

5401	[Access Control]		
5-401-103	Default Document ACL	CTL	[0 to 3 / 0 / 1]
5-401-104	Authentication Time	CTL	[0 to 255 / 0 / 1 sec/step]

5-401-162	Extend Certification Detail	CTL	[0 to 0xFF / 0 / 1]
5-401-200	SDK1 UniqueID	CTL	[0 to 0xFFFFFFFF / 0 / 1]
5-401-201	SDK1 Certification Method	CTL	[0 to 0xFF / 0 / 1]
5-401-210	SDK2 UniqueID	CTL	[0 to 0xFFFFFFFF / 0 / 1]
5-401-211	SDK2 Certification Method	CTL	[0 to 0xFF / 0 / 1]
5-401-220	SDK3 UniqueID	CTL	[0 to 0xFFFFFFFF / 0 / 1]
5-401-221	SDK3 Certification Method	CTL	[0 to 0xFF / 0 / 1]
5-401-230	SDK Certification Device	*CTL	[0 to 7 / 0 / power of 2] 0-1: SDK authentication available 0-0: Disable all functions 1-1: SKB Display 1-0: Disable 2-1: Administrator login 2-0: Disable 3 to 7-0: Reserved (set "0" only)
5-401-240	Detail Option	*CTL	[0 to 7 / 0x00 / 0x01]
	0: Logout confirm option -1: ON, 0: OFF 2 to 1: Auto-logout timer(retry timer) -1 1: 30sec, 10: 20sec, 01: 10sec, 00: 60sec 3: personal authority / Group authority and operation -1: ON, 0: OFF 4: Skip password entry -1: ON, 0: OFF 5: Set the display of the remaining Frequency -1: ON, 0: OFF 6 to 7: Set the display time -1: ON, 0: OFF		

5402	[Access Control]
-------------	-------------------------

5-402-101	SDKJ1 Limit Setting	CTL	[0 to 0xff / 0 / 1]
5-402-102	SDKJ2 Limit Setting	CTL	[0 to 0xff / 0 / 1]
5-402-103	SDKJ3 Limit Setting	CTL	[0 to 0xff / 0 / 1]
5-402-104	SDKJ4 Limit Setting	CTL	[0 to 0xff / 0 / 1]
5-402-105	SDKJ5 Limit Setting	CTL	[0 to 0xff / 0 / 1]
5-402-106	SDKJ6 Limit Setting	CTL	[0 to 0xff / 0 / 1]
5-402-107	SDKJ7 Limit Setting	CTL	[0 to 0xff / 0 / 1]
5-402-108	SDKJ8 Limit Setting	CTL	[0 to 0xff / 0 / 1]
5-402-109	SDKJ9 Limit Setting	CTL	[0 to 0xff / 0 / 1]
5-402-110	SDKJ10 Limit Setting	CTL	[0 to 0xff / 0 / 1]
5-402-111	SDKJ11 Limit Setting	CTL	[0 to 0xff / 0 / 1]
5-402-112	SDKJ12 Limit Setting	CTL	[0 to 0xff / 0 / 1]
5-402-113	SDKJ13 Limit Setting	CTL	[0 to 0xff / 0 / 1]
5-402-114	SDKJ14 Limit Setting	CTL	[0 to 0xff / 0 / 1]
5-402-115	SDKJ15 Limit Setting	CTL	[0 to 0xff / 0 / 1]
5-402-116	SDKJ16 Limit Setting	CTL	[0 to 0xff / 0 / 1]
5-402-117	SDKJ17 Limit Setting	CTL	[0 to 0xff / 0 / 1]
5-402-118	SDKJ18 Limit Setting	CTL	[0 to 0xff / 0 / 1]
5-402-119	SDKJ19 Limit Setting	CTL	[0 to 0xff / 0 / 1]
5-402-120	SDKJ20 Limit Setting	CTL	[0 to 0xff / 0 / 1]
5-402-121	SDKJ21 Limit Setting	CTL	[0 to 0xff / 0 / 1]
5-402-122	SDKJ22 Limit Setting	CTL	[0 to 0xff / 0 / 1]
5-402-123	SDKJ23 Limit Setting	CTL	[0 to 0xff / 0 / 1]
5-402-124	SDKJ24 Limit Setting	CTL	[0 to 0xff / 0 / 1]
5-402-125	SDKJ25 Limit Setting	CTL	[0 to 0xff / 0 / 1]
5-402-126	SDKJ26 Limit Setting	CTL	[0 to 0xff / 0 / 1]

5-402-127	SDKJ27 Limit Setting	CTL	[0 to 0xff / 0 / 1]
5-402-128	SDKJ28 Limit Setting	CTL	[0 to 0xff / 0 / 1]
5-402-129	SDKJ29 Limit Setting	CTL	[0 to 0xff / 0 / 1]
5-402-130	SDKJ30 Limit Setting	CTL	[0 to 0xff / 0 / 1]
5-402-141	SDKJ1 ProductID	CTL	[0 to 0xffffffff / 0 / 1]
5-402-142	SDKJ2 ProductID	CTL	[0 to 0xffffffff / 0 / 1]
5-402-143	SDKJ3 ProductID	CTL	[0 to 0xffffffff / 0 / 1]
5-402-144	SDKJ4 ProductID	CTL	[0 to 0xffffffff / 0 / 1]
5-402-145	SDKJ5 ProductID	CTL	[0 to 0xffffffff / 0 / 1]
5-402-146	SDKJ6 ProductID	CTL	[0 to 0xffffffff / 0 / 1]
5-402-147	SDKJ7 ProductID	CTL	[0 to 0xffffffff / 0 / 1]
5-402-148	SDKJ8 ProductID	CTL	[0 to 0xffffffff / 0 / 1]
5-402-149	SDKJ9 ProductID	CTL	[0 to 0xffffffff / 0 / 1]
5-402-150	SDKJ10 ProductID	CTL	[0 to 0xffffffff / 0 / 1]
5-402-151	SDKJ11 ProductID	CTL	[0 to 0xffffffff / 0 / 1]
5-402-152	SDKJ12 ProductID	CTL	[0 to 0xffffffff / 0 / 1]
5-402-153	SDKJ13 ProductID	CTL	[0 to 0xffffffff / 0 / 1]
5-402-154	SDKJ14 ProductID	CTL	[0 to 0xffffffff / 0 / 1]
5-402-155	SDKJ15 ProductID	CTL	[0 to 0xffffffff / 0 / 1]
5-402-156	SDKJ16 ProductID	CTL	[0 to 0xffffffff / 0 / 1]
5-402-157	SDKJ17 ProductID	CTL	[0 to 0xffffffff / 0 / 1]
5-402-158	SDKJ18 ProductID	CTL	[0 to 0xffffffff / 0 / 1]
5-402-159	SDKJ19 ProductID	CTL	[0 to 0xffffffff / 0 / 1]
5-402-160	SDKJ20 ProductID	CTL	[0 to 0xffffffff / 0 / 1]
5-402-161	SDKJ21 ProductID	CTL	[0 to 0xffffffff / 0 / 1]
5-402-162	SDKJ22 ProductID	CTL	[0 to 0xffffffff / 0 / 1]

5-402-163	SDKJ23 ProductID	CTL	[0 to 0xffffffff / 0 / 1]
5-402-164	SDKJ24 ProductID	CTL	[0 to 0xffffffff / 0 / 1]
5-402-165	SDKJ25 ProductID	CTL	[0 to 0xffffffff / 0 / 1]
5-402-166	SDKJ26 ProductID	CTL	[0 to 0xffffffff / 0 / 1]
5-402-167	SDKJ27 ProductID	CTL	[0 to 0xffffffff / 0 / 1]
5-402-168	SDKJ28 ProductID	CTL	[0 to 0xffffffff / 0 / 1]
5-402-169	SDKJ29 ProductID	CTL	[0 to 0xffffffff / 0 / 1]
5-402-170	SDKJ30 ProductID	CTL	[0 to 0xffffffff / 0 / 1]

5404	[User Code Count Clear]		
5-404-001	User Code Count Clear	*CTL	[- / - / -] [Execute]
5-404-101	User Code Count Clear Permit Setting	*CTL	[0 or 1 / 0 / 1]

5411	[LDAP-Certification]		
5-411-004	Easy Certification	*CTL	[0 or 1 / 1 / 1] 1: On 0: Off
5-411-005	Password Null Not Permit	*CTL	[0 or 1 / 0 / 1] 0: Password NULL not permitted. 1: Password NULL permitted.
5-411-006	Detail Option	*CTL	[0 or 1 / 0 / 1] 0: OFF 1: ON

5412	[Krb-Certification]		
5-412-100	Encrypt Mode	CTL	[0 to 0xFF / 0x1F / 1]

5413		[Lockout Setting]	
5-413-001	Lockout On/Off	* CTL	[0 or 1 / 0 / 1] 0: Off 1: On
5-413-002	Lockout Threshold	* CTL	[1 to 10 / 5 / 1]
5-413-003	Cancellation On/Off	* CTL	[0 or 1 / 0 / 1] 0: Off (no wait time, lockout not cancelled) 1: On (system waits, cancels lockout if correct user ID and password are entered).
5-413-004	Cancellation Time	* CTL	[1 to 9999 / 60 / 1min]

5414		[Access Mitigation]	
5-414-001	Mitigation On/Off	* CTL	[0 or 1 / 0 / 1] 0: OFF 1: ON
5-414-002	Mitigation Time	* CTL	[0 to 60 / 15 / 1min/step]

5415		[Password Attack]	
5-415-001	Permissible Number	* CTL	[0 to 100 / 30 / 1attempt/step]
5-415-002	Detect Time	* CTL	[1 to 10 / 5 / 1sec/step]

5416		[Access Information]	
5-416-001	Access User Max Num	* CTL	[50 to 200 / 200 / 1user/step]
5-416-002	Access Password Max Num	* CTL	[50 to 200 / 200 / 1password/step]
5-416-003	Monitor Interval	* CTL	[1 to 10 / 3 / 1sec/step]

5417		[Access Attack]	
5-417-001	Access Permissible Number	* CTL	[0 to 500 / 100 / 1/step]

5-417-002	Attack Detect Time	*CTL	[10 to 30 / 10 / 1sec/step]
5-417-003	Productivity Fall Wait	*CTL	[0 to 9 / 3 / 1sec/step]
5-417-004	Attack Max Num	*CTL	[50 to 200 / 200 / 1attempt/step]

5420	[User Authentication]		
5-420-001	Copy	*CTL	[0 to 1 / 0 / 1] 0: On 1: Off
5-420-002	Color Security Setting	*CTL	[0x00 to 0xFF / 0x00 / 1]
5-420-011	DocumentServer	*CTL	[0 or 1 / 0 / 1] 0: On 1: Off
5-420-021	Fax	*CTL	[0 or 1 / 0 / 1] 0: On 1: Off
5-420-031	Scanner	*CTL	[0 or 1 / 0 / 1] 0: On 1: Off
5-420-041	Printer	*CTL	[0 or 1 / 0 / 1] 0: On 1: Off
5-420-051	SDK1	*CTL	[0 or 1 / 0 / 1] 0: ON 1: OFF
5-420-061	SDK2	*CTL	
5-420-071	SDK3	*CTL	
5-420-081	Browser	*CTL	[0 or 1 / 0 / 1] 0: ON 1: OFF

5430	[Auth Dialog Message Change]		
-------------	-------------------------------------	--	--

5-430-001	Message Change On/Off	CTL	[0 or 1 / 0 / 1]
5-430-002	Message Text Download	CTL	[- / - / -]
5-430-003	Message Text ID	CTL	[- / - / -]

5431	[External Auth User Preset]		
5-431-010	Tag	CTL	[0 or 1 / 1 / 1]
5-431-011	Entry	CTL	[0 or 1 / 1 / 1]
5-431-012	Group	CTL	[0 or 1 / 1 / 1]
5-431-020	Mail	CTL	[0 or 1 / 1 / 1]
5-431-030	Fax	CTL	[0 or 1 / 1 / 1]
5-431-031	FaxSub	CTL	[0 or 1 / 1 / 1]
5-431-032	Folder	CTL	[0 or 1 / 1 / 1]
5-431-033	ProtectCode	CTL	[0 or 1 / 1 / 1]
5-431-034	SmtptAuth	CTL	[0 or 1 / 1 / 1]
5-431-035	LdapAuth	CTL	[0 or 1 / 1 / 1]
5-431-036	Smb Ftp Fldr Auth	CTL	[0 or 1 / 1 / 1]
5-431-037	AcntAcl	CTL	[0 or 1 / 1 / 1]
5-431-038	DocumentAcl	CTL	[0 or 1 / 1 / 1]
5-431-040	CertCrypt	CTL	[0 or 1 / 0 / 1]
5-431-050	UserLimitCount	CTL	[0 or 1 / 1 / 1]

5481	[Authentication Error Code]		
5-481-001	System Log Disp	*CTL	[0 or 1 / 0 / 1] 0: Off 1: On

5-481-002	Panel Disp	*CTL	[0 or 1 / 0 / 1] 1: On 0: Off
-----------	------------	------	-------------------------------------

5490	[MF KeyCard (Japan only)]		
5-490-001	Job Permit Setting	*CTL	[0 to 1 / 0 / 1] 0: Disabled. Cancels operation without a user code. 1: Enabled. Allows operation without a user code.
5-490-002	Count Mode Setting	*CTL	-

5491	[Optional Counter]		
5-491-001	Detail Option	*CTL	[0 to 0xff / 0 / 1]

5501	[PM Alarm]		
5-501-001	PM Alarm Level	*CTL	[0 to 9999 / 0 / 1] 0: Alarm off 1 to 9999: Alarm goes off when Value (1 to 9999) x 1000 > PM counter

5504	[Jam Alarm]		
5-504-001	-	*CTL	[0 to 3 / 3 / 1] 0: Z 1: L 2: M 3: H
5-504-002	Threshold	*CTL	[1 to 99 / 10 / 1]

5505	[Error Alarm]		
-------------	----------------------	--	--

5-505-001	Error Alarm	*CTL	[0 to 255 / * / 1 x10 ² sheets/step] 0: Alarm Off * C2503 :20 / C2003:15
5-505-002	Threshold	*CTL	[1 to 99 / 5 / 1]

5507	[Supply/CC Alarm]		
5-507-001	Paper Supply Alarm	*CTL	[0 or 1 / 0 / 1] 0: OFF 1: ON
5-507-002	Staple Supply Alarm	*CTL	[0 or 1 / 0 / 1] 0: OFF 1: ON
5-507-003	Toner Supply Alarm	*CTL	[0 or 1 / 0 / 1] 0: OFF 1: ON
5-507-006	WasteTonerBottle	*CTL	[0 to 2 / 1 / 1] 0:OFF 1: Supply Call ON 2: CC Call ON
5-507-080	Toner Call Timing	*CTL	[0 or 1 / 0 / 1] 0: Toner bottle replacement 1: Less than toner threshold
5-507-080	Toner Call Timing	CTL	[0 or 1 / 0 / 1]
5-507-081	Toner Call Threshold:Bk	CTL	[10 to 90 / 10 / 10%/step]
5-507-082	Toner Call Threshold:CMY	CTL	[10 to 90 / 10 / 10%/step]
5-507-128	Interval :Others	*CTL	[250 to 10000 / 1000 / 1 page/step]
5-507-132	Interval :A3	*CTL	[250 to 10000 / 1000 / 1 page/step]

5-507-133	Interval :A4	*CTL	[250 to 10000 / 1000 / 1 page/step]
5-507-134	Interval :A5	*CTL	[250 to 10000 / 1000 / 1 page/step]
5-507-141	Interval :B4	*CTL	[250 to 10000 / 1000 / 1 page/step]
5-507-142	Interval :B5	*CTL	[250 to 10000 / 1000 / 1 page/step]
5-507-160	Interval :DLT	*CTL	[250 to 10000 / 1000 / 1 page/step]
5-507-164	Interval: LG	*CTL	[250 to 10000 / 1000 / 1 page/step]
5-507-166	Interval :LT	*CTL	[250 to 10000 / 1000 / 1 page/step]
5-507-172	Interval :HLT	*CTL	[250 to 10000 / 1000 / 1 page/step]

5508	[CC Call]		
5-508-001	Jam Remains	*CTL	[0 or 1 / 1 / 1] 0: Disable 1: Enable
5-508-002	Continuous Jams	*CTL	[0 or 1 / 1 / 1] 0: Disable 1: Enable
5-508-003	Continuous Door Open	*CTL	[0 or 1 / 1 / 1] 0: Disable 1: Enable
5-508-011	Jam Detection: Time Length	*CTL	[3 to 30 / 10 / 1 min/step]
5-508-012	Jam Detection: Continuous Count	*CTL	[2 to 10 / 5 / 1 time/step]
5-508-013	Door Open: Time Length	*CTL	[3 to 30 / 10 / 1 min/step]

5513	[PartsAlarmlevelCount]		
5-513-001	Normal	*CTL	[1 to 9999 / 300 / 1]
5-513-002	Df	*CTL	[1 to 9999 / 300 / 1]

5514	[PartsAlarmlev]		
5-514-001	Normal	*CTL	[0 or 1 / 1 / 1]
5-514-002	Df	*CTL	[0 or 1 / 0 / 1]

4

5515	[SC/Alarm Setting]		
5-515-001	SC Call	*CTL	[0 or 1 / 1 / 1] 0: OFF 1: ON
5-515-002	Service Parts Near End Call	*CTL	
5-515-003	Service Parts End Call	*CTL	
5-515-004	User Call	*CTL	
5-515-006	Communication Test Call	*CTL	
5-515-007	Machine Information Notice	*CTL	
5-515-008	Alarm Notice	*CTL	
5-515-009	Non Genuine Tonner Ararm	*CTL	
5-515-010	Supply Automatic Ordering Call	*CTL	
5-515-011	Supply Management Report Call	*CTL	
5-515-012	Jam/Door Open Call	*CTL	
5-515-050	Timeout:Manual Call	*CTL	
5-515-051	Timeout:Other Call	*CTL	[1 to 255 / 10 / 1 min/step]

5517	[Get Machine Information]		
5-517-031	Get SMC Info: Retry Interval	*CTL	[10 to 255 / 10 / 1 min/step]

5618	[Color Mode Display Selection]		
5-618-001	-	*CTL	[0 or 1 / 1 / 1] 0: ACS, Color, Black & White, Two Colors, Single color 1: ACD, Full Color, Black & White

5728	[Network Setting]		
5-728-001	NAT Machine Port1	CTL	[1 to 65535 / 49101 / 1]
5-728-002	NAT UI Port1	CTL	[1 to 65535 / 55101 / 1]
5-728-003	NAT Machine Port2	CTL	[1 to 65535 / 49102 / 1]
5-728-004	NAT UI Port2	CTL	[1 to 65535 / 55102 / 1]
5-728-005	NAT Machine Port3	CTL	[1 to 65535 / 49103 / 1]
5-728-006	NAT UI Port3	CTL	[1 to 65535 / 55103 / 1]
5-728-007	NAT Machine Port4	CTL	[1 to 65535 / 49104 / 1]
5-728-008	NAT UI Port4	CTL	[1 to 65535 / 55104 / 1]
5-728-009	NAT Machine Port5	CTL	[1 to 65535 / 49105 / 1]
5-728-010	NAT UI Port5	CTL	[1 to 65535 / 55105 / 1]
5-728-011	NAT Machine Port6	CTL	[1 to 65535 / 49106 / 1]
5-728-012	NAT UI Port6	CTL	[1 to 65535 / 55106 / 1]
5-728-013	NAT Machine Port7	CTL	[1 to 65535 / 49107 / 1]
5-728-014	NAT UI Port7	CTL	[1 to 65535 / 55107 / 1]
5-728-015	NAT Machine Port8	CTL	[1 to 65535 / 49108 / 1]
5-728-016	NAT UI Port8	CTL	[1 to 65535 / 55108 / 1]
5-728-017	NAT Machine Port9	CTL	[1 to 65535 / 49109 / 1]
5-728-018	NAT UI Port9	CTL	[1 to 65535 / 55109 / 1]
5-728-019	NAT Machine Port10	CTL	[1 to 65535 / 49110 / 1]
5-728-020	NAT UI Port10	CTL	[1 to 65535 / 55110 / 1]

5730	[Extended Function Setting]		
5-730-001	JavaTM Platform setting	*CTL	[0 or 1 / 1 / -] 0: Disable, 1: Enable
5-730-010	Expiration Prior Alarm Set	*CTL	[0 to 999 / 20 / 1 day/step]

5731	[Counter Effect]		
This SP is used only for DOM machines.			
5-731-001	Change MK1 Cnt (Paper->Combine)	*CTL	[0 or 1 / 0 / 1]

5732	[Reset Job After Jam(Copy)]		
5-732-002		*CTL	[0 or 1 / 0 / 1]

5734	[PDF Setting]		
5-734-001	PDF/A Fixed	*CTL	[0 or 1 / 0 / 1]

5741	[Node Authentication Timuout]		
5-741-001		*CTL	[1 to 255 / 60 / 1 sec/step]

5745	[DeemedPowerConsumption]		
5-745-211	Controller Standby	*CTL	[0 to 9999 / 0 / 1]
5-745-212	STR	*CTL	[0 to 9999 / 0 / 1]
5-745-213	Main Power Off	*CTL	[0 to 9999 / 0 / 1]
5-745-214	Scanning and Printing	*CTL	[0 to 9999 / 0 / 1]
5-745-215	Printing	*CTL	[0 to 9999 / 0 / 1]
5-745-216	Scanning	*CTL	[0 to 9999 / 0 / 1]
5-745-217	Engine Standby	*CTL	[0 to 9999 / 0 / 1]
5-745-218	Low Power Consumption	*CTL	[0 to 9999 / 0 / 1]
5-745-219	Silent condition	*CTL	[0 to 9999 / 0 / 1]

5-745-220	Heater Off	*CTL	[0 to 9999 / 0 / 1]
-----------	------------	------	---------------------

5748	[OpePanel Setting]		
5-748-101	Op Type Action Setting	CTL	[0x00 to 0xFF / 0 / 0x01] <ul style="list-style-type: none"> bit0 0: Normal operation panel 1: Smart operation panel
5-748-201	Cheetah Panel Connect Setting	CTL	[0 or 1 / 0 / 0] 0: OFF 1: ON

4

5749	[Import/Export]		
5-749-001	Export	CTL	[- / - / -] Target: System, Printer, Fax, Scanner Option: Unique, Secret Copy config: Encryption, Encryption key(if selected) [Execute]
5-749-101	Import	CTL	[- / - / -] Option: Unique Copy config: Encryption, Encryption key(if selected) [Execute]

5751	[Key Event Encryption Setting]		
5-751-001	Password	CTL	[0 to 255 / 0 / 1]

5752	[Copy:WebAPI Setting]			
5-752-001	Copy FlairAPI Setting	*CTL	* see BitSwitch below:	
Bit	Setting	meanings		Description
		0	1	

bit 0	Start of FlairAPI Server	Off (Do not Start)	On (Start)	Sets whether to start exclusive FlairAPI http server. If it is 0, scanning FlairAPI function and simple UI function will be disabled. The machine installed Android operating panel option, set "1", others set "0".
bit 1	Access permission of FlairAPI from outside of the machine	Disabled	Enabled	If it is "0", accessing is limited from the machine only, such as operating panel, SDK/J, MFP browsers etc... If it is "1", accessing is allowed from outside of FlairAPI such as PC, Remote UI, IT-Box etc...
bit 2	Reserved	-	-	-
bit 3	Reserved	-	-	-
bit 4	Simple UI Function	Disabled	Enabled	If it is "1", the machine can be used Scanner Simple UI. If it is "0", requesting URL of Simple UI returns "404 Not Found"
bit 5	Accessing permission of Simple UI from outside of the machine	Disabled	Enabled	If it is "0", accessing is limited from the machine only (operating panel and MFP browser). If it is "1", accessing is allowed from outside of Simple UI such as PC, mobile devices, and so on.
bit 6	Reserved	-	-	-
bit 7	Reserved	-	-	-

5755	[Display Setting]		
5-755-001	Disp Administrator Password Change Scrn	CTL	[- / - / -]
5-755-002	Hide Administrator Password Change Scrn	CTL	[- / - / -]

5758	[RemoteUI Setting]		
5-758-001	Authentication	*CTL	[0 or 1 / 0 / 1]

5759	[Machine Limit Count]		
5-759-001	Machine Limit Count Setting	*CTL	[0 or 1 / 0 / 1]
5-759-061	Full Color Limit Count	*CTL	[0 to 999999999 / 0 / 1]
5-759-062	Mono Color Limit Count	*CTL	[0 to 999999999 / 0 / 1]

5801	[Memory Clear]		
5-801-001	All Clear	CTL	[- / - / -] [Execute]
5-801-003	SCS	CTL	[- / - / -] [Execute]
5-801-004	IMH Memory Clr	CTL	[- / - / -] [Execute]
5-801-005	Mcs	CTL	[- / - / -] [Execute]
5-801-006	Copier Application	CTL	[- / - / -] [Execute]
5-801-007	Fax Application	CTL	[- / - / -] [Execute]

5-801-008	Printer Application	CTL	[- / - / -] [Execute]
<p>The following service settings:</p> <ul style="list-style-type: none"> • Bit switches • Gamma settings (User & Service) • Toner Limit <p>The following user settings:</p> <ul style="list-style-type: none"> • Tray Priority • Menu Protect • System Setting except for setting of Energy Saver • I/F Setup (I/O Buffer and I/O Timeout) • PCL Menu 			
5-801-009	Scanner Application	CTL	[- / - / -] [Execute]
5-801-010	Web Service	CTL	[- / - / -] [Execute]
5-801-011	NCS	CTL	[- / - / -] [Execute]
5-801-012	R-Fax	CTL	[- / - / -] [Execute]
5-801-014	Clear DCS Setting	CTL	[- / - / -] [Execute]
5-801-015	Clear UCS Setting	CTL	[- / - / -] [Execute]
5-801-016	MIRS Memory Clr	CTL	[- / - / -] [Execute]
5-801-017	CCS	CTL	[- / - / -] [Execute]
5-801-018	SRM Memory Clr	CTL	[- / - / -] [Execute]

5-801-019	LCS Memory Clr	CTL	[- / - / -] [Execute]
5-801-020	Web Uapli	CTL	[- / - / -] [Execute]
5-801-021	ECS	CTL	[- / - / -] [Execute]
5-801-023	AICS	CTL	[- / - / -] [Execute]
5-801-025	Websys	CTL	[- / - / -] [Execute]
5-801-026	PLN	CTL	[- / - / -] [Execute]
5-801-027	SAS	CTL	[- / - / -] [Execute]
5-801-028	Rest WebService	CTL	[- / - / -] [Execute]

5812	[Service Tel. No. Setting]		
5-812-001	Service	*CTL	[up to 20 / - / 1]
5-812-002	Facsimile	*CTL	[up to 20 / - / 1]
5-812-003	Supply	*CTL	[up to 20 / - / 1]
5-812-004	Operation	*CTL	[up to 20 / - / 1]

5816	[Remote Service]		
5-816-001	I/F Setting	*CTL	[0 to 2 / 2 / 1] 0: Remote service off 1: CSS remote service on 2: NRS remote service on

5-816-002	CE Call	*CTL	[0 or 1 / 0 / 1] 0: Start of the service 1: End of the service
5-816-003	Function Flag	*CTL	[0 or 1 / 0 / 1] 0: Disabled 1: Enabled
5-816-007	SSL Disable	*CTL	[0 or 1 / 0 / 1] 0: Yes. SSL not used. 1: No. SSL used.
5-816-008	RCG Connect Timeout	*CTL	[1 to 90 / 30 / 1second/step]
5-816-009	RCG Write Timeout	*CTL	[0 to 100 / 60 / 1second/step]
5-816-010	RCG Read Timeout	*CTL	[0 to 100 / 60 / 1second/step]
5-816-011	Port 80 Enable	*CTL	[0 or 1 / 0 / 1] 0: No. Access denied 1: Yes. Access granted.
5-816-013	RFU Timing	*CTL	[0 or 1 / 1 / 1] 0: Any status of a target machine 1: Sleep or panel off mode only
5-816-014	RCG Error Cause	CTL	[0 or 1 / 0 / 1] 0: Initial state, normal condition 1: Error
5-816-021	RCG – C Registered	*CTL	[0 or 1 / 0 / 1] 0: Installation not completed 1: Installation completed
5-816-023	connect type(N/M)	*CTL	[0 or 1 / 0 / 1] 0: internet connection 1: Dial-up connection
5-816-061	Cert Expire Timing	*CTL	[0 to 0xffffffff / 0 / 1] 0: Not use 1: Use

5-816-062	Use Proxy	*CTL	[0 or 1 / 0 / 1] 0: Not use 1: Use
5-816-063	Proxy Host	*CTL	[- / - / -]
5-816-064	Proxy PortNumber	*CTL	[0 to 0xffff / 0 / 1]
5-816-065	Proxy User Name	*CTL	[up to 31 / - / 1]
5-816-066	Proxy Password	*CTL	[up to 31 / - / 1]

5-816-067	Proxy Password	*CTL	[0 to 255 / 0 / 1]
<p>Displays status of the certification used for Cumin.</p> <p>If it is not installed as Cumin, the value of this SP will be set when it installed, after checking the certification status.</p>			
0	The certification adequately set on the machine.		
1	Request for certification update in progress.		
2	Certification Update completed and notification of the success status to the G/W in progress.		
3	Certification Update failed and notification of the result to the G/W in progress.		
4	Certification expiration date will be coming soon. Notifying the G/W to request for certification update.		
11	Rescue certification setting for connecting to the rescue G/W in progress because update for rescue certification needed.		
12	Setting for rescue certification has completed. Requesting to the rescue G/W for updating certification.		
13	Notification for certification updating request has completed. Waiting for the certification update request from the rescue G/W.		
14	Received the notification for certification updating request from the rescue G/W. Writing the certification.		
15	Writing the certification has completed. Notifying the result of certification update to the G/W.		
16	Writing the certification has failed. Notifying the result of certification update to the G/W.		
17	Writing a rescue certification because received a certification error again after completed the certification update request from the G/W and noticed the result of certification update with the updated certification.		
18	The writing operation mentioned in #17 has completed. Notifying the result of certification update to the rescue G/W.		

5-816-068	CERT: Error	*CTL	[0 to 255 / 0 / 1]
	Displays a number code that describes the reason for the request for update of the certification.		
	0	Normal. There is no request for certification update in progress.	
	1	Request for certification update in progress. The current certification has expired.	
	2	An SSL error notification has been issued. Issued after the certification has expired.	
	3	Notification of shift from a common authentication to an individual certification.	
	4	Notification of a common certification without ID2.	
	5	Notification that no certification was issued.	
5-816-069	CERT: Up ID	*CTL	[- / - / -]
	-		
5-816-083	Firm Up Status	*CTL	[0 to 5 / 0 / 1] 0: Waiting for accepting firm update 1: Waiting for firm update start schedule 2: Waiting for user confirmation 3: In preparation for the machine firm update 4: processing the machine firm update 5: processing the closing operation of the machine firm update
5-816-085	Firm Up User Check	CTL	[- / - / -]
5-816-086	Firmware Size	CTL	[- / - / -]
5-816-087	CERT:Macro Ver.	CTL	[8digits / - / 1 digit/step]
5-816-088	CERT:PAC Ver.	CTL	[16digits / - / 1 digit/step]
5-816-089	CERT:ID2Code	CTL	[17digits / - / 1 digit/step]

5-816-090	CERT:Subject	CTL	[17digits / - / 1digit/step]
5-816-091	CERT:Serial No.	CTL	[16digits / - / 1digit/step]
5-816-092	CERT:Issuer	CTL	[30digits / - / 1digit/step]
5-816-093	CERT:Valid Start	CTL	[10digits / - / 1digit/step]
5-816-094	CERT:Valid End	CTL	[10digits / - / 1digit/step]
5-816-102	CERT:Encrypt Level	*CTL	[1 to 2 / 1 / 1]
5-816-103	Client Communication Method	CTL	[0 to 3 / 0 / 1]
5-816-104	Client Communication Limit	CTL	[1 to 7 / 7 / 1]
5-816-115	Network Information Waiting timer	CTL	[5 to 255 / 5 / 1sec/step]
5-816-150	Selection Country	CTL	[0 to 10 / 1 / 1] 0: Japan 1: USA 2: Canada 3: UK 4: Germany 5: France 6: Italy 7: Netherlands 8: Belgium 9: Luxembourg 10: Spain
	Select the country where embedded RCG-M is installed in the machine. After selecting the country, you must also set the following SP codes for embedded RCG-M: <ul style="list-style-type: none"> • SP5816-153 • SP5816-154 • SP5816-161 		
5-816-151	Line Type AutomaticJudgment	CTL	[- / - / -] [Execute]

5-816-152	Line Type Judgment Result	CTL	[0 to 9 / - / 1]
<p>Displays a number to show the result of the execution of SP5816151. Here is a list of what the numbers mean.</p> <p>0: Success</p> <p>1: In progress (no result yet). Please wait.</p> <p>2: Line abnormal</p> <p>3: Cannot detect dial tone automatically</p> <p>4: Line is disconnected</p> <p>5: Insufficient electrical power supply</p> <p>6: Line classification not supported</p> <p>7: Error because fax transmission in progress – ioctl() occurred.</p> <p>8: Other error occurred</p> <p>9: Line classification still in progress. Please wait.</p>			
5-816-153	Selection Dial / Push	CTL	[0 or 1 / 0 / 1] 0: Tone Dialing Phone 1: Pulse Dialing Phone Inside Japan "2" may also be displayed: 0: Tone Dialing Phone 1: Pulse Dialing Phone 10PPS 2: Pulse Dialing Phone 20PPS
5-816-154	Outside Line Outgoing Number	CTL	[- / - / -]
5-816-156	Dial Up User Name	CTL	[up to 32 / - / 1]
5-816-157	Dial Up Password	CTL	[up to 32 / - / 1]
5-816-161	Local Phone Number	CTL	[up to 24 / - / 1]
5-816-162	Connection Timing Adjustment Incoming	CTL	[0 to 24 / 1 / 1]
5-816-163	Access Point	CTL	[0 to 16 / 0 / 1]
5-816-164	Line Connecting	CTL	[0 to 1 / 0 / 1] 0: Sharing Fax 1: No Sharing Fax

5-816-173	Modem Serial No.	CTL	[- / - / -]
5-816-174	Retransmission Limit	CTL	[- / - / -]
5-816-187	FAX TX Priority	CTL	[0 or 1 / 0 / 1] 0: Disable 1: Enable
5-816-190	3G DongleID	CTL	[0 to 0 / 0 / 0]
5-816-199	ppp Connect Timer	CTL	[15 to 30 / 15 / 1min/step]
5-816-200	Manual Polling	CTL	[- / - / -] [Execute]
5-816-201	Regist Status	CTL	[0 to 4 / 0 / 1] [Execute]
	Displays the installation status as the target of NRS services.		
	0	Not installed as NRS machines or Cumin.	
	1	Installing as Cumin. Box enrollment has completed. Unable to response for the machine searching from Basil at this status.	
	2	Installation has completed. Unable to response for the machine searching from Basil at this status.	
	3	As a NRS machine, installation has completed. It cannot install as Cumin.	
4	NRS modules is not being launched.		
5-816-202	Letter Number	*CTL	[- / - / -]
5-816-203	Confirm Execute	*CTL	[- / - / -] [Execute]

5-816-204	Confirm Result	CTL	<p>[0 to 255 / 0 / 1]</p> <p>0: Success Inquiry</p> <p>1: Request number error</p> <p>3: Communication error (Enabled Proxy)</p> <p>4: Communication error (Disabled Proxy)</p> <p>5: Proxy error (failed auth.)</p> <p>6: Communication error</p> <p>8: Other error (See SP5-816-208 for detail)</p> <p>9: Processing inquiry</p> <p>20: Failed Dial-up auth.</p> <p>21: Failed answer tone detection</p> <p>22: Failed career detection</p> <p>23: Invalid modem value</p> <p>24: Shortage of electrical current</p> <p>25: Cable disconnected</p> <p>26: Line occupied</p>
Displays the result of SP5-816-203.			

5-816-205	Confirm Place	CTL	[0 to 255 / 0 / 1] 0: Success registration 1: Request number error 3: Communication error (Enabled Proxy) 4: Communication error (Disabled Proxy) 5: Proxy error (failed auth.) 6: Communication error 8: Other error (See SP5-816-208 for detail) 9: Processing registration 20: Failed Dial-up auth. 21: Failed answer tone detection 22: Failed career detection 23: Invalid modem value 24: Shortage of electrical current 25: Cable disconnected 26: Line occupied
	Displays the installed section informed from G/W for response of request number inquiry if the section is enrolled on the G/W.		
5-816-206	Register Execute	CTL	[- / - / -] [Execute]
	Executes the registration of Cumin.		
5-816-207	Register Result	CTL	[0 to 255 / 0 / 1]
	Displays the registration result. Shows the executed status of SP5-816-206.		
5-816-208	Error Code	CTL	[-2147483647 to 2147483647 / 0 / -]
	Displays the registration result of SP5-816-204.		

5-816-208	Invalid modem parameter	
	-11001	Chat parameter error.
	-11002	Chat execution error.
	-11003	Unexpected error
	-11004	Disconnect operation occurred during modem communication,
	-11005	NCS reboot occurred during modem communication.
5-816-208	Errors with invalid procedure or settings	
	-12002	Attempted to inquiry or registration without obtaining the installation status.
	-12003	Attempted to registrate without inquiry despite un-registered status.
	-12004	Attempted to install with invalid certification, ID2, and without input the machine number.
	-12005	Executed inquiry/ registration in a invalid Cumin function and prohibited @Remote communication.
5-816-208	-12006	Attempted to inquiry in BOX registration completed.
	-12007	Registration attempted with the different request number from the number used for the last inquiry.
	-12008	Certification update failed because Job processing etc.
	-12009	Mismatched between ID2 in NR-RAM and ID2 in the individual certification.
	-12010	Not initialized the certification area.
5-816-208	Error with error response from G/W	
	-2385	Inappropriate international dialing prefix
	-2387	Not supported in the center.
	-2389	DB failure
	-2390	Program failure
	-2391	Double registration of the machine

5-816-208	-2392	Parameter error		
	-2393	Not managed Basil		
	-2394	Not managed machine		
	-2395	Invalid BOX ID of Basil		
	-2396	Invalid Device ID of Basil		
	-2397	Different format of ID2 (includes invalid ID2)		
	-2398	Different format of request number		
5-816-209	Instl Clear	CTL	[0 or 1 / 0 / 1]	
5-816-240	CommErrorTime	CTL	[0 to 0 / 0 / 1]	
5-816-241	CommErrorCode 1	CTL	[0 to 0xffffffff / 0x00000000 / 1]	
5-816-242	CommErrorCode 2	CTL	[0 to 0xffffffff / 0x00000000 / 1]	
5-816-243	CommErrorCode 3	CTL	[0 to 0xffffffff / 0x00000000 / 1]	
5-816-244	CommErrorState 1	CTL	[0 to 0xffff / 0x0000 / 1]	
5-816-245	CommErrorState 2	CTL	[0 to 0xffff / 0x0000 / 1]	
5-816-246	CommErrorState 3	CTL	[0 to 0xffff / 0x0000 / 1]	
5-816-247	SSL Error Count	CTL	[0 to 255 / 0 / 1]	
5-816-248	Other Error Count	CTL	[0 to 255 / 0 / 1]	
5-816-250	Commlog Print	CTL	[0 to 255 / 0 / 1]	

5821	[Remote Service RCG Setting]		
5-821-002	RCG IP Address	*CTL	[00000000h to FFFFFFFFh / 00000000h / 1]
5-821-003	RCG Port Number	*CTL	[0 to 65535 / 443 / 1]
5-821-004	RCG IPv4 URL Path	*CTL	[0 to 0 / 0 / 0]
5-821-005	RCG IPv6 Address	*CTL	[0 to 0 / 0 / 0]
5-821-006	RCG IPv6 URL Path	*CTL	[0 to 0 / 0 / 0]

5-821-007	RCG Host Name	*CTL	[0 to 0 / 0 / 0]
5-821-008	RCG Host URL Path	*CTL	[0 to 0 / 0 / 0]

5824	[NV-RAM Data Upload]		
5-824-001		CTL	[- / - / -] [Execute]

5825	[NV-RAM Data Download]		
5-825-001		CTL	[- / - / -] [Execute]

5828	[Network Setting]		
5-828-039	User Class	CTL	[0 to 0 / 0 / 0]
5-828-040	Class Id	CTL	[0 to 0 / 0 / 0]
5-828-050	1284 Compatibility (Centro)	*CTL	[0 or 1 / 1 / 1] 0: Disabled 1: Enabled
5-828-052	ECP (Centro)	*CTL	[0 or 1 / 1 / 1] 0: Disabled 1: Enabled
	Enables or disables ECP Compatibility.		
5-828-065	Job Spooling	*CTL	[0 or 1 / 0 / 1] 0: Disabled 1: Enabled
5-828-066	Job Spooling Clear: Start Time	*CTL	[0 or 1 / 1 / 1] 0: ON (Data is cleared) 1: OFF (Automatically printed)

5-828-069	Job Spooling (Protocol)	* CTL	[0 or 1 / 0 / 1] 0: Validates 1: Invalidates bit0: LPR bit1: FTP bit2: IPP bit3: SMB bit4: BMLinkS bit5: DIPRINT bit6: sftp bit7: (Reserved)
5-828-087	Protocol usage Shows which protocols have been used with the network. 0: Off (Not used the network with the protocol.) 1: On (Used the network with the protocol once or more.) bit0: IPsec, bit1: IPv6, bit2: IEEE 802. 1X, bit3:Wireless LAN, bit4: Security mode level setting, bit5:Appletalk, bit6: DHCP, bit7: DHCPv6, bit8: telnet, bit9: SSL, bit10: HTTPS, bit11: BMLinkS printing, bit12: diprint printing, bit13: LPR printing, bit14: ftp printing, bit15: rsh printing, bit16: SMB printing, bit17: WSD-Printer, bit18: WSD-Scanner, bit19: Scan to SMB, bit20: Scan to NCP, bit21: Reserve, bit22: Bluetooth, bit23: IEEE 1284, bit24: USB printing, bit25: Dynamic DNS, bit26: Netware printing, bit27: LLTD, bit28: IPP printing, bit29: IPP printing (SSL), bit30: ssh, bit31: sftp	* CTL	[0 or 1 / 0x00000000 / 1bit]
5-828-090	TELNET (0: OFF 1: ON)	* CTL	[0 or 1 / 1 / 1] 0: Disable 1: Enable
5-828-091	Web (0: OFF 1: ON)	* CTL	[0 or 1 / 1 / 1] 0: Disable 1: Enable

5-828-145	Active IPv6 Link Local Address	CTL	[- / - / -]
5-828-147	Active IPv6 Stateless Address 1	CTL	[00000000000000000000000000000000h to
5-828-149	Active IPv6 Stateless Address 2	CTL	FFFFFFFFFFFFFFFFFFFFFFFFFFFFFFFF8
5-828-151	Active IPv6 Stateless Address 3	CTL	0h / 00000000000000000000000000000000 00000040h / -] These SPs are the IPv6 status addresses (1 to 5) referenced on the Ethernet or wireless LAN (802.11b) in the format: "Status Address" + "Prefix Length" The IPv6 address consists of a total 128 bits configured in 8 blocks of 16 bits each.
5-828-153	Active IPv6 Stateless Address 4	CTL	[00000000000000000000000000000000h to
5-828-155	Active IPv6 Stateless Address 5	CTL	FFFFFFFFFFFFFFFFFFFFFFFFFFFFFFFF8
5-828-156	IPv6 Manual Address	*CTL	0h / 00000000000000000000000000000000 00000040h / -] These SPs are the IPv6 status addresses (1 to 5) referenced on the Ethernet or wireless LAN (802.11b) in the format: "Status Address" + "Prefix Length" The IPv6 address consists of a total 128 bits configured in 8 blocks of 16 bits each.
5-828-158	IPv6 Gateway Address	*CTL	[00000000000000000000000000000000h to FFFFFFFFFFFFFFFFFFFFFFFFFFFFFFFFh / 00000000000000000000000000000000 000000h / -]

5-828-161	IPv6 Stateless Auto Setting	*CTL	[0 or 1 / 1 / 1] 0: Disable 1: Enable
5-828-219	IPsec Aggressive Mode Setting	CTL	[0 or 1 / 0 / 1]
5-828-236	Web Item visible	*CTL	[0x0000 to 0xffff / 0xffff / -]
	Displays or does not display the Web system items. bit0: Net RICOH bit1: Consumable Supplier bit2-15: Reserved (all)		
5-828-237	Web shopping link visible	*CTL	[0 or 1 / 1 / 1] 0: Not display 1:Display
5-828-238	Web supplies Link visible	*CTL	[Up to 31 char / URL1 / 1] 0: Not display 1: Display
5-828-239	Web Link1 Name	*CTL	[Up to 31 char / URL1 / 1]
5-828-240	Web Link1 URL	*CTL	[Up to 127char / URL1 / 1]
5-828-241	Web Link1 visible	*CTL	[Up to 31 char / URL2/ -] 0: Not display 1: Display
5-828-242	Web Link2 Name	*CTL	[- / - / -]
5-828-243	Web Link2 URL	*CTL	[- / - / -]
5-828-244	Web Link2 visible	*CTL	[- / - / -]
5-828-249	DHCPv6 DUID	CTL	[- / - / -]

5832	[HDD]		
5-832-001	HDD Formatting (ALL)	CTL	[- / - / -] [Execute]

5-832-002	HDD Formatting (IMH)	CTL	[- / - / -] [Execute]
5-832-003	HDD Formatting (Thumbnail)	CTL	[- / - / -] [Execute]
5-832-004	HDD Formatting (Job Log)	CTL	[- / - / -] [Execute]
5-832-005	HDD Formatting (Printer Fonts)	CTL	[- / - / -] [Execute]
5-832-006	HDD Formatting (User Info 1)	CTL	[- / - / -] [Execute]
5-832-007	Mail RX Data	CTL	[- / - / -] [Execute]
5-832-008	Mail TX Data	CTL	[- / - / -] [Execute]
5-832-009	HDD Formatting (Data for a Design)	CTL	[- / - / -] [Execute]
5-832-010	HDD Formatting (Log)	CTL	[- / - / -] [Execute]
5-832-011	HDD Formatting (Ridoc I/F)	CTL	[- / - / -] [Execute]
5-832-012	HDD Formatting (Thumbnail)	CTL	[- / - / -] [Execute]

5836	[Capture Setting]		
5-836-001	Capture Function (0:Off 1:On)	* CTL	[0 or 1 / 0 / 1] 0: Disable 1: Enable
5-836-011	Capture Setting: Copy	* CTL	[0 or 1 / 0 / 1]
5-836-012	Capture Setting: Doc. Svr.	* CTL	[0 or 1 / 0 / 1]

5-836-013	Capture Setting: Fax RX Printer	* CTL	[0 or 1 / 0 / 1]
5-836-014	Capture Setting: Fax TX	* CTL	[0 or 1 / 0 / 1]
5-836-015	Capture Setting: Printer	* CTL	[0 or 1 / 0 / 1]
5-836-016	Capture Setting: Scanner	* CTL	[0 or 1 / 0 / 1]
5-836-017	Capture Setting: SDK	* CTL	[0 or 1 / 0 / 1]
5-836-061	Captured File Resend (0:Off 1:On)	* CTL	[0 or 1 / 1 / 1]

5836	[Capture Setting]		
5-836-071	Reduction for Copy Color	* CTL	[0 to 3 / 2 / 1] 0: 1to-1 1: 1/2 2: 1/3 3: 1/4
5-836-072	Reduction for Copy B&W Text	* CTL	[0 to 3, 6 / 0 / 1] 0: 1to-1 1: 1/2 2: 1/3 3: 1/4 6: 2/3
5-836-073	Reduction for Copy B&W Other	* CTL	[0 to 3, 6 / 0 / 1] 0: 1to-1 1: 1/2 2: 1/3 3: 1/4 6: 2/3
5-836-074	Reduction for Printer Color	* CTL	[0 to 3 / 2 / 1] 0: 1to-1 1: 1/2 2: 1/3 3: 1/4

5-836-075	Reduction for Printer B&W	*CTL	[0 to 3, 6 / 0 / 1] 0: 1to-1 1: 1/2 2: 1/3 3: 1/4 6: 2/3
5-836-077	Reduction for Printer Color 1200dpi	*CTL	[1, 3 to 5 / 4 / 1] 1:1/2 3:1/4 4:1/6 5:1/8
5-836-078	Reduction for Printer B&W 1200dpi	*CTL	[0 to 5 / 1 / 1] 0: 1 1: 1/2 2: 1/3 3: 1/4 4: 1/6 5: 1/8
5-836-081	Format for Copy Color	*CTL	[0 / 0 / 1] 0: JFIF/JPEG 1: TIFF/MMR 2: TIFF/MH 3: TIFF/MR
5-836-082	Format for Copy B&W Text	*CTL	[0 to 3 / 1 / 1] 0: JFIF/JPEG 1: TIFF/MMR 2: TIFF/MH 3: TIFF/MR

5-836-083	Format for Copy B&W Other	*CTL	[0 to 3 / 1 / 1] 0: JFIF/JPEG 1: TIFF/MMR 2: TIFF/MH 3: TIFF/MR
5-836-084	Format for Printer Color	*CTL	[0 / 0 / 1]
5-836-085	Format for Printer B&W	*CTL	[0 to 3 / 1 / 1] 0: JFIF/JPEG 1: TIFF/MMR 2: TIFF/MH 3: TIFF/MR
5-836-091	Default for JPEG	*CTL	[5 to 95 / 50 / 1]
5-836-101	Primary srv IP address	*CTL	[000.000.000.000 to 255.255.255.255 / - / 1]
5-836-102	Primary srv scheme	*CTL	[0 to 6 char / NULL / -]
5-836-103	Primary srv port number	*CTL	[1 to 65535 / 80 / 1]
5-836-104	Primary srv URL path	*CTL	[0 to 16 char / - / 1]
5-836-111	Secondary srv IP address	*CTL	[000.000.000.000 to 255.255.255.255 / - / 1]
5-836-112	Secondary srv scheme	*CTL	[0 to 6 char / NULL / -]
5-836-113	Secondary srv port number	*CTL	[1 to 65535 / 80 / 1]
5-836-114	Secondary srv URL path	*CTL	[0 to 16 char / - / 1]
5-836-120	Default Reso Rate Switch	*CTL	[0 or 1 / 0 / 1]

5-836-121	Reso Copy(Color)	*CTL	[0 to 255 / 2 / 1] 0:600DPi 1:400DPi 2:300DPi 3:200DPi 4:150DPi 5:100DPi 6:75DPi
5-836-122	Reso: Copy(Mono)	*CTL	[0 to 255 / 3 / 1] 0: 600dpi/ 1: 400dpi/ 2: 300dpi/ 3: 200dpi/ 4: 150dpi/ 5: 100dpi/ 6: 75dpi
5-836-123	Reso Print(Color)	*CTL	[0 to 255 / 2 / 1] 0:600DPi 1:400DPi 2:300DPi 3:200DPi 4:150DPi 5:100DPi 6:75DPi
5-836-124	Reso: Print(Mono)	*CTL	[0 to 255 / 3 / 1] 0:600DPi 1:400DPi 2:300DPi 3:200DPi 4:150DPi 5:100DPi 6:75DPi

5-836-125	Reso: Fax(Color)	*CTL	[0 to 255 / 4 / 1] 0:600DPi 1:400DPi 2:300DPi 3:200DPi 4:150DPi 5:100DPi 6:75DPi
5-836-126	Reso: Fax(Mono)	*CTL	[0 to 255 / 3 / 1] 0:600DPi 1:400DPi 2:300DPi 3:200DPi 4:150DPi 5:100DPi 6:75DPi
5-836-127	Reso: Scanner(Color)	*CTL	[0 to 255 / 4 / 1] 0:600DPi 1:400DPi 2:300DPi 3:200DPi 4:150DPi 5:100DPi 6:75DPi
5-836-128	Reso: Scanner(Mono)	*CTL	[0 to 255 / 3 / 1] 0:600DPi 1:400DPi 2:300DPi 3:200DPi 4:150DPi 5:100DPi 6:75DPi

5-836-129	Reso: SDK(Color)	*CTL	[0 to 255 / 4 / 1]
5-836-130	Reso: SDK(Mono)	*CTL	[0 to 255 / 3 / 1]
5-836-141	All Addr Info Switch	*CTL	[0 or 1 / 1 / 1]
5-836-142	Stand-by Doc Max Number	*CTL	[10 to 10000 / 2000 / 1]
5-836-143	ClearLightPDF Switch	*CTL	[0 or 1 / 0 / 1]

5840	[IEEE 802.11]		
5-840-006	Channel Max	*CTL	[1 to 11 or 13 / 11 or 13 / 1] Europe/Asia: 1 to 13 NA/ Asia: 1 to 11
	DFU		
5-840-007	Channel Min	*CTL	[1 to 11 or 13 / 1 / 1] Europe: 1 to 13 NA/ Asia: 1 to 11
	DFU		
5-840-011	WEP key Select	*CTL	[00 to 11 / 00 / 1binary] 00: Key #1 01: Key #2 (Reserved) 10: Key #3 (Reserved) 11: Key #4 (Reserved)
5-840-045	WPA Debug Lvl	*CTL	[1 to 3 / 3 / 1] 1: Info 2: wArning 3: error
5-840-046	11w	*CTL	[0 to 2 / 0 / 1]
5-840-047	PSK Set Type	*CTL	[0 or 1 / 0 / 1]

5841	[Supply Name Setting]		
-------------	------------------------------	--	--

5-841-001	Toner Name Setting:Black	* CTL	Specifies supply names. These appear on the screen when the user presses the Inquiry button in the user tools screen. [0 to 20 / NULL / 1byte]
5-841-002	Toner Name Setting:Cyan	* CTL	
5-841-003	Toner Name Setting:Yellow	* CTL	
5-841-004	Toner Name Setting:Magenta	* CTL	
5-841-007	OrgStamp	* CTL	
5-841-009	WasteTonerBottle	* CTL	[0 to 20 / NULL / 1byte]
5-841-011	Staple Std1	* CTL	Specifies supply names. These appear on the screen when the user presses the Inquiry button in the user tools screen. [0 to 20 / NULL / 1byte]
5-841-012	Staple Std2	* CTL	
5-841-013	Staple Std3	* CTL	
5-841-014	Staple Std4	* CTL	
5-841-021	Staple Bind 1	* CTL	Specifies supply names. These appear on the screen when the user presses the Inquiry button in the user tools screen. [0 to 20 / NULL / 1byte]
5-841-022	Staple Bind 2	* CTL	
5-841-023	Staple Bind 3	* CTL	

5842	[GWWS Analysis]
-------------	------------------------

5-842-001	Setting 1	*CTL	[8bit assign / 00000000 / bit switch] 0bit[LSB]: system, other group 1bit: capture related group 2bit: authentication related group 3bit: address book related group 4bit: device management related group 5bit: output related(print, FAX, and delivery) group 6bit: repository, FO,etc. document related group 7bit: debug log level suppression
	Default: 00000000 – do not change Netfiles: Jobs to be printed from the document server using a PC and the DeskTopBinder software		
5-842-002	Setting 2	*CTL	[8bit assign / 00000000 / bit switch] 0~6bit: unused 7bit: time stamp setting for 5682mmesg log. (1: min./sec/msec, 0: day/hour/min./sec)

5844	[USB]		
5-844-001	Transfer Rate	*CTL	[1 to 4 / 0x04 / -] 0x01: Full speed 0x04: Auto Change
5-844-002	Vendor ID	*CTL	[- / - / -]
	DFU		
5-844-003	Product ID	*CTL	[- / - / -]
	DFU		
5-844-004	Device Release Number	*CTL	[- / - / -]
	DFU		

5-844-005	Fixed USB Port	*CTL	[0 to 2 / 0 / 1]
5-844-006	PnP Model Name	*CTL	[0 to 0 / 0 / 0]
5-844-007	PnP Serial Number	*CTL	[0 to 0 / 0 / 0]
5-844-008	Mac Supply Level	*CTL	[0 or 1 / 1 / 1]
5-844-100	Notify Unsupport	*CTL	[0 or 1 / 1 / 1]

5845	[Delivery Server Setting]		
5-845-001	FTP Port No.	*CTL	[0 to 65535 / 3670 / 1]
5-845-002	IP Address (Primary)	*CTL	[000.000.000.000 to 255.255.255.255 / 000.000.000.000 / -]
5-845-006	Delivery Error Display Time	*CTL	[0 to 999 / 300 / 1 second]
5-845-008	IP Address (Secondary)	*CTL	[000.000.000.000 to 255.255.255.255 / 000.000.000.000 / -]
5-845-009	Delivery Server Model	*CTL	[0 to 4 / 0 / 1] 0: Unknown 1: SG1 Provided 2: SG1 Package 3: SG2 Provided 4: SG2 Package

5-845-010	Delivery Svr. Capability	* CTL	[0 to 255 / - / 1]
	Bit7	1 Comment information exists	
	Bit6	1 Direct specification of mail address possible	
	Bit5	1 Mail RX confirmation setting possible	
	Bit4	1 Address book automatic update function exists	
	Bit3	1 Fax RX delivery function exists	
	Bit2	1 Sender password function exists	
	Bit1	1 Function to link MK-1 user and Sender exists	
	Bit0	1 Sender specification required (if set to 1, Bit6 is set to "0")	
5-845-011	Delivery Svr Capability (Ext)	* CTL	[0 to 255 / - / 1]
	Bit7 = 1 Address book usage limitation (Limitation for each authorized user) Bit6 = 1 RDH authorization link Bit5 to 0: Not used		
5-845-013	Server Scheme (Primary)	* CTL	[Up to 6 char / - / -]
5-845-014	Server Port Number (Primary)	* CTL	[- / - / -]
5-845-015	Server URL Path (Primary)	* CTL	[- / - / -]
5-845-016	Server Scheme (Secondary)	* CTL	[Up to 6 char / - / -]
5-845-017	Server Port Number (Secondary)	* CTL	[1 to 65535 / 80 / 1]
5-845-018	Server URL Path (Secondary)	* CTL	[Up to 16 byte / - / -]
5-845-022	Rapid Sending Control	* CTL	[0 or 1 / 1 / -] 0: Control disabled 1: Control enabled

5846	[UCS Setting]		
5-846-001	Machine ID (for Delivery Server)	* CTL	[- / - / -]
5-846-002	Machine ID Clear(for Delivery Server)	* CTL	[- / - / -] [Execute]

5-846-003	Maximum Entries	*CTL	[2000 to 20000 / 2000 / 1]
5-846-006	Delivery Server Retry Timer	*CTL	[0 to 255 / 0 / 1]
5-846-007	Delivery Server Retry Times	*CTL	[0 to 255 / 0 / 1]
5-846-008	Delivery Server Maximum Entries	*CTL	[2000 to 20000 / 2000 / 1]
5-846-010	LDAP Search Timeout	*CTL	[1 to 255 / 60 / 1]
5-846-020	WSD Maximum Entries	*CTL	[50 to 250 / 250 / 1]
5-846-021	Folder Auth Change	*CTL	[0 or 1 / 0 / 1] 0: Login User, 1: Destination
5-846-040	Addr Book Migration(USB->HDD)	*CTL	[- / - / -] [Execute]
5-846-041	Fill Addr Acl Info	*CTL	[- / - / -] [Execute]
5-846-043	Addr Book Media	*CTL	[0 to 30 / 0 / 1] 0: Unconfirmed 1: SD Slot 1 2: SD Slot 2 3: SD Slot 3 4: USB Flash ROM 10: SD Slot 10 20: HDD 30: Nothing
5-846-047	Initialize Local Address Book	CTL	[- / - / -] [Execute]
5-846-048	Initialize Delivery Addr Book	CTL	[- / - / -] [Execute]
5-846-049	Initialize LDAP Addr Book	CTL	[- / - / -] [Execute]
5-846-050	Initialize All Addr Book	CTL	[- / - / -] [Execute]

5-846-051	Backup All Addr Book	CTL	[- / - / -] [Execute]
5-846-052	Restore All Addr Book	CTL	[- / - / -] [Execute]
5-846-053	Clear Backup Info	CTL	[- / - / -] [Execute]
5-846-060	Search Option	*CTL	[0x00 to 0xff / 0x0f / 1]
	<p>This SP uses bit switches to set up the fuzzy search options for the UCS local address book.</p> <p>Bit: Meaning</p> <p>0: Checks both upper/lower case characters</p> <p>1: Japan Only</p> <p>2: Japan Only</p> <p>3: Japan Only</p> <p>4 to 7: Not Used</p>		
5-846-062	Complexity Option 1	*CTL	[0 to 32 / 0 / 1]
5-846-063	Complexity Option 2	*CTL	[0 to 32 / 0 / 1]
5-846-064	Complexity Option 3	*CTL	[0 to 32 / 0 / 1]
5-846-065	Complexity Option 4	*CTL	[0 to 32 / 0 / 1]
5-846-091	FTP Auth Port Setting	*CTL	[0 to 65535 / 3671 / 1]
5-846-094	Encryption Stat	*CTL	[0 to 255 / - / 1]

5847	[Rep Resolution Reduction]		
5-847-001	Rate for Copy Color	*CTL	[0 to 5 / 2 / 1] 0: 1x 1: 1/2x 2: 1/3x 3: 1/4x 4: 1/6x 5: 1/8x

5-847-002	Rate for Copy B&W Text	*CTL	[0 to 6 / 0 / 1]
5-847-003	Rate for Copy B&W Other	*CTL	0: 1x 1: 1/2x 2: 1/3x 3: 1/4x 4: 1/6x 5: 1/8x 6: 2/3x
5-847-004	Rate for Printer Color	*CTL	[0 to 5 / 2 / 1] 0: 1x 1: 1/2x 2: 1/3x 3: 1/4x 4: 1/6x 5: 1/8x
5-847-005	Rate for Printer B&W	*CTL	[0 to 6 / 0 / 1] 0: 1x 1: 1/2x 2: 1/3x 3: 1/4x 4: 1/6x 5: 1/8x 6: 2/3x
5-847-006	Rate for Printer Color 1200dpi	*CTL	[0 to 5 / 4 / 1] 0: 1x 1: 1/2x 2: 1/3x 3: 1/4x 4: 1/6x 5: 1/8x

5-847-007	Rate for Printer B&W 1200dpi	*CTL	[0 to 6 / 1 / 1] 0: 1x 1: 1/2x 2: 1/3x 3: 1/4x 4: 1/6x 5: 1/8x 6: 2/3x
5-847-021	Network Quality Default for JPEG	*CTL	[5 to 95 / 50 / 1]

5848	[Web Service]		
5-848-002	Access Ctrl: Repository (only Lower 4 bits)	*CTL	[- / - / -] 0000: No access control 0001: Denies access to DeskTop Binder. 0010: No writing control
5-848-003	Access Control: Doc. Svr. Print (Lower 4 bits)	*CTL	[- / - / -] 0000: No access control 0001: Denies access to DeskTop Binder.
5-848-004	Access Control: uirectory (Lower 4 bits)	*CTL	[- / - / -] 0000: No access control 0001: Denies access to DeskTop Binder.
5-848-007	Access Ctrl: Comm. Log Fax (Lower 4 bits)	*CTL	[- / - / -] 0000: No access control 0001: Denies access to DeskTop Binder.

5-848-009	Access Ctrl: Job Ctrl (Lower 4 bits)	*CTL	[- / - / -] 0000: No access control 0001: Denies access to DeskTop Binder.
5-848-011	Access Ctrl: Devicemanagement (Lower 4bits)	*CTL	[- / - / -] 0000: No access control 0001: Denies access to DeskTop Binder.
5-848-021	Access Ctrl: Delivery (Lower 4 bits)	*CTL	[- / - / -] 0000: No access control 0001: Denies access to DeskTop Binder.
5-848-022	Access Ctrl: uadministration (Lower 4bits)	*CTL	[- / - / -] 0000: No access control 0001: Denies access to DeskTop Binder.
5-848-024	Access Ctrl: Log Service (Lower 4bits)	*CTL	[- / - / -] 0000: No access control 0001: Denies access to DeskTop Binder.
5-848-025	Access Ctrl: Rest WebService (Lower 4bits)	*CTL	[- / - / -] 0000: No access control 0001: Denies access to DeskTop Binder.
5-848-099	Repository: Download Image Setting	*CTL	DFU
5-848-100	Repository: Download Image Max. Size	*CTL	[1 to 2048 / 2048 / 1 MB/step]
5-848-150	Log Operation Mode	*CTL	[0 to 9 / 0 / 1]
5-848-217	Setting: Timing	*CTL	NIA

5849	[Installation Date]
-------------	----------------------------

5-849-001	Display	*CTL	[- / - / -]
5-849-002	Switch to Print	*CTL	[0 or 1 / 1 / 1] 0: OFF (No Print) 1: ON (Print)
5-849-003	Setup Count	*CTL	[0 to 99999999 / 0 / 1]

5850	[Address Book Function]		
5-850-003	Replacement of Circuit Classifications	*CTL	[0 to 13 / 1 / 1] 1: G3 2: EXT 3: G3-1 4: G3-1- EXT 5: G3-2 6: G3-2- EXT 7: G3-3 8: G3-3-EXT 9: G3-idle-EXT 10: idle-EXT 11: I-G3 12: I-G3-EXT 13: G4

5851	[Bluetooth]		
5-851-001	mode	*CTL	[0 or 1 / 0 / 1]

5853	[Stamp Date Download]		
5-853-001	-	CTL	[- / - / -]

5856	[Remote ROM Update]		
	Allows the technician to upgrade the firmware using a local port (IEEE1284) when updating the remote ROM.		

5-856-002	Local Port	*CTL	[0 or 1 / 0 / 1] 0: Disable 1: Enable
-----------	------------	------	---

5858	[Collect Machine Info]		
5-858-001	0:OFF 1:ON	CTL	[0 or 1 / 1 / 1]
5-858-002	Save To (0:HDD 1:SD)	CTL	[0 or 1 / 0 / 1]
5-858-003	Make Log Trace Dir	CTL	[0 or 1 / 0 / 0]
5-858-101	Failure Occuring Date	CTL	[0 to 20371212 / 0 / 1]
5-858-102	Tracing Days	CTL	[1 to 180 / 2 / 1 day/step]
5-858-103	Acquire Fax Address(0:OFF 1:ON)	CTL	[0 or 1 / 0 / 1]
5-858-111	Acquire All Info & Logs	CTL	[0 or 1 / 0 / 0]
5-858-121	Acquire Configuration Page	CTL	[0 or 1 / 0 / 0]
5-858-122	Acquire Font Page	CTL	[0 or 1 / 0 / 0]
5-858-123	Acquire Print Setting List	CTL	[0 or 1 / 0 / 0]
5-858-124	Acquire Error Log	CTL	[0 or 1 / 0 / 0]
5-858-131	Acquire Fax Info	CTL	[0 or 1 / 0 / 0]
5-858-141	Acquire All Debug Logs	CTL	[0 or 1 / 0 / 0]
5-858-142	Acquire Controller Debug Logs Only	CTL	[0 or 1 / 0 / 0]
5-858-143	Acquire Engine Debug Logs Only	CTL	[0 or 1 / 0 / 0]
5-858-144	Acquire Opepanel Debug Logs Only	CTL	[0 or 1 / 0 / 0]
5-858-145	Acquire FCU Debug Logs Only	CTL	[0 or 1 / 0 / 0]

5860	[SMTP/POP3/IMAP4]		
5-860-020	Partial Mail Receive Timeout	*CTL	[1 to 168 / 72 / 1 hour/step]

5-860-021	MDN Response RFC2298 Compliance	*CTL	[0 or 1 / 1 / 1] 0: No 1: Yes
5-860-022	SMTP Auth. From Field Replacement	*CTL	[0 to 1 / 0 / 1] 0: No. "From" item not switched. 1: Yes. "From item switched.
5-860-025	SMTP Auth. Direct Setting	*CTL	[0 to 255 / 0 / -]
	<p>Selects the authentication method for SMTP.</p> <p>Bit switch:</p> <p>Bit 0: LOGIN</p> <p>Bit 1: PLAIN</p> <p>Bit 2: CRAM MD5</p> <p>Bit 3: DIGEST MD5</p> <p>Bit 4 to 7: Not used</p> <p> Note</p> <ul style="list-style-type: none"> This SP is activated only when SMTP authorization is enabled by UP mode. 		
5-860-026	S/MIME:MIME Header Setting	*CTL	[0 to 2 / 0 / 1] 0: Microsoft Outlook Express standard 1: Internet Draft standard 2: RFC standard
5-860-028	S/MIME: Authentication Check	*CTL	[0 or 1 / 0 / 1] 0: No (not check) 1: Yes (check)

5866	[Email Report]		
5-866-001	Report Validity	CTL	[0 or 1 / 0 / 1] 0: Enabled 1: Disabled
5-866-005	Add Date Field	CTL	[0 or 1 / 0 / 1] 0: Enabled 1: Disabled

5-866-110	CounterE-Mail:Validity	CTL	[0 or 1 / 0 / 1]
5-866-111	CounterE-Mail:Destination Registration	CTL	[0 to 0 / 0 / 0]
5-866-112	CounterE-Mail:Send Test	CTL	[0 to 0 / 0 / 0]
5-866-113	CounterE-Mail:Next Send Date	CTL	[0 to 0 / 0 / 0]
5-866-114	CounterE-Mail:Send Date Setting	CTL	[0 to 31 / 0 / 1]
5-866-115	CounterE-Mail:Send Time Setting	CTL	[0 to 2359 / 0 / 1]
5-866-121	CounterE-Mail:Destination1	CTL	[0 to 0 / 0 / 0]
5-866-122	CounterE-Mail:Destination2	CTL	[0 to 0 / 0 / 0]
5-866-123	CounterE-Mail:Destination3	CTL	[0 to 0 / 0 / 0]

5870	[Common Key Info Writing]		
5-870-001	Writing	CTL	[- / - / -] [Execute]
5-870-003	Initialize	CTL	[- / - / -] [Execute]
5-870-004	Writing: 2048bit	CTL	[- / - / -] [Execute]

5873	[SD Card Appli Move]		
5-873-001	Move Exec	CTL	[- / - / -] [Execute]
5-873-002	Undo Exec	CTL	[- / - / -] [Execute]

5875	[SC Auto Reboot]		
5-875-001	Reboot Setting	* CTL	[0 or 1 / 0 / 1]

5-875-002	Reboot Type	*CTL	[0 or 1 / 0 / 1] 0: Manual reboot 1: Automatic reboot
-----------	-------------	------	---

5878	[Option Setup]		
5-878-001	Data Overwrite Security	CTL	[- / - / -] [Execute]
5-878-002	HDD Encryption	CTL	[- / - / -] [Execute]
5-878-004	OCR Dictionary	CTL	[- / - / -] [Execute]

5881	[Fixed Phrase Block Erasing]		
5-881-001	-	CTL	[- / - / -]
	Delete the fixed phrase.		

5885	[Set WIM Function] Web Image Monitor Settings		
5-885-020	DocSvr Acc Ctrl	*CTL	[0 or 1 / 0 / 1] 0: OFF 1: ON Bit Meaning 0: Forbid all document server access (1) 1: Forbid user mode access (1) 2: Forbid print function (1) 3: Forbid fax TX (1) 4: Forbid scan sending (1) 5: Forbid downloading (1) 6: Forbid delete (1) 7: Reserved

5-885-050	DocSvr Format	*CTL	[0 to 2 / 0 / 1] 0: Thumbnail, 1: Icon, 2: Details
5-885-051	DocSvr Trans	*CTL	[5 to 20 / 10 / 1]
5-885-100	Set Signature	*CTL	[0 to 2 / 0 / 1] 0: Setting for each e-mail 1: Signature for all 2: No signature
5-885-101	Set Encrypsion	*CTL	[0 to 1 / 0 / 1] 0: Not encrypted 1: Encryption
5-885-200	DocSvr Timeout	*CTL	Not Used

5886	[Farm Update Setting]		
5-886-100	Skip Version Check	CTL	[0 or 1 / 0 / 1]
5-886-101	Skip LR Check	CTL	[0 or 1 / 0 / 1]
5-886-111	Auto Update Setting	CTL	[0 or 1 / 0 / 1]
5-886-112	Auto Update Prohibit Term Setting	CTL	[0 or 1 / 1 / 1]
5-886-113	Auto Update Prohibit Start hour	CTL	[0 to 23 / 9 / 1hour/step]
5-886-114	Auto Update Prohibit End hour	CTL	[0 to 23 / 17 / 1hour/step]
5-886-115	SFU Auto Download Setting	CTL	[0 or 1 / 0 / 1]
5-886-116	Auto Update Next Date	CTL	[0 to 0 / 0 / 0]
5-886-117	Auto Update Retry Interval Hour	CTL	[1 to 24 / 1 / 1hour/step]
5-886-119	Auto Update @Remote Using Setting	CTL	[0 or 1 / 0 / 1]
5-886-120	Auto Update Prohibit Day of Week Setting	CTL	[0 to 255 / 0 / 1]
5-886-151	Permit SubId Update	CTL	[0 or 1 / 0 / 1]
5-886-201	Restore Date	CTL	[0 to 0 / 0 / 0]

5-886-202	Save Old Version List	CTL	[0 to 0 / 0 / 0]
-----------	-----------------------	-----	------------------

5887	[SD GetCounter]		
5-887-001	-	CTL	[- / - / -] [Execute]

5888	[Personal Information Protect]		
5-888-001	-	*CTL	[0 or 1 / 0 / 1]
Selects the protection level for logs. 0: No authentication, No protection for logs 1: No authentication, Protected logs (only an administrator can see the logs)			

5893	[SDK Apli Cnt Name]		
5-893-001	SDK-1	CTL	[- / - / -] [Display text]
5-893-002	SDK-2	CTL	[- / - / -] [Display text]
5-893-003	SDK-3	CTL	[- / - / -] [Display text]
5-893-004	SDK-4	CTL	[- / - / -] [Display text]
5-893-005	SDK-5	CTL	[- / - / -] [Display text]
5-893-006	SDK-6	CTL	[- / - / -] [Display text]
5-893-007	SDK-7	CTL	[- / - / -] [Display text]
5-893-008	SDK-8	CTL	[- / - / -] [Display text]

5-893-009	SDK-9	CTL	[- / - / -] [Display text]
5-893-010	SDK-10	CTL	[- / - / -] [Display text]
5-893-011	SDK-11	CTL	[- / - / -] [Display text]
5-893-012	SDK-12	CTL	[- / - / -] [Display text]

4

5895	[Application invalidation]		
5-895-001	Printer	CTL	[- / - / -]
5-895-002	Scanner	CTL	[- / - / -]

5907	[Plug & Play Maker/Model Name]		
5-907-001		*CTL	[- / - / -]

5913	[Switchover Permission Time]		
5-913-002	Print Application Timer	*CTL	[3 to 30, immediate / 3 / 1sec/ step]

5967	[Copy Server: Set Function]		
5-967-001	(0: ON 1: OFF)	*CTL	[0 or 1 / 0 / 1] 0: ON 1: OFF

5973	[User Stamp Registration]		
5-973-101	Frame deletion setting	CTL	[0 to 3 / 0 / 1]

5985	[Device Setting]		
-------------	-------------------------	--	--

5-985-001	On Board NIC	CTL	[0 to 2 / 0 / 1] 0: Disable 1: Enable 2: Function limitation
5-985-002	On Board USB	CTL	[0 or 1 / 0 / 1]

5990	[SP Print Mode]		
5-990-001	All (Data List)	CTL	[- / - / -]
5-990-002	SP (Mode Data List)	CTL	[- / - / -]
5-990-003	User Program	CTL	[- / - / -]
5-990-004	Logging Data	CTL	[- / - / -]
5-990-005	Diagnostic Report	CTL	[- / - / -]
5-990-006	Non-Default	CTL	[- / - / -]
5-990-007	NIB Summary	CTL	[- / - / -]
5-990-008	Capture Log	CTL	[- / - / -]
5-990-021	Copier User Program	CTL	[- / - / -]
5-990-022	Scanner SP	CTL	[- / - / -]
5-990-023	Scanner User Program	CTL	[- / - / -]
5-990-024	SDK/J Summary	CTL	[- / - / -]
5-990-025	SDK/J Application Info	CTL	[- / - / -]
5-990-026	Printer SP	CTL	[- / - / -]
5-990-027	SmartOperationPanel SP	CTL	[- / - / -]
5-990-028	SmartOperationPanel UP	CTL	[- / - / -]

5992	[SP Text mode]		
-------------	-----------------------	--	--

5-992-001	All (Data List)	CTL	[- / - / -] [Execute]
5-992-002	SP (Mode Data List)	CTL	
5-992-003	User Program	CTL	
5-992-004	Logging Data	CTL	
5-992-005	Diagnostic Report	CTL	
5-992-006	Non-Default	CTL	
5-992-007	NIB Summary	CTL	
5-992-008	Capture Log	CTL	
5-992-021	Copier User Program	CTL	[- / - / -] [Execute]
5-992-022	Scanner SP	CTL	
5-992-023	Scanner User Program	CTL	
5-992-024	SDK/J Summary	CTL	
5-992-025	SDK/J Application Info	CTL	
5-992-026	Printer SP mode	CTL	
5-992-027	SmartOperationPanel SP	CTL	[- / - / -] [Execute]
5-992-028	SmartOperationPanel UP	CTL	

Controller SP Tables - SP7000

SP7-XXX (Data Log)

7401	[Total SC]		
	Stores total SC occurring count. If the same SC codes are detected continuously and total counter is not increasing, it only logs once in case of deleting other SC code logs.		
7-401-001	SC Counter	*CTL	[0 to 65535 / 0 / 1/step]
7-401-002	Total SC Counter	*CTL	[0 to 65535 / 0 / 1/step]

7403	[SC History]		
	Logs and displays the SC codes detected. The 10 most recently detected SC Codes are displayed on the screen, and also can be seen on the SMC (logging) outputs. Note <ul style="list-style-type: none"> If the same SC codes are detected continuously and total counter is not increasing, it only logs once in case of deleting other SC code logs. 		
7-403-001	Latest	*CTL	[- / - / -]
7-403-002	Latest 1	*CTL	
7-403-003	Latest 2	*CTL	
7-403-004	Latest 3	*CTL	
7-403-005	Latest 4	*CTL	
7-403-006	Latest 5	*CTL	
7-403-007	Latest 6	*CTL	
7-403-008	Latest 7	*CTL	
7-403-009	Latest 8	*CTL	
7-403-010	Latest 9	*CTL	

7404		[Software Error History]	
7-404-001	Latest	*CTL	[- / - / -]
7-404-002	Latest 1	*CTL	
7-404-003	Latest 2	*CTL	
7-404-004	Latest 3	*CTL	
7-404-005	Latest 4	*CTL	
7-404-006	Latest 5	*CTL	
7-404-007	Latest 6	*CTL	
7-404-008	Latest 7	*CTL	
7-404-009	Latest 8	*CTL	
7-404-010	Latest 9	*CTL	

7502		[Total Paper Jam]	
7-502-001	Jam Counter	*CTL	[0 to 65535 / 0 / 1 sheet/step]
7-502-002	Total Jam Counter	*CTL	[0 to 65535 / 0 / 1 sheet/step]

7503		[Total Original Jam Counter]	
7-503-001	-	*CTL	[0 to 65535 / 0 / 1/step]
7503		[Total Original Jam]	
7-503-002	Total Original Counter	*CTL	[0 to 65535 / 0 / 1/step]

7504		[Paper Jam Location]	
7-504-001	At Power On	*CTL	Paper is not fed at power on. [0 to 65535 / 0 / 1/step]
7-504-003	Tray 1: On	*CTL	[0 to 65535 / 0 / 1/step]
7-504-004	Tray 2: On	*CTL	[0 to 65535 / 0 / 1/step]
7-504-005	Tray 3: On	*CTL	[0 to 65535 / 0 / 1/step]

7-504-006	Tray 4: On	*CTL	[0 to 65535 / 0 / 1/step]
7-504-007	LCT: On	*CTL	[0 to 65535 / 0 / 1/step]
7-504-008	Bypass: On	*CTL	[0 to 65535 / 0 / 1/step]
7-504-009	Duplex: On	*CTL	[0 to 65535 / 0 / 1/step]
7-504-011	Transport Sensor 1: On	*CTL	[0 to 65535 / 0 / 1/step]
7-504-012	Transport Sensor 2: On	*CTL	[0 to 65535 / 0 / 1/step]
7-504-013	Vertical Trans. Sn 3: On	*CTL	[0 to 65535 / 0 / 1/step]
7-504-014	Vertical Trans. Sn 4: On	*CTL	[0 to 65535 / 0 / 1/step]
7-504-015	LCT Transport Sensor: On	*CTL	[0 to 65535 / 0 / 1/step]
7-504-017	Registration Sensor: On	*CTL	[0 to 65535 / 0 / 1/step]
7-504-018	Fusing Entrance Sensor: On	*CTL	[0 to 65535 / 0 / 1/step]
7-504-019	Fusing Exit Sensor: On	*CTL	[0 to 65535 / 0 / 1/step]
7-504-020	Paper Exit Sensor: On	*CTL	[0 to 65535 / 0 / 1/step]
7-504-021	Bridge Exit: On	*CTL	[0 to 65535 / 0 / 1/step]
7-504-022	Bridge Transport: On	*CTL	[0 to 65535 / 0 / 1/step]
7-504-024	Inverter Sn: On	*CTL	[0 to 65535 / 0 / 1/step]
7-504-025	Duplex Exit Sensor: On	*CTL	[0 to 65535 / 0 / 1/step]
7-504-027	Duplex Entrance Sensor: On	*CTL	[0 to 65535 / 0 / 1/step]
7-504-048	Bypass Transport Sensor 1: Off	*CTL	[0 to 65535 / 0 / 1/step]
7-504-051	Transport Sensor 1: Off	*CTL	[0 to 65535 / 0 / 1/step]
7-504-052	Transport Sensor 2: Off	*CTL	[0 to 65535 / 0 / 1/step]
7-504-053	Vertical Trans. Sn 3: Off	*CTL	[0 to 65535 / 0 / 1/step]
7-504-054	Vertical Trans. Sn 4: Off	*CTL	[0 to 65535 / 0 / 1/step]
7-504-057	Registration Sensor: Off	*CTL	[0 to 65535 / 0 / 1/step]
7-504-058	LCT Transport Sensor: Off	*CTL	[0 to 65535 / 0 / 1/step]
7-504-060	Paper Exit Sensor: Off	*CTL	[0 to 65535 / 0 / 1/step]

7-504-061	Bridge Exit Sensor: Off	*CTL	[0 to 65535 / 0 / 1/step]
7-504-062	Bridge Transport: Off	*CTL	[0 to 65535 / 0 / 1/step]
7-504-064	Inverter Sensor: Off	*CTL	[0 to 65535 / 0 / 1/step]
7-504-065	Duplex Exit Sensor: Off	*CTL	[0 to 65535 / 0 / 1/step]
7-504-067	Duplex Entrance Sensor: Off	*CTL	[0 to 65535 / 0 / 1/step]
7-504-096	Timing: On	*CTL	[0 to 65535 / 0 / 1/step]
7-504-100	Entrance Sensor: On	*CTL	[0 to 65535 / 0 / 1/step]
7-504-101	Entrance Sensor: Off	*CTL	[0 to 65535 / 0 / 1/step]
7-504-102	Transport Sensor: On	*CTL	[0 to 65535 / 0 / 1/step]
7-504-103	Transport Sensor: Off	*CTL	[0 to 65535 / 0 / 1/step]
7-504-104	Paper Exit	*CTL	[0 to 65535 / 0 / 1/step]
7-504-105	Front Jogger Motor	*CTL	[0 to 65535 / 0 / 1/step]
7-504-106	Rear Jogger Motor	*CTL	[0 to 65535 / 0 / 1/step]
7-504-107	Shift Roller Motor	*CTL	[0 to 65535 / 0 / 1/step]
7-504-108	Positioning Roller Motor	*CTL	[0 to 65535 / 0 / 1/step]
7-504-109	Exit Guide Plate Motor	*CTL	[0 to 65535 / 0 / 1/step]
7-504-110	Stapler Movement Motor	*CTL	[0 to 65535 / 0 / 1/step]
7-504-111	Shift Tray Lift Motor	*CTL	[0 to 65535 / 0 / 1/step]
7-504-112	Staple Motor	*CTL	[0 to 65535 / 0 / 1/step]
7-504-113	Paper Stopper Motor	*CTL	[0 to 65535 / 0 / 1/step]
7-504-114	Punch Motor	*CTL	[0 to 65535 / 0 / 1/step]
7-504-115	Punch Unit Movement Motor	*CTL	[0 to 65535 / 0 / 1/step]
7-504-116	Horizontal Reg. Movement Motor	*CTL	[0 to 65535 / 0 / 1/step]
7-504-148	No Exit Response	*CTL	[0 to 65535 / 0 / 1/step]

7-504-149	Invalid Main Machine Data Setting	*CTL	[0 to 65535 / 0 / 1/step]
7-504-150	Entrance Sensor: On	*CTL	[0 to 65535 / 0 / 1/step]
7-504-151	Entrance Sensor: Off	*CTL	[0 to 65535 / 0 / 1/step]
7-504-152	Horizontal Transport Sn: On	*CTL	[0 to 65535 / 0 / 1/step]
7-504-153	Horizontal Transport Sn: Off	*CTL	[0 to 65535 / 0 / 1/step]
7-504-154	Switchback Transport Sn: On	*CTL	[0 to 65535 / 0 / 1/step]
7-504-155	Switchback Transport Sn: Off	*CTL	[0 to 65535 / 0 / 1/step]
7-504-156	Proof Tray Exit: On	*CTL	[0 to 65535 / 0 / 1/step]
7-504-157	Proof Tray Exit: Off	*CTL	[0 to 65535 / 0 / 1/step]
7-504-158	Shift Tray Exit: On	*CTL	[0 to 65535 / 0 / 1/step]
7-504-159	Shift Tray Exit: Off	*CTL	[0 to 65535 / 0 / 1/step]
7-504-160	Booklet Stapler Exit: On	*CTL	[0 to 65535 / 0 / 1/step]
7-504-161	Booklet Stapler Exit: Off	*CTL	[0 to 65535 / 0 / 1/step]
7-504-162	Entrance Transport Motor	*CTL	[0 to 65535 / 0 / 1/step]
7-504-163	Horizontal Transport Motor	*CTL	[0 to 65535 / 0 / 1/step]
7-504-164	Pre-Stack Transport Motor	*CTL	[0 to 65535 / 0 / 1/step]
7-504-165	Intermediate Transport Motor	*CTL	[0 to 65535 / 0 / 1/step]
7-504-166	Paper Exit Motor	*CTL	[0 to 65535 / 0 / 1/step]
7-504-167	Trailing Edge Stopper Motor	*CTL	[0 to 65535 / 0 / 1/step]
7-504-168	Paper Exit Guide Plate Motor	*CTL	[0 to 65535 / 0 / 1/step]
7-504-169	Punch Unit Drive Motor	*CTL	[0 to 65535 / 0 / 1/step]
7-504-170	Punch Unit Movement Motor	*CTL	[0 to 65535 / 0 / 1/step]
7-504-171	S-to-S Regist Move Motor	*CTL	[0 to 65535 / 0 / 1/step]
7-504-172	Lower Junction Gate Motor	*CTL	[0 to 65535 / 0 / 1/step]
7-504-173	Jogger Motor	*CTL	[0 to 65535 / 0 / 1/step]

7-504-174	Positioning Roller Drive Motor	*CTL	[0 to 65535 / 0 / 1/step]
7-504-175	Feed Out Motor	*CTL	[0 to 65535 / 0 / 1/step]
7-504-176	Corner Stapler Movement Motor	*CTL	[0 to 65535 / 0 / 1/step]
7-504-177	Corner Stapler Motor	*CTL	[0 to 65535 / 0 / 1/step]
7-504-178	Booklet Jogger Motor	*CTL	[0 to 65535 / 0 / 1/step]
7-504-179	Booklet Guide Motor	*CTL	[0 to 65535 / 0 / 1/step]
7-504-180	Booklet Jogger Fence Motor	*CTL	[0 to 65535 / 0 / 1/step]
7-504-181	Booklet Stapler Motor	*CTL	[0 to 65535 / 0 / 1/step]
7-504-182	Movement Roller Transport Motor	*CTL	[0 to 65535 / 0 / 1/step]
7-504-183	Folding Transport Motor	*CTL	[0 to 65535 / 0 / 1/step]
7-504-184	Square Folding Motor	*CTL	[0 to 65535 / 0 / 1/step]
7-504-185	Tray Lift Motor	*CTL	[0 to 65535 / 0 / 1/step]
7-504-186	Shift Motor	*CTL	[0 to 65535 / 0 / 1/step]
7-504-187	Front Shift Jogger Motor	*CTL	[0 to 65535 / 0 / 1/step]
7-504-188	Rear Shift Jogger Motor	*CTL	[0 to 65535 / 0 / 1/step]
7-504-189	Shift Jogger Retraction Motor	*CTL	[0 to 65535 / 0 / 1/step]
7-504-190	Drag Roller Vibrating Motor	*CTL	[0 to 65535 / 0 / 1/step]
7-504-191	Leading Edge Guide Motor	*CTL	[0 to 65535 / 0 / 1/step]
7-504-192	Positioning Transport Motor	*CTL	[0 to 65535 / 0 / 1/step]
7-504-193	Paper Guide Motor	*CTL	[0 to 65535 / 0 / 1/step]
7-504-194	Invalid Main Machine Data Setting	*CTL	[0 to 65535 / 0 / 1/step]
7-504-200	Entrance: On	*CTL	[0 to 65535 / 0 / 1/step]
7-504-201	Entrance: Off	*CTL	[0 to 65535 / 0 / 1/step]
7-504-202	Proof Tray Exit: On	*CTL	[0 to 65535 / 0 / 1/step]

7-504-203	Proof Tray Exit: Off	*CTL	[0 to 65535 / 0 / 1/step]
7-504-204	Intermediate Transport (R): On	*CTL	[0 to 65535 / 0 / 1/step]
7-504-205	Intermediate Transport (L): On	*CTL	[0 to 65535 / 0 / 1/step]
7-504-206	Intermediate Transport (L): Off	*CTL	[0 to 65535 / 0 / 1/step]
7-504-207	Shift Tray Paper Exit: On	*CTL	[0 to 65535 / 0 / 1/step]
7-504-208	Shift Tray Paper Exit: Off	*CTL	[0 to 65535 / 0 / 1/step]
7-504-209	Paper Bundle Transport: On	*CTL	[0 to 65535 / 0 / 1/step]
7-504-210	Trailing Edge Stopper Trans.: On	*CTL	[0 to 65535 / 0 / 1/step]
7-504-211	Trailing Edge Stopper Trans.: Off	*CTL	[0 to 65535 / 0 / 1/step]
7-504-212	Center-Folding Exit: On	*CTL	[0 to 65535 / 0 / 1/step]
7-504-213	Center-Folding Exit: Off	*CTL	[0 to 65535 / 0 / 1/step]
7-504-220	Entrance Transport Motor	*CTL	[0 to 65535 / 0 / 1/step]
7-504-221	Proof Transport Motor	*CTL	[0 to 65535 / 0 / 1/step]
7-504-222	Exit Trans./Posit & Move Rllr Mt	*CTL	[0 to 65535 / 0 / 1/step]
7-504-223	Shift Motor	*CTL	[0 to 65535 / 0 / 1/step]
7-504-224	Jogger Motor	*CTL	[0 to 65535 / 0 / 1/step]
7-504-225	Exit Guide Plate Motor	*CTL	[0 to 65535 / 0 / 1/step]
7-504-226	Feed Out Motor	*CTL	[0 to 65535 / 0 / 1/step]
7-504-227	Tray Lift Motor	*CTL	[0 to 65535 / 0 / 1/step]
7-504-228	Positioning Motor	*CTL	[0 to 65535 / 0 / 1/step]
7-504-229	Stapler Movement Motor	*CTL	[0 to 65535 / 0 / 1/step]
7-504-230	Stapler Motor	*CTL	[0 to 65535 / 0 / 1/step]
7-504-231	Punch Motors	*CTL	[0 to 65535 / 0 / 1/step]
7-504-232	Paper Bundle Transport Motors	*CTL	[0 to 65535 / 0 / 1/step]
7-504-233	Trailing Edge Stopper Motor	*CTL	[0 to 65535 / 0 / 1/step]
7-504-234	Folding Blade Motor	*CTL	[0 to 65535 / 0 / 1/step]

7-504-235	Paper Guide Motor	*CTL	[0 to 65535 / 0 / 1/step]
7-504-236	Stapleless Stapler Movement Motor	*CTL	[0 to 65535 / 0 / 1/step]
7-504-237	Stapleless Stapler Motor	*CTL	[0 to 65535 / 0 / 1/step]
7-504-238	Moveable Guide Plate Motor	*CTL	[0 to 65535 / 0 / 1/step]
7-504-248	No Exit Response	*CTL	[0 to 65535 / 0 / 1/step]
7-504-249	Invalid Main Machine Data Setting	*CTL	[0 to 65535 / 0 / 1/step]

4

7505	[Original Jam Detection]		
7-505-001	At Power On	*CTL	[0 to 65535 / 0 / 1/step]
7-505-013	Separation Sensor: On	*CTL	
7-505-014	Skew Correction Sn: On	*CTL	
7-505-015	Scanning Entrance Sn: On	*CTL	
7-505-016	Registration Sensor: On	*CTL	
7-505-017	Original Exit Sensor: On	*CTL	
7-505-063	Separation Sensor: Off	*CTL	
7-505-034	Skew Correction Sn: Off	*CTL	
7-505-065	Scanning Entrance Sn: Off	*CTL	
7-505-066	Registration Sensor: Off	*CTL	
7-505-037	Original Exit Sensor: Off	*CTL	
7-505-239	Original Pullout	*CTL	

7506	[Jam Count by Paper Size]		
-------------	----------------------------------	--	--

7-506-005	A4 LEF	*CTL	[0 to 65535 / 0 / 1/step]
7-506-006	A5 LEF	*CTL	
7-506-014	B5 LEF	*CTL	
7-506-038	LT LEF	*CTL	
7-506-044	HLT LEF	*CTL	
7-506-132	A3 SEF	*CTL	
7-506-133	A4 SEF	*CTL	
7-506-134	A5 SEF	*CTL	
7-506-141	B4 SEF	*CTL	
7-506-142	B5 SEF	*CTL	
7-506-160	DLT SEF	*CTL	
7-506-164	LG SEF	*CTL	
7-506-166	LT SEF	*CTL	
7-506-172	HLT SEF	*CTL	
7-506-255	Others	*CTL	

7507	[Plotter Jam History]
-------------	------------------------------

7-507-001	Latest	*CTL	[- / - / -]
7-507-002	Latest 1	*CTL	
7-507-003	Latest 2	*CTL	
7-507-004	Latest 3	*CTL	
7-507-005	Latest 4	*CTL	
7-507-006	Latest 5	*CTL	
7-507-007	Latest 6	*CTL	
7-507-008	Latest 7	*CTL	
7-507-009	Latest 8	*CTL	
7-507-010	Latest 9	*CTL	

7508	[Original Jam History]		
7-508-001	Latest	*CTL	[- / - / -]
7-508-002	Latest 1	*CTL	
7-508-003	Latest 2	*CTL	
7-508-004	Latest 3	*CTL	
7-508-005	Latest 4	*CTL	
7-508-006	Latest 5	*CTL	
7-508-007	Latest 6	*CTL	
7-508-008	Latest 7	*CTL	
7-508-009	Latest 8	*CTL	
7-508-010	Latest 9	*CTL	

7509	[Paper Jam Location]		
7-509-045	Entrance Sensor: On	*CTL	[0 to 65535 / 0 / 1/step]
7-509-046	Entrance Sensor: Off	*CTL	[0 to 65535 / 0 / 1/step]
7-509-047	Exit Sensor: On	*CTL	[0 to 65535 / 0 / 1/step]

7-509-048	Exit Sensor: Off	*CTL	[0 to 65535 / 0 / 1/step]
7-509-049	Shift Motor	*CTL	[0 to 65535 / 0 / 1/step]
7-509-050	Junction Solenoid Motor	*CTL	[0 to 65535 / 0 / 1/step]
7-509-051	Exit Paper Pressure Motor	*CTL	[0 to 65535 / 0 / 1/step]
7-509-052	Stapler Motor	*CTL	[0 to 65535 / 0 / 1/step]
7-509-093	No Exit Response	*CTL	[0 to 65535 / 0 / 1/step]

7514	[Paper Jam Count by Location]		
7-514-001	At Power On	*CTL	Paper is not fed at power on. [0 to 65535 / 0 / 1/step]
7-514-003	Tray 1: On	*CTL	[0 to 65535 / 0 / 1/step]
7-514-004	Tray 2: On	*CTL	[0 to 65535 / 0 / 1/step]
7-514-005	Tray 3: On	*CTL	[0 to 65535 / 0 / 1/step]
7-514-006	Tray 4: On	*CTL	[0 to 65535 / 0 / 1/step]
7-514-007	LCT: On	*CTL	[0 to 65535 / 0 / 1/step]
7-514-008	Bypass: On	*CTL	[0 to 65535 / 0 / 1/step]
7-514-009	Duplex: On	*CTL	[0 to 65535 / 0 / 1/step]
7-514-011	Transport Sensor 1: On	*CTL	[0 to 65535 / 0 / 1/step]
7-514-012	Transport Sensor 2: On	*CTL	[0 to 65535 / 0 / 1/step]
7-514-013	Vertical Trans. Sn 3: On	*CTL	[0 to 65535 / 0 / 1/step]
7-514-014	Vertical Trans. Sn 4: On	*CTL	[0 to 65535 / 0 / 1/step]
7-514-015	LCT Transport Sensor: On	*CTL	[0 to 65535 / 0 / 1/step]
7-514-017	Registration Sensor: On	*CTL	[0 to 65535 / 0 / 1/step]
7-514-018	Fusing Entrance Sensor: On	*CTL	[0 to 65535 / 0 / 1/step]
7-514-019	Fusing Exit Sensor: On	*CTL	[0 to 65535 / 0 / 1/step]
7-514-020	Paper Exit Sensor: On	*CTL	[0 to 65535 / 0 / 1/step]

7-514-021	Bridge Exit: On	*CTL	[0 to 65535 / 0 / 1/step]
7-514-022	Bridge Transport: On	*CTL	[0 to 65535 / 0 / 1/step]
7-514-024	Inverter Sn: On	*CTL	[0 to 65535 / 0 / 1/step]
7-514-025	Duplex Exit Sensor: On	*CTL	[0 to 65535 / 0 / 1/step]
7-514-027	Duplex Entrance Sensor: On	*CTL	[0 to 65535 / 0 / 1/step]
7-514-048	Bypass Transport Sensor 1: Off	*CTL	[0 to 65535 / 0 / 1/step]
7-514-051	Transport Sensor 1: Off	*CTL	[0 to 65535 / 0 / 1/step]
7-514-052	Transport Sensor 2: Off	*CTL	[0 to 65535 / 0 / 1/step]
7-514-053	Vertical Trans. Sn 3: Off	*CTL	[0 to 65535 / 0 / 1/step]
7-514-054	Vertical Trans. Sn 4: Off	*CTL	[0 to 65535 / 0 / 1/step]
7-514-057	Registration Sensor: Off	*CTL	[0 to 65535 / 0 / 1/step]
7-514-058	LCT Transport Sensor: Off	*CTL	[0 to 65535 / 0 / 1/step]
7-514-060	Paper Exit Sensor: Off	*CTL	[0 to 65535 / 0 / 1/step]
7-514-061	Bridge Exit Sensor: Off	*CTL	[0 to 65535 / 0 / 1/step]
7-514-062	Bridge Transport: Off	*CTL	[0 to 65535 / 0 / 1/step]
7-514-064	Inverter Sensor: Off	*CTL	[0 to 65535 / 0 / 1/step]
7-514-065	Duplex Exit Sensor: Off	*CTL	[0 to 65535 / 0 / 1/step]
7-514-067	Duplex Entrance Sensor: Off	*CTL	[0 to 65535 / 0 / 1/step]
7-514-096	Timing: On	*CTL	[0 to 65535 / 0 / 1/step]
7-514-100	Entrance Sensor: On	*CTL	[0 to 65535 / 0 / 1/step]
7-514-101	Entrance Sensor: Off	*CTL	[0 to 65535 / 0 / 1/step]
7-514-102	Transport Sensor: On	*CTL	[0 to 65535 / 0 / 1/step]
7-514-103	Transport Sensor: Off	*CTL	[0 to 65535 / 0 / 1/step]
7-514-104	Paper Exit	*CTL	[0 to 65535 / 0 / 1/step]
7-514-105	Front Jogger Motor	*CTL	[0 to 65535 / 0 / 1/step]
7-514-106	Rear Jogger Motor	*CTL	[0 to 65535 / 0 / 1/step]

7-514-107	Shift Roller Motor	*CTL	[0 to 65535 / 0 / 1/step]
7-514-108	Positioning Roller Motor	*CTL	[0 to 65535 / 0 / 1/step]
7-514-109	Exit Guide Plate Motor	*CTL	[0 to 65535 / 0 / 1/step]
7-514-110	Stapler Movement Motor	*CTL	[0 to 65535 / 0 / 1/step]
7-514-111	Shift Tray Lift Motor	*CTL	[0 to 65535 / 0 / 1/step]
7-514-112	Staple Motor	*CTL	[0 to 65535 / 0 / 1/step]
7-514-113	Paper Stopper Motor	*CTL	[0 to 65535 / 0 / 1/step]
7-514-114	Punch Motor	*CTL	[0 to 65535 / 0 / 1/step]
7-514-115	Punch Unit Movement Motor	*CTL	[0 to 65535 / 0 / 1/step]
7-514-116	Horizontal Reg. Movement Motor	*CTL	[0 to 65535 / 0 / 1/step]
7-514-148	No Exit Response	*CTL	[0 to 65535 / 0 / 1/step]
7-514-149	Invalid Main Machine Data Setting	*CTL	[0 to 65535 / 0 / 1/step]
7-514-150	Entrance Sensor: On	*CTL	[0 to 65535 / 0 / 1/step]
7-514-151	Entrance Sensor: Off	*CTL	[0 to 65535 / 0 / 1/step]
7-514-152	Horizontal Transport Sn: On	*CTL	[0 to 65535 / 0 / 1/step]
7-514-153	Horizontal Transport Sn: Off	*CTL	[0 to 65535 / 0 / 1/step]
7-514-154	Switchback Transport Sn: On	*CTL	[0 to 65535 / 0 / 1/step]
7-514-155	Switchback Transport Sn: Off	*CTL	[0 to 65535 / 0 / 1/step]
7-514-156	Proof Tray Exit: On	*CTL	[0 to 65535 / 0 / 1/step]
7-514-157	Proof Tray Exit: Off	*CTL	[0 to 65535 / 0 / 1/step]
7-514-158	Shift Tray Exit: On	*CTL	[0 to 65535 / 0 / 1/step]
7-514-159	Shift Tray Exit: Off	*CTL	[0 to 65535 / 0 / 1/step]
7-514-160	Booklet Stapler Exit: On	*CTL	[0 to 65535 / 0 / 1/step]
7-514-161	Booklet Stapler Exit: Off	*CTL	[0 to 65535 / 0 / 1/step]
7-514-162	Entrance Transport Motor	*CTL	[0 to 65535 / 0 / 1/step]
7-514-163	Horizontal Transport Motor	*CTL	[0 to 65535 / 0 / 1/step]

7-514-164	Pre-Stack Transport Motor	*CTL	[0 to 65535 / 0 / 1/step]
7-514-165	Intermediate Transport Motor	*CTL	[0 to 65535 / 0 / 1/step]
7-514-166	Paper Exit Motor	*CTL	[0 to 65535 / 0 / 1/step]
7-514-167	Trailing Edge Stopper Motor	*CTL	[0 to 65535 / 0 / 1/step]
7-514-168	Paper Exit Guide Plate Motor	*CTL	[0 to 65535 / 0 / 1/step]
7-514-169	Punch Unit Drive Motor	*CTL	[0 to 65535 / 0 / 1/step]
7-514-170	Punch Unit Movement Motor	*CTL	[0 to 65535 / 0 / 1/step]
7-514-171	S-to-S Regist Move Motor	*CTL	[0 to 65535 / 0 / 1/step]
7-514-172	Lower Junction Gate Motor	*CTL	[0 to 65535 / 0 / 1/step]
7-514-173	Jogger Motor	*CTL	[0 to 65535 / 0 / 1/step]
7-514-174	Positioning Roller Drive Motor	*CTL	[0 to 65535 / 0 / 1/step]
7-514-175	Feed Out Motor	*CTL	[0 to 65535 / 0 / 1/step]
7-514-176	Corner Stapler Movement Motor	*CTL	[0 to 65535 / 0 / 1/step]
7-514-177	Corner Stapler Motor	*CTL	[0 to 65535 / 0 / 1/step]
7-514-178	Booklet Jogger Motor	*CTL	[0 to 65535 / 0 / 1/step]
7-514-179	Booklet Guide Motor	*CTL	[0 to 65535 / 0 / 1/step]
7-514-180	Booklet Jogger Fence Motor	*CTL	[0 to 65535 / 0 / 1/step]
7-514-181	Booklet Stapler Motor	*CTL	[0 to 65535 / 0 / 1/step]
7-514-182	Movement Roller Transport Motor	*CTL	[0 to 65535 / 0 / 1/step]
7-514-183	Folding Transport Motor	*CTL	[0 to 65535 / 0 / 1/step]
7-514-184	Square Folding Motor	*CTL	[0 to 65535 / 0 / 1/step]
7-514-185	Tray Lift Motor	*CTL	[0 to 65535 / 0 / 1/step]
7-514-186	Shift Motor	*CTL	[0 to 65535 / 0 / 1/step]
7-514-187	Front Shift Jogger Motor	*CTL	[0 to 65535 / 0 / 1/step]
7-514-188	Rear Shift Jogger Motor	*CTL	[0 to 65535 / 0 / 1/step]
7-514-189	Shift Jogger Retraction Motor	*CTL	[0 to 65535 / 0 / 1/step]

7-514-190	Drag Roller Vibrating Motor	*CTL	[0 to 65535 / 0 / 1/step]
7-514-191	Leading Edge Guide Motor	*CTL	[0 to 65535 / 0 / 1/step]
7-514-192	Positioning Transport Motor	*CTL	[0 to 65535 / 0 / 1/step]
7-514-193	Paper Guide Motor	*CTL	[0 to 65535 / 0 / 1/step]
7-514-194	Invalid Main Machine Data Setting	*CTL	[0 to 65535 / 0 / 1/step]
7-514-200	Entrance: On	*CTL	[0 to 65535 / 0 / 1/step]
7-514-201	Entrance: Off	*CTL	[0 to 65535 / 0 / 1/step]
7-514-202	Proof Tray Exit: On	*CTL	[0 to 65535 / 0 / 1/step]
7-514-203	Proof Tray Exit: Off	*CTL	[0 to 65535 / 0 / 1/step]
7-514-204	Intermediate Transport (R): On	*CTL	[0 to 65535 / 0 / 1/step]
7-514-205	Intermediate Transport (L): On	*CTL	[0 to 65535 / 0 / 1/step]
7-514-206	Intermediate Transport (L): Off	*CTL	[0 to 65535 / 0 / 1/step]
7-514-207	Shift Tray Paper Exit: On	*CTL	[0 to 65535 / 0 / 1/step]
7-514-208	Shift Tray Paper Exit: Off	*CTL	[0 to 65535 / 0 / 1/step]
7-514-209	Paper Bundle Transport: On	*CTL	[0 to 65535 / 0 / 1/step]
7-514-210	Trailing Edge Stopper Trans.: On	*CTL	[0 to 65535 / 0 / 1/step]
7-514-211	Trailing Edge Stopper Trans.: Off	*CTL	[0 to 65535 / 0 / 1/step]
7-514-212	Center-Folding Exit: On	*CTL	[0 to 65535 / 0 / 1/step]
7-514-213	Center-Folding Exit: Off	*CTL	[0 to 65535 / 0 / 1/step]
7-514-220	Entrance Transport Motor	*CTL	[0 to 65535 / 0 / 1/step]
7-514-221	Proof Transport Motor	*CTL	[0 to 65535 / 0 / 1/step]
7-514-222	Exit Trans./Posit & Move Rllr Mt	*CTL	[0 to 65535 / 0 / 1/step]
7-514-223	Shift Motor	*CTL	[0 to 65535 / 0 / 1/step]
7-514-224	Jogger Motor	*CTL	[0 to 65535 / 0 / 1/step]
7-514-225	Exit Guide Plate Motor	*CTL	[0 to 65535 / 0 / 1/step]
7-514-226	Feed Out Motor	*CTL	[0 to 65535 / 0 / 1/step]

7-514-227	Tray Lift Motor	*CTL	[0 to 65535 / 0 / 1/step]
7-514-228	Positioning Motor	*CTL	[0 to 65535 / 0 / 1/step]
7-514-229	Stapler Movement Motor	*CTL	[0 to 65535 / 0 / 1/step]
7-514-230	Stapler Motor	*CTL	[0 to 65535 / 0 / 1/step]
7-514-231	Punch Motors	*CTL	[0 to 65535 / 0 / 1/step]
7-514-232	Paper Bundle Transport Motors	*CTL	[0 to 65535 / 0 / 1/step]
7-514-233	Trailing Edge Stopper Motor	*CTL	[0 to 65535 / 0 / 1/step]
7-514-234	Folding Blade Motor	*CTL	[0 to 65535 / 0 / 1/step]
7-514-235	Paper Guide Motor	*CTL	[0 to 65535 / 0 / 1/step]
7-514-236	Stapleless Stapler Movement Motor	*CTL	[0 to 65535 / 0 / 1/step]
7-514-237	Stapleless Stapler Motor	*CTL	[0 to 65535 / 0 / 1/step]
7-514-238	Moveable Guide Plate Motor	*CTL	[0 to 65535 / 0 / 1/step]
7-514-248	No Exit Response	*CTL	[0 to 65535 / 0 / 1/step]
7-514-249	Invalid Main Machine Data Setting	*CTL	[0 to 65535 / 0 / 1/step]

7515	[Original Jam Count by Detection]		
7-515-001	At Power On	*CTL	[0 to 65535 / 0 / 1/step]
7-515-013	Separation Sensor: On	*CTL	[0 to 65535 / 0 / 1/step]
7-515-014	Skew Correction Sn: On	*CTL	[0 to 65535 / 0 / 1/step]
7-515-015	Scanning Entrance Sn: On	*CTL	[0 to 65535 / 0 / 1/step]
7-515-016	Registration Sensor: On	*CTL	[0 to 65535 / 0 / 1/step]
7-515-017	Original Exit Sensor: On	*CTL	[0 to 65535 / 0 / 1/step]
7-515-063	Separation Sensor: Off	*CTL	[0 to 65535 / 0 / 1/step]
7-515-034	Skew Correction Sn: Off	*CTL	[0 to 65535 / 0 / 1/step]
7-515-035	Scanning Entrance Sn: Off	*CTL	[0 to 65535 / 0 / 1/step]

7-515-066	Registration Sensor: Off	*CTL	[0 to 65535 / 0 / 1/step]
7-515-067	Original Exit Sensor: Off	*CTL	[0 to 65535 / 0 / 1/step]
7-515-239	Original Pullout	*CTL	[0 to 65535 / 0 / 1/step]

7516	[Jam Paper Size Cnt]		
	Displays occurring count of transfer paper jams by each paper size.		
7-516-005	A4 LEF	*CTL	[0 to 9999 / 0 / 1 sheet/step]
7-516-006	A5 LEF	*CTL	
7-516-014	B5 LEF	*CTL	
7-516-038	LT LEF	*CTL	
7-516-044	HLT LEF	*CTL	
7-516-132	A3 SEF	*CTL	[0 to 9999 / 0 / 1 sheet/step]
7-516-133	A4 SEF	*CTL	
7-516-134	A5 SEF	*CTL	
7-516-141	B4 SEF	*CTL	
7-516-142	B5 SEF	*CTL	
7-516-160	DLT SEF	*CTL	[0 to 9999 / 0 / 1 sheet/step]
7-516-164	LG SEF	*CTL	
7-516-166	LT SEF	*CTL	
7-516-172	HLT SEF	*CTL	
7-516-255	Others	*CTL	

7519	[Paper Jam Count by Location]		
7-519-045	Entrance Sensor: On	*CTL	[0 to 65535 / 0 / 0]
7-519-046	Entrance Sensor: Off	*CTL	[0 to 65535 / 0 / 0]
7-519-047	Exit Sensor: On	*CTL	[0 to 65535 / 0 / 0]
7-519-048	Exit Sensor: Off	*CTL	[0 to 65535 / 0 / 0]

7-519-049	Shift Motor	*CTL	[0 to 65535 / 0 / 0]
7-519-050	Junction Solenoid Motor	*CTL	[0 to 65535 / 0 / 0]
7-519-051	Exit Paper Pressure Motor	*CTL	[0 to 65535 / 0 / 0]
7-519-052	Stapler Motor	*CTL	[0 to 65535 / 0 / 0]
7-519-093	No Exit Response	*CTL	[0 to 65535 / 0 / 0]

7520	[Update Log]		
7-520-001	ErrorRecord1	*CTL	[0 to 255 / 0 / 1]
7-520-002	ErrorRecord2	*CTL	[0 to 255 / 0 / 1]
7-520-003	ErrorRecord3	*CTL	[0 to 255 / 0 / 1]
7-520-004	ErrorRecord4	*CTL	[0 to 255 / 0 / 1]
7-520-005	ErrorRecord5	*CTL	[0 to 255 / 0 / 1]
7-520-006	ErrorRecord6	*CTL	[0 to 255 / 0 / 1]
7-520-007	ErrorRecord7	*CTL	[0 to 255 / 0 / 1]
7-520-008	ErrorRecord8	*CTL	[0 to 255 / 0 / 1]
7-520-009	ErrorRecord9	*CTL	[0 to 255 / 0 / 1]
7-520-010	ErrorRecord10	*CTL	[0 to 255 / 0 / 1]
7-520-011	Auto:StartDate1	*CTL	[- / - / -]
7-520-012	Auto:StartDate2	*CTL	[- / - / -]
7-520-013	Auto:StartDate3	*CTL	[- / - / -]
7-520-014	Auto:StartDate4	*CTL	[- / - / -]
7-520-015	Auto:StartDate5	*CTL	[- / - / -]
7-520-021	Auto:EndDate1	*CTL	[- / - / -]
7-520-022	Auto:EndDate2	*CTL	[- / - / -]
7-520-023	Auto:EndDate3	*CTL	[- / - / -]
7-520-024	Auto:EndDate4	*CTL	[- / - / -]

7-520-025	Auto:EndDate5	*CTL	[- / - / -]
7-520-031	Auto:Piecemark1	*CTL	[- / - / -]
7-520-032	Auto:Piecemark2	*CTL	[- / - / -]
7-520-033	Auto:Piecemark3	*CTL	[- / - / -]
7-520-034	Auto:Piecemark4	*CTL	[- / - / -]
7-520-035	Auto:Piecemark5	*CTL	[- / - / -]
7-520-041	Auto:Version1	*CTL	[- / - / -]
7-520-042	Auto:Version2	*CTL	[- / - / -]
7-520-043	Auto:Version3	*CTL	[- / - / -]
7-520-044	Auto:Version4	*CTL	[- / - / -]
7-520-045	Auto:Version5	*CTL	[- / - / -]
7-520-051	Auto:Result1	*CTL	[0 to 255 / 0 / 1]
7-520-052	Auto:Result2	*CTL	[0 to 255 / 0 / 1]
7-520-053	Auto:Result3	*CTL	[0 to 255 / 0 / 1]
7-520-054	Auto:Result4	*CTL	[0 to 255 / 0 / 1]
7-520-055	Auto:Result5	*CTL	[0 to 255 / 0 / 1]
7-520-056	Auto:Result6	*CTL	[0 to 255 / 0 / 1]
7-520-057	Auto:Result7	*CTL	[0 to 255 / 0 / 1]
7-520-058	Auto:Result8	*CTL	[0 to 255 / 0 / 1]
7-520-059	Auto:Result9	*CTL	[0 to 255 / 0 / 1]
7-520-060	Auto:Result10	*CTL	[0 to 255 / 0 / 1]

7624	[Parts Replacement Operation ON/OFF]		
7-624-002	#Photoconductor Unit (Black)	*CTL	[0 or 1 / 1 / 1]
7-624-003	#Development unit: Bk	*CTL	[0 or 1 / 1 / 1]
7-624-025	#Photoconductor Unit (Cyan)	*CTL	[0 or 1 / 1 / 1]

7-624-026	#Development unit: C	*CTL	[0 or 1 / 1 / 1]
7-624-048	#Photoconductor Unit (Magenta)	*CTL	[0 or 1 / 1 / 1]
7-624-049	#Development unit: M	*CTL	[0 or 1 / 1 / 1]
7-624-071	#Photoconductor Unit (Yellow)	*CTL	[0 or 1 / 1 / 1]
7-624-072	#Development unit: Y	*CTL	[0 or 1 / 1 / 1]
7-624-093	#Intermediate Transfer Unit	*CTL	[0 or 1 / 1 / 1]
7-624-102	#ITB Cleaning Unit	*CTL	[0 or 1 / 1 / 1]
7-624-109	#Paper Transfer Unit	*CTL	[0 or 1 / 1 / 1]
7-624-115	#Fuser Unit	*CTL	[0 or 1 / 1 / 1]
7-624-116	Fuser Unit: Belt	*CTL	[0 or 1 / 1 / 1]
7-624-118	Fuser Unit: Pressure Roller	*CTL	[0 or 1 / 1 / 1]
7-624-131	#Dust Filter	*CTL	[0 or 1 / 1 / 1]
7-624-142	#Wast Toner bottle	*CTL	[0 or 1 / 1 / 1]
7-624-206	#ADF Pick-up Roller	*CTL	[0 or 1 / 1 / 1]
7-624-207	#ADF Paper Supply Belt	*CTL	[0 or 1 / 1 / 1]
7-624-208	#ADF Separate Roller	*CTL	[0 or 1 / 1 / 1]

7801	[ROM No./ Firmware Version]		
7-801-255	-	CTL	[- / - / -]

7803	[PM Counter Display]		
7-803-001	Paper	*CTL	[0 to 999999 / 0 / 1/step]

7804	[PM Counter Reset]		
7-804-001	Paper	CTL	[- / - / -] [Execute]

7807	[SC/Jam Counter Reset]		
-------------	-------------------------------	--	--

7-807-001	-	*CTL	[- / - / -] [Execute]
-----------	---	------	--------------------------

7826	[MF Error Counter]		
7-826-001	Error Total	*CTL	[0 to 99999999 / - / 1/step]
7-826-002	Error Staple	*CTL	[0 to 99999999 / - / 1/step]

7827	[MF Error Counter Clear]		
7-827-001	-	*CTL	[- / - / -] [Execute]

7832	[Self-Diagnose Result Display]		
7-832-001	-	CTL	[- / - / -] [Execute]

7835	[ACC Counter]		
7-835-001	Copy ACC	*CTL	[0 to 99999999 / - / 1/step]
7-835-002	Printer ACC	*CTL	[0 to 99999999 / - / 1/step]

7836	[Total Memory Size]		
Displays the memory capacity of the controller system.			
7-836-001	Total Memory Size	CTL	[- / - / -]

7840	[Service SP Entry Code Chg Hist]		
7-840-001	Change Time :Latest	*CTL	[- / - / -]
7-840-002	Change Time : Last1	*CTL	[- / - / -]
7-840-101	Initialize Time : Latest	*CTL	[- / - / -]
7-840-102	Initialize Time : Last1	*CTL	[- / - / -]

7851	[Unified Counter]		
-------------	--------------------------	--	--

7-851-001	Copy Program Number Registered	*CTL	[0 to 255 / 0 / 1/step]
-----------	--------------------------------	------	-------------------------

7855	[Coverage Range]		
7-855-001	Coverage Range 1	*CTL	[1 to 200 / 5 /1]
7-855-002	Coverage Range 2	*CTL	[1 to 200 / 20 /1]

7901	[Assert Info.]		
7-901-001	File Name	*CTL	[- / - / -]
7-901-002	Number of Lines	*CTL	[- / - / -]
7-901-003	Location	*CTL	[- / - / -]

7910	[ROM No]		
7-910-001	System/Copy	CTL	[- / - / -]
7-910-002	Engine	CTL	[- / - / -]
7-910-003	Lcdc	CTL	[- / - / -]
7-910-005	ADF	CTL	[- / - / -]
7-910-007	Finisher1	CTL	[- / - / -]
7-910-009	Bank	CTL	[- / - / -]
7-910-010	LCT	CTL	[- / - / -]
7-910-012	FCU	CTL	[- / - / -]
7-910-018	NetworkSupport	CTL	[- / - / -]
7-910-019	Bank2	CTL	[- / - / -]
7-910-022	BIOS	CTL	[- / - / -]
7-910-023	HDD Format Option	CTL	[- / - / -]
7-910-150	RPCS	CTL	[- / - / -]
7-910-151	PS	CTL	[- / - / -]

7-910-152	RPDL	CTL	[- / - / -]
7-910-153	R98	CTL	[- / - / -]
7-910-154	R16	CTL	[- / - / -]
7-910-155	RPGL	CTL	[- / - / -]
7-910-156	R55	CTL	[- / - / -]
7-910-157	RTIFF	CTL	[- / - / -]
7-910-158	PCL	CTL	[- / - / -]
7-910-159	PCLXL	CTL	[- / - / -]
7-910-160	MSIS	CTL	[- / - / -]
7-910-162	PDF	CTL	[- / - / -]
7-910-164	PictBridge	CTL	[- / - / -]
7-910-165	PJL	CTL	[- / - / -]
7-910-167	MediaPrint:JPEG	CTL	[- / - / -]
7-910-168	MediaPrint:TIFF	CTL	[- / - / -]
7-910-169	XPS	CTL	[- / - / -]
7-910-180	FONT	CTL	[- / - / -]
7-910-181	FONT1	CTL	[- / - / -]
7-910-182	FONT2	CTL	[- / - / -]
7-910-183	FONT3	CTL	[- / - / -]
7-910-184	FONT4	CTL	[- / - / -]
7-910-185	FONT5	CTL	[- / - / -]
7-910-200	Factory	CTL	[- / - / -]
7-910-201	Copy	CTL	[- / - / -]
7-910-202	NetworkDocBox	CTL	[- / - / -]
7-910-203	Fax	CTL	[- / - / -]
7-910-204	Printer	CTL	[- / - / -]

7-910-205	Scanner	CTL	[- / - / -]
7-910-206	RFax	CTL	[- / - / -]
7-910-210	MIB	CTL	[- / - / -]
7-910-211	Websupport	CTL	[- / - / -]
7-910-212	WebUapl	CTL	[- / - / -]
7-910-213	SDK1	CTL	[- / - / -]
7-910-214	SDK2	CTL	[- / - / -]
7-910-215	SDK3	CTL	[- / - / -]
7-910-250	Package	CTL	[- / - / -]

7911	[Firmware Version]		
7-911-001	System/Copy	CTL	[- / - / -]
7-911-002	Engine	CTL	[- / - / -]
7-911-003	Lcdc	CTL	[- / - / -]
7-911-005	ADF	CTL	[- / - / -]
7-911-007	Finisher1	CTL	[- / - / -]
7-911-009	Bank	CTL	[- / - / -]
7-911-010	LCT	CTL	[- / - / -]
7-911-012	FCU	CTL	[- / - / -]
7-911-018	NetworkSupport	CTL	[- / - / -]
7-911-019	Bank2	CTL	[- / - / -]
7-911-022	BIOS	CTL	[- / - / -]
7-911-023	HDD Format Option	CTL	[- / - / -]
7-911-150	RPCS	CTL	[- / - / -]
7-911-151	PS	CTL	[- / - / -]
7-911-152	RPDL	CTL	[- / - / -]

7-911-153	R98	CTL	[- / - / -]
7-911-154	R16	CTL	[- / - / -]
7-911-155	RPGL	CTL	[- / - / -]
7-911-156	R55	CTL	[- / - / -]
7-911-157	RTIFF	CTL	[- / - / -]
7-911-158	PCL	CTL	[- / - / -]
7-911-159	PCLXL	CTL	[- / - / -]
7-911-160	MSIS	CTL	[- / - / -]
7-911-162	PDF	CTL	[- / - / -]
7-911-164	PictBridge	CTL	[- / - / -]
7-911-165	PJL	CTL	[- / - / -]
7-911-167	MediaPrint:JPEG	CTL	[- / - / -]
7-911-168	MediaPrint:TIFF	CTL	[- / - / -]
7-911-169	XPS	CTL	[- / - / -]
7-911-180	FONT	CTL	[- / - / -]
7-911-181	FONT1	CTL	[- / - / -]
7-911-182	FONT2	CTL	[- / - / -]
7-911-183	FONT3	CTL	[- / - / -]
7-911-184	FONT4	CTL	[- / - / -]
7-911-185	FONT5	CTL	[- / - / -]
7-911-200	Factory	CTL	[- / - / -]
7-911-201	Copy	CTL	[- / - / -]
7-911-202	NetworkDocBox	CTL	[- / - / -]
7-911-203	Fax	CTL	[- / - / -]
7-911-204	Printer	CTL	[- / - / -]
7-911-205	Scanner	CTL	[- / - / -]

7-911-206	RFax	CTL	[- / - / -]
7-911-210	MIB	CTL	[- / - / -]
7-911-211	Websupport	CTL	[- / - / -]
7-911-212	WebUapl	CTL	[- / - / -]
7-911-213	SDK1	CTL	[- / - / -]
7-911-214	SDK2	CTL	[- / - / -]
7-911-215	SDK3	CTL	[- / - / -]
7-911-250	Package	CTL	[- / - / -]

Controller SP Tables - SP8000

SP8-XXX (Data Log 2)

Many of these counters are provided for features that are currently not available, such as sending color faxes, and so on. However, here are some Group 8 codes that when used in combination with others, can provide useful information.

SP Numbers	What They Do
SP8211 to SP8216	The number of pages scanned to the document server.
SP8401 to SP8406	The number of pages printed from the document server
SP8691 to SP8696	The number of pages sent from the document server

Specifically, the following questions can be answered:

- How is the document server actually being used?
- What application is using the document server most frequently?
- What data in the document server is being reused?

Most of the SPs in this group are prefixed with a letter that indicates the mode of operation (the mode of operation is referred to as an "application"). Before reading the Group 8 Service Table, make sure that you understand what these prefixes mean.

Prefixes	What it means	
T:	Total: (Grand Total).	Grand total of the items counted for all applications (C, F, P, etc.).
C:	Copy application.	Totals (pages, jobs, etc.) executed for each application when the job was not stored on the document server.
F:	Fax application.	
P:	Print application.	
S:	Scan application.	

L:	Local storage (document server)	Totals (jobs, pages, etc.) for the document server. The L: counters work differently case by case. Sometimes, they count jobs/pages stored on the document server; this can be in document server mode (from the document server window), or from another mode, such as from a printer driver or by pressing the Store File button in the Copy mode window. Sometimes, they include occasions when the user uses a file that is already on the document server. Each counter will be discussed case by case.
O:	Other applications (external network applications, for example)	Refers to network applications such as Web Image Monitor. Utilities developed with the SDK (Software Development Kit) will also be counted with this group in the future.

The Group 8 SP codes are limited to 17 characters, forced by the necessity of displaying them on the small LCDs of printers and faxes that also use these SPs. Read over the list of abbreviations below and refer to it again if you see the name of an SP that you do not understand.

Keys and abbreviations in Data Log 2

Abbreviation	What it means
/	"By", e.g. "T:Jobs/Apl" = Total Jobs "by" Application
>	More (2> "2 or more", 4> "4 or more")
AddBook	Address Book
Apl	Application
B/W	Black & White
Bk	Black
C	Cyan
ColCr	Color Create
ColMode	Color Mode
Comb	Combine
Comp	Compression

Abbreviation	What it means
Deliv	Delivery
DesApl	Designated Application. The application (Copy, Fax, Scan, Print) used to store the job on the document server, for example.
Dev Counter	Development Count, no. of pages developed.
Dup, Duplex	Duplex, printing on both sides
Emul	Emulation
FC	Full Color
FIN	Post-print processing, i.e. finishing (punching, stapling, etc.)
Full Bleed	No Margins
GenCopy	Generation Copy Mode
GPC	Get Print Counter. For jobs 10 pages or less, this counter does not count up. For jobs larger than 10 pages, this counter counts up by the number that is in excess of 10 (e.g., for an 11-page job, the counter counts up $11 - 10 = 1$)
IFax	Internet Fax
ImgEdt	Image Edit performed on the original with the copier GUI, e.g. border removal, adding stamps, page numbers, etc.
K	Black (YMCK)
LS	Local Storage. Refers to the document server.
LSize	Large (paper) Size
Mag	Magnification
MC	One color (monochrome)
NRS	New Remote Service, which allows a service center to monitor machines remotely. "NRS" is used overseas, "CSS" is used in Japan.
Org	Original for scanning
OrgJam	Original Jam

Abbreviation	What it means
Palm 2	Print Job Manager/Desk Top Editor: A pair of utilities that allows print jobs to be distributed evenly among the printers on the network, and allows files to moved around, combined, and converted to different formats.
PC	Personal Computer
PGS	Pages. A page is the total scanned surface of the original. Duplex pages count as two pages, and A3 simplex count as two pages if the A3/DLT counter SP is switched ON.
PJob	Print Jobs
Ppr	Paper
PrtJam	Printer (plotter) Jam
PrtPGS	Print Pages
R	Red (Toner Remaining). Applies to the wide format model A2 only. This machine is under development and currently not available.
Rez	Resolution
SC	Service Code (Error SC code displayed)
Scn	Scan
Sim, Simplex	Simplex, printing on 1 side.
S-to-Email	Scan-to-E-mail
SMC	SMC report printed with SP5990. All of the Group 8 counters are recorded in the SMC report.
Svr	Server
TonEnd	Toner End
TonSave	Toner Save
TXJob	Send, Transmission
YMC	Yellow, Magenta, Cyan
YMCK	Yellow, Magenta, Cyan, Black

Note

- All of the Group 8 SPs are able to reset by "SP5 801 1 Memory All Clear".

8001	[T:Total Jobs]	*CTL	<p>These SPs count the number of times each application is used to do a job.</p> <p>[0 to 99999999 / - / 1]</p> <p>Note: The L: counter is the total number of times the other applications are used to send a job to the document server, plus the number of times a file already on the document server is used.</p>
8002	[C:Total Jobs]	*CTL	
8003	[F:Total Jobs]	*CTL	
8004	[P:Total Jobs]	*CTL	
8005	[S:Total Jobs]	*CTL	
8006	[L:Total Jobs]	*CTL	

- These SPs reveal the number of times an application is used, not the number of pages processed.
- When an application is opened for image input or output, this counts as one job.
- Interrupted jobs (paper jams, etc.) are counted, even though they do not finish.
- Only jobs executed by the customer are counted. Jobs executed by the customer engineer using the SP modes are not counted.
- When using secure printing (when a password is required to start the print job), the job is counted at the time when either "Delete Data" or "Specify Output" is specified.
- A job is counted as a fax job when the job is stored for sending.
- When a fax is received to fax memory, the F: counter increments but the L: counter does not (the document server is not used).
- A fax broadcast counts as one job for the F: counter (the fax destinations in the broadcast are not counted separately).
- A fax broadcast is counted only after all the faxes have been sent to their destinations. If one transmission generates an error, then the broadcast will not be counted until the transmission has been completed.
- A printed fax report counts as one job for the F: counter.
- The F: counter does not distinguish between fax sending or receiving.
- When a copy job on the document server is printed, SP8022 also increments, and when a print job stored on the document server is printed, SP8024 also increments.
- When an original is both copied and stored on the document server, the C: and L: counters both increment.
- When a print job is stored on the document server, only the L: counter increments.
- When the user presses the Document Server button to store the job on the document server, only the L: counter increments.

- When the user enters document server mode and prints data stored on the document server, only the L: counter increments.
- When an image received from Palm 2 is received and stored, the L: counter increments.
- When the customer prints a report (user code list, for example), the O: counter increments. However, for fax reports and reports executed from the fax application, the F: counter increments.

8011	[T:Jobs/LS]	*CTL	These SPs count the number of jobs stored to the document server by each application, to reveal how local storage is being used for input. [0 to 99999999 / 0 / 1] The L: counter counts the number of jobs stored from within the document server mode screen at the operation panel.
8012	[C:Jobs/LS]	*CTL	
8013	[F:Jobs/LS]	*CTL	
8014	[P:Jobs/LS]	*CTL	
8015	[S:Jobs/LS]	*CTL	
8016	[L:Jobs/LS]	*CTL	
8017	[O:Jobs/LS]	*CTL	

- When a scan job is sent to the document server, the S: counter increments. When you enter document server mode and then scan an original, the L: counter increments.
- When a print job is sent to the document server, the P: counter increments.
- When a network application sends data to the document server, the O: counter increments.
- When an image from Palm 2 is stored on the document server, the O: counter increments.
- When a fax is sent to the document server, the F: counter increments.

8021	[T:Pjob/LS]	*CTL	These SPs reveal how files printed from the document server were stored on the document server originally. [0 to 99999999 / 0 / 1] The L: counter counts the number of jobs stored from within the document server mode screen at the operation panel.
8022	[C:Pjob/LS]	*CTL	
8023	[F:Pjob/LS]	*CTL	
8024	[P:Pjob/LS]	*CTL	
8025	[S:Pjob/LS]	*CTL	
8026	[L:Pjob/LS]	*CTL	
8027	[O:Pjob/LS]	*CTL	

- When a copy job stored on the document server is printed with another application, the C: counter increments.

- When an application like DeskTopBinder merges a copy job that was stored on the document server with a print job that was stored on the document server, the C: and P: counters both increment.
- When a job already on the document server is printed with another application, the L: counter increments.
- When a scanner job stored on the document server is printed with another application, the S: counter increments. If the original was scanned from within document server mode, then the L: counter increments.
- When images stored on the document server by a network application (including Palm 2), are printed with another application, the O: counter increments.
- When a copy job stored on the document server is printed with a network application (Web Image Monitor, for example), the C: counter increments.
- When a fax on the document server is printed, the F: counter increments.

8031	[T:Pjob/DesApl]	*CTL	These SPs reveal what applications were used to output documents from the document server. [0 to 99999999 / 0 / 1] The L: counter counts the number of jobs printed from within the document server mode screen at the operation panel.
8032	[C:Pjob/DesApl]	*CTL	
8033	[F:Pjob/DesApl]	*CTL	
8034	[P:Pjob/DesApl]	*CTL	
8035	[S:Pjob/DesApl]	*CTL	
8036	[L:Pjob/DesApl]	*CTL	
8037	[O:Pjob/DesApl]	*CTL	

- When documents already stored on the document server are printed, the count for the application that started the print job is incremented.
- When the print job is started from a network application (Desk Top Binder, Web Image Monitor, etc.) the L: counter increments.

8041	[T:TX Jobs/LS]	* CTL	These SPs count the applications that stored files on the document server that were later accessed for transmission over the telephone line or over a network (attached to an e-mail, or as a fax image by I-Fax). [0 to 99999999 / 0 / 1] Note: Jobs merged for sending are counted separately. The L: counter counts the number of jobs scanned from within the document server mode screen at the operation panel.
8042	[C:TX Jobs/LS]	* CTL	
8043	[F:TX Jobs/LS]	* CTL	
8044	[P:TX Jobs/LS]	* CTL	
8045	[S:TX Jobs/LS]	* CTL	
8046	[L:TX Jobs/LS]	* CTL	
8047	[O:TX Jobs/LS]	* CTL	

- When a stored copy job is sent from the document server, the C: counter increments.
- When images stored on the document server by a network application or Palm2 are sent as an e-mail, the O: counter increments.

8051	[T:TX Jobs/DesApl]	* CTL	These SPs count the applications used to send files from the document server over the telephone line or over a network (attached to an e-mail, or as a fax image by I-Fax). Jobs merged for sending are counted separately. [0 to 99999999 / 0 / 1] The L: counter counts the number of jobs sent from within the document server mode screen at the operation panel.
8052	[C:TX Jobs/DesApl]	* CTL	
8053	[F:TX Jobs/DesApl]	* CTL	
8054	[P:TX Jobs/DesApl]	* CTL	
8055	[S:TX Jobs/DesApl]	* CTL	
8056	[L:TX Jobs/DesApl]	* CTL	
8057	[O:TX Jobs/DesApl]	* CTL	

- If the send is started from Desk Top Binder or Web Image Monitor, for example, then the O: counter increments.

8061	[T:FIN Jobs]	These SPs total the finishing methods. The finishing method is specified by the application.
	[P:FIN Jobs]	
8062	[P:FIN Jobs]	These SPs total finishing methods for print jobs only. The finishing method is specified by the application.
	[T:FIN Jobs]	

8063	[F:FIN Jobs]		
	These SPs total finishing methods for fax jobs only. The finishing method is specified by the application. Note: Finishing features for fax jobs are not available at this time.		
8064	[P:FIN Jobs]		
	These SPs total finishing methods for print jobs only. The finishing method is specified by the application.		
8065	[S:FIN Jobs]		
	These SPs total finishing methods for scan jobs only. The finishing method is specified by the application. Note: Finishing features for scan jobs are not available at this time.		
8066	[L:FIN Jobs]		
	These SPs total finishing methods for jobs output from within the document server mode screen at the operation panel. The finishing method is specified from the print window within document server mode.		
8067	[O:FIN Jobs]		
	These SPs total finishing methods for jobs executed by an external application, over the network. The finishing method is specified by the application.		
001	Sort	*CTL	[0 to 99999999 / 0 / 1/step]
	Number of jobs started in Sort mode.		
002	Stack	*CTL	[0 to 99999999 / 0 / 1/step]
	Number of jobs started out of Sort mode.		
003	Staple	*CTL	[0 to 99999999 / 0 / 1/step]
	Number of jobs started in Staple mode.		
004	Booklet	*CTL	[0 to 99999999 / 0 / 1/step]
	Number of jobs started in Booklet mode. If the machine is in staple mode, the Staple counter also increments.		

005	Z-Fold	*CTL	[0 to 99999999 / 0 / 1/step]
	Number of jobs started In any mode other than the Booklet mode and set for folding (Z-fold).		
006	Punch	*CTL	[0 to 99999999 / 0 / 1/step]
	Number of jobs started in Punch mode. When Punch is set for a print job, the P: counter increments. (See SP8-064-6.)		
007	Other	*CTL	[0 to 99999999 / 0 / 1/step]
008	Inside-Flod	*CTL	[0 to 99999999 / 0 / 1/step]
009	Three-In-Fold	*CTL	[0 to 99999999 / 0 / 1/step]
010	Three-OUT-Fold	*CTL	[0 to 99999999 / 0 / 1/step]
011	Four-Fold	*CTL	[0 to 99999999 / 0 / 1/step]
012	KANNON-Fold	*CTL	[0 to 99999999 / 0 / 1/step]
013	Perfect-Bind	*CTL	[0 to 99999999 / 0 / 1/step]
014	Ring-Bind	*CTL	[0 to 99999999 / 0 / 1/step]
015	3rd Vendor	*CTL	[0 to 99999999 / 0 / 1/step]

8071	[T:Jobs/PGS]
	These SPs count the number of jobs broken down by the number of pages in the job, regardless of which application was used.
8072	[C:Jobs/PGS]
	These SPs count and calculate the number of copy jobs by size based on the number of pages in the job.
8073	[F:Jobs/PGS]
	These SPs count and calculate the number of fax jobs by size based on the number of pages in the job.
8074	[P:Jobs/PGS]
	These SPs count and calculate the number of print jobs by size based on the number of pages in the job.

8075	[S:Jobs/PGS]		
	These SPs count and calculate the number of scan jobs by size based on the number of pages in the job.		
8076	[L:Jobs/PGS]		
	These SPs count and calculate the number of jobs printed from within the document server mode window at the operation panel, by the number of pages in the job.		
8077	[O:Jobs/PGS]		
	These SPs count and calculate the number of "Other" application jobs (Web Image Monitor, Palm 2, etc.) by size based on the number of pages in the job.		
001	1 Page	*CTL	[0 to 99999999 / 0 / 1/step]
002	2 Pages	*CTL	[0 to 99999999 / 0 / 1/step]
003	3 Pages	*CTL	[0 to 99999999 / 0 / 1/step]
004	4 Pages	*CTL	[0 to 99999999 / 0 / 1/step]
005	5 Pages	*CTL	[0 to 99999999 / 0 / 1/step]
006	6 to 10 Pages	*CTL	[0 to 99999999 / 0 / 1/step]
007	11 to 20 Pages	*CTL	[0 to 99999999 / 0 / 1/step]
008	21 to 50 Pages	*CTL	[0 to 99999999 / 0 / 1/step]
009	51 to 100 Pages	*CTL	[0 to 99999999 / 0 / 1/step]
010	101 to 300 Pages	*CTL	[0 to 99999999 / 0 / 1/step]
011	301 to 500 Pages	*CTL	[0 to 99999999 / 0 / 1/step]
012	501 to 700 Pages	*CTL	[0 to 99999999 / 0 / 1/step]
013	701 to 1000 Pages	*CTL	[0 to 99999999 / 0 / 1/step]
014	1001 to Pages	*CTL	[0 to 99999999 / 0 / 1/step]

- For example: When a copy job stored on the document server is printed in document server mode, the appropriate L: counter (SP8076 0xx) increments.
- Printing a fax report counts as a job and increments the F: counter (SP 8073).
- Interrupted jobs (paper jam, etc.) are counted, even though they do not finish.
- If a job is paused and re-started, it counts as one job.

- If the finisher runs out of staples during a print and staple job, then the job is counted at the time the error occurs.
- For copy jobs (SP 8072) and scan jobs (SP 8075), the total is calculated by multiplying the number of sets of copies by the number of pages scanned. (One duplex page counts as 2.)
- The first test print and subsequent test prints to adjust settings are added to the number of pages of the copy job (SP 8072).
- When printing the first page of a job from within the document server screen, the page is counted.

8111	[T:FAX TX Jobs]		
	These SPs count the total number of jobs (color or black-and-white) sent by fax, either directly or using a file stored on the document server, on a telephone line. Note: Color fax sending is not available at this time.		
001	B/W	*CTL	[0 to 99999999 / 0 / 1/step]
002	Color	*CTL	[0 to 99999999 / 0 / 1/step]

8113	[F:FAX TX Jobs]		
	These SPs count the total number of jobs (color or black-and-white) sent by fax directly on a telephone line. Note: Color fax sending is not available at this time.		
001	B/W	*CTL	[0 to 99999999 / 0 / 1/step]
002	Color	*CTL	[0 to 99999999 / 0 / 1/step]

- These counters count jobs, not pages.
- This SP counts fax jobs sent over a telephone line with a fax application, including documents stored on the document server.
- If the mode is changed during the job, the job will count with the mode set when the job started.
- If the same document is faxed to both a public fax line and an I-Fax at a destination where both are available, then this counter increments, and the I-Fax counter (8 12x) also increments.
- The fax job is counted when the job is scanned for sending, not when the job is sent.

8121	[T:IFAX TX Jobs]		
	These SPs count the total number of jobs (color or black-and-white) sent, either directly or using a file stored on the document server, as fax images using I-Fax. Note: Color fax sending is not available at this time.		

8123	[F:IFAX TX Jobs]		
	<p>These SPs count the number of jobs (color or black-and-white) sent (not stored on the document server), as fax images using I-Fax.</p> <p>Note: Color fax sending is not available at this time.</p>		
001	B/W	*CTL	[0 to 99999999 / 0 / 1/step]
002	Color	*CTL	[0 to 99999999 / 0 / 1/step]

- These counters count jobs, not pages.
- The counters for color are provided for future use; the color fax feature is not available at this time.
- The fax job is counted when the job is scanned for sending, not when the job is sent.

8131	[T:S-to-Email Jobs]		
	<p>These SPs count the total number of jobs (color or black-and-white) scanned and attached to an e-mail, regardless of whether the document server was used or not.</p>		
8135	[S:S-to-Email Jobs]		
	<p>These SPs count the number of jobs (color or black-and-white) scanned and attached to e-mail, without storing the original on the document server.</p>		
001	B/W	*CTL	[0 to 99999999 / 0 / 1/step]
002	Color	*CTL	[0 to 99999999 / 0 / 1/step]
003	ACS	*CTL	[0 to 99999999 / 0 / 1/step]

- These counters count jobs, not pages.
- If the job is stored on the document server, after the job is stored it is determined to be color or black-and-white then counted.
- If the job is cancelled during scanning, or if the job is cancelled while the document is waiting to be sent, the job is not counted.
- If the job is cancelled during sending, it may or may not be counted, depending on what stage of the process had been reached when the job was cancelled.
- If several jobs are combined for sending to the Scan Router, Scan-to-Email, or Scan-to-PC, or if one job is sent to more than one destination. each send is counted separately. For example, if the same document is sent by Scan-to-Email as well as Scan-to-PC, then it is counted twice (once for Scan-to-Email and once for Scan-to-PC).

8141	[T:Deliv Jobs/Svr]		
	These SPs count the total number of jobs (color or black-and-white) scanned and sent to a Scan Router server.		
8145	[S:Deliv Jobs/Svr]		
	These SPs count the number of jobs (color or black-and-white) scanned in scanner mode and sent to a Scan Router server.		
001	B/W	*CTL	[0 to 99999999 / 0 / 1/step]
002	Color	*CTL	[0 to 99999999 / 0 / 1/step]
003	ACS	*CTL	[0 to 99999999 / 0 / 1/step]

- These counters count jobs, not pages.
- The jobs are counted even though the arrival and reception of the jobs at the Scan Router server cannot be confirmed.
- If even one color image is mixed with black-and-white images, then the job is counted as a "Color" job.
- If the job is cancelled during scanning, or if the job is cancelled while the document is waiting to be delivered, the job is not counted.
- If the job is cancelled during sending, it may or may not be counted, depending on what stage of the process had been reached when the job was cancelled.
- Even if several files are combined for sending, the transmission counts as one job.

8151	[T:Deliv Jobs/PC]		
	These SPs count the total number of jobs (color or black-and-white) scanned and sent to a folder on a PC (Scan-to-PC). Note: At the present time, 8 151 and 8 155 perform identical counts.		
8155	[S:Deliv Jobs/PC]		
	These SPs count the total number of jobs (color or black-and-white) scanned and sent with Scan-to-PC.		
001	B/W	*CTL	[0 to 99999999 / 0 / 1/step]
002	Color	*CTL	[0 to 99999999 / 0 / 1/step]
003	ACS	*CTL	[0 to 99999999 / 0 / 1/step]

- These counters count jobs, not pages.

- If the job is cancelled during scanning, it is not counted.
- If the job is cancelled while it is waiting to be sent, the job is not counted.
- If the job is cancelled during sending, it may or may not be counted, depending on what stage of the process had been reached when the job was cancelled.
- Even if several files are combined for sending, the transmission counts as one job.

8161	[T:PCFAX TX Jobs]	*CTL	These SPs count the number of PC Fax transmission jobs. A job is counted from when it is registered for sending, not when it is sent. [0 to 99999999 / 0 / 1/step] Note: At the present time, these counters perform identical counts.
8163	[F:PCFAX TX Jobs]	*CTL	

- This counts fax jobs started from a PC using a PC fax application, and sending the data out to the destination from the PC through the copier.

8171	[T:Deliv Jobs/WSD]		
	These SPs count the pages scanned by WS.		
8175	[S:Deliv Jobs/WSD]		
	These SPs count the pages scanned by WS.		
001	B/W	*CTL	[0 to 99999999 / 0 / 1/step]
002	Color	*CTL	[0 to 99999999 / 0 / 1/step]
003	ACS	*CTL	[0 to 99999999 / 0 / 1/step]

8181	[T:Scan to Media Jobs]		
	These SPs count the scanned pages in a media by the scanner application.		
8185	[S:Scan to Media Jobs]		
	These SPs count the scanned pages in a media by the scanner application.		
001	B/W	*CTL	[0 to 99999999 / 0 / 1/step]
002	Color	*CTL	[0 to 99999999 / 0 / 1/step]
003	ACS	*CTL	[0 to 99999999 / 0 / 1/step]

8191	[T:Total Scan PGS]	*CTL	These SPs count the pages scanned by each application that uses the scanner to scan images. [0 to 99999999 / 0 / 1]
8192	[C:Total Scan PGS]	*CTL	
8193	[F:Total Scan PGS]	*CTL	
8195	[S:Total Scan PGS]	*CTL	
8196	[L:Total Scan PGS]	*CTL	

- SP 8 191 to 8 196 count the number of scanned sides of pages, not the number of physical pages.
- These counters do not count reading user stamp data, or reading color charts to adjust color.
- Previews done with a scanner driver are not counted.
- A count is done only after all images of a job have been scanned.
- Scans made in SP mode are not counted.

Examples

- If 3 B5 pages and 1 A3 page are scanned with the scanner application but not stored, the S: count is 4.
- If both sides of 3 A4 sheets are copied and stored to the document server using the Store File button in the Copy mode window, the C: count is 6 and the L: count is 6.
- If both sides of 3 A4 sheets are copied but not stored, the C: count is 6.
- If you enter document server mode then scan 6 pages, the L: count is 6.

8201	[T:LSize Scan PGS]	*CTL	[0 to 99999999 / 0 / 1/step]
	These SPs count the total number of large pages input with the scanner for scan and copy jobs. Large size paper (A3/DLT) scanned for fax transmission are not counted. Note: These counters are displayed in the SMC Report, and in the User Tools display.		
8203	[F:LSize Scan PGS]	*CTL	[0 to 99999999 / 0 / 1/step]
	These SPs count the total number of large pages input with the scanner for fax transmission. Note: These counters are displayed in the SMC Report, and in the User Tools display.		
8205	[S:LSize Scan PGS]	*CTL	[0 to 99999999 / 0 / 1/step]
	These SPs count the total number of large pages input with the scanner for scan jobs only. Large size paper (A3/DLT) scanned for fax transmission are not counted. Note: These counters are displayed in the SMC Report, and in the User Tools display.		

8211	[T:Scan PGS/LS]	*CTL	These SPs count the number of pages scanned into the document server. [0 to 99999999 / 0 / 1] The L: counter counts the number of pages stored from within the document server mode screen at the operation panel, and with the Store File button from within the Copy mode screen
8212	[C:Scan PGS/LS]	*CTL	
8213	[F:Scan PGS/LS]	*CTL	
8215	[S:Scan PGS/LS]	*CTL	
8216	[L:Scan PGS/LS]	*CTL	

- Reading user stamp data is not counted.
- If a job is cancelled, the pages output as far as the cancellation are counted.
- If the scanner application scans and stores 3 B5 sheets and 1 A4 sheet, the S: count is 4.
- If pages are copied but not stored on the document server, these counters do not change.
- If both sides of 3 A4 sheets are copied and stored to the document server, the C: count is 6 and the L: count is 6.
- If you enter document server mode then scan 6 pages, the L: count is 6.

8221	[ADF Org Feeds]		
	These SPs count the number of pages fed through the ADF for front and back side scanning.		
001	Front	*CTL	[0 to 99999999 / 0 / 1/step]
	Number of front sides fed for scanning: With an ADF that can scan both sides simultaneously, the Front side count is the same as the number of pages fed for either simplex or duplex scanning. With an ADF that cannot scan both sides simultaneously, the Front side count is the same as the number of pages fed for duplex front side scanning. (The front side is determined by which side the user loads face up.)		
002	Back	*CTL	[0 to 99999999 / 0 / 1/step]
	Number of rear sides fed for scanning: With an ADF that can scan both sides simultaneously, the Back count is the same as the number of pages fed for duplex scanning. With an ADF that cannot scan both sides simultaneously, the Back count is the same as the number of pages fed for duplex rear-side scanning.		

- When 1 sheet is fed for duplex scanning the Front count is 1 and the Back count is 1.

- If a jam occurs during the job, recovery processing is not counted to avoid double counting. Also, the pages are not counted if the jam occurs before the first sheet is output.

8231	[Scan PGS/Mode]		
	These SPs count the number of pages scanned by each ADF mode to determine the work load on the ADF.		
001	Large Volume	*CTL	[0 to 99999999 / 0 / 1/step]
	Selectable. Large copy jobs that cannot be loaded in the ADF at one time.		
002	SADF	*CTL	[0 to 99999999 / 0 / 1/step]
	Selectable. Feeding pages one by one through the ADF.		
003	Mixed Size	*CTL	[0 to 99999999 / 0 / 1/step]
	Selectable. Select "Mixed Sizes" on the operation panel.		
004	Custom Size	*CTL	[0 to 99999999 / 0 / 1/step]
	Selectable. Originals of non-standard size.		
005	Platen	*CTL	[0 to 99999999 / 0 / 1/step]
	Book mode. Raising the ADF and placing the original directly on the platen.		
006	Mixed 1side/ 2side	*CTL	[0 to 99999999 / 0 / 1/step]
	Simplex and Duplex mode.		

- If the scan mode is changed during the job, for example, if the user switches from ADF to Platen mode, the count is done for the last selected mode.
- The user cannot select mixed sizes or non-standard sizes with the fax application so if the original's page sizes are mixed or non-standard, these are not counted.
- If the user selects "Mixed Sizes" for copying in the platen mode, the Mixed Size count is enabled.
- In the SADF mode if the user copies 1 page in platen mode and then copies 2 pages with SADF, the Platen count is 1 and the SADF count is 3.

8241	[T:Scan PGS/Org]	*CTL	[0 to 99999999 / 0 / 1 / step]
	These SPs count the total number of scanned pages by original type for all jobs, regardless of which application was used.		

8242	[C:Scan PGS/Org]	*CTL	[0 to 99999999 / 0 / 1 / step			
	These SPs count the number of pages scanned by original type for Copy jobs.					
8243	[F:Scan PGS/Org]	*CTL	[0 to 99999999 / 0 / 1 / step			
	These SPs count the number of pages scanned by original type for Fax jobs.					
8245	[S:Scan PGS/Org]	*CTL	[0 to 99999999 / 0 / 1 / step			
	These SPs count the number of pages scanned by original type for Scan jobs.					
8246	[L:Scan PGS/Org]	*CTL	[0 to 99999999 / 0 / 1 / step			
	These SPs count the number of pages scanned and stored from within the document server mode screen at the operation panel, and with the Store File button from within the Copy mode screen					
		8241	8242	8243	8245	8246
001	Text	Yes	Yes	Yes	Yes	Yes
002	Text/Photo	Yes	Yes	Yes	Yes	Yes
003	Photo	Yes	Yes	Yes	Yes	Yes
004	GenCopy, Pale	Yes	Yes	No	Yes	Yes
005	Map	Yes	Yes	No	No	Yes
006	Normal/Detail	Yes	No	Yes	No	No
007	Fine/Super Fine	Yes	No	Yes	No	No
008	Binary	Yes	No	No	Yes	No
009	Grayscale	Yes	No	No	Yes	No
010	Color	Yes	No	No	Yes	No
011	Other	Yes	Yes	Yes	Yes	Yes

- If the scan mode is changed during the job, for example, if the user switches from ADF to Platen mode, the count is done for the last selected mode.

8251	[T:Scan PGS/ImgEdt]	*CTL	These SPs show how many times Image Edit features have been selected at the operation panel for each application. Some examples of these editing features are: Erase> Border Erase> Center Image Repeat Centering Positive/Negative [0 to 99999999 / 0 / 1/step] Note: The count totals the number of times the edit features have been used. A detailed breakdown of exactly which features have been used is not given.
8252	[C:Scan PGS/ImgEdt]	*CTL	
8255	[S:Scan PGS/ImgEdr]	*CTL	
8256	[L:Scan PGS/ImgEdt]	*CTL	
8257	[O:Scan PGS/ImgEdt]	*CTL	

The L: counter counts the number of pages stored from within the document server mode screen at the operation panel, and with the Store File button from within the Copy mode screen.

8261	[T:Scan PGS/ColCr]		
8262	[C:Scan PGS/ ColCr]		
8265	[S:Scn PGS/Color]		
8266	[L:Scn PGS/ColCr]		
These SPs show how many times color creation features have been selected at the operation panel.			
001	Color Conversion	*CTL	[0 to 99999999 / 0 / 1/step]
002	Color Erase	*CTL	[0 to 99999999 / 0 / 1/step]
003	Background	*CTL	[0 to 99999999 / 0 / 1/step]
004	Other	*CTL	[0 to 99999999 / 0 / 1/step]

8281	[T:Scan PGS/TWAIN]	*CTL	<p>These SPs count the number of pages scanned using a TWAIN driver. These counters reveal how the TWAIN driver is used for delivery functions.</p> <p>[0 to 99999999 / 0 / 1/step]</p> <p>Note: At the present time, these counters perform identical counts.</p>
8285	[S:Scan PGS/TWAIN]	*CTL	

8291	[T:Scan PGS/Stamp]	*CTL	<p>These SPs count the number of pages stamped with the stamp in the ADF unit.</p> <p>[0 to 99999999 / 0 / 1/step]</p> <p>The L: counter counts the number of pages stored from within the document server mode screen at the operation panel, and with the Store File button from within the Copy mode screen</p>
8293	[F:Scan PGS/Stamp]	*CTL	
8295	[S:Scan PGS/Stamp]	*CTL	

8301	[T:Scan PGS/Size]	<p>These SPs count by size the total number of pages scanned by all applications. Use these totals to compare original page size (scanning) and output (printing) page size [SP 8-441].</p>
8302	[C:Scan PGS/Size]	<p>These SPs count by size the total number of pages scanned by the Copy application. Use these totals to compare original page size (scanning) and output (printing) page size [SP 8-442].</p>
8303	[F:Scan PGS/Size]	<p>These SPs count by size the total number of pages scanned by the Fax application. Use these totals to compare original page size (scanning) and output page size [SP 8-443].</p>
8305	[S:Scan PGS/Size]	<p>These SPs count by size the total number of pages scanned by the Scan application. Use these totals to compare original page size (scanning) and output page size [SP 8-445].</p>

8306	[L:Scan PGS/Size]		
	These SPs count by size the total number of pages scanned and stored from within the document server mode screen at the operation panel, and with the Store File button from within the Copy mode screen. Use these totals to compare original page size (scanning) and output page size [SP 8-446].		
001	A3	*CTL	[0 to 99999999 / 0 / 1/step]
002	A4	*CTL	[0 to 99999999 / 0 / 1/step]
003	A5	*CTL	[0 to 99999999 / 0 / 1/step]
004	B4	*CTL	[0 to 99999999 / 0 / 1/step]
005	B5	*CTL	[0 to 99999999 / 0 / 1/step]
006	DLT	*CTL	[0 to 99999999 / 0 / 1/step]
007	LG	*CTL	[0 to 99999999 / 0 / 1/step]
008	LT	*CTL	[0 to 99999999 / 0 / 1/step]
009	HLT	*CTL	[0 to 99999999 / 0 / 1/step]
010	Full Bleed	*CTL	[0 to 99999999 / 0 / 1/step]
254	Other (Standard)	*CTL	[0 to 99999999 / 0 / 1/step]
255	Other (Custom)	*CTL	[0 to 99999999 / 0 / 1/step]

8311	T:Scan PGS/Rez	*CTL	[0 to 99999999 / 0 / 1]
	These SPs count by resolution setting the total number of pages scanned by applications that can specify resolution settings.		
8315	S: Scan PGS/Rez	*CTL	[0 to 99999999 / 0 / 1]
	These SPs count by resolution setting the total number of pages scanned by applications that can specify resolution settings. Note: At the present time, SP8-311 and SP8-315 perform identical counts.		
001	1200dpi <	*CTL	[0 to 99999999 / 0 / 1/step]
002	600dpi to 1199dpi	*CTL	[0 to 99999999 / 0 / 1/step]
003	400dpi to 599dpi	*CTL	[0 to 99999999 / 0 / 1/step]

004	200dpi to 399dpi	*CTL	[0 to 99999999 / 0 / 1/step]
005	< 199dpi	*CTL	[0 to 99999999 / 0 / 1/step]

- Copy resolution settings are fixed so they are not counted.
- The Fax application does not allow finely-adjusted resolution settings so no count is done for the Fax application.

8321	[T: Sacn Poster]		
8322	[C: Sacn Poster]		
8326	[L: Sacn Poster]		
001	2 Sheet	*CTL	[0 to 99999999 / 0 / 1/step]
002	4 Sheet	*CTL	[0 to 99999999 / 0 / 1/step]
003	9 Sheet	*CTL	[0 to 99999999 / 0 / 1/step]

4

8381	[T: Total PrtPGS]	*CTL	These SPs count the number of pages printed by the customer. The counter for the application used for storing the pages increments. [0 to 99999999 / 0 / 1/step]
8382	[C: Total PrtPGS]	*CTL	
8383	[F: Total PrtPGS]	*CTL	
8384	[P: Total PrtPGS]	*CTL	
8385	[S: Total PrtPGS]	*CTL	
8386	[L: Total PrtPGS]	*CTL	
8387	[O: Total PrtPGS]	*CTL	

- When the A3/DLT double count function is switched on with SP5104, 1 A3/DLT page is counted as 2.
- When several documents are merged for a print job, the number of pages stored are counted for the application that stored them.
- These counters are used primarily to calculate charges on use of the machine, so the following pages are not counted as printed pages:
 - Blank pages in a duplex printing job.
 - Blank pages inserted as document covers, chapter title sheets, and slip sheets.
 - Reports printed to confirm counts.
 - All reports done in the service mode (service summaries, engine maintenance reports, etc.)

- Test prints for machine image adjustment.
- Error notification reports.
- Partially printed pages as the result of a copier jam.

8391	LSize PrtPGS	*CTL	[0 to 99999999 / 0 / 1/step]
	These SPs count pages printed on paper sizes A3/DLT and larger. Note: In addition to being displayed in the SMC Report, these counters are also displayed in the User Tools display on the copy machine.		
001	A3/DLT, Larger		
003	Bannaer Paper		

4

8401	[T:PrtPGS/LS]	*CTL	These SPs count the number of pages printed from the document server. The counter for the application used to print the pages is incremented. The L: counter counts the number of jobs stored from within the document server mode screen at the operation panel. [0 to 99999999 / 0 / 1/step]
8402	[C:PrtPGS/LS]	*CTL	
8403	[F:PrtPGS/LS]	*CTL	
8404	[P:PrtPGS/LS]	*CTL	
8405	[S:PrtPGS/LS]	*CTL	
8406	[L:PrtPGS/LS]	*CTL	

- Print jobs done with Web Image Monitor and Desk Top Binder are added to the L: count.
- Fax jobs done with Web Image Monitor and Desk Top Binder are added to the F: count.

8411	Prints/Duplex	*CTL	This SP counts the amount of paper (front/back counted as 1 page) used for duplex printing. Last pages printed only on one side are not counted. [0 to 99999999 / 0 / 1]
------	---------------	------	---

8421	[T:PrtPGS/Dup Comb]		
	These SPs count by binding and combine, and n-Up settings the number of pages processed for printing. This is the total for all applications.		
8422	[C:PrtPGS/Dup Comb]		
	These SPs count by binding and combine, and n-Up settings the number of pages processed for printing by the copier application.		

8423	[F:PrtPGS/Dup Comb]		
	These SPs count by binding and combine, and n-Up settings the number of pages processed for printing by the fax application.		
8424	[P:PrtPGS/Dup Comb]		
	These SPs count by binding and combine, and n-Up settings the number of pages processed for printing by the printer application.		
8425	[S:PrtPGS/Dup Comb]		
	These SPs count by binding and combine, and n-Up settings the number of pages processed for printing by the scanner application.		
8426	[L:PrtPGS/Dup Comb]		
	These SPs count by binding and combine, and n-Up settings the number of pages processed for printing from within the document server mode window at the operation panel.		
8427	[O:PrtPGS/Dup Comb]		
	These SPs count by binding and combine, and n-Up settings the number of pages processed for printing by Other applications		
001	Simplex> Duplex	*CTL	[0 to 99999999 / 0 / 1/step]
002	Duplex> Duplex	*CTL	[0 to 99999999 / 0 / 1/step]
003	Book> Duplex	*CTL	[0 to 99999999 / 0 / 1/step]
004	Simplex Combine	*CTL	[0 to 99999999 / 0 / 1/step]
005	Duplex Combine	*CTL	[0 to 99999999 / 0 / 1/step]
006	2in1	*CTL	[0 to 99999999 / 0 / 1/step]
	2 pages on 1 side (2-Up)		
007	4 in1	*CTL	[0 to 99999999 / 0 / 1/step]
	4 pages on 1 side (4-Up)		
008	6 in1	*CTL	[0 to 99999999 / 0 / 1/step]
	6 pages on 1 side (6-Up)		

009	8 in1	*CTL	[0 to 99999999 / 0 / 1/step]
	8 pages on 1 side (8-Up)		
010	9 in1	*CTL	[0 to 99999999 / 0 / 1/step]
	9 pages on 1 side (9-Up)		
011	16 in1	*CTL	[0 to 99999999 / 0 / 1/step]
	16 pages on 1 side (16-Up)		
012	Booklet	*CTL	[0 to 99999999 / 0 / 1/step]
013	Magazine	*CTL	[0 to 99999999 / 0 / 1/step]
014	2-in-1 + Booklet	*CTL	[0 to 99999999 / 0 / 1/step]
015	4-in-1 + Booklet	*CTL	[0 to 99999999 / 0 / 1/step]
016	6-in-1 + Booklet	*CTL	[0 to 99999999 / 0 / 1/step]
017	8-in-1 + Booklet	*CTL	[0 to 99999999 / 0 / 1/step]
018	9-in-1 + Booklet	*CTL	[0 to 99999999 / 0 / 1/step]
019	2-in-1 + Magazine	*CTL	[0 to 99999999 / 0 / 1/step]
020	4-in-1 + Magazine	*CTL	[0 to 99999999 / 0 / 1/step]
021	6-in-1 + Magazine	*CTL	[0 to 99999999 / 0 / 1/step]
022	8-in-1 + Magazine	*CTL	[0 to 99999999 / 0 / 1/step]
023	9-in-1 + Magazine	*CTL	[0 to 99999999 / 0 / 1/step]
024	16-in-1 + Magazine	*CTL	[0 to 99999999 / 0 / 1/step]

- These counts (SP8 421 to SP8 427) are especially useful for customers who need to improve their compliance with ISO standards for the reduction of paper consumption.
- Pages that are only partially printed with the n-Up functions are counted as 1 page.
- Here is a summary of how the counters work for Booklet and Magazine modes:

Booklet		Magazine	
Original Pages	Count	Original Pages	Count
1	1	1	1

Booklet		Magazine	
Original Pages	Count	Original Pages	Count
2	2	2	2
3	2	3	2
4	2	4	2
5	3	5	4
6	4	6	4
7	4	7	4
8	4	8	4

8431	[T:PrtPGS/ImgEdt]		
	These SPs count the total number of pages output with the three features below, regardless of which application was used.		
8432	[C:PrtPGS/ImgEdt]		
	These SPs count the total number of pages output with the three features below with the copy application.		
8434	[P:PrtPGS/ImgEdt]		
	These SPs count the total number of pages output with the three features below with the print application.		
8436	[L:PrtPGS/ImgEdt]		
	These SPs count the total number of pages output from within the document server mode window at the operation panel with the three features below.		
8437	[O:PrtPGS/ImgEdt]		
	These SPs count the total number of pages output with the three features below with Other applications.		
001	Cover/Slip Sheet	*CTL	[0 to 99999999 / 0 / 1/step]
	Total number of covers or slip sheets inserted. The count for a cover printed on both sides counts 2.		

002	Series/Book	*CTL	[0 to 99999999 / 0 / 1/step]
	The number of pages printed in series (one side) or printed as a book with booklet right/left pagination.		
003	User Stamp	*CTL	[0 to 99999999 / 0 / 1/step]
	The number of pages printed where stamps were applied, including page numbering and date stamping.		

4

8441	[T:PrtPGS/Ppr Size]		
	These SPs count by print paper size the number of pages printed by all applications.		
8442	[C:PrtPGS/Ppr Size]		
	These SPs count by print paper size the number of pages printed by the copy application.		
8443	[F:PrtPGS/Ppr Size]		
	These SPs count by print paper size the number of pages printed by the fax application.		
8444	[P:PrtPGS/Ppr Size]		
	These SPs count by print paper size the number of pages printed by the printer application.		
8445	[S:PrtPGS/Ppr Size]		
	These SPs count by print paper size the number of pages printed by the scanner application.		
8446	[L:PrtPGS/Ppr Size]		
	These SPs count by print paper size the number of pages printed from within the document server mode window at the operation panel.		
8447	[O:PrtPGS/Ppr Size]		
	These SPs count by print paper size the number of pages printed by Other applications.		
001	A3	*CTL	[0 to 99999999 / 0 / 1/step]
002	A4	*CTL	[0 to 99999999 / 0 / 1/step]
003	A5	*CTL	[0 to 99999999 / 0 / 1/step]
004	B4	*CTL	[0 to 99999999 / 0 / 1/step]

005	B5	*CTL	[0 to 99999999 / 0 / 1/step]
006	DLT	*CTL	[0 to 99999999 / 0 / 1/step]
007	LG	*CTL	[0 to 99999999 / 0 / 1/step]
008	LT	*CTL	[0 to 99999999 / 0 / 1/step]
009	HLT	*CTL	[0 to 99999999 / 0 / 1/step]
010	Full Bleed	*CTL	[0 to 99999999 / 0 / 1/step]
254	Other (Standard)	*CTL	[0 to 99999999 / 0 / 1/step]
255	Other (Custom)	*CTL	[0 to 99999999 / 0 / 1/step]

- These counters do not distinguish between LEF and SEF.

8451	[PrtPGS/Ppr Tray]		
	These SPs count the number of sheets fed from each paper feed station.		
001	Bypass Tray	*CTL	Bypass Tray [0 to 99999999 / 0 / 1/step]
002	Tray 1	*CTL	Copier [0 to 99999999 / 0 / 1/step]
003	Tray 2	*CTL	
004	Tray 3	*CTL	Paper Tray Unit (Option) [0 to 99999999 / 0 / 1/step]
005	Tray 4	*CTL	
006	Tray 5	*CTL	Currently not used.
007	Tray 6	*CTL	Currently not used.
008	Tray 7	*CTL	Currently not used.
009	Tray 8	*CTL	Currently not used.
010	Tray 9	*CTL	Currently not used.
011	Tray 10	*CTL	Currently not used.
012	Tray 11	*CTL	Currently not used.
013	Tray 12	*CTL	Currently not used.

014	Tray 13	*CTL	Currently not used.
015	Tray 14	*CTL	Currently not used.
016	Tray 15	*CTL	Currently not used.

8461	[T:PrtPGS/Ppr Type]		
	<p>These SPs count by paper type the number pages printed by all applications.</p> <ul style="list-style-type: none"> • These counters are not the same as the PM counter. The PM counter is based on feed timing to accurately measure the service life of the feed rollers. However, these counts are based on output timing. • Blank sheets (covers, chapter covers, slip sheets) are also counted. • During duplex printing, pages printed on both sides count as 1, and a page printed on one side counts as 1. 		
8462	[C:PrtPGS/Ppr Type]		
	These SPs count by paper type the number pages printed by the copy application.		
8463	[F:PrtPGS/Ppr Type]		
	These SPs count by paper type the number pages printed by the fax application.		
8464	[P:PrtPGS/Ppr Type]		
	These SPs count by paper type the number pages printed by the printer application.		
8466	[L:PrtPGS/Ppr Type]		
	These SPs count by paper type the number pages printed from within the document server mode window at the operation panel.		
001	Normal	*CTL	[0 to 99999999 / 0 / 1/step]
002	Recycled	*CTL	[0 to 99999999 / 0 / 1/step]
003	Special	*CTL	[0 to 99999999 / 0 / 1/step]
004	Thick	*CTL	[0 to 99999999 / 0 / 1/step]
005	Normal (Back)	*CTL	[0 to 99999999 / 0 / 1/step]
006	Thick (Back)	*CTL	[0 to 99999999 / 0 / 1/step]
007	OHP	*CTL	[0 to 99999999 / 0 / 1/step]

008	Other	*CTL	[0 to 999999999 / 0 / 1/step]
-----	-------	------	-------------------------------

8471	[PrtPGS/Mag]		
	These SPs count by magnification rate the number of pages printed.		
001	< 49%	*CTL	[0 to 999999999 / 0 / 1/step]
002	50% to 99%	*CTL	
003	100%	*CTL	
004	101% to 200%	*CTL	
005	201% <	*CTL	

4

Counts are done for magnification adjusted for pages, not only on the operation panel but performed remotely with an external network application capable of performing magnification adjustment as well. Magnification adjustments done with printer drivers with PC applications such as Excel are also counted. Magnification adjustments done for adjustments after they have been stored on the document server are not counted.

Magnification adjustments performed automatically during Auto Reduce/Enlarge copying are counted. The magnification rates of blank cover sheets, slip sheets, etc. are automatically assigned a rate of 100%.

8481	[T:PrtPGS/TonSave]	*CTL	[0 to 999999999 / 0 / 1/step]
8484	[P:PrtPGS/TonSave]	*CTL	
These SPs count the number of pages printed with the Toner Save feature switched on. Note: These SPs return the same results as this SP is limited to the Print application.			

8491	[T:PrtPGS/Col Mode]
8492	[C:PrtPGS/Col Mode]
8493	[F:PrtPGS/Col Mode]
8496	[L:PrtPGS/Col Mode]
8497	[O:PrtPGS/Col Mode]

001	B/W	*CTL	These SPs count the number of pages printed in the Color Mode by each application.
002	Single Color	*CTL	
003	Two Color	*CTL	
004	Full Color	*CTL	
051	B/W(Banner)	*CTL	
052	Single Color(Banner)	*CTL	
053	Two Color(Banner)	*CTL	
054	Full Color	*CTL	

8501	[T:PrPGS/Col Mode]		
8504	[P:PrPGS/Col Mode]		
8507	[O:PrPGS/Col Mode]		
001	B/W	*CTL	These SPs count the number of pages printed in the Color Mode by the print application.
002	Mono Color	*CTL	
003	Full Color	*CTL	
004	Single Color	*CTL	
005	Two Color	*CTL	
051	B/W(Banner)	*CTL	
052	Full Color(Banner)	*CTL	
053	Single Color(Banner)	*CTL	
054	Two Color(Banner)	*CTL	

8511	[T:PrPGS/Emul]		
	These SPs count by printer emulation mode the total number of pages printed.		
8514	[P:PrPGS/Emul]		
	These SPs count by printer emulation mode the total number of pages printed.		
001	RPCS	*CTL	[0 to 99999999 / 0 / 1/step]

002	RPDL	*CTL	[0 to 99999999 / 0 / 1/step]
003	PS3	*CTL	[0 to 99999999 / 0 / 1/step]
004	R98	*CTL	[0 to 99999999 / 0 / 1/step]
005	R16	*CTL	[0 to 99999999 / 0 / 1/step]
006	GL/GL2	*CTL	[0 to 99999999 / 0 / 1/step]
007	R55	*CTL	[0 to 99999999 / 0 / 1/step]
008	RTIFF	*CTL	[0 to 99999999 / 0 / 1/step]
009	PDF	*CTL	[0 to 99999999 / 0 / 1/step]
010	PCL5e/5c	*CTL	[0 to 99999999 / 0 / 1/step]
011	PCL XL	*CTL	[0 to 99999999 / 0 / 1/step]
012	IPDL-C	*CTL	[0 to 99999999 / 0 / 1/step]
013	BM-Links	*CTL	Japan Only
014	Other	*CTL	[0 to 99999999 / 0 / 1/step]
015	IPDS	*CTL	[0 to 99999999 / 0 / 1/step]
016	XPS	*CTL	[0 to 99999999 / 0 / 1/step]

- SP8 511 and SP8 514 return the same results as they are both limited to the Print application.
- Print jobs output to the document server are not counted.

8521	[T:PrnPGS/FIN]
	These SPs count by finishing mode the total number of pages printed by all applications.
8522	[C:PrnPGS/FIN]
	These SPs count by finishing mode the total number of pages printed by the Copy application.
8523	[F:PrnPGS/FIN]
	These SPs count by finishing mode the total number of pages printed by the Fax application. NOTE: Print finishing options for received faxes are currently not available.

8524	[P:PrtPGS/FIN]		
	These SPs count by finishing mode the total number of pages printed by the Print application.		
8525	[S:PrtPGS/FIN]		
	These SPs count by finishing mode the total number of pages printed by the Scanner application.		
8526	[L:PrtPGS/FIN]		
	These SPs count by finishing mode the total number of pages printed from within the document server mode window at the operation panel.		
001	Sort	*CTL	[0 to 99999999 / 0 / 1/step]
002	Stack	*CTL	[0 to 99999999 / 0 / 1/step]
003	Staple	*CTL	[0 to 99999999 / 0 / 1/step]
004	Booklet	*CTL	[0 to 99999999 / 0 / 1/step]
005	Z-Fold	*CTL	[0 to 99999999 / 0 / 1/step]
006	Punch	*CTL	[0 to 99999999 / 0 / 1/step]
007	Other	*CTL	[0 to 99999999 / 0 / 1/step]
008	Inside Fold	*CTL	[0 to 99999999 / 0 / 1/step]
	Half-Fold (FM2) (Multi Fold Unit)		
009	Three-IN-Fold	*CTL	[0 to 99999999 / 0 / 1/step]
	Letter Fold-in (FM4) (Multi Fold Unit)		
010	Three-OUT-Fold	*CTL	[0 to 99999999 / 0 / 1/step]
	Letter Fold-out (FM3) (Multi Fold Unit)		
011	Four Fold	*CTL	[0 to 99999999 / 0 / 1/step]
	Double Parallel Fold (FM5) (Multi Fold Unit)		
012	KANNON-Fold	*CTL	[0 to 99999999 / 0 / 1/step]
	Gate Fold (FM6) (Multi Fold Unit)		

013	Perfect-Bind	*CTL	[0 to 99999999 / 0 / 1/step]
	Perfect Binder		
014	Ring-Bind	*CTL	[0 to 99999999 / 0 / 1/step]
	Ring Binder		
015	3rd Vendor	*CTL	[0 to 99999999 / 0 / 1/step]

Note

- If stapling is selected for finishing and the stack is too large for stapling, the unstapled pages are still counted.
- The counts for staple finishing are based on output to the staple tray, so jam recoveries are counted.

8531	[Staple]		
001	Staples	*CTL	[0 to 99999999 / 0 / 1/step]
002	Stapless	*CTL	

8551	[T:PrtBooks/FIN]		
8552	[C:PrtBooks/FIN]		
8554	[P:PrtBooks/FIN]		
8556	[L:PrtBooks/FIN]		
001	Perfect-Bind	*CTL	[0 to 99999999 / 0 / 1/step]
002	Ring-Bind	*CTL	

8561	[T:A Sheet Of Paper]		
8562	[C:A Sheet Of Paper]		
8563	[F:A Sheet Of Paper]		
8564	[P:A Sheet Of Paper]		
8566	[L:A Sheet Of Paper]		
8567	[O:A Sheet Of Paper]		

001	Total: Over A3/DLT	*CTL	[0 to 99999999 / 0 / 1]
002	Total: Under A3/DLT	*CTL	
003	Duplex: Over A3/DLT	*CTL	
004	Duplex: Under A3/DLT	*CTL	

8581	[T:Counter]			
	These SPs count the total output broken down by color output, regardless of the application used. In addition to being displayed in the SMC Report, these counters are also displayed in the User Tools display on the copy machine.			
001	Total	*CTL	[0 to 99999999 / 0 / 1]	
002	Total: Full Color	*CTL		
003	B&W/Single Color	*CTL		
004	Development: CMY	*CTL		
005	Development: K	*CTL		
008	Print: Color	*CTL		
009	Print: B/W	*CTL		
010	Total: Color	*CTL		
011	Total: B/W	*CTL		[0 to 99999999 / 0 / 1]
012	Full Color: A3	*CTL		
013	Full Color: B4 JIS	*CTL		
014	Full Color Print	*CTL		
015	Mono Color Print	*CTL		
017	Twin Color Mode Print	*CTL		
018	Full Color Print (Twin)	*CTL		
019	Mono Color Print (Twin)	*CTL		
020	Full Color Total (CV)	*CTL		

021	Mono Color Total (CV)	*CTL	[0 to 99999999 / 0 / 1]
022	Full Color Print (CV)	*CTL	
028	Development: CMY (A3)	*CTL	
029	Development: K (A3)	*CTL	
030	Total: Color (A3)	*CTL	
031	Total: B/W (A3)	*CTL	

8582	[C:Counter]		
	These SPs count the total output of the copy application broken down by color output.		
001	B/W	*CTL	[0 to 99999999 / 0 / 1]
002	Single Color	*CTL	
003	Two Color	*CTL	
004	Full Color	*CTL	

8583	[F:Counter]		
	These SPs count the total output of the fax application broken down by color output.		
001	B/W	*CTL	[0 to 99999999 / 0 / 1]
002	Single Color	*CTL	

8584	[P:Counter]		
	These SPs count the total output of the print application broken down by color output.		
001	B/W	*CTL	[0 to 99999999 / 0 / 1]
002	Mono Color	*CTL	
003	Full Color	*CTL	
004	Single Color	*CTL	
005	Two Color	*CTL	

8586	[L:Counter]		
	These SPs count the total output of the local storage broken down by color output.		
001	B/W	*CTL	[0 to 99999999 / 0 / 1]
002	Single Color	*CTL	
003	Two Color	*CTL	
004	Full Color	*CTL	

8591	[O:Counter]		
	These SPs count the totals for A3/DLT paper use, number of duplex pages printed, and the number of staples used. These totals are for Other (O:) applications only.		
001	A3/DLT	*CTL	[0 to 99999999 / 0 / 1/step]
002	Duplex	*CTL	
003	Banner	*CTL	

8601	[T:Coverage Counter]		
	These SPs count the total coverage for each color and the total printout pages for each printing mode.		
001	B/W	*CTL	[0 to 2147483647 / 0 / 1% / step]
002	Color	*CTL	
011	B/W Printing Pages	*CTL	[0 to 99999999 / 0 / 1/step]
012	Color Printing Pages	*CTL	[0 to 99999999 / 0 / 1/step]
021	Coverage Counter 1	*CTL	[0 to 99999999 / 0 / 1/step]
022	Coverage Counter 2	*CTL	
023	Coverage Counter 3	*CTL	
031	Coverage Counter 1 (YMC)	*CTL	[0 to 99999999 / 0 / 1/step]
032	Coverage Counter 2 (YMC)	*CTL	
033	Coverage Counter 3 (YMC)	*CTL	

8602	[C:Coverage Counter]		
001	B/W	*CTL	[0 to 2147483647 / 0 / 1% / step]
002	Single Color	*CTL	
003	Two Color	*CTL	
004	Full Color	*CTL	

8603	[F:Coverage Counter]		
001	B/W	*CTL	[0 to 2147483647 / 0 / 1% / step]
002	Single Color	*CTL	

8604	[P:Coverage Counter]		
001	B/W	*CTL	[0 to 2147483647 / 0 / 1% / step]
002	Single Color	*CTL	
003	Two Color	*CTL	
004	Full Color	*CTL	

8606	[L: Coverage Counter]		
001	B/W	*CTL	[0 to 2147483647 / 0 / 1% / step]
002	Single Color	*CTL	
003	Two Color	*CTL	
004	Full Color	*CTL	

8617	[SDK Apli Counter]		
These SPs count the total printout pages for each SDK application.			

001	SDK-1	*CTL	[0 to 99999999 / 0 / 1/step]
002	SDK-2	*CTL	
003	SDK-3	*CTL	
004	SDK-4	*CTL	
005	SDK-5	*CTL	
006	SDK-6	*CTL	
007	SDK-7	*CTL	[0 to 99999999 / 0 / 1/step]
008	SDK-8	*CTL	
009	SDK-9	*CTL	
010	SDK-10	*CTL	
011	SDK-11	*CTL	
012	SDK-12	*CTL	

8621	Func Use Counter		
001	Function-001	*CTL	[0 to 99999999 / 0 / 1/step]
002	Function-002	*CTL	
003	Function-003	*CTL	
004	Function-004	*CTL	
005	Function-005	*CTL	
006	Function-006	*CTL	[0 to 99999999 / 0 / 1/step]
007	Function-007	*CTL	
008	Function-008	*CTL	
009	Function-009	*CTL	
010	Function-010	*CTL	

011	Function-011	*CTL	[0 to 999999999 / 0 / 1/step]
012	Function-012	*CTL	
013	Function-013	*CTL	
014	Function-014	*CTL	
015	Function-015	*CTL	
016	Function-016	*CTL	[0 to 999999999 / 0 / 1/step]
017	Function-017	*CTL	
018	Function-018	*CTL	
019	Function-019	*CTL	
020	Function-020	*CTL	
021	Function-021	*CTL	[0 to 999999999 / 0 / 1/step]
022	Function-022	*CTL	
023	Function-023	*CTL	
024	Function-024	*CTL	
025	Function-025	*CTL	
026	Function-026	*CTL	[0 to 999999999 / 0 / 1/step]
027	Function-027	*CTL	
028	Function-028	*CTL	
029	Function-029	*CTL	
030	Function-030	*CTL	

031	Function-031	*CTL	[0 to 999999999 / 0 / 1/step]
032	Function-032	*CTL	
033	Function-033	*CTL	
034	Function-034	*CTL	
035	Function-035	*CTL	
036	Function-036	*CTL	
037	Function-037	*CTL	
038	Function-038	*CTL	
039	Function-039	*CTL	
040	Function-040	*CTL	
041	Function-041	*CTL	[0 to 999999999 / 0 / 1/step]
042	Function-042	*CTL	
043	Function-043	*CTL	
044	Function-044	*CTL	
045	Function-045	*CTL	
046	Function-046	*CTL	
047	Function-047	*CTL	
048	Function-048	*CTL	
049	Function-049	*CTL	
050	Function-050	*CTL	

051	Function-051	*CTL	[0 to 99999999 / 0 / 1/step]
052	Function-052	*CTL	
053	Function-053	*CTL	
054	Function-054	*CTL	
055	Function-055	*CTL	
056	Function-056	*CTL	
057	Function-057	*CTL	
058	Function-058	*CTL	
059	Function-059	*CTL	
060	Function-060	*CTL	
061	Function-061	*CTL	[0 to 99999999 / 0 / 1/step]
062	Function-062	*CTL	
063	Function-063	*CTL	
064	Function-064	*CTL	

8631	[T:FAX TX PGS]		
	These SPs count by color mode the number of pages sent by fax to a telephone number.		
001	B/W	*CTL	[0 to 99999999 / 0 / 1/step]
002	Color	*CTL	[0 to 99999999 / 0 / 1/step]

8633	[F:FAX TX PGS]		
	These SPs count by color mode the number of pages sent by fax to a telephone number.		
001	B/W	*CTL	[0 to 99999999 / 0 / 1/step]
002	Color	*CTL	[0 to 99999999 / 0 / 1/step]

- If a document has color and black-and-white pages mixed, the pages are counted separately as B/W or Color.

- At the present time, this feature is provided for the Fax application only so SP8631 and SP8633 are the same.
- The counts include error pages.
- If a document is sent to more than one destination with a Group transmission, the count is done for each destination.
- Polling transmissions are counted but polling RX are not.
- Relay, memory, and confidential mailbox transmissions and are counted for each destination.

8641	[T:IFAX TX PGS]		
	These SPs count by color mode the number of pages sent by fax to as fax images using I-Fax.		
001	B/W	*CTL	[0 to 99999999 / 0 / 1/step]
002	Color	*CTL	[0 to 99999999 / 0 / 1/step]

8643	[F:IFAX TX PGS]		
	These SPs count by color mode the number of pages sent by Fax as fax images using I-Fax.		
001	B/W	*CTL	[0 to 99999999 / 0 / 1/step]
002	Color	*CTL	[0 to 99999999 / 0 / 1/step]

- If a document has color and black-and-white pages mixed, the pages are counted separately as B/W or Color.
- At the present time, this feature is provided for the Fax application only so SP8641 and SP8643 are the same.
- The counts include error pages.
- If a document is sent to more than one destination with a Group transmission, the count is done for each destination.
- Polling transmissions are counted but polling RX are not.
- Relay, memory, and confidential mailbox transmissions and are counted for each destination.

8651	[T:S-to-Email PGS]		
	These SPs count by color mode the total number of pages attached to an e-mail for both the Scan and document server applications.		
001	B/W	*CTL	[0 to 99999999 / 0 / 1/step]

002	Color	*CTL	[0 to 99999999 / 0 / 1/step]
-----	-------	------	------------------------------

8655	[S:S-to-Email PGS]		
	These SPs count by color mode the total number of pages attached to an e-mail for both the Scan and document server applications.		
001	B/W	*CTL	[0 to 99999999 / 0 / 1/step]
002	Color	*CTL	[0 to 99999999 / 0 / 1/step]

Note

- The count for B/W and Color pages is done after the document is stored on the HDD. If the job is cancelled before it is stored, the pages are not counted.
- If Scan-to-Email is used to send a 10-page document to 5 addresses, the count is 10 (the pages are sent to the same SMTP server together).
- If Scan-to-PC is used to send a 10-page document to 5 folders, the count is 50 (the document is sent to each destination of the SMB/FTP server).
- Due to restrictions on some devices, if Scan-to-Email is used to send a 10-page document to a large number of destinations, the count may be divided and counted separately. For example, if a 10-page document is sent to 200 addresses, the count is 10 for the first 100 destinations and the count is also 10 for the second 100 destinations, for a total of 20.

8661	[T:Deliv PGS/Svr]		
	These SPs count by color mode the total number of pages sent to a Scan Router server by both Scan and LS applications.		
001	B/W	*CTL	[0 to 99999999 / 0 / 1/step]
002	Color	*CTL	[0 to 99999999 / 0 / 1/step]

8665	[S:Deliv PGS/Svr]		
	These SPs count by color mode the total number of pages sent to a Scan Router server by the Scan application.		
001	B/W	*CTL	[0 to 99999999 / 0 / 1/step]
002	Color	*CTL	[0 to 99999999 / 0 / 1/step]

Note

- The B/W and Color counts are done after the document is stored on the HDD of the Scan Router server.
- If the job is canceled before storage on the Scan Router server finishes, the counts are not done.
- The count is executed even if regardless of confirmation of the arrival at the Scan Router server.

8671	[T:Deliv PGS/PC]		
	These SPs count by color mode the total number of pages sent to a folder on a PC (Scan-to-PC) with the Scan and LS applications.		
8675	[S: Deliv PGS/PC]		
	These SPs count by color mode the total number of pages sent with Scan-to-PC with the Scan application.		
001	B/W	*CTL	[0 to 99999999 / 0 / 1/step]
002	Color	*CTL	[0 to 99999999 / 0 / 1/step]

8681	[T:PCFAX TXPGS]	*CTL	These SPs count the number of pages sent by PC Fax. These SPs are provided for the Fax application only, so the counts for SP8 681 and SP8 683 are the same. [0 to 99999999 / 0 / 1/step]
8683	[F:PCFAX TXPGS]	*CTL	

- This counts pages sent from a PC using a PC fax application, from the PC through the copier to the destination.
- When sending the same message to more than one place using broadcasting, the pages are only counted once. (For example, a 10-page fax is sent to location A and location B. The counter goes up by 10, not 20.)

8691	[T:TX PGS/LS]	*CTL	These SPs count the number of pages sent from the document server. The counter for the application that was used to store the pages is incremented. [0 to 99999999 / 0 / 1/step] The L: counter counts the number of pages stored from within the document server mode screen at the operation panel. Pages stored with the Store File button from within the Copy mode screen go to the C: counter.
8692	[C:TX PGS/LS]	*CTL	
8693	[F:TX PGS/LS]	*CTL	
8694	[P:TX PGS/LS]	*CTL	
8695	[S:TX PGS/LS]	*CTL	
8696	[L:TX PGS/LS]	*CTL	

 **Note**

- Print jobs done with Web Image Monitor and Desk Top Binder are added to the count.
- If several documents are merged for sending, the number of pages stored are counted for the application that stored them.
- When several documents are sent by a Fax broadcast, the F: count is done for the number of pages sent to each destination.

8701	[TX PGS/Port]		
	These SPs count the number of pages sent by the physical port used to send them. For example, if a 3-page original is sent to 4 destinations via ISDN G4, the count for ISDN (G3, G4) is 12.		
001	PSTN-1	*CTL	[0 to 99999999 / 0 / 1/step]
002	PSTN-2	*CTL	[0 to 99999999 / 0 / 1/step]
003	PSTN-3	*CTL	[0 to 99999999 / 0 / 1/step]
004	ISDN (G3,G4)	*CTL	[0 to 99999999 / 0 / 1/step]
005	Network	*CTL	[0 to 99999999 / 0 / 1/step]

8711	[T:Scan PGS/Comp]		
8715	[S:Scan PGS/Comp]		
	These SPs count the number of pages sent by each compression mode.		
001	JPEG/JPEG2000	*CTL	[0 to 99999999 / 0 / 1/step]
002	TIFF(Multi/Single)	*CTL	[0 to 99999999 / 0 / 1/step]
003	PDF	*CTL	[0 to 99999999 / 0 / 1/step]
004	Other	*CTL	[0 to 99999999 / 0 / 1/step]
005	PDF/Comp	*CTL	[0 to 99999999 / 0 / 1/step]
006	PDF/A	*CTL	[0 to 99999999 / 0 / 1/step]
007	PDF(OCR)	*CTL	[0 to 99999999 / 0 / 1/step]
008	PDF/Comp(OCR)	*CTL	[0 to 99999999 / 0 / 1/step]
009	PDF/A(OCR)	*CTL	[0 to 99999999 / 0 / 1/step]

8721	[T:Deliv PGS/WSD]		
8725	[S: Dvliv PGS/WSD]		
	These SPs count the number of pages scanned by each scanner mode.		
001	B/W	*CTL	[0 to 99999999 / 0 / 1/step]
002	Color	*CTL	[0 to 99999999 / 0 / 1/step]

8731	[T:Scan PGS/Media]		
8735	[S:Scan PGS/Media]		
	These SPs count the number of pages scanned and saved in a media by each scanner mode.		
001	B/W	*CTL	[0 to 99999999 / 0 / 1/step]
002	Color	*CTL	[0 to 99999999 / 0 / 1/step]

8741	[RX PGS/Port]		
	These SPs count the number of pages received by the physical port used to receive them.		
001	PSTN-1	*CTL	[0 to 99999999 / 0 / 1/step]
002	PSTN-2	*CTL	[0 to 99999999 / 0 / 1/step]
003	PSTN-3	*CTL	[0 to 99999999 / 0 / 1/step]
004	ISDN (G3,G4)	*CTL	[0 to 99999999 / 0 / 1/step]
005	Network	*CTL	[0 to 99999999 / 0 / 1/step]

8771	[Dev Counter]		
	These SPs count the frequency of use (number of rotations of the development rollers) for black and other color toners.		

001	Total	*CTL	[0 to 99999999 / 0 / 1/step]
002	K	*CTL	
003	Y	*CTL	
004	M	*CTL	
005	C	*CTL	

8781	[Toner_Botol_Info.]		
001	BK	*CTL	[0 to 99999999 / 0 / 1/step]
002	Y	*CTL	
003	M	*CTL	
004	C	*CTL	

8791	[LS Memory Remain]	*CTL	This SP displays the percent of space available on the document server for storing documents. [0 to 100 / 0 / 1%/step]
-------------	---------------------------	------	---

8801	[Toner Remain]		
These SPs display the percent of toner remaining for each color. This SP allows the user to check the toner supply at any time.			
Note: This precise method of measuring remaining toner supply (1% steps) is better than other machines in the market that can only measure in increments of 10 (10% steps).			
001	K	*CTL	[0 to 100 / 0 / 1%/step]
002	Y	*CTL	
003	M	*CTL	
004	C	*CTL	

8811	[Eco Counter]		
-			

001	Eco Total	*CTL	[0 to 99999999 / 0 / 1/step]
002	Color	*CTL	
003	Full Color	*CTL	
004	Duplex	*CTL	
005	Combine	*CTL	
006	Color (%)	*CTL	[0 to 100 / 0 / 1% / step]
007	Full Color (%)	*CTL	
008	Duplex (%)	*CTL	
009	Combine (%)	*CTL	
010	Paper Cut (%)	*CTL	
051	Sync Eco Total	*CTL	[0 to 99999999 / 0 / 1/step]
052	Sync Color	*CTL	
053	Sync Full Color	*CTL	
054	Sync Duplex	*CTL	
055	Sync Combine	*CTL	
056	Sync Color(%)	*CTL	[0 to 100 / 0 / 1% / step]
057	Sync Full Color(%)	*CTL	
058	Sync Duplex(%)	*CTL	
059	Sync Combine(%)	*CTL	
060	Sync Paper Cut(%)	*CTL	
101	Eco Totalr>Last	*CTL	[0 to 99999999 / 0 / 1/step]
102	Color>Last	*CTL	
103	Full Color>Last	*CTL	
104	Duplex>Last	*CTL	
105	Combine>Last	*CTL	

106	Color(%):Last	*CTL	[0 to 100 / 0 / 1% / step]
107	Full Color(%):Last	*CTL	
108	Duplex(%):Last	*CTL	
109	Combine(%):Last	*CTL	
110	Paper Cut(%):Last	*CTL	
151	Sync Eco Totalr:Last	*CTL	[0 to 99999999 / 0 / 1/step]
152	Sync Color:Last	*CTL	
153	Sync Full Color:Last	*CTL	
154	Sync Duplex:Last	*CTL	
155	Sync Combine:Last	*CTL	
156	Sync Color(%):Last	*CTL	[0 to 100 / 0 / 1% / step]
157	Sync Full Color(%):Last	*CTL	
158	Sync Duplex(%):Last	*CTL	
159	Sync Combine(%):Last	*CTL	
160	Sync Paper Cut(%):Last	*CTL	

8851	[Cvr Cnt: 0-10%]		
	These SPs display the number of scanned sheets on which the coverage of each color is from 0% to 10%.		
011	0 to 2%: BK	*CTL	[0 to 99999999 / 0 / 1 / step]
012	0 to 2%: Y	*CTL	
013	0 to 2%: M	*CTL	
014	0 to 2%: C	*CTL	

021	3 to 4%: BK	*CTL	[0 to 99999999 / 0 / 1 / step]
022	3 to 4%: Y	*CTL	
023	3 to 4%: M	*CTL	
024	3 to 4%: C	*CTL	
031	5 to 7%: BK	*CTL	[0 to 99999999 / 0 / 1 / step]
032	5 to 7%: Y	*CTL	
033	5 to 7%: M	*CTL	
034	5 to 7%: C	*CTL	
041	8 to 10%: BK	*CTL	[0 to 99999999 / 0 / 1 / step]
042	8 to 10%: Y	*CTL	
043	8 to 10%: M	*CTL	
044	8 to 10%: C	*CTL	

8861	[Cvr Cnt: 11-20%]		
	These SPs display the number of scanned sheets on which the coverage of each color is from 11% to 20%.		
001	BK	*CTL	[0 to 99999999 / 0 / 1 / step]
002	Y	*CTL	
003	M	*CTL	
004	C	*CTL	

8871	[Cvr Cnt: 21-30%]		
	These SPs display the number of scanned sheets on which the coverage of each color is from 21% to 30%.		

001	BK	*CTL	[0 to 99999999 / 0 / 1 / step]
002	Y	*CTL	
003	M	*CTL	
004	C	*CTL	

8881	[Cvr Cnt: 31%-]		
	These SPs display the number of scanned sheets on which the coverage of each color is 31% or higher.		
001	BK	*CTL	[0 to 99999999 / 0 / 1 / step]
002	Y	*CTL	
003	M	*CTL	
004	C	*CTL	

4

8891	[Page/Toner Bottle]		
	These SPs display the amount of the remaining current toner for each color.		
001	BK	*CTL	[0 to 99999999 / 0 / 1 / step]
002	Y	*CTL	
003	M	*CTL	
004	C	*CTL	

8901	[Page/Toner_Prev1]		
	These SPs display the amount of the remaining previous toner for each color.		
001	BK	*CTL	[0 to 99999999 / 0 / 1 / step]
002	Y	*CTL	
003	M	*CTL	
004	C	*CTL	

8911	[Page/Toner_Prev2]		
	These SPs display the amount of the remaining 2nd previous toner for each color.		
001	BK	*CTL	[0 to 99999999 / 0 / 1 / step]
002	Y	*CTL	
003	M	*CTL	
004	C	*CTL	

8921	[Cvr Cnt/Total]		
	Displays the total coverage and total printout number for each color.		
001	Coverage (%) Bk	*CTL	[0 to 2147483647 / 0 / 1% / step]
002	Coverage (%) Y	*CTL	
003	Coverage (%) M	*CTL	
004	Coverage (%) C	*CTL	
011	Coverage/P: Bk	*CTL	[0 to 99999999 / 0 / 1/step]
012	Coverage/P: Y	*CTL	
013	Coverage/P: M	*CTL	
014	Coverage/P: C	*CTL	

8941	[Machine Status]		
	These SPs count the amount of time the machine spends in each operation mode. These SPs are useful for customers who need to investigate machine operation for improvement in their compliance with ISO Standards.		
001	Operation Time	*CTL	[0 to 99999999 / 0 / 1/step]
	Engine operation time. Does not include time while controller is saving data to HDD (while engine is not operating).		
002	Standby Time	*CTL	[0 to 99999999 / 0 / 1/step]
	Engine not operating. Includes time while controller saves data to HDD. Does not include time spent in Energy Save, Low Power, or Off modes.		

003	Energy Save Time	*CTL	[0 to 99999999 / 0 / 10 / step]
	Includes time while the machine is performing background printing.		
004	Low Power Time	*CTL	[0 to 99999999 / 0 / 1/step]
	Includes time in Energy Save mode with Engine on. Includes time while machine is performing background printing.		
005	Off Mode Time	*CTL	[0 to 99999999 / 0 / 1/step]
	Includes time while machine is performing background printing. Does not include time machine remains powered off with the power switches.		
006	SC	*CTL	[0 to 99999999 / 0 / 1/step]
	Total time when SC errors have been staying.		
007	PrtJam	*CTL	[0 to 99999999 / 0 / 1/step]
	Total time when paper jams have been staying during printing.		
008	OrgJam	*CTL	[0 to 99999999 / 0 / 1/step]
	Total time when original jams have been staying during scanning.		
009	Supply PM Unit End	*CTL	[0 to 99999999 / 0 / 1/step]
	Total time when toner end has been staying		

8951	[AddBook Register]		
	These SPs count the number of events when the machine manages data registration.		
001	User Code/User ID	*CTL	[0 to 99999999 / 0 / 1/step]
	User code registrations.		
002	Mail Address	*CTL	[0 to 99999999 / 0 / 1/step]
	Mail address registrations.		
003	Fax Destination	*CTL	[0 to 99999999 / 0 / 1/step]
	Fax destination registrations.		
004	Group	*CTL	[0 to 99999999 / 0 / 1/step]
	Group destination registrations.		

005	Transfer Request	*CTL	[0 to 99999999 / 0 / 1/step]
	Fax relay destination registrations for relay TX.		
006	F-Code	*CTL	[0 to 99999999 / 0 / 1/step]
	F-Code box registrations.		
007	Copy Program	*CTL	[0 to 255 / 0 / 255 / step]
	Copy application registrations with the Program (job settings) feature.		
008	Fax Program	*CTL	[0 to 255 / 0 / 255 / step]
	Fax application registrations with the Program (job settings) feature.		
009	Printer Program	*CTL	[0 to 255 / 0 / 255 / step]
	Printer application registrations with the Program (job settings) feature.		
010	Scanner Program	*CTL	[0 to 255 / 0 / 255 / step]
	Scanner application registrations with the Program (job settings) feature.		

8961	[Electricity Status]		
	-		
001	Ctrl Standby Time	*CTL	[0 to 99999999 / 0 / 1/step]
002	STR Time	*CTL	
003	Main Power Off Time	*CTL	
004	Reading and Printing Time	*CTL	

005	Printing Time	*CTL	[0 to 99999999 / 0 / 1/step]
006	Reading Time	*CTL	
007	Eng Waiting Time	*CTL	
008	Low Power State Time	*CTL	
009	Silent State Time	*CTL	
010	Heater Off State Time	*CTL	
011	LCD on Time	*CTL	
101	Silent Print	*CTL	

8971	[Unit Control]		
	-		
001	Engine Off Recovery Count	*CTL	[0 to 99999999 / 0 / 1/step]
002	Power Off Count	*CTL	
003	Force Power Off Count	*CTL	

Printer Service Menu

SP1-XXX (Service Mode)

1001	[Bit Switch]			
1-001-001	Bit Switch 1		0	1
	bit 0	DFU	-	-
	bit 1	Responding with the hostname as the sysName	Model name (PnP name)	Hostname
		This BitSwitch can change the value of the sysName. 0 (default): Model name (PnP name) such as "MP C401SP" 1: Host name		
	bit 2	DFU	-	-
	bit 3	No I/O Timeout	Disabled	Enabled
		Enables/Disables MFP I/O Timeouts. If enabled, the MFP I/O Timeout setting will have no affect. I/O Timeouts will never occur.		
	bit 4	SD Card Save Mode	Disabled	Enabled
		If this bit switch is enabled, print jobs will be saved to the GW SD slot and not output to paper.		
	bit 5	[PS and PDF] Paper size error margin	±5pt	±10pt
When a PS job is printed by using a custom paper size, the job might not be printed because of a paper size mismatch caused by a calculation error. By default, the error margin for matching to a paper size is ±5 points. By enabling this BitSwitch, the error margin for matching to a paper size can be extended to ±10 points.				

	bit 6	Color balance switching	0:Disabled	1:Enabled
	This BitSwitch can be used to restore the color balance to match that of previous models. If this BitSwitch is set to "1" (Enabled), the color balance that is equivalent to Fuji-Xerox printers will be used.			
	bit 7	[RPCS,PCL]: Printable area frame border	Disabled	Enabled
	Prints all RPCS and PCL jobs with a border around the printable area.			

1001	[Bit Switch]			
1-001-002	Bit Switch 2		0	1
	bit 0	Color balance switching	Disabled	Enabled
		This BitSwitch can be used to restore the color balance to match that of previous models. If this BitSwitch is set to "1" (Enabled), the color balance from 09S and earlier models will be used.		
	bit 1	DFU	-	-
	bit 2	Applying a Collate Type	Shift Collate	Normal Collate
		A collate type (shift or normal) will be applied to all jobs that do not explicitly define a collate type. Note: If #5-0 is enabled, this BitSwitch has no effect.		
bit 3	[PCL5e/c,PS]: PDL Auto Switching	Enabled	Disabled	
	Enables/Disables the MFPs ability to change the PDL processor mid-job. Some host systems submit jobs that contain both PS and PCL5e/c. If Auto PDL switching is disabled, these jobs will not be printed properly.			

	bit 4	Color balance switching	Disabled	Enabled
	This BitSwitch can be used to restore the color balance to match that of previous models. If this BitSwitch is set to "1" (Enabled), the color balance from 09A and Extended 09A models will be used.			
	bit 5	DFU	-	-
	bit 6	Switch dither	Use normal dither	Use alternative dither
		*Please refer to RTB#RDO14018		
bit 7	DFU	-	-	

1001	[Bit Switch]			
1-001-003	Bit Switch 3		0	1
	bit 0	DFU	-	-
	bit 1	DFU	-	-
	bit 2	[PCL5e/c]: Legacy HP compatibility	Disabled	Enabled
		Uses the same left margin as older HP models such as HP4000/HP8000. In other words, the left margin defined in the job (usually "<ESC>*r0A") will be changed to "<ESC>*r1A".		
	bit 3	DFU	-	-
	bit 4	DFU	-	-
	bit 5	DFU	-	-
	bit 6	DFU	-	-
	bit 7	DFU	-	-

1001	[Bit Switch]			
-------------	---------------------	--	--	--

1-001-004	Bit Switch 4		0	1
	bit 0	DFU	-	-
	bit 1	DFU	-	-
	bit 2	DFU	-	-
	bit 3	IPDS print-side reversal	Disabled	Enabled
		If enabled, the simplex pages of IPDS jobs will be printed on the front side because of printing on the back side of the page. This might reduce printing speed.		
	bit 4	DFU	-	-
	bit 5	DFU	-	-
	bit 6	DFU	-	-
bit 7	You can enable/disable the port for IPDS printing.	Off	On	

1001	[Bit Switch]
------	--------------

1-001-005	Bit Switch 5		0	1
	bit 0	Show "Collate Type", "Staple Type" and "Punch Type" buttons on the operation panel.	Disabled	Enabled
	<p>If enabled, users will be able to configure a Collate Type, Staple Type, and Punch Type from the operation panel. The available Types will depend on the device and configured options.</p> <p>After enabling this BitSw, the settings will appear under: "User Tools > Printer Features > System"</p>			
	bit 1	Multiple copies if a paper size or type mismatch occurs	Disabled (single copy)	Enabled (multiple)
	<p>If a paper size or type mismatch occurs during the printing of multiple copies, only a single copy is output by default. Using this BitSw, the device can be configured to print all copies even if a paper mismatch occurs.</p>			
	bit 2	Prevent SDK applications from altering the contents of a job.	Disabled	Enabled
<p>If this BitSw is enabled, SDK applications will not be able to alter print data. This is achieved by preventing SDK applications from accessing a module called the "GPS Filter".</p> <p>Note: The main purpose of this BitSw is for troubleshooting the effects of SDK applications on data.</p>				

	bit 3	[PS] PS Criteria	Pattern3	Pattern 1
		Change the number of PS criterion used by the PS interpreter to determine whether a job is PS data or not. For details, refer to page 675 "Printing Features".		
	bit 4	Increase max. number of stored jobs.	Disabled (100)	Enabled (750)
		Changes the maximum number of jobs that can be stored on the HDD. The default (disabled) is 100. If this is enabled, the max. will be raised to 750 or 1000 depending on the model.		
	bit 5	DFU	-	-
	bit 6	Method for determining the image rotation for the edge to bind on.	Disabled	Enabled
		If enabled, the image rotation will be performed as they were in the specifications of older models for the binding of pages of mixed orientation jobs. The old models are below: - PCL: Pre-04A models - PS/PDF/RPCS:Pre-05S models		
	bit 7	Letterhead mode printing	Disabled	Enabled (Duplex)
		Routes all pages through the duplex unit. If this is disabled, simplex pages or the last page of an odd-paged duplex job, are not routed through the duplex unit. This could result in problems with letterhead/pre-printed pages. Only affects pages specified as Letterhead paper.		
1001	[Bit Switch]			

1-001-006	Bit Switch 6		0	1
	bit 0	DFU	-	-
	bit 1	DFU	-	-
	bit 2	DFU	-	-
	bit 3	DFU	-	-
	bit 4	DFU	-	-
	bit 5	DFU	-	-
	bit 6	DFU	-	-
	bit 7	DFU	-	-

1001	[Bit Switch]			
1-001-007	Bit Switch 7		0	1
	bit 0	Print path	Disabled	Enabled
		If enabled, simplex pages (in mixed simplex/duplex PS/PCL5 jobs only) and the last page of an odd paged duplex job (PS, PCL5, PCL6), are always routed through the duplex unit. Not having to switch paper paths increases the print speed slightly.		
	bit 1	DFU	-	-
	bit 2	DFU	-	-
	bit 3	DFU	-	-
	bit 4	DFU	-	-
	bit 5	DFU	-	-
	bit 6	DFU	-	-
bit 7	DFU	-	-	

1001	[Bit Switch]		
-------------	---------------------	--	--

1-001-008	Bit Switch 8		0	1
	bit 0	DFU	-	-
	bit 1	DFU	-	-
	bit 2	DFU	-	-
	bit 3	[PCL,PS]: Allow BW jobs to print without requiring User Code	Disabled	Enabled (allow BW jobs to print without a user code)
	BW jobs submitted without a user code will be printed even if usercode authentication is enabled. Note: Color jobs will not be printed without a valid user code.			
	bit 4	DFU	-	-
	bit 5	DFU	-	-
	bit 6	PCL, RPCS, PS: Forced BW print	Enabled	Disabled
	Switches whether to ignore PDL color command.			
bit 7	[PDF]: Orientation Auto Detect Function	Enabled	Disabled	
Automatically chooses page orientations of PDF jobs (Landscape or Portrait) based on the content.				
1001	[Bit Switch]			

1-001-009	Bit Switch 9		0	1
	bit 0	PDL Auto Detection timeout of jobs submitted via USB or Parallel Port (IEEE 1284).	Disabled (Immediately)	Enabled (10 seconds)
	To be used if PDL auto-detection fails. A failure of PDL auto detection doesn't necessarily mean that the job can't be printed. This bit switch tells the device whether to time-out immediately (default) upon failure or to wait 10 seconds.			
	bit 1	DFU	-	-
	bit 2	Job Cancel	Disabled (Not cancelled)	Enabled (Cancelled)
<p>If this bit switch, all jobs will be cancelled after a jam occurs.</p> <p>Note: If this bit switch is enabled, printing under the following conditions might result in problems:</p> <ul style="list-style-type: none"> - Job submission via USB or Parallel Port - Spool printing (WIM > Configuration > Device Settings > System) 				

bit 3	PCL/PS bypass tray paper rotation (SEF/LEF)	Disabled	Enabled
<p>This bitsw causes the device to revert to the behavior of previous generations. It only takes effect if "Bypass Tray Setting Priority" = "Driver/Command".</p> <p>Previous spec (bitsw=1): If a standard sized paper mismatch occurred in the bypass tray, the MFP always prompted for SEF paper.</p> <p>If this bitsw=0 (default) then in the event of a standard sized paper mismatch, the MFP will always prompt for paper of the rotation (SEF/LEF) determined by the MFP bypass tray paper setting or by the bypass tray sensor.</p>			
bit 4	Timing of the PJI Status ReadBack (JOB END) when printing multiple collated copies.	Disable	Enable
<p>This bitsw determines the timing of the PJI USTATUS JOB END sent when multiple collated copies are being printed.</p> <p>0 (default): JOB END is sent by the device to the client after the first copy has completed printing. This causes the page counter to be incremented after the first copy and then again at the end of the job.</p> <p>1: JOB END is sent by the device to the client after the last copy has finished printing. This causes the page counter to be incremented at the end of each job.</p>			

	bit 5	Display UTF-8 text in the operation panel	Enabled	Disabled
	<p>Enabled (=0): Text composed of UTF-8 characters can be displayed in the operation panel.</p> <p>Disabled (=1): UTF-8 characters cannot be displayed in the operation panel.</p> <p>For example, job names are sometimes stored in the MIB using UTF-8 encoded characters. When these are displayed on the operation panel, they will be garbled unless this BitSw is enabled (=0).</p>			
	bit 6	Disable super option	Enabled	Disabled
<p>Switches super option disable on / off. If this is On, multiple jobs are grouped at LPR port. PJI settings are enabled even jobs that are specified queue names are sent.</p>				
	bit 7	Enable/Disable Print from USB/SD's Preview function	Enabled	Disabled
	<p>Determines whether Print from USB/SD will have the Preview function.</p> <p>Enabled (=0): Print from USB/SD will have the Preview function.</p> <p>Disabled (=1): Print from USB/SD will not have the Preview function.</p>			

1001	[Bit Switch]			
1-001-010	Bit Switch A		0	1
	bit 0	DFU	-	-
	bit 1	DFU	-	-
	bit 2	DFU	-	-
	bit 3	DFU	-	-
	bit 4	DFU	-	-
	bit 5	Store and Skip Errored Job locks the queue	Queue is not locked after SSEJ	Queue locked after SSEJ
	<p>If this is 1, then after a job is stored using Store and Skip Errored Job (SSEJ), new jobs cannot be added to the queue until the stored job has been completely printed.</p>			

	bit 6	Allow use of Store and Skip Errored Job if connected to an external charge device.	Does not allow SSEJ with ECD	Allows SSEJ with ECD
	<p>If this is 0, Store and Skip Errored Job (SSEJ) will be automatically disabled if an external charge device is connected.</p> <p>Note: We do not officially support enabling this bitsw (1). Use it at your own risk.</p>			
	bit 7	Job cancels remaining pages when the paid-for pages have been printed on an external charge device	Job does not cancel	Job cancels
	<p>When setting 1 is enabled, after printing the paid-for pages on an external charge device, the job that includes any remaining pages will be canceled.</p> <p>This setting will prevent the next user from printing the unnecessary pages from the previous user's print job.</p>			
1001	[Bit Switch]			

1-001-011	Bit Switch B		0	1
	bit 0	Show Menu List	Hide Menu List	Show Menu List
	If this is 0, the Menu List button will be removed from Printer Features.			
	bit 1	Print job interruption	Does not allow interruption	Allow interruption
	0 (default): Print jobs are not interrupted. If a job is promoted to the top of the print queue, it will wait for the currently printing job to finish. 1: If a job is promoted to the top of the queue, it will interrupt the currently printing job and start printing immediately.			
	bit 2	DFU	-	-
	bit 3	Not Used	-	-
	bit 4	DFU	-	-
bit 5	DFU	-	-	
bit 6	DFU	-	-	
bit 7	DFU	-	-	

1001	[Bit Switch]
------	--------------

1-001-012	Bit Switch C		0	1
	bit 0	DFU	-	-
	bit 1	DFU	-	-
	bit 2	DFU	-	-
	bit 3	DFU	-	-
	bit 4	DFU	-	-
	bit 5	Change the user ID type displayed on the operation panel	Login User Name	User ID
	<p>As of 15S models, the Login User Name can be displayed on the operation panel. The user ID type displayed on the operation panel can be changed by configuring BitSwitch #12-5 as follows:</p> <ul style="list-style-type: none"> - 0 (default): Login User Name - 1: User ID. If this is enabled, User ID will be displayed, which is equivalent to the behavior exhibited in 14A and earlier models. 			
bit 6	Ability to use AirPrint		Enabled	Disabled
	For 15S and later models that support AirPrint, AirPrint can be disabled by changing this Bit Switch from 0 (default) to 1.			
bit 7	DFU	-	-	

1003	[Clear Setting]		
1-003-001	Initialize System	*CTL	[- / - / -] [Execute]
Initializes settings in the "System" menu of the user mode.			
1-003-003	Delete Program	*CTL	[- / - / -] [Execute]

1004	[Print Summary]		
Prints the service summary sheet (a summary of all the controller settings).			
1-004-001	Print Summary	*CTL	[- / - / -] [Execute]

1-004-002	Print Summary2	*CTL	[- / - / -] [Execute]
-----------	----------------	------	--------------------------

1005	[Display Version]		
1-005-002	Printer Version	*CTL	[- / - / -]
	Displays the version of the controller firmware.		

1006	[Sample / Proof Print]		
1-006-001	Sample / Proof Print	*CTL	[0 or 1 / 1 / 1 /step] 0: Linked, 1: On
	Enables and disables the document server. When you select "0," the document server is enabled or disabled in accordance with Copy Service Mode SP5-967. When you select "1," the document server is enabled regardless of Copy Service Mode SP5-967.		

1101	[Data Recall]		
	Recalls a set of gamma settings. This can be either a) the factory setting, b) the previous setting, or c) the current setting.		
1-101-001	Factory	*CTL	[- / - / -]
1-101-002	Previous	*CTL	[Execute]
1-101-003	Current	*CTL	
1-101-004	ACC	*CTL	

1102	[Resolution Setting]		
	Selects the printing mode (resolution) for the printer gamma adjustment.		

1-102-001	Tone Control Mode Selection	CTL	[0 to 9 / 0 / 1/step] 0: 1200x1200 Photo (2bit/4col) 1: 1200x1200 Photo (1bit/4col) 2: 600x600 Photo (4bit/4col) 3: 600x600 Photo (2bit/4col) 4: 600x600 Photo (1bit/4col) 5: 1200x1200 Text (2bit/4col) 6: 1200x1200 Text (1bit/4col) 7: 600x600 Text (4bit/4col) 8: 600x600 Text (2bit/4col) 9: 600x600 Text (1bit/4col)
-----------	-----------------------------	-----	--

1103	[Test Page]		
	Prints the test page to check the color balance before and after the gamma adjustment.		
1-103-001	Color Gray Scale	CTL	[- / - / -]
1-103-002	Color Pattern	CTL	[Execute]

1104	[Gamma Adjustment]		
	Adjusts the printer gamma for the mode selected in the "Mode Selection" menu.		

1-104-001	Black: Highlight	CTL	[0 to 30 / 00 / 1/step]
1-104-002	Black: Shadow	CTL	
1-104-003	Black: Middle	CTL	
1-104-004	Black: IDmax	CTL	
1-104-021	Cyan: Highlight	CTL	
1-104-022	Cyan: Shadow	CTL	
1-104-023	Cyan: Middle	CTL	
1-104-024	Cyan: IDmax	CTL	
1-104-041	Magenta: Highlight	CTL	
1-104-042	Magenta: Shadow	CTL	
1-104-043	Magenta: Middle	CTL	
1-104-044	Magenta: IDmax	CTL	
1-104-061	Yellow: Highlight	CTL	
1-104-062	Yellow: Shadow	CTL	
1-104-063	Yellow: Middle	CTL	
1-104-064	Yellow: IDmax	CTL	

1105	[Save Tone Control Value]		
	Stores the print gamma adjusted with the "Gamma Adj." menu item as the current setting. Before the machine stores the new "current setting", it moves the data currently stored as the "current setting" to the "previous setting" memory storage location.		
1-105-001	Save Tone Control Value	*CTL	[- / - / -] [Execute]

1106	[Toner Limit]		
	Adjusts the maximum toner amount for image development.		
1-106-001	Toner Limit Value	*CTL	[0 to 400 / 0 / 1 %/step]

1110	[Media Print Device Setting]		
	Selects the setting for the media print device.		
1-110-002	0: Disable 1: Enable	*CTL	[0 or 1 / 1 / 1/step]

1111	[All Job Delete Mode]		
	Selects whether to include an image processing job in jobs subject to full cancellation from the SCS job list.		
1-111-001	-	*CTL	[0 or 1 / 0 / 1/step] 0: Excluding New Job 1: Including New Job

1113	[IBACC Exec]		
	Sets IBACC correction execution (calculation IBACC gamma) on / off. 0: Not calculate IBACC gamma. (Sets IBACC gamma linear) 1: Calculate IBACC gamma		
1-113-001	0:Off 1:On	*CTL	[0 or 1 / 1 / 1/step]

1114	[IBACC ToneCtlSet]		
	Sets back to the previous value of IBACC gamma correction for all resolutions. If there is no previous value, sets to the factory default values.		
1-114-001	Tone (Prev.)	CTL	-
1-114-002	Tone (Factory)	CTL	-

1115	[IBACC Exec Time]		
	Displays the time when IBACC is executed or sets back to the previous / initial value.		
1-115-001	Time	CTL	-

Scanner Service Menu

SP1-XXX (System and Others)

1001	[Scan Nv Version]		
1-001-005	-	*CTL	[- / - / -]
1005	[Erase Margin(Remote scan)]		
1-005-001	Range from 0 to 5 mm	*CTL	[0 to 5 / 0 / 1 mm/step]
1009	[Remote scan disable]		
1-009-001	-	*CTL	[0 or 1 / 0 / 1/step] 0: ON (enabled) 1: OFF (disabled)
1010	[Non Display Clear Light PDF]		
1-010-001	-	*CTL	[0 or 1 / 0 / 1/step] 0: Display, 1: No display
1011	[Org Count Display]		
1-011-001	-	*CTL	[0 or 1 / 0 / 1/step] 0: OFF (no display) 1: ON (count displays)
1012	[User Info Release]		
1-012-001	-	*CTL	[0 or 1 / 1 / 1/step] 1: Release 0: Do not release
1013	[Multi Media Function]		

1-013-002	-	*CTL	[0 or 1 / 1 / 1/step] 0: Disable 1: Enable
-----------	---	------	--

1014	[Scan to Folder Pass Input Set]		
1-014-001	0: OFF 1: ON	*CTL	[0 or 1 / 0 / 1/step] 0: OFF 1: ON

1041	[Scan:FlairAPI Setting]			
1-041-001	0x00 – 0xff	*CTL	* see BitSwitch below:	
Sets Scanner FlairAPI Function enable / disable. This SP is set by BitSwitch and needs to reboot the machine after making changes.				
bit	Setting	meanings		Description
		0	1	
bit 0	Start of FlairAPI Server	Off (Do not Start)	On (Start)	Sets whether to start exclusive FlairAPI http server. If it is 0, scanning FlairAPI function and simple UI function will be disabled.
bit 1	Access permission of FlairAPI from outside of the machine	Disabled	Enabled	If it is "0", accessing is limited from the machine only, such as operating panel, SDK/J, MFP browsers etc... If it is "1", accessing is allowed from outside of FlairAPI such as PC, Remote UI, IT-Box etc...

bit 2	IPv6 (Exclusive) / IPv4 (Priority) Switching	IPv6 (Exclusive)	IPv4 (Priority)	<p>If this bit is "0", only IPv6 accessing is permitted.</p> <p>If this bit is "1" and IPv4 is enabled, the machine uses IPv4 accessing. If this bit is "1" and IPv4 is disabled, the machine uses IPv6 accessing. In this case, it is unable to access through Smart Operation Panel if IPv4 address is enabled.</p>
bit 3	Remote UI Function	Not Used	Use	Sets use of Remote UI for scanner function.
bit 4	Reserved	-	-	-
bit 5	Reserved	-	-	-
bit 6	Reserved	-	-	-
bit 7	Reserved	-	-	-

SP2-XXX (Scanning-image quality)

2021	[Compression Level (Gray-scale)]		
2-021-001	Comp1:5-95	*CTL	[5 to 95 / 20 / 1/step]
2-021-002	Comp2:5-95	*CTL	[5 to 95 / 40 / 1/step]
2-021-003	Comp3:5-95	*CTL	[5 to 95 / 65 / 1/step]
2-021-004	Comp4:5-95	*CTL	[5 to 95 / 80 / 1/step]
2-021-005	Comp5:5-95	*CTL	[5 to 95 / 95 / 1/step]

2023	[ACS setting of ClearLightPDF]		
	This SP code enables/disables the ACS function.		
2-023-001	-	*CTL	<p>[0 or 1 / 1 / 1/step]</p> <p>0: Disable</p> <p>1: Enable</p>

2024	[Compression ratio of ClearLight PDF]		
2-024-001	Compression Ratio (Normal image)	*CTL	[5 to 95 / 20 / 1/step]
2-024-002	Compression Ratio (High)	*CTL	[5 to 95 / 20 / 1/step]

2025	[Compression ratio of ClearLightPDF JPEG2000]		
2-025-001	Compression Ratio (Normal) JPEG2000	*CTL	[5 to 95 / 20 / 1/step]
2-025-002	Compression Ratio (High) JPEG2000	*CTL	[5 to 95 / 20 / 1/step]

2030	[OCR PDF DetectSens]		
2-030-001	Level5:	*CTL	[0 to 255 / 250 / 1/step]
2-030-002	Level5:	*CTL	[0 to 100 / 80 / 1/step]
2-030-003	Level5:	*CTL	[0 to 100 / 80 / 1/step]

9001	[BitSwitch]		
	Sets module debug output mode.		
9-001-001	cmm	*CTL	[0 to 255 / 0 / by a factor of two]
9-001-002	jcm	*CTL	[0 to 255 / 0 / by a factor of two]
9-001-003	ucm	*CTL	[0 to 255 / 0 / by a factor of two]
9-001-004	rsp	*CTL	[0 to 255 / 0 / by a factor of two]
9-001-005	rsp2	*CTL	[0 to 255 / 0 / by a factor of two]
9-001-006	nas	*CTL	[0 to 255 / 0 / by a factor of two]
9-001-007	miw	*CTL	[0 to 255 / 0 / by a factor of two]
9-001-008	mib	*CTL	[0 to 255 / 0 / by a factor of two]
9-001-009	itm	*CTL	[0 to 255 / 0 / by a factor of two]

5. Software Configuration

Printing Features

Auto PDL Detection Function

Overview

The auto PDL detection function gives the MFP the ability to determine the PDL of a job or of specific parts of a job. This can be especially useful in cases where the PDL is not specified or if the job contains multiple PDLs. This is only possible if the job was not created using a driver.

Conditions for Detection of the PDL

The MFP will only attempt to detect a job's PDL if all of the following conditions are met.

- No @PJL ENTER LANGUAGE command is contained in the job
- No submission protocol options (lpr, ftp, rcp, or rsh options) have been used to specify the PDL
- User Tools > Printer > System > Printer Language = Auto

Note

- The printer is unable to detect PCL6 or RPCS. However these are almost always created using a driver and therefore contain the PDL command specifying the PDL.

PDL Detection by the Printer System, PCL Interpreter and PS Interpreter

There are 3 components in the printer which can perform Auto PDL Detection:

1. **Printer system:**

Uses a set of triggers unique to PCL5, PS or PDF. Up to 2KB from the start of the job can be searched for triggers.

2. **PCL interpreter:**

It can detect PS triggers in PCL data. If a PS trigger is detected, the PCL interpreter will abort processing and return the unprocessed part of the job back to the printer system. Up to 256 bytes from the start of each page can be searched for triggers.

3. **PS interpreter:**

It can detect PCL5 triggers in PS data. If a PCL trigger is detected, the PS interpreter will abort processing and return the unprocessed part of the job back to the printer system. The entire page (regardless of the number of bytes) is searched for triggers.

Note

- 2. and 3. can be disabled using Printer Bit Switch 2-3=1.
- If the "Printer Language" is configured to anything other than Auto, all detection will be disabled.
- An interpreter submits a job page by page to the rasterizer. Therefore, when an interpreter detects a trigger mid-job, the previous pages will have already been submitted and will be output using the previously detected PDL.
- If the PDL cannot be detected by the printer system, then the PDL defaults to the one configured in "Configuration > Printer Basic Settings > Default Printer Language".

The Printer Language setting and Default Printer Language setting in WIM:

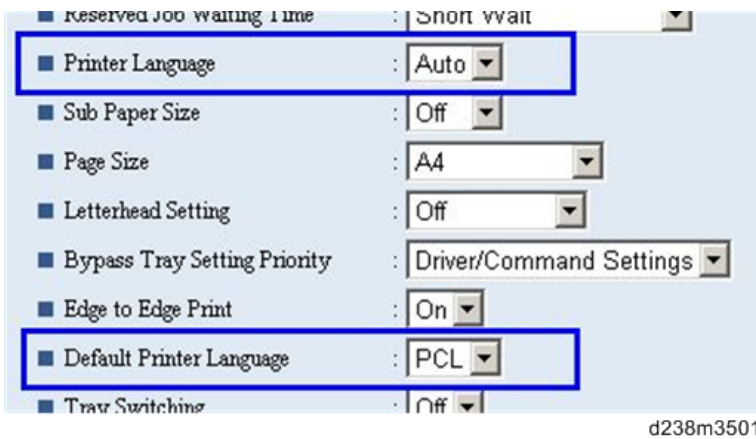

PDL Selection and Switching

Three types of PDL selection/switching are performed:

1. PDL selection (PCL5 or PS (including PDF)) at the beginning of the job: performed by the printer system

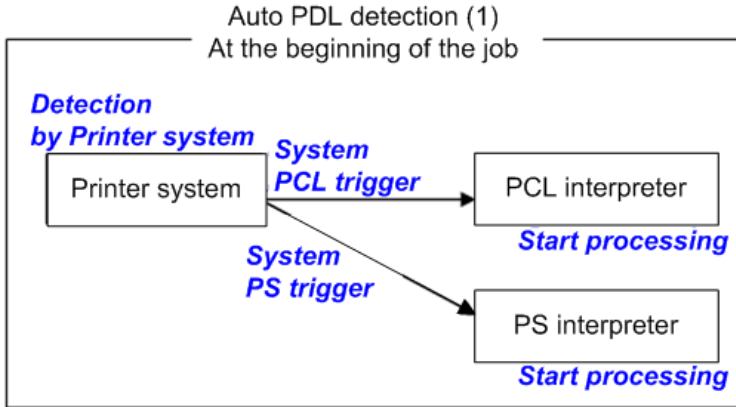

w_d238m3502

- PDL switching from PCL5 to PS: performed by the PCL interpreter and the printer system

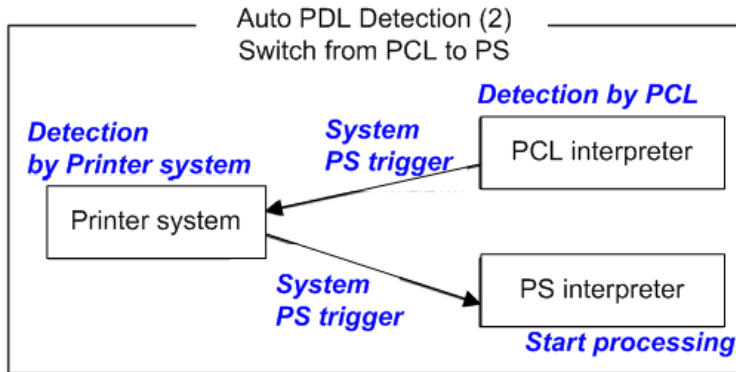

w_d238m3503

- PDL switching from PS to PCL5: performed by the PS interpreter and the printer system

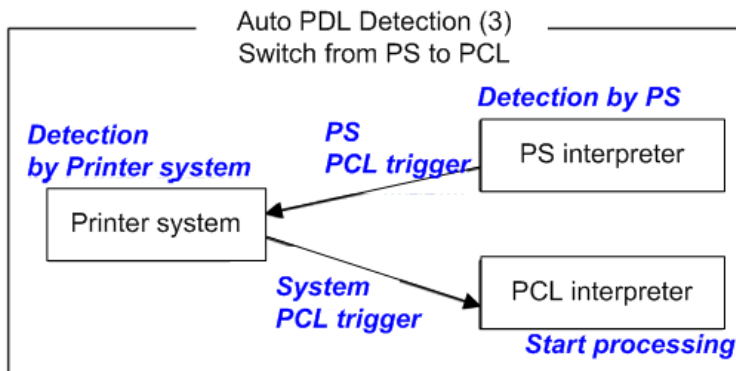

w_d238m3504

Triggers

Printer system

PCL5 triggers	[ESC]E [FF]
PS triggers	%!PS-Adobe-3.1 "%!" "dict begin" "bind def" "findfont" "showpage" "/statusdict" "O startjob" [EOT] "}" + space character + "def" "userdict" (*)
PDF triggers	%PDF- %!PS-Adobe-M.nPDF- (*M, n=numeric)

* "userdict" is excluded by configuring Printer Bit Switch 5-3=1.

↓ Note

- Up to 2KB from the start of the job can be searched for triggers.
- "%%" can be added to the PS triggers by configuring printer bit switch 5-3=1
- If a job is identified as PDF, it will be sent to the PS interpreter to be processed as a regular PS job.

PS interpreter

PCL5 trigger	[ESC]E and 2 or more continuous PCL commands
--------------	--

↓ Note

- Up to 256 bytes from the start of each page can be searched for triggers.

Some Possible Problems

Garbled output:

If a string of characters (or binary data) is mistaken as a trigger and an incorrect PDL is applied, the output will be garbled.

Incorrect printer settings:

Printer settings, for example the paper size, is incorrectly applied. This can happen when the printer settings at the beginning of the job are initialized before a PDL switch occurred and no settings were configured for the rest of the job.

Printer Bit Switch Description

Bit Switch 2-3

This controls auto PDL detection by the PCL interpreter and PS interpreter.

BitSW 2-3=0 (default):

If PDL switching is applied to the job, all of the printer system, PCL interpreter and PS interpreter will search for switching criteria (triggers).

BitSW 2-3=1:

Only the printer system will search for switching criteria (triggers). PCL/PS interpreters will not.

Bit Switch 5-3

This affects the PDL switching criteria (triggers) used by the printer system.

BitSW 5-3=0 (default):

"%%" is not used as a printer system PS trigger. "%%" will not call the PS interpreter.

BitSW 5-3=1:

"%%" is used as a printer system PS trigger.

The reason that "%%" is not included as a trigger by default, is that a string of text in the body of the job such as the following, could result in a false positive. This would trigger a switch and result in garbled output.

%%%%%%%%%

However some customers prefer that "%%" be included as a switching criteria. BitSW5-3=1 should be used in such a case.

Note

- A side effect of BitSW5-3=1 is that "userdict" will no longer be used as a PS trigger.

Bit Switch 9-0

These determine whether Auto PDL Detection for print jobs transmitted via USB/parallel will wait 10 seconds to make sure the first 2KB of the job has been sent.

The printer system portion of the auto PDL detection function is only performed on the first 2KB of a job and can wait up to 10 seconds for that first 2KB to arrive. As the printer is unable to detect the end of jobs submitted over a USB/Parallel connection, it might be preferable to not wait 10 seconds if jobs of less than 2KB are going to be printed. Enabling/disabling this waiting time is the purpose of BitSw 9-0.

BitSw 9-0=0 (default):

The printer system will not wait 10 seconds for the first 2KB of data to arrive.

BitSw 9-0=1:

The printer system will wait up to 10 seconds for the first 2KB of data to arrive.

Print Image Rotation

Printer Bit Switch Description

5

Bit Switch 5-6

This change the way an MFP/LP rotates PCL, PS, PDF, or RPCS print images.

BitSW 5-6=0 (default):

A uniform binding edge (short or long edge) will be applied to every page of every job. Pages will always be rotated as if they were to be bound on that edge.

BitSW 5-6=1:

A uniform binding edge (short or long edge) will only be applied if the job is stapled, punched, or Z-folded. Otherwise, the bound edge might differ from page to page.

Example:

A 3-page job. Page 1 has the PCL simplex command. Page 2 and 3 have the PCL duplex long-edge bind commands.

No finishing options (staple, punch, z-fold) are used.

Bit Switch #5-6=0:

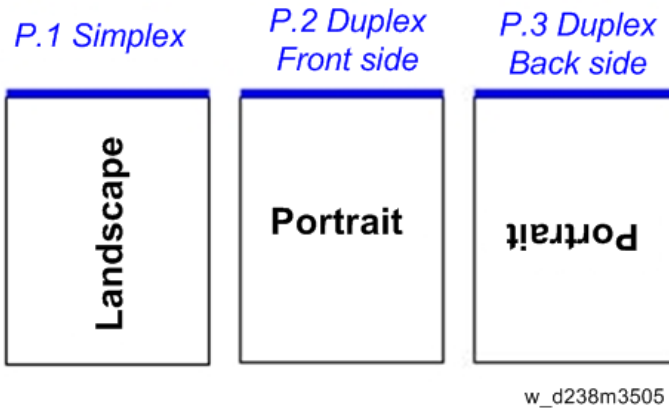

Bit Switch #5-6=1:

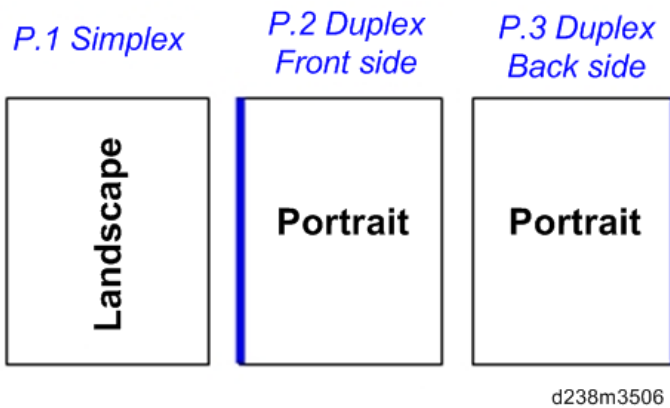

Note

- Used in conjunction with Bit Switch #5-6, Orientation Auto Detect for PS/PDF jobs might cause unexpected results.

PJL USTATUS

Printer Bit Switch Description

Bit Switch 9-4

These control the way PJL USTATUS returns page count totals in cases where multiple copies of a job are being printed.

BitSw 9-4=0 (default):

This change the way an MFP/LP rotates PCL, PS, PDF, or RPCS print images.

1. The page count for a single copy is returned after the first copy is printed.
2. The page count for the rest of the copies, excluding the first copy, is returned after all copies have been printed.
3. This emulates an older HP PCL firmware spec. It is only needed for compatibility with legacy software.

BitSw 9-4=1:

The page count for all copies is output after all copies have been printed.

This emulates more recent HP PCL firmware specs.

For example, consider 3 copies of a 3 page job:

9-4 = 0

@PJL USTATUS JOB

START

NAME="TEST_page1-3"

@PJL USTATUS PAGE

1

@PJL USTATUS PAGE

2

@PJL USTATUS PAGE

3

@PJL USTATUS JOB

END

NAME="TEST_page1-3"

PAGES=3

<comment> The page count of the first copy is returned.</comment>

@PJL USTATUS PAGE

1

@PJL USTATUS PAGE

2

@PJL USTATUS PAGE

3

@PJL USTATUS PAGE

4

@PJL USTATUS PAGE

5

@PJL USTATUS PAGE

6

<comment> The page count of the remaining two copies is returned.</comment>

9-4 = 1

@PJL USTATUS JOB

START

NAME="Microsoft Word - TEST_page1-3"

@PJL USTATUS PAGE

1

@PJL USTATUS PAGE

2

@PJL USTATUS PAGE

3

@PJL USTATUS PAGE

4

@PJL USTATUS PAGE

5

@PJL USTATUS PAGE

6@PJL USTATUS PAGE

7

@PJL USTATUS PAGE

8

@PJL USTATUS PAGE

9

@PJL USTATUS JOB

END

NAME="Microsoft Word - TEST_page1-3"

PAGES=9

<comment> The page count of all three copies is returned.</comment>

Scanner Features

Display Settings of Recently Used Scan Destination

Configuring the scanner interface so that the most recently used scan destination is cleared.

Whether the MFP clears the most recently used scan destination, can be configured using Scanner SP 1-012-001.

By default, this is cleared to avoid subsequent users scanning to it by mistake.

Scanner SP 1-012-001

1 (default): Clear

0: Do not clear

This will cause all of the following to be cleared after the scanning is complete:

- Destination
- Sender
- Email subject
- Email message
- File name

Scanner SP 1-012-001=1 (default):

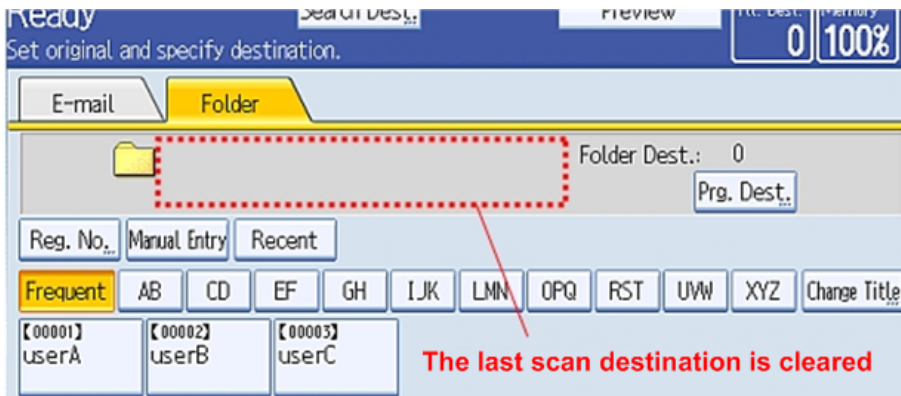

w_d238m3507

Exceptions:

- User Auth.:
If SP 1-012-001 = 0 and if User Auth. (excluding User Code authentication) is enabled, the most recently used scan destination will only be retained until the user logs out.
- Scanner Auto Reset timer:

Even if SP 1-012-001 = 0 the most recently used scan destination can still be cleared by the Scanner Auto Reset timer. If the Scanner Auto Reset timer is shorter than the System Auto Reset timer, then the most recently used scan destination will be cleared when the Scanner Auto Reset timer elapses.

The Setting of SMTP Authentication in Scan to Email

Scan to Email fails with the error message "Transmission has failed ". The SMTP username and password are correct. How can I make Scan to Email pass ?

Change SP 5-860-022 "SMTP Auth. From Field Replacement" to On. By doing this, Scan to Email will pass the SMTP authentication.

↓ Note

- Using this option to solve the above problem, the device email address will appear in the email's "From" field. The email address of the user who sent the email will appear in the "Reply-to" field.

Explanation

This is an SMTP authentication issue that aborts transmission of an already started Scan to Email. Currently this has only been reproduced using MS-Exchange server.

MS-Exchange requires that all of the following match:

1. The sender's address in the "MAIL FROM" field. This is also known as the "envelope sender" or "MIME sender". It is an SMTP command sent at the beginning of the email transmission process.
2. The sender's address in the mail header "From:" field. This appears as "From" in email clients. It is a part of the email itself.
3. The email address corresponding to the SMTP username used to login into the SMTP server.

When the MFP logs into the SMTP server, the email address of the username 3) will be compared to 1) and 2). If these comparisons fail, authentication will also fail. Exchange server will stop the transmission procedure, and the "Transmission has failed" message will be returned to the sender.

Typical Example

NG case:

SP5-860-022 is Off:

1. The "MAIL FROM" field = device (Fig.1)
2. The mail header "From:" field = user (Fig.2)
3. The SMTP username = device (Fig.1)

When the SMTP server compares 2) and 3) the Exchange Server will stop the transmission procedure.

OK case:

SP5-860 can be used to make the values in the above example, match.

In this example, if SP5-860-022 is On, the user's email address in the mail header '2)' will be replaced by the Administrator's email address. (see Fig.3)

To solve the problem, the Administrator's address must be the same as the device's address.

If this is done:

1. The "Mail From: field = device (Fig.1)
2. The mail header "From:" field = administrator (Fig.3)
3. The SMTP username = device (Fig.1)

1,2 and 3 must match and the authentication should be successful.

Note

- The user's email address will still be inserted into the reply-to field.

Fig.1 Default device SMTP username, password and email address

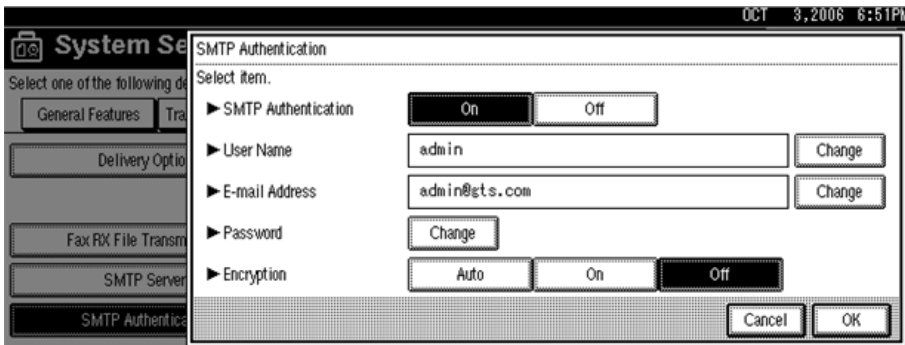

d238m3508

Fig.2 A user's email address in the Address Book

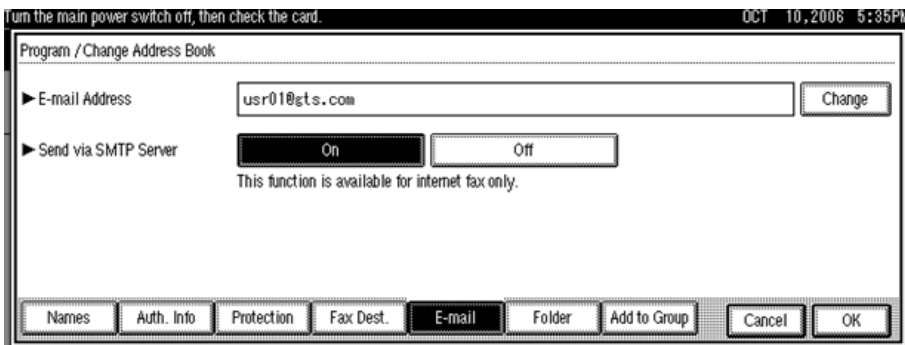

d238m3509

Fig.3 Administrator's email address

Cannot connect with the wireless card. OCT 3, 2006 6:48PM

System Settings Exit

Select one of the following default settings.

General Features | Tray Paper Settings | Timer Settings | **Interface Settings** | File Transfer | Administrator Tools

Delivery Option	Off	POP before SMTP	Off
Fax RX File Transmission		Reception Protocol	POP3
SMTP Server	133.139.166.73	POP3 / IMAP4 Settings	
SMTP Authentication	Off	Administrator's E-mail Address	admin@gt.s.com

1/3 ▲ Previous ▼ Next
d238m3510

The Qualification Switching of Scan to Folder

5

Determining which account Scan to Folder uses to access a scan destination and the effects of System SP 5-846-021.

This method depends on how the destination is accessed, whether authentication is being used, and SP 5-846-021.

Cases:

Case	Destination selection	User auth.	Account used to access the folder
A	Manual entry	Either enabled or disabled	The user's account *
B	Destination list	disabled	The recipient's account (as configured in the Address Book's Folder Authentication setting)
C		enabled	If SP 5-846-021 = 0 (default): The authenticated user's account 1: The recipient's account (as configured in the Address Book's Folder Authentication setting)

* The "user's account" will be either the one entered during scanning (see the Manual Entry screen capture) or if User Auth. is enabled, the account configured in the user's Folder Authentication setting will be used.

The destination's access logs:

Case A or Case C with SP=0: The access logs can be used to determine which user sent the scan.

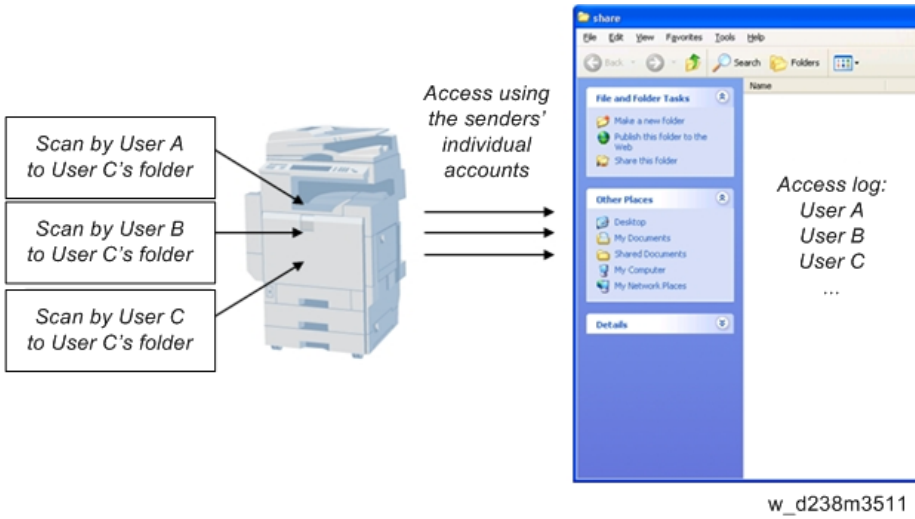

5

Case B or Case C with SP=1: All access will be logged as the same user.

