

RICOH



SERVICE MANUAL

M160/M161

It is the reader's responsibility when discussing the information contained within this document to maintain a level of confidentiality that is in the best interest of Ricoh Americas Corporation and its member companies.

NO PART OF THIS DOCUMENT MAY BE REPRODUCED IN ANY FASHION AND DISTRIBUTED WITHOUT THE PRIOR PERMISSION OF RICOH AMERICAS CORPORATION.

All product names, domain names or product illustrations, including desktop images, used in this document are trademarks, registered trademarks or the property of their respective companies.

They are used throughout this book in an informational or editorial fashion only and for the benefit of such companies. No such use, or the use of any trade name, or web site is intended to convey endorsement or other affiliation with Ricoh products.

WARNING

The Service Manual contains information regarding service techniques, procedures, processes and spare parts of office equipment distributed by Ricoh Americas Corporation. Users of this manual should be either service trained or certified by successfully completing a Ricoh Technical Training Program.

Untrained and uncertified users utilizing information contained in this service manual to repair or modify Ricoh equipment risk personal injury, damage to property or loss of warranty protection.

Ricoh Americas Corporation

LEGEND

PRODUCT CODE	COMPANY		
	LANIER	RICOH	SAVIN
M160	SP 4510SF	SP 4510SF	SP 4510SF
M161	MP 401SPF	MP 401SPF	MP 401SPF

DOCUMENTATION HISTORY

REV. NO.	DATE	COMMENTS
*	01/2015	Original Printing

M160/M161

TABLE OF CONTENTS

1. PRODUCT INFORMATION	1-1
1.1 PRODUCT OVERVIEW	1-1
1.1.1 COMPONENT LAYOUT	1-1
1.1.2 PAPER PATH.....	1-2
1.1.3 DRIVE LAYOUT	1-3
1.2 MACHINE CODES AND PERIPHERAL CONFIGURATION	1-4
1.2.1 MAIN FRAME	1-4
1.2.2 EXTERNAL OPTIONS	1-4
1.2.3 INTERNAL OPTIONS.....	1-5
1.2.4 CONSUMABLES FOR M160 (USER MAINTENANCE MODEL)	1-6
2. INSTALLATION	2-1
2.1 INSTALLATION REQUIREMENTS.....	2-1
2.1.1 ENVIRONMENT.....	2-1
2.1.2 MACHINE SPACE REQUIREMENTS.....	2-2
2.1.3 MACHINE DIMENSIONS.....	2-3
2.1.4 POWER REQUIREMENTS.....	2-4
2.2 MAIN MACHINE INSTALLATION	2-5
2.2.1 IMPORTANT NOTICE ON SECURITY ISSUES.....	2-5
Overview.....	2-5
Password Setting Procedure.....	2-6
2.2.2 ACCESSORY CHECK (M160).....	2-9
2.2.3 ACCESSORY CHECK (M161).....	2-11
2.2.4 INSTALLATION PROCEDURE	2-12
Removal of packing materials and shipping retainers	2-12
Connecting the Power Cord.....	2-15
Loading Paper	2-16
Printing a Configuration Page	2-17
2.2.5 INSTRUCTIONS FOR THE CUSTOMERS	2-17
2.2.6 MOVING THE MACHINE	2-18
2.3 PAPER FEED UNIT PB1060/ PAPER FEED UNIT PB1070	2-20
2.3.1 COMPONENT CHECK	2-20
2.3.2 INSTALLATION PROCEDURE	2-21
2.4 CONTROLLER OPTIONS	2-22
2.4.1 OVERVIEW	2-22

2.5	SD CARD APPLI MOVE	2-23
2.5.1	OVERVIEW	2-23
2.5.2	NOTES ON USING THE SD MERGE FUNCTION.....	2-23
2.5.3	SD CARD APPLICATIONS	2-24
2.5.4	MOVE EXEC	2-24
2.5.5	UNDO EXEC	2-26
2.6	IPDS UNIT TYPE M6	2-28
2.6.1	COMPONENT CHECK	2-28
2.6.2	INSTALLATION PROCEDURE	2-28
2.7	SD CARD FOR NETWARE PRINTING TYPE M6	2-30
2.7.1	COMPONENT CHECK	2-30
2.7.2	INSTALLATION PROCEDURE	2-30
2.8	BROWSER UNIT TYPE M6.....	2-32
2.8.1	COMPONENT CHECK	2-32
2.8.2	OUTLINE OF THE BROWSER UNIT	2-32
2.8.3	INSTALLATION PROCEDURE	2-33
2.8.4	RICOH JAVASCRIPT	2-36
2.8.5	EXJS FIRMWARE UPDATE.....	2-36
	Preparation	2-37
	Main procedure.....	2-37
2.8.6	UPDATING THE EXTENDED JAVASCRIPT	2-38
2.8.7	UN-INSTALLING EXJS FIRMWARE.....	2-39
2.9	XPS DIRECT PRINT OPTION TYPE M6	2-40
2.9.1	COMPONENT CHECK	2-40
2.9.2	INSTALLATION PROCEDURE	2-40
2.10	VM CARD TYPE W	2-42
2.10.1	COMPONENT CHECK	2-42
2.10.2	INSTALLATION PROCEDURE	2-42
2.11	OCR UNIT TYPE M2	2-44
2.11.1	COMPONENT CHECK	2-44
2.11.2	DETAILS ABOUT SEARCHABLE PDF	2-44
2.11.3	INSTALLATION PROCEDURE	2-45
	Restoration Procedure	2-46
2.12	MEMORY UNIT TYPE M1 1.5GB	2-48
2.12.1	COMPONENT CHECK	2-48
2.12.2	INSTALLATION PROCEDURE	2-48
2.13	HARD DISK DRIVE OPTION TYPE M6	2-51
2.13.1	COMPONENT CHECK	2-51
2.13.2	INSTALLATION PROCEDURE	2-51

2.14	FILE FORMAT CONVERTER TYPE E	2-55
2.14.1	COMPONENT CHECK	2-55
2.14.2	INSTALLATION PROCEDURE	2-55
2.15	IEEE 1284 INTERFACE BOARD TYPE A	2-57
2.15.1	COMPONENT CHECK	2-57
2.15.2	INSTALLATION PROCEDURE	2-57
2.16	IEEE802.11 INTERFACE UNIT TYPE O	2-59
2.16.1	COMPONENT CHECK	2-59
2.16.2	INSTALLATION PROCEDURE	2-59
2.16.3	UP MODE SETTINGS FOR WIRELESS LAN	2-60
2.16.4	SP MODE AND UP MODE SETTINGS FOR IEEE 802.11 A/B/G/N, WIRELESS LAN	2-62
2.17	BLUETOOTH INTERFACE UNIT TYPE D.....	2-63
2.17.1	COMPONENT CHECK	2-63
2.17.2	INSTALLATION PROCEDURE	2-64
2.18	COPY DATA SECURITY UNIT TYPE G	2-65
2.18.1	COMPONENT CHECK	2-65
2.18.2	INSTALLATION PROCEDURE	2-66
2.18.3	USER TOOL SETTING	2-68
2.19	DATA OVERWRITE SECURITY UNIT TYPE I.....	2-69
2.19.1	OVERVIEW	2-69
2.19.2	COMPONENT LIST.....	2-69
2.19.3	BEFORE YOU BEGIN THE PROCEDURE	2-69
Seal Check and Removal.....		2-70
2.19.4	INSTALLATION PROCEDURE	2-71
2.20	SECURITY SETTINGS	2-72
2.20.1	SECURITY FUNCTION INSTALLATION	2-72
2.20.2	DATA OVERWRITE SECURITY	2-73
Before You Begin the Procedure.....		2-73
Installation Procedure.....		2-73
Using Auto Erase Memory.....		2-74
2.20.3	HDD ENCRYPTION	2-75
Before You Begin the Procedure:.....		2-75
Installation Procedure.....		2-75
Enable Encryption Setting		2-76
Backing Up the Encryption Key.....		2-77
Encryption Key Restoration.....		2-78
2.21	SETTINGS FOR @REMOTE SERVICE.....	2-80
2.21.1	CHECK POINTS BEFORE MAKING @REMOTE SETTINGS.....	2-80

2.21.2 EXECUTE THE @REMOTE SETTINGS	2-81
---	------

3. PREVENTIVE MAINTENANCE..... 3-1

3.1 PREVENTIVE MAINTENANCE TABLES	3-1
3.2 IMAGE QUALITY STANDARDS.....	3-2
3.3 PAPER TRANSFER QUALITY STANDARDS.....	3-4

4. REPLACEMENT AND ADJUSTMENT 4-1

4.1 GENERAL CAUTIONS	4-1
4.1.1 NOTES ON THE MAIN POWER SWITCH.....	4-1
Characteristics of the Push Switch (DC Switch)	4-1
Shutdown Method.....	4-2
Forced Shutdown	4-3
4.2 SPECIAL TOOLS	4-4
4.3 EXTERIOR COVERS.....	4-5
4.3.1 FRONT COVER	4-5
4.3.2 LEFT COVER	4-7
4.3.3 RIGHT COVER.....	4-8
4.3.4 REAR COVER / REAR LOWER COVER	4-9
4.3.5 UPPER COVER	4-10
4.3.6 OPERATION PANEL	4-11
4.3.7 OPERATION PANEL LOWER INNER COVER	4-12
4.4 LED OPTICS.....	4-13
4.4.1 LED UNIT	4-13
How to Re-engage Disengaged Springs.....	4-16
4.5 PCDU	4-20
4.5.1 PCDU.....	4-20
4.6 TONER CARTRIDGE	4-21
4.6.1 TONER CARTRIDGE.....	4-21
4.7 IMAGE TRANSFER	4-22
4.7.1 IMAGE TRANSFER ROLLER	4-22
4.8 DRIVE UNIT.....	4-23
4.8.1 MAIN MOTOR	4-23
4.8.2 DUPLEX EXIT MOTOR.....	4-23
4.8.3 TONER SUPPLY CLUTCH	4-24
4.8.4 REGISTRATION CLUTCH	4-25
4.8.5 PAPER FEED CLUTCH	4-25
4.8.6 DRIVE UNIT	4-26
4.8.7 GEAR UNIT	4-26
4.8.8 BY-PASS FEED CLUTCH	4-27

4.8.9	RELAY CLUTCH	4-27
4.8.10	BY-PASS BOTTOM PLATE CLUTCH	4-28
4.8.11	DUPLEX CLUTCH	4-28
4.8.12	JUNCTION GATE SOLENOID	4-29
4.9	FUSING	4-30
4.9.1	FUSING UNIT	4-30
4.9.2	UPPER FUSING UNIT / LOWER FUSING UNIT	4-31
4.9.3	FUSING PRESSURE ROLLER	4-32
4.9.4	FUSING LAMP / HOT ROLLER	4-33
4.9.5	THERMOSTAT	4-35
4.9.6	THERMISTOR	4-36
4.9.7	HOT ROLLER STRIPPER	4-38
4.10	PAPER FEED	4-39
4.10.1	PAPER FEED TRAY	4-39
4.10.2	PAPER FEED ROLLER	4-39
4.10.3	FRICITION PAD	4-40
4.10.4	PAPER END SENSOR	4-40
4.10.5	BY-PASS FEED UNIT	4-41
4.10.6	BY-PASS FEED ROLLER	4-42
4.10.7	BY-PASS FRICITION PAD	4-43
4.10.8	BY-PASS PAPER END SENSOR	4-44
4.10.9	BY-PASS BOTTOM PLATE HP SENSOR	4-45
4.10.10	PAPER SIZE DETECTION SWITCH	4-45
4.11	PAPER TRANSPORT	4-47
4.11.1	PAPER EXIT SENSOR	4-47
4.11.2	PAPER OVERFLOW SENSOR	4-47
4.11.3	DUPLEX EXIT SENSOR	4-47
4.11.4	DUPLEX ENTRANCE SENSOR	4-48
4.11.5	REGISTRATION ROLLER (DRIVEN)	4-49
4.11.6	REGISTRATION ROLLER (DRIVE)	4-51
4.11.7	REGISTRATION SENSOR	4-51
4.12	ELECTRICAL COMPONENTS	4-53
4.12.1	FCU BOARD	4-53
4.12.2	SPEAKER	4-55
4.12.3	PSU	4-56
4.12.4	CONTROLLER BOARD	4-58
	Before replacing the controller board in the model without HDD	4-58
	Replacement Procedure	4-58
	After installing the controller board	4-59

4.12.5	NVRAM ON THE CONTROLLER BOARD	4-60
4.12.6	BICU	4-61
4.12.7	EEPROM ON THE BICU.....	4-62
4.12.8	HDD.....	4-63
	Before HDD Replacement.....	4-63
	Replacement Procedure.....	4-63
	After HDD Replacement.....	4-63
	Reinstallation	4-64
4.12.9	TONER END SENSOR	4-64
4.12.10	HVPS	4-65
4.12.11	HVPS WITH BRACKET.....	4-66
4.12.12	FUSING FAN.....	4-67
4.12.13	PCDU COOLING FAN.....	4-68
4.12.14	PSU COOLING FAN.....	4-68
4.12.15	DC SWITCH.....	4-70
4.12.16	FRONT DOOR INTERLOCK SWITCH.....	4-70
4.12.17	REAR DOOR INTERLOCK SWITCH.....	4-71
4.12.18	DIMM.....	4-71
4.12.19	TEMP HUMID SENSOR	4-72
4.12.20	REAR COVER SWITCH.....	4-72
4.13	ARDF.....	4-73
4.13.1	ARDF UNIT	4-73
4.13.2	ARDF FRONT COVER	4-75
4.13.3	ARDF REAR COVER.....	4-76
4.13.4	ARDF TOP COVER.....	4-77
4.13.5	ARDF ORIGINAL TRAY	4-78
4.13.6	ORIGINAL FEED UNIT	4-78
4.13.7	ARDF FRICTION PAD	4-79
4.13.8	ARDF DRIVE MOTOR	4-79
4.13.9	ARDF TOP COVER SENSOR	4-82
4.13.10	ARDF ORIGINAL SET SENSOR.....	4-82
4.13.11	ARDF REGISTRATION SENSOR.....	4-83
4.13.12	DFRB	4-84
4.13.13	PICK-UP SOLENOID.....	4-85
4.13.14	JUNCTION GATE SOLENOID	4-85
4.14	SCANNER.....	4-87
4.14.1	SCANNER UNIT (WITH ARDF)	4-87
4.14.2	SCANNER UPPER COVER.....	4-90
4.14.3	ARDF OPEN/CLOSED SENSOR	4-90

4.14.4 CARRIAGE	4-91
4.14.5 CARRIAGE UNIT HP SENSOR	4-92
4.14.6 SCANNER MOTOR.....	4-93
5. SYSTEM MAINTENANCE.....	5-1
5.1 SERVICE PROGRAM MODE.....	5-1
5.1.1 SP TABLES	5-1
5.1.2 ENABLING AND DISABLING SERVICE PROGRAM MODE.....	5-1
Entering SP Mode	5-1
Exiting SP Mode	5-1
5.1.3 TYPES OF SP MODES.....	5-2
5.1.4 SP MODE BUTTON SUMMARY.....	5-2
5.1.5 SERVICE MODE LOCK/UNLOCK.....	5-3
5.2 UPDATING THE FIRMWARE.....	5-4
5.2.1 OVERVIEW	5-4
5.2.2 TYPE OF FIRMWARE.....	5-4
5.2.3 UPDATING FIRMWARE.....	5-6
Before You Begin.....	5-6
Preparation	5-6
Updating Procedure	5-7
Firmware Update Error.....	5-10
Recovery after Power Loss	5-10
5.2.4 HANDLING FIRMWARE UPDATE ERRORS	5-10
5.3 UPLOADED/DOWNLOADING NVRAM DATA.....	5-14
5.3.1 UPLOADED CONTENT OF NVRAM TO AN SD CARD	5-14
5.3.2 DOWNLOADING AN SD CARD TO NVRAM.....	5-15
5.4 ADDRESS BOOK UPLOAD/DOWNLOAD.....	5-16
5.4.1 INFORMATION LIST	5-16
5.4.2 UPLOAD (BACKUP) TO SD CARD	5-16
5.4.3 DOWNLOAD (RESTORE) TO MACHINE.....	5-17
5.4.4 ERASING THE BACKUP DATA	5-17
5.5 CAPTURING LOG TO SD CARD.....	5-18
5.5.1 OVERVIEW	5-18
Security of the Operation Log	5-20
5.5.2 RETRIEVING THE DEBUG LOGS	5-20
Procedure for Retrieving the Debug Log	5-20
6. TROUBLESHOOTING.....	6-1
6.1 SELF-DIAGNOSTIC MODE.....	6-1
6.1.1 SELF-DIAGNOSTIC MODE AT POWER ON.....	6-1

6.2 SERVICE CALL	6-2
6.2.1 SUMMARY	6-2
When a Level “D” SC code occurs	6-2
6.2.2 SC100 (SCANNING)	6-3
6.2.3 SC200 (LED OPTICS).....	6-7
6.2.4 SC300 (IMAGE PROCESSING – 1)	6-9
6.2.5 SC400 (IMAGE PROCESSING – 2)	6-11
6.2.6 SC500 (PAPER FEED AND FUSING)	6-12
6.2.7 SC600 (DEVICE COMMUNICATION)	6-20
6.2.8 SC700 (PERIPHERALS).....	6-35
6.2.9 SC800 (CONTROLLER)	6-35
6.2.10 SC900 (OTHERS)	6-102
6.3 JAM DETECTION	6-108
6.3.1 JAM DISPLAYS	6-108
6.3.2 JAM HISTORY.....	6-108
6.3.3 SENSOR POSITION LAYOUT.....	6-109
6.3.4 SENSOR POSITION	6-109
ARDF.....	6-110
Main Machine	6-110
Optional Bank	6-111
6.4 TROUBLESHOOTING	6-112
6.4.1 TEST PATTERN PRINTING.....	6-112
6.4.2 IMAGE POSITION ADJUSTMENT	6-113
6.4.3 REGISTRATION ADJUSTMENT	6-114
Print Area.....	6-114
Adjustment Reference Values	6-114
Adjustment Procedure.....	6-114
6.4.4 SCANNER, ARDF IMAGE ADJUSTMENT	6-115
Scanner Image Adjustment	6-115
ARDF Image Adjustment.....	6-116
6.4.5 PROBLEM AT REGULAR INTERVALS	6-117
When Vertical Banding is Generated	6-118
When Black Spots are Generated on Print Image	6-119
6.4.6 PAPER FEED (SKEW).....	6-120
6.4.7 STACK ERROR (SPILLING OF THE PAPER STACKED IN THE OUTPUT TRAY)	
6-120	
6.4.8 RECYCLED OR THIN PAPER IS SEVERELY CURLED AFTER PRINTING	6-121
7. ENERGY SAVE.....	7-1
7.1 ENERGY SAVE.....	7-1

7.1.1 ENERGY SAVER MODES	7-1
Sleep Mode Setting	7-1
Weekly Timer	7-2
Fusing Off Mode	7-3
Return to Stand-by Mode	7-3
Recommendation	7-4
7.1.2 ENERGY SAVE EFFECTIVENESS	7-4
7.2 PAPER SAVE	7-6
7.2.1 EFFECTIVENESS OF DUPLEX/COMBINE FUNCTION	7-6
1. Duplex:	7-6
2. Combine mode:	7-6
3. Duplex + Combine:.....	7-7
Recommendation	7-7

READ THIS FIRST

Important Safety Notices

Important Safety Notices

Prevention of Physical Injury

1. Before disassembling or assembling parts of the main machine and peripherals, make sure that the power cord of the main machine is unplugged.
2. The wall outlet should be near the machine and easily accessible.
3. Note that some components of the machine and the paper tray unit are supplied with electrical voltage even if the main power switch is turned off.
4. If any adjustment or operation check has to be made with exterior covers off or open while the main switch is turned on, keep hands away from electrified or mechanically driven components.
5. The inside and the metal parts of the fusing unit become extremely hot while the machine is operating. Be careful to avoid touching those components with your bare hands.

WARNING

- To prevent a fire or explosion, keep the machine away from flammable liquids, gases, and aerosols.

Health Safety Conditions

1. Toner and developer is non-toxic, but if you get either of them in your eyes by accident, it may cause temporary eye discomfort. Immediately wash eyes with plenty of water. If unsuccessful, get medical attention.
2. This machine, which uses a high voltage power source, can generate ozone gas. High ozone density is harmful to human health. Therefore, the machine must be installed in a well-ventilated room.

Observance of Electrical Safety Standards

1. This machine and its peripherals must be serviced by a customer service representative who has completed the training course on those models.
2. The NVRAM on the system control board has a lithium battery which can explode if replaced incorrectly. Replace the NVRAM only with an identical one. The manufacturer recommends replacing the entire NVRAM. Do not recharge or burn this battery. Used NVRAM must be handled in accordance with local regulations.

Handling Toner

- Work carefully when removing paper jams or replacing toner bottles or cartridges to avoid spilling toner on clothing or the hands.
- If toner is inhaled, immediately gargle with large amounts of cold water and move to a well ventilated location. If there are signs of irritation or other problems, seek medical attention.
- If toner gets on the skin, wash immediately with soap and cold running water.
- If toner gets into the eyes, flush the eyes with cold running water or eye wash. If there are signs of irritation or other problems, seek medical attention.
- If toner is swallowed, drink a large amount of cold water to dilute the ingested toner. If there are signs of any problem, seek medical attention.
- If toner spills on clothing, wash the affected area immediately with soap and cold water. Never use hot water! Hot water can cause toner to set and permanently stain fabric.
- Always store toner and developer supplies such as toner and developer packages, cartridges, and bottles (including used toner and empty bottles and cartridges) out of the reach of children.
- Always store fresh toner supplies or empty bottles or cartridges in a cool, dry location that is not exposed to direct sunlight.

WARNING







- Do not use a vacuum cleaner to remove spilled toner (including used toner). Vacuumed toner may cause a fire or explosion due to sparks or electrical contact inside the cleaner. However, it is possible to use a cleaner designed to be dust explosion-proof. If toner is spilled over the floor, sweep up spilled toner slowly and clean up any remaining toner with a wet cloth.

Safety and Ecological Notes for Disposal

1. Do not incinerate toner bottles or used toner. Toner dust may ignite suddenly when exposed to an open flame.
2. Dispose of used toner, the maintenance unit which includes developer or the organic photoconductor in accordance with local regulations. (These are non-toxic supplies.)
3. Dispose of replaced parts in accordance with local regulations.
4. When keeping used lithium batteries in order to dispose of them later, do not put more than 100 batteries per sealed box. Storing larger numbers or not sealing them apart may lead to chemical reactions and heat build-up.

Symbols, Abbreviations and Trademarks

This manual uses several symbols and abbreviations. The meaning of those symbols and abbreviations are as follows:

	See or Refer to
	Clip ring
	Screw
	Connector
	Clamp
	E-ring
SEF	Short Edge Feed
LEF	Long Edge Feed

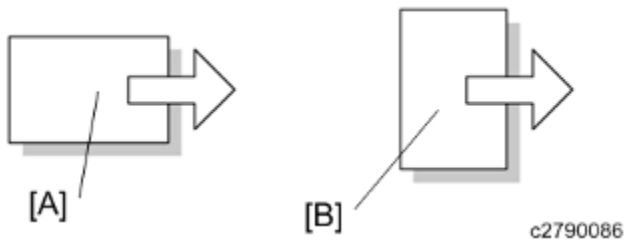

[A] Short Edge Feed (SEF)

[B] Long Edge Feed (LEF)

Trademarks

NetWare is registered trademark of Novell, Inc. in the USA.

PostScript® is a registered trademark of Adobe Systems, Incorporated.

PCL® is a registered trademark of Hewlett-Packard Company.

Other product names used herein are for identification purposes only and may be trademarks of their respective companies. We disclaim any and all rights involved with those marks.

PRODUCT INFORMATION

REVISION HISTORY		
Page	Date	Added/Updated/New
		None

1. PRODUCT INFORMATION

1.1 PRODUCT OVERVIEW

1.1.1 COMPONENT LAYOUT

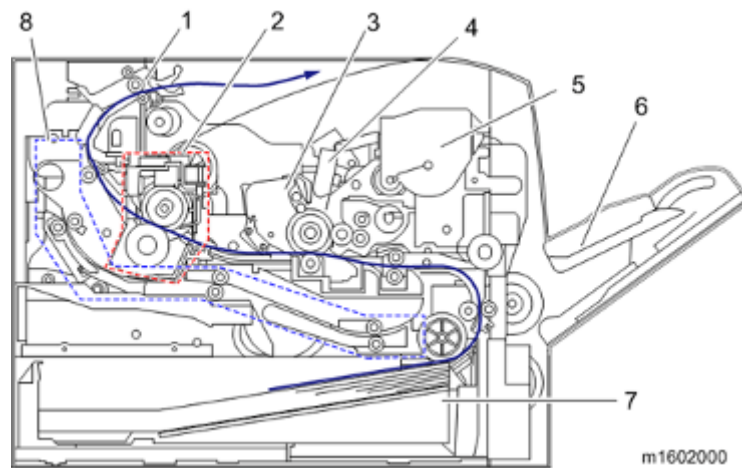

1. Exit / Switchback unit
2. Fusing unit
3. PCDU
4. LED head
5. Toner cartridge
6. By-pass feed tray
7. Paper feed unit
8. Duplex paper path

1.1.2 PAPER PATH

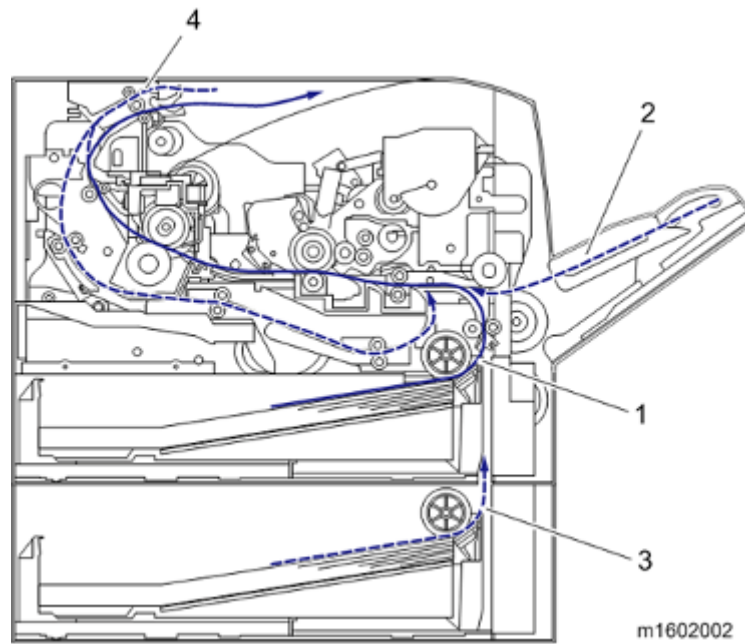

1. Main machine paper feed path
2. By-pass paper feed path
3. Optional tray paper feed path
4. Duplex paper feed path

1.1.3 DRIVE LAYOUT

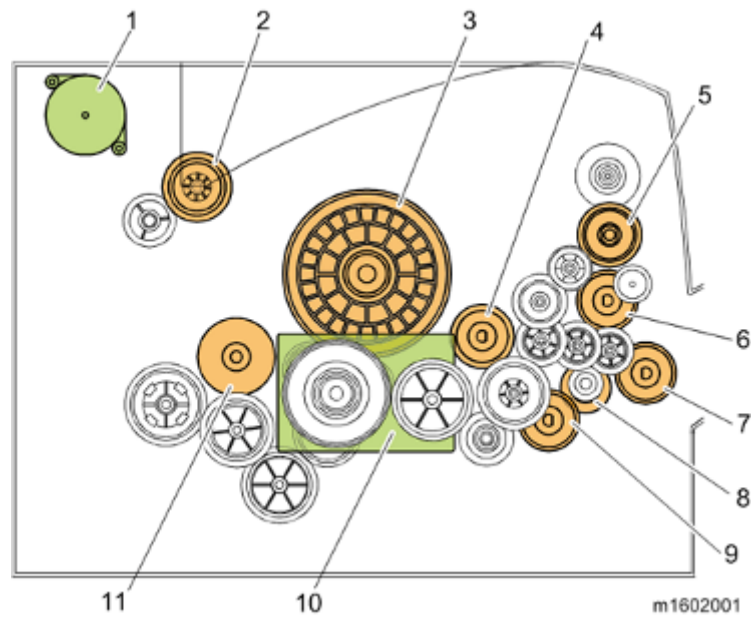

1. Duplex exit motor
2. Fusing drive gear
3. Drum gear
4. Registration clutch
5. Toner supply clutch
6. By-pass feed clutch
7. By-pass bottom plate clutch
8. Relay clutch
9. Paper feed clutch
10. Main motor
11. Duplex clutch

1.2 MACHINE CODES AND PERIPHERAL CONFIGURATION

1.2.1 MAIN FRAME

Item	Machine Code	Remarks
M160 (User Maintenance Model)	M160-17 (NA) M160-27 (EU/AP) M160-21 (CHN)	NEW
M161 (Service Maintenance Model)	M161-17 (NA) M161-27 (EU) M161-29 (AP)	NEW

1.2.2 EXTERNAL OPTIONS

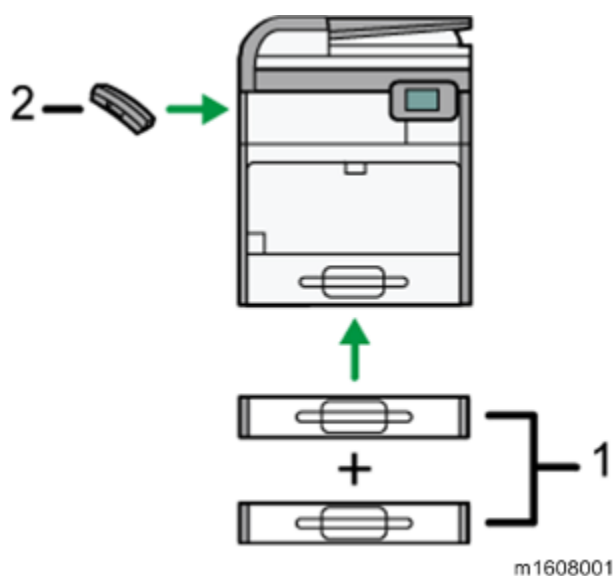

No.	Item	Machine Code	Remarks
1	Paper Feed Unit PB1070	M440-17	NEW
	Paper Feed Unit PB1060	M441-17	NEW
2	Handset HS1010	M444-38 (NA) M445-02 (CHN)	NEW

1.2.3 INTERNAL OPTIONS

Item	Machine Code	Remarks
IEEE802.11 Interface Unit Type O	M417-06	*1
VM CARD Type W	M417-19 (NA) M417-20 (EU) M417-21 (AP/CHN)	*2
Hard Disk Drive Option Type M6	M444-01	NEW
IPDS Unit Type M6	M444-05 (NA) M444-29 (EU) M444-30 (AP/CHN)	NEW
SD card for NetWare printing Type M6	M444-07	NEW
Browser Unit Type M6	M444-09 (NA) M444-27 (EU) M444-28 (AP/CHN)	NEW
XPS Direct Print Option Type M6	M444-22	NEW
IEEE1284 Interface Board Type A	B679-17	*1
Optional Counter Interface Unit Type A	B870-11	-
OCR Unit Type M2	D166-25 (NA) D166-26 (EU) D166-24 (AP/CHN)	-
File Format Converter Type E	D377-04	-
Bluetooth Interface Unit Type D	D566-01	-
Copy Data Security Unit Type G	D640-41	-
Memory Unit Type M1 1.5GB	D701-08	-
Data Overwrite Security Unit Type I	D362-12	-

*1: You can only install one of these at a time.

*2: To install this, Hard Disk Drive Option Type M6 and Memory Unit Type M1 must first be installed.

1.2.4 CONSUMABLES FOR M160 (USER MAINTENANCE MODEL)

Item	Machine Code	Remarks	Yield
Print Cartridge SP 4500HA	M901-17	NEW	12,000 pages (ISO)
Print Cartridge SP 4500HE	M901-27	NEW	
Print Cartridge SP 4500HS	M901-20	NEW	
Print Cartridge SP 4500HC	M901-21	NEW	
Print Cartridge SP 4500A	M902-17	NEW	6,000 pages (ISO)
Print Cartridge SP 4500E	M902-27	NEW	
Print Cartridge SP 4500S	M902-20	NEW	
Print Cartridge SP 4500C	M902-21	NEW	
Print Cartridge SP 4500LA	M903-17	NEW	3,000 pages (ISO)
Print Cartridge SP 4500LE	M903-27	NEW	
Print Cartridge SP 4500LS	M903-20	NEW	
Print Cartridge SP 4500LC	M903-21	NEW	
Photo Conductor Unit SP 4500	M906-17 (NA/EU/AP) M906-21 (CHN)	NEW	20,000 pages (3P/J)
Maintenance Kit SP 4500	M907-17 (NA) M907-27 (EU/AP/CHN)	NEW	-

Consumables for M161 (Service Maintenance Model)

Item	Machine Code	Remarks	Yield
PRINT CARTRIDGE MP 401	M904-17 (NA) M904-25 (AP) M904-29 (AP) M904-27 (EU/NA/AP)	NEW	10,400 pages (6%, 3P/J)
PRINT CARTRIDGE MP 401S	M904-20	NEW	

Note

- (ISO): The number of printable pages is based on pages that are compliant with ISO/IEC 19752 with the image density set as the factory default. ISO/IEC 19752 is an international standard for measurement of printable pages, set by the International Organization for Standardization.
- (6%, 3P/J): A4/Letter 6% test chart, 3 pages/job.
- (3P/J): A4/Letter, 3 pages/job.

INSTALLATION

REVISION HISTORY		
Page	Date	Added/Updated/New
		None

2. INSTALLATION

2.1 INSTALLATION REQUIREMENTS

2.1.1 ENVIRONMENT

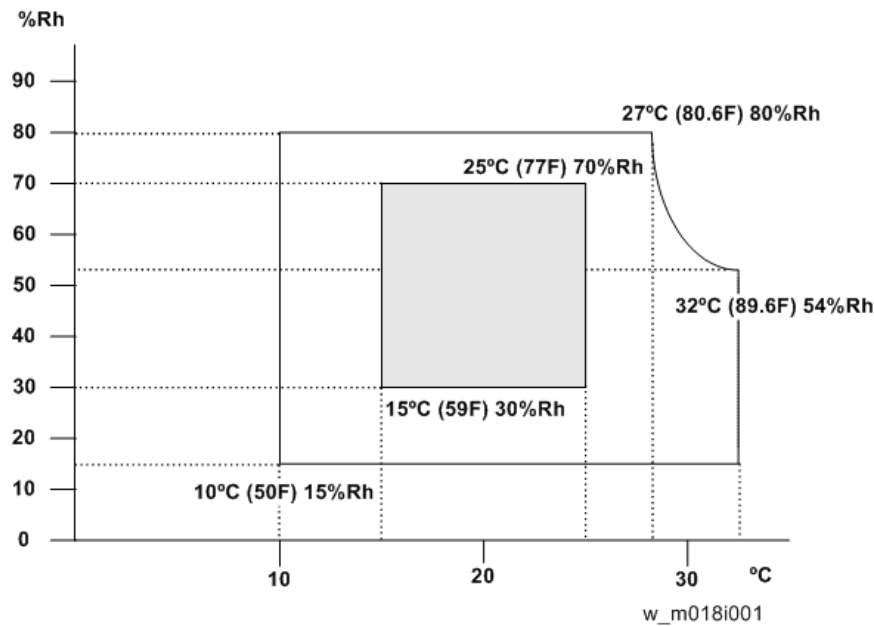

1. Temperature Range: 10°C to 32°C (50°F to 89.6°F)
2. Humidity Range: 15% to 80% RH
3. Ambient Illumination: Less than 1,500 lux (do not expose to direct sunlight)
4. Ventilation: 3 times/hr/person
5. Do not install the machine at locations over 2,000 m (6,562 ft.) above sea level.

2.1.2 MACHINE SPACE REQUIREMENTS

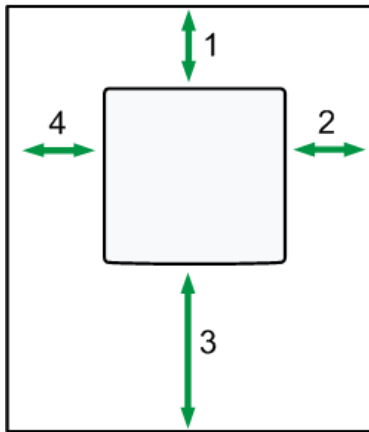

m1600239

1	Rear	Over 20 cm (7.9 inches)
2	Right	Over 10 cm (3.9 inches)
3	Front	Over 35 cm (13.8 inches)
4	Left	Over 10 cm (3.9 inches)

2.1.3 MACHINE DIMENSIONS

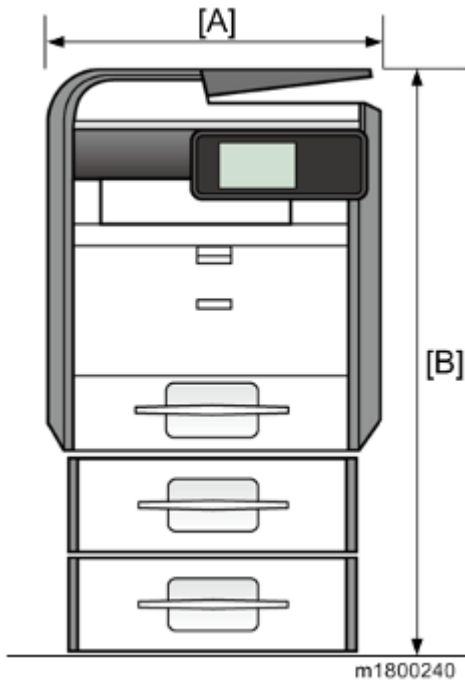

Installation

[A]	419 mm (16.5 inches)
[B]	With Paper Feed Unit PB1060 (250 Sheets) attached: 674 mm (26.5 inches)
	With Paper Feed Unit PB1070 (500 Sheets) attached: 734 mm (28.9 inches)
Depth	427 mm (16.8 inches)

2.1.4 POWER REQUIREMENTS

CAUTION

- Make sure the plug is firmly inserted in the outlet.
- Avoid multi-wiring.
- Be sure to ground the machine.
- Never place anything on the power cord.

1. Input voltage level:

Destination	Power supply voltage	Frequency	Rated current consumption
NA	120 V to 127 V	60 Hz	More than 10 A
EU/AP/CHN	220 V to 240V	50 Hz/60 Hz	5.3 A

2. Permissible voltage fluctuation:

Destination	For printing images	For operating
NA	+8.66 / -10%	+8.66 / -15%
EU/AP/CHN	±10%	±15%

2.2 MAIN MACHINE INSTALLATION

★ Important

- The user maintenance model (**M160**) is for installation by users. However, the customer engineer must do the installation if the sales representative requests it.
- The service maintenance model (**M161**) is for installation by the customer engineer.

2.2.1 IMPORTANT NOTICE ON SECURITY ISSUES

In order to increase the security of the MFP, and to ensure that the customer sets the administrator password, an administrator set/change prompt display is shown up at the first power-up.

Overview

- The following Program/Change Administrator screen is displayed at the first power-up.

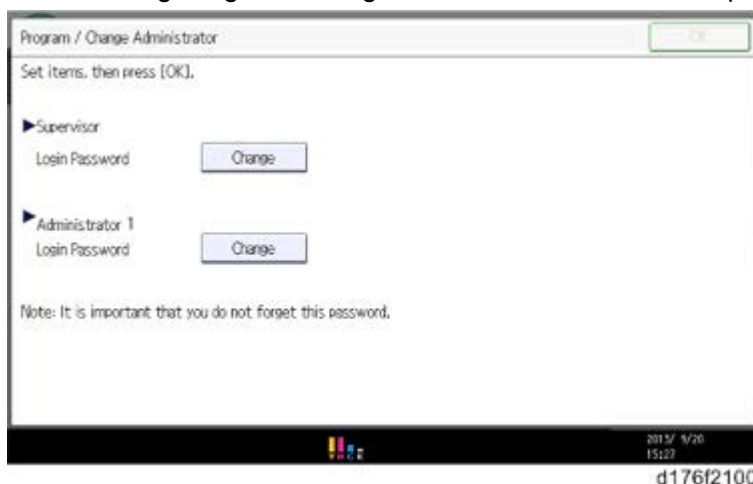

- When the customers set the administrator/supervisor login password, the display disappears and the home display will appear. The customers, however, can erase this screen with the following procedure if they think there is no need to set the password.
1. **On the Program/Change Administrator screen, press [Change] next to Supervisor and then touch [OK] without inputting any password.**
 2. **Touch [OK] again when the Confirm password display shows up.**
 3. **For Administrator 1, do the same procedure as steps 1 and 2.**
 4. **Press the [OK] button, then the home display appears.**
- SP5-755-002 allows you to skip this screen temporarily and continue the installation procedure without setting an administrator password. However, the Program/Change Administrator screen appears every time you turn the power OFF/ON, if the password is not set.

Password Setting Procedure

Note

- For more details about this security issue, see “Notes on Using Multi-Function Printers Safely” supplied with the MFP.

CAUTION

- When Supervisor / Administrator 1-4 passwords are configured via network, the “Change Supervisor login password” window will not display.
- The passwords for Supervisor or Administrator 1 to 4 can be set via “System Settings”. But the Program/Change Administrator screen appears every time the power switch is turned ON if the passwords are input this way. So we recommend the customers to set the passwords via network or the Program/Change Administrator screen.

1. Install the MFP.
2. Turn the main power switch ON.
3. Change the Supervisor login password.

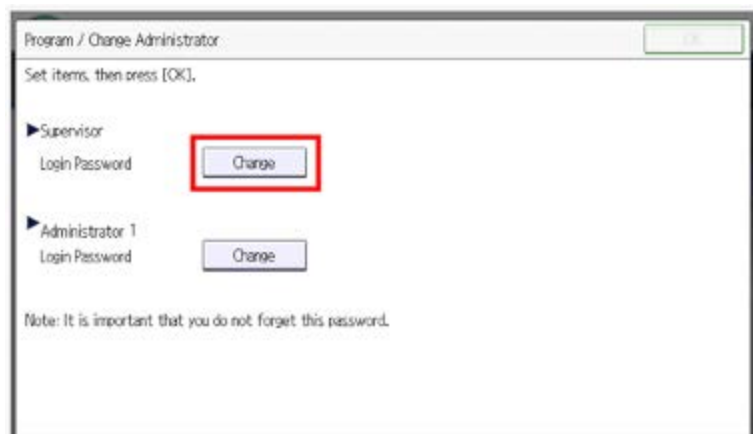

d176f2101

4. Input the password.



d176f2102

5. Press [OK].

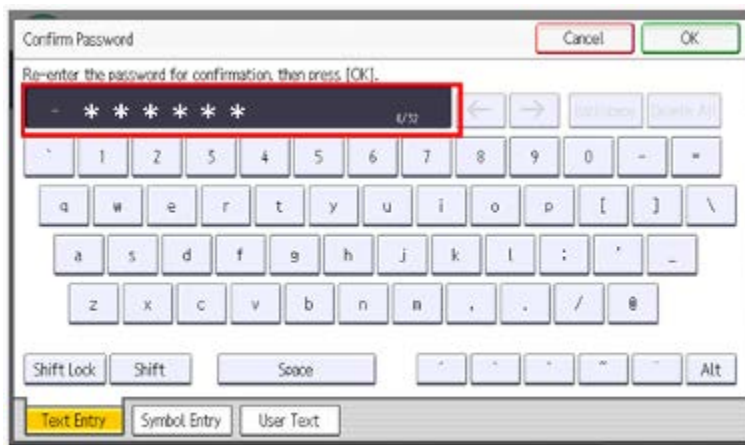

d176f2103

6. Confirm the Password.

d176f2104

7. Press [OK].

d176f2105

8. Change the Administrator 1 login password.

Main Machine Installation

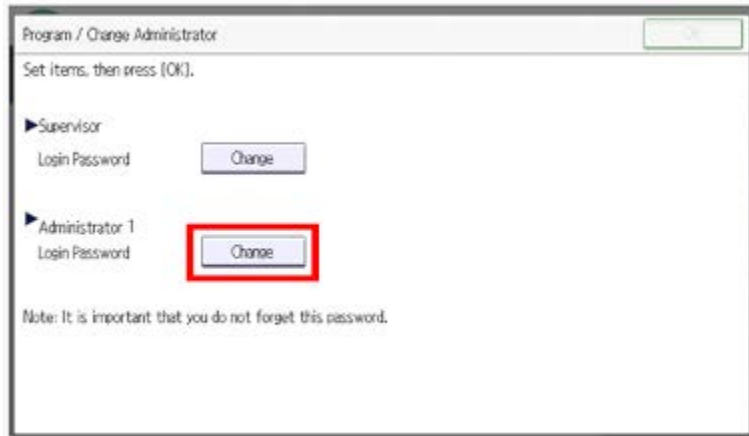

d176f2106

9. Input the password.



d176f2102

10. Press [OK].



d176f2103

11. Confirm the password.

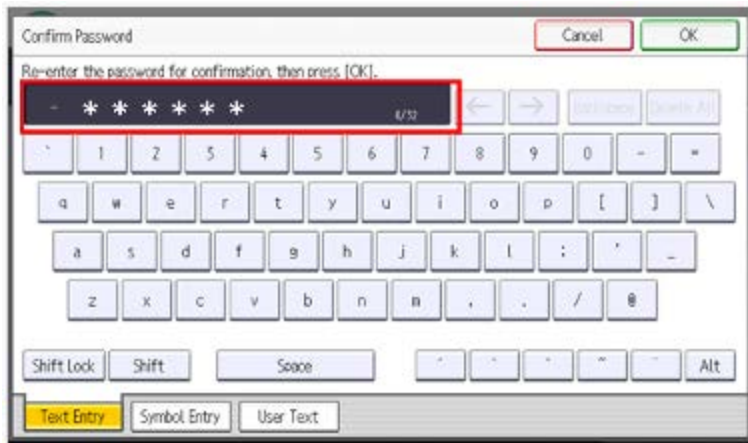

d176f2104

12. Press [OK].



d176f2105

13. Cycle the power OFF/ON.

2.2.2 ACCESSORY CHECK (M160)

Description	Q'ty		
	-17	-21	-27
Power Cord	1	1	1
Telephone Cable with Ferrite Core	1	-	-
Ferrite Core	-	1	-
Cleaner: Lens: LED Head	1	1	1
Sheet - Security Password	1	1	1
Sheet - EULA (End User License Agreement)	1	1	1
Sheet - Notes_FCC	1	-	-

Main Machine Installation

Description	Q'ty		
	-17	-21	-27
Sheet – SECU	1	1	1
Sheet - TEL Name	-	1	-
Sheet - Caution Chart: SANBAO	-	1	-
Sheet - Safety Informaion	-	-	1
Sheet - EMC – Traceability	-	-	1
Manual - User Guide	1	1	-
Manual - Read This First	1	1	1
Manual - Quick installation Guide	1	1	1
Manual - Initial Guide for FAX	1	1	-
CD-ROM – Driver	1	-	1
CD-ROM – OI	1	-	1
CD-ROM - Driver/OI	-	1	-
Seal – Caution	1	1	1
Decal – Function	1	1	1
Decal - Function (blanl)	1	1	1
Decal - Paper Tray Size	1	-	-
Decal - FAX: BLIND	-	-	1
Decal - SDK: ABS	1	1	1
Leaflet – Help Desk Card	1	-	-
User Registration Sheet	1	-	-
Warranty (English)	1	-	-
Warranty (Chinese)	-	1	-

Description	Q'ty		
	-17	-21	-27
Starter Toner User maintenance model (M160) : 6,000 pages	1	1	1

2.2.3 ACCESSORY CHECK (M161)

Description	Q'ty		
	-17	-27	-29
Power Cord	1	1	1
Telephone Cable with Ferrite Core	1	-	-
Cleaner: Lens: LED Head	1	1	1
Sheet - Security Password	1	1	1
Sheet - EULA (End User License Agreement)	1	1	1
Sheet - Notes_FCC	1	-	-
Sheet - Notes_SECU	1	1	1
Sheet - Notes_Envelope	1	1	1
Sheet - Safety Informaion (-27 only)	-	1	-
Sheet - EMC - Traceability (-27 only)	-	1	-
Manual - User Guide (-17, -21 only)	1	-	1
Manual - Read This First	1	1	1
CD-ROM – Driver	1	1	1
CD-ROM - OI	1	1	1
Seal – Caution	1	1	1
Decal – Function	1	1	1

Description	Q'ty		
	-17	-27	-29
Decal - Function (blank)	1	1	1
Decal - FAX: BLIND	-	1	-
Decal - SDK: ABS	1	1	1
PLATE:LOGOTYPE:GES:IG	-	-	1
PLATE:LOGOTYPE:LAN:IG	-	-	1
PLATE:LOGO:RIC	1	1	1
Starter Toner Service maintenance model (M161) : 10,400 pages	1	1	1

2.2.4 INSTALLATION PROCEDURE

Removal of packing materials and shipping retainers

⚠ CAUTION

- When lifting the machine, use the inset grips on both sides. The machine could break or cause an injury if dropped.

1. Remove the machine from the box, and check the items in the package.
2. Remove the adhesive tape attached on the machine's exterior.



↓ Note

- Pull out the paper tray, and then remove the adhesive tape [A] on its side.

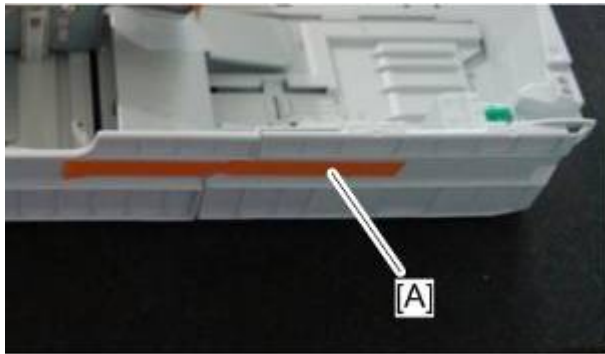

m1600175

3. Open the rear cover, and then remove the adhesive tape from the machine and the envelope lever.

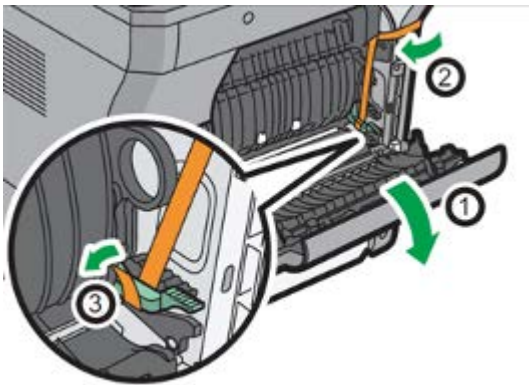

m1600283

4. Pull up the envelope lever, and then close the rear cover.

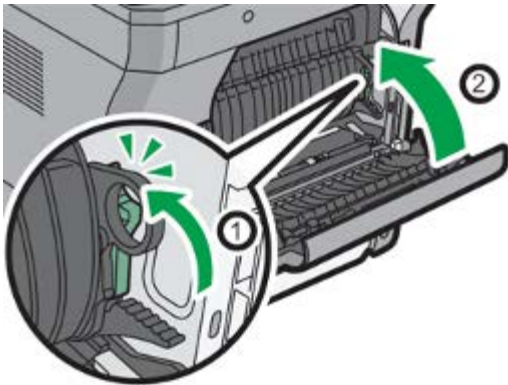

m1600284

5. Open the ARDF, and then remove the protective materials.

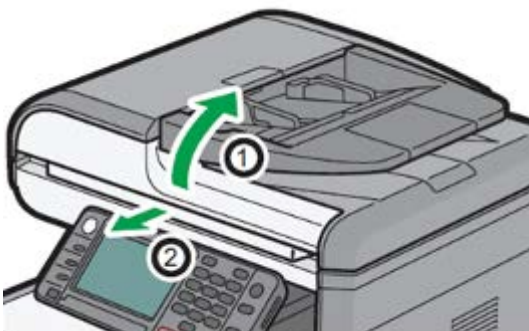

m1600242

6. Pull up the open lever of the ARDF cover, and then open the ARDF cover.



m1600243

7. Pull and lift the paper feed roller slightly to remove it, and then remove the protective sheet.



m1600244

8. With the roller part facing downwards, insert the ends of the paper feed roller shaft to return the paper feed roller to its original position.

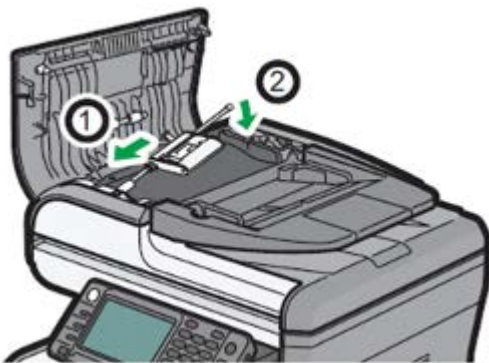

m1600245

9. Close the ARDF cover.

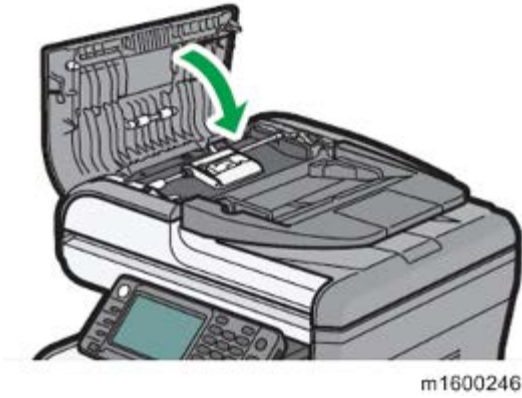

10. Open Tray 1, and remove the protective materials.

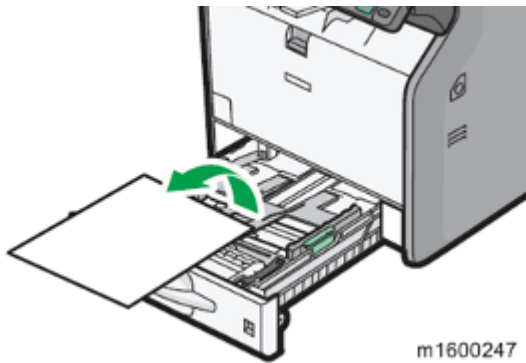

Connecting the Power Cord

1. Plug the power cord into the rear of the machine.

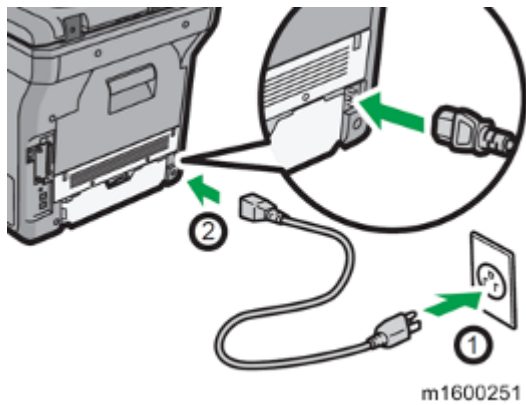

2. Push the main power switch.

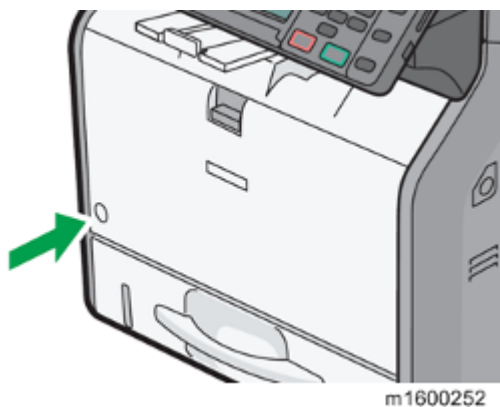

Loading Paper

1. Check that paper in the paper tray is not being used, and then pull out the paper tray carefully. Adjust the paper size dial to match the size and feed direction of the paper in the paper tray.

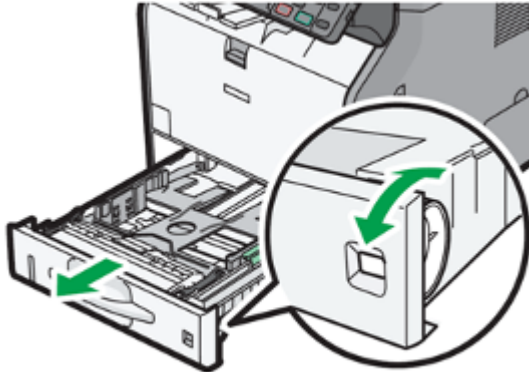

m1600249

2. Pull the tray carefully until it stops, lift the front side of the tray, and then pull it out of the machine.
3. Squeezing the releases on the side and end paper guides, adjust the guides' positions according to the size of paper to be loaded.

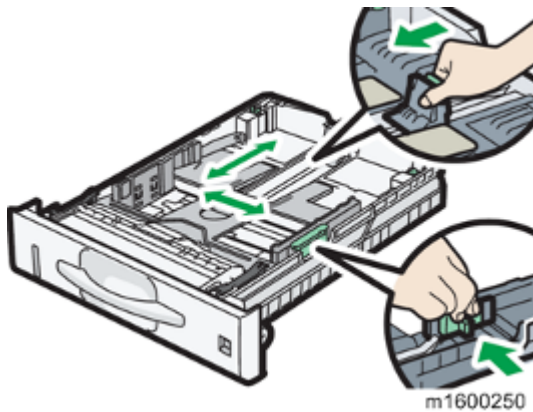

m1600250

4. Load the paper, insert the tray while keeping its front slightly raised, and then push it in all the way in.

Printing a Configuration Page

After you set up the machine or install options, print the configuration page to check the machine status.

1. Press the [User Tools/Counter] key.

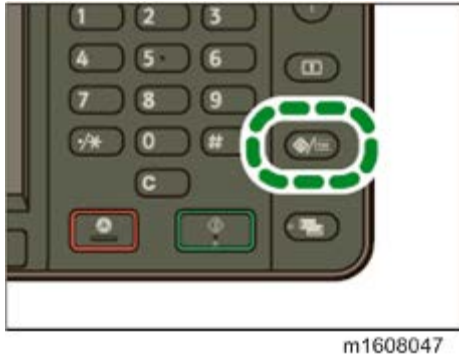

2. Press [Printer Features].
3. Press [List / Test Print].
4. Press [Configuration Page].
5. Press the [User Tools/Counter] key.

Note

- After setting up the machine, configure the hard disk overwriting and data encryption settings. (page 2-73 "Data Overwrite Security", page 2-75 "HDD Encryption")

2.2.5 INSTRUCTIONS FOR THE CUSTOMERS

Provide instructions on the following matters to customers. For detailed procedures, see the user manuals.

- Operating the printer/copier/scanner/fax functions
- Installing consumables and loading paper
- Operating the main power switch
- Removing jammed paper
- Registering/changing/deleting data in the address book
- Providing precautions on use
- Connecting to computers (such as configuring the port setting)
- Giving a brief outline of the tabs in the drivers

2.2.6 MOVING THE MACHINE

CAUTION

- It is dangerous to handle the power cord plug with wet hands. Doing so could result in electric shock.

CAUTION

- Unplug the power cord from the wall outlet before you move the machine. While moving the machine, take care that the power cord is not damaged under the machine. Failing to take these precautions could result in fire or electric shock.

CAUTION

- If you have to move the machine when the optional paper tray unit is attached, do not push on the main unit's top section. Doing so can cause the optional paper tray unit to detach, possibly resulting in injury.

CAUTION

- When disconnecting the power cord from the wall outlet, always pull the plug, not the cord. Pulling the cord can damage the power cord. Use of damaged power cords could result in fire or electric shock.

CAUTION

- The machine weighs approximately 23 kg (50.7 lb.). When moving the machine, use the inset grips on both sides, and lift slowly in pairs. The machine will break or cause injury if dropped.

CAUTION

- Do not hold the control panel while moving the machine. Doing so may damage the control panel, cause a malfunction, or result in injury.

★ Important

- Be careful when moving the machine. Take the following precautions:
- Close all covers and trays, including the front cover and by-pass tray.
- If optional paper feed units are attached, remove them from the machine and move them separately.
- Keep the machine level and carry it carefully, taking care not to jolt or tip it. Rough handling may cause a malfunction or damage the hard disk or memory, resulting in loss of stored files.

1. Be sure to check the following:

The main power switch is turned off.

The power cord is unplugged from the wall outlet.

The interface cable is unplugged from the machine.

2. If any external options are attached, remove them.**3. Lift the machine using the inset grips on both sides of the machine, and then move it horizontally to the place where you want to use it.****4. If you removed options, reattach them.****↓ Note**

- Be sure to move the machine horizontally. To prevent toner from scattering, move the machine slowly.

2.3 PAPER FEED UNIT PB1060/ PAPER FEED UNIT

PB1070

CAUTION

- When lifting the machine, use the inset grips on both sides. The machine could break or cause an injury if dropped.

2.3.1 COMPONENT CHECK

To attach two lower paper trays at the same time, first stack them one upon the other, and then attach them as a single tray.

Check the quantity and condition of the accessories against the following list.

Paper Feed Unit PB1070 (500 Sheets M440)

No.	Description	Q'ty
1	Installation Procedure	1
2	Manufacturer Information / Authorized Representative Information (Paper)	1

Paper Feed Unit PB1060 (250 Sheets M441)

No.	Description	Q'ty
1	Installation Procedure	1
2	Manufacturer Information / Authorized Representative Information (Paper)	1
3	Paper Size Decal / Paper Tray Number Decal	1

2.3.2 INSTALLATION PROCEDURE

⚠ CAUTION

- Turn off the main power switch of the machine and unplug the power cord before you start the installation procedure.

★ Important

- To attach two lower paper trays at the same time, first stack them one upon the other, and then attach them as a single unit.

1. Remove the packaging from the lower paper tray.
2. Lift the machine slowly using the inset grips on both sides, and then position it immediately above the lower paper tray.
3. There are three upright pins on the optional lower paper tray. Align them with the holes on the underside of the machine, and then carefully lower the machine.

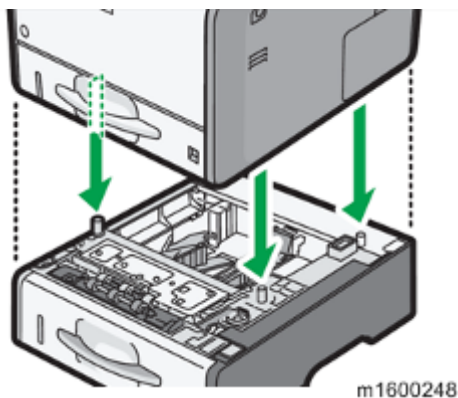

4. Plug in the power cord, and then turn on the machine.
5. Print the configuration page to confirm that the tray was attached correctly.

↓ Note

- Check "Attached Equipment" on the configuration page. If the tray was attached correctly, "Tray 2" and "Tray 3" will appear.

2.4 CONTROLLER OPTIONS

2.4.1 OVERVIEW

★ Important

- Always touch a grounded surface to discharge static electricity from your hands before you handle SD cards, printed circuit boards, or memory boards.

The machine is equipped with a USB host interface, I/F card slot, and SD card slots for controller options.

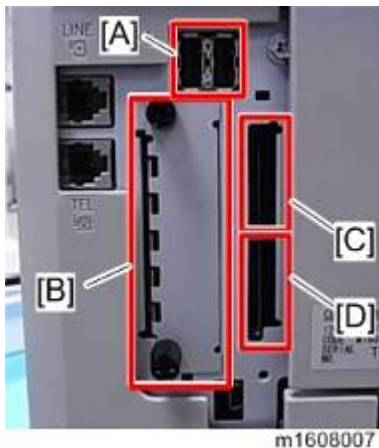

Remove the SD card slot cover to use the SD card slots.

USB Host Interface

Use the USB host interface [A] for connecting the Bluetooth interface unit.

I/F Card Slot

Slot [B] can be used to attach an interface for IEEE 1284, IEEE 802.11a/b/g/n (Wireless LAN), or File Format Converter.

SD Card Slots

Slot 1 (upper) [C] is used for optional applications (e.g.: Netware, Postscript3, Browser Unit, etc).

Slot 2 (lower) [D] is used for installing applications, or for service only (for example, updating the firmware).

2.5 SD CARD APPLI MOVE

2.5.1 OVERVIEW

Since there are only two SD card slots (one of them is a service slot), three or more SD card applications cannot be used simultaneously.

However, if multiple SD card applications are merged, three or more SD card options can be used.

This function is referred to as the “SD card merge function.”

The “SD card merge function” is a function which enables the use of three or more functions within the capacity of two SD cards by physically transferring the function of one SD card to other SD cards (all SD card options can be stored in two SD cards).

However, SD card applications are under license, therefore, since an SD card license after merge is transferred to the target SD card, it cannot be used even if it is moved to the target machine.

Also, a process to prevent illegal copying is performed.

The service program "SD Card Appli Move" (SP5-873) lets you move application programs from one SD card to another SD card.

2.5.2 NOTES ON USING THE SD MERGE FUNCTION

- The data necessary for authentication is transferred with the application program from an SD card to another SD card. Authentication fails if you try to use the SD card after you move the application program from one card to another card.
- Do not use the SD card if it has been used before for other purposes. Normal operation is not guaranteed when such an SD card is used.
- An SD card, which becomes empty after moving the data in it to another card, cannot be reused.
- After moving the data in an SD card to another card so that the source card becomes empty, keep the empty card in place by, for example, affixing it near the SD card slot with adhesive tape. This is done for the following reasons:
 - The SD card can be the only proof that the user is licensed to use the application program.
 - You may need to check the SD card and its data to solve a problem in the future.

Note

- Do not move OCR Unit Type M2 (optional) to another SD card.

2.5.3 SD CARD APPLICATIONS

SD Card Option	Card Size Capacity	Movable to another SD card	Target SD card	Remarks
IPDS Unit Type M6	128M	Yes	Yes	Available for use in Slot 1 (Upper) and Slot 2 (Lower)
SD card for NetWare printing Type M6	128M	Yes	Yes	
XPS Direct Print Option Type M6	128M	Yes	Yes	
OCR Unit Type M2	128M	No	No	
Browser Unit Type M6	128M	Yes	Yes	
VM Card Type W	512M	No	Yes	Available for use only in Slot 1 (Upper)

- Both Slots 1 and 2 are vacant when the machine is shipped from the factory.
- OCR Unit Type M2 cannot be moved to another SD card and is unavailable for target SD card.
- VM Card Type W cannot be moved to another SD card.

2.5.4 MOVE EXEC

The menu "Move Exec" (SP5-873-001) lets you move application programs from the original SD card to another SD card.

★ Important

- Do not turn ON the write protect switch of the system SD card or application SD card on the machine. If the write protect switch is ON, a download error (e.g. Error Code 44) occurs during a firmware upgrade or application merge.

1. Turn the main power switch off.
2. SD card slot cover [A].



m1600237

3. Make sure that a target SD card is in SD Card Slot 1 [A]. The application program is moved to this SD card.

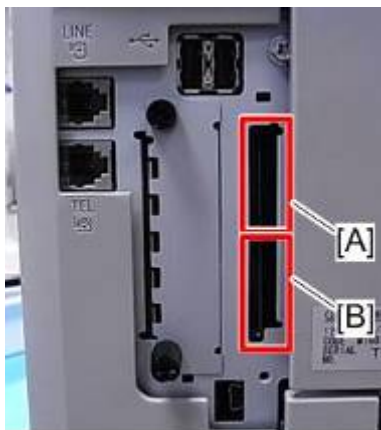

m1600238

4. Insert the source SD card with the application program in SD Card Slot 2 [B]. The application program is copied from this source SD card.
5. Turn the main power switch on.
6. Start the SP mode.
7. Select SP5-873-001 "Move Exec".
8. Follow the messages shown on the operation panel.
9. Turn the main power switch off.
10. Remove the source SD card from SD Card Slot 2 [B].
11. Attach the SD card slot cover.
12. Turn the main power switch on.
13. Check that the application programs run normally.

2.5.5 UNDO EXEC

"Undo Exec" (SP5-873-002) lets you move back application programs from an SD card in SD Card Slot 1 (upper) to the original SD card in SD Card Slot 2 (lower). You can use this program when, for example, you have mistakenly copied some programs by using Move Exec (SP5-873-001).

★ Important

- Do not turn ON the write protect switch of the system SD card or application SD card on the machine. If the write protect switch is ON, a download error (e.g. Error Code 44) occurs during a firmware upgrade or application merge.

- Turn the main power switch off.
- SD card slot cover [A].



- Insert the integrated SD card in Slot 1 [A].

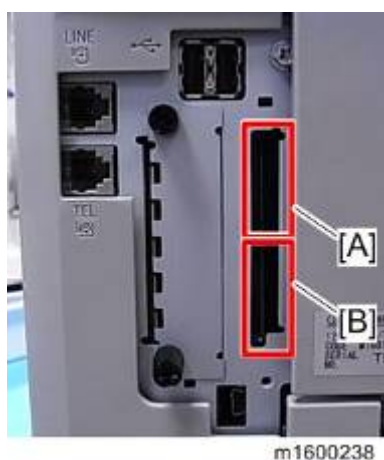

- Insert the SD card which became empty after integration in Slot 2 [B].
- Turn the main power switch on.
- Start the SP mode.

7. **Select SP5-873-002 "Undo Exec."**
8. **Follow the messages shown on the operation panel.**
9. **Turn the main power switch off.**
10. **Remove the SD card from SD Card Slot 2 [B].**
11. **Attach the SD card slot cover.**
12. **Turn the main power switch on.**
13. **Check that the application has been deleted.**

2.6 IPDS UNIT TYPE M6

2.6.1 COMPONENT CHECK

No.	Description	Q'ty
1	SD Card: IPDS	1

2.6.2 INSTALLATION PROCEDURE

⚠ CAUTION

- Unplug the main machine power cord before you do the following procedure.

1. Loosen the screw and remove the SD card slot cover at an angle.

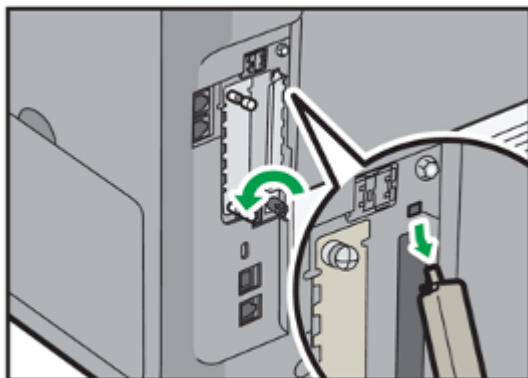

m1600265

2. Insert the SD card (IPDS Unit) in SD slot 1 (upper). Then push it slowly until it clicks.

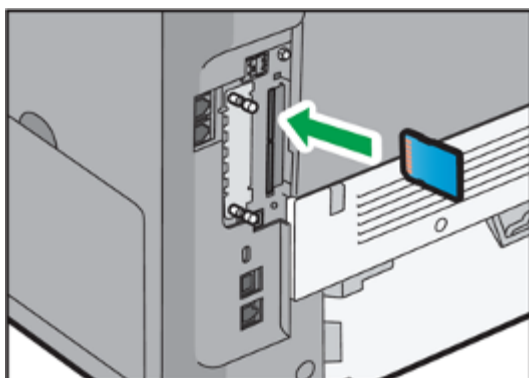

m1600266

3. Hook the SD card slot cover onto the opening, attach it flat against the controller board, and then fasten it using the screw.
4. Plug in the power cord, and then turn on the machine.
5. Print the configuration page to confirm the installation (page 2-17 "Printing a Configuration Page").

Note

- Confirm that the IPDS was correctly installed by printing the configuration page. If it is correctly installed, "IPDS Menu" will appear on the configuration page.

2.7 SD CARD FOR NETWARE PRINTING TYPE M6

2.7.1 COMPONENT CHECK

No.	Description	Q'ty
1	SD Card: NetWare	1
2	RoHS Decal	1
3	LABEL:ROHS:DATE:40MM	1

2.7.2 INSTALLATION PROCEDURE

⚠ CAUTION

- Unplug the main machine power cord before you do the following procedure.

1. Loosen the screw and remove the SD card slot cover at an angle.

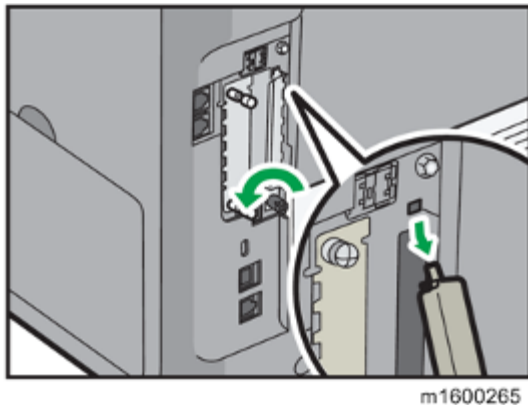

2. Insert the SD card (Netware Printing) in SD slot 1 (upper). Then push it slowly until it clicks.

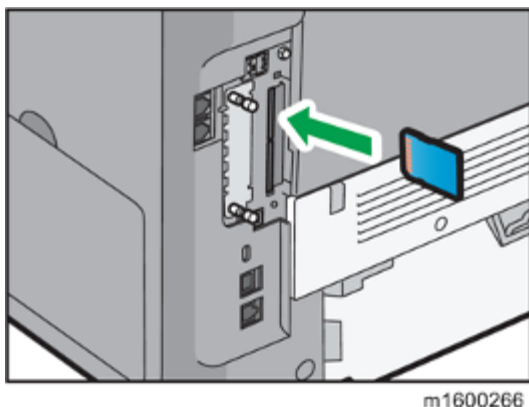

3. Hook the SD card slot cover onto the opening, attach it flat against the controller board, and then fasten it using the screw.

4. **Plug in the power cord, and then turn on the machine.**
5. **Print the configuration page to confirm the installation (page 2-17 "Printing a Configuration Page").**

 **Note**

- Confirm that the NetWare was correctly installed by printing the configuration page. If it is correctly installed, "NetWare" will appear for "Interface Information" on the configuration page.

2.8 BROWSER UNIT TYPE M6

2.8.1 COMPONENT CHECK

No.	Description	Q'ty
1	SD Card: Browser Unit	1

2.8.2 OUTLINE OF THE BROWSER UNIT

★ Important

- The browser for these models is not installed in the SD card HDD, but in order to start up using the data on the SD card, it must be operated with the SD card inserted.

The browser unit uses a native application such as a full browser in order to improve web browsing.

Also, to provide a solution utilizing the web as in previous machines, Extended JavaScript is also provided as an ESA application.

Due to the above, the browser unit for this model has two firmware modules, native application firmware, and Type-C application EXJS firmware.

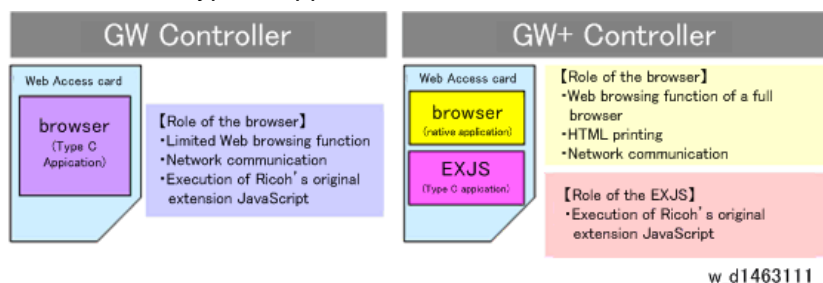

2.8.3 INSTALLATION PROCEDURE

This option requires a HDD unit.

⚠ CAUTION

- Unplug the main machine power cord before you do the following procedure.

1. Loosen the screw and remove the SD card slot cover at an angle.

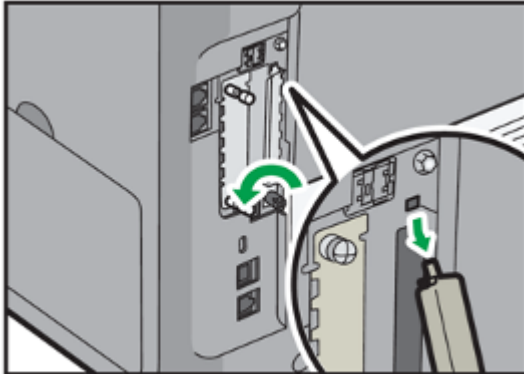

2. Insert the Browser Option SD card in SD slot 1 (upper). Then push it slowly until it clicks.

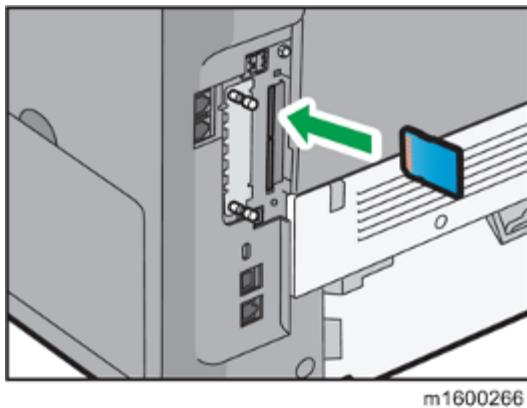

3. Turn the main power switch on.
4. Push the [User Tools/Counter] key.
5. Touch "Extended Feature Settings" twice on the LCD.

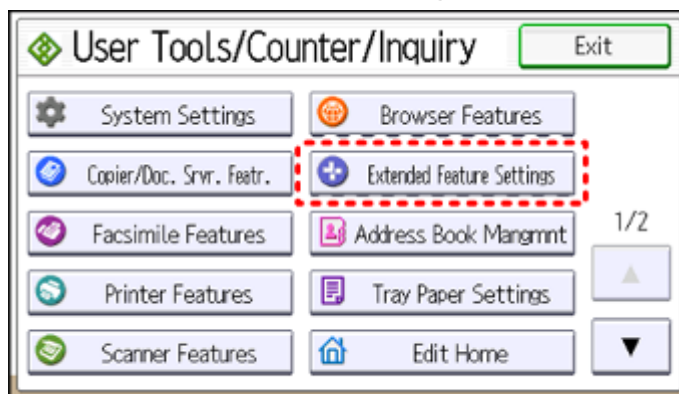

w_d1585058

6. Make sure that "Extended JS" application was automatically installed in the Startup Settings tab.
7. Turn the main power switch OFF/ON.
8. Push the [User Tools/Counter] key.
9. Touch "Edit Home".

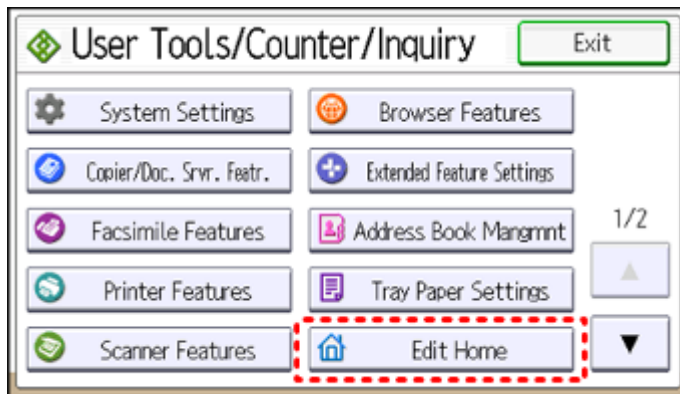

w_d1585006

10. Touch "Add Icon".

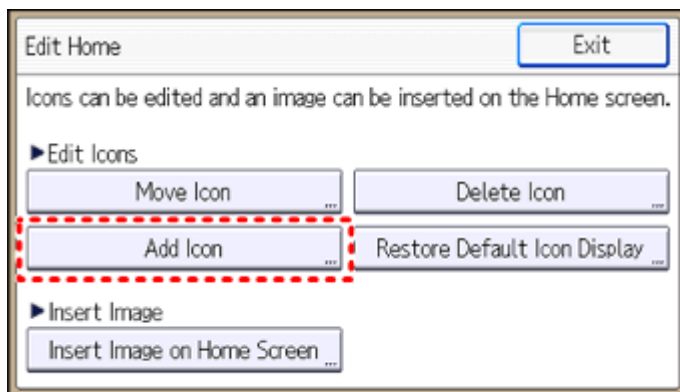

w_d1585007

11. Touch "Select Icon to Add".

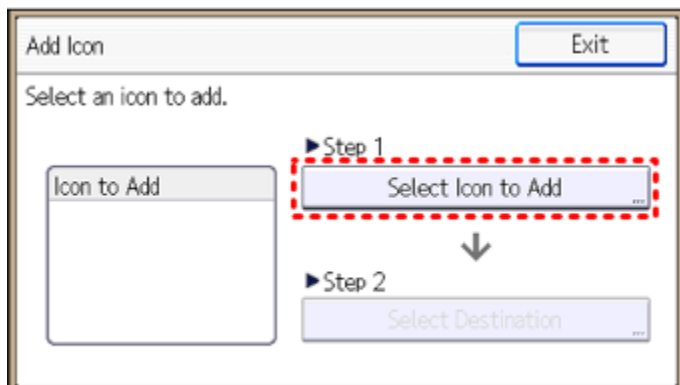

w_d1585008

12. Touch "Application".

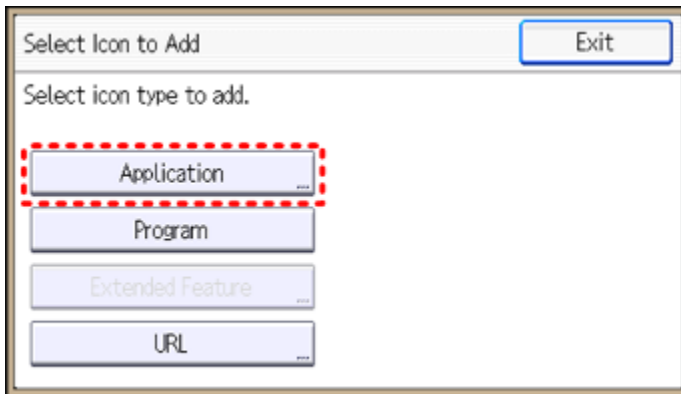

w_d1585009

13. Touch "Browser".

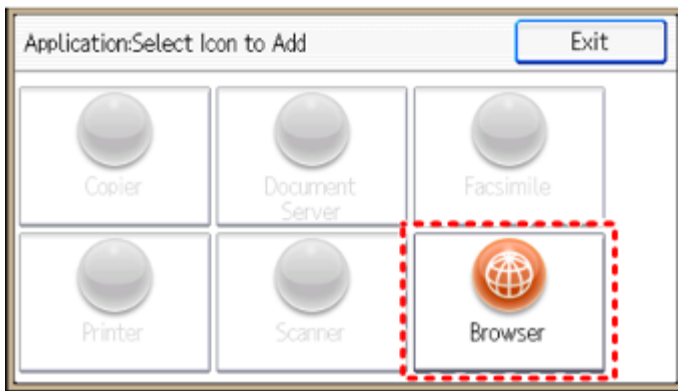

w_d1585010

14. Touch "Select Destination".

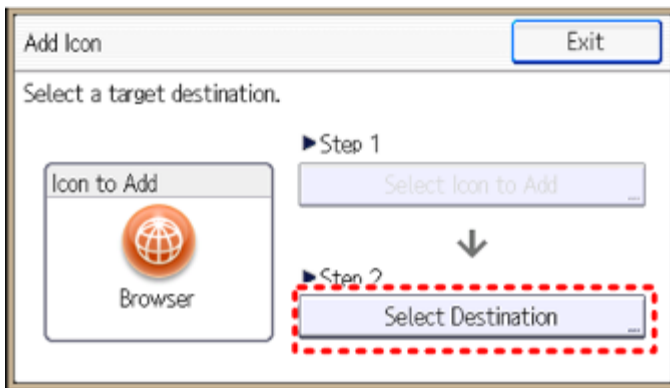

w_d1585011

15. Touch a "Blank" to set a location for the browser icon.

16. Touch "Exit" to end the browser icon addition.

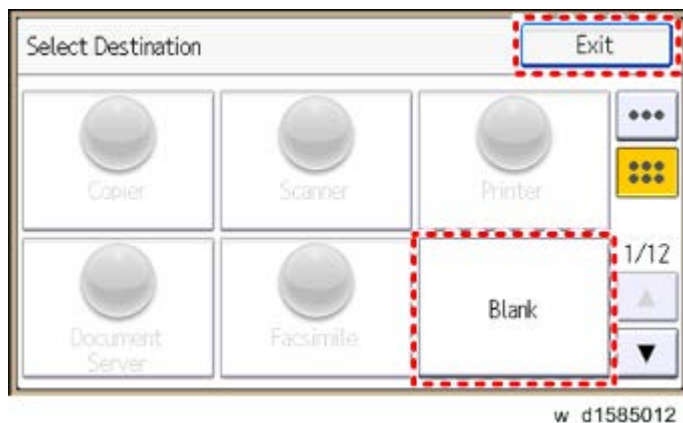

2.8.4 RICOH JAVASCRIPT

Do the following steps if the customer is using the Ricoh JavaScript connected to a Web application developed by Operius/RiDP.

1. Turn the main power switch ON.
2. Push the [User Tools/Counter] key.
3. Touch "Browser Features".

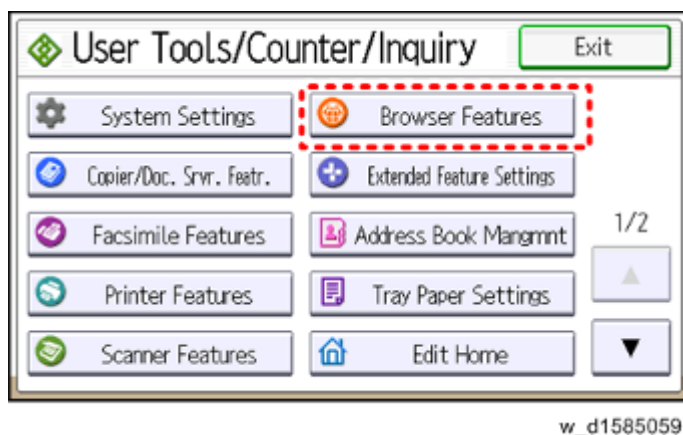

4. Touch "Java Script".
5. Change the Extended JavaScript setting to "Activate".

2.8.5 EXJS FIRMWARE UPDATE

ⓘ Note

- The Browser Unit consists of the Browser firmware and EXJS firmware. The EXJS firmware is equivalent to the existing browser firmware. Therefore, it is possible to update the EXJS firmware using the same procedure as that of SDK application firmware.

Preparation

1. Extract the exe file (XXXX. exe), after which the following two files are generated:
XXXX_machine. exe/ XXXX_stock.exe.

↓ Note

- Note: The file (XXXX_machine) is for updating the EXJS firmware in the field.

2. Extract the file (XXXX_machine), after which the “SDK” folder is created.

↓ Note

- Note: XXXX = part number.

3. Copy the “SDK” folder to an SD card.

Main procedure

⚠ CAUTION

- Unplug the main machine power cord before you do the following procedure.

1. Loosen the screw and remove the SD card slot cover at an angle.

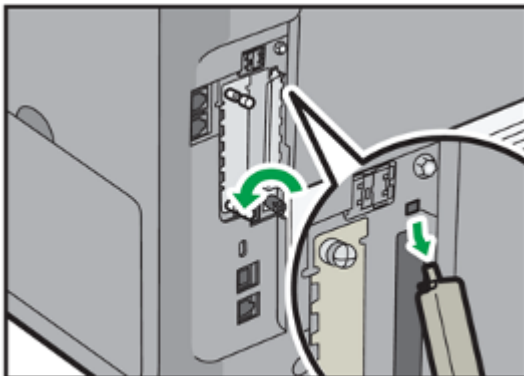

m1600265

2. Insert the SD card included for firmware update into SD slot 2 (lower). Then push it slowly until it clicks.

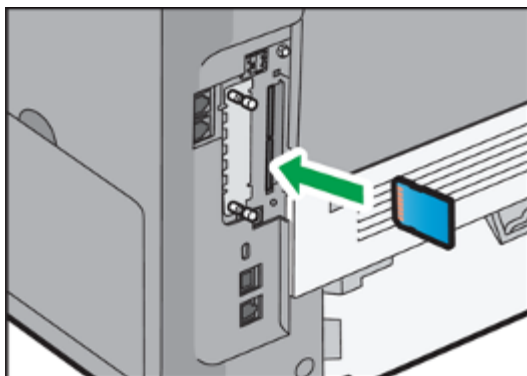

m1600286

3. Turn the main power switch on.
4. After the Update screen is displayed, select the "Browser".
5. Touch "Update (#)".
6. After the "Update Done" message appears on the screen, turn the main power switch OFF.
7. Remove the SD card from the lower slot.

2.8.6 UPDATING THE EXTENDED JAVASCRIPT

Do the following steps if you are updating the Extended JavaScript.

1. Turn the main power switch on.
2. Push the [User Tools/Counter] key.
3. Touch "Extended Feature Settings" twice on the LCD.

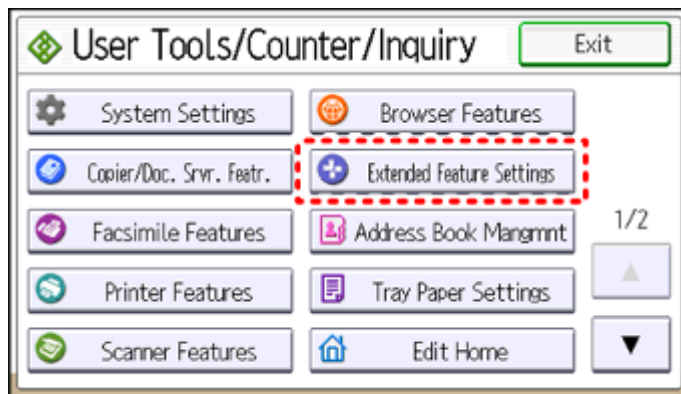

w_d1585058

4. Change the status of "Extended JS" to "Ending" in the Startup Settings tab.
5. Turn the main power switch OFF.
6. Insert the SD card containing the Extended JS firmware into SD slot 2 (lower).
7. Turn the main power switch on.
8. Push the [User Tools/Counter] key.
9. Touch "Extended Feature Settings" twice on the LCD.
10. Touch the "Install" tab.
11. Touch "SD card", then select "Extended JS" from the list of Extended Features.
12. Select "Machine HDD" as the "Install to" destination, then touch "Next".
13. Check the Extended Features information on the "Ready to Install" screen, then press "OK".
14. After "The following extended feature has already been installed. Are you sure you want to overwrite it?" is displayed, press "Yes".
15. Change the status of Extended JS to "waiting" in the Startup Settings tab.
16. Turn the main power switch OFF.
17. Remove the SD card from slot 2 (lower slot).
18. Turn the main power switch ON.

19. Press the “User Tools/Counter” key.
20. On the touch panel, touch “Extended Feature settings”.
21. Touch “Extended Feature settings” in the Extended Feature settings Menu.
22. Make sure that the “Extended JS” has been updated to the latest version in the Startup Settings tab.

2.8.7 UN-INSTALLING EXJS FIRMWARE

1. Turn the main power switch ON.
2. Push the [User Tools/Counter] key.
3. Login with an administrator user name and password.
4. Touch "Extended Feature Settings" twice on the LCD.
5. Touch “Uninstall”.
6. Touch “Browser”, and then touch “Yes” after “Are you sure you want to uninstall the following extended feature?” is displayed.

Note

- “Uninstalling the extended feature... Please wait” is then displayed on the touch screen.

7. After "Completed" is displayed, turn the main power switch OFF.

Note

- The Browser firmware is un-installed from the machine when the Browser SD card is removed.

2.9 XPS DIRECT PRINT OPTION TYPE M6

2.9.1 COMPONENT CHECK

No.	Description	Q'ty
1	SD Card: XPS	1
2	RoHS Decal	1
3	LABEL:ROHS:DATE:40MM	1

2.9.2 INSTALLATION PROCEDURE

⚠ CAUTION

- Unplug the main machine power cord before you do the following procedure.

1. Loosen the screw and remove the SD card slot cover at an angle.

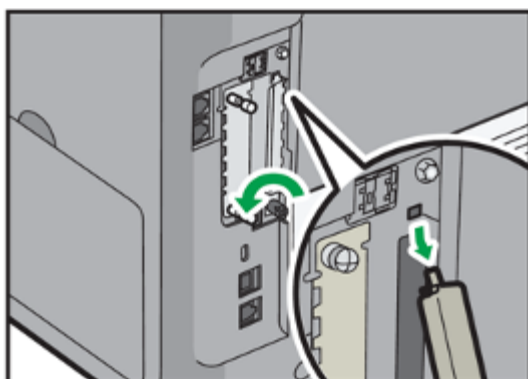

m1600265

2. Insert the SD card (XPS Direct Print) in SD slot 1 (upper). Then push it slowly until it clicks.

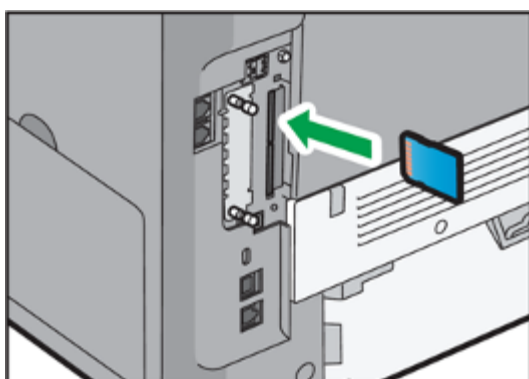

m1600266

3. Hook the SD card slot cover onto the opening, attach it flat against the controller board, and then fasten it using the screw.

4. **Plug in the power cord, and then turn on the machine.**
5. **Print the configuration page to confirm the installation (page 2-17 "Printing a Configuration Page").**

 **Note**

- Confirm that the XPS was correctly installed by printing the configuration page. If it is correctly installed, "XPS Menu" will appear on the configuration page.

2.10 VM CARD TYPE W

2.10.1 COMPONENT CHECK

No.	Description	Q'ty
1	SD Card: VM Card	1

2.10.2 INSTALLATION PROCEDURE

To install the VM card, Hard Disk Drive Option Type M6 and Memory Unit Type M1 must first be installed.

1. Press the [User Tools/Counter] key to display **System Settings>Timer Settings**, and then set [Sleep Mode Timer] to five minutes or longer.

This will prevent the machine from switching to the Sleep mode while installing Java™ Platform.

2. Turn off the main power, and then disconnect the power cord.
3. Loosen the screw and remove the SD card slot cover at an angle.

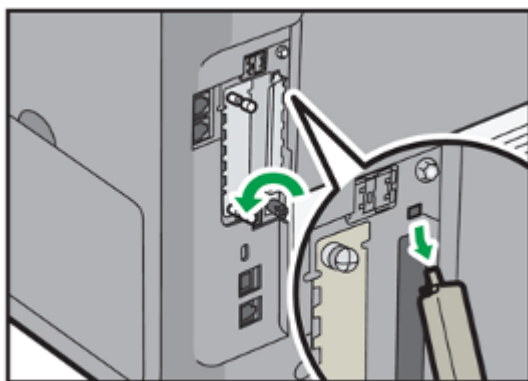

m1600265

4. Insert the SD card (VM Card) in SD slot 1 (upper). Then push it slowly until it clicks.

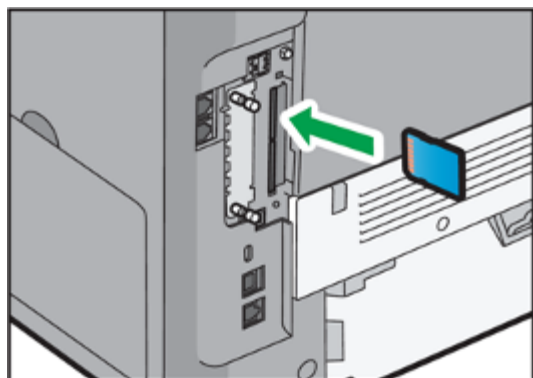

m1600266

5. Hook the SD card slot cover onto the opening, attach it flat against the controller board, and then fasten it using the screw.

6. Plug in the power cord, and then turn on the machine.

When you insert the SD card and turn the main power switch on, installation of Java™ Platform starts automatically. Automatic installation takes approximately three minutes.

★ Important

- If you turn the power off during installation, the VM card may be damaged. Be sure to check the following before turning the power off.

7. Press [User Tools/Counter] key, and then press [Extended Features].

If installation has completed correctly, [Java™ Platform] appears in the Extended Features menu.

8. Press [Exit] twice to exit from the Extended Features menu.

Operate the machine with the VM card installed in SD Card Slot 1 (upper).

★ Important

- If you have changed the [Sleep Mode Timer] setting in Step 1, change the setting back to the previous one once installation is complete.

2.11 OCR UNIT TYPE M2

With this option, you can add the Searchable PDF function to the scanning function. After installing the function on the hard disk from the SD card, remove the SD card.

2.11.1 COMPONENT CHECK

No.	Description	Q'ty
1	SD Card: OCR	1
2	Caution chart: EMC traceability (EU/AP only)	1
3	RoHS Decal (China only)	1
4	LABEL:ROHS: DATE:40MM (China only)	1

2.11.2 DETAILS ABOUT SEARCHABLE PDF

- Searchable PDF embeds the text information in the scanned document without processing the data on your computer.
If this option is installed:
 - You can search the text in the scanned document.
 - You can add extra text to the file name.
 - The orientation of the originals is detected, and the document is automatically rotated.
- The OCR unit is provided on an SD card. By installing the SD card on the main machine, the function key is added to the operation panel. You don't need to install the OCR unit on the computer.
- After installing the OCR unit, you can specify the settings of the searchable PDF function.
- The machine embeds the text information of the scanned document after scanning the originals (after the originals are ejected from the ARDF). Therefore, you can remove the originals from the exposure glass or ARDF.
- You can use other applications such as copy and printer while the machine embeds the text information of the scanned document.

2.11.3 INSTALLATION PROCEDURE

⚠ CAUTION

- Unplug the main machine power cord before you do the following procedure.

1. Loosen the screw and remove the SD card slot cover at an angle.

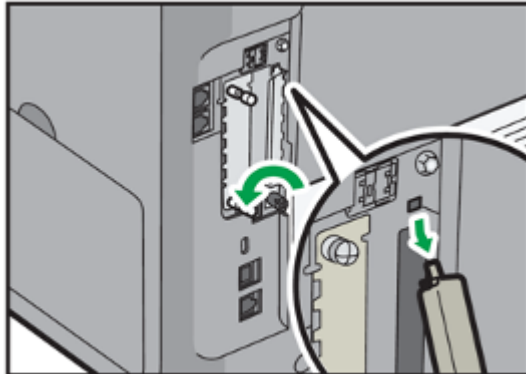

m1600265

2. Insert the SD card (OCR Unit) in SD slot 2 (lower). Then push it slowly until it clicks.

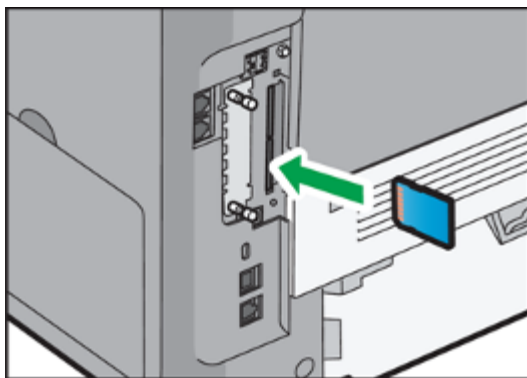

m1600286

3. Plug in the power cord, and then turn on the machine.
4. Go to SP 5-878-004 (Option Setup: OCR) and press [EXECUTE].

The SD card ID is recorded in NVRAM, and the machine ID of the main machine is recorded in the SD card.

5. When the display tells you that the execution is completed, press [Exit].

ⓘ Note

- If the execution failed, the display tells you that the execution failed.
- If the execution failed, do the following.
Check if the SD card is already used.
- Check whether the SD card has been used with another MFP (whether the OCR unit in the SD card has been installed in another MFP).
- Turn off the main power switch, and do steps 1 to 5 again.

6. Turn the main power switch off and on.
7. Go to SP 5-878-004 (Option Setup: OCR) and press [EXECUTE].

The OCR dictionary is copied to the HDD from the SD card.

Note

- SP 5-878-004 links the SD card and the machine in the first execution, and then copies the OCR dictionary to the HDD in the second execution.

8. Turn off the main power switch, and then remove the SD card from the SD card slot.
9. Re-attach the SD card slot cover.
10. Turn on the main power switch.
11. Press [Send Settings] on the [Scanner] screen.



w_m1608032

12. Press [File Type], and then press [PDF File Type].
13. Check if [OCR Settings] is displayed on the [PDF File Type] screen.

Note

- Keep the empty card in place by, for example, affixing it near the SD card slot with adhesive tape.
- You can switch the searchable PDF function on and off in the [OCR Settings] screen after installing the OCR unit.
- If you want to use the searchable PDF function, select [On] for [OCR Settings]. (Default: [Off])

Restoration Procedure

When you install the OCR Unit Type M2, the searchable PDF function is saved on the HDD and the SD card ID is saved in NVRAM.

Therefore, you need to re-install the OCR Unit Type M2 after replacing the HDD or NVRAM.

When the original SD card exists

- When you replace the HDD
Re-install the OCR Unit Type M2 from the original SD card.
- When you replace the NVRAM
If you upload / download the NVRAM data, re-install the OCR Unit Type M2 from the original SD card.
If you don't upload / download the NVRAM data, order a new SD card (service part) of the OCR Unit Type M2. Then re-install the OCR Unit Type M2 from the new SD card.
- When you replace the HDD and NVRAM at the same time
Re-install the OCR Unit Type M2 from the original SD card.

When the original SD card is lost

Order a new SD card (service part) of the OCR Unit Type M2, and then re-install from the new SD card.

Note

- When you re-install the OCR Unit Type M2, do the same procedure as the original installation procedure.

2.12 MEMORY UNIT TYPE M1 1.5GB

2.12.1 COMPONENT CHECK

No.	Description	Q'ty
1	SDRAM module	1
2	RoHS Decal 20MM	1
3	LABEL:ROHS:CHN:DATE:40MM	1

2.12.2 INSTALLATION PROCEDURE

⚠ CAUTION

- Unplug the main machine power cord before you do the following procedure.
- Before beginning work, ground yourself by touching something metal to discharge any static electricity. Static electricity can damage the memory unit.

1. Remove the memory cover.

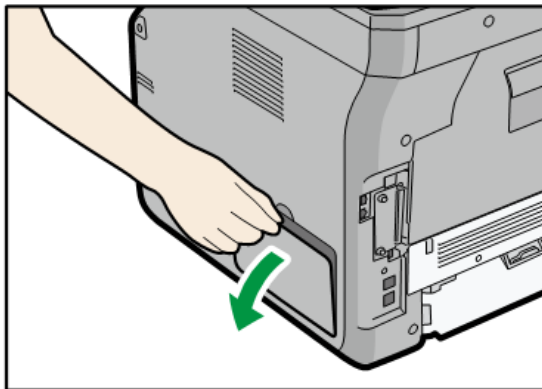

m1608009

2. Loosen the screw by using a coin, and then slide the inner cover towards the front to remove it.

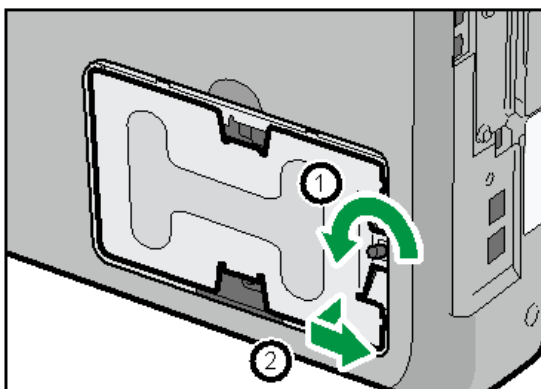

m1608010

3. Push the levers on both ends of the slot outward, and then remove the default module.

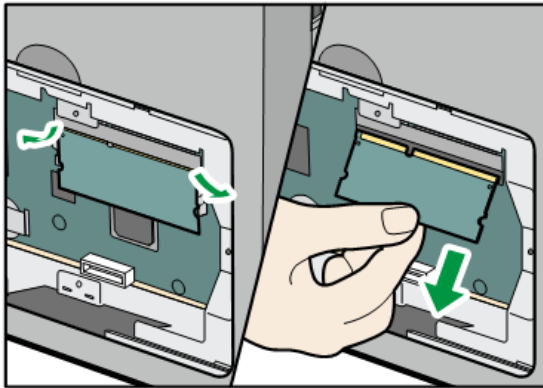

m1608011

4. To install the recommended memory, align the notch of the recommended memory with the protruding part of the vacant slot, and then carefully insert the module at an angle.

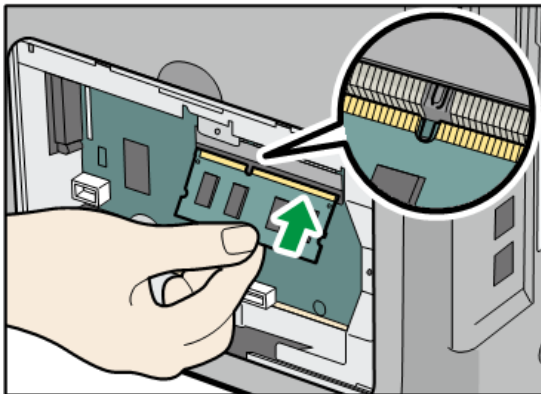

m1608020

5. Keeping the module at an angle, press it down until it clicks into place.

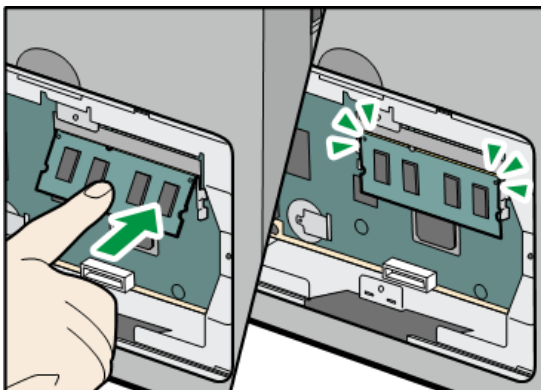

m1608012

6. When also installing the hard disk, install it before returning the inner cover to the machine.

For instructions about installing the hard disk, see page 2-51 "Hard Disk Drive Option Type M6".

7. Insert the two left protrusions of the inner cover, and then insert the two right protrusions into the notches on the machine.

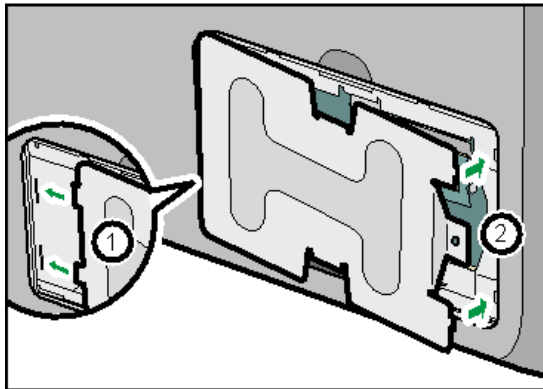

m1608019

8. Tighten the screw.

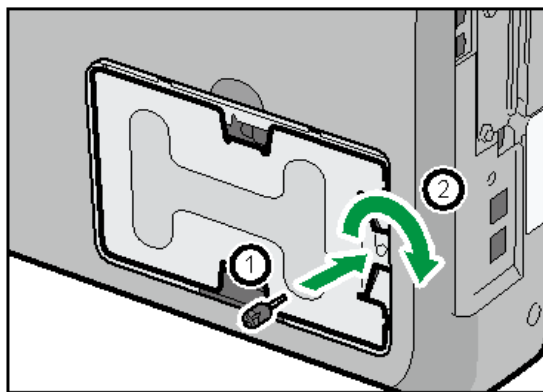

m1608013

9. Attach the memory cover.
10. Plug in the power cord, and then turn on the machine.
11. Print the configuration page to confirm the installation (page 2-17 "Printing a Configuration Page").

Note

- Confirm that the SDRAM module was correctly installed by printing the configuration page. Check that the total memory value is shown in "Total Memory" on the configuration page.

2.13 HARD DISK DRIVE OPTION TYPE M6

2.13.1 COMPONENT CHECK

No.	Description	Q'ty
1	Hard disk	1
2	CABLE:HDD:SATA:RED:102	1
3	CABLE:HDD:SATA:POWER_3P:70	1
4	KNOB SCREW:M3	2
-	SHEET:EMC:ADDRESS:TAI	1
-	DECAL:DOC:NA	1
-	DECAL:DOC:EU	1
-	DECAL:DOC:CHN	1
-	RoHS Decal	1
-	LABEL:ROHS:DATE:40MM	1

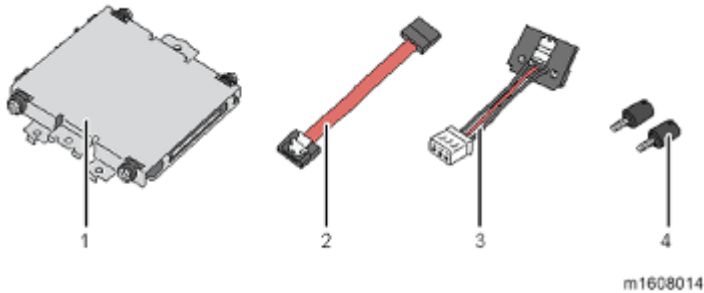

2.13.2 INSTALLATION PROCEDURE

Important

- Unplug the machine power cord before starting the following procedure.

1. Remove the memory cover.

Hard Disk Drive Option Type M6

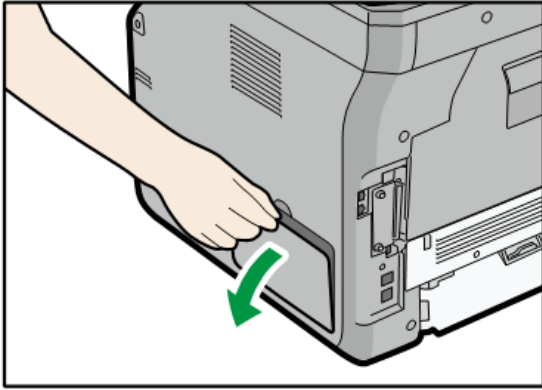

m1608009

2. Loosen the screw by using a coin, and then slide the inner cover towards the front to remove it.

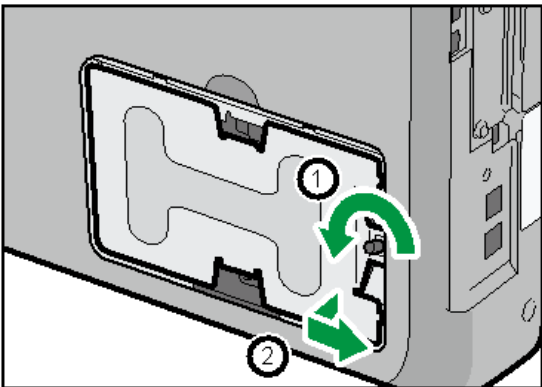

m1608010

3. Connect the flat cable and power cord to the hard disk.

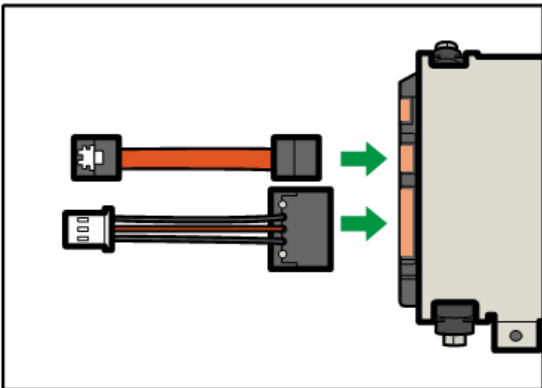

m1608018

4. Check the installation position of the hard disk.

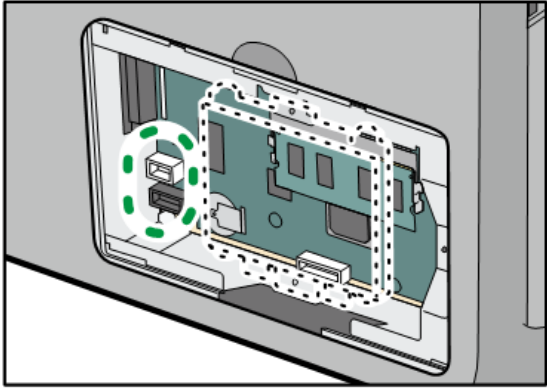

m1608015

5. Connect the flat cable and power cord to the board of the machine.

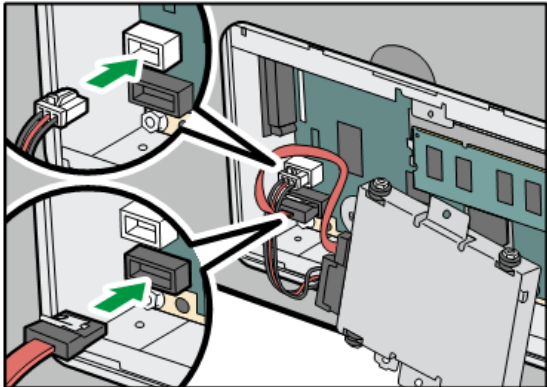

m1608016

6. Install the hard disk, and then fasten the hard disk to the machine with the screws.

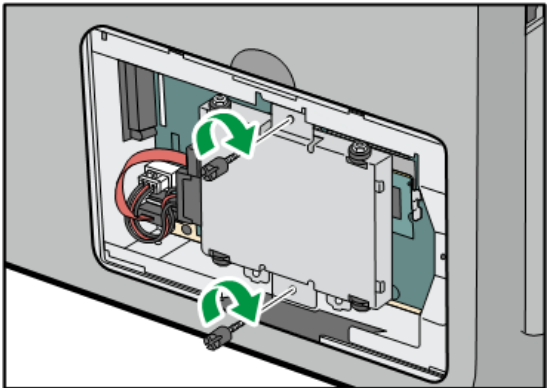

m1608017

7. Insert the two left protrusions of the inner cover, and then insert the two right protrusions into the notches on the machine.

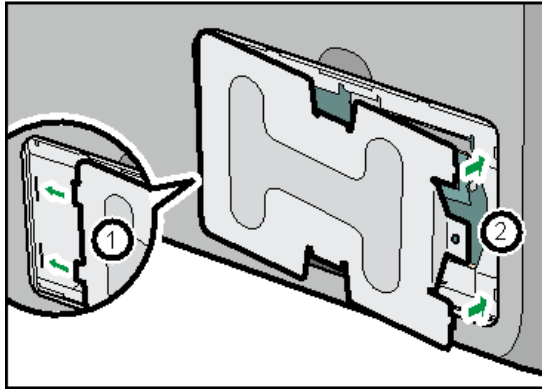

m1608019

8. Tighten the screw.

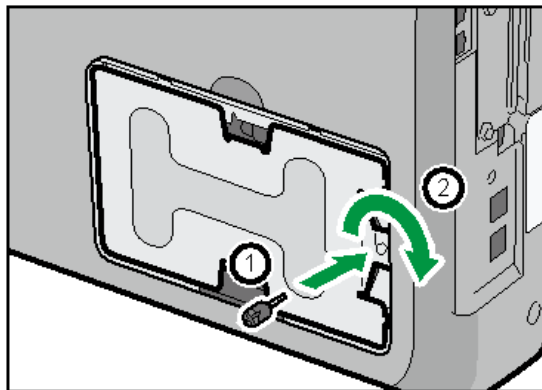

m1608013

9. Attach the memory cover.

10. Plug in the power cord, and then turn on the machine.

11. Print the configuration page to confirm the installation (page 2-17 "Printing a Configuration Page").

Note

- Confirm that the hard disk was correctly installed by printing the configuration page. If it is correctly installed, "Hard Disk" will appear for "Device Connection" on the configuration page.

2.14 FILE FORMAT CONVERTER TYPE E

2.14.1 COMPONENT CHECK

No.	Description	Q'ty
1	PCB Unit	1
2	RoHS Decal	1
3	LABEL:ROHS:CHN:DATE:40MM	1
4	SHEET:FCC:CLASS_B:VERIFICATION	1

2.14.2 INSTALLATION PROCEDURE

⚠ CAUTION

- Unplug the main machine power cord before you do the following procedure.
- Before beginning work, ground yourself by touching something metal to discharge any static electricity. Static electricity can damage the file format converter.

1. Loosen the two screws and remove the slot cover.

The removed cover will not be reused.

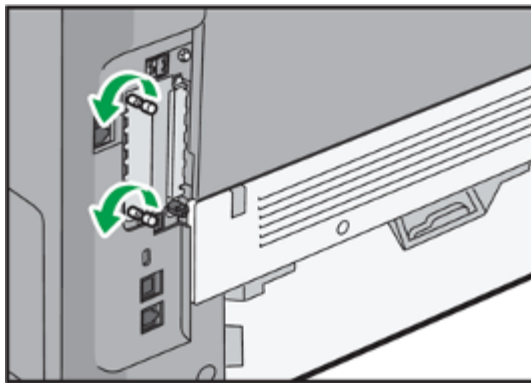

2. Fully insert the file format converter.

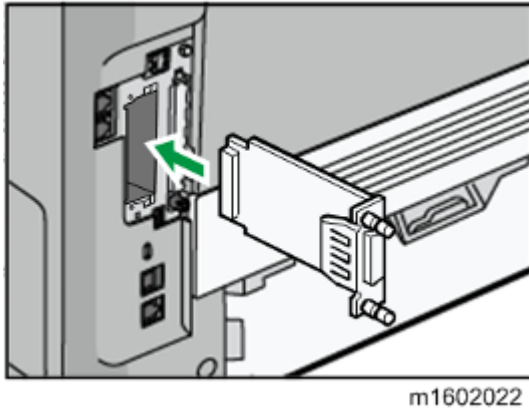

3. Tighten the two screws to secure the file format converter.
4. Plug in the power cord, and then turn on the machine.
5. Check or set the following SP codes with the values shown below.

SP No.	Title	Setting
SP5-836-001	Capture Function (0:Off 1:On)	"1"
SP5-836-002	Panel Setting	"0"

6. Press the [User Tools/Counter] key. In System Settings>Administrator Tools, check that [Capture Priority] appears.

2.15 IEEE 1284 INTERFACE BOARD TYPE A

2.15.1 COMPONENT CHECK

No.	Description	Q'ty
1	PCB Unit	1
2	SHEET:UL:PERMISSION	1
3	SHEET:FCCDOC:IEEE1284(TYPE_A)	1
4	RoHS Decal	1
5	RoHS Sheet	1
6	LABEL:ROHS:DATE:40MM	1
7	CAUTION CHART:INSTALLATION PROCEDURE:14LANGUAGES	1

2.15.2 INSTALLATION PROCEDURE

⚠ CAUTION

- Unplug the main machine power cord before you do the following procedure.
- Before beginning work, ground yourself by touching something metal to discharge any static electricity. Static electricity can damage the interface board.

You can only install one of the following network interfaces at a time: (IEEE 802.11 a/b/g/n (Wireless LAN), IEEE1284)

1. Loosen the two screws and remove the slot cover.

The removed cover will not be reused.

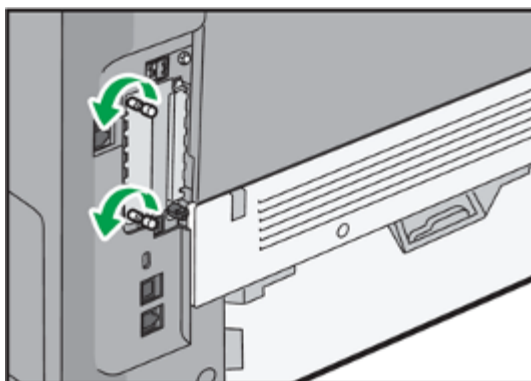

m1600267

2. Fully insert the IEEE 1284 I/F board.

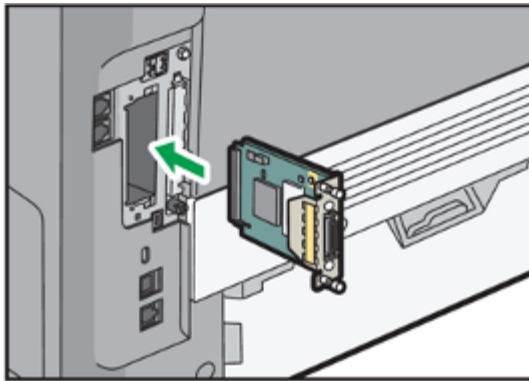

m1600268

- 3. Tighten the two screws to secure the board.**
- 4. Plug in the power cord, and then turn on the machine.**
- 5. Print the configuration page to confirm that the board was attached correctly (page 2-17 "Printing a Configuration Page").**

Note

- Confirm that the IEEE 1284 I/F board was correctly installed by printing the configuration page. If it is correctly installed, "Parallel Interface" will appear for "Device Connection" on the configuration page.

2.16 IEEE802.11 INTERFACE UNIT TYPE O

2.16.1 COMPONENT CHECK

No.	Description	Q'ty
1	PCB Unit	1
2	SHEET:CEDOC:W-LAN	1
3	SHEET:CAUTION CHART:W-LAN:AUS:NZL	1
4	SHEET:CAUTION CHART:W-LAN:CAN	1
5	SHEET:CAUTION CHART:USERS:W-LAN	1
6	SHEET:CAUTION CHART:W-LAN:GB	1
7	INSTALLATION SUB PROCEDURE:WL:EU	1
8	SHEET:FCCDOC:W-LAN:R-CMN-851	1

2.16.2 INSTALLATION PROCEDURE

⚠ CAUTION

- Unplug the main machine power cord before you do the following procedure.
- Before beginning work, ground yourself by touching something metal to discharge any static electricity. Static electricity can damage the interface unit.

You can only install one of the following network interfaces at a time: (IEEE 802.11 a/b/g/n (Wireless LAN), IEEE1284)

1. Loosen the two screws and remove the slot cover.

The removed cover will not be reused.

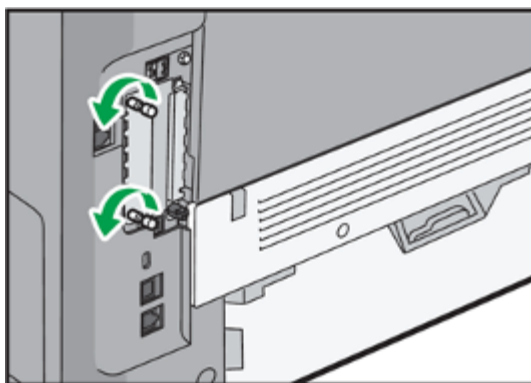

m1600267

2. Fully insert the Wireless LAN board.

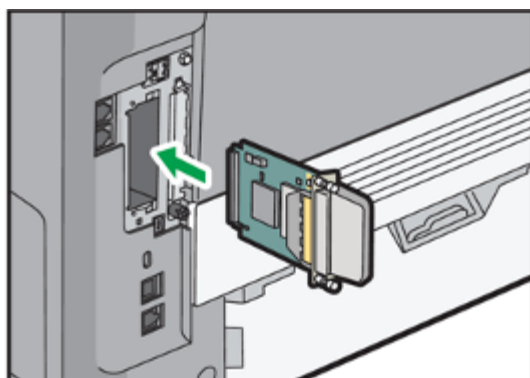

m1600269

- 3. Tighten the two screws to secure the board.**
- 4. Plug in the power cord, and then turn on the machine.**
- 5. Print the configuration page to confirm that the board was attached correctly (page 2-17 "Printing a Configuration Page").**

Note

- Confirm that the Wireless LAN board was correctly installed by printing the configuration page. If it is correctly installed, "Wireless LAN" will appear for "Device Connection" on the configuration page.
- You may have to move the machine if the reception is not clear.
- Make sure that the machine is not located near an appliance or any type of equipment that generates strong magnetic fields.
- Install the machine as close as possible to the access point.

2.16.3 UP MODE SETTINGS FOR WIRELESS LAN

Enter the UP mode. Then do the procedure below to perform the initial interface settings for IEEE 802.11 a/b/g/n. These settings take effect every time the machine is powered on.

Note

- You cannot use the wireless LAN if you use Ethernet.

- 1. Press the [User Tools/Counter] key.**
- 2. On the touch panel, press [System Settings].**

Note

- Select "Interface Settings"> "Network" > "LAN Type". The "LAN Type" (default: Ethernet) must be set for either Ethernet or wireless LAN.

- 3. Select [Interface Settings].**
- 4. Press "Wireless LAN". Only the wireless LAN options show.**
- 5. Press "Communication Mode". Select either "802.11 Ad-Hoc Mode", or "Infrastructure Mode".**
- 6. Press "SSID Setting". Enter the SSID setting. (The setting is case sensitive.)**
- 7. Press "Ad-HocChannel". You need this setting when Ad Hoc Mode is selected.**

Region A (mainly Europe and Asia)

Range: 1-13, 36, 40, 44 and 48 channels (default: 11)

In some countries, only the following channels are available:

Range: 1-11 channels (default: 11)

Region B (mainly North America)

Range: 1-11, 36, 40, 44 and 48 channels (default: 11)

8. Set the "Security Method" to specify the encryption of the Wireless LAN.

- The "WEP" (Wired Equivalent Privacy) setting is designed to protect wireless data transmission. The same WEP key is required on the receiving side in order to unlock encoded data. There are 64 bit and 128 bit WEP keys.

- Range of Allowed Settings:

64 bit: 10 characters

128 bit: 26 characters

- Specify "WPA2" when "Communication Mode" is set to "Infrastructure Mode". Set the "WPA2 Authent. Method".

- WPA2 Authent. Method:

Select either "WPA2-PSK" or "WPA2".

If you select "WPA2-PSK", enter the pre-shared key (PSK) of 8-63 characters in ASCII code.

When "WPA2" is selected, authentication settings and certificate installation settings are required.

9. Press "Wireless LAN Signal" to check the machine's radio wave status using the operation panel.

You can check the status only if [Communication Mode] is set to [Infrastructure Mode].

10. Press "Restore Factory Defaults" to initialize the wireless LAN settings.

2.16.4 SP MODE AND UP MODE SETTINGS FOR IEEE 802.11 A/B/G/N, WIRELESS LAN

The following SP commands and UP modes can be set for IEEE 802.11 a/b/g/n.

SP No.	Name	Function
5840-006	Channel MAX	Sets the maximum range of the channel settings for the country.
5840-007	Channel MIN	Sets the minimum range of the channels settings allowed for your country.
5840-011	WEP Key Select	Used to select the WEP key (Default: 00).
UP mode	SSID	Used to confirm the current SSID setting.
	WEP Key	Used to confirm the current WEP key setting.
	WEP Mode	Used to show the maximum length of the string that can be used for the WEP Key entry.
	WPA2 Authent. Method	Used to confirm the current WPA authentication setting and preshared key.

2.17 BLUETOOTH INTERFACE UNIT TYPE D

2.17.1 COMPONENT CHECK

No.	Description	Q'ty
1	Bluetooth Module	1
2	CD-ROM	1
3	SHEET:CAUTION CHART: BLUETOOTH:EXP	1
4	SHEET:FCCDOC:BLUETOOTH	1
5	CAUTION CHART:CE:BLUETOOTH	1

2.17.2 INSTALLATION PROCEDURE

⚠ CAUTION

- Unplug the main machine power cord before you do the following procedure.
- Do not remove the Bluetooth unit while the power of the machine is on.

You can only install one of the following network interfaces at a time: (IEEE a/b/g/n (Wireless LAN), Bluetooth).

1. Insert the Bluetooth Interface adapter into the USB connector .

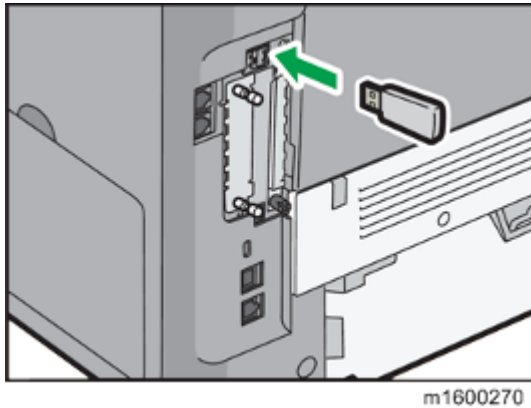

2. Plug in the power cord, and then turn on the machine.
3. Print the configuration page to confirm the installation (page 2-17 "Printing a Configuration Page").

ⓘ Note

- Confirm that the Bluetooth interface unit was correctly installed by printing the configuration page. If it is correctly installed, "Bluetooth" will appear for "Device Connection" on the configuration page.

2.18 COPY DATA SECURITY UNIT TYPE G

2.18.1 COMPONENT CHECK

No.	Description	Q'ty	For this model
1	ICIB-3	1	Yes
2	BRACKET:ICIB	1	Yes
3	Screw – M3 x 6	4	Yes
4	BRACKET	1	Not used
5	Screw – M3 x 4	2	Yes
-	Tapping screw – M3 x 8	2	Not used
-	RoHS Decal	1	Yes
-	LABEL:ROHS:DATE:40MM	1	Yes



d1822216

2.18.2 INSTALLATION PROCEDURE

⚠ CAUTION

- Unplug the main machine power cord before you do the following procedure.

1. Attach bracket [A] to the ICIB-3 [B] (M3 x 4;  x 2).



2. Right Cover (page 4-8 "

Right Cover")

3. Mount Copy Data Security Unit [A] on the BICU board with the connector on the upper right part aligned (M3 x 6;  x 2).

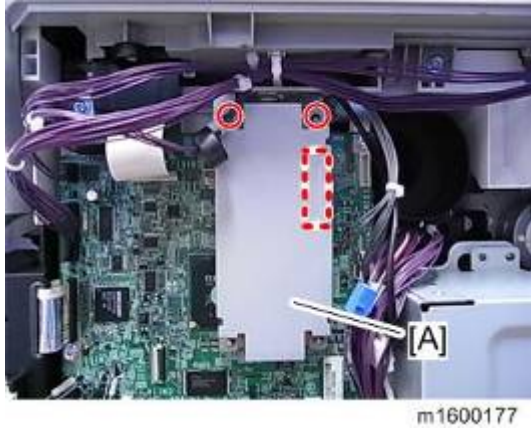

Installation

2.18.3 USER TOOL SETTING

1. Plug in, and turn the main power switch on.
2. Go into the User Tools mode, and select **System Settings > Administrator Tools > Detect Data Security for Copying > "On"**.
3. Exit the User Tools.

 **Note**

- The machine will issue an SC165 error if the machine is powered on with the ICIB-1 removed and the "Detect Data Security for Copying" feature is set to "On".
- When you remove this option from the machine, first set the setting to "OFF" with the user tool before removing this board. If you forget to do this, "Detect Data Security for Copying" feature cannot appear in the user tool settings. And then SC165 will appear every time the machine is switched on, and the machine cannot be used.

2.19 DATA OVERWRITE SECURITY UNIT TYPE I

2.19.1 OVERVIEW

This option should be installed only for the customer who requires the **CC certified Data Overwrite Security function**.

The function of this option is completely the same as the Data Overwrite Security in Security Functions, which is standard on this machine.

2.19.2 COMPONENT LIST

Check the quantity and condition of the accessories in the box against the following list.

No.	Description	Q'ty
1.	SD Card	1

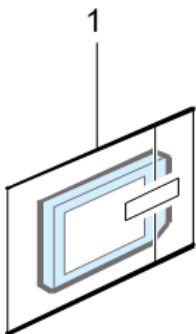

d1351921

2.19.3 BEFORE YOU BEGIN THE PROCEDURE

1. Confirm that the Data Overwrite Security unit SD card is the correct type for the machine. The correct type for this machine is **"Type I"**.

★ Important

- If you install any version other than **"Type I"**, you will have to replace the NVRAM and do this installation procedure again.

2. Make sure that the following settings are not at their factory default values:
 - Supervisor login password
 - Administrator login name
 - Administrator login password

If any of these settings is at a factory default value, tell the customer these settings must be changed before you do the installation procedure.

3. Make sure that "Machine Management" is on.

[System Settings] -> [Administrator Tools] -> [Administrator Authentication Management] -> [Machine Management] -> [On]

If this setting is OFF, tell the customer this setting must be ON before you do the installation procedure.

4. Make sure that "Administrator Tools" is enabled (selected).

[System Settings] -> [Administrator Tools] -> [Administrator Authentication Management] -> [Machine Management] -> [On] -> [Select available settings]

If this setting is disabled (not selected), tell the customer this setting must be enabled (selected) before you do the installation procedure.

Seal Check and Removal

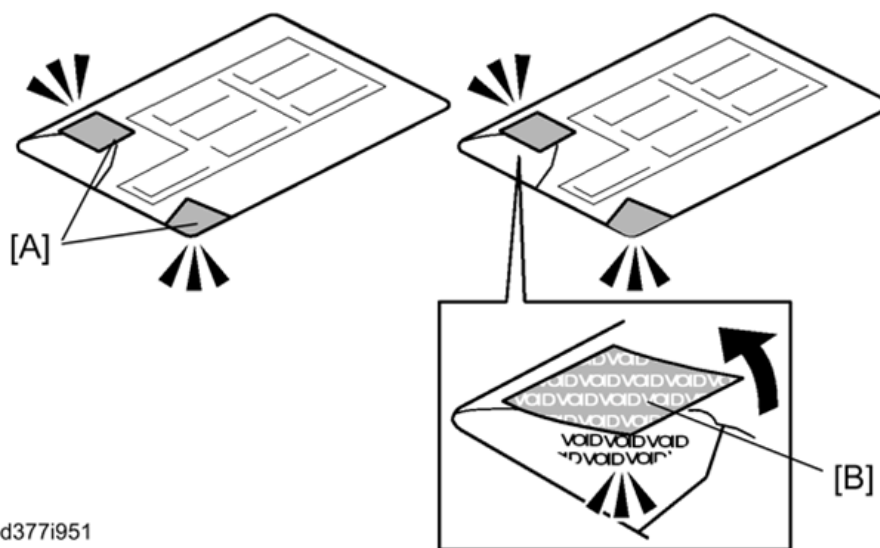

d377i951

⚠ CAUTION

- You must check the box seals to make sure that they were not removed after the items were sealed in the box at the factory before you do the installation.
1. Check the box seals [A] on each corner of the box.
 - Make sure that a tape is attached to each corner.
 - The surfaces of the tapes must be blank. If you see "VOID" on the tapes, do not install the components in the box.
 2. If the surfaces of the tapes do not show "VOID", remove them from the corners of the box.
 3. You can see the "VOID" marks [B] when you remove each seal. In this condition, they cannot be attached to the box again.

2.19.4 INSTALLATION PROCEDURE

1. Insert the SD card (DataOverwriteSecurity Unit) in SD slot 1 (upper) [A] with its label face towards the front of the machine. Then push it slowly into SD slot 1 (upper) until you hear a click.



2. Install the application using SP5-878-001.

2.20 SECURITY SETTINGS

2.20.1 SECURITY FUNCTION INSTALLATION

The machine contains the Security functions (Data Overwrite Security and HDD Encryption unit) in the controller board.

If you are installing a new machine, it is recommended to activate the Data Overwrite Security and HDD Encryption by selecting "Format All Data" from "System Settings" on the operation panel.

Note

- This method is recommended because there is no user data on the hard drive yet (Address Book data, image data, etc.).

If the customer wishes to activate the Data Overwrite Security and HDD Encryption unit on a machine that is already running, it is recommended to activate the unit by selecting "All Data" from "System Settings" on the operation panel.

Important

- **Selecting "All Data" will preserve the data that has already been saved to the hard drive. (If "Format All Data" is selected, all user data saved to the hard drive up to that point will be erased).**

Immediately after encryption is enabled, the encryption setting process will take several minutes to complete before you can begin using the machine.

Note

- If encryption is enabled after data has been stored on the disk, or if the encryption key is changed, this process can take up to three and a half hours or more.

The machine cannot be operated while data is being encrypted.

Once the encryption process begins, it cannot be stopped.

Make sure that the machine's main power is not turned off while the encryption process is in progress.

If the machine's main power is turned off while the encryption process is in progress, the hard disk will be damaged and all data on it will be unusable.

Print the encryption key and keep the encryption key (which is printed as a paper sheet).

Keep the encryption key in a safe place. If the encryption key is lost and is needed, the controller board, hard disk and NVRAM must all be replaced at the same time.

Note

- "NVRAM" mentioned in here means the NVRAM on the Controller Board.
- "NVRAM" or EEPROM on the BCU has nothing to do with this.

Please use the following procedure when the Data Overwrite Security and HDD Encryption are reinstalled.

2.20.2 DATA OVERWRITE SECURITY

Before You Begin the Procedure

1. Make sure that the following settings (1) to (3) are not at their factory default values.
 - (1) Supervisor login password
 - (2) Administrator login name
 - (3) Administrator login password

If any of these settings is at a factory default value, tell the customer these settings must be changed before you do the installation procedure.
2. Make sure that "Machine Management" is on.

[User Tools/Counter] key -> [System Settings] -> [Administrator Tools] -> [Administrator Authentication Management] -> [Machine Management] -> [On]

If this setting is off, tell the customer this setting must be on before you do the installation procedure.
3. Make sure that "Administrator Tools" is enabled (selected).

[User Tools/Counter] key -> [System Settings] -> [Administrator Tools] -> [Administrator Authentication Management] -> [Machine Management] -> [On] -> [Select available settings] -> [Administrator Tools]

If this setting is disabled (not selected), tell the customer this setting must be enabled (selected) before you do the installation procedure.

Installation Procedure

1. Connect the network cable if it needs to be connected.
2. Turn on the main power switch.
3. Go into the SP mode and push "EXECUTE" in SP5-878-001.
4. Exit the SP mode and turn off the main power switch.
5. Turn on the machine power.
6. Do SP5-990-005 (SP print mode Diagnostic Report).
7. Go into the User Tools mode, and select [System Settings] - [Administrator Tools] - [Auto Erase Memory Setting] - [On].
8. Exit the User Tools mode.

Using Auto Erase Memory

The Auto Erase Memory function can be enabled by the following procedure.

1. Log in as the machine administrator from the control panel.
2. Press [System Settings].
3. Press [Administrator Tools].
4. Press [▼] to display Page 9.
5. Press [Auto Erase Memory Setting].

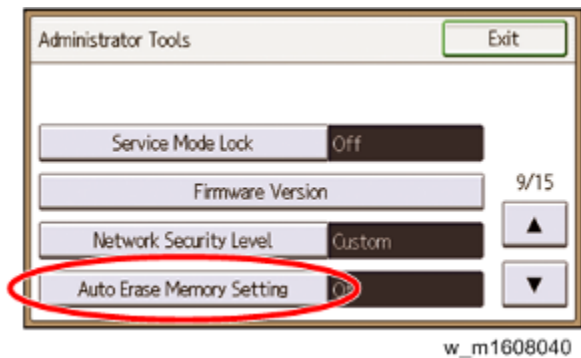



6. Press [On].
7. Select the method of overwriting.
If you select [NSA] or [DoD], proceed to step 10.
If you select [Random Numbers], proceed to step 8.
8. Enter the number of times that you want to overwrite using the number keys, and then press [#].
9. Press [OK]. Auto Erase Memory is set.
10. Log out.
11. Check the display and make sure that the overwrite erase icon appears.
12. Check the overwrite erase icon.

The icon [1] is lit when there is temporary data to be overwritten, and blinks during overwriting.

The icon [2] is lit when there is no temporary data to be overwritten.



	Icon [1]	This icon is lit when there is temporary data to be overwritten, and blinks during overwriting.
	Icon [2]	This icon is lit when there is no temporary data to be overwritten.

2.20.3 HDD ENCRYPTION

Before You Begin the Procedure:

1. Make sure that the following settings (1) to (3) are not at the factory default settings.
 - (1) Supervisor login password
 - (2) Administrator login name
 - (3) Administrator login password

These settings must be set up by the customer before the HDD Encryption unit can be installed.
2. Make sure that "Machine Management" is on.

[User Tools/Counter] key -> [System Settings] -> [Administrator Tools] -> [Administrator Authentication Management] -> [Machine Management] -> [On]

If this setting is off, tell the customer this setting must be on before you do the installation procedure.
3. Make sure that "Administrator Tools" is enabled (selected).

[User Tools/Counter] key -> [System Settings] -> [Administrator Tools] -> [Administrator Authentication Management] -> [Machine Management] -> [On] -> [Select available settings] -> [Administrator Tools]

If this setting is disabled (not selected), tell the customer this setting must be enabled (selected) before you do the installation procedure.

Installation Procedure

1. Turn on the main power switch, and then enter the SP mode.
2. Select SP5878-002, and then press "Execute" on the LCD.
3. Exit the SP mode after "Completed" is displayed on the LCD.
4. Turn off the main power switch.

Enable Encryption Setting

Machine Data Encryption Settings can be enabled by the following procedure.

★ Important

- When setting up encryption, specify whether to start encryption after deleting data (initialize) or encrypt and retain existing data. If data is retained, it may take some time to encrypt it.

1. Log in as the machine administrator from the control panel.
2. Press [System Settings].
3. Press [Administrator Tools].
4. Press [▼] to display Page 11.
5. Press [Machine Data Encryption Settings].

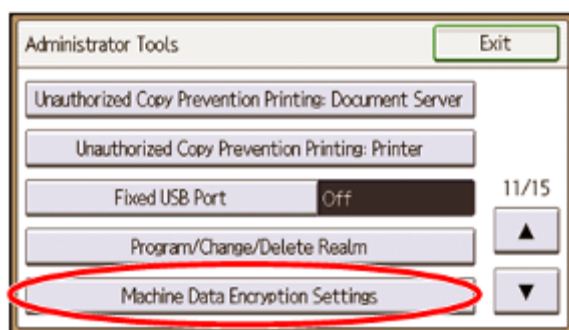

w_m1608042

6. Press [Encrypt].

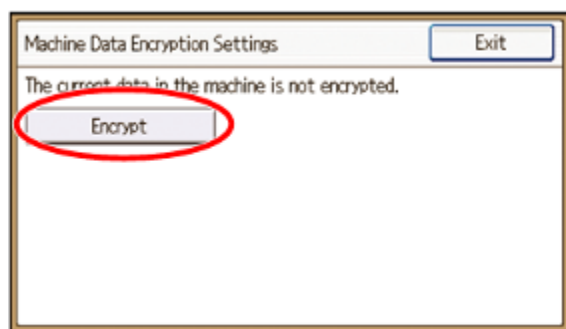

w_m1608043

7. Select the data to be carried over to the hard disk and not be reset.
To carry all of the data over to the hard disk, select [All Data].
To carry over only the machine settings data, select [File System Data Only].
To reset all of the data, select [Format All Data].
8. Select the backup method.
If you have selected [Save to SD], load an SD card into the media slot on the side of the control panel and press [OK] to back up the machine's data encryption key.
If you have selected [Print on Ppr], press the [Start] key. Print out the machine's data encryption key.

9. Press [OK].
10. Press [Exit].
11. Press [Exit]
12. Log out.
13. Turn off the main power switch, and then turn the main power switch back on.
The machine will start to convert the data on the memory after you turn on the machine. Wait until the message "Memory conversion complete. Turn the main power switch off." appears, and then turn the main power switches off again.

Check the Encryption Settings

1. Press the [User Tools/Counter] key.
2. Press [System Settings].
3. Press [Administrator Tools].
4. Press [Machine Data Encryption Settings].
5. If the following message appears, the encryption settings have been enabled.
"The data in the machine has been encrypted. Select item."

Backing Up the Encryption Key

The encryption key can be backed up. Select whether to save it to an SD card or to print it.

★ Important

- The encryption key is required for data recovery if the machine malfunctions. Be sure to store the encryption key safely for retrieving backup data.

1. Log in as the machine administrator from the control panel.
2. Press [System Settings].
3. Press [Administrator Tools].
4. Press [▼] to display Page 11.
5. Press [Machine Data Encryption Settings].
6. Press [Print Encryption Key].
7. Select the backup method.

If you have selected [Save to SD], load an SD card into the media slot on the side of the control panel and press [OK]; once the machine's data encryption key is backed up, press [Exit].

If you have selected [Print on Ppr], press the [Start] key. Print out the machine's data encryption key.

8. Press [Exit].
9. Log out.

Encryption Key Restoration

How to restore the old encryption key to the machine

The following message appears after the controller board is replaced. In such a case, it is necessary to restore the encryption key to the new controller board.

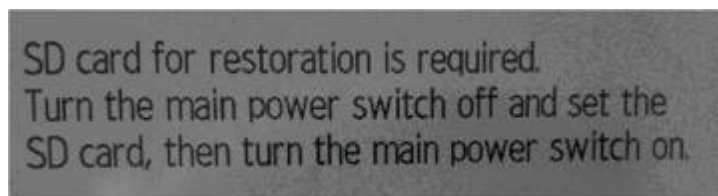

d1420101

To do this, follow the procedure below.

1. Prepare an SD card that has been initialized in FAT16 format.
2. Using a PC, create a folder in the SD card and name it "restore_key".
3. Create a folder in the "restore_key" folder and name it the same as machine's serial number, "xxxxxxxxxxx" (11 digits).
4. Create a text file called "key_xxxxxxxxxx.txt" and save it in the "xxxxxxxxxxx" folder.
Write the encryption key in the text file.

/restore_key/xxxxxxxxxxx/key_xxxxxxxxxx.txt

Note

- Ask an Administrator to enter the encryption key. The key has already been printed out by the user and may have been saved in the "key_xxxxxxxxxx.txt" file. (The function of back-up the encryption key to the SD card directly is provided 11A products or later.)
5. Turn on the machine's main power switch.
 6. Confirm that a message is displayed on the LCD telling to insert the SD card that contains the encryption key.
 7. Turn off the main power switch.
 8. Insert the SD card that contains the encryption key into Slot 2 (the lower slot).
 9. Turn on the main power switch.

Note

- The machine will automatically restore the encryption key to the flash memory on the controller board.
10. Turn off the main power switch when the machine has returned to normal status.
 11. Remove the SD card from Slot 2.

How to do a forced start up with no encryption key

If the encryption key back-up has been lost, follow the procedure below to do a forced start-up.

★ Important

- The HDD will be formatted after the forced start-up.
- Encrypted data will be deleted.
- User settings will be cleared.

1. Prepare an SD card.
2. Create a directory named "restore_key" inside the root directory of the SD card. Then, save the "nvram_key.txt" file using the following name:
/restore_key/nvram_key.txt
3. Create a text file and write "nvclear".

★ Important

- Write this string at the head of the file.
 - Use all lower-case letters.
 - Do not use quotation marks or blank spaces.
 - It is judged that a forced start has been selected when the content of "nvclear" is executed and the machine shifts to the alternate system (forced start).
4. Confirm that a message is displayed on the LCD telling to insert the SD card that contains the encryption key.
 5. Turn off the main power switch.
 6. Insert the SD card that contains the encryption key into Slot 2 (the lower slot).
 7. Turn on the main power switch.
 8. Turn on the main power switch, the machine automatically clear the HDD encryption.
 9. Turn off the main power switch when the machine has returned to normal status.
 10. Remove the SD card from Slot 2.
 11. Turn on the main power switch.
 12. Memory clear SP5-801-xx (Exclude SP-5-801-001: All Clear and SP-5-801-002: Engine), and clear SP5-846-046: address book.
 13. Set necessary user settings in User Tools key.

2.21 SETTINGS FOR @REMOTE SERVICE

Note

- Prepare and check the following check points before you visit the customer site. For details, ask the @Remote key person.

2.21.1 CHECK POINTS BEFORE MAKING @REMOTE SETTINGS

1. **The setting of SP5816-201 in the mainframe must be "0".**
2. **Print the SMC with SP5990-002 and then check if a device ID2 (SP5811-003) must be correctly programmed.**
 - 6 spaces must be put between the 3-digit prefix and the following 8-digit number (e.g. xxx____xxx).
xxx____xxx).
3. **The following settings must be correctly programmed.**
4. **If a proxy server is available, configure the following SP settings.**
 - Use Proxy (SP5816-062) Set to "1: Enable".
 - Proxy server IP address (SP5816-063)
 - Proxy server Port number (SP5816-064)
 - Proxy User ID (SP5816-065)
 - Proxy Password (SP5816-066)
5. **Get a Request Number**

2.21.2 EXECUTE THE @REMOTE SETTINGS

1. Enter the SP mode.
2. Input the Request number which you have obtained from @Remote Center GUI, and then enter [OK] with SP5816-202.
3. Confirm the Request number, and then click [EXECUTE] with SP5816-203.
4. Check the confirmation result with SP5816-204.

Value	Meaning	Solution/ Workaround
0	Succeeded	-
3	Communication error (proxy enabled)	Check the network condition.
4	Communication error (proxy disabled)	Check the network condition.
5	Proxy error (Illegal user name or password)	Check Proxy user name and password.
6	Communication error	Check the network condition.
8	Other error	See "SP5816-208 Error Codes" below this.
9	Request number confirmation executing	Processing... Please wait.
11	Request number error (Data is already registered under this number.)	Check the request number again.
12	Request number error (invalid parameter)	Check the request number again.

5. Make sure that the screen displays the Location Information with SP5816-205 only when it has been input at the Center GUI.
6. Click [EXECUTE] to execute the registration with SP5816-206.
7. Check the registration result with SP5816-207.

Value	Meaning	Solution/ Workaround
0	Succeeded	-
2	Already registered	Check the registration status.
3	Communication error (proxy enabled)	Check the network condition.
4	Communication error (proxy disabled)	Check the network condition.
5	Proxy error (Illegal user name or password)	Check Proxy user name and password.
8	Other error	See "SP5816-208 Error Codes" below this.
9	Request number confirmation executing	Processing... Please wait.
10	Request number error (The applicable device was not registered when moving the machine was requested.)	-
11	Request number error (Data is already registered under this number.)	Check the request number again.
12	Request number error (invalid parameter)	Check the request number again.

8. Exit the SP mode.

SP5816-208 Error Codes

Cause	Code	Meaning	Solution/ Workaround
Operation Error, Incorrect Setting	-12002	Inquiry, registration attempted without acquiring Request No.	Obtain a Request Number before attempting the Inquiry or Registration.

Cause	Code	Meaning	Solution/ Workaround
	-12003	Attempted registration without execution of a confirmation and no previous registration.	Perform Confirmation before attempting the Registration.
	-12004	Attempted setting with illegal entries for certification and ID2.	Check ID2 of the mainframe.
	-12005	@Remote communication is prohibited. The device has an Embedded RC gate-related problem.	Make sure that "Remote Service" in User Tools is set to "Do not prohibit".
	-12006	A confirmation request was made after the confirmation had been already completed.	Execute registration.
	-12007	The request number used at registration was different from the one used at confirmation.	Check Request No.
	-12008	Update certification failed because mainframe was in use.	Check the mainframe condition. If the mainframe is in use, try again later.
	-12009	The ID2 in the NVRAM does not match the ID2 in the individual certification.	Check ID2 of the mainframe.
	-12010	The certification area is not initialized.	Initialize the certification area.
Error Caused by Response from GW URL	-2385	Other error	
	-2387	Not supported at the Service Center	
	-2389	Database out of service	
	-2390	Program out of service	

Settings for @Remote Service

Cause	Code	Meaning	Solution/ Workaround
	-2391	Two registrations for the same mainframe	Check the registration condition of the mainframe
	-2392	Parameter error	
	-2393	External RCG not managed	
	-2394	Mainframe not managed	
	-2395	Box ID for external RCG is illegal.	
	-2396	Mainframe ID for external RCG is illegal.	
	-2397	Incorrect ID2 format	Check the ID2 of the mainframe.
	-2398	Incorrect request number format	Check the Request No.

PREVENTIVE MAINTENANCE

REVISION HISTORY		
Page	Date	Added/Updated/New
		None

3. PREVENTIVE MAINTENANCE

3.1 PREVENTIVE MAINTENANCE TABLES

See "Appendices" for the following information:

- Preventive Maintenance

3.2 IMAGE QUALITY STANDARDS

Engine

Item	Specification	Remarks
Assured Image Area	Leading edge: 4.3 mm Left/Right: 4.3 mm Trailing edge: 4.3 mm	Envelopes Leading edge: 15 mm Left/Right: 10 mm Trailing edge: 15 mm
Magnification Error	± 0.75% or less	Not applicable to the back of the paper when performing duplex printing.
Perpendicularity	± 0.7 mm/100 mm	
Linearity	± 0.25 mm/100 mm	
Parallelism	In an office environment: ± 1.0mm or less In other environments: ± 1.5mm or less	

Copy

Item	Specification	Remarks
Resolution	100%/Enlargement: Min 3.6 lines/mm or more Reduction: Min 3.6 × M lines /mm or more	Not applicable when using the ARDF
Assured Image Area	Leading edge: 4.3 mm Left/Right: 4.3 mm Trailing edge: 4.3 mm	Envelopes Leading edge: 15 mm Left/Right: 10 mm Trailing edge: 15 mm

Item	Specification	Remarks
Magnification Error	<ul style="list-style-type: none"> ▪ 100% Main: $\pm 1.25\%$ or less Sub: $\pm 1.25\%$ or less ▪ Reduced-size Both: $\pm 1.25\%$ or less ▪ Enlarged-size Both: $\pm 1.25\%$ or less 	Not applicable to the back of the paper when performing duplex printing.
Perpendicularity	± 1.2 mm/100 mm or less ± 2.4 mm/200 mm or less	
Missing Image Area	Left: 2.0 ± 1.5 mm Right: 2.0 mm Leading edge: 3.0 ± 1.5 mm Trailing edge: 3.0 mm	

ARDF

Item	Specification	Remarks
Magnification Error	100% SEF: $\pm 1.75\%$ or less Reduction/Enlargement SEF: $\pm 1.75\%$ or less	

 **Note**

- To check whether the problem is with the image or is due to another issue, print the test pattern.

3.3 PAPER TRANSFER QUALITY STANDARDS

Engines

Item	Specification	Remarks
Margin position	<p>Single Side: Main Scan: 0 ± 2.0 mm Sub Scan: 0 ± 1.5 mm</p> <p>Back of the paper when performing duplex printing: Main Scan: 0 ± 2.0 mm Sub Scan: 0 ± 1.5 mm</p>	
Skew	<p>Single Side: ± 1.2 mm/200 mm or less (B5 SEF or more) ± 1.0 mm/100 mm or less (Less than B5 SEF)</p> <p>Duplex: ± 1.0 mm/100 mm or less (B5 SEF or more) ± 1.5 mm/100 mm or less (Less than B5 SEF)</p>	Not applicable to paper fed from the by-pass tray (Reference value when using the by-pass tray: ± 1.0 mm/100 mm)
Curling after fusing	20 mm or less from the leading and trailing edges with a radius of 40 mm or greater.	In an office environment

ARDF

Item	Specification	Remarks
Margin position	Main Scan: 0 ± 2.0 mm Sub Scan: 0 ± 1.5 mm	
Skew	Single Side: ± 2.0 mm/200 mm or less (B5 SEF or more) ± 2.5 mm/200 mm or less (Less than B5 SEF) Duplex: ± 2.5 mm/100 mm or less	Paper thickness (ream weight) Single Side: 45-110 kg Duplex: 45-90 kg

Preventive
Maintenance

These standards are determined using standard paper under standard conditions.

Values may vary depending on environmental conditions such as temperature, humidity, use of used paper, etc.

REPLACEMENT AND ADJUSTMENT

REVISION HISTORY		
Page	Date	Added/Updated/New
		None

4. REPLACEMENT AND ADJUSTMENT

4.1 GENERAL CAUTIONS

4.1.1 NOTES ON THE MAIN POWER SWITCH

The main power button of this machine has been changed to a push-button switch (push button) from the conventional rocker switch. The push switch has characteristics and specifications different from the rocker switch. Care must be taken when replacing and adjusting parts.

Characteristics of the Push Switch (DC Switch)

Power is supplied to the machine even when the main power switch is turned OFF.

The push switch in this machine uses DC (direct current). Therefore, if the AC power cord is connected to an electrical outlet, power is supplied to the controller board, the operation unit and other modules even when the main power is turned OFF. When replacing the controller board and the operation unit in this state, not only these boards, it will damage other electrical components.

So, when performing maintenance work such as replacing parts, in addition to turning off the main power with the push switch, always unplug the AC power cord.

When you disconnect the power cord from the AC wall outlet, inside the machine there is still residual charge.

When you disconnect the power cord from the AC wall outlet, inside the machine for a while there is still residual charge. Therefore, if you remove boards in this state, it can cause a blown fuse or memory failure.

--How to remove the residual charge inside the machine--

After you unplug the power cord from the AC wall outlet, in order to remove the residual charge from inside the machine, be sure to press the main power switch. Thus, the charge remaining in the machine is released, and it is possible to remove boards.

When you reconnect the AC power cord into an AC wall outlet, the machine will start automatically.

In order to remove the residual charge, push the main power switch while you disconnect the AC power cord. At that time, the power ON flag inside the machine is set. Therefore, after you finish work on the machine and reconnect the power cord to the AC, even if you do not press the main power switch, the machine will start automatically and the moving parts will begin to move. When working on moving parts, be careful that fingers or clothes do not get caught.

Note

- Automatic restart deals with cases when you accidentally unplugged the AC power cord or unexpected power outages. By keeping the power flag ON, after the resumption of power, the machine will start up automatically.

In rare cases, when you reconnect the AC power cord to a power outlet, the machine does not start automatically. In this case, the machine has not failed. The cause is due to the timing of releasing the residual charge. If you press the main power switch while the residual charge was already released, the power ON flag will not be set. At this time, start the machine manually by pressing the main power switch.

Shutdown Method

1. **Press the main power switch [A] on the left side of the machine.**



m171m0003

After the shutdown process, the main power is turned off automatically.

When the shutdown is complete

Main power LED: Off

Operation panel LED: Off

2. **Take out the power cord.**
3. **Wait 3 minutes (this is the time required if you will remove the rear cover and access the interior of the machine, to take out the controller board for example).**

Note: If some LEDs on any of the boards are blinking or lit, current is still flowing.

How to start from shutdown

To start the machine, press the main power switch. However, if you press the main power switch between the beginning and the end of a shutdown, the machine will not start.

Forced Shutdown

In case normal shutdown does not complete for some reason, the machine has a forced shutdown function.

To make a forced shutdown, press and hold the main power switch for 6 seconds.

In general, do not use the forced shutdown.

★ Important

- **Forced shutdown may damage the hard disk and memory, and can cause damage to the machine. Use a forced shutdown only if it is unavoidable.**

4.2 SPECIAL TOOLS

Part Number	Description	Q'ty
B6455010	SD Card 128MB	1
B6455020	SD Card 1GB	1

⬇ Note

- A PC (Personal Computer) is required for creating the Encryption key file on an SD card when replacing the controller board for a model in which HDD encryption has been enabled.

4.3 EXTERIOR COVERS

4.3.1 FRONT COVER

1. Paper Cassette
2. Open the by-pass tray [A].
3. Release four hinges indicated below to detach the paper guide plate [B].



4. (⌀x2) on the by-pass tray [A].



5. Release the both end hinges of the by-pass tray [A] to detach it.

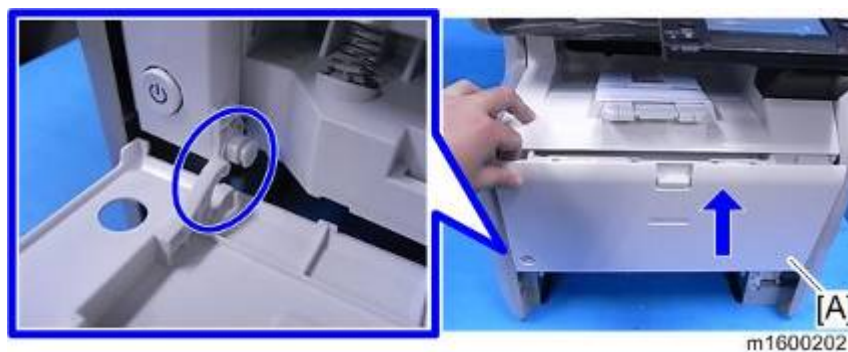

⬇ Note

- To remove the by-pass tray, lift the left hinge first to release while raising the by-pass tray upwards.
- The left hinge is C-cut.

Exterior Covers

6. (🔧 x1) on the front cover [A] in order to remove the strap that ties the front cover to the machine.



7. Open the front cover [A] and release the strap [B].



8. Release both side hinges to detach the front cover [A].



⬇ Note

- Release the left hinge [B] first to detach the front cover.

4.3.2 LEFT COVER

Note

- There are three tabs on the back of the left cover. Refer to the picture below.

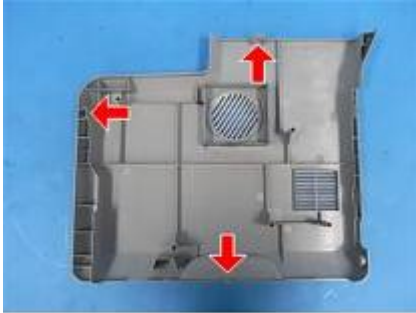

m1600069

1. Open the Front Cover.
2. Open the Rear Cover.
3. Left Cover [A] (⚙️ x4, Hook x3)

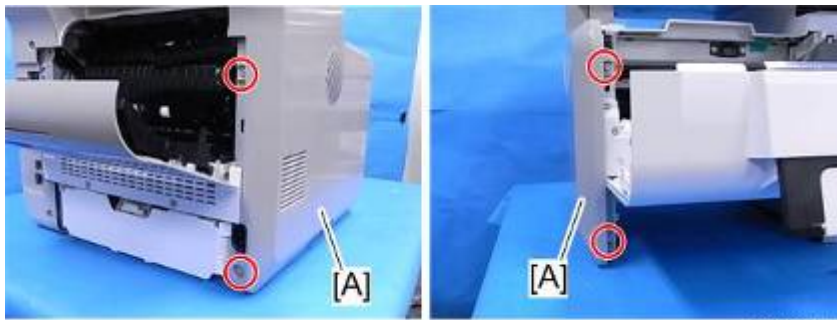

m1600066

4.3.3 RIGHT COVER

Note

- There are four tabs on the back of the right cover. Refer to the picture below.



m1600067

1. Open the Front Cover.
2. Open the Rear Cover.
3. Right Cover [A] (⚙️ x4, Hook x4)



m1600068

4.3.4 REAR COVER / REAR LOWER COVER

1. Two screws on Rear Lower Cover [A] (⚙️ x2)
2. Open the rear cover [B].



3. Release both side hinges to detach the rear cover [A].

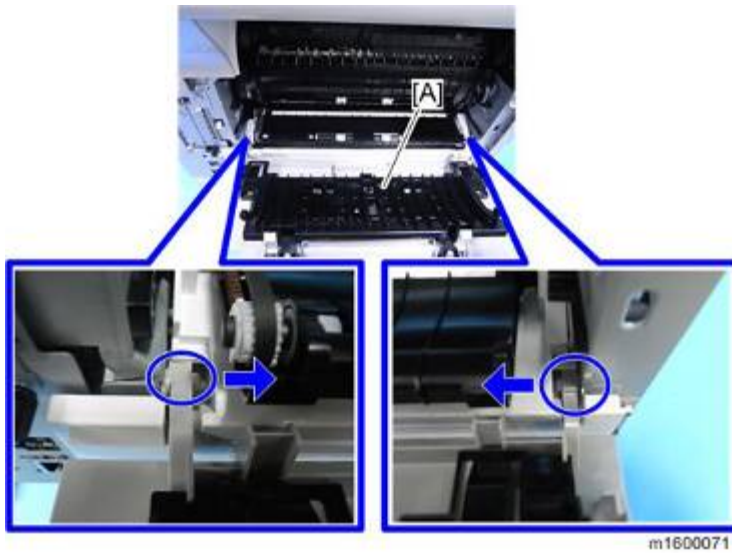

4. Rear Lower Cover [A]



4.3.5 UPPER COVER

1. ARDF and Scanner Unit (page 4-87 "Scanner Unit (with ARDF)")
2. Operation Panel (page 4-11 "Operation Panel")
3. (🔩x3) on the left side of the upper cover [A].

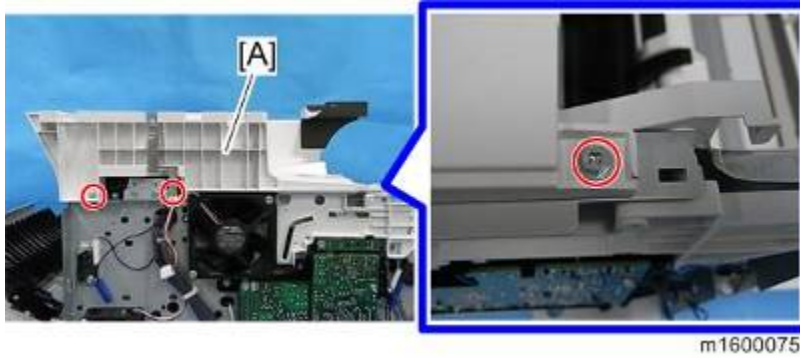

4. (🔩x4) on the right side of the upper cover [A]

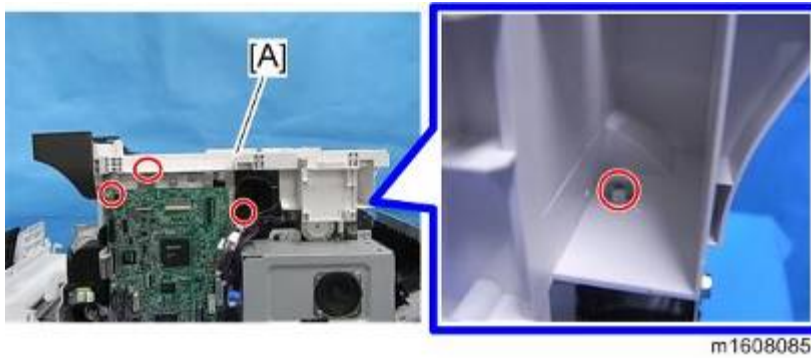

5. Upper Cover [A]



4.3.6 OPERATION PANEL

1. Scanner Unit (page 4-87 "Scanner Unit (with ARDF)")
2. Two connectors on the BICU [A] indicated below.



3. Operation Panel [A] (🔧x6, 🖨️x2)



4.3.7 OPERATION PANEL LOWER INNER COVER

1. Operation Panel (page 4-11 "Operation Panel")
2. Operation Panel Lower Inner Cover [A] (Hook x2)

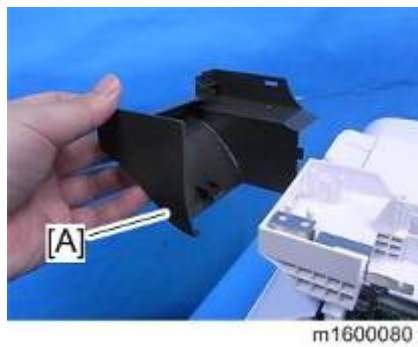
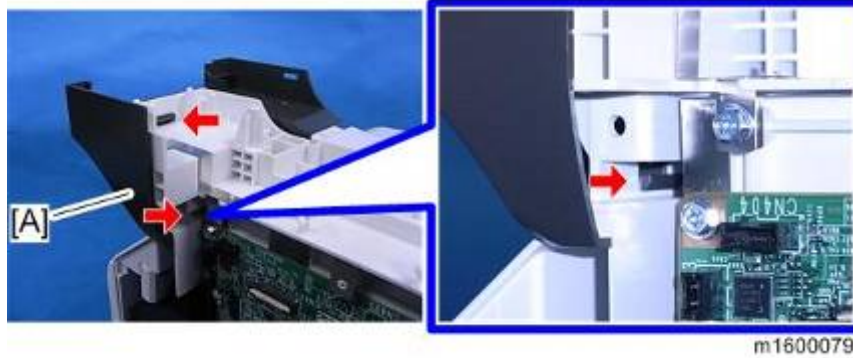

4.4 LED OPTICS

⚠ CAUTION

- Turn off the main power switch and disconnect the power cord before you start any of the procedures in this section.

4.4.1 LED UNIT

★ Important

- Be sure to clean the lens of the LED head after replacing the LED unit or if you inadvertently touch the lens when replacing another unit.

- PCDU (page 4-20 "PCDU")
- Upper Cover (page 4-10 "Upper Cover")
- Duct [A] (Hook x 12)

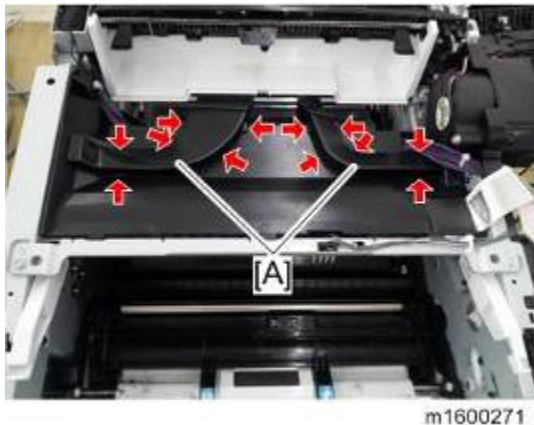

- Upper Inner Cover [A] (⚙ x2, Hook x3)

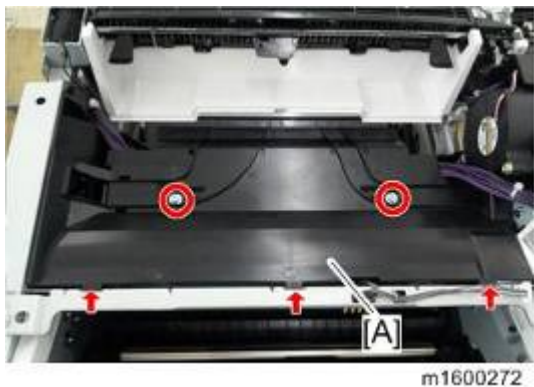

- Remove the securing screws of the front stay [A] (⚙ x2).



6. Push the LED unit [A] in.



7. Remove the spacer [A], ground wire [B], and flat cable [C] from the LED unit.

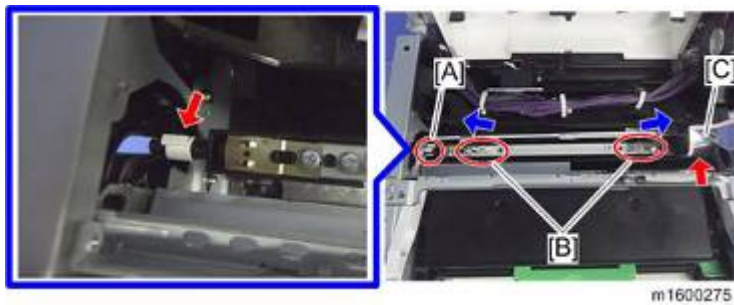

⬇ Note

- The spacer [A] has a protruding part that engages with the groove in the shaft to secure the spacer. When you remove the spacer, pull its handle downward as if to rotate the spacer slightly.

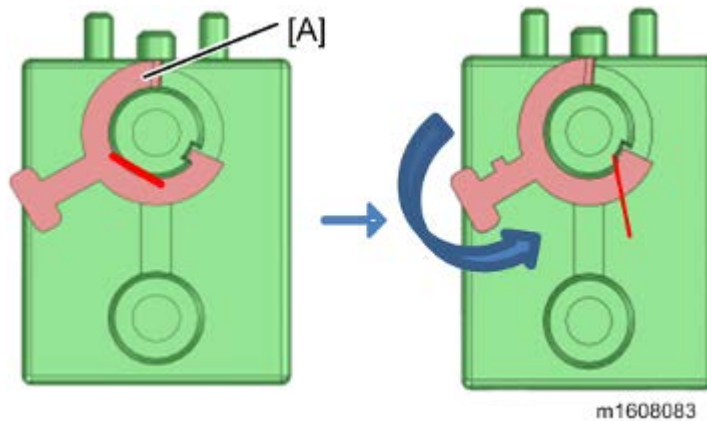

8. Slightly flex the side plates outward and pull the LED unit [A] out of the machine.



Note

- When you attach the LED unit, engage the LED unit's shaft ends (on the upper part) with the holes in the LED unit holder. Be careful not to force the LED unit in. Doing so may cause the LED unit holder's springs to come off.



9. Bend the stay [A] to release the left and right tabs, and then separate the stay from the LED head [B].

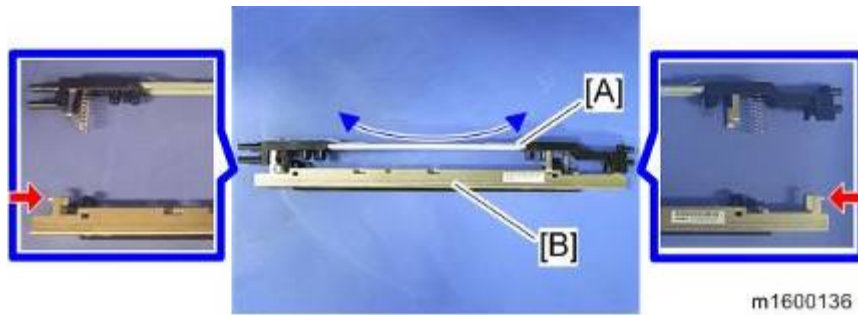

10. Remove the two spring holders [B] from the LED head [A].

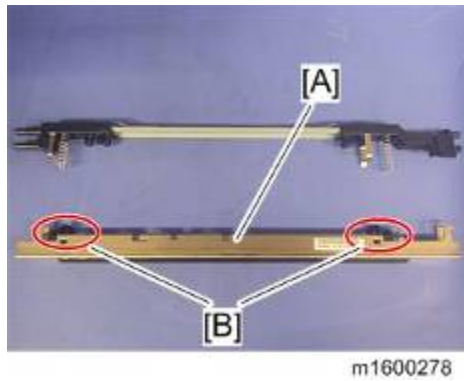

How to Re-engage Disengaged Springs

If the spring hook [A] of the LED unit holder is disengaged, re-engage it according to the following procedure:

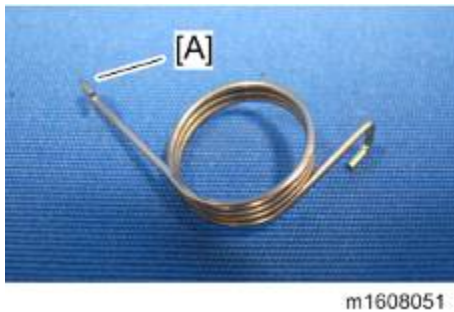

Hook disengaged [A]

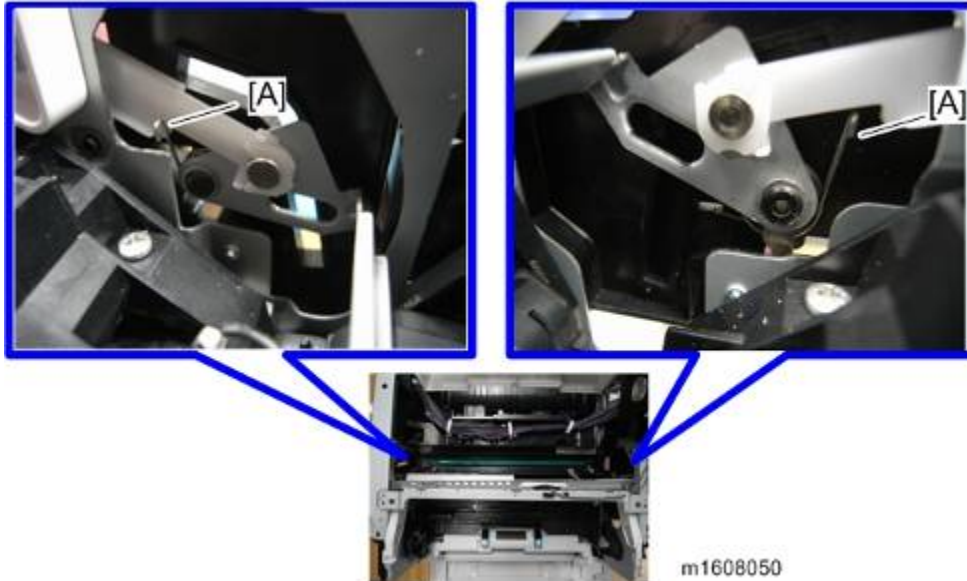

Hook correctly engaged [B]

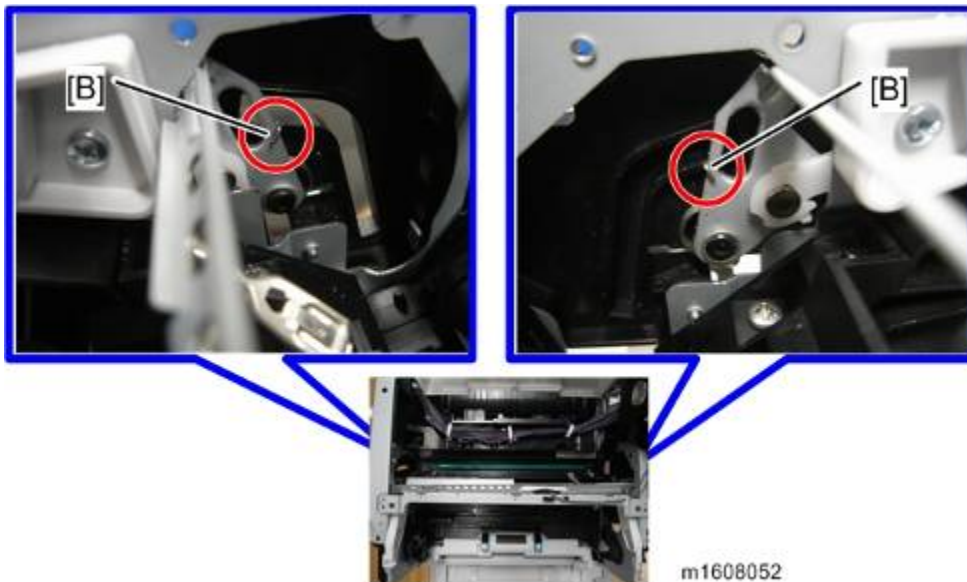

If the hook is engaged correctly, the LED unit holder is raised to the front by the spring.

Right side

1. Remove the right cover, and then remove the gear unit. (page 4-26 "Gear Unit")
2. Loosen the screws on the cover [A]. (⚙️x3).

⬇️ Note

- Be sure to loosen the screws holding the cover [A] just enough to insert tweezers or a screwdriver into the gap. Do not actually remove the screws.

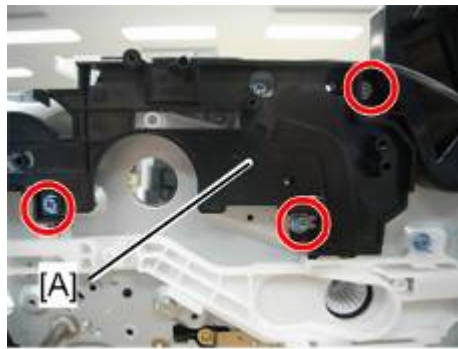

3. Insert tweezers or a screwdriver into the gap between the cover [A] and frame and re-engage the spring hook [B] in the correct position.

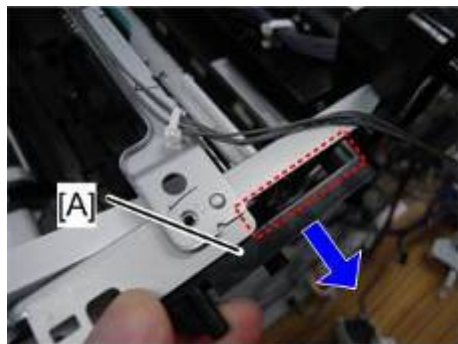

Left side

1. Remove the left cover, and then raise the spring using tweezers or a screwdriver inserted through the gap at the lower right of the spring [A].

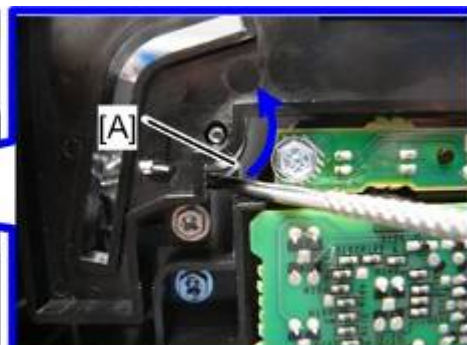

2. You can check the position of the hook [A] through the guide of the LED unit. Using tweezers or a screwdriver, re-engage the hook in the correct position.

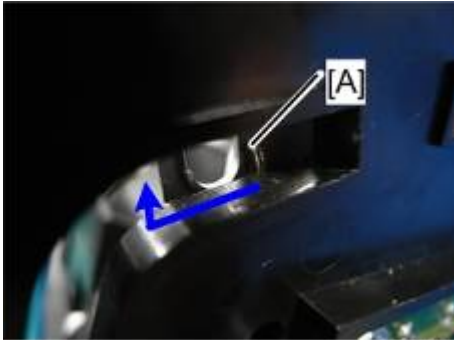

m1608054



m1608058

4.5 PCDU

4.5.1 PCDU

1. Open the front cover [A].



2. Hold the grip to pull the PCDU [A] out.



4.6 TONER CARTRIDGE

4.6.1 TONER CARTRIDGE

1. Open the front cover [A] and push down the lever of the toner cartridge [B] circled in the picture below.

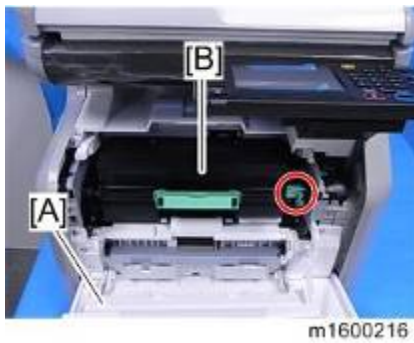

↓ Note

- The release lever works in two steps. To release the lock, push down the release lever to the horizontal position.



2. Hold the grip to pull the toner cartridge [A] out.



4.7 IMAGE TRANSFER

4.7.1 IMAGE TRANSFER ROLLER

1. PCDU (page 4-20 "PCDU")
2. Pinch both green ends of the guide [A] and pull it towards you.

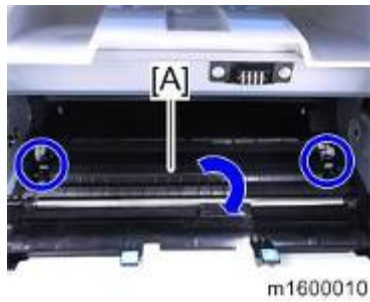

3. Image Transfer Roller [A]



4.8 DRIVE UNIT

⚠ CAUTION

- Turn off the main power switch and disconnect the power cord before you start any of the procedures in this section.

4.8.1 MAIN MOTOR

1. Right Cover (page 4-8 "Right Cover")
2. Drive Unit (page 4-26 "Drive Unit")
3. Main Motor [A] (⚙ x4, ⚙ x1)



4.8.2 DUPLEX EXIT MOTOR

1. Upper Cover (page 4-10 "Upper Cover")
2. Duplex Exit Motor [A] (⚙ x2, ⚙ x1, ⚙ x1)

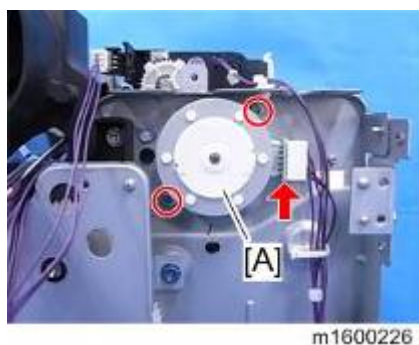

4.8.3 TONER SUPPLY CLUTCH

1. Gear Unit (page 4-26 "Gear Unit")
2. Temp Humid Sensor (page 4-72 "Temp Humid Sensor")
3.  x1

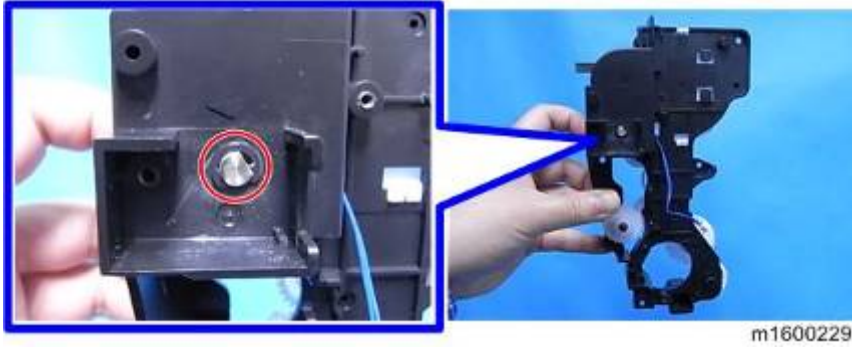

4. Toner Supply Clutch [A] with shaft (Gear x1)



5. All things attached to the toner supply clutch [A]. (Gear x1, Shaft x1)

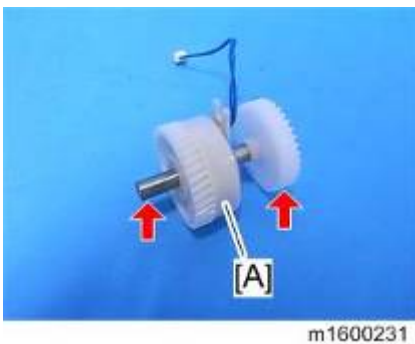

4.8.4 REGISTRATION CLUTCH

1. BICU (page 4-61 "BICU")
2. Registration Clutch [A] (🔧x1, 🛠️x1, 📺x1)

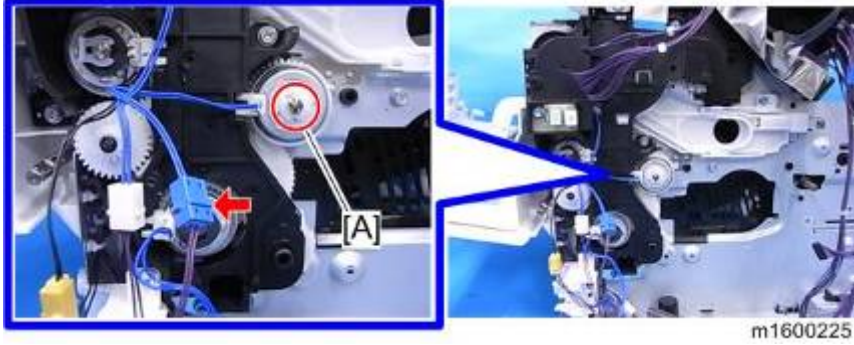

4.8.5 PAPER FEED CLUTCH

1. BICU (page 4-61 "BICU")
2. Paper Feed Clutch [A] (🔧x1)

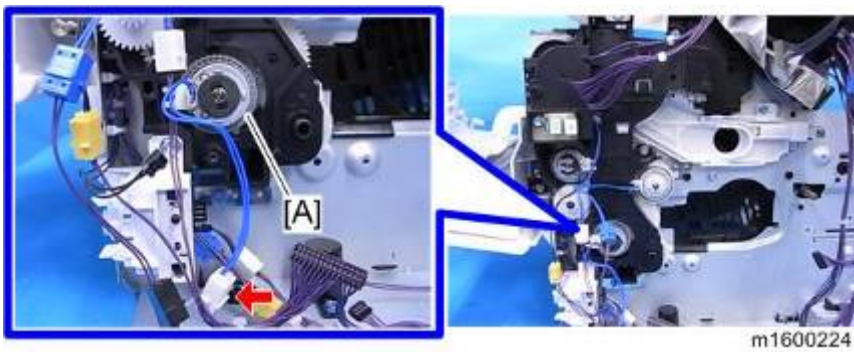

Replacement
and Adjustment

4.8.6 DRIVE UNIT

1. BICU (page 4-61 "BICU")
2. Duplex Clutch (page 4-28 "Duplex Clutch")
3. Drive Unit [A] (⚙️ x5, Grounding Plate x1)

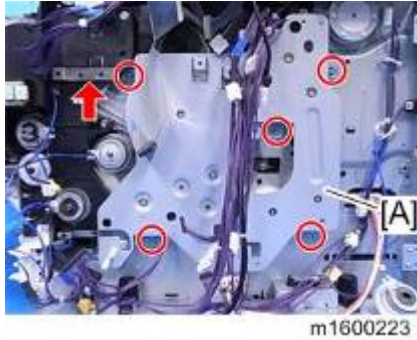

4.8.7 GEAR UNIT

1. Drive Unit (page 4-26 "Drive Unit")
2. Paper Size Detection Switch (page 4-45 "Paper Size Detection Switch")
3. Gear Unit [A] (⚙️ x4, ⚙️ x2, Gear x1)

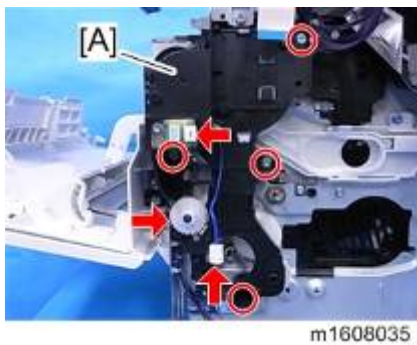

4.8.8 BY-PASS FEED CLUTCH

1. Right Cover (page 4-8 "Right Cover")
2. Harness Guide [A] (🔧x1, 📦x1)



3. By-pass Feed Clutch [A] (🔧x1, 📦x1)



4.8.9 RELAY CLUTCH

1. By-pass Feed Unit (page 4-41 "By-pass Feed Unit")
2. Gear Unit (page 4-26 "Gear Unit")
3. Relay Clutch [A] (🔧x1)

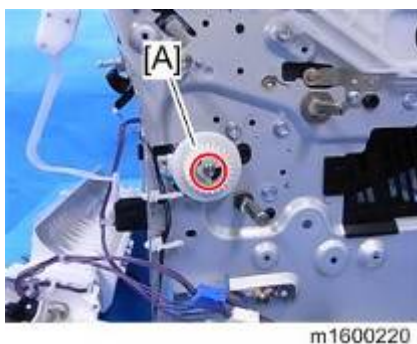

4.8.10 BY-PASS BOTTOM PLATE CLUTCH

1. Right Cover (page 4-8 "Right Cover")
2. By-pass Bottom Plate Clutch [A] (⚙️x1, 🛠️x1, 📏x1)



4.8.11 DUPLEX CLUTCH

1. Controller Board (page 4-58 "Controller Board")
2. Duplex Clutch [A] (⚙️x1, Bracket x1, 🛠️x1, 📏x1)

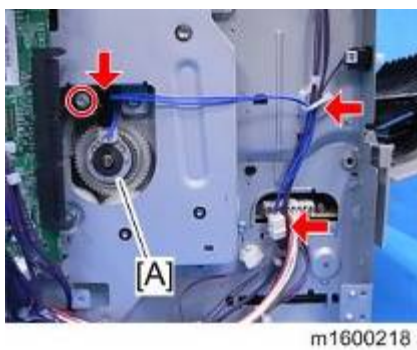

4.8.12 JUNCTION GATE SOLENOID

1. Upper Cover (page 4-10 "Upper Cover")
2. Release the harness of the Junction Gate Solenoid. (🔧x3)

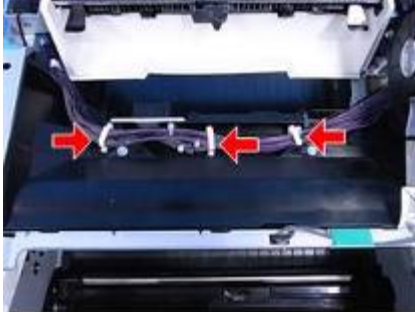

m1600120

3. 🛠️x1 of the Junction Gate Solenoid.



m1600121

4. Junction Gate Solenoid [A] (🔧x2, Spring x1)



m1600119



m1600122

4.9 FUSING

⚠ CAUTION

- Because there is a danger of burns on contact with hot parts of the fusing unit, start work when the temperature drops to a low enough temperature.
- Turn off the main power switch and disconnect the power cord before you start any of the procedures in this section. (page 4-1 "General Cautions")

4.9.1 FUSING UNIT

1. Open the rear cover [A].
2. Release the lock levers [B].

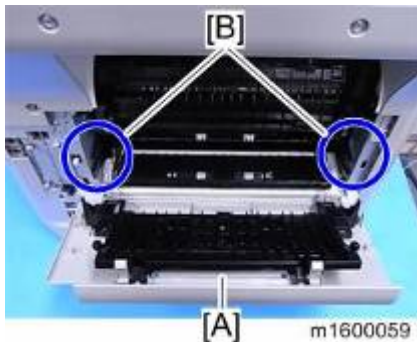

3. Fusing Unit [A]



Adjustment after Replacement

- Service Maintenance Model (M161)
For PM: Install a fusing unit without new product detection capability and reset PM Counter Fuser setting (engine SP 7-804-003) after replacement.
- User Maintenance Model (M160)
For PM: Install a fusing unit with new product detection capability from the Maintenance Kit. (User operation)

4.9.2 UPPER FUSING UNIT / LOWER FUSING UNIT

1. Fusing Unit (page 4-30 "Fusing Unit")
2. Remove the screws of the fusing unit. (⚙️ x5)

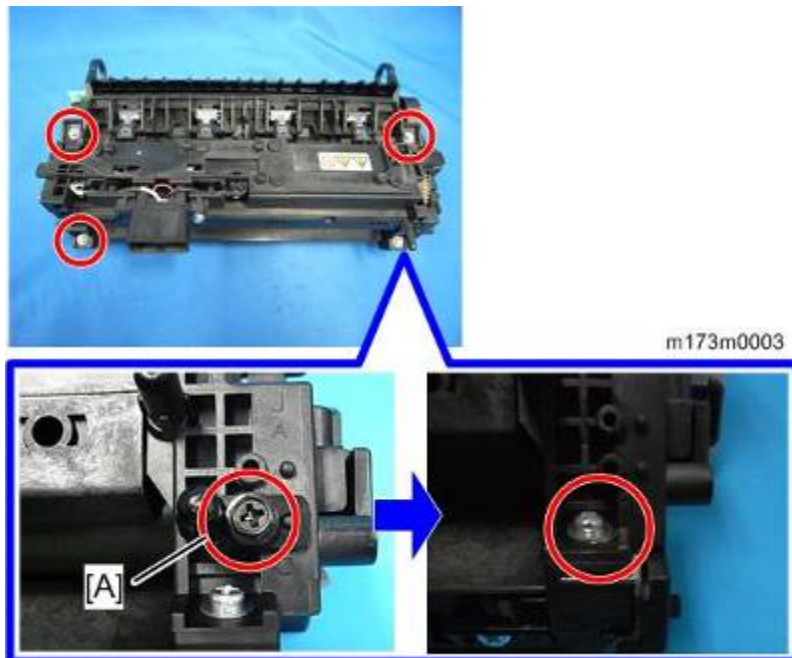

↓ Note

- When reassembling, be sure to attach the pin [A] to the correct position. If not, the fusing unit cannot be attached to the main body properly.

3. Separate the fusing unit into the upper and lower fusing units.
4. Right cover [A] (⚙️ x2)



[B]: Lower Fusing Unit
[C]: Upper Fusing Unit

Fusing

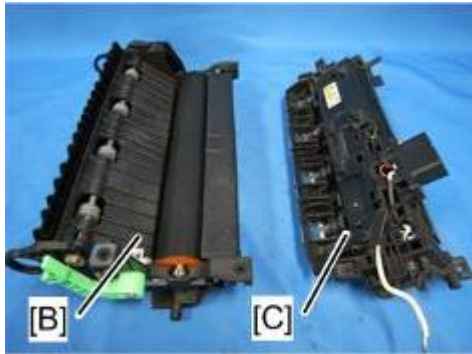

m173m0005

Note

- You can rejoin the upper and lower fusing units with more ease by lowering the envelope lever.

4.9.3 FUSING PRESSURE ROLLER

- Separate the fusing unit into the upper and lower fusing units. (page 4-31 "Upper Fusing Unit / Lower Fusing Unit")
- Fusing Pressure Roller [A]

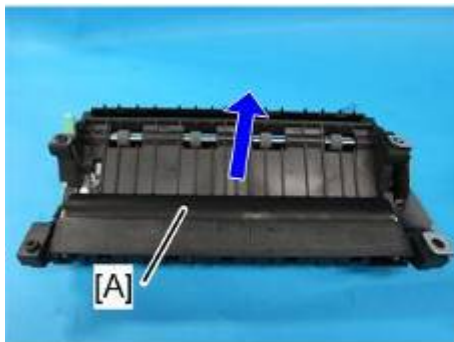

m173m0006

4.9.4 FUSING LAMP / HOT ROLLER

★ Important

- Be careful not to break the lamp when removing screws.
- When removing/attaching lamp securing screws on the side that is away from the drive mechanism, it is recommended to insert a pin or jeweller's screwdriver as shown in the photo below in order to secure the flat nut to the upper frame.



m173m0048

1. Separate the fusing unit into the upper and lower fusing units. (page 4-31 "Upper Fusing Unit / Lower Fusing Unit")
2. Cover [A] (🔩 x1)



m173m0007

3. Remove the screws of the fusing lamp. (🔩 x3)

Fusing

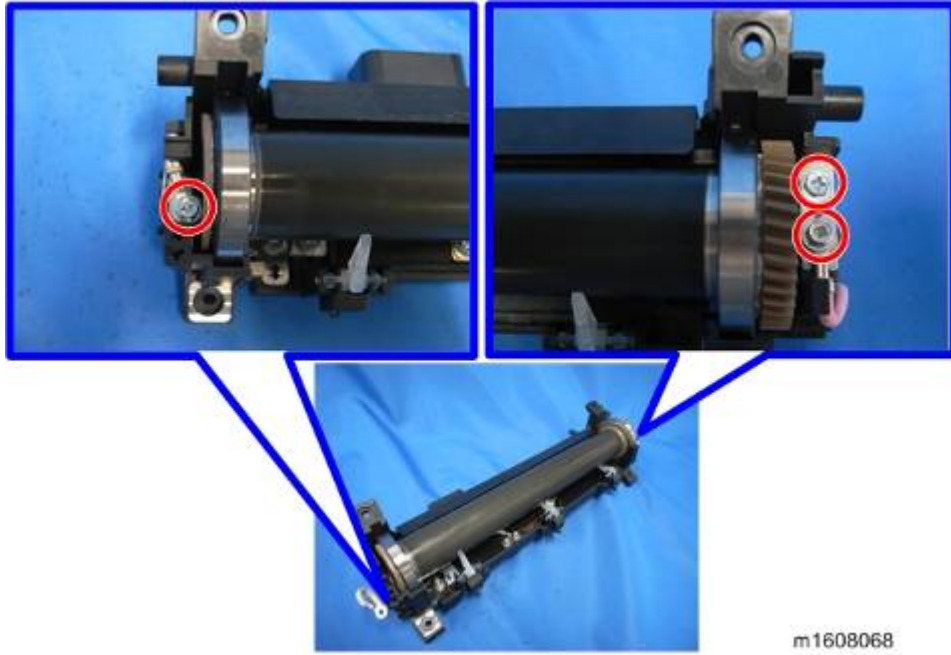

4. Two brackets [A]

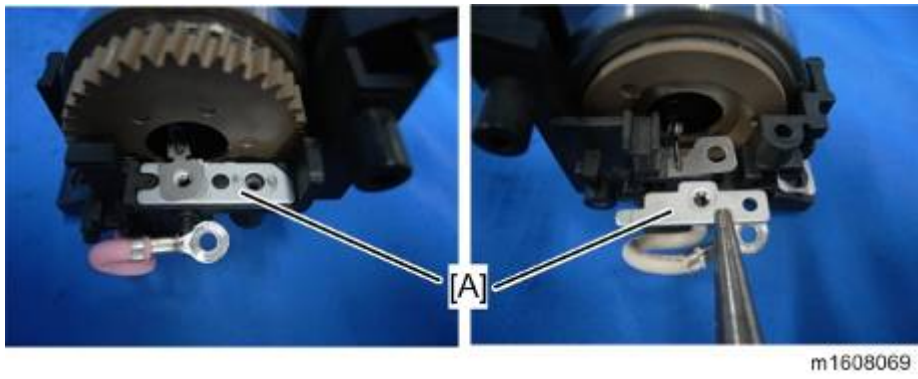

5. Fusing lamp [A]

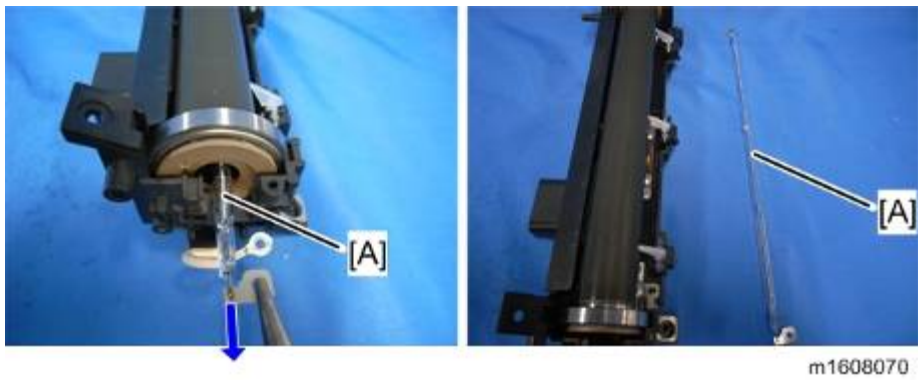

6. Hot Roller [A]

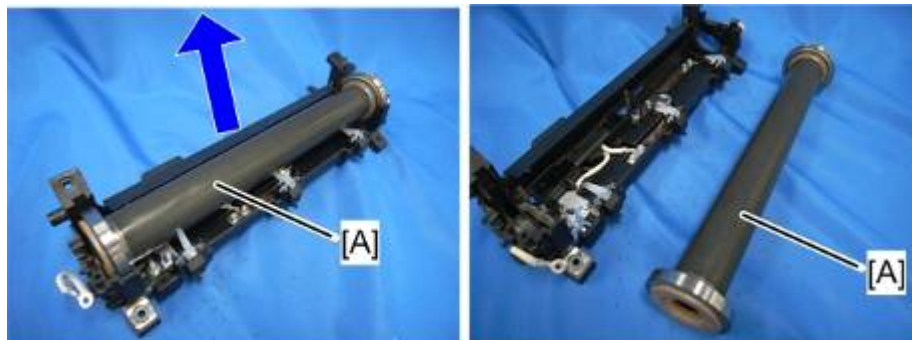

m1608071

4.9.5 THERMOSTAT

1. Separate the fusing unit into the upper and lower fusing units. (page 4-31 "Upper Fusing Unit / Lower Fusing Unit")
2. Hot Roller (page 4-33 "Fusing Lamp / Hot Roller")
3. Thermostat [A] (⚙️x2)

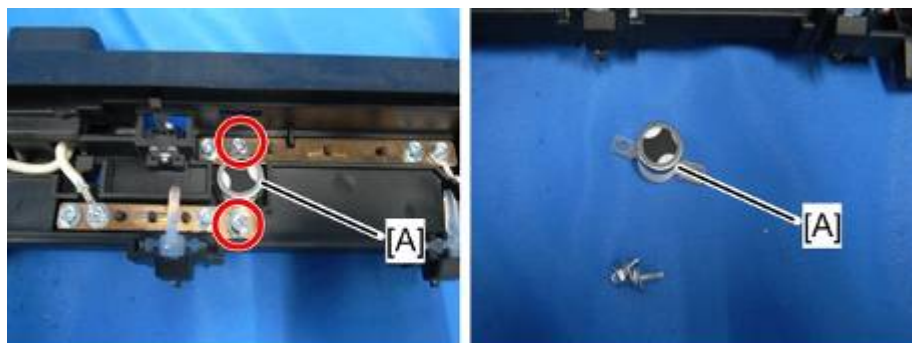

m1608072

4.9.6 THERMISTOR

Note

- The thermistor is integrated with the drawer connector.

1. Separate the fusing unit into the upper and lower fusing units. (page 4-31 "Upper Fusing Unit / Lower Fusing Unit")
2. Hot Roller (page 4-33 "Fusing Lamp / Hot Roller")
3. Remove the screws of the harness. (🔧x3)



m1608073

4. Remove the bracket of the drawer connector, and then remove the screws of the thermistor. (🔧x3)

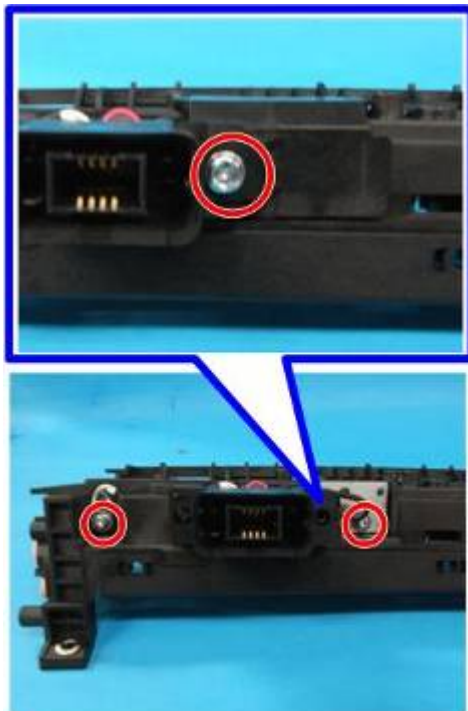

m173m0008

5. Thermistor [A]

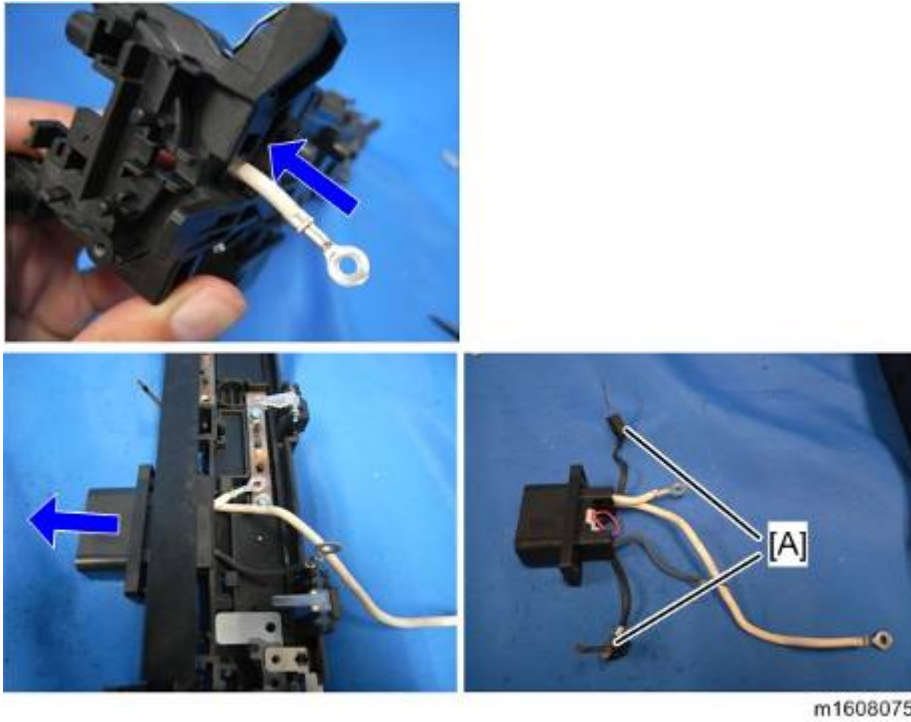

Notes on reassembly

Be sure to attach the drawer connector with its protruding part [A] in the position shown below.



Insert the flat nut [A]. Be sure not to drop them during disassembly.



4.9.7 HOT ROLLER STRIPPER

1. Separate the fusing unit into the upper and lower fusing units. (page 4-31 "Upper Fusing Unit / Lower Fusing Unit")
2. Spring [A]

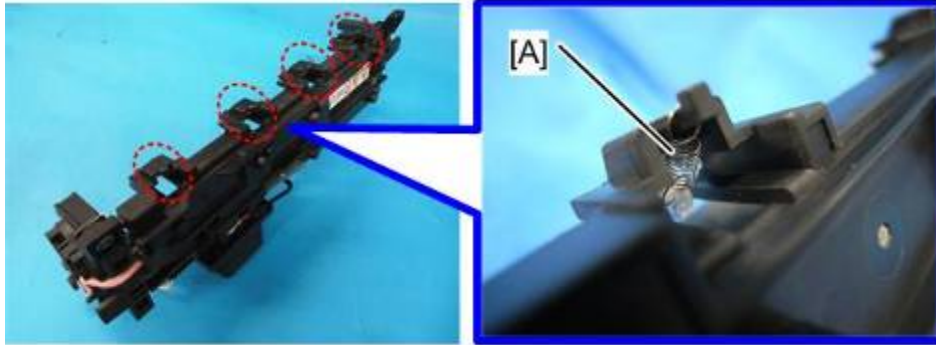

m173m0010

3. Hot Roller Stripper [A]



m1608079

4.10 PAPER FEED

⚠ CAUTION

- Turn off the main power switch and disconnect the power cord before you start any of the procedures in this section.

4.10.1 PAPER FEED TRAY

1. Paper Feed Tray [A]



m1600081

4.10.2 PAPER FEED ROLLER

1. Paper Feed Tray (page 4-39 "Paper Feed Tray")
2. Slide the lever [B] to the left to detach the paper feed roller [A].

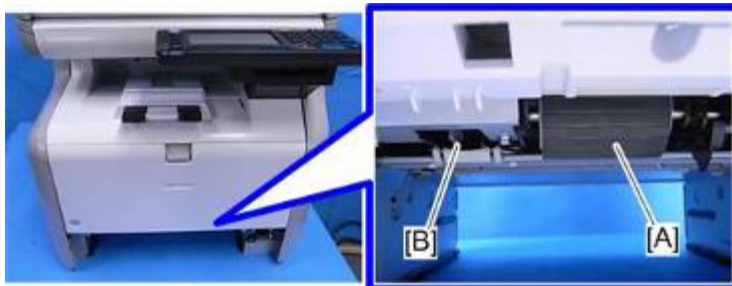

m1600118

4.10.3 FRICTION PAD

1. Paper Feed Tray (page 4-39 "Paper Feed Tray")
2. Release the hooks on the bottom of the paper feed tray to detach the friction pad [A].

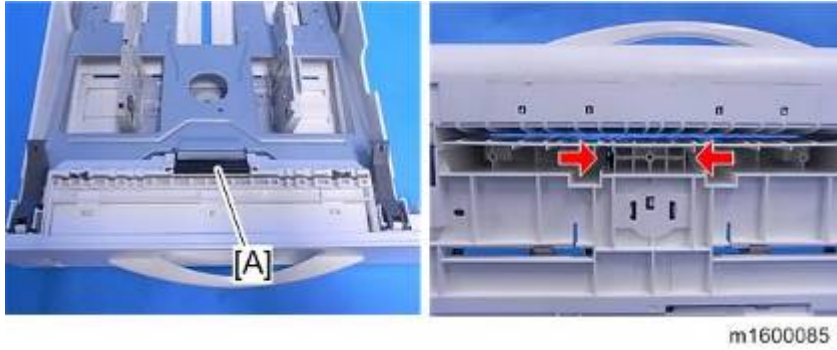

4.10.4 PAPER END SENSOR

1. By-pass Feed Unit (page 4-41 "By-pass Feed Unit")
2. Bracket [A] (🔧 x6)

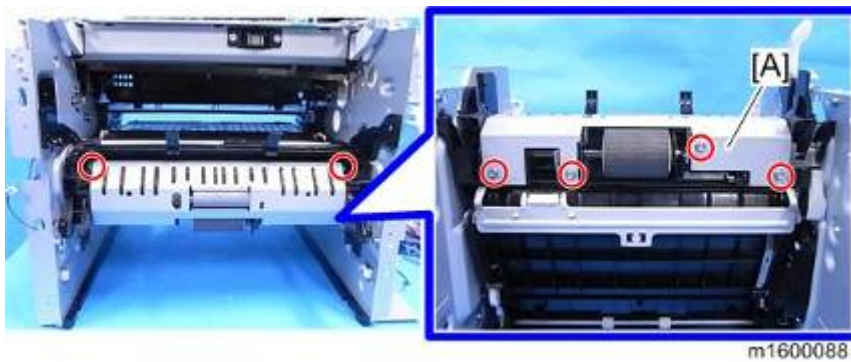

3. Paper End Sensor [A] (🔧 x1, Hook)

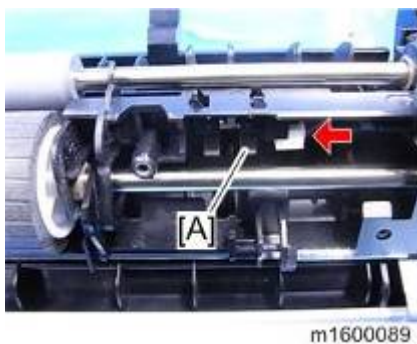

4.10.5 BY-PASS FEED UNIT

1. Front Cover (page 4-5 "Front Cover")
2. Left Cover (page 4-7 "Left Cover")
3. Right Cover (page 4-8 "Right Cover")
4. By-pass Bottom Plate Clutch (page 4-28 "By-pass Bottom Plate Clutch")
5. By-pass Feed Unit [A] (⚙️ x5, 📄 x2)

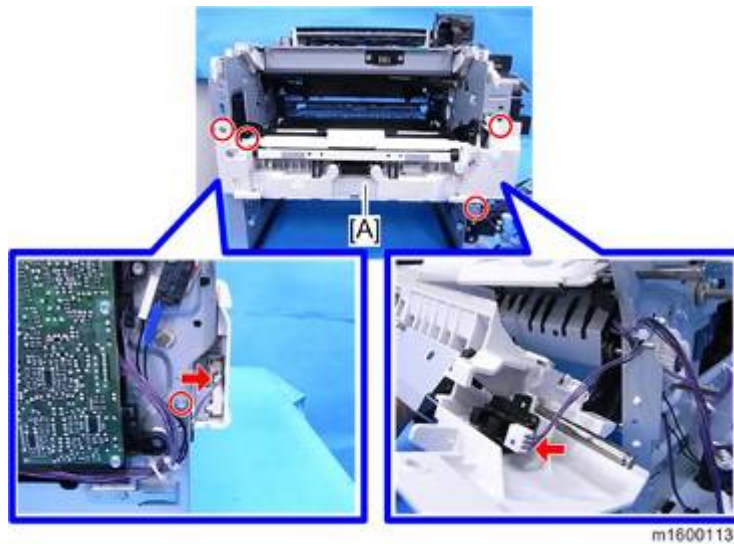

⚠️ Note

- Release the hook [A] and then insert a flat-blade screwdriver into the space [B] to detach the by-pass feed unit from the machine.

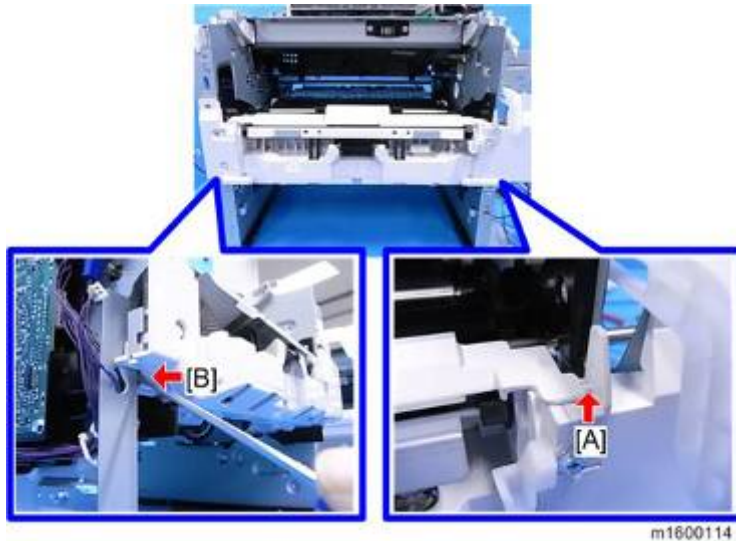

4.10.6 BY-PASS FEED ROLLER

1. By-pass Feed Unit (page 4-41 "By-pass Feed Unit")
2. Gear Unit (page 4-26 "Gear Unit")
3. (⚙️x2, Bearing x2) on both sides of the by-pass feed roller (guide) [A]

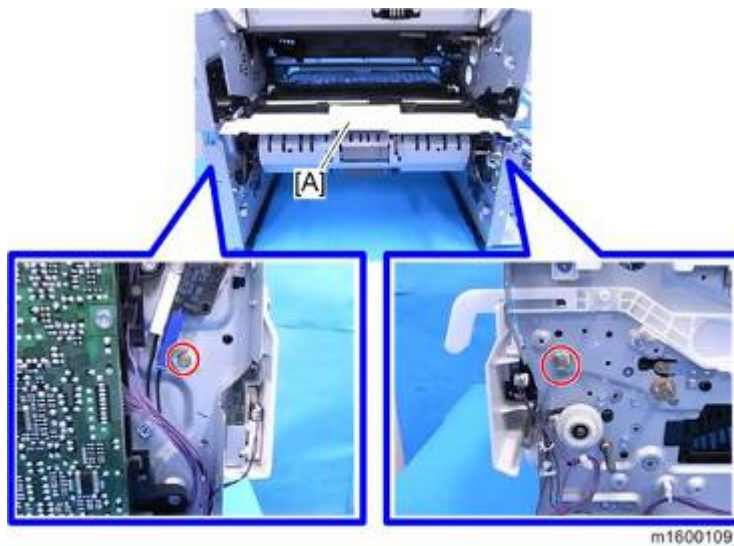

4. Slide the by-pass feed guide [A] with the by-pass feed roller to the right to detach it from the machine.



- Detach the by-pass feed roller with the shaft [B] from the guide [A].

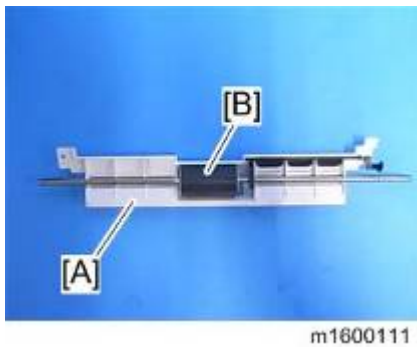

- Separate the bypass feed roller [A] from the shaft (Hook x1)

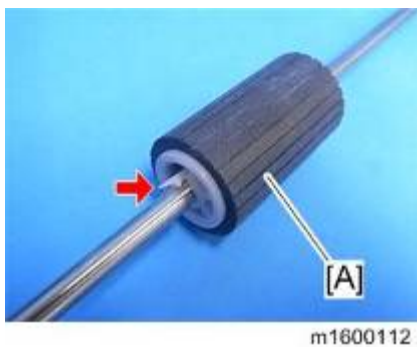

4.10.7 BY-PASS FRICTION PAD

- By-pass Feed Unit (page 4-41 "By-pass Feed Unit")
- Bottom Plate [A]

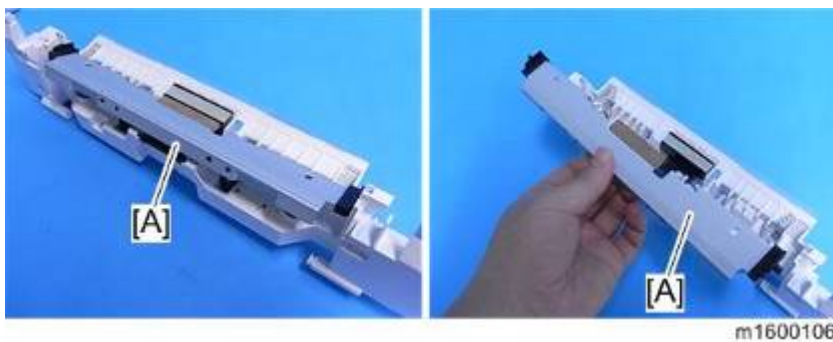

⏴ Note

- If you cannot remove the bottom plate because the part [A] prevents the cam [B] from releasing, rotate the shaft [C] to let the cam [B] avoid the bottom plate link [A].

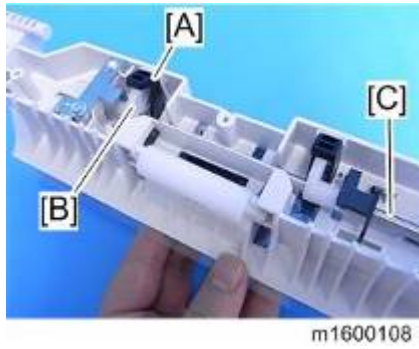

3. Push the friction pad [A] down to detach it. (Spring x1)

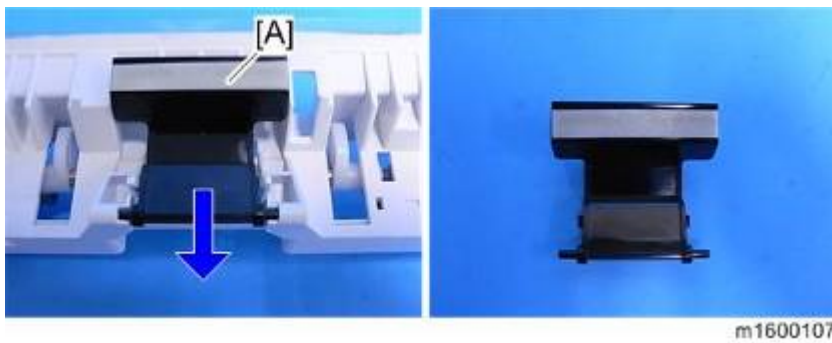

4.10.8 BY-PASS PAPER END SENSOR

1. By-pass Feed Unit (page 4-41 "By-pass Feed Unit")
2. Bracket with By-pass Sensor [A] (x1)



3. Detach the By-pass Paper End Sensor [A] from the bracket. (Hook)

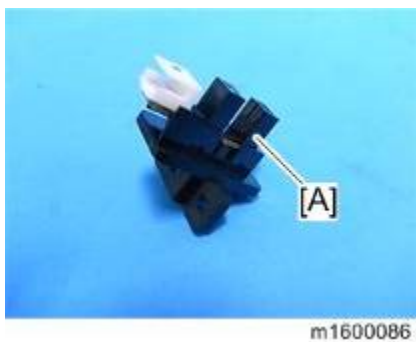

4.10.9 BY-PASS BOTTOM PLATE HP SENSOR

1. By-pass Feed Unit (page 4-41 "By-pass Feed Unit")
2. By-pass Feed Lower Cover [A] (🔩 x3)



3. By-pass Bottom Plate HP Sensor [A] (🔩 x1, Hook)

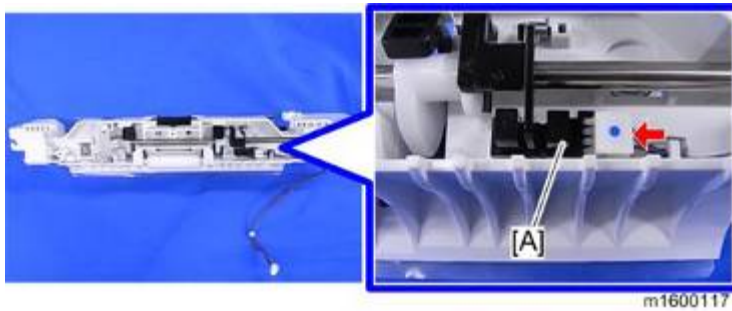

Replacement and Adjustment

4.10.10 PAPER SIZE DETECTION SWITCH

1. Right Cover (page 4-8 "Right Cover")
2. Bracket with Paper Size Detection Switch [A] (🔩 x4, 📏 x1)



3. Detach the Paper Size Detection Switch [A] from the bracket. (Hook x2)

Paper Feed

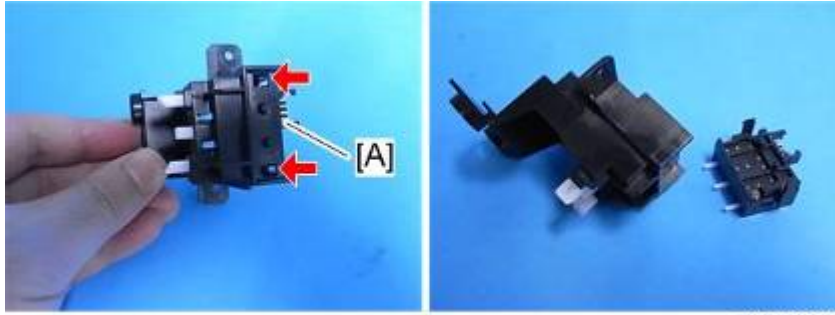

m1600104

4.11 PAPER TRANSPORT

⚠ CAUTION

- Turn off the main power switch and disconnect the power cord before you start any of the procedures in this section.

4.11.1 PAPER EXIT SENSOR

- Open the rear cover.
- Paper Exit Sensor [A] (🔧 x1, Hook)



4.11.2 PAPER OVERFLOW SENSOR

- Upper Cover (page 4-10 "Upper Cover")
- Paper Overflow Sensor [A] (🔧 x1, Hook)

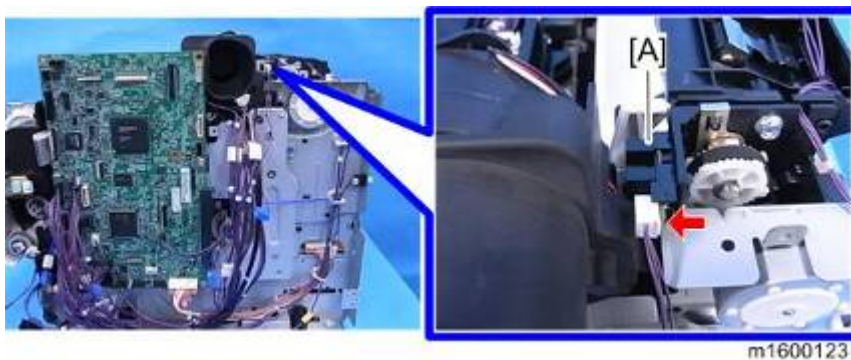

4.11.3 DUPLEX EXIT SENSOR

- Upper Cover (page 4-10 "Upper Cover")
- Duplex Exit Sensor [A] (🔧 x1, Hook)



4.11.4 DUPLEX ENTRANCE SENSOR

1. PSU (page 4-56 "PSU")
2. Duplex Clutch (page 4-28 "Duplex Clutch")
3. Open the duplex exit guide plate [A].



4. Remove screws circled in the picture below (🔩x5).
[A] Duplex exit guide unit



5. Release the linking part to remove duplex exit guide unit [A].

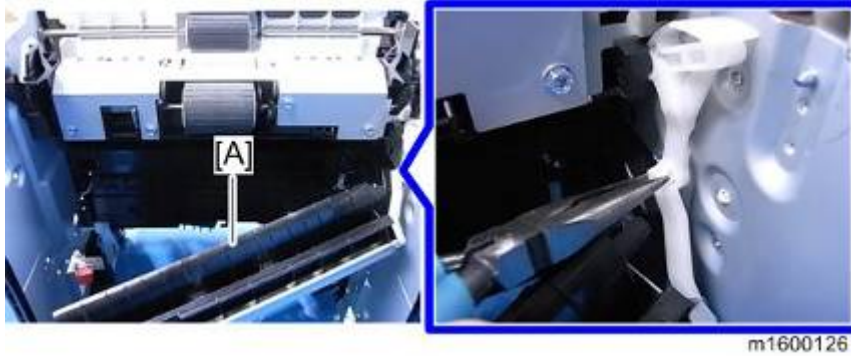

↓ Note

- Use pliers to pinch the linking part in order to separate.

6. Duplex Entrance Sensor [A] (🔧 x1, Hook)

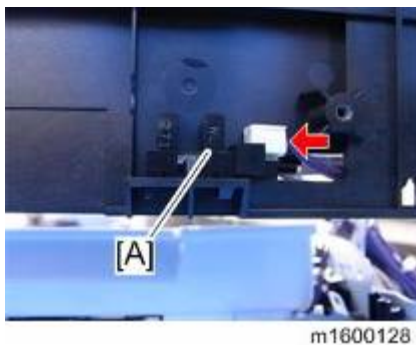

4.11.5 REGISTRATION ROLLER (DRIVEN)

1. Drive Unit (page 4-26 "Drive Unit")
2. Gear Unit (page 4-26 "Gear Unit")
3. Paper Size Detection Switch (page 4-45 "Paper Size Detection Switch")
4. Registration Sensor (page 4-51 "Registration Sensor")
5. HVPS with bracket (page 4-66 "HVPS with Bracket")
6. Release the bearing [A] x1 at the left end of the registration roller (drive) and fixing plate[B] x1. (🔧 x1, 🔩 x2)

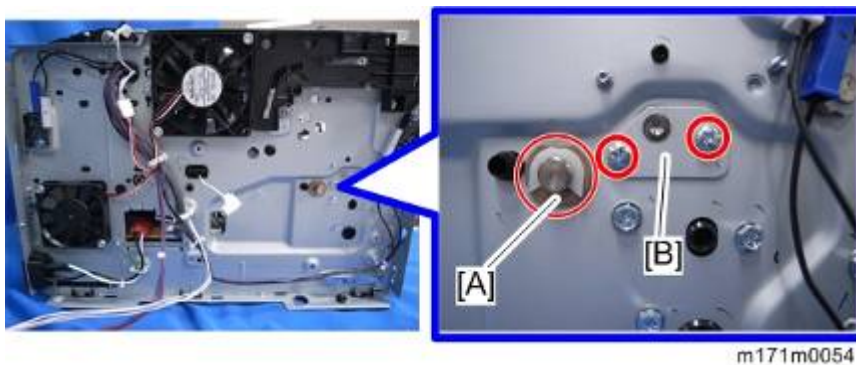

7. Release the bearing at the right end of the registration roller (drive), and remove the grounding plate [A]. (🔧 x 1, 🔩 x 1)

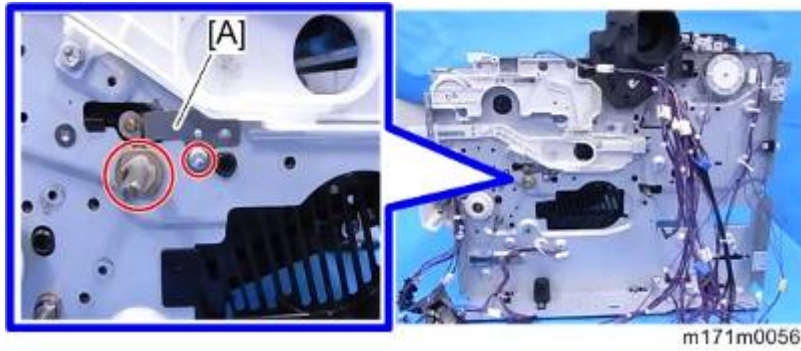

8. Insert a flathead screwdriver into the gap on the left of the registration roller guide to release the protruding part.



9. Release the harness from the guide [A] to detach the guide [A] with the registration roller (driven).



10. Detach the registration roller (driven) [B] from the guide [A].

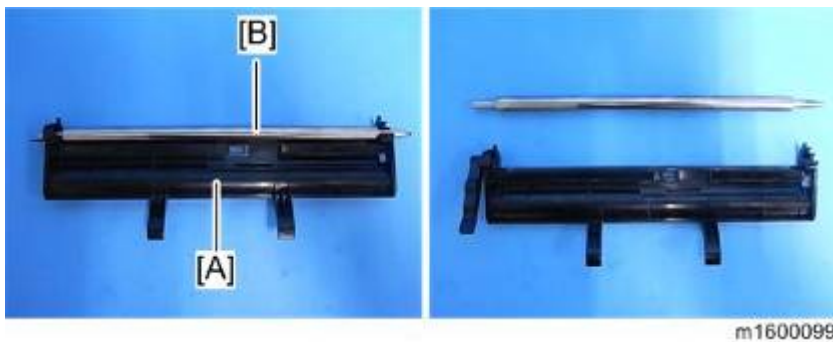

4.11.6 REGISTRATION ROLLER (DRIVE)

1. Registration Roller (Driven) (page 4-49 "Registration Roller (Driven)")
2. Slide the registration roller (drive) [A] to the right to remove it.

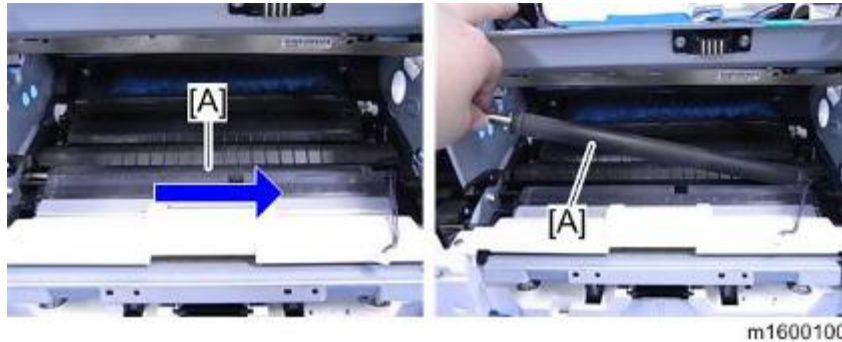

4.11.7 REGISTRATION SENSOR

1. PCDU (page 4-20 "PCDU")
2. Sheet [A]

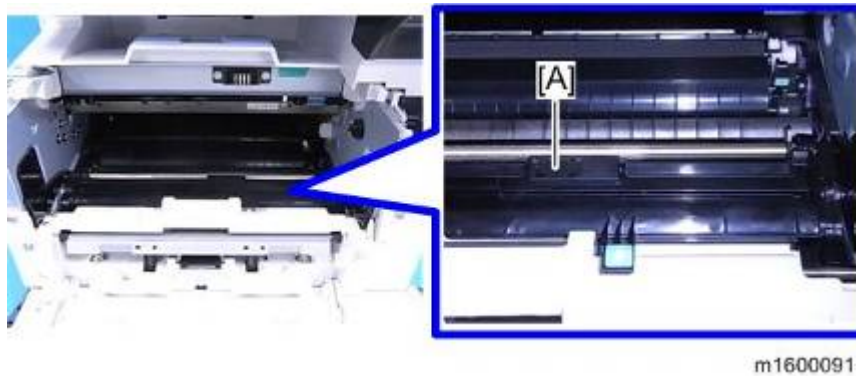

3. Release the hooks of the harness cover [A] with a screwdriver to remove it.



4. Registration Sensor [A] (Hook,  x1)

Paper Transport



m1600092

4.12 ELECTRICAL COMPONENTS

⚠ CAUTION

- Turn off the main power switch and disconnect the power cord before you start any of the procedures in this section.

4.12.1 FCU BOARD

- Open the Front cover.
- Open the Rear cover.
- Right Cover [A] (⚙ x4, Hook x3)



- Remove the five screws of the bracket [A] (⚙ x 5), then remove the FCU board [B] with bracket (⚙ x 1, ⚙ x 1)

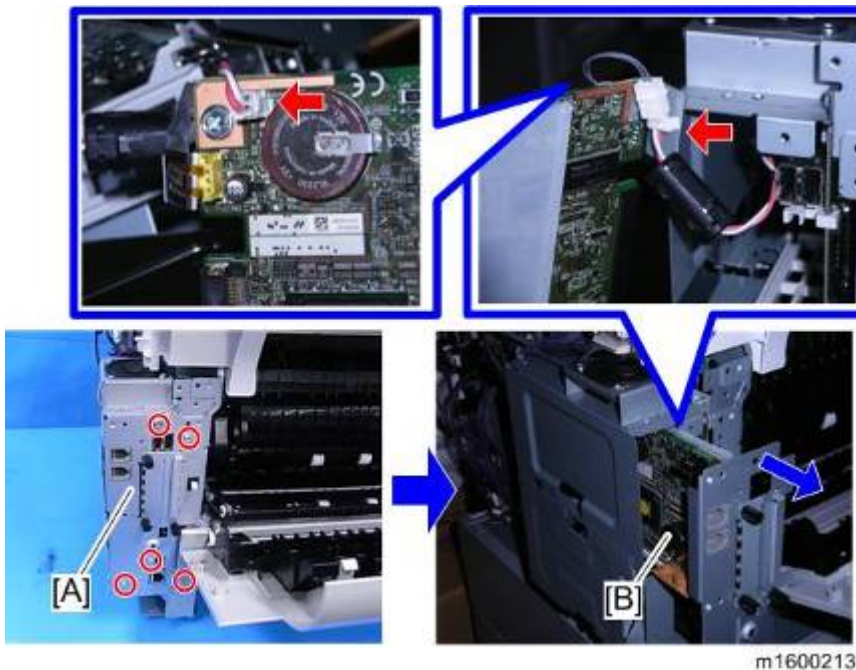

- Detach the brackets [B] and [C] from the FCU board [A]. (⚙ x3)



6. Replace the FCU board. (🔧x3)
7. Slide the battery backup jumper switch [A] to the ON position.



8. Mount the new FCU board in the machine by means of the bracket. (🔧x5, 📏x1, 🖨️x1)
9. Insert one end of the supplied flat cable into the CN603 connector on the new FCU board.
 - Be careful not to insert the cable at an angle.
10. Insert the other end of the flat cable into the CN603 connector on the old FCU board.
 - Be careful not to insert the cable at an angle.

⚠️ CAUTION

- To prevent a short circuit, make sure the old FCU board does not come into contact with anything metal.

11. Turn the main power switch on.
12. The SRAM data transfer begins. Transfer is complete when a beep sounds.

📌 Note

- The volume of the beep is set to the same level as the speaker volume.
- If the speaker volume is set to off, the volume of the beep is set to its initial factory-set level.
- If the machine does not beep, switch the main power off and then back on and try the data transfer again. Try several times if necessary.
- Be sure to check the transfer result after executing data transfer. If the transfer has

failed, you need to specify settings manually in the SP mode.

13. When the message "Ready" appears on the control panel, switch the power off, and then remove the AC power plug from the receptacle.
14. Disconnect the flat cable from both FCU boards.
15. Reattach the cover.
16. Reattach the cover.
17. Turn the main power switch on.
18. Enter the SP mode, print the system parameter list from SP6-101 in the Fax SP menu, and then check the list to see whether the SRAM data has been transferred correctly.

4.12.2 SPEAKER

1. Right Cover (page 4-8 "Right Cover")
2. Remove the five screws of the bracket [A] (⚙️ x 5), then remove the FCU board [B] with bracket (🔌 x 1, 📡 x 1)

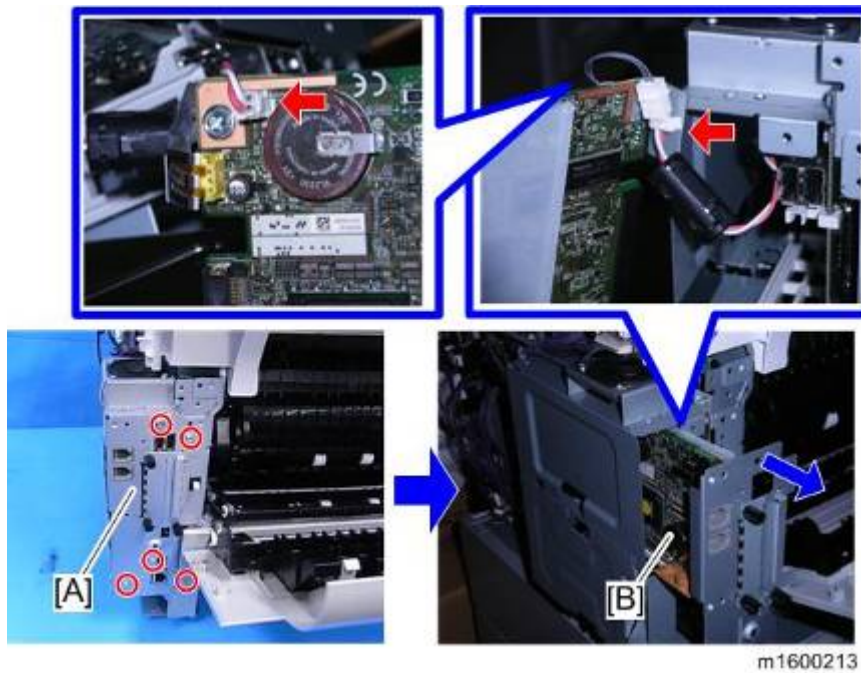

3. Controller Box [A] (⚙️ x4, 📡 x2)

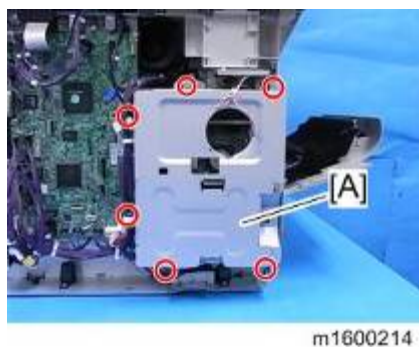

4. Speaker [A] (🔊 x2)

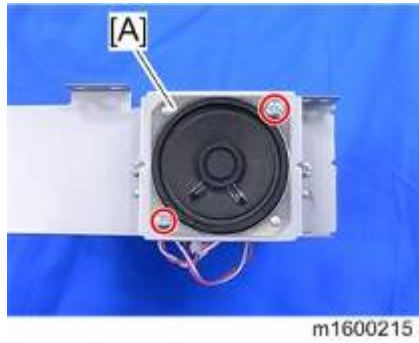

4.12.3 PSU

1. Paper Feed Tray (page 4-39 "Paper Feed Tray")
2. Left Cover (page 4-7 "Left Cover")
3. Right Cover (page 4-8 "Right Cover")
4. Rear Cover (page 4-9 "Rear Cover / Rear Lower Cover")
5. Rear Lower Cover (page 4-9 "Rear Cover / Rear Lower Cover")
6. (🔧x3, 🛠️x2, 🛠️x2) on the left side of the PSU.

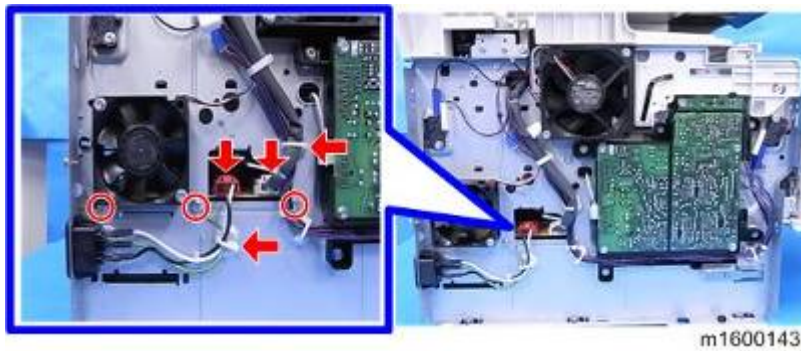

7. (🔧x1, 🛠️x1, 🛠️x1) on the right side of the PSU.

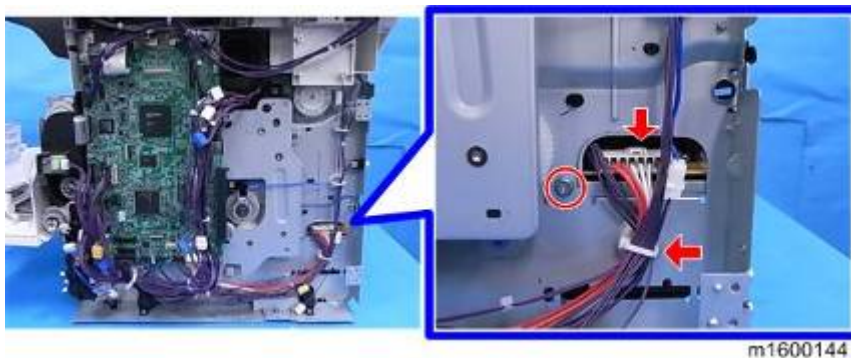

8. (🔧x2) on the rear side of the PSU.



m1600148

9. PSU [A] with Bracket (🔩 x1)



m1600145

10. Cover [A] (🔩 x2)

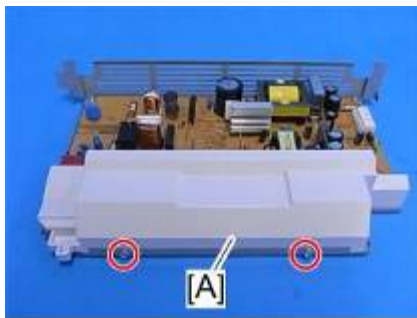

m1600146

11. Detach the PSU [A] from the bracket. (🔩 x6)

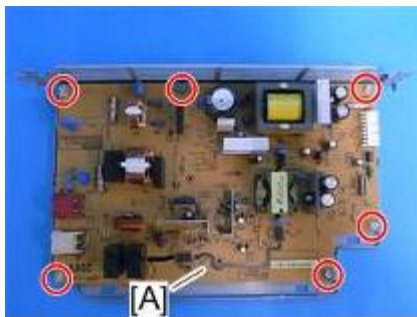

m1600147

4.12.4 CONTROLLER BOARD

★ Important

- If you intend to replace the NVRAM, upload its contents to an SD card with SP5-824 before you remove NVRAM and replace it with a new one. Never remove the NVRAM until after you have uploaded its contents.

Before replacing the controller board in the model without HDD

When you replace the controller board in a model without a HDD, address book data can be copied from an old controller board to a new controller board using an SD card.

Copy the address book data to an SD card from the flash ROM on the controller board with SP5-846-051 if possible.

Replacement Procedure

1. Controller Box (page 4-55 "Speaker")
2. Detach the controller board [A] by sliding it to the right. (⚙️x4, 🗑️x1).



3. Remove the NVRAM [C], the upper brace [A] and the lower brace [B].



Note

- Before removing the NVRAM, back up data.
- When replacing the controller board, remove the NVRAM from the old controller board. Then install it at the same position on the new controller board. Install so that the indentation [C] on NVRAM [A] is facing the direction of the arrow [B] that is printed on the controller board.

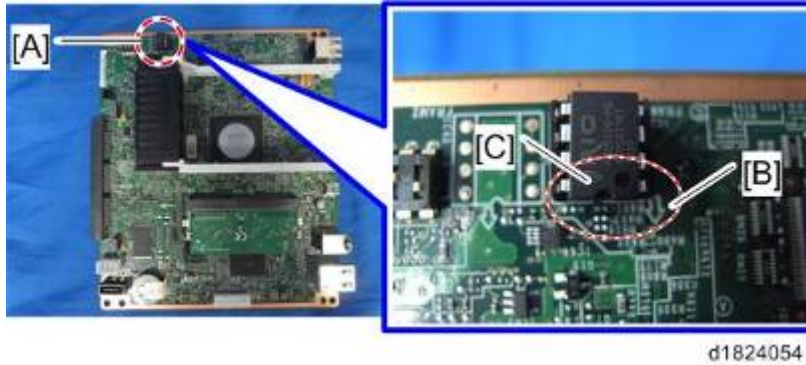

- Before replacing the controller board check which ESA applications have been installed. After replacing the controller board, re-install the ESA applications by following the installation instructions for each application.
- After reinstalling the ESA applications, print the SMC (SP-5-990-024/025 (SMC: SDK/ Application Info)).

4. If you have replaced the controller board, set the DIP switches on the new controller board to the same settings as the old board.

After installing the controller board

1. For a model without a HDD, do SP5-846-052 to copy back the address book to the flash ROM on the controller board from the SD card to which you have already copied the address book data if possible.
2. If the customer is using the data encryption feature, the encryption key must be restored.
 - If the message “SD card for restoration is required.” appears after the controller replacement, the encryption key should be restored.
3. Turn the main power switch off and on.

4.12.5 NVRAM ON THE CONTROLLER BOARD

1. Make sure that you have the SMC report (factory settings). This report comes with the machine.
2. Output the SMC data (“ALL”) using SP5-990-001. (SP5-990-001)
3. Turn off the main power switch.
4. Insert a blank SD card into slot #2, and then turn on the main power switch.
5. Upload the NVRAM data to the blank SD card using SP5-824-001 (NVRAM Data Upload).
6. Turn off the main power switch, and then unplug the AC power cord.
7. Remove the SD card containing the NVRAM data from slot #2.
8. Replace the NVRAM on the controller board with a new one.
9. Plug in the AC power cord, and then turn on the main power switch.

 Note

- When you do this, SC995-02 (Defective NVRAM) will be displayed. However, DO NOT turn off the main power switch. Continue with this procedure.

10. Re-insert the SD card that you removed in step 5 back into slot #2.
11. Download the old NVRAM data from the SD card onto the new NVRAM using SP5-825-001 (NVRAM Data Download).

 Note

- This will take about 2 or 3 minutes.

12. Turn off the main power switch, and then remove the SD card from slot #2.
13. Turn on the main power switch.
14. Output the SMC data (“ALL”) using SP5-990-001, and make sure that it matches the SMC data you printed out in step 2 above (except for the value of the total counter).

 Important

- Do all of the following if SP5-824-001 (NVRAM Data Upload) and SP5-825-001 (NVRAM Data Download) cannot be performed for some reason.
 1. Manually enter all data on the SMC report (factory settings).
 2. Install the Security function (Data Overwrite Security and HDD Encryption unit) again.

4.12.6 BICU

1. Controller Board (page 4-58 "Controller Board")
2. BICU [A] (🔧x6, 📏x all)



3. Remove the EEPROM [A] from the old board and install it on the new board.
Install so that the indentation [B] on EEPROM is facing the direction of the dent [C] that is printed on the BICU board.



4. Install the new BICU in the machine.
5. Enter the BICU serial number.
 - ⏴ Note
 - If the BICU serial number is not entered correctly, SC995-01 (serial number entry error) appears.
6. Turn the main power switch off and on.
7. Set the DIP switches on the new BICU board to the same settings as the old board.

- ⏴ Note
 - Make sure the EEPROM is correctly installed on the BICU. Insert the EEPROM in the EEPROM slot with the "half-moon" pointing [C] to the downside.

4.12.7 EEPROM ON THE BICU

CAUTION

- Keep EEPROM away from any objects that can cause static electricity. Static electricity can damage EEPROM data.
1. **Make sure that you have the SMC report (factory settings). This report comes with the machine.**
 2. **Print out the SMC data (SP5-990-001).**
 3. **Turn the main power switch off.**
 4. **Install an SD card into SD card slot 2. Then turn the main power on.**
 5. **Copy the EEPROM data to an SD card (SP5-824-001) onto the SD card.**
 6. **Turn off the main power switch. Then unplug the power cord.**
 7. **Replace the EEPROM on the BICU and reassemble the machine.**
 8. **Plug in the power cord. Then turn the main power switch on.**

When you do this, SC995 will be displayed. However, DO NOT turn off the main power switch. Continue with this procedure.

9. **Copy the data from the SD card to the EEPROM (SP5-825-001).**
10. **Enter the BICU serial number.**
11. **Turn the main power switch off. Then remove the SD card from SD card slot 2.**
12. **Turn the main power switch on.**

Important

- **If the BICU serial number is not entered correctly, SC995-01 (serial number entry error) appears.**

13. **Access SP5-996-001 and set the area code.**

Important

- **SP5-996-001 is a Factory SP mode. Please contact your Service key-person about the access method.**
- **The initial value stored in the EEPROM is “1”.**
- **After the EEPROM is replaced, the display for SP5-996-001 changes to Japanese.**
- **Refer to the following area code list.**

Area code Destination	
1	Japan
2	North America
3	EU
4	Taiwan

Area code Destination	
5	Asia
6	China
7	Korea

14. Turn the main power switch off and on.
15. In accordance with SMC data, input the UP and SP mode settings.

4.12.8 HDD

Before HDD Replacement

1. Insert an SD card in SD card slot 2 (lower slot).
2. Go into the SP mode.
3. Do SP5-846 51 to upload the address book data to the SD card.

Replacement Procedure

For details about the replacement procedure, see page 2-51 "Hard Disk Drive Option Type M6" in 2, "Installation".

Important

- If the HDD is damaged, you may not be able to retrieve this data from the HDD.

After HDD Replacement

1. When you turn the main power switch on after installing the hard disk, initialization of the disk starts automatically.
2. Go into the SP mode.
3. Do SP5-846-52 to restore the address book data to the HDD.

Note

- Never remove a used HDD unit from the work site (even if it is suspected of being damaged) without the consent of the client.
- The HDD must remain with the customer for disposal or safe keeping.
- The HDD may contain proprietary or classified (Confidential, Secret) information. Specifically, the HDD contains document server documents and data stored in temporary files created automatically during copy job sorting and jam recovery. Such data is stored on the HDD in a special format, so it cannot normally be read but it can possibly be recovered with illegal methods.

Reinstallation

- Explain to the customer that the following information stored on the HDD is lost when the HDD is replaced: document server documents, document server address book.
- The address book and document server documents (if needed) must be input again.
- If the customer is using the Data Overwrite Security, the Data Encryption feature or OCR Scanned PDF, these applications must be installed again.

4.12.9 TONER END SENSOR

1. Left Cover (page 4-7 "Left Cover")
2. Toner End Sensor [A] (⚙️ x1, 📏 x1, Tab x1)

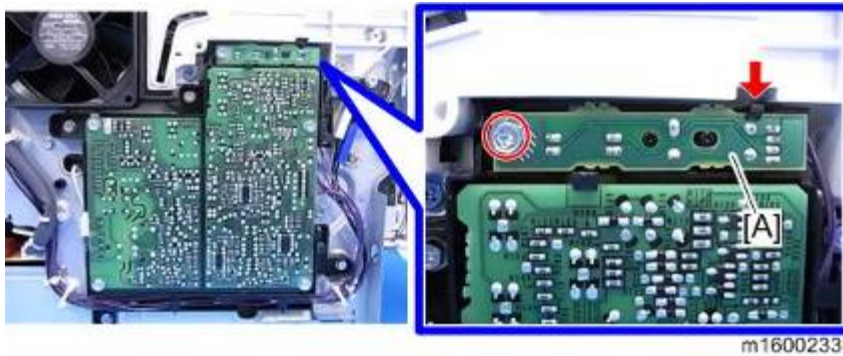

4.12.10 HVPS

1. Left Cover (page 4-7 "

Left Cover")

2. HVPS [A] (🔩 x4, 📏 x2, Tab x1)



4.12.11 HVPS WITH BRACKET

1. Left Cover (page 4-7 "

Left Cover")

2. Toner End Sensor [B] and HVPS [A] with Bracket (⚙️ x5, 🔌 x3, 🖨️ x2)

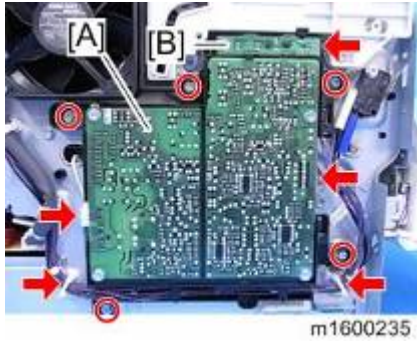

4.12.12 FUSING FAN

1. Left Cover (page 4-7 "

Left Cover")

2. Fusing Fan [A] (⚙️x2, 📏x1)



⬇️ Note

- When you reattach the Fusing Fan, attach it correctly (as shown above, the face of the fan with the sticker is on the outside).

4.12.13 PCDU COOLING FAN

1. Upper Cover (page 4-10 "Upper Cover")
2. BICU (page 4-61 "BICU")
3. PCDU Cooling Fan [A] with Bracket (⚙️x2, 📏x1)

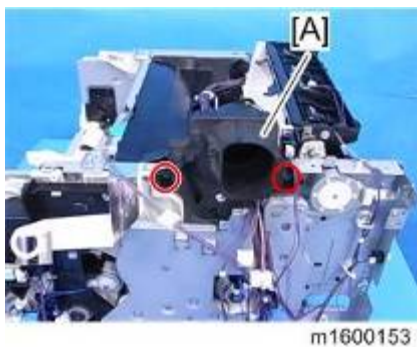

4. Detach the PCDU Cooling Fan [A] from the bracket. (⚙️x3)



4.12.14 PSU COOLING FAN

1. Left Cover (page 4-7 "Left Cover")
2. PSU Cooling Fan [A] (⚙️x2, 📏x1)

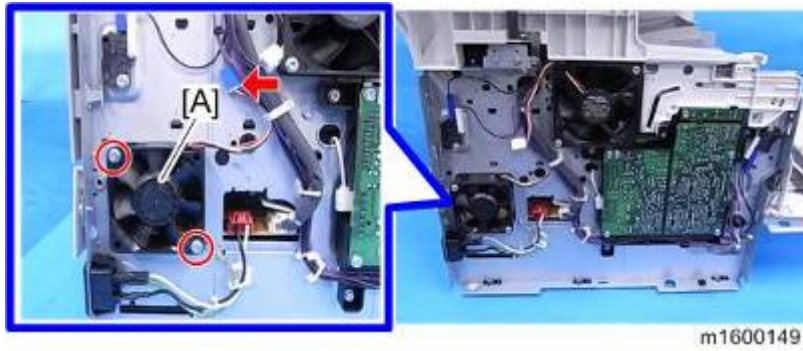

Note

- When you reattach the PSU cooling fan, the face of the fan with the sticker must be on the inside.

4.12.15 DC SWITCH

1. By-pass Feed Unit (page 4-41 "By-pass Feed Unit")
2. DC Switch [A] with Bracket (⚙️ x1)



3. Detach the DC Switch from the bracket [A]. (⚙️ x1)



4.12.16 FRONT DOOR INTERLOCK SWITCH

1. Left Cover (page 4-7 "Left Cover")
2. Front Door Interlock Switch [A] (⚙️ x1, 📏 x2)

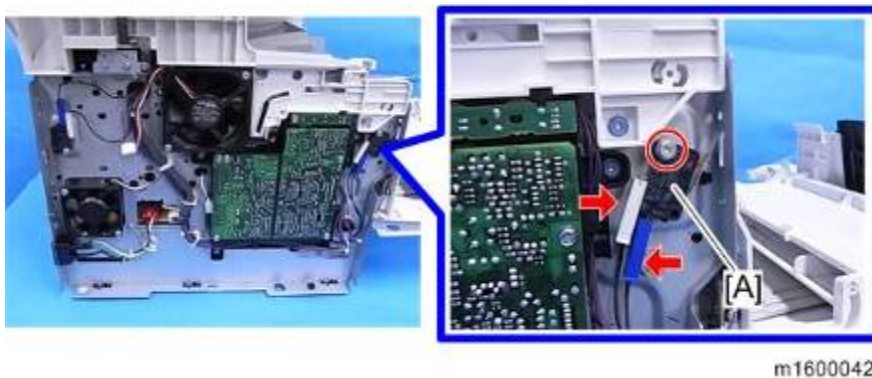

4.12.17 REAR DOOR INTERLOCK SWITCH

1. Left Cover (page 4-7 "Left Cover")
2. Rear Door Interlock Switch [A] (⚙️ x1, 🔌 x2)

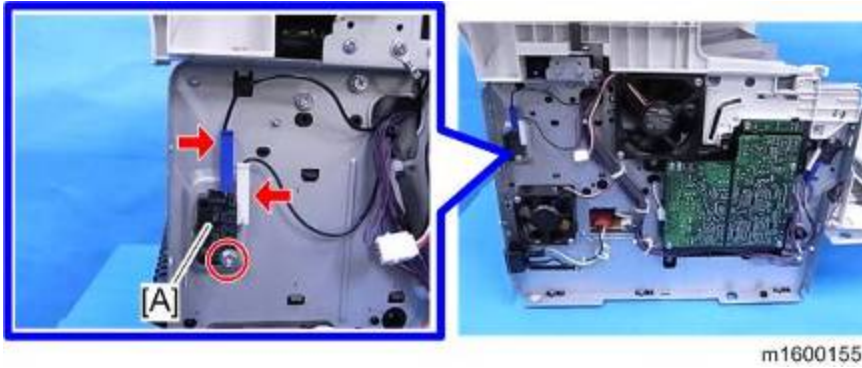

4.12.18 DIMM

1. Cover [A]



2. Shield [A] (⚙️ x1)



3. DIMM [A]

Replacement and Adjustment

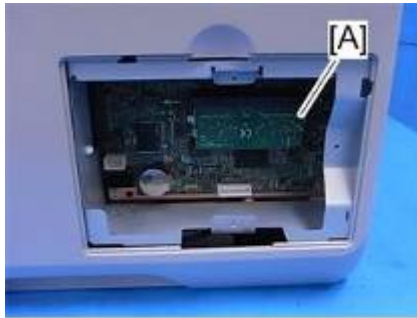

m1600210

4.12.19 TEMP HUMID SENSOR

1. Right Cover (page 4-8 "Right Cover")
2. Temp Humid Sensor [A] (🔧 x1, 📦 x1)



m1600084

4.12.20 REAR COVER SWITCH

1. Controller Board (page 4-58 "Controller Board")
2. Rear Cover Switch [A] (🔧 x1, Hook)



m1600087

4.13 ARDF

⚠ CAUTION

- Turn off the main power switch and disconnect the power cord before you start any of the procedures in this section.

4.13.1 ARDF UNIT

1. Scanner Rear Cover [A] (🔧 x2)



2. Scanner Rear Upper Cover [A]



3. (🔧 x2, 📏 x1, 📏 x1) shown below



ⓘ Note

- Use longnose pliers to pinch and release the clamp.

ARDF



m1600285

4. Lift the ARDF [A] to detach.

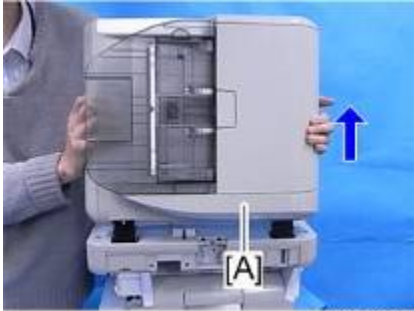

m1600028

ⓘ Note

- The joint parts of the ARDF have tabs that latch onto the scanner. So you need to push the ARDF forward fully while trying to detach it in order to detach the tabs.

4.13.2 ARDF FRONT COVER

Note

- There are four tabs on the back of the ARDF front cover. Refer to the picture below.

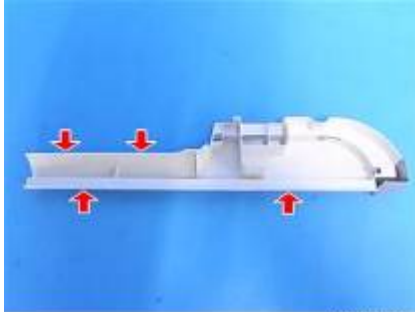

m1600022

1. Open the ARDF top cover [A].
2. ARDF Front Cover [B] (x1 ,Tab x4)

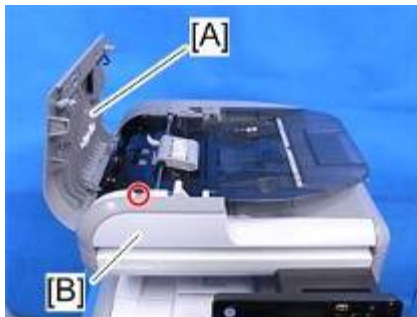

m1600020

4.13.3 ARDF REAR COVER

1. Open the ARDF [A] and release the three hooks.



2. Close the ARDF and then detach the ARDF rear cover [A]. (⚙️ x1)



4.13.4 ARDF TOP COVER

1. ARDF Rear Cover (page 4-76 "ARDF Rear Cover")
2. ARDF Top Cover [A] (x1)

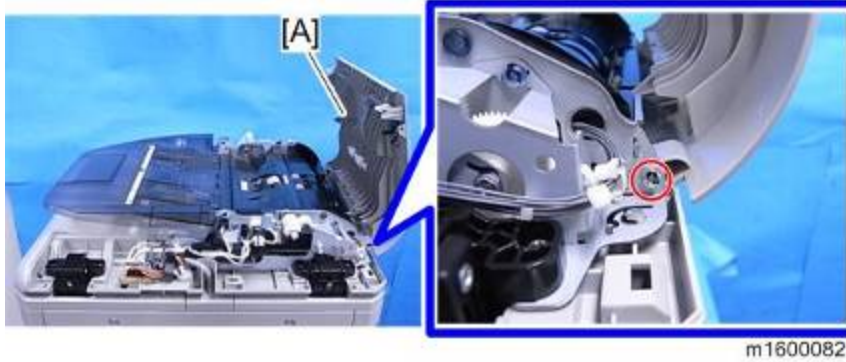

4.13.5 ARDF ORIGINAL TRAY

1. ARDF Front Cover (page 4-75 "ARDF Front Cover")
2. ARDF Rear Cover (page 4-76 "ARDF Rear Cover")
3. Slide the ARDF original tray [A] to detach (🔌x1)



4.13.6 ORIGINAL FEED UNIT

1. Open the ARDF top cover [A].
2. Slide the original feed unit [B] towards the front to detach.

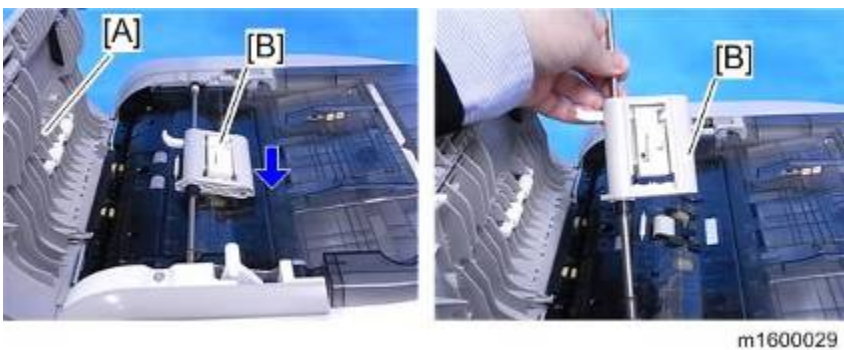

4.13.7 ARDF FRICTION PAD

1. Original Feed Unit (page 4-78 "Original Feed Unit")
2. Release the lever [A] and then detach the ARDF friction pad [B].

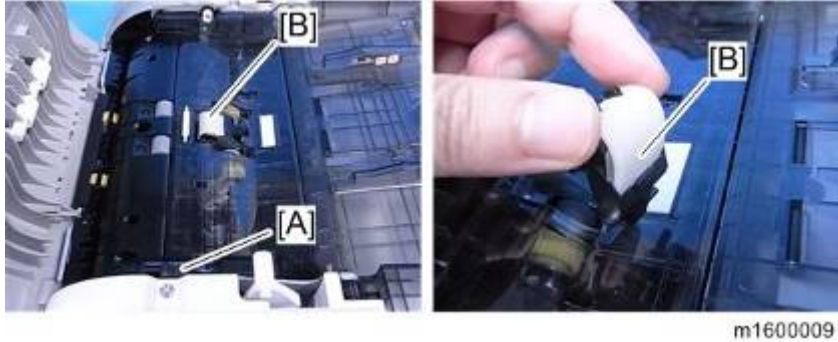

4.13.8 ARDF DRIVE MOTOR

1. ARDF Rear Cover (page 4-76 "ARDF Rear Cover")
2. Original Feed Unit (page 4-78 "Original Feed Unit")
3. Push down the lever [A] to the right.

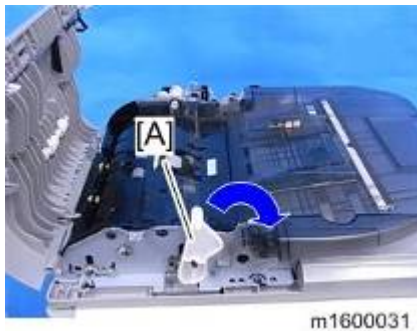

↓ Note

- Push up the lever [A] to the initial position when the replacement is finished.

4. Release the hinges arrowed below to detach the upper guide plate [A].

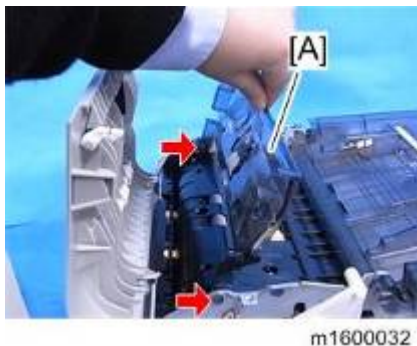

5. Lower Guide Plate [A] (⚙️x5)

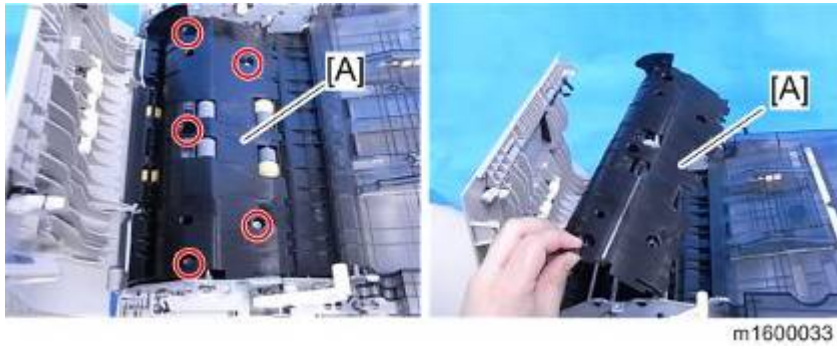

6. Release the harness. (🔧x4)



7. Detach the harness from the harness guide [A]. (🔧x8, 🛠️x1)

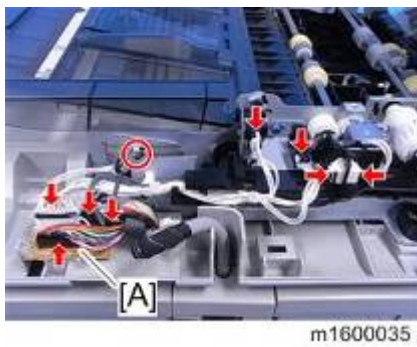

8. Harness Guide [A] (🔧x1, 🛠️x1)

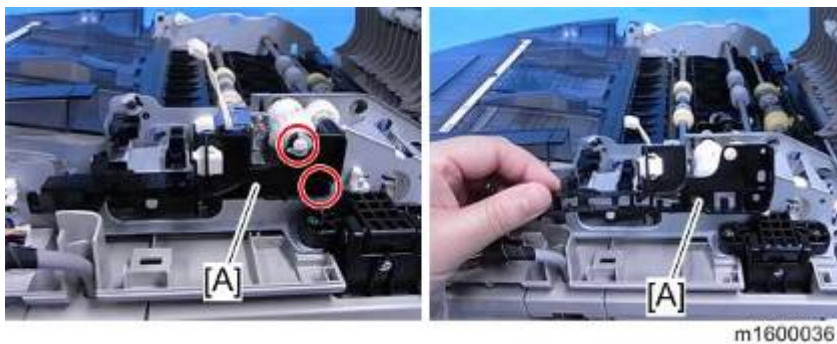

9. Junction Gate Solenoid [A] (🛠️x1)

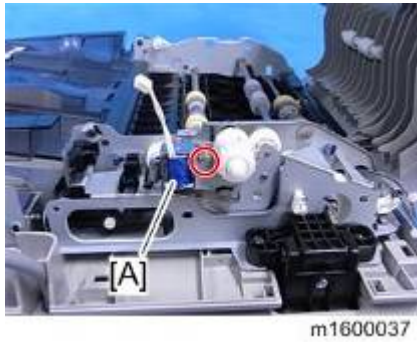

10. Bracket [A] with the joint part [B] (⚙️ x4)



⬇️ Note

- Do not remove the indicated screw [A].

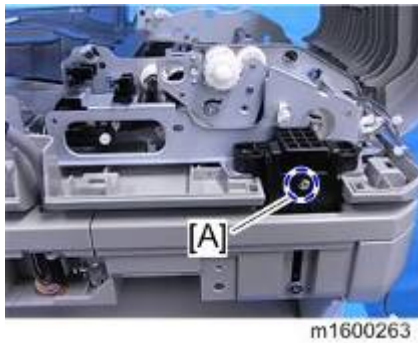

11. (⚙️ x2) on the ARDF drive motor.

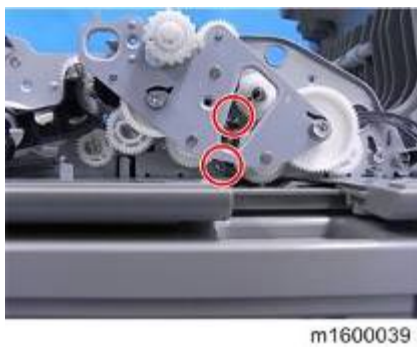

12. ARDF Drive Motor [A] (🔌 x1)



4.13.9 ARDF TOP COVER SENSOR

1. ARDF Rear Cover (page 4-76 "ARDF Rear Cover")
2. ARDF Top Cover Sensor [A] (1 x1 ,Hook)



4.13.10 ARDF ORIGINAL SET SENSOR

1. ARDF Rear Cover (page 4-76 "ARDF Rear Cover")
2. ARDF Original Set Sensor [A] (1 x1 ,Hook)



4.13.11 ARDF REGISTRATION SENSOR

1. Open the ARDF [A].
2. Release the hook to remove the white plate [B].

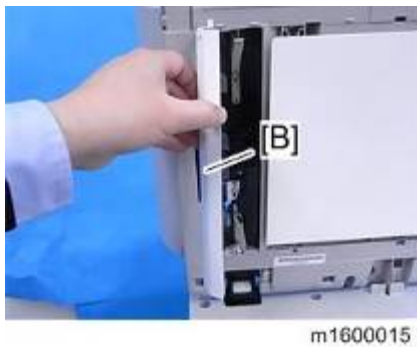
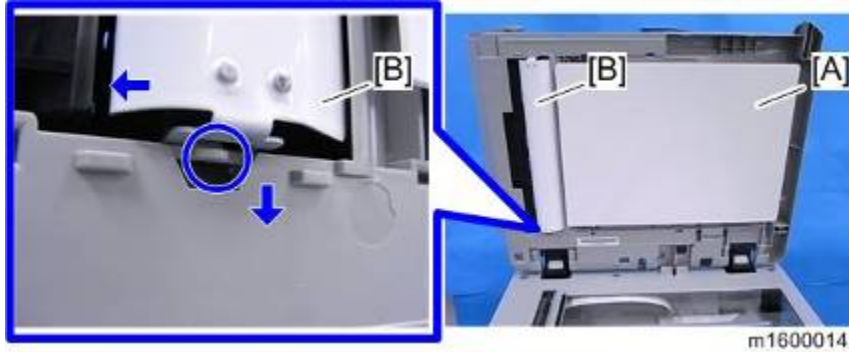

⬇ Note

- Push the white plate inward and push the hook down when you try to detach the white plate. The shepe of the hook is shown below.



3. ARDF Registration Sensor [A] with bracket (⚙ x1)

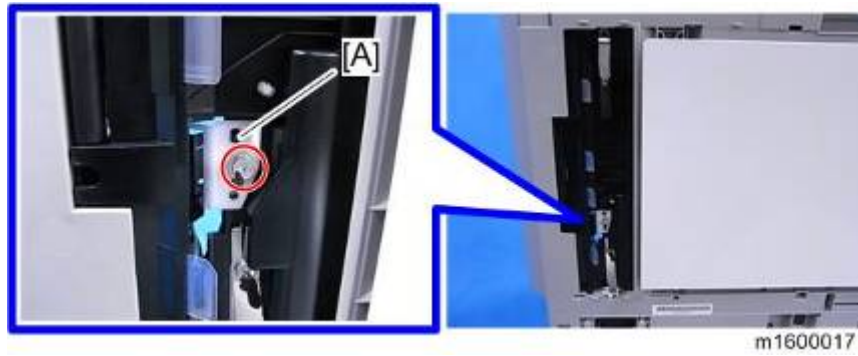

4. Detach the registration sensor [A] from the bracket. (Hook x1 ,Hook)



4.13.12 DFRB

1. ARDF Rear Cover (page 4-76 "ARDF Rear Cover")
2. DFRB [A] (x all ,Hook x1)

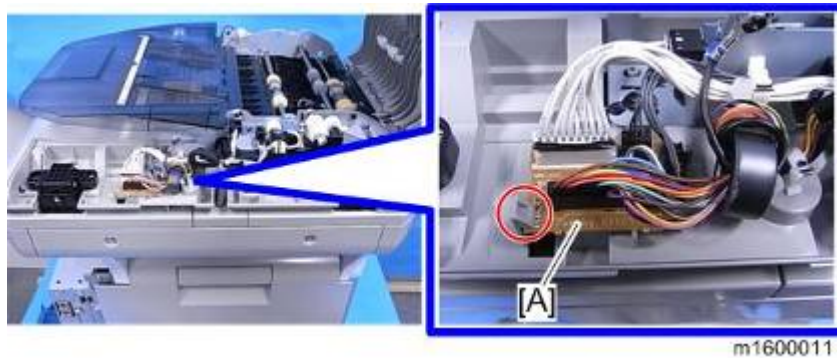

4.13.13 PICK-UP SOLENOID

1. ARDF Rear Cover (page 4-76 "ARDF Rear Cover")
2. Pick-up Solenoid [A] (🔧x1 , 📦x1)

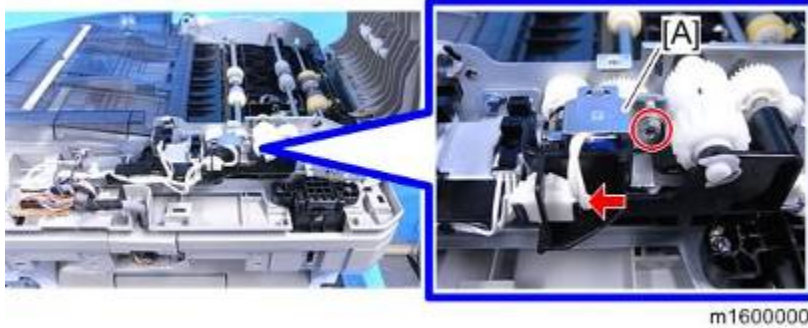

4.13.14 JUNCTION GATE SOLENOID

1. ARDF Rear Cover (page 4-76 "ARDF Rear Cover")
2. (🔧x1 , 📦x1 , 📦x1 , Spring x1) shown below

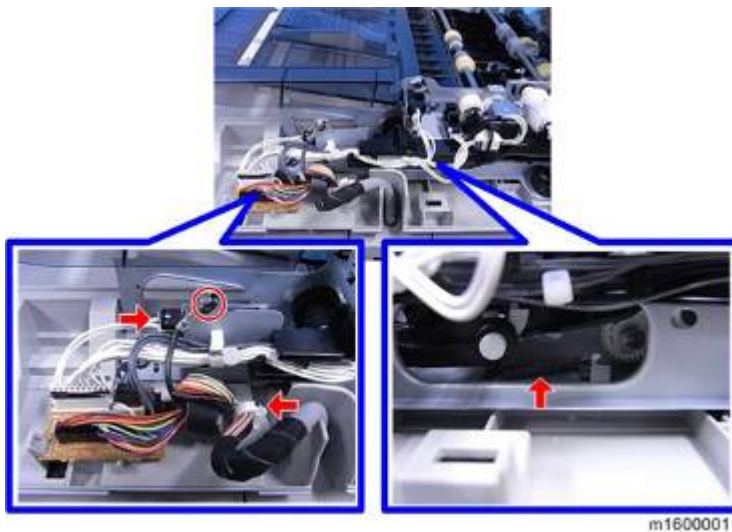

3. (🔧x2) that fixes the Junction Gate Solenoid

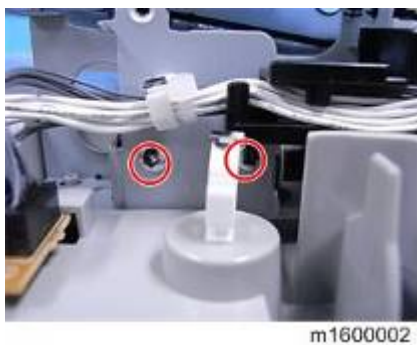

4. Lift the ARDF original tray [A].

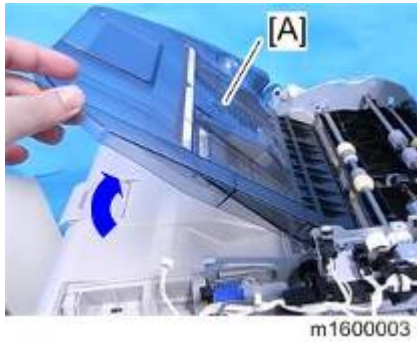

5. Release the link [A] of the junction gate solenoid.



6. Junction Gate Solenoid [A]



4.14 SCANNER

⚠ CAUTION

- Turn off the main power switch and disconnect the power cord before you start any of the procedures in this section.

4.14.1 SCANNER UNIT (WITH ARDF)

↓ Note

- When you want to detach only the ARDF, see page 4-73 "ARDF Unit".

- Left Cover (page 4-7 "Left Cover")
- Right Cover (page 4-8 "Right Cover")
- Pulling the side of the operation panel lower cover [B], release the hooks of the operation panel upper cover [A] and remove the covers. (Hook x4)



↓ Note

- There are four tabs on the back of the front right cover [A]. Refer to the picture below before the replacement. Release the tab [B] first when removing the front right cover.



- 4. Operation Panel Lower Inner Cover (page 4-12 "Operation Panel Lower Inner Cover")
- 5. Scanner Front Cover [A] (Hook x4)



- 6. Remove the screws for Scanner Unit and ARDF Unit [A] (Right Side:  x3,  x1,  x4 / Left Side:  x1 / Upper:  x1)

Right Side

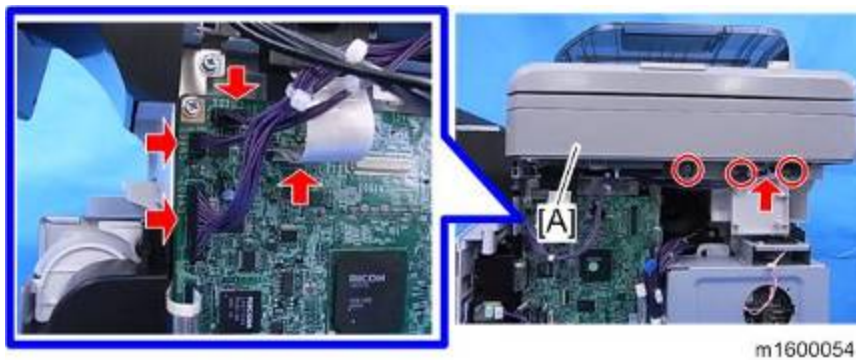

Left Side



Upper Side



7. Slide the ARDF and the scanner unit [A] to the right and then lift them to detach from the machine.



4.14.2 SCANNER UPPER COVER

1. ARDF (page 4-73 "ARDF Unit")
2. Scanner Front Cover (page 4-87 "Scanner Unit (with ARDF)")
3. Scanner Upper Cover [A] (⚙️ x6)

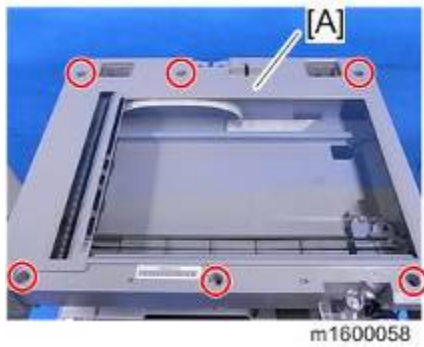

4.14.3 ARDF OPEN/CLOSED SENSOR

1. Scanner Upper Cover (page 4-90 "Scanner Upper Cover")
2. ARDF Open/Closed Sensor [A] (⚙️ x1, Hook, Bracket x1)

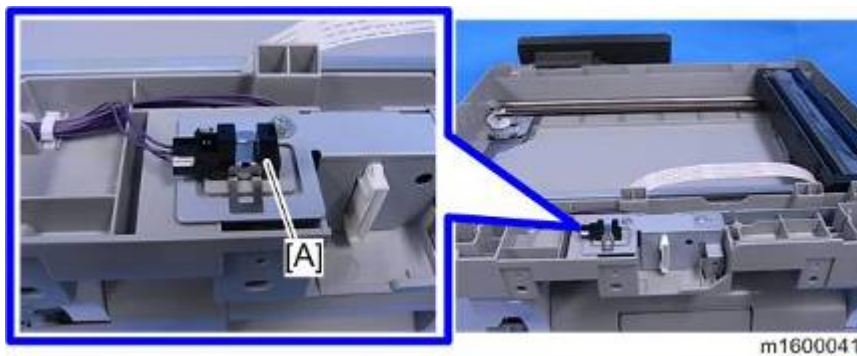

4.14.4 CARRIAGE

1. Scanner Upper Cover (page 4-90 "Scanner Upper Cover")
2. Move carriage [A] to the right.

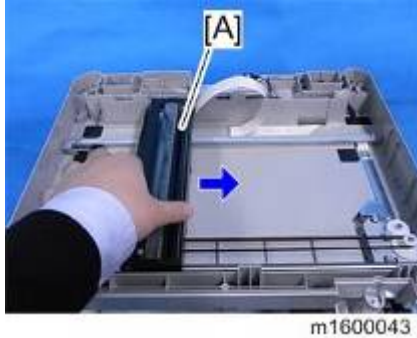

3. Slide the bracket [B] as shown below to detach the belt [A] from the pulley.
4. Bracket [C] (⚙️ x3)

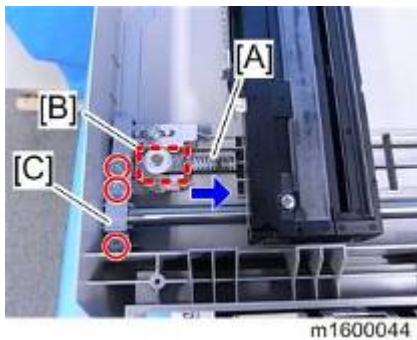

5. Carriage [A] (🔧 x1)

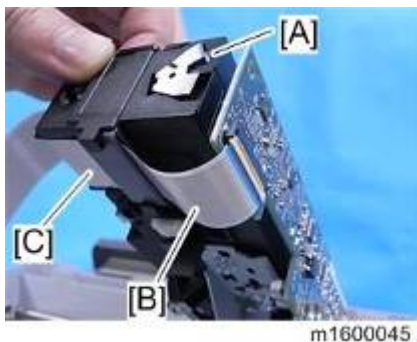

⚠️ Note

- In the area [C], the flat cable [B] is fixed with double-sided tape. Do not try to strip the flat cable [B] off by force.

6. Remove the shaft [B] from the carriage [A].

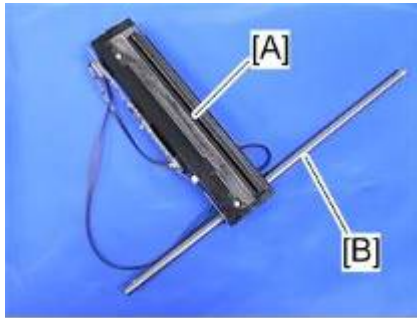

m1600046

4.14.5 CARRIAGE UNIT HP SENSOR

1. Scanner Upper Cover (page 4-90 "Scanner Upper Cover")
2. Move the carriage [A] to the middle of the scanner unit.
3. Bracket [B] and Rail [C] (x4)

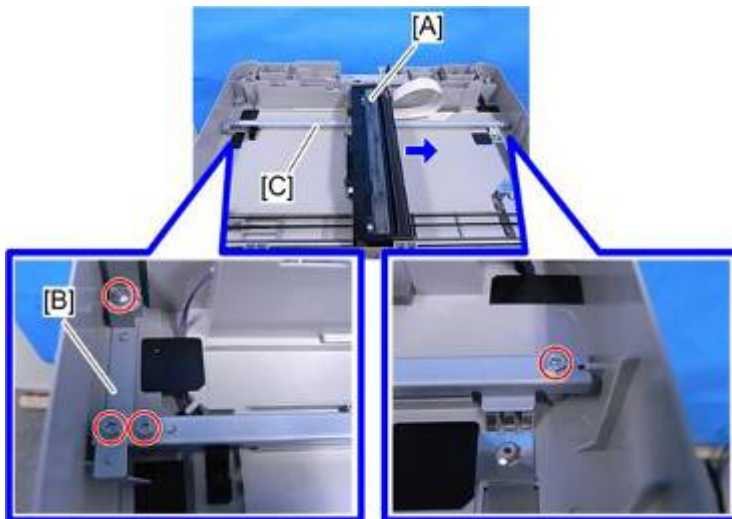

m1600047

4. Carriage Unit HP Sensor [A] (x1, Hook)

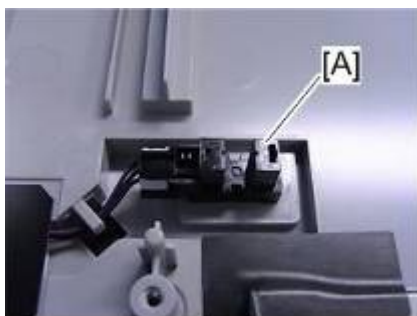

m1600048

4.14.6 SCANNER MOTOR

1. Scanner Upper Cover (page 4-90 "Scanner Upper Cover")
2. Detach the scanner motor [A] from the scanner unit. (⚙️ x4)



m1600049

3. Scanner Motor [A] (⚙️ x2, 📏 x1)

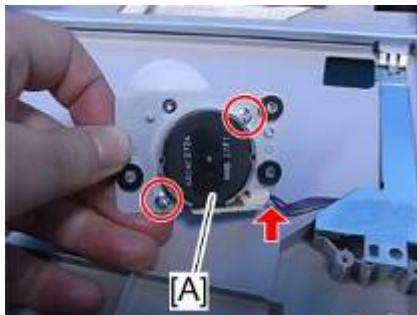

m1600050

SYSTEM MAINTENANCE

REVISION HISTORY		
Page	Date	Added/Updated/New
		None

5. SYSTEM MAINTENANCE

5.1 SERVICE PROGRAM MODE

CAUTION

- Make sure that the data-in LED is not on before you go into the SP mode. This LED indicates that some data is coming to the machine. When the LED is on, wait for the printer to process the data.
- Do not let the user access the SP mode. Only service representatives are allowed to access the SP mode. The machine quality or its operation is NOT guaranteed if persons other than service representatives accesses the SP mode.

5.1.1 SP TABLES

See "Appendices" for the following information:

- Service SP Tables
- Engine SP Tables-1
- Engine SP Tables-2
- Engine SP Tables-3
- Engine SP Tables-4
- Engine SP Tables-5
- Engine SP Tables-6
- Engine SP Tables-7
- Engine SP Tables-8

5.1.2 ENABLING AND DISABLING SERVICE PROGRAM MODE

Entering SP Mode

For details, ask your supervisor.

Exiting SP Mode

Press "Exit" on the LCD twice to return to the user screen.

Note

- To make the settings effective, turn the main power switch off and on after exiting service mode.

5.1.3 TYPES OF SP MODES

Type	Description
System SP	SP modes related to the engine functions
Printer SP	SP modes related to the controller functions
Scanner SP	SP modes related to the scanner functions
Fax SP	SP modes related to the fax functions

Select one of the Service Program modes (System, Printer, Scanner, or Fax) from the touch panel as shown in the diagram below after you access the SP mode. This section explains the functions of the System/Printer/Scanner SP modes. Refer to the Fax service manual for the Fax SP modes.



5.1.4 SP MODE BUTTON SUMMARY

Here is a short summary of the touch-panel buttons.

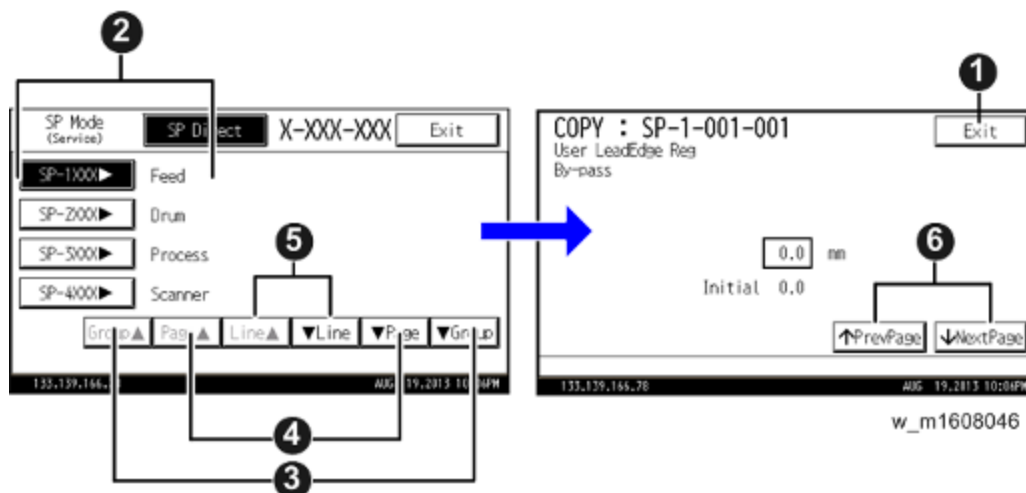

1	Press two times to leave the SP mode and return to the user screen to resume normal operation.
2	Press any Class 1 number to open a list of Class 2 SP modes.
3	Press to scroll the show to the previous or next group.
4	Press to scroll to the previous or next display in segments the size of the screen display (page).
5	Press to scroll the show the previous or next line (line by line).
6	Press to move the highlight on the left to the previous or next selection in the list.

5.1.5 SERVICE MODE LOCK/UNLOCK

At locations where the machine contains sensitive data, the customer engineer cannot operate the machine until the Administrator turns the service mode lock off. This function makes sure that work on the machine is always done with the permission of the Administrator.

- 1. If you cannot go into the SP mode, ask the Administrator to log in with the User Tool and then set "Service Mode Lock" to OFF after he or she logs in:**

User Tools > System Settings > Administrator Tools > Service Mode Lock > OFF

- This unlocks the machine and lets you get access to all the SP codes.
 - The CE can service the machine and turn the machine off and on. It is not necessary to ask the Administrator to log in again each time the machine is turned on.
- 2. Go into the SP mode and set SP5169 to "1" if you must use the printer bit switches.**
 - 3. After machine servicing is completed:**
 - Change SP5169 from "1" to "0".
 - Turn the machine off and on. Tell the administrator that you have completed servicing the machine.
 - The Administrator will then set the "Service Mode Lock" to ON.

5.2 UPDATING THE FIRMWARE

5.2.1 OVERVIEW

To update the firmware for this machine, you must have the new version of the firmware downloaded onto an SD (Secure Digital) Card. The SD Card is inserted into SD Card Slot 2 (lower) on the left rear side of the controller box.

5.2.2 TYPE OF FIRMWARE

There are several types of firmware as shown below.

Type of firmware	Function	Location of firmware	Message shown
Engine	Printer engine control	BICU Flash ROM	Engine
System	Operating system	Flash ROM on the controller board	System
Lcdc	Panel control	Operation Panel	Lcdc
ARDF control	ARDF Main Control Board	ARDF	ADF
Bank	Bank control	Bank	Bank
Fax FCU	Fax control	FCU	FCU
NIB/DESS	Network interface/ Security control	Flash ROM on the controller board	Network Support
Security & Encryption	HDD encryption / Data Overwrite	Flash ROM on the controller board	HDD Format Option
RPCS	Page description Language (RPCS for XPS driver data process)	Flash ROM on the controller board	RPCS
PS3/PDF Adobe	Page description language (PostScript3)	Flash ROM on the controller board	PS/PDF

Type of firmware	Function	Location of firmware	Message shown
PCL/ PCLXL	Page description language (PCL)	Flash ROM on the controller board	PCL/PCL XL
MediaPrint: JPEG/TIFF	MediaPrint control	Flash ROM on the controller board	MediaPrint: JPEG/TIFF
Summary Font	Summary fonts	Flash ROM on the controller board	Font
PCL Font	PCL fonts	Flash ROM on the controller board	FONT1
PS Font	PostScript3 fonts	Flash ROM on the controller board	FONT2
Netfile Application	Feature application	Flash ROM on the controller board	NetworkDocBox
Fax Application	Feature application	Flash ROM on the controller board	Fax
Printer Application	Feature application	Flash ROM on the controller board	Printer
Scanner Application	Feature application	Flash ROM on the controller board	Scanner
Remote Fax	Fax control	Flash ROM on the controller board	RFax
WebSys	Web Service application	Flash ROM on the controller board	Web Support
WebDocBox	Document server application	Flash ROM on the controller board	Web Uapl
Java VM	Java VM platform	Java VM card Option	SDK1

5.2.3 UPDATING FIRMWARE

Before You Begin

An SD card is a precision device. Always observe the following precautions when you handle SD cards:

- Always switch the machine off before you insert an SD card. Never insert the SD card into the slot with the power on.
- Do not remove the SD card from the service slot after the power has been switched on.
- Never switch the machine off while the firmware is downloading from the SD card.
- Keep SD cards in a safe location where they are not exposed to high temperature, high humidity, or exposure to direct sunlight.
- Always handle SD cards with care. Do not bend or scratch them. Do not let the SD card get exposed to shock or vibration.
- Make sure that the write protection of an SD card is unlocked when you download an application to it. If not, downloading fails and a download error (e.g. Error Code 44) occurs during a firmware upgrade.
- Keep the following points in mind when you use the firmware update software:
 - "Upload" means to send data from the machine to the SD card. "Download" means to send data from the SD card to the machine.
 - To select an item on the LCD, touch the appropriate button on the soft touch-screen of the LCD.
 - Disconnect the Ethernet interface cable, IEEE1284 interface cable and remove the Wireless LAN interface board before you start the firmware update procedure. Make sure that the machine is disconnected from the network to prevent a print job for arriving while the firmware update is in progress.

Preparation

- If the SD card is blank, copy the entire "romdata" folder onto the SD card.
- If the card already contains the "romdata" folder, copy the "M160" folder onto the card.

If the card already contains folders up to "M160", copy the necessary firmware files (e.g. M160xxxx.fwu) into this folder.

Note

- Do not put multiple machine firmware programs on the same SD card. Copy the only model firmware you want.

Updating Procedure

1. Turn the main power switch off.
2. Remove the slot cover [A] (⚙️ x 1).
3. Insert the SD card into SD Card Slot 2 [B].

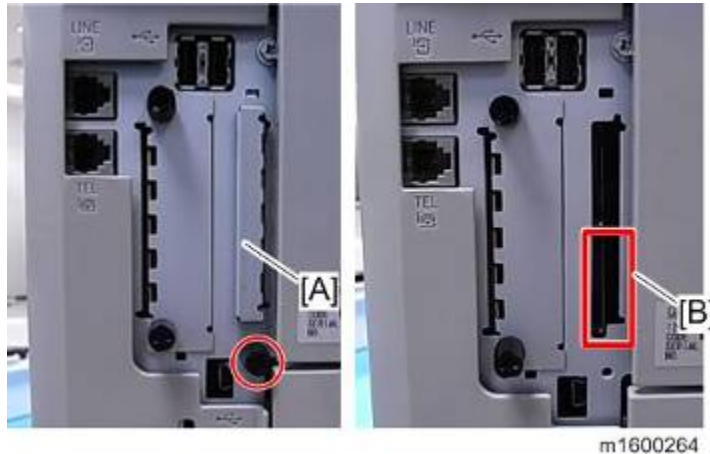

Note

- Make sure the label on the SD card faces the front side of the machine.
- Slowly push the SD card into the slot so it locks in place. You will hear it click. Make sure the SD card locks in place.
- To remove the SD, push it in to unlock the spring lock. Then release it so it pops out of the slot.

4. Disconnect the network cable if the machine is connected to a network.
5. Turn the main power switch on.

After a few seconds, the initial version update screen appears on the LCD in English.

6. If the SD card contains more than one software application, the screen will be almost the same as the one below. The screen below shows that the SC card contains two applications: "Engine" and "Printer".

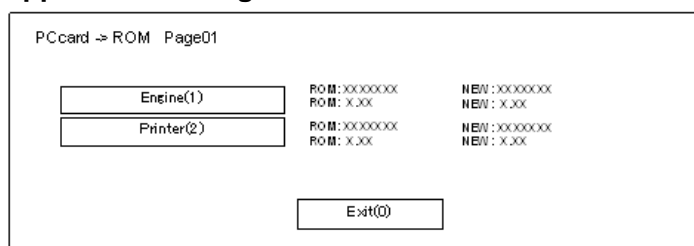

b246s903

7. To select the item for upgrade, touch the selection on the touch panel, or push the corresponding key on the 10-key pad (1 to 5) of the operation panel. The number in parentheses tells you which key to push. When you make a selection, the [Verify(J*)] and [Update(#)] buttons come on the screen.

Updating the Firmware

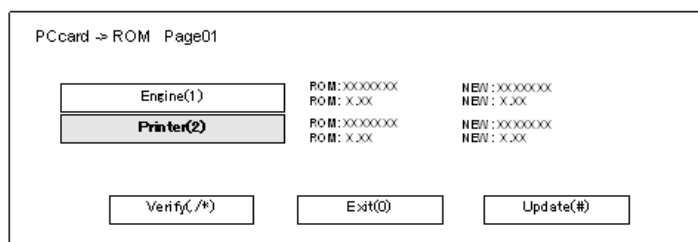

b246s904

key/ screen description

	What it means
[Exit] (or the [0] key)	Return to the normal operation screen.
[Start] key	Select all the firmware.
[Clear]	Cancel your selections.
Verify (or the (/)* key)	Update the ROM of the selected firmware.
Update (or the # key)	Check for an error in the selected firmware.
NEW:	Number of the module and name version on the SD card. The first line is the module number, the second line the version name.
ROM:	Number of the module and name of the version currently installed. The first line is the module number, the second line the version name.

Note

- Controller, engine and operation panel firmware cannot be updated at the same time. It is recommended to update firmware modules one by one.

8. With the selected items shown in reverse color, push the [Update] button or the [#] key on the operation panel to start the update.

After you push [Update], following screen appears.

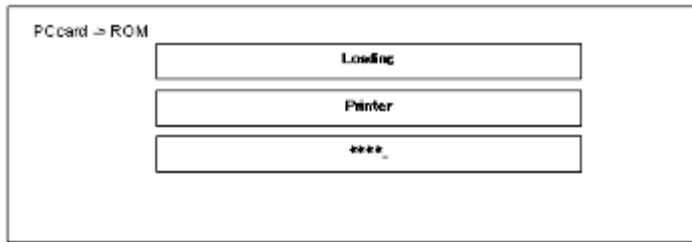

b246s905

Note

- The progress bar appears on the operation panel.

9. The "Update Done" message appears on the operation panel after completing the updating.

The message differs depending on the firmware that has been updated.

The name of the module in the bottom bar is the name of the last module that was updated (only the name of the last module is shown, if several modules were been updated).

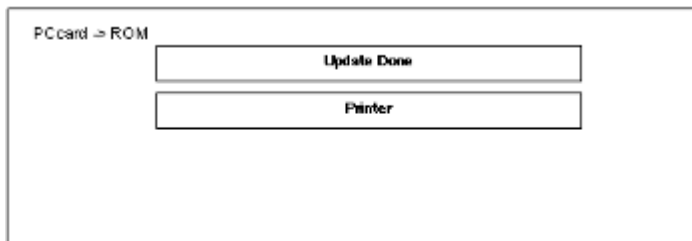

b246s906

10. Turn the main power off and on. Then, select the items that you updated, and then push the [Verify] button.

This is to check that the modules were updated correctly. Press in the SD card to release it. Then remove it from the slot.

11. If you see "Verify Error" in the first bar on the screen, then you must do the procedure again for the module shown in the bottom bar.

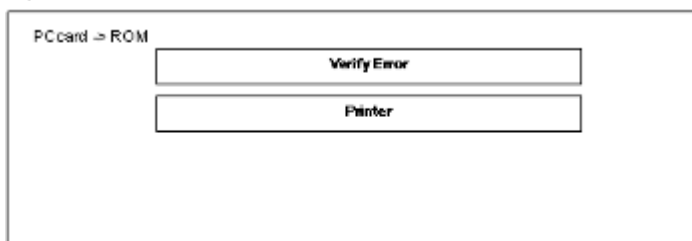

b246s907

Note

- The "Verify" procedure is not necessary but it is strongly recommended.

12. After the firmware is correctly updated, turn the main power switch off, and then switch the machine on for normal operation.

Firmware Update Error

If firmware update fails, an error code appears.

An error message shows in the first line if an error occurs during the download.

The error code consists of the letter "E" and a number (for example, "E36"). For details, refer to the Error Message Table. (Handling Firmware Update Errors in this section)

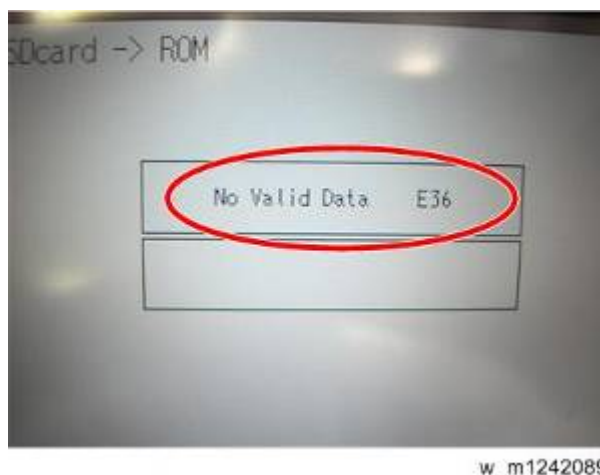

Recovery after Power Loss

If the ROM update is interrupted as a result of accidental loss of power while the firmware is updating, then the correct operation of the machine cannot be guaranteed after the machine is switched on again. If the ROM update does not complete successfully for any reason, then in order to ensure the correct operation of the machine, the ROM update error will continue to show until the ROM is updated successfully.

In this case, insert the card again and switch on the machine to continue the firmware download automatically from the card without the menu display.

5.2.4 HANDLING FIRMWARE UPDATE ERRORS

Error Message Table

Code	Meaning	Solution
20	Cannot map logical address	<ul style="list-style-type: none"> ▪ Cycle the machine off/on. ▪ If the program starts in the SD card, reinsert the SD card. ▪ If you cannot resolve the problem with the above steps, replace the controller board.

Code	Meaning	Solution
21	Not enough memory for downloading	<ul style="list-style-type: none"> ▪ Cycle the machine off/on. ▪ If you cannot resolve the problem with the above steps, replace the controller board.
22	Cannot decompress compressed data	<ul style="list-style-type: none"> ▪ Cycle the machine off/on. ▪ Replace the SD card that was used to update ▪ If you cannot resolve the problem with the above steps, replace the controller board.
24	SD card access error	<ul style="list-style-type: none"> ▪ Cycle the machine off/on. ▪ Make sure SD card inserted correctly, or use another SD card. ▪ If you cannot resolve the problem with the above steps, replace the controller board.
30	Cannot download stamp data (no HDD)	<ul style="list-style-type: none"> ▪ Connect HDD correctly. ▪ In the case of HDD failure, replace the HDD. ▪ Cannot be downloaded to a machine with no HDD.
32	Different SD card between download interruption and download resumption	<ul style="list-style-type: none"> ▪ Setting the SD card was interrupted. Cycle the machine off/on. ▪ If the update cannot be made even if you insert the correct SD card, there is a possibility that the SD card is broken. Retry again with a different SD card. ▪ If you cannot resolve the problem with the above steps, replace the controller board. ▪ If the program is in the SD card, reinsert the SD card. ▪ If you updated engine, FCU, or operating unit, replace each board.
33	Incorrect version data in the SD card	<ul style="list-style-type: none"> ▪ Acquire correct update data then install again.
34	Module error - Correct module (destination) is not in the SD card.	<ul style="list-style-type: none"> ▪ Acquire the correct data (Japan, Overseas, OEM, etc.) then install again.

Updating the Firmware

Code	Meaning	Solution
35	Module error – Module in the SD card is not for this machine	<ul style="list-style-type: none"> Acquire correct update data then install again.
36	Module error – The machine does not have the program that you are trying to download.	<ul style="list-style-type: none"> Install the correct program in advance. Make sure SD card inserted correctly. If the update cannot be made even if you insert the correct SD card, there is a possibility that the SD card is broken. Retry again with a different SD card.
38	Program version is not allowed to update	<ul style="list-style-type: none"> Acquire correct update data then install again.
40	Engine module download failed	<ul style="list-style-type: none"> Cycle the machine off/on. If the download failed again, replace the controller board.
41	Fax module download failed	<ul style="list-style-type: none"> Cycle the machine off/on. If the download failed again, replace the controller board and FCU.
42	Operation/language module download failed	<ul style="list-style-type: none"> Cycle the machine off/on. If the download failed again, replace the controller board and operation board.
43	Stamp data module download failed	<ul style="list-style-type: none"> Cycle the machine off/on. If the update cannot be made even if you insert the correct SD card, there is a possibility that the SD card is broken. Retry again with a different SD card.
44	Controller module download failed (access error)	<ul style="list-style-type: none"> Cycle the machine off/on. If the program is in the SD card, replace the SD card. If the program is in the controller board, replace the controller board.
49	Firmware update is prohibited	<ul style="list-style-type: none"> Firmware update is disabled in the administrator settings. Retry by changing the settings to allow firmware update.

Code	Meaning	Solution
50	Digital certificate check result of updating data was NG.	<ul style="list-style-type: none"><li data-bbox="611 286 1235 320">▪ Acquire correct update data then install again.

5.3 UPLOADING/DOWNLOADING NVRAM DATA

5.3.1 UPLOADING CONTENT OF NVRAM TO AN SD CARD

Do the following procedure to upload SP code settings from NVRAM to an SD card.

Note

- All data that is stored in NV-RAM of the engine and controller is subject to update.

Note

- This data should always be uploaded to an SD card before the NVRAM is replaced.
- Make sure that the write protection of an SD card is unlocked

1. **Do SP5990 (SMC Print) before you switch the machine off. You will need a record of the NVRAM settings if the upload fails.**
2. **Turn the machine main power switch off.**
3. **Remove the SD slot cover [A] (x 1)**
4. **Insert the SD card into SD card slot [B].**

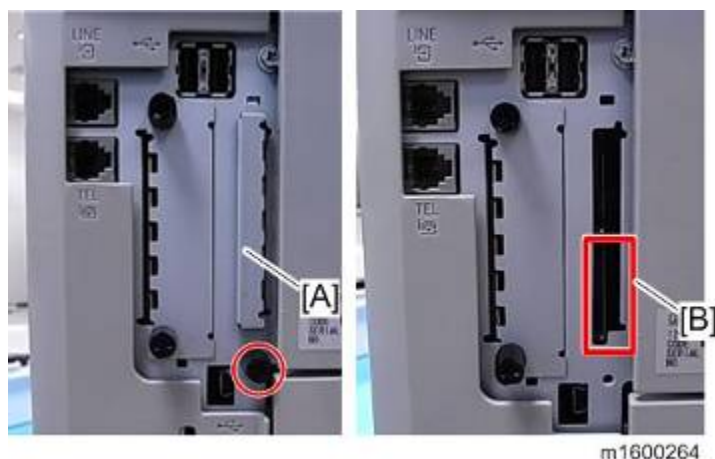

5. **Then turn the machine on.**
6. **Execute SP5-824-001 (NVRAM Data Upload) and then press the “Execute” key.**
7. **The following files are copied to an NVRAM folder on the SD card when the upload procedure is finished. The file is saved to the following path and filename:**
NVRAM\Here is an example with Serial Number “K5000017114”:
NVRAM\K5000017114.NV
8. **In order to prevent an error during the download, be sure to mark the SD card that holds the uploaded data with the number of the machine from which the data was uploaded.**

Note

- You can upload NVRAM data from more than one machine to the same SD card.

5.3.2 DOWNLOADING AN SD CARD TO NVRAM

Do the following procedure to download SP data from an SD card to the NVRAM in the machine.

Note

- The NVRAM data download may fail if the SD card with the NVRAM data is damaged, or if the connection between the controller and BICU is defective.
- Do the download procedure again if the download fails.
- Do the following procedure if the second attempt fails:
- Enter the NVRAM data manually using the SMC print you created before uploading the NVRAM data.

1. Turn the machine main power switch off.
2. Remove the SD slot cover [A] (x 1)
3. Insert the SD card with the NVRAM data into SD Card Slot [B].

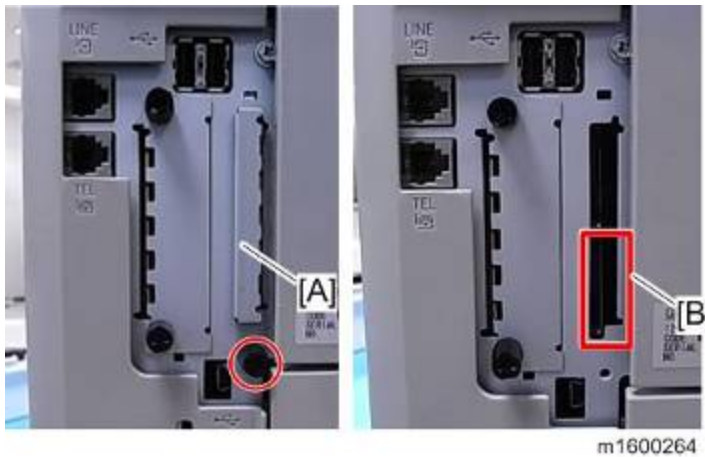

4. Turn the machine main power switch on.
5. Do SP5-825-001 (NVRAM Data Download) and press the “Execute” key.

Note

- The serial number of the file on the SD card must match the serial number of the machine for the NVRAM data to download successfully. The download fails if the serial numbers do not match.

The following data cannot be downloaded to the NVRAM:

- Total Count
- Total: Full Color
- B&W/Single Color
- Charging Counters
- Copier function option settings specified by the customer support system

5.4 ADDRESS BOOK UPLOAD/DOWNLOAD

5.4.1 INFORMATION LIST

The following information can be uploaded and downloaded.

Information	
<ul style="list-style-type: none"> ▪ Registration No. ▪ User Code ▪ E-mail ▪ Protection Code ▪ Fax Destination ▪ Fax Option ▪ Group Name ▪ Key Display 	<ul style="list-style-type: none"> ▪ Select Title ▪ Folder ▪ Local Authentication ▪ Folder Authentication ▪ Account ACL ▪ New Document Initial ACL ▪ LDAP Authentication

5.4.2 UPLOAD (BACKUP) TO SD CARD

1. Prepare a formatted SD card.
2. Make sure that the write-protection on the SD card is off.
3. Turn off the main power switch.
4. Remove the SD card slot cover [A] (x 1), and then install the SD card into the SD card slot 2 [B] (for service use).

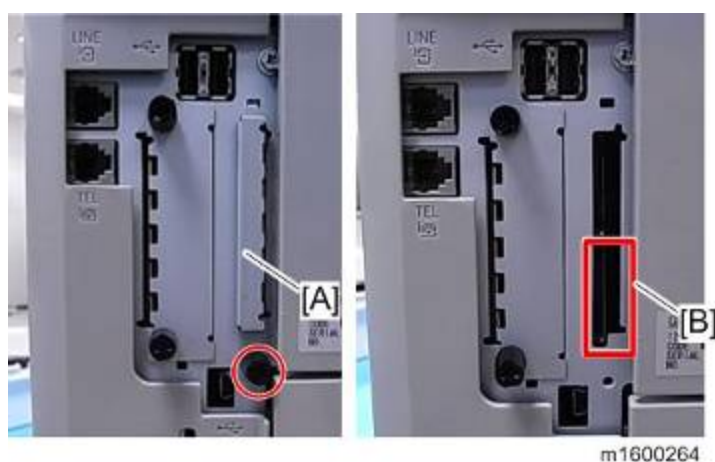

5. Turn on the main power switch.
6. Enter the SP mode, and then execute SP5-846-051 (Backup All Addr Book).
7. Exit from the SP mode, and then turn off the main power switch.
8. Remove the SD card from the SD card slot 2.
9. Install the SD card slot cover.

↓ Note

- If the capacity of SD card is not enough to store the local user information, an error message is displayed.
- Carefully handle the SD card, which contains user information. Do not take it back to your location.

5.4.3 DOWNLOAD (RESTORE) TO MACHINE

1. Turn off the main power switch.
2. Remove the SD card slot cover [A] (x 1), and then install the SD card, in which the data has been uploaded, into the SD card slot 2 [B].

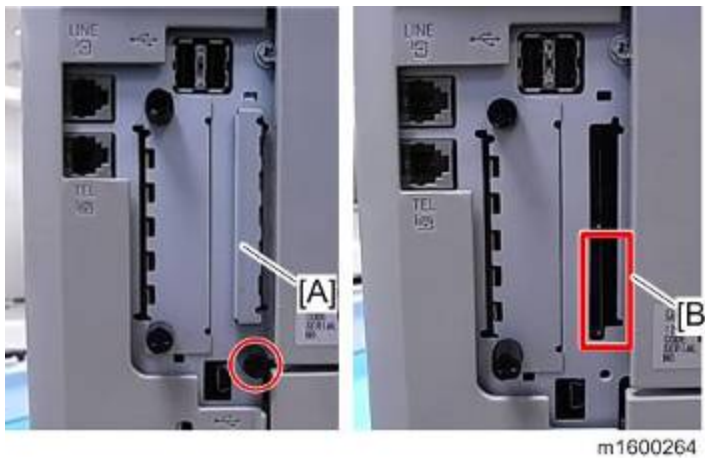

3. Turn on the main power switch.
4. Enter the SP mode, and then execute SP5-846-052 (Restore All Addr Book).
5. Exit from the SP mode, and then turn off the main power switch.
6. Remove the SD card from the SD card slot 2.
7. Install the SD card slot cover.
8. Turn on the main power, and then check that the address book has been restored.

↓ Note

- The counter in the user code information is initialized after uploading.
- The information of an administrator and supervisor cannot be downloaded nor uploaded.
- If there is no data of address book information in the SD card, an error message is displayed.

5.4.4 ERASING THE BACKUP DATA

After restoring the data, execute SP5-846-053 (Clear Backup Info) to erase the address book data stored in the SD card.

5.5 CAPTURING LOG TO SD CARD

5.5.1 OVERVIEW

★ Important

- **This function is not available on models without a hard disk.**

With this feature, you can save debug logs that are stored in the machine (HDD or operation panel) on an SD card. It allows the Customer Engineer to save and retrieve error information for analysis.

The Capturing Log feature saves debug logs for the following three.

- Controller debug log
- Engine debug log
- Debug log of the operation panel

★ Important

- In older models, a technician enabled the logging tool after a problem occurred. After that, when the problem had been reproduced, the technician was able to retrieve the debug log.
- However, this new feature saves the debug logs at the time that problems occur. Then you can copy the logs to an SD card.
- You can retrieve the debug logs using an SD card without a network.
- Analysis of the debug log is effective for problems caused by the software. Analysis of the debug log is not valid for the selection of defective parts or problems caused by hardware.

Types of debug logs that can be saved

Type	Storage Timing	Destination (maximum storage capacity)
Controller debug log (GW debug log)	<ul style="list-style-type: none"> ▪ Saved at all times 	HDD (4 GB) Compressed when written to an SD card from the HDD (from 4 GB to about 300 MB)

Type	Storage Timing	Destination (maximum storage capacity)
Engine debug log	<ul style="list-style-type: none"> ▪ When an engine SC occurs ▪ When paper feeding/output stop by jams ▪ When the machine doors are opened during normal operation 	HDD (Up to 300 times)
Operation panel debug log	<ul style="list-style-type: none"> ▪ When a controller SC occurs ▪ When saving by manual operation with the Number keys and the Reset key (Press "Reset", "0", "1" and "C"(hold for 3 seconds)) ▪ When the operation unit detects an error ▪ When the operation panel detects an error 	Operation panel (400 MB /Up to 30 times) When updating the firmware for the operation panel, the debug logs are erased.

Note

- Debug logs are not saved in the following conditions.
- When there is no optional HDD.
- While erasing all memory
- While data encryption equipment is installed
- While changing the firmware configuration
- Forced power OFF (accidentally disconnecting the outlet)
- Engine debug log in shutdown
- When the power supply to the HDD is off because of energy saving (engine OFF mode /STR mode)

Security of the Operation Log

- User ID
- Password
- IP address
- Telephone number
- Encryption key
- Transition to SP mode

Also the following operation logs are not saved.

- Number keys (0 to 9) on the operation panel
- Soft keyboard on the touch panel display
- External keyboard

5.5.2 RETRIEVING THE DEBUG LOGS

★ Important

- Retrieve debug logs to identify the date of occurrence of the problems and to find details of the problems
- e.g.: At around 8:00 am on March 10, an engine stall occurred. The operation panel does not respond. Turn the main power supply off / on.
- You need to retrieve the debug logs dating back three days from the date of the problem.
- Analysis of the debug log is effective for problems caused by the software. Analysis of the debug log is not valid for the selection of defective parts or problems caused by hardware.

Procedure for Retrieving the Debug Log

1. Insert the SD card into the slot on the side of the operation panel.
2. Enter SP mode.
3. Set the start date of the log with SP5-857-101 (Start date of debug log output)
e.g.: March 28, 2013: input 20130328 (yyyymmdd)
 - Set the date three days earlier than the occurrence of the problems.
4. Set the end date of the log with SP5-857-102 (End date of debug log output)
e.g.: March 31, 2013: input 20130331 (yyyymmdd)
5. Execute SP5-857-103 (Get a debug log of all) to write the debug log to the SD card.
6. If the transfer is finished successfully, 'completed' is displayed on the touch panel display.

Note

- The approximate time it takes to transfer the debug log is as follows. Transfer time may be affected by the type or format of the SD card. (It is recommended that you format the SD card using the Panasonic SD Formatter (freeware)).
- Controller debug log (GW debug log): 2 - 20 minutes
- Engine debug log: 2 minutes
- Operation panel debug log: 2 - 20 minutes

7. Make sure that the SD card access LED is off, then remove the SD card.

Note

- If 'failed' appears on the touch panel display, turn the power off, and then recover from step 1 again.

The debug logs are saved with the following file names.

Controller debug log (GW debug log)	/LogTrace/machine number/watching/yyyymmdd_hhmmss_unique identification number.gz
Engine debug log	/LogTrace/machine number/engine/yyyymmdd_hhmmss.gz
Operation panel debug log	/LogTrace/machine number/opepanel/yyyymmdd_hhmmss.tar.gz

TROUBLESHOOTING

REVISION HISTORY		
Page	Date	Added/Updated/New
		None

6. TROUBLESHOOTING

6.1 SELF-DIAGNOSTIC MODE

6.1.1 SELF-DIAGNOSTIC MODE AT POWER ON

As soon as the main machine is powered on, the controller waits for the initial settings of the copy engine to take effect and then starts an independent self-diagnostic test program.

The self-diagnostic test checks the CPU, memory, HDD, and so on. An SC code is displayed if the self-diagnostic program detects any malfunction or abnormal condition. In the case of the error that can start the machine, record it in System Error Log.

6.2 SERVICE CALL

6.2.1 SUMMARY

Level	Definition	Reset Procedure
A	To prevent damage to the machine, the main machine cannot be operated until the SC has been reset by a service representative (see the note below).	Enter SP mode, go into SP5-810-001, press [Execute], and turn the main power switch off and on.
B	SCs that disable only the features that use the defective item. Although these SCs are not shown to the user under normal conditions, they are displayed on the operation panel only when the defective feature is selected.	Turn the main power switch off and on.
C	The SC history is updated. The machine can be operated as usual.	The SC will not be displayed. Only the SC history is updated.
D	Turning the main power switch off then on resets SCs displayed on the operation panel. These are re-displayed if the error occurs again.	Turn the main power switch off and on.

When a Level “D” SC code occurs

When a Level D SC occurs, a screen opens on the operation panel to tell the operator:

- An error occurred
- The job in progress will be erased
- The machine will reboot automatically after approximately 30 seconds.

The operator can wait until the machine reboots automatically or touch “Reset” on the screen to reset the machine immediately and go back to the copy screen.

If the operator does not touch “Reset”

The next message tells the operator that the machine will reset automatically and that the previous job was lost and must be started again. After reading the message, the operator touches “Confirm” on the screen. The next screen shows the number and title of the SC code, and stops until the operator turns the machine off and on.

If the operator touches “Reset”

If the operator touches "Reset" to bypass the 30-second interval for the machine to reboot, the machine reboots immediately and the operation panel displays the copy screen.

★ Important

- Do not try to use the operation panel during an automatic reboot. If the Remote Service System is in use, the SC code is sent immediately to the Service Center.

6.2.2 SC100 (SCANNING)

SC No.	Level	Error Name/Error Condition/Major Cause/Solution
SC101	D	Exposure Lamp Error
		The scanner has scanned the white plate, but cannot detect the certain white level.
		<ul style="list-style-type: none"> ▪ Defective exposure lamp ▪ Defective exposure lamp stabilizer ▪ Defective power source harness ▪ Defective signal harness ▪ High-voltage cable leak ▪ Defective darkness starting characteristic
		Turn the main power OFF and then ON.

SC No.	Level	Error Name/Error Condition/Major Cause/Solution
SC120	D	Scanner home position error 1
		The scanner home position sensor does not detect the scanner leaving the home position.
		<ul style="list-style-type: none"> ▪ Defective scanner home position sensor ▪ Defective scanner home position sensor harness ▪ Defective scanner motor driver ▪ Defective scanner motor

Service Call

SC No.	Level	Error Name/Error Condition/Major Cause/Solution
		Turn the main power OFF and then ON.

SC No.	Level	Error Name/Error Condition/Major Cause/Solution
SC121	D	Scanner home position error 2
		The scanner home position sensor does not detect the scanner coming back to the home position.
		<ul style="list-style-type: none"> ▪ Defective scanner home position sensor ▪ Defective scanner home position sensor harness ▪ Defective scanner motor driver ▪ Defective scanner motor
		Turn the main power OFF and then ON.

SC No.	Level	Error Name/Error Condition/Major Cause/Solution
SC141	D	Black level correction error
		The automatic adjustment has failed to correct the black level to the permissible range.
		<ul style="list-style-type: none"> ▪ Defective SBU board ▪ Defective harness
		Turn the main power OFF and then ON.

SC No.	Level	Error Name/Error Condition/Major Cause/Solution
SC142	D	White level correction error
		The automatic adjustment has failed to correct the white level to the permissible range.
		<ul style="list-style-type: none"> ▪ Defective scanner drive ▪ Defective optical section ▪ Defective SBU board ▪ Defective harness
		Turn the main power OFF and then ON.

SC No.	Level	Error Name/Error Condition/Major Cause/Solution
SC144	D	SBU Communication Error
		Cannot correctly establish communication with the SBU.
		<ul style="list-style-type: none"> ▪ Defective harness ▪ Defective destination device (e.g., BICU, etc) ▪ Defective SBU
		Reboot the machine.

SC No.	Level	Error Name/Error Condition/Major Cause/Solution
SC161-01	D	IPU error (LSYNC error)
		When turning the power on or when recovering from energy saving mode, the machine performs a BICU self-diagnostic test. If it detects an error, it reports an IPU (LSUNC) error.
		<ul style="list-style-type: none"> ▪ Defective IPU or BICU (or bad connection between the ASIC and the LEO, LSYNC Abnormal, etc) ▪ Faulty cable connection between the SBU and IPU (or BICU).
		<ul style="list-style-type: none"> ▪ Check the connection between SBU and IPU (BICU) ▪ Replace the IPU (BICU)

SC No.	Level	Error Name/Error Condition/Major Cause/Solution
SC161-02	D	IPU error (RI response error)
		Detecting an error on access to the RI.
		Defective IPU (BICU, ICTL) or RI abnormal performance, etc
		Replace the IPU (BICU)

SC No.	Level	Error Name/Error Condition/Major Cause/Solution
SC165	D	Unauthorized copy protection failed
		<ul style="list-style-type: none"> ▪ The machine detects that the optional ICIB is not installed or is faulty even if "Unauthorized Copy Protection" in User Tools is enabled. ▪ When the machine is switched on or recovers from the energy saver mode, it detects that the installed optional ICIB is faulty.
		<ul style="list-style-type: none"> ▪ ICIB not attached correctly ▪ Defective ICIB
		<ul style="list-style-type: none"> ▪ Connect the ICIB correctly ▪ Replace the ICIB

SC No.	Level	Error Name/Error Condition/Major Cause/Solution
SC195	D	Machine serial number error
		Comparison of the product identification code in the machine serial number (11 digits).
		The product identification code in the machine serial number (11 digits) does not match.
		Re-enter the machine serial number.

6.2.3 SC200 (LED OPTICS)

SC No.	Level	Error Name/Error Condition/Major Cause/Solution
SC230-00	D	FGATE ^{*1} : Does not turn ON.
		GPIO ^{*2} has not been asserted, although the specified time (200 ms) elapsed after setting JOB to be started and reaching the FGAT assert time.
		Control Board
		Turn the main power OFF and then ON.

(*1)FGATE: Signals used between the controller and the engine in order to send the information about the sub scan length of the page to be printed.

(*2)GPIO: A type of input/output terminal

SC No.	Level	Error Name/Error Condition/Major Cause/Solution
SC231-00	D	FGATE ^{*1} : Does not turn OFF.
		GPIO ^{*2} has not been negated, although the specified time (200 ms) elapsed after detecting GPIO*assert and then reaching the expected FGATE negate time.
		* This is an I/O pin. Such I/O pins can be used for a variety of applications, depending on the setting.
		<ul style="list-style-type: none"> ▪ Control Board ▪ Engine Board

(*1)FGATE: Signals used between the controller and the engine in order to send the information about the sub scan length of the page to be printed.

(*2)GPIO: A type of input/output terminal

SC No.	Level	Error Name/Error Condition/Major Cause/Solution
SC270-00	D	Write ASIC communication error
		<ul style="list-style-type: none"> ▪ When the Engine Board could not read the Unique ID of the Writing ASIC properly when starting this machine. ▪ When an Error bit occurred in the communication between the Engine Board and the Writing ASIC.
		The unique ID of the write ASIC was not read normally.
		<ul style="list-style-type: none"> ▪ Turn the main power OFF and then ON. ▪ Engine Board

SC No.	Level	Error Name/Error Condition/Major Cause/Solution
SC277-00 SC277-10	D	LEDA communication error
		The head type data was read three times in succession
		<p>(277-00)</p> <ul style="list-style-type: none"> ▪ Defective ASIC ▪ Defective LEDA <p>(277-10)</p> <ul style="list-style-type: none"> ▪ LEDA power source error
		<ul style="list-style-type: none"> ▪ Turn the main power OFF and then ON. ▪ Replace the LED head

6.2.4 SC300 (IMAGE PROCESSING – 1)

SC No.	Level	Error Name/Error Condition/Major Cause/Solution
SC302	D	High voltage output error: Charge unit /Development unit
		This SC is issued if the BICU detects a short in the power pack 10 times consecutively.
		Open circuit (+) / Short circuit (-)
		<ul style="list-style-type: none"> ▪ Turn the main power OFF and then ON. ▪ Replace the controller board. ▪ Check the connector connection.

SC No.	Level	Error Name/Error Condition/Major Cause/Solution
SC332-00	D	Toner supply feed lock Toner supply coil drive mechanism error
		Under the condition that the Toner Cartridge has not reached the end, an error that no toner is supplied has been detected over n times in succession. n: The value was specified at SP2-931-005.
		<ul style="list-style-type: none"> ▪ Disconnected or broken Solenoid: Upper cover. (Failed to open the toner supply shutter) ▪ Disconnection of Toner Supply Clutch ▪ Defective PCDU. (Toner leak) ▪ Toner clogging
		<ul style="list-style-type: none"> ▪ Check the connector connection or check for a broken wire. ▪ Replace the Solenoid: Upper Cover ▪ Replace the PCDU ▪ Replace the Toner Cartridge.

SC No.	Level	Error Name/Error Condition/Major Cause/Solution
SC364-00	D	Toner End Sensor output count error
		Under the condition that the toner cartridge has not reached the end, an error that no toner is supplied has been detected over n times in succession. (where n is to be configured using SP2-931-003)
		<ul style="list-style-type: none"> ▪ Bad connector contact or connector disconnected/wire broken ▪ Failed TE sensor
		<ul style="list-style-type: none"> ▪ Turn the main power of the printer OFF and then ON ▪ Check the connector connection or check for broken wire. ▪ Replace the LED Head. ▪ Replace the TE sensor (using the same troubleshooting procedure as for the LED).

6.2.5 SC400 (IMAGE PROCESSING – 2)

SC No.	Level	Error Name/Error Condition/Major Cause/Solution
SC440-00	D	High voltage output error: Transfer unit
		This SC is issued if the BICU detects a short in the power pack 10 times consecutively.
		Open circuit (+) / Short circuit (-)
		<ul style="list-style-type: none"> ▪ Turn the main power OFF and then ON. ▪ Replace the controller board. ▪ Check the connector connection.

SC No.	Level	Error Name/Error Condition/Major Cause/Solution
SC498-00	C	Temperature/humidity Sensor error
		<ul style="list-style-type: none"> ▪ Temperature sensor output error: Out of range between 0.76 V and 2.90 V ▪ Humidity sensor output error: 2.4 V or more
		<ul style="list-style-type: none"> ▪ Unmounted sensor (Disconnected connector or broken wire) ▪ Failed sensor
		<ul style="list-style-type: none"> ▪ Turn the main power OFF and then ON. ▪ Check that the connector is set. ▪ Set the sensor. ▪ Replace the sensor. ▪ Replace the connector.

6.2.6 SC500 (PAPER FEED AND FUSING)

SC No.	Level	Error Name/Error Condition/Major Cause/Solution
SC508-00	B	By-pass bottom plate operation error
		The signal from the by-pass bottom plate position sensor has not changed (the signal has not changed from ON to OFF or vice versa) for 4 seconds or more after the start of reverse Paper Feed Unit rotation, If the error is detected three times in succession, the SC number is displayed on the operation panel.
		<ul style="list-style-type: none"> ▪ By-pass bottom plate sensor connector disconnected or other error ▪ By-pass bottom plate sensor feeler stuck or other error
		<ul style="list-style-type: none"> ▪ Turn the main power OFF and then ON. ▪ Check and replace the by-pass bottom plate sensor connector connection. ▪ Replace the by-pass bottom plate sensor feeler. ▪ Replace the Paper Feed Motor. ▪ Replace the harness. ▪ Replace the BICU.

SC No.	Level	Error Name/Error Condition/Major Cause/Solution
SC520-00	D	Main motor error
		When the main motor is driven, the lock (state of rotation) signal is checked every 100 milliseconds. If the machine detects the lock signal in the High status 20 times in succession, it reports this error.
		<ul style="list-style-type: none"> ▪ The main motor incurs too much load from a defective unit. ▪ The main motor is defective.
		Replace the defective unit or the motor

SC No.	Level	Error Name/Error Condition/Major Cause/Solution
SC530-00	D	Fusing fan error
		The fan motor lock (rotating state) signal is sampled at 100 ms intervals and the machine fails to receive the lock signal 50 times in succession.
		<ul style="list-style-type: none"> ▪ Failed fan motor ▪ Disconnected connector
		<ul style="list-style-type: none"> ▪ Replace the fan motor. ▪ Check the connector. ▪ Replace the harness. ▪ Replace the IOB.

SC No.	Level	Error Name/Error Condition/Major Cause/Solution
SC531-00	D	Development Cooling fan error
		The fan motor lock (rotating state) signal is sampled at 100 ms intervals and the machine fails to receive the lock signal 50 times in succession.
		<ul style="list-style-type: none"> ▪ Failed fan motor ▪ Disconnected connector
		<ul style="list-style-type: none"> ▪ Replace the fan motor. ▪ Check the connector. ▪ Replace the harness. ▪ Replace the IOB.

SC No.	Level	Error Name/Error Condition/Major Cause/Solution
SC532-00	D	PSU Cooling fan error
		The fan motor lock (rotating state) signal is sampled at 100 ms intervals and the machine fails to receive the lock signal 50 times in succession.
		<ul style="list-style-type: none"> ▪ Failed fan motor ▪ Disconnected connector
		<ul style="list-style-type: none"> ▪ Replace the fan motor. ▪ Check the connector. ▪ Replace the harness. ▪ Replace the IOB.

SC No.	Level	Error Name/Error Condition/Major Cause/Solution
SC541-00	A	Broken fusing (Center) thermistor wire
		The condition whereby the temperature is -20 deg C or less for 5 seconds has been detected 10 times or more.
		<ul style="list-style-type: none"> ▪ Broken thermistor wire ▪ Bad connector contact
		<ul style="list-style-type: none"> ▪ Clear the SP: fusing SC. ▪ Check the connector connection. ▪ Replace the fusing (Center) thermistor.

SC No.	Level	Error Name/Error Condition/Major Cause/Solution
SC542-01	A	Fusing lamp (Center) thermistor not reloaded 1
		The heater thermistor has increased by less than 2.0 degrees in 1.5 seconds 5 times in a row.
		<ul style="list-style-type: none"> ▪ Deformed or floating thermistor ▪ Input voltage out of range
		<ul style="list-style-type: none"> ▪ Clear the SP: fusing SC. ▪ Replace the thermistor.

SC No.	Level	Error Name/Error Condition/Major Cause/Solution
SC542-02	A	Fusing lamp (Center) thermistor not reloaded 2
		The heater (Center) thermistor does not reach the reload temperature 50 seconds after the start of motor rotation.
		<ul style="list-style-type: none"> ▪ Fusing lamp disconnected ▪ The overtemperature prevention mechanism started working
		<ul style="list-style-type: none"> ▪ Clear the SP: fusing SC. ▪ Replace the thermistor.

SC No.	Level	Error Name/Error Condition/Major Cause/Solution
SC543-00	A	Fusing (Center) thermopile high-temperature detected (software)
		The temperature is detected to stay at 245 deg C or higher for one second.
		<ul style="list-style-type: none"> ▪ Shorted triac ▪ Failed Engine Board
		<ul style="list-style-type: none"> ▪ Clear the SP: fusing SC. ▪ Replace the PSU. ▪ Replace the Engine Board.

SC No.	Level	Error Name/Error Condition/Major Cause/Solution
SC544-00	A	Fusing (Center) thermopile high-temperature detected (hardware)
		The hardware high-temperature error sensor flag is detected.
		<ul style="list-style-type: none"> ▪ Damaged triac (shorted) ▪ Failed engine control board ▪ Failed fusing thermopile ▪ Failed fusing thermistor ▪ Abnormal fusing control software behavior ▪ The PWM signal is continuously supplied from the IH inverter (due to a software or temperature sensor error).
		<ul style="list-style-type: none"> ▪ Clear the SP: fusing SC. ▪ Replace the PSU. ▪ Replace the Engine Board. ▪ Replace the fusing thermopile. ▪ Replace the Fusing Unit.

SC No.	Level	Error Name/Error Condition/Major Cause/Solution
SC545-00	A	Fusing (Center) lamp stays ON
		The thermistor (center) has not detected the target temperature, even after the fusing lamp stays ON for more than 30 seconds after reloading.
		<ul style="list-style-type: none"> ▪ Deformed or floating thermistor ▪ Broken fusing lamp wire ▪ The overtemperature prevention mechanism started working
		<ul style="list-style-type: none"> ▪ Clear the SP: fusing SC. ▪ Replace the fusing thermistor. ▪ Replace the fusing (Center) lamp.

SC No.	Level	Error Name/Error Condition/Major Cause/Solution
SC547-01	D	Zero-crossing error (adhered relay contact)
		When the fusing relay is in an OFF state, a "zero-crossing interrupt request" occurs in 50 ms.
		Damaged fusing relay (adhered contact)
		<ul style="list-style-type: none"> ▪ Turn the main power OFF and then ON. ▪ Replace the harness. ▪ Replace the PC board. ▪ Replace the PSU.
SC547-02	D	Zero-crossing error (bad relay contact)
		If a "zero-crossing interrupt request" does not occur when the fusing relay is in an ON state, an error results.
		<ul style="list-style-type: none"> - Damaged fusing relay (open contact) - Failed fusing relay drive circuit - PSU fuse (24VS) blown
		<ul style="list-style-type: none"> ▪ Turn the main power OFF and then ON. ▪ Replace the harness. ▪ Replace the Engine Board. ▪ Replace the PSU. ▪ Replace the fuse.
SC547-03	D	Zero-crossing error (low frequency error)
		The number of zero-crossing interrupts does not reach a certain value in 500 ms.
		The frequency of the commercial power supply is unstable.
		<ul style="list-style-type: none"> ▪ Turn the main power OFF and then ON. ▪ Check the commercial power supply. ▪ Replace the harness. ▪ Replace the Engine Board. ▪ Replace the PSU.

Service Call

SC No.	Level	Error Name/Error Condition/Major Cause/Solution
SC551-00	A	Broken fusing (End) thermistor wire
		At least ten times, the temperature is detected to stay at -20 deg C or less for 5 seconds.
		<ul style="list-style-type: none"> ▪ Broken thermistor wire ▪ Bad connector contact
		<ul style="list-style-type: none"> ▪ Clear the SP: fusing SC. ▪ Check the connector connection. ▪ Replace the fusing (End) thermistor.

SC No.	Level	Error Name/Error Condition/Major Cause/Solution
SC553-01 SC553-02	A	Fusing (End) thermistor high-temperature detected (software)
		<p>(553-01)</p> <p>In a condition of 235 degrees C or higher temperature, the temperature has increased more than 10 degrees C per 1 second, the heater has continuously reached 100% (maximum) duty, and the center thermistor has detected the failure to reach the target temperature by 11 degrees C.</p> <p>(553-02)</p> <p>The temperature is detected to stay at 245 deg C or higher for one second.</p>
		<ul style="list-style-type: none"> ▪ Shorted triac ▪ Failed Engine Board
		<ul style="list-style-type: none"> ▪ Clear the SP: fusing SC. ▪ Replace the PSU. ▪ Replace the Engine Board.

SC No.	Level	Error Name/Error Condition/Major Cause/Solution
SC554-00	A	Fusing (End) thermistor high-temperature detected (hardware)
		The hardware high-temperature error sensor flag is detected.
		<ul style="list-style-type: none"> ▪ Damaged triac (shorted) ▪ Failed engine control board ▪ Failed fusing thermopile ▪ Failed fusing thermistor ▪ Abnormal fusing control software behavior ▪ The PWM signal is continuously supplied from the IH inverter (due to a software or temperature sensor error).
		<ul style="list-style-type: none"> ▪ Clear the SP: fusing SC. ▪ Replace the PSU. ▪ Replace the Engine Board. ▪ Replace the fusing thermopile. ▪ Replace the Fusing Unit.

SC No.	Level	Error Name/Error Condition/Major Cause/Solution
SC557-00	C	Zero-crossing frequency exceeded
		The number of zero-crossing interrupts exceeds a certain value in 500 ms.
		The frequency of the commercial power supply line is unstable or noise occurs.
		None

SC No.	Level	Error Name/Error Condition/Major Cause/Solution
SC559-00	A	Fusing jam detected 3 times in succession
		Fusing jam is detected three times in succession.
		Paper is wrapped around the fusing roller.
		Clear the SP: fusing SC.

6.2.7 SC600 (DEVICE COMMUNICATION)

SC No.	Level	Error Name/Error Condition/Major Cause/Solution
SC632-00	B	Counter device error 1
		After 3 attempts to send a data frame to the optional counter device via the serial communication line, no ACK signal was received within 100 ms.
		Serial line between the optional counter device, the relay board and copier control board is disconnected or damaged.
		<ul style="list-style-type: none"> ▪ Turn the main power off/on. ▪ Check the serial communication line.

SC No.	Level	Error Name/Error Condition/Major Cause/Solution
SC633-00	B	Counter device error 2
		After communication was established, the controller received the brake signal from the accounting device.
		Serial line between the optional counter device, the relay board and copier control board is disconnected or damaged.
		<ul style="list-style-type: none"> ▪ Turn the main power off/on. ▪ Check the serial communication line.

SC No.	Level	Error Name/Error Condition/Major Cause/Solution
SC634-00	B	Counter device error 3
		A backup RAM error was returned by the counter device.
		Counter device control board or the backup battery of counter device is defective
		<ul style="list-style-type: none"> ▪ Replace the counter device control board. ▪ Replace the backup battery.

SC No.	Level	Error Name/Error Condition/Major Cause/Solution
SC635-00	B	Counter device error 4
		A backup battery error was returned by the counter device.
		Counter device control board or the backup battery of counter device is defective
		<ul style="list-style-type: none"> ▪ Replace the counter device control board. ▪ Replace the backup battery.

SC No.	Level	Error Name/Error Condition/Major Cause/Solution
SC636-01	D	IC Card Error (Expanded authentication module error)
		<p>Issued when expanded authentication management is set to "ON" but either of the following occur.</p> <ul style="list-style-type: none"> ▪ There is no expanded authentication module in the machine. ▪ The SD card or the file of the expanded authentication module is broken. ▪ There is no DESS module in the machine.
		<ul style="list-style-type: none"> ▪ There is no DESS module in the machine (models on which the function is optional). ▪ There is no expanded authentication module in the machine. ▪ The SD card or the file of the expanded authentication module is broken.

SC No.	Level	Error Name/Error Condition/Major Cause/Solution
		<ul style="list-style-type: none"> ▪ Set a working SD card/expanded authentication module file. ▪ Install the DESS module. ▪ In the SSP mode set SP5-401-160 to 0. ▪ In the SSP mode, set SP5-401-161 to 0. ▪ Replace the NVRAM.

SC No.	Level	Error Name/Error Condition/Major Cause/Solution
SC636-02	D	IC Card Error (Version error)
		The version of the expanded authentication module is not correct.
		Incorrect module version
		Install the correct file of the expanded authentication module.

SC No.	Level	Error Name/Error Condition/Major Cause/Solution
SC636-11	D	IC Card Error (OSM user code file error)
		<ul style="list-style-type: none"> ▪ The correct "usercode" file could not be found in the root folder of the SD card. ▪ The "usercode" file on the SD card could not be read.
		<ul style="list-style-type: none"> ▪ The "usercode" file does not exist on the SD card. ▪ The "usercode" file on the SD card is an invalid file. ▪ Data in the "usercode" file on the SD card is invalid. ▪ "usercode" file was not moved when moving the application to another SD card
		Use the user code configuration tool for OSM users (ldissuer.exe) to create the "usercode" and store it in the root folder of the SD card containing the IC card module (eccm.mod).

SC No.	Level	Error Name/Error Condition/Major Cause/Solution
SC637-01	D	Tracking Information Notification Error (Tracking application error)
		Tracking information was lost.
		<ul style="list-style-type: none"> ▪ Tracking SDK application error ▪ Internal notification error
		Turn the main power off/on.

SC No.	Level	Error Name/Error Condition/Major Cause/Solution
SC637-02	D	Tracking Information Notification Error (Management server error)
		Tracking information was lost.
		Communication with tracking management server failed. <ul style="list-style-type: none"> ▪ Network error ▪ tracking management server error ▪ Tracking SDK application error
		Turn the main power off/on.

SC No.	Level	Error Name/Error Condition/Major Cause/Solution
SC650-01	B	Remote Service Modem Communication Error (Dialup authentication failure)
		<ul style="list-style-type: none"> ▪ An error related to communication (dialup connection, modem board etc.) using the RC Gate Type M was detected or an error that prevents RC Gate operation was detected at power on. ▪ Displayed only when an error is detected while RC Gate is operating. ▪ SC is not issued if an error occurs during RC Gate installation (because it can be referenced using SP).
		Dialup authentication failure

SC No.	Level	Error Name/Error Condition/Major Cause/Solution
		Check the following SPs. <ul style="list-style-type: none"> ▪ SP5-816-156 ▪ SP5-816-157

SC No.	Level	Error Name/Error Condition/Major Cause/Solution
SC650-04	B	Remote Service Modem Communication Error (dialup failing because of incorrect modem configuration)
		<ul style="list-style-type: none"> ▪ An error related to communication (dialup connection, modem board etc.) using the RC Gate Type M was detected or an error that prevents RC Gate operation was detected at power on. ▪ Displayed only when an error is detected while RC Gate is operating. ▪ SC is not issued if an error occurs during RC Gate installation (because it can be referenced using SP).
		Dialup failing because of incorrect modem configuration
		Check if the setting of SP5-816-160 is correct. If it is correct, then there is a software bug.

SC No.	Level	Error Name/Error Condition/Major Cause/Solution
SC650-05	B	Remote Service Modem Communication Error (insufficient current or connection fault)
		<ul style="list-style-type: none"> ▪ An error related to communication (dialup connection, modem board etc.) using the RC Gate Type M was detected or an error that prevents RC Gate operation was detected at power on. ▪ Displayed only when an error is detected while RC Gate is operating. ▪ SC is not issued if an error occurs during RC Gate installation (because it can be referenced using SP).
		Insufficient current or connection fault
		The line is not supported and nothing can be done.

SC No.	Level	Error Name/Error Condition/Major Cause/Solution
SC650-13	B	Remote Service Modem Communication Error (RC Gate Type M was installed but modem is not present (detected during operation))
		<ul style="list-style-type: none"> ▪ An error related to communication (dialup connection, modem board etc.) using the RC Gate Type M was detected or an error that prevents RC Gate operation was detected at power on. ▪ Displayed only when an error is detected while RC Gate is operating. ▪ SC is not issued if an error occurs during RC Gate installation (because it can be referenced using SP).
		RC Gate Type M was installed but modem is not present (detected during operation)
		<ul style="list-style-type: none"> ▪ If a modem board is not installed, install it. ▪ Check again if the modem driver configurations (SP5-816-160, SP5-816-165 to 171, SP5-816-165 to 171) are correct. ▪ If the problem is not solved, replace the modem.

SC No.	Level	Error Name/Error Condition/Major Cause/Solution
SC650-14	B	Remote Service Modem Communication Error (RC Gate Type N was installed but modem is present or wired/wireless LAN is not working correctly)
		<ul style="list-style-type: none"> ▪ An error related to communication (dialup connection, modem board etc.) using the RC Gate was detected or an error that prevents RC Gate operation was detected at power on. ▪ Displayed only when an error is detected while RC Gate is operating. ▪ SC is not issued if an error occurs during RC Gate installation (because it can be referenced using SP).
		RC Gate Type N was installed but modem is present or wired/wireless LAN is not working correctly
		<ul style="list-style-type: none"> ▪ If a modem board is attached, remove it. ▪ Check if wired/wireless LAN works.

SC No.	Level	Error Name/Error Condition/Major Cause/Solution
SC651-01	C	Illegal Remote Service Dial-up (Chat program parameter error)
		An unexpected error occurred when RC Gate Type M dialed up the NRS Center.
		Software bug
		Logging only.

SC No.	Level	Error Name/Error Condition/Major Cause/Solution
SC651-02	C	Illegal Remote Service Dial-up (Chat program execution error)
		An unexpected error occurred when RC Gate dialed up the NRS Center.
		Software bug
		Logging only.

SC No.	Level	Error Name/Error Condition/Major Cause/Solution
SC652-00	D	Remote service ID2 mismatching
		There was an authentication mismatch between ID2 for @Remote, the controller board, and NVRAM.
		<ul style="list-style-type: none"> ▪ Used controller board installed ▪ Used NVRAM installed (such action is not allowed.)
		<ul style="list-style-type: none"> ▪ If this occurs during RC Gate installation: Check the validity of the certificate and the NVRAM, check the machine serial number, write the common certificate, and then begin installation again. ▪ If this occurs after RC Gate installation: Clear the RC Gate install status, check the validity of the certificate and the NVRAM, check the machine serial number, write the common certificate, and then begin installation again.

SC No.	Level	Error Name/Error Condition/Major Cause/Solution
SC653-00	D	Incorrect remote service ID2
		ID2 stored in the NVRAM has either of the following problems. <ul style="list-style-type: none"> ▪ Number of characters is not 17. ▪ Includes a character that cannot be printed. ▪ All spaces ▪ NULL
		Replace the NVRAM.
		Clear the RC Gate installation status, write the common certificate, and then begin installation again.

SC No.	Level	Error Name/Error Condition/Major Cause/Solution
SC669-**	D	EEPROM communication error
		An error is notified during EEPROM communication and the printer does not recover after three retries.
		669 - 1 ID error during EEPROM OPEN 669 - 2 Channel error during EEPROM OPEN 669 - 3 Device error during EEPROM OPEN 669 - 4 Communication interrupted error during EEPROM OPEN 669 - 5 Communication timeout error 669 - 6 Not operating error during EEPROM OPEN 669 - 7 Buffer full during EEPROM OPEN 669 - 8 No error code during EEPROM OPEN 669 - 9 ID error 669 - 10 No error code during EEPROM Close 669 - 11 ID error during EEPROM data write 669 - 12 Channel error during EEPROM data write 669 - 13 Device error during EEPROM data write 669 - 14 Communication interrupted error during EEPROM data write
		669 - 15 Communication timeout error 669 - 16 Not operating error during EEPROM data write 669 - 17 Buffer full during EEPROM data write 669 - 18 No error code during EEPROM data write 669 - 19 ID error during EEPROM data read 669 - 20 Channel error EEPROM data read 669 - 21 Device error during EEPROM data read 669 - 22 Communication interrupted error during EEPROM data read 669 - 23 Communication timeout error 669 - 24 Not operating error during EEPROM data read 669 - 25 Buffer full during EEPROM data read 669 - 26 No error code during EEPROM data read <ul style="list-style-type: none"> ▪ Electromagnetic noise ▪ EEPROM error

SC No.	Level	Error Name/Error Condition/Major Cause/Solution
		<ul style="list-style-type: none"> ▪ Turn the main power OFF and then ON. ▪ Replace the BICU

SC No.	Level	Error Name/Error Condition/Major Cause/Solution
SC669-36	D	EEPROM communication error
		The EEPROM data has been transferred to the SRAM twice in succession, but the two sets of transferred data do not match.
		669 - 36 EEPROM SRAM OPEN: Verified error <ul style="list-style-type: none"> ▪ Electromagnetic noise ▪ EEPROM error
		<ul style="list-style-type: none"> ▪ Turn the main power OFF and then ON.

SC No.	Level	Error Name/Error Condition/Major Cause/Solution
SC670-00	D	Engine start up error
		<ul style="list-style-type: none"> ▪ Case 1 <ul style="list-style-type: none"> ▪ /ENGRDY signal was not asserted when the machine was turned on or returned from energy saver mode. ▪ /IPURDY signal was not asserted when the machine was turned on or returned from energy saver mode. ▪ The EC response from the engine was not received within the specified time after turning on the power. ▪ The PC response from the engine was not received within the specified time after turning on the power. ▪ The SC response from the engine was not received within the specified time after turning on the power (MFP models only). ▪ Writing to Rapi driver failed (the other party not found through PCI). ▪ Case 2 <ul style="list-style-type: none"> ▪ Unexpected down status was detected after /ENGRDY assertion.

SC No.	Level	Error Name/Error Condition/Major Cause/Solution
		<ul style="list-style-type: none"> ▪ Case 1 <ul style="list-style-type: none"> ▪ Engine board does not start up. ▪ Case 2 <ul style="list-style-type: none"> ▪ Engine board reset unexpectedly.
		<p>Check the connection between the engine board and the controller board.</p> <ul style="list-style-type: none"> ▪ If this problem always occurs, replace the engine board. If the problem persists, consider replacing the controller board or other boards between them. ▪ If this problem occasionally occurs, multiple causes are to be considered, such as the software, engine board, controller board, and PSU.

SC No.	Level	Error Name/Error Condition/Major Cause/Solution
SC672-10	D	Controller start up error
		The controller and control panel failed to establish communication when the power was turned on.
		<ul style="list-style-type: none"> ▪ Controller stalled ▪ Board installed incorrectly ▪ Controller board defective ▪ Operation panel connector is loose, broken, or defective ▪ Controller's late response
		<ul style="list-style-type: none"> ▪ Turn the main power off/on. ▪ Check the connection of the controller board. ▪ Replace the controller board. ▪ Check the control panel harness.

SC No.	Level	Error Name/Error Condition/Major Cause/Solution
SC672-11	D	Controller start up error
		After the machine was powered on, communication between the controller and the operation panel was not established, or data transmission failed after a normal startup.
		<ul style="list-style-type: none"> ▪ Controller stalled ▪ Board installed incorrectly ▪ Controller board defective ▪ Operation panel connector is loose, broken, or defective ▪ Controller's late response
		<ul style="list-style-type: none"> ▪ Turn the main power off/on. ▪ Check the connection of the controller board. ▪ Replace the controller board. ▪ Check the control panel harness.

SC No.	Level	Error Name/Error Condition/Major Cause/Solution
SC672-12	D	Controller start up error
		Communication with controller was interrupted after a normal startup.
		<ul style="list-style-type: none"> ▪ Controller stalled ▪ Board installed incorrectly ▪ Controller board defective ▪ Operation panel connector is loose, broken, or defective ▪ Controller's late response
		<ul style="list-style-type: none"> ▪ Turn the main power off/on. ▪ Check the connection of the controller board. ▪ Replace the controller board. ▪ Check the control panel harness.

SC No.	Level	Error Name/Error Condition/Major Cause/Solution
SC672-13	D	Controller start up error
		The operation panel detected that the controller is down.
		<ul style="list-style-type: none"> ▪ Controller stalled ▪ Board installed incorrectly ▪ Controller board defective ▪ Operation panel connector is loose, broken, or defective ▪ Controller's late response
		<ul style="list-style-type: none"> ▪ Turn the main power off/on. ▪ Check the connection of the controller board. ▪ Replace the controller board. ▪ Check the control panel harness.

SC No.	Level	Error Name/Error Condition/Major Cause/Solution
SC672-99	D	Controller start up error
		The operation panel software ended abnormally.
		<ul style="list-style-type: none"> ▪ Controller stalled ▪ Board installed incorrectly ▪ Controller board defective ▪ Operation panel connector is loose, broken, or defective ▪ Controller's late response
		<ul style="list-style-type: none"> ▪ Turn the main power off/on. ▪ Check the connection of the controller board. ▪ Replace the controller board. ▪ Check the control panel harness.

SC No.	Level	Error Name/Error Condition/Major Cause/Solution
SC681-**	D	Device ID is not identified (toner cartridge)
		An error is notified during the ID identification after three retries.
		681 - 1 Device ID error (Incorrect ID) 681 - 6 Channel error 681 - 11 Device ID error (No ID chip) 681 - 16 Communication Error 681 - 21 Communication timeout 681 - 26 The device has stopped its operation 681 - 31 The requested buffer is full 681 - 36 EEPROM SRAM OPEN: Verification error
		<ul style="list-style-type: none"> ▪ Turn the main power OFF and then ON. ▪ Replace the toner cartridge (ID chip)

SC No.	Level	Error Name/Error Condition/Major Cause/Solution
SC682-**	D	Device ID is not identified (PCDU)
		An error is notified during the ID identification after three retries.
		682 - 1 Device ID error (Incorrect ID) 682 - 6 Channel error 682 - 11 Device ID error (No ID chip) 682 - 16 Communication Error 682 - 21 Communication timeout 682 - 26 The device has stopped its operation 682 - 31 The requested buffer is full 682 - 36 EEPROM SRAM OPEN: Verification error
		<ul style="list-style-type: none"> ▪ Turn the main power OFF and then ON. ▪ Replace the PCDU (ID chip)

SC No.	Level	Error Name/Error Condition/Major Cause/Solution
SC687-00	D	RAPI-PER receipt failure
		Even though 120 seconds have elapsed after RAPI-PES (request for image transfer) is issued, a RAPI-PER receipt is not received from the controller board.
		<ul style="list-style-type: none"> ▪ Defective controller board ▪ Noise
		<ul style="list-style-type: none"> ▪ Turn the main power OFF and then ON. ▪ Replace the controller board.

SC No.	Level	Error Name/Error Condition/Major Cause/Solution
SC688-00	D	PRREQ signal not asserted
		The print request signal (PRREQ) signal is not asserted within the prescribed time after paper reaches the registration stand-by position,
		<ul style="list-style-type: none"> ▪ Noise ▪ Engine Board error
		<ul style="list-style-type: none"> ▪ Turn the main power OFF and then ON. ▪ Replace the Engine Board.

6.2.8 SC700 (PERIPHERALS)

SC No.	Level	Error Name/Error Condition/Major Cause/Solution
SC790-00	D	Maximum number of banks (paper tray units) exceeded
		When the power is turned ON, the number of mounted paper tray units is detected and the number exceeds three.
		The number of mounted paper tray units exceeds the specifications.
		Reduce the number of mounted paper tray units according to the specifications.

6.2.9 SC800 (CONTROLLER)

SC No.	Level	Error Name/Error Condition/Major Cause/Solution
SC816-00	[0x0000]	Energy save I/O subsystem error
SC816-01	D	Subsystem error
SC816-02	D	Sysarch (LPUX_GET_PORT_INFO) error
SC816-03	D	Transition to STR was denied.
SC816-04	D	Interrupt in kernel communication driver
SC816-05	D	Preparation for transition to STR failed.
SC816-07	D	Sysarch (LPUX_GET_PORT_INFO) error
SC816-08	D	Sysarch (LPUX_ENGINE_TIMERCTRL) error
SC816-09	D	Sysarch (LPUX_RETURN_FACTOR_STR) error
SC816-10	D	Sysarch (LPUX_GET_PORT_INFO) error
SC816-11	D	Sysarch (LPUX_GET_PORT_INFO) error
SC816-12	D	Sysarch (LPUX_GET_PORT_INFO) error
SC816-13	D	open() error

SC No.	Level	Error Name/Error Condition/Major Cause/Solution
SC816-14	D	Memory address error
SC816-15	D	open() error
SC816-16	D	open() error
SC816-17	D	open() error
SC816-18	D	open() error
SC816-19	D	Double open() error
SC816-20	D	open() error
SC816-22	D	Parameter error
SC816-23	D	read() error
SC816-24	D	read() error
SC816-25	D	read() error
SC816-26	D	write() communication retry error
SC816-27	D	write() communication retry error
SC816-28	D	write() communication retry error
SC816-29	D	write() communication retry error
SC816-30	D	write() communication retry error
SC816-35	D	read() error
SC816-36 to94	D	Subsystem error
		Energy save I/O subsystem detected some abnormality.
		<ul style="list-style-type: none"> ▪ Energy save I/O subsystem defective ▪ Energy save I/O subsystem detected a controller board error (non-response). ▪ Error was detected during preparation for transition to STR.
		<ul style="list-style-type: none"> ▪ Turn the main power off/on. ▪ Replace the controller board.

SC No.	Level	Error Name/Error Condition/Major Cause/Solution
SC818-00	D	Watchdog timer error
		<ul style="list-style-type: none"> The system program fell into a bus-hold state or an endless loop of the program interruption occurred, causing other process to stop.
		<ul style="list-style-type: none"> System program defective Controller board defective Optional board defective
		<ul style="list-style-type: none"> Turn the main power off/on. Replace the controller board.

SC No.	Level	Error Name/Error Condition/Major Cause/Solution
SC819-00	D	Fatal kernel error [XXXX]: Detailed error code
		Due to a control error, a RAM overflow occurred during system processing. One of the following messages was displayed on the operation panel.
		<ul style="list-style-type: none"> System program defective Controller board defective Optional board defective
		Replace controller firmware
[0x5032]		HAIC-P2 error
		HAIC-P2 decompression error (An error occurred in the ASIC compression/decompression module.)
[0x6261]		HDD defective
		6261 6420 6469 7200 00 → "bad dir"
[0x696e]		gwinit process ending
		x69742064 → "init died"
[0x766d]		VM is full
		0x5f706167 → "vm_pageout: VM is full"

SC No.	Level	Error Name/Error Condition/Major Cause/Solution
----		Others
		Error in the OS
		Others
		"init died", "vm_pageout: VM is full", "Cache Error"

SC No.	Level	Error Name/Error Condition/Major Cause/Solution
SC820-00	D	Self-diagnostics error: CPU [XXXX]: Detailed error code
[0001] to [06FF] [0801] to [4005]		CPU error During the self-diagnosis, the controller CPU detects an error. There are 47 types of error code (0001 to 4005) depending on the cause of the error. The CPU detects an error and displays the specific error code with the program address where the error occurs.
		<ul style="list-style-type: none"> ▪ System firmware problem ▪ Defective controller <ol style="list-style-type: none"> 1. Turn the main power switch off and on. 2. Reinstall the controller system firmware. 3. Replace the controller. <p>When the problem cannot be fixed with the above procedure, the following information displayed on the screen needs to be reported to the technical support center.</p> <ul style="list-style-type: none"> - SC code - Detailed error code - Program address
[0701] to [070A]		CPU/Memory Error
		<ul style="list-style-type: none"> ▪ System firmware problem ▪ Defective RAM-DIMM ▪ Defective controller

SC No.	Level	Error Name/Error Condition/Major Cause/Solution
		<ul style="list-style-type: none"> ▪ Reinstall the controller system software. ▪ Replace the RAM-DIMM. ▪ Replace the controller.

SC No.	Level	Error Name/Error Condition/Major Cause/Solution
SC821-00	D	Self-diagnostics error: ASIC [XXXX]: Detailed error code
[0B00]		ASIC register check error
		The write-&-verify check has occurred in the ASIC.
		Defective ASIC device
		Replace the controller board.
[0B06]		ASIC detection error
		The I/O ASIC for system control is not detected.
		<ul style="list-style-type: none"> ▪ Defective ASIC ▪ Defective North Bridge and PCII/F
		Replace the controller board.
[50A2]		Video bridge device (ASIC) register error 1
		The CPU detects the video bridge device, but detects error data from the video bridge device.
		Defective I/F between the video bridge device and controller
		Replace the controller board.

SC No.	Level	Error Name/Error Condition/Major Cause/Solution
SC822-00	B	Self-diagnostics error: HDD [XXXX]: Detailed error code
[3003]		HDD timeout
		Check performed only when HDD is installed: <ul style="list-style-type: none"> ▪ The BSY bit of the HDD device has remained busy for 31 seconds. ▪ After a diagnostic command is set for the HDD, the device remains busy for over 6 seconds.
		<ul style="list-style-type: none"> ▪ Defective HDD device ▪ Defective HDD connector ▪ Defective ASIC device
		<ul style="list-style-type: none"> ▪ Replace or uninstall the HDD device. ▪ Replace the HDD connector. ▪ Replace the controller board.
[3004]		Diagnostics command error
		Result of the issuance of diagnostic command is error.
		Defective HDD device
		Replace or remove the HDD device.

SC No.	Level	Error Name/Error Condition/Major Cause/Solution
SC823-00	B	Self-diagnostics error: NIC [XXXX]: Detailed error code
[6101]		MAC address check sum error
		The result of the MAC address check sum does not match the check sum stored in ROM.
		<ul style="list-style-type: none"> ▪ Defective SEEP ROM ▪ Defective I2C bus (connection)
		Replace the controller board.
[6104]		PHY IC error
		The PHY IC on the controller cannot be correctly recognized.
		<ul style="list-style-type: none"> ▪ Defective PHY chip ▪ Defective ASIC MII I/F
		Replace the controller board.
[6105]		PHY IC loop-back error
		An error occurred during the loop-back test for the PHY IC on the controller.
		<ul style="list-style-type: none"> ▪ PHY chip ▪ Defective MAC of ASIC (SIMAC/COMIC/CELLO) ▪ Defective I/F with the PHY board ▪ Defective solder on the PHY board
		Replace the controller board.

SC No.	Level	Error Name/Error Condition/Major Cause/Solution
SC824-00	D	Self-diagnostics error: NVRAM (resident) [XXXX]: Detailed error code
[1401]		NVRAM verify error
		NVRAM device is missing or NVRAM device is damaged.
		<ul style="list-style-type: none"> ▪ The NVRAM device is missing. ▪ The NVRAM device is damaged. ▪ NVRAM backup battery exhausted ▪ NVRAM socket damaged
		Replace the NVRAM device.

SC No.	Level	Error Name/Error Condition/Major Cause/Solution
SC827-00	D	Self-diagnostic error: Standard SDRAM DIMM [XXXX]: Detailed error code
[0201]		Verification error
		Error detected during a write/verify check for the standard RAM (SDRAM DIMM).
		<ul style="list-style-type: none"> ▪ Loose connection ▪ Defective SDRAM DIMM ▪ Defective controller
[0202]		Resident memory error
		The SPD values in all RAM DIMM are incorrect or unreadable.
		<ul style="list-style-type: none"> ▪ Defective RAM DIMM ▪ Defective SPD ROM on RAM DIMM ▪ Defective 12C bus
		Replace the RAM DIMM

SC No.	Level	Error Name/Error Condition/Major Cause/Solution
SC828-00	D	Self-diagnostic error: ROM [XXXX]: Detailed error code
[0101]		Check sum error 1
		The boot monitor and OS program stored in the ROM DIMM is checked. If the check sum of the program is incorrect, this SC code is displayed.
		Replace the controller board.

SC No.	Level	Error Name/Error Condition/Major Cause/Solution
SC829-00	D	Self-diagnostic error: Optional RAM [XXXX]: Detailed error code
[0301] [0401]		Verification error (Optional RAM slot)
		Error detected during a write/verify check for the optional RAM (SDRAM DIMM).
		<ul style="list-style-type: none"> ▪ Loose connection ▪ Defective SDRAM DIMM ▪ Defective controller
		<ul style="list-style-type: none"> ▪ Turn the main power switch off and on. ▪ Replace the SDRAM DIMM. ▪ Replace the controller.
[0302] [0402]		Memory structure data error (Optional RAM slot)
		The memory structure data error for the optional RAM (SDRAM DIMM) is detected during self-diagnosis.
		<ul style="list-style-type: none"> ▪ Defective RAM DIMM ▪ Defective SPD ROM on RAM DIMM ▪ Defective 12C bus
		Replace the RAM DIMM.

SC No.	Level	Error Name/Error Condition/Major Cause/Solution
SC835-00	B	Self-diagnostic error: Standard SDRAM DIMM [XXXX]: Detailed error code
[1102]		The loopback connector is connected but check results is an error.
		<ul style="list-style-type: none"> ▪ IEEE1284 connector error ▪ Centronic loopback connector defective
		Replace the controller board.
[110C]		The loopback connector is connected but check results is an error.
		<ul style="list-style-type: none"> ▪ ASIC device error ▪ IEEE1284 connector error ▪ Centronic loopback connector is defective
		Replace the controller board.
[1120]		Centronic loopback connector is not connected for detailed self-diagnostic test.
		<ul style="list-style-type: none"> ▪ Centronic loopback connector not connected correctly ▪ Centronic loopback connector is defective ▪ ASIC device is defective
		Replace the controller board.

SC No.	Level	Error Name/Error Condition/Major Cause/Solution
SC838-00	D	Self-diagnostic Error: Clock Generator [XXXX]: Detailed error code
[2701]		A verify error occurred when setting data was read from the clock generator via the I2C bus.
		<ul style="list-style-type: none"> ▪ Defective clock generator ▪ Defective I2C bus ▪ Defective I2C port on the CPU
		Replace the controller board.

SC No.	Level	Error Name/Error Condition/Major Cause/Solution
SC839-00	D	Self-diagnostic Error: Serial Flash [XXXX]: Detailed error code
[9001]		USB NAND Flash ROM cannot be read.
		Defective controller board

SC No.	Level	Error Name/Error Condition/Major Cause/Solution
SC840-00	D	EEPROM access error
		While executing I/O to the EEPROM, an error is detected: <ul style="list-style-type: none"> ▪ When a read error still occurs even after three attempts; ▪ When a write error has occurred.
		EEPROM is defective or has reached its end of life.
		-

SC No.	Level	Error Name/Error Condition/Major Cause/Solution
SC841-00	D	Error in data read from the EEPROM
		When mirrored data read from three different regions in the EEPROM differ each other.
		For some reason, the data stored in a particular region of the EEPROM has been overwritten.
		-

SC No.	Level	Error Name/Error Condition/Major Cause/Solution
SC842-00	C	Verification error in the NAND-Flash update
		When updating the remote ROM and the ROM, SCS encountered an error in writing to the NAND-Flash memory that holds the module data.
		Defective NAND-Flash memory.
		Turn the main power switch off and on.

SC No.	Level	Error Name/Error Condition/Major Cause/Solution
SC842-01	B	Verification error during NAND-Flash update
		When starting-up the machine or re-stating it from the energy saving, the machine reads the state of the NAND-Flash and detects that there are defective blocks whose amount exceeds the threshold. This means that the life of the NAND-Flash is near-end.
		Near-end Life of NAND-Flash
		Replace the controller board as soon as possible.

SC No.	Level	Error Name/Error Condition/Major Cause/Solution
SC842-02	B	NAND-Flash Block-deletion Excess-error
		When starting-up the machine or re-starting it from the energy saving, the machine reads the state of the NAND-Flash and detects that there are block-deletions whose amount exceeds the threshold. This means that the life of the NAND-Flash is near-end.
		Near-end Life of NAND-Flash
		Replace the controller board as soon as possible.

SC No.	Level	Error Name/Error Condition/Major Cause/Solution
SC853-00	B	Bluetooth device connection error
		When a Bluetooth hardware device (USB type) is connected after startup.
		A Bluetooth hardware device (USB type) has been connected after startup.
		Connect the Bluetooth hardware device (USB type) before turning on the main power switch.

SC No.	Level	Error Name/Error Condition/Major Cause/Solution
SC854-00	B	Bluetooth device removal error
		When a Bluetooth hardware device (USB type) is removed after startup.
		A Bluetooth hardware device (USB type) has been removed after startup.
		Connect the Bluetooth hardware device (USB type) before turning on the main power switch.

SC No.	Level	Error Name/Error Condition/Major Cause/Solution
SC855-01	B	Wireless LAN board error (driver attachment failure)
		Wireless LAN board error (wireless LAN card: 802.11 is covered)
		<ul style="list-style-type: none"> ▪ Defective wireless LAN board ▪ Loose connection
		<ul style="list-style-type: none"> ▪ Turn the main power off/on. ▪ Replace wireless LAN board

SC No.	Level	Error Name/Error Condition/Major Cause/Solution
SC855-02	B	Wireless LAN board error (driver initialization failure)
		Wireless LAN board error (wireless LAN card: 802.11 is covered)
		<ul style="list-style-type: none"> ▪ Defective wireless LAN board ▪ Loose connection
		<ul style="list-style-type: none"> ▪ Turn the main power off/on. ▪ Replace wireless LAN board

SC No.	Level	Error Name/Error Condition/Major Cause/Solution
SC857-00	B	USB driver error
		USB I/F is not available due to USB driver error.
		<ul style="list-style-type: none"> ▪ Make sure that the USB is connected correctly. ▪ Replace the controller board.

SC No.	Level	Error Name/Error Condition/Major Cause/Solution
SC858-00	A	Data encryption conversion error (Key error)
		A serious error occurred during an attempt to update the encryption key.
		<ul style="list-style-type: none"> ▪ Data in the USB Flash etc. is corrupted ▪ Communication error because of electromagnetic interference etc. ▪ Controller board is defective
		Replace the Controller Board.

SC No.	Level	Error Name/Error Condition/Major Cause/Solution
SC858-01	A	Data encryption conversion error (HDD Key Setting Error)
		A serious error occurred during an attempt to update the encryption key.
		<ul style="list-style-type: none"> ▪ Data in the USB Flash etc. is corrupted ▪ Communication error because of electromagnetic interference etc. ▪ Controller board is defective
		Replace the Controller Board.

SC No.	Level	Error Name/Error Condition/Major Cause/Solution
SC858-02	A	Data encryption conversion error (NVRAM read/write error)
		A serious error occurred after data conversion during an attempt to update the encryption key.
		NVRAM is defective
		Replace the Controller Board.

SC No.	Level	Error Name/Error Condition/Major Cause/Solution
SC858-30	A	Data encryption conversion error (NVRAM Before Replace error)
		A serious error occurred after data conversion during an attempt to update the encryption key.
		Software error such as conversion parameters being invalid.
		Replace the Controller Board.

SC No.	Level	Error Name/Error Condition/Major Cause/Solution
SC858-31	A	Data encryption conversion error (Other Error)
		A serious error occurred after data conversion during an attempt to update the encryption key.
		Controller board is defective
		Replace the Controller Board.

SC No.	Level	Error Name/Error Condition/Major Cause/Solution
SC859-01	B	Data encryption conversion HDD conversion error (HDD check error)
		HDD was not converted correctly during an attempt to update the encryption key. Only an error screen is displayed and no SC is issued during conversion. This SC is issued after machine restarts.
		<ul style="list-style-type: none"> ▪ HDD conversion was selected in the Encryption key update function but the machine was turned on with the HDD removed. ▪ Power failure occurred during encryption key update. ▪ HDD was not successfully converted during encryption key update due to HDD errors or cable noises.
		<ul style="list-style-type: none"> ▪ Check HDD connection. ▪ Format the HDD. ▪ If there is a problem with the HDD, it has to be replaced.

SC No.	Level	Error Name/Error Condition/Major Cause/Solution
SC859-02	B	Data encryption conversion HDD conversion error (Power failure during conversion)
		HDD was not converted correctly during an attempt to update the encryption key. Only an error screen is displayed and no SC is issued during conversion. This SC is issued after machine restarts. Details: NVRAM/HDD conversion is incomplete.
		Power failure occurred during encryption key update.
		None The display after the restarting instructs the user to format the HDD.

SC No.	Level	Error Name/Error Condition/Major Cause/Solution
SC859-10	B	Data encryption conversion HDD conversion error (Data read/write command error)
		HDD was not converted correctly during an attempt to update the encryption key. Only an error screen is displayed and no SC is issued during conversion. This SC is issued after machine restarts. Details: Abnormal DMAC return value has been received two or more times (DMAC timeout, serial communication error etc.)
		HDD was not successfully converted during encryption key update due to HDD errors or cable noises.
		<ul style="list-style-type: none"> ▪ Check HDD connection. ▪ Format the HDD. ▪ If there is a problem with the HDD, it has to be replaced.

SC No.	Level	Error Name/Error Condition/Major Cause/Solution
SC860-00	B	Hard disk startup error at power-on

SC No.	Level	Error Name/Error Condition/Major Cause/Solution
		<p>A hard disk is connected, but the driver detected the following errors:</p> <p>SS_NOT_READY (-2) The HDD is not ready.</p> <p>SS_BAD_LABEL (-4) Incorrect partition type.</p> <p>SS_READ_ERROR (-5) An error occurred while reading or checking labels.</p> <p>SS_WRITE_ERROR (-6) An error occurred while writing or checking labels.</p> <p>SS_FS_ERROR (-7) Failed to restore filesystem.</p> <p>SS_MOUNT_ERROR (-8) Failed to mount filesystem.</p> <p>SS_COMMAND_ERROR (-9) The driver does not respond to the command.</p> <p>SS_KERNEL_ERROR (-10) Internal kernel error.</p> <p>SS_SIZE_ERROR: (-11) The drive is too small.</p> <p>SS_NO_PARTITION: (-12) The specified partition does not exist.</p> <p>SS_NO_FILE No device file exists.</p> <p>Tried to obtain the information about the status of the hard disk from the driver, but no response has been returned for more than 30 seconds.</p>
		<ul style="list-style-type: none"> ▪ The hard disk has not yet initialized. ▪ Broken label data ▪ Defective hard disk
		Initialize the hard disk from SP mode.

SC No.	Level	Error Name/Error Condition/Major Cause/Solution
SC863-01	D	HDD data read failure
		The data written to the HDD cannot be read normally.
		Bad sectors were generated during operation. (An error occurred in an area that does not belong to a partition, such as the disklabel area.)
		<p>Guide for when to replace the HDD</p> <ol style="list-style-type: none"> 1. When SC863 has occurred ten times or more <ul style="list-style-type: none"> ▪ The interval is short. ▪ Repeatedly occurs in the same situation (At power-on, etc.). ▪ Startup takes a long time when the main power is turned on. 2. It takes a long time after main power on for the operation panel to become ready. HDD access may be consuming time. Normal HDD access time after main power on is about 5 seconds. If the machine is not waiting for the engine to be ready and it still takes 20 to 30 seconds or more, the HDD may be the cause. If there is a problem with the HDD, HDD-related SCs such as SC860 and SC863 will occur frequently. Print the SC log data and check them.

SC No.	Level	Error Name/Error Condition/Major Cause/Solution
SC863-02	D	HDD data read failure
		The data written to the HDD cannot be read normally.
		Bad sectors were generated during operation. (An error occurred in partition "a".)
		<p>Guide for when to replace the HDD</p> <ol style="list-style-type: none"> 1. When SC863 has occurred ten times or more <ul style="list-style-type: none"> ▪ The interval is short. ▪ Repeatedly occurs in the same situation (At power-on, etc.). ▪ Startup takes a long time when the main power is turned on. 2. It takes a long time after main power on for the operation panel to become ready. HDD access may be consuming time. Normal HDD access time after main power on is about 5 seconds. If the machine is not waiting for the engine to be ready and it still takes 20 to 30 seconds or more, the HDD may be the cause. If there is a problem with the HDD, HDD-related SCs such as SC860 and SC863 will occur frequently. Print the SC log data and check them.

SC No.	Level	Error Name/Error Condition/Major Cause/Solution
SC863-03	D	HDD data read failure
		The data written to the HDD cannot be read normally.
		Bad sectors were generated during operation. (An error occurred in partition "b".)
		<p>Guide for when to replace the HDD</p> <ol style="list-style-type: none"> 1. When SC863 has occurred ten times or more <ul style="list-style-type: none"> ▪ The interval is short. ▪ Repeatedly occurs in the same situation (At power-on, etc.). ▪ Startup takes a long time when the main power is turned on. 2. It takes a long time after main power on for the operation panel to become ready. HDD access may be consuming time. Normal HDD access time after main power on is about 5 seconds. If the machine is not waiting for the engine to be ready and it still takes 20 to 30 seconds or more, the HDD may be the cause. If there is a problem with the HDD, HDD-related SCs such as SC860 and SC863 will occur frequently. Print the SC log data and check them.

SC No.	Level	Error Name/Error Condition/Major Cause/Solution
SC863-04	D	HDD data read failure
		The data written to the HDD cannot be read normally.
		Bad sectors were generated during operation. (An error occurred in partition "c".)
		<p>Guide for when to replace the HDD</p> <ol style="list-style-type: none"> 1. When SC863 has occurred ten times or more <ul style="list-style-type: none"> ▪ The interval is short. ▪ Repeatedly occurs in the same situation (At power-on, etc.). ▪ Startup takes a long time when the main power is turned on. 2. It takes a long time after main power on for the operation panel to become ready. HDD access may be consuming time. Normal HDD access time after main power on is about 5 seconds. If the machine is not waiting for the engine to be ready and it still takes 20 to 30 seconds or more, the HDD may be the cause. If there is a problem with the HDD, HDD-related SCs such as SC860 and SC863 will occur frequently. Print the SC log data and check them.

SC No.	Level	Error Name/Error Condition/Major Cause/Solution
SC863-05	D	HDD data read failure
		The data written to the HDD cannot be read normally.
		Bad sectors were generated during operation. (An error occurred in partition "d".)
		<p>Guide for when to replace the HDD</p> <ol style="list-style-type: none"> 1. When SC863 has occurred ten times or more <ul style="list-style-type: none"> ▪ The interval is short. ▪ Repeatedly occurs in the same situation (At power-on, etc.). ▪ Startup takes a long time when the main power is turned on. 2. It takes a long time after main power on for the operation panel to become ready. HDD access may be consuming time. Normal HDD access time after main power on is about 5 seconds. If the machine is not waiting for the engine to be ready and it still takes 20 to 30 seconds or more, the HDD may be the cause. If there is a problem with the HDD, HDD-related SCs such as SC860 and SC863 will occur frequently. Print the SC log data and check them.

SC No.	Level	Error Name/Error Condition/Major Cause/Solution
SC863-06	D	HDD data read failure
		The data written to the HDD cannot be read normally.
		Bad sectors were generated during operation. (An error occurred in partition "e".)
		<p>Guide for when to replace the HDD</p> <ol style="list-style-type: none"> 1. When SC863 has occurred ten times or more <ul style="list-style-type: none"> ▪ The interval is short. ▪ Repeatedly occurs in the same situation (At power-on, etc.). ▪ Startup takes a long time when the main power is turned on. 2. It takes a long time after main power on for the operation panel to become ready. HDD access may be consuming time. Normal HDD access time after main power on is about 5 seconds. If the machine is not waiting for the engine to be ready and it still takes 20 to 30 seconds or more, the HDD may be the cause. If there is a problem with the HDD, HDD-related SCs such as SC860 and SC863 will occur frequently. Print the SC log data and check them.

SC No.	Level	Error Name/Error Condition/Major Cause/Solution
SC863-07	D	HDD data read failure
		The data written to the HDD cannot be read normally.
		Bad sectors were generated during operation. (An error occurred in partition "f".)
		<p>Guide for when to replace the HDD</p> <ol style="list-style-type: none"> 1. When SC863 has occurred ten times or more <ul style="list-style-type: none"> ▪ The interval is short. ▪ Repeatedly occurs in the same situation (At power-on, etc.). ▪ Startup takes a long time when the main power is turned on. 2. It takes a long time after main power on for the operation panel to become ready. HDD access may be consuming time. Normal HDD access time after main power on is about 5 seconds. If the machine is not waiting for the engine to be ready and it still takes 20 to 30 seconds or more, the HDD may be the cause. If there is a problem with the HDD, HDD-related SCs such as SC860 and SC863 will occur frequently. Print the SC log data and check them.

SC No.	Level	Error Name/Error Condition/Major Cause/Solution
SC863-08	D	HDD data read failure
		The data written to the HDD cannot be read normally.
		Bad sectors were generated during operation. (An error occurred in partition "g".)
		<p>Guide for when to replace the HDD</p> <ol style="list-style-type: none"> 1. When SC863 has occurred ten times or more <ul style="list-style-type: none"> ▪ The interval is short. ▪ Repeatedly occurs in the same situation (At power-on, etc.). ▪ Startup takes a long time when the main power is turned on. 2. It takes a long time after main power on for the operation panel to become ready. HDD access may be consuming time. Normal HDD access time after main power on is about 5 seconds. If the machine is not waiting for the engine to be ready and it still takes 20 to 30 seconds or more, the HDD may be the cause. If there is a problem with the HDD, HDD-related SCs such as SC860 and SC863 will occur frequently. Print the SC log data and check them.

SC No.	Level	Error Name/Error Condition/Major Cause/Solution
SC863-09	D	HDD data read failure
		The data written to the HDD cannot be read normally.
		Bad sectors were generated during operation. (An error occurred in partition "h".)
		<p>Guide for when to replace the HDD</p> <ol style="list-style-type: none"> 1. When SC863 has occurred ten times or more <ul style="list-style-type: none"> ▪ The interval is short. ▪ Repeatedly occurs in the same situation (At power-on, etc.). ▪ Startup takes a long time when the main power is turned on. 2. It takes a long time after main power on for the operation panel to become ready. HDD access may be consuming time. Normal HDD access time after main power on is about 5 seconds. If the machine is not waiting for the engine to be ready and it still takes 20 to 30 seconds or more, the HDD may be the cause. If there is a problem with the HDD, HDD-related SCs such as SC860 and SC863 will occur frequently. Print the SC log data and check them.

SC No.	Level	Error Name/Error Condition/Major Cause/Solution
SC863-10	D	HDD data read failure
		The data written to the HDD cannot be read normally.
		Bad sectors were generated during operation. (An error occurred in partition "i".)
		<p>Guide for when to replace the HDD</p> <ol style="list-style-type: none"> 1. When SC863 has occurred ten times or more <ul style="list-style-type: none"> ▪ The interval is short. ▪ Repeatedly occurs in the same situation (At power-on, etc.). ▪ Startup takes a long time when the main power is turned on. 2. It takes a long time after main power on for the operation panel to become ready. HDD access may be consuming time. Normal HDD access time after main power on is about 5 seconds. If the machine is not waiting for the engine to be ready and it still takes 20 to 30 seconds or more, the HDD may be the cause. If there is a problem with the HDD, HDD-related SCs such as SC860 and SC863 will occur frequently. Print the SC log data and check them.

SC No.	Level	Error Name/Error Condition/Major Cause/Solution
SC863-11	D	HDD data read failure
		The data written to the HDD cannot be read normally.
		Bad sectors were generated during operation. (An error occurred in partition "j".)
		<p>Guide for when to replace the HDD</p> <ol style="list-style-type: none"> 1. When SC863 has occurred ten times or more <ul style="list-style-type: none"> ▪ The interval is short. ▪ Repeatedly occurs in the same situation (At power-on, etc.). ▪ Startup takes a long time when the main power is turned on. 2. It takes a long time after main power on for the operation panel to become ready. HDD access may be consuming time. Normal HDD access time after main power on is about 5 seconds. If the machine is not waiting for the engine to be ready and it still takes 20 to 30 seconds or more, the HDD may be the cause. If there is a problem with the HDD, HDD-related SCs such as SC860 and SC863 will occur frequently. Print the SC log data and check them.

SC No.	Level	Error Name/Error Condition/Major Cause/Solution
SC863-12	D	HDD data read failure
		The data written to the HDD cannot be read normally.
		Bad sectors were generated during operation. (An error occurred in partition "k".)
		<p>Guide for when to replace the HDD</p> <ol style="list-style-type: none"> 1. When SC863 has occurred ten times or more <ul style="list-style-type: none"> ▪ The interval is short. ▪ Repeatedly occurs in the same situation (At power-on, etc.). ▪ Startup takes a long time when the main power is turned on. 2. It takes a long time after main power on for the operation panel to become ready. HDD access may be consuming time. Normal HDD access time after main power on is about 5 seconds. If the machine is not waiting for the engine to be ready and it still takes 20 to 30 seconds or more, the HDD may be the cause. If there is a problem with the HDD, HDD-related SCs such as SC860 and SC863 will occur frequently. Print the SC log data and check them.

SC No.	Level	Error Name/Error Condition/Major Cause/Solution
SC863-13	D	HDD data read failure
		The data written to the HDD cannot be read normally.
		Bad sectors were generated during operation. (An error occurred in partition "I".)
		<p>Guide for when to replace the HDD</p> <ol style="list-style-type: none"> 1. When SC863 has occurred ten times or more <ul style="list-style-type: none"> ▪ The interval is short. ▪ Repeatedly occurs in the same situation (At power-on, etc.). ▪ Startup takes a long time when the main power is turned on. 2. It takes a long time after main power on for the operation panel to become ready. HDD access may be consuming time. Normal HDD access time after main power on is about 5 seconds. If the machine is not waiting for the engine to be ready and it still takes 20 to 30 seconds or more, the HDD may be the cause. If there is a problem with the HDD, HDD-related SCs such as SC860 and SC863 will occur frequently. Print the SC log data and check them.

SC No.	Level	Error Name/Error Condition/Major Cause/Solution
SC863-14	D	HDD data read failure
		The data written to the HDD cannot be read normally.
		Bad sectors were generated during operation. (An error occurred in partition "m".)
		<p>Guide for when to replace the HDD</p> <ol style="list-style-type: none"> 1. When SC863 has occurred ten times or more <ul style="list-style-type: none"> ▪ The interval is short. ▪ Repeatedly occurs in the same situation (At power-on, etc.). ▪ Startup takes a long time when the main power is turned on. 2. It takes a long time after main power on for the operation panel to become ready. HDD access may be consuming time. Normal HDD access time after main power on is about 5 seconds. If the machine is not waiting for the engine to be ready and it still takes 20 to 30 seconds or more, the HDD may be the cause. If there is a problem with the HDD, HDD-related SCs such as SC860 and SC863 will occur frequently. Print the SC log data and check them.

SC No.	Level	Error Name/Error Condition/Major Cause/Solution
SC863-15	D	HDD data read failure
		The data written to the HDD cannot be read normally.
		Bad sectors were generated during operation. (An error occurred in partition "n".)
		<p>Guide for when to replace the HDD</p> <ol style="list-style-type: none"> 1. When SC863 has occurred ten times or more <ul style="list-style-type: none"> ▪ The interval is short. ▪ Repeatedly occurs in the same situation (At power-on, etc.). ▪ Startup takes a long time when the main power is turned on. 2. It takes a long time after main power on for the operation panel to become ready. HDD access may be consuming time. Normal HDD access time after main power on is about 5 seconds. If the machine is not waiting for the engine to be ready and it still takes 20 to 30 seconds or more, the HDD may be the cause. If there is a problem with the HDD, HDD-related SCs such as SC860 and SC863 will occur frequently. Print the SC log data and check them.

SC No.	Level	Error Name/Error Condition/Major Cause/Solution
SC863-16	D	HDD data read failure
		The data written to the HDD cannot be read normally.
		Bad sectors were generated during operation. (An error occurred in partition "o".)
		<p>Guide for when to replace the HDD</p> <ol style="list-style-type: none"> 1. When SC863 has occurred ten times or more <ul style="list-style-type: none"> ▪ The interval is short. ▪ Repeatedly occurs in the same situation (At power-on, etc.). ▪ Startup takes a long time when the main power is turned on. 2. It takes a long time after main power on for the operation panel to become ready. HDD access may be consuming time. Normal HDD access time after main power on is about 5 seconds. If the machine is not waiting for the engine to be ready and it still takes 20 to 30 seconds or more, the HDD may be the cause. If there is a problem with the HDD, HDD-related SCs such as SC860 and SC863 will occur frequently. Print the SC log data and check them.

SC No.	Level	Error Name/Error Condition/Major Cause/Solution
SC863-17	D	HDD data read failure
		The data written to the HDD cannot be read normally.
		Bad sectors were generated during operation. (An error occurred in partition "p".)
		<p>Guide for when to replace the HDD</p> <ol style="list-style-type: none"> 1. When SC863 has occurred ten times or more <ul style="list-style-type: none"> ▪ The interval is short. ▪ Repeatedly occurs in the same situation (At power-on, etc.). ▪ Startup takes a long time when the main power is turned on. 2. It takes a long time after main power on for the operation panel to become ready. HDD access may be consuming time. Normal HDD access time after main power on is about 5 seconds. If the machine is not waiting for the engine to be ready and it still takes 20 to 30 seconds or more, the HDD may be the cause. If there is a problem with the HDD, HDD-related SCs such as SC860 and SC863 will occur frequently. Print the SC log data and check them.

SC No.	Level	Error Name/Error Condition/Major Cause/Solution
SC863-18	D	HDD data read failure
		The data written to the HDD cannot be read normally.
		Bad sectors were generated during operation. (An error occurred in partition "q".)
		<p>Guide for when to replace the HDD</p> <ol style="list-style-type: none"> 1. When SC863 has occurred ten times or more <ul style="list-style-type: none"> ▪ The interval is short. ▪ Repeatedly occurs in the same situation (At power-on, etc.). ▪ Startup takes a long time when the main power is turned on. 2. It takes a long time after main power on for the operation panel to become ready. HDD access may be consuming time. Normal HDD access time after main power on is about 5 seconds. If the machine is not waiting for the engine to be ready and it still takes 20 to 30 seconds or more, the HDD may be the cause. If there is a problem with the HDD, HDD-related SCs such as SC860 and SC863 will occur frequently. Print the SC log data and check them.

SC No.	Level	Error Name/Error Condition/Major Cause/Solution
SC863-19	D	HDD data read failure
		The data written to the HDD cannot be read normally.
		Bad sectors were generated during operation. (An error occurred in partition "r".)
		<p>Guide for when to replace the HDD</p> <ol style="list-style-type: none"> 1. When SC863 has occurred ten times or more <ul style="list-style-type: none"> ▪ The interval is short. ▪ Repeatedly occurs in the same situation (At power-on, etc.). ▪ Startup takes a long time when the main power is turned on. 2. It takes a long time after main power on for the operation panel to become ready. HDD access may be consuming time. Normal HDD access time after main power on is about 5 seconds. If the machine is not waiting for the engine to be ready and it still takes 20 to 30 seconds or more, the HDD may be the cause. If there is a problem with the HDD, HDD-related SCs such as SC860 and SC863 will occur frequently. Print the SC log data and check them.

SC No.	Level	Error Name/Error Condition/Major Cause/Solution
SC863-20	D	HDD data read failure
		The data written to the HDD cannot be read normally.
		Bad sectors were generated during operation. (An error occurred in partition "s".)
		<p>Guide for when to replace the HDD</p> <ol style="list-style-type: none"> 1. When SC863 has occurred ten times or more <ul style="list-style-type: none"> ▪ The interval is short. ▪ Repeatedly occurs in the same situation (At power-on, etc.). ▪ Startup takes a long time when the main power is turned on. 2. It takes a long time after main power on for the operation panel to become ready. HDD access may be consuming time. Normal HDD access time after main power on is about 5 seconds. If the machine is not waiting for the engine to be ready and it still takes 20 to 30 seconds or more, the HDD may be the cause. If there is a problem with the HDD, HDD-related SCs such as SC860 and SC863 will occur frequently. Print the SC log data and check them.

SC No.	Level	Error Name/Error Condition/Major Cause/Solution
SC863-21	D	HDD data read failure
		The data written to the HDD cannot be read normally.
		Bad sectors were generated during operation. (An error occurred in partition "t".)
		<p>Guide for when to replace the HDD</p> <ol style="list-style-type: none"> 1. When SC863 has occurred ten times or more <ul style="list-style-type: none"> ▪ The interval is short. ▪ Repeatedly occurs in the same situation (At power-on, etc.). ▪ Startup takes a long time when the main power is turned on. 2. It takes a long time after main power on for the operation panel to become ready. HDD access may be consuming time. Normal HDD access time after main power on is about 5 seconds. If the machine is not waiting for the engine to be ready and it still takes 20 to 30 seconds or more, the HDD may be the cause. If there is a problem with the HDD, HDD-related SCs such as SC860 and SC863 will occur frequently. Print the SC log data and check them.

SC No.	Level	Error Name/Error Condition/Major Cause/Solution
SC863-22	D	HDD data read failure
		The data written to the HDD cannot be read normally.
		Bad sectors were generated during operation. (An error occurred in partition "u".)
		<p>Guide for when to replace the HDD</p> <ol style="list-style-type: none"> 1. When SC863 has occurred ten times or more <ul style="list-style-type: none"> ▪ The interval is short. ▪ Repeatedly occurs in the same situation (At power-on, etc.). ▪ Startup takes a long time when the main power is turned on. 2. It takes a long time after main power on for the operation panel to become ready. HDD access may be consuming time. Normal HDD access time after main power on is about 5 seconds. If the machine is not waiting for the engine to be ready and it still takes 20 to 30 seconds or more, the HDD may be the cause. If there is a problem with the HDD, HDD-related SCs such as SC860 and SC863 will occur frequently. Print the SC log data and check them.

SC No.	Level	Error Name/Error Condition/Major Cause/Solution
SC863-23	D	HDD data read failure
		The data written to the HDD cannot be read normally.
		Bad sectors were generated during operation. (An error occurred in partition "v".)
		<p>Guide for when to replace the HDD</p> <ol style="list-style-type: none"> When SC863 has occurred ten times or more <ul style="list-style-type: none"> The interval is short. Repeatedly occurs in the same situation (At power-on, etc.). Startup takes a long time when the main power is turned on. It takes a long time after main power on for the operation panel to become ready. HDD access may be consuming time. Normal HDD access time after main power on is about 5 seconds. If the machine is not waiting for the engine to be ready and it still takes 20 to 30 seconds or more, the HDD may be the cause. If there is a problem with the HDD, HDD-related SCs such as SC860 and SC863 will occur frequently. Print the SC log data and check them.

SC No.	Level	Error Name/Error Condition/Major Cause/Solution
SC864-00	D	HDD data CRC error
		While reading data from the HDD or storing data in the HDD, data transmission fails.
		Defective HDD
		<ul style="list-style-type: none"> Format the HDD. Replace the HDD.

SC No.	Level	Error Name/Error Condition/Major Cause/Solution
SC864-01	D	HDD data CRC error
		During HDD operation, the HDD returned a CRC error.
		Bad sectors were generated during operation. (An error occurred in an area that does not belong to a partition, such as the disklabel area.)
		<ul style="list-style-type: none"> ▪ Format the HDD. ▪ Replace the HDD.

SC No.	Level	Error Name/Error Condition/Major Cause/Solution
SC864-02	D	HDD data CRC error
		During HDD operation, the HDD returned a CRC error.
		Bad sectors were generated during operation. (An error occurred in partition "a".)
		<ul style="list-style-type: none"> ▪ Format the HDD. ▪ Replace the HDD.

SC No.	Level	Error Name/Error Condition/Major Cause/Solution
SC864-03	D	HDD data CRC error
		During HDD operation, the HDD returned a CRC error.
		Bad sectors were generated during operation. (An error occurred in partition "b".)
		<ul style="list-style-type: none"> ▪ Format the HDD. ▪ Replace the HDD.

SC No.	Level	Error Name/Error Condition/Major Cause/Solution
SC864-04	D	HDD data CRC error
		During HDD operation, the HDD returned a CRC error.
		Bad sectors were generated during operation. (An error occurred in partition "c".)
		<ul style="list-style-type: none"> ▪ Format the HDD. ▪ Replace the HDD.

SC No.	Level	Error Name/Error Condition/Major Cause/Solution
SC864-05	D	HDD data CRC error
		During HDD operation, the HDD returned a CRC error.
		Bad sectors were generated during operation. (An error occurred in partition "d".)
		<ul style="list-style-type: none"> ▪ Format the HDD. ▪ Replace the HDD.

SC No.	Level	Error Name/Error Condition/Major Cause/Solution
SC864-06	D	HDD data CRC error
		During HDD operation, the HDD returned a CRC error.
		Bad sectors were generated during operation. (An error occurred in partition "e".)
		<ul style="list-style-type: none"> ▪ Format the HDD. ▪ Replace the HDD.

SC No.	Level	Error Name/Error Condition/Major Cause/Solution
SC864-07	D	HDD data CRC error
		During HDD operation, the HDD returned a CRC error.
		Bad sectors were generated during operation. (An error occurred in partition "f".)
		<ul style="list-style-type: none"> ▪ Format the HDD. ▪ Replace the HDD.

SC No.	Level	Error Name/Error Condition/Major Cause/Solution
SC864-08	D	HDD data CRC error
		During HDD operation, the HDD returned a CRC error.
		Bad sectors were generated during operation. (An error occurred in partition "g".)
		<ul style="list-style-type: none"> ▪ Format the HDD. ▪ Replace the HDD.

SC No.	Level	Error Name/Error Condition/Major Cause/Solution
SC864-09	D	HDD data CRC error
		During HDD operation, the HDD returned a CRC error.
		Bad sectors were generated during operation. (An error occurred in partition "h".)
		<ul style="list-style-type: none"> ▪ Format the HDD. ▪ Replace the HDD.

SC No.	Level	Error Name/Error Condition/Major Cause/Solution
SC864-10	D	HDD data CRC error
		During HDD operation, the HDD returned a CRC error.
		Bad sectors were generated during operation. (An error occurred in partition "i".)
		<ul style="list-style-type: none"> ▪ Format the HDD. ▪ Replace the HDD.

SC No.	Level	Error Name/Error Condition/Major Cause/Solution
SC864-11	D	HDD data CRC error
		During HDD operation, the HDD returned a CRC error.
		Bad sectors were generated during operation. (An error occurred in partition "j".)
		<ul style="list-style-type: none"> ▪ Format the HDD. ▪ Replace the HDD.

SC No.	Level	Error Name/Error Condition/Major Cause/Solution
SC864-12	D	HDD data CRC error
		During HDD operation, the HDD returned a CRC error.
		Bad sectors were generated during operation. (An error occurred in partition "k".)
		<ul style="list-style-type: none"> ▪ Format the HDD. ▪ Replace the HDD.

SC No.	Level	Error Name/Error Condition/Major Cause/Solution
SC864-13	D	HDD data CRC error
		During HDD operation, the HDD returned a CRC error.
		Bad sectors were generated during operation. (An error occurred in partition "l".)
		<ul style="list-style-type: none"> ▪ Format the HDD. ▪ Replace the HDD.

SC No.	Level	Error Name/Error Condition/Major Cause/Solution
SC864-14	D	HDD data CRC error
		During HDD operation, the HDD returned a CRC error.
		Bad sectors were generated during operation. (An error occurred in partition "m".)
		<ul style="list-style-type: none"> ▪ Format the HDD. ▪ Replace the HDD.

SC No.	Level	Error Name/Error Condition/Major Cause/Solution
SC864-15	D	HDD data CRC error
		During HDD operation, the HDD returned a CRC error.
		Bad sectors were generated during operation. (An error occurred in partition "n".)
		<ul style="list-style-type: none"> ▪ Format the HDD. ▪ Replace the HDD.

SC No.	Level	Error Name/Error Condition/Major Cause/Solution
SC864-16	D	HDD data CRC error
		During HDD operation, the HDD returned a CRC error.
		Bad sectors were generated during operation. (An error occurred in partition "o".)
		<ul style="list-style-type: none"> ▪ Format the HDD. ▪ Replace the HDD.

SC No.	Level	Error Name/Error Condition/Major Cause/Solution
SC864-17	D	HDD data CRC error
		During HDD operation, the HDD returned a CRC error.
		Bad sectors were generated during operation. (An error occurred in partition "p".)
		<ul style="list-style-type: none"> ▪ Format the HDD. ▪ Replace the HDD.

SC No.	Level	Error Name/Error Condition/Major Cause/Solution
SC864-18	D	HDD data CRC error
		During HDD operation, the HDD returned a CRC error.
		Bad sectors were generated during operation. (An error occurred in partition "q".)
		<ul style="list-style-type: none"> ▪ Format the HDD. ▪ Replace the HDD.

SC No.	Level	Error Name/Error Condition/Major Cause/Solution
SC864-19	D	HDD data CRC error
		During HDD operation, the HDD returned a CRC error.
		Bad sectors were generated during operation. (An error occurred in partition "r".)
		<ul style="list-style-type: none"> ▪ Format the HDD. ▪ Replace the HDD.

SC No.	Level	Error Name/Error Condition/Major Cause/Solution
SC864-20	D	HDD data CRC error
		During HDD operation, the HDD returned a CRC error.
		Bad sectors were generated during operation. (An error occurred in partition "s".)
		<ul style="list-style-type: none"> ▪ Format the HDD. ▪ Replace the HDD.

SC No.	Level	Error Name/Error Condition/Major Cause/Solution
SC864-21	D	HDD data CRC error
		During HDD operation, the HDD returned a CRC error.
		Bad sectors were generated during operation. (An error occurred in partition "t".)
		<ul style="list-style-type: none"> ▪ Format the HDD. ▪ Replace the HDD.

SC No.	Level	Error Name/Error Condition/Major Cause/Solution
SC864-22	D	HDD data CRC error
		During HDD operation, the HDD returned a CRC error.
		Bad sectors were generated during operation. (An error occurred in partition "u".)
		<ul style="list-style-type: none"> ▪ Format the HDD. ▪ Replace the HDD.

SC No.	Level	Error Name/Error Condition/Major Cause/Solution
SC864-23	D	HDD data CRC error
		During HDD operation, the HDD returned a CRC error.
		Bad sectors were generated during operation. (An error occurred in partition "v".)
		<ul style="list-style-type: none"> ▪ Format the HDD. ▪ Replace the HDD.

SC No.	Level	Error Name/Error Condition/Major Cause/Solution
SC865-00	D	HDD access error
		During HDD operation, the HDD returned an error.
		The HDD returned an error that does not constitute SC863 (bad sector) or SC864 (CRC error).
		Replace the HDD.

SC No.	Level	Error Name/Error Condition/Major Cause/Solution
SC865-01	D	HDD access error
		During HDD operation, the HDD returned an error.
		The HDD returned an error that does not constitute SC863 (bad sector) or SC864 (CRC error). (An error occurred in an area that does not belong to a partition, such as the disklabel area.)
		Replace the HDD.

SC No.	Level	Error Name/Error Condition/Major Cause/Solution
SC865-02	D	HDD access error
		During HDD operation, the HDD returned an error.
		The HDD returned an error that does not constitute SC863 (bad sector) or SC864 (CRC error). (An error occurred in partition "a".)
		Replace the HDD.

SC No.	Level	Error Name/Error Condition/Major Cause/Solution
SC865-03	D	HDD access error
		During HDD operation, the HDD returned an error.
		The HDD returned an error that does not constitute SC863 (bad sector) or SC864 (CRC error). (An error occurred in partition "b".)
		Replace the HDD.

SC No.	Level	Error Name/Error Condition/Major Cause/Solution
SC865-04	D	HDD access error
		During HDD operation, the HDD returned an error.
		The HDD returned an error that does not constitute SC863 (bad sector) or SC864 (CRC error). (An error occurred in partition "c".)
		Replace the HDD.

SC No.	Level	Error Name/Error Condition/Major Cause/Solution
SC865-05	D	HDD access error
		During HDD operation, the HDD returned an error.
		The HDD returned an error that does not constitute SC863 (bad sector) or SC864 (CRC error). (An error occurred in partition "d".)
		Replace the HDD.

SC No.	Level	Error Name/Error Condition/Major Cause/Solution
SC865-06	D	HDD access error
		During HDD operation, the HDD returned an error.
		The HDD returned an error that does not constitute SC863 (bad sector) or SC864 (CRC error). (An error occurred in partition "e".)
		Replace the HDD.

SC No.	Level	Error Name/Error Condition/Major Cause/Solution
SC865-07	D	HDD access error
		During HDD operation, the HDD returned an error.
		The HDD returned an error that does not constitute SC863 (bad sector) or SC864 (CRC error). (An error occurred in partition "f".)
		Replace the HDD.

SC No.	Level	Error Name/Error Condition/Major Cause/Solution
SC865-08	D	HDD access error
		During HDD operation, the HDD returned an error.
		The HDD returned an error that does not constitute SC863 (bad sector) or SC864 (CRC error). (An error occurred in partition "g".)
		Replace the HDD.

SC No.	Level	Error Name/Error Condition/Major Cause/Solution
SC865-09	D	HDD access error
		During HDD operation, the HDD returned an error.
		The HDD returned an error that does not constitute SC863 (bad sector) or SC864 (CRC error). (An error occurred in partition "h".)
		Replace the HDD.

SC No.	Level	Error Name/Error Condition/Major Cause/Solution
SC865-10	D	HDD access error
		During HDD operation, the HDD returned an error.
		The HDD returned an error that does not constitute SC863 (bad sector) or SC864 (CRC error). (An error occurred in partition "i".)
		Replace the HDD.

SC No.	Level	Error Name/Error Condition/Major Cause/Solution
SC865-11	D	HDD access error
		During HDD operation, the HDD returned an error.
		The HDD returned an error that does not constitute SC863 (bad sector) or SC864 (CRC error). (An error occurred in partition "j".)
		Replace the HDD.

SC No.	Level	Error Name/Error Condition/Major Cause/Solution
SC865-12	D	HDD access error
		During HDD operation, the HDD returned an error.
		The HDD returned an error that does not constitute SC863 (bad sector) or SC864 (CRC error). (An error occurred in partition "k".)
		Replace the HDD.

SC No.	Level	Error Name/Error Condition/Major Cause/Solution
SC865-13	D	HDD access error
		During HDD operation, the HDD returned an error.
		The HDD returned an error that does not constitute SC863 (bad sector) or SC864 (CRC error). (An error occurred in partition "l".)
		Replace the HDD.

SC No.	Level	Error Name/Error Condition/Major Cause/Solution
SC865-14	D	HDD access error
		During HDD operation, the HDD returned an error.
		The HDD returned an error that does not constitute SC863 (bad sector) or SC864 (CRC error). (An error occurred in partition "m".)
		Replace the HDD.

SC No.	Level	Error Name/Error Condition/Major Cause/Solution
SC865-15	D	HDD access error
		During HDD operation, the HDD returned an error.
		The HDD returned an error that does not constitute SC863 (bad sector) or SC864 (CRC error). (An error occurred in partition "n".)
		Replace the HDD.

SC No.	Level	Error Name/Error Condition/Major Cause/Solution
SC865-16	D	HDD access error
		During HDD operation, the HDD returned an error.
		The HDD returned an error that does not constitute SC863 (bad sector) or SC864 (CRC error). (An error occurred in partition "o".)
		Replace the HDD.

SC No.	Level	Error Name/Error Condition/Major Cause/Solution
SC865-17	D	HDD access error
		During HDD operation, the HDD returned an error.
		The HDD returned an error that does not constitute SC863 (bad sector) or SC864 (CRC error). (An error occurred in partition "p".)
		Replace the HDD.

SC No.	Level	Error Name/Error Condition/Major Cause/Solution
SC865-18	D	HDD access error
		During HDD operation, the HDD returned an error.
		The HDD returned an error that does not constitute SC863 (bad sector) or SC864 (CRC error). (An error occurred in partition "q".)
		Replace the HDD.

SC No.	Level	Error Name/Error Condition/Major Cause/Solution
SC865-19	D	HDD access error
		During HDD operation, the HDD returned an error.
		The HDD returned an error that does not constitute SC863 (bad sector) or SC864 (CRC error). (An error occurred in partition "r".)
		Replace the HDD.

SC No.	Level	Error Name/Error Condition/Major Cause/Solution
SC865-20	D	HDD access error
		During HDD operation, the HDD returned an error.
		The HDD returned an error that does not constitute SC863 (bad sector) or SC864 (CRC error). (An error occurred in partition "s".)
		Replace the HDD.

SC No.	Level	Error Name/Error Condition/Major Cause/Solution
SC865-21	D	HDD access error
		During HDD operation, the HDD returned an error.
		The HDD returned an error that does not constitute SC863 (bad sector) or SC864 (CRC error). (An error occurred in partition "t".)
		Replace the HDD.

SC No.	Level	Error Name/Error Condition/Major Cause/Solution
SC865-22	D	HDD access error
		During HDD operation, the HDD returned an error.
		The HDD returned an error that does not constitute SC863 (bad sector) or SC864 (CRC error). (An error occurred in partition "u".)
		Replace the HDD.

SC No.	Level	Error Name/Error Condition/Major Cause/Solution
SC865-23	D	HDD access error
		During HDD operation, the HDD returned an error.
		The HDD returned an error that does not constitute SC863 (bad sector) or SC864 (CRC error). (An error occurred in partition "v".)
		Replace the HDD.

SC No.	Level	Error Name/Error Condition/Major Cause/Solution
SC866-00	B	SD card authentication error
		When a correct license for digital authentication is not found in an SD card application.
		The SD card contains the wrong program data.
		Store the correct program data on the SD card.

SC No.	Level	Error Name/Error Condition/Major Cause/Solution
SC867-00	D	SD card removal detection
		When an application SD card is removed from the slot while the application is being activated.
		An application SD card has been removed from the slot (from the mount point /mnt/sd0).
		Turn the main power switch off and on.

SC No.	Level	Error Name/Error Condition/Major Cause/Solution
SC867-01	D	SD card removal detection
		When an application SD card is removed from the slot while the application is being activated.
		An application SD card has been removed from the slot (from the mount point /mnt/sd1).
		Turn the main power switch off and on.

SC No.	Level	Error Name/Error Condition/Major Cause/Solution
SC868-00	D	SD card access error
		The SD controller returned an error during operation. (An error occurred at the mount point of /mnt/sd0)
		<ul style="list-style-type: none"> ▪ SD card is defective ▪ SD controller is defective
		<ul style="list-style-type: none"> ▪ Reformat the SD card (using the "SD Formatter" made by Panasonic).* ▪ Check the SD card insertion status. ▪ Replace the SD card. ▪ Replace the controller board.

* Do not format the SD card supplied with the main machine or sold as an option. You may only format SD cards used for Firmware Update by the Customer Engineer.

SC No.	Level	Error Name/Error Condition/Major Cause/Solution
SC868-01	D	SD card access error
		The SD controller returned an error during operation. (An error occurred at the mount point of /mnt/sd1)
		<ul style="list-style-type: none"> ▪ SD card is defective ▪ SD controller is defective
		<p>SD card used for starting an application</p> <ul style="list-style-type: none"> ▪ Turn the main power off and check the SD card insertion status. <ul style="list-style-type: none"> ▪ If no problem is found, insert the SD card and turn the main power on. ▪ If an error occurs, replace the SD card. ▪ SD card for users <ul style="list-style-type: none"> ▪ In the case of a file system error, reformat the SD card (using the "SD Formatter" made by Panasonic).* ▪ In the case of a device access error, turn the main power off and check the SD card insertion status. ▪ If no problem is found, insert the SD card and turn the main power on. ▪ If an error occurs, use another SD card. ▪ If the error persists even after replacing the SD card, replace the controller board.

* Do not format the SD card supplied with the main machine or sold as an option. You may only format SD cards used for Firmware Update by the Customer Engineer.

SC No.	Level	Error Name/Error Condition/Major Cause/Solution
SC870-00	B	Address Book data error (Anytime: Address Book Error.)
SC870-01	B	Address Book data error (On startup: Media required for storing the Address Book is missing.)
SC870-02	B	Address Book data error (On startup: encryption is configured but the module required for encryption (DESS) is missing.)

SC No.	Level	Error Name/Error Condition/Major Cause/Solution
SC870-03	B	Address Book data error (Initialization: Failed to generate a file to store internal Address Book.)
SC870-04	B	Address Book data error (Initialization: Failed to generate a file to store delivery sender.)
SC870-05	B	Address Book data error (Initialization: Failed to generate a file to store delivery destination.)
SC870-06	B	Address Book data error (Initialization: Failed to generate a file to store information required for LDAP search.)
SC870-07	B	Address Book data error (Initialization: Failed to initialize entries required for machine operation.)
SC870-08	B	Address Book data error (Machine configuration: HDD is present but the space for storing the Address Book is unusable.)
SC870-09	B	Address Book data error (Machine configuration: Inconsistency in the NVRAM area used for storing settings required for Address Book configuration.)
SC870-10	B	Address Book data error (Machine configuration: Cannot make a directory for storing the Address Book in the SD/USB FlashROM.)
SC870-11	B	Address Book data error (On startup: Inconsistency in Address Book entry number.)
SC870-20	B	Address Book data error (File I/O: Failed to initialize file.)
SC870-21	B	Address Book data error (File I/O: Failed to generate file.)
SC870-22	B	Address Book data error (File I/O: Failed to open file.)
SC870-23	B	Address Book data error (File I/O: Failed to write to file.)
SC870-24	B	Address Book data error (File I/O: Failed to read file.)
SC870-25	B	Address Book data error (File I/O: Failed to check file size.)
SC870-26	B	Address Book data error (File I/O: Failed to delete data.)
SC870-27	B	Address Book data error (File I/O: Failed to add data.)

SC No.	Level	Error Name/Error Condition/Major Cause/Solution
SC870-30	B	Address Book data error (Search: Failed to obtain data from cache when searching in the machine Address Book. delivery destination/sender.)
SC870-31	B	Address Book data error (Search:Failed to obtain data from cache during LDAP search.)
SC870-32	B	Address Book data error (Search:Failed to obtain data from cache while searching the WS-Scanner Address Book.)
SC870-41	B	Address Book data error (Cache: failed to obtain data from cache.)
SC870-50	B	Address Book data error (On startup: Detected abnormality of the Address Book encryption status.)
SC870-51	B	Address Book data error (Encryption settings: Failed to create directory required for conversion between plaintext and encrypted text.)
SC870-52	B	Address Book data error (Encryption settings: Failed to convert from plaintext to encrypted text.)
SC870-53	B	Address Book data error (Encryption settings: Failed to convert from encrypted text to plaintext.)
SC870-54	B	Address Book data error (Encryption settings: Detected data inconsistency when reading the encrypted Address Book.)
SC870-55	B	Address Book data error (Encryption settings: Failed to delete file when changing encryption setting.)
SC870-56	B	Address Book data error (Encryption settings: Failed to erase the file that records the encryption key during an attempt to change the encryption setting.)
SC870-57	B	Address Book data error (Encryption settings: Failed to move a file during an attempt to change the encryption setting.)
SC870-58	B	Address Book data error (Encryption settings: Failed to delete a directory during an attempt to change the encryption setting.)

SC No.	Level	Error Name/Error Condition/Major Cause/Solution
SC870-59	B	Address Book data error (Encryption settings: Detected a resource shortage during an attempt to change the encryption setting.)
SC870-60	B	Address Book data error (Unable to obtain the on/off setting for administrator authentication (06A and later).)
		When an error related to the Address Book is detected during startup or operation.
		<ul style="list-style-type: none"> ▪ Software bug ▪ Inconsistency of Address Book source location (machine/delivery server/LDAP server) ▪ Inconsistency of Address Book encryption setting or encryption key (NVRAM or HDD was replaced individually without formatting the Address Book) ▪ Address Book storage device (SD/HDD) was temporarily removed or hardware configuration does not match the application configuration. ▪ Address Book data corruption was detected.
		<ul style="list-style-type: none"> ▪ Check the HDD connection. ▪ Initialize all UCS settings and address/authentication information (SP5-846-046). ▪ Initialize the Address Book partition (SP5-832-006).

SC No.	Level	Error Name/Error Condition/Major Cause/Solution
SC872-00	B	HDD mail received data error
		An error is detected in the HDD at machine power-on.
		<ul style="list-style-type: none"> ▪ Defective HDD ▪ Power failure while accessing the HDD
		<ul style="list-style-type: none"> ▪ Use SP5832-007 to initialize the HDD (HDD-related: Format: Mail received data). ▪ Replace the HDD.

SC No.	Level	Error Name/Error Condition/Major Cause/Solution
SC873-00	B	HDD mail transfer error
		An error is detected in the HDD at machine power-on.
		<ul style="list-style-type: none"> ▪ Defective HDD ▪ Power failure while accessing the HDD
		<ul style="list-style-type: none"> ▪ Use SP5832-008 to initialize the HDD (HDD-related: Format: Mail transfer data). ▪ Replace the HDD.

SC No.	Level	Error Name/Error Condition/Major Cause/Solution
SC875-**	D	Delete All error (HDD)
		An error is detected before executing HDD Erase.
		875-01 <ul style="list-style-type: none"> ▪ Error occurred at “hddchack -l”. 875-02 <ul style="list-style-type: none"> ▪ Data erase failed.
		Turn the main power switch off and on.

SC No.	Level	Error Name/Error Condition/Major Cause/Solution
SC876-01	D	Log Data Error 1
		An error was detected in the acquisition or configuration of the log data at power on or during machine operation.
		Damaged log data file
		Initialize the HDD (SP5-832-004).

SC No.	Level	Error Name/Error Condition/Major Cause/Solution
SC876-02	D	Log Data Error 2
		An error was detected in the acquisition or configuration of the log data at power on or during machine operation.
		Log encryption is enabled but encryption module is not installed.
		<ul style="list-style-type: none"> ▪ Replace or re-install the encryption module. ▪ Disable the log encryption setting.

SC No.	Level	Error Name/Error Condition/Major Cause/Solution
SC876-03	D	Log Data Error 3
		An error was detected in the acquisition or configuration of the log data at power on or during machine operation.
		Inconsistency of encryption key between NV-RAM and HDD.
		<ul style="list-style-type: none"> ▪ Disable the log encryption setting. ▪ Initialize LCS memory (SP5801-019). ▪ Initialize the HDD (SP5-832-004).

SC No.	Level	Error Name/Error Condition/Major Cause/Solution
SC876-04	D	Log Data Error 4
		An error was detected in the acquisition or configuration of the log data at power on or during machine operation.
		<ul style="list-style-type: none"> ▪ Log encryption key is disabled but the log data file is encrypted.(NVRAM data corruption) ▪ Log encryption key is enabled but the log data file is not encrypted.(NVRAM data corruption)
		<ul style="list-style-type: none"> ▪ Initialize the HDD (SP5-832-004).

SC No.	Level	Error Name/Error Condition/Major Cause/Solution
SC876-05	D	Log Data Error 5

SC No.	Level	Error Name/Error Condition/Major Cause/Solution
		An error was detected in the acquisition or configuration of the log data at power on or during machine operation.
		<ul style="list-style-type: none"> ▪ Only the NV-RAM has been replaced with one previously used in another machine. ▪ Only the HDD has been replaced with one previously used in another machine.
		<ul style="list-style-type: none"> ▪ Attach the original NV-RAM. ▪ Attach the original HDD. ▪ With the configuration that caused the SC, initialize the HDD (SP5-832-004).

SC No.	Level	Error Name/Error Condition/Major Cause/Solution
SC876-99	D	Log Data Error 99
		An error was detected in the acquisition or configuration of the log data at power on or during machine operation.
		Other causes
		-

SC No.	Level	Error Name/Error Condition/Major Cause/Solution
SC877-00	B	Data Overwrite Security card error
		The "Auto Erase Memory" function of the Data Overwrite Security is enabled but it cannot be executed.
		<ul style="list-style-type: none"> ▪ Data Overwrite Security option SD card is broken. ▪ Data Overwrite Security option SD card has been removed.
		<ul style="list-style-type: none"> ▪ If the SD card is broken, prepare a new Data Overwrite Security option SD card and replace the NVRAM. ▪ If the SD card has been removed, turn the main power off and reinstall a working Data Overwrite Security option SD card.

SC No.	Level	Error Name/Error Condition/Major Cause/Solution
SC878-00	D	TPM electronic authentication error
		The machine failed TPM electronic authentication. System hash registered in the TPM did not match the data on the USB flash.
		<ul style="list-style-type: none"> ▪ System module was updated in an unauthorized manner. ▪ USB flash is not working correctly.
		Replace the controller board.

SC No.	Level	Error Name/Error Condition/Major Cause/Solution
SC878-01	D	USB Flash error
		USB Flash file system error
		USB Flash file system has been destroyed.
		Replace the controller board.

SC No.	Level	Error Name/Error Condition/Major Cause/Solution
SC878-02	D	TPM error
		An error occurred in the TPM or TPM driver.
		TPM is defective
		Replace the controller board.

SC No.	Level	Error Name/Error Condition/Major Cause/Solution
SC878-03	D	TCSO error
		An error occurred in TPM software stack.
		<ul style="list-style-type: none"> ▪ Unable to start TPM ▪ Necessary files missing from the TPM.
		Replace the controller board.

SC No.	Level	Error Name/Error Condition/Major Cause/Solution
SC880-00	D	MLB error
		The response is not received within the specified time during the access to the MLB.
		Defective MLB
		<ul style="list-style-type: none"> ▪ Replace the MLB ▪ Remove the MLB

SC No.	Level	Error Name/Error Condition/Major Cause/Solution
SC881-01	D	Management area error
		Defective software has been detected.
		Abnormal accumulation of authentication information in the software
		Turn the main power switch off and on.

SC No.	Level	Error Name/Error Condition/Major Cause/Solution
SC899-00	D	Software performance error (signal reception end)
		-
		Occurs when an internal program behaves abnormally.
		<p>In the case of a hardware defect</p> <ul style="list-style-type: none"> ▪ Replace the hardware. <p>In the case of a software error</p> <ul style="list-style-type: none"> ▪ Turn the main power off/on. ▪ Try updating the firmware.

6.2.10 SC900 (OTHERS)

SC No.	Level	Error Name/Error Condition/Major Cause/Solution
SC900-00	D	Electronic counter error
		The value provided by the electronic total counter is outside the normal range.
		<ul style="list-style-type: none"> ▪ Unexpected NVRAM installed ▪ Defective NVRAM ▪ NVRAM data corruption ▪ Data is stored in an unexpected area due to external causes. ▪ The count requests made by SRM upon receiving the PRT have not yet been processed.
		Install an NVRAM device designed specifically for the model.

SC No.	Level	Error Name/Error Condition/Major Cause/Solution
SC920-**	B	Printer application error
		A serious application error that stops the machine from operating is detected.
		<ul style="list-style-type: none"> ▪ 920-00 At PM startup, no response was returned within the specified period of time. ▪ 920-01 A time-out occurred during PM operation. ▪ 920-02 WORK memory acquisition failed. ▪ 920-03 The filter process cannot be started. ▪ 920-04 The filter process was aborted.
		Turn the main power switch off and on.

SC No.	Level	Error Name/Error Condition/Major Cause/Solution
SC921-00	B	Printer font error
		A font that is usually included as the standard font was not found when the printer application was started.
		The standard font file is missing.
		Turn the main power switch off and on.

SC No.	Level	Error Name/Error Condition/Major Cause/Solution
SC925-00 SC925-01	B	Net File function error
		The Net File storage area on the HDD is not available, or the management file used for handling the Net File data is broken. As a result, access to the Net File data cannot be continued.

SC No.	Level	Error Name/Error Condition/Major Cause/Solution
		<ul style="list-style-type: none"> ▪ Defective HDD ▪ HDD inconsistency caused by switching the machine off while writing to HDD ▪ Software bug ▪ When HDD error-related service calls (SC860-SC865) are issued at the same time: This error can be caused by a defective HDD. Therefore, take the necessary countermeasures specified for SC860, etc. <ul style="list-style-type: none"> ▪ When other HDD error-related service calls (SC860-SC865) are NOT issued at the same time: <ol style="list-style-type: none"> 1) Turn the main power switch off and on. 2) If it cannot be restored by taking the above measure, initialize the Net File partition in the HDD. Note, however, that this may delete stored data such as documents remaining in the Fax transmission queue and those waiting for capture. Therefore, you must obtain the consent of your customer before executing the initialization. Note that after executing commands including Plumeria/Palm2, the job history will also be cleared. 3) If the error persists even after taking the above step, initialize all of the partitions in the HDD in accordance with SP5-832-001, then turn the main power off and then on again. Note, however, that this step will clear all of the data stored on the HDD including various documents, address book data, and so on. Therefore, again you must obtain the prior consent of your customers. Note that saved received Fax documents will be protected, but the receiving order may not be maintained. 4) If the error still cannot be restored, replace the HDD.

SC No.	Level	Error Name/Error Condition/Major Cause/Solution
SC990-00	D	Software performance error
		The software attempted to make an unexpected operation.

SC No.	Level	Error Name/Error Condition/Major Cause/Solution
		<ul style="list-style-type: none"> ▪ Incorrect argument ▪ Incorrect internal parameter ▪ Insufficient working memory ▪ Abnormal performance caused by an error that cannot be detected in normal SC detection due to hardware specifications.
		<ul style="list-style-type: none"> ▪ Turn the main power switch off and on. ▪ Reinstall the software of the controller board. ▪ Reinstall the software of the engine board.

SC No.	Level	Error Name/Error Condition/Major Cause/Solution
		Software continuity error
		The software has attempted to perform an unexpected operation. (However, the process can continue running if recovery processing is carried out.)
SC991-00	C	<ul style="list-style-type: none"> ▪ Incorrect argument ▪ Incorrect internal parameter ▪ Insufficient working memory ▪ May have resulted from an error that cannot be detected by the hardware using normal SC detection.
		Not required

SC No.	Level	Error Name/Error Condition/Major Cause/Solution
		Undefined SC error
		An error that is not controlled by the system occurred (the error does not come under any other SC code).
SC992-00	D	A SC code used in the previous machine was applied erroneously.
		Turn the main power switch off and on.

Service Call

SC No.	Level	Error Name/Error Condition/Major Cause/Solution
SC994-00	C	Operation error caused by abnormalities that are normally undetectable.
		An error occurred because the number of records exceeded the limit for images managed in the service layer of the firmware.
		This can occur if there are too many application screens open on the operation panel.
		Logging only.

SC No.	Level	Error Name/Error Condition/Major Cause/Solution
SC995-**	D	CPM setting error
		Comparison of machine serial number (11 digits) and machine identification code. Details: <ul style="list-style-type: none"> ▪ Machine serial number cannot be identified because of BICU replacement or malfunctioning. ▪ Machine serial number cannot be identified because of NV-RAM replacement
		Machine serial number (11 digits) or machine identification code does not match.
		<ul style="list-style-type: none"> ▪ Replace the board(s) to match the CPM of the controller and BICU boards. ▪ Turn the main power switch off and on.

SC No.	Level	Error Name/Error Condition/Major Cause/Solution
SC997-00	B	Application function selection error
		<ul style="list-style-type: none"> ▪ The application has not responded to the set command created by SCS within a certain period of time. ▪ The application selected ended abnormally.
		Software bug

SC No.	Level	Error Name/Error Condition/Major Cause/Solution
		<ul style="list-style-type: none"> ▪ Check whether an option required by the application (RAM, DIMM, board) is installed properly. ▪ Check whether downloaded applications are correctly configured. <p>(Take necessary countermeasures specific to the application in which the error occurs. In some applications, the logs can be taken from the monitor. If this option is available, analyze the logs.)</p>

SC No.	Level	Error Name/Error Condition/Major Cause/Solution
SC998-00	D	Application start error
		<ul style="list-style-type: none"> ▪ After power on, no application program is registered to the system within a predetermined period of time. (No application starts or ends normally.) ▪ Even if they are started, all applications have become unable to be rendered due to an unknown defect.
		<ul style="list-style-type: none"> ▪ Software bug ▪ An option required by the application (RAM, DIMM, board) is not installed properly
		<ul style="list-style-type: none"> ▪ Turn the main power switch off and on. ▪ Check whether an option required by the application (RAM, DIMM, board) is installed properly. ▪ Check whether downloaded applications are correctly configured. ▪ Replace the Controller Board.

6.3 JAM DETECTION

6.3.1 JAM DISPLAYS

When a jam occurs, the location is displayed on the operation panel.

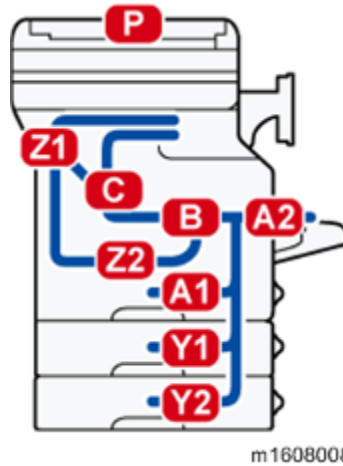

6.3.2 JAM HISTORY

SP7-507 shows the paper jam history.

```
CODE :011
SIZE  :05h
TOTAL:000034
DATE  :Fri Feb 15 11:44:50 2006
```

- CODE: Indicates the jam code.
- SIZE: Indicates the paper Size Code.
- TOTAL: Indicates the total counter (SP7-502-001).
- DATE: indicates the date when the jam occurred.

Note

- The 10 latest printer jams are displayed.
- Initial jams are not recorded.

6.3.3 SENSOR POSITION LAYOUT

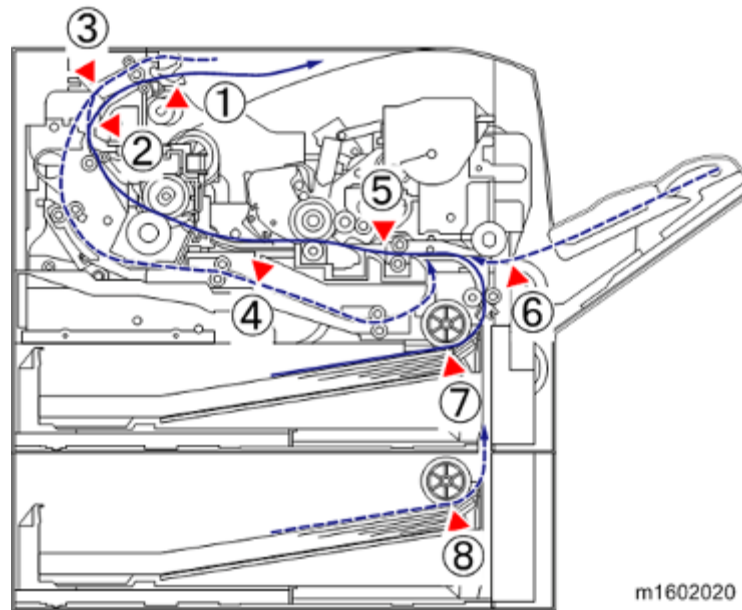

1. Paper Overflow Sensor
2. Paper Exit Sensor
3. Duplex Exit Sensor
4. Duplex Entrance Sensor
5. Registration Sensor
6. By-pass Paper End Sensor
7. Paper End Sensor (Main Machine)
8. Paper End Sensor (Optional Bank)

6.3.4 SENSOR POSITION

ⓘ Note

- Jam code: Shows the cause of a jam. Appears in the log data.
- Position code: Shows the location of a jam. Appears on the operation panel.

These are lists of jam codes for the main machine and peripheral devices. Please note:

- **Late jam.** The paper has failed to arrive within the prescribed time due to a jam that has occurred upstream of the referenced sensor.
- **Lag jam.** The paper has failed to leave the location of the referenced sensor within the prescribed time due to a jam downstream of the referenced sensor.

ARDF

Jam Code	Jam Type	Position Code
4	Registration Sensor: Late jam	P
54	Registration Sensor: Lag jam	P
100	Motor defective	P
1	Initial jam	P

Main Machine

Jam Code	Jam Type	Position Code
1	Registration Sensor Jam	B
1	Paper Exit Sensor Jam	B Z1
1	Duplex Exit Sensor Jam	Z1
1	Duplex Entrance Sensor Jam	Z1 Z2
3	Tray 1 : No Paper Feeding	A1
8	By-pass Tray : No Paper Feeding	A2
9	Duplex : No Paper Feeding	Z2
17	Registration Sensor: Late Jam	A1
20	Paper Exit Sensor: Late Jam	B C
57	Registration Sensor: Lag Jam	B
60	Paper Exit Sensor: Lag Jam	B Z1

Jam Code	Jam Type	Position Code
23	Duplex Exit Sensor: Late Jam	B C
63	Duplex Exit Sensor: Lag Jam	Z1
26	Duplex Entrance Sensor: Late Jam	Z1
66	Duplex Entrance Sensor: Lag Jam	Z1 Z2

Optional Bank

Jam Code	Jam Type	Position Code
4	Tray 2 : No Paper Feeding	Y1
13	Tray 2 Relay Sensor(Vertical Transprot Sensor) : Late Jam	Y2
53	Tray 2 Relay Sensor(Vertical Transprot Sensor) : Lag Jam	A1 Y1
1	Tray 2 Relay Sensor(Vertical Transprot Sensor) Jam	Y1
5	Tray 3 : No Paper Feeding	Y2
54	Tray 3 Relay Sensor(Vertical Transprot Sensor) : Lag Jam	A1 Y1 Y2
1	Tray 3 Relay Sensor(Vertical Transprot Sensor) Jam	Y2

6.4 TROUBLESHOOTING

6.4.1 TEST PATTERN PRINTING

Follow the test pattern print procedure below to print a test pattern.

Note

- Do not operate the machine until the test pattern has been printed. Otherwise, an SC occurs.
1. Enter the SP mode, and then select SP2-109-001.
 2. Select the pattern number, and then press [OK].
 3. Display the Copy function by pressing [Start] key, and then specify the scanning conditions for test pattern print.
 4. Press [Start] key to print the test pattern.
 5. Check the test pattern, and then go back to SP mode.

No.	Pattern	No.	Pattern
0	None	9	Arg. Grid 20mm
1	Vert. (1 dot)	10	Indep. (1 dot)
2	Hori. (1 dot)	11	Indep. (2 dot)
3	Vert. (2 dot)	12	Indep. (4 dot)
4	Hori. (2 dot)	13	Full
5	Grid Vert.	14	Band
6	Grid Hori.	15	Gray 10mm
7	Grid 20mm	16	Gray 20mm
8	Arg. Grid	17	Trim Area

6.4.2 IMAGE POSITION ADJUSTMENT

ⓘ Note

- Adjust the blank margin width only if it cannot be adjusted by registration (leading edge/side-to-side). First adjust C and D; then A and B.

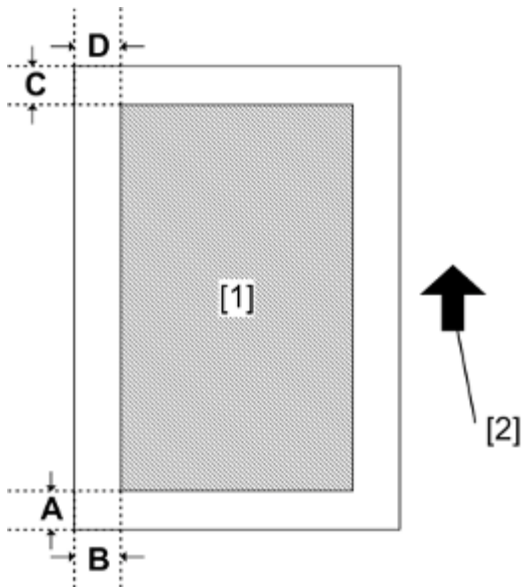

- [1]: Print area
- [2]: Paper feed direction

- Enter the SP mode, and then print the test pattern (17: Trim Area) with SP2-109-001.
- Adjust the blank margin width of the image with SP2-103-(001-004).
 - Leading edge: 2.7 to 9.9 mm (Default: 3.0 mm)
 - Trailing edge: 0.0 to 9.9 mm (Default: 2.0 mm)
 - Left: 0.0 to 9.9 mm (Default: 2.0 mm)
 - Right: 0.0 to 9.9 mm (Default: 2.0 mm)

6.4.3 REGISTRATION ADJUSTMENT

Print Area

Check that the adjustment meets the product specification.

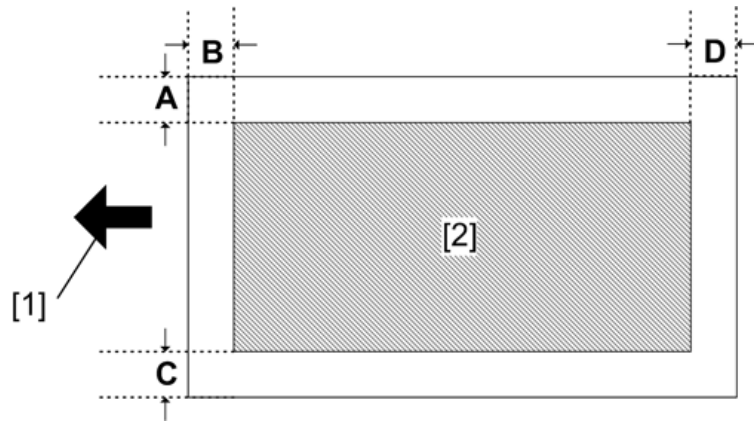

- [1]: Paper feed direction
- [2]: Print area

Adjustment Reference Values

- B: Leading edge (Sub scanning direction): 3.0 ± 1.5 mm
- D: Trailing edge (Sub scanning direction): 3.0 mm
- C: Left (Main scanning direction): 2.0 ± 1.5 mm
- A: Right (Main scanning direction): 2.0 mm

Adjustment Procedure

1. Enter the SP mode, and then print the test pattern (17: Trim Area) with SP2-109-001.

Note

- Print the test pattern, and then adjust the leading edge registration in the SP mode to the optimum value.
2. Do SP1-002-(001,002,003,004,006) to check and adjust the registration.
 3. Check the side-to-side registration for each paper feed trays.

6.4.4 SCANNER, ARDF IMAGE ADJUSTMENT

Scanner Image Adjustment

Before the scanner adjustment, do the Side-to-Side registration and blank margin width adjustment.

Note

- Use "Test Chart" to adjust this setting.

Magnification

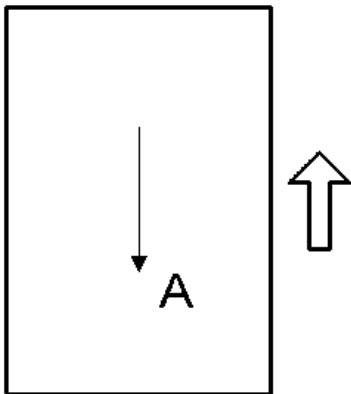

A: Sub-scan magnification

- Place the test chart on the exposure glass and make a copy from one of the paper feed trays.
- Check the magnification ratio. If necessary, adjust the magnification with the following SP mode.

SP No.	Name	Specification
SP4-008	Sub-scan magnification	± 1.0%

Registration

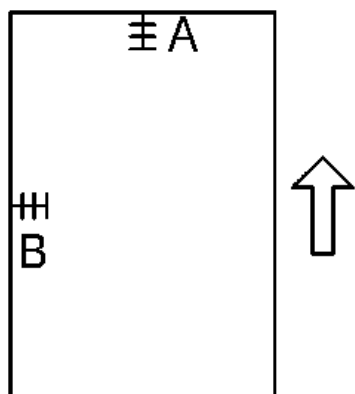

- A: Leading edge registration
 - B: Side-to-side registration
1. Place the test chart on the exposure glass and make a copy from one of the paper feed trays.
 2. Check the leading edge and side-to-side registration, and adjust as necessary with the following SP modes.

Name	SP No.	Specification
L-Edge Regist Adjustment	SP4-010-001	0 ± 2mm
S-to-S Regist Adjustment	SP4-011-001	0 ± 2.5mm

ARDF Image Adjustment

Registration

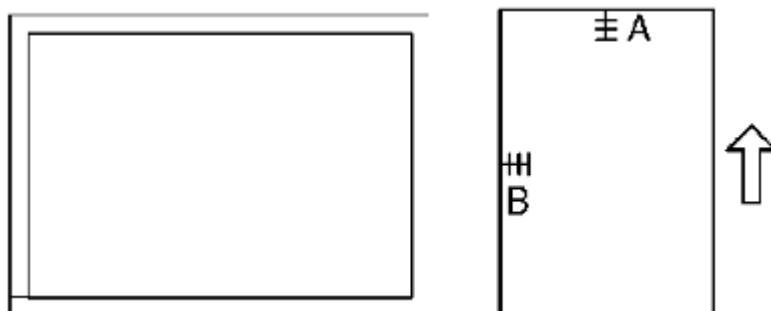

Note

- Use "Test Chart" to adjust this setting.
1. Place the temporary test chart on the ARDF and make a copy from one of the paper feed trays.
 2. Check the registrations, and adjust as necessary with the appropriate SP modes, as follows.

Allowable Misregistration: 4.2 ± 2 mm (Leading edge) / 2 ± 1 mm (Left, right)

SP No.	Name	Range
SP6-006-001	Side-to-Side Regist: Front	± 2.0 mm
SP6-006-003	Leading Edge Regist: Front	± 5.0 mm
SP6-006-007	Rear Edge Erase	± 5.0 mm

Magnification

1. Place the temporary test chart on the ARDF and make a copy from one of the paper feed trays.
2. Check the magnification and adjust it with SP6-017-001 if necessary.

SP No.	Name	Range
SP6-017-001	ADF Adjustment Magnification	± 5.0 %

6.4.5 PROBLEM AT REGULAR INTERVALS

Image problems may appear at regular intervals that depend on the circumference of certain components.

The following diagram shows the possible symptoms (black or white dots at regular intervals or other problems).

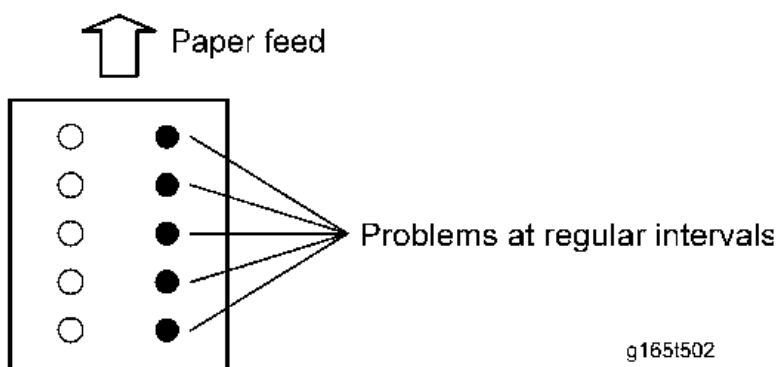

Problems	Intervals	Defective parts
Problems with the printed result	29.9mm	Charge roller
	37.7mm	Registration roller

Problems	Intervals	Defective parts
(other than black or white dots)	45.8mm	Image transfer roller
	112mm	Fusing pressure roller
	94mm	Fusing roller
	100.5mm	Paper feed roller
Black or white dots	35.6mm	Development roller
	94.4mm	Drum

The LED head contains 26 LED chips, each covering a line 8 mm wide. If a line 8 mm wide extending in the paper feed direction appears, an LED chip may be damaged. If so, replace the LED head.

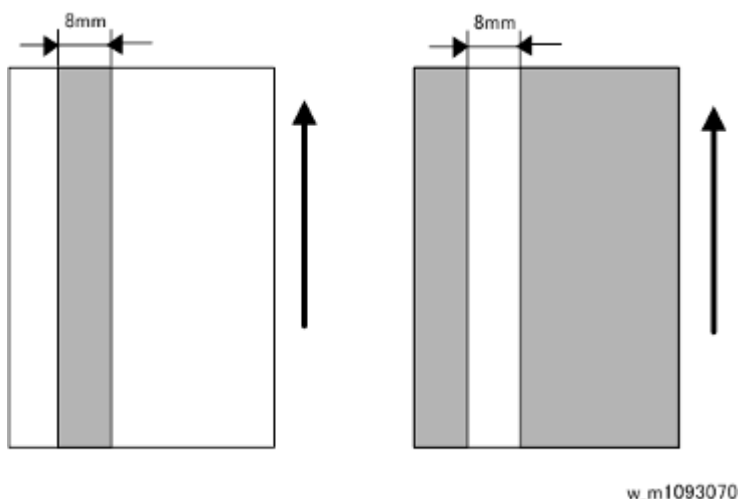

When Vertical Banding is Generated

The vertical banding on a print image may be improved by the [Drum Rotation] function.

1. Select a drum rotation level.

[User Tools/Counter] key > Maintenance > Drum Rotation

2. Select a drum rotation level from the following 2 levels: Level 1 (Normal) and Level 2 (Strong).

<Operation>

- Level1 : Photo conductor idles for 55 seconds
- Level2 : Photo conductor idles for 30 seconds (for black and white vertical banding)

<Effectively Prevented Phenomena>

- Level1 : Pieces of white banding (for half tone or continuous printing)
- Level2 : White vertical banding (for half tone), black vertical banding, and black horizontal banding

Note

- If the [Drum Rotation] function is performed many times, the life of the drum unit may be shortened.

When Black Spots are Generated on Print Image

The black spots on a print image may be improved by the [Fusing Roller Cleaning].

1. **Load a paper (A4 or LT size plain paper) to the by-pass tray.**
2. **Perform the [Fusing Roller Cleaning] (toners are consumed).**
[User Tools/Counter] key > Maintenance > Fusing Roller Cleaning
3. **A paper is fed and images are printed on both sides of the paper.**

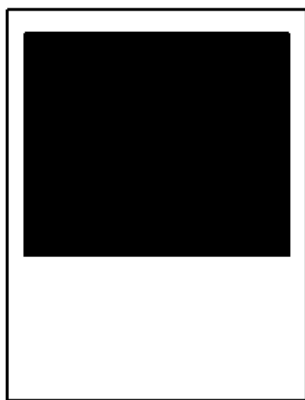

m1608086

4. **Check that the black spots do not appear any more.**

Note

- The effectiveness of the fusing cleaning varies depending on the types of images printed or papers used until now. Therefore, the problem may be improved by performing the [Fusing Roller Cleaning] several times, which consumes the toners.

6.4.6 PAPER FEED (SKEW)

Use the following flowchart to determine the cause and deal with the problem.

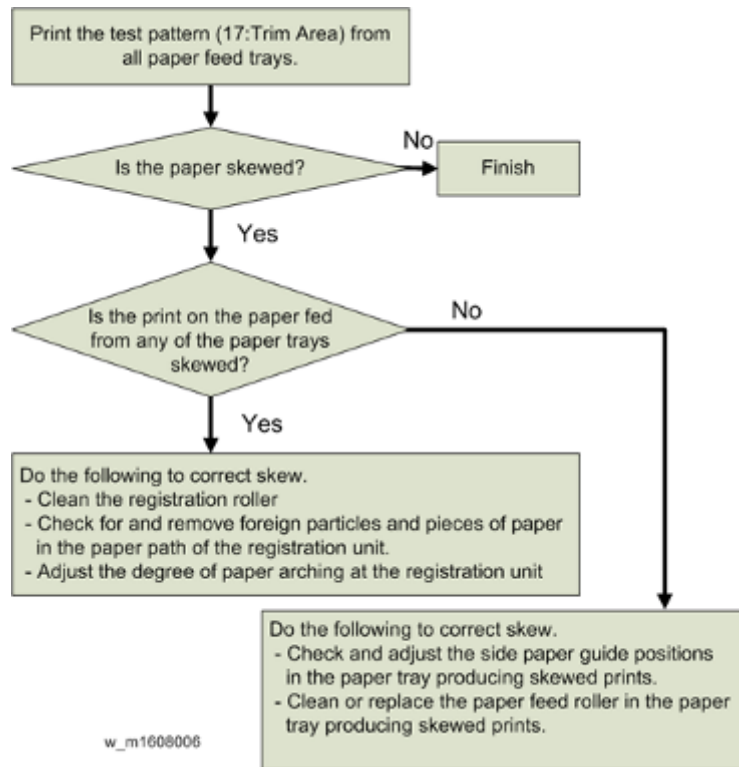

6.4.7 STACK ERROR (SPILLING OF THE PAPER STACKED IN THE OUTPUT TRAY)

Depending on the number of sheets delivered, the stacked paper may spill.



m1600178

If the number of stacked sheets is substantial, you can prevent the stack from spilling by adjusting the stop [A]. The stop supports paper up to Legal size.

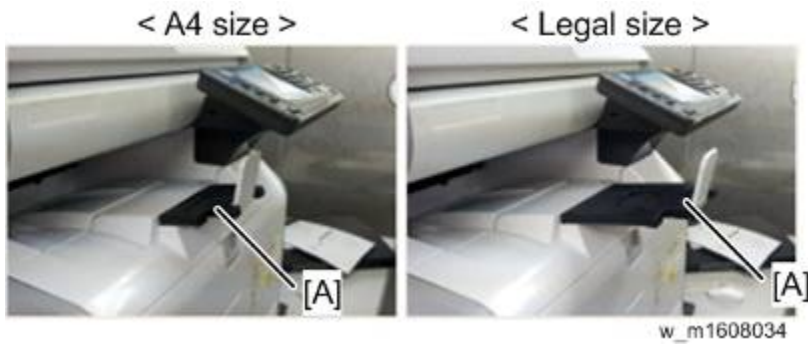

6.4.8 RECYCLED OR THIN PAPER IS SEVERELY CURLED AFTER PRINTING

If the delivered paper is curled, it cannot be stacked properly. In such a case, raise the paper stop on the output tray and remove the delivered paper frequently. You can also configure [Curl Prevention] in the UP mode (Maintenance).

If you set [Curl Prevention] to [Active], the machine idles for 20 seconds before it starts printing. By adding the idle time before printing, it takes longer to print, but paper curling can be reduced. To stop the 20-second idling, set [Curl Prevention] to [Inactive].

ENERGY SAVE

REVISION HISTORY		
Page	Date	Added/Updated/New
		None

7. ENERGY SAVE

7.1 ENERGY SAVE

7.1.1 ENERGY SAVER MODES

Customers should use energy saver modes properly, to save energy and protect the environment.

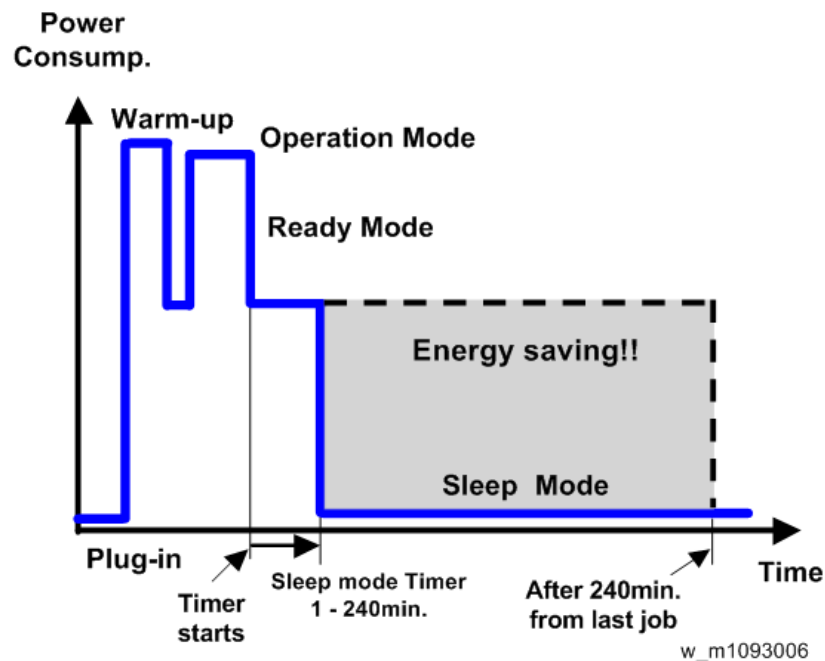

The area shaded grey in this diagram represents the amount of energy that is saved when the timers are at the default settings. If the timers are changed, then the energy saved will be different. For example, if the timers are all set to 240 min., the grey area will disappear, and no energy is saved before 240 min. expires.

Sleep Mode Setting

Sleep Mode Entry by Sleep Mode Timer

The user can specify whether or not to use Sleep Mode with User Tools. (System settings > Administrator Tools > Sleep Mode Entry by Sleep Mode Timer)

Default: [Enable]

Sleep Mode Timer

The user can set these timers with User Tools (System settings > Timer setting > Sleep Mode Timer)

Default: 1 min. (1- 240 min):

Weekly Timer

(System settings > Timer Settings > Weekly Timer)

Specify the time when the machine switches to and from Off mode or Sleep mode. This timer can be set for Monday through Sunday. You can set up to six timer settings a day.

Default: [Inactive]

If you select [Daily] or [Day of the Week], specify [Weekly Timer Code], [Weekly Timer Schedule], or [Timer Suspension Period].

- Weekly Timer Schedule
 - Weekly Timer 1 to 6
 - Event
 - Enter Sleep Mode
 - Cancel Weekly Timer Code
 - Power Off
 - Power On
 - None

Default for "Event": [None]

If an event is selected, enter the time for the event in "Event Timer".

- Timer Suspension Period

Set the dates for [Start Date] and [End Date] using the number keys.

If the Weekly Timer setting is specified, you can set a password (using up to eight digits) for when the machine recovers from Off mode or Sleep mode. After the password has been registered, the screen requiring the password is displayed when you press the [Energy Saver] key or [Check Status] key during Off mode or Sleep mode. The machine will recover from Off mode or Sleep mode when you press the [Energy Saver] key or [Check Status] key after entering the password. If you select [Off], you do not have to enter a password to recover the machine from Off mode or Sleep mode.

If the Timer Suspension Period timer has been set and the machine's main power switch is not turned on at the date specified for [End Date] in [Timer Suspension Period], the Power On timer will not be performed although the Timer Suspension Period term expires. To enable Power On timer, you need to turn the main power switch on manually.

Fusing Off Mode

(System settings > Timer Settings > Fusing Unit Off Mode (Energy Saving) On/Off)

Fusing Unit Off Mode (Energy Saving) On/Off

The user can specify whether the machine enters Fusing Unit Off Mode or not.

When the machine is in Fusing Unit Off Mode, the display is on but the fusing unit is off to save energy.

Default: Off

- On

The user can specify when to exit Fusing Unit Off Mode and the time to elapse before entering Fusing Unit Off Mode.

- Off

Turns off Fusing Unit Off Mode.

Exit Fusing Unit Off Mode

The user can specify the condition for the printer to exit Fusing Unit Off Mode.

Default: On Printing

- On Printing

The machine exits Fusing Unit Off Mode when printing is performed.

- On Operating Control Panel

The machine exits Fusing Unit Off Mode when a key other than the copy function key is pressed on the control panel of the machine.

If printing is performed with the copy function or a key in the copy function is pressed on the control panel of the machine, the machine exits Fusing Unit Off Mode regardless of this setting.

Fusing Unit Off Mode Timer

Set the time from 10 seconds to 240 minutes, using the number keys.

Default: 10 seconds (10 seconds - 240 minutes)

Return to Stand-by Mode

Sleep Mode

Recovery time: 9 sec.

Recommendation

We recommend that the default settings should be kept.

- If the customer requests that these settings should be changed, please explain that their energy costs could increase, and that they should consider the effects on the environment of extra energy use.
- If it is necessary to change the settings, please try to make sure that the Sleep Mode timer is not too long. Try with a shorter setting first, such as 5 min., then go to a longer one (such as 15 min.) if the customer is not satisfied.
- If the Sleep Mode timer is all set to the maximum value, the machine will not begin saving energy until 240 minutes has expired after the last job. This means that after the customer has finished using the machine for the day, energy will be consumed that could otherwise be saved.
- If you change the settings, the energy consumed can be measured using SP8941, as explained below.

7.1.2 ENERGY SAVE EFFECTIVENESS

SP 8941 (Machine Status) keeps a record of the amount of time that the machine spends in each mode.

- 8941-001: Operating mode
- 8941-002: Standby mode
- 8941-003: Panel off mode (Not used in this model)
- 8941-004: Sleep mode (Fusing off mode)
- 8941-005: Off mode

With this data, and the power consumption values from the specifications, we can estimate the amount of energy that is used by the machine.

This should only be used as a reference value, because the power consumption specifications are measured in a controlled environment with a constant power supply.

To get an exact measurement at the customers site, a watt meter must be used to measure the actual energy consumed.

To use SP8941 to calculate the energy consumed:

- At the start of the measurement period, read the values of SP8941 001 to 005.
- At the end of the measurement period, read the values of SP8941 001 to 005 again.
- Find the amount of time spent in each mode (subtract the earlier measurement from the later measurement).
- Multiply this by the power consumption spec for each mode.
- Convert the result to kWh (kilowatt hours)

Here is an example calculation.

Machine Date	Power Consumption (W): Data: a	SP8941: Machine Status	Start Time: (min.) Data: b	End Time: (min.) Data: c	Time Differences (Data:b - Data: c) (min.) Data: d	Power Consumption (Data:a x Data:d) (Wmin.) Data: e
Operating mode	NA: 543W EU: 565W	001: Operating Time	21089	21386	21386	NA: 161271 EU: 167805
Ready mode (stand by)	51W	002: Standby Time	306163	308046	308046	96033
Energy mode (Panel off)	1W or less	003: Energy Save Time	0	0	0	0
Low power mode	20W or less	004: Low power Time	71386	71386	75111	74500
Sleep mode	1W or less	005: Off mode Time	508776	508776	520377	11601
Total Time of Data: d (min.)					17506	
Total Time of Data: d/60min. (Hour)					291.7667	
Total Power Consumption of Data: e (Wmin.)						NA: 343405 EU: 349939
Total Power Consumption of Data: e /60min./1000W (KWH)						NA:5.72342 EU: 5.83232

7.2 PAPER SAVE

7.2.1 EFFECTIVENESS OF DUPLEX/COMBINE FUNCTION

Duplexing and the combine functions reduce the amount of paper used. This means that less energy overall is used for paper production, which improves the environment.

1. Duplex:

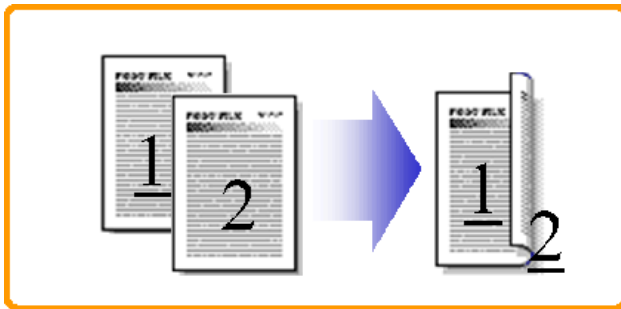

d062d102

Reduce paper volume in half!

2. Combine mode:

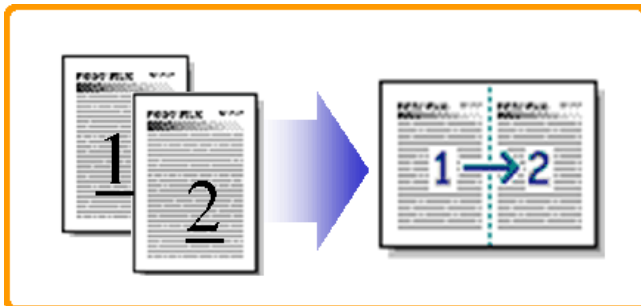

d062d100

Reduce paper volume in half!

3. Duplex + Combine:

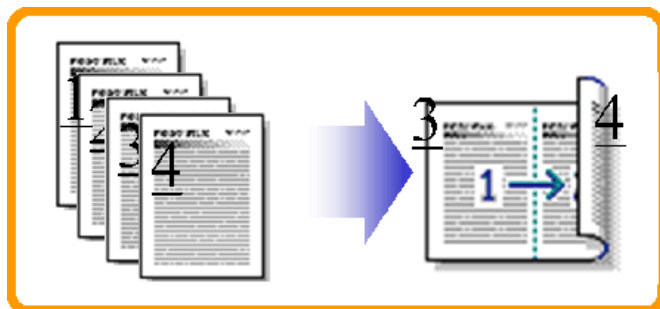

d062d101

Using both features together can further reduce paper volume by 1/4!

To check the paper consumption, look at the total counter and the duplex counter.

The total counter counts all pages printed.

- For one duplex page, the total counter goes up by 2.
- For a duplex job of a three-page original, the total counter goes up by 3.
- The duplex counter counts pages that have images on both sides.
- For one duplex page, the duplex counter goes up by 1.
- For a duplex job of a three-page original, the duplex counter will only increase by 1, even though two sheets are used.

Recommendation

Please explain the above features to the customers, so that they can reduce their paper usage.

- Total counter: SP 8581-001
- Duplex counter: SP 8411-001
- Single-sided with combine mode: SP 8421-004
- Duplex with combine mode: SP 8421-005

The following table shows paper savings and how the counters increase for some simple examples of single-sided and duplex jobs

Paper Save

Duplex mode:

Originals	Simplex Sheet used	Duplex Sheets used	Paper Saved	Total counter SP8581-001	Duplex counter SP8411-001
1	1	1	0	1	0
2	2	1	1	2	1
3	3	2	1	3	1
4	4	2	2	4	2
5	5	3	2	5	2
10	10	5	5	10	5
20	20	10	10	20	10

If combine mode is used, the total and duplex counters work in the same way as explained previously. The following table shows paper savings and how the counters increase for some simple examples of duplex/combine jobs.

2 in 1 mode:

Originals	Simplex Sheet used	Duplex Sheets used	Paper Saved	Total counter SP8581-001	Single-sided with combine mode SP8421-004
1	1	1	0	1	1
2	2	1	1	1	1
3	3	2	1	2	2
4	4	2	2	2	2
5	5	3	2	3	2
10	10	5	5	5	5
20	20	10	10	10	10

Duplex + 2 in 1 mode:

Originals	Simplex Sheet used	Duplex Sheets used	Paper Saved	Total counter SP8581-001	Duplex with combine mode SP8421-005
1	1	1	0	1	1
2	2	1	1	1	1
3	3	1	2	2	2
4	4	1	3	2	2
5	5	2	3	3	3
6	6	2	4	3	3
7	7	2	5	4	4
8	8	2	6	4	4
9	9	3	6	5	5
10	10	3	7	5	5
11	11	3	8	6	6
12	12	3	9	6	6

M160/M161
SERVICE MANUAL APPENDICES

M160/M161 APPENDICES

TABLE OF CONTENTS

1. APPENDICES: SPECIFICATIONS	1-1
1.1 GENERAL SPECIFICATIONS	1-1
1.1.1 MAINFRAME	1-1
1.1.2 PRINTER.....	1-4
1.1.3 SCANNER.....	1-5
1.2 SUPPORTED PAPER SIZES	1-7
1.2.1 PAPER FEED	1-7
1.2.2 PAPER EXIT.....	1-9
Mainframe.....	1-9
1.2.3 PLATEN/ARDF ORIGINAL SIZE DETECTION.....	1-12
1.3 SOFTWARE ACCESSORIES.....	1-14
1.3.1 PRINTER DRIVERS.....	1-14
1.3.2 SCANNER AND LAN FAX DRIVERS	1-15
1.3.3 UTILITY SOFTWARE.....	1-16
1.4 OPTIONAL EQUIPMENT.....	1-17
1.4.1 PAPER FEED UNIT PB1060.....	1-17
1.4.2 PAPER FEED UNIT PB1070.....	1-18
2. APPENDICES: PREVENTIVE MAINTENANCE TABLES	2-1
2.1 PREVENTIVE MAINTENANCE TABLES	2-1
2.1.1 MAINTENANCE TABLES FOR USER MAINTENANCE MODEL (M160).....	2-1
Mainframe.....	2-1
Paper Feed Tray PB1060 / Paper Feed Tray PB1070.....	2-2
2.1.2 MAINTENANCE TABLES FOR SERVICE MAINTENANCE MODEL (M161)	2-3
Mainframe.....	2-3
Paper Feed Tray PB1060 / Paper Feed Tray PB1070.....	2-7
2.1.3 OTHER	2-8
3. APPENDICES: SP MODE TABLES	3-1
3.1 SERVICE PROGRAM MODE.....	3-1
3.1.1 SERVICE TABLE KEY	3-1
3.2 MAIN SP TABLES-1	3-2
3.2.1 SP1-XXX (FEED)	3-2

3.3	MAIN SP TABLES-2.....	3-11
3.3.1	SP2-XXX (DRUM).....	3-11
3.4	MAIN SP TABLES-3.....	3-26
3.4.1	SP3-XXX (PROCESS).....	3-26
3.5	MAIN SP TABLES-4.....	3-27
3.5.1	SP4-XXX (SCANNER).....	3-27
3.6	MAIN SP TABLES-5.....	3-60
3.6.1	SP5-XXX (MODE).....	3-60
3.7	MAIN SP TABLES-6.....	3-146
3.7.1	SP6-XXX (PERIPHERALS).....	3-146
3.8	MAIN SP TABLES-7.....	3-147
3.8.1	SP7-XXX (DATA LOG).....	3-147
3.9	MAIN SP TABLES-8.....	3-164
3.9.1	SP8-XXX (DATA LOG 2).....	3-164
	Keys and abbreviations in Data Log 2.....	3-165
3.10	INPUT AND OUTPUT CHECK.....	3-212
3.10.1	INPUT CHECK TABLE.....	3-212
3.10.2	OUTPUT CHECK TABLE.....	3-214
3.11	PRINTER SERVICE MODE.....	3-217
3.11.1	SP1-XXX (SERVICE MODE).....	3-217
3.12	SCANNER SP MODE.....	3-228
3.12.1	SP1-XXX (SYSTEM AND OTHERS).....	3-228
3.12.2	SP2-XXX (SCANNING-IMAGE QUALITY).....	3-230
3.12.3	SP3-XXX.....	3-231
3.13	TEST PATTERN PRINTING.....	3-233
3.13.1	TEST PATTERN PRINTING.....	3-233

APPENDIX: SPECIFICATIONS

REVISION HISTORY		
Page	Date	Added/Updated/New
		None

1. APPENDICES: SPECIFICATIONS

1.1 GENERAL SPECIFICATIONS

1.1.1 MAINFRAME

Items	Specification	
Type	Desktop	
CPU	PMC-Sierra RM7035C-533L 533MHz	
Memory	Standard: 1GB Extension: 1.5GB	
Photosensitivity Type	OPC Drum	
Copy System	LED alley and electro-photographic printing	
Development System	Non-magnetic one-component development system	
Fusing System	Thin, hard heating roller fusing system	
Scanning Method	One-dimensional solid scanning system through CCD	
Warm-up Time	19 seconds or less (23°C, rated voltage)	
First Print Time	5 seconds or less	
First Copy Time	6 seconds or less	
Continuous Copy Speed	One-sided copy	40 cpm / 40 cpm: Bypass 40 cpm / 42 cpm: Tray 1 - 3
	Two-sided copy	35 cpm / 36 cpm: Tray1, 2 and Bypass 34 cpm / 35 cpm: Tray3
Max Original Size	<ul style="list-style-type: none"> ▪ Exposure Glass: 216 × 297 mm ▪ Auto Document Feeder (ADF): One-sided originals: 216 × 600 mm Two-sided originals: 216 × 356 mm 	

General Specifications

Items	Specification	
Originals	Sheet, Book, Three-dimensional object, ID card	
ADF Original Size	Fixed: LG (SEF), LT (SEF), HLT, F(8" x 132), A4 (SEF), B5, A5 Custom Size: Max. 216 x 600 mm (One-side), 216 x 355 mm (Two-side)	
ADF Original Thickness	<ul style="list-style-type: none"> ▪ One-sided originals: 52 - 128 g/m² (45 - 110kg) ▪ Two-sided originals: 60 - 105 g/m² (55 - 90kg) 	
ADF Original Capacity	50 sheets (Thickneses: 67g/m ²)	
Copy Paper Size	Std. Tray	A4 (SEF), B5 (SEF), A5, B6 (SEF), A6 (SEF), LG (SEF), LT (SEF), HLT (SEF), Executive (SEF), F (SEF), Foolscap (SEF), Folio (SEF), 16K (SEF) Custom size: Min. 100mm x 148mm (4.0"x5.9"), Max. 216mm x 356mm (8.5"x14.0")
	Bypass Tray	A4 (SEF), B5 (SEF), A5, B6, A6 (SEF), LG (SEF), LT (SEF), HLT, Executive (SEF), F (SEF), Foolscap (SEF), Folio (SEF), 16K (SEF) Custom size: Min. 60mm x 127mm (2.4" x 5.0"), Max. 216mm x 900mm (8.5" x 35.4")
	Op. Paper Tray	A4 (SEF), B5 (SEF), A5, B6 (SEF), A6 (SEF), LG (SEF), LT (SEF), HLT (SEF), Executive (SEF), F (SEF), Foolscap (SEF), Folio (SEF), 16K (SEF) Custom size: Min. 100mm x 210mm (4.0" x 8.3"), Max. 216mm x 356mm (8.5" x 14.0")
Copy Paper Thickness	<ul style="list-style-type: none"> ▪ Tray1: 52 - 162g/m²(45 - 139kg) ▪ Bypass: 52 - 162g/m²(45 - 139kg) ▪ Duplex: 52 - 162g/m²(45 - 139kg) 	
Auto Original Size Detection	ADF: Yes Exposure Glass: No	

Items	Specification	
Missing Image Area (Copier)	<ul style="list-style-type: none"> ▪ Leading edge: 3.0±1.5mm ▪ Trailing edge: 3.0mm ▪ Left edge: 2.0±1.5mm ▪ Right edge: 2.0mm <p>The missing image area of envelopes is 15 mm (0.6 inches) for the leading edge and 10 mm (0.4 inches) for the other edges.</p>	
Reproduction Ratio (Fixed)	1: 1, 2, 1.41, 0.93, 0.71, 0.5 Magnification error: width/length ± 1.0%	
Reproduction Ratio (Zoom)	25 - 400% (by 1% step)	
Resolution (Scan)	Exposure Glass: 600 × 600dpi ADF: 600 × 300dpi	
Resolution (Print)	1200dpi	
Tone	256 tones	
Paper Feed Capacity (80g/m ² , 20lb.Bond)	Max. 1600 sheets Standard: 500 sheets (Main) + 100 sheets (Bypass tray) Option: 500 sheet tray x 2	
Power Source	NA	120 – 127V, 60 Hz, 10A
	EU/AP/CHN	220 – 240V, 50 / 60 Hz, 5.3A
Max Power Consumption	NA	1180W or less
	EU/AP/CHN	1140W or less
Dimensions	W × D × H(up to ADF): 419 x 427 x 484mm (16.5 x 16.8 x 19.1 inches)	
Space for Main Unit	WxD: 424 x 629mm (16.7 x 24.8 inches): Including the bypass tray	
Weight	Approx. 23kg (50.7 lb.)	

1.1.2 PRINTER

Items	Specification
Print Size	<ul style="list-style-type: none"> ▪ Fixed: Max. A4(LEF)(210×297mm), 8 1/2×14(SEF)(215.9×355.6mm) ▪ Custom: Max.216.0 × 900.0mm (Bypass tray)
Continuous Printing Speed	One-side printing: 40 ppm (A4 SEF), 42 ppm (LT SEF) Two-side printing: 35 ppm (A4 SEF), 36 ppm (LT SEF)
Resolution	300/600/1200dpi
Printer Language	<ul style="list-style-type: none"> ▪ Standard: RPCS, PCL5e/6, Postscript3, PDF Direct ▪ Option: XPS, IPDS
Interface	<ul style="list-style-type: none"> ▪ Standard: Ethernet(1000BASE-T, 100BASE-TX, 10BASE-T), USB2.0 (Type A), USB2.0 (Type B), SD card ▪ Option: IEEE1284, IEEE802.11a/b/g/n (Wireless LAN), NIC (Print server)
Protocol	TCP/IP (IPv4, IPv6), AppleTalk, SNMP, MIB, WSM, IPP
Compatible OS	<ul style="list-style-type: none"> ▪ Standard: Windows XP/Vista/7/8, Windows Server 2003/2003 R2/2008/2008 R2/2012 ▪ Option: Mac OS X 10.4 or later
Resident Fonts	PCL: 45 fonts + International fonts 13 fonts PS: 136 fonts IPDS: 108 fonts (Option)
Reproduction Ratio	25 - 400%

1.1.3 SCANNER

Items	Specification
Type	Full color Scanner
Scanning Method	Flatbed Scanning
Image Sensor Type	CCD Image Sensor
Scan Type	Sheet, book, three-dimensional object, ID card
Original size	Length: 10 - 216mm Width: 10 - 356mm
Scan Speed	Scan to Email / Scan to Folder / WSD scanner / Save to external media / Network delivery scanner: Original size: A4(SEF), Scanning one-side) <ul style="list-style-type: none"> ▪ Black/White: 30 ipm or more (200dpi/300dpi) ▪ Full color: 30 ipm or more (200dpi) 20 ipm or more (300dpi)
Tone	<ul style="list-style-type: none"> ▪ Black and White: 2 tones ▪ Full color / Gray scale: 256 tones
Scanning Resolution	<ul style="list-style-type: none"> ▪ Basic: 200dpi ▪ Scan to Email: 100dpi, 200dpi, 300dpi, 400dpi, 600dpi ▪ Scan to Folder: 100dpi, 200dpi, 300dpi, 400dpi, 600dpi ▪ Network TWAIN scanner: 100 - 1200dpi ▪ WIA scanner: 100 - 1200dpi
Compression Method	<ul style="list-style-type: none"> ▪ Black and White: TIFF(MH, MR, MMR, JBIG2) ▪ Full color / Gray scale: JPEG
Interface	<ul style="list-style-type: none"> ▪ Standard: Ethernet(1000BASE-T, 100BASE-TX, 10BASE-T), USB2.0 (Type A: Operation Panel), SD card slot (Operation Panel) ▪ Option: IEEE802.11a/b/g/n (Wireless LAN)

General Specifications

Items	Specification
Protocol	<ul style="list-style-type: none">▪ Network: TCP/IP▪ Scan to Email: SMTP▪ Scan to Folder: SMB, FTP, NCP▪ WSD scanner: Web Service on Devices for Scanning▪ Network TWAIN scanner: TCP/IP▪ WIA scanner: TCP/IP
Scan to Email/Folder Format	TIFF, JPEG, PDF, High Compression PDF, PDF/A

1.2 SUPPORTED PAPER SIZES

1.2.1 PAPER FEED

Paper	Size (W x L)	Standard Tray	Optional Tray	Bypass Tray	Duplex Tray
12 x 18inch (SEF)	305x458	N	N	N	N
A3 (SEF)	297x420	N	N	N	N
A3 (LEF)	420x297	N	N	N	N
B4 (SEF)	257x364	N	N	N	N
B4 (LEF)	364x257	N	N	N	N
A4 (SEF)	210x297	A	A	D	C
A4 (LEF)	297x210	N	N	N	N
B5 (SEF)	182x257	B	B	D	C
B5 (LEF)	257x182	N	N	N	N
A5 (SEF)	148x210	A	A	D	C
A5 (LEF)	210x148	B	B	D	C
B6 (SEF)	128x182	B	B	D	C
B6 (LEF)	182x128	N	N	D	N
A6 (SEF)	105x148	A	A	D	C
A6 (LEF)	148x105	N	N	N	N
DLT (SEF)	11"x17"	N	N	N	N
DLT (LEF)	17"x11"	N	N	N	N
LG (SEF)	8 1/2"x14"	A	A	D	C
LG (LEF)	14"x8 1/2"	N	N	N	N
LT (SEF)	8 1/2"x11"	A	A	D	C

Supported Paper Sizes

Paper	Size (W x L)	Standard Tray	Optional Tray	Bypass Tray	Duplex Tray
LT (LEF)	11"x8 1/2"	N	N	N	N
HLT (SEF)	5 1/2"x8 1/2"	A	A	D	C
HLT (LEF)	8 1/2"x5 1/2"	N	N	D	N
Exective (SEF)	7 1/4"x10 1/2"	B	B	D	C
Exective (LEF)	10 1/2"x7 1/4"	N	N	N	N
F (SEF)	8"x13"	B	B	D	C
F (LEF)	13"x8"	N	N	N	N
Foolscap (SEF)	8 1/2"x13"	B	B	D	C
Foolscap (LEF)	13"x8 1/2"	N	N	N	N
Folio (SEF)	8 1/4"x13"	B	B	D	C
Folio (LEF)	13"x8 1/4"	N	N	N	N
8K (SEF)	267x390	N	N	N	N
16K (SEF)	195x267	B	B	D	C
16K (LEF)	267x195	N	N	N	N
Custom Size (Width)	mm	100 – 216	100 – 216	60 – 216	100 – 216
Custom Size (Length)	mm	148 - 356	210 – 356	127 – 900	148 – 356
Postcard (SEF)	100x148	B	B	D	N
Postcard (LEF)	148x100	N	N	N	N
Double postcard (SEF)	200x148	B	B	D	N
Double postcard (LEF)	148x200	B	B	D	N

Remarks: Standard Tray, Optional Tray

A	Supported size. Need to set the dial to the paper size.
B	Supported size. Need to set the dial "*" and select the paper size by operation panel.
N	Not supported.

Remarks: Bypass Tray

C	Supported.
D	Supported. Need to select the Bypass Tray and the paper size on operation panel.
N	Not supported.

Remarks: Duplex

C	Supported.
N	Not supported.

1.2.2 PAPER EXIT

Mainframe

Paper	Size (W x L)	Paper Exit Tray
12 x 18inch (SEF)	305x458	N
A3 (SEF)	297x420	N
A3 (LEF)	420x297	N
B4 (SEF)	257x364	N
B4 (LEF)	364x257	N
A4 (SEF)	210x297	C

Supported Paper Sizes

Paper	Size (W x L)	Paper Exit Tray
A4 (LEF)	297x210	N
B5 (SEF)	182x257	C
B5 (LEF)	257x182	N
A5 (SEF)	148x210	C
A5 (LEF)	210x148	C
B6 (SEF)	128x182	C
B6 (LEF)	182x128	N
A6 (SEF)	105x148	C
A6 (LEF)	148x105	N
DLT (SEF)	11"x17"	N
DLT (LEF)	17"x11"	N
LG (SEF)	8 1/2"x14"	C
LG (LEF)	14"x8 1/2"	N
LT (SEF)	8 1/2"x11"	C
LT (LEF)	11"x8 1/2"	N
HLT (SEF)	5 1/2"x8 1/2"	C
HLT (LEF)	8 1/2"x5 1/2"	N
Executive (SEF)	7 1/4"x10 1/2"	C
Executive (LEF)	10 1/2"x7 1/4"	N
F (SEF)	8"x13"	C
F (LEF)	13"x8"	N
Foolscap (SEF)	8 1/2"x13"	C
Foolscap (LEF)	13"x8 1/2"	N
Folio (SEF)	8 1/4"x13"	C
Folio (LEF)	13"x8 1/4"	N

Paper	Size (W x L)	Paper Exit Tray
8K (SEF)	267x390	N
16K (SEF)	195x267	C
16K (LEF)	267x195	N
Custom Size (Width)	mm	60 – 216
Custom Size (Length)	mm	127 – 900
Postcard (SEF)	100x148	C
Postcard (LEF)	148x100	N
Double postcard (SEF)	200x148	C
Double postcard (LEF)	148x200	C

Remarks: Output Tray

C	Supported.
N	Not supported.

1.2.3 PLATEN/ARDF ORIGINAL SIZE DETECTION

Size (width x length) [mm]	Platen	ARDF	Platen	ARDF
	Inches	Inches	Metric	Metric
A3 (297 x 420) SEF	-	Y	Y*3	Y
B4 (257 x 364) SEF	-	-	Y*3	Y
A4 (210 x 297) SEF	Y*1	Y	Y*3	Y
A4 (297 x 210) LEF	Y*3	Y	Y*3	Y
B5 (182 x 257) SEF	-	-	Y*3	Y
B5 (257 x 182) LEF	-	-	Y*3	Y
A5 (148 x 210) SEF	-	-	_*1	Y
A5 (210 x 148) LEF	-	-	_*1	Y
B6 (128 x 182) SEF	-	-	-	Y
B6 (182 x 128) LEF	-	-	-	Y
11" x 17" (DLT)	Y	Y*2	-	Y*2
11" x 15"	-	y*2	-	-
10" x 14"	-	Y	-	-
8.5" x 14" (LG)	Y	Y*2	-	-
8.5" x 13" (F4)	-	y*2	Y*4	Y*4
8.25" x 13"	-	-	Y*4	Y*4
8" x 13"(F)	-	-	Y*4	Y*4
8.5" x 11" (LT)	Y*3	Y*2	Y*3	Y*2
11" x 8.5" (LT)	Y*3	Y*2	Y*3	Y*2
8" x 10"	-	y*2	-	-
5.5" x 8.5" (HLT)	_*1	Y	-	-

8.5" x 5.5" (HLT)	-*1	Y	-	-
8K (267 x 390)	-	-	Y*3	y*2
16K L (195 x 267)	-	-	Y*3	y*2
16K S (267 x 195)	-	-	Y*3	y*2
7.25" x 10.5" (Executive)	-	Y	-	-
10.5" x 7.25" (Executive)	-	y*2	-	-

*1: Use SP4-303 to detect original sizes as A5 lengthwise/HLT when the message "Can-t detect original size" shows.

*2: The machine can detect the paper size depending on the setting of SP6-016-1. In default setting, "Y" is detected. "y" can be detected if you change setting of SP6-016-1.

*3: The machine can detect the paper size depending on the setting of SP4-305-1.

*4: The machine can detect the paper size depending on the setting of SP5-126-1.

1.3 SOFTWARE ACCESSORIES

The printer drivers and utility software are provided on one CD-ROM. An auto-run installer lets you select the components you want to install.

1.3.1 PRINTER DRIVERS

Printer Language	Windows XP	Windows Vista	Windows 7	Windows 8
PCL 5e / 6	Yes	Yes	Yes	Yes
RPCS	Yes	Yes	Yes	Yes
PostScript3	Yes	Yes	Yes	Yes
XPS	Yes	Yes	Yes	Yes

Printer Language	Windows Server 2003	Windows Server 2008 / 2008 R2	Windows Server 2012	Mac OSX 10.5 or later
PCL 5e / 6	Yes	Yes	Yes	No
RPCS	Yes	Yes	Yes	No
PostScript3	Yes	Yes	Yes	Yes*
XPS	Yes	Yes	Yes	No

1.3.2 SCANNER AND LAN FAX DRIVERS

Printer Language	Windows XP	Windows Vista	Windows 7	Windows 8
TWAIN	Yes	Yes	Yes	No
PC-FAX	Yes	Yes	Yes	Yes

Printer Language	Windows Server 2003	Windows Server 2008 / 2008 R2	Windows Server 2012	Mac OSX 10.5 or later
TWAIN	Yes	Yes	No	No
PC-FAX	Yes	Yes	Yes	No

Note

- The Network TWAIN and LAN Fax drivers are provided on the scanner drivers CD-ROM.
- This software lets you fax documents directly from your PC. Address Book Editor and Cover Sheet Editor are to be installed as well. (These require the optional fax unit.)

1.3.3 UTILITY SOFTWARE

The following utilities are available.

Software	Description
Device Manager NX Lite	A PC Client based application program that monitors and manages up to 250 networked print devices.
Device Manager NX Accounting	
DeskTopBinder-SmartDeviceMonitor for Client	<p>A printer management utility for client users.</p> <p>A utility for peer-to-peer printing over a NetBEUI or TCP/IP network.</p> <p>A peer-to-peer print utility over a TCP/IP network. This provides the parallel printing and recovery printing features.</p> <p>This is provided on the printer drivers CD-ROM.</p>
Remote Communication Gate A	A communication device that enables digital MFPs and printers to be connected to the communication server in the maintenance center.

1.4 OPTIONAL EQUIPMENT

1.4.1 PAPER FEED UNIT PB1060

Category	Item	Unit
Paper Size	A4, B5, A5, B6, A6, Legal, Letter, HLT, Executive, F, Foolscap, Folio, 16K, Custom size: Min. 100mm x 216mm (3.93" x 8.46"), Max. 216mm x 356mm (8.46" x 14.0")	
Paper Weight	52-162	g/m ²
	14-43	lbs
Paper Output Capacity	250	sheet
Power Consumption	15.0 or less (Power is supplied from the main unit.)	W
Dimension (W x D x H)	W370xD392xH95	mm
	W14.6xD15.4xH3.7	inch
Weight	4.1	kg
	9.0	lbs.

1.4.2 PAPER FEED UNIT PB1070

Category	Item	Unit
Paper Size	A4, B5, A5, B6, A6, Legal, Letter, HLT, Executive, F, Foolscap, Folio, 16K, Custom size: Min. 100mm x 216mm (3.93" x 8.46"), Max. 216mm x 356mm (8.46" x 14.0")	
Paper Weight	52-162	g/m ²
	14-43	lbs
Paper Output Capacity	500	sheet
Power Consumption	15.0 or less (Power is supplied from the main unit.)	W
Dimension (W x D x H)	W370xD392xH125	mm
	W14.6xD15.4xH4.9	inch
Weight	4.5	kg
	9.9	lbs.

APPENDICES:
PREVENTIVE MAINTENANCE TABLES

REVISION HISTORY		
Page	Date	Added/Updated/New
		None

2. APPENDICES: PREVENTIVE MAINTENANCE TABLES

2.1 PREVENTIVE MAINTENANCE TABLES

2.1.1 MAINTENANCE TABLES FOR USER MAINTENANCE MODEL (M160)

Chart: A4 (LT)/5%

Mode: 3 prints/job

Ratio: 50%

Environment: Normal temperature and humidity

Yield may change depending on circumstances and print conditions.

Symbol keys: C: Clean, R: Replace

Mainframe

Paper Feed

Item	20K	120K	600K	EM	Remarks
Paper Feed Roller (Tray)		R		C	<ul style="list-style-type: none"> ▪ Replace when a feeding failure occurs ▪ Wipe with a damp cloth when cleaning
Friction Pad (Tray)		R		C	<ul style="list-style-type: none"> ▪ Replace when a double feed occurs ▪ Wipe with a dry cloth when cleaning

PCDU

Item	20K	120K	600K	EM	Remarks
PCDU	R				

LED Optics

Item	20K	120K	600K	EM	Remarks
LED Lens	C				<ul style="list-style-type: none"> ▪ Customers perform this concurrently with PCDU replacement ▪ Use the LED lens cleaner packed with the unit or mainframe

Transfer/Fusing

Item	20K	120K	600K	EM	Remarks
Transport Roller		R			Replace to the maintenance kit
Fusing Unit		R			

Paper Feed Tray PB1060 / Paper Feed Tray PB1070

Item	20K	120K	600K	EM	Remarks
Grip Roller				C	<ul style="list-style-type: none"> ▪ Wipe with a damp cloth when cleaning
Paper Feed Roller (Tray)		R		C	<ul style="list-style-type: none"> ▪ Replace when a feeding failure occurs ▪ Wipe with a damp cloth when cleaning
Friction Pad (Tray)		R		C	<ul style="list-style-type: none"> ▪ Replace when a double feed occurs ▪ Wipe with a dry cloth when cleaning

2.1.2 MAINTENANCE TABLES FOR SERVICE MAINTENANCE MODEL (M161)

Chart: A4 (LT)/5%

Mode: 3 prints/job

Ratio: 50%

Environment: Normal temperature and humidity

Yield may change depending on circumstances and print conditions.

Symbol keys: C: Clean, R: Replace

Mainframe

Paper Feed

Item	40K	180K	600K	EM	Remarks
Registration Roller				C	Wipe with a damp cloth when cleaning
Registration Sensor				C	Remove paper dusts
Transport Roller				C	Wipe with a damp cloth when cleaning
Paper Feed Roller (Tray)		R		C	<ul style="list-style-type: none"> ▪ Replace when a feeding failure occurs ▪ Wipe with a damp cloth when cleaning
Friction Pad (Tray)		R		C	<ul style="list-style-type: none"> ▪ Replace when a double feed occurs ▪ Wipe with a dry cloth when cleaning
Paper Feed Roller (Bypass)				C	<ul style="list-style-type: none"> ▪ Replace when a feeding failure occurs ▪ Wipe with a damp cloth when cleaning
Friction Pad (Bypass)				C	<ul style="list-style-type: none"> ▪ Replace when a double feed occurs ▪ Wipe with a dry cloth when cleaning

PCDU

Item	40K	180K	600K	EM	Remarks
PCDU	R				

LED Optics

Item	40K	180K	600K	EM	Remarks
LED Lens	C				<ul style="list-style-type: none"> ▪ Perform this concurrently with PCDU replacement ▪ Use the LED lens cleaner packed with the unit or mainframe

Transfer/Fusing

Item	40K	180K	600K	EM	Remarks
Transfer Roller		R			
Fusing Unit		R			
Image Transfer Entrance Guide (front)	C				*1
Image Transfer Exit Guide (Rear)	C				*1

Paper Exit

Item	40K	180K	600K	EM	Remarks
Paper Exit Roller				C	Wipe with a damp cloth, then dry cloth when cleaning
Paper Exit Sensor				C	Remove paper dusts

Scanner

Item	40K	180K	600K	EM	Remarks
Exposure Glass				C	Use the Ricoh exposure glass cleaner
ADF Exposure Glass				C	Use the Ricoh exposure glass cleaner

ARDF

Item	40K	180K	600K	EM	Remarks
Friction Pad				C	Wipe with a dry cloth when cleaning
Pick-up Roller				C	Wipe with a damp cloth when cleaning
Feed Roller				C	Wipe with a damp cloth when cleaning
Registration Roller				C	Wipe with a damp cloth when cleaning
Transport Roller				C	Wipe with a damp cloth when cleaning
Exit Roller				C	Wipe with a damp cloth when cleaning

Item	40K	180K	600K	EM	Remarks
Inverter Roller				C	Wipe with a damp cloth when cleaning

*1 When replacing the PCDU, be sure to clean the following parts;

1. Image Transfer Entrance Guide (front)

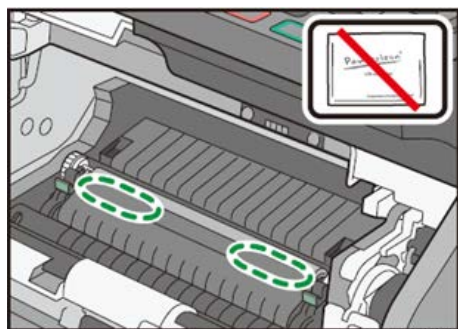

m160z0300

Note

- Do not use the LED lens cleaner.

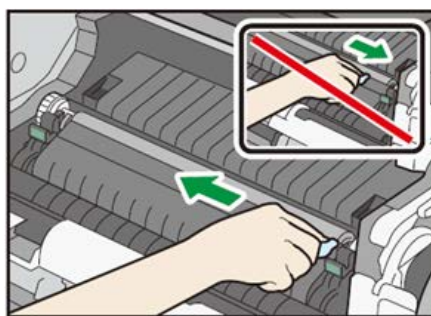
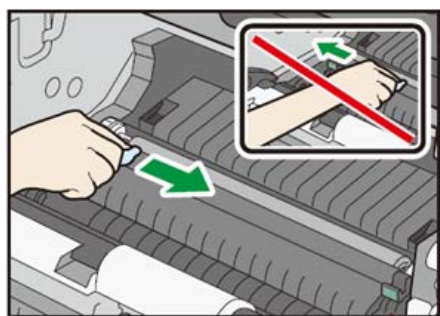

m160z0301

Clean toner and paper dust with a slightly wet cloth. Wipe off towards to the center from the green seals indicated at both sides. Make sure you do not use alcohol or detergent but water, and also do not wipe off to the outside.

2. Image Transfer Exit Guide (Rear)

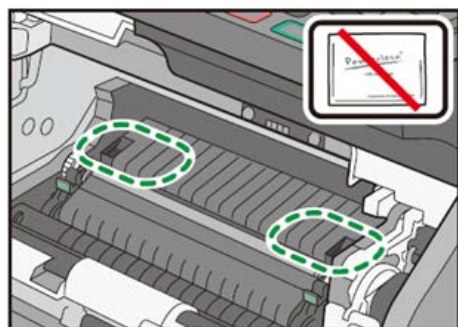

m160z0302

Note

- Do not use the LED lens cleaner.

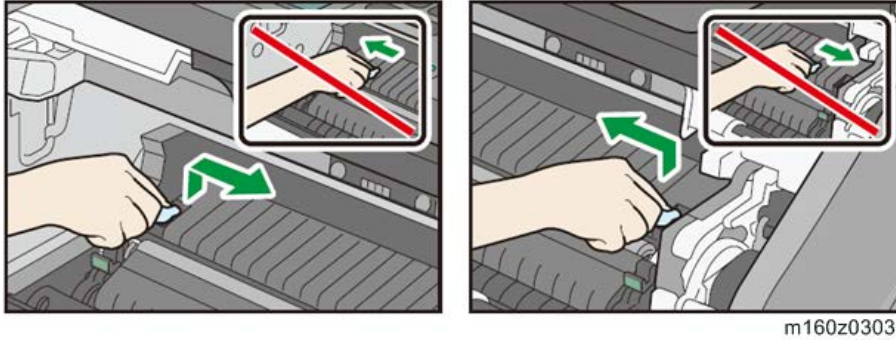

Clean toner stacked in the hollows with a slightly wet cloth. Wipe off five to six times towards to the center from outside until stacked toner is completely wiped off.

Make sure you do not use detergent and also do not wipe off to the outside.

Paper Feed Tray PB1060 / Paper Feed Tray PB1070

Item	40K	180K	600K	EM	Remarks
Grip Roller				C	<ul style="list-style-type: none"> Wipe with a damp cloth when cleaning
Paper Feed Roller (Tray)		R		C	<ul style="list-style-type: none"> Replace when a feeding failure occurs Wipe with a damp cloth when cleaning
Friction Pad (Tray)		R		C	<ul style="list-style-type: none"> Replace when a double feed occurs Wipe with a dry cloth when cleaning

2.1.3 OTHER

	Yield – Condition		Compatibility	
	Yield (Page)	Condition	User Maintenance Model (M160)	Service Maintenance Model (M161)
Extra High Yield Toner	12,000	ISO	Available	N/A
High Yield Toner	6,000	ISO	Available	N/A
Low Yield Toner	3,000	ISO	Available	N/A
Toner for Service Maintenance Model	10,400	6%, 3P/J	N/A	Available
Standard PCDU	20,000	3P/J	Available	N/A
PCDU for Service Maintenance Model	40,000	3P/J	N/A	Available

As for Service Maintenance Model (M161), service technicians must replace all the consumables other than toners.

APPENDICES: SP MODE TABLES

REVISION HISTORY		
Page	Date	Added/Updated/New
		None

3. APPENDICES: SP MODE TABLES

3.1 SERVICE PROGRAM MODE

3.1.1 SERVICE TABLE KEY

Notation	What it means
[range / default / step]	Example: [-9 to +9 / 0 / 0.1 mm step]. The setting can be adjusted in the range ± 9 , value reset to +3.0 after an NVRAM reset, and the value can be changed in 0.1 mm steps with each key press.
*	Value stored in NVRAM. After a RAM reset, this default value (factory setting) is restored.
DFU	Denotes "Design or Factory Use". Do not change this value.
Japan only	The feature or item is for Japan only. Do not change this value.
SSP	This denotes a "Special Service Program" mode.
FSP	This denotes a "Factory Service Program" mode.

3.2 MAIN SP TABLES-1

3.2.1 SP1-XXX (FEED)

1001	[User LeadEdge Reg]		
	Adjusts the leading edge registration by changing the registration motor operation timing for each mode.		
	<ul style="list-style-type: none"> ▪ Increasing a value: an image is moved to the trailing edge of paper. ▪ Decreasing a value: an image is moved to the leading edge of paper. 		
	1-001-001	By-pass	E*
	1-001-002	Tray 1	E*
	1-001-003	Tray 2	E*
1-001-004	Tray 3	E*	
1-001-006	Duplex	E*	[-4.0 to 4.0 / 0.0 / 0.1 mm/step]

1002	[User S-to-S Reg]		
	Adjusts the printing side-to-side registration from each paper feed station, using the Trimming Area Pattern.		
	<ul style="list-style-type: none"> ▪ To move the start position to the right, increase the value (+). ▪ To move the start position to the left, decrease the value (-). 		
	1-002-001	By-pass	E*
	1-002-002	Tray 1	E*
	1-002-003	Tray 2	E*
1-002-004	Tray 3	E*	[-4.0 to 4.0 / 0.0 / 0.1 mm/step]
1-002-006	Duplex	E*	

1003	[Paper Buckle]		
	This SP eliminates the amount of buckle at the registration roller.		
	<ul style="list-style-type: none"> ▪ When paper is fed from the paper cassette, before the registration rollers start to rotate the leading edge of the paper stops and hits the nip of the registration rollers and stops. ▪ The registration rollers remain idle long enough to stop the paper from skewing in the paper path. ▪ This SP adjusts the amount of time that the registration rollers remain idle to reduce paper buckle. ▪ Raise this setting to lengthen the amount of time that the paper pauses at the nip of the registration rollers if you notice a large amount of skew in printouts. 		
	1-003-011	By-pass: Plain	E*
	1-003-012	By-pass: Thick	E*
	1-003-013	By-pass: Envelope	E*
	1-003-021	Tray1: Plain	E*
	1-003-022	Tray1: Thick	E*
	1-003-023	Tray1: Envelope	E*
	[-5 to 5 / 0 / 1 mm/step]		
	1-003-031	Tray2: Plain	E*
	1-003-032	Tray2: Thick	E*
	1-003-041	Tray3: Plain	E*
1-003-042	Tray3: Thick	E*	
[-5 to 5 / 0 / 1 mm/step]			
1-003-061	Duplex: Plain	E*	
1-003-062	Duplex: Thick	E*	

1101	[Flicker Control] Sets the flicker control (0: Disable, 1: Enable).		
1-101-001	Flicker Control	E*	[0 or 1 / 0 / 1 /step] 0: Disabled 1: Enabled

1105	[PrintTargetTemp] Adjusts the target fusing temperature for each paper type. "C" indicates the center of the roller.		
1-105-001	C: Plain1	E*	[140 to 205 / 178 / 1deg/step]
1-105-003	C: Plain2	E*	[140 to 205 / 183 / 1deg/step]
1-105-005	C: Thick1	E*	[140 to 205 / 192 / 1deg/step]
1-105-007	C: Thick2	E*	[140 to 230 / 191 / 1deg/step]
1-105-011	C: Thin	E*	[140 to 205 / 168 / 1deg/step]
1-105-013	C: Envelope	E*	[140 to 230 / 205 / 1deg/step]
1-105-015	C: Card	E*	[140 to 205 / 195 / 1deg/step]
1-105-017	C: Transparency	E*	[140 to 205 / 173 / 1deg/step]
1-105-019	C: Special	E*	[140 to 205 / 185 / 1deg/step]

1105	[CurlDecMode]		
1-105-021	Mode Display	E*	[0 or 1 / 0 / 1 /step] Enables or disables the CurlDecMode (0: Disabled, 1: Enabled)
1-105-022	PreprtRotTime	E*	[500 to 60000 / 20000 / 500msec/step] Sets the pre-print rotation time for reducing curls.

1105	[PrintTargetTemp] Specifies the heating roller target temperature for coated paper (Center) during printing.		
1-105-023	C:Middle Thick	E*	[140 to 205 / 187 / 1deg/step]
1-105-025	C:Thick1(LowTemp)	E*	[140 to 205 / 185 / 1deg/step]
1-105-031	FuserOffMode	E*	[0 or 1 / 1 / 1/step] The switch that turns the fuser off after the idle process runs over 30 minutes.

1106	[FusingTempDisp] This SP displays the hot roller and pressure roller temperatures.		
1-106-001	RollerCenter	E	[-20 to 250 / 0 / 1deg/step] Displays the current fusing thermistor temperature (Center).
1-106-002	RollerEnds	E	[-20 to 250 / 0 / 1deg/step] Displays the current fusing thermistor temperature (Ends).
1-106-003	MachinePowerOn	E	[-20 to 250 / 0 / 1deg/step] Displays the external temperature measured at power ON, which is detected with the temperature and humidity sensor.

1135	[Inrush Control] Enables or disables the setting of Inrush control (0: Disabled, 1: Enabled)		
1-135-001	Inrush control	E*	[0 or 1 / 0 / 1 /step]

1152	[NipWidthMeasuring] Checks the fusing nip band.		
1-152-001	0:OFF 1:ON	E	[0 or 1 / 0 / 1 /step]

1159	[FusingJamDetect] Disables or enables the consecutive jam error for the fusing unit. When set to "1" (on) this SC code is issued after the 3rd consecutive jam in the fusing unit.		
1-152-001	SCdisplay	E*	[0 or 1 / 0 / 1 /step] 0: Not detects SC 1: Detects SC

1801	[Motor Speed Adj] This SP adjusts the speed of the motor. The motor speed can be adjusted to correct images that appear scratchy or of uneven density. This can occur when: <ul style="list-style-type: none"> ▪ Copying originals with large quantities of black. ▪ Copying originals with a large quantity of black near the trailing edge. ▪ Printing multiple copies of positive/negative (reverse) images. 		
1-801-011	Exit Reverse	E*	[-4.0 to 4.0 / 0.0 / 0.1%/step]

1907	[Paper Timing Adj] Adjusts the timing of paper feed. (A "+" setting broadens paper feed interval, a "-" setting narrows paper feed interval.)		
1-907-005	Reverse Stop Posi	E*	[-10 to 10 / 0 / 1mm/step] Adjusts the reverse stop timing of the range from the Registration Sensor OFF to the Paper Exit Inverter motor. Makes it slower (+) or faster (-) than the default.

1-907-015	Re-Feed Stop Posi	E*	[-10 to 10 / 0 / 1mm/step] Adjusts the reverse stop timing of the range from the duplex entrance sensor ON to the duplex clutch. Makes it slower (+) or faster (-) than the default.
-----------	-------------------	----	---

1908	[Paper Timing Adj] Adjusts the timing of paper feed. (A "+" setting broadens paper feed interval, a "-" setting narrows paper feed interval.)		
1-908-015	Junc Gate SOL:ON	E*	[-10 to 10 / 0 / 1mm/step]
1-908-017	Junc Gate SOL:ON	E*	

1921	[Fact LeadEdge Reg] <ul style="list-style-type: none"> ▪ Increasing a value: an image is moved to the trailing edge of paper. ▪ Decreasing a value: an image is moved to the leading edge of paper. 		
1-921-011	By-Pass: Plain	E*	[-4.0 to 4.0 / 0.0 / 0.1mm/step] Reflects adjustment values with no change.
1-921-012	By-Pass: Thick	E*	[-4.0 to 4.0 / 0.0 / 0.1mm/step] Adds on to the adjusted values of the Plain paper.
1-921-013	By-Pass: Envelope	E*	[-4.0 to 4.0 / 0.0 / 0.1mm/step] Adds on to the adjusted values of the Plain paper.
1-921-021	Tray1: Plain	E*	[-4.0 to 4.0 / 0.0 / 0.1mm/step] Reflects adjustment values with no change.
1-921-022	Tray1: Thick	E*	[-4.0 to 4.0 / 0.0 / 0.1mm/step] Adds on to the adjusted values of the Plain paper.

Main SP Tables-1

1-921-023	Tray1: Envelope	E*	[-4.0 to 4.0 / 0.0 / 0.1mm/step] Adds on to the adjusted values of the Plain paper.
1-921-031	Tray2: Plain	E*	[-4.0 to 4.0 / 0.0 / 0.1mm/step] Reflects adjustment values with no change.
1-921-032	Tray2: Thick	E*	[-4.0 to 4.0 / 0.0 / 0.1mm/step] Adds on to the adjusted values of the Plain paper.
1-921-041	Tray3: Plain	E*	[-4.0 to 4.0 / 0.0 / 0.1mm/step] Reflects adjustment values with no change.
1-921-042	Tray3: Thick	E*	[-4.0 to 4.0 / 0.0 / 0.1mm/step] Adds on to the adjusted values of the Plain paper.
1-921-061	Duplex: Plain	E*	[-4.0 to 4.0 / 0.0 / 0.1mm/step] Reflects adjustment values with no change.
1-921-062	Duplex: Thick	E*	[-4.0 to 4.0 / 0.0 / 0.1mm/step] Adds on to the adjusted values of the Plain paper.

1922	[Fact S-to-S Reg]		
	Reflects adjustment values with no change. <ul style="list-style-type: none"> ▪ To move the start position to the right, increase the value (+). ▪ To move the start position to the left, decrease the value (-). 		
1-922-001	By-pass	E*	[-4.0 to 4.0 / 0.0 / 0.1mm/step]
1-922-002	Tray 1	E*	
1-922-003	Tray 2	E*	
1-922-004	Tray 3	E*	
1-922-006	Duplex	E*	[-4.0 to 4.0 / 0.0 / 0.1mm/step] The value of this SP adds on to the adjusted values of the front page of each tray.





1952	[Fan Off Mode Time]		
	-		
1-952-001	-	E*	[0 to 60 / 13 / 1min/step]





Main SP Tables-1

1998	[Reserve SP]		
1-998-001	reserve01	E*	[0 to 255 / 0 / 1/step]
1-998-002	reserve02	E*	
1-998-003	reserve03	E*	
1-998-004	reserve04	E*	
1-998-005	reserve05	E*	
1-998-006	reserve06	E*	[0 to 65535 / 0 / 1/step]
1-998-007	reserve07	E*	
1-998-008	reserve08	E*	
1-998-009	reserve09	E*	
1-998-010	reserve10	E*	

3.3 MAIN SP TABLES-2

3.3.1 SP2-XXX (DRUM)

2001	[C biasControl]		
2-001-001	C setting	E	<p>[-1350 to -900 / -1020 / 1V/step] C: bias value.</p> <p> Note</p> <ul style="list-style-type: none"> This setting is available when the bias control is OFF.
2-001-002	C(low) setting	E	<p>[-400 to -200 / -350 / 50V /step] C(low): The value of C(low) output.</p>
2-001-011	Vd_ref_lowhumi	E	<p>[-700 to -400 / -420 / 10V / step] Displays or adjusts the target dark potential (Vd) in the Env Division, low humidity.</p> <p> Note</p> <ul style="list-style-type: none"> This setting is available when the bias control is ON.
2-001-012	Vd_ref_midhumi	E	<p>[-700 to -400 / -430 / 10V/step] Displays or adjusts the target dark potential (Vd) in the Env Division, mid humidity.</p> <p> Note</p> <ul style="list-style-type: none"> This setting is available when the bias control is ON.
2-001-013	Vd_ref_highhumi	E	<p>[-700 to -400 / -470 / 10V/step] Displays and adjusts the target dark potential (Vd) in the Env Division, high humidity.</p> <p> Note</p> <ul style="list-style-type: none"> This setting is available when the bias control is ON.

2-001-100	F:Coefficient:a0	E	<p>[-500 to -350 / -350 / 1/step]</p> <p>Displays and adjusts the coefficient a0 used for the C-calculated function F (Vd, AH, D).</p> <p> Note</p> <ul style="list-style-type: none"> This setting is available when the bias control is ON.
2-001-101	F:Coefficient:a1	E	<p>[0.80 to 1.20 / 1.00 / 0.01/step]</p> <p>Displays and adjusts the coefficient a1 used for the C-calculated function F (Vd, AH, D).</p> <p> Note</p> <ul style="list-style-type: none"> This setting is available when the bias control is ON.
2-001-102	F:Coefficient:a2	E	<p>[0.0 to 10.0 / 5.0 / 0.1/step]</p> <p>Displays and adjusts the coefficient a2 that is of the C-calculated function F (Vd, AH, D).</p> <p> Note</p> <ul style="list-style-type: none"> This setting is available when the bias control is ON.
2-001-103	F:Coefficient:a3	E	<p>[-20 to 0 / -9.9 / 0.1/step]</p> <p>Displays and adjusts the coefficient a3 that is of the C-calculated function F (Vd, AH, D).</p> <p> Note</p> <ul style="list-style-type: none"> This setting is available when the bias control is ON.

2101	[Reg Correct] The amount of the correction for the main scan position.		
2-101-001	Main Dot	E	[-300 to 300 / 0 / 1dot/step]

2102	[Magnification Adj] Sub Scan Magnification Adjustment		
2-102-002	Sub Mag.:N	E	[-1.0 to 1.0 / 0.0 / 0.1%/step]
2-102-004	Sub Mag.:L	E	

2103	[Erase Margin Adj] Image Erase Margin Adjustment Adjusts the erase margin by deleting image data at the margins.		
2-103-001	Lead Edge Width	E	[2.7 to 9.9 / 3.0 / 0.1mm/step]
2-103-002	Trail. Edge Width	E	[0.0 to 9.9 / 2.0 / 0.1mm/step]
2-103-003	Left	E	
2-103-004	Right	E	
2103	[Erase Margin Adj] Image Erase Margin Adjustment: Back side		
2-103-005	Duplex:Lead	E	[0.0 to 4.0 / 0.0 / 0.1mm/step]
2-103-006	Duplex:Trail.	E	
2-103-007	Duplex:Left Width	E	
2-103-008	Duplex:RightWidth	E	

2104	[Exposure energy]		
2-104-010	Normal Print	E	[0.23 to 0.98 / 0.50 / 0.01 uJ/cm ² /step] LEDA light emission energy: Normal printing Bk: Display/Setting
2-104-011	Nomal Discharge	E	[0.23 to 0.98 / 0.70 / 0.01 uJ/cm ² /step] LEDA light emission energy: Quenching pattern Normal speed: Display/Setting
2-104-012	Low Discharge	E	[0.23 to 0.98 / 0.70 / 0.01uJ/cm ² /step] LEDA light emission energy: Quenching pattern Low speed: Display/Setting

2105	[LED Emit Time Adj] Adjusts the LEDA Light emission time.		
2-105-001	Normal Speed	E*	[50 to 200 / 100 / 1%/step]
2-105-002	Low Speed	E*	

2106	[LEDA Emit Time] LEDA Light emission time.		
2-106-021	Print:Normal	E	[1000 to 8800 / 3000 / 1ns/step]
2-106-022	Print:Low	E	
2-106-023	Quenching:Normal	E	
2-106-024	Quenching:Low	E	

2109	[Test Printing] Printing test patterns		
2-109-001	Pattern Selection	E	[0 to 17 / 0 / 1/step] See the selections below. See also page 3-233 for checking the procedure.
2-109-002	1 Sheet Printing	E	[0 or 1 / 0 / 1/step]
2-109-003	Cont. Printing	E	
2-109-004	Print Side Select	E	

Selections for SP2109

0	None	9	Arg. Grid20mm
1	Vert. (1dot)	10	Indep. (1dot)
2	Hori. (1dot)	11	Indep. (2dot)
3	Vert/ (2dot)	12	Indep. (4dot)
4	Hori. (2dot)	13	Full
5	Grid Vert.	14	Band

6	Grid Hori.	15	Gray 10mm
7	Grid 20mm	16	Gray 20mm
8	Arg. Grid	17	Trim Area

2201	[DV bias Control]		
2-201-001	DV(-)_setting	E*	[-350 to -10 / -150 / 1v/step]
2-201-002	DV(+)_offset	E*	[-100 to 0 / 0 / 25v/step]
2-201-003	DV(-)_offset	E*	[-75 to 75 / 0 / 25v/step]
2-201-011	Line1:L1	E*	[500000 to 950000 / 500000 / 50000mm/step]
2-201-012	Line2:L2	E*	[1000000 to 1950000 / 1000000 / 50000mm/step]
2-201-013	Line3:L3	E*	[2000000 to 3950000 / 3000000 / 50000mm/step]
2-201-014	Line4:L4	E*	[4000000 to 7950000 / 5000000 / 50000mm/step]
2-201-015	Line5:L5	E*	[8000000 to 19950000 / 8000000 / 50000mm/step]
2-201-016	Line6:L6	E*	[20000000 to 29950000 / 20000000 / 50000mm/step]
2-201-017	Line7:L7	E*	[30000000 to 39950000 / 33000000 / 50000mm/step]
2-201-204	Coefficient:a4	E*	[0.00 to 0.50 / 0.13 / 0.01/step]
2-201-205	Coefficient:a5	E*	[0.0 to 5.0 / 0.0 / 0.1/step]
2-201-206	Coefficient:a6	E*	[-200 to 0 / 0 / 1/step]

2211	[PcuReverse] Switches the PCU reverse on / off.		
2-211-001	On/Off	E*	[0 to1 / 1 / 1/step] 0: Switch Off 1: Switch On with the reverse rotation sheet counts

2212	[ExeSheets]		
2-212-001	Normal	E*	[1 to 500 / 100 / 1page/step] Stops printing and executing reversing PCU every sheets that has been set for normal printing.
2-212-002	LowPrinting	E*	[1 to 500 / 50 / 1page/step] Stops printing and executing reversing PCU every sheets that has been set for low printing.

2221	[LEDA Data:Display] Displays LEDA data.		
2-221-005	Serial No.	E	[- / - / -]
2-221-009	Power Error	E	[0 or 1 / 0 / 1/step]

2301	<p>[T bias Control] Transfer Bias Control</p> <p>Use these SP's to adjust the power output and power coefficient used to transfer the toner image from drum to paper. Four separate voltages are applied before the leading edge, at the leading edge of the paper, across the image area and at the trailing edge of the paper.</p> <p>Notes:</p> <ul style="list-style-type: none"> ▪ The coefficient adjustment should be done before the power output. ▪ The amount of voltage applied to each area can be set independently in each area for the type of paper in use. 		
2-301-001	T(+)_1:setting	E*	<p>[1 to 50 / 14 / 1uA/step]</p> <p>Displays the setting of the transfer bias control level for non image area.</p>
2-301-002	T(+)_2_FaceOffset	E*	<p>[-15 to 15 / 0 / 1uA/step]</p> <p>Displays the setting of the offset amount of transfer bias control level during creating an image on the face page.</p>
2-301-003	T(+)_2_BackOffset	E*	<p>[-15 to 15 / 0 / 1uA/step]</p> <p>Displays the setting of the offset amount of transfer bias control level during creating an image on the back page.</p>
2-301-101	Used Adjust A2	E*	<p>[0 to 100 / 80 / 1%/step]</p> <p>Output adjustment for the value of the transfer output table which is to be a basis when the transfer paper count is in the range of 15K and 30K.</p>
2-301-102	Used Adjust A3	E*	<p>[0 to 100 / 70 / 1%/step]</p> <p>Output adjustment for the value of the transfer output table which is to be a basis when the transfer paper count is in the range of 30K and 60K.</p>

Main SP Tables-2

2-301-103	Used Adjust A4	E*	[0 to 100 / 65 / 1%/step] Output adjustment for the value of the transfer output table which is to be a basis when the transfer paper count is in the range of 60K and 90K.
2-301-104	Used Adjust A5	E*	[0 to 100 / 60 / 1%/step] Output adjustment for the value of the transfer output table which is to be a basis when the transfer paper count is over 90K.

2401	[Timing Control]		
2-401-003	T[rotation print]	E*	[600 to 9900 / 600 / 100msec/step]
2-401-004	T[rotation WU]	E*	[600 to 9900 / 5000 / 100msec/step]

2411	[envi_section]		
2-411-001	AH_LM	E*	[0.0 to 10.0 / 5.5 / 0.5g/m ³ /step] Displays and adjusts the threshold under low/mid humidity on environment section in regard to control the Environment Correction.
2-411-002	AH_MH	E*	[11.0 to 30.0 / 15.0 / 0.5g/m ³ /step] Displays and adjusts the threshold under mid/high humidity on environment section in regard to control the Environment Correction.

2924	[Supply Speed] For circulating the time to supply certain amount		
2-924-001	Remaining H:240	E*	[0.01 to 1.00 / 0.35 / 0.01g/sec/step]
2-924-002	Remaining M:240	E*	[0.01 to 1.00 / 0.29 / 0.01g/sec/step]
2-924-003	Remaining L:240	E*	[0.01 to 1.00 / 0.22 / 0.01g/sec/step]

2-924-004	Remaining H:182	E*	[0.01 to 1.00 / 0.25 / 0.01g/sec/step]
2-924-005	Remaining M:182	E*	[0.01 to 1.00 / 0.21 / 0.01g/sec/step]
2-924-006	Remaining L:182	E*	[0.01 to 1.00 / 0.17 / 0.01g/sec/step]

2925	[Toner Supply]		
2-925-001	consumed amount	E*	[0.0 to 100000.0 / 0.0 / 0.1mg/step] Counter for judging to supply toner during printing.
2-925-002	Supply Threshold	E*	[1.0 to 100000.0 / 300.0 / 0.1mg/step] Threshold for judging to supply toner during printing.
2-925-003	Sup- Coefficient	E*	[0.0 to 5.0 / 0.7 / 0.1/step] Coefficient for calculating toner amount to supply during printing.

2926	[Recovery Supply]		
2-926-001	Recovery Amount	E*	[0 to 300 / 5 / 1g/step] Amount for Recovery Supply.
2-926-002	Mixing Time	E*	[0 to 300 / 10 / 1sec/step] Idle time to mix for Recovery Supply.
2-926-003	Recovery Count	E*	[0 to 10000 / 0 / 1count/step] Total count of executed Recovery Supply
2-926-004	Self-Recovery	E	[- / - / -] [Execute] Forcibly executes one time Recovery Supply.

2927	[Initial Supply]		
2-927-001	Initial Amount	E*	[1 to 50 / 5 / 1g/step] Target toner amount for supplying fixed amount of toner when replacing.
2-927-002	Initial Mixing T	E*	[0 to 300 / 10 / 1sec/step] Idle time to mix for supplying fixed amount of toner when replacing.
2-927-003	Ini-Coefficient	E*	[0.0 to 5.0 / 1.5 / 0.1/step] Coefficient for calculating the amount of toner supplying during printing after toner cartridge is replaced.
2-927-004	Initial Flag	E*	[0 or 1 / 0 / 1/step] Information used to detect the replacements and judge the upper limit.
2-927-005	Exchange Count	E*	[0 to 1000 / 0 / 1count/step] Counter for new toner detection.

2930	[Detection]		
2-930-001	Cleaner Count	E*	[1 to 20 / 5 / 1cycle/step] Counter to rotate the cleaner parts when remaining toner in the developer detected.
2-930-002	stabilization T	E*	[0.0 to 3.0 / 0.0 / 0.1sec/step] Stability time of the sensor used for detecting remaining toner in the developer.
2-930-003	Upper n cycle	E*	[0 to 20 / 1 / 1/step] Upper counter to exclude from the obtained result when toner remaining in the developer detected.

2-930-004	Lower m cycle	E*	[0 to 20 / 1 / 1/step] Lower counter to set it aside from the obtained result if toner remaining in the developer detected.
2-930-005	HH:240 Upper	E*	[0 to 70 / 25 / 1count/step] Counter for judging the upper limit when toner remaining in the developer detected.
2-930-006	HH:240 Lower	E*	[0 to 70 / 38 / 1count/step] Counter for judging the lower limit when toner remaining in the developer detected.
2-930-007	MM:240 Upper	E*	[0 to 70 / 18 / 1count/step] Counter for judging the upper limit when toner remaining in the developer detected.
2-930-008	MM:240 Lower	E*	[0 to 70 / 34 / 1count/step] Counter for judging the lower limit when toner remaining in the developer detected.
2-930-009	LL:240 Upper	E*	[0 to 70 / 18 / 1count/step] Counter for judging the upper limit when toner remaining in the developer detected.
2-930-010	LL:240 Lower	E*	[0 to 70 / 36 / 1count/step] Counter for judging the lower limit when toner remaining in the developer detected.
2-930-011	HH:182 Upper	E*	[0 to 70 / 38 / 1count/step] Counter for judging the upper limit when toner remaining in the developer detected.

2-930-012	HH:182 Lower	E*	[0 to 70 / 52 / 1count/step] Counter for judging the lower limit when toner remaining in the developer detected.
2-930-013	MM:182 Upper	E*	[0 to 70 / 33 / 1count/step] Counter for judging the upper limit when toner remaining in the developer detected.
2-930-014	MM:182 Lower	E*	[0 to 70 / 48 / 1count/step] Counter for judging the lower limit when toner remaining in the developer detected.
2-930-015	LL:182 Upper	E*	[0 to 70 / 34 / 1count/step] Counter for judging the upper limit when toner remaining in the developer detected.
2-930-016	LL:182 Lower	E*	[0 to 70 / 46 / 1count/step] Counter for judging the lower limit when toner remaining in the developer detected.
2-930-017	Sensor Standard V	E*	[0.0 to 3.3 / 2.0 / 0.1V/step] Threshold for judging the detection result of toner end sensor.
2-930-018	Average Count	E*	[0 to 255 / 0 / 1count/step] Result of remaining detection in the developer.
2-930-019	Self- Detection	E	[- / - / -] [Execute] Detects forcibly the toner remaining in the developer.
2-930-020	Self-Mixing Time	E*	[0 to 300 / 10 / 1sec/step] Required time for mixing prior to forcibly execute remaining detection.

2931	[Supply Error]		
2-931-002	0 count	E*	[0 to 10000 / 0 / 1count/step] Counter for detecting the SC364.
2-931-003	0 count Threshold	E*	[1 to 50 / 30 / 1count/step] Threshold for detecting the SC364.
2-931-004	Lower Count	E*	[0 to 10000 / 0 / 1count/step] Counter for detecting the SC332.
2-931-005	Lower Threshold	E*	[1 to 10 / 5 / 1count/step] Threshold for detecting the SC332.
2-931-006	SC332 Count	E*	[0 to 10 / 0 / 1count/step] Counts that continuously detected the SC332.

2932	[End Detection]		
2-932-001	End Count	E*	[0 to 10000 / 0 / 1count/step]
2-932-002	End Threshold	E*	[1 to 10 / 3 / 1count/step]

2940	[Remain Control]		
2-940-001	Remaining Amount	E*	[0.0 to 30.0 / 0.0 / 0.1g/step] Counter for detecting toner end.
2-940-002	Remaining Time	E*	[0 to 300 / 0 / 1sec/step] Threshold for detecting toner end.

2941	[Remain Control] Counter for supplying triggered by the front cover open/close during Power ON.		
2-941-001	closing count	E*	[0 to 65535 / 0 / 1count/step]

2952	[S_PaperRefresh] Correction coefficients of the toner refresh control when printing the small sized paper.		
2-952-001	Input Coefficient	E*	[1000 to 3000 / 1884 /1 / step]
2-952-002	Threshold Dist	E	[2010 to 7500 / 2100 /1mm / step]
2-952-003	W.T.Coefficient	E	[1800 to 7100 / 2280 /10 / step]

2961	[CleaningOperation]		
2-961-001	Level 1	E*	[0 or 1 / 0 /1 / step] The trigger of drum cleaning operation level 1. Select 1 to execute.
2-961-002	Level 2	E*	[0 or 1 / 0 /1 / step] The trigger of drum cleaning operation level 2. Select 1 to execute.

2990	[Duty Control] Correction values of printing interval control in order to avoid the increasing temperature from continuous printing.		
2-990-001	Counter	E*	[0 to 65535 / 0 /1count / step]
2-990-002	Lower	E*	[2000 to 60000 / 14400 /1count / step]
2-990-003	Upper	E*	[2000 to 60000 / 158400 /1count / step]
2-990-004	OFF/ON	E*	[0 to 1 / 0 /1 / step]
2-990-005	Accumulation	E*	[0 to 65535 / 0 /1count / step]

2998	[Timing Control]		
2-998-001	T:ReverseRotation	E*	[1 to 100 / 34 / 1msec/step] Adjusts the reverse rotation time of PCU reverse rotation.
2-998-002	T:MotorStop	E*	[550 to 1000 / 550 / 50msec/step] Adjusts the stop rotation time of PCU reverse rotation.
2-998-003	T:NormalRotation	E*	[1 to 100 / 30 / 1msec/step] Adjusts the normal rotation time of PCU reverse rotation.
2-998-004	T:NormalRotation2	E*	[1 to 200 / 100 / 1msec/step] Adjusts the normal rotation time of PCU reverse rotation.

3.4 MAIN SP TABLES-3

3.4.1 SP3-XXX (PROCESS)

3098	[Days Before End] Switches the near end timing: days before end toner		
3-098-001	Toner	E*	[0 to 2 / 1 / 1/step] 0: earlier 1: normal 2: later

3501	[Dev Bias Control] Development Bias Control: On/Off designation.		
3-501-001	On/Off	E*	[0 or 1 / 1 / 1-/step] 0: Off 1: On

3502	[C Bias Control] C bias Control: On/Off designation		
3-502-001	On/Off	E*	[0 or 1 / 1 / 1/step] 0: Off 1: On

3800	[Days Before End] Switches the near end timing: days before end toner		
3-800-001	Waste Toner	E*	[0 to 2 / 1 / 1/step] 0: earlier 1: normal 2: later

3.5 MAIN SP TABLES-4

3.5.1 SP4-XXX (SCANNER)

4008	[Sub Scan Mag.Adjustment] Adjusts the sub-scan magnification by changing the scanner motor speed.		
4-008-001	-	E*	[-1.0 to 1.0 / 0.0 / 0.1%/step]

4010	[L-Edge Regist Adjustment] Adjusts the leading edge registration for scanning.		
4-010-001	-	E*	[-1.0 to 1.0 / 0.0 / 0.1mm/step]

4011	[S-to-S Regist Adjustment] Adjusts the side-to-side registration by changing the scanning start timing in the main scan direction.		
4-011-001	-	E*	[-2.0 to 2.0 / 0.0 / 0.1mm/step]

4012	[Scanner Erase Margin: Scale] Adjusts scanning margins for the leading and trailing edges (sub scan) and right and left edge (main scan). Note <ul style="list-style-type: none"> Do not adjust unless the customer desires a scanner margin greater than the printer margin. These settings are adjusted to erase shadows caused by the gap between the original and the scale of the scanner unit. 		
4-012-001	Book: Leading Edge	E*	[0.0 to 3.0 / 1.0 / 0.1mm/step]
4-012-002	Book: Trailing Edge	E*	[0.0 to 3.0 / 0.0 / 0.1mm/step]
4-012-003	Book: Left	E*	[0.0 to 3.0 / 1.0 / 0.1mm/step]
4-012-004	Book: Right	E*	[0.0 to 3.0 / 0.0 / 0.1mm/step]

4013	[Scanner Free run] Performs a scanner free run with the exposure lamp on or off.		
4-013-001	Lamp OFF	E	[0 or 1 / 0 / 1/step]
4-013-002	Lamp ON	E	

4014	[Scan] Executes the scanner free run with each mode.		
4-014-001	HP Detection Enable	E	[- / - / -] [Execute]
4-014-002	HP Detection Disable	E	
4-014-003	HP Detection Enable: FC600dpi	E	
4-014-004	HP Detection Enable: BW600dpi	E	
4-014-005	HP Detection Enable: FC1200dpi	E	

4016	[DF Scan] -		
4-016-001	FC 600x300 Duplex	E	[0 or 1 / 0 / 1/step]
4-016-002	BW 600x300 Duplex	E	
4-016-003	FC 600x600 Duplex	E	
4-016-004	BW 600x600 Duplex	E	
4-016-005	FC 600x200 Duplex	E	
4-016-006	FC 600x300 Simplex	E	[0 or 1 / 0 / 1/step]
4-016-007	BW 600x300 Simplex	E	
4-016-008	FC 600x600 Simplex	E	
4-016-009	BW 600x600 Simplex	E	
4-016-010	FC 600x200 Simplex	E	

4020	<p>[Dust Check]</p> <p>This function checks the narrow scanning glass of the ADF for dust that can cause black lines in copies. If dust is detected a system banner message is displayed, but processing does not stop.</p>		
4-020-001	DustDetect:On/Off	E*	<p>Issues a warning if there is dust on the narrow scanning glass of the ADF when the original size is detected before a job starts. This function can detect dust on the white plate above the scanning glass, as well as dust on the glass. Sensitivity of the level of detection is adjusted with SP4020-2.</p> <p>[0 to 1 / 1 / 1]</p> <p>0: Off. No dust warning.</p> <p>1: On. Dust warning. This warning does not stop the job.</p> <p> Note</p> <ul style="list-style-type: none"> ▪ Before switching this setting on, clean the ADF scanning glass and the white plate above the scanning glass.

4-020-002	Dust Detect:Lvl	E*	<p>Adjusts the sensitivity for dust detection on the ADF scanning glass. This SP is available only after SP4020-1 is switched on.</p> <p>[0 to 8 / 4 / 1]</p> <p>If you see black streaks in copies when no warning has been issued, raise the setting to increase the level of sensitivity. If warnings are issued when you see not black streaks in copies, lower the setting.</p> <p>Note</p> <ul style="list-style-type: none"> Dust that triggers a warning could move be removed from the glass by the originals in the feed path. If the dust is removed by passing originals, this is not detected and the warning remains on.
4-020-003	Dust Reject:Lvl	E*	<p>Selects the level of the sub scan line correction when using the ADF.</p> <p>[0 to 4 / 0 / 1]</p> <p>0: OFF, 1: Weakest, 2: Weak, 3: Strong, 4: Strongest</p>

4400	<p>[Scanner Erase Margin] These SPs set the area to be masked during platen (book) mode scanning.</p>		
4-400-001	Book: Leading Edge	E*	[0.0 to 3.0 / 0.0 / 0.1mm/step]
4-400-002	Book: Trailing Edge	E*	
4-400-003	Book: Left	E*	
4-400-004	Book: Right	E*	
4-400-005	ADF:Trailing Edge	E*	[0.0 to 3.0 / 0.0 / 0.1mm/step]
4-400-007	ADF:Left	E*	
4-400-008	ADF:Right	E*	

4417	[IPU Test Pattern] Selects the IPU test Pattern.		
4-417-001	Test Pattern	E	[0 to 8 / 0 / 1/step] See the selections below

Selections for SP4417

0	Scanned image	5	Slant grid pattern C
1	256-Gradation main scan A	6	Argyle pattern D
2	Patch 16C	7	Scanned+Slant Grid C
3	Grid pattern A	8	Scanned+Slant Grid D
4	Slant grid pattern B	-	-

4429	[Select Copy Data Security] Adjusts the pattern density of illegal copy output for Copy, Scanner, and Fax.		
4-429-001	Copying	E*	[0 to 3 / 3 / 1/step]
4-429-002	Scanning	E*	
4-429-003	Fax Operation	E*	

4450	[Scan Image Pass Selection]		
4-450-001	Black Subtraction ON/OFF	E	[0 or 1 / 1 / 1/step] Uses or does not use the black reduction image path.
4-450-002	SH ON/OFF	E	[0 or 1 / 0 / 1/step] Uses or does not use the shading image path.

4460	[Digital AE] Adjusts the background level.		
4-460-001	Low Limit Value	E*	[0 to 1023 / 364 / 1/step]
4-460-002	Background level	E*	[512 to 1535 / 932 / 1/step]

4550	[Scan Apli:Txt/Print] Sets the text/print MTF level of the scanner application.		
4-550-005	MTF: 0(Off) 1-15 (Weak-Strong)	E*	[0 to 15 / 8 / 1/step] 0: MTF OFF Sets the MTF level (Modulation Transfer Function) designed to improve image contrast. Set higher for stronger effect, lower for weaker effect.
4-550-006	Smoothing: 0(x1) 1-7 (Weak-Strong)	E*	[0 to 7 / 4 / 1/step] Use to remove "jaggies" if they appear. Set higher for smoother images.
4-550-007	Brightness: 1-255	E*	[1 to 255 / 128 / 1/step] Set higher for darker, set lower for lighter.
4-550-008	Contrast: 1-255	E*	[1 to 255 / 128 / 1/step] Set higher for more contrast, set lower for less contrast.
4-550-009	Ind Dot Erase: 0(Off) 1-7 (Weak-Strong)	E*	[0 to 7 / 0 / 1/step] Sets the erasure level of Irregular Dots. Set higher for stronger effect, lower for weaker effect. 0: Not activated

4551	[Scan Apli:Txt]		
4-551-005	MTF: 0(Off) 1-15 (Weak-Strong)	E*	[0 to 15 / 8 / 1/step] 0: MTF OFF Sets the MTF level (Modulation Transfer Function) designed to improve image contrast. Set higher for stronger effect, lower for weaker effect.
4-551-006	Smoothing: 0(x1) 1-7 (Weak-Strong)	E*	[0 to 7 / 4 / 1/step] Use to remove "jaggies" if they appear. Set higher for smoother images.
4-551-007	Brightness: 1-255	E*	[1 to 255 / 128 / 1/step] Set higher for darker, set lower for lighter.
4-551-008	Contrast: 1-255	E*	[1 to 255 / 128 / 1/step] Set higher for more contrast, set lower for less contrast.
4-551-009	Ind Dot Erase: 0(Off) 1-7 (Weak-Strong)	E*	[0 to 7 / 0 / 1/step] Sets the erasure level of Irregular Dots. Set higher for stronger effect, lower for weaker effect. 0: Not activated

4552	[Scan Apli:Txt Dropout]		
4-552-005	MTF: 0(Off) 1-15 (Weak-Strong)	E*	[0 to 15 / 8 / 1/step] 0: MTF OFF Sets the MTF level (Modulation Transfer Function) designed to improve image contrast. Set higher for stronger effect, lower for weaker effect.
4-552-006	Smoothing: 0(x1) 1-7 (Weak-Strong)	E*	[0 to 7 / 4 / 1/step] Use to remove "jaggies" if they appear. Set higher for smoother images.
4-552-007	Brightness: 1-255	E*	[1 to 255 / 128 / 1/step] Set higher for darker, set lower for lighter.
4-552-008	Contrast: 1-255	E*	[1 to 255 / 128 / 1/step] Set higher for more contrast, set lower for less contrast.
4-552-009	Ind Dot Erase: 0(Off) 1-7 (Weak-Strong)	E*	[0 to 7 / 0 / 1/step] Sets the erasure level of Irregular Dots. Set higher for stronger effect, lower for weaker effect. 0: Not activated

4553		[Scan Apli:Txt/Photo]	
4-553-005	MTF: 0(Off) 1-15 (Weak-Strong)	E*	[0 to 15 / 8 / 1/step] 0: MTF OFF Sets the MTF level (Modulation Transfer Function) designed to improve image contrast. Set higher for stronger effect, lower for weaker effect.
4-553-006	Smoothing: 0(x1) 1-7 (Weak-Strong)	E*	[0 to 7 / 4 / 1/step] Use to remove "jaggies" if they appear. Set higher for smoother images.
4-553-007	Brightness: 1-255	E*	[1 to 255 / 128 / 1/step] Set higher for darker, set lower for lighter.
4-553-008	Contrast: 1-255	E*	[1 to 255 / 128 / 1/step] Set higher for more contrast, set lower for less contrast.
4-553-009	Ind Dot Erase: 0(Off) 1-7 (Weak-Strong)	E*	[0 to 7 / 0 / 1/step] Sets the erasure level of Irregular Dots. Set higher for stronger effect, lower for weaker effect. 0: Not activated

4554		[Scan Apli:Photo]	
4-554-005	MTF: 0(Off) 1-15 (Weak-Strong)	E*	[0 to 15 / 8 / 1/step] 0: MTF OFF Sets the MTF level (Modulation Transfer Function) designed to improve image contrast. Set higher for stronger effect, lower for weaker effect.
4-554-006	Smoothing: 0(x1) 1-7 (Weak-Strong)	E*	[0 to 7 / 4 / 1/step] Use to remove "jaggies" if they appear. Set higher for smoother images.

4-554-007	Brightness: 1-255	E*	[1 to 255 / 128 / 1/step] Set higher for darker, set lower for lighter.
4-554-008	Contrast: 1-255	E*	[1 to 255 / 128 / 1/step] Set higher for more contrast, set lower for less contrast.
4-554-009	Ind Dot Erase: 0(Off) 1-7 (Weak-Strong)	E*	[0 to 7 / 0 / 1/step] Sets the erasure level of Irregular Dots. Set higher for stronger effect, lower for weaker effect. 0: Not activated

4565	[Scan Apli:GrayScale]		
4-565-005	MTF: 0(Off) 1-15 (Weak-Strong)	E*	[0 to 15 / 8 / 1/step] 0: MTF OFF Sets the MTF level (Modulation Transfer Function) designed to improve image contrast. Set higher for stronger effect, lower for weaker effect.
4-565-006	Smoothing: 0(x1) 1-7 (Weak-Strong)	E*	[0 to 7 / 4 / 1/step] Use to remove "jaggies" if they appear. Set higher for smoother images.
4-565-007	Brightness: 1-255	E*	[1 to 255 / 128 / 1/step] Set higher for darker, set lower for lighter.
4-565-008	Contrast: 1-255	E*	[1 to 255 / 128 / 1/step] Set higher for more contrast, set lower for less contrast.
4-565-009	Ind Dot Erase: 0(Off) 1-7 (Weak-Strong)	E*	[0 to 7 / 0 / 1/step] Sets the erasure level of Irregular Dots. Set higher for stronger effect, lower for weaker effect. 0: Not activated

4570	[Scan Apli:Col Txt/Photo]		
4-570-005	MTF: 0(Off) 1-15 (Weak-Strong)	E*	[0 to 15 / 8 / 1/step] 0: MTF OFF Sets the MTF level (Modulation Transfer Function) designed to improve image contrast. Set higher for stronger effect, lower for weaker effect.
4-570-006	Smoothing: 0(x1) 1-7 (Weak-Strong)	E*	[0 to 7 / 4 / 1/step] Use to remove "jaggies" if they appear. Set higher for smoother images.
4-570-007	Brightness: 1-255	E*	[1 to 255 / 128 / 1/step] Set higher for darker, set lower for lighter.
4-570-008	Contrast: 1-255	E*	[1 to 255 / 128 / 1/step] Set higher for more contrast, set lower for less contrast.
4-570-009	Ind Dot Erase: 0(Off) 1-7 (Weak-Strong)	E*	[0 to 7 / 0 / 1/step] Sets the erasure level of Irregular Dots. Set higher for stronger effect, lower for weaker effect. 0: Not activated

4571	[Scan Apli:Col Gloss Photo]		
4-571-005	MTF: 0(Off) 1-15 (Weak-Strong)	E*	[0 to 15 / 8 / 1/step] 0: MTF OFF Sets the MTF level (Modulation Transfer Function) designed to improve image contrast. Set higher for stronger effect, lower for weaker effect.
4-571-006	Smoothing: 0(x1) 1-7 (Weak-Strong)	E*	[0 to 7 / 4 / 1/step] Use to remove "jaggies" if they appear. Set higher for smoother images.
4-571-007	Brightness: 1-255	E*	[1 to 255 / 128 / 1/step] Set higher for darker, set lower for lighter.
4-571-008	Contrast: 1-255	E*	[1 to 255 / 128 / 1/step] Set higher for more contrast, set lower for less contrast.
4-571-009	Ind Dot Erase: 0(Off) 1-7 (Weak-Strong)	E*	[0 to 7 / 0 / 1/step] Sets the erasure level of Irregular Dots. Set higher for stronger effect, lower for weaker effect. 0: Not activated

4572	[Scan Apli:AutoCol]		
4-572-005	MTF: 0(Off) 1-15 (Weak-Strong)	E*	[0 to 15 / 8 / 1/step] 0: MTF OFF Sets the MTF level (Modulation Transfer Function) designed to improve image contrast. Set higher for stronger effect, lower for weaker effect.
4-572-006	Smoothing: 0(x1) 1-7 (Weak-Strong)	E*	[0 to 7 / 4 / 1/step] Use to remove "jaggies" if they appear. Set higher for smoother images.

4-572-007	Brightness: 1-255	E*	[1 to 255 / 128 / 1/step] Set higher for darker, set lower for lighter.
4-572-008	Contrast: 1-255	E*	[1 to 255 / 128 / 1/step] Set higher for more contrast, set lower for less contrast.
4-572-009	Ind Dot Erase: 0(Off) 1-7 (Weak-Strong)	E*	[0 to 7 / 0 / 1/step] Sets the erasure level of Irregular Dots. Set higher for stronger effect, lower for weaker effect. 0: Not activated

4580	[Fax Apli:Txt/Chart]		
4-580-005	MTF: 0(Off) 1-15 (Weak-Strong)	E*	[0 to 15 / 8 / 1/step] Sets the MTF level (Modulation Transfer Function) designed to improve image contrast. Set higher for stronger effect, lower for weaker effect.
4-580-006	Smoothing: 0(x1) 1-7 (Weak-Strong)	E*	[0 to 7 / 4 / 1/step] Use to remove "jaggies" if they appear. Set higher for smoother images.
4-580-007	Brightness: 1-255	E*	[1 to 255 / 128 / 1/step] Set higher for darker, set lower for lighter.
4-580-008	Contrast: 1-255	E*	[1 to 255 / 128 / 1/step] Set higher for more contrast, set lower for less contrast.
4-580-009	Ind Dot Erase: 0(Off) 1-7 (Weak-Strong)	E*	[0 to 7 / 0 / 1/step] Sets the erasure level of Irregular Dots. Set higher for stronger effect, lower for weaker effect. 0: Not activated

Main SP Tables-4

4-580-010	Texture Erase: 0	E*	[0 to 2 / 0 / 1/step] Sets the erasure level of textures. Set higher for stronger effect, lower for weaker effect.
-----------	------------------	----	--

4581	[Fax Apli:Txt]		
4-581-005	MTF: 0(Off) 1-15 (Weak-Strong)	E*	[0 to 15 / 8 / 1/step] Sets the MTF level (Modulation Transfer Function) designed to improve image contrast. Set higher for stronger effect, lower for weaker effect.
4-581-006	Smoothing: 0(x1) 1-7 (Weak-Strong)	E*	[0 to 7 / 4 / 1/step] Use to remove "jaggies" if they appear. Set higher for smoother images.
4-581-007	Brightness: 1-255	E*	[1 to 255 / 128 / 1/step] Set higher for darker, set lower for lighter.
4-581-008	Contrast: 1-255	E*	[1 to 255 / 128 / 1/step] Set higher for more contrast, set lower for less contrast.
4-581-009	Ind Dot Erase: 0(Off) 1-7 (Weak-Strong)	E*	[0 to 7 / 0 / 1/step] Sets the erasure level of Irregular Dots. Set higher for stronger effect, lower for weaker effect. 0: Not activated

4582		[Fax Apli:Txt/Photo]	
4-582-005	MTF: 0(Off) 1-15 (Weak-Strong)	E*	[0 to 15 / 8 / 1/step] Sets the MTF level (Modulation Transfer Function) designed to improve image contrast. Set higher for stronger effect, lower for weaker effect.
4-582-006	Smoothing: 0(x1) 1-7 (Weak-Strong)	E*	[0 to 7 / 4 / 1/step] Use to remove "jaggies" if they appear. Set higher for smoother images.
4-582-007	Brightness: 1-255	E*	[1 to 255 / 128 / 1/step] Set higher for darker, set lower for lighter.
4-582-008	Contrast: 1-255	E*	[1 to 255 / 128 / 1/step] Set higher for more contrast, set lower for less contrast.
4-582-009	Ind Dot Erase: 0(Off) 1-7 (Weak-Strong)	E*	[0 to 7 / 0 / 1/step] Sets the erasure level of Irregular Dots. Set higher for stronger effect, lower for weaker effect. 0: Not activated
4-582-010	Texture Erase: 0	E*	[0 to 2 / 0 / 1/step] Sets the erasure level of textures. Set higher for stronger effect, lower for weaker effect.

4583		[Fax Apli:Photo]	
4-583-005	MTF: 0(Off) 1-15 (Weak-Strong)	E*	[0 to 15 / 8 / 1/step] Sets the MTF level (Modulation Transfer Function) designed to improve image contrast. Set higher for stronger effect, lower for weaker effect.

4-583-006	Smoothing: 0(x1) 1-7 (Weak-Strong)	E*	[0 to 7 / 4 / 1/step] Use to remove "jaggies" if they appear. Set higher for smoother images.
4-583-007	Brightness: 1-255	E*	[1 to 255 / 128 / 1/step] Set higher for darker, set lower for lighter.
4-583-008	Contrast: 1-255	E*	[1 to 255 / 128 / 1/step] Set higher for more contrast, set lower for less contrast.
4-583-009	Ind Dot Erase: 0(Off) 1-7 (Weak-Strong)	E*	[0 to 7 / 0 / 1/step] Sets the erasure level of Irregular Dots. Set higher for stronger effect, lower for weaker effect. 0: Not activated
4-583-010	Texture Erase: 0	E*	[0 to 2 / 0 / 1/step] Sets the erasure level of textures. Set higher for stronger effect, lower for weaker effect.

4584	[Fax Apli:Original 1]		
4-584-005	MTF: 0(Off) 1-15 (Weak-Strong)	E*	[0 to 15 / 8 / 1/step] Sets the MTF level (Modulation Transfer Function) designed to improve image contrast. Set higher for stronger effect, lower for weaker effect.
4-584-006	Smoothing: 0(x1) 1-7 (Weak-Strong)	E*	[0 to 7 / 4 / 1/step] Use to remove "jaggies" if they appear. Set higher for smoother images.
4-584-007	Brightness: 1-255	E*	[1 to 255 / 128 / 1/step] Set higher for darker, set lower for lighter.
4-584-008	Contrast: 1-255	E*	[1 to 255 / 128 / 1/step] Set higher for more contrast, set lower for less contrast.

4-584-009	Ind Dot Erase: 0(Off) 1-7 (Weak-Strong)	E*	[0 to 7 / 0 / 1/step] Sets the erasure level of Irregular Dots. Set higher for stronger effect, lower for weaker effect. 0: Not activated
-----------	--	----	---

4585	[Fax Apli:Original 2]		
4-585-005	MTF: 0(Off) 1-15 (Weak-Strong)	E*	[0 to 15 / 8 / 1/step] Sets the MTF level (Modulation Transfer Function) designed to improve image contrast. Set higher for stronger effect, lower for weaker effect.
4-585-006	Smoothing: 0(x1) 1-7 (Weak-Strong)	E*	[0 to 7 / 4 / 1/step] Use to remove "jaggies" if they appear. Set higher for smoother images.
4-585-007	Brightness: 1-255	E*	[1 to 255 / 128 / 1/step] Set higher for darker, set lower for lighter.
4-585-008	Contrast: 1-255	E*	[1 to 255 / 128 / 1/step] Set higher for more contrast, set lower for less contrast.
4-585-009	Independent Dot Erase (0)/ 1-7 (Strong)	E*	[0 to 7 / 0 / 1/step] Sets the erasure level of Irregular Dots. Set higher for stronger effect, lower for weaker effect. 0: Not activated

4603	[AGC Execution] Executes the AGC and enables the home position detection.		
4-603-001	HP Detection Enable	E	[- / - / -] [Execute] Executes the AGC with the scanner detection.
4-603-002	HP Detection Disable	E	[- / - / -] [Execute] Executes the AGC with the scanner detection.

4604	[FGATE Open/Close]		
4-604-001	-	E	[0 or 1 / 0 / 1/step] 0: OFF, 1: ON Opens or closes the FGATE signal. This SP automatically returns to the default status (close) after exiting this SP.

4606	[White Level Adjust]		
4-606-001	Color 600	E*	[0 to 1024 / 784 / 1digit/step]

4607	[White Level Adjust]		
4-607-001	Color 1200	E*	[0 to 1024 / 784 / 1digit/step]

4608	[White Level Adjust]		
4-608-001	Bk	E*	[0 to 1024 / 784 / 1digit/step]

4609	[Gray Balance Set: R]		
4-609-001	Book Scan	E*	[-384 to 255 / -89 / 1digit/step] Displays the scanning level value (adjustment) for the red signal in Book Scan.
4-609-002	DF Scan	E*	[-384 to 255 / -89 / 1digit/step] Displays the scanning level value (adjustment) for the red signal in DF Scan.

4610	[Gray Balance Set: G]		
4-610-001	Book Scan	E*	[-384 to 255 / -76 / 1digit/step] Displays the scanning level value (adjustment) for the green signal in Book Scan.
4-610-002	DF Scan	E*	[-384 to 255 / -76 / 1digit/step] Displays the scanning level value (adjustment) for the green signal in DF Scan.

4610	[Gray Balance Set: BW] Displays the adjustment value of the gray balance for BW		
4-610-003	Book Scan	E*	[-384 to 255 / -92 / 1digit/step]
4-610-004	DF Scan	E*	

4611		[Gray Balance Set: B]	
4-611-001	Book Scan	E*	[-384 to 255 / -85 / 1digit/step] Displays the scanning level value (adjustment) for the blue signal in Book Scan.
4-611-002	DF Scan	E*	[-384 to 255 / -85 / 1digit/step] Displays the scanning level value (adjustment) for the blue signal in DF Scan.

4623		[Black Level Adj. Display]	
4-623-001	Latest: R Color 600	E	[0 to 255 / 0 / 1digit/step] Displays the black offset value (rough adjustment) for the even red signal in the SBU (color printing speed).
4-623-002	Latest: R Color 1200	E	[0 to 255 / 0 / 1digit/step] Displays the black offset value (rough adjustment) for the odd red signal in the SBU (color printing speed).

4624	[Black Level Adj. Display] E: Even signal, O: Odd signal		
4-624-001	Latest: G Color 600	E	[0 to 255 / 0 / 1digit/step] Displays the black offset value (rough adjustment) for the even green signal in the SBU (color printing speed).
4-624-002	Latest: G Color 1200	E	[0 to 255 / 0 / 1digit/step] Displays the black offset value (rough adjustment) for the odd green signal in the SBU (color printing speed).
4-624-003	Latest: BkE	E	[0 to 255 / 0 / 1digit/step] Displays the black offset value (rough adjustment) for the even black signal in the SBU (color printing speed).
4-624-004	Latest: BkO	E	[0 to 255 / 0 / 1digit/step] Displays the black offset value (rough adjustment) for the odd black signal in the SBU (color printing speed).

4625	[Black Level Adj. Display]		
4-625-001	Latest: B Color 600	E	[0 to 255 / 0 / 1digit/step] Displays the black offset value (rough adjustment) for the even blue signal in the SBU (color printing speed).
4-625-002	Latest: B Color 1200	E	[0 to 255 / 0 / 1digit/step] Displays the black offset value (rough adjustment) for the odd blue signal in the SBU (color printing speed).

4631	[Digital Gain Adjust] Displays the gain value of the amplifiers on the controller for RE or RO. E: Even signal, O: Odd signal		
4-631-001	Latest: R Color 600	E	[0 to 511 / 0 / 1digit/step]
4-631-002	Latest: R Color 1200	E	

4632	[Digital Gain Adjust] Displays the gain value of the amplifiers on the controller for GE, GO, BkE, or BkO. E: Even signal, O: Odd signal		
4-632-001	Latest: G Color 600	E	[0 to 511 / 0 / 1digit/step]
4-632-002	Latest: G Color 1200	E	
4-632-003	Latest: BkE	E	
4-632-004	Latest: BkO	E	

4633	[Digital Gain Adjust] Displays the gain value of the amplifiers on the controller for BE or BO. E: Even signal, O: Odd signal		
4-633-001	Latest: B Color 600	E	[0 to 511 / 0 / 1digit/step]
4-633-002	Latest: B Color 1200	E	

4645	[Scan Adjust Error] Displays the error value of the white level or black level adjustment.		
4-645-001	White level	E	[0 to 65535 / 0 / 1/step]
4-645-002	Black level	E	

4647	[Scanner Hard Error] Displays result of SBU connection check.		
4-647-001	Power-ON	E	[0 to 65535 / 0 / 1/step]

4654	[Black Level Adj. Display] Displays Black level digital adjustment value. Black level adjustment is continuously done hardwarelly by SBUs ASIC (SCAT). Black level is checked when scanner turns on, then adjustment value is given. Use for design evaluation, analyzing cause of malfunction (abnormal images, SC).		
4-654-001	Last Correct Value: R Color 600	E*	[0 to 255 / 0 / 1digit/step]
4-654-002	Last Correct Value: R Color 1200	E*	

4655	[Black Level Adj. Display] Displays Black level digital adjustment value. Black level adjustment is continuously done hardwarelly by SBUs ASIC (SCAT). Black level is checked when scanner turns on, then adjustment value is given. Use for design evaluation, analyzing cause of malfunction (abnormal images, SC). E: Even signal, O: Odd signal		
4-655-001	Last Correct Value: G Color 600	E*	[0 to 255 / 0 / 1digit/step]
4-655-002	Last Correct Value: G Color 1200	E*	
4-655-003	Last Correct Value: BkE	E*	
4-655-004	Last Correct Value: BkO	E*	

4656	[Black Level Adj. Display] Displays Black level digital adjustment value. Black level adjustment is continuously done hardwarelly by SBUs ASIC (SCAT). Black level is checked when Scanner turns on, then Adjustment value is given. Use for design evaluation, analyzing cause of malfunction (abnormal images, SC).			
	4-656-001	Last Correct Value: B Color 600	E*	[0 to 255 / 0 / 1digit/step]
	4-656-002	Last Correct Value: B Color 1200	E*	

4661	[Digital Gain Adjust] Displays Digital gain adjustment value. White level adjustment will be done to keep hold of image signal's dynamic range when scanner turns on. Gain adjustment will be done hardwarelly by SBUs ASIC (SCAT) and be given, cause to the fact that White level adjustment will amplify or attenuated image signal. Use for design evaluation, analyzing cause of malfunction (abnormal images, SC).			
	4-661-001	Last Correct Value: R Color 600	E*	[0 to 511 / 0 / 1digit/step]
	4-661-002	Last Correct Value: R Color 1200	E*	

4662	[Digital Gain Adjust] Displays Digital gain adjustment value. White level adjustment will be done to keep hold of image signal's dynamic range when scanner turns on. Gain adjustment will be done hardwarelly by SBUs ASIC (SCAT) and be given, cause to the fact that White level adjustment will amplify or attenuated image signal. Use for design evaluation, analyzing cause of malfunction (abnormal images, SC).		
	4-662-001	Last Correct Value: G Color 600	E*
	4-662-002	Last Correct Value: G Color 1200	E*
	4-662-003	Last Correct Value: BkE	E*
	4-662-004	Last Correct Value: BkO	E*
			[0 to 511 / 0 / 1digit/step]

4663	[Digital Gain Adjust] Displays Digital gain adjustment value. White level adjustment will be done to keep hold of image signal's dynamic range when scanner turns on. Gain adjustment will be done hardwarelly by SBUs ASIC (SCAT) and be given, cause to the fact that White level adjustment will amplify or attenuated image signal. Use for design evaluation, analyzing cause of malfunction (abnormal images, SC).		
	4-663-001	Last Correct Value: B Color 600	E*
	4-663-002	Last Correct Value: B Color 1200	E*
			[0 to 511 / 0 / 1digit/step]

4673	[Black Level Adj. Display] Display/Saves Factory Black level digital adjusting value. Factory Black level digital adjusting value from Main unit warranty process is saved. Use for design evaluation, analyzing cause of malfunction (abnormal images, SC).		
	4-673-001	Factory Setting: R Color 600	E*
	4-673-002	Factory Setting: R Color 1200	E*
[0 to 255 / 0 / 1digit/step]			

4674	[Black Level Adj. Display] Display/Saves Factory Black level digital adjusting value. Factory Black level digital adjusting value from Main unit warranty process is saved. Use for design evaluation, analyzing cause of malfunction (abnormal images, SC). E: even, O: Odd signal.		
	4-674-001	Factory Setting: G Color 600	E*
	4-674-002	Factory Setting: G Color 1200	E*
	4-674-003	Factory Setting: BkE	E*
	4-674-004	Factory Setting: BkO	E*
[0 to 255 / 0 / 1digit/step]			

4675	[Black Level Adj. Display] Display/Saves Factory Black level digital adjusting value. Factory Black level digital adjusting value from Main unit warranty process is saved. Use for design evaluation, analyzing cause of malfunction (abnormal images, SC).		
	4-675-001	Factory Setting: B Color 600	E*
	4-675-002	Factory Setting: B Color 1200	E*
[0 to 255 / 0 / 1digit/step]			

4680	[Digital Gain Adjust] Displays the gain value of the amplifiers on the controller for Red. RE: Red even, RO: Red Odd signal.		
	4-680-001	Factory Setting: RE Color	E*
	4-680-002	Factory Setting: RO Color	E*
[0 to 511 / 0 / 1digit/step]			

4681	[Digital Gain Adjust] Displays the gain value of the amplifiers on the controller for Green. GE: Green even, GO: Green Odd signal.		
	4-681-001	Factory Setting: GE Color	E*
	4-681-002	Factory Setting: GO Color	E*
	4-681-003	Factory Setting: BkE	E*
	4-681-004	Factory Setting: BkO	E*
[0 to 511 / 0 / 1digit/step]			

4682	[Digital Gain Adjust] Displays the gain value of the amplifiers on the controller for Blue. BE: Blue even, BO: Blue Odd signal.		
	4-682-001	Factory Setting: BE Color	E*
	4-682-002	Factory Setting: BO Color	E*
[0 to 511 / 0 / 1digit/step]			

4688	[ADF Adjustment Density]		
	Adjusts the white shading parameter when scanning an image with the DF. Adjusts the density level if the ID of outputs made in the DF and Platen mode is different.		
4-688-001	-	E	[50 to150 / 100 / 1%/step]

4690	[White Level Peak Read]		
	Displays the peak level of the white level scanning. If these scanned white levels are out of the correct range, SC142 may be issued.		
	4-690-001	R Color 600	E
4-690-002	R Color 1200	E	[0 to 1023 / 0 / 1digit/step]

4691	[White Level Peak Read]		
	Displays the peak level of the white level scanning. If these scanned white levels are out of the correct range, SC142 may be issued.		
	4-691-001	G Color 600	E
	4-691-002	G Color 1200	E
	4-691-003	BkE	E
4-691-004	BkO	E	[0 to 1023 / 0 / 1digit/step]

4692	[White Level Peak Read]		
	Displays the peak level of the white level scanning. If these scanned white levels are out of the correct range, SC142 may be issued.		
	4-692-001	B Color 600	E
4-692-002	B Color 1200	E	[0 to 1023 / 0 / 1digit/step]

4693	[Black Level Peak Read]		
	Displays the peak level of the black level scanning. If these scanned white levels are out of the correct range, SC142 may be issued.		
	4-693-001	R Color 600	E
4-693-002	R Color 1200	E	[0 to 1023 / 0 / 1digit/step]

4694	[Black Level Peak Read]		
	Display the peak level of the black level scanning. If these scanned white levels are out of the correct range, SC142 may be issued.		
	4-694-001	G Color 600	E
	4-694-002	G Color 1200	E
	4-694-003	BkE	E
4-694-004	BkO	E	[0 to 1023 / 0 / 1digit/step]

4695	[Black Level Peak Read]		
	Display the peak level of the black level scanning. If these scanned white levels are out of the correct range, SC142 may be issued.		
	4-695-001	B Color 600	E
4-695-002	B Color 1200	E	[0 to 1023 / 0 / 1digit/step]

4802	[DF Shading FreeRun]		
	Executes the scanner free run for shading movement with the exposure lamp on or off. The free run moves the scanning lamp a short distance and immediately returns it to its home position.		
	4-802-001	Lamp OFF	E
4-802-002	Lamp ON	E	[0 or 1 / 0 / 1/step]

4804	[Home Position] Moves the exposure lamp a short distance and immediately returns it to its home position. Touch [Execute]> "Completed"> [Exit].		
4-804-001	-	E	[- / - / -] [Execute]

4806	[Carriage Save] Moves the exposure lamp a short distance away from the home position and stops. <ul style="list-style-type: none"> ▪ Touch [Execute]> "Completed"> [Exit] ▪ Do SP4804 to return the exposure lamp to its home position. <p>Note</p> <ul style="list-style-type: none"> ▪ This SP is done before shipping the machine to another location. Turning the machine power off/on also returns the exposure lamp to its home position. 		
4-806-001	-	E	[- / - / -] [Execute]

4808	[Factory Setting Input]		
4-808-002	Execution Flag	E*	[0 or 1 / 0 / 1/step]

4810	[PWM]		
4-810-001	Latest: Color 600	E	[1 to 5956 / 1 / 1digit/step]
4-810-002	Latest: Color 1200	E	
4-810-003	Latest: Bk	E	
4-810-004	Last Correct Value: Color 600	E*	[1 to 5956 / 4255 / 1digit/step]
4-810-005	Last Correct Value: Color 1200	E*	
4-810-006	Last Correct Value: Bk	E*	
4-810-007	Factory Setting: Color 600	E*	[1 to 5956 / 1 / 1digit/step]

4-810-008	Factory Setting: Color 1200	E*	
4-810-009	Factory Setting: Bk	E*	

4811	[LED White Level Peak Read]		
4-811-001	Latest: R Color 600	E*	[0 to 1023 / 0 / 1digit/step]
4-811-002	Latest: R Color 1200	E*	
4-811-003	Latest: G Color 600	E*	
4-811-004	Latest: G Color 1200	E*	
4-811-005	Latest: BkE	E*	
4-811-006	Latest: BkO	E*	
4-811-007	Latest: B Color 600	E*	
4-811-008	Latest: B Color 1200	E*	

4812	[LED White Level Peak Read]		
4-812-001	Factory Setting: R Color 600	E*	[0 to 1023 / 0 / 1digit/step]
4-812-002	Factory Setting: R Color 1200	E*	
4-812-003	Factory Setting: G Color 600	E*	
4-812-004	Factory Setting: G Color 1200	E*	
4-812-005	Factory Setting: BkE	E*	
4-812-006	Factory Setting: BkO	E*	
4-812-007	Factory Setting: B Color 600	E*	
4-812-008	Factory Setting: B Color 1200	E*	

4813	[LED White Level Adjust]		
	-		
4-813-001	Color 600	E*	[0 or 1023 / 784 / 1digit/step]
4-813-002	Color 1200	E*	
4-813-003	Bk	E*	[0 or 1023 / 540 / 1digit/step]

4903	[Filter Setting]		
	This SP outputs the final data read at the end of ACC execution. A zero is returned if there was an error reading the data.		
	4-903-001	Ind Dot Erase: Text	E*
4-903-002	Ind Dot Erase: Generation Copy	E*	[0 to 7 / 0 / 1/step] Photo M Patch Level 1 (8-bit)

4905	[Select Gradation Level]		
	Checks the whole area (0 = All) or the specific areas (1 = One) to adjust the ADS level. The specific areas are as follows: ADF: 15 to 90 mm from the left edge Platen Cover: 15 to 90 mm from the left edge		
4-905-001	-	E*	[0 to 255 / 0 / 1/step]

4918	[Man Gamma Adj]		
	Adjusts the manual gamma for Copy/Photo or Copy/Text with the soft keys on the operation panel.		
4-918-009	-	E	[- / - / -] [Change]

4954	[Read/Restore Std]		
	Reads or restores the standard chart.		
4-954-005	Chromaticity Rank	E*	[0 to 255 / 0 / 1/step]

4993	[High Light Correction]		
4-993-001	Sensitivity Selection	E*	Selects the Highlight correction level. [0 to 9 / 4 / 1 / step] 0: weakest sensitivity 9: strongest sensitivity
4-993-002	Range Selection	E*	Selects the range level of Highlight correction. [0 to 9 / 4 / 1 / step] 0: weakest skew correction, 9: strongest skew correction

4994	[Adj Txt/Photo Recog Level]		
	Selects the definition level between Text and Photo for high compression PDF.		
4-994-001	High Compression PDF	E*	[0 to 2 / 1 / 1/step]

4996	[White Paper Detection Level]		
4-996-001	-	E*	[0 to 6 / 3 / 1/step] Sets blank paper detection level. Increasing the value: more sensitive detecting.

3.6 MAIN SP TABLES-5

3.6.1 SP5-XXX (MODE)

5009	<p>[Add Display Language] Adds language available in user choice. (Only the languages registered in the machine) Refer to the displayed language list to set in the way showed below. List Number Assigned Bit Switch No.1 to 8 BIT1 to 8 (SP5009-201) No.9 to 16BIT1 to 8 (SP5009-202) No.17 to 24BIT1 to 8 (SP5009-203) No.25 to 32BIT1 to 8 (SP5009-204) Example: To add American(No.3 in the list) or Czech (No.15) Turn Bit 3 of "SP5009-201" 0 to 1 for American. Turn Bit 7 of "SP5009-202" 0 to 1 for Czech. After setting, turn the main power switch off and on to make the setting valid. 0: None, 1: Japanese (ja), 2: British English (en-GB), 3: American English (en-US), 4: French (fr), 5: German (de), 6: Italian (it), 7: Spanish (es), 8: Dutch (nl), 9: Norwegian (no), 10: Danish (da), 11: Swedish (sv), 12: Polish (pl), 13: Portuguese (pt), 14: Hungarian (hu), 15: Czech (cs), 16: Finnish (fi), 17: Chinese (zh-CN), 18: Taiwanese (zh-TW), 19: Thai (th), 20: Russian (ru), 21: Hebrew (iw), 22: Arabic (ar), 23: Greek (el), 24: Korean (ko), 25: Catalan(ct), 26: Turkish (tr), 27: Brazilian Portuguese(br), 28: Language Definition End</p>			
	5-009-201	1-8	C*	[1 to 255 / 00000000 / 1/step]
	5-009-202	9-16	C*	
	5-009-203	17-24	C*	
	5-009-204	25-32	C*	

5024	[mm/inch Display Selection] Selects whether mm or inches are used in the display. Note: After selecting the number, you must turn the main power switch off and on.		
5-024-001	0:mm 1:inch	C*	[0 or 1 / 1 / 1/step] 0: mm (Europe/Asia) 1: inch (USA)

5045	[Accounting counter] Selects whether the accounting counter is displayed on the LCD or not. SP5-801-001/003 will not clear this SP. The value will be under an exclusive control because the value varies in segments.		
5-045-001	Counter Method	C*	[0 or 1 / 0 / 1/step] 0: Set 1: Unset

5051	[TonerRefillDetectionDisplay] Enables or disables the toner refill detection display.		
5-051-001	-	C*	[0 or 1 / 0 / 1/step] 0: ON 1: OFF

5055	[Display IP Address] Display or does not display the IP address on the operation panel.		
5-055-001	-	C*	[0 or 1 / 0 / 1/step] 0: OFF 1: ON

5071	[Set Bypass Paper Size Display] Turn on or off the paper size confirmation pop-up on the LED. This pop-up prevents mismatching between a paper size selected by the operation panel and an actual paper size on the by-pass tray.		
5-071-001	-	C*	[0 or 1 / 0 / 1/step] 0: Off 1: On

5074	[Home Key Customization] Sets the application that appears when the home key is pressed.		
5-074-002	Login Setting	C*	[FFh / 00000000 / 1hex/step] 0:On 1:Off Sets the log-in operation mode of the home menu.
5-074-050	Show Home Edit Menu	C*	[0 to 2 / 0 / 1 /step] 0: Auto 1: Display 2: Not display Sets whether to display the home edit menu on the system initial setting or WebImageMonitor. It depends whether the machine has the Smart Oeration Panel or not.
5-074-091	Function Setting	C*	[0 to 2 / 0 / 1/step] 0: Function disable 1: SDK application 2: MFP browser application Selects the application to show up when pressed the home key.
5-074-092	Product ID	C*	[0x00 to 0xFFFF FFFF / 0h / 1/step] Sets the Application product ID.

5-074-093	Application Screen ID	C*	[0 to 255 / 0 / 1/step] Sets the display category of the application that is specified in the SP5075-001
-----------	-----------------------	----	--

5076	[Copy:LT/LG Sizes Setting] Enables or disables the Copy LT/LG consolidation setting.		
5-076-001	0:OFF 1:ON	C*	[0 or 1 / 1 / 1/step] 0: Disabled 1: Enabled

5081	[ServiceSP Entry Code Setting] DFU		
5-081-001	-	C*	[- / - / -]

5083	[LED Light Switch Setting] Specifies whether the alert LED is lit or not when toner near end condition is detected. (This does not change the toner near end condition indication in the operation panel LCD.)		
5-083-001	Toner Near End	C*	[0 or 1 / 0 / 1/step] 0: OFF 1: ON

5112	[Non-Std. Paper Sel.] Selects On/Off to allow the setting of the custom size.		
5-112-001	(0:OFF 1:ON)	C*	[0 or 1 / 1 / 1/step] 0: OFF 1: ON

5113	[Optional Counter Type]		
5-113-001	Default Optional Counter Type	C*	[0 to 5 / 0 / 1/step] 0: None 1: Key card (RK 2, 3, 4) 2: Key card (down) 3: PrepaidCard 4: Coin Rack 5: MFKeyCard 11: Exp.KeyCard(Add) 12: Exp.KeyCard(Deduct) This program specifies the counter type.
5-113-002	External Optional Counter Type	C*	[0 to 3 / 0 / 1/step] 0: None 1: Expansion Device 1 2: Expansion Device 2 3: Expansion Device 3 This program specifies the external counter type.

5114	[Optional Counter I/F] Set when connecting an expansion unit using the MF key card I/F.		
5-114-001	MF Key Card Extension	C*	[0 or 1 / 0 / 1/step] 0: Not installed 1: Installed (scanning accounting)

5118	[Disable Copying] This program disables copying.		
5-118-001	-	C*	[0 or 1 / 0 / 1/step] 0: Not disabled 1: Disabled

5120	[Mode Clear Opt. Counter Removal] Sets the mode clear operation in removal of counters to all the accounting counter devices. Sets whether to operate the mode clear or not when the accounting devices released (e.g. no key-card, no remains in a card) before starting a job or during idle after a job end. If the accounting devices released during a job, the machine starts canceling the job and then stops the counter. This SP, thus, is aimed to set whether to do the mode clear operation if the stopped timing was during job canceling.		
5-120-001	0: Yes 1: StandBy 2: No	C*	[0 to 2 / 0 / 1/step] 0: Yes (removed) 1: Standby (installed but not used) 2: No (not removed)

5121	[Counter Up Timing] Determines whether the optional key counter counts up at paper feed-in or at paper exit.		
5-121-001	0:Feed 1:Exit	C*	[0 or 1 / 0 / 1/step] 0: Feed 1: Exit

5127	[APS Mode] Selects whether the APS function is enabled or disabled with the contact of a pre-paid card or coin lock.		
5-127-001	-	C*	[0 or 1 / 0 / 1/step] 0: Not disabled 1: Disabled

5162	[App. Switch Method] Determines whether the application screen is switched with a hardware switch or software switch.		
5-162-001	-	C	[0 or 1 / 0 / 1/step] 0: Soft Key Set 1: Hard Key Set

5167	[Fax Printing Mode at Optional Counter Off] Enables or disables the automatic print out without an accounting device. This SP is used when the receiving fax is accounted by an external accounting device.		
5-167-001	-	C	[0 or 1 / 0 / 1/step] 0: Automatic printing 1: No automatic printing

5169	[CE Login] If you will change the printer bit switches, you must "log in" to service mode with this SP before you go into the printer SP mode.		
5-169-001	-	C*	[0 or 1 / 0 / 1/step] 0: Disabled 1: Enabled

5188	[Copy Nv Version] Displays the version number of the NVRAM on the controller board.		
5-188-001	-	C*	[- / - / -]

5191	[Mode Set] Shifts to the power save mode or not.		
5-191-001	Power Str Set	C*	[0 or 1 / 1 / 1/step] 0: OFF 1: ON

5195	[Limitless Sw] Sets limitless paper feed.		
5-195-001	-	C*	[0 or 1 / 0 / 1/step]

5302	[Set Time] Adjusts the RTC (real time clock) time setting for the local time zone. Examples: For Japan (+9 GMT), enter 540 (9 hours x 60 min.) JP: +540 (Tokyo) NA: -300 (New York) EU: + 60 (Paris) CH: +480 (Peking) TW: +480 (Taipei) AS: +480 (Hong Kong) KO: +540 (Korea)		
5-302-002	Time Difference	C*	[-1440 to 1440 / -300 / 1min./step]

5305	[Auto Off Set] Auto Off Limit Set		
5-305-101	Auto Off Limit Set	C*	[0 or 1 / 0 / 1/step]

5307	[Daylight Saving Time]		
5-307-101	Setting	C*	<p>[0 or 1 / 1 / 1/step]</p> <p>0: Disabled</p> <p>1: Enabled</p> <p>(Default)</p> <p>1: NA and EUR</p> <p>0: ASIA and others</p> <p>Enables or disables the summer time mode.</p> <p>Note</p> <ul style="list-style-type: none"> Make sure that both SP5-307-3 and -4 are correctly set. Otherwise, this SP is not activated even if this SP is set to "1".

5-307-003	Rule Set(Start)	<p data-bbox="818 215 1031 248">[- / 3200210h / -]</p> <p data-bbox="818 264 1222 342">Specifies the start setting for the summer time mode.</p> <p data-bbox="818 358 1294 584">There are 8 digits in this SP. For months 1 to 9, the "0" cannot be input in the first digit, so the eight-digit setting for -2 or -3 becomes a seven-digit setting.</p> <p data-bbox="818 600 1310 633">1st and 2nd digits: The month. [1 to 12]</p> <p data-bbox="818 649 1294 728">3rd digit: The week of the month. [1 to 5]</p> <p data-bbox="818 743 1310 822">4th digit: The day of the week. [0 to 6 = Sunday to Saturday]</p> <p data-bbox="818 837 1294 871">5th and 6th digits: The hour. [00 to 23]</p> <p data-bbox="818 887 1278 965">7th digit: The length of the advanced time. [0 to 9 / 1 hour /step]</p> <p data-bbox="818 981 1278 1059">8th digit: The length of the advanced time. [0 to 5 / 10 minutes /step]</p> <ul data-bbox="818 1075 1310 1249" style="list-style-type: none"> <li data-bbox="818 1075 1310 1153">▪ The digits are counted from the left. <li data-bbox="818 1169 1310 1249">▪ Make sure that SP5-307-1 is set to "1". <p data-bbox="818 1317 1262 1350">For example: 3500010 (EU default)</p> <p data-bbox="818 1366 1302 1444">The timer is advanced by 1 hour at am 0:00 on the 5th Sunday in March</p>
-----------	-----------------	--

5-307-004	Rule Set(End)	C*	<p>[- / 11100200h / -]</p> <p>Specifies the end setting for the summer time mode.</p> <p>There are 8 digits in this SP.</p> <p>1st and 2nd digits: The month. [1 to 12]</p> <p>3rd digit: The week of the month. [0 to 5]</p> <p>4th digit: The day of the week. [0 to 7 = Sunday to Saturday]</p> <p>5th and 6th digits: The hour. [00 to 23]</p> <p>The 7th and 8 digits must be set to "00".</p> <ul style="list-style-type: none"> ▪ The digits are counted from the left. ▪ Make sure that SP5-307-1 is set to "1".
-----------	---------------	----	---

5401	[Access Control] DFU		
5-401-103	Default Document ACL	C*	[- / 0 / -]
5-401-104	Authentication Time	C*	
5-401-162	Extend Certification Detail	C*	
5-401-200	SDK1 UniqueID	C*	
5-401-201	SDK1 Certification Method	C*	
5-401-210	SDK2 UniqueID	C*	[- / 0 / -]
5-401-211	SDK2 Certification Method	C*	
5-401-220	SDK3 UniqueID	C*	
5-401-221	SDK3 Certification Method	C*	
5-401-230	SDK Certification Device	C*	
5-401-240	Detail Option	C*	

5402	[Accsss Control]		
	bit0: SDKJ Authentication		
	-0: Panel Type		
	-1: Remote Type		
	bit1: Using user code setup		
	-0: OFF, 1: ON		
	bit2: Using key-counter setup		
	-0: OFF, 1: ON		
	bit3: Using external billing device setup		
	-0: OFF, 1: ON		
	bit4: Using extended external billing device setup		
	-0: OFF, 1: ON		
	bit5~6: Not used		
	bit7: Using extended function J limit users		
	-0: OFF, 1: ON		
5-402-101	SDKJ1 Limit Setting	C*	[- / 0x00 / 0x01/step]
5-402-102	SDKJ2 Limit Setting	C*	
5-402-103	SDKJ3 Limit Setting	C*	
5-402-104	SDKJ4 Limit Setting	C*	
5-402-105	SDKJ5 Limit Setting	C*	
5-402-106	SDKJ6 Limit Setting	C*	
5-402-107	SDKJ7 Limit Setting	C*	
5-402-108	SDKJ8 Limit Setting	C*	
5-402-109	SDKJ9 Limit Setting	C*	
5-402-110	SDKJ10 Limit Setting	C*	
5-402-111	SDKJ11 Limit Setting	C*	[- / 0x00 / 0x01/step]
5-402-112	SDKJ12 Limit Setting	C*	
5-402-113	SDKJ13 Limit Setting	C*	
5-402-114	SDKJ14 Limit Setting	C*	
5-402-115	SDKJ15 Limit Setting	C*	

Main SP Tables-5

5-402-116	SDKJ16 Limit Setting	C*	
5-402-117	SDKJ17 Limit Setting	C*	
5-402-118	SDKJ18 Limit Setting	C*	
5-402-119	SDKJ19 Limit Setting	C*	
5-402-120	SDKJ20 Limit Setting	C*	
5-402-121	SDKJ21 Limit Setting	C*	
5-402-122	SDKJ22 Limit Setting	C*	[- / 0x00 / 0x01/step]
5-402-123	SDKJ23 Limit Setting	C*	
5-402-124	SDKJ24 Limit Setting	C*	
5-402-125	SDKJ25 Limit Setting	C*	
5-402-126	SDKJ26 Limit Setting	C*	
5-402-127	SDKJ27 Limit Setting	C*	
5-402-128	SDKJ28 Limit Setting	C*	
5-402-129	SDKJ29 Limit Setting	C*	
5-402-130	SDKJ30 Limit Setting	C*	

5402	[Accsss Control] Sets limited uses for SDKJ application data.		
5-402-141	SDKJ1ProductID	C*	[0 to 0xffffffff / 0 / 1/step]
5-402-142	SDKJ2 ProductID	C*	
5-402-143	SDKJ3 ProductID	C*	
5-402-144	SDKJ4 ProductID	C*	
5-402-145	SDKJ5 ProductID	C*	
5-402-146	SDKJ6 ProductID	C*	
5-402-147	SDKJ7 ProductID	C*	
5-402-148	SDKJ8 ProductID	C*	

5-402-149	SDKJ9 ProductID	C*	
5-402-150	SDKJ10 ProductID	C*	[0 to 0xffffffff / 0 / 1/step]
5-402-151	SDKJ11 ProductID	C*	
5-402-152	SDKJ12 ProductID	C*	
5-402-153	SDKJ13 ProductID	C*	
5-402-154	SDKJ14 ProductID	C*	
5-402-155	SDKJ15 ProductID	C*	
5-402-156	SDKJ16 ProductID	C*	
5-402-157	SDKJ17 ProductID	C*	
5-402-158	SDKJ18 ProductID	C*	
5-402-159	SDKJ19 ProductID	C*	
5-402-160	SDKJ20 ProductID	C*	
5-402-161	SDKJ21 ProductID	C*	
5-402-162	SDKJ22 ProductID	C*	
5-402-163	SDKJ23 ProductID	C*	
5-402-164	SDKJ24 ProductID	C*	
5-402-165	SDKJ25 ProductID	C*	
5-402-166	SDKJ26 ProductID	C*	
5-402-167	SDKJ27 ProductID	C*	
5-402-168	SDKJ28 ProductID	C*	
5-402-169	SDKJ29 ProductID	C*	
5-402-170	SDKJ30 ProductID	C*	

5404	[User Code Count Clear] Clears the counts for the user codes assigned by the key operator to restrict the use of the machine. Press [Execute] to clear.		
5-404-001	-	C*	[- / - / -] [Execute]

5411	[LDAP-Certification]		
5-411-004	Simplified Authentication	C*	[0 or 1 / 1 / 1/step] 0: OFF 1: ON Determines whether easy LDAP certification is done.
5-411-005	Password Null Not Permit	C*	[0 or 1 / 1 / 1/step] 0: Password NULL permitted. 1: Password NULL not permitted. This SP is referenced only when SP5411-4 is set to "1" (On).
5-411-006	Detail Option	C*	[- / 00000000 / 0x01/step] Determines whether LDAP option (anonymous certification) is turned on or off.

5412	[Krb-Certification] Sets the level of Kerberos Certification.		
5-412-100	Encrypt Mode	C*	[- / 11111111 / 1/step] 0x01:AES256-CTS-HMAC-SHA1-96 0x02:AES128-CTS-HMAC-SHA1-96 0x04:DES3-CBC-SHA1 0x08:RC4-HMAC 0x10:DES-CBC-MD5 0xFF(0x1F):ALL

5413	[Lockout Setting] Sets the lockout setting for local address book.		
5-413-001	Lockout On/Off	C*	[0 or 1 / 0 / 1/step] 0: OFF 1: ON Switches on/off the lock on the local address book account.
5-413-002	Lockout Threshold	C*	[1 to 10 / 5 / 1time/step] Sets a limit on the frequency of lockouts for account lockouts.
5-413-003	Cancellation On/Off	C*	[0 or 1 / 0 / 1/step] 0: OFF (lockout not cancelled) 1: ON (system waits, cancels lockout if correct user ID and password are entered) Determines whether the system waits the prescribed.
5-413-004	Cancelation Time	C*	[1 to 9999 / 60 / 1min./step] Determines the length of time that the system waits for correct input of the user ID and password after a lockout has occurred. This setting is used only if SP5413-3 is set to "1" (on).

5414	[Access Mitigation]		
5-414-001	Mitigation On/Off	C*	[0 or 1 / 0 / 1/step] 0: OFF 1: ON Switches on/off masking of continuously used IDs and passwords that are identical.
5-414-002	Mitigation Time	C*	[0 to 60 / 15 / 1min./step] Sets the length of time for excluding continuous access for identical user IDs and passwords.

5415		[Password Attack]	
5-415-001	Permissible Number	C*	[0 to 100 / 30 / 1 time/step] Sets the number of attempts to attack the system with random passwords to gain illegal access to the system.
5-415-002	Detect Time	C*	[1 to 10 / 5 / 1sec/step] Sets the time limit to stop a password attack once such an attack has been detected.

5416		[Access Information]	
5-416-001	Access User Max Num	C*	[50 to 200 / 200 / 1 users/step] Limits the number of users used by the access exclusion and password attack detection functions.
5-416-002	Access Password Max Num	C*	[50 to 200 / 200 / 1 users/step] Limits the number of passwords used by the access exclusion and password attack detection functions.
5-416-003	Monitor Interval	C*	[1 to 10 / 3 / 1 sec/step] Sets the processing time interval for referencing user ID and password information.

5417		[Access Attack]	
5-417-001	Access Permissible Number	C*	[0 to 500 / 100 / 1time/step] Sets a limit on access attempts when an excessive number of attempts are detected for MFP features.
5-417-002	Attack Detect Time	C*	[10 to 30 / 10 / 1sec/step] Sets the length of time for monitoring the frequency of access to MFP features.

5-417-003	Productivity Fall Waite	C*	[0 to 9 / 3 / 1sec/step] Sets the wait time to slow down the speed of certification when an excessive number of access attempts have been detected.
5-417-004	Attack Max Num	C*	[50 to 200 / 200 / 1/step] Sets a limit on the number of requests received for certification in order to slow down the certification speed when an excessive number of access attempts have been detected.

5420	<p>[User Authentication]</p> <p>These settings should be done with the System Administrator.</p> <p> Note</p> <ul style="list-style-type: none"> These functions are enabled only after the user access feature has been enabled. 		
5-420-001	Copy	C*	[0 or 1 / 0 / 1/step] 0: Authentication ON 1: Authentication OFF Determines whether certification is required before a user can use the copy applications.
5-420-011	DocumentServer	C*	[0 or 1 / 0 / 1/step] 0: Authentication ON 1: Authentication OFF Determines whether certification is required before a user can use the document server.
5-420-021	Fax	C*	[0 or 1 / 0 / 1/step] 0: Authentication ON 1: Authentication OFF Determines whether certification is required before a user can use the fax application.

5-420-031	Scanner	C*	[0 or 1 / 0 / 1/step] 0: Authentication ON 1: Authentication OFF Determines whether certification is required before a user can use the scanner applications.
5-420-041	Printer	C*	[0 or 1 / 0 / 1/step] 0: Authentication ON 1: Authentication OFF Determines whether certification is required before a user can use the printer applications.
5-420-051	SDK1	C*	[0 or 1 / 0 / 1/step] 0: Authentication ON 1: Authentication OFF Determines whether certification is required before a user can use the SDK application.
5-420-061	SDK2	C*	
5-420-071	SDK3	C*	
5-420-081	Browser	C*	[0 or 1 / 0 / 1/step] 0: Authentication ON 1: Authentication OFF Determines whether certification is required before a user can use the Browser application.

5430	[Auth Dialog Message Change] Displays the Authentication dialog message or not.		
5-430-001	Message Chande On/Off	C*	[0 or 1 / 0 / 1/step] Turns on or off the displayed message change for the authentication.
5-430-002	Message Text Download	C*	[- / - / -] [Execute] Executes the message download for the authentication.

5-430-003	Message Text ID	C*	[characters(max.16Byte) / \0 /-] Inputs message text for the authentication.
-----------	-----------------	----	---

5431	[External Auth User Preset]		
5-431-010	Tag	C*	[0 or 1 / 1 / 1/step] Turns on or off the tag copy permission for the external authentication. 0: Not permit, 1: Permit
5-431-011	Entry	C*	[0 or 1 / 1 / 1/step] Turns on or off the copy permission of the entry information for the external authentication. 0: Not permit, 1: Permit
5-431-012	Group	C*	[0 or 1 / 1 / 1/step] Turns on or off the copy permission of the group information for the external authentication. 0: Not permit, 1: Permit
5-431-020	Mail	C*	[0 or 1 / 1 / 1/step] Turns on or off the copy permission of the mail information for the external authentication. 0: Not permit, 1: Permit
5-431-030	Fax	C*	[0 or 1 / 1 / 1/step] Turns on or off the copy permission of the fax information for the external authentication. 0: Not permit, 1: Permit
5-431-031	FaxSub	C*	[0 or 1 / 1 / 1/step] Turns on or off the copy permission of the fax additional information for the external authentication. 0: Not permit, 1: Permit

5-431-032	Folder	C*	[0 or 1 / 1 / 1/step] Turns on or off the copy permission of the folder information for the external authentication. 0: Not permit, 1: Permit
5-431-033	ProtectCode	C*	[0 or 1 / 1 / 1/step] Turns on or off the copy permission of the protection code information for the external authentication. 0: Not permit, 1: Permit
5-431-034	SmtplAuth	C*	[0 or 1 / 1 / 1/step] Turns on or off the copy permission of the SMTP information for the external authentication. 0: Not permit, 1: Permit
5-431-035	LdapAuth	C*	[0 or 1 / 1 / 1/step] Turns on or off the copy permission of the LDAP information for the external authentication. 0: Not permit, 1: Permit
5-431-036	Smb Ftp Fldr Auth	C*	[0 or 1 / 1 / 1/step] Turns on or off the copy permission of the SMB/FTP information for the external authentication. 0: Not permit, 1: Permit
5-431-037	AcntAcl	C*	[0 or 1 / 1 / 1/step] Turns on or off the copy permission of the account ACL information for the external authentication. 0: Not permit, 1: Permit
5-431-038	DocumentAcl	C*	[0 or 1 / 1 / 1/step] Turns on or off the copy permission of the document ACL information for the external authentication. 0: Not permit, 1: Permit

5-431-040	CertCrypt	C*	[0 or 1 / 0 / 1/step] Turns on or off the copy permission of the authentication information for the external authentication. 0: Not permit, 1: Permit
5-431-050	UserLimitCount	C*	[0 or 1 / 1 / 1/step] Turns on or off the copy permission of the maximum number information for the external authentication. 0: Not permit, 1: Permit

5481	[Authentication Error Code] Determines how the authentication failures are displayed.		
5-481-001	System Log Disp	C*	[0 or 1 / 0 / 1/step] 0: Display OFF 1: Display ON Determines whether an error code appears in the system log after a user authentication failure occurs.
5-481-002	Panel Disp	C*	[0 or 1 / 1 / 1/step] 0: Display OFF 1: Display ON Determines whether an error code appears on the operation panel after a user authentication failure occurs.

5490	[MF KeyCard] Sets up operation of the machine with a keycard.		
5-490-001	Job Permit Setting	C*	[0 or 1 / 0 / 1/step] 0: Disabled. Cancels operation if no code is input. 1: Enabled. Allows operation if another code is input and decrements the counter once for use of the entered code.

5491		[Optional Counter]	
5-491-001	Detail Option	C*	<p>[0 or 1 / 00000000 / 1/step]</p> <p>Determines whether to cancel the job when MK1 keycard is pulled out from the machine during job.</p> <p>bit0: Forced Job Canceling</p> <p>0: On. Cancels the job.</p> <p>1: Off. Allows operation if MK1 keycard is pulled out from the machine during the job.</p>

5501		[PM Alarm]	
5-501-001	PM Alarm Level	C*	<p>[0 to 9999 / 0 / 1/step]</p> <p>0: Alarm off</p> <p>1 to 9999: Alarm goes off when Value (1 to 9999) x 1000 > PM counter</p>
5-501-002	Original Count Alarm	C*	<p>[0 or 1 / 0 / 1/step]</p> <p>0: No alarm sounds</p> <p>1: Alarm sounds after the number of originals passing through the ADF > 10,000</p>

5504		[Jam Alarm]	
5-504-001	-	C*	<p>[0 to 3 / 3 / 1/step]</p> <p>0: Zero (Off)</p> <p>1: Low (2.5K jams)</p> <p>2: Medium (3K jams)</p> <p>3: High (6K jams)</p> <p>Sets the alarm to sound for the specified jam level (document misfeeds are not included).</p>

5505	[Error Alarm]		
	Sets the error alarm level. The error alarm counter counts "1" when any SC is detected. However, the error alarm counter decreases by "1" when an SC is not detected during a set number of copied sheets (for example, default 700 sheets). The error alarm occurs when the SC error alarm counter reaches "5".		
5-505-001	-	C*	[0 to 255 / 15 / 1hundred/step] 0: Alarm Off

5507	[Supply/CC Alarm]		
	Enables or disables the notifying a supply call via the @Remote.		
	5-507-001	Paper Supply Alarm	C* [0 or 1 / 0 / 1/step] Switches the control call on/off for the paper supply. DFU 0: No alarm 1: Sets the alarm to sound for the specified number transfer sheets for each paper size (A3, A4, B4, B5, DLT, LG, LT, HLT)
	5-507-003	Toner Supply Alarm	C* [0 or 1 / 1 / 1/step] Switches the control call on/off for the stapler installed in the finisher. DFU If you select "1" the alarm will sound when the copier detects toner end. 0: Off 1: On
	5-507-004	MaintenanceKIt	C* [0 or 1 / 1 / 1/step] 0: OFF 1: ON
	5-507-005	DrumLifeRemain	C* [0 or 1 / 1 / 1/step] 0: OFF 1: ON
	5-507-006	Toner Collection Bottle Alarm	C* [0 or 1 / 1 / 1/step] 0: OFF 1: ON

5-507-080	Toner Call Timing	C*	[0 or 1 / 0 / 1/step] 0: At replacement 1: AtLessThanThresh Changes the timing of the "Toner Supply Call" via the @Remote, when the following conditions occur.
5-507-081	Toner Call Threshold	C*	[10 or 90 / 10 / 10%/step]
5-507-128	Interval: Others	C*	[250 to 10000 / 1000 / 1page/step] The "Paper Supply Call Level: nn" SPs specify the paper control call interval for the referenced paper sizes. DFU
5-507-133	Interval: A4	C*	
5-507-134	Interval: A5	C*	
5-507-142	Interval: B5	C*	
5-507-164	Interval: LG	C*	
5-507-166	Interval: LT	C*	
5-507-172	Interval: HLT	C*	

5508	[CC Call]		
5-508-001	Jam Remains	C*	[0 or 1 / 1 / 1/step]
5-508-002	Continuous Jams	C*	0: Disable 1: Enable
5-508-003	Continuous Door Open	C*	Enables/disables initiating a call.
5-508-011	Jam Detection: Time Length	C*	[3 to 30 / 10 / 1min./step] Sets the length of time to determine paper jams required to initiate a call.
5-508-012	Jam Detection: Continuous Count	C*	[2 to 10 / 5 / 1time/step] Sets the number of continuous paper jams required to initiate a call.
5-508-013	Door Open: Time Length	C*	[3 to 30 / 10 / 1min./step] Sets the length of time the door remains open before the machine initiates a call.

5515	[SC/Alarm Setting] With NRS (New Remote Service) in use, these SP codes can be set to issue an SC call when an SC error occurs. If this SP is switched off, the SC call is not issued when an SC error occurs.		
5-515-001	SC Call	C*	[0 or 1 / 1 / 1/step] 0: OFF 1: ON
5-515-002	Service Parts Near End Call	C*	
5-515-003	Service Parts End Call	C*	
5-515-004	User Call	C*	
5-515-006	Communication Test Call	C*	
5-515-007	Machine Information Notice	C*	
5-515-008	Alarm Notice	C*	
5-515-009	Non Genuine Tonner Ararm	C*	
5-515-010	Supply Automatic Ordering Call	C*	
5-515-011	Supply Management Report Call	C*	
5-515-012	Jam/Door Open Call	C*	

5516	[Individual PM Part Alarm Call] With @Remote in use, these SP codes can be set to issue a PM alarm call when one of SP parts reaches its yield.		
5-516-001	Disable/Enable Setting (0:Not Send,1:Send)	C*	[0 or 1 / 1 / 1/step] 0: Not send 1: Send
5-516-004	Percent yield for triggering PM alert	C*	[1 to 255 / 75 / 1%/step]

5517	[Get Machine Information] When SMC info collect is interrupt, retries during the time between receiving Request for obtaining SMC info, to value set with this setting.		
-------------	---	--	--

5-517-031	Get SMC Info: Retry Interval	C*	[10 to 255 / 10 / 1min/step]
-----------	------------------------------	----	-------------------------------------

5611	[Toner Color in 2C]		
5-611-001	B-C	E*	[0 to 128 / 100 / 1/step]
5-611-002	B-M	E*	
5-611-003	G-C	E*	
5-611-004	G-Y	E*	
5-611-005	R-M	E*	
5-611-006	R-Y	E*	

5730	[Extended Function Setting]		
5-730-010	Expiration Prior Alarm Set	C*	[0 to 999 / 20 / 1day/step]

5731	[Counter Effect] Converts the paper count to the combine count for MK-1 counter.		
5-731-001	Change MK1 Cnt (Paper->Combine)	C*	[0 or 1 / 0 / 1/step]

5734	[PDF Setting]		
5-734-001	PDF/A Fixed	C*	[0 or 1 / 0 / 1/step] 0: All PDF categories 1: PDF/A only

5741	[Node Authentication Timeout]		
5-741-001	-	C*	[- / - / -]

5745	[DeemedPowerConsumption] Displays the deemed power consumption of each condition.		
5-745-211	Contoroller Standby	C*	[0 to 9999 / 0 / 1/step]

5-745-212	STR	C*	
5-745-213	Main Power Off	C*	
5-745-214	Scanning and Printing	C*	
5-745-215	Printing	C*	
5-745-216	Scanning	C*	
5-745-217	Engine Standby	C*	
5-745-218	Low Power Consumption	C*	
5-745-219	Silent condition	C*	
5-745-220	Heater Off	C*	

5747	[Browser Setting]		
5-747-201	JPEG Quality	C*	[- / - / -]
5-747-203	Extended Memory Limit	C*	
5-747-204	Vertical Scroll Display Setting	C*	
5-747-206	Browser Setting 3	C*	
5-747-207	Browser Setting 4	C*	
5-747-208	Browser Setting 5	C*	[- / - / -]
5-747-209	Browser Setting 6	C*	
5-747-210	Browser Setting 7	C*	
5-747-211	Browser Setting 8	C*	
5-747-212	Browser Setting 9	C*	
5-747-213	Browser Setting 10	C*	

5749	[Import/Export] Imports and exports preference information.		
5-749-001	Export	C*	[- / - / -]
5-749-101	Import	C*	[Execute]

5751	[Key Event Encryption Setting] Specifies the key to encrypt the key information.		
5-751-001	Password	C*	[Letters (Up to 31) / NULL / -]

5752	[Copy FlairAPI Setting] CopyFlairAPI Function enable / disable.			
5-752-001	0x00 – 0xff	C*	* see BitSwitch below	
bit	Setting	meanings		Description
		0	1	
bit 0	Start of FlairAPI Server	Off (Do not Start)	On (Start)	Sets whether to start exclusive FlairAPI http server. If it is 0, scanning FlairAPI function and simple UI function will be disabled. The machine installed Android operating panel option, set "1", others set "0".
bit 1	Access permission of FlairAPI from outside of the machine	Disabled	Enabled	If it is "0", accessing is limited from the machine only, such as operating panel, SDK/J, MFP browsers etc... If it is "1", accessing is allowed from outside of FlairAPI such as PC, Remote UI, IT-Box etc...

bit 2	Switching IPv6 only / IPv4 (priority)	IPv6 only	IPv4 (priority)	If it is "0", limited to IPv6 accessing. If it is "1", use IPv4 if it is available, if not, use IPv6. In this case, it is not able to access from android operation panel when IPv4 is enabled.
bit 3	Reserved	-	-	-
bit 4	Simple UI Function	Disabled	Enabled	If it is "1", the machine can be used Scanner Simple UI. If it is "0", requesting URL of Simple UI returns "404 Not Found"
bit 5	Accessing permission of Simple UI from outside of the machine	Disabled	Enabled	If it is "0", accessing is limited from the machine only (operating panel and MFP browser). If it is "1", accessing is allowed from outside of Simple UI such as PC, mobile devices, and so on.
bit 6	Reserved	-	-	-
bit 7	Reserved	-	-	-

5755	[Display Setting] Sets the display for the administrator password.		
5-755-001	Disp Administrator Password Change Scrn	C	[- / - / -] [Execute] Displays the password setting screen for the supervisor and administrator 1 in the startup after the execution.

5-755-002	Hide Administrator Password Change Scrn	C	[- / - / -] [Execute] Hides the input screen of the administrator password temporarily after the execution.
-----------	---	---	---

5801	[Memory Clear]		
5-801-001	All Clear	C	[- / - / -] [Execute] Initializes items 002 to 027. Take a memo of the settings prior to execute this SP
5-801-002	Engine	E	[0 or 1 / 0 / 1/step] Initializes all registration settings for the engine and copy process settings.
5-801-003	SCS	C	[- / - / -] [Execute] Initializes default system settings, SCS (System Control Service) settings, operation display coordinates, and ROM update information.
5-801-004	IMH Memory Clr	C	[- / - / -] [Execute]
5-801-005	MCS	C	[- / - / -] [Execute] Initializes the Mcs settings.
5-801-006	Copier Application	C	[- / - / -] [Execute] Initializes all copier application settings.
5-801-007	FAX Application	C	[- / - / -] [Execute] Initializes the fax reset time, job login ID, all TX/RX settings, local storage file numbers, and off-hook timer.

5-801-008	Printer Application	C	<p>[- / - / -] [Execute]</p> <p>The following service settings:</p> <ul style="list-style-type: none"> ▪ Bit switches ▪ Gamma settings (User & Service) ▪ Toner Limit <p>The following user settings:</p> <ul style="list-style-type: none"> ▪ Tray Priority ▪ Menu Protect ▪ System Setting except for setting of Energy Saver ▪ I/F Setup (I/O Buffer and I/O Timeout) ▪ PCL Menu
5-801-009	Scanner Application	C	<p>[- / - / -] [Execute]</p> <p>Initializes the scanner defaults for the scanner and all the scanner SP modes.</p>
5-801-010	Web Service	C	<p>[- / - / -] [Execute]</p> <p>Deletes the network file application management files and thumbnails, and initializes the job login ID.</p>
5-801-011	NCS	C	<p>[- / - / -] [Execute]</p> <p>All setting of Network Setup (User Menu) (NCS: Network Control Service)</p>
5-801-012	R-Fax	C	<p>[- / - / -] [Execute]</p> <p>Initializes the R-FAX settings.</p>
5-801-014	Clear DCS Setting	C	<p>[- / - / -] [Execute]</p> <p>Initializes the DCS (Delivery Control Service) settings.</p>

5-801-015	Clear UCS Setting	C	[- / - / -] [Execute] Initializes the UCS (User Information Control Service) settings.
5-801-016	MIRS Setting	C	[- / - / -] [Execute] Initializes the MIRS (Machine Information Report Service) settings.
5-801-017	CCS	C	[- / - / -] [Execute] Initializes the CCS (Certification and Charge-control Service) settings.
5-801-018	SRM Memory Clr	C	[- / - / -] [Execute] Initializes the SRM (System Resource Manager) settings.
5-801-019	LCS	C	[- / - / -] [Execute] Initializes the LCS settings.
5-801-020	WebUapli	C	[- / - / -] [Execute] Initializes the Web user application settings.
5-801-021	ECS	C	[- / - / -] [Execute] Initializes the ECS settings.
5-801-023	AICS	C	[- / - / -] Initializes the AICS settings.
5-801-024	BROWSER	C	[- / - / -] Initializes the Browser settings.
5-801-025	Websys	C	[- / - / -] [Execute]
5-801-026	PLN	C	
5-801-027	SAS	C	

5803	[INPUT Check] See "page 3-212"		
5804	[OUTPUT Check] See "page 3-214"		
5810	[SC Reset] Cancel SC of the CE cancellation.		
5-810-001	Fusing SC Reset	E	[0 or 1 / 0 / 1/step] [Execute]
5811	[MachineSerial]		
5-811-002	Display	E*	[0 to 255 / 0 / 1/step] Displays the machine serial number.
5-811-004	BCU	E	[0 to 255 / 0 / 1/step] Inputs the serial number.
5812	[Service Tel. No. Setting]		
5-812-001	Service	C*	[up to 20 / - / 1/step] Sets the telephone number for a service representative. This number is printed on the Counter List, which can be printed with the user's "Counter" menu. This can be up to 20 characters (both numbers and alphabetic characters can be input).

5-812-002	Facsimile	C*	[up to 20 / - / 1/step] Sets the fax or telephone number for a service representative. This number is printed on the Counter List. This can be up to 20 characters (both numbers and alphabetic characters can be input).
5-812-003	Supply	C*	[up to 20 / - / 1/step] Use this to input the telephone number of your supplier for consumables. Enter the number and press #.
5-812-004	Operation	C*	[up to 20 / - / 1/step] Use this to input the telephone number of your sales agency. Enter the number and press #.
5-812-101	Disp Inquiry	C*	[0 or 1 / 0 / 1/step]

5816	[Remote Service]		
5-816-001	I/F Setting	C*	[0 to 2 / 2 / 1/step] 0: Remote service off 1: CSS remote service on 2: NRS remote service on Selects the remote service setting.
5-816-002	CE Call	C*	[0 or 1 / 0 / 1/step] 0: Start of the service 1: End of the service Performs the CE Call at the start or end of the service. Note: This SP is activated only when SP5816-001 is set to "1".

5-816-003	Function Flag	C*	<p>[0 or 1 / 0 / 1/step]</p> <p>0: Disabled 1: Enabled</p> <p>Enables or disables the remote service function.</p> <p>NOTE: This SP setting is changed to "1" after @Remote register has been completed.</p>
5-816-007	SSL Disable	C*	<p>[0 or 1 / 0 / 1/step]</p> <p>0: No. SSL used. 1: Yes. SSL not used.</p> <p>Controls if RCG (Remote Communication Gate) confirmation is done by SSL during an RCG send for the @Remote over a network interface.</p>
5-816-008	RCG Connect Timeout	C*	<p>[1 to 90 / 30 / 1second/step]</p> <p>Sets the length of time (seconds) for the time-out when the RCG (Remote Communication Gate) connects during a call via the @Remote network.</p>
5-816-009	RCG Write Timeout	C*	<p>[0 to 100 / 60 / 1second/step]</p> <p>Sets the length of time (seconds) for the time-out when sent data is written to the RCG during a call over the @Remote network.</p>
5-816-010	RCG Read Timeout	C*	<p>[0 to 100 / 60 / 1second/step]</p> <p>Sets the length of time (seconds) for the timeout when sent data is written from the RCG during a call over the @Remote network.</p>
5-816-011	Port 80 Enable	C*	<p>[0 or 1 / 0 / 1/step]</p> <p>0: No. Access denied 1: Yes. Access granted</p> <p>Controls if permission is given to get access to the SOAP method over Port 80 on the @Remote network.</p>

5-816-013	RFU Timing	C*	[0 or 1 / 1 / 1/step] 0: RFU is executed whenever update request is received. 1: RFU is executed only when the machine is in the sleep mode. Selects the timing for the remote firmware updating.
5-816-014	RCG Error Cause	C*	[0 or 1 / 0 / 1/step] 0: Initial state, normal condition 1: Error Displays RCG connection error. cause
5-816-021	RCG-C Registered	C*	[0 or 1 / 0 / 1/step] 0: Initial state, normal condition 1: Error Displays the Embedded RC Gate installation end flag.
5-816-023	Connect Type(N/M)	C*	[0 or 1 / 0 / 1/step] 0: Initial state, normal condition 1: Error Displays/selects the Embedded RC Gate connection method.
5-816-061	Cert Expire Timing	C*	[- / 0 / -] Proximity of the expiration of the certification.
5-816-062	Use Proxy	C*	[- / - / -] Determines if the proxy server is used when the machine communicates with the service center.

5-816-063	Proxy Host	C*	<p>[up to 127 / - / 1/step]</p> <p>This SP sets the address of the proxy server used for communication between the RCG device and the gateway. Use this SP to set up or display the customer proxy server address.</p> <p>The address is necessary to set up the embedded RCG-N.</p> <p>Note</p> <ul style="list-style-type: none"> The address display is limited to 128 characters. Characters beyond the 128 character are ignored. This address is customer information and is not printed in the SMC report.
5-816-064	Proxy PortNumber	C*	<p>[0 to 0xffff / 0 / 1/step]</p> <p>This SP sets the port number of the proxy server used for communication between the embedded RCG-N and the gateway. This setting is necessary to set up the embedded RC Gate-N.</p> <p>Note</p> <ul style="list-style-type: none"> This port number is customer information and is not printed in the SMC report.
5-816-065	Proxy User Name	C*	<p>[up to 31 / - / 1/step]</p> <p>This SP sets the HTTP proxy certification user name.</p> <p>Note</p> <ul style="list-style-type: none"> The length of the name is limited to 31 characters. Any character beyond the 31st character is ignored. This name is customer information and is not printed in the SMC report.

5-816-066	Proxy Password	C*	<p>[up to 31 / - / 1/step]</p> <p>This SP sets the HTTP proxy certification password.</p> <p> Note</p> <ul style="list-style-type: none"> ▪ The length of the password is limited to 31 characters. Any character beyond the 31st character is ignored. ▪ This name is customer information and is not printed in the SMC report.
5-816-067	CERT:Up State		<p>[- / - / -]</p> <p>Displays the status of the certification update.</p>
	0	The certification used by Embedded RC Gate is set correctly.	
	1	The certification request (setAuthKey) for update has been received from the GW URL and certification is presently being updated.	
	2	The certification update is completed and the GW URL is being notified of the successful update.	
	3	The certification update failed, and the GW URL is being notified of the failed update.	
	4	The period of the certification has expired and new request for an update is being sent to the GW URL.	
	11	A rescue update for certification has been issued and a rescue certification setting is in progress for the rescue GW connection.	
	12	The rescue certification setting is completed and the GW URL is being notified of the certification update request.	
	13	The notification of the request for certification update has completed successfully, and the system is waiting for the certification update request from the rescue GW URL.	
	14	The notification of the certification request has been received from the rescue GW controller, and the certification is being stored.	

	15	The certification has been stored, and the GW URL is being notified of the successful completion of this event.	
	16	The storing of the certification has failed, and the GW URL is being notified of the failure of this event.	
	17	The certification update request has been received from the GW URL, the GW URL was notified of the results of the update after it was completed, but a certification error has been received, and the rescue certification is being recorded.	
	18	The rescue certification of No. 17 has been recorded, and the GW URL is being notified of the failure of the certification update.	
5-816-068	CERT:Error	C*	[- / - / -] Displays a number code that describes the reason for the request for update of the certification.
	0	Normal. There is no request for certification update in progress.	
	1	Request for certification update in progress. The current certification has expired.	
	2	An SSL error notification has been issued. Issued after the certification has expired.	
	3	Notification of shift from a common authentication to an individual certification.	
	4	Notification of a common certification without ID2.	
	5	Notification that no certification was issued.	
	6	Notification that GW URL does not exist.	
5-816-069	CERT:Up ID	C*	[- / - / -] The ID of the request for certification.
5-816-083	Firm Up Status	C*	[- / - / -] Displays the status of the firmware update.

5-816-085	Firm Up User Check	C*	[- / - / -] Determines if the operator can confirm the previous version of the firmware before the firmware update execution. If the option to confirm the previous version is selected, a notification is sent to the system manager and the firmware update is done with the firmware files from the URL.
5-816-086	Firmware Size	C*	[- / - / -] Allows the service technician to confirm the size of the firmware data files during the firmware update execution.
5-816-087	CERT:Macro Ver.	C*	[- / - / -] Displays the macro version of the @Remote certification.
5-816-088	CERT:PAC Ver.	C*	[- / - / -] Displays the PAC version of the @Remote certification.
5-816-089	CERT:ID2Code	C*	[- / - / -] Displays ID2 for the @Remote certification. Spaces are displayed as underscores (_). Asterisks (*) indicate that no @Remote certification exists. "000000_____" indicates "Common certification".
5-816-090	CERT:Subject	C*	[- / - / -] Displays the common name of the @Remote certification subject. CN = the following 17 bytes. Spaces are displayed as underscores (_). Asterisks (*) indicate that no @Remote certification exists. "000000_____" indicates "Common certification".

5-816-091	CERT:SerialNo.	C*	[- / - / -] Displays serial number for the @Remote certification. Asterisks (*) indicate that no @Remote certification exists.
5-816-092	CERT:Issuer	C*	[- / - / -] Displays the common name of the issuer of the @Remote certification. CN = the following 30 bytes. Asterisks () indicate that no @Remote certification exists.
5-816-093	CERT:Valid Start	C*	[- / - / -] Displays the start time of the period for which the current @Remote certification is enabled.
5-816-094	CERT: Valid End	C*	[- / - / -] Displays the end time of the period for which the current @Remote certification is enabled.
5-816-102	CERT:Encrypt Level	C*	[- / 1 / -] Displays cryptic strength of the NRS certification.
5-816-200	Manual Polling	C*	[- / - / -] [Execute] Executes the center polling manually.

5-816-201	Regist Status	C*	<p>[0 to 4 / 0 / 1/step]</p> <p>Displays a number that indicates the status of the @Remote service device.</p> <p>0: Neither the @Remote device nor Embedded RCG Gate is set.</p> <p>1: The Embedded RCG Gate is being set. Only Box registration is completed. In this status, @Remote device cannot communicate with this device.</p> <p>2: The Embedded RCG Gate is set. In this status, the @Remote device cannot communicate with this device.</p> <p>3: The @Remote device is being set. In this status the Embedded RCG Gate cannot be set.</p> <p>4: The @Remote module has not started.</p>
5-816-202	Letter Number	C*	<p>[- / - / -]</p> <p>Allows entry of the request number needed for the Embedded RCG Gate.</p>
5-816-203	Confirm Execute	C*	<p>[- / - / -]</p> <p>[Execute]</p> <p>Executes the confirmation request to the @Remote Gateway.</p>
5-816-204	Confirm Result	C*	<p>[0 to 255/ 0 / 1/step]</p> <p>Displays a number that indicates the result of the inquiry executed with SP5816-203.</p> <p>0: Succeeded</p> <p>1: Inquiry number error</p> <p>3: Proxy error (proxy enabled)</p> <p>4: Proxy error (proxy disabled)</p> <p>5: Proxy error (Illegal user name or password)</p> <p>6: Communication error</p> <p>8: Other error</p> <p>9: Inquiry executing</p>

5-816-205	Confirm Place	C*	[- / - / -] Displays the result of the notification sent to the device from the GW URL in answer to the inquiry request. Displayed only when the result is registered at the GW URL.
5-816-206	Register Execute	C*	[- / - / -] [Execute] Executes "Embedded RCG Registration".
5-816-207	Register Result	C*	[0 to 255 / 0 / 1/step] Displays a number that indicates the registration result. 0: Succeeded 1: Inquiry number error 2: Registration in progress 3: Proxy error (proxy enabled) 4: Proxy error (proxy disabled) 5: Proxy error (Illegal user name or password) 8: Other error 9: Registration executing
5-816-208	Error Code	C*	[-2147483647 to 2147483647 / -]
	Cause	Code	Meaning
	Illegal Modem Parameter	-11001	Chat parameter error
		-11002	Chat execution error
		-11003	Unexpected error
		-11004	Cutting process occurred during modem communication.
		-11005	NCS reboot occurred during modem communication.
	Operation Error,Incorrect Setting	-12002	Inquiry, registration attempted without acquiring device status.

		-12003	Attempted registration without execution of an inquiry and no previous registration.	
		-12004	Attempted setting with illegal entries for certification and ID2.	
		-12005	@Remote communication is prohibited. The device has an Embedded RC gate-related problem.	
		-12006	A confirmation request was made after the confirmation had been already completed.	
		-12007	The request number used at registration was different from the one used at confirmation.	
		-12008	Update certification failed because mainframe was in use.	
		-12009	D2 mismatch between an individual certification and NVRAM.	
		-12010	Certification area is not initialized.	
	Error Caused by Response from GW URL	-2385	Attempted dial up overseas without the correct international prefix for the telephone number.	
		-2387	Not supported at the Service Center	
		-2389	Database out of service	
		-2390	Program out of service	
		-2391	Two registrations for same device	
		-2392	Parameter error	
		-2393	Basil not managed	

		-2394	Device not managed	
		-2395	Box ID for Basil is illegal	
		-2396	Device ID for Basil is illegal	
		-2397	Incorrect ID2 format	
		-2398	Incorrect request number format	
5-816-209	Instl Clear	C	[- / - / -] [Execute] Releases the machine from its embedded RCG setup.	
5-816-240	CommErrorTime	C		
5-816-241	CommErrorCode 1	C	[- / - / -]	
5-816-242	CommErrorCode 2	C	[Execute]	
5-816-243	CommErrorCode 3	C		
5-816-244	CommErrorState 1	C		
5-816-245	CommErrorState 2	C	[- / - / -] [Execute]	
5-816-246	CommErrorState 3	C		
5-816-247	SSL Error Count	C		
5-816-248	Other Err Count	C	[- / 0 / -]	
5-816-250	CommLog Print	C	[- / - / -] [Execute]	

5821	[Remote Service Address]		
5-821-002	RCG IP Address	C*	[00000000h to FFFFFFFFh / 00000000h / 1/step] Sets the IP address of the RCG (Remote Communication Gate) destination for call processing at the remote service center.

5-821-003	RCG Port	C*	[0 to 65535/ 443 / 1/step] Sets the port number of the RCG (Remote Communication Gate) destination for call processing at the remote service center.
5-821-004	RCG URL Path	C*	[0 to 16 characters (half characters) Default /RCG/services/ -]

5824	[NV-RAM Data Upload]		
5-824-001	-	C*	[- / - / -] [Execute] Uploads the NVRAM data to an SD card. Push Execute. Note: When uploading data in this SP mode, the front door must be open.

5825	[NV-RAM Data Download] Downloads data from an SD card to the NVRAM in the machine. After downloading is completed, remove the card and turn the machine power off and on.		
5-825-001	-	C	[- / - / -] [Execute]

5828	[Network Setting] Job pool settings/ Interface selection for Ethernet and wireless LAN		
5-828-050	1284 Compatibility (Centro)	C*	[0 or 1 / 1 / 1/step] Enables or disables 1284 Compatibility. 0: Disabled, 1: Enabled
5-828-052	ECP (Centro)	C*	[0 or 1 / 1 / 1/step] Displays/sets the ECP. 0: not allowed 1: allowed The 1284 mode must be allowed when the ECP allowed.

5-828-065	Job Spooling		C*	[0 or 1 / 0 / 1 /step] Switches the job spooling on and off. 0: No spooling 1: Spooling enabled
5-828-066	Job Spooling Clear: Start Time		C*	[0 or 1 / 1 / 1/step] Determines whether the job interrupted at power off is resumed at the next power on. This SP operates only when SP5828-065 is set to "1". 0: ON 1: OFF
5-828-069	Job Spooling (Protocol)		C*	[0 or 1 / 1 / 1/step] Determines whether job spooling is enabled or disabled for each protocol. This is an 8-bit setting.
	0	LPR	4	BMLinks (Japan Only)
	1	FTP (Not Used)	5	DIPRINT
	2	IPP	6	Reserved (Not Used)
	3	SMB	7	Reserved (Not Used)

5-828-087	Protocol usage	C*	<p>[- / - / -]</p> <p>Shows which protocols have been used with the network.</p> <p>0: Off (Not used the network with the protocol.)</p> <p>1: On (Used the network with the protocol once or more.)</p> <p>bit0: IPsec, bit1: IPv6, bit2: IEEE 802.1X, bit3: Wireless LAN, bit4: Security mode level setting, bit5: Appletalk, bit6: DHCP, bit7: DHCPv6, bit8: telnet, bit9: SSL, bit10: HTTPS, bit11: BMLinkS printing, bit12: diprint printing, bit13: LPR printing, bit14: ftp printing, bit15: rsh printing, bit16: SMB printing, bit17: WSD-Printer, bit18: WSD-Scanner, bit19: Scan to SMB, bit20: Scan to NCP, bit21: Reserve, bit22: Bluetooth, bit23: IEEE 1284, bit24: USB printing, bit25: Dynamic DNS, bit26: Netware printing, bit27: LLTD, bit28: IPP printing, bit29: IPP printing (SSL), bit30: ssh, bit31: sftp</p>
5-828-090	TELNET(0:OFF 1:ON)	C*	<p>[0 or 1 / 1 / 1/step]</p> <p>Enables or disables the Telnet protocol.</p> <p>0: Disable, 1: Enable</p>
5-828-091	Web (0:OFF 1:ON)	C*	<p>[0 or 1 / 1 / 1/step]</p> <p>Enables or disables the Web operation.</p> <p>0: Disable, 1: Enable</p>

5-828-145	Active IPv6 Link Local Address	C*	[- / - / -] This is the IPv6 local address link referenced on the Ethernet or wireless LAN (802.11b) in the format: "Link Local Address" + "Prefix Length" The IPv6 address consists of a total 128 bits configured in 8 blocks of 16 bits each.
5-828-147	Active IPv6 Stateless Address 1	C*	[- / - / -] These SPs are the IPv6 status addresses (1 to 5) referenced on the Ethernet or wireless LAN (802.11b) in the format: "Status Address" + "Prefix Length" The IPv6 address consists of a total 128 bits configured in 8 blocks of 16 bits each.
5-828-149	Active IPv6 Stateless Address 2	C*	
5-828-151	Active IPv6 Stateless Address 3	C*	
5-828-153	Active IPv6 Stateless Address 4	C*	
5-828-155	Active IPv6 Stateless Address 5	C*	
5-828-156	IPv6 Manual Adress	C*	[- / - / -] This SP is the IPv6 manually set address referenced on the Ethernet or wireless LAN (802.11b) in the format: "Manual Set Address" + "Prefix Length" The IPv6 address consists of a total 128 bits configured in 8 blocks of 16 bits each.
5-828-158	IPv6 Gateway Adress	C*	[- / - / -] This SP is the IPv6 gateway address referenced on the Ethernet or wireless LAN (802.11b). The IPv6 address consists of a total 128 bits configured in 8 blocks of 16 bits each.

5-828-161	IPv6 Stateless Auto Setting	C*	[0 or 1 / 1 / 1 /step] Enables or disables the automatic setting for IPv6 stateless. 0: Disable, 1: Enable
5-828-236	Web Item visible	C*	[0x0000 to 0xffff / FFFh / 0x0001/step] Displays or does not display the Web system items. bit0: Net RICOH bit1: Consumable Supplier bit2-15: Reserved (all)
5-828-237	Web shopping link visible	C*	[0 or 1 / 1 / 1 /step] Displays or does not display the link to Net RICOH on the top page and link page of the web system. 0: Not display 1: Display
5-828-238	Web Supplies link visible	C*	[0 or 1 / 1 / 1 /step] Displays or does not display the link to Consumable Supplier on the top page and link page of the web system. 0: Not display 1: Display
5-828-239	Web Link1 Name	C*	[- / - / -] Confirms or changes the URL1 name on the link page of the web system. The maximum characters for the URL name are 31 characters.
5-828-240	Web Link1 URL	C*	[- / - / -] Confirms or changes the link to URL1 on the link page of the web system. The maximum characters for the URL are 127 characters.
5-828-241	Web Link1 visible	C*	[0 or 1 / 1 / 1/step] Displays or does not display the link to URL1 on the top page of the web system.

5-828-242	Web Link2 Name	C*	[- / - / -] Same as "-239"
5-828-243	Web Link2 URL	C*	[- / - / -] Same as "-240"
5-828-244	Web Link2 visible	C*	[- / 1 / -] Same as "-241"
5-828-249	DHCPv6 DUID	C*	[- / - / -] Sets DHCPv6 DUID.

5832	[HDD] Initializes the hard disk. Use this SP mode only if there is a hard disk error.		
5-832-001	HDD Formatting (ALL)	C	[- / - / -] [Execute]
5-832-002	HDD Formatting (IMH)	C	
5-832-003	HDD Formatting (Thumbnail)	C	
5-832-004	HDD Formatting (Job Log)	C	
5-832-005	HDD Formatting (Printer Fonts)	C	
5-832-006	HDD Formatting (User Info)	C	
5-832-007	Mail RX Data	C	[- / - / -] [Execute]
5-832-008	Mail TX Data	C	
5-832-009	HDD Formatting (Data for a Design)	C	
5-832-010	HDD Formatting (Log)	C	
5-832-011	HDD Formatting (Ridoc I/F)	C	

5836	[Capture Setting]		
5-836-001	Capture Function (0:Off 1:On)	C*	[0 or 1 / 0 / 1/step] 0: Disable, 1: Enable With this function disabled, the settings related to the capture feature cannot be initialized, displayed, or selected.
5-836-002	Panel Setting	C*	[0 or 1 / 0 / 1/step] 0: Displayed, 1: Not displayed Displays or does not display the capture function buttons.
5-836-072	Reduction for Copy B&W Text	C*	[0 to 6 / 0 / 1/step] 0: 1 1: 1/2 2: 1/3 3: 1/4 6: 2/3
5-836-073	Reduction for Copy B&W Other	C*	
5-836-075	Reduction for Printer B&W	C*	[0 to 6 / 0 / 1/step] 0: 1 1: 1/2 2: 1/3 3: 1/4 6: 2/3
5-836-082	Format for Copy B&W Text	C*	[0 to 3 / 1 / 1/step] This SP is available with MLB-equipped machines. 0: JFIF/JPEG 1: TIFF/MMR 2: TIFF/MH 3: TIFF/MR
5-836-083	Format for Copy B&W Other	C*	
5-836-085	Format for Printer B&W	C*	

5-836-091	Default for JPEG	C*	[5 to 95 / 50 / 1/step] Sets the JPEG format default for documents sent to the document management server with the MLB, with JPEG selected as the format. Enabled only when optional File Format Converter (MLB: Media Link Board) is installed.
5-836-092	High Quality for JPEG	C*	[5 to 95 / 60 / 1/step]
5-836-093	Low Quality for JPEG	C*	[5 to 95 / 40 / 1/step]
5-836-094	Default Format for Back Up Files	C*	[- / 0 / -]
5-836-095	Default Resolution for Back Up Files	C*	[- / 2 / -] 0: 1/1 1: 1/2 2: 1/3 3: 1/4
5-836-096	Default User Name for Back Up Files	C*	[- / - / -]
5-836-097	Default Compression for Back Up Files	C*	[- / 0 / -]
5-836-101	Primary srv IP adress	C*	[- / - / -] Sets the IP address for the primary capture server. This is basically adjusted by the remote system.
5-836-102	Primary srv Scheme	C*	[- / - / -] This is basically adjusted by the remote system.
5-836-103	Primary srv port number	C*	[- / 80 / -] This is basically adjusted by the remote system.

5-836-104	Primary srv URL path	C*	[- / - / -] Sets the IP address for the primary capture server. This is basically adjusted by the remote system.
5-836-111	Secondary srv IP adress	C*	[- / - / -] This is basically adjusted by the remote system.
5-836-112	Secondary srv scheme	C*	[- / - / -] This is basically adjusted by the remote system.
5-836-113	Secondary srv port number	C*	[- / 80 / -] This is basically adjusted by the remote system.
5-836-114	Secondary srv URL path	C*	[- / - / -] This is basically adjusted by the remote system.
5-836-120	Default Reso Rate Switch	C*	[0 or 1 / 0 / 1/step] This is basically adjusted by the remote system.
5-836-122	Reso: Copy(Mono)	C*	[0 to 6 / 3 / 1/step] Selects the resolution for BW copy mode. This is basically adjusted by the remote system. 0: 600dpi 1: 400dpi 2: 300dpi 3: 200dpi 4: 150dpi 5: 100dpi 6: 75dpi

5-836-124	Reso: Print(Mono)	C*	<p>[0 to 6 / 3 / 1/step]</p> <p>Selects the resolution for BW copy mode. This is basically adjusted by the remote system.</p> <p>0: 600dpi 1: 400dpi 2: 300dpi 3: 200dpi 4: 150dpi 5: 100dpi 6: 75dpi</p>
5-836-126	Reso: Fax(Mono)	C*	<p>[0 to 6 / 3 / 1/step]</p> <p>Selects the resolution for BW fax mode. This is basically adjusted by the remote system.</p> <p>0: 600dpi 1: 400dpi 2: 300dpi 3: 200dpi 4: 150dpi 5: 100dpi 6: 75dpi</p>
5-836-127	Reso: Scan(Color)	C*	<p>[0 to 6 / 4 / 1/step]</p> <p>Selects the resolution for color scanning mode. This is basically adjusted by the remote system.</p> <p>0: 600dpi 1: 400dpi 2: 300dpi 3: 200dpi 4: 150dpi 5: 100dpi 6: 75dpi</p>

Main SP Tables-5

5-836-128	Reso: Scan(Mono)	C*	<p>[0 to 6 / 3 / 1/step]</p> <p>Selects the resolution for BW scanning mode. This is basically adjusted by the remote system.</p> <p>0: 600dpi 1: 400dpi 2: 300dpi 3: 200dpi 4: 150dpi 5: 100dpi 6: 75dpi</p>
5-836-141	All Addr Info Switch	C*	<p>[0 or 1 / 1 / 1/step]</p> <p>Turns on or off the all address information transmission for the captured resources.</p> <p>0: Off 1: On</p>
5-836-142	Stand-by Doc Max Number	C*	<p>[10 to 9999 / 2000 / 1/step]</p> <p>Selects the maximum number of captured documents to be transmitted to the document server.</p>

5840	[IEEE 802.11]		
5-840-006	Channel MAX	C*	<p>[- / 14 / -]</p> <p>DFU</p>
5-840-007	Channel MAX	C*	<p>[- / 1 / -]</p> <p>DFU</p>
5-840-011	WEP Key Select	C*	<p>[- / 00000000 / -]</p> <p>Selects the WEP key.</p>

5-840-045	WPA debug Lvl	C*	[1 to 3 / 3 / 1/step] Selects the debug level for WPA authentication application. This SP is displayed only when the IEEE802.11 card is installed. 1: Info 2: warning 3: error
5-840-046	11w	C*	[0 to 2 / 0 / 1/step]
5-840-047	PSK Set Type	C*	[0 to 1 / 0 / 1/step]

5841	[Supply Name Setting] Specifies supply names. These appear on the screen when the user presses the Inquiry button in the user tools screen.		
5-841-001	Toner Name Setting: Black	C*	[- / - / -] The top 1 byte: character code scheme Rest 20 bytes: character string

5842	[GWWS Analysis] This is a debugging tool. It sets the debugging output mode of each Net File process.		
5-842-001	Setting 1	C*	[- / 00000000 / -]
5-842-002	Setting 2	C*	

5844	[USB]		
5-844-001	Transfer Rate	C*	[- / 0x04 / -] Sets the speed for USB data transmission. 0x01: Full Speed 0x04: Auto Change
5-844-002	Vendor ID	C*	[- / 5CAh / -] DFU
5-844-003	Product ID	C*	[- / 403h / -] DFU
5-844-004	Device Release Number	C*	[- / 100 / -] DFU
5-844-005	Fixed USB Port	C*	[0 to 2 / 0 / 1/step] Standardizes for common use the model name and serial number for USB PnP (Plug & Play). It determines whether the driver requires re-installation. 0: OFF 1: Level1 2: Level2
5-844-006	PnP Model Name	C*	[up to 20 characters / - / -] Sets the model name to be used by the USB PnP when "Function Enable (Level 2) is set so the USB Serial No. can have a common name (SP5-844-005).

5-844-007	PnP Serial Number	C*	<p>[- / - / -]</p> <p>Sets the serial number to be used by the USB PnP when "Function Enable (Level 2) set so the USB Serial No. can have a common name (SP5-844-005).</p> <ul style="list-style-type: none"> ▪ Make sure that this entry is the same as the serial number in use. ▪ At initialization the serial number generated from the model name is used, not the setting of this SP code. ▪ At times other than initialization, the value set for this SP code is used.
5-844-008	Mac Supply Level	C*	<p>[0 or 1 / 1 / 1/step]</p> <p>0: OFF</p> <p>1: ON</p>
5-844-100	Notify Unsupported	C*	[0 or 1 / 1 / 1/step]

5845	[Delivery Server Setting] These are delivery server settings.		
5-845-001	FTP Port No.	C*	[0 to 65535 / 3670 / 1/step]
5-845-002	IP Address (Primary)	C*	<p>[000.000.000.000 to 255.255.255.255 / - / 1/step]</p> <p>Use this SP to set the Scan Router Server address. The IP address under the transfer tab can be used with the initial system setting.</p>
5-845-006	Delivery Error Display Time	C*	<p>[0 to 999 / 300 / 1sec/step]</p> <p>Use this setting to set the length of time that the message is shown when a test error occurs during document transfer with the NetFile application and an external device.</p>

5-845-008	IP Address (Secondary)	C*	[- / - / -] Sets the IP address that is given to the computer that is the secondary delivery server for Scan Router. This SP lets you set only the IP address, and does not refer to the DNS setting.
5-845-009	Delivery Server Model	C*	[0 to 4 / 0 / 1/step] Allows changing the model of the delivery server registered by the I/O device.
5-845-010	Delivery Svr. Capability	C*	[0 to 255 / 0 / 1/step]
	Changes the capability of the registered that the I/O device registered. Bit7 = 1 Comment information exits Bit6 = 1 Direct specification of mail address possible Bit5 = 1 Mail RX confirmation setting possible Bit4 = 1 Address book automatic update function exists Bit3 = 1 Fax RX delivery function exists Bit2 = 1 Sender password function exists Bit1 = 1 Function to link MK-1 user and Sender exists Bit0 = 1 Sender specification required (if set to 1, Bit6 is set to "0")		
5-845-011	Delivery Svr. Capability (Ext)	C*	[- / 00000000 / -] Not in use. Reserved for SP5845-010.
5-845-013	Server Scheme (Primary)	C*	[Up to 6 char / - / -/step] This SP is used for the scan router program.
5-845-014	Server Port Number (Primary)	C*	[1 to 65535 / 80 / 1/step] This SP is used for the scan router program.
5-845-015	Server URL Path (Primary)	C*	[Up to 16 byte / - / -/step] This SP is used for the scan router program.
5-845-016	Server Scheme (Secondary)	C*	[Up to 6 char / - / -/step] This SP is used for the scan router program.

5-845-017	Server Port Number (Secondary)	C*	[1 to 65535 / 80 / 1/step] This SP is used for the scan router program.
5-845-018	Server URL Path (Secondary)	C*	[Up to 16 byte / - / -/step] This SP is used for the scan router program.
5-845-022	Rapid Sending Control	C*	[0 or 1 / 1 / -/step] 0: Control disabled 1: Control enabled Enables or disables the prevention function for the continuous data sending error.

5846	[UCS Setting]		
5-846-001	Machine ID (for Delivery Server)	C*	[- / - / -] Displays the unique device ID in use by the delivery server directory. The value is only displayed and cannot be changed. This ID is created from the NIC MAC or IEEE 1394 EUI. The ID is displayed as either 6-byte or 8-byte binary.
5-846-002	Machine ID Clear(for Delivery Server)	C*	[- / - / -] [Execute] Clears the unique ID of the device used as the name in the file transfer directory. Execute this SP if the connection of the device to the delivery server is unstable. After clearing the ID, the ID will be established again automatically by cycling the machine off and on.

5-846-003	Maximum Entries	C*	[2000 to 20000 / 2000 / 1/step] Changes the maximum number of entries that UCS can handle. If a value smaller than the present value is set, the UCS managed data is cleared, and the data (excluding user code information) is displayed.
5-846-006	Delivery Server Retry Timer	C*	[0 to 255 / 0 / 1/step] Sets the interval for retry attempts when the delivery server fails to acquire the delivery server address book.
5-846-007	Delivery Server Retry Times	C*	[0 to 255 / 0 / 1/step] Sets the number of retry attempts when the delivery server fails to acquire the delivery server address book.
5-846-008	Delivery Server Maximum Entries	C*	[2000 to 20000 / 2000 / 1/step] Sets the maximum number account entries of the delivery server user information managed by UCS.
5-846-010	LDAP Search Timeout	C*	[1 to 255 / 60 / 1/step] Sets the length of the timeout for the search of the LDAP server.
5-846-020	WSD Maximum Entries	C*	[5 to 250 / 250 / 1/step] Sets the maximum entries for the address book of the WSD (WS-scanner).
5-846-021	Folder Auth Change	C*	[0 or 1 / 0 / 1/step] 0: Login User, 1: Destination
5-846-022	Initial Value of Upper Limit Count	C*	[0 to 999999 / 500 / 1/step] Sets the initial max. printable value that allows a user to print.
5-846-040	Addr Book Migration(USB->HDD)	C	[- / - / -] [Execute]

5-846-041	Fill Addr Acl Info	C*	<p>[- / - / -] [Execute]</p> <p>This SP must be executed immediately after installation of an HDD unit in a basic machine that previously had no HDD. The first time the machine is powered on with the new HDD installed, the system automatically takes the address book from the NVRAM and writes it onto the new HDD. However, the new address book on the HDD can be accessed only by the system administrator at this stage. Executing this SP by the service technician immediately after power on grants full address book access to all users.</p> <p>Procedure</p> <ol style="list-style-type: none"> 1. Turn the machine off. 2. Install the new HDD. 3. Turn the machine on. 4. The address book and its initial data are created on the HDD automatically. 5. However, at this point the address book can be accessed by only the system administrator or key operator. 6. Enter the SP mode and do SP5846-041. After this SP executes successfully, any user can access the address book.
-----------	--------------------	----	--

5-846-043	Addr Book Media	C*	[0 to 30 / 0 /1/step] 0: Unconfirmed 1: SD Slot 1 2: SD Slot 2 3: SD Slot 3 4: USB Flash ROM 10: SD Slot 10 20: HDD 30: Nothing
5-846-047	Initialize Local Address Book	C	[- / - / -] [Execute] Clears the local address book information, including the user code.
5-846-048	Initialize Delivery Addr Book	C	[- / - / -] [Execute] Clears the distribution address book information, except the user code.
5-846-049	Initialize LDAP Addr Book	C	[- / - / -] [Execute] Clears the LDAP address book information, except the user code.
5-846-050	Initialize All Addr Book	C	[- / - / -] [Execute] Clears all directory information managed by UCS, including all user codes.
5-846-051	Backup All Addr Book	C	[- / - / -] [Execute] Uploads all directory information to the SD card.
5-846-052	Restore All Addr Book	C	[- / - / -] [Execute] Downloads all directory information from the SD card.

5-846-053	Clear Backup Info	C	<p>[- / - / -] [Execute]</p> <p>Deletes the address book data from the SD card in the service slot.</p> <p>Deletes only the files that were uploaded from this machine.</p> <p>This feature does not work if the card is write-protected.</p> <p>Note</p> <ul style="list-style-type: none"> After you do this SP, go out of the SP mode, and then turn the power off. Do not remove the SD card until the Power LED stops flashing.
5-846-060	Search Option	C*	<p>[0x00 to 0xff / 00001111 / 1/step]</p> <p>This SP uses bit switches to set up the fuzzy search options for the UCS local address book.</p> <p>Bit: Meaning</p> <p>0: Checks both upper/lower case characters</p> <p>1: Japan Only</p> <p>2: Japan Only</p> <p>3: Japan Only</p> <p>4 to 7: Not Used</p>

5-846-062	Complexity Option 1	C*	<p>[0 to 32 / 0 / 1/step]</p> <p>Use this SP to set the conditions for password entry to access the local address book. Specifically, this SP limits the password entry to upper case and sets the length of the password.</p> <p> Note</p> <ul style="list-style-type: none"> ▪ This SP does not normally require adjustment. ▪ This SP is enabled only after the system administrator has set up a group password policy to control access to the address book.
5-846-063	Complexity Option 2	C*	<p>[0 to 32 / 0 / 1/step]</p> <p>Use this SP to set the conditions for password entry to access the local address book. Specifically, this SP limits the password entry to lower case and defines the length of the password.</p>
5-846-064	Complexity Option 3	C*	<p>[0 to 32 / 0 / 1/step]</p> <p>Use this SP to set the conditions for password entry to access the local address book. Specifically, this SP limits the password entry to numbers and defines the length of the password.</p>
5-846-065	Complexity Option 4	C*	<p>[0 to 32 / 0 / 1/step]</p> <p>Use this SP to set the conditions for password entry to access the local address book. Specifically, this SP limits the password entry to symbols and defines the length of the password.</p>
5-846-091	FTP Auth Port Setting	C*	<p>[0 to 65535 / 3671 / 1/step]</p> <p>Specifies the FTP port for getting a distribution server address book that is used in the identification mode.</p>

5-846-094	Encryption Stat	C*	[0 to 255 / - / 1/step]
-----------	-----------------	----	-------------------------

5847	[Rep Resolution Reproduction] Changes the default settings of image data sent externally by the Net File page reference function.		
5-847-002	Rate for Copy B&W Text	C*	[- / 0 / -]
5-847-003	Rate for Copy B&W Other	C*	
5-847-005	Rate for Printer B&W	C*	
5-847-007	Rate for Printer B&W 1200dpi	C*	[- / 1 / -]
5-847-021	Network Quality Default for JPEG	C*	[- / 50 / -] Sets the default value for the quality of JPEG images sent as NetFile pages. This function is available only with the MLB (Media Link Board) option installed.

5848	[Web Service] Sets the 4-bit switch assignment for the access control setting.		
5-848-002	Access Ctrl: Repository (onlyLower4bits)	C*	[4bit assign / 00000010 / bit switch]
5-848-003	Access Ctrl: Doc.Svr.Print (Lower 4bits)	C*	
5-848-004	Access Ctrl: udirectory (Lower 4bits)	C*	
5-848-007	Access Ctrl: Comm. Log Fax(Lower 4bits)	C*	
5-848-009	Access Ctrl: Job Ctrl(Lower 4bits)	C*	[4bit assign / 00000000 / bit switch]
5-848-011	Access Ctrl: Devicemanagement (Lower 4bits)	C*	

5-848-021	Access Ctrl: Delivery (Lower 4bits)	C*	
5-848-022	Access Ctrl: uadministration (Lower 4bits)	C*	
5-848-024	Access Ctrl: Log Service (Lower 4bits)	C*	[4bit assign / 0000 / bit switch] 0000: No access control 0001: Access control
5-848-099	Repository: Download Image Setting	C*	[4bit assign / 0000 / bit switch] From Right; First bit: For Mac OS Second bit: For Windows OS third bit: Other OS Fourth bit: No Use (0: Setting 0, 1: Setting 1)
5-848-100	Repository: Download Image Max. Size	C*	[1 to 2048 / 2048 / 1MByte/step]
5-848-217	Setting: Timing	C*	[0 to 2 / 0 / 1/step]

5849	[Installation Date] Displays or prints the installation date of the machine.		
5-849-001	Display	C*	[- / - / -] Displays the installation date. The installation date is set automatically after test copies are done at the installation site.
5-849-002	Switch to Print	C*	[0 or 1 / 1 / 1 /step] 0: OFF (No Print) 1: ON (Print) Determines whether the installation date is printed on the printout for the total counter.

5-849-003	Total Counter	C*	[0 to 99999999 / 0 / 1/step] Displays the total counts at the installed date (SP5-849-001).
-----------	---------------	----	---

5851	[Bluetooth]		
5-851-001	Mode	C*	[0 or 1 / 0 / 1/step] Sets the operation mode for the Bluetooth Unit. 0: Public 1: Private

5856	[Remote ROM Update] Allows reception of firmware data via the local port (IEEE 1284) during a remote ROM update, when the value set to "1". This setting is reset to "0" after the machine is cycled off and on. Allows the technician to upgrade the firmware using a parallel cable.		
5-856-002	Local Port	C*	[0 or 1 / 0 / 1/step] 0: Disable 1: Enable

5857	[Save Debug Log]		
5-857-001	On/Off	C*	[0 or 1 / 0 / 1 / -] 0: OFF 1: ON Switches on the debug log feature. The debug log cannot be captured until this feature is switched on.
5-857-002	Target (2:HDD 3:SD)	C*	[1 to 3 / 2 / 1/step] 1: IC Card 2: HDD 3: SD Card Selects the destination where the debugging information generated by the event selected by SP5-858 will be stored if an error is generated.

5-857-005	Save to HDD	C*	<p>[- / - / -] [Execute]</p> <p>Saves the debug log of the input SC number in memory to the HDD.</p> <p>A unique file name is generated to avoid overwriting existing file names on the SD Card. Up to 4MB can be copied to an SD Card. 4 MB segments can be copied one by one to each SD Card.</p>
5-857-006	Save to SD Card	C*	<p>[- / - / -] [Execute]</p> <p>Specifies the decimal key number of the log to be written to the SD card.</p>
5-857-009	Copy HDD to SD Card (Latest 4MB)	C*	<p>[- / - / -] [Execute]</p> <p>Takes the most recent 4 MB of the log written to the hard disk and copies them to the SD Card.</p> <p>A unique file name is generated to avoid overwriting existing file names on the SD Card. Up to 4MB can be copied to an SD Card. 4 MB segments can be copied one by one to each SD Card.</p>
5-857-010	Copy HDD to SD Card (Latest 4MB Any Key)	C*	<p>[- / - / -] [Execute]</p> <p>Takes the log of the specified key from the log on the hard disk and copies it to the SD Card.</p> <p>A unique file name is generated to avoid overwriting existing file names on the SD Card. Up to 4 MB can be copied to an SD Card. 4 MB segments can be copied one by one to each SD Card.</p> <p>This SP does not execute if there is no log on the HDD and no key specified.</p>

5-857-011	Erase HDD Debug Data	C*	[- / - / -] [Execute] Erases all debug logs on the HDD.
5-857-012	Erase SD Card Debug Data	C*	[- / - / -] [Execute] Erases all debug logs on the SD Card. If the card contains only debugging files generated by an event specified by SP5858, the files are erased when SP5857 010 or 011 is executed. To enable this SP, the machine must be cycled off and on.
5-857-013	Free Space on SD Card	C*	[- / - / -] [Execute] Displays the amount of space available on the SD card.
5-857-014	Copy SD to SD (Latest 4MB)	C*	[- / - / -] [Execute] Copies the last 4MB of the log (written directly to the card from shared memory) onto an SD card.
5-857-015	Copy SD to SD (Latest 4MB Any Key)	C*	[- / - / -] [Execute] Copies the log on an SD card (the file that contains the information written directly from shared memory) to a log specified by key number.
5-857-016	Make HDD Debug	C*	[- / - / -] [Execute] Creates a 32 MB file to store a log on the HDD.
5-857-017	Make SD Debug	C*	[- / - / -] [Execute] Creates a 4 MB file to store a log on the SD card.

5-857-101	Debug Logging Start Date	C*	[- / 20120101 / 1/step] Sets start date of the debug log output.
5-857-102	Debug Logging End Date	C*	[- / 20371212 / -] Sets end date of the debug log output.
5-857-103	Aquire All Debug Logs	C*	[- / - / -] [Execute] Obtains all debug logs.
5-857-104	Aquire Only Contoroller Debug Logs	C*	[- / - / -] [Execute] Obtains controller debug logs.
5-857-105	Aquire Only Engine Debug Logs	C*	[- / - / -] [Execute] Obtains engine debug logs.
5-857-106	Aquire Only Snapshot Debug Logs	C*	[- / - / -] [Execute] Obtains snapshot debug logs.
5-857-107	Aquire Only Opepanel Debug Logs	C*	[- / - / -] [Execute] Obtains controller debug logs to the media inserted front I/F.
5-857-120	Make LogTrace Dir	C*	[- / - / -] [Execute]

5858	[Debug Save When] These SPs select the content of the debugging information to be saved to the destination selected by SP5857-002. SP5858-3 stores one SC specified by number. Refer to Section 4 for a list of SC error codes.		
5-858-001	Engine SC Error (0: OFF, 1: ON)	C*	[0 or 1 / 0 / 1/ step] 0: OFF 1: ON
5-858-002	Controller SC Error (0: OFF, 1: ON)	C*	
5-858-003	Any SC Error	C*	[0 to 65535 / 0 / 1 /step]
5-858-004	Jam(0: OFF 1: ON)	C*	[0 or 1 / 0 / 1/ step] 0: OFF 1: ON Stores jam errors.

5859	[Debug Save Key No.] These SPs allow you to set up to 10 keys for log files for functions that use common memory on the controller board.		
5-859-001	Key 1	C*	[-999999 to 99999999 / 0 / 1/step]
5-859-002	Key 2	C*	
5-859-003	Key 3	C*	
5-859-004	Key 4	C*	
5-859-005	Key 5	C*	
5-859-006	Key 6	C*	
5-859-007	Key 7	C*	
5-859-008	Key 8	C*	
5-859-009	Key 9	C*	
5-859-010	Key 10	C*	

5860	[SMTP/POP3/IMAP4]		
5-860-020	Partial Mail Receive Timeout	C*	<p>[1 or 168 / 72 / 1/step]</p> <p>Sets the amount of time to wait before saving a mail that breaks up during reception. The received mail is discarded if the remaining portion of the mail is not received during this prescribed time.</p>
5-860-021	MDN Response RFC2298 Compliance	C*	<p>[0 or 1 / 1 / 1/step]</p> <p>0: No 1: Yes</p> <p>Determines whether RFC2298 compliance is switched on for MDN reply mail.</p>
5-860-022	SMTP Auth. From Field Replacement	C*	<p>[0 or 1 / 0 / 1/step]</p> <p>0: No 1: Yes</p> <p>Determines whether the FROM item of the mail header is switched to the validated account after the SMTP server is validated.</p>

5-860-025	SMTP Auth. Direct Setting	C*	<p>[- / 00000000 / -]</p> <p>Occasionally, SMTP certification may fail with encryption enabled for the SMTP server. This can occur if the SMTP server does not meet RFC standards. In such cases you can use this SP to set the SMTP certification method directly. However, this SP can be used only encryption has been enabled.</p> <p>Selects the authentication method for SMTP.</p> <p>Bit switch:</p> <p>Bit 0: LOGIN</p> <p>Bit 1: PLAIN</p> <p>Bit 2: CRAM MD5</p> <p>Bit 3: DIGEST MD5</p> <p>Bit 4 to 7: Not used</p>
5-860-026	S/MIME: MIME Header Setting	C*	<p>[0 to 2 / 0 / 1 /step]</p> <p>Selects the MIME header type of an E-mail sent by S/MIME.</p> <p>0: Microsoft Outlook Express standard</p> <p>1: Internet Draft standard</p> <p>2: RFC standard</p>
5-860-028	S/MIME: Authentication Check	C*	<p>[0 or 1 / 0 / 1/step]</p> <p>0: No (not check)</p> <p>1: Yes (check)</p> <p>Specifies whether to check destination certificate when sending S/MIME mail.</p>

5866	[E-Mail Report]		
5-866-001	Report Validity	C	[0 or 1 / 0 / 1/step] Enables or disables the E-mail alert function.
5-866-005	Add Date Field	C	[0 or 1 / 0 / 1/step] Adds or does not add the date field to the header of the alert mail. 0: Not added 1: Added

5869	[RAM Disk Setting] Enables or disables the email sending/receiving function. Although the RAM Disk size for receiving email can be configured with this setting, the system will manage the size because the size (MB) depends on each machine. The RAM Disk will be created during gwinit started, thus it will be applied with the main power OFF/ON after SCS(SP) writes the size on the NVRAM of gwinit.		
5-869-001	Mail Function	C	[0 or 1 / 0 / 1/step] 0: Enabled 1: Disabled

5870	[Common Key Info Writing] Writes to flash ROM the common proof for validating the device for NRS specifications.		
5-870-001	Writing	C	[- / - / -] [Execute] Writes the authentication data (used for NRS) in the memory.
5-870-003	Initialize	C	[- / - / -] [Execute]
5-870-004	Writing: 2048bit	C	[- / - / -] [Execute] Writes the authentication data 2048bit (used for NRS) in the memory.

5873	[SD Card Appli Move] Allows you to move applications from one SD card to another.		
5-873-001	MoveExec	C	[- / - / -] [Execute] This SP copies the application programs from the original SD card to another.
5-873-002	UndoExec	C	[- / - / -] [Execute] This SP copies back the application programs from an SD card to the original SD card. Use this menu when you have mistakenly copied some programs by using "Move Exec" (SP5873-1).

5875	[SC Auto Reboot] Determines whether the machine reboots automatically when an SC error occurs.		
5-875-001	Reboot Setting	*C	[0 or 1/ 0 / 1/step] Enables or disables the automatic reboot function when an SC error occurs. The reboot is not executed for Type A or C SC codes. 0: The machine reboots automatically when the machine issues an SC error and logs the SC error code. If the same SC occurs again, the machine does not reboot. 1: The machine does not reboot when an SC error occurs.
5-875-002	Reboot Type	*C	[0 or 1 / 1 / 1/step] 0: Manual reboot 1: Automatic reboot Selects the reboot method for SC.

5878	[Option Setup] Enables the Data Overwrite Security option or HDD Encryption Option after installation.		
5-878-001	Data Overwrite Security	C	[- / - / -] [Execute]
5-878-002	HDD Encryption	C	[- / - / -] [Execute] Executes the encryption set-up.
5-878-004	OCR Dictionary	C	[- / - / -] [Execute]

	<p>Install Procedure</p> <ol style="list-style-type: none"> 1. Insert a SD card into the back SD throttle (service throttle), then start the machine. 2. Execute SP5-878-4. 3. Switch the main power OFF/ON. 4. Execute SP5-878-4. <p>This SP can link the SD card at the first time execution, and can copy the OCR dictionary at the second time execution.</p> <p>It needs restart the main power before executing the second.</p> <p>You can overwrite the OCR dictionary, and the method is the same as the first time installation. Install it with the above procedure with the new SD card.</p>
--	--

5881	[Fixed Phrase Block Erasing]		
	DFU		
5-881-001	-	C	[0 or 1 / 0 / 1/step]

5885	[Set WIM Function]		
	Close or disclose the functions of web image monitor.		
5-885-020	DocSvr Acc Ctrl	C*	<p>[8bit assign / 00000000 / bit switch]</p> <p>Bit Meaning</p> <p>0: Forbid all document server access (1)</p> <p>1: Forbid user mode access (1)</p> <p>2: Forbid print function (1)</p> <p>3: Forbid fax TX (1)</p> <p>4: Forbid scan sending (1)</p> <p>5: Forbid downloading (1)</p> <p>6: Forbid delete (1)</p> <p>7: Forbid guest mode access (1)</p>
5-885-050	DocSvr Format	C*	<p>[0 to 2 / 0 / 1/step]</p> <p>Selects the display type for the document box list.</p>

5-885-051	DocSvr Trans	C*	[5 to 20 / 10 / 1/step] Sets the number of documents to be displayed in the document box list.
5-885-100	Set Signature	C*	[0 to 2 / 0 / 1/step] Selects whether the signature is added to the scanned documents with the WIM when they are transmitted by an e-mail.
5-885-101	Set Encryption	C*	[0 or 1 / 0 / 1/step] Determines whether the scanned documents with the WIM are encrypted when they are transmitted by an e-mail.
5-885-201	DocSvr Timeout	C*	[- / 30 / -]

5887	<p>[SD GetCounter]</p> <p>This SP sends a text file to an SD card inserted in SD card Slot 2 (lower slot). The operation stores. The file is stored in a folder created in the root directory of the SD card called SD_COUNTER. The file is saved as a text file (*.txt) prefixed with the number of the machine.</p> <p>Insert the SD card in SD card Slot 2 (lower slot). Select SP5887 then touch [EXECUTE]. Touch [Execute] in the message when you are prompted.</p> <p> Note</p> <ul style="list-style-type: none"> “SD_COUNTER” folder must be created under the root directory of the SC card before this SP is executed. 		
5-887-001	-	C*	[- / - / -] [Execute]

5888	[Personal Information Protect] Selects the protection level for logs.		
5-888-001	-	C*	[0 or 1 / 0 / 1/step] 0: No authentication, No protection for logs 1: No authentication, Protected logs (only an administrator can see the logs)

5893	[SDK Application Counter] Displays the counter name of each SDK application.		
5-893-001	SDK-1	C	[- / - / -] [Display text]
5-893-002	SDK-2	C	
5-893-003	SDK-3	C	
5-893-004	SDK-4	C	[- / - / -] [Display text]
5-893-005	SDK-5	C	
5-893-006	SDK-6	C	

5894	[ExternalCountSet] Switch the Charge Mode of External Mech Count		
5-894-001	SW Change Mode	E*	[0 to 2 / 0 / 1/step]

5900	[Engine Log Upload]		
5-900-001	Pattern	E*	Specifies the Target Module group for Engine Log Upload. [0 to 4 / 0 / 1/step]
5-900-002	Trigger	E*	Specifies the Target Trigger group for Engine Log Upload. [0 to 3 / 0 / 1/step]

5907	[Plug & Play Maker/Model Name]		
	<p>Selects the brand name and the production name for Windows Plug & Play. This information is stored in the NVRAM. If the NVRAM is defective, these names should be registered again.</p> <p>After selecting, press the "Original Type" key and "#" key at the same time. When the setting is completed, the beeper sounds five times.</p>		
5-907-001	-	C*	[- / - / -]

5913	[Switchover Permission Time]		
	<p>Sets the length of time to elapse before allowing another application to take control of the display when the application currently controlling the display is not operating because a key has not been pressed.</p>		
5-913-002	Print Application Timer	C*	[0 to 30 / 3 / 1/step]

5930	[MeterClick Charge]		
5-930-001	Setting	E*	[0 or 1 / 0 / 1/step]

5931	[Life Alert Disp.]		
5-931-001	Maintenance Kit	E*	[0 or 1 / 0 / 1/step]
5-931-002	PCDU	E*	

5967	[Copy Server: Set Function]		
	<p>Enables or disables the document server. This is a security measure that prevents image data from being left in the temporary area of the HDD. After changing this setting, you must switch the main switch off and on to enable the new setting.</p>		
5-967-001	(0:ON 1:OFF)	C*	[0 or 1 / 0 / 1/step]

5974	[Cherry Server] Specifies which version of ScanRouter, "Light" or "Full", is installed.		
5-974-001	(0: Light 1: Full)	C*	[- / 0 / -]

5985	[Device Setting] Enables/disables the on-board device.		
5-985-001	On Board NIC	E*	<p>[0 to 2 / 0 / 1/step]</p> <p>When the "Function limitation" is set, "On board NIC" is limited only for the NRS or LDAP/NT authentication.</p> <p>Note</p> <ul style="list-style-type: none"> Other network applications than NRS or LDAP/NT authentication are not available when this SP is set to "2". Even though you can change the initial settings of those network applications, the settings do not work. <p>0: Disable 1: Enable 2: Function limitation</p>
5-985-002	On Board USB	E*	<p>[0 or 1 / 0 / 1/step]</p> <p>0: Disable 1: Enable</p>

5987	[Mech. Counter] This SP detects that a mechanical counter device is removed. If it is detected, SC610 occurs.		
5-987-001	0:OFF / 1:ON	E*	<p>[0 or 1 / 0 / 1/step]</p> <p>0: OFF. 1: ON</p>

5990	[SP Print Mode] Prints out the SMC sheets.		
5-990-001	All(Data List)	C	[- / - / -] [Execute] Press "Execute" key to start printing the SMC sheets.
5-990-002	SP(Mode Data List)	C	
5-990-003	User Program	C	
5-990-004	Logging Data	C	
5-990-005	Diagnostic Report	C	
5-990-006	Non-Default	C	
5-990-007	NIB Summary	C	
5-990-008	Capture Log	C	
5-990-021	Copier User Program	C	[- / - / -] [Execute] Press "Execute" key to start printing the SMC sheets.
5-990-022	Scanner SP	C	
5-990-023	Scanner User Program	C	
5-990-024	SDK/J Summary	C	
5-990-025	SDK/J Application Info	C	
5-990-026	Printer SP	C	

5992	[SP Text Mode]		
	Exports the SMC sheet data to the SD Card. Press "Execute" key to start exporting the SMC data in the SP mode display.		
5-992-001	All(Data List)	C	[- / - / -]
5-992-002	SP(Mode Data List)	C	[Execute]
5-992-003	User Program	C	[- / - / -] [Execute] * MFP only
5-992-004	Logging Data	C	[- / - / -] [Execute]
5-992-005	Diagnostic Report	C	
5-992-006	Non-Default	C	
5-992-007	NIB Summary	C	
5-992-008	Capture Log	C	[- / - / -] [Execute] * MFP only
5-992-021	Copier User Program	C	
5-992-022	Scanner SP	C	
5-992-023	Scanner User Program	C	
5-992-024	SDK/J Summary	C	[- / - / -] [Execute]
5-992-025	SDK/J Application Info	C	
5-992-026	Printer SP	C	

3.7 MAIN SP TABLES-6

3.7.1 SP6-XXX (PERIPHERALS)

6006	[ADF Adjustment]		
	Adjusts the side-to-side and leading edge registration for simplex and duplex original feeding in ARDF mode.		
	SP6006-5 sets the maximum setting allowed for rear edge erase.		
	6-006-001	Side-to-Side Regist: Front	E*
	6-006-002	Side-to-Side Regist: Rear	E*
	6-006-003	Leading Edge Regist: Front	E*
	6-006-004	Leading Edge Regist: Rear	E*
6-006-007	Rear Edge Erase	E*	
			[-2.0 to 2.0 / 0.0 / 0.1mm/step]
			[-5.0 to 5.0 / 0.0 / 0.1mm/step]

6007	[ADF INPUT Check]		
	See "page 3-212"		

6008	[ADF OUTPUT Check]		
	See "page 3-214"		

6910	[ADF Adjustment Shading Time]		
6-910-001	-	E*	[0 to 90 / 60 / 1sec/step]

3.8 MAIN SP TABLES-7

3.8.1 SP7-XXX (DATA LOG)

7401	[Total SC] Stores total SC occurring count. If the same SC codes are detected continuously and total counter is not increasing, it only logs once in case of deleting other SC code logs.		
	7-401-001	SC Counter	C*
	7-401-002	Total SC Counter	C*
[0 to 65535 / - / 1/step]			

7403	[SC History] Logs and displays the SC codes detected. The 10 most recently detected SC Codes are displayed on the screen, and also can be seen on the SMC (logging) outputs.  Note <ul style="list-style-type: none"> If the same SC codes are detected continuously and total counter is not increasing, it only logs once in case of deleting other SC code logs. 		
	7-403-001	Latest	C*
	7-403-002	Latest 1	C*
	7-403-003	Latest 2	C*
	7-403-004	Latest 3	C*
	7-403-005	Latest 4	C*
	7-403-006	Latest 5	C*
	7-403-007	Latest 6	C*
	7-403-008	Latest 7	C*
	7-403-009	Latest 8	C*
	7-403-010	Latest 9	C*
[0 to 65535 / - / 1/step]			

7404	[SC990 / SC991 History]			
	Logs and displays the SC990 / SC991 detected.			
	The 10 most recently detected SC.			
	 Note			
	<ul style="list-style-type: none"> If the same SC codes are detected continuously and total counter is not increasing, it only logs once in case of deleting other SC code logs. 			
	7-401-001	Latest	C*	[- / - / -]
	7-401-002	Latest 1	C*	
	7-401-003	Latest 2	C*	
	7-401-004	Latest 3	C*	
	7-401-005	Latest 4	C*	
	7-401-006	Latest 5	C*	[- / - / -]
7-401-007	Latest 6	C*		
7-401-008	Latest 7	C*		
7-401-009	Latest 8	C*		
7-401-010	Latest 9	C*		

7502	[Total Paper Jam]		
	Displays the total number of jams detected.		
	7-502-001	Jam Counter	C*
7-502-002	Total Jam Counter	C*	[00000 to 65535 / 0 / 1/step]

7503	[Total Original Jam Counter]		
	Displays the total number of original jams.		
	7-503-001	-	C*
7-503-002	Total Original Counter	C*	

7504	[Paper Jam Count by Location] Displays counts for transfer paper jam for each incidence place.		
7-504-001	At Power On	C*	[0000 to 9999 / - / 1/step] Note <ul style="list-style-type: none"> Paper is not fed at power on.
7-504-003	Tray1: On	C*	[0000 to 9999 / - / 1/step]
7-504-004	Tray2: On	C*	
7-504-005	Tray3: On	C*	
7-504-008	Bypass: On	C*	
7-504-009	Duplex: On	C*	
7-504-013	Tray 2 Vertical Trans.Sn: On	C*	
7-504-017	R: On	C*	
7-504-020	Paper Exit: On	C*	[0000 to 9999 / - / 1/step]
7-504-023	Duplex Inverter: On	C*	
7-504-026	Duplex Entrance: On	C*	
7-504-053	Tray 2 Vertical Trans.Sn: Off	C*	
7-504-054	Tray 3 Vertical Trans.Sn: Off	C*	
7-504-057	Registration Sensor: Off	C*	
7-504-060	Paper Exit: Off	C*	
7-504-063	Duplex Inverter: Off	C*	
7-504-066	Duplex Entrance: Off	C*	

7505	[Original Jam Detection] Displays the original jam counts with four digits according to the shown list below.		
7-505-001	At Power On	C*	[0000 to 9999 / - / 1/step]
7-505-004	Registration Sensor: On	C*	
7-505-054	Registration Sensor: Off	C*	

Main SP Tables-7

7-505-100	Motor Error	C*	[0000 to 9999 / 0 / 1/step]
-----------	-------------	----	-----------------------------

7506	[Jam Count by Paper Size] Displays the number of jams according to the paper size.		
7-506-005	A4 LEF	C*	[0000 to 9999 / 0 / 1/step]
7-506-006	A5 LEF	C*	
7-506-014	B5 LEF	C*	
7-506-038	LT LEF	C*	
7-506-044	HLT LEF	C*	
7-506-132	A3 SEF	C*	
7-506-133	A4 SEF	C*	
7-506-134	A5 SEF	C*	
7-506-141	B4 SEF	C*	[0000 to 9999 / 0 / 1/step]
7-506-142	B5 SEF	C*	
7-506-160	DLT SEF	C*	
7-506-164	LG SEF	C*	
7-506-166	LT SEF	C*	
7-506-172	HLT SEF	C*	
7-506-255	Others	C*	

7507	[Plotter Jam History] Logs and displays the 10 most recent detected transfer paper jams. (CAUSE, SIZE, TOTAL, DATE)		
7-507-001	Latest	C*	[0 to 9999 / 0 / 1 sheets/step]
7-507-002	Latest 1	C*	
7-507-003	Latest 2	C*	
7-507-004	Latest 3	C*	
7-507-005	Latest 4	C*	
7-507-006	Latest 5	C*	[0 to 9999 / 0 / 1 sheets/step]
7-507-007	Latest 6	C*	
7-507-008	Latest 7	C*	
7-507-009	Latest 8	C*	
7-507-010	Latest 9	C*	

7508	[Original Jam History] Logs and displays the 10 most recent detected original jams. (CAUSE, SIZE, TOTAL, DATE)		
7-508-001	Latest	C*	[- / - / -]
7-508-002	Latest 1	C*	
7-508-003	Latest 2	C*	
7-508-004	Latest 3	C*	
7-508-005	Latest 4	C*	
7-508-006	Latest 5	C*	[- / - / -]
7-508-007	Latest 6	C*	
7-508-008	Latest 7	C*	
7-508-009	Latest 8	C*	
7-508-010	Latest 9	C*	

7514	[Paper Jam Count by Location]		
	Total counter of transfer paper jam by each incidence place. Displays occurring count of transfer paper jams by each incidence place.		
7-514-001	At Power On	C*	[0000 to 9999 / - / 1/step]
7-514-003	Tray 1: On	C*	
7-514-004	Tray 2: On	C*	
7-514-005	Tray 3: On	C*	
7-514-008	Bypass: On	C*	
7-514-009	Duplex: On	C*	[0000 to 9999 / - / 1/step]
7-514-013	-	C*	
7-514-017	Resistration: On	C*	
7-514-018	Paper Exit: On	C*	
7-514-023	-	C*	
7-514-026	-	C*	
7-514-053	-	C*	
7-514-054	-	C*	[0000 to 9999 / - / 1/step]
7-514-057	Resistration Sensor: Off	C*	
7-514-060	Paper Exit: Off	C*	
7-514-063	-	C*	
7-514-066	Duplex Entrance: Off	C*	

7515	[Original Jam Count by Detection]		
	-		
7-515-001	At Power On	C*	[0000 to 9999 / - / 1/step]
7-515-004	Registration Sensor: On	C*	
7-515-054	Registration Sensor: Off	C*	
7-515-100	-	C*	

7516	[-] Displays occurring count of transfer paper jams by each paper size.		
7-516-005	A4 LEF	C*	[0 to 9999 / 0 / 1 sheets/step]
7-516-006	A5 LEF	C*	
7-516-014	B5 LEF	C*	
7-516-038	LT LEF	C*	
7-516-044	HLT LEF	C*	
7-516-132	A3 SEF	C*	[0 to 9999 / 0 / 1 sheets/step]
7-516-133	A4 SEF	C*	
7-516-134	A5 SEF	C*	
7-516-141	B4 SEF	C*	
7-516-142	B5 SEF	C*	
7-516-160	DLT SEF	C*	[0 to 9999 / 0 / 1 sheets/step]
7-516-164	LG SEF	C*	
7-516-166	LT SEF	C*	
7-516-172	HLT SEF	C*	
7-516-255	Others	C*	

7520	[Update Log] Displays the error history of the 10 most recent firmware updates. [-001] indicates the latest history and [-010] indicates 10 times before. Records older than 10 times will be discarded. If the recent update succeeded, a success log will be recorded on the [-001]. The step of updating is one time, hence if multiple modules updated all at once, it logs the last one of them.		
	7-520-001	ErrorRecord1	C*
	7-520-002	ErrorRecord2	C*
	7-520-003	ErrorRecord3	C*
	7-520-004	ErrorRecord4	C*
	7-520-005	ErrorRecord5	C*
	7-520-006	ErrorRecord6	C*
	7-520-007	ErrorRecord7	C*
	7-520-008	ErrorRecord8	C*
	7-520-009	ErrorRecord9	C*
7-520-010	ErrorRecord10	C*	

7801	[ROM No./ Firmware Version] Displays all version numbers, part numbers in machine.		
	7-801-255	-	C [- / - / -] [9 digit characters]

7803	[PM Counter Display] Displays the PM counter value.		
	7-803-001	Paper	C* [0 to 9999999 / - / -]

7803	[Disp. PM Counter] Displays and sets the Sheets/Distance/Usage counter		
	7-803-002	Sheets PCDU	E*
	7-803-003	Sheets Fuser	E*

Main SP Tables-7

7-803-004	Sheets Trans.	E*	
7-803-005	Sheets Feed	E*	
7-803-006	Sheets Fric. Pad	E*	
7-803-012	Distance PCDU	E*	[0 to 999999999 / 0 / 1mm/step]
7-803-013	Distance Fuser	E*	
7-803-014	Distance Trans.	E*	
7-803-022	Usage PCDU	E*	[0 to 255 / 0 / 1%/step]
7-803-023	Usage Fuser	E*	
7-803-024	Usage Trans.	E*	
7-803-025	Usage Feed	E*	
7-803-026	Usage Fric. Pad	E*	

7804	<p>[PM Counter Reset] Clears the PM counter. Press the Enter key after the machine asks "Execute?", which will store the PM counter value in SP7-906 (PM Counter - Previous) and reset the value of the current PM counter (SP7-803) to "0".</p>		
7-804-001	Paper	C	[- / - / -] [Execute]

7804	<p>[Reset PM Counter] Counter reset by execution SP.</p>		
7-804-002	PCDU	E	[- / - / -]
7-804-003	Fuser	E	
7-804-004	Trans.	E	
7-804-005	Feed	E	[- / - / -]
7-804-006	Fric. Pad	E	
7-804-010	Maintenance Kit	E	

7-804-011	All	E	
-----------	-----	---	--

7805	[Counter Continue]		
7-805-001	Setting	C*	[- / - / -] [Execute]
7-805-002	Distance PCDU	C*	[0 to 9999999 / - / -]

7807	[SC/Jam Counter Reset] Resets the SC, paper, original, and total jam counters. When the program ends normally, the message "Completed" is displayed.  Note <ul style="list-style-type: none"> ▪ SP7-807-1 does not reset the following logs: SP7-507 (Display-Paper Jam History) and SP7-508 (Display-Original Jam History). 		
7-807-001	-	C	[- / - / -] [Execute]

7826	[MF Error Counter]		
Displays the counter that could not send count command to the MF charging device.			
7-826-001	Error Total	C*	[0000000 to 9999999 / - / -]
7-826-002	Error Staple	C*	

7827	[MF Error Counter Clear] Clears all the SP7-826 [MF Error Counter] to "0". Available when the MK-1 is connected.		
7-827-001	-	C	[- / - / -] [Execute]

7832	[Self-Diagnose Display] Displays the result of the diagnostics. To scroll the return codes, press the up-arrow key or the down-arrow key.		
7-832-001	-	C	[- / - / -] [Execute]

7836	[Total Memory Size] Displays the memory capacity of the controller system.		
7-836-001	-	C	[- / - / -]

7840	[ServiceSP Entry Code Chg Hist] Records dates and times of resetting / changing "Service SP mode switch code setting" for the recent 2 times. (Decides whether the record is for setting changes or resets by branch number.)		
7-840-001	Change Time :Latest	C*	[- / - / -]
7-840-002	Change Time : Last1	C*	
7-840-101	Initialize Time : Latest	C*	
7-840-102	Initialize Time : Last1	C*	

7850	[Toner Counter] Counter resetting by execution SP.		
7-850-001	PCDU Distance	E*	[0 to 999999999 / 0 / 1mm/step]
7-850-002	Total Consump	E*	[0.0 to 10000000.0 / 0.0 / 0.1mg/step]

7852	[DF Glass Dust Check] Counter resetting by execution SP.		
7-852-001	Dust Detection Counter	E*	[0 to 65535 / 0 / 1/step] Dust detection counter for DF glass.

7-852-002	Dust Detection Clear Counter	E*	[0 to 65535 / 0 / 1/step] Clear Dust detection counter for DF glass.
-----------	------------------------------	----	---

7901	[Assert Info.] Displays the detail information of SC990 that occurred lastly.		
7-901-001	File Name	C*	[- / - / -]
7-901-002	Number of Lines	C*	
7-901-003	Location	C*	

7931	[Toner Info.] Displays the ID chip information in the toner cartridge. Returns "0", if it could not access to the ID chip.		
7-931-001	Machine ID	E	[0 to 255 / 0 / 1/step]
7-931-002	Version	E	
7-931-003	Brand ID	E	
7-931-004	Area ID	E	
7-931-005	Class ID	E	
7-931-006	Color ID	E	
7-931-007	Maintenance ID	E	
7-931-008	New AIO	E	
7-931-009	Recycle Count	E	
7-931-010	EDP Code	E	[- / - / -]
7-931-011	Serial No.	E	
7-931-012	Remaining Toner	E	[0 to 100 / 0 / 20%/step]
7-931-013	Toner End	E	[- / - / -]
7-931-014	Refill Flag	E	
7-931-015	R:Total Cnt.	E	[0 to 99999999 / 0 / 1sheet/step]

Main SP Tables-7

7-931-016	E:Total Cnt.	E	
7-931-017	Unit Output Cnt.	E	
7-931-018	Install Date	E	[- / - / -]
7-931-019	Toner End Date	E	
7-931-020	Total Consump	E	[0.0 to 10000000.0 / 0.0 / 0.1mg/step]
7-931-021	PCDU Distance	E	[0 to 999999999 / 0 / 1mm/step]
7-931-022	Initial Amount	E	[0 to 65535 / 0 / 1g/step]

7932	[PCDU Info.] Displays the ID chip information in the PCDU. Returns "0", if it could not access to the ID chip.		
7-932-001	Machine ID	E	[0 to 255 / 0 / 1/step]
7-932-002	Class ID	E	
7-932-003	Maintenance ID	E	
7-932-004	New AIO	E	
7-932-005	Serial No.	E	[- / - / -]
7-932-006	Install Date	E	
7-932-007	Sheets	E	[0 to 999999 / 0 / 1sheet/step]
7-932-008	Distance	E	[0 to 999999999 / 0 / 1mm/step]
7-932-010	Control Distance	E	
7-932-011	PM Chg Sheets	E	
7-932-012	PM Chg Distance	E	
7-932-013	Cleaning1Count	E	[0 to 65535 / 0 / 1count / step]
7-932-014	Cleaning2Count	E	

7935	[Toner Info. Log] Displays the ID chip log data in the toner cartridge.		
7-935-001	1:Serial No.	E*	[- / - / -]
7-935-002	1:Install Date	E*	
7-935-003	1:R:Total Cnt.	E*	[0 to 99999999 / 0 / 1/step]
7-935-004	1:Refill Flag	E*	[- / - / -]
7-935-005	2:Serial No.	E*	
7-935-006	2:Install Date	E*	
7-935-007	2:R:Total Cnt.	E*	[0 to 99999999 / 0 / 1/step]
7-935-008	2:Refill Flag	E*	[- / - / -]
7-935-009	3:Serial No.	E*	
7-935-010	3:Install Date	E*	
7-935-011	3:R:Total Cnt.	E*	[0 to 99999999 / 0 / 1/step]
7-935-012	3:Refill Flag	E*	[- / - / -]
7-935-013	4:Serial No.	E*	
7-935-014	4:Install Date	E*	
7-935-015	4:R:Total Cnt.	E*	[0 to 99999999 / 0 / 1/step]
7-935-016	4:Refill Flag	E*	[- / - / -]
7-935-017	5:Serial No.	E*	
7-935-018	5:Install Date	E*	
7-935-019	5:R:Total Cnt.	E*	[0 to 99999999 / 0 / 1/step]
7-935-020	5:Refill Flag	E*	[- / - / -]
7-935-021	1:Toner End	E*	
7-935-022	2:Toner End	E*	
7-935-023	3:Toner End	E*	

Main SP Tables-7

7-935-024	4:Toner End	E*	
7-935-025	5:Toner End	E*	

7936	[PCDU Log] Displays the ID chip log data in the toner cartridge.		
7-936-001	1:Serial No	E*	[0 / 0 / 1/step]
7-936-002	1:Install Date	E*	[0 / 0 / 0/step]
7-936-003	2:Serial No	E*	[0 / 0 / 1/step]
7-936-004	2:Install Date	E*	[0 / 0 / 0/step]
7-936-005	3:Serial No	E*	[0 / 0 / 1/step]
7-936-006	3:Install Date	E*	[0 / 0 / 0/step]
7-936-007	4:Serial No	E*	[0 / 0 / 1/step]
7-936-008	4:Install Date	E*	[0 / 0 / 0/step]
7-936-009	5:Serial No	E*	[0 / 0 / 1/step]
7-936-010	5:Install Date	E*	[0 / 0 / 0/step]

7952	[Days Before End] Switch the timing of the near end: Days until the end.		
7-952-001	Maintenance Kit	E*	[0 to 2 / 1 / 1/step] 0: Earlier 1: Normal 2: Later
7-952-002	PCDU	E*	[0 to 2 / 1 / 1/step] 0: Earlier 1: Normal 2: Later

7993	[Total Counter] Sheet number counter: Engine: Total		
7-993-001	-	E*	[0 to 99999999 / 0 / 1/step]

3.9 MAIN SP TABLES-8

3.9.1 SP8-XXX (DATA LOG 2)

Many of these counters are provided for features that are currently not available, such as sending color faxes, and so on. However, here are some Group 8 codes that when used in combination with others, can provide useful information.

SP Numbers	What They Do
SP8211 to SP8216	The number of pages scanned to the document server.
SP8401 to SP8406	The number of pages printed from the document server
SP8691 to SP8696	The number of pages sent from the document server

Specifically, the following questions can be answered:

- How is the document server actually being used?
- What application is using the document server most frequently?
- What data in the document server is being reused?

Most of the SPs in this group are prefixed with a letter that indicates the mode of operation (the mode of operation is referred to as an "application"). Before reading the Group 8 Service Table, make sure that you understand what these prefixes mean.

Prefixes	What it means	
T:	Total: (Grand Total).	Grand total of the items counted for all applications (C, F, P, etc.).
C:	Copy application.	Totals (pages, jobs, etc.) executed for each application when the job was not stored on the document server.
F:	Fax application.	
P:	Print application.	
S:	Scan application.	

L:	Local storage (document server)	Totals (jobs, pages, etc.) for the document server. The L: counters work differently case by case. Sometimes, they count jobs/pages stored on the document server; this can be in document server mode (from the document server window), or from another mode, such as from a printer driver or by pressing the Store File button in the Copy mode window. Sometimes, they include occasions when the user uses a file that is already on the document server. Each counter will be discussed case by case.
O:	Other applications (external network applications, for example)	Refers to network applications such as Web Image Monitor. Utilities developed with the SDK (Software Development Kit) will also be counted with this group in the future.

The Group 8 SP codes are limited to 17 characters, forced by the necessity of displaying them on the small LCDs of printers and faxes that also use these SPs. Read over the list of abbreviations below and refer to it again if you see the name of an SP that you do not understand.

Keys and abbreviations in Data Log 2

Abbreviation	What it means
/	"By", e.g. "T:Jobs/Apl" = Total Jobs "by" Application
>	More (2> "2 or more", 4> "4 or more")
AddBook	Address Book
Apl	Application
B/W	Black & White
Bk	Black
C	Cyan
ColCr	Color Create
ColMode	Color Mode

Abbreviation	What it means
Comb	Combine
Comp	Compression
Deliv	Delivery
DesApl	Designated Application. The application (Copy, Fax, Scan, Print) used to store the job on the document server, for example.
Dev Counter	Development Count, no. of pages developed.
Dup, Duplex	Duplex, printing on both sides
Emul	Emulation
FC	Full Color
FIN	Post-print processing, i.e. finishing (punching, stapling, etc.)
Full Bleed	No Margins
GenCopy	Generation Copy Mode
GPC	Get Print Counter. For jobs 10 pages or less, this counter does not count up. For jobs larger than 10 pages, this counter counts up by the number that is in excess of 10 (e.g., for an 11-page job, the counter counts up 11-10 =1)
IFax	Internet Fax
ImgEdt	Image Edit performed on the original with the copier GUI, e.g. border removal, adding stamps, page numbers, etc.
K	Black (YMCK)
LS	Local Storage. Refers to the document server.
LSize	Large (paper) Size
Mag	Magnification
MC	One color (monochrome)

Abbreviation	What it means
NRS	New Remote Service, which allows a service center to monitor machines remotely. "NRS" is used overseas, "CSS" is used in Japan.
Org	Original for scanning
OrgJam	Original Jam
Palm 2	Print Job Manager/Desk Top Editor: A pair of utilities that allows print jobs to be distributed evenly among the printers on the network, and allows files to move around, combined, and converted to different formats.
PC	Personal Computer
PGS	Pages. A page is the total scanned surface of the original. Duplex pages count as two pages, and A3 simplex count as two pages if the A3/DLT counter SP is switched ON.
PJob	Print Jobs
Ppr	Paper
PrtJam	Printer (plotter) Jam
PrtPGS	Print Pages
R	Red (Toner Remaining). Applies to the wide format model A2 only. This machine is under development and currently not available.
Rez	Resolution
SC	Service Code (Error SC code displayed)
Scn	Scan
Sim, Simplex	Simplex, printing on 1 side.
S-to-Email	Scan-to-E-mail
SMC	SMC report printed with SP5990. All of the Group 8 counters are recorded in the SMC report.
Svr	Server

Abbreviation	What it means
TonEnd	Toner End
TonSave	Toner Save
TXJob	Send, Transmission
YMC	Yellow, Magenta, Cyan
YMCK	Yellow, Magenta, Cyan, Black

Note

- All of the Group 8 SPs are able to reset by "SP5-801-001 Memory All Clear".

8001	[T:Total Jobs]	C*	[0 to 99999999 / - / 1/step] These SPs count the number of times each application is used to do a job. Note: The L: counter is the total number of times the other applications are used to send a job to the document server, plus the number of times a file already on the document server is used.
8002	[C:Total Jobs]	C*	
8003	[F:Total Jobs]	C*	
8004	[P:Total Jobs]	C*	
8005	[S:Total Jobs]	C*	
8006	[L:Total Jobs]	C*	

- These SPs reveal the number of times an application is used, not the number of pages processed.
- When an application is opened for image input or output, this counts as one job.
- Interrupted jobs (paper jams, etc.) are counted, even though they do not finish.
- Only jobs executed by the customer are counted. Jobs executed by the customer engineer using the SP modes are not counted.
- When using secure printing (when a password is required to start the print job), the job is counted at the time when either "Delete Data" or "Specify Output" is specified.
- A job is counted as a fax job when the job is stored for sending.
- When a fax is received to fax memory, the F: counter increments but the L: counter does not (the document server is not used).
- A fax broadcast counts as one job for the F: counter (the fax destinations in the broadcast are not counted separately).
- A fax broadcast is counted only after all the faxes have been sent to their destinations. If one transmission generates an error, then the broadcast will not be counted until the transmission

has been completed.

- A printed fax report counts as one job for the F: counter.
- The F: counter does not distinguish between fax sending or receiving.
- When a copy job on the document server is printed, SP8-022 also increments, and when a print job stored on the document server is printed, SP8024 also increments.
- When an original is both copied and stored on the document server, the C: and L: counters both increment.
- When a print job is stored on the document server, only the L: counter increments.
- When the user presses the Document Server button to store the job on the document server, only the L: counter increments.
- When the user enters document server mode and prints data stored on the document server, only the L: counter increments.
- When an image received from Palm 2 is received and stored, the L: counter increments.
- When the customer prints a report (user code list, for example), the O: counter increments. However, for fax reports and reports executed from the fax application, the F: counter increments.

8011	[T:Jobs/LS]	C*	[0 to 9999999 / 0 / 1/step]
8012	[C:Jobs/LS]	C*	These SPs count the number of jobs stored to the document server by each application, to reveal how local storage is being used for input. The L: counter counts the number of jobs stored from within the document server mode screen at the operation panel.
8013	[F:Jobs/LS]	C*	
8014	[P:Jobs/LS]	C*	
8015	[S:Jobs/LS]	C*	
8016	[L:Jobs/LS]	C*	
8017	[O:Jobs/LS]	C*	

- When a scan job is sent to the document server, the S: counter increments. When you enter document server mode and then scan an original, the L: counter increments.
- When a print job is sent to the document server, the P: counter increments.
- When a network application sends data to the document server, the O: counter increments.
- When an image from Palm 2 is stored on the document server, the O: counter increments.
- When a fax is sent to the document server, the F: counter increments.

8021	[T:Pjob/LS]	C*	[0 to 99999999 / 0 / 1/step] These SPs reveal how files printed from the document server were stored on the document server originally. The L: counter counts the number of jobs stored from within the document server mode screen at the operation panel.
8022	[C:Pjob/LS]	C*	
8023	[F:Pjob/LS]	C*	
8024	[P:Pjob/LS]	C*	
8025	[S:Pjob/LS]	C*	
8026	[L:Pjob/LS]	C*	
8027	[O:Pjob/LS]	C*	

- When a copy job stored on the document server is printed with another application, the C: counter increments.
- When an application like DeskTopBinder merges a copy job that was stored on the document server with a print job that was stored on the document server, the C: and P: counters both increment.
- When a job already on the document server is printed with another application, the L: counter increments.
- When a scanner job stored on the document server is printed with another application, the S: counter increments. If the original was scanned from within document server mode, then the L: counter increments.
- When images stored on the document server by a network application (including Palm 2), are printed with another application, the O: counter increments.
- When a copy job stored on the document server is printed with a network application (Web Image Monitor, for example), the C: counter increments.
- When a fax on the document server is printed, the F: counter increments.

8031	[T:Pjob/DesApl]	C*	[0 to 99999999 / 0 / 1/step] These SPs reveal what applications were used to output documents from the document server. The L: counter counts the number of jobs printed from within the document server mode screen at the operation panel.
8032	[C:Pjob/DesApl]	C*	
8033	[F:Pjob/DesApl]	C*	
8034	[P:Pjob/DesApl]	C*	
8035	[S:Pjob/DesApl]	C*	
8036	[L:Pjob/DesApl]	C*	
8037	[O:Pjob/DesApl]	C*	

- When documents already stored on the document server are printed, the count for the application that started the print job is incremented.
- When the print job is started from a network application (Desk Top Binder, Web Image Monitor, etc.) the L: counter increments.

8041	[T:TX Jobs/LS]	C*	[0 to 9999999 / 0 / 1/step]
8042	[C:TX Jobs/LS]	C*	These SPs count the applications that stored files on the document server that were later accessed for transmission over the telephone line or over a network (attached to an e-mail, or as a fax image by I-Fax). Note: Jobs merged for sending are counted separately. The L: counter counts the number of jobs scanned from within the document server mode screen at the operation panel.
8043	[F:TX Jobs/LS]	C*	
8044	[P:TX Jobs/LS]	C*	
8045	[S:TX Jobs/LS]	C*	
8046	[L:TX Jobs/LS]	C*	
8047	[O:TX Jobs/LS]	C*	

- When a stored copy job is sent from the document server, the C: counter increments.
- When images stored on the document server by a network application or Palm2 are sent as an e-mail, the O: counter increments.

8051	[T:TX Jobs/DesApl]	C*	[0 to 9999999 / 0 / 1/step]
8052	[C:TX Jobs/DesApl]	C*	These SPs count the applications used to send files from the document server over the telephone line or over a network (attached to an e-mail, or as a fax image by I-Fax). Jobs merged for sending are counted separately. The L: counter counts the number of jobs sent from within the document server mode screen at the operation panel.
8053	[F:TX Jobs/DesApl]	C*	
8054	[P:TX Jobs/DesApl]	C*	
8055	[S:TX Jobs/DesApl]	C*	
8056	[L:TX Jobs/DesApl]	C*	
8057	[O:TX Jobs/DesApl]	C*	

- If the send is started from Desk Top Binder or Web Image Monitor, for example, then the O: counter increments.

8061	[T:FIN Jobs] These SPs total the finishing methods. The finishing method is specified by the application.		
8062	[P:FIN Jobs] These SPs total finishing methods for print jobs only. The finishing method is specified by the application.		
8063	[F:FIN Jobs] These SPs total finishing methods for print jobs only. The finishing method is specified by the application.		
8064	[P:FIN Jobs] These SPs total finishing methods for print jobs only. The finishing method is specified by the application.		
8065	[S:FIN Jobs] These SPs total finishing methods for scan jobs only. The finishing method is specified by the application. Note: Finishing features for scan jobs are not available at this time.		
8066	[L:FIN Jobs] These SPs total finishing methods for jobs output from within the document server mode screen at the operation panel. The finishing method is specified from the print window within document server mode.		
8067	[O:FIN Jobs] These SPs total finishing methods for jobs executed by an external application, over the network. The finishing method is specified by the application.		
8-06x-001	Sort	C*	[0 to 9999999 / 0 / 1/step] Number of jobs started in Sort mode.
8-06x-002	Stack	C*	[0 to 9999999 / 0 / 1/step] Number of jobs started out of Sort mode.
8-06x-003	Staple	C*	[0 to 9999999 / 0 / 1/step] Number of jobs started in Staple mode.

8-06x-004	Booklet	C*	[0 to 9999999 / 0 / 1/step] Number of jobs started in Booklet mode. If the machine is in staple mode, the Staple counter also increments.
8-06x-005	Z-Fold	C*	[0 to 9999999 / 0 / 1/step] Number of jobs started In any mode other than the Booklet mode and set for folding (Z-fold).
8-06x-006	Punch	C*	[0 to 9999999 / 0 / 1/step] Number of jobs started in Punch mode. When Punch is set for a print job, the P: counter increments. (See SP8-064-6.)
8-06x-007	Other	C*	[0 to 9999999 / 0 / 1/step] (Reserved)
8-06x-008	Inside-Flod	C*	[0 to 9999999 / 0 / 1/step]
8-06x-009	Three-In-Fold	C*	[0 to 9999999 / 0 / 1/step]
8-06x-010	Three-OUT-Fold	C*	[0 to 9999999 / 0 / 1/step]
8-06x-011	Four-Fold	C*	[0 to 9999999 / 0 / 1/step]
8-06x-012	KANNON-Fold	C*	[0 to 9999999 / 0 / 1/step]
8-06x-013	Perfect-Bind	C*	[0 to 9999999 / 0 / 1/step]
8-06x-014	Ring-Bind	C*	[0 to 9999999 / 0 / 1/step]

8071	[T:Jobs/PGS] These SPs count the number of jobs broken down by the number of pages in the job, regardless of which application was used.
8072	[C:Jobs/PGS] These SPs count and calculate the number of copy jobs by size based on the number of pages in the job.
8073	[F:Jobs/PGS] These SPs count and calculate the number of copy jobs by size based on the number of pages in the job.

8074	[P:Jobs/PGS] These SPs count and calculate the number of print jobs by size based on the number of pages in the job.		
8075	[S:Jobs/PGS] These SPs count and calculate the number of scan jobs by size based on the number of pages in the job.		
8076	[L:Jobs/PGS] These SPs count and calculate the number of jobs printed from within the document server mode window at the operation panel, by the number of pages in the job.		
8077	[O:Jobs/PGS] These SPs count and calculate the number of "Other" application jobs (Web Image Monitor, Palm 2, etc.) by size based on the number of pages in the job.		
8-07x-001	1 Page	C*	[0 to 99999999 / 0 / 1/step]
8-07x-002	2 Pages	C*	
8-07x-003	3 Pages	C*	
8-07x-004	4 Pages	C*	
8-07x-005	5 Pages	C*	
8-07x-006	6 to 10 Pages	C*	
8-07x-007	11 to 20 Pages	C*	[0 to 99999999 / 0 / 1/step]
8-07x-008	21 to 50 Pages	C*	
8-07x-009	51 to 100 Pages	C*	
8-07x-010	101 to 300 Pages	C*	
8-07x-011	301 to 500 Pages	C*	[0 to 99999999 / 0 / 1/step]
8-07x-012	501 to 700 Pages	C*	
8-07x-013	701 to 1000 Pages	C*	
8-07x-014	1001 to Pages	C*	

- For example: When a copy job stored on the document server is printed in document server mode, the appropriate L: counter (SP8-076-0xx) increments.
- Printing a fax report counts as a job and increments the F: counter (SP8-073).
- Interrupted jobs (paper jam, etc.) are counted, even though they do not finish.
- If a job is paused and re-started, it counts as one job.
- If the finisher runs out of staples during a print and staple job, then the job is counted at the time the error occurs.
- For copy jobs (SP8-072) and scan jobs (SP8-075), the total is calculated by multiplying the number of sets of copies by the number of pages scanned. (One duplex page counts as 2.)
- The first test print and subsequent test prints to adjust settings are added to the number of pages of the copy job (SP8-072).
- When printing the first page of a job from within the document server screen, the page is counted.

8111	[T:FAX TX Jobs]	C*	[0 to 9999999 / 0 / 1/step]
8113	[F:FAX TX Jobs]	C*	
8121	[T:IFAX TX Jobs]	C*	
8123	[T:IFAX TX Jobs]	C*	

8131	[T:S-to-Email Jobs] These SPs count the total number of jobs (color or black-and-white) scanned and attached to an e-mail, regardless of whether the document server was used or not.		
8135	[S: S-to-Email Jobs] These SPs count the number of jobs (color or black-and-white) scanned and attached to e-mail, without storing the original on the document server.		
8-13x-001	B/W	C*	[0 to 9999999 / 0 / 1/step]
8-13x-002	Color	C*	
8-13x-003	ACS	C*	

- These counters count jobs, not pages.
- If the job is stored on the document server, after the job is stored it is determined to be color or black-and-white then counted.
- If the job is cancelled during scanning, or if the job is cancelled while the document is waiting to be sent, the job is not counted.
- If the job is cancelled during sending, it may or may not be counted, depending on what stage of the process had been reached when the job was cancelled.
- If several jobs are combined for sending to the Scan Router, Scan-to-Email, or Scan-to-PC, or if one job is sent to more than one destination. Each send is counted separately. For example, if the same document is sent by Scan-to-Email as well as Scan-to-PC, then it is counted twice (once for Scan-to-Email and once for Scan-to-PC).

8141	[T:Deliv Jobs/Svr] These SPs count the total number of jobs (color or black-and-white) scanned and sent to a Scan Router server.		
8145	[S: Deliv Jobs/Svr] These SPs count the number of jobs (color or black-and-white) scanned in scanner mode and sent to a Scan Router server.		
8-14x-001	B/W	C*	[0 to 9999999 / 0 / 1/step]
8-14x-002	Color	C*	
8-14x-003	ACS	C*	

- These counters count jobs, not pages.
- The jobs are counted even though the arrival and reception of the jobs at the Scan Router server cannot be confirmed.
- If even one color image is mixed with black-and-white images, then the job is counted as a "Color" job.
- If the job is cancelled during scanning, or if the job is cancelled while the document is waiting to be delivered, the job is not counted.
- If the job is cancelled during sending, it may or may not be counted, depending on what stage of the process had been reached when the job was cancelled.
- Even if several files are combined for sending, the transmission counts as one job.

8151	[T:Deliv Jobs/PC]		
8155	[S:Deliv Jobs/PC]		
8-15x-001	B/W	C*	[0 to 9999999 / 0 / 1/step] These SPs count the total number of jobs (color or black-and-white) scanned and sent to a folder on a PC (Scan-to-PC). Note: At the present time, SP8-151 and SP8-155 perform identical counts.
8-15x-002	Color	C*	
8-15x-003	ACS	C*	

- These counters count jobs, not pages.
- If the job is cancelled during scanning, it is not counted.
- If the job is cancelled while it is waiting to be sent, the job is not counted.
- If the job is cancelled during sending, it may or may not be counted, depending on what stage of the process had been reached when the job was cancelled.
- Even if several files are combined for sending, the transmission counts as one job.

8161	[T:PCFAX TX Jobs]	C*	[0 to 9999999 / 0 / 1/step]
8163	[F:PCFAX TX Jobs]	C*	

8171	[T:Deliv Jobs/WSD]		
8175	[S:Deliv Jobs/WSD]		
8-17x-001	B/W	C*	[0 to 9999999 / 0 / 1/step] These SPs count the pages scanned by WS.
8-17x-002	Color	C*	
8-17x-003	ACS	C*	

8181	[T:Scan to Media Jobs]		
8185	[S:Scan to Media Jobs]		
8-18x-001	B/W	C*	[0 to 9999999 / 0 / 1/step] These SPs count the scanned pages in a media by the scanner application.
8-18x-002	Color	C*	
8-18x-003	ACS	C*	

8191	[T:Total Scan PGS]	C*	[0 to 9999999 / 0 / 1/step] These SPs count the pages scanned by each application that uses the scanner to scan images.
8192	[C:Total Scan PGS]	C*	
8193	[F:Total Scan PGS]	C*	
8195	[S:Total Scan PGS]	C*	
8196	[L:Total Scan PGS]	C*	

- These SPs count the number of scanned sides of pages, not the number of physical pages.
- These counters do not count reading user stamp data, or reading color charts to adjust color.
- Previews done with a scanner driver are not counted.
- A count is done only after all images of a job have been scanned.
- Scans made in SP mode are not counted.

Examples

- If 3 B5 pages and 1 A3 page are scanned with the scanner application but not stored, the S: count is 4.
- If both sides of 3 A4 sheets are copied and stored to the document server using the Store File button in the Copy mode window, the C: count is 6 and the L: count is 6.
- If both sides of 3 A4 sheets are copied but not stored, the C: count is 6.
- If you enter document server mode then scan 6 pages, the L: count is 6.

8201	[T:LSize Scan PGS]	C*	[0 to 9999999 / 0 / 1/step] These SPs count the total number of large pages input with the scanner for scan and copy jobs. Large size paper (A3/DLT) scanned for fax transmission is not counted. Note: These counters are displayed in the SMC Report, and in the User Tools display.
8203	[F:LSize Scan PGS]	C*	[0 to 9999999 / 0 / 1/step] These SPs count the total number of large pages input with the scanner for scan and copy jobs. Large size paper (A3/DLT) scanned for fax transmission is not counted. Note: These counters are displayed in the SMC Report, and in the User Tools display.
8205	[S:LSize Scan PGS]	C*	[0 to 9999999 / 0 / 1/step] These SPs count the total number of large pages input with the scanner for scan jobs only. Large size paper (A3/DLT) scanned for fax transmission is not counted. Note: These counters are displayed in the SMC Report, and in the User Tools display.

8211	[T:Scan PGS/LS]	C*	[0 to 9999999 / 0 / 1/step]
8212	[C:Scan PGS/LS]	C*	These SPs count the number of pages scanned into the document server. The L: counter counts the number of pages stored from within the document server mode screen at the operation panel, and with the Store File button from within the Copy mode screen.
8213	[F:Scan PGS/LS]	C*	
8215	[S:Scan PGS/LS]	C*	
8216	[L:Scan PGS/LS]	C*	

Main SP Tables-8

- Reading user stamp data is not counted.
- If a job is cancelled, the pages output as far as the cancellation are counted.
- If the scanner application scans and stores 3 B5 sheets and 1 A4 sheet, the S: count is 4.
- If pages are copied but not stored on the document server, these counters do not change.
- If both sides of 3 A4 sheets are copied and stored to the document server, the C: count is 6 and the L: count is 6.
- If you enter document server mode then scan 6 pages, the L: count is 6.

8221	<p>[ADF Org Feeds] These SPs count the number of pages fed through the ADF for front and back side scanning.</p>		
8-221-001	Front	C*	<p>[0 to 9999999 / 0 / 1/step] Number of front sides fed for scanning: With an ADF that can scan both sides simultaneously, the Front side count is the same as the number of pages fed for either simplex or duplex scanning. With an ADF that cannot scan both sides simultaneously, the Front side count is the same as the number of pages fed for duplex front side scanning. (The front side is determined by which side the user loads face-up.)</p>
8-221-002	Back	C*	<p>[0 to 9999999 / 0 / 1/step] Number of rear sides fed for scanning: With an ADF that can scan both sides simultaneously, the Back count is the same as the number of pages fed for duplex scanning. With an ADF that cannot scan both sides simultaneously, the Back count is the same as the number of pages fed for duplex rear-side scanning.</p>

- When 1 sheet is fed for duplex scanning the Front count is 1 and the Back count is 1.
- If a jam occurs during the job, recovery processing is not counted to avoid double counting. Also, the pages are not counted if the jam occurs before the first sheet is output.

8231	[Scan PGS/Mode] These SPs count the number of pages scanned by each ADF mode to determine the work load on the ADF.		
8-231-001	Large Volume	C*	[0 to 9999999 / 0 / 1/step] Selectable. Large copy jobs that cannot be loaded in the ADF at one time.
8-231-002	SADF	C*	[0 to 9999999 / 0 / 1/step] Selectable. Feeding pages one by one through the ADF.
8-231-003	Mixed Size	C*	[0 to 9999999 / 0 / 1/step] Selectable. Select "Mixed Sizes" on the operation panel.
8-231-004	Custom Size	C*	[0 to 9999999 / 0 / 1/step] Selectable. Originals of non-standard size.
8-231-005	Platen	C*	[0 to 9999999 / 0 / 1/step] Book mode. Raising the ADF and placing the original directly on the platen.
8-231-006	Mixed 1side/ 2side	C*	[0 to 9999999 / 0 / 1/step] Simplex and Duplex mode.

- If the scan mode is changed during the job, for example, if the user switches from ADF to Platen mode, the count is done for the last selected mode.
- The user cannot select mixed sizes or non-standard sizes with the fax application so if the original's page sizes are mixed or non-standard, these are not counted.
- If the user selects "Mixed Sizes" for copying in the platen mode, the Mixed Size count is enabled.
- In the SADF mode if the user copies 1 page in platen mode and then copies 2 pages with SADF, the Platen count is 1 and the SADF count is 3.

8241	[T:Scan PGS/Org]	C*	[0 to 9999999 / 0 / 1/step] These SPs count the total number of scanned pages by original type for all jobs, regardless of which application was used.				
8242	[C:Scan PGS/Org]	C*	[0 to 9999999 / 0 / 1/step] These SPs count the number of pages scanned by original type for Copy jobs.				
8243	[C:Scan PGS/Org]	C*	[0 to 9999999 / 0 / 1/step] These SPs count the number of pages scanned by original type for copy jobs.				
8245	[S:Scan PGS/Org]	C*	[0 to 9999999 / 0 / 1/step] These SPs count the number of pages scanned by original type for Scan jobs.				
8246	[L:Scan PGS/Org]	C*	[0 to 9999999 / 0 / 1/step] These SPs count the number of pages scanned and stored from within the document server mode screen at the operation panel, and with the Store File button from within the copy mode screen				
			8241	8242	8243	8245	8246
8-24x-001	Text		Yes	Yes	Yes	Yes	Yes
8-24x-002	Text/Photo		Yes	Yes	Yes	Yes	Yes
8-24x-003	Photo		Yes	Yes	Yes	Yes	Yes
8-24x-004	GenCopy, Pale		Yes	Yes	No	Yes	Yes
8-24x-005	Map		Yes	Yes	No	Yes	Yes
8-24x-006	Normal/Detail		Yes	No	Yes	No	No
8-24x-007	Fine/Super Fine		Yes	No	Yes	No	No
8-24x-008	Binary		Yes	No	No	Yes	No
8-24x-009	Grayscale		Yes	No	No	Yes	No

8-24x-010	Color	Yes	No	No	Yes	No
8-24x-011	Other	Yes	Yes	Yes	Yes	Yes

- If the scan mode is changed during the job, for example, if the user switches from ADF to Platen mode, the count is done for the last selected mode.

8251	[T:Scan PGS/ImgEdt]	C*	[0 to 9999999 / 0 / 1/step]
8252	[C:Scan PGS/ImgEdt]	C*	These SPs show how many times Image Edit features have been selected at the operation panel for each application. Some examples of these editing features are: Erase> Border Erase> Center Image Repeat Centering Positive/Negative Note: The count totals the number of times the edit features have been used. A detailed breakdown of exactly which features have been used is not given.
8255	[S:Scan PGS/ImgEdr]	C*	
8256	[L:Scan PGS/ImgEdt]	C*	
8257	[O:Scan PGS/ImgEdt]	C*	

The L: counter counts the number of pages stored from within the document server mode screen at the operation panel, and with the Store File button from within the Copy mode screen.

8281	[T:Scan PGS/TWAIN]	C*	[0 to 9999999 / 0 / 1/step]
8285	[S:Scan PGS/TWAIN]	C*	These SPs count the number of pages scanned using a TWAIN driver. These counters reveal how the TWAIN driver is used for delivery functions. Note: At the present time, these counters perform identical counts.

8291	[T:Scan PGS/Stamp]	C*	[0 to 9999999 / 0 / 1/step]
8295	[S:Scan PGS/Stamp]	C*	These SPs count the number of pages stamped with the stamp in the ADF unit. The L: counter counts the number of pages stored from within the document server mode screen at the operation panel, and with the Store File button from within the Copy mode screen

8301	[T:Scan PGS/Size] These SPs count by size the total number of pages scanned by all applications. Use these totals to compare original page size (scanning) and output (printing) page size [SP 8-441].		
8302	[C:Scan PGS/Size] These SPs count by size the total number of pages scanned by the Copy application. Use these totals to compare original page size (scanning) and output (printing) page size [SP 8-442].		
8303	[F:Scan PGS/Size] These SPs count by size the total number of pages scanned by the Copy application. Use these totals to compare original page size (scanning) and output (printing) page size [SP 8-442].		
8305	[S:Scan PGS/Size] These SPs count by size the total number of pages scanned by the Scan application. Use these totals to compare original page size (scanning) and output page size [SP 8-445].		
8306	[L:Scan PGS/Size] These SPs count by size the total number of pages scanned and stored from within the document server mode screen at the operation panel, and with the Store File button from within the Copy mode screen. Use these totals to compare original page size (scanning) and output page size [SP 8-446].		
8-30x-001	A3	C*	[0 to 9999999 / 0 / 1/step]
8-30x-002	A4	C*	

8-30x-003	A5	C*	[0 to 9999999 / 0 / 1/step]
8-30x-004	B4	C*	
8-30x-005	B5	C*	
8-30x-006	DLT	C*	
8-30x-007	LG	C*	
8-30x-008	LT	C*	
8-30x-009	HLT	C*	
8-30x-010	Full Bleed	C*	
8-30x-254	Other (Standard)	C*	
8-30x-255	Other (Custom)	C*	

8311	T:Scan PGS/Rez	C*	[0 to 9999999 / 0 / 1/step]
8315	S: Scan PGS/Rez	C*	These SPs count by resolution setting the total number of pages scanned by applications that can specify resolution settings. Note: At the present time, SP8-311 and SP8-315 perform identical counts.
8-31x-001	1200dpi <	C*	[0 to 9999999 / 0 / 1/step]
8-31x-002	600dpi to 1199dpi	C*	
8-31x-003	400dpi to 599dpi	C*	
8-31x-004	200dpi to 399dpi	C*	
8-31x-005	< 199dpi	C*	

- Copy resolution settings are fixed so they are not counted.
- The Fax application does not allow finely-adjusted resolution settings so no count is done for the Fax application.

8381	[T:Total PrtPGS]	C*	[0 to 99999999 / 0 / 1/step] These SPs count the number of pages printed by the customer. The counter for the application used for storing the pages increments.
8382	[C:Total PrtPGS]	C*	
8383	[F:Total PrtPGS]	C*	
8384	[P:Total PrtPGS]	C*	
8385	[S:Total PrtPGS]	C*	
8386	[L:Total PrtPGS]	C*	
8387	[O:Total PrtPGS]	C*	

- When the A3/DLT double count function is switched on with SP5-104, 1 A3/DLT page is counted as 2.
- When several documents are merged for a print job, the number of pages stored is counted for the application that stored them.
- These counters are used primarily to calculate charges on use of the machine, so the following pages are not counted as printed pages:
 - Blank pages in a duplex printing job.
 - Blank pages inserted as document covers, chapter title sheets, and slip sheets.
 - Reports printed to confirm counts.
 - All reports done in the service mode (service summaries, engine maintenance reports, etc.)
 - Test prints for machine image adjustment.
 - Error notification reports.
 - Partially printed pages as the result of a copier jam.

8391	LSize PrtPGS	C*	[0 to 99999999 / 0 / 1/step] These SPs count pages printed on paper sizes A3/DLT and larger. Note: In addition to being displayed in the SMC Report, these counters are also displayed in the User Tools display on the copy machine.
------	--------------	----	--

8401	[T:PrtPGS/LS]	C*	[0 to 9999999 / 0 / 1/step]
8402	[C:PrtPGS/LS]	C*	These SPs count the number of pages printed from the document server. The counter for the application used to print the pages is incremented. The L: counter counts the number of jobs stored from within the document server mode screen at the operation panel.
8403	[F:PrtPGS/LS]	C*	
8404	[P:PrtPGS/LS]	C*	
8405	[S:PrtPGS/LS]	C*	
8406	[L:PrtPGS/LS]	C*	

- Print jobs done with Web Image Monitor and Desk Top Binder are added to the L: count.
- Fax jobs done with Web Image Monitor and Desk Top Binder are added to the F: count.

8411	Prints/Duplex	C*	[0 to 99999999 / 0 / 1/step] This SP counts the amount of paper (front/back counted as 1 page) used for duplex printing. Last pages printed only on one side are not counted.
------	---------------	----	--

8421	[T:PrtPGS/Dup Comb]		These SPs count by binding and combine, and n-Up settings the number of pages processed for printing. This is the total for all applications.
8422	[C:PrtPGS/Dup Comb]		These SPs count by binding and combine, and n-Up settings the number of pages processed for printing by the copier application.
8423	[F:PrtPGS/Dup Comb]		These SPs count by binding and combine, and n-Up settings the number of pages processed for printing by the copier application.
8424	[P:PrtPGS/Dup Comb]		These SPs count by binding and combine, and n-Up settings the number of pages processed for printing by the printer application.
8425	[S:PrtPGS/Dup Comb]		These SPs count by binding and combine, and n-Up settings the number of pages processed for printing by the scanner application.

8426	[L:PrtPGS/Dup Comb] These SPs count by binding and combine, and n-Up settings the number of pages processed for printing from within the document server mode window at the operation panel.		
8427	[O:PrtPGS/Dup Comb] These SPs count by binding and combine, and n-Up settings the number of pages processed for printing by Other applications		
8-42x-001	Simplex> Duplex	C*	[0 to 99999999 / 0 / 1/step]
8-42x-002	Duplex> Duplex	C*	
8-42x-003	Book> Duplex	C*	
8-42x-004	Simplex Combine	C*	
8-42x-005	Duplex Combine	C*	
8-42x-006	2in1	C*	[0 to 99999999 / 0 / 1/step] 2 pages on 1 side (2-Up)
8-42x-007	4 in1	C*	[0 to 99999999 / 0 / 1/step] 4 pages on 1 side (4-Up)
8-42x-008	6 in1	C*	[0 to 99999999 / 0 / 1/step] 6 pages on 1 side (6-Up)
8-42x-009	8 in1	C*	[0 to 99999999 / 0 / 1/step] 8 pages on 1 side (8-Up)
8-42x-010	9 in1	C*	[0 to 99999999 / 0 / 1/step] 9 pages on 1 side (9-Up)
8-42x-011	16 in1	C*	[0 to 99999999 / 0 / 1/step] 16 pages on 1 side (16-Up)
8-42x-012	Booklet	C*	[0 to 99999999 / 0 / 1/step]
8-42x-013	Magazine	C*	
8-42x-014	2-in-1 + Booklet	C*	
8-42x-015	4-in-1 + Booklet	C*	
8-42x-016	6-in-1 + Booklet	C*	

8-42x-017	8-in-1 + Booklet	C*	[0 to 99999999 / 0 / 1/step]
8-42x-018	9-in-1 + Booklet	C*	
8-42x-019	2-in-1 + Magazine	C*	
8-42x-020	4-in-1 + Magazine	C*	
8-42x-021	6-in-1 + Magazine	C*	
8-42x-022	8-in-1 + Magazine	C*	
8-42x-023	9-in-1 + Magazine	C*	
8-42x-024	16-in-1 + Magazine	C*	

- These counts (SP8-421 to SP8-427) are especially useful for customers who need to improve their compliance with ISO standards for the reduction of paper consumption.
- Pages that are only partially printed with the n-Up functions are counted as 1 page.
- Here is a summary of how the counters work for Booklet and Magazine modes:

Booklet		Magazine	
Original Pages	Count	Original Pages	Count
1	1	1	1
2	2	2	2
3	2	3	2
4	2	4	2
5	3	5	4
6	4	6	4
7	4	7	4
8	4	8	4

8431	[T:PrtPGS/ImgEdt] These SPs count the total number of pages output with the three features below, regardless of which application was used.		
8432	[C:PrtPGS/ImgEdt] These SPs count the total number of pages output with the three features below with the copy application.		
8434	[P:PrtPGS/ImgEdt] These SPs count the total number of pages output with the three features below with the print application.		
8436	[L:PrtPGS/ImgEdt] These SPs count the total number of pages output from within the document server mode window at the operation panel with the three features below.		
8437	[O:PrtPGS/ImgEdt] These SPs count the total number of pages output with the three features below with Other applications.		
8-43x-001	Cover/Slip Sheet	C*	[0 to 99999999 / 0 / 1/step] Total number of covers or slip sheets inserted. The count for a cover printed on both sides counts 2.
8-43x-002	Series/Book	C*	[0 to 99999999 / 0 / 1/step] The number of pages printed in series (one side) or printed as a book with booklet right/left pagination.
8-43x-003	User Stamp	C*	[0 to 99999999 / 0 / 1/step] The number of pages printed where stamps were applied, including page numbering and date stamping.

8441	[T:PrtPGS/Ppr Size] These SPs count by print paper size the number of pages printed by all applications.		
8442	[C:PrtPGS/Ppr Size] These SPs count by print paper size the number of pages printed by the copy application.		
8444	[P:PrtPGS/Ppr Size] These SPs count by print paper size the number of pages printed by the printer application.		
8445	[S:PrtPGS/Ppr Size] These SPs count by print paper size the number of pages printed by the scanner application.		
8446	[L:PrtPGS/Ppr Size] These SPs count by print paper size the number of pages printed from within the document server mode window at the operation panel.		
8447	[O:PrtPGS/Ppr Size] These SPs count by print paper size the number of pages printed by Other applications.		
8-44x-001	A3	C*	[0 to 99999999 / 0 / 1/step]
8-44x-002	A4	C*	
8-44x-003	A5	C*	
8-44x-004	B4	C*	
8-44x-005	B5	C*	
8-44x-006	DLT	C*	
8-44x-007	LG	C*	[0 to 99999999 / 0 / 1/step]
8-44x-008	LT	C*	
8-44x-009	HLT	C*	
8-44x-010	Full Bleed	C*	
8-44x-254	Other (Standard)	C*	

Main SP Tables-8

8-44x-255	Other (Custom)	C*	
-----------	----------------	----	--

- These counters do not distinguish between LEF and SEF.

8451	[PrtPGS/Ppr Tray] These SPs count the number of sheets fed from each paper feed station.		
8-451-001	Bypass Tray	C*	[0 to 99999999 / 0 / 1/step] Bypass Tray
8-451-002	Tray 1	C*	[0 to 99999999 / 0 / 1/step] Copier
8-451-003	Tray 2	C*	
8-451-004	Tray 3	C*	[0 to 99999999 / 0 / 1/step] Paper Tray Unit (Option)
8-451-005	Tray 4	C*	
8-451-006	Tray 5	C*	[0 to 99999999 / 0 / 1/step] LCT (Option)
8-451-007	Tray 6	C*	Currently not used.
8-451-008	Tray 7	C*	
8-451-009	Tray 8	C*	
8-451-010	Tray 9	C*	
8-451-011	Tray 10	C*	
8-451-012	Tray 11	C*	
8-451-013	Tray 12	C*	
8-451-014	Tray 13	C*	
8-451-015	Tray 14	C*	
8-451-016	Tray 15	C*	

8461	[T:PrtPGS/Ppr Type] These SPs count by paper type the number pages printed by all applications. <ul style="list-style-type: none"> ▪ These counters are not the same as the PM counter. The PM counter is based on feed timing to accurately measure the service life of the feed rollers. However, these counts are based on output timing. ▪ Blank sheets (covers, chapter covers, slip sheets) are also counted. ▪ During duplex printing, pages printed on both sides count as 1, and a page printed on one side counts as 1. 		
8462	[C:PrtPGS/Ppr Type] These SPs count by paper type the number pages printed by the copy application.		
8463	[F:PrtPGS/Ppr Type] These SPs count by paper type the number pages printed by the copy application.		
8464	[P:PrtPGS/Ppr Type] These SPs count by paper type the number pages printed by the printer application.		
8466	[L:PrtPGS/Ppr Type] These SPs count by paper type the number pages printed from within the document server mode window at the operation panel.		
8-46x-001	Normal	C*	[0 to 99999999 / 0 / 1/step]
8-46x-002	Recycled	C*	
8-46x-003	Special	C*	
8-46x-004	Thick	C*	
8-46x-005	Normal (Back)	C*	[0 to 99999999 / 0 / 1/step]
8-46x-006	Thick (Back)	C*	
8-46x-007	OHP	C*	
8-46x-008	Other	C*	

8471	[PrtPGS/Mag] These SPs count by magnification rate the number of pages printed.		
8-471-001	< 49%	C*	[0 to 99999999 / 0 / 1/step]
8-471-002	50% to 99%	C*	
8-471-003	100%	C*	
8-471-004	101% to 200%	C*	
8-471-005	201% <	C*	

Counts are done for magnification adjusted for pages, not only on the operation panel but performed remotely with an external network application capable of performing magnification adjustment as well.

Magnification adjustments done with printer drivers with PC applications such as Excel are also counted.

Magnification adjustments done for adjustments after they have been stored on the document server are not counted.

Magnification adjustments performed automatically during Auto Reduce/Enlarge copying are counted.

The magnification rates of blank cover sheets, slip sheets, etc. are automatically assigned a rate of 100%.

8481	[T:PrtPGS/TonSave]	C*	[0 to 99999999 / 0 / 1/step]
8484	[P:PrtPGS/TonSave]	C*	These SPs count the number of pages printed with the Toner Save feature switched on. Note: These SPs return the same results as this SP is limited to the Print application.

8511	[T:PrtPGS/Emul]	C*	[0 to 99999999 / 0 / 1/step]
8514	[P:PrtPGS/Emul]	C*	These SPs count by printer emulation mode the total number of pages printed.
8-51x-001	RPCS	C*	[0 to 99999999 / 0 / 1/step]
8-51x-002	RPDL	C*	

8-51x-003	PS3	C*	
8-51x-004	R98	C*	
8-51x-005	R16	C*	
8-51x-006	GL/GL2	C*	
8-51x-007	R55	C*	[0 to 99999999 / 0 / 1/step]
8-51x-008	RTIFF	C*	
8-51x-009	PDF	C*	
8-51x-010	PCL5e/5c	C*	[0 to 99999999 / 0 / 1/step]
8-51x-011	PCL XL	C*	
8-51x-012	IPDL-C	C*	
8-51x-013	BM-Links	C*	Japan Only
8-51x-014	Other	C*	
8-51x-015	IPDS	C*	[0 to 99999999 / 0 / 1/step]
8-51x-016	XPS	C*	

- SP8-511 and SP8-514 return the same results as they are both limited to the Print application.
- Print jobs output to the document server are not counted.

8521	[T:PrtPGS/FIN] These SPs count by finishing mode the total number of pages printed by all applications.
8522	[C:PrtPGS/FIN] These SPs count by finishing mode the total number of pages printed by the copy application.
8523	[F:PrtPGS/FIN] These SPs count by finishing mode the total number of pages printed by the copy application.
8524	[P:PrtPGS/FIN] These SPs count by finishing mode the total number of pages printed by the print application.

8525	[S:PrtPGS/FIN] These SPs count by finishing mode the total number of pages printed by the scanner application.		
8526	[L:PrtPGS/FIN] These SPs count by finishing mode the total number of pages printed from within the document server mode window at the operation panel.		
8-52x-001	Sort	C*	[0 to 99999999 / 0 / 1/step]
8-52x-002	Stack	C*	
8-52x-003	Staple	C*	
8-52x-004	Booklet	C*	
8-52x-005	Z-Fold	C*	[0 to 99999999 / 0 / 1/step]
8-52x-006	Punch	C*	
8-52x-007	Other	C*	
8-52x-008	Inside Fold	C*	[0 to 99999999 / 0 / 1/step] Half-Fold (FM2) (Multi Fold Unit)
8-52x-009	Three-IN-Fold	C*	[0 to 99999999 / 0 / 1/step] Letter Fold-in (FM4) (Multi Fold Unit)
8-52x-010	Three-OUT-Fold	C*	[0 to 99999999 / 0 / 1/step] Letter Fold-out (FM3) (Multi Fold Unit)
8-52x-011	Four Fold	C*	[0 to 99999999 / 0 / 1/step] Double Parallel Fold (FM5) (Multi Fold Unit)
8-52x-012	KANNON-Fold	C*	[0 to 99999999 / 0 / 1/step] Gate Fold (FM6) (Multi Fold Unit)
8-52x-013	Perfect-Bind	C*	[0 to 99999999 / 0 / 1/step] Perfect Binder
8-52x-014	Ring-Bind	C*	[0 to 99999999 / 0 / 1/step] Ring Binder

 **Note**

- If stapling is selected for finishing and the stack is too large for stapling, the unstapled pages are still counted.
- The counts for staple finishing are based on output to the staple tray, so jam recoveries are counted.

8531	[Staples]	C*	[0 to 9999999 / 0 / 1/step] This SP counts the amount of staples used by the machine.
-------------	------------------	----	---

8551	[T:FIN Books]		
8552	[C:FIN Books]		
8554	[P:FIN Books]		
8556	[L:FIN Books]		
8-55x-001	Perfect-Bind	C*	Booklet finishing
8-55x-002	Ring-Bind	C*	Not used

8561	[T:A Sheet Of Paper]		
8562	[C:A Sheet Of Paper]		
8563	[F:A Sheet Of Paper]		
8564	[P:A Sheet Of Paper]		
8566	[L:A Sheet Of Paper]		
8567	[O:A Sheet Of Paper]		
8-56x-001	Total: Over A3/DLT	C*	[0 to 99999999 / 0 / 1/step]
8-56x-002	Total: Under A3/DLT	C*	
8-56x-003	Duplex: Over A3/DLT	C*	
8-56x-004	Duplex: Under A3/DLT	C*	

Main SP Tables-8

8581	[T:Counter] These SPs count the total output broken down by color output, regardless of the application used. In addition to being displayed in the SMC Report, these counters are also displayed in the User Tools display on the copy machine.		
8-581-001	Total	C*	[0 to 99999999 / 0 / 1/step]
8-581-032	Total (A3)	C*	

8591	[O:Counter] These SPs count the totals for A3/DLT paper use, number of duplex pages printed, and the number of staples used. These totals are for Other (O:) applications only.		
8-591-001	A3/DLT	C*	[0 to 99999999 / 0 / 1/step]
8-591-002	Duplex	C*	

8601	[T:CoverageCounter] These SPs count the total coverage for each color and the total printout pages for each printing mode.		
8-601-001	B/W	C*	[0 to 2147483647 / 0 / 1%/step]
8-601-011	B/W Printing Page	C*	[0 to 9999999 / 0 / 1/step]

8602	[C:Coverage Counter]	C*	[0 to 2147483647 / 0 / 1%/step]
8603	[F:Coverage Counter]	C*	
8604	[P:Coverage Counter]	C*	
8606	[L:Coverage Counter]	C*	

8617	[SDK Apli Counter] These SPs count the total printout pages for each SDK application.		
8-617-001	SDK-1	C*	[0 to 99999999 / 0 / 1/step]
8-617-002	SDK-2	C*	
8-617-003	SDK-3	C*	
8-617-004	SDK-4	C*	
8-617-005	SDK-5	C*	
8-617-006	SDK-6	C*	

8621	[Func Use Counter]		
8-621-001	Function-001	C*	[0 to 99999999 / 0 / 1/step]
8-621-002	Function-002	C*	
8-621-003	Function-003	C*	
8-621-004	Function-004	C*	
8-621-005	Function-005	C*	
8-621-006	Function-006	C*	
8-621-007	Function-007	C*	
8-621-008	Function-008	C*	
8-621-009	Function-009	C*	[0 to 99999999 / 0 / 1/step]
8-621-010	Function-010	C*	
8-621-011	Function-011	C*	
8-621-012	Function-012	C*	
8-621-013	Function-013	C*	
8-621-014	Function-014	C*	
8-621-015	Function-015	C*	
8-621-016	Function-016	C*	

Main SP Tables-8

8-621-017	Function-017	C*	[0 to 99999999 / 0 / 1/step]
8-621-018	Function-018	C*	
8-621-019	Function-019	C*	
8-621-020	Function-020	C*	
8-621-021	Function-021	C*	
8-621-022	Function-022	C*	
8-621-023	Function-023	C*	
8-621-024	Function-024	C*	
8-621-025	Function-025	C*	[0 to 99999999 / 0 / 1/step]
8-621-026	Function-026	C*	
8-621-027	Function-027	C*	
8-621-028	Function-028	C*	
8-621-029	Function-029	C*	
8-621-030	Function-030	C*	
8-621-031	Function-031	C*	
8-621-032	Function-032	C*	
8-621-033	Function-033	C*	[0 to 99999999 / 0 / 1/step]
8-621-034	Function-034	C*	
8-621-035	Function-035	C*	
8-621-036	Function-036	C*	
8-621-037	Function-037	C*	
8-621-038	Function-038	C*	
8-621-039	Function-039	C*	
8-621-040	Function-040	C*	
8-621-041	Function-041	C*	[0 to 99999999 / 0 / 1/step]
8-621-042	Function-042	C*	

8-621-043	Function-043	C*	
8-621-044	Function-044	C*	
8-621-045	Function-045	C*	
8-621-046	Function-046	C*	
8-621-047	Function-047	C*	
8-621-048	Function-048	C*	
8-621-049	Function-049	C*	[0 to 99999999 / 0 / 1/step]
8-621-050	Function-050	C*	
8-621-051	Function-051	C*	
8-621-052	Function-052	C*	
8-621-053	Function-053	C*	
8-621-054	Function-054	C*	
8-621-055	Function-055	C*	
8-621-056	Function-056	C*	
8-621-057	Function-057	C*	[0 to 99999999 / 0 / 1/step]
8-621-058	Function-058	C*	
8-621-059	Function-059	C*	
8-621-060	Function-060	C*	
8-621-061	Function-061	C*	
8-621-062	Function-062	C*	
8-621-063	Function-063	C*	
8-621-064	Function-064	C*	

8631	[T:FAX TX PGS]	C*	[0 to 99999999 / 0 / 1/step]
8633	[F:FAX TX PGS]	C*	

8641	[T:IFAX TX PGS]	C*	[0 to 9999999 / 0 / 1/step]
8643	[T:IFAX TX PGS]	C*	

8651	[T:S-to-Email PGS]	C*	[0 to 9999999 / 0 / 1/step]
8655	[S:S-to-Email PGS]	C*	These SPs count by color mode the total number of pages attached to an e-mail for both the Scan and document server applications.
8-65x-001	B/W	C*	[0 to 9999999 / 0 / 1/step]
8-65x-002	Color	C*	

 **Note**

- The count for B/W and Color pages is done after the document is stored on the HDD. If the job is cancelled before it is stored, the pages are not counted.
- If Scan-to-Email is used to send a 10-page document to 5 addresses, the count is 10 (the pages are sent to the same SMTP server together).
- If Scan-to-PC is used to send a 10-page document to 5 folders, the count is 50 (the document is sent to each destination of the SMB/FTP server).
- Due to restrictions on some devices, if Scan-to-Email is used to send a 10-page document to a large number of destinations, the count may be divided and counted separately. For example, if a 10-page document is sent to 200 addresses, the count is 10 for the first 100 destinations and the count is also 10 for the second 100 destinations, for a total of 20.).

8661	[T:Deliv PGS/Svr]	These SPs count by color mode the total number of pages sent to a Scan Router server by both Scan and LS applications.	
8665	[S:Deliv PGS/Svr]	These SPs count by color mode the total number of pages sent to a Scan Router server by the Scan application.	
8-66x-001	B/W	C*	[0 to 9999999 / 0 / 1/step]
8-66x-002	Color	C*	

 **Note**

- The B/W and Color counts are done after the document is stored on the HDD of the Scan Router server.
- If the job is canceled before storage on the Scan Router server finishes, the counts are not done.
- The count is executed even if regardless of confirmation of the arrival at the Scan Router server.

8671	[T:Deliv PGS/PC] These SPs count by color mode the total number of pages sent to a folder on a PC (Scan-to-PC) with the Scan and LS applications.		
8675	[S: Deliv PGS/PC] These SPs count by color mode the total number of pages sent with Scan-to-PC with the Scan application.		
8-67x-001	B/W	C*	[0 to 9999999 / 0 / 1/step]
8-67x-002	Color	C*	

8681	[T:PCFAX TXPGS]		
8683	[F:PCFAX TXPGS]		
8-68x-001	B/W	C*	[0 to 9999999 / 0 / 1/step]
8-68x-002	Color	C*	

8691	[T:TX PGS/LS]	C*	[0 to 9999999/ 0 / 1/step]
8692	[C:TX PGS/LS]	C*	These SPs count the number of pages sent from the document server. The counter for the application that was used to store the pages is incremented. The L: counter counts the number of pages stored from within the document server mode screen at the operation panel. Pages stored with the Store File button from within the copy mode screen go to the C: counter.
8693	[F:TX PGS/LS]	C*	
8694	[P:TX PGS/LS]	C*	
8695	[S:TX PGS/LS]	C*	
8696	[L:TX PGS/LS]	C*	

Note

- Print jobs done with Web Image Monitor and Desk Top Binder are added to the count.
- If several documents are merged for sending, the number of pages stored are counted for the application that stored them.
- When several documents are sent by a Fax broadcast, the F: count is done for the number of pages sent to each destination.

8701	[TX PGS/Port]		
	These SPs count the number of pages sent by the physical port used to send them. For example, if a 3-page original is sent to 4 destinations via ISDN G4, the count for ISDN (G3, G4) is 12.		
	8-701-001	PSTN-1	C*
	8-701-002	PSTN-2	C*
	8-701-003	PSTN-3	C*
	8-701-004	ISDN (G3,G4)	C*
8-701-005	Network	C*	
			[0 to 9999999 / 0 / 1/step]

8711	[T:Scan PGS/Comp]		
8715	[S:Scan PGS/Comp]		
8-71x-001	JPEG/JPEG2000	C*	[0 to 9999999 / 0 / 1/step] These SPs count the number of pages sent by each compression mode.
8-71x-002	TIFF(Multi/Single)	C*	
8-71x-003	PDF	C*	
8-71x-004	Other	C*	
8-71x-005	PDF/Comp	C*	
8-71x-006	PDF/A	C*	
8-71x-007	PDF(OCR)	C*	
8-71x-008	PDF/Comp(OCR)	C*	

8721	[T:Deliv PGS/WSD]		
8725	[S: Dvliv PGS/WSD]		
8-72x-001	B/W	C*	[0 to 9999999 / 0 / 1/step]
8-72x-002	Color	C*	These SPs count the number of pages scanned by each scanner mode.

8731	[T:Scan PGS/Media]		
8735	[S:Scan PGS/Media]		
8-73x-001	B/W	C*	[0 to 9999999 / 0 / 1/step]
8-73x-002	Color	C*	These SPs count the number of pages scanned and saved in a media by each scanner mode.

8741	[RX PGS/Port] These SPs count the number of pages received by the physical port used to receive them.		
8-741-001	PSTN-1	C*	[0 to 9999999/ 0 / 1/step]
8-741-002	PSTN-2	C*	
8-741-003	PSTN-3	C*	
8-741-004	ISDN (G3,G4)	C*	
8-741-005	Network	C*	

8771	[Dev Counter]	C*	[0 to 99999999 / 0 / 1/step] This SP counts the frequency of use (number of rotations of the development rollers) for black and other color toners.
-------------	----------------------	----	--

8781	[Toner_Botol_Info.]	E*	[0 to 9999999 / 0 / 1/step] This SP displays the number of already replaced toner bottles. NOTE: Currently, the data in SP7-833-011 through -014 and the data in SP8-781-001 through -004 are the same.
-------------	----------------------------	----	--

8791	[LS Memory Remain]	C*	[0 to 100 / 0 / 1%/step] This SP displays the percent of space available on the document server for storing documents.
-------------	---------------------------	----	--

8801	[Toner Remain]	C*	[0 to 100 / 0 / 10%/step] This SP displays the percent of toner remaining for each color. This SP allows the user to check the toner supply at any time.
-------------	-----------------------	----	--

8811	[Eco Counter]		
8-811-001	Eco Total	C*	[0 to 99999999 / 0 / 1/step]
8-811-004	Duplex	C*	
8-811-005	Combine	C*	
8-811-008	Duplex (%)	C*	[0 to 100 / 0 / 1%/step]
8-811-009	Combine (%)	C*	
8-811-010	Paper Cut (%)	C*	
8-811-101	Eco Totalr>Last	C*	[0 to 99999999 / 0 / 1/step]
8-811-104	Duplex>Last	C*	
8-811-105	Combine>Last	C*	
8-811-108	Duplex (%):Last	C*	[0 to 100 / 0 / 1%/step]

8-811-109	Combine (%):Last	C*	
8-811-110	Paper Cut (%):Last	C*	

8851	[Cvr Cnt: 0-10%] These SPs display the number of scanned sheets on which the coverage of each color is from 0% to 10%.		
8-851-011	0 to 2%: BK	E*	[0 to 99999999 / 0 / 1/step]
8-851-021	3 to 4%: BK	E*	
8-851-031	5 to 7%: BK	E*	
8-851-041	8 to 10%: BK	E*	

8861	[Cvr Cnt: 11-20%]	E*	[0 to 99999999 / 0 / 1/step] This SP displays the number of scanned sheets on which the coverage of each color is from 11% to 20%.
-------------	--------------------------	----	---

8871	[Cvr Cnt: 21-30%]	E*	[0 to 99999999 / 0 / 1/step] This SP displays the number of scanned sheets on which the coverage of each color is from 21% to 30%.
-------------	--------------------------	----	---

8881	[Cvr Cnt: 31%-]	E*	[0 to 99999999 / 0 / 1/step] This SP displays the number of scanned sheets on which the coverage of each color is 31% or higher.
-------------	------------------------	----	---

8891	[Page/Toner Bottle]	E*	[0 to 99999999 / 0 / 1/step] This SP displays the amount of the remaining current toner for each color.
-------------	----------------------------	----	--

8901	[Page/Toner_prev1]	E*	[0 to 99999999 / 0 / 1/step] This SP displays the amount of the remaining previous toner for each color.
-------------	---------------------------	----	---

8911	[Page/Toner_prev2]	E*	[0 to 99999999 / 0 / 1/step] This SP displays the amount of the remaining 2nd previous toner for each color.
-------------	---------------------------	----	---

8921	[Cvr Cnt/Total] This SP displays the total coverage and total printout number for each color.		
8-921-001	Coverage (%) Bk	C*	[0 to 2147483647 / 0 / 1%/step]
8-921-011	Coverage /P: Bk	C*	[0 to 99999999 / 0 / 1/step]

8941	[Machine Status] These SPs count the amount of time the machine spends in each operation mode. These SPs are useful for customers who need to investigate machine operation for improvement in their compliance with ISO Standards.		
8-941-001	Operation Time	C*	[0 to 99999999 / 0 / 1/step] Engine operation time. Does not include time while controller is saving data to HDD (while engine is not operating).
8-941-002	Standby Time	C*	[0 to 99999999 / 0 / 1/step] Engine not operating. Includes time while controller saves data to HDD. Does not include time spent in Energy Save, Low Power, or Off modes.
8-941-003	Energy Save Time	C*	[0 to 99999999 / 0 / 10/step] Includes time while the machine is performing background printing.

8-941-004	Low Power Time	C*	[0 to 99999999 / 0 / 1/step] Includes time in Energy Save mode with Engine on. Includes time while machine is performing background printing.
8-941-005	Off Mode Time	C*	[0 to 99999999 / 0 / 1/step] Includes time while machine is performing background printing. Does not include time machine remains powered off with the power switches.
8-941-006	SC	C*	[0 to 99999999 / 0 / 1/step] Total time when SC errors have been staying.
8-941-007	PrtJam	C*	[0 to 99999999 / 0 / 1/step] Total time when paper jams have been staying during printing.
8-941-008	OrgJam	C*	[0 to 99999999 / 0 / 1/step] Total time when original jams have been staying during scanning.
8-941-009	Supply PM Unit End	C*	[0 to 99999999 / 0 / 1/step] Total time when toner end has been staying

8951	[AddBook Register] These SPs count the number of events when the machine manages data registration.		
8-951-001	User Code/User ID	C*	[0 to 99999 / 0 / 1/step] User code registrations.
8-951-002	Mail Address	C*	[0 to 99999 / 0 / 1/step] Mail addresses registrations.
8-951-003	Fax Destination	C*	[0 to 99999 / 0 / 1/step] Fax destination registrations.

Main SP Tables-8

8-951-004	Group	C*	[0 to 99999 / 0 / 1/step] Group destination registrations.
8-951-005	Transfer Request	C*	[0 to 99999 / 0 / 1/step] Fax relay destination registrations for relay TX.
8-951-006	F-Code	C*	[0 to 99999 / 0 / 1/step] F-Code box registrations
8-951-007	Copy Program	C*	[0 to 255 / 0 / 1/step] Copy application registrations with the Program (job settings) feature.
8-951-008	Fax Program	C*	[0 to 255 / 0 / 1/step] Fax application registrations with the Program (job settings) feature.
8-951-009	Printer Program	C*	[0 to 255 / 0 / 1/step] Printer application registrations with the Program (job settings) feature.
8-951-010	Scanner Program	C*	[0 to 255 / 0 / 1/step] Scanner application registrations with the Program (job settings) feature.

8961	[Electricity Status]		
8-961-001	Ctrl Standby Time	C*	[0 to 99999999 / 0 / 1/step]
8-961-002	STR Time	C*	
8-961-003	Main Power Off Time	C*	
8-961-004	Reading and Printing Time	C*	
8-961-005	Printing Time	C*	
8-961-006	Reading Time	C*	
8-961-007	Eng Waiting Time	C*	[0 to 99999999 / 0 / 1/step]
8-961-008	Low Power State Time	C*	

8-961-009	Silent State Time	C*	
8-961-010	Heater Off State Time	C*	
8-961-011	LCD on Time	C*	

8971	[Unit Control]		
8-971-001	Engine Off Recovery Count	C*	[0 to 99999999 / 0 / 1/step]
8-971-002	Power Off Count	C*	
8-971-003	Force Power Off Count	C*	

8999	[Admin. Counter List]		
8-999-001	Total	C*	[0 to 99999999 / 0 / 1/step]
8-999-003	Copy: BW	C*	
8-999-007	Printer:BW	C*	
8-999-010	Fax Print: BW	C*	
8-999-013	Duplex	C*	
8-999-023	Copy: BW(%)	C*	[0 to 2147483647/ 0 / 1/step]
8-999-027	Printer: BW(%)	C*	
8-999-030	Fax Print: BW(%)	C*	
8-999-101	Transmission Total: Color	C*	[0 to 99999999 / 0 / 1/step]
8-999-102	Transmission Total: BW	C*	
8-999-103	FAX Transmission	C*	
8-999-104	Scanner Transmission: Color	C*	
8-999-105	Scanner Transmission: BW	C*	

3.10 INPUT AND OUTPUT CHECK

When entering the Input Check mode, 8 digits display the result for a section. Each digit corresponds to a different device as shown in the table.

Bit No.	7	6	5	4	3	2	1	0
Result	0 or 1	0 or 1	0 or 1	0 or 1	0 or 1	0 or 1	0 or 1	0 or 1

3.10.1 INPUT CHECK TABLE

5803	[INPUT Check]		
5-803-001	Paper Size	E	[0 to 15 / 0 / 1/step]
5-803-002	Paper End	E	[0 or 1 / 0 / 1/step]
5-803-003	Bypass:Paper End	E	
5-803-004	Bypass:Tray	E	
5-803-005	Paper Exit Full	E	
5-803-006	Paper Exit	E	
5-803-008	Registration	E	
5-803-010	Duplex:Entrance	E	[0 or 1 / 0 / 1/step]
5-803-011	Duplex:Reverse	E	
5-803-012	Rear Interlock	E	
5-803-013	Front Interlock	E	
5-803-014	Rear Cover Open	E	
5-803-017	Fusing Unit New	E	
5-803-018	Fusing Unit Set	E	[0 or 1 / 0 / 1/step]
5-803-019	HVP: SC_C_DV	E	
5-803-020	HVP: SC_T	E	

5-803-022	PSU Fan Lock	E		
5-803-023	Fusing Fan Lock	E		
5-803-024	Drum Fan Lock	E		
5-803-025	Main Motor Lock	E	[0 or 1 / 0 / 1/step]	
5-803-026	Key Card Set	E		
5-803-027	BiCU Ver	E	[0 to 7 / 0 / 1/step]	
5-803-028	Key Counter Set1	E	[0 or 1 / 0 / 1/step]	
5-803-029	Key Counter Set2	E		
5-803-083	BANK1: 500 / 250	E		
5-803-084	BANK2: 500 / 250	E		
5-803-087	BANK1:Relay SN	E		
5-803-088	BANK2:Relay SN	E		
5-803-092	BANK1:Paper End	E		
5-803-093	BANK2:Paper End	E		
5-803-094	BANK1:Paper Size	E		[0 to 7 / 0 / 1/step]
5-803-095	BANK2:Paper Size	E		
5-803-200	Scanner HP Sensor	E	[0 or 1 / 0 / 1/step]	
5-803-201	Platen Cover Sensor	E		

6007	[ADF INPUT Check]		
6-007-009	Original Detection	E	[0 or 1 / 0 / 1STEP/step]
6-007-013	Registration Sensor	E	
6-007-015	Feed Cover	E	

3.10.2 OUTPUT CHECK TABLE

5804	[OUTPUT Check]		
5-804-001	All Off	E	[0 or 1 / 0 / 1/step]
5-804-002	MainMT:CW:High	E	
5-804-003	MainMT:CW:Mid	E	
5-804-004	MainMT:CW:Low	E	
5-804-005	MainMT:CCW:High	E	
5-804-006	MainMT:CCW:Mid	E	[0 or 1 / 0 / 1/step]
5-804-007	MainMT:CCW:Low	E	
5-804-009	PSU Fan	E	
5-804-010	Fusing Fan: High	E	
5-804-011	Fusing Fan: Low	E	
5-804-012	Drum Fan: High	E	[0 or 1 / 0 / 1/step]
5-804-013	Drum Fan: Low	E	
5-804-014	Registration CL	E	
5-804-015	Paper Feed CL	E	
5-804-016	Feed Connect CL	E	
5-804-017	Duplex CL	E	[0 or 1 / 0 / 1/step]
5-804-018	Bypass:Feed CL	E	
5-804-019	Bypass:Tray CL	E	
5-804-020	Toner Supply CL	E	
5-804-021	Exit Junc SOL	E	
5-804-023	HVP: Charge	E	[0 or 1 / 0 / 1/step]
5-804-024	HVP: Development	E	

5-804-025	HVP: Transfer: -	E	
5-804-026	HVP: Transfer: +	E	
5-804-027	BICTL	E	
5-804-029	Toner End Sensor	E	
5-804-030	ExtRevMt:HOLD	E	
5-804-031	ExtRevMt:CW:Hi	E	[0 or 1 / 0 / 1/step]
5-804-032	ExtRevMt:CW:Mid	E	
5-804-033	ExtRevMt:CW:Low	E	
5-804-034	ExtRevMt:CCW:Hi	E	
5-804-035	ExtRevMt:CCW:Mid	E	
5-804-036	ExtRevMt:CCW:Low	E	[0 or 1 / 0 / 1/step]
5-804-163	BANK1:Motor:High	E	
5-804-164	BANK1:Motor:Mid	E	
5-804-165	BANK2:Motor:High	E	
5-804-166	BANK2:Motor:Mid	E	
5-804-169	BANK1:Feed CL	E	[0 or 1 / 0 / 1/step]
5-804-170	BANK2:Feed CL	E	
5-804-202	Scanner Lamp: Color 600	E	
5-804-203	Scanner Lamp: Color 1200	E	
5-804-204	Scanner Lamp: Bk	E	[0 or 1 / 0 / 1/step]

Input and Output Check

6008	[ADF OUTPUT Check]		
6-008-003	Feed Motor Forward	E	[0 or 1 / 0 / 1STEP/step]
6-008-004	Feed Motor Reverse	E	
6-008-009	Feed Solenoid	E	
6-008-011	Inverter Solenoid	E	

3.11 PRINTER SERVICE MODE

3.11.1 SP1-XXX (SERVICE MODE)

1001	[Bit Switch]			
001	Bit Switch 1 Settings		0	1
	bit 0	DFU	-	-
	bit 1	DFU	-	-
	bit 2	DFU	-	-
	bit 3	No I/O Timeout	Disabled	Enabled
		Enables/Disables MFP I/O Timeouts. If enabled, the MFP I/O Timeout setting will have no affect. I/O Timeouts will never occur.		
	bit 4	SD Card Save Mode	Disabled	Enabled
		If this bit switch is enabled, print jobs will be saved to the GW SD slot and not output to paper.		
	bit 5	DFU	-	-
	bit 6	DFU	-	-
bit 7	[RPCS,PCL]: Printable area frame border	Disabled	Enabled	
	Prints all RPCS and PCL jobs with a border around the printable area.			

1001	[Bit Switch]			
002	Bit Switch 2 Settings		0	1
	bit 0	DFU	-	-
	bit 1	DFU	-	-
	bit 2	DFU	-	-
	bit 3	[PCL5e/c,PS]: PDL Auto Switching	Enabled	Disabled
		Enables/Disables the MFPs ability to change the PDL processor mid-job. Some host systems submit jobs that contain both PS and PCL5e/c. If Auto PDL switching is disabled, these jobs will not be printed properly.		
	bit 4	DFU	-	-
	bit 5	DFU	-	-
bit 6	Switch dither *Please refer to RTB#RD014018	Use normal dither	Use alternative dither	
bit 7	DFU	-	-	

1001	[Bit Switch]			
003	Bit Switch 3 Settings		0	1
	bit 0	DFU	-	-
	bit 1	DFU	-	-
	bit 2	[PCL5e/c]: Legacy HP compatibility	Disabled	Enabled
		Uses the same left margin as older HP models such as HP4000/HP8000. In other words, the left margin defined in the job (usually "<ESC>*r0A") will be changed to "<ESC>*r1A".		
	bit 3	DFU	-	-
	bit 4	DFU	-	-
bit 5	DFU	-	-	

	bit 6	DFU	-	-
	bit 7	DFU	-	-

1001	[Bit Switch]			
004	Bit Switch 4 Settings		0	1
	bit 0	DFU	-	-
	bit 1	DFU	-	-
	bit 2	DFU	-	-
	bit 3	IPDS print-side reversal	Disabled	Enabled
		If enabled, the simplex pages of IPDS jobs will be printed on the front side because of printing on the back side of the page. This might reduce printing speed.		
	bit 4	DFU	-	-
	bit 5	DFU	-	-
	bit 6	[PCL, PS, PDF]: Changes the paper direction used with the settings "Any Size/Type" or "Any Custom Size/Type".	LEF	SEF
		By default "Any Size/Type" and "Any Custom Size/Type" treat all paper in the bypass tray as if it were loaded in the SEF direction. This bitswitch changes the assumed direction to LEF.		
	bit 7	DFU	-	-

1001	[Bit Switch]		
005	Bit Switch 5 Settings	0	1
	<p>Show "Collate Type", "Staple Type" and "Punch Type" buttons on the operation panel.</p>	Disabled	Enabled
	<p>bit 0</p> <p>If enabled, users will be able to configure a Collate Type, Staple Type, and Punch Type from the operation panel. The available types will depend on the device and configured options.</p> <p>After enabling the function, the settings will appear under: "User Tools > Printer Features > System"</p>		
	<p>bit 1</p> <p>Multiple copies if a paper size or type mismatch occurs</p>	Disabled (single copy)	Enabled (multiple)
	<p>If a paper size or type mismatch occurs during the printing of multiple copies, only a single copy is output by default. Using this BitSw, the device can be configured to print all copies even if a paper mismatch occurs.</p>		
	<p>bit 2</p> <p>Prevent SDK applications from altering the contents of a job.</p>	Disabled	Enabled
	<p>If this switch is enabled, SDK applications will not be able to alter print data. This is achieved by preventing SDK applications from accessing a module called the "GPS Filter".</p> <p>Note: The main purpose of this switch is for troubleshooting the effects of SDK applications on data.</p>		
	<p>bit 3</p> <p>[PS] PS Criteria</p>	Pattern3	Pattern1
	<p>Change the number of PS criterion used by the PS interpreter to determine whether a job is PS data or not.</p> <p>Pattern3: includes most PS commands.</p> <p>Pattern1: A small number of PS tags and headers</p>		
	<p>bit 4</p> <p>Increase max number of the stored jobs.</p>	Disabled (100)	Enabled (750)

		Changes the maximum number of jobs that can be stored on the HDD. The default (disabled) is 100. If this is enabled, the max. will be raised to 750.		
	bit 5	DFU	-	-
	bit 6	Method for determining the image rotation for the edge to bind on.	Disabled	Enabled
		If enabled, the image rotation will be performed as they were in the specifications of older models for the binding of pages of mixed orientation jobs. The old models are below: - PCL: Pre-04A models - PS/PDF/RPCS:Pre-05S models		
	bit 7	Letterhead mode printing	Disabled	Enabled (Duplex)
		Routes all pages through the duplex unit. If this is disabled, simplex pages or the last page of an odd-paged duplex job, are not routed through the duplex unit. This could result in problems with letterhead/pre-printed pages. Only affects pages specified as Letterhead paper.		

1001	[Bit Switch]			
006	Bit Switch 6 Settings	-	-	

1001	[Bit Switch]			
007	Bit Switch 7 Settings		0	1
	bit 0	Print path	Disabled	Enabled
If enabled, simplex pages (in mixed simplex/duplex PS/PCL5 jobs only) and the last page of an odd paged duplex job (PS, PCL5, PCL6), are always routed through the duplex unit. Not having to switch paper paths increases the print speed slightly.				
	bit 1	DFU	-	-
	bit 2	DFU	-	-

Printer Service Mode

	bit 3	DFU	-	-
	bit 4	DFU	-	-
	bit 5	DFU	-	-
	bit 6	DFU	-	-
	bit 7	DFU	-	-

1001	[Bit Switch]			
008	Bit Switch 8 Settings		0	1
	bit 0	DFU	-	-
	bit 1	DFU	-	-
	bit 2	DFU	-	-
	bit 3	[PCL,PS]: Allow BW jobs to print without requiring User Code	Disabled	Enabled (allow BW jobs to print without a user code)
	BW jobs submitted without a user code will be printed even if usercode authentication is enabled. Note: Color jobs will not be printed without a valid user code.			
	bit 4	DFU	-	-
	bit 5	DFU	-	-
	bit 6	PCL, RPCS, PS: Forced BW print	Enabled	Disabled
	Switches whether to ignore PDL color command.			
bit 7	DFU	-	-	

1001	[Bit Switch]			
009	Bit Switch 9 Settings		0	1
	bit 0	PDL Auto Detection timeout of jobs submitted via USB or Parallel Port (IEEE 1284).	Disabled (Immediately)	Enabled (10 seconds)
	To be used if PDL auto-detection fails. A failure of PDL autodetection doesn't necessarily mean that the job can't be printed. This bit switch tells the device whether to time-out immediately (default) upon failure or to wait 10 seconds.			
	bit 1	DFU	-	-
	bit 2	Job Cancel	Disabled (Not cancelled)	Enabled (Cancelled)
	If this bit switch, all jobs will be cancelled after a jam occurs. Note: If this bit switch is enabled, printing under the following conditions might result in problems: - Job submission via USB or Parallel Port - Spool printing (WIM > Configuration > Device Settings > System)			
	bit 3	DFU	-	-
	bit 4	Timing of the PDL Status ReadBack (JOB END) when printing multiple collated copies.	Disable	Enable
	This switch determines the timing of the PDL USTATUS JOB END sent when multiple collated copies are being printed. 0 (default): JOB END is sent by the device to the client after the first copy has completed printing. This causes the page counter to be incremented after the first copy and then again at the end of the job. 1: JOB END is sent by the device to the client after the last copy has finished printing. This causes the page counter to be incremented at the end of each job.			
	bit 5	Display UTF-8 text in the operation panel	Enabled	Disabled

		<p>Enabled (=0): Text composed of UTF-8 characters can be displayed in the operation panel.</p> <p>Disabled (=1): UTF-8 characters cannot be displayed in the operation panel.</p> <p>For example, job names are sometimes stored in the MIB using UTF-8 encoded characters. When these are displayed on the operation panel, they will be garbled unless this switch is enabled (=0).</p>			
	bit 6	Disable super option	<table border="1"> <tr> <td>OFF</td> <td>ON</td> </tr> </table> <p>Switches super option disable on / off.</p> <p>If this is On, multiple jobs are grouped at LPR port. PJP settings are enabled even jobs that are specified queue names are sent.</p>	OFF	ON
OFF	ON				
	bit 7	Enable/Disable Print from USB/SD's Preview function	<table border="1"> <tr> <td>Enabled</td> <td>Disabled</td> </tr> </table> <p>Determines whether Print from USB/SD will have the Preview function.</p> <p>Enabled (=0): Print from USB/SD will have the Preview function.</p> <p>Disabled (=1): Print from USB/SD will not have the Preview function.</p>	Enabled	Disabled
Enabled	Disabled				

1001	[Bit Switch]			
010	Bit Switch A Settings		0	1
	bit 0	DFU	-	-
	bit 1	DFU	-	-
	bit 2	DFU	-	-
	bit 3	DFU	-	-
	bit 4	DFU	-	-
	bit 5	Auto Job Promotion locks the queue	Queue is not locked after AJP	Queue locked after AJP
	<p>If this is 1, then after a job is stored using Auto Job Promotion, new jobs cannot be added to the queue until the stored job has been completely printed.</p>			

	bit 6	Allow use of Auto Job Promotion if connected to an external charge device.	Does not allow AJP with ECD	Allows AJP with ECD
	<p>If this is 0, Auto Job Promotion will be automatically disabled if an external charge device is connected.</p> <p>Note: We do not officially support enabling this switch (1). Use it at your own risk.</p>			
	bit 7	DFU	-	-

1001	[Bit Switch]			
011	Bit Switch B Settings		0	1
	bit 0	DFU	-	-
	bit 1	Print job interruption	Does not allow interruption	Allow interruption
	<p>0 (default): Print jobs are not interrupted. If a job is promoted to the top of the print queue, it will wait for the currently printing job to finish.</p> <p>1: If a job is promoted to the top of the queue, it will interrupt the currently printing job and start printing immediately.</p>			
	bit 2	DFU	-	-
	bit 3	DFU	-	-
	bit 4	DFU	-	-
	bit 5	DFU	-	-
	bit 6	DFU	-	-
	bit 7	DFU	-	-

1001	[Bit Switch]			
012	Bit Switch C Settings		0	1
	bit 0	DFU	-	-
	bit 1	DFU	-	-
	bit 2	DFU	-	-
	bit 3	DFU	-	-
	bit 4	DFU	-	-
	bit 5	DFU	-	-
	bit 6	DFU	-	-
	bit 7	DFU	-	-

1003	[Clear Setting]		
001	Initialize Printer System	*CTL	[- / - / -] [Execute]
	Initializes settings in the "System" menu of the user mode.		
003	Delete Program	*CTL	[- / - / -] [Execute]

1004	[Print Summary]		
	Prints the service summary sheet (a summary of all the controller settings).		
001	Print Printer Summary	CTL	[- / - / -] [Execute]

1005	[Display Version]		
001	-	CTL	[- / - / -]
	Displays the version of the controller firmware.		

1006	[Sample/Locked Print]		
001	0:Link with Doc. Srv 1:Enable	CTL	[- / 0 / -]

1007	[Supply Display]		
	Sets displaying remaining supply amount information or not. 0: Displays remaining supply amount information 1: Does not display remaining supply amount information		
002	PCU	*CTL	[0 or 1 / 1 / 1 /step]
006	Fuser	*CTL	*The Default setting is 1 but the Factory setting is 0

1110	[Media Print Device Setting]		
002	0:Disable 1:Enable	CTL	[- / 1 / -]

1111	[All Job Delete Mode]		
001	0:excluding New Job 1:including New Job	*CTL	[- / 1 / -]

3.12 SCANNER SP MODE

3.12.1 SP1-XXX (SYSTEM AND OTHERS)

1001	[Scan Nv Version]		
1-001-005	-	C*	-

1005	[Erase margin] Creates an erase margin for all edges of the scanned image. If the machine has scanned the edge of the original, create a margin. This SP is activated only when the machine uses TWAIN scanning.		
1-005-001	Range from 0 to 5 mm	C*	[0 to 5 / 0 / 1 mm/step]

1009	[Remote scan disable] Enable or disable remote scan.		
1-009-001	0:Enable 1:Disable	C*	[0 or 1 / 0 / -] 0: enable, 1: disable

1010	[Non Display Clear Light PDF] Enable or disable remote scan.		
1-010-001	0:Enable 1:Disable	C*	[0 or 1 / 0 / -] 0: Display, 1: No display

1011	[Org count Disp] Selects the original counter display. 0: Displays remaining memory for the original scanning.. 1: Displays original counter.		
1-011-001	0:ON 1:OFF	C*	[0 or 1 / 0 / -]

1012	[UserInfo release] Clear the following settings: Address, Sender, Text / Subject, Filename		
1-012-001	0:NO 1:YES	C*	[0 or 1 / 1 / -] 0: No, 1: Yes

1013	[Scan to Media Device Setting] On or off multimedia function		
1-013-001	0:OFF 1:ON	C*	[0 or 1 / 1 / -] 0: OFF, 1: ON

1014	[Scan to Folder Pass Input Set]		
1-014-001	0:OFF 1:ON	C*	[0 or 1 / 0 / -] 0: OFF, 1: ON

1040	[Scan:LT/LG Mixed Size Setting]		
1-040-001	0:OFF 1:ON	C*	[0 or 1 / 1 / -] 0: OFF, 1: ON

1041	[Scan:FlairAPI Setting]		
1-041-001	0x00 – 0xff	C*	[- / 00000000 / -]

3.12.2 SP2-XXX (SCANNING-IMAGE QUALITY)

2021	[Compression Level (Grayscale)] Selects the compression ratio for grayscale processing mode (JPEG) for the three settings that can be selected at the operation panel.		
2-021-001	Comp 1: 5-95	C*	[5 to 95 / 20 / 1 /step]
2-021-002	Comp 2: 5-95		[5 to 95 / 40 / 1 /step]
2-021-003	Comp 3: 5-95		[5 to 95 / 65 / 1 /step]
2-021-004	Comp 4: 5-95		[5 to 95 / 80 / 1 /step]
2-021-005	Comp 5: 5-95		[5 to 95 / 95 / 1 /step]

2024	[Compression ratio of ClearLight PDF] Selects the compression ratio for clearlight PDF for the two settings that can be selected at the operation panel.		
2-024-001	Compression Ratio (Normal)	C*	[5 to 95 / 25 / 1 /step]
2-024-002	Compression Ratio (High)		[5 to 95 / 20 / 1 /step]

2025	[Compression ratio of ClearLight PDF JPEG2000] Selects the compression ratio for clearlight PDF for the two settings that can be selected at the operation panel.		
2-025-001	Compression Ratio (Normal) JPEG2000	C*	[5 to 95 / 25 / 1 /step]
2-025-002	Compression Ratio (High) JPEG2000		[5 to 95 / 20 / 1 /step]

2030	[OCR PDF DetectSens]		
2-030-001	White Lumi Value: 0 - 255	C*	[- / 250 / -]
2-030-002	White Pix Ratio: 0 - 100		[- / 80 / -]
2-030-003	White Tile Ratio: 0 - 100		[- / 80 / -]

3.12.3 SP3-XXX

3043	[-] -		
3-043-001	-	C*	<p>[0 to 1 / 0 / 1/step]</p> <p>Sets the attachment method of the image data read when mail transmission.</p> <p>0: Attach a document that has been read (initial value).</p> <p>1: Attaches URL link of a document that has been read.</p>

3044	[-] -		
3-044-001	-	C*	<p>[0 to 1 / 1 / 1/step]</p> <p>Sets compression method of image data that has been read when using clear light PDF.</p> <p>0: high</p> <p>1: normal (initial value)</p>

3045	[-] -		
3-045-001	-	C*	<p>[0 to 5 / 5 / 1/step]</p> <p>Selects priority search server when searching mail address.</p> <p>0: LDAP server 1 1: LDAP server 2 2: LDAP server 3 3: LDAP server 4 4: LDAP server 5 5: BODY address table (initial value)</p>

3053	[-] -		
3-053-001	-	C*	<p>[0 to 1 / 0 / 1/step]</p> <p>Sets compression method of image data that has been read when using clear light PDF.</p> <p>0: JPEG initial value 1: JPEG2000</p>

3.13 TEST PATTERN PRINTING

3.13.1 TEST PATTERN PRINTING

Printing Test pattern: SP2-109

Some of these test patterns are used for copy image adjustments but most are used primarily for design testing.

Note

- Do not operate the machine until the test pattern is printed out completely. Otherwise, an SC occurs.
1. Enter the SP mode and select **SP2-109-001**.
 2. Select the number for the test pattern that you want to print and press [OK].
 3. Press the "Start" key to open the copy menu, then select the settings for the test print (paper size etc.).
 4. Press the "Start" key twice to start the test print.
 5. After checking the test pattern, press [To SP] on the LCD to return to the SP mode.
 6. Touch [Exit] three times to exit SP mode.

0	None	9	Arg. Grid20mm
1	Vert. (1dot)	10	Indep. (1dot)
2	Hori. (1dot)	11	Indep. (2dot)
3	Vert/ (2dot)	12	Indep. (4dot)
4	Hori. (2dot)	13	Full
5	Grid Vert.	14	Band
6	Grid Hori.	15	Gray 10mm
7	Grid 20mm	16	Gray 20mm
8	Arg. Grid	17	Trim Area

M160/M161 FAX OPTION

REVISION HISTORY		
Page	Date	Added/Updated/New
		None

M160/M161 FAX OPTION

TABLE OF CONTENTS

1. INSTALLATION	1
1.1 FAX UNIT OPTION	1
1.1.1 HANDSET (HS1010).....	1
Component Check.....	1
Installation Procedure.....	1
Selecting the telephone line type of the handset	3
Adjusting the handset bell volume	3
2. REPLACEMENT AND ADJUSTMENT	4
2.1 FCU.....	4
2.1.1 SRAM DATA TRANSFER PROCEDURE	4
3. TROUBLESHOOTING.....	7
3.1 ERROR CODES	7
3.2 IFAX TROUBLESHOOTING	29
3.3 IP-FAX TROUBLESHOOTING	32
3.3.1 IP-FAX TRANSMISSION.....	32
Cannot send by IP Address/Host Name.....	32
Cannot send via VoIP Gateway	33
Cannot send by Alias Fax number	34
3.3.2 IP-FAX RECEPTION	36
Cannot receive via IP Address/Host Name.....	36
Cannot receive by VoIP Gateway	37
Cannot receive by Alias Fax number	38
4. SERVICE TABLES	40
4.1 CAUTIONS.....	40
4.2 SERVICE PROGRAM TABLES	41
4.2.1 SP1-XXX (BIT SW).....	41
4.2.2 SP2-XXX (RAM).....	42
4.2.3 SP3-XXX (MACHINE SET)	43
4.2.4 SP4-XXX (ROM VERSIONS).....	44
4.2.5 SP5-XXX (RAM CLEAR).....	44
4.2.6 SP6-XXX (REPORTS)	45
4.2.7 SP7-XXX (TESTS)	47

4.3 BIT SWITCHES - 1	48
4.3.1 SYSTEM SWITCHES.....	48
4.4 BIT SWITCHES - 2	64
4.4.1 I-FAX SWITCHES.....	64
4.4.2 PRINTER SWITCHES.....	72
4.5 BIT SWITCHES - 3	79
4.5.1 COMMUNICATION SWITCHES	79
4.6 BIT SWITCHES - 4	88
4.6.1 G3 SWITCHES.....	88
4.7 BIT SWITCHES - 6	99
4.7.1 IP FAX SWITCHES	99
4.8 NCU PARAMETERS.....	111
4.9 DEDICATED TRANSMISSION PARAMETERS	126
4.9.1 PROGRAMMING PROCEDURE	126
4.9.2 PARAMETERS	126
Fax Parameters.....	126
E-mail Parameters.....	131
4.10 SERVICE RAM ADDRESSES.....	134
5. DETAILED SECTION DESCRIPTIONS	143
5.1 OVERVIEW	143
5.2 BOARDS	144
5.2.1 FCU	144
FACE3.5 (Fax Application Control Engine).....	144
Modem (FAME2)	144
DRAM	144
SAF Memory Back-up	145
ROM	145
SRAM	145
SRAM Back-up.....	145
Switches	145
CPU	145
5.3 FAX COMMUNICATION FEATURES	146
5.3.1 INTERNET MAIL COMMUNICATION.....	146
Mail Transmission.....	146
Data Formats.....	147
Direct SMTP Transmission.....	147
Selectable Options	148
Secure Internet Transmission	148
Mail Reception.....	148

POP3/IMAP4 Mail Reception Procedure	148
SMTP Reception	149
Mail Delivery Conditions: Transferring Mail Received With SMTP	149
Auth. E-mail RX.....	150
Handling Mail Reception Errors	150
Remaining SAF capacity error	151
Secure Internet Reception.....	151
Transfer Request: Request By Mail	151
E-Mail Options (Sub TX Mode)	152
Subject and Level of Importance.....	152
How the Subject Differs According to Mail Type	152
Subjects Displayed on the PC.....	153
E-mail Messages	154
Message Disposition Notification (MDN)	154
Handling Reports.....	155
Report Sample.....	156
5.4 IP-FAX.....	157
5.4.1 WHAT IS IP-FAX?	157
5.4.2 T.38 PACKET FORMAT.....	157
UDP Related Switches	157
5.4.3 SETTINGS.....	157
6. SPECIFICATIONS	158
6.1 GENERAL SPECIFICATIONS	158
6.1.1 FCU	158
6.2 CAPABILITIES OF PROGRAMMABLE ITEMS.....	159
6.3 IFAX SPECIFICATIONS.....	160
6.4 IP-FAX SPECIFICATIONS.....	162
6.5 FAX UNIT CONFIGURATION.....	163

READ THIS FIRST

Important Safety Notices

WARNING

- Never install telephone wiring during a lightning storm.
- Never install telephone jacks in wet locations unless the jack is specifically designed for wet locations.
- Never touch uninsulated telephone wires or terminals unless the telephone line has been disconnected at the network interface.
- Use caution when installing or modifying telephone lines.
- Avoid using a telephone (other than a cordless type) during an electrical storm. There may be a remote risk of electric shock from lightning.
- Do not use a telephone or cellular phone to report a gas leak in the vicinity of the leak.

CAUTION

- Before installing the fax unit, switch off the main switch, and disconnect the power cord.
- The fax unit contains a lithium battery. The danger of explosion exists if a battery of this type is incorrectly replaced. Replace only with the same or an equivalent type recommended by the manufacturer. Discard batteries in accordance with the manufacturer's instructions and local regulations.





Note

- **Note for Australia:**
- Unit must be connected to Telecommunication Network through a line cord that meets the requirements of ACA Technical Standard TS008.

Symbols and Abbreviations

Conventions Used in this Manual

This manual uses several symbols.

Symbol	What it means
	Screw
	Connector
	Clip ring
	Clamp
SEF	Short Edge Feed
LEF	Long Edge Feed

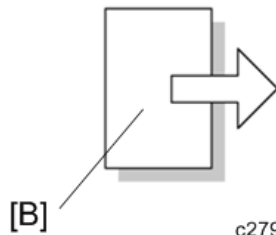
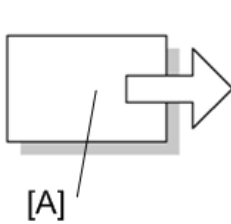

c2790086

[A] Short Edge Feed (SEF)

[B] Long Edge Feed (LEF)

Cautions, Notes, etc.

The following headings provide special information:

WARNING

- Failure to obey warning information could result in serious injury or death.

CAUTION

- Obey these guidelines to ensure safe operation and prevent minor injuries.

Important

- **Obey these guidelines to avoid problems such as misfeeds, damage to originals, loss of valuable data and to prevent damage to the machine.**
- **Always obey these guidelines to avoid serious problems such as misfeeds, damage to originals, loss of valuable data and to prevent damage to the machine. bold is added for emphasis.**

Note

- This document provides tips and advice about how to best service the machine.

1. INSTALLATION

1.1 FAX UNIT OPTION

1.1.1 HANDSET (HS1010)

↓ Note

- The optional handset is available for the U.S. version only.

Component Check

Check the quantity and condition of the components against the following list.

No.	Description	Q'ty
1	Handset	1
2	Cradle	1
3	Bracket	1
4	Round Screw (for cradle)	2

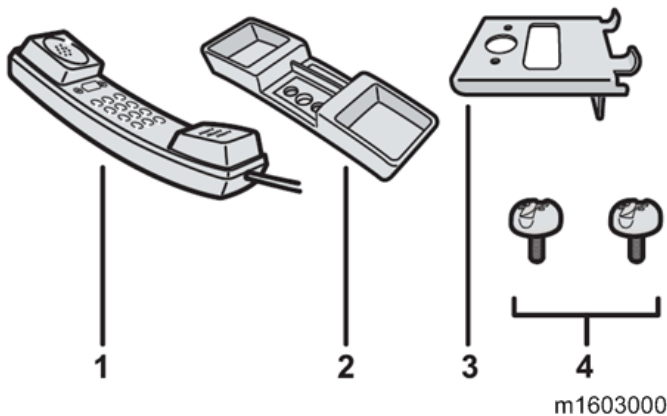

Installation Procedure

↓ Note

- Do not apply strong impact or force to the handset bracket. Or it may be damaged.
- The ferrite core is attached to the handset cord for reducing noise. Do not remove the ferrite core.

1. **Remove the protective tape from the handset bracket, and attach the bracket at the left side of the machine, as shown below.**

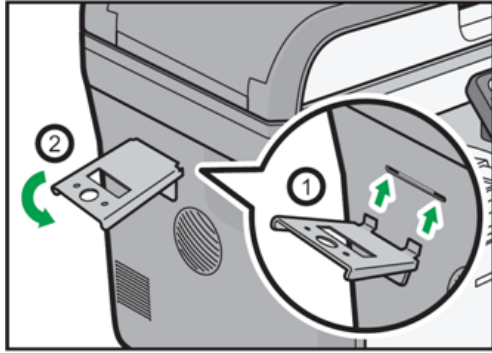

m1603001

2. Remove the inquiry card from the handset cradle.

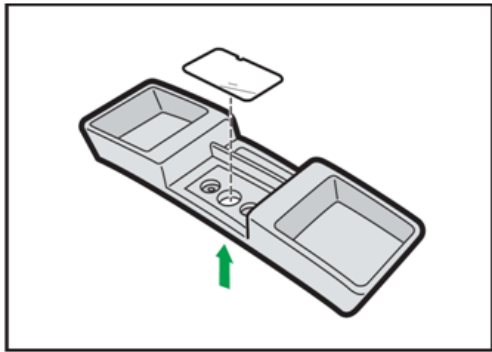

m1603002

3. Fix the handset cradle to the handset bracket by turning the screws with a coin.

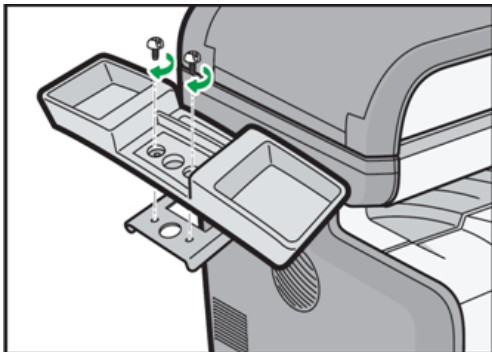

m1603003

4. Place the inquiry card back on the handset cradle.

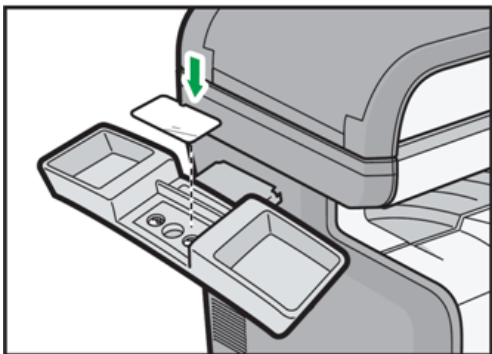

m1603004

5. Place the handset on the handset cradle, and connect the handset cord to TEL.

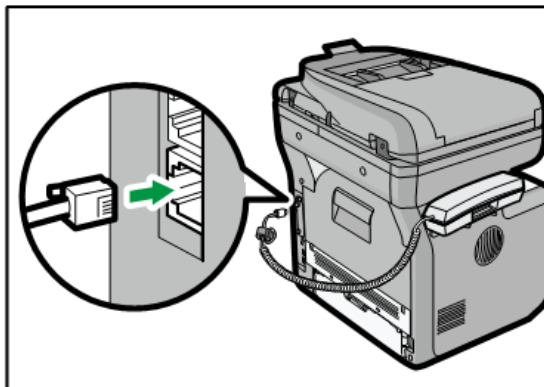

m1608037

Selecting the telephone line type of the handset

With a thin pointed object, set the switch on the handset to the line type you are using.

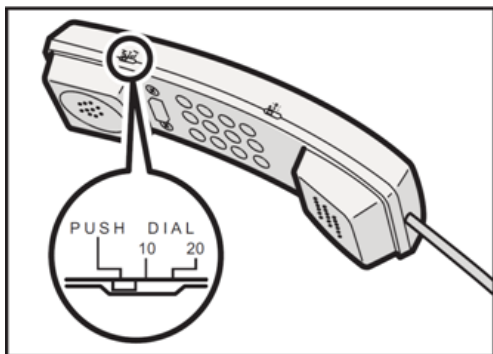

m1603006

- Push button phone: DTMF dial tones
- Dial phone: 10 (PPS) or 20 (PPS)

Adjusting the handset bell volume

With a thin pointed object, adjust the bell volume using the volume switch.

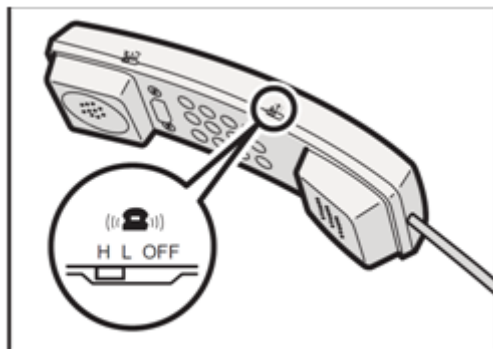

m1603007

- High : H
- Low : L
- No sound : OFF

2. REPLACEMENT AND ADJUSTMENT

2.1 FCU

2.1.1 SRAM DATA TRANSFER PROCEDURE

When you replace the FCU board, transfer the SRAM data from the old FCU board to the new FCU board. Do the following procedure to back up the SRAM data.

⚠ Note

- The following data can be transferred: TTI, RTI, CSI, Fax bit switch settings, RAM address settings, NCU parameter settings

1. Open the front cover.
2. Open the rear cover.
3. Remove the right cover [A] (⚙ x 4, hook x 3).



4. Remove the five screws of the bracket [A] (⚙ x 5), and then, remove the FCU board [B] with bracket (⚙ x 1, ⚙ x 1)

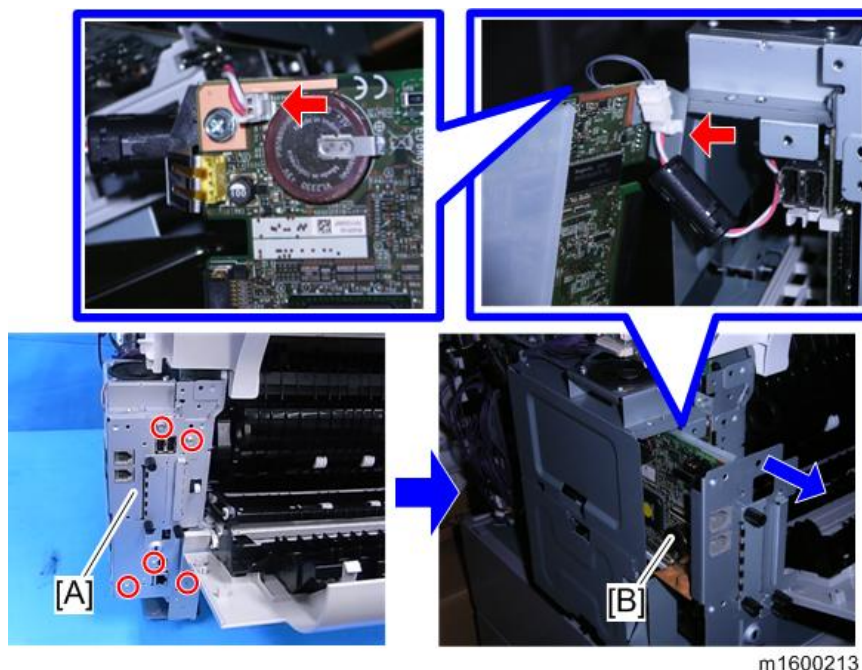

5. Detach the bracket [B] and [C] from the FCU board [A]. (⚙️ x 3).

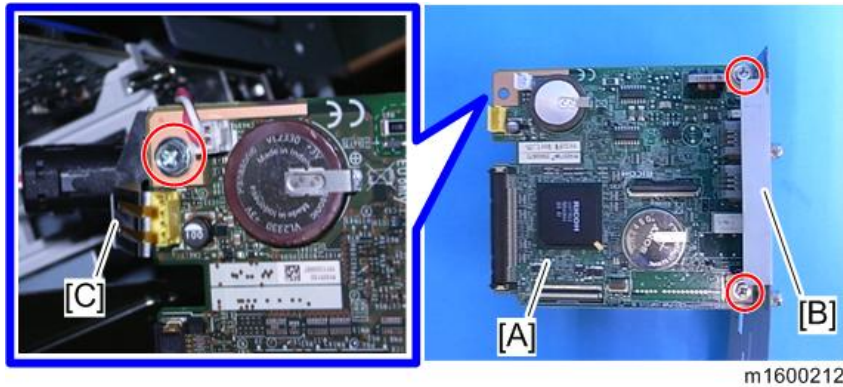

6. Replace the FCU board. (⚙️ x2)
7. Slide the battery backup jumper switch [A] to the ON position.

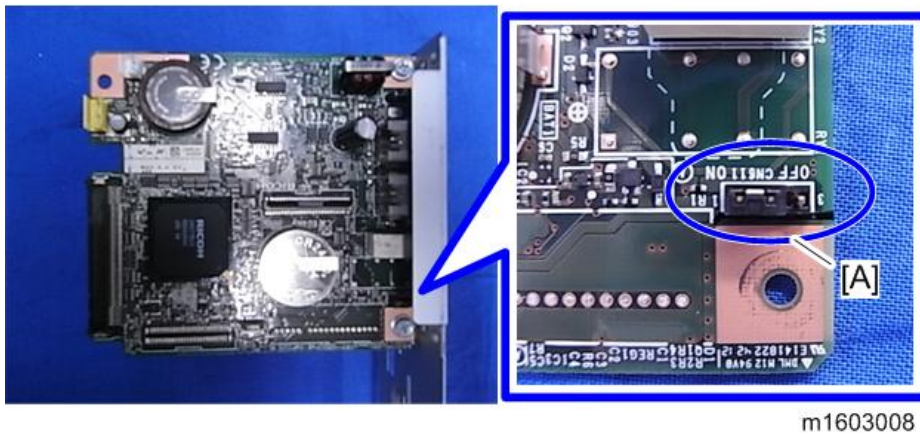

8. Mount the new FCU board in the machine by means of the bracket. (⚙️ x5, 📏 x1)
9. Insert one end of the supplied flat cable into the CN603 connector on the new FCU board.
▪ Be careful not to insert the cable at an angle.
10. Insert the other end of the flat cable into the CN603 connector on the old FCU board.
▪ Be careful not to insert the cable at an angle.

⚠️ CAUTION

- To prevent a short circuit, make sure the old FCU board does not come into contact with anything metal.

11. Turn the main power switch on.
12. The SRAM data transfer begins. Transfer is complete when a beep sounds.

Note

- The volume of the beep is set to the same level as the speaker volume.
- If the speaker volume is set to off, the volume of the beep is set to its initial factory-set level.
- If the machine does not beep, switch the main power off and then back on and try the data transfer again. Try several times if necessary.
- Be sure to check the transfer result after executing data transfer. If the transfer has failed, you need to specify settings manually in the SP mode.

- 13. When the message "Ready" appears on the control panel, switch the power off, and then remove the AC power plug from the receptacle.**
- 14. Disconnect the flat cable from both FCU boards.**
- 15. Reattach the covers.**
- 16. Turn the main power switch on.**
- 17. Enter the SP mode, print the system parameter list from SP6-101 in the Fax SP menu, and then check the list to see whether the SRAM data has been transferred correctly.**

3. TROUBLESHOOTING

3.1 ERROR CODES

If an error code occurs, retry the communication. If the same problem occurs, try to fix the problem as suggested below. Note that some error codes appear only in the error code display and on the service report.

Code	Meaning	Suggested Cause/Action
0-00	DIS/NSF not detected within 40 s of Start being pressed	<ul style="list-style-type: none"> ▪ Check the line connection. ▪ The machine at the other end may be incompatible. ▪ Replace the FCU. ▪ Check for DIS/NSF with an oscilloscope. ▪ If the rx signal is weak, there may be a bad line.
0-01	DCN received unexpectedly	<ul style="list-style-type: none"> ▪ The other party is out of paper or has a jammed printer. ▪ The other party pressed Stop during communication.
0-03	Incompatible modem at the other end	The other terminal is incompatible.
0-04	CFR or FTT not received after modem training	<ul style="list-style-type: none"> ▪ Check the line connection. ▪ Try changing the tx level and/or cable equalizer settings. ▪ Replace the FCU. ▪ The other terminal may be faulty; try sending to another machine. ▪ If the rx signal is weak or defective, there may be a bad line. <p>Cross reference</p> <ul style="list-style-type: none"> ▪ Tx level - NCU Parameter 01 (PSTN) ▪ Cable equalizer - G3 Switch 07 (PSTN) ▪ Dedicated tx parameters in Service Program Mode

Error Codes

Code	Meaning	Suggested Cause/Action
0-05	Modem training fails even G3 shifts down to 2400 bps	<ul style="list-style-type: none"> ▪ Check the line connection. ▪ Try adjusting the tx level and/or cable equalizer. ▪ Replace the FCU. ▪ Check for line problems. <p>Cross reference See error code 0-04.</p>
0-06	The other terminal did not reply to DCS	<ul style="list-style-type: none"> ▪ Check the line connection. ▪ Try adjusting the tx level and/or cable equalizer settings. ▪ Replace the FCU. ▪ The other end may be defective or incompatible; try sending to another machine. ▪ Check for line problems. <p>Cross reference See error code 0-04.</p>
0-07	No post-message response from the other end after a page was sent	<ul style="list-style-type: none"> ▪ Check the line connection. ▪ Replace the FCU. ▪ The other end may have jammed or run out of paper. ▪ The other end user may have disconnected the call. ▪ Check for a bad line. ▪ The other end may be defective; try sending to another machine.

Code	Meaning	Suggested Cause/Action
0-08	The other end sent RTN or PIN after receiving a page, because there were too many errors	<ul style="list-style-type: none"> ▪ Check the line connection. ▪ Replace the FCU. ▪ The other end may have jammed, or run out of paper or memory space. ▪ Try adjusting the tx level and/or cable equalizer settings. ▪ The other end may have a defective modem/FCU; try sending to another machine. ▪ Check for line problems and noise. <p>Cross reference</p> <ul style="list-style-type: none"> ▪ Tx level - NCU Parameter 01 (PSTN) ▪ Cable equalizer - G3 Switch 07 (PSTN) ▪ Dedicated tx parameters in Service Program Mode
0-14	Non-standard post message response code received	<ul style="list-style-type: none"> ▪ Incompatible or defective remote terminal; try sending to another machine. ▪ Noisy line: resend. ▪ Try adjusting the tx level and/or cable equalizer settings. ▪ Replace the FCU. <p>Cross reference</p> <p>See error code 0-08.</p>
0-15	The other terminal is not capable of specific functions.	<p>The other terminal is not capable of accepting the following functions, or the other terminal's memory is full.</p> <ul style="list-style-type: none"> ▪ Confidential rx ▪ Transfer function ▪ SEP/SUB/PWD/SID

Error Codes

Code	Meaning	Suggested Cause/Action
0-16	CFR or FTT not detected after modem training in confidential or transfer mode	<ul style="list-style-type: none"> ▪ Check the line connection. ▪ Replace the FCU. ▪ Try adjusting the tx level and/or cable equalizer settings. ▪ The other end may have disconnected, or it may be defective; try calling another machine. ▪ If the rx signal level is too low, there may be a line problem. <p>Cross reference See error code 0-08.</p>
0-17	Communication was interrupted by pressing the [Stop] key	If the [Stop] key was not pressed and this error keeps occurring, replace the operation panel or the operation panel drive board.
0-20	Facsimile data not received within 6 s of retraining	<ul style="list-style-type: none"> ▪ Check the line connection. ▪ Replace the FCU. ▪ Check for line problems. ▪ Try calling another fax machine. ▪ Try adjusting the reconstruction time for the first line and/or rx cable equalizer setting. <p>Cross reference</p> <ul style="list-style-type: none"> ▪ Reconstruction time - G3 Switch 0A, bit 6 ▪ Rx cable equalizer - G3 Switch 07 (PSTN)
0-21	EOL signal (end-of-line) from the other end not received within 5 s of the previous EOL signal	<ul style="list-style-type: none"> ▪ Check the connections between the FCU and line. ▪ Check for line noise or other line problems. ▪ Replace the FCU. ▪ The remote machine may be defective or may have disconnected. <p>Cross reference Maximum interval between EOLs and between ECM frames - G3 Switch 0A, bit 4</p>

Code	Meaning	Suggested Cause/Action
0-22	The signal from the other end was interrupted for more than the acceptable modem carrier drop time (default: 200 ms)	<ul style="list-style-type: none"> ▪ Check the line connection. ▪ Replace the FCU. ▪ Defective remote terminal. ▪ Check for line noise or other line problems. ▪ Try adjusting the acceptable modem carrier drop time. <p>Cross reference Acceptable modem carrier drop time - G3 Switch 0A, bits 0 and 1</p>
0-23	Too many errors during reception	<ul style="list-style-type: none"> ▪ Check the line connection. ▪ Replace the FCU. ▪ Defective remote terminal ▪ Check for line noise or other line problems. ▪ Try asking the other end to adjust their tx level. ▪ Try adjusting the rx cable equalizer setting and/or rx error criteria. <p>Cross reference</p> <ul style="list-style-type: none"> ▪ Rx cable equalizer - G3 Switch 07 (PSTN) ▪ Rx error criteria - Communication Switch 02, bits 0 and 1
0-29	Data block format failure in ECM reception	<ul style="list-style-type: none"> ▪ Check for line noise or other line problems. ▪ Check the FCU - NCU connectors. ▪ Replace the NCU or FCU.
0-30	The other terminal did not reply to NSS(A) in AI short protocol mode.	<ul style="list-style-type: none"> ▪ Check the line connection. ▪ Try adjusting the tx level and/or cable equalizer settings. ▪ The other terminal may not be compatible. <p>Cross reference Dedicated tx parameters - Section 4</p>
0-32	The other terminal sent a DCS, which contained functions that the receiving machine cannot handle.	<ul style="list-style-type: none"> ▪ Check the protocol dump list. ▪ Ask the other party to contact the manufacturer.

Error Codes

Code	Meaning	Suggested Cause/Action
0-33	The data reception (not ECM) is not completed within 10 minutes.	<ul style="list-style-type: none"> ▪ Check the line connection. ▪ The other terminal may have a defective modem/FCU.
0-52	Polarity changed during communication	<ul style="list-style-type: none"> ▪ Check the line connection. ▪ Retry communication.
0-55	FCU does not detect the SG3.	<ul style="list-style-type: none"> ▪ FCU firmware or board defective. ▪ SG3 firmware or board defective.
0-56	The stored message data exceeds the capacity of the mailbox in the SG3.	SG3 firmware or board defective.
0-70	The communication mode specified in CM/JM was not available. (V.8 calling and called terminal)	<ul style="list-style-type: none"> ▪ The other terminal did not have a compatible communication mode (e.g., the other terminal was a V.34 data modem and not a fax modem.) ▪ A polling tx file was not ready at the other terminal when polling rx was initiated from the calling terminal.
0-74	The calling terminal fell back to T.30 mode, because it could not detect ANSam after sending CI.	<ul style="list-style-type: none"> ▪ The calling terminal could not detect ANSam due to noise, etc. ▪ ANSam was too short to detect. ▪ Check the line connection and condition. ▪ Try making a call to another V.8/V.34 fax.
0-75	The called terminal fell back to T.30 mode, because it could not detect a CM in response to ANSam (ANSam timeout).	<ul style="list-style-type: none"> ▪ The terminal could not detect ANSam. ▪ Check the line connection and condition. ▪ Try receiving a call from another V.8/V.34 fax.
0-76	The calling terminal fell back to T.30 mode, because it could not detect a JM in response to CM (CM timeout).	<ul style="list-style-type: none"> ▪ The called terminal could not detect a CM due to noise, etc. ▪ Check the line connection and condition. ▪ Try making a call to another V.8/V.34 fax.

Code	Meaning	Suggested Cause/Action
0-77	The called terminal fell back to T.30 mode, because it could not detect a CJ in response to JM (JM timeout).	<ul style="list-style-type: none"> ▪ The calling terminal could not detect a JM due to noise, etc. ▪ A network that has narrow bandwidth cannot pass JM to the other end. ▪ Check the line connection and condition. ▪ Try receiving a call from another V.8/V.34 fax.
0-79	The called terminal detected CI while waiting for a V.21 signal.	<ul style="list-style-type: none"> ▪ Check for line noise or other line problems. ▪ If this error occurs, the called terminal falls back to T.30 mode.
0-80	The line was disconnected due to a timeout in V.34 phase 2 – line probing.	<ul style="list-style-type: none"> ▪ The guard timer expired while starting these phases. Serious noise, narrow bandwidth, or low signal level can cause these errors. <p>If these errors happen at the transmitting terminal:</p> <ul style="list-style-type: none"> ▪ Try making a call at a later time. ▪ Try using V.17 or a slower modem using dedicated tx parameters. ▪ Try increasing the tx level. ▪ Try adjusting the tx cable equalizer setting. <p>If these errors happen at the receiving terminal:</p> <ul style="list-style-type: none"> ▪ Try adjusting the rx cable equalizer setting. ▪ Try increasing the tx level. ▪ Try using V.17 or a slower modem if the same error is frequent when receiving from multiple senders.
0-81	The line was disconnected due to a timeout in V.34 phase 3 – equalizer training.	
0-82	The line was disconnected due to a timeout in the V.34 phase 4 – control channel start-up.	
0-83	The line was disconnected due to a timeout in the V.34 control channel restart sequence.	
0-84	The line was disconnected due to abnormal signaling in V.34 phase 4 – control channel start-up.	<ul style="list-style-type: none"> ▪ The signal did not stop within 10 s. ▪ Turn off the main power switch, then turn it back on. ▪ If the same error is frequent, replace the FCU.

Error Codes

Code	Meaning	Suggested Cause/Action
0-85	The line was disconnected due to abnormal signaling in V.34 control channel restart.	<ul style="list-style-type: none"> ▪ The signal did not stop within 10 s. ▪ Turn off the main power switch, then turn it back on. ▪ If the same error is frequent, replace the FCU.
0-86	The line was disconnected because the other terminal requested a data rate using MPh that was not available in the currently selected symbol rate.	<ul style="list-style-type: none"> ▪ The other terminal was incompatible. ▪ Ask the other party to contact the manufacturer.
0-87	The control channel started after an unsuccessful primary channel.	<ul style="list-style-type: none"> ▪ The receiving terminal restarted the control channel because data reception in the primary channel was not successful. ▪ This does not result in an error communication.
0-88	The line was disconnected because PPR was transmitted/received 9 (default) times within the same ECM frame.	<ul style="list-style-type: none"> ▪ Try using a lower data rate at the start. ▪ Try adjusting the cable equalizer setting.
2-11	Only one V.21 connection flag was received	Replace the FCU.
2-12	Modem clock irregularity	Replace the FCU.
2-13	Modem initialization error	<ul style="list-style-type: none"> ▪ Turn off the machine, then turn it back on. ▪ Update the modem ROM. ▪ Replace the FCU.
2-22	Counter overflow error of JBIG chip	If error occurs frequently, change the settings for resolution, paper size, compression type.
2-23	JBIG compression or reconstruction error	Turn off the machine, then turn it back on.
2-24	JBIG ASIC error	Turn off the machine, then turn it back on.

Code	Meaning	Suggested Cause/Action
2-25	JBIG data reconstruction error (BIH error)	<ul style="list-style-type: none"> ▪ JBIG data error ▪ Check the sender's JBIG function. ▪ Update the FCU ROM.
2-26	JBIG data reconstruction error (Float marker error)	
2-27	JBIG data reconstruction error (End marker error)	
2-28	JBIG data reconstruction error (Timeout)	
2-29	JBIG trailing edge maker error	<ul style="list-style-type: none"> ▪ FCU defective ▪ Check the destination device.
2-50	The machine resets itself for a fatal FCU system error	If this is frequent, update the ROM, or replace the FCU.
2-51	The machine resets itself because of a fatal communication error	If this is frequent, update the ROM, or replace the FCU.
2-53	Snd msg() in the manual task is an error because the mailbox for the operation task is full.	The user did the same operation many times, and this gave too much load to the machine.
4-01	Line current was cut	<ul style="list-style-type: none"> ▪ Check the line connector. ▪ Check for line problems. ▪ Replace the FCU.
4-10	Communication failed because of an ID Code mismatch (Closed Network) or Tel. No./CSI mismatch (Protection against Wrong Connections)	<ul style="list-style-type: none"> ▪ Get the ID Codes the same and/or the CSIs programmed correctly, then resend. ▪ The machine at the other end may be defective.
5-00	Data reconstruction not possible	Replace the FCU.
5-10	DCR timer expired	Replace the FCU.

Error Codes

Code	Meaning	Suggested Cause/Action
5-20	Storage impossible because of a lack of memory	<ul style="list-style-type: none"> ▪ Temporary memory shortage ▪ Test the SAF memory.
5-21	Memory overflow	
5-23	Print data error when printing a substitute rx or confidential rx message	<ul style="list-style-type: none"> ▪ Test the SAF memory. ▪ Ask the other end to resend the message.
5-25	SAF file access error	<ul style="list-style-type: none"> ▪ Replace an SD card or HDD. ▪ Replace the FCU.
6-00	G3 ECM - T1 time out during reception of facsimile data	<ul style="list-style-type: none"> ▪ Try adjusting the rx cable equalizer. ▪ Replace the FCU.
6-01	G3 ECM - no V.21 signal was received	
6-02	G3 ECM - EOR was received	
6-04	G3 ECM - RTC not detected	<ul style="list-style-type: none"> ▪ Check the line connection. ▪ Check for a bad line or defective remote terminal. ▪ Replace the FCU.
6-05	G3 ECM - facsimile data frame not received within 18 s of CFR, but there was no line fail	<ul style="list-style-type: none"> ▪ Check the line connection. ▪ Check for a bad line or defective remote terminal. ▪ Replace the FCU. ▪ Try adjusting the rx cable equalizer <p>Cross reference Rx cable equalizer - G3 Switch 07 (PSTN)</p>
6-06	G3 ECM - coding/decoding error	<ul style="list-style-type: none"> ▪ Defective FCU ▪ The other terminal may be defective.
6-08	G3 ECM - PIP/PIN received in reply to PPS.NULL	<ul style="list-style-type: none"> ▪ The other end pressed Stop during communication. ▪ The other terminal may be defective.

Code	Meaning	Suggested Cause/Action
6-09	G3 ECM - ERR received	<ul style="list-style-type: none"> ▪ Check for a noisy line. ▪ Adjust the tx levels of the communicating machines. ▪ See code 6-05.
6-10	G3 ECM - error frames still received at the other end after all communication attempts at 2400 bps	<ul style="list-style-type: none"> ▪ Check for line noise. ▪ Adjust the tx level (use NCU parameter 01 or the dedicated tx parameter for that address). ▪ Check the line connection. ▪ Defective remote terminal
6-21	V.21 flag detected during high speed modem communication	The other terminal may be defective or incompatible.
6-22	The machine resets the sequence because of an abnormal handshake in the V.34 control channel	<ul style="list-style-type: none"> ▪ Check for line noise. ▪ If the same error occurs frequently, replace the FCU. ▪ Defective remote terminal
6-99	V.21 signal not stopped within 6 s	Replace the FCU.
13-17	SIP user name registration error	<ul style="list-style-type: none"> ▪ Double registration of the SIP user name ▪ Capacity for user-name registration in the SIP server is not sufficient.
13-18	SIP server access error	<ul style="list-style-type: none"> ▪ Incorrect initial setting for the SIP server ▪ Defective SIP server
13-24	SIP authentication error	<ul style="list-style-type: none"> ▪ Registered password in the device does not match the password in the SIP server.
13-25	Network I/F setting error	<ul style="list-style-type: none"> ▪ IPV4 is not active in the active protocol setting. ▪ IP address of the device is not registered.
13-26	Network I/F setting error at power on	<ul style="list-style-type: none"> ▪ Active protocol setting does not match the I/F setting for SIP server. ▪ IP address of the device is not registered.
13-27	IP address setting error	IP address of the device is not registered.

Error Codes

Code	Meaning	Suggested Cause/Action
14-00	SMTP Send Error	Error occurred during sending to the SMTP server. Occurs for any error other than 14-01 to 16. For example, the mail address of the system administrator is not registered.
14-01	SMTP Connection Failed	<ul style="list-style-type: none"> ▪ Failed to connect to the SMTP server (timeout) because the server could not be found. ▪ The PC is not ready to transfer files. ▪ SMTP server not functioning correctly ▪ The DNS IP address is not registered. ▪ Network not operating correctly ▪ Destination folder selection not correct
14-02	No Service by SMTP Service (421)	<ul style="list-style-type: none"> ▪ SMTP server operating incorrectly, or the destination for direct SMTP sending is not correct. ▪ Contact the system administrator and check that the SMTP server has the correct settings and operates correctly. ▪ Contact the system administrator for direct SMTP sending and check the sending destination.

Code	Meaning	Suggested Cause/Action
14-03	Access to SMTP Server Denied (450)	<ul style="list-style-type: none"> ▪ Failed to access the SMTP server because the access is denied. ▪ SMTP server operating incorrectly. Contact the system administrator to determine if there is a problem with the SMTP server and to check that the SMTP server settings are correct. ▪ Folder send destination is incorrect. Contact the system administrator to determine that the SMTP server settings and path to the server are correct. ▪ Device settings incorrect. Confirm that the user name and password settings are correct. ▪ Direct SMTP destination incorrect. Contact the system administrator to determine if there is a problem at the destination at that the settings at the destination are correct.
14-04	Access to SMTP Server Denied (550)	<ul style="list-style-type: none"> ▪ SMTP server operating incorrectly ▪ Direct SMTP sending not operating correctly

Error Codes

Code	Meaning	Suggested Cause/Action
14-05	SMTP Server HDD Full (452)	<ul style="list-style-type: none"> ▪ Failed to access the SMTP server because the HDD on the server is full ▪ Insufficient free space on the HDD of the SMTP server. Contact the system administrator and check the amount of space remaining on the SMTP server HDD. ▪ Insufficient free space on the HDD where the destination folder is located. Contact the system administrator and check the amount of space remaining on the HDD where the target folder is located. ▪ Insufficient free space on the HDD at the target destination for SMTP direct sending. Contact the system administrator and check the amount of space remaining on the target HDD.
14-06	User Not Found on SMTP Server (551)	<ul style="list-style-type: none"> ▪ The designated user does not exist. ▪ The designated user does not exist on the SMTP server. ▪ The designated address is not for use with direct SMTP sending.
14-07	Data Send to SMTP Server Failed (4XX)	<ul style="list-style-type: none"> ▪ Failed to access the SMTP server because the transmission failed ▪ PC not operating correctly ▪ SMTP server operating incorrectly ▪ Network not operating correctly ▪ Destination folder setting incorrect ▪ Direct SMTP sending not operating correctly

Code	Meaning	Suggested Cause/Action
14-08	Data Send to SMTP Server Failed (5XX)	<ul style="list-style-type: none"> ▪ Failed to access the SMTP server because the transmission failed ▪ SMTP server operating incorrectly ▪ Destination folder setting incorrect ▪ Direct SMTP sending not operating correctly. ▪ Software application error
14-09	Authorization Failed for Sending to SMTP Server	<ul style="list-style-type: none"> ▪ POP-Before-SMTP or SMTP authorization failed. ▪ Incorrect setting for file transfer
14-10	Addresses Exceeded	Number of broadcast addresses exceeded the limit for the SMTP server.
14-11	Buffer Full	The send buffer is full so the transmission could not be completed. Buffer is full due to using Scan-to-Email while the buffer is being used send mail at the same time.
14-12	Data Size Too Large	Transmission was cancelled because the detected size of the file was too large.
14-13	Send Cancelled	Processing is interrupted because the user pressed Stop.
14-14	Security Locked File Error	Update the software because of the defective software.
14-15	Mail Data Error	<ul style="list-style-type: none"> ▪ The transmitting a mail is interrupted via DCS due to the incorrect data. ▪ Update the software because of the defective software.
14-16	Maximum Division Number Error	<ul style="list-style-type: none"> ▪ When a mail is divided for the mail transmission and the division number of a mail are more than the specified number, the mail transmission is interrupted. ▪ Update the software because of the defective software.

Error Codes

Code	Meaning	Suggested Cause/Action
14-17	Incorrect Ticket	Update the software because of the defective software.
14-18	Access to MCS File Error	<ul style="list-style-type: none"> ▪ The access to MCS file is denied due to the no permission of access. ▪ Update the software because of the defective software.
14-20	SMTP Authentication error	Make sure the administrator's e-mail address is same as the SMTP authentication address or POP before SMTP address.
14-21	Transmission error of S/MIME	Register the correct user certificate and device certificate.
14-22	Destination certificate is invalid in S/MIME transmission.	Register the correct destination certificate.
14-23	Device certificate is invalid in S/MIME transmission.	Register the correct device certificate.
14-24	Destination and device certificate is in valid in S/MIME.	Register the correct user certificate and device certificate.
14-30	MCS File Creation Failed	Failed to create the MCS file because: <ul style="list-style-type: none"> ▪ The number of files created with other applications on the Document Server has exceeded the limit. ▪ HDD is full or not operating correctly. ▪ Software error
14-31	UFS File Creation Failed	UFS file could not be created: <ul style="list-style-type: none"> ▪ Not enough space in UFS area to handle both Scan-to-Email and IFAX transmission ▪ HDD full or not operating correctly ▪ Software error
14-32	Cancelled the Mail Due to Error Detected by NFAX	Error detected with NFAX and send was cancelled due to a software error.

Code	Meaning	Suggested Cause/Action
14-33	No Mail Address For the Machine	Neither the mail address of the machine nor the mail address of the network administrator is registered.
14-34	Address designated in the domain for SMTP sending does not exist	<ul style="list-style-type: none"> ▪ Operational error in normal mail sending or direct SMTP sending. ▪ Check the address selected in the address book for SMTP sending. ▪ Check the domain selection.
14-50	Mail Job Task Error	Due to an FCU mail job task error, the send was cancelled: <ul style="list-style-type: none"> ▪ Address book was being edited during creation of the notification mail. ▪ Software error
14-51	UCS Destination Download Error	Not even one return notification can be downloaded: <ul style="list-style-type: none"> ▪ The address book was being edited. ▪ The number for the specified destination does not exist (it was deleted or edited after the job was created).
14-60	Send Cancel Failed	The cancel operation by the user failed to cancel the send operation.
14-61	Notification Mail Send Failed for All Destinations	All addresses for return notification mail failed.
14-62	Transmission Error due to the existence of zero line page	When the 0 line page exists in received pages with G3 communication, the transmission is interrupted.
15-01	POP3/IMAP4 Server Not Registered	At startup, the system detected that the IP address of the POP3/IMAP4 server has not been registered in the machine.
15-02	POP3/IMAP4 Mail Account Information Not Registered	The POP3/IMAP4 mail account has not been registered.
15-03	Mail Address Not Registered	The mail address has not been registered.

Error Codes

Code	Meaning	Suggested Cause/Action
15-10	DCS Mail Receive Error	Error other than 15-11 to 15-18.
15-11	Connection Error	The DNS or POP3/IMAP4 server could not be found: <ul style="list-style-type: none"> ▪ The IP address for DNS or POP3/IMAP4 server is not stored in the machine. ▪ The DNS IP address is not registered. ▪ Network not operating correctly
15-12	Authorization Error	POP3/IMAP4 send authorization failed: <ul style="list-style-type: none"> ▪ Incorrect IFAX user name or password ▪ Access was attempted by another device, such as the PC. ▪ POP3/IMAP4 settings incorrect
15-13	Receive Buffer Full	Occurs only during manual reception. Transmission cannot be received due to insufficient buffer space. The buffer is being used for mail send or Scan-to-Email.
15-14	Mail Header Format Error	The mail header is not standard format. For example, the Date line description is incorrect.
15-15	Mail Divide Error	The e-mail is not in standard format. There is no boundary between parts of the e-mail, including the header.
15-16	Mail Size Receive Error	The mail cannot be received because it is too large.
15-17	Receive Timeout	May occur during manual receiving only because the network is not operating correctly.
15-18	Incomplete Mail Received	Only one portion of the mail was received.
15-31	Final Destination for Transfer Request Reception Format Error	The format of the final destination for the transfer request was incorrect.

Code	Meaning	Suggested Cause/Action
15-39	Send/Delivery Destination Error	The transmission cannot be delivered to the final destination: <ul style="list-style-type: none"> Destination file format is incorrect. Could not create the destination for the file transmission.
15-41	SMTP Receive Error	Reception rejected because the transaction exceeded the limit for the "Auth. E-mail RX" setting.
15-42	Off Ramp Gateway Error	The delivery destination address was specified with Off Ramp Gateway OFF.
15-43	Address Format Error	Format error in the address of the Off Ramp Gateway.
15-44	Addresses Over	The number of addresses for the Off Ramp Gateway exceeded the limit of 30.
15-61	Attachment File Format Error	The attached file is not TIFF format.
15-62	TIFF File Compatibility Error	Could not receive transmission due to: <ul style="list-style-type: none"> Resolution error Image of resolution greater than 200 dpi without extended memory. Resolution is not supported. Page size error The page size was larger than A3. Compression error File was compressed with other than MH, MR, or MMR.
15-63	TIFF Parameter Error	The TIFF file sent as the attachment could not be received because the TIFF header is incorrect: <ul style="list-style-type: none"> The TIFF file attachment is a type not supported. The TIFF file attachment is corrupted. Software error

Error Codes

Code	Meaning	Suggested Cause/Action
15-64	TIFF Decompression Error	The file received as an attachment caused the TIFF decompression error: <ul style="list-style-type: none"> ▪ The TIFF format of the attachment is corrupted. ▪ Software error
15-71	Not Binary Image Data	The file could not be received because the attachment was not binary image data.
15-73	MDN Status Error	Could not find the Disposition line in the header of the Return Receipt, or there is a problem with the firmware.
15-74	MDN Message ID Error	Could not find the Original Message ID line in the header of the Return Receipt, or there is a problem with the firmware.
15-80	Mail Job Task Read Error	Could not receive the transmission because the destination buffer is full and the destination could not be created (this error may occur when receiving a transfer request or a request for notification of reception).
15-81	Repeated Destination Registration Error	Could not repeat receive the transmission because the destination buffer is full and the destination could not be created (this error may occur when receiving a transfer request or a request for notification of reception).
15-91	Send Registration Error	Could not receive the file for transfer to the final destination: <ul style="list-style-type: none"> ▪ The format of the final destination or the transfer destination is incorrect. ▪ Destinations are full so the final and transfer destinations could not be created.
15-92	Memory Overflow	Transmission could not be received because memory overflowed during the transaction.
15-93	Memory Access Error	Transaction could not complete due to a malfunction of SAF memory.

Code	Meaning	Suggested Cause/Action
15-94	Incorrect ID Code	The machine rejected an incoming e-mail for transfer request, because the ID code in the incoming e-mail did not match the ID code registered in the machine.
15-95	Transfer Station Function	The machine rejected an incoming e-mail for transfer because the transfer function was unavailable.
22-00	Original length exceeded the maximum scan length	<ul style="list-style-type: none"> ▪ Divide the original into more than one page. ▪ Check the resolution used for scanning. Lower the scan resolution if possible. ▪ Add optional page memory.
22-01	Memory overflow while receiving	<ul style="list-style-type: none"> ▪ Wait for the files in the queue to be sent. ▪ Delete unnecessary files from memory. ▪ Transfer the substitute reception files to an another fax machine, if the machine's printer is busy or out of order. ▪ Add an optional SAF memory card or hard disk.
22-02	Tx or rx job stalled due to line disconnection at the other end	<ul style="list-style-type: none"> ▪ The job started normally but did not finish normally; data may or may not have been received fully. ▪ Restart the machine.
22-04	The machine cannot store received data in the SAF	<ul style="list-style-type: none"> ▪ Update the ROM ▪ Replace the FCU.
22-05	No G3 parameter confirmation answer	Defective FCU board or firmware
23-00	Data read timeout during construction	<ul style="list-style-type: none"> ▪ Restart the machine. ▪ Replace the FCU.
25-00	The machine software resets itself after a fatal transmission error occurred	<ul style="list-style-type: none"> ▪ Update the ROM. ▪ Replace the FCU.

Error Codes

Code	Meaning	Suggested Cause/Action
F0-xx	V.34 modem error	Replace the FCU.
F6-xx	SG3 modem error	<ul style="list-style-type: none">▪ Update the SG3 modem ROM.▪ Check for line noise or other line problems.▪ Try communicating another V.8/V.34 fax.

3.2 IFAX TROUBLESHOOTING

Use the following procedures to determine whether the machine or another part of the network is causing the problem.

Communication Route	Item	Action [Remarks]
General LAN	1. Connection with the LAN	<ul style="list-style-type: none"> ▪ Check that the LAN cable is connected to the machine. ▪ Check that the LEDs on the hub are lit.
	1. LAN activity	Check that other devices connected to the LAN can communicate through the LAN.
Between IFAX and PC	1. Network settings on the PC	<ul style="list-style-type: none"> ▪ Check the network settings on the PC. [Is the IP address registered in the TCP/IP properties in the network setup correct? Check the IP address with the administrator of the network.]
	1. Check that PC can connect with the machine	<ul style="list-style-type: none"> ▪ Use the “ping” command on the PC to contact the machine. <p>[At the MS-DOS prompt, type ping then the IP address of the machine, then press Enter.]</p>
	1. LAN settings in the machine	<ul style="list-style-type: none"> ▪ Check the LAN parameters ▪ Check if there is an IP address conflict with other PCs. <p>[Use the “Network” function in the User Tools. If there is an IP address conflict, inform the administrator.]</p>
Between machine and e-mail server	1. LAN settings in the machine	<ul style="list-style-type: none"> ▪ Check the LAN parameters ▪ Check if there is an IP address conflict with other PCs. <p>Use the “Network” function in the User Tools. If there is an IP address conflict, inform the administrator.]</p>

Communication Route	Item	Action [Remarks]
	1. E-mail account on the server	<ul style="list-style-type: none"> ▪ Make sure that the machine can log into the e-mail server. ▪ Check that the account and password stored in the server are the same as in the machine. <p>[Ask the administrator to check.]</p>
	1. E-mail server	<ul style="list-style-type: none"> ▪ Make sure that the client devices which have an account in the server can send/receive e-mail. <p>[Ask the administrator to check. Send a test e-mail with the machine's own number as the destination. The machine receives the returned e-mail if the communication is performed successfully.]</p>
Between e-mail server and internet	1. E-mail account on the Server	<ul style="list-style-type: none"> ▪ Make sure that the PC can log into the e-mail server. ▪ Check that the account and password stored in the server are the same as in the machine. <p>[Ask the administrator to check.]</p>
	1. E-mail server	<ul style="list-style-type: none"> ▪ Make sure that the client devices which have an account in the server can send/receive e-mail. <p>[Ask the administrator to check. Send a test e-mail with the machine's own number as the destination. The machine receives the returned e-mail if the communication is performed successfully.]</p>
	1. Destination e-mail address	<ul style="list-style-type: none"> ▪ Make sure that the e-mail address is actually used. ▪ Check that the e-mail address does not contain incorrect characters such as spaces.

Communication Route	Item	Action [Remarks]
	1. Router settings	<ul style="list-style-type: none"> ▪ Use the “ping” command to contact the router. ▪ Check that other devices connected to the router can send data over the router. <p>[Ask the administrator of the server to check.]</p>
	1. Error message by e-mail from the network of the destination.	<ul style="list-style-type: none"> ▪ Check whether e-mail can be sent to another address on the same network, using the application e-mail software. ▪ Check the error e-mail message. <p>[Inform the administrator of the LAN.]</p>

3.3 IP-FAX TROUBLESHOOTING

3.3.1 IP-FAX TRANSMISSION

Cannot send by IP Address/Host Name

Check Point		Action
1	LAN cable connected?	Check the LAN cable connection.
2	Specified IP address/host name correct?	Check the IP address/host name.
3	Firewall/NAT is installed?	Cannot breach the firewall. Send by using another method (Fax, Internet Fax)
4	Transmission sent manually?	Manual sending not supported.
5	IP address of local machine registered?	Register the IP address.
6	Remote terminal port number setting other than 1720 (when using H.323) or 5060 (when using SIP)?	Send by specifying the port number.
7	Specified port number correct?	Confirm the port number of the remote fax.
8	DNS server registered when host name specified?	Contact the network administrator.
9	Remote fax a T.38 terminal?	Check whether the remote fax is a T38 terminal.
10	Remote fax switched off or busy?	Check that the remote fax is switched on.
11	Network bandwidth too narrow?	Request the network administrator to increase the bandwidth.
		Raise the delay level. IPFAX SW 01 Bit 0 to 3

Check Point		Action
		IP-Fax bandwidth is the same as the DCS speed. Set IP-Fax SW00 Bit 6 to 1.
12	Remote fax cancelled transmission?	Check whether the remote fax cancelled the transmission.

Cannot send via VoIP Gateway

Check Point		Action
1	LAN cable connected?	Check the LAN cable connection.
2	VoIP Gateway T.38 standard?	Contact the network administrator.
3	VoIP Gateway installed correctly?	Contact the network administrator.
4	VoIP Gateway power switched on?	Contact the network administrator.
5	Is the IP address/host name of the specified Gateway correct?	Check the IP address/host name.
6	Number of the specified fax correct?	Check the remote fax number.
7	Firewall/NAT is installed?	Cannot breach the firewall. Send by using another method (Fax, Internet Fax)
8	Transmission sent manually?	Manual sending not supported.
9	IP address of local fax registered?	Register the IP address.
10	DNS registered when host name specified?	Contact the network administrator.
11	Remote fax a G3 fax?	Check that the remote fax is a G3 fax.
12	G3 fax is connected to VoIP gateway?	Check that G3 fax is connected.
13	Remote G3 fax turned on?	Check that G3 fax is switched on.
14	Network bandwidth too narrow?	Request the network administrator to increase the bandwidth.

Check Point		Action
		Raise the network delay level. IPFAX SW 01 Bit 0 to 3
		IP-Fax bandwidth is the same as the DCS speed. Set IP-Fax SW00 Bit 6 to 1.

Cannot send by Alias Fax number

Check Point		Action
1	LAN cable connected?	Check the LAN cable connection.
2	Number of specified Alias fax correct?	Confirm the Alias of the remote fax. Error Code: 13-14
3	Firewall/NAT installed?	Cannot breach the firewall. Send by using another method (Fax, Internet Fax)
4	Transmission sent manually?	Manual sending not supported.
5	Gatekeeper/SIP server installed correctly?	Contact the network administrator.
6	Gatekeeper/SIP server power switched on?	Contact the network administrator.
7	IP address/host name of Gatekeeper/SIP server correct?	Check the IP address/host name.
8	DNS server registered when Gatekeeper/SIP server host name specified?	Contact the network administrator.
9	Enable H.323/Enable SIP SW is set to on?	Check the settings. See User Parameter SW 34 Bit 0/SW 34 Bit 1
10	IP address of local fax registered?	Register the IP address of the local fax.

Check Point		Action
11	Alias number of local fax registered?	Register the Alias number of the local fax.
12	Remote fax registered in Gatekeeper?	Contact the network administrator.
13	Remote fax a T.38 terminal?	Check whether the remote fax is a T38 terminal.
14	Remote fax switched off or busy?	Contact the network administrator.
15	Network bandwidth too narrow?	Request the system administrator to increase the bandwidth.
		Raise the delay level. IPFAX SW 01 Bit 0 to 3
		Lower the modem transmission baud rate. IPFAX SW 05
16	Remote fax cancelled transmission?	Check whether the remote fax cancelled the transmission.

3.3.2 IP-FAX RECEPTION



Cannot receive via IP Address/Host Name

Check Point		Action
1	LAN cable connected?	Check the LAN cable connection.
2	Firewall/NAT is installed?	Cannot breach the firewall. Send by using another method (Fax, Internet Fax)
3	IP address of local fax registered?	Register the IP address.
4	Port number specified at remote sender fax (if required)?	Request the sender to specify the port number.
5	Specified port number correct (if required)?	Request the sender to check the port number.
6	DNS server registered when host name specified on sender side?	<p>Contact the network administrator.</p> <p> Note</p> <ul style="list-style-type: none"> The sender machine displays this error code if the sender fax is a Ricoh model.
7	Network bandwidth too narrow?	Request the system administrator to increase the bandwidth.
		<p>Lower the start modem reception baud rate on the receiving side.</p> <p>IPFAX SW06</p>
8	Remote fax cancelled transmission?	Check whether the remote fax cancelled the transmission.

Cannot receive by VoIP Gateway

Check Point		Action
1	LAN cable connected?	Check the LAN cable connection.
2	Firewall/NAT is installed?	Cannot breach the firewall. Request the remote fax to send by using another method (Fax, Internet Fax)
3	VoIP Gateway installed correctly?	Contact the network administrator.
4	VoIP Gateway power switched on?	Contact the network administrator.
5	IP address/host name of specified VoIP Gateway correct on sender's side?	Request the remote fax to check the IP address/host name.
6	DNS server registered when host name specified on sender side?	Contact the network administrator.
7	Network bandwidth too narrow?	Request the network administrator to increase the bandwidth.
8	G3 fax connected?	Check that G3 fax is connected.
9	G3 fax power switched on?	Check that G3 fax is switched on.

Cannot receive by Alias Fax number

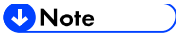
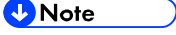
Check Point		Action
1	LAN cable connected?	Check the LAN cable connection.
2	Firewall/NAT is installed?	Cannot the breach firewall. Request the remote fax to send by using another method (Fax, Internet Fax)
3	Gatekeeper/SIP server installed correctly?	Contact the network administrator.  Note <ul style="list-style-type: none"> The sender machine displays this error code when the sender fax is a Ricoh model.
4	Power to Gatekeeper/SIP server switched on?	Contact the network administrator.  Note <ul style="list-style-type: none"> The sender machine displays this error code when the sender fax is a Ricoh model.
5	IP address/host name of Gatekeeper/SIP server correct on the sender's side?	Request the sender to check the IP address/host name.  Note <ul style="list-style-type: none"> The sender machine displays this error code when the sender fax is a Ricoh model.
6	DNS server registered when Gatekeeper/SIP server host name specified on sender's side?	Contact the network administrator.  Note <ul style="list-style-type: none"> The sender machine displays this error code when the sender fax is a Ricoh model.

Check Point		Action
7	Enable H.323/Enable SIP SW is set to on?	Request the sender to check the settings. User Parameter SW 34 Bit 0/SW 34 Bit 1 Note <ul style="list-style-type: none"> Only if the remote sender fax is a Ricoh fax.
8	Local fax IP address registered?	Register the IP address.
9	Local fax Alias number registered?	Register the Alias number.
10	Network bandwidth too narrow?	Request the system administrator to increase the bandwidth.
		Lower the start modem reception baud rate on the receiving side. IPFAX SW06
11	Remote fax cancelled transmission?	Check whether the remote fax cancelled the transmission.
12	Local fax registered in Gatekeeper/SIP server?	Contact the network administrator. Note <ul style="list-style-type: none"> The sender machine displays this error code when the sender fax is a Ricoh model.

4. SERVICE TABLES

4.1 CAUTIONS

Important

- Never turn off the main power switch when the power LED is lit or flashing. To avoid damaging the hard disk or memory, press the operation power switch to switch the power off, wait for the power LED to go off, and then switch the main power switch off.

Note

- The main power LED lights or flashes while the platen cover or ARDF is open, while the main machine is communicating with a facsimile or the network server, or while the machine is accessing the hard disk or memory for reading or writing data.

4.2 SERVICE PROGRAM TABLES

4.2.1 SP1-XXX (BIT SW)

1	Mode No.		Function
101	System Switch		
	001 – 032	00 – 1F	Change the bit switches for system settings for the fax option "page 48 "Bit Switches - 1" : "System Switches"
102	I fax Switch		
	001 – 016	00 – 0F	Change the bit switches for internet fax settings for the fax option "page 64 "Bit Switches - 2" : "I-Fax Switches"
103	Printer Switch		
	001 – 016	00 – 0F	Change the bit switches for printer settings for the fax option "page 64 "Bit Switches - 2" : "Printer Switches"
104	Communication Switch		
	001 – 032	00 – 1F	Change the bit switches for communication settings for the fax option "page 79 "Bit Switches - 3" : "Communication Switches"
105	G3-1 Switch		
	001 – 016	00 – 0F	Change the bit switches for the protocol settings of the standard G3 board "page 88 "Bit Switches - 4" : "G3 Switches"
111	IP fax Switch		
	001 – 016	00 – 0F	Change the bit switches for optional IP fax parameters "page 99 "Bit Switches - 6" : "IP Fax Switches"

4.2.2 SP2-XXX (RAM)

2	Mode No.		Function
101	000	RAM Read/Write	Change RAM data for the fax board directly. page 134 "Service RAM Addresses"
102	Memory Dump		
	001	G3-1 Memory Dump	Print out RAM data for the fax board. page 134 "Service RAM Addresses"
103	G3-1 NCU Parameters		
	001 – 023	CC, 01 – 22	NCU parameter settings for the standard G3 board. page 111 "NCU Parameters"

4.2.3 SP3-XXX (MACHINE SET)

3	Mode No.		Function
101	Service Station		
	001	Fax Number	Enter the fax number of the service station.
102	000	Serial Number	Enter the fax unit's serial number.
103	PSTN-1 Port Settings		
	001	Select Line	Select the line type setting for the G3-1 line. If the machine is installed on a PABX line, select "PABX", "PABX(GND)" or "PABX(FLASH)".
	002	PSTN Access Number	Enter the PSTN access number for the G3-1 line.
	003	Memory Lock Disabled	If the customer does not want to receive transmissions using Memory Lock on this line, turn this SP on.
107	IPFAX Port Settings		
	001	H323 Port	Sets the H323 port number.
	002	SIP Port	Sets the SIP port number.
	003	RAS Port	Sets the RAS port number.
	004	Gatekeeper port	Sets the Gatekeeper port number.
	005	T.38 Port	Sets the T.38 port number.
	006	SIP Server Port	Sets the SIP port number.
	007	IP FAX Protocol Priority	Select "H323" or "SIP".
201	FAX SW		
	001 – 032	00 – 1F	

4.2.4 SP4-XXX (ROM VERSIONS)

4	Mode No.		Function
101	001	FCU ROM Version	Displays the FCU ROM version.
102	001	Error Codes	Displays the latest 64 fax error codes.
103	001	G3-1 ROM Version	Displays the G3-1 modem version.

4.2.5 SP5-XXX (RAM CLEAR)

5	Mode No.		Function
101	000	Initialize SRAM (except Secure)	Initializes the bit switches and user parameters, user data in the SRAM, files in the SAF memory, and clock.
102	000	Erase All Files	Erases all files stored in the SAF memory.
103	000	Reset Bit Switches (except Secure)	Resets the bit switches and user parameters.
104	000	Factory Setting	Resets the bit switches and user parameters, user data in the SRAM and files in the SAF memory.
105	000	Reset All Bit Switches	Resets all the current bit switch settings.
106	000	Reset Security Bit Switches	Resets only the security bit switches. If you select automatic output/display for the user parameter switches, the security settings are initialized.

4.2.6 SP6-XXX (REPORTS)

6	Mode No.		Function
101	000	System Parameter List	Touch the "ON" button to print the system parameter list.
102	000	Service Monitor Report	Touch the "ON" button to print the service monitor report.
103	G3 Protocol Dump List		
	002	G3-1 (All Communications)	Prints the protocol dump list of all communications for the G3-1 line.
	003	G3-1 (1 Communication)	Prints the protocol dump list of the last communication for the G3-1 line.
105	000	All Files print out	Prints out all the user files in the SAF memory, including confidential messages.  Note <ul style="list-style-type: none"> Do not use this function, unless the customer is having trouble printing confidential messages or recovering files stored using the memory lock feature.
106	Journal Print out		
	001	All Journals	The machine prints all the communication records on the report.
	002	Specified Date	The machine prints all communication records after the specified date.
107	Log List Print out		
	001	All log files	These log print out functions are for designer use only.
	002	Printer	
	003	SC/TRAP Stored	
	004	Decompression	

Service Program Tables

6	Mode No.		Function
	005	Scanner	
	006	JOB/SAF	
	007	Reconstruction	
	008	JBIG	
	009	Fax Driver	
	010	G3CCU	
	011	Fax Job	
	012	CCU	
	013	Scanner Condition	
108	IP Protocol Dump List		
	001	All Communications	
	002	1 Communication	

4.2.7 SP7-XXX (TESTS)

These are the test modes for PTT approval.

7	Function
101	G3-1 Modem Tests
102	G3-1 DTMF Tests
103	Ringer Test
104	G3-1 V34 (S2400baud)
105	G3-1 V34 (S2800baud)
106	G3-1 V34 (S3000baud)
107	G3-1 V34 (S3200baud)
108	G3-1 V34 (S3429baud)
109	Recorded Message Test

4.3 BIT SWITCHES - 1

Note

- Do not adjust a bit switch or use a setting that is described as "Not used", as this may cause the machine to malfunction or to operate in a manner that is not accepted by local regulations. Such bits are for use only in other areas, such as Japan.

Default settings for bit switches are not listed in this manual. Refer to the System Parameter List printed by the machine.

4.3.1 SYSTEM SWITCHES

System Switch 00 (SP No. 1-101-001)		
No	Function	Comments
0	Dedicated transmission parameter programming 0: Disabled 1: Enabled	Set this bit to 1 before changing any dedicated transmission parameters. This setting is automatically reset to "0" after turning off and on.
1	Not used	Do not change this setting.
2	Technical data printout on the Journal 0: Disabled 1: Enabled	1: Instead of the personal name, the following data are listed on the Journal for each G3 communication.

System Switch 00 (SP No. 1-101-001)		
No	Function	Comments
	<p>Example:</p> <p>0000 32V34 288/264 L0100 03 04 (1) (2)(3) (4) (5) (6) (7) (8)</p> <p>(1): EQM value (Line quality data). A larger number means more errors. (2): Symbol rate (V.34 only) (3): Final modem type used (4): Starting data rate (for example, 288 means 28.8 kbps) (5): Final data rate (6): Rx level (see below for how to read the rx level) (7): Total number of error lines that occurred during non-ECM reception. (8): Total number of burst error lines that occurred during non-ECM reception.</p> <p>Note</p> <ul style="list-style-type: none"> EQM and rx level are fixed at "FFFF" in tx mode. The seventh and eighth numbers are fixed at "00" for transmission records and ECM reception records. 	
	<p>Rx level calculation</p> <p>Example:</p> <p>0000 32V34 288/264 L0100 03 04 (1) (2)(3) (4) (5) (6) (7) (8)</p> <p>The four-digit hexadecimal value (N) after "L" indicates the rx level. The high byte is given first, followed by the low byte. Divide the decimal value of N by -16 to get the rx level. In the above example, the decimal value of N (= 0100 [H]) is 256. So, the actual rx level is 256/-16 = -16 dB</p>	
4	<p>Line error mark print 0: OFF, 1: ON (print)</p>	<p>When "1" is selected, a line error mark is printed on the printout if a line error occurs during reception. This shows error locations when ECM is turned off.</p>
5	<p>G3 communication parameter display 0: Disabled 1: Enabled</p>	<p>This is a fault-finding aid. The LCD shows the key parameters (see "G3 Communication Parameters" below this table). This is normally disabled because it cancels the CSI display for the user. Be sure to reset this bit to "0" after testing.</p>

System Switch 00 (SP No. 1-101-001)		
No	Function	Comments
6	Protocol dump list output after each communication 0: Off 1: On	This is only used for communication troubleshooting. It shows the content of the transmitted facsimile protocol signals. Always reset this bit to 0 after finishing testing. If system switch 09 bit 6 is at "1", the list is only printed if there was an error during the communication.

G3 Communication Parameters

Modem rate	336: 33600 bps 168: 16800 bps 312: 31200 bps 144: 14400 bps 288: 28800 bps 120: 12000 bps 264: 26400 bps 96: 9600 bps 240: 24000 bps 72: 7200 bps 216: 21600 bps 48: 4800 bps 192: 19200 bps 24: 2400 bps
Resolution	S: Standard (8 x 3.85 dots/mm) D: Detail (8 x 7.7 dots/mm) 21: Standard (200 x 100 dpi) 22: Detail (200 x 200 dpi)
Compression mode	MMR: MMR compression MR: MR compression MH: MH compression JBB: JBIG compression (Basic mode)
Communication mode	ECM: With ECM NML: With no ECM
Width and reduction	A4: A4 (8.3"), no reduction B4: B4 (10.1"), no reduction A3: A3 (11.7"), no reduction

I/O rate	0: 0 ms/line 5: 5 ms/line 10: 10 ms/line 20: 20 ms/line 25: 2.5 ms/line 40: 40 ms/line ↓ Note <ul style="list-style-type: none"> ▪ "40" is displayed while receiving a fax message using AI short protocol.
----------	---

System Switch 01 - Not used (Do not change the factory settings.)

System Switch 02 (SP No. 1-101-003)		
No	Function	Comments
2	Forced reset after transmission stalls 0: Off 1: On	With this setting on, the machine resets itself automatically if a transmission stalls and fails to complete the job.
4	File retention time 0: Depends on User Parameter 24 [18(H)] 1: No limit	1: A file that had a communication error will not be erased unless the communication is successful.
6-7	Not used	Do not change the factory settings.

System Switch 03 (SP No. 1-101-004)		
No	Function	Comments
0-7	Not used	Do not change the factory settings.

System Switch 04 (SP No. 1-101-005)		
No	Function	Comments
0	Not used	Do not change this setting.
3	Printing dedicated tx parameters on Quick/Speed Dial Lists 0: Disabled 1: Enabled	1: Each Quick/Speed dial number on the list is printed with the dedicated tx parameters (10 bytes each). The first 10 bytes of data are the programmed dedicated tx parameters; 34 bytes of data are printed (the other 24 bytes have no use for service technicians).
5-7	Not used	Do not change these settings.

System Switch 05 - Not used (Do not change the factory settings.)

System Switch 06 - Not used (Do not change the factory settings.)

System Switch 07 - Not used (Do not change the factory settings.)

System Switch 08 - Not used (Do not change the factory settings.)

System Switch 09 (SP No. 1-101-010)		
No	Function	Comments
0	Addition of image data from confidential transmissions on the transmission result report 0: Disabled 1: Enabled	If this feature is enabled, the top half of the first page of confidential messages will be printed on transmission result reports.
1	Print timing of communication reports on the Journal when no image data was exchanged. 0: After DCS/NSS communication (default), 1: After polling	0: The Journal is printed only when image data is sent. 1: The Journal is printed when any data is sent.

System Switch 09 (SP No. 1-101-010)		
No	Function	Comments
2	Automatic error report printout 0: Disabled 1: Enabled	0: Error reports will not be printed. 1: Error reports will be printed automatically after failed communications.
3	Printing of the error code on the error report 0: No 1: Yes	1: Error codes are printed on the error reports. This can be used for detecting an error which occurs rarely.
5	Power failure report 0: Disabled 1: Enabled (default)	1: A power failure report will be automatically printed after the power is switched on if a fax message disappeared from the memory when the power was turned off last. Note <ul style="list-style-type: none"> If "0" is selected, no reports are printed and no one may recognize that fax data is gone due to a power failure.
6	Conditions for printing the protocol dump list 0: Print for all communications 1: Print only when there is a communication error	This switch becomes effective only when system switch 00 bit 6 is set to 1. 1: Set this bit to 1 when you wish to print a protocol dump list only for communications with errors. Note <ul style="list-style-type: none"> The memory size is limited. Use this bit switch only when some log reports are necessary.
7	Priority given to various types of remote terminal ID when printing reports 0: RTI > CSI > Dial label > Tel. number 1: Dial label > Tel. number > RTI > CSI	This bit determines which set of priorities the machine uses when listing remote terminal names on reports. Dial Label: The name stored, by the user, for the Quick/Speed Dial number.

System Switch 0A (SP No. 1-101-011)		
No	Function	Comments
0	Not used	Do not change this setting.
3	Not used	Do not change this setting.
4	Dialing on the ten-key pad when the external telephone is off-hook 0: Disabled 1: Enabled	0: Prevents dialing from the ten-key pad while the external telephone is off-hook. Use this setting when the external telephone is not by the machine, or if a wireless telephone is connected as an external telephone. 1: The user can dial on the machine's ten-key pad when the handset is off-hook.
5	On hook dial 0: Disabled 1: Enabled	0: On hook dial is disabled.
6-7	Not used	Do not change these settings.

System Switch 0B - Not used (Do not change the factory settings.)

System Switch 0C - Not used (Do not change the factory settings.)

System Switch 0E (SP No. 1-101-015)		
No	Function	Comments
2	Enable/disable for direct sending selection 0: Direct sending off 1: Direct sending on	Direct sending cannot operate when the capture function is on during sending. Setting this switch to "1" enables direct sending without capture. Setting this switch to "0" masks the direct sending function on the operation panel so direct sending with Scan Router cannot be selected.

System Switch 0E (SP No. 1-101-015)		
No	Function	Comments
3	Action when the external handset goes off-hook 0: Manual tx and rx operation 1: Memory tx and rx operation (the display remains the same)	0: Manual tx is possible while the external handset is off-hook. However, manual tx during handset off-hook may not be sent to a correct direction. Manual tx is not possible. 1: The display stays in standby mode even when the external handset is used, so that other people can use the machine for memory tx operation. Note that manual tx and rx are not possible with this setting.
4	Not used	Do not change this setting.
7	Not used	Do not change this setting.

System Switch 0F (SP No. 1-101-016)			
No	Function	Comments	
0-7	Country/area code for functional settings (Hex)	This country/area code determines the factory settings of bit switches and RAM addresses. However, it has no effect on the NCU parameter settings and communication parameter RAM addresses. Cross reference NCU country code: SP No. 2-103-001 for G3-1	
	00: France		12: Asia
	01: Germany		13: Japan
	02: UK		14: Hong Kong
	03: Italy		15: South Africa
	04: Austria		16: Australia
	05: Belgium		17: New Zealand
	06: Denmark		18: Singapore
	07: Finland		19: Malaysia
	08: Ireland		1A: China
	09: Norway		1B: Taiwan
	0A: Sweden		1C: Korea

System Switch 0F (SP No. 1-101-016)			
No	Function		Comments
	0B: Switz.	1D: Brazil	
	0C: Portugal	20: Turkey	
	0D: Holland	21: Greece	
	0E: Spain	22: Hungary	
	0F: Israel	23: Czech	
	10: ---	24: Poland	
	11: USA		

System Switch 10 (SP No. 1-101-017)		
No	Function	Comments
0-7	Threshold memory level for parallel memory transmission	Threshold = N x 128 KB + 256 KB N can be between 00 - FF(H) Default setting: 02(H) = 512 KB

System Switch 11 (SP No. 1-101-018)		
No	Function	Comments
0	TTI printing position 0: Superimposed on the page data 1: Printed before the data leading edge	Change this bit to 1 if the TTI overprints information that the customer considers to be important (G3 transmissions).  Note ▪ If "1" is selected, it is possible that sent data is printed on two sheets of paper.
1	Not used	Do not change this setting.
3	TTI used for broadcasting 0: The TTIs selected for each Quick/Speed dial are used 1: The same TTI is used for all destinations	1: The TTI (TTI_1 or TTI_2) which is selected for all destinations during broadcasting.

System Switch 11 (SP No. 1-101-018)		
No	Function	Comments
4	Not used	Do not change this setting.
7	Not used	Do not change this setting.

System Switch 12 (SP No. 1-101-019)		
No	Function	Comments
0-7	TTI printing position in the main scan direction	<p>TTI: 08 to 92 (BCD) mm Input even numbers only.</p> <p>This setting determines the print start position for the TTI from the left edge of the paper. If the TTI is moved too far to the right, it may overwrite the file number which is on the top right of the page. On an A4 page, if the TTI is moved over by more than 50 mm, it may overwrite the page number.</p>

System Switch 14 - Not used (Do not change the factory settings.)

System Switch 15 (SP No. 1-101-022)		
No	Function	Comments
1	<p>Going into the Energy Saver mode automatically</p> <p>0: Enabled 1: Disabled</p>	<p>1: The machine will restart from the Energy Saver mode quickly, because the +5V power supply is active even in the Energy Saver mode. The LED of the operation switch is flashing instead of entering Energy Saver mode.</p> <p>Use this setting if an external telephone has to be used when the machine is in the Energy Saver mode.</p>
2	Not used	Do not change this setting.

System Switch 15 (SP No. 1-101-022)				
No	Function			Comments
4-5	Interval for preventing the machine from entering Energy Saver mode if there is a pending transmission file.			<p>If there is a file waiting for transmission, the machine does not go to Energy Saver mode during the selected period.</p> <p>After transmitting the file, if there is no file waiting for transmission, the machine goes to the Energy Saver mode.</p>
	Bit 5	Bit 4	Setting	
	0	0	1 min	
	0	1	30 min	
	1	0	1 hour	
	1	1	24 hours	
6	Not used			Do not change this setting.

System Switch 16 (SP No. 1-101-023)				
No	Function			Comments
0	Parallel Broadcasting 0: Disabled 1: Enabled			1: The machine sends messages simultaneously using all available ports during broadcasting.  Note <ul style="list-style-type: none"> ▪ If a customer wants to keep a line available for fax reception or other reasons, select "0" (Disable).
1-3	Not used			Do not change these settings.
7	Not used			Do not change this setting.

System Switch 17 - Not used (Do not change the factory settings.)

System Switch 18 - Not used (Do not change the factory settings.)

System Switch 19 (SP No. 1-101-026)		
No	Function	Comments
3-4	Not used	Do not change these settings.
6	Extended scanner page memory after memory option is installed 0: Disabled 1: Enabled	0: After installing the memory expansion option, the scanner page memory is extended to 4 MB from 2 MB. 1: If this bit is set to 1 after installing the memory expansion option, the scanner page memory is extended to 12 MB. But the SAF memory decreases to 18 MB.
7*	Special Original mode 0: Disabled 1: Enabled	1: If the customer frequently wishes to transmit a form or letterhead which has a colored or printed background, change this bit to "1". "Original 1" and "Original 2" can be selected in addition to the "Text", "Text/Photo" and "Photo" modes.

* This setting can be used for the remote machine.

System Switch 1A (SP No. 1-101-027)		
No	Function	Comments
0-7	LS RX memory capacity threshold setting 00-FF (0-1020 Kbyte: Hex)	<p>Sets the value to x4KB. When the amount of available memory drops below this setting, RX documents are printed to conserve memory. Initial setting 0x80 (512 KB)</p> <p> Note</p> <ul style="list-style-type: none"> ▪ If a customer wants available memory size to be larger, decrease this threshold.

System Switch 1D (SP No. 1-101-030)		
No	Function	Comments
0	RTI/CSI/CPS code display 0: Enable 1: Disable	<p>0: RTI, CSI, CPS codes are displayed on the top line of the LCD panel during communication.</p> <p>1: Codes are switched off (no display)</p>
2-3	Not used	Do not change these settings.

System Switch 1E (SP No. 1-101-031)		
No	Function	Comments
0	<p>Communication after the Journal data storage area has become full</p> <p>0: Impossible 1: Possible</p>	<p>0: When this switch is on and the journal history becomes full, the next report prints. If the journal history is not deleted, the next transmission cannot be received. This prevents overwriting communication records before the machine can print them.</p> <p>1: If the buffer memory of the communication records for the Journal is full, fax communications are still possible. But the machine will overwrite the oldest communication records.</p> <p>Note</p> <ul style="list-style-type: none"> This setting is effective only when Automatic Journal printout is enabled but the machine cannot print the report (e.g., no paper).
1*	<p>Action when the SAF memory has become full during scanning</p> <p>0: The current page is erased. 1: The entire file is erased.</p>	<p>0: If the SAF memory becomes full during scanning for a memory transmission, the successfully scanned pages are transmitted.</p> <p>1: If the SAF memory becomes full during scanning for a memory transmission, the file is erased and no pages are transmitted.</p> <p>Note</p> <ul style="list-style-type: none"> This setting is effective only when Automatic Journal printout is enabled but the machine cannot print the report (e.g., no paper).
2	<p>RTI/CSI display priority</p> <p>0: RTI 1: CSI</p>	<p>This bit determines which identifier, RTI or CSI, is displayed on the LCD while the machine is communicating in G3 non-standard mode.</p>

System Switch 1E (SP No. 1-101-031)		
No	Function	Comments
3	File No. printing 0: Enabled 1: Disabled	1: File numbers are not printed on any reports.  Note <ul style="list-style-type: none"> The file numbers may not be printed in the sequential order. If a customer does not like this numbering, select "0".
4	Action when authorized reception is enabled but authorized RTIs/CSIs are not yet programmed 0: Faxes can be received if the sender has an RTI or CSI 1: All fax reception is disabled	0: If the user has stored no acceptable sender RTIs or CSIs, the user can select "ON" in the authorized reception setting but the setting becomes invalid ("OFF"). The machine will not be able to receive any fax messages. If the customer wishes to receive messages from any sender that includes an RTI or CSI, and to block messages from senders that do not include an RTI or CSI, change this bit to "0", then enable Authorized Reception. Otherwise, keep this bit at "1 (default setting)".
5	Not used	Do not change this setting.
7	Not used	Do not change this setting.

* This setting can be used for the remote machine.

System Switch 1F (SP No. 1-101-032)		
No	Function	Comments
1	Report printout after an original jam during SAF storage or if the SAF memory fills up 0: Enabled 1: Disabled	0: When an original jams, or the SAF memory overflows during scanning, a report will be printed. Change this bit to "1" if the customer does not want to have a report in these cases. Memory tx – Memory storage report Parallel memory tx – Transmission result report
2	Not used	Do not change this setting.
3	Received fax print start timing (G3 reception) 0: After receiving each page 1: After receiving all pages	0: The machine prints each page immediately after the machine receives it. 1: The machine prints the complete message after the machine receives all the pages in the memory.
4-6	Not used	Do not change these settings.
7	Action when a fax SC has occurred 0: Automatic reset 1: Fax unit stops	0: When the fax unit detects a fax SC code other than SC1201 and SC1207, the fax unit automatically resets itself. 1: When the fax unit detects any fax SC code, the fax unit stops. Cross Reference Fax SC codes - See "Troubleshooting"

4.4 BIT SWITCHES - 2

ⓘ Note

- Do not adjust a bit switch or use a setting that is described as "Not used", as this may cause the machine to malfunction or to operate in a manner that is not accepted by local regulations. Such bits are for use only in other areas, such as Japan.

Default settings for bit switches are not listed in this manual. Refer to the System Parameter List printed by the machine.

4.4.1 I-FAX SWITCHES

I-fax Switch 00 (SP No. 1-102-001)		
No	Function	Comments
-	Original Width of TX Attachment File	This setting sets the maximum size of the original that the destination can receive. (Bits 3-6 are reserved for future use or not used.)
0	A4	
1	B4	
2	A3	
3-6	Reserved	
<p>0: Off (not selected), 1: On (selected)</p> <p>If more than one of these three bits is set to "1", the larger size has priority. For example, if both Bit 2 and Bit 1 are set to "1" then the maximum size is "A3" (Bit 2).</p> <p>When mail is sent, there is no negotiation with the receiving machine at the destination, so the sending machine cannot make a selection for the receiving capabilities (original width setting) of the receiving machine. The original width selected with this switch is used as the RX machine's original width setting, and the original is reduced to this size before sending. The default is A4.</p> <p>If the width selected with this switch is higher than the receiving machine can accept, the machine detects this and this causes an error.</p>		

I-fax Switch 01 (SP No. 1-102-002)		
No	Function	Comments
-	Original Line Resolution of TX Attachment File	These settings set the maximum resolution of the original that the destination can receive.
0	200x100 Standard	0: Not selected 1: Selected If more than one of these three bits is set to "1", the higher resolution has priority. For example, if both Bit 0 and Bit 2 are set to "1" Then The Resolution is set for "Bit 2 200 x 400.
1	200x200 Detail	
2	200x400 Fine	
3	300 x 300 Reserve	
4	400 x 400 Super Fine	
5	600 x 600 Reserve	
6	Reserve	
7	mm/inch	
	<p>This setting selects mm/inch conversion for mail transmission. 0: Off (No conversion), 1: On (Conversion) When on (set to "1"), the machine converts millimeters to inches for sending mail. There is no switch for converting inches to millimeters. Unlike G3 fax transmissions which can negotiate between sender and receiver to determine the setting, mail cannot negotiate between terminals; the mm/inch selection is determined by the sender fax. When this switch is Off (0):</p> <ul style="list-style-type: none"> ▪ Images scanned in inches are sent in inches. ▪ Images scanned in mm are sent in mm. ▪ Images received in inches are transmitted in inches. ▪ Images received in mm are transmitted in mm. <p>When this switch is On (1):</p> <ul style="list-style-type: none"> ▪ Images scanned in inches are sent in inches. ▪ Images scanned in mm are converted to inches. ▪ Images received in inches are transmitted in inches. ▪ Images received in mm are converted to inches. 	

I-fax Switch 02 (SP No. 1-102-003)		
No	Function	Comments
0	RX Text Mail Header Processing	
		<p>This setting determines whether the header information is printed with text e-mails when they are received.</p> <p>0: Prints only text mail. 1: Prints mail header information attached to text mail.</p> <p>When a text mail is received with this switch On (1), the "From" address and "Subject" address are printed as header information.</p> <p>When a mail with only binary data is received (a TIFF-F file, for example), this setting is ignored and no header is printed.</p>
1	Output from Attached Document at E-mail TX Error	
		<p>This setting determines whether only the first page or all pages of an e-mail attachment are printed at the sending station when a transmission error occurs. This allows the customer to see which documents have not reached their intended destinations if sent to the wrong e-mail addresses, for example.</p> <p>0: Prints 1st page only. 1: Prints all pages.</p>
2-3	Text String for Return Receipt	
		<p>This setting determines the text string output for the Return Receipt that confirms the transmission was received normally at the destination.</p>

I-fax Switch 02 (SP No. 1-102-003)		
No	Function	Comments
	00: "Dispatched" Sends from PC mail a request for a Return Receipt. Receives the Return Receipt with "dispatched" in the 2nd part: Disposition: Automatic-action/MDN-send automatically; dispatched The "dispatched" string is included in the Subject string. 01: "Displayed" Sends from PC mail a request for a Return Receipt. Receives the Return Receipt with "displayed" in the 2nd part: Disposition: Automatic-action/MDN-send automatically; displayed The "displayed" string is included in the Subject string. 10: Reserved 11: Reserved A mail requesting a Return Receipt sent from an IFAX with this switch set to "00" (for "dispatched") received by Microsoft Outlook 2000 may cause an error. If any setting other than "displayed" (01) causes a problem, change the setting to "01" to enable normal sending of the Return Receipt.	
4	Media accept feature	This setting adds or does not add the media accept feature to the answer mail to confirm a reception. 0: Does not add the media accept feature to the answer mail 1: Adds the media accept feature to the answer mail. Use this bit switch if a problem occurs when the machine receives an answer mail, which contains the media accept feature field.
7	Image Resolution of RX Text Mail	This setting determines the image resolution of the received mail. 0: 200 x 200 1: 400 x 400 The "1" setting requires installation of the Memory Unit in order to have enough SAF (Store and Forward) memory to receive images at 400 x 400 resolution.

I-fax Switch 03 - Not used (Do not change the factory settings.)

I-fax Switch 04 (SP No. 1-102-005)		
No	Function	Comments
0	<p>Subject for Delivery TX/Memory Transfer</p>	<p>This setting determines whether the RTI/CSI registered on this machine or the RTI/CSI of the originator is used in the subject lines of transferred documents.</p> <p>0: Puts the RTI/CSI of the originator in the Subject line. If this is used, either the RTI or CSI is used. Only one of these can be received for use in the subject line.</p> <p>1: Puts the RTI/CSI registered on this machine in the Subject line.</p> <p>When this switch is used to transfer and deliver mail to a PC, the information in the Subject line that indicates where the transmission originated can be used to determine automatically the destination folder for each e-mail.</p>
1	<p>Subject corresponding to mail post database</p> <p>0: Standard subject</p> <p>1: Mail post database subject</p>	<p>The standard subject is replaced by the mail post database subject in the following three cases:</p> <ol style="list-style-type: none"> 1) When the service technician sets the service (software) switch. 2) When memory sending or delivery specified by F code is applied by the SMTP server 3) With relay broadcasting (1st stage without the Schmidt 4 function). <p>Note</p> <ul style="list-style-type: none"> ▪ This switch does not apply for condition 3) when the RX system is set up for memory sending, delivery by F-code, sending with SMTP RX and when operators are using FOL (to prevent problems when receiving transmissions).

I-fax Switch 05 (SP No. 1-102-006)		
No	Function	Comments
0	Mail Addresses of SMTP Broadcast Recipients	
		<p>Determines whether the e-mail addresses of the destinations that receive transmissions broadcasted using SMTP protocol are recorded in the Journal.</p> <p>For example: "1st destination + Total number of destinations: 9" in the Journal indicates a broadcast to 9 destinations.</p> <p>0: Not recorded 1: Recorded</p>
1	IFAXTX Retries	
		<p>Determines whether the machine retries sending IFAX when connection and transmission fails due to errors.</p> <p>0: Disabled 1: Enabled</p>

I-fax Switch 07 - Not used (Do not change the factory settings.)

I-fax Switch 08 (SP No. 1-102-009)		
No	Function	Comments
0-7	Memory Threshold for POP Mail Reception	
		<p>This setting determines the amount of SAF (Store and Forward) memory. (SAF stores fax messages to send later for transmission to more than one location, and also holds incoming messages if they cannot be printed.) When the amount of SAF memory available falls below this setting, mail can no longer be received; received mail is then stored on the mail server.</p> <p>00-FF (0 to 1024 KB: HEX)</p> <p>The hexadecimal number you enter is multiplied by 4 KB to determine the amount of memory.</p>

I-fax Switch 09 (SP No. 1-102-010)		
No	Function	Comments
4-7	Restrict TX Retries	This setting determines the number of retries when connection and transmission fails due to errors. 01-F (1-15 Hex)

I-fax Switch 0D (SP No. 1-102-014)				
No	Function			Comments
2-3	Select the signature when sending mail notification of the send results			In response to IEEE2600.1.
	Bit 2	Bit 3	Setting	
	0	0	No sign	
	0	1	No setting	
	1	0	Individual setting	
	1	1	Always sign	
4-5	Select the signature when sending mail.			In response to IEEE2600.1.
	Bit 5	Bit 4	Setting	
	0	0	No sign	
	0	1	No setting	
	1	0	Individual setting	
	1	1	Always sign	
6-7	Not used			Do not change these settings.

I-fax Switch 0E - Not used (Do not change the factory settings.)

I-fax Switch 0F (SP No. 1-102-016)		
No	Function	Comments
0	Delivery Method for SMTP RX Files	
	This setting determines whether files received with SMTP protocol are delivered or output immediately. 0: Off. Files received via SMTP are output immediately without delivery. 1: On. Files received via SMTP are delivered immediately to their destinations.	
1	Set to select the signature when receiving SMTP mail.	
	0: No sign 1: Always sign	
2	Set to encrypt the data when receiving SMTP mail.	
	0: No encryption 1: Encryption	

4.4.2 PRINTER SWITCHES

Printer Switch 00 (SP No. 1-103-001)		
No	Function	Comments
0	Select page separation marks 0: Off 1: On	<p>0: If a 2 page RX transmission is split, [*] is printed in the bottom right corner of the 1st page and only a [2] is printed in the upper right corner of the 2nd page.</p> <p>1: If a 2 page RX transmission is split into two pages, for example, [*] [2] is printed in the bottom right corner of the 1st page and only a [2] is printed in the upper right corner of the 2nd page.</p> <p>Note</p> <ul style="list-style-type: none"> This helps the user to identify pages that have been split because the size of the paper is smaller than the size of the document received. (When A5 is used to print an A4 size document, for example.)
1	Repetition of data when the received page is longer than the printer paper 0: Off 1: On	<p>1: Default. 10 mm of the trailing edge of the previous page are repeated at the top of the next page.</p> <p>0: The next page continues from where the previous page stopped without any repeated text.</p>
2	Prints the date and time on received fax messages 0: Disabled 1: Enabled	<p>This switch is only effective when user parameter 02 - bit 2 (printing the received date and time on received fax messages) is enabled.</p> <p>1: The machine prints the received and printed date and time at the bottom of each received page.</p>

Printer Switch 01 - Not used (Do not change the factory settings.)

Relationship between available paper sizes and printer width used in the setup protocol

Available Paper Size	Printer width used in the Protocol (NSF/DIS)
A4 or 8.5" x 11"	297 mm width
B5	256 mm width
A5 or 8.5" x 5.5"	216 mm width
No paper available (Paper end)	216 mm width

Printer Switch 02 (SP No. 1-103-003)		
No	Function	Comments
0*	1st paper feed station usage for fax printing 0: Enabled 1: Disabled	<p>0: The paper feed station can be used to print fax messages and reports.</p> <p>1: The specified paper feed station will not be used for printing fax messages and reports.</p> <p>Note</p> <ul style="list-style-type: none"> Do not disable usage for a paper feed station which has been specified by User Parameter Switch 0F (15), or which is used for the Specified Cassette Selection feature.
1*	2nd paper feed station usage for fax printing 0: Enabled 1: Disabled	
2*	3rd paper feed station usage for fax printing 0: Enabled 1: Disabled	
3*	4th paper feed station usage for fax printing 0: Enabled 1: Disabled	
4*	LCT usage for fax printing 0: Enabled 1: Disabled	

* This setting can be used for the remote machine.

Printer Switch 03 (SP No. 1-103-004)		
No	Function	Comments
0*	Length reduction of received data 0: Disabled 1: Enabled	0: Incoming pages are printed without length reduction. (Page separation threshold: Printer Switch 03, bits 4 to 7) 1: Incoming page length is reduced when printing. (Maximum reducible length: Printer Switches 04, bits 0 to 4)
4-7	Page separation setting when sub scan compression is forbidden 00-0F (0-15 mm: Hex) Default: 6 mm	Page separation threshold (with reduction disabled with switch 03-0 above). For example, if this setting is set to "10", and A4 is the selected paper size: If the received document is 10 mm or less longer than A4, then the 10 mm are cut and only 1 page prints. If the received document is 10 mm longer than A4, then the document is split into 2 pages.

* This setting can be used for the remote machine.

Printer Switch 04 (SP No. 1-103-005)						
No	Function					Comments
0-4	Maximum reducible length when length reduction is enabled with switch 03-0 above. [Maximum reducible length] = [Paper length] + (N x 5mm) "N" is the decimal value of the binary setting of bits 0 to 4.					
	Bit 4	Bit 3	Bit 2	Bit 1	Bit 0	Setting
	0	0	0	0	0	0 mm
	0	0	0	0	1	5 mm
	0	0	1	0	0	20 mm
	1	1	1	1	1	155 mm

Printer Switch 04 (SP No. 1-103-005)			
No	Function	Comments	
	For A5 sideways and B5 sideways paper [Maximum reducible length] = [Paper length] + 0.75 x (N x 5mm)		
5-6	Length of the duplicated image on the next page, when page separation has taken place.		
	Bit 6	Bit 5	Setting
	0	0	4 mm
	0	1	10 mm
	1	0	15 mm

Printer Switch 06 (SP No. 1-103-007)		
No	Function	Comments
0*	Printing while a paper cassette is pulled out, when the Just Size Printing feature is enabled. 0: Printing will not start 1: Printing will start if another cassette has a suitable size of paper, based on the paper size selection priority tables.	Cross reference Just size printing on/off – User switch 05, bit 5

* This setting can be used for the remote machine.

Printer Switch 07 (SP No. 1-103-008)		
No	Function	Comments
0	Not used	Do not change this setting.
1	Print letter-size paper at a reduced size (95%) when printing on sheets with the width of letter-size paper. 0: No 1: Yes	The image is printed with slight size reduction (95% in the leading edge and side-to-side directions) only when printing on sheets with the width of letter-size paper (This is not applied to the configuration page and paper fed from the bypass tray.). The side-to-side size reduction is adjusted in accordance with the automatic side-to-side size reduction function.
4	List of destinations in the Communication Failure Report for broadcasting 0: All destinations 1: Only destinations where communication failure occurred	1: Only destinations where communication failure occurred are printed on the Communication Failure Report.

Printer Switch 08 - Not used (Do not change the factory settings.)

Printer Switch 0E (SP No. 1-103-015)				
No	Function		Comments	
0*	Paper size selection priority 0: Width 1: Length		0: A paper size that has the same width as the received data is selected first. 1: A paper size which has enough length to print all the received lines without reduction is selected first.	
1*	Paper size selected for printing A4 width fax data 0: 8.5" x 11" size 1: A4 size		This switch determines which paper size is selected for printing A4 width fax data, when the machine has both A4 and 8.5" x 11" size paper.	
2	Page separation 0: Enabled 1: Disabled		1: If all paper sizes in the machine require page separation to print a received fax message, the machine does not print the message (Substitute Reception is used). After a larger size of paper is set in a cassette, the machine automatically prints the fax message.	
3-4	Printing the sample image on reports		"Same size" means the sample image is printed at 100%, even if page separation occurs. User Parameter Switch 19 (13H) bit 4 must be set to "0" to enable this switch. Refer to Detailed Section Descriptions for more on this feature.	
	Bit 4	Bit 3		Setting
	0	0		The upper half only
	0	1		50% reduction (sub-scan only)
	1	0	Same size	

Printer Switch 0E (SP No. 1-103-015)		
No	Function	Comments
7	Equalizing the reduction ratio among separated pages (Page Separation) 0: Enabled 1: Disabled	0: When page separation has taken place, all the pages are reduced with the same reduction ratio. 1: Only the last page is reduced to fit the selected paper size when page separation has taken place. Other pages are printed without reduction.

* This setting can be used for the remote machine.

Printer Switch 0F (SP No. 1-103-016)				
No	Function			Comments
0-1*	Smoothing feature			(0, 0) (0, 1): Disable smoothing if the machine receives halftone images from other manufacturers fax machines frequently.
	Bit 1	Bit 0	Setting	
	0	0	Disabled	
	0	1	Disabled	
	1	0	Enabled	
2*	Duplex printing 0: Disabled 1: Enabled			1: The machine always prints received fax messages in duplex printing mode:
3	Binding direction for Duplex printing 0: Left binding 1: Top binding			0: Sets the binding for the left edge of the stack. 1: Sets the binding for the top of the stack.
4	Not used			Do not change this setting.

* This setting can be used for the remote machine.

4.5 BIT SWITCHES - 3

Note

- Do not adjust a bit switch or use a setting that is described as "Not used", as this may cause the machine to malfunction or to operate in a manner that is not accepted by local regulations. Such bits are for use only in other areas, such as Japan.

Default settings for bit switches are not listed in this manual. Refer to the System Parameter List printed by the machine.

4.5.1 COMMUNICATION SWITCHES

Communication Switch 00 (SP No. 1-104-001)				
No	Function			Comments
0-1	Compression modes available in receive mode			These bits determine the compression capabilities to be declared in phase B (handshaking) of the T.30 protocol.
	Bit 1	Bit 0	Modes	
	0	0	MH only	
	0	1	MH/MR	
	1	0	MH/MR/MMR	
	1	1	MH/MR/MMR/JBIG	
2-3	Compression modes available in transmit mode			These bits determine the compression capabilities to be used in the transmission and to be declared in phase B (handshaking) of the T.30 protocol.
	Bit 3	Bit 2	Modes	
	0	0	MH only	
	0	1	MH/MR	
	1	0	MH/MR/MMR	
	1	1	MH/MR/MMR/JBIG	
5	JBIG compression method: Reception 0: Only basic supported 1: Basic and optional both supported			Change the setting when communication problems occur using JBIG compression.

Communication Switch 00 (SP No. 1-104-001)		
No	Function	Comments
6	JBIG compression method: Transmission 0: Basic mode priority 1: Optional mode priority	Change the setting when communication problems occur using JBIG compression.
7	Closed network (reception) 0: Disabled 1: Enabled	1: Reception will not go ahead if the polling ID code of the remote terminal does not match the polling ID code of the local terminal. This function is only available in NSF/NSS mode.

Communication Switch 01 (SP No. 1-104-002)				
No	Function			Comments
0	ECM 0: Off 1: On			If this bit is set to 0, ECM is switched off for all communications. In addition, V.8 protocol and JBIG compression are switched off automatically.
2-3	Wrong connection prevention method			(0,1): The machine will disconnect the line without sending a fax message, if the last 8 digits of the received CSI do not match the last 8 digits of the dialed telephone number. This does not work when manually dialed. (1,0): The same as above, except that only the last 4 digits are compared. (1,1): The machine will disconnect the line without sending a fax message, if the other end does not identify itself with an RTI or CSI. (0,0): Nothing is checked; transmission will always go ahead. ↓ Note <ul style="list-style-type: none"> ▪ This function does not work when dialing is done from the external telephone.
	Bit 3	Bit 2	Setting	
	0	0	None	
	0	1	8 digit CSI	
	1	0	4 digit CSI	
	1	1	CSI/RTI	

Communication Switch 01 (SP No. 1-104-002)				
No	Function			Comments
6-7	Maximum printable page length available			The setting determined by these bits is informed to the transmitting terminal in the pre-message protocol exchange (in the DIS/NSF frames).
	Bit 7	Bit 6	Setting	
	0	0	No limit	
	0	1	B4 (364 mm)	
	1	0	A4 (297 mm)	

Communication Switch 02 (SP No. 1-104-003)					
No	Function			Comments	
0	G3 Burst error threshold 0: Low 1: High			If there are more consecutive error lines in the received page than the threshold, the machine will send a negative response. The Low and High threshold values depend on the sub-scan resolution, and are as follows.	
				100 dpi	6(L) →12(H)
				200 dpi	12(L) →24(H)
				300 dpi	18(L) →36(H)
				400 dpi	24(L) →48(H)
1	Acceptable total error line ratio 0: 5% 1: 10%			If the error line ratio for a page exceeds the acceptable ratio, RTN will be sent to the other end.	
2	Treatment of pages received with errors during G3 reception 0: Deleted from memory without printing 1: Printed			0: Pages received with errors are not printed.	

Communication Switch 02 (SP No. 1-104-003)		
No	Function	Comments
3	Hang-up decision when a negative code (RTN or PIN) is received during G3 immediate transmission 0: No hang-up, 1: Hang-up	0: The next page will be sent even if RTN or PIN is received. 1: The machine will send DCN and hang up if it receives RTN or PIN. This bit is ignored for memory transmissions or if ECM is being used.
4-5	Not used	Do not change these settings.
7	Not used	Do not change this setting.

Communication Switch 03 (SP No. 1-104-004)		
No	Function	Comments
0-7	Maximum number of page retransmissions in a G3 memory transmission	00 - FF (Hex) times. This setting is not used if ECM is switched on. Default setting - 03(H)

Communication Switch 04 (SP No. 1-104-005)		
No	Function	Comments
0	Remote mode switch (TEL mode) 0: Disable 1: Enable (Active)	Set this bit to ON when you wish to switch TEL mode to FAX mode remotely.
1	Remote mode switch (FAX mode) 0: Disable 1: Enable (Active)	Set this bit to ON when you wish to turn on the remote mode switch after automatic reception with FAX mode.
2	Remote mode switch (AUTO mode) 0: Disable 1: Enable (Active)	Set this bit to ON when you wish to turn on the remote mode switch after automatic reception with AUTO mode.

Communication Switch 05 (SP No. 1-104-006)		
No	Function	Comments
0-3	Remote mode switch number 00-09 (0-9:HEX)	Enter the number to switch between TEL/FAX modes using the external phone.

Communication Switch 06 - Not used (Do not change the factory settings.)

Communication Switch 07 - Not used (Do not change the factory settings.)

Communication Switch 09 (SP No. 1-104-009)		
No	Function	Comments
0-7	Minimum interval between automatic dialing attempts	This value is the minimum time that the machine waits before it dials the next destination.

Communication Switch 0A (SP No. 1-104-011)		
No	Function	Comments
0	Point of resumption of memory transmission upon redialing 0: From the error page 1: From page 1	0: The transmission begins from the page where transmission failed the previous time. 1: Transmission begins from the first page, using normal memory transmission.
7	Not used	Do not change this setting.

Communication Switch 0B (SP No. 1-104-012)		
No	Function	Comments
0-3	Not used	Do not change these settings.
4	Printout of the message when acting as a Transfer Station 0: Disabled, 1: Enabled	When the machine is acting as a Transfer Station, this bit determines whether the machine prints the fax message coming in from the Requesting Terminal.
5	Not used	Do not change this setting.

Communication Switch 0C - Not used (Do not change the factory settings.)

Communication Switch 0D (SP No. 1-104-014)		
No	Function	Comments
0-7	The available memory threshold, below which ringing detection (and therefore reception into memory) is disabled.	00 to FF (Hex), unit = 4 kbytes (e.g., 06(H) = 24 kbytes) One page is about 24 kbytes. The machine refers to this setting before each fax reception. If the amount of remaining memory is below this threshold, the machine cannot receive any fax messages. If this setting is kept at 0, the machine will detect ringing signals and go into receive mode even if there is no memory available. This will result in communication failure.

Communication Switch 0E (SP No. 1-104-015)		
No	Function	Comments
0-7	Minimum interval between automatic dialing attempts	06 to FF (Hex), unit = 2 s (e.g., 06(H) = 12 s) This value is the minimum time that the machine waits before it dials the next destination.

Communication Switch 0F – Not used (Do not change the factory settings.)

Communication Switch 10 (SP No. 1-104-017)		
No	Function	Comments
0-7	Memory transmission: Maximum number of dialing attempts to the same destination.	01 – FE (Hex) times

Communication Switch 11 – Not used (Do not change the factory settings.)

Communication Switch 12 (SP No. 1-104-019)		
No	Function	Comments
0-7	Memory transmission: Interval between dialing attempts to the same destination.	01 – FF (Hex) minutes

Communication Switch 13 – Not used (Do not change the factory settings.)

Communication Switch 14 (SP No. 1-104-021)				
No	Function			Comments
0	Inch-to-mm conversion during transmission 0: Disabled, 1: Enabled			<p>0: In immediate transmission, data scanned in inch format are transmitted without conversion. In memory transmission, data stored in the SAF memory in mm format are transmitted without conversion.</p> <p>Note: When storing the scanned data into SAF memory, the fax unit always converts the data into mm format.</p> <p>1: The machine converts the scanned data or stored data in the SAF memory to the format which was specified in the set-up protocol (DIS/NSF) before transmission.</p>
6-7	Available unit of resolution in which fax messages are received			<p>For the best performance, do not change the factory settings.</p> <p>The setting determined by these bits is informed to the transmitting terminal in the pre-message protocol exchange (in the DIS/NSF frames).</p>
	Bit 7	Bit 6	Unit	
	0	0	mm	
	0	1	inch	
	1	0	mm and inch	

Communication Switch 15 – Not used (Do not change the factory settings.)

Communication Switch 16 – Not used (Do not change the factory settings.)

Communication Switch 17 (SP No. 1-104-024)		
No	Function	Comments
0	SEP reception 0: Disabled 1: Enabled	0: Polling transmission to another maker's machine using the SEP (Selective Polling) signal is disabled.
1	SUB reception 0: Disabled 1: Enabled	0: Confidential reception to another maker's machine using the SUB (Sub-address) signal is disabled.
2	PWD reception 0: Disabled 1: Enabled	0: Disables features that require PWD (Password) signal reception.
3-4	Not used	Do not change these settings.
5	PSTN dial-in routing setting 0: OFF 1: ON	1: The machine sets multiple PSTN dial-in numbers in the PSTN dial-in line and transfers received data from each PSTN dial-in number to each address.
7	Action when there is no box with an F-code that matches the received SUB code 0: Disconnect the line 1: Receive the message (using normal reception mode)	Change this setting when the customer requires.

Communication Switch 18 (SP No. 1-104-025)		
No	Function	Comments
5	IP-Fax dial-in routing selection 0: Off 1: On	1: Transfers received data to each IP-Fax dial-in number. IP-Fax dial-in number is a 4-digit number.
6-7	Not used	Do not change these settings.

Communication Switch 1B (SP No. 1-104-028)		
No	Function	Comments
0-7	Extension access code (0 to 7) to turn V.8 protocol On/Off 0: On 1: Off	If the PABX does not support V.8/V.34 protocol procedure, set this bit to "1" to disable V.8. Example: If "0" is the PSTN access code, set bit 0 to 1. When the machine detects "0" as the first dialed number, it automatically disables V.8 protocol. (Alternatively, if "3" is the PSTN access code, set bit 3 to 1.)

Communication Switch 1C (SP No. 1-104-029)		
No	Function	Comments
0-1	Extension access code (8 and 9) to turn V.8 protocol On/Off 0: On 1: Off	Refer to communication switch 1B. Example: If "8" is the PSTN access code, set bit 0 to 1. When the machine detects "8" as the first dialed number, it automatically disables V.8 protocol. (If "9" is the PSTN access code, use bit 1.)

4.6 BIT SWITCHES - 4

Note

- Do not adjust a bit switch or use a setting that is described as "Not used", as this may cause the machine to malfunction or to operate in a manner that is not accepted by local regulations. Such bits are for use only in other areas, such as Japan.

Default settings for bit switches are not listed in this manual. Refer to the System Parameter List printed by the machine.

4.6.1 G3 SWITCHES

G3 Switch 00 (SP No. 1-105-001)				
No	Function			Comments
0-1	Monitor speaker during communication (tx and rx)			(0, 0): The monitor speaker is disabled all through the communication. (0, 1): The monitor speaker is on up to phase B in the T.30 protocol. (1, 0): Used for testing. The monitor speaker is on all through the communication. Make sure that you reset these bits after testing.
	Bit 1	Bit 0	Setting	
	0	0	Disabled	
	0	1	Up to Phase B	
	1	0	All the time	
2	Monitor speaker during memory transmission 0: Disabled 1: Enabled			1: The monitor speaker is enabled during memory transmission.
6	Dedicated G3 line mode selection 0: Off 1: On (Dedicated)			Set this bit to 1 when you wish to dedicate a line for G3.
7	Not used			Do not change this setting.

G3 Switch 01 (SP No. 1-105-002)		
No	Function	Comments
0-1	Not used	Do not change these settings.
4	DIS frame length 0: 10 bytes 1: 4 bytes	1: The bytes in the DIS frame after the 4th byte will not be transmitted (set to 1 if there are communication problems with PC-based faxes which cannot receive the extended DIS frames).
6	Forbid CED/ANSam output 0: Off 1: On (Forbid output)	Do not change this setting (Default: 0: Off), unless communication problem is caused by a CED or ANSam transmission.

G3 Switch 02 (SP No. 1-105-003)		
No	Function	Comments
0	G3 protocol mode used 0: Standard and non-standard 1: Standard only	Change this bit to 1 only when the other end can only communicate with machines that send T.30-standard frames only. 1: Disables NSF/NSS signals (these are used in non-standard mode communication)
5-6	Not used	Do not change these settings.
7	Short preamble 0: Disabled 1: Enabled	Refer to Appendix B in the Group 3 Facsimile Manual for details about Short Preamble.

G3 Switch 03 (SP No. 1-105-004)		
No	Function	Comments
0	DIS detection number (Echo countermeasure) 0: 1 1: 2	0: The machine will hang up if it receives the same DIS frame twice. 1: Before sending DCS, the machine will wait for the second DIS which is caused by echo on the line.
1	Not Used	Do not change this setting.
2	V.8 protocol 0: Disabled 1: Enabled	0: V.8/V.34 communications will not be possible. Note <ul style="list-style-type: none"> Do not set to 0 unless the line condition is always bad enough to slow down the data rate to 14.4 kbps or lower.
3	ECM frame size 0: 256 bytes 1: 64 bytes	Keep this bit at "0" in most cases.
4	CTC transmission conditions 0: After one PPR signal received 1: After four PPR signals received (ITU-T standard)	0: When using ECM in non-standard (NSF/NSS) mode, the machine sends a CTC to drop back the modem rate after receiving a PPR, if the following condition is met in communications at 14.4, 12.0, 9.6, and 7.2 kbps. $\sqrt{N_{\text{Transmit}} \leq N_{\text{Resend}}}$ NTransmit- Number of transmitted frames NResend- Number of frames to be retransmitted 1: When using ECM, the machine sends a CTC to drop back the modem rate after receiving four PPRs. PPR, CTC: These are ECM protocol signals. This bit is not effective in V.34 communications.

G3 Switch 03 (SP No. 1-105-004)		
No	Function	Comments
5	Modem rate used for the next page after receiving a negative code (RTN or PIN) 0: No change 1: Fallback	1: The machine's tx modem rate will fall back before sending the next page if a negative code is received. This bit is ignored if ECM is being used.
6	Not used	Do not change this setting.
7	Select detection of reverse polarity in ringing 0: Off 1: On	This switch is used to prevent reverse polarity in ringing on the phone line (applied to PSTN-G3 ringing). Do not change this setting 0: No detection 1: Detection (Japan and Korea only)

G3 Switch 04 (SP No. 1-105-005)		
No	Function	Comments
0-3	Training error detection threshold	0 - F (Hex); 0 - 15 bits If the number of error bits in the received TCF is below this threshold, the machine informs the sender that training has succeeded.

G3 Switch 05 (SP No. 1-105-006)						
No	Function					Comments
0-3	Initial Tx modem rate (kbps)					These bits set the initial starting modem rate for transmission. Use the dedicated transmission parameters if you need to change this for specific receivers. If a modem rate 14.4 kbps or slower is selected, V.8 protocol should be disabled manually. Cross reference V.8 protocol on/off - G3 switch 03, bit 2
	Bit 3	Bit 2	Bit 1	Bit 0	kbps	
	0	0	0	1	2.4	
	0	0	1	0	4.8	
	0	0	1	1	7.2	
	0	1	0	0	9.6	
	0	1	0	1	12.0	

G3 Switch 05 (SP No. 1-105-006)						
No	Function				Comments	
	0	1	1	0	14.4	
	0	1	1	1	16.8	
	1	0	0	0	19.2	
	1	0	0	1	21.6	
	1	0	1	0	24.0	
	1	0	1	1	26.4	
	1	1	0	0	28.8	
	1	1	0	1	31.2	
	1	1	1	0	33.6	
4-5	Initial modem type for 9.6 k or 7.2 kbps.				These bits set the initial modem type for 9.6 and 7.2 kbps, if the initial modem rate is set at these speeds.	
	Bit 5	Bit 4	Setting			
	0	0	V.29			
	0	1	V.17			
	1	0	V.34			

G3 Switch 06 (SP No. 1-105-007)						
No	Function					Comments
0-3	Initial Rx modem rate(kbps)					These bits set the initial starting modem rate for reception. Use a lower setting if high speeds pose problems during reception. If a modem rate 14.4 kbps or slower is selected, V.8 protocol should be disabled manually. Cross reference V.8 protocol on/off - G3 switch 03, bit2
	Bit 3	Bit 2	Bit 1	Bit 0	kbps	
	0	0	0	1	2.4	
	0	0	1	0	4.8	
	0	0	1	1	7.2	
	0	1	0	0	9.6	
	0	1	0	1	12.0	
	0	1	1	0	14.4	
	0	1	1	1	16.8	
	1	0	0	0	19.2	
	1	0	0	1	21.6	
	1	0	1	0	24.0	
	1	0	1	1	26.4	
	1	1	0	0	28.8	
	1	1	0	1	31.2	
1	1	1	0	33.6		
4-7	Modem types available for reception The setting of these bits is used to inform the transmitting terminal of the available modem type for the machine in receive mode. If V.34 is not selected, V.8 protocol must be disabled manually. Cross reference V.8 protocol on/off - G3 switch 03, bit 2					
	Bit 7	Bit 6	Bit 5	Bit 4	Types	
	0	0	0	1	V.27ter	
	0	0	1	0	V.27ter, V.29	

G3 Switch 06 (SP No. 1-105-007)					
No	Function				Comments
	0	0	1	1	V.27ter, V.29, V.33
	0	1	0	0	V.27ter, V.29, V.17
	0	1	0	1	V.27ter, V.29, V.17, V.34

G3 Switch 07 (SP No. 1-105-008)					
No	Function				Comments
0-1	PSTN cable equalizer (tx mode: Internal)				Use a higher setting if there is signal loss at higher frequencies because of the length of wire between the modem and the telephone exchange. Use the dedicated transmission parameters for specific receivers. Also, try using the cable equalizer if one or more of the following symptoms occurs. Communication error Modem rate fallback occurs frequently. Note <ul style="list-style-type: none"> This setting is not effective in V.34 communications.
	Bit 1	Bit 0	Setting		
	0	0	None		
	0	1	Low		
	1	0	Medium		
	1	1	High		
2-3	PSTN cable equalizer (rx mode: Internal)				Use a higher setting if there is signal loss at higher frequencies because of the length of wire between the modem and the telephone exchange. Also, try using the cable equalizer if one or more of the following symptoms occurs. Communication error with error codes such as 0-20, 0-23, etc.
	Bit 3	Bit 2	Setting		
	0	0	None		
	0	1	Low		
	1	0	Medium		
	1	1	High		

G3 Switch 07 (SP No. 1-105-008)		
No	Function	Comments
		Modem rate fallback occurs frequently. ↓ Note <ul style="list-style-type: none"> This setting is not effective in V.34 communications.
4	PSTN cable equalizer (V.8/V.17 rx mode: External) 0: Disabled 1: Enabled	Keep this bit at "1".
5	Not used	Do not change this setting.
6	Parameter selection for dial tone detection 0: Normal parameter 1: Specific parameter	0: This uses the fixed table in the ROM for dial tone detection. 1: This uses the specific parameter adjusted with SRAM (69ECBEH - 69ECDEH). Select this if the dial tone cannot be detected when the "Normal parameter: 0" is selected.

G3 Switch 08 - Not used (Do not change the factory settings.)

G3 Switch 09 - Not used (Do not change the factory settings.)

G3 Switch 0A (SP No. 1-105-011)				
No	Function			Comments
0-1	Maximum allowable carrier drop during image data reception			These bits set the acceptable modem carrier drop time. Try a longer setting if error code 0-22 is frequent.
	Bit 1	Bit 0	Value (ms)	
	0	0	200	
	0	1	400	
	1	0	800	
2	Select cancellation of high-speed RX if carrier signal lost while receiving 0: Off 1: On			This switch setting determines if high-speed receiving ends if the carrier signal is lost when receiving during non-ECM mode
4	Maximum allowable frame interval during image data reception. 0: 5 s 1: 13 s			This bit set the maximum interval between EOL (end-of-line) signals and the maximum interval between ECM frames from the other end. Try using a longer setting if error code 0-21 is frequent.
6	Reconstruction time for the first line in receive mode 0: 6 s 1: 12 s			When the sending terminal is controlled by a computer, there may be a delay in receiving page data after the local machine accepts set-up data and sends CFR. This is outside the T.30 recommendation. But, if this delay occurs, set this bit to 1 to give the sending machine more time to send data. Refer to error code 0-20. ITU-T T.30 recommendation: The first line should come within 5 s of CFR.

G3 Switch 0B Not used (Do not change the factory settings.)

G3 Switch 0C (SP No. 1-105-013)		
No	Function	Comments
0-1	Not used	Do not change these settings.
4-5	Select detection of DTMF/DP detection when using remote switch. 00: DTMF+PSTN (Simultaneous detection) 01: DTMF 10: DP (10 PPPS) 11: DP (20 PPS)	This setting determines how to detect the signals from the handset when remote switch is active.

G3 Switch 0D Not used (Do not change the factory settings.)

G3 Switch 0E (SP No. 1-105-015)		
No	Function	Comments
0-7	Set CNG send time interval Some machines on the receiving side may not be able to automatically switch the 3-second CNG interval.	
	High order bit	3000-2250ms: 3000-50xNms 3000 – 50 x Nms 0F (3000 ms) <= N <= FF (2250 ms)
	Low order bit	00-0E(3000-3700ms: 3000+50xNms 3000 – 50 x Nms 0F (3000 ms) <= N <= 0F (3700 ms)

G3 Switch 0F (SP No. 1-105-016)		
No	Function	Comments
0	Alarm when an error occurred in Phase C or later 0: Disabled 1: Enabled	If the customer wants to hear an alarm after each error communication, change this bit to "1".
1	Alarm when the handset is off-hook at the end of communication 0: Disabled 1: Enabled	If the customer wants to hear an alarm if the handset is off-hook at the end of fax communication, change this bit to "1".
2-3	Not used	Do not change these settings.
4	Sidaa manual calibration setting 0: Off 1: On	1: manually calibrates for communication with a line whose current change occurs such as an optical fiber line.
6	Not used	Do not change this setting.

4.7 BIT SWITCHES - 6

Note

- Do not adjust a bit switch or use a setting that is described as "Not used", as this may cause the machine to malfunction or to operate in a manner that is not accepted by local regulations. Such bits are for use only in other areas, such as Japan.

Default settings for bit switches are not listed in this manual. Refer to the System Parameter List printed by the machine.

4.7.1 IP FAX SWITCHES

IP Fax Switch 00 (SP No. 1-111-001)		
No	Function	Comments
1	IP Fax Transport 0: TCP, 1: UDP	Selects TCP or UDP protocol for IP-Fax
2	IP Fax single port selection 0: OFF, 1: ON (enable)	Selects single data port.
3	IP Fax double ports (single data port) selection 0: OFF, 1: ON (enable)	Selects whether IP-Fax uses a double port.
4	IP Fax Gatekeeper 0: OFF, 1: ON (enable)	Enables/disables the gatekeeper for IP-Fax.
5	IP Fax T30 bit signal reverse 0: LSB first, 1: MSB first	Reverses the T30 bit signal.
6	IP Fax max bit rate setting 0: Not affected, 1: Affected	When "0" is selected, the max bit rate does not affect the value of the DIS/DCS. When "1" is selected, the max bit rate affects the value of the DIS/DCS.

IP Fax Switch 00 (SP No. 1-111-001)		
No	Function	Comments
7	IP Fax received telephone number confirmation 0: No confirmation, 1: Confirmation	When "0" is selected, fax data is received without checking the telephone number. When "1" is selected, fax data is received only when confirming that the telephone number from the sender matches the registered telephone number in this machine. If this confirmation fails, the line is disconnected.

IP Fax Switch 01 (SP No. 1-111-002)					
No	Function				Comments
0-3	IP Fax delay level setting Selects the acceptable delay level. Level 0 is the highest quality Default is "0000" (level 0).				
	Bit 3	Bit 2	Bit 1	Bit 0	
	0	0	0	0	Level 0
	0	0	0	1	Level 1
	0	0	1	0	Level 2
	0	0	1	1	Level 3
4-7	IP Fax preamble wait time setting				Selects the preamble wait time. [00 to 0f] There are 16 values in this 4-bit binary switch combination. Waiting time: set value level x 100 ms Max: 0f (1500 ms) Min: 00 (No wait time) The default is "0000" (00H).

IP Fax Switch 02 (SP No. 1-111-003)		
No	Function	Comments
0	IP Fax bit signal reverse setting 0: Maker code setting 1: Internal bit switch setting	When "0" is selected, the bit signal reverse method is decided by the maker code. When "1" is selected, the bit signal reverse method is decided by the internal bit switch. (When communicating between IP Fax devices, LSB first is selected.)
1	IP Fax transmission speed setting 0: Modem speed 1: No limitation	Selects the transmit speed for IP Fax communication.
2	SIP transport setting 0: TCP 1: UDP	This bit switch sets the transport that has priority for receiving IP Fax data. This function is activated only when the sender has both TCP and UDP.
3	CCM connection 0: No CCM connection 1: CCM connection	When "1" is selected, only the connection call message with H.323 or no tunneled H.245 is transmitted via CCM.
4	Message reception selection from non-registered SIP server 0: Answer 1: Not answer	0: This answers the INVITE message from the SIP server not registered for the machine. 1: This does not receive the INVITE message from the SIP server not registered for the machine and send a refusal message.
5	ECM communication setting 0: No limit for image compression 1: Limit for image compression	0: This does not limit the type of the image compression with ECM communication. 1: When the other end machine is Cisco, this permits the image compression other than JBIG or MMR with ECM communication.

IP Fax Switch 03 (SP No. 1-111-004)		
No	Function	Comments
0	Effective field limitation for G3 standard function information 0: OFF, 1: 4byte (DIS)	Limits the effective field for standard G3 function information.
1	Switching between G3 standard and G3 non standard 0: Enable switching 1: G3 standard only	Enables/disables switching between G3 standard and G3 non-standard.
2	Not used	Do not change this setting.
3	ECM frame size selection at transmitting 0: 256byte, 1: 64byte	Selects the ECM frame size for sending.
4	DIS detection times for echo prevention 0: 1 time, 1: 2 times	Sets the number of times for DIS to detect echoes.
5	CTC transmission selection 0: PPRx1 1: PPRx4	When "0" is selected, the transmission condition is decided by error frame numbers. When "1" is selected, the transmission condition is based on the ITU-T method.
6	Shift down setting at receiving negative code 0: OFF, 1: ON	Selects whether to shift down when negative codes are received.

IP Fax Switch 04 (SP No. 1-111-005)		
No	Function	Comments
0-3	TCF error threshold	Sets the TCF error threshold level. [00 to 0f] The default is "1111" (0fH).

IP Fax Switch 05 (SP No. 1-111-006)						
No	Function				Comments	
0-3	Modem bit rate setting for transmission (kbps)					Sets the modem bit rate for transmission. The default is "0110" (14.4K bps).
	Bit 3	Bit 2	Bit 1	Bit 0	kbps	
	0	0	0	1	2.4	
	0	0	1	0	4.8	
	0	0	1	1	7.2	
	0	1	0	0	9.6	
	0	1	0	1	12.0	
	0	1	1	0	14.4	
4-5	Modem setting for transmission				Sets the modem type for transmission. The default is "00" (V29).	
	Bit 5		Bit 4			Types
	0		0			V29
	0		1			V17

IP Fax Switch 06 (SP No. 1-111-007)					
No	Function				Comments
0-3	Modem bit rate setting for reception Sets the modem bit rate for reception. The default is "0110" (14.4K bps).				
4-7	Modem setting for reception Sets the modem type for reception. The default is "0100" (V27ter, V29, V17).				
	Bit 7	Bit 6	Bit 5	Bit 4	Types
	0	0	0	1	V.27ter
	0	0	1	0	V.27ter, V.29
	0	0	1	1	V.27ter, V.29, V.33
0	1	0	0	V.27ter, V.29, V.17	

IP Fax Switch 07 (SP No. 1-111-008)		
No	Function	Comments
0	TSI information 0: Not added, 1: Added	Adds or does not add TSI information to NSS(S).
1	DCN transmission setting at T1 timeout 0: Not transmitted 1: Transmitted	Transmits or does not transmit DCN at T1 timeout.
2	Not used	Do not change this setting.
3	Hang up setting at DIS reception disabled 0: No hang up 1: Hang up after transmitting DCN	Sets whether the machine disconnects after DIS reception.
4	Number of times for training 0: 1 time, 1: 2 times	Selects the number of times training is done at the same bit rate.
5	Space CSI transmission setting at no CSI registration 0: Not transmitted 1: Transmitted	When "0" is selected, frame data is enabled. When "1" is selected, the transmitted data is all spaces.

IP Fax Switch 08 (SP No. 1-111-009)				
No	Function			Comments
0-1	T1 timer adjustment			Adjusts the T1 timer. The default is "00" (35 seconds).
	Bit 1	Bit 0		
	0	0	35 s	
	0	1	40 s	
	1	0	50 s	
	1	1	60 s	
2-3	T4 timer adjustment			Adjust the T4 timer. The default is "00" (3 seconds).
	Bit 3	Bit 2		
	0	0	3 s	
	0	1	3.5 s	
	1	0	4 s	
	1	1	5 s	
4-5	T0 timer adjustment			Adjusts the fail safe timer. This timer sets the interval between "setup" data transmission and T.38 phase decision. If your destination return is late on the network or G3 fax return is late, adjust the longer interval timer. The default is "00" (75 seconds).
	Bit 5	Bit 4		
	0	0	75 s	
	0	1	120 s	
	1	0	180 s	
	1	1	240 s	

IP Fax Switch 09 (SP No. 1-111-010)				
No	Function		Comments	
0	Network I/F setting for SIP connection 0: IPv4 1: IPv6		Selects the connection type (IPV4 or IPV6) to connect to the SIP server.	
1	Network I/F setting for Fax communication 0: Same setting as SIP server connection 1: Automatic setting		0: The I/F setting for fax communication follows the setting for SIP server connection. 1: The negotiation between the SIP server and the device decides whether IPv4 or IPv6 is used for the I/F setting for fax communication.	
2	Record-route setting 0: Disable 1: Enable		0: Disables the record-route function of the SIP server. 1: Enables the record-route function of the SIP server.	
3-4	re-INVITE transmission delay timer setting		This changes the interval for transmit re-INVITE after receiving the ACK message transmitted by T.38 device.	
	Bit 4	Bit 3		
	0	0		No delay
	0	1		1 sec
	1	0		2 sec
	1	1	3 sec	
5	SIP-IPFAX: Adding vender information selection 0: Declare T38VendorInfo=RICOH 1: Not declare T38VendorInfo=RICOH		0: Use this setting normally. 1: This setting is used only when a customer wants to connect the machine with SIP server + VOIP-GW provided by AVAYA Inc.	

IP Fax Switch 0A (SP No. 1-111-011)		
No	Function	Comments
0	NGN-HGW connection mode 0: Off (Do not connect to HGW.) 1: On	
1	Text String for specifying the 1stINVITEt38 media to be declared in SDP(HGW). 0: m=application t38 1: m=image t38	
2-3	Specify the media for 1stINVITE to be declared (no-HGW). 00: audio only 01: audio + t38 10: t38 only	
4	Declare the non-use media information for SDP (when answering SDP) 0: Declare the available port for non-use media information as "0". 1: Delete the non-use media information.	
5	IP-FAX: Declaration for SDP speed (no-HGW). 0: Bandwidth offer 1: No-Bandwidth offer	

IP Fax Switch 0B (SP No. 1-111-012)		
No	Function	Comments
0-7	Maximum sending speed registration -High (HGW) Indicate in 8-bit format Increase in units of 8 kbps	Specify the maximum sending speed (sending bandwidth) for sending IP-FAX.

IP Fax Switch 0C (SP No. 1-111-013)		
No	Function	Comments
0-7	Maximum sending speed registration -Med (HGW) Indicate in 8-bit format Increase in units of 8 kbps	Specify the maximum sending speed (sending bandwidth) for sending IP-FAX.

IP Fax Switch 0D (SP No. 1-111-014)		
No	Function	Comments
0-7	Maximum sending speed registration -Low (HGW) Indicate in 8-bit format Increase in units of 8 kbps	Specify the maximum sending speed (sending bandwidth) for sending IP-FAX.

IP Fax Switch 0E (SP No. 1-111-015)		
No	Function	Comments
0-1	SIP: IP-FAX port mode (UDP) 00: 3 port mode 01: 2 port mode 10: 1 port mode	Switch the port mode for IP-FAX (T38 transport: UDP) at SIP call control.
2-3	SIP: IP-FAX port mode (TCP) 00: 3 port mode 01: 2 port mode 10: 1 port mode	Switch the port mode for IP-FAX (T38 transport: TCP) at SIP call control.

4.8 NCU PARAMETERS

The following tables give the RAM addresses and the parameter calculation units that the machine uses for ringing signal detection and automatic dialing. The factory settings for each country are also given. Most of these must be changed by RAM read/write (SP2-102), but some can be changed using NCU Parameter programming (SP2-103); if SP2-103 can be used, this will be indicated in the Remarks column. The RAM is programmed in hex code unless (BCD) is included in the Unit column.

⬇ Note

- The following addresses describe settings for the standard NCU.

Address	Function					
680500	Country/Area code for NCU parameters					
	Use the Hex value to program the country/area code directly into this address, or use the decimal value to program it using SP2-103-001					
	Country /Area	Decimal	Hex	Country /Area	Decimal	Hex
	France	00	00	Asia	18	12
	Germany	01	01	Japan	19	13
	UK	02	02	Hong Kong	20	14
	Italy	03	03	South Africa	21	15
	Austria	04	04	Australia	22	16
	Belgium	05	05	New Zealand	26	17
	Denmark	06	06	Singapore	24	18
	Finland	07	07	Malaysia	25	19
	Ireland	08	08	China	26	1A
	Norway	09	09	Taiwan	27	1B
	Sweden	10	0A	Korea	28	1C
	Switzerland	11	0B	Brazil	29	1D

NCU Parameters

Address	Function					
	Portugal	12	0C	Turkey	32	20
	Holland	13	0D	Greece	33	21
	Spain	14	0E	Hungary	34	22
	Israel	15	0F	Czech	35	23
	USA	17	11	Poland	36	24

Address	Function	Unit	Remarks
680501	Line current detection time	20 ms	Line current detection is disabled. Line current is not detected if 680501 contains FF.
680502	Line current wait time		
680503	Line current drop detect time		
680504	PSTN dial tone frequency upper limit (high byte)	Hz (BCD)	If both addresses contain FF (H), tone detection is disabled.
680505	PSTN dial tone frequency upper limit (low byte)		
680506	PSTN dial tone frequency lower limit (high byte)	Hz (BCD)	If both addresses contain FF (H), tone detection is disabled.
680507	PSTN dial tone frequency lower limit (low byte)		
680508	PSTN dial tone detection time	20 ms	If 680508 contains FF (H), the machine pauses for the pause time (address 68050D / 68050E). Italy: See Note 2.
680509	PSTN dial tone reset time (LOW)		
68050A	PSTN dial tone reset time (HIGH)		
68050B	PSTN dial tone continuous tone time		
68050C	PSTN dial tone permissible drop time		
68050D	PSTN wait interval (LOW)		-

Address	Function	Unit	Remarks
68050E	PSTN wait interval (HIGH)		
68050F	PSTN ring-back tone detection time	20 ms	Detection is disabled if this contains FF.
680510	PSTN ring-back tone off detection time	20 ms	-
680511	PSTN detection time for silent period after ring-back tone detected (LOW)	20 ms	-
680512	PSTN detection time for silent period after ring-back tone detected (HIGH)	20 ms	-
680513	PSTN busy tone frequency upper limit (high byte)	Hz (BCD)	If both addresses contain FF (H), tone detection is disabled.
680514	PSTN busy tone frequency upper limit (low byte)		
680515	PSTN busy tone frequency lower limit (high byte)	Hz (BCD)	If both addresses contain FF (H), tone detection is disabled.
680516	PSTN busy tone frequency lower limit (low byte)		
680517	PABX dial tone frequency upper limit (high byte)	Hz (BCD)	If both addresses contain FF (H), tone detection is disabled.
680518	PABX dial tone frequency upper limit (low byte)		

Address	Function	Unit	Remarks
680519	PABX dial tone frequency lower limit (high byte)	Hz (BCD)	If both addresses contain FF (H), tone detection is disabled.
68051A	PABX dial tone frequency lower limit (low byte)		
68051B	PABX dial tone detection time	20 ms	If 68051B contains FF, the machine pauses for the pause time (680520 / 680521).
68051C	PABX dial tone reset time (LOW)		
68051D	PABX dial tone reset time (HIGH)		
68051E	PABX dial tone continuous tone time		
68051F	PABX dial tone permissible drop time		
680520	PABX wait interval (LOW)		
680521	PABX wait interval (HIGH)		
680522	PABX ringback tone detection time	20 ms	If both addresses contain FF (H), tone detection is disabled.
680523	PABX ringback tone off detection time	20 ms	
680524	PABX detection time for silent period after ringback tone detected (LOW)	20 ms	If both addresses contain FF (H), tone detection is disabled.
680525	PABX detection time for silent period after ringback tone detected (HIGH)	20 ms	
680526	PABX busy tone frequency upper limit (high byte)	Hz (BCD)	If both addresses contain FF (H), tone detection is disabled.
680527	PABX busy tone frequency upper limit (low byte)		

Address	Function	Unit	Remarks
680528	PABX busy tone frequency lower limit (high byte)	Hz (BCD)	If both addresses contain FF (H), tone detection is disabled.
680529	PABX busy tone frequency lower limit (low byte)		
68052A	Busy tone ON time: range 1	20 ms	
68052B	Busy tone OFF time: range 1		
68052C	Busy tone ON time: range 2		
68052D	Busy tone OFF time: range 2		
68052E	Busy tone ON time: range 3	20 ms	
68052F	Busy tone OFF time: range 3		
680530	Busy tone ON time: range 4		
680531	Busy tone OFF time: range 4		
680532	Busy tone continuous tone detection time		
680533	<p>Busy tone signal state time tolerance for all ranges, and number of cycles required for detection (a setting of 4 cycles means that ON-OFF-ON or OFF-ON-OFF must be detected twice).</p> <p>Tolerance (\pm)</p> <p>Bit 1: 0, Bit 0: 0 = 75% Bits 2 and 3 must always be kept at 0.</p> <p>Bit 1: 0, Bit 0: 0 = 50% Bits 2 and 3 must always be kept at 0.</p> <p>Bit 1: 0, Bit 0: 0 = 25%</p> <p>Bit 1: 0, Bit 0: 0 = 12.5%</p> <p>Bits 7, 6, 5, 4 - number of cycles required for cadence detection</p>		
680534	International dial tone frequency upper limit (high byte)	Hz (BCD)	If both addresses contain FF (H), tone detection is disabled.
680535	International dial tone frequency upper limit (low byte)		
680536	International dial tone frequency lower limit (high byte)	Hz (BCD)	If both addresses contain FF (H), tone detection is

NCU Parameters

Address	Function	Unit	Remarks
680537	International dial tone frequency lower limit (low byte)		disabled.
680538	International dial tone detection time	20 ms	If 680538 contains FF, the machine pauses for the pause time (68053D / 68053E). Belgium: See Note 2.
680539	International dial tone reset time (LOW)		
68053A	International dial tone reset time (HIGH)		
68053B	International dial tone continuous tone time		
68053C	International dial tone permissible drop time		
68053D	International dial wait interval (LOW)		
68053E	International dial wait interval (HIGH)		
68053F	Country dial tone upper frequency limit (HIGH)		
680540	Country dial tone upper frequency limit (LOW)		
680541	Country dial tone lower frequency limit (HIGH)	If both addresses contain FF (H), tone detection is disabled.	
680542	Country dial tone lower frequency limit (LOW)		
680543	Country dial tone detection time	20 ms	If 680543 contains FF, the machine pauses for the pause time (680548 / 680549).
680544	Country dial tone reset time (LOW)		
680545	Country dial tone reset time (HIGH)		

Address	Function	Unit	Remarks
680546	Country dial tone continuous tone time	-	-
680547	Country dial tone permissible drop time	20 ms	-
680548	Country dial wait interval (LOW)		
680549	Country dial wait interval (HIGH)		
68054A	Time between opening or closing the DO relay and opening the OHDI relay	1 ms	See Notes 3, 6 and 8. SP2-103-012 (parameter 11).
68054B	Break time for pulse dialing	1 ms	See Note 3. SP2-103-013 (parameter 12).
68054C	Make time for pulse dialing	1 ms	See Note 3. SP2-103-014 (parameter 13).
68054D	Time between final OHDI relay closure and DO relay opening or closing	1 ms	See Notes 3, 6 and 8. SP2-103-015 (parameter 14). This parameter is only valid in Europe.
68054E	Minimum pause between dialed digits (pulse dial mode)	20 ms	See Note 3 and 8. SP2-103-016 (parameter 15).
68054F	Time waited when a pause is entered at the operation panel		SP2-103-017 (parameter 16). See Note 3.
680550	DTMF tone on time	1 ms	SP2-103-018 (parameter 17).
680551	DTMF tone off time		SP2-103-019 (parameter 18).

NCU Parameters

Address	Function	Unit	Remarks
680552	Tone attenuation level of DTMF signals while dialing	-N x 0.5 -3.5 dBm	SP2-103-020 (parameter 19). See Note 5.
680553	Tone attenuation value difference between high frequency tone and low frequency tone in DTMF signals	-dBm x 0.5	SP2-103-021 (parameter 20). The setting must be less than -5dBm, and should not exceed the setting at 680552h above. See Note 5.
680554	PSTN: DTMF tone attenuation level after dialing	-N x 0.5 -3.5 dBm	SP2-103-022 (parameter 21). See Note 5.
680555	ISDN: DTMF tone attenuation level after dialing	-dBm x 0.5	See Note 5.
680556	Not used	-	Do not change the settings.
680557	Time between 68054Dh (NCU parameter 14) and 68054Eh (NCU parameter 15)	1 ms	This parameter takes effect when the country code is set to France.
680558	Not used	-	Do not change the setting.
680559	Grounding time (ground start mode)	20 ms	The Gs relay is closed for this interval.
68055A	Break time (flash start mode)	1 ms	The OHDI relay is open for this interval.
68055B	International dial access code (High)	BCD	For a code of 100: 68055B - F1 68055C - 00
68055C	International dial access code (Low)		

Address	Function	Unit	Remarks
68055D	PSTN access pause time	20 ms	This time is waited for each pause input after the PSTN access code. If this address contains FF[H], the pause time stored in address 68054F is used. Do not set a number more than 7 in the UK.
68055E	Progress tone detection level, and cadence detection enable flags	Bit 7: 0, Bit 6: 0, Bit 5: 0 = -25.0 dBm Bit 7: 0, Bit 6: 0, Bit 5: 1 = -35.0 dBm Bit 7: 0, Bit 6: 1, Bit 5: 0 = -30.0 dBm Bit 7: 1, Bit 6: 0, Bit 5: 0 = -40.0 dBm Bit 7: 1, Bit 6: 1, Bit 5: 0 = -49.0 dBm Bits 2, 0 - See Note 2.	
68055F to 680564	Not used	-	Do not change the settings.
680565	Long distance call prefix (HIGH)	BCD	For a code of 0: 680565 – FF 680566 - FF
680566	Long distance call prefix (LOW)	BCD	
680567 to 680571	Not used	-	Do not change the settings.
680572	Acceptable ringing signal frequency: range 1, upper limit	1000/ N (Hz)	SP2-103-003 (parameter 02).
680573	Acceptable ringing signal frequency: range 1, lower limit		SP2-103-004 (parameter 03).
680574	Acceptable ringing signal frequency: range 2, upper limit		SP2-103-005 (parameter 04).
680575	Acceptable ringing signal frequency: range 2, lower limit		SP2-103-006 (parameter 05).

NCU Parameters

Address	Function	Unit	Remarks
680576	Number of rings until a call is detected.	1	SP2-103-007 (parameter 06). The setting must not be zero.
680577	Minimum required length of the first ring	20 ms	See Note 4. SP2-103-008 (parameter 07).
680578	Minimum required length of the second and subsequent rings	20 ms	SP2-103-009 (parameter 08).
680579	Ringling signal detection reset time (LOW)	20 ms	SP2-103-010 (parameter 09).
68057A	Ringling signal detection reset time (HIGH)		SP2-103-011 (parameter 10).
68057B to 680580	Not used	-	Do not change the settings.
680581	Interval between dialing the last digit and switching the Oh relay over to the external telephone when dialing from the operation panel in handset mode.	20 ms	Factory setting: 500 ms
680582	<p>Bits 0 and 1 - Handset off-hook detection time</p> <p>Bit 1:0, Bit 0: 0 = 200 ms</p> <p>Bit 1:0, Bit 0: 1 = 800 ms</p> <p>Other Not used</p> <p>Bits 2 and 3 - Handset on-hook detection time</p> <p>Bit 3: 0, Bit 2: 0 = 200 ms</p> <p>Bit 3: 0, Bit 2: 1 = 800 ms</p> <p>Other Not used</p> <p>Bits 4 to 7 - Not used</p>	-	

Address	Function	Unit	Remarks
680583 to 6805A0	Not used	-	Do not change the settings.
6805A1	Acceptable CED detection frequency upper limit (high byte)	BCD (Hz)	If both addresses contain FF (H), tone detection is disabled.
6805A2	Acceptable CED detection frequency upper limit (low byte)		
6805A3	Acceptable CED detection frequency lower limit (high byte)	BCD (Hz)	If both addresses contain FF (H), tone detection is disabled.
6805A4	Acceptable CED detection frequency lower limit (low byte)		
6805A5	CED detection time	20 ms \pm 20 ms	Factory setting: 200 ms
6805A6	Acceptable CNG detection frequency upper limit (high byte)	BCD (Hz)	If both addresses contain FF (H), tone detection is disabled.
6805A7	Acceptable CNG detection frequency upper limit (low byte)		
6805A8	Acceptable CNG detection frequency lower limit (high byte)	BCD (Hz)	If both addresses contain FF (H), tone detection is disabled.
6805A9	Acceptable CNG detection frequency lower limit (low byte)		
6805AA	Not used	-	Do not change the setting.
6805AB	CNG on time	20 ms	Factory setting: 500 ms
6805AC	CNG off time	20 ms	Factory setting: 3000 ms
6805AD	Number of CNG cycles required for detection	-	The data is coded in the same way as address 680533.
6805AE	Not used	-	Do not change the settings.

NCU Parameters

Address	Function	Unit	Remarks
6805AF	Acceptable AI short protocol tone (800Hz) detection frequency upper limit (high byte)	Hz (BCD)	If both addresses contain FF (H), tone detection is disabled.
6805B0	Acceptable AI short protocol tone (800Hz) detection frequency upper limit (low byte)		
6805B1	Acceptable AI short protocol tone (800Hz) detection frequency lower limit (high byte)	Hz(BCD)	If both addresses contain FF (H), tone detection is disabled.
6805B2	Acceptable AI short protocol tone (800Hz) detection frequency lower limit (low byte)		
6805B3	Detection time for 800 Hz AI short protocol tone	20 ms	Factory setting: 360 ms
6805B4	PSTN: Tx level from the modem	-N – 3 dBm	SP2-103-002 (parameter 01).
6805B5	PSTN: 1100 Hz tone transmission level	- N 6805B4 - 0.5N 6805B5 –3.5 (dB) See Note 7.	
6805B6	PSTN: 2100 Hz tone transmission level	- N6805B4 - 0.5N 6805B6 –3 (dB) See Note 7.	
6805B7	PABX: Tx level from the modem	- dBm	
6805B8	PABX: 1100 Hz tone transmission level	- N 6805B7 - 0.5N 6805B8 (dB)	
6805B9	PABX: 2100 Hz tone transmission level	- N 6805B7 - 0.5N 6805B9 (dB)	
6805BD	Modem turn-on level (incoming signal detection level)	-37-0.5N (dBm)	
6805BE to 6805C6	Not used	-	Do not change the settings.

Address	Function	Unit	Remarks
6805C7	Bits 0 to 3 – Not used Bit 4 = V.34 protocol dump 0: Simple, 1: Detailed (default) Bits 5 to 7 – Not used.		
6805C8 to 6805D9	Not used	-	Do not change the settings.
6805DA	T.30 T1 timer	1 s	
6805E0 bit 3	Maximum wait time for post message	0: 12 s 1: 30 s	1: Maximum wait time for post message (EOP/EOM/MPS) can be changed to 30 s. Change this bit to “1” if communication errors occur frequently during V.17 reception.
6805E3	Bits 0 and 1 – DCV (TIP/RING) Voltage Bit 1:0, Bit 0: 0 = 3.1 V Bit 1:0, Bit 0: 1 = 3.2 V Bit 1:1, Bit 0: 0 = 3.35 V Bit 1:1, Bit 0: 1 = 3.5 V Bits 2 and 3 – MINI (minimum loop electric current) Bit 2:0, Bit 3: 0 = 10 mA Bit 2:0, Bit 2: 1 = 12 mA Bit 2:1, Bit 3: 0 = 14 mA Bit 2:1, Bit 3: 1 = 16 mA Bits 6 and 7 – ACIM (AC impedance) Bit 7:0, Bit 6: 0 Bit 5:0, Bit 4: 0= 600 Bit 7:0, Bit 6: 0 Bit 5:1, Bit 4: 0= TBR21		

Address	Function	Unit	Remarks
6805E4	<p>Bit 0 – OHS (on hook speed) 0: OHS=0 1: OHS=1</p> <p>Bit 1 – SQ (spark quench) 0: SQ=00 1: SQ=11</p> <p>Bit 2 – RZ (call signal Impedance) 0: RZ=0 (high) 1: RZ=1 (low)</p> <p>Bit 3 – RT (call signal detection level) 0: RT=0 (low) 1: RT=1 (high)</p> <p>Bit 4 – ILIM (DC limitation) 0: ILIM=0 (CTR 21) 1: ILIM=1 (other than CTR 21)</p> <p>Bit 5 –FILTER 0: FILTER=0 (around 5Hz) 1: FILTER=1 (around 200Hz)</p> <p>Bits 6 to 7 – Calibration in off hook state Bit 6:0, Bit 7: 0 = off hook to ACAL:128 ms, off hook to MCAL: 1000 ms Bit 6:1, Bit 7: 0 = off hook to ACAL:128 ms, off hook to MCAL: 500 ms Bit 6:0, Bit 7: 1 = off hook to ACAL:128 ms (no MCAL) Bit 6:1, Bit 7: 1 = off hook to ACAL:8 ms (no MCAL)</p>		
6805E5	<p>Bits 0 to 6 – Not used</p> <p>Bits 7 – Energy saving for DSP, COMBLK, SiDAA 0: Does not save energy 1: Saves energy</p>		

NOTES

1. If a setting is not required, store FF in the address.
2. Italy and Belgium only
 RAM address 68055E: the lower four bits have the following meaning.
 Bit 2 - 1: International dial tone cadence detection enabled (Belgium)
 Bit 1 - Not used
 Bit 0 - 1: PSTN dial tone cadence detection enabled (Italy)
 If bit 0 or bit 2 is set to 1, the functions of the following RAM addresses are changed.
 680508 (if bit 0 = 1) or 680538 (if bit 2 = 1): tolerance for on or off state duration (%), and

number of cycles required for detection, coded as in address 680533.

68050B (if bit 0 = 1) or 68053B (if bit 2 = 1): on time, hex code (unit = 20 ms)

68050C (if bit 0 = 1) or 68053C (if bit 2 = 1): off time, hex code (unit = 20 ms)

3. Pulse dial parameters (addresses 68054A to 68054F) are the values for 10 pps. If 20 pps is used, the machine automatically compensates.
4. The first ring may not be detected until 1 to 2.5 wavelengths after the time specified by this parameter.
5. The calculated level must be between 0 and 10.

The attenuation levels calculated from RAM data are:

High frequency tone:

- $-0.5 \times N_{680552/680554} - 3.5$ dBm
- $-0.5 \times N_{680555}$ dBm

Low frequency tone:

- $-0.5 \times (N_{680552/680554} + N_{680553}) - 3.5$ dBm
- $-0.5 \times (N_{680555} + N_{680553})$ dBm

 **Note**

- N_{680552} , for example, means the value stored in address 680552(H)
6. 68054A: Europe - Between Ds opening and Di opening, France - Between Ds closing and Di opening
68054D: Europe - Between Ds closing and Di closing, France - Between Ds opening and Di closing
 7. Tone signals which frequency is lower than 1500Hz (e.g., 800Hz tone for AI short protocol) refer to the setting at 6805B5h. Tones which frequency is higher than 1500Hz refer to the setting at 6805B6h.
 8. 68054A, 68054D, 68054E: The actual inter-digit pause (pulse dial mode) is the sum of the period specified by the RAM addresses 68054A, 68054D, and 68054E.

4.9 DEDICATED TRANSMISSION PARAMETERS

There are two sets of transmission parameters: Fax and E-mail

Each Quick Dial Key and Speed Dial Code has eight bytes of programmable parameters allocated to it. If transmissions to a particular machine often experience problems, store that terminal's fax number as a Quick Dial or Speed Dial, and adjust the parameters allocated to that number.

The programming procedure will be explained first. Then, the eight bytes will be described.

4.9.1 PROGRAMMING PROCEDURE

1. Set the bit 0 of System Bit Switch 00 to 1.
2. Enter Address Book Management mode ([User Tools]> System Settings> Key Operator> Address Book Management).
3. Select the address book that you want to program.
4. For the fax parameter, select "Fax Dest.", for the E-mail parameter, select "E-mail", then press "Start". Make sure that the LED of the Start button lights green.
5. The settings for the switch 00 are now displayed. Press the bit number that you wish to change.
6. To scroll through the parameter switches, either:
7. Select the next switch: press "Next" or Select the previous switch: "Prev." until the correct switch is displayed. Then go back to step 6.
8. After the setting is changed, press "OK".
9. After finishing, reset bit 0 of System Bit Switch 00 to 0.

4.9.2 PARAMETERS

Fax Parameters

The initial settings of the following fax parameters are all FF(H) - all the parameters are disabled.

Switch 00	
FUNCTION AND COMMENTS	
<p>ITU-T T1 time (for PSTN G3 mode)</p> <p>If the connection time to a particular terminal is longer than the NCU parameter setting, adjust this byte. The T1 time is the value stored in this byte (in hex code), multiplied by 1 second.</p> <p>Range: 0 to 120 s (00h to 78h)</p> <p>FFh - The local NCU parameter factory setting is used.</p> <p>Do not program a value between 79h and FEh.</p>	

Switch 01							
No	FUNCTION					COMMENTS	
0-4	Tx level						<p>If communication with a particular remote terminal often contains errors, the signal level may be inappropriate. Adjust the Tx level for communications with that terminal until the results are better.</p> <p>If the setting is "Disabled", the NCU parameter 01 setting is used.</p> <p>Note</p> <ul style="list-style-type: none"> Do not use settings other than listed on the left.
	Bit4	Bit3	Bit2	Bit1	Bit0		
	0	0	0	0	0	0	
	0	0	0	0	1	-1	
	0	0	0	1	0	-2	
	0	0	0	1	1	-3	
	0	0	1	0	0	-4	
	↓	↓	↓	↓	↓	↓	
	0	1	1	1	1	-15	
	1	1	1	1	1	Disabled	

Switch 01		
No	FUNCTION	COMMENTS
5-7	<p>Cable equalizer</p> <p>Bit 7: 0, Bit 6: 0, Bit 5: 0 = None</p> <p>Bit 7: 0, Bit 6: 0, Bit 5: 1 = Low</p> <p>Bit 7: 0, Bit 6: 1, Bit 5: 0 = Medium</p> <p>Bit 7: 0, Bit 6: 1, Bit 5: 1 = High</p> <p>Bit 7: 1, Bit 6: 1, Bit 5: 1 = Disabled</p>	<p>Use a higher setting if there is signal loss at higher frequencies because of the length of wire between the modem and the telephone exchange when calling the number stored in this Quick/Speed Dial.</p> <p>Also, try using the cable equalizer if one or more of the following symptoms occurs.</p> <p>Communication error with error codes such as 0-20, 0-23, etc.</p> <p>Modem rate fallback occurs frequently.</p> <p>Note</p> <ul style="list-style-type: none"> Do not use settings other than listed on the left. <p>If the setting is "Disabled", the bit switch setting is used.</p>

Switch 02						
No	FUNCTION					COMMENTS
0-3	Initial Tx modem rate					<p>If training with a particular remote terminal always takes too long, the initial modem rate may be too high. Reduce the initial Tx modem rate using these bits.</p> <p>For the settings 14.4 or kbps slower, Switch 04 bit 4 must be changed to 0.</p> <p>Note</p> <ul style="list-style-type: none"> Do not use settings other than listed on the left. If the setting is "Disabled", the bit switch setting is used.
	Bit3	Bit2	Bit1	Bit0	Bps	
	0	0	0	0	Not used	
	0	0	0	1	2400	
	0	0	1	0	4800	
	0	0	1	1	7200	
	0	1	0	0	9600	
	0	1	0	1	12000	
	0	1	1	0	14400	

Switch 02					
No	FUNCTION				COMMENTS
	0	1	1	1	16800
	1	0	0	0	19200
	1	0	0	1	21600
	1	0	1	0	24000
	1	0	1	1	26400
	1	1	0	0	28800
	1	1	0	1	31200
	1	1	1	0	33600
	1	1	1	1	Disabled
	Other settings: Not used				
6	Not used				Do not change this setting.

Switch 03		
No	FUNCTION	COMMENTS
0-1	Inch-mm conversion before tx Bit 1: 0, Bit 0: 0 = Inch-mm conversion available Bit 1: 0, Bit 0: 1 = Inch only Bit 1: 1, Bit 0: 0 = Not used Bit 1: 1, Bit 0: 1 = Disabled	If "inch only" is selected on the machine uses inch-based resolutions for scanning, the printed copy may be slightly distorted at the other end if that machine uses mm-based resolutions. If the setting is "Inch-mm conversion available ", Inch-mm conversion become effective to the special senders. If the setting is "Disabled", the bit switch setting is used.

Switch 03		
No	FUNCTION	COMMENTS
2-3	DIS/NSF detection method Bit 3: 0, Bit 2: 0 = First DIS or NSF Bit 3: 0, Bit 2: 1 = Second DIS or NSF Bit 3: 1, Bit 2: 0 = Not used Bit 3: 1, Bit 2: 1 = Disabled	(0, 1): Use this setting if echoes on the line are interfering with the set-up protocol at the start of transmission. The machine will then wait for the second DIS or NSF before sending DCS or NSS. If the setting is "Disabled", the bit switch setting is used.
4	V.8 protocol 0: Off 1: Disabled	If transmissions to a specific destination always end at a lower modem rate (14,400 bps or lower), disable V.8 protocol so as not to use V.34 protocol. 0: V.34 communication will not be possible. If the setting is "Disabled", the bit switch setting is used.
5	Compression modes available in transmit mode 0: MH only 1: Disabled	This bit determines the capabilities that are informed to the other terminal during transmission. If the setting is "Disabled", the bit switch setting is used.
6-7	ECM during transmission Bit 7: 0, Bit 6: 0 = Off Bit 7: 0, Bit 6: 1 = On Bit 7: 1, Bit 6: 0 = Not used Bit 7: 1, Bit 6: 1 = Disabled	For example, if ECM is switched on but is not wanted when sending to a particular terminal, use the (0, 0) setting. Note <ul style="list-style-type: none"> ▪ V.8/V.34 protocol and JBIG compression are automatically disabled if ECM is disabled. ▪ If the setting is "Disabled", the bit switch setting is used.

Switch 06 - Not used (Do not change the settings.)
Switch 07 - Not used (Do not change the settings.)
Switch 08 - Not used (Do not change the settings.)
Switch 09 - Not used (Do not change the settings.)

E-mail Parameters

The initial settings of the following e-mail parameters are all "0" (all parameters disabled).

Switch 00		
No	FUNCTION	COMMENTS
0	MH Compression mode for e-mail attachments 0: Off 1: On	Switches MH compression on and off for files attached to e-mails for sending.
1	MR Compression mode for e-mail attachments 0: Off 1: On	Switches MR compression on and off for files attached to e-mails for sending.
2	MMR Compression mode for e-mail attachments 0: Off 1: On	Switches MMR compression on and off for files attached to e-mails for sending.
3-6	Not used	Do not change these settings.
7	Designates the bits to reference for compression method of e-mail attachments 0: Registered (Bit 0 to 6) 1: No registration.	The "0" selection (default) references the settings for Bits 00, 01, 02 above. The "1" selection ignores the selections of Bits 00, 01, 02.

Dedicated Transmission Parameters

Switch 01		
No	FUNCTION	COMMENTS
0	Original width of e-mail attachment: A4 0: Off 1: On	Sets the original width of the e-mail attachment as A4.
1-6	Not used	Do not change these settings.
7	Designates the bits to reference for original size of e-mail attachments 0: Registered (Bit 0 to 6) 1: No registration.	The "0" selection (default) references the settings for Bits 00, 01, 02 above. The "1" selection ignores the selections of Bits 00, 01, 02.

Switch 02		
No	FUNCTION	COMMENTS
0	Line resolution of e-mail attachment: 200 x 100 0: Off 1: On	Sets the line resolution of the e-mail attachment as 200 x100.
1	Line resolution of e-mail attachment: 200 x 200 0: Off 1: On	Sets the line resolution of the e-mail attachment as 200 x 200.
2-6	Not used	Do not change these settings.
7	Designates the bits to reference for original size of e-mail attachments 0: Registered (Bit 0 to 6) 1: No registration.	The "0" selection (default) references the settings for Bits 00, 01, 02, 04 above. The "1" selection ignores the selections of Bits 00, 01, 02, 04.

Switch 03 - Not used (Do not change the settings.)

Switch 04		
No	FUNCTION	COMMENTS
0	Full mode address selection 0: Full mode address 1: No full mode (simple mode)	If the other ends have the addresses, which have the full mode function flag ("0"), this machine determines them as full mode standard machines. <ul style="list-style-type: none"> ▪ This machine attaches the "demand of reception confirmation" to a message when transmitting. ▪ This machine updates the reception capability to the address book when receiving.

Switch 05		
No	FUNCTION	COMMENTS
0	Direct transmission selection to SMTP server 0: ON 1: OFF	Allows or does not allow the direct transmission to SMTP server.

4.10 SERVICE RAM ADDRESSES

CAUTION

- Do not change the settings which are marked as “Not used” or “Read only.”

680001 to 680004(H) - ROM version (Read only)

680001(H) - Revision number (BCD)

680002(H) - Year (BCD)

680003(H) - Month (BCD)

680004(H) - Day (BCD)

680006 to 680015(H) - Machine's serial number (16 digits - ASCII)

680016(H) - Language code

0: Japanese, 1: UK English, 2: US English, 3: French, 4: German, 5: Spanish, 6: Italian, 7: Dutch, 8: Swedish, 9: Norwegian, 10: Danish, 11: Finnish, 12: Czech, 13: Hungarian, 14: Polish, 15: Portuguese, 16: Russian, 17: Traditional Chinese, 18: Simplified Chinese, 19: Korean

680018(H) - Total program checksum (low)

680019(H) - Total program checksum (high)

680020 to 68003F(H) - System bit switches

680050 to 68005F(H) - Printer bit switches

680060 to 68007F(H) - Communication bit switches

680080 to 68008F(H) - G3 bit switches

6800D2(H) - User parameter switch 02 (SWUSR_02)

Bit 0: Forwarding mark printing on forwarded messages 0: Disabled, 1: Enabled

Bit 1: Center mark printing on received copies (This switch is not printed on the user parameter list.) 0: Disabled, 1: Enabled

Bit 2: Reception time printing (This switch is not printed on the user parameter list.) 0: Disabled, 1: Enabled

Bit 3: TSI print on received messages 0: Disabled, 1: Enabled

Bit 4: Checkered mark printing (This switch is not printed on the user parameter list.) 0: Disabled, 1: Enabled

Bit 5 and 6: Not used

6800D3(H) - User parameter switch 03 (SWUSR_03: Automatic report printout)

Bit 0: Transmission result report (memory transmissions) 0: Off, 1: On

Bit 1: Not used

Bit 2: Memory storage report 0: Off, 1: On

Bit 3: Polling reserve report (polling reception) 0: Off, 1: On

Bit 4: Polling result report (polling reception) 0: Off, 1: On

Bit 5: Transmission result report (immediate transmissions) 0: Off, 1: On

Bit 6: Not used

Bit 7: Journal 0: Off, 1: On

6800D4(H) - User parameter switch 04 (SWUSR_04: Automatic report printout)

Bit 0: Not used

Bit 1: Automatic communication failure report and transfer result report output 0: Off, 1: On

Bit 4: Indicates the parties 0: Not indicated, 1: Indicated

Bit 5: Include sender's name on reports 0: Off, 1: On

Bit 7: Inclusion of a sample image on reports 0: Off, 1: On

6800D5(H) - User parameter switch 05 (SWUSR_05)

Bit 0: Substitute reception when the base copier is in an SC condition 0: Enabled, 1: Disabled

Bits 1 and 2: Condition for substitute rx when the machine cannot print messages (Paper end, toner end, jam, and during night mode)

Bit 2: 0, Bit 1: 0 = The machine receives all the fax messages.

Bit 2: 0, Bit 1: 1 = The machine receives the fax messages with RTI or CSI.

Bit 2: 1, Bit 1: 0 = The machine receives the fax messages with the same ID code.

Bit 2: 1, Bit 1: 1 = The machine does not receive anything.

Bit 4: Not used

Bit 5: Just size printing 0: Off, 1: On

Bit 6: Not used

Bit 7: Add paper display when a cassette is empty 0: Off, 1: On

6800D6(H) - User parameter switch 06 (SWUSR_06): Not used

6800D7(H) - User parameter switch 07 (SWUSR_07)

Bit 0 Ringing 0: Off, 1: On

Bit 1: Automatic answering message 0: Off, 1: On

Bit 2: Parallel memory transmission 0: Off, 1: On

Bit 5: Remote control 0: Off, 1: On

6800D8(H) - User parameter switch 08 (SWUSR_08)

Bits 1: Not used.

Bit 2: Authorized reception 0: Only faxes from senders whose RTIs/CSIs are specified for this feature are accepted., 1: Only faxes from senders whose RTIs/CSIs are not specified for this feature are accepted.

6800DA(H) - User parameter switch 10 (SWUSR_0A)

Bits 0: Restrict control panel operations such as printing or deleting received documents 0: Off, 1: On

Bits 1: Combined two originals 0: Off, 1: On

Bit 3 to 5: Not used

Bit 6: Use both e-mail notification and printed reports to confirm the transmission results 0: Off, 1: On

Bit 7: Have the machine delete the document data without printing it when an error occurs 0: Off, 1: On

6800DB(H) - User parameter switch 11 (SWUSR_0B)

Service RAM Addresses

Bits 1 and 2: Not used

Bit 3: Receive rejection for 1300 Hz transmission 0: Off (receive), 1: On (not receive)

Bit 5: Print documents that are forwarded to other parties with Forwarding per Sender 0: Off, 1: On

Bit 6: Printout of messages received while acting as a forwarding station 0: Off, 1: On

Bit 7: Not used

6800DD(H) - User parameter switch 13 (SWUSR_0D): Not used

6800DE(H) - User parameter switch 14 (SWUSR_0E)

Bit 0: Message printout while the machine is in Night Printing mode 0: On, 1: Off

Bit 1: Maximum document length detection 0: Double letter, 1: Longer than double-letter (well log) – up to 1,200 mm

Bit 2: Not used

Bit 3: Fax mode settings, such as resolution, before a mode key (Copy/Fax/Printer/Scanner) is pressed 0: Not cleared, 1: Cleared

Bit 7: Not used

6800DF(H) - User parameter switch 15 (SWUSR_0F)

(This switch is not printed on the user parameter list.)

Bits 0, 1 and 2: Cassette for fax printout

Bit 2: 0, Bit 1: 0, Bit 0: 1 = 1st paper feed station

Bit 2: 0, Bit 1: 1, Bit 0: 0 = 2nd paper feed station

Bit 2: 0, Bit 1: 1, Bit 0: 1 = 3rd paper feed station

Bit 2: 1, Bit 1: 0, Bit 0: 0 = 4th paper feed station

Bit 2: 1, Bit 1: 0, Bit 0: 1 = LCT

Other settings Not used

Bit 5: Using the cassette specified by bits 0, 1 and 2 above only 0: On, 1: Off

6800E0(H) – User parameter switch 16 (SWUSR_10): Not used

6800E1(H) – User parameter switch 17 (SWUSR_11)

Bit 0: Not used

Bit 1: Prohibit broadcasting 0: No, 1: Yes

Bit 2: Inclusion of the “Add” button when a sequence of Quick/Speed dials is selected for broadcasting 0: Not needed, 1: Needed

Bits 3: Whether or not to reset the settings when original is scanned 0: On, 1: Off

Bits 4: Display the confirmation message prompting the user to check the destination before sending a file 0: No, 1: Yes

Bits 5: Automatic entry of the external line access code 0: Off, 1: On

Bits 7: Not used

6800E2(H) - User parameter switch 18 (SWUSR_12)

Bit 0: TTI date 0: Off, 1: On

Bit 1: TTI sender 0: Off, 1: On

Bit 2: TTI file number 0: Off, 1: On

Bit 3: TTI page number 0: Off, 1: On

Bit 7: Japan only

6800E3(H) - User parameter switch 19 (SWUSR_13)

Bit 0: Use paper delivery shift function 0: Off, 1: On

Bit 1: Sort Journal by line type 0: The Journal is separated into transmissions and receptions., 1: The Journal is separated into G3-1, G3-2, and G3-3 communications

Bit 2: Select the function to postpone the printing of a received file if the selected paper tray has run out of paper 0: Off, 1: On

Bit 3: Not used

Bit 4: Reduction of sample images on reports to 50% in the main scan and sub-scan directions. (This switch is not printed on the user parameter list.) 0: Technician adjustment (printer switch 0E bits 3 and 4), 1: 50% reduction

Bit 5: Use of A5 size paper for reports (This switch is not printed on the user parameter list.) 0: Off, 1: On

6800E4(H) - User parameter switch 20 (SWUSR_14)

Bit 0: Automatic printing of the LAN fax result report 0: Off, 1: On

Bit 1: Not used

Bits 2 to 5: Store documents in memory which could not be printed from PC fax (LAN fax) driver

Bit 5	Bit 4	Bit 3	Bit 2	Setting
0	0	0	0	0 min.
0	0	0	1	1 min.
↓	↓	↓	↓	↓
1	1	1	0	14 min.
1	1	1	1	15 min.

Bit 7: Not used.

6800E5(H) - User parameter switch 21 (SWUSR_15)

Bit 0: Print results of sending reception notice request message 0: Disabled (print only when error occurs), 1: Enabled

Bit 1: Respond to e-mail reception acknowledgment request 0: Disabled, 1: Enabled

Bit 2: Choose whether to print JPEG or PDF files attached to incoming e-mail 0: Off (Do not print), 1: On

Bit 3: File format for forwarded folders 0: TIFF, 1:PDF

Bit 4: Transmit Journal by E-mail 0: Disabled, 1: Enabled

Service RAM Addresses

Bit 5: Limit printing of subjects and texts in normal e-mail (attached TIFF files) 0: No, 1: Yes

Bit 6: Network error display 0: Displayed, 1: Not displayed

Bit 7: Transmit error mail notification 0: Enabled, 1: Disabled

6800E6(H) - User parameter switch 22 (SWUSR_16)

(This switch is not printed on the user parameter list.)

Bit 0: Dial tone detection (PSTN 1) 0: Disabled, 1: Enabled

Bits 1 to 7: Not used

6800E7(H) - User parameter switch 23 (SWUSR_17)

Bit 0 to 7: Information to be printed for transmit terminal identification (TTI)

6800E8(H) - User parameter switch 24 (SWUSR_18)

Bit 0: Store documents that could not be transmitted in memory 0: Off, 1: On

Bit 1: Length of time documents that could not be transmitted are stored in memory 0: 24hours, 1: 72 hours

Bit 2: Retain the files stored in the Document Server, regardless of the settings of [Auto Delete File in Document Server] under [System Settings] 0: No, 1: Yes

Bit 3: Cancel the use of the fixed sentence when sending a file by e-mail 0: No, 1: Yes

6800E9(H) - User parameter switch 25 (SWUSR_19)

Bit 1: Reception mode switch timer 0: Off, 1: On (switching Fax or Fax/Tel)

Bit 2: Mode priority switch 0: Fax first, 1: Tel first

Bit 3: Dial in function (Japan Only)

Bit 4: Not used.

Bit 5 to 7: Not used

6800EA(H) and 6800EB(H) - User parameter switches 26 and 27 (SWUSR_1A and 1B): Not used

6800EC(H) - User parameter switch 28(SWUSR_1C): Not used

6800ED(H) - User parameter switch 29(SWUSR_1D): Not used

6800EE(H) and 6800EF(H) - User parameter switches 30 and 31 (SWUSR_1E and 1F): Not used

6800F0(H) - User parameter switch 32 (SWUSR_20)

Bit 0: Quotation priority for a destination when there is no destination of the specified type 0: Paper output priority = Priority order: 1. IP-fax destination, 2. Fax Number, 3. E-mail address, 4. Folder

1: Electric putout order = Priority order: 1. E-mail address, 2. Folder, 3. IP-fax destination, 4. Fax number

Bits 1 to 7: Not used

6800F1(H) - User parameter switch 33 (SWUSR_21): Not used

6800F2(H) - User parameter switch 34 (SWUSR_22)

Bit 0: Gatekeeper server used with IP-Fax 0: Disabled, 1: Enabled

Bit 1: SIP server used with IP-Fax 0: Disabled, 1: Enabled

Bits 2 to 7: Not used

6800F3(H) - User parameter switch 35 (SWUSR_23)

Redial interval when sending a backup file

6800F4(H) - User parameter switch 36 (SWUSR_24)

Maximum number of redials when sending a backup file

6800F5(H) - User parameter switch 37 (SWUSR_25)

Bit 0: Whether to stop sending a backup file if the destination folder becomes full while the machine is sending or waiting to send a fax or the backup file. 0: No, 1: Yes

Bit 2 and 3: Backup file is printed along with the TX communication failure report when a backup file transmission failure occurs. 00: Do not print, 01: Print first page only, 10: Print whole file

Bit 4: Display the sender's information in the file name of documents that are forwarded to folder destinations. 0: Disabled, 1: Enabled

Bit 5: Limit the file names of documents that are forwarded to folder destinations to plain characters only. 0: Disabled, 1: Enabled

Bit 6: When using the remote fax function, the sub-machine beeps to let you know when it has printed a received document (If you specify "On", the machine will beep according to the setting of [Panel Key Sound] under [System Settings].) 0: On, 1: Off

6800F6(H) - User parameter switch 38 (SWUSR_26): Not used

6800F7(H) - User parameter switch 39 (SWUSR_27): Not used

6800F8(H) - User parameter switch 40 (SWUSR_28)

Bit 0: When memory space is insufficient, the machine prints and then deletes the oldest faxes, creating memory space for storage of new faxes. 0: Disabled, 1: Enabled

6800FD (H) - User parameter switch 45 (SWUSR_2D)

Bit 0 and 1: Not used

Bit 2: File format for files transmitted to e-mail addresses and folders registered as forwarding, destinations of backup file transmission, receivers for Personal Box, or end receivers for Transfer Box. 0: PDF 1: PDF/A

Bit 3: Specify the criteria for printing files when forwarding them 0: Depends on Reception file settings, 1: Do not print

680130 to 68016F(H) - Service Switches

680170 to 68017F(H) - IFAX Switches

680180 to 68018F(H) - IP-FAX Switches

680190 to 6801A3(H) - PSTN-1 RTI (Max. 20 characters - ASCII) - See the following note.

6801CF to 68020E(H) - TTI 1 (Max. 64 characters - ASCII) - See the following note.

68020F to 68024E(H) - TTI 2

68024F to 68028E(H) - TTI 3

68028F to 6802CE(H) - TTI 4

6802CF to 68030E(H) - TTI 5

68030F to 68034E(H) - TTI 6

68034F to 68038E(H) - TTI 7

68038F to 6803CE(H) - TTI 8

6803CF to 68040E(H) - TTI 9

68040F to 68044E(H) - TTI 10

 **Note**

- If the number of characters is less than the maximum (20 for RTI, 32 for TTI), add a stop code (00[H]) after the last character.

68044F(H) - Printing format for TTI 1 0: DOM (Japan), 1:EXP (Export)

680450(H) - Printing format for TTI 2 0: DOM, 1:EXP

680451(H) - Printing format for TTI 3 0: DOM, 1:EXP

680452(H) - Printing format for TTI 4 0: DOM, 1:EXP

680453(H) - Printing format for TTI 5 0: DOM, 1: EXP

680454(H) - Printing format for TTI 6 0: DOM, 1: EXP

680455(H) - Printing format for TTI 7 0: DOM, 1: EXP

680456(H) - Printing format for TTI 8 0: DOM, 1: EXP

680457(H) - Printing format for TTI 9 0: DOM, 1: EXP

680458(H) - Printing format for TTI 10 0: DOM, 1: EXP

680459 to 68046C(H) - PSTN-1 CSI (Max. 20 characters - ASCII)

680495(H) - Number of PSTN-1 CSI characters (Hex)

6804C6(H) - Memory Lock ID (BCD)

6804D2 to 6804D9(H) - Last power off time (Read only)

6804D2(H) - 01(H) - 24-hour clock, 00(H) - 12-hour clock (AM), 02(H) - 12-hour clock (PM)

6804D3(H) - Year (BCD)

6804D4(H) - Month (BCD)

6804D5(H) - Day (BCD)

6804D6 (H) - Hour

6804D7 (H) - Minute

6804D8(H) - Second

6804D8 (H) - 00: Monday, 01: Tuesday, 02: Wednesday, /// , 06: Sunday

6804E6(H) - Optional equipment (Read only – Do not change the settings)

Bit 0: Page Memory 0: Not installed, 1: Installed

Bit 1: SAF Memory (4M) 0: Not installed, 1: Installed

Bit 2: SAF Memory 0: Not installed, 1: Installed

Bits 3 to 7; Not used

6804E7(H) - Optional equipment (Read only – Do not change the settings)

Bits 0 to 7: Not used

6804EE(H) - Machine code (Check ram 3)

680500(H) - Start address of G3 table for G3-1

680820 to 68083F(H) - Service station's fax number (SP3-101)

680840 to 680849(H) - Own fax PABX extension number - Not used
68084A to 680853(H) - Own fax number (PSTN) - Not used
680868 to 680873(H) - The first subscriber number (ISDN G3) - Not used
680874 to 68087F(H) - The second subscriber number (ISDN G3) - Not used
680908(H) - G3-1 Modem ROM version (Read only)
680918(H) - Number of multiple sets print (Read only)
68096E(H) - Not used
68096F(H) - Not used
68098A(H) - Transmission monitor volume 00 - 07(H)
68098B(H) - Reception monitor volume 00 - 07(H)
68098C(H) - On-hook monitor volume 00 - 07(H)
68098D(H) - Dialing monitor volume 00 - 07(H)
68098E(H) - Buzzer volume 00 - 07(H)
68098F(H) - Beeper volume 00 - 07(H)
6809A0(H) - Machine code (Check ram 4)
6809CA(H) - Machine serial number (ASCII)
686D98 to 686D9B(H) - Transmission counter 00000000 - FFFFFFFF(H)
686D9C to 686D9F(H) - Reception counter 00000000 - FFFFFFFF(H)
686E08 to 686E0B(H) - Mail transmission counter 00000000 - FFFFFFFF(H)
686E0C to 686E0F(H) - Mail reception counter 00000000 - FFFFFFFF(H)
6A69EE(H) to 6A6CED(H) - SIP server address (Read only)
6A69EE(H) - Proxy server - Main (Max. 128 characters - ASCII)
6A6A6E(H) - Proxy server - Sub (Max. 128 characters - ASCII)
6A6AEE(H) - Redirect server - Main (Max. 128 characters - ASCII)
6A6B6E(H) - Redirect server - Sub (Max. 128 characters - ASCII)
6A6BEE(H) - Registrar server - Main (Max. 128 characters - ASCII)
6A6C6E(H) - Registrar server - Sub (Max. 128 characters - ASCII)
6A6CEE(H) - Gatekeeper server address - Main (Max. 128 characters - ASCII)
6A6D6E(H) - Gatekeeper server address - Sub (Max. 128 characters - ASCII)
6A6DEE(H) - Alias Number (Max. 128 characters - ASCII)
6A6E6E(H) - SIP user name (Max. 128 characters - ASCII)
6A6EEE(H) - SIP digest authentication password (Max. 128 characters - ASCII)
6A6F6E(H) - Gateway address information (Max. 7100 characters - ASCII)
6A8B2A(H) - NGN initial setting method 0: Simple, 1: Manual
6A8B2B(H) - SIP digest authentication user name (Max. 128 characters - ASCII)
6A8BAB(H) - NGN-SIP domain name (Max. 64 characters - ASCII)
6A8BEB(H) - NGN-home gateway address (Max. 128 characters - ASCII)
6A8C6C(H) - Stand-by port number for H.323 connection
6A8C6E(H) - Stand-by port number for SIP connection

Service RAM Addresses

6A8C70(H) - RAS port number

6A8C72(H) - Gatekeeper port number

6A8C74(H) - Port number of data waiting for T.38

6A8C76(H) - Port number of SIP server

6A8C78(H) - Priority for SIP and H.323 0: H.323, 1: SIP

6A8C79(H) - SIP function 0: Disabled, 1: Enabled

6A8C7A(H) - H.323 function 0: Disabled, 1: Enabled

6A8C7B(H) - **SIP digest authentication function** 0: Disabled, 1: Enabled

6B35A4(H) - 6B35C4 (H) - Dial tone detection parameter (Max. 11 x 3 lines)

This initializes following order. [0x04, 0x40, 0x03, 0x60, 0x64, 0xf4, 0x01,0x64, 0x04, 0xc8, 0x00]

6B35A4(H) - Dial tone detection frequency – Upper limit (High)

Defaults: NA: 06, EU: 06, ASIA: 06

6B35A5(H) - Dial tone detection frequency – Upper Limit (Low)

Defaults: NA: 50, EU: 50, ASIA: 50

6B35A6(H) - Dial tone detection frequency – Lower Limit (High)

Defaults: NA: 03, EU: 02, ASIA: 02

6B35A7(H) - Dial tone detection frequency – Lower Limit (Low)

Defaults: NA: 60, EU: 90, ASIA: 90

6B35A8(H) - Dial tone detection waiting time (20 ms)

Defaults: NA: 64, EU 64, ASIA: 64

6B35A9 to 6B35AA - Dial tone detection monitoring time (20 ms)

Defaults

Area	6B35A9	6B35AA
NA	F4	01
EU	F4	01
ASIA	F4	01

6B35AB(H) - Dial tone detect judge time (20 ms)

Defaults: NA: 64, EU: 1B, ASIA: 32

6B35AC(H) - Dial tone disconnect permission time (20 ms)

Defaults: NA: 11, EU: 0F, ASIA: 11

5. DETAILED SECTION DESCRIPTIONS

5.1 OVERVIEW

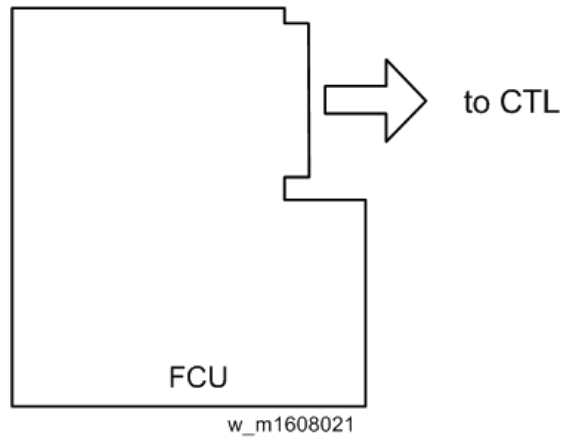

The FCU controls all the fax communications and fax features, in cooperation with the controller board. Also, the FCU contains the ROM, SRAM and NCU circuits.

5.2 BOARDS

5.2.1 FCU

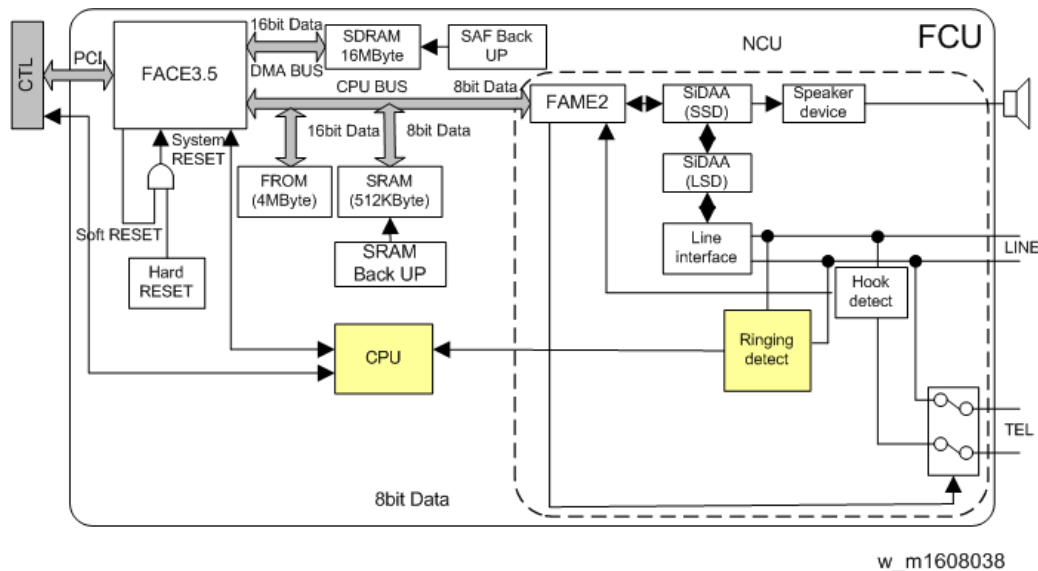

The FCU (Facsimile Control Unit) controls fax communications, the video interface to the base copier's engine, and all the fax options.

FACE3.5 (Fax Application Control Engine)

- CPU
- Data compression and reconstruction (DCR)
- DMA control
- Clock generation
- DRAM backup control

Modem (FAME2)

V.34, V.33, V.17, V.29, V.27ter, V.21, and V.8

DRAM

The 16 MB of DRAM is shared as follows.

- SAF memory: 4MB
- Working memory: 4MB
- Page memory: 4MB
- The SAF memory is backed up by a rechargeable battery.

SAF Memory Back-up

A rechargeable battery backs up the SAF memory (DRAM) for 12 hours.

ROM

4 MB flash ROMs for system software storage

SRAM

The 512 KB SRAM for system and user parameter storage is backed up by a lithium battery.

SRAM Back-up

A lithium battery backs up the system parameters and programmed items in the SRAM, in case the base copier's main power switch is turned off.

Switches

Item	Description
SW1	Switches the SRAM backup battery on/off.

CPU

This controls the energy-efficient operation of the FCU board.

5.3 FAX COMMUNICATION FEATURES

5.3.1 INTERNET MAIL COMMUNICATION

Mail Transmission

This machine supports T.37 full mode. (ITU-T Recommendation, RFC2532). The difference between T.37 simple mode and full mode is as follows.

Function	T.37 Simple Mode	T.37 Full Mode
Resolution	200 x 100 200 x 200	200 x 100 200 x 200 200 x 400 400 x 400 (if available)
RX Paper Width	A4, 8.5" x 14"	A4, B4, A3
RX Data Compression Method	MH	MH (default), MR, MMR,
Signals	Image data transmission only	Image data transmission, exchange of capability information between the two terminals, and acknowledgement of receipt of fax messages

Data Formats

The scanned data is converted into a TIFF-F formatted file.

The fields of the e-mail and their contents are as follows:

Field	Content
From	Mail address of the sender
Reply To	Destination requested for reply
To	Mail address of the destination
Bcc	Backup mail address
Subject	From CSI or RTI (Fax Message No. xxxx)
Content Type	Multipart/mixed Attached files: image/tiff
Content Transfer Encoding	Base 64, 7-bit, 8-bit, Quoted Printable
Message Body	MIME-converted TIFF-F (MIME standards specify how files are attached to e-mail messages)

Direct SMTP Transmission

Internet Fax documents can be sent directly to their destinations without going through the SMTP server. (Internet Faxes normally transmit via the SMTP server.)

For example:

e-mail address:	gts@ricoh.co.jp
SMTP server address:	gts.abcd.com

In this case, this feature destination e-mail address (gts@ricoh.co.jp) is read as the SMTP server address "gts.abcd.com", and the transmissions bypass the SMTP server.

Selectable Options

These options are available for selection:

- With the default settings, the scan resolution can be either standard or detail. Inch-mm conversion before TX depends on IFAX SW01 Bit 7. Detail resolution will be used if Super Fine resolution is selected, unless Fine resolution is enabled with IFAX SW01.
- The requirements for originals (document size, scan width, and memory capacity) are the same as for G3 fax memory TX.
- The default compression is TIFF-F format.
- IFAX SW00: Acceptable paper widths for sending
- IFAX SW09: Maximum number of attempts to the same destination

Secure Internet Transmission

SMTP Authentication:

- User Tools> System Settings> File Transfer> SMTP Authentication

POP Before SMTP:

- User Tools> System Settings> File Transfer> POP Before SMTP

Mail Reception

This machine supports three types of e-mail reception:

- POP3 (Post Office Protocol Ver. 3.)
- IMAP4 (Internet Messaging Access Protocol)
- SMTP (Simple Mail Transfer Protocol)

Note

- For details: Core Technology Manual – Facsimile Processes – Faxing from a PC – Internet/LAN Fax Boards – Mail Reception

POP3/IMAP4 Mail Reception Procedure

The machine automatically picks up e-mail from the server at an interval which is adjustable in the range 2 to 1440 min. in 1-minute steps:

- User Tools> System Settings> File Transfer> E-mail Reception Interval

SMTP Reception

1. The IFAX must be registered as an SMTP server in the MX record of the DNS server, and the address of the received mail must specify the IFAX.
2. To enable SMTP reception: User Tools> System Settings> File Transfer> Reception Protocol
 - Even if the MX record on the DNS server includes the IFAX, mail cannot be received with SMTP until SMTP reception is enabled:
 - However, if SMTP reception is selected and the machine is not registered in the MX record of the DNS server, then either IMAP4 or POP3 is used, depending on the setting: User Tools> System Settings> File Transfer> Reception Protocol

Mail Delivery Conditions: Transferring Mail Received With SMTP

1. The machine must be set up for SMTP mail delivery:
User Tools> Facsimile Features> Reception Settings> SMTP RX File Delivery Settings
2. If the user wishes to limit this feature so that the machine will only deliver mail from designated senders, the machine's "Auth. E-mail RX" feature must be set (User Tools> Facsimile Features> E-mail Settings > SMTP RX File Delivery Settings).
3. If the "SMTP RX File Delivery Setting" is set to "0" to prohibit SMTP receiving, and if there is mail designated for delivery, then the machine responds with an error. (User Tools> Facsimile Features> E-mail Settings > SMTP RX File Delivery Settings)
4. If the quick dial, speed dial, or group dial entry is incorrect, the mail transmission is lost, and the IFAX issues an error to the SMTP server and outputs an error report.

Auth. E-mail RX

In order to limit access to mail delivery with IFAX, the addresses of senders must be limited using the Access Limit Entry. Only one entry can be registered.

1. Access Limit Entry

For example, to limit access to @IFAX.ricoh.co.jp:

gts@IFAX.ricoh.co.jp	Matches and is delivered.
gts@IFAX.abcde.co.jp	Does not match and is not delivered.
IFAX@ricoh.co.jp	Does not match and is not delivered.

2. Conditions

- The length of the Access Limit Entry is limited to 127 characters.
- If the Access Limit Entry address and the mail address of the incoming mail do not match, the incoming mail is discarded and not delivered, and the SMTP server responds with an error. However, in this case an error report is not output.
- If the Access Limit Entry address is not registered, and if the incoming mail specifies a delivery destination, then the mail is delivered unconditionally.

Handling Mail Reception Errors

Abnormal files

When an error of this type occurs, the machine stops receiving and commands the server to erase the message. Then the machine prints an error report and sends information about the error by e-mail to the sender address (specified in the "From" or "Reply-to" field of the message). If there is an incomplete received message in the machine memory, it will be erased.

The machine prints an error message when it fails to send the receive error notification after a certain number of attempts.

The following types of files are judged to be abnormal if one or more of the following are detected:

1. Unsupported MIME headers.

Supported types of MIME header

Header	Supported Types
Content-Type	Multipart/mixed, text/plain, message/rfc822 Image/tiff
Charset	US-ASCII, ISO 8859 X. Other types cannot be handled, and some garbage may appear in the data.

Header	Supported Types
Content-Transfer-Encoding	Base 64, 7-bit, 8-bit, Quoted Printable

2. MIME decoding errors
3. File format not recognized as TIFF-F format
4. Resolution, document size, or compression type cannot be accepted

Remaining SAF capacity error

The machine calls the server but does not receive e-mail if the remaining SAF capacity is less than a certain value (the value depends on IFAX Switch 08. The e-mail will be received when the SAF capacity increases (for example, after substitute reception files have been printed). The error handling method for this type of error is the same as for "Abnormal files".

If the capacity of the SAF memory drops to zero during reception, the machine operates in the same way as when receiving an abnormal file (refer to "Abnormal files" above).

Secure Internet Reception

To enable password encryption and higher level security: User Tools> System Settings> File Transfer> POP3/IMAP4 Settings> Encryption (set to "On")

Transfer Request: Request By Mail

For details: Core Technology Manual – Facsimile Processes – Faxing from a PC – Internet/LAN Fax Boards – Transfer Request

The fields of the e-mail and their contents are as follows:

Field	Content
From	E-mail address of the requesting terminal
To	Destination address (Transfer Station address)
Bcc	Blind carbon copy
Subject	From TSI (Fax Message No. xxxx)
Content-Type	Multipart/mixed Text/Plain (for a text part), image/tiff (for attached files)
Content-Transfer-Encoding	Base 64, 7-Bit, 8-bit, Quoted Printable

Field	Content
Mail body (text part)	RELAY-ID-: xxxx (xxxx: 4 digits for an ID code) RELAY: #01#*X#**01....
Message body	MIME-converted TIFF-F.

E-Mail Options (Sub TX Mode)

The following features are available as options for mail sending: entering a subject, designating the level of importance, confirming reception of the mail.

Subject and Level of Importance

You can enter a subject message with: Sub TX Mode> E-mail Options

The Subject entry for the mail being sent is limited to 64 characters. The subject can also be prefixed with an "Urgent" or "High" notation.

How the Subject Differs According to Mail Type

Mail Type	Item 1	Item 2		Item 3
Subject Entry	---	Entry Condition		
No Subject Entry		1. "CSI" ("RTI")		Fax Message No. + File No.
		2. "RTI"	CSI not registered	
		3. "CSI"	RTI not registered	
		4. None	CSI, RTI not registered	
Confirmation of Reception	From	1. "CSI" ("RTI")		Normal: Return Receipt (dispatched). You can select "displayed" with IFAX SW02 Bits 2 and 3.
		2. "RTI"	CSI not registered	
		3. "CSI"	RTI not registered	Error: Return Receipt (processed/error)
		4. None	CSI, RTI not registered	

Mail Type	Item 1	Item 2		Item 3
Mail delivery, memory transfer, SMTP receiving and delivery	From	RTI or CSI of the station designated for delivery	Mail delivery	Fax Message No. + File Number
		RTI or CSI of sender	Mail sending from G3 memory	
		Mail address of sender	Memory sending	
		Mail address of sender	SMTP receiving and delivery (Off Ramp Gateway)	
Mail error notification	---	Error Message No. xxxx From CSI (RTI)		

Items 1, 2, and 3 in the table above are in the Subject.

Subjects Displayed on the PC

Sender	Date	Size	Subject
Substation 2	04/25/2002	1,513	Parts List
Substation 2	04/26/2002	1,147	Specifications
Main Station	06/09/2002	33,561	[Urgent] Memo 2041
		21,624,200	

b868d505

E-mail Messages

After entering the subject, you can enter a message with: Sub TX Mode> E-mail Options

An e-mail message (up to 5 lines) can be pre-registered with: User Tools> System Settings> File Transfer> Program/Change/Delete E-mail Message

Limitations on Entries

Item	Maximum
Number of Lines	5 lines
Line Length	80 characters
Name Length	20 characters

Message Disposition Notification (MDN)

For details: Core Technology Manual – Facsimile Processes – Faxing from a PC – Internet/LAN Fax Boards – E-mail Options

The network system administrator can confirm whether a sent mail has been received correctly or not. This function is enabled only when "I-FAX switch 02 Bit 4" is set to "1". This confirmation is done in four steps.

1. Send request for confirmation of mail reception. To enable or disable this request (known as MDN):
2. Sub TX Mode> E-mail Options
3. Mail reception (receive confirmation request)
4. Send confirmation of mail reception
5. Receive confirmation of mail reception

The other party's machine will not respond to the request unless the two conditions below are met:

- The other party's machine must be set up to respond to the confirmation request.
- The other party's machine must support MDN (Message Disposition Notification).

- Setting up the Receiving Party -

The receiving party will respond to the confirmation request if:

1. The "Disposition Notification To" field is in the received mail header (automatically inserted in the 4th line in the upper table on the previous page, if MDN is enabled), and
2. Sending the disposition notification must be enabled (User Parameter Setting SW21 (15 [H]) Bit 1 for this model). The content of the response is as follows:

Normal reception:	"Return Receipt (dispatched)" in the Subject line
IFAX SW02 (Bit 2, 3)	"Return Receipt (displayed)" in the Subject line
Error:	"Return Receipt (processed/error)" in the Subject line

Handling Reports

1. Sending a Request for a Return Receipt by Mail

After the mail sender transmits a request for a return receipt, the mail sender's journal is annotated with two hyphens (--) in the Result column and a "Q" in the Mode column.

2. Mail Receipt (Request for Receipt Confirmation) and Sending Mail Receipt Response

After the mail receiver sends a response to the request for a return receipt, the mail receiver's journal is annotated with two hyphens (--) in the Result column and an "A" in the Mode column.

3. Receiving the Return Receipt Mail

- After the mail sender receives a return receipt, the information in the mail sender's journal about the receipt request is replaced, i.e. the journal is annotated with "OK" in the Result column.
- When the return receipt reports an error, the journal is annotated with an "E" in the Result column.
- The arrival of the return receipt is not recorded in the journal as a separate communication. Its arrival is only reported by the presence of "OK" or "E" in the Result column.
- If the mail address used by the sender specifies a mailing list (i.e., a Group destination; the machine sends the mail to more than one location. See "How to set up Mail Delivery"), the Result column of the Journal is updated every time a return receipt is received. For example, if the mailing list was to 5 destinations, the Result column indicates the result of the communication with the 5th destination only. The results of the communications to the first 4 destinations are not shown.

Exceptions: If one of the communications had an error, the Result column will indicate E, even if subsequent communications were OK.

If two of the communications had an error, the Journal will indicate the destination for the first error only.

Report Sample

DATE	TIME	ADDRESS	MODE	TIME	PAGE
-----RES-----					
MAY. 5	10:15	fuser_01@domlg. ricoh. co.	Mail SM	0'09"	2
	10:16	fuser_01@domlg. ricoh. co.	Mail SXQ	0'05"	1
	10:17	s_yedashi@domlg. ricoh. co.	Mail SXQ	0'09"	2
	10:18	m_masataka@domlg. ricoh. co.	Mail SMA	0'05"	1

b868d506

5.4 IP-FAX

5.4.1 WHAT IS IP-FAX?

For details: Core Technology Manual – Facsimile Processes – Faxing from a PC – Internet/LAN Fax Boards – IP-FAX

5.4.2 T.38 PACKET FORMAT

TCP is selected by default for this machine, but you can change this to UDP with IPFAX SW 00 Bit 1.

UDP Related Switches

IP-Fax Switch 01						
No.	Function					Comments
0-3	Select IP FAX Delay Level					Raise the level by selecting a higher setting if too many transmission errors are occurring on the network. If TCP/UDP is enabled on the network, raise this setting on the T.30 machine. Increasing the delay time allows the recovery of more lost packets. If only UDP is enabled, increase the number of redundant packets. Level 1~2: 3 Redundant packets Level 3: 4 Redundant packets
	Bit 3	Bit 2	Bit 1	Bit 0	Level	
	0	0	0	0	0	
	0	0	0	1	1	
	0	0	1	0	2	
0	0	1	1	3		

5.4.3 SETTINGS

User parameter switch 34 (22[H]), bit 0

IP-Fax Gate Keeper usage, 0: No, 1: Yes

IP Fax Switches: Various IP-FAX settings (see the bit switch table)

6. SPECIFICATIONS

6.1 GENERAL SPECIFICATIONS

6.1.1 FCU

Standard:	Group 3
Resolution:	8 x 3.85 lines/mm, 200 x 100 dpi (Standard character) 8 x 7.7 lines/mm, 200 x 200 dpi (Detail character)
Transmission Time:	3 seconds at 28,800 bps, Standard resolution (JBIG transmission: 2 seconds)
Data Compression:	MH, MR, MMR, JBIG
Maximum Original Size:	Standard: A4 (SEF) or 8.5" x 14" (SEF) Custom: 216 mm x 600 mm (8.5" x 23.6")
Maximum Scanning Size:	216 mm x 600 mm (8.5" x 23.6")
Print Process:	LED alley and electro-photographic printing
Transmission speed:	33,600/31,200/28,800/26,400/24,000/21,600/19,200/16,800/14,400/12,000/9,600/ 7,200/4,800/2,400 bps (Auto shift down system)

6.2 CAPABILITIES OF PROGRAMMABLE ITEMS

The following table shows the capabilities of each programmable items.

Item	Standard
Quick Dial	1000
Groups	100
Destination per Group	500
Destination per document	500
Programs	100
Communication records for Journal stored in the memory	200
Specific Senders	250
Memory Transmission file	800
Maximum number of page for memory transmission	320

↓ Note

- Measured using an ITU-T #1 test document (Slerexe letter) at the standard resolution, the auto image density mode and the Text mode.

6.3 IFAX SPECIFICATIONS

Network:	Standard: Ethernet interface (1000 Base-T/100 Base-TX/10 Base-T) Optional: IEEE802.11a/b/g/n (Wireless LAN interface)
Transmit function:	E-mail
Scan line density:	<ul style="list-style-type: none"> ▪ 200 × 100 dpi (Standard character) ▪ 200 × 200 dpi (Detail character)
Original Size (Scanning width):	A4, (8.5" x 14")
E-mail File Format:	Single/multi-part, MIME conversion Attached file forms: TIFF-F (MH, MR ^{*1} , MMR ^{*1} compression)
Communication Protocol:	Transmission: SMTP, TCP/IP Reception: POP3, SMTP, IMAP4, TCP/IP
E-mail Format:	Single/Multi-part, MIME Conversion Attached file forms: TIFF-F (MH, MR ^{*1} , MMR ^{*1} compression)
Authentication method:	SMTP-AUTH, POP before SMTP, A-POP
Internet communication:	Send and receive e-mail with a computer that has an e-mail address
Encryption method:	S/MIME
Internet Fax send functions:	Automatic conversion of sent documents to e-mail format and e-mail transmission. Memory transmission only.
Internet Fax receive functions:	Automatic detection and printing of appended TIFF-F (MH) files and ASCII text. Memory reception only.

*1 :Full mode

 **Note**

- The machine must be set up as an e-mail client before installation. Any client PCs connected to the machine through a LAN must also be e-mail clients, or some features will not work (e.g. Autorouting).

6.4 IP-FAX SPECIFICATIONS

Network:	Standard: Ethernet interface (1000 Base-T/100 Base-TX/10 Base-T) Optional: IEEE802.11 a/b/g/n wireless LAN interface
Scan line density:	8 x 3.85 lines/mm, 200 x 100 dpi (Standard character) 8 x 7.7 lines/mm, 200 x 200 dpi (Detail character)
Maximum Original size:	Standard: A4 (SEF) or 8.5" x 14" (SEF) Custom: 216 mm x 600 mm (8.5" x 23.6")
Maximum scanning size:	216 mm x 600 mm (8.5" x 23.6")
Transmission protocol:	Recommended: T.38, TCP, UDP/IP communication, SIP (RFC 3261 compliant), H.323 v2
Compatible machines:	IP-Fax compatible machines
IP-Fax transmission function:	Specify an IP address and send faxes to an IP-Fax compatible fax through a network. Also capable of sending faxes to a G3 fax connected to a telephone line via a VoIP gateway.
IP-Fax reception function:	Receive faxes sent from an IP-Fax compatible fax through a network. Also capable of receiving faxes from a G3 fax connected to a telephone line via a VoIP gateway.

6.5 FAX UNIT CONFIGURATION

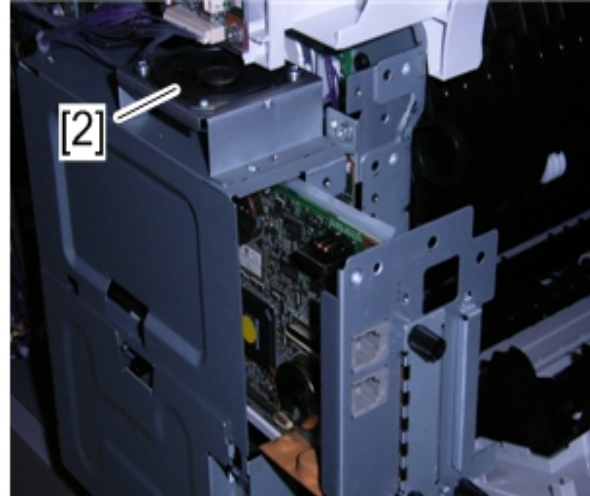
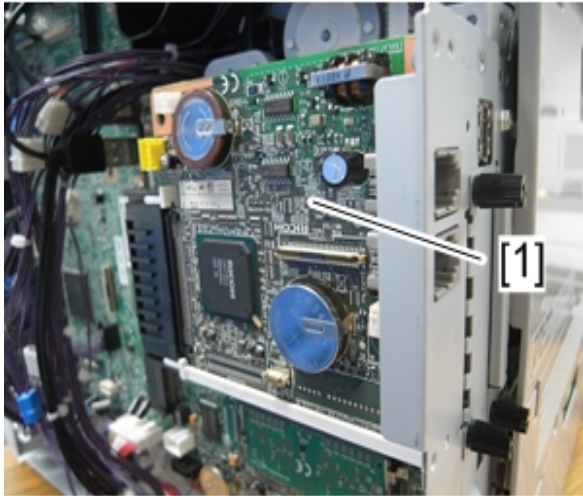

m1608033

Component	No.	Remarks
FCU	1	
Speaker	2	

M440/M441
PAPER FEED UNIT PB1070 /
PAPER FEED UNIT PB1060

REVISION HISTORY		
Page	Date	Added/Updated/New
		None

PAPER FEED UNIT PB1070 / PAPER FEED UNIT PB1060 (M440/M441)

TABLE OF CONTENTS

1. PRODUCT INFORMATION	1
1.1 OVERVIEW	1
1.1.1 SPECIFICATION	1
1.1.2 MECHANICAL COMPONENTS	2
1.1.3 DETAILED DESCRIPTIONS	3
Paper size detection	3
Paper Feed and Separation	4
Paper Lift	5
Paper End Detection	5
2. REPLACEMENT AND ADJUSTMENT	6
2.1 PAPER FEED UNIT PB1060 (250 SHEETS) / PB1070 (500 SHEETS)	6
2.1.1 PAPER FEED TRAY	6
2.1.2 EXTERIOR	6
Right Cover PB1070 (500 Sheets)	6
Right Cover PB1060 (250 Sheets)	7
2.1.3 FRICTION PAD	8
2.1.4 PAPER FEED ROLLER	8
2.1.5 TRAY MAIN BOARD	9
2.1.6 PAPER FEED CLUTCH	9
2.1.7 PAPER FEED MOTOR	10
2.1.8 PAPER END SENSOR	11
2.1.9 PAPER FEED SENSOR	12
2.1.10 PAPER SIZE DETECTION SWITCH	13

1. PRODUCT INFORMATION

1.1 OVERVIEW

1.1.1 SPECIFICATION

	PB1070 (M440) 500 Sheets	PB1060 (M441) 250 Sheets
Paper feed method	Friction pad system	
Paper size	<ul style="list-style-type: none"> ▪ Selected by the paper size dial A4 SEF, A5 SEF, A6 SEF, 8 1/2 × 14 SEF, 8 1/2 × 11 SEF, 5 1/2 × 8 1/2 SEF ▪ Selected by "Tray Paper Settings" under "System Settings" A5 LEF, B5JIS SEF, B6 JIS SEF, 8 1/2 × 13 SEF, 8 1/4 × 14 SEF, 8 1/4 × 13 SEF, 8 × 13 SEF, 8 × 10 1/2 SEF, 8 × 10 SEF, 7 1/4 × 10 1/2 SEF, 16K SEF ▪ Custom size Vertical: 148.0 - 356.0 mm (5.83 - 14.01 inch) Horizontal: 100.0 - 216.0 mm (3.94 - 8.50 inch) 	
Paper weight	52g/m ² –162g/m ² (14 lb. Bond–90 lb. Index)	
Power consumption	15 W or less (Power is supplied from the main unit.)	
Dimensions (W × D × H)	370 × 392 × 125 mm (14.6 × 15.4 × 4.9 inches)	370 × 392 × 95 mm (14.6 × 15.4 × 3.7 inches)
Weight	Approx. 4.5 kg (9.9 lb.)	Approx. 4.1 kg (9.0 lb.)
Power source	Draw from main unit	
Operational life	5 years or 600,000 sheets, whichever limit is reached first	

1.1.2 MECHANICAL COMPONENTS

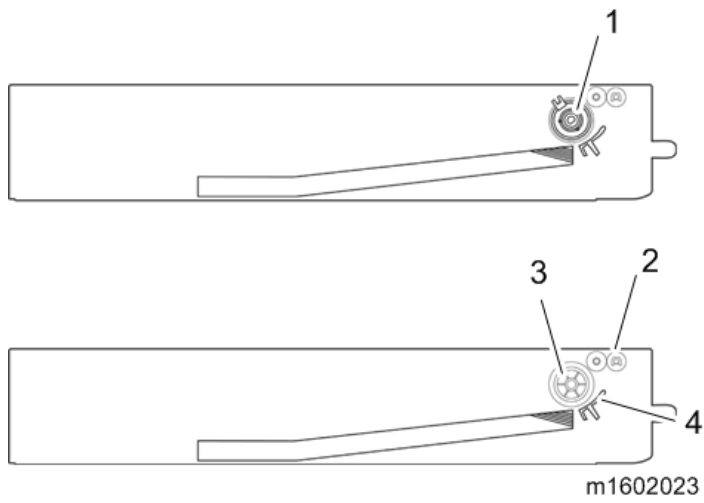

1. Paper feed clutch
2. Grip roller
3. Paper feed roller
4. Friction pad

1.1.3 DETAILED DESCRIPTIONS

Paper size detection

The paper size is detected by a combination of three detection switches on a Paper Size Detection Switch [2]. The switches are operated by the Size Detection Dial [1] located on the right side of the Paper Feed Tray.

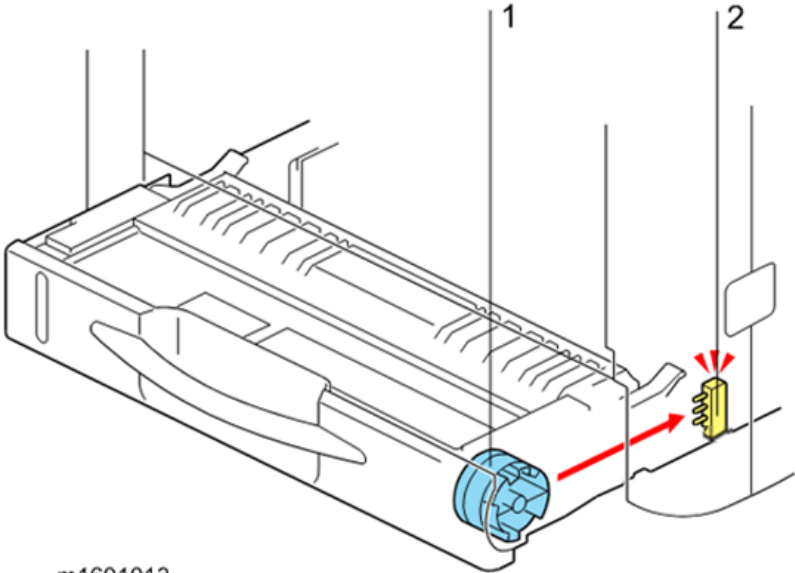

m1601013

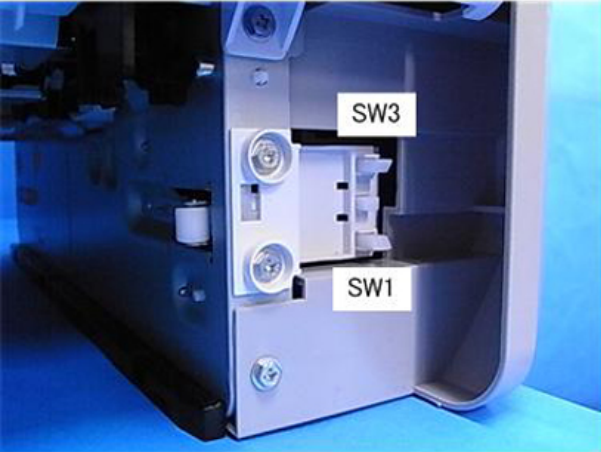

w_m1601014

Paper size detect combination (Switch is pressed:L)

	SW 1	SW 2	SW 3	Paper Size
1	L	L	L	A4 SEF
2	L	H	L	A5 SEF
3	H	L	L	A6 LEF
4	H	H	L	Legal SEF
5	L	L	H	Letter SEF
6	L	H	H	-
7	H	L	H	Half Letter SEF
8	H	H	H	Paper cassette is not set.

Paper Feed and Separation

The paper feed unit uses the feed roller and friction pad method to separate paper. The friction pad method makes it possible to feed only one sheet at a time (the top sheet) by the friction between the friction pad and the paper.

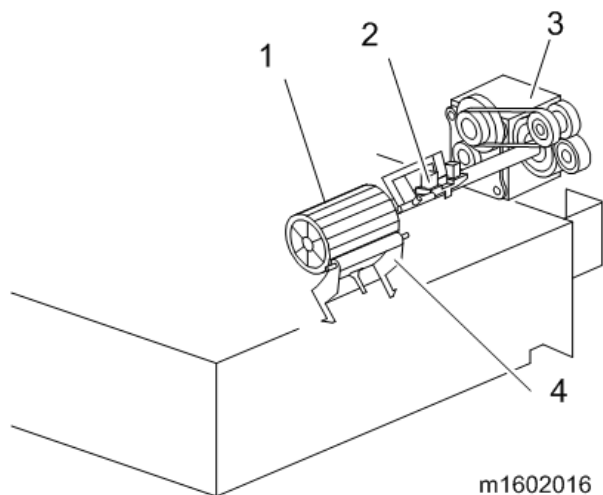

1. Paper feed roller
2. Paper feed sensor
3. Paper feed motor
4. Friction pad

Paper Lift

Pushing in the paper cassette makes the tray arms rise along the groove in the tilted guide and lift the bottom plate by springs.

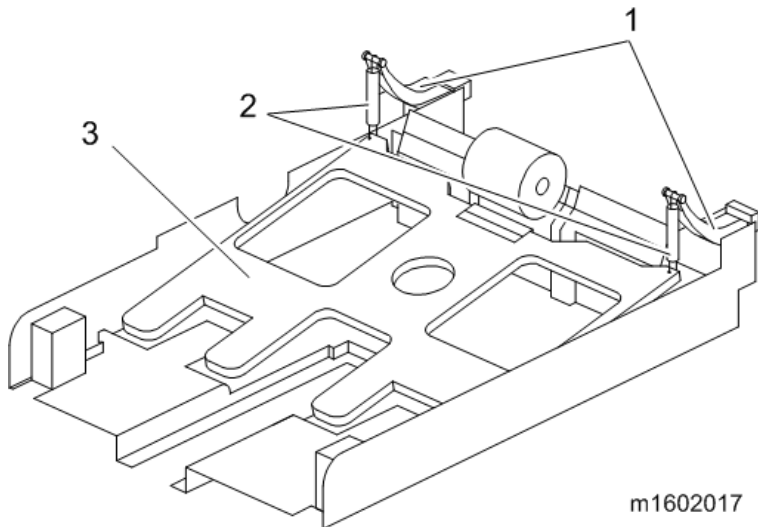

1. Tray arms
2. Springs
3. Bottom plate

Paper End Detection

When the optional bank [1] runs out of paper, the feeler [2] drops into the cutout in the bottom plate to actuate the paper end sensor [3].

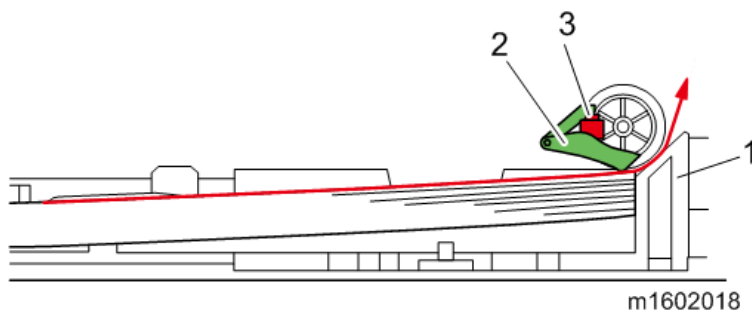

1. Optional bank
2. Feeler
3. Paper end sensor

2. REPLACEMENT AND ADJUSTMENT

2.1 PAPER FEED UNIT PB1060 (250 SHEETS) / PB1070 (500 SHEETS)

2.1.1 PAPER FEED TRAY

1. Paper Feed Tray [A]

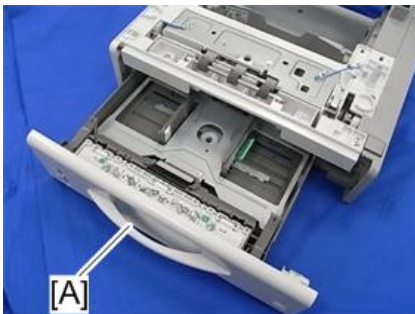

m1600236

2.1.2 EXTERIOR

Right Cover PB1070 (500 Sheets)

1. Paper Feed Tray (page 6 "Paper Feed Tray")
2. Right Cover [A] (⚙ x4, Tab x2)

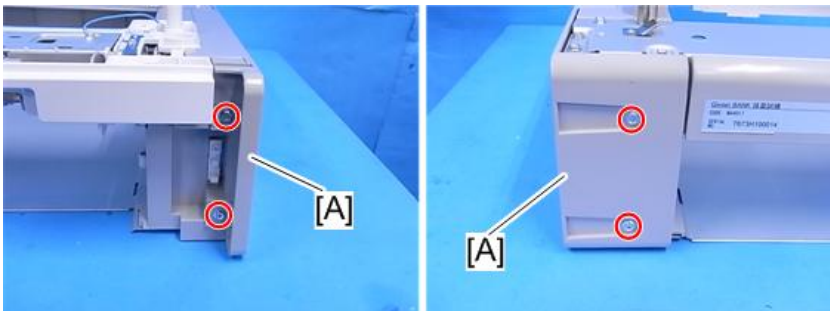

m1600171

⚠ Note

- Be sure to release two tabs on the bottom of (and behind) the right cover while trying to remove it.

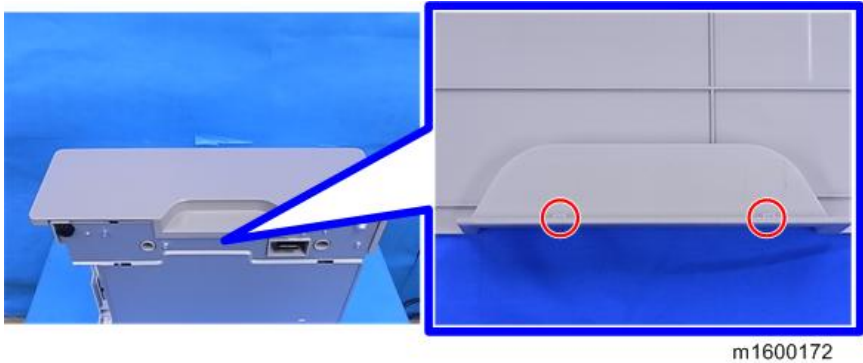

PAPER FEED UNIT PB1070 /
PAPER FEED UNIT PB1060
(M440/M441)

Right Cover PB1060 (250 Sheets)

1. Paper Feed Tray (page 6 "Paper Feed Tray")
2. Right Cover [A] (⌀ x2, Tab)

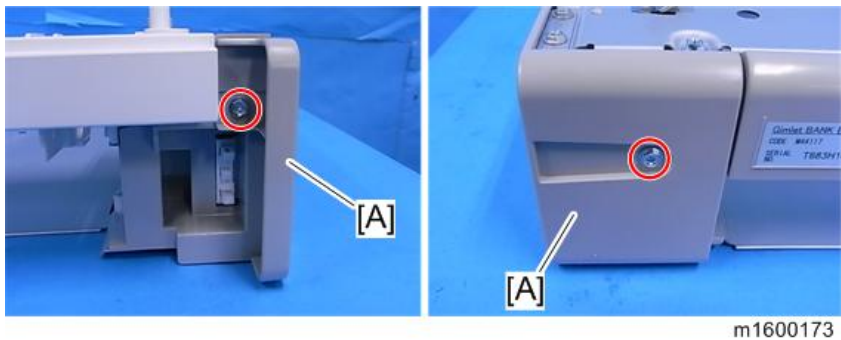

Note

- Be sure to release two tabs on the bottom of (and behind) the right cover while trying to remove it.

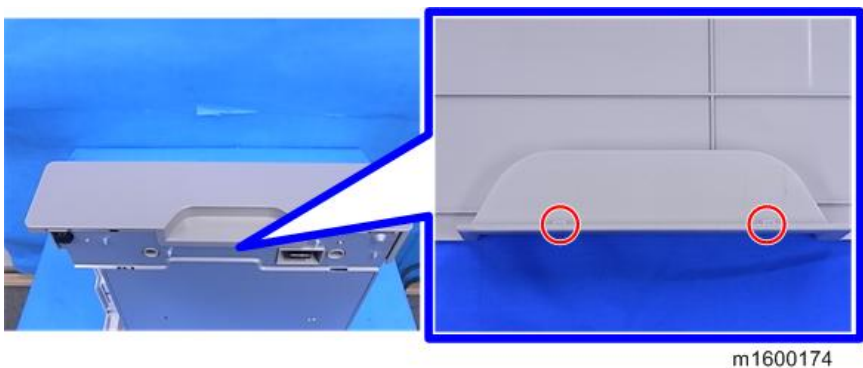

2.1.3 FRICTION PAD

1. Paper Feed Tray (page 6 "Paper Feed Tray")
2. Friction Pad [A] (Tab x2, Spring x1)

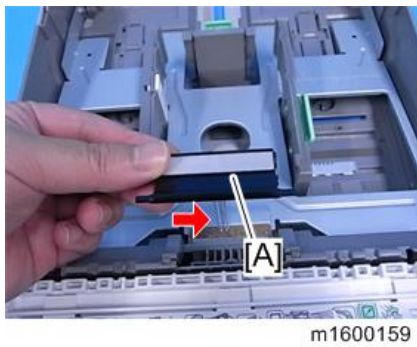
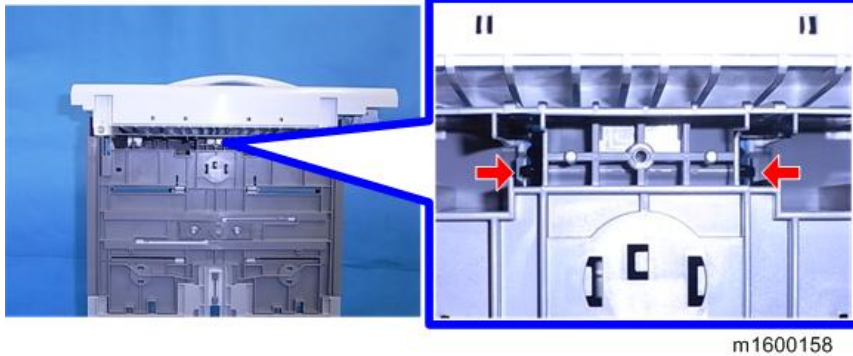

2.1.4 PAPER FEED ROLLER

1. Paper Feed Tray (page 6 "Paper Feed Tray")
2. Release the lever to the left as shown below to remove the paper feed roller [A].

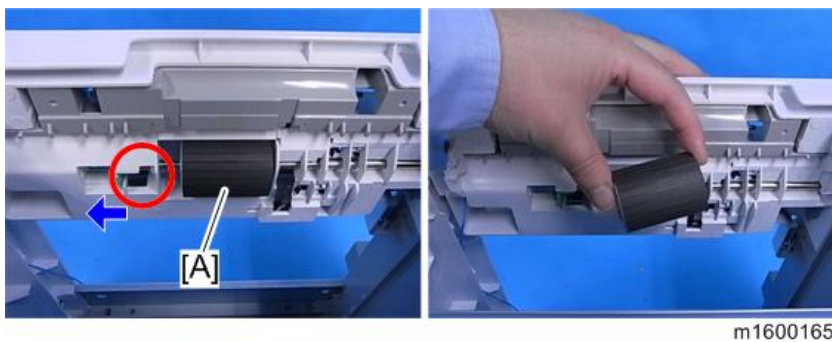

2.1.5 TRAY MAIN BOARD

1. Paper Feed Tray (page 6 "Paper Feed Tray")
2. Right Cover (page 6 "Exterior")
3. Tray Main Board [A] (🔧x4, 📏x all)

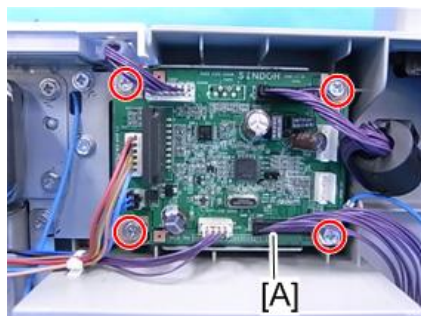

m1600166

2.1.6 PAPER FEED CLUTCH

1. Paper Feed Tray (page 6 "Paper Feed Tray")
2. Right Cover (page 6 "Exterior")
3. Paper Feed Clutch [A] (📏x1, 📏x2, 🔧x1)

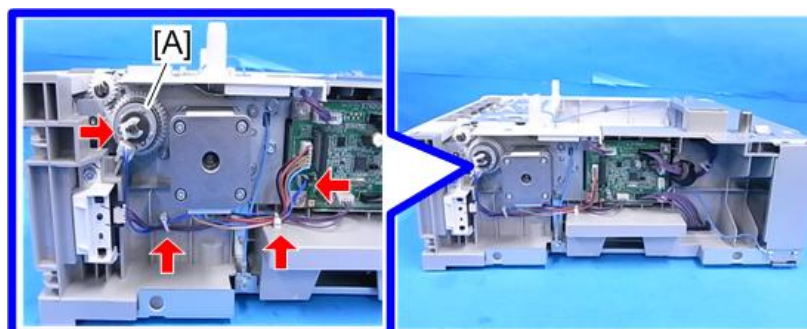

m1600164

2.1.7 PAPER FEED MOTOR

1. Paper Feed Clutch (page 9 "Paper Feed Clutch")
2. Bracket [A] with Paper Feed Motor (⚙️ x3, 📏 x1, 📏 x1)

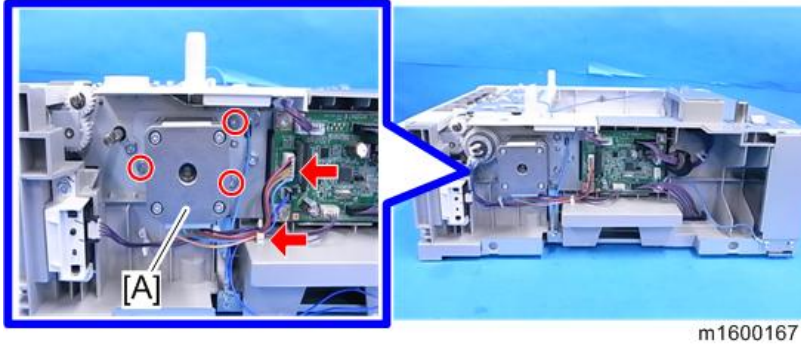

3. Detach the paper feed motor [B] from the bracket [A]. (⚙️ x2)

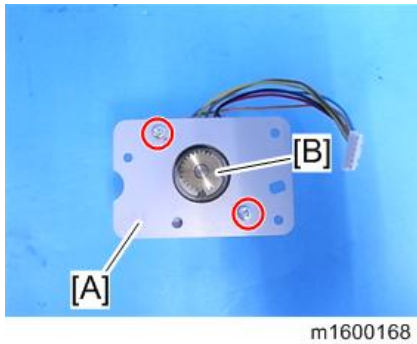

2.1.8 PAPER END SENSOR

1. Paper Feed Tray (page 6 "Paper Feed Tray")
2. Bracket [A] (🔩x4)

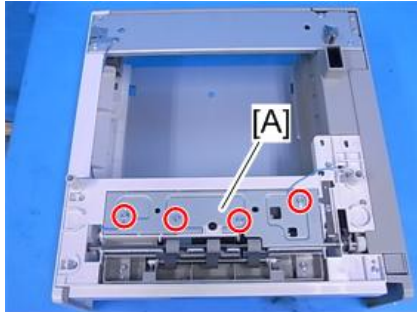

m1600162

3. Paper End Sensor [A] (🔌x1, Hook)



m1600163

2.1.9 PAPER FEED SENSOR

1. Paper Feed Tray (page 6 "Paper Feed Tray")
2. Bracket [A] (🔧x4)

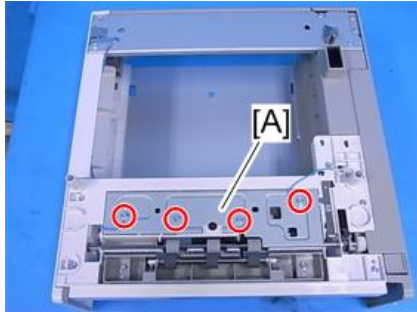

m1600160

3. Paper Feed Sensor [A] (🔧x1, Hook)

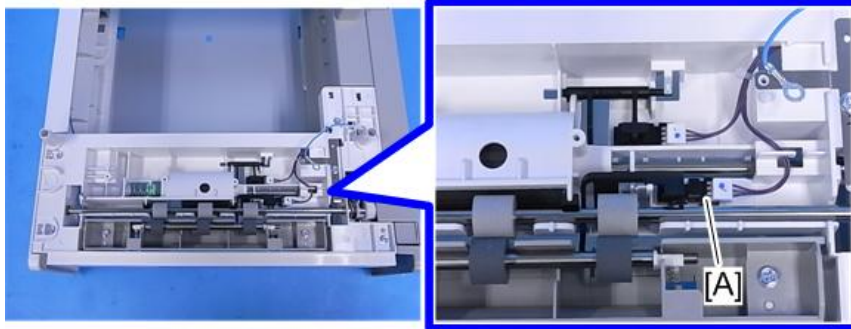

m1600161

2.1.10 PAPER SIZE DETECTION SWITCH

1. Paper Feed Tray (page 6 "Paper Feed Tray")
2. Right Cover (page 6 "Exterior")
3. Bracket [A] with Paper Size Switch (🔧 x2, 🛠️ x1, 🖨️ x1)

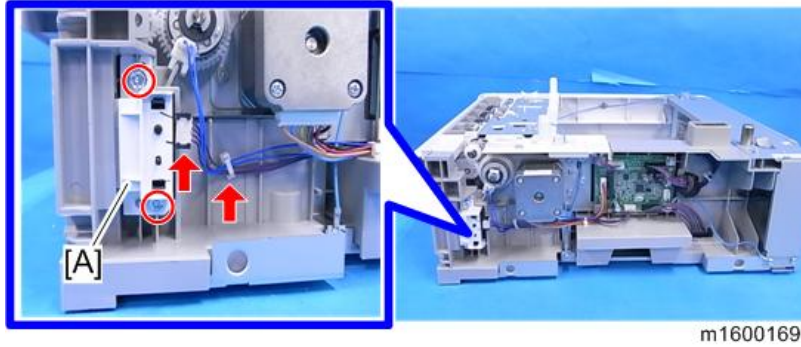

4. Detach the paper size switch from the bracket [A]. (Hook x2)

