

IM C4500/C4500A/C5500/C5500A/C6000
(D0BN/D0BP/D0BQ-EU)
Parts Catalog

Model	Product Code	PC Style
IM C3000/C3500 series GS3030c	D0BL/D0BM	3D
IM C4500/C5500/C6000 series GS3160c/GS3045c	D0BN/D0BP/D0BQ	3D
IM C2000/C2500 series	D0BJ/D0BK	3D
ARDF DF3110	D3FE	3D
SPDF DF3120		
Small Paper Feeding Unit Type M37	D3FF	3D
Page Keeper Type M37		
Paper Feed Unit PB3280	D3FY	3D
Paper Feed Unit PB3300	D3FZ	3D
Paper Feed Unit PB3270	D3G0	3D
LCIT PB3290	D3G2	3D
LCIT RT3040	D3G1	3D
Bridge Unit BU3090	D3FW	3D
1 Bin Tray BN3130	D3CQ	3D
Internal Shift Tray SH3080	D3FV	3D
Side Tray Type M37	D3FX	3D
Booklet Finisher SR3290	D3FN	3D
Finisher SR3280	D3G4	3D
Punch Unit PU3090	D3FP	3D
Booklet Finisher SR3270	D3FQ	3D
Finisher SR3260	D3FR	3D
Punch Unit PU3080	D3G5	3D
Internal Finisher SR3250	D3FG	3D
Punch Unit PU3070	D3FM	3D
Internal Finisher SR3300	D3FT	3D
Internal Multi-Fold Unit FD3010	D3FS	3D
Fax Option Type M37	D3GF	Traditional
Fax Connection Unit Type M37	D3GF	Traditional
FAX Memory Unit Type M19 64MB	D3BZ	Traditional
IEEE 1284 Interface Board Type M19	D3C0	Traditional
File Format Converter Type M19	D3BR	Traditional
Device Server Option Type M37	D3GF	Traditional
VM CARD Type M37	D3GF	Traditional
DataOverwriteSecurity Unit Type M19	D3BS	Traditional
Caster Table Type M3	D178	Traditional
External Keyboard Bracket Type M19	D3BR	Traditional
Camera Direct Print Card Type M37	D3GF	Traditional
XPS Direct Print Option Type M37	D3GF	Traditional
NFC Card Reader Type M37	D3GF	Traditional
SD Card for Fonts Type D	D641	Traditional
IEEE 802.11a/g/n Interface Unit Type M19	D3BR	Traditional
Memory Unit Type M37 4GB	D3GF	Traditional
OCR Unit Type M13	D3AC	Traditional
Enhanced Security HDD Option Type M12	D3A6	Traditional
Platen Cover PN2000	D700	Traditional
Imageable Area Extension Unit Type M19	D3BR	Traditional
PostScript3 Unit Type M37	D3GF	Traditional
Smart Card Reader Built-in Unit Type M37	D3GF	Traditional

Unit All

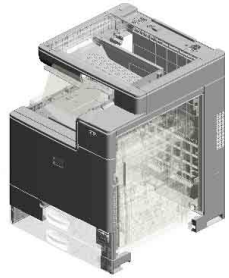

U001
EXTERIOR

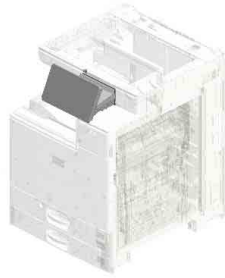

U002
OPERATION



U003
SCANNER

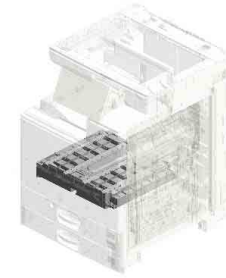

U004
LASER UNIT

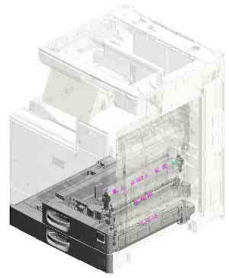

U005
PAPER FEED

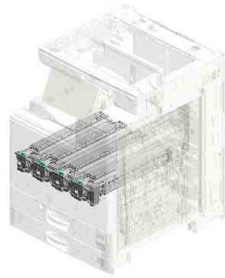

U006
PCDU

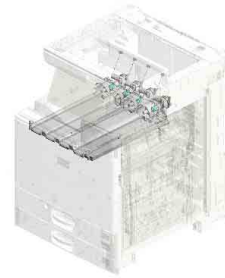

U007
DEVELOPMENT

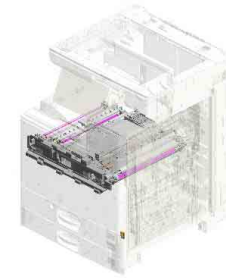

U008
ITB UNIT

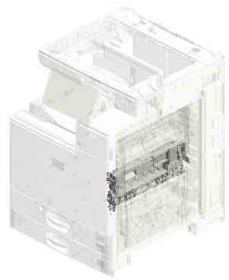

U009
TRANSFER/SEPARATION

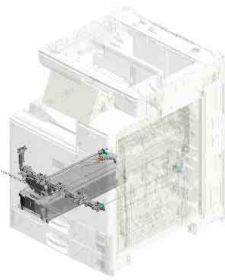

U010
USED TONER

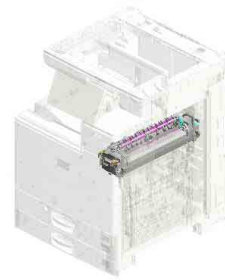

U011
FUSING

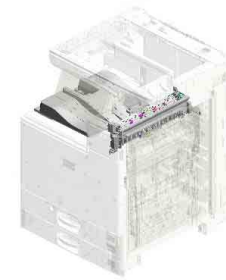

U012
PAPER EXIT

Unit All

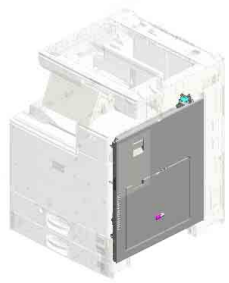

U013
DUPLEX

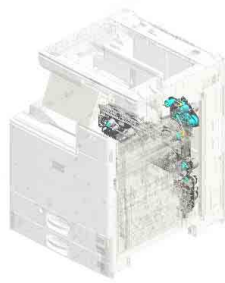

U014
MAIN DRIVE

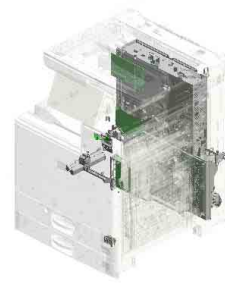

U015
ELECTRICAL

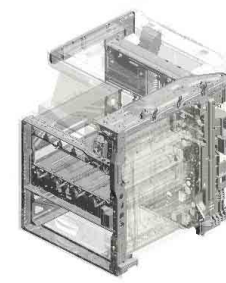

U016
MAIN FRAME

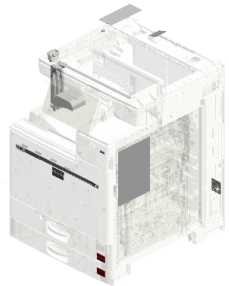

U017
ACCESSORIES

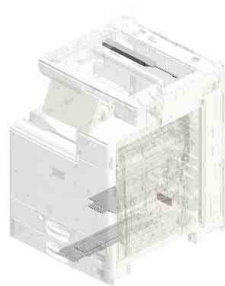

U018
KIT:HEATER

U001 EXTERIOR

- 8.AA143537 (x4) SCREW:M3:BLACK
- 13.D0BQ1230 (x2) COVER:UPPER
- 9.AA143595 (x2) STEPPED SCREW: M3
- 2.04543006Q (x2) TAPPING SCREW - M3X6
- 11.D0AF1290 (x2) COVER:SCANNER: UPPER:REAR

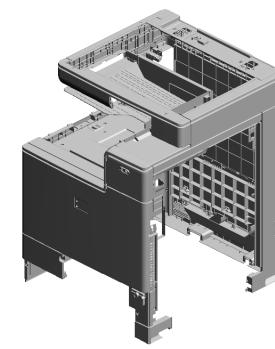

- 20.D0BQ1249 (x2) COVER:FRONT:LENGHTHWISE

- 14.D0BQ1231 (x2) COVER:UPPER:FRONT

- 1.04513008P (x2) TAPPING SCREW - 3X8

- 4.04543008Q (x4) TAPPING SCREW: 3X8

- 6.52062686 (x2) SNAP RING

- 19.D0BQ1247 (x2) COVER:FRONT:USED TONER
- 7.AA021031 (x2) MAGNETIC CATCH
- 12.D0BP1276 (x2) INNER COVER:TONER BOTTLE
- 16.D0BQ1242 (x2) COVER:FRONT:PEEN
- 10.AG070513 (x2) MAGNET CATCH

- 15.D0BQ1232 (x2) COVER:UPPER:EXT:IDG

- 18.D0BQ1245 (x2) COVER:FRONT:UPPER

- 5.04583008N (x34) HEXAGON HEAD TAPPING SCREW:3 X8

- 17.D0BQ1244 (x2) COVER:FRONT:RIGHT UPPER

- 3.04543008N (x100) TAPPING SCREW: ROUND POINT:3X8

U001 EXTERIOR

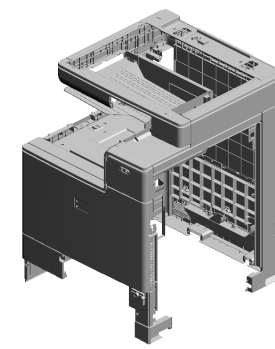

- 28.D1491237 (x2) COVER:UPPER:INNER BACK:LEFT LOWER
- 30.D1491252 (x2) COVER:LEFT:UPPER:REAR
- 26.D1491233 (x2) COVER:UPPER:INNER BACK
- 25.D1441085 (x14) STEPPED SCREW: M3
- 35.D1491294 (IM C4500/C5500/G S3045c):CAP:HARN ESS:CORNER

- 38.D1494492 (x2) TRAY:REVERSE

- 21.D0BQ1281 (x2) COVER:SCANNER:FRONT

- 31.D1491257 (x2) CAP:34X55

- 33.D1491278 (x2) TORSION SPRING:COVER:USED TONER

- 29.D1491248 (x2) HINGE:COVER:FRONT:USED TONER

- 32.D1491274 (x2) INNER COVER:FRONT:USED TONER
- 24.D0BQ1309 (x2) MAGNET CATCH:COVER:FRONT
- 39.D1495883 (x2) KEYTOP:MAIN SWITCH
- 40.D1495884 (x2) COMPRESSION SPRING:KEYTOP
- 37.D1491307 (x2) SPRING PLATE:BA ND

- 23.D0BQ1288 (x2) COVER:SCANNER:UPPER:RIGHT

- 27.D1491234 (x2) COVER:UPPER:INNER BACK:MIDDLE

- 22.D0BQ1287 (x2) COVER:SCANNER:RIGHT

- 34.D1491291 (x2) CAP:HARN ESS

- 36.D1491305 (x4) CAP:TOTAL COUNTER

U001 EXTERIOR

- 58.D2411284 (x2) COVER:SCANNER: LEFT
- 59.D2411285 (x2) COVER:SCANNER: UPPER:LEFT
- 49.D1501282 (x2) COVER:SCANNER: UPPER:FRONT
- 48.D1501235 (x2) COVER:UPPER:INNER BACK:BIN
- 60.D2411297 (x2) BRACKET:COVER: LEFT UPPER REAR

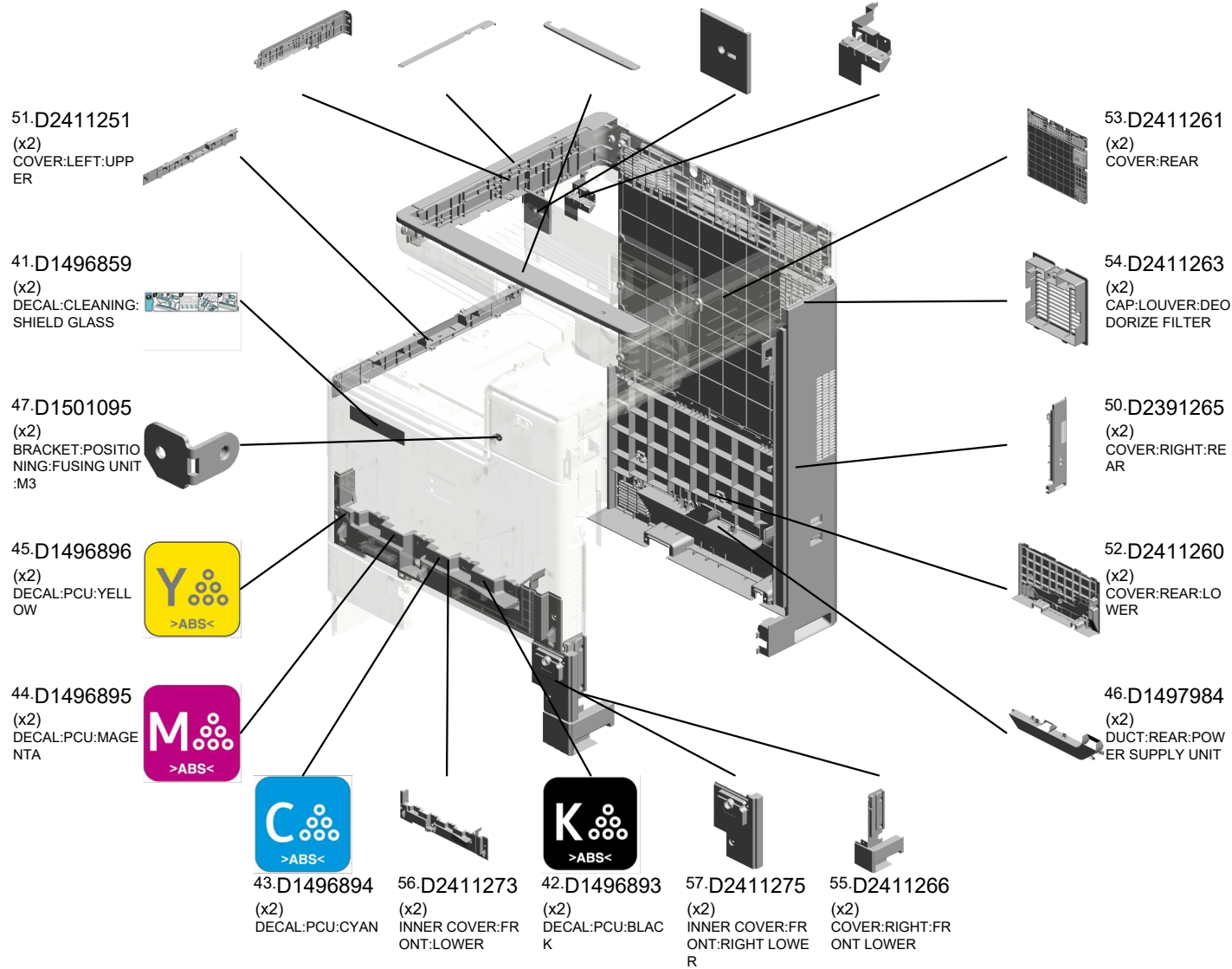
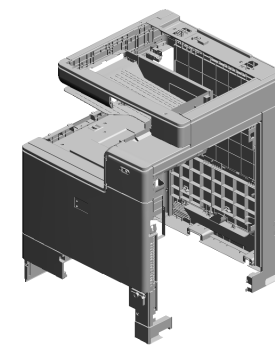

U001 EXTERIOR

64.D2414458 (x8) GUIDE:COVER:UPPER
 65.D2415711 (x2) COVER:HUMAN DETECTION SENSOR CONNECTOR
 67.D2421267 (x2) COVER:RIGHT:UPPER

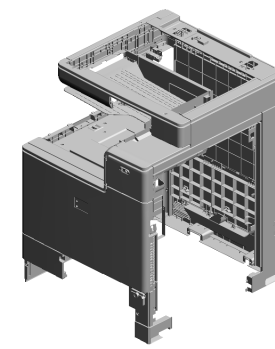

69.M0AJ1250 (x2) COVER:LEFT

63.D2411309 (x2) MAGNET CATCH

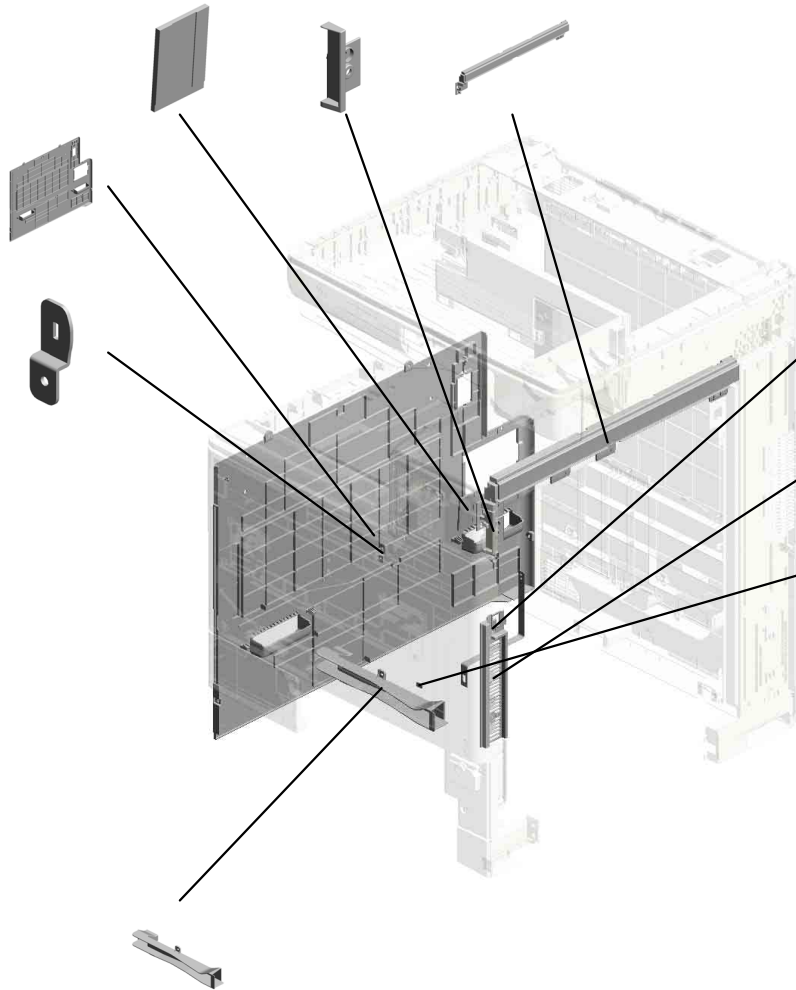

62.D2411308 (x2) BAND:STOPPER:DOOR

61.D2411298 (x2) INNER COVER:RIGHT

68.GA003994 (x8) DECAL:LEVER:RELEASE

66.D2417913 (x2) DUCT:OPTICAL WRITING UNIT

U001	U002	U003	U004	U005	U006	U007	U008	U009	U010	U011	U012	U013	U014	U015	U016	U017	U018
------	------	------	------	------	------	------	------	------	------	------	------	------	------	------	------	------	------

U002.OPERATION

U002 S001
D0BQ1500
(EU/NA/AA/KOR/TWN):OPER
ATION SUB-UNIT:COMMON:
ASSY

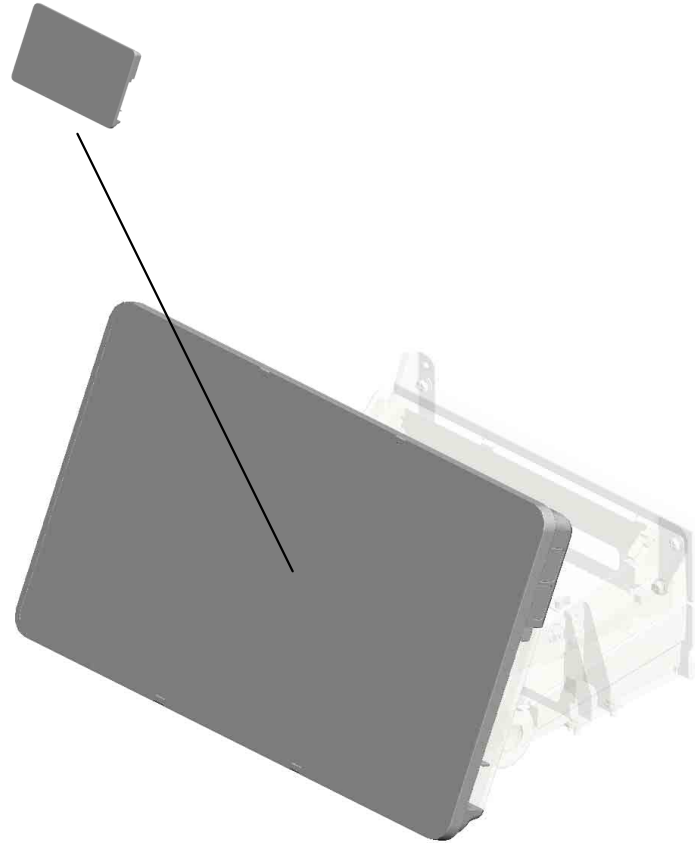

U001	U002	U003	U004	U005	U006	U007	U008	U009	U010	U011	U012	U013	U014	U015	U016	U017	U018
------	-------------	------	------	------	------	------	------	------	------	------	------	------	------	------	------	------	------

U002_S001.(EU/NA/AA/KOR/TWN):OPERATION SUB-UNIT:COMMON:ASS'Y

U002 S001 S001
D0BQ5620
(EU/NA/AA/KOR/TWN):PCB:A
SS'Y:(PCB13)

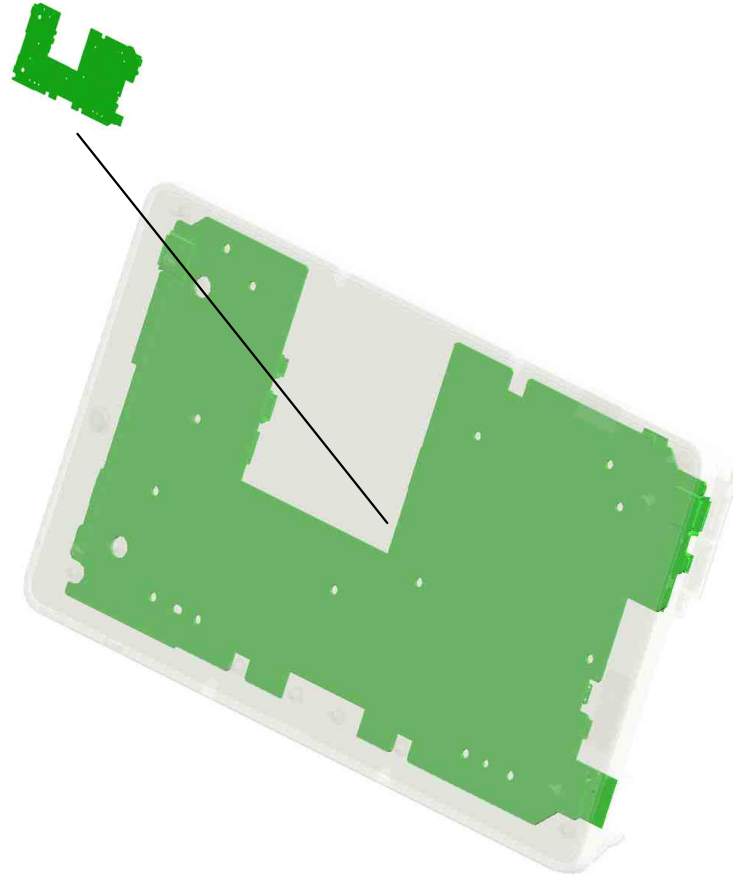

U001	U002	U003	U004	U005	U006	U007	U008	U009	U010	U011	U012	U013	U014	U015	U016	U017	U018
------	-------------	------	------	------	------	------	------	------	------	------	------	------	------	------	------	------	------

U002 OPERATION

- 27.D0BQ1553 GUIDE:OPERATION SUB-UNIT:HARN
- 32.D0BQ1564 COVER:REAR:MID DLE
- 30.D0BQ1561 COVER:HINGE:RIG HT
- 12.D0BQ1299 (x8) HEXAGON HEAD S CREW:PLAIN WAS HER:M3X8
- 38.D0BQ1595 BRACKET:OPERAT ION SUB-UNIT:PEE N

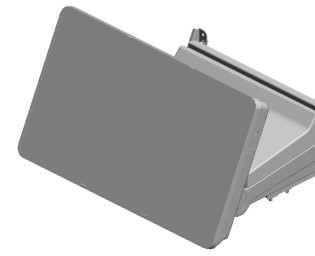

- 31.D0BQ1563 COVER:HINGE:LEF T

- 2.03530040P (x3) SCREW - M3X4

- 16.D0BQ1522 HINGE:LEFT

- 7.09573006N (x8) SCREW:SMALL RO UND/SPRING:M3X6

- 3.03530060N (x4) BIND SCREW - M3 X6

- 39.D0BQ1598 COVER:BRACKET: OPERATION SUB-UNIT:LOWER
- 15.D0BQ1521 HINGE:RIGHT
- 33.D0BQ1565 COVER:RIGHT
- 41.D2951509 CAP:HINGE

- 9.11050723 CLAMPS:WES-050 7

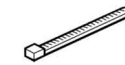

- 8.11050046 (x15) HARNESS BAND



- 10.11050760 (x2) CLAMP:LWSM-051 1A

- 10.11050760 CLAMP:LWSM-051 1A

- 5.04543008N(x 1) TAPPING SCREW:ROUND POINT:3X8

- 5.04543008N (x2) TAPPING SCREW: ROUND POINT:3X8

- 4.03603006N (x2) SCREW - M3X6

U002_S001

(EU/NA/AA/KOR/TWN):OPERATION SUB-UNIT:COMMON:ASS'Y

- 6.04593008N (x2) BINDING HEAD TAPPING SCREW:3X8
- 11.18310003 LCD:TFT:WSVGA-10.1:LED:MV
- 19.D0BQ1541 COVER:FRONT
- 17.D0BQ1531 FRAME:LCD:PEEN
- 28.D0BQ1555 (x2) CUSHION:LCD:L



- 14.D0BQ1500 (EU/NA/AA/KOR/TWN):OPERATION SUB-UNIT:COMMON:ASS'Y

- 22.D0BQ1547 KEYTOP:RESET SWITCH

- 2.03530040P (x13) SCREW - M3X4

- 23.D0BQ1548 COVER:CAP:PUSH SWITCH

- 18.D0BQ1533 (x2) BRACKET:LCD

- 1.03520030N (x4) SCREW:M2X3

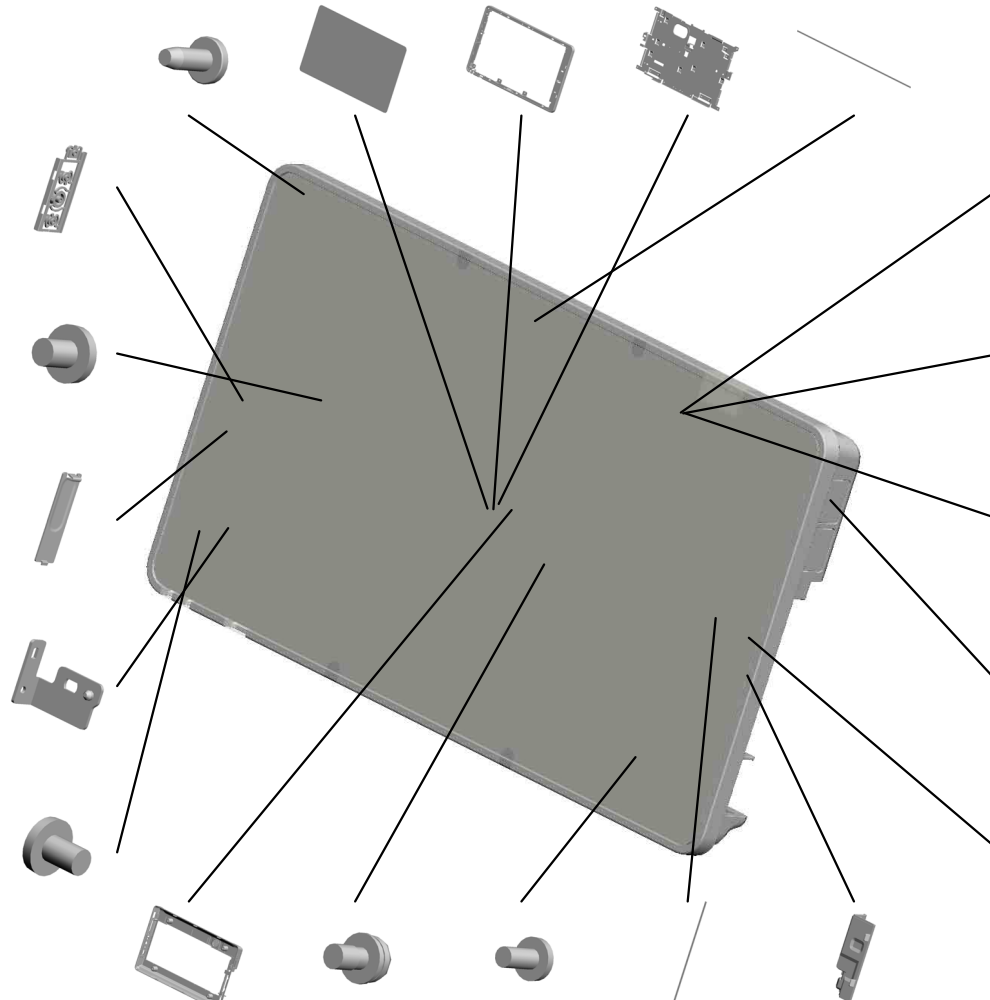

- 13.D0BQ1432 SPEAKER

- 25.D0BQ1551 HOLDER:OPERATION SUB-UNIT:SPEAKER

- 26.D0BQ1552 CUSHION:OPERATION SUB-UNIT:SPEAKER

- 24.D0BQ1549 (x2) COVER:CAP

- 34.D0BQ1581 (x2) DUAL FACES TAPE:TOUCH PANEL:LENGTHWISE

- 20.D0BQ1545 COVER:REAR
- 7.09573006N (x9) SCREW:SMALL ROUND/SPRING:M3X6
- 3.03530060N (x4) BIND SCREW - M3X6
- 29.D0BQ1556 (x2) CUSHION:LCD:S
- 21.D0BQ1546 INNER COVER:OPERATION SUB-UNIT:RIGHT

U001	U002	U003	U004	U005	U006	U007	U008	U009	U010	U011	U012	U013	U014	U015	U016	U017	U018
------	------	------	------	------	------	------	------	------	------	------	------	------	------	------	------	------	------

U002_S001
(EU/NA/AA/KOR/TWN):OPERATION SUB-UNIT:COMMON:ASS'Y

37.D0BQ1586
SHEET:SIDE



14.D0BQ1500
(EU/NA/AA/KOR/T
WN):OPERATION S
UB-UNIT:COMMON
:ASS'Y

42.D2951554
MIKE:PVM-6018-C4
02G-7ZZ4

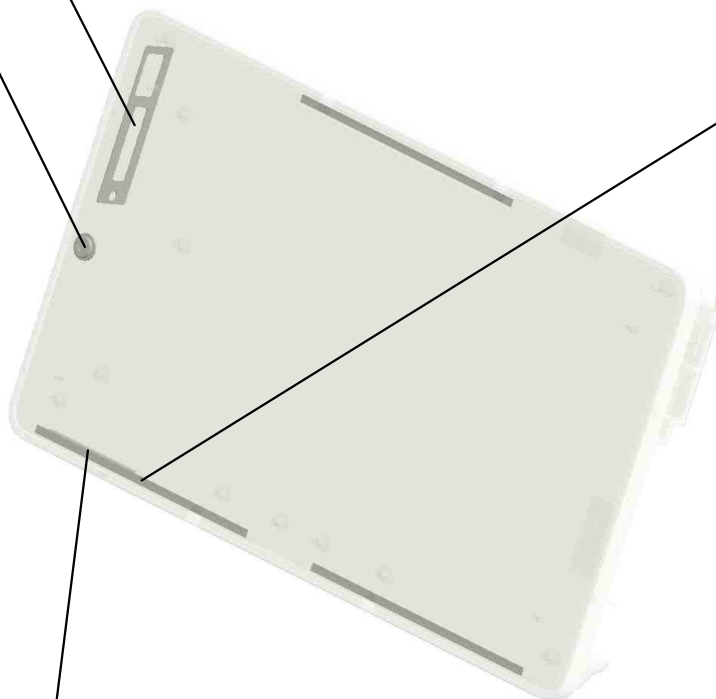

35.D0BQ1582
(x3)
DUAL FACES TAPE
:TOUCH PANEL:SI
DE

36.D0BQ1585
SHEET:LIGHT SHIE
LD COAT



U001	U002	U003	U004	U005	U006	U007	U008	U009	U010	U011	U012	U013	U014	U015	U016	U017	U018
------	------	------	------	------	------	------	------	------	------	------	------	------	------	------	------	------	------

U002_S001_S001
(EU/NA/AA/KOR/TWN):PCB:ASS'Y:(PCB13)

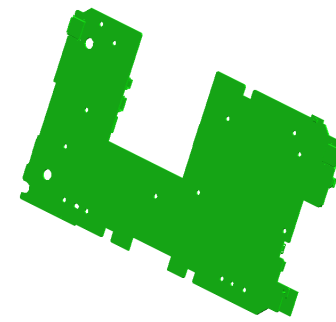

40.D0BQ5620
(EU/NA/AA/KOR/T
WN);PCB:ASS'Y:(P
CB13)

1.03520030N(x 1)
SCREW:M2X3

U001	U002	U003	U004	U005	U006	U007	U008	U009	U010	U011	U012	U013	U014	U015	U016	U017	U018
------	------	------	------	------	------	------	------	------	------	------	------	------	------	------	------	------	------

U003.SCANNER

U003 S001
D0BQ1640
OPTICAL READING UNIT:CA
RRIAGE:SCANNER:IMC2000-
6000

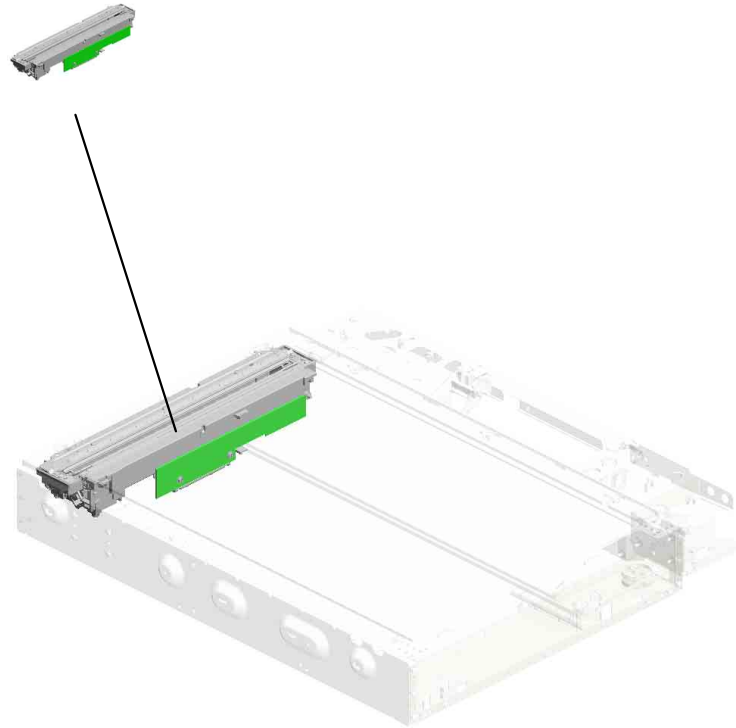

U001	U002	U003	U004	U005	U006	U007	U008	U009	U010	U011	U012	U013	U014	U015	U016	U017	U018
------	------	------	------	------	------	------	------	------	------	------	------	------	------	------	------	------	------

U003 SCANNER

- 7.03603005N (x8) SCREW - M3X5
- 18.11050758 (x5) CLAMP:LWSM-030 6A
- 24.AW020207 PHOTOINTERRUP TOR:FLAT:PICH2M M:M4:(S43)
- 2.03140120N SCREW - M4X12
- 22.AA143537 (x6) SCREW:M3:BLACK

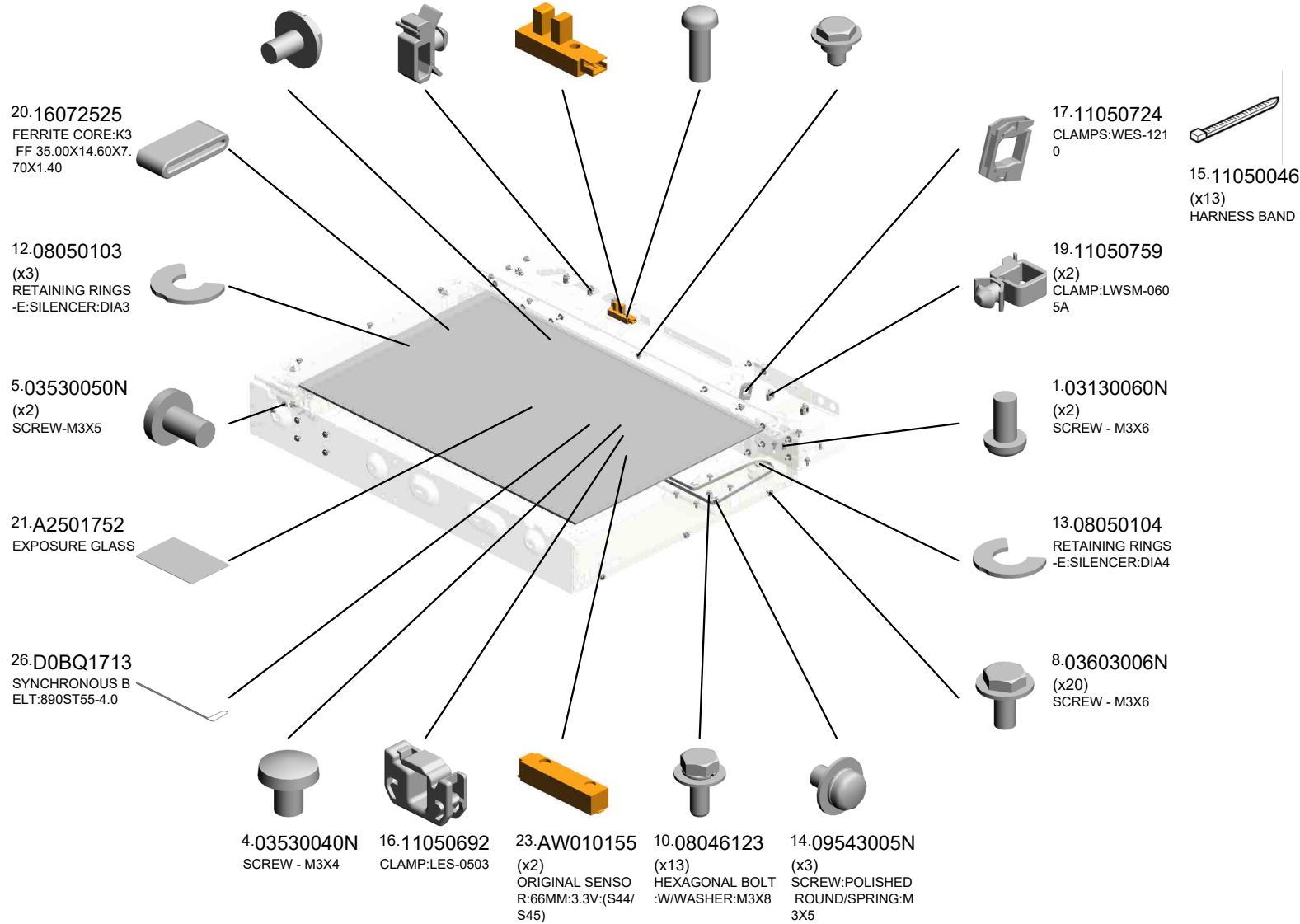
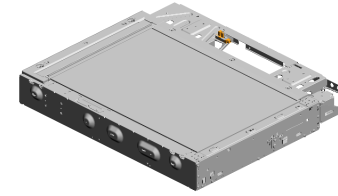

U001	U002	U003	U004	U005	U006	U007	U008	U009	U010	U011	U012	U013	U014	U015	U016	U017	U018
------	------	------	------	------	------	------	------	------	------	------	------	------	------	------	------	------	------

U003 SCANNER

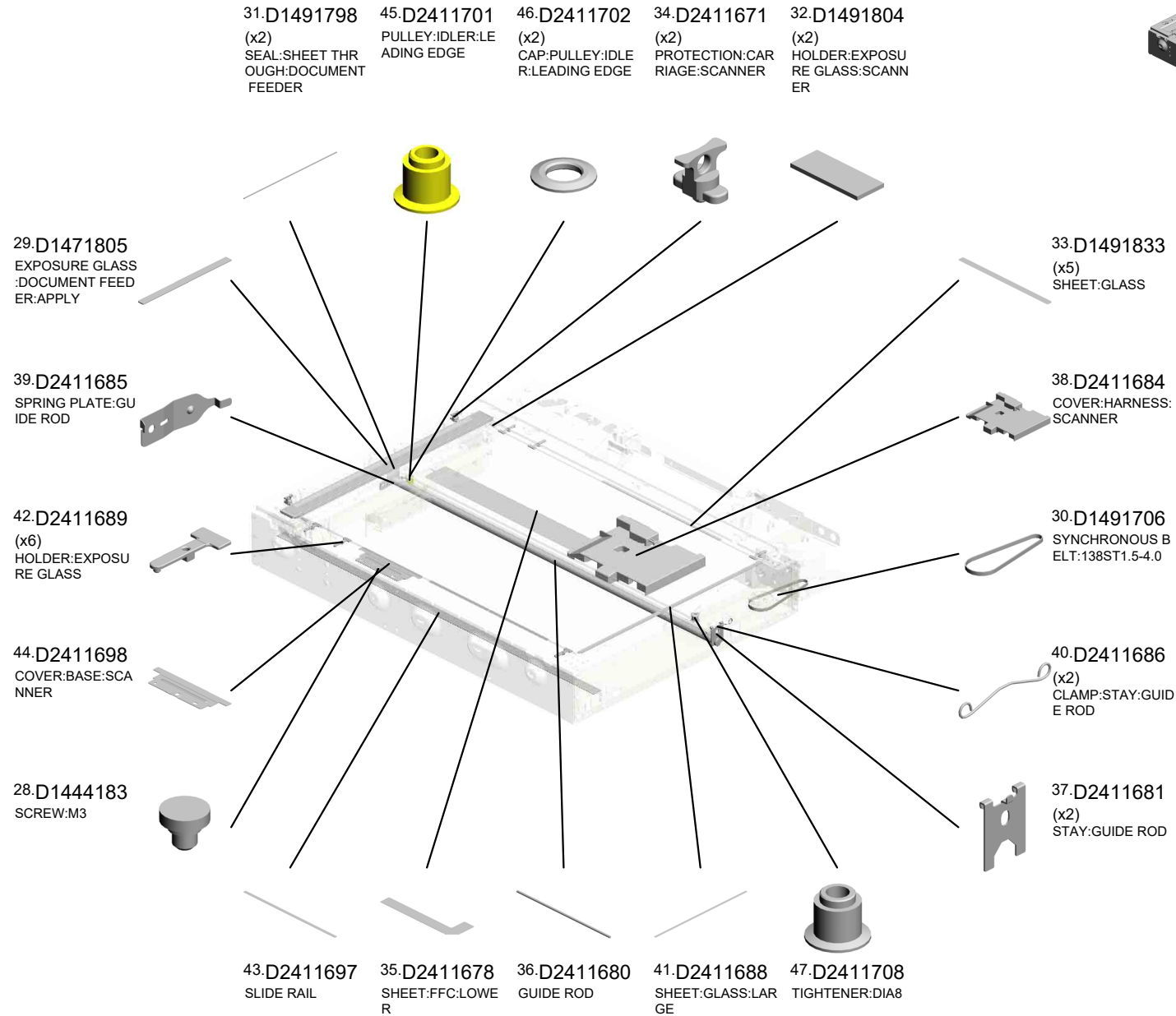
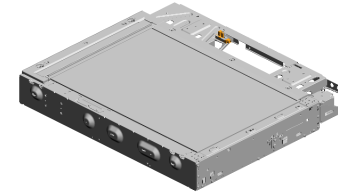

U003 SCANNER

63.D2411766 SHEET:FLAT CABL E:SBU
 66.GW020024 PHOTointerrup TOR:LG2A24BL1:G F:(S5/S34/S42)
 60.D2411741 BRACKET:DOCUM ENT FEEDER:LEFT
 59.D2411738 SCALE:REAR:PRIN TING:MM
 62.D2411744 DOCUMENT FEED ER:CABLE:BRACK ET

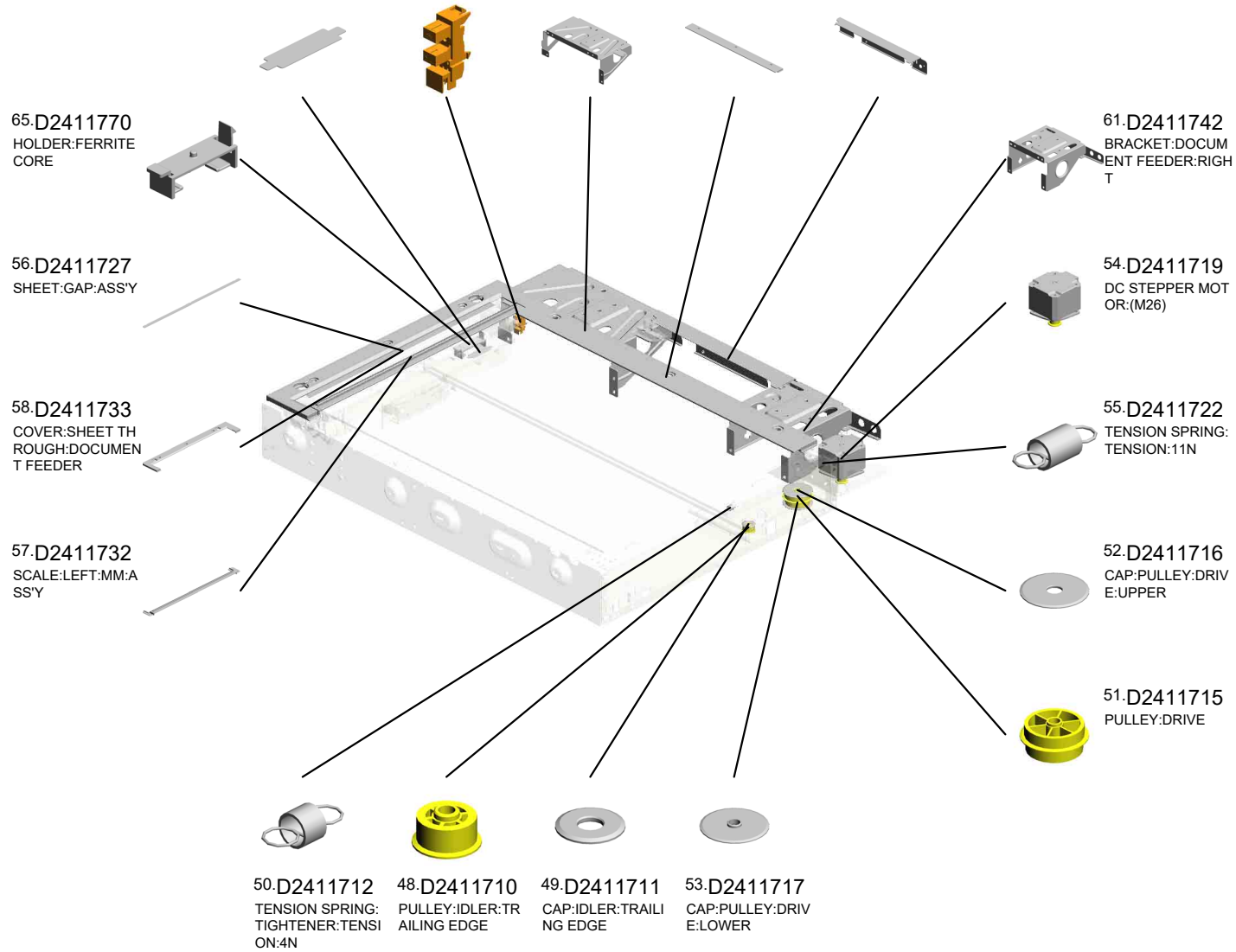
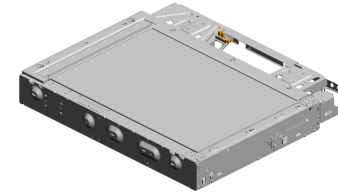

U003_S001
OPTICAL READING UNIT:CARRIAGE:SCANNER:IMC2000-6000

9.04583010N 27.D0BQ1780
(x4) ILLUMINATION UNI
HEXAGON HEAD T T:ASSY
APPING SCREW:3
X10

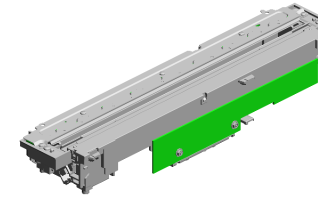

25.D0BQ1640
OPTICAL READING
UNIT:CARRIAGE:S
CANNER:IMC2000-
6000

6.03530060N
(x3)
BIND SCREW - M3
X6

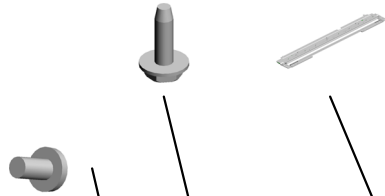

64.D2411767
PLAIN SHAFT BEA
RING:90ANG



11.08046128
(x2)
HEXAGONAL BOLT
:DOUBLE SCREW:
M3X10

8.03603006N
(x2)
SCREW - M3X6

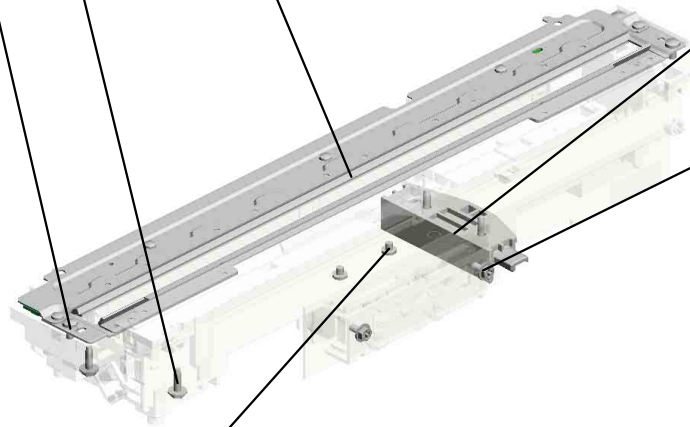

3.03530030N
(x2)
SCREW:M3X3



U001	U002	U003	U004	U005	U006	U007	U008	U009	U010	U011	U012	U013	U014	U015	U016	U017	U018
------	------	------	------	------	------	------	------	------	------	------	------	------	------	------	------	------	------

U004.LASER UNIT

U004 S001
D0BQ1855
OPTICAL WRITING UNIT:IMC
4500/IMC5500/IMC6000

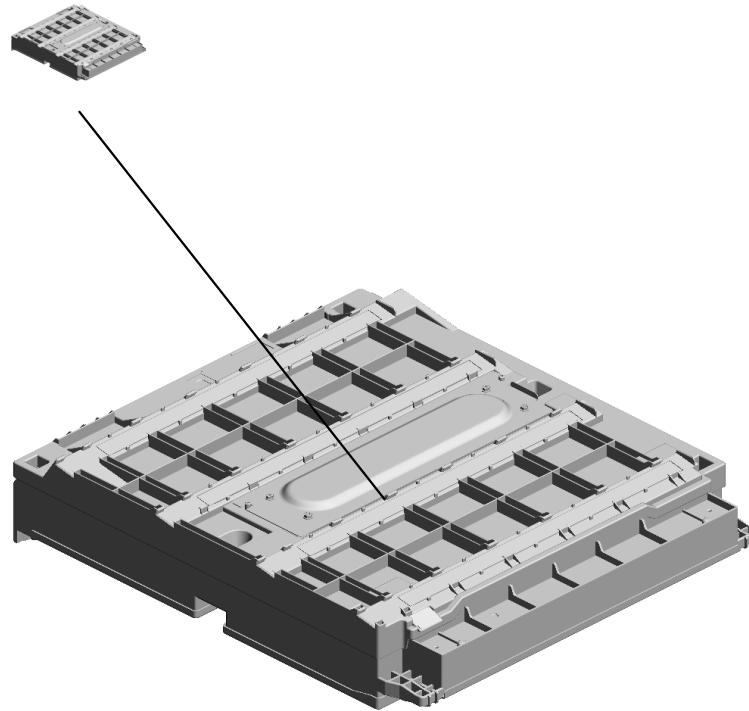

U001	U002	U003	U004	U005	U006	U007	U008	U009	U010	U011	U012	U013	U014	U015	U016	U017	U018
------	------	------	-------------	------	------	------	------	------	------	------	------	------	------	------	------	------	------

U004
LASER UNIT

1-04543008Q
(x2)
TAPPING SCREW:
3X8

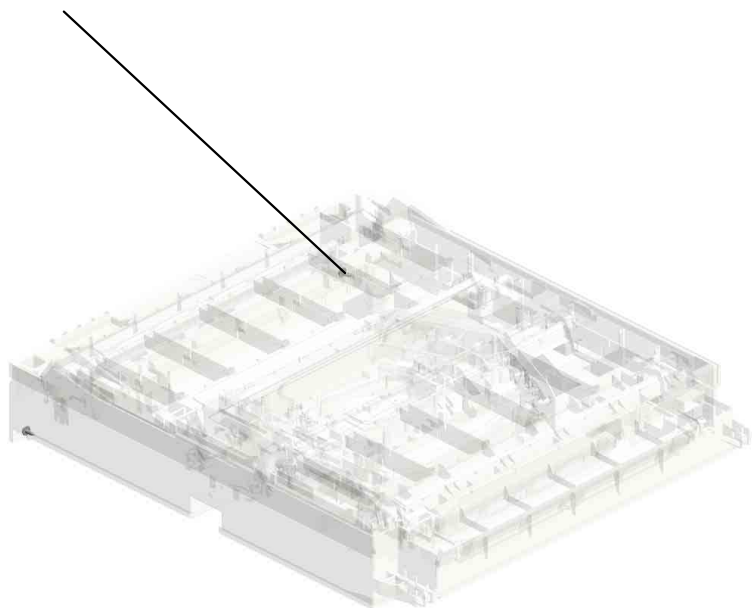
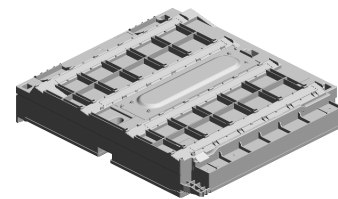

U001	U002	U003	U004	U005	U006	U007	U008	U009	U010	U011	U012	U013	U014	U015	U016	U017	U018
------	------	------	-------------	------	------	------	------	------	------	------	------	------	------	------	------	------	------

U004_S001
OPTICAL WRITING UNIT:IMC4500/IMC5500/IMC6000

3.AX060519
DC POLYGON MIR
ROR MOTOR:(M27)

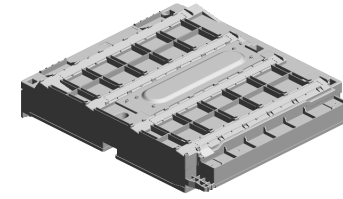

4.D0BQ1855
OPTICAL WRITING
UNIT:IMC4500/IMC
5500/IMC6000

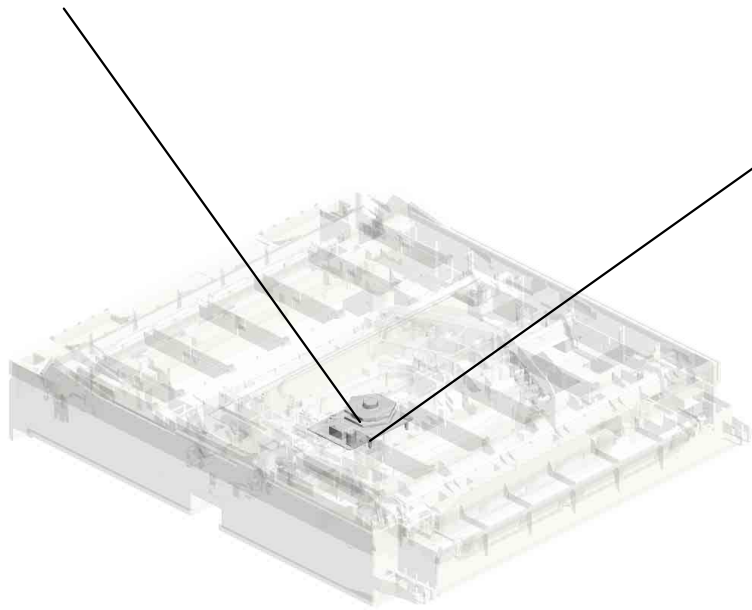
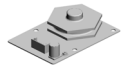

2.04593010N
(x4)
BINDING HEAD TA
PPING SCREW:3X
10

U001	U002	U003	U004	U005	U006	U007	U008	U009	U010	U011	U012	U013	U014	U015	U016	U017	U018
------	------	------	------	------	------	------	------	------	------	------	------	------	------	------	------	------	------

U005.PAPER FEED

U005 S006
D1492905
SUPPORTER:RIGHT:NO.1:AS
SY

U005 S001
D0BQ2711
PAPER FEED UNIT:NO.1:ASS
Y

U005 S003
D1492713
GUIDE PLATE:SWIVEL:NO.1

U005 S004
D0BQ2800
PAPER TRAY:NO.1:ASSY

U005 S008
D2412906
LEVER:STRETCH:PAPER TR
AY:ASSY

U005 S005
D0BQ2805
PAPER TRAY:NO.2:ASSY

U005 S009
D2412906
LEVER:STRETCH:PAPER TR
AY:ASSY

U005 S002
D0BQ2712
PAPER FEED UNIT:NO.2:ASS
Y

U005 S007
D1492903
SUPPORTER:RIGHT:NO.2:AS
SY

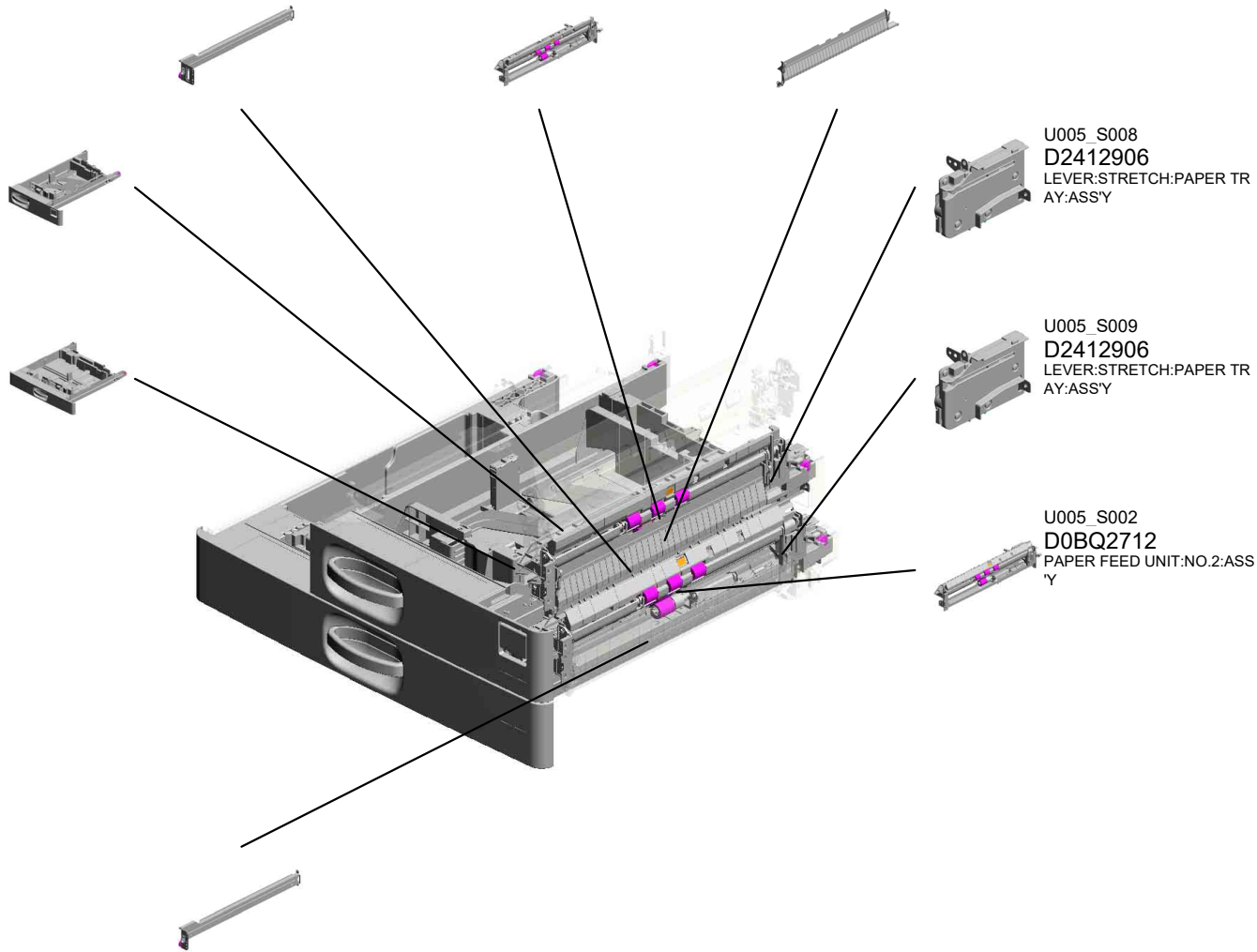

U001	U002	U003	U004	U005	U006	U007	U008	U009	U010	U011	U012	U013	U014	U015	U016	U017	U018
------	------	------	------	------	------	------	------	------	------	------	------	------	------	------	------	------	------

U005_S001.PAPER FEED UNIT:NO.1:ASS'Y

U005 S001 S001
D2412705
STAY:PAPER FEED UNIT:LO
WER:ASS'Y



U001	U002	U003	U004	U005	U006	U007	U008	U009	U010	U011	U012	U013	U014	U015	U016	U017	U018
------	------	------	------	------	------	------	------	------	------	------	------	------	------	------	------	------	------

U005_S002.PAPER FEED UNIT:NO.2:ASS'Y

U005 S002 S001
D2412705
STAY:PAPER FEED UNIT:LO
WER:ASS'Y

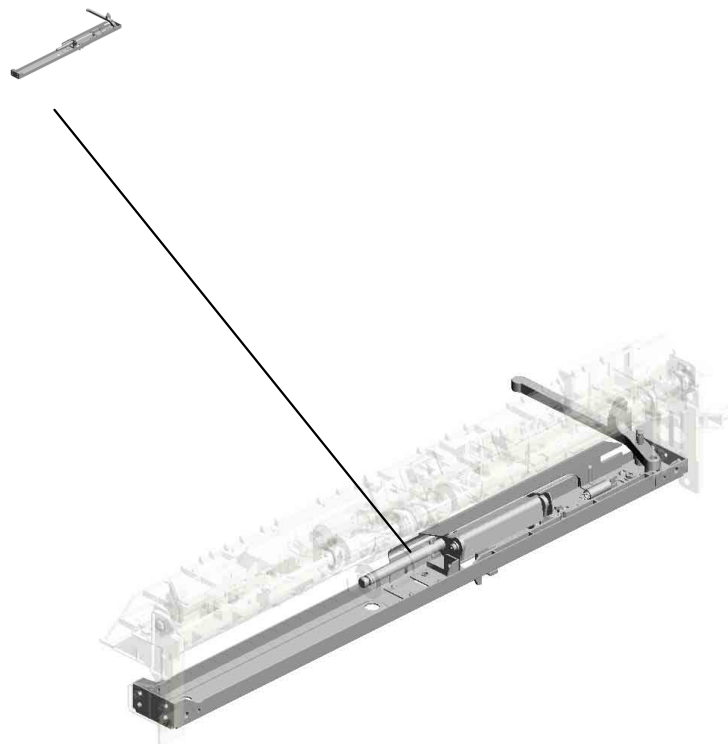

U001	U002	U003	U004	U005	U006	U007	U008	U009	U010	U011	U012	U013	U014	U015	U016	U017	U018
------	------	------	------	------	------	------	------	------	------	------	------	------	------	------	------	------	------

U005_S004.PAPER TRAY:NO.1:ASS'Y

U005 S004 S001
D0BQ2828
SIDE FENCE:FRONT:NO.1:A
SS'Y

U005 S004 S003
D0BQ2840
END FENCE:PAPER TRAY:A
SS'Y

U005_S004_S002
D0BQ2838
SIDE FENCE:REAR:NO.1:AS
S'Y

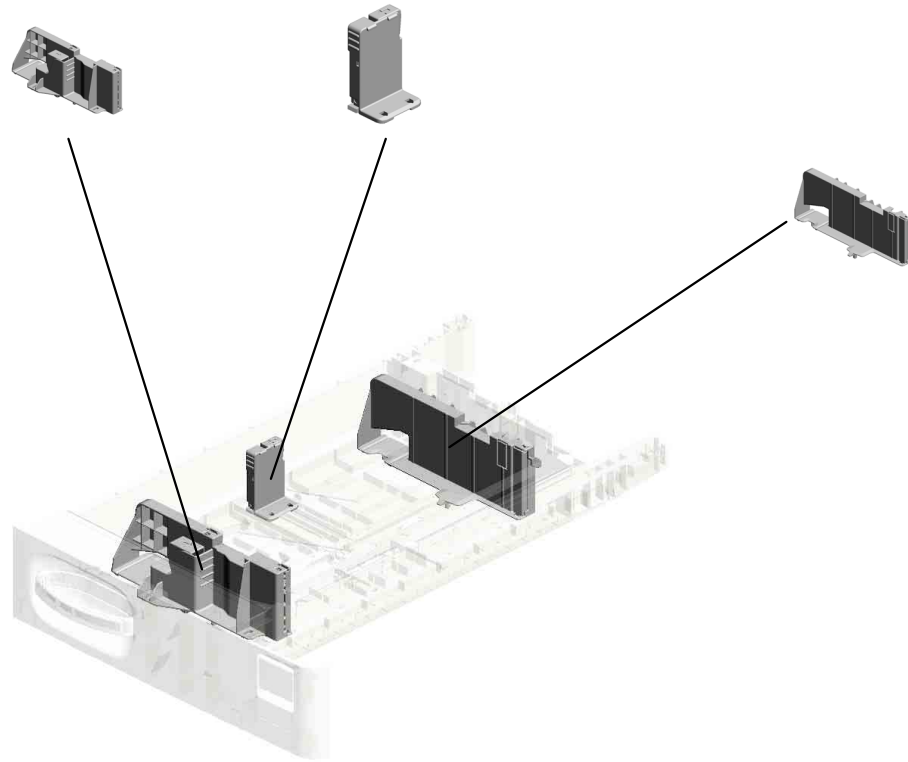

U001	U002	U003	U004	U005	U006	U007	U008	U009	U010	U011	U012	U013	U014	U015	U016	U017	U018
------	------	------	------	-------------	------	------	------	------	------	------	------	------	------	------	------	------	------

U005_S005.PAPER TRAY:NO.2:ASS'Y

U005 S005 S001
D0BQ2875
SIDE FENCE:FRONT:ASS'Y

U005 S005 S005
D2412873
SIDE FENCE:AUXILIARY

U005 S005 S004
D2412873
SIDE FENCE:AUXILIARY

U005 S005 S002
D0BQ2881
SIDE FENCE:REAR:SUB-ASS
'Y

U005 S005 S003
D0BQ2840
END FENCE:PAPER TRAY:A
SS'Y

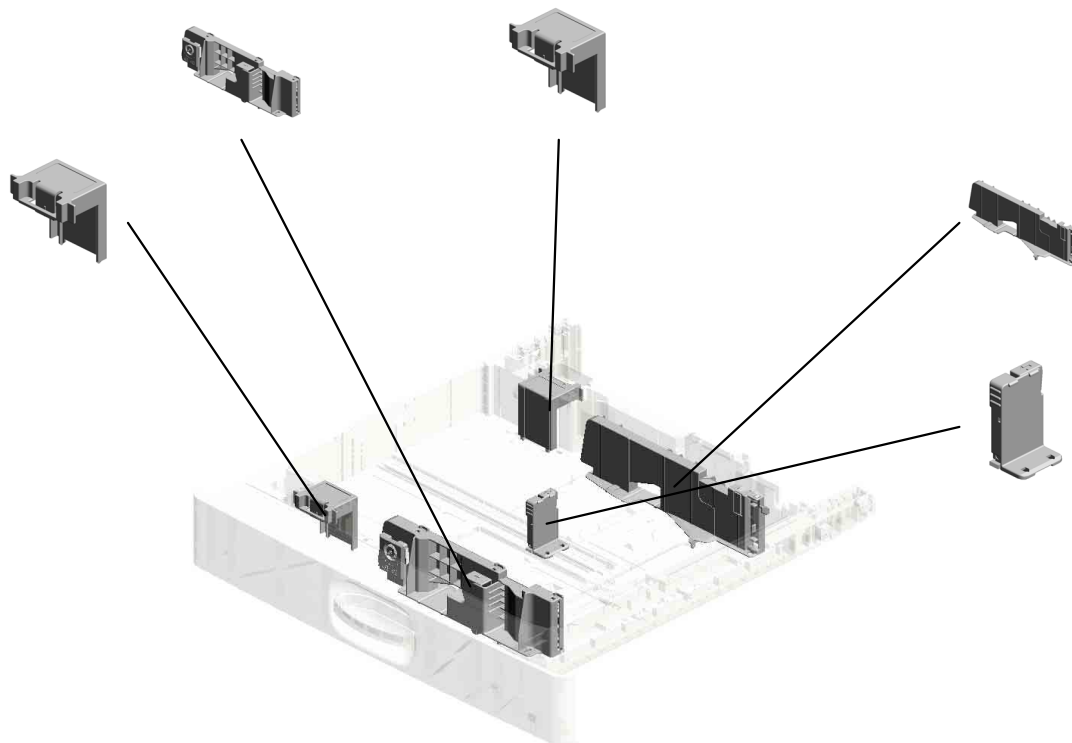

U001	U002	U003	U004	U005	U006	U007	U008	U009	U010	U011	U012	U013	U014	U015	U016	U017	U018
------	------	------	------	------	------	------	------	------	------	------	------	------	------	------	------	------	------

U005 PAPER FEED

- 13.11050765 CLAMP:LWS-2218A
- 25.AW500049 (x2) PUSH SWITCH:SW 1AG-550:(S4/S17/S 19/S21)
- 12.11050758 (x2) CLAMP:LWSM-030 6A
- 17.AA082175 (x2) PLAIN SHAFT BEA RING:8X12X7
- 8.07200060E (x3) RETAINING RING - M6

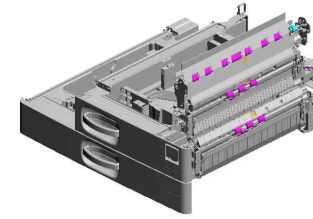

- 3.04543006Q (x43) TAPPING SCREW - M3X6

- 56.D1492562 (x2) COLLAR:REGISTRATI ON ROLLER

- 24.AW500044 PUSH SWITCH:PA PER SIZE SENSOR :(SW1)

- 15.AA082173 (x2) PLAIN SHAFT BEA RING:6X10X6

- 9.08050103 (x2) RETAINING RINGS -E:SILENCER-DIA3

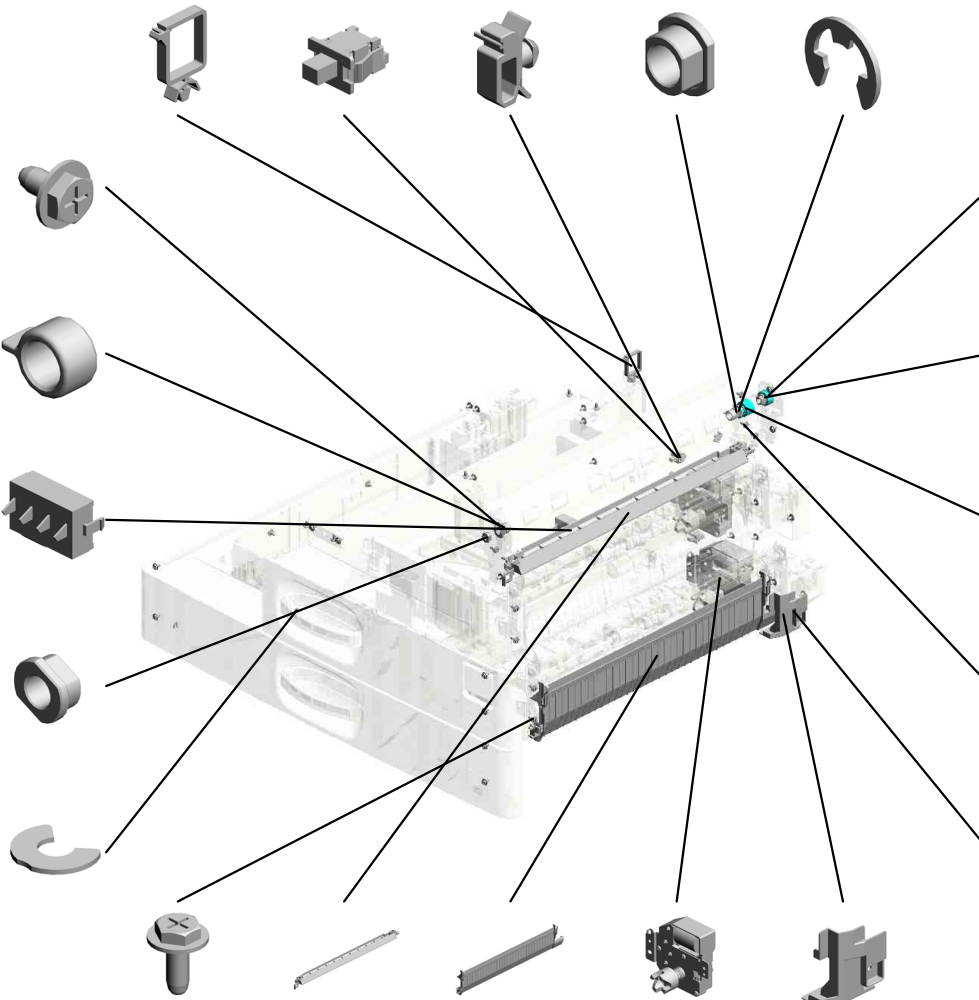

- 7.07200040E (x2) RETAINING RING - M4



- 11.11050046 (x2) HARNESS BAND

- 20.AB011573 GEAR:REGISTRATI ON:NO.2



- 19.AB011572 GEAR:Z19:DRIVEN: REGISTRATION



- 5.04583008N (x4) HEXAGON HEAD T APPING SCREW:3 X8



- 68.D1492787 BRACKET:SUPPO RT:COVER



- 4.04543008Q (x5) TAPPING SCREW: 3X8

- 29.D0BQ2566 CASE:REMOVE PA PER DUST:ASS'Y

- 59.D1492721 GUIDE PLATE:SWI VEL:NO.2

- 26.AX040273 (x2) DC MOTOR:RISING TRAY:ASS'Y:1.007 W:BRUSH:(M9/M10)

- 69.D1492788 INNER COVER:HA RNESS:PAPER FE ED UNIT

U001	U002	U003	U004	U005	U006	U007	U008	U009	U010	U011	U012	U013	U014	U015	U016	U017	U018
------	------	------	------	------	------	------	------	------	------	------	------	------	------	------	------	------	------

U005 PAPER FEED

98.D1492930 SUPPORTER:LEFT LOWER:NO.1:PEE N
 93.D1492918 SUPPORTER:LEFT UPPER:NO.1
 90.D1492889 COVER:TRAY:REA R LEFT:NO.2
 88.D1492887 COVER:TRAY:REA R LEFT:NO.1

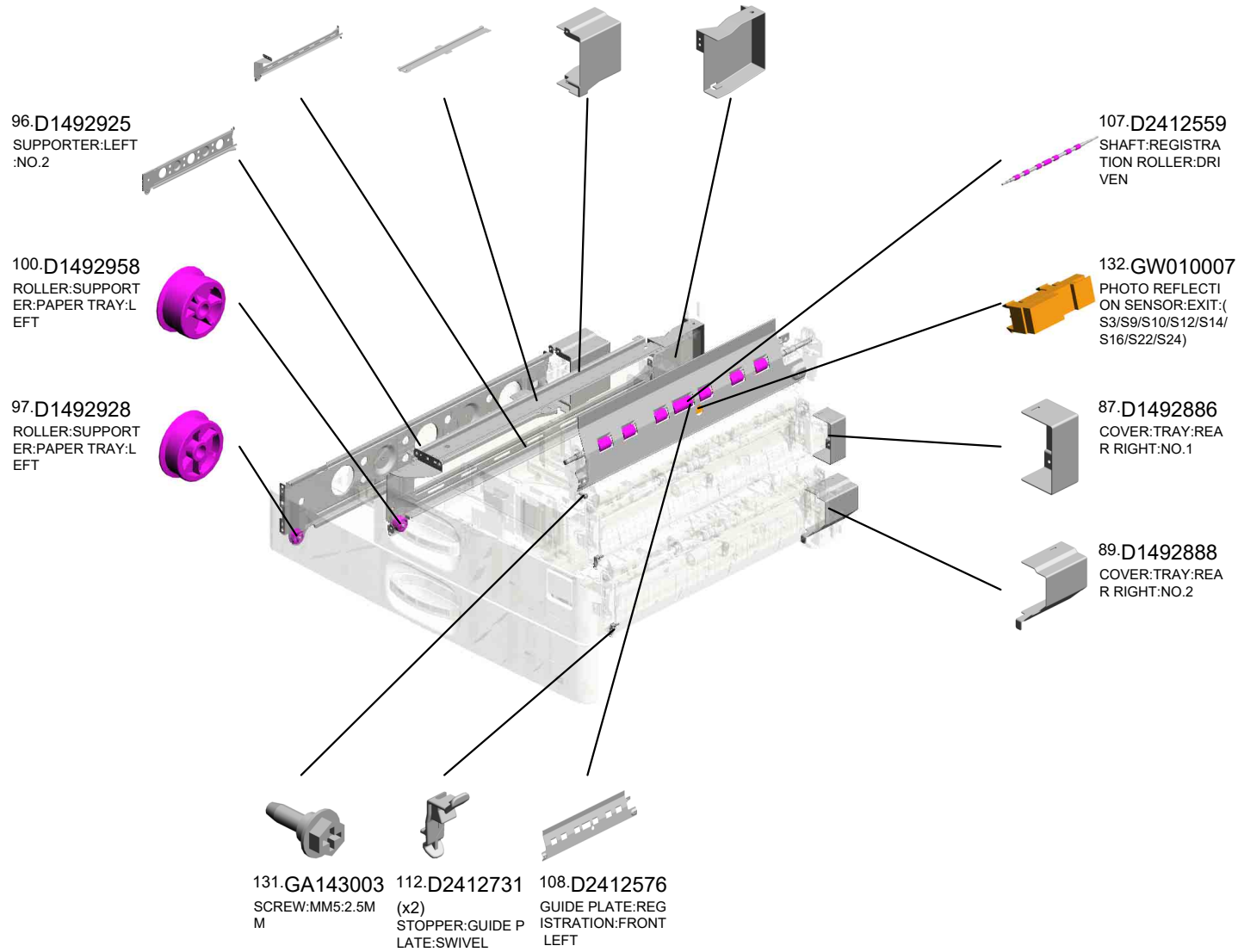
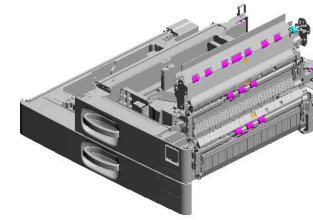

U001	U002	U003	U004	U005	U006	U007	U008	U009	U010	U011	U012	U013	U014	U015	U016	U017	U018
------	------	------	------	------	------	------	------	------	------	------	------	------	------	------	------	------	------

U005_S001
PAPER FEED UNIT:NO.1:ASS'Y

- 63.D1492774 PULLEY:IDLER:PICKUP
- 22.AF031085 PAPER FEED ROLLER - FEED
- 28.B8303504 TIMING BELT - 40S 2M100
- 62.D1492773 PULLEY:PICKUP:MECHANICAL ROLLER CLUTCH
- 16.AA082174 PLAIN SHAFT BEARING RING:6X10X9

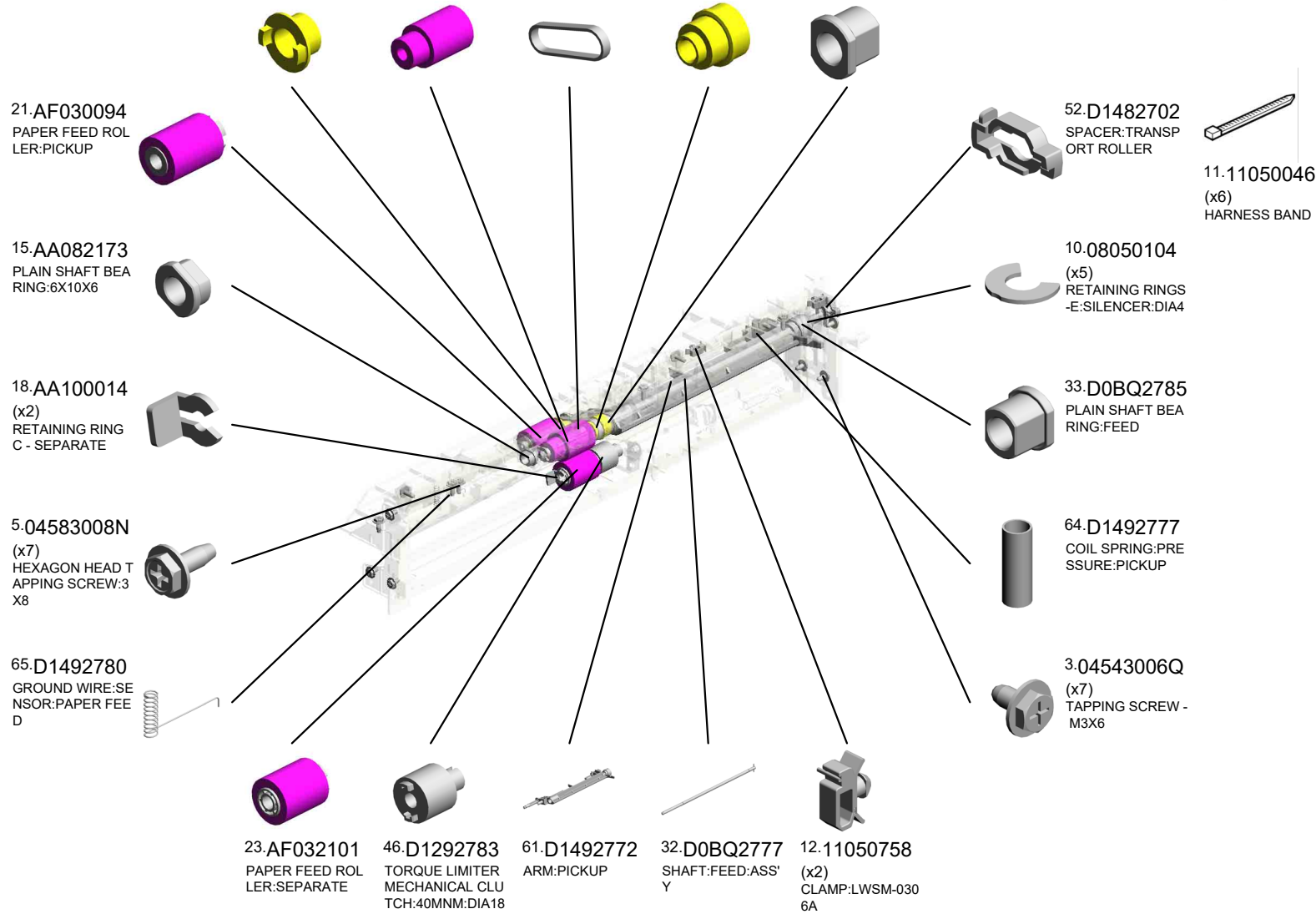
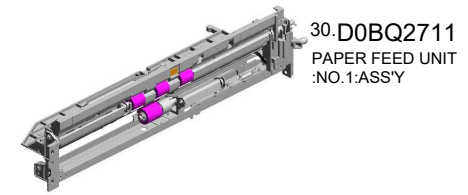

U001	U002	U003	U004	U005	U006	U007	U008	U009	U010	U011	U012	U013	U014	U015	U016	U017	U018
------	------	------	------	------	------	------	------	------	------	------	------	------	------	------	------	------	------

U005_S001
 PAPER FEED UNIT:NO.1:ASS'Y

132.GW010007 (x2) PHOTO REFLECTI ON SENSOR:EXIT:(S3/S9/S10/S12/S14/ S16/S22/S24)
 105.D2022778 FEELER:PAPER E ND
 114.D2412741 GUIDE PLATE:VER TICAL TRANSPOR T:PAPER FEED UN IT:NO.1

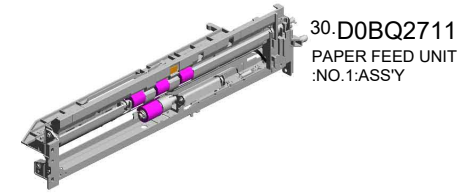

67.D1492784 BRACKET:SENSO R:PAPER FEED

66.D1492781 GROUND PLATE:P APER FEED UNIT

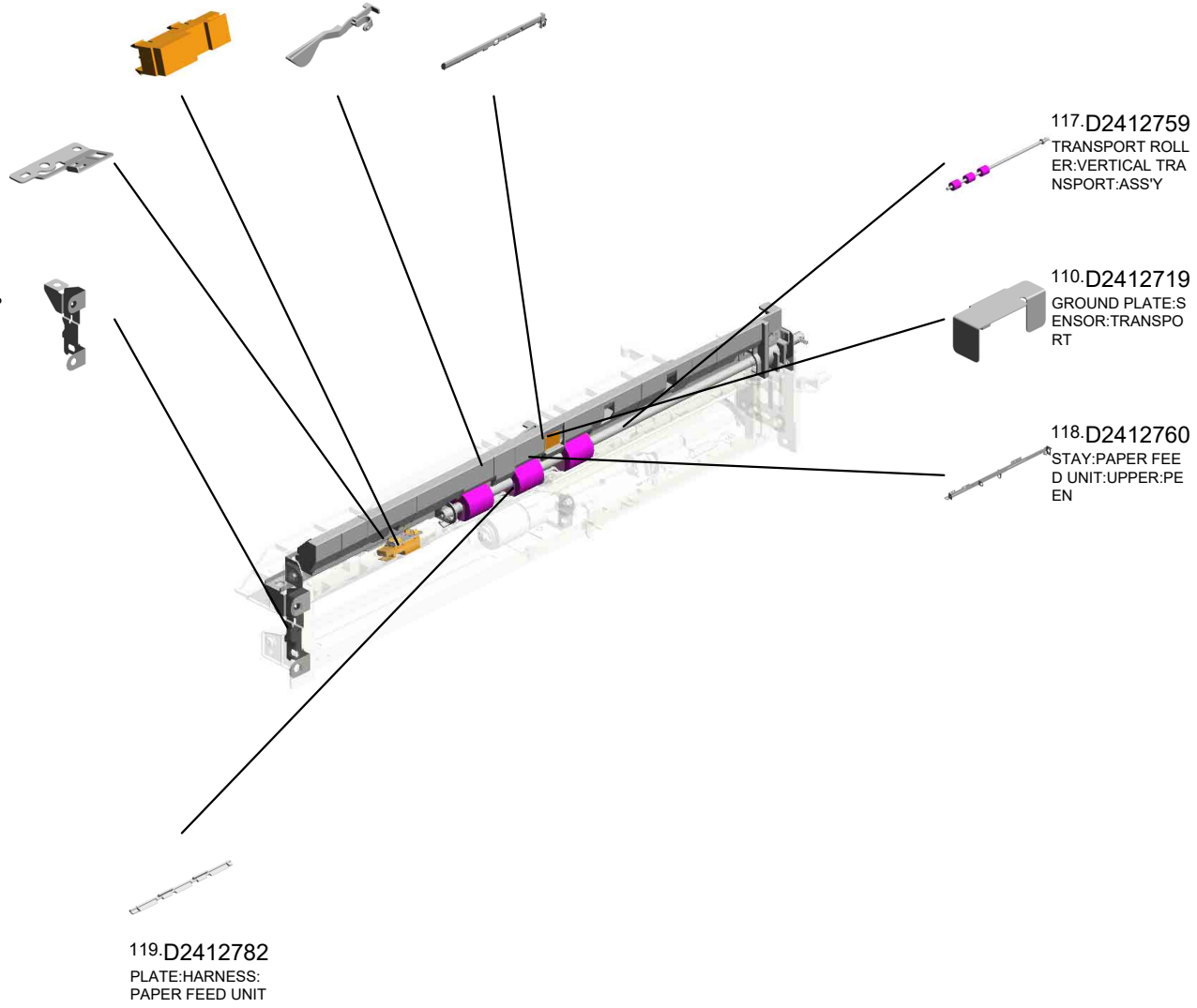

U001	U002	U003	U004	U005	U006	U007	U008	U009	U010	U011	U012	U013	U014	U015	U016	U017	U018
------	------	------	------	------	------	------	------	------	------	------	------	------	------	------	------	------	------

U005_S001_S001

STAY:PAPER FEED UNIT:LOWER:ASS'Y

48.D1472737 LEVER:PRESSURE:SEPARATE
 53.D1482751 ARM:PRESSURE:SEPARATE
 10.08050104 RETAINING RINGS-E:SILENCER:DIA4
 60.D1492739 LEVER:PRESSURE RELEASE

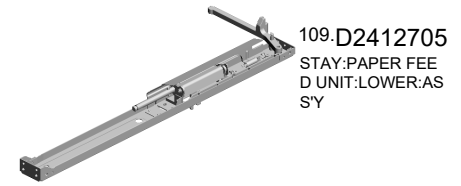

109.D2412705
 STAY:PAPER FEED UNIT:LOWER:ASS'Y

50.D1472752
 SHAFT:SEPARATE:ASS'Y

111.D2412730
 STAY:SEPARATE:PEEN

116.D2412754
 COIL SPRING:PRESSURE:SEPARATE

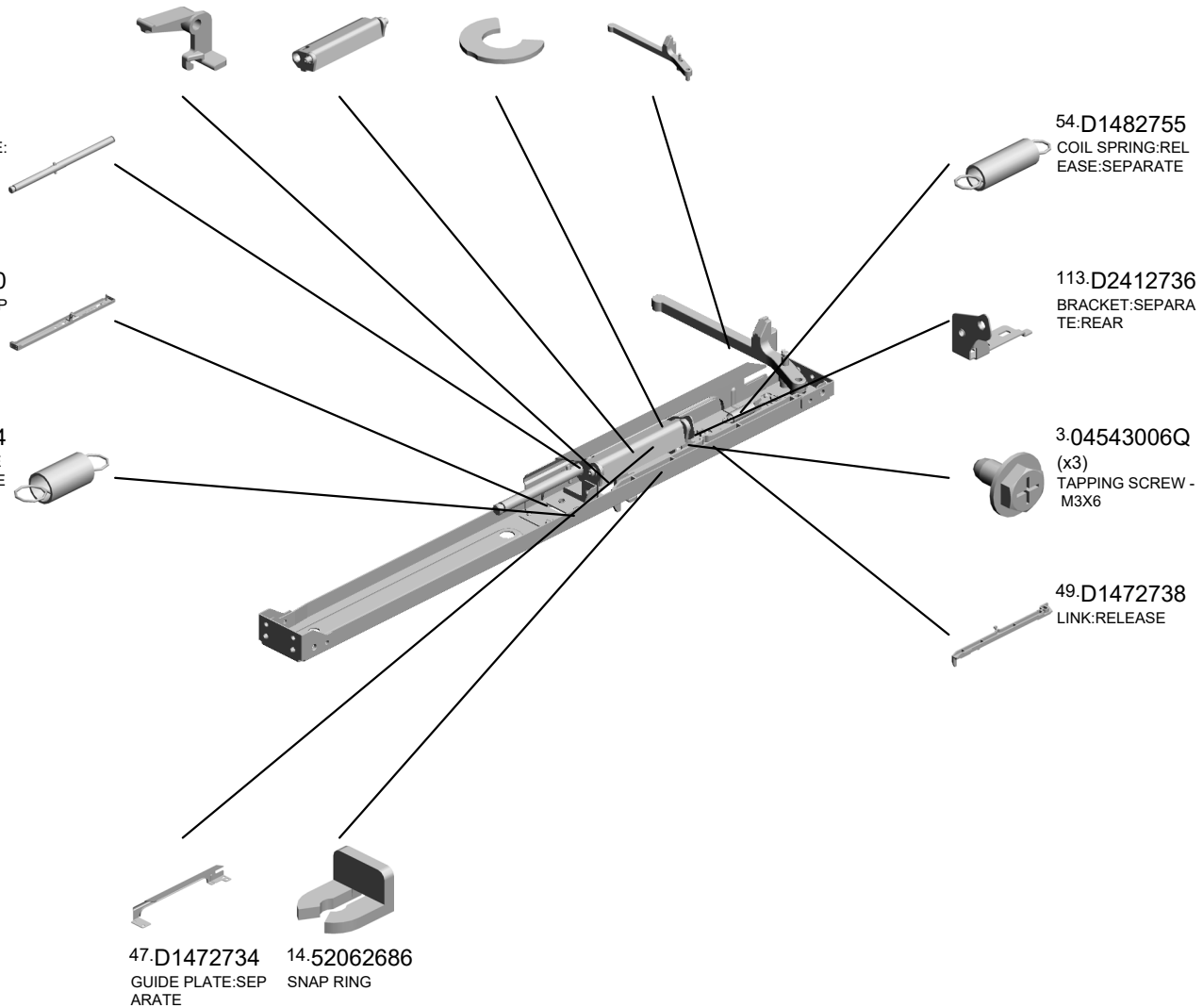

U001	U002	U003	U004	U005	U006	U007	U008	U009	U010	U011	U012	U013	U014	U015	U016	U017	U018
------	------	------	------	------	------	------	------	------	------	------	------	------	------	------	------	------	------

U005_S002
PAPER FEED UNIT:NO.2:ASS'Y

- 63.D1492774 PULLEY:IDLER:PIKUP
- 28.B8303504 TIMING BELT - 40S 2M100
- 62.D1492773 PULLEY:PICKUP:MECHANICAL ROLLER CLUTCH
- 16.AA082174 PLAIN SHAFT BEARING:6X10X9
- 12.11050758 CLAMP:LWSM-030 6A

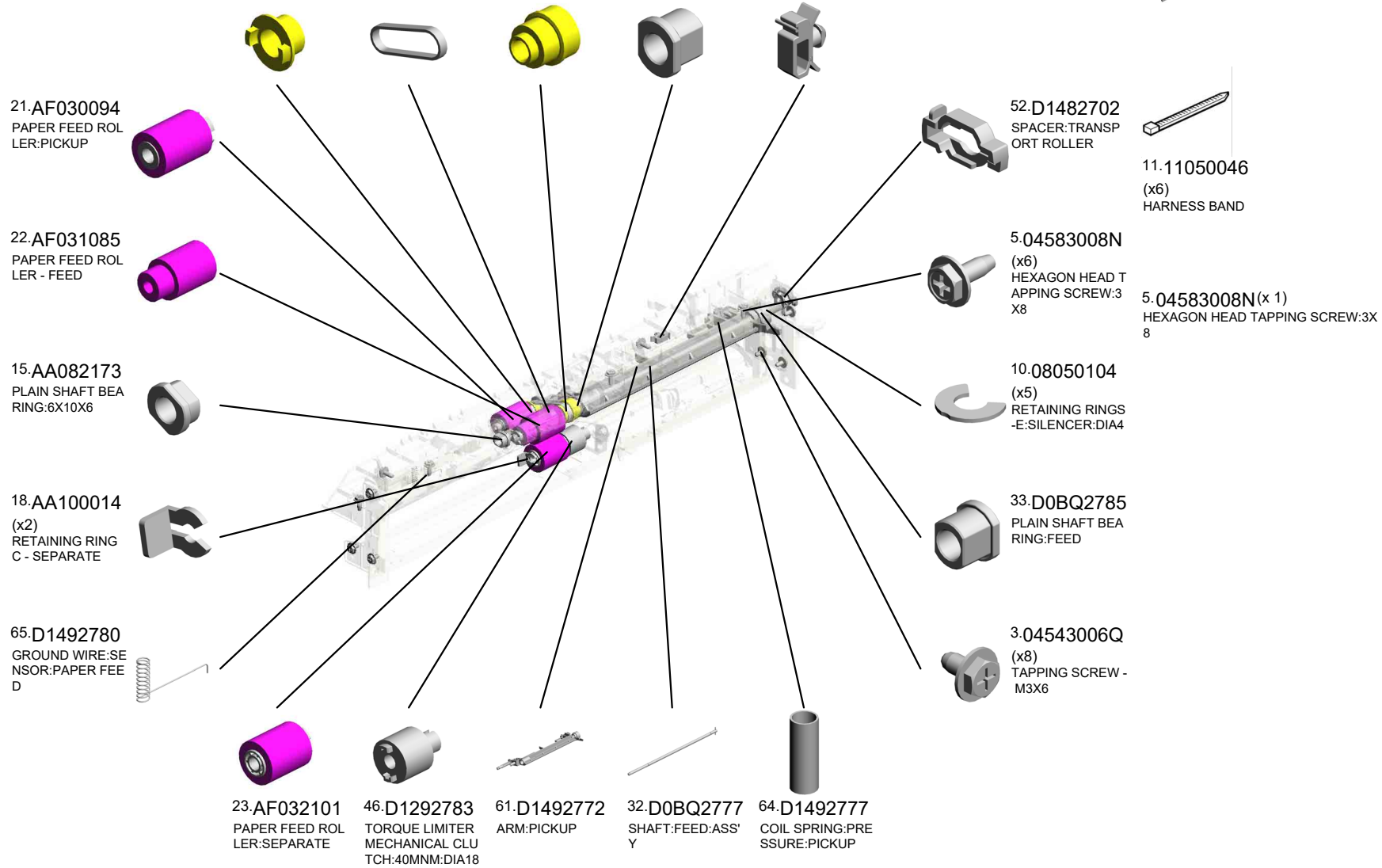
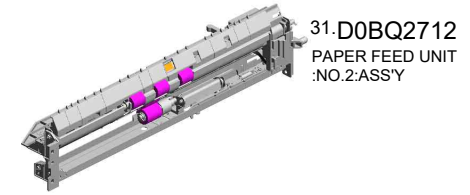

U001	U002	U003	U004	U005	U006	U007	U008	U009	U010	U011	U012	U013	U014	U015	U016	U017	U018
------	------	------	------	------	------	------	------	------	------	------	------	------	------	------	------	------	------

U005_S002
 PAPER FEED UNIT:NO.2:ASS'Y

132.GW010007 (x2) PHOTO REFLECTI
 ON SENSOR:EXIT:(
 S3/S9/S10/S12/S14/
 S16/S22/S24)
 105.D2022778 FEELER:PAPER E
 ND
 110.D2412719 GROUND PLATE:S
 ENSOR:TRANSPO
 RT

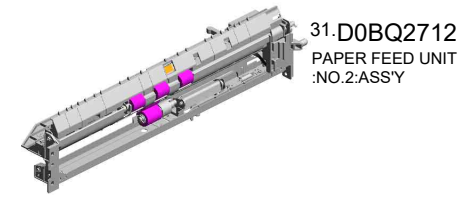

67.D1492784
 BRACKET:SENSO
 R:PAPER FEED

66.D1492781
 GROUND PLATE:P
 APER FEED UNIT

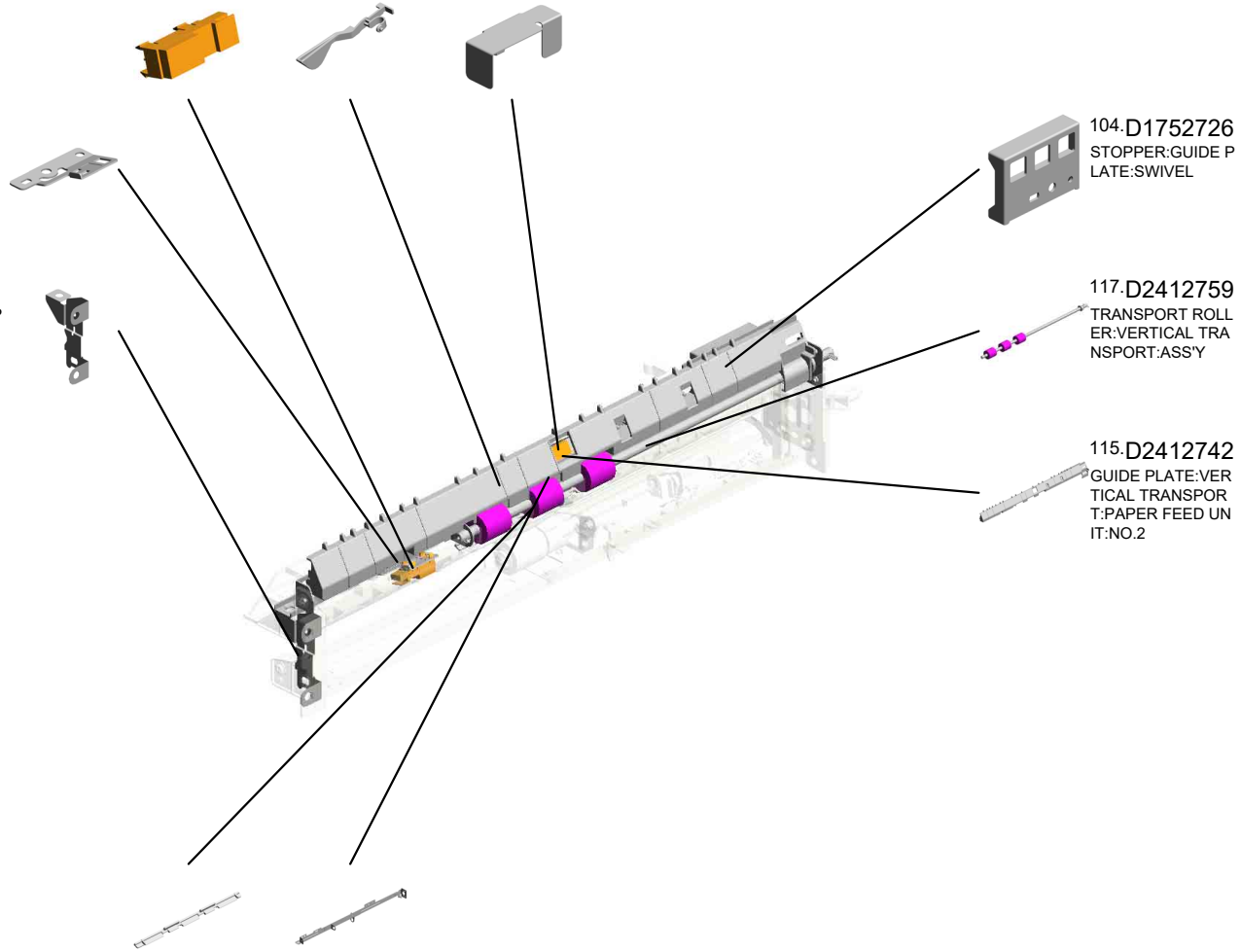

104.D1752726
 STOPPER:GUIDE P
 LATE:SWIVEL

117.D2412759
 TRANSPORT ROLL
 ER:VERTICAL TRA
 NSPORT:ASS'Y

115.D2412742
 GUIDE PLATE:VER
 TICAL TRANSPOR
 T:PAPER FEED UN
 IT:NO.2

119.D2412782 PLATE:HARNESS:
 PAPER FEED UNIT
 118.D2412760 STAY:PAPER FEE
 D UNIT:UPPER:PE
 EN

U001	U002	U003	U004	U005	U006	U007	U008	U009	U010	U011	U012	U013	U014	U015	U016	U017	U018
------	------	------	------	------	------	------	------	------	------	------	------	------	------	------	------	------	------

U005_S002_S001

STAY:PAPER FEED UNIT:LOWER:ASS'Y

- 48.D1472737 LEVER:PRESSURE:SEPARATE
- 53.D1482751 ARM:PRESSURE:SEPARATE
- 10.08050104 RETAINING RINGS:E:SILENCER:DIA4
- 60.D1492739 LEVER:PRESSURE RELEASE

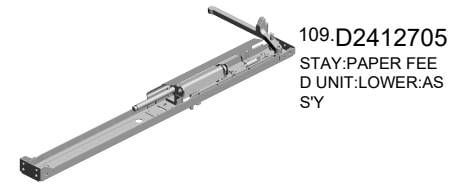

50.D1472752
SHAFT:SEPARATE:ASS'Y

111.D2412730
STAY:SEPARATE:PEEN

116.D2412754
COIL SPRING:PRESSURE:SEPARATE

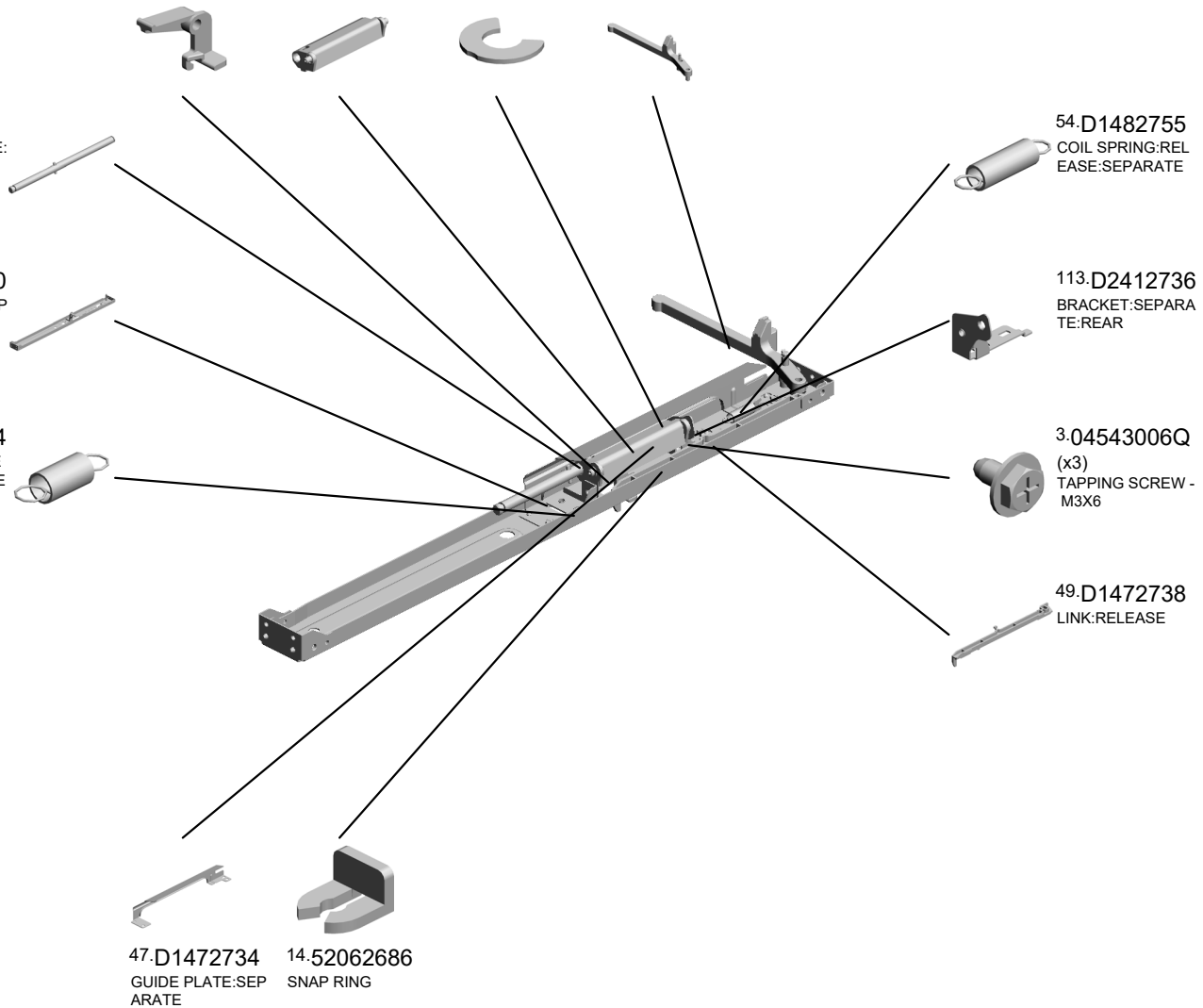

U001	U002	U003	U004	U005	U006	U007	U008	U009	U010	U011	U012	U013	U014	U015	U016	U017	U018
------	------	------	------	------	------	------	------	------	------	------	------	------	------	------	------	------	------

U005_S003
GUIDE PLATE:SWIVEL:NO.1

57.D1492712
SHEET:GUIDE PLA
TE:SWIVEL

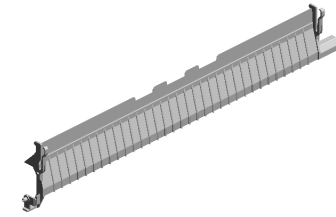

58.D1492713
GUIDE PLATE:SWI
VEL:NO.1

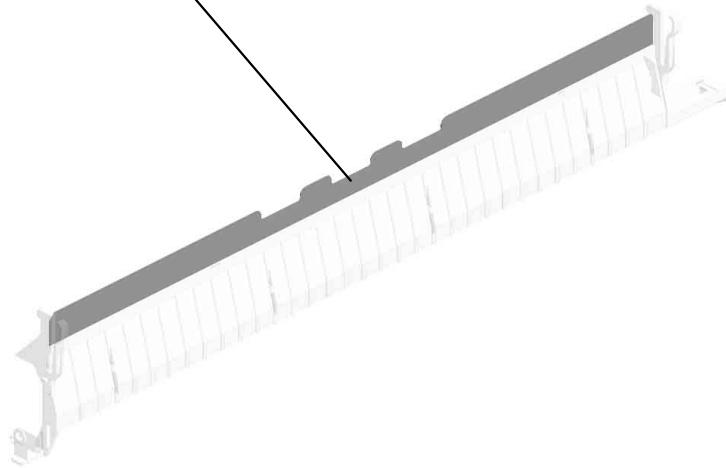
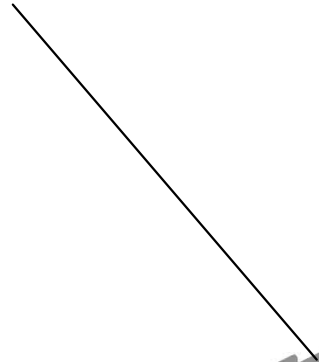

U001	U002	U003	U004	U005	U006	U007	U008	U009	U010	U011	U012	U013	U014	U015	U016	U017	U018
------	------	------	------	------	------	------	------	------	------	------	------	------	------	------	------	------	------

U005_S004
PAPER TRAY:NO.1:ASS'Y

44.D0BQ2896
DECAL:SIZE INDIC
ATION:SIDE FENC
E:NO.1

39.D0BQ2846
DECAL:SIZE INDIC
ATION:END FENCE
:NO.1:FRONT

83.D1492847
DECAL:SIZE INDIC
ATION:END FENCE
:NO.1:REAR

72.D1492814
COIL SPRING:EAR
TH

70.D1492812
(x4)
ROLLER:PAPER T
RAY:DIA19

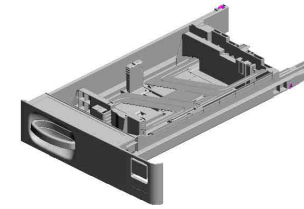

34.D0BQ2800
PAPER TRAY:NO.1
:ASS'Y

40.D0BQ2863
DECAL:PAPER SE
T DIRECTION:TRA
Y:NO.1

6.04583010N
(x2)
HEXAGON HEAD T
APPING SCREW:3
X10

129.D2442856
GRIP:PAPER TRAY

121.D2412865
COVER:PAPER TR
AY:NO.1

106.D2411242
COVER:MAIN SWIT
CH

78.D1492835
(x2)
RACK:SIDE FENCE

79.D1492836
GEAR:Z20

6.04583010N(x 7)
HEXAGON HEAD TAPPING SCREW:3X
10

10.08050104
RETAINING RINGS
-E:SILENCER:DIA4

71.D1492813
PIN:STRETCH:TRA
Y

73.D1492816
SHAFT:RISE:ASS'Y

74.D1492818
LEVER:RISE

2.03603006N
(x2)
SCREW - M3X6

U005_S004_S001
SIDE FENCE:FRONT:NO.1:ASS'Y

75.D1492824
LEVER:STOPPER:
FRONT

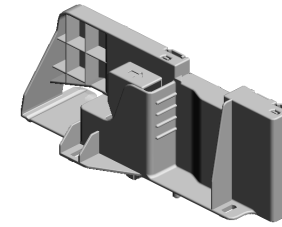

36.D0BQ2828
SIDE FENCE:FRON
T:NO.1:ASS'Y

77.D1492827
COMPRESSION SP
RING:SIDE FENCE:
POSITIONING

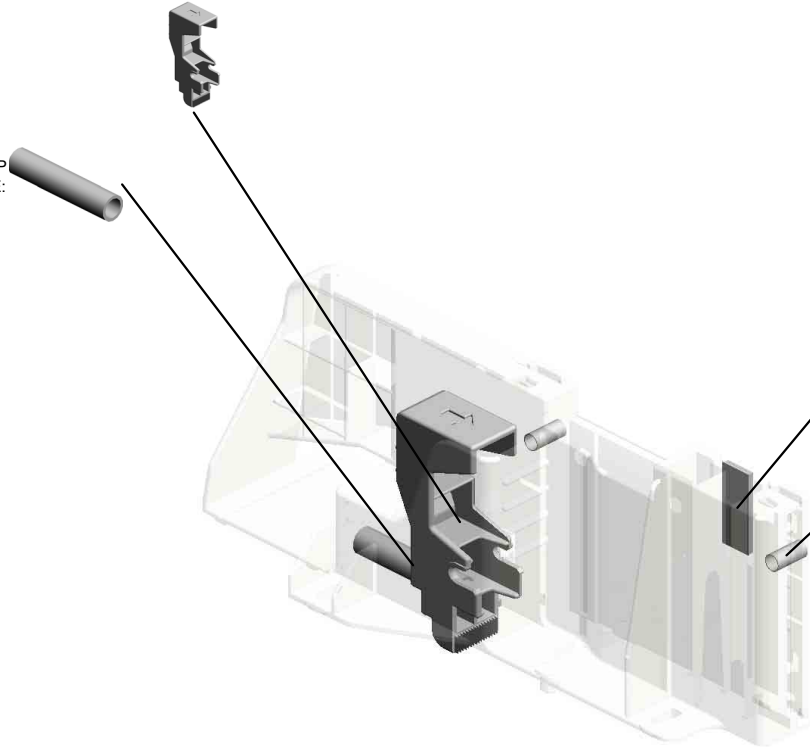

27.B2342864
PAD:CLEANER

76.D1492826
(x2)
COMPRESSION SP
RING:SIDE FENCE:
PLATE:FRONT

U001	U002	U003	U004	U005	U006	U007	U008	U009	U010	U011	U012	U013	U014	U015	U016	U017	U018
------	------	------	------	-------------	------	------	------	------	------	------	------	------	------	------	------	------	------

U005_S004_S002
SIDE FENCE:REAR:NO.1:ASS'Y

27.B2342864
PAD:CLEANER

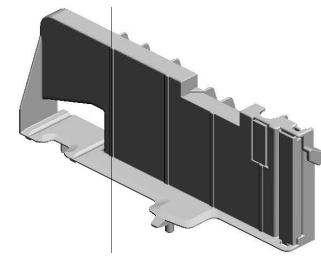

37.D0BQ2838
SIDE FENCE:REAR
:NO.1:ASS'Y

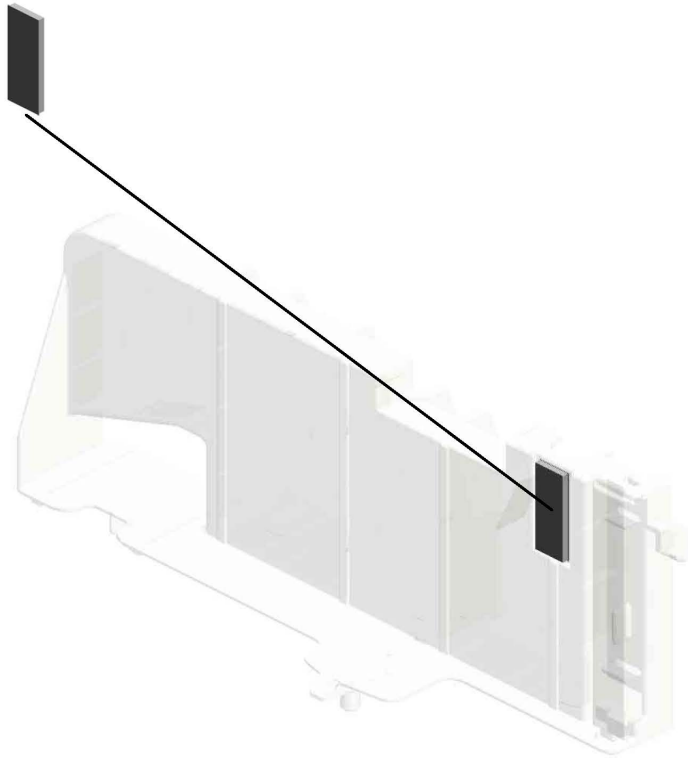

U001	U002	U003	U004	U005	U006	U007	U008	U009	U010	U011	U012	U013	U014	U015	U016	U017	U018
------	------	------	------	------	------	------	------	------	------	------	------	------	------	------	------	------	------

U005_S004_S003
END FENCE:PAPER TRAY:ASS'Y

80.D1492842 81.D1492843
LEVER:END FENC CLICK:END FENCE
E

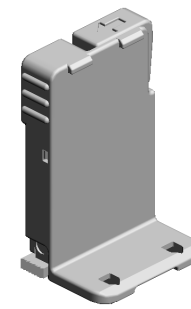

38.D0BQ2840
END FENCE:PAPE
R TRAY:ASS'Y

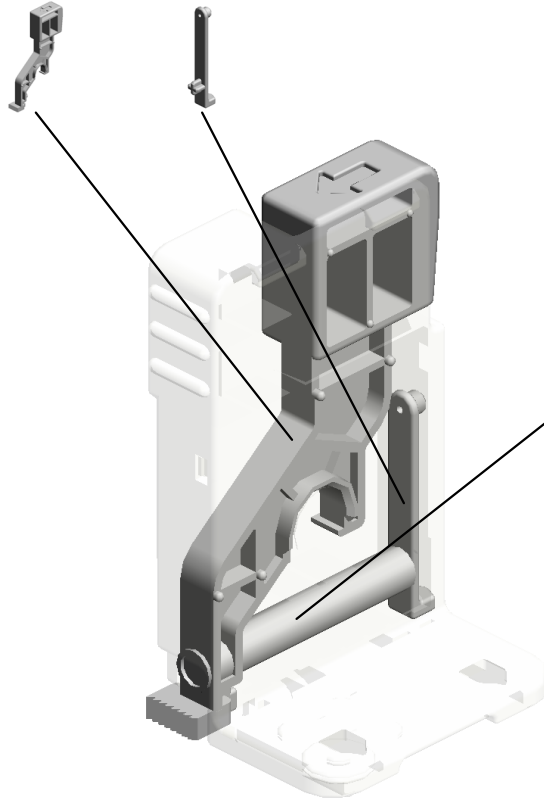

82.D1492845
COMPRESSION SP
RING:END FENCE:
LEVER:5N

U001	U002	U003	U004	U005	U006	U007	U008	U009	U010	U011	U012	U013	U014	U015	U016	U017	U018
------	------	------	------	-------------	------	------	------	------	------	------	------	------	------	------	------	------	------

U005_S005
PAPER TRAY:NO.2:ASS'Y

- 120.D2412837 DECAL:SET:SIDE FENCE:AUXILIARY
- 84.D1492848 DECAL:SIZE INDICATION:END FENCE:NO.2:FRONT
- 85.D1492849 DECAL:SIZE INDICATION:END FENCE:NO.2:REAR
- 125.D2412884 DECAL:SIZE INDICATION:SIDE FENCE:AUXILIARY:REAR
- 70.D1492812 (x4) ROLLER:PAPER TRAY:DIA19

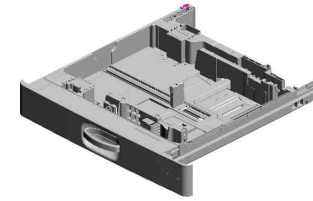

35.D0BQ2805
PAPER TRAY:NO.2
:ASS'Y

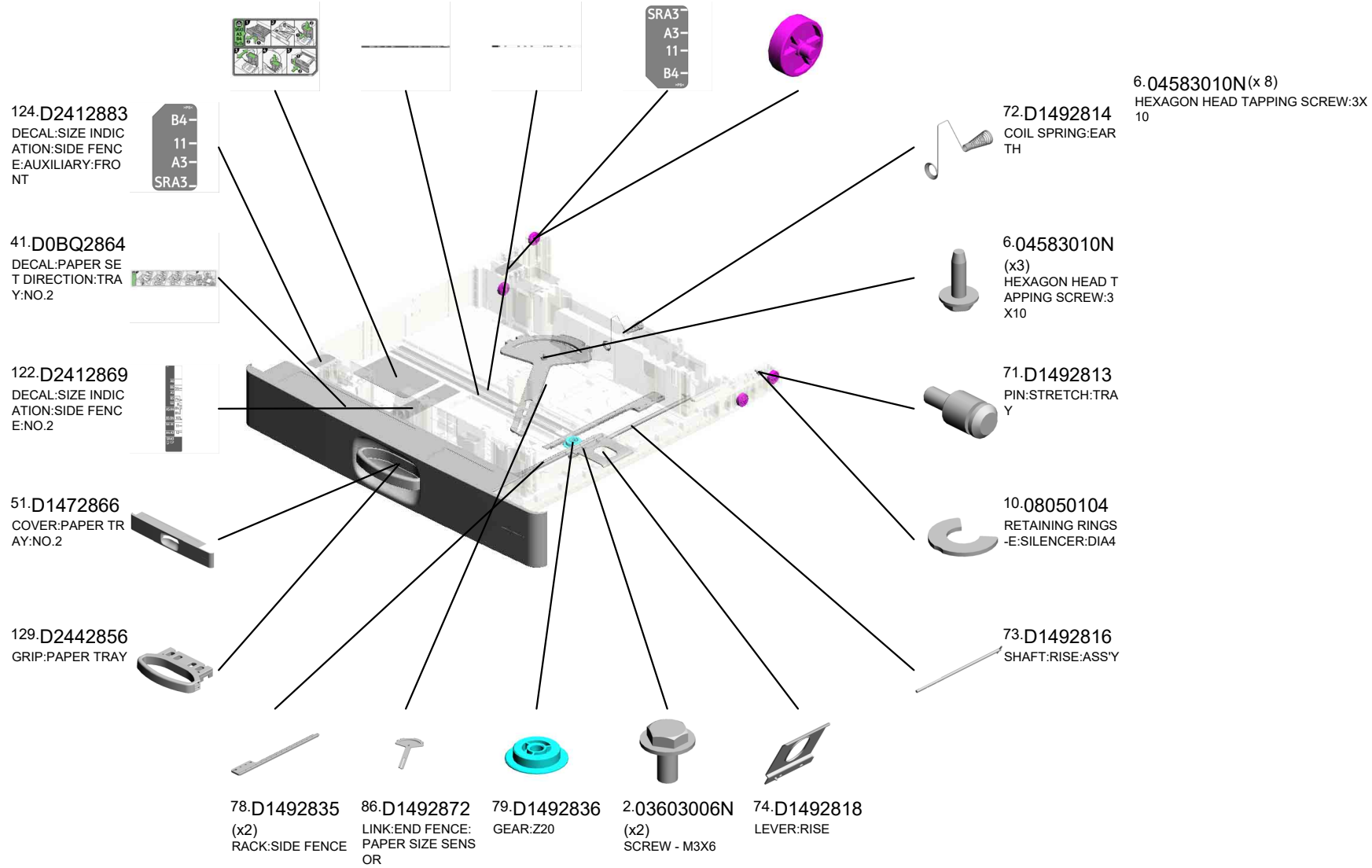

U001	U002	U003	U004	U005	U006	U007	U008	U009	U010	U011	U012	U013	U014	U015	U016	U017	U018
------	------	------	------	------	------	------	------	------	------	------	------	------	------	------	------	------	------

U005_S005
PAPER TRAY:NO.2:ASS'Y

130.D6932867
SUPPORTING PLATE:COVER:FRONT:
PAPER TRAY

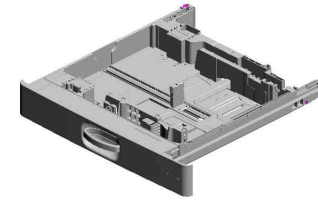

35.D0BQ2805
PAPER TRAY:NO.2
:ASS'Y



U001	U002	U003	U004	U005	U006	U007	U008	U009	U010	U011	U012	U013	U014	U015	U016	U017	U018
------	------	------	------	-------------	------	------	------	------	------	------	------	------	------	------	------	------	------

U005_S005_S001
SIDE FENCE:FRONT:ASS'Y

77.D1492827 75.D1492824
COMPRESSION SP LEVER:STOPPER:
RING:SIDE FENCE: FRONT
POSITIONING

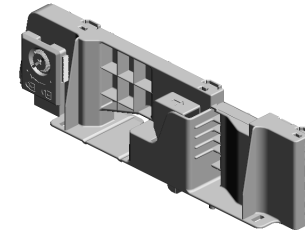

42.D0BQ2875
SIDE FENCE:FRON
T:ASS'Y

10.08050104
RETAINING RINGS
-E:SILENCER:DIA4



45.D0BQ2967
KNOB SCREW:STA
Y:END FENCE



27.B2342864
PAD:CLEANER

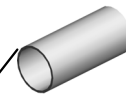

76.D1492826
(x3)
COMPRESSION SP
RING:SIDE FENCE:
PLATE:FRONT

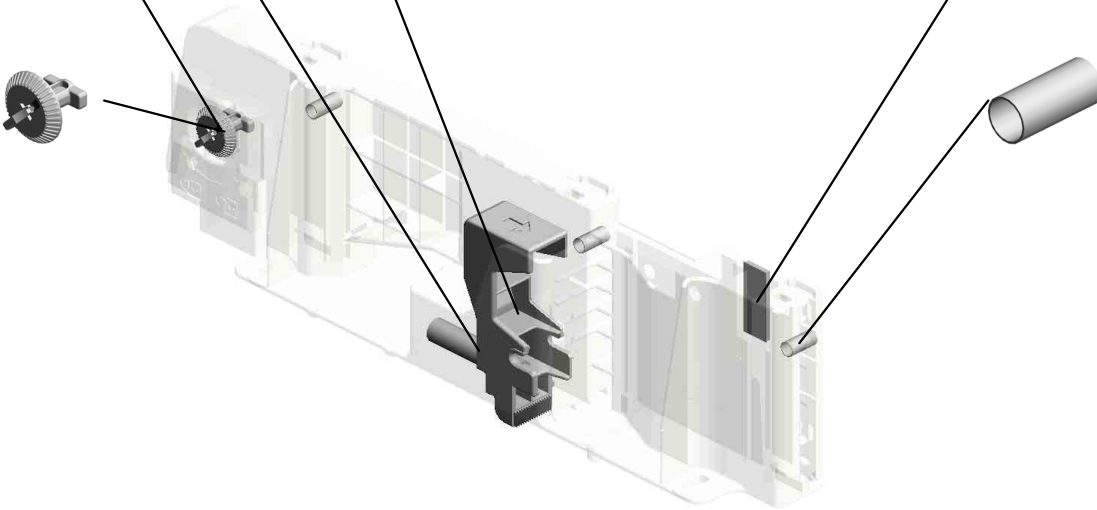

U001	U002	U003	U004	U005	U006	U007	U008	U009	U010	U011	U012	U013	U014	U015	U016	U017	U018
------	------	------	------	------	------	------	------	------	------	------	------	------	------	------	------	------	------

U005_S005_S002
SIDE FENCE:REAR:SUB-ASS'Y

27.B2342864
PAD:CLEANER

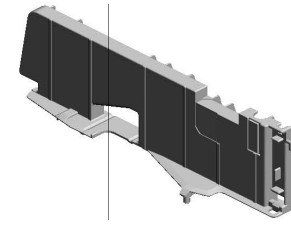

43.D0BQ2881
SIDE FENCE:REAR
:SUB-ASS'Y

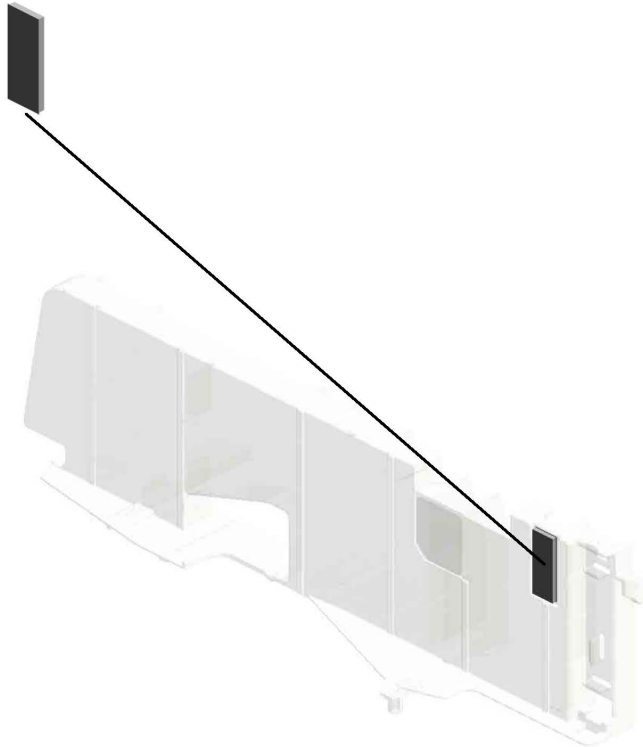

U001	U002	U003	U004	U005	U006	U007	U008	U009	U010	U011	U012	U013	U014	U015	U016	U017	U018
------	------	------	------	------	------	------	------	------	------	------	------	------	------	------	------	------	------

U005_S005_S003
END FENCE:PAPER TRAY:ASS'Y

80.D1492842 81.D1492843
LEVER:END FENC CLICK:END FENCE
E

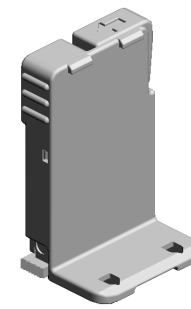

38.D0BQ2840
END FENCE:PAPE
R TRAY:ASS'Y

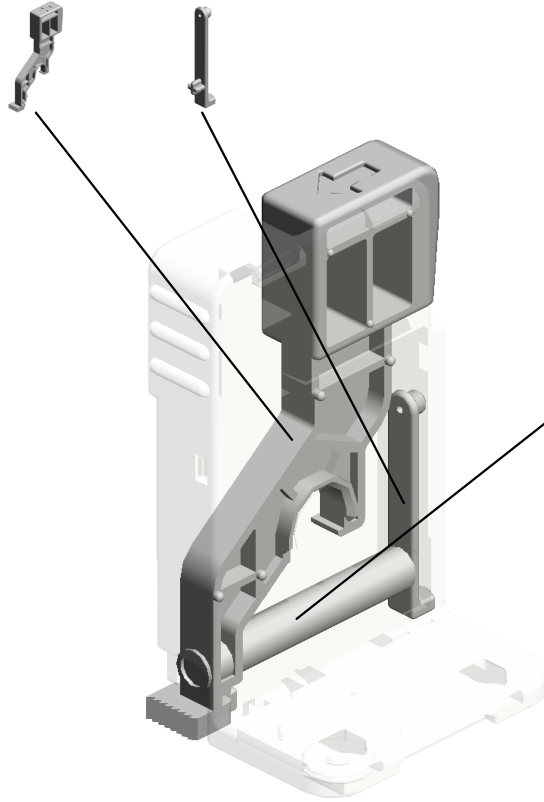

82.D1492845
COMPRESSION SP
RING:END FENCE:
LEVER:5N

U001	U002	U003	U004	U005	U006	U007	U008	U009	U010	U011	U012	U013	U014	U015	U016	U017	U018
------	------	------	------	------	------	------	------	------	------	------	------	------	------	------	------	------	------

U005_S005_S004
SIDE FENCE:AUXILIARY

126.D2412885
DECAL:SIDE FENC
E:AUXILIARY

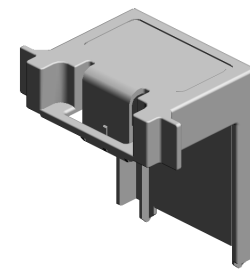
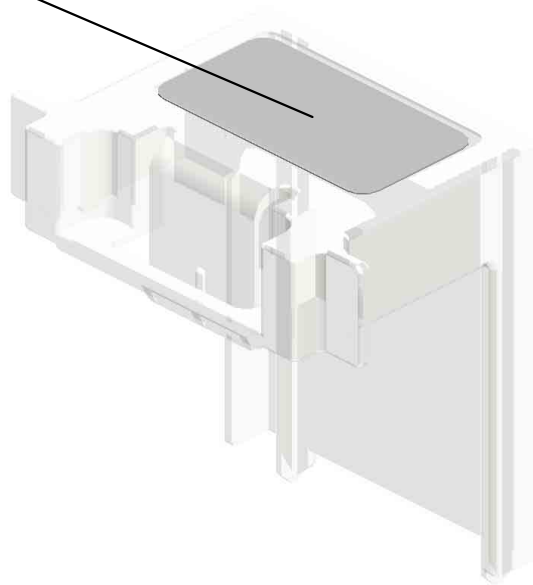

123.D2412873
SIDE FENCE:AUXIL
IARY

U001	U002	U003	U004	U005	U006	U007	U008	U009	U010	U011	U012	U013	U014	U015	U016	U017	U018
------	------	------	------	------	------	------	------	------	------	------	------	------	------	------	------	------	------

U005_S005_S005
SIDE FENCE:AUXILIARY

126.D2412885
DECAL:SIDE FENC
E:AUXILIARY

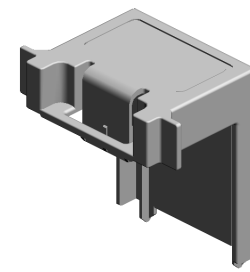
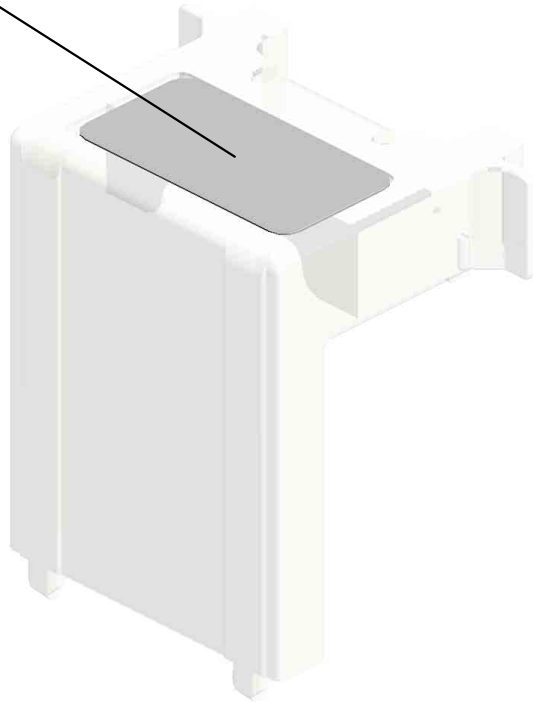

123.D2412873
SIDE FENCE:AUXIL
IARY

U001	U002	U003	U004	U005	U006	U007	U008	U009	U010	U011	U012	U013	U014	U015	U016	U017	U018
------	------	------	------	------	------	------	------	------	------	------	------	------	------	------	------	------	------

U005_S006
SUPPORTER:RIGHT:NO.1:ASS'Y

3.04543006Q
(x3)
TAPPING SCREW -
M3X6



92.D1492905
SUPPORTER:RIGHT:
T:NO.1:ASS'Y

95.D1492924
STOPPER:PAPER
TRAY

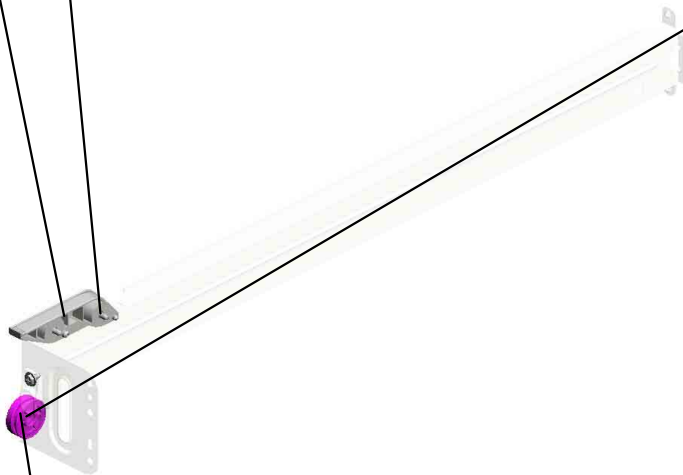

99.D1492956
ROLLER:SUPPORT
ER:PAPER TRAY



9.08050103
RETAINING RINGS
-E:SILENCER:DIA3



U001	U002	U003	U004	U005	U006	U007	U008	U009	U010	U011	U012	U013	U014	U015	U016	U017	U018
------	------	------	------	------	------	------	------	------	------	------	------	------	------	------	------	------	------

U005_S007
SUPPORTER:RIGHT:NO.2:ASS'Y

95.D1492924
STOPPER:PAPER
TRAY

91.D1492903
SUPPORTER:RIGHT:
T:NO.2:ASSY

3.04543006Q
(x3)
TAPPING SCREW -
M3X6

94.D1492923
ROLLER:SUPPORT
ER:PAPER TRAY

9.08050103
RETAINING RINGS
-E:SILENCER:DIA3

U001	U002	U003	U004	U005	U006	U007	U008	U009	U010	U011	U012	U013	U014	U015	U016	U017	U018
------	------	------	------	------	------	------	------	------	------	------	------	------	------	------	------	------	------

U005_S008
 LEVER:STRETCH:PAPER TRAY:ASS'Y

128.D2412943 102.D1492964
 TENSION SPRING: LEVER:LOCK:PAW
 LEVER:AUXILIARY L

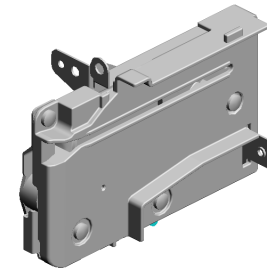

127.D2412906
 LEVER:STRETCH:
 PAPER TRAY:ASS'
 Y

1.03530040N
 (x5)
 SCREW - M3X4

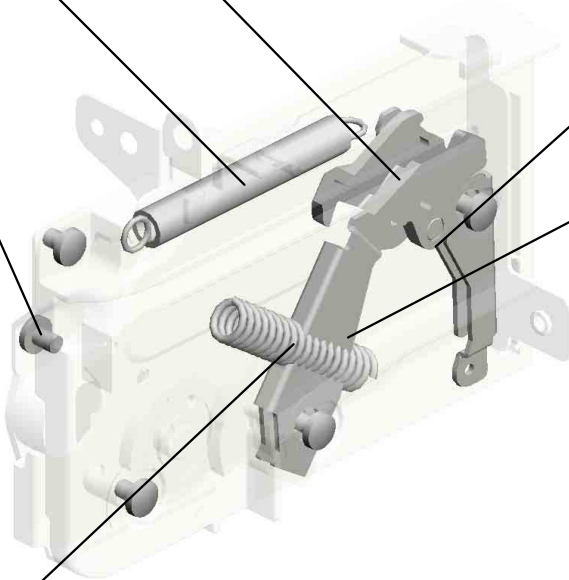

103.D1492965
 LEVER:STRETCH:
 COIL SPRING



101.D1492961
 LEVER:STRETCH:
 PEEN



55.D1482942
 TENSION SPRING:
 LEVER

U001	U002	U003	U004	U005	U006	U007	U008	U009	U010	U011	U012	U013	U014	U015	U016	U017	U018
------	------	------	------	------	------	------	------	------	------	------	------	------	------	------	------	------	------

U005_S009
 LEVER:STRETCH:PAPER TRAY:ASS'Y

128.D2412943 102.D1492964
 TENSION SPRING: LEVER:LOCK:PAW
 LEVER:AUXILIARY L

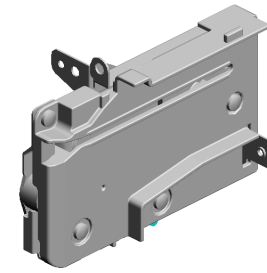

127.D2412906
 LEVER:STRETCH:
 PAPER TRAY:ASS'
 Y

1.03530040N
 (x5)
 SCREW - M3X4

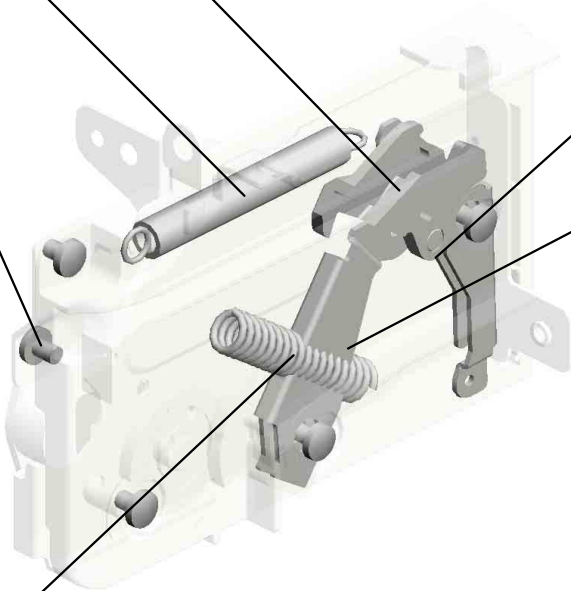

103.D1492965
 LEVER:STRETCH:
 COIL SPRING



101.D1492961
 LEVER:STRETCH:
 PEEN



55.D1482942
 TENSION SPRING:
 LEVER

U001	U002	U003	U004	U005	U006	U007	U008	U009	U010	U011	U012	U013	U014	U015	U016	U017	U018
------	------	------	------	------	------	------	------	------	------	------	------	------	------	------	------	------	------

U006.PCDU

U006_S003
D0BN2226
PCDU:M:IMC4500-6000

U006_S004
D0BN2227
PCDU:Y:IMC4500-6000

U006_S001
D0BN2224
PCDU:K:IMC3000-6000

U006_S002
D0BN2225
PCDU:C:IMC4500-6000

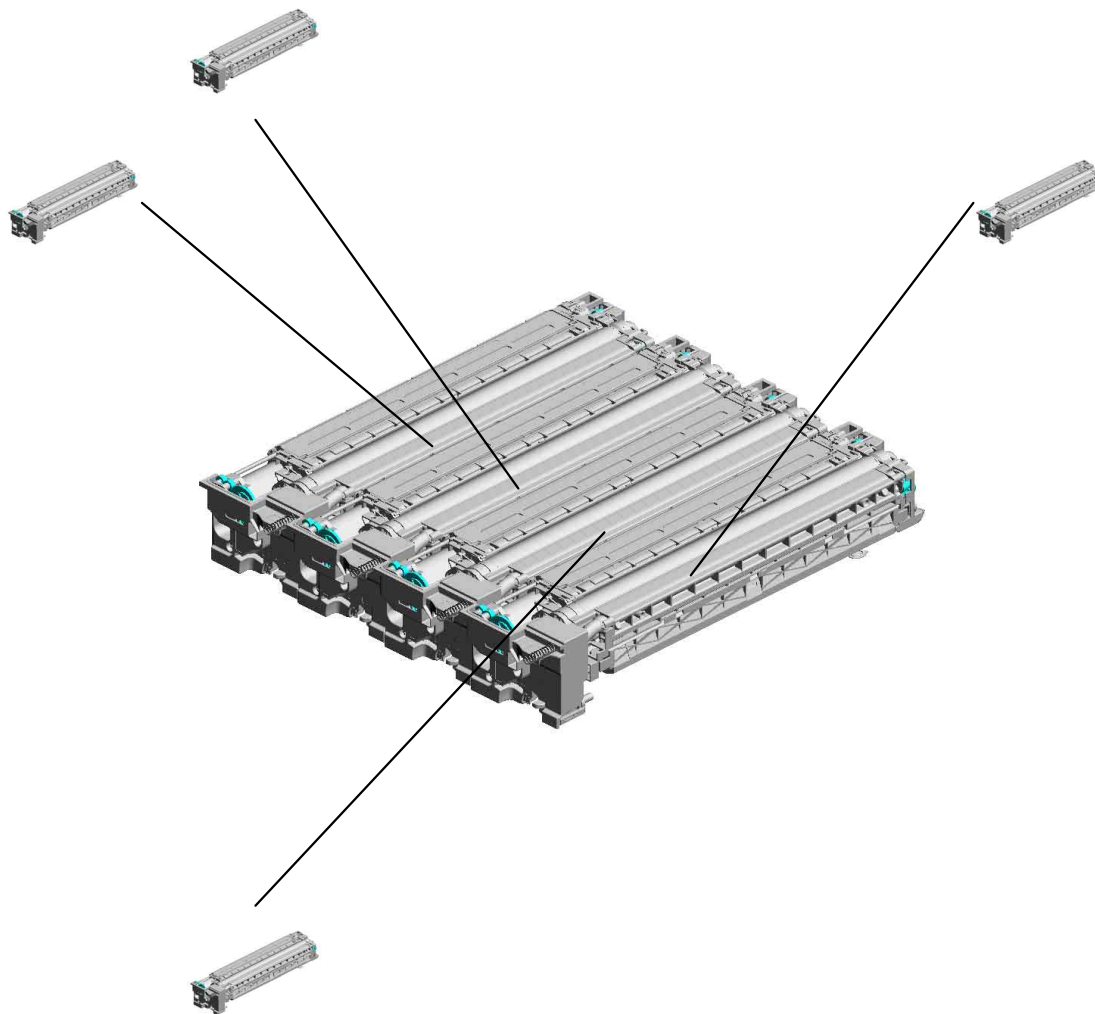

U001	U002	U003	U004	U005	U006	U007	U008	U009	U010	U011	U012	U013	U014	U015	U016	U017	U018
------	------	------	------	------	-------------	------	------	------	------	------	------	------	------	------	------	------	------

U006_S001.PCDU:K:IMC3000-6000

U006_S001_S002
D0BQ3000
DEVELOPMENT UNIT:K:IMC3
000-6000

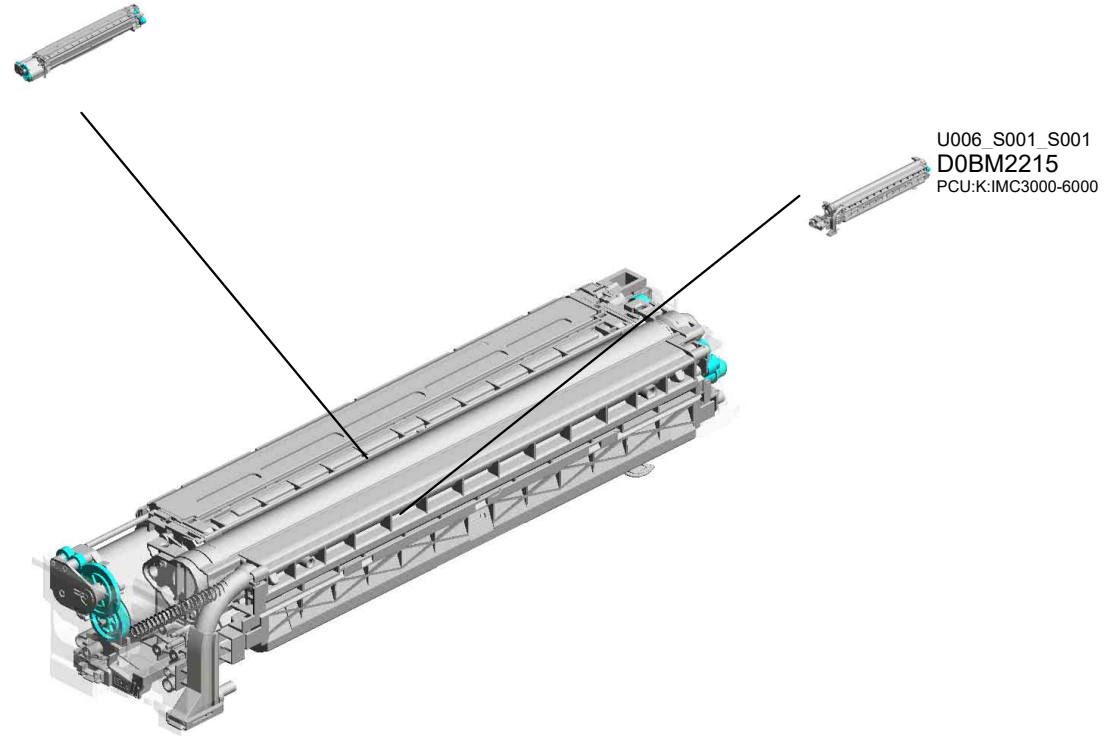

U001	U002	U003	U004	U005	U006	U007	U008	U009	U010	U011	U012	U013	U014	U015	U016	U017	U018
------	------	------	------	------	-------------	------	------	------	------	------	------	------	------	------	------	------	------

U006_S002.PCDU:C:IMC4500-6000

U006_S002_S002
D0BQ3001
DEVELOPMENT UNIT:C:IMC4
500-6000

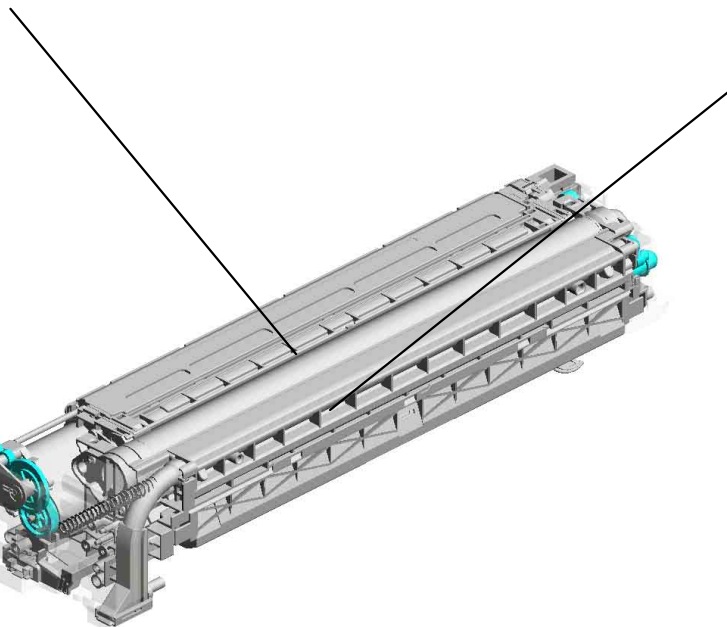
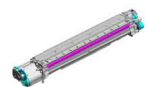

U006_S002_S001
D0BN2215
PCU:CMY:IMC4500-6000



U001	U002	U003	U004	U005	U006	U007	U008	U009	U010	U011	U012	U013	U014	U015	U016	U017	U018
------	------	------	------	------	-------------	------	------	------	------	------	------	------	------	------	------	------	------

U006_S003.PCDU:M:IMC4500-6000

U006 S003 S002
D0BQ3002
DEVELOPMENT UNIT:M:IMC
4500-6000

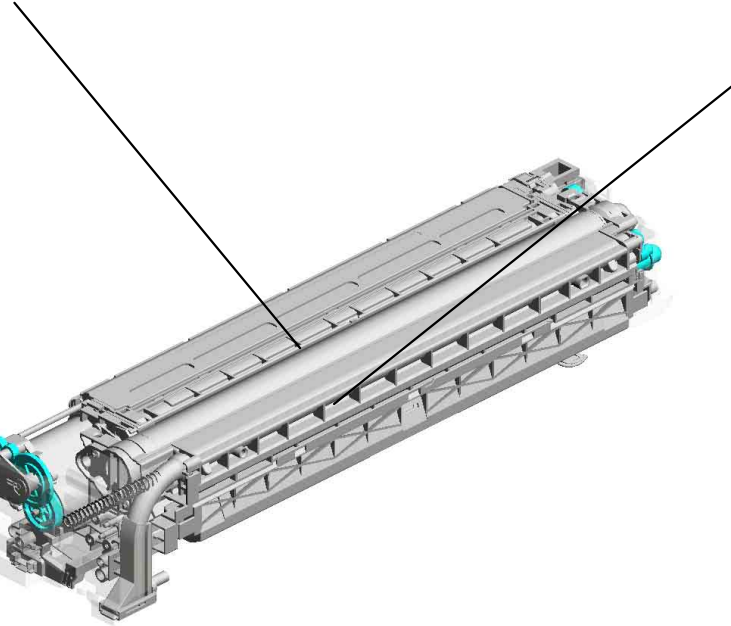
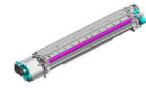

U006_S003_S001
D0BN2215
PCU:CMY:IMC4500-6000

U001	U002	U003	U004	U005	U006	U007	U008	U009	U010	U011	U012	U013	U014	U015	U016	U017	U018
------	------	------	------	------	-------------	------	------	------	------	------	------	------	------	------	------	------	------

U006_S004.PCDU:Y:IMC4500-6000

U006 S004 S002
D0BQ3003
DEVELOPMENT UNIT:Y:IMC4
500-6000

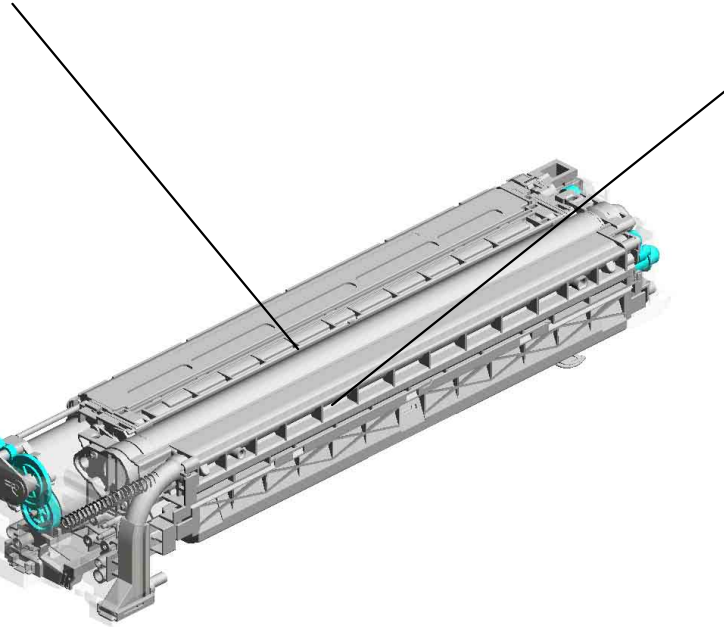
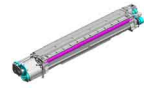

U006_S004_S001
D0BN2215
PCU:CMY:IMC4500-6000



U001	U002	U003	U004	U005	U006	U007	U008	U009	U010	U011	U012	U013	U014	U015	U016	U017	U018
------	------	------	------	------	-------------	------	------	------	------	------	------	------	------	------	------	------	------

U006
PCDU

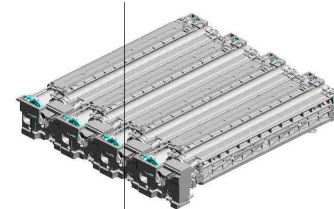

U001	U002	U003	U004	U005	U006	U007	U008	U009	U010	U011	U012	U013	U014	U015	U016	U017	U018
------	------	------	------	------	------	------	------	------	------	------	------	------	------	------	------	------	------

U006_S001
PCDU:K:IMC3000-6000

20.GA003993 3.04583010N
DECAL:LEVER:FIX (x2)
HEXAGON HEAD TAPPING SCREW:3X10

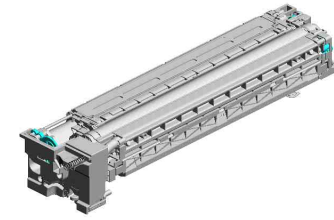

12.D0BN2224
PCDU:K:IMC3000-6000



5.04593010N
BINDING HEAD TAPPING SCREW:3X10

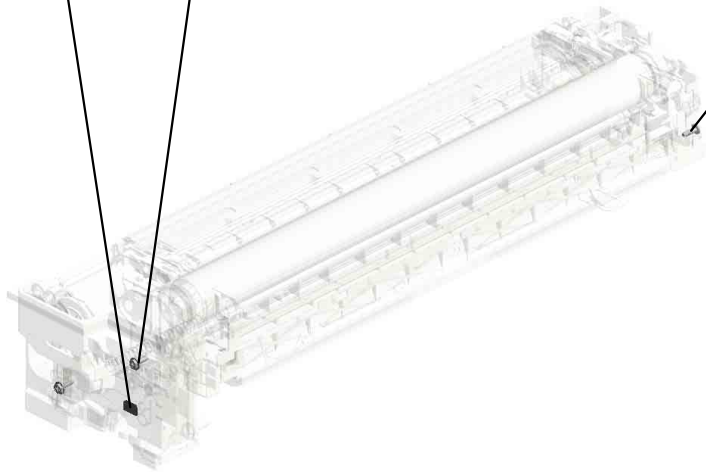

U001	U002	U003	U004	U005	U006	U007	U008	U009	U010	U011	U012	U013	U014	U015	U016	U017	U018
------	------	------	------	------	-------------	------	------	------	------	------	------	------	------	------	------	------	------

U006_S001_S001
PCU:K:IMC3000-6000

5.04593010N
(x15)
BINDING HEAD TA
PPING SCREW:3X
10

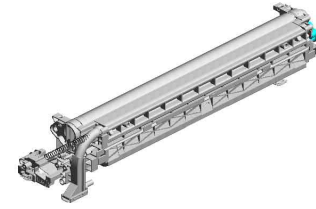

10.D0BM2215
PCU:K:IMC3000-60
00



6.07200030E
RETAINING RING -
M3



U001	U002	U003	U004	U005	U006	U007	U008	U009	U010	U011	U012	U013	U014	U015	U016	U017	U018
------	------	------	------	------	-------------	------	------	------	------	------	------	------	------	------	------	------	------

2.04503008N TAPPING SCREW - M3X8
6.07200030E (x2) RETAINING RING - M3
8.08050100 RETAINING RING - M2.5



16.D0BQ3000
DEVELOPMENT U
NIT:K:IMC3000-600
0

7.07200040E
RETAINING RING -
M4

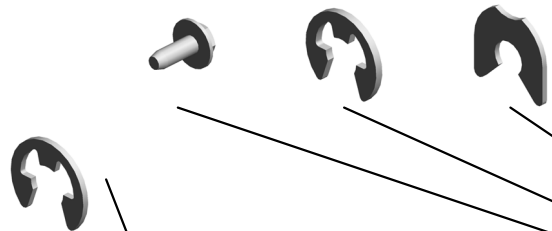

6.07200030E (x 3)
RETAINING RING - M3

9.08050103
RETAINING RINGS
-E-SILENCER:DIA3

4.04593008N
(x2)
BINDING HEAD TA
PPING SCREW:3X
8

1.03603006N
(x2)
SCREW - M3X6

U001	U002	U003	U004	U005	U006	U007	U008	U009	U010	U011	U012	U013	U014	U015	U016	U017	U018
------	------	------	------	------	-------------	------	------	------	------	------	------	------	------	------	------	------	------

U006_S002
PCDU:C:IMC4500-6000

3.04583010N 20.GA003993
(x2) DECAL:LEVER:FIX
HEXAGON HEAD TAPPING SCREW:3X10

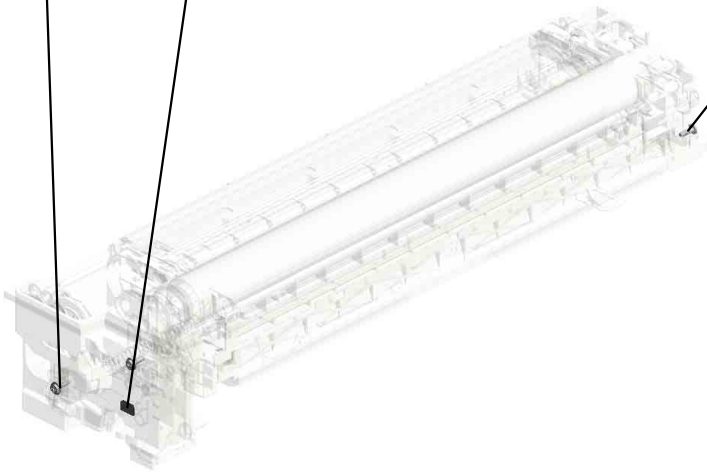

5.04593010N
BINDING HEAD TAPPING SCREW:3X10

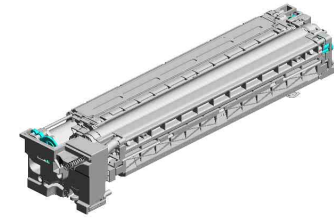

13.D0BN2225
PCDU:C:IMC4500-6000

U001	U002	U003	U004	U005	U006	U007	U008	U009	U010	U011	U012	U013	U014	U015	U016	U017	U018
------	------	------	------	------	-------------	------	------	------	------	------	------	------	------	------	------	------	------

U006_S002_S001
PCU:CMY:IMC4500-6000

5.04593010N
(x15)
BINDING HEAD TA
PPING SCREW:3X
10

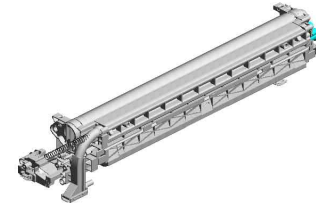

11.D0BN2215
PCU:CMY:IMC4500
-6000



6.07200030E
RETAINING RING -
M3



U001	U002	U003	U004	U005	U006	U007	U008	U009	U010	U011	U012	U013	U014	U015	U016	U017	U018
------	------	------	------	------	-------------	------	------	------	------	------	------	------	------	------	------	------	------

- 2.04503008N TAPPING SCREW - M3X8
- 6.07200030E (x2) RETAINING RING - M3
- 8.08050100 RETAINING RING - M2.5

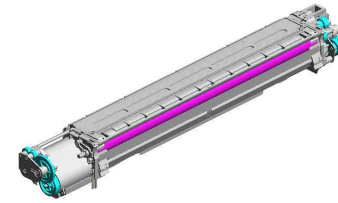

17.D0BQ3001
DEVELOPMENT U
NIT:C:IMC4500-600
0

7.07200040E
RETAINING RING -
M4

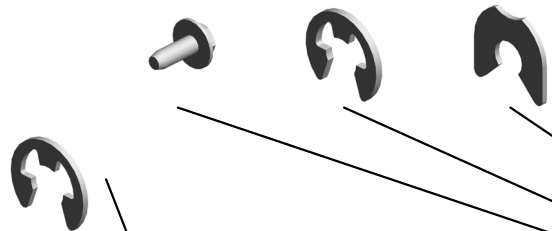

6.07200030E (x 3)
RETAINING RING - M3

9.08050103
RETAINING RINGS
-E-SILENCER:DIA3



4.04593008N
(x2)
BINDING HEAD TA
PPING SCREW:3X
8

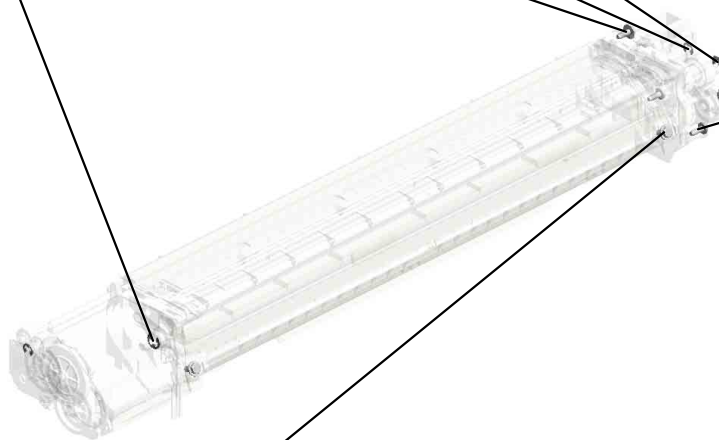

1.03603006N
(x2)
SCREW - M3X6



U001	U002	U003	U004	U005	U006	U007	U008	U009	U010	U011	U012	U013	U014	U015	U016	U017	U018
------	------	------	------	------	------	------	------	------	------	------	------	------	------	------	------	------	------

U006_S003
PCDU:M:IMC4500-6000

20.GA003993 3.04583010N
DECAL:LEVER:FIX (x2)
HEXAGON HEAD TAPPING SCREW:3X10

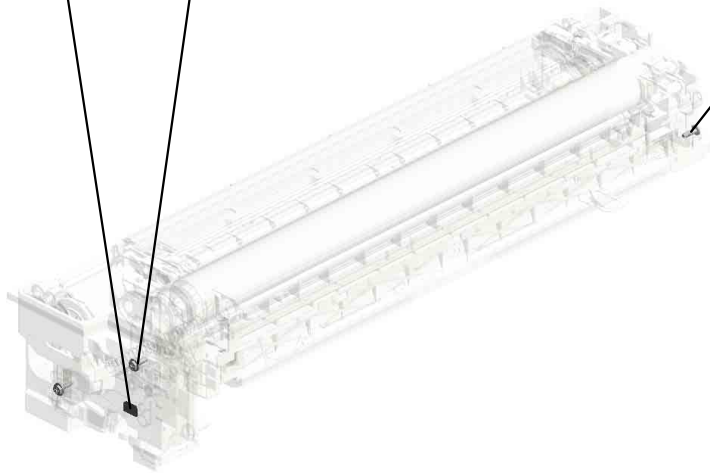

5.04593010N
BINDING HEAD TAPPING SCREW:3X10

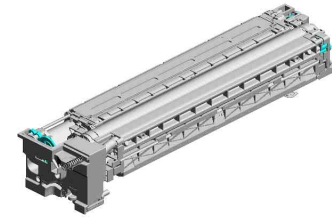

14.D0BN2226
PCDU:M:IMC4500-6000

U001	U002	U003	U004	U005	U006	U007	U008	U009	U010	U011	U012	U013	U014	U015	U016	U017	U018
------	------	------	------	------	-------------	------	------	------	------	------	------	------	------	------	------	------	------

U006_S003_S001
PCU:CMY:IMC4500-6000

5.04593010N
(x15)
BINDING HEAD TA
PPING SCREW:3X
10

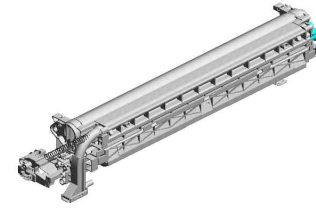

11.D0BN2215
PCU:CMY:IMC4500
-6000



6.07200030E
RETAINING RING -
M3



U001	U002	U003	U004	U005	U006	U007	U008	U009	U010	U011	U012	U013	U014	U015	U016	U017	U018
------	------	------	------	------	-------------	------	------	------	------	------	------	------	------	------	------	------	------

2.04503008N TAPPING SCREW - M3X8
6.07200030E (x2) RETAINING RING - M3
8.08050100 RETAINING RING - M2.5

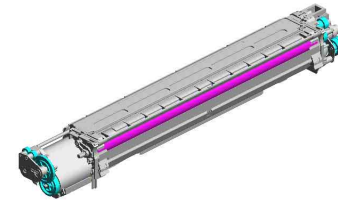

18.D0BQ3002
DEVELOPMENT U
NIT:M:IMC4500-600
0

7.07200040E
RETAINING RING -
M4

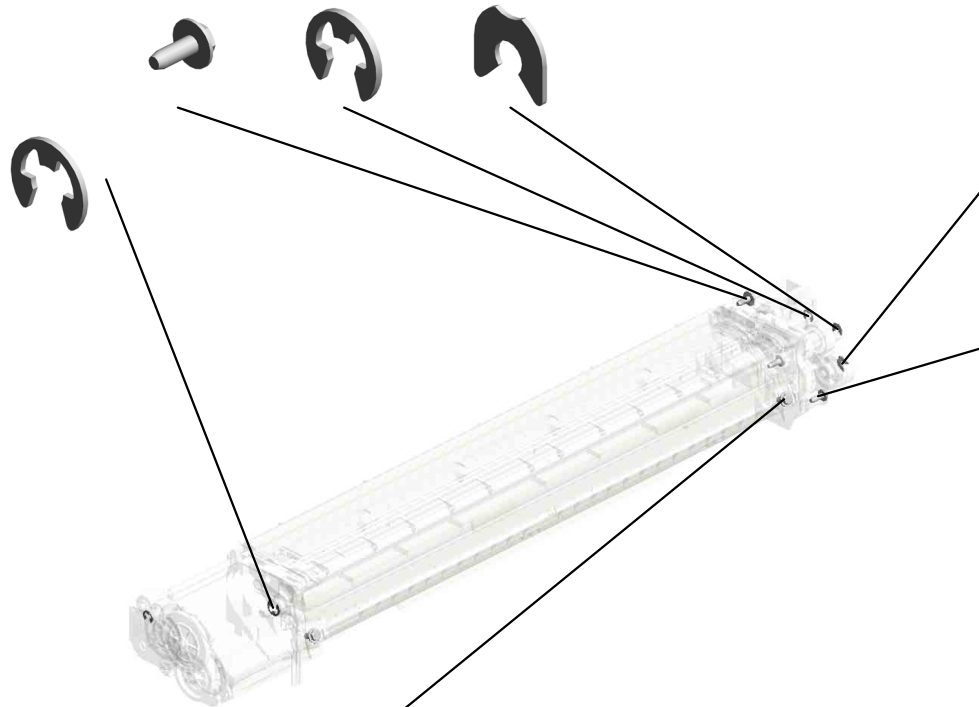

9.08050103
RETAINING RINGS
-E-SILENCER:DIA3

6.07200030E (x 3)
RETAINING RING - M3

4.04593008N
(x2)
BINDING HEAD TA
PPING SCREW:3X
8

1.03603006N
(x2)
SCREW - M3X6

U001	U002	U003	U004	U005	U006	U007	U008	U009	U010	U011	U012	U013	U014	U015	U016	U017	U018
------	------	------	------	------	-------------	------	------	------	------	------	------	------	------	------	------	------	------

U006_S004
PCDU:Y:IMC4500-6000

20.GA003993 3.04583010N
DECAL:LEVER:FIX (x2)
HEXAGON HEAD TAPPING SCREW:3X10

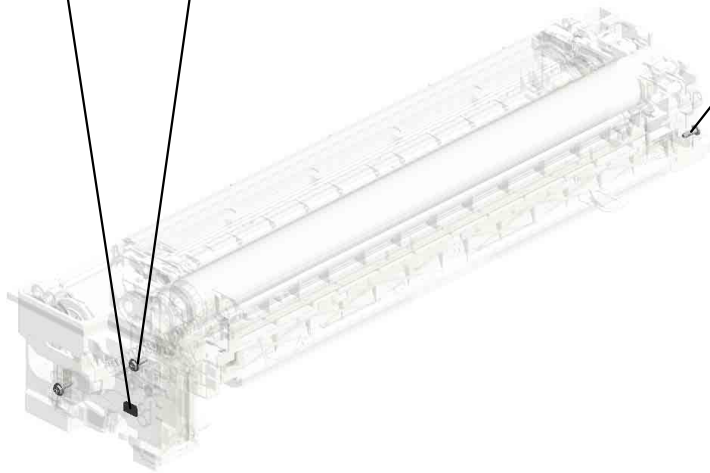

5.04593010N
BINDING HEAD TAPPING SCREW:3X10

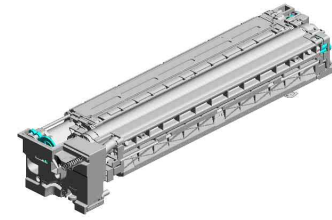

15.D0BN2227
PCDU:Y:IMC4500-6000

U001	U002	U003	U004	U005	U006	U007	U008	U009	U010	U011	U012	U013	U014	U015	U016	U017	U018
------	------	------	------	------	-------------	------	------	------	------	------	------	------	------	------	------	------	------

U006_S004_S001
PCU:CMY:IMC4500-6000

5.04593010N
(x15)
BINDING HEAD TA
PPING SCREW:3X
10

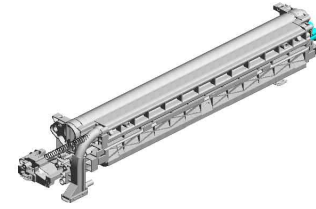

11.D0BN2215
PCU:CMY:IMC4500
-6000



6.07200030E
RETAINING RING -
M3



U001	U002	U003	U004	U005	U006	U007	U008	U009	U010	U011	U012	U013	U014	U015	U016	U017	U018
------	------	------	------	------	-------------	------	------	------	------	------	------	------	------	------	------	------	------

2.04503008N TAPPING SCREW - M3X8
6.07200030E (x2) RETAINING RING - M3
8.08050100 RETAINING RING - M2.5

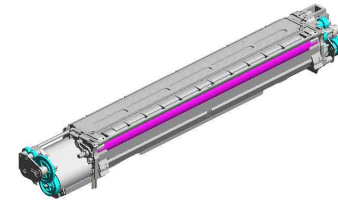

19.D0BQ3003
DEVELOPMENT U
NIT:Y:IMC4500-600
0

7.07200040E
RETAINING RING -
M4

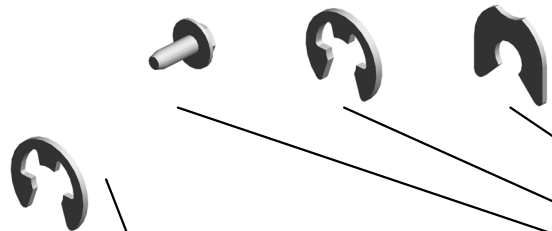

6.07200030E (x 3)
RETAINING RING - M3

9.08050103
RETAINING RINGS
-E-SILENCER:DIA3

4.04593008N
(x2)
BINDING HEAD TA
PPING SCREW:3X
8

1.03603006N
(x2)
SCREW - M3X6

U001	U002	U003	U004	U005	U006	U007	U008	U009	U010	U011	U012	U013	U014	U015	U016	U017	U018
------	------	------	------	------	-------------	------	------	------	------	------	------	------	------	------	------	------	------

U007.DEVELOPMENT

U007_S011
D0BQ3219
DRIVE UNIT:TONER BOTTLE
:ASSY

U007_S006
D0BQ3288
TRANSPORT SCREW:NOZZL
E:CMY:ASSY

U007_S010
D0BQ3219
DRIVE UNIT:TONER BOTTLE
:ASSY

U007_S008
D0BQ3288
TRANSPORT SCREW:NOZZL
E:CMY:ASSY

U007_S012
D0BQ3219
DRIVE UNIT:TONER BOTTLE
:ASSY

U007_S004
D0BQ3310
TONER HOPPER:TONER SU
PPLY:Y:ASSY

U007_S005
D0BQ3287
TRANSPORT SCREW:NOZZL
E:BK:ASSY

U007_S003
D0BQ3280
TONER HOPPER:TONER SU
PPLY:M:ASSY

U007_S001
D0BQ3240
TONER HOPPER:TONER SU
PPLY:BK:ASSY

U007_S009
D1493256
BASE:TONER HOPPER:REA
R:ASSY

U007_S002
D0BQ3270
TONER HOPPER:TONER SU
PPLY:C:ASSY

U007_S007
D0BQ3288
TRANSPORT SCREW:NOZZL
E:CMY:ASSY

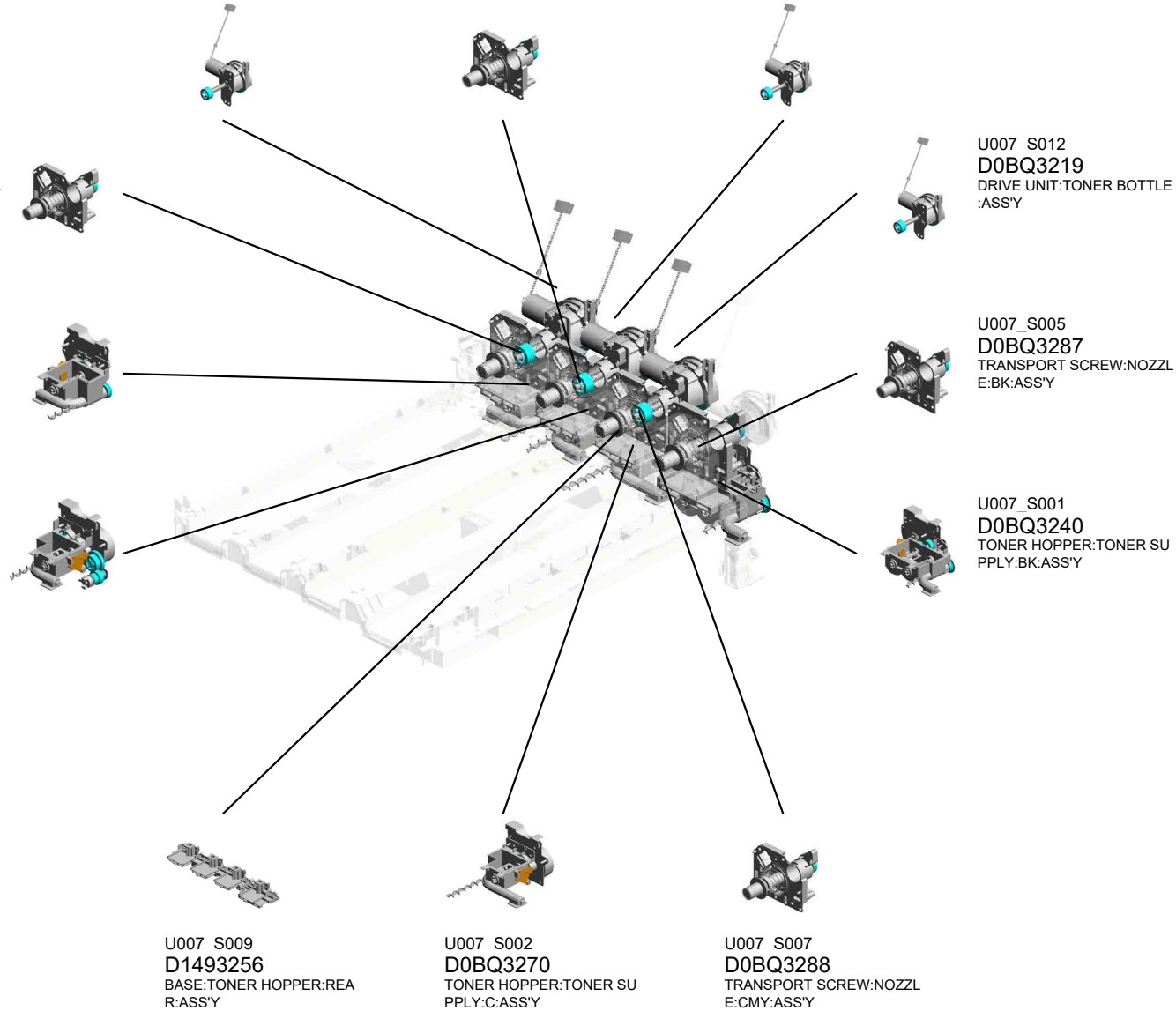

U001	U002	U003	U004	U005	U006	U007	U008	U009	U010	U011	U012	U013	U014	U015	U016	U017	U018
------	------	------	------	------	------	------	------	------	------	------	------	------	------	------	------	------	------

U007.DEVELOPMENT

U007_S016
D1473282
HOUSING:TONER CARTRID
GE:CMY:ASS'Y

U007_S015
D1473282
HOUSING:TONER CARTRID
GE:CMY:ASS'Y

U007_S017
D1473282
HOUSING:TONER CARTRID
GE:CMY:ASS'Y

U007_S013
D0BQ3219
DRIVE UNIT:TONER BOTTLE
:ASS'Y

U007_S014
D1473281
HOUSING:TONER CARTRID
GE:BK:ASS'Y

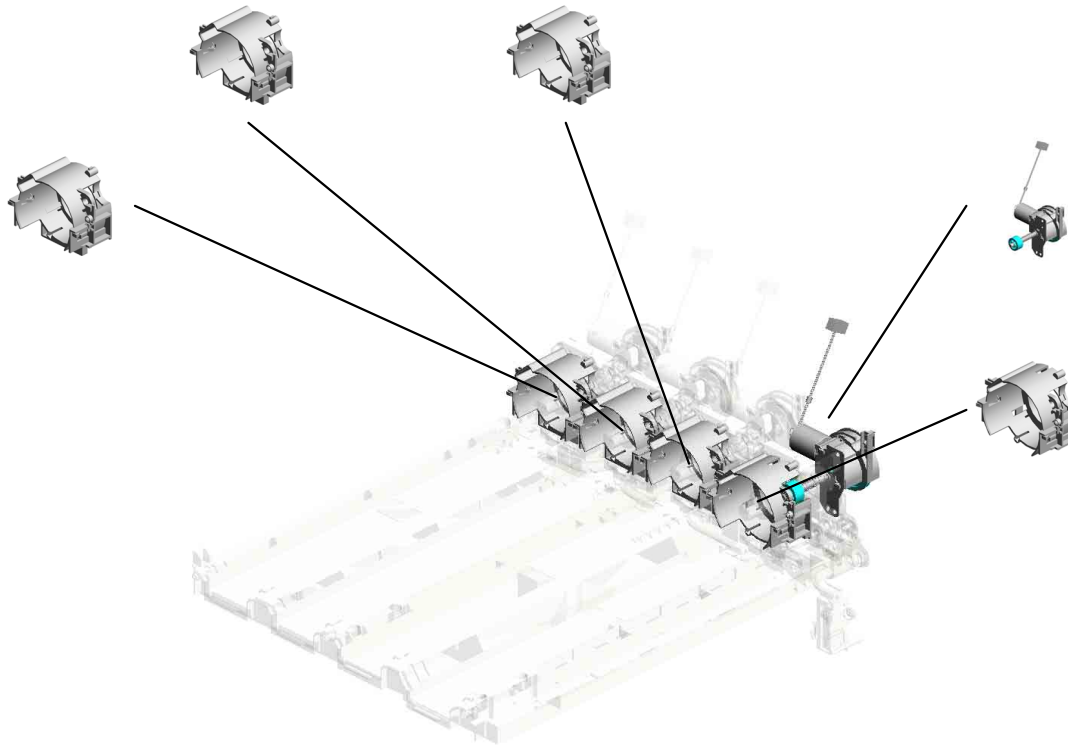

U001	U002	U003	U004	U005	U006	U007	U008	U009	U010	U011	U012	U013	U014	U015	U016	U017	U018
------	------	------	------	------	------	------	------	------	------	------	------	------	------	------	------	------	------

U007_S010.DRIVE UNIT:TONER BOTTLE:ASS'Y

U007 S010 S001
D1493210
DC MOTOR:TONER BOTTLE:
ASS'Y:5.28W:BRUSH:(M11/M
12/M13/M14)

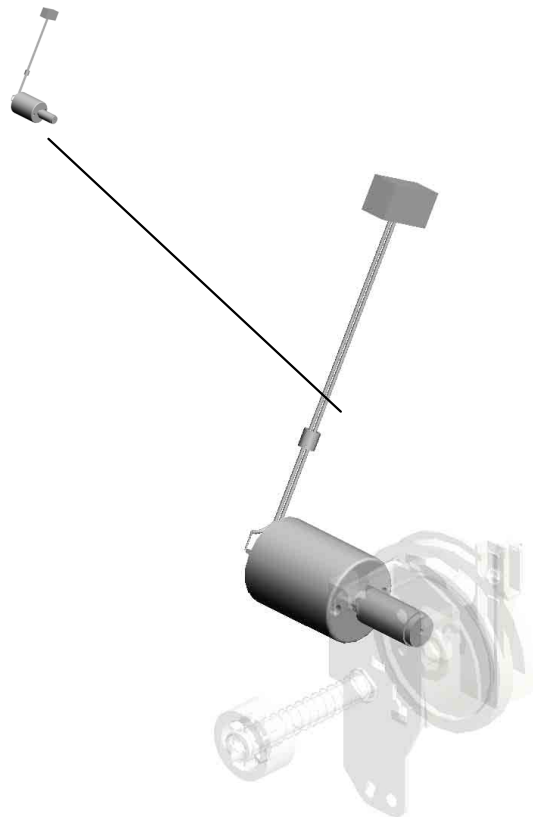

U001	U002	U003	U004	U005	U006	U007	U008	U009	U010	U011	U012	U013	U014	U015	U016	U017	U018
------	------	------	------	------	------	------	------	------	------	------	------	------	------	------	------	------	------

U007_S011.DRIVE UNIT:TONER BOTTLE:ASS'Y

U007 S011 S001
D1493210
DC MOTOR:TONER BOTTLE:
ASS'Y:5.28W:BRUSH:(M11/M
12/M13/M14)

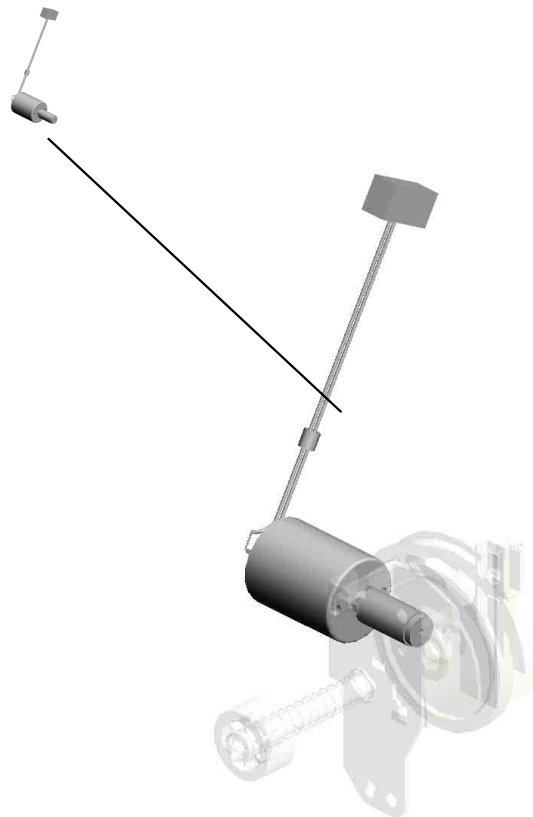

U001	U002	U003	U004	U005	U006	U007	U008	U009	U010	U011	U012	U013	U014	U015	U016	U017	U018
------	------	------	------	------	------	------	------	------	------	------	------	------	------	------	------	------	------

U007_S012.DRIVE UNIT:TONER BOTTLE:ASS'Y

U007 S012 S001
D1493210
DC MOTOR:TONER BOTTLE:
ASS'Y:5.28W:BRUSH:(M11/M
12/M13/M14)

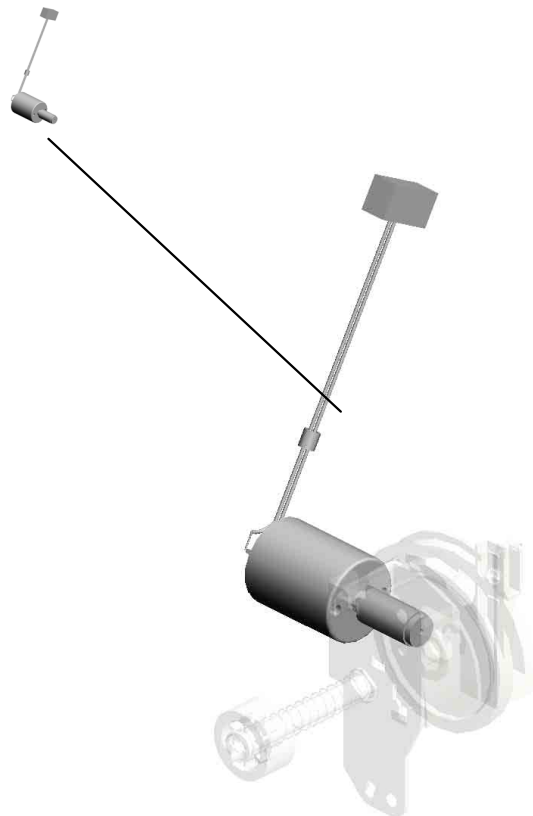

U001	U002	U003	U004	U005	U006	U007	U008	U009	U010	U011	U012	U013	U014	U015	U016	U017	U018
------	------	------	------	------	------	------	------	------	------	------	------	------	------	------	------	------	------

U007_S013.DRIVE UNIT:TONER BOTTLE:ASS'Y

U007 S013 S001
D1493210
DC MOTOR:TONER BOTTLE:
ASS'Y:5.28W:BRUSH:(M11/M
12/M13/M14)

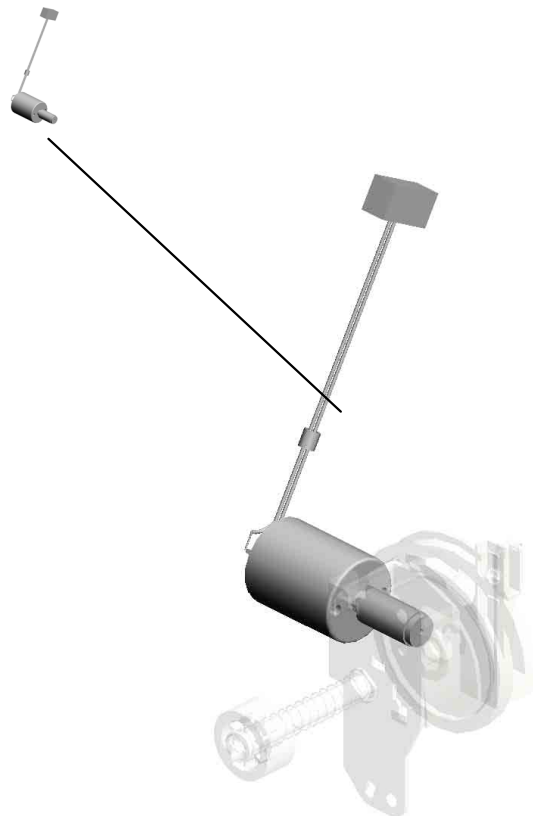

U001	U002	U003	U004	U005	U006	U007	U008	U009	U010	U011	U012	U013	U014	U015	U016	U017	U018
------	------	------	------	------	------	------	------	------	------	------	------	------	------	------	------	------	------

U007 DEVELOPMENT

21.D0BQ5172 (x4) PCB:TCB:(PCB3/PCB4/PCB5/PCB6)
 3.04583008N (x35) HEXAGON HEAD TAPPING SCREW:3X8
 30.D1493331 COVER:GEAR:TONER SUPPLY SUB-UNIT
 8.11050488 HARNESS CLAMP

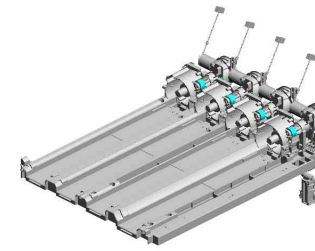

29.D1493330 (x4) SEAL:CONNECTOR:CARTRIDGE:TONER SUPPLY

11.11050760 (x3) CLAMP:LWSM-0511A

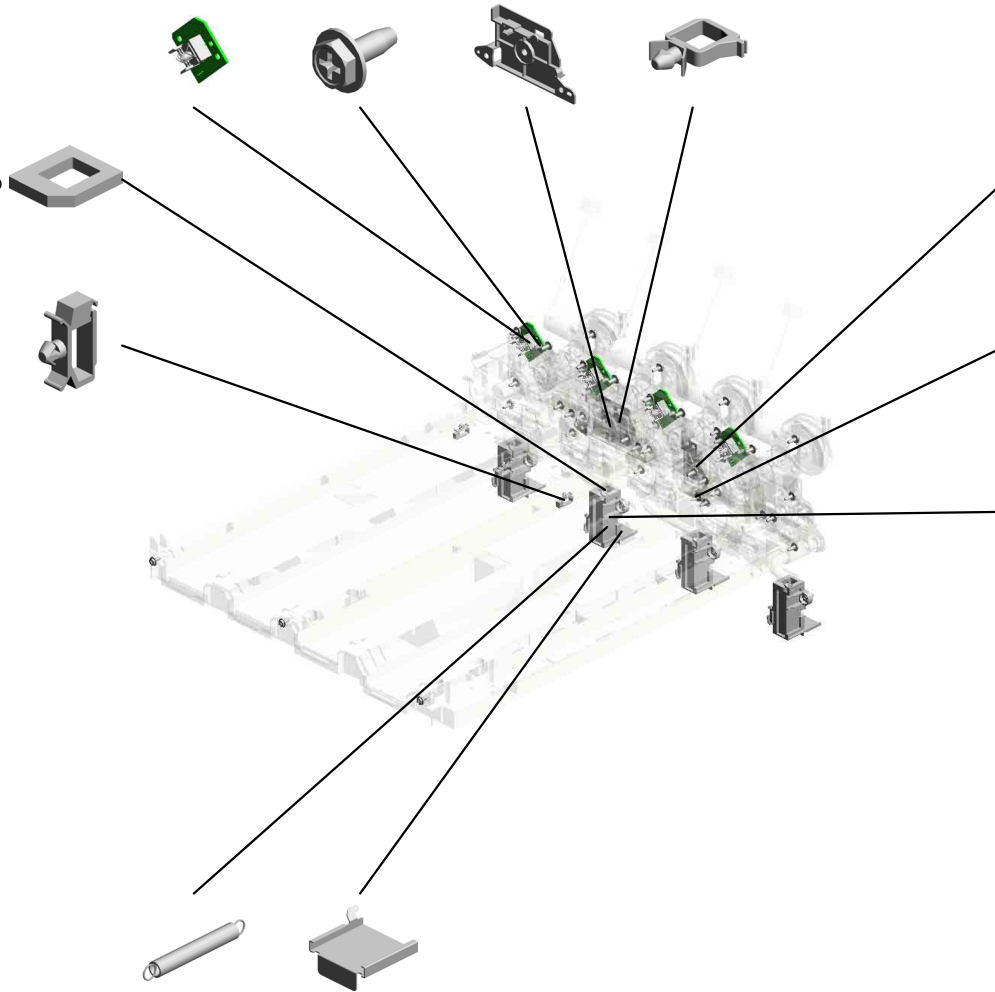

34.D2413336 COVER:GEAR:TONER SUPPLY SUB-UNIT:C

2.04543008Q (x18) TAPPING SCREW:3X8

27.D1493321 (x4) DUCT:VERTICAL TRANSPORT:TONE R SUPPLY

13.B2233241 (x4) SPRING:SHUTTER:PUMP UNIT
 28.D1493322 (x4) SHUTTER:DUCT:TONER SUPPLY

U001	U002	U003	U004	U005	U006	U007	U008	U009	U010	U011	U012	U013	U014	U015	U016	U017	U018
------	------	------	------	------	------	------	------	------	------	------	------	------	------	------	------	------	------

U007_S001
 TONER HOPPER:TONER SUPPLY:BK:ASS'Y

3-04583008N 1-03530030N 4-04583010N
 HEXAGON HEAD TAPPING SCREW:3 X8 (x2) SCREW:M3X3 (x3) HEXAGON HEAD TAPPING SCREW:3 X10

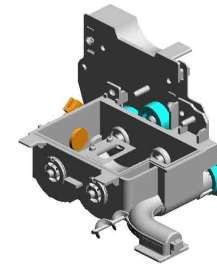

15.D0BQ3240
 TONER HOPPER:TONER SUPPLY:BK:ASS'Y

35.GW230008
 TONER END SENSOR:
 (S28/S29/S30/S31)

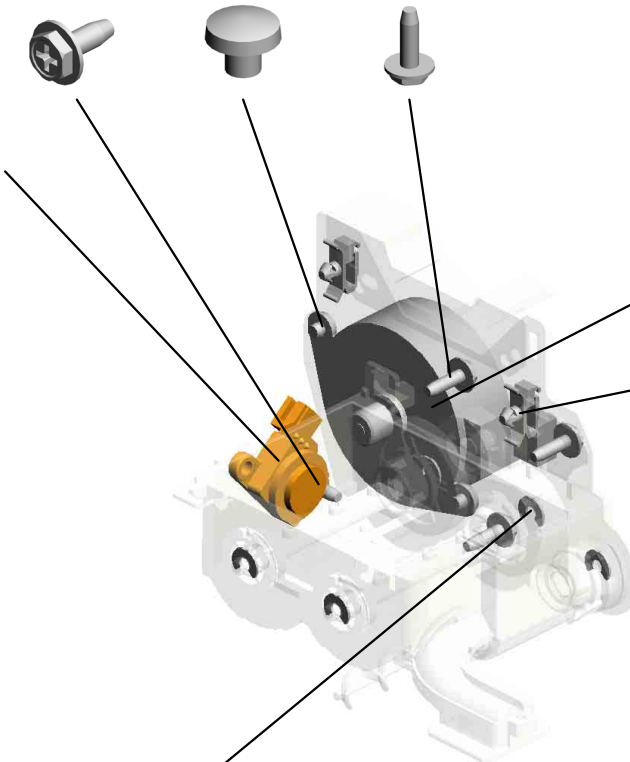

32.D1493350
 DC STEPPER MOTOR:
 (TONER SUPPLY:
 M19/M20/M22)



9.11050758
 (x2)
 CLAMP:LWSM-030
 6A



6-08050103
 (x5)
 RETAINING RINGS
 -E:SILENCER:DIA3

U001	U002	U003	U004	U005	U006	U007	U008	U009	U010	U011	U012	U013	U014	U015	U016	U017	U018
------	------	------	------	------	------	------	------	------	------	------	------	------	------	------	------	------	------

U007_S002
 TONER HOPPER:TONER SUPPLY:C:ASS'Y

6.08050103 (x3)
 RETAINING RINGS
 -E:SILENCER:DIA3

1.03530030N (x2)
 SCREW:M3X3

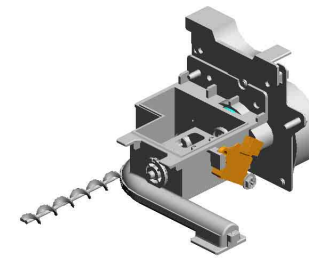

16.D0BQ3270
 TONER HOPPER:T
 ONER SUPPLY:C:A
 SS'Y

4.04583010N (x3)
 HEXAGON HEAD T
 APPING SCREW:3
 X10

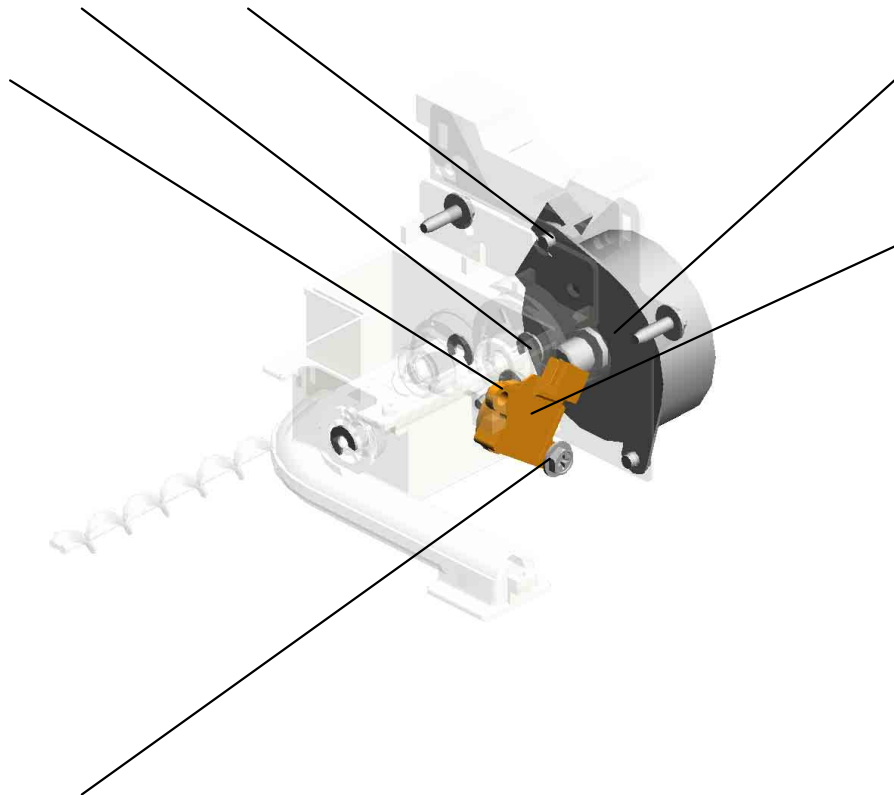

32.D1493350
 DC STEPPER MOT
 OR:TONER SUPPL
 Y:(M19/M20/M22)



35.GW230008
 TONER END SENS
 OR:(S28/S29/S30/S
 31)



3.04583008N
 HEXAGON HEAD T
 APPING SCREW:3
 X8

U001	U002	U003	U004	U005	U006	U007	U008	U009	U010	U011	U012	U013	U014	U015	U016	U017	U018
------	------	------	------	------	------	------	------	------	------	------	------	------	------	------	------	------	------

U007_S003
 TONER HOPPER:TONER SUPPLY:M:ASS'Y

6.08050103 (x4)
 RETAINING RINGS
 -E:SILENCER:DIA3

1.03530030N (x2)
 SCREW:M3X3

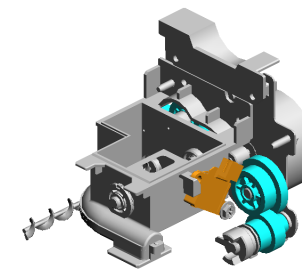

17.D0BQ3280
 TONER HOPPER:T
 ONER SUPPLY:M:A
 SS'Y

4.04583010N (x3)
 HEXAGON HEAD T
 APPING SCREW:3
 X10



35.GW230008
 TONER END SENS
 OR:(S28/S29/S30/S
 31)

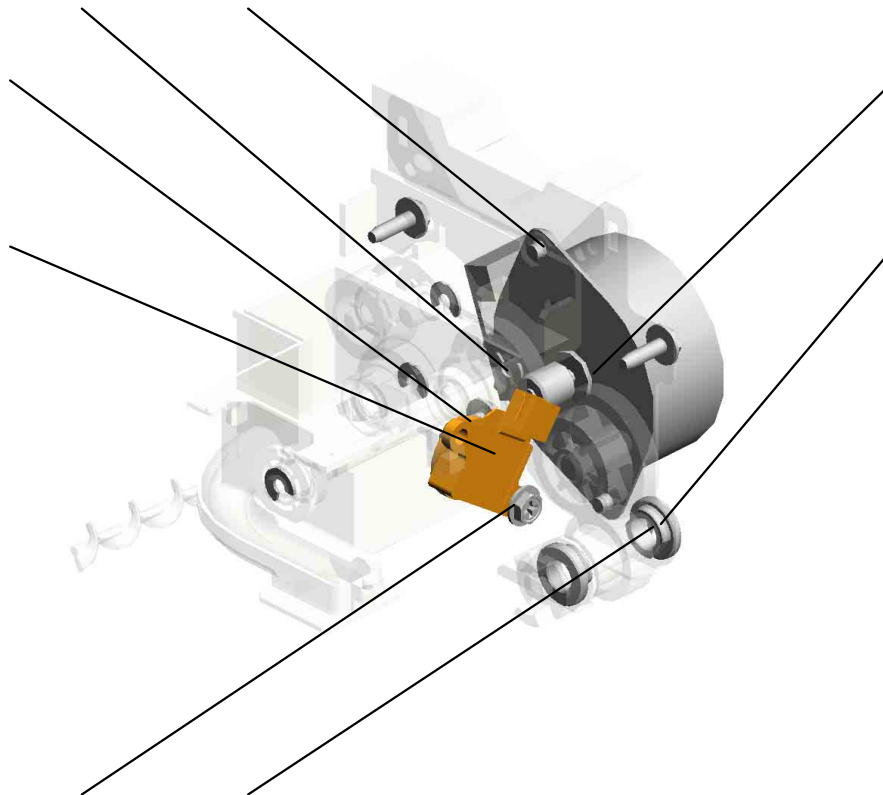

33.D1496318
 DC STEPPER MOT
 OR:ON-OFF:(M21)



5.07200040E
 RETAINING RING -
 M4



3.04583008N
 HEXAGON HEAD T
 APPING SCREW:3
 X8



31.D1493343 (x2)
 COLLAR:TONER S
 UPPLY



U001	U002	U003	U004	U005	U006	U007	U008	U009	U010	U011	U012	U013	U014	U015	U016	U017	U018
------	------	------	------	------	------	------	------	------	------	------	------	------	------	------	------	------	------

U007_S004
 TONER HOPPER:TONER SUPPLY:Y:ASS'Y

35.GW230008 1.03530030N
 TONER END SENS (x2)
 OR:(S28/S29/S30/S SCREW:M3X3
 31)

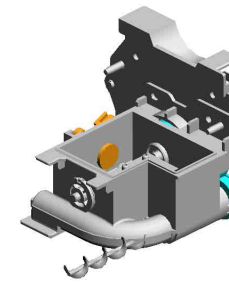

20.D0BQ3310
 TONER HOPPER:T
 ONER SUPPLY:Y:A
 SS'Y

3.04583008N
 HEXAGON HEAD T
 APPING SCREW:3
 X8



32.D1493350
 DC STEPPER MOT
 OR:TONER SUPPL
 Y:(M19/M20/M22)



4.04583010N
 (x3)
 HEXAGON HEAD T
 APPING SCREW:3
 X10

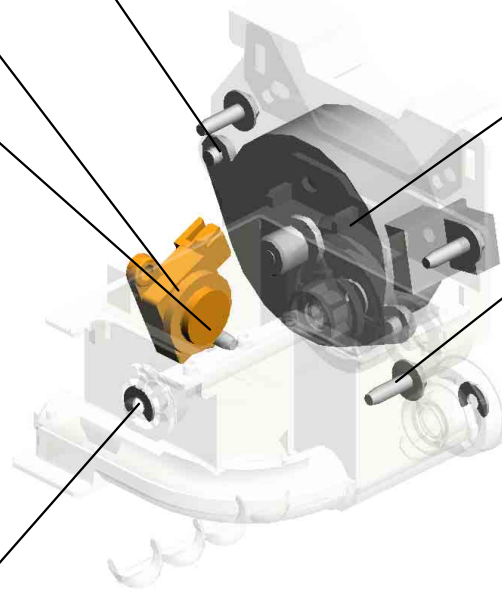

6.08050103
 (x3)
 RETAINING RINGS
 -E:SILENCER:DIA3



U001	U002	U003	U004	U005	U006	U007	U008	U009	U010	U011	U012	U013	U014	U015	U016	U017	U018
------	------	------	------	------	------	------	------	------	------	------	------	------	------	------	------	------	------

U007_S005
TRANSPORT SCREW:NOZZLE:BK:ASS'Y

10.11050759
CLAMP:LWSM-060
5A

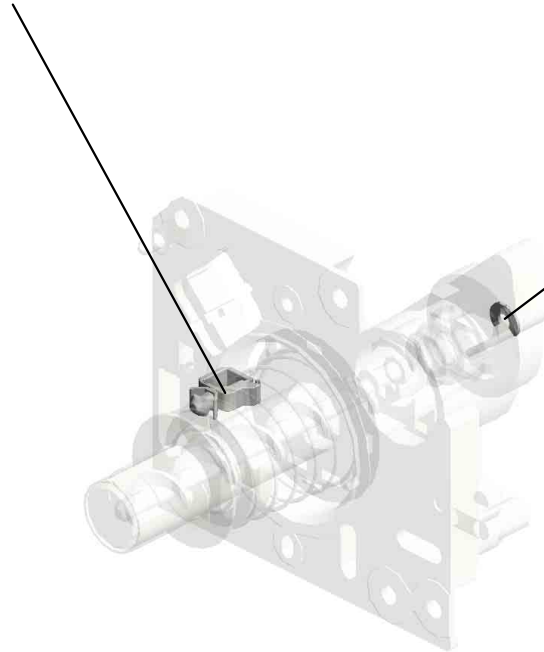
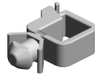

6.08050103
RETAINING RINGS
-E-SILENCER:DIA3

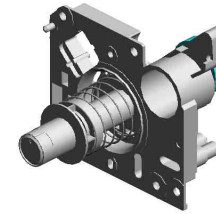

18.D0BQ3287
TRANSPORT SCR
EW:NOZZLE:BK:AS
SY

U001	U002	U003	U004	U005	U006	U007	U008	U009	U010	U011	U012	U013	U014	U015	U016	U017	U018
------	------	------	------	------	------	------	------	------	------	------	------	------	------	------	------	------	------

U007_S006
TRANSPORT SCREW:NOZZLE:CMY:ASS'Y

10.11050759
CLAMP:LWSM-060
5A

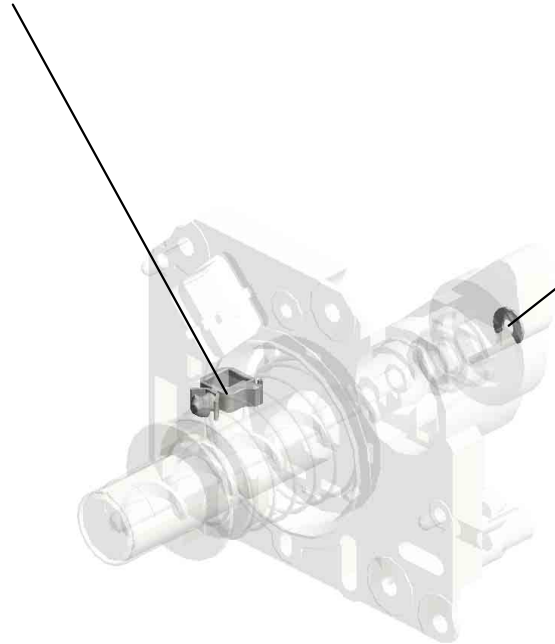
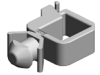

6.08050103
RETAINING RINGS
-E:SILENCER:DIA3

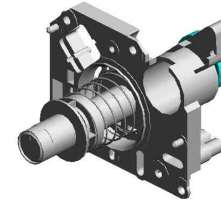

19.D0BQ3288
TRANSPORT SCR
EW:NOZZLE:CMY:
ASS'Y

U001	U002	U003	U004	U005	U006	U007	U008	U009	U010	U011	U012	U013	U014	U015	U016	U017	U018
------	------	------	------	------	------	------	------	------	------	------	------	------	------	------	------	------	------

U007_S007
TRANSPORT SCREW:NOZZLE:CMY:ASS'Y

10.11050759
CLAMP:LWSM-060
5A

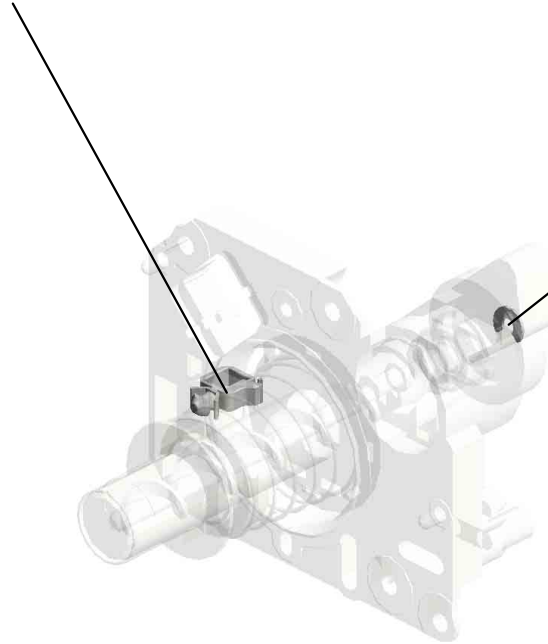

6.08050103
RETAINING RINGS
-E-SILENCER:DIA3

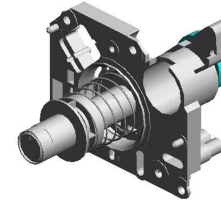

19.D0BQ3288
TRANSPORT SCR
EW:NOZZLE:CMY:
ASS'Y

U001	U002	U003	U004	U005	U006	U007	U008	U009	U010	U011	U012	U013	U014	U015	U016	U017	U018
------	------	------	------	------	------	------	------	------	------	------	------	------	------	------	------	------	------

U007_S008
TRANSPORT SCREW:NOZZLE:CMY:ASS'Y

10.11050759
CLAMP:LWSM-060
5A

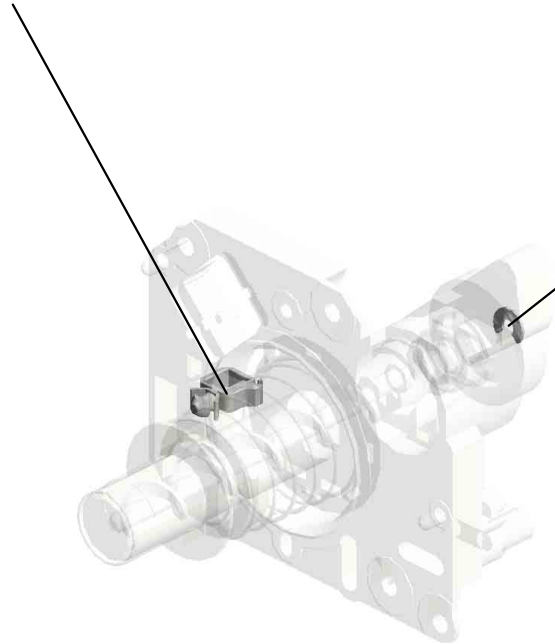

6.08050103
RETAINING RINGS
-E-SILENCER:DIA3

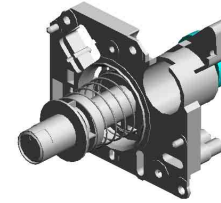

19.D0BQ3288
TRANSPORT SCR
EW:NOZZLE:CMY:
ASS'Y

U001	U002	U003	U004	U005	U006	U007	U008	U009	U010	U011	U012	U013	U014	U015	U016	U017	U018
------	------	------	------	------	------	------	------	------	------	------	------	------	------	------	------	------	------

U007_S009
BASE:TONER HOPPER:REAR:ASS'Y

11.11050760
(x4)
CLAMP:LWSM-051
1A

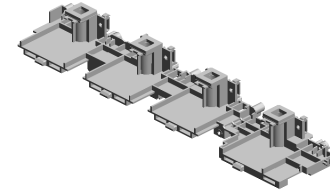

26.D1493256
BASE:TONER HOP
PER:REAR:ASS'Y

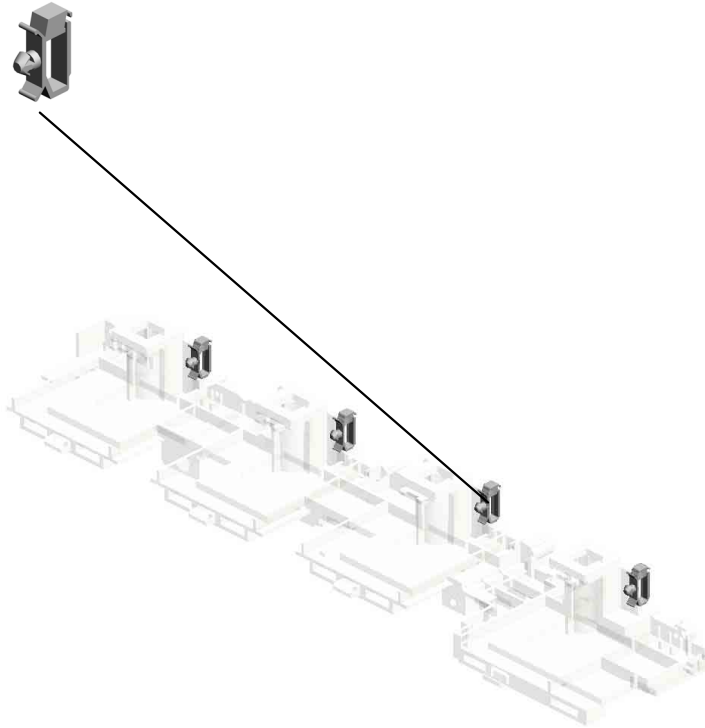

U001	U002	U003	U004	U005	U006	U007	U008	U009	U010	U011	U012	U013	U014	U015	U016	U017	U018
------	------	------	------	------	------	------	------	------	------	------	------	------	------	------	------	------	------

U007_S010
DRIVE UNIT:TONER BOTTLE:ASS'Y

1-03530030N
(x2)
SCREW:M3X3



14.D0BQ3219
DRIVE UNIT:TONER
BOTTLE:ASS'Y

5-07200040E
(x2)
RETAINING RING -
M4



12-11050762
CLAMP:LWS-0711A



31-D1493343
(x2)
COLLAR:TONER S
UPPLY



U001	U002	U003	U004	U005	U006	U007	U008	U009	U010	U011	U012	U013	U014	U015	U016	U017	U018
------	------	------	------	------	------	------	------	------	------	------	------	------	------	------	------	------	------

U007_S010_S001
DC MOTOR:TONE R BOTTLE:ASS'Y:5.28W:BRUSH:(M11/M12/M13/M14)



25.D1493210
DC MOTOR:TONE
R BOTTLE:ASS'Y:5.
28W:BRUSH:(M11/
M12/M13/M14)



7.11050046
HARNESS BAND

U001	U002	U003	U004	U005	U006	U007	U008	U009	U010	U011	U012	U013	U014	U015	U016	U017	U018
------	------	------	------	------	------	------	------	------	------	------	------	------	------	------	------	------	------

U007_S011
DRIVE UNIT:TONER BOTTLE:ASS'Y

1.03530030N
(x2)
SCREW:M3X3

5.07200040E
(x2)
RETAINING RING -
M4

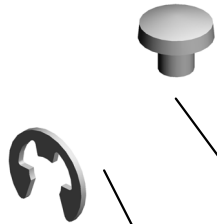

12.11050762
CLAMP:LWS-0711A



31.D1493343
(x2)
COLLAR:TONER S
UPPLY



14.D0BQ3219
DRIVE UNIT:TONER
BOTTLE:ASS'Y

U001	U002	U003	U004	U005	U006	U007	U008	U009	U010	U011	U012	U013	U014	U015	U016	U017	U018
------	------	------	------	------	------	------	------	------	------	------	------	------	------	------	------	------	------

U007_S011_S001
DC MOTOR:TONE R BOTTLE:ASS'Y:5.28W:BRUSH:(M11/M12/M13/M14)



25.D1493210
DC MOTOR:TONE
R BOTTLE:ASS'Y:5.
28W:BRUSH:(M11/
M12/M13/M14)



7.11050046
HARNESS BAND

U001	U002	U003	U004	U005	U006	U007	U008	U009	U010	U011	U012	U013	U014	U015	U016	U017	U018
------	------	------	------	------	------	------	------	------	------	------	------	------	------	------	------	------	------

U007_S012
DRIVE UNIT:TONER BOTTLE:ASS'Y

1-03530030N
(x2)
SCREW:M3X3



14.D0BQ3219
DRIVE UNIT:TONER
BOTTLE:ASS'Y

5-07200040E
(x2)
RETAINING RING -
M4



12-11050762
CLAMP:LWS-0711A



31-D1493343
(x2)
COLLAR:TONER S
UPPLY



U001	U002	U003	U004	U005	U006	U007	U008	U009	U010	U011	U012	U013	U014	U015	U016	U017	U018
------	------	------	------	------	------	------	------	------	------	------	------	------	------	------	------	------	------

U007_S012_S001
DC MOTOR:TONE R BOTTLE:ASS'Y:5.28W:BRUSH:(M11/M12/M13/M14)



25.D1493210
DC MOTOR:TONE
R BOTTLE:ASS'Y:5.
28W:BRUSH:(M11/
M12/M13/M14)



7.11050046
HARNESS BAND

U001	U002	U003	U004	U005	U006	U007	U008	U009	U010	U011	U012	U013	U014	U015	U016	U017	U018
------	------	------	------	------	------	------	------	------	------	------	------	------	------	------	------	------	------

U007_S013
DRIVE UNIT:TONER BOTTLE:ASS'Y

1-03530030N
(x2)
SCREW:M3X3



14.D0BQ3219
DRIVE UNIT:TONER
BOTTLE:ASS'Y

5-07200040E
(x2)
RETAINING RING -
M4



12-11050762
CLAMP:LWS-0711A



31-D1493343
(x2)
COLLAR:TONER S
UPPLY



U001	U002	U003	U004	U005	U006	U007	U008	U009	U010	U011	U012	U013	U014	U015	U016	U017	U018
------	------	------	------	------	------	------	------	------	------	------	------	------	------	------	------	------	------

U007_S013_S001
DC MOTOR:TONE R BOTTLE:ASS'Y:5.28W:BRUSH:(M11/M12/M13/M14)



25.D1493210
DC MOTOR:TONE
R BOTTLE:ASS'Y:5.
28W:BRUSH:(M11/
M12/M13/M14)



7.11050046
HARNESS BAND

U001	U002	U003	U004	U005	U006	U007	U008	U009	U010	U011	U012	U013	U014	U015	U016	U017	U018
------	------	------	------	------	------	------	------	------	------	------	------	------	------	------	------	------	------

U007_S014
HOUSING:TONER CARTRIDGE:BK:ASS'Y

31.D1493343
COLLAR:TONER SUPPLY

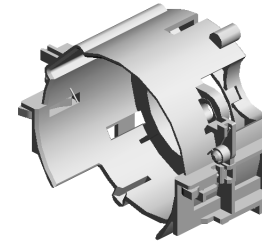

22.D1473281
HOUSING:TONER
CARTRIDGE:BK:AS
SY

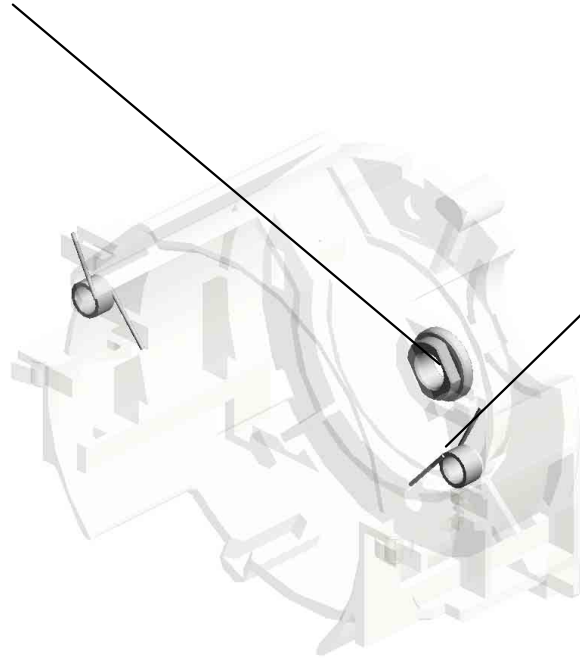

24.D1473325
(x2)
TORSION SPRING:
STOPPER:TONER
CARTRIDGE:4.8N



U001	U002	U003	U004	U005	U006	U007	U008	U009	U010	U011	U012	U013	U014	U015	U016	U017	U018
------	------	------	------	------	------	------	------	------	------	------	------	------	------	------	------	------	------

U007_S015
HOUSING:TONER CARTRIDGE:CMY:ASS'Y

31.D1493343
COLLAR:TONER S
UPPLY

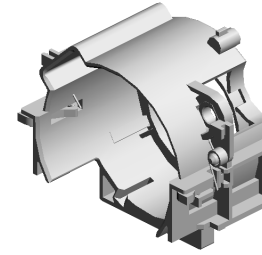

23.D1473282
HOUSING:TONER
CARTRIDGE:CMY:
ASS'Y

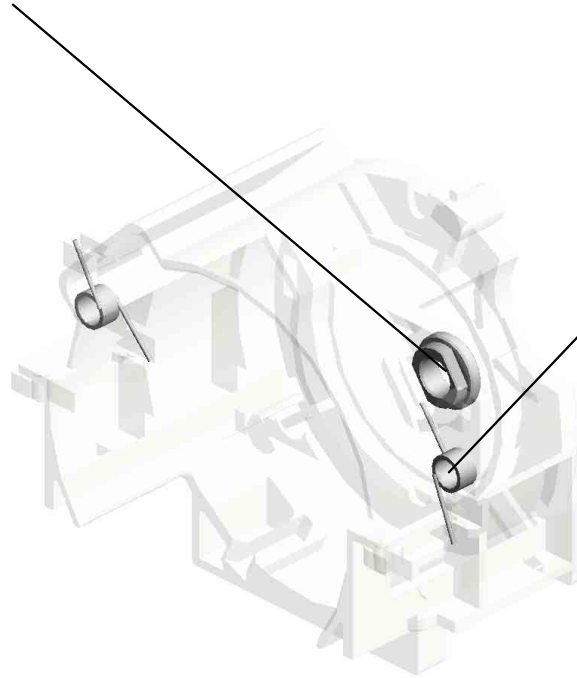

24.D1473325
(x2)
TORSION SPRING:
STOPPER:TONER
CARTRIDGE:4.8N

U001	U002	U003	U004	U005	U006	U007	U008	U009	U010	U011	U012	U013	U014	U015	U016	U017	U018
------	------	------	------	------	------	------	------	------	------	------	------	------	------	------	------	------	------

U007_S016
HOUSING:TONER CARTRIDGE:CMY:ASS'Y

31.D1493343
COLLAR:TONER S
UPPLY

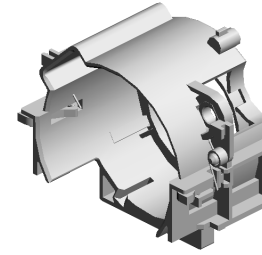

23.D1473282
HOUSING:TONER
CARTRIDGE:CMY:
ASS'Y

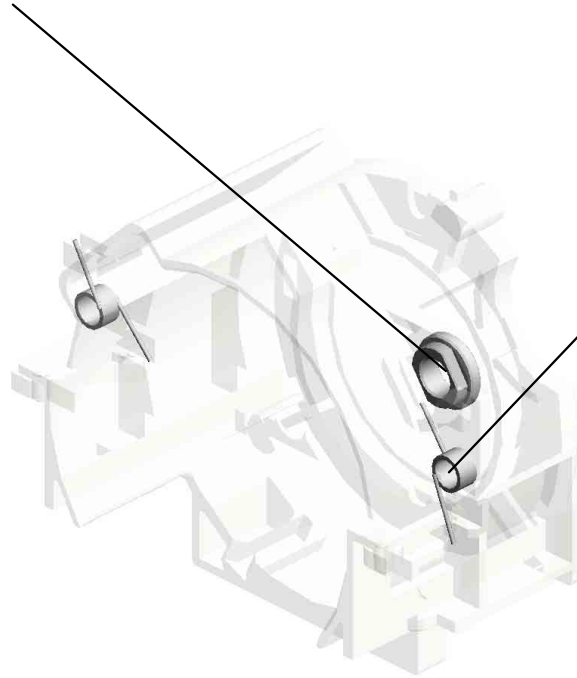

24.D1473325
(x2)
TORSION SPRING:
STOPPER:TONER
CARTRIDGE:4.8N

U001	U002	U003	U004	U005	U006	U007	U008	U009	U010	U011	U012	U013	U014	U015	U016	U017	U018
------	------	------	------	------	------	------	------	------	------	------	------	------	------	------	------	------	------

U007_S017
HOUSING:TONER CARTRIDGE:CMY:ASS'Y

31.D1493343
COLLAR:TONER S
UPPLY

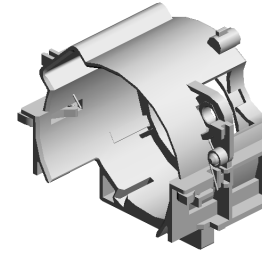

23.D1473282
HOUSING:TONER
CARTRIDGE:CMY:
ASS'Y

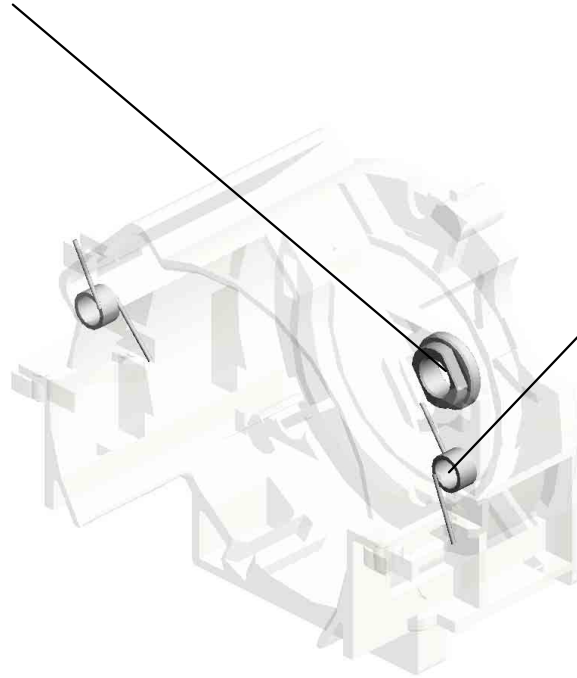

24.D1473325
(x2)
TORSION SPRING:
STOPPER:TONER
CARTRIDGE:4.8N

U001	U002	U003	U004	U005	U006	U007	U008	U009	U010	U011	U012	U013	U014	U015	U016	U017	U018
------	------	------	------	------	------	------	------	------	------	------	------	------	------	------	------	------	------

U008.ITB UNIT

U008 S001
D0BQ6005
TRANSFER UNIT:INTERMEDI
ATE TRANSFER:IMC2000-60
00

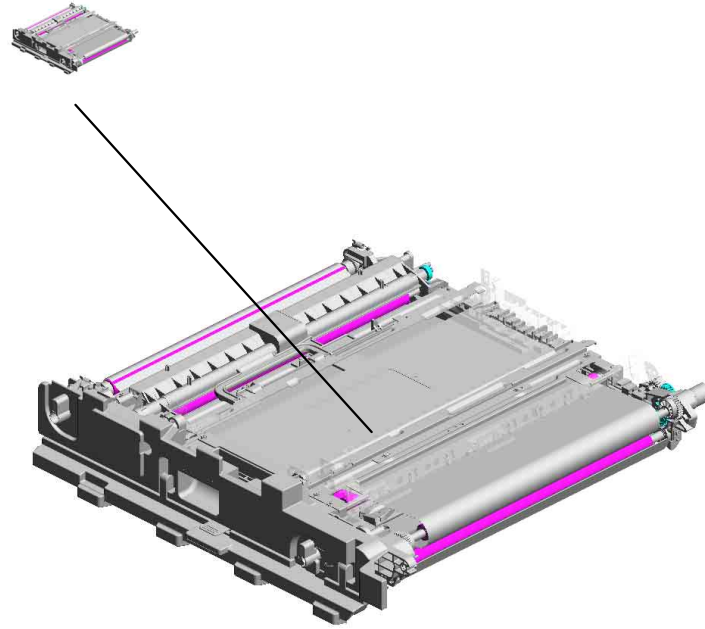

U001	U002	U003	U004	U005	U006	U007	U008	U009	U010	U011	U012	U013	U014	U015	U016	U017	U018
------	------	------	------	------	------	------	-------------	------	------	------	------	------	------	------	------	------	------

U008_S001.TRANSFER UNIT:INTERMEDIATE TRANSFER:IMC2000-6000

U008 S001 S003
M0AJ6175
TONER OUTLET UNIT:BELT
CLEANING:ASS'Y

U008 S001 S002
D0BQ6141
CLEANING UNIT:BELT CLEA
NING:ASS'Y

U008 S001 S001
D0BQ6001
TRANSFER UNIT:INTERMEDI
ATE TRANSFER:ASS'Y

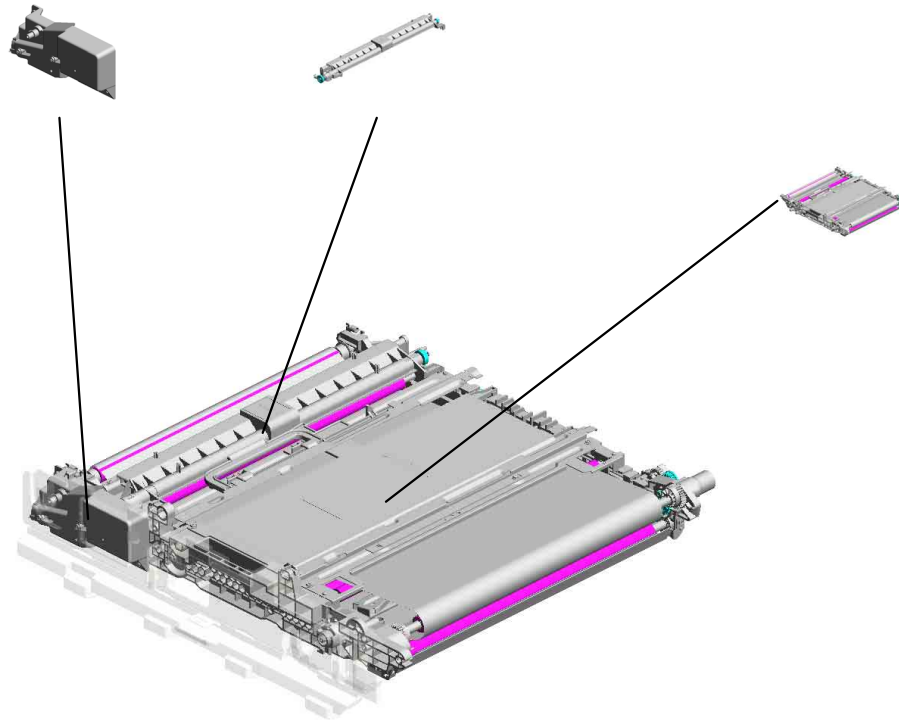

U001	U002	U003	U004	U005	U006	U007	U008	U009	U010	U011	U012	U013	U014	U015	U016	U017	U018
------	------	------	------	------	------	------	-------------	------	------	------	------	------	------	------	------	------	------

U008 ITB UNIT

21.D0BQ6311 GEAR:ON-OFF:COLLAR:OUTPUT:HS
 36.D1496309 SHAFT:ON-OFF:COLLAR:MAIN
 11.AA082101 (x2) BUSHING - 6X10X6
 37.D1496310 BRACKET:ON-OFF:COLLAR
 38.D1496312 JOINT:ON-OFF:COLLAR

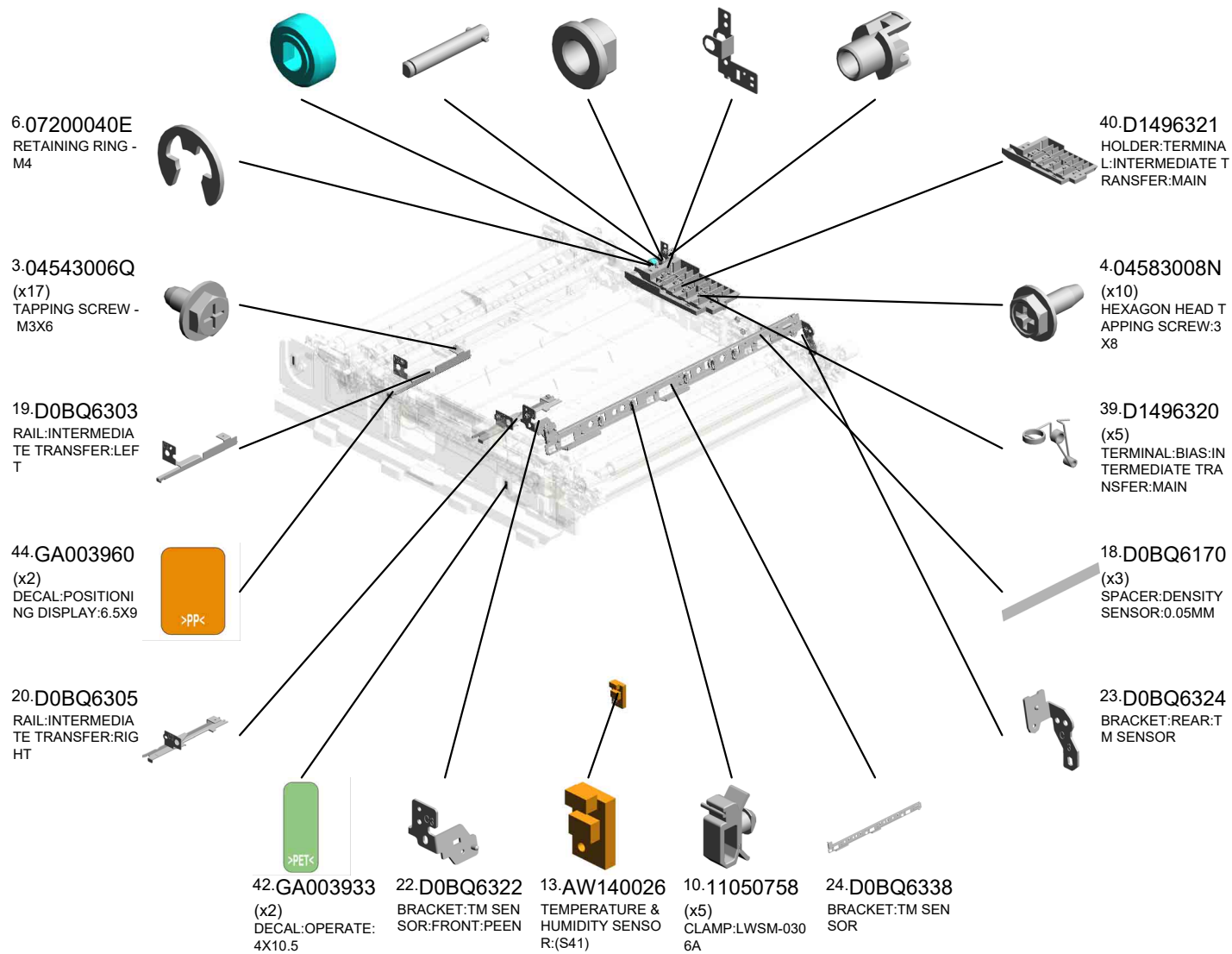
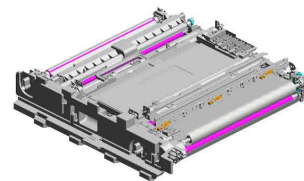

U008
ITB UNIT

47.GW010009
(x3)
DENSITY SENSOR:
(S48)

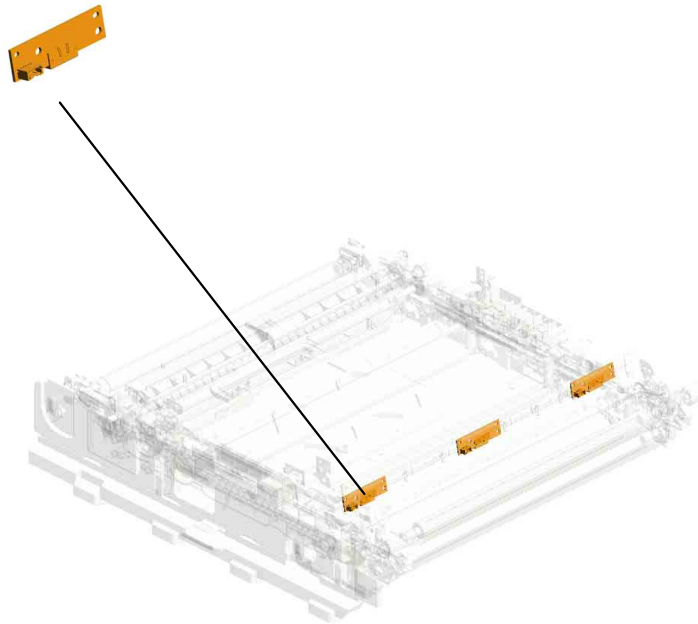
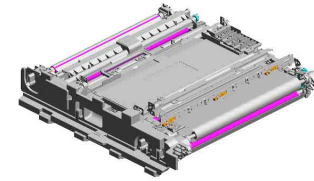

U001	U002	U003	U004	U005	U006	U007	U008	U009	U010	U011	U012	U013	U014	U015	U016	U017	U018
------	------	------	------	------	------	------	-------------	------	------	------	------	------	------	------	------	------	------

- 45.GA003993 (x2) DECAL:LEVER:FIX
- 25.D1175916 STEPPED SCREW: M3X8:SECOND KIND
- 4.04583008N (x10) HEXAGON HEAD TAPPING SCREW:3 X8

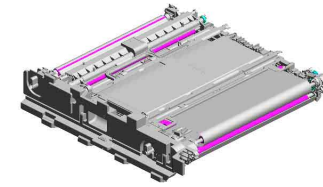

16.D0BQ6005
TRANSFER UNIT:INTERMEDIATE TRANSFER:IMC2000-6000

1.03603006N (x2) SCREW - M3X6



46.GA003994 (x2) DECAL:LEVER:RELEASE



31.D1496173 BRACKET:BELT CLEANING:REAR



30.D1496172 BRACKET:BELT CLEANING:FRONT



43.GA003934 (x2) DECAL:OPERATE:4X41



7.08050103 (x2) RETAINING RINGS -E-SILENCER:DIA3



U008_S001_S001

TRANSFER UNIT:INTERMEDIATE TRANSFER:ASS'Y

- 2.04513006N (x2) TAPPING SCREW - 3X6
- 4.04583008N (x31) HEXAGON HEAD TAPPING SCREW:3 X8
- 41.D2416097 FLAT BELT-TRANSFER:INTERMEDIATE TRANSFER:TT
- 26.D1441085 (x2) STEPPED SCREW: M3
- 5.07200030E RETAINING RING - M3

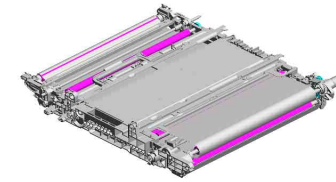

- 15.D0BQ6001 TRANSFER UNIT:INTERMEDIATE TRANSFER:ASS'Y

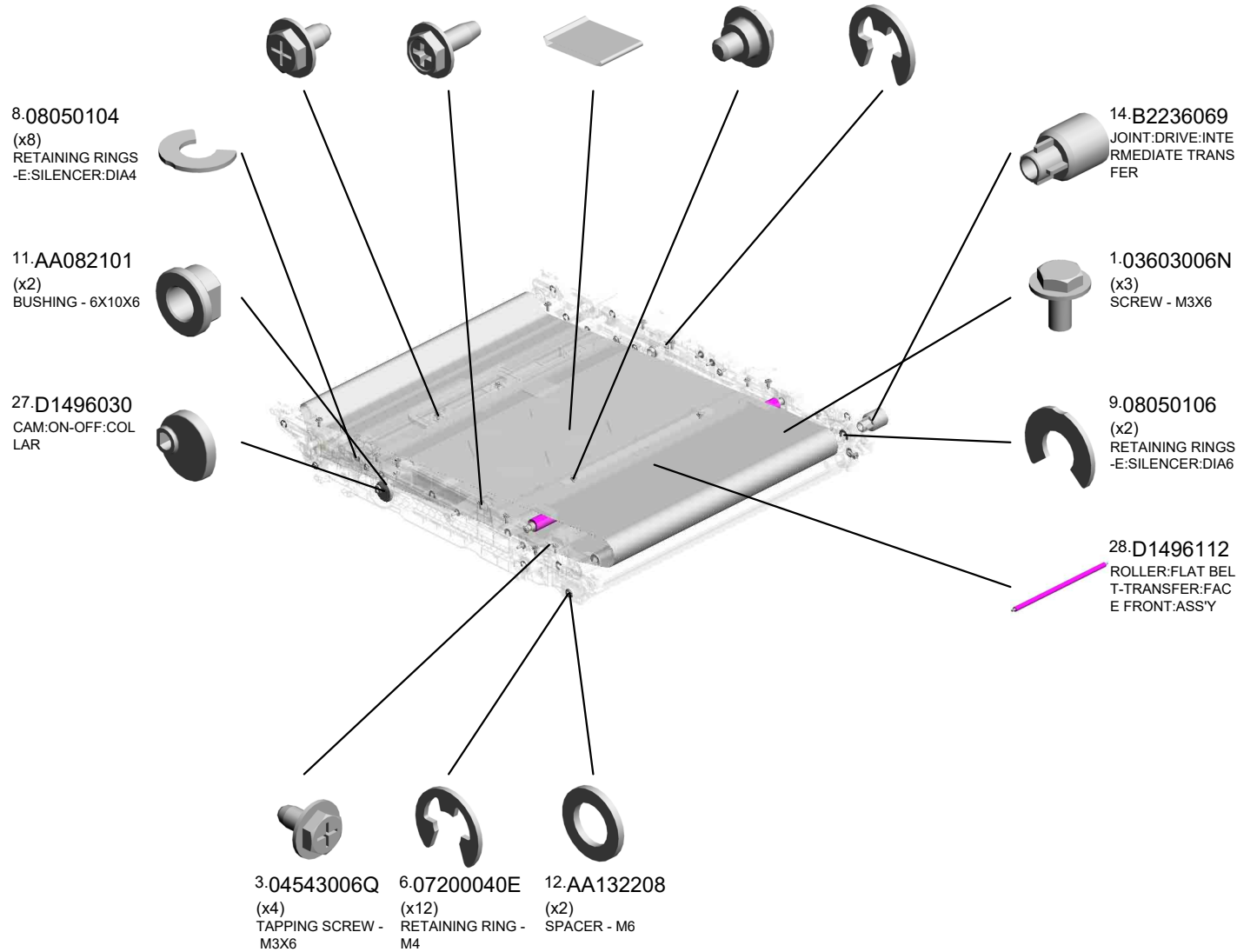

U001	U002	U003	U004	U005	U006	U007	U008	U009	U010	U011	U012	U013	U014	U015	U016	U017	U018
------	------	------	------	------	------	------	------	------	------	------	------	------	------	------	------	------	------

U008_S001_S002

CLEANING UNIT:BELT CLEANING:ASS'Y

29.D1496163 11.AA082101
TENSION SPRING: (x2)
SHUTTER:BELT CL BUSHING - 6X10X6
EAINING

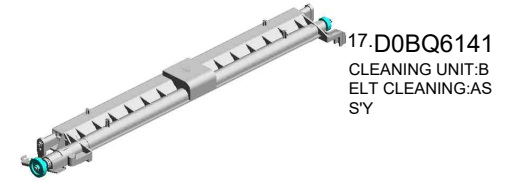

7.08050103
RETAINING RINGS
-E:SILENCER:DIA3

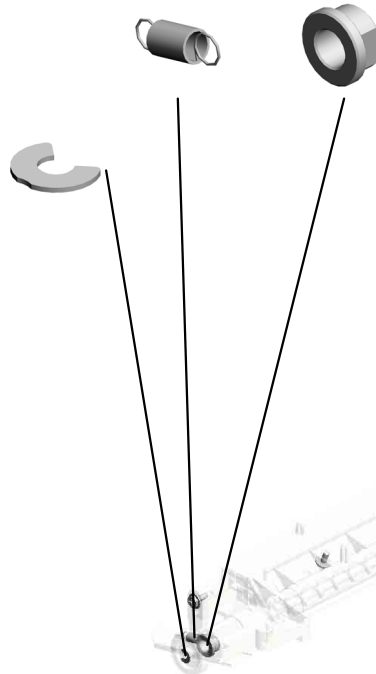

4.04583008N
(x2)
HEXAGON HEAD TAPPING SCREW:3 X8



1.03603006N
(x3)
SCREW - M3X6



U001	U002	U003	U004	U005	U006	U007	U008	U009	U010	U011	U012	U013	U014	U015	U016	U017	U018
------	------	------	------	------	------	------	------	------	------	------	------	------	------	------	------	------	------

U008_S001_S003

TONER OUTLET UNIT:BELT CLEANING:ASS'Y

35.D1496195
CAM:DISCHARGE
USED TONER

3.04543006Q
TAPPING SCREW -
M3X6

32.D1496177
HOLDER:DISCHARGE
USED TONER:
ASS'Y

29.D1496163
(x2)
TENSION SPRING:
SHUTTER:BELT CL
EANING

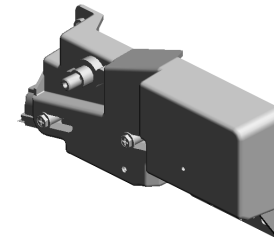

48.M0AJ6175
TONER OUTLET U
NIT:BELT CLEANIN
G:ASS'Y

4.04583008N
(x2)
HEXAGON HEAD T
APPING SCREW:3
X8

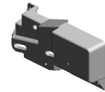

11.AA082101
BUSHING - 6X10X6



34.D1496190
GEAR:DISCHARGE
USED TONER



7.08050103
RETAINING RINGS
-E:SILENCER:DIA3



33.D1496179
GEAR:IDLER:DISC
HARGE USED TON
ER

U001	U002	U003	U004	U005	U006	U007	U008	U009	U010	U011	U012	U013	U014	U015	U016	U017	U018
------	------	------	------	------	------	------	------	------	------	------	------	------	------	------	------	------	------

U009.TRANSFER/SEPARATION

U009_S002
D0BQ6212
TRANSFER ROLLER:SECON
D:ASSY

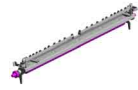

U009_S001
D0BQ6215
GUIDE PLATE:TRANSFER:S
ECOND:ASSY

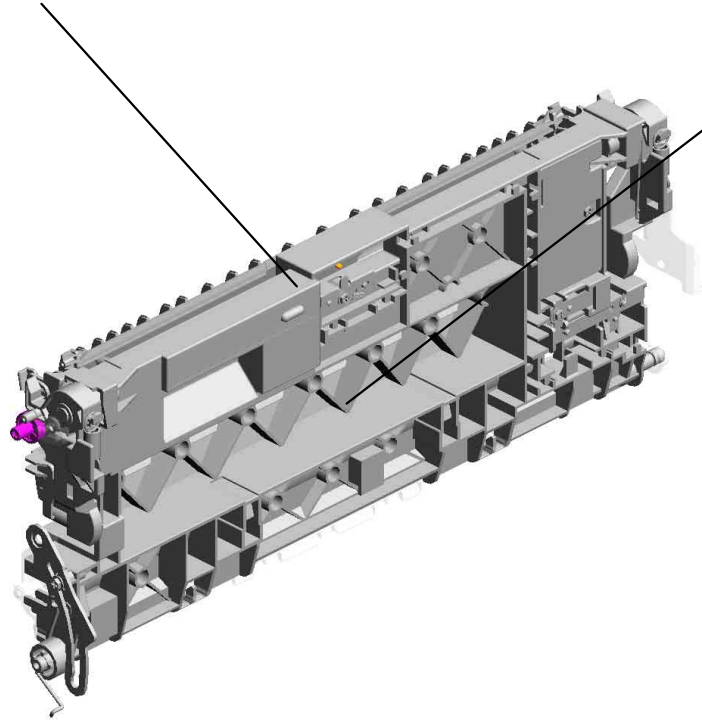
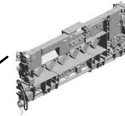

U001	U002	U003	U004	U005	U006	U007	U008	U009	U010	U011	U012	U013	U014	U015	U016	U017	U018
------	------	------	------	------	------	------	------	------	------	------	------	------	------	------	------	------	------

U009 TRANSFER/SEPARATION

- 38.D1496290 GUIDE:SET:TRANSFER/SEPARATION UNIT:FRONT
- 22.D1492586 GUIDE:REGISTRATION:FRONT RIGHT
- 42.D2412583 REGISTRATION ROLLER:DRIVE
- 39.D1496291 GUIDE:SET:TRANSFER/SEPARATION UNIT:REAR
- 2.04543008Q (x2) TAPPING SCREW: 3X8

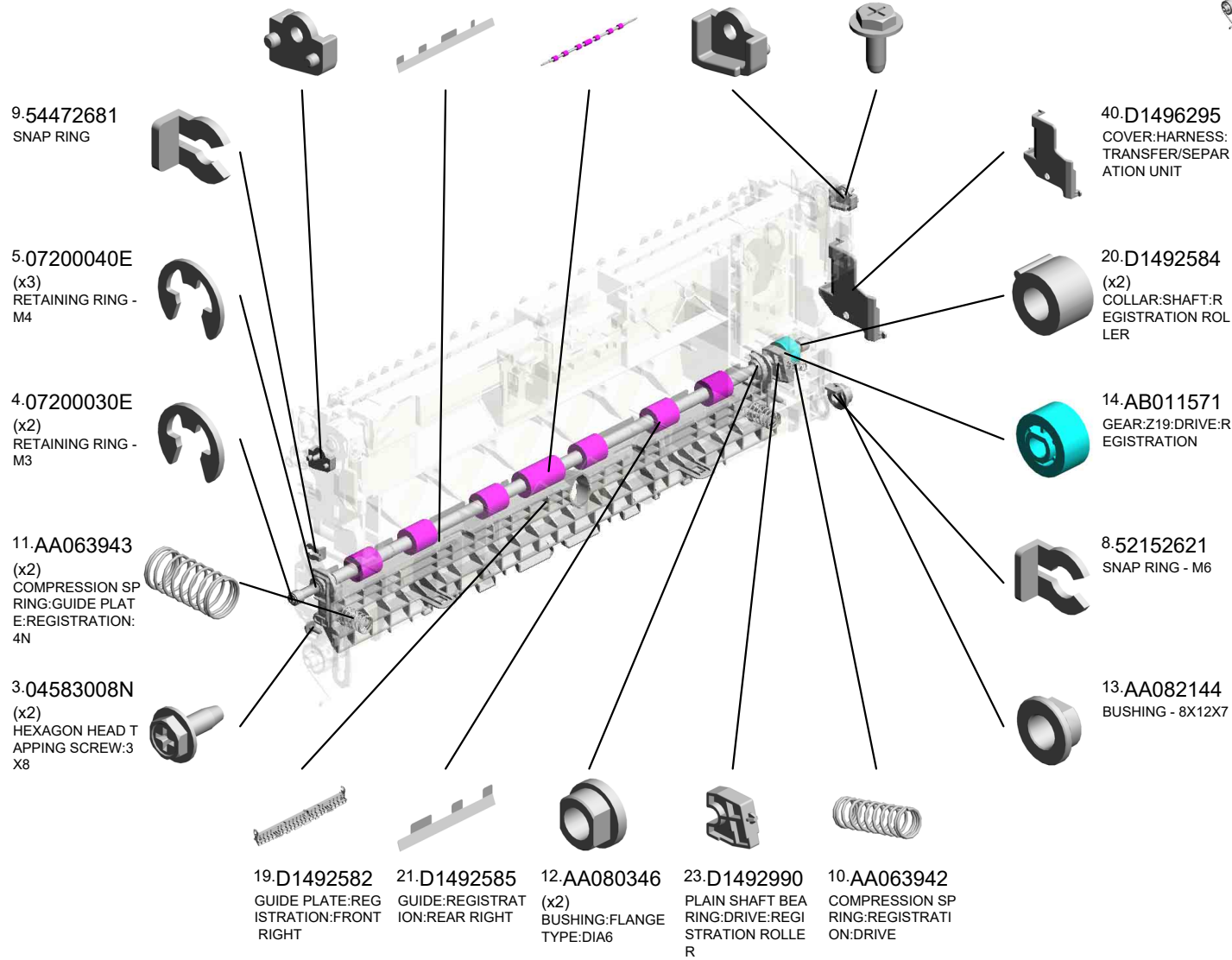
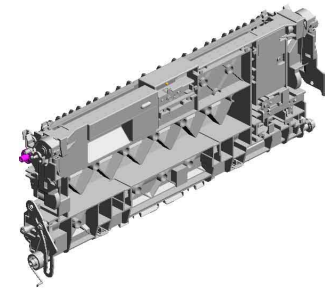

U001	U002	U003	U004	U005	U006	U007	U008	U009	U010	U011	U012	U013	U014	U015	U016	U017	U018
------	------	------	------	------	------	------	------	------	------	------	------	------	------	------	------	------	------

U009
TRANSFER/SEPARATION

44.D2412993
(x2)
STOPPER:REGIST
RATION ROLLER

43.D2412991
(x2)
PLAIN SHAFT BEA
RING:INNER:DRIV
E:REGISTRATION
ROLLER

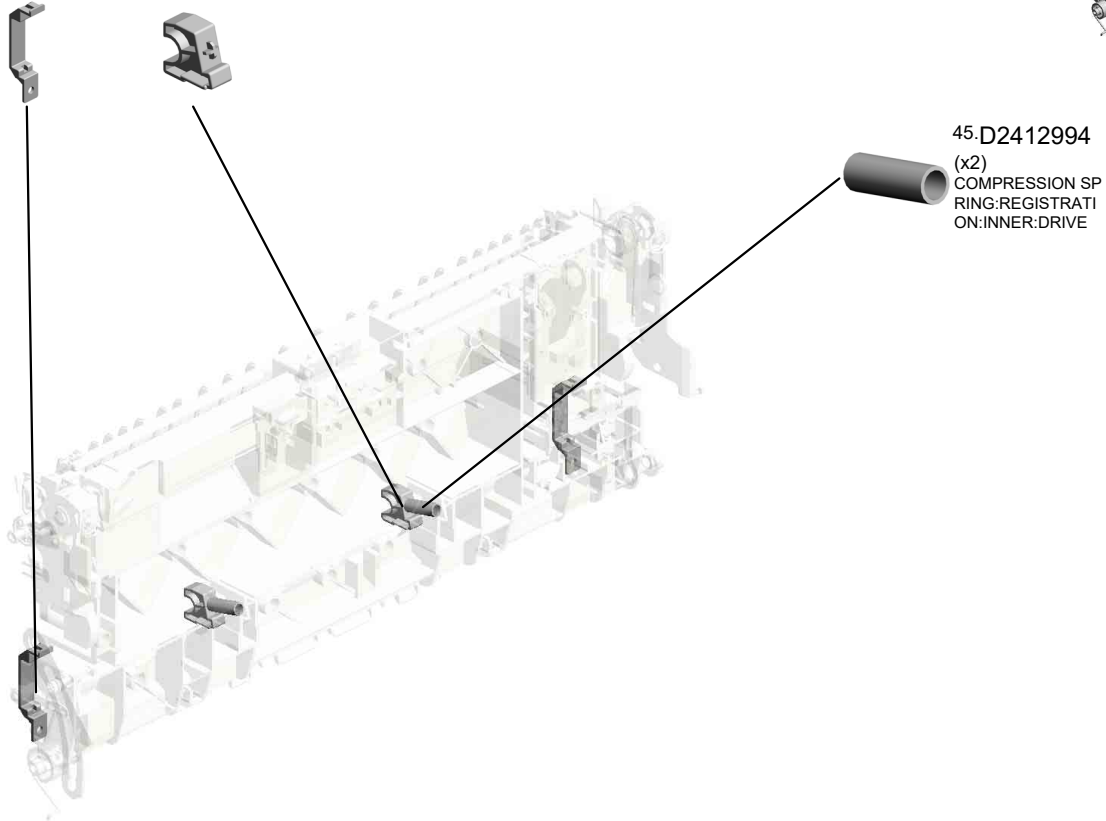
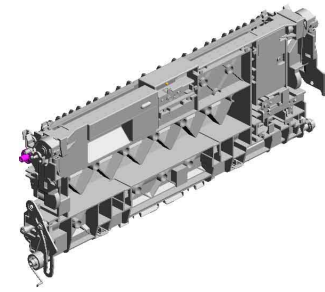

45.D2412994
(x2)
COMPRESSION SP
RING:REGISTRATI
ON:INNER:DRIVE

U001	U002	U003	U004	U005	U006	U007	U008	U009	U010	U011	U012	U013	U014	U015	U016	U017	U018
------	------	------	------	------	------	------	------	------	------	------	------	------	------	------	------	------	------

U009_S001
GUIDE PLATE:TRANSFER:SECOND:ASS'Y

- 36.D1496254 DECAL:GRIP:B:LOWER
- 41.D2026255 DECAL:GRIP:B
- 35.D1496248 CAP:LED
- 24.D1494662 DIFFUSION PLATE:LED
- 15.AW010147 PHOTO REFLECTI ON SENSOR:(S1/S27)

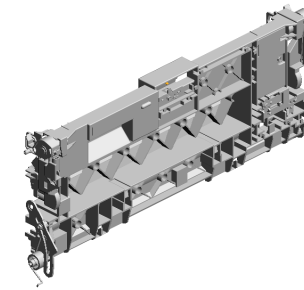

18.D0BQ6215
GUIDE PLATE:TRANSFER:SECOND:ASS'Y

25.D1496226
LEVER:TRANSFER /SEPARATION UNIT:FRONT

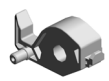

27.D1496228
TORSION SPRING:LEVER:SET:FRONT



28.D1496229
(x2)
TENSION SPRING:LEVER:SET



26.D1496227
LEVER:SET:FRONT



32.D1496242
(x2)
COMPRESSION SPRING:PRESSURE:TRANSFER ROLLER

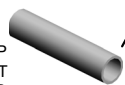

1.04543006Q
TAPPING SCREW - M3X6



16.D0BQ5100
PCB:DIODE

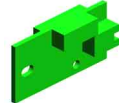

33.D1496243
RECEIVE PLATE:COMPRESSION SPRING:TRANSFER ROLLER



34.D1496245
GROUND PLATE:TRANSFER/SEPARATION UNIT



37.D1496257
GROUND PLATE:REGISTRATION ROLLER



29.D1496231
LEVER:TRANSFER /SEPARATION UNIT:REAR



6.07200060E
(x2)
RETAINING RING - M6



31.D1496233
TORSION SPRING:LEVER:SET:REAR



30.D1496232
LEVER:SET:REAR



3.04583008N
(x6)
HEXAGON HEAD TAPPING SCREW:3 X8



7.11050046
(x6)
HARNESS BAND

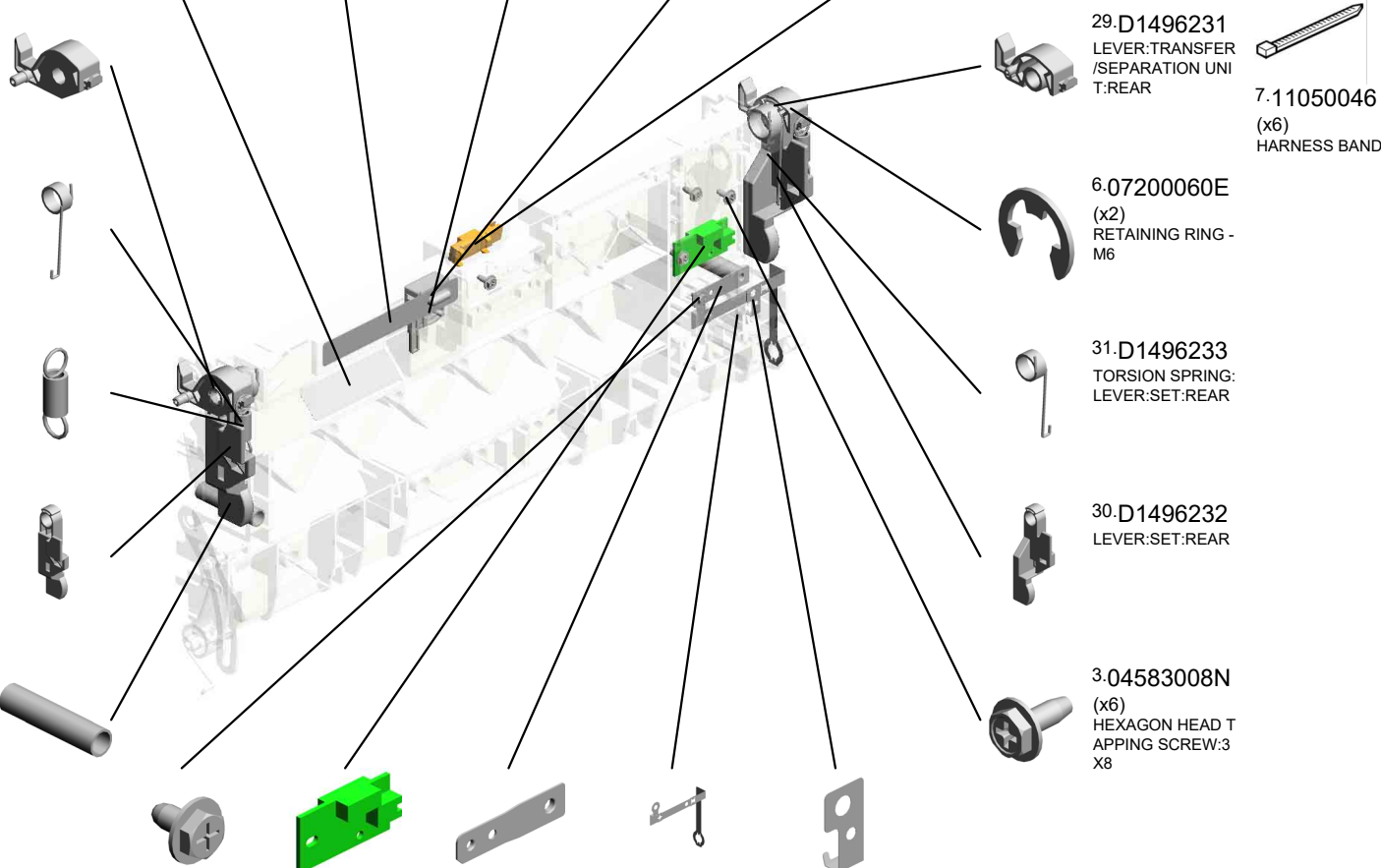
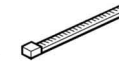

U009_S001
GUIDE PLATE:TRANSFER:SECOND:ASS'Y

46.D2416240
LEVER:PRESSURE
:TRANSFER ROLL
ER:FRONT:DIA19.5

53.D2416290
LED:RED

52.D2416275
SHEET:ENTRANCE
:TRANSFER

49.D2416250
GROUND WIRE:BR
ACKET:ENTRANCE
SENSOR

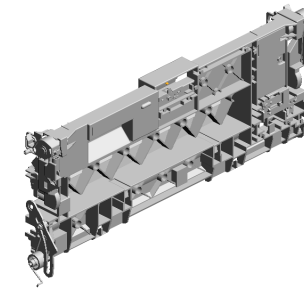

18.D0BQ6215
GUIDE PLATE:TRA
NSFER:SECOND:A
SS'Y

54.GA143003
SCREW:MM5:2.5M
M

56.M0BW6246
LINK:TRANSFER/S
EPARATION UNIT:
MO

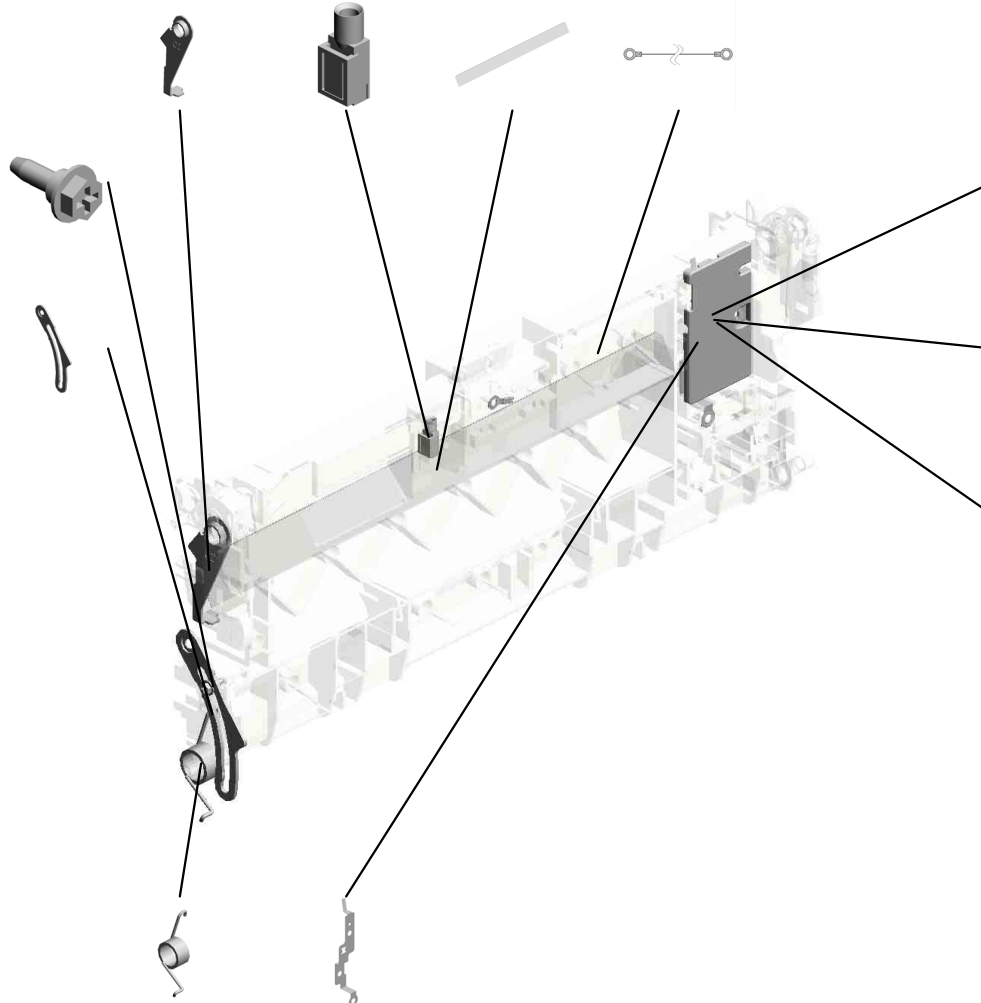

48.D2416244
GROUND PLATE:S
EPARATION

47.D2416241
LEVER:PRESSURE
:TRANSFER ROLL
ER:REAR:DIA19.5

51.D2416258
COVER:TRANSFE
R/SEPARATION UN
IT

55.M0BW6228
TORSION SPRING:
SEPARATION/TRA
NSPORT:28N

50.D2416256
GROUND PLATE:G
UIDE:TRANSPORT

U001	U002	U003	U004	U005	U006	U007	U008	U009	U010	U011	U012	U013	U014	U015	U016	U017	U018
------	------	------	------	------	------	------	------	------	------	------	------	------	------	------	------	------	------

U009_S002
TRANSFER ROLLER:SECOND:ASS'Y

5-07200040E
RETAINING RING -
M4

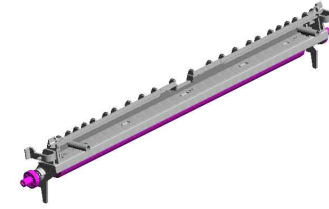

17-D0BQ6212
TRANSFER ROLLE
R:SECOND:ASSY



U001	U002	U003	U004	U005	U006	U007	U008	U009	U010	U011	U012	U013	U014	U015	U016	U017	U018
------	------	------	------	------	------	------	------	------	------	------	------	------	------	------	------	------	------

U010.USED TONER

U010_S002
D0BQ6511
PIPE:ASS'Y



U010_S001
D0BQ6400
COLLECTION BOTTLE:ASS'Y

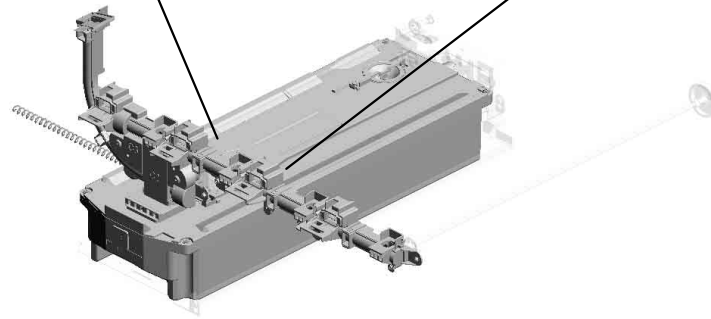

U001	U002	U003	U004	U005	U006	U007	U008	U009	U010	U011	U012	U013	U014	U015	U016	U017	U018
------	------	------	------	------	------	------	------	------	------	------	------	------	------	------	------	------	------

U010 USED TONER

- 21.D1496556 TENSION SPRING: BELT TENSIONER
- 16.D1491174 GEAR:COLLECTION BOTTLE
- 1.04543006Q (x5) TAPPING SCREW - M3X6
- 15.D1491173 GEAR:IDLER:TONE R BOTTLE
- 8.08050103 (x4) RETAINING RINGS -E:SILENCER:DIA3

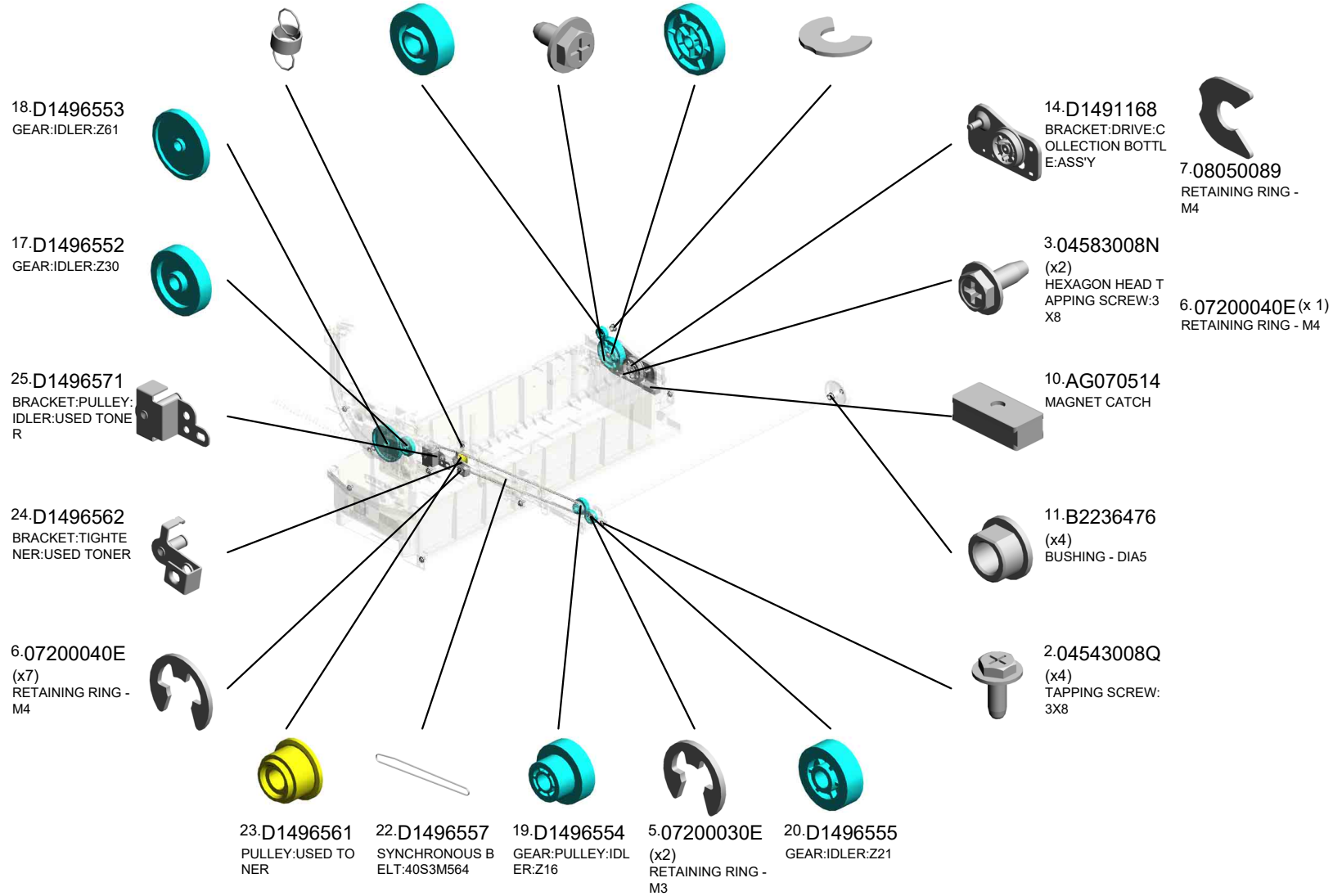
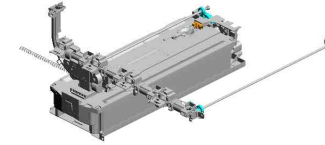

U001	U002	U003	U004	U005	U006	U007	U008	U009	U010	U011	U012	U013	U014	U015	U016	U017	U018
------	------	------	------	------	------	------	------	------	------	------	------	------	------	------	------	------	------

U010 USED TONER

27.D1496575 FLANGE:IDLER:USED TONER
 31.D1496586 SHAFT:DRIVE:USED TONER:LEFT
 35.GW020024 PHOTOINTERRUPTOR:LG2A24BL1:GF:(S5/S34/S42)

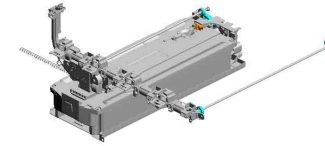

32.D1496587 GEAR:USED TONER:LEFT



26.D1496574 GEAR:PULLEY:IDLER:Z18



30.D1496583 GEAR:USED TONER:INPUT



28.D1496581 SHAFT:DRIVE:USED TONER:RIGHT



29.D1496582 GEAR:USED TONER:RIGHT



33.D1496592 RAIL:COLLECTION BOTTLE



U001	U002	U003	U004	U005	U006	U007	U008	U009	U010	U011	U012	U013	U014	U015	U016	U017	U018
------	------	------	------	------	------	------	------	------	------	------	------	------	------	------	------	------	------

U010_S001
COLLECTION BOTTLE:ASS'Y

4.04583010N
(x5)
HEXAGON HEAD TAPPING SCREW:3 X10

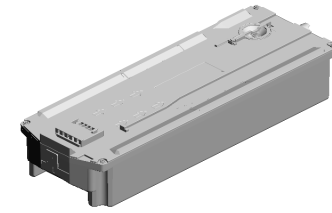

12.D0BQ6400
COLLECTION BOT
TLE:ASS'Y

9.AA080346
(x2)
BUSHING:FLANGE
TYPE:DIA6



7.08050089
(x3)
RETAINING RING -
M4

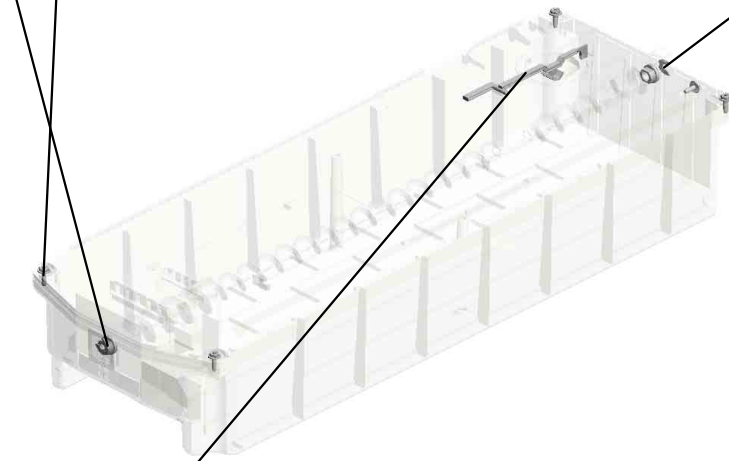

34.D2426432
FEELER:COLLECTI
ON BOTTLE



U001	U002	U003	U004	U005	U006	U007	U008	U009	U010	U011	U012	U013	U014	U015	U016	U017	U018
------	------	------	------	------	------	------	------	------	------	------	------	------	------	------	------	------	------

U010_S002
PIPE:ASS'Y

4.04583010N
(x4)
HEXAGON HEAD TAPPING SCREW:3
X10

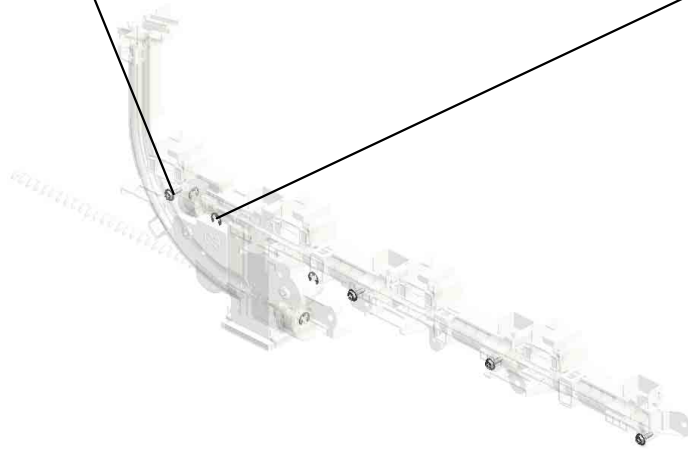

6.07200040E
(x4)
RETAINING RING -
M4

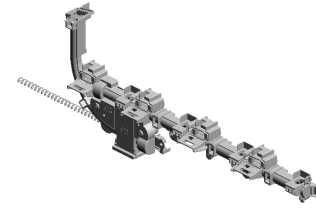

13.D0BQ6511
PIPE:ASS'Y

U001	U002	U003	U004	U005	U006	U007	U008	U009	U010	U011	U012	U013	U014	U015	U016	U017	U018
------	------	------	------	------	------	------	------	------	------	------	------	------	------	------	------	------	------

U011.FUSING

U011 S001
D0BQ4022
(EU/AA/KOR/CHN):FUSING U
NIT:220-240V:IMC4500-6000

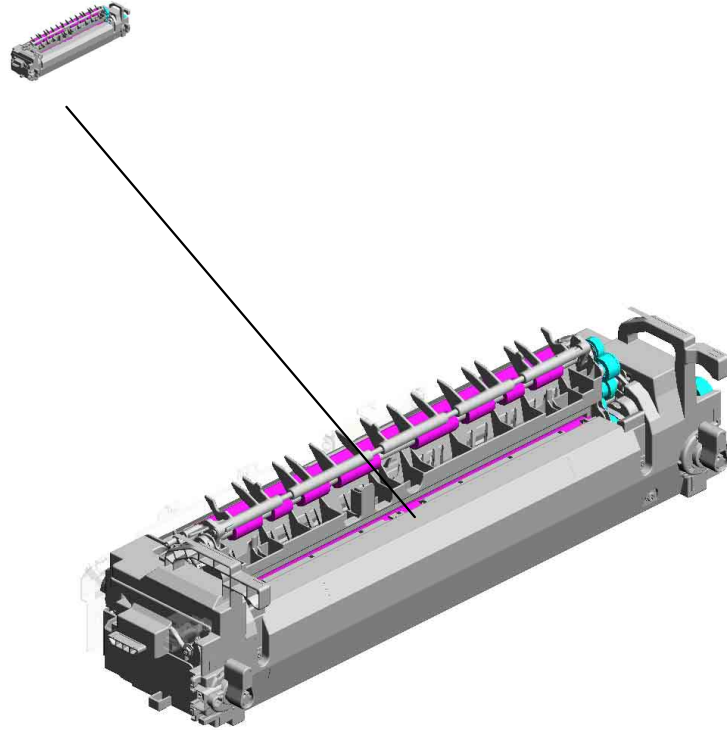

U001	U002	U003	U004	U005	U006	U007	U008	U009	U010	U011	U012	U013	U014	U015	U016	U017	U018
------	------	------	------	------	------	------	------	------	------	------	------	------	------	------	------	------	------

U011_S001.(EU/AA/KOR/CHN):FUSING UNIT:220-240V:IMC4500-6000

U011_S001_S002
D0BQ4052
(EU/AA/KOR/CHN):SLEEVE:F
USING:220-240V:IMC4500-60
00



U011_S001_S001
M0AJ4261
FUSING COVER:UPPER:ASS'
Y

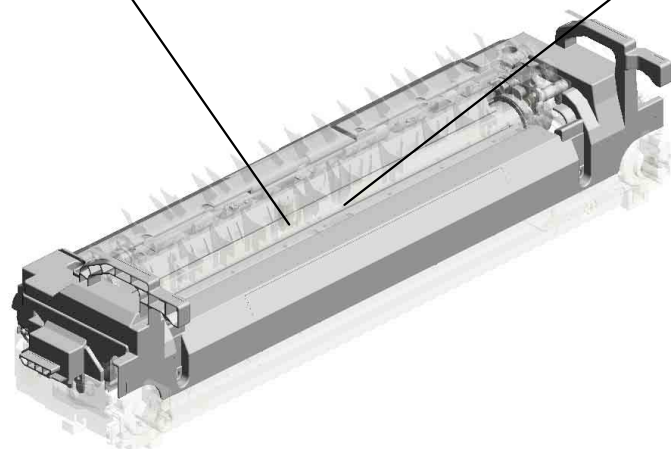

U001	U002	U003	U004	U005	U006	U007	U008	U009	U010	U011	U012	U013	U014	U015	U016	U017	U018
------	------	------	------	------	------	------	------	------	------	------	------	------	------	------	------	------	------

U011 FUSING

3.04543006Q (x8) TAPPING SCREW - M3X6
 16.11050692 CLAMP:LES-0503
 20.11050759 CLAMP:LWSM-060 5A
 15.09574008N SCREW:SMALL ROUND/SPRING:M4X8
 18.11050723 (x2) CLAMPS:WES-0507

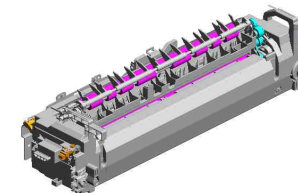

2.03603006N (x4) SCREW - M3X6



84.D2414366 BRACKET:THERMOPILE

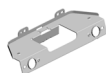

83.D2414365 (x2) HOLDER:THERMOPILE



61.D1494371 BRACKET:PHOTO INTERRUPTOR



44.AW020190 (x2) PHOTO INTERRUPTOR:(S26/S50)



48.AW100183 (x2) THERMOPILE:(TH1/TH2)

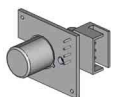

29.AA143219 (x2) STEPPED SCREW



19.11050758 CLAMP:LWSM-030 6A



1.03530060N (x2) BIND SCREW - M3 X6



21.AA061207 TENSION SPRING: BRACKET:IDLER



4.04583008N (x2) HEXAGON HEAD TAPPING SCREW:3 X8



32.AB012102 GEAR:IDLER:WORKING GEAR



30.AA148871 SHAFT:GEAR:IDLER:WORM GEAR

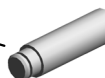

33.AB012104 GEAR:IDLER:LIGHT SHIELDING PLATE



8.07200040E (x2) RETAINING RING - M4



U011 FUSING

89.D2424386
BRACKET:DC STE
PPER MOTOR

102.M0AJ4388
COVER:DRIVE UNI
T:LIGHT SHIELDIN
G P

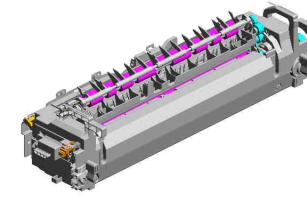

85.D2414367
(x2)
STOPPER:THERM
OPILE

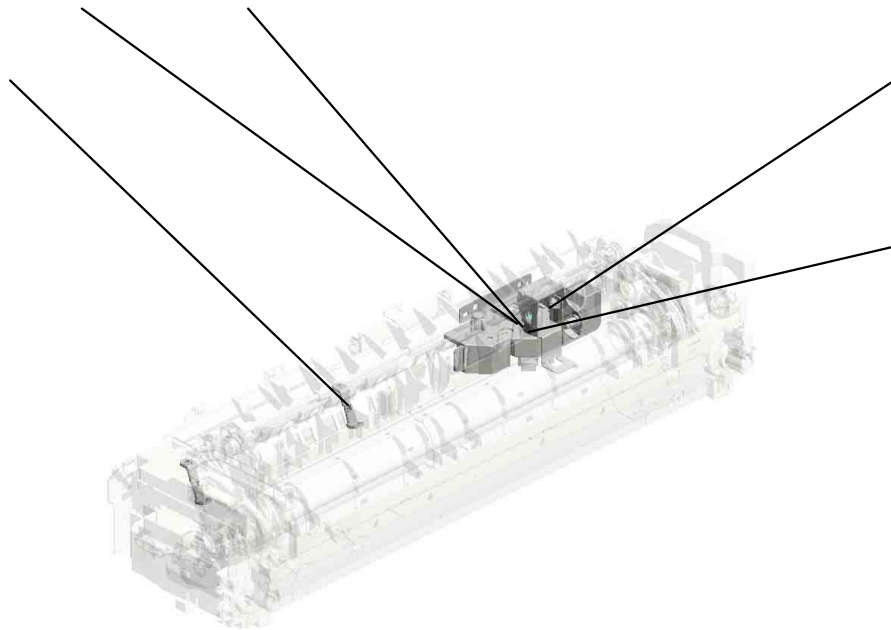

88.D2424383
BRACKET:IDLER:D
C STEPPER MOTO
R



87.D2424382
DC STEPPER MOT
OR:ASS'Y:(M28)

U001	U002	U003	U004	U005	U006	U007	U008	U009	U010	U011	U012	U013	U014	U015	U016	U017	U018
------	------	------	------	------	------	------	------	------	------	------	------	------	------	------	------	------	------

U011_S001
 (EU/AA/KOR/CHN):FUSING UNIT:220-240V:IMC4500-6000

- 22.AA061208 (x2) TENSION SPRING: STRIPPER PLATE
- 23.AA061209 TENSION SPRING: GATE PAWL
- 7.07200030E (x3) RETAINING RING - M3
- 26.AA080387 PLAIN SHAFT BEARING:EXIT ROLLER:FUSING EXIT:RIGHT:FRONT
- 17.11050713 CLAMP:LWSM-030 6H GRAY

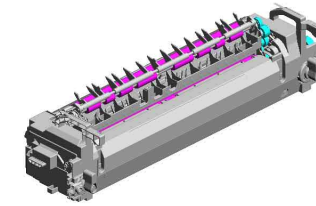

51.D0BQ4022
 (EU/AA/KOR/CHN):
 FUSING UNIT:220-2
 40V:IMC4500-6000

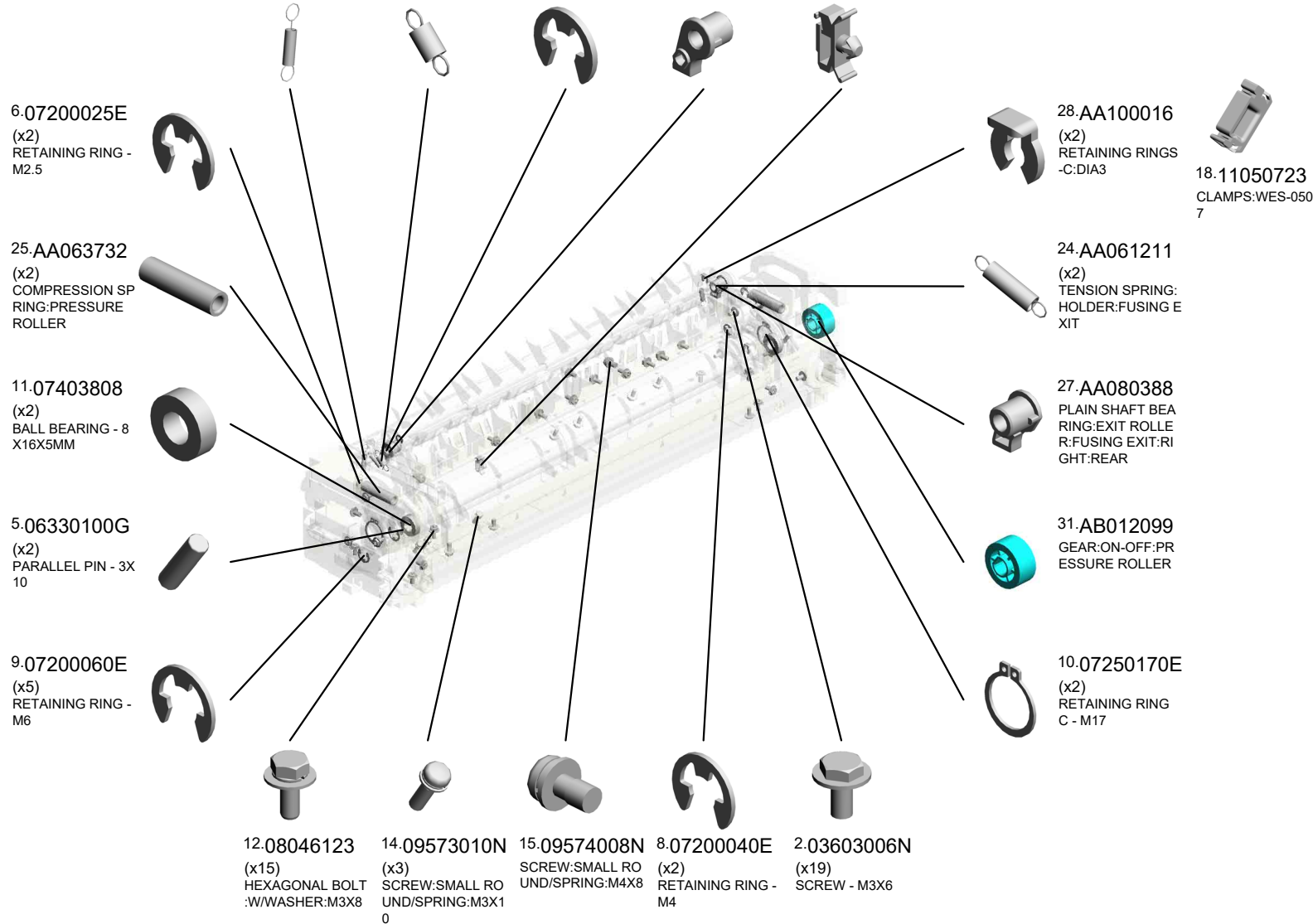

U001	U002	U003	U004	U005	U006	U007	U008	U009	U010	U011	U012	U013	U014	U015	U016	U017	U018
------	------	------	------	------	------	------	------	------	------	------	------	------	------	------	------	------	------

U011_S001
(EU/AA/KOR/CHN):FUSING UNIT:220-240V:IMC4500-6000

- 55.D0BQ4317 GUIDE:HARNES: DRAWER:PRESS FIT
- 53.D0BQ4102 DRIVEN ROLLER:FUSING EXIT:ASS'Y
- 49.AW110111 THERMOSTAT:MIDDLE
- 42.AE020261 PRESSURE ROLLER:DIA32
- 37.AB012110 GEAR:EXIT ROLLER:FUSING EXIT:RIGHT

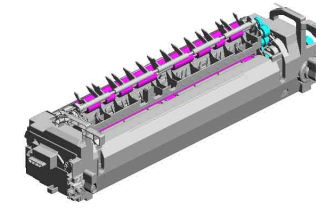

51.D0BQ4022
(EU/AA/KOR/CHN):
FUSING UNIT:220-240V:
IMC4500-6000

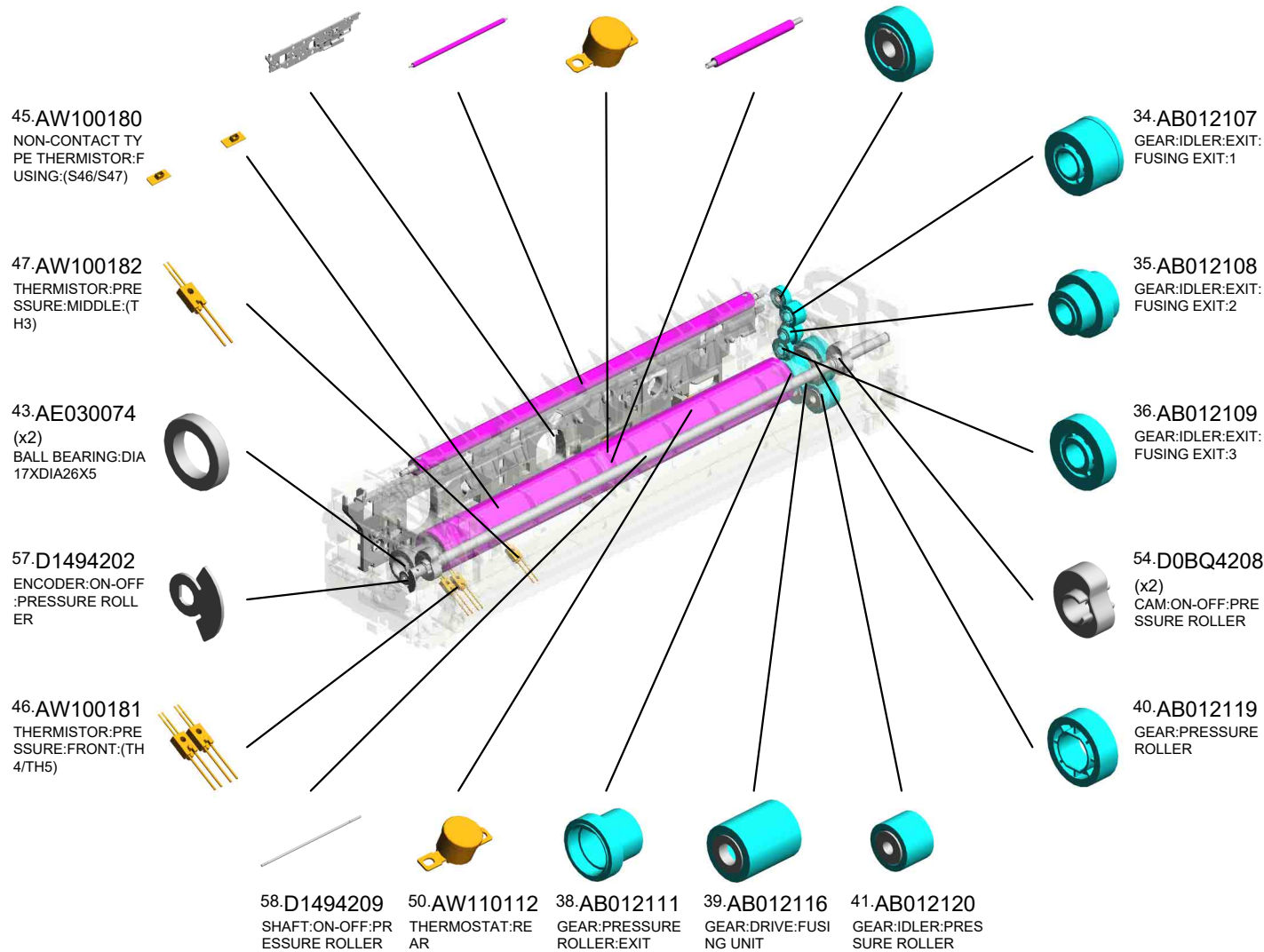

U001	U002	U003	U004	U005	U006	U007	U008	U009	U010	U011	U012	U013	U014	U015	U016	U017	U018
------	------	------	------	------	------	------	------	------	------	------	------	------	------	------	------	------	------

U011_S001
 (EU/AA/KOR/CHN):FUSING UNIT:220-240V:IMC4500-6000

- 64.D2414108 GUIDE:FUSING EXIT:LEFT
- 76.D2414221 STRIPPER PLATE:FUSING EXIT:ASSY
- 73.D2414212 GATE PAWL:FUSING EXIT
- 74.D2414215 GUIDE:FUSING EXIT:RIGHT:ASSY
- 59.D1494235 (x15) STEPPED SCREW:M3

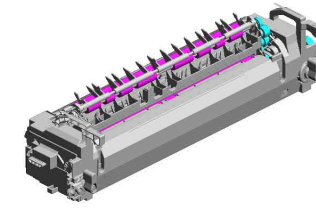

51.D0BQ4022
 (EU/AA/KOR/CHN):
 FUSING UNIT:220-2
 40V:IMC4500-6000

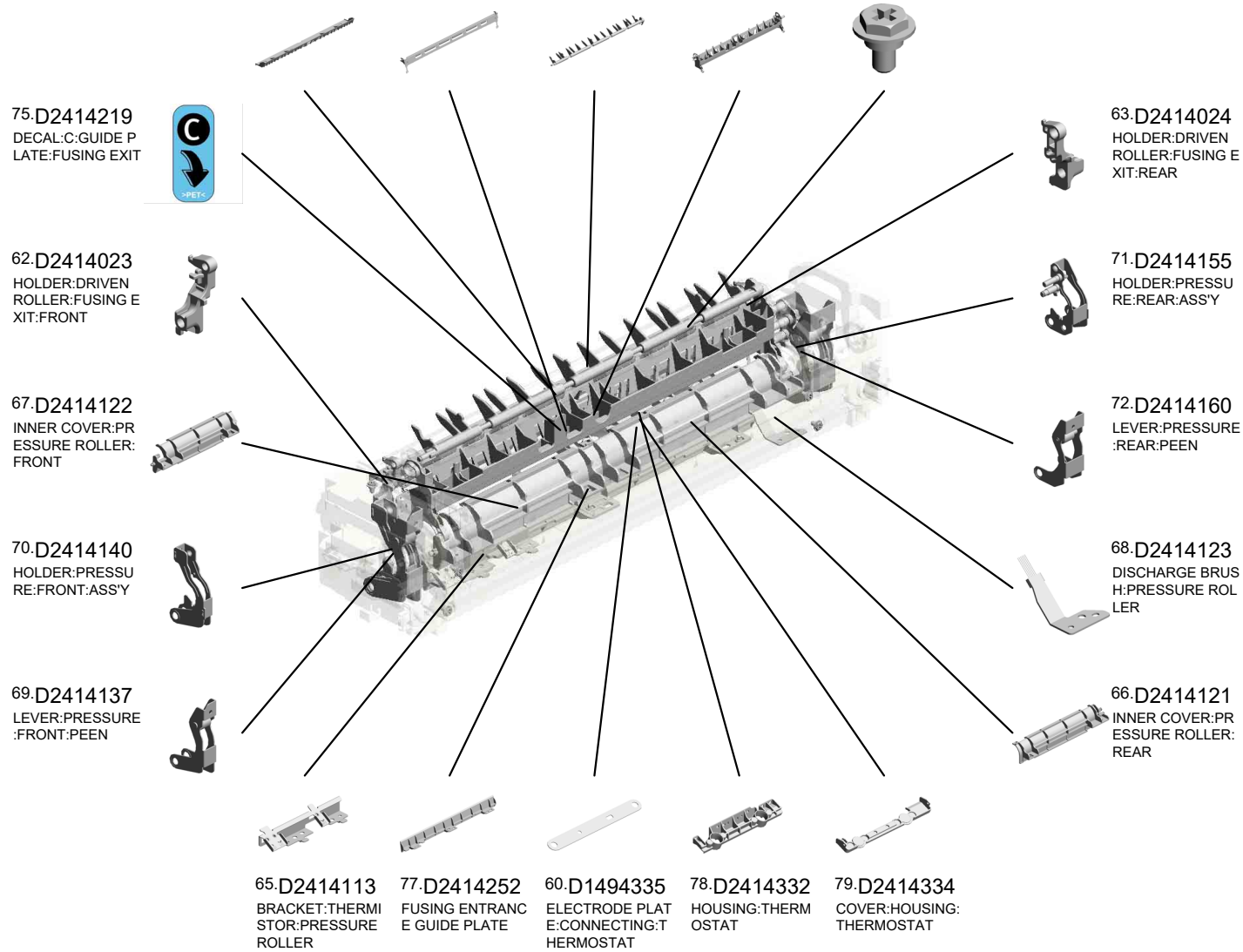

U011_S001
 (EU/AA/KOR/CHN):FUSING UNIT:220-240V:IMC4500-6000

82.D2414342 HOUSING:NON-CO
 NTACTION TYPE THE
 RMISTOR
 81.D2414338 TERMINAL:THERM
 OSTAT:HEATER
 86.D2424262 FUSING COVER:L
 OWER
 80.D2414337 TERMINAL:THERM
 OSTAT:DRAWER

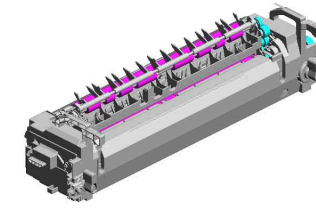

51.D0BQ4022
 (EU/AA/KOR/CHN):
 FUSING UNIT:220-2
 40V:IMC4500-6000

101.M0AJ4279
 HOOK:FUSING:FR
 ONT



100.M0AJ4278
 COVER:LEVER:FU
 SING:FRONT



94.GA003933
 (x2)
 DECAL:OPERATE:
 4X10.5

99.M0AJ4273
 (x2)
 LEVER:FUSING



97.M0AJ4271
 COVER:LEVER:FU
 SING:REAR



93.GA003932
 (x2)
 DECAL:LEVER:REL
 EASE



98.M0AJ4272
 HOOK:FUSING:RE
 AR

U011_S001_S001
 FUSING COVER:UPPER:ASS'Y

56.D1124264 90.GA003929
 DECAL:WARNING ((x2)
 HIGH TEMPERATU DECAL:OPERATE:
 RE):FUSING 4X27

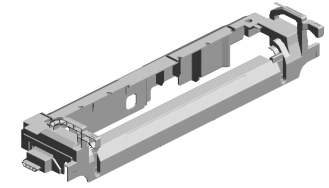

96.M0AJ4261
 FUSING COVER:U
 PPER:ASS'Y

91.GA003930
 DECAL:LEVER:FR
 ONT:FUSING

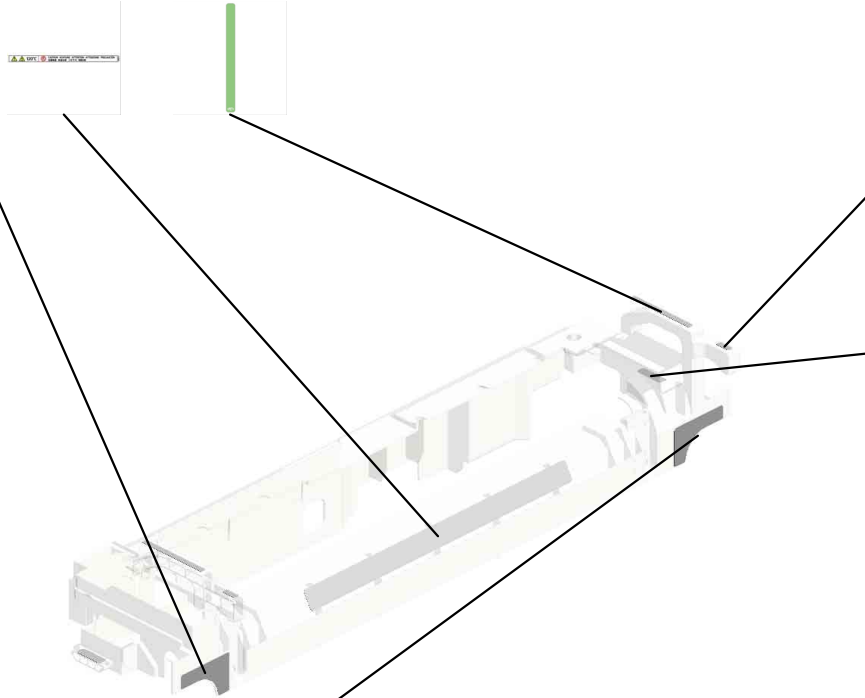

94.GA003933
 (x2)
 DECAL:OPERATE:
 4X10.5



95.GA003957
 (x2)
 DECAL:POSITIONI
 NG DISPLAY:FUSI
 NG



92.GA003931
 DECAL:LEVER:RE
 AR:FUSING

U001	U002	U003	U004	U005	U006	U007	U008	U009	U010	U011	U012	U013	U014	U015	U016	U017	U018
------	------	------	------	------	------	------	------	------	------	------	------	------	------	------	------	------	------

U011_S001_S002
(EU/AA/KOR/CHN):SLEEVE:FUSING:220-240V:IMC4500-6000

2.03603006N
(x5)
SCREW - M3X6

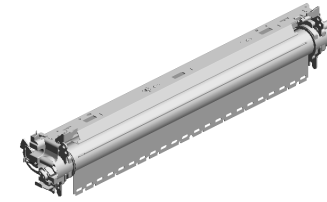

52.D0BQ4052
(EU/AA/KOR/CHN):
SLEEVE:FUSING:2
20-240V:IMC4500-6
000

13.08046128
(x4)
HEXAGONAL BOLT
:DOUBLE SCREW:
M3X10



12.08046123
(x3)
HEXAGONAL BOLT
:WASHER:M3X8



6.07200025E
RETAINING RING -
M2.5

U001	U002	U003	U004	U005	U006	U007	U008	U009	U010	U011	U012	U013	U014	U015	U016	U017	U018
------	------	------	------	------	------	------	------	------	------	------	------	------	------	------	------	------	------

U012.PAPER EXIT

U012_S001
D0BQ4404
PAPER EXIT UNIT:ASSY

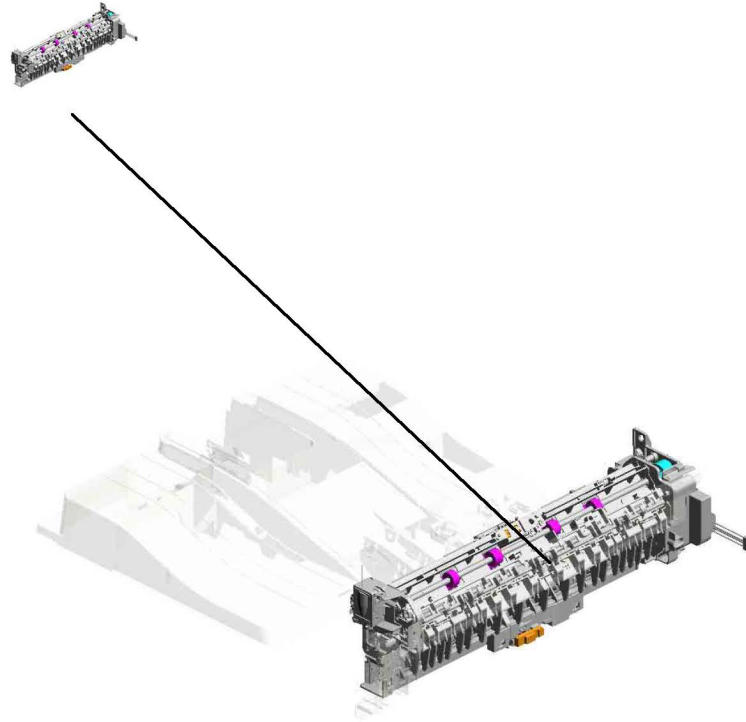

U001	U002	U003	U004	U005	U006	U007	U008	U009	U010	U011	U012	U013	U014	U015	U016	U017	U018
------	------	------	------	------	------	------	------	------	------	------	------	------	------	------	------	------	------

U012_S001.PAPER EXIT UNIT:ASS'Y

U012 S001 S001
D2414950
ROLLER:EXIT:PRESSURE:2T
YPE:ASS'Y

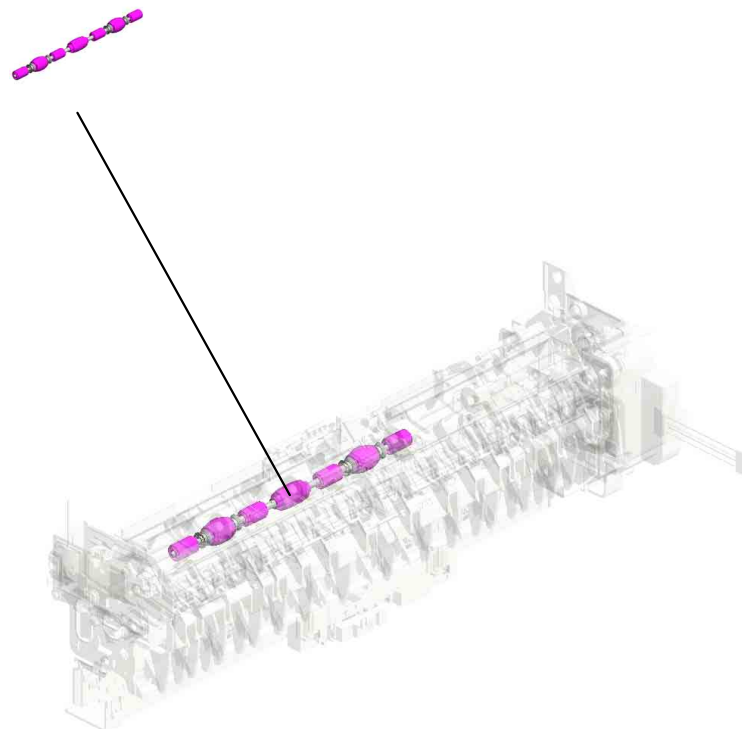

U001	U002	U003	U004	U005	U006	U007	U008	U009	U010	U011	U012	U013	U014	U015	U016	U017	U018
------	------	------	------	------	------	------	------	------	------	------	------	------	------	------	------	------	------

U012 PAPER EXIT

47.D2414494 TRAY:AUXILIARY:EXIT
 48.D2414499 COMPRESSION SPRING:BASE:TRAY:EXIT
 26.D0BQ4960 BASE:PLATE:EXIT:1 DG
 61.D2414971 (x2) LINK:PLATE:EXIT

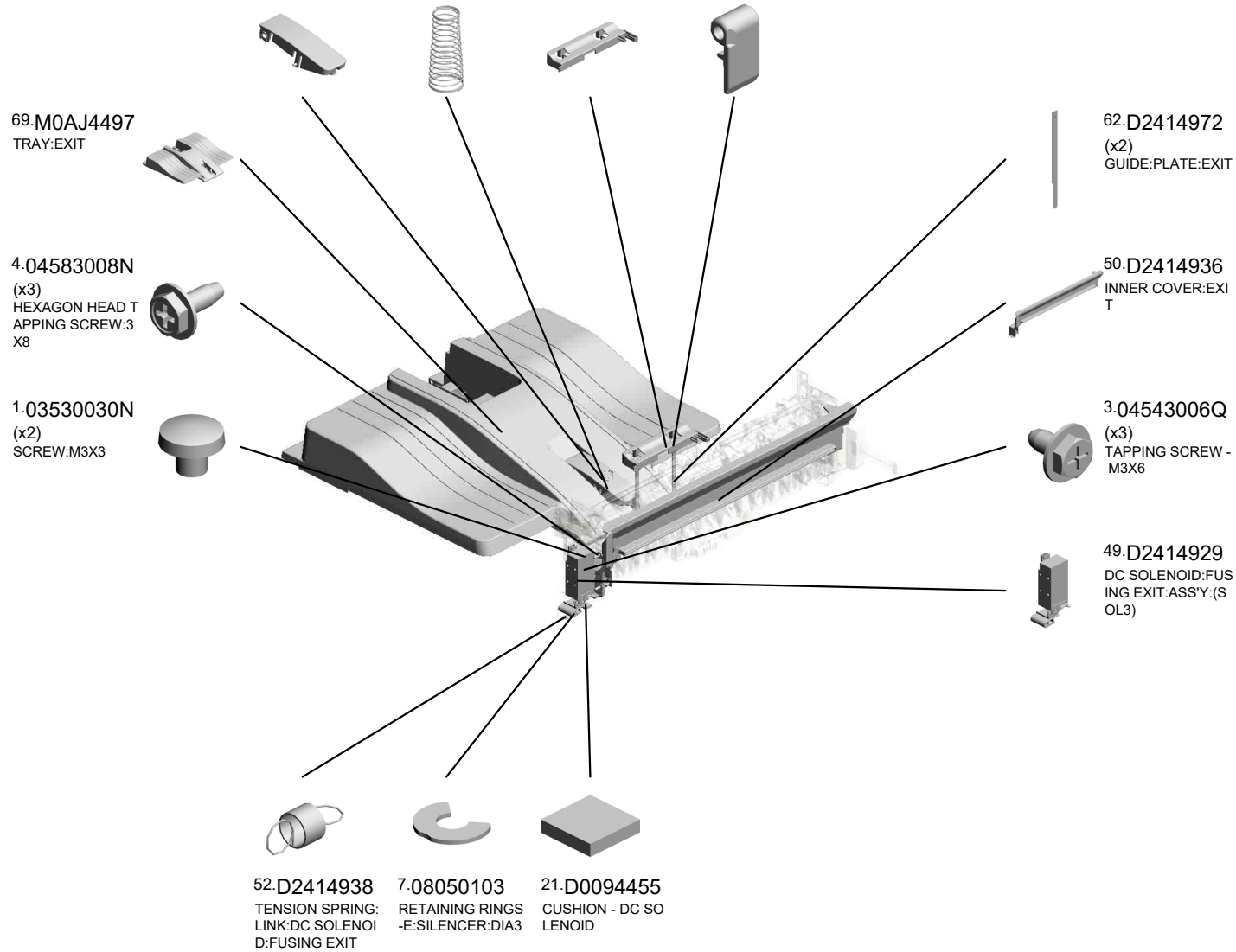
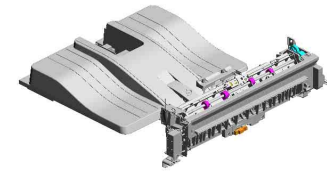

U001	U002	U003	U004	U005	U006	U007	U008	U009	U010	U011	U012	U013	U014	U015	U016	U017	U018
------	------	------	------	------	------	------	------	------	------	------	------	------	------	------	------	------	------

U012_S001
PAPER EXIT UNIT:ASS'Y

- 7.08050103 (x13) RETAINING RINGS -E:SILENCER:DIA3
- 15.AA080252 (x2) BUSHING - M4
- 20.D0094407 FEELER - OVERFLOW
- 23.D0394927 (x2) COMPRESSION SPRING:PRESSURE:REVERSE:DRIVEN
- 3.04543006Q (x13) TAPPING SCREW - M3X6

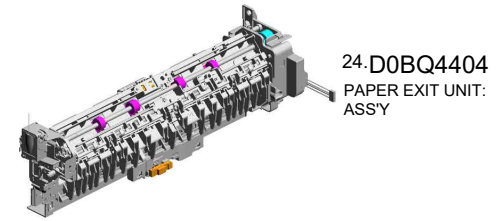

24.D0BQ4404
PAPER EXIT UNIT: ASS'Y

10.11050692 (x3) CLAMP:LES-0503

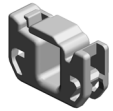

1.03530030N (x3) SCREW:M3X3



8.08050104 RETAINING RINGS -E:SILENCER:DIA4



12.11050759 CLAMP:LWSM-0605A



21.D0094455 CUSHION - DC SOLENOID

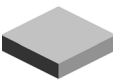

19.AW010147 PHOTO REFLECTION SENSOR:(S1/S27)



18.AF040571 (x11) GUIDE ROLLER



22.D0394925 (x4) ROLLER:REVERSE:DRIVEN



5.04583010N (x8) HEXAGON HEAD TAPPING SCREW:3X10



2.04513006N (x6) TAPPING SCREW - 3X6



16.AA082170 (x4) PLAIN SHAFT BEARING:RING:DIA4XDIA8X5:EG-1



9.11050046 (x13) HARNESS BAND

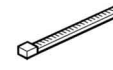

11.11050758 (x7) CLAMP:LWSM-0306A



17.AA082173 (x2) PLAIN SHAFT BEARING:RING:6X10X6



14.AA043339 TIMING BELT:PAPER EXIT:40S2M122



13.A2324666 CUSHION - STEPPER MOTOR



U012_S001
PAPER EXIT UNIT:ASS'Y

- 35.D1494468 SHAFT:DRIVEN:REVERSE ROLLER
- 44.D2414476 EXIT ROLLER
- 39.D2024477 REVERSE ROLLER
- 41.D2414448 SHAFT:FEELER:OVERFLOW
- 34.D1494463 GROUND WIRE:SENSOR:REVERSE

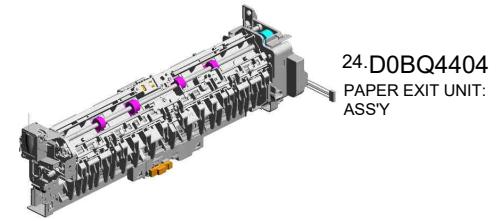

24.D0BQ4404
PAPER EXIT UNIT:
ASS'Y

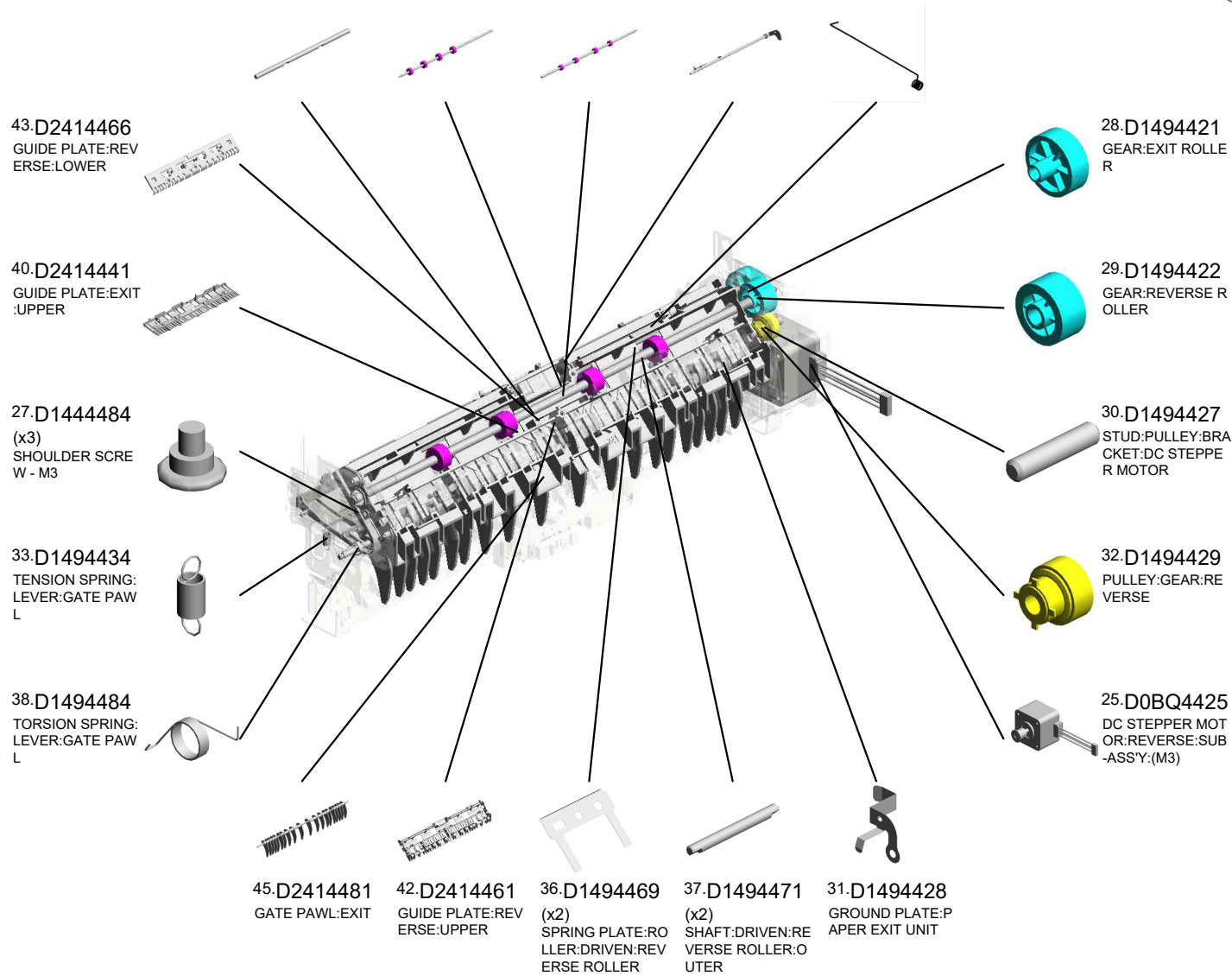

U001	U002	U003	U004	U005	U006	U007	U008	U009	U010	U011	U012	U013	U014	U015	U016	U017	U018
------	------	------	------	------	------	------	------	------	------	------	------	------	------	------	------	------	------

U012_S001
PAPER EXIT UNIT:ASS'Y

- 63.D2414981 (x2) COIL SPRING:ROLLER:PRESSURE:EXIT
- 51.D2414937 (x4) TENSION SPRING:GATE:REVERSE
- 64.D2414992 DISCHARGE BRUSH:EXIT
- 60.D2414955 HOLDER:ROLLER:EXIT:PRESSURE:2 TYPE
- 68.GW010007 (x2) PHOTO REFLECTION SENSOR:EXIT:(S3/S9/S10/S12/S14/S16/S22/S24)

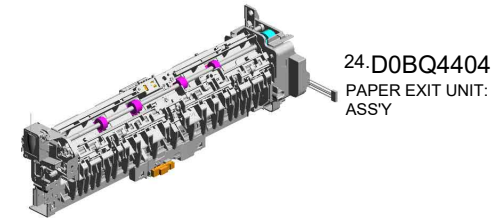

24.D0BQ4404
PAPER EXIT UNIT:ASS'Y

66.D2414996
DC SOLENOID:ASS'Y:(SOL2)

57.D2414947
GATE PAWL:REVERSE:FRONT

67.D2414998
CUSHION:DC SOLENOID:4MM

46.D2414483
LEVER:GATE PAWL

70.M0AJ4981
DECAL:EXIT:GUIDE P:LOWER:MIDDLE

53.D2414941
GATE PAWL:REVERSE:FRONT MIDDLE

65.D2414994
GUIDE PLATE:EXIT:LOWER

55.D2414943
GATE PAWL:REVERSE:REAR

71.M0AJ4982
DECAL:EXIT:GUIDE P:LOWER:INNER BACK

54.D2414942
GATE PAWL:REVERSE:REAR MIDDLE

58.D2414948
GUIDE:HARNES:REVERSE

56.D2414946
SHAFT:GATE PAWL:REVERSE

U012_S001_S001
ROLLER:EXIT:PRESSURE:2TYPE:ASS'Y

6.07200020G
(x4)
RETAINING RING -
M2

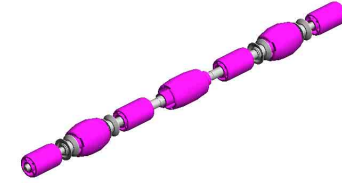
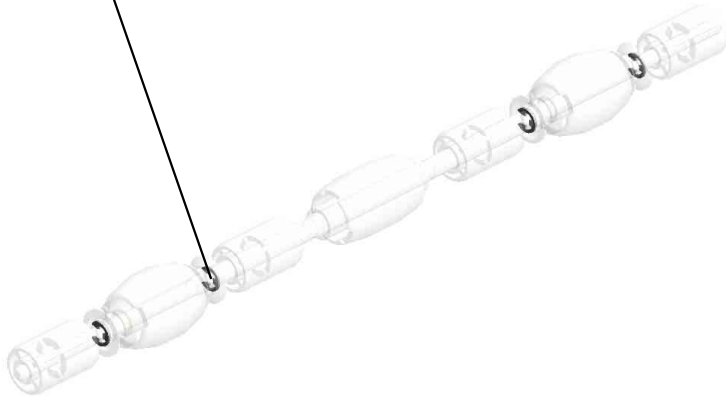

59.D2414950
ROLLER:EXIT:PRE
SSURE:2TYPE:ASS
'Y

U001	U002	U003	U004	U005	U006	U007	U008	U009	U010	U011	U012	U013	U014	U015	U016	U017	U018
------	------	------	------	------	------	------	------	------	------	------	------	------	------	------	------	------	------

U013.DUPLEX

U013_S001
D0BQ4555
DUPLEX UNIT:IMC3000-6000

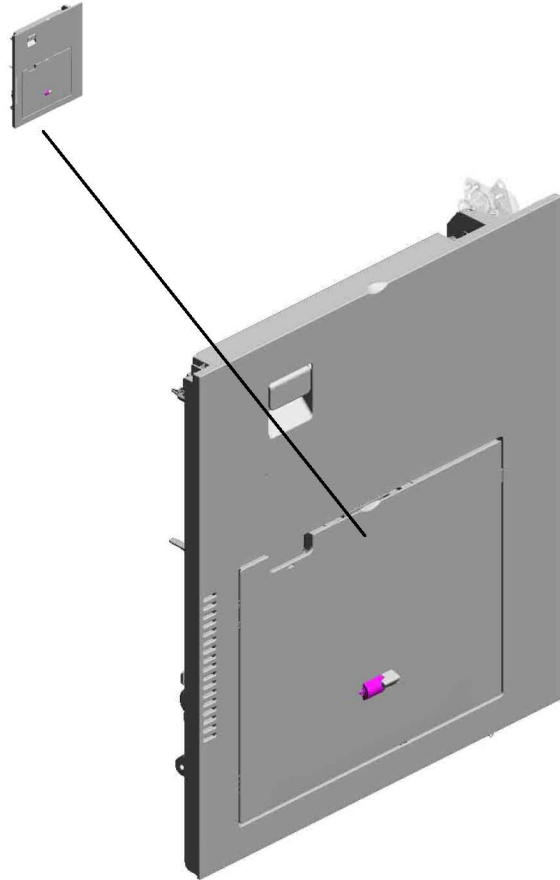

U001	U002	U003	U004	U005	U006	U007	U008	U009	U010	U011	U012	U013	U014	U015	U016	U017	U018
------	------	------	------	------	------	------	------	------	------	------	------	------	------	------	------	------	------

U013_S001.DUPLEX UNIT:IMC3000-6000

U013 S001 S002
D0BQ4563
MANUAL FEED TABLE:IMC20
00-6000

U013 S001 S003
D2412671
GUIDE PLATE:VERTICAL TR
ANSPORT:NO.1:DRIVEN:ASS
Y

U013 S001 S001
D0BQ2601
MANUAL FEED UNIT:ASSY

U013 S001 S004
D2412672
GUIDE PLATE:VERTICAL TR
ANSPORT:NO.2:DRIVEN:ASS
Y

U001	U002	U003	U004	U005	U006	U007	U008	U009	U010	U011	U012	U013	U014	U015	U016	U017	U018
------	------	------	------	------	------	------	------	------	------	------	------	------	------	------	------	------	------

U013_S001_S002.MANUAL FEED TABLE:IMC2000-6000

U013_S001_S002_S001
D0BQ2630
SIDE FENCE:FRONT:ASS'Y

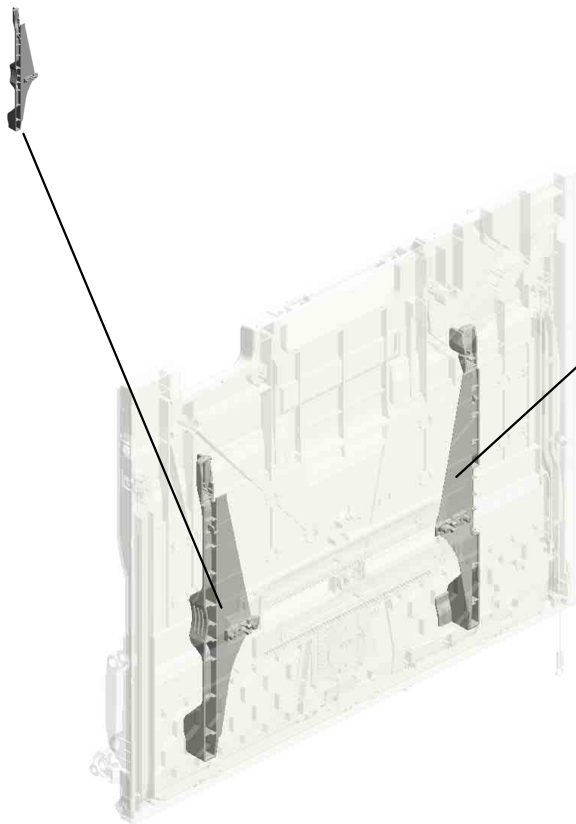

U013_S001_S002_S002
D0BQ2632
SIDE FENCE:REAR:ASS'Y

U001	U002	U003	U004	U005	U006	U007	U008	U009	U010	U011	U012	U013	U014	U015	U016	U017	U018
------	------	------	------	------	------	------	------	------	------	------	------	------	------	------	------	------	------

U013 DUPLEX

4.04543006Q (x3) TAPPING SCREW - M3X6
 90.D1494623 GROUND WIRE:BRACKET:ENTRANCE:DUPLEX
 2.03603006N SCREW - M3X6
 6.04583008N (x3) HEXAGON HEAD TAPPING SCREW:3X8

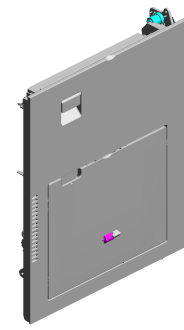

181.D2414755
GEAR:OUTPUT:DUPLEX:ENTRANCE

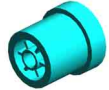

182.D2414757
SPACER:DC MOTOR:DUPLEX



10.07200040E
RETAINING RING - M4



39.AX060464
DC MOTOR:ENCODER:NO:10W:GEAR:BRUSHLESS:(M1/M2/M5/M6)



180.D2414750
BRACKET:MOTOR:DUPLEX



38.AW500049
PUSH SWITCH:SW1AG-550:(S4/S17/S19/S21)



20.54472681
(x2)
SNAP RING



3.04513006N (x2) TAPPING SCREW - 3X6
 112.D1494755 BRACKET:HINGE:DUPLEX:FRONT
 19.52152621 SNAP RING - M6

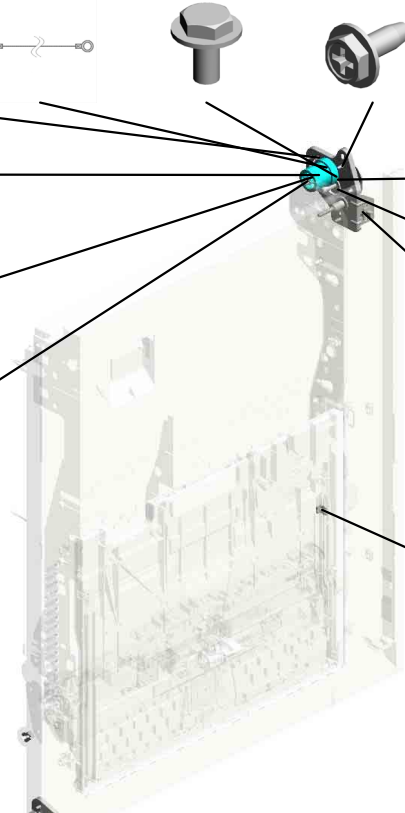

U013_S001
 DUPLEX UNIT:IMC3000-6000

- 2.03603006N (x2) SCREW - M3X6
- 5.04543008Q (x2) TAPPING SCREW: 3X8
- 6.04583008N (x24) HEXAGON HEAD TAPPING SCREW:3X8
- 21.AA043980 TIMING BELT:30S2 M300
- 15.11050692 (x4) CLAMP:LES-0503

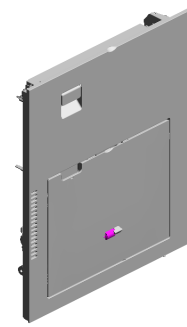

65.D0BQ4555
 DUPLEX UNIT:IMC
 3000-6000

7.04583010N
 (x8)
 HEXAGON HEAD TAPPING SCREW:3X10



22.AA082170
 (x2)
 PLAIN SHAFT BEARING RING:DIA4XDIA8X5.5EG-1



12.08050103
 (x6)
 RETAINING RINGS -E:SILENCER:DIA3



9.07200030E
 (x4)
 RETAINING RING - M3



13.08050104
 (x8)
 RETAINING RINGS -E:SILENCER:DIA4



4.04543006Q (x9) TAPPING SCREW - M3X6



24.AA082173 (x9) PLAIN SHAFT BEARING RING:6X10X6



26.AA083014 ONE-WAY CLUTCH



16.11050723 CLAMPS:WES-0507



17.11050724 CLAMPS:WES-1210



11.07200060E
 RETAINING RING - M6

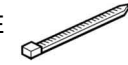

14.11050046 (x15) HARNESS BAND

30.AA143807 SCREW:A



18.11050758 (x9) CLAMP:LWSM-0306A



10.07200040E (x5) RETAINING RING - M4



27.AA083018 ROLLER CLUTCH - 6X14X10



U013_S001
 DUPLEX UNIT:IMC3000-6000

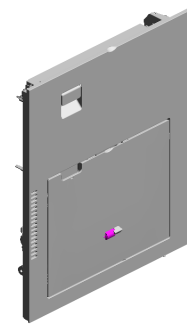

65.D0BQ4555
 DUPLEX UNIT:IMC
 3000-6000

- 45.D0094485 (x2) BUSHING - GATE
- 69.D0BQ4654 SHAFT:LEVER:LOCK
- 49.D0394525 (x2) COMPRESSION SPRING:SHAFT:GUIDE PLATE:EXIT
- 95.D1494653 TENSION SPRING: SWIVEL
- 94.D1494647 SYNCHRONOUS BELT:30S2M212

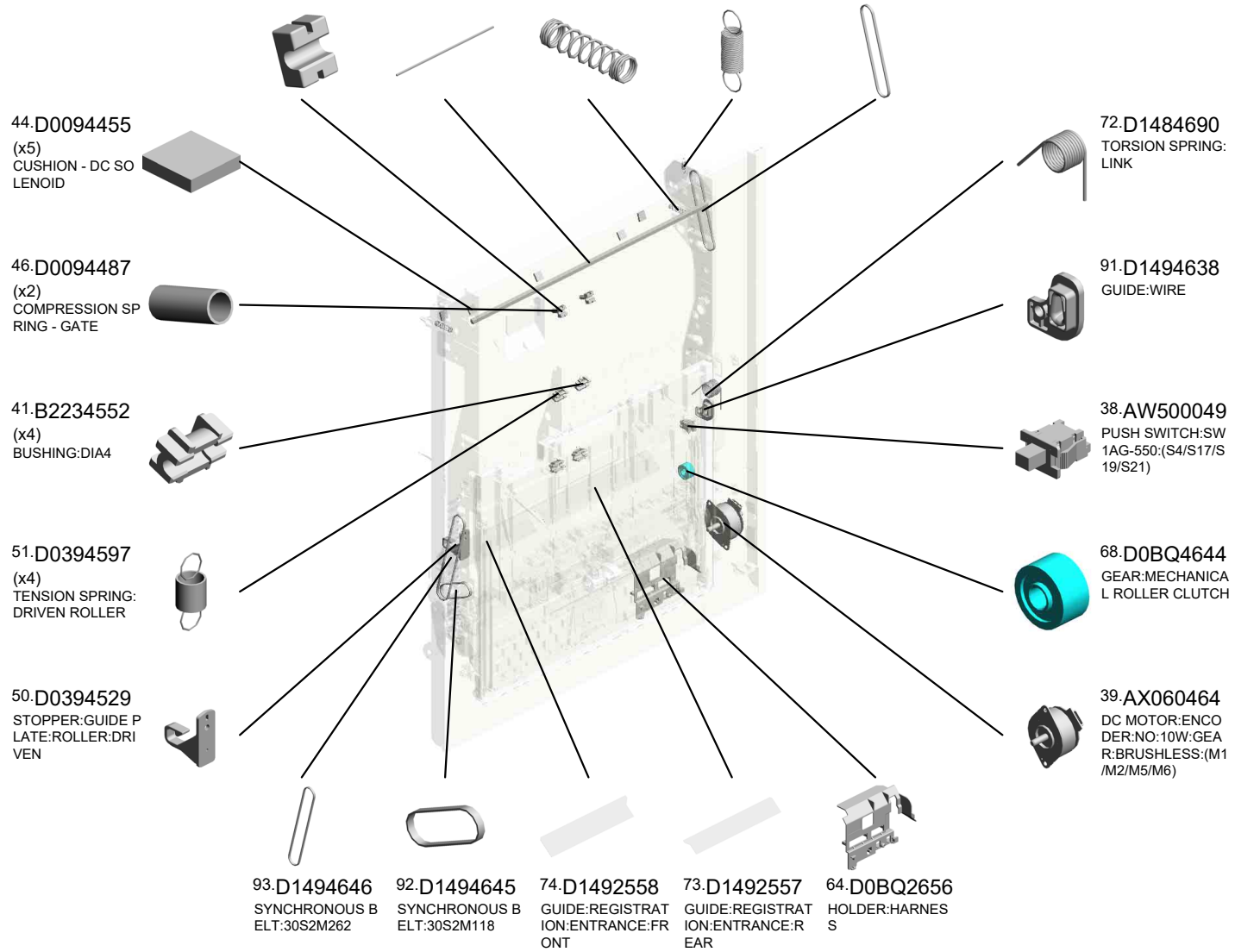

U001	U002	U003	U004	U005	U006	U007	U008	U009	U010	U011	U012	U013	U014	U015	U016	U017	U018
------	------	------	------	------	------	------	------	------	------	------	------	------	------	------	------	------	------

U013_S001
 DUPLEX UNIT:IMC3000-6000

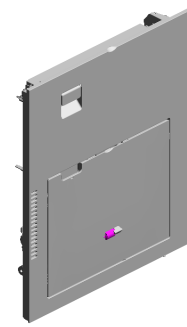

65.D0BQ4555
 DUPLEX UNIT:IMC
 3000-6000

- 98.D1494658 COIL SPRING:LEVER:DUPLEX
- 132.D2024674 TORSION SPRING:DUPLEX:ENTRANCE SENSOR
- 131.D2024673 FEELER:DUPLEX:ENTRANCE SENSOR
- 137.D2024692 (x2) SHAFT:PRESSURE GUIDE PLATE:UPPER
- 97.D1494657 HOOK:STOPPER:DUPLEX UNIT:REAR

96.D1494656 HOOK:STOPPER:DUPLEX UNIT:FRONT

106.D1494715 DECAL:GRIP:Z



114.D1494850 ARM:PUSH SWITCH

136.D2024684 GROUND WIRE:BRACKET:DRIVEN ROLLER

103.D1494695 LINK:FRONT

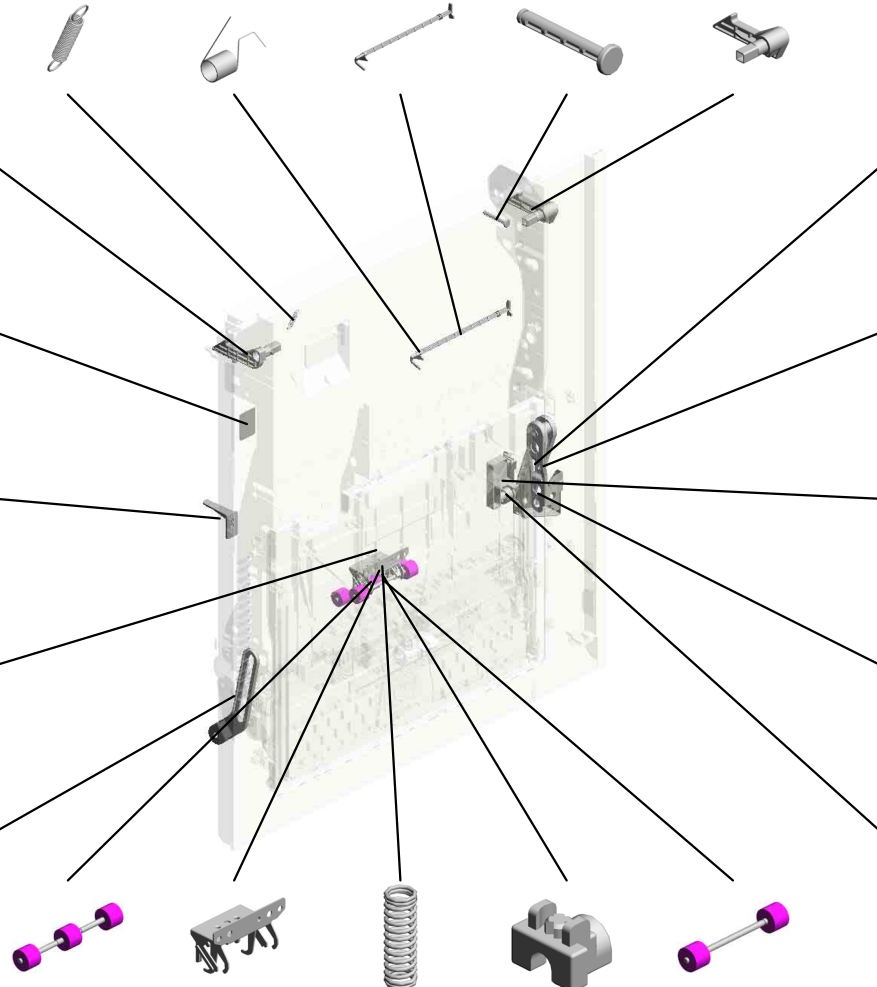

102.D1494688 LINK:DUPLEX:MAIN

139.D2024722 LINK:DUPLEX

100.D1494675 COVER:PUSH SWITCH

138.D2024721 BRACKET:LINK:DUPLEX

101.D1494677 STAY:CONTACT POINT:GUIDE PLATE:DRIVEN

135.D2024682 DRIVEN ROLLER:DRIVEN ROLLER:PRESSURE

134.D2024680 BRACKET:DRIVEN ROLLER:PRESSURE

99.D1494672 (x4) COMPRESSION SPRING:DRIVEN

118.D1754737 (x4) PLAIN SHAFT BEARING:DRIVEN

133.D2024679 DRIVEN ROLLER:DRIVEN ROLLER:PRESSURE

U001	U002	U003	U004	U005	U006	U007	U008	U009	U010	U011	U012	U013	U014	U015	U016	U017	U018
------	------	------	------	------	------	------	------	------	------	------	------	------	------	------	------	------	------

U013_S001
 DUPLEX UNIT:IMC3000-6000

165.D2414660 GUIDE PLATE:UPPER:RIGHT:DUPLEX
 160.D2414635 SHEET:CUSHION
 163.D2414643 (x2) TRANSPORT ROLLER:ENTRANCE
 167.D2414676 (x2) LEVER:PRESSURE:DUPLEX
 164.D2414652 GEAR:PULLEY:SWIVEL

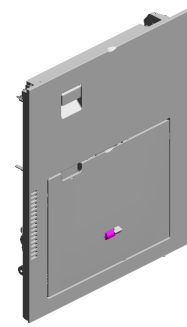

65.D0BQ4555
 DUPLEX UNIT:IMC
 3000-6000

168.D2414677 (x2) COMPRESSION SPRING:EXIT:UPPER

166.D2414673 GUIDE PLATE:DRIVEN

158.D2414627 COVER:DUPLEX

162.D2414642 TRANSPORT ROLLER:DUPLEX:1

172.D2414693 INNER COVER:FRONT:DUPLEX

161.D2414640 TRANSPORT ROLLER:EXIT:DIA8

159.D2414628 GUIDE PLATE:DUPLEX:EXIT

157.D2414617 TRANSPORT ROLLER:DUPLEX:2:DIA8

170.D2414684 GEAR:OUTPUT

169.D2414681 BRACKET:MOTOR:PEEN

173.D2414694 CAP:BELT:DUPLEX

171.D2414692 INNER COVER:REAR:DUPLEX

174.D2414697 GROUND WIRE:EXIT SENSOR:DUPLEX

140.D2024726 TORSION SPRING:LINK:CONTACT POINT

175.D2414707 GEAR:FEED:MANUAL FEED:DRIVE

U001	U002	U003	U004	U005	U006	U007	U008	U009	U010	U011	U012	U013	U014	U015	U016	U017	U018
------	------	------	------	------	------	------	------	------	------	------	------	-------------	------	------	------	------	------

U013_S001
 DUPLEX UNIT:IMC3000-6000

190.D2414995 GUIDE PLATE:UPPER
 184.D2414762 DRIVEN ROLLER:DI
 193.GW020024 PHOTOINTERRUPTOR:LG2A24BL1:G
 185.D2414763 GUIDE:HARNESS:ENTRANCE SENS
 OR:DUPLEX

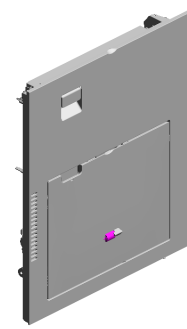

65.D0BQ4555
 DUPLEX UNIT:IMC
 3000-6000

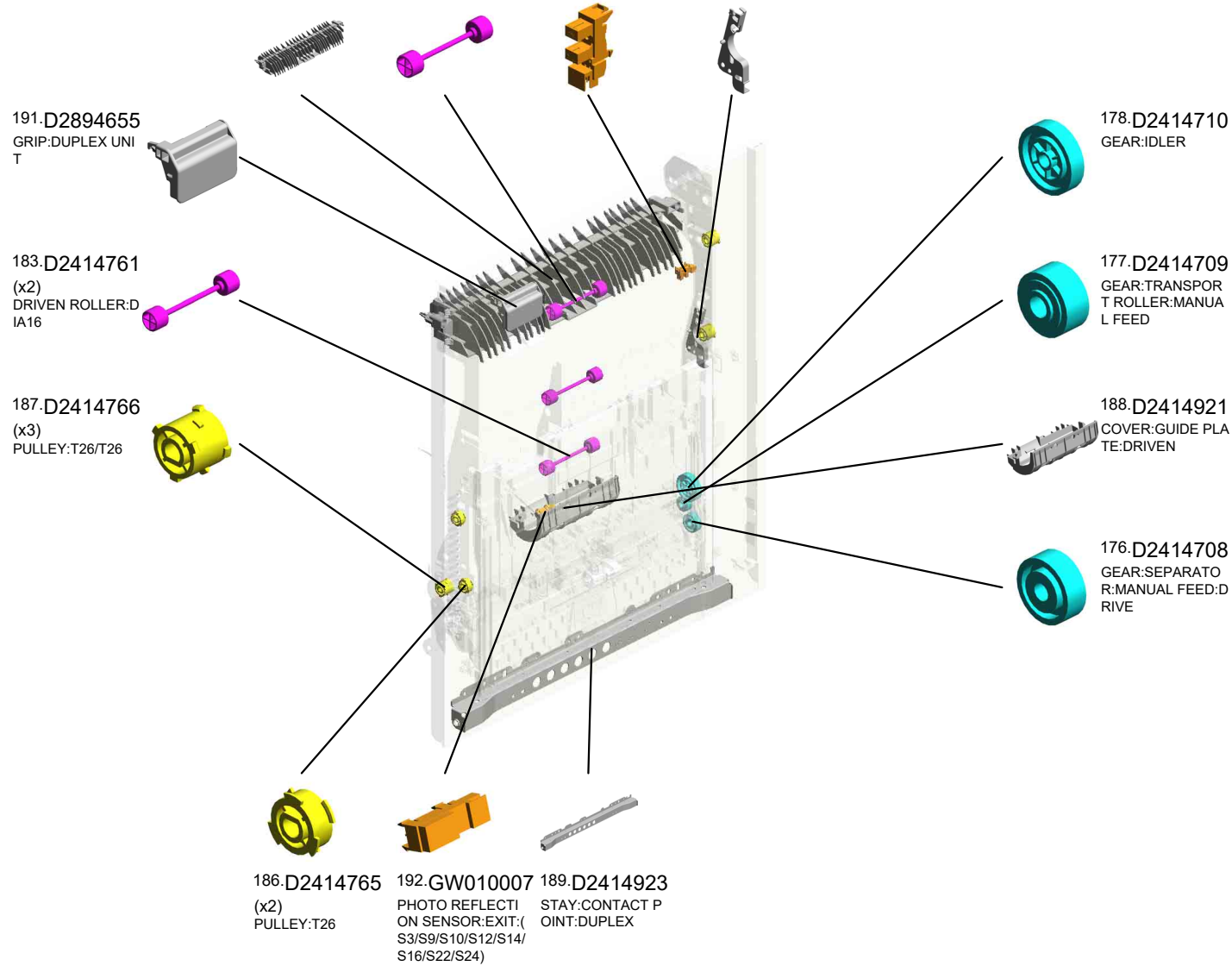

U001	U002	U003	U004	U005	U006	U007	U008	U009	U010	U011	U012	U013	U014	U015	U016	U017	U018
------	------	------	------	------	------	------	------	------	------	------	------	------	------	------	------	------	------

U013_S001_S001
MANUAL FEED UNIT:ASS'Y

- 4.04543006Q (x2) TAPPING SCREW - M3X6
 25.AA082187 BUSHING:DIA6XDI A10X9:EG-1
 34.AB011252 GEAR - 20Z
 1.03530030N (x2) SCREW:M3X3
 5.04543008Q (x5) TAPPING SCREW: 3X8

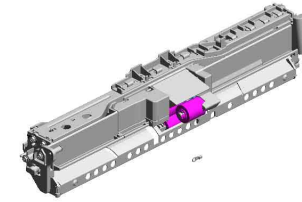

52.D0BQ2601
MANUAL FEED UNI
T:ASS'Y

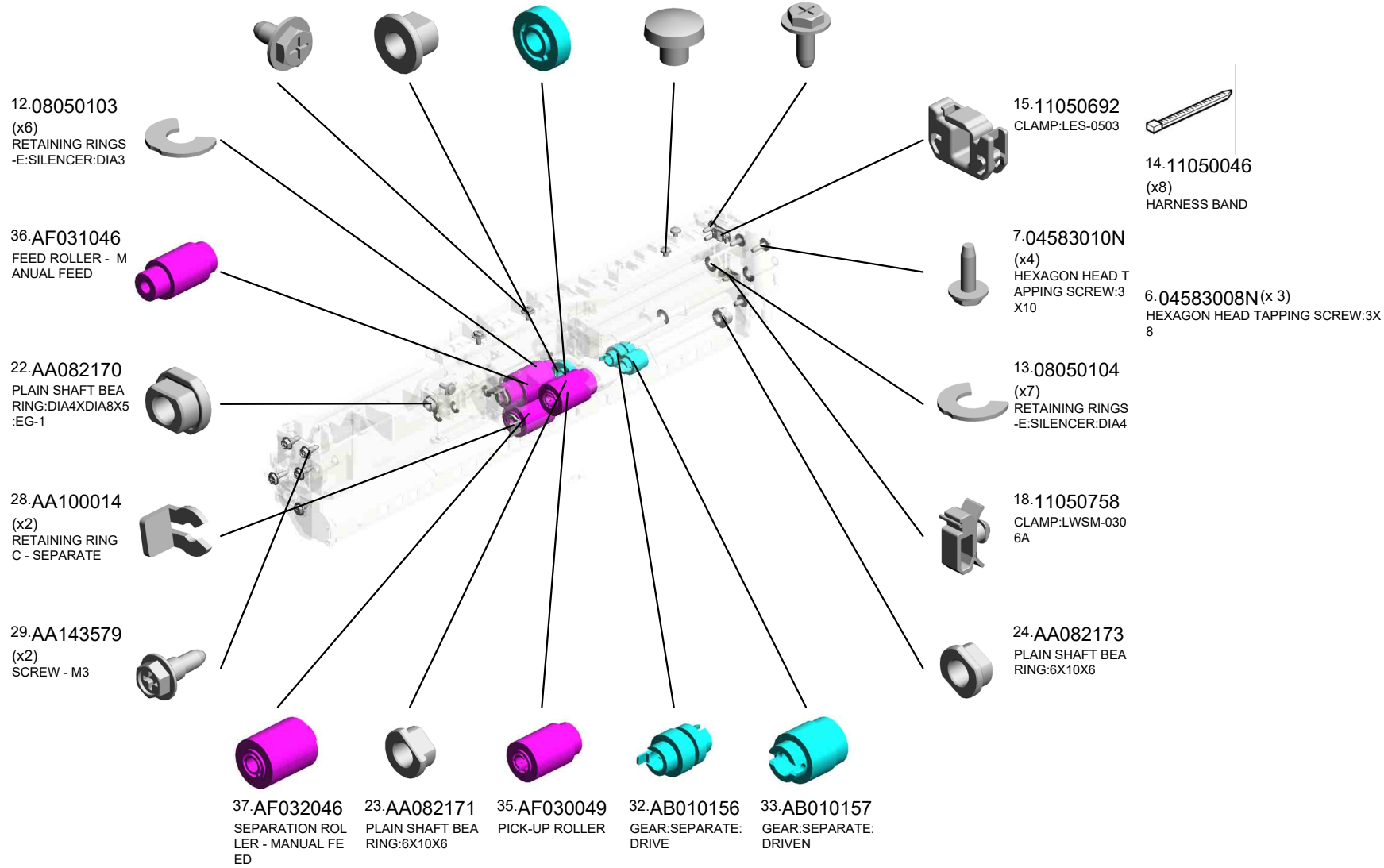

U001	U002	U003	U004	U005	U006	U007	U008	U009	U010	U011	U012	U013	U014	U015	U016	U017	U018
------	------	------	------	------	------	------	------	------	------	------	------	-------------	------	------	------	------	------

U013_S001_S001 MANUAL FEED UNIT:ASS'Y

- 54.D0BQ2615 GUIDE PLATE:SEPARATOR:ASS'Y
- 84.D1492658 COVER:PAPER FEED ROLLER
- 119.D2022614 COIL SPRING:RELEASE:PICKUP:MANUAL FEED
- 81.D1492642 SHAFT:LINK:PAPER STOPPER
- 79.D1492635 TRANSPORT ROLLER:MANUAL FEED

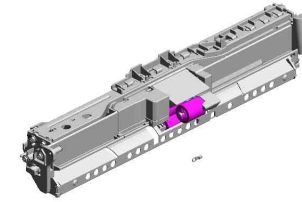

52.D0BQ2601
MANUAL FEED UNIT:ASS'Y

63.D0BQ2654
(x2)
CUSHION:GUIDE PLATE:SEPARATOR

82.D1492655
FEELER:PAPER END SENSOR

77.D1492614
(x2)
TENSION SPRING:GRIP:PRESSURE

83.D1492656
TORSION SPRING:PAPER END SENSOR

75.D1492612
(x3)
ROLLER:GRIP:DRIVEN

76.D1492613
SHAFT:GRIP:DRIVEN

70.D1292783
TORQUE LIMITER MECHANICAL CLUTCH:40MM:DIA18

59.D0BQ2637
PAPER STOPPER:MANUAL FEED

56.D0BQ2623
ARM:PICKUP:MANUAL FEED

62.D0BQ2653
COIL SPRING:PRESSURE:SEPARATOR

78.D1492633
SHAFT:FEED:MANUAL FEED

55.D0BQ2619
SHAFT:SEPARATOR:DRIVE:ASS'Y

60.D0BQ2638
LINK:PAPER STOPPER:MANUAL FEED

53.D0BQ2608
SHAFT:SEPARATOR:DRIVEN:ASS'Y

80.D1492639
SHAFT:PAPER STOPPER

U001	U002	U003	U004	U005	U006	U007	U008	U009	U010	U011	U012	U013	U014	U015	U016	U017	U018
------	------	------	------	------	------	------	------	------	------	------	------	------	------	------	------	------	------

U013_S001_S001
 MANUAL FEED UNIT:ASS'Y

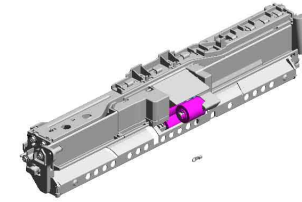

52.D0BQ2601
 MANUAL FEED UNIT:ASS'Y

- 146.D2412652 GROUND PLATE:SHAFT:FEED
- 143.D2412641 COVER:PAPER STOPPER:MANUAL FEED
- 145.D2412644 TORSION SPRING:LINK:PAPER STOPPER
- 144.D2412643 ARM:LINK:PAPER STOPPER

122.D2022624 COVER:PAPER END

123.D2022625 BRACKET:PAPER END SENSOR:MANUAL FEED

179.D2414722 BRACKET:FRONT

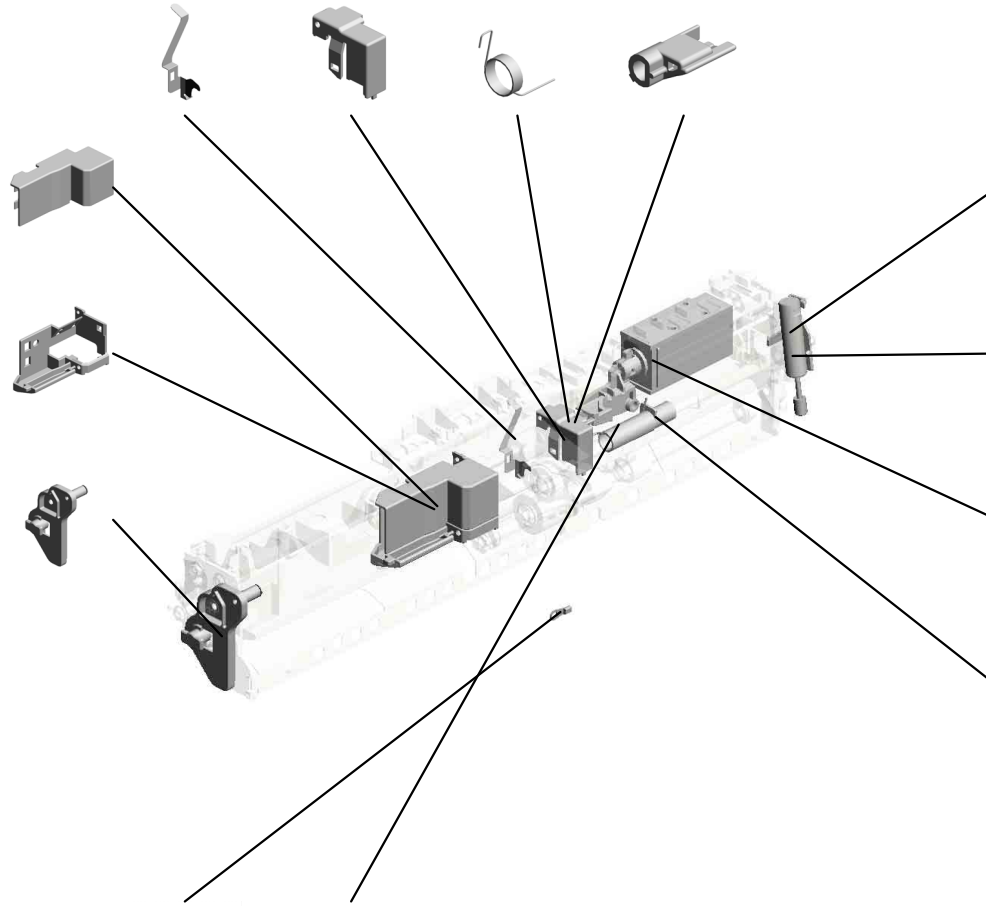

142.D2412622 COVER:DAMPER

195.M0662749 OIL DAMPER:STRAIGHT:30N

141.D2412612 DC SOLENOID:PICKUP:ASS'Y:(SOL1)

121.D2022620 SHOE:TORSION SPRING:PICKUP

- 147.D2412657 GROUND WIRE:MANUAL FEED UNIT:REAR
- 120.D2022619 TORSION SPRING:PICKUP

U001	U002	U003	U004	U005	U006	U007	U008	U009	U010	U011	U012	U013	U014	U015	U016	U017	U018
------	------	------	------	------	------	------	------	------	------	------	------	------	------	------	------	------	------

U013_S001_S002

MANUAL FEED TABLE:IMC2000-6000

125.D2022640
EXTENSION TRAY:
NO.1

126.D2022641
EXTENSION TRAY:
NO.2

124.D2022638
FEELER:PAPER SI
ZE SENSOR:MANU
AL FEED

88.D1492693
(x2)
STOPPER:MANUA
L FEED TABLE

86.D1492688
TENSION SPRING:
WIRE



66.D0BQ4563
MANUAL FEED TA
BLE:IMC2000-6000

40.B2231099
(x2)
FLAT SCREW



111.D1494731
(x2)
COMPRESSION SP
RING:RACK:MANU
AL FEED



31.AA143850
(x2)
FLAT SCREW:M3X
5:SIDE FENCE



87.D1492692
ARM:MANUAL FEE
D:FRONT UPPER

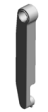

104.D1494706
PIN:ARM:FRONT L
OWER



115.D1494883
ARM:MANUAL FEE
D:FRONT LOWER



89.D1492694
(x2)
COMPRESSION SP
RING:STOPPER:M
ANUAL FEED TABL
E



67.D0BQ4570
PAPER SIZE SENS
OR:SENSOR:IMC2
000-6000:(S8)



1.03530030N
SCREW:M3X3



8.04593008N
(x6)
BINDING HEAD TA
PPING SCREW:3X
8



13.08050104
(x5)
RETAINING RINGS
-E:SILENCER:DIA4



14.11050046
(x6)
HARNES BAND

85.D1492686
WIRE:MANUAL FE
ED TABLE:TC075



61.D0BQ2644
(x2)
BRACKET:SIDE FE
NCE:MANUAL FEE
D



116.D1494884
ARM:MANUAL FEE
D:REAR LOWER



117.D1502666
GEAR:SIDE FENCE
:MANUAL FEED TA
BLE

U001	U002	U003	U004	U005	U006	U007	U008	U009	U010	U011	U012	U013	U014	U015	U016	U017	U018
------	------	------	------	------	------	------	------	------	------	------	------	------	------	------	------	------	------

U013_S001_S002
 MANUAL FEED TABLE:IMC2000-6000

130.D2022677 156.D2412685
 DECAL:SCALE:MA DECAL:PAPER SE
 NUAL FEED:REAR T DIRECTION:MAN
 NUAL FEED



66.D0BQ4563
 MANUAL FEED TA
 BLE:IMC2000-6000

129.D2022676
 DECAL:SCALE:MA
 NUAL FEED:MIDDL
 E

148.D2412663
 DECAL:SCALE:MA
 NUAL FEED:FRON
 T

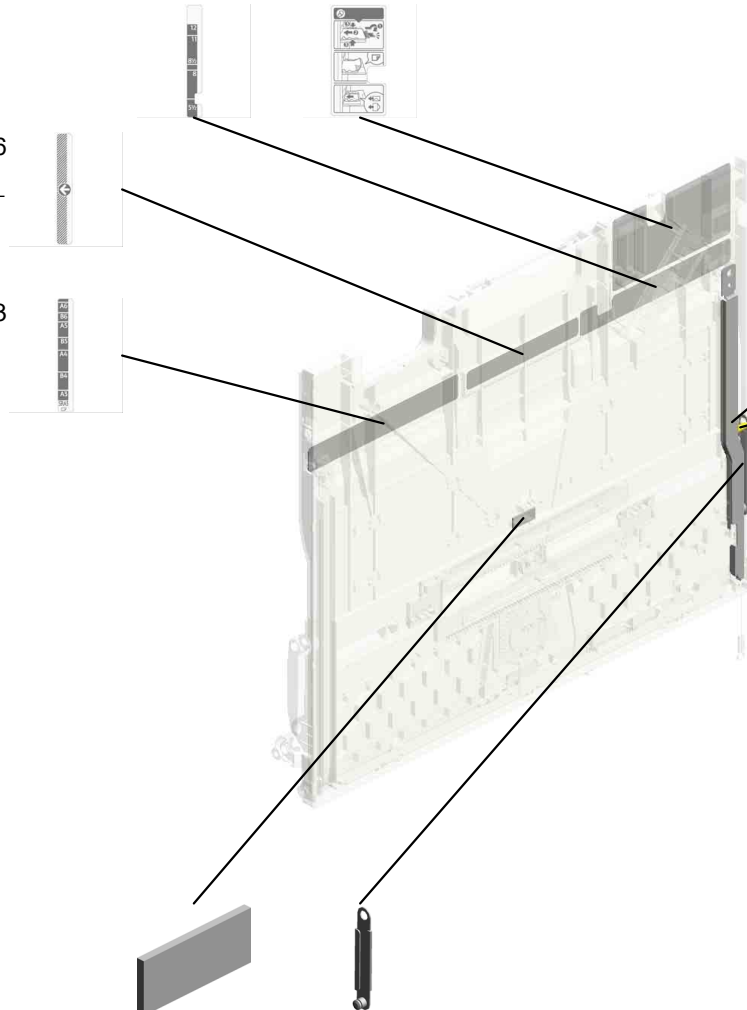

155.D2412682
 STAY:REAR:MANU
 AL FEED TABLE

127.D2022642
 PULLEY:WIRE:MA
 NUAL FEED TABLE

194.M0662743 128.D2022646
 FRICTION PAD:MA ARM:MANUAL FEE
 NUAL FEED TABLE D:REAR UPPER
 :18X7.5

U001	U002	U003	U004	U005	U006	U007	U008	U009	U010	U011	U012	U013	U014	U015	U016	U017	U018
------	------	------	------	------	------	------	------	------	------	------	------	------	------	------	------	------	------

U013_S001_S002_S001
SIDE FENCE:FRONT:ASS'Y

107.D1494717
PLATE:SIDE FENC
E:FRONT



57.D0BQ2630
SIDE FENCE:FRON
T:ASSY

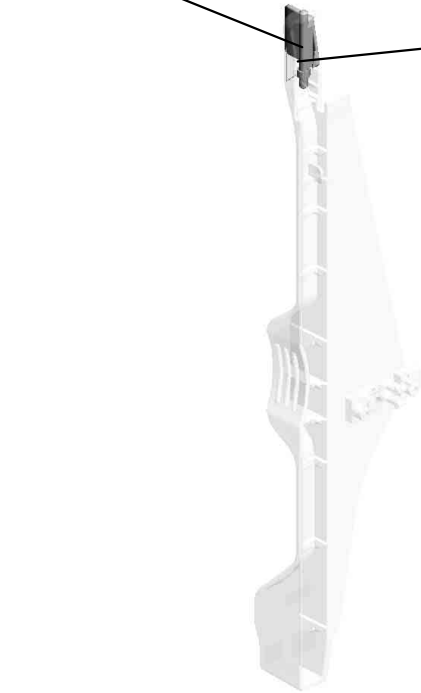

108.D1494718
TORSION SPRING:
SIDE FENCE:FRON
T

U001	U002	U003	U004	U005	U006	U007	U008	U009	U010	U011	U012	U013	U014	U015	U016	U017	U018
------	------	------	------	------	------	------	------	------	------	------	------	------	------	------	------	------	------

U013_S001_S002_S002
SIDE FENCE:REAR:ASS'Y

109.D1494720 110.D1494721
PLATE:SIDE FENC TORSION SPRING:
E:REAR SIDE FENCE:REAR

58.D0BQ2632
SIDE FENCE:REAR
:ASS'Y



105.D1494711
DECAL:SIDE FENC
E:MANUAL FEED



U001	U002	U003	U004	U005	U006	U007	U008	U009	U010	U011	U012	U013	U014	U015	U016	U017	U018
------	------	------	------	------	------	------	------	------	------	------	------	------	------	------	------	------	------

U013_S001_S003

GUIDE PLATE:VERTICAL TRANSPORT:NO.1:DRIVEN:ASS'Y

- 42.D0092573 (x3) PULLEY - VERTICAL TRANSPORT
- 113.D1494777 (x2) COMPRESSION SPRING:FLAT CONVEYER BELT:DRIVEN
- 151.D2412673 GUIDE PLATE:VERTICAL TRANSPORT:NO.1:DRIVEN

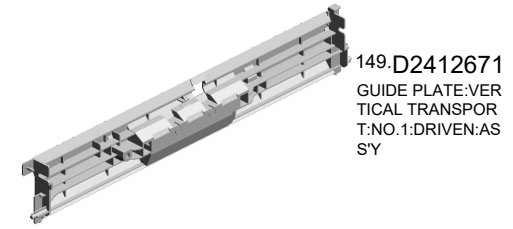

- 149.D2412671 GUIDE PLATE:VERTICAL TRANSPORT:NO.1:DRIVEN:ASS'Y

- 47.D0292677 (x3) TRANSPORT BELT:DRIVEN:VERTICAL TRANSPORT

- 71.D1444489 (x2) STOPPER:DRIVEN ROLLER

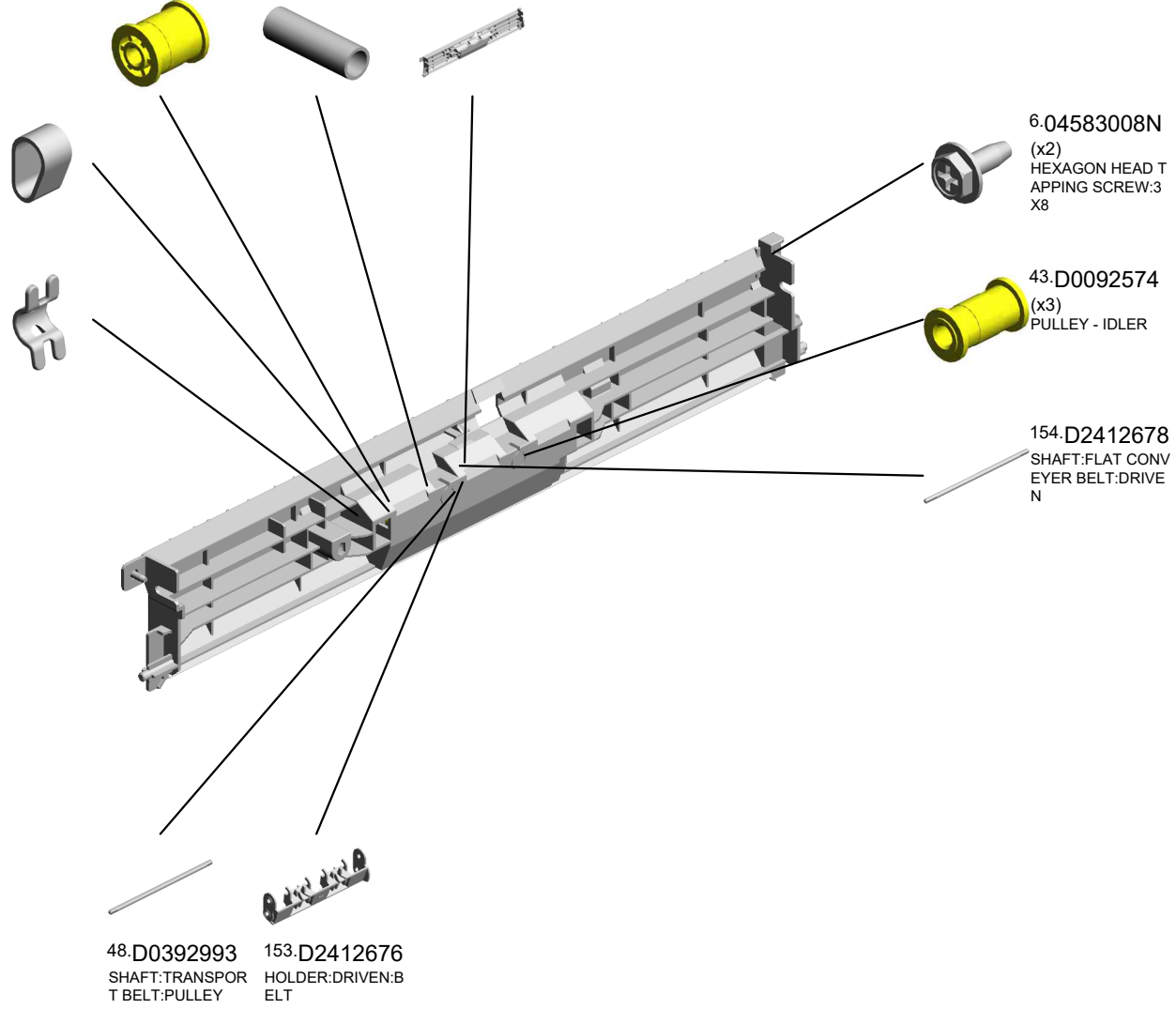

U001	U002	U003	U004	U005	U006	U007	U008	U009	U010	U011	U012	U013	U014	U015	U016	U017	U018
------	------	------	------	------	------	------	------	------	------	------	------	------	------	------	------	------	------

U013_S001_S004

GUIDE PLATE:VERTICAL TRANSPORT:NO.2:DRIVEN:ASS'Y

- 113.D1494777 (x2) COMPRESSION SPRING:FLAT CONVEYER BELT:DRIVEN
- 152.D2412674 GUIDE PLATE:VERTICAL TRANSPORT:NO.2:DRIVEN
- 154.D2412678 SHAFT:FLAT CONVEYER BELT:DRIVEN

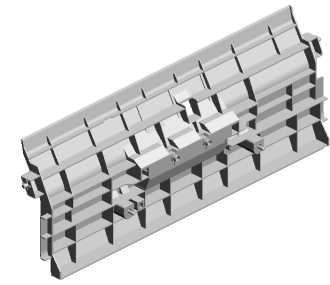

- 150.D2412672 GUIDE PLATE:VERTICAL TRANSPORT:NO.2:DRIVEN:ASS'Y

- 42.D0092573 (x3) PULLEY - VERTICAL TRANSPORT



- 47.D0292677 (x3) TRANSPORT BELT:DRIVEN:VERTICAL TRANSPORT



- 71.D1444489 (x2) STOPPER:DRIVEN ROLLER



- 43.D0092574 (x3) PULLEY - IDLER

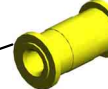

- 5.04543008Q (x2) TAPPING SCREW: 3X8



- 48.D0392993 SHAFT:TRANSPORT BELT:PULLEY
- 153.D2412676 HOLDER:DRIVEN:BELT



U001	U002	U003	U004	U005	U006	U007	U008	U009	U010	U011	U012	U013	U014	U015	U016	U017	U018
------	------	------	------	------	------	------	------	------	------	------	------	------	------	------	------	------	------

U014.MAIN DRIVE

U014 S002
D0BQ1357
DRIVE UNIT:FUSING/PAPER
EXIT UNIT:ASS'Y

U014 S003
D1491351
DRIVE UNIT:REGISTRATION:
ASSY

U014 S001
D0BQ1399
DRIVE UNIT:PAPER FEED:AS
S'Y

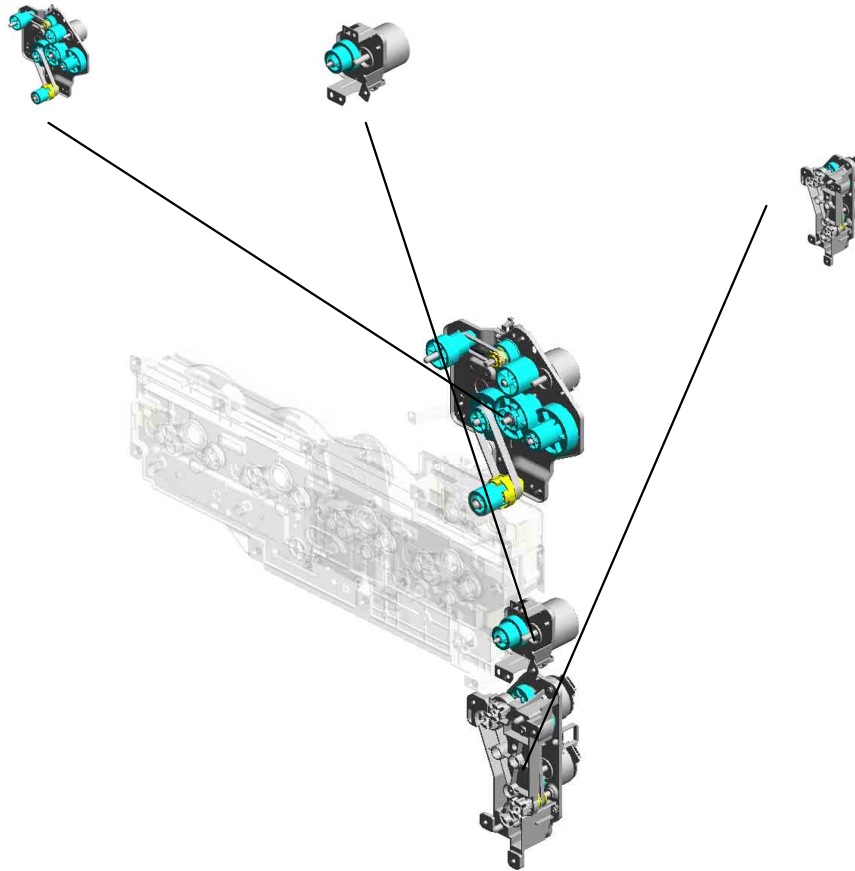

U001	U002	U003	U004	U005	U006	U007	U008	U009	U010	U011	U012	U013	U014	U015	U016	U017	U018
------	------	------	------	------	------	------	------	------	------	------	------	------	-------------	------	------	------	------

U014 MAIN DRIVE

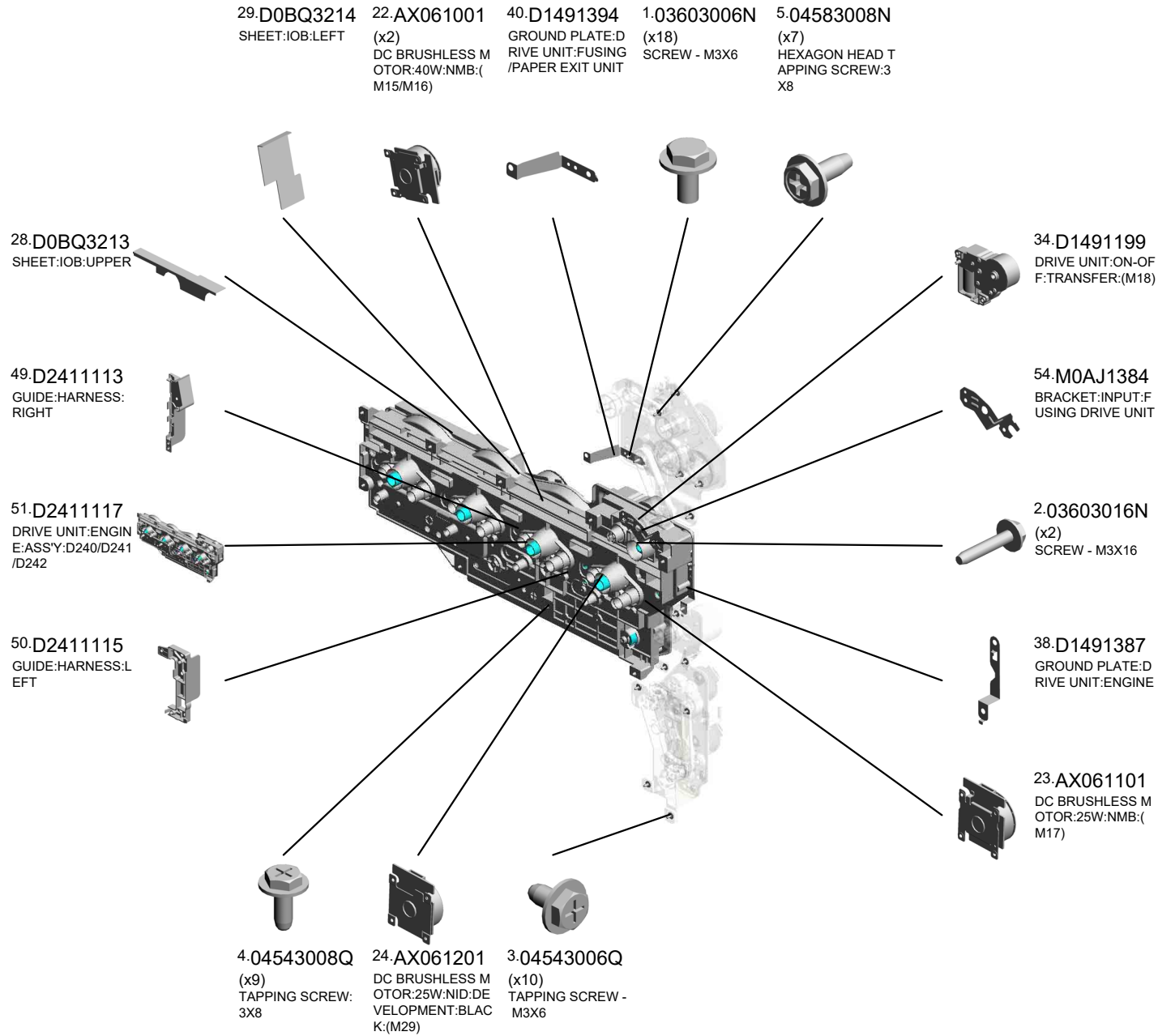
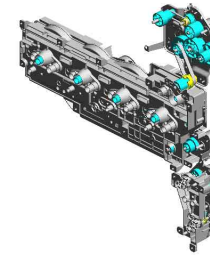

U001	U002	U003	U004	U005	U006	U007	U008	U009	U010	U011	U012	U013	U014	U015	U016	U017	U018
------	------	------	------	------	------	------	------	------	------	------	------	------	-------------	------	------	------	------

U014_S001
DRIVE UNIT:PAPER FEED:ASS'Y

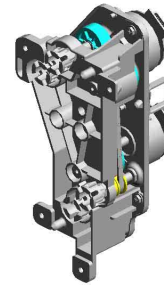

27.D0BQ1399
DRIVE UNIT:PAPE
R FEED:ASS'Y

10.08050104 (x3) RETAINING RINGS
-E:SILENCER:DIA4
46.D2021193 (x2) STUD:PAPER FEE
D:GRIP:ASS'Y
45.D2021191 GEAR:GRIP:NO.1
6.06320100G (x2) PIN - 2X10MM
33.D1491197 GEAR:IDLER:PAPE
R FEED:GRIP:NO.1

30.D1491194
PULLEY:PAPER FE
ED:FEED:NO.1:ME
CHANICAL ROLLE
R CLUTCH

39.D1491392
FLANGE:PAPER F
EED:FEED

43.D2021143
(x4)
JOINT:DRIVE

16.AA043623
TIMING BELT - B40
S2M180

44.D2021152
BRACKET:DRIVE U
NIT:PAPER FEED:A
SS'Y

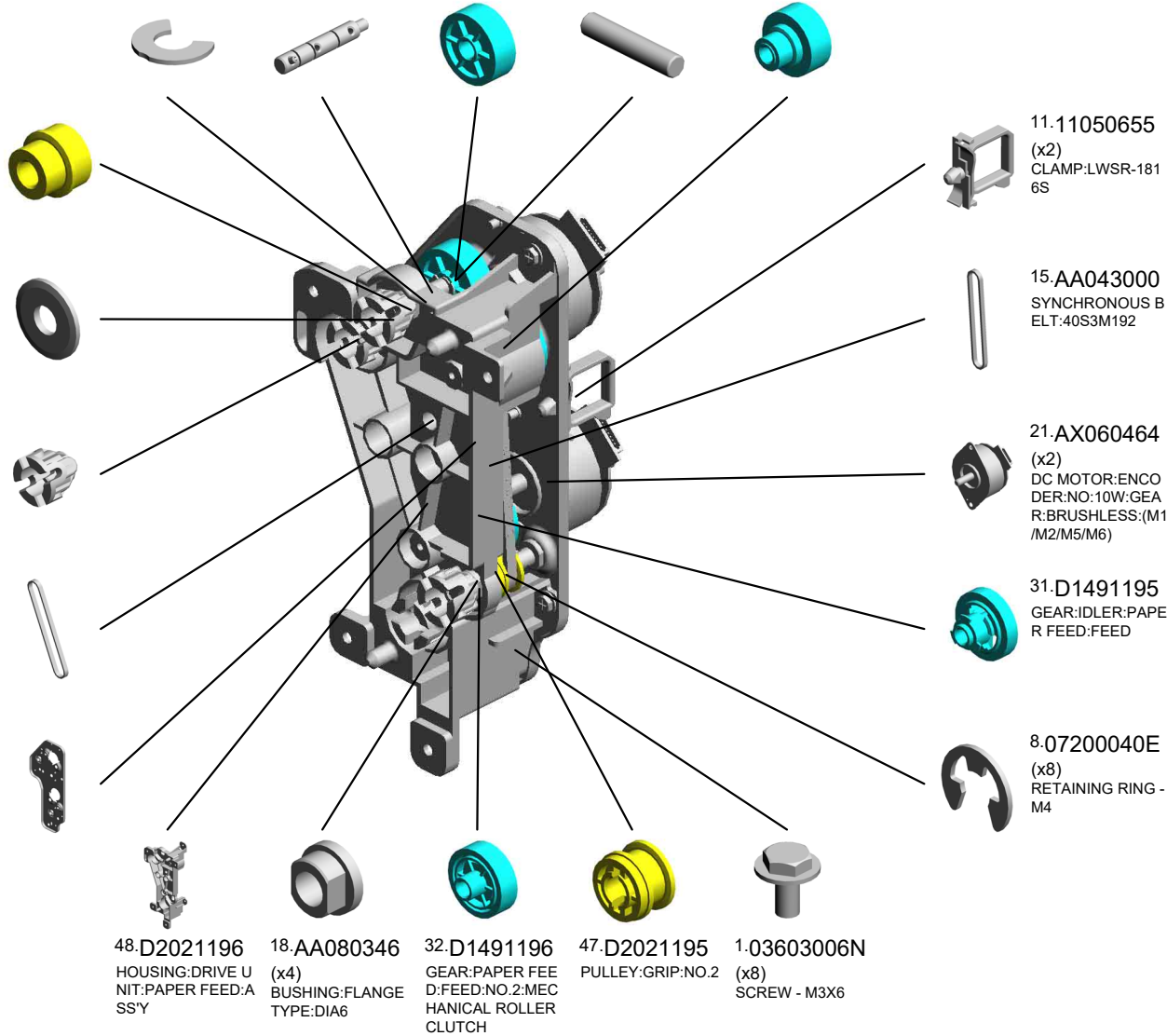

U001 U002 U003 U004 U005 U006 U007 U008 U009 U010 U011 U012 U013 U014 U015 U016 U017 U018

U014_S002

DRIVE UNIT:FUSING/PAPER EXIT UNIT:ASS'Y

- 13.11050760 (x5) CLAMP:LWSM-0511A
- 8.07200040E (x5) RETAINING RING - M4
- 14.11050762 CLAMP:LWS-0711A
- 19.AX050349 DC MOTOR:ENCO DER:NO:7W:GEAR: BRUSHLESS:(M4)

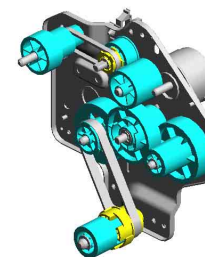

26.D0BQ1357
DRIVE UNIT:FUSIN
G/PAPER EXIT UNI
T:ASS'Y

25.AX061202
DC BRUSHLESS M
OTOR:25W:NID:FU
SING UNIT:(M8)

53.D2411396
HOLDER:TORQUE
LIMITER MECHAN
ICAL CLUTCH:PRE
SSURE RELEASE

7.06320140G
PARALLEL PIN

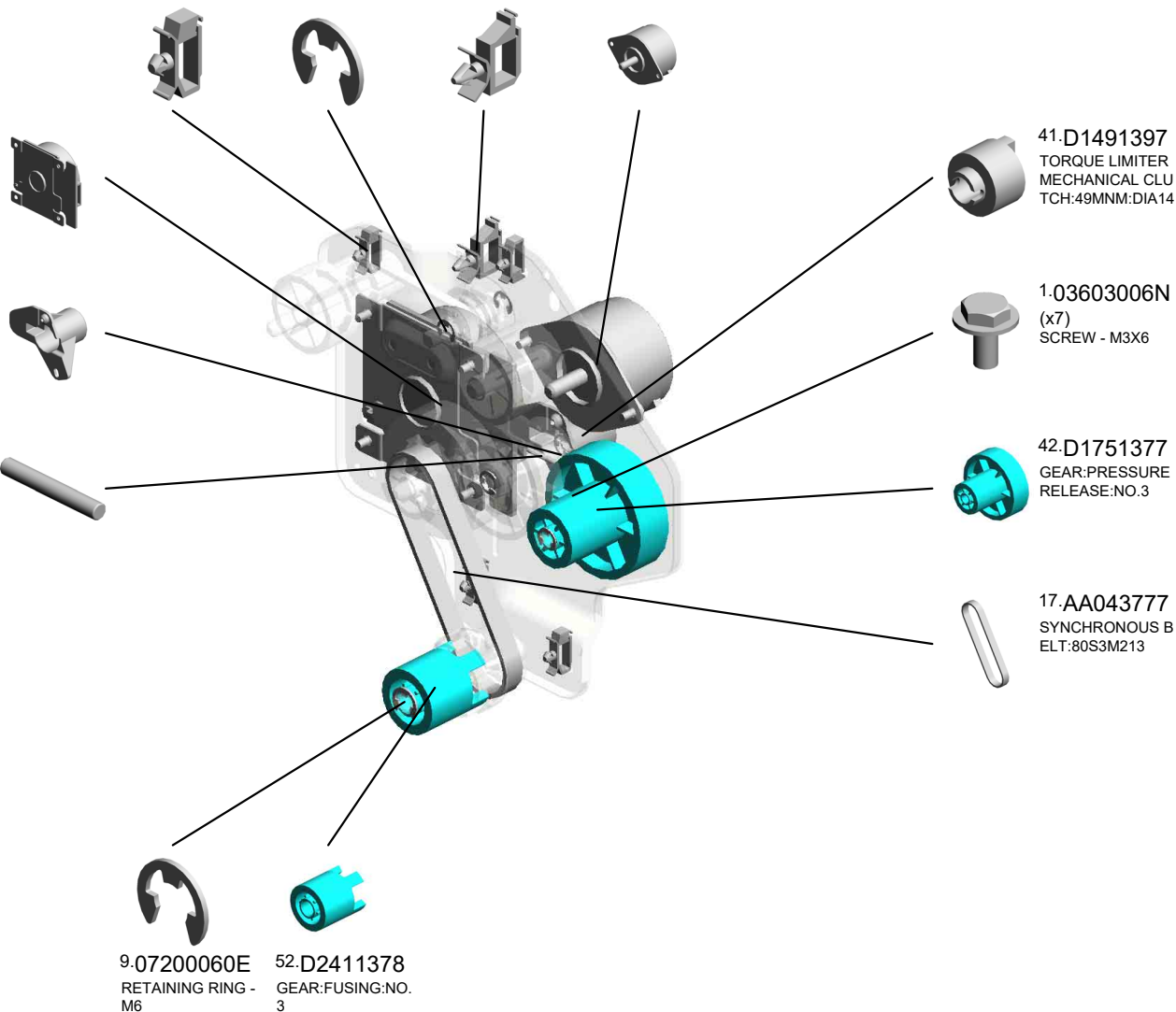

U001	U002	U003	U004	U005	U006	U007	U008	U009	U010	U011	U012	U013	U014	U015	U016	U017	U018
------	------	------	------	------	------	------	------	------	------	------	------	------	------	------	------	------	------

U014_S003
 DRIVE UNIT:REGISTRATION:ASS'Y

36.D1491352 1.03603006N
 BRACKET:DRIVE U (x2)
 NIT:REGISTRATION:ASS'Y SCREW - M3X6

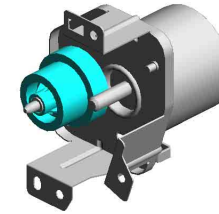

35.D1491351
 DRIVE UNIT:REGISTRATION:ASS'Y

37.D1491355
 GEAR:REGISTRATION:NO.1



20.AX060435
 DC MOTOR:GEAR:10W:BRUSHLESS:(M7)



12.11050759
 CLAMP:LWSM-0605A

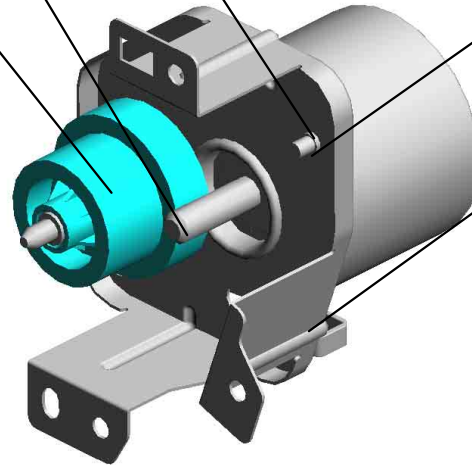

U001	U002	U003	U004	U005	U006	U007	U008	U009	U010	U011	U012	U013	U014	U015	U016	U017	U018
------	------	------	------	------	------	------	------	------	------	------	------	------	------	------	------	------	------

U015 ELECTRICAL

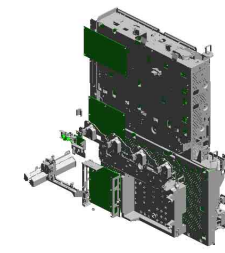

- 1.03530060N BIND SCREW - M3 X6
- 3.04513006N (x13) TAPPING SCREW - 3X6
- 11.04543020Q (x2) TAPPING SCREW:: 3X20
- 24.11050760 CLAMP:LWSM-051 1A
- 9.04543008Q (x2) TAPPING SCREW: 3X8

- 6.04543006N (x16) TAPPING SCREW: ROUND POINT:3X6

- 7.04543006Q (x67) TAPPING SCREW - M3X6

- 19.11050725 CLAMPS:WES-111 7

- 5.04513025N TAPPING SCREW: M3X25

- 13.08050103 RETAINING RINGS -E:SILENCER:DIA3

- 22.11050758 CLAMP:LWSM-030 6A
- 10.04543010Q (x5) TAPPING SCREW: 3X10
- 27.11050765 (x7) CLAMP:LWS-2218A 7
- 17.11050723 CLAMPS:WES-050 7
- 12.04583008N (x25) HEXAGON HEAD TAPPING SCREW:3 X8

- 20.11050726 (x2) CLAMPS:WES-221 7

- 2.03603006N (x2) SCREW - M3X6

- 16.11050692 (x2) CLAMP:LES-0503

- 18.11050724 CLAMPS:WES-121 0

- 23.11050759 (x16) CLAMP:LWSM-060 5A

- 14.11050046 (x186) HARNESS BAND
- 15.11050488 (x6) HARNESS CLAMP

- 16.11050692 (x2) CLAMP:LES-0503
- 17.11050723 (x3) CLAMPS:WES-050 7

- 18.11050724 (x2) CLAMPS:WES-121 0
- 21.11050752 SADDLE:EDS-3005 LS-V0

- 22.11050758 (x9) CLAMP:LWSM-030 6A
- 23.11050759 (x35) CLAMP:LWSM-060 5A

U001	U002	U003	U004	U005	U006	U007	U008	U009	U010	U011	U012	U013	U015	U016	U017	U018
------	------	------	------	------	------	------	------	------	------	------	------	------	------	------	------	------

U015 ELECTRICAL

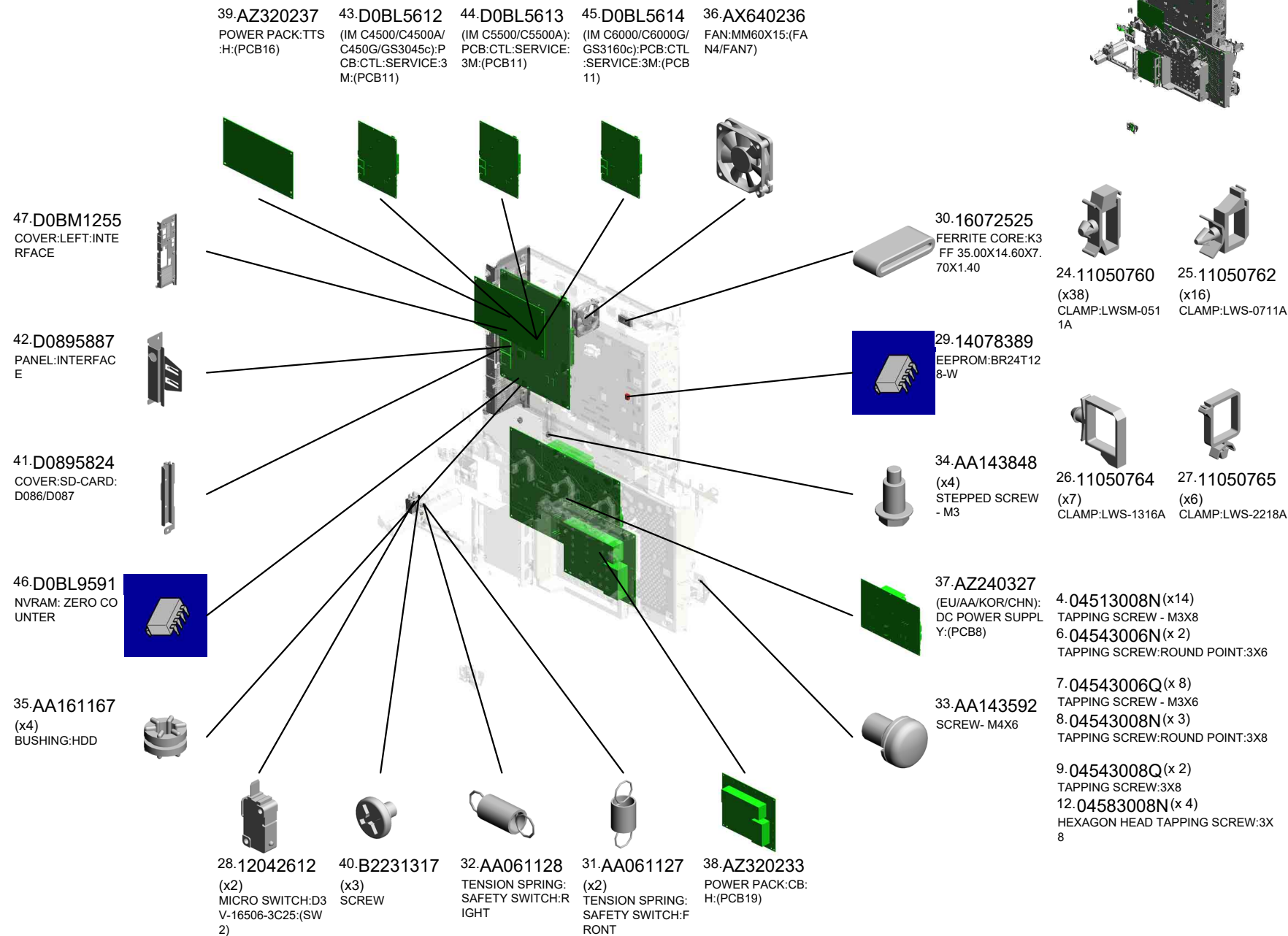

U001	U002	U003	U004	U005	U006	U007	U008	U009	U010	U011	U012	U013	U014	U015	U016	U017	U018
------	------	------	------	------	------	------	------	------	------	------	------	------	------	------	------	------	------

U015 ELECTRICAL

52.D0BQ5190 (x2) PCB:MSSENS1:(S49)
 53.D0BQ5192 PCB:MSSENS2:(PCB18)
 50.D0BQ5129 PCB:IOB:ENGINE:(PCB2)
 54.D0BQ5611 PCB:DDR3L-DIMM:2GB
 59.D1465786 BRACKET:HDD

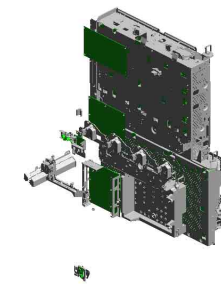

63.D1495714
SHAFT:ARM:SAFETY SWITCH

61.D1495711
BRACKET:ARM:SAFETY SWITCH:FRONT

65.D1495718
TORSION SPRING:SAFETY SWITCH

62.D1495713
ARM:SAFETY SWITCH:FRONT

67.D1495742
COVER:HARNESS:OPTICAL WRITING UNIT

60.D1495703
BRACKET:MICRO SWITCH

64.D1495717
BASE:SAFETY SWITCH

58.D1421805 (x2)
SHAFT:SCALE

66.D1495726
LEVER:SAFETY SWITCH:RIGHT

49.D0BQ5127
PCB:IOB:TRANSPORT:(PCB1)

57.D0BQ5802
GUIDE:HARNESS:RACK

55.D0BQ5791
RACK:BASE

56.D0BQ5796
RACK:MIDDLE

48.D0BQ5114
BICU:ASSY:(PCB10)

51.D0BQ5186
(EU/AA/KOR/CHN):AC CONTROL BOARD:(PCB9)

U015 ELECTRICAL

68.D1495776 COVER:USB:SMAL
L
72.D2395772 PANEL:CONTROL
BOARD:D238/D239
82.D2415803 GUIDE:HARNESS:
C/T BOX
81.D2415801 COVER:RACK:REA
R
69.D1495810 BRACKET:RACK:U
PPER

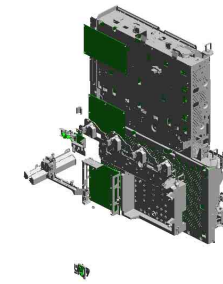

73.D2395888
COVER:FAX

74.D2395889
RAIL:FAX

85.D2415832
(x4)
CAP:GUIDE:COIL S
PRING

76.D2415712
PLATE:HUMAN DE
TECTION SENSOR:
SENSOR

75.D2415707
BRACKET:HUMAN
DETECTION SENS
OR

77.D2415737
BRACKET:MAIN S
WITCH

87.D2415842
COVER:GUIDE:WI
RE

71.D1495824
COVER:CONNECT
OR:HEATER:0.4MM

79.D2415765
CASE:POWER PAC
K:CB

78.D2415764
COVER:POWER P
ACK:CB

80.D2415800
RACK:RIGHT:AUXI
LIARY

83.D2415817
GUIDE:FFC:2

70.D1495818
SPACER:FFC

84.D2415831
(x4)
CAP:GUIDE:WIRE

86.D2415841
BASE:GUIDE:WIRE

U001	U002	U003	U004	U005	U006	U007	U008	U009	U010	U011	U012	U013	U014	U015	U016	U017	U018
------	------	------	------	------	------	------	------	------	------	------	------	------	------	------	------	------	------

U015 ELECTRICAL

102.M4445201 HDD:320GB:AQUA RIUS:(PCB12)
 92.D2415854 WIRE:CHARGE:M
 91.D2415853 WIRE:DEVELOPME NT:C
 96.D2415875 (x4) WIRE:CHARGE:CB
 90.D2415852 WIRE:CHARGE:C

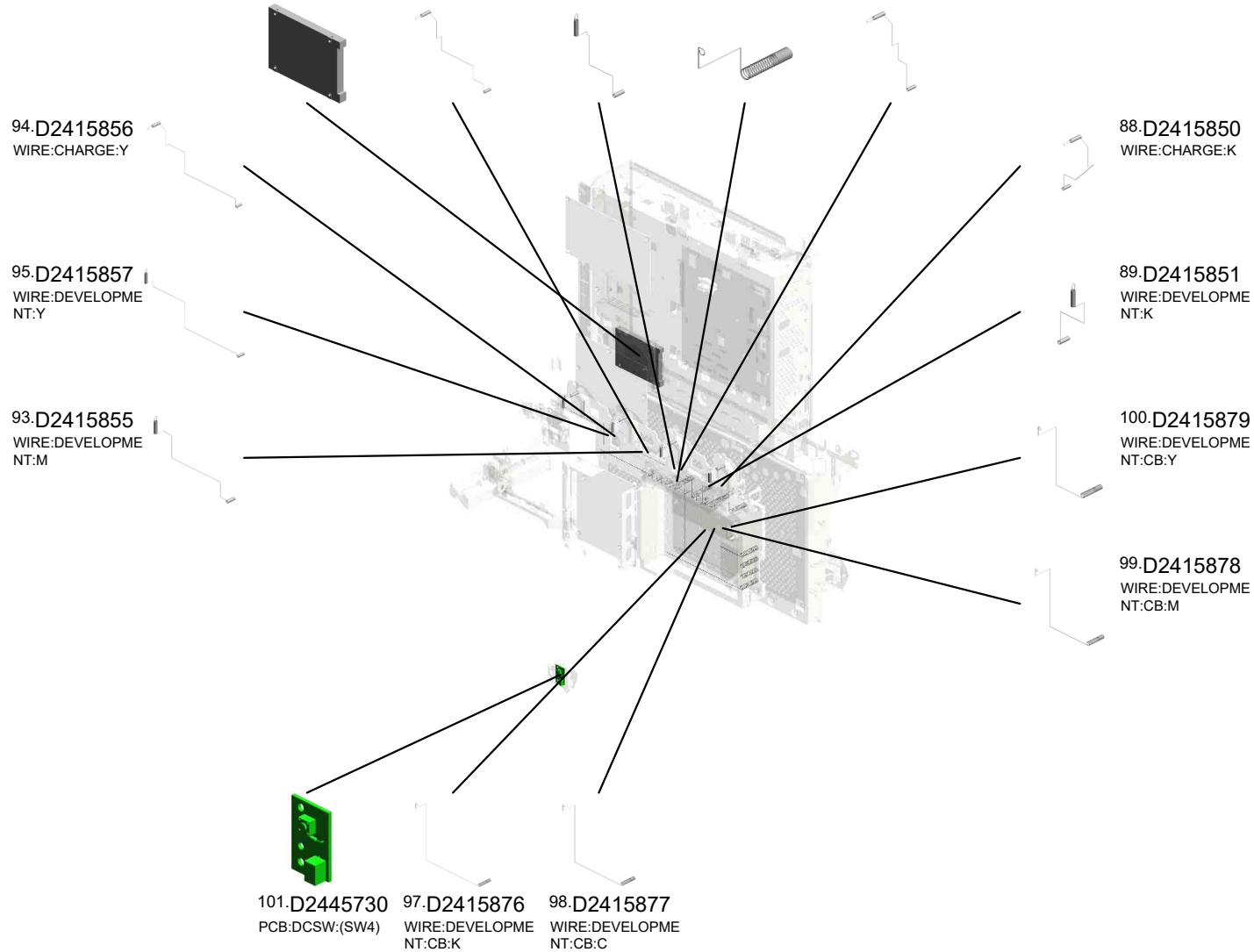
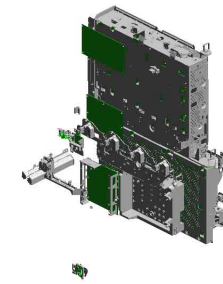

U001	U002	U003	U004	U005	U006	U007	U008	U009	U010	U011	U012	U013	U014	U015	U016	U017	U018
------	------	------	------	------	------	------	------	------	------	------	------	------	------	------	------	------	------

U016.MAIN FRAME

U016_S001
D0BQ7935
CAP:FILTER:ASS'Y

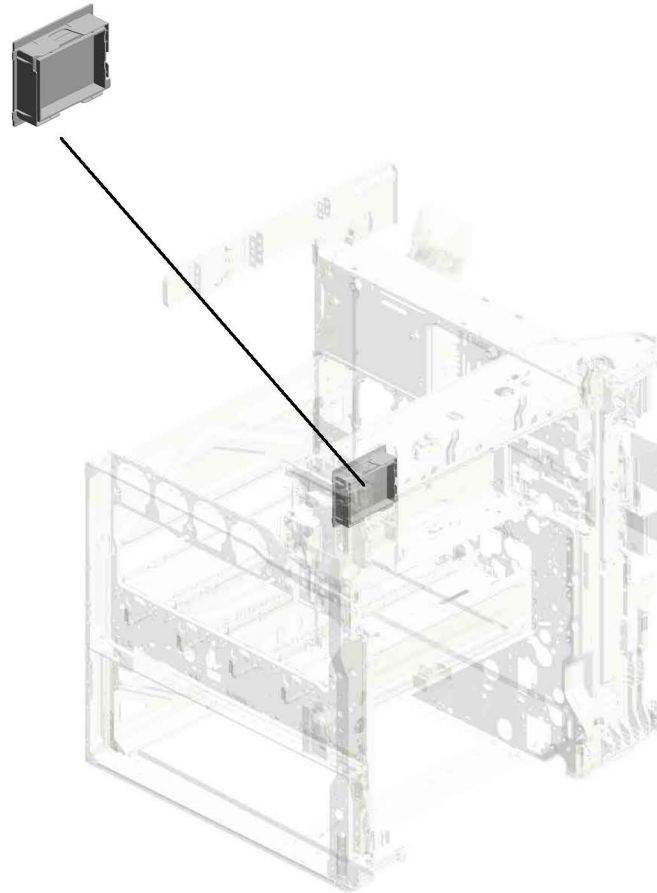

U001	U002	U003	U004	U005	U006	U007	U008	U009	U010	U011	U012	U013	U014	U015	U016	U017	U018
------	------	------	------	------	------	------	------	------	------	------	------	------	------	------	------	------	------

U016 MAIN FRAME

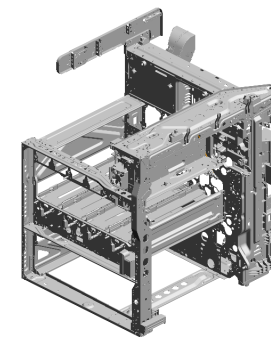

- 23.D1491099 (x2) COVER:GRIP:LEFT
- 12.08025328 (x2) HEXAGON HEAD TAPPING SCREW:3X40
- 17.AX650064 DC FAN MOTOR:SI ROCCO:DC24V:PW M:(FAN3)
- 13.11050764 CLAMP:LWS-1316A
- 6.04543006N (x2) TAPPING SCREW: ROUND POINT:3X6

- 10.04583008N (x65) HEXAGON HEAD TAPPING SCREW:3X8

- 2.04503025N (x2) TAPPING SCREW: 3X25

- 16.AX640236 FAN:MM60X15:(FAN4/FAN7)

- 7.04543006Q (x228) TAPPING SCREW - M3X6

- 1.03603006N (x4) SCREW - M3X6

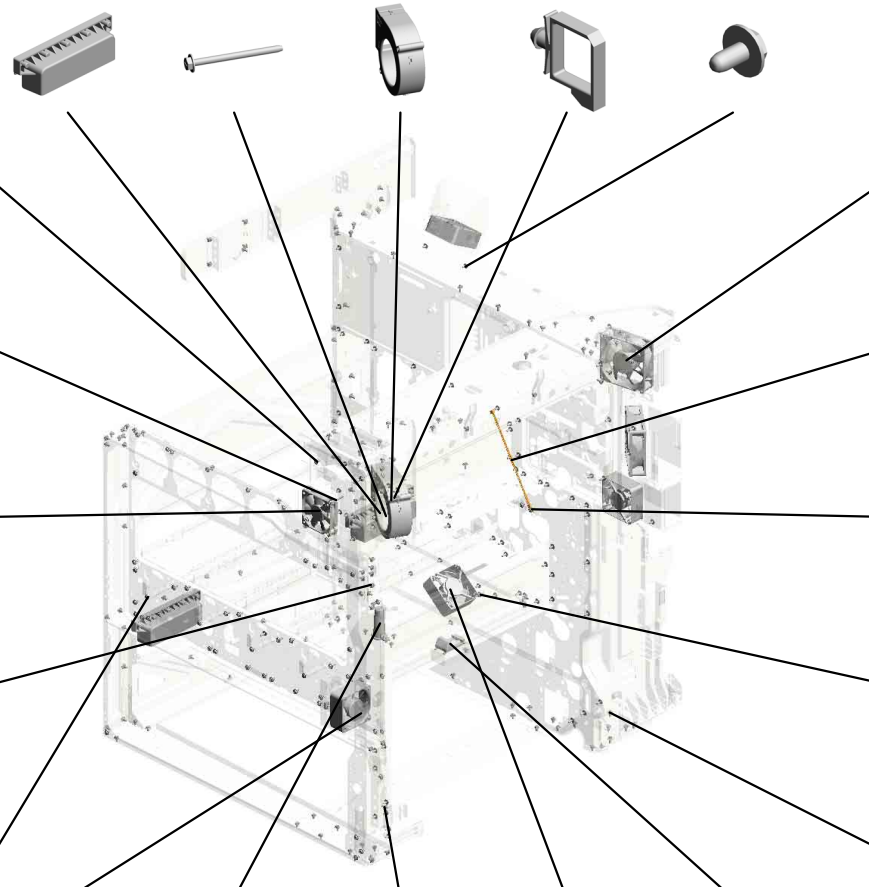

- 14.AX640199 (x2) FAN:MM80:25MM:DC 2.16W:(FAN1/FAN5)

- 22.D1175303 THERMISTOR:(S33)

- 5.04533008N BINDING SELF TAPPING SCREW:3X8

- 11.08025299 TAPPING SCREW - M3X8

- 9.04543008Q (x19) TAPPING SCREW: 3X8

- 4.04513006N (x 6) TAPPING SCREW - 3X6
- 10.04583008N (x 1) HEXAGON HEAD TAPPING SCREW:3X8

- 3.04503035N (x2) TAPPING SCREW: 3X35
- 19.B2381089 COVER - POSITIONING PIN
- 8.04543008N TAPPING SCREW: ROUND POINT:3X8
- 15.AX640219 (x4) DC FAN MOTOR:DC 24V:MM60:25MM:(FAN1/FAN2/FAN8/FAN9)
- 18.B2381088 COVER - CONNECTOR

U001	U002	U003	U004	U005	U006	U007	U008	U009	U010	U011	U012	U013	U014	U015	U016	U017	U018
------	------	------	------	------	------	------	------	------	------	------	------	------	------	------	------	------	------

U016 MAIN FRAME

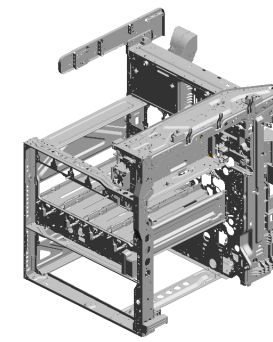

- 40.D1497973 DUCT:EXHAUST:R EAR:C
- 39.D1497972 DUCT:EXHAUST:R EAR:B
- 38.D1497971 DUCT:EXHAUST:R EAR:A
- 30.D1497951 DUCT:SUPPLY:A
- 31.D1497952 DUCT:SUPPLY:B

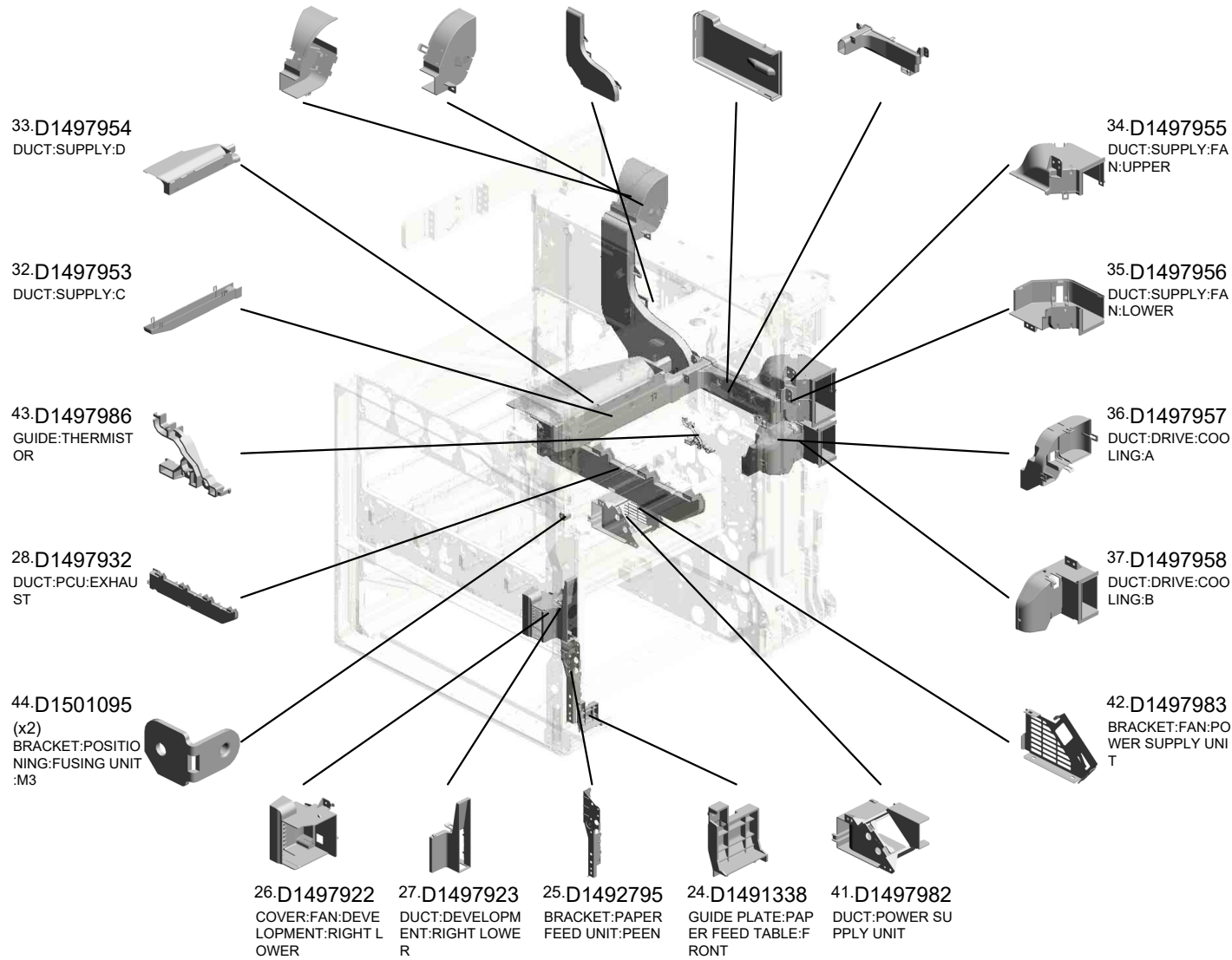

U001	U002	U003	U004	U005	U006	U007	U008	U009	U010	U011	U012	U013	U014	U015	U016	U017	U018
------	------	------	------	------	------	------	------	------	------	------	------	------	------	------	------	------	------

U016 MAIN FRAME

62.M0AJ7995 SEAL:DUCT:DEVELOPMENT:EXHAUST
 60.M0AJ7993 DUCT:DEVELOPMENT:EXHAUST:C
 61.M0AJ7994 SEAL:CAP:FILTER
 47.D2417943 DUCT:EXHAUST:UPPER:C
 48.D2417944 DUCT:EXHAUST:UPPER:D

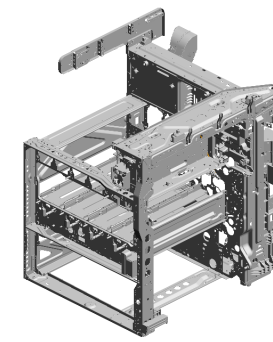

52.GA003933
(x4)
DECAL:OPERATE:
4X10.5



55.M0AJ1093
(x4)
COMPRESSION SPRING:LOCK:PCU



56.M0AJ1098
(x4)
LEVER:LOCK:PCU:M-PAC



54.M0AJ1092
(x4)
CAM:LOCK:PCU

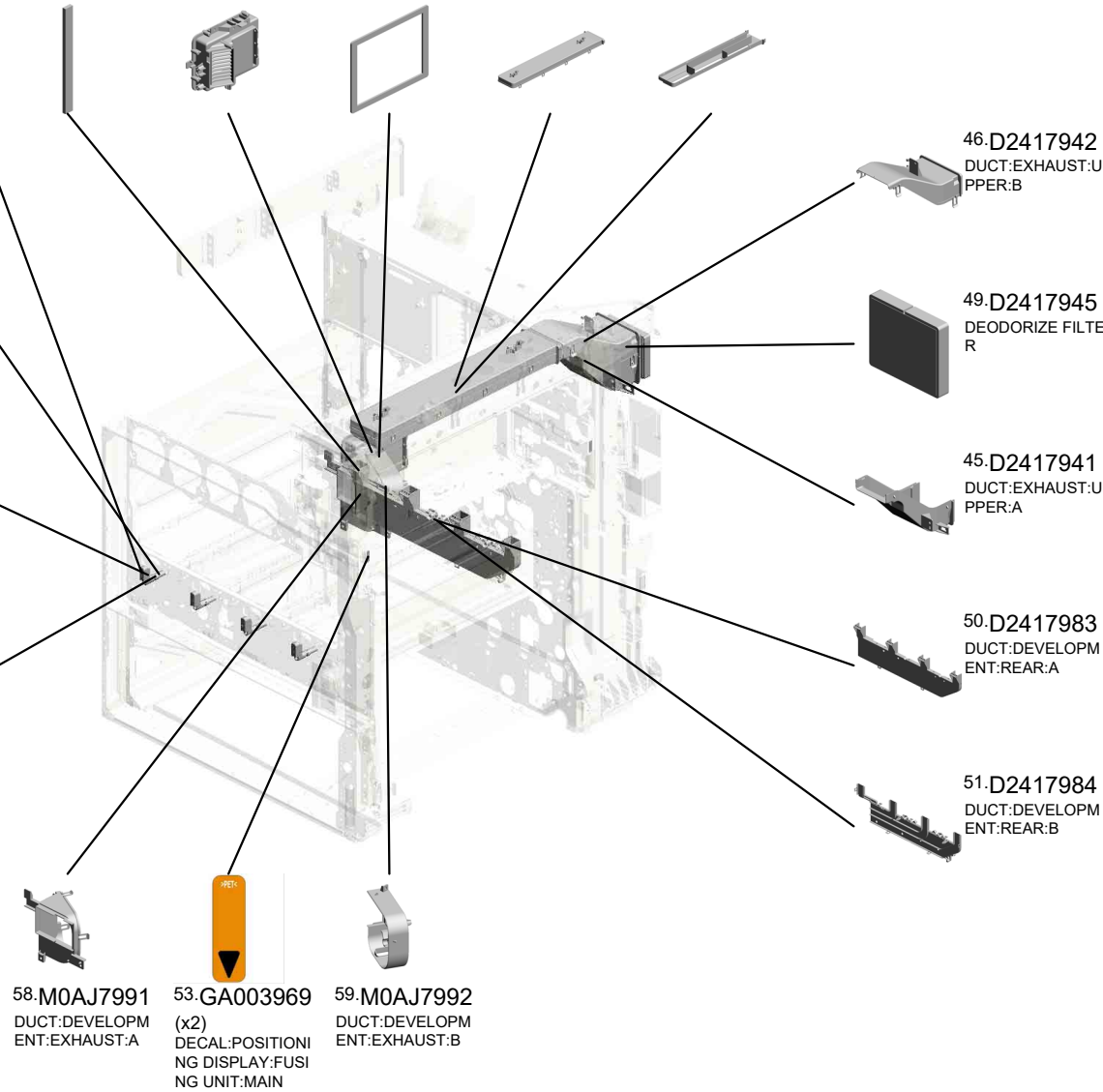

46.D2417942
DUCT:EXHAUST:UPPER:B

49.D2417945
DEODORIZE FILTER

45.D2417941
DUCT:EXHAUST:UPPER:A

50.D2417983
DUCT:DEVELOPMENT:REAR:A

51.D2417984
DUCT:DEVELOPMENT:REAR:B

58.M0AJ7991
DUCT:DEVELOPMENT:EXHAUST:A

53.GA003969
(x2)
DECAL:POSITIONING DISPLAY:FUSION UNIT:MAIN

59.M0AJ7992
DUCT:DEVELOPMENT:EXHAUST:B

U001	U002	U003	U004	U005	U006	U007	U008	U009	U010	U011	U012	U013	U014	U015	U016	U017	U018
------	------	------	------	------	------	------	------	------	------	------	------	------	------	------	------	------	------

U016_S001
CAP:FILTER:ASS'Y

29.D1497938
OZONE FILTER

57.M0AJ7936
CAP:LOUVER:FILTER:LEFT

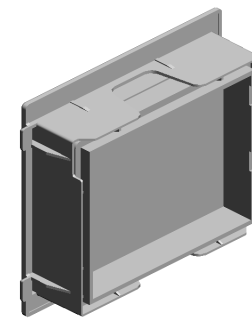

20.D0BQ7935
CAP:FILTER:ASS'Y

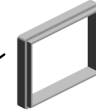
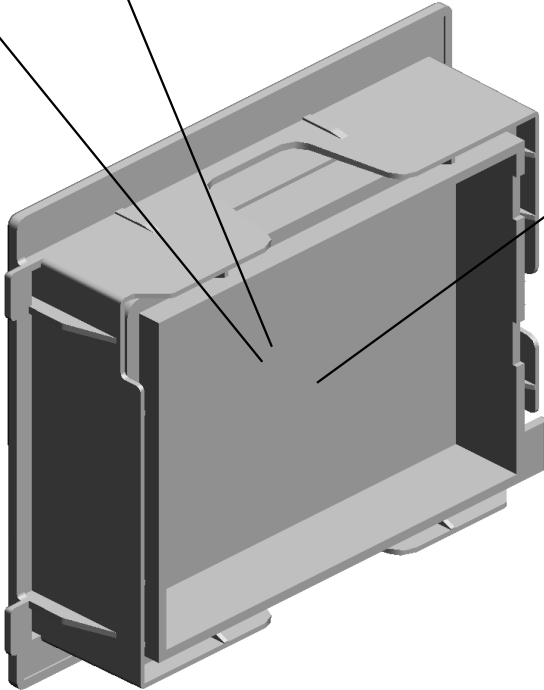
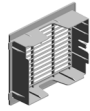

21.D0BQ7937
FILTER:PREVENTF
ENCE:13.5

U001	U002	U003	U004	U005	U006	U007	U008	U009	U010	U011	U012	U013	U014	U015	U016	U017	U018
------	------	------	------	------	------	------	------	------	------	------	------	------	------	------	------	------	------

U017 ACCESSORIES

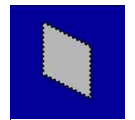
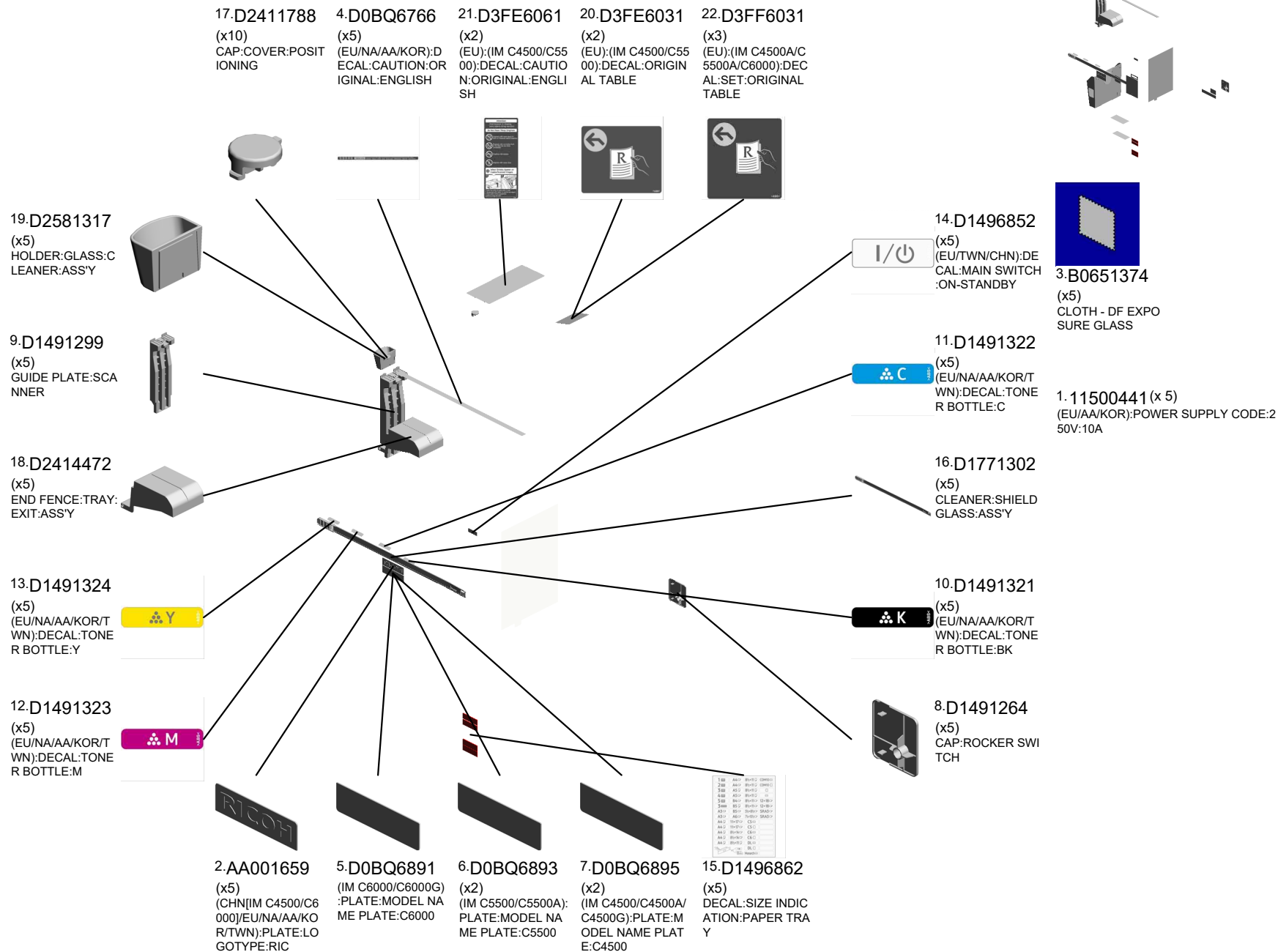

3.B0651374 (x5) CLOTH - DF EXPOSURE GLASS

1. 11500441 (x 5) (EU/AA/KOR):POWER SUPPLY CODE:2 50V:10A

U017 ACCESSORIES

23.D3FF6303
(x3)
(EU):(IM C4500A/C
5500A/C6000);DEC
AL:CAUTION:ORIGI
NAL:ENGLISH

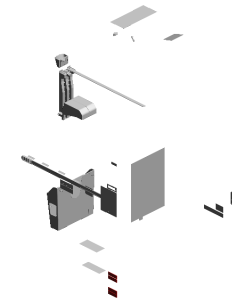

24.M0AJ6856
(x5)
(EU/NA/AA/KOR):D
ECAL:INKJET:EN:M
ANUAL FEED



U001	U002	U003	U004	U005	U006	U007	U008	U009	U010	U011	U012	U013	U014	U015	U016	U017	U018
------	------	------	------	------	------	------	------	------	------	------	------	------	------	------	------	-------------	------

U018
KIT:HEATER

3-D3BR2202 1-D2380072
(EU/AA/KOR/CHN): (EU/AA/KOR/CHN):
HEATER:PHOTOC HEATER:SCANNE
ONDUCTOR:ASSY R:220/240V:ASS'Y

2-D2386640
(EU/AA/KOR/CHN):
HEATER:PAPER T
RAY:220/240V:ASS'
Y

4-D3G36650
(EU/AA/KOR/CHN):
ELECTRICAL COM
PONENTS SECTIO
N:SCANNER:200V:
ASS'Y

5-D3G36662
(EU/AA/KOR/CHN):
ELECTRICAL COM
PONENTS SECTIO
N:PAPER TRAY:20
0V:ASS'Y

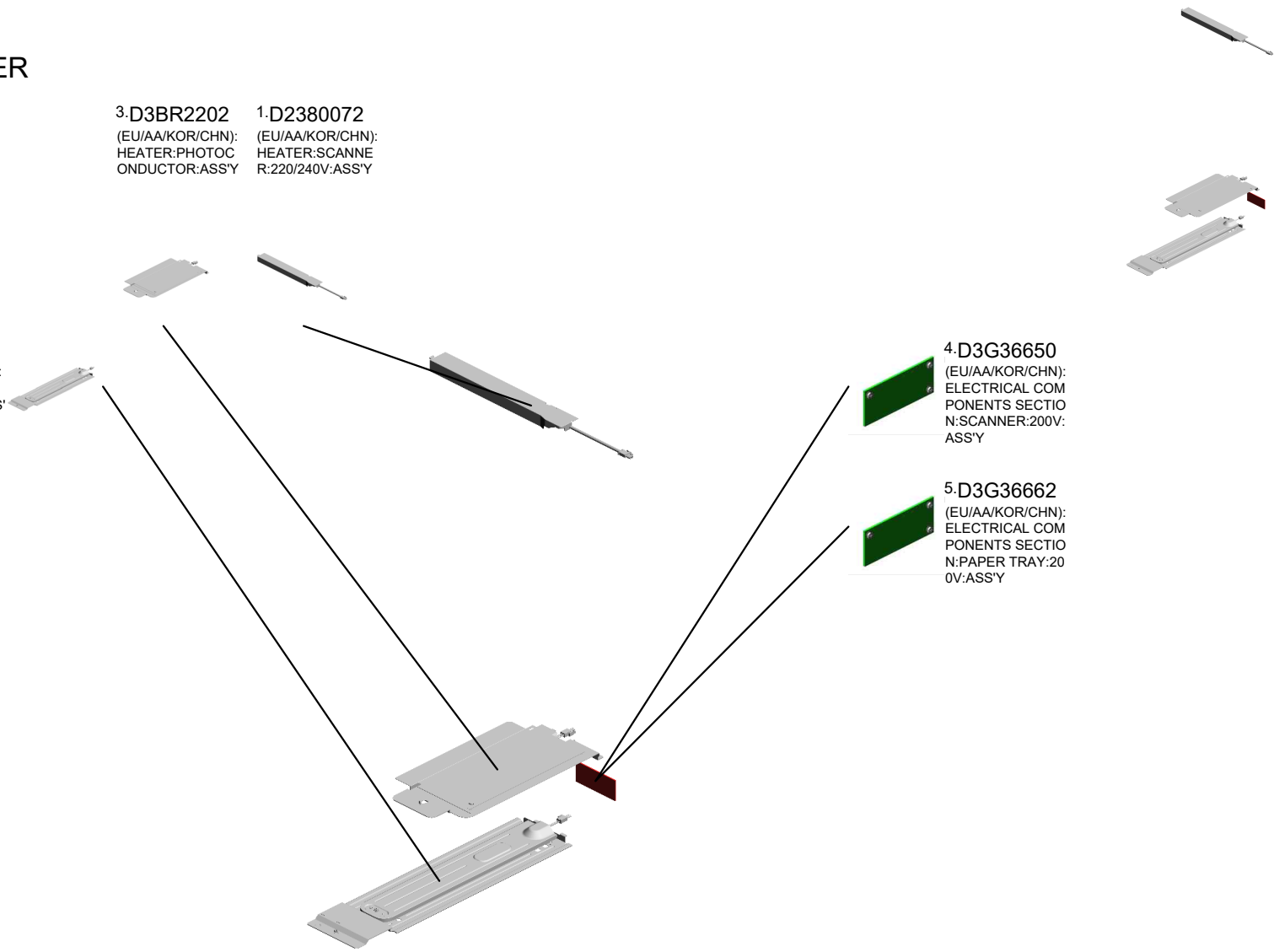

U001	U002	U003	U004	U005	U006	U007	U008	U009	U010	U011	U012	U013	U014	U015	U016	U017	U018
------	------	------	------	------	------	------	------	------	------	------	------	------	------	------	------	------	------



1.D3FE0002
(EU[IM C4500/C5500]):ARDF:NON-OP
TION

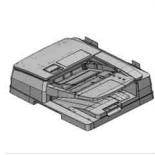

2.D3FF7001
(EU[IM C4500A/C5500A/C6000])/NA/A
A/KOR/TWN):ADF:ASSY



3.Note1
See 3D parts catalog for the compon
ts of the ARDF DF3110.



4.Note2
See 3D parts catalog for the compon
ts of the SPDF DF3120.

ADF

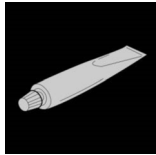

1.52039502
Silicon Grease G-501



2.A0929503
C4 COLOR TEST CHART (3 PCS/SET
)

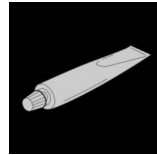

3.A2579300
GREASE - BARRIERTA S552R

SPECIAL TOOLS

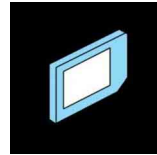

4.B6455030
SD-CARD:SERVICE PARTS:2GB:ASS'
Y

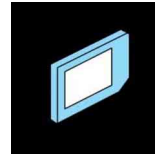

5.B6455040
SD-CARD:SERVICE PARTS:8GB:ASS'
Y

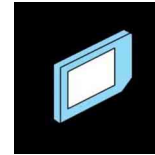

6.B6455060
SD-CARD:SERVICE PARTS:16GB:AS
S'Y



7.C4019503
20X MAGNIFICATION SCOPE

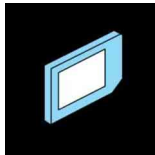

8.D2388100
SERVICE PARTS:SD-CARD:QMT_PH



9.VSSG9002
FLUOTRIBO MG GREASE : 100G

Exclusive Parts

Number	Part Name	Group	ID
52039502	Silicon Grease G-501	SPECIAL TOOLS	1
52062686	SNAP RING	U001	6
		U005_S001_S001	14
		U005_S002_S001	14
52152621	SNAP RING - M6	U009	8
		U013	19
54472681	SNAP RING	U009	9
		U013	20
A0929503	C4 COLOR TEST CHART (3 PCS/SET)	SPECIAL TOOLS	2
A2324666	CUSHION - STEPPER MOTOR	U012_S001	13
A2501752	EXPOSURE GLASS	U003	21
A2579300	GREASE - BARRIERTA S552R	SPECIAL TOOLS	3
AA001659	(CHN[IM C4500/C6000]/EU/NA/AA/KOR/TWN):PLATE:LOGOTYPE:RIC	U017	2
AA021031	MAGNETIC CATCH	U001	7
AA043000	SYNCHRONOUS BELT:40S3M192	U014_S001	15
AA043339	TIMING BELT:PAPER EXIT:40S2M122	U012_S001	14
AA043623	TIMING BELT - B40S2M180	U014_S001	16
AA043777	SYNCHRONOUS BELT:80S3M213	U014_S002	17
AA043980	TIMING BELT:30S2M300	U013_S001	21
AA061127	TENSION SPRING:SAFETY SWITCH:FRONT	U015	31
AA061128	TENSION SPRING:SAFETY SWITCH:RIGHT	U015	32
AA061207	TENSION SPRING:BRACKET:IDLER	U011	21
AA061208	TENSION SPRING:STRIPPER PLATE	U011_S001	22
AA061209	TENSION SPRING:GATE PAWL	U011_S001	23
AA061211	TENSION SPRING:HOLDER:FUSING EXIT	U011_S001	24
AA063732	COMPRESSION SPRING:PRESSURE ROLLER	U011_S001	25
AA063942	COMPRESSION SPRING:REGISTRATION:DRIVE	U009	10
AA063943	COMPRESSION SPRING:GUIDE PLATE	U009	11

Number	Part Name	Group	ID
	ATE:REGISTRATION:4N		
AA080252	BUSHING - M4	U012_S001	15
AA080346	BUSHING:FLANGE TYPE:DIA6	U009	12
		U010_S001	9
		U014_S001	18
AA080387	PLAIN SHAFT BEARING:EXIT ROLLER:FUSING EXIT:RIGHT:FRONT	U011_S001	26
AA080388	PLAIN SHAFT BEARING:EXIT ROLLER:FUSING EXIT:RIGHT:REAR	U011_S001	27
AA082101	BUSHING - 6X10X6	U008	11
		U008_S001_S001	11
		U008_S001_S002	11
	U008_S001_S003	11	
AA082144	BUSHING - 8X12X7	U009	13
AA082170	PLAIN SHAFT BEARING:DIA4XDIA8X5:EG-1	U012_S001	16
		U013_S001	22
		U013_S001_S001	22
AA082171	PLAIN SHAFT BEARING:6X10X6	U013_S001_S001	23
AA082173	PLAIN SHAFT BEARING:6X10X6	U005	15
		U005_S001	15
		U005_S002	15
		U012_S001	17
		U013_S001	24
	U013_S001_S001	24	
AA082174	PLAIN SHAFT BEARING:6X10X9	U005_S001	16
		U005_S002	16
AA082175	PLAIN SHAFT BEARING:8X12X7	U005	17
AA082187	BUSHING:DIA6XDIA10X9:EG-1	U013_S001_S001	25
AA083014	ONE-WAY CLUTCH	U013_S001	26
AA083018	ROLLER CLUTCH - 6X14X10	U013_S001	27
AA100014	RETAINING RING C - SEPARATE	U005_S001	18
		U005_S002	18
		U013_S001_S001	28
AA100016	RETAINING RINGS-C:DIA3	U011_S001	28
AA132208	SPACER - M6	U008_S001_S001	12
AA143219	STEPPED SCREW	U011	29
AA143537	SCREW:M3:BLACK	U001	8
		U003	22

Exclusive Parts

Number	Part Name	Group	ID
AA143579	SCREW - M3	U013_S001_S001	29
AA143592	SCREW- M4X6	U015	33
AA143595	STEPPED SCREW:M3	U001	9
AA143807	SCREW:A	U013_S001	30
AA143848	STEPPED SCREW - M3	U015	34
AA143850	FLAT SCREW:M3X5:SIDE FENCE	U013_S001_S002	31
AA148871	SHAFT:GEAR:IDLER:WORM GEAR	U011	30
AA161167	BUSHING:HDD	U015	35
AB010156	GEAR:SEPARATE:DRIVE	U013_S001_S001	32
AB010157	GEAR:SEPARATE:DRIVEN	U013_S001_S001	33
AB011252	GEAR - 20Z	U013_S001_S001	34
AB011571	GEAR:Z19:DRIVE:REGISTRATION	U009	14
AB011572	GEAR:Z19:DRIVEN:REGISTRATIO N	U005	19
AB011573	GEAR:REGISTRATION:NO.2	U005	20
AB012099	GEAR:ON-OFF:PRESSURE ROLLE R	U011_S001	31
AB012102	GEAR:IDLER:WORM GEAR	U011	32
AB012104	GEAR:IDLER:LIGHT SHIELDING PL ATE	U011	33
AB012107	GEAR:IDLER:EXIT:FUSING EXIT:1	U011_S001	34
AB012108	GEAR:IDLER:EXIT:FUSING EXIT:2	U011_S001	35
AB012109	GEAR:IDLER:EXIT:FUSING EXIT:3	U011_S001	36
AB012110	GEAR:EXIT ROLLER:FUSING EXIT: RIGHT	U011_S001	37
AB012111	GEAR:PRESSURE ROLLER:EXIT	U011_S001	38
AB012116	GEAR:DRIVE:FUSING UNIT	U011_S001	39
AB012119	GEAR:PRESSURE ROLLER	U011_S001	40
AB012120	GEAR:IDLER:PRESSURE ROLLER	U011_S001	41
AE020261	PRESSURE ROLLER:DIA32	U011_S001	42
AE030074	BALL BEARING:DIA17XDIA26X5	U011_S001	43
AF030049	PICK-UP ROLLER	U013_S001_S001	35
AF030094	PAPER FEED ROLLER:PICKUP	U005_S001	21
		U005_S002	21
AF031046	FEED ROLLER - MANUAL FEED	U013_S001_S001	36
AF031085	PAPER FEED ROLLER - FEED	U005_S001	22
		U005_S002	22
AF032046	SEPARATION ROLLER - MANUAL	U013_S001_S001	37

Number	Part Name	Group	ID
	FEED		
AF032101	PAPER FEED ROLLER:SEPARATE	U005_S001	23
		U005_S002	23
AF040571	GUIDE ROLLER	U012_S001	18
AG070513	MAGNET CATCH	U001	10
AG070514	MAGNET CATCH	U010	10
AW010147	PHOTO REFLECTION SENSOR:(S1 /S27)	U009_S001	15
		U012_S001	19
AW010155	ORIGINAL SENSOR:66MM:3.3V:(S4 4/S45)	U003	23
AW020190	PHOTOINTERRUPTOR:(S26/S50)	U011	44
AW020207	PHOTOINTERRUPTOR:FLAT:PICH 2MM:M4:(S43)	U003	24
AW100180	NON-CONTACT TYPE THERMISTO R:FUSING:(S46/S47)	U011_S001	45
AW100181	THERMISTOR:PRESSURE:FRONT: (TH4/TH5)	U011_S001	46
AW100182	THERMISTOR:PRESSURE:MIDDLE :(TH3)	U011_S001	47
AW100183	THERMOPILE:(TH1/TH2)	U011	48
AW110111	THERMOSTAT:MIDDLE	U011_S001	49
AW110112	THERMOSTAT:REAR	U011_S001	50
AW140026	TEMPERATURE & HUMIDITY SEN SOR:(S41)	U008	13
AW500044	PUSH SWITCH:PAPER SIZE SENS OR:(SW1)	U005	24
AW500049	PUSH SWITCH:SW1AG-550:(S4/S1 7/S19/S21)	U005	25
		U013	38
		U013_S001	38
AX040273	DC MOTOR:RISING TRAY:ASS'Y:1. 007W:BRUSH:(M9/M10)	U005	26
AX050349	DC MOTOR:ENCODER:NO:7W:GE AR:BRUSHLESS:(M4)	U014_S002	19
AX060435	DC MOTOR:GEAR:10W:BRUSHLES S:(M7)	U014_S003	20
AX060464	DC MOTOR:ENCODER:NO:10W:GE AR:BRUSHLESS:(M1/M2/M5/M6)	U013	39
		U013_S001	39
		U014_S001	21

Exclusive Parts

Number	Part Name	Group	ID
AX060519	DC POLYGON MIRROR MOTOR:(M27)	U004_S001	3
AX061001	DC BRUSHLESS MOTOR:40W:NMB:(M15/M16)	U014	22
AX061101	DC BRUSHLESS MOTOR:25W:NMB:(M17)	U014	23
AX061201	DC BRUSHLESS MOTOR:25W:NID:DEVELOPMENT:BLACK:(M29)	U014	24
AX061202	DC BRUSHLESS MOTOR:25W:NID:FUSING UNIT:(M8)	U014_S002	25
AX640199	FAN:MM80:25MM:DC 2.16W:(FAN1/FAN5)	U016	14
AX640219	DC FAN MOTOR:DC24V:MM60:25MM:(FAN1/FAN2/FAN8/FAN9)	U016	15
AX640236	FAN:MM60X15:(FAN4/FAN7)	U015 U016	36 16
AX650064	DC FAN MOTOR:SIROCCO:DC24V:PWM:(FAN3)	U016	17
AZ240327	(EU/AA/KOR/CHN):DC POWER SUPPLY:(PCB8)	U015	37
AZ320233	POWER PACK:CB:H:(PCB19)	U015	38
AZ320237	POWER PACK:TTS:H:(PCB16)	U015	39
B0651374	CLOTH - DF EXPOSURE GLASS	U017	3
B2231099	FLAT SCREW	U013_S001_S002	40
B2231317	SCREW	U015	40
B2233241	SPRING:SHUTTER:PUMP UNIT	U007	13
B2234552	BUSHING:DIA4	U013_S001	41
B2236069	JOINT:DRIVE:INTERMEDIATE TRANSFER	U008_S001_S001	14
B2236476	BUSHING - DIA5	U010	11
B2342864	PAD:CLEANER	U005_S004_S001 U005_S004_S002 U005_S005_S001 U005_S005_S002	27 27 27 27
B2381088	COVER - CONNECTOR	U016	18
B2381089	COVER - POSITIONING PIN	U016	19
B6455030	SD-CARD:SERVICE PARTS:2GB:ASSY	SPECIAL TOOLS	4

Number	Part Name	Group	ID
B6455040	SD-CARD:SERVICE PARTS:8GB:ASSY	SPECIAL TOOLS	5
B6455060	SD-CARD:SERVICE PARTS:16GB:ASSY	SPECIAL TOOLS	6
B8303504	TIMING BELT - 40S2M100	U005_S001 U005_S002	28 28
C4019503	20X MAGNIFICATION SCOPE	SPECIAL TOOLS	7
D0092573	PULLEY - VERTICAL TRANSPORT	U013_S001_S003 U013_S001_S004	42 42
D0092574	PULLEY - IDLER	U013_S001_S003 U013_S001_S004	43 43
D0094407	FEELER - OVERFLOW	U012_S001	20
D0094455	CUSHION - DC SOLENOID	U012 U012_S001 U013_S001	21 21 44
D0094485	BUSHING - GATE	U013_S001	45
D0094487	COMPRESSION SPRING - GATE	U013_S001	46
D0292677	TRANSPORT BELT:DRIVEN:VERTICAL TRANSPORT	U013_S001_S003 U013_S001_S004	47 47
D0392993	SHAFT:TRANSPORT BELT:PULLEY	U013_S001_S003 U013_S001_S004	48 48
D0394525	COMPRESSION SPRING:SHAFT:GUIDE PLATE:EXIT	U013_S001	49
D0394529	STOPPER:GUIDE PLATE:ROLLER:DRIVEN	U013_S001	50
D0394597	TENSION SPRING:DRIVEN ROLLER	U013_S001	51
D0394925	ROLLER:REVERSE:DRIVEN	U012_S001	22
D0394927	COMPRESSION SPRING:PRESSURE:REVERSE:DRIVEN	U012_S001	23
D0895824	COVER:SD-CARD:D086/D087	U015	41
D0895887	PANEL:INTERFACE	U015	42
D0AF1290	COVER:SCANNER:UPPER:REAR	U001	11
D0BL5612	(IM C4500/C4500A/C450G/GS3045c):PCB:CTL:SERVICE:3M:(PCB11)	U015	43
D0BL5613	(IM C5500/C5500A):PCB:CTL:SERVICE:3M:(PCB11)	U015	44
D0BL5614	(IM C6000/C6000G/GS3160c):PCB:	U015	45

Exclusive Parts

Number	Part Name	Group	ID
	CTL:SERVICE:3M:(PCB11)		
D0BL9591	NVRAM: ZERO COUNTER	U015	46
D0BM1255	COVER:LEFT:INTERFACE	U015	47
D0BM2215	PCU:K:IMC3000-6000	U006_S001_S001	10
D0BN2215	PCU:CMY:IMC4500-6000	U006_S002_S001	11
		U006_S003_S001	11
		U006_S004_S001	11
D0BN2224	PCDU:K:IMC3000-6000	U006_S001	12
D0BN2225	PCDU:C:IMC4500-6000	U006_S002	13
D0BN2226	PCDU:M:IMC4500-6000	U006_S003	14
D0BN2227	PCDU:Y:IMC4500-6000	U006_S004	15
D0BP1276	INNER COVER:TONER BOTTLE	U001	12
D0BQ1230	COVER:UPPER	U001	13
D0BQ1231	COVER:UPPER:FRONT	U001	14
D0BQ1232	COVER:UPPER:EXIT:IDG	U001	15
D0BQ1242	COVER:FRONT:PEEN	U001	16
D0BQ1244	COVER:FRONT:RIGHT UPPER	U001	17
D0BQ1245	COVER:FRONT:UPPER	U001	18
D0BQ1247	COVER:FRONT:USED TONER	U001	19
D0BQ1249	COVER:FRONT:LENGTHWISE	U001	20
D0BQ1281	COVER:SCANNER:FRONT	U001	21
D0BQ1287	COVER:SCANNER:RIGHT	U001	22
D0BQ1288	COVER:SCANNER:UPPER:RIGHT	U001	23
D0BQ1299	HEXAGON HEAD SCREW:PLAIN WASHER:M3X8	U002	12
D0BQ1309	MAGNET CATCH:COVER:FRONT	U001	24
D0BQ1357	DRIVE UNIT:FUSING/PAPER EXIT UNIT:ASS'Y	U014_S002	26
D0BQ1399	DRIVE UNIT:PAPER FEED:ASS'Y	U014_S001	27
D0BQ1432	SPEAKER	U002_S001	13
D0BQ1500	(EU/NA/AA/KOR/TWN):OPERATION SUB-UNIT:COMMON:ASS'Y	U002_S001	14
D0BQ1521	HINGE:RIGHT	U002	15
D0BQ1522	HINGE:LEFT	U002	16
D0BQ1531	FRAME:LCD:PEEN	U002_S001	17
D0BQ1533	BRACKET:LCD	U002_S001	18
D0BQ1541	COVER:FRONT	U002_S001	19
D0BQ1545	COVER:REAR	U002_S001	20

Number	Part Name	Group	ID
D0BQ1546	INNER COVER:OPERATION SUB-UNIT:RIGHT	U002_S001	21
D0BQ1547	KEYTOP:RESET SWITCH	U002_S001	22
D0BQ1548	COVER:CAP:PUSH SWITCH	U002_S001	23
D0BQ1549	COVER:CAP	U002_S001	24
D0BQ1551	HOLDER:OPERATION SUB-UNIT:SPEAKER	U002_S001	25
D0BQ1552	CUSHION:OPERATION SUB-UNIT:SPEAKER	U002_S001	26
D0BQ1553	GUIDE:OPERATION SUB-UNIT:HANDLE	U002	27
D0BQ1555	CUSHION:LCD:L	U002_S001	28
D0BQ1556	CUSHION:LCD:S	U002_S001	29
D0BQ1561	COVER:HINGE:RIGHT	U002	30
D0BQ1563	COVER:HINGE:LEFT	U002	31
D0BQ1564	COVER:REAR:MIDDLE	U002	32
D0BQ1565	COVER:RIGHT	U002	33
D0BQ1581	DUAL FACES TAPE:TOUCH PANEL:LENGTHWISE	U002_S001	34
D0BQ1582	DUAL FACES TAPE:TOUCH PANEL:SIDE	U002_S001	35
D0BQ1585	SHEET:LIGHT SHIELD COAT	U002_S001	36
D0BQ1586	SHEET:SIDE	U002_S001	37
D0BQ1595	BRACKET:OPERATION SUB-UNIT:PEEN	U002	38
D0BQ1598	COVER:BRACKET:OPERATION SUB-UNIT:LOWER	U002	39
D0BQ1640	OPTICAL READING UNIT:CARRIAGE:SCANNER:IMC2000-6000	U003_S001	25
D0BQ1713	SYNCHRONOUS BELT:890ST55-4.0	U003	26
D0BQ1780	ILLUMINATION UNIT:ASS'Y	U003_S001	27
D0BQ1855	OPTICAL WRITING UNIT:IMC4500/IMC5500/IMC6000	U004_S001	4
D0BQ2566	CASE:REMOVE PAPER DUST:ASS'Y	U005	29
D0BQ2601	MANUAL FEED UNIT:ASS'Y	U013_S001_S001	52
D0BQ2608	SHAFT:SEPARATOR:DRIVEN:ASS'Y	U013_S001_S001	53

Exclusive Parts

Number	Part Name	Group	ID
	Y		
D0BQ2615	GUIDE PLATE:SEPARATOR:ASS'Y	U013_S001_S001	54
D0BQ2619	SHAFT:SEPARATOR:DRIVE:ASS'Y	U013_S001_S001	55
D0BQ2623	ARM:PICKUP:MANUAL FEED	U013_S001_S001	56
D0BQ2630	SIDE FENCE:FRONT:ASS'Y	U013_S001_S002	57
D0BQ2632	SIDE FENCE:REAR:ASS'Y	U013_S001_S002	58
D0BQ2637	PAPER STOPPER:MANUAL FEED	U013_S001_S001	59
D0BQ2638	LINK:PAPER STOPPER:MANUAL FEED	U013_S001_S001	60
D0BQ2644	BRACKET:SIDE FENCE:MANUAL FEED	U013_S001_S002	61
D0BQ2653	COIL SPRING:PRESSURE:SEPARATOR	U013_S001_S001	62
D0BQ2654	CUSHION:GUIDE PLATE:SEPARATOR	U013_S001_S001	63
D0BQ2656	HOLDER:HARNESS	U013_S001	64
D0BQ2711	PAPER FEED UNIT:NO.1:ASS'Y	U005_S001	30
D0BQ2712	PAPER FEED UNIT:NO.2:ASS'Y	U005_S002	31
D0BQ2777	SHAFT:FEED:ASS'Y	U005_S001	32
		U005_S002	32
D0BQ2785	PLAIN SHAFT BEARING:FEED	U005_S001	33
		U005_S002	33
D0BQ2800	PAPER TRAY:NO.1:ASS'Y	U005_S004	34
D0BQ2805	PAPER TRAY:NO.2:ASS'Y	U005_S005	35
D0BQ2828	SIDE FENCE:FRONT:NO.1:ASS'Y	U005_S004_S001	36
D0BQ2838	SIDE FENCE:REAR:NO.1:ASS'Y	U005_S004_S002	37
D0BQ2840	END FENCE:PAPER TRAY:ASS'Y	U005_S004_S003	38
		U005_S005_S003	38
D0BQ2846	DECAL:SIZE INDICATION:END FENCE:NO.1:FRONT	U005_S004	39
D0BQ2863	DECAL:PAPER SET DIRECTION:TRAY:NO.1	U005_S004	40
D0BQ2864	DECAL:PAPER SET DIRECTION:TRAY:NO.2	U005_S005	41
D0BQ2875	SIDE FENCE:FRONT:ASS'Y	U005_S005_S001	42
D0BQ2881	SIDE FENCE:REAR:SUB-ASS'Y	U005_S005_S002	43

Number	Part Name	Group	ID
D0BQ2896	DECAL:SIZE INDICATION:SIDE FENCE:NO.1	U005_S004	44
D0BQ2967	KNOB SCREW:STAY:END FENCE	U005_S005_S001	45
D0BQ3000	DEVELOPMENT UNIT:K:IMC3000-6000	U006_S001_S002	16
D0BQ3001	DEVELOPMENT UNIT:C:IMC4500-6000	U006_S002_S002	17
D0BQ3002	DEVELOPMENT UNIT:M:IMC4500-6000	U006_S003_S002	18
D0BQ3003	DEVELOPMENT UNIT:Y:IMC4500-6000	U006_S004_S002	19
D0BQ3213	SHEET:IOB:UPPER	U014	28
D0BQ3214	SHEET:IOB:LEFT	U014	29
D0BQ3219	DRIVE UNIT:TONER BOTTLE:ASS'Y	U007_S010	14
		U007_S011	14
		U007_S012	14
		U007_S013	14
D0BQ3240	TONER HOPPER:TONER SUPPLY:BK:ASS'Y	U007_S001	15
D0BQ3270	TONER HOPPER:TONER SUPPLY:C:ASS'Y	U007_S002	16
D0BQ3280	TONER HOPPER:TONER SUPPLY:M:ASS'Y	U007_S003	17
D0BQ3287	TRANSPORT SCREW:NOZZLE:BK:ASS'Y	U007_S005	18
D0BQ3288	TRANSPORT SCREW:NOZZLE:CMY:ASS'Y	U007_S006	19
		U007_S007	19
		U007_S008	19
D0BQ3310	TONER HOPPER:TONER SUPPLY:Y:ASS'Y	U007_S004	20
D0BQ4022	(EU/AA/KOR/CHN):FUSING UNIT:220-240V:IMC4500-6000	U011_S001	51
D0BQ4052	(EU/AA/KOR/CHN):SLEEVE:FUSING:220-240V:IMC4500-6000	U011_S001_S002	52
D0BQ4102	DRIVEN ROLLER:FUSING EXIT:ASS'Y	U011_S001	53
D0BQ4208	CAM:ON-OFF:PRESSURE ROLLER	U011_S001	54
D0BQ4317	GUIDE:HARNESS:DRAWER:PRESSURE	U011_S001	55

Exclusive Parts

Number	Part Name	Group	ID
	S FIT		
D0BQ4404	PAPER EXIT UNIT:ASS'Y	U012_S001	24
D0BQ4425	DC STEPPER MOTOR:REVERSE:SUB-ASS'Y:(M3)	U012_S001	25
D0BQ4555	DUPLEX UNIT:IMC3000-6000	U013_S001	65
D0BQ4563	MANUAL FEED TABLE:IMC2000-6000	U013_S001_S002	66
D0BQ4570	PAPER SIZE SENSOR:SENSOR:IMC2000-6000:(S8)	U013_S001_S002	67
D0BQ4644	GEAR:MECHANICAL ROLLER CLUTCH	U013_S001	68
D0BQ4654	SHAFT:LEVER:LOCK	U013_S001	69
D0BQ4960	BASE:PLATE:EXIT:IDG	U012	26
D0BQ5100	PCB:DIODE	U009_S001	16
D0BQ5114	BICU:ASS'Y:(PCB10)	U015	48
D0BQ5127	PCB:IOB:TRANSPORT:(PCB1)	U015	49
D0BQ5129	PCB:IOB:ENGINE:(PCB2)	U015	50
D0BQ5172	PCB:TCB:(PCB3/PCB4/PCB5/PCB6)	U007	21
D0BQ5186	(EU/AA/KOR/CHN):AC CONTROL BOARD:(PCB9)	U015	51
D0BQ5190	PCB:MSSENS1:(S49)	U015	52
D0BQ5192	PCB:MSSENS2:(PCB18)	U015	53
D0BQ5611	PCB:DDR3L-DIMM:2GB	U015	54
D0BQ5620	(EU/NA/AA/KOR/TWN):PCB:ASS'Y:(PCB13)	U002_S001_S001	40
D0BQ5791	RACK:BASE	U015	55
D0BQ5796	RACK:MIDDLE	U015	56
D0BQ5802	GUIDE:HARNESS:RACK	U015	57
D0BQ6001	TRANSFER UNIT:INTERMEDIATE TRANSFER:ASS'Y	U008_S001_S001	15
D0BQ6005	TRANSFER UNIT:INTERMEDIATE TRANSFER:IMC2000-6000	U008_S001	16
D0BQ6141	CLEANING UNIT:BELT CLEANING:ASS'Y	U008_S001_S002	17
D0BQ6170	SPACER:DENSITY SENSOR:0.05MM	U008	18
D0BQ6212	TRANSFER ROLLER:SECOND:ASS'Y	U009_S002	17

Number	Part Name	Group	ID
D0BQ6215	GUIDE PLATE:TRANSFER:SECOND:ASS'Y	U009_S001	18
D0BQ6303	RAIL:INTERMEDIATE TRANSFER:LEFT	U008	19
D0BQ6305	RAIL:INTERMEDIATE TRANSFER:RIGHT	U008	20
D0BQ6311	GEAR:ON-OFF:COLLAR:OUTPUT:HS	U008	21
D0BQ6322	BRACKET:TM SENSOR:FRONT:PEEN	U008	22
D0BQ6324	BRACKET:REAR:TM SENSOR	U008	23
D0BQ6338	BRACKET:TM SENSOR	U008	24
D0BQ6400	COLLECTION BOTTLE:ASS'Y	U010_S001	12
D0BQ6511	PIPE:ASS'Y	U010_S002	13
D0BQ6766	(EU/NA/AA/KOR):DECAL:CAUTION:ORIGINAL:ENGLISH	U017	4
D0BQ6891	(IM C6000/C6000G):PLATE:MODEL NAME PLATE:C6000	U017	5
D0BQ6893	(IM C5500/C5500A):PLATE:MODEL NAME PLATE:C5500	U017	6
D0BQ6895	(IM C4500/C4500A/C4500G):PLATE:MODEL NAME PLATE:C4500	U017	7
D0BQ7935	CAP:FILTER:ASS'Y	U016_S001	20
D0BQ7937	FILTER:PREVENTFENCE:13.5	U016_S001	21
D1124264	DECAL:WARNING (HIGH TEMPERATURE):FUSING	U011_S001_S001	56
D1175303	THERMISTOR:(S33)	U016	22
D1175916	STEPPED SCREW:M3X8:SECOND KIND	U008_S001	25
D1292783	TORQUE LIMITER MECHANICAL CLUTCH:40MM:DIA18	U005_S001 U005_S002 U013_S001_S001	46 46 70
D1421805	SHAFT:SCALE	U015	58
D1441085	STEPPED SCREW:M3	U001 U008_S001_S001	25 26
D1444183	SCREW:M3	U003	28
D1444484	SHOULDER SCREW - M3	U012_S001	27
D1444489	STOPPER:DRIVEN ROLLER	U013_S001_S003	71

Exclusive Parts

Number	Part Name	Group	ID
		U013_S001_S004	71
D1465786	BRACKET:HDD	U015	59
D1471805	EXPOSURE GLASS:DOCUMENT FEEDER:APPLY	U003	29
D1472734	GUIDE PLATE:SEPARATE	U005_S001_S001	47
		U005_S002_S001	47
D1472737	LEVER:PRESSURE:SEPARATE	U005_S001_S001	48
		U005_S002_S001	48
D1472738	LINK:RELEASE	U005_S001_S001	49
		U005_S002_S001	49
D1472752	SHAFT:SEPARATE:ASS'Y	U005_S001_S001	50
		U005_S002_S001	50
D1472866	COVER:PAPER TRAY:NO.2	U005_S005	51
D1473281	HOUSING:TONER CARTRIDGE:BK:ASS'Y	U007_S014	22
D1473282	HOUSING:TONER CARTRIDGE:CMY:ASS'Y	U007_S015	23
		U007_S016	23
		U007_S017	23
D1473325	TORSION SPRING:STOPPER:TONER CARTRIDGE:4.8N	U007_S014	24
		U007_S015	24
		U007_S016	24
		U007_S017	24
D1482702	SPACER:TRANSPORT ROLLER	U005_S001	52
		U005_S002	52
D1482751	ARM:PRESSURE:SEPARATE	U005_S001_S001	53
		U005_S002_S001	53
D1482755	COIL SPRING:RELEASE:SEPARATE	U005_S001_S001	54
		U005_S002_S001	54
D1482942	TENSION SPRING:LEVER	U005_S008	55
		U005_S009	55
D1484690	TORSION SPRING:LINK	U013_S001	72
D1491099	COVER:GRIP:LEFT	U016	23
D1491168	BRACKET:DRIVE:COLLECTION BOTTLE:ASS'Y	U010	14
D1491173	GEAR:IDLER:TONER BOTTLE	U010	15
D1491174	GEAR:COLLECTION BOTTLE	U010	16
D1491194	PULLEY:PAPER FEED:FEED:NO.1:MECHANICAL ROLLER CLUTCH	U014_S001	30

Number	Part Name	Group	ID
D1491195	GEAR:IDLER:PAPER FEED:FEED	U014_S001	31
D1491196	GEAR:PAPER FEED:FEED:NO.2:MECHANICAL ROLLER CLUTCH	U014_S001	32
D1491197	GEAR:IDLER:PAPER FEED:GRIP:NO.1	U014_S001	33
D1491199	DRIVE UNIT:ON-OFF:TRANSFER:(M18)	U014	34
D1491233	COVER:UPPER:INNER BACK	U001	26
D1491234	COVER:UPPER:INNER BACK:MIDDLE	U001	27
D1491237	COVER:UPPER:INNER BACK:LEFT LOWER	U001	28
D1491248	HINGE:COVER:FRONT:USED TONER	U001	29
D1491252	COVER:LEFT:UPPER:REAR	U001	30
D1491257	CAP:34X55	U001	31
D1491264	CAP:ROCKER SWITCH	U017	8
D1491274	INNER COVER:FRONT:USED TONER	U001	32
D1491278	TORSION SPRING:COVER:USED TONER	U001	33
D1491291	CAP:HARNESS	U001	34
D1491294	(IM C4500/C5500/GS3045c):CAP:HARNESS:CORNER	U001	35
D1491299	GUIDE PLATE:SCANNER	U017	9
D1491305	CAP:TOTAL COUNTER	U001	36
D1491307	SPRING PLATE:BAND	U001	37
D1491321	(EU/NA/AA/KOR/TWN):DECAL:TONER BOTTLE:BK	U017	10
D1491322	(EU/NA/AA/KOR/TWN):DECAL:TONER BOTTLE:C	U017	11
D1491323	(EU/NA/AA/KOR/TWN):DECAL:TONER BOTTLE:M	U017	12
D1491324	(EU/NA/AA/KOR/TWN):DECAL:TONER BOTTLE:Y	U017	13
D1491338	GUIDE PLATE:PAPER FEED TABLE:FRONT	U016	24
D1491351	DRIVE UNIT:REGISTRATION:ASS'Y	U014_S003	35

Exclusive Parts

Number	Part Name	Group	ID
D1491352	BRACKET:DRIVE UNIT:REGISTRATION:ASS'Y	U014_S003	36
D1491355	GEAR:REGISTRATION:NO.1	U014_S003	37
D1491387	GROUND PLATE:DRIVE UNIT:ENGINE	U014	38
D1491392	FLANGE:PAPER FEED:FEED	U014_S001	39
D1491394	GROUND PLATE:DRIVE UNIT:FUSING/PAPER EXIT UNIT	U014	40
D1491397	TORQUE LIMITER MECHANICAL CLUTCH:49MMN:DIA14	U014_S002	41
D1491706	SYNCHRONOUS BELT:138ST1.5-4.0	U003	30
D1491798	SEAL:SHEET THROUGH:DOCUMENT FEEDER	U003	31
D1491804	HOLDER:EXPOSURE GLASS:SCANNER	U003	32
D1491833	SHEET:GLASS	U003	33
D1492557	GUIDE:REGISTRATION:ENTRANCE:REAR	U013_S001	73
D1492558	GUIDE:REGISTRATION:ENTRANCE:FRONT	U013_S001	74
D1492562	COLLAR:REGISTRATION ROLLER	U005	56
D1492582	GUIDE PLATE:REGISTRATION:FRONT RIGHT	U009	19
D1492584	COLLAR:SHAFT:REGISTRATION ROLLER	U009	20
D1492585	GUIDE:REGISTRATION:REAR RIGHT	U009	21
D1492586	GUIDE:REGISTRATION:FRONT RIGHT	U009	22
D1492612	ROLLER:GRIP:DRIVEN	U013_S001_S001	75
D1492613	SHAFT:GRIP:DRIVEN	U013_S001_S001	76
D1492614	TENSION SPRING:GRIP:PRESSURE	U013_S001_S001	77
D1492633	SHAFT:FEED:MANUAL FEED	U013_S001_S001	78
D1492635	TRANSPORT ROLLER:MANUAL FEED	U013_S001_S001	79
D1492639	SHAFT:PAPER STOPPER	U013_S001_S001	80

Number	Part Name	Group	ID
D1492642	SHAFT:LINK:PAPER STOPPER	U013_S001_S001	81
D1492655	FEELER:PAPER END SENSOR	U013_S001_S001	82
D1492656	TORSION SPRING:PAPER END SENSOR	U013_S001_S001	83
D1492658	COVER:PAPER FEED ROLLER	U013_S001_S001	84
D1492686	WIRE:MANUAL FEED TABLE:TC075	U013_S001_S002	85
D1492688	TENSION SPRING:WIRE	U013_S001_S002	86
D1492692	ARM:MANUAL FEED:FRONT UPPER	U013_S001_S002	87
D1492693	STOPPER:MANUAL FEED TABLE	U013_S001_S002	88
D1492694	COMPRESSION SPRING:STOPPER:MANUAL FEED TABLE	U013_S001_S002	89
D1492712	SHEET:GUIDE PLATE:SWIVEL	U005_S003	57
D1492713	GUIDE PLATE:SWIVEL:NO.1	U005_S003	58
D1492721	GUIDE PLATE:SWIVEL:NO.2	U005	59
D1492739	LEVER:PRESSURE RELEASE	U005_S001_S001	60
		U005_S002_S001	60
D1492772	ARM:PICKUP	U005_S001	61
		U005_S002	61
D1492773	PULLEY:PICKUP:MECHANICAL ROLLER CLUTCH	U005_S001	62
		U005_S002	62
D1492774	PULLEY:IDLER:PICKUP	U005_S001	63
		U005_S002	63
D1492777	COIL SPRING:PRESSURE:PICKUP	U005_S001	64
		U005_S002	64
D1492780	GROUND WIRE:SENSOR:PAPER FEED	U005_S001	65
		U005_S002	65
D1492781	GROUND PLATE:PAPER FEED UNIT	U005_S001	66
		U005_S002	66
D1492784	BRACKET:SENSOR:PAPER FEED	U005_S001	67
		U005_S002	67
D1492787	BRACKET:SUPPORT:COVER	U005	68
D1492788	INNER COVER:HARNESS:PAPER FEED UNIT	U005	69
D1492795	BRACKET:PAPER FEED UNIT:PEEN	U016	25
D1492812	ROLLER:PAPER TRAY:DIA19	U005_S004	70

Exclusive Parts

Number	Part Name	Group	ID
		U005_S005	70
D1492813	PIN:STRETCH:TRAY	U005_S004	71
		U005_S005	71
D1492814	COIL SPRING:EARTH	U005_S004	72
		U005_S005	72
D1492816	SHAFT:RISE:ASS'Y	U005_S004	73
		U005_S005	73
D1492818	LEVER:RISE	U005_S004	74
		U005_S005	74
D1492824	LEVER:STOPPER:FRONT	U005_S004_S001	75
		U005_S005_S001	75
D1492826	COMPRESSION SPRING:SIDE FENCE:PLATE:FRONT	U005_S004_S001	76
		U005_S005_S001	76
D1492827	COMPRESSION SPRING:SIDE FENCE:POSITIONING	U005_S004_S001	77
		U005_S005_S001	77
D1492835	RACK:SIDE FENCE	U005_S004	78
		U005_S005	78
D1492836	GEAR:Z20	U005_S004	79
		U005_S005	79
D1492842	LEVER:END FENCE	U005_S004_S003	80
		U005_S005_S003	80
D1492843	CLICK:END FENCE	U005_S004_S003	81
		U005_S005_S003	81
D1492845	COMPRESSION SPRING:END FENCE:LEVER:5N	U005_S004_S003	82
		U005_S005_S003	82
D1492847	DECAL:SIZE INDICATION:END FENCE:NO.1:REAR	U005_S004	83
D1492848	DECAL:SIZE INDICATION:END FENCE:NO.2:FRONT	U005_S005	84
D1492849	DECAL:SIZE INDICATION:END FENCE:NO.2:REAR	U005_S005	85
D1492872	LINK:END FENCE:PAPER SIZE SENSOR	U005_S005	86
D1492886	COVER:TRAY:REAR RIGHT:NO.1	U005	87
D1492887	COVER:TRAY:REAR LEFT:NO.1	U005	88
D1492888	COVER:TRAY:REAR RIGHT:NO.2	U005	89
D1492889	COVER:TRAY:REAR LEFT:NO.2	U005	90
D1492903	SUPPORTER:RIGHT:NO.2:ASS'Y	U005_S007	91

Number	Part Name	Group	ID
D1492905	SUPPORTER:RIGHT:NO.1:ASS'Y	U005_S006	92
D1492918	SUPPORTER:LEFT UPPER:NO.1	U005	93
D1492923	ROLLER:SUPPORTER:PAPER TRAY	U005_S007	94
D1492924	STOPPER:PAPER TRAY	U005_S006	95
		U005_S007	95
D1492925	SUPPORTER:LEFT:NO.2	U005	96
D1492928	ROLLER:SUPPORTER:PAPER TRAY:LEFT	U005	97
D1492930	SUPPORTER:LEFT LOWER:NO.1:PEEN	U005	98
D1492956	ROLLER:SUPPORTER:PAPER TRAY	U005_S006	99
D1492958	ROLLER:SUPPORTER:PAPER TRAY:LEFT	U005	100
D1492961	LEVER:STRETCH:PEEN	U005_S008	101
		U005_S009	101
D1492964	LEVER:LOCK:PAWL	U005_S008	102
		U005_S009	102
D1492965	LEVER:STRETCH:COIL SPRING	U005_S008	103
		U005_S009	103
D1492990	PLAIN SHAFT BEARING:DRIVE:REGISTRATION ROLLER	U009	23
D1493210	DC MOTOR:TONER BOTTLE:ASS'Y:5.28W:BRUSH:(M11/M12/M13/M14)	U007_S010_S001	25
		U007_S011_S001	25
		U007_S012_S001	25
		U007_S013_S001	25
D1493256	BASE:TONER HOPPER:REAR:ASS'Y	U007_S009	26
D1493321	DUCT:VERTICAL TRANSPORT:TONER SUPPLY	U007	27
D1493322	SHUTTER:DUCT:TONER SUPPLY	U007	28
D1493330	SEAL:CONNECTION:CARTRIDGE:TONER SUPPLY	U007	29
D1493331	COVER:GEAR:TONER SUPPLY SUB-UNIT	U007	30
D1493343	COLLAR:TONER SUPPLY	U007_S003	31
		U007_S010	31

Exclusive Parts

Number	Part Name	Group	ID
		U007_S011	31
		U007_S012	31
		U007_S013	31
		U007_S014	31
		U007_S015	31
		U007_S016	31
		U007_S017	31
D1493350	DC STEPPER MOTOR:TONER SUPPLY:(M19/M20/M22)	U007_S001	32
		U007_S002	32
		U007_S004	32
D1494202	ENCODER:ON-OFF:PRESSURE ROLLER	U011_S001	57
D1494209	SHAFT:ON-OFF:PRESSURE ROLLER	U011_S001	58
D1494235	STEPPED SCREW:M3	U011_S001	59
D1494335	ELECTRODE PLATE:CONNECTING:THERMOSTAT	U011_S001	60
D1494371	BRACKET:PHOTOINTERRUPTOR	U011	61
D1494421	GEAR:EXIT ROLLER	U012_S001	28
D1494422	GEAR:REVERSE ROLLER	U012_S001	29
D1494427	STUD:PULLEY:BRACKET:DC STEPPER MOTOR	U012_S001	30
D1494428	GROUND PLATE:PAPER EXIT UNIT	U012_S001	31
D1494429	PULLEY:GEAR:REVERSE	U012_S001	32
D1494434	TENSION SPRING:LEVER:GATE PAWL	U012_S001	33
D1494463	GROUND WIRE:SENSOR:REVERSE	U012_S001	34
D1494468	SHAFT:DRIVEN:REVERSE ROLLER	U012_S001	35
D1494469	SPRING PLATE:ROLLER:DRIVEN:REVERSE ROLLER	U012_S001	36
D1494471	SHAFT:DRIVEN:REVERSE ROLLER:OUTER	U012_S001	37
D1494484	TORSION SPRING:LEVER:GATE PAWL	U012_S001	38
D1494492	TRAY:REVERSE	U001	38

Number	Part Name	Group	ID
D1494623	GROUND WIRE:BRACKET:ENTRANCE:DUPLEX	U013	90
D1494638	GUIDE:WIRE	U013_S001	91
D1494645	SYNCHRONOUS BELT:30S2M118	U013_S001	92
D1494646	SYNCHRONOUS BELT:30S2M262	U013_S001	93
D1494647	SYNCHRONOUS BELT:30S2M212	U013_S001	94
D1494653	TENSION SPRING:SWIVEL	U013_S001	95
D1494656	HOOK:STOPPER:DUPLEX UNIT:FRONT	U013_S001	96
D1494657	HOOK:STOPPER:DUPLEX UNIT:REAR	U013_S001	97
D1494658	COIL SPRING:LEVER:DUPLEX	U013_S001	98
D1494662	DIFFUSION PLATE:LED	U009_S001	24
D1494672	COMPRESSION SPRING:DRIVEN	U013_S001	99
D1494675	COVER:PUSH SWITCH	U013_S001	100
D1494677	STAY:CONTACT POINT:GUIDE PLATE:DRIVEN	U013_S001	101
D1494688	LINK:DUPLEX:MAIN	U013_S001	102
D1494695	LINK:FRONT	U013_S001	103
D1494706	PIN:ARM:FRONT LOWER	U013_S001_S002	104
D1494711	DECAL:SIDE FENCE:MANUAL FEED	U013_S001_S002	105
D1494715	DECAL:GRIP:Z	U013_S001	106
D1494717	PLATE:SIDE FENCE:FRONT	U013_S001_S002	107
D1494718	TORSION SPRING:SIDE FENCE:FRONT	U013_S001_S002	108
D1494720	PLATE:SIDE FENCE:REAR	U013_S001_S002	109
D1494721	TORSION SPRING:SIDE FENCE:REAR	U013_S001_S002	110
D1494731	COMPRESSION SPRING:RACK:MANUAL FEED	U013_S001_S002	111
D1494755	BRACKET:HINGE:DUPLEX:FRONT	U013	112
D1494777	COMPRESSION SPRING:FLAT CONVEYER BELT:DRIVEN	U013_S001_S003	113
		U013_S001_S004	113
D1494850	ARM:PUSH SWITCH	U013_S001	114
D1494883	ARM:MANUAL FEED:FRONT LOWER	U013_S001_S002	115

Exclusive Parts

Number	Part Name	Group	ID
	R		
D1494884	ARM:MANUAL FEED:REAR LOWE R	U013_S001_S002	116
D1495703	BRACKET:MICRO SWITCH	U015	60
D1495711	BRACKET:ARM:SAFETY SWITCH:F RONT	U015	61
D1495713	ARM:SAFETY SWITCH:FRONT	U015	62
D1495714	SHAFT:ARM:SAFETY SWITCH	U015	63
D1495717	BASE:SAFETY SWITCH	U015	64
D1495718	TORSION SPRING:SAFETY SWITC H	U015	65
D1495726	LEVER:SAFETY SWITCH:RIGHT	U015	66
D1495742	COVER:HARNESS:OPTICAL WRITI NG UNIT	U015	67
D1495776	COVER:USB:SMALL	U015	68
D1495810	BRACKET:RACK:UPPER	U015	69
D1495818	SPACER:FFC	U015	70
D1495824	COVER:CONNECTOR:HEATER:0.4 MM	U015	71
D1495883	KEYTOP:MAIN SWITCH	U001	39
D1495884	COMPRESSION SPRING:KEYTOP	U001	40
D1496030	CAM:ON-OFF:COLLAR	U008_S001_S001	27
D1496112	ROLLER:FLAT BELT-TRANSFER:F ACE FRONT:ASS'Y	U008_S001_S001	28
D1496163	TENSION SPRING:SHUTTER:BELT CLEANING	U008_S001_S002	29
		U008_S001_S003	29
D1496172	BRACKET:BELT CLEANING:FRON T	U008_S001	30
D1496173	BRACKET:BELT CLEANING:REAR	U008_S001	31
D1496177	HOLDER:DISCHARGE USED TONE R:ASS'Y	U008_S001_S003	32
D1496179	GEAR:IDLER:DISCHARGE USED T ONER	U008_S001_S003	33
D1496190	GEAR:DISCHARGE USED TONER	U008_S001_S003	34
D1496195	CAM:DISCHARGE USED TONER	U008_S001_S003	35
D1496226	LEVER:TRANSFER/SEPARATION UNIT:FRONT	U009_S001	25
D1496227	LEVER:SET:FRONT	U009_S001	26

Number	Part Name	Group	ID
D1496228	TORSION SPRING:LEVER:SET:FR ONT	U009_S001	27
D1496229	TENSION SPRING:LEVER:SET	U009_S001	28
D1496231	LEVER:TRANSFER/SEPARATION UNIT:REAR	U009_S001	29
D1496232	LEVER:SET:REAR	U009_S001	30
D1496233	TORSION SPRING:LEVER:SET:RE AR	U009_S001	31
D1496242	COMPRESSION SPRING:PRESSU RE:TRANSFER ROLLER	U009_S001	32
D1496243	RECEIVE PLATE:COMPRESSION S PRING:TRANSFER ROLLER	U009_S001	33
D1496245	GROUND PLATE:TRANSFER/SEPA RATION UNIT	U009_S001	34
D1496248	CAP:LED	U009_S001	35
D1496254	DECAL:GRIP:B:LOWER	U009_S001	36
D1496257	GROUND PLATE:REGISTRATION ROLLER	U009_S001	37
D1496290	GUIDE:SET:TRANSFER/SEPARATI ON UNIT:FRONT	U009	38
D1496291	GUIDE:SET:TRANSFER/SEPARATI ON UNIT:REAR	U009	39
D1496295	COVER:HARNESS:TRANSFER/SE PARATION UNIT	U009	40
D1496309	SHAFT:ON-OFF:COLLAR:MAIN	U008	36
D1496310	BRACKET:ON-OFF:COLLAR	U008	37
D1496312	JOINT:ON-OFF:COLLAR	U008	38
D1496318	DC STEPPER MOTOR:ON-OFF:(M2 1)	U007_S003	33
D1496320	TERMINAL:BIAS:INTERMEDIATE T RANSFER:MAIN	U008	39
D1496321	HOLDER:TERMINAL:INTERMEDIAT E TRANSFER:MAIN	U008	40
D1496552	GEAR:IDLER:Z30	U010	17
D1496553	GEAR:IDLER:Z61	U010	18
D1496554	GEAR:PULLEY:IDLER:Z16	U010	19
D1496555	GEAR:IDLER:Z21	U010	20
D1496556	TENSION SPRING:BELT TENSION	U010	21

Exclusive Parts

Number	Part Name	Group	ID
	ER		
D1496557	SYNCHRONOUS BELT:40S3M564	U010	22
D1496561	PULLEY:USED TONER	U010	23
D1496562	BRACKET:TIGHTENER:USED TONER	U010	24
D1496571	BRACKET:PULLEY:IDLER:USED TONER	U010	25
D1496574	GEAR:PULLEY:IDLER:Z18	U010	26
D1496575	FLANGE:IDLER:USED TONER	U010	27
D1496581	SHAFT:DRIVE:USED TONER:RIGHT	U010	28
D1496582	GEAR:USED TONER:RIGHT	U010	29
D1496583	GEAR:USED TONER:INPUT	U010	30
D1496586	SHAFT:DRIVE:USED TONER:LEFT	U010	31
D1496587	GEAR:USED TONER:LEFT	U010	32
D1496592	RAIL:COLLECTION BOTTLE	U010	33
D1496852	(EU/TWN/CHN):DECAL:MAIN SWITCH:ON-STANDBY	U017	14
D1496859	DECAL:CLEANING:SHIELD GLASS	U001	41
D1496862	DECAL:SIZE INDICATION:PAPER TRAY	U017	15
D1496893	DECAL:PCU:BLACK	U001	42
D1496894	DECAL:PCU:CYAN	U001	43
D1496895	DECAL:PCU:MAGENTA	U001	44
D1496896	DECAL:PCU:YELLOW	U001	45
D1497922	COVER:FAN:DEVELOPMENT:RIGHT LOWER	U016	26
D1497923	DUCT:DEVELOPMENT:RIGHT LOWER	U016	27
D1497932	DUCT:PCU:EXHAUST	U016	28
D1497938	OZONE FILTER	U016_S001	29
D1497951	DUCT:SUPPLY:A	U016	30
D1497952	DUCT:SUPPLY:B	U016	31
D1497953	DUCT:SUPPLY:C	U016	32
D1497954	DUCT:SUPPLY:D	U016	33
D1497955	DUCT:SUPPLY:FAN:UPPER	U016	34
D1497956	DUCT:SUPPLY:FAN:LOWER	U016	35
D1497957	DUCT:DRIVE:COOLING:A	U016	36

Number	Part Name	Group	ID
D1497958	DUCT:DRIVE:COOLING:B	U016	37
D1497971	DUCT:EXHAUST:REAR:A	U016	38
D1497972	DUCT:EXHAUST:REAR:B	U016	39
D1497973	DUCT:EXHAUST:REAR:C	U016	40
D1497982	DUCT:POWER SUPPLY UNIT	U016	41
D1497983	BRACKET:FAN:POWER SUPPLY UNIT	U016	42
D1497984	DUCT:REAR:POWER SUPPLY UNIT	U001	46
D1497986	GUIDE:THERMISTOR	U016	43
D1501095	BRACKET:POSITIONING:FUSING UNIT:M3	U001 U016	47 44
D1501235	COVER:UPPER:INNER BACK:BIN	U001	48
D1501282	COVER:SCANNER:UPPER:FRONT	U001	49
D1502666	GEAR:SIDE FENCE:MANUAL FEED TABLE	U013_S001_S002	117
D1751377	GEAR:PRESSURE RELEASE:NO.3	U014_S002	42
D1752726	STOPPER:GUIDE PLATE:SWIVEL	U005_S002	104
D1754737	PLAIN SHAFT BEARING:DUPLEX:EXIT	U013_S001	118
D1771302	CLEANER:SHIELD GLASS:ASS'Y	U017	16
D2021143	JOINT:DRIVE	U014_S001	43
D2021152	BRACKET:DRIVE UNIT:PAPER FEED:ASS'Y	U014_S001	44
D2021191	GEAR:GRIP:NO.1	U014_S001	45
D2021193	STUD:PAPER FEED:GRIP:ASS'Y	U014_S001	46
D2021195	PULLEY:GRIP:NO.2	U014_S001	47
D2021196	HOUSING:DRIVE UNIT:PAPER FEED:ASS'Y	U014_S001	48
D2022614	COIL SPRING:RELEASE:PICKUP:MANUAL FEED	U013_S001_S001	119
D2022619	TORSION SPRING:PICKUP	U013_S001_S001	120
D2022620	SHOE:TORSION SPRING:PICKUP	U013_S001_S001	121
D2022624	COVER:PAPER END	U013_S001_S001	122
D2022625	BRACKET:PAPER END SENSOR:MANUAL FEED	U013_S001_S001	123
D2022638	FEELER:PAPER SIZE SENSOR:MANUAL FEED	U013_S001_S002	124

Exclusive Parts

Number	Part Name	Group	ID
D2022640	EXTENSION TRAY:NO.1	U013_S001_S002	125
D2022641	EXTENSION TRAY:NO.2	U013_S001_S002	126
D2022642	PULLEY:WIRE:MANUAL FEED TAB LE	U013_S001_S002	127
D2022646	ARM:MANUAL FEED:REAR UPPER	U013_S001_S002	128
D2022676	DECAL:SCALE:MANUAL FEED:MID DLE	U013_S001_S002	129
D2022677	DECAL:SCALE:MANUAL FEED:RE AR	U013_S001_S002	130
D2022778	FEELER:PAPER END	U005_S001 U005_S002	105 105
D2024477	REVERSE ROLLER	U012_S001	39
D2024673	FEELER:DUPLEX:ENTRANCE SEN SOR	U013_S001	131
D2024674	TORSION SPRING:DUPLEX:ENTR ANCE SENSOR	U013_S001	132
D2024679	DRIVEN ROLLER:DIA16:DUPLEX	U013_S001	133
D2024680	BRACKET:DRIVEN ROLLER:PRES SURE	U013_S001	134
D2024682	DRIVEN ROLLER:DIA16	U013_S001	135
D2024684	GROUND WIRE:BRACKET:DRIVEN ROLLER	U013_S001	136
D2024692	SHAFT:PRESSURE:GUIDE PLATE: UPPER	U013_S001	137
D2024721	BRACKET:LINK:DUPLEX	U013_S001	138
D2024722	LINK:DUPLEX	U013_S001	139
D2024726	TORSION SPRING:LINK:CONTACT POINT	U013_S001	140
D2026255	DECAL:GRIP:B	U009_S001	41
D2380072	(EU/AA/KOR/CHN):HEATER:SCAN NER:220/240V:ASS'Y	U018	1
D2386640	(EU/AA/KOR/CHN):HEATER:PAPER TRAY:220/240V:ASS'Y	U018	2
D2388100	SERVICE PARTS:SD-CARD:QMT_P HASE1	SPECIAL TOOLS	8
D2391265	COVER:RIGHT:REAR	U001	50
D2395772	PANEL:CONTROL BOARD:D238/D2 39	U015	72

Number	Part Name	Group	ID
D2395888	COVER:FAX	U015	73
D2395889	RAIL:FAX	U015	74
D2411113	GUIDE:HARNESS:RIGHT	U014	49
D2411115	GUIDE:HARNESS:LEFT	U014	50
D2411117	DRIVE UNIT:ENGINE:ASS'Y:D240/ D241/D242	U014	51
D2411242	COVER:MAIN SWITCH	U005_S004	106
D2411251	COVER:LEFT:UPPER	U001	51
D2411260	COVER:REAR:LOWER	U001	52
D2411261	COVER:REAR	U001	53
D2411263	CAP:LOUVER:DEODORIZE FILTER	U001	54
D2411266	COVER:RIGHT:FRONT LOWER	U001	55
D2411273	INNER COVER:FRONT:LOWER	U001	56
D2411275	INNER COVER:FRONT:RIGHT LO WER	U001	57
D2411284	COVER:SCANNER:LEFT	U001	58
D2411285	COVER:SCANNER:UPPER:LEFT	U001	59
D2411297	BRACKET:COVER:LEFT UPPER R EAR	U001	60
D2411298	INNER COVER:RIGHT	U001	61
D2411308	BAND:STOPPER:DOOR	U001	62
D2411309	MAGNET CATCH	U001	63
D2411378	GEAR:FUSING:NO.3	U014_S002	52
D2411396	HOLDER:TORQUE LIMITER MECH ANICAL CLUTCH:PRESSURE REL EASE	U014_S002	53
D2411671	PROTECTION:CARRIAGE:SCANNE R	U003	34
D2411678	SHEET:FFC:LOWER	U003	35
D2411680	GUIDE ROD	U003	36
D2411681	STAY:GUIDE ROD	U003	37
D2411684	COVER:HARNESS:SCANNER	U003	38
D2411685	SPRING PLATE:GUIDE ROD	U003	39
D2411686	CLAMP:STAY:GUIDE ROD	U003	40
D2411688	SHEET:GLASS:LARGE	U003	41
D2411689	HOLDER:EXPOSURE GLASS	U003	42
D2411697	SLIDE RAIL	U003	43
D2411698	COVER:BASE:SCANNER	U003	44

Exclusive Parts

Number	Part Name	Group	ID
D2411701	PULLEY:IDLER:LEADING EDGE	U003	45
D2411702	CAP:PULLEY:IDLER:LEADING EDGE	U003	46
D2411708	TIGHTENER:DIA8	U003	47
D2411710	PULLEY:IDLER:TRAILING EDGE	U003	48
D2411711	CAP:IDLER:TRAILING EDGE	U003	49
D2411712	TENSION SPRING:TIGHTENER:TENSION:4N	U003	50
D2411715	PULLEY:DRIVE	U003	51
D2411716	CAP:PULLEY:DRIVE:UPPER	U003	52
D2411717	CAP:PULLEY:DRIVE:LOWER	U003	53
D2411719	DC STEPPER MOTOR:(M26)	U003	54
D2411722	TENSION SPRING:TENSION:11N	U003	55
D2411727	SHEET:GAP:ASS'Y	U003	56
D2411732	SCALE:LEFT:MM:ASS'Y	U003	57
D2411733	COVER:SHEET THROUGH:DOCUMENT FEEDER	U003	58
D2411738	SCALE:REAR:PRINTING:MM	U003	59
D2411741	BRACKET:DOCUMENT FEEDER:LEFT	U003	60
D2411742	BRACKET:DOCUMENT FEEDER:RIGHT	U003	61
D2411744	DOCUMENT FEEDER:CABLE:BRACKET	U003	62
D2411766	SHEET:FLAT CABLE:SBU	U003	63
D2411767	PLAIN SHAFT BEARING:90ANG	U003_S001	64
D2411770	HOLDER:FERRITE CORE	U003	65
D2411788	CAP:COVER:POSITIONING	U017	17
D2412559	SHAFT:REGISTRATION ROLLER:DRIVEN	U005	107
D2412576	GUIDE PLATE:REGISTRATION:FRONT LEFT	U005	108
D2412583	REGISTRATION ROLLER:DRIVE	U009	42
D2412612	DC SOLENOID:PICKUP:ASS'Y:(SOLL1)	U013_S001_S001	141
D2412622	COVER:DAMPER	U013_S001_S001	142
D2412641	COVER:PAPER STOPPER:MANUAL FEED	U013_S001_S001	143

Number	Part Name	Group	ID
D2412643	ARM:LINK:PAPER STOPPER	U013_S001_S001	144
D2412644	TORSION SPRING:LINK:PAPER STOPPER	U013_S001_S001	145
D2412652	GROUND PLATE:SHAFT:FEED	U013_S001_S001	146
D2412657	GROUND WIRE:MANUAL FEED UNIT:REAR	U013_S001_S001	147
D2412663	DECAL:SCALE:MANUAL FEED:FRONT	U013_S001_S002	148
D2412671	GUIDE PLATE:VERTICAL TRANSPORT:NO.1:DRIVEN:ASS'Y	U013_S001_S003	149
D2412672	GUIDE PLATE:VERTICAL TRANSPORT:NO.2:DRIVEN:ASS'Y	U013_S001_S004	150
D2412673	GUIDE PLATE:VERTICAL TRANSPORT:NO.1:DRIVEN	U013_S001_S003	151
D2412674	GUIDE PLATE:VERTICAL TRANSPORT:NO.2:DRIVEN	U013_S001_S004	152
D2412676	HOLDER:DRIVEN:BELT	U013_S001_S003	153
		U013_S001_S004	153
D2412678	SHAFT:FLAT CONVEYER BELT:DRIVEN	U013_S001_S003	154
		U013_S001_S004	154
D2412682	STAY:REAR:MANUAL FEED TABLE	U013_S001_S002	155
D2412685	DECAL:PAPER SET DIRECTION:MANUAL FEED	U013_S001_S002	156
D2412705	STAY:PAPER FEED UNIT:LOWER:ASS'Y	U005_S001_S001	109
		U005_S002_S001	109
D2412719	GROUND PLATE:SENSOR:TRANSPORT	U005_S001	110
		U005_S002	110
D2412730	STAY:SEPARATE:PEEN	U005_S001_S001	111
		U005_S002_S001	111
D2412731	STOPPER:GUIDE PLATE:SWIVEL	U005	112
D2412736	BRACKET:SEPARATE:REAR	U005_S001_S001	113
		U005_S002_S001	113
D2412741	GUIDE PLATE:VERTICAL TRANSPORT:PAPER FEED UNIT:NO.1	U005_S001	114
D2412742	GUIDE PLATE:VERTICAL TRANSPORT:PAPER FEED UNIT:NO.2	U005_S002	115
D2412754	COIL SPRING:PRESSURE:SEPARATE	U005_S001_S001	116
		U005_S002_S001	116

Exclusive Parts

Number	Part Name	Group	ID
D2412759	TRANSPORT ROLLER:VERTICAL TRANSPORT:ASS'Y	U005_S001	117
		U005_S002	117
D2412760	STAY:PAPER FEED UNIT:UPPER:PEEN	U005_S001	118
		U005_S002	118
D2412782	PLATE:HARNESS:PAPER FEED UNIT	U005_S001	119
		U005_S002	119
D2412837	DECAL:SET:SIDE FENCE:AUXILIARY	U005_S005	120
D2412865	COVER:PAPER TRAY:NO.1	U005_S004	121
D2412869	DECAL:SIZE INDICATION:SIDE FENCE:NO.2	U005_S005	122
D2412873	SIDE FENCE:AUXILIARY	U005_S005_S004	123
		U005_S005_S005	123
D2412883	DECAL:SIZE INDICATION:SIDE FENCE:AUXILIARY:FRONT	U005_S005	124
D2412884	DECAL:SIZE INDICATION:SIDE FENCE:AUXILIARY:REAR	U005_S005	125
D2412885	DECAL:SIDE FENCE:AUXILIARY	U005_S005_S004	126
		U005_S005_S005	126
D2412906	LEVER:STRETCH:PAPER TRAY:ASS'Y	U005_S008	127
		U005_S009	127
D2412943	TENSION SPRING:LEVER:AUXILIARY	U005_S008	128
		U005_S009	128
D2412991	PLAIN SHAFT BEARING:INNER:DRIVE:REGISTRATION ROLLER	U009	43
D2412993	STOPPER:REGISTRATION ROLLER	U009	44
D2412994	COMPRESSION SPRING:REGISTRATION:INNER:DRIVE	U009	45
D2413336	COVER:GEAR:TONER SUPPLY SUB-UNIT:C	U007	34
D2414023	HOLDER:DRIVEN ROLLER:FUSING EXIT:FRONT	U011_S001	62
D2414024	HOLDER:DRIVEN ROLLER:FUSING EXIT:REAR	U011_S001	63
D2414108	GUIDE:FUSING EXIT:LEFT	U011_S001	64
D2414113	BRACKET:THERMISTOR:PRESSURE ROLLER	U011_S001	65

Number	Part Name	Group	ID
D2414121	INNER COVER:PRESSURE ROLLER:REAR	U011_S001	66
D2414122	INNER COVER:PRESSURE ROLLER:FRONT	U011_S001	67
D2414123	DISCHARGE BRUSH:PRESSURE ROLLER	U011_S001	68
D2414137	LEVER:PRESSURE:FRONT:PEEN	U011_S001	69
D2414140	HOLDER:PRESSURE:FRONT:ASS'Y	U011_S001	70
D2414155	HOLDER:PRESSURE:REAR:ASS'Y	U011_S001	71
D2414160	LEVER:PRESSURE:REAR:PEEN	U011_S001	72
D2414212	GATE PAWL:FUSING EXIT	U011_S001	73
D2414215	GUIDE:FUSING EXIT:RIGHT:ASS'Y	U011_S001	74
D2414219	DECAL:C:GUIDE PLATE:FUSING EXIT	U011_S001	75
D2414221	STRIPPER PLATE:FUSING EXIT:ASS'Y	U011_S001	76
D2414252	FUSING ENTRANCE GUIDE PLATE	U011_S001	77
D2414332	HOUSING:THERMOSTAT	U011_S001	78
D2414334	COVER:HOUSING:THERMOSTAT	U011_S001	79
D2414337	TERMINAL:THERMOSTAT:DRAWER	U011_S001	80
D2414338	TERMINAL:THERMOSTAT:HEATER	U011_S001	81
D2414342	HOUSING:NON-CONTACT TYPE THERMISTOR	U011_S001	82
D2414365	HOLDER:THERMOPILE	U011	83
D2414366	BRACKET:THERMOPILE	U011	84
D2414367	STOPPER:THERMOPILE	U011	85
D2414441	GUIDE PLATE:EXIT:UPPER	U012_S001	40
D2414448	SHAFT:FEELER:OVERFLOW	U012_S001	41
D2414458	GUIDE:COVER:UPPER	U001	64
D2414461	GUIDE PLATE:REVERSE:UPPER	U012_S001	42
D2414466	GUIDE PLATE:REVERSE:LOWER	U012_S001	43
D2414472	END FENCE:TRAY:EXIT:ASS'Y	U017	18
D2414476	EXIT ROLLER	U012_S001	44
D2414481	GATE PAWL:EXIT	U012_S001	45
D2414483	LEVER:GATE PAWL	U012_S001	46
D2414494	TRAY:AUXILIARY:EXIT	U012	47

Exclusive Parts

Number	Part Name	Group	ID
D2414499	COMPRESSION SPRING:BASE:TRAY:EXIT	U012	48
D2414617	TRANSPORT ROLLER:DUPLX:2:DIA8	U013_S001	157
D2414627	COVER:DUPLX	U013_S001	158
D2414628	GUIDE PLATE:DUPLX:EXIT	U013_S001	159
D2414635	SHEET:CUSHION	U013_S001	160
D2414640	TRANSPORT ROLLER:EXIT:DIA8	U013_S001	161
D2414642	TRANSPORT ROLLER:DUPLX:1	U013_S001	162
D2414643	TRANSPORT ROLLER:ENTRANCE	U013_S001	163
D2414652	GEAR:PULLEY:SWIVEL	U013_S001	164
D2414660	GUIDE PLATE:UPPER:RIGHT:DUPLX	U013_S001	165
D2414673	GUIDE PLATE:DRIVEN	U013_S001	166
D2414676	LEVER:PRESSURE:DUPLX	U013_S001	167
D2414677	COMPRESSION SPRING:EXIT:UPPER	U013_S001	168
D2414681	BRACKET:MOTOR:PEEN	U013_S001	169
D2414684	GEAR:OUTPUT	U013_S001	170
D2414692	INNER COVER:REAR:DUPLX	U013_S001	171
D2414693	INNER COVER:FRONT:DUPLX	U013_S001	172
D2414694	CAP:BELT:DUPLX	U013_S001	173
D2414697	GROUND WIRE:EXIT SENSOR:DUPLX	U013_S001	174
D2414707	GEAR:FEED:MANUAL FEED:DRIVE	U013_S001	175
D2414708	GEAR:SEPARATOR:MANUAL FEED:DRIVE	U013_S001	176
D2414709	GEAR:TRANSPORT ROLLER:MANUAL FEED	U013_S001	177
D2414710	GEAR:IDLER	U013_S001	178
D2414722	BRACKET:FRONT	U013_S001_S001	179
D2414750	BRACKET:MOTOR:DUPLX	U013	180
D2414755	GEAR:OUTPUT:DUPLX:ENTRANCE	U013	181
D2414757	SPACER:DC MOTOR:DUPLX	U013	182
D2414761	DRIVEN ROLLER:DIA16	U013_S001	183
D2414762	DRIVEN ROLLER:DIA18	U013_S001	184
D2414763	GUIDE:HARNESS:ENTRANCE SENS	U013_S001	185

Number	Part Name	Group	ID
	SOR:DUPLX		
D2414765	PULLEY:T26	U013_S001	186
D2414766	PULLEY:T26/T26	U013_S001	187
D2414921	COVER:GUIDE PLATE:DRIVEN	U013_S001	188
D2414923	STAY:CONTACT POINT:DUPLX	U013_S001	189
D2414929	DC SOLENOID:FUSING EXIT:ASS'Y:(SOL3)	U012	49
D2414936	INNER COVER:EXIT	U012	50
D2414937	TENSION SPRING:GATE:REVERSE	U012_S001	51
D2414938	TENSION SPRING:LINK:DC SOLENOID:FUSING EXIT	U012	52
D2414941	GATE PAWL:REVERSE:FRONT MIDDLE	U012_S001	53
D2414942	GATE PAWL:REVERSE:REAR MIDDLE	U012_S001	54
D2414943	GATE PAWL:REVERSE:REAR	U012_S001	55
D2414946	SHAFT:GATE PAWL:REVERSE	U012_S001	56
D2414947	GATE PAWL:REVERSE:FRONT	U012_S001	57
D2414948	GUIDE:HARNESS:REVERSE	U012_S001	58
D2414950	ROLLER:EXIT:PRESSURE:2TYPE:ASS'Y	U012_S001_S001	59
D2414955	HOLDER:ROLLER:EXIT:PRESSURE:2TYPE	U012_S001	60
D2414971	LINK:PLATE:EXIT	U012	61
D2414972	GUIDE:PLATE:EXIT	U012	62
D2414981	COIL SPRING:ROLLER:PRESSURE:EXIT	U012_S001	63
D2414992	DISCHARGE BRUSH:EXIT	U012_S001	64
D2414994	GUIDE PLATE:EXIT:LOWER	U012_S001	65
D2414995	GUIDE PLATE:UPPER	U013_S001	190
D2414996	DC SOLENOID:ASS'Y:(SOL2)	U012_S001	66
D2414998	CUSHION:DC SOLENOID:4MM	U012_S001	67
D2415707	BRACKET:HUMAN DETECTION SENSOR	U015	75
D2415711	COVER:HUMAN DETECTION SENSOR:CONNECTOR	U001	65
D2415712	PLATE:HUMAN DETECTION SENSOR	U015	76

Exclusive Parts

Number	Part Name	Group	ID
	OR:SENSOR		
D2415737	BRACKET:MAIN SWITCH	U015	77
D2415764	COVER:POWER PACK:CB	U015	78
D2415765	CASE:POWER PACK:CB	U015	79
D2415800	RACK:RIGHT:AUXILIARY	U015	80
D2415801	COVER:RACK:REAR	U015	81
D2415803	GUIDE:HARNESS:C/T BOX	U015	82
D2415817	GUIDE:FFC:2	U015	83
D2415831	CAP:GUIDE:WIRE	U015	84
D2415832	CAP:GUIDE:COIL SPRING	U015	85
D2415841	BASE:GUIDE:WIRE	U015	86
D2415842	COVER:GUIDE:WIRE	U015	87
D2415850	WIRE:CHARGE:K	U015	88
D2415851	WIRE:DEVELOPMENT:K	U015	89
D2415852	WIRE:CHARGE:C	U015	90
D2415853	WIRE:DEVELOPMENT:C	U015	91
D2415854	WIRE:CHARGE:M	U015	92
D2415855	WIRE:DEVELOPMENT:M	U015	93
D2415856	WIRE:CHARGE:Y	U015	94
D2415857	WIRE:DEVELOPMENT:Y	U015	95
D2415875	WIRE:CHARGE:CB	U015	96
D2415876	WIRE:DEVELOPMENT:CB:K	U015	97
D2415877	WIRE:DEVELOPMENT:CB:C	U015	98
D2415878	WIRE:DEVELOPMENT:CB:M	U015	99
D2415879	WIRE:DEVELOPMENT:CB:Y	U015	100
D2416097	FLAT BELT-TRANSFER:INTERMEDIATE TRANSFER:TT	U008_S001_S001	41
D2416240	LEVER:PRESSURE:TRANSFER ROLLER:FRONT:DIA19.5	U009_S001	46
D2416241	LEVER:PRESSURE:TRANSFER ROLLER:REAR:DIA19.5	U009_S001	47
D2416244	GROUND PLATE:SEPARATION	U009_S001	48
D2416250	GROUND WIRE:BRACKET:ENTRANCE SENSOR	U009_S001	49
D2416256	GROUND PLATE:GUIDE:TRANSPORT	U009_S001	50
D2416258	COVER:TRANSFER/SEPARATION UNIT	U009_S001	51

Number	Part Name	Group	ID
D2416275	SHEET:ENTRANCE:TRANSFER	U009_S001	52
D2416290	LED:RED	U009_S001	53
D2417913	DUCT:OPTICAL WRITING UNIT	U001	66
D2417941	DUCT:EXHAUST:UPPER:A	U016	45
D2417942	DUCT:EXHAUST:UPPER:B	U016	46
D2417943	DUCT:EXHAUST:UPPER:C	U016	47
D2417944	DUCT:EXHAUST:UPPER:D	U016	48
D2417945	DEODORIZE FILTER	U016	49
D2417983	DUCT:DEVELOPMENT:REAR:A	U016	50
D2417984	DUCT:DEVELOPMENT:REAR:B	U016	51
D2421267	COVER:RIGHT:UPPER	U001	67
D2424262	FUSING COVER:LOWER	U011_S001	86
D2424382	DC STEPPER MOTOR:ASS'Y:(M28)	U011	87
D2424383	BRACKET:IDLER:DC STEPPER MOTOR	U011	88
D2424386	BRACKET:DC STEPPER MOTOR	U011	89
D2426432	FEELER:COLLECTION BOTTLE	U010_S001	34
D2442856	GRIP:PAPER TRAY	U005_S004 U005_S005	129 129
D2445730	PCB:DCSW:(SW4)	U015	101
D2581317	HOLDER:GLASS:CLEANER:ASS'Y	U017	19
D2894655	GRIP:DUPLEX UNIT	U013_S001	191
D2951509	CAP:HINGE	U002	41
D2951554	MIKE:PVM-6018-C402G-7ZZ4	U002_S001	42
D3BR2202	(EU/AA/KOR/CHN):HEATER:PHOTO CONDUCTOR:ASS'Y	U018	3
D3FE0002	(EU[IM C4500/C5500]):ARDF:NON-OPTION	ADF	1
D3FE6031	(EU):(IM C4500/C5500):DECAL:ORIGINAL TABLE	U017	20
D3FE6061	(EU):(IM C4500/C5500):DECAL:CAUTION:ORIGINAL:ENGLISH	U017	21
D3FF6031	(EU):(IM C4500A/C5500A/C6000):DECAL:SET:ORIGINAL TABLE	U017	22
D3FF6303	(EU):(IM C4500A/C5500A/C6000):DECAL:CAUTION:ORIGINAL:ENGLISH	U017	23
D3FF7001	(EU[IM C4500A/C5500A/C6000])/NA/	ADF	2

Exclusive Parts

Number	Part Name	Group	ID
	AA/KOR/TWN):ADF:ASS'Y		
D3G36650	(EU/AA/KOR/CHN):ELECTRICAL COMPONENTS SECTION:SCANNER:200V:ASS'Y	U018	4
D3G36662	(EU/AA/KOR/CHN):ELECTRICAL COMPONENTS SECTION:PAPER TRAY:200V:ASS'Y	U018	5
D6932867	SUPPORTING PLATE:COVER:FRONT:PAPER TRAY	U005_S005	130
GA003929	DECAL:OPERATE:4X27	U011_S001_S001	90
GA003930	DECAL:LEVER:FRONT:FUSING	U011_S001_S001	91
GA003931	DECAL:LEVER:REAR:FUSING	U011_S001_S001	92
GA003932	DECAL:LEVER:RELEASE	U011_S001	93
GA003933	DECAL:OPERATE:4X10.5	U008	42
		U011_S001	94
		U011_S001_S001	94
		U016	52
GA003934	DECAL:OPERATE:4X41	U008_S001	43
GA003957	DECAL:POSITIONING DISPLAY:FUSING	U011_S001_S001	95
GA003960	DECAL:POSITIONING DISPLAY:6.5X9	U008	44
GA003969	DECAL:POSITIONING DISPLAY:FUSING UNIT:MAIN	U016	53
GA003993	DECAL:LEVER:FIX	U006_S001	20
		U006_S002	20
		U006_S003	20
		U006_S004	20
		U008_S001	45
GA003994	DECAL:LEVER:RELEASE	U001	68
		U008_S001	46
GA143003	SCREW:MM5:2.5MM	U005	131
		U009_S001	54
GW010007	PHOTO REFLECTION SENSOR:EXIT:(S3/S9/S10/S12/S14/S16/S22/S24)	U005	132
		U005_S001	132
		U005_S002	132
		U012_S001	68
		U013_S001	192

Number	Part Name	Group	ID
GW010009	DENSITY SENSOR:(S48)	U008	47
GW020024	PHOTOINTERRUPTOR:LG2A24BL1:GF:(S5/S34/S42)	U003	66
		U010	35
		U013_S001	193
GW230008	TONER END SENSOR:(S28/S29/S30/S31)	U007_S001	35
		U007_S002	35
		U007_S003	35
		U007_S004	35
M0662743	FRICTION PAD:MANUAL FEED TABLE:18X7.5	U013_S001_S002	194
M0662749	OIL DAMPER:STRAIGHT:30N	U013_S001_S001	195
M0AJ1092	CAM:LOCK:PCU	U016	54
M0AJ1093	COMPRESSION SPRING:LOCK:PCU	U016	55
M0AJ1098	LEVER:LOCK:PCU:M-PAC	U016	56
M0AJ1250	COVER:LEFT	U001	69
M0AJ1384	BRACKET:INPUT:FUSING DRIVE UNIT	U014	54
M0AJ4261	FUSING COVER:UPPER:ASS'Y	U011_S001_S001	96
M0AJ4271	COVER:LEVER:FUSING:REAR	U011_S001	97
M0AJ4272	HOOK:FUSING:REAR	U011_S001	98
M0AJ4273	LEVER:FUSING	U011_S001	99
M0AJ4278	COVER:LEVER:FUSING:FRONT	U011_S001	100
M0AJ4279	HOOK:FUSING:FRONT	U011_S001	101
M0AJ4388	COVER:DRIVE UNIT:LIGHT SHIELDING P	U011	102
M0AJ4497	TRAY:EXIT	U012	69
M0AJ4981	DECAL:EXIT:GUIDE P:LOWER:MIDDLE	U012_S001	70
M0AJ4982	DECAL:EXIT:GUIDE P:LOWER:INNER BACK	U012_S001	71
M0AJ6175	TONER OUTLET UNIT:BELT CLEANING:ASS'Y	U008_S001_S003	48
M0AJ6856	(EU/NA/AA/KOR):DECAL:INKJET:EMANUAL FEED	U017	24
M0AJ7936	CAP:LOUVER:FILTER:LEFT	U016_S001	57
M0AJ7991	DUCT:DEVELOPMENT:EXHAUST:A	U016	58
M0AJ7992	DUCT:DEVELOPMENT:EXHAUST:B	U016	59

Exclusive Parts

Number	Part Name	Group	ID
M0AJ7993	DUCT:DEVELOPMENT:EXHAUST: C	U016	60
M0AJ7994	SEAL:CAP:FILTER	U016	61
M0AJ7995	SEAL:DUCT:DEVELOPMENT:EXHA UST	U016	62
M0BW6228	TORSION SPRING:SEPARATION/T RANSPORT:28N	U009_S001	55
M0BW6246	LINK:TRANSFER/SEPARATION UN IT:MO	U009_S001	56
M4445201	HDD:320GB:AQUARIUS:(PCB12)	U015	102
Note1	See 3D parts catalog for the compon ents of the ARDF DF3110.	ADF	3
Note2	See 3D parts catalog for the compon ents of the SPDF DF3120.	ADF	4
VSSG9002	FLUOTRIBO MG GREASE : 100G	SPECIAL TOOLS	9

Standard Parts



03130060N
SCREW - M3X6



03140120N
SCREW - M4X12



03520030N
SCREW:M2X3

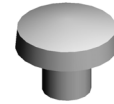

03530030N
SCREW:M3X3

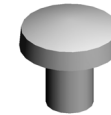

03530040N
SCREW - M3X4



03530040P
SCREW - M3X4

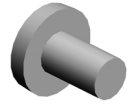

03530050N
SCREW-M3X5



03530060N
BIND SCREW - M3X6

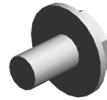

03603005N
SCREW - M3X5



03603006N
SCREW - M3X6



03603016N
SCREW - M3X16



04503008N
TAPPING SCREW - M3X8

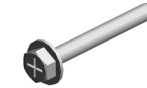

04503025N
TAPPING SCREW:3X25



04503035N
TAPPING SCREW:3X35



04513006N
TAPPING SCREW - 3X6



04513008N
TAPPING SCREW - M3X8

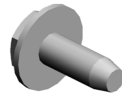

04513008P
TAPPING SCREW - 3X8



04513025N
TAPPING SCREW:M3X25



04533008N
BINDING SELF TAPPING SCREW:3X8



04543006N
TAPPING SCREW:ROUND POINT:3X6



04543006Q
TAPPING SCREW - M3X6



04543008N
TAPPING SCREW:ROUND POINT:3X8



04543008Q
TAPPING SCREW:3X8



04543010Q
TAPPING SCREW:3X10



04543020Q
TAPPING SCREW::3X20



04583008N
HEXAGON HEAD TAPPING SCREW:3X8



04583010N
HEXAGON HEAD TAPPING SCREW:3X10



04593008N
BINDING HEAD TAPPING SCREW:3X8

Standard Parts

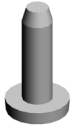

04593010N
BINDING HEAD TAPPING SCREW:3X10

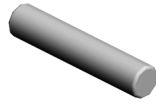

06320100G
PIN - 2X10MM

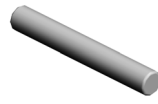

06320140G
PARALLEL PIN



06330100G
PARALLEL PIN - 3X10



07200020G
RETAINING RING - M2



07200025E
RETAINING RING - M2.5



07200030E
RETAINING RING - M3



07200040E
RETAINING RING - M4



07200060E
RETAINING RING - M6



07250170E
RETAINING RING C - M17



07403808
BALL BEARING - 8X16X5MM



08025299
TAPPING SCREW - M3X8



08025328
HEXAGON HEAD TAPPING SCREW:3X40

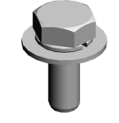

08046123
HEXAGONAL BOLT:W/WASHER:M3X8



08046128
HEXAGONAL BOLT:DOUBLE SCREW:M3X10



08050089
RETAINING RING - M4



08050100
RETAINING RING - M2.5



08050103
RETAINING RINGS-E:SILENCER:DIA3



08050104
RETAINING RINGS-E:SILENCER:DIA4



08050106
RETAINING RINGS-E:SILENCER:DIA6



09543005N
SCREW:POLISHED ROUND/SPRING:M3X5



09573006N
SCREW:SMALL ROUND/SPRING:M3X6



09573010N
SCREW:SMALL ROUND/SPRING:M3X10



09574008N
SCREW:SMALL ROUND/SPRING:M4X8

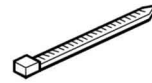

11050046
HARNES BAND

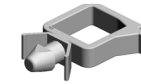

11050488
HARNES CLAMP



11050655
CLAMP:LWSR-1816S

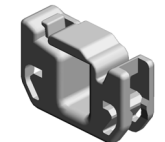

11050692
CLAMP:LES-0503

Standard Parts

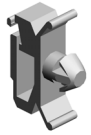

11050713
CLAMP:LWSM-0306H GRAY



11050723
CLAMPS:WES-0507

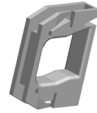

11050724
CLAMPS:WES-1210



11050725
CLAMPS:WES-1117

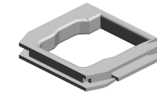

11050726
CLAMPS:WES-2217

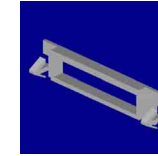

11050752
SADDLE:EDS-3005LS-V0



11050758
CLAMP:LWSM-0306A

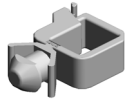

11050759
CLAMP:LWSM-0605A



11050760
CLAMP:LWSM-0511A



11050762
CLAMP:LWS-0711A



11050764
CLAMP:LWS-1316A



11050765
CLAMP:LWS-2218A

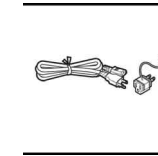

11500441
(EU/AA/KOR):POWER SUPPL
Y CODE:250V:10A



12042612
MICRO SWITCH:D3V-16506-3
C25:(SW2)

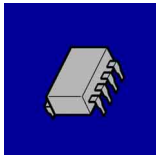

14078389
EEPROM:BR24T128-W

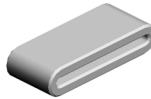

16072525
FERRITE CORE:K3 FF 35.00X
14.60X7.70X1.40



18310003
LCD:TFT:WSVGA-10.1:LED:M
V

PM Part List

Number	Part Name	Num	Group	ID
D0BN2224	PCDU:K:IMC3000-6000	1	U006_S001	12
D0BQ4022	(EU/AA/KOR/CHN):FUSING UNIT:220-240V:IMC4500-6000	1	U011_S001	51
D0BQ6005	TRANSFER UNIT:INTERMEDIATE TRANSFER:IMC2000-6000	1	U008_S001	16
D0BQ6400	COLLECTION BOTTLE:ASS'Y	1	U010_S001	12
D0BQ7935	CAP:FILTER:ASS'Y	1	U016_S001	20

