

**Color Printers
(M075-EU/AA)
Parts Catalog**

Parts change information sample

 **Add**

 **Update**

 **Delete**

Model	Product Code	PC Style
Color Printers	M075	3D
Paper Feed Unit TK 1010	G849	Traditional
Memory Unit Type G 256MB	D362-21	Traditional
Memory Unit Type I 512MB	D435-01	Traditional
Camera Direct Print Card Type H	M385-01	Traditional
IEEE 1284 Interface Board Type A	B679-17	Traditional
IEEE802.11a/g Interface Unit Type L/ Type M	M344-01/02	Traditional
Gigabit Ethernet Board Type A	G874-01	Traditional
Hard Disk Drive Option Type C320	M394-01	Traditional
VM CARD Type O	M385-03,04,05	Traditional
SD Card for NetWare Printing Type F	M394-10	Traditional

Unit All



U001
EXTERIOR



U002
OPERATION

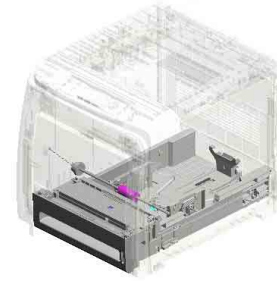

U003
PAPER FEED



U004
MANUAL FEED



U005
LASER UNIT



U006
ITB CLEANING



U007
PAPER TRANSPORT

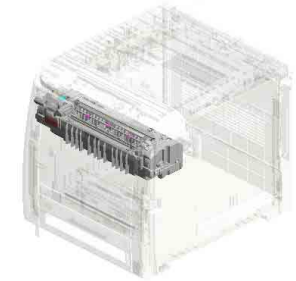

U008
FUSING

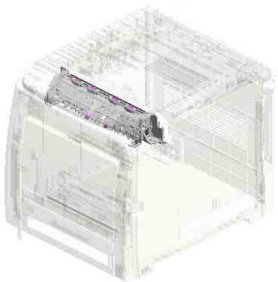

U009
PAPER EXIT

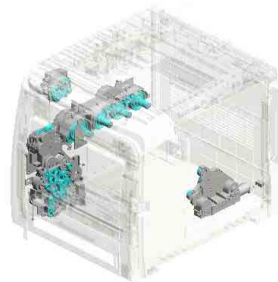

U010
MAIN DRIVE

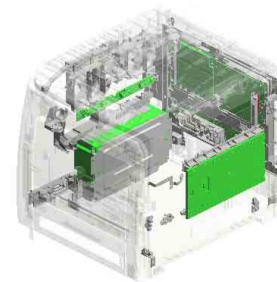

U011
ELECTRICAL

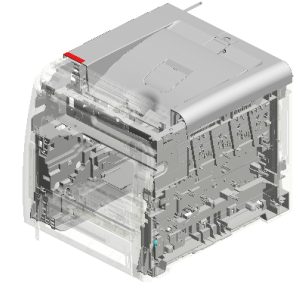

U012
MAIN FRAME

U001 EXTERIOR

- 5.04543006Q TAPPING SCREW - M3X6
- 2.04503010N (x4) TAPPING SCREW - M3X10
- 18.M0751252 (x2) SEAL:STOPPER:LOUVER
- 17.M0751251 (x2) GUIDE:LOUVER
- 19.M0751253 (x2) LOUVER

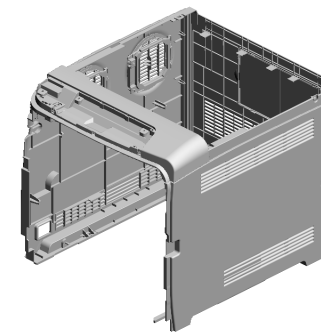

7.11029153
CONNECTOR:1-29
2215-1

8.11050511
HARNES CLAMP -
LWS-0306ZC

9.G1631259
INNER COVER:GU
ARD:SAFETY SWIT
CH

10.G1631278
INNER COVER:EXI
T

6.04543008Q
(x5)
TAPPING SCREW:
3X8

3.04504010N
(x2)
TAPPING SCREW:
M4X10

13.G1631314
SEAL:FRAME:LOW
ER:1

14.G1631316
SEAL:FRAME:LOW
ER:3

15.G1631317
SEAL:FRAME:LOW
ER:4

1.03603008N
(x2)
SCREW:M3X8

11.G1631311
SEAL:COVER:LEFT
:3

4.04524010N
(x5)
BINDING SELF-TA
PPING SCREW:4X
10

20.M0751259
COVER:MEMORY

12.G1631313
SEAL:COVER:LEFT
:5

16.G1661315
LOWER SEAL - 2

U001 EXTERIOR

29.M0751315 (x2) SEAL:COVER:EXIT
 28.M0751309 (x2) SEAL:GUIDE:LOUVER:LOWER
 27.M0751308 (x2) SEAL:GUIDE:LOUVER:UPPER

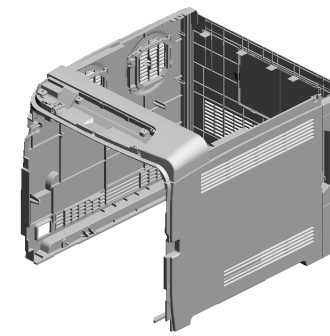

24.M0751277 COVER:PAPER EXI

23.M0751273 COVER:RIGHT

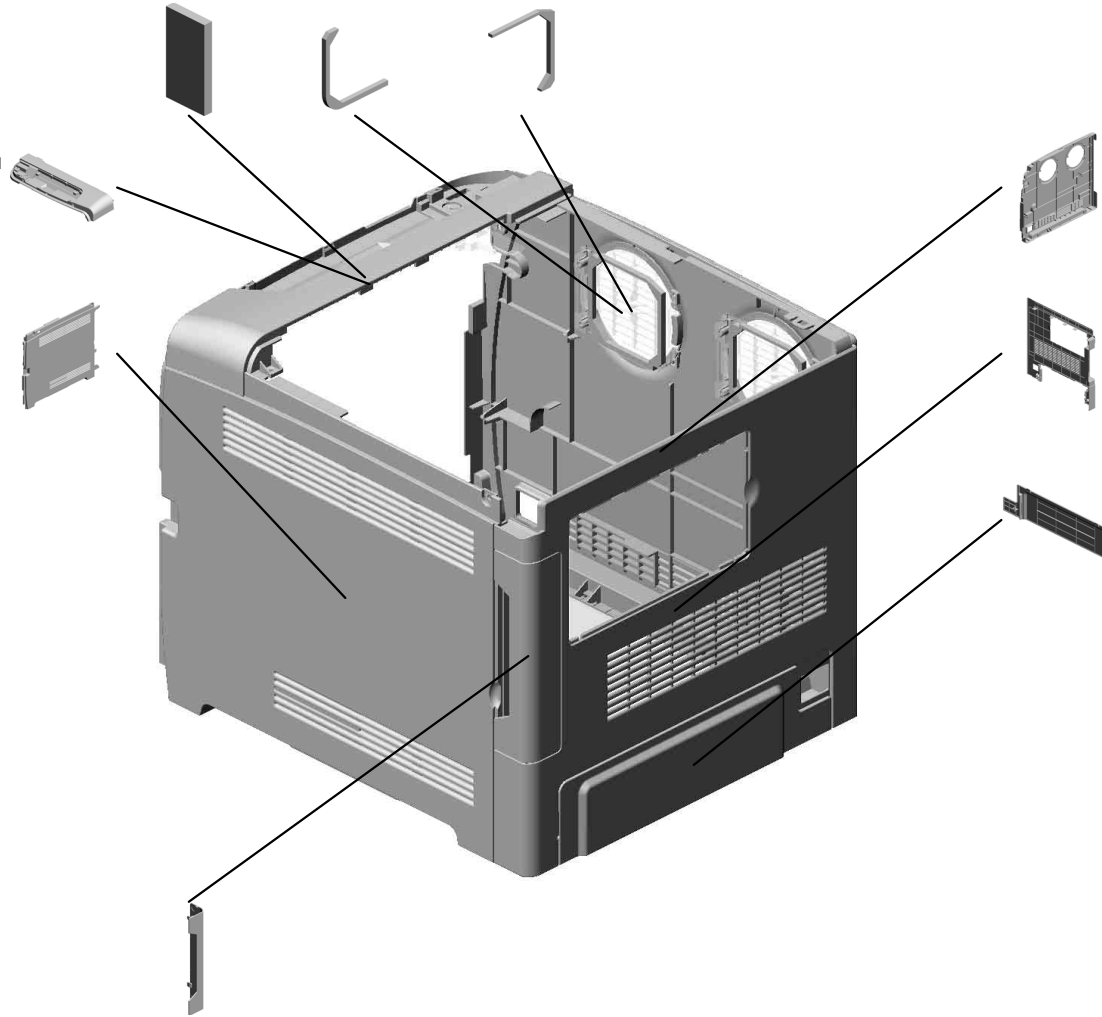

26.M0751306 COVER:LEFT

25.M0751304 COVER:REAR

22.M0751262 COVER:CASSETTE

21.M0751260 COVER:INTERFAC
E

U002 OPERATION

1.M0751402
OPERATION PANE
L

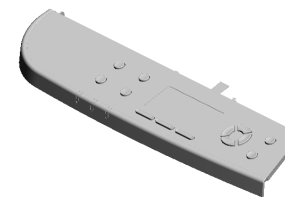
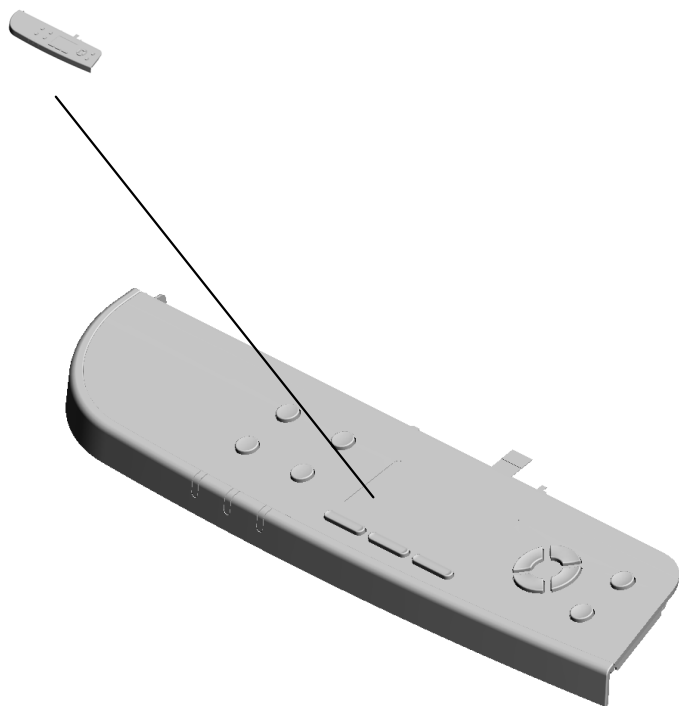

U003.PAPER FEED

U003 S001
M0752521
PAPER TRAY - A4

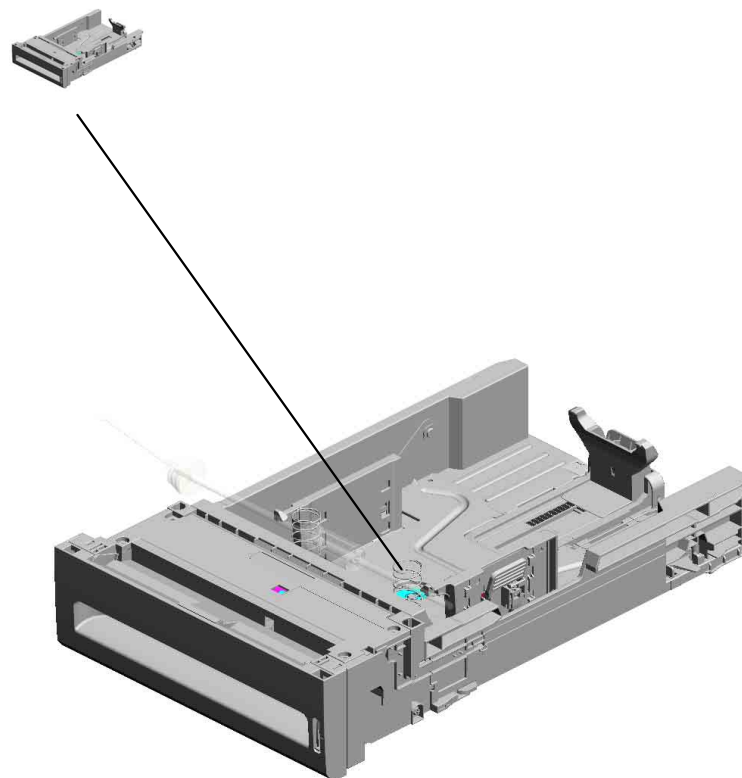

U001	U002	U003	U004	U005	U006	U007	U008	U009	U010	U011	U012
------	------	------	------	------	------	------	------	------	------	------	------

U003_S001.PAPER TRAY - A4

U003 S001 S001
M0752550
CASSETTE:PAPER TRAY:AS
SY

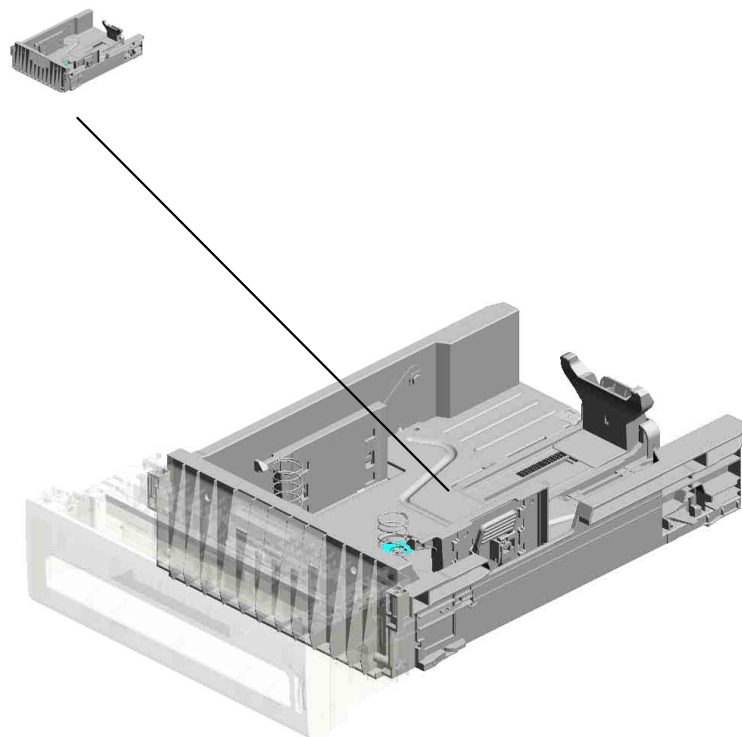

U001	U002	U003	U004	U005	U006	U007	U008	U009	U010	U011	U012
------	------	------	------	------	------	------	------	------	------	------	------

U003 PAPER FEED

41.GX201121
MAGNETIC CLUTCH

36.G1662580
SHAFT - PAPER FEED ROLLER

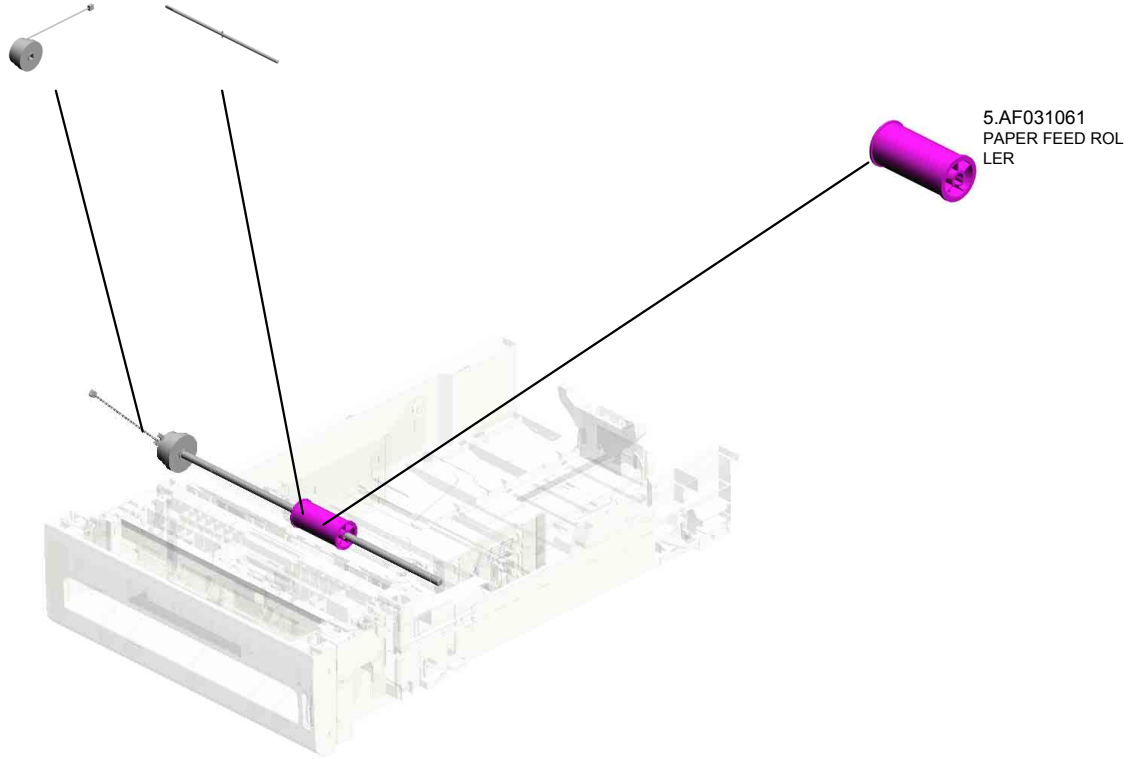
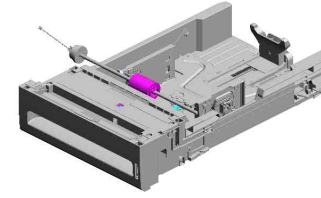

U001	U002	U003	U004	U005	U006	U007	U008	U009	U010	U011	U012
------	------	------	------	------	------	------	------	------	------	------	------

U003_S001 PAPER TRAY - A4

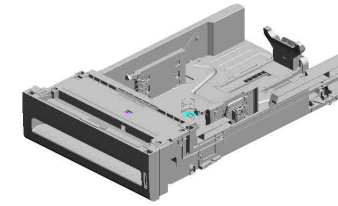

42.M0752521
PAPER TRAY - A4

24.G1632822
GEAR:IDLER:CAM

19.G1632812
GEAR:TRANSPORT
ROLLER:MANUAL
FEED

15.G1632805
SPRING:BASE:MA
NUAL FEED

20.G1632813
SHAFT:TRANSPORT
PAPER FEED ROLLER:
PRESS FIT

13.G1632800
FRICTION PAD:AD
HESION

26.G1632844
GEAR:IDLER:TRANSPORT:
PAPER FEED ROLLER

18.G1632809
SPRING:CAM

23.G1632820
BRACKET:MANUAL
FEED

25.G1632835
CAM:LEFT:MANUAL
FEED

6.G1632552
CASSETTE COVER

16.G1632806
SHAFT:CAM

12.G1632605
HOUSING:MANUAL
FEED:PAPER TRAY

3.AA080265
(x2)
BUSHING:6X8X5

22.G1632818
FEELER:PAPER END
SENSOR:MANUAL
FEED

17.G1632807
CAM:RIGHT:MANUAL
FEED

21.G1632817
GEAR:IDLER:PAPER
FEED ROLLER

14.G1632802
SPRING:FRICTION
PAD:MANUAL FEED

4.AA082101
(x4)
BUSHING - 6X10X6

11.G1632569
GROUND PLATE:MANUAL
FEED

10.G1632567
LEVER:PAPER VOLUME
SENSOR

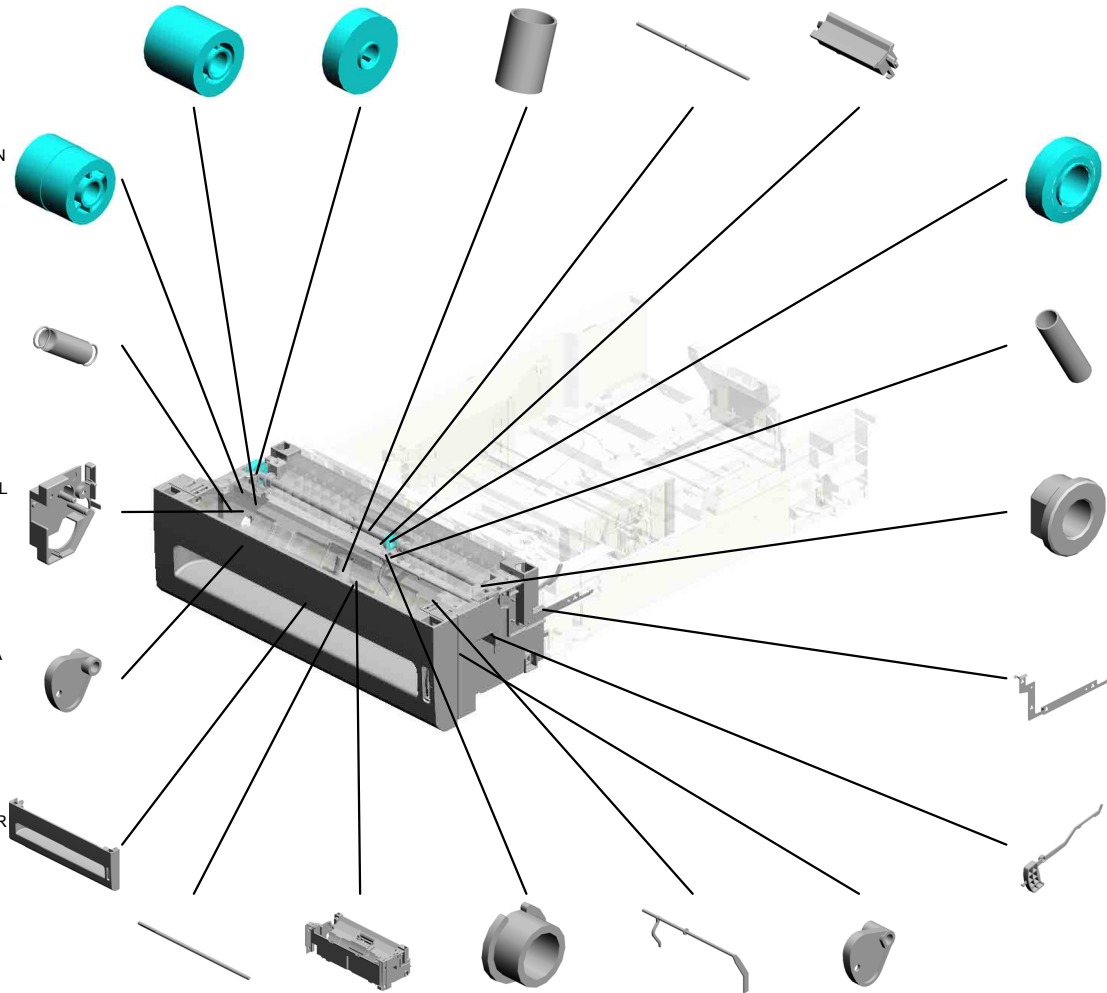

U003_S001 PAPER TRAY - A4

29.G1632872
(x4)
SCREW:DIA4:12.5
MM

33.G1632878
SHEET:DISCHARGE
BRUSH:MANUAL
FEED

28.G1632871
SHAFT:TRANSPORT:
PICKUP ROLLER

27.G1632870
GUIDE:MANUAL FEED:
PAPER TRAY

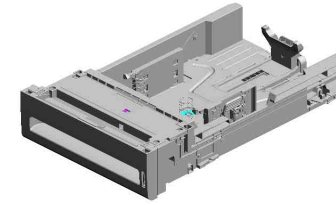

42.M0752521
PAPER TRAY - A4

64.M0752808
GEAR:CAM

38.GA148015
(x2)
PIN:ROLLER:TRAY
BOTTOM PLATE:DI
A2

32.G1632877
DISCHARGE BRUSH:
MANUAL FEED

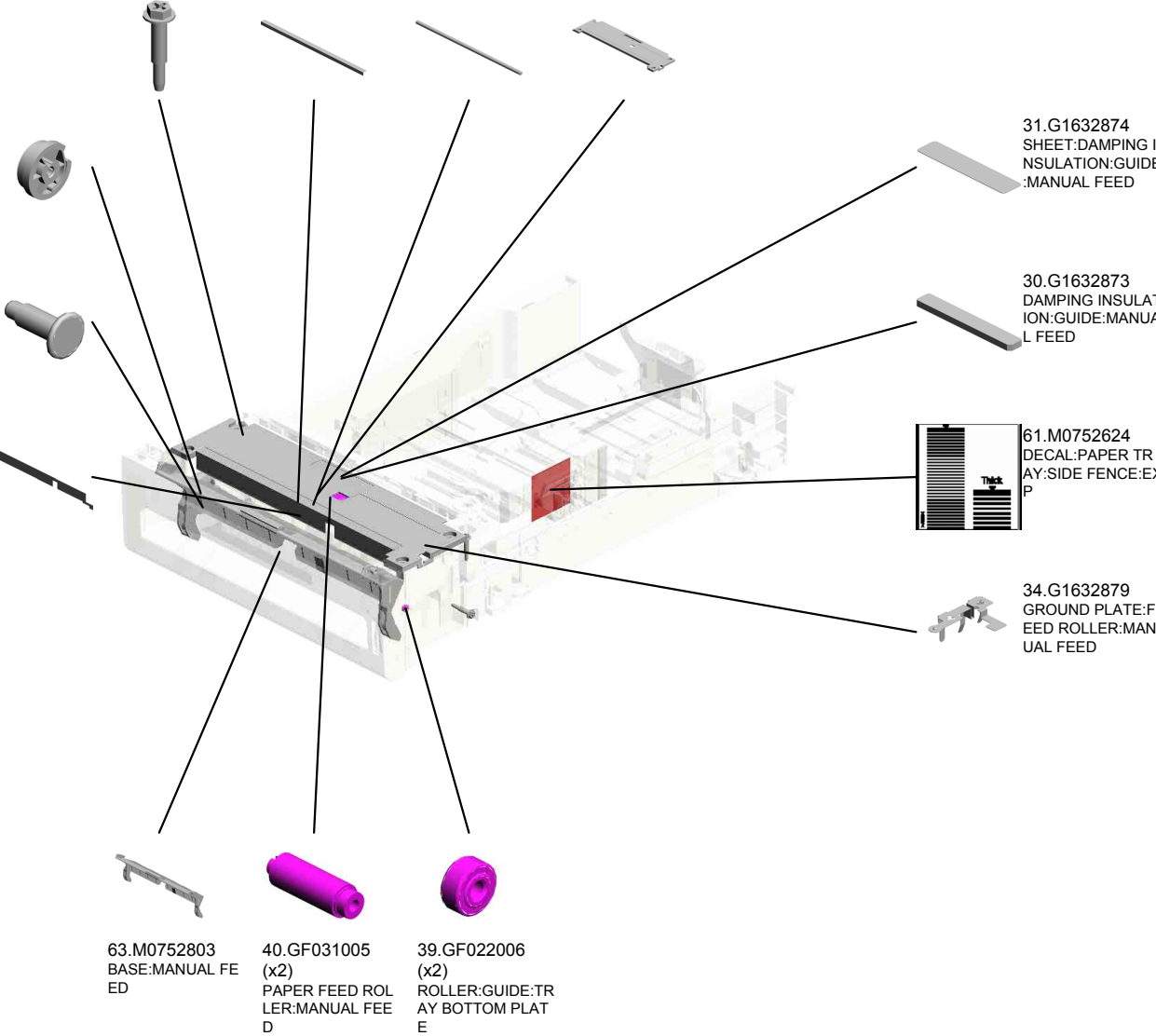

31.G1632874
SHEET:DAMPING INSULATION:GUIDE:
MANUAL FEED

30.G1632873
DAMPING INSULATION:GUIDE:MANUAL
FEED

61.M0752624
DECAL:PAPER TRAY:SIDE FENCE:EXP

34.G1632879
GROUND PLATE:FEED ROLLER:MANUAL
FEED

63.M0752803
BASE:MANUAL FEED

40.GF031005
(x2)
PAPER FEED ROLLER:MANUAL FEED

39.GF022006
(x2)
ROLLER:GUIDE:TRAY BOTTOM PLATE

U003_S001_S001 CASSETTE:PAPER TRAY:ASS'Y

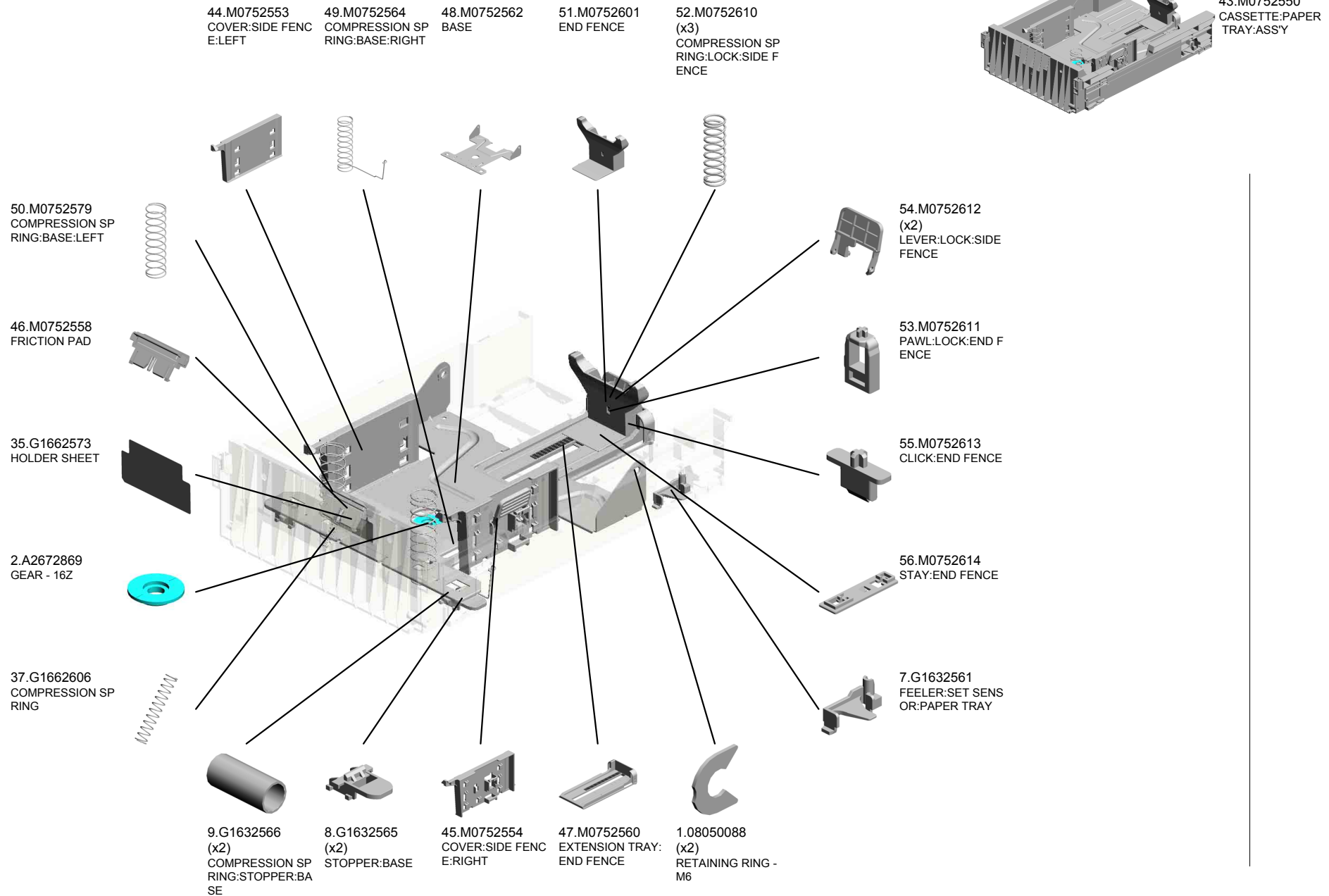

U003_S001_S001
CASSETTE:PAPER TRAY:ASS'Y

58.M0752617
SIDE FENCE:LEFT
59.M0752621
SIDE FENCE:RIGHT

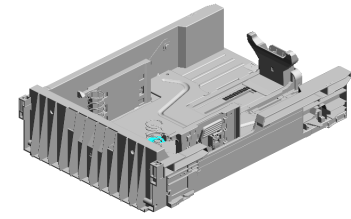

43.M0752550
CASSETTE:PAPER
TRAY:ASS'Y

62.M0752625
RETAINER:PINION

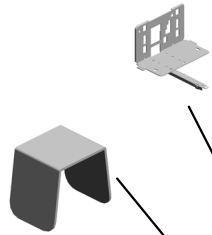

57.M0752615
PLATE:END FENCE



60.M0752622
PAWL:LOCK:SIDE
FENCE

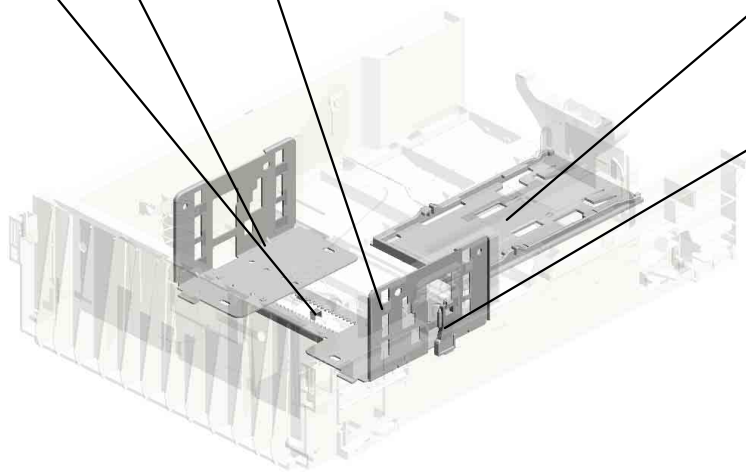

U004 MANUAL FEED

2.G1632850
(x2)
PAWL:TRAY:MANU
AL FEED

9.G1632858
(x2)
COIL SPRING:PAW
L:TRAY:MANUAL F
EED

1.G1632834
COVER:TRAY:MAN
UAL FEED

5.G1632853
EXTENSION TRAY:
MANUAL FEED



14.M0752847
TRAY:MANUAL FE
ED



12.M0752828
SIDE FENCE:LEFT:
MANUAL FEED



7.G1632855
(x2)
SPRING:TRAY:MA
NUAL FEED

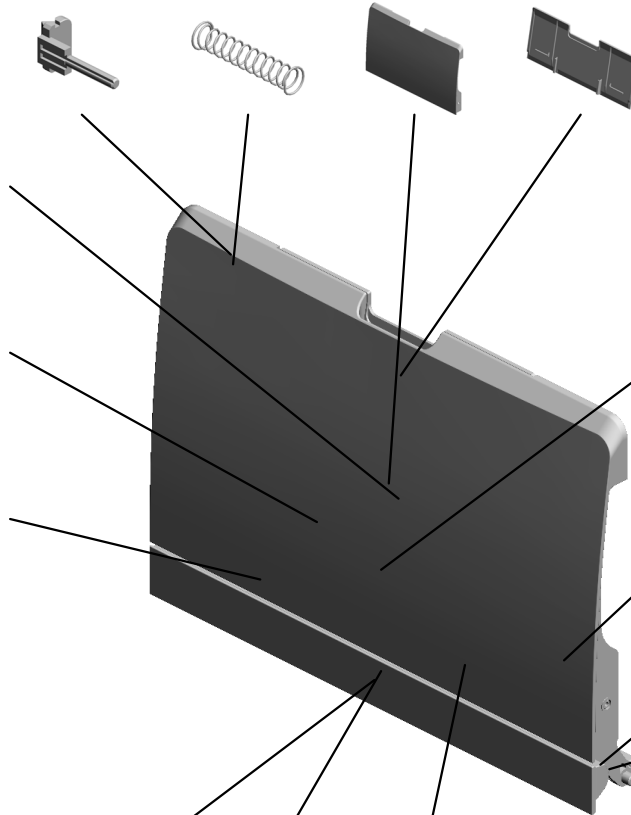

11.G8003133
SIDE FENCE GEAR



10.G1632862
DECAL:SIDE FENC
E:MANUAL FEED:E
XP

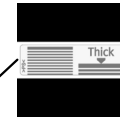

8.G1632856
SPRING:SHAFT:TR
AY:MANUAL FEED



6.G1632854
SHAFT:TRAY:MAN
UAL FEED

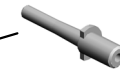

3.G1632851
COVER:MANUAL F
EED:LOWER

4.G1632852
GUIDE:COVER:MA
NUAL FEED:LOWE
R

13.M0752829
SIDE FENCE:RIGH
T:MANUAL FEED



U005
LASER UNIT

1.M0751851
IMAGING UNIT

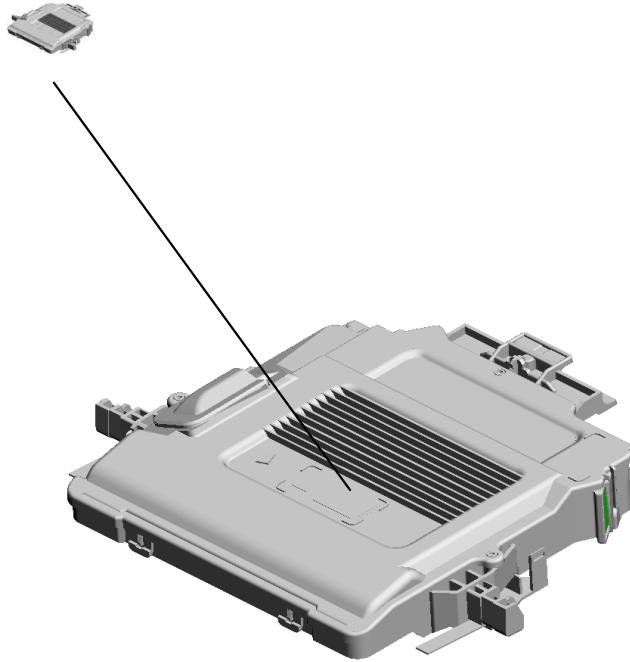
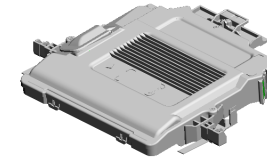

U001	U002	U003	U004	U005	U006	U007	U008	U009	U010	U011	U012
------	------	------	------	-------------	------	------	------	------	------	------	------

U006 ITB CLEANING

3.G1636196 SLIDER:FIX:INTER
MEDIATE TRANSFER:RIGHT

7.G1666099 (x2)
COMPRESSION SPRING

9.G1666194 RIGHT HOLDER - TRANSFER BELT UNIT

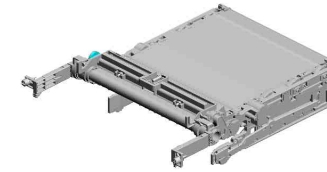

2.G1636119 (x2)
KNOB SCREW:FIX:INTERMEDIATE TRANSFER

10.H3103640 (x2)
SPACER

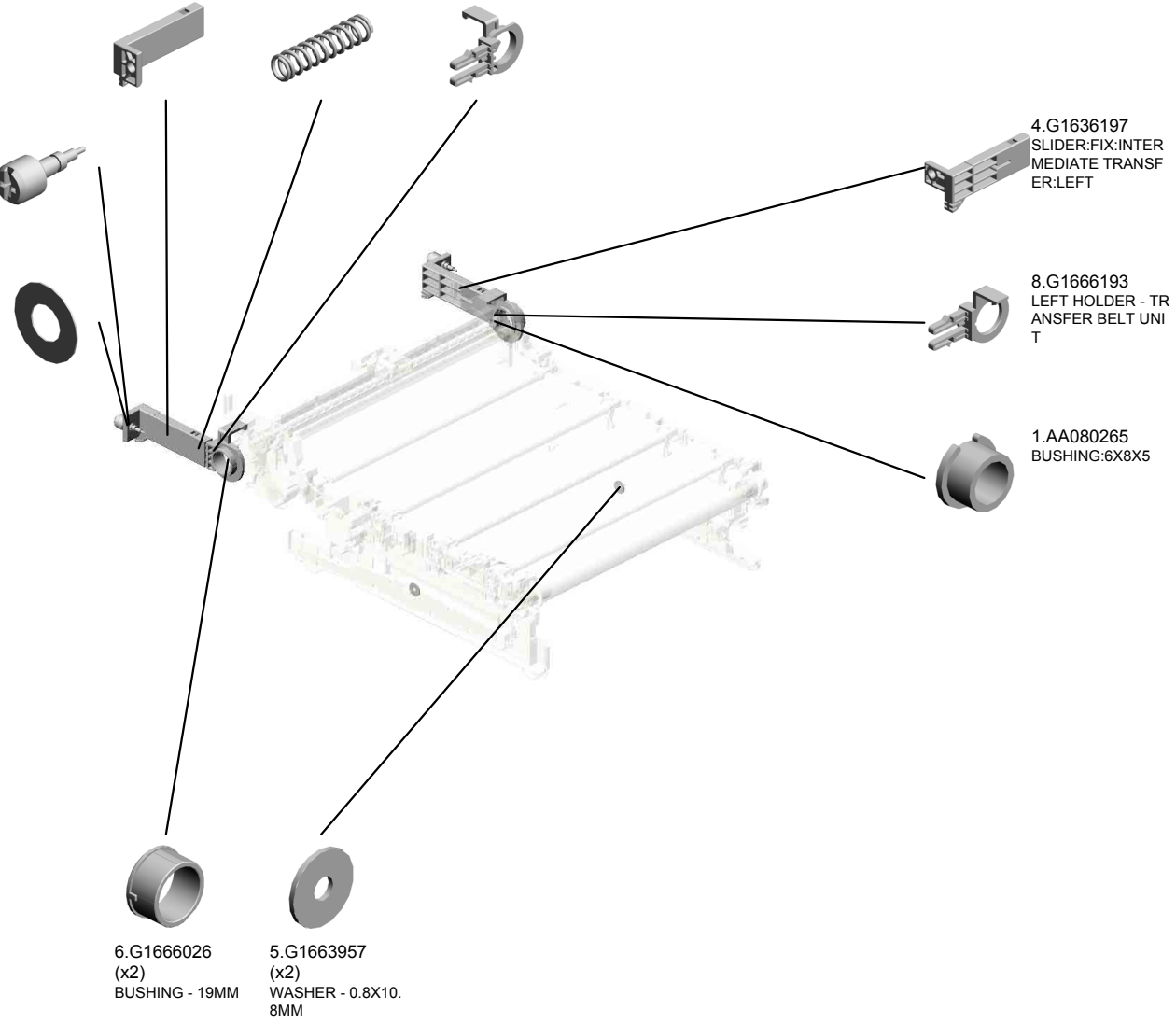

U001	U002	U003	U004	U005	U006	U007	U008	U009	U010	U011	U012
------	------	------	------	------	------	------	------	------	------	------	------

U007.PAPER TRANSPORT

U007 S001
M0753800
HOUSING:TRANSPORT SUB-
UNIT:ASS'Y

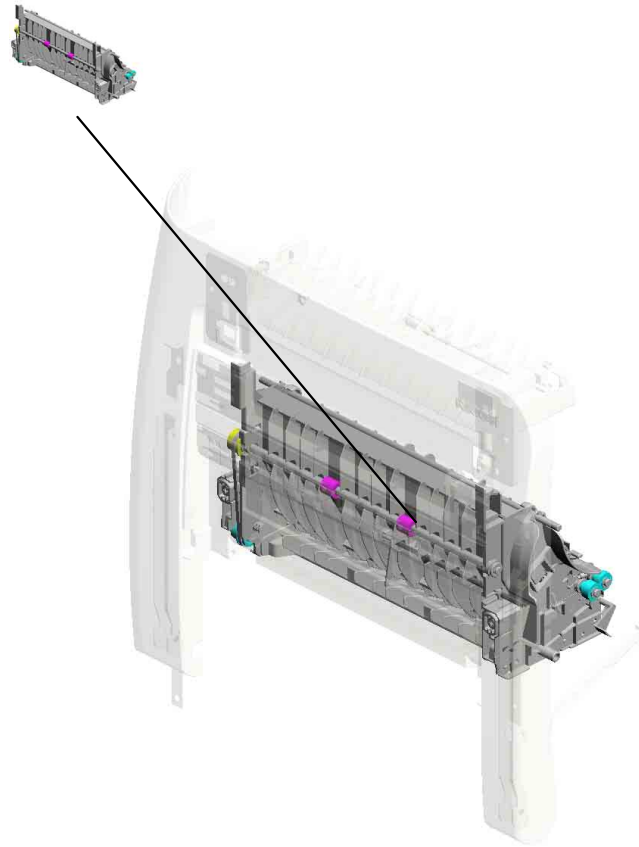

U001	U002	U003	U004	U005	U006	U007	U008	U009	U010	U011	U012
------	------	------	------	------	------	------	------	------	------	------	------

U007_S001.HOUSING:TRANSPORT SUB-UNIT:ASS'Y

U007 S001 S001
M0753949
TRANSFER ROLLER:SUB-AS
S'Y

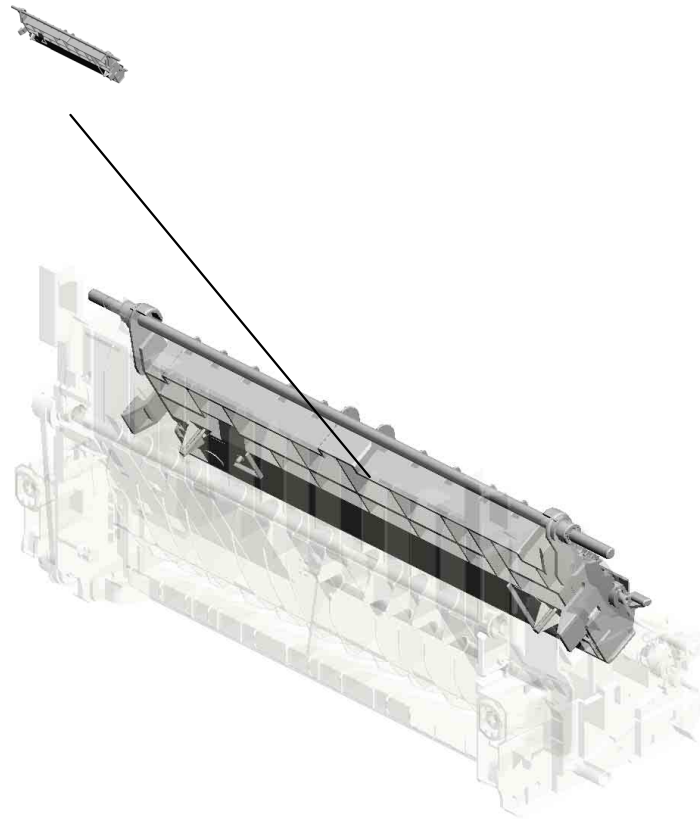

U001	U002	U003	U004	U005	U006	U007	U008	U009	U010	U011	U012
------	------	------	------	------	------	------	------	------	------	------	------

U007 PAPER TRANSPORT

- 8.G1633913 HOLDER:GUIDE PLATE:REVERSE:LEFT
- 9.G1633921 (x2) SPRING:GUIDE PLATE:MIDDLE
- 12.G1633926 GUIDE PLATE:EXIT:MIDDLE
- 13.G1633927 GUIDE PLATE:EXIT:MIDDLE:INNER
- 11.G1633925 TORSION SPRING:FEELER:PAPER FEED SENSOR

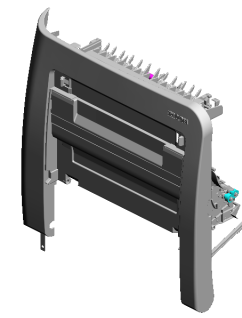

26.G1633970
HOOK:FIX:TRANSFER/SEPARATION:LEFT

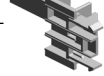

32.G1633989 (x2)
DECAL:COVER:FRONT:POSITIONING DISPLAY



15.G1633935
DESIGN PLATE:COVER:FRONT:UPPER

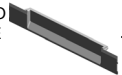

4.G1633904
FRAME:COVER:FRONT:LEFT



28.G1633972
SLIDER:TRANSPORT UNIT:LEFT



14.G1633932
COVER:FRONT



6.G1633908
ARM:LEVER:LOCK



16.G1633936
DESIGN PLATE:COVER:FRONT:LOWER



31.G1633975
SLIDER:TRANSPORT UNIT:RIGHT



3.G1633903
FRAME:COVER:FRONT:RIGHT



10.G1633924
FEELER:PAPER FEED SENSOR



7.G1633912
HOLDER:GUIDE PLATE:REVERSE:RIGHT



17.G1633937
DECAL:CAUTION:OPERATE:MANUAL FEED



5.G1633907
GUIDE:LOCK



27.G1633971
HOOK:FIX:TRANSFER/SEPARATION:RIGHT



U007 PAPER TRANSPORT

- 59.G1663972 (x2) COMPRESSION SPRING - GRIP
- 71.M0754607 (x2) SPRING:PRESSURE:DUPL
- 61.G1664606 (x2) DUPLEX ROLLER
- 54.G1663926 EXIT GUIDE ROLLER - MIDDLE

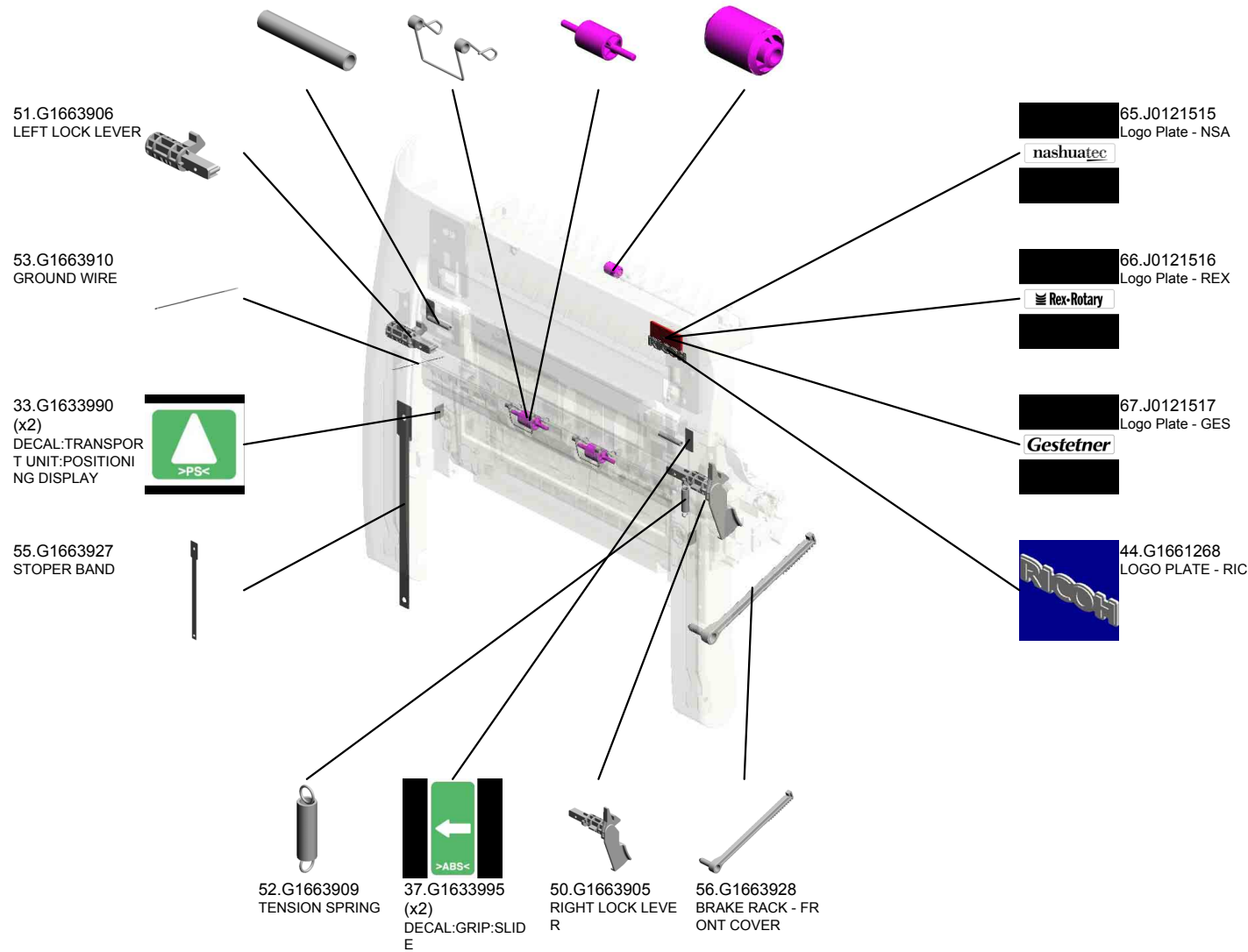
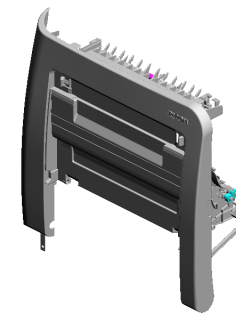

U007_S001 HOUSING:TRANSPORT SUB-UNIT:ASS'Y

- 40.G1634604 PULLEY:TRANSPORT ROLLER:DUPL
EX
- 38.G1633997 (x2) COMPRESSION SP
RING:HOUSING:TR
ANSPORT
- 1.07010030N WASHER DIA3
- 41.G1634605 BELT PULLEY:DUP
LEX
- 24.G1633965 ELECTRODE PLAT
E:EARTH:LINK

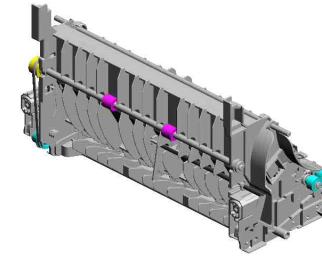

68.M0753800
HOUSING:TRANSP
ORT SUB-UNIT:AS
SY

33.G1633990
(x4)
DECAL:TRANSPOR
T UNIT:POSITIONI
NG DISPLAY



29.G1633973
(x2)
COVER:COMPRES
SION SPRING



2.B2384714
TIMING BELT - 30S
2M206



22.G1633959
SUPPORTING PLA
TE:HOUSING:TRA
NSFER



39.G1634603
GEAR:TRANSPOR
T ROLLER:DUPL
EX:LOWER



20.G1633952
GUIDE:DUPL
EX SUB-UNIT:LOWER

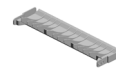

19.G1633951
GUIDE:PAPER FEE
D SUB-UNIT

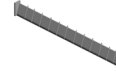

30.G1633974
(x2)
SCREW:HOUSING:
TRANSPORT



34.G1633991
(x2)
COVER:COMPRES
SION SPRING



25.G1633968
GROUND WIRE:RE
GISTRATION ROLL
ER



35.G1633992
(x2)
DECAL:TRANSFER
/SEPARATION

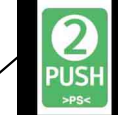

18.G1633950
REGISTRATION G
UIDE

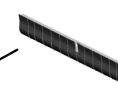

36.G1633993
(x2)
DECAL:GRIP:HO
USING

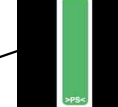

23.G1633960
(x2)
SHEET:REGISTRA
TION

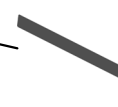

21.G1633955
FEELER:REGISTR
ATION SENSOR



U007_S001
HOUSING:TRANSPORT SUB-UNIT:ASS'Y

48.G1663865
(x2)
GEAR - 14Z

62.GA082015
(x6)
PLAIN SHAFT BEARING
RING:DIA6:DIA9:7

64.GF020052
TRANSPORT ROLLER:
ER:DUPLIX

63.GF020000
REGISTRATION ROLLER - DRIVE

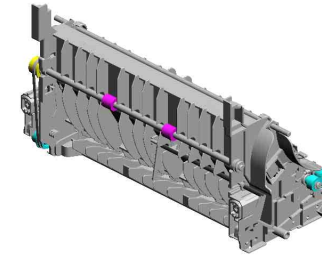

68.M0753800
HOUSING:TRANSPORT SUB-UNIT:ASS'Y

43.G1634607
GROUND WIRE:DUPLIX

58.G1663968
ELECTRODE PLATE - CONTACT POINT

60.G1663989
RESISTOR - 100M OHM +-10% 0.5W

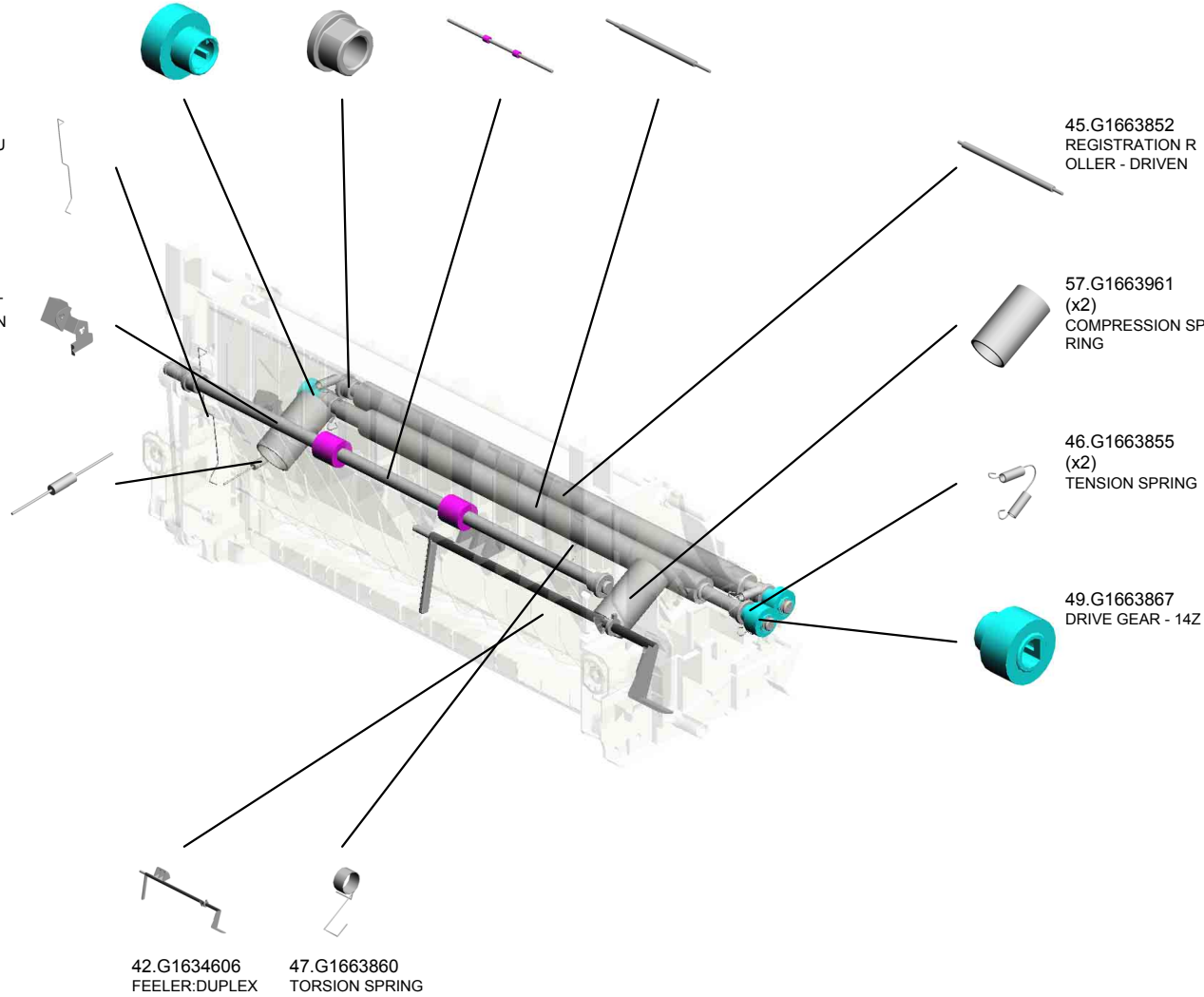

45.G1663852
REGISTRATION ROLLER - DRIVEN

57.G1663961
(x2)
COMPRESSION SPRING

46.G1663855
(x2)
TENSION SPRING

49.G1663867
DRIVE GEAR - 14Z

42.G1634606
FEELER:DUPLIX

47.G1663860
TORSION SPRING

U007_S001_S001
TRANSFER ROLLER:SUB-ASS'Y

70.M0753978
TRANSFER ROLLE
R:TRANSFER/SEP
ARATION:M:P2

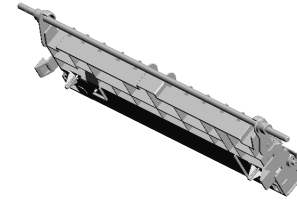

69.M0753949
TRANSFER ROLLE
R:SUB-ASS'Y

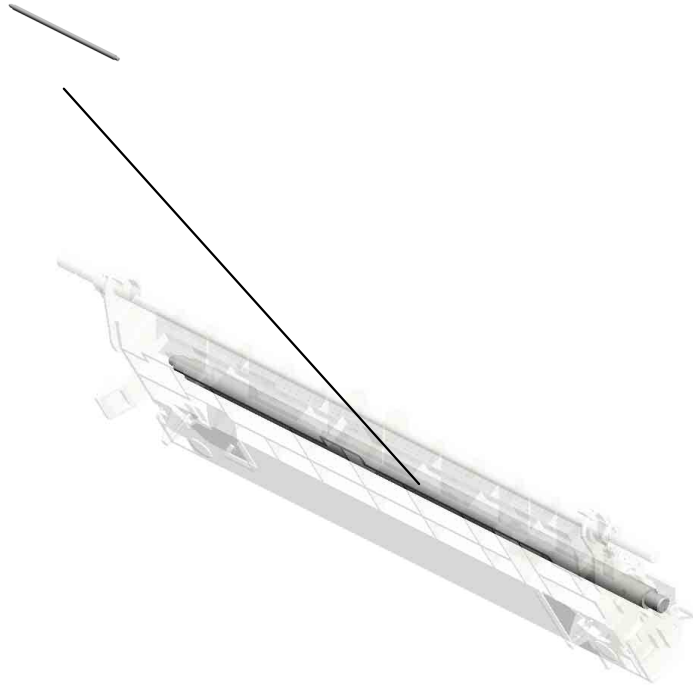

U001	U002	U003	U004	U005	U006	U007	U008	U009	U010	U011	U012
------	------	------	------	------	------	------	------	------	------	------	------

U008.FUSING

U008 S001
M8780223
FUSING UNIT - 220V

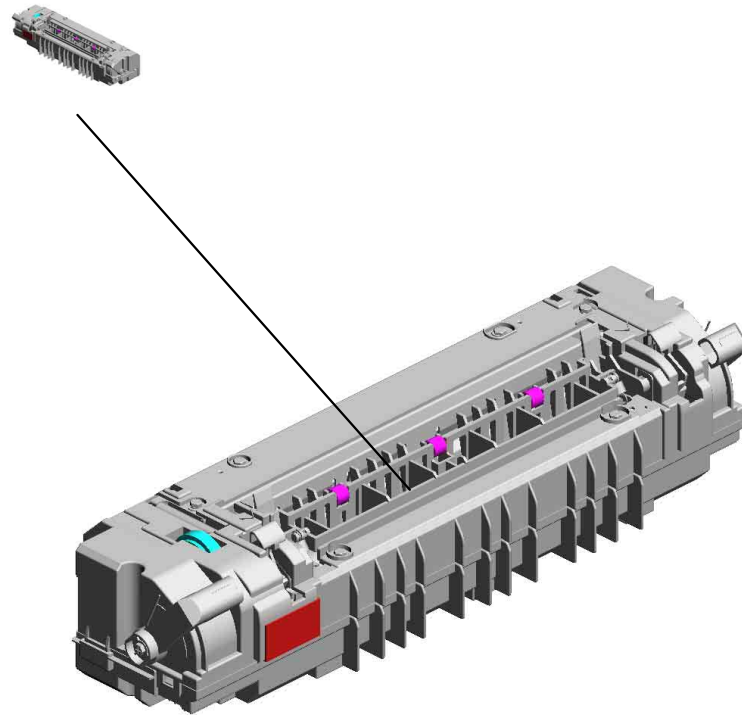

U001	U002	U003	U004	U005	U006	U007	U008	U009	U010	U011	U012
------	------	------	------	------	------	------	------	------	------	------	------

U008
FUSING

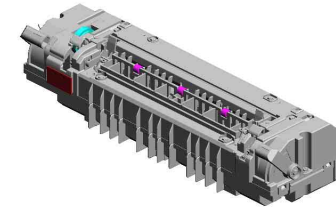

U001	U002	U003	U004	U005	U006	U007	U008	U009	U010	U011	U012
------	------	------	------	------	------	------	------	------	------	------	------

U008_S001 FUSING UNIT - 220V

17.G1634276 TORSION SPRING: SEPARATION:LEFT
 14.G1634264 COLLAR:STRIPPER PLATE:LEFT
 11.G1634216 (x8) SHAFT:GUIDE:PAPER
 16.G1634271 GUIDE PLATE:FUSING EXIT
 10.G1634214 FUSE HOLDER

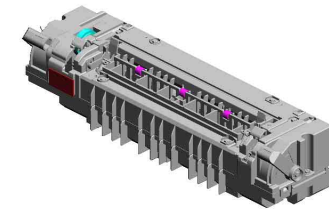

51.M8780223
[A]
 FUSING UNIT - 220V
 201105-01 O/O

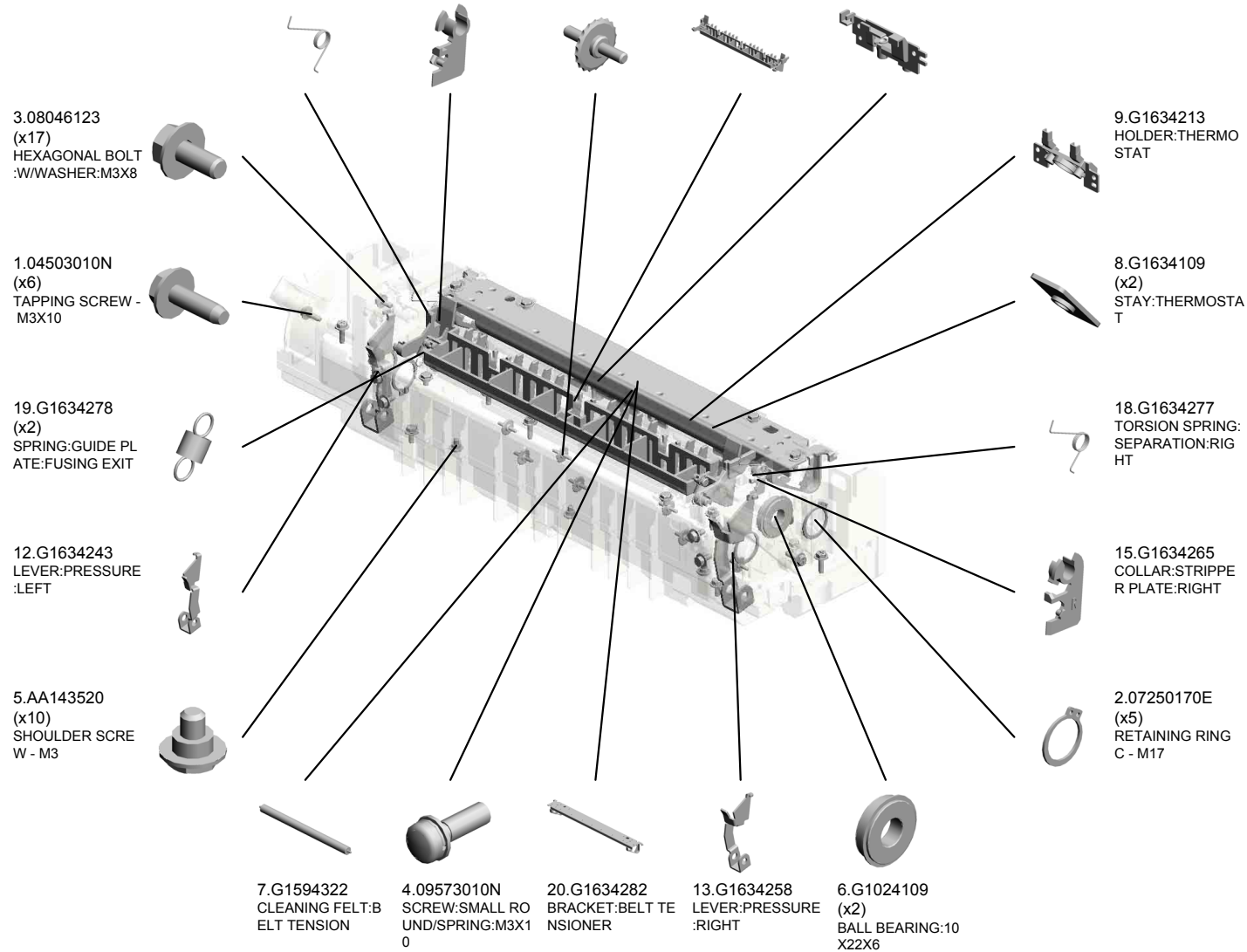

U008_S001 FUSING UNIT - 220V

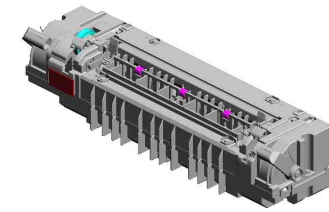

51.M8780223
[A]
FUSING UNIT - 220V
201105-01 O/O

- 36.GB013075 GEAR:IDLER:DUPL EX
- 39.GB013086 GEAR:HOT ROLLER:ROLLER CLUTCH:Z29
- 33.G1664399 (x2) DECAL:FUSING EXIT:OPEN AND CLOSE
- 22.G1634313 BRACKET:TERMINAL
- 35.GA063081 (x2) COMPRESSION SPRING:CLEANER

29.G1634364 SPRING:LEVER:LOCK:LEFT

28.G1634363 LEVER:LOCK

40.GB017055 GEAR:SLOW DOWN:PAPER FEED:1

37.GB013078 GEAR:IDLER:DRIVE

32.G1664310 DECAL:WARNING (HIGH TEMPERATURE):1:CUD



38.GB013080 GEAR:IDLER:1

30.G1634374 GUIDE:HARNESS:FUSING:LEFT

23.G1634341 COVER:LOWER

25.G1634356 COVER:UPPER

24.G1634347 FUSING ENTRANCE GUIDE PLATE

34.GA063080 (x2) COMPRESSION SPRING:BELT:TENSION

31.G1634375 GUIDE:HARNESS:FUSING:RIGHT

27.G1634360 SPRING:LEVER:LOCK:RIGHT

26.G1634358 LEVER:LOCK:RIGHT

21.G1634311 BRACKET:HEATER:FUSING

U008_S001 FUSING UNIT - 220V

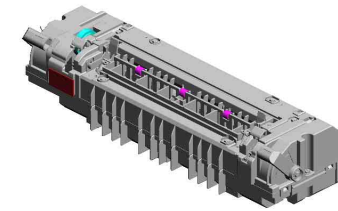

51.M8780223
[A]
FUSING UNIT - 220V
201105-01 O/O

- 46.GE031012 (x2) PLAIN SHAFT BEARING:CLEANING FELT
- 45.GE031011 (x2) PLAIN SHAFT BEARING:BELT TENSIONER
- 53.M0754142 (x3) ROLLER:MIDDLE:FUSING
- 42.GE010011 HOT ROLLER ELT
- 58.M0754273 STRIPPER PLATE:COAT

55.M0754248 (x2) SPRING:PRESSURE:30N

56.M0754249 KNOB:LEVER:PRESSURE RELEASE:L

59.M0754354 (x2) LEVER:PRESSURE RELEASE

43.GE020011 PRESSURE ROLLER

54.M0754215 FUSING ENTRANCE GUIDE PLATE

52.M0754105 FUSING BELT

41.GE010006 HEAT ROLLER:DIA 20:COAT

50.GX450014 HEATER:230V:1000W

47.GE040010 ROLLER:BELT TENSIONER:FUSING BELT

49.GW110006 THERMOSTAT

48.GW100017 THERMISTOR:COUPLING

57.M0754250 KNOB:LEVER:PRESSURE RELEASE:RIGHT

44.GE030008 (x4) BALL BEARING:HOT ROLLER

M0750228
[A]
FUSING SECTION: MAINTENANCE:EU
201105-01 O/O

U009 PAPER EXIT

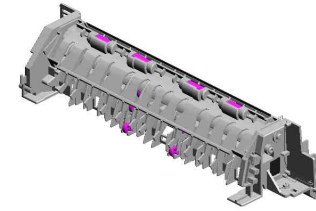

- 13.G1634467 (x2) ROLLER:DRIVEN:DUPL
- 15.G1634469 (x4) SPRING:PRESSUR E:DUPL
- 2.AF040574 (x6) GUIDE ROLLER
- 20.GA120012 DISCHARGE BRUSH:EXIT
- 7.G1634459 STOPPER:EXIT:EXIT

18.G1664462
STOPPER - PHOTO INTERRUPTOR

16.G1634474
GROUND WIRE:EXIT:RESISTOR

10.G1634463 (x2)
GUIDE:PLATE:EXIT

1.04543006Q (x2)
TAPPING SCREW - M3X6

12.G1634466 (x2)
ROLLER:DRIVEN:EXIT

3.G1631318
SEAL:GUIDE PLATE:EXIT:LOWER

9.G1634462 (x2)
BRACKET:ROLLER:EXIT

5.G1634454
GATE PAWL:REVERSE

4.G1634453
GUIDE PLATE:REVERSE:UPPER

14.G1634468 (x2)
SPRING:PRESSURE:EXIT:INNER

11.G1634465 (x2)
ROLLER:DRIVEN:DUPL:INNER

8.G1634460 (x2)
ROLLER:DRIVEN:EXIT

6.G1634458 (x2)
GUIDE:PLATE:EXIT:OUTER

19.GA082014 (x2)
PLAIN SHAFT BEARING:RING:DIA6:DIA10:9

17.G1634489
GEAR:EXIT

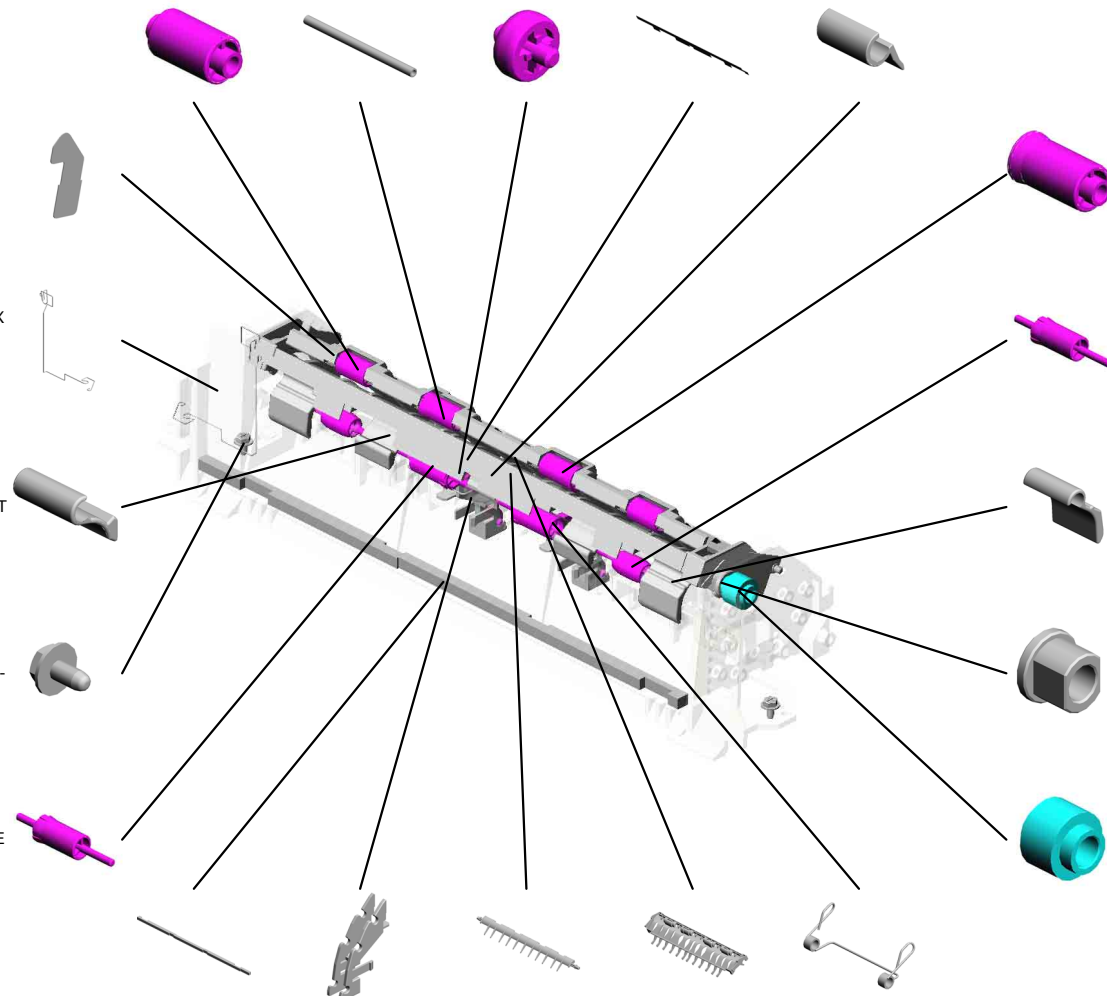

U009 PAPER EXIT

21.GF020040
EXIT ROLLER

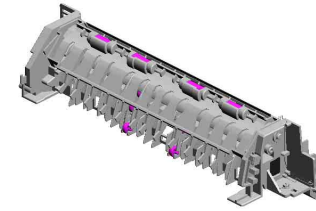

22.GW020020
PHOTOINTERRUP
TOR:LG248NL1

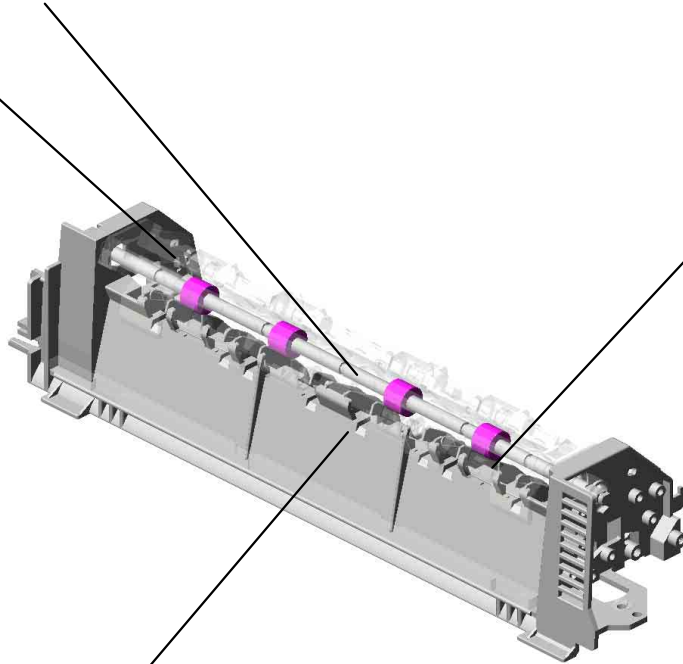

24.M0754461
(x2)
SPRING:PRESSUR
E:EXIT:OUTER



23.M0754451
GUIDE PLATE:EXIT
:LOWER



U001	U002	U003	U004	U005	U006	U007	U008	U009	U010	U011	U012
------	------	------	------	------	------	------	------	------	------	------	------

U010 MAIN DRIVE

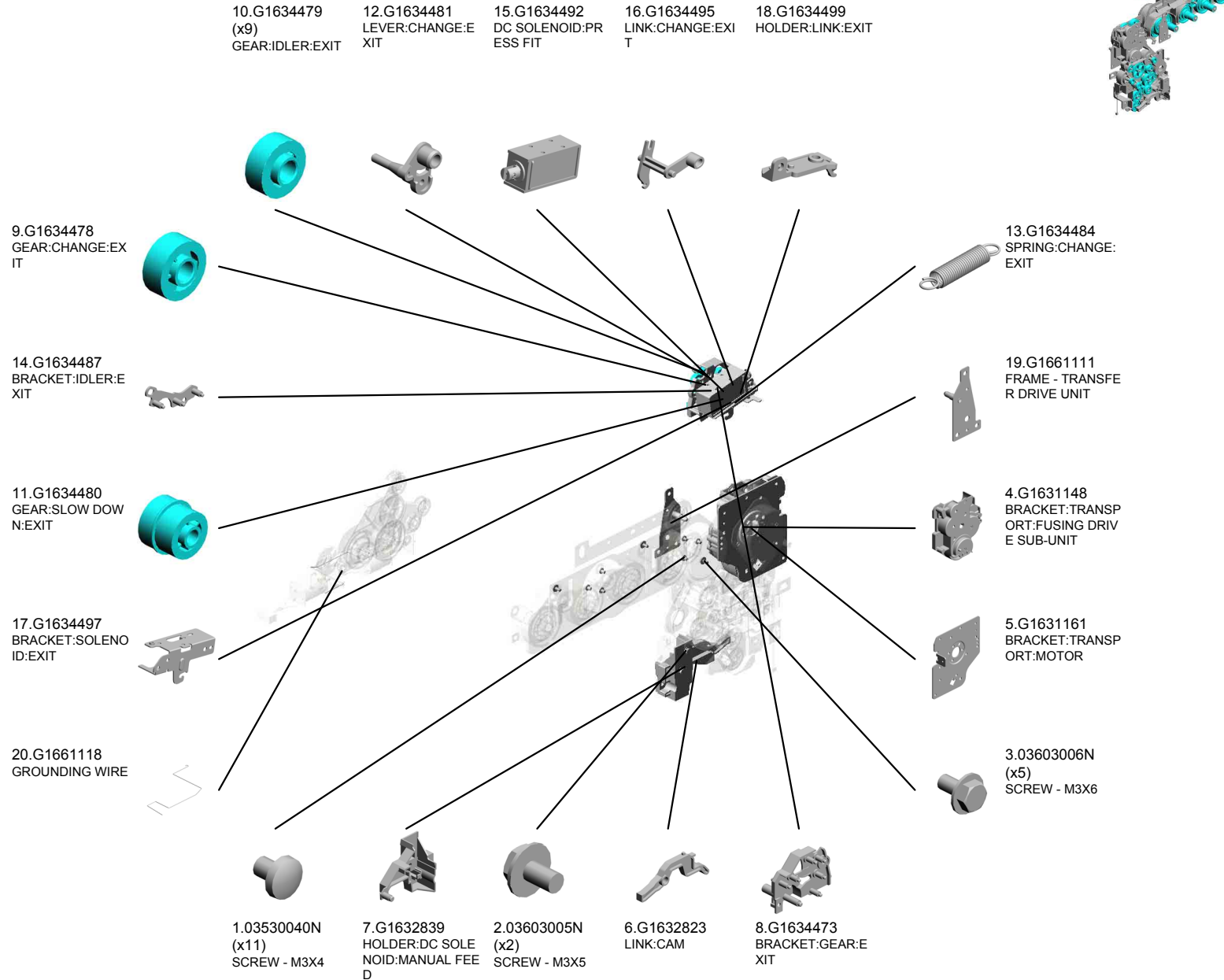

U010 MAIN DRIVE

- 30.GB010039 (x2) GEAR:AIO:DRIVE:MIDDLE
- 27.GA132101 (x5) SPACER - 0.13 X 1.2MM
- 31.GB010040 GEAR:AIO:DRIVE:1
- 28.GA148016 SHAFT - 6 X 26.7M M
- 29.GA148018 (x2) SHAFT - 6 X 21.9M M

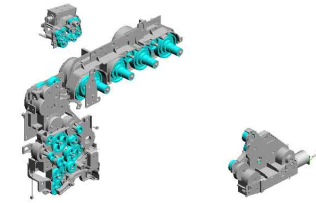

22.G1661123
FRAME - ON-OFF
DRIVE UNIT

23.G1661125
SHIELDING PLATE

25.G1661135
MOTOR - DC24V 1.
6W

21.G1661119
(x2)
MOTOR BRACKET

24.G1661131
DC MOTOR - DC24
V 5.3W

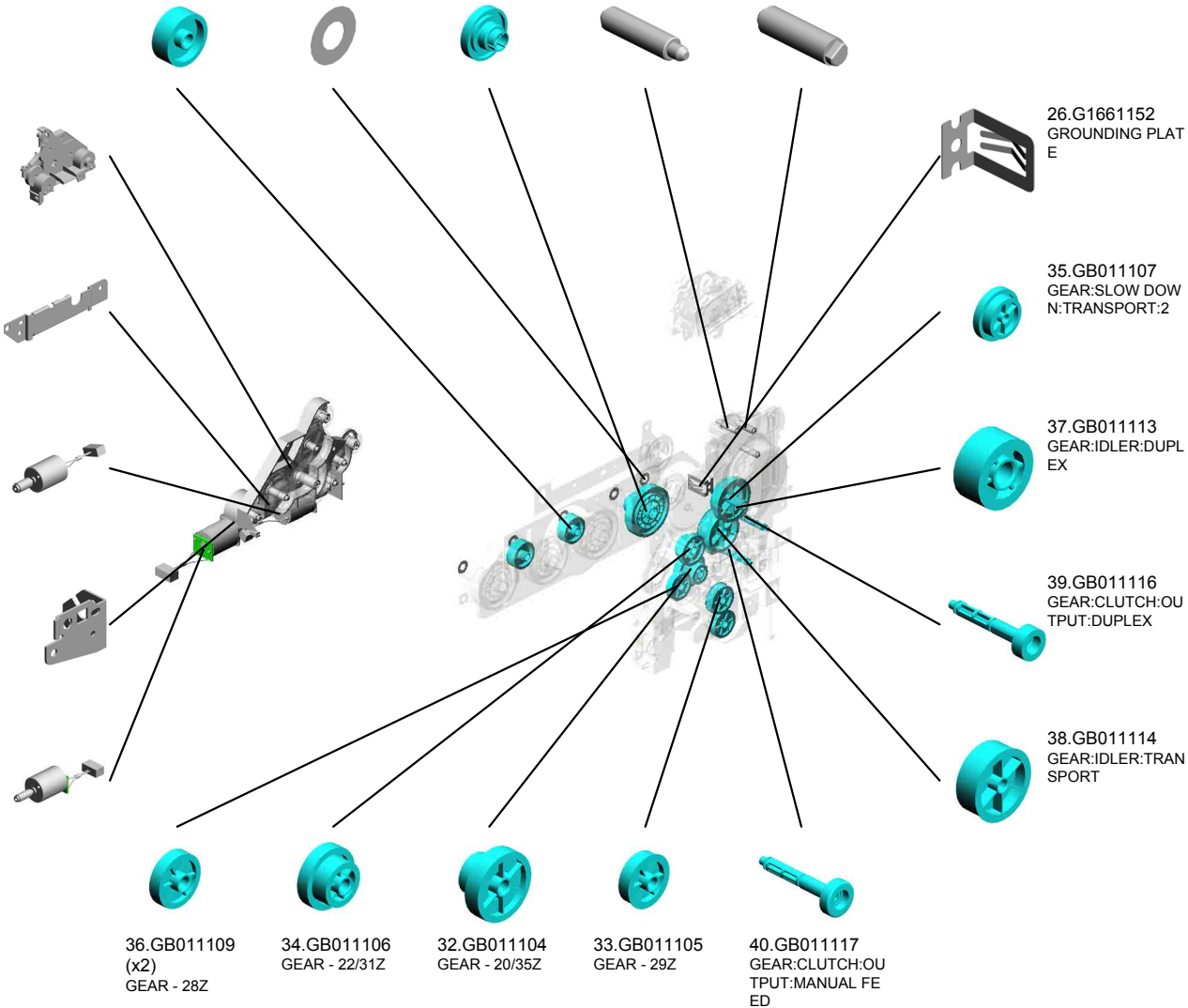

36.GB011109
(x2)
GEAR - 28Z

34.GB011106
GEAR - 22/31Z

32.GB011104
GEAR - 20/35Z

33.GB011105
GEAR - 29Z

40.GB011117
GEAR:CLUTCH:OU
TPUT:MANUAL FE
ED

26.G1661152
GROUNDING PLAT
E

35.GB011107
GEAR:SLOW DOW
N:TRANSPORT:2

37.GB011113
GEAR:IDLER:DUPL
EX

39.GB011116
GEAR:CLUTCH:OU
TPUT:DUPL EX

38.GB011114
GEAR:IDLER:TRAN
SPORT

U010 MAIN DRIVE

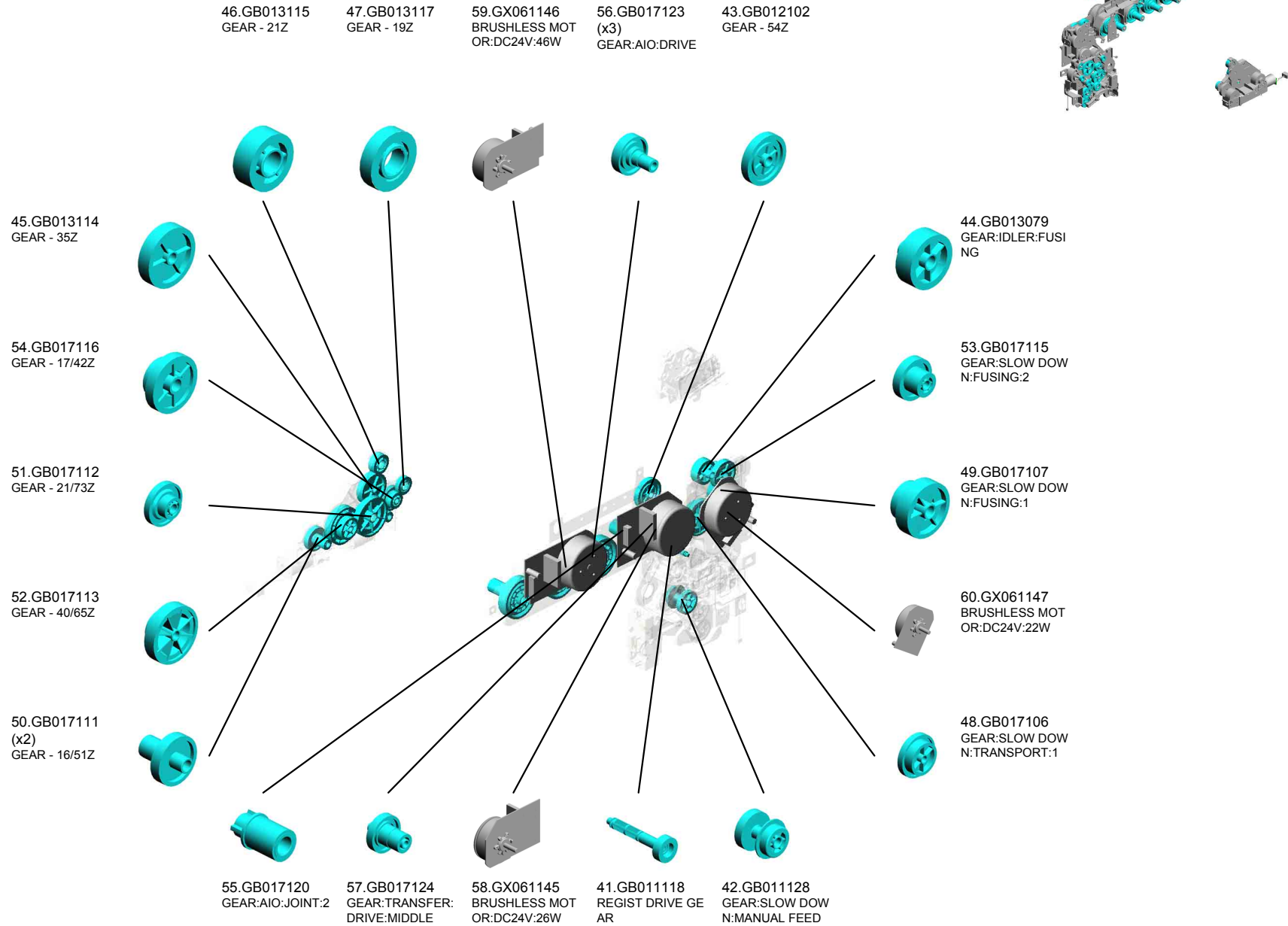

U010 MAIN DRIVE

64.M0751107
SHIELDING PLATE:
GEAR:2

61.GX201121
(x2)
MAGNETIC CLUTC
H

65.M0751139
BRACKET:TRANSP
ORT:PAPER FEED
DRIVE

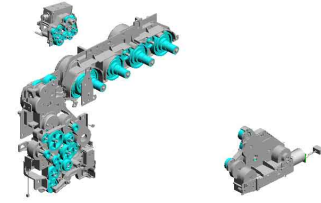

63.M0751105
BRACKET:MOTOR

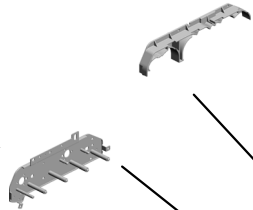

66.M0751140
CLUTCH SHAFT H
OLDER

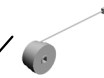

62.GX201122
MAGNETIC CLUTC
H:0.25N



67.M0752842
DC SOLENOID:MA
NUAL FEED

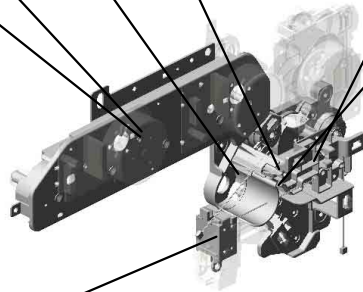

U001	U002	U003	U004	U005	U006	U007	U008	U009	U010	U011	U012
------	------	------	------	------	------	------	------	------	------	------	------

U011.ELECTRICAL

U011 S001
G1666003
DENSITY SENSOR:ASS'Y

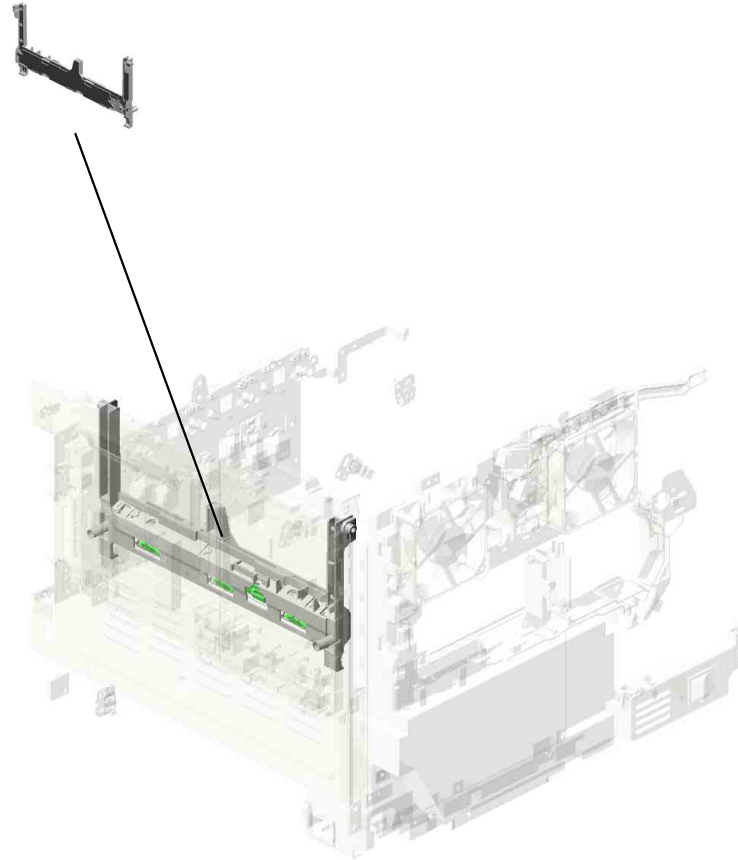

U001	U002	U003	U004	U005	U006	U007	U008	U009	U010	U011	U012
------	------	------	------	------	------	------	------	------	------	------	------

U011 ELECTRICAL

1.03603006N
(x11)
SCREW - M3X6

13.B5845120
PCB:DDR1-DIMM-3
2B:128MB:ASSY

20.G1635731
BASE:HIGH VOLTA
GE:3

8.14075317
EEPROM:M24C16-
WBN6(REV.S/W/G)

17.G1631068
(x4)
BRACKET - PHOTO
INTERRUPTOR

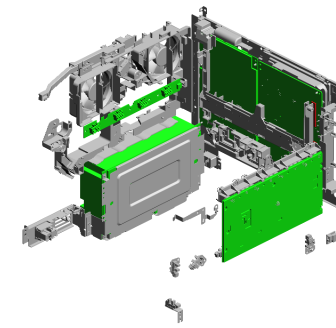

14.D0295861
GASKET:65TFV5-0.
5.L90

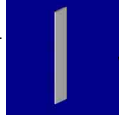

12.B1886198
GASKET:GUIDE PL
ATE:UPPER FRON
T:LOWER

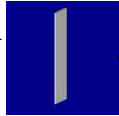

16.G1045141
(x3)
KNOB SCREW:M3



15.G1022789
STOPPER:PHOTOI
NTERRUPTOR



10.AW140015
TEMPERATURE &
HUMIDITY SENSO
R



9.AA143592
SCREW- M4X6



18.G1632837
HOLDER:PAPER E
ND SENSOR



11.AX640199
(x2)
FAN:MM80:25MM:D
C 2.16W

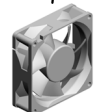

2.11033902
CONNECTOR - 10P



4.11050723
CLAMPS:WES-050
7



6.12042612
(x3)
MICRO SWITCH:D3
V-16506-3C25



19.G1635728
(x4)
SEAL:FAN:2

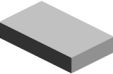

7.12042872
SWITCH:AJ8R2011
BBCF

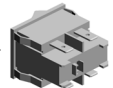

3.11050508
HARNES CLAMP -
LWS-0711



5.11050724
CLAMPS:WES-121
0



U011 ELECTRICAL

- 30.G1665708 2NDTERMINAL- TR
ANSFER
- 35.G1665733 LINK - SAFETY SW
ITCH
- 38.G1665736 TENSION SPRING -
SAFETY SWITCH
- 36.G1665734 TORSION SPRING
- SAFETY SWITCH
- 39.G1665737 COMPRESSION SP
RING - SAFETY S
WITCH

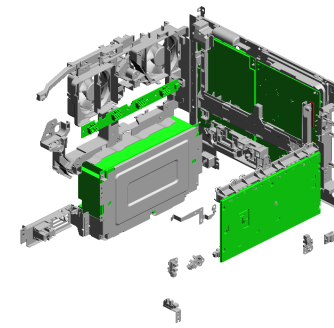

32.G1665716
(X12)
TERMINAL:AIO



40.G1665738
1ST TERMINAL - T
RANSFER



33.G1665725
HARNESS COVER

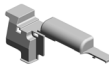

23.G1635756
GROUND PLATE:S
HAFT:FRAME:REA
R LEFT



24.G1636590
TERMINAL:SPRING
PLATE:UPPER:NE
W ARTICLE SENS
OR



25.G1636591
TERMINAL:SPRING
PLATE:LOWER:NE
W ARTICLE SENS
OR



31.G1665715
BRACKET - MAIN S
WITCH



27.G1661059
DUCT



29.G1665280
TERMINAL BOARD



28.G1661110
HARNESS GUIDE



26.G1661058
EXIT DUCT



22.G1635754
GROUND PLATE:F
RAME:FUSING



21.G1635751
HOLDER:RESISTO
R:FUSING



37.G1665735
LEVER:SAFETY S
WITCH



34.G1665732
BRACKET SAFETY
SWITCH



36.G1665734
TORSION SPRING
- SAFETY SWITCH



38.G1665736
TENSION SPRING -
SAFETY SWITCH



39.G1665737
COMPRESSION SP
RING - SAFETY S
WITCH



35.G1665733
LINK - SAFETY SW
ITCH



30.G1665708
2NDTERMINAL- TR
ANSFER



32.G1665716
(X12)
TERMINAL:AIO

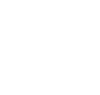

40.G1665738
1ST TERMINAL - T
RANSFER



33.G1665725
HARNESS COVER



23.G1635756
GROUND PLATE:S
HAFT:FRAME:REA
R LEFT



24.G1636590
TERMINAL:SPRING
PLATE:UPPER:NE
W ARTICLE SENS
OR



25.G1636591
TERMINAL:SPRING
PLATE:LOWER:NE
W ARTICLE SENS
OR



31.G1665715
BRACKET - MAIN S
WITCH



27.G1661059
DUCT



29.G1665280
TERMINAL BOARD



28.G1661110
HARNESS GUIDE



26.G1661058
EXIT DUCT



22.G1635754
GROUND PLATE:F
RAME:FUSING



21.G1635751
HOLDER:RESISTO
R:FUSING



37.G1665735
LEVER:SAFETY S
WITCH



34.G1665732
BRACKET SAFETY
SWITCH



36.G1665734
TORSION SPRING
- SAFETY SWITCH



38.G1665736
TENSION SPRING -
SAFETY SWITCH



39.G1665737
COMPRESSION SP
RING - SAFETY S
WITCH



35.G1665733
LINK - SAFETY SW
ITCH



30.G1665708
2NDTERMINAL- TR
ANSFER



U011 ELECTRICAL

59.M0755712
COVER:MEMORY

57.M0755213
PCB:CTL

54.GZ300003
POWER PACK

55.M0185754
SCREW

50.G1666586
FEELER - SET SEN
SOR

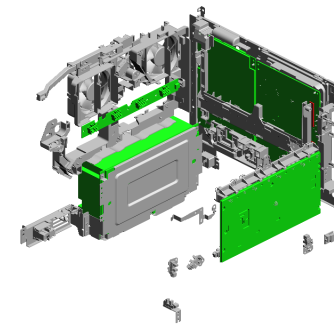

61.M0755745
COVER:SD-CARD:
CONTROL BOARD

43.G1666045
SPRING - FEELER

44.G1666046
SENSOR FEELER

45.G1666103
SENSOR HOLDER

52.GW020020
PHOTOINTERRUP
TOR:LG248NL1
201106-01

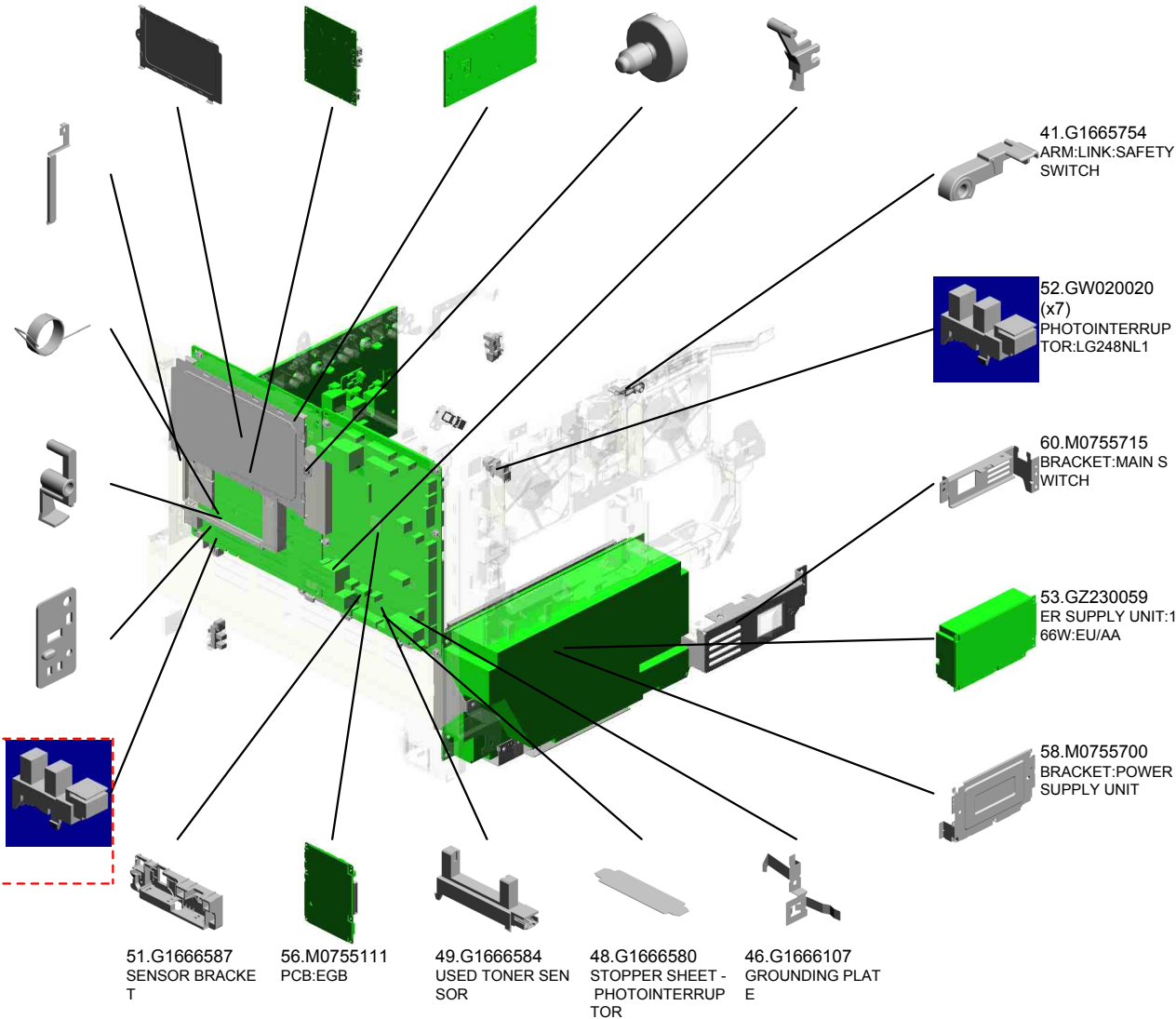

41.G1665754
ARM:LINK:SAFETY
SWITCH

52.GW020020
(x7)
PHOTOINTERRUP
TOR:LG248NL1

60.M0755715
BRACKET:MAIN S
WITCH

53.GZ230059
ER SUPPLY UNIT:1
66W:EU/AA

58.M0755700
BRACKET:POWER
SUPPLY UNIT

51.G1666587
SENSOR BRACKE
T

56.M0755111
PCB:EGB

49.G1666584
USED TONER SEN
SOR

48.G1666580
STOPPER SHEET -
PHOTOINTERRUP
TOR

46.G1666107
GROUNDING PLAT
E

U011
ELECTRICAL

62.M0755760
GASKET:65TFV5-0.
5:L30

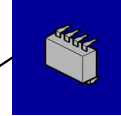
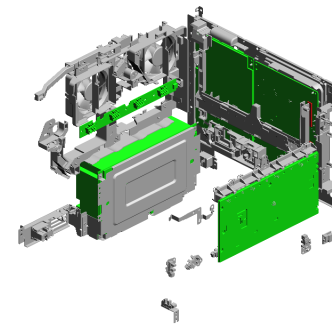

63.M0759590
(x2)
NV-RAM - ZERO C
OUNTER
201104-01

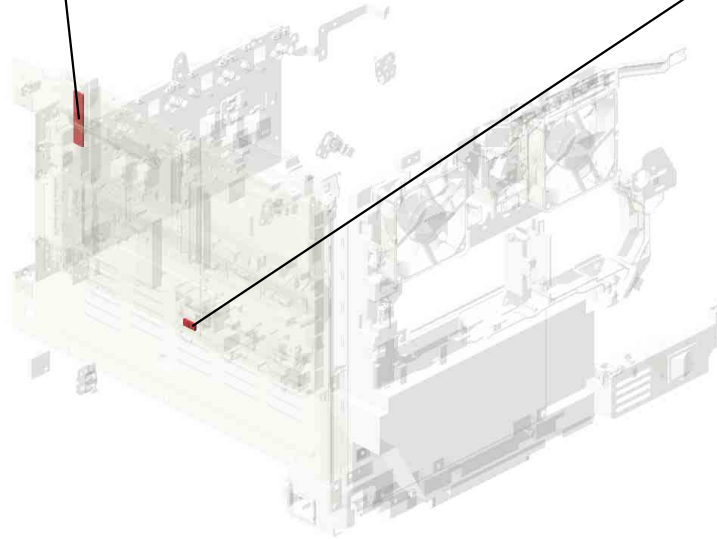

U001	U002	U003	U004	U005	U006	U007	U008	U009	U010	U011	U012
------	------	------	------	------	------	------	------	------	------	------	------

U011_S001
DENSITY SENSOR:ASS'Y

47.G1666191
CLEANER DECAL -
DENSITY SENSOR

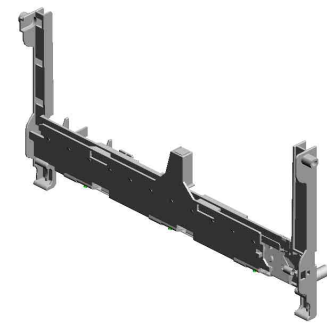

42.G1666003
DENSITY SENSOR:
ASS'Y

U001	U002	U003	U004	U005	U006	U007	U008	U009	U010	U011	U012
------	------	------	------	------	------	------	------	------	------	------	------

U012.MAIN FRAME

U012 S001
G1661240
BRAKE:COVER:UPPER

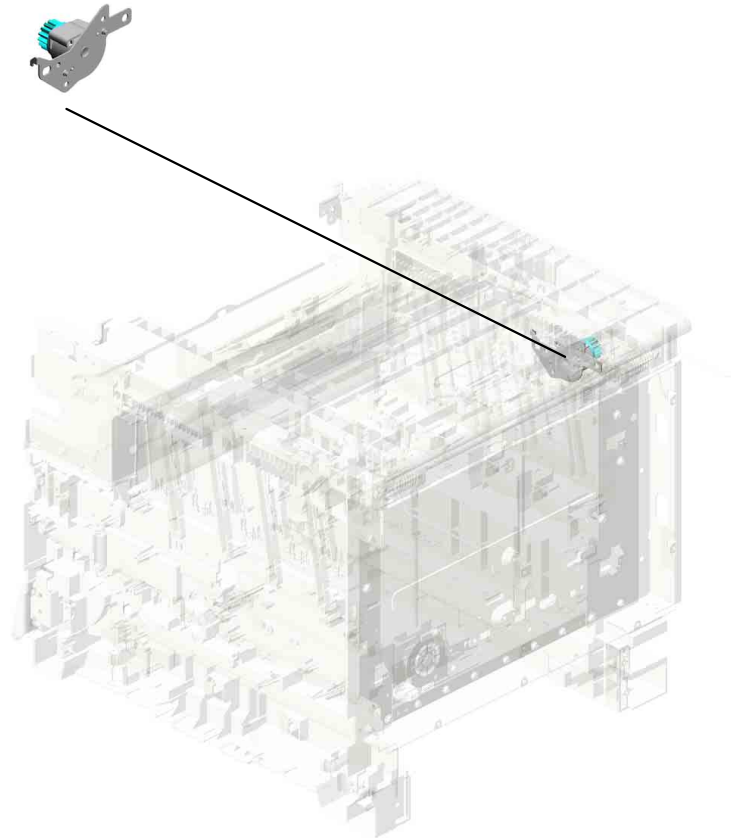

U001	U002	U003	U004	U005	U006	U007	U008	U009	U010	U011	U012
------	------	------	------	------	------	------	------	------	------	------	------

U012 MAIN FRAME

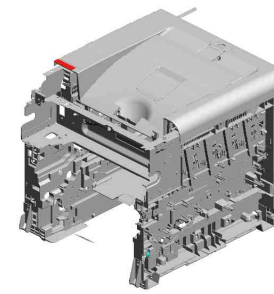

- 4.04543006Q (x9) TAPPING SCREW - M3X6
- 19.G1635755 HOLDER:RESISTOR:EXIT
- 21.G1661046 COLOR DECAL - M AGENTA
- 3.04504010N (x16) TAPPING SCREW: M4X10
- 11.G1631096 GROUND PLATE:FRONT



9.G1631059
TENSION SPRING:
BRAKE:COVER:FRONT

7.07200040E
RETAINING RING - M4

20.G1661008
CLUTCH/BRAKE BRAKET

6.07200030E
(x2)
RETAINING RING - M3

16.G1632577
SPRING:EARTH:PA
PER FEED

13.G1632573
COMPRESSION SPRING:RING:EAR
TH:BASE

17.G1632578
SPRING:PAPER TRAY:POSITIONING

15.G1632576
HOLDER:FEELER

14.G1632575
FEELER:PAPER END SENSOR

5.04543008Q
(x21)
TAPPING SCREW: 3X8

8.11050516
CLAMP

18.G1633954
GROUND PLATE:REGISTRATION ROLLER

2.04503016N
(x2)
TAPPING SCREW: 3X16

12.G1631097
GROUND PLATE:AI
O:LEFT

10.G1631060
DUCT:FAN:SIROCCO

U012 MAIN FRAME

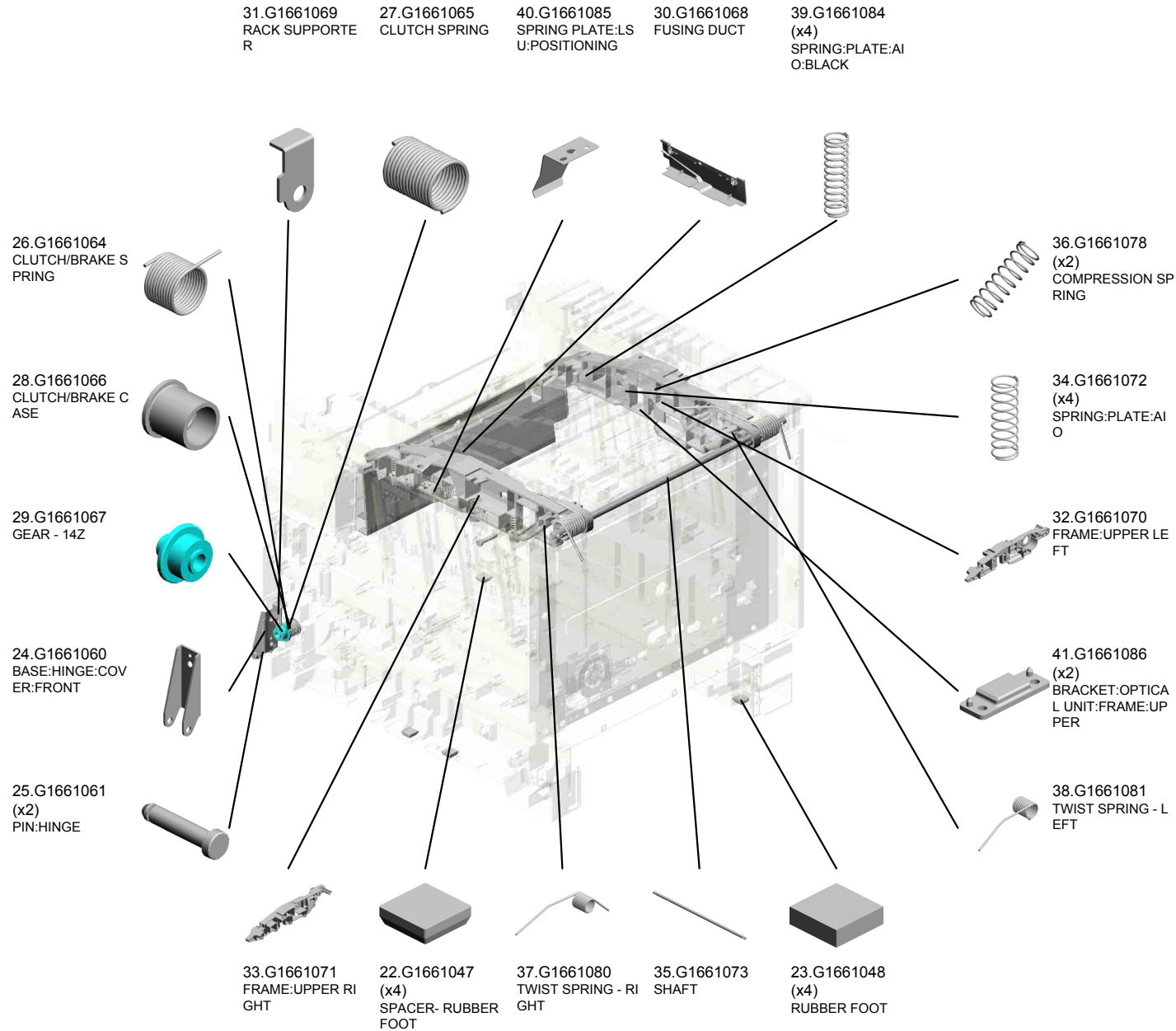
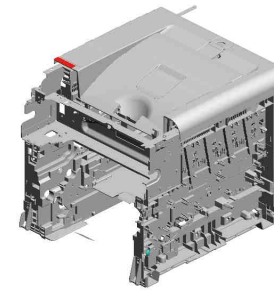

U012 MAIN FRAME

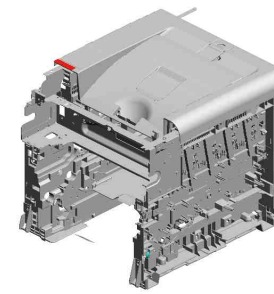

60.G1663333
DECAL - CYAN

43.G1661088
UPPER FRONT DU
CT

65.G1665705
SHIELDING PLATE

42.G1661087
(x2)
SPRING:CUSHION:
FRAME:UPPER

52.G1661280
CUSHION - IMAGIN
G UNIT

64.G1663994
RESISTOR - 50M O
HM +-10% 0.5W

59.G1663331
DECAL - BLACK

62.G1663957
WASHER - 0.8X10.
8MM

47.G1661093
GEAR - 20Z

63.G1663993
RESISTOR - 100M
OHM +-10% 0.5W

61.G1663334
DECAL - YELLOW

46.G1661091
GROUND PLATE -
POWER SUPPLY U
NIT

66.G1665706
GROUND PLATE:S
HAFT:IMAGING UN
IT

58.G1661390
CAUTION DECAL -
TRANSFER BELT

45.G1661090
GROUND PLATE -
DCHIP

51.G1661269
STOPPER BAND

53.G1661342
RACK:DAMPER

67.G1665724
HARNESS CLAMP
HOLDER

44.G1661089
(x8)
PIN:PLATE:DEVEL
OPMENT UNIT

48.G1661095
SHEET:BASE:FRA
ME

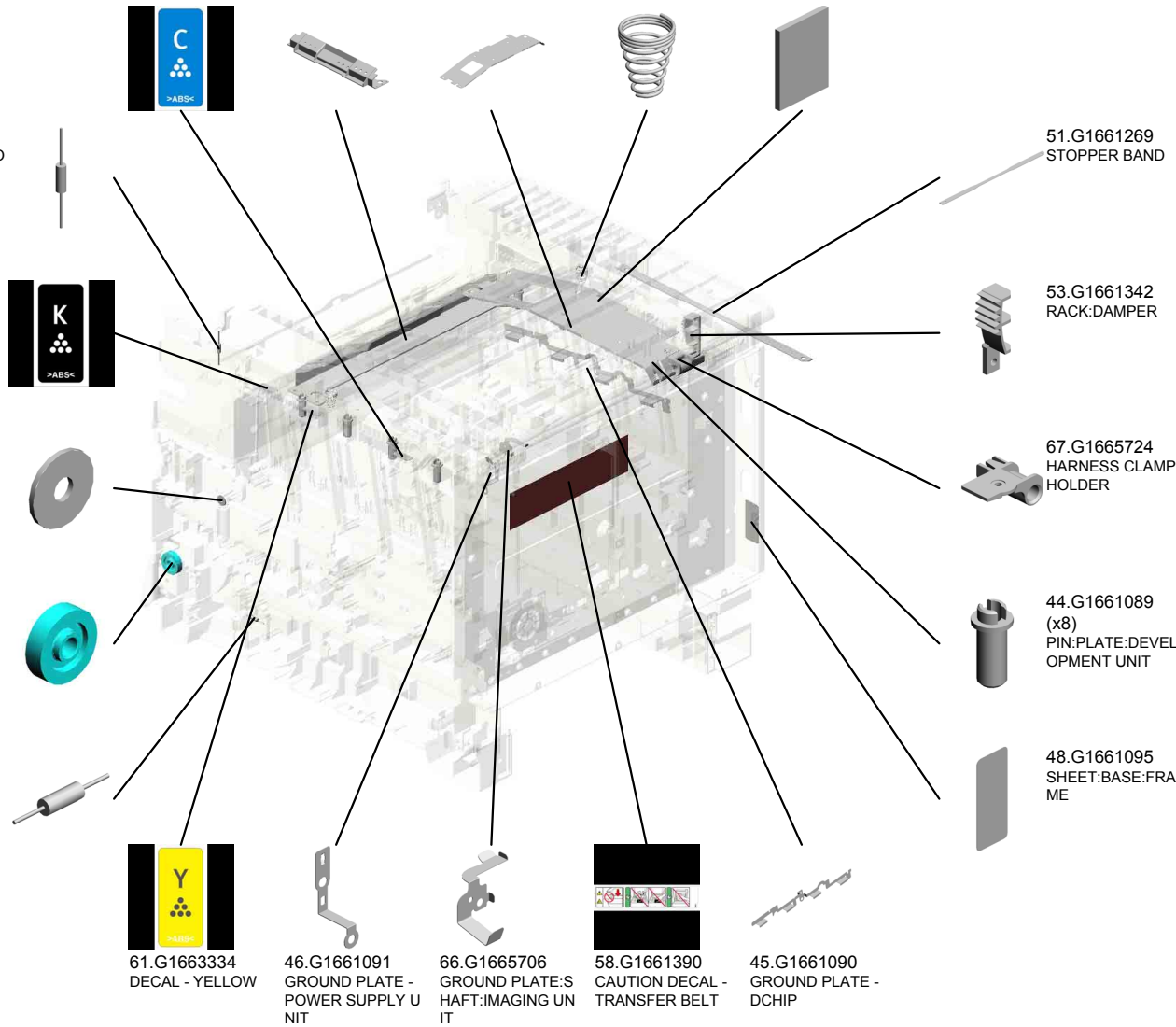

U012 MAIN FRAME

80.M0751364 Decal:Name Plate:NSA
 81.M0751371 DECAL:NAME PLATE
 82.M0751375 Decal:Name Plate:REX
 83.M0751376 Decal:Name Plate:GES

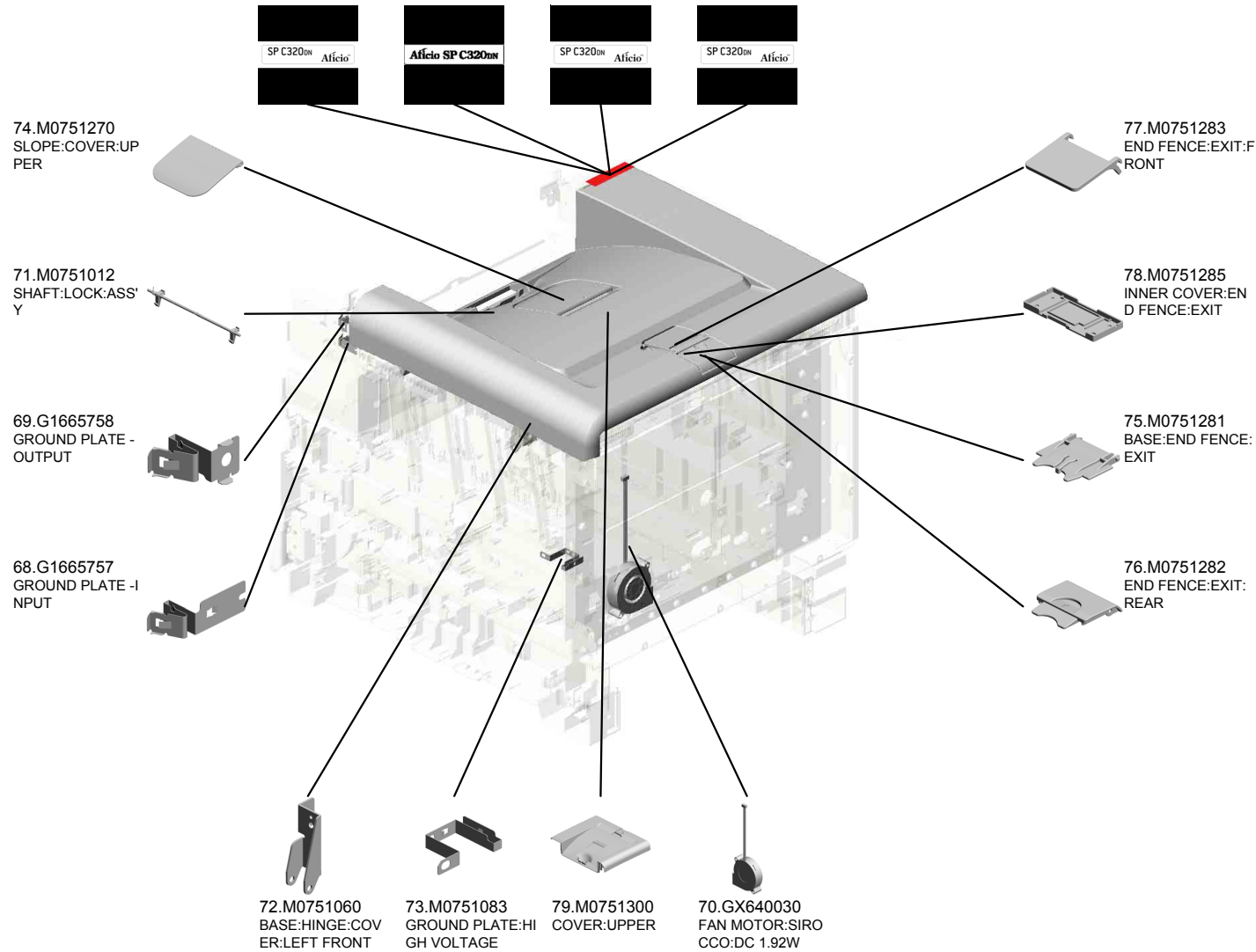
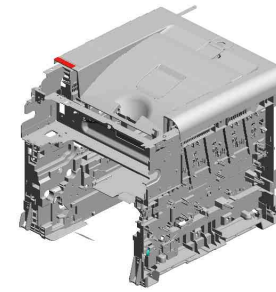

U012_S001
BRAKE:COVER:UPPER

56.G1661386
BRAKE SPRING

54.G1661383
BRAKE COLLER

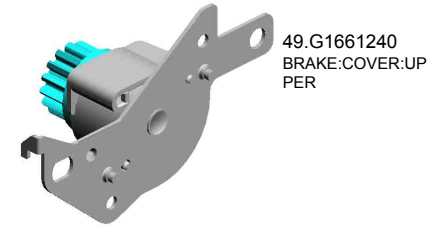

50.G1661241
BRAKE BRACKET

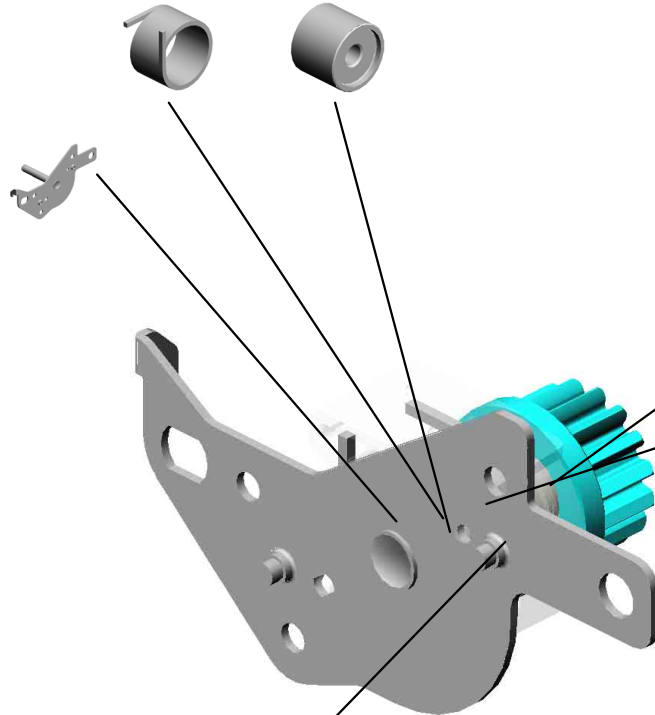

1.03603006N
(x2)
SCREW - M3X6

U001	U002	U003	U004	U005	U006	U007	U008	U009	U010	U011	U012
------	------	------	------	------	------	------	------	------	------	------	------

ACCESSORIES



1.16072257
FERRITE CORE:K3 NFR-08BBK0



2.G1665430
POWER SUPPLY CODE:125V:15A:NA

DECALS AND DOCUMENTS



1.G1632862
DECAL:SIDE FENCE:MANUAL FEED:
EXP

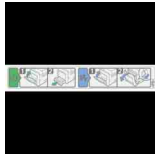

2.G1633937
DECAL:CAUTION:OPERATE:MANUAL
FEED



3.G1633989
DECAL:COVER:FRONT:POSITIONIN
G DISPLAY



4.G1633990
DECAL:TRANSPORT UNIT:POSITION
ING DISPLAY



5.G1633992
DECAL:TRANSFER/SEPARATION



6.G1633993
DECAL:GRIP:HOUSING

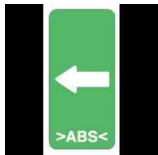

7.G1633995
DECAL:GRIP:SLIDE



8.G1661046
COLOR DECAL - MAGENTA

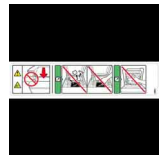

9.G1661390
CAUTION DECAL - TRANSFER BELT



10.G1662593
CAUTIONDECAL - INKJET PAPER

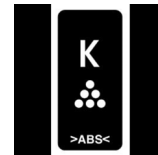

11.G1663331
DECAL - BLACK

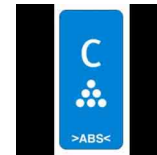

12.G1663333
DECAL - CYAN



13.G1663334
DECAL - YELLOW



14.G1664310
DECAL:WARNING (HIGH TEMPERAT
URE):1:CUD



15.G1664399
DECAL:FUSING EXIT:OPEN AND CL
OSE

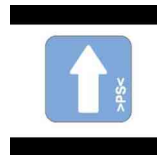

16.G1666191
CLEANER DECAL - DENSITY SENSO
R



17.M0751364
Decal:Name Plate:NSA



18.M0751371
DECAL:NAME PLATE

DECALS AND DOCUMENTS



19.M0751375
Decal:Name Plate:REX



20.M0751376
Decal:Name Plate:GES

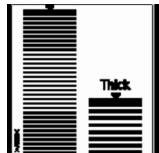

21.M0752624
DECAL:PAPER TRAY:SIDE FENCE:EXP

Exclusive Parts

Number	Part Name	Group	ID
A2672869	GEAR - 16Z	U003_S001_S001	2
AA080265	BUSHING:6X8X5	U003_S001	3
		U006	1
AA082101	BUSHING - 6X10X6	U003_S001	4
AA143520	SHOULDER SCREW - M3	U008_S001	5
AA143592	SCREW- M4X6	U011	9
AF031061	PAPER FEED ROLLER	U003	5
AF040574	GUIDE ROLLER	U009	2
AW140015	TEMPERATURE & HUMIDITY SENSOR	U011	10
AX640199	FAN:MM80:25MM:DC 2.16W	U011	11
B1886198	GASKET:GUIDE PLATE:UPPER FRONT:LOWER	U011	12
B2384714	TIMING BELT - 30S2M206	U007_S001	2
B5845120	PCB:DDR1-DIMM-32B:128MB:ASS'Y	U011	13
D0295861	GASKET:65TFV5-0.5:L90	U011	14
G1022789	STOPPER:PHOTOINTERRUPTOR	U011	15
G1024109	BALL BEARING:10X22X6	U008_S001	6
G1045141	KNOB SCREW:M3	U011	16
G1594322	CLEANING FELT:BELT TENSION	U008_S001	7
G1631059	TENSION SPRING:BRAKE:COVER:FRONT	U012	9
G1631060	DUCT:FAN:SIROCCO	U012	10
G1631068	BRACKET - PHOTOINTERRUPTOR	U011	17
G1631096	GROUND PLATE:FRONT	U012	11
G1631097	GROUND PLATE:AIO:LEFT	U012	12
G1631148	BRACKET:TRANSPORT:FUSING DRIVE SUB-UNIT	U010	4
G1631161	BRACKET:TRANSPORT:MOTOR	U010	5
G1631259	INNER COVER:GUARD:SAFETY SWITCH	U001	9
G1631278	INNER COVER:EXIT	U001	10
G1631311	SEAL:COVER:LEFT:3	U001	11
G1631313	SEAL:COVER:LEFT:5	U001	12
G1631314	SEAL:FRAME:LOWER:1	U001	13
G1631316	SEAL:FRAME:LOWER:3	U001	14
G1631317	SEAL:FRAME:LOWER:4	U001	15

Number	Part Name	Group	ID
G1631318	SEAL:GUIDE PLATE:EXIT:LOWER	U009	3
G1632552	CASSETTE COVER	U003_S001	6
G1632561	FEELER:SET SENSOR:PAPER TRAY	U003_S001_S001	7
G1632565	STOPPER:BASE	U003_S001_S001	8
G1632566	COMPRESSION SPRING:STOPPER:BASE	U003_S001_S001	9
G1632567	LEVER:PAPER VOLUME SENSOR	U003_S001	10
G1632569	GROUND PLATE:MANUAL FEED	U003_S001	11
G1632573	COMPRESSION SPRING:EARTH:BASE	U012	13
G1632575	FEELER:PAPER END SENSOR	U012	14
G1632576	HOLDER:FEELER	U012	15
G1632577	SPRING:EARTH:PAPER FEED	U012	16
G1632578	SPRING:PAPER TRAY:POSITIONING	U012	17
G1632605	HOUSING:MANUAL FEED:PAPER TRAY	U003_S001	12
G1632800	FRICTION PAD:ADHESION	U003_S001	13
G1632802	SPRING:FRICTION PAD:MANUAL FEED	U003_S001	14
G1632805	SPRING:BASE:MANUAL FEED	U003_S001	15
G1632806	SHAFT:CAM	U003_S001	16
G1632807	CAM:RIGHT:MANUAL FEED	U003_S001	17
G1632809	SPRING:CAM	U003_S001	18
G1632812	GEAR:TRANSPORT ROLLER:MANUAL FEED	U003_S001	19
G1632813	SHAFT:TRANSPORT:PAPER FEED ROLLER:PRESS FIT	U003_S001	20
G1632817	GEAR:IDLER:PAPER FEED ROLLER	U003_S001	21
G1632818	FEELER:PAPER END SENSOR:MANUAL FEED	U003_S001	22
G1632820	BRACKET:MANUAL FEED	U003_S001	23
G1632822	GEAR:IDLER:CAM	U003_S001	24
G1632823	LINK:CAM	U010	6
G1632834	COVER:TRAY:MANUAL FEED	U004	1
G1632835	CAM:LEFT:MANUAL FEED	U003_S001	25

Exclusive Parts

Number	Part Name	Group	ID
G1632837	HOLDER:PAPER END SENSOR	U011	18
G1632839	HOLDER:DC SOLENOID:MANUAL FEED	U010	7
G1632844	GEAR:IDLER:TRANSPORT:PAPER FEED ROLLER	U003_S001	26
G1632850	PAWL:TRAY:MANUAL FEED	U004	2
G1632851	COVER:MANUAL FEED:LOWER	U004	3
G1632852	GUIDE:COVER:MANUAL FEED:LOWER	U004	4
G1632853	EXTENSION TRAY:MANUAL FEED	U004	5
G1632854	SHAFT:TRAY:MANUAL FEED	U004	6
G1632855	SPRING:TRAY:MANUAL FEED	U004	7
G1632856	SPRING:SHAFT:TRAY:MANUAL FEED	U004	8
G1632858	COIL SPRING:PAWL:TRAY:MANUAL FEED	U004	9
G1632862	DECAL:SIDE FENCE:MANUAL FEED:EXP	DECALS AND DOCUMENTS	1
		U004	10
G1632870	GUIDE:MANUAL FEED:PAPER TRAY	U003_S001	27
G1632871	SHAFT:TRANSPORT:PICKUP ROLLER	U003_S001	28
G1632872	SCREW:DIA4:12.5MM	U003_S001	29
G1632873	DAMPING INSULATION:GUIDE:MANUAL FEED	U003_S001	30
G1632874	SHEET:DAMPING INSULATION:GUIDE:MANUAL FEED	U003_S001	31
G1632877	DISCHARGE BRUSH:MANUAL FEED	U003_S001	32
G1632878	SHEET:DISCHARGE BRUSH:MANUAL FEED	U003_S001	33
G1632879	GROUND PLATE:FEED ROLLER:MANUAL FEED	U003_S001	34
G1633903	FRAME:COVER:FRONT:RIGHT	U007	3
G1633904	FRAME:COVER:FRONT:LEFT	U007	4
G1633907	GUIDE:LOCK	U007	5
G1633908	ARM:LEVER:LOCK	U007	6

Number	Part Name	Group	ID
G1633912	HOLDER:GUIDE PLATE:REVERSE:RIGHT	U007	7
G1633913	HOLDER:GUIDE PLATE:REVERSE:LEFT	U007	8
G1633921	SPRING:GUIDE PLATE:MIDDLE	U007	9
G1633924	FEELER:PAPER FEED SENSOR	U007	10
G1633925	TORSION SPRING:FEELER:PAPER FEED SENSOR	U007	11
G1633926	GUIDE PLATE:EXIT:MIDDLE	U007	12
G1633927	GUIDE PLATE:EXIT:MIDDLE:INNER	U007	13
G1633932	COVER:FRONT	U007	14
G1633935	DESIGN PLATE:COVER:FRONT:UPPER	U007	15
G1633936	DESIGN PLATE:COVER:FRONT:LOWER	U007	16
G1633937	DECAL:CAUTION:OPERATE:MANUAL FEED	DECALS AND DOCUMENTS	2
		U007	17
G1633950	REGISTRATION GUIDE	U007_S001	18
G1633951	GUIDE:PAPER FEED SUB-UNIT	U007_S001	19
G1633952	GUIDE:DUPLEX SUB-UNIT:LOWER	U007_S001	20
G1633954	GROUND PLATE:REGISTRATION ROLLER	U012	18
G1633955	FEELER:REGISTRATION SENSOR	U007_S001	21
G1633959	SUPPORTING PLATE:HOUSING:TRANSFER	U007_S001	22
G1633960	SHEET:REGISTRATION	U007_S001	23
G1633965	ELECTRODE PLATE:EARTH:LINK	U007_S001	24
G1633968	GROUND WIRE:REGISTRATION ROLLER	U007_S001	25
G1633970	HOOK:FIX:TRANSFER/SEPARATION:LEFT	U007	26
G1633971	HOOK:FIX:TRANSFER/SEPARATION:RIGHT	U007	27
G1633972	SLIDER:TRANSPORT UNIT:LEFT	U007	28
G1633973	COVER:COMPRESSION SPRING	U007_S001	29
G1633974	SCREW:HOUSING:TRANSPORT	U007_S001	30
G1633975	SLIDER:TRANSPORT UNIT:RIGHT	U007	31

Exclusive Parts

Number	Part Name	Group	ID
G1633989	DECAL:COVER:FRONT:POSITIONING DISPLAY	DECALS AND DOCUMENTS	3
		U007	32
G1633990	DECAL:TRANSPORT UNIT:POSITIONING DISPLAY	DECALS AND DOCUMENTS	4
		U007	33
		U007_S001	33
G1633991	COVER:COMPRESSION SPRING	U007_S001	34
G1633992	DECAL:TRANSFER/SEPARATION	DECALS AND DOCUMENTS	5
		U007_S001	35
G1633993	DECAL:GRIP:HOUSING	DECALS AND DOCUMENTS	6
		U007_S001	36
G1633995	DECAL:GRIP:SLIDE	DECALS AND DOCUMENTS	7
		U007	37
G1633997	COMPRESSION SPRING:HOUSING:TRANSPORT	U007_S001	38
G1634109	STAY:THERMOSTAT	U008_S001	8
G1634213	HOLDER:THERMOSTAT	U008_S001	9
G1634214	FUSE HOLDER	U008_S001	10
G1634216	SHAFT:GUIDE:PAPER	U008_S001	11
G1634243	LEVER:PRESSURE:LEFT	U008_S001	12
G1634258	LEVER:PRESSURE:RIGHT	U008_S001	13
G1634264	COLLAR:STRIPPER PLATE:LEFT	U008_S001	14
G1634265	COLLAR:STRIPPER PLATE:RIGHT	U008_S001	15
G1634271	GUIDE PLATE:FUSING EXIT	U008_S001	16
G1634276	TORSION SPRING:SEPARATION:LEFT	U008_S001	17
G1634277	TORSION SPRING:SEPARATION:RIGHT	U008_S001	18
G1634278	SPRING:GUIDE PLATE:FUSING EXIT	U008_S001	19
G1634282	BRACKET:BELT TENSIONER	U008_S001	20
G1634311	BRACKET:HEATER:FUSING	U008_S001	21
G1634313	BRACKET:TERMINAL	U008_S001	22
G1634341	COVER:LOWER	U008_S001	23

Number	Part Name	Group	ID
G1634347	FUSING ENTRANCE GUIDE PLATE	U008_S001	24
G1634356	COVER:UPPER	U008_S001	25
G1634358	LEVER:LOCK:RIGHT	U008_S001	26
G1634360	SPRING:LEVER:LOCK:RIGHT	U008_S001	27
G1634363	LEVER:LOCK	U008_S001	28
G1634364	SPRING:LEVER:LOCK:LEFT	U008_S001	29
G1634374	GUIDE:HARNESS:FUSING:LEFT	U008_S001	30
G1634375	GUIDE:HARNESS:FUSING:RIGHT	U008_S001	31
G1634453	GUIDE PLATE:REVERSE:UPPER	U009	4
G1634454	GATE PAWL:REVERSE	U009	5
G1634458	GUIDE:PLATE:EXIT:OUTER	U009	6
G1634459	STOPPER:EXIT:EXIT	U009	7
G1634460	ROLLER:DRIVEN:EXIT	U009	8
G1634462	BRACKET:ROLLER:EXIT	U009	9
G1634463	GUIDE:PLATE:EXIT	U009	10
G1634465	ROLLER:DRIVEN:DUPLEX:INNER	U009	11
G1634466	ROLLER:DRIVEN:EXIT	U009	12
G1634467	ROLLER:DRIVEN:DUPLEX	U009	13
G1634468	SPRING:PRESSURE:EXIT:INNER	U009	14
G1634469	SPRING:PRESSURE:DUPLEX	U009	15
G1634473	BRACKET:GEAR:EXIT	U010	8
G1634474	GROUND WIRE:EXIT:RESISTOR	U009	16
G1634478	GEAR:CHANGE:EXIT	U010	9
G1634479	GEAR:IDLER:EXIT	U010	10
G1634480	GEAR:SLOW DOWN:EXIT	U010	11
G1634481	LEVER:CHANGE:EXIT	U010	12
G1634484	SPRING:CHANGE:EXIT	U010	13
G1634487	BRACKET:IDLER:EXIT	U010	14
G1634489	GEAR:EXIT	U009	17
G1634492	DC SOLENOID:PRESS FIT	U010	15
G1634495	LINK:CHANGE:EXIT	U010	16
G1634497	BRACKET:SOLENOID:EXIT	U010	17
G1634499	HOLDER:LINK:EXIT	U010	18
G1634603	GEAR:TRANSPORT ROLLER:DUPLICATION:LOWER	U007_S001	39
G1634604	PULLEY:TRANSPORT ROLLER:DUPLICATION	U007_S001	40
G1634605	BELT PULLEY:DUPLICATION	U007_S001	41

Exclusive Parts

Number	Part Name	Group	ID
G1634606	FEELER:DUPLEX	U007_S001	42
G1634607	GROUND WIRE:DUPLEX	U007_S001	43
G1635728	SEAL:FAN:2	U011	19
G1635731	BASE:HIGH VOLTAGE:3	U011	20
G1635751	HOLDER:RESISTOR:FUSING	U011	21
G1635754	GROUND PLATE:FRAME:FUSING	U011	22
G1635755	HOLDER:RESISTOR:EXIT	U012	19
G1635756	GROUND PLATE:SHAFT:FRAME:R EAR LEFT	U011	23
G1636119	KNOB SCREW:FIX:INTERMEDIATE TRANSFER	U006	2
G1636196	SLIDER:FIX:INTERMEDIATE TRAN SFER:RIGHT	U006	3
G1636197	SLIDER:FIX:INTERMEDIATE TRAN SFER:LEFT	U006	4
G1636590	TERMINAL:SPRING PLATE:UPPER :NEW ARTICLE SENSOR	U011	24
G1636591	TERMINAL:SPRING PLATE:LOWER :NEW ARTICLE SENSOR	U011	25
G1661008	CLUTCH/BRAKE BRAKET	U012	20
G1661046	COLOR DECAL - MAGENTA	DECALS AND DO CUMENTS	8
		U012	21
G1661047	SPACER- RUBBER FOOT	U012	22
G1661048	RUBBER FOOT	U012	23
G1661058	EXIT DUCT	U011	26
G1661059	DUCT	U011	27
G1661060	BASE:HINGE:COVER:FRONT	U012	24
G1661061	PIN:HINGE	U012	25
G1661064	CLUTCH/BRAKE SPRING	U012	26
G1661065	CLUTCH SPRING	U012	27
G1661066	CLUTCH/BRAKE CASE	U012	28
G1661067	GEAR - 14Z	U012	29
G1661068	FUSING DUCT	U012	30
G1661069	RACK SUPPORTER	U012	31
G1661070	FRAME:UPPER LEFT	U012	32
G1661071	FRAME:UPPER RIGHT	U012	33
G1661072	SPRING:PLATE:AIO	U012	34

Number	Part Name	Group	ID
G1661073	SHAFT	U012	35
G1661078	COMPRESSION SPRING	U012	36
G1661080	TWIST SPRING - RIGHT	U012	37
G1661081	TWIST SPRING - LEFT	U012	38
G1661084	SPRING:PLATE:AIO:BLACK	U012	39
G1661085	SPRING PLATE:LSU:POSITIONING	U012	40
G1661086	BRACKET:OPTICAL UNIT:FRAME: UPPER	U012	41
G1661087	SPRING:CUSHION:FRAME:UPPER	U012	42
G1661088	UPPER FRONT DUCT	U012	43
G1661089	PIN:PLATE:DEVELOPMENT UNIT	U012	44
G1661090	GROUND PLATE - DCHIP	U012	45
G1661091	GROUND PLATE - POWER SUPPL Y UNIT	U012	46
G1661093	GEAR - 20Z	U012	47
G1661095	SHEET:BASE:FRAME	U012	48
G1661110	HARNESS GUIDE	U011	28
G1661111	FRAME - TRANSFER DRIVE UNIT	U010	19
G1661118	GROUNDING WIRE	U010	20
G1661119	MOTOR BRACKET	U010	21
G1661123	FRAME - ON-OFF DRIVE UNIT	U010	22
G1661125	SHIELDING PLATE	U010	23
G1661131	DC MOTOR - DC24V 5.3W	U010	24
G1661135	MOTOR - DC24V 1.6W	U010	25
G1661152	GROUNDING PLATE	U010	26
G1661240	BRAKE:COVER:UPPER	U012_S001	49
G1661241	BRAKE BRACKET	U012_S001	50
G1661268	LOGO PLATE - RIC	U007	44
G1661269	STOPPER BAND	U012	51
G1661280	CUSHION - IMAGING UNIT	U012	52
G1661315	LOWER SEAL - 2	U001	16
G1661342	RACK:DAMPER	U012	53
G1661383	BRAKE COLLER	U012_S001	54
G1661384	GEAR - 15Z	U012_S001	55
G1661386	BRAKE SPRING	U012_S001	56
G1661387	CLUTCH SPRING	U012_S001	57
G1661390	CAUTION DECAL - TRANSFER BEL T	DECALS AND DO CUMENTS	9

Exclusive Parts

Number	Part Name	Group	ID
		U012	58
G1662573	HOLDER SHEET	U003_S001_S001	35
G1662580	SHAFT - PAPER FEED ROLLER	U003	36
G1662593	CAUTIONDECAL - INKJET PAPER	DECALS AND DOCUMENTS	10
G1662606	COMPRESSION SPRING	U003_S001_S001	37
G1663331	DECAL - BLACK	DECALS AND DOCUMENTS	11
		U012	59
G1663333	DECAL - CYAN	DECALS AND DOCUMENTS	12
		U012	60
G1663334	DECAL - YELLOW	DECALS AND DOCUMENTS	13
		U012	61
G1663852	REGISTRATION ROLLER - DRIVEN	U007_S001	45
G1663855	TENSION SPRING	U007_S001	46
G1663860	TORSION SPRING	U007_S001	47
G1663865	GEAR - 14Z	U007_S001	48
G1663867	DRIVE GEAR - 14Z	U007_S001	49
G1663905	RIGHT LOCK LEVER	U007	50
G1663906	LEFT LOCK LEVER	U007	51
G1663909	TENSION SPRING	U007	52
G1663910	GROUND WIRE	U007	53
G1663926	EXIT GUIDE ROLLER - MIDDLE	U007	54
G1663927	STOPPER BAND	U007	55
G1663928	BRAKE RACK - FRONT COVER	U007	56
G1663957	WASHER - 0.8X10.8MM	U006	5
		U012	62
G1663961	COMPRESSION SPRING	U007_S001	57
G1663968	ELECTRODE PLATE - CONTACT POINT	U007_S001	58
G1663972	COMPRESSION SPRING - GRIP	U007	59
G1663989	RESISTOR - 100M OHM +-10% 0.5W	U007_S001	60
G1663993	RESISTOR - 100M OHM +-10% 0.5W	U012	63
G1663994	RESISTOR - 50M OHM +-10% 0.5W	U012	64

Number	Part Name	Group	ID
G1664310	DECAL:WARNING (HIGH TEMPERATURE):1:CUD	DECALS AND DOCUMENTS	14
		U008_S001	32
G1664399	DECAL:FUSING EXIT:OPEN AND CLOSE	DECALS AND DOCUMENTS	15
		U008_S001	33
G1664462	STOPPER - PHOTOINTERRUPTOR	U009	18
G1664606	DUPLEX ROLLER	U007	61
G1665280	TERMINAL BOARD	U011	29
G1665430	POWER SUPPLY CODE:125V:15A:NA	ACCESSORYS	2
G1665705	SHIELDING PLATE	U012	65
G1665706	GROUND PLATE:SHAFT:IMAGING UNIT	U012	66
G1665708	2NDTERMINAL- TRANSFER	U011	30
G1665715	BRACKET - MAIN SWITCH	U011	31
G1665716	TERMINAL:AIO	U011	32
G1665724	HARNESS CLAMP HOLDER	U012	67
G1665725	HARNESS COVER	U011	33
G1665732	BRACKET SAFETY SWITCH	U011	34
G1665733	LINK - SAFETY SWITCH	U011	35
G1665734	TORSION SPRING - SAFETY SWITCH	U011	36
G1665735	LEVER:SAFETY SWITCH	U011	37
G1665736	TENSION SPRING - SAFETY SWITCH	U011	38
G1665737	COMPRESSION SPRING - SAFETY SWITCH	U011	39
G1665738	1ST TERMINAL - TRANSFER	U011	40
G1665754	ARM:LINK:SAFETY SWITCH	U011	41
G1665757	GROUND PLATE -INPUT	U012	68
G1665758	GROUND PLATE - OUTPUT	U012	69
G1666003	DENSITY SENSOR:ASS'Y	U011_S001	42
G1666026	BUSHING - 19MM	U006	6
G1666045	SPRING - FEELER	U011	43
G1666046	SENSOR FEELER	U011	44
G1666099	COMPRESSION SPRING	U006	7
G1666103	SENSOR HOLDER	U011	45

Exclusive Parts

Number	Part Name	Group	ID
G1666107	GROUNING PLATE	U011	46
G1666191	CLEANER DECAL - DENSITY SENS OR	DECALS AND DO CUMENTS	16
		U011_S001	47
G1666193	LEFT HOLDER - TRANSFER BELT UNIT	U006	8
G1666194	RIGHT HOLDER - TRANSFER BEL T UNIT	U006	9
G1666580	STOPPER SHEET - PHOTOINTER UPTOR	U011	48
G1666584	USED TONER SENSOR	U011	49
G1666586	FEELER - SET SENSOR	U011	50
G1666587	SENSOR BRACKET	U011	51
G8003133	SIDE FENCE GEAR	U004	11
GA063080	COMPRESSION SPRING:BELT:TE NSION	U008_S001	34
GA063081	COMPRESSION SPRING:CLEANE R	U008_S001	35
GA082014	PLAIN SHAFT BEARING:DIA6:DIA1 0:9	U009	19
GA082015	PLAIN SHAFT BEARING:DIA6:DIA9: 7	U007_S001	62
GA120012	DISCHARGE BRUSH:EXIT	U009	20
GA132101	SPACER - 0.13 X 12MM	U010	27
GA148015	PIN:ROLLER:TRAY BOTTOM PLAT E:DIA2	U003_S001	38
GA148016	SHAFT - 6 X 26.7MM	U010	28
GA148018	SHAFT - 6 X 21.9MM	U010	29
GB010039	GEAR:AIO:DRIVE:MIDDLE	U010	30
GB010040	GEAR:AIO:DRIVE:1	U010	31
GB011104	GEAR - 20/35Z	U010	32
GB011105	GEAR - 29Z	U010	33
GB011106	GEAR - 22/31Z	U010	34
GB011107	GEAR:SLOW DOWN:TRANSPORT: 2	U010	35
GB011109	GEAR - 28Z	U010	36
GB011113	GEAR:IDLER:DUPLEX	U010	37
GB011114	GEAR:IDLER:TRANSPORT	U010	38

Number	Part Name	Group	ID
GB011116	GEAR:CLUTCH:OUTPUT:DUPLEX	U010	39
GB011117	GEAR:CLUTCH:OUTPUT:MANUAL FEED	U010	40
GB011118	REGIST DRIVE GEAR	U010	41
GB011128	GEAR:SLOW DOWN:MANUAL FEE D	U010	42
GB012102	GEAR - 54Z	U010	43
GB013075	GEAR:IDLER:DUPLEX	U008_S001	36
GB013078	GEAR:IDLER:DRIVE	U008_S001	37
GB013079	GEAR:IDLER:FUSING	U010	44
GB013080	GEAR:IDLER:1	U008_S001	38
GB013086	GEAR:HOT ROLLER:ROLLER CLU TCH:Z29	U008_S001	39
GB013114	GEAR - 35Z	U010	45
GB013115	GEAR - 21Z	U010	46
GB013117	GEAR - 19Z	U010	47
GB017055	GEAR:SLOW DOWN:PAPER FEED: 1	U008_S001	40
GB017106	GEAR:SLOW DOWN:TRANSPORT: 1	U010	48
GB017107	GEAR:SLOW DOWN:FUSING:1	U010	49
GB017111	GEAR - 16/51Z	U010	50
GB017112	GEAR - 21/73Z	U010	51
GB017113	GEAR - 40/65Z	U010	52
GB017115	GEAR:SLOW DOWN:FUSING:2	U010	53
GB017116	GEAR - 17/42Z	U010	54
GB017120	GEAR:AIO:JOINT:2	U010	55
GB017123	GEAR:AIO:DRIVE	U010	56
GB017124	GEAR:TRANSFER:DRIVE:MIDDLE	U010	57
GE010006	HEAT ROLLER:DIA20:COAT	U008_S001	41
GE010011	HOT ROLLER	U008_S001	42
GE020011	PRESSURE ROLLER	U008_S001	43
GE030008	BALL BEARING:HOT ROLLER	U008_S001	44
GE031011	PLAIN SHAFT BEARING:BELT TEN SIONER	U008_S001	45
GE031012	PLAIN SHAFT BEARING:CLEANIN G FELT	U008_S001	46
GE040010	ROLLER:BELT TENSIONER:FUSIN	U008_S001	47

Exclusive Parts

Number	Part Name	Group	ID
	G BELT		
GF020000	REGISTRATION ROLLER - DRIVE	U007_S001	63
GF020040	EXIT ROLLER	U009	21
GF020052	TRANSPORT ROLLER:DUPLX	U007_S001	64
GF022006	ROLLER:GUIDE:TRAY BOTTOM PLATE	U003_S001	39
GF031005	PAPER FEED ROLLER:MANUAL FEED	U003_S001	40
GW020020	PHOTOINTERRUPTOR:LG248NL1	U009	22
		U011	52
GW100017	THERMISTOR:COUPLING	U008_S001	48
GW110006	THERMOSTAT	U008_S001	49
GX061145	BRUSHLESS MOTOR:DC24V:26W	U010	58
GX061146	BRUSHLESS MOTOR:DC24V:46W	U010	59
GX061147	BRUSHLESS MOTOR:DC24V:22W	U010	60
GX201121	MAGNETIC CLUTCH	U003	41
		U010	61
GX201122	MAGNETIC CLUTCH:0.25N	U010	62
GX450014	HEATER:230V:1000W	U008_S001	50
GX640030	FAN MOTOR:SIROCCO:DC 1.92W	U012	70
GZ230059	ER SUPPLY UNIT:166W:EU/AA	U011	53
GZ300003	POWER PACK	U011	54
H3103640	SPACER	U006	10
J0121515	Logo Plate - NSA	U007	65
J0121516	Logo Plate - REX	U007	66
J0121517	Logo Plate - GES	U007	67
M0185754	SCREW	U011	55
M0751012	SHAFT:LOCK:ASS'Y	U012	71
M0751060	BASE:HINGE:COVER:LEFT FRONT	U012	72
M0751083	GROUND PLATE:HIGH VOLTAGE	U012	73
M0751105	BRACKET:MOTOR	U010	63
M0751107	SHIELDING PLATE:GEAR:2	U010	64
M0751139	BRACKET:TRANSPORT:PAPER FEED DRIVE	U010	65
M0751140	CLUTCH SHAFT HOLDER	U010	66
M0751251	GUIDE:LOUVER	U001	17
M0751252	SEAL:STOPPER:LOUVER	U001	18
M0751253	LOUVER	U001	19

Number	Part Name	Group	ID
M0751259	COVER:MEMORY	U001	20
M0751260	COVER:INTERFACE	U001	21
M0751262	COVER:CASSETTE	U001	22
M0751270	SLOPE:COVER:UPPER	U012	74
M0751273	COVER:RIGHT	U001	23
M0751277	COVER:PAPER EXI	U001	24
M0751281	BASE:END FENCE:EXIT	U012	75
M0751282	END FENCE:EXIT:REAR	U012	76
M0751283	END FENCE:EXIT:FRONT	U012	77
M0751285	INNER COVER:END FENCE:EXIT	U012	78
M0751300	COVER:UPPER	U012	79
M0751304	COVER:REAR	U001	25
M0751306	COVER:LEFT	U001	26
M0751308	SEAL:GUIDE:LOUVER:UPPER	U001	27
M0751309	SEAL:GUIDE:LOUVER:LOWER	U001	28
M0751315	SEAL:COVER:EXIT	U001	29
M0751364	Decal:Name Plate:NSA	DECALS AND DOCUMENTS	17
		U012	80
M0751371	DECAL:NAME PLATE	DECALS AND DOCUMENTS	18
		U012	81
M0751375	Decal:Name Plate:REX	DECALS AND DOCUMENTS	19
		U012	82
M0751376	Decal:Name Plate:GES	DECALS AND DOCUMENTS	20
		U012	83
M0751402	OPERATION PANEL	U002	1
M0751851	IMAGING UNIT	U005	1
M0752521	PAPER TRAY - A4	U003_S001	42
M0752550	CASSETTE:PAPER TRAY:ASS'Y	U003_S001_S001	43
M0752553	COVER:SIDE FENCE:LEFT	U003_S001_S001	44
M0752554	COVER:SIDE FENCE:RIGHT	U003_S001_S001	45
M0752558	FRICTION PAD	U003_S001_S001	46
M0752560	EXTENSION TRAY:END FENCE	U003_S001_S001	47
M0752562	BASE	U003_S001_S001	48
M0752564	COMPRESSION SPRING:BASE:RI	U003_S001_S001	49

Exclusive Parts

Number	Part Name	Group	ID
	GHT		
M0752579	COMPRESSION SPRING:BASE:LEFT	U003_S001_S001	50
M0752601	END FENCE	U003_S001_S001	51
M0752610	COMPRESSION SPRING:LOCK:SIDE FENCE	U003_S001_S001	52
M0752611	PAWL:LOCK:END FENCE	U003_S001_S001	53
M0752612	LEVER:LOCK:SIDE FENCE	U003_S001_S001	54
M0752613	CLICK:END FENCE	U003_S001_S001	55
M0752614	STAY:END FENCE	U003_S001_S001	56
M0752615	PLATE:END FENCE	U003_S001_S001	57
M0752617	SIDE FENCE:LEFT	U003_S001_S001	58
M0752621	SIDE FENCE:RIGHT	U003_S001_S001	59
M0752622	PAWL:LOCK:SIDE FENCE	U003_S001_S001	60
M0752624	DECAL:PAPER TRAY:SIDE FENCE:EXP	DECALS AND DOCUMENTS	21
		U003_S001	61
M0752625	RETAINER:PINION	U003_S001_S001	62
M0752803	BASE:MANUAL FEED	U003_S001	63
M0752808	GEAR:CAM	U003_S001	64
M0752828	SIDE FENCE:LEFT:MANUAL FEED	U004	12
M0752829	SIDE FENCE:RIGHT:MANUAL FEED	U004	13
M0752842	DC SOLENOID:MANUAL FEED	U010	67
M0752847	TRAY:MANUAL FEED	U004	14
M0753800	HOUSING:TRANSPORT SUB-UNIT:ASS'Y	U007_S001	68
M0753949	TRANSFER ROLLER:SUB-ASS'Y	U007_S001_S001	69
M0753978	TRANSFER ROLLER:TRANSFER/SEPARATION:M:P2	U007_S001_S001	70
M0754105	FUSING BELT	U008_S001	52
M0754142	ROLLER:MIDDLE:FUSING	U008_S001	53
M0754215	FUSING ENTRANCE GUIDE PLATE	U008_S001	54
M0754248	SPRING:PRESSURE:30N	U008_S001	55
M0754249	KNOB:LEVER:PRESSURE RELEASE:LEFT	U008_S001	56
M0754250	KNOB:LEVER:PRESSURE RELEASE:RIGHT	U008_S001	57

Number	Part Name	Group	ID
M0754273	STRIPPER PLATE:COAT	U008_S001	58
M0754354	LEVER:PRESSURE RELEASE	U008_S001	59
M0754451	GUIDE PLATE:EXIT:LOWER	U009	23
M0754461	SPRING:PRESSURE:EXIT:OUTER	U009	24
M0754607	SPRING:PRESSURE:DUPLEX	U007	71
M0755111	PCB:EGB	U011	56
M0755213	PCB:CTL	U011	57
M0755700	BRACKET:POWER SUPPLY UNIT	U011	58
M0755712	COVER:MEMORY	U011	59
M0755715	BRACKET:MAIN SWITCH	U011	60
M0755745	COVER:SD-CARD:CONTROL BOARD	U011	61
M0755760	GASKET:65TFV5-0.5:L30	U011	62
M0759590	NV-RAM - ZERO COUNTER	U011	63
M8780223	FUSING UNIT - 220V	U008_S001	51

Standard Parts



03530040N
SCREW - M3X4



03603005N
SCREW - M3X5



03603006N
SCREW - M3X6



03603008N
SCREW:M3X8

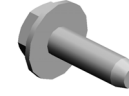

04503010N
TAPPING SCREW - M3X10



04503016N
TAPPING SCREW:3X16



04504010N
TAPPING SCREW:M4X10



04524010N
BINDING SELF-TAPPING SCREW:4X10



04543006Q
TAPPING SCREW - M3X6



04543008Q
TAPPING SCREW:3X8



07010030N
WASHER DIA3



07200030E
RETAINING RING - M3



07200040E
RETAINING RING - M4



07250170E
RETAINING RING C - M17

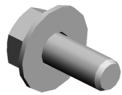

08046123
HEXAGONAL BOLT:W/WASHER:M3X8



08050088
RETAINING RING - M6



09573010N
SCREW:SMALL ROUND/SPRING:M3X10

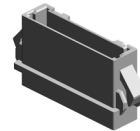

11029153
CONNECTOR:1-292215-1

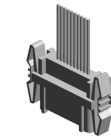

11033902
CONNECTOR - 10P

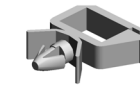

11050508
HARNESS CLAMP - LWS-071



11050511
HARNESS CLAMP - LWS-030

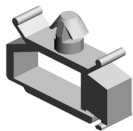

11050516
CLAMP



11050723
CLAMPS:WES-0507

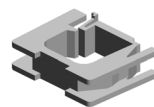

11050724
CLAMPS:WES-1210



12042612
MICRO SWITCH:D3V-16506-3

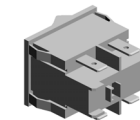

12042872
SWITCH:AJ8R2011BBCF



14075317
EEPROM:M24C16-WBN6(RE V.S/W/G)



16072257
FERRITE CORE:K3 NFR-08B BK0

Design Change List

Number	Title	Set	Old Part		New Part		Index No.		Q'ty	Interchg		Reason	Cut-in S/N
			P/N	Name	P/N	Name	Group	ID		Indiv.	Set		
201106-01	1106 Modification	-			GW020020	PHOTOINTERRUPTOR:LG248NL1	U011	52	1				M07527:
201105-01	1105 Modification	-	M0750228	FUSING SECTION:MAINTENANCE:EU	M8780223	FUSING UNIT - 20V	U008_S001	51	1	O/O			M07527:
201104-01	1104 Modification	-			M0759590	NV-RAM - ZERO COUNTER	U011	63	1				M07527:
					M0759590	NV-RAM - ZERO COUNTER	U011	63	1				

