



RICOH UNIVERSITY

Learning ♦ Knowledge ♦ Performance



M018/M019
SERVICE MANUAL

004349MIU

LANIER RICOH SAVIN



M018/M019
SERVICE MANUAL

LANIER
RICOH
SAVIN®



RICOH UNIVERSITY
Learning ♦ Knowledge ♦ Performance

M018/M019

SERVICE MANUAL

004349MIU

LANIER RICOH SAVIN

WARNING

The Service Manual contains information regarding service techniques, procedures, processes and spare parts of office equipment distributed by Ricoh Americas Corporation. Users of this manual should be either service trained or certified by successfully completing a Ricoh Technical Training Program.

Untrained and uncertified users utilizing information contained in this service manual to repair or modify Ricoh equipment risk personal injury, damage to property or loss of warranty protection.

Ricoh Americas Corporation

LEGEND

PRODUCT CODE	COMPANY			
	GESTETNER	LANIER	RICOH	SAVIN
M018	SP C231SF	SP C231SF	Aficio SP C231SF	SP C231SF
M019	SP C232SF	SP C232SF	Aficio SP C232SF	SP C232SF

DOCUMENTATION HISTORY

REV. NO.	DATE	COMMENTS
*	02/2009	Original Printing

M018/M019

TABLE OF CONTENTS

PRODUCT INFORMATION

1. PRODUCT INFORMATION.....	1-1
1.1 SPECIFICATIONS	1-1
1.2 MACHINE OVERVIEW	1-2
1.2.1 COMPONENT LAYOUT	1-2
Engine	1-2
ADF	1-3
Scanner.....	1-3
1.2.2 PAPER PATH	1-4
Engine	1-4
ADF	1-4
1.2.3 DRIVE LAYOUT.....	1-5
1.3 MACHINE CONFIGURATION	1-7
1.4 GUIDANCE FOR THOSE WHO ARE FAMILIAR WITH PREDECESSOR PRODUCTS.....	1-8

INSTALLATION

2. INSTALLATION	2-1
2.1 INSTALLATION REQUIREMENTS.....	2-1
2.1.1 ENVIRONMENT	2-1
2.1.2 MACHINE LEVEL	2-1
2.1.3 MACHINE SPACE REQUIREMENT	2-2
2.1.4 POWER REQUIREMENTS.....	2-3
2.1.5 INSTALLATION PROCEDURE.....	2-3

PREVENTIVE MAINTENANCE

3. PREVENTIVE MAINTENANCE	3-1
3.1 PREVENTIVE MAINTENANCE	3-1

REPLACEMENT & ADJUSTMENT

4. REPLACEMENT & ADJUSTMENT	4-1
4.1 BEFORE YOU START	4-1
4.2 SPECIAL TOOLS.....	4-2
4.3 EXTERIOR COVERS.....	4-3
4.3.1 REAR COVER	4-3
4.3.2 OPERATION PANEL	4-4
4.3.3 RIGHT COVER	4-5
4.3.4 LEFT COVER	4-5
4.3.5 FRONT COVER UNIT	4-6
4.4 LASER OPTICS.....	4-7
4.4.1 CAUTION DECAL LOCATION.....	4-7
4.4.2 LASER OPTICS HOUSING UNIT	4-8
After replacing the laser optics housing unit.....	4-11
4.5 AIO CARTRIDGE.....	4-12
4.5.1 AIO CARTRIDGE (ALL IN ONE CARTRIDGE).....	4-12
4.5.2 BLACK AIO MOTOR.....	4-13
4.5.3 COLOR AIO MOTOR.....	4-16
4.6 IMAGE TRANSFER	4-17
4.6.1 IMAGE TRANSFER BELT UNIT	4-17
After replacing the image transfer belt unit.....	4-18
4.6.2 ITB (IMAGE TRANSFER BELT) CLEANING UNIT.....	4-19
4.6.3 AGITATOR MOTOR	4-20
4.6.4 ITB (IMAGE TRANSFER BELT) CONTACT MOTOR.....	4-21
4.6.5 ITB (IMAGE TRANSFER BELT) CONTACT SENSOR.....	4-22
4.6.6 TM (TONER MARK) SENSOR BASE	4-23
4.6.7 WASTE TONER BOTTLE SET SENSOR.....	4-24
4.6.8 WASTE TONER OVERFLOW SENSOR	4-26
4.7 PAPER TRANSFER.....	4-27
4.7.1 TRANSFER UNIT	4-27
4.7.2 TRANSFER ROLLER	4-28

4.7.3 REGISTRATION ROLLER.....	4-30
Reassembling the registration roller unit	4-30
4.7.4 REGISTRATION SENSOR	4-31
4.7.5 REGISTRATION CLUTCH.....	4-32
4.8 IMAGE FUSING	4-33
4.8.1 FUSING UNIT	4-33
4.8.2 FUSING LAMP	4-34
When Reinstalling the Fusing Lamp	4-34
4.8.3 TRANSPORT/FUSING MOTOR	4-35
4.9 PAPER FEED	4-36
4.9.1 PAPER FEED CLUTCH.....	4-36
4.9.2 PAPER FEED ROLLER	4-37
4.9.3 SEPARATION PAD	4-38
4.9.4 PAPER END SENSOR	4-39
4.10 PAPER EXIT	4-40
4.10.1 PAPER EXIT ROLLER	4-40
When reinstalling the paper exit roller	4-41
4.10.2 PAPER EXIT SENSOR.....	4-42
4.11 ELECTRICAL COMPONENTS	4-43
4.11.1 CONTROLLER BOARD.....	4-43
Main Controller Board	4-43
PDL Board (M019 only)	4-44
4.11.2 EGB (ENGINE BOARD)	4-45
When installing the new EGB	4-46
4.11.3 FCU	4-46
4.11.4 INTERLOCK SWITCHES.....	4-47
4.11.5 FUSING FAN MOTOR	4-48
4.11.6 LSU FAN MOTOR	4-49
4.11.7 ID CHIP BOARD	4-50
4.11.8 PSU	4-52
Fuse	4-54
4.11.9 HIGH VOLTAGE POWER SUPPLY BOARD	4-54
4.11.10 TEMPERATURE/HUMIDITY SENSOR	4-55
4.11.11 DUPLEX MOTOR.....	4-56
4.11.12 SPEAKER	4-57
4.11.13 EEPROM.....	4-58

Replacement Procedure.....	4-58
PnP Name (Plug and Play) Procedure	4-59
4.12 ADF.....	4-60
4.12.1 ADF UNIT	4-60
4.12.2 ORIGINAL TRAY	4-61
4.12.3 ADF FEED UNIT	4-62
4.12.4 ADF SEPARATION PAD	4-62
4.12.5 ADF FRONT COVER.....	4-63
4.12.6 ADF REAR COVER	4-63
4.12.7 ADF COVER.....	4-64
4.12.8 ADF MOTOR	4-65
4.12.9 ORIGINAL SET SENSOR.....	4-66
4.12.10 ADF COVER OPEN SENSOR	4-67
4.12.11 ADF FEED SENSOR	4-68
4.12.12 ADF DRIVE BOARD	4-69
4.13 SCANNER	4-70
4.13.1 SCANNER UNIT	4-70
4.13.2 SCANNER TOP COVER	4-72
4.13.3 SCANNER CARRIAGE UNIT	4-73
4.13.4 EXPOSURE LAMP	4-75
When reinstalling the exposure lamp	4-76
4.13.5 LAMP STABILIZER BOARD	4-77
4.13.6 SCANNER MOTOR	4-78

SYSTEM MAINTENANCE REFERENCE

5. SYSTEM MAINTENANCE REFERENCE	5-1
5.1 SERVICE PROGRAM.....	5-1
5.1.1 OVERVIEW.....	5-1
5.2 CONFIGURATION PAGE INFORMATION	5-2
5.2.1 OVERVIEW.....	5-2
To Print the Configuration Page/ Maintenance Page	5-2
5.3 FIRMWARE UPDATING	5-3
5.3.1 CHECKING THE MACHINE FIRMWARE VERSION	5-3
5.3.2 UPDATING THE CONTROLLER FIRMWARE	5-3
Preparation.....	5-3
Updating Procedure	5-4

Messages that appear in the update tool window.....	5-6
5.3.3 UPDATING FAILURE	5-10
5.3.4 UPDATING THE ENGINE FIRMWARE	5-12
5.3.5 BOOT LOADER FIRMWARE.....	5-13

TROUBLESHOOTING

6. TROUBLESHOOTING	6-1
6.1 TROUBLESHOOTING GUIDE.....	6-1
6.2 IMAGE PROBLEMS.....	6-2
6.2.1 OVERVIEW.....	6-2
6.2.2 CHECKING A SAMPLE PRINTOUT	6-3
Printer Driver Setting for Printing a Sample.....	6-4

M018/M019 SERVICE MANUAL APPENDICES

SEE M018/M019 SERVICE MANUAL APPENDICES SECTION FOR DETAILED TABLE OF CONTENTS

PRODUCT INFORMATION

APPENDIX: SPECIFICATIONS

TAB
POSITION 1

INSTALLATION

APPENDIX: PREVENTIVE MAINTENANCE

TAB
POSITION 2

PREVENTIVE MAINTENANCE

APPENDIX: TROUBLESHOOTING GUIDE

TAB
POSITION 3

REPLACEMENT AND ADJUSTMENT

APPENDIX: SP MODE TABLES

TAB
POSITION 4

SYSTEM MAINTENANCE REFERENCE

APPENDIX: MACHINE SWAP

TAB
POSITION 5

TROUBLESHOOTING

TAB
POSITION 6

TAB
POSITION 7

TAB
POSITION 8

Read This First

Safety Notices

Important Safety Notices

Prevention of Physical Injury

1. Before disassembling or assembling parts of the machine and peripherals, make sure that the machine power cord is unplugged.
2. The wall outlet should be near the machine and easily accessible.
3. If any adjustment or operation check has to be made with exterior covers off or open while the main switch is turned on, keep hands away from electrified or mechanically driven components.
4. The machine drives some of its components when it completes the warm-up period. Be careful to keep hands away from the mechanical and electrical components as the machine starts operation.
5. The inside and the metal parts of the fusing unit become extremely hot while the machine is operating. Be careful to avoid touching those components with your bare hands.

Health Safety Conditions

Toner is non-toxic, but if you get either of them in your eyes by accident, it may cause temporary eye discomfort. Try to remove with eye drops or flush with water as first aid. If unsuccessful, get medical attention.

Observance of Electrical Safety Standards

The machine and its peripherals must be serviced by a customer service representative who has completed the training course on those models.

Safety and Ecological Notes for Disposal

1. Do not incinerate toner bottles or used toner. Toner dust may ignite suddenly when exposed to an open flame.
2. Dispose of used toner, the maintenance unit which includes developer or the organic photoconductor in accordance with local regulations. (These are non-toxic supplies.)
3. Dispose of replaced parts in accordance with local regulations.

WARNING

- To prevent a fire or explosion, keep the machine away from flammable liquids, gases, and aerosols. A fire or an explosion might occur.

CAUTION

- The Controller board on the MF model contains a lithium battery. The danger of explosion exists if a battery of this type is incorrectly replaced. Replace only with the same or an equivalent type recommended by the manufacturer. Discard batteries in accordance with the manufacturer's instructions and local regulations.

Laser Safety

The Center for Devices and Radiological Health (CDRH) prohibits the repair of laser-based optical units in the field. The optical housing unit can only be repaired in a factory or at a location with the requisite equipment. The laser subsystem is replaceable in the field by a qualified Customer Engineer. The laser chassis is not repairable in the field. Customer engineers are therefore directed to return all chassis and laser subsystems to the factory or service depot when replacement of the optical subsystem is required.

WARNING

- Use of controls, or adjustment, or performance of procedures other than those specified in this manual may result in hazardous radiation exposure.

⚠WARNING

WARNING:

Turn off the main switch before attempting any of the procedures in the Laser Optics Housing Unit section. Laser beams can seriously damage your eyes.







CAUTION MARKING:



3b_decad

Symbols, Abbreviations and Trademarks

This manual uses several symbols and abbreviations. The meaning of those symbols and abbreviations are as follows:

	See or Refer to
	Clip ring
	Screw
	Connector
	Clamp
	E-ring
SEF	Short Edge Feed
LEF	Long Edge Feed

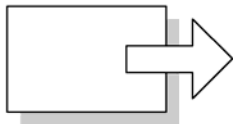

Short Edge Feed (SEF)

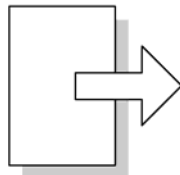

Long Edge Feed (LEF)

Trademarks

Microsoft[®], Windows[®], and MS-DOS[®] are registered trademarks of Microsoft Corporation in the United States and /or other countries.

PostScript[®] is a registered trademark of Adobe Systems, Incorporated.

PCL[®] is a registered trademark of Hewlett-Packard Company.

Ethernet[®] is a registered trademark of Xerox Corporation.

PowerPC[®] is a registered trademark of International Business Machines Corporation.

Other product names used herein are for identification purposes only and may be trademarks of their respective companies. We disclaim any and all rights involved with those marks.

SPECIFICATIONS

SPECIFICATIONS REVISION HISTORY		
Page	Date	Added/Updated/New
		None

1. PRODUCT INFORMATION

1.1 SPECIFICATIONS

See "Appendices" for the following information:

- "General Specifications"
- "Supported Paper Sizes"

1.2 MACHINE OVERVIEW

1.2.1 COMPONENT LAYOUT

Engine

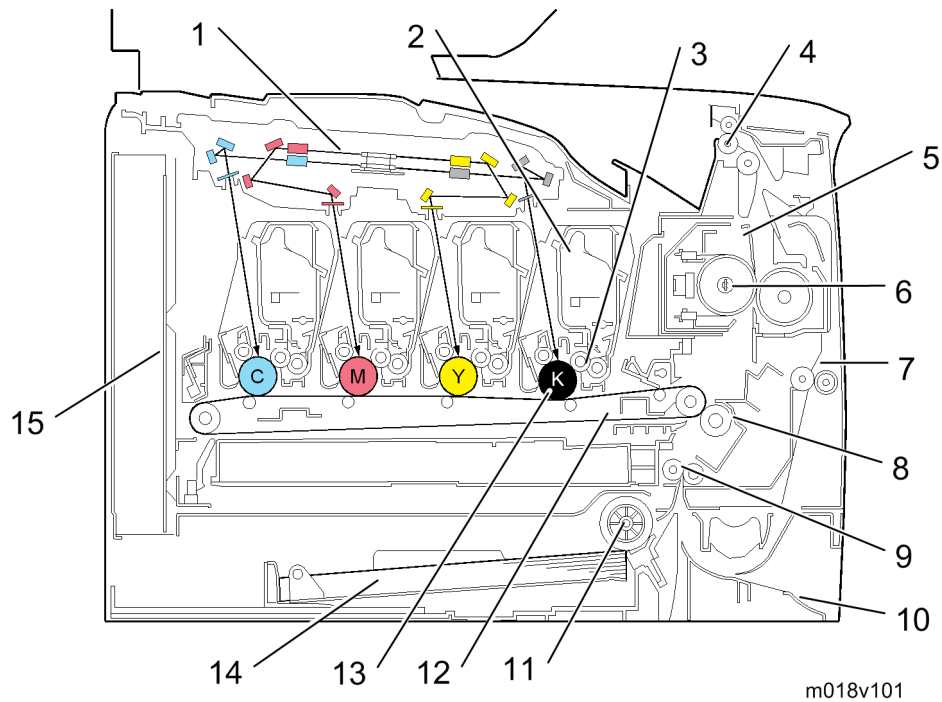

1. Laser Optics Housing Unit	9. Registration Roller
2. Print Cartridge (AIO)	10. By-pass
3. Development Roller (AIO)	11. Paper Feed Roller
4. Paper Exit	12. ITB (Image Transfer Belt) Unit
5. Fusing Unit	13. OPC (AIO)
6. Fusing Lamp	14. Tray 1
7. Duplex Path	15. EGB/Controller
8. Transfer Roller	

ADF

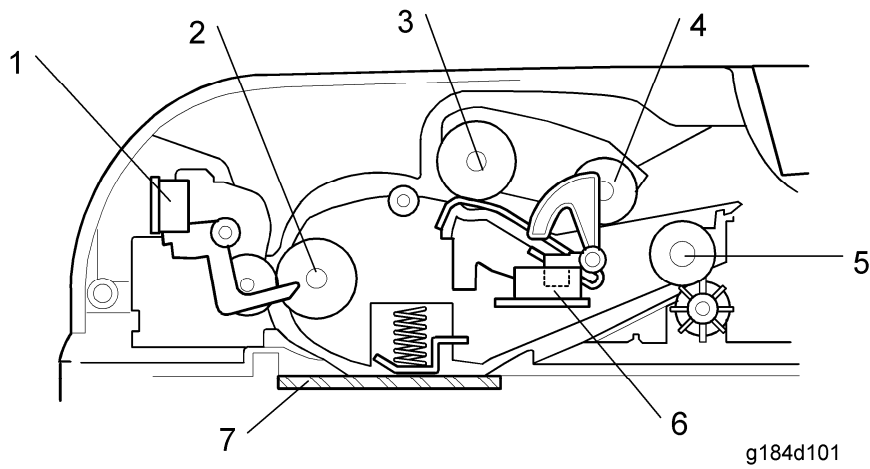

g184d101

<ul style="list-style-type: none"> 1. Feed Sensor 2. Feed Roller 3. Separation Roller 4. Pick-up Roller 	<ul style="list-style-type: none"> 5. Exit Roller 6. Original Set Sensor 7. DF Exposure Glass
---	--

Scanner

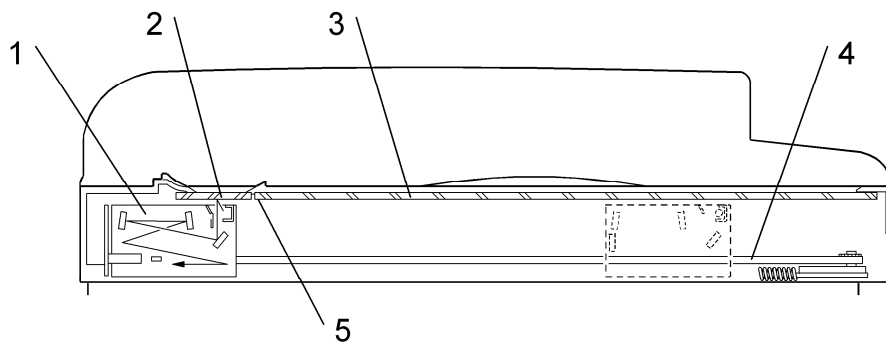

g184d201

<ul style="list-style-type: none"> 1. Scanner Carriage Unit 2. DF Exposure Glass 3. Exposure Glass 	<ul style="list-style-type: none"> 4. Carriage Drive Bar 5. White Plate
---	---

1.2.2 PAPER PATH

Engine

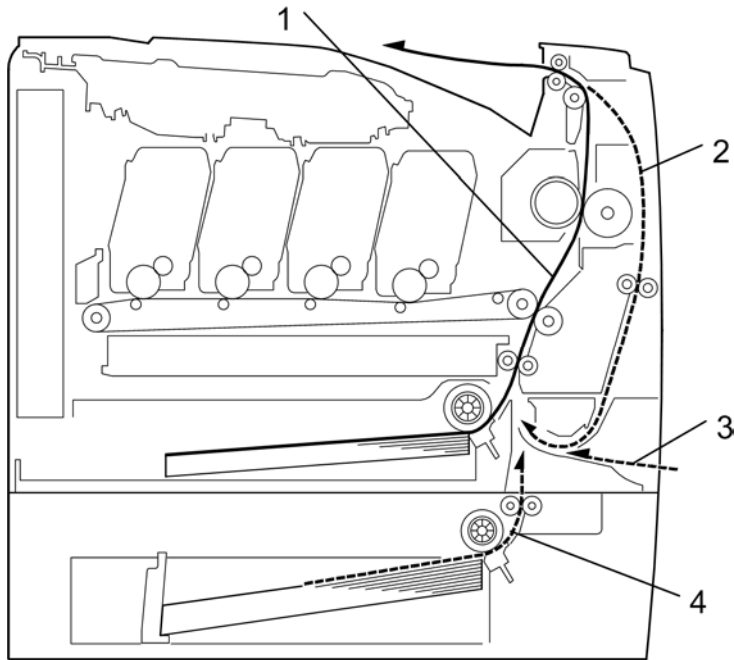

1. Paper path from tray 1
2. Duplex path
3. By-pass tray
4. Paper path from tray 2 (optional)

ADF

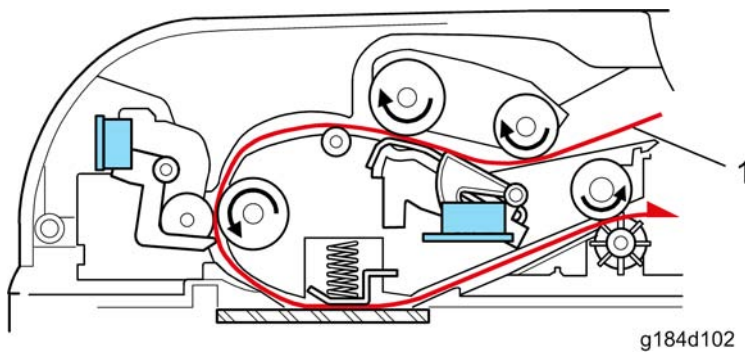

1. Original path

1.2.3 DRIVE LAYOUT

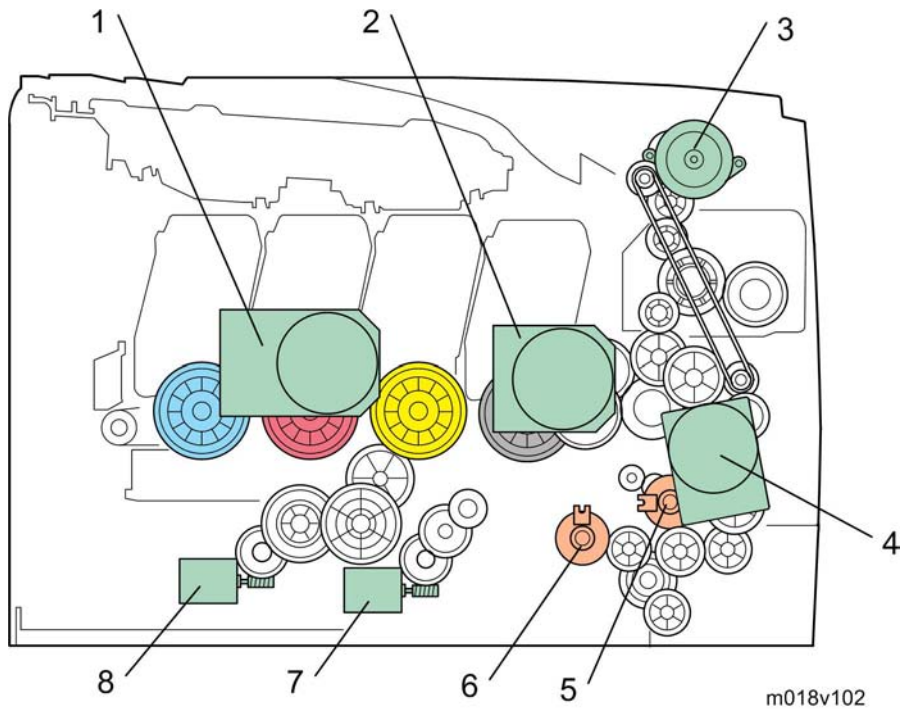

1. Color AIO Motor	5. Registration Clutch
2. Black AIO Motor	6. Paper Feed Clutch
3. Duplex Motor	7. Agitator Motor
4. Transport/Fusing Motor	8. ITB (Image Transfer Belt) Contact Motor

- **Color AIO Motor:**
This drives the color AIOs (Cyan, Magenta and Yellow)
- **Black AIO Motor:**
This drives the black AIO and the ITB (Image Transfer Belt).
- **Duplex Motor:**
This drives the paper exit roller and the duplex roller.
- **Transport/Fusing Motor:**
This drives the fusing unit, paper feed roller, registration roller and paper exit roller via the paper feed clutch, registration clutch and gears.

Machine Overview

- **Registration Clutch:**
This transfers drive from the transport/ fusing motor to the registration roller.
- **Paper Feed Clutch:**
This transfers drive from the transport/ fusing motor to the paper feed roller.
- **Agitator Motor:**
This moves the agitators in the waste toner bottle.
- **ITB Contact Motor:**
This moves the ITB into contact with and away from the color OPCs.

1.3 MACHINE CONFIGURATION

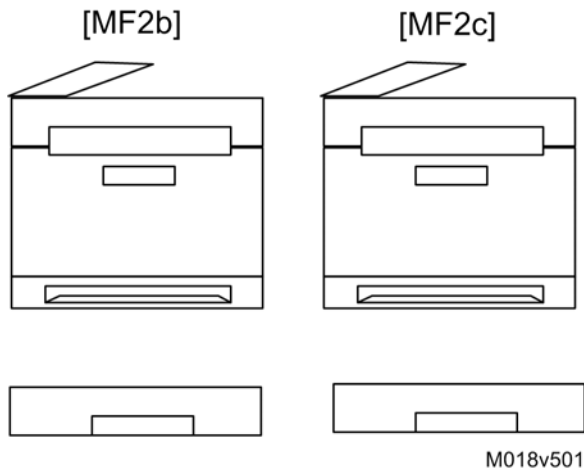

Models	Duplex Unit	Optional Memory	Optional Tray (G849)	DDST (GDI)	PCL PS	Fax
M018	Auto	N	500x1	Y	N	Y
M019	Auto	Y	500x1	N	Y	Y

1.4 GUIDANCE FOR THOSE WHO ARE FAMILIAR WITH PREDECESSOR PRODUCTS

The M018/M019 series models are similar to the G181/G183/G184 series. If you have experience with those products, the following information will be of help when you read this manual.

Different Points from Previous Products

	M018/M019	G181/G183/G184
Print Cartridge (AIO)	Longer life Print Cartridge (AIO)	-
Operation Panel	Four separated menu keys and user tool button	One menu key and no user tool button

INSTALLATION

INSTALLATION REVISION HISTORY		
Page	Date	Added/Updated/New
		None

2. INSTALLATION

2.1 INSTALLATION REQUIREMENTS

2.1.1 ENVIRONMENT

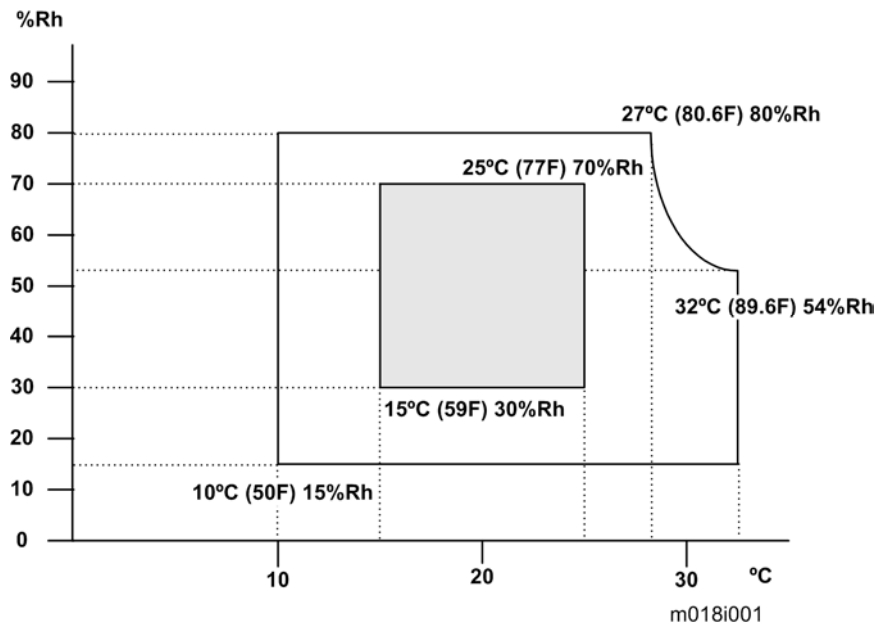

1. Temperature Range: 10°C to 32°C (50°F to 89.6°F)
2. Humidity Range: 15% to 80% RH
3. Ambient Illumination: Less than 2,000 lux (do not expose to direct sunlight)
4. Ventilation: 3 times/hr/person
5. Do not put the machine in areas that get sudden temperature changes. This includes:
 - Areas directly exposed to cool air from an air conditioner
 - Areas directly exposed to heat from a heater.
6. Do not put the machine in areas that get exposed to corrosive gas.
7. Do not install the machine at locations over 2,500 m (8,125 ft.) above sea level.
8. Put the machine on a strong, level base. (Inclination on any side must be no more than 5 mm.)
9. Do not put the machine in areas with strong vibrations.

2.1.2 MACHINE LEVEL

Front to back: Within 5 mm (0.2") of level

Right to left: Within 5 mm (0.2") of level

Installation Requirements

2.1.3 MACHINE SPACE REQUIREMENT

Put the machine near the power source with these clearances:

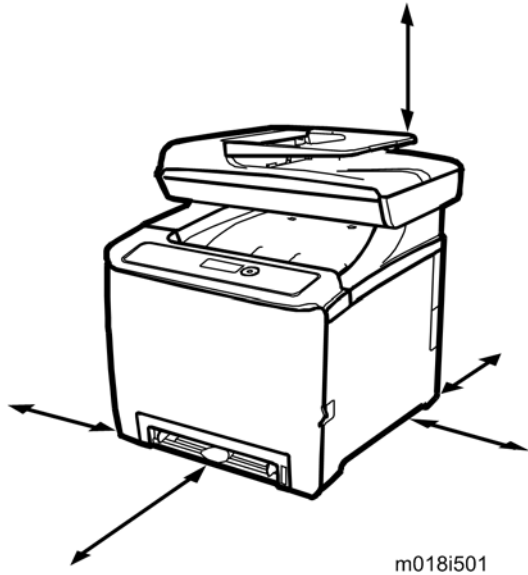

Left side: Over 20 cm (7.9")

Rear: Over 20 cm (7.9")

Right side: Over 10 cm (4")

Front: Over 70 cm (27.5")

Top: Over 24 cm (9.5")

2.1.4 POWER REQUIREMENTS

CAUTION

- Make sure that the plug is tightly in the outlet.
- Avoid multi-wiring.
- Make sure that you ground the machine.

Input voltage level	120 V, 60 Hz: More than 11 A (for North America) 220 V to 240 V, 50 Hz/60 Hz: More than 6 A (for Europe/ Asia)
Permitted voltage fluctuation: 10%	
Do not set anything on the power cord.	

2.1.5 INSTALLATION PROCEDURE

Refer to the Quick Installation Guide for details about installing the machine.

PREVENTIVE MAINTENANCE

PREVENTIVE MAINTENANCE REVISION HISTORY		
Page	Date	Added/Updated/New
		None

3. PREVENTIVE MAINTENANCE

3.1 PREVENTIVE MAINTENANCE

See "Appendices" for the "User Replaceable Items."

REPLACEMENT & ADJUSTMENT

REPLACEMENT & ADJUSTMENT REVISION HISTORY		
Page	Date	Added/Updated/New
58 ~ 59	02/03/2010	Added <i>PnP Name (Plug and Play) Procedure</i>

4. REPLACEMENT & ADJUSTMENT

4.1 BEFORE YOU START

CAUTION

- If there are printer jobs in the machine, print out all jobs in the printer buffer.
- Turn off the main power switch and unplug the machine before you do the procedures in this section.

Special Tools

4.2 SPECIAL TOOLS

- PC: Windows 2000/XP/Vista, Windows Server 2003/2003 R2, or Mac OS X.
- USB cable or Crossover cable

4.3 EXTERIOR COVERS

CAUTION

- Turn off the main power switch and unplug the machine before you do the procedures in this section.

4.3.1 REAR COVER



m018r503

1. Rear tray cover [A]

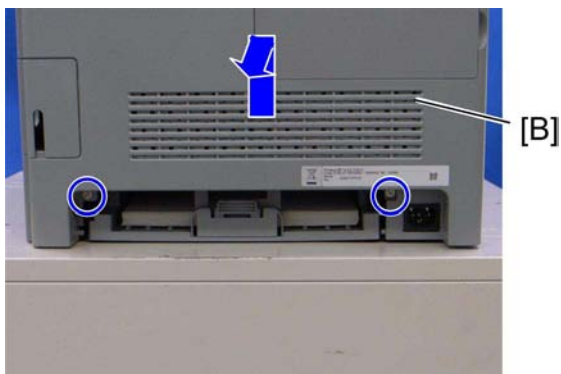

m018r504

2. Rear cover [B] ( x 2)

4.3.2 OPERATION PANEL



m018r512

1. Open the top cover [A].



m018r522

2. Open the front cover [B].
3. Front harness cover [C] (🔑 x 1)



m018r523

4. Operation panel [D] (🔑 x 1, 📄 x 1)

4.3.3 RIGHT COVER

1. Rear cover (➔ p.4-3)
2. Operation panel (➔ p.4-4)

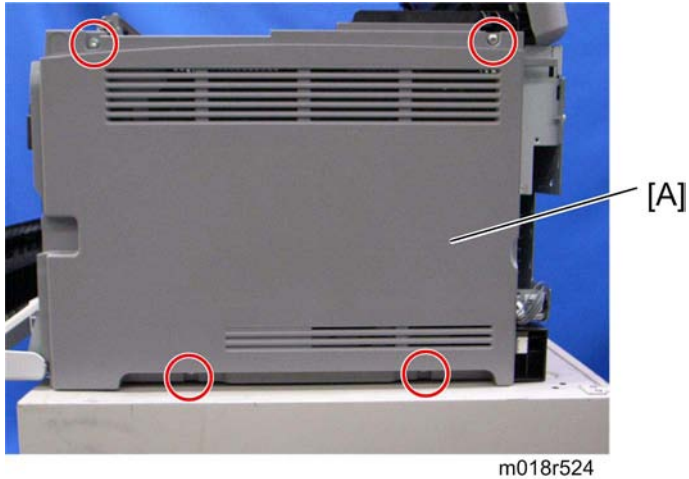

3. Right cover [A] (🔩 x 4)

↓ Note

- Top front screw: M3x8, others: M4x10

4.3.4 LEFT COVER

1. Rear cover (➔ p.4-3)
2. Operation panel (➔ p.4-4)

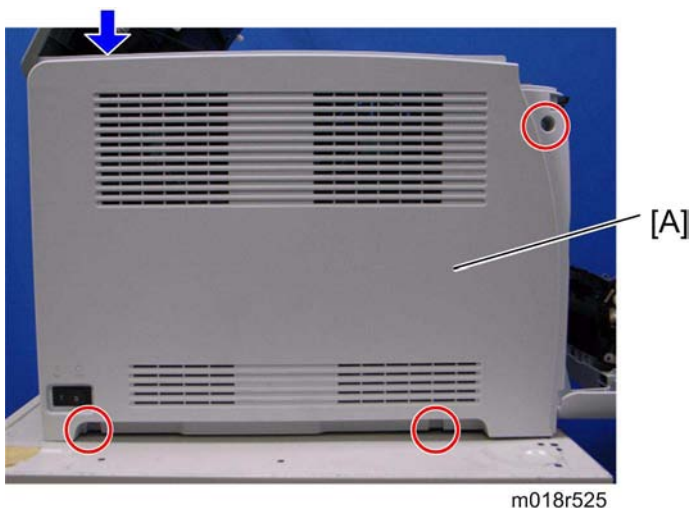

3. Left cover [A] (🔩 x 3, hook at arrow mark)

↓ Note

- Top front screw: M3x8, others: M4x10

4.3.5 FRONT COVER UNIT

1. Rear cover (➔ p.4-3)
2. Operation panel (➔ p.4-4)
3. Transfer unit (➔ p.4-27)
4. Right cover (➔ p.4-5)

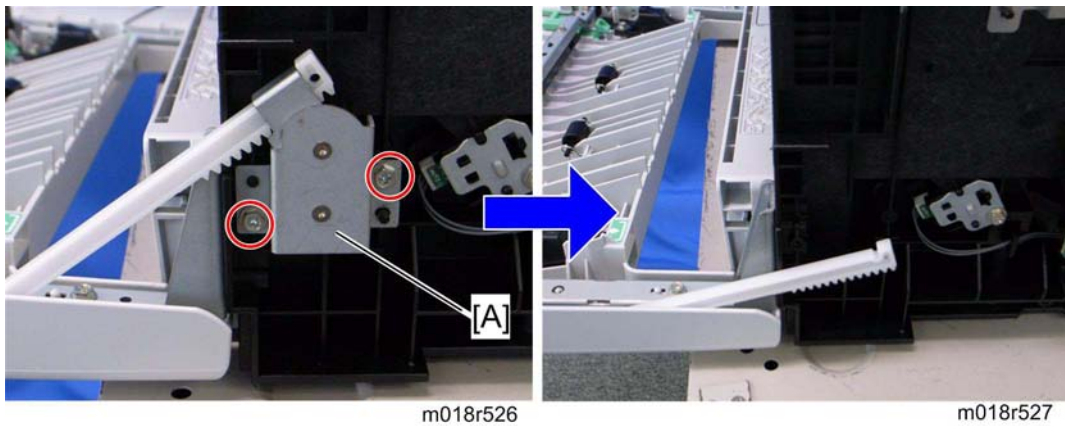

5. Cover link gear unit [A] (⚙️ x 2)

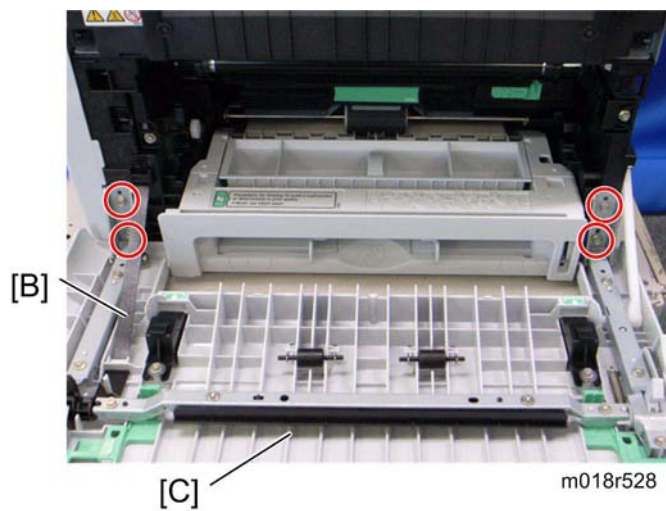

6. Release the belt [B]
7. Front cover unit [C] (⚙️ x 4)

4.4 LASER OPTICS

WARNING

- Turn off the main power switch and unplug the machine before beginning any of the procedures in this section. Laser beams can cause serious eye injury.

4.4.1 CAUTION DECAL LOCATION

Caution decals are attached as shown below.

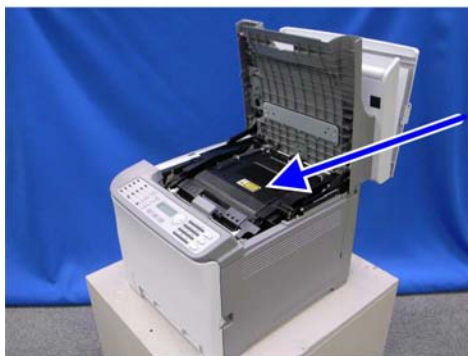

m018r501



WARNING

- Be sure to turn off the main power switch and disconnect the power plug from the power outlet before beginning any disassembly or adjustment of the laser unit. This printer uses a class IIIb laser beam with a wavelength of 780 nm and an output of 7 mW. The laser can cause serious eye injury.

4.4.2 LASER OPTICS HOUSING UNIT

1. Rear cover (➡ p.4-3)
2. Controller box cover (➡ p.4-43 "Controller Board")
3. Remove the controller bracket (➡ p.4-45 "EGB (Engine Board)")



m018r510

4. Disconnect the three harnesses from CN301, 302 and 303 on the EGB (🔌 x 3).



m018r512

5. Open the top cover [A].

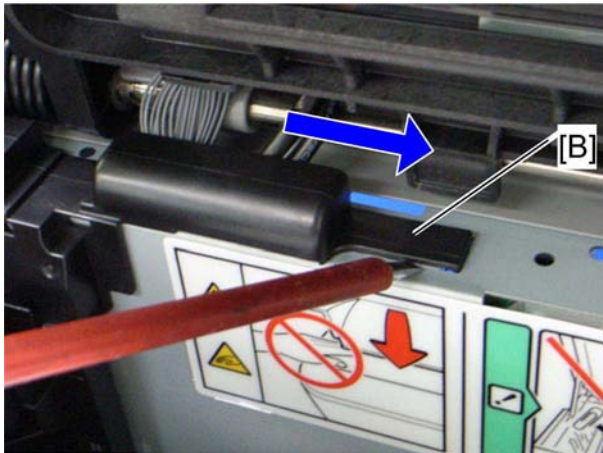

m018r514

6. Lift up the hook [B] of the harness guide at the rear-left frame and slide the harness guide to the right.

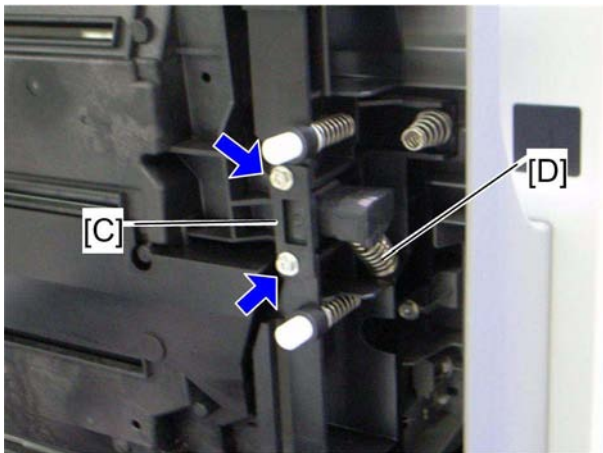

m018r515

7. Remove the springs [D] (left side and right side).
8. Stoppers [C] (x 2 each; left side and right side)



m018r516



m018r517

9. Remove the laser optics housing unit [E] from the top cover and place it on the main body.

Laser Optics

↓ Note

- Always use two hands when carrying the laser optics housing unit. Be sure not to drop the laser optics housing unit.

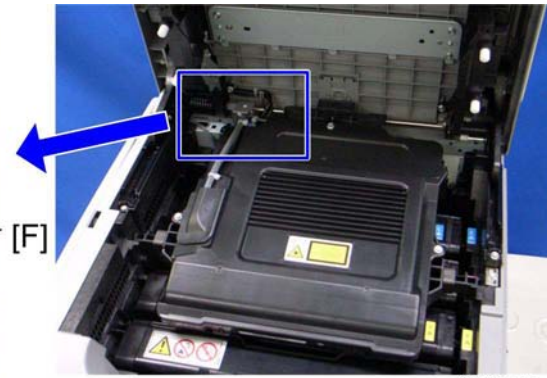
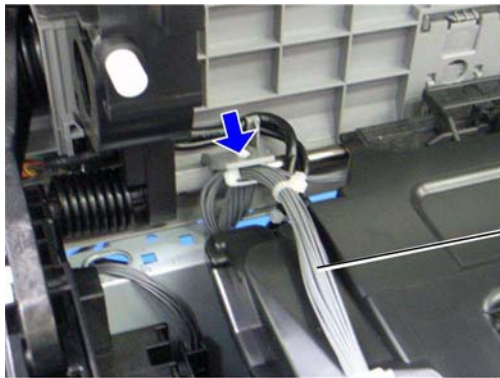

10. Take out the harnesses [F] (x 1).
11. Pull out the harnesses from the rear side.

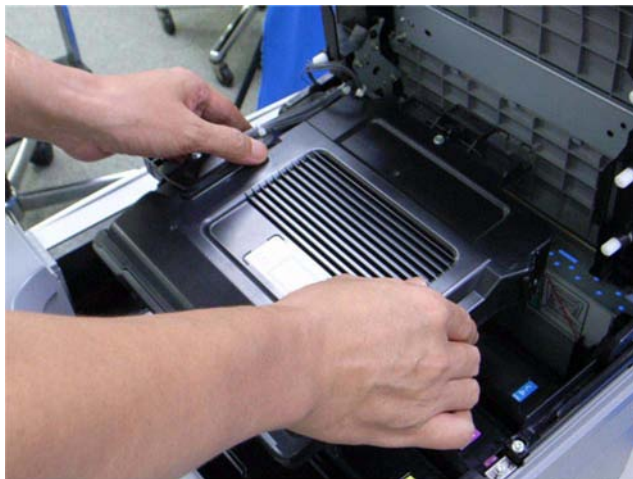

12. Remove the laser optics housing unit.

After replacing the laser optics housing unit**★ Important**

- Do the following step 4 with the front cover of the machine open.

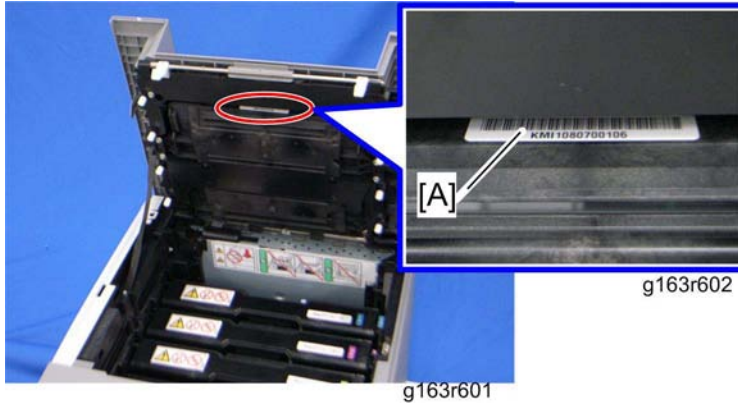

- Open the front cover and turn on the machine.
- Look for the lot number [A] attached to the new laser optics housing unit. Then look for this lot number on the information sheet (this sheet will be released separately, and will contain lists of input data for each lot number)

Input the data for this lot number from the information sheets with steps 3 to 7 below.

- Open the front cover and turn on the machine.
- Input the setting values for the laser optics housing unit ("User Tools" > "Maintenance Mode" > "Engine Maintenance" > "LSU Adjustment").
- Close the front cover.
- Execute "Color Registration" in the "Engine Maintenance" menu.
- Adjust the registration settings for each tray and for the front and rear sides of the paper with the "Engine Maintenance" menu if necessary.

AIO Cartridge

4.5 AIO CARTRIDGE

4.5.1 AIO CARTRIDGE (ALL IN ONE CARTRIDGE)

1. Open the top cover.



2. AIO cartridge [A]

4.5.2 BLACK AIO MOTOR

1. Left cover (➔ p.4-5)

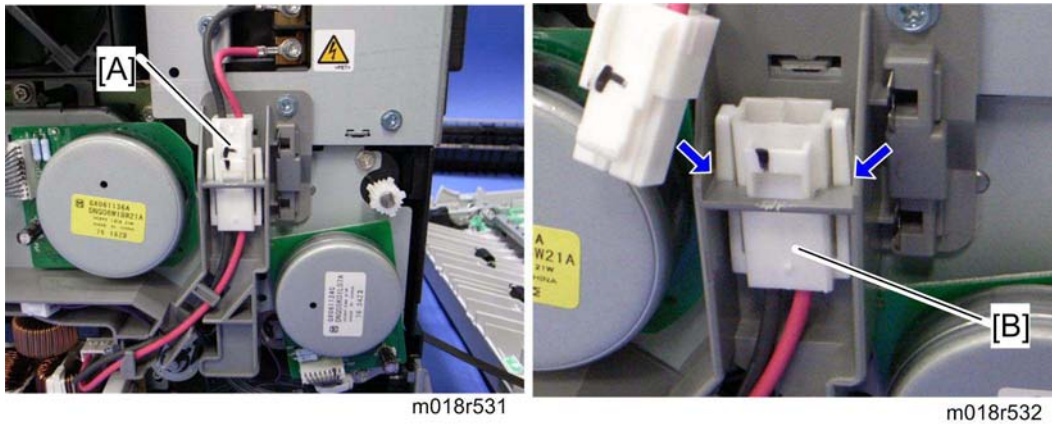

2. Disconnect the fusing connector [A] and remove the fusing relay harness [B] (hooks).

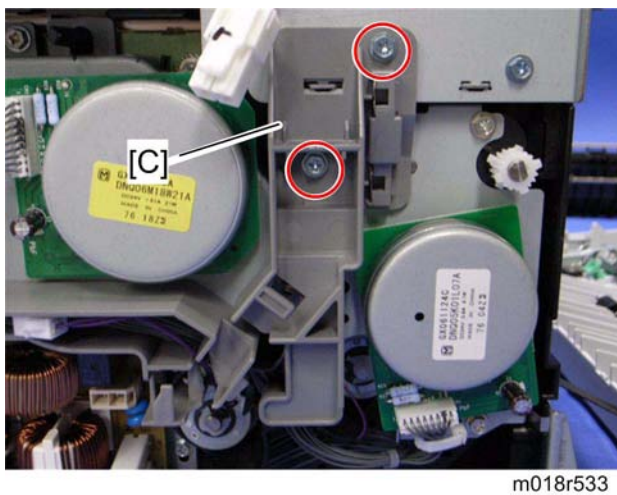

3. Fusing harness guide [C] (⚙️ x 2)

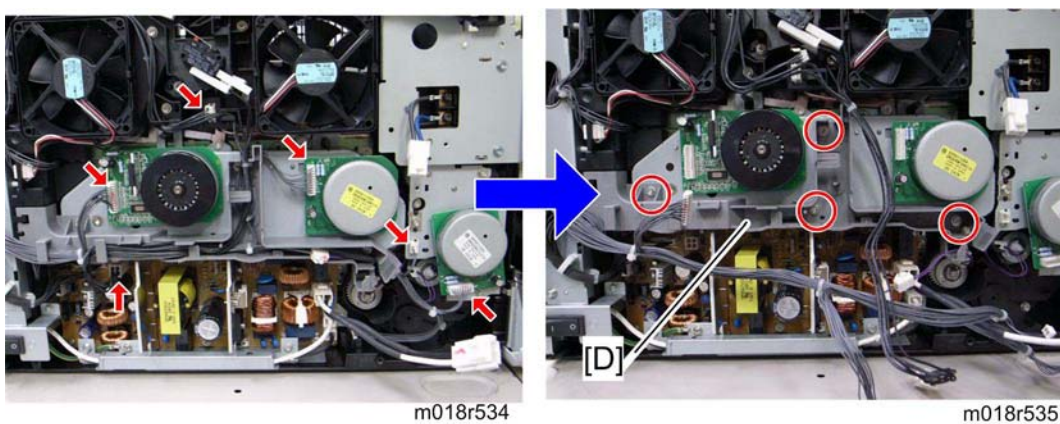

4. Disconnect the connectors shown by arrows in the above picture and release all harnesses on the harness guide [D].

Replacement
&
Adjustment

AIO Cartridge

5. Harness guide [D] (🔩 x 4)
6. Interlock switch base (➡ Interlock Switches)
7. Controller bracket (➡ p.4-43 "Controller Board")
8. Disconnect the connector (CN305) on the EGB.

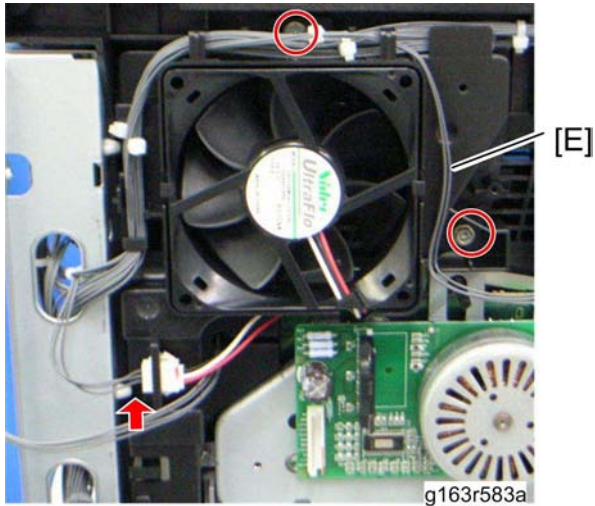

9. LSU fan motor base [E] (🔩 x 2, 🛠 x 1)

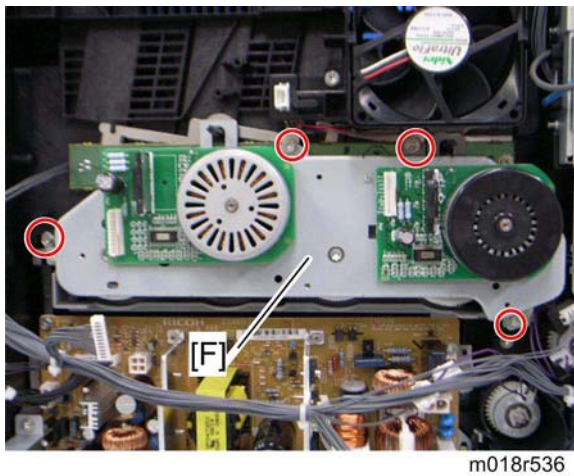

10. Drive unit [F] (🔩 x 4)

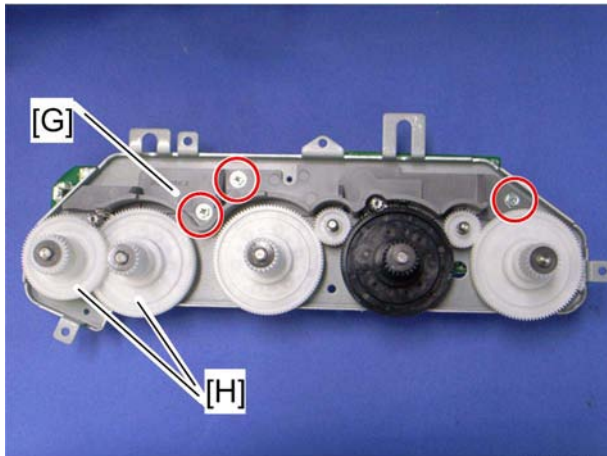

m018r537

- 11. Drive unit guide [G] (🔩 x 3)
- 12. Black AIO gear [H] (snap ring x 1)

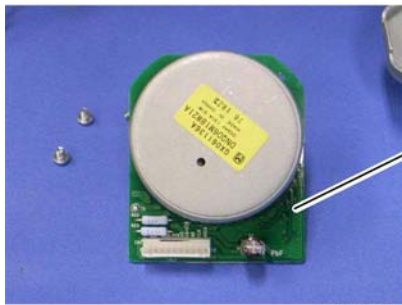

m018r541

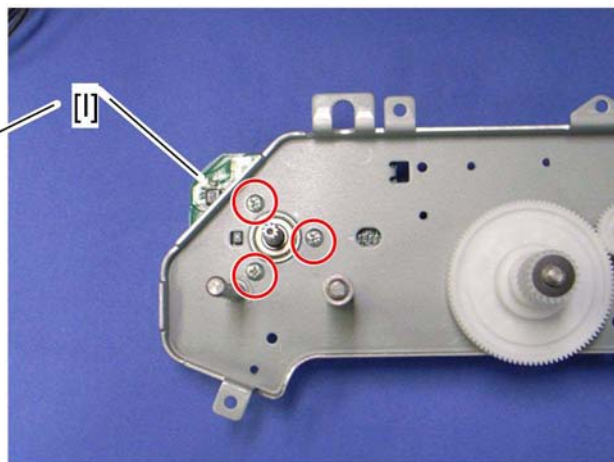

m018r540

- 13. Black AIO motor [I] (🔩 x 3)

Replacement
&
Adjustment

4.5.3 COLOR AIO MOTOR

1. Drive unit (➔ p.4-13 "Black AIO Motor")

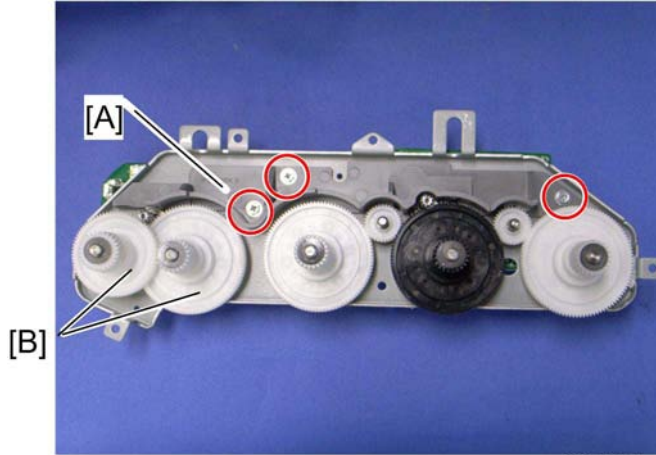

m018r537a

2. Drive unit guide [A] (⚙ x 3)
3. Color AIO gears [B] (ring stopper x 1 each)

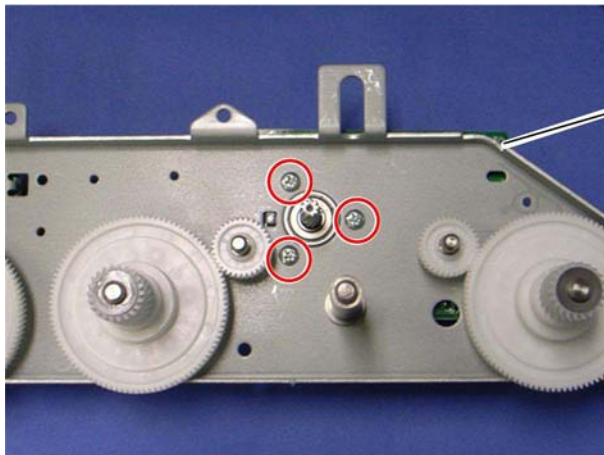

m018r538

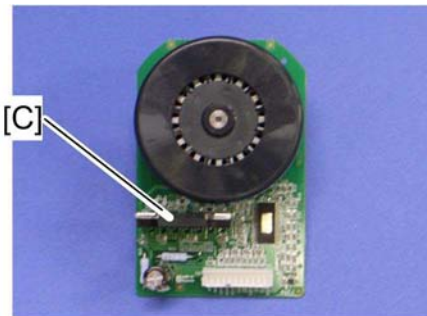

m018r539

4. Color AIO motor [C] (⚙ x 3)

4.6 IMAGE TRANSFER

4.6.1 IMAGE TRANSFER BELT UNIT

1. Remove all the AIO cartridges (➔ p.4-12).
2. Transfer unit (➔ p.4-27)

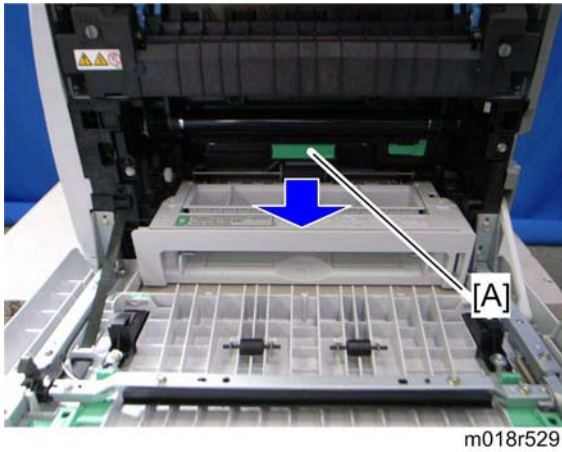

3. Pull out the waste toner bottle [A].

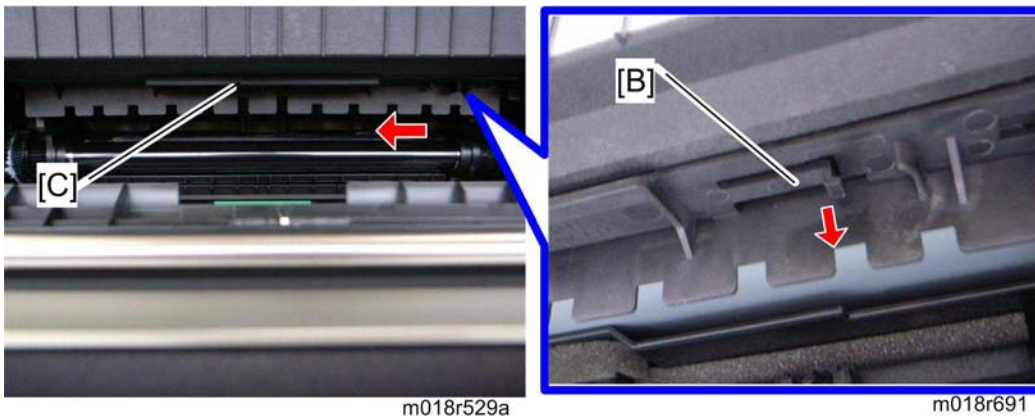

4. Release the hook [B] under the guide plate.
5. Move the guide plate [C] underneath the fusing unit to the left, and then remove it.

Image Transfer

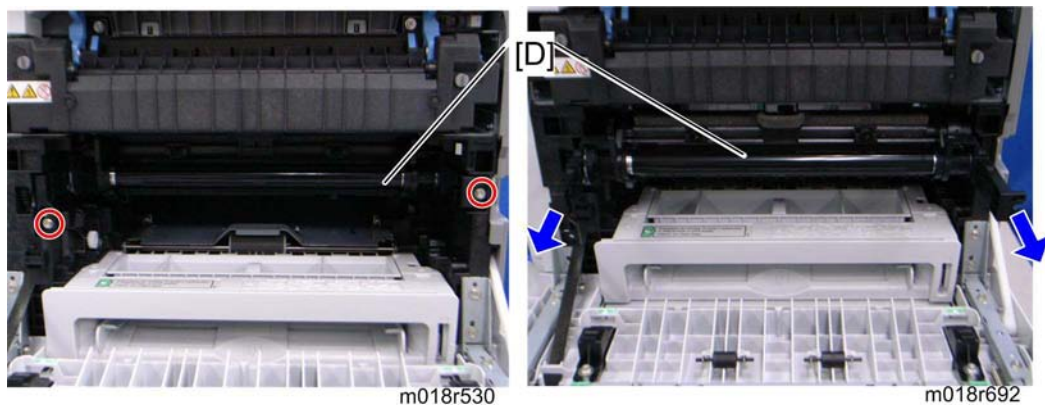

6. Pull out the image transfer belt unit [D] (🔧 x 2).

After replacing the image transfer belt unit

★ Important

- Do the following step 2 with the front cover of the machine open.
1. Open the front cover and turn on the machine.
 2. Execute "Reset Transfer Unit Life Counter" with the "Engine Maintenance" menu.
 3. Close the front cover.
 4. Execute "Trans. Belt Adjust" with the "Engine Maintenance" menu.
 5. Adjust the registration settings for each tray and for the front and rear sides of the paper with the "Engine Maintenance" menu if necessary.

4.6.2 ITB (IMAGE TRANSFER BELT) CLEANING UNIT

↓ Note

- The ITB cleaning unit contains waste toner. When removing the ITB cleaning unit, put it on a sheet of paper.

1. Image transfer belt unit (↔ p.4-17)

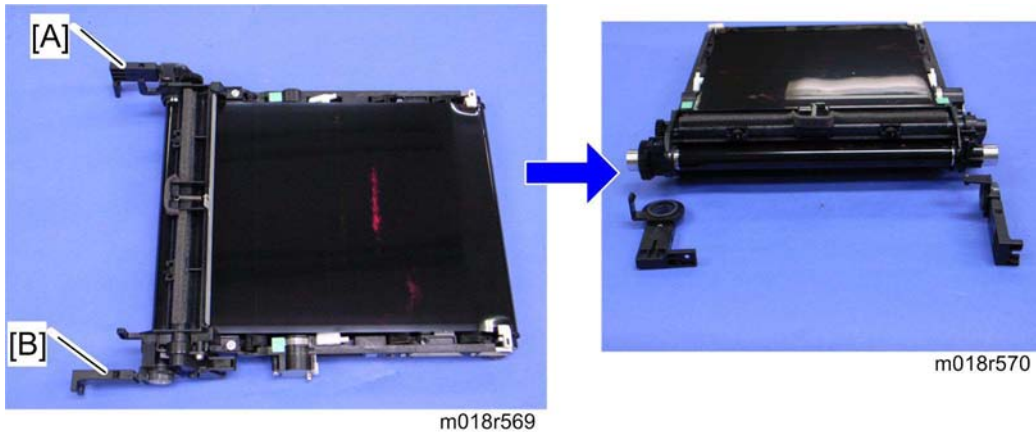

2. Left handle [A] (hook, bushing x 1)
3. Right handle [B] (hook, bushing x 1)

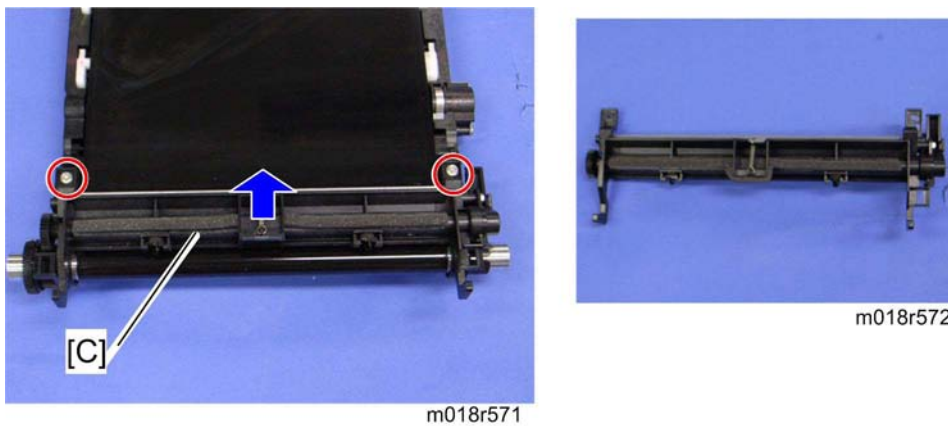

4. ITB cleaning unit [C] (🔩 x 2)

4.6.3 AGITATOR MOTOR

1. Right cover (➔ p.4-5)

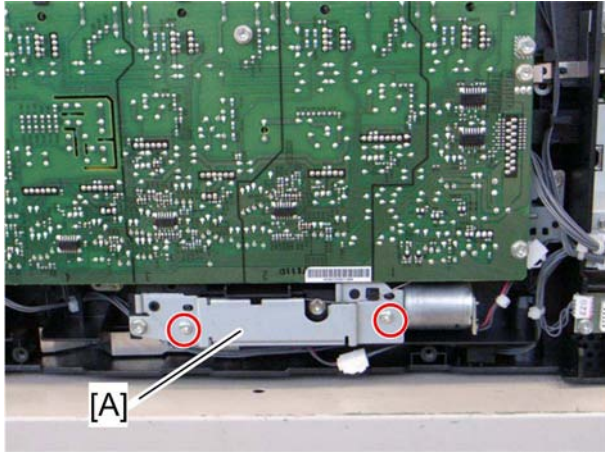

m018r541

2. Motor bracket [A] (🔩 x 2)

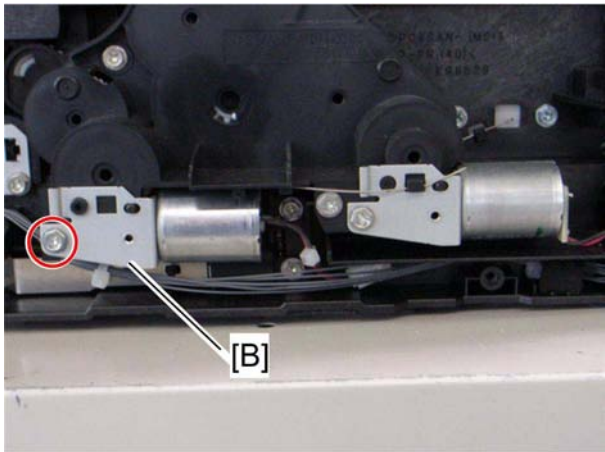

m018r542

3. Agitator motor assembly [B] (🔩 x 1, 📌 x 1)

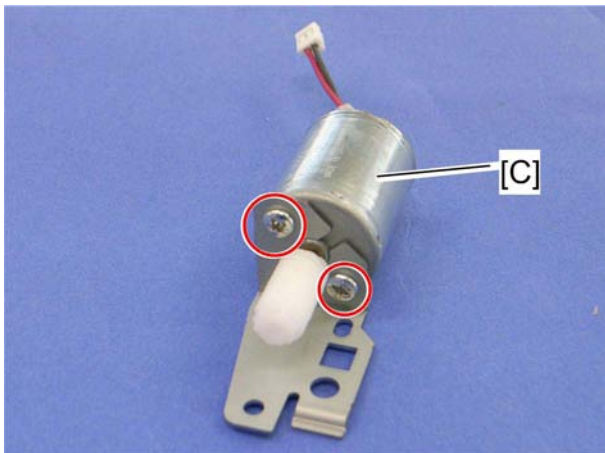

m018r543

4. Agitator motor [C] (🔩 x 2)

4.6.4 ITB (IMAGE TRANSFER BELT) CONTACT MOTOR

1. Agitator motor (↔ p.4-20)

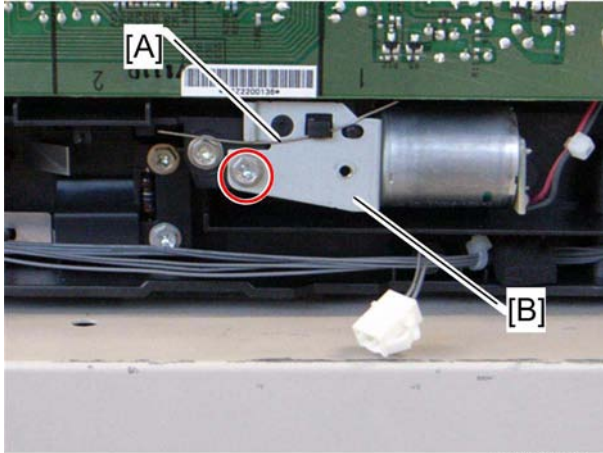

m018r544

2. Release the wire [A].
3. ITB contact motor assembly [B] (🔩 x 1, 📏 x 1)

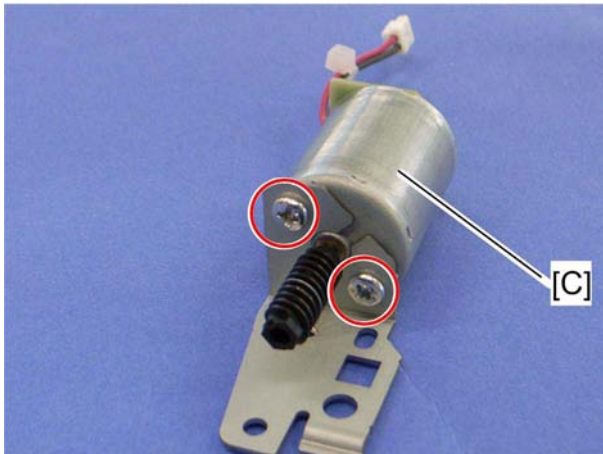

m018r545

4. ITB contact motor [C] (🔩 x 2)

4.6.5 ITB (IMAGE TRANSFER BELT) CONTACT SENSOR

1. Right cover (➔ p.4-5)
2. High voltage power supply board (➔ p.4-54)

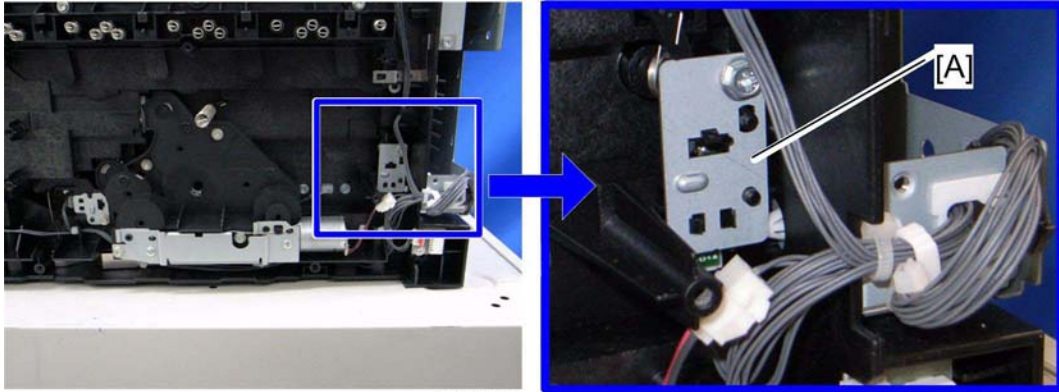

m018r546

m018r547

3. ITB contact sensor assembly [A] (🔧 x 1, 📏 x 1)

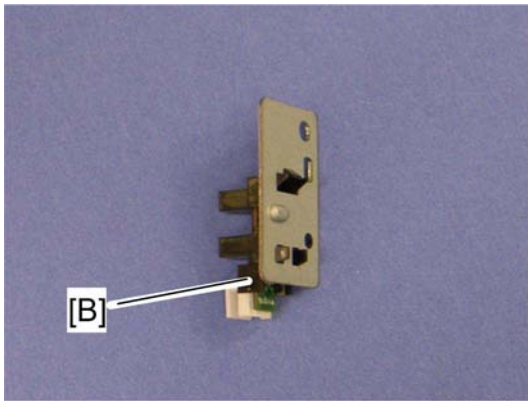

m018r548

4. ITB contact sensor [B] (hooks)

4.6.6 TM (TONER MARK) SENSOR BASE

1. Open the top cover.
2. Remove all AIO cartridges (➔ p.4-12).
3. Slide the ITB unit to the front side or remove it.
4. Rear cover (➔ p.4-5)
5. Controller box cover (➔ p.4-43 "Controller Board")
6. Controller bracket (➔ p.4-45 "EGB (Engine Board)")



m018r689

7. Disconnect CN306 on the EGB (🖨️ x 1).

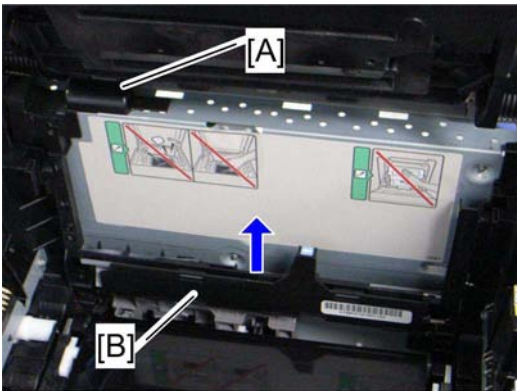

m018r573

8. Harness cover [A] (hook)
9. TM sensor base [B]

4.6.7 WASTE TONER BOTTLE SET SENSOR

1. Remove all AIO cartridges. (↖ p.4-12)
2. Image transfer belt unit (↖ p.4-17)
3. EGB (↖ p.4-45)

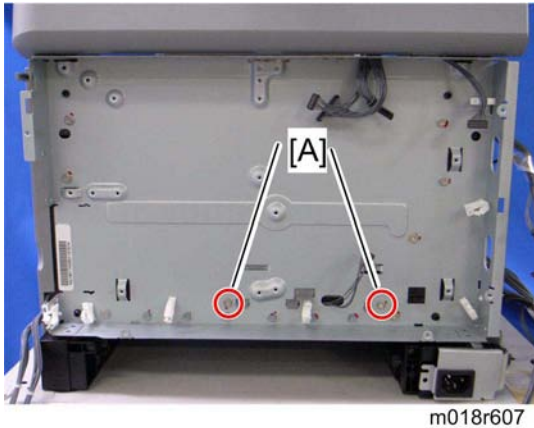

m018r607

4. Remove two screws [A] for the waste toner sensor base.

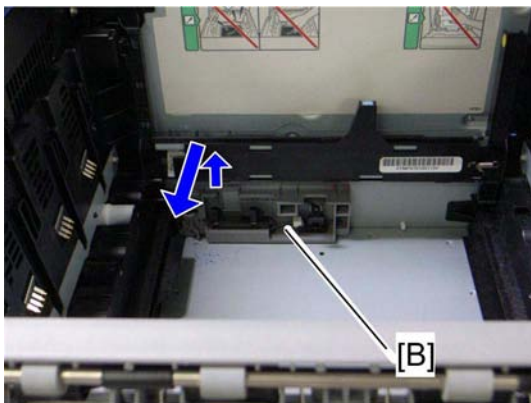

m018r608

5. Waste toner sensor base [B]

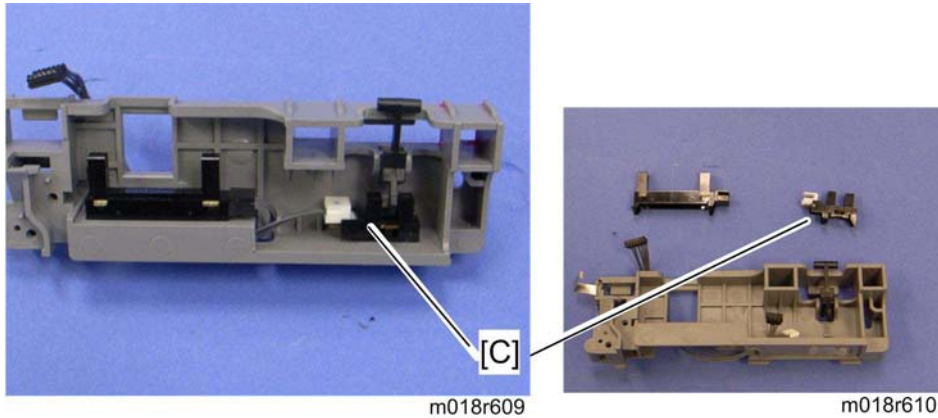

6. Remove the mylar fixing three hooks of the waste toner bottle set sensor.
7. Waste toner bottle set sensor [C] (hooks, x 1)

↓ Note

- When reinstalling the waste toner bottle set sensor, connect it to the white connector of the harness.

4.6.8 WASTE TONER OVERFLOW SENSOR

1. Remove all AIO cartridges. (↖ p.4-12)
2. Image transfer belt unit (↖ p.4-17)
3. EGB (↖ p.4-45)
4. Waste toner sensor base (↖ p.4-24 "Waste Toner Bottle Set Sensor")

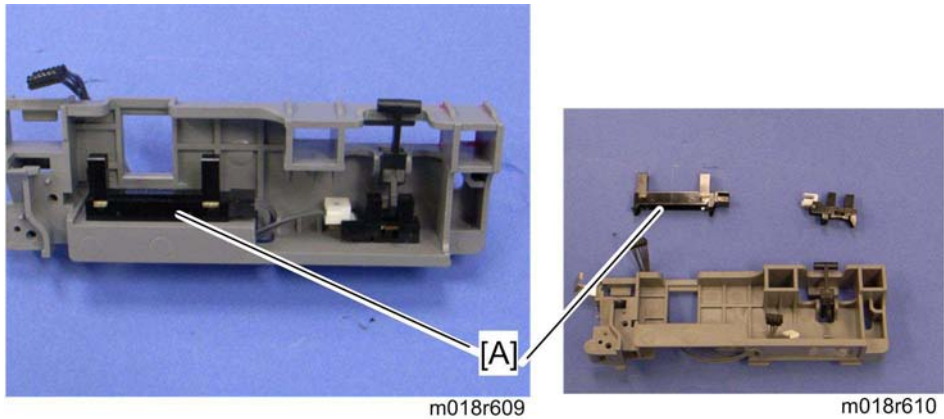

5. Remove the mylar fixing three hooks of the waste toner bottle set sensor.
6. Waste toner overflow sensor [A] (hooks,  x 1)

 Note

- When reinstalling the waste toner overflow sensor, connect it to the black connector of the harness.

4.7 PAPER TRANSFER

4.7.1 TRANSFER UNIT

1. Open the front cover.

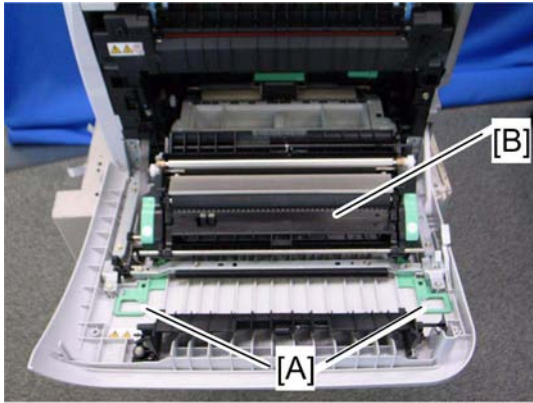

m018r549

2. Release the locks [A].
3. Transfer unit [B]

4.7.2 TRANSFER ROLLER

1. Transfer Unit (↪ p.4-27)



1. Release the two hooks [A] at both sides of the transfer unit.

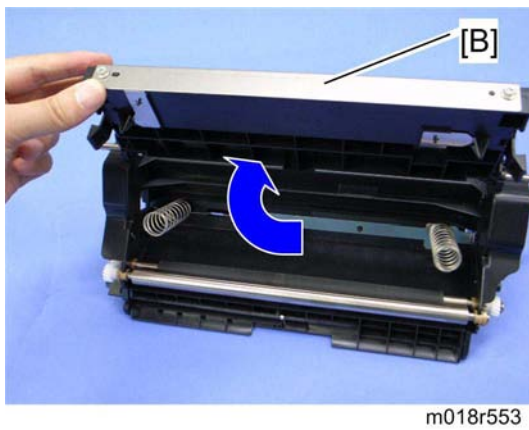

2. Open the transfer roller unit [B] and remove it.

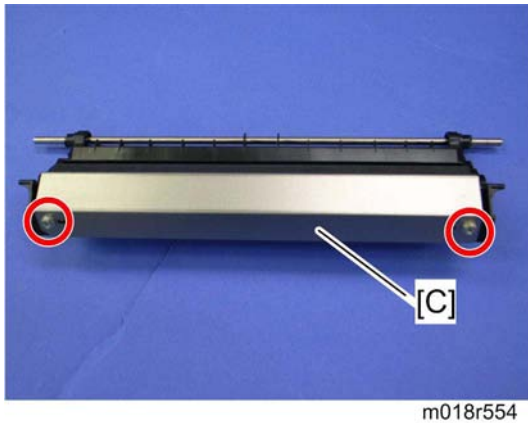

3. Transfer roller assembly [C] (⚙️ x 2)

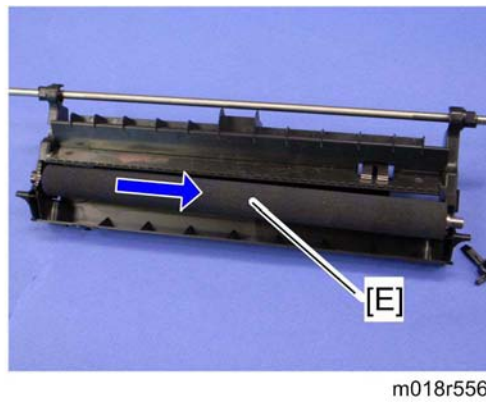
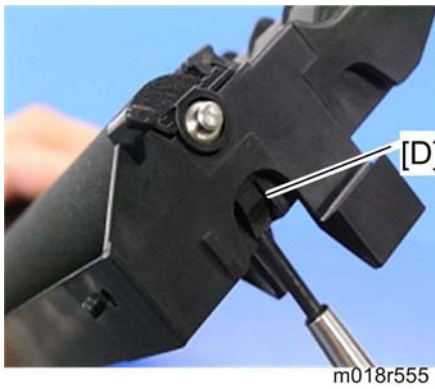

4. Release the holder [D] at the left side of the transfer roller unit (hook).
5. Transfer roller [E]

4.7.3 REGISTRATION ROLLER

1. Transfer unit (↗ p.4-27)
2. Transfer roller unit (↗ p.4-28)

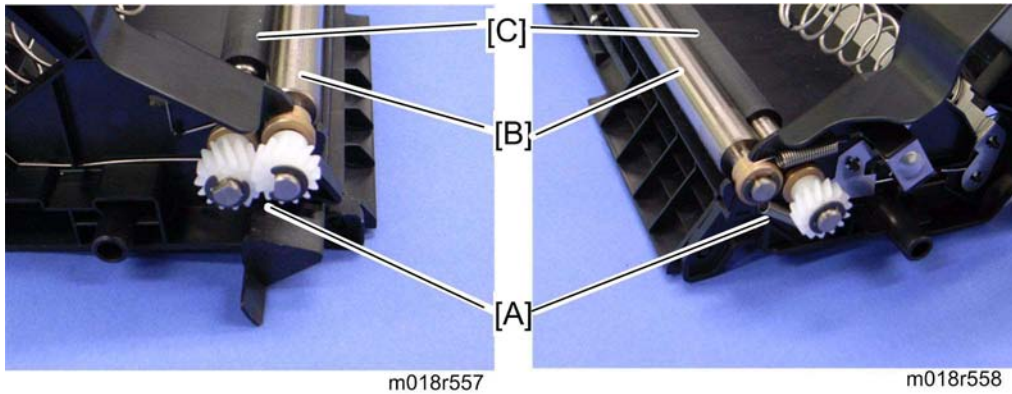

3. Tension springs [A] (both sides)
4. Registration idle roller [B] (⌀ x 2, gear x 1, bushing x 2)
5. Registration roller [C] (⌀ x 2, gear x 2, bushing x 2)

Reassembling the registration roller unit

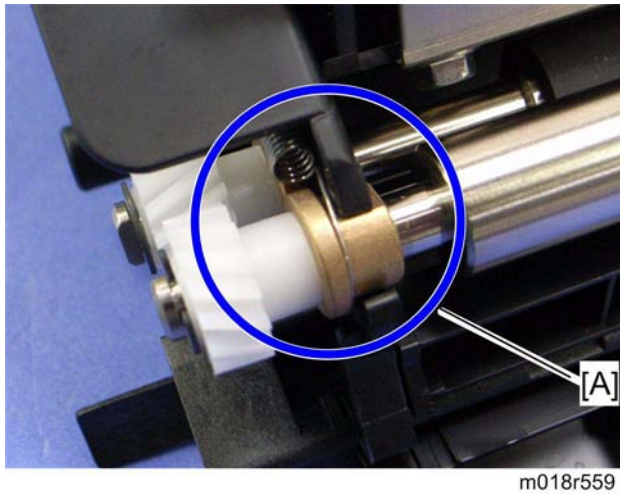

When installing the tension spring, make sure that the tension spring correctly hooks onto the bushing of the registration idle roller as shown above [A].

4.7.4 REGISTRATION SENSOR

1. Rear cover (➔ p.4-3)
2. Right Cover (➔ p.4-5)

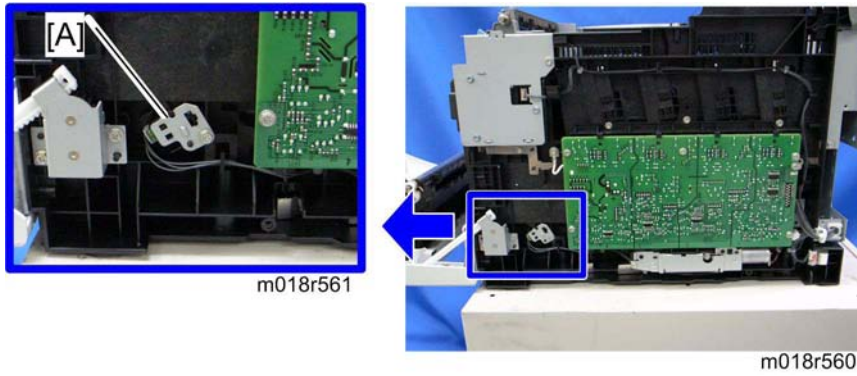

3. Registration sensor assembly [A] (🔧 x 1, 📦 x 1)

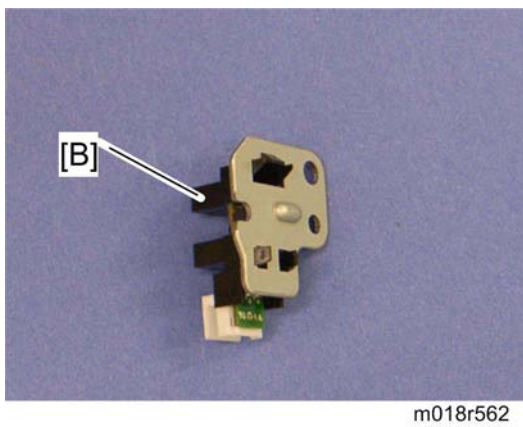

4. Registration sensor [B] (hooks)

4.7.5 REGISTRATION CLUTCH

1. Rear cover (➔ p.4-3)
2. Left cover (➔ p.4-5)
3. Transport/Fusing motor (➔ p.4-35)

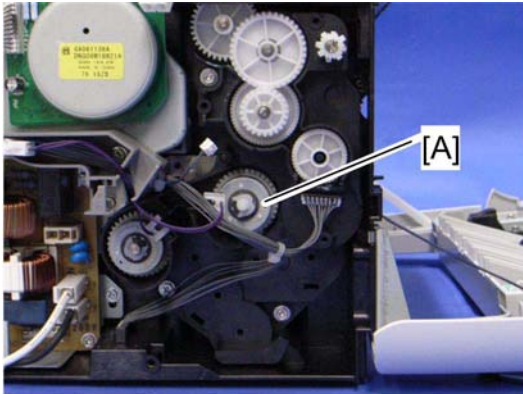

m018d592

4. Registration clutch [A] (🔗 x 1)

4.8 IMAGE FUSING

⚠ CAUTION

- Make sure that the fusing unit is cool before you touch it. The fusing unit can be very hot.
- Make sure to restore the insulators, shields, etc after you service the fusing unit.

4.8.1 FUSING UNIT

1. Open the front cover.
2. Rear cover (➡ p.4-3)
3. Right cover (➡ p.4-5)
4. Left cover (➡ p.4-5)

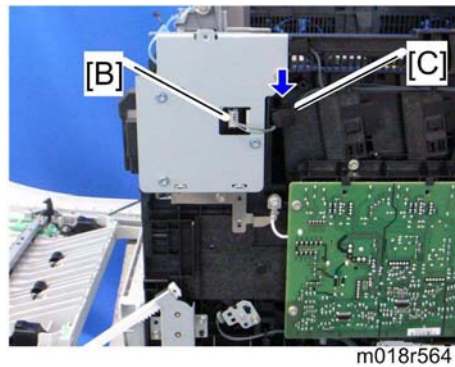
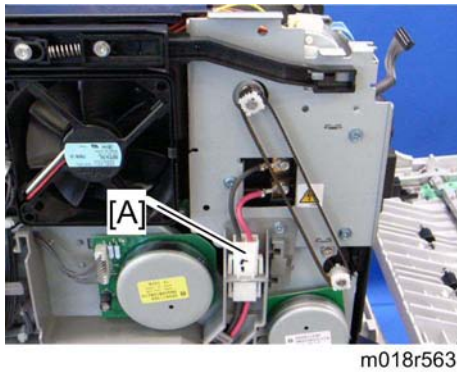

5. Disconnect the connectors [A] (hook) [B].

↓ Note

- The sponge [C] clamps the harness. Install this sponge in the same position after reinstalling the fusing unit.

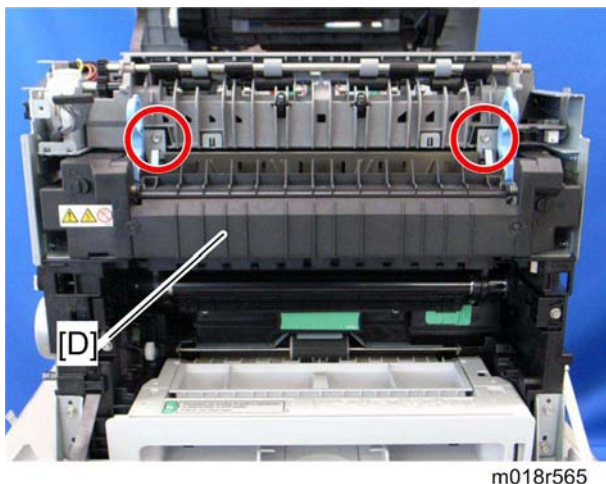

6. Fusing unit [D] (🔧 x 2)

4.8.2 FUSING LAMP

1. Fusing unit (↪ p.4-33)

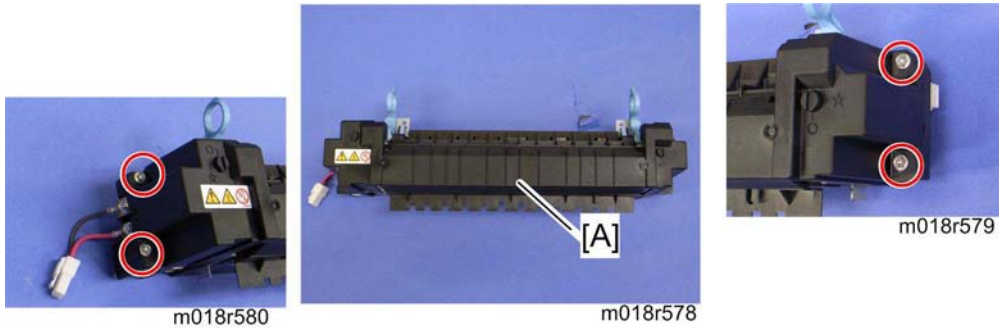

2. Fusing front cover [A] (⚙ x 4)



3. Fusing lamp [B] (⚙ x 2, ground cable x 1)

When Reinstalling the Fusing Lamp

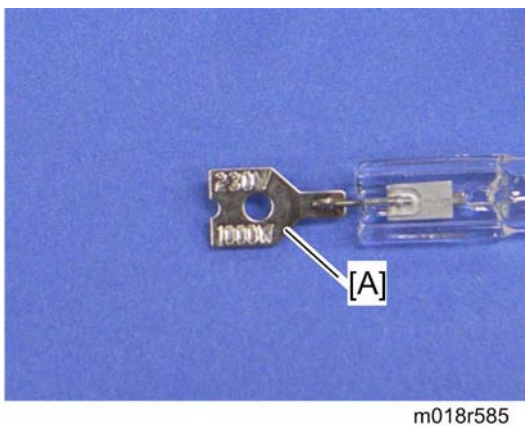

The terminal [A], which shows the voltage and power ratings, must be placed at the left side of the fusing unit (fusing cable side).

4.8.3 TRANSPORT/FUSING MOTOR

1. Rear cover (➔ p.4-3)
2. Left cover (➔ p.4-5)

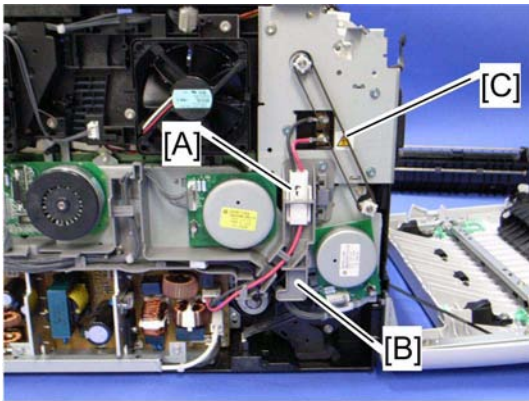

m018r587

3. Disconnect the fusing connector [A] (hook).
4. Fusing harness guide [B] (⚙️ x 2)
5. Duplex timing belt [C]

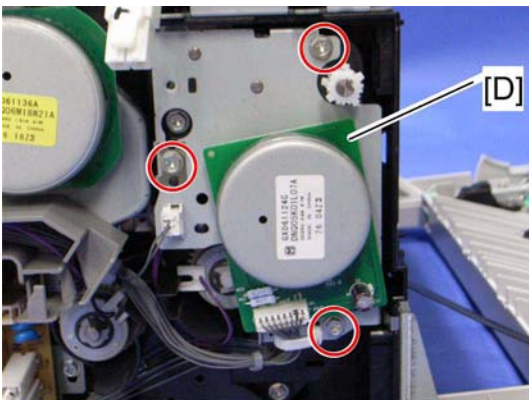

B018r590

6. Transport/Fusing motor assembly [D] (⚙️ x 3, ⚙️ x 3, ground plate x 1)

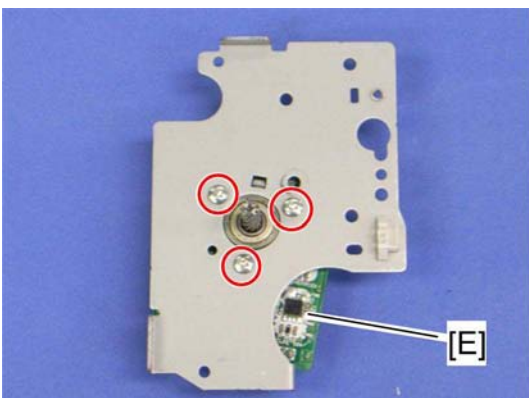

m018r591

7. Transport/Fusing motor [E] (⚙️ x 3)



m018r592

4.9 PAPER FEED

4.9.1 PAPER FEED CLUTCH

1. Rear cover (↗ p.4-3)
2. Left cover (↗ p.4-5)

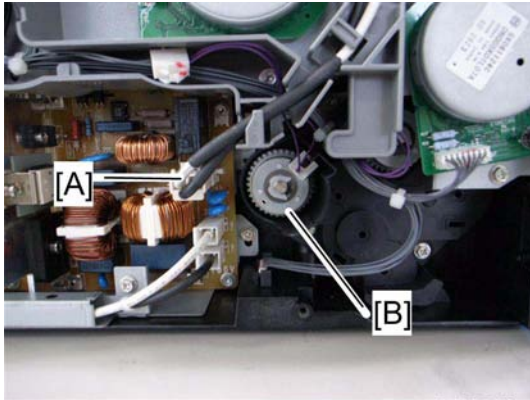

m018r596

3. Disconnect the fusing relay harness [A] (hook).
4. Paper feed clutch [B] (🌀 x 1, 📁 x 1)

4.9.2 PAPER FEED ROLLER

1. Remove all the AIO cartridges.
2. Remove the waste toner bottle.
3. Rear cover (➡ p.4-3)
4. Left cover (➡ p.4-5)
5. Paper feed clutch (➡ p.4-36)
6. Close the top cover and front cover.
7. Pull out the tray.

8. Stand the machine with the rear side facing the table.



m018r597

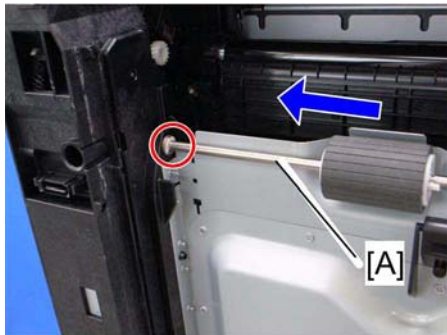

m018r598

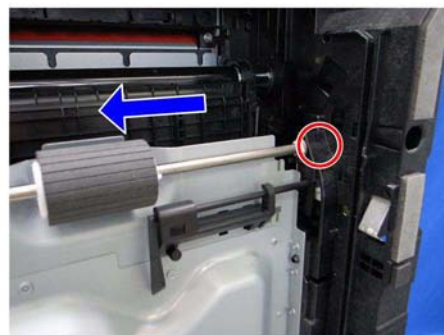

m018r599

9. Slide the paper feed shaft [A] to the left side (🔄 x 2).

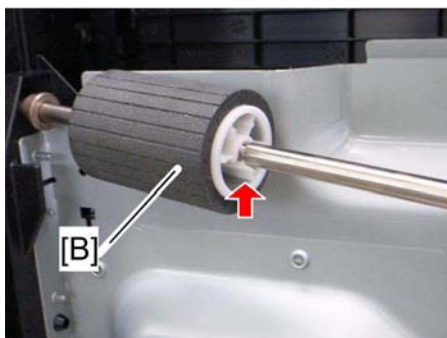

m018r600



m018r601

10. Paper feed roller [B] (hook)

4.9.3 SEPARATION PAD

1. Pull out the tray.

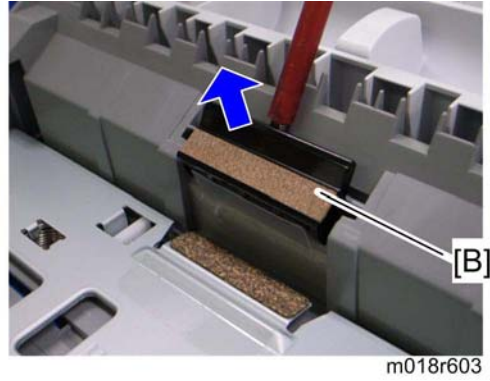
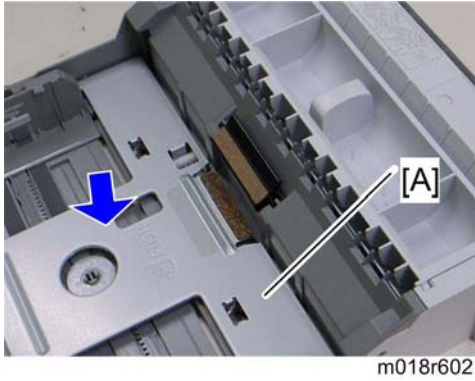

2. Push down the bottom plate [A].
3. Separation pad [B] (hooks, spring x 1)

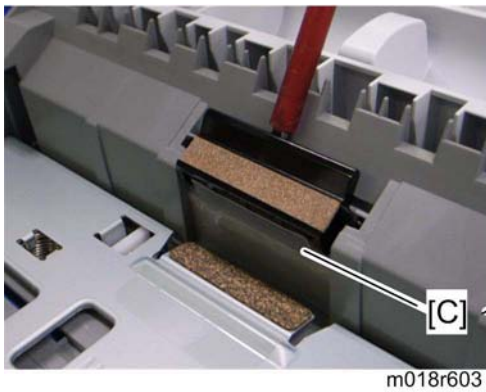

↓ Note

- When reinstalling the separation pad, make sure that the mylar [C] is not placed under the separation pad. The right side image above shows incorrect installation.

4.9.4 PAPER END SENSOR

1. Rear cover (➔ p.4-3)
2. Right cover (➔ p.4-5)
3. High voltage power supply board (➔ p.4-54)

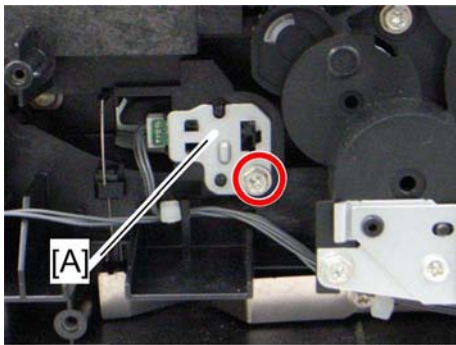

m018r566

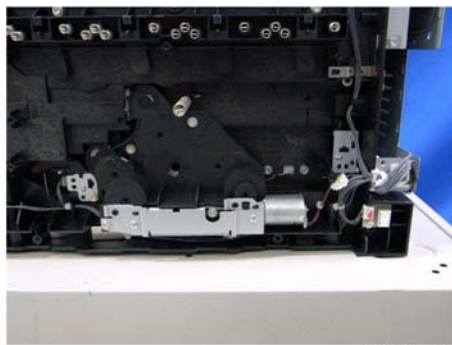

m018r546

4. Paper end sensor assembly [A] (📎 x 1)

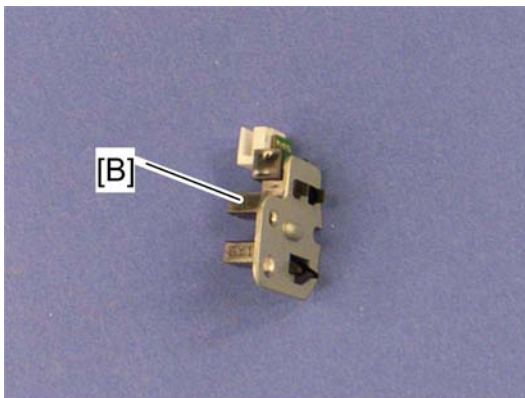

m018r567

5. Paper end sensor [B] (hooks)

4.10 PAPER EXIT

4.10.1 PAPER EXIT ROLLER

1. Operation panel (→ p.4-4)

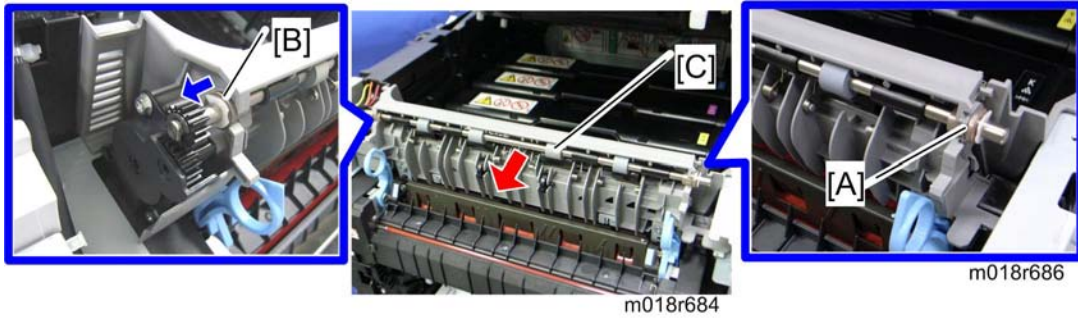

2. Remove the bushing [A] (⌚ x 1)
3. Move the bushing [B] to the left side (⌚ x 1).
4. Paper exit roller [B]

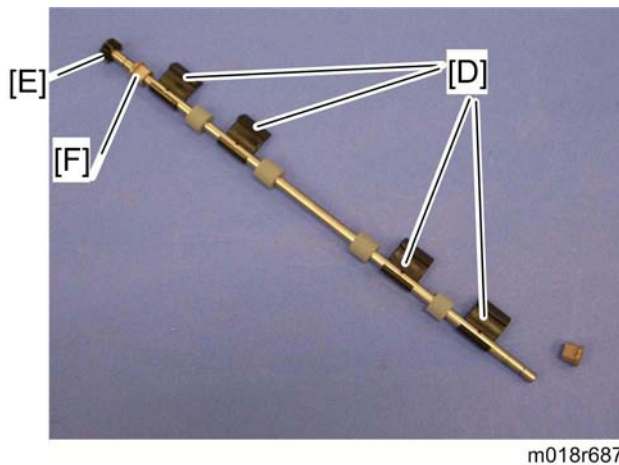

5. Remove the four exit guides [D], gear [E] (⌚ x 1) and bushing [F].

When reinstalling the paper exit roller

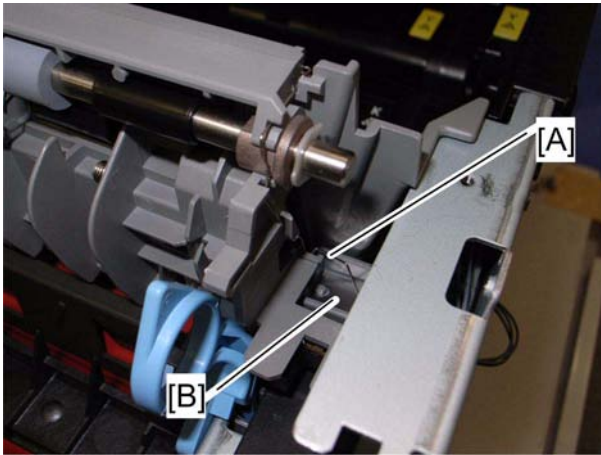

m018r688

Make sure that the ground wire [A] from the discharge sheet touches the ground plate [B] on the machine after reinstalling the paper exit roller.

4.10.2 PAPER EXIT SENSOR

1. Rear cover (➔ p.4-3)
2. Right cover (➔ p.4-5)

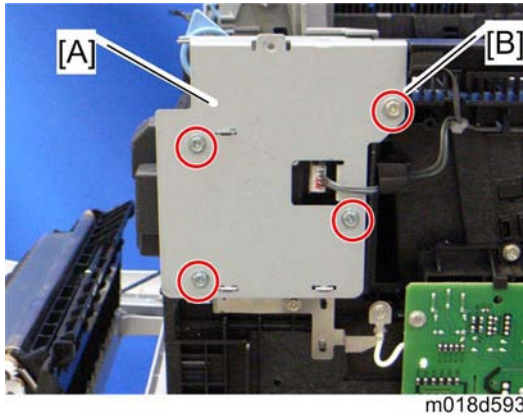

3. Right bracket [A] (🔩 x 3: M3x8, 🔩 x 1 [B]: M4x10)

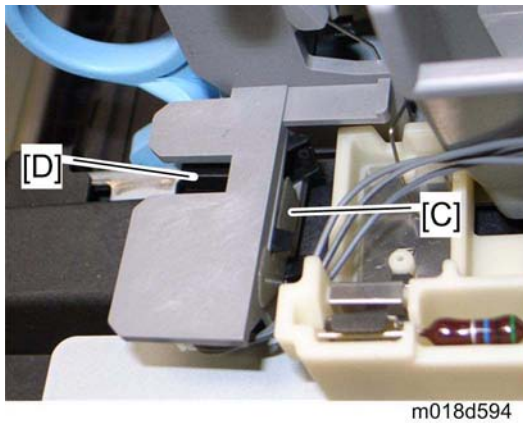

4. Mylar [C]



- This mylar is necessary for reinstalling the paper exit sensor.

5. Paper exit sensor [D] (hooks, 📌 x 1)

4.11 ELECTRICAL COMPONENTS

4.11.1 CONTROLLER BOARD

Main Controller Board

1. Rear cover (→ p.4-3)
2. Controller box cover [A] (🔩 x 7)

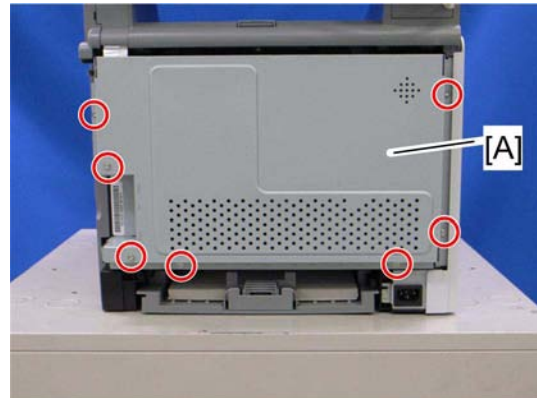

m018r505a

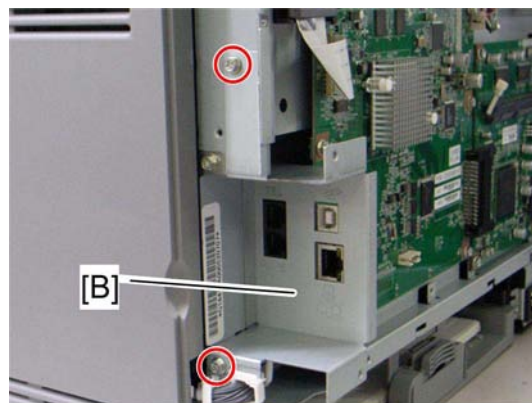

3. Interface bracket [B] (🔩 x 2)

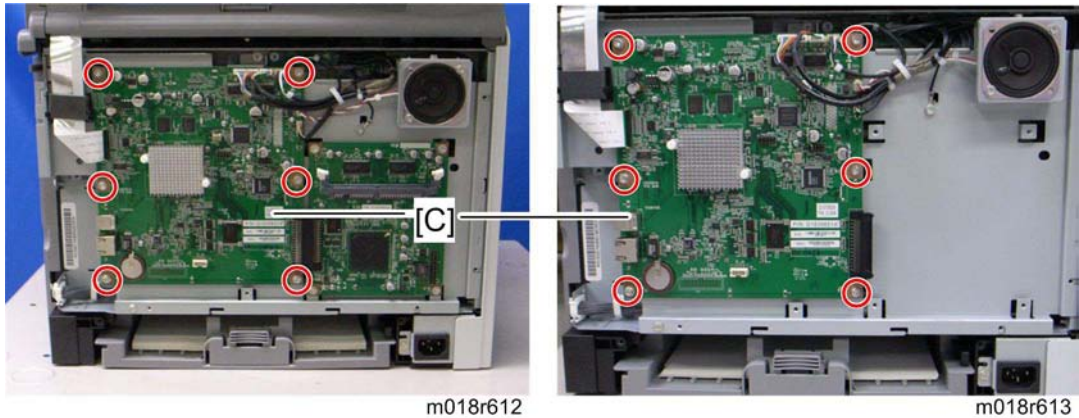

m018r611

Electrical Components



4. Main controller board [C] (flat cable x 1, all s,  x 6)

Note

- The photo above left shows the M019, and the photo above right shows the M018.

PDL Board (M019 only)

1. Rear cover (see p.4-3)
2. Controller box cover (see "p.4-43 "Main Controller Board "" above)
3. Interface bracket (see "p.4-43 "Main Controller Board "" above)

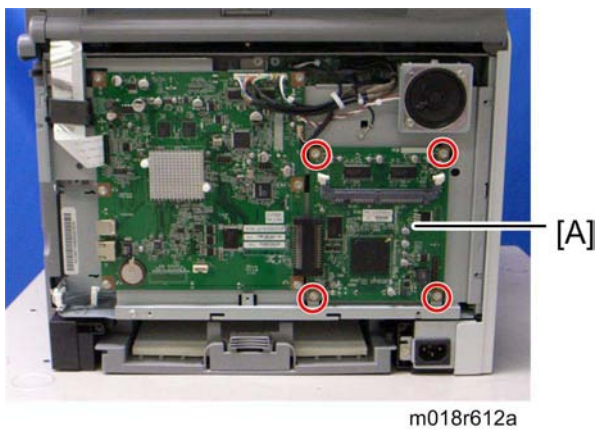

4. PDL board [A] ( x 4)

4.11.2 EGB (ENGINE BOARD)

1. Rear cover (➔ p.4-3)
2. Controller box cover (➔ p.4-43 "Controller Board")

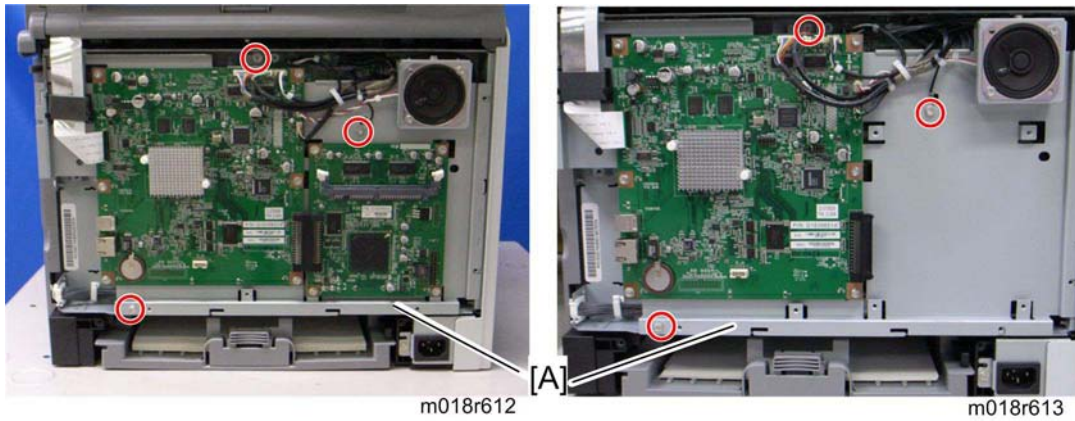

3. Controller bracket [A] (⚙️ x 3, ground cable x 1, all ⚙️s, flat cable x 1)

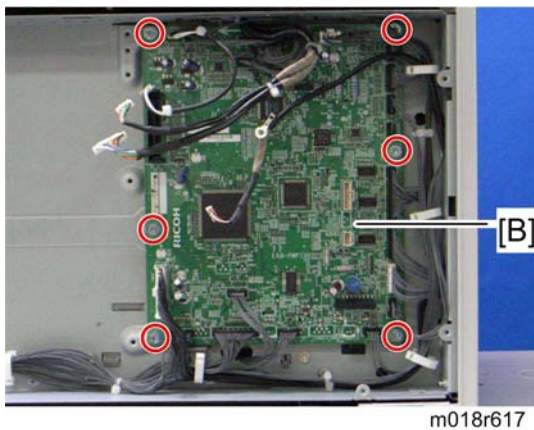

4. EGB [B] (⚙️ x 6, all ⚙️s)

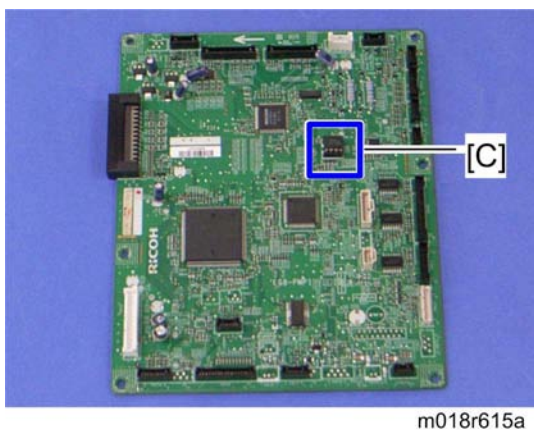

5. EEPROM [C]

Replacement
&
Adjustment

When installing the new EGB

1. Remove the EEPROM from the old EGB.

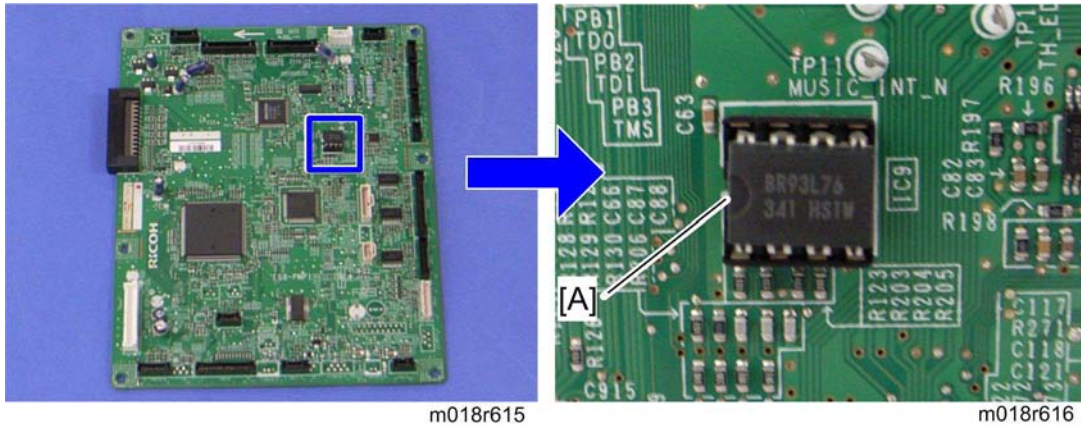

2. Install it on the new EGB with the mark [A] pointing to the left side of the board after you replace the EGB.
3. Replace the EEPROM if the EEPROM on the old EGB is defective.

⚠ CAUTION

- Keep the EEPROM away from any objects that can cause static electricity. Static electricity can damage EEPROM data.
- Make sure that the EEPROM is correctly installed on the EGB.

4.11.3 FCU

1. Rear cover (➡ p.4-3)
2. Controller box cover (➡ p.4-43 "Controller Board")
3. Controller bracket (➡ p.4-45 "EGB Engine Board")

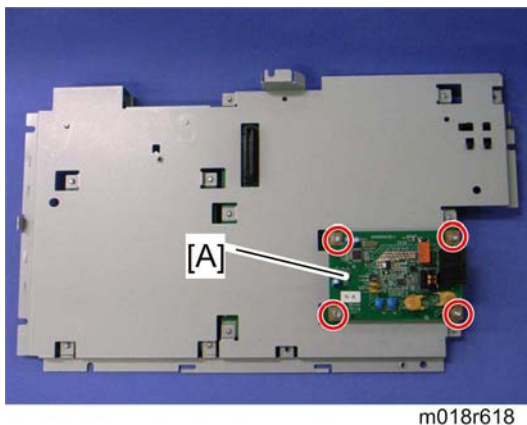

4. FCU [A] (⚙ x 4)

4.11.4 INTERLOCK SWITCHES

1. Operation panel (➔ p.4-4)
2. Rear cover (➔ p.4-3)
3. Left cover (➔ p.4-5)

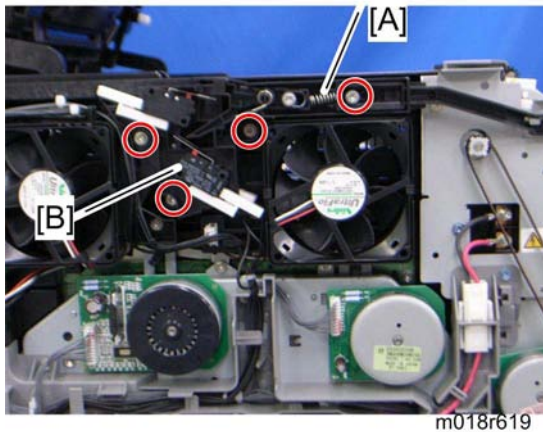

4. Remove the spring [A].
5. Interlock switch base [B] (⚙ x 4, all ⚙s)

↓ Note

- Remove all the connectors after the interlock switch base has been removed.

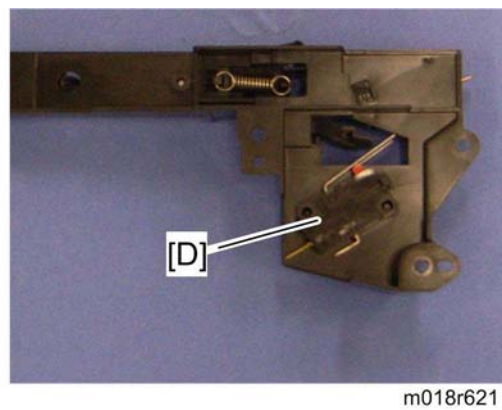
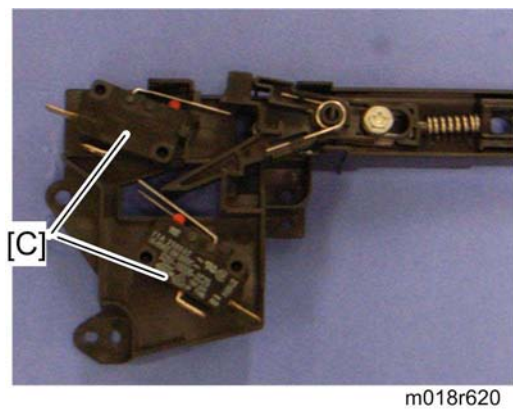

6. Two interlock switches [C] at the outside of the base and one interlock switch [D] at the inside of the base (hooks)

4.11.5 FUSING FAN MOTOR

1. Operation panel (➔ p.4-4)
2. Rear cover (➔ p.4-3)
3. Left cover (➔ p.4-5)
4. Interlock switch base (➔ p.4-47 "Interlock Switches")

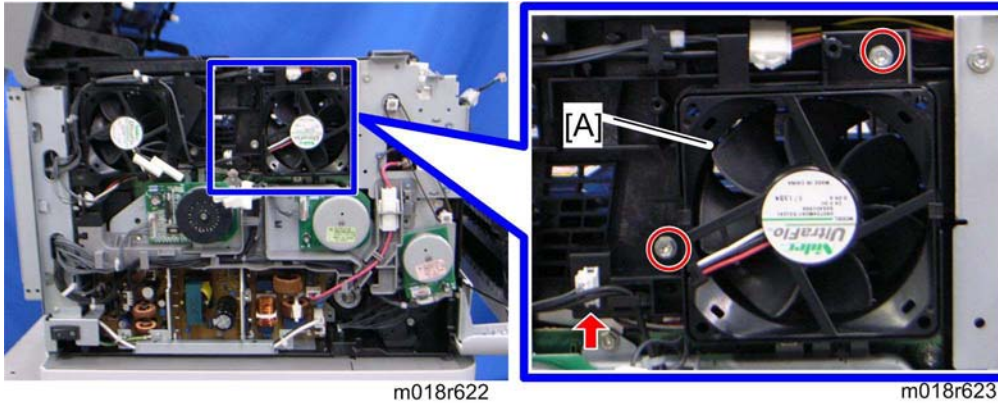

5. Fusing fan base [A] (⚙ x 2, ⚙ x 1)

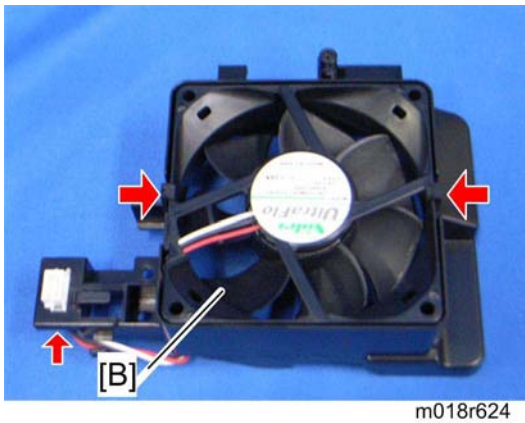

6. Fusing fan motor [B] (hooks, ⚙ x 1)

CAUTION

- Install the fusing fan motor with its decal facing the outside of the machine.

4.11.6 LSU FAN MOTOR

1. Operation panel (➔ p.4-4)
2. Rear cover (➔ p.4-3)
3. Left cover (➔ p.4-5)

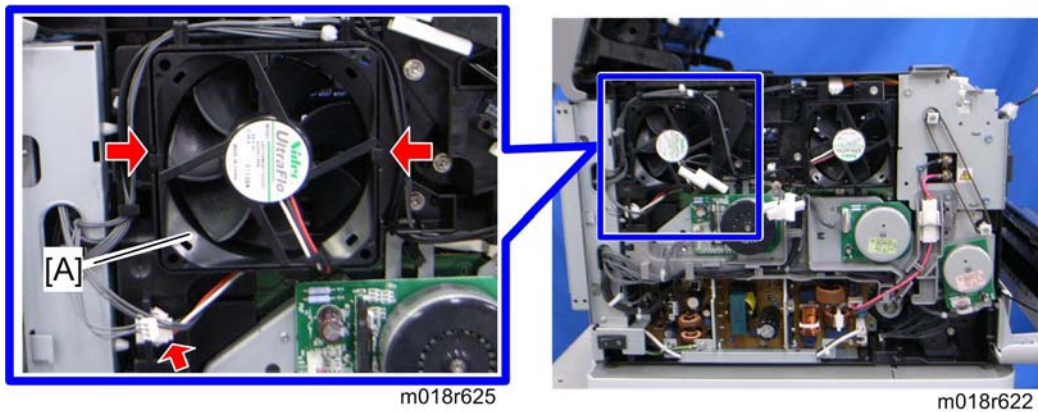

4. LSU fan motor [A] (hooks,  x 1)

⚠ CAUTION

- Install the LSU fan motor with its decal facing the outside of the machine.

4.11.7 ID CHIP BOARD

1. Operation panel (☛ p.4-4)
2. Rear cover (☛ p.4-3)
3. Left cover (☛ p.4-5)
4. Controller bracket (☛ p.4-43 "Controller Board")
5. Disconnect the connector (CN305) on the EGB.
6. Interlock switch base (☛ p.4-47 "

Interlock Switches")

7. Fusing fan base (➔ p.4-48 "Fusing Fan Motor")
8. Drive unit (➔ p.4-13 "Black AIO Motor")
9. Take the harnesses aside around the LSU fan base [A].
10. LSU fan base [A] (🔧 x 2, 📏 x 1)

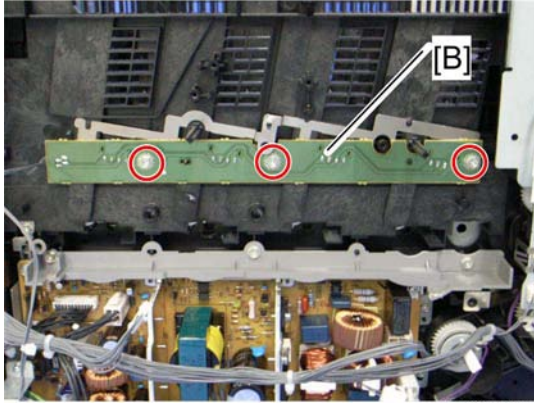

11. ID Chip Board [B] (🔧 x 3)

4.11.8 PSU

1. Operation panel (➔ p.4-4)
2. Rear cover (➔ p.4-3)
3. Left cover (➔ p.4-5)
4. Drive unit (➔ p.4-13 "Black AIO Motor")
5. LSU fan base (➔ p.4-49 "LSU Fan Motor")

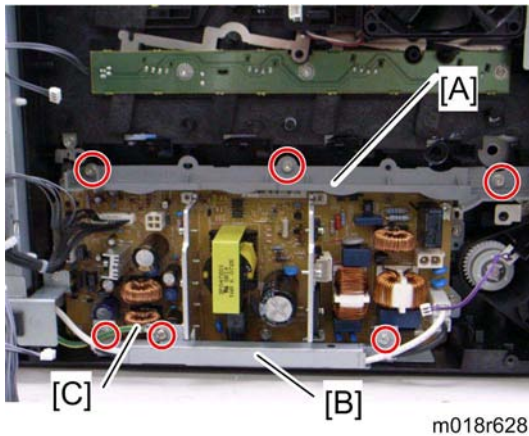

6. PSU guide [A] (⚙️ x 3)
7. Power cord bracket [B] (⚙️ x 2)
8. Ground cable [C] (⚙️ x 1)

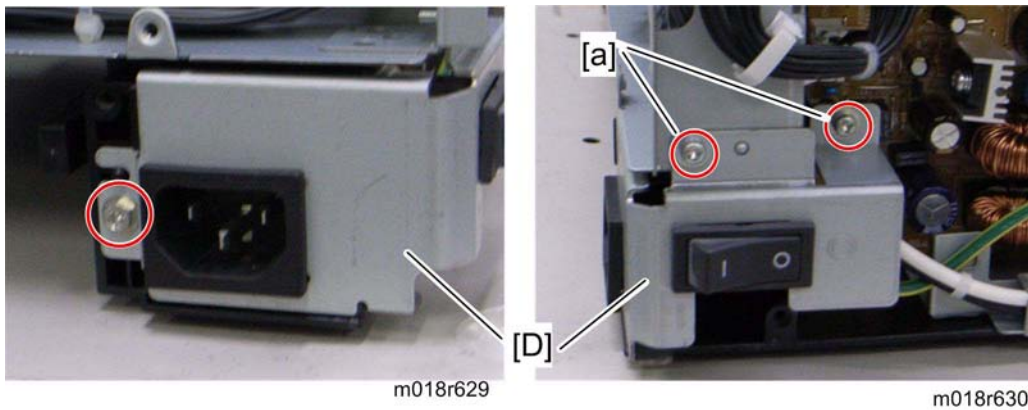

9. Power switch assembly [D] (washer screw [a] x 2, ⚙️ x 1, 📏 x 2)

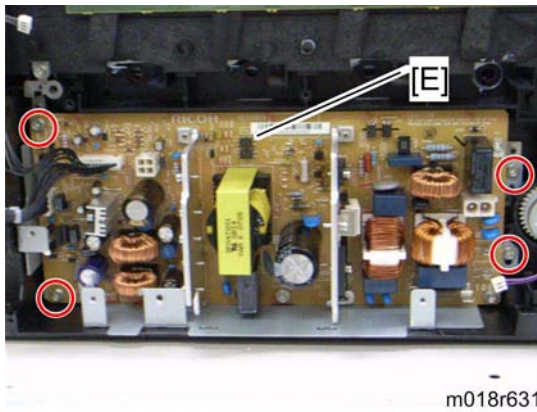

10. PSU assembly [E] (⚙️ x 4, all ⚙️s)

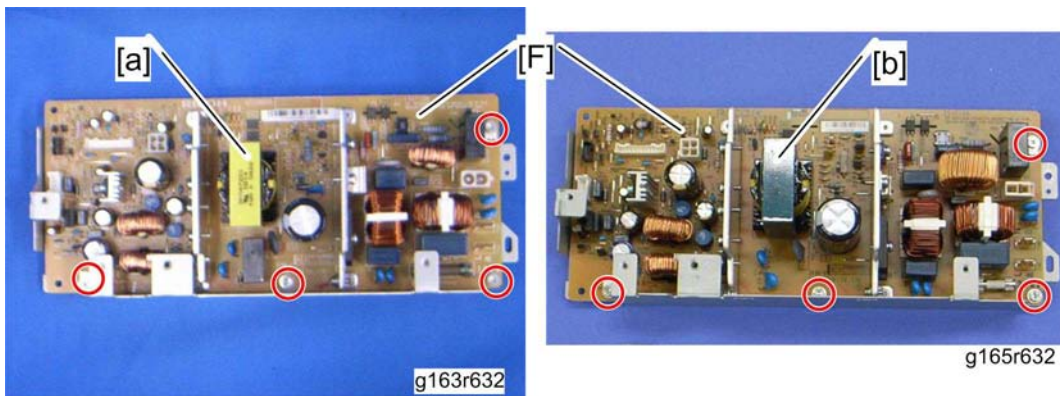

11. PSU [F] (⚙️ x 4)

★ Important

- There are two types of PSUs for this model. Do not install a wrong PSU in the machine.
- PSU that has yellow [a] on the transistor is for NA models and PSU that has green [b] on the transistor is for EU models.

Replacement & Adjustment

Fuse

There is the removable fuse on the PSU.

Fuse No.	Rating
FU101: NA	15 A, 125V
FU101: EU, ASIA	6.3A, 250V

CAUTION

- Use a correct rating fuse for the fuse replacement. Never use a wrong rating fuse. If you do so, the machine may be damaged.
- Never try direct connection of PSU circuit without a fuse.

4.11.9 HIGH VOLTAGE POWER SUPPLY BOARD

1. Remove all AIO cartridges.
1. Operation panel (➔ p.4-4)
2. Rear cover (➔ p.4-3)
3. Right cover (➔ p.4-5)

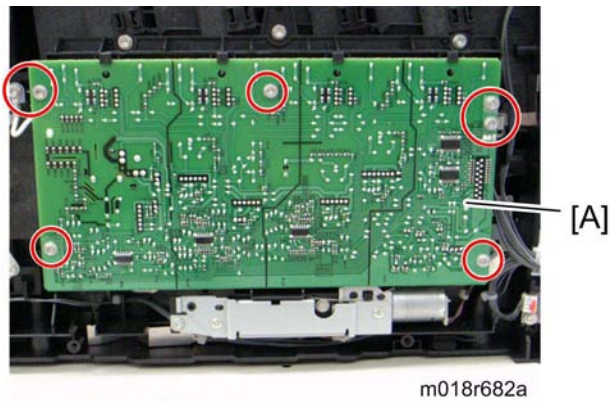

4. High Voltage Power Supply Board [A] (🔩 x 7, ground cable x 1, 📁 x 1)

4.11.10 TEMPERATURE/HUMIDITY SENSOR

1. Operation panel (➔ p.4-4)
2. Rear cover (➔ p.4-3)
3. Right cover (➔ p.4-5)

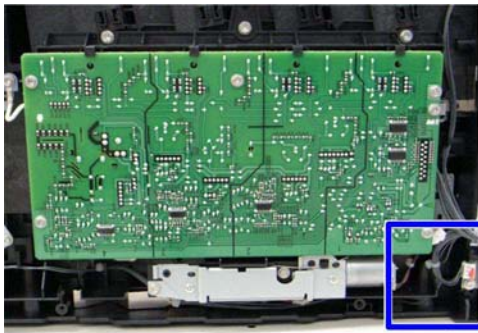

m018r682

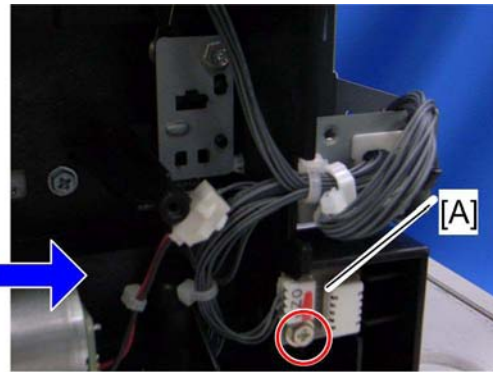

m018r683

4. Temperature/Humidity sensor [A] (🔧 x 1, 📦 x 1)

4.11.11 DUPLEX MOTOR

1. Operation panel (➔ p.4-4)
2. Rear cover (➔ p.4-3)
3. Left cover (➔ p.4-5)

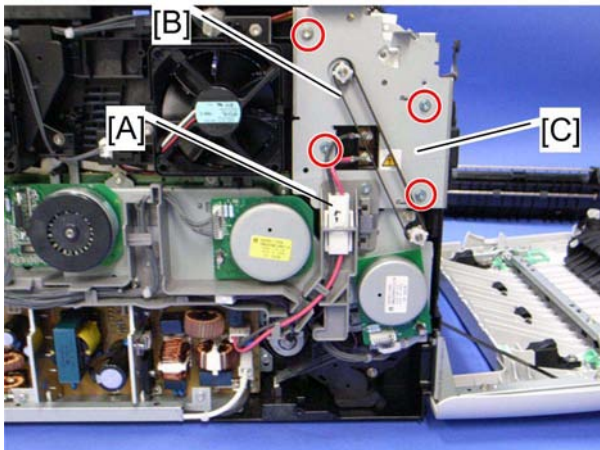

m018r587a

4. Disconnect the fusing connector [A]
5. Duplex timing belt [B]
6. Left bracket [C] (⚙️ x 4)

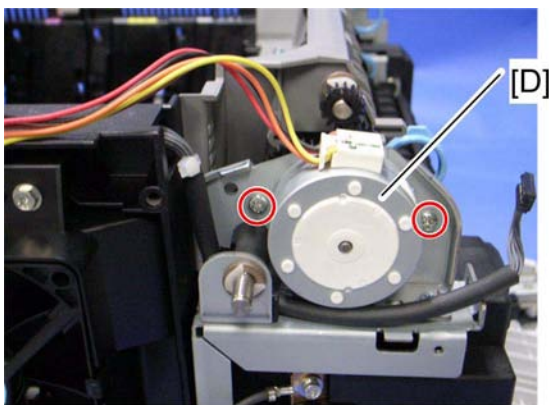

m018r677

7. Duplex motor [D] (⚙️ x 2, 📁 x 1)

4.11.12 SPEAKER

1. Rear cover (➔ p.4-3)
2. Controller box cover (➔ p.4-43 "Controller Board")

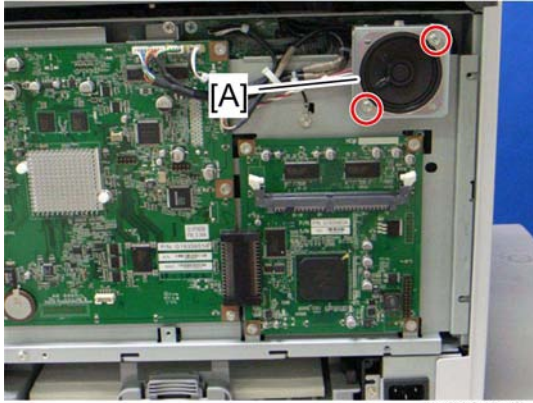

m018r678

3. Speaker [A] (🔩 x 2, 📏 x 1)

4.11.13 EEPROM

 Note

- Replacement and Reinstallation procedures for the EEPROM are included in the "EGB (Engine Board)" replacement procedure. Refer to "EGB (Engine Board)" for details.

When replacing an old EEPROM with a new EEPROM, EEPROM setting is required. Follow the EEPROM setting procedure described below.





 Note

Be sure to set the PnP Name as described in *PnP Name Procedure*.

Replacement Procedure

 Important

- Do the following steps 1 to 14 with the front cover of the machine open. After completing these steps, turn off the machine.
1. Open the front cover and turn ON the machine.
-  Note
- The machine may issue an error code (because the cover is open), but continue this procedure.
2. Enter the following keys consecutively in order to enter "Engine Maintenance" in the "Maintenance Mode Menu".
 3. Select "Init Engine EEPROM" item and execute it to initialize the EEPROM.
 4. Press the "Clear/Stop" key to exit the "Engine Maintenance" menu.
 5. Select the "Serial No." item, and then input a serial number.
-  Note
- Ask your supervisor about how to access the serial number input display.
6. Exit the serial number input display, and then enter "Engine Maintenance" again.
 7. Select "Destination", and then select a destination.
 8. Select "Model", and then select a model.
 9. Select "PnP Name", and then select a plug and play name.
 10. Select "LSU Adjustment", and then input the LSU (laser optics housing unit) setting values.
 11. Turn OFF the machine.
 12. Turn ON the machine with the front cover open.
 13. Enter "Engine Maintenance" in the "Maintenance Mode Menu" again.
 14. Close the front cover.
 15. Select "Trans. Belt Adjust", and then execute "Trans. Belt Adjust" to adjust the ITB (Image Transfer Belt) unit.
 16. Select "Fuser SC Detect", and then select "ON" or "OFF" for the consecutive fusing jam detection.



- The default setting is "OFF". Select "ON" only if the customer wants to use this feature.
17. Select "Registration", and then adjust the registration for each direction (vertical and horizontal direction) and tray if necessary.
 18. Select "2nd Transfer Fuser Temp", and then adjust the transfer roller bias and the temperature reduction of the fusing unit for each paper type and for the front and back sides. The default settings for normal operation are all '0'.
 19. Exit "Engine Maintenance".

⇒ **PnP Name (Plug and Play) Procedure**

Set the PnP name as follows when replacing the EEPROM of the MF version.

0xAB

A indicates the brand. **B** indicates the model.

A: Brand

Brand	0	1	2	3	4	5	6	7
Name	Not used	RICOH	Gestetner	Not used	LANIER	NRG	Savin	Generic

B: Model

Brand	Ricoh: 1				Gestetner, LANIER, NRG, Savin: A= 2, 4, 5, or 6			Generic:7		
Model	0 x 00	0 x 11	0 x 12	0 x 13	0 x A4	0 x A5	0 x A6	0 x 77	0 x 78	0 x 79
Name	not used	not used	Aficio SP C231SF	Aficio SP C232SF	not used	SP C231SF	SP C232SF	not used	C231SF	C232SF

Brand ID: 0x01 (default)

This ID is not related to the PnP Brand name. Do not change the setting; otherwise, a malfunction may occur.

Maintenance ID: 0x00 (default)

Do not change the setting; otherwise, a malfunction may occur.

LSU Adjustment

Input the data using the number keys. The cursor can be moved to the right or the left with the Down arrow or the Up arrow keys. You can change the alphanumeric characters by repeatedly pressing the number keys (like a mobile phone). (Example: 2 → a → b → c)
There is no "back space" function. If you input incorrect data, you have to delete all the data input by pressing the Clear/Stop key. Then, input the LSU data again.

ADF

4.12 ADF

4.12.1 ADF UNIT

1. Stand left cover [A]

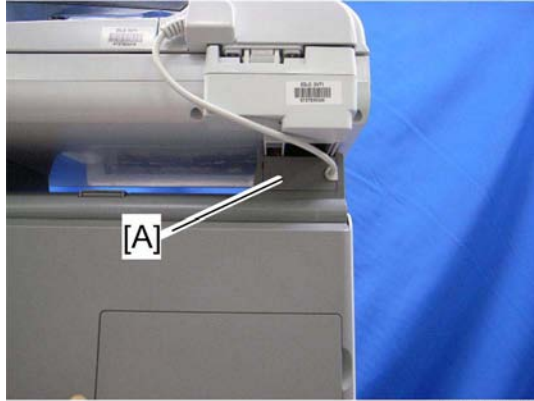

m018r672

2. Disconnect the ADF harness [B] and power cord [C].

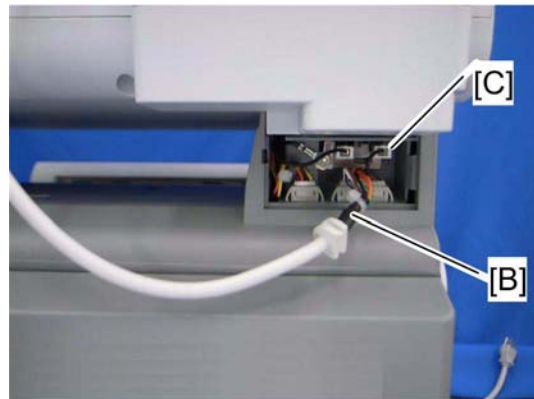

m018r690

3. Open the ADF unit [D]



m018r674

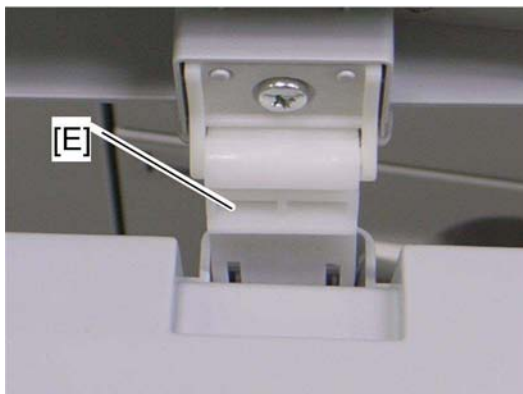

m018r675

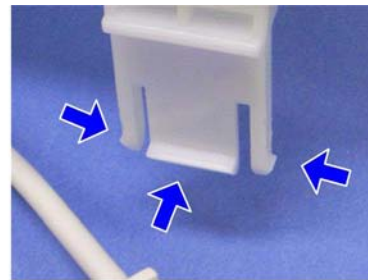

m018r676

4. Release the three hooks of the right hinge [E]
5. Lift the ADF unit.

4.12.2 ORIGINAL TRAY

1. Open the ADF cover.

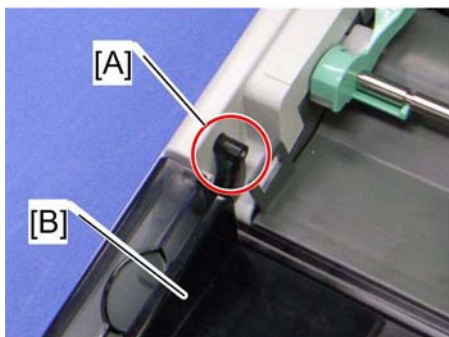

m018r659



m018r658

2. Release the front tab [A].
3. Original tray [B]

ADF

4.12.3 ADF FEED UNIT

1. Open the ADF cover.

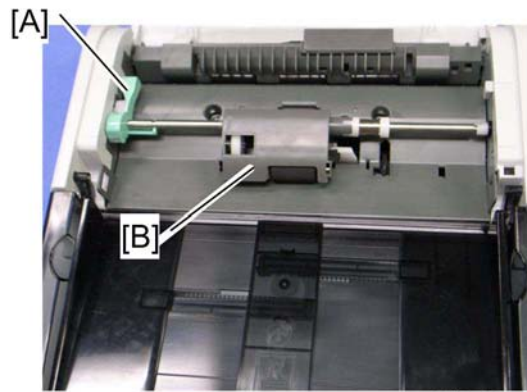

m018r658a

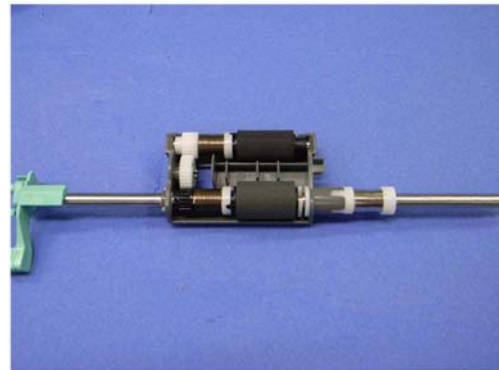

m018r660

2. Release the lock lever [A]
3. ADF feed unit [B]

4.12.4 ADF SEPARATION PAD

1. Open the ADF cover.
2. ADF feed unit (↖ p.4-62)

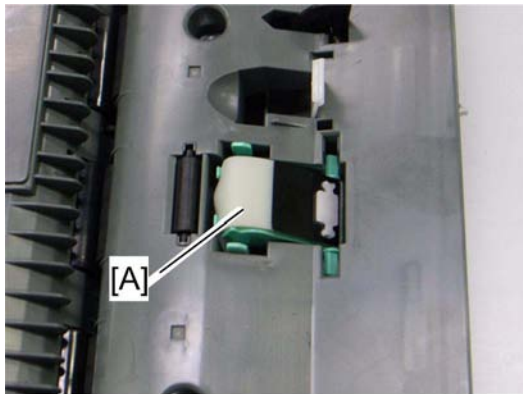

m018r661

3. ADF separation pad [A] (hook x 2, spring x 1)

4.12.5 ADF FRONT COVER

1. ADF unit (↔ p.4-60)
2. Original Tray (↔ p.4-61)
3. ADF feed unit (↔ p.4-62)

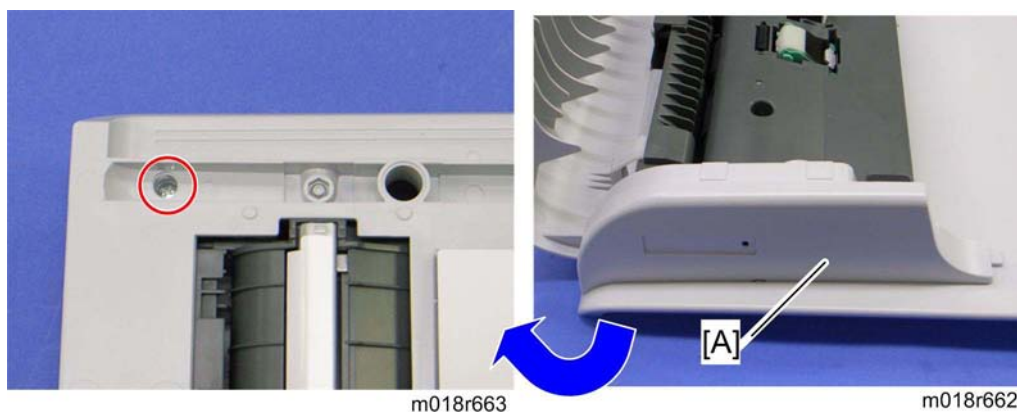

4. ADF front cover [A] (🔩 x 1)

4.12.6 ADF REAR COVER

1. ADF unit (↔ p.4-60)
2. Original Tray (↔ p.4-61)
3. ADF feed unit (↔ p.4-62)

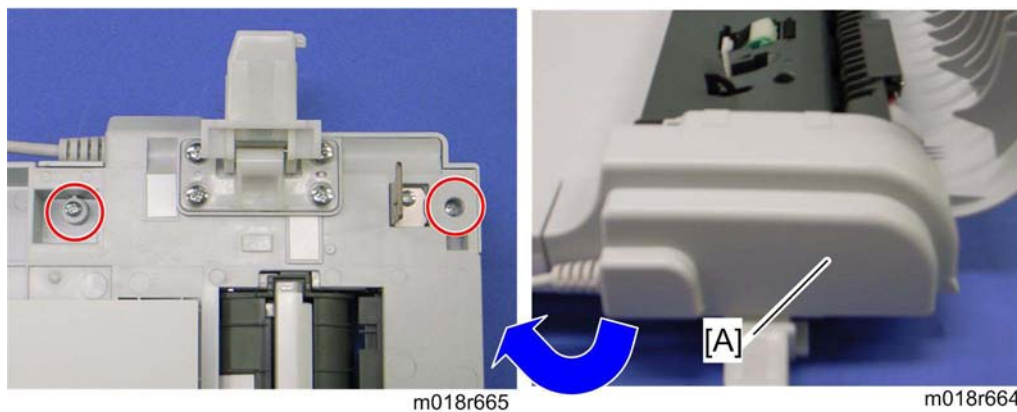

4. ADF rear cover [A] (🔩 x 2)

ADF

4.12.7 ADF COVER

1. ADF unit (☛ p.4-60)
2. ADF front cover (☛ p.4-63)
3. ADF rear cover (☛ p.4-63)

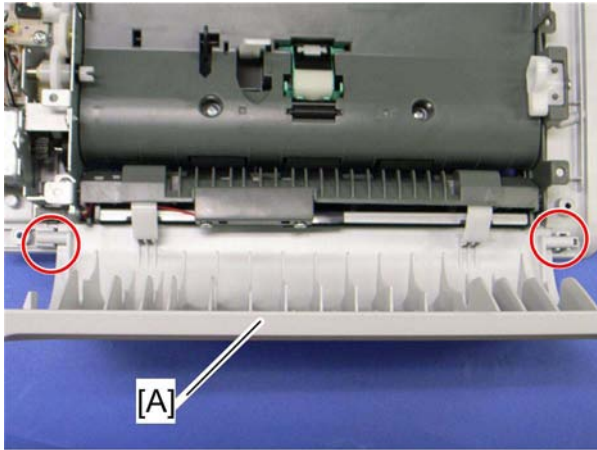

m018r666

4. ADF top cover [A] (two tabs)

4.12.8 ADF MOTOR

1. ADF unit (☞ p.4-60)
 2. Original Tray (☞ p.4-61)
 3. ADF feed unit (☞ p.4-62)
 4. ADF front cover (☞ p.4-63)
 5. ADF rear cover (☞ p.4-63)
6. ADF drive unit [A] (⚙️ x 4, all 🛠️s)

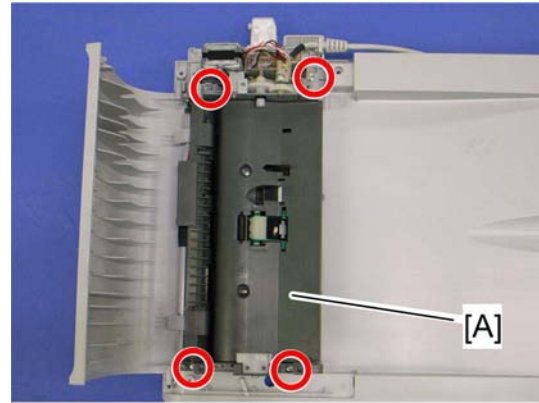

m018r667

7. ADF motor assembly [B] (⚙️ x 2)

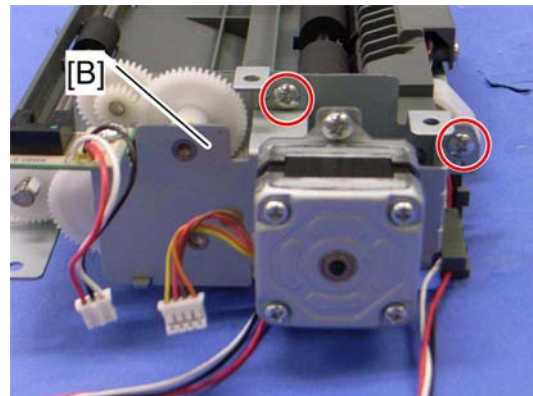

m018r668

8. ADF motor [C] (⚙️ x 2)

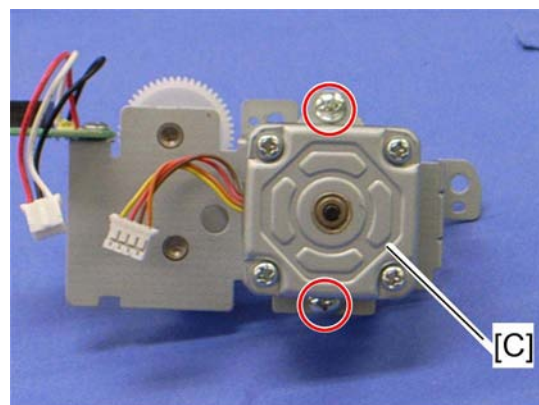

m018r669

ADF

4.12.9 ORIGINAL SET SENSOR

1. ADF unit (☛ p.4-60)
2. ADF feed unit (☛ p.4-62)
3. ADF motor assembly (☛ p.4-65)

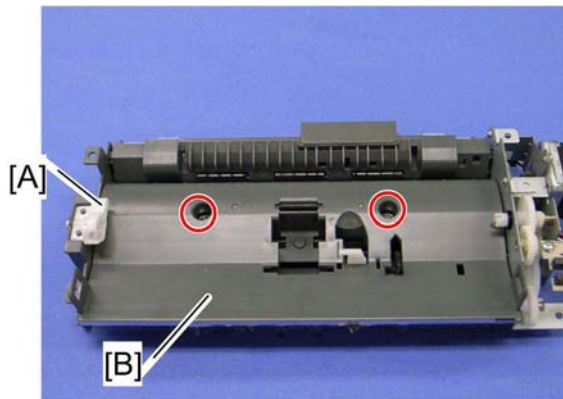

m018r670

4. Feed roller holder [A] (☛ x 1)
5. Upper guide [B] (☛ x 2)

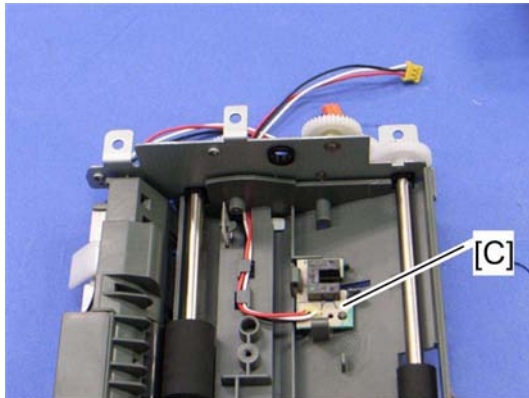

m018r671

6. Original set sensor [C] (hooks)

4.12.10 ADF COVER OPEN SENSOR

1. Original tray (➔ p.4-61)
2. ADF rear cover (➔ p.4-63)

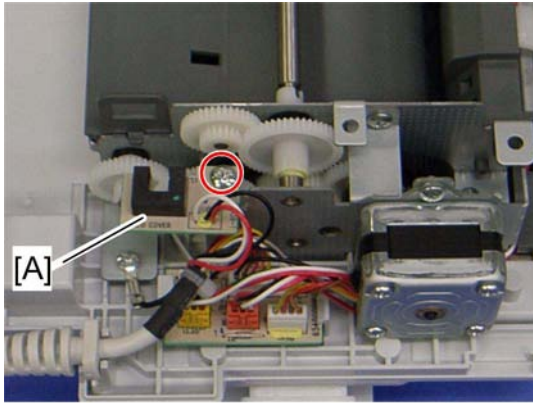

m018r679

3. ADF cover open sensor (🔧 x 1, 📁 x 1)

ADF

4.12.11 ADF FEED SENSOR

1. ADF unit (☛ p.4-60)
2. ADF feed unit (☛ p.4-62)

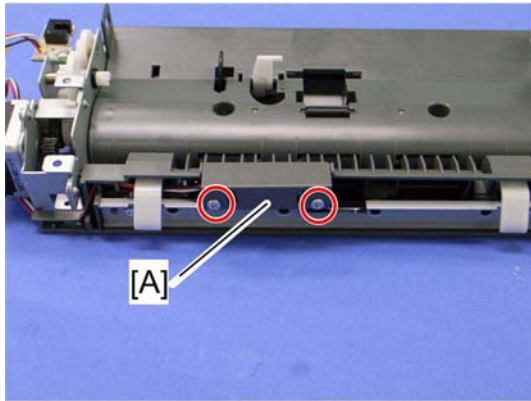

m018r680

3. Sensor cover [A] (🔩 x 2)

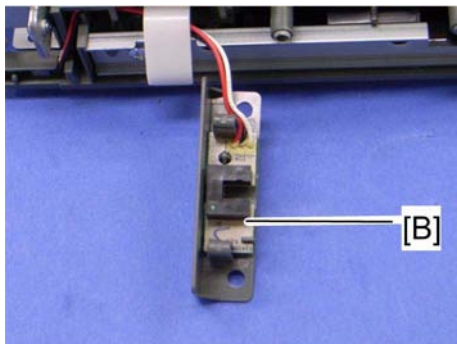

m018r681

4. ADF feed sensor [B] (hooks)

4.12.12 ADF DRIVE BOARD

1. Original tray (➔ p.4-61)
2. ADF rear cover (➔ p.4-63)

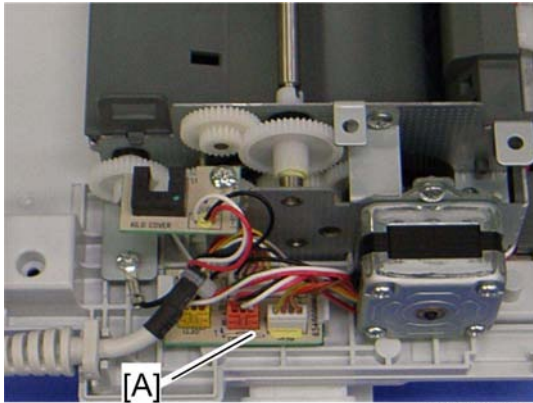

3. ADF drive board [A] (all ⚙️s, hooks)

4.13 SCANNER

4.13.1 SCANNER UNIT

1. Controller box cover (➔ p.4-43 "Controller Board")



m018r633

2. Disconnect the flat cable [A].
3. Stand left cover [B] and right cover [C] (1 hook each)

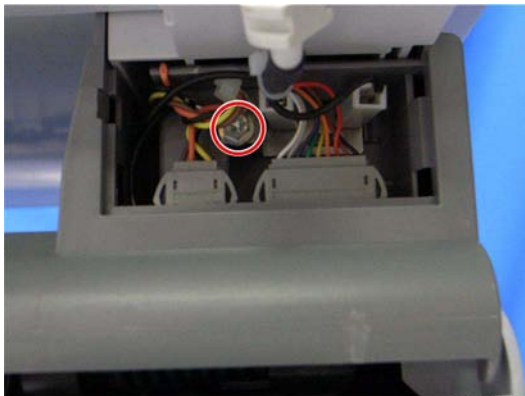

m018r634

4. Disconnect the scanner harness, power cord and ground cable (and the ADF harness and power cord if the ADF is installed in the scanner unit) (⚠ x 1).
5. Open the top cover of the machine.

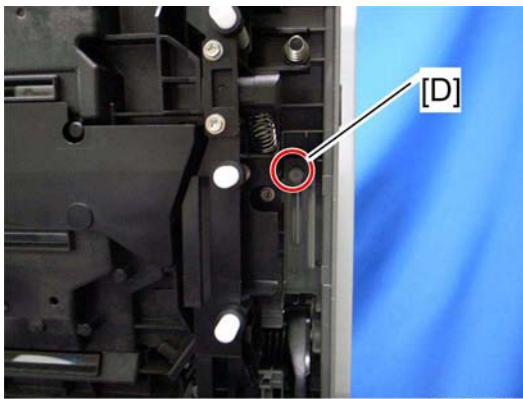

m018r635

6. Remove the stepped screw [D].



m018r636

7. Push the lock button [E] and slide the scanner unit to the rear side.
8. ADF unit (→ p.4-60)

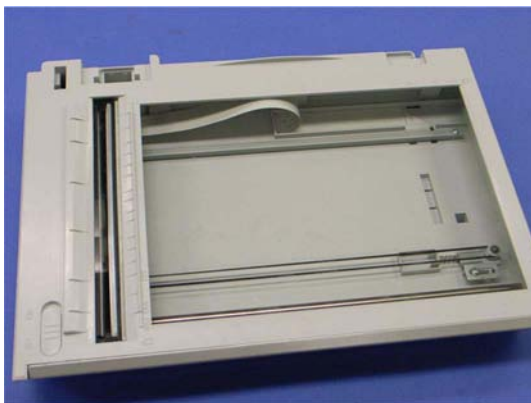

m018r637

9. Scanner unit

Scanner

4.13.2 SCANNER TOP COVER

1. Scanner unit (➔ p.4-70)

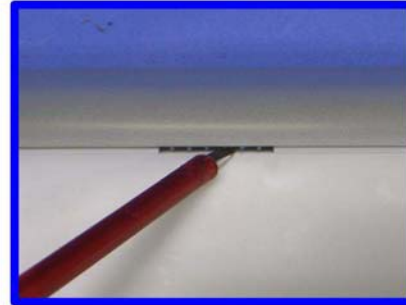
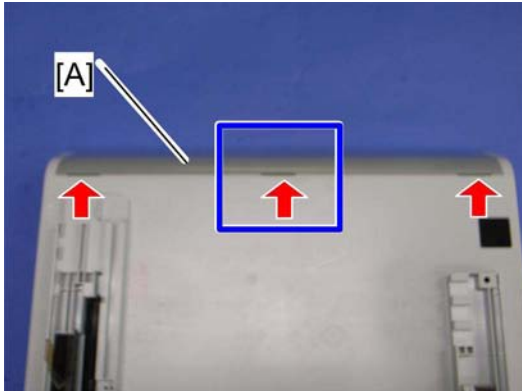

m018r639

2. Turn over the scanner unit.
3. Scanner front cover [A] (tabs x 3)

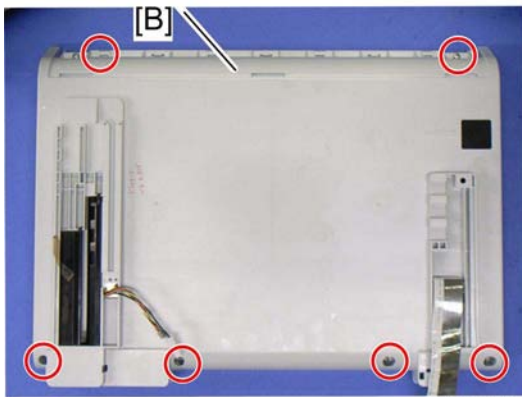

m018r640

4. Remove the six screws at the bottom of the scanner base [B].

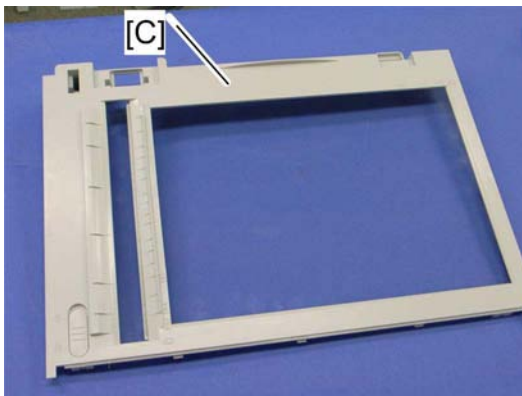

m018r641

5. Scanner top cover [C]

4.13.3 SCANNER CARRIAGE UNIT

1. Scanner unit (➔ p.4-70)
2. Scanner top cover (➔ p.4-72)

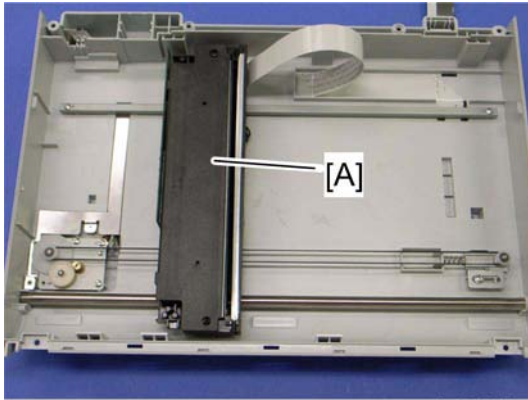

m018r642

3. Slide the scanner carriage unit [A] to the right side.

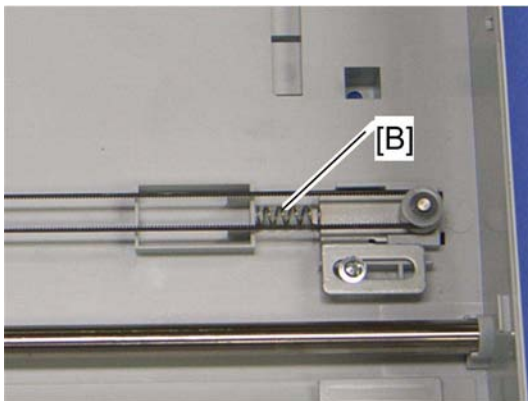

m018r643

4. Remove the timing belt tension spring [B]

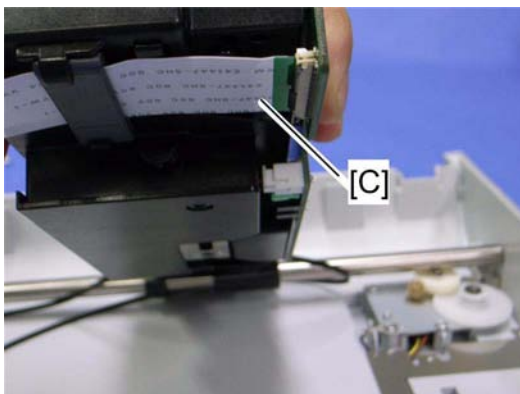

m018r644

5. Remove the flat cable [C] from the scanner carriage unit.

Scanner

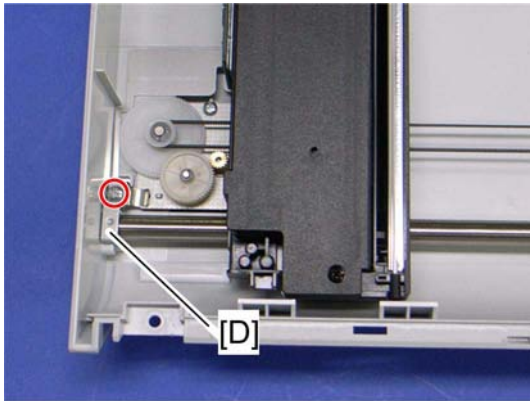

m018r645

6. Bar holder [D] (🔩 x 1)

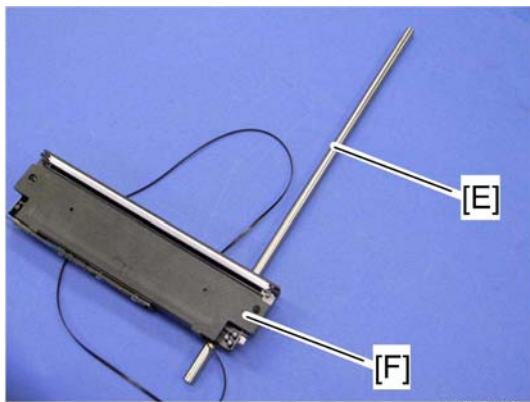

m018r646

7. Carriage bar [E] and scanner carriage unit [F]

4.13.4 EXPOSURE LAMP

1. Scanner carriage unit (➔ p.4-73)

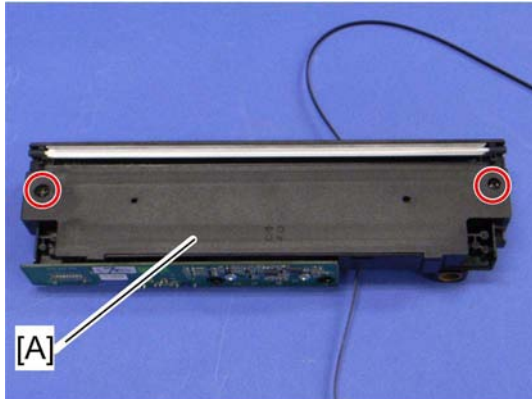

m018r647

2. Carriage top cover [A] (🔩 x 2, 📌 x 1)

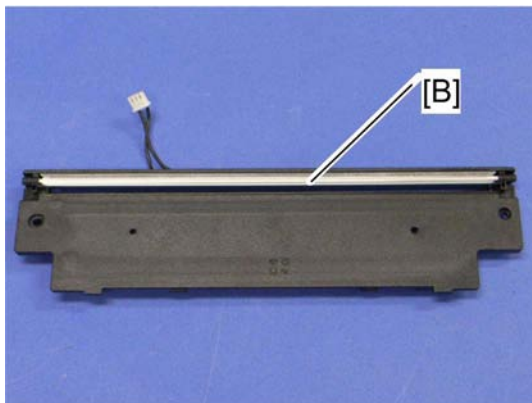

m018r648

3. Exposure lamp [B] (hooks)

Scanner

When reinstalling the exposure lamp

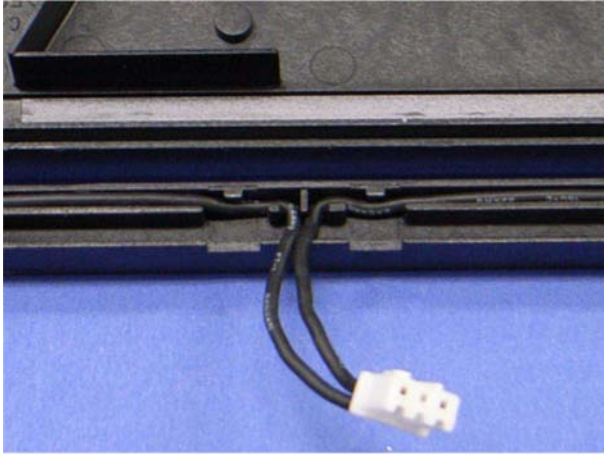

m018r649

Wire the lamp cords as shown above. Otherwise, the top cover pinches the lamp cords and damages them when reinstalling the top cover on the scanner carriage unit.

4.13.5 LAMP STABILIZER BOARD

1. Scanner carriage unit (➔ p.4-73)

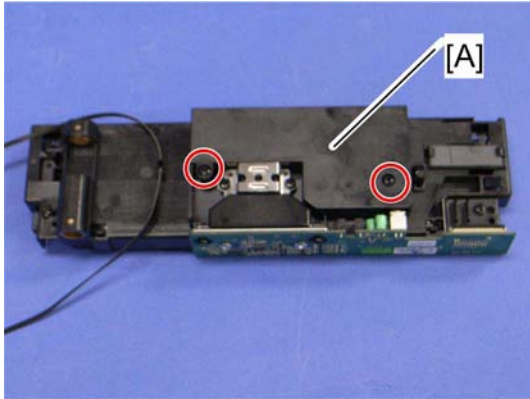

m018r650

2. Carriage bottom cover [A] (🔩 x 2)

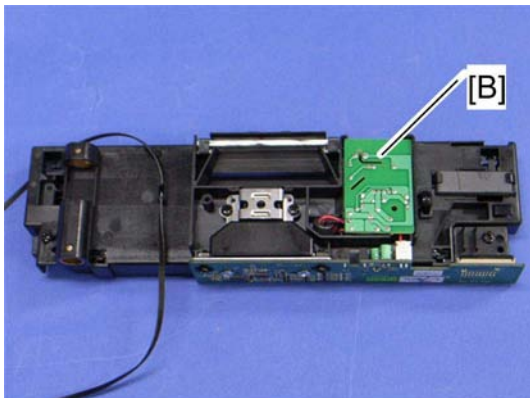

m018r651

3. Lamp stabilizer [B] (🔩 x 1)

4.13.6 SCANNER MOTOR

1. Scanner carriage unit (➔ p.4-73)

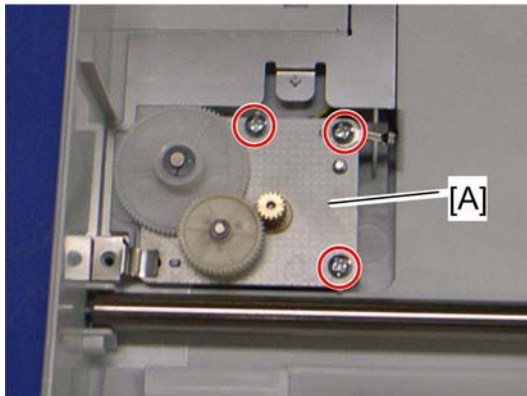

m018r652

2. Scanner motor [A] (🔧 x 3)

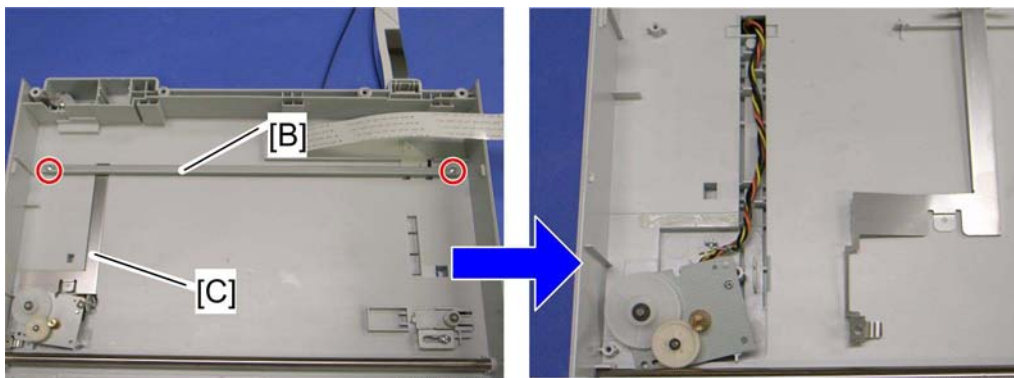

m018r653

m018r654

3. Carriage rail [B] (🔧 x 2)
4. Ground plate [C] (double-sided tape)
5. Scanner motor

SYSTEM MAINTENANCE REFERENCE

SYSTEM MAINTENANCE REFERENCE REVISION HISTORY		
Page	Date	Added/Updated/New
		None

5. SYSTEM MAINTENANCE REFERENCE

5.1 SERVICE PROGRAM

See "Appendices" for "Service Menu".

5.1.1 OVERVIEW

There is an LCD on these models. To execute the service program, access the "Maintenance Mode Menu" or "Fax Service Menu" with special key assignments. For details, refer to the "Service Menu" section.

5.2 CONFIGURATION PAGE INFORMATION

5.2.1 OVERVIEW

The configuration page and maintenance page have information about the machine's status. Print this sheet as shown below. Check the configuration page or maintenance page when doing machine maintenance.

To Print the Configuration Page/ Maintenance Page

1. Turn on the machine.
2. Press the "User Tools" key.
3. Press the "▲" or "▼" key to select "Reports Print", and then press the "OK" key.
4. Press the "▲" or "▼" key to select "Configuration Page" or "Maintenance Page", and then press the "OK" key.
5. The configuration page or maintenance page is printed.

5.3 FIRMWARE UPDATING

CAUTION

- Do not turn off the main power of the machine during the firmware updating. If you do so, the engine board or controller board may be damaged.

5.3.1 CHECKING THE MACHINE FIRMWARE VERSION

- Turn the machine on.
- Press "User/Tools" key and select "Report Print" with the "Up" or "Down" key.
- Press "OK" and select "Maintenance Page" with the "Up" or "Down" key.
- Press "OK" to display the "Firmware version (Controller)" and "Engine FW version"

5.3.2 UPDATING THE CONTROLLER FIRMWARE

Using the following procedure to update the controller firmware. Be sure to print the configuration page both before and after the update. Comparing pre- and post-update configuration pages allows you to check whether or not the update was successful. Follow the procedure carefully, and note that it will vary in parts depending on which version of the firmware is currently installed.

Preparation

- Download the firmware file on you PC.



m018s505

- Unzip the firmware file.
 - The firmware file contains the manual folder and other updating applications as show above.

Updating Procedure

CAUTION

- The update may take a while to complete. Do not turn off the power during the update.
- Turn off the power only when the machine beeps and "Firmware Update Done Please Reboot" appears on the control panel display.

Important

- When using a computer running on a Windows operating system, you must have an account that has Manage Printers permission. Log on as an Administrators or Power Users group member to acquire this permission.
 - The following procedure is based on Windows XP as an example.
1. Disconnect the telephone line cable from the machine.
 2. Turn on the machine.
 3. Press any menu key on the machine's control panel.
 4. Press the [▲] [▼] keys to select [Reports Print], and then press the [OK] key.
 5. Press the [▲] [▼] keys to select [Configuration Page], and then press the [OK] key.

The configuration page is printed out. Take note of the current firmware version (shown under "Firmware Version" on the configuration page).

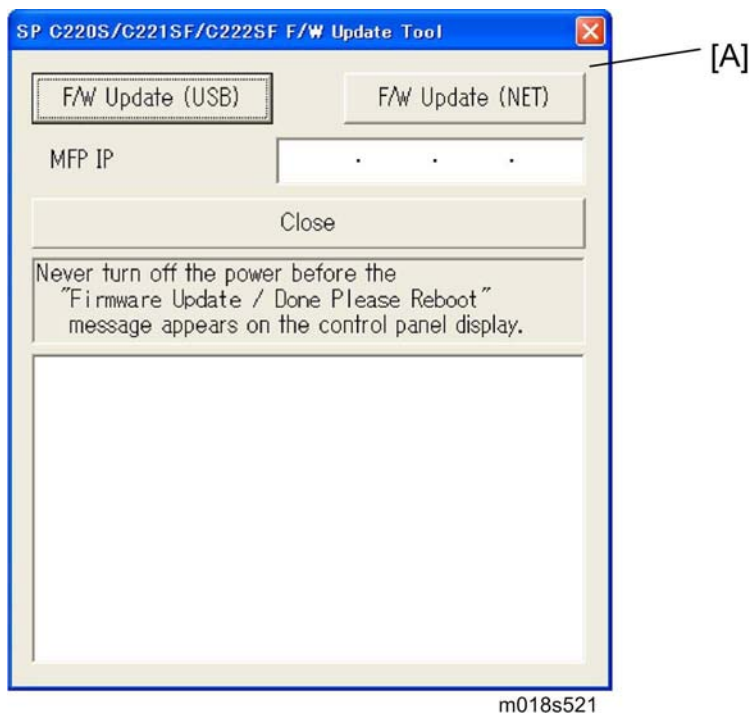

6. Double-click the [UpdateTool.exe] icon to launch the firmware update tool [A].

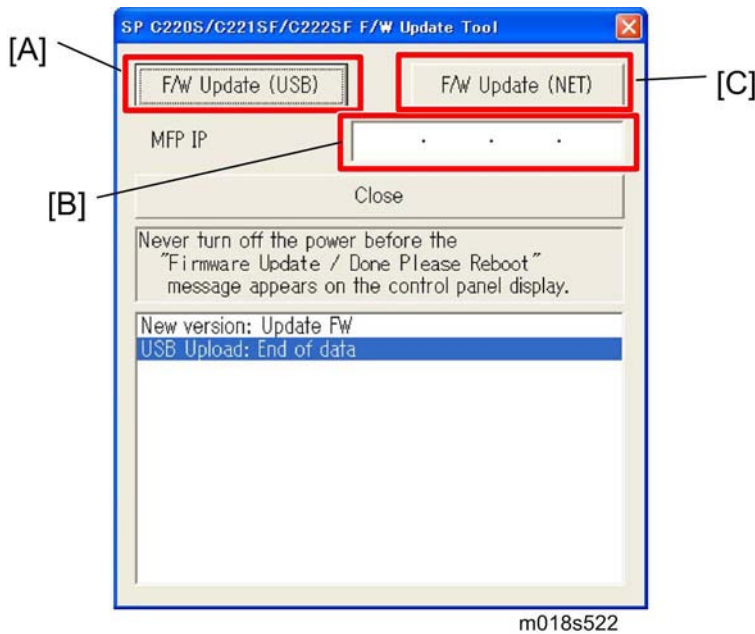

7. For a USB connection, click [F/W Update (USB)] [A]. For a network connection, enter the machine's IP address in [MFP IP] [B], and then click [F/W Update (NET)] [C].
8. Check the control panel display for messages and the update's current percentage of completion.

↓ Note

- The Update may take a while to complete. Do not turn off the power during the update.
 - Turn off the power only when the machine beeps and "Firmware Update Done Please Reboot" appears on the control panel display.
9. Wait until the machine beeps once and "Firmware Update Done Please Reboot" appears on the control panel display.
 - Click [Close] to the update tool.
 10. Turn off the power, and turn it back on.
 - After you turn the power back on, "Initializing" appears on the control panel display.
 11. Wait until the initial screen appears on the control panel display.
 - If the initial screen does not appear after more than one minute, the update is not complete. In this case, see "Updating Failure".
 12. Repeat Steps 3 to 5 to print the configuration page again.

Take note of the new firmware version (shown under "Firmware Version" on the configuration page).
 13. Reconnect the telephone line cable to the machine.

Firmware Updating

↓ Note

- The update's percentage of completion might not be displayed, depending on which version of the firmware is currently installed.
- In addition to printing a configuration page, you can check the machine's firmware version by accessing the machine using a web browser. For details, see "Checking Machine Status", in the User Guide.
- Depending on how it is configured, the machine might start up in fax mode following the firmware update.

Messages that appear in the update tool window

Message	Cause/ Solutions
Can't open ROM file. Please check ROM file.	The firmware file (*.brn/*.dwn) or setting file (*.ini) is not stored in the same folder as the update tool.
	<ul style="list-style-type: none">▪ Make sure that the firmware file (*.brn/*.dwn) and setting file (*.ini) are stored in the same folder as the update tool.▪ Also, make sure that you do not modify the setting file.
	The path to the location of the update tool is too long.
	<ul style="list-style-type: none">▪ Make sure that the path to the update tool is not too long. For convenience, save the update tool in a subfolder directly under your computer's C: drive.

Message	Cause/ Solutions
Fail to open USB port.	The USB cable is not connected.
	<ul style="list-style-type: none"> ▪ Make sure the USB connection between the machine and computer is secure. ▪ If this message persists, try another USB cable.
	The USB printer driver is not installed in your computer.
	<ul style="list-style-type: none"> ▪ Install the USB printer driver in your computer.
	The machine is turned off or an error has occurred.
	<ul style="list-style-type: none"> ▪ Turn off the power, turn it back on, and then perform the update again. ▪ If this message reappears after you turn the power back on, see "Error and Status Messages on the Screen" in the User Guide.
Net Connection : FAIL(X)*1	The IP address specified for either the machine or your computer is invalid.
	<ul style="list-style-type: none"> ▪ Check that both IP addresses are valid.
	The [F/W Update (USB)] or [F/W Update (NET)] button was clicked when the update was already in progress.
	<ul style="list-style-type: none"> ▪ Clicking the [F/W Update (USB)] or [F/W Update (NET)] button during the update process does not interfere with any ongoing update. ▪ Ignore this error message and complete the update using the procedure shown in this manual.
	The machine is turned off or an error has occurred.

Firmware Updating

	<ul style="list-style-type: none"> ▪ Turn off the power, turn it back on, and then perform the update again. ▪ If this message reappears after you turn the power back on, see "Error and Status Messages on the Screen" in the User Guide.
	<p>The machine is being operated through the operation panel.</p>
	<ul style="list-style-type: none"> ▪ Cancel any operations being performed through the operation panel. ▪ Put the machine into standby mode, and then perform the update again.
<p>Net Server : Connecting...</p>	<p>Your computer is searching the network for the machine.</p> <ul style="list-style-type: none"> ▪ Wait a while until the machine is found.
<p>Net Upload : End of data</p>	<p>Firmware has been transferred to the machine successfully.</p> <ul style="list-style-type: none"> ▪ Follow the instructions in this manual to complete the update.
<p>USB Upload : End of data</p>	<p>Firmware has been transferred to the machine successfully.</p> <ul style="list-style-type: none"> ▪ Follow the instructions in this manual to complete the update.

Message	Cause/ Solutions
USB Upload : FAIL	The [F/W Update (USB)] or [F/W Update (NET)] button was clicked when the update was already in progress.
	<ul style="list-style-type: none"> ▪ Clicking the [F/W Update (USB)] or [F/W Update (NET)] button during the update process does not interfere with any ongoing update. ▪ Ignore this error message and complete the update using the procedure shown in this manual.
	The machine is being operated through the operation panel.
	<ul style="list-style-type: none"> ▪ Cancel any operations being performed through the operation panel. ▪ Put the machine into standby mode, and then perform the update again.

*1: "X" indicates an error code.

5.3.3 UPDATING FAILURE

If the initial screen does not appear and the message below remains on the operation panel display for more than one minute following firmware update, a power failure or similar interruption prevented the update from completing.

If this happens, use the following procedure to recover from the failure and complete the update.

 **Important**

- To recover the machine following a failed update, the machine must be connected to a computer by USB.
 - When using a computer running on a Windows operating system, you must have an account that has Manage Printers permission. Log on as an Administrator or Power Users group member to acquire this permission.
1. If you performed the update through a network connection, disconnect the network cable, and then connect the machine to your computer using a USB cable.
 2. While “Initializing” is shown on the operation panel display, double-click the [UpdateTool.exe] icon to launch the firmware update tool.
 3. Click [F/W Update (USB)].
 4. Wait until “Please Download FW Again Now!” appears on the operation panel display.
 - Make sure that you keep the power of the machine turned on.
 5. Click [F/W Update (USB)] again.
 6. Check the operation panel display for messages and the update’s current percentage of completion.

 **Note**

- The update may take a while to complete. Do not turn off the power during the update.
 - Turn off the power only when the machine beeps and “Firmware Update Done Please Reboot.” appears on the operation panel display.
7. Wait until the machine beeps once and “Firmware Update Done Please Reboot.” appears on the operation panel display.
 - Click [Close] to close the update tool.
 8. Turn off the power, and then turn it back on.
 - After you turn the power back on, “Initializing” appears on the operation panel display.
 9. Wait until the initial screen appears on the operation panel display.

10. Press any menu key on the machine's operation panel.
11. Press the [▲] [▼] keys to select [Reports Print], and then press the [OK] key.
12. Press the [▲] [▼] keys to select [Configuration Page] and then press the [OK] key.

↓ Note

- Take note of the new firmware version (shown under "Firmware Version" on the configuration page).

13. Reconnect the telephone line cable to the machine.

↓ Note

- The update's percentage of completion might not be displayed, depending on which version of the firmware is currently installed.
- In addition to printing a configuration page, you can check the machine's firmware version by accessing the machine using a web browser. For details, see "Checking Machine Status" in the User Guide.
- Depending on how it is configured, the machine might start up in fax mode following the firmware update.

5.3.4 UPDATING THE ENGINE FIRMWARE

1. Make a folder in your computer.
2. Save the files (".bin", ".fwu", ".ini" and ".exe") in the folder.

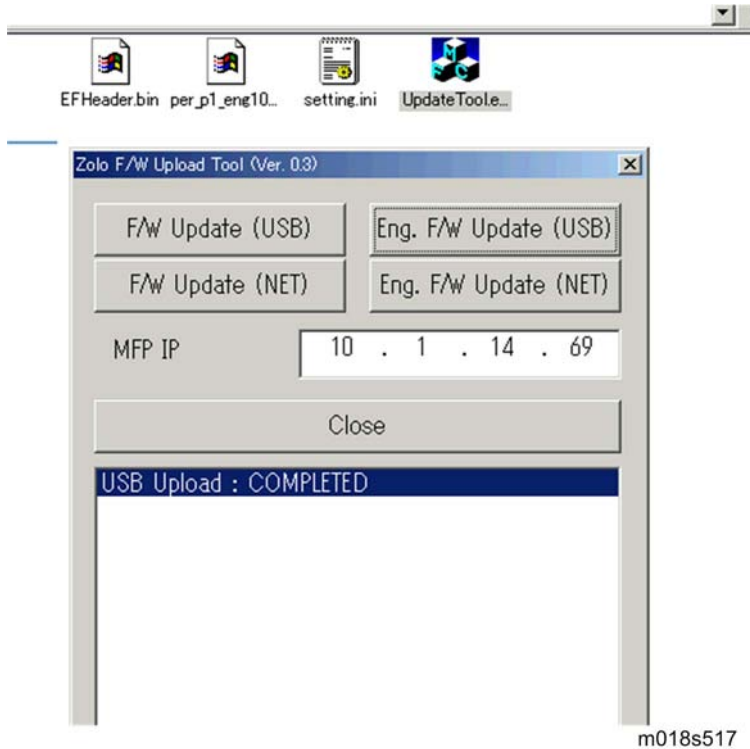

3. Click the exe file to execute the updating program.
4. Click "Eng. F/W Update (USB or NET)" to send the engine firmware from PC to MF printer.
 - The "F/W Update (USB or NET)" buttons are for designer use only. Do not use these buttons.
5. The machine makes a beep sound when starting the firmware update.
6. The image above is displayed at the PC and "Firmware update" and "Updating" are displayed on the operation panel.
7. Then, you can close this window at your PC.

 CAUTION

- Do not turn off the machine until "Done Please reboot" is displayed in the operation panel. Otherwise, the controller board will be damaged.
- If "Done Please reboot" does not appear, the download failed. Try again. You can also switch from an Ethernet connection to a USB connection and see if that works. If you still cannot download the firmware, it may be necessary to change the EGB and/or the controller board.
- If power failed during the download, try again. If you still cannot download the firmware, it may be necessary to change the EGB and/or the controller board.

5.3.5 BOOT LOADER FIRMWARE

This is also listed on the configuration page, but this firmware is not updated in the field.

TROUBLESHOOTING

TROUBLESHOOTING REVISION HISTORY		
Page	Date	Added/Updated/New
		None

6. TROUBLESHOOTING

6.1 TROUBLESHOOTING GUIDE

See "Appendices" for the following information:

- Error Messages
- Service Call Conditions

6.2 IMAGE PROBLEMS

6.2.1 OVERVIEW

Image problems may appear at regular intervals that depend on the circumference of certain components. The following diagram shows the possible symptoms (black or white dots at regular intervals).

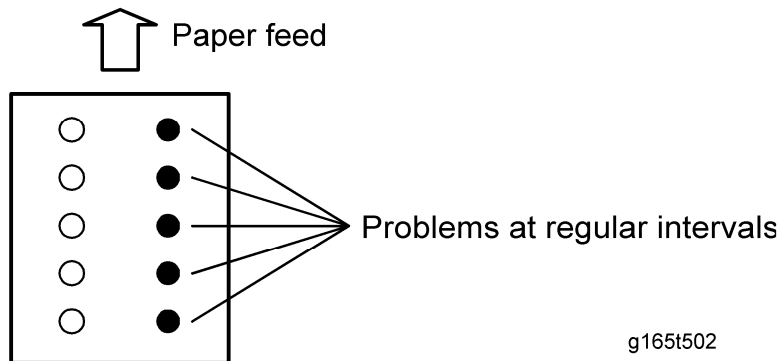

g165t502

- Abnormal image at 24-mm intervals: Paper feed roller
- Abnormal image at 25.5-mm intervals: Image transfer belt unit
- Colored spots at 27-mm intervals: Print cartridge (Development roller)
- Abnormal image at 30-mm intervals: Charge roller
- Abnormal image at 38-mm intervals: Registration roller
- Abnormal image at 60-mm intervals: Transfer roller
- Colored spots at 76-mm intervals: Print cartridge (OPC drum)
- Abnormal image at 110-mm intervals: Fusing unit (Pressure roller)
- Abnormal image at 115.5-mm intervals: Fusing unit (Heat roller)

6.2.2 CHECKING A SAMPLE PRINTOUT

Print out a mono-color pattern (all K, C, M, or Y), which will clarify if the cause is a problem with one of the AIOs, the image transfer belt, image transfer roller, or the fusing unit. A sample page is provided with the printer driver's CD. You can print the sample page from the printer driver's CD. Before printing, you have to adjust the printer driver settings to make the problem become obvious. For details about adjusting the settings, refer to "Printer Driver Setting for Printing a Sample" described below.

- Occurs with 1-3 colors: AIO unit(s) failure
- Occurs with all four colors: Image transfer belt, transfer roller or fusing unit failure

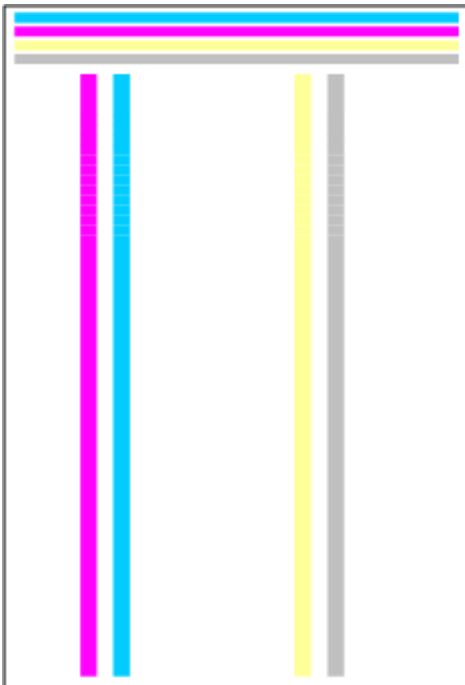

g165c502

Image Problems

Printer Driver Setting for Printing a Sample

1. Click "Properties" on the printer driver.

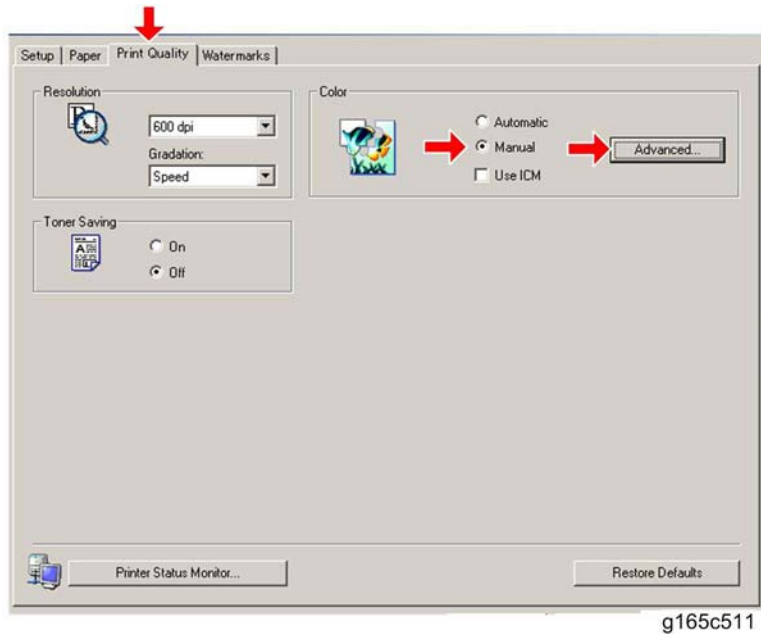

2. Click the "Print Quality" tab.
3. Check "Manual" in the color setting.
4. Click "Advanced..."

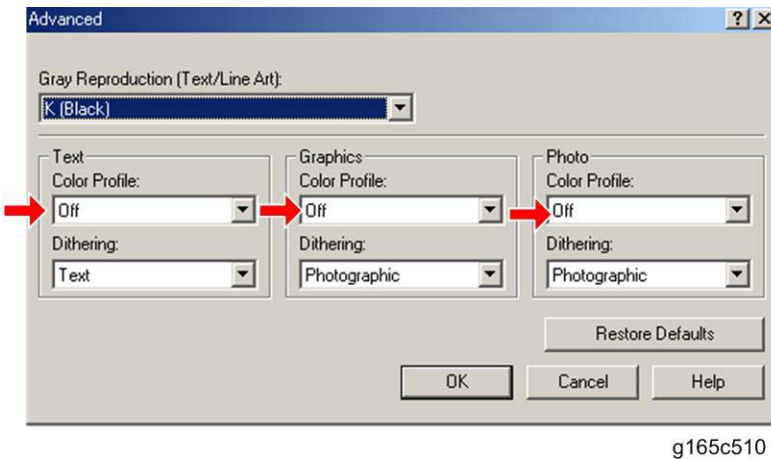

5. Select "Off" from the pull-down menu in "Color Profile" in the "Text" area.
6. Select "Off" from the pull-down menu in "Color Profile" in the "Graphics" area.
7. Select "Off" from the pull-down menu in "Color Profile" in the "Photo" area.

M018/M019
SERVICE MANUAL APPENDICES

M018/M019 Appendices

TABLE OF CONTENTS

1. APPENDIX: SPECIFICATIONS	1-1
1.1 GENERAL SPECIFICATIONS	1-1
1.1.1 ENGINE	1-1
Copier.....	1-4
Scanner.....	1-6
Fax	1-7
1.1.2 OPTION	1-8
Paper Feed Unit	1-8
1.2 SUPPORTED PAPER SIZES	1-9
2. APPENDIX: PREVENTIVE MAINTENANCE	2-1
2.1 PREVENTIVE MAINTENANCE	2-1
2.1.1 USER REPLACEABLE ITEMS	2-1
3. APPENDIX: TROUBLESHOOTING GUIDE	3-1
3.1 ERROR MESSAGES	3-1
3.1.1 OVERVIEW.....	3-1
3.1.2 ERROR MESSAGES LIST	3-1
3.2 SERVICE CALL CONDITIONS.....	3-6
3.2.1 SUMMARY.....	3-6
3.2.2 ENGINE SC	3-7
SC 1xx (Other Error)	3-7
SC 2xx (Laser Optics Error)	3-7
SC 3xx (Charge Error).....	3-9
SC 4xx (Image Transfer and Transfer Error).....	3-10
SC 5xx (Motor and Fusing Error).....	3-12
SC 6xx (Communication and Other Error).....	3-17
3.2.3 CONTROLLER SC	3-18
SC8xx.....	3-18

4. APPENDIX: SP MODE TABLES	4-1
4.1 SERVICE MENU.....	4-1
4.1.1 OVERVIEW.....	4-1
4.1.2 MAINTENANCE MODE MENU.....	4-1
Selecting an Item.....	4-1
Going into the Next Level/ Returning to the Previous Level	4-1
Exiting the Maintenance Mode Menu	4-1
Menu List.....	4-2
4.1.3 FAX SERVICE TEST MENU.....	4-14
Entering the Fax Service Test Menu	4-14
Selecting an Item.....	4-14
Going into the Next Level/ Returning to the Previous Level	4-14
Exiting the Maintenance Mode Menu	4-14
Menu List.....	4-14
5. APPENDIX: MACHINE SWAP.....	5-1
5.1 EXCHANGE AND REPLACE PROCEDURE	5-1
5.1.1 INSTRUCTION	5-1
Before the substitute machine gets to the customer site	5-1
When the substitute machine gets to the customer site	5-1
5.1.2 CLEANING POINTS AFTER MACHINE ARRIVAL AT DEPOT	5-2

APPENDIX: SPECIFICATIONS

SPECIFICATIONS REVISION HISTORY		
Page	Date	Added/Updated/New
		None

1. APPENDIX: SPECIFICATIONS

1.1 GENERAL SPECIFICATIONS

1.1.1 ENGINE

Type		Desktop	
Technology		Flatbed with CCD array image-sensor	
		Laser beam scanning and electro-photographic printing	
		Mono-component toner development	
		4-drum tandem method	
Resolution (dpi, bit/pixel)		600 × 600 dpi Speed (1bit) 600 × 600 dpi Standard (2bits) 600 × 600 dpi Fine (4bits)	
Printing Speed	General Paper	A4/LT	BW/FC: 20ppm (LT:21ppm)
First Print Speed (A4/LT, SEF, Std. Tray)	Mono		14.0 sec or less
	F/C		14.0 sec or less
Duplex Printing/Copying	A4, LT, B5, LG, Exe		Auto
Dimensions (W x D x H)		420 x 493 x 476 mm	

General Specifications

Weight			30 kg *Includes consumables.
Input capacity	Standard	Std Tray	250 sheets (80 g/m ²)
		Bypass tray	1 sheet
	Op. Paper Tray	Paper Feed Unit	500 sheets (80 g/m ²) x 1
	Max		Up to 751 sheets
Output capacity	Standard Tray	Face down	Up to 150 sheets (A4/LT or 80g/m ² , 20lb)
Input Paper Size	Standard Tray		A4, B5, A5, B6, A6, Legal, Letter, HLT, Executive, Foolscap, Folio Custom size: Min. 90mm x 148mm (3.6" x 5.92"), Max. 216mm x 356mm (8.64" x 14.24")
	Bypass Tray		A4, B5, A5, B6, A6, Legal, Letter, HLT, Executive, Foolscap, Folio Custom size: Min. 90mm x 148mm (3.6" x 5.92"), Max. 216mm x 356mm (8.64" x 14.24")
	Op. Paper Tray		A4, Letter
Media Type	Std. Tray		Plain Paper, Recycle Paper, Application Paper, Envelope, Glossy, Thick Paper, Label
	Bypass Tray		Plain Paper, Recycle Paper, Application Paper, Envelope, Glossy, Thick Paper, Label
	Op. Paper Feed Unit		Plain Paper, Recycle Paper

Paper Weight	Standard Tray		60-160g/m ² (16-40lb)
	Bypass tray		60-160g/m ² (16-40lb)
	Op. Paper Tray	Paper Feed Unit	60-105g/m ² (16-28lb)
ADF	Capacity		35 sheets (80g/m ² , 20lb)
	Original size		Letter/A4: Width 139.7-215.9 mm (5.5" - 8.5"), Length: 139.7-355.6 mm (5.5" - 14")
	Original weight		52 - 105 g/m ² (14 - 28lbs.)
Rating Power Spec.	NA version		120V, 60Hz
	EU version		220 to 240V, 50/60Hz
Power Consumption	NA version	Max.	1300W or less
		Energy Saver	M018 20 W or less M019 25 W or less
	EU version	Max.	1300W or less
		Energy Saver	M018 20 W or less M019 25 W or less
Warm-up Time			48 sec or less (from power on)
Energy Save Mode	Sleep Mode		48 sec (Uses approx 15W)
	Low Power Mode		10 sec (Uses approx 100W)

General Specifications

Copier

1st copy speed		Platen/ADF	B&W: Less than 30 sec. FC: Less than 30 sec.
Maximum original size		Platen	A4 (210 x 297mm) / Letter (215.9 x 279.4mm)
		ADF	A4 (210 x 297mm) / Letter (215.9 x 279.4mm) / Legal (215.9 x 355.6mm)
Copy Speed	Single Document	Platen	B/W: 20 cpm (A4), 21 cpm (LT) FC: 20 cpm (A4), 21 cpm (LT)
	Multiple Copy	ADF	B/W: 20 cpm, FC: 20 cpm (A4), B/W: 21 cpm, FC: 21 cpm (LT)
	Multiple Document Single Copy	ADF	B/W: 20 cpm, FC: 10 cpm
Multiple copy		Up to 99	
Resolution (H x V)		Scanning	600 x 600 dpi (Flatbed), 600 x 300 dpi (ADF)
		Printing	600 x 600 dpi
Grayscale		256 levels	
Reduction / Enlargement		Fix	NA: 50, 65, 78, 93, 129, 155, 200, 400% EU: 50, 71, 82, 93, 122, 141, 200, 400%
		Custom	25 – 400% in 1% steps

Image density adjustment	Yes, Manual only: 5 levels
Copy mode	Text/Photo/Mixed
Memory copy	Yes
Auto-duplex copy	No
Interrupt copy	No
Combine copy	2 in 1, 4 in 1 (Only ADF)
APS/AMS	No/No
Auto Tray Switch	No
Directional Magnification	No
Directional Size Magnification	No
Photo Mode	Yes
Auto Start	No
User Program	No
Electronic Sorting	Standard (collation, ADF only)
Image Rotation	No
Series Copy	No

General Specifications

Scanner

Scanning Device	CCD array image-sensor	
Resolution	Scanner: 1200 x 1200 dpi	
	Driver: Max. 19200 x 19200 dpi (interpolated)	
Gray scale	256 levels	
Scan modes/ speed (A4, 300dpi, USB2.0)	<ul style="list-style-type: none"> ▪ ADF: B/W: less than 5 sec. / Gray Scale: less than 5 sec. / Color: less than 10 sec ▪ Platen B/W: less than 5 sec. / Gray Scale: less than 5 sec. / Color: less than 10 sec 	
Maximum original size	Platen	Width max: Up to 216mm, Length max: Up to 297mm
	ADF	Width max: Up to 216mm, Length max: Up to 356mm
Scan Depth	48bit color processing (input), 24bit color processing (output)	
PC Interface	USB2.0, 10/100Base-TX	
TWAIN Compliment	TWAIN, WIA	
Scanner utilities and Drivers	TWAIN Driver, Scanner utility (PageManager)	

Fax

Circuit	PSTN/ PABX
Compatibility:	ITU-T Group 3
Coding system:	MH/MR/MMR
Modem speed:	Automatic Fallback: 33600 bps
Document size:	Platen: A4/ LT/ LG Width max: 216 mm (8.5"), Length max: 297 mm (11.7") ADF: A4/ LT/ DLT Width: 139.7-215.9mm (5.5" - 8.5") Length: 139.7-355.6 mm (5.5" - 14")
Scanning width:	Max. 210 mm (8.3")
Printing width:	Max. 208 mm (8.2")
Gray scale:	256 levels
Polling type:	Standard, Sequential
Contrast control:	Normal/Light/Dark (manual setting)
Resolution:	8 x 3.85/ 8 x 7.7 lines/mm 200 x 100/ 200 x 200 dpi
Scanning Speed	Less than 5 sec. (A4 SEF, 200 dpi)
Modem Speed	Automatic Fallback: 33600, 31200, 28800, 26400, 24000, 21600, 19200, 16800, 14400, 12000, 9600, 7200, 4800, 2400bps
Transmission Speed	Approx. 3 sec *ITU No.1 chart, Compression: MMR, Resolution: Standard, Speed: 33.6kbps

General Specifications

SAF Memory	100 pages (ITU No.1 chart, Compression: MMR, Resolution: Standard)
Memory Backup	1 hour
One-touch dial:	20 (10 x 2)
Broadcasting:	100 stations
Communication source:	Public switched telephone network
PC Fax utility:	Not available
Automatic re-dial	5/4/3/2 times after 5 minutes (Default 5 times)
Auto Answer	1-99 rings (Default 2 rings)

1.1.2 OPTION

Paper Feed Unit

Paper Tray (500x1)	Paper Size	A4,Letter
	Paper Weight	60-105g/m ² (16-28lb)
	Paper capacity	500 sheets x 1 tray
	Dimensions (W x D x H)	400 x 450 x 127mm/16 x 18 x 5.08 inch
	Weight	6 kg/13.2 lb

1.2 SUPPORTED PAPER SIZES

A	Supported and the size is molded in the tray. Need to select paper size by operation panel/driver.
B	Supported but size is not molded in the tray. Need to select paper size by operation panel/driver.
C	Need to input paper size by operation panel and driver.
N	Not supported.

Type		SEF/ LEF	Size	Input Tray			Auto. Dup.
				Standard Tray	Option PFU	Bypass Tray	
Plain Paper	A4	SEF	210x297	A	A	B	Y
		LEF	297x210	N	N	N	N
	B5	SEF	182x257	A	N	B	Y
		LEF	257x182	N	N	N	N
	A5	SEF	148x210	A	N	B	N
		LEF	210x148	N	N	N	N
	B6	SEF	128x182	B	N	B	N
		LEF	182x128	N	N	N	N
	A6	SEF	105x148	B	N	B	N
		LEF	148x105	N	N	N	N

Supported Paper Sizes

Type		SEF/ LEF	Size	Input Tray			Auto. Dup.
				Standard Tray	Option PFU	Bypass Tray	
Plain Paper	DLT	SEF	11" x 17"	N	N	N	N
	Legal	SEF	8 1/2"x14"	A	N	B	Y
	Letter	SEF	8 1/2"x11"	A	A	B	Y
		LEF	11"x 8 1/2"	N	N	N	N
	Half Letter	SEF	5 1/2" x 8 1/2"	C	N	C	N
	Executive	SEF	7 1/4"x10 1/2"	A	N	B	Y
		LEF	10 1/2"x7 1/4"	N	N	N	N
	F	SEF	8" x 13"	B	N	B	N
	Foolscap	SEF	8 1/2" x 13"	B	N	B	N
Folio	SEF	8 1/4" x 13"	B	N	B	N	
Plain Paper	8 Kai	SEF	267 x 390	N	N	N	N
	16 Kai	SEF	195 x 267	C	N	C	N
		LEF	267 x 195	N	N	N	N

Supported Paper Sizes

Type		SEF/ LEF	Size	Input Tray			Auto. Dup.
				Standard Tray	Option PFU	Bypass Tray	
Envelope	Com10	SEF	4 1/8" x 9 1/2"	C	N	C	N
	Monarch	SEF	3 7/8" x 7 1/2"	C	N	C	N
	C6	SEF	114 x 162	C	N	C	N
	C5	SEF	162 x 229	C	N	C	N
	DL Env	SEF	110 x 220	C	N	C	N
Custom		Width	90-216mm (3.6"x 8.5")	C	N	C	N
		Length	148 – 356mm (5.8"x 14.24")	C	N	C	N

APPENDIX:

PREVENTIVE MAINTENANCE

PREVENTIVE MAINTENANCE REVISION HISTORY		
Page	Date	Added/Updated/New
		None

2. APPENDIX: PREVENTIVE MAINTENANCE

2.1 PREVENTIVE MAINTENANCE

2.1.1 USER REPLACEABLE ITEMS

Item	Yield
Print Cartridge (AIO)	Starter/Short: Approx. 2.5 k prints/cartridge Long: 6.5 k for BK, 6.0 k for CMY (prints/cartridge)
Waste Toner Bottle	Approx. 25 k prints/ bottle (See condition 5)

Condition:

1. An A4 (8.5"x11")/ 5% chart was used to measure the above yield except the Print Cartridge (AIO).
2. The yield was measured at standard temperature and humidity.
3. The expected yield measurement for the Print Cartridge (AIO) is based on the ISO 19798 (ISO chart, continuous prints).
4. These yield values may change depending on the circumstances and printing conditions.
5. Waste Toner Bottle yield was measured for 3P/J when the printer is used 50% for color and 50% for black-and-white

APPENDIX:

TROUBLESHOOTING GUIDE

TROUBLESHOOTING GUIDE REVISION HISTORY		
Page	Date	Added/Updated/New
		None

3. APPENDIX: TROUBLESHOOTING GUIDE

3.1 ERROR MESSAGES

3.1.1 OVERVIEW

The error codes will be displayed on the LCD if the machine has a problem. These can be recovered by a customer.

3.1.2 ERROR MESSAGES LIST

000	Cover Open
	The front or top cover is open.
	<ol style="list-style-type: none"> 1. Close the front or top cover. 2. Replace the interlock switches or actuator mechanism.

010	AIO Set Error (Black)
011	AIO Set Error (Magenta)
012	AIO Set Error (Cyan)
013	AIO Set Error (Yellow)
	<ul style="list-style-type: none"> ▪ Black AIO not set ▪ Defective connection of the ID chip terminal on the black AIO
	<ol style="list-style-type: none"> 1. Install the AIO (black, magenta, cyan or yellow). Reinstall or replace the AIO (black, magenta, cyan or yellow).

Error Messages

014	Waste Toner Bottle Set Error
	<ul style="list-style-type: none"> ▪ Waste toner bottle not set ▪ Disconnected or defective harness of the waste toner bottle set sensor ▪ Defective waste toner bottle set sensor
	<ol style="list-style-type: none"> 1. Install the waste toner bottle. 2. Check or replace the harness of the waste toner bottle set sensor. 3. Replace the waste toner bottle set sensor.

030	Tray/Paper Selection Error
	<ul style="list-style-type: none"> ▪ No paper in the tray or tray not set in the machine ▪ Paper size requested by the job does not match the paper in the tray
	<ol style="list-style-type: none"> 1. Install the tray or put the correct size paper in the tray. 2. Check the paper setting in the user menu mode.

031	Paper Selection Error: Feed and Exit
	<ul style="list-style-type: none"> ▪ Paper size requested by the job does not match the paper in the tray ▪ Selection error for the paper feed and paper exit location in duplex mode
	Check the paper feed and exit location in the user menu mode.

050	Jam Error: No Feed from Tray 1
	<ul style="list-style-type: none"> ▪ Paper slipped
	Remove the paper jam at tray 1.

052	Jam Error: No Feed from Optional Tray
	<ul style="list-style-type: none"> ▪ Paper slipped
	Remove the paper jam at the optional tray (Tray 2).

055	Inner Jam Error: Registration/ Paper Exit
	A sheet of paper stays at the registration sensor or paper exit sensor. <ul style="list-style-type: none"> ▪ Paper slipped ▪ Paper double feed
	Remove the paper jam at the registration sensor or paper exit sensor.

056	Paper Exit Jam Error: Paper Exit/ Fusing Unit
	A sheet of paper stays at the paper exit sensor or winds around the rollers in the fusing unit. <ul style="list-style-type: none"> ▪ Paper slipped ▪ A sheet of paper is wound around the rollers in the fusing unit
	Remove the paper jam at the paper exit sensor or in the fusing unit.

070	Printing Error: No Paper
	<ul style="list-style-type: none"> ▪ No paper in the tray
	Put paper in the tray.

080	Toner Near End: Black AIO
081	Toner End: Black AIO
	<ul style="list-style-type: none"> ▪ Black toner near-end or end
	Replace the black AIO.

Error Messages

082	Toner Near End: Magenta AIO
083	Toner End: Magenta AIO
	<ul style="list-style-type: none">▪ Magenta toner near-end or end
	Replace the magenta AIO.

084	Toner Near End: Cyan AIO
085	Toner End: Cyan AIO
	<ul style="list-style-type: none">▪ Cyan toner near-end or end
	Replace the Cyan AIO.

086	Toner Near End: Yellow AIO
087	Toner End: Yellow AIO
	<ul style="list-style-type: none">▪ Yellow toner near-end or end
	Replace the yellow AIO.

088	Waste Toner Bottle: Near Full
089	Waste Toner Bottle: Full
	<ul style="list-style-type: none">▪ Waste toner bottle near-full or full
	Replace the waste toner bottle.

999	Color Registration (MUSIC) Error
	<ul style="list-style-type: none">▪ Color registration (MUSIC) failure
	This error is not displayed even if this error occurs. It is just logged. This error is automatically recovered after the color registration (MUSIC) has been done successfully.

3.2 SERVICE CALL CONDITIONS

3.2.1 SUMMARY

This machine issues an SC (Service Call) code if an error occurs on the machine. The error code can be seen on the operation panel.

Make sure that you understand the following points;

1. All SCs are logged.
2. At first, always turn the main switch off and on if an SC code is issued.
3. First, disconnect then reconnect the connectors before you replace the PCBs, if the problem concerns electrical circuit boards.
4. First, check the mechanical load before you replace motors or sensors, if the problem concerns a motor lock.
5. Fusing related SCs: To prevent damage to the machine, the main machine cannot be operated until the fusing related SC has been reset by a service representative.
 - Enter the engine maintenance mode.
 - Press "O.K" in "Fuser SC Reset" with engine maintenance mode, and then turn the main power switch off and on.

3.2.2 ENGINE SC

SC 1xx (Other Error)

195	Serial Number Error
	The serial number stored in the memory (EGB) is not correct.
	<ul style="list-style-type: none"> ▪ EEPROM defective ▪ EGB replaced without original EEPROM <ol style="list-style-type: none"> 1. Check the serial number. 2. If the stored serial number is incorrect, contact your supervisor.

SC 2xx (Laser Optics Error)

202	Polygon motor error 1: ON timeout
	The polygon mirror motor does not reach the targeted operating speed within 5 sec. after turning on or changing speed
203	Polygon motor error 2: OFF timeout
	The polygon mirror motor does not leave the READY status within 3 sec. after the polygon motor switched off.
204	Polygon motor error 3: XSCRDY signal error
	The SCRDY_N signal remains HIGH for 200 ms while the LD unit is firing.
	<ul style="list-style-type: none"> ▪ Polygon motor/driver board harness loose or disconnected ▪ Polygon motor/driver board defective ▪ Laser optics unit defective ▪ IPU (EGB) defective <ol style="list-style-type: none"> 1. Replace the interface harness of the laser optics unit. 2. Replace the laser optics unit. 3. Replace the EGB (Engine Board).

Service Call Conditions

220	Laser Synchronizing Detection Error: [K]/[Y]
	The laser synchronizing detection signal for LDB [K]/[Y] is not output after the LDB unit has turned on while the polygon motor is rotating normally.
222	Laser Synchronizing Detection Error: [M]/[C]
	The laser synchronizing detection signal for LDB [M]/[C] is not output after the LDB unit has turned on while the polygon motor is rotating normally.
	<ul style="list-style-type: none"> ▪ Disconnected cable from the laser synchronizing detection unit or defective connection ▪ Defective laser synchronizing detector ▪ Defective LDB ▪ Defective EGB <ol style="list-style-type: none"> 1. Check the connectors. 2. Replace the laser optics unit. 3. Replace the EGB.

240	LD error
	The IPU (EGB) detects a problem at the LD unit.
	<ul style="list-style-type: none"> ▪ Worn-out LD ▪ Disconnected or broken harness of the LD. <ol style="list-style-type: none"> 1. Replace the laser optics unit.

SC 3xx (Charge Error)

300	High voltage power output error
	The measured voltage is not correct when the EGB measures each charge output (charge, development, image transfer belt unit, and transfer unit).
	<ul style="list-style-type: none"> ▪ Disconnected or defective high voltage harness ▪ Defective high voltage power supply ▪ Defective EGB <ol style="list-style-type: none"> 1. Check or replace the harnesses. 2. Replace the high voltage power supply board 3. Replace the EGB.

396	Black drum motor error
	The LOCK signal error is detected when the EGB monitors the black drum motor state. (This monitoring is done immediately after power-on, when the motor starts rotating, and immediately after the motor stops.)
	<ul style="list-style-type: none"> ▪ Disconnected or defective motor harness. ▪ Motor slips due to excessive load <ol style="list-style-type: none"> 1. Check the harness from the black drum motor. Replace it if necessary.
397	Color drum motor error
	The LOCK signal error is detected when the EGB monitors the color drum motor state. (This monitoring is done immediately after power-on, when the motor starts rotating, and immediately after the motor stops.)
	<ul style="list-style-type: none"> ▪ Disconnected or defective motor harness. ▪ Motor slips due to excessive load <ol style="list-style-type: none"> 1. Check the harness from the color drum motor. Replace it if necessary.

Appendix:
Trouble-
Shooting
Guide

SC 4xx (Image Transfer and Transfer Error)

445	ITB (Image Transfer Belt) Unit: Home Position Error
	The ITB contact sensor does not detect the home position of the ITB for 5 seconds after the ITB unit initialization has been done.
	ITB (Image Transfer Belt) Unit: Contact Position Error
	The ITB contact sensor does not detect the contact position of the ITB for 5 seconds after the ITB unit has moved to the contact position.
	ITB (Image Transfer Belt) Unit: No-contact Position Error
	The ITB contact sensor does not detect the home position of the ITB for 5 seconds after the ITB unit has moved to no-contact position.
	<ul style="list-style-type: none"> ▪ Defective ITB contact motor ▪ Defective ITB contact sensor ▪ Defective ITB unit <ol style="list-style-type: none"> 1. Replace the ITB contact motor. 2. Replace the ITB contact sensor. 3. Replace the ITB unit.

480	Agitator Motor Error
	The agitator motor error is detected twice for 10 msec during the initialization at power-on or after the cover is closed.
	<ul style="list-style-type: none"> ▪ Disconnected or defective harness ▪ Defective agitator motor <ol style="list-style-type: none"> 1. Check or replace the harness. 2. Replace the agitator motor.

490	ITB (Image Transfer Belt) Unit Set Error
	The TM sensor does not detect the reflection from the ITB.
	<ul style="list-style-type: none"> ▪ No ITB unit in the machine ▪ Dirty TM sensor <ol style="list-style-type: none"> 1. Check the installation of the ITB unit. 2. Clean the TM sensor.

SC 5xx (Motor and Fusing Error)

500	Transport/Fusing Motor Error
	The LOCK signal error is detected when the EGB monitors the transport/fusing motor state. (This monitoring is done immediately after power-on, when the motor starts rotating, and immediately after the motor stops.)
	<ul style="list-style-type: none"> ▪ Disconnected or defective motor harness. ▪ Motor slips due to excessive load <ol style="list-style-type: none"> 1. Check the harness from the transport/fusing motor. Replace it if necessary.

530	LSU Fan Motor Error
	A LOCK signal is not detected for more than ten seconds while the motor START signal is on and if this error occurs twice consecutively, this SC is issued.
	<ul style="list-style-type: none"> ▪ Disconnected or defective motor harness. ▪ Defective LSU fan motor <ol style="list-style-type: none"> 1. Check or replace the motor harness. 2. Replace the LSU fan motor.

531	Fusing Fan Motor Error
	A LOCK signal is not detected for more than ten seconds while the motor START signal is on and if this error occurs twice consecutively, this SC is issued.
	<ul style="list-style-type: none"> ▪ Disconnected or defective motor harness. ▪ Defective LSU fan motor <ol style="list-style-type: none"> 1. Check or replace the motor harness. 2. Replace the fusing fan motor.

541	Thermistor Error
	The thermistor output is less than 0°C for 7 seconds.
	<ul style="list-style-type: none"> ▪ Disconnected thermistor ▪ Defective harness connection <ol style="list-style-type: none"> 1. Check the harness connection of the thermistor. 2. Replace the fusing unit. <p>★ Important</p> <ul style="list-style-type: none"> ▪ Execute "Engine Maintenance Menu" to recover the machine after completing the recovery procedure. Otherwise, the machine continues to issue this SC code and cannot be operated.

542	Print Ready Temperature Error
	<ul style="list-style-type: none"> ▪ The heating roller temperature increase during a set time is not correct. ▪ The fusing temperature does not reach the print ready temperature within a set time after the fusing lamp has turned on.
	<ul style="list-style-type: none"> ▪ Defective thermistor ▪ Incorrect power supply input at the main power socket ▪ Defective fusing lamp <ol style="list-style-type: none"> 1. Check the voltage of the wall outlet. 2. Replace the fusing unit 3. Replace the fusing lamp. <p>★ Important</p> <ul style="list-style-type: none"> ▪ Execute "Engine Maintenance Menu" to recover the machine after completing the recovery procedure. Otherwise, the machine continues to issue this SC code and cannot be operated.

Service Call Conditions

543	High Temperature Detection Error
	<p>This SC is issued if one of following conditions occurs:</p> <ul style="list-style-type: none"> ▪ The thermistor (center) detects 255°C or thermistor (end) detects 245°C. ▪ The thermistor (center) detects a 3°C increment or more for five seconds at 220°C or more or the thermistor (end) detects a 4°C increment or more for five seconds at 210°C or more.
	<ul style="list-style-type: none"> ▪ Defective I/O control (EGB) ▪ Defective EGB <ol style="list-style-type: none"> 1. Replace the EGB <p>★ Important</p> <ul style="list-style-type: none"> ▪ Execute "Engine Maintenance Menu" to recover the machine after completing the recovery procedure. Otherwise, the machine continues to issue this SC code and cannot be operated.

545	Heating Lamp Full-Power Error
	<p>The fusing lamp is fully-powered for a certain time while the fusing unit stays in the stand-by mode and is not rotating.</p>
	<ul style="list-style-type: none"> ▪ Deformed thermistor ▪ Thermistor not in the correct position ▪ Defective fusing lamp <ol style="list-style-type: none"> 1. Replace the fusing unit. 2. Replace the fusing lamp. <p>★ Important</p> <ul style="list-style-type: none"> ▪ Execute "Engine Maintenance Menu" to recover the machine after completing the recovery procedure. Otherwise, the machine continues to issue this SC code and cannot be operated.

547	Zero Cross Error
	The zero cross signal is not detected for three seconds even though the fusing lamp relay is on after turning on the main power or closing the front door.
	<ul style="list-style-type: none"> ▪ Defective fusing lamp relay <ol style="list-style-type: none"> 1. Turn the main power switch off and on. <p>★ Important</p> <ul style="list-style-type: none"> ▪ Execute "Engine Maintenance Menu" to recover the machine after completing the recovery procedure. Otherwise, the machine continues to issue this SC code and cannot be operated.

548	Low Temperature Error
	The center thermistor detects 100°C or less for 4 seconds.
	<ul style="list-style-type: none"> ▪ Defective fusing lamp ▪ Defective thermistor <ol style="list-style-type: none"> 1. Replace the fusing unit. 2. Replace the fusing lamp. <p>★ Important</p> <ul style="list-style-type: none"> ▪ Execute "Engine Maintenance Menu" to recover the machine after completing the recovery procedure. Otherwise, the machine continues to issue this SC code and cannot be operated.

Service Call Conditions

557	Zero Cross Frequency Error
	The detection error occurs ten times consecutively in ten zero cross signal detections. This error is defined when the detected zero cross signal is 17 or less/27 or more for 0.2 seconds.
	<ul style="list-style-type: none"> ▪ Defective fusing lamp relay ▪ Unstable input power source <ol style="list-style-type: none"> 1. Check the power supply source. 2. Replace the fusing unit. <p>★ Important</p> <ul style="list-style-type: none"> ▪ Execute "Engine Maintenance Menu" to recover the machine after completing the recovery procedure. Otherwise, the machine continues to issue this SC code and cannot be operated.

559	Consecutive Fusing Jam
	<p>The paper jam counter for the fusing unit reaches 3. The paper jam counter is cleared if the paper is fed correctly.</p> <p>This SC is activated only when this function is enabled with "Engine Maintenance" (default "OFF").</p>
	<ul style="list-style-type: none"> ▪ Defective fusing unit ▪ Defective fusing control <ol style="list-style-type: none"> 1. Clear this SC to send a command after a jam removal. 2. Turn off this function after a jam removal. <p>★ Important</p> <ul style="list-style-type: none"> ▪ Execute "Engine Maintenance Menu" to recover the machine after completing the recovery procedure. Otherwise, the machine continues to issue this SC code and cannot be operated.

SC 6xx (Communication and Other Error)

669	EEPROM Error
	An unexpected value exists in the initialization flag of the EEPROM
	<ul style="list-style-type: none"> ▪ EEPROM not initialized ▪ Defective EEPROM <ol style="list-style-type: none"> 1. Initialize the EEPROM. 2. Replace the EEPROM. 3. Replace the EGB.

690	GAVD Communication Error
	The ID of the GAVD is not identified during initialization.
	The chip ID of the GAVD cannot be detected by the machine at power-on.
	<ul style="list-style-type: none"> ▪ Defective EGB <ol style="list-style-type: none"> 1. Replace the EGB.

3.2.3 CONTROLLER SC

SC8xx

819	Service Cycle Power
	<ul style="list-style-type: none"> ▪ Incorrect combination of EGB and controller board. ▪ An unexpected error occurs in the EEPROM on the controller board.
	<ul style="list-style-type: none"> ▪ Controller board defective <ol style="list-style-type: none"> 1. Install the correct EGB and controller boards for this machine. 2. Replace the controller board

823	USB/ Network Device Error
	An interface error in the USB connection or NIB connection occurs.
	<ul style="list-style-type: none"> ▪ Controller board defective <ol style="list-style-type: none"> 1. Replace the controller board.

824	EEPROM Error
	An EEPROM check error at power-on occurs.
	<ul style="list-style-type: none"> ▪ Controller board defective <ol style="list-style-type: none"> 1. Replace the controller board.

827	On-Board Memory Check Error
	An on-board memory check error at power-on occurs.
	<ul style="list-style-type: none"> ▪ Controller board defective <ol style="list-style-type: none"> 1. Replace the controller board.

828	ROM Checksum Error
	A ROM checksum error at power-on occurs.
	1. Replace the controller board.

APPENDIX:

SP MODE TABLES

SP MODE TABLES REVISION HISTORY		
Page	Date	Added/Updated/New
14 ~ 15	07/02/2009	Updated Information – Service Menu
70	06/29/2009	Corrected Copy Data Security Unit Type F (B829)
112 ~ 142	12/10/2008	Added Scanner Accessibility Option Type 5000

4. APPENDIX: SP MODE TABLES

4.1 SERVICE MENU

4.1.1 OVERVIEW

This model has several service menus. Each service menu has several adjustment items. This section explains how to enter each service menu and what you can do in each service menu.

Each menu is classified into two "Modes" depending on how you enter the service menus.

- "Menu Mode" can be executed by pushing a sequence of keys.
- "Special Mode" can be executed if you press certain keys at the same time as you turn the power on.

Each menu is classified as follows:

Menu Mode	
Maintenance Mode Menu	This is a menu for maintenance and service.
Special Mode	
Fax Service Test Menu	This is a menu for checking the fax mode.

4.1.2 MAINTENANCE MODE MENU

Selecting an Item

To select an item, press the "Up" or "Down" key.

Going into the Next Level/ Returning to the Previous Level

- To go into the next level of an item, select an item then press the "OK" key.
- To return to the previous level of an item, press the "Return" key.

Exiting the Maintenance Mode Menu

To exit the maintenance mode menu, press the "Clear/Stop" or "Return" key until the "Ready" display appears.

Service Menu

Menu List

Display Info		
Model Name		Displays the Model Name, Depends on Engine Firmware Settings
FW Ver.	CTL FW Ver.	Displays the Firmware Version
	FAX FW Ver.	Displays the PDL Firmware Version.
	MCTL FW Ver.	Displays the Engine Firmware Version
	PDL FW Ver.	Displays the PDL Firmware Version.
Counter	Printer Counter	Displays the following counters of the printer engine. Total Page/ Color Image/ Black Image
	Scanner Counter	Displays the sum total of scanner counters for each mode. Total Page/ Black Page/ Color Page / ADF Used
	Jam Counter	Displays the number of paper jams at each location. Total/ ADF/ Printer Output Bin/ Internal/ Tray1 / Tray2/ Duplex
	Coverage 1/ Coverage 2	Coverage 1: [0 to 100 / 5 / 1/step] Coverage 2: [0 to 100 / 20 / 1/step] Changes the thresholds for each coverage counter.

Print Reports	
G3 Protocol dump list	G3 protocol dump of the latest communication is printed. Off (Default)/ Error/ On

Engine Maintenance		
Toner Limit	Text	Determines the maximum amount of ink/toner you can use in any area of your text. This is where you are controlling exactly how much ink will be used during printing. [200 to 400 / 250 (Default)/ 10/step] Setting 0: Off
	Graphic	Determines the maximum amount of ink/toner you can use in any area of your graphic. This is where you are controlling exactly how much ink will be used during printing. [200 to 400 / 250 (Default)/ 10/step] Setting 0: Off
	Image	Determines the maximum amount of ink/toner you can use in any area of your image. This is where you are controlling exactly how much ink will be used during printing. [200 to 400 / 250 (Default)/ 10/step] Setting 0: Off
P _N P Name	NA Model: RICOH/ 'nul' EU Model: RICOH/ NRG/ LANIER ASIA Model: RICOH/ LANIER China Model: RICOH	

Appendix:
SP Mode
Tables

Service Menu

Engine Maintenance		
Destination	Sets the destination and updates the engine setting. JPN/ NA (Default)/ EU/ ASIA/ China	
2nd Transfer Fuser Temp.	2nd Transfer Front	Adjusts the transfer roller current, based on the default value. [-15 to 15 / 0 (Default) / 1 μ A/step]
	2nd Transfer Back	Adjusts the transfer roller current, based on the default value. [-15 to 15 / 0 (Default) / 1 μ A/step]
	Fuser Temperature	Adjusts the temperature of the fusing unit, based on the default value. [-30 to 0 / 0 (Default) / 2°C/step]
	Media Type	Plain Paper (90-105 g/m ²)/ Plain Paper/ Thick Paper (1405-110 g/m ²)/ Thin Paper (60-75 g ²)/ Thick Paper (Post Card)/ Envelop/ Cardstock/ Bond paper/ Label Paper/ Prepunched/ Preprinted/ Letterhead/ Color/ Recycled
Registration	Horiz. Tray1	Adjusts the horizontal registration for tray 1. If the machine settings are reset to the factory defaults, this value does not change. [-15 to 15 / 0 (Default) / 4 mm/step]
	Vert.Tray1	Adjusts the vertical registration for tray 1. If the machine settings are reset to the factory defaults, this value does not change. [-15 to 15 / 0 (Default) / 0.24 mm/step]
	Horiz.Tray2	Adjusts the horizontal registration for tray 2. If the machine settings are reset to the factory defaults, this value does not change. [-15 to 15 / 0 (Default) / 4 mm/step]

Engine Maintenance		
	Vert.Tray2	Adjusts the vertical registration for tray 2. If the machine settings are reset to the factory defaults, this value does not change. [-15 to 15 / 0 (Default) / 0.3 mm/step]
Registration	Horiz.Bypass	Adjusts the horizontal registration for the bypass tray. If the machine settings are reset to the factory defaults, this value does not change. [-15 to 15 / 0 (Default) / 4 mm/step]
	Vert.Bypass	Adjusts the vertical registration for the bypass tray. If the machine settings are reset to the factory defaults, this value does not change. [-15 to 15 / 0 (Default) / 0.3 mm/step]
	Horiz.Dup.Back	Adjusts the horizontal registration for the back side in duplex mode. If the machine settings are reset to the factory defaults, this value does not change. [-15 to 15 / 0 (Default) / 4 mm/step]
	Vert.Dup.Back	Adjusts the vertical registration for the back side in duplex mode. If the machine settings are reset to the factory defaults, this value does not change. [-15 to 15 / 0 (Default) / 0.3 mm/step]
Reset Count	Resets counters to factory defaults.	
Clear Count	Clears the Scanner and Jam Counters.	
Replace Fuser	Resets the maintenance counter for the fusing unit. This item appears only when the fusing unit life is almost expired or has expired.	

Service Menu

Engine Maintenance		
Init Engine EEPROM	<p>This clears all counters except "Full Color" and "Black and White" in the total counter.</p> <p>When you execute "Init Engine EEPROM", the engine EEPROM is initialized.</p> <p>Turn the machine power off/on after you change this setting.</p>	
Model	<p>Displays only</p> <p>1: MF2b</p> <p>2: M019</p> <p>Displays the current model in a dropdown list.</p> <p>Do not change this setting (Designed for Factory Use).</p>	
Brand ID	<p>00* – 7F</p> <p>Displays the current brand ID number.</p> <p>Do not change this setting (Designed for Factory Use).</p>	
LSU Adjustment	Input 160 bytes setting.	<p>Character: alphanumeric "0-9", "a-f", "A-F", only valid data can be input.</p> <p>Input length: 160 bytes</p>
Trans. Belt Adjust	<p>When you execute "Trans. Belt Adjust", the transfer belt adjustment is done. This calibrates the motor speed to match the length of the new transfer belt.</p>	
Fuser SC Detect	On/Off*	<p>If On, the engine detects SC559. If Off, the engine does not detect "Fusing SC Reset".</p>
Color Registration	<p>The engine will do color registration and density tuning automatically.</p> <p>The machine will warm up automatically after this setting is changed.</p>	
Reset Transfer Unit Life Counter	<p>Resets the transfer unit life counter.</p>	

Engine Maintenance	
Fuser SC Reset	This button is for resetting an SC related with the fusing errors.
Special Mode	For future use, this mode is not used in this mode. [0 to 7F] Write command: EEC34 (0xA2, 0x00 to 7F) Read command: EEC34 (0xE2, 0x01)

Service Menu

Scan Maintenance		
Mono Compression Setting	Sets the monochrome compression type for scanning. MH (Default)/ MR/ MMR	
Regist Adjust	ADF Main Reg.	Adjusts the ADF Scan main-scan registration. [-2.0 to 2.0 / 0 (Default)/ 0.1 mm/step]
	ADF Sub Reg.	Adjusts the ADF Scan sub-scan registration. [-2.0 to 2.0 / 0 (Default)/ 0.1 mm/step]
	Flatbed Main Reg.	Adjusts the Flatbed Scan main-scan registration. [-2.0 to 2.0 / 0 (Default)/ 0.1 mm/step]
	Flatbed Sub Reg.	Adjusts the Flatbed Scan sub-scan registration. [-2.0 to 2.0 / 0 (Default)/ 0.1 mm/step]
Size Adjust	ADF Main Reg.	Adjusts the ADF Scan main-scan magnification. [-0.9 to 0.9 / 0 (Default)/ 0.1 %/step]
	ADF Sub Reg.	Adjusts the ADF Scan sub-scan magnification. [-0.9 to 0.9 / 0 (Default)/ 0.1 %/step]
	Flatbed Main Reg.	Adjusts the Flatbed Scan main-scan magnification. [-0.9 to 0.9 / 0 (Default)/ 0.1 %/step]
	Flatbed Sub Reg.	Adjusts the Flatbed Scan sub-scan magnification. [-0.9 to 0.9 / 0 (Default)/ 0.1 %/step]

Fax Maintenance		
Modem Settings	RX Level	Sets the reception level. [-43 dBm (Default)/ -33 dBm/ -26 dBm / -16 dBm]
	TX Level	Sets the transmission level. [0 dBm/ -1 dBm/ -2 dBm/ -3 dBm/ -4 dBm / -5 dBm/ -6 dBm/ -7 dBm/ -8 dBm/ -9 dBm / -10 dBm/ -11 dBm/ -12 dBm/ -13 dBm / -14 dBm/ -15 dBm]
	Cable Equalizer	These selectors are used to improve the pass-band characteristics of analogue signals on the telephone line. [0Km (Default)/ 1.8Km/ 3.6Km/ 7.2Km]
Protocol Definition	Training Retries	This sets the number of training retries to be repeated before automatic fallback. [1 Time/ 2 Times (Default)/ 3 Times/ 4 Times]
	Encoding	Sets the compression method for Tx/Rx. [MMR+MR+MH (Default)/ MR+MH/ MH]
Protocol Definition Timer	T0 Timer	Timeout for response from the called station in automatic sending mode [35 Sec/ 45 Sec/ 55 Sec (Default)/ 60 Sec/ 90 Sec/ 140 Sec]
	T1 Timer	Set the time length for the T1 timer. [40 Sec (Default)/ 50 Sec]
	T4 Timer	Set the time length for the T4 timer. [3 Sec (Default)/ 4.5 Sec]

Service Menu

Fax Maintenance		
RX Settings	Silence Detection Time	Silence (No tone) detection time (Rx mode : FAX/ TAD Only) After the line is connected via the external telephone, the machine can detect silence (no tone) for the time length specified by this setting. [30 sec (Default)]
	CNG Tone Detection Time	CNG tone detection time (RX mode : FAX / TEL, FAX / TAD Only) After the line is connected via the external telephone, the machine can detect a CNG signal for the time length specified by this setting. [5 Sec (Default)/ 10 Sec]
	CNG Cycles	Number of CNG cycles to be detected This setting is only effective for FAX/TAD mode. [1.5 Cycle (Default)/ 2.0 Cycle]
	Tone Sound Monitoring	Determines the period when tones from the line are monitored. [No Monitoring/ Up To Phase B (Default)/ All TX Phases]
	Stop/Clear key	Pressing the Stop/Clear key can stop the current receiving operation. Received data is lost. [Not Functional (Default)/ Functional]
	Off-Hook Level	Sets the off-hook detection threshold. [10V (Default)/ 15V/ 20V/ 25V]
TX Settings	Redial Interval	Sets the redial interval when Tx fails. [5 Min/ 6 Min]
	Redialings	Sets the number of redials when Tx fails. [2 times/ 3 Times/ 4 Times/ 5 Times]

Fax Maintenance		
Overseas Comm Mode Settings	Overseas Comm Mode	This sets the machine to ignore a DIS signal sent from the called station once in a sending operation. [Off (Default)/ Ignore DIS Once]
	Minimum Time Length	If this setting is set to "On", the machine detects the CNG signal after the line is connected. If it is set to "Off", the machine detects the CNG signal as long as the line is connected. [100 Ms/ 200 Ms/ 300 Ms/ 400 Ms (Default)]
Dial Pulse Setting	Dial Pulse Type	This sets the number of pulses that are generated during dialing. <ul style="list-style-type: none"> ▪ N: Dialing '0' generates 10 pulses --- Dialing '9' generates 9 pulses. ▪ N+1: Dialing '0' generates 1 pulses --- Dialing '9' generates 10 pulses. ▪ 10-N: Dialing '0' generates 10 pulses --- Dialing '9' generates 1 pulse.
Tone Signal Settings	Tone Signal Transmission Time Length	Sets the tone signal transmission time length [100 ms (Default)]
	Minimum Pause In Tone Dialing	Sets the minimum pause during tone dialing [100 ms (Default)/ 150 ms/ 200 ms]
	Attenuator For Pseudo Ring Backtone To the Line	Sets the attenuator for pseudo ringback tone to the line [0 to 15 / 10 (Default)/ 1 dB/step]
	DTMF Level	Sets the transmission level of DTMF tones. [-12 dBu / -11 dBu/ -10 dBu/ -8 dBu/ -6 dBu]

Service Menu

Fax Maintenance		
	DTMF Delta	Sets the level difference between high band frequency signals and low band frequency signals when sending DTMF tones. [2 dBu/ 3 dBu]
1Dial Tone Detection	Wait Time	The machine starts dialing after the specified interval without detection of a dial tone when Dial tone detection is set to "No detection". [3.5 Sec (Default)/ 7.0 Sec/ 10.5 Sec / 14.0 Sec]
	Timeout Length	This setting sets the time-out length for the 1st dial tone detection. The machine waits for a dial tone for the specified time and disconnects itself from the line when no dial tone is input. [10 Sec (Default)/ 15 Sec/ 20 Sec/ 30 Sec]
BT (Busy Tone) Detection	BT Setting	DFU [Off/ On] BT: Busy tone
	BT Frequency	DFU [300-550 Hz/ 300-650 Hz/ 325-525 Hz/ 340-550 Hz/ 350-500 Hz/ 350-550 Hz/ 375-475 Hz/ 380-520 Hz]
	BT Level	DFU [-35 dB/ -36 dB/ -37 dB/ -38 dB/ -39 dB]
	BT Cadence	DFU [0.10/ 0.15/ 0.20/ 0.25/ 0.30/ 0.35/ 0.40/ 0.45/ 0.50/ 0.75]

Fax Maintenance		
Comm Settings	RTN Rate	The machine checks the actual data reconstruction errors and then transmits an RTN depending on the decoding error rate that is set by this setting (Number of lines containing an error per page / Total number of lines per page). [10%/ 15%]
	V34 Modem	DFU [Permitted (Default)/ Prohibited]
	V17 Modem	DFU [Permitted (Default)/ Prohibited]
V34 Settings	Equalizer	These selectors set the equalizer's training level to be applied if training fails due to poor line connection. [Automatic (Default)/ 4 Points/ 16 Points]
	Redialing	Resend when a communication error occurs. [Disabled (Default)/ Not Disabled]
	First TX Speed	Sets the first transmission speed choice, before fallback. [2400 Bps/ 4800 Bps/ 7200 Bps/ 9600 Bps / 12000 Bps/ 14400 Bps/ 16800 Bps/ 19200 Bps/ 21600 Bps/ 24000 Bps/ 26400 Bps/ 28800 Bps/ 31200 Bps/ 33600 Bps (Default)]
	Symbol Rate	This setting limits the transmission speed range in V.34 mode by masking the desired symbol rate(s). [Not Used (Default)/ 3429 Sym/Sec / 3200 Sym/Sec/ 3000 Sym/Sec / 2800 Sym/Sec/ 2400 Sym/Sec]

Appendix:
SP Mode
Tables



- ⇒
- The "Reseller Default" menu can be entered directly at power-on. If you want to enter this mode directly, try the following procedure SPC 232SF Reset Password.
 1. Power OFF the unit.
 2. Power ON the unit while holding down the "Copy" key.
 3. Continue to hold down the "Copy" key until the display indicates "*Factory Default Execute*".
 4. Release the "Copy" key.
 5. Press the Down Arrow, the display will change to "*Factory Default Execute*".
 6. Press the OK key.
 7. The machine will display "*Executing*" and will perform a soft boot.
 8. When the unit returns to the ready condition, reboot by turning the Main Switch OFF and then ON.
 9. Set Language, Fax Number, Name and Country.
 10. Reboot the machine.

4.1.3 FAX SERVICE TEST MENU

Entering the Fax Service Test Menu

Turn ON the machine while pressing the "Fax" key.

Selecting an Item

To select the item, press the "Up" or "Down" key.

Going into the Next Level/ Returning to the Previous Level

- To go into the next level of an item, select an item then press the "OK" key.
- To return to the previous level of an item, press the "Return" key.

Exiting the Maintenance Mode Menu

To exit the maintenance mode menu, press the "Clear/Stop" or "Return" key until the "Ready" display appears.

Menu List

Fax Test		
Off-Hook Test	On Hook	Executes the on hook test.
	Off Hook	Executes the off hook test
CED Test		Executes the CED test.
CNG Test	1100 Hz	Executes the CNG test
ANSam		Executes the ANSam test.
Ring Tone Test		Executes the ring tone test.
DTMF Test	Tone [0] to [9]	Executes the DTMF tone 0 to 9 test.
	Tone [*]	Executes the DTMF tone * test.
	Tone [#]	Executes the DTMF tone # test.
	Tone Stop	Executes the Stop DTMF tone test.
Modem Test	[V34] 33600 bps	Generates the [V34] 33600 bps signal.
	[V34] 28800 bps	Generates the [V34] 28800 bps signal.
	[V17] 14400 bps	Generates the [V17] 14400 bps signal.
	[V17] 12000 bps	Generates the [V17] 12000 bps signal.
	[V17] 9600 bps	Generates the [V17] 9600 bps signal.
	[V17] 7200 bps	Generates the [V17] 7200 bps signal.
	[V29] 9600 bps	Generates the [V29] 9600 bps signal.
	[V29] 7200 bps	Generates the [V29] 7200 bps signal.
	[V27] 4800 bps	Generates the [V27] 4800 bps signal.
	[V27] 2400 bps	Generates the [V27] 2400 bps signal.
	[V21] 300 bps	Generates the [V21] 300 bps signal.
	Signal Stop	Generates the Stop signal.

APPENDIX:

MACHINE SWAP

MACHINE SWAP REVISION HISTORY		
Page	Date	Added/Updated/New
		None

5. APPENDIX: MACHINE SWAP

5.1 EXCHANGE AND REPLACE PROCEDURE

If the machine exchange and replacement is required, arrange to send a machine without the four print cartridges (AIO) to the customer site.

5.1.1 INSTRUCTION

Instruct the customer to do the following procedure.

Before the substitute machine gets to the customer site

- Save the customer settings by using a web browser. For details, refer to the "User Guide".
- Clear customer settings in the problem machine.

When the substitute machine gets to the customer site

1. Remove the four print cartridges (AIO) from the problem machine.
2. Install the four print cartridges (AIO) into the substitute machine.
3. Restore the customer settings by using a web browser.
4. Send back the problem machine to the repair center.

5.1.2 CLEANING POINTS AFTER MACHINE ARRIVAL AT DEPOT

1. Open the front cover.

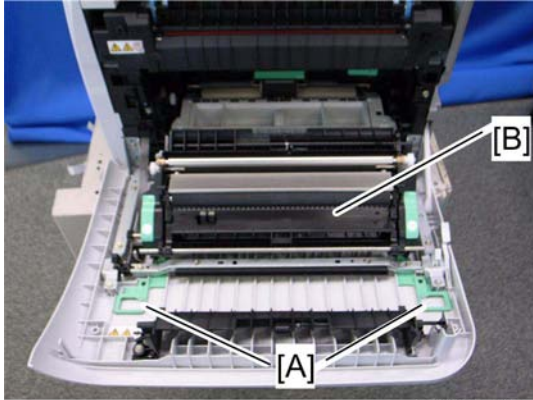

m018r549

2. Release the locks [A].
3. Transfer unit [B]

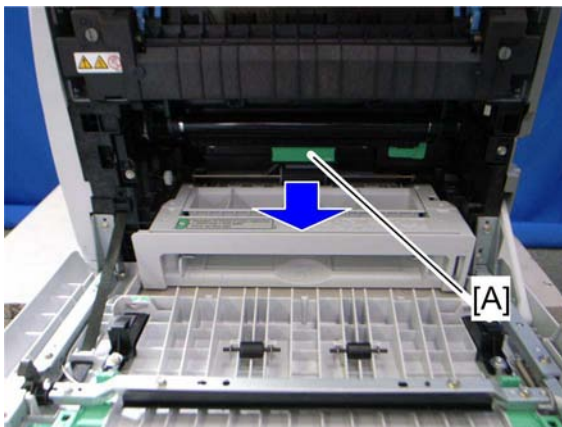

m018r529

4. Pull out the waste toner bottle [A].

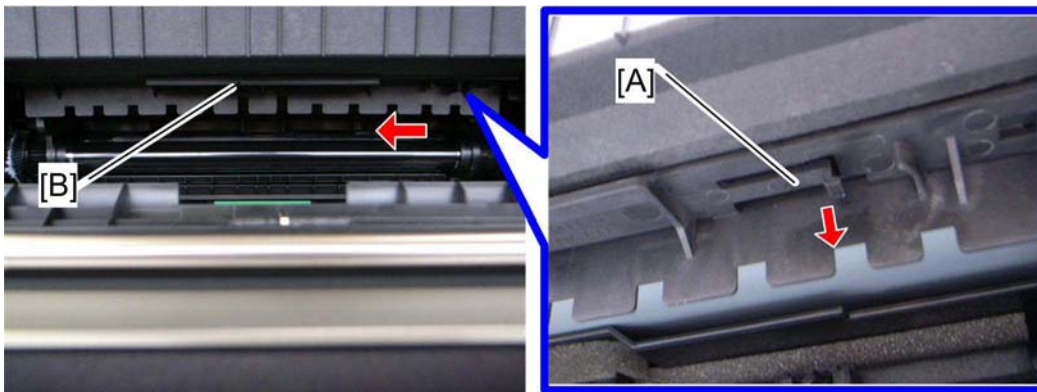

m018r529b

m018r691b

5. Release the hook [A] under the guide plate.

6. Move the guide plate [B] underneath the fusing unit to the left, and then remove it.

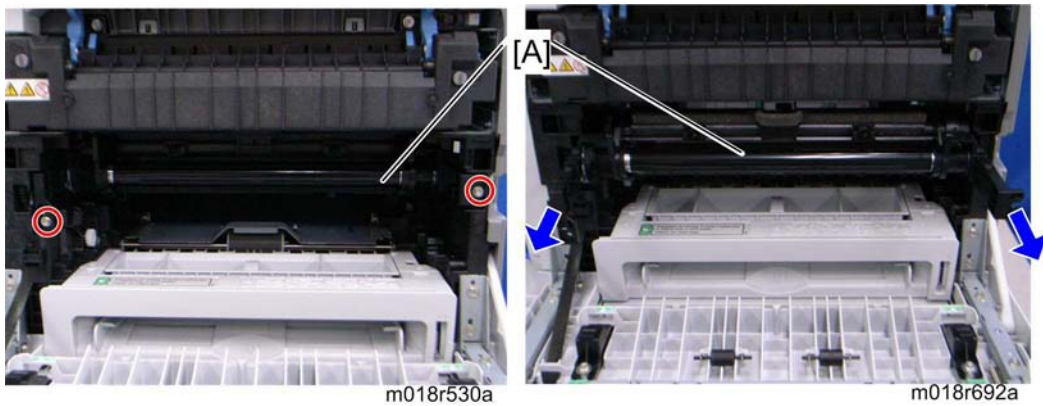

7. Pull out the image transfer belt unit [A] (x 2).

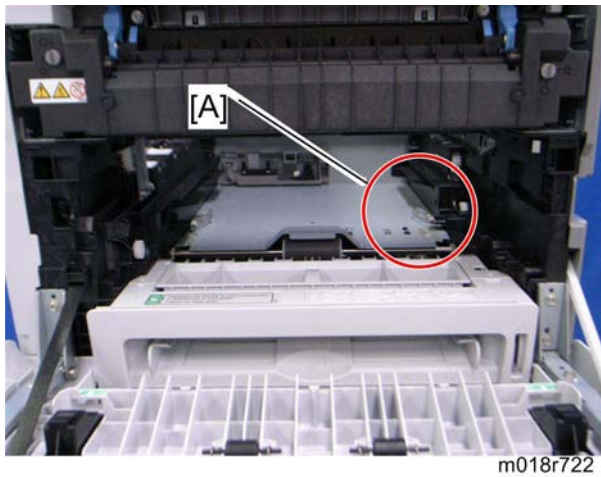

8. Clean inside the machine, especially around the circled area [A].

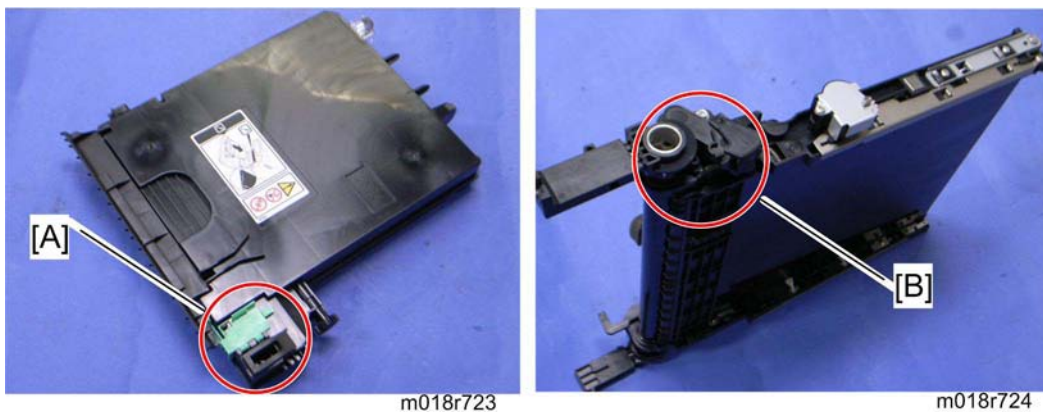

9. Clean the circled area at the waste toner bottle [A] and circled area [B] at image transfer belt unit.
10. Reassemble the machine.

PAPER FEED UNIT TK1010 (G849)

PAPER FEED UNIT TK1010 (G849) REVISION HISTORY		
Page	Date	Added/Updated/New
		None

PAPER FEED UNIT TK1010 (G849)

TABLE OF CONTENTS

1. REPLACEMENT AND ADJUSTMENT	1
1.1 PAPER FEED UNIT	1
1.1.1 TOP COVER.....	1
1.1.2 PAPER FEED AND RELAY CLUTCH	1
1.1.3 PAPER END AND RELAY SENSOR.....	2
1.1.4 PAPER FEED ROLLER.....	3
When reassembling.....	4
1.1.5 FRICTION PAD	5
When reassembling.....	5
2. DETAILED SECTION DESCRIPTIONS.....	7
2.1 OVERVIEW.....	7
2.1.1 COMPONENT LAYOUT	7
2.2 BASIC OPERATION	8
2.2.1 PAPER SEPARATION AND FEED.....	8
2.2.2 PAPER LIFT	9
2.2.3 PAPER END DETECTION	10

Read This First

Safety and Symbols

Replacement Procedure Safety

CAUTION

- Turn off the main power switch and unplug the machine before beginning any of the replacement procedures in this manual.

Symbols Used in this Manual

This manual uses the following symbols.

: See or Refer to

: Screws

: Connector

: Clip ring

: E-ring

1. REPLACEMENT AND ADJUSTMENT

1.1 PAPER FEED UNIT

1.1.1 TOP COVER

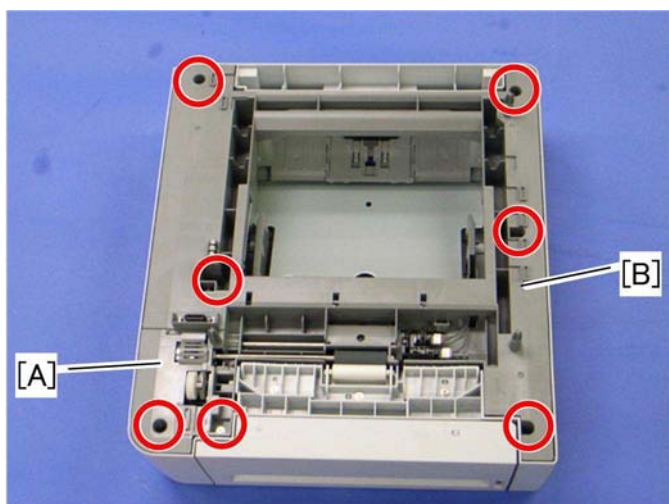

g849r501

1. Top left cover [A] (🔩 x 1)
2. Top cover [B] (🔩 x 6)

1.1.2 PAPER FEED AND RELAY CLUTCH

1. Top cover (👉 Top Cover)

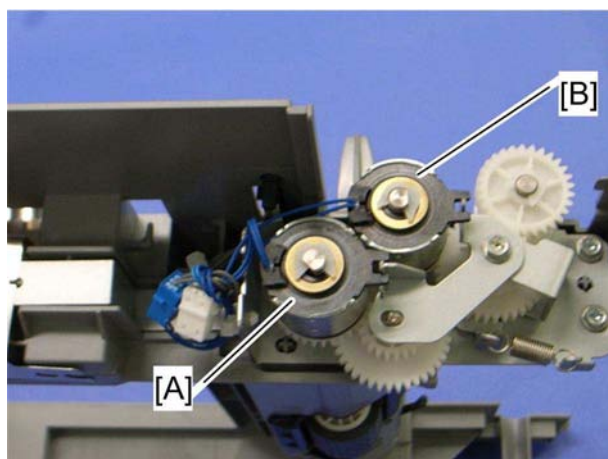

g849r504

2. Paper feed clutch [A] (🔩 x 1, 🛠️ x 1)
3. Relay clutch [B] (🔩 x 1, 🛠️ x 1)

Paper Feed Unit TK1010 (G849)

Paper Feed Unit

1.1.3 PAPER END AND RELAY SENSOR

1. Top cover (← Top Cover)

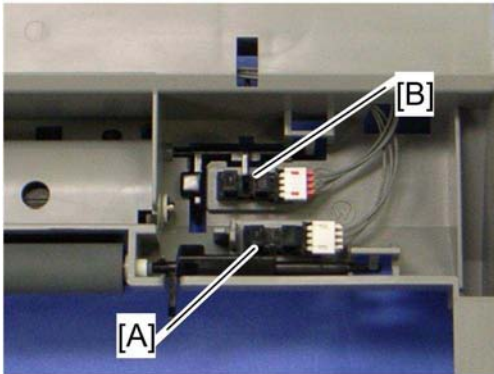

g849r505

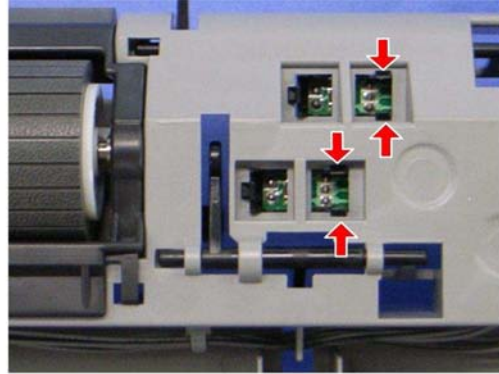

g849r506

2. Paper end sensor [A] (hooks, 𐄀 x 1)
3. Relay sensor [B] (hooks, 𐄀 x 1)

1.1.4 PAPER FEED ROLLER

1. Top cover (☞ Top Cover)
2. Paper feed clutch (☞ Top Cover)

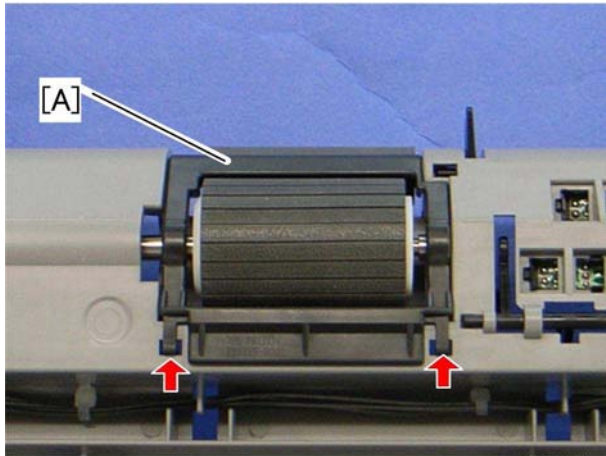

g849r502

3. Paper guide [A] (hooks)

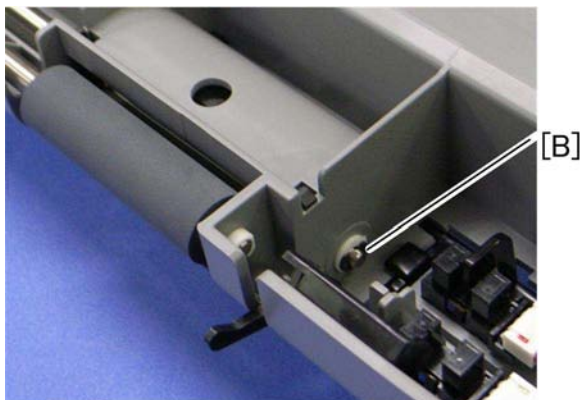

g849r503

4. Remove the e-ring [B] at the right edge of the feed roller shaft.

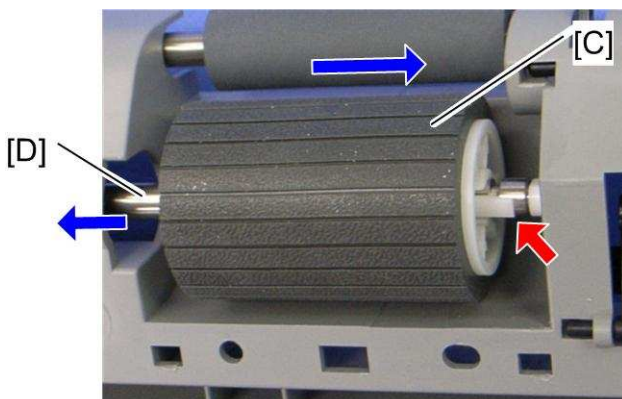

g849r506

5. Slide the paper feed roller [C] to the right side (hook).
6. Pull out the feed roller shaft [D] to the left side (bushing x 1).

Paper Feed Unit

When reassembling

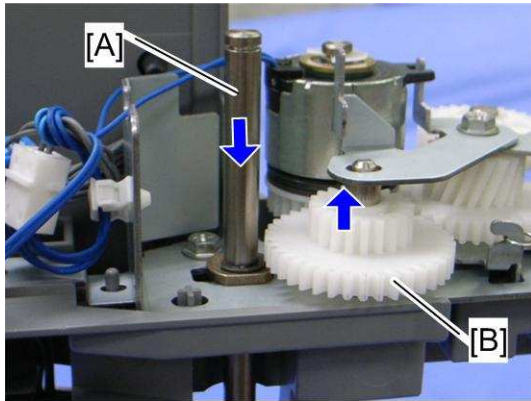

If the feed roller shaft [A] cannot be inserted easily, pull the gear [B], and then insert the feed roller shaft.

1.1.5 FRICTION PAD

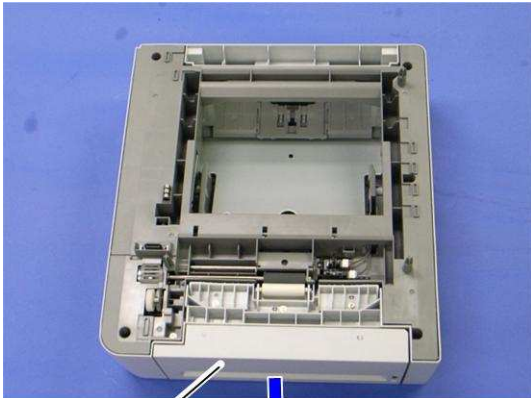

[A] g849r501a

1. Pull out the tray [A]

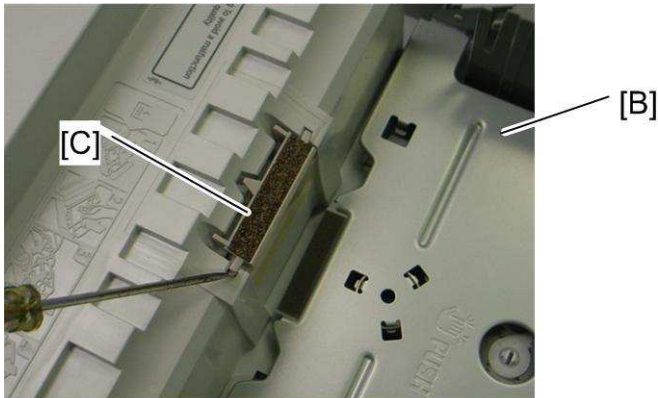

g849r508

2. Press down the bottom plate [B]
3. Friction pad [C] (hooks, spring x 1)

When reassembling

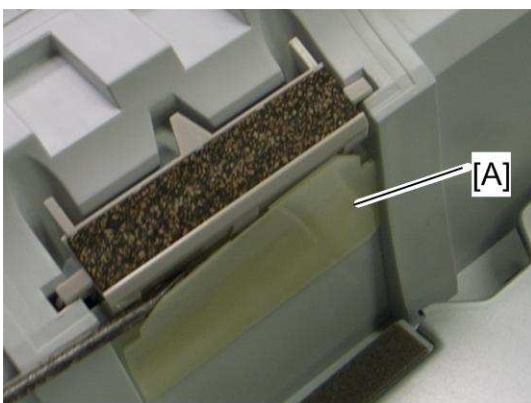

g849r509

When re-installing the friction pad, make sure that the mylar [A] does not go under the friction pad.

2. DETAILED SECTION DESCRIPTIONS

2.1 OVERVIEW

2.1.1 COMPONENT LAYOUT

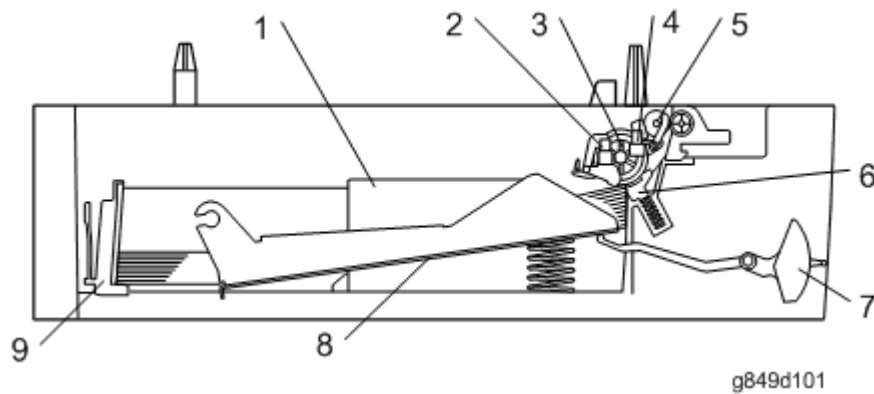

1. Side Fence	6. Friction Pad
2. Paper End Sensor	7. Paper Height Lever
3. Paper Feed Roller	8. Bottom Plate
4. Relay Sensor	9. Rear Fence
5. Relay Roller	

2.2 BASIC OPERATION

2.2.1 PAPER SEPARATION AND FEED

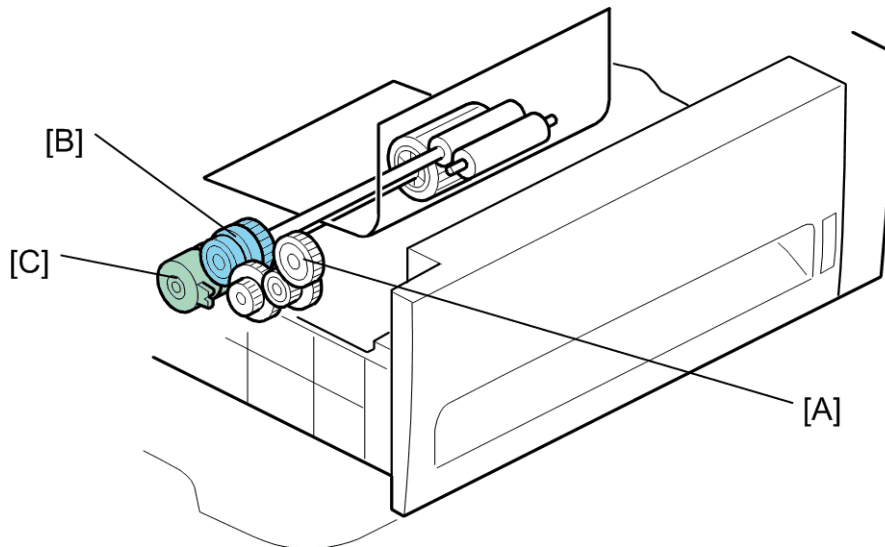

The paper tray holds 500 sheets of paper.

The paper feed unit uses a friction pad system.

The gear [A] is driven by the transport/fusing motor in the mainframe.

The relay clutch [B] and paper feed clutch [C] control drive from the mainframe. When the optional tray is selected as the feed tray, the relay clutch and paper feed clutch transmit drive power to the relay roller and paper feed roller.

2.2.2 PAPER LIFT

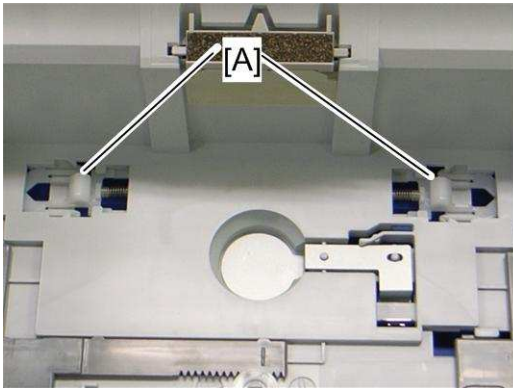

g849d501

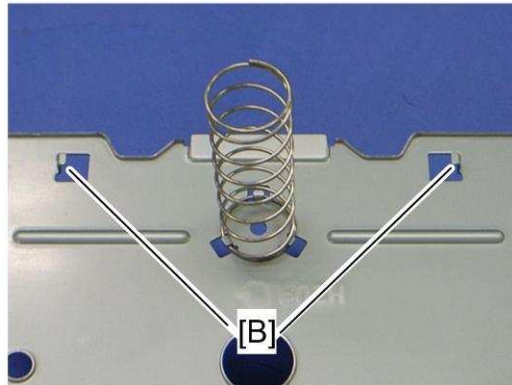

g849d502

The bottom plate is always pressed up by the spring in the tray. Therefore, you must press down the bottom plate when you insert the tray in the machine.

The bottom tray lock levers [A] hold the tabs [B] under the bottom plate after the bottom plate is pressed down.

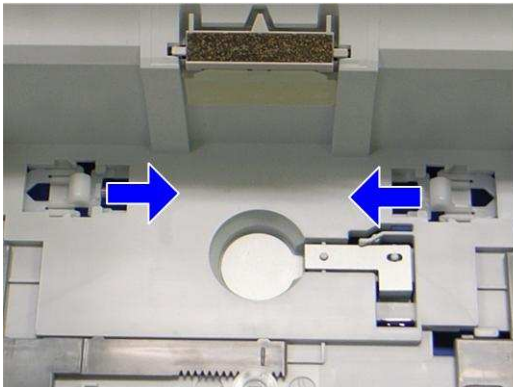

g849d501

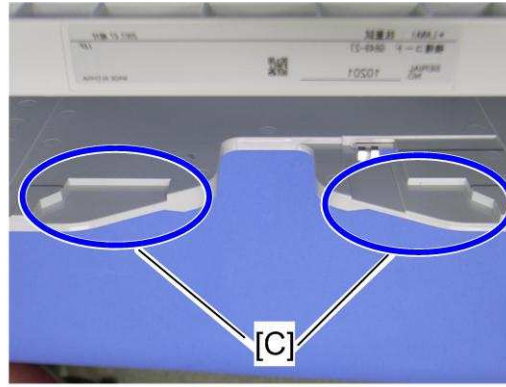

g849d503

When the tray is inserted in the machine, the lock lever guides [C] in the paper feed unit push the bottom plate lock levers, and then the lock levers release the tabs under the bottom plate. As a result, the bottom plate is lifted by the spring.

2.2.3 PAPER END DETECTION

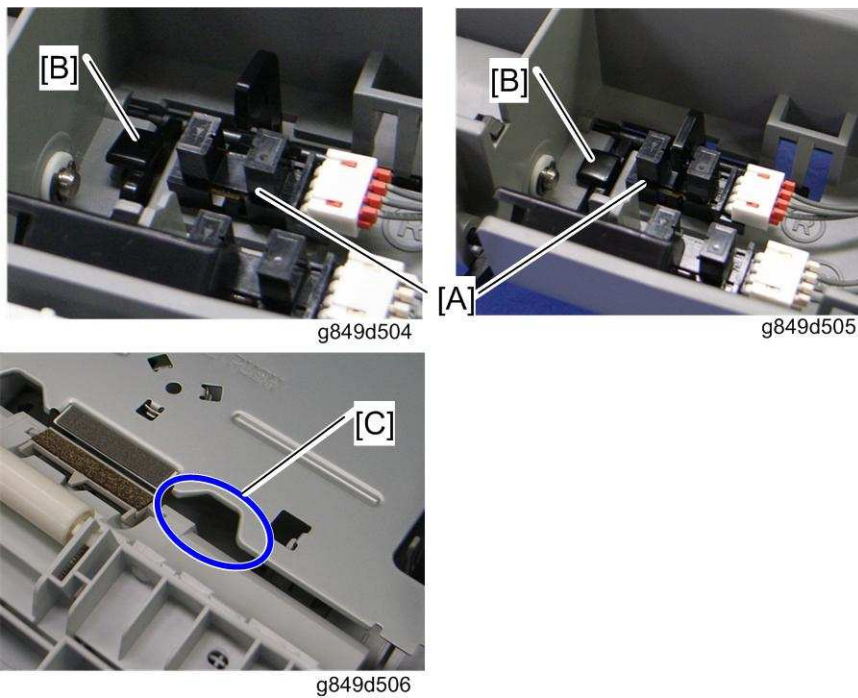

There is a paper end sensor [A] in the tray. The feeler [B] drops into the cutout [C] in the bottom plate and the actuator interrupts the paper end sensor. This sensor also detects whether the tray is set.

M018/M019 POINT TO POINT DIAGRAM

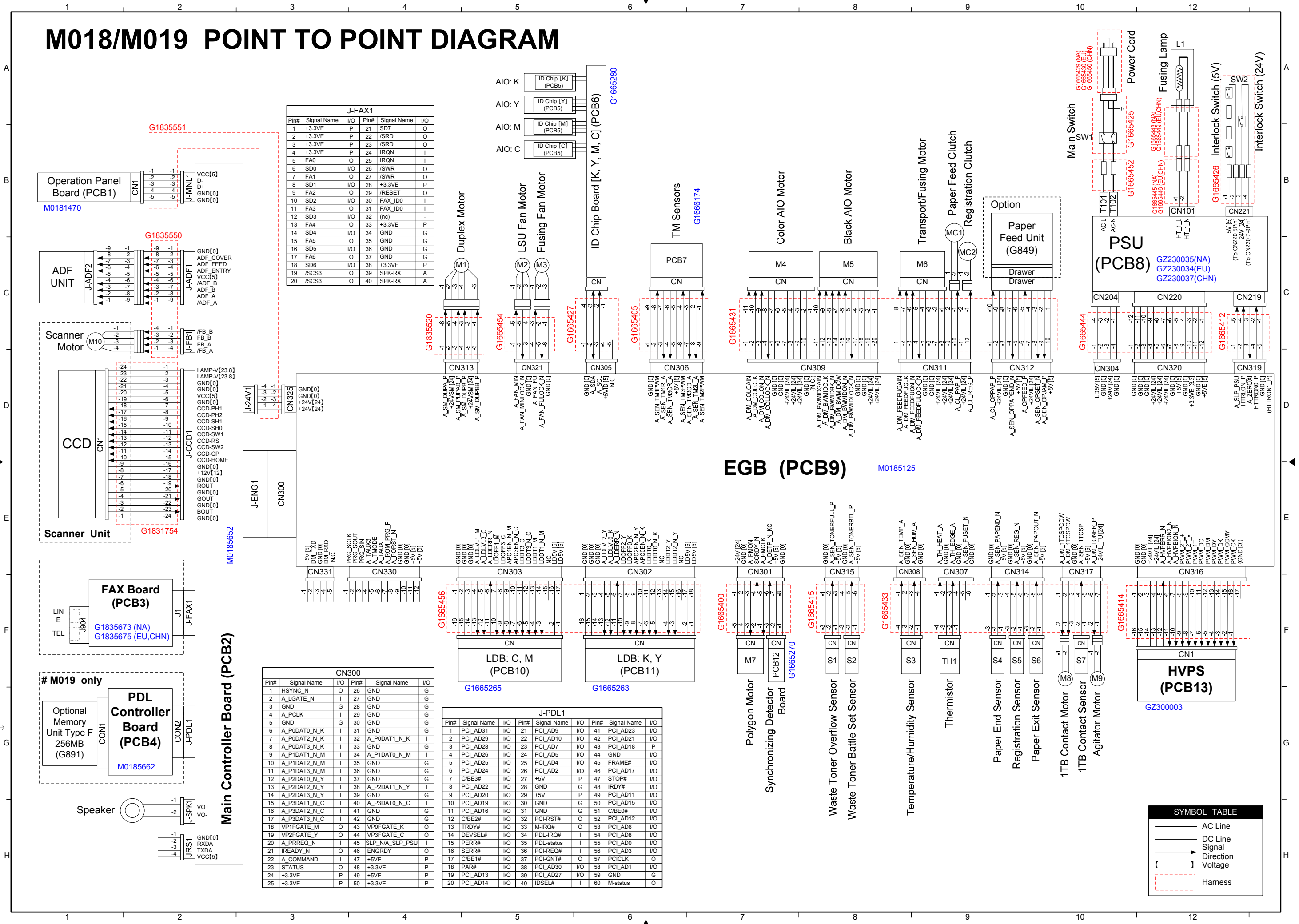

Pin#	Signal Name	I/O	Pin#	Signal Name	I/O
1	+3.3VE	P	21	SD7	O
2	+3.3VE	P	22	/SRD	O
3	+3.3VE	P	23	/SRD	O
4	+3.3VE	P	24	IRON	I
5	FA0	O	25	IRON	I
6	SD0	I/O	26	/SWR	O
7	FA1	O	27	/SWR	O
8	SD1	I/O	28	+3.3VE	P
9	FA2	O	29	/RESET	O
10	SD2	I/O	30	FAX_ID0	I
11	FA3	O	31	FAX_ID0	I
12	SD3	I/O	32	(nc)	-
13	FA4	O	33	+3.3VE	P
14	SD4	I/O	34	GND	G
15	FA5	O	35	GND	G
16	SD5	I/O	36	GND	G
17	FA6	O	37	GND	G
18	SD6	I/O	38	+3.3VE	P
19	/SCS3	O	39	SPK-RX	A
20	/SCS3	O	40	SPK-RX	A

Pin#	Signal Name	I/O	Pin#	Signal Name	I/O
1	HSYNC_N	O	26	GND	G
2	A_LGATE_N	I	27	GND	G
3	GND	G	28	GND	G
4	A_PCLK	I	29	GND	G
5	GND	G	30	GND	G
6	A_P0DAT0_N_K	I	31	GND	G
7	A_P0DAT2_N_K	I	32	A_P0DAT1_N_K	I
8	A_P0DAT3_N_K	I	33	GND	G
9	A_P1DAT1_N_M	I	34	A_P1DAT0_N_M	I
10	A_P1DAT2_N_M	I	35	GND	G
11	A_P1DAT3_N_M	I	36	GND	G
12	A_P2DAT0_N_Y	I	37	GND	G
13	A_P2DAT2_N_Y	I	38	A_P2DAT1_N_Y	I
14	A_P2DAT3_N_Y	I	39	GND	G
15	A_P3DAT1_N_C	I	40	A_P3DAT0_N_C	I
16	A_P3DAT2_N_C	I	41	GND	G
17	A_P3DAT3_N_C	I	42	GND	G
18	VP1FGATE_M	O	43	VP0FGATE_K	O
19	VP2FGATE_Y	O	44	VP3FGATE_C	O
20	A_PPRREQ_N	I	45	SLP_N/A_SLP_PSU	I
21	IREADY_N	O	46	ENGRDY	O
22	A_COMMAND	I	47	+5VE	P
23	STATUS	O	48	+3.3VE	P
24	+3.3VE	P	49	+5VE	P
25	+3.3VE	P	50	+3.3VE	P

Pin#	Signal Name	I/O	Pin#	Signal Name	I/O	Pin#	Signal Name	I/O
1	PCI_AD31	I/O	21	PCI_AD9	I/O	41	PCI_AD23	I/O
2	PCI_AD29	I/O	22	PCI_AD10	I/O	42	PCI_AD21	I/O
3	PCI_AD28	I/O	23	PCI_AD7	I/O	43	PCI_AD18	P
4	PCI_AD26	I/O	24	PCI_AD5	I/O	44	GND	G
5	PCI_AD25	I/O	25	PCI_AD4	I/O	45	FRAME#	I/O
6	PCI_AD24	I/O	26	PCI_AD2	I/O	46	PCI_AD17	I/O
7	C/BE3#	I/O	27	+5V	P	47	STOP#	I/O
8	PCI_AD22	I/O	28	GND	G	48	IRDY#	I/O
9	PCI_AD20	I/O	29	+5V	P	49	PCI_AD11	I/O
10	PCI_AD19	I/O	30	GND	G	50	PCI_AD15	I/O
11	PCI_AD16	I/O	31	GND	G	51	C/BE0#	I/O
12	C/BE2#	I/O	32	PCI-RST#	O	52	PCI_AD12	I/O
13	TRDY#	I/O	33	M-IRQ#	O	53	PCI_AD6	I/O
14	DEVSEL#	I/O	34	PDL-IRQ#	I	54	PCI_AD8	I/O
15	PERR#	I/O	35	PDL-status	I	55	PCI_AD0	I/O
16	SERR#	I/O	36	PCI-REQ#	I	56	PCI_AD3	I/O
17	C/BE1#	I/O	37	PCI-GNT#	O	57	PCICLK	O
18	PAR#	I/O	38	PCI_AD30	I/O	58	PCI_AD1	I/O
19	PCI_AD13	I/O	39	PCI_AD27	I/O	59	GND	G
20	PCI_AD14	I/O	40	IDSEL#	I	60	M-status	O

	AC Line
	DC Line
	Signal
	Direction
	Voltage
	Harness

M018/M019 ELECTRICAL COMPONENT LAYOUT

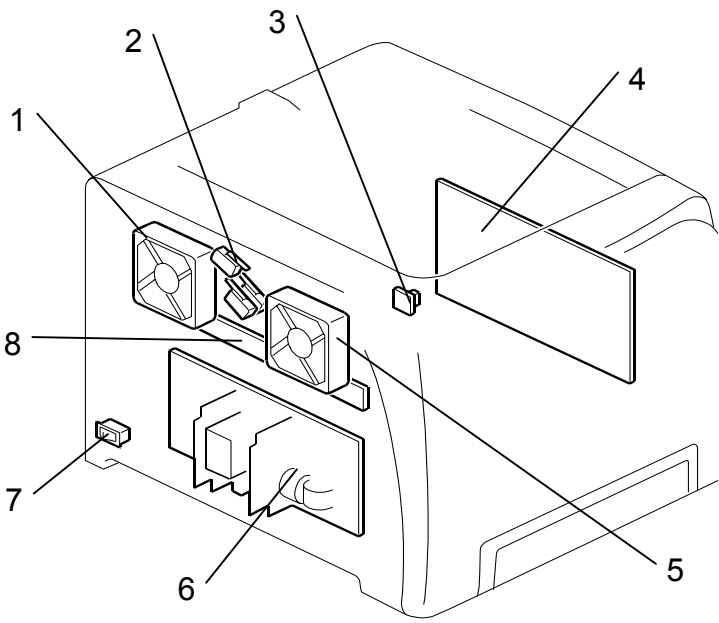

m018v103

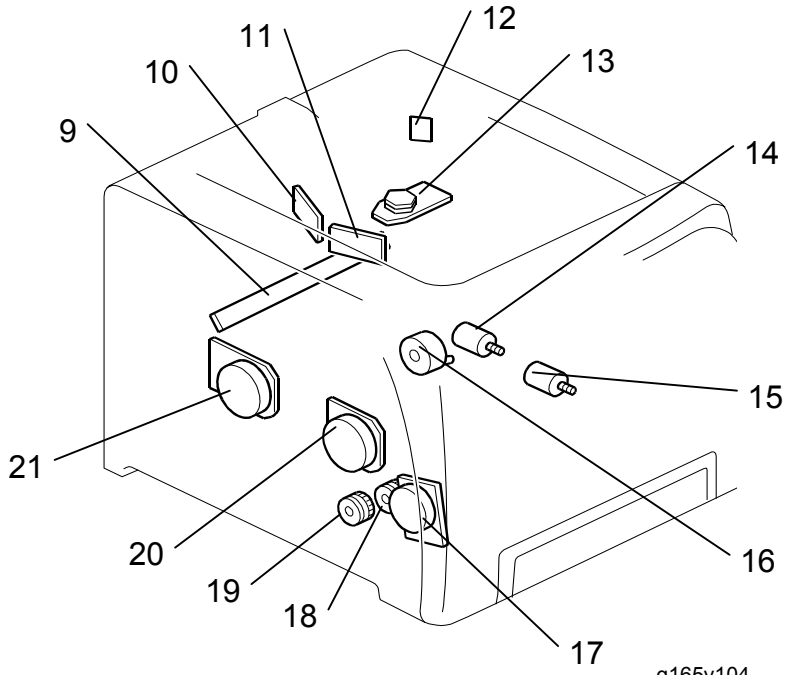

g165v104

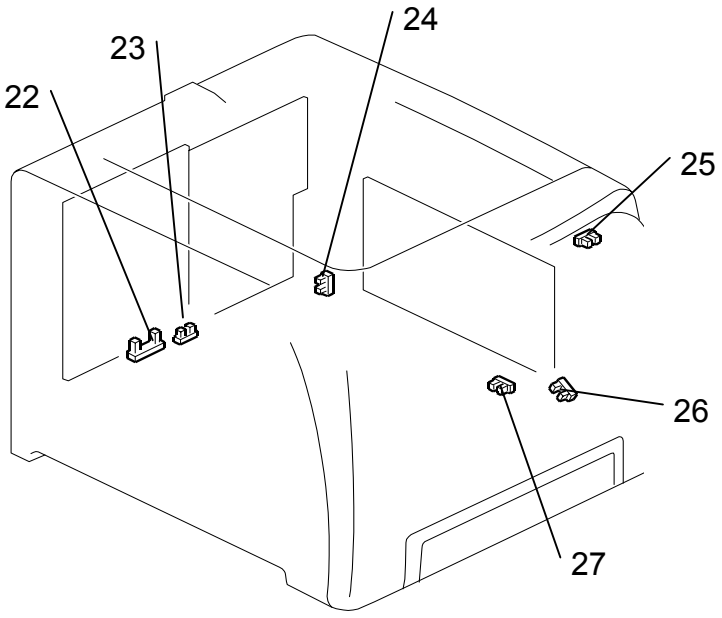

g165v105

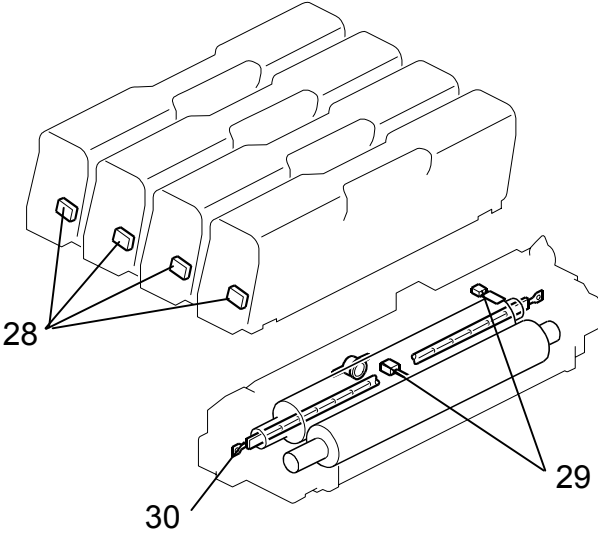

g165v106

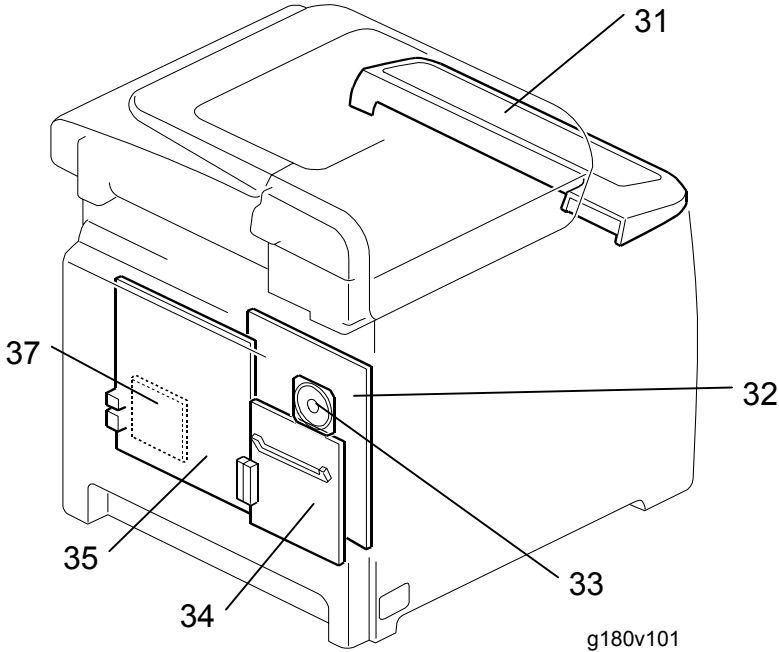

g180v101

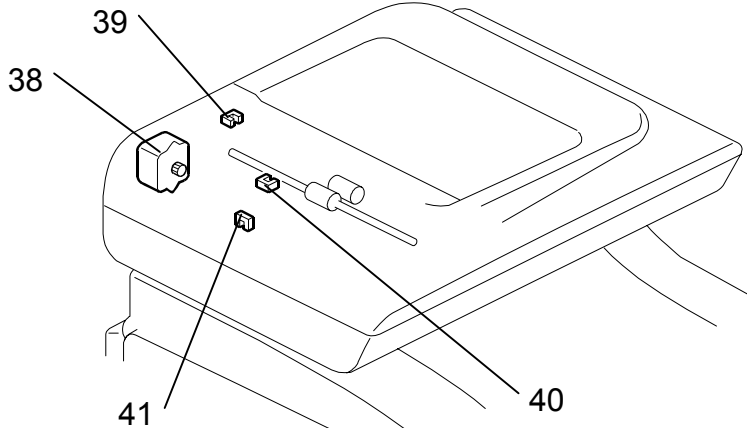

g180v102

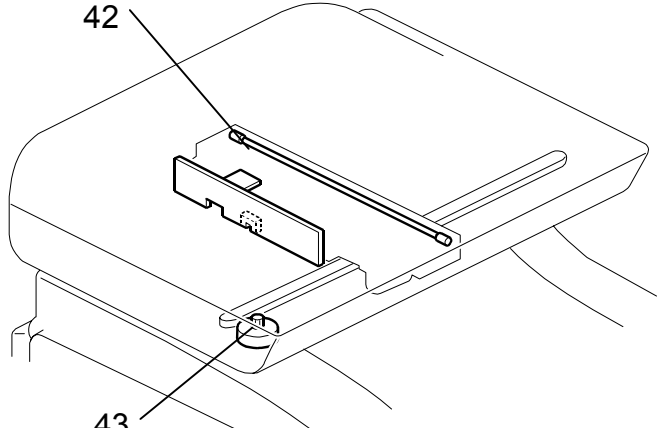

g180v103

Symbol	Name	Index No.	P to P
Motors			
M1	Duplex Motor	16	C5
M2	LSU Fan Motor	1	C5
M3	Fusing Fan Motor	5	C5
M4	Color AIO Motor	21	C7
M5	Black AIO Motor	20	C8
M6	Transport/Fusing	17	C9
M7	Polygon Motor	13	F7
M8	ITB Contact Motor	14	F10
M9	Aqitator Motor	15	F10
M10	Scanner Motor	48	C1
M11	ADF Motor	43	-

Symbol	Name	Index No.	P to P
Sensors			
S1	Waste Toner Overflow Sensor	22	F8
S2	Waste Toner Bottle Set Sensor	23	F8
S3	Temperature/Humidity Sensor	3	F6
S4	Paper End Sensor	27	F6
S5	Registration Sensor	26	F6
S6	Paper Exit Sensor	25	F10
S7	ITB Contact Sensor	24	F10
S8	ADF Cover Open	39	-
S9	Original Set Sensor	40	-
S10	ADF Feed Sensor	41	-

Symbol	Name	Index No.	P to P
Magnetic Clutches			
MC1	Registration Clutch	18	C9
MC2	Paper Feed Clutch	19	C9
Switches			
SW1	Main Switch	7	B10
SW2	Interlock Switches	2	B12
Others			
L1	Fusing Lamp	30	A12
L2	Exosure Lamp	42	-
TH1	Thermistors	29	F9
SP1	Speaker	33	H2

Symbol	Name	Index No.	P to P
PCBs			
PCB1	Operation Panel	31	B2
PCB2	Main Controller Board	35	F2
PCB3	Fax Board	36	F2
PCB4	PDL Board	34	G2-5
PCB5	ID Chip [B, Y, M, C]	28	A-B5
PCB6	ID Chip Board	8	B6
PCB7	TM Sensor Board	9	C6
PCB8	PSU	6	C10
PCB9	EGB	32	E7
PCB10	LD Board - C/M	10	F5
PCB11	LD Board - K/Y	11	F6
PCB12	Synchronizing Detector Board	12	F7
PCB13	High Voltage Power Supply Board	4	F12



RICOH UNIVERSITY

Learning ♦ Knowledge ♦ Performance



M018/M019
PARTS CATALOG

004350MIU

LANIER RICOH SAVIN



M018/M019
PARTS CATALOG

LANIER
RICOH
SAVIN®



RICOH UNIVERSITY

Learning ♦ Knowledge ♦ Performance

M018/M019 PARTS CATALOG

004350MIU

LANIER RICOH SAVIN®

LEGEND

PRODUCT CODE	COMPANY			
	GESTETNER	LANIER	RICOH	SAVIN
M018	SP C231SF	SP C231SF	Aficio SP C231SF	SP C231SF
M019	SP C232SF	SP C232SF	Aficio SP C232SF	SP C232SF
G849	Paper Feed Unit TK1010			

DOCUMENTATION HISTORY

REV. NO.	DATE	COMMENTS
*	02/2009	Original Printing

Digital Color Copiers
(M018/M019-NA)
Parts Catalog

Parts change information sample

Add

Update

Delete

Model	Product Code	PC Style
Digital Color Copiers	M018/M019	3D
Paper Feed Unit Type TK1010	G849	Traditional

Unit All



U001
Laser Unit



U002
Fusing



U003
ADF



U004
Main Frame

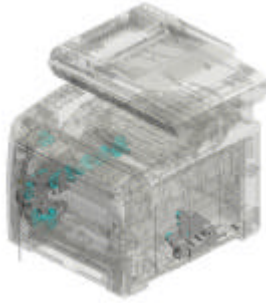

U005
Main Drive



U006
Exterior



U007
Operation



U008
Scanner



U009
Paper Feed



U010
Transport



U011
Paper Exit

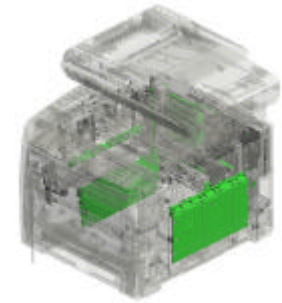

U012
Electrical

Unit All



U013
INTERMEDIATE TRANSFER UNIT

U001
Laser Unit

1.G1661851
IMAGING UNIT:ASSY

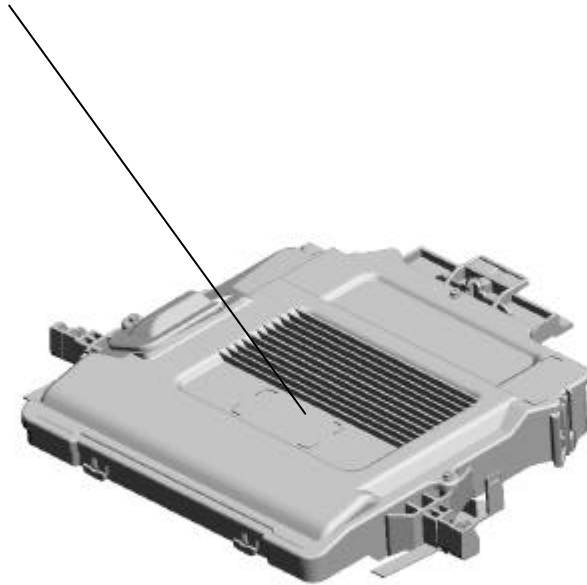

U002.Fusing

U002_S001
G1664012
FUSING UNIT - 120V

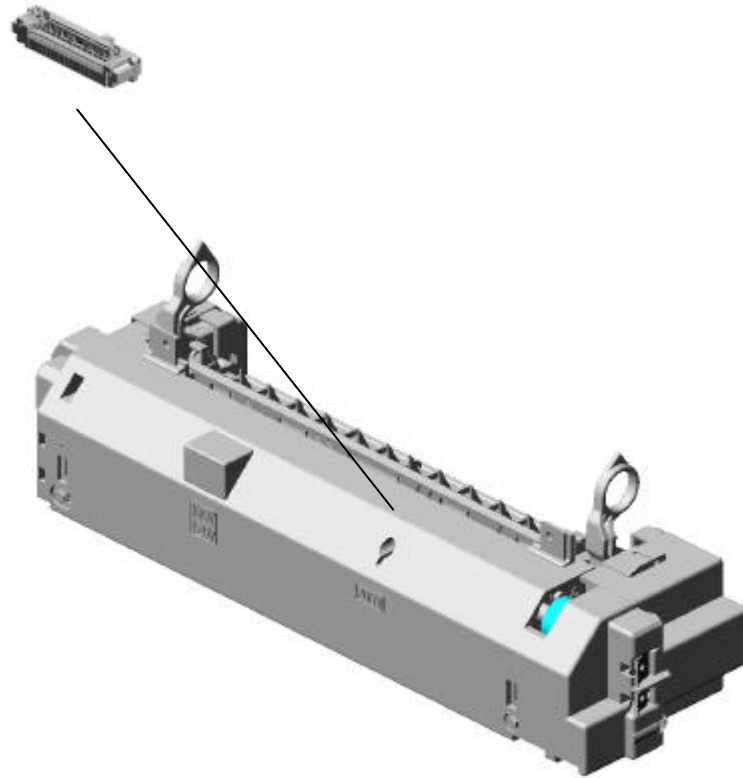

U001	U002	U003	U004	U005	U006	U007	U008	U009	U010	U011	U012	U013
------	------	------	------	------	------	------	------	------	------	------	------	------

U002
Fusing



U001	U002	U003	U004	U005	U006	U007	U008	U009	U010	U011	U012	U013
------	------	------	------	------	------	------	------	------	------	------	------	------

U002_S001 FUSING UNIT - 120V



7.G1664012
FUSING UNIT - 120V

- 8.G1664055
REAR COVER - FUSING UNIT
- 13.G1664286
STRIPPER PLATE
- 10.G1664071
FUSING ENTRANCE GUIDE - UPPER
- 9.G1664066
FRONT COVER - FUSING UNIT
- 12.G1664088
GUIDE PLATE - FUSING EXIT

14.G1664288
RIGHT COLLAR- STRIPPER PLATE

17.G1664292
RIGHT POSITIONING PLATE - STRIPPER

3.09573010N
(x2)
SCREW:SMALL ROUND SPRING-M3X10

1.04503010N
(x7)
TAPPING SCREW - M3X10

4.AA143520
(x2)
SHOULDER SCREW - M8

5.AA143801
(x2)
SCREW:M4:EXTERIOR

15.G1664289
LEFT COLLAR- STRIPPER PLATE

18.G1664323
(x2)
TORSION SPRING - STRIPPER PLATE

16.G1664291
LEFT POSITIONING PLATE- STRIPPER



11.G1664072
FUSING ENTRANCE GUIDE - LOWER

6.C2175102
(x2)
SPRING WASHER

20.GB013068
IDLE GEAR - 20Z

2.07200040E
RETAINING RING - M4

21.GB017053
IDLE GEAR - 15/25Z

U002_S001
FUSING UNIT - 120V

22GX450002
FUSING LAMP - 120V
1000W

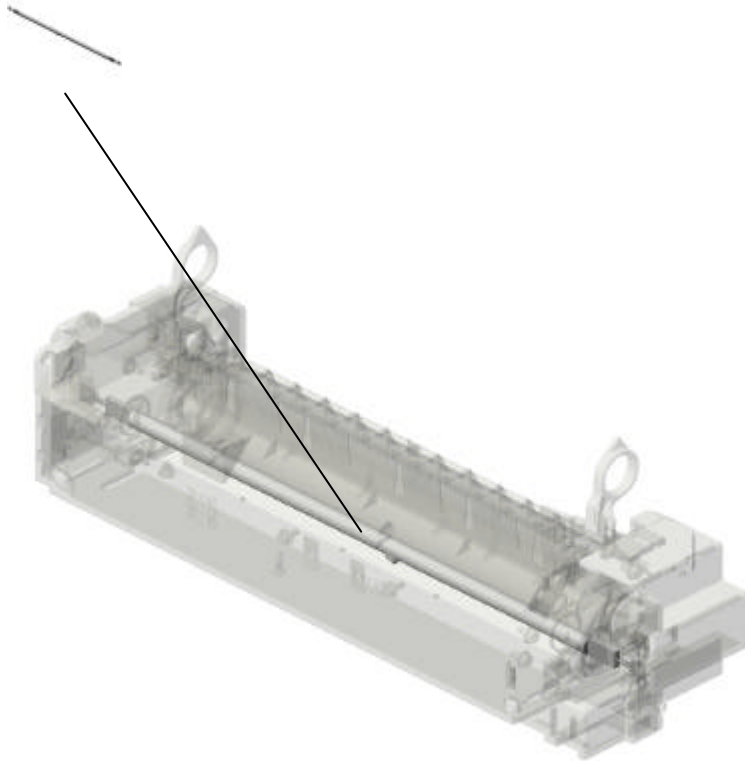

7.G1664012
FUSING UNIT - 120V

U001	U002	U003	U004	U005	U006	U007	U008	U009	U010	U011	U012	U013
------	------	------	------	------	------	------	------	------	------	------	------	------

U003.ADF

U003_S001
G1831630
ADF:ASSY



U001	U002	U003	U004	U005	U006	U007	U008	U009	U010	U011	U012	U013
------	------	------	------	------	------	------	------	------	------	------	------	------

U003
ADF



U001	U002	U003	U004	U005	U006	U007	U008	U009	U010	U011	U012	U013
------	------	------	------	------	------	------	------	------	------	------	------	------

U003_S001
ADF:ASS'Y



1.G1831630
ADF:ASS'Y

3.G1831741
COVER:FRONT:ADF

15.G1832553
COIL SPRING:GEAR:SLIDE

16.G1832554
GEAR:SLIDE

18.G1832558
(x2)
PADDLE:ROLLER:EXIT

19.G1832559
(x2)
DRIVEN ROLLER:EXIT

7.G1831745
SIDE FENCE:LEFT

5.G1831743
BASE:SLIDER

8.G1831746
EXTENSION TRAY:ADF

2.G1831740
FRAME:ADF

9.G1831747
PAPER STOPPER:ADF

21.G1832561
(x2)
COIL SPRING:EXIT

20.G1832560
SHAFT:DRIVEN ROLLER:EXIT

6.G1831744
SIDE FENCE:RIGHT

17.G1832555
CABLE:ADF

12.G1832550
ARM:SENSOR

11.G1831822
ADF DECAL - PICK-UP PAPER JAM

13.G1832551
COIL SPRING:ARM:SENSOR

4.G1831742
COVER:REAR:ADF

10.G1831775
HOOK:ADF

14.G1832552
(x4)
SHEET:ADF:KILO

U003_S001
ADF:ASS'Y



1.G1831630
ADF:ASS'Y

27.G1832567
FRAME:LOWER

37.G1832579
(x3)
DRIVEN ROLLER:FEED
D

30.G1832571
(x2)
SHEET:GUIDE

24.G1832564
COVER:ADF

34.G1832576
(x4)
COIL SPRING:FEED R
OLLER:DRIVEN

31.G1832572
(x4)
FLANGE:BUSHING

29.G1832570
PLATE

33.G1832574
EXIT ROLLER:ADF

22.G1832562
COVER:EXIT

25.G1832565
SHEET:PRESSURE P
LATE

28.G1832569
COIL SPRING:PLATE

32.G1832573
FEED ROLLER:ADF

40.G1832582
SHAFT:DRIVEN ROLL
ER:FEED

26.G1832566
FLANGE:BUSHING:GE
AR

23.G1832563
PCB:DIP:ADF

41.G1832583
FIX STAND:SENSOR:
FEED

38.G1832580
STAY:FEED

39.G1832581
GUIDE:FEED:DRIVEN

35.G1832577
FEELER:SENSOR:FE
ED

36.G1832578
(x2)
ARM:PRESSURE REL
EASE

U003_S001
ADF:ASS'Y



1.G1831630
ADF:ASS'Y

- 56.G1832601 SEPARATION PAD:ADF
- 57.G1832602 FRAME:UPPER
- 53.G1832598 ROLLER:BACK UP:FEED
- 59.G1832604 FEELER:SET SENSOR
- 42.G1832585 SHEET:FEELER:FEED

60.G1832605
HOLDER:SEPARATION UNIT

61.G1832606
(x2)
SHEET:STOPPER:EXIT

55.G1832600
SHUTTER:PAPER

54.G1832599
COIL SPRING:SHUTTER:PAPER

58.G1832603
COIL SPRING:FEELER:SET SENSOR

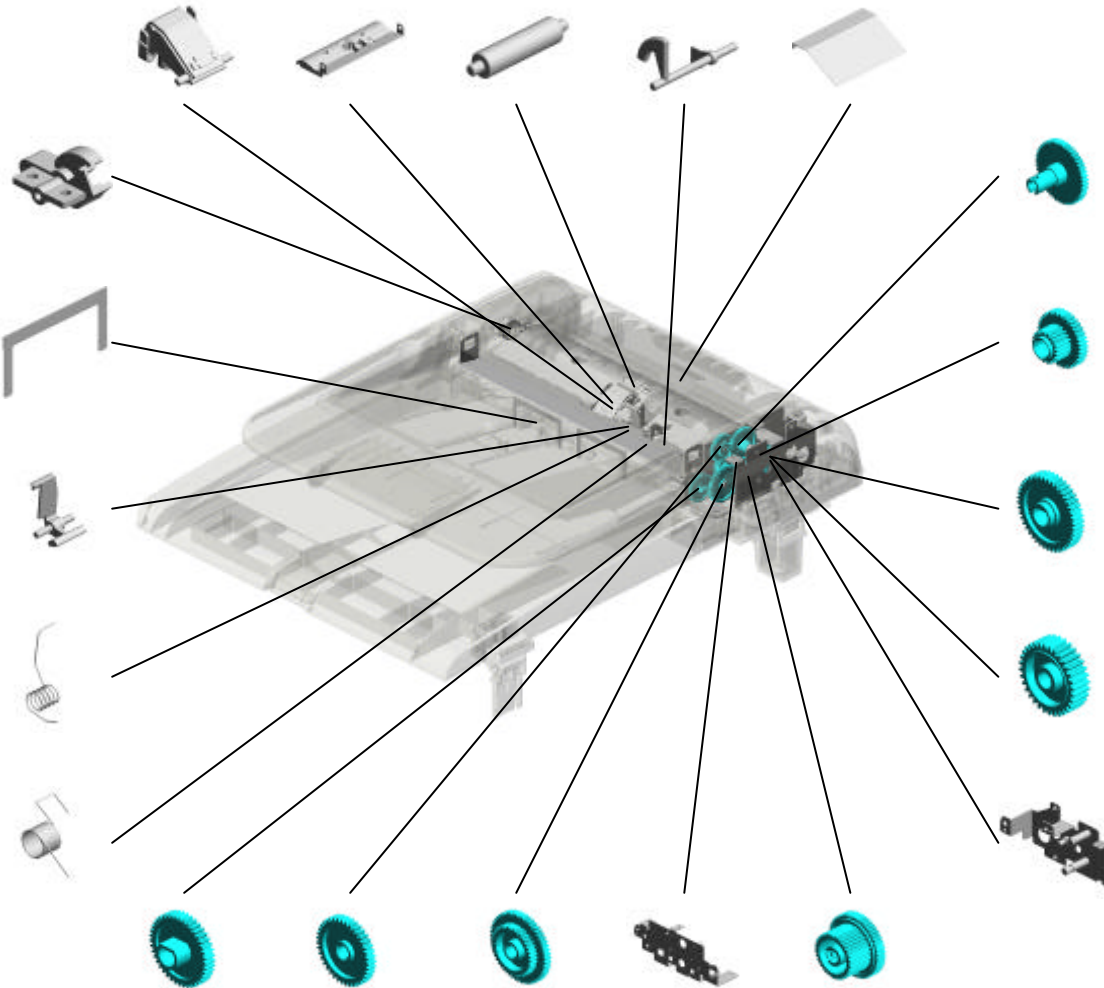

49.G1832592
GEAR:51T

48.G1832591
GEAR:21T37T

44.G1832587
GEAR:FEED:44T

47.G1832590
(x2)
GEAR:MIDDLE:32T

51.G1832594
PLATE:MOTOR

45.G1832588
GEAR:EXIT:41T

46.G1832589
GEAR:20T39T

50.G1832593
GEAR:DRIVE:39T55T

43.G1832586
PLATE:REAR

52.G1832595
GEAR:DRIVE:40T56T

U003_S001
ADF:ASS'Y

63.G1832608
SEPARATION UNIT:A
DF
66.G1832613
PCB:DIP:FEED
200908 XO



1.G1831630
ADF:ASS'Y

62.G1832607
DISCHARGE BRUSH:
EXIT

67.G1832612
PCB:DIP:SET SENSO
R
200908 XO

64.G1832609
DC STEPPER MOTOR

69.G1832614
PCB:DIP:ON OFF DET
ECTOR
200906 XO

66.G1832611
HINGE:RIGHT

65.G1832610
HINGE:LEFT

U001	U002	U003	U004	U005	U006	U007	U008	U009	U010	U011	U012	U013
------	------	------	------	------	------	------	------	------	------	------	------	------

U004 Main Frame

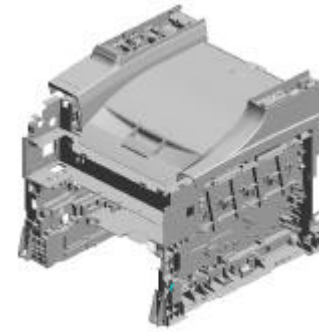

- 10.07200060E (x4) RETAINING RING - M6
- 1.03603006N (x2) SCREW - M3X6
- 4.04503016N (x4) TAPPING SCREW:3X16
- 13B1251474 RIVET:MM5
- 15.G1661046 COLOR DECAL - MAG ENTA

2.04503008N (x4) TAPPING SCREW - M3X8

11.11050516 CLAMP

12B0394480 STEPPED SCREW - M5

7.04543008Q (x22) TAPPING SCREW:3X8

3.04503010N (x40) TAPPING SCREW - M3X10

8.07200030E (x2) RETAINING RING - M3

18.G1661060 (x2) BASE:HINGE:COVER:

19.G1661061 (x2) PIN:HINGE

16.G1661047 (x4) SPACER- RUBBER F

17.G1661048 (x4) RUBBER FOOT



9.07200040E (x3) RETAINING RING - M4

6.04543006Q (x8) TAPPING SCREW - M3X6

14.G1661008 CLUTCH/BRAKE BRAKET

20.G1661064 CLUTCH/BRAKE SPRING

5.04504010N (x17) TAPPING SCREW:M4X10

3.04503010N (x1) TAPPING SCREW - M3X10

U004 Main Frame

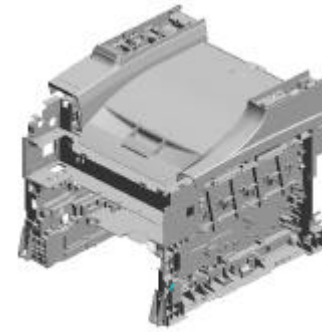

32.G1661083
GROUNDING PLATE -
HIGH VOLTAGE

27.G1661071
FRAME:UPPER RIGH
T

35.G1661086
(x2)
BRACKET:OPTICAL
UNIT:FRAME:UPPER

34.G1661085
SPRING PLATE:LSU:
POSITIONING

36.G1661087
(x2)
SPRING:CUSHION:FR
AME:UPPER

29.G1661073
SHAFT

31.G1661081
TWIST SPRING - LEF
T

26.G1661070
FRAME:UPPER LEFT

30.G1661078
(x2)
COMPRESSION SPRI
NG

39.G1661090
GROUND PLATE - DC
HIP

40.G1661091
GROUND PLATE - PO
WER SUPPLY UNIT

37.G1661088
UPPER FRONT DUCT

24.G1661068
FUSING DUCT

22.G1661066
CLUTCH/BRAKE CAS
E

21.G1661065
CLUTCH SPRING

28.G1661072
(x4)
SPRING:PLATE:AIO

33.G1661084
(x4)
SPRING:PLATE:AIO:B
LACK

38.G1661089
(x8)
PIN:PLATE:DEVELOP
MENT UNIT

25.G1661069
RACK SUPPORTER

23.G1661067
GEAR - 14Z

U004 Main Frame

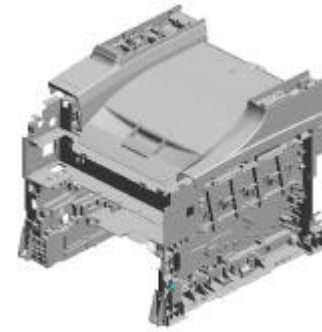

- 47.G1661281 BASE - EXIT END FENCE
- 48.G1661282 REAR END FENCE - EXIT
- 49.G1661283 FRONT END FENCE - EXIT
- 51.G1661343 KEY:FUSING
- 50.G1661323 (x3) SHEET:FRAME:RIGHT

52.G1661382
BRACKET:BRAKE:COVER:UPPER

46.G1661280
CUSHION - IMAGING UNIT

44.G1661097
GROUND PLATE - LEFT

45.G1661112
GEAR COVER

58.G1662588
HOLDER:PAPER TRAY:POSITIONING



53.G1661389
DECAL - HIGH VOLTAGE



43.G1661096
GROUND PLATE - FRONT



60.G1662597
SPRING PLATE:RESISTOR:BASE:LOWER



57.G1662586
FEELER HOLDER



56.G1662585
FEELER - PAPER END SENSOR

59.G1662596
HOLDER:RESISTOR:BASE

42.G1661095
(x3) SHEET:BASE:FRAME

41.G1661093
GEAR - 20Z

54.G1662582
GROUNDING SPRING

55.G1662583
SPRING PLATE:PAPER TRAY:POSITIONING

U004 Main Frame

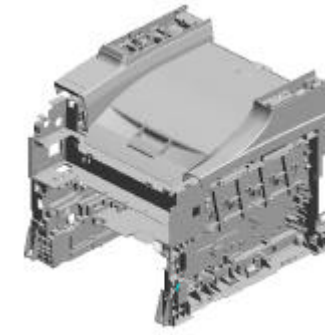

68.G1665706 GROUND PLATE:SHAFT:IMAGING UNIT
 77.G1831053 RIGHT TORSION SPRING - ARM
 75.G1831051 RIGHT SLIDE ARM
 63.G1663333 DECAL - CYAN 200910 X/O
 79.G1831055 SLIDE RAIL:RIGHT

69.G1665724 HARNESS CLAMP HOLDER

80.G1831056 HINGE - TORQUE LIMITER

76.G1831052 LEFT TORSION SPRING - ARM

74.G1831050 LEFT SLIDE ARM

78.G1831054 SLIDE RAIL:LEFT

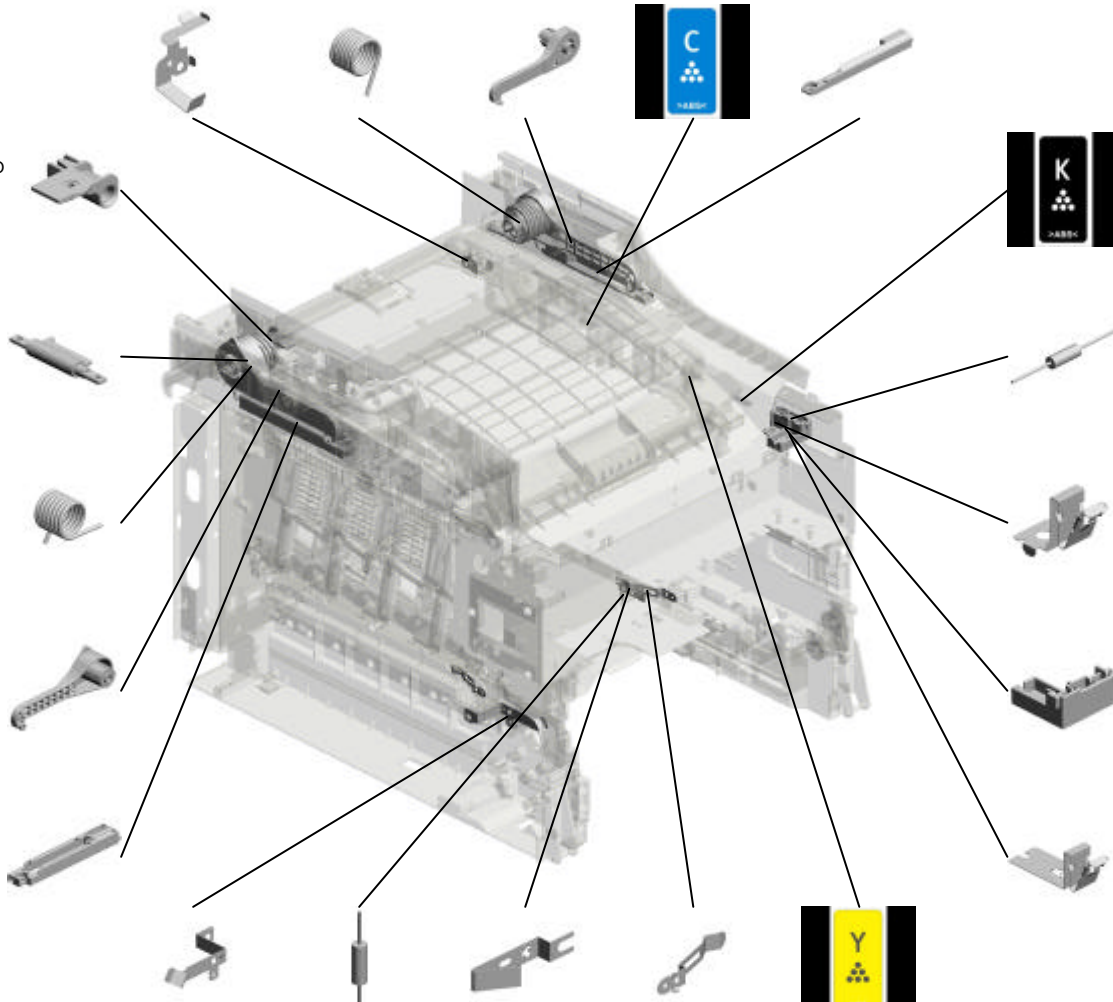

62.G1663331 DECAL - BLACK 200910 X/O

67.G1663994 RESISTOR - 50M OHM +10% 0.5W

72.G1665758 GROUND PLATE - OUTPUT

70.G1665756 RESISTORHOLDER - EXIT

71.G1665757 GROUND PLATE -INPUT

65.G1663866 GROUND PLATE:REGISTRATION ROLLER
 66.G1663993 RESISTOR - 100M OHM +10% 0.5W
 61.G1662598 SPRING PLATE:RESISTOR:BASE:UPPER
 73.G1666592 SPRING PLATE -COL (x2)
 64.G1663334 DECAL - YELLOW 200910 X/O

U001	U002	U003	U004	U005	U006	U007	U008	U009	U010	U011	U012	U013
------	------	------	------	------	------	------	------	------	------	------	------	------

U004 Main Frame

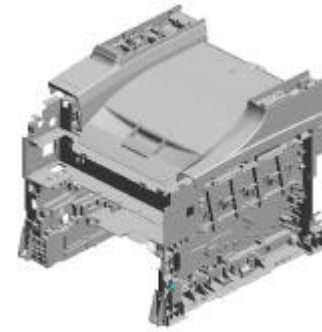

- 95.G1831090 GROUND PLATE:SUP
PORTING PLATE:LEF
T
- 85.G1831067 STOPPER PLATE - S
CANNER
- 93.G1831085 BRACKET - ARM
- 90.G1831072 WIRE - SCANNER LO
CK
- 98.G1831251 RIGHT HARNESS CO
VER -SCANNER

99.G1831252
LEFT HARNESS COV
ER - SCANNER

100.G1831834
LEFT GROUND PLAT
E - SCANNER

84.G1831066
TORSION SPRING- SL
IDE STOPPER

89.G1831071
RIGHT ACTUATOR -
STOPPER

83.G1831065
LEFT SLIDE STOPPE
R - SCANNER

81.G1831060
SEPARATION PLATE
- SLIDE

94.G1831088
TENSION SPRING -LO
CK ARM

82.G1831061
TORSION SPRING - S
EPARATION PLATE

92.G1831082
ARM - LOCK LEVER

91.G1831075
PLATE:SHAFT

87.G1831069
COMPRESSION SPRI
NG - STOPPER

86.G1831068
RIGHT SLIDE STOPP
ER - SCANNER

96.G1831091
GROUND PLATE:SUP
PORTING PLATE:RIG
HT

88.G1831070
UPPER SUPPORTING
PLATE - COVER

97.G1831250
UPPER COVER

U005 Main Drive

5.04503010N (x15) TAPPING SCREW - M 3X10
 15.G1661123 FRAME - ON-OFF DRIVE UNIT
 1.03530030N (x6) SCREW/M3X3
 10.AA082101 (x2) BUSHING - 6X10X6
 3.03530060N (x2) BIND SCREW - M3X6

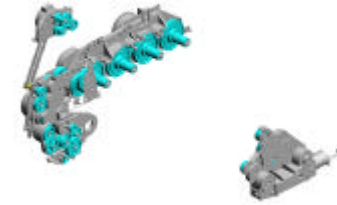

16.G1661125 SHIELDING PLATE

18.G1661135 MOTOR - DC24V 1.6W

13.G1661118 GROUNDING WIRE

14.G1661119 (x2) MOTOR BRACKET

17.G1661131 DC MOTOR - DC24V 5.3W

4.03603006N (x3) SCREW - M3X6

11.G1661104 SHIELDING PLATE

12.G1661111 FRAME - TRANSFER DRIVE UNIT

19.G1661139 FRAME - TRANSPORT DRIVE UNIT

8.11024473 CT CONNECTOR - 2P

6.04543006Q (x2) TAPPING SCREW - M 3X6

7.08050089 (x3) RETAINING RING - M4

2.03530040N (x9) SCREW - M3X4

20.G1661151 MOTOR BRACKET

9.11050516 CLAMP

U005 Main Drive

38.GB011108
(x2)
GEAR - 21Z

28.GA145014
SHAFT - 6 X 55.3MM

23.G1665745
HARNESS COVER

22.G1661194
FRAME - DUPLEX DRIVE UNIT

24.GA043030
TIMING BELT - 60S2M 280

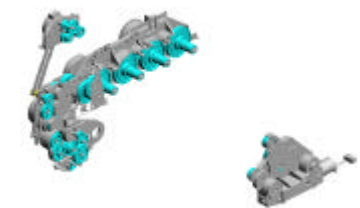

33.GB011102
GEAR - 19/38Z

29.GA148016
SHAFT - 6 X 26.7MM

25.GA132101
(x5)
SPACER - 0.13 X 12MM

31.GB010121
GEAR:AIO.DRIVE:1

26.GA132102
(x2)
SPACER - 0.13 X 10MM

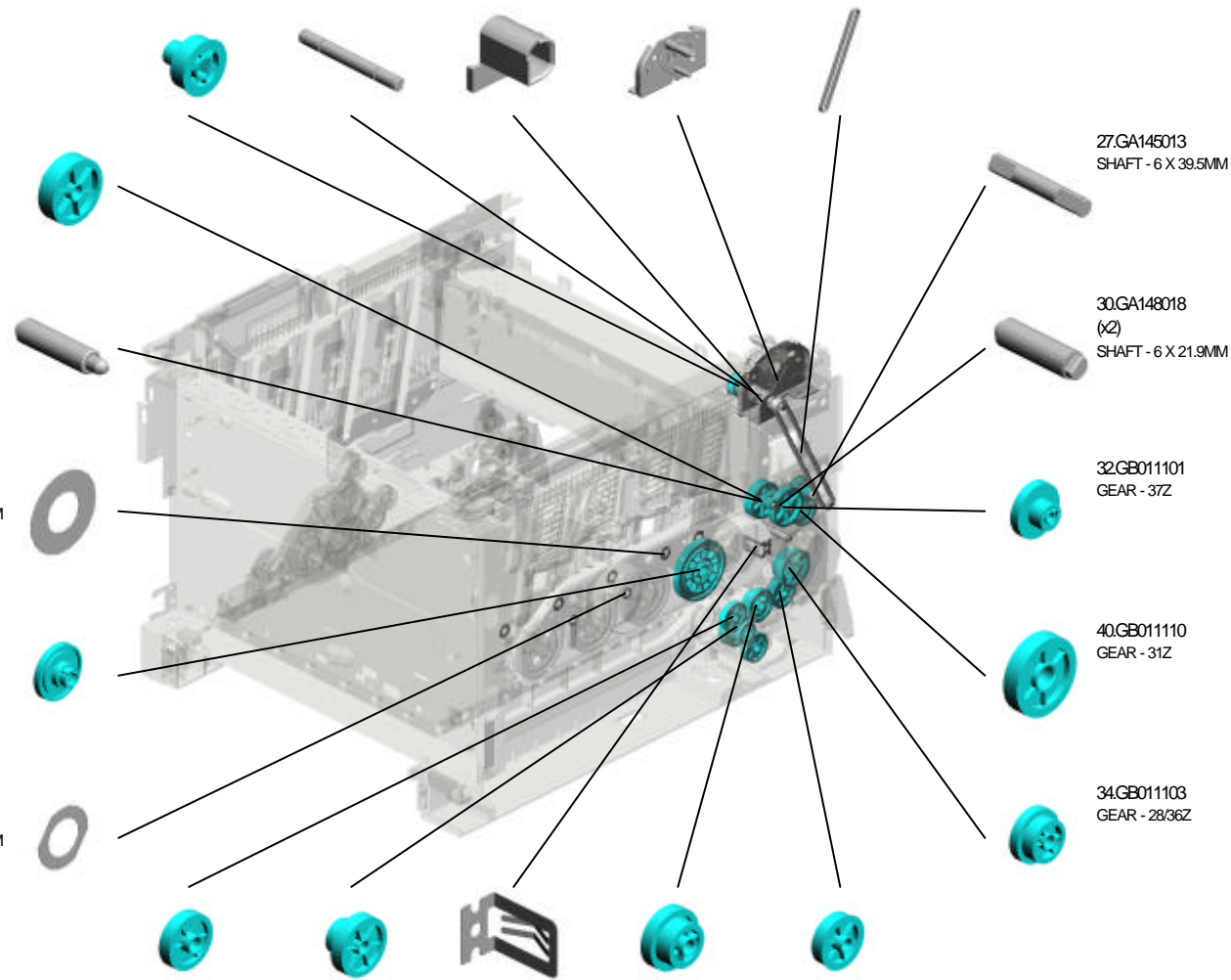

27.GA145013
SHAFT - 6 X 39.5MM

30.GA148018
(x2)
SHAFT - 6 X 21.9MM

32.GB011101
GEAR - 37Z

40.GB011110
GEAR - 31Z

34.GB011103
GEAR - 28/36Z

39.GB011109
(x2)
GEAR - 28Z

35.GB011104
GEAR - 20/35Z

21.G1661152
GROUNDING PLATE

37.GB011106
GEAR - 22/31Z

36.GB011105
GEAR - 29Z

U005 Main Drive

47.GB013115
GEAR - 21Z

48.GB013117
GEAR - 19Z

42.GB011112
GEAR - 29Z

41.GB011111
GEAR - 19Z

53.GB017109
GEAR - 16/42Z

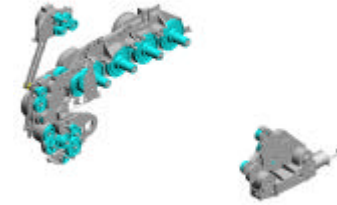

46.GB013114
GEAR - 35Z



58.GB017116
GEAR - 17/42Z



56.GB017112
GEAR - 21/73Z



57.GB017113
GEAR - 40/65Z



55.GB017111
(x2)
GEAR - 16/51Z



54.GB017110
GEAR - 22/99Z CYAN

44.GB012101
(x2)
GEAR - 33Z

49.GB017101
(x2)
GEAR - 22/99Z

59.GB017120
GEAR:AIO:JOINT:2

50.GB017102
GEAR - 27/76Z



U005 Main Drive

66.M0181102
BRACKET:MOTOR:AS
SY

61.GX041120
STEPPER MOTOR - D
C 14.8W

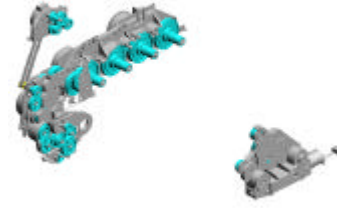

64.GX060036
BRUSHLESS MOTOR:
DC24V:40W

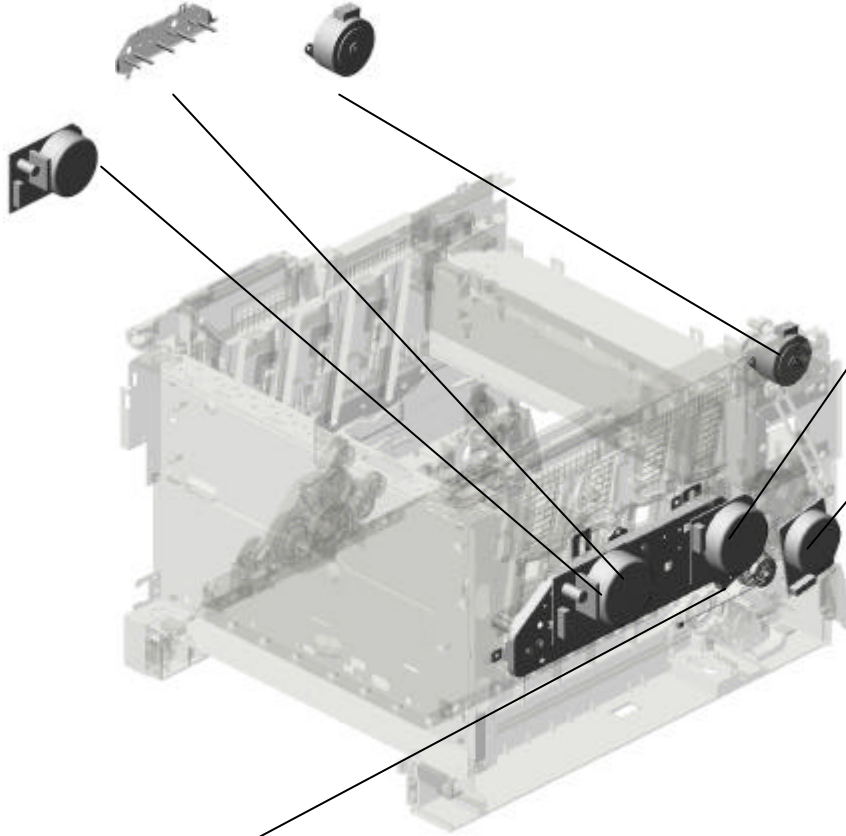

63.GX060034
BRUSHLESS MOTOR:
DC24V:24W

62.GX060033
BRUSHLESS MOTOR:
DC24V:10W

65.GX201121
MAGNETIC CLUTCH

U001	U002	U003	U004	U005	U006	U007	U008	U009	U010	U011	U012	U013
------	------	------	------	-------------	------	------	------	------	------	------	------	------

U006 Exterior



9.G1661306 LEFT COVER - NON EU
 10.G1831257 COVER - PAPER EXIT
 5.G1661259 MEMORY COVER

1.03603010N
 SCREW:M3X10

4.04543008Q
 (x3)
 TAPPING SCREW:3X8

6.G1661261
 INNER COVER - EXIT

12.G1831264
 REAR COVER

11.G1831258
 COVER - INTERFACE

2.04504010N
 (x2)
 TAPPING SCREW:M4X10

3.04524010N
 (x5)
 BINDING SELF-TAPPING

8.G1661303
 RIGHT COVER - NON EU

7.G1661262
 CASSETTE COVER

U001	U002	U003	U004	U005	U006	U007	U008	U009	U010	U011	U012	U013
------	------	------	------	------	------	------	------	------	------	------	------	------

U007.Operation

U007_S001
M0181401
OPERATION PANEL:NA

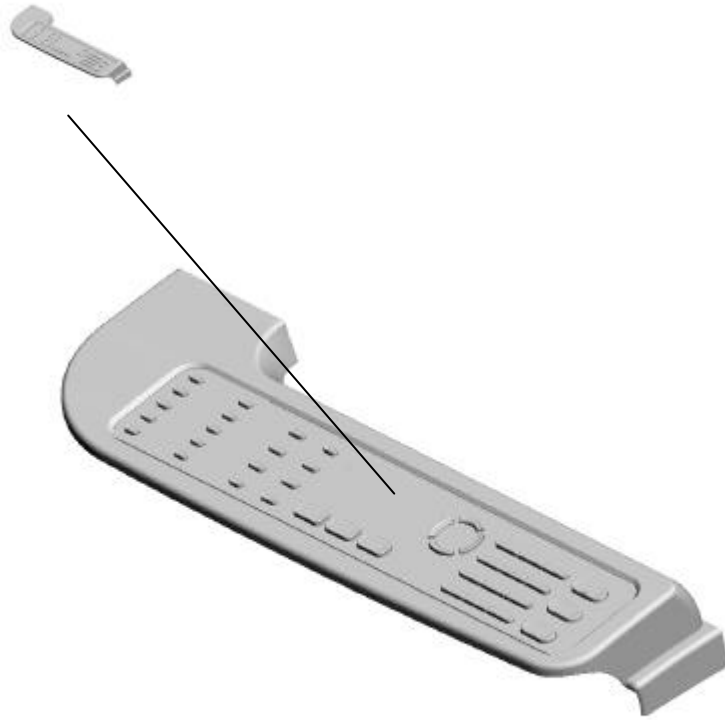

U001	U002	U003	U004	U005	U006	U007	U008	U009	U010	U011	U012	U013
------	------	------	------	------	------	------	------	------	------	------	------	------

U007 Operation

1.04523010N
(x4)
BINDING SELF-TAPPI
NG SCREW:3X10



U007_S001
OPERATION PANEL:NA



9.M0181401
OPERATION PANEL:
NA

12.M0181452
KEYTOP:SHIFT

14.M0181454
KEY:SHIFT

3.G1831455
KEY - APPLICATION

15.M0181455
SHEET:ANEL:NA

10.M0181450
COVER:OPERATION
PANEL

5.G1831457
KEYTOP - 10KEY

6.G1831461
KEYTOP - START/ST
OP

2.G1831453
KEYT - 10KEY

4.G1831456
KEY - START/STOP

7.G1831462
KEYTOP - APPLICATI
ON

1.04523010N
(x9)
BINDING SELF-TAPPI
NG SCREW:3X10

8.G1831465
GROUND PLATE:OPE
RATION SUB-UNIT:RI
GHT

16.M0181470
PCB:OPU

13.M0181453
KEY:MENU

11.M0181451
KEYTOP:MENU

U001	U002	U003	U004	U005	U006	U007	U008	U009	U010	U011	U012	U013
------	------	------	------	------	------	------	------	------	------	------	------	------

U008.Scanner

U008_S001
M0181600
SCANNER:ASSY



U001	U002	U003	U004	U005	U006	U007	U008	U009	U010	U011	U012	U013
------	------	------	------	------	------	------	------	------	------	------	------	------

U008
Scanner



U001	U002	U003	U004	U005	U006	U007	U008	U009	U010	U011	U012	U013
------	------	------	------	------	------	------	------	------	------	------	------	------

U008_S001
SCANNER:ASS'Y



- 3.G1831750 PLATE:GUIDE ROD:SCANNER
- 15.G1831762 FLUORESCENT TUBE:CARRIAGE
- 14.G1831761 COVER:CARRIAGE:UPPER
- 17.G1831765 CCD:MODULE:ASSY 200905-2XO
- 16.G1831764 COVER:INVERTOR

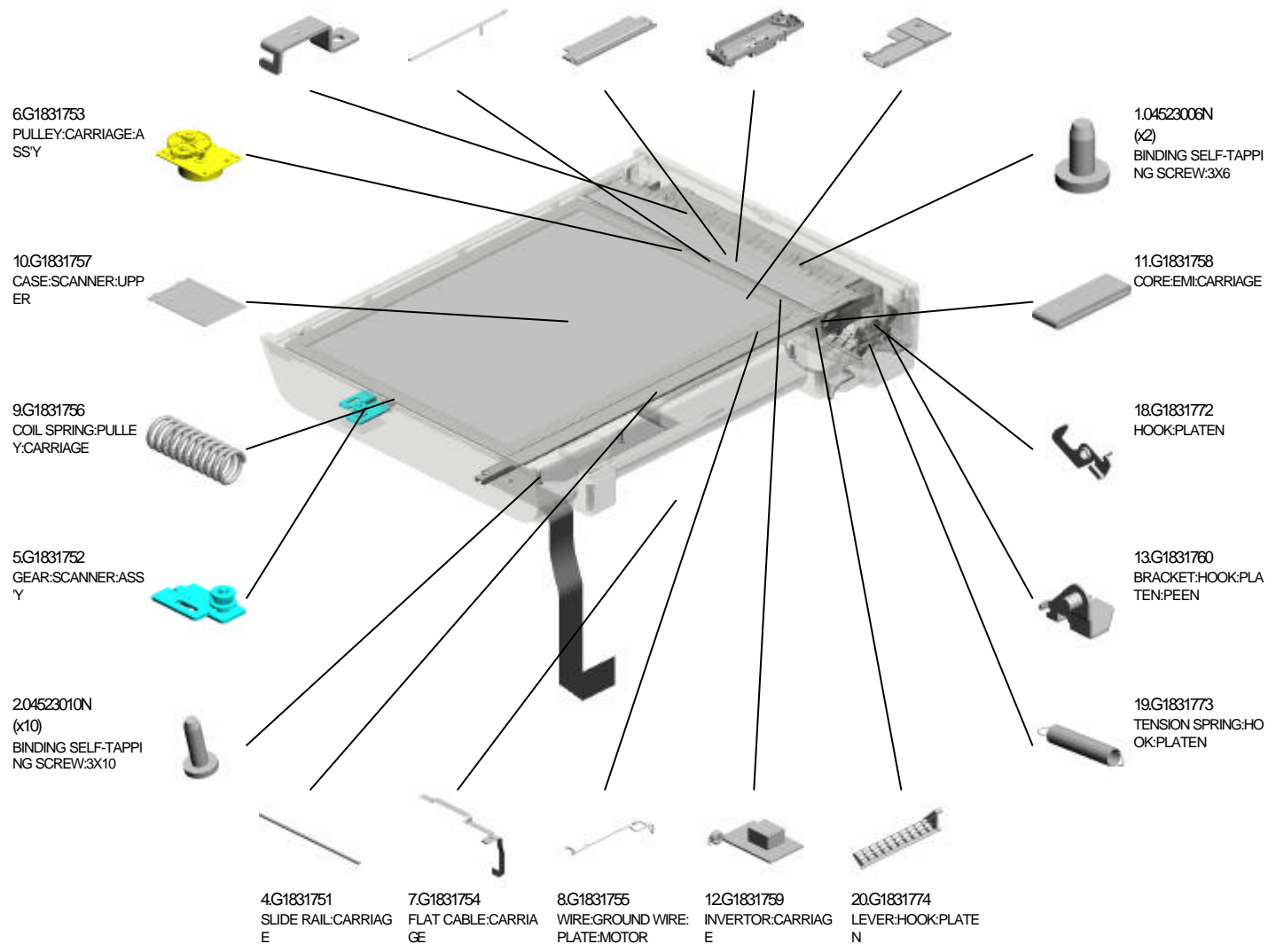

31.M0181600
SCANNER:ASSY

U001	U002	U003	U004	U005	U006	U007	U008	U009	U010	U011	U012	U013
------	------	------	------	------	------	------	------	------	------	------	------	------

U008_S001
SCANNER:ASS'Y



32.M0181826 COVER:SCANNER:FRONT:2
28.G1831824 GUIDE ROD:SCANNER
27.G1831821 CASE:SCANNER:LOWER
26.G1831820 CASE:SCANNER:UPPER

29.G1831825 PLATE:STUD:IDLER

25.G1831784 SHEET:SCANNER 200906 XO

23.G1831782 PLATE:COVER:UPPER

21.G1831780 LEVER:LOCK:COVER:UPPER

22.G1831781 TORSION SPRING:LEVER:LOCK:COVER:UPPER

24.G1831783 TORSION SPRING:LOCK:COVER:UPPER
30.G1831827 GROUND PLATE:SCANNER:LEFT

U001	U002	U003	U004	U005	U006	U007	U008	U009	U010	U011	U012	U013
------	------	------	------	------	------	------	------	------	------	------	------	------

U009.Paper Feed

U009_S001
M01825Z7
PAPER TRAY

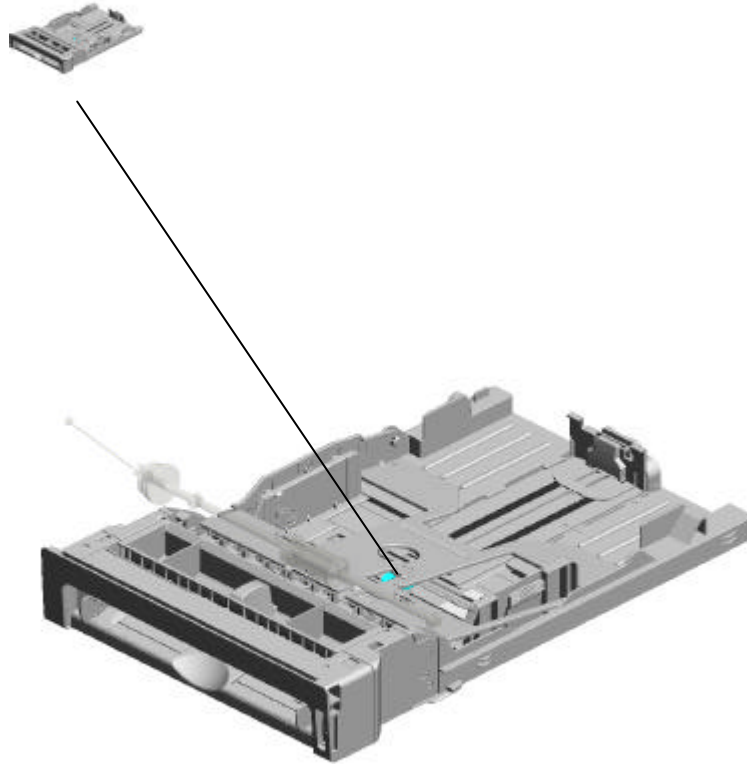

U001	U002	U003	U004	U005	U006	U007	U008	U009	U010	U011	U012	U013
------	------	------	------	------	------	------	------	------	------	------	------	------

U009_S001.PAPER TRAY

U009_S001_S001
M0182562
BASE:ADHESION

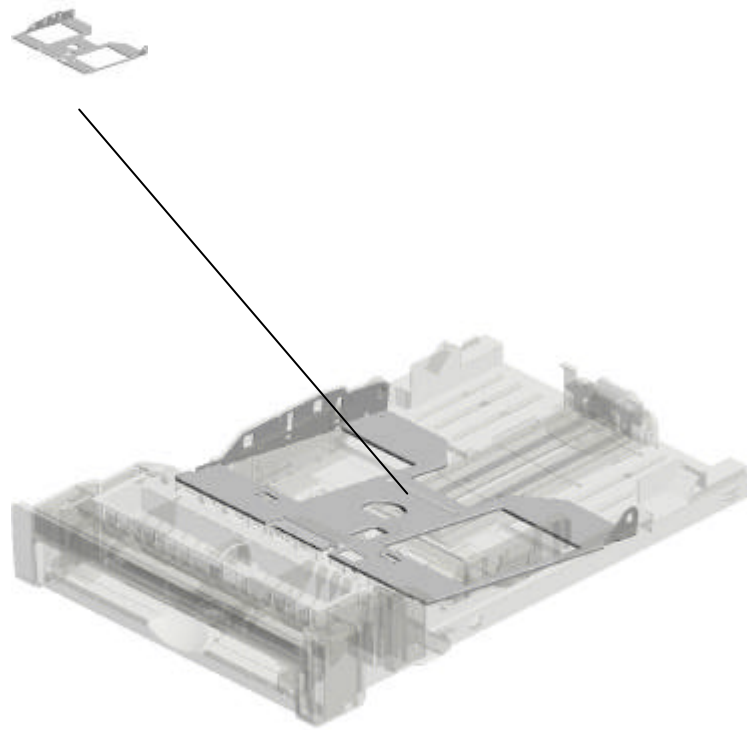

U001	U002	U003	U004	U005	U006	U007	U008	U009	U010	U011	U012	U013
------	------	------	------	------	------	------	------	------	------	------	------	------

U009 Paper Feed

28.G1662580
SHAFT - PAPER FEED ROLLER

8.AF031061
PAPER FEED ROLLER

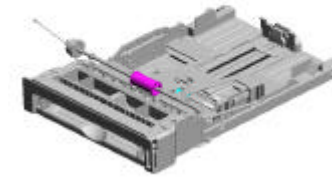

34.GX201121
MAGNETIC CLUTCH

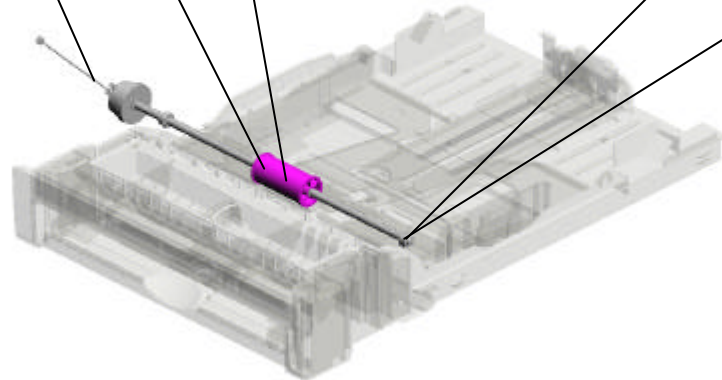
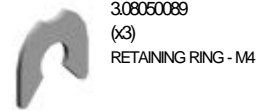
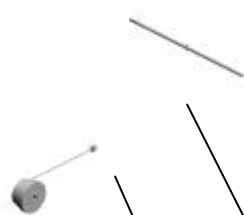

U009_S001 PAPER TRAY

22.G1662570
(x2)
COMPRESSION SPRING

1.04503010N
TAPPING SCREW - M
3X10

13.G1662555
LEFT SIDE FENCE

7.AA132013
SPACER - 8.2
200905

9.D0094511
SPACER: DIA8.0:1.5M
M
200905



35.M0182527
PAPER TRAY

12.G1662554
DUPLEX GUIDE

17.G1662560
LEFT SIDE FENCE - M
ANUAL FEED

10.G1662552
PAPER TRAY - FRONT

11.G1662553
CASSETTE COVER

23.G1662571
SHEET - CASSETTE

16.G1662559
END FENCE

15.G1662558
EXTENSION TRAY

2.08050088
RETAINING RING - M6

14.G1662556
RIGHT SIDE FENCE

24.G1662572
EARTH SPRING

18.G1662561
RIGHT SIDE FENCE -
MANUAL FEED

20.G1662568
COMPRESSION SPRING

21.G1662569
LEVER PAPER VOLUME
SENSOR

5.A2672869
GEAR - 16Z

19.G1662567
BOTTOM PLATE STOPPER

U001	U002	U003	U004	U005	U006	U007	U008	U009	U010	U011	U012	U013
------	------	------	------	------	------	------	------	------	------	------	------	------

U009_S001
PAPER TRAY

38.M0352620
FRICTION PAD:ADHE
SION
200911 00

37.M0182608
COVER:BASE

31.G1662619
SHEET:BASE



35.M0182527
PAPER TRAY

30.G1662606
COMPRESSION SPRI
NG

33.G8003133
SIDE FENCE GEAR

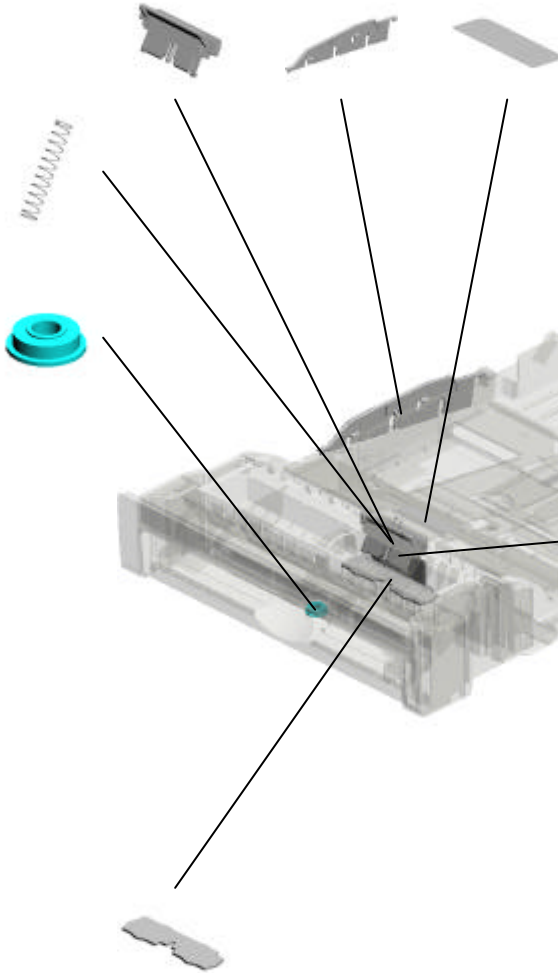

27.G1662578
COMPRESSION SPRI
NG

26.G1662577
END FENCE - PRESS
URE

25.G1662573
HOLDER SHEET

29.G1662589
DAMPING INSULATIO
N

U001	U002	U003	U004	U005	U006	U007	U008	U009	U010	U011	U012	U013
------	------	------	------	------	------	------	------	------	------	------	------	------

U009_S001_S001
BASE:ADHESION

452152713
BOTTOM PLATE PAD

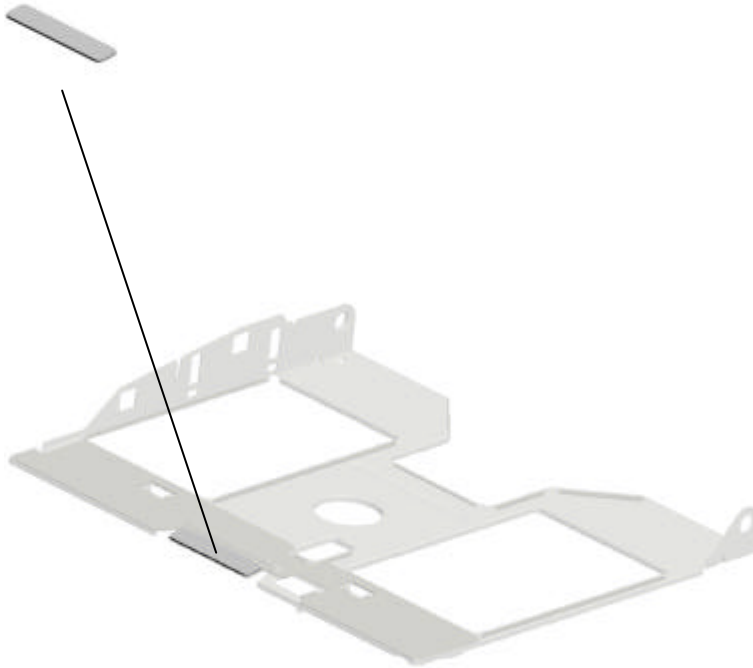

36M0182562
BASE:ADHESION

U001	U002	U003	U004	U005	U006	U007	U008	U009	U010	U011	U012	U013
------	------	------	------	------	------	------	------	------	------	------	------	------

U010.Transport

U010_S001
M0183800
HOUSING:TRANSPORT SUB-UNI
T:ASSY

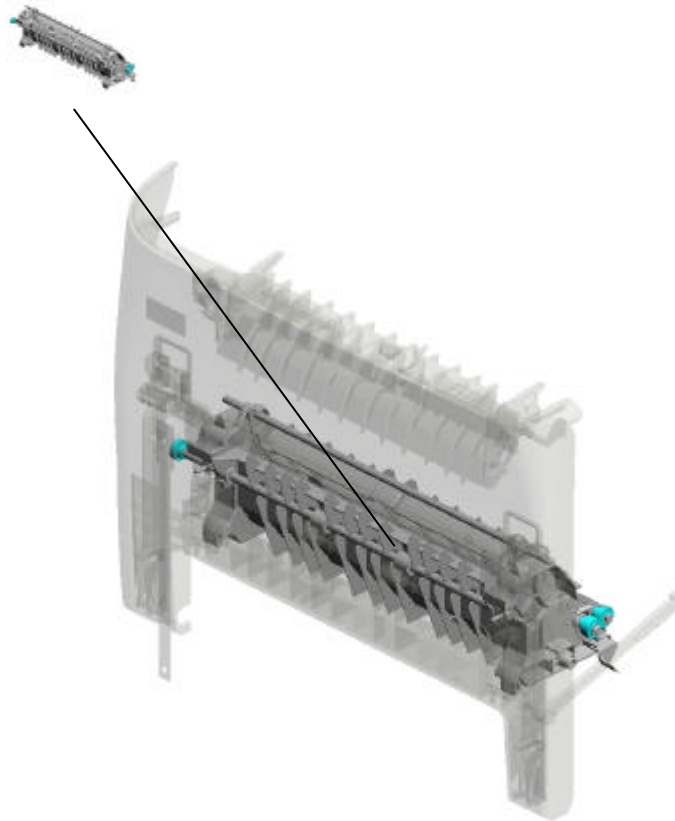

U001	U002	U003	U004	U005	U006	U007	U008	U009	U010	U011	U012	U013
------	------	------	------	------	------	------	------	------	------	------	------	------

U010_S001.HOUSING:TRANSPORT SUB-UNIT:ASS'Y

U010_S001_S001
M0183962
TRANSFER ROLLER:2.SUB-ASS'
Y

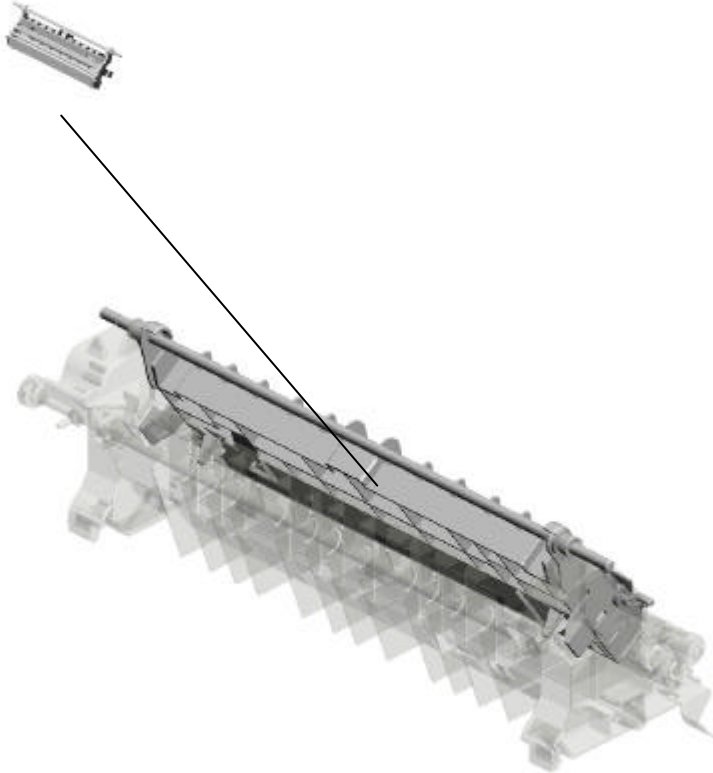

U001	U002	U003	U004	U005	U006	U007	U008	U009	U010	U011	U012	U013
------	------	------	------	------	------	------	------	------	------	------	------	------

U010 Transport



- 22.G1663912 GUIDE PLATE HOLDER
- 24.G1663923 EXIT GUIDE PLATE - MIDDLE
- 27.G1663926 EXIT GUIDE ROLLER - MIDDLE
- 30.G1663933 STOPPER:FEELER:APER FEED SENSOR
- 26.G1663925 TORSION SPRING - FEELER

17.G1663906
LEFT LOCK LEVER

21.G1663910
GROUND WIRE

15.G1663904
LEFT FRAME - FRONT COVER

19.G1663908
LOCK LEVER ARM

28.G1663927
STOPPER BAND

25.G1663924
FEELER - PAPER FEED SENSOR

23.G1663921
(x2)
GUIDE PLATE SPRING - MIDDLE

20.G1663909
TENSION SPRING

16.G1663905
RIGHT LOCK LEVER

29.G1663928
BRAKE RACK - FRONT COVER

18.G1663907
LOCK GUIDE

31.G1663957
(x2)
WASHER - 0.8X10.8M

33.G1663962
(x2)
COMPRESSION SPRING

14.G1663903
RIGHT FRAME - FRONT COVER

1.04503010N
(x13)
TAPPING SCREW - M

U001	U002	U003	U004	U005	U006	U007	U008	U009	U010	U011	U012	U013
------	------	------	------	------	------	------	------	------	------	------	------	------

U010 Transport

46.G1664464
DECAL-HIGHTEMPER
ATURE

49.G1833902
FRONT COVER



39.G1663972
(x2)
COMPRESSION SPRI
NG - GRIP

37.G1663970
LEFT HOOK



38.G1663971
RIGHT F-HOOK



40.G1663974
(x2)
COMPRESSION SPRI
NG - UPPER



47.G1664606
(x2)
DUPLIX ROLLER



48.G1664607
(x2)
PRESSURE SPRING -

U001	U002	U003	U004	U005	U006	U007	U008	U009	U010	U011	U012	U013
------	------	------	------	------	------	------	------	------	------	------	------	------

U010_S001
HOUSING:TRANSPORT SUB-UNIT:ASS'Y

12.G1663865 (x2) GEAR - 14Z
 2.07200040E (x5) RETAINING RING - M4
 6.G1663853 (x6) BUSHING - 6MM
 10.G1663862 (x2) GUIDE SHEET - REGISTRATION
 4.G1633979 GUIDE:EXIT:TRANSFER/SEPARATION:M



53.M0183800
HOUSING:TRANSPORT SUB-UNIT:ASSY

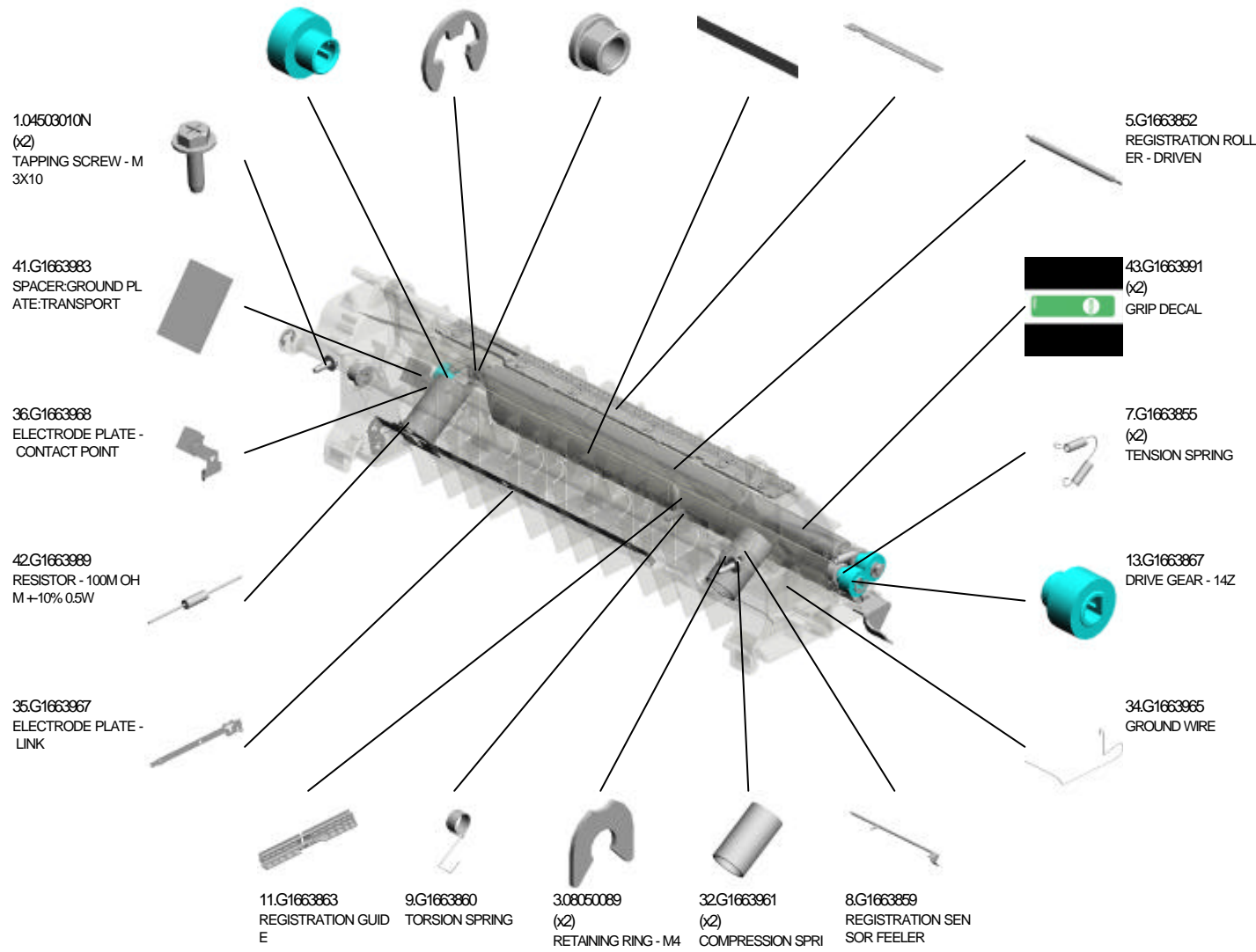

U001	U002	U003	U004	U005	U006	U007	U008	U009	U010	U011	U012	U013
------	------	------	------	------	------	------	------	------	------	------	------	------

U010_S001
HOUSING:TRANSPORT SUB-UNIT:ASS'Y

45.G1663998
GROUND WIRE- DUPL
EX
52.GF020054
TRANSPORT ROLLE
R:DUPL



53.M0183800
HOUSING:TRANSPOR
T SUB-UNIT:ASSY

50.GB011133
GEAR - 15Z

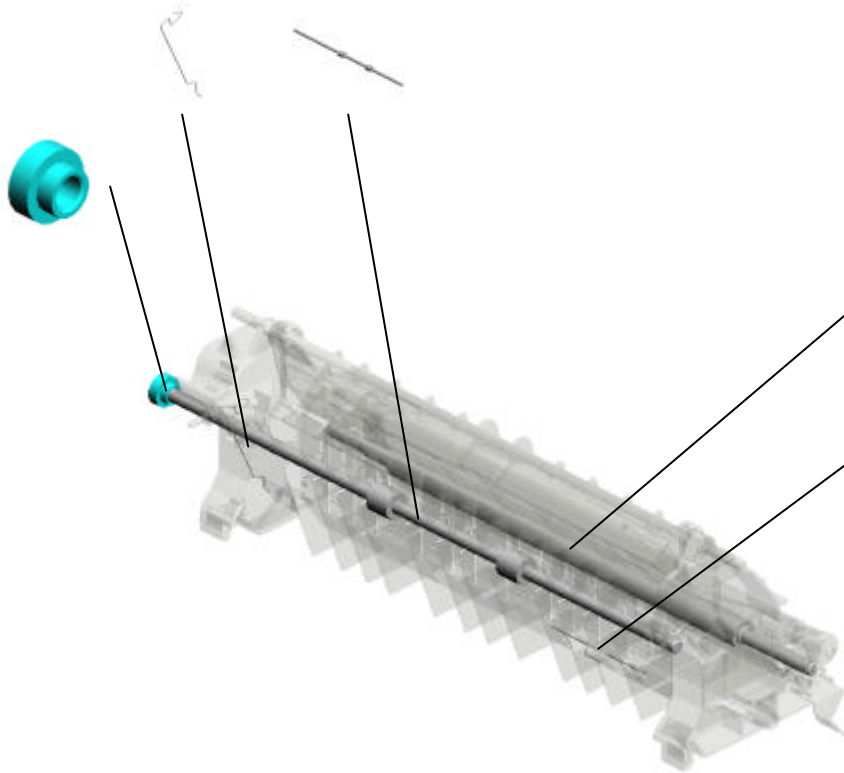

51.GF020000
REGISTRATION ROLL
ER - DRIVE

44.G1663997
GROUND WIRE:TRAN
SFER/SEPARATION

U001	U002	U003	U004	U005	U006	U007	U008	U009	U010	U011	U012	U013
------	------	------	------	------	------	------	------	------	------	------	------	------

U010_S001_S001
TRANSFER ROLLER:2:SUB-ASS'Y

207200040E
(x2)
RETAINING RING - M4

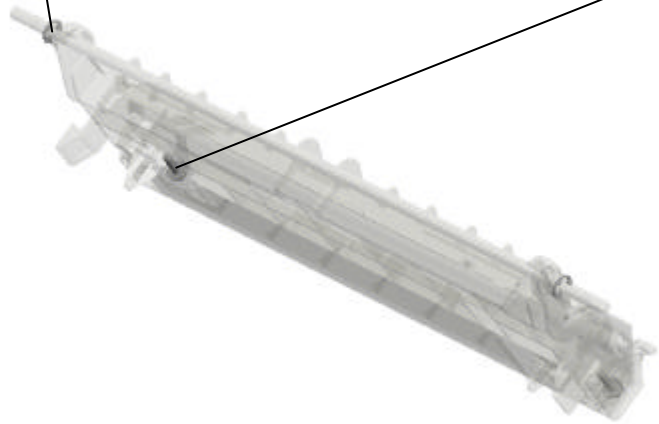

1.04500010N
(x2)
TAPPING SCREW - M
3X10



54.M0183952
TRANSFER ROLLER:
2.SUB-ASSY

U001	U002	U003	U004	U005	U006	U007	U008	U009	U010	U011	U012	U013
------	------	------	------	------	------	------	------	------	------	------	------	------

U011.Paper Exit

U011_S001
M0184450
GUIDE:EXIT:ASSY

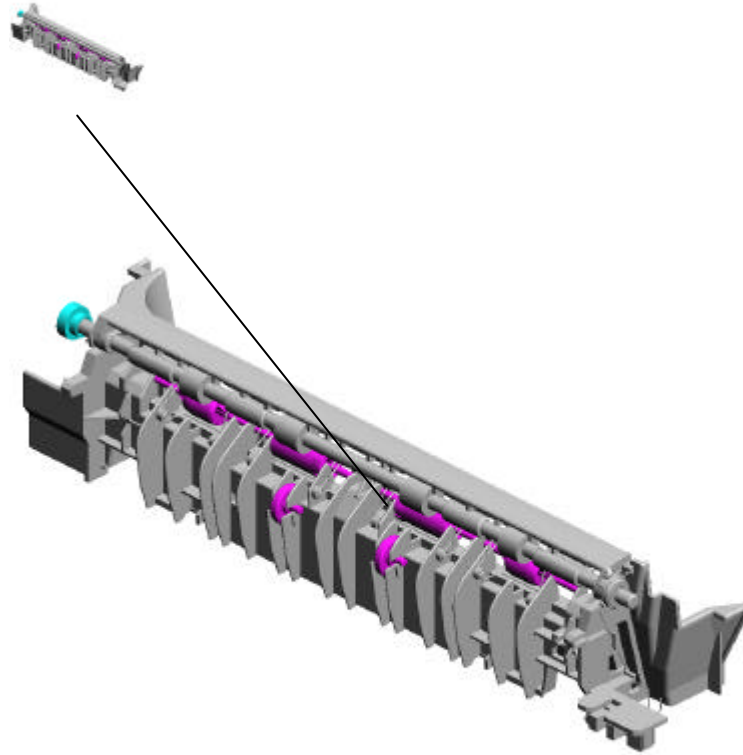

U001	U002	U003	U004	U005	U006	U007	U008	U009	U010	U011	U012	U013
------	------	------	------	------	------	------	------	------	------	------	------	------

U011
Paper Exit



U001	U002	U003	U004	U005	U006	U007	U008	U009	U010	U011	U012	U013
------	------	------	------	------	------	------	------	------	------	------	------	------

U011_S001
GUIDE:EXIT:ASS'Y

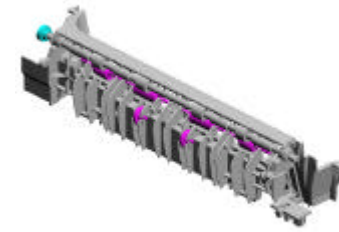

15.M0184450
GUIDE:EXIT:ASS'Y

- 18.M0184460 (x2) SPRING:PRESSURE:EXIT:OUTER
- 17.M0184459 (x2) ROLLER:DRIVEN:EXIT:OUTER
- 13.GF020055 EXIT ROLLER
- 4.G1664455 LOWER EXIT GUIDE
- 11.GA120011 DISCHARGE BRUSH EXIT

2.07200040E
RETAINING RING - M4

12.GB011133
GEAR - 15Z

10.GA082010 (x2)
BUSHING:DIA6:DIA10:9

5.G1664456 (x2)
GUIDE ROLLER - EXIT

9.G1664463 (x2)
EXIT GUIDE PLATE

19.M0184464 (x2)
GUIDE:PLATE:EXIT:OUTER

3.08050089 (x2)
RETAINING RING - M4

7.G1664461
GROUND WIRE

1.04543006Q (x2)
TAPPING SCREW - M3X6

- 16.M0184458 (x2) SPRING:PRESSURE:DRIVEN ROLLER - EX
- 6.G1664457 (x2) DRIVEN ROLLER - EX
- 14.GW020020 PHOTOINTERRUPTOR:R.LG248NL1
- 8.G1664462 STOPPER - PHOTOINTERRUPTOR

U001	U002	U003	U004	U005	U006	U007	U008	U009	U010	U011	U012	U013
------	------	------	------	------	------	------	------	------	------	------	------	------

U012.Electrical

U012_S001
G1666003
DENSITY SENSOR:ASSY

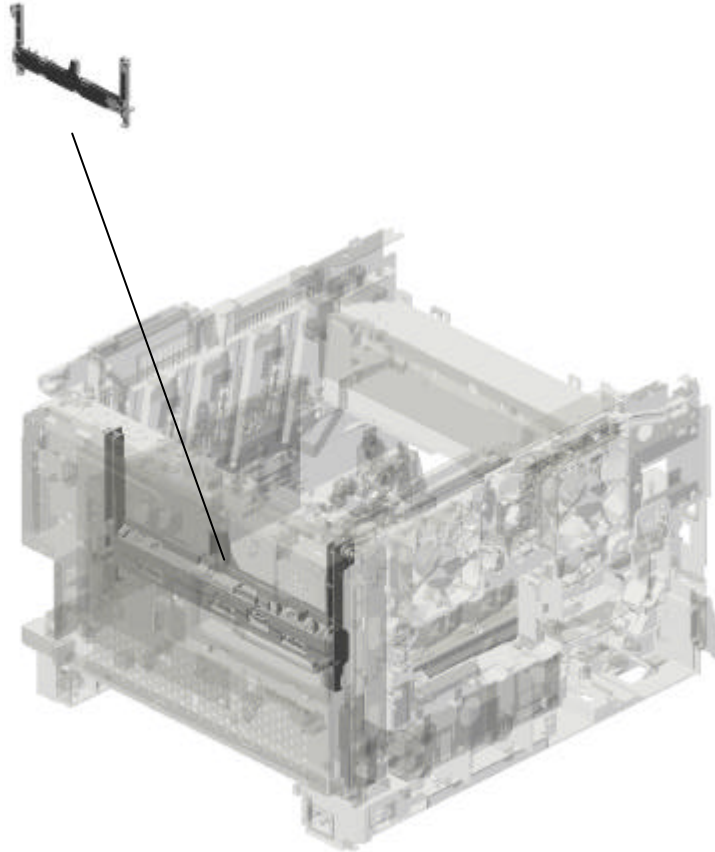

U001	U002	U003	U004	U005	U006	U007	U008	U009	U010	U011	U012	U013
------	------	------	------	------	------	------	------	------	------	------	------	------

U012 Electrical

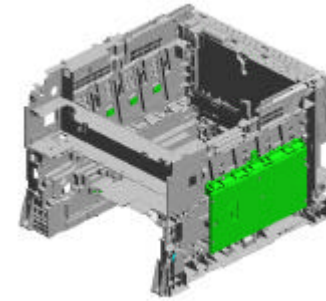

15.16072056
FERRITE CORE:33.5X
6.5X20

22.G1635731
BASE:HIGH VOLTAGE
E:3

1.03603006N
(x31)
SCREW - M3X6

13.14076657
EEPROM:BR93L76-W

20.G1631068
(x2)
BRACKET - PHOTOIN
TERRUPTOR

10.11050516
(x3)
CLAMP

11.11050518
EDGE SADDLE - LES-
1010

17AW140015
TEMPERATURE & HU
MIDITY SENSOR

8.11050487
(x2)
HARNESS CLAMP

19.G1022789
STOPPER:PHOTOIN
ERRUPTOR

9.11050508
(x4)
HARNESS CLAMP - L

2.04503010N
(x33)
TAPPING SCREW - M

3.04543006Q
(x6)
TAPPING SCREW - M

7.11024559
(x2)
CONNECTOR - 3P

16.AA143592
SCREW- M4X6

12.12042612
(x3)
MICRO SWITCH:D3V-
16506-3C25

14.16070892
FERRITE CORE - ZCA
T1518-0730

23.G1661058
EXIT DUCT

21.G1635728
(x4)
SEAL:FAN:2

18.AX640199
(x2)
FAN:MM80.25MMDC 2.
16W

5.09543008N
(x2)
SCREW - M3X8

2.04503010N (x1)
TAPPING SCREW - M3X10
4.04543008Q (x2)
TAPPING SCREW:3X8
6.11024473 (x3)
CT CONNECTOR - 2P

U012 Electrical

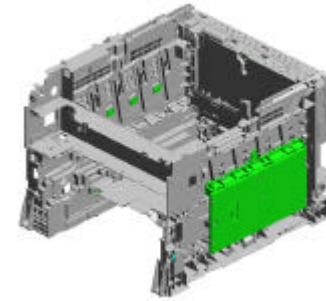

- 29.G1665708 2ND TERMINAL - TRANSFER
- 36.G1665733 LINK - SAFETY SWITCH
- 41.G1665747 ARM - SAFETY SWITCH
- 38.G1665736 TENSION SPRING - SAFETY SWITCH
- 37.G1665734 TORSION SPRING - SAFETY SWITCH

32.G1665716
(x12)
TERMINAL-AIO

40.G1665738
1ST TERMINAL - TRANSFER

33.G1665725
HARNESS COVER

30.G1665712
(x2)
MEMORY COVER (M019)

34.G1665726
(x3)
CUSHION - HARNESS

31.G1665715
BRACKET - MAIN SWITCH

24.G1661059
DUCT

27.G1665700
BRACKET - POWER SUPPLY UNIT

28.G1665701
HARNESS COVER - POWER SUPPLY UNIT

25.G1661110
HARNESS GUIDE

42.G1665748
LEVER - SAFETY SWITCH

39.G1665737
COMPRESSION SPRING - SAFETY SWITCH

35.G1665732
BRACKET SAFETY SWITCH

43.G1665751
CONNECTOR HOLDER - FUSING

26.G1665280
TERMINAL BOARD

U012 Electrical

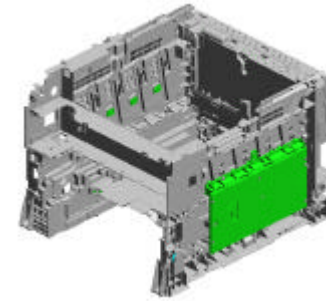

- 60.G1835824 CASE - CORE
- 64.GZ300003 POWER PACK
- 57.G1835820 BRACKET - CONTROL BOARD
- 53.G1666586 FEELER - SET SENSOR
- 55.G1835300 SPEAKER - DIA50

59.G1835823
BRACKET - INTERFACE

46.G1666045
SPRING - FEELER

47.G1666046
SENSOR FEELER

56.G1835673
PCB:FAX:NA:ASSY

48.G1666103
SENSOR HOLDER

44.G1665759
GROUND PLATE - FUSING

61.G1835826
BRACKET - SPEAKER

65.M0185126
PCB:EGB

58.G1835822
(x2)
STOPPER:MEMORY:(M019)

63.GZ230035
POWER SUPPLY UNIT - 115V

62.GW020020
(x4)
PHOTOINTERRUPTOR

54.G1666587
SENSOR BRACKET

52.G1666584
USED TONER SENSOR

51.G1666580
STOPPER SHEET - PHOTOINTERRUPTOR

49.G1666107
GROUNDING PLATE

U001	U002	U003	U004	U005	U006	U007	U008	U009	U010	U011	U012	U013
------	------	------	------	------	------	------	------	------	------	------	------	------

U012
Electrical

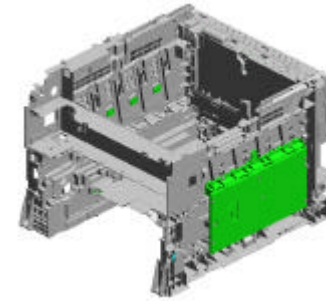

70.M0185752
SPACER:GROUND PL
ATE:FLAT CABLE:SC
ANNER UNIT

71.M0185753
(x4)
SHEET:COVER:SHAD
ING PLATE:MEMOR
Y

68.M0185701
(x2)
COVER:CONTROL BO
ARD:MF2C:ASSY:(M0
19)

66.M0185652
PCB:MAIN:ASSY

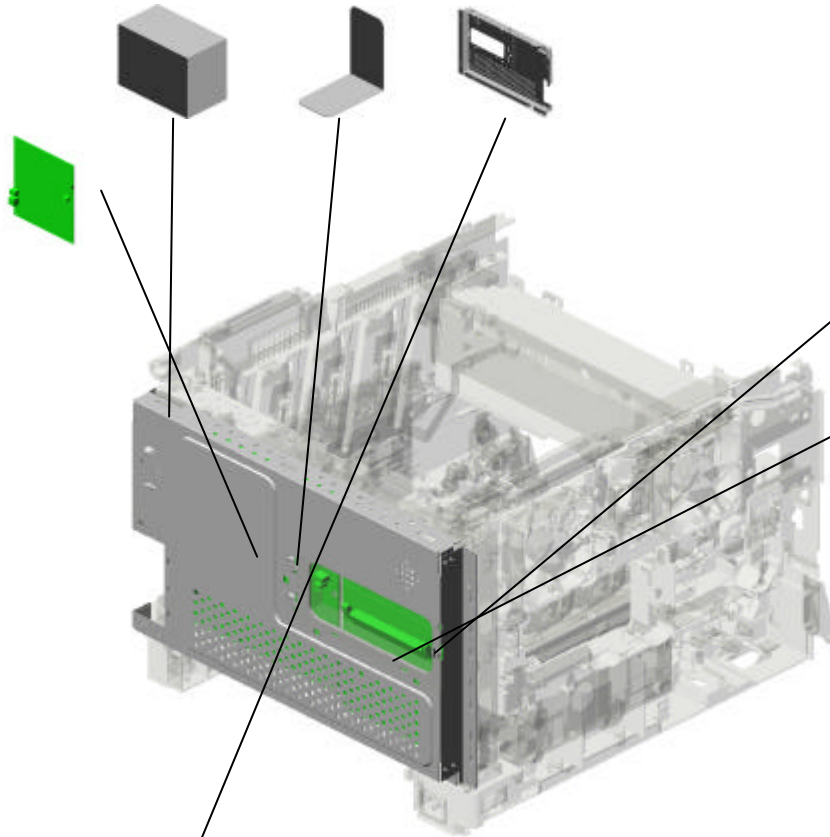

72.M0185754
(x2)
SCREW:(M019)

67.M0185662
(x2)
PCB:PDL:ASSY:(M01
9)

69.M0185711
COVER:CONTROL BO
ARD:MF2B:ASSY:(M0
19)

U001	U002	U003	U004	U005	U006	U007	U008	U009	U010	U011	U012	U013
------	------	------	------	------	------	------	------	------	------	------	------	------

U012_S001
DENSITY SENSOR:ASS'Y

50.G1666191
CLEANER DECAL - D
ENSITY SENSOR

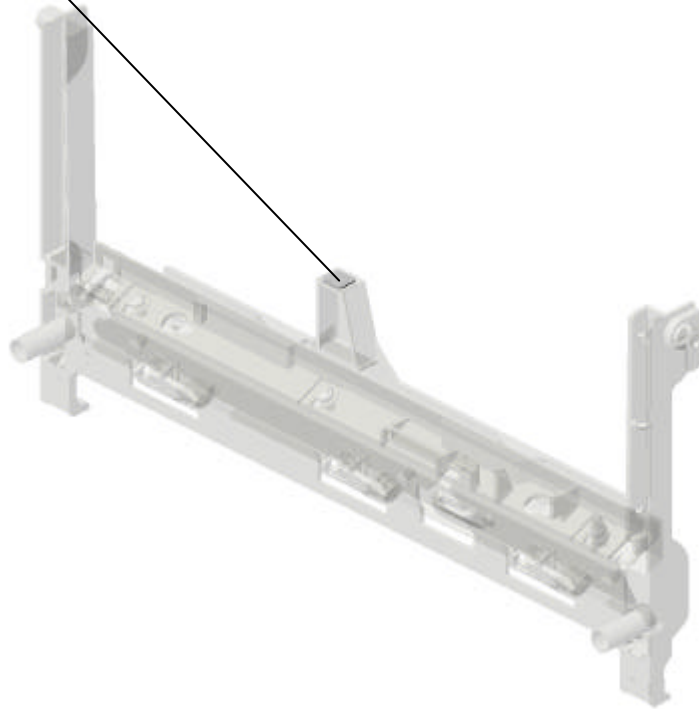

45.G1666003
DENSITY SENSOR: A
SSY

U001	U002	U003	U004	U005	U006	U007	U008	U009	U010	U011	U012	U013
------	------	------	------	------	------	------	------	------	------	------	------	------

U013 INTERMEDIATE TRANSFER UNIT

6.G1666194
RIGHT HOLDER - TRA
NSFER BELT UNIT

3.G1666026
(x2)
BUSHING - 19MM



9.M0180692
INTERMEDIATE TRA
NSFER UNIT

7.G1666196
RIGHT SLIDER - TRA
NSFER BELT UNIT



4.G1666099
(x2)
COMPRESSION SPRI
NG



5.G1666193
LEFT HOLDER - TRA
NSFER BELT UNIT



2.07200040E
(x2)
RETAINING RING - M4



1.04503010N
(x5)
TAPPING SCREW - M



8.G1666197
LEFT SLIDER - TRAN
SFER BELT UNIT



U001	U002	U003	U004	U005	U006	U007	U008	U009	U010	U011	U012	U013
------	------	------	------	------	------	------	------	------	------	------	------	------

Accessories



1.G1665429
POWER SUPPLY CORD - 125V/15A



2.G1661268
LOGO PLATE - RIC



3.G1661390
CAUTION DECAL - TRANSFER BELT



4.G1661397
DECAL CAUTION PRESSURE RELEASE



5.G1662592
SIDE FENCE DECAL



6.G1663996
DECAL INSERT SUB-UNIT COVER



7.G1831320
DECAL CAUTION WEIGHT:G183/G184



8.G1831475
SHEET PANEL ADDRESS



9.G1831881
DECAL CAUTION COPY - ENGLISH



10.G1831886
DECAL CAUTION SET ORIGINAL - ENGLISH



11.H5235350
TELEPHONE CABLE



17.M0160415
DECAL ID_CARD COPY EXP



12.M0181301
DECAL NAME PLATE



13.M0181302
DECAL NAME PLATE MF20NAGEN



14.M0181324
DECAL HIGH TEMPERATURE:110 CENTIGRADE



15.M0191301
DECAL NAME PLATE



16.M0191302
DECAL NAME PLATE MF20NAGEN

Exclusive Parts

Number	Part Name	Group	ID
52152713	BOTTOM PLATE PAD	U009_S001_S001	4
A2672869	GEAR - 16Z	U009_S001	5
AA082101	BUSHING - 6X10X6	U005	10
		U009	6
AA132013	SPACER - 8.2	U009_S001	7
AA143520	SHOULDER SCREW - M3	U002_S001	4
AA143592	SCREW- M4X6	U012	16
AA143801	SCREW:M4:EXTERIOR	U002_S001	5
AF031061	PAPER FEED ROLLER	U009	8
AW140015	TEMPERATURE & HUMIDITY SENSOR	U012	17
AX640199	FAN:MM80:25MM:DC 2.16W	U012	18
B0394480	STEPPED SCREW - M5	U004	12
B1251474	RIVET:MM5	U004	13
C2175102	SPRING WASHER	U002_S001	6
D0094511	SPACER:DIA8.0:1.5MM	U009_S001	9
G1022789	STOPPER:PHOTOINTERRUPTOR	U012	19
G1631068	BRACKET - PHOTOINTERRUPTOR	U012	20
G1633979	GUIDE:EXIT:TRANSFER/SEPARATION:M	U010_S001	4
G1635728	SEAL:FAN:2	U012	21
G1635731	BASE:HIGH VOLTAGE:3	U012	22
G1661008	CLUTCH/BRAKE BRAKET	U004	14
G1661046	COLOR DECAL - MAGENTA	U004	15
G1661047	SPACER- RUBBER FOOT	U004	16
G1661048	RUBBER FOOT	U004	17
G1661058	EXIT DUCT	U012	23
G1661059	DUCT	U012	24
G1661060	BASE:HINGE:COVER:FRONT	U004	18
G1661061	PIN:HINGE	U004	19
G1661064	CLUTCH/BRAKE SPRING	U004	20
G1661065	CLUTCH SPRING	U004	21
G1661066	CLUTCH/BRAKE CASE	U004	22
G1661067	GEAR - 14Z	U004	23
G1661068	FUSING DUCT	U004	24
G1661069	RACK SUPPORTER	U004	25
G1661070	FRAME:UPPER LEFT	U004	26
G1661071	FRAME:UPPER RIGHT	U004	27
G1661072	SPRING:PLATE:AIO	U004	28
G1661073	SHAFT	U004	29

Number	Part Name	Group	ID
G1661078	COMPRESSION SPRING	U004	30
G1661081	TWIST SPRING - LEFT	U004	31
G1661083	GROUNDING PLATE - HIGH VOLTAGE	U004	32
G1661084	SPRING:PLATE:AIO:BLACK	U004	33
G1661085	SPRING PLATE:LSU:POSITIONING	U004	34
G1661086	BRACKET:OPTICAL UNIT:FRAME:UPPER	U004	35
G1661087	SPRING:CUSHION:FRAME:UPPER	U004	36
G1661088	UPPER FRONT DUCT	U004	37
G1661089	PIN:PLATE:DEVELOPMENT UNIT	U004	38
G1661090	GROUND PLATE - DCHIP	U004	39
G1661091	GROUND PLATE - POWER SUPPLY UNIT	U004	40
G1661093	GEAR - 20Z	U004	41
G1661095	SHEET:BASE:FRAME	U004	42
G1661096	GROUND PLATE - FRONT	U004	43
G1661097	GROUND PLATE - LEFT	U004	44
G1661104	SHIELDING PLATE	U005	11
G1661110	HARNESS GUIDE	U012	25
G1661111	FRAME - TRANSFER DRIVE UNIT	U005	12
G1661112	GEAR COVER	U004	45
G1661118	GROUNDING WIRE	U005	13
G1661119	MOTOR BRACKET	U005	14
G1661123	FRAME - ON-OFF DRIVE UNIT	U005	15
G1661125	SHIELDING PLATE	U005	16
G1661131	DC MOTOR - DC24V 5.3W	U005	17
G1661135	MOTOR - DC24V 1.6W	U005	18
G1661139	FRAME - TRANSPORT DRIVE UNIT	U005	19
G1661151	MOTOR BRACKET	U005	20
G1661152	GROUNDING PLATE	U005	21
G1661194	FRAME - DUPLEX DRIVE UNIT	U005	22
G1661259	MEMORY COVER	U006	5
G1661261	INNER COVER - EXIT	U006	6
G1661262	CASSETTE COVER	U006	7
G1661268	LOGO PLATE - RIC		
G1661280	CUSHION - IMAGING UNIT	U004	46
G1661281	BASE - EXIT END FENCE	U004	47
G1661282	REAR END FENCE - EXIT	U004	48

Exclusive Parts

Number	Part Name	Group	ID
G1661283	FRONT END FENCE - EXIT	U004	49
G1661303	RIGHT COVER - NON EU	U006	8
G1661306	LEFT COVER - NON EU	U006	9
G1661323	SHEET:FRAME:RIGHT	U004	50
G1661343	KEY:FUSING	U004	51
G1661382	BRACKET:BRAKE:COVER:UPPER	U004	52
G1661389	DECAL - HIGH VOLTAGE	U004	53
G1661390	CAUTION DECAL - TRANSFER BELT		
G1661397	DECAL:CAUTION:PRESSURE RELEASE		
G1661851	IMAGING UNIT:ASSY	U001	1
G1662552	PAPER TRAY - FRONT	U009_S001	10
G1662553	CASSETTE COVER	U009_S001	11
G1662554	DUPLEX GUIDE	U009_S001	12
G1662555	LEFT SIDE FENCE	U009_S001	13
G1662556	RIGHT SIDE FENCE	U009_S001	14
G1662558	EXTENSION TRAY	U009_S001	15
G1662559	END FENCE	U009_S001	16
G1662560	LEFT SIDE FENCE - MANUAL FEED	U009_S001	17
G1662561	RIGHT SIDE FENCE - MANUAL FEED	U009_S001	18
G1662567	BOTTOM PLATE STOPPER	U009_S001	19
G1662568	COMPRESSION SPRING	U009_S001	20
G1662569	LEVER PAPER VOLUME SENSOR	U009_S001	21
G1662570	COMPRESSION SPRING	U009_S001	22
G1662571	SHEET - CASSETTE	U009_S001	23
G1662572	EARTH SPRING	U009_S001	24
G1662573	HOLDER SHEET	U009_S001	25
G1662577	END FENCE - PRESSURE	U009_S001	26
G1662578	COMPRESSION SPRING	U009_S001	27
G1662580	SHAFT - PAPER FEED ROLLER	U009	28
G1662582	GROUNDING SPRING	U004	54
G1662583	SPRING PLATE:PAPER TRAY:POSITIONING	U004	55
G1662585	FEELER - PAPER END SENSOR	U004	56
G1662586	FEELER HOLDER	U004	57
G1662588	HOLDER:PAPER TRAY:POSITIONING	U004	58
G1662589	DAMPING INSULATION	U009_S001	29
G1662592	SIDE FENCE DECAL		
G1662596	HOLDER:RESISTOR:BASE	U004	59

Number	Part Name	Group	ID
G1662597	SPRING PLATE:RESISTOR:BASE:LOWE R	U004	60
G1662598	SPRING PLATE:RESISTOR:BASE:UPPE R	U004	61
G1662606	COMPRESSION SPRING	U009_S001	30
G1662619	SHEET:BASE	U009_S001	31
G1663331	DECAL - BLACK	U004	62
G1663333	DECAL - CYAN	U004	63
G1663334	DECAL - YELLOW	U004	64
G1663852	REGISTRATION ROLLER - DRIVEN	U010_S001	5
G1663853	BUSHING - 6MM	U010_S001	6
G1663855	TENSION SPRING	U010_S001	7
G1663859	REGISTRATION SENSOR FEELER	U010_S001	8
G1663860	TORSION SPRING	U010_S001	9
G1663862	GUIDE SHEET - REGISTRATION	U010_S001	10
G1663863	REGISTRATION GUIDE	U010_S001	11
G1663865	GEAR - 14Z	U010_S001	12
G1663866	GROUND PLATE:REGISTRATION ROLL ER	U004	65
G1663867	DRIVE GEAR - 14Z	U010_S001	13
G1663903	RIGHT FRAME - FRONT COVER	U010	14
G1663904	LEFT FRAME - FRONT COVER	U010	15
G1663905	RIGHT LOCK LEVER	U010	16
G1663906	LEFT LOCK LEVER	U010	17
G1663907	LOCK GUIDE	U010	18
G1663908	LOCK LEVER ARM	U010	19
G1663909	TENSION SPRING	U010	20
G1663910	GROUND WIRE	U010	21
G1663912	GUIDE PLATE HOLDER	U010	22
G1663921	GUIDE PLATE SPRING - MIDDLE	U010	23
G1663923	EXIT GUIDE PLATE - MIDDLE	U010	24
G1663924	FEELER - PAPER FEED SENSOR	U010	25
G1663925	TORSION SPRING - FEELER	U010	26
G1663926	EXIT GUIDE ROLLER - MIDDLE	U010	27
G1663927	STOPPER BAND	U010	28
G1663928	BRAKE RACK - FRONT COVER	U010	29
G1663933	STOPPER:FEELER:PAPER FEED SENS OR	U010	30

Exclusive Parts

Number	Part Name	Group	ID
G1663957	WASHER - 0.8X10.8MM	U010	31
G1663961	COMPRESSION SPRING	U010_S001	32
G1663962	COMPRESSION SPRING HOLDER	U010	33
G1663965	GROUND WIRE	U010_S001	34
G1663967	ELECTRODE PLATE - LINK	U010_S001	35
G1663968	ELECTRODE PLATE - CONTACT POINT	U010_S001	36
G1663970	LEFT HOOK	U010	37
G1663971	RIGHT FHOOK	U010	38
G1663972	COMPRESSION SPRING - GRIP	U010	39
G1663974	COMPRESSION SPRING - UPPER	U010	40
G1663983	SPACER:GROUND PLATE:TRANSPORT	U010_S001	41
G1663989	RESISTOR - 100M OHM +-10% 0.5W	U010_S001	42
G1663991	GRIP DECAL	U010_S001	43
G1663993	RESISTOR - 100M OHM +-10% 0.5W	U004	66
G1663994	RESISTOR - 50M OHM +-10% 0.5W	U004	67
G1663996	DECAL:INSERT SUB-UNIT:COVER		
G1663997	GROUND WIRE:TRANSFER/SEPARATION	U010_S001	44
G1663998	GROUND WIRE- DUPLEX	U010_S001	45
G1664012	FUSING UNIT - 120V	U002_S001	7
G1664055	REAR COVER - FUSING UNIT	U002_S001	8
G1664066	FRONT COVER - FUSING UNIT	U002_S001	9
G1664071	FUSING ENTRANCE GUIDE - UPPER	U002_S001	10
G1664072	FUSING ENTRANCE GUIDE - LOWER	U002_S001	11
G1664088	GUIDE PLATE - FUSING EXIT	U002_S001	12
G1664286	STRIPPER PLATE	U002_S001	13
G1664288	RIGHT COLLAR- STRIPPER PLATE	U002_S001	14
G1664289	LEFT COLLAR- STRIPPER PLATE	U002_S001	15
G1664291	LEFT POSITIONING PLATE- STRIPPER	U002_S001	16
G1664292	RIGHT POSITIONING PLATE - STRIPPER	U002_S001	17
G1664323	TORSION SPRING - STRIPPER PLATE	U002_S001	18
G1664398	DECAL - HIGH TEMPERATURE	U002_S001	19
G1664455	LOWER EXIT GUIDE	U011_S001	4
G1664456	GUIDE ROLLER - EXIT	U011_S001	5
G1664457	DRIVEN ROLLER - EXIT	U011_S001	6
G1664461	GROUND WIRE	U011_S001	7
G1664462	STOPPER - PHOTOINTERRUPTOR	U011_S001	8

Number	Part Name	Group	ID
G1664463	EXIT GUIDE PLATE	U011_S001	9
G1664464	DECAL:HIGHTEMPERATURE	U010	46
G1664606	DUPLEX ROLLER	U010	47
G1664607	PRESSURE SPRING - DUPLEX ROLLER	U010	48
G1665280	TERMINAL BOARD	U012	26
G1665429	POWER SUPPLY CORD - 125V 15A		
G1665700	BRACKET - POWER SUPPLY UNIT	U012	27
G1665701	HARNESS COVER - POWER SUPPLY UNIT	U012	28
G1665706	GROUND PLATE:SHAFT:IMAGING UNIT	U004	68
G1665708	2NDTERMINAL- TRANSFER	U012	29
G1665712	MEMORY COVER:(M019)	U012	30
G1665715	BRACKET - MAIN SWITCH	U012	31
G1665716	TERMINAL:AIO	U012	32
G1665724	HARNESS CLAMP HOLDER	U004	69
G1665725	HARNESS COVER	U012	33
G1665726	CUSHION - HARNESS	U012	34
G1665732	BRACKET SAFETY SWITCH	U012	35
G1665733	LINK - SAFETY SWITCH	U012	36
G1665734	TORSION SPRING - SAFETY SWITCH	U012	37
G1665736	TENSION SPRING - SAFETY SWITCH	U012	38
G1665737	COMPRESSION SPRING - SAFETY SWITCH	U012	39
G1665738	1ST TERMINAL - TRANSFER	U012	40
G1665745	HARNESS COVER	U005	23
G1665747	ARM - SAFETY SWITCH	U012	41
G1665748	LEVER - SAFETY SWITCH	U012	42
G1665751	CONNECTOR HOLDER - FUSING	U012	43
G1665756	RESISTORHOLDER - EXIT	U004	70
G1665757	GROUND PLATE -INPUT	U004	71
G1665758	GROUND PLATE - OUTPUT	U004	72
G1665759	GROUND PLATE - FUSING	U012	44
G1666003	DENSITY SENSOR:ASSY	U012_S001	45
G1666026	BUSHING - 19MM	U013	3
G1666045	SPRING - FEELER	U012	46
G1666046	SENSOR FEELER	U012	47
G1666099	COMPRESSION SPRING	U013	4

Exclusive Parts

Number	Part Name	Group	ID
G1666103	SENSOR HOLDER	U012	48
G1666107	GROUNDING PLATE	U012	49
G1666191	CLEANER DECAL - DENSITY SENSOR	U012_S001	50
G1666193	LEFT HOLDER - TRANSFER BELT UNIT	U013	5
G1666194	RIGHT HOLDER - TRANSFER BELT UNIT	U013	6
G1666196	RIGHT SLIDER - TRANSFER BELT UNIT	U013	7
G1666197	LEFT SLIDER - TRANSFER BELT UNIT	U013	8
G1666580	STOPPER SHEET - PHOTOINTERRUPTOR	U012	51
G1666584	USED TONER SENSOR	U012	52
G1666586	FEELER - SET SENSOR	U012	53
G1666587	SENSOR BRACKET	U012	54
G1666592	SPRING PLATE -COLLECTION BOTTLE	U004	73
G1831050	LEFT SLIDE ARM	U004	74
G1831051	RIGHT SLIDE ARM	U004	75
G1831052	LEFT TORSION SPRING - ARM	U004	76
G1831053	RIGHT TORSION SPRING - ARM	U004	77
G1831054	SLIDE RAIL:LEFT	U004	78
G1831055	SLIDE RAIL:RIGHT	U004	79
G1831056	HINGE - TORQUE LIMITER	U004	80
G1831060	SEPARATION PLATE - SLIDE	U004	81
G1831061	TORSION SPRING - SEPARATION PLATE	U004	82
G1831065	LEFT SLIDE STOPPER - SCANNER	U004	83
G1831066	TORSION SPRING- SLIDE STOPPER	U004	84
G1831067	STOPPER PLATE - SCANNER	U004	85
G1831068	RIGHT SLIDE STOPPER - SCANNER	U004	86
G1831069	COMPRESSION SPRING - STOPPER	U004	87
G1831070	UPPER SUPPORTING PLATE - COVER	U004	88
G1831071	RIGHT ACTUATOR - STOPPER	U004	89
G1831072	WIRE - SCANNER LOCK	U004	90
G1831075	PLATE:SHAFT	U004	91
G1831082	ARM - LOCK LEVER	U004	92
G1831085	BRACKET - ARM	U004	93
G1831088	TENSION SPRING -LOCK ARM	U004	94
G1831090	GROUND PLATE:SUPPORTING PLATE:LEFT	U004	95

Number	Part Name	Group	ID
G1831091	GROUND PLATE:SUPPORTING PLATE:RIGHT	U004	96
G1831250	UPPER COVER	U004	97
G1831251	RIGHT HARNESS COVER -SCANNER	U004	98
G1831252	LEFT HARNESS COVER - SCANNER	U004	99
G1831257	COVER - PAPER EXIT	U006	10
G1831258	COVER - INTERFACE	U006	11
G1831264	REAR COVER	U006	12
G1831320	DECAL:CAUTION:WEIGHT:G183/G184		
G1831453	KEYT - 10KEY	U007_S001	2
G1831455	KEY - APPLICATION	U007_S001	3
G1831456	KEY - START/STOP	U007_S001	4
G1831457	KEYTOP - 10KEY	U007_S001	5
G1831461	KEYTOP - START/STOP	U007_S001	6
G1831462	KEYTOP - APPLICATION	U007_S001	7
G1831465	GROUND PLATE:OPERATION SUB-UNIT:RIGHT	U007_S001	8
G1831475	SHEET:PANEL:ADDRESS		
G1831630	ADF:ASSY	U003_S001	1
G1831740	FRAME:ADF	U003_S001	2
G1831741	COVER:FRONT:ADF	U003_S001	3
G1831742	COVER:REAR:ADF	U003_S001	4
G1831743	BASE:SLIDER	U003_S001	5
G1831744	SIDE FENCE:RIGHT	U003_S001	6
G1831745	SIDE FENCE:LEFT	U003_S001	7
G1831746	EXTENSION TRAY:ADF	U003_S001	8
G1831747	PAPER STOPPER:ADF	U003_S001	9
G1831750	PLATE:GUIDE ROD:SCANNER	U008_S001	3
G1831751	SLIDE RAIL:CARRIAGE	U008_S001	4
G1831752	GEAR:SCANNER:ASSY	U008_S001	5
G1831753	PULLEY:CARRIAGE:ASSY	U008_S001	6
G1831754	FLAT CABLE:CARRIAGE	U008_S001	7
G1831755	WIRE:GROUND WIRE:PLATE:MOTOR	U008_S001	8
G1831756	COIL SPRING:PULLEY:CARRIAGE	U008_S001	9
G1831757	CASE:SCANNER:UPPER	U008_S001	10
G1831758	CORE:EMI:CARRIAGE	U008_S001	11
G1831759	INVERTOR:CARRIAGE	U008_S001	12
G1831760	BRACKET:HOOK:PLATEN:PEEN	U008_S001	13

Exclusive Parts

Number	Part Name	Group	ID
G1831761	COVER:CARRIAGE:UPPER	U008_S001	14
G1831762	FLUORESCENT TUBE:CARRIAGE	U008_S001	15
G1831764	COVER:INVERTOR	U008_S001	16
G1831765	CCD:MODULE:ASS'Y	U008_S001	17
G1831772	HOOK:PLATEN	U008_S001	18
G1831773	TENSION SPRING:HOOK:PLATEN	U008_S001	19
G1831774	LEVER:HOOK:PLATEN	U008_S001	20
G1831775	HOOK:ADF	U003_S001	10
G1831780	LEVER:LOCK:COVER:UPPER	U008_S001	21
G1831781	TORSION SPRING:LEVER:LOCK:COVER:UPPER	U008_S001	22
G1831782	PLATE:COVER:UPPER	U008_S001	23
G1831783	TORSION SPRING:LOCK:COVER:UPPER	U008_S001	24
G1831784	SHEET:SCANNER	U008_S001	25
G1831820	CASE:SCANNER:UPPER	U008_S001	26
G1831821	CASE:SCANNER:LOWER	U008_S001	27
G1831822	ADF DECAL - PICK-UP PAPER JAM	U003_S001	11
G1831824	GUIDE ROD:SCANNER	U008_S001	28
G1831825	PLATE:STUD:IDLER	U008_S001	29
G1831827	GROUND PLATE:SCANNER:LEFT	U008_S001	30
G1831834	LEFT GROUND PLATE - SCANNER	U004	100
G1831881	DECAL:CAUTION:COPY - ENGLISH		
G1831886	DECAL:CAUTION:SET:ORIGINAL - ENGLISH		
G1832550	ARM:SENSOR	U003_S001	12
G1832551	COIL SPRING:ARM:SENSOR	U003_S001	13
G1832552	SHEET:ADF:KILO	U003_S001	14
G1832553	COIL SPRING:GEAR:SLIDE	U003_S001	15
G1832554	GEAR:SLIDE	U003_S001	16
G1832555	CABLE:ADF	U003_S001	17
G1832558	PADDLE:ROLLER:EXIT	U003_S001	18
G1832559	DRIVEN ROLLER:EXIT	U003_S001	19
G1832560	SHAFT:DRIVEN ROLLER:EXIT	U003_S001	20
G1832561	COIL SPRING:EXIT	U003_S001	21
G1832562	COVER:EXIT	U003_S001	22
G1832563	PCB:DIP:ADF	U003_S001	23
G1832564	COVER:ADF	U003_S001	24

Number	Part Name	Group	ID
G1832565	SHEET:PRESSURE PLATE	U003_S001	25
G1832566	FLANGE:BUSHING:GEAR	U003_S001	26
G1832567	FRAME:LOWER	U003_S001	27
G1832569	COIL SPRING:PLATE	U003_S001	28
G1832570	PLATE	U003_S001	29
G1832571	SHEET:GUIDE	U003_S001	30
G1832572	FLANGE:BUSHING	U003_S001	31
G1832573	FEED ROLLER:ADF	U003_S001	32
G1832574	EXIT ROLLER:ADF	U003_S001	33
G1832576	COIL SPRING:FEED ROLLER:DRIVEN	U003_S001	34
G1832577	FEELER:SENSOR:FEED	U003_S001	35
G1832578	ARM:PRESSURE RELEASE	U003_S001	36
G1832579	DRIVEN ROLLER:FEED	U003_S001	37
G1832580	STAY:FEED	U003_S001	38
G1832581	GUIDE:FEED:DRIVEN	U003_S001	39
G1832582	SHAFT:DRIVEN ROLLER:FEED	U003_S001	40
G1832583	FIX STAND:SENSOR:FEED	U003_S001	41
G1832585	SHEET:FEELER:FEED	U003_S001	42
G1832586	PLATE:REAR	U003_S001	43
G1832587	GEAR:FEED:44T	U003_S001	44
G1832588	GEAR:EXIT:41T	U003_S001	45
G1832589	GEAR:20T39T	U003_S001	46
G1832590	GEAR:MIDDLE:32T	U003_S001	47
G1832591	GEAR:21T37T	U003_S001	48
G1832592	GEAR:51T	U003_S001	49
G1832593	GEAR:DRIVE:39T55T	U003_S001	50
G1832594	PLATE:MOTOR	U003_S001	51
G1832595	GEAR:DRIVE:40T56T	U003_S001	52
G1832598	ROLLER:BACK UP:FEED	U003_S001	53
G1832599	COIL SPRING:SHUTTER:PAPER	U003_S001	54
G1832600	SHUTTER:PAPER	U003_S001	55
G1832601	SEPARATION PAD:ADF	U003_S001	56
G1832602	FRAME:UPPER	U003_S001	57
G1832603	COIL SPRING:FEELER:SET SENSOR	U003_S001	58
G1832604	FEELER:SET SENSOR	U003_S001	59
G1832605	HOLDER:SEPARATION UNIT	U003_S001	60
G1832606	SHEET:STOPPER:EXIT	U003_S001	61
G1832607	DISCHARGE BRUSH:EXIT	U003_S001	62

Exclusive Parts

Number	Part Name	Group	ID
G1832608	SEPARATION UNIT:ADF	U003_S001	63
G1832609	DC STEPPER MOTOR	U003_S001	64
G1832610	HINGE:LEFT	U003_S001	65
G1832611	HINGE:RIGHT	U003_S001	66
G1832612	PCB:DIP:SET SENSOR	U003_S001	67
G1832613	PCB:DIP:FEED	U003_S001	68
G1832614	PCB:DIP:ON OFF DETECTOR	U003_S001	69
G1833902	FRONT COVER	U010	49
G1835300	SPEAKER - DIA50	U012	55
G1835673	PCB:FAX:NA:ASSY	U012	56
G1835820	BRACKET - CONTROL BOARD	U012	57
G1835822	STOPPER:MEMORY:(M019)	U012	58
G1835823	BRACKET - INTERFACE	U012	59
G1835824	CASE - CORE	U012	60
G1835826	BRACKET - SPEAKER	U012	61
G8003133	SIDE FENCE GEAR	U009_S001	33
GA043030	TIMING BELT - 60S2M280	U005	24
GA082010	BUSHING:DIA6:DIA10:9	U011_S001	10
GA120011	DISCHARGE BRUSH EXIT	U011_S001	11
GA132101	SPACER - 0.13 X 12MM	U005	25
GA132102	SPACER - 0.13 X 10MM	U005	26
GA145013	SHAFT - 6 X 39.5MM	U005	27
GA145014	SHAFT - 6 X 55.3MM	U005	28
GA148016	SHAFT - 6 X 26.7MM	U005	29
GA148018	SHAFT - 6 X 21.9MM	U005	30
GB010121	GEAR:AIO:DRIVE:1	U005	31
GB011101	GEAR - 37Z	U005	32
GB011102	GEAR - 19/38Z	U005	33
GB011103	GEAR - 28/36Z	U005	34
GB011104	GEAR - 20/35Z	U005	35
GB011105	GEAR - 29Z	U005	36
GB011106	GEAR - 22/31Z	U005	37
GB011108	GEAR - 21Z	U005	38
GB011109	GEAR - 28Z	U005	39
GB011110	GEAR - 31Z	U005	40
GB011111	GEAR - 19Z	U005	41
GB011112	GEAR - 29Z	U005	42
GB011118	REGIST DRIVE GEAR	U005	43

Number	Part Name	Group	ID
GB011133	GEAR - 15Z	U010_S001	50
		U011_S001	12
GB012101	GEAR - 33Z	U005	44
GB012102	GEAR - 54Z	U005	45
GB013068	IDLE GEAR - 20Z	U002_S001	20
GB013114	GEAR - 35Z	U005	46
GB013115	GEAR - 21Z	U005	47
GB013117	GEAR - 19Z	U005	48
GB017053	IDLE GEAR - 15/25Z	U002_S001	21
GB017101	GEAR - 22/99Z	U005	49
GB017102	GEAR - 27/76Z	U005	50
GB017103	GEAR - 21/45Z	U005	51
GB017104	GEAR - 24/57Z	U005	52
GB017109	GEAR - 16/42Z	U005	53
GB017110	GEAR - 22/99Z CYAN	U005	54
GB017111	GEAR - 16/51Z	U005	55
GB017112	GEAR - 21/73Z	U005	56
GB017113	GEAR - 40/65Z	U005	57
GB017116	GEAR - 17/42Z	U005	58
GB017120	GEAR:AIO:JOINT:2	U005	59
GB030036	PULLEY - 18T	U005	60
GF020000	REGISTRATION ROLLER - DRIVE	U010_S001	51
GF020054	TRANSPORT ROLLER:DUPLX	U010_S001	52
GF020055	EXIT ROLLER	U011_S001	13
GW020020	PHOTOINTERRUPTOR:LG248NL1	U011_S001	14
		U012	62
GX041120	STEPPER MOTOR - DC 14.8W	U005	61
GX060033	BRUSHLESS MOTOR:DC24V:10W	U005	62
GX060034	BRUSHLESS MOTOR:DC24V:24W	U005	63
GX060036	BRUSHLESS MOTOR:DC24V:40W	U005	64
GX201121	MAGNETIC CLUTCH	U005	65
		U009	34
GX450002	FUSING LAMP - 120V 1000W	U002_S001	22
GZ230035	POWER SUPPLY UNIT - 115V	U012	63
GZ300003	POWER PACK	U012	64
H5235350	TELEPHONE CABLE		
M0160415	DECAL:ID CARDCOPY:EXP		
M0180692	INTERMEDIATE TRANSFER UNIT	U013	9

Exclusive Parts

Number	Part Name	Group	ID
M0181102	BRACKET:MOTOR:ASSY	U005	66
M0181301	DECAL:NAME PLATE		
M0181302	DECAL:NAME PLATE:MF2B:NA:GEN		
M0181324	DECAL:HIGH TEMPERATURE:110 CENTI DEGREE		
M0181401	OPERATION PANEL:NA	U007_S001	9
M0181450	COVER:OPERATION PANEL	U007_S001	10
M0181451	KEYTOP:MENU	U007_S001	11
M0181452	KEYTOP:SHIFT	U007_S001	12
M0181453	KEY:MENU	U007_S001	13
M0181454	KEY:SHIFT	U007_S001	14
M0181455	SHEET:PANEL:NA	U007_S001	15
M0181470	PCB:OPU	U007_S001	16
M0181600	SCANNER:ASSY	U008_S001	31
M0181826	COVER:SCANNER:FRONT:2	U008_S001	32
M0182527	PAPER TRAY	U009_S001	35
M0182562	BASE:ADHESION	U009_S001_S001	36
M0182608	COVER:BASE	U009_S001	37
M0183800	HOUSING:TRANSPORT SUB-UNIT:ASSY	U010_S001	53
M0183952	TRANSFER ROLLER:2.SUB-ASSY	U010_S001_S001	54
M0184450	GUIDE:EXIT:ASSY	U011_S001	15
M0184458	SPRING:PRESSURE:EXIT:INNER	U011_S001	16
M0184459	ROLLER:DRIVEN:EXIT:OUTER	U011_S001	17
M0184460	SPRING:PRESSURE:EXIT:OUTER	U011_S001	18
M0184464	GUIDE:PLATE:EXIT:OUTER	U011_S001	19
M0185126	PCB:EGB	U012	65
M0185652	PCB:MAIN:ASSY	U012	66
M0185662	PCB:PDL:ASSY:(M019)	U012	67
M0185701	COVER:CONTROL BOARD:MF2C:ASSY:(M019)	U012	68
M0185711	COVER:CONTROL BOARD:MF2B:ASSY:(M018)	U012	69
M0185752	SPACER:GROUND PLATE:FLAT CABLE:SCANNER UNIT	U012	70
M0185753	SHEET:COVER:SHADEING PLATE:MEMORY	U012	71
M0185754	SCREW:(M019)	U012	72

Number	Part Name	Group	ID
M0191301	DECAL:NAME PLATE		
M0191302	DECAL:NAME PLATE:MF2C:NA:GEN		
M0352620	FRICTION PAD:ADHESION	U009_S001	38

Standard Parts



03530030N
SCREW-M3X3



03530040N
SCREW-M3X4



03530060N
BIND SCREW-M3X6



03603006N
SCREW-M3X6



03603010N
SCREW-M3X10



04503008N
TAPPING SCREW-M3X8



04503010N
TAPPING SCREW-M3X10



04503016N
TAPPING SCREW-M3X16



04504010N
TAPPING SCREW-M4X10



04523006N
BINDING SELF-TAPPING SCREW-M3X6



04523010N
BINDING SELF-TAPPING SCREW-M3X10



04524010N
BINDING SELF-TAPPING SCREW-M4X10



04543006Q
TAPPING SCREW-M3X6



04543008Q
TAPPING SCREW-M3X8



07200030E
RETAINING RING-M3



07200040E
RETAINING RING-M4



07200060E
RETAINING RING-M6



08050088
RETAINING RING-M6



08050089
RETAINING RING-M4



09543008N
SCREW-M3X8



09573010N
SCREW-SMALL ROUND SPRING-M3



11024473
CT CONNECTOR-2P



11024559
CONNECTOR-3P



11050487
HARNESS CLAMP



11050508
HARNESS CLAMP-LWS0711



11050516
CLAMP



11050518
EDGE SADDLE-LES1010



12042612
MICRO SWITCH-D3V-16506-3C25

Standard Parts



14076657
EEPROM:BR93L76-W



16070892
FERRITE CORE - ZCAT1518-0730



16072056
FERRITE CORE:33.5X6.5X20

Design Change List

Number	Title	Set	Old Part		New Part		Index No.		Qty	Interchg		Reason	Cut-in S/N
			P/N	Name	P/N	Name	Group	ID		Indiv.	Set		
200912	0912 Modification	-			M0160415	DECAL:ID_CARDC							M01811: M01817:
200911	0911 Modification	-	G1662620	FRCTION PAD	M0352620	FRICITION PAD:ADHESION	U009_S001	38	1	O/O			M01811: M01817:
200910	0910 Modification	-	G1663292	COLOR DECAL -CYAN	G1663333	DECAL - CYAN	U004	63	1	X/O			M01811: M01817:
			G1663293	DECAL - YELLOW	G1663334	DECAL - YELLOW	U004	64	1	X/O			
			G1663290	DECAL - BLACK	G1663331	DECAL - BLACK	U004	62	1	X/O			
200908	0908 Modification	-	G1832568	PCB:DIP:SET SENSOR	G1832612	PCB:DIP:SET SENSOR	U003_S001	67	1	X/O			M01811: M01817:
			G1832584	PCB:DIP:FEED	G1832613	PCB:DIP:FEED	U003_S001	68	1	X/O			
200906	0906 Modification	-	G1662571	SHEET - CASSETTE	G1831784	SHEET:SCANNER	U008_S001	25	1	X/O			M01811: M01817:
			G1832596	PCB:DIP:ON OFF DETECTOR	G1832614	PCB:DIP:ON OFF DETECTOR	U003_S001	69	1	X/O			
200905-2	0905 Modification	-	G1831763	CCD:MODULE	G1831765	CCD:MODULE:ASSY	U008_S001	17	1	X/O			M01811: M01817:
					M0183952	TRANSFER ROLLER:2.SUB-ASSY	U010_S001_S001	54	1				
200905	0905 Modification	-			AA132013	SPACER - 8.2	U009_S001	7	1				M01811: M01817:
					D0094511	SPACER:DIA8.0:1.5MM	U009_S001	9	1				

