

B&W Printers
(M116/M117-EU,-AA)
Parts Catalog

Model	Product Code	PC Style
B/W Printer	M116/M117	3D
Paper Feed Unit TK 1080	M355	3D

Unit All



U001
EXTERIOR

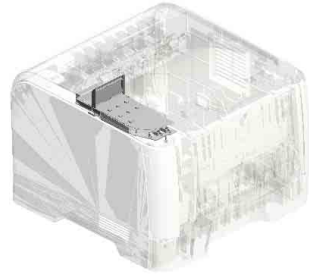

U002
OPERATION

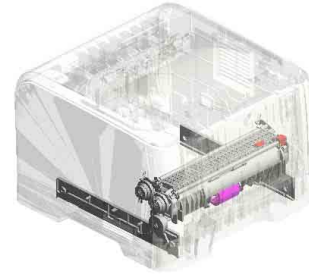

U003
PAPER FEED

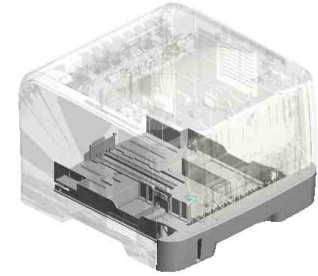

U004
PAPER TRAY

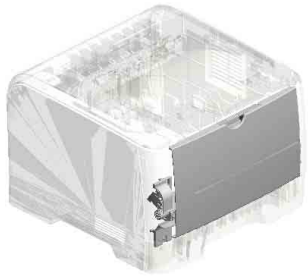

U005
BY-PASS FEED

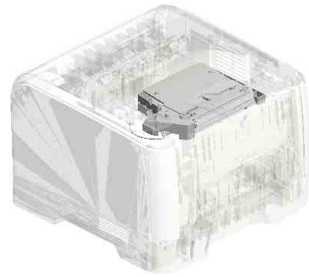

U006
LASER UNIT

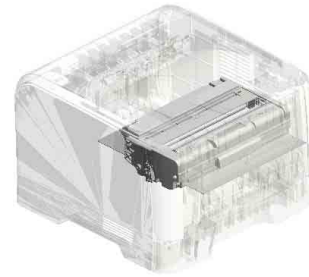

U007
PCU

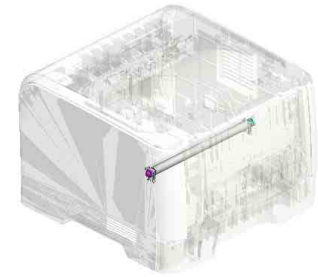

U008
TRANSFER/SEPARATION

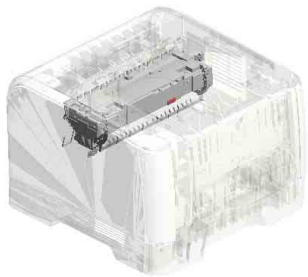

U009
FUSING

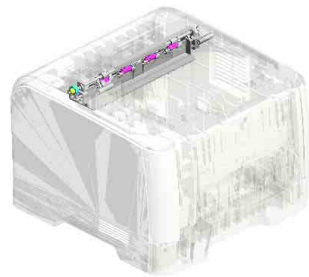

U010
PAPER EXIT:(M116)

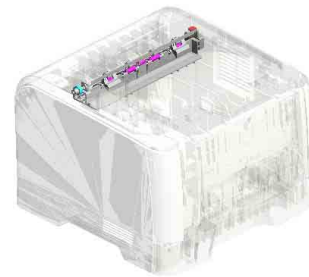

U011
PAPER EXIT:(M117)

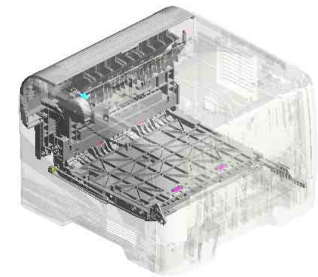

U012
DUPLEX:(M117)

Unit All

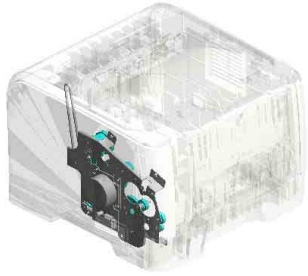

U013
MAIN DRIVE

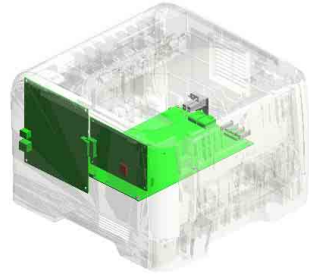

U014
ELECTRICAL

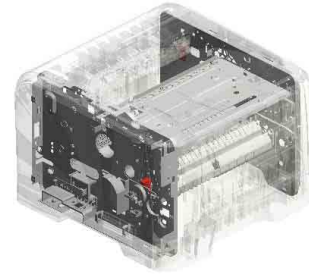

U015
MAIN FRAME

U001 EXTERIOR

- 4.J0121508 (x2) PLATE:LOGO:GES
- 5.J0121515 PLATE:LOGO:NSA: (for AA)
- 6.J0121516 PLATE:LOGO:REX: (for AA)
- 7.J0121517 PLATE:LOGO:NSA: (for AA)
- 18.M1161324 EXTENSION TRAY: GUIDE

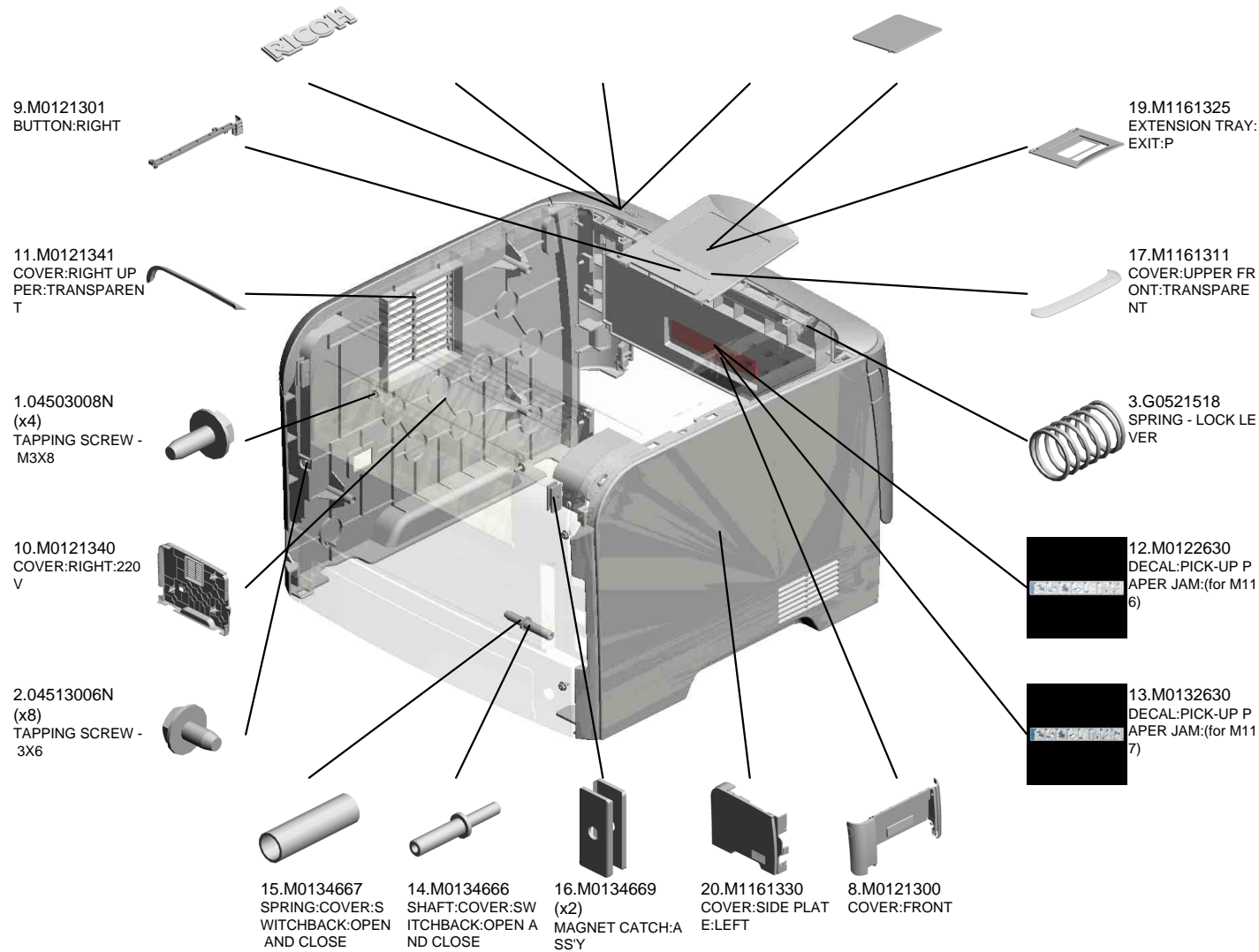
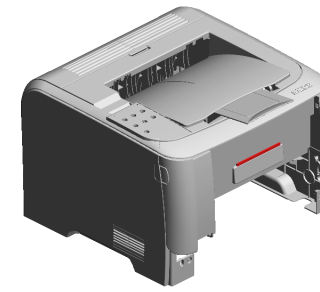

U001 EXTERIOR

22.M1161350
GUIDE PLATE:(for
M116)

25.M1161450
COVER:UPPER

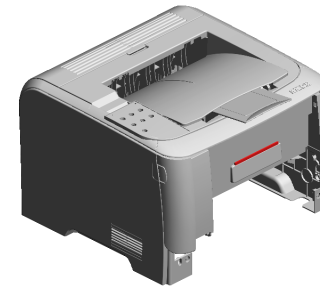

26.M1174662
COVER:SWITCHBA
CK:OPEN AND CL
OSE

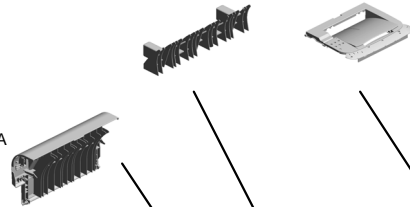

21.M1161331
COVER:SIDE PLAT
E:LEFT UPPER:TR
ANSPARENT

23.M1161360
COVER:REAR MID
DLE

24.M1161370
COVER:REAR LO
WER

U001	U002	U003	U004	U005	U006	U007	U008	U009	U010	U011	U012	U013	U014	U015
------	------	------	------	------	------	------	------	------	------	------	------	------	------	------

U002.OPERATION

U002_S001
M1161401
OPERATION PANEL:EXP:AS
SY

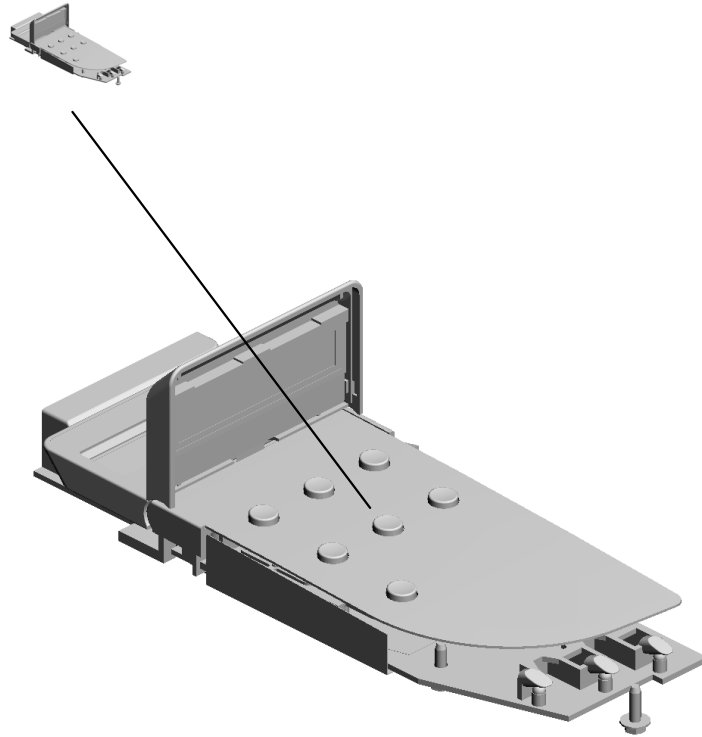

U001	U002	U003	U004	U005	U006	U007	U008	U009	U010	U011	U012	U013	U014	U015
------	-------------	------	------	------	------	------	------	------	------	------	------	------	------	------

U002
OPERATION

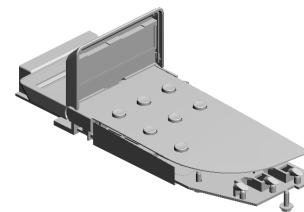

U002_S001
OPERATION PANEL:EXP:ASS'Y

1.04503010N
(x6)
TAPPING SCREW -
M3X10

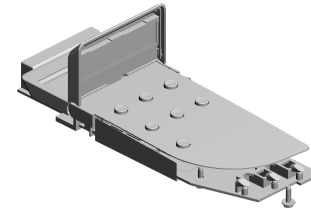

2.M1161401
OPERATION PANE
L:EXP:ASS'Y

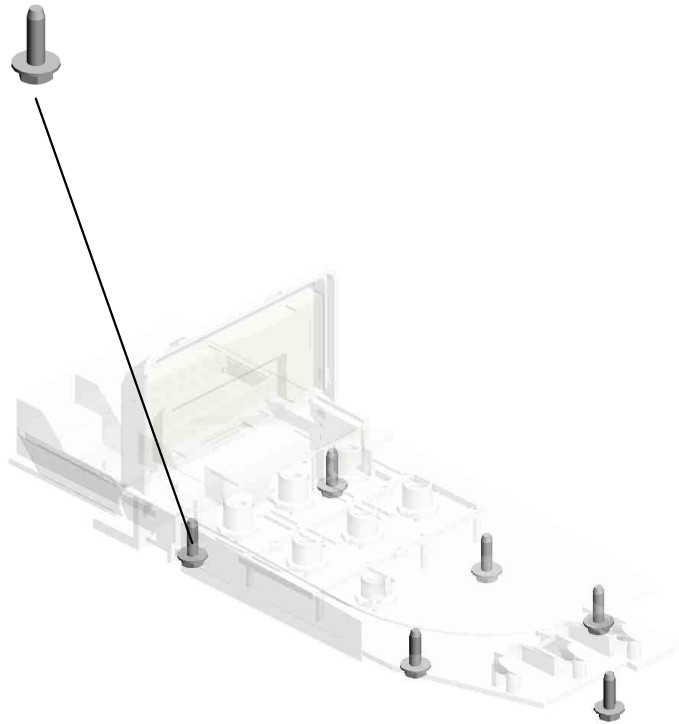

U003 PAPER FEED

18.M0122719 REGISTRATION ROLLER:DRIVEN
 17.M0122717 REGISTRATION ROLLER:DRIVE
 16.M0122715 GUIDE PLATE:TRANSPORT:UPPER
 13.M0122702 ROLLER:INTERFACED:DRIVEN
 12.M0122701 ROLLER:INTERFACED:DRIVE

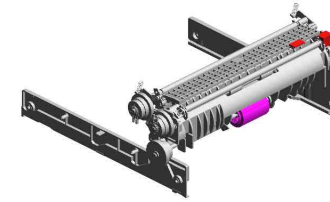

14.M0122705 (x2) SPRING:ROLLER



19.M0122722 (x2) SPRING:ROLLER:REGISTRATION



1.04503008N (x2) TAPPING SCREW - M3X8



8.G1272627 PAPER FEED ROLLER - MM32



11.M0122673 RAIL:PAPER TRAY:RIGHT



20.M0122723 FEELER:REGISTRATION:SENSOR



10.M0122671 FEELER:PAPER END SENSOR



9.M0122668 SHAFT:PAPER FEED:ASSY



5.AW020198 PHOTOINTERRUPTOR:LG2A14NL1



7.G0201160 (x2) SNAP RING



2.04513006N TAPPING SCREW - 3X6



4.A1532117 ROLLER TERMINAL



15.M0122711 BUSHING:REGISTRATION:DRIVEN:LEFT



6.D1272514 (x3) ELECTROMAGNETIC CLUTCH:3.5T:MANUAL FEED



3.08050089 (x7) RETAINING RING - M4



U003 PAPER FEED

27.M0122745
GROUND PLATE:D
RIVEN

28.M0122753
(x2)
BUSHING:ROLLER:
DRIVEN

25.M0122743
DECAL:GUIDE PLA
TE:TRANSPORT:U
PPER

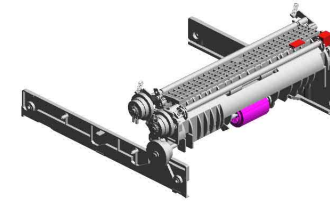

22.M0122730
BUSHING:REGIST
RATION:DRIVEN:RI
GHT

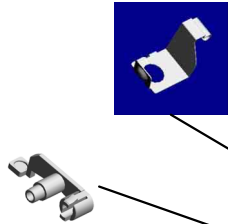

29.M0124488
(x6)
BUSHING:DIA6XDI
A10X6



24.M0122742
GROUND PLATE:D
RIVEN:REGISTRAT
ION ROLLER



21.M0122725
SPRING:FEELER:R
EGISTRATION



23.M0122741
GROUND PLATE:D
RIVE:REGISTRATI
ON ROLLER



30.M1162672
RAIL:PAPER TRAY:
LEFT



26.M0122744
(x2)
GUIDE:REGISTRAT
ION



U004.PAPER TRAY

U004_S001
M0122504
PAPER TRAY:ASSY

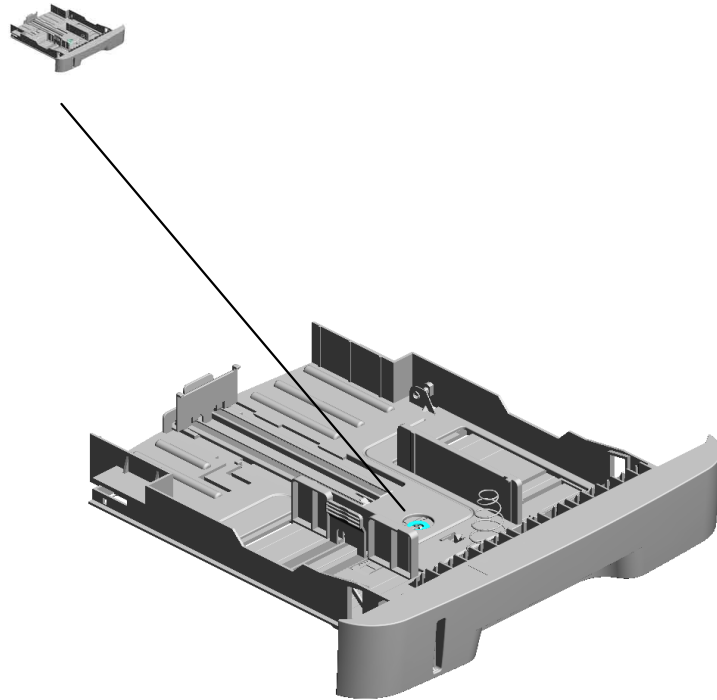

U001	U002	U003	U004	U005	U006	U007	U008	U009	U010	U011	U012	U013	U014	U015
------	------	------	------	------	------	------	------	------	------	------	------	------	------	------

U004_S001.PAPER TRAY:ASS'Y

U004_S001_S001
M0122610
TRAY BOTTOM PLATE

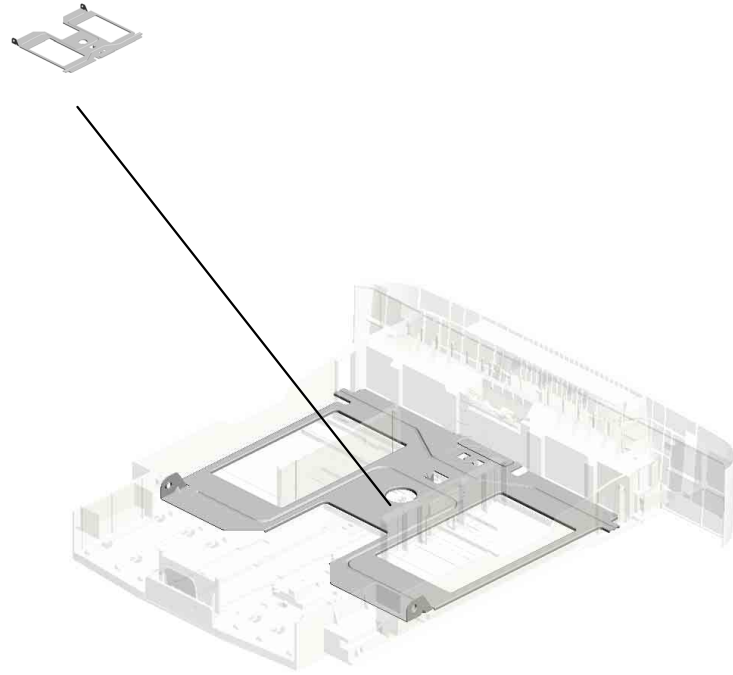

U001	U002	U003	U004	U005	U006	U007	U008	U009	U010	U011	U012	U013	U014	U015
------	------	------	-------------	------	------	------	------	------	------	------	------	------	------	------

U004
PAPER TRAY

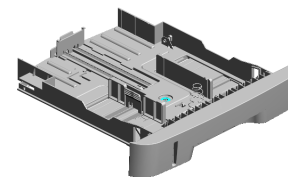

U001	U002	U003	U004	U005	U006	U007	U008	U009	U010	U011	U012	U013	U014	U015
------	------	------	------	------	------	------	------	------	------	------	------	------	------	------

U004_S001 PAPER TRAY:ASS'Y

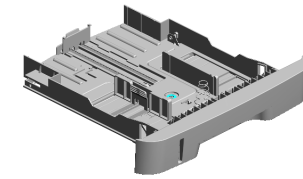

3.M0122504
PAPER TRAY:ASS'
Y

- 6.M0122603 STOPPER:BASE PLATE
- 14.M0122615 SIDE FENCE:RIGHT
- 11.M0122612 COMPRESSION SPRING:TRAY BOTTOM PLATE
- 8.M0122605 FRICTION PAD:ADHESION

1.G8003133
SIDE FENCE GEAR



4.M0122589
PAPER TRAY:REAR



9.M0122608
END FENCE

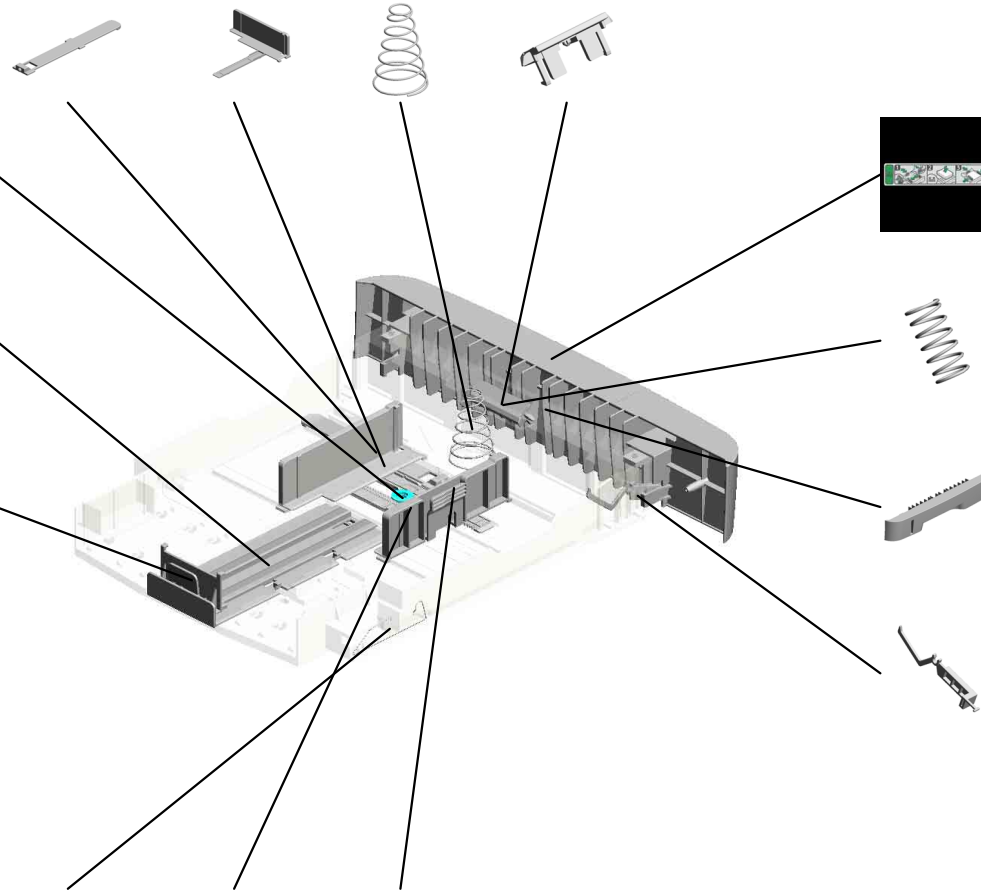

16.M0122618
DECAL:PAPER TRAY:FRONT

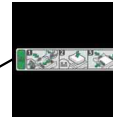

12.M0122613
COMPRESSION SPRING:SEPARATION



17.M0122629
COVER:PAPER TRAY



15.M0122616
LEVER:PAPER VOLUME SENSOR



5.M0122590
COIL SPRING:EAR TH

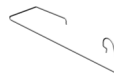

13.M0122614
SIDE FENCE:LEFT



7.M0122604
SPRING:RELEASE:TRAY BOTTOM PLATE



U004_S001_S001
TRAY BOTTOM PLATE

2.GF013001
BOTTOM PLATE P
AD

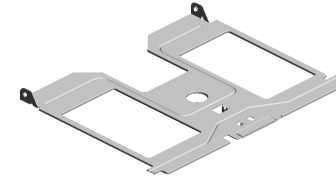

10.M0122610
TRAY BOTTOM PL
ATE

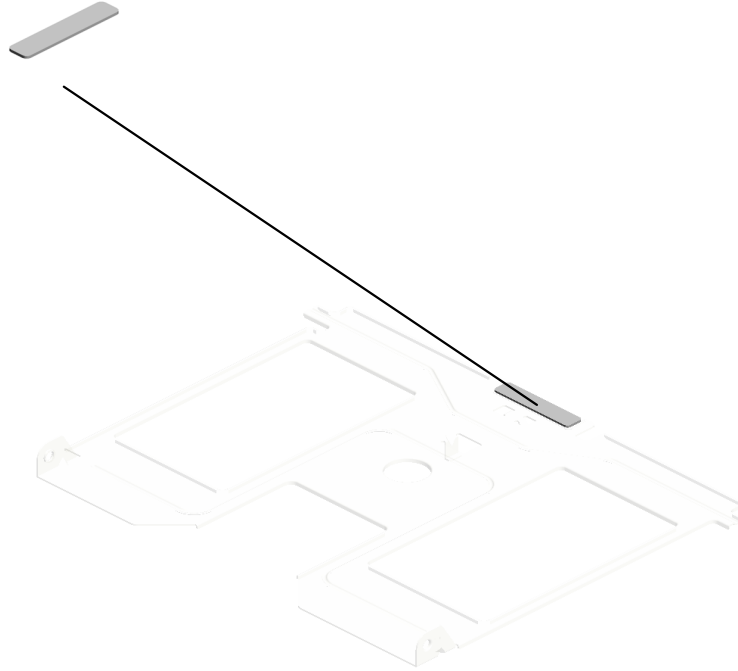

U001	U002	U003	U004	U005	U006	U007	U008	U009	U010	U011	U012	U013	U014	U015
------	------	------	------	------	------	------	------	------	------	------	------	------	------	------

U005.BY-PASS FEED

U005_S001
M0122868
MANUAL FEED TABLE:SUB-A
SS'Y

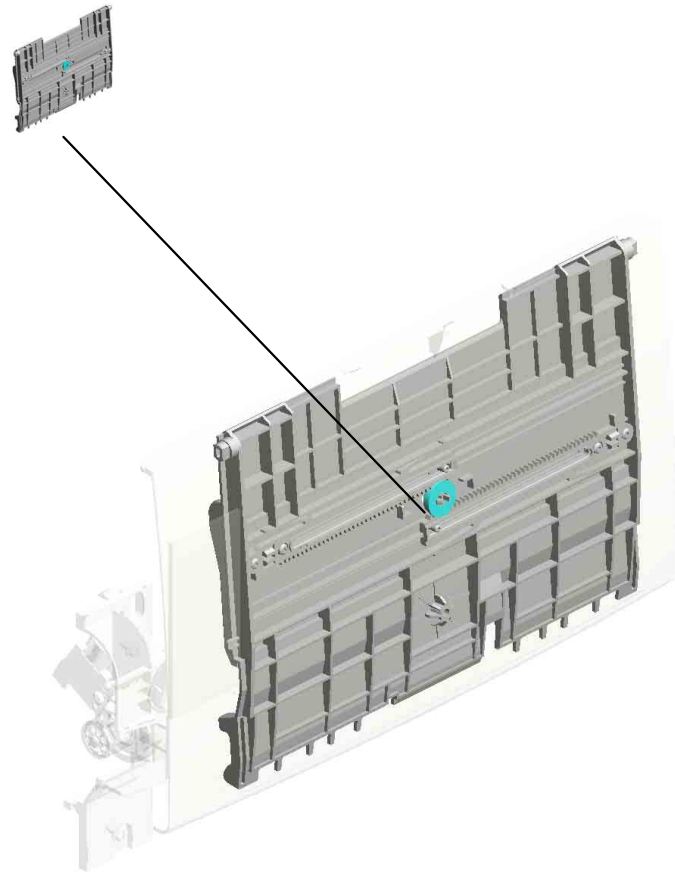

U001	U002	U003	U004	U005	U006	U007	U008	U009	U010	U011	U012	U013	U014	U015
------	------	------	------	-------------	------	------	------	------	------	------	------	------	------	------

U005 BY-PASS FEED

11.M0122815 DECAL:FEED PAPER AGAIN:PREVENTION
 18.M0122860 PAPER FEED ROLLER:MANUAL FEED
 10.M0122806 SHEET:GUIDE:MANUAL FEED SUB-UNIT
 20.M0122870 COVER:MANUAL FEED TABLE
 24.M0122879 EXTENSION TRAY:MANUAL FEED

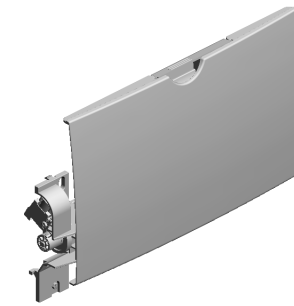

15.M0122831 DC SOLENOID:9.6W:24V



5.G1022717 COVER:DC SOLENOID



1.04513006N (x3) TAPPING SCREW - 3X6



14.M0122830 MECHANICAL SPRING CLUTCH:MANUAL FEED



2.AW020198 PHOTOINTERRUPTOR:LG2A14NL1



7.G1022789 STOPPER:PHOTO INTERRUPTOR



13.M0122824 FEELER:MANUAL FEED



17.M0122859 GUIDE PLATE:UPPER:MANUAL FEED



21.M0122874 COMPRESSION SPRING:MANUAL FEED

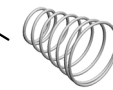

9.M0122805 GUIDE PLATE:MANUAL FEED:LOWER



25.M0122880 COMPRESSION SPRING:SEPARATION



12.M0122816 FRICTION PAD:HOLDER:MANUAL FEED:ASSY



4.G0292767 BY-PASS FEED COVER



U005_S001
 MANUAL FEED TABLE:SUB-ASS'Y

16.M0122833 3.G0123050
 DECAL:SIDE FENC SIDE FENCE GEAR
 E:MANUAL FEED

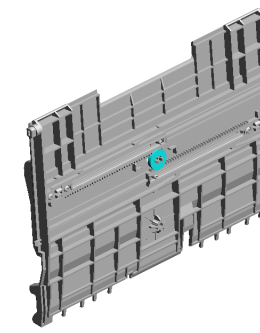

19.M0122868
 MANUAL FEED TA
 BLE:SUB-ASS'Y

22.M0122875
 SIDE FENCE:MAN
 UAL FEED:RIGHT

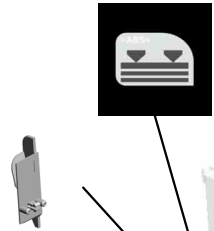

6.G1022755
 (x2)
 RACK:SIDE FENCE
 :REAR



23.M0122877
 SIDE FENCE:MAN
 UAL FEED:LEFT



8.GF013001
 BOTTOM PLATE P
 AD



U001	U002	U003	U004	U005	U006	U007	U008	U009	U010	U011	U012	U013	U014	U015
------	------	------	------	------	------	------	------	------	------	------	------	------	------	------

U006.LASER UNIT

U006_S001
M1171851
IMAGING UNIT:ASS'Y

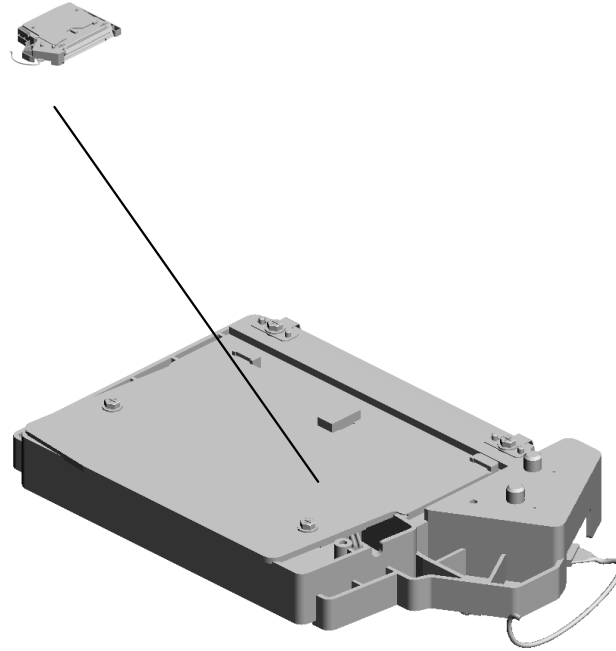

U001	U002	U003	U004	U005	U006	U007	U008	U009	U010	U011	U012	U013	U014	U015
------	------	------	------	------	-------------	------	------	------	------	------	------	------	------	------

U006
LASER UNIT

2.04543008Q
(x3)
TAPPING SCREW:
3X8

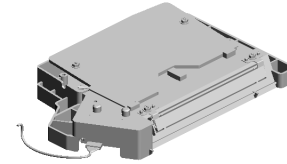

U001	U002	U003	U004	U005	U006	U007	U008	U009	U010	U011	U012	U013	U014	U015
------	------	------	------	------	-------------	------	------	------	------	------	------	------	------	------

U006_S001
IMAGING UNIT:ASS'Y

1.04503008N
(x6)
TAPPING SCREW -
M3X8

3.M0121908
COVER:OPTICAL U
NIT

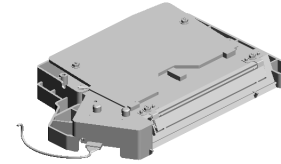

7.M1171851
IMAGING UNIT:AS
SY

5.M0121979
SEAL:COVER:NO.2

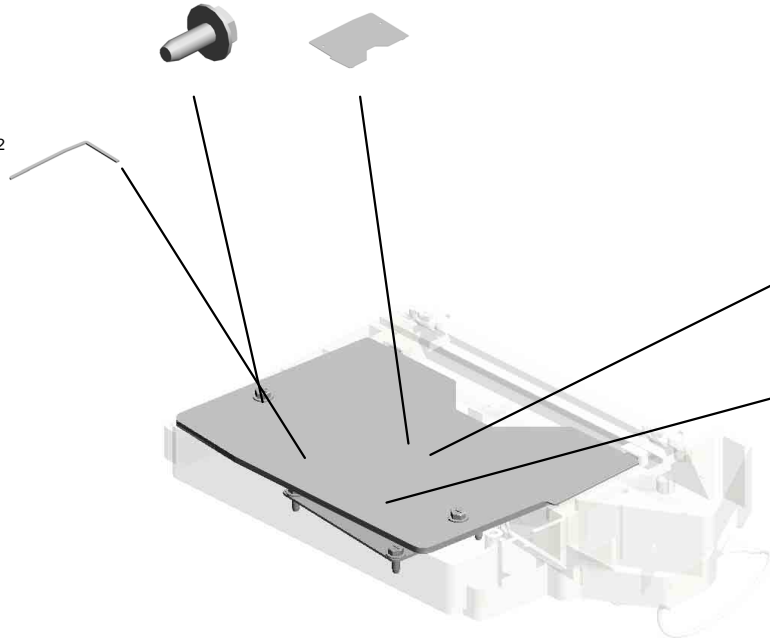

6.M0121980
SEAL:COVER:NO.1

4.M0121957
POLYGON MOTOR
:DC 18W

U001	U002	U003	U004	U005	U006	U007	U008	U009	U010	U011	U012	U013	U014	U015
------	------	------	------	------	-------------	------	------	------	------	------	------	------	------	------

U007
PCU

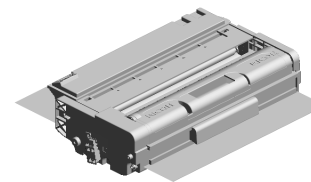

U001	U002	U003	U004	U005	U006	U007	U008	U009	U010	U011	U012	U013	U014	U015
------	------	------	------	------	------	------	------	------	------	------	------	------	------	------

U008 TRANSFER/SEPARATION

6.M0126259 ELECTRODE PLAT
E:SEPARATION
7.M0126260 COVER:ELECTRO
DE PLATE

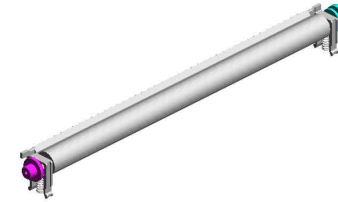

5.M0126256
ROLLER:POSITION
ING:TRANSFER R
OLLER



2.M0126253
BUSHING:TRANSF
ER ROLLER:LEFT



4.M0126255
GEAR:TRANSFER
ROLLER



1.M0126252
BUSHING:TRANSF
ER ROLLER:RIGHT

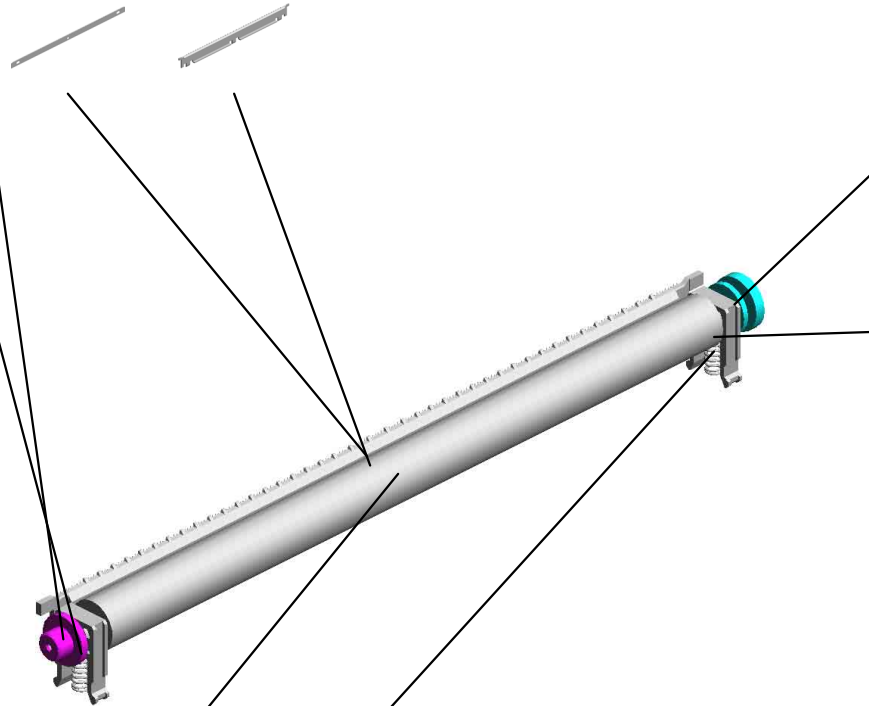

8.M1016250
TRANSFER ROLLE
R



3.M0126254
(x2)
SPRING:TRANSFE
R ROLLER



U009.FUSING

U009_S001
M1164031
FUSING UNIT:220V:ASS'Y

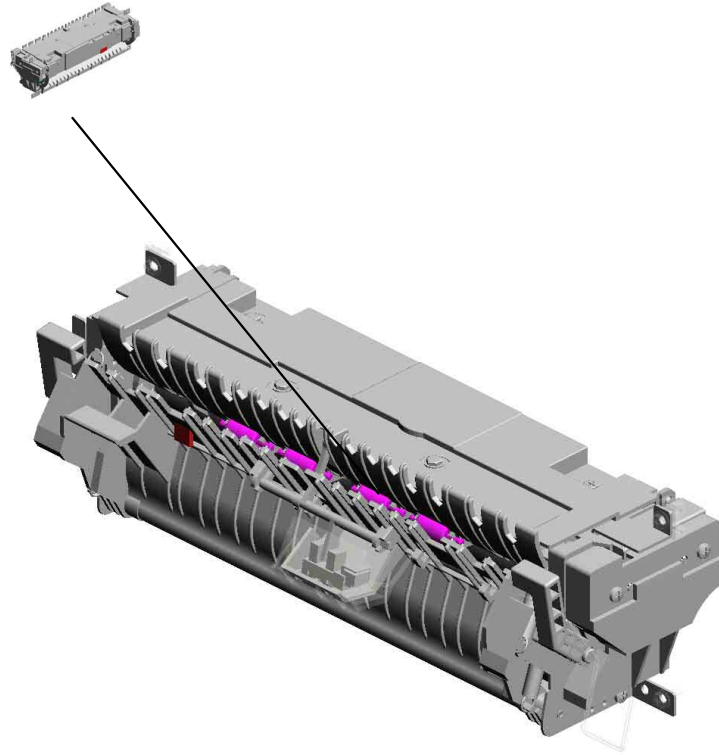

U001	U002	U003	U004	U005	U006	U007	U008	U009	U010	U011	U012	U013	U014	U015
------	------	------	------	------	------	------	------	------	------	------	------	------	------	------

U009 FUSING

50.M0124699
DECAL:WARNING (HIGH TEMPERATURE):FRONT

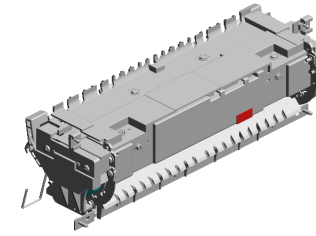

39.M0124270
(x2)
THERMAL INSULATING BUSHING:FUSING UNIT



4.04513008N
(x2)
TAPPING SCREW - M3X8

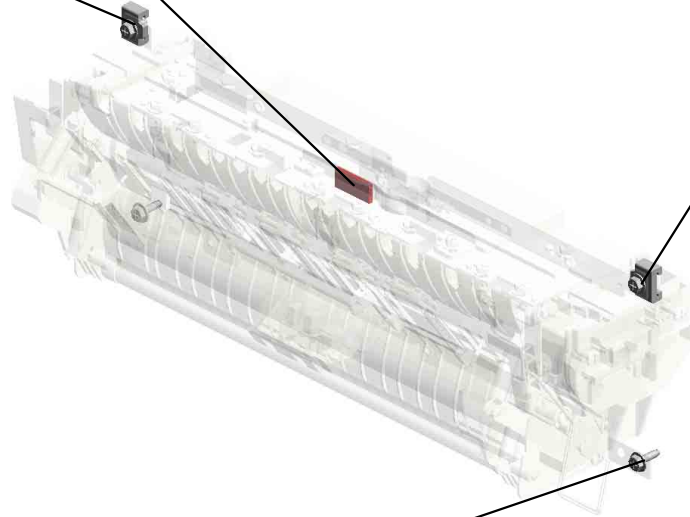

2.04503010N
(x2)
TAPPING SCREW - M3X10



U001	U002	U003	U004	U005	U006	U007	U008	U009	U010	U011	U012	U013	U014	U015
------	------	------	------	------	------	------	------	------	------	------	------	------	------	------

U009_S001
FUSING UNIT:220V:ASS'Y

10.AA143520
(x7)
SHOULDER SCRE
W - M3

18.M0124121
HEATER:700W:220
V

8.08046127
(x4)
HEXAGONAL BOLT
:DOUBLE SCREW:
M3X8

9.09543010N
SCREW:POLISHED
ROUND/SPRING:M
3X10

12.AW110058
THERMOSTAT:177

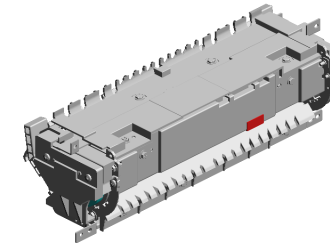

51.M1164031
FUSING UNIT:220V
:ASS'Y

13.G1274328
DECAL - HIGH TEM
PERATURE



21.M0124202
(x2)
LEVER:PRESSURE



5.04533006N
(x6)
TAPPING SCREW -
M3X6



16.M0124109
SPRING:FEELER:E
XIT



19.M0124135
FEELER:PAPER FE
ED SENSOR



11.AW020198
PHOTOINTERRUPT
OR:LG2A14NL1



1.03603006N
(x11)
SCREW - M3X6



17.M0124120
(x3)
TENSION SPRING:
PICKOFF PAWL



6.07200040E
(x2)
RETAINING RING -
M4



4.04513008N
(x4)
TAPPING SCREW -
M3X8



3.04513006N
(x2)
TAPPING SCREW -
3X6



7.08025318
(x4)
BINDING HEAD TA
PPING SCREWS:
3X10



20.M0124186
COVER:LEFT UPPE
R:ASS'Y

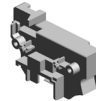

15.M0124055
(x2)
RADIAL BALL BEA
RING:35X47X7



14.M0124053
GEAR:HOT ROLLE
R



U009_S001
FUSING UNIT:220V:ASS'Y

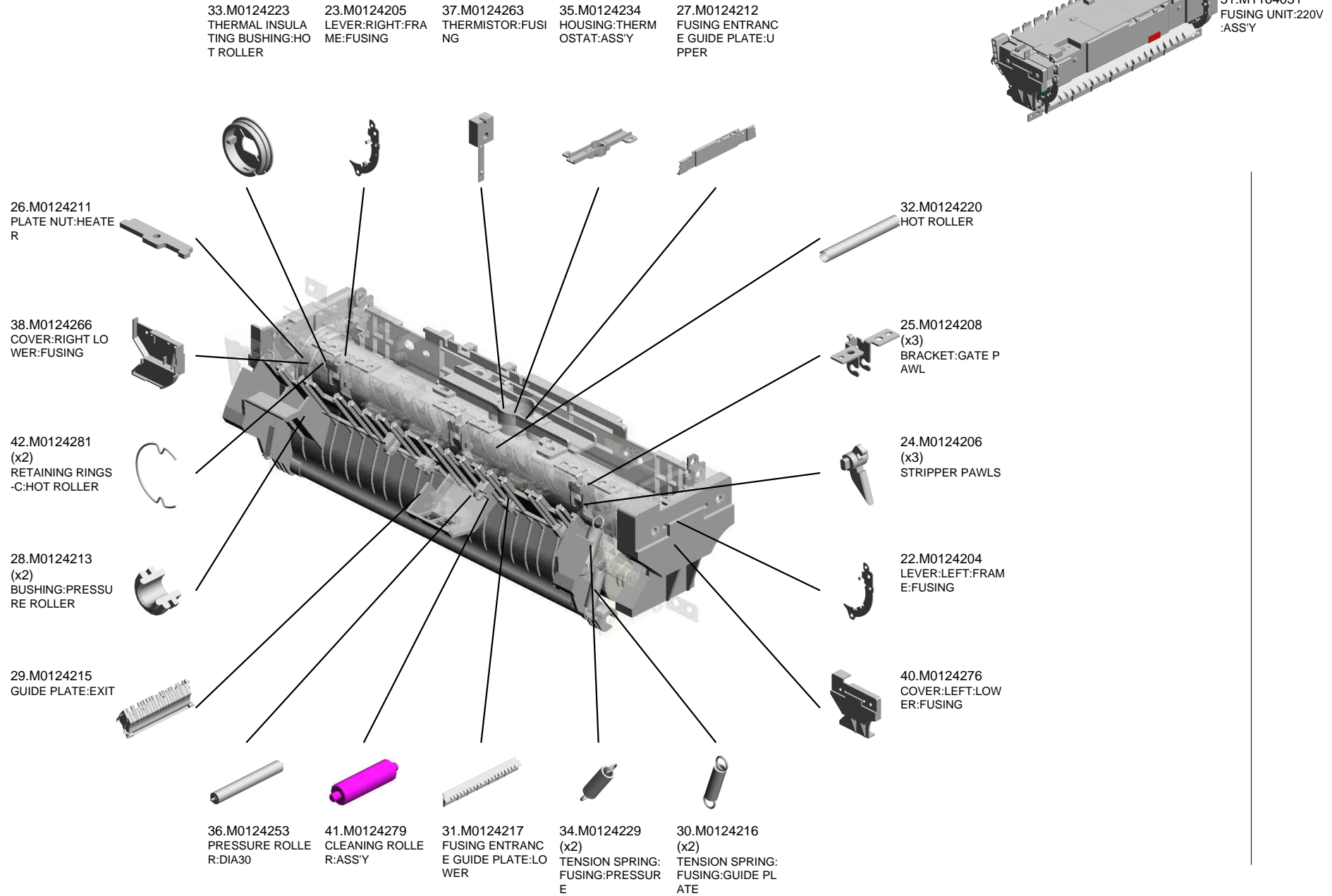

U009_S001
FUSING UNIT:220V:ASS'Y

45.M0124287
COVER:RIGHT UP
PER:FUSING

48.M0124295
GROUND PLATE:AS
S'Y

49.M0124603
DECAL:GUIDE PLA
TE:B

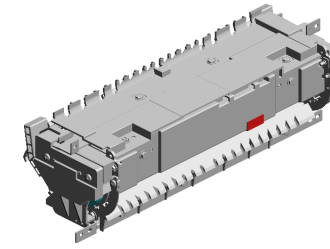

51.M1164031
FUSING UNIT:220V
:ASS'Y



43.M0124284
LEVER:PRESSURE
:LEFT

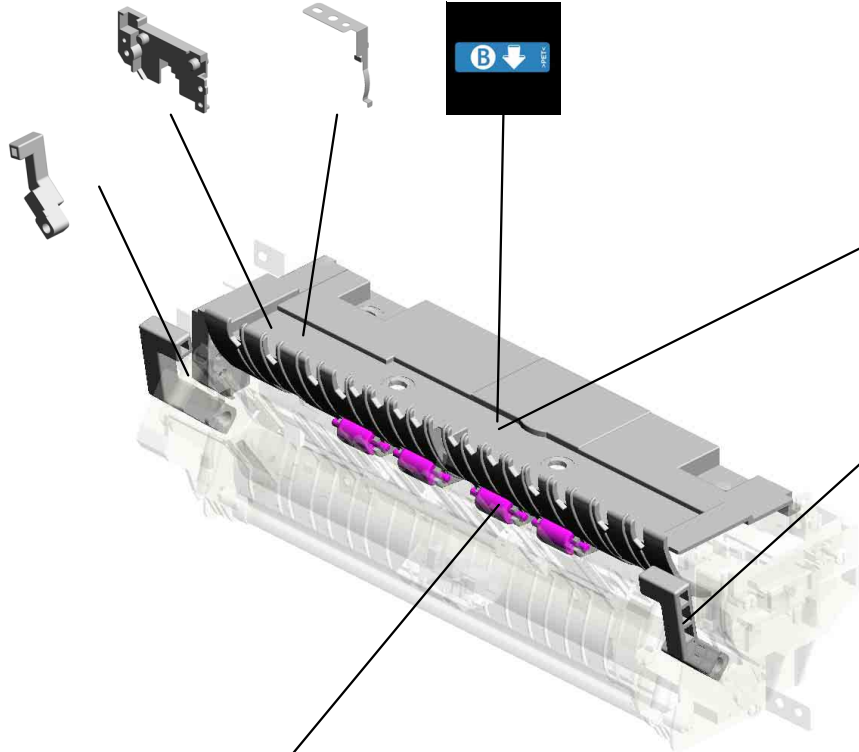

46.M0124292
FUSING COVER:U
PPER

44.M0124285
LEVER:PRESSURE
:RIGHT

47.M0124293
(x4)
EXIT ROLLER:EXIT
:FUSING

U001	U002	U003	U004	U005	U006	U007	U008	U009	U010	U011	U012	U013	U014	U015
------	------	------	------	------	------	------	------	------	------	------	------	------	------	------

U010 PAPER EXIT:(M116)

2.07200040E
(x2)
RETAINING RING -
M4

8.M0124470
EXIT ROLLER:ASS'
Y:(for M116)

6.M0124458
DISCHARGE BRUS
H:EXIT:ASSY DRA
WING

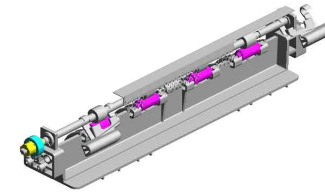

7.M0124465
PULLEY:EXIT:(for M
116)

1.04503008N
(x2)
TAPPING SCREW -
M3X8

5.M0124457
GROUND PLATE:E
XIT:DISCHARGE B
RUSH

9.M0124488
(x2)
BUSHING:DIA6XDI
A10X6

10.M0124499
GROUND PLATE:E
XIT ROLLER

4.M0124454
(x4)
SPRING:EXIT ROL
LER:EXIT

3.M0124453
(x4)
EXIT ROLLER

U001	U002	U003	U004	U005	U006	U007	U008	U009	U010	U011	U012	U013	U014	U015
------	------	------	------	------	------	------	------	------	------	------	------	------	------	------

U011
PAPER EXIT:(M117)

- 3.M0124457 GROUND PLATE:EXIT:DISCHARGE BRUSH
- 1.M0124453 (x4) EXIT ROLLER
- 2.M0124454 (x4) SPRING:EXIT ROLLER:EXIT

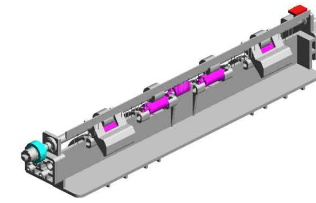

- 6.M0124499 GROUND PLATE:EXIT ROLLER

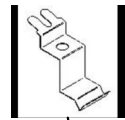

- 5.M0124488 (x2) BUSHING:DIA6XDI A10X6



- 7.M0134455 GEAR:DRIVE:EXIT ROLLER:(for M117)

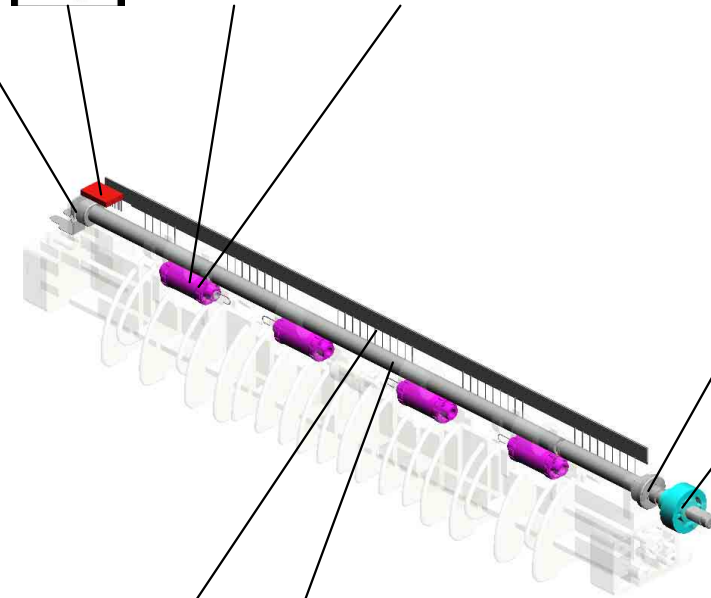

- 4.M0124458 DISCHARGE BRUSH:EXIT:ASS'Y DRAWING
- 8.M0134470 EXIT ROLLER:DUPLEX:(for M117)

U012 DUPLEX:(M117)

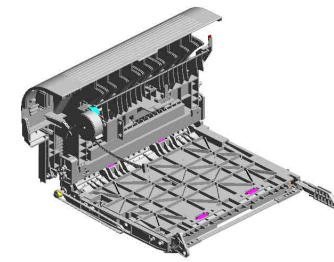

- 6.08050088 RETAINING RING - M6:(for M117)
- 16.M0134635 SPRING:OPEN AND CLOSE:RIGHT:(for M117)
- 4.04543006Q (x4) TAPPING SCREW - M3X6
- 9.AX050265 STEPPER MOTOR: DC24V 7.2W:(for M117)
- 7.08050089 (x5) RETAINING RING - M4

14.M0134623 (x2) SPRING:EXIT:(for M117)

13.M0134622 (x4) EXIT ROLLER:DUPLEX:(for M117)

5.07200040E (x2) RETAINING RING - M4

1.04503008N (x2) TAPPING SCREW - M3X8

19.M0134668 SHEET:GUIDE:HORIZONTAL TRANSPORT:LOWER:(for M117)

2.04503010N (x2) TAPPING SCREW - M3X10

15.M0134624 (x2) SPRING:EXIT:NO.2:(for M117)

18.M0134664 GUIDE PLATE:VERTICAL TRANSPORT:UPPER:(for M117)

17.M0134663 GUIDE PLATE:VERTICAL TRANSPORT:LOWER:(for M117)

8.AW020198 (x2) PHOTOINTERRUPTOR:LG2A14NL1

12.M0134610 GEAR:DRIVE:DUPLEX:(for M117)

3.04533006N (x2) TAPPING SCREW - M3X6

20.M0134669 (x2) MAGNET CATCH:ASSY

10.G0961019 (x2) TRANSPORT GUIDE PIN:(for M117)

11.M0124488 (x4) BUSHING:DIA6XDI A10X6

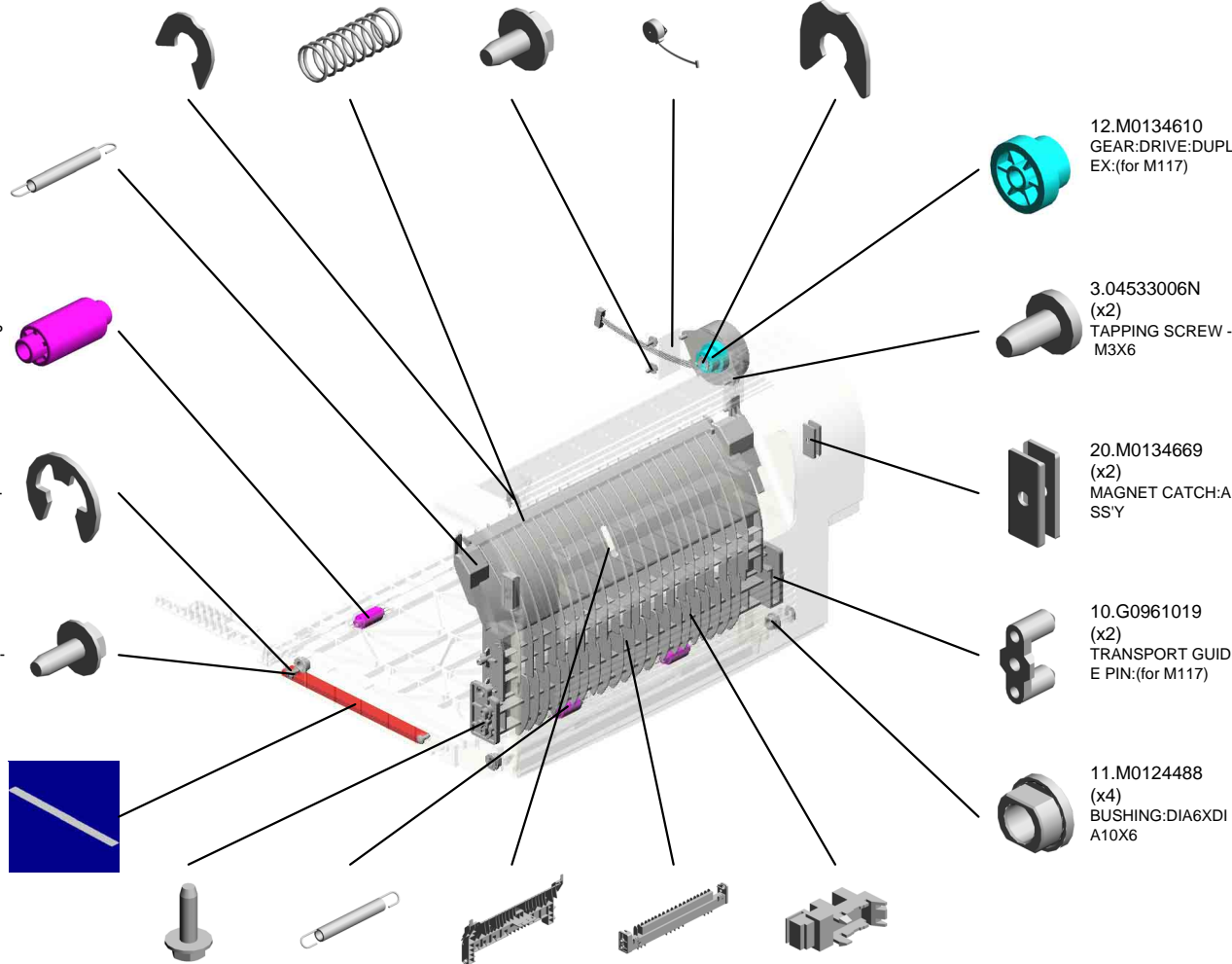

U001	U002	U003	U004	U005	U006	U007	U008	U009	U010	U011	U012	U013	U014	U015
------	------	------	------	------	------	------	------	------	------	------	------	------	------	------

U012 DUPLX:(M117)

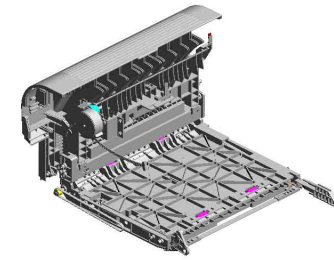

- 32.M0134696 LEVER:OPEN AND CLOSE:LEFT:(for M117)
- 24.M0134674 LEVER:OPEN AND CLOSE:NO.2:(for M117)
- 23.M0134673 LEVER:OPEN AND CLOSE:NO.1:(for M117)
- 27.M0134687 GROUND PLATE:HORIZONTAL TRANSPORT:FRONT:(for M117)
- 25.M0134684 SHEET:DUPLX:(for M117)

34.M0134698 BRACKET:OPEN AND CLOSE:LOWER:(for M117)

36.M0134762 TRANSPORT ROLLER:DUPLX:EXIT:(for M117)

26.M0134685 BUTTON:OPEN AND CLOSE:LOWER:(for M117)

33.M0134697 LEVER:OPEN AND CLOSE:RIGHT:(for M117)

38.M0134771 TIMING BELT:HORIZONTAL TRANSPORT:(for M117)

37.M0134765 (x3) PULLEY:TRANSPORT:(for M117)

21.M0134671 SHEET:HORIZONTAL TRANSPORT:LEFT:(for M117)

31.M0134695 GUIDE:HORIZONTAL TRANSPORT:LOWER:(for M117)

30.M0134694 GUIDE:HORIZONTAL TRANSPORT:UPPER:(for M117)

35.M0134761 TRANSPORT ROLLER:DUPLX:MIDDLE:(for M117)

29.M0134691 LEVER:OPEN AND CLOSE:LOWER:(for M117)

39.M0134772 TIMING BELT:DRIVE:(for M117)

28.M0134688 GROUND PLATE:HORIZONTAL TRANSPORT:REAR:(for M117)

40.M0134778 FEELER:SENSOR:HORIZONTAL TRANSPORT:(for M117)

22.M0134672 SHEET:HORIZONTAL TRANSPORT:RIGHT:(for M117)

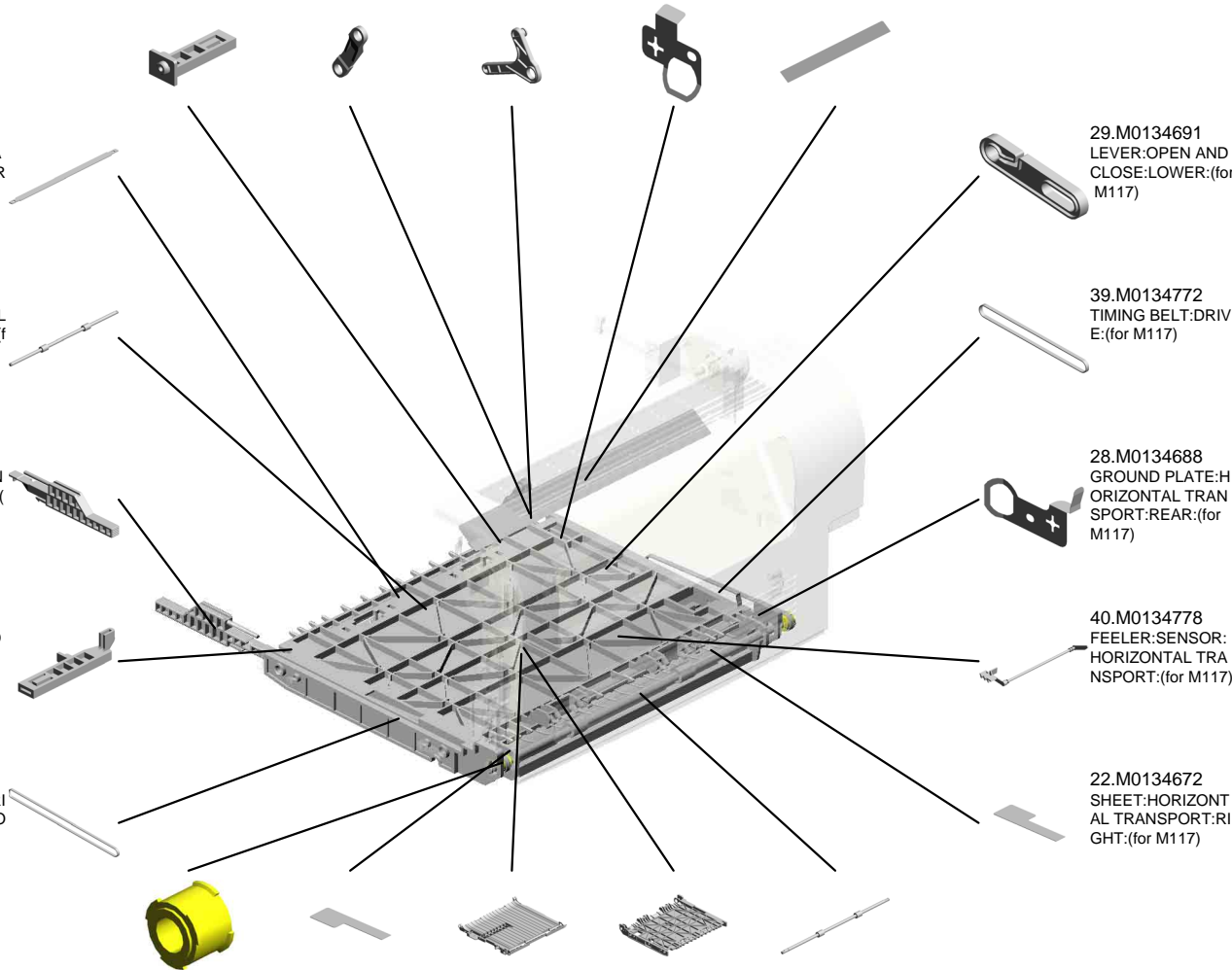

U012
 DUPLEX:(M117)

42.M0134794
 DECAL:GUIDE PLATE:VERTICAL TRANSPORT:UPPER:(for M117)

44.M0134797
 FEELER:SENSOR:VERTICAL TRANSPORT:(for M117)

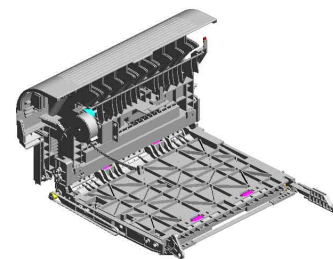

41.M0134785
 SPRING:COVER:SWITCHBACK:OPEN AND CLOSE

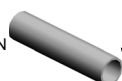

45.M1174662
 COVER:SWITCHBACK:OPEN AND CLOSE



43.M0134795
 (x4)
 PIN:GUIDE:UPPER:
 (for M117)

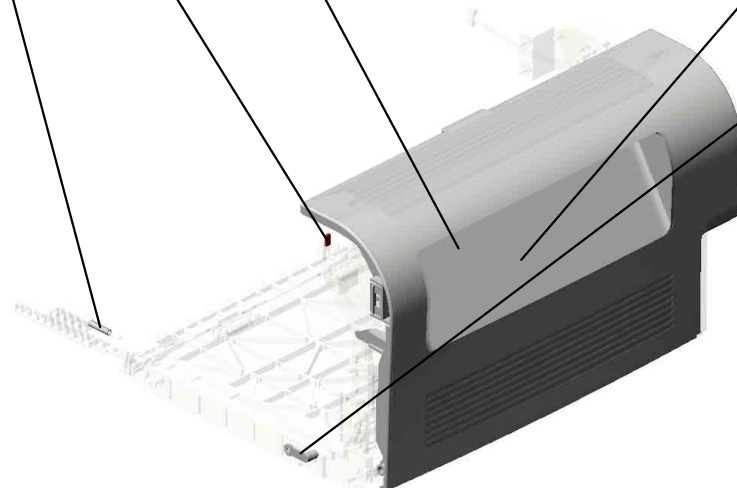

U001	U002	U003	U004	U005	U006	U007	U008	U009	U010	U011	U012	U013	U014	U015
------	------	------	------	------	------	------	------	------	------	------	------	------	------	------

U013 MAIN DRIVE

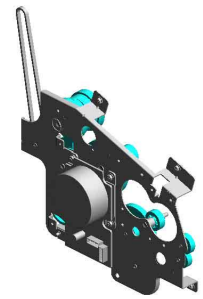
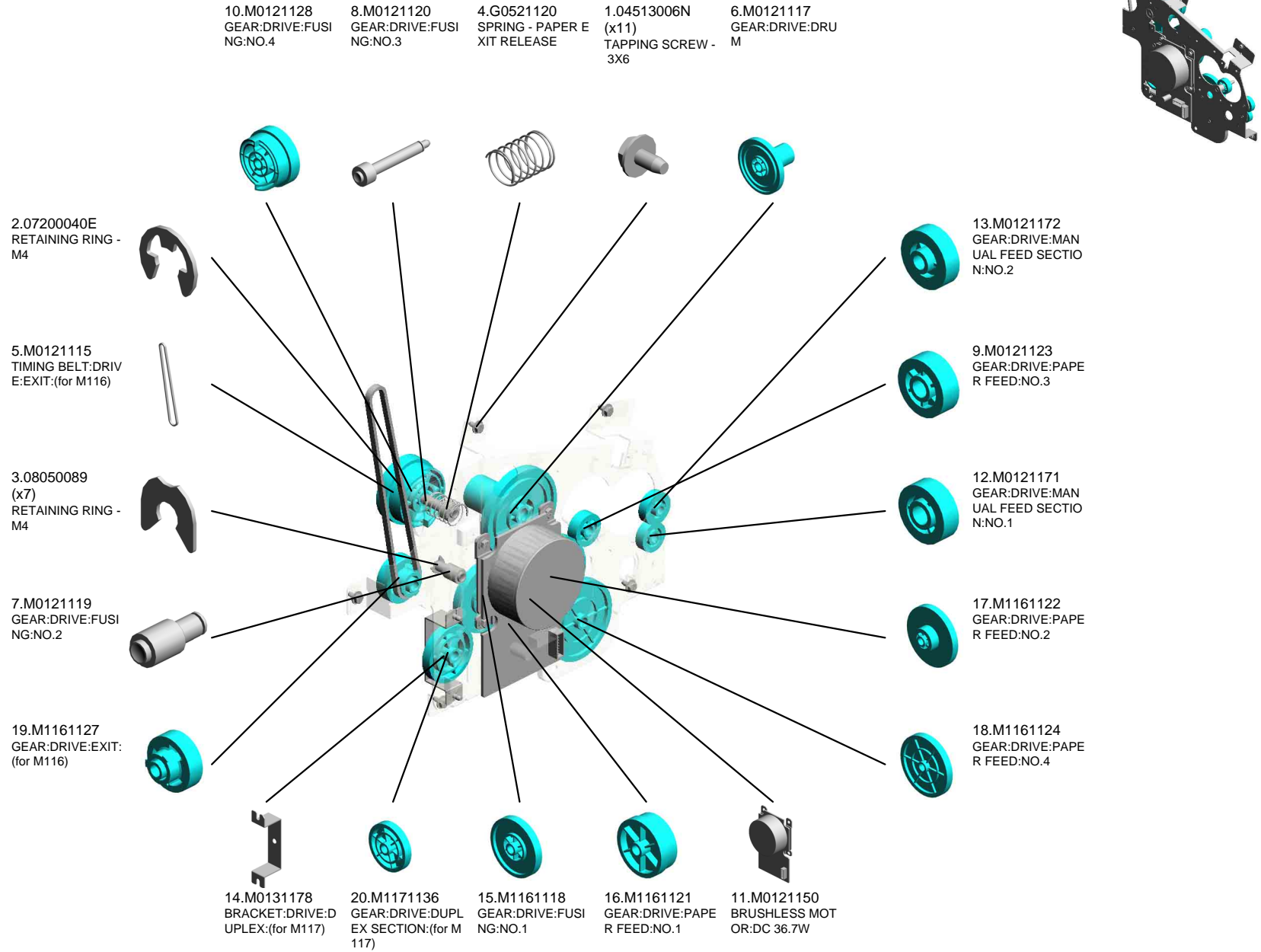

U014.ELECTRICAL

U014_S001
M0125039
MAIN SWITCH:SERVICE:ASS
Y

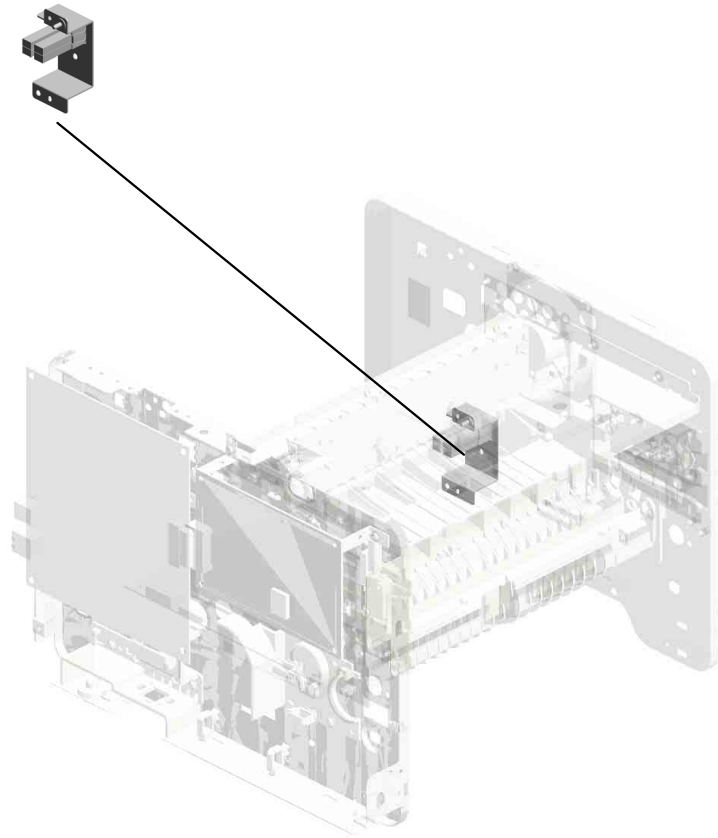

U001	U002	U003	U004	U005	U006	U007	U008	U009	U010	U011	U012	U013	U014	U015
------	------	------	------	------	------	------	------	------	------	------	------	------	------	------

U014 ELECTRICAL

6.M1165453 7.M1175453
PCB:ECB:M116/M1 PCB:ECB:M117/M1
18:ASS'Y:(for M116) 19:ASS'Y:(for M117)

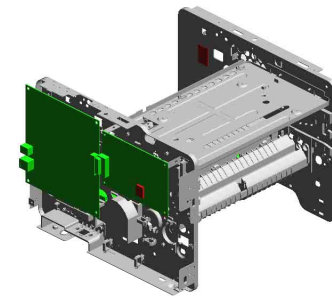

5.M1165103
PCB:CTL:ASS'Y

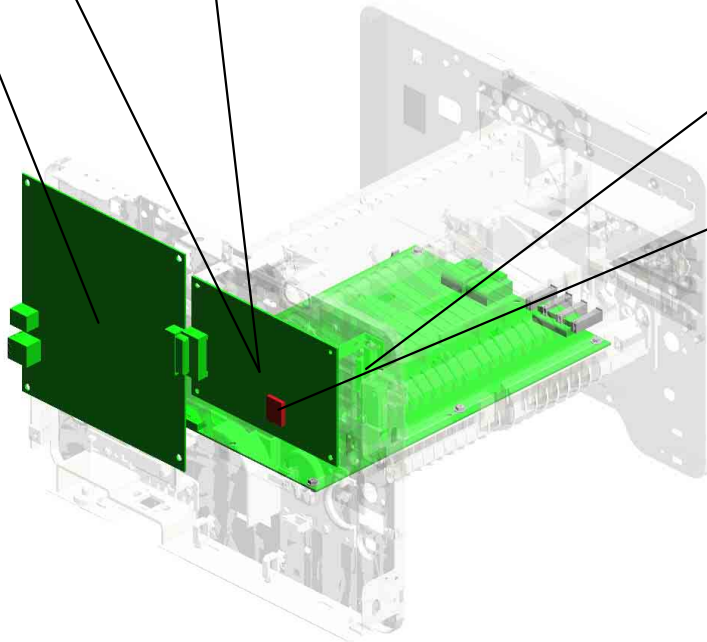
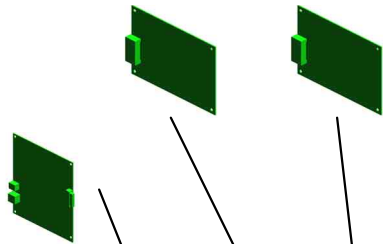

3.M0125021
POWER SUPPLY U
NIT:EU/AA/CHN

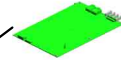

2.14077435
EEPROM:CAT93C7
6LI-G

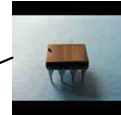

U001	U002	U003	U004	U005	U006	U007	U008	U009	U010	U011	U012	U013	U014	U015
------	------	------	------	------	------	------	------	------	------	------	------	------	------	------

U014_S001
MAIN SWITCH:SERVICE:ASS'Y

1.12042879
SWITCH:ABL-21-15
N2

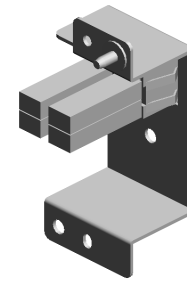
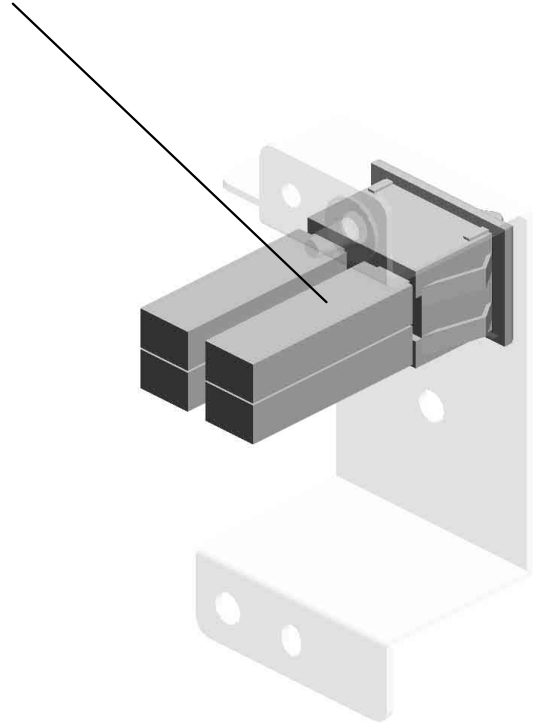
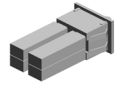

4.M0125039
MAIN SWITCH:SER
VICE:ASS'Y

U001	U002	U003	U004	U005	U006	U007	U008	U009	U010	U011	U012	U013	U014	U015
------	------	------	------	------	------	------	------	------	------	------	------	------	------	------

U015 MAIN FRAME

- 4.04513030N (x2) TAPPING SCREW: 3X30
- 20.M0121066 (x4) SPRING:TERMINAL :CHARGE
- 1.04503008N (x12) TAPPING SCREW - M3X8
- 18.M0121063 (x4) TERMINAL:CHARGE
- 19.M0121065 CASE:TERMINAL

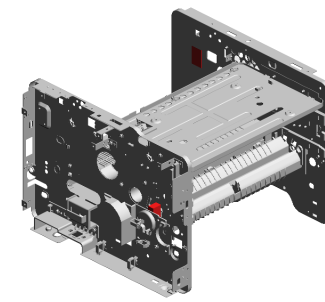

11.AX640199
FAN:MM80:25MM:D
C 2.16W



9.11050534
CLAMP



10.12042879
SWITCH:A8L-21-15
N2



5.04543006Q
(x5)
TAPPING SCREW -
M3X6



6.04543014Q
TAPPING SCREW:
3X14



8.11050511
(x12)
HARNESS CLAMP -
LWS-0306ZC

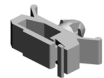

17.M0121050
FRAME:MAIN:SUB-
ASSY



2.04513006N
(x13)
TAPPING SCREW -
3X6



13.G0271180
(x2)
RUBBER FOOT - G
F



15.M0121037
TONER BOTTLE:C
ASE



16.M0121040
CASE:DISCHARGE
LAMP



12.B2681085
(x2)
SWITCH:LF-105-11



3.04513014N
TAPPING SCREW:
3X14



14.GW010007
PHOTO REFLECTI
ON SENSOR:EXIT

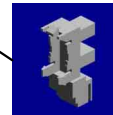

7.11050508
(x4)
HARNESS CLAMP -
LWS-0711

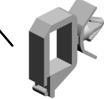

U015 MAIN FRAME

24.M0121099
HEAT INSULATING
PLATE:FUSING:FR
ONT

21.M0121088
COIL SPRING:RAIL
:RIGHT

25.M0122056
DISCHARGE LAMP

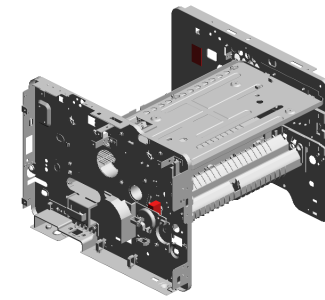

28.M0124602
DECAL:LEVER:EN
VELOPE:RIGHT



26.M0124120
(x3)
TENSION SPRING:
PICKOFF PAWL

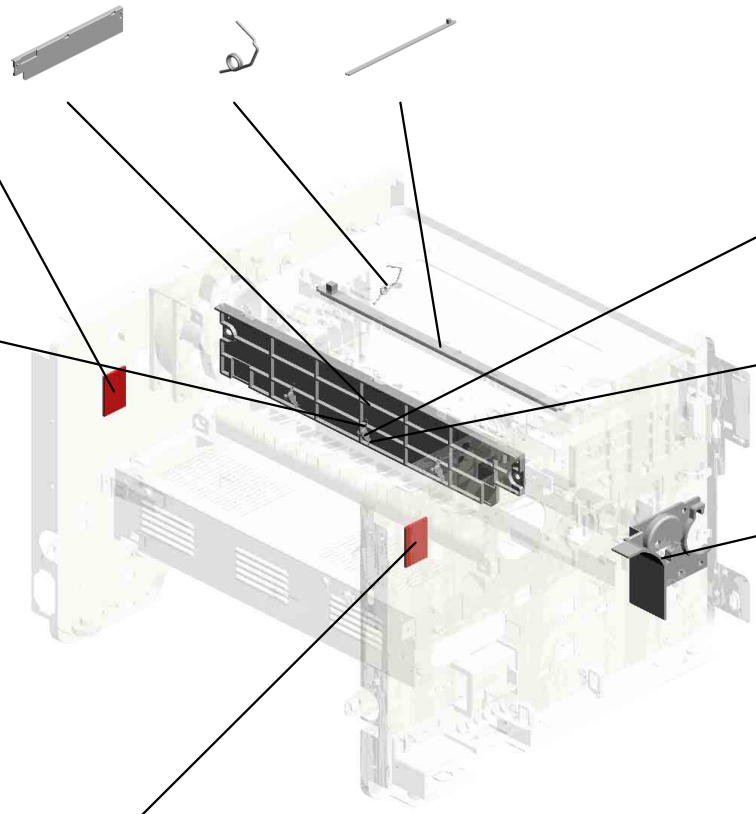

23.M0121097
(x3)
SUPPORTER:PAPE
R:TRANSPORT



22.M0121089
(x3)
GUIDE:PAPER:LEA
DING EDGE



29.M1161043
DUCT:HARNESS

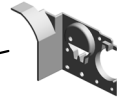

27.M0124601
DECAL:LEVER:EN
VELOPE:LEFT



ACCESSORIES



1.M0125699

POWER SUPPLY CORD:250V:10A:EU

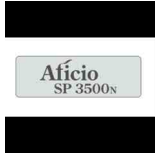

2.M1160402

MODEL NAME PLATE:M116:(for M116
-EU)

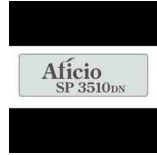

3.M1170402

MODEL NAME PLATE:M117:(for M117
-EU)

Exclusive Parts

Number	Part Name	Group	ID
A1532117	ROLLER TERMINAL	U003	4
AA143520	SHOULDER SCREW - M3	U009_S001	10
AW020198	PHOTOINTERRUPTOR:LG2A14NL 1	U003	5
		U005	2
		U009_S001	11
		U012	8
AW110058	THERMOSTAT:177	U009_S001	12
AX050265	STEPPER MOTOR:DC24V 7.2W:(for M117)	U012	9
AX640199	FAN:MM80:25MM:DC 2.16W	U015	11
B2681085	SWITCH:LF-105-11	U015	12
D1272514	ELECTROMAGNETIC CLUTCH:3.5 T:MANUAL FEED	U003	6
G0123050	SIDE FENCE GEAR	U005_S001	3
G0201160	SNAP RING	U003	7
G0271180	RUBBER FOOT - GF	U015	13
G0292767	BY-PASS FEED COVER	U005	4
G0521120	SPRING - PAPER EXIT RELEASE	U013	4
G0521518	SPRING - LOCK LEVER	U001	3
G0961019	TRANSPORT GUIDE PIN:(for M117)	U012	10
G1022717	COVER:DC SOLENOID	U005	5
G1022755	RACK:SIDE FENCE:REAR	U005_S001	6
G1022789	STOPPER:PHOTOINTERRUPTOR	U005	7
G1272627	PAPER FEED ROLLER - MM32	U003	8
G1274328	DECAL - HIGH TEMPERATURE	U009_S001	13
G8003133	SIDE FENCE GEAR	U004_S001	1
GF013001	BOTTOM PLATE PAD	U004_S001_S001	2
		U005_S001	8
GW010007	PHOTO REFLECTION SENSOR:EXI T	U015	14
J0121508	PLATE:LOGO:GES	U001	4
J0121515	PLATE:LOGO:NSA:(for AA)	U001	5
J0121516	PLATE:LOGO:REX:(for AA)	U001	6
J0121517	PLATE:LOGO:NSA:(for AA)	U001	7
M0121037	TONER BOTTLE:CASE	U015	15
M0121040	CASE:DISCHARGE LAMP	U015	16
M0121050	FRAME:MAIN:SUB-ASS'Y	U015	17
M0121063	TERMINAL:CHARGE	U015	18

Number	Part Name	Group	ID
M0121065	CASE:TERMINAL	U015	19
M0121066	SPRING:TERMINAL:CHARGE	U015	20
M0121088	COIL SPRING:RAIL:RIGHT	U015	21
M0121089	GUIDE:PAPER:LEADING EDGE	U015	22
M0121097	SUPPORTER:PAPER:TRANSPORT	U015	23
M0121099	HEAT INSULATING PLATE:FUSING :FRONT	U015	24
M0121115	TIMING BELT:DRIVE:EXIT:(for M11 6)	U013	5
M0121117	GEAR:DRIVE:DRUM	U013	6
M0121119	GEAR:DRIVE:FUSING:NO.2	U013	7
M0121120	GEAR:DRIVE:FUSING:NO.3	U013	8
M0121123	GEAR:DRIVE:PAPER FEED:NO.3	U013	9
M0121128	GEAR:DRIVE:FUSING:NO.4	U013	10
M0121150	BRUSHLESS MOTOR:DC 36.7W	U013	11
M0121171	GEAR:DRIVE:MANUAL FEED SECT ION:NO.1	U013	12
M0121172	GEAR:DRIVE:MANUAL FEED SECT ION:NO.2	U013	13
M0121300	COVER:FRONT	U001	8
M0121301	BUTTON:RIGHT	U001	9
M0121340	COVER:RIGHT:220V	U001	10
M0121341	COVER:RIGHT UPPER:TRANSPAR ENT	U001	11
M0121908	COVER:OPTICAL UNIT	U006_S001	3
M0121957	POLYGON MOTOR:DC 18W	U006_S001	4
M0121979	SEAL:COVER:NO.2	U006_S001	5
M0121980	SEAL:COVER:NO.1	U006_S001	6
M0122056	DISCHARGE LAMP	U015	25
M0122504	PAPER TRAY:ASS'Y	U004_S001	3
M0122589	PAPER TRAY:REAR	U004_S001	4
M0122590	COIL SPRING:EARTH	U004_S001	5
M0122603	STOPPER:BASE PLATE	U004_S001	6
M0122604	SPRING:RELEASE:TRAY BOTTOM PLATE	U004_S001	7
M0122605	FRICTION PAD:ADHESION	U004_S001	8
M0122608	END FENCE	U004_S001	9
M0122610	TRAY BOTTOM PLATE	U004_S001_S001	10

Exclusive Parts

Number	Part Name	Group	ID
M0122612	COMPRESSION SPRING:TRAY BOTTOM PLATE	U004_S001	11
M0122613	COMPRESSION SPRING:SEPARATION	U004_S001	12
M0122614	SIDE FENCE:LEFT	U004_S001	13
M0122615	SIDE FENCE:RIGHT	U004_S001	14
M0122616	LEVER:PAPER VOLUME SENSOR	U004_S001	15
M0122618	DECAL:PAPER TRAY:FRONT	U004_S001	16
M0122629	COVER:PAPER TRAY	U004_S001	17
M0122630	DECAL:PICK-UP PAPER JAM:(for M116)	U001	12
M0122668	SHAFT:PAPER FEED:ASS'Y	U003	9
M0122671	FEELER:PAPER END SENSOR	U003	10
M0122673	RAIL:PAPER TRAY:RIGHT	U003	11
M0122701	ROLLER:INTERFACE:DRIVE	U003	12
M0122702	ROLLER:INTERFACE:DRIVEN	U003	13
M0122705	SPRING:ROLLER	U003	14
M0122711	BUSHING:REGISTRATION:DRIVEN:LEFT	U003	15
M0122715	GUIDE PLATE:TRANSPORT:UPPER	U003	16
M0122717	REGISTRATION ROLLER:DRIVE	U003	17
M0122719	REGISTRATION ROLLER:DRIVEN	U003	18
M0122722	SPRING:ROLLER:REGISTRATION	U003	19
M0122723	FEELER:REGISTRATION:SENSOR	U003	20
M0122725	SPRING:FEELER:REGISTRATION	U003	21
M0122730	BUSHING:REGISTRATION:DRIVEN:RIGHT	U003	22
M0122741	GROUND PLATE:DRIVE:REGISTRATION ROLLER	U003	23
M0122742	GROUND PLATE:DRIVEN:REGISTRATION ROLLER	U003	24
M0122743	DECAL:GUIDE PLATE:TRANSPORT:UPPER	U003	25
M0122744	GUIDE:REGISTRATION	U003	26
M0122745	GROUND PLATE:DRIVEN	U003	27
M0122753	BUSHING:ROLLER:DRIVEN	U003	28
M0122805	GUIDE PLATE:MANUAL FEED:LOW	U005	9

Number	Part Name	Group	ID
	ER		
M0122806	SHEET:GUIDE:MANUAL FEED SUB-UNIT	U005	10
M0122815	DECAL:FEED PAPER AGAIN:PREVENTION	U005	11
M0122816	FRICTION PAD:HOLDER:MANUAL FEED:ASS'Y	U005	12
M0122824	FEELER:MANUAL FEED	U005	13
M0122830	MECHANICAL SPRING CLUTCH:MANUAL FEED	U005	14
M0122831	DC SOLENOID:9.6W:24V	U005	15
M0122833	DECAL:SIDE FENCE:MANUAL FEED	U005_S001	16
M0122859	GUIDE PLATE:UPPER:MANUAL FEED	U005	17
M0122860	PAPER FEED ROLLER:MANUAL FEED	U005	18
M0122868	MANUAL FEED TABLE:SUB-ASS'Y	U005_S001	19
M0122870	COVER:MANUAL FEED TABLE	U005	20
M0122874	COMPRESSION SPRING:MANUAL FEED	U005	21
M0122875	SIDE FENCE:MANUAL FEED:RIGHT	U005_S001	22
M0122877	SIDE FENCE:MANUAL FEED:LEFT	U005_S001	23
M0122879	EXTENSION TRAY:MANUAL FEED	U005	24
M0122880	COMPRESSION SPRING:SEPARATION	U005	25
M0124053	GEAR:HOT ROLLER	U009_S001	14
M0124055	RADIAL BALL BEARING:35X47X7	U009_S001	15
M0124109	SPRING:FEELER:EXIT	U009_S001	16
M0124120	TENSION SPRING:PICKOFF PAWL	U009_S001	17
		U015	26
M0124121	HEATER:700W:220V	U009_S001	18
M0124135	FEELER:PAPER FEED SENSOR	U009_S001	19
M0124186	COVER:LEFT UPPER:ASS'Y	U009_S001	20
M0124202	LEVER:PRESSURE	U009_S001	21
M0124204	LEVER:LEFT:FRAME:FUSING	U009_S001	22
M0124205	LEVER:RIGHT:FRAME:FUSING	U009_S001	23

Exclusive Parts

Number	Part Name	Group	ID
M0124206	STRIPPER PAWLS	U009_S001	24
M0124208	BRACKET:GATE PAWL	U009_S001	25
M0124211	PLATE NUT:HEATER	U009_S001	26
M0124212	FUSING ENTRANCE GUIDE PLATE :UPPER	U009_S001	27
M0124213	BUSHING:PRESSURE ROLLER	U009_S001	28
M0124215	GUIDE PLATE:EXIT	U009_S001	29
M0124216	TENSION SPRING:FUSING:GUIDE PLATE	U009_S001	30
M0124217	FUSING ENTRANCE GUIDE PLATE :LOWER	U009_S001	31
M0124220	HOT ROLLER	U009_S001	32
M0124223	THERMAL INSULATING BUSHING: HOT ROLLER	U009_S001	33
M0124229	TENSION SPRING:FUSING:PRESS URE	U009_S001	34
M0124234	HOUSING:THERMOSTAT:ASS'Y	U009_S001	35
M0124253	PRESSURE ROLLER:DIA30	U009_S001	36
M0124263	THERMISTOR:FUSING	U009_S001	37
M0124266	COVER:RIGHT LOWER:FUSING	U009_S001	38
M0124270	THERMAL INSULATING BUSHING: FUSING UNIT	U009	39
M0124276	COVER:LEFT:LOWER:FUSING	U009_S001	40
M0124279	CLEANING ROLLER:ASS'Y	U009_S001	41
M0124281	RETAINING RINGS-C:HOT ROLLE R	U009_S001	42
M0124284	LEVER:PRESSURE:LEFT	U009_S001	43
M0124285	LEVER:PRESSURE:RIGHT	U009_S001	44
M0124287	COVER:RIGHT UPPER:FUSING	U009_S001	45
M0124292	FUSING COVER:UPPER	U009_S001	46
M0124293	EXIT ROLLER:EXIT:FUSING	U009_S001	47
M0124295	GROUND PLATE:ASS'Y	U009_S001	48
M0124453	EXIT ROLLER	U010	3
		U011	1
M0124454	SPRING:EXIT ROLLER:EXIT	U010	4
		U011	2
M0124457	GROUND PLATE:EXIT:DISCHARG E BRUSH	U010	5
		U011	3

Number	Part Name	Group	ID
M0124458	DISCHARGE BRUSH:EXIT:ASS'Y D RAWING	U010	6
		U011	4
M0124465	PULLEY:EXIT:(for M116)	U010	7
M0124470	EXIT ROLLER:ASS'Y:(for M116)	U010	8
M0124488	BUSHING:DIA6XDIA10X6	U003	29
		U010	9
		U011	5
		U012	11
M0124499	GROUND PLATE:EXIT ROLLER	U010	10
		U011	6
M0124601	DECAL:LEVER:ENVELOPE:LEFT	U015	27
M0124602	DECAL:LEVER:ENVELOPE:RIGHT	U015	28
M0124603	DECAL:GUIDE PLATE:B	U009_S001	49
M0124699	DECAL:WARNING (HIGH TEMPER ATURE):FRONT	U009	50
M0125021	POWER SUPPLY UNIT:EU/AA/CHN	U014	3
M0125039	MAIN SWITCH:SERVICE:ASS'Y	U014_S001	4
M0125699	POWER SUPPLY CORD:250V:10A: EU	ACCESSORIES	1
M0126252	BUSHING:TRANSFER ROLLER:RIG HT	U008	1
M0126253	BUSHING:TRANSFER ROLLER:LE FT	U008	2
M0126254	SPRING:TRANSFER ROLLER	U008	3
M0126255	GEAR:TRANSFER ROLLER	U008	4
M0126256	ROLLER:POSITIONING:TRANSFER ROLLER	U008	5
M0126259	ELECTRODE PLATE:SEPARATION	U008	6
M0126260	COVER:ELECTRODE PLATE	U008	7
M0131178	BRACKET:DRIVE:DUPLEX:(for M11 7)	U013	14
M0132630	DECAL:PICK-UP PAPER JAM:(for M 117)	U001	13
M0134455	GEAR:DRIVE:EXIT ROLLER:(for M1 17)	U011	7
M0134470	EXIT ROLLER:DUPLEX:(for M117)	U011	8
M0134610	GEAR:DRIVE:DUPLEX:(for M117)	U012	12
M0134622	EXIT ROLLER:DUPLEX:(for M117)	U012	13

Exclusive Parts

Number	Part Name	Group	ID
M0134623	SPRING:EXIT:(for M117)	U012	14
M0134624	SPRING:EXIT:NO.2:(for M117)	U012	15
M0134635	SPRING:OPEN AND CLOSE:RIGHT :(for M117)	U012	16
M0134663	GUIDE PLATE:VERTICAL TRANSP ORT:LOWER:(for M117)	U012	17
M0134664	GUIDE PLATE:VERTICAL TRANSP ORT:UPPER:(for M117)	U012	18
M0134666	SHAFT:COVER:SWITCHBACK:OPE N AND CLOSE	U001	14
M0134667	SPRING:COVER:SWITCHBACK:OP EN AND CLOSE	U001	15
M0134668	SHEET:GUIDE:HORIZONTAL TRAN SPORT:LOWER:(for M117)	U012	19
M0134669	MAGNET CATCH:ASS'Y	U001 U012	16 20
M0134671	SHEET:HORIZONTAL TRANSPORT :LEFT:(for M117)	U012	21
M0134672	SHEET:HORIZONTAL TRANSPORT :RIGHT:(for M117)	U012	22
M0134673	LEVER:OPEN AND CLOSE:NO.1:(fo r M117)	U012	23
M0134674	LEVER:OPEN AND CLOSE:NO.2:(fo r M117)	U012	24
M0134684	SHEET:DUPLEX:(for M117)	U012	25
M0134685	BUTTON:OPEN AND CLOSE:LOWE R:(for M117)	U012	26
M0134687	GROUND PLATE:HORIZONTAL TR ANSPORT:FRONT:(for M117)	U012	27
M0134688	GROUND PLATE:HORIZONTAL TR ANSPORT:REAR:(for M117)	U012	28
M0134691	LEVER:OPEN AND CLOSE:LOWER :(for M117)	U012	29
M0134694	GUIDE:HORIZONTAL TRANSPORT :UPPER:(for M117)	U012	30
M0134695	GUIDE:HORIZONTAL TRANSPORT :LOWER:(for M117)	U012	31
M0134696	LEVER:OPEN AND CLOSE:LEFT:(f	U012	32

Number	Part Name	Group	ID
	or M117)		
M0134697	LEVER:OPEN AND CLOSE:RIGHT:(for M117)	U012	33
M0134698	BRACKET:OPEN AND CLOSE:LOW ER:(for M117)	U012	34
M0134761	TRANSPORT ROLLER:DUPLEX:MI DDLE:(for M117)	U012	35
M0134762	TRANSPORT ROLLER:DUPLEX:EX IT:(for M117)	U012	36
M0134765	PULLEY:TRANSPORT:(for M117)	U012	37
M0134771	TIMING BELT:HORIZONTAL TRAN SPORT:(for M117)	U012	38
M0134772	TIMING BELT:DRIVE:(for M117)	U012	39
M0134778	FEELER:SENSOR:HORIZONTAL T RANSPORT:(for M117)	U012	40
M0134785	SPRING:COVER:SWITCHBACK:OP EN AND CLOSE	U012	41
M0134794	DECAL:GUIDE PLATE:VERTICAL T RANSPORT:UPPER:(for M117)	U012	42
M0134795	PIN:GUIDE:UPPER:(for M117)	U012	43
M0134797	FEELER:SENSOR:VERTICAL TRAN SPORT:(for M117)	U012	44
M1016250	TRANSFER ROLLER	U008	8
M1160402	MODEL NAME PLATE:M116:(for M1 16-EU)	ACCESSORIES	2
M1161043	DUCT:HARNESS	U015	29
M1161118	GEAR:DRIVE:FUSING:NO.1	U013	15
M1161121	GEAR:DRIVE:PAPER FEED:NO.1	U013	16
M1161122	GEAR:DRIVE:PAPER FEED:NO.2	U013	17
M1161124	GEAR:DRIVE:PAPER FEED:NO.4	U013	18
M1161127	GEAR:DRIVE:EXIT:(for M116)	U013	19
M1161311	COVER:UPPER FRONT:TRANSPA RENT	U001	17
M1161324	EXTENSION TRAY:GUIDE	U001	18
M1161325	EXTENSION TRAY:EXIT:P	U001	19
M1161330	COVER:SIDE PLATE:LEFT	U001	20
M1161331	COVER:SIDE PLATE:LEFT UPPER: TRANSPARENT	U001	21

Exclusive Parts

Number	Part Name	Group	ID
M1161350	GUIDE PLATE:(for M116)	U001	22
M1161360	COVER:REAR MIDDLE	U001	23
M1161370	COVER:REAR LOWER	U001	24
M1161401	OPERATION PANEL:EXP:ASS'Y	U002_S001	2
M1161450	COVER:UPPER	U001	25
M1162672	RAIL:PAPER TRAY:LEFT	U003	30
M1164031	FUSING UNIT:220V:ASS'Y	U009_S001	51
M1165103	PCB:CTL:ASS'Y	U014	5
M1165453	PCB:ECB:M116/M118:ASS'Y:(for M116)	U014	6
M1170402	MODEL NAME PLATE:M117:(for M117-EU)	ACCESSORIES	3
M1171136	GEAR:DRIVE:DUPLEX SECTION:(for M117)	U013	20
M1171851	IMAGING UNIT:ASS'Y	U006_S001	7
M1174662	COVER:SWITCHBACK:OPEN AND CLOSE	U001	26
		U012	45
M1175453	PCB:ECB:M117/M119:ASS'Y:(for M117)	U014	7

Standard Parts



03603006N
SCREW - M3X6



04503008N
TAPPING SCREW - M3X8

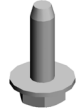

04503010N
TAPPING SCREW - M3X10

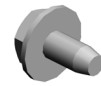

04513006N
TAPPING SCREW - 3X6

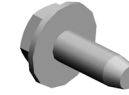

04513008N
TAPPING SCREW - M3X8

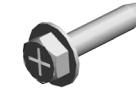

04513014N
TAPPING SCREW:3X14



04513030N
TAPPING SCREW:3X30



04533006N
TAPPING SCREW - M3X6



04543006Q
TAPPING SCREW - M3X6



04543008Q
TAPPING SCREW:3X8



04543014Q
TAPPING SCREW:3X14



07200040E
RETAINING RING - M4



08025318
BINDING HEAD TAPPING SC
REW:ES:3X10



08046127
HEXAGONAL BOLT:DOUBLE
SCREW:M3X8



08050088
RETAINING RING - M6:(for M1
17)



08050089
RETAINING RING - M4



09543010N
SCREW:POLISHED ROUND/
SPRING:M3X10



11050508
HARNES CLAMP - LWS-071
1

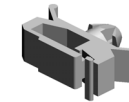

11050511
HARNES CLAMP - LWS-030
6ZC



11050534
CLAMP

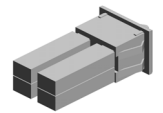

12042879
SWITCH:A8L-21-15N2



14077435
EEPROM:CAT93C76LI-G

