

**Digital B&W Copier**  
**(D127/D128-EU)**  
**Parts Catalog**

Model	Product Code	PC Style
Digital Copier	D127/D128	3D
Paper Feed Unit PB1040	D661	3D

# Unit All

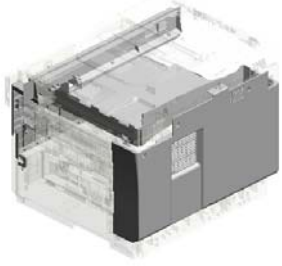

U001  
EXTERIOR

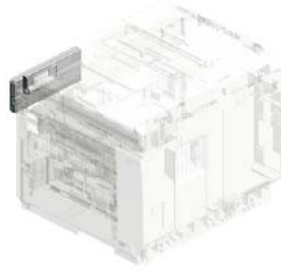

U002  
OPERATION

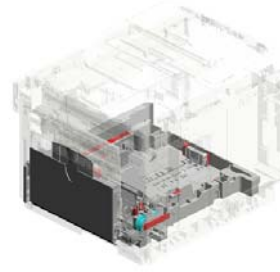

U003  
PAPER FEED



U004  
ADF



U005  
SCANNER

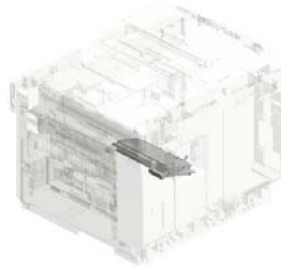

U006  
LASER UNIT

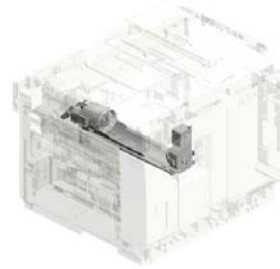

U007  
DEVELOPMENT



U008  
PCU

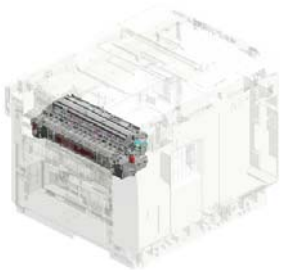

U009  
FUSING



U010  
DUPLEX

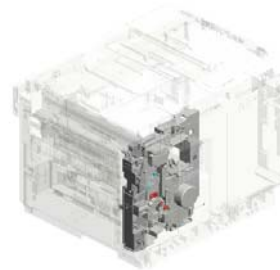

U011  
MAIN DRIVE

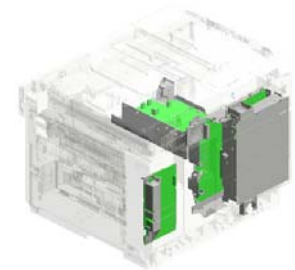

U012  
ELECTRICAL

# Unit All

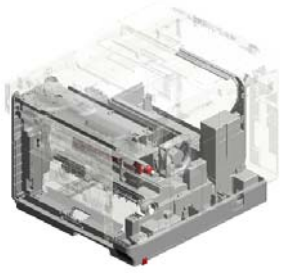

U013  
MAIN FRAME

# U001.EXTERIOR

U001\_S001  
D1271200  
COVER:SCANNER:FRONT:A  
SS'Y

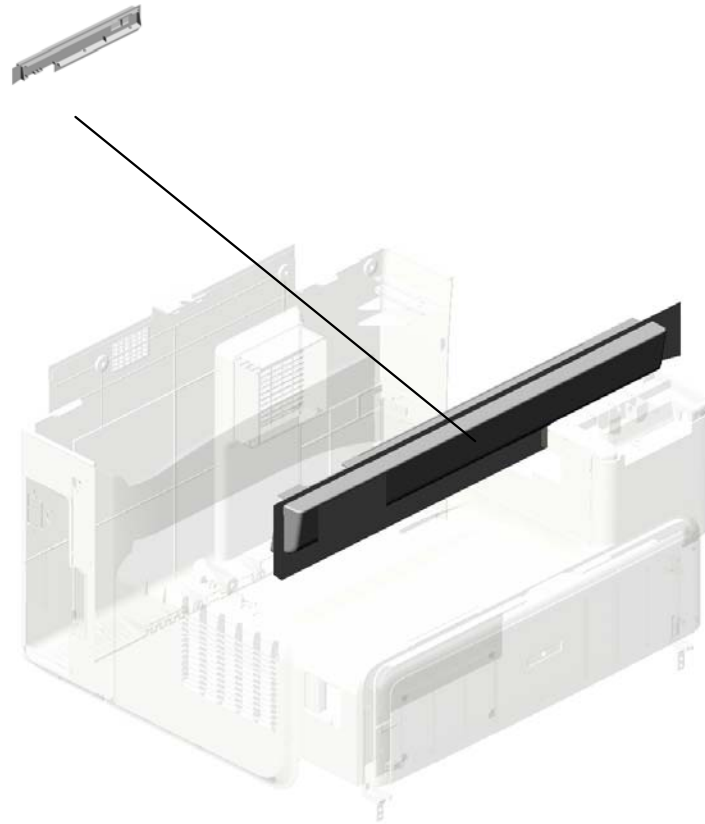

U001	U002	U003	U004	U005	U006	U007	U008	U009	U010	U011	U012	U013
------	------	------	------	------	------	------	------	------	------	------	------	------

# U001 EXTERIOR

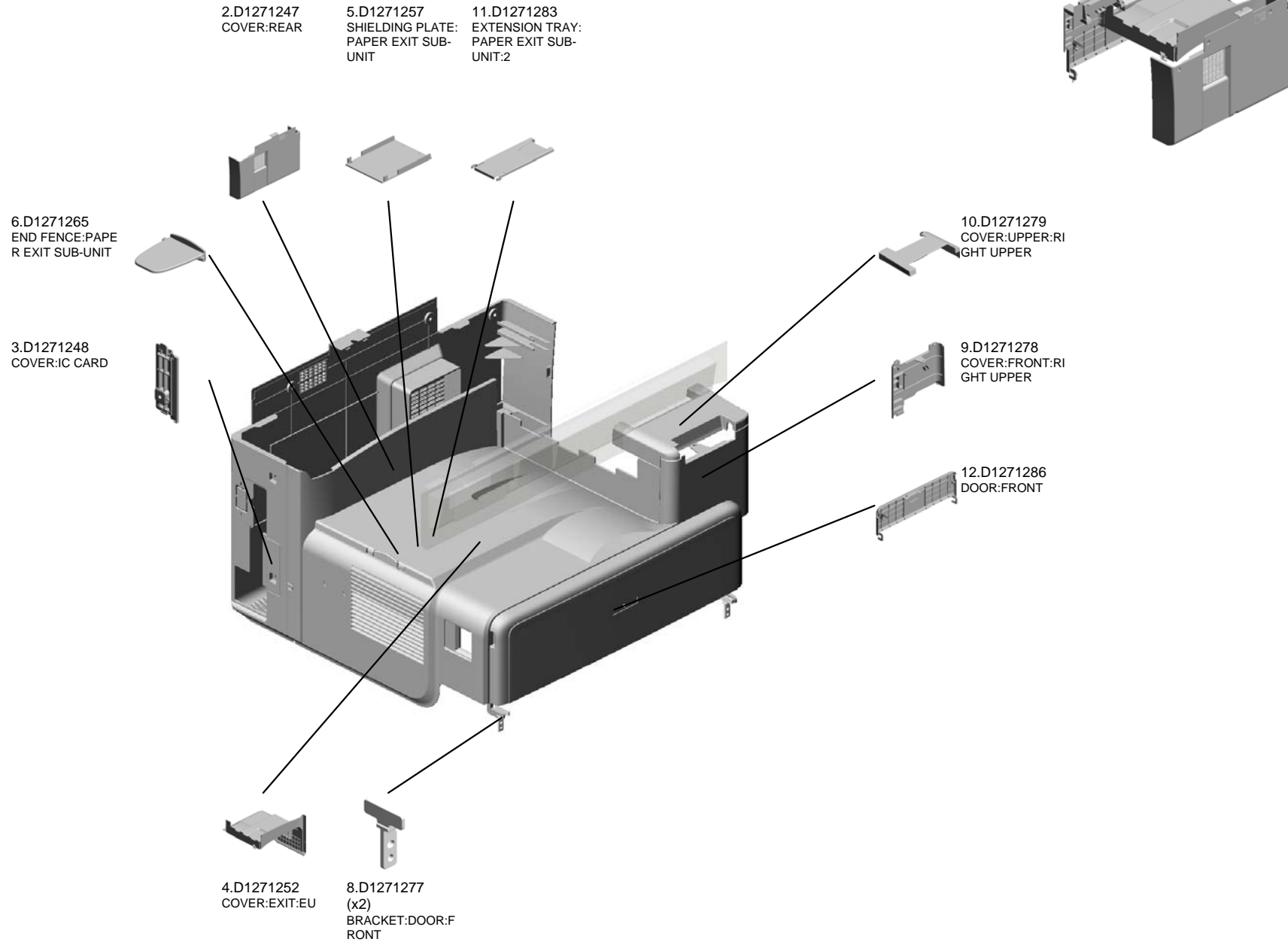

U001	U002	U003	U004	U005	U006	U007	U008	U009	U010	U011	U012	U013
------	------	------	------	------	------	------	------	------	------	------	------	------

U001\_S001  
COVER:SCANNER:FRONT:ASS'Y

13.M0261293  
SHEET:COVER:SC  
ANNER:FRONT:MO  
DEL NAME PLATE

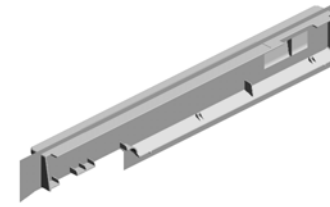
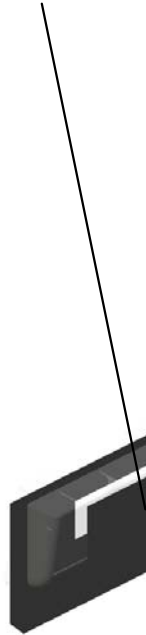

1.D1271200  
COVER:SCANNER:  
FRONT:ASSY



7.D1271268  
SHEET:COVER:SC  
ANNER:FRONT

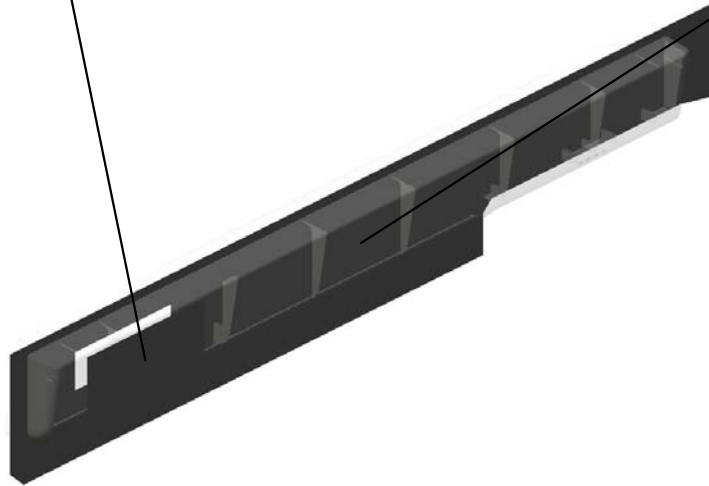

U001	U002	U003	U004	U005	U006	U007	U008	U009	U010	U011	U012	U013
------	------	------	------	------	------	------	------	------	------	------	------	------

# U002.OPERATION

U002\_S001  
D1271412  
OPERATION PANEL:EU:ASS'  
Y

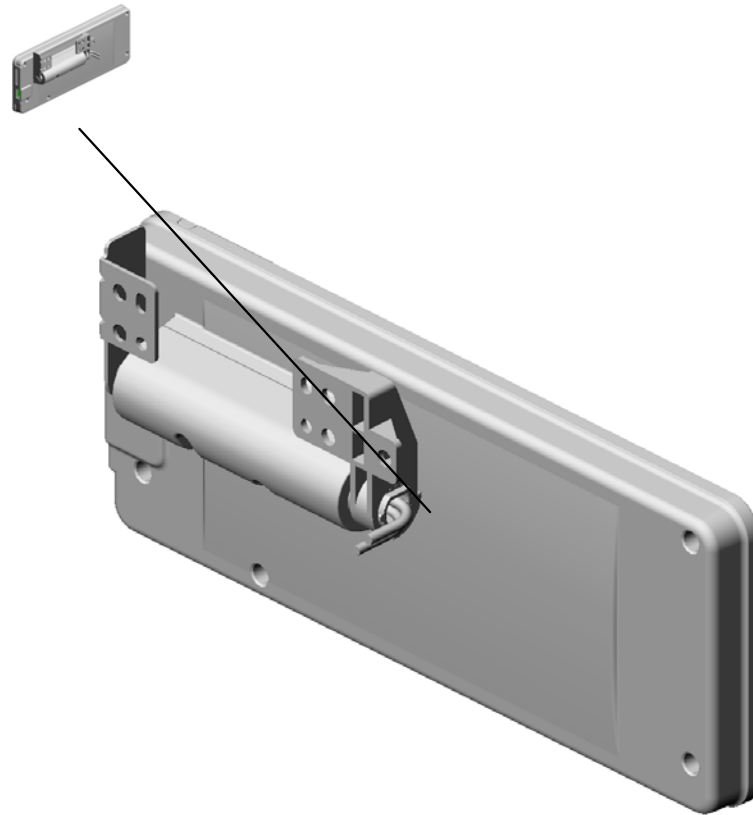

U001	<b>U002</b>	U003	U004	U005	U006	U007	U008	U009	U010	U011	U012	U013
------	-------------	------	------	------	------	------	------	------	------	------	------	------



U002  
OPERATION



U001	<b>U002</b>	U003	U004	U005	U006	U007	U008	U009	U010	U011	U012	U013
------	-------------	------	------	------	------	------	------	------	------	------	------	------

U002\_S001  
OPERATION PANEL:EU:ASS'Y

2.04522006N (x22) BINDING SELF-TAPPING SCREW - M2X6  
 18.D1171517 BRACKET:HINGE  
 8.D1171502 COVER:HINGE  
 12.D1171508 KEYTOP:RESET SWITCH  
 16.D1171514 SHAFT:CABLE



**32.D1271412**  
OPERATION PANEL:EU:ASS'Y

10.D1171504 KEYTOP:RIGHT

4.D1171460 PCB:UWVGA:OP-R:ASS'Y

3.04522008P BINDING SELF-TAPPING SCREW:2X8

13.D1171510 KEYTOP:START

14.D1171511 KEYTOP:STOP

7.D1171501 COVER:REAR

20.D1171519 SHEET:LCDC

17.D1171516 BRACKET:LCDC

6.D1171470 FPC:LED:ASS'Y

15.D1171513 LENS:FRONT

1.03520030N (x13) SCREW:M2X3

9.D1171503 KEYTOP:HOME

19.D1171518 SHADEING PLATE: TOUCH PANEL

5.D1171465 PCB:UWVGA:OP-L:ASS'Y

11.D1171505 KEYTOP:LEFT

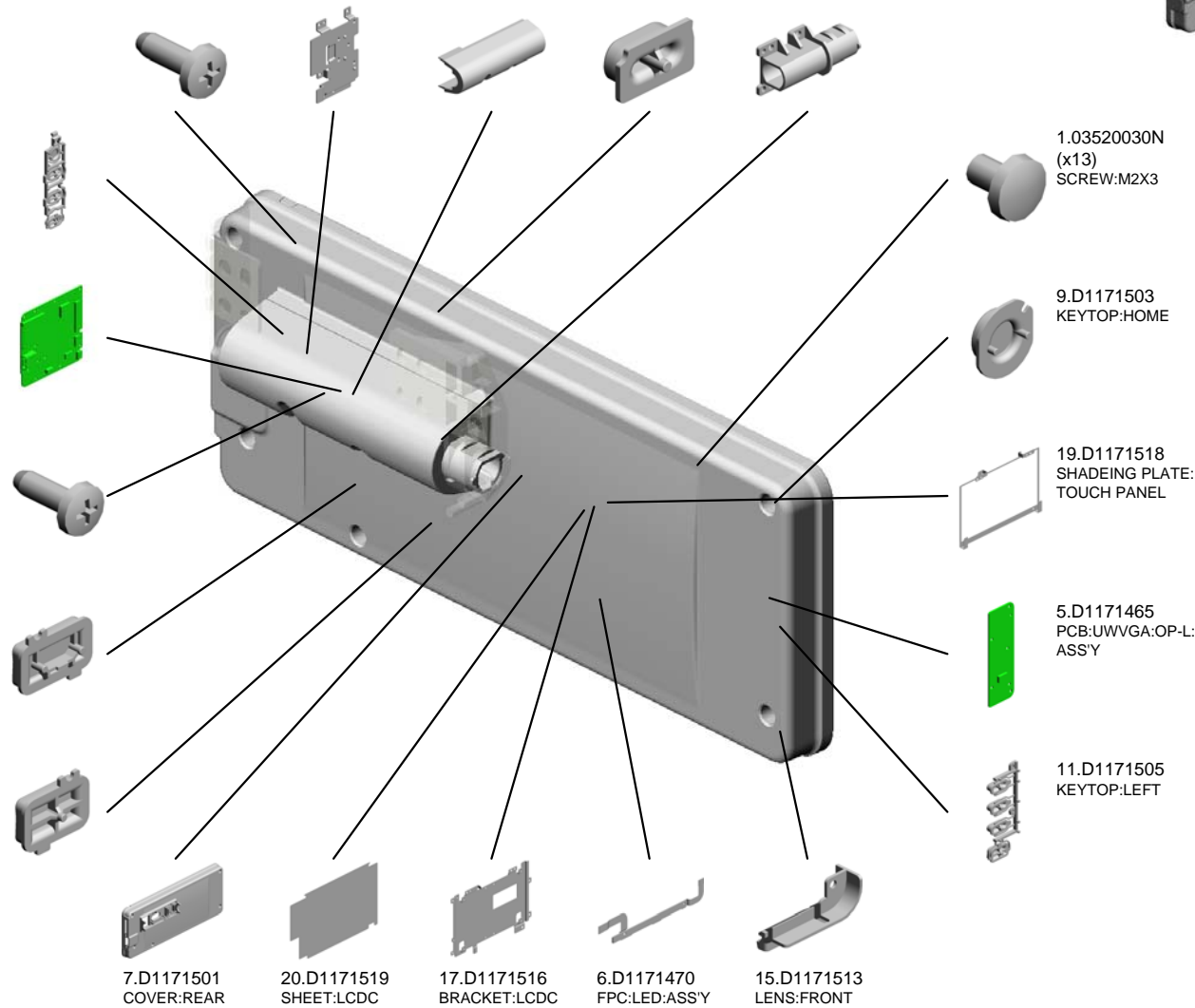

U002\_S001  
OPERATION PANEL:EU:ASS'Y

30.D1171543 KEYTOP:10KEY:B:EU  
 29.D1171542 KEYTOP:10KEY:A:EU  
 28.D1171533 HOLDER:HINGE:LEFT  
 27.D1171531 BRACKET:HINGE:LEFT



**32.D1271412**  
OPERATION PANEL:EU:ASS'Y

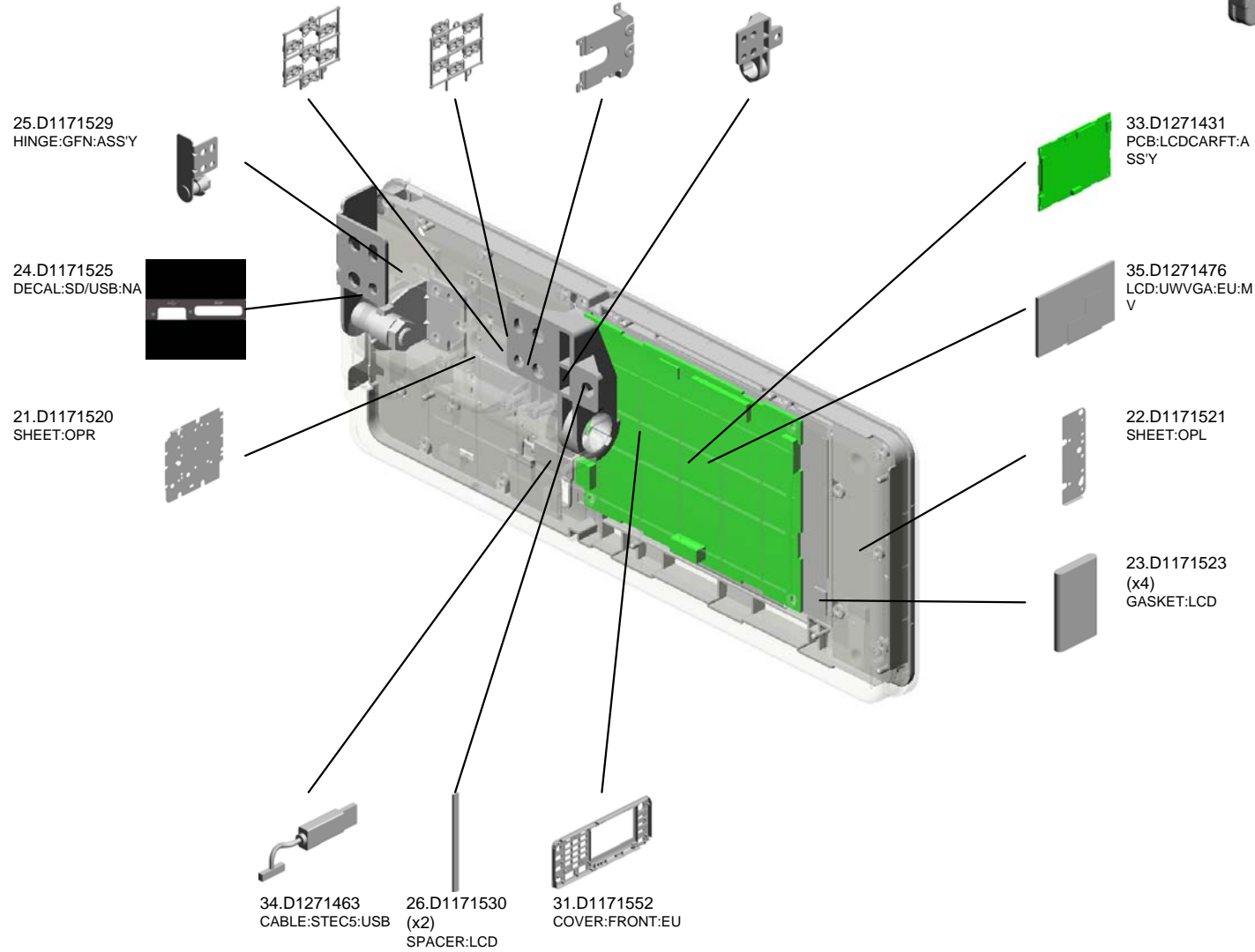

# U003.PAPER FEED

U003\_S001  
D1272510  
PAPER TRAY:ASSY

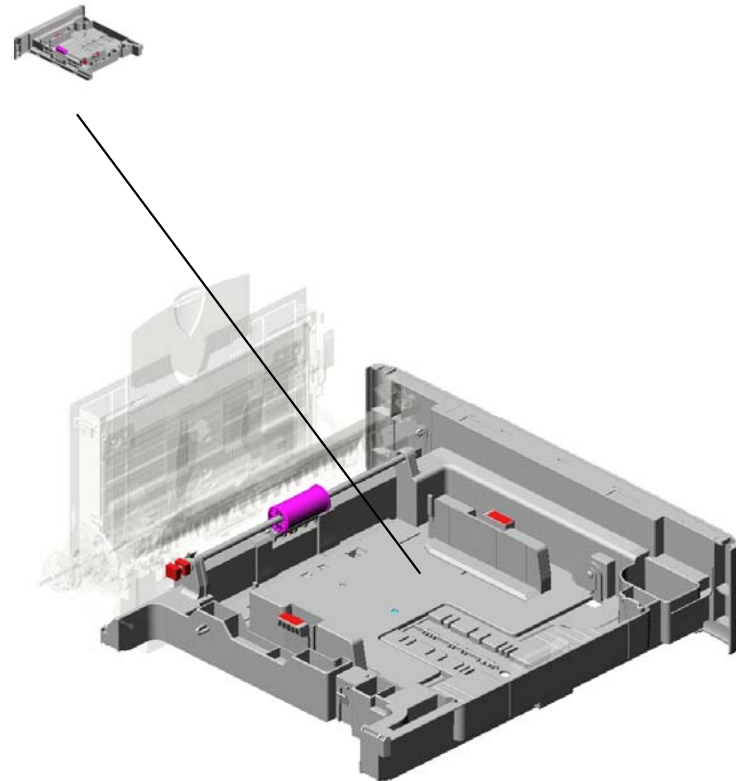

U001	U002	U003	U004	U005	U006	U007	U008	U009	U010	U011	U012	U013
------	------	------	------	------	------	------	------	------	------	------	------	------

# U003\_S001.PAPER TRAY:ASS'Y

U003\_S001\_S003  
D1272708  
SIDE FENCE:REAR:ASS'Y

U003\_S001\_S002  
D1272707  
SIDE FENCE:FRONT:ASS'Y

U003\_S001\_S001  
B0442704  
TRAY BOTTOM PLATE

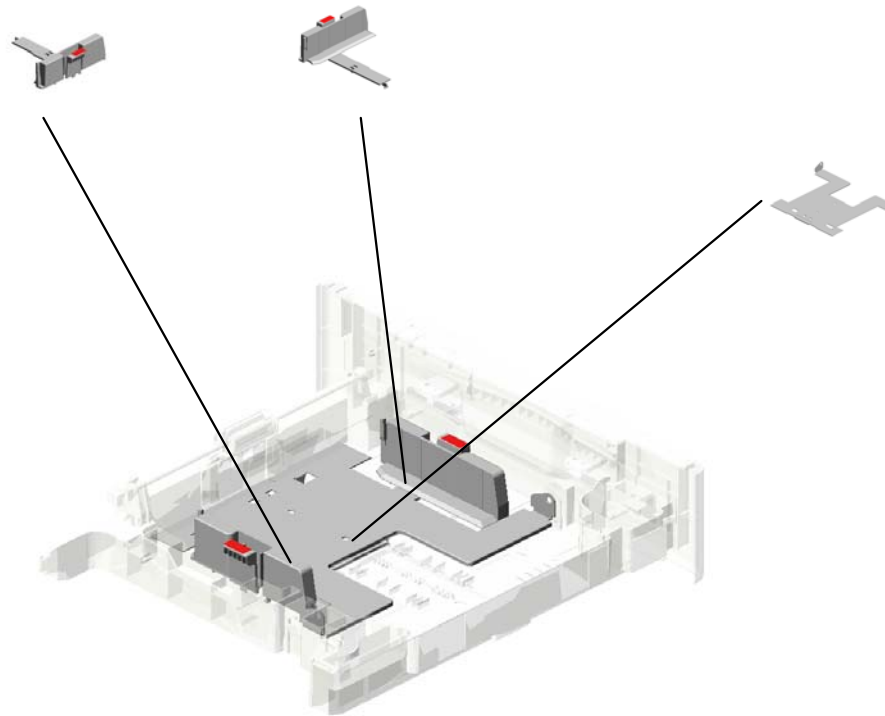

U001	U002	U003	U004	U005	U006	U007	U008	U009	U010	U011	U012	U013
------	------	------	------	------	------	------	------	------	------	------	------	------

# U003 PAPER FEED

4.AA080322  
(x2)  
BUSHING - 6MM

13.B0442603  
REGISTRATION FE  
ELER

32.B0442807  
STAY - TRAY BOTT  
OM PLATE

3.52152713  
**BOTTOM PLATE P  
AD**

10.AF031086  
**BY-PASS FEED RO  
LLER**

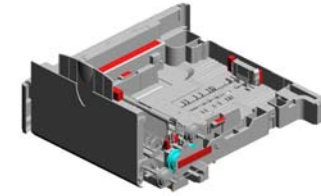

15.B0442605  
REAR BUSHING



11.AW020198  
PHOTOINTERRUPT  
TOR:LG2A14NL1



7.AB017586  
COUPLED GEAR -  
43/53Z



6.AB011438  
GEAR - 41Z



1.07200040E  
(x3)  
RETAINING RING -  
M4



21.B0442656  
GUIDE PLATE STO  
PPER



16.B0442616  
(x2)  
SUPPORT BUSHIN  
G



8.AF022143  
GUIDE ROLLER



20.B0442654  
PAPER FEEDGUID  
E



19.B0442653  
GUIDE PLATE - PA  
PER FEED



14.B0442604  
FRONT BUSHING



18.B0442622  
SPACER - REGIST  
RATION



17.B0442617  
HOLDER ASS'Y - P  
APER DUST REMO  
VAL



12.B0442602  
TURN ROLLER



25.B0442715  
(x2)  
SPONGE - END FE  
NCE



# U003 PAPER FEED

33.B0442809  
SPRING - MANUAL  
FEED TABLE

61.D1272721  
DECAL:MANUAL F  
EED:PAPER SET D  
IRECTION

38.B0442825  
SPACER-MANUAL  
FEED ROLLER

39.B0445300  
PAPER END SENS  
OR

42.B2592786  
LEVER SHAFT

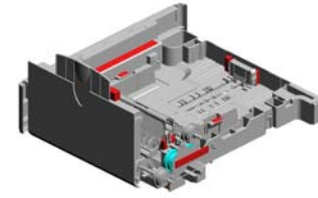

52.D1272517  
ELECTROMAGNET  
IC CLUTCH:3.5T:R  
EGISTRATION

49.D1272512  
SHAFT:FEED:MAN  
UAL FEED

40.B1291157  
SIDE PLATE - MAN  
UAL FEED

41.B1292820  
GROUND PLATE -  
MANUAL FEED

50.D1272514  
ELECTROMAGNET  
IC CLUTCH:3.5T:M  
ANUAL FEED



43.B2622623  
GUIDE - PAPER DU  
ST REMOVER

44.B2622624  
GROUNDING PLAT  
E

51.D1272515  
REGISTRATION R  
OLLER:DRIVE

60.D1272720  
DECAL:CASSETTE  
OPERATION

55.D1272706  
END FENCE

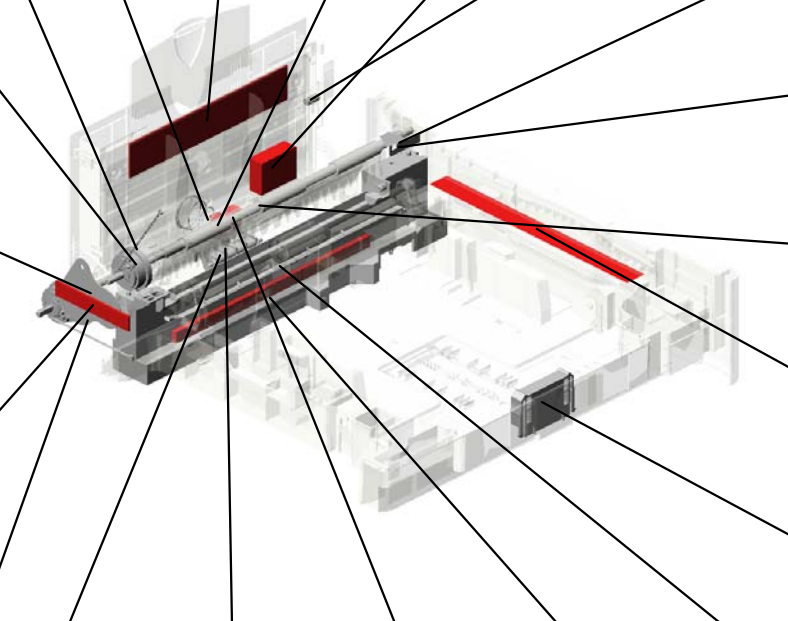

36.B0442817  
FRICION PAD SPRI  
NG

35.B0442815  
FRICION PAD - M  
ANUAL FEED

37.B0442824  
CUSHION-MANUAL  
FEED ROLLER

34.B0442814  
EXIT GUIDE

53.D1272651  
RAIL:RIGHT



# U003 PAPER FEED

67.D1272808 GUIDE:PAPER:MANUAL FEED  
 65.D1272805 SIDE FENCE:MANUAL FEED:REAR  
 62.D1272801 COVER:MANUAL FEED TABLE  
 64.D1272804 SIDE FENCE:MANUAL FEED:FRONT

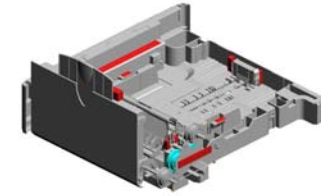

72.G8003133 SIDE FENCE GEAR



63.D1272803 TRAY BOTTOM PLATE



73.H5213355 C RING - PAPER FEED ROLLER

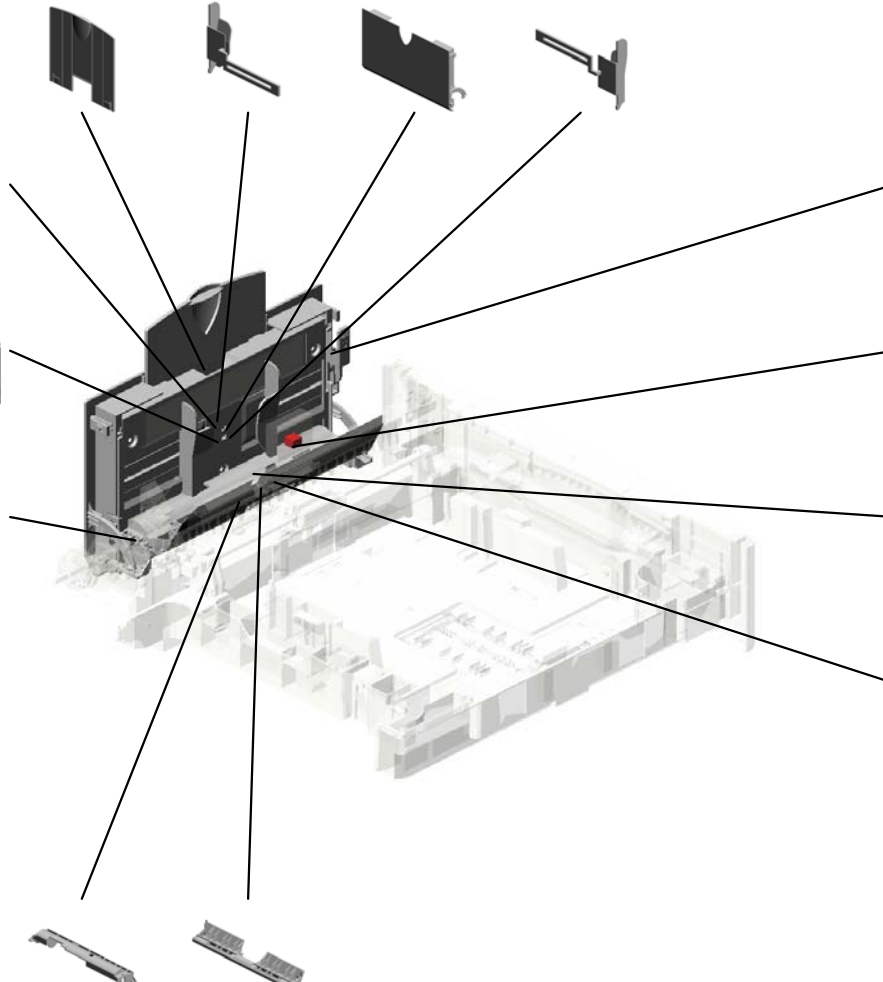

66.D1272806 LEVER:RISING TRAY



71.G0202772 BY-PASS PAPER END SENSOR



69.D1272866 STOPPER:PAPER END SENSOR:MANUAL FEED



75.H5562820 MYLER REVERSE

68.D1272811 GUIDE PLATE:MANUAL FEED:UPPER

74.H5562818 GUIDE PLATE



U003\_S001  
PAPER TRAY:ASS'Y

24.B0442714 RUBBER PLATE - FRICTION PAD  
 47.D0672710 FRICTION PAD:ADHESION  
 31.B0442758 SHAFT - PAPER FEED ROLLER  
 9.AF031061 PAPER FEED ROLLER  
 5.AA082101 BUSHING - 6X10X6

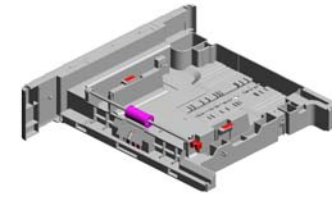

48.D1272510 PAPER TRAY:ASS'Y

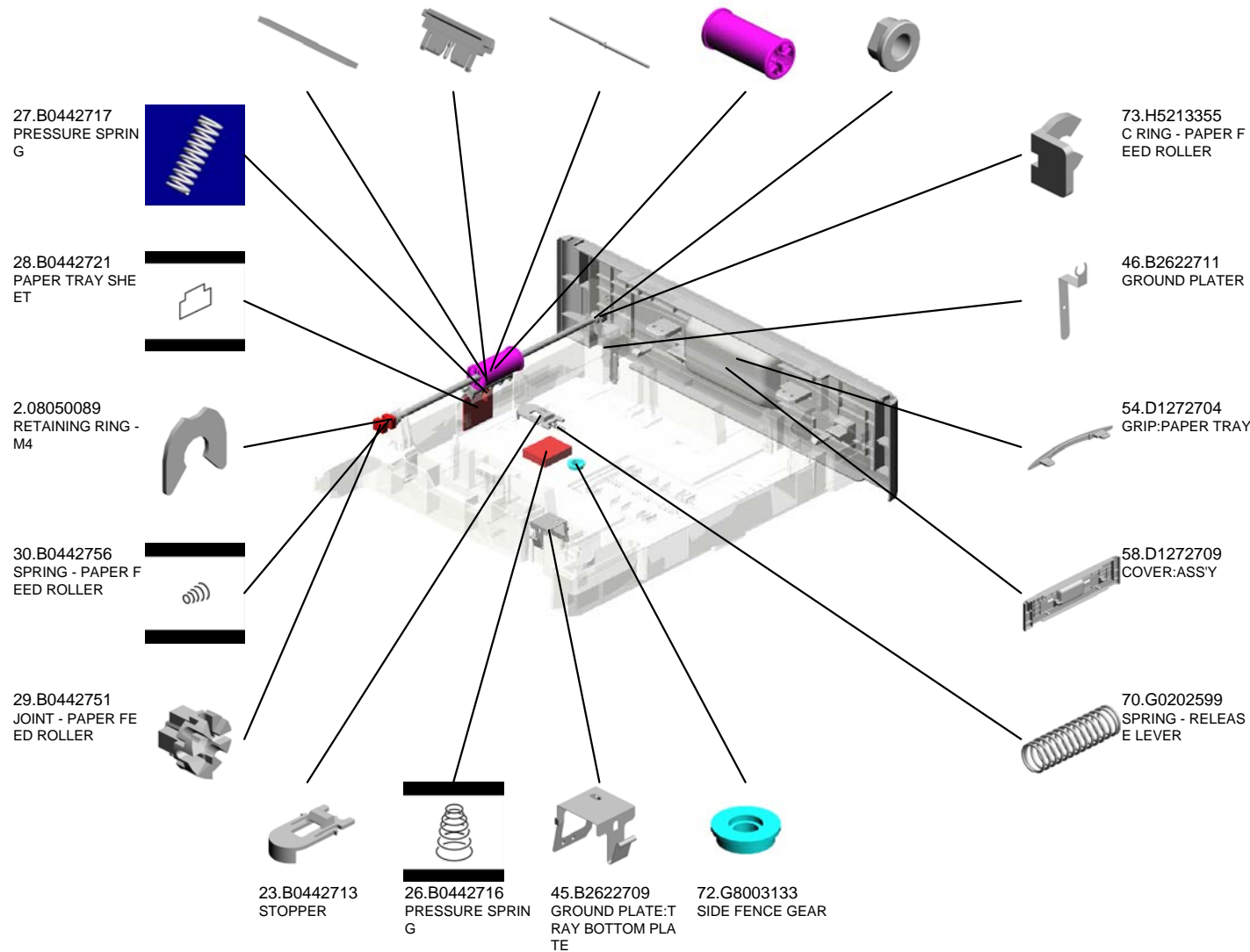

U003\_S001\_S001  
TRAY BOTTOM PLATE

3.52152713  
BOTTOM PLATE P  
AD

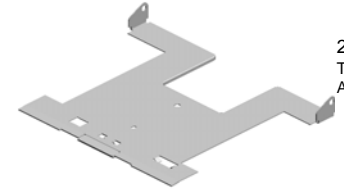
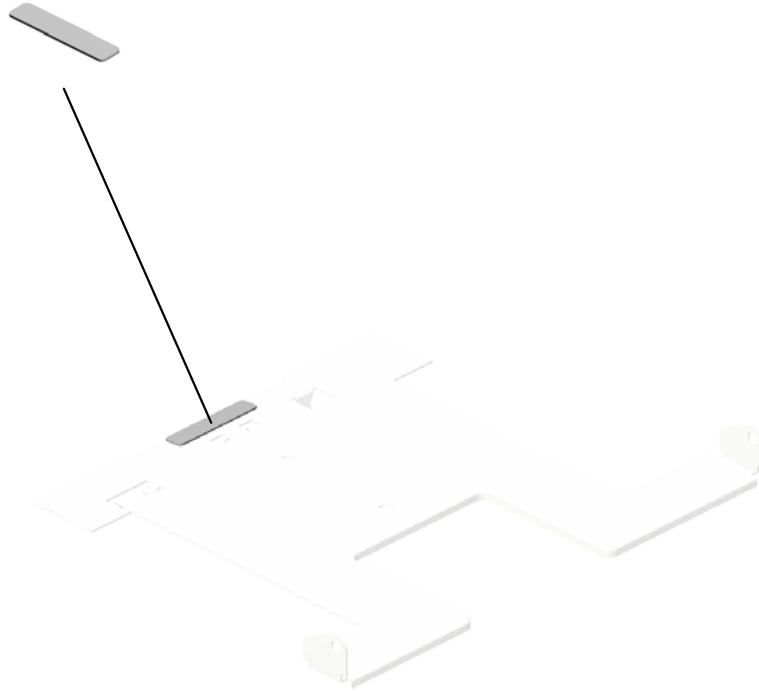

22.B0442704  
TRAY BOTTOM PL  
ATE

U001	U002	U003	U004	U005	U006	U007	U008	U009	U010	U011	U012	U013
------	------	------	------	------	------	------	------	------	------	------	------	------

U003\_S001\_S002  
SIDE FENCE:FRONT:ASS'Y

59.D1272718  
DECAL:SIDE FENC  
E:RELEASE

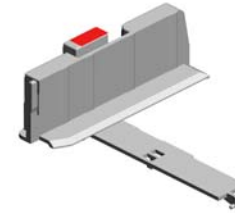

56.D1272707  
SIDE FENCE:FRON  
T:ASS'Y

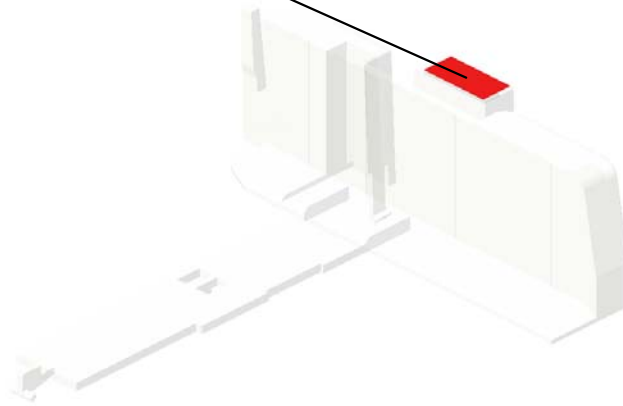

U001	U002	U003	U004	U005	U006	U007	U008	U009	U010	U011	U012	U013
------	------	------	------	------	------	------	------	------	------	------	------	------

U003\_S001\_S003  
SIDE FENCE:REAR:ASS'Y

59.D1272718  
DECAL:SIDE FENC  
E:RELEASE

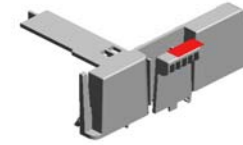
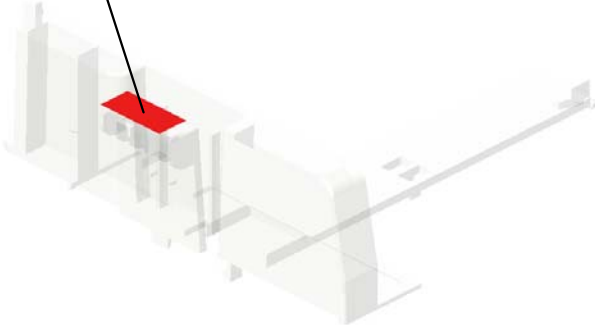

57.D1272708  
SIDE FENCE:REAR  
:ASS'Y

U001	U002	U003	U004	U005	U006	U007	U008	U009	U010	U011	U012	U013
------	------	------	------	------	------	------	------	------	------	------	------	------

# U004.ADF

U004\_S001  
D6062100  
PAPER FEED UNIT:ASS'Y

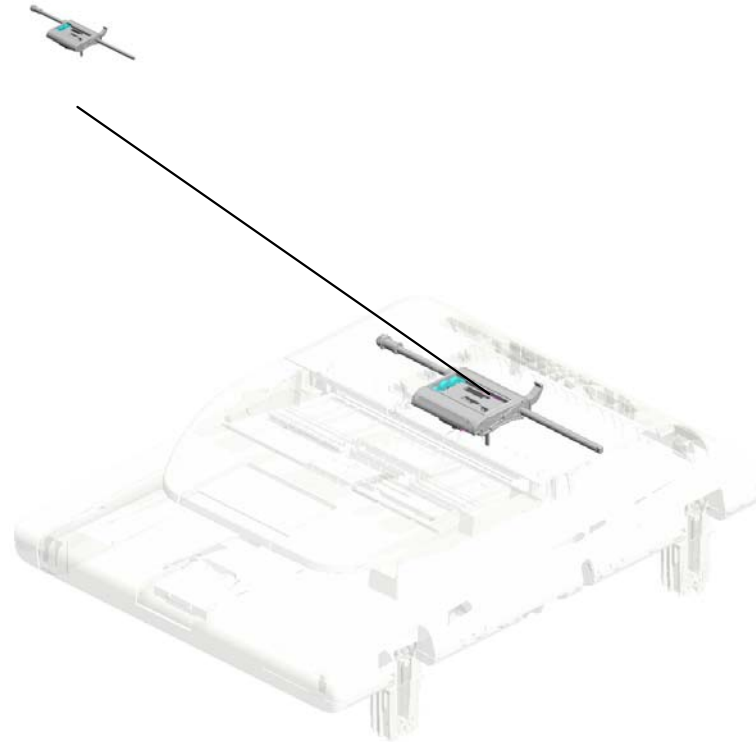

U001	U002	U003	U004	U005	U006	U007	U008	U009	U010	U011	U012	U013
------	------	------	------	------	------	------	------	------	------	------	------	------

# U004 ADF

- 11.08050089 (x9) RETAINING RING - M4
- 26.D6061114 (x2) COMPRESSION SPRING:EXIT:DRIVEN
- 4.04503010N (x10) TAPPING SCREW - M3X10
- 2.03603006N (x2) SCREW - M3X6
- 17.AW010151 PHOTO REFLECTIVE SENSOR:PS122T L1-A

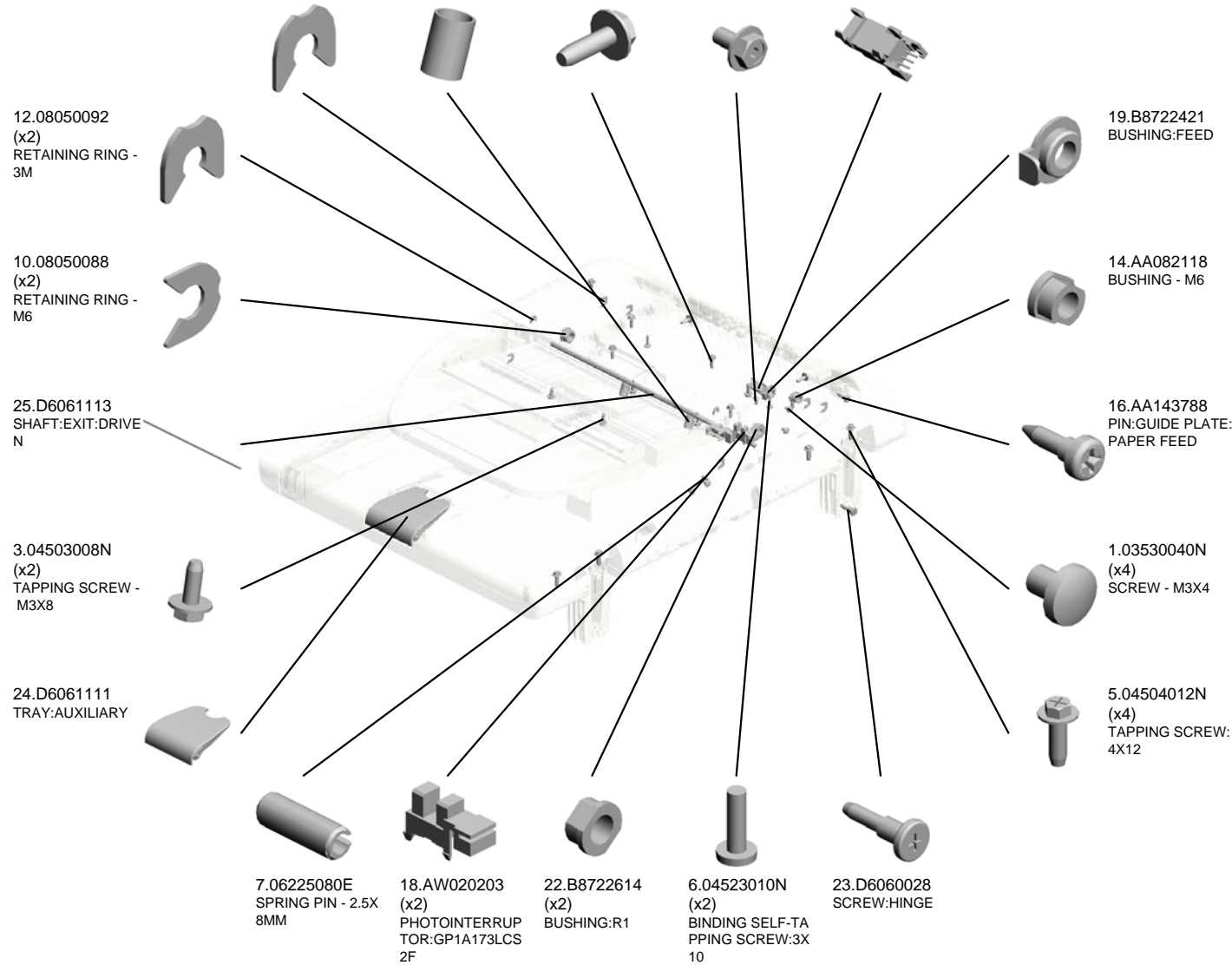

U004  
ADF

31.D6061411  
(x4)  
SHEET:SCANNING:  
FRONT LOWER

54.D6063110  
GUIDE PLATE:PAP  
ER FEED

56.D6063112  
FRICTION PAD

57.D6063114  
COMPRESSION SP  
RING:SEPARATIO  
N

58.D6063115  
ROLLER:SEPARAT  
ION



39.D6061611  
PIN:MISFEED REM  
OVAL

40.D6061612  
COIL SPRING:MISF  
EED REMOVAL

38.D6061610  
LEVER:MISFEED R  
EMOVAL

55.D6063111  
HOLDER:FRICTION  
PAD

27.D6061116  
(x2)  
CUSHION:PRESSU  
RE PLATE

59.D6063116  
LEVER:PRESSURE  
RELEASE:SEPAR  
ATION

29.D6061118  
HOLDER:COMPRES  
SION SPRING:EXI  
T ROLLER

28.D6061117  
(x2)  
ROLLER:DRIVEN:E  
XIT

30.D6061410  
GUIDE PLATE:SCA  
NNING:FRONT LO  
WER

37.D6061510  
(x2)  
HINGE:DOCUMENT  
FEEDER

36.D6061420  
(x4)  
ROLLER:AUXILIAR  
Y:ASSY

34.D6061415  
(x2)  
ROLLER:DRIVEN:SC  
ANNING

32.D6061413  
LEVER:DRIVEN:SC  
ANNING

33.D6061414  
SHAFT:DRIVEN:SC  
ANNING

35.D6061416  
(x2)  
COMPRESSION SP  
RING:SCANNING:DR  
IVEN

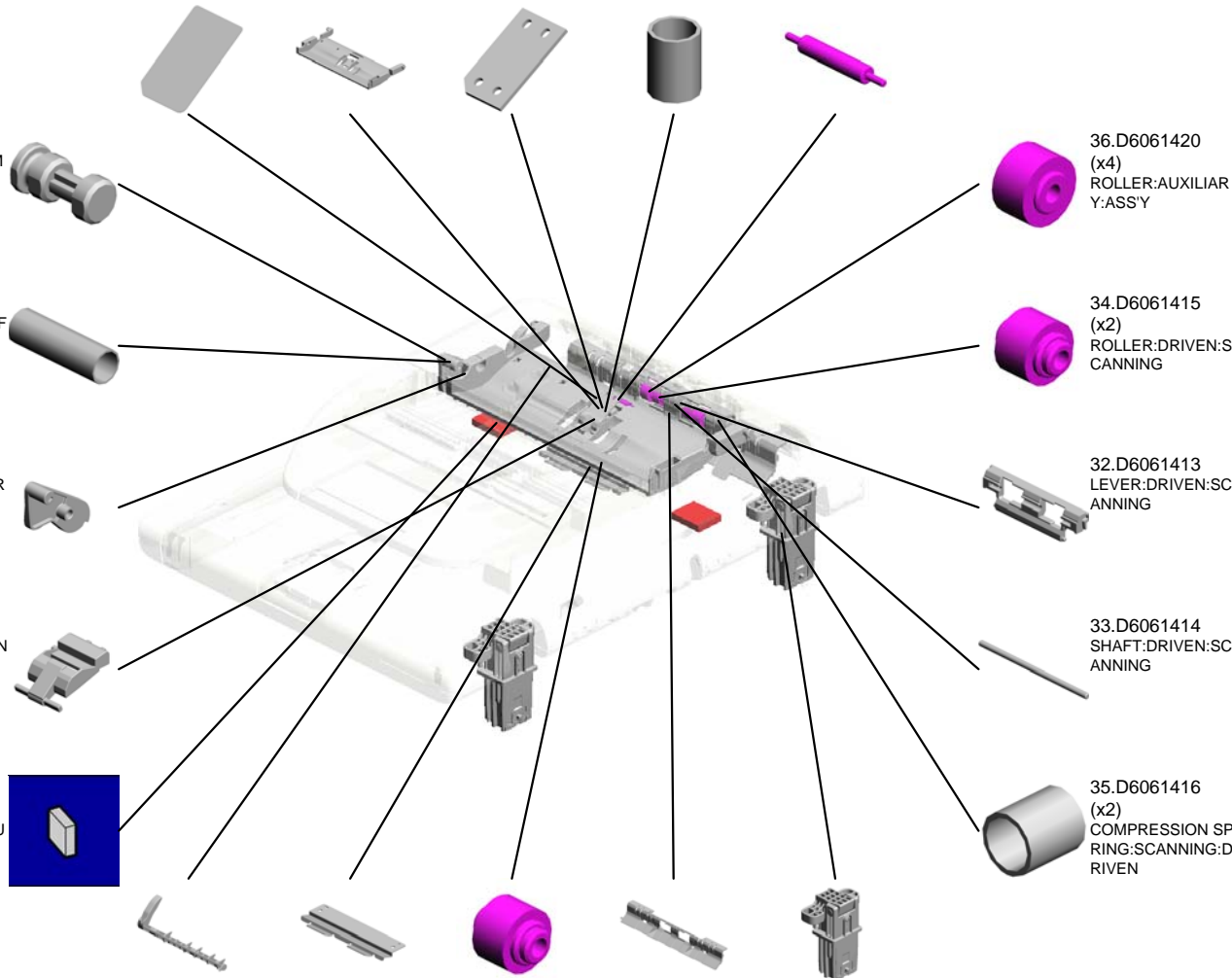

# U004 ADF

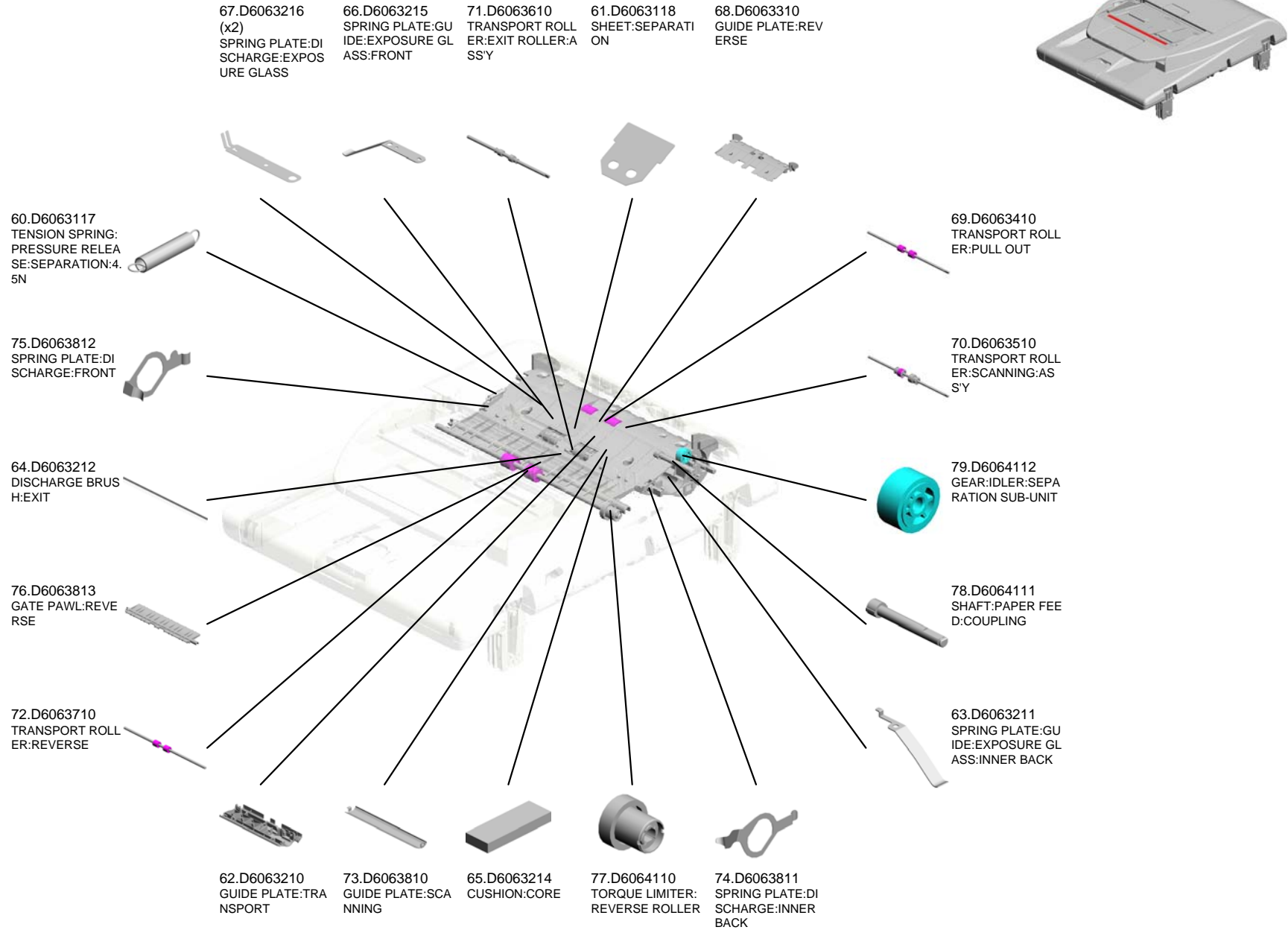



U004  
ADF



- 81.D6064114 (x2) GEAR:IDLER:NO.4
- 90.D6064123 GEAR:IDLER:MECHANICAL ROLLER CLUTCH:LOWER
- 91.D6064124 COLLAR:REVERSE
- 89.D6064122 GEAR:IDLER:MECHANICAL ROLLER CLUTCH:UPPER POSITION
- 80.D6064113 GEAR:IDLER:PULL OUT

92.D6064125 ARM:SWIVEL:REVERSE

94.D6064127 (x2) GEAR:SWIVEL:REVERSE

98.D6064131 PLANE SHAFT BEARING:REVERSE

93.D6064126 GEAR:SWIVEL:CONTACT POINT:REVERSE

95.D6064128 LEVER:GATE PAWL

96.D6064129 LINK:GATE PAWL:REVERSE

97.D6064130 TENSION SPRING:GATE PAWL:REVERSE

88.D6064121 GEAR:ROLLER:EXIT

84.D6064117 GEAR:SLOW DOWN:EXIT

82.D6064115 (x2) GEAR:SLOW DOWN:MOTOR

86.D6064119 GEAR:ROLLER:PULL OUT

85.D6064118 GEAR:SLOW DOWN:PULL OUT

99.D6064151 SPRING:MECHANICAL SPRING CLUTCH:PAPER FEED

87.D6064120 GEAR:ROLLER:SCANNING

83.D6064116 GEAR:SLOW DOWN:SCANNING

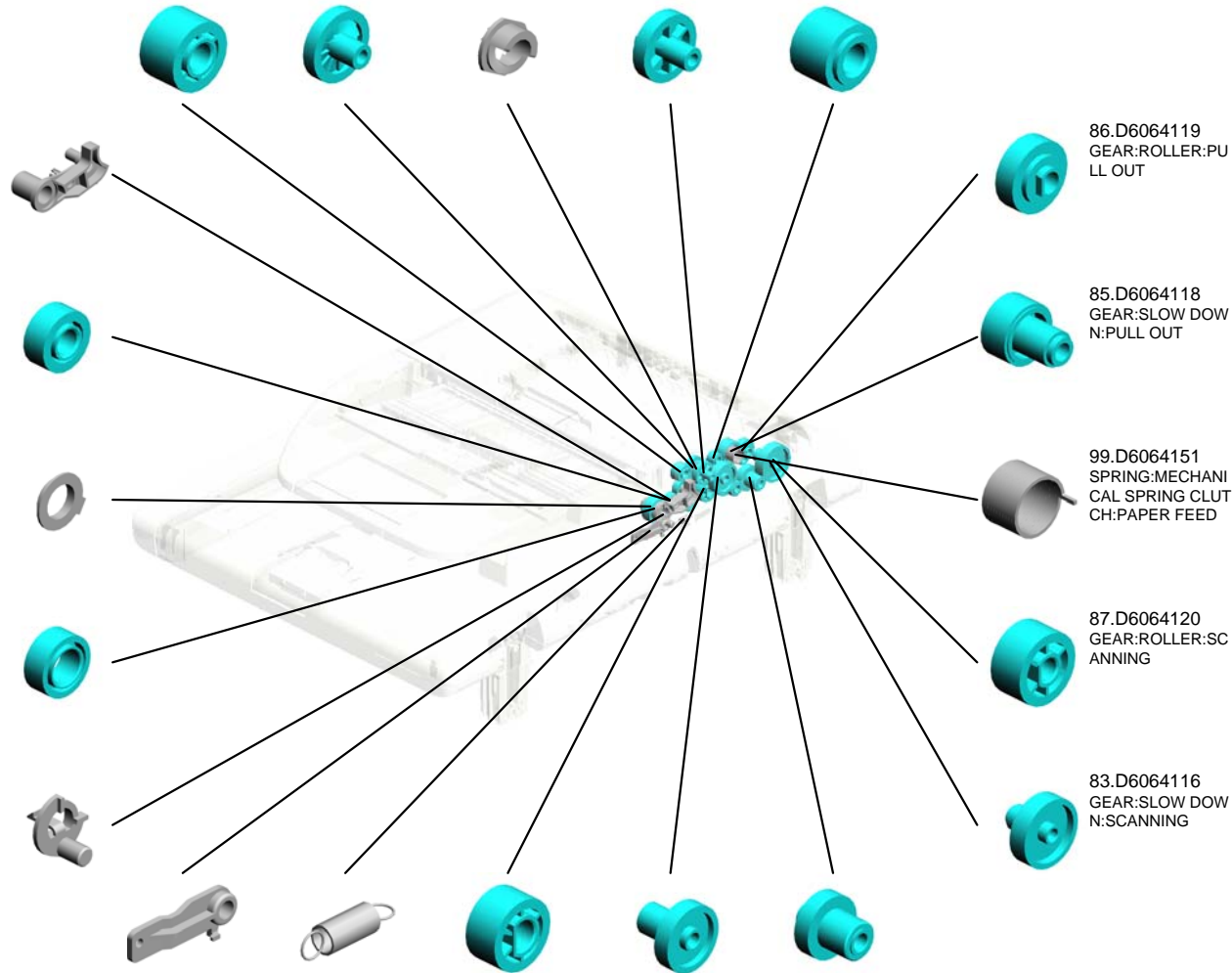

U004  
ADF

107.D6064511  
LEVER:COVER:PA  
PER FEED

109.D6064513  
TORSION SPRING:  
COVER:PAPER FE  
ED:INNER BACK

113.D6064517  
(x2)  
PLANE SHAFT BEA  
RING:4MM

106.D6064510  
COVER:PAPER FE  
ED

112.D6064516  
SHAFT:ROLLER:P  
ULL OUT



108.D6064512  
(x2)  
PAWL:COVER:PAP  
ER FEED

119.D6064613  
SIDE FENCE:FRON  
T

116.D6064610  
ORIGINAL TABLE

118.D6064612  
SIDE FENCE:INNE  
R BACK

117.D6064611  
EXTENSION TRAY

115.D6064519  
FEELER:ORIGINAL  
SENSOR

111.D6064515  
(x2)  
ROLLER:DRIVEN:S  
HORT

110.D6064514  
TORSION SPRING:  
COVER:PAPER FE  
ED:FRONT

105.D6064340  
DC MOTOR UNIT:1  
1W/20W:BRUSH

104.D6064311  
BRACKET:DRIVE S  
UB-UNIT

114.D6064518  
(x2)  
COMPRESSION SP  
RING:DRIVEN ROL  
LER:PULL OUT

100.D6064152  
GEAR:MECHANICA  
L SPRING CLUTCH  
:PAPER FEED

101.D6064153  
RATCHET:MECHA  
NICAL SPRING CL  
UTCH:PAPER FEE  
D

102.D6064154  
DRUM:MECHANIC  
AL SPRING CLUTC  
H:PAPER FEED

103.D6064310  
BRACKET:DRIVE

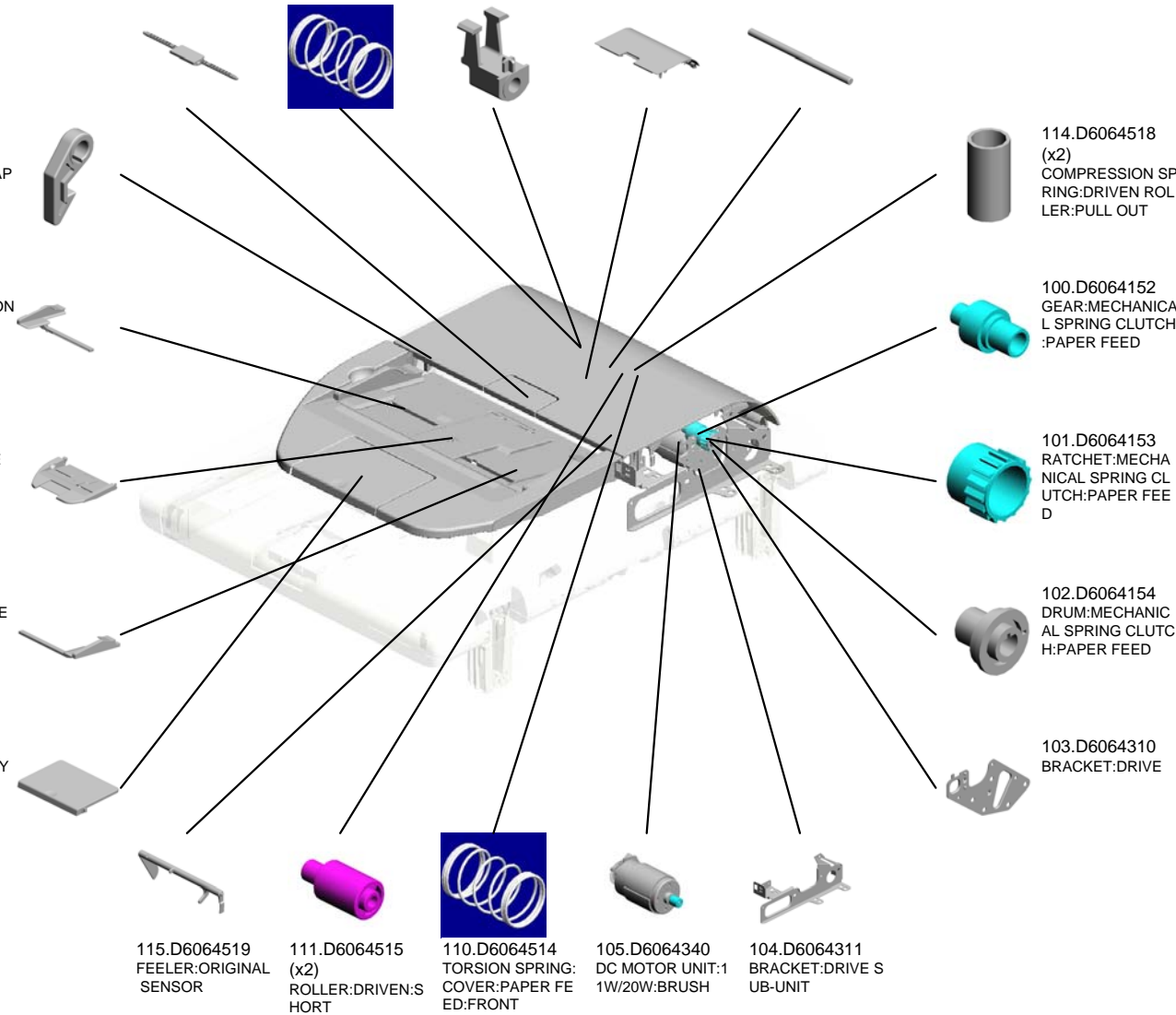

# U004 ADF

121.D6064615 PIN:SIDE FENCE  
 122.D6064616 DISC:SIDE FENCE  
 125.D6064619 (x2) SPRING PLATE:REVERSE:PRESSURE  
 132.GA082010 (x5) BUSHING:DIA6:DIA10:9  
 139.M3644821 (x2) TAPE:PRESSURE PLATE:LEFT



127.D6064810 COVER:FRONT

130.D6066031 DECAL:ORIGINAL SCALE

120.D6064614 GEAR:SIDE FENCE

123.D6064617 COIL SPRING:SIDE FENCE:ARDF:12N

140.M3644823 (x2) TAPE:PRESSURE PLATE

136.M3641381 (x2) HOLDER:PRESSURE PLATE:RIGHT

128.D6064910 PRESSURE PLATE

129.D6065110 PCB:DFRB

133.GX110023 DC SOLENOID:24V:REVERSE

126.D6064710 COVER:REAR

135.H5211350 PAD - PICK-UP

124.D6064618 ROLLER:REVERSE:DRIVEN

134.GX110024 DC SOLENOID:MECHANICAL SPRING CLUTCH:PAPER FEED UNIT

137.M3641387 (x2) BRACKET:PRESSURE PLATE

131.D6066032 DECAL:SIDE FENCE

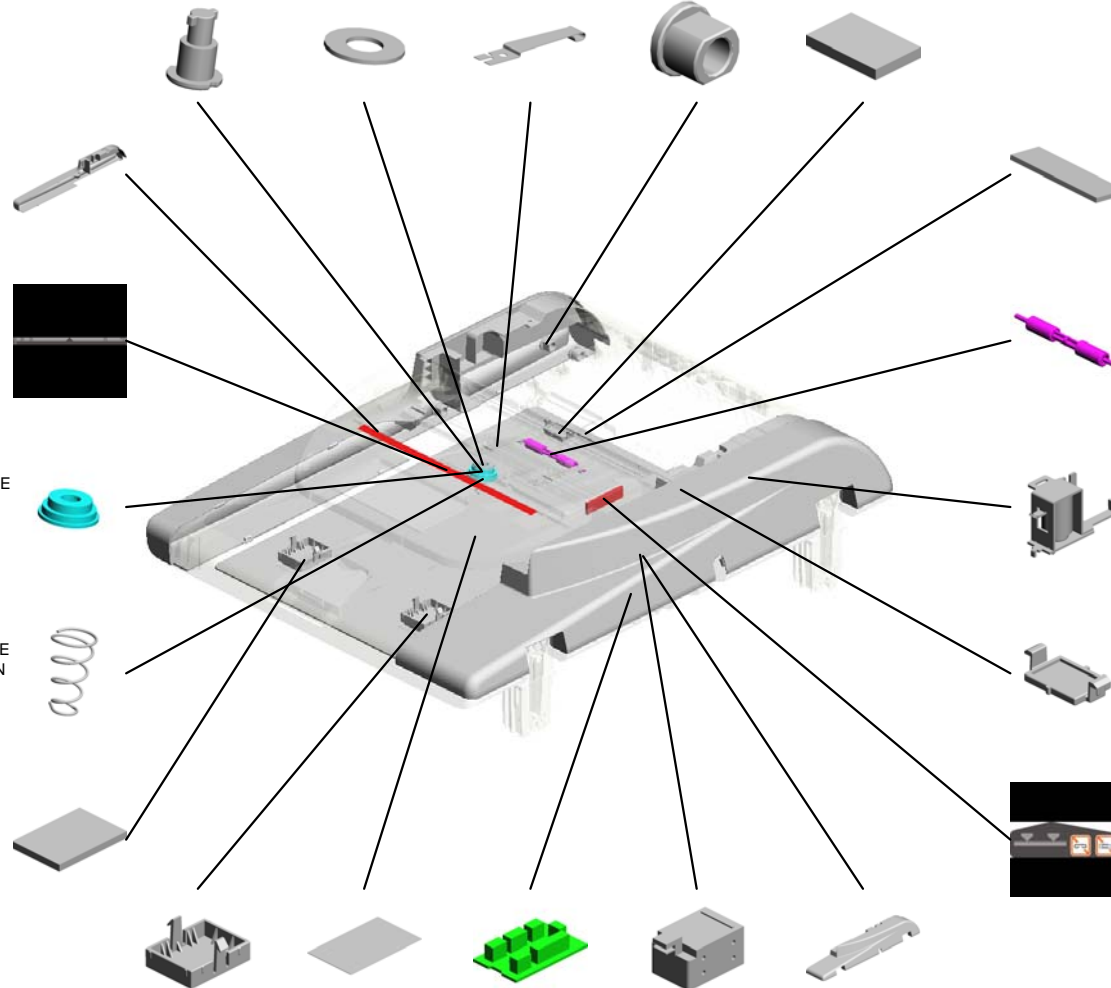

# U004\_S001 PAPER FEED UNIT:ASS'Y

138.M3642124  
COMPRESSION SPRING: PAPER FEED UNIT

47.D6062115  
TORQUE LIMITER MECHANICAL CLUTCH: FEED

49.D6062117  
(x3)  
GEAR: IDLER: FEED

8.06320080G  
PARALLEL KEY - 2 X8MM

48.D6062116  
GEAR: FEED



41.D6062100  
PAPER FEED UNIT: ASS'Y

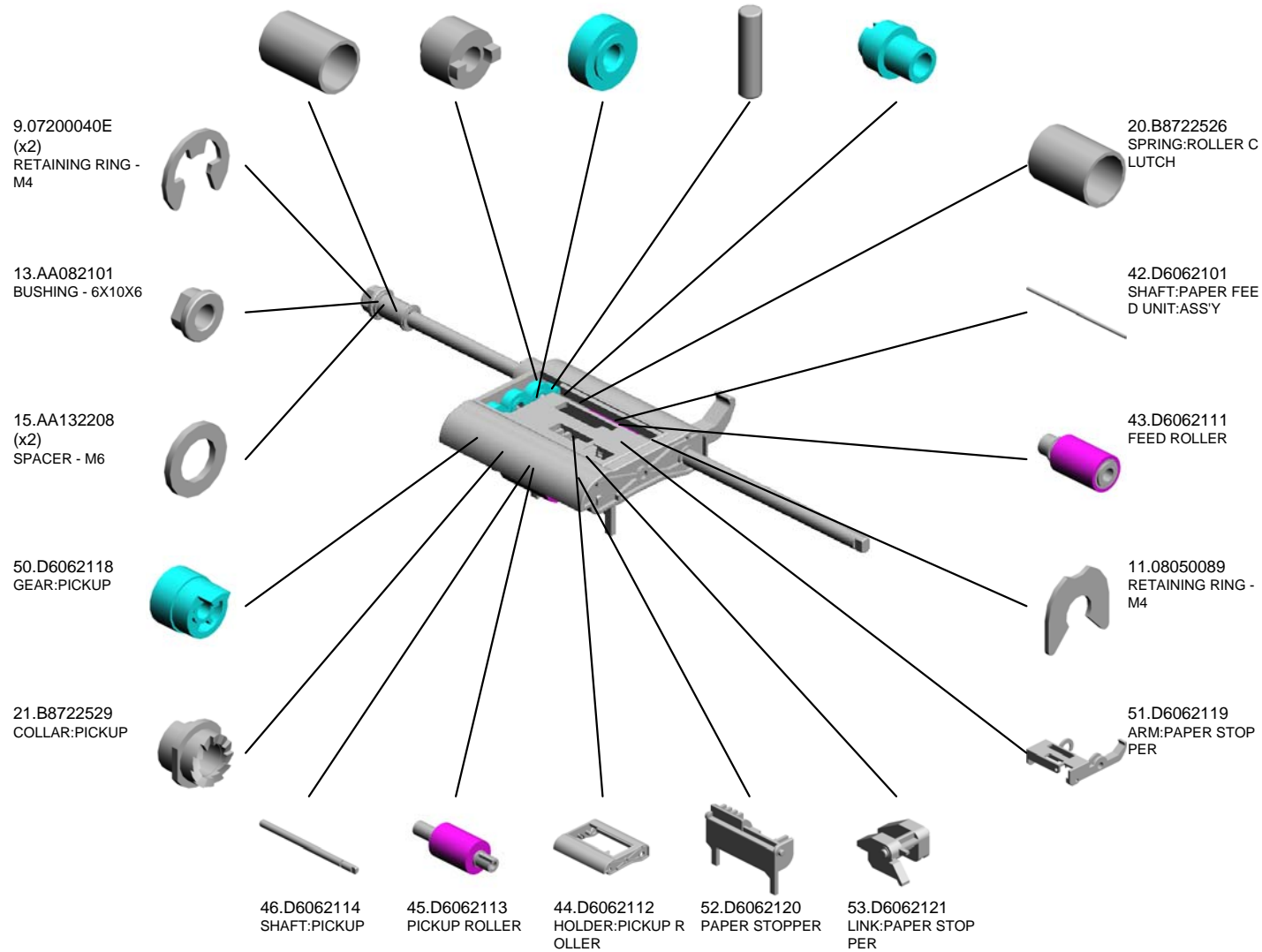

U001	U002	U003	U004	U005	U006	U007	U008	U009	U010	U011	U012	U013
------	------	------	------	------	------	------	------	------	------	------	------	------

# U005 SCANNER

7.AW020203 PHOTOINTERRUPTOR:GP1A173LCS 2F  
 9.D1171651 CARRIAGE:SCANNER:ASSY  
 10.D1171657 EXPOSURE GLASS UNIT:SCANNER:ASSY  
 12.D1171753 SLIDE RAIL  
 11.D1171752 RAIL:SCANNER

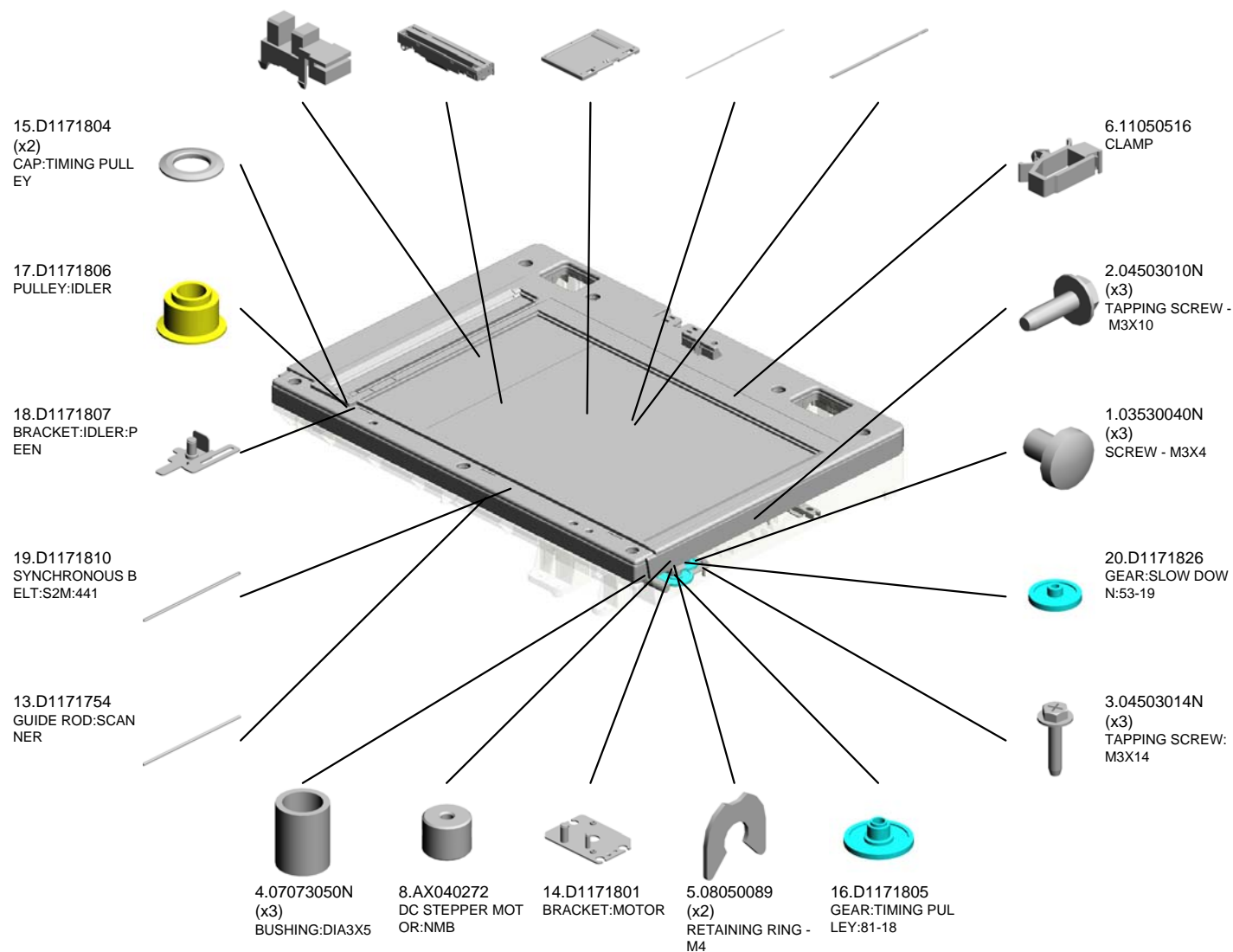

U001	U002	U003	U004	U005	U006	U007	U008	U009	U010	U011	U012	U013
------	------	------	------	------	------	------	------	------	------	------	------	------

# U005 SCANNER

21.D1171837  
COIL SPRING:TEN  
SION

23.M0261718  
DECAL:SCALE:LEF  
T:EU

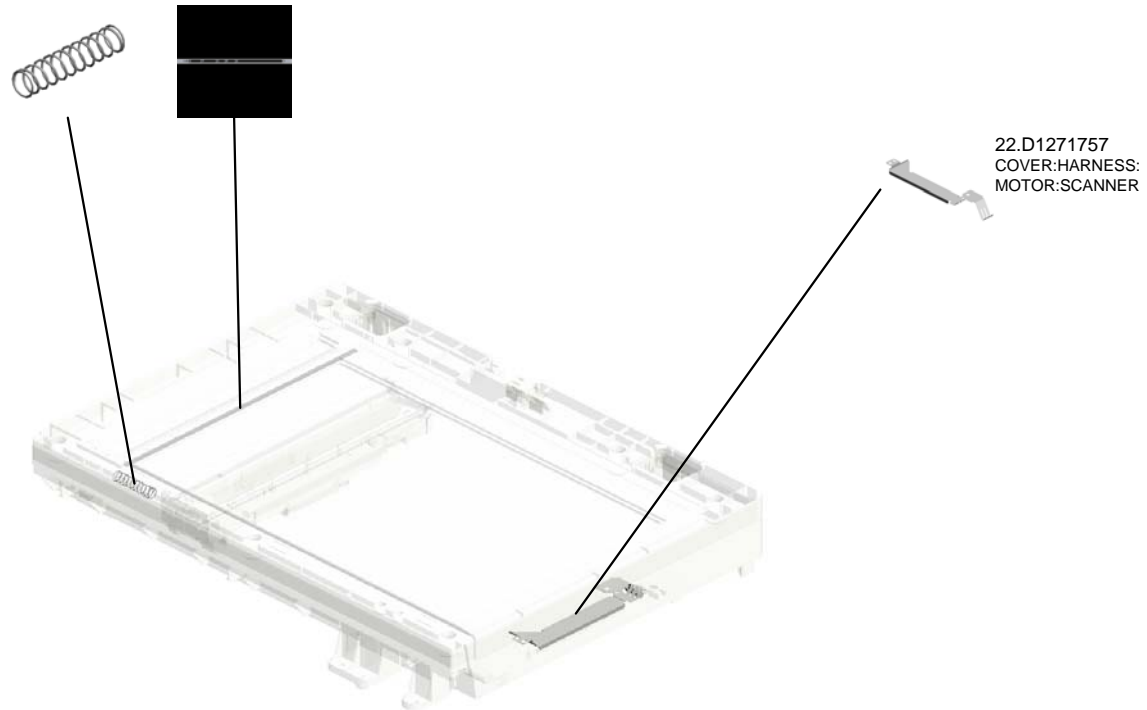
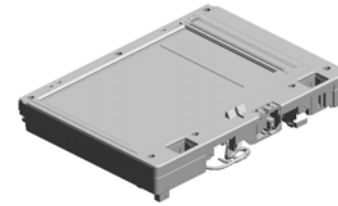

U001	U002	U003	U004	<b>U005</b>	U006	U007	U008	U009	U010	U011	U012	U013
------	------	------	------	-------------	------	------	------	------	------	------	------	------

# U006.LASER UNIT

U006\_S001  
D1271850  
OPTICAL WRITING UNIT:ASS  
Y

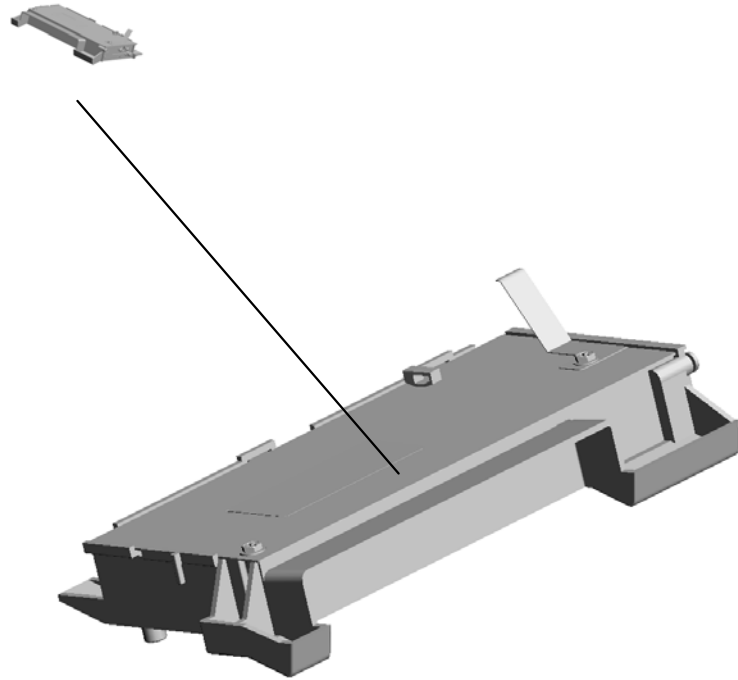

U001	U002	U003	U004	U005	U006	U007	U008	U009	U010	U011	U012	U013
------	------	------	------	------	------	------	------	------	------	------	------	------

U006  
LASER UNIT

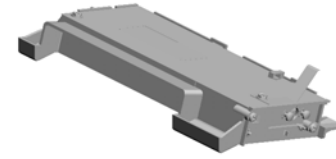

U001	U002	U003	U004	U005	U006	U007	U008	U009	U010	U011	U012	U013
------	------	------	------	------	------	------	------	------	------	------	------	------



U006\_S001  
OPTICAL WRITING UNIT:ASS'Y

3.D1271956  
DC POLYGON MIRROR MOTOR:11.5  
W:BRUSHLESS

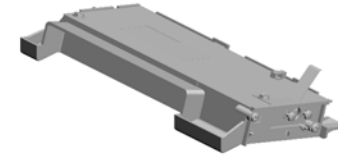

2.D1271850  
OPTICAL WRITING  
UNIT:ASSY

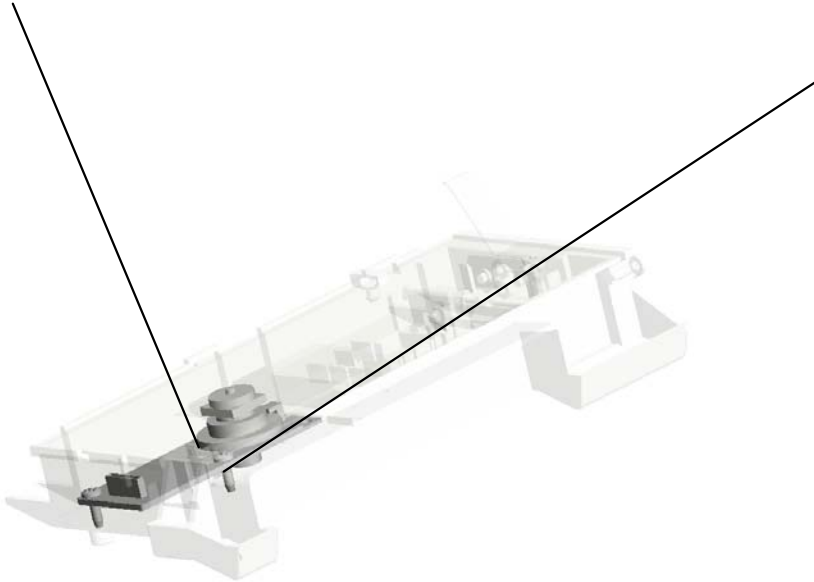

1.08025318  
(x3)  
BINDING HEAD TAPPING SCREWS:  
3X10

U001	U002	U003	U004	U005	<b>U006</b>	U007	U008	U009	U010	U011	U012	U013
------	------	------	------	------	-------------	------	------	------	------	------	------	------

# U007.DEVELOPMENT

U007\_S001  
D1273020  
TONER SUPPLY UNIT



U001	U002	U003	U004	U005	U006	U007	U008	U009	U010	U011	U012	U013
------	------	------	------	------	------	------	------	------	------	------	------	------

U007  
DEVELOPMENT

9.D1273201  
DC MOTOR:TONE  
R BOTTLE:2.4W:B  
RUSH

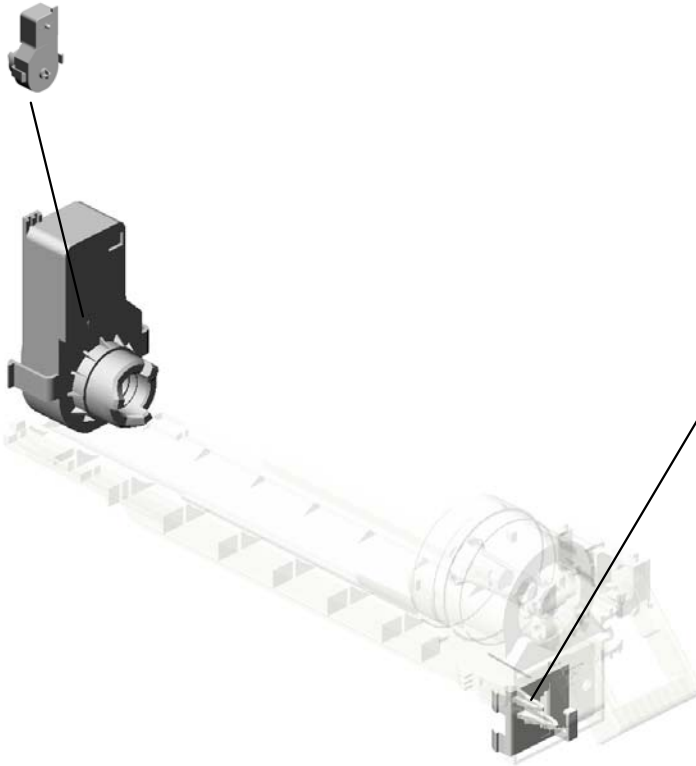

7.D1271105  
POSITIONING PLA  
TE:TONER SUPPL  
Y

U001	U002	U003	U004	U005	U006	U007	U008	U009	U010	U011	U012	U013
------	------	------	------	------	------	------	------	------	------	------	------	------

# U007\_S001 TONER SUPPLY UNIT

11.D1273465 COVER:TONER BOTTLE:ASS'Y  
 1.A1843420 BOTTLE CHUCK  
 6.B0443485 SLIDER ASS'Y



8.D1273020  
TONER SUPPLY UNIT

2.A2673556 CHUCK SPRING - TONER BOTTLE

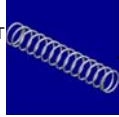

5.B0443470 TONER SUPPLY CASE ASS'Y



3.B0443426 CHUCK SHAFT



4.B0443427 SLIDE SHAFT

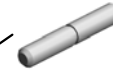

10.D1273461 CAM:HANDLE

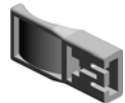
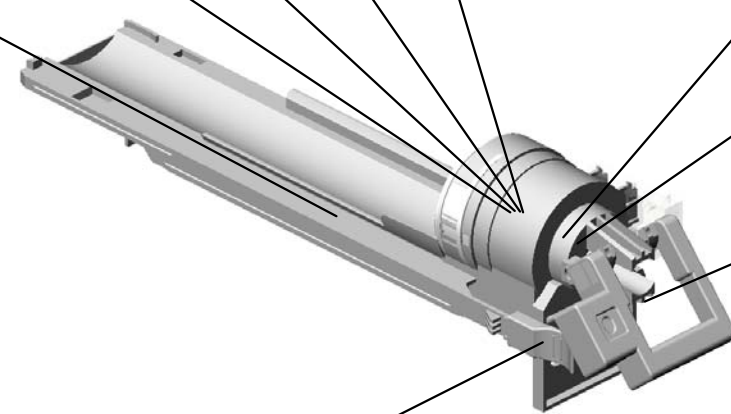

12.D1273475 GRIP:UN LOCK:TONER SUPPLY UNIT

U001	U002	U003	U004	U005	U006	U007	U008	U009	U010	U011	U012	U013
------	------	------	------	------	------	------	------	------	------	------	------	------

U008  
PCU

1.D1272110  
PCU

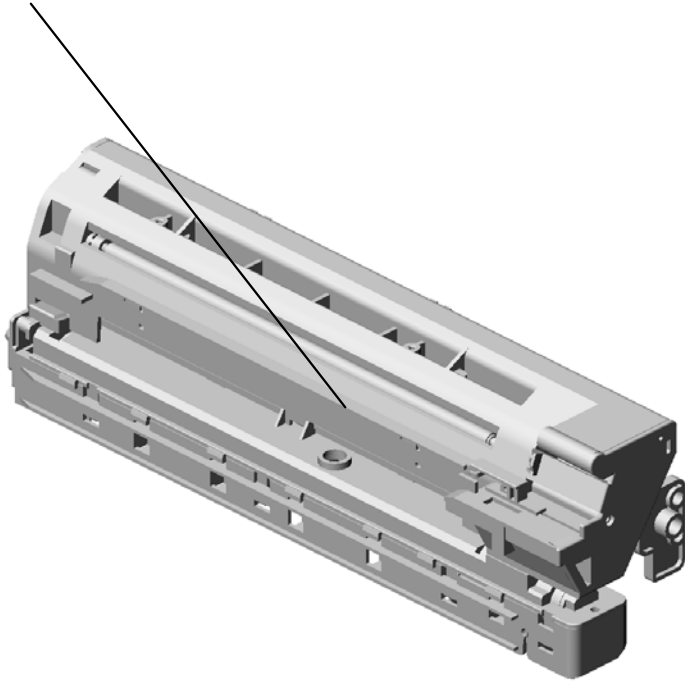

U001	U002	U003	U004	U005	U006	U007	<b>U008</b>	U009	U010	U011	U012	U013
------	------	------	------	------	------	------	-------------	------	------	------	------	------

# U009.FUSING

U009\_S001  
D1274028  
FUSING UNIT:EU/AP

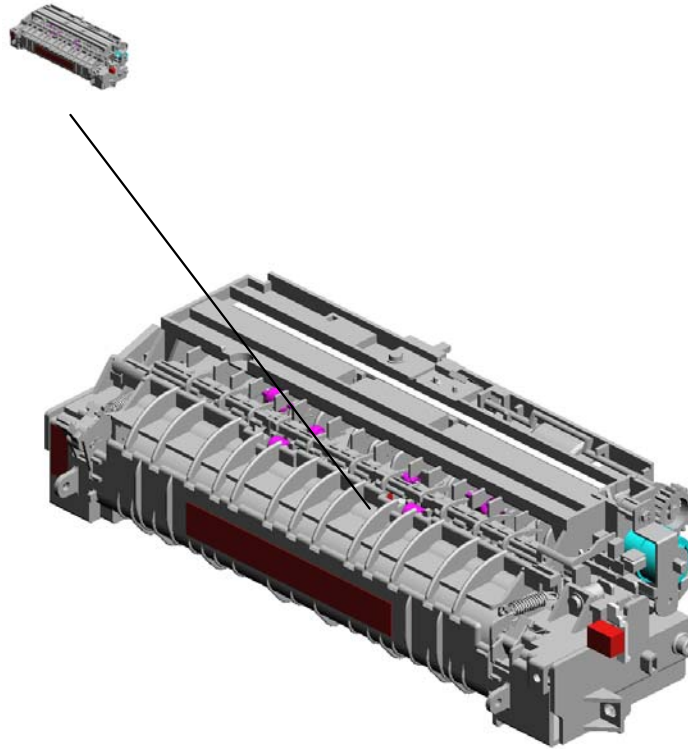

U001	U002	U003	U004	U005	U006	U007	U008	U009	U010	U011	U012	U013
------	------	------	------	------	------	------	------	------	------	------	------	------

U009  
FUSING

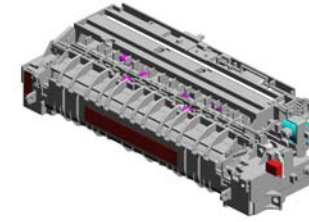

U001	U002	U003	U004	U005	U006	U007	U008	U009	U010	U011	U012	U013
------	------	------	------	------	------	------	------	------	------	------	------	------

U009\_S001  
FUSING UNIT:EU/AP

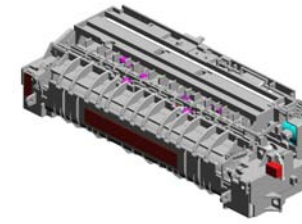

30.D1274028  
FUSING UNIT:EU/AP

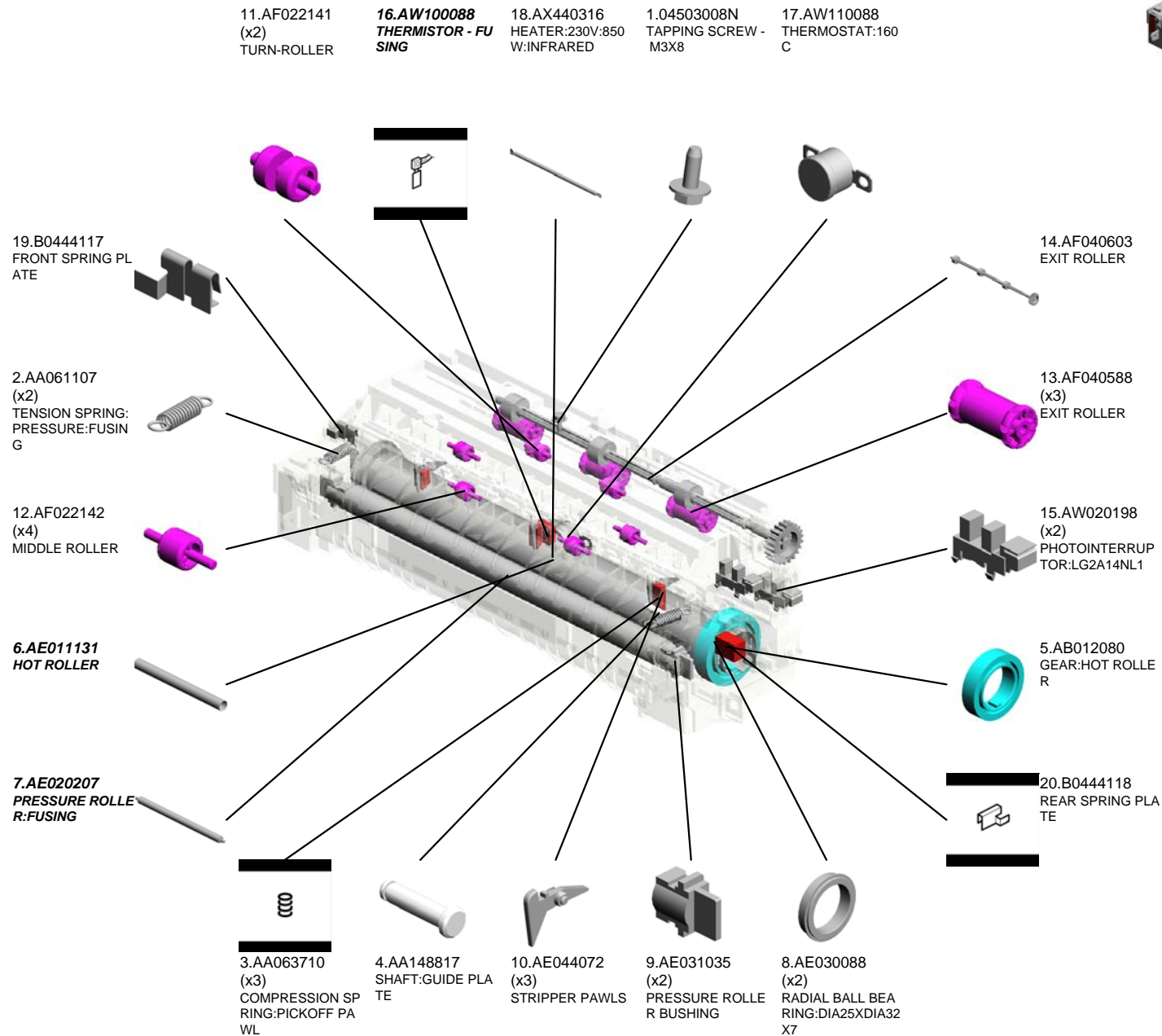

U001	U002	U003	U004	U005	U006	U007	U008	U009	U010	U011	U012	U013
------	------	------	------	------	------	------	------	------	------	------	------	------



U009\_S001  
FUSING UNIT:EU/AP

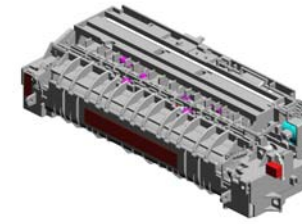

30.D1274028  
FUSING UNIT:EU/A  
P

32.D1274104 FRAME:PRESSURE  
28.B1294294 SCREW-M3X13  
27.B0444401 PAPER HOLDER STAND  
29.D0674165 DISCHARGE BRUSH:EXIT  
25.B0444166 SPRING PLATE

36.D1274132 SIDE PLATE:PRESSURE:FRONT

23.B0444150 (x2) HOT ROLLER STOPPER

41.D1274153 (x2) CUSHION:PRESSURE RELEASE

33.D1274113 CAP:HOT ROLLER

34.D1274129 LEVER:PRESSURE:FUSING:FRONT:ASSY

35.D1274131 LEVER:PRESSURE:FUSING:REAR:ASSY

38.D1274134 ELECTRODE PLATE:FUSING

37.D1274133 SIDE PLATE:PRESSURE:REAR

39.D1274136 GROUND PLATE:FUSING

40.D1274147 COVER:ELECTRODE PLATE

22.B0444138 (x2) SPRING

24.B0444154 EXIT SPRING

26.B0444183 FEELER

31.D1274086 STUD:GEAR:FIX

21.B0444135 LAMP HOLDER

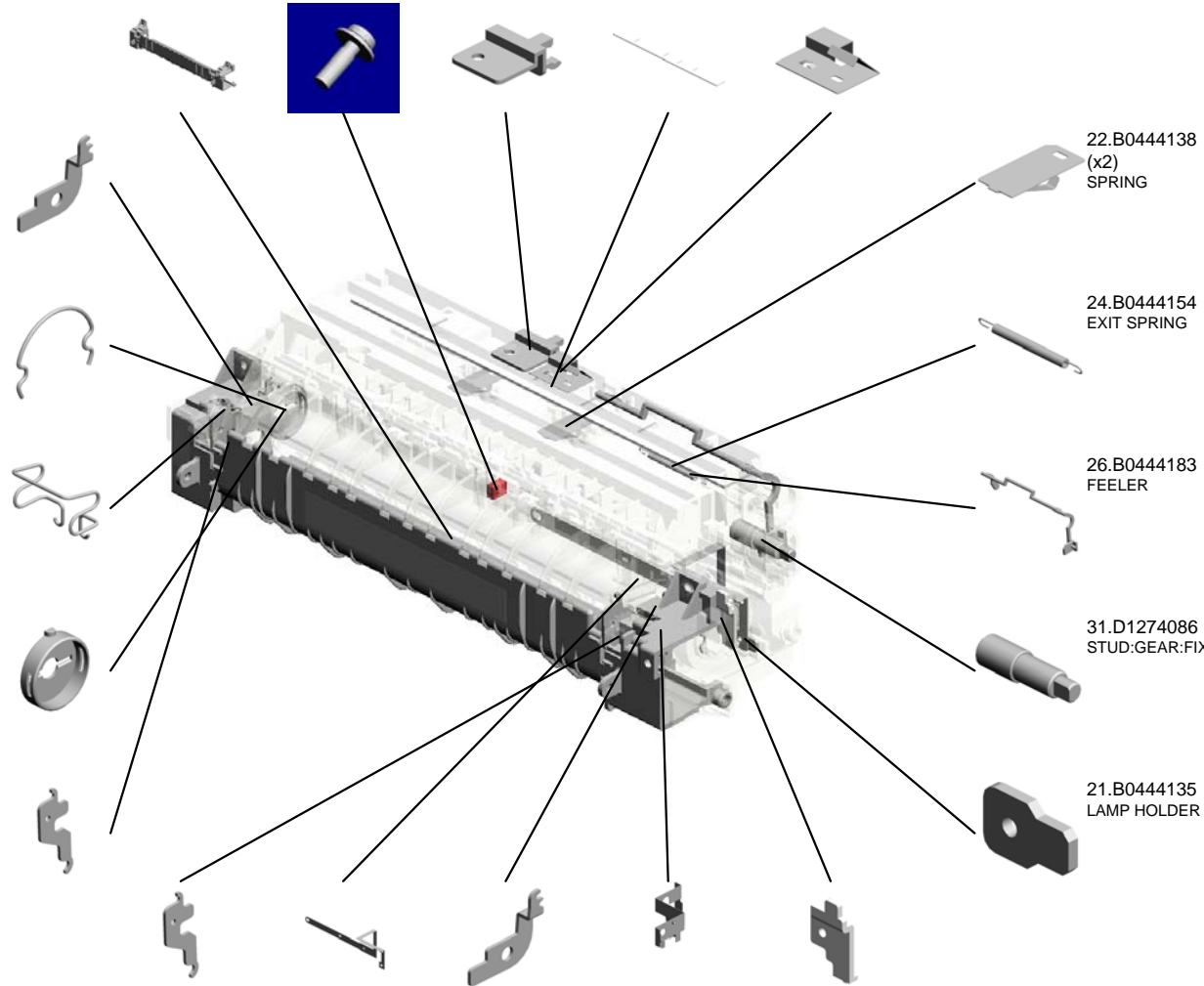

U009\_S001  
FUSING UNIT:EU/AP

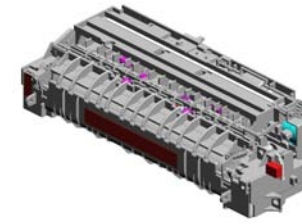

30.D1274028  
FUSING UNIT:EU/AP

54.H5562220  
(x2)  
ROLLER

49.D1274457  
(x2)  
GUIDE:GATE PLATE:  
E:FRONT

50.D1274458  
GATE PLATE:FUSI  
NG

47.D1274409  
GUIDE PLATE:EXIT

42.D1274154  
LEVER:PRESSURE  
RELEASE:FRONT

45.D1274165  
DECAL:C:GRIP

44.D1274163  
GUIDE PLATE:PRE  
SSURE:DUPLIX

51.D1274460  
DECAL:H-TEMP W  
ARNING

43.D1274155  
LEVER:PRESSURE  
RELEASE:REAR

48.D1274456  
(x2)  
GUIDE:GATE PLATE:  
E:REAR

46.D1274179  
(x3)  
HOLDER:PICKOFF  
PAWL

52.H5562210  
GEAR - 19/28Z

53.H5562219  
GEAR BRACKET

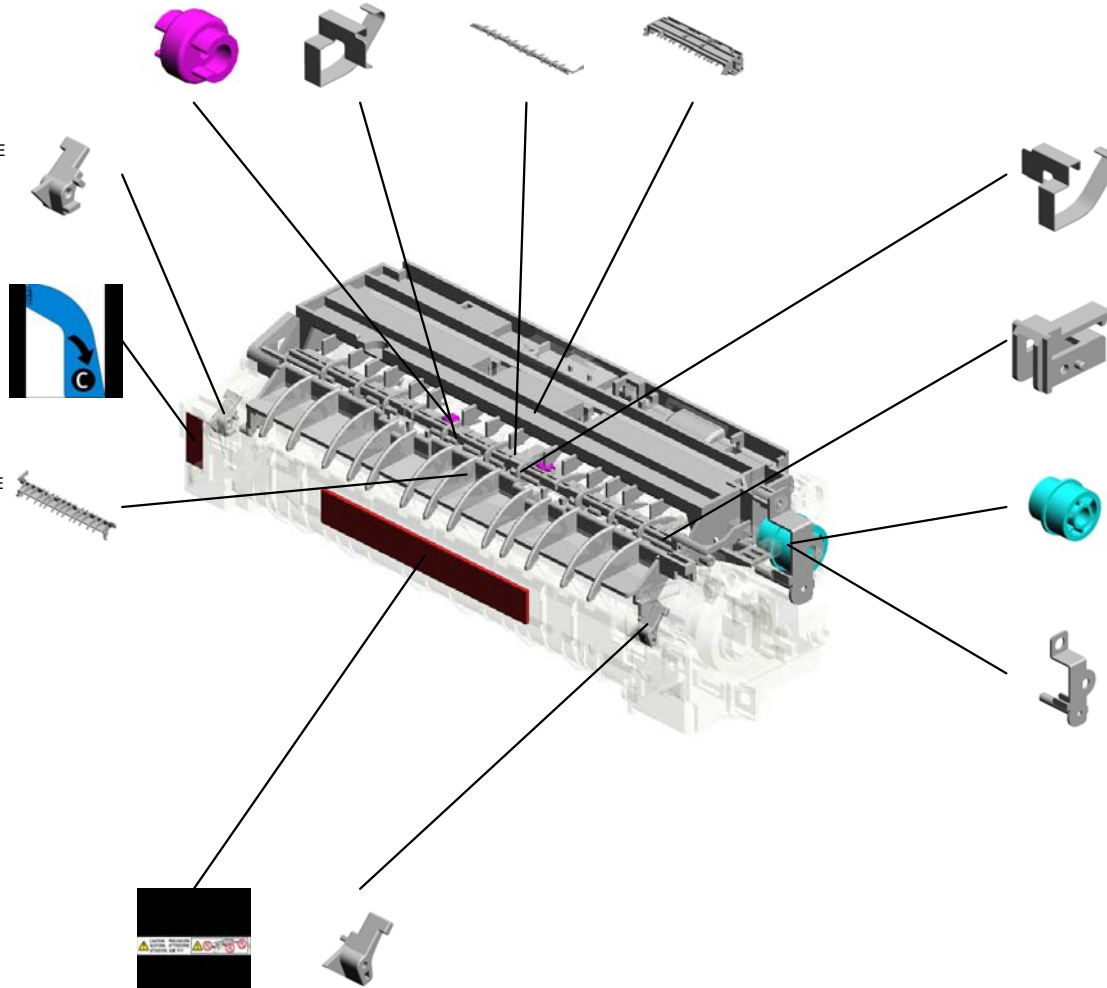

# U010 DUPLEX

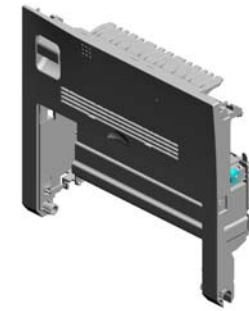

- 16.B0443860 TRANSFER PLATE
- 3.07200040E (x4) RETAINING RING - M4
- 6.AB012033 GEAR - 21Z
- 1.04503008N TAPPING SCREW - M3X8
- 4.50530447 (x2) BUSHING - 6MM

18.B0443866 TRANSFER ROLLER SPRING - REAR



11.B0442615 (x2) PRESSURE SPRING



12.B0442621 BUSHING - DRIVE N ROLLER



15.B0442861 REAR STOPPER PLATE



7.AF022139 (x2) DRIVEN ROLLER - FRONT REAR



20.B0443894 DENSITY SENSOR: LONGDIST:ADHESION



19.B0443870 TRANSFER GUIDE



8.AF022140 MIDDLE DRIVEN ROLLER

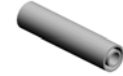

13.B0442624 REGISTRATION ROLLER SHAFT



9.B0442612 GUIDE PLATE



5.AA063409 RIGHT DOOR SPRING



2.04503010N TAPPING SCREW - M3X10



17.B0443865 TRANSFER ROLLER SPRING - FRONT



10.B0442614 DRIVEN ROLLER BUSHING



14.B0442860 FRONT STOPPER PLATE



# U010 DUPLEX

- 35.D1274805 (x2) ROLLER:DUPLEX:DRIVE
- 36.D1274806 TRANSPORT ROLLER:DUPLEX:DRIVE
- 33.D1274680 GUIDE PLATE:COVER
- 31.D1274660 COVER:RIGHT
- 28.D1274605 LEVER:COVER:RIGHT

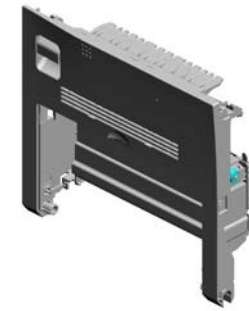

40.H5564186 POSITIONING ROLLER

26.D1274321 ELECTRODE PLATE:TRANSFER/DISCHARGE

37.D1274807 COMPRESSION SPRING:1:DUPLEX:CONNECTING:DRIVEN

23.D1176256 ELECTRODE PLATE:DISCHARGE

25.D1273802 TRANSFER ROLLER:ASS'Y

27.D1274604 GUIDE PLATE:REVERSE:1

29.D1274631 GUIDE PLATE:2:REVERSE

24.D1272198 SPRING PLATE:TRANSFER/DISCHARGE

38.D1274809 ELECTRODE PLATE:DISCHARGE

21.B0443990 (x2) POSITIONING SPRING - TRANSFER ROLLER

32.D1274669 COMPRESSION SPRING:LEVER

30.D1274654 PLATE:COMPRESSION SPRING:RIGHT:COVER

39.D1274816 COMPRESSION SPRING:2:DUPLEX:CONNECTING:DRIVEN

34.D1274705 SPRING PLATE:DISCHARGE:FEED PAPER AGAIN

22.B0444624 RIGHT DOOR BELT

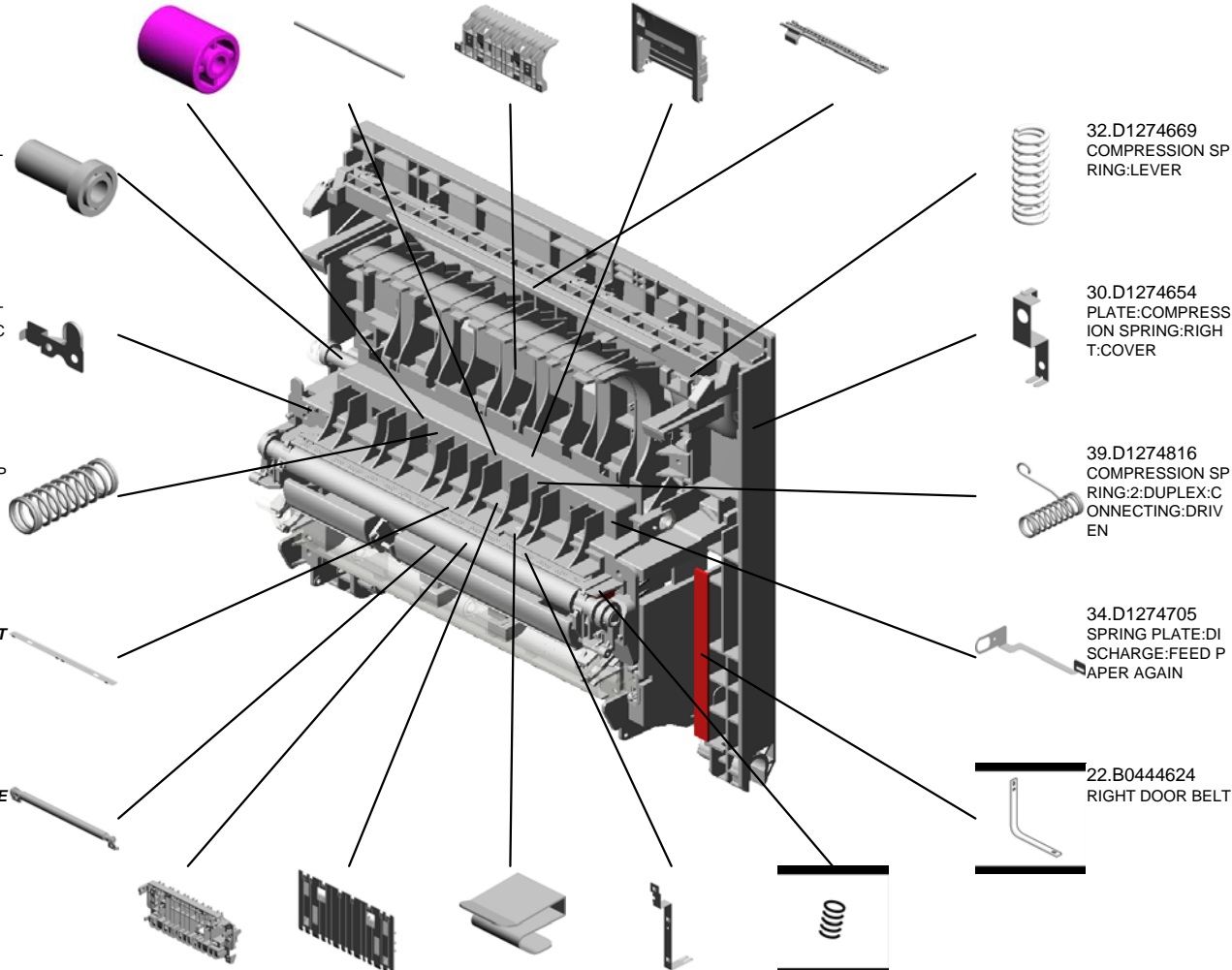

U010  
DUPLEX

41.H5564190  
TRANSPORT ROLL  
ER

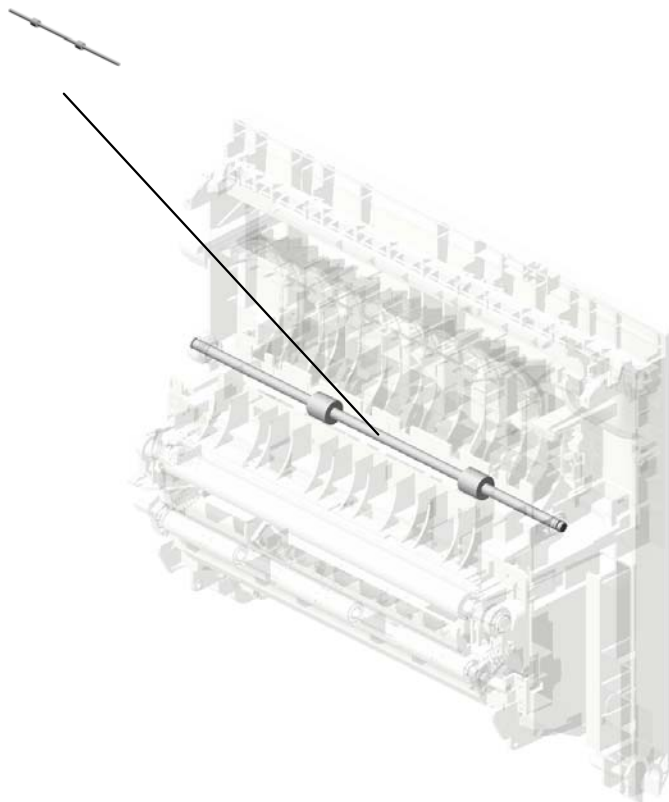
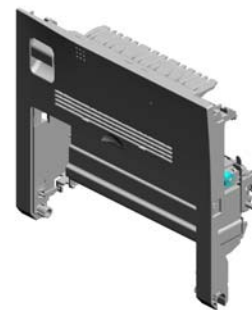

U001	U002	U003	U004	U005	U006	U007	U008	U009	U010	U011	U012	U013
------	------	------	------	------	------	------	------	------	------	------	------	------

# U011.MAIN DRIVE

U011\_S001  
D1271034  
PLATE:DRIVE:REAR:1:ASSY

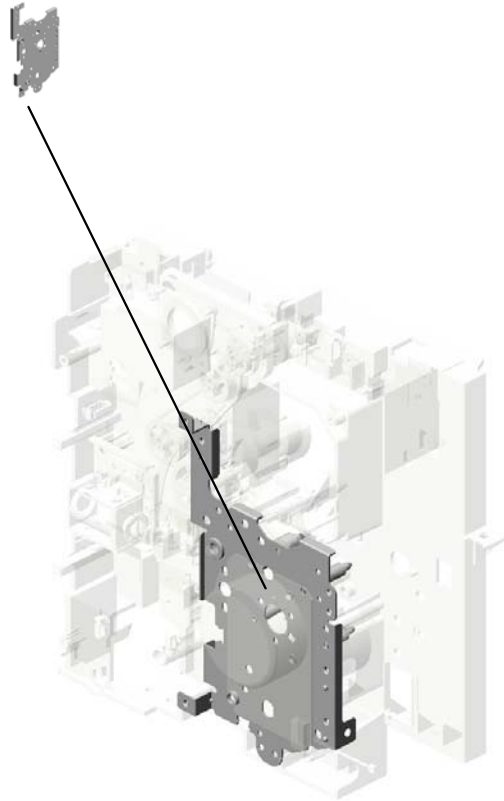

U001	U002	U003	U004	U005	U006	U007	U008	U009	U010	U011	U012	U013
------	------	------	------	------	------	------	------	------	------	------	------	------

# U011 MAIN DRIVE

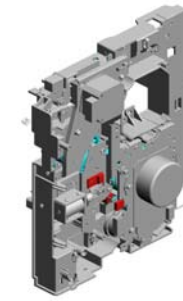

- 1.04503010N (x3) TAPPING SCREW - M3X10
- 2.04533006N (x5) TAPPING SCREW - M3X6
- 8.A2324666 CUSHION - STEPPER MOTOR
- 3.07200040E RETAINING RING - M4
- 9.AA043604 TIMING BELT:B40S 2M110

5.11050516 (x4) CLAMP

6.11050534 CLAMP

16.AA143804 FUSING SHAFT 5

15.AA120124 GROUND PLATE - DRUM DRIVE

10.AA062326 SPRING - SWIVEL FUSING

17.AA161157 BRACKET CUSHION

4.11050511 (x2) HARNESS CLAMP - LWS-0306ZC

21.AB017628 GEAR - 19/38Z

14.AA120104 GROUND PLATE - REGISTRATION

20.AB017585 COUPLED GEAR - 17/44Z

13.AA113035 ELECTRODE PLATE - TRANSFER

18.AB010358 GEAR - 64Z

11.AA113032 ELECTRODE PLATE - DEVELOPMENT

19.AB011492 GEAR - 29Z

12.AA113034 ELECTRODE PLATE - CHARGE

U001	U002	U003	U004	U005	U006	U007	U008	U009	U010	U011	U012	U013
------	------	------	------	------	------	------	------	------	------	------	------	------

# U011 MAIN DRIVE

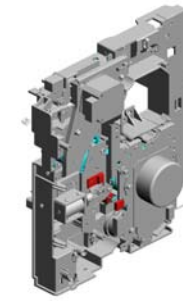

37.D1271137 GEAR:FUSING:NO.5  
 22.AB032071 PULLEY - 24Z  
 39.D1271143 GEAR:FUSING:NO.6  
 31.D1271041 SHAFT:DRUM:ASS'Y  
 42.D1271171 GROUND PLATE:BRACKET:REAR

27.B1291161 LEVER DC SOLENOID ASS'Y

28.D1271031 BRACKET:FUSING:SWIVEL:ASS'Y

38.D1271138 PLATE:DRIVE:REAR:2

26.B1291129 PLATE CUSHION

25.B1291056 SHAFT SPACER

24.B0441139 (x2) DAMPING INSULATOR

41.D1271170 BUSHING:DIA6XDI A10X7:C5

36.D1271136 GEAR:DEVELOPMENT:FUSING:NO.2

40.D1271151 BRUSHLESS MOTOR:MAIN:24V:44W

35.D1271135 GEAR:DEVELOPMENT:FUSING:NO.1

23.B0441102 REGISTRATION ELECTRODE PLATE

30.D1271040 SHAFT:DEVELOPMENT:ASS'Y

34.D1271134 GEAR:DRUM:NO.2

33.D1271133 GEAR:DRUM:NO.1

32.D1271132 GEAR:PAPER FEED:NO.1

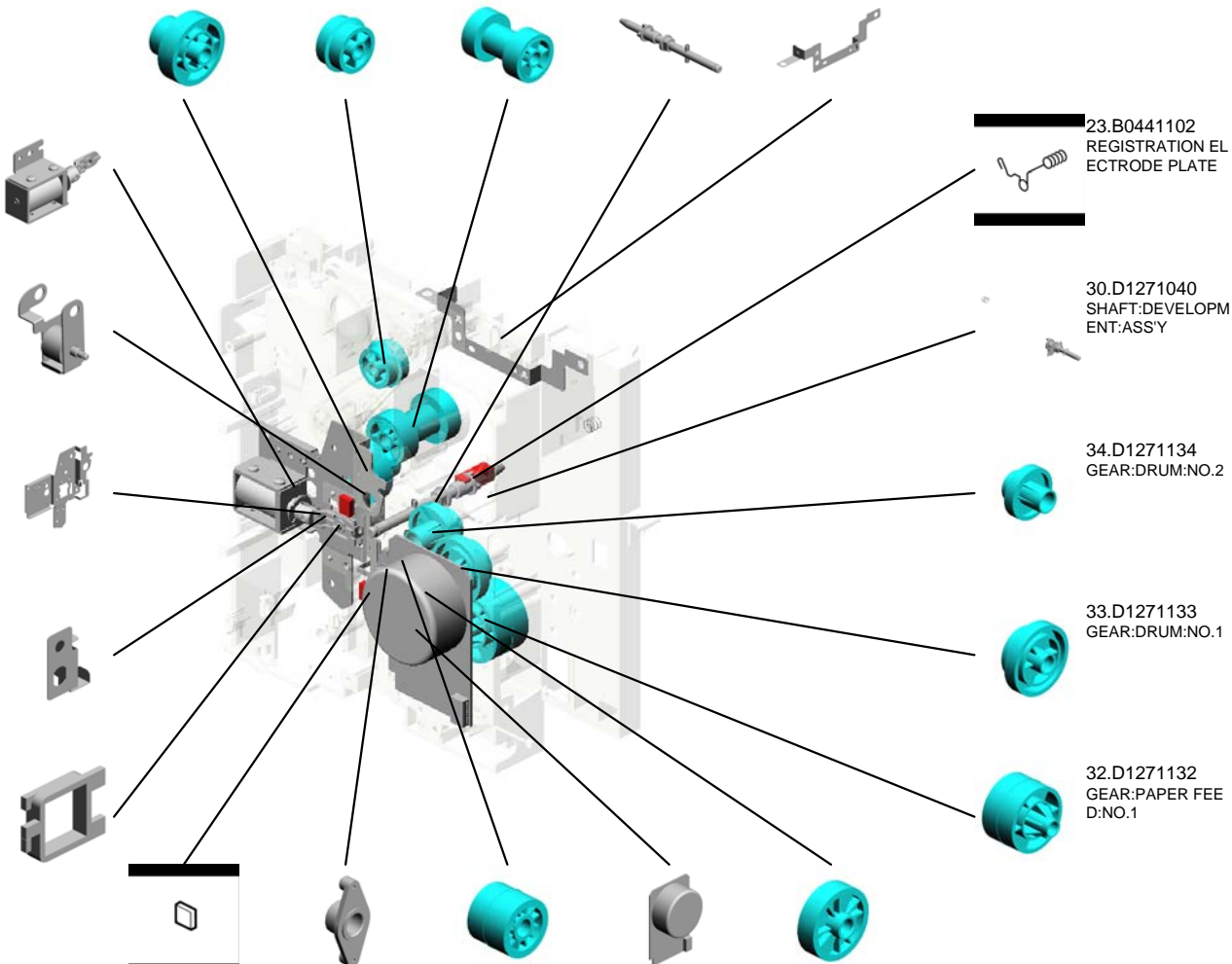



# U011 MAIN DRIVE

48.D1274661  
BRACKET:PLATE

51.D1274707  
BRACKET:BOTH E  
NDS:DRIVE:ASS'Y

50.D1274679  
GEAR:SLOW DOW  
N:DC STEPPER M  
OTOR

49.D1274678  
GEAR:TRANSPOR  
T ROLLER:DRIVE

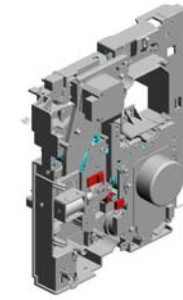

45.D1274507  
DC STEPPER MOT  
OR:DUPLEX:ASS'Y

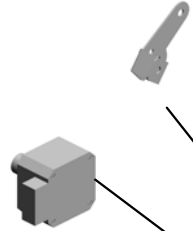

52.GA043033  
SYNCHRONOUS B  
ELT:S2M:L200



47.D1274657  
BRACKET:DC STE  
PPER MOTOR:ASS'  
Y



46.D1274577  
GROUND PLATE:B  
RACKET:DUPLEX:L  
OWER



44.D1272533  
SHAFT:PAPER FEE  
D ROLLER



43.D1272509  
ELECTROMAGNET  
IC CLUTCH:3.5T:P  
APER FEED



53.H5213355  
C RING - PAPER F  
EED ROLLER



U001	U002	U003	U004	U005	U006	U007	U008	U009	U010	U011	U012	U013
------	------	------	------	------	------	------	------	------	------	------	------	------

U011\_S001  
PLATE:DRIVE:REAR:1:ASS'Y

7.50530447  
BUSHING - 6MM

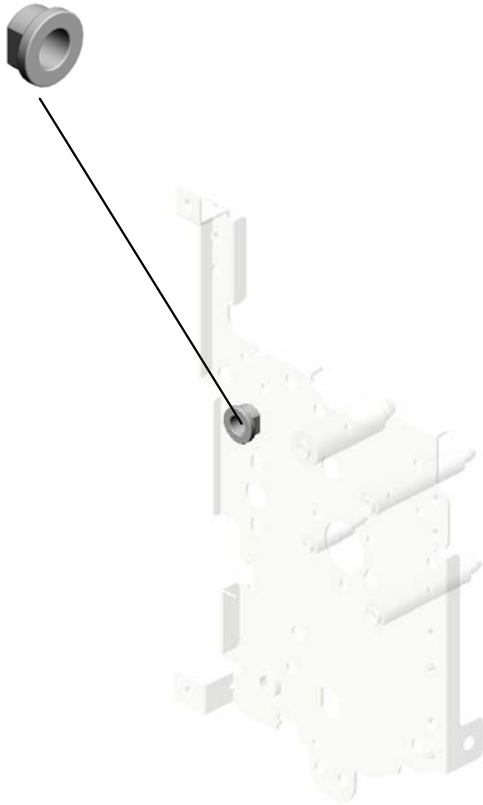

29.D1271034  
PLATE:DRIVE:REA  
R:1:ASS'Y

U001	U002	U003	U004	U005	U006	U007	U008	U009	U010	U011	U012	U013
------	------	------	------	------	------	------	------	------	------	------	------	------

# U012.ELECTRICAL

U012\_S001  
D1275410  
PCB:CTL:ASS'Y

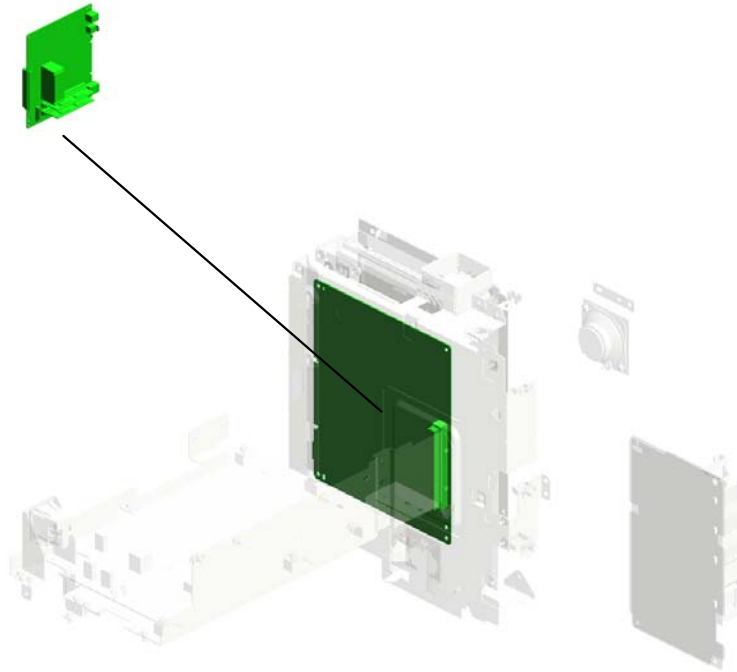

U001	U002	U003	U004	U005	U006	U007	U008	U009	U010	U011	U012	U013
------	------	------	------	------	------	------	------	------	------	------	------	------

# U012 ELECTRICAL

1.03603006N  
(x6)  
SCREW - M3X6

18.B1291309  
INTERFACE COVE  
R

2.03604006N  
(x2)  
SCREW - M4X6

20.B6225874  
RAIL: FAX CONTRO  
L UNIT

5.04513020N  
TAPPING SCREW:  
3X20

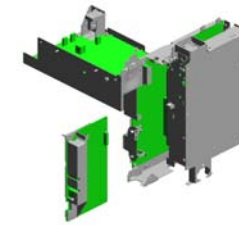

6.04533006N  
(x4)  
TAPPING SCREW -  
M3X6

12.12042909  
ROCKER SWITCH:  
A8GS-T1185KR

14.AZ230261  
POWER SUPPLY U  
NIT:EU:159.5W

4.04513006N  
(x27)  
TAPPING SCREW -  
3X6

13.AA143592  
SCREW- M4X6

9.11050511  
(x2)  
HARNESS CLAMP -  
LWS-0306ZC

17.B1291060  
PSU STAY

3.04503008N  
(x8)  
TAPPING SCREW -  
M3X8

7.11050409  
(x2)  
CARD SPACER - 6.  
4MM

8.11050487  
(x2)  
HARNESS CLAMP

11.11050518  
EDGE SADDLE - L  
ES-1010

19.B2845050  
SPEAKER: B284

10.11050516  
CLAMP

16.B0441158  
BRACKET

15.AZ320179  
POWER PACK: BCT  
D

U001	U002	U003	U004	U005	U006	U007	U008	U009	U010	U011	U012	U013
------	------	------	------	------	------	------	------	------	------	------	------	------

# U012 ELECTRICAL

33.D6555185  
PCB:GWFCU:EU:ASSY

24.D0671314  
INSULATING SHEET: FAX CONTROL UNIT

28.D1271322  
SEAL:FAN:CTL

34.GX640028  
FAN MOTOR DC24V 1.92W

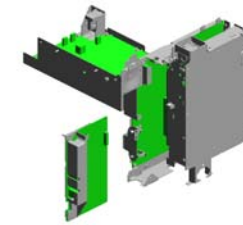

23.D0671313  
INSULATING SHEET: CTL

22.D0095899  
RIGHT RAIL - SMALL

36.N6074550  
CHOKE COIL:RITL-0107

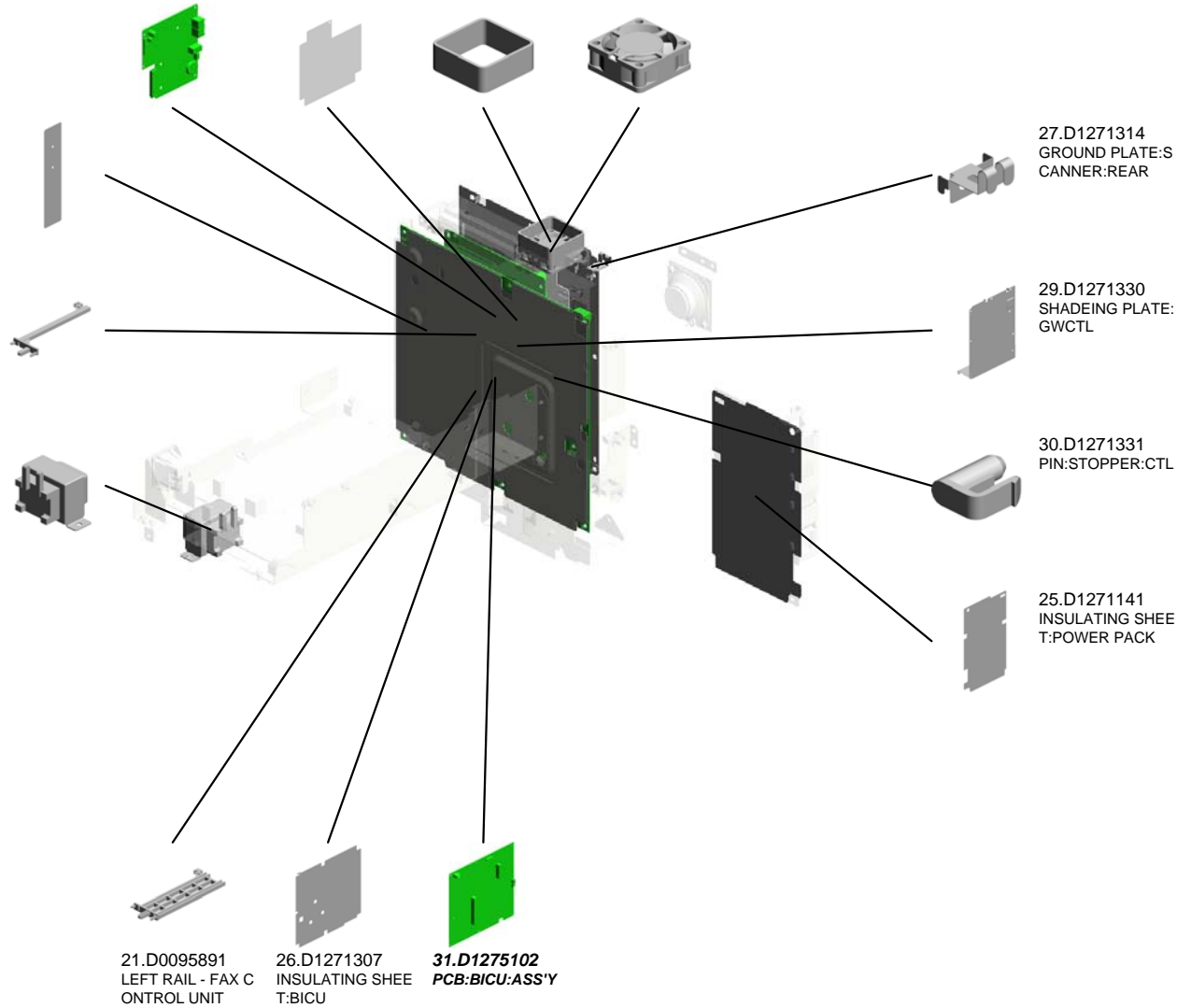

27.D1271314  
GROUND PLATE: SCANNER: REAR

29.D1271330  
SHADEING PLATE: GWCTL

30.D1271331  
PIN: STOPPER: CTL

25.D1271141  
INSULATING SHEET: POWER PACK

21.D0095891  
LEFT RAIL - FAX CONTROL UNIT

26.D1271307  
INSULATING SHEET: BICU

**31.D1275102**  
PCB: BICU: ASSY

U001	U002	U003	U004	U005	U006	U007	U008	U009	U010	U011	U012	U013
------	------	------	------	------	------	------	------	------	------	------	------	------

U012\_S001  
PCB:CTL:ASS'Y

35.M0525391  
(x2)  
PCB:MEMORY:512  
MB

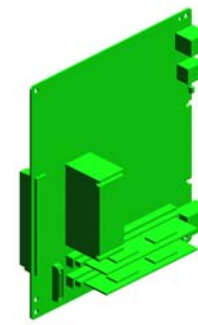
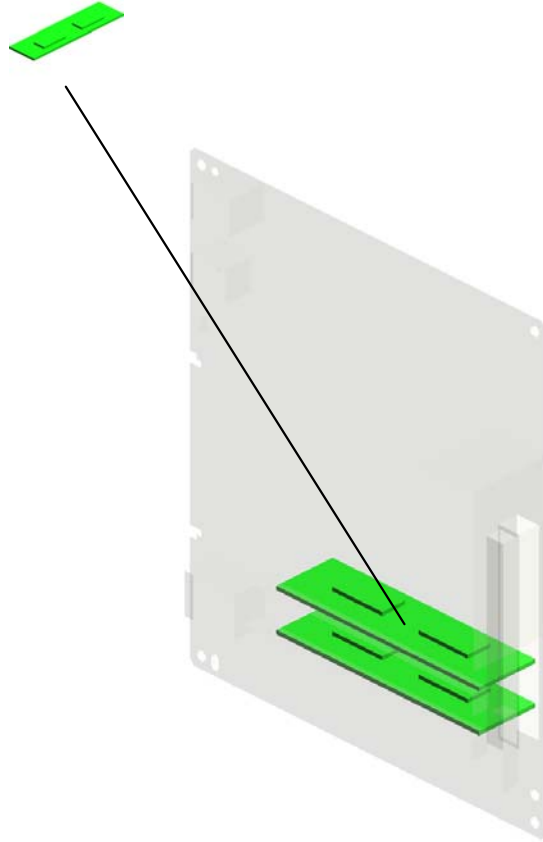

32.D1275410  
PCB:CTL:ASS'Y

U001	U002	U003	U004	U005	U006	U007	U008	U009	U010	U011	U012	U013
------	------	------	------	------	------	------	------	------	------	------	------	------

# U013 MAIN FRAME

5.11050516  
(x2)  
CLAMP

4.11050511  
(x2)  
HARNESS CLAMP -  
LWS-0306ZC

13.B0442202  
MYLAR-QUENCHIN  
G LAMP

2.04503010N  
(x10)  
TAPPING SCREW -  
M3X10

6.12042612  
(x2)  
MICRO SWITCH:D3  
V-16506-3C25

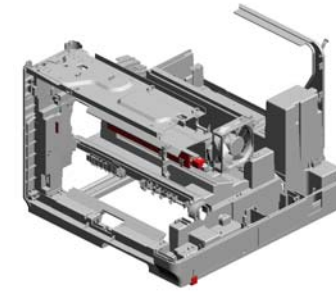

15.B0444201  
FUSING HARNESS  
COVER

7.AX500098  
QUENCHING LAMP

14.B0444200  
FUSING PLATE NU  
T

17.B2591106  
FAN MOTOR:MM80  
:DC24V 3.6W

11.B0441101  
SHUTTER SPRING

10.B0441100  
SHUTTER

12.B0441103  
SHUTTER COVER

8.B0441066  
GROUND PLATE -  
OPTION TRAY

20.D1271069  
(x2)  
SHADEING PLATE:  
RAIL:TONER SUPP  
LY

18.D0671068  
SHEET:BLOCK LIG  
HT:DISCHARGE LA  
MP

1.04503008N  
(x11)  
TAPPING SCREW -  
M3X8

3.04543006Q  
TAPPING SCREW -  
M3X6

9.B0441069  
DUCT SHIELD

19.D1271067  
RAIL:TONER SUPP  
LY:MACHINE OR C  
OPIER

16.B1291111  
INNER COVER

# U013 MAIN FRAME

26.D1271293  
LEVER:DOOR SWI  
TCH:ASSY

23.D1271288  
COIL SPRING:SAF  
ETY SWITCH:FRO  
NT

28.D1271295  
LEVER:SAFETY S  
WITCH:UPPER:FR  
ONT

24.D1271289  
TENSION SPRING:  
SAFETY SWITCH

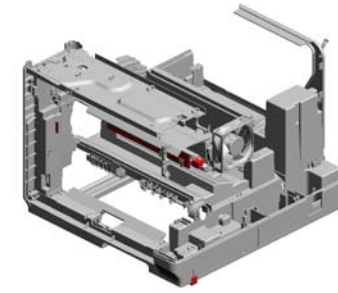

30.G0205626  
PUSH SWITCH



25.D1271292  
LEVER:SAFETY S  
WITCH:UPPER



27.D1271294  
LEVER:SAFETY S  
WITCH:FRONT



29.D1271296  
COVER:SAFETY S  
WITCH



22.D1271094  
INNER COVER:BA  
SE:BASE

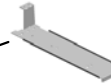

31.G5123029  
(x2)  
RUBBER FOOT

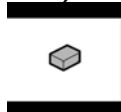

21.D1271073  
GROUND PLATE:S  
CANNER:LEFT





## ACCESSORIES



1.AA001527  
PLATE:LOGOTYPE:GES



2.AA001528  
PLATE:LOGOTYPE:REX



3.AA001529  
PLATE:LOGO:INF



4.AA001530  
PLATE:LOGO:NSA



5.D1171536  
DECAL:FAX:BLIND



6.D1272722  
DECAL:PAPER TRAY:SIZE INDICATI  
ON



7.D1276907  
MODEL NAME PLATE:D127:NRG

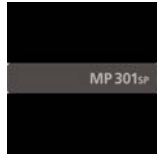

8.D1276908  
MODEL NAME PLATE:D127:INF



9.D1286900  
MODEL NAME PLATE:D128:RIC



10.D1286907  
MODEL NAME PLATE:D128:NRG



11.D1286908  
MODEL NAME PLATE:D128:INF



12.D6066033  
DECAL:ORIGINAL TABLE



13.G1025502  
POWER SUPPLY CORD:EU



14.M0266890  
DECAL:CAUTION:ORIGINAL:ENGLIS  
H



15.M1011301  
PLATE:LOGO:RIC

## Exclusive Parts

Number	Part Name	Group	ID
50530447	BUSHING - 6MM	U010	4
		U011_S001	7
52152713	BOTTOM PLATE PAD	U003	3
		U003_S001_S001	3
A1843420	BOTTLE CHUCK	U007_S001	1
A2324666	CUSHION - STEPPER MOTOR	U011	8
A2673556	CHUCK SPRING - TONNER BOTTL E	U007_S001	2
AA001527	PLATE:LOGOTYPE:GES	ACCESSORIES	1
AA001528	PLATE:LOGOTYPE:REX	ACCESSORIES	2
AA001529	PLATE:LOGO:INF	ACCESSORIES	3
AA001530	PLATE:LOGO:NSA	ACCESSORIES	4
AA043604	TIMING BELT:B40S2M110	U011	9
AA061107	TENSION SPRING:PRESSURE:FU SING	U009_S001	2
AA062326	SPRING - SWIVEL FUSING	U011	10
AA063409	RIGHT DOOR SPRING	U010	5
AA063710	COMPRESSION SPRING:PICKOFF PAWL	U009_S001	3
AA080322	BUSHING - 6MM	U003	4
AA082101	BUSHING - 6X10X6	U003_S001	5
		U004_S001	13
AA082118	BUSHING - M6	U004	14
AA113032	ELECTRODE PLATE - DEVELOPM ENT	U011	11
AA113034	ELECTRODE PLATE - CHARGE	U011	12
AA113035	ELECTRODE PLATE - TRANSFER	U011	13
AA120104	GROUND PLATE - REGISTRATION	U011	14
AA120124	GROUND PLATE - DRUM DRIVE	U011	15
AA132208	SPACER - M6	U004_S001	15
AA143592	SCREW- M4X6	U012	13
AA143788	PIN:GUIDE PLATE:PAPER FEED	U004	16
AA143804	FUSING SHAFT 5	U011	16
AA148817	SHAFT:GUIDE PLATE	U009_S001	4
AA161157	BRACKET CUSHION	U011	17
AB010358	GEAR - 64Z	U011	18
AB011438	GEAR - 41Z	U003	6
AB011492	GEAR - 29Z	U011	19

Number	Part Name	Group	ID
AB012033	GEAR - 21Z	U010	6
AB012080	GEAR:HOT ROLLER	U009_S001	5
AB017585	COUPLED GEAR - 17/44Z	U011	20
AB017586	COUPLED GEAR - 43/53Z	U003	7
AB017628	GEAR - 19/38Z	U011	21
AB032071	PULLEY - 24Z	U011	22
AE011131	HOT ROLLER	U009_S001	6
AE020207	PRESSURE ROLLER:FUSING	U009_S001	7
AE030088	RADIAL BALL BEARING:DIA25XDIA 32X7	U009_S001	8
AE031035	PRESSURE ROLLER BUSHING	U009_S001	9
AE044072	STRIPPER PAWLS	U009_S001	10
AF022139	DRIVEN ROLLER - FRONT REAR	U010	7
AF022140	MIDDLE DRIVEN ROLLER	U010	8
AF022141	TURN-ROLLER	U009_S001	11
AF022142	MIDDLE ROLLER	U009_S001	12
AF022143	GUIDE ROLLER	U003	8
AF031061	PAPER FEED ROLLER	U003_S001	9
AF031086	BY-PASS FEED ROLLER	U003	10
AF040588	EXIT ROLLER	U009_S001	13
AF040603	EXIT ROLLER	U009_S001	14
AW010151	PHOTO REFLECTION SENSOR:PS1 22TL1-A	U004	17
AW020198	PHOTOINTERRUPTOR:LG2A14NL 1	U003	11
		U009_S001	15
AW020203	PHOTOINTERRUPTOR:GP1A173L CS2F	U004	18
		U005	7
AW100088	THERMISTOR - FUSING	U009_S001	16
AW110088	THERMOSTAT:160C	U009_S001	17
AX040272	DC STEPPER MOTOR:NMB	U005	8
AX440316	HEATER:230V:850W:INFRARED	U009_S001	18
AX500098	QUENCHING LAMP	U013	7
AZ230261	POWER SUPPLY UNIT:EU:159.5W	U012	14
AZ320179	POWER PACK:BCTD	U012	15
B0441066	GROUND PLATE - OPTION TRAY	U013	8
B0441069	DUCT SHIELD	U013	9
B0441100	SHUTTER	U013	10
B0441101	SHUTTER SPRING	U013	11

## Exclusive Parts

Number	Part Name	Group	ID
B0441102	REGISTRATION ELECTRODE PLATE	U011	23
B0441103	SHUTTER COVER	U013	12
B0441139	DAMPING INSULATION	U011	24
B0441158	BRACKET	U012	16
B0442202	MYLAR-QUENCHING LAMP	U013	13
B0442602	TURN ROLLER	U003	12
B0442603	REGISTRATION FEELER	U003	13
B0442604	FRONT BUSHING	U003	14
B0442605	REAR BUSHING	U003	15
B0442612	GUIDE PLATE	U010	9
B0442614	DRIVEN ROLLER BUSHING	U010	10
B0442615	PRESSURE SPRING	U010	11
B0442616	SUPPORT BUSHING	U003	16
B0442617	HOLDER ASS'Y - PAPER DUST REMOVAL	U003	17
B0442621	BUSHING - DRIVEN ROLLER	U010	12
B0442622	SPACER - REGISTRATION	U003	18
B0442624	REGISTRATION ROLLER SHAFT	U010	13
B0442653	GUIDE PLATE - PAPER FEED	U003	19
B0442654	PAPER FEEDGUIDE	U003	20
B0442656	GUIDE PLATE STOPPER	U003	21
B0442704	TRAY BOTTOM PLATE	U003_S001_S001	22
B0442713	STOPPER	U003_S001	23
B0442714	RUBBER PLATE - FRICTION PAD	U003_S001	24
B0442715	SPONGE - END FENCE	U003	25
B0442716	PRESSURE SPRING	U003_S001	26
B0442717	PRESSURE SPRING	U003_S001	27
B0442721	PAPER TRAY SHEET	U003_S001	28
B0442751	JOINT - PAPER FEED ROLLER	U003_S001	29
B0442756	SPRING - PAPER FEED ROLLER	U003_S001	30
B0442758	SHAFT - PAPER FEED ROLLER	U003_S001	31
B0442807	STAY - TRAY BOTTOM PLATE	U003	32
B0442809	SPRING - MANUAL FEED TABLE	U003	33
B0442814	EXIT GUIDE	U003	34
B0442815	FRICTION PAD - MANUAL FEED	U003	35
B0442817	FRICTION PAD SPRING	U003	36
B0442824	CUSHION-MANUAL FEED ROLLER	U003	37

Number	Part Name	Group	ID
B0442825	SPACER-MANUAL FEED ROLLER	U003	38
B0442860	FRONT STOPPER PLATE	U010	14
B0442861	REAR STOPPER PLATE	U010	15
B0443426	CHUCK SHAFT	U007_S001	3
B0443427	SLIDE SHAFT	U007_S001	4
B0443470	TONER SUPPLY CASE ASS'Y	U007_S001	5
B0443485	SLIDER ASS'Y	U007_S001	6
B0443860	TRANSFER PLATE	U010	16
B0443865	TRANSFER ROLLER SPRING - FRONT	U010	17
B0443866	TRANSFER ROLLER SPRING - REAR	U010	18
B0443870	TRANSFER GUIDE	U010	19
B0443894	DENSITY SENSOR:LONGDIST:ADHESION	U010	20
B0443990	POSITIONING SPRING - TRANSFER ROLLER	U010	21
B0444117	FRONT SPRING PLATE	U009_S001	19
B0444118	REAR SPRING PLATE	U009_S001	20
B0444135	LAMP HOLDER	U009_S001	21
B0444138	SPRING	U009_S001	22
B0444150	HOT ROLLER STOPPER	U009_S001	23
B0444154	EXIT SPRING	U009_S001	24
B0444166	SPRING PLATE	U009_S001	25
B0444183	FEELER	U009_S001	26
B0444200	FUSING PLATE NUT	U013	14
B0444201	FUSING HARNESS COVER	U013	15
B0444401	PAPER HOLDER STAND	U009_S001	27
B0444624	RIGHT DOOR BELT	U010	22
B0445300	PAPER END SENSOR	U003	39
B1291056	SHAFT SPACER	U011	25
B1291060	PSU STAY	U012	17
B1291111	INNER COVER	U013	16
B1291129	PLATE CUSHION	U011	26
B1291157	SIDE PLATE - MANUAL FEED	U003	40
B1291161	LEVER DC SOLENOID ASS'Y	U011	27
B1291309	INTERFACE COVER	U012	18
B1292820	GROUND PLATE - MANUAL FEED	U003	41

## Exclusive Parts

Number	Part Name	Group	ID
B1294294	SCREW-M3X13	U009_S001	28
B2591106	FAN MOTOR:MM80:DC24V 3.6W	U013	17
B2592786	LEVER SHAFT	U003	42
B2622623	GUIDE -PAPER DUST REMOVER	U003	43
B2622624	GROUNDING PLATE	U003	44
B2622709	GROUND PLATE:TRAY BOTTOM PLATE	U003_S001	45
B2622711	GROUND PLATER	U003_S001	46
B2845050	SPEAKER:B284	U012	19
B6225874	RAIL:FAX CONTROL UNIT	U012	20
B8722421	BUSHING:FEED	U004	19
B8722526	SPRING:ROLLER CLUTCH	U004_S001	20
B8722529	COLLAR:PICKUP	U004_S001	21
B8722614	BUSHING:R1	U004	22
D0095891	LEFT RAIL - FAX CONTROL UNIT	U012	21
D0095899	RIGHT RAIL - SMALL	U012	22
D0671068	SHEET:BLOCK LIGHT:DISCHARGE LAMP	U013	18
D0671313	INSULATING SHEET:CTL	U012	23
D0671314	INSULATING SHEET:FAX CONTROL UNIT	U012	24
D0672710	FRICTION PAD:ADHESION	U003_S001	47
D0674165	DISCHARGE BRUSH:EXIT	U009_S001	29
D1171460	PCB:UWVGA:OP-R:ASS'Y	U002_S001	4
D1171465	PCB:UWVGA:OP-L:ASS'Y	U002_S001	5
D1171470	FPC:LED:ASS'Y	U002_S001	6
D1171501	COVER:REAR	U002_S001	7
D1171502	COVER:HINGE	U002_S001	8
D1171503	KEYTOP:HOME	U002_S001	9
D1171504	KEYTOP:RIGHT	U002_S001	10
D1171505	KEYTOP:LEFT	U002_S001	11
D1171508	KEYTOP:RESET SWITCH	U002_S001	12
D1171510	KEYTOP:START	U002_S001	13
D1171511	KEYTOP:STOP	U002_S001	14
D1171513	LENS:FRONT	U002_S001	15
D1171514	SHAFT:CABLE	U002_S001	16
D1171516	BRACKET:LCDC	U002_S001	17
D1171517	BRACKET:HINGE	U002_S001	18

Number	Part Name	Group	ID
D1171518	SHADEING PLATE:TOUCH PANEL	U002_S001	19
D1171519	SHEET:LCDC	U002_S001	20
D1171520	SHEET:OPR	U002_S001	21
D1171521	SHEET:OPL	U002_S001	22
D1171523	GASKET:LCD	U002_S001	23
D1171525	DECAL:SD/USB:NA	U002_S001	24
D1171529	HINGE:GFN:ASS'Y	U002_S001	25
D1171530	SPACER:LCD	U002_S001	26
D1171531	BRACKET:HINGE:LEFT	U002_S001	27
D1171533	HOLDER:HINGE:LEFT	U002_S001	28
D1171536	DECAL:FAX:BLIND	ACCESSORIES	5
D1171542	KEYTOP:10KEY:A:EU	U002_S001	29
D1171543	KEYTOP:10KEY:B:EU	U002_S001	30
D1171552	COVER:FRONT:EU	U002_S001	31
D1171651	CARRIAGE:SCANNER:ASS'Y	U005	9
D1171657	EXPOSURE GLASS UNIT:SCANNER:ASS'Y	U005	10
D1171752	RAIL:SCANNER	U005	11
D1171753	SLIDE RAIL	U005	12
D1171754	GUIDE ROD:SCANNER	U005	13
D1171801	BRACKET:MOTOR	U005	14
D1171804	CAP:TIMING PULLEY	U005	15
D1171805	GEAR:TIMING PULLEY:81-18	U005	16
D1171806	PULLEY:IDLER	U005	17
D1171807	BRACKET:IDLER:PEEN	U005	18
D1171810	SYNCHRONOUS BELT:S2M:441	U005	19
D1171826	GEAR:SLOW DOWN:53-19	U005	20
D1171837	COIL SPRING:TENSION	U005	21
D1176256	ELECTRODE PLATE:DISCHARGE	U010	23
D1271031	BRACKET:FUSING:SWIVEL:ASS'Y	U011	28
D1271034	PLATE:DRIVE:REAR:1:ASS'Y	U011_S001	29
D1271040	SHAFT:DEVELOPMENT:ASS'Y	U011	30
D1271041	SHAFT:DRUM:ASS'Y	U011	31
D1271067	RAIL:TONER SUPPLY:MACHINE OR COPIER	U013	19
D1271069	SHADEING PLATE:RAIL:TONER SUPPLY	U013	20
D1271073	GROUND PLATE:SCANNER:LEFT	U013	21

## Exclusive Parts

Number	Part Name	Group	ID
D1271094	INNER COVER:BASE:BASE	U013	22
D1271105	POSITIONING PLATE:TONER SUPPLY	U007	7
D1271132	GEAR:PAPER FEED:NO.1	U011	32
D1271133	GEAR:DRUM:NO.1	U011	33
D1271134	GEAR:DRUM:NO.2	U011	34
D1271135	GEAR:DEVELOPMENT:FUSING:NO.1	U011	35
D1271136	GEAR:DEVELOPMENT:FUSING:NO.2	U011	36
D1271137	GEAR:FUSING:NO.5	U011	37
D1271138	PLATE:DRIVE:REAR:2	U011	38
D1271141	INSULATING SHEET:POWER PACK	U012	25
D1271143	GEAR:FUSING:NO.6	U011	39
D1271151	BRUSHLESS MOTOR:MAIN:24V:44W	U011	40
D1271170	BUSHING:DIA6XDIA10X7:C5	U011	41
D1271171	GROUND PLATE:BRACKET:REAR	U011	42
D1271200	COVER:SCANNER:FRONT:ASS'Y	U001_S001	1
D1271247	COVER:REAR	U001	2
D1271248	COVER:IC CARD	U001	3
D1271252	COVER:EXIT:EU	U001	4
D1271257	SHIELDING PLATE:PAPER EXIT SUB-UNIT	U001	5
D1271265	END FENCE:PAPER EXIT SUB-UNIT	U001	6
D1271268	SHEET:COVER:SCANNER:FRONT	U001_S001	7
D1271277	BRACKET:DOOR:FRONT	U001	8
D1271278	COVER:FRONT:RIGHT UPPER	U001	9
D1271279	COVER:UPPER:RIGHT UPPER	U001	10
D1271283	EXTENSION TRAY:PAPER EXIT SUB-UNIT:2	U001	11
D1271286	DOOR:FRONT	U001	12
D1271288	COIL SPRING:SAFETY SWITCH:FRONT	U013	23
D1271289	TENSION SPRING:SAFETY SWITCH	U013	24

Number	Part Name	Group	ID
D1271292	LEVER:SAFETY SWITCH:UPPER	U013	25
D1271293	LEVER:DOOR SWITCH:ASS'Y	U013	26
D1271294	LEVER:SAFETY SWITCH:FRONT	U013	27
D1271295	LEVER:SAFETY SWITCH:UPPER:FRONT	U013	28
D1271296	COVER:SAFETY SWITCH	U013	29
D1271307	INSULATING SHEET:BICU	U012	26
D1271314	GROUND PLATE:SCANNER:REAR	U012	27
D1271322	SEAL:FAN:CTL	U012	28
D1271330	SHADEING PLATE:GWCTL	U012	29
D1271331	PIN:STOPPER:CTL	U012	30
D1271412	OPERATION PANEL:EU:ASS'Y	U002_S001	32
D1271431	PCB:LCD:CARFT:ASS'Y	U002_S001	33
D1271463	CABLE:STEC5:USB	U002_S001	34
D1271476	LCD:UWVGA:EU:MV	U002_S001	35
D1271757	COVER:HARNESS:MOTOR:SCANNER	U005	22
D1271850	OPTICAL WRITING UNIT:ASS'Y	U006_S001	2
D1271956	DC POLYGON MIRROR MOTOR:11.5W:BRUSHLESS	U006_S001	3
D1272110	PCU	U008	1
D1272198	SPRING PLATE:TRANSFER/DISCHARGE	U010	24
D1272509	ELECTROMAGNETIC CLUTCH:3.5T:PAPER FEED	U011	43
D1272510	PAPER TRAY:ASS'Y	U003_S001	48
D1272512	SHAFT:FEED:MANUAL FEED	U003	49
D1272514	ELECTROMAGNETIC CLUTCH:3.5T:MANUAL FEED	U003	50
D1272515	REGISTRATION ROLLER:DRIVE	U003	51
D1272517	ELECTROMAGNETIC CLUTCH:3.5T:REGISTRATION	U003	52
D1272533	SHAFT:PAPER FEED ROLLER	U011	44
D1272651	RAIL:RIGHT	U003	53
D1272704	GRIP:PAPER TRAY	U003_S001	54
D1272706	END FENCE	U003	55
D1272707	SIDE FENCE:FRONT:ASS'Y	U003_S001_S002	56
D1272708	SIDE FENCE:REAR:ASS'Y	U003_S001_S003	57

## Exclusive Parts

Number	Part Name	Group	ID
D1272709	COVER:ASS'Y	U003_S001	58
D1272718	DECAL:SIDE FENCE:RELEASE	U003_S001_S002	59
		U003_S001_S003	59
D1272720	DECAL:CASSETTE OPERATION	U003	60
D1272721	DECAL:MANUAL FEED:PAPER SE T DIRECTION	U003	61
D1272722	DECAL:PAPER TRAY:SIZE INDICA TION	ACCESSORIES	6
D1272801	COVER:MANUAL FEED TABLE	U003	62
D1272803	TRAY BOTTOM PLATE	U003	63
D1272804	SIDE FENCE:MANUAL FEED:FRON T	U003	64
D1272805	SIDE FENCE:MANUAL FEED:REAR	U003	65
D1272806	LEVER:RISING TRAY	U003	66
D1272808	GUIDE:PAPER:MANUAL FEED	U003	67
D1272811	GUIDE PLATE:MANUAL FEED:UPP ER	U003	68
D1272866	STOPPER:PAPER END SENSOR:M ANUAL FEED	U003	69
D1273020	TONER SUPPLY UNIT	U007_S001	8
D1273201	DC MOTOR:TONER BOTTLE:2.4W: BRUSH	U007	9
D1273461	CAM:HANDLE	U007_S001	10
D1273465	COVER:TONER BOTTLE:ASS'Y	U007_S001	11
D1273475	GRIP:UN LOCK:TONER SUPPLY U NIT	U007_S001	12
D1273802	TRANSFER ROLLER:ASS'Y	U010	25
D1274028	FUSING UNIT:EU/AP	U009_S001	30
D1274086	STUD:GEAR:FIX	U009_S001	31
D1274104	FRAME:PRESSURE	U009_S001	32
D1274113	CAP:HOT ROLLER	U009_S001	33
D1274129	LEVER:PRESSURE:FUSING:FRON T:ASS'Y	U009_S001	34
D1274131	LEVER:PRESSURE:FUSING:REAR: ASS'Y	U009_S001	35
D1274132	SIDE PLATE:PRESSURE:FRONT	U009_S001	36
D1274133	SIDE PLATE:PRESSURE:REAR	U009_S001	37
D1274134	ELECTRODE PLATE:FUSING	U009_S001	38

Number	Part Name	Group	ID
D1274136	GROUND PLATE:FUSING	U009_S001	39
D1274147	COVER:ELECTRODE PLATE	U009_S001	40
D1274153	CUSHION:PRESSURE RELEASE	U009_S001	41
D1274154	LEVER:PRESSURE RELEASE:FRO NT	U009_S001	42
D1274155	LEVER:PRESSURE RELEASE:REA R	U009_S001	43
D1274163	GUIDE PLATE:PRESSURE:DUPL E X	U009_S001	44
D1274165	DECAL:C:GRIP	U009_S001	45
D1274179	HOLDER:PICKOFF PAWL	U009_S001	46
D1274321	ELECTRODE PLATE:TRANSFER/DI SCHARGE	U010	26
D1274409	GUIDE PLATE:EXIT	U009_S001	47
D1274456	GUIDE:GATE PLATE:REAR	U009_S001	48
D1274457	GUIDE:GATE PLATE:FRONT	U009_S001	49
D1274458	GATE PLATE:FUSING	U009_S001	50
D1274460	DECAL:H-TEMP WARNING	U009_S001	51
D1274507	DC STEPPER MOTOR:DUPL EX:AS S'Y	U011	45
D1274577	GROUND PLATE:BRACKET:DUPL EX:LOWER	U011	46
D1274604	GUIDE PLATE:REVERSE:1	U010	27
D1274605	LEVER:COVER:RIGHT	U010	28
D1274631	GUIDE PLATE:2:REVERSE	U010	29
D1274654	PLATE:COMPRESSION SPRING:RI GHT:COVER	U010	30
D1274657	BRACKET:DC STEPPER MOTOR:A SS'Y	U011	47
D1274660	COVER:RIGHT	U010	31
D1274661	BRACKET:PLATE	U011	48
D1274669	COMPRESSION SPRING:LEVER	U010	32
D1274678	GEAR:TRANSPORT ROLLER:DRIV E	U011	49
D1274679	GEAR:SLOW DOWN:DC STEPPER MOTOR	U011	50
D1274680	GUIDE PLATE:COVER	U010	33
D1274705	SPRING PLATE:DISCHARGE:FEED	U010	34

## Exclusive Parts

Number	Part Name	Group	ID
	PAPER AGAIN		
D1274707	BRACKET:BOTH ENDS:DRIVE:ASS'Y	U011	51
D1274805	ROLLER:DUPLEX:DRIVE	U010	35
D1274806	TRANSPORT ROLLER:DUPLEX:DRIVEN	U010	36
D1274807	COMPRESSION SPRING:1:DUPLEX:CONNECTING:DRIVEN	U010	37
D1274809	ELECTRODE PLATE:DISCHARGE	U010	38
D1274816	COMPRESSION SPRING:2:DUPLEX:CONNECTING:DRIVEN	U010	39
D1275102	PCB:BICU:ASS'Y	U012	31
D1275410	PCB:CTL:ASS'Y	U012_S001	32
D1276907	MODEL NAME PLATE:D127:NRG	ACCESSORIES	7
D1276908	MODEL NAME PLATE:D127:INF	ACCESSORIES	8
D1286900	MODEL NAME PLATE:D128:RIC	ACCESSORIES	9
D1286907	MODEL NAME PLATE:D128:NRG	ACCESSORIES	10
D1286908	MODEL NAME PLATE:D128:INF	ACCESSORIES	11
D6060028	SCREW:HINGE	U004	23
D6061111	TRAY:AUXILIARY	U004	24
D6061113	SHAFT:EXIT:DRIVEN	U004	25
D6061114	COMPRESSION SPRING:EXIT:DRIVEN	U004	26
D6061116	CUSHION:PRESSURE PLATE	U004	27
D6061117	ROLLER:DRIVEN:EXIT	U004	28
D6061118	HOLDER:COMPRESSION SPRING:EXIT ROLLER	U004	29
D6061410	GUIDE PLATE:SCANNING:FRONT LOWER	U004	30
D6061411	SHEET:SCANNING:FRONT LOWER	U004	31
D6061413	LEVER:DRIVEN:SCANNING	U004	32
D6061414	SHAFT:DRIVEN:SCANNING	U004	33
D6061415	ROLLER:DRIVEN:SCANNING	U004	34
D6061416	COMPRESSION SPRING:SCANNING:DRIVEN	U004	35
D6061420	ROLLER:AUXILIARY:ASS'Y	U004	36
D6061510	HINGE:DOCUMENT FEEDER	U004	37
D6061610	LEVER:MISFEED REMOVAL	U004	38

Number	Part Name	Group	ID
D6061611	PIN:MISFEED REMOVAL	U004	39
D6061612	COIL SPRING:MISFEED REMOVAL	U004	40
D6062100	PAPER FEED UNIT:ASS'Y	U004_S001	41
D6062101	SHAFT:PAPER FEED UNIT:ASS'Y	U004_S001	42
D6062111	FEED ROLLER	U004_S001	43
D6062112	HOLDER:PICKUP ROLLER	U004_S001	44
D6062113	PICKUP ROLLER	U004_S001	45
D6062114	SHAFT:PICKUP	U004_S001	46
D6062115	TORQUE LIMITER MECHANICAL CLUTCH:FEED	U004_S001	47
D6062116	GEAR:FEED	U004_S001	48
D6062117	GEAR:IDLER:FEED	U004_S001	49
D6062118	GEAR:PICKUP	U004_S001	50
D6062119	ARM:PAPER STOPPER	U004_S001	51
D6062120	PAPER STOPPER	U004_S001	52
D6062121	LINK:PAPER STOPPER	U004_S001	53
D6063110	GUIDE PLATE:PAPER FEED	U004	54
D6063111	HOLDER:FRICTION PAD	U004	55
D6063112	FRICTION PAD	U004	56
D6063114	COMPRESSION SPRING:SEPARATION	U004	57
D6063115	ROLLER:SEPARATION	U004	58
D6063116	LEVER:PRESSURE RELEASE:SEPARATION	U004	59
D6063117	TENSION SPRING:PRESSURE RELEASE:SEPARATION:4.5N	U004	60
D6063118	SHEET:SEPARATION	U004	61
D6063210	GUIDE PLATE:TRANSPORT	U004	62
D6063211	SPRING PLATE:GUIDE:EXPOSURE GLASS:INNER BACK	U004	63
D6063212	DISCHARGE BRUSH:EXIT	U004	64
D6063214	CUSHION:CORE	U004	65
D6063215	SPRING PLATE:GUIDE:EXPOSURE GLASS:FRONT	U004	66
D6063216	SPRING PLATE:DISCHARGE:EXPOSURE GLASS	U004	67
D6063310	GUIDE PLATE:REVERSE	U004	68
D6063410	TRANSPORT ROLLER:PULL OUT	U004	69

## Exclusive Parts

Number	Part Name	Group	ID
D6063510	TRANSPORT ROLLER:SCANNING: ASS'Y	U004	70
D6063610	TRANSPORT ROLLER:EXIT ROLLER:ASS'Y	U004	71
D6063710	TRANSPORT ROLLER:REVERSE	U004	72
D6063810	GUIDE PLATE:SCANNING	U004	73
D6063811	SPRING PLATE:DISCHARGE:INNER BACK	U004	74
D6063812	SPRING PLATE:DISCHARGE:FRONT	U004	75
D6063813	GATE PAWL:REVERSE	U004	76
D6064110	TORQUE LIMITER:REVERSE ROLLER	U004	77
D6064111	SHAFT:PAPER FEED:COUPLING	U004	78
D6064112	GEAR:IDLER:SEPARATION SUB-UNIT	U004	79
D6064113	GEAR:IDLER:PULL OUT	U004	80
D6064114	GEAR:IDLER:NO.4	U004	81
D6064115	GEAR:SLOW DOWN:MOTOR	U004	82
D6064116	GEAR:SLOW DOWN:SCANNING	U004	83
D6064117	GEAR:SLOW DOWN:EXIT	U004	84
D6064118	GEAR:SLOW DOWN:PULL OUT	U004	85
D6064119	GEAR:ROLLER:PULL OUT	U004	86
D6064120	GEAR:ROLLER:SCANNING	U004	87
D6064121	GEAR:ROLLER:EXIT	U004	88
D6064122	GEAR:IDLER:MECHANICAL ROLLER CLUTCH:UPPER POSITION	U004	89
D6064123	GEAR:IDLER:MECHANICAL ROLLER CLUTCH:LOWER	U004	90
D6064124	COLLAR:REVERSE	U004	91
D6064125	ARM:SWIVEL:REVERSE	U004	92
D6064126	GEAR:SWIVEL:CONTACT POINT:REVERSE	U004	93
D6064127	GEAR:SWIVEL:REVERSE	U004	94
D6064128	LEVER:GATE PAWL	U004	95
D6064129	LINK:GATE PAWL:REVERSE	U004	96
D6064130	TENSION SPRING:GATE PAWL:REVERSE	U004	97

Number	Part Name	Group	ID
D6064131	PLANE SHAFT BEARING:REVERSE	U004	98
D6064151	SPRING:MECHANICAL SPRING CLUTCH:PAPER FEED	U004	99
D6064152	GEAR:MECHANICAL SPRING CLUTCH:PAPER FEED	U004	100
D6064153	RATCHET:MECHANICAL SPRING CLUTCH:PAPER FEED	U004	101
D6064154	DRUM:MECHANICAL SPRING CLUTCH:PAPER FEED	U004	102
D6064310	BRACKET:DRIVE	U004	103
D6064311	BRACKET:DRIVE SUB-UNIT	U004	104
D6064340	DC MOTOR UNIT:11W/20W:BRUSH	U004	105
D6064510	COVER:PAPER FEED	U004	106
D6064511	LEVER:COVER:PAPER FEED	U004	107
D6064512	PAWL:COVER:PAPER FEED	U004	108
D6064513	TORSION SPRING:COVER:PAPER FEED:INNER BACK	U004	109
D6064514	TORSION SPRING:COVER:PAPER FEED:FRONT	U004	110
D6064515	ROLLER:DRIVEN:SHORT	U004	111
D6064516	SHAFT:ROLLER:PULL OUT	U004	112
D6064517	PLANE SHAFT BEARING:4MM	U004	113
D6064518	COMPRESSION SPRING:DRIVEN ROLLER:PULL OUT	U004	114
D6064519	FEELER:ORIGINAL SENSOR	U004	115
D6064610	ORIGINAL TABLE	U004	116
D6064611	EXTENSION TRAY	U004	117
D6064612	SIDE FENCE:INNER BACK	U004	118
D6064613	SIDE FENCE:FRONT	U004	119
D6064614	GEAR:SIDE FENCE	U004	120
D6064615	PIN:SIDE FENCE	U004	121
D6064616	DISC:SIDE FENCE	U004	122
D6064617	COIL SPRING:SIDE FENCE:ARDF:12N	U004	123
D6064618	ROLLER:REVERSE:DRIVEN	U004	124
D6064619	SPRING PLATE:REVERSE:PRESSURE	U004	125



## Exclusive Parts

Number	Part Name	Group	ID
D6064710	COVER:REAR	U004	126
D6064810	COVER:FRONT	U004	127
D6064910	PRESSURE PLATE	U004	128
D6065110	PCB:DFRB	U004	129
D6066031	DECAL:ORIGINAL SCALE	U004	130
D6066032	DECAL:SIDE FENCE	U004	131
D6066033	DECAL:ORIGINAL TABLE	ACCESSORIES	12
D6555185	PCB:GWFCU:EU:ASS'Y	U012	33
G0202599	SPRING - RELEASE LEVER	U003_S001	70
G0202772	BY-PASS PAPER END SENSOR	U003	71
G0205626	PUSH SWITCH	U013	30
G1025502	POWER SUPPLY CORD:EU	ACCESSORIES	13
G5123029	RUBBER FOOT	U013	31
G8003133	SIDE FENCE GEAR	U003	72
		U003_S001	72
GA043033	SYNCHRONOUS BELT:S2M:L200	U011	52
GA082010	BUSHING:DIA6:DIA10:9	U004	132
GX110023	DC SOLENOID:24V:REVERSE	U004	133
GX110024	DC SOLENOID:MECHANICAL SPRING CLUTCH:PAPER FEED UNIT	U004	134
GX640028	FAN MOTOR DC24V 1.92W	U012	34
H5211350	PAD - PICK-UP	U004	135
H5213355	C RING - PAPER FEED ROLLER	U003	73
		U003_S001	73
		U011	53
H5562210	GEAR - 19/28Z	U009_S001	52
H5562219	GEAR BRACKET	U009_S001	53
H5562220	ROLLER	U009_S001	54
H5562818	GUIDE PLATE	U003	74
H5562820	MYLER REVERSE	U003	75
H5564186	POSITIONING ROLLER	U010	40
H5564190	TRANSPORT ROLLER	U010	41
M0261293	SHEET:COVER:SCANNER:FRONT: MODEL NAME PLATE	U001_S001	13
M0261718	DECAL:SCALE:LEFT:EU	U005	23
M0266890	DECAL:CAUTION:ORIGINAL:ENGLISH	ACCESSORIES	14
M0525391	PCB:MEMORY:512MB	U012_S001	35

Number	Part Name	Group	ID
M1011301	PLATE:LOGO:RIC	ACCESSORIES	15
M3641381	HOLDER:PRESSURE PLATE:RIGHT	U004	136
M3641387	BRACKET:PRESSURE PLATE	U004	137
M3642124	COMPRESSION SPRING:PAPER FEED UNIT	U004_S001	138
M3644821	TAPE:PRESSURE PLATE:LEFT	U004	139
M3644823	TAPE:PRESSURE PLATE	U004	140
N6074550	CHOKE COIL:RITL-0107	U012	36

## Standard Parts



03520030N  
SCREW:M2X3



03530040N  
SCREW - M3X4



03603006N  
SCREW - M3X6



03604006N  
SCREW - M4X6



04503008N  
TAPPING SCREW - M3X8



04503010N  
TAPPING SCREW - M3X10



04503014N  
TAPPING SCREW:M3X14



04504012N  
TAPPING SCREW:4X12



04513006N  
TAPPING SCREW - 3X6



04513020N  
TAPPING SCREW:3X20



04522006N  
BINDING SELF-TAPPING SCREW - M2X6



04522008P  
BINDING SELF-TAPPING SCREW:2X8



04523010N  
BINDING SELF-TAPPING SCREW:3X10



04533006N  
TAPPING SCREW - M3X6



04543006Q  
TAPPING SCREW - M3X6



06225080E  
SPRING PIN - 2.5X8MM



06320080G  
PARALLEL KEY - 2X8MM



07073050N  
BUSHING:DIA3X5



07200040E  
RETAINING RING - M4



08025318  
BINDING HEAD TAPPING SCREW:ES:3X10



08050088  
RETAINING RING - M6



08050089  
RETAINING RING - M4



08050092  
RETAINING RING - 3M



11050409  
CARD SPACER- 6.4MM



11050487  
HARNESS CLAMP



11050511  
HARNESS CLAMP - LWS-030 6ZC

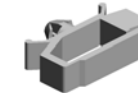

11050516  
CLAMP

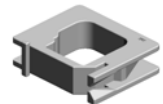

11050518  
EDGE SADDLE - LES-1010

## Standard Parts



11050534  
CLAMP



12042612  
MICRO SWITCH:D3V-16506-3  
C25



12042909  
ROCKER SWITCH:A8GS-T11  
85KR

## PM Part List

Number	Part Name	Num	Group	ID
52152713	BOTTOM PLATE PAD	2	U003	3
			U003_S001_S001	3
AE011131	HOT ROLLER	1	U009_S001	6
AE020207	PRESSURE ROLLER:FUSIN G	1	U009_S001	7
AF031061	PAPER FEED ROLLER	1	U003_S001	9
AF031086	BY-PASS FEED ROLLER	1	U003	10
AW100088	THERMISTOR - FUSING	1	U009_S001	16
AX500098	QUENCHING LAMP	1	U013	7
AZ230261	POWER SUPPLY UNIT:EU:15 9.5W	1	U012	14
D0672710	FRICTION PAD:ADHESION	1	U003_S001	47
D1176256	ELECTRODE PLATE:DISCHA RGE	1	U010	23
D1271412	OPERATION PANEL:EU:ASS' Y	1	U002_S001	32
D1273802	TRANSFER ROLLER:ASS'Y	1	U010	25
D1275102	PCB:BICU:ASS'Y	1	U012	31
D1275410	PCB:CTL:ASS'Y	1	U012_S001	32
G0202772	BY-PASS PAPER END SENS OR	1	U003	71