

**Model S-C5**  
**Machine Code: D127/D128**  
**Field Service Manual**

24 February, 2012



---

# Important Safety Notices

---

## Prevention of Physical Injury

---

1. Be sure that the power cord is unplugged before disassembling or assembling parts of the copier or peripherals.
2. The wall outlet should be near the copier and easily accessible.
3. Note that electrical voltage is supplied to some components of the copier and the paper tray unit even while the main power switch is off.
4. If any adjustment or operation check has to be made with exterior covers off or open while the main switch is turned on, keep hands away from electrified or mechanically driven components.
5. If you start a job before the copier completes the warm-up or initializing period, keep hands away from the mechanical and electrical components until job execution has started. The copier will start making copies as soon as warm-up or initialization is finished.
6. The inside and the metal parts of the fusing unit become extremely hot while the copier is operating. Be careful to avoid touching those components with your bare hands.

---

## Health Safety Conditions

---

Toner and developer are nontoxic, but getting either of these into your eyes may cause temporary eye discomfort. Try to remove with eye drops or flush with water. If material remains in eye or if discomfort continues, get medical attention.

---

## Observance of Electrical Safety Standards

---

The copier and its peripherals must be installed and maintained by a customer service representative who has completed the training course on those relevant models.

### **WARNING**

- Keep the machine away from flammable liquids, gases, and aerosols. A fire or an explosion might occur if this precaution is not observed.

---

## Lithium Batteries

---

Incorrect replacement of lithium battery(s) on the FCU, controller board and memory board unit may pose risk of explosion. Replace only with the same type or with an equivalent type recommended by the manufacturer. Discard used batteries in accordance with the manufacturer's instructions.

---

## Safe and Ecological Disposal

---

1. Do not incinerate toner bottles or used toner. Toner dust may ignite suddenly if exposed to an open flame.
2. Dispose of used toner, developer, and organic photoconductors in accordance with local regulations. (These are nontoxic supplies.)
3. Dispose of replaced parts in accordance with local regulations.
4. When keeping used lithium batteries in order to dispose of them later, do not put more than 100 batteries per sealed box. Storing larger numbers or not sealing them apart may lead to chemical reactions and heat build-up.

---

## Laser Safety

---

The Center for Devices and Radiological Health (CDRH) prohibits the repair of laser-based optical units in the field. The optical housing unit can only be repaired in a factory or at a location with the requisite equipment. The laser subsystem is replaceable in the field by a qualified Customer Engineer. The laser chassis is not repairable in the field. Customer engineers are therefore directed to return all chassis and laser subsystems to the factory or service depot when replacement of the optical subsystem is required.

### **WARNING**

- Use of controls not specified in this manual, or performance of adjustments or procedures not specified in this manual, may result in hazardous radiation exposure.
- Do not use the cleaner to suck spilled toner (including used toner). Sucked toner may cause firing or explosion due to electrical contact flickering inside the cleaner. However, it is possible to use the cleaner designed for dust explosion-proof purpose. If toner is spilled over the floor, sweep up spilled toner slowly and clean remainder with wet cloth.

 **WARNING FOR LASER UNIT**

---

**⚠ WARNING**

- Turn off the main switch before attempting any of the procedures in the Laser Unit section. Laser beams can seriously damage your eyes.







CAUTION MARKING:



---

# Symbols and Abbreviations

This manual uses several symbols and abbreviations. The meaning of those symbols and abbreviations is as follows:

	See or Refer to
	Clip ring
	E-ring
	Screw
	Connector
	Clamp
SEF	Short Edge Feed
LEF	Long Edge Feed
-	Core Technology manual

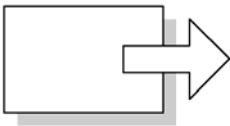

**Short Edge Feed (SEF)**

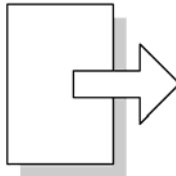

**Long Edge Feed (LEF)**

## Cautions, Notes, etc.

The following headings provide special information:

### **WARNING**

- Failure to obey warning information could result in serious injury or death.

### **CAUTION**

- Obey these guidelines to ensure safe operation and prevent minor injuries.

### **Note**

- This information provides tips and advice about how to best service the machine.

# TABLE OF CONTENTS

---

- Important Safety Notices..... 1
  - Prevention of Physical Injury..... 1
  - Health Safety Conditions..... 1
  - Observance of Electrical Safety Standards..... 1
  - Lithium Batteries..... 1
  - Safe and Ecological Disposal..... 2
  - Laser Safety..... 2

- Symbols and Abbreviations..... 4

## 1. Product Information

---

- Specifications..... 13
- Machine Configuration..... 14
  - Mainframe..... 14
  - System Components..... 15
- Overview..... 17
  - Component Layout..... 17
    - Mainframe..... 17
    - ARDF..... 18
  - Electrical Components..... 19
    - Electrical Components 1..... 19
    - Electrical Components 2..... 20
    - ARDF..... 21
  - Paper Path..... 22
  - Drive Layout..... 23
    - Mainframe..... 23
    - ARDF..... 24
- Guidance for Those Who are Familiar with Predecessor Products..... 25

## 2. Installation

---

- Installation Cautions..... 27
- Installation Requirements..... 28
  - Environment..... 28
  - Machine Level..... 29
  - Minimum Operational Space Requirements..... 29
  - Power Requirements..... 30

---

Copier.....	31
Accessory Check.....	31
Printer/Scanner (D127)/ Scanner and Fax Model (D128).....	31
Installation Procedure.....	31
Interface settings .....	35
Copier settings .....	35
Fax Settings.....	36
Optional Handset.....	36
Accessory Check.....	36
Installation Procedure.....	37
Paper Tray Unit (D661).....	39
Accessory Check.....	39
Installation Procedure.....	39
Paper Tray Unit Heater.....	42
Accessory Check.....	42
Installation Procedure (For one of PTU installed machine).....	43
Installation Procedure (For two of PTU installed machine).....	49
Joint bracket (Joint the copier and the upper PTU).....	56
Joint bracket (Joint the upper and the lower PTU).....	57
Controller Options.....	58
Overview.....	58
Wireless LAN (IEEE 802.11a/g) Installation.....	58
Accessories.....	58
Installation Procedure.....	59
SP Mode Settings for IEEE 802.11a/g Wireless LAN.....	60
IEEE 1284 Installation.....	60
Accessories.....	60
Installation Procedure.....	61
VM Card Type S (D656).....	61
Accessories.....	61
Installation.....	62
Gigabit Ethernet.....	62
Fax Option (D655).....	63



---

Component Check.....	64
Installation Procedure.....	65
Grounding Wire.....	66
HDD Option (D659).....	66
Component Check.....	66
Installation Procedure.....	67
Installing the Security Card.....	69
Activating the Security Applications.....	70
HDD Encryption Recovery from a Device Problem.....	70
Restoring the Encryption key.....	71
Clearing the NVRAM.....	71

### **3. Preventive Maintenance**

---

Maintenance Tables.....	73
How to Clear the PM Counter.....	74

### **4. Replacement and Adjustment**

---

Precautions.....	75
General.....	75
Lithium Batteries.....	75
Halogen-free Cable.....	75
Static Electricity.....	76
Special Tools and Lubricants.....	77
Exterior Covers and Operation Panel.....	78
Rear Cover.....	78
Copy Tray.....	78
Operation Panel.....	79
Right Door.....	81
Bypass Tray.....	81
Platen Cover and ARDF Sensor.....	82
Scanner Unit.....	83
Scanner Cover and Exposure Glass.....	83
LED Unit.....	83
Scanner Motor.....	84
Scanner HP Sensor.....	85

---

Fusing.....	86
Fusing Unit.....	86
Exit Sensor.....	87
Hot Roller Stripper Pawls.....	87
Hot Roller and Fusing Lamp.....	88
Thermoswitches and Thermistor.....	90
Pressure Roller.....	91
Fusing NIP Band Check By-pass (Checking the NIP band).....	92
PCU and Quenching Lamp.....	93
PCU.....	93
Quenching Lamp.....	94
Exhaust Fan and Main Motor.....	95
Exhaust Fan.....	95
Main Motor.....	95
Paper Feed.....	97
Paper Feed Roller and Friction Pad.....	97
Paper End Sensor.....	98
Registration Sensor.....	98
Bypass Paper End Sensor.....	99
Bypass Feed Roller.....	100
Bypass Feed Clutch and Friction Pad.....	101
Paper Feed and Registration Clutches.....	102
Image Transfer.....	103
Transfer Roller.....	103
ID Sensor and Duplex Roller.....	104
Discharge plate.....	106
BICU and Controller Board.....	107
BICU.....	107
Preparation.....	107
Procedure.....	107
Controller Board.....	108
Preparation:.....	108
Procedure.....	108

---

When installing a new controller board.....	110
When replacing the NVRAM on the controller board.....	111
Other Replacements.....	113
Duplex Motor.....	113
High-Voltage Power Supply Board .....	114
PSU.....	115
Contact-Release Solenoid.....	116
Toner Supply Motor.....	116
FCU.....	117
Lithium Batteries.....	117
Procedure.....	117
Laser Unit.....	119
Location of the Caution Decal.....	119
Laser Unit.....	120
LD Unit and Polygon Mirror Motor.....	121
ARDF.....	122
ARDF Unit.....	122
When installing the ARDF.....	123
ARDF Rear Cover.....	124
Original Feed Unit.....	124
Pick-up Roller.....	125
Feed Roller.....	125
Friction Pad.....	127
DFRB.....	128
ARDF Top Cover Sensor/ Original Set Sensor.....	128
ARDF Drive Motor.....	128
White Plate.....	131
When installing the white plate.....	132
Registration Sensor.....	132
Adjusting Copy Image Area.....	134
Printing.....	134
Adjusting Registration.....	134
Adjusting Blank Margin.....	135

Adjusting Main-Scan Magnification.....	136
Scanning.....	136
Adjusting Registration.....	137
Adjusting Magnification.....	138
DF Image Adjustment.....	138

## 5. System Maintenance Reference

Service Program.....	141
SP Tables.....	141
Using SP and SSP Modes.....	141
Starting SP Mode.....	142
Selecting Programs.....	142
Specifying Values.....	142
Activating Copy Mode.....	142
Quitting Programs/Ending (S) SP Mode.....	142
Conventions used in the tables:.....	142
Using SP Mode.....	144
NVRAM Data Upload/Download.....	144
Uploading Content of NVRAM to an SD card.....	144
Downloading an SD Card to NVRAM.....	144
Firmware Update Procedure.....	145
Before You Begin.....	145
Firmware Update Procedure.....	146
Error Messages.....	147
Firmware Update Error.....	147
Recovery after Power Loss.....	148
Browser Unit Update Procedure.....	148
Handling Firmware Update Errors.....	149
Error Message Table.....	149
Test Pattern Print (SP2-109-001).....	150
Executing Test Pattern Printing.....	150
Test Patterns.....	151
Memory Clear.....	152
Exceptions.....	152

Memory Clear Procedure.....	153
SMC Print (SP5-990).....	153
ID Sensor Error Analysis (SP2-220).....	153
Fax Service Tables.....	155

## 6. Troubleshooting

SC Tables.....	157
Summary.....	157
Engine SC Code Descriptions.....	158
SC Code Descriptions.....	169
SC6xx.....	169
SC8xx.....	172
SC9xx.....	187
Electrical Component Defects.....	190
Sensor/Switch.....	190
Blown Fuse Conditions.....	191
Card Save Function.....	192
Overview.....	192
Card Save:.....	192
Procedure.....	192
Error Messages.....	194
Fax Troubleshooting Guide.....	195

## 7. Energy Saving

Energy Save.....	197
Energy Saver Modes.....	197
Timer Settings.....	197
Recommendation.....	198
Energy Save Effectiveness.....	198
Paper Save.....	200
Effectiveness of Duplex/Combine Function.....	200
1. Duplex:.....	200
2. Combine mode:.....	200
3. Duplex + Combine:.....	200
Recommendation.....	201

---

Model S-C5.....	201
-----------------	-----

# 1. Product Information

---

## Specifications

1

See "Appendices" for the following information:

- General Specifications
- Supported Paper Sizes

# Machine Configuration

1

## Mainframe

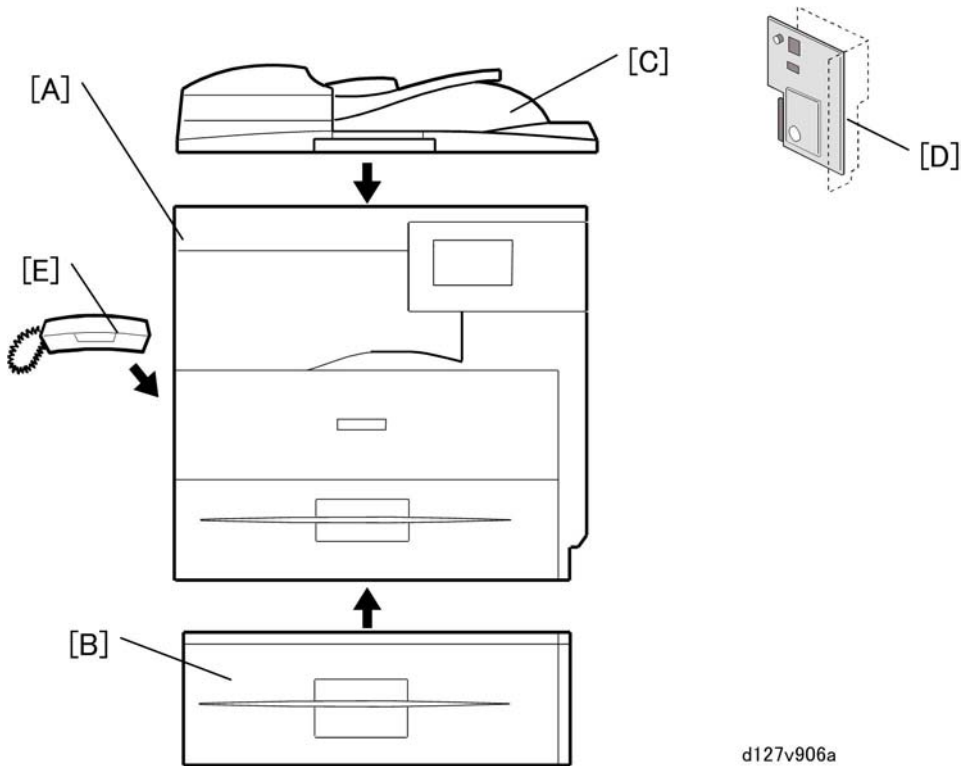

d127v906a

	Standard Component	Machine Code	Remarks
1	Copier [A]	D127/D128	-
2	ARDF [C]	D606	Standard expect for EU Option for EU
3	Platen Cover	D607	Standard for EU
4	Fax Unit [D]	D655	Standard only for D128 Option only for D127

	Optional Components	Machine Code	Remarks
5	500-sheet Paper Feed Unit [B]	D661	Two units can be added at maximum.



6	Handset [F]	D645	NA only
---	-------------	------	---------

## System Components

1

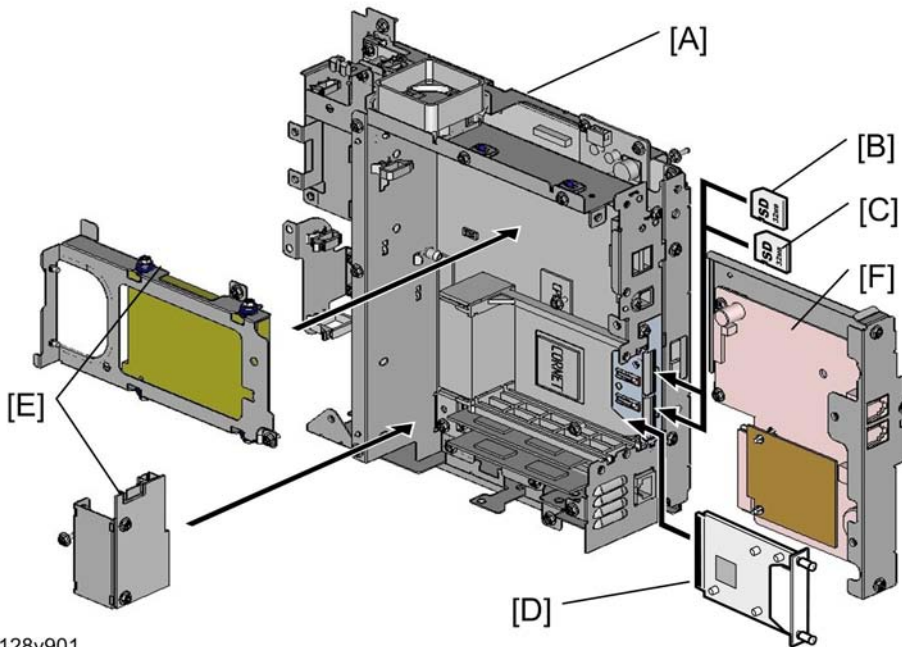

d128v901

Item	Machine Code		Remarks
Controller Box	-	[A]	Standard
Printer/Scanner unit	D468	[B]	SD card for the Printer/Scanner Unit Standard
FAX Option	D655	[F]	
FAX Connection Unit	D660	[B]	
Browser Unit	D656	[B]	
VM Card	D656	[C]	In SD slot 2 (lower)
Net Ware	D659	[C]	SD Card for Net Ware printing Type 1

IEEE 1284	B679	[D]	One from the two
Gigabit Ethernet Board	G874	[D]	
HDD	D659	[E]	Optional HDD with Interface board Merge the Security Card into the Printer/ Scanner SD card.

# Overview

## Component Layout

1

### Mainframe

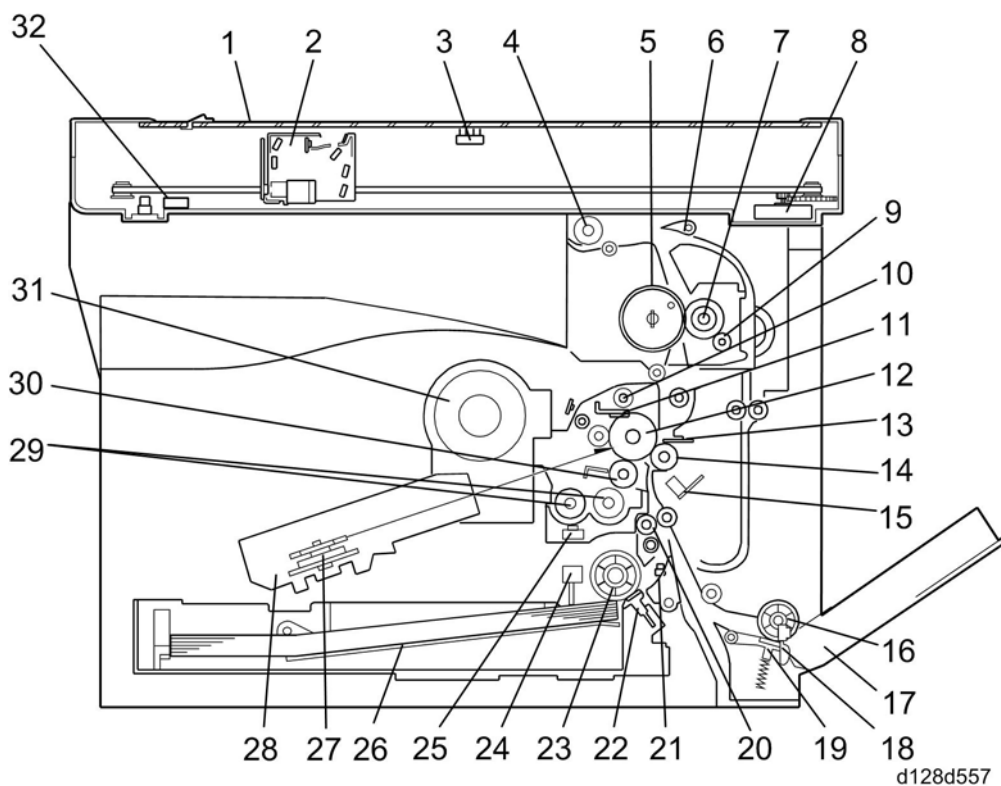

1. Exposure Glass	17. Bypass Tray
2. LED Unit	18. Bypass Paper End Sensor
3. Platen Cover Sensor	19. Bypass Friction Pad
4. Exit Roller	20. Registration Roller
5. Hot Roller	21. Registration Sensor
6. Exit Sensor	22. (Main) Friction Pad
7. Pressure Roller	23. Paper Feed Roller

8. Scanner Motor	24. Paper End Sensor
9. Cleaning Web Roller	25. TD (Toner Density) Sensor
10. Toner Collection Coil	26. Bottom Plate
11. Cleaning Blade	27. Polygon Mirror Motor
12. OPC drum	28. Laser Unit
13. Discharge Plate	29. Mixing Augers
14. Transfer Roller	30. Development Roller
15. ID (Image Density) Sensor	31. Toner Supply Bottle
16. Bypass Paper Feed Roller	32. Scanner HP Sensor

**ARDF**

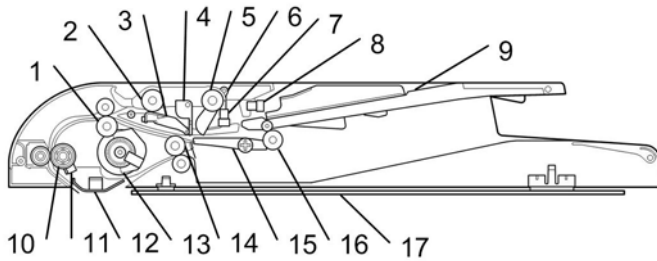

d128d105.jpg

1. Pull-out Roller	10. Registration Roller
2. Feed Roller	11. Registration Sensor
3. Friction Pad	12. Scanner Guide
4. Paper Stopper	13. ARDF drive motor
5. Pick-up Roller	14. Exit Roller
6. Original Set Feeler	15. Junction Gate
7. Original Set Sensor	16. Inverter Roller
8. Upper Cover Sensor	17. Platen Sheet
9. Original Set Tray	

## Electrical Components

### Electrical Components 1

1

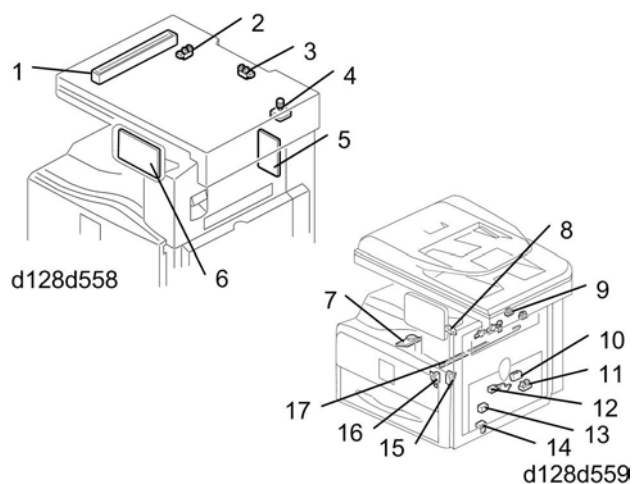

1. LED Unit	10. ID (Image Density) Sensor
2. Scanner HP Sensor	11. Registration Sensor
3. Platen Cover Sensor	12. Paper End Sensor
4. Scanner Motor	13. Toner Density Sensor
5. High-Voltage Power Supply Board	14. Bypass Paper End Sensor
6. Operation Panel Board	15. Right Door Safety Switch
7. Polygon Mirror Motor	16. Front Door Safety Switch
8. LD Unit	17. Quenching Lamp
9. Exit Sensor	

## Electrical Components 2

1

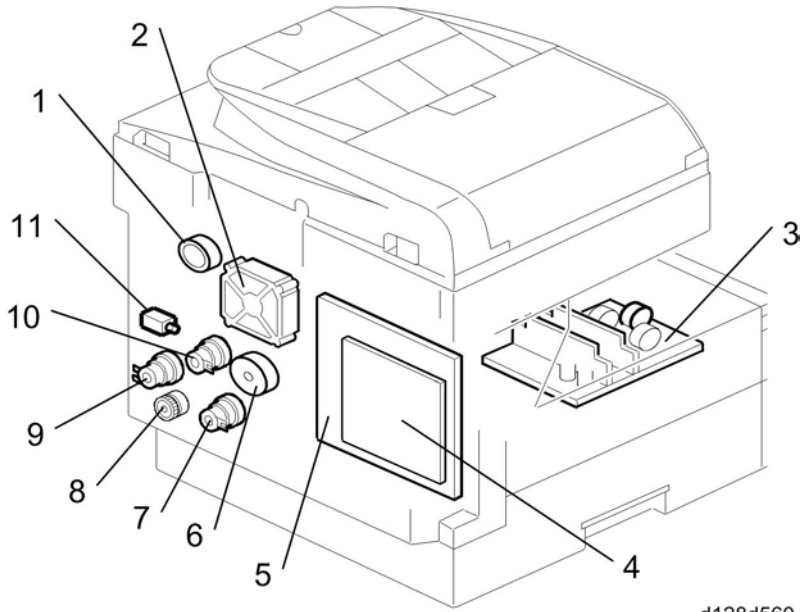

d128d560

1. Duplex Motor	7. Paper Feed Clutch
2. Exhaust Fan	8. Toner Supply Motor
3. PSU	9. Bypass Feed Clutch
4. Controller Board	10. Registration Clutch
5. BICU	11. Fusing Solenoid
6. Main Motor	

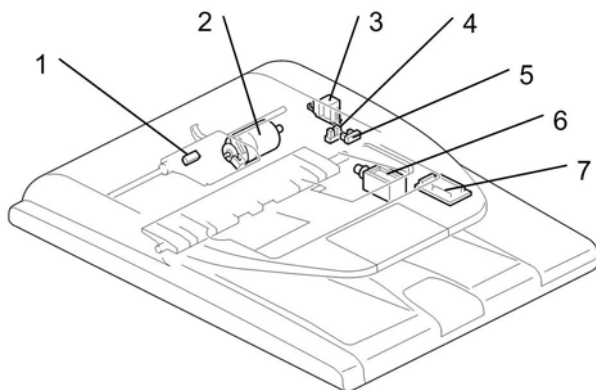
**ARDF**

d128d101.jpg

1. Registration Sensor	5. Upper Cover Sensor
2. ARDF Drive Motor	6. Junction Gate Solenoid
3. Pick-up Solenoid	7. ARDF Relay Board
4. Original Set Sensor	

## Paper Path

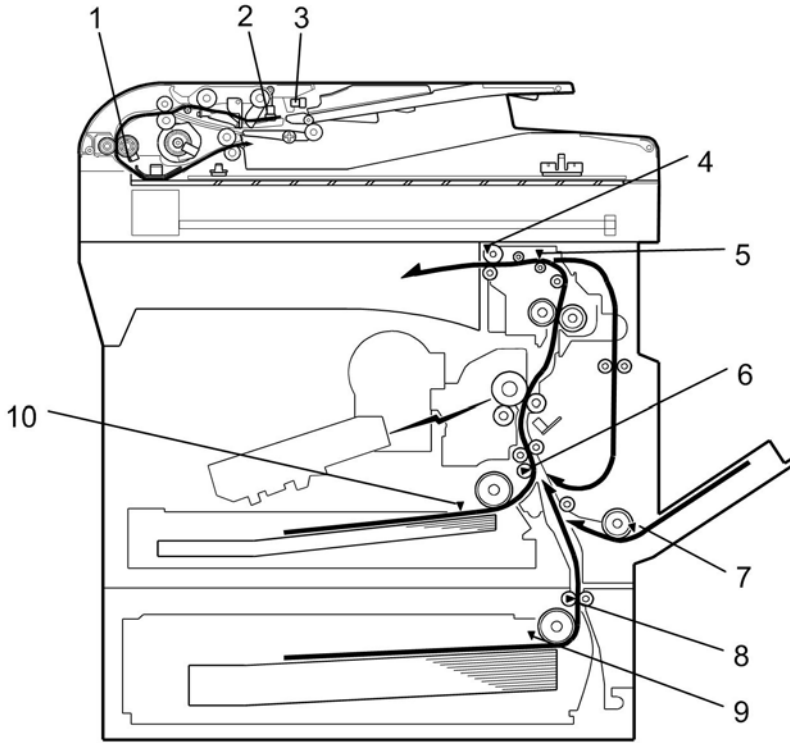

d128d905

1. Original Registration Sensor (Document Feeder)
2. Original Set Sensor (Document Feeder)
3. Upper Cover Sensor (Document Feeder)
4. Exit Sensor
5. Paper Path Sensor
6. Registration Sensor
7. By-pass Paper End Sensor
8. Paper Feed Sensor (Optional Tray)
9. Paper End Sensor (Optional Tray)
10. Paper End Sensor



## Drive Layout

### Mainframe

1

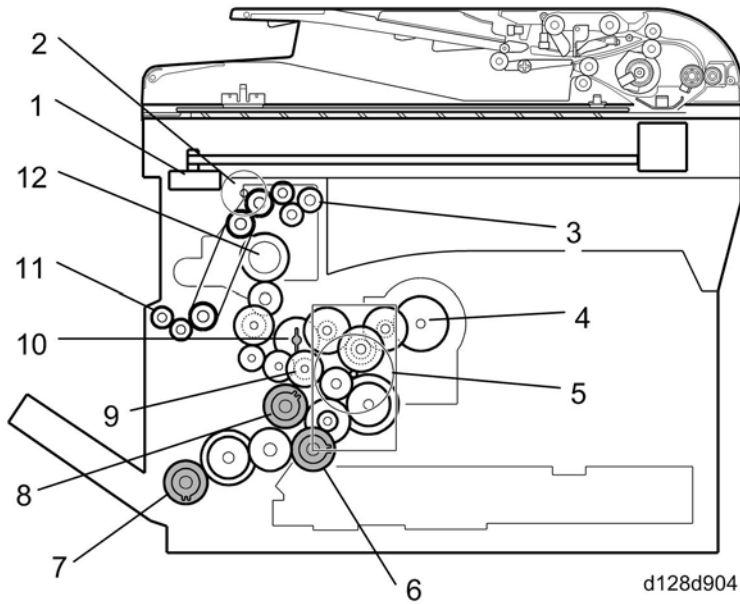

1. Scanner Motor	7. Bypass Feed Clutch
2. Duplex motor	8. Registration Clutch
3. Exit Roller	9. Developer Driver Gear
4. Toner Supply Motor	10. Drum Drive Gear
5. Main Motor	11. One-way Gear (Duplex Unit)
6. Paper Feed Clutch	12. Fusing Drive Gear

## ARDF

1

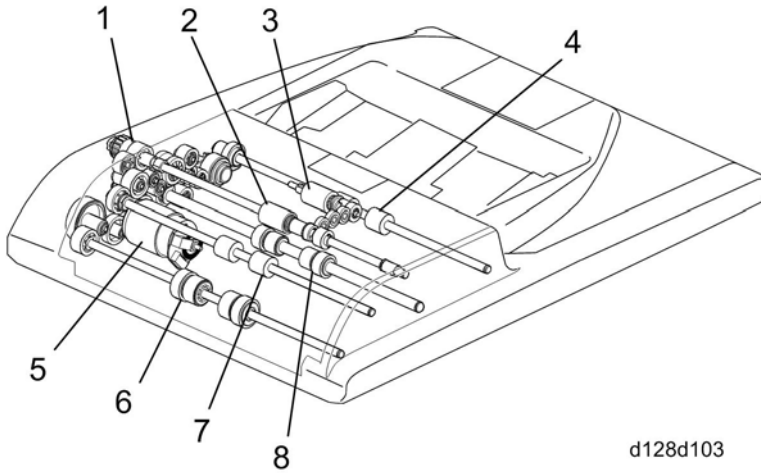

d128d103

1. DF Feed Clutch

2. Feed Roller

3. Pick-up Roller

4. Inverter Roller

5. DF Feed Motor

6. Registration Roller

7. Pull-out Roller

8. Exit Roller

- DF Feed Motor [5]: Drives the feed, pull-out, pick-up, and registration and inverter rollers.

# Guidance for Those Who are Familiar with Predecessor Products

The D127/D128 range of machines is the successor model to the D115/D116 range of machines. If you have experience with the predecessor line, the following information may be of help when you read this manual.

## Differences from Predecessor Products

	D127/D128	D115/D116
Security Card (HDD Encryption and Data Overwrite Security Unit)	Standard	Standard only for D115
Copying Speed	30cpm: Memory copy 30cpm: ADF 1 to 1	20cpm: Memory copy 16cpm: ADF 1 to 1

### ★ Important

- **The following parts are unique for D127/D128. When replacing the following parts, use the parts specified for each model. DO NOT mix up the following parts for D115/D116 and D127/D128. Otherwise, both of the machine operation and output quality are not guaranteed.**

1. LED Scanning Unit (Scanner Unit)
2. Laser Unit (Writing Unit)
3. ARDF
4. Pressing Roller (Fusing Unit)
5. Toner Bottle (Toner Supply Unit)
6. Operation Panel
7. Bank Unit Motor (Optional Bank Unit)
8. One Chip Microcomputer (Engine Control)



# 2. Installation

---

## Installation Cautions

### CAUTION

- Before installing an optional unit, do the following:
- Print out all messages stored in the memory, all user-programmed items, and a system parameter list.
- If there is a printer option on the machine, print out all data in the printer buffer.
- Turn off the main switch and disconnect the power cord, the telephone line, and the network cable.

# Installation Requirements

## Environment

2

### –Temperature and Humidity Chart–

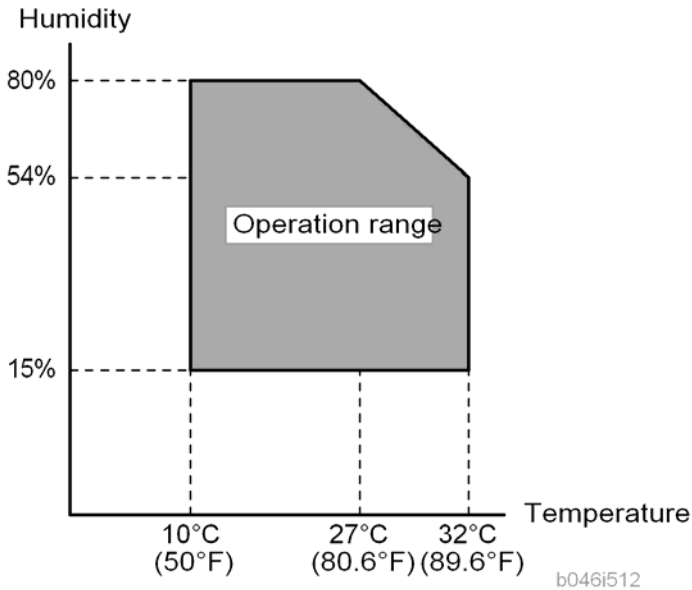

- Temperature Range: 10°C to 32°C (50°F to 89.6°F)
- Humidity Range: 15% to 80% RH
- Ambient Illumination: Less than 1,500 lux (Do not expose to direct sunlight.)
- Ventilation: Room air should turn over at least 3 times/hr/person
- Ambient Dust: Less than 0.1 mg/m<sup>3</sup>
- Do not install the machine where it will be exposed to direct sunlight or to direct airflow (from a fan, air conditioner, air cleaner, etc.).
- Do not install the machine where it will be exposed to corrosive gas.
- Place the machine on a firm and level base.
- Do not install the machine where it may be subjected to strong vibration.
- Do not install the machine at any location over 2,000 m (6,500 ft.) above sea level.

## Machine Level

Front to back:	Within 5 mm (0.2") of level
Right to left:	Within 5 mm (0.2") of level

2

## Minimum Operational Space Requirements

Place the machine near the power source, providing clearance as shown.

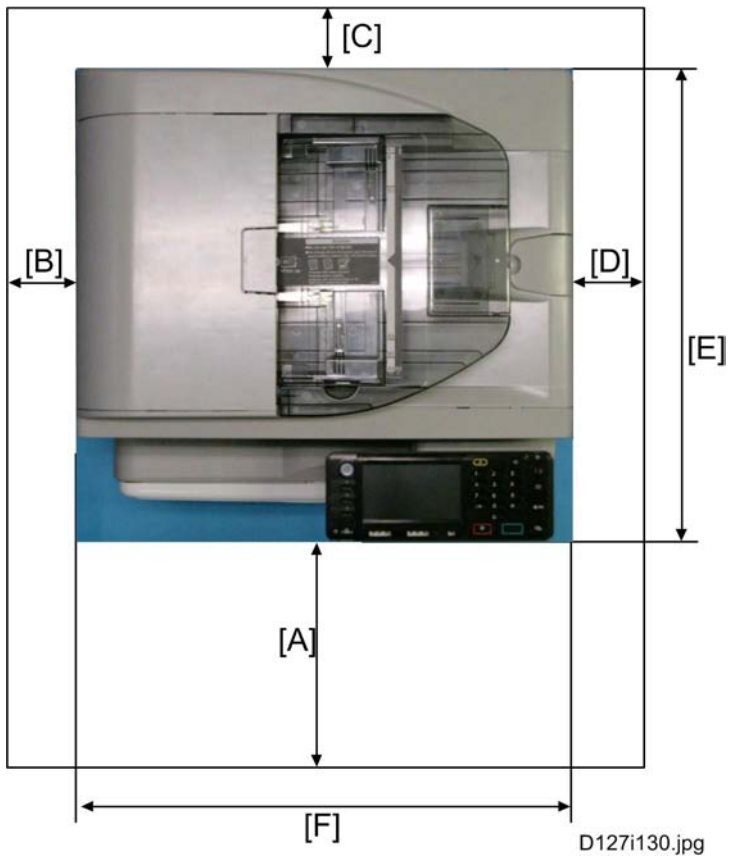

A: Front – 750 mm (29.6")

B: Left – 100 mm (3.9")

C: Rear – 100 mm (3.9")

D: Right – 100 mm (3.9")

E: Depth – 450 mm (17.7")

F: Width – 476 mm (19.1")

**Note**

- The 750-mm front space indicated above is sufficient to allow the paper tray to be pulled out. Additional space is required to allow an operator to stand at the front of the machine.
- Actual minimum space requirement for left, rear, and right sides is 10mm (0.4") each, but note that this will not allow room for opening of the bypass tray, right door or ARDF unit.

---

## Power Requirements

---

### CAUTION

- Make sure that the wall outlet is near the machine and easily accessible. After completing installation, make sure the plug fits firmly into the outlet.
- Avoid multiple connections to the same power outlet.
- Be sure to ground the machine.

#### Input voltage:

North America:	120 – 127 V, 60 Hz, 15 A
Europe:	220 – 240 V, 50/60 Hz, 10 A

Image quality guaranteed at rated voltage  $\pm 10\%$ .

Operation guaranteed at rated voltage  $\pm 15\%$ .



# Copier

## Accessory Check

### Printer/Scanner (D127)/ Scanner and Fax Model (D128)

2

Description	Q'ty
Operating Instructions – Book (-17, -29)	1 set
Operating Instructions – CD ROM (-17, -29)	1
Handset Bracket (-17)	1
Modular Cable (-17)	1
EMC Caution Sheet (-27)	1
EULA Sheet (-27)	1
Caution Sheet (-27)	1
Operation Panel Key Name Sign (-17,-21,-27,-29)	1
PFU Size And Drawer Num Decal (-17,-21,-27,-29)	1
FAX Masking Decal (D12727,D12729)	1
Printer/Scanner Accessories (-17,-21,-27,-29)	1 set
Power Supply Cord (-17,-21,-27,-29)	1
Installation Procedure Book (-17,-27,-29)	1
Quick Guide (-17,-29)	1
Machine Num Decal (-17,-21,-27,-29)	1
Under Communication Sign Decal (-27)	1

### Installation Procedure

#### CAUTION

- Make sure that the copier remains unplugged during installation.

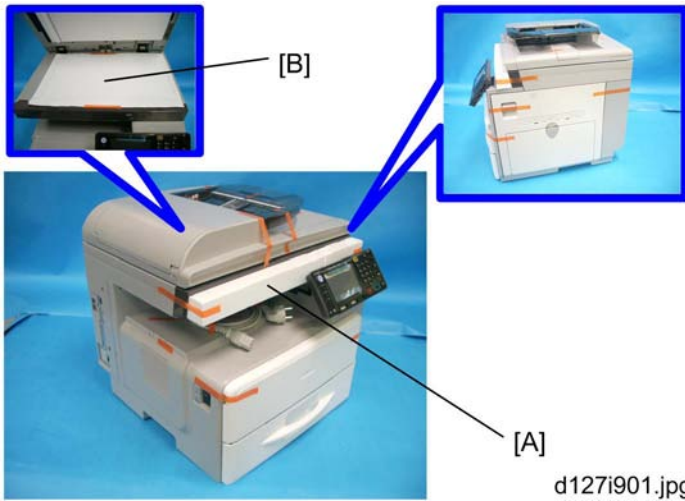

1. Remove the all strips of tape.
2. Remove the bag, SMC, padding [A] and A3 sheet of paper [B] on the exposure glass.
3. Fold the SMC and put it in the back of the front door.

**Note**

- Power supply cord is attached on the back of the main machine.

4. Open the front door [D].

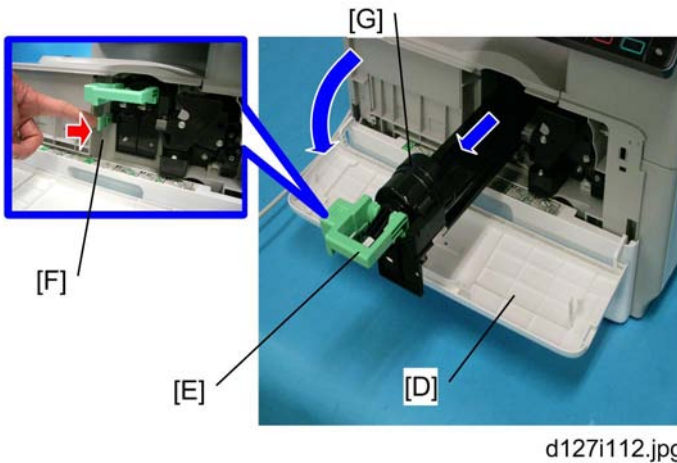

5. Lift lever [E], press in on latch [F] and pull the bottle holder [G] out. (You do not need to pull it completely out of the machine.)
6. Take a new bottle of toner, and shake it several times.

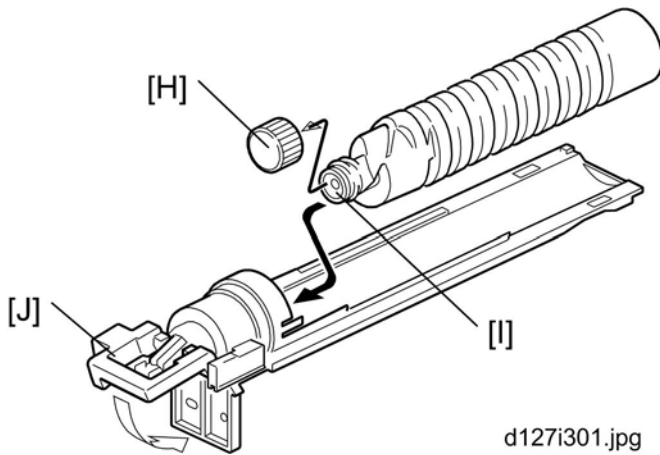

d127i301.jpg

7. Remove the outer cap [H].

**Note**

- Do not remove the inner cap [I].

8. Load the bottle on the holder.

**Note**

- Do not forcefully turn the toner bottle on the holder. After you turn on the main power switch, the copier sets the bottle in place.

9. Push the bottle holder back into the machine.

10. Press the latch [J] down to lock the holder.

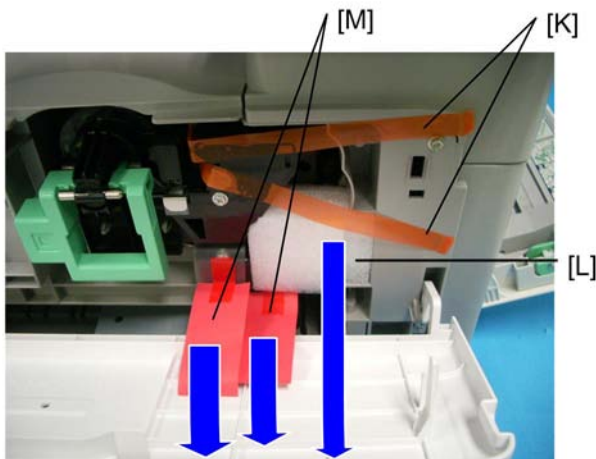

d127i903.jpg

11. Remove the tapes [K].

12. Remove the padding [L].

13. Pull each tabbed strip [M] out of the PCU with one hand, supporting the PCU with the other.

**Note**

- Do not pull both strips at the same time, as this could damage the PCU.

14. Close the front door.

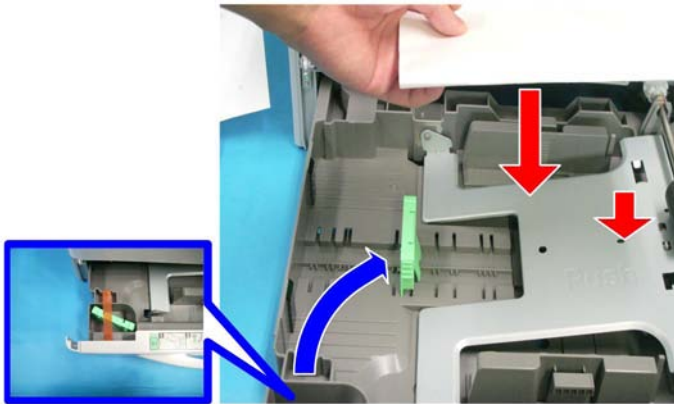

d127i119.jpg

15. Pull out the paper tray, and remove the tape securing the end fence in the compartment.

16. Push the bottom plate down, and then load the paper.

17. Adjust the side fences. If you load paper shorter than A4, set the end fence in the correct position.

18. Push the tray back into the copier.

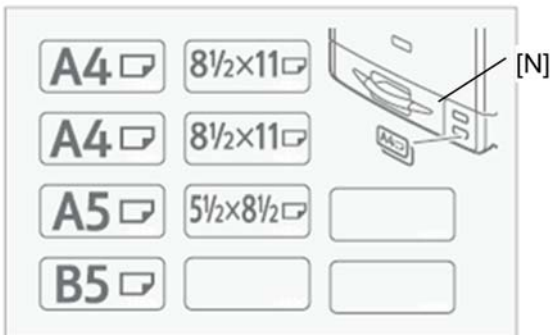

d6610003a

19. Attach the appropriate tray number decal and paper-size decal to the paper tray [N].

20. Install optional units (if any).

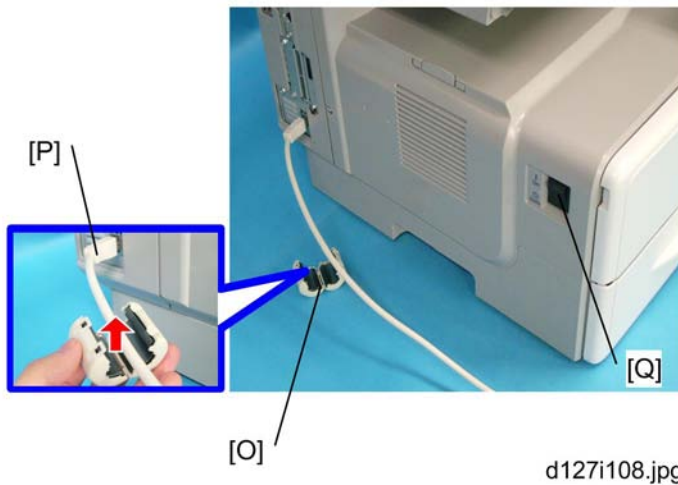

d127i108.jpg

21. Attach the ferrite core [O] to the end of the network cable [P] when connecting the cable.
22. Attach the ferrite core to the telephone line in the same manner as step 21.
23. Connect the telephone line to the "LINE" jack.

#### ↓ Note

- The end of the ferrite core must be about 9 cm (3.6") from the end of the cable. (EU, AP, CHN)

24. Plug in the machine and turn on the main power switch [Q].
25. Select the language used in the operation panel as necessary (🔍/🔍 > Language).

## Interface settings

1. Start the SP mode.
2. Select SP5-985-001 (NIC setting) and change the setting value to "1" (ON).
3. Select SP5-985-002 (USB setting) and change the setting value to "1" (ON).
4. Turn the main switch off and on.

## Copier settings

1. Start the SP mode.
2. Select SP5-801-001 and execute the initialization.
3. Exit the SP mode, and then start the UP mode.
4. Select the "@Remote Service" ("User Tool" > "System Settings > Administrator Tools" > "Extended Security" > @Remote Service) and select "Do not Prohibit".
5. Exit the UP mode, and then start the SP mode.

6. Select SP5-907-001 and specify the "Plug & Play".
7. Select SP5-302-002 and specify the time zone.
8. Select SP5-307-001, 003, and 004 and specify the daylight-saving-time settings.
9. Exit the SP mode and turn the main switch off and on.
10. Start the UP mode.
11. Specify the date and time with "Set Date" or "Set Time" (User Tool" > "System Settings" > "Timer Settings" > "Set Date" or "Set Time").
12. Turn the main switch off and on.
13. Check the operations.
14. Make a full size copy, and check if the side-to-side and leading edge registrations are correct. If they are not, adjust the registrations.

## Fax Settings

### Initializing the Fax unit

When you press the Fax key for the first time after installation, the error "SRAM problem occurred / SRAM was formatted" will show on the LCD for initializing the program of the fax unit. Turn the main power switch off/on to clear the error display.

#### ↓ Note

- If another error occurs after initialization, this can be a functional problem.
  1. Select fax SP1-101-016 and specify the country code.
  2. Select fax SP3-101-001 and specify the service station.

## Optional Handset

### Accessory Check

Check that you have the components and accessories.

No.	Description	Q'ty
1	Handset	1
2	Handset cradle	1
3	Screws	2
4	Handset curly cord with core	1

No.	Description	Q'ty
5	Handset bracket	1

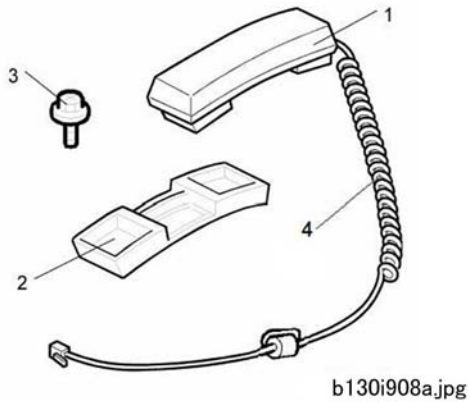

2

## Installation Procedure

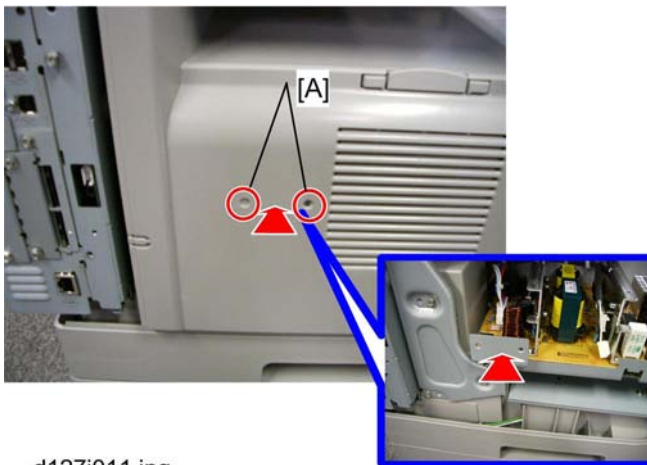



1. Make two holes [A] through which the screws fasten the handset bracket to the main machine. (Just penetrate with a screw driver)

### ↓ Note

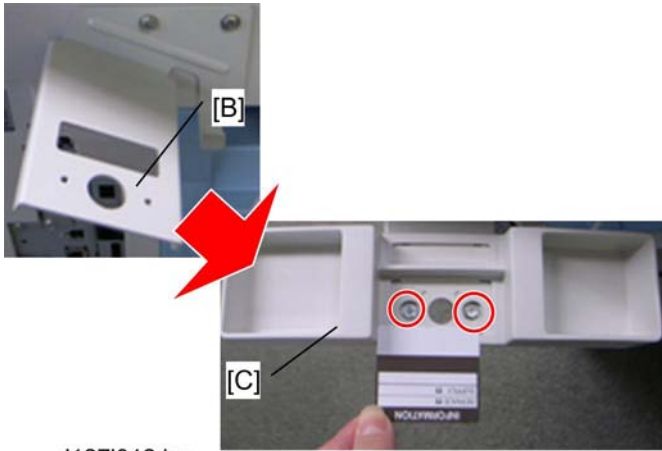
- You should detach the tray cover and make holes on it. Or you might damage the PSU.



d127i012.jpg

2. Attach the handset bracket [B] to the side of the tray cover. (  x 2)
3. Remove the label from the handset cradle [C].
4. Attach the cradle [C] to the handset bracket (  x 2).
5. Reattach the label.
6. Set the handset on the cradle.
7. Connect the core attached handset cable to the "TEL" jack.



# Paper Tray Unit (D661)

## Accessory Check

Confirm that you have these accessories.

Description	Q'ty
1. Paper-size decals	1 sheet
2. Installation Procedure (for service person)	1

2

## Installation Procedure

### ⚠ CAUTION

- 1. Turn off the main switch of the copier and unplug the power cord before you start the installation procedure.
- 2. You need two or more persons to lift the copier. The copier is highly unstable when lifted by one person, and may cause human injury or property damage.
- 3. Do not lift the copier with the paper feed unit installed. The handle and grips may be damaged.

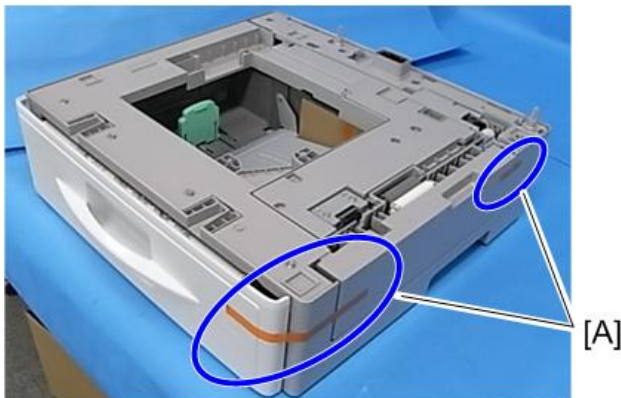

d6610001

1. Remove the tapes [A].

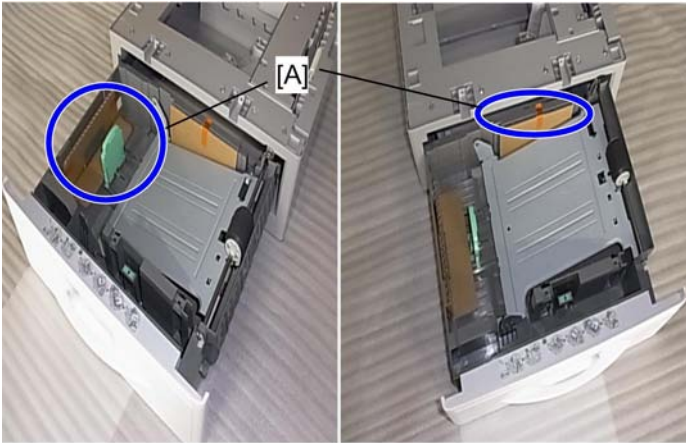

d6610002.jpg

2. Pull the paper tray part way out of the unit, remove the tape and cardboard [A], and push the tray back in.



d6610004

3. Set the copier onto the paper tray unit.

**↓ Note**

- When installing a second paper tray unit, place on the first paper tray unit before placing the copier onto the pair of paper tray units.

4. Remove the paper tray(s) from the paper tray unit(s).
5. Load paper into the paper tray(s). Adjust the side and end fences as necessary. If loading 8 1/2"x 14" paper, remove the end fence and set it into the special compartment.
6. Set the paper tray(s) back into the paper tray unit(s).

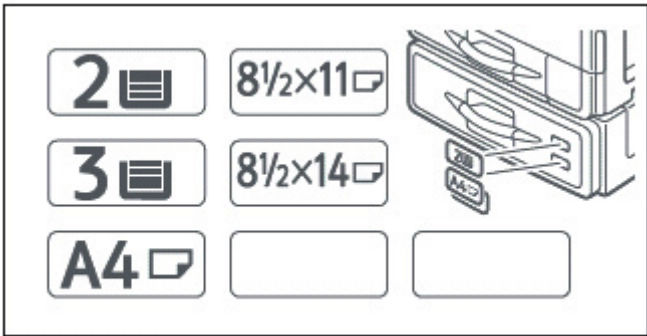

d6610003

7. Stick on the appropriate tray-number decal(s) and paper-size decal(s), at the locations indicated in the illustration.

## Paper Tray Unit Heater

The paper tray unit heater is installed in different place depending on the number of installed paper tray units (Two units can be installed at a maximum).

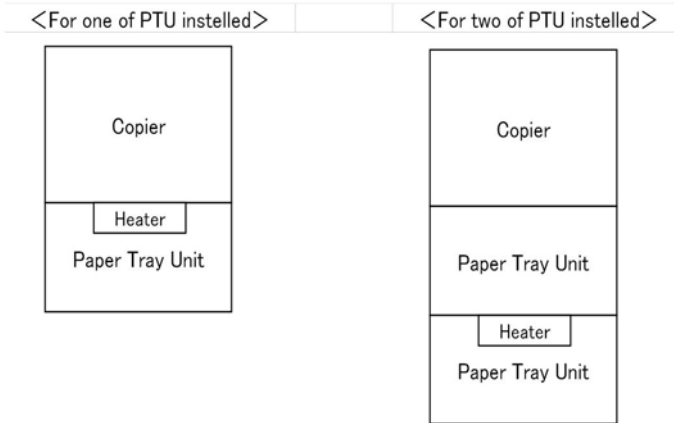

d127i999.jpg

### **⚠ CAUTION**

- The operation system doesn't work when more than three of the paper tray units are installed.

## Accessory Check

Confirm that you have the accessories listed below.

Description	Q'ty
1. Heater fastening screw	2
2. Grounding wire and Harness cover fastening screw	7
3. Washer	7
4. Spring washer	7
5. Joint bracket fastening screw	8
6. Clamp (Large)	2
7. Clamp (Mid)	5
8. Clamp (Small)	2

Description	Q'ty
9. Edge saddle	1
10. Joint bracket (Front)	4
11. Joint bracket (Rear)	2
12. Heater Harness (Long)	1
13. Heater Harness (Mid)	1
14. Heater Harness (short)	1
15. Grounding wire (Long)	1
16. Grounding wire (Short)	1
17. Harness cover	1
18. Guard	1
19. Heater bracket (NA:Blue, EU:Red)	1
20. High temperature caution decal	1

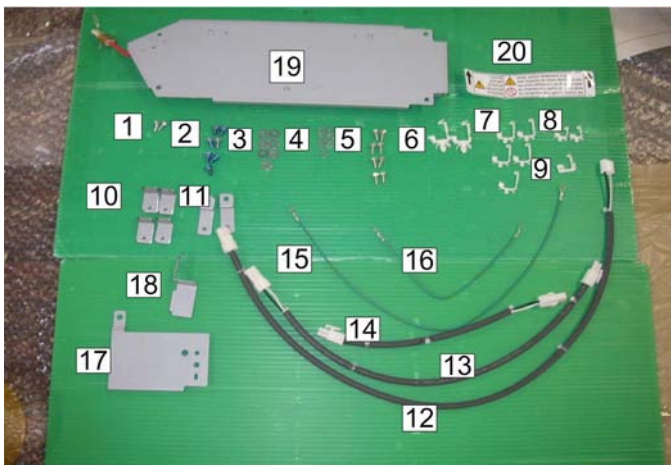

d127i518.jpg

## Installation Procedure (For one of PTU installed machine)

### **⚠ CAUTION**

- Unplug the main machine's power cord before starting the following procedure.

1. Remove the paper tray unit from the copier if it is already installed.

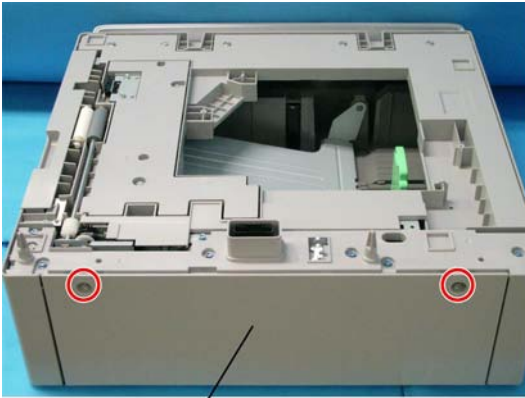

[1]

d127i519.jpg

2. Remove the rear cover [1] from the paper tray unit (  x 2).

**Note**

- Right screw on the picture is a shoulder screw.

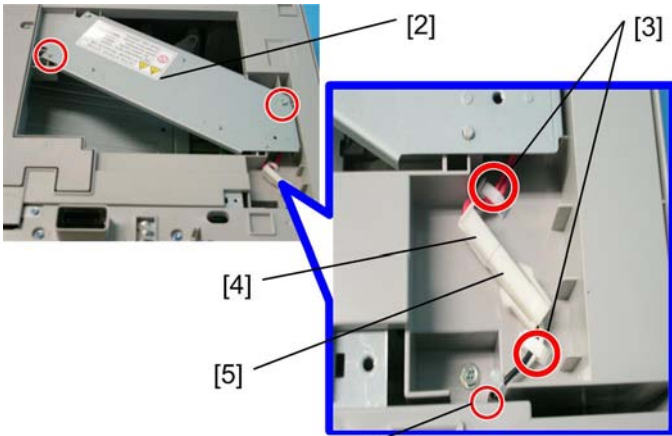

[6]

d127i500.jpg

3. Fasten the heater [2] (  x 2).
4. Put the clamps (Small) [3] in the holes
5. Joint the connector [4] to the heater harness (Short) [5].
6. Pass the heater harness (Short) [5] through the hole [6].
7. Attach the heater harness (Short) through the clamps as shown.

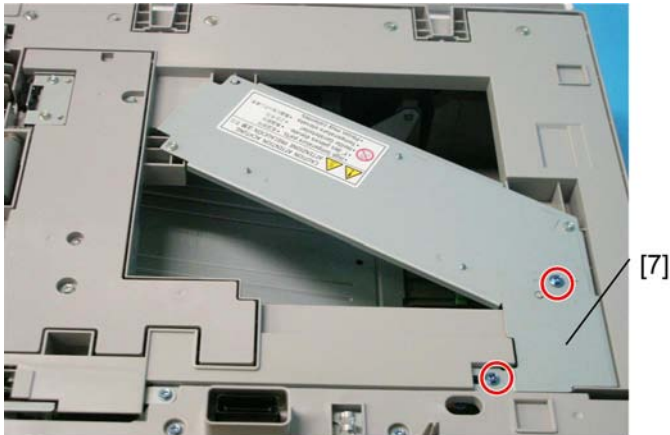

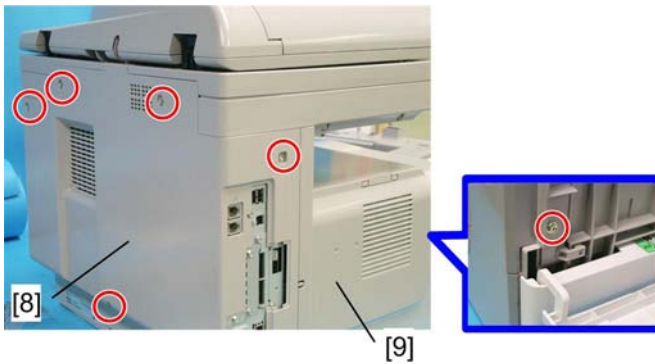

d127i501.jpg

8. Attach the harness cover [7] (  x 2, Washer x 2, Spring Washer x 2).



d127i921.jpg

9. Remove the rear cover [8] (  x 5) and the copy tray [9] (  x 1)

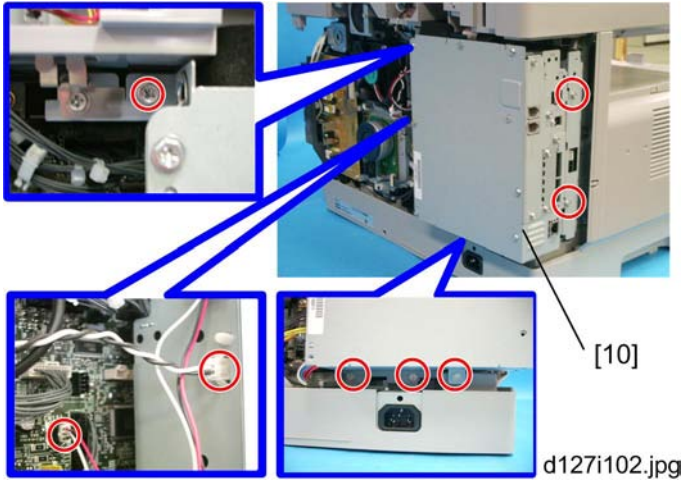

10. Remove the controller box [10] (🔧 x 2, 🛠️ x 6).

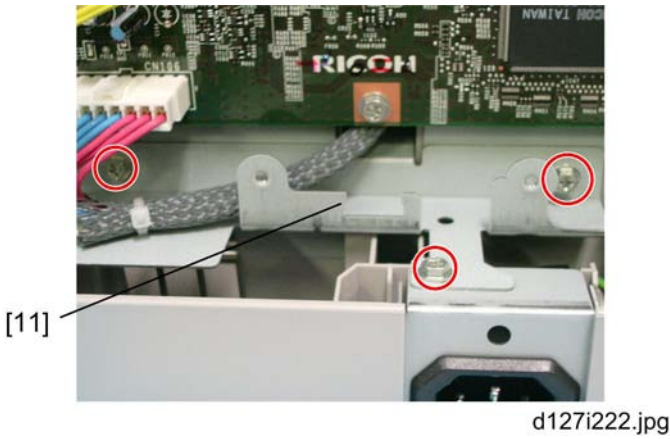

11. Remove the support bracket [11] (🛠️ x 3).

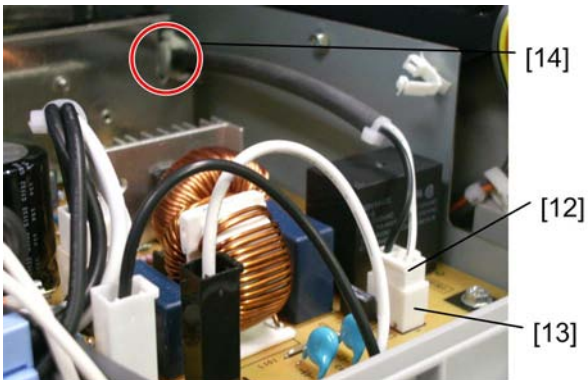



12. Attach the heater harness (Long) [12] to the connector [13] on the board.
13. Attach the clamp (Large) [14]
14. Lead the heater harness (Long) [12] through the clamp (Large) [14] toward inner side of the copier as shown.

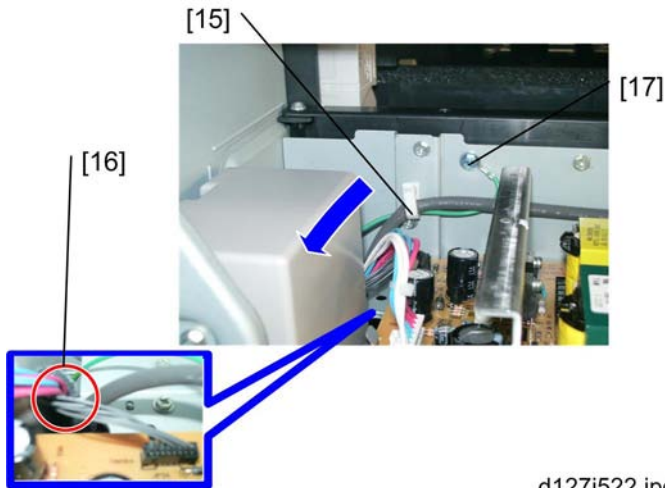

d127i522.jpg

15. Attach the clamp (Large) [15].
16. Pass the heater harness through the hole [16] to the rear of the copier.
17. Attach the grounding wire (Long) [17] (  x 1, Washer x1, Spring washer x1).
18. Pass the grounding wire (Long) [17] through the hole [16] to the rear of the copier.

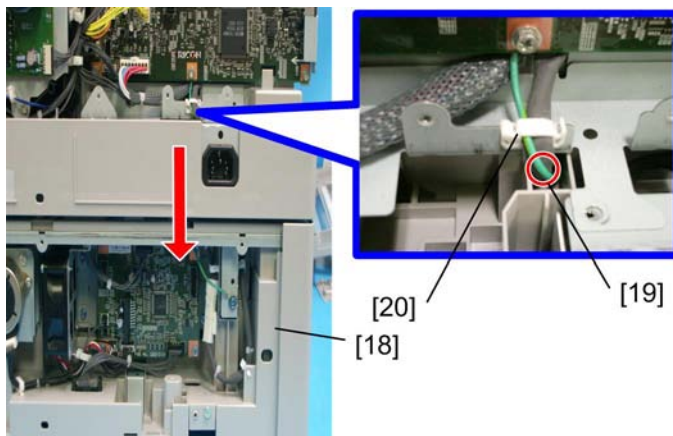

d127i520.jpg

19. Mount the copier on the paper tray unit [18].
20. Put the heater harness (Long) in the hole [19].

**Note**

- Be sure to put the heater harness (Long) in the hole on keeping the end of the heater harness (Long) horizontally long. This makes insertion easy.

21. Pass the support bracket between the copier and the heater harness (Long) on keeping the end of the heater harness (Long) in the hole.

**Note**

- To do step 21 easily, be sure not to pass the heater harness (Long) completely through the hole [19] at the step of 20.

22. Attach the edge saddle [20] to the support bracket.

23. Attach the heater harness (Long) and the grounding wire (Long) through the edge saddle as shown.

24. Pass the grounding wire (Long) through the hole.

25. Pull the heater harness (Long) and the grounding wire (Long) to the paper tray unit side.

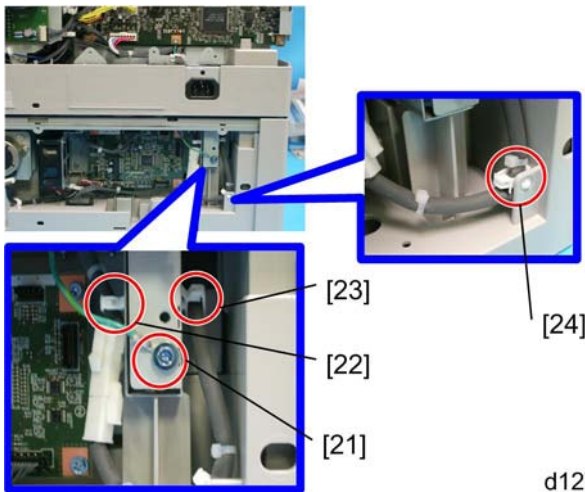

d127i521.jpg

26. Attach the grounding wire (Long) [21] (  x 1, Washer x1, Spring washer x1)

27. Attach two of the clamps (Mid) [22] [23].

28. Attach the clamp (Mid) [24].

29. Connect the heater harness (Long) to the heater harness (Short).

30. Attach the heater harness through the clamps as shown.

**Note**

- Be sure to make the bind attached on the heater harness upper than the clamp (Mid) [22] [24].



[25]

d127i523.jpg

31. Remove the drawer from the paper tray unit.
32. Attach the caution decal [25] in the bottom of the paper tray unit.
33. Reassemble the copier.
34. Plug in the power cord, and check the operation.

### Installation Procedure (For two of PTU installed machine)

#### **⚠ CAUTION**

- Unplug the main machine's power cord before starting the following procedure.

1. Remove the upper and the lower paper tray unit from the copier if it is already installed.

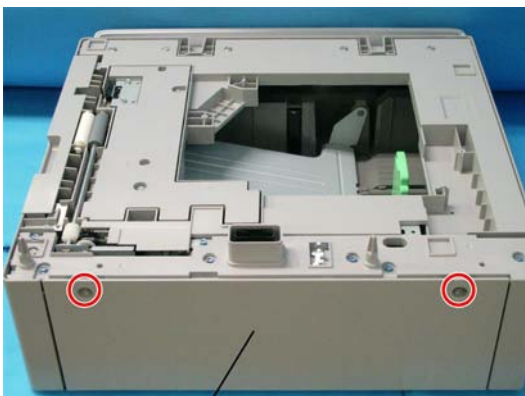

[1]

d127i519.jpg

2. Remove the rear cover [1] from two of the paper tray units (  x 4).

**Note**

- Right screw on the picture is a shoulder screw.

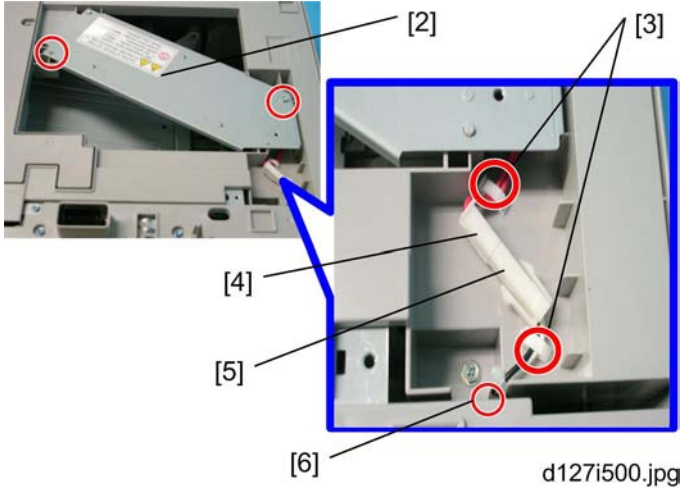

3. Attach the heater [2] to the lower paper tray unit (  x 2).
4. Put the clamps (Small) [3] in the holes.
5. Joint the connector [4] to the heater harness (Mid) [5].
6. Pass the heater harness (Mid) [5] through the hole [6].
7. Attach the heater harness (Mid) through the clamps as shown.



8. Attach the harness cover [7]. (  x 2, Washer x 2, Spring Washer x 2)

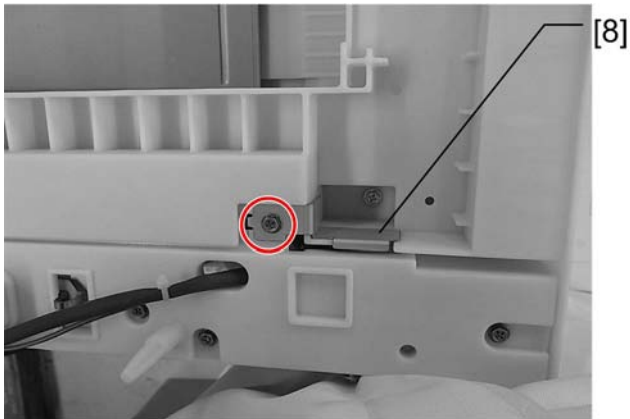

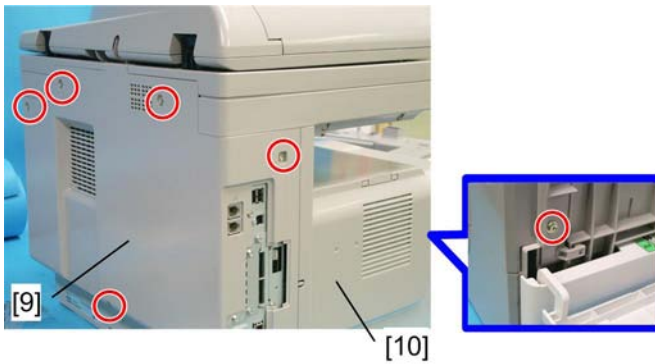

d127i922.jpg

9. Attach the guard [8] to the top face of the upper paper tray unit. (  x 1, Washer x 1, Spring Washer x 1)



d127i936.jpg

10. Remove the rear cover [9] (  x 5) and the copy tray [10] (  x 1).

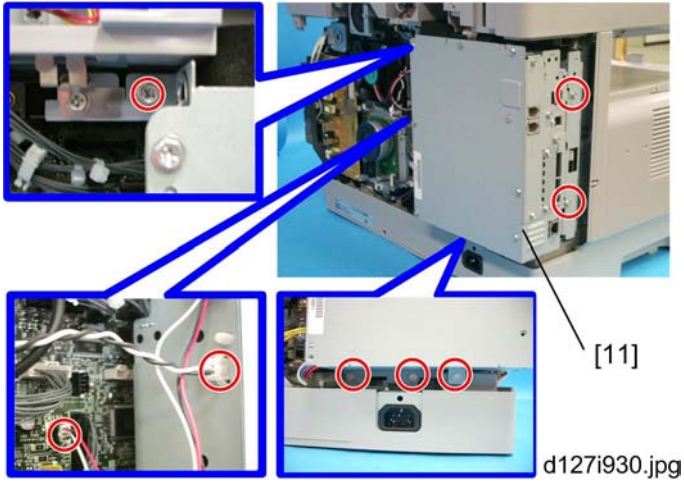

11. Remove the controller box [11] (🔩 x 2, 🛠️ x 6).

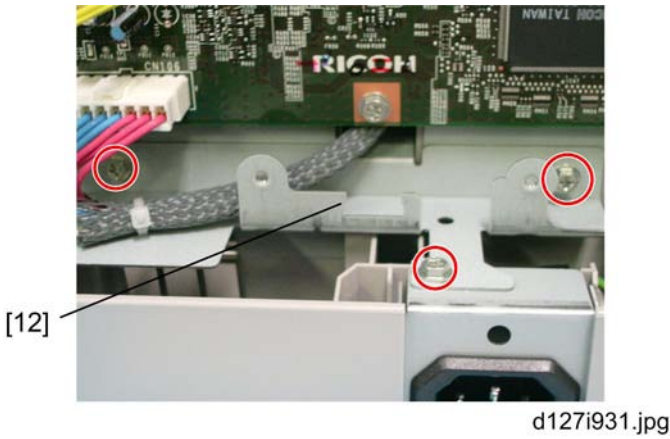

12. Remove the support bracket [12] (🛠️ x 3).

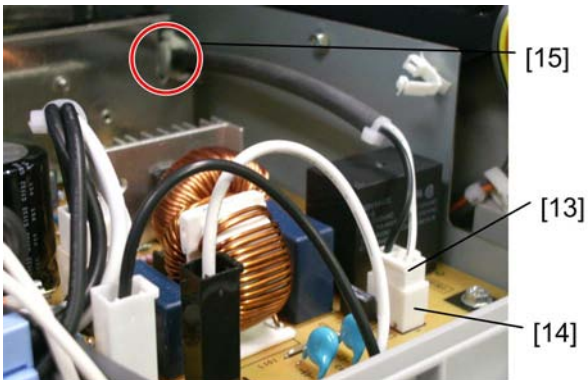

d127i932.jpg

13. Attach the heater harness (Long) [13] to the connector [14] on the board.
14. Attach the clamp (Large) [15]
15. Lead the heater harness (Long) [13] through the clamp (Large) [15] toward inner side of the copier as shown.

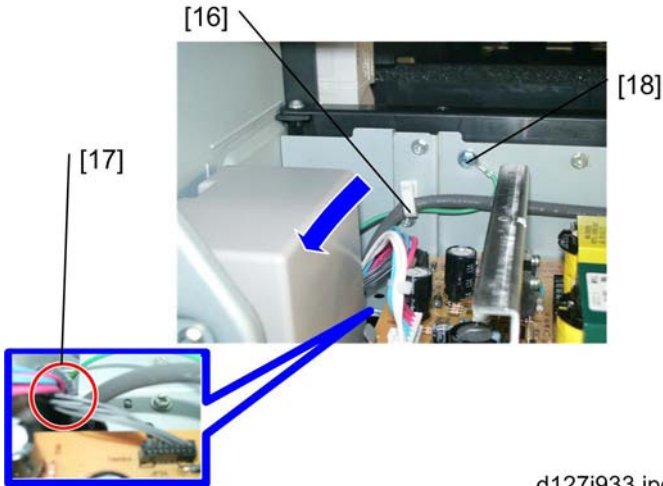

d127i933.jpg

16. Attach the clamp (Large) [16].
17. Pass the heater harness through the hole [17] to the rear of the copier.
18. Attach the grounding wire (Long) [18] (  $\text{⚡}$  x 1, Washer x1, Spring washer x1)
19. Pass the grounding wire (Long) [18] through the hole [17] to the rear of the copier.

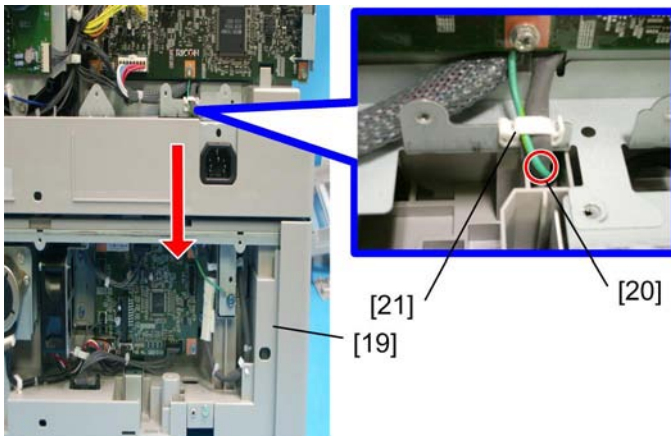

d127i934.jpg

20. Mount the copier on two of the paper tray units [19].
21. Put the heater harness (Long) in the hole [20].

**Note**

- Be sure to put the heater harness (Long) in the hole on keeping the end of the heater harness (Long) horizontally long. This makes insertion easy.

22. Pass the support bracket between the copier and the heater harness (Long) on keeping the end of the heater harness (Long) in the hole.

**Note**

- To do step 22 easily, be sure not to pass the heater harness (Long) completely thorough the hole [20] at the step of 21.

23. Attach the edge saddle [21] to the support bracket.

24. Attach the heater harness (Long) and the grounding wire (Long) through the edge saddle as shown.

25. Pass the grounding wire (Long) through the hole.

26. Pull the heater harness (Long) and the grounding wire (Long) to the paper tray unit side.

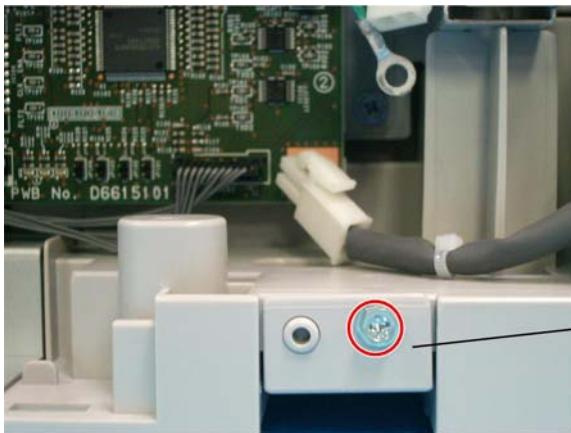



d127i923.jpg

27. Remove the hole cover [22] of the upper paper tray unit. (  x 1 )

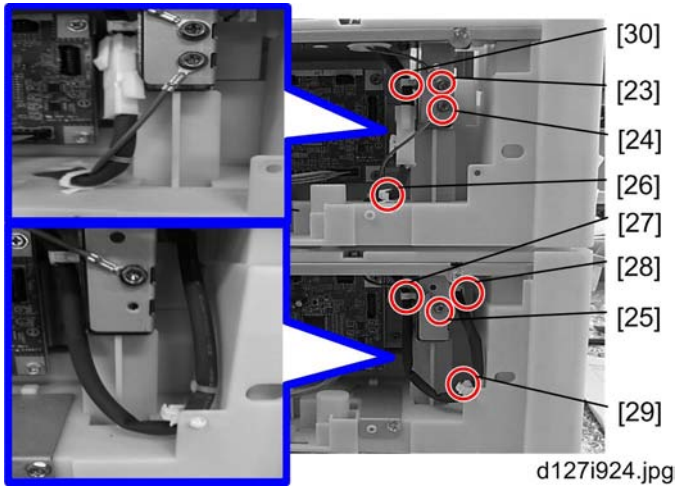



28. Attach the grounding wire (Long) [23] (  x 1, Washer x1, Spring washer x1).
29. Attach the grounding wire (Short) between [24] to [25] through the hole. (  x 2, Washer x2, Spring washer x2).
30. Attach three of the clamps (Mid) [26] [27] [28].
31. Attach the clamp (Mid) [29] [30].
32. Connect the heater harness (Long) to the heater harness (Mid).
33. Attach the heater harness through the clamps as shown.

 **Note**

- Be sure to make the bind attached on the heater harness upper than the clamp (Mid) [29] [30].



[31] d127i935.jpg

34. Remove the drawer from the lower paper tray unit.
35. Attach the caution decal [31] in the bottom of the lower paper tray unit as shown.
36. Reassemble the copier.

37. Plug in the power cord, and check the operation.

## Joint bracket (Joint the copier and the upper PTU)

2

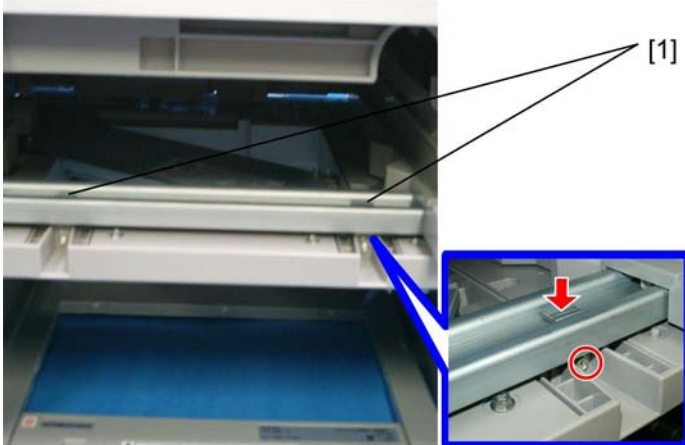

d127i925.jpg

1. Remove each of the drawers.
2. Insert the joint bracket (Front) [1] into the slot as the arrow shows and fasten (  x 2)

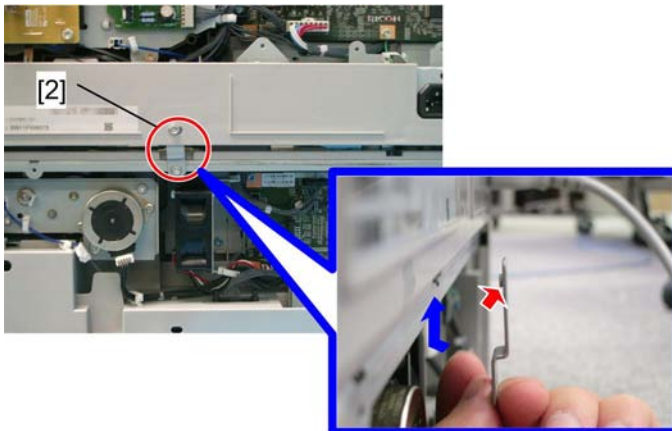

d127i926.jpg

3. Attach the joint bracket (Rear) [2] as shown. (  x 2)

### Note

- The red arrow on the picture above shows the convex side of the screw hole. This is the important clue to attach the bracket correctly.

## Joint bracket (Joint the upper and the lower PTU)

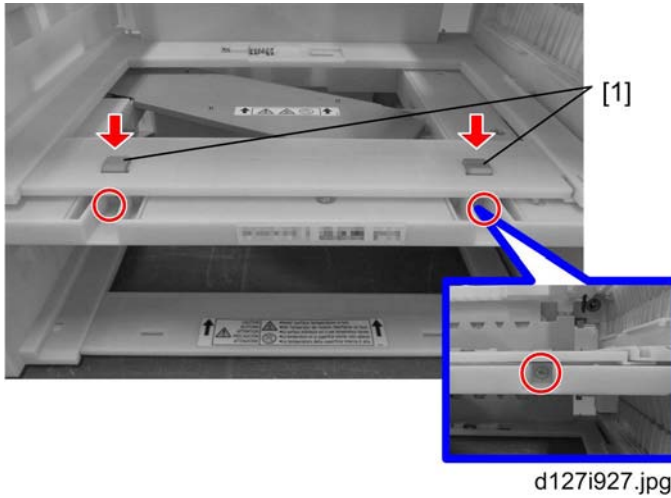

1. Attach the joint bracket (Front) [1] as shown. (🔩 x 2)

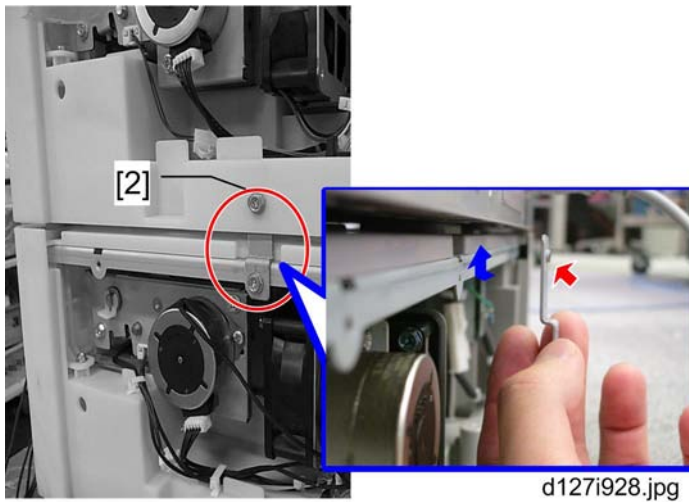

2. Attach the joint bracket (Rear) [2] as shown. (🔩 x 2)

### ⬇️ Note

- The red arrow on the picture above shows the convex side of the screw hole. This is the important clue to attach the bracket correctly.

# Controller Options

## Overview

2

This machine has I/F card slots and SD card slots for optional I/F connections and applications.

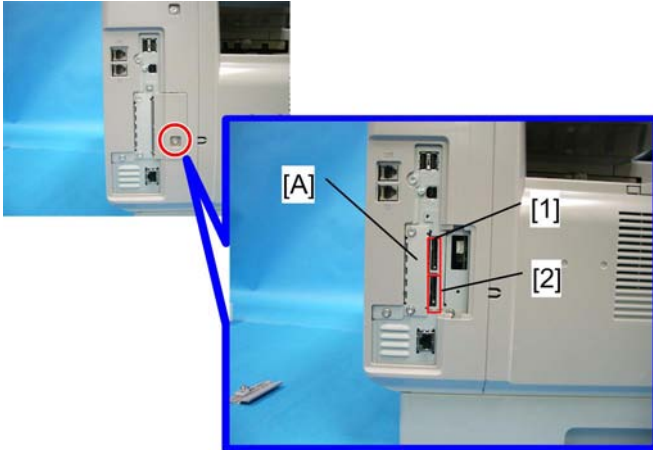

d127i014jpg

### I/F Card Slot

- Slot [A] is used for one of the optional I/F connections: (IEEE1284, IEEE802.11a/g (Wireless LAN) or Gigabit Ethernet).

### SD Card Slot

- Slot [1] is used for options provided on SD cards. The application SD card (Printer/Scanner or Security Card) should be installed in Slot 1. If more than one application is to be used, move the applications to the same SD card with SP5873.
- Slot [2] is used for options provided on SD cards and servicing. The VM card must be installed in Slot 2.

## Wireless LAN (IEEE 802.11a/g) Installation

### CAUTION

- Unplug the machine power cord before starting the following procedure.



### Accessories

Check the accessories and their quantities against the table below.

No.	Description	Q'ty
1	Wireless Adapter	1
2	Wireless LAN Card	1
3	LAN Card Cover	1
4	Caution Sheet	1
5	Label	1

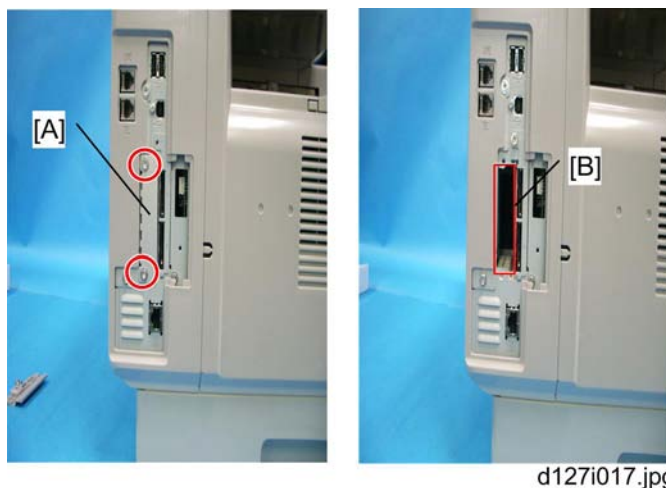
## Installation Procedure



1. Remove the interface cover [A] (  x 2).
2. Install the Wireless adaptor into I/F slot [B] (  x 2).
3. Install the Wireless LAN card in the wireless adaptor.
4. Attach the antenna cap to the wireless LAN card.
5. Turn on the main power switch.
6. Print out the configuration page (User Tools/Counter > Printer Features > List/Test Print), and then check that this device is detected.

If reception is poor, you may need to move the machine:

- Make sure that the machine is not located near an appliance or any type of equipment that could generate a strong magnetic field.
- Position the machine as close as possible to the access point.

## SP Mode Settings for IEEE 802.11 a/g Wireless LAN

The following SP commands can be set for IEEE 802.11 a/g

SP No.	Name	Function
5840 004	SSID	Used to confirm the current SSID setting.
5840 006	Channel MAX	Sets the maximum range of the channel settings for the country.
5840 007	Channel MIN	Sets the minimum range of the channel settings allowed for your country.
5840 011	WEP Key Select	Used to select the WEP key (Default: 00).

## IEEE 1284 Installation

### CAUTION

- Unplug the machine power cord before starting the following procedure.

### Accessories



Check the accessories and their quantities against the table below.

No.	Description	Q'ty
1	IEEE1284 Interface Ass'y	1
2	UL Sheet	1
3	Caution Sheet	1

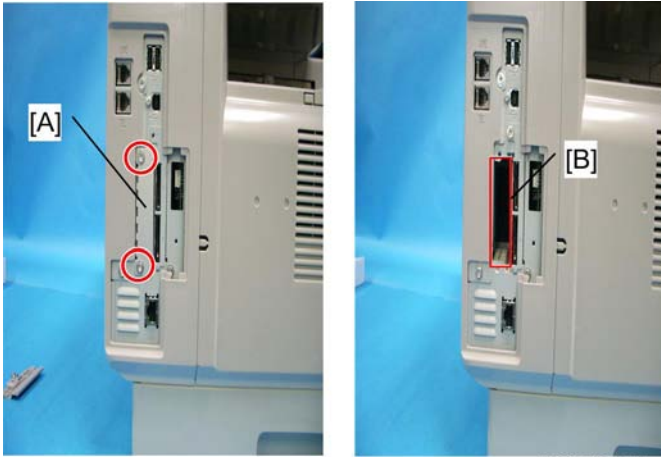
## Installation Procedure



d127i017.jpg

1. Remove the interface cover [A] (  x 2).
2. Install the IEEE 1284 board into I/F slot [B] (  x 2).
3. Turn on the main power switch.
4. Print out the configuration page (User Tools/Counter > Printer Features > List/Test Print), and then check that this device is detected.

## VM Card Type S (D656)

### Accessories

Check the accessories and their quantities against the table below. Accessories

No.	Description	Q'ty
1	VM SD Card	1
2	Decal	1

## Installation

---

2



d127i020.jpg

1. Remove the interface cover [A] (  x 1).



d127i019.jpg

2. Switch the machine off.
3. Insert the SD card [A] into SD Slot 2 (lower).

**★ Important**

- This SD card must be inserted into Slot 2, the lower slot.

---

## Gigabit Ethernet

---

### CAUTION

- Unplug the main machine power cord before you do the following procedure.



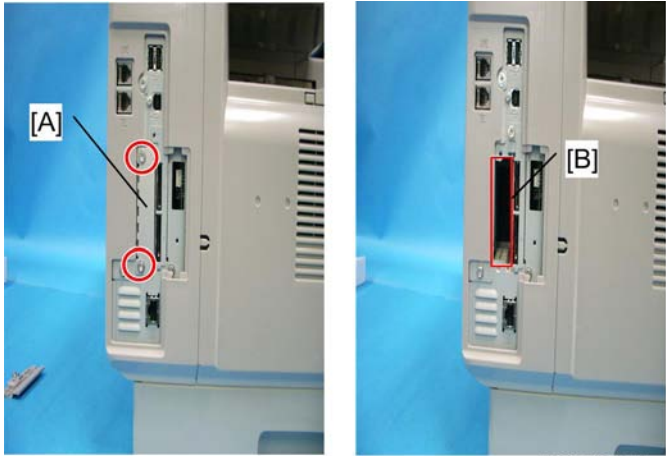

d127i017.jpg

1. Remove the I/F-slot cover [A] (  x 2).
2. Install the Gigabit Ethernet board (Knob-screw x 2) into the I/F-slot [B].

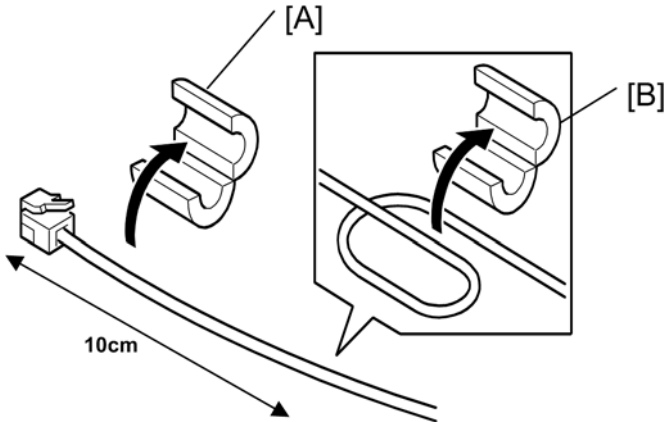

d067r113

3. Attach one ferrite core [A] to the end of the Ethernet interface cable, and then attach the other ferrite core [B] about 10cm from the end of the Ethernet interface cable.
4. Connect the Ethernet interface cable to the Gigabit Ethernet port.

Make sure that the machine can recognize this option (see 'Check All Connections' at the end of this section).

### Fax Option (D655)

Fax Unit is option for D127 but standard for D128.

The bracket on which Fax Unit is mounted is embedded in the controller box.

### Component Check

No.	Description	Q'ty
1	Fax Unit	1
2	Speaker	1
3	Insulating Sheet	1
4	Screw for Fax Unit	4
5	Screw (thin) for Speaker	2
6	Screw (thick) for Grounding Wire	2
7	Harness with Band	1
8	Ferrite Core (EU/AP/CN)	1
9	Decal (Super G3)	1
10	Grounding Wire	2
11	Bracket Guide	1
12	Core attached Telephone Cord (NA only)	1
13	Ferrite Core	1

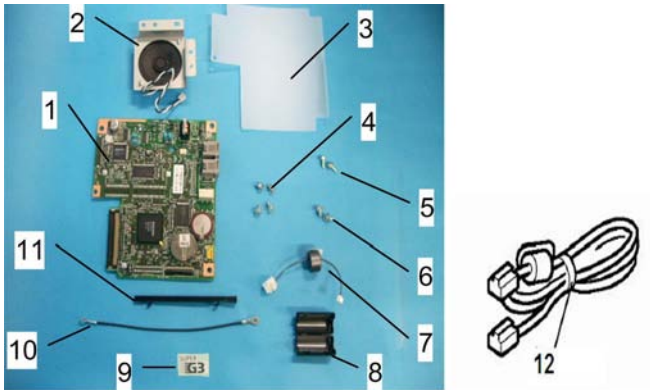

d127r030.jpg

## Installation Procedure

1. Rear cover (  x 5)

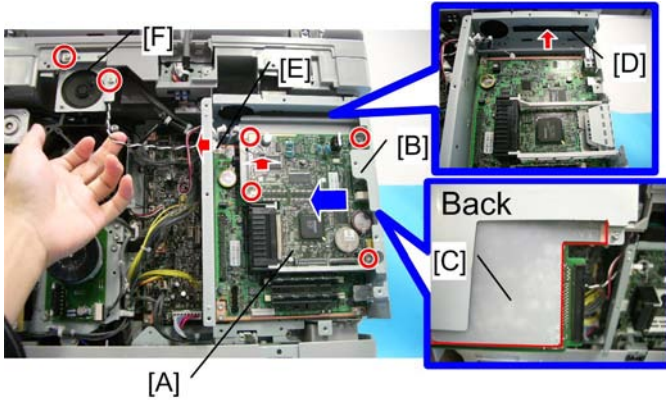

d127r031.jpg

2. Attach the Fax Unit [A] to the bracket [B] with placing the sheet [C] between the unit [A] and the bracket [B]. (  x 4)
3. Attach the Bracket Guide [D] as shown.
4. Slot the bracket assembled in procedure 2 in between two of the guides as the blue arrow shows.
5. Attach the large end of the Harness with the Band [E] and connect the small end to on the Fax Unit [A] as the red arrows shows.
6. Attach the Speaker [F] and its connector to the large end of the Harness [E].

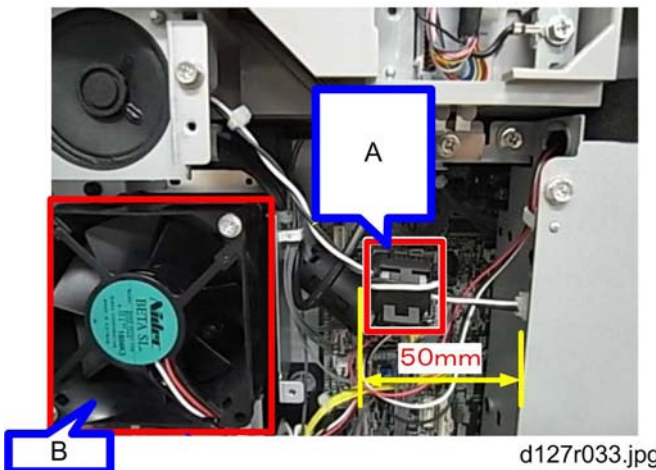

d127r033.jpg

7. Attach the ferrite core [A] on the speaker harness within 50mm from the end of the controller board. This prevents the harness from being involved in the fan [B].

## Grounding Wire

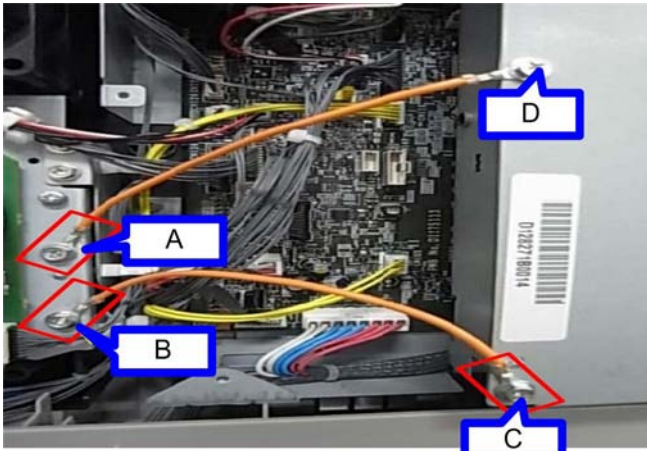

d127r032.jpg

Attach the grounding wire as shown.

[A] and [B] are attached with screws (thick) for the grounding wire.

[C] and [D] are with screws for the controller board cover.

### ↓ Note

- Be sure to make [A], [B] and [C] attached in upward direction.

## HDD Option (D659)

### Component Check

No.	Description	Q'ty
1	HDD Unit	1
2	Screw	6
3	SAT Interface Board	1
4	Cable (Small)	1
5	Cable (Large)	1

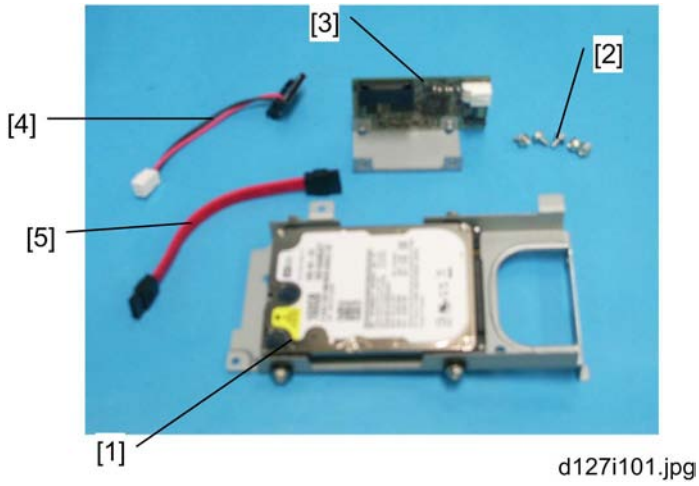

d127i101.jpg

### Installation Procedure

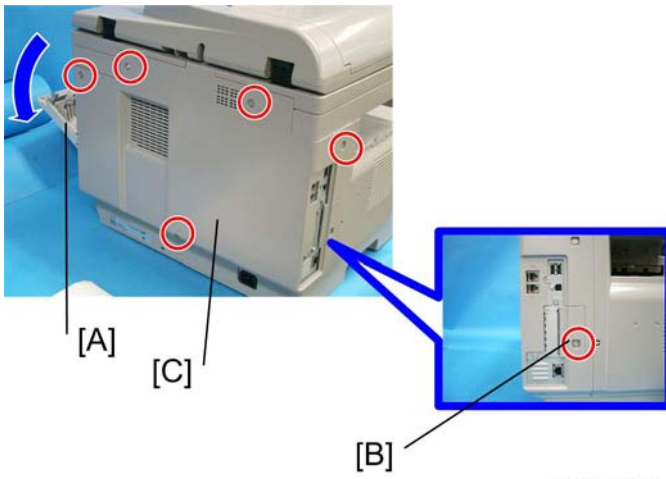

d068r102.jpg

1. Open the right door [A].
2. Interface cover [B] ( 🛠 x 1)
3. Rear cover [C] ( 🛠 x 5)

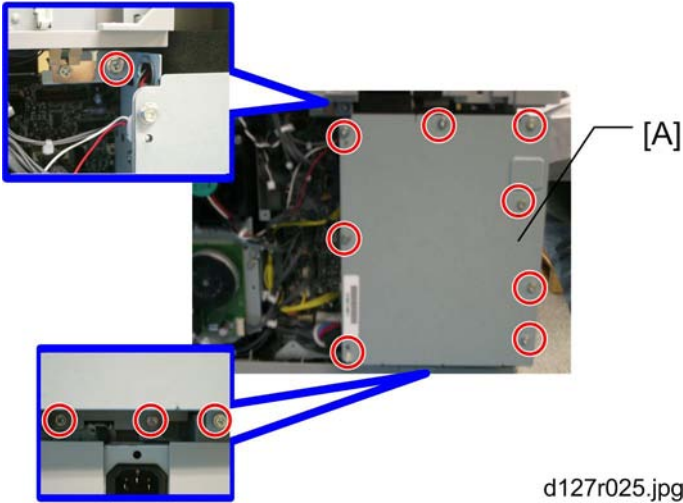

d127r025.jpg

4. Controller box cover [A] (  x 11 )

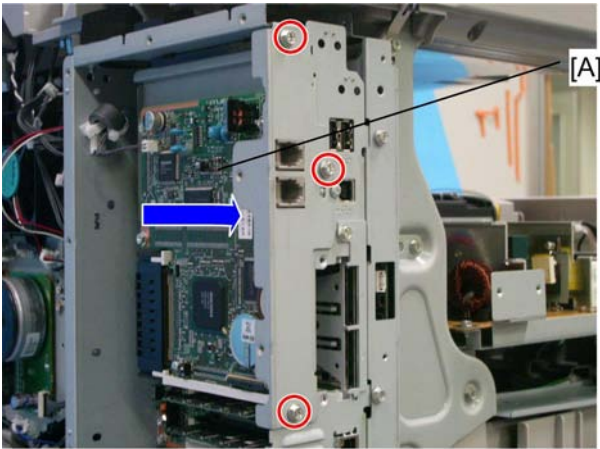

d127r028.jpg

5. Remove three of the screws and pull the bracket as the arrow shows to detach the board [A].

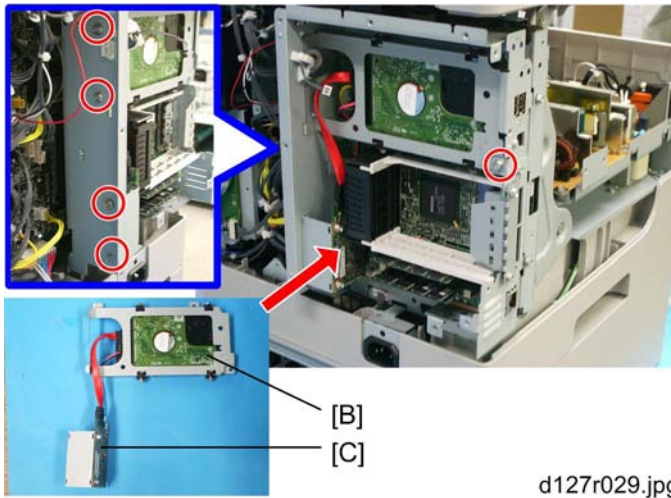

d127r029.jpg

6. Connect the HDD Unit [B] and SAT Interface Board [C] with the Cable (small) and the Cable (large).

7. Install the HDD Unit [B] and the SAT Interface Board [C] in the controller board (  x 5).

#### ↓ Note

- Be sure to lead two of the cables over the HDD bracket to the SAT interface board [C]. This makes installation easy.

8. Reinstall the controller box cover and rear cover in the machine.

Turn the main power switch on.

9. Touch the "Format" button displayed with the message on start-up.

10. Turn the main power switch off/on after the message directs to do so.

## Installing the Security Card

1. Insert the Security Card in the SD slot.

- **For D127**, use slot 2 (lower) and merge the Security Card into the Printer/Scanner card with SP5-873-001. Remove the Security Card from the SD slot 2 after moving the security applications and keep the Security Card at a safe location.
- **For D128**, use slot 1 (upper).

2. Enter the SP mode.

3. Input a machine serial number with SP 5811-001.

4. Go into the SP mode and push "EXECUTE" with SP5-878-001.

5. Select SP5878-002, and then press "Execute" on the LCD.

6. Exit the SP mode after "Completed" is displayed on the LCD.

## Activating the Security Applications

1. Make sure that the following settings are not at their factory default values:

- Supervisor login password
- Administrator login name
- Administrator login password

If any of these settings is at a factory default value, tell the customer these settings must be changed before you do the installation procedure.

2. Make sure that "Admin. Authentication" is ON.

[System Settings] – [Administrator Tools] – [Administrator Authentication Management] - [Admin. Authentication]

If this setting is OFF, tell the customer this setting must be ON before you do the installation procedure.

3. Make sure that "Administrator Tools" is enabled (selected).

[System Settings] – [Administrator Tools] – [Administrator Authentication Management] - [Available Settings]

If this setting is disabled (not selected), tell the customer this setting must be enabled (selected) before you do the installation procedure.

4. Refer to the Security Reference for details about activating the security applications (HDD Encryption Unit and DataOverwriteSecurity).

## HDD Encryption Recovery from a Device Problem

The flowchart below shows the recovery possibility of the HDD encryption if one of devices related with the HDD encryption is defective.

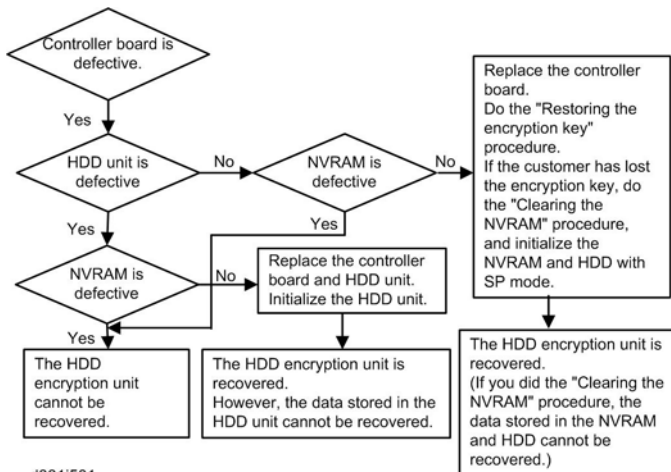

d381f501



## Restoring the Encryption key

When replacing the controller board for a model in which the HDD encryption unit has been installed, updating the encryption key is required.

1. Prepare an SD card which is initialized.
2. Make the "restore\_key" folder in the SD card.
3. Make an "nvram\_key.txt" file in the "restore\_key" folder in the SD card.
4. Ask an administrator to input the encryption key (this has been printed out earlier by the user) into the "nvram\_key.txt" file.
5. Remove only the HDD unit.
6. Turn on the main power switch.
7. Confirm that the prompt on the LCD tells you to install the SD card (storing the encryption key) in the machine.
8. Turn off the main power switch.
9. Insert the SD card that contains the encryption key into slot 1.
10. Turn on the main power switch, and the machine automatically restores the encryption key in the flash memory on the controller board.
11. Turn off the main power switch after the machine has returned to normal status.
12. Remove the SD card from slot 1.
13. Reinstall the HDD unit.

## Clearing the NVRAM

When replacing the controller board for a model in which the HDD encryption unit has been installed and a customer has lost the encryption key, clearing the NVRAM is required to recover the HDD encryption unit.

1. Prepare an SD card which is initialized.
2. Make the "restore\_key" folder in the SD card.
3. Make an "nvram\_key.txt" file in the "restore\_key" folder in the SD card.
4. Input "nvclear" into the "nvram\_key.txt" file.
5. Turn on the main power switch.
6. Confirm that the prompt on the LCD tells you to install the SD card (storing the encryption key) in the machine.
7. Turn off the main power switch.
8. Insert the SD card that contains "nvclear" into slot 1.
9. Turn on the main power switch, and the machine automatically restores the encryption key in the flash memory on the controller board.

10. Turn off the main power switch after the machine has returned to normal status.
11. Remove the SD card from slot 1.
12. Turn on the main power switch.
13. Initialize the NVRAM (SP5801-001) and HDD unit (SP5832-001) with SP mode.
14. The user must enable the HDD encryption unit with a user tool.

# 3. Preventive Maintenance

---

## Maintenance Tables

See "Appendices" for the following information:

- PM tables

## How to Clear the PM Counter

Reset the PM counter after your maintenance work.



d127p901.jpg

1. Activate the SP mode.
2. Select SP7-804-001.
3. Press the EXECUTE. The message "Completed" is displayed when the program ends normally. An error message is displayed if the program ends abnormally.
4. Press the Exit to end the program.

# 4. Replacement and Adjustment

## Precautions

### General

#### CAUTION

- Turn off the main power switch and unplug the machine before starting replacement.

Before turning off the main power switch, check that no mechanical component is operating. Mechanical components may stop out of their home positions if you turn off the main power switch while they are operating. The component may be damaged if you try to remove it when it is not in the home position.

### Lithium Batteries

#### CAUTION

- Incorrect replacement of lithium battery(s) on the controller or on the fax unit poses risk of explosion. Replace only with the same type or with an equivalent type recommended by the manufacturer. Discard used batteries in accordance with the manufacturer's instructions.

### Halogen-free Cable

#### CAUTION

- Use extreme caution while handling cables.

To comply with local regulations, halogen-free cables are used in this machine. Halogen-free cables are environment-friendly, but no stronger than conventional cables. These cables may be damaged in any of the following cases:

- The cable is caught between hard objects such as brackets, screws, PCBs, and exterior covers.
- The cable is rubbed on a hard object such as brackets, screws, PCBs, and exterior covers.
- The cable is scratched with a hard object such as brackets, screws, PCBs, exterior covers, screwdrivers, and fingernails.

---

## **Static Electricity**

---

Always touch a grounded surface to discharge static electricity from your hands before you handle SD cards, printed circuit boards, or memory boards.

## Special Tools and Lubricants



Part Number	Description	Q'ty
B6455010	SD Card	1
52039502	Silicon Grease G-501	1
B6795100	Plug-IEEE1284 Type C	1

# Exterior Covers and Operation Panel

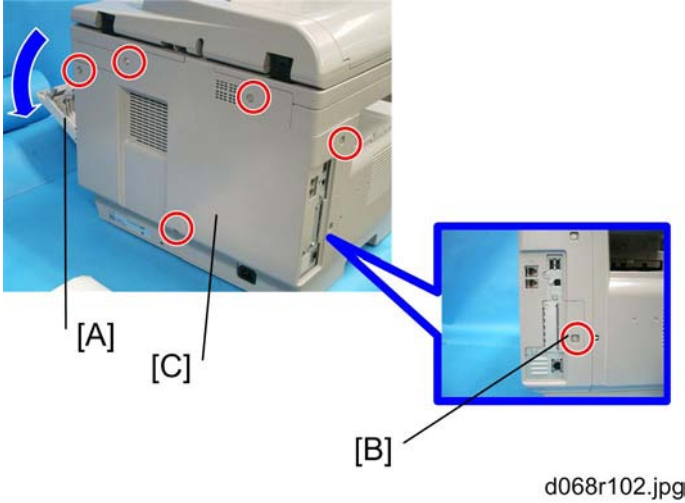
## Rear Cover



4

1. Open the right door [A].
2. Interface cover [B] (  x 1)
3. Open the right door [A].
4. Rear cover [C] (  x 5)

## Copy Tray

### CAUTION

- Make sure that the cables under the copy tray are in place before reassembling the copier. If these cables are caught between the copy tray and the inner cover, they may be severely damaged.



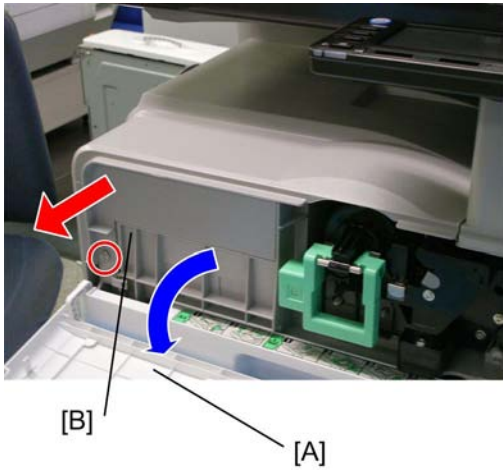

d127r902.jpg

1. Open the front door [A].
2. Copy tray [B] (  x1)

4

## Operation Panel

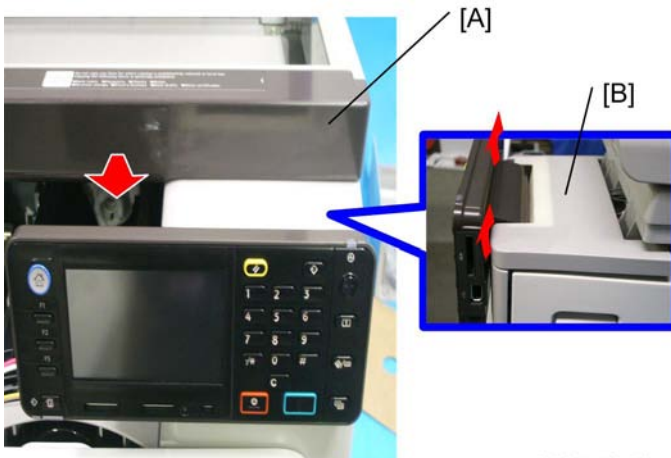

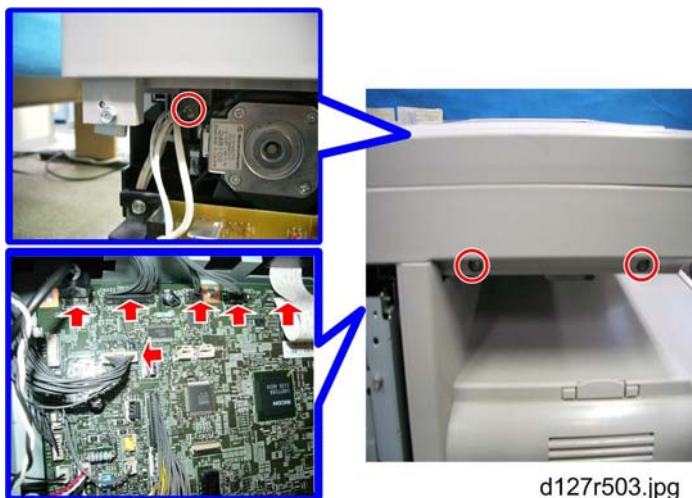

d127r501.jpg

1. Remove the Scanner front cover [A].(Hook)
2. Remove the Right front cover [B].(Hook)



3. Remove the screws and the harnesses showed above for detaching the scanner unit.



4. Scanner unit [C] (  x 5,  x 4)

5. Operation panel [D] (  x 5,  x 2)

## Right Door

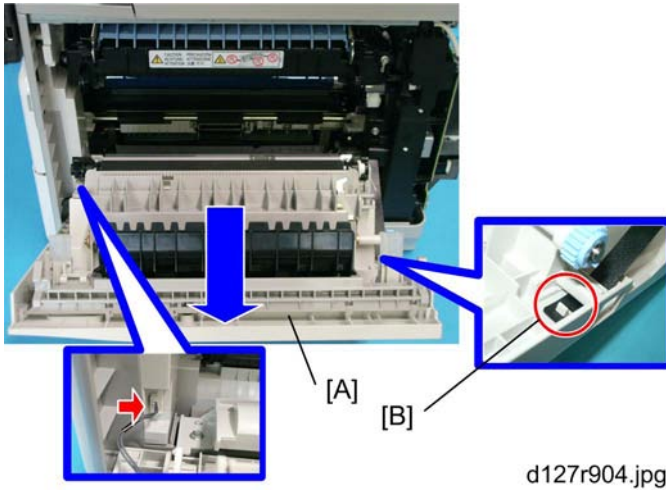

d127r904.jpg

1. Open the right door [A].
2. Release the strap [B].
3. Open the door fully and pull out.
4. Right door (☞ x 1)

## Bypass Tray

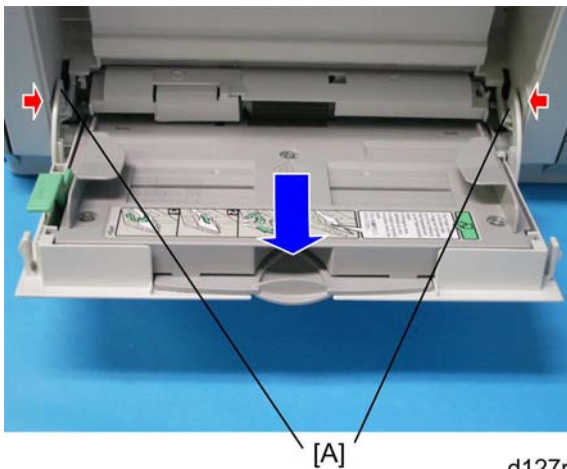

d127r945.jpg

1. Press the stopper rails [A] inward.
2. Pull out with pressing the rails.
3. Bypass Tray (Hook)

---

## Platen Cover and ARDF Sensor

---

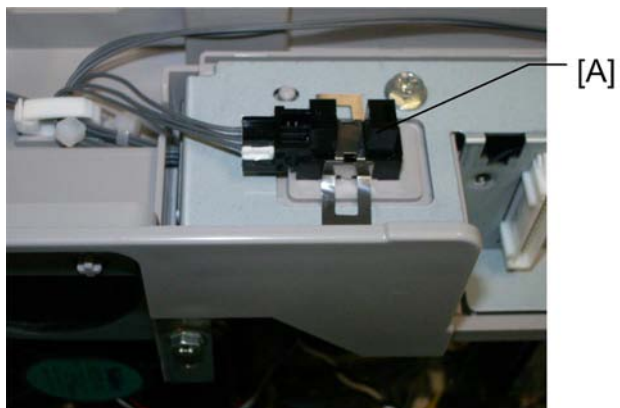

d127r505.jpg

1. Scanner Cover (📄 p.83 "Scanner Cover and Exposure Glass")
2. Platen cover sensor [A] (📄 x 1, hook)

# Scanner Unit

To clean the mirrors and lenses, use a blower brush or wet cotton.

## Scanner Cover and Exposure Glass

Exposure glass is united with Scanner cover.

To clean the exposure glass, use alcohol or glass cleaner.

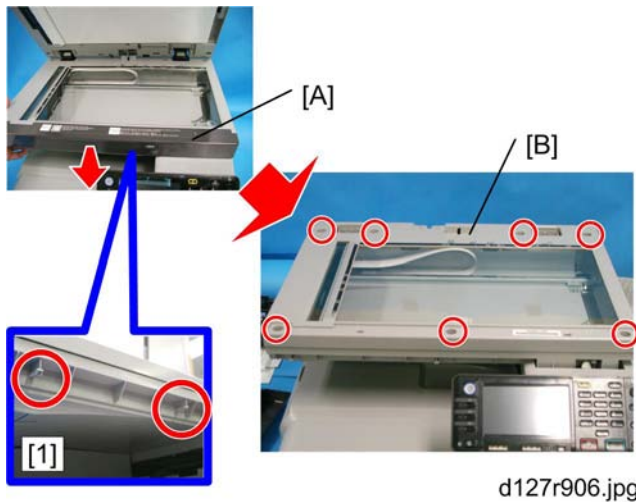

1. Platen cover or ARDF (p. 122 "ARDF Unit")
2. Scanner front cover [A] (Hook)

### Note

- The front scanner cover is attached by 2 of the hooks the picture [1] shows. Pulling the cover downward to keep the hooks off while removing, makes detaching easy.

3. Scanner cover [B] ( x 7, Hook)

## LED Unit

### CAUTION

- Do not disassemble the LED Unit. The LED Unit is precision adjusted before shipment.
- Do not touch the screws on the CCD. The CCD is precision adjusted before shipment.
- Do not wipe the oil coated on the guide rod off. The oil doesn't exist in service parts.

d127r946.jpg

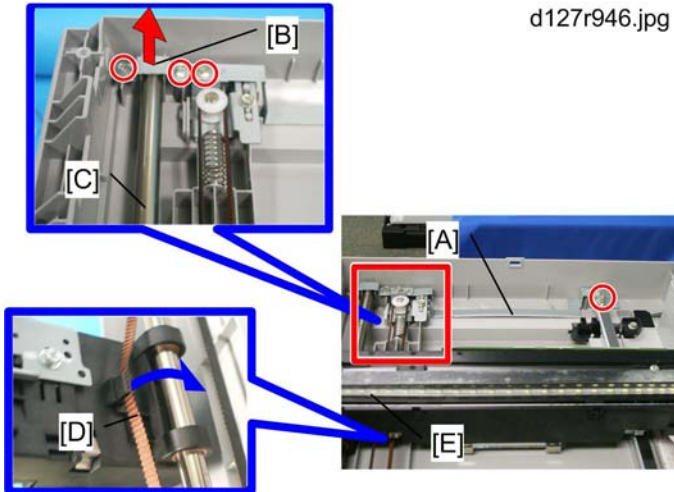

4

1. Scanner Cover and Exposure Glass (p.83 "Scanner Cover and Exposure Glass")
2. Remove the long bracket [A] and the guide rod bracket [B]. ( x 4)
3. Lift the guide rod [C] as the red arrow shows.
4. Put the belt [D] off as blue arrow shows to release the LED Unit [E] from the guide rod.



**Note**

- Do not loosen the paint-locked screws holding the lens in place.
- After installing a new lens, carry out copy adjustments (p.134 "Adjusting Copy Image Area").

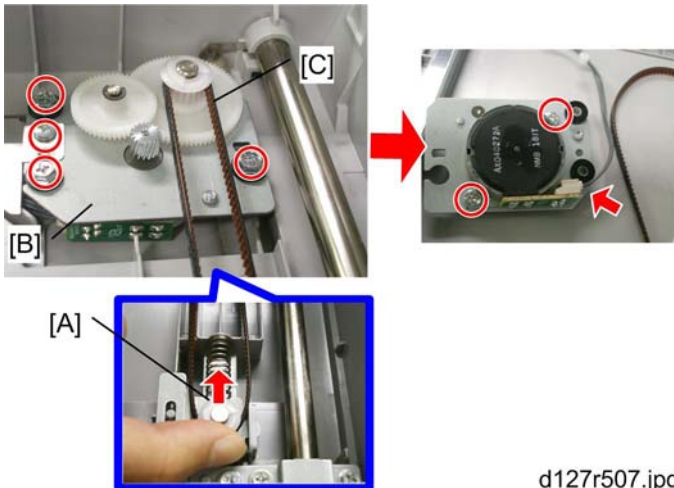
## Scanner Motor





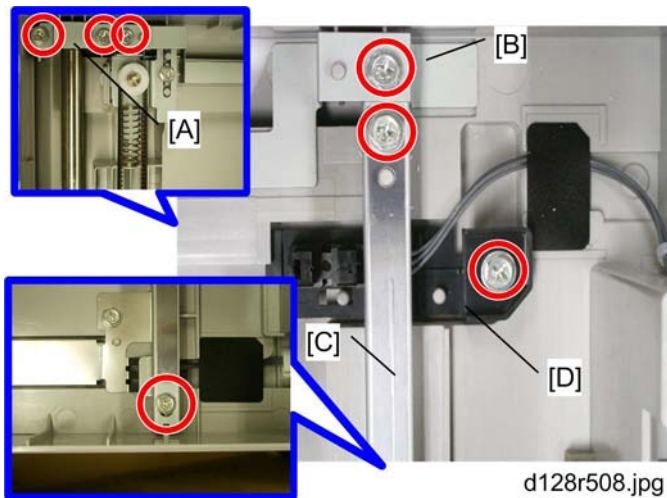

d127r507.jpg

1. Push the spring [A] located on the opposite side of the scanner motor [B] to loosen the belt [C] from the scanner motor gear.
2. Remove the screws on the top of the scanner motor [B] (  x 4).
3. Turn the scanner motor [B] back. Then remove the screws and the harness on the back (  x 2  x 1).

## Scanner HP Sensor



1. Rear cover (  p.78 "Rear Cover")
2. Scanner Cover and Exposure Glass (  Scanner Cover and Exposure Glass)
3. Two of the brackets [A] [B] and the rail [C] (  x 6)
4. Scanner HP sensor [D] (  x 1,  x 1)

# Fusing

## Fusing Unit

### CAUTION

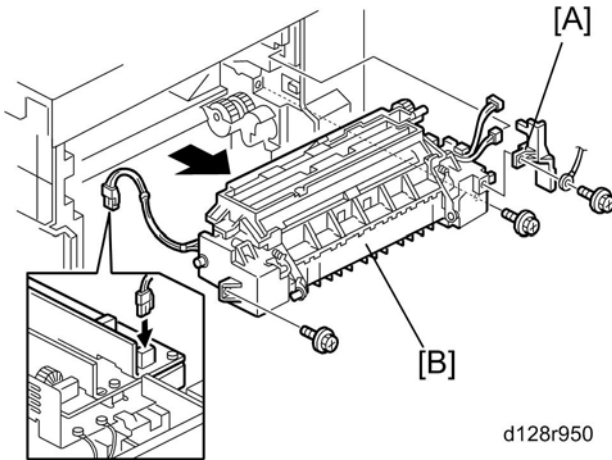

- Before handling the fusing unit, make sure that the unit is cool enough. The fusing unit can be very hot.



1. Copy tray (▶ p.78 "Copy Tray")
2. Open the right door.
3. Connector cover [A] (  x 1 )

#### Note

- When reinstalling, attach the ground wire.

4. Fusing unit [B] (  x 2,  x 4 )



---

## Exit Sensor

---

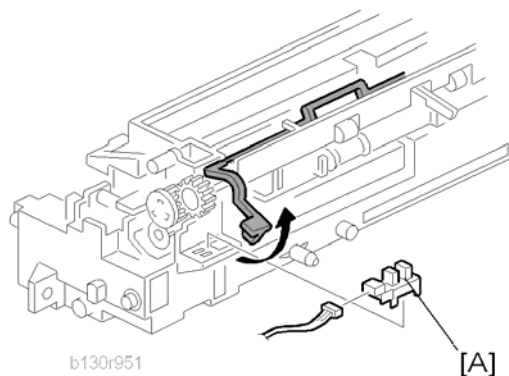

1. Fusing unit (p.86 "Fusing Unit")
2. Exit sensor [A] (x 1)

---

## Hot Roller Stripper Pawls

---

### ★ Important

- Take care not to damage the hot roller stripper pawls and the tension springs.

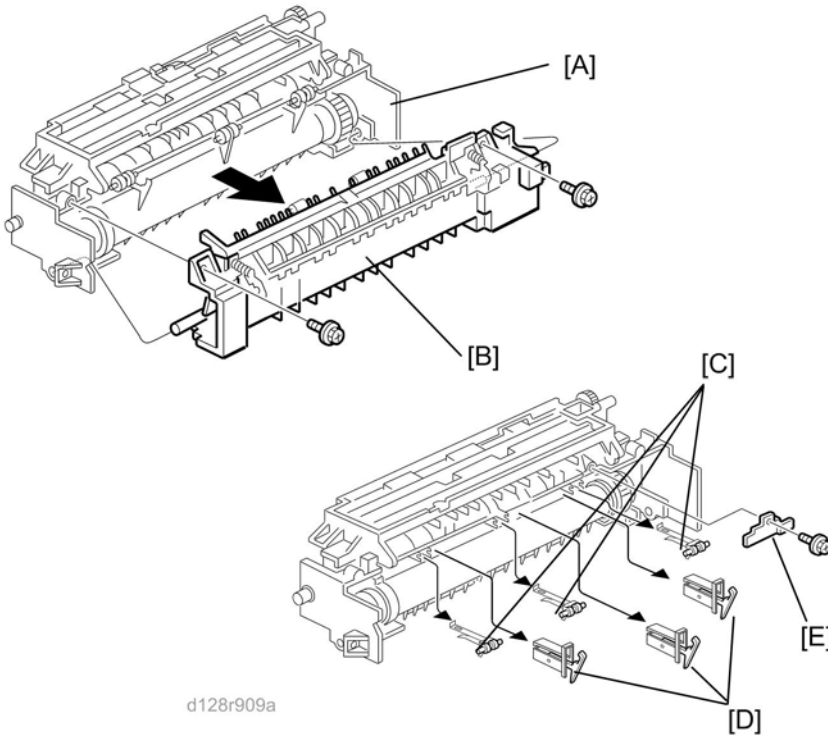

d128r909a

1. Fusing unit (➤ p.86 "Fusing Unit")
2. Separate the fusing unit into two sections: the hot roller section [A] and the pressure roller section [B] (⚙ x 2).  
After removing the screws, lower the pressure roller section about halfway and then slide it toward the front side to detach it.
3. Support rollers [C]
4. Hot roller stripper pawls [D]

**Note**

- Remove the spacer [E] (⚙ x 1) if you are removing the hot roller assembly (➤ p.88 "Hot Roller and Fusing Lamp").

## Hot Roller and Fusing Lamp

### ⚠ CAUTION

- Do not touch the fusing lamp and rollers with your bare hands.

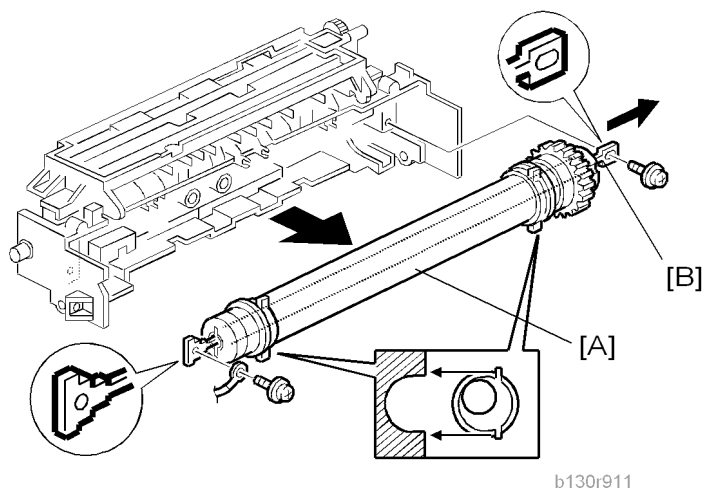

1. Hot roller stripper pawls and spacers (p.87 "Hot Roller Stripper Pawls")
2. Hot roller assembly [A] ( x 2)
3. Fusing lamp [B]

#### ↓ Note

- When reassembling, check that the direction of the fusing lamp is correct.

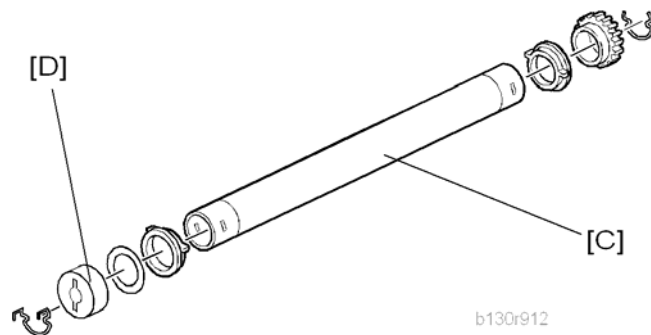

4. Hot roller [C] (2 C-rings, 1 spacer, 1 gear, 2 bushings, 1 cover [D])

### Reassembling

Be sure that:

- The fusing lamp is positioned correctly.
- The fusing lamp does not touch the internal part of the hot roller.

## Thermostiches and Thermistor

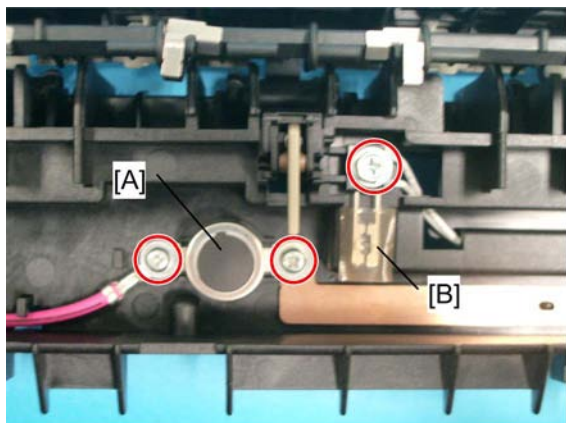

d128r913.jpg

1. Hot roller assembly ( p.88 "Hot Roller and Fusing Lamp")
2. Thermostiches [A] ( x 2 )
3. Thermistor [B] ( x 1 )

### Reassembling

Make sure of the following:

- That the thermistor is in contact with the hot roller.
- That the hot roller turns smoothly.

#### ↓ Note

- Do not recycle a thermostich that is already opened. Safety is not guaranteed if you do this.

## Pressure Roller

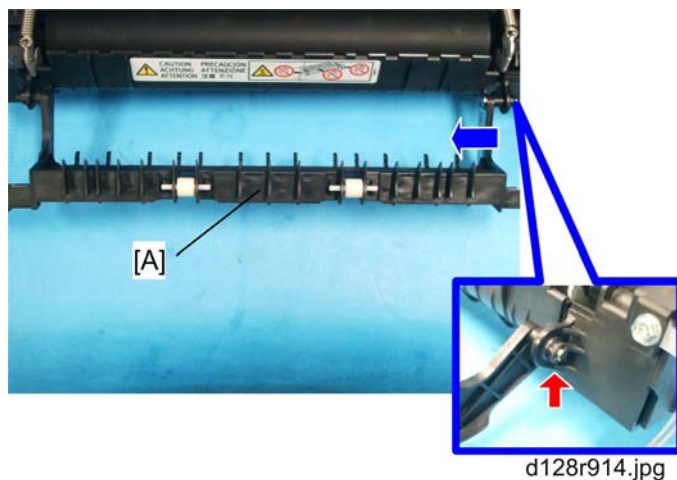

4

1. Separate the fusing unit into two sections (p.87 "Hot Roller Stripper Pawls").
2. Fusing entrance guide [A] (x 1)

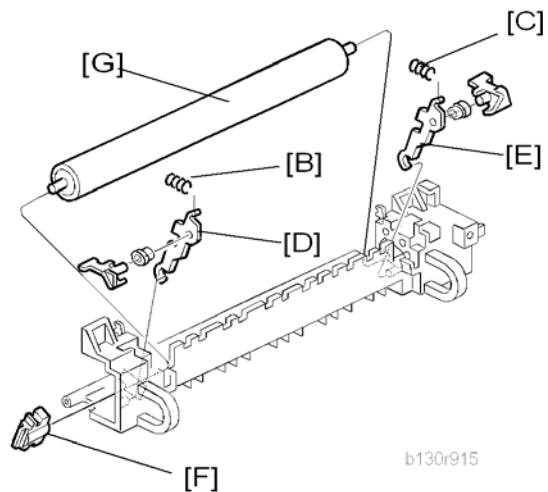

3. Two springs [B][C]
4. Two pressure arms [D][E]
5. Bushing [F]
6. Pressure roller [G]

---

## Fusing NIP Band Check By-pass (Checking the NIP band)

---

You can check the nip band to see if the fusing unit is in a good condition—especially, if the hot roller and pressure roller are correctly installed.

1. Place an OHP sheet on the by-pass tray.
2. Activate the SP mode.
3. Select SP1-152-001.
4. The copier feeds the OHP sheet, and stops it between the hot roller and the pressure roller for about 40 seconds.
5. Wait until the OHP sheet is output.
6. After output, quit the SP mode.

You see an opaque stripe on the OHP sheet. This is the trace of the nip band. The normal nip band is symmetrical on the OHP sheet. Both ends are slightly thicker than the center.

 **Note**

- There are no specifications or standards for the nip band of this copier.

# PCU and Quenching Lamp

When handling the photo conductor unit (PCU), use caution:

- Do not touch the OPC drum with your bare hands. When the OPC drum is unclean, clean it with dry cloth, or clean it with wet cotton and wipe it with dry cloth.
- Do not use alcohol or any other chemicals to clean the OPC drum. These substances damage the OPC-drum surface.
- Keep PCUs in a cool, dry place.
- Do not expose the OPC to any corrosive gas such as ammonia.
- Do not shake a used PCU. Remaining toner and developer may spill out.
- Dispose of used PCUs in accordance with local regulations.

4

## PCU

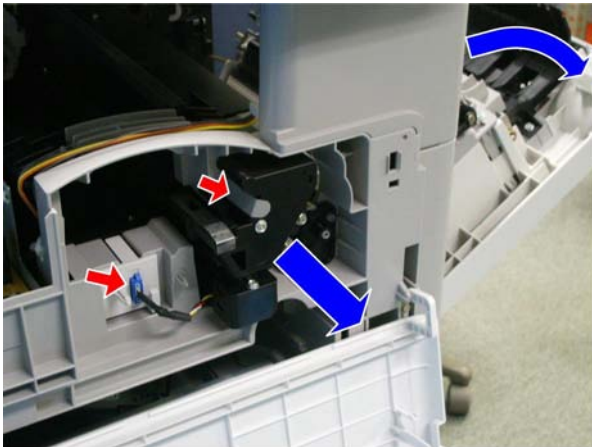

d127r952.jpg

1. Open the right door.

↓ **Note**

- The PCU may become stuck if you try to remove it while the front door is closed.

2. Open the front door.
3. Remove the toner bottle holder.

↓ **Note**

- Clean all spilled toner off the toner bottle area and the inside of the front door.

4. Pull out the PCU [A] on pushing the part as the red arrow shows. (📄 x 1).

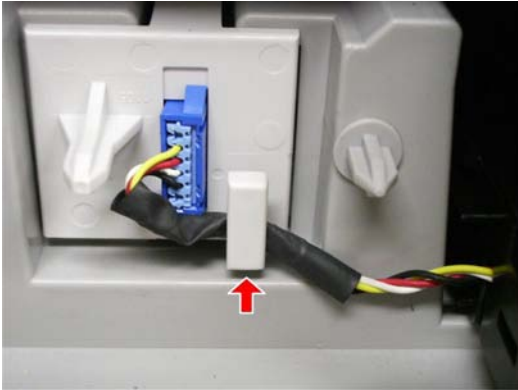

d127r951.jpg

4

**Note**

- When reinstall the PCU, be sure to hook the PCU connector cable as shown above so as not to damage the cable.

5. When having installed a new PCU, remove the Styrofoam and tags (p.31 "Copier" in the chapter "Installation").

**Initialization**

After replacement, Do "SP2801-001" to initialize the copier setting for PCU.

---

## Quenching Lamp

---

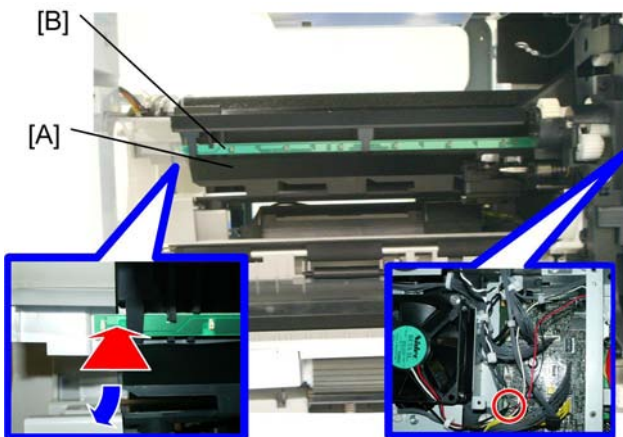

d127r953.jpg

1. PCU (p.93 "PCU")
2. Remove the Lamp Shading [A] (Adhered)
3. Put the Quenching lamp [B] out as the blue arrow shows on pushing carefully as the red arrow shows. (x 1)



# Exhaust Fan and Main Motor

## Exhaust Fan

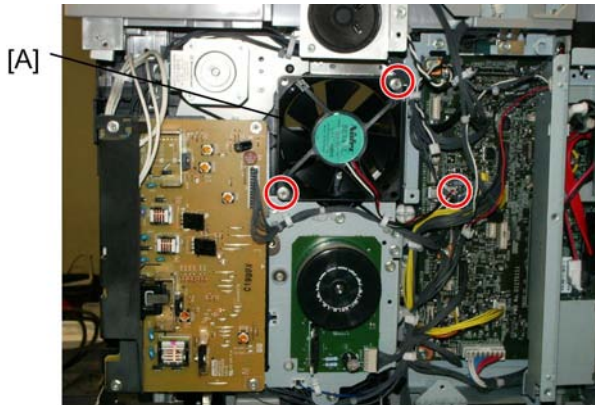

d127r926.jpg

1. Rear cover (📄 p.78 "Rear Cover")
2. Exhaust fan [A] (🔩 x 2, 📄 x 1)

## Main Motor

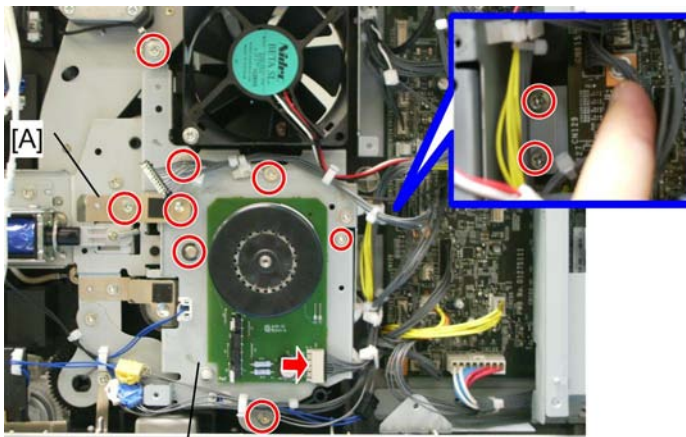

[B]

d127r917.jpg

1. Rear cover (📄 p.78 "Rear Cover")
2. High-voltage power supply board (📄 p.114 "High-Voltage Power Supply Board ")
3. Ground plate [A] (🔩 x 1)

4. Main motor with the gear cover [B] (⚙️ x 1, 🔩 x 7, Ⓢ x 2, 2 bushings)

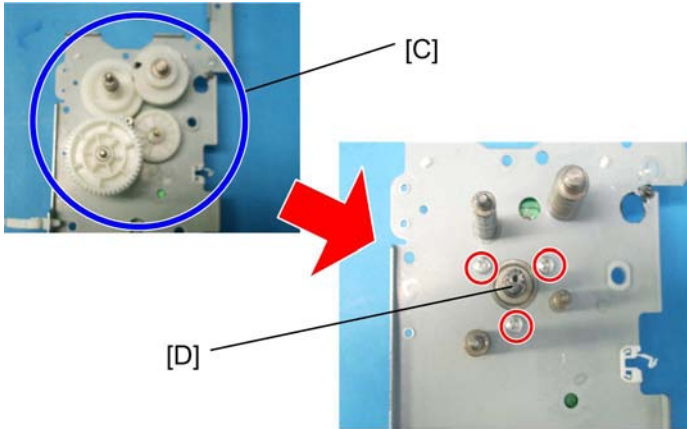

d127r927.jpg

5. All gears [C]  
6. Main motor [D] (⚙️ x 3)

### Reassembling

Attach the main motor before attaching the gears.

#### ↓ Note

- When you have difficulty in reattaching two of the snap rings, remove the PCU to push the axles on the back of the main motor as the picture shows below. Then the ditches in which the snap rings attach are pushed out.



d127r928.jpg

# Paper Feed

## Paper Feed Roller and Friction Pad

When handling the paper tray or the paper feed roller, use caution:

- Do not touch the surface of paper feed rollers.
- To avoid paper jams, correctly set the side and end fences in the paper tray.

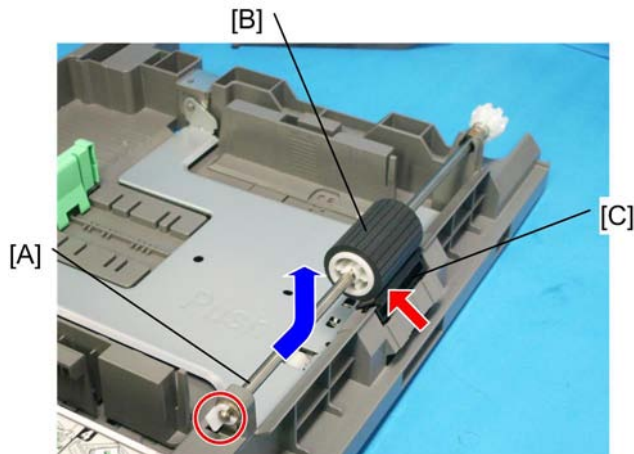

d127r955.jpg

1. Paper tray
2. Shaft [A] (☞ x 1)
3. Remove either or both of the following:
  - Paper feed roller [B] as the blue arrow shows.
  - Friction pad [C] as the red arrow shows.

## Paper End Sensor

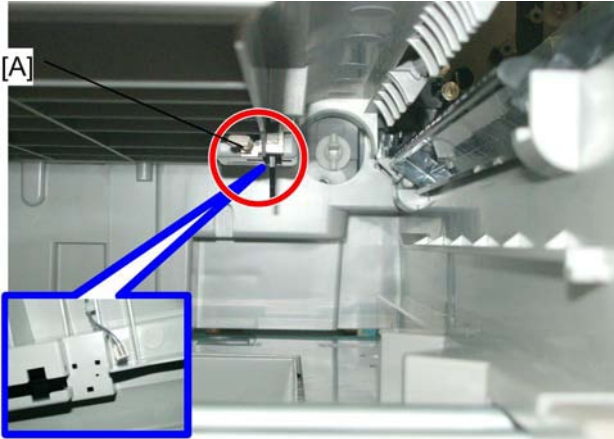

d127r956.jpg

1. Draw the paper tray out from the copier.
2. Open the right door.
3. Paper end sensor [A] (EJ x 1, Hook)

### Note

- Be sure to make the feeler be able to move up and down correctly when reattaching the Paper End Sensor.

## Registration Sensor

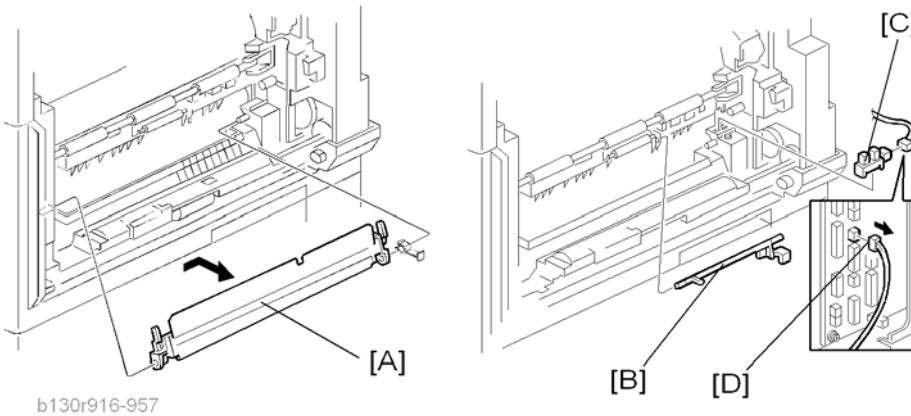

1. Paper tray
2. Open the right door.

- Open the paper guide [A].

**Note**

- Remove the paper guide (Clip x 1) if you have difficulty removing the registration sensor.

- Registration sensor feeler [B]

- Registration sensor [C] (Clip x 1)

**Note**

- Disconnect the connector (CN127 [D]) if you have difficulty removing the registration sensor.

## Bypass Paper End Sensor

4

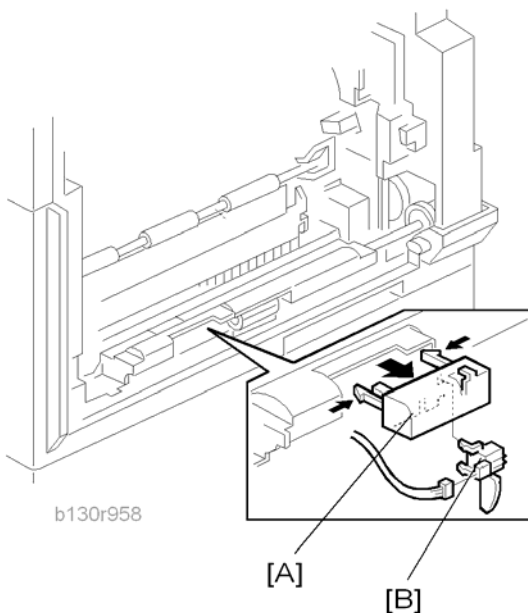

- Right door (p.81 "Right Door")
- Sensor compartment [A]
- Bypass paper end sensor [B] (Clip x 1)

**Note**

- If it is difficult to reattach the Sensor compartment, turn the feed roller housing upside down. (Bypass Feed Roller: Procedure 2)

## Bypass Feed Roller

4

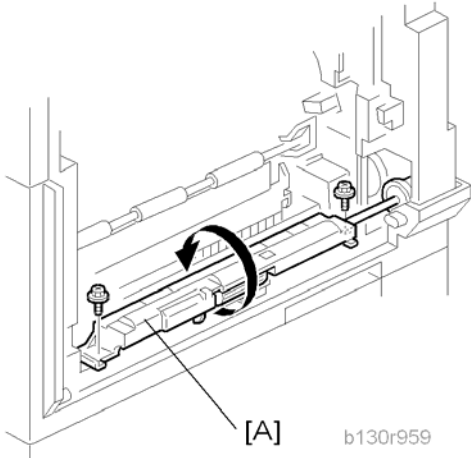

1. Right door (p.81 "Right Door")
2. Turn the feed roller housing upside down [A] (x 2).

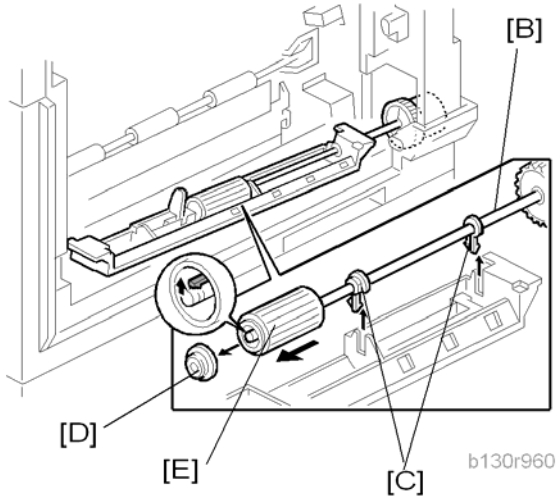

3. Feed roller shaft [B] (2 snap pawls [C], 1 spacer [D])
4. Bypass feed roller [E]

## Bypass Feed Clutch and Friction Pad

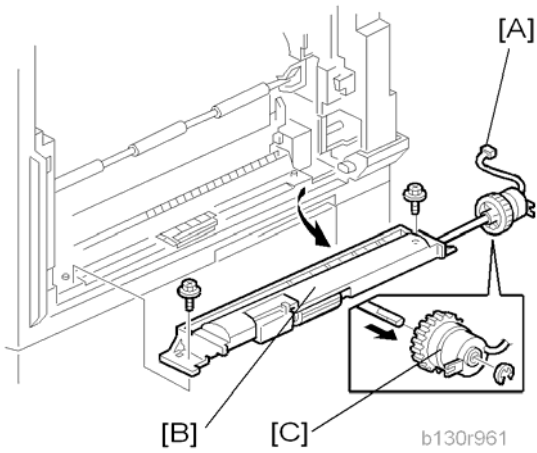

1. Rear cover (p.78 "Rear Cover")
2. Right door (p.81 "Right Door")
3. Disconnect the bypass feed clutch connector [A] (CN93).
4. Bypass feed roller housing [B] (x 2)
5. Bypass feed clutch [C] (x 1)

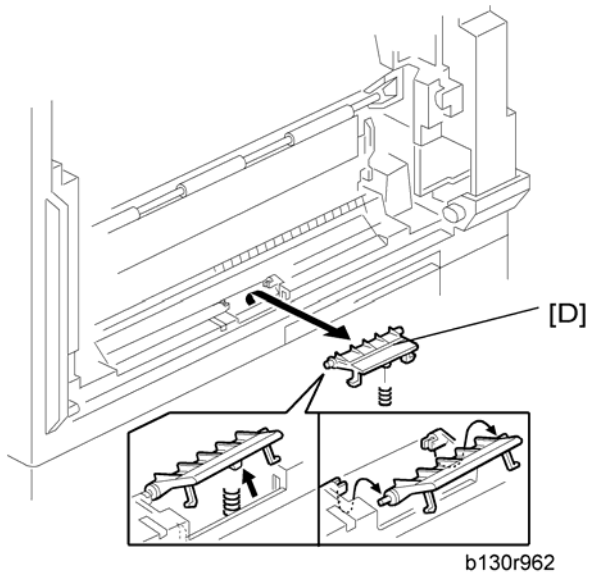



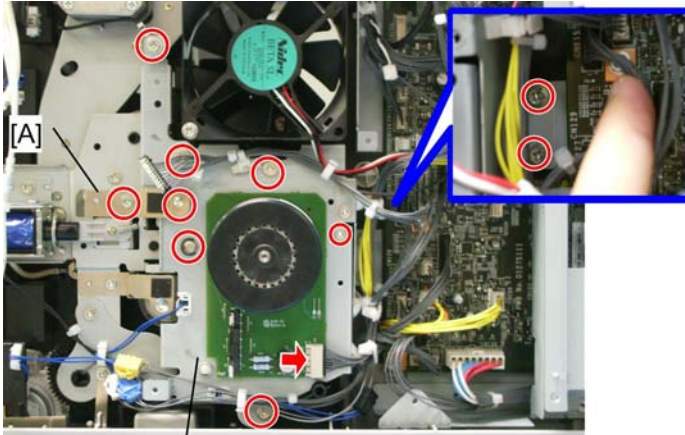

6. Bypass friction pad [D]

## Paper Feed and Registration Clutches



d127r917.jpg



1. Paper tray
2. High-voltage power supply board (p.114 "High-Voltage Power Supply Board ")
3. Ground plate [A] (  x 1 )
4. Gear cover [B] (  x 1,  x 7,  x 2, 2 bushings)

**Note**

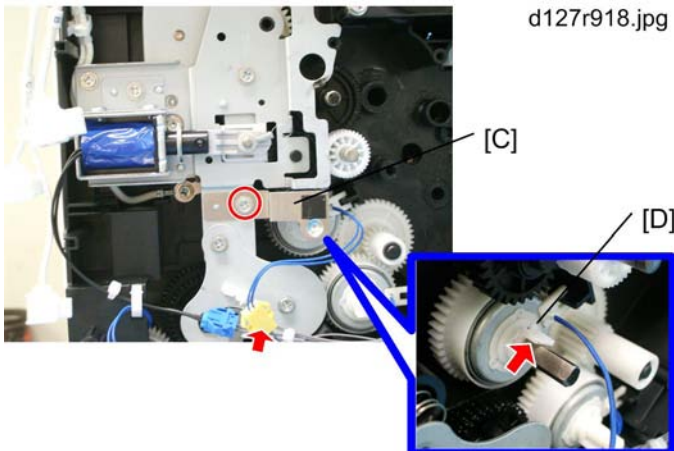
- Do not remove the main motor from the gear cover.



d127r918.jpg

5. Ground plate [C] (  x 1 )
6. Paper feed clutch [D] (  x 1,  x 1 )



# Image Transfer

## Transfer Roller

### ⚠ CAUTION

- Do not touch the transfer roller with your bare hands.
- Do not scratch the transfer roller. The transfer roller is easily damaged.

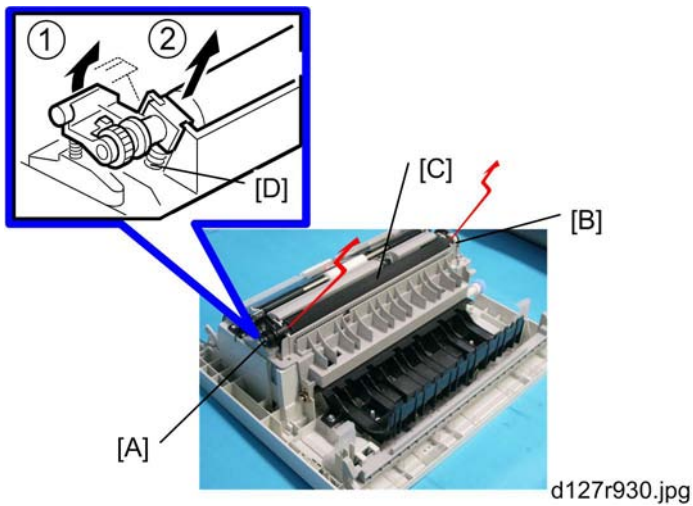

1. Right door (p.81 "Right Door")
2. Raise the levers [A],[B] at the ends of the image transfer roller.
3. Release the image transfer roller [C].

### Reassembling

Make sure that the springs [D] are in the original positions.

## ID Sensor and Duplex Roller

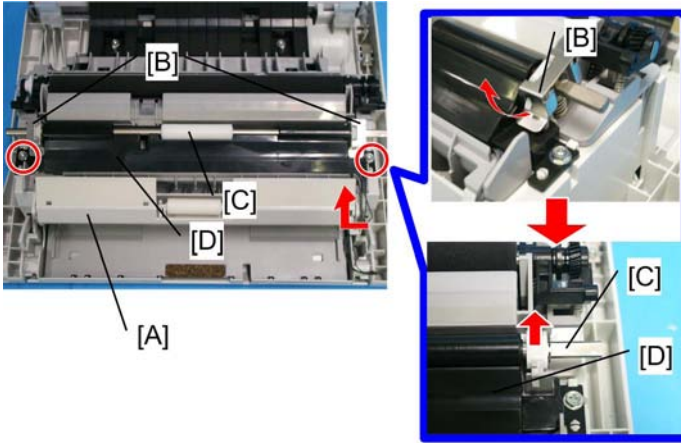

d127r919.jpg

1. Right door (p.81 "Right Door")
2. Remove the lower guide [A] by releasing the hook to lift one side of the lower guide [A] as the red arrow shows then lift the other side.
3. Idle roller holders [B].
4. Idle roller [C]
5. Roller guide [D] (  x 2)

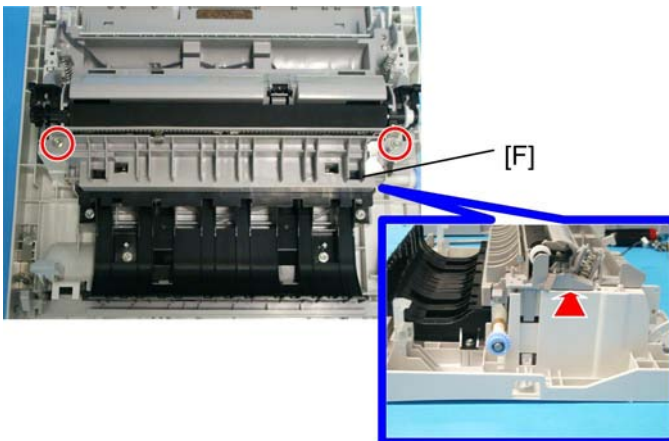

d127r921.jpg

6. Transfer unit [F] (  x 2)

### Note

- To remove the transfer unit easily, insert a slotted screwdriver into the one side of the unit as the red arrow shows and lift to release. Then release the other side.

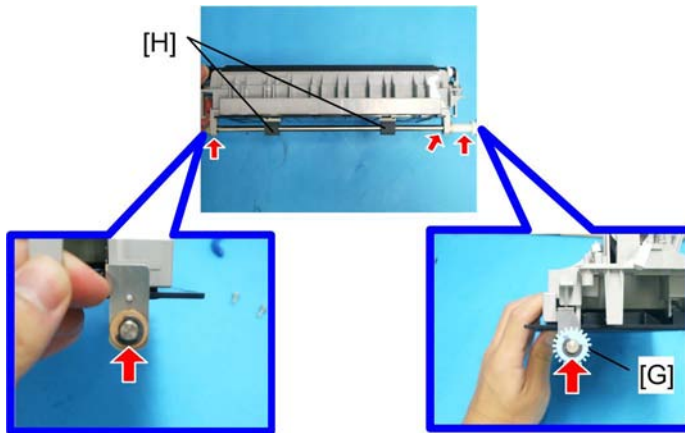

d127r922.jpg

7. One-way gear [G] (Ⓒ x 1)

8. Duplex roller [H] (Ⓒ x 1, 3 bushings)

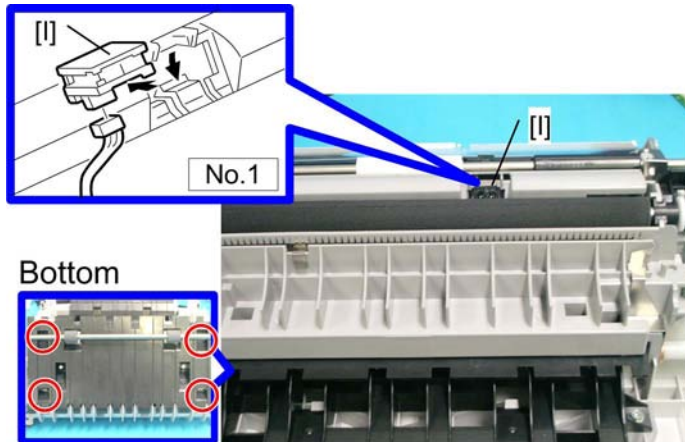

b130r931.jpg

9. ID sensor [I] (Ⓒ x 1)

↓ **Note**

- If you have difficulty removing in the way of No.1 on the picture, Put four of the hooks off in the bottom and make space through which you can take the sensor out. But you don't need to remove the bottom cover.

## Discharge plate

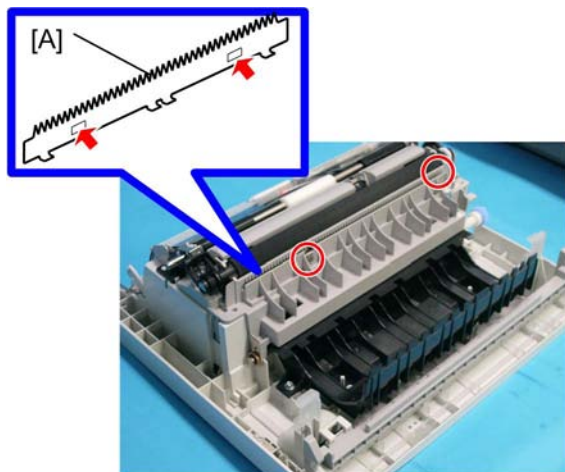

d127r932.jpg

1. Right door (p.81 "Right Door")
2. Discharge plate [A] (Red arrow: Hook, Red circle: Pressed)

# BICU and Controller Board

## ⚠ CAUTION

- Turn off the main power switch and unplug the machine before starting replacement.
- Before turning off the main power switch, check that no mechanical component is operating. Mechanical components may stop out of their home positions if you turn off the main power switch while they are operating. The component may be damaged if you try to remove it when it is not in the home position.

## BICU

4

### Preparation

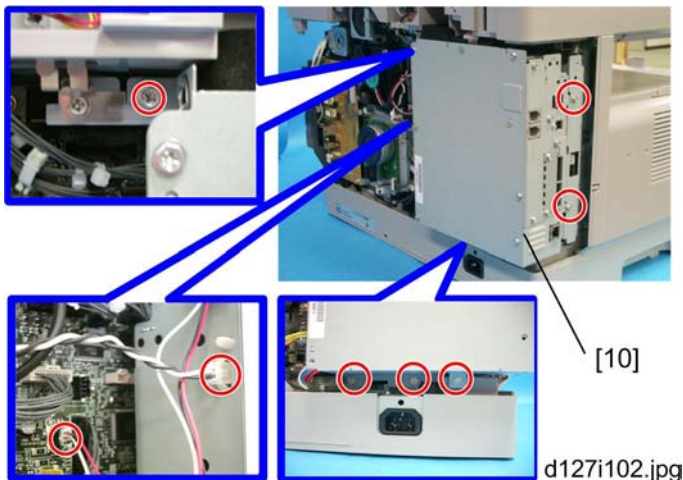

- Before replacing the NVRAM, be sure to save the NVRAM data.
- Saving from the BICU NVRAM to an SD card (p.144 "NVRAM Data Upload/Download" in the "System Service Mode" of the appendices of the this manual.)

### Procedure

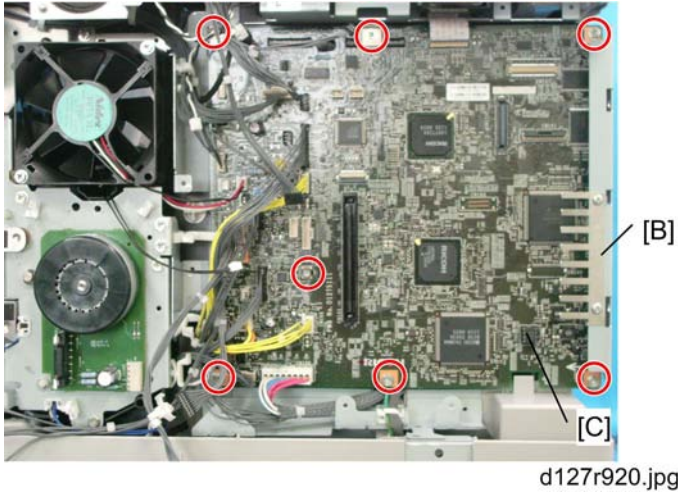

1. Rear cover (p.78 "Rear Cover")
2. Controller box [A] ( x 6, x 2)



3. Ground plate [B] (  x 2)
4. BICU [C] (all , 1 flat cables,  x 7)

**Note**

- When replacing the BICU, remove the NVRAM [D] from the board. Install the NVRAM to the new board.
5. After replacing the NVRAM, copy the saved data to the NVRAM.
    - From an SD card to the NVRAM (  p.144 "NVRAM Data Upload/Download" in the "System Service Mode" of the appendices of this manual.)

---

## Controller Board

---



### Preparation:

---

- Before replacing the controller board, be sure to print out SMC or save the NVRAM data.
- Saving from the Controller NVRAM to an SD card (  p.144 "NVRAM Data Upload/Download" in the "System Service Mode" of the appendices of this manual.)

### Procedure

---

1. Rear cover (  p.78 "Rear Cover")
2. FCU (  p.117 "FCU")

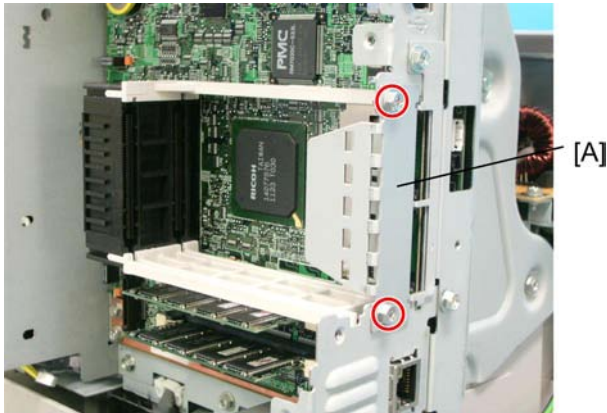



d127r020.jpg

4

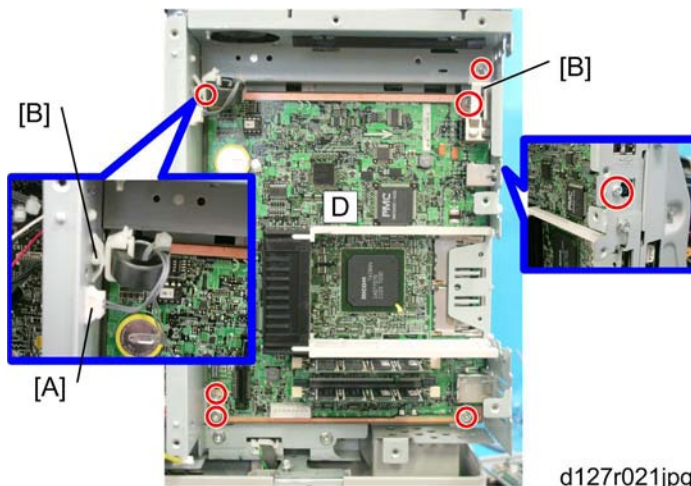
3. Remove the printer/scanner SD card.
4. Remove I/F cover [A] (or I/F options if they have been installed) (  x 2).



d127r021.jpg

5. Remove the relay connector [A] and the clamp [B].
6. Remove the ground plate [B] (  x 1).
7. Remove the controller board with the rails [C] (  x 6).

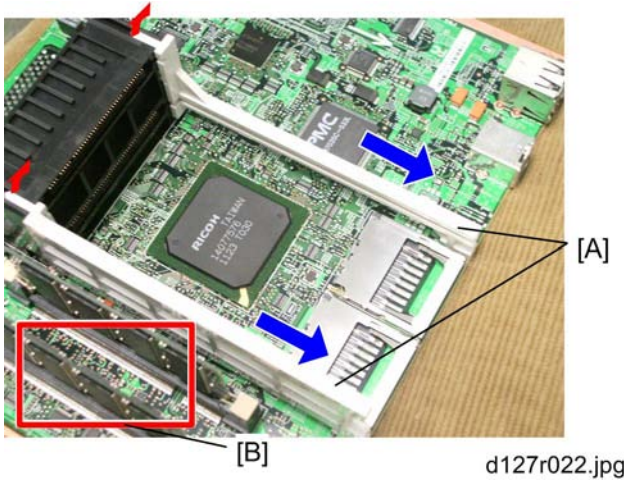

4

8. Release the hooks as the red arrows show, and then pull out the rails [A].
9. Remove the DIMM [B] if it has been installed.

**Note**

- When replacing the controller board, remove the NVRAMs from the board. Install the NVRAMs to the new board.

### When installing a new controller board

1. Install the NVRAM from the old controller board on a new controller board.
2. Install the new controller board in the machine.
3. Disconnect the cables of the HDD from the controller board if the HDD option has already been installed.

**Important**

- **Disconnecting the cables of the HDD is very important. Otherwise, the HDD is automatically formatted and all data in the HDD is lost due to the security limitation.**

4. Reassemble the machine.
5. Turn on the main power of the machine.
  - If the HDD option has not been installed, the installation procedure is completed.
  - If the HDD option has already been installed, go to next step.
6. Turn off the main power of the machine, and then connect the cables of the HDD again.

**Note**

- Make sure you print out the SMC reports ("SP Mode Data" and "Logging Data") before you replace the NVRAM.



## ⚠ CAUTION

- Keep NVRAMs away from any objects that can cause static electricity. Static electricity can damage NVRAM data.
- Make sure the NVRAM is correctly installed on the controller board.

### When replacing the NVRAM on the controller board

1. Disconnect the cables of the HDD from the controller board.

#### ★ Important

- Disconnecting the cables of the HDD is very important. Otherwise, the HDD is automatically formatted and all data in the HDD is lost due to the security limitation.

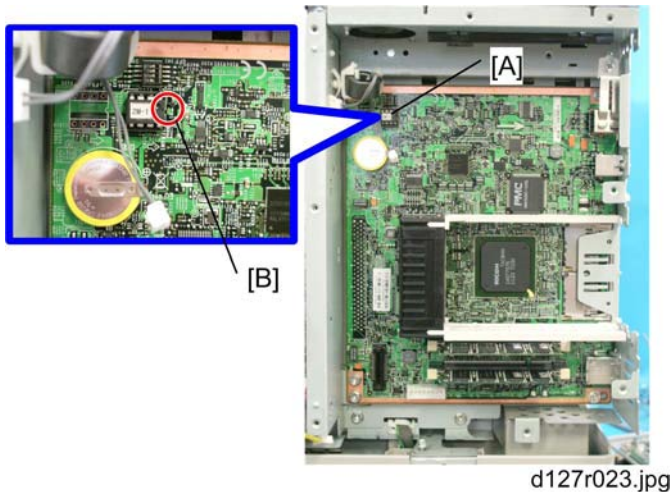

2. Install a New NVRAM on the controller. Then reassemble the machine.
  - When you replace the NVRAM [A], make sure that the NVRAM is correctly installed.
  - The mark [B] on the NVRAM should be directed to the right side (seen from the back side of the machine).
3. Remove the Security Card or Printer/Scanner card from SD slot 1.
4. Install a new Security Card in SD slot 1.
5. Turn the main switch on.
6. SC995-02 occurs.
7. Turn the machine off.
8. Connect the cables of the HDD to the controller board.
9. Reassemble the machine, and then turn on the machine.
10. Do the process control self-check.

11. Do ACC for the copier application program.
12. Do ACC for the printer application program.
13. Do SP5-878-001 to install the DataOverwriteSecurity application.
14. Do SP5878-002 to install the HDD Encryption application.
15. Merge all applications in a one SD card in SD slot 1 with SP5831-001 if necessary.
16. Copy the old NVRAM data to the new NVRAM with SP5-825 or input the SMC data in the machine. (For details, refer to the p.144 "NVRAM Data Upload/Download" in the "System Service Mode" of the appendices of the this manual)

# Other Replacements

## Duplex Motor

1. Rear cover (🔧 p.78 "Rear Cover")
2. High-Voltage Power Supply Board (🔧 p.114 "High-Voltage Power Supply Board ")
3. Main motor (🔧 p.95 "Main Motor")
4. Exhaust Fan (🔧 p.95 "Exhaust Fan")

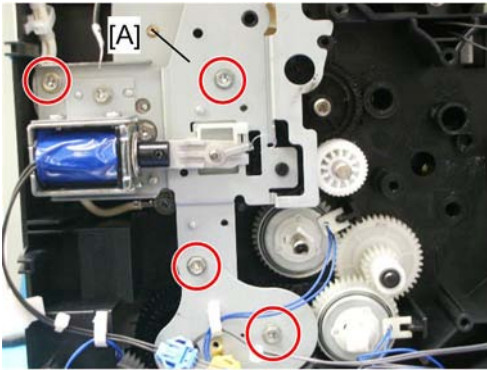

d128r930.jpg

5. SOL bracket (🔧 x 4)

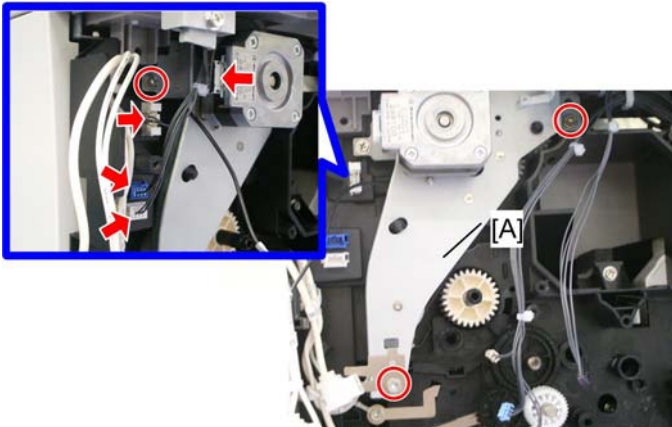

d128r929.jpg

6. Duplex Motor Bracket (🔧 x 4, 🔧 x 3)

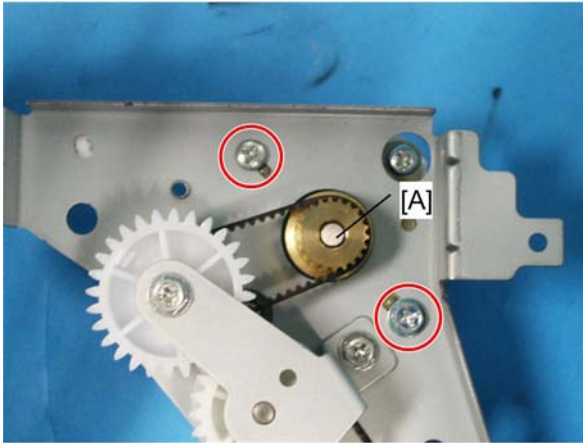

d128r928.jpg



4

7. Duplex motor [A] (  x 2)

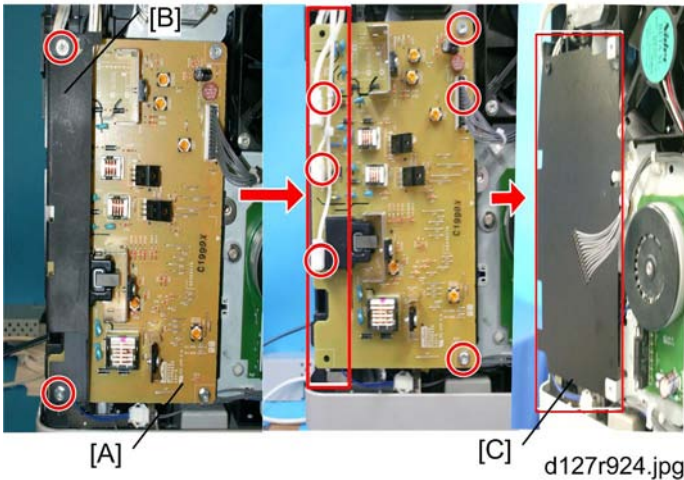

## High-Voltage Power Supply Board



d127r924.jpg

1. Rear cover (  p.78 "Rear Cover")
2. High-voltage power supply board [A] with the cover [B] (all  ,  x 4)

### Note

- Remove the insulating sheet [C] if you are going to remove the contact-release solenoid (  p. 116 "Contact-Release Solenoid") or the gear cover (  p.102 "Paper Feed and Registration Clutches").

PSU

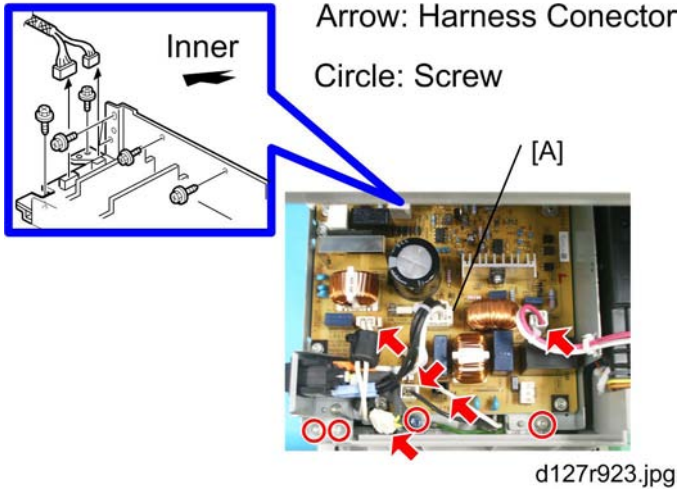

1. Open the front door.
2. Copy tray (p.78 "Copy Tray")
3. PSU assembly [A] (x 7, x 10)

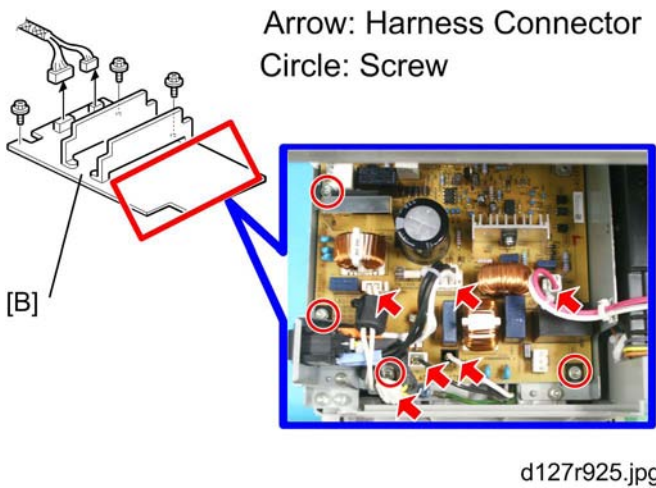

4. PSU [B] (x 8, x 7)

## Contact-Release Solenoid

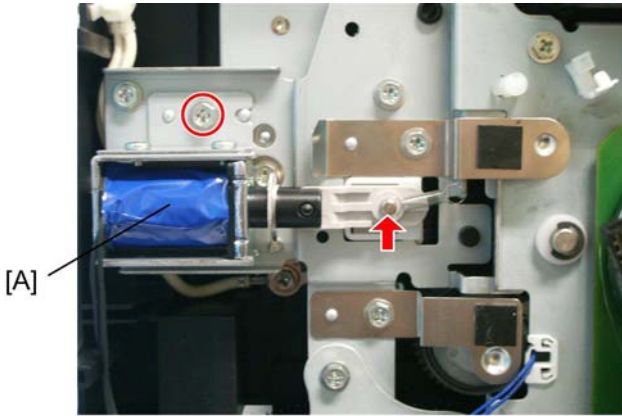

d127r929.jpg

1. Rear cover (p.78 "Rear Cover")
2. High-voltage power supply board (p.114 "High-Voltage Power Supply Board ")
3. Contact-release solenoid [A] (1 spring, x 1)

## Toner Supply Motor

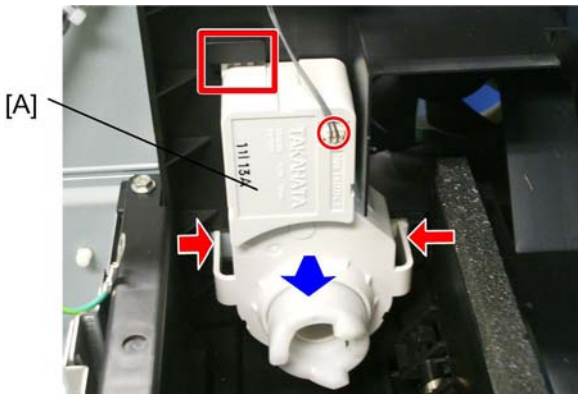

d127r954.jpg

1. Toner bottle holder
2. Hold both sides of the Toner Supply Clutch [A] as the red arrows show. Then pull to your side with trying to release the upper hook the red square shows.
3. Remove the harness the red circle shows.

---



---

## FCU

---

### Lithium Batteries

---

#### CAUTION

- Incorrect replacement of lithium battery(s) on the controller or on the fax unit poses risk of explosion. Replace only with the same type or with an equivalent type recommended by the manufacturer. Discard used batteries in accordance with the manufacturer's instructions.

#### Procedure

---

1. Rear cover ( p.78 "Rear Cover")

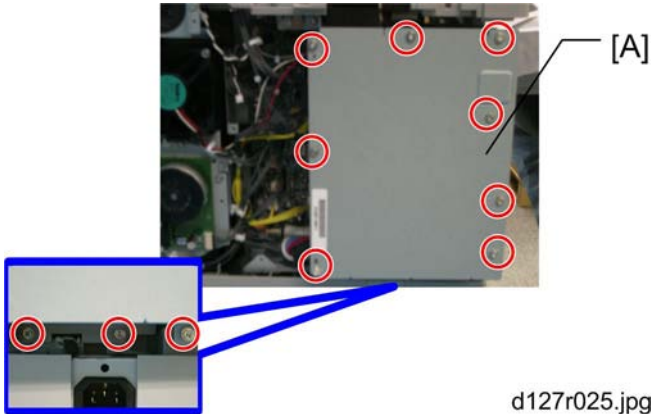

d127r025.jpg

2. Controller box cover [A] ( x 11)

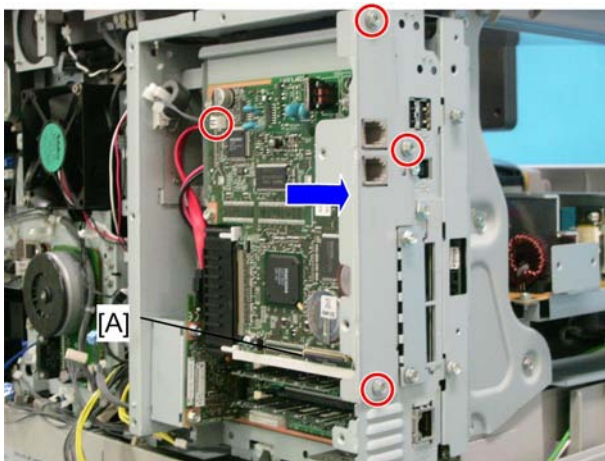

d127r026.jpg

3. FCU [A] ( x 3,  x 1)

4. When you replace the FCU board, remove the MBU board from the old FCU board and install it on the new FCU board.
5. Set the correct date and time with the User Tools: User Tools> System Settings> Timer Setting> Set Date/Time

 **Note**

- Do not turn off the battery switch (SW1).
- Do SP6-101 in the "Fax SP" to print the system parameters, and check the settings.



## Laser Unit

### ⚠ WARNING

- Turn off the main power switch and unplug the copier before starting replacement. The laser beam can damage your eyes severely.

### ⚠ CAUTION

- Do not touch the screws on the LD board on the LD unit. Do not try to adjust any part of the LD unit. The LD unit is precision adjusted before shipment.
- Do not touch the polygon mirror, shield glass, or lenses with your bare hands.

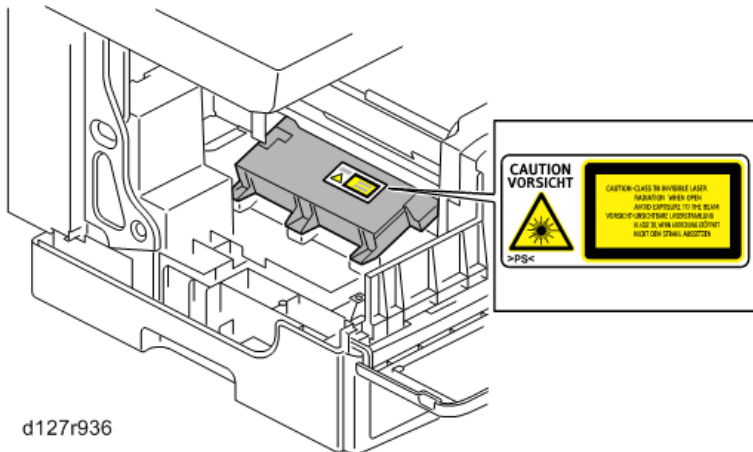

### Location of the Caution Decal

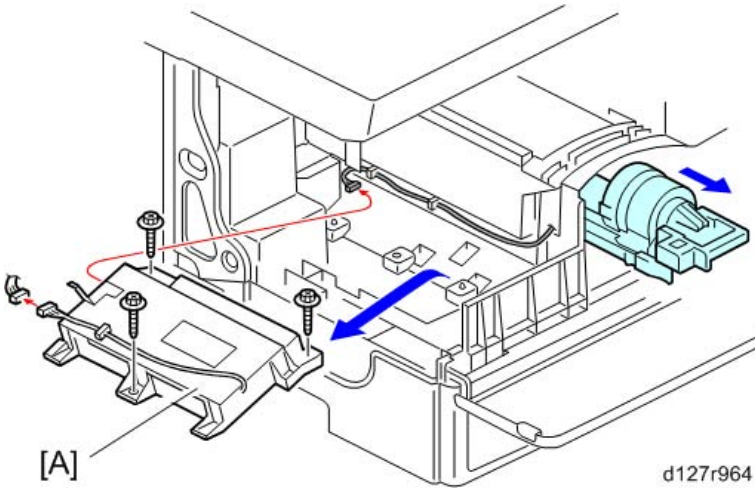

## Laser Unit



4

1. PSU assembly (p.115 "PSU")
2. Toner bottle holder
3. Remove 2 of the mylars (Film) sealing the holes on the bottom of the toner bottle rail.
4. Laser unit [A] (  x 3,  x 2)
5. Replace the mylars (Film) with new ones.

### ↓ Note

- The mylars are necessary to seal the holes in order for the laser unit not to be tainted with toner powder.

## LD Unit and Polygon Mirror Motor

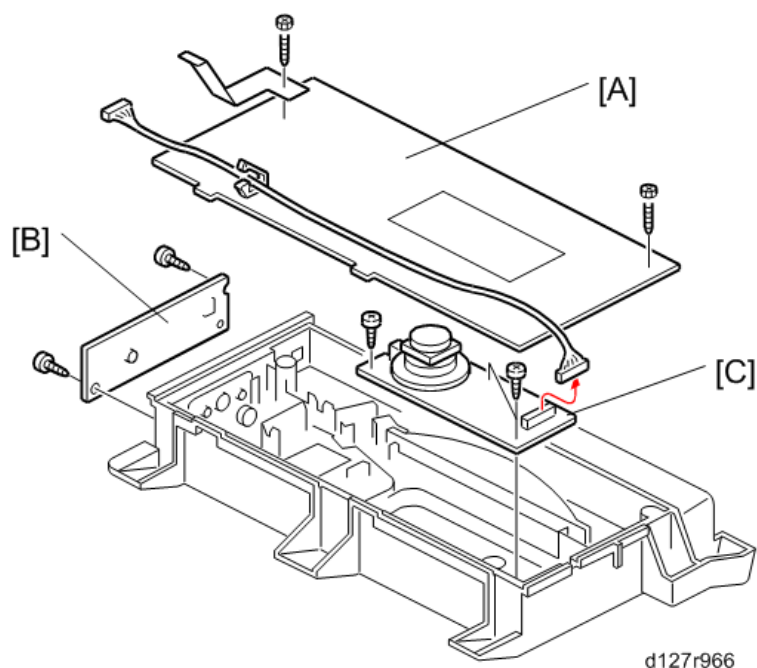

1. Laser unit (p.120 "Laser Unit")
2. Laser unit cover [A] ( x 2, 1 grounding plate)
3. LD unit [B] ( x 2)
4. Polygon mirror motor [C] ( x 3)

### Reassembling

Check that the polygon mirror and toroidal lens are clean. Dust or other foreign substances may interfere with the operation of the LD unit.

# ARDF

## ARDF Unit

1. Rear cover (➡ p.78 "Rear Cover").

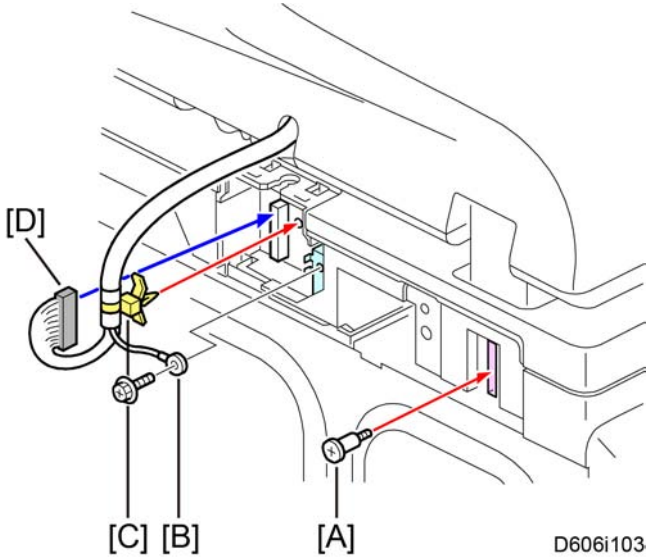

2. Remove the stud screw [A].
3. Remove the ground cable [B] (⚠ x 1).
4. Remove the clamp [C].
5. Disconnect the I/F cable [D].

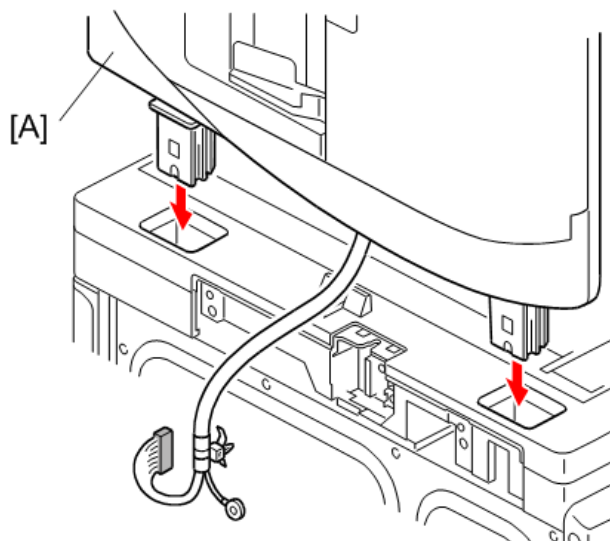

d606i102

6. Remove the ARDF [A] from the copier as shown.

### When installing the ARDF

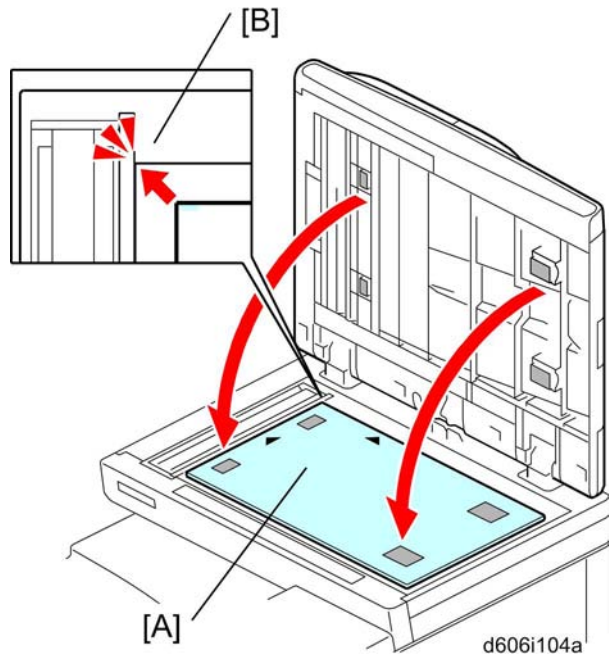

1. Open the ARDF.
2. Place the platen sheet [A] on the exposure glass.
3. Line up the rear left corner of the platen sheet flush against corner [B] on the exposure glass.

4. Close the ARDF.
5. Reopen the ARDF.
6. Press the surface of the platen sheet gently to fix it on the ARDF firmly.

## ARDF Rear Cover

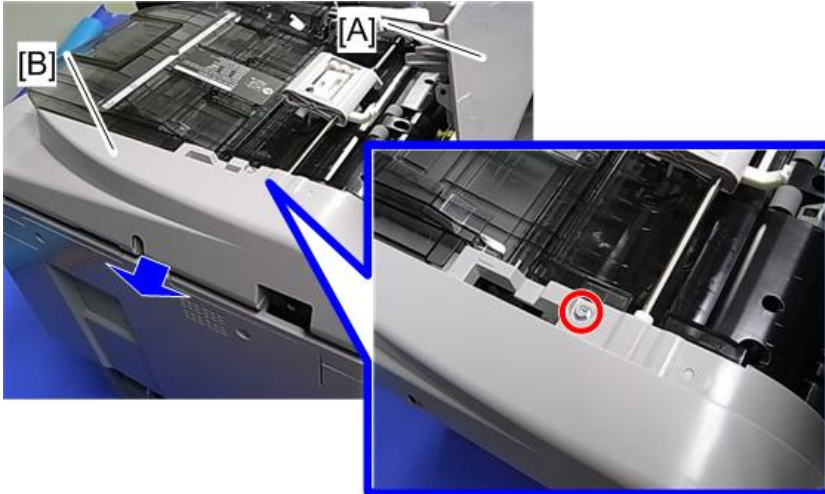

d117r826

1. Open the ARDF left cover [A].
2. ARDF rear cover [B] (  x 1)

## Original Feed Unit

1. Open the ARDF left cover (  p.124 "ARDF Rear Cover").

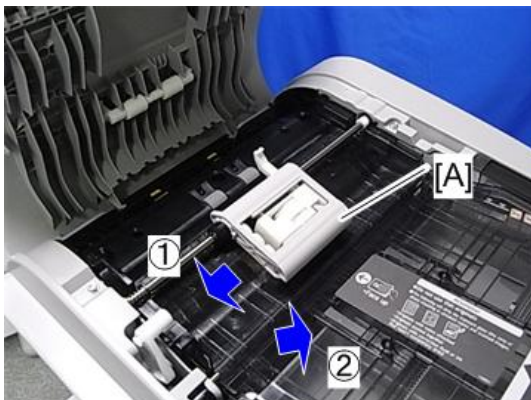

d117r837

2. Original feed unit [A]

---

## Pick-up Roller

---

1. Original feed unit (p.124 "Original Feed Unit")

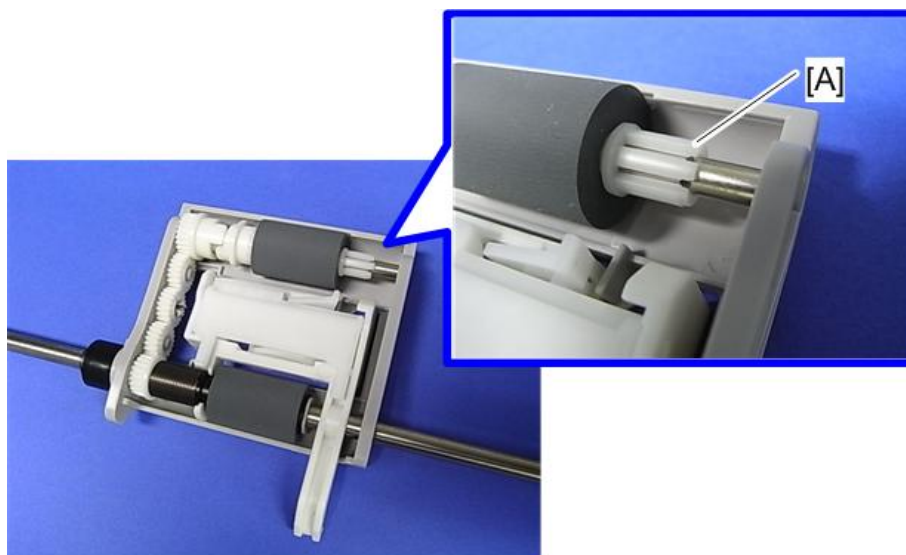

d117r820

2. Release the hook [A].

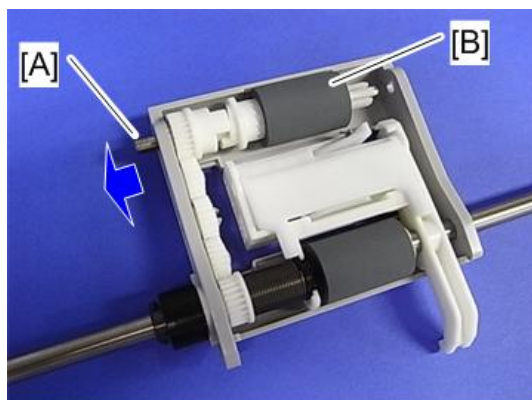

d117r821

3. Slide the shaft [A], and then remove the pick-up roller [B].

---

## Feed Roller

---

1. Original feed unit (p.124 "Original Feed Unit")

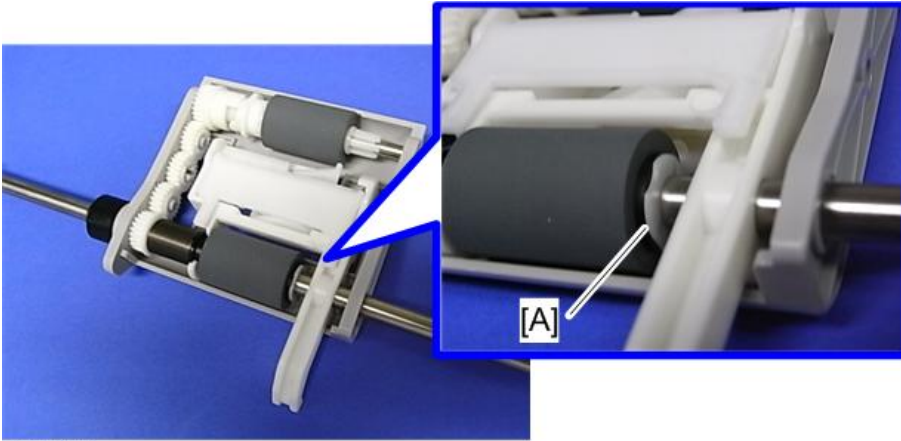

d117r817

4

2. Remove the clip [A].

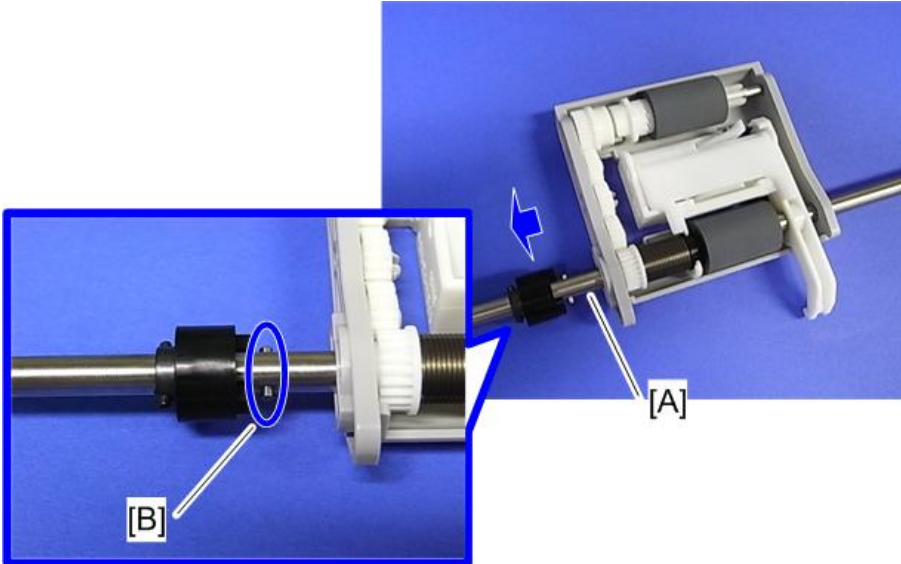

d117r818

3. Slide the shaft [A], and then remove the pin [B].



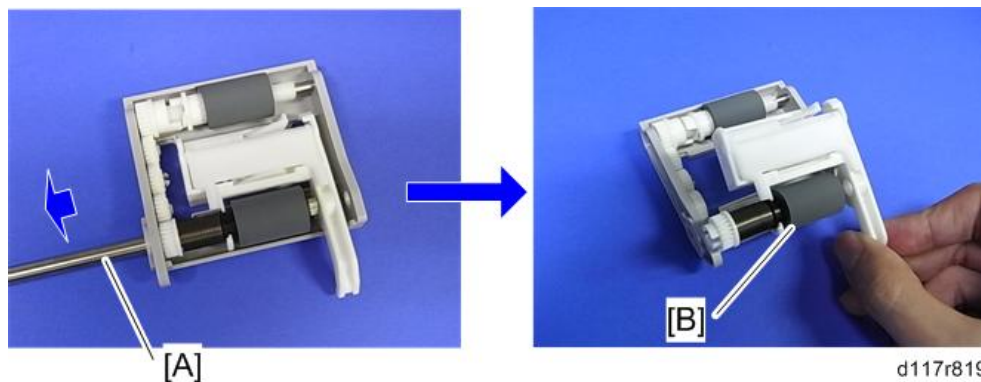

d117r819

4. Slide the shaft [A], and then remove the feed roller [B].

4

## Friction Pad

1. Original feed unit (p.124 "Original Feed Unit")

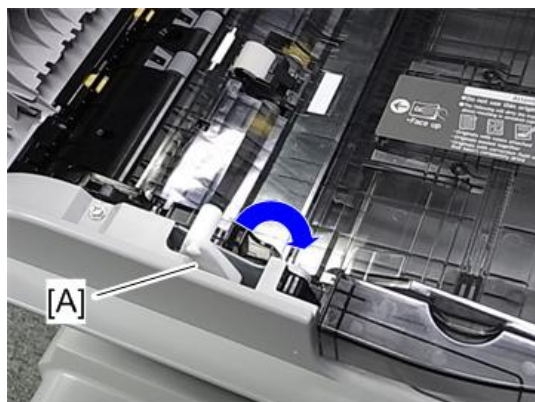

d117r838

2. Turn the lock lever [A] clockwise.

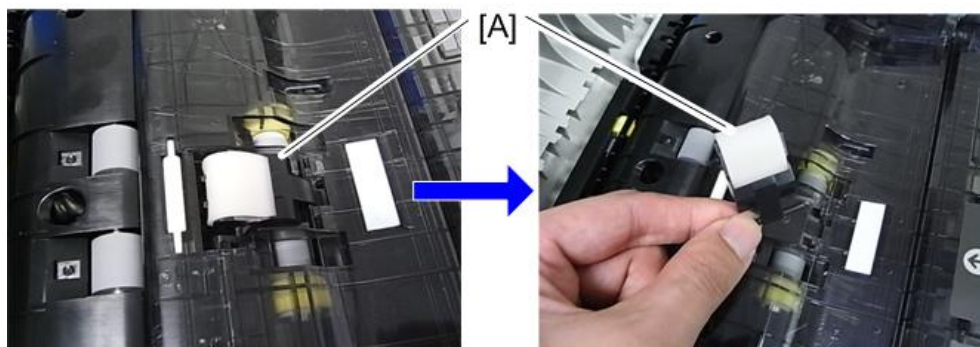

d117r822

3. Friction pad [A] (hook x 3)

---

## DFRB

---

1. ARDF rear cover (📄 p.124 "ARDF Rear Cover")

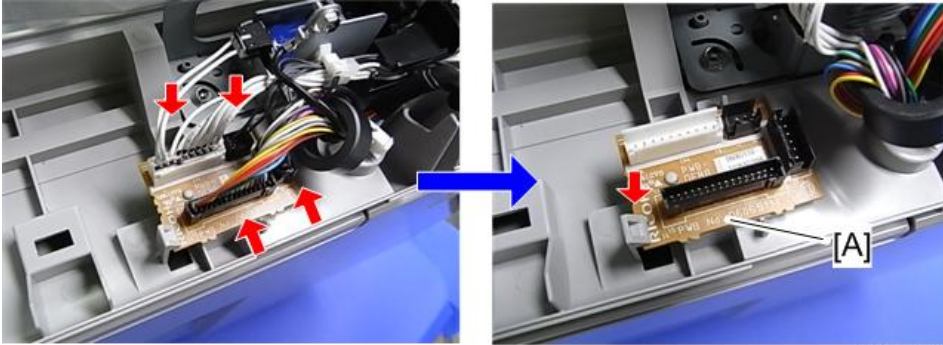

d117r827

2. DFRB [A] (📄 x 4, hook x 1)

---

## ARDF Top Cover Sensor/ Original Set Sensor

---

1. ARDF rear cover (📄 p.124 "ARDF Rear Cover")

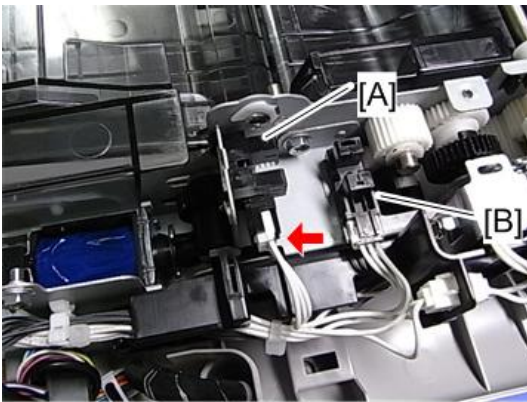

d117r828

2. ARDF top cover sensor [A] (📄 x 1, hooks)
3. Original set sensor [B] (📄 x 1, hooks)

---

## ARDF Drive Motor

---

1. ARDF rear cover (📄 p.124 "ARDF Rear Cover")

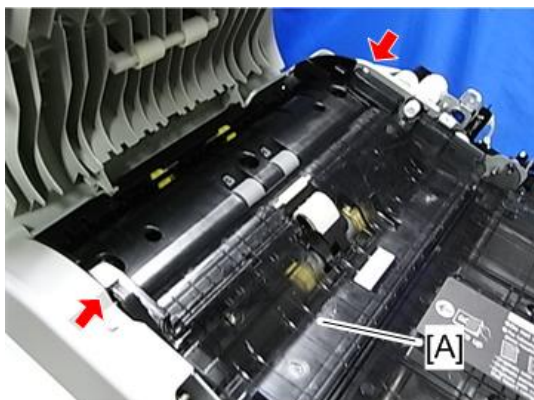

d117r829

2. Guide plate [A] (hook x 2)

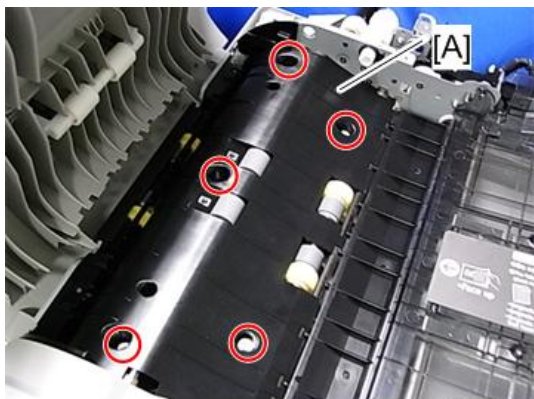

d117r830

3. Guide plate [A] (⚙ x 5)

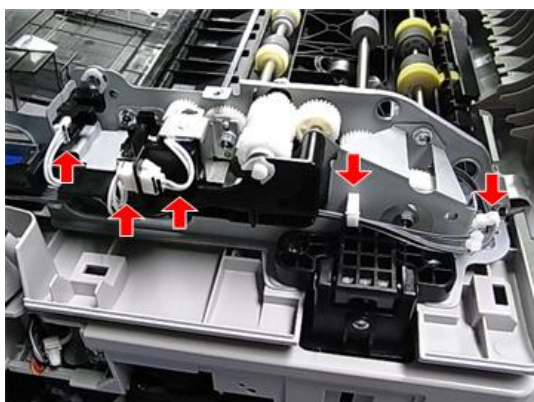

d117r831

4. Release the clamps and disconnect the connectors (🔌 x 3, 🖨 x 2).

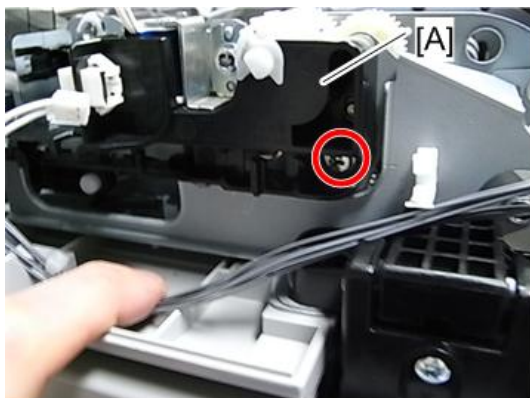

d117r832

4

5. Holder [A] ( 1 x 1)

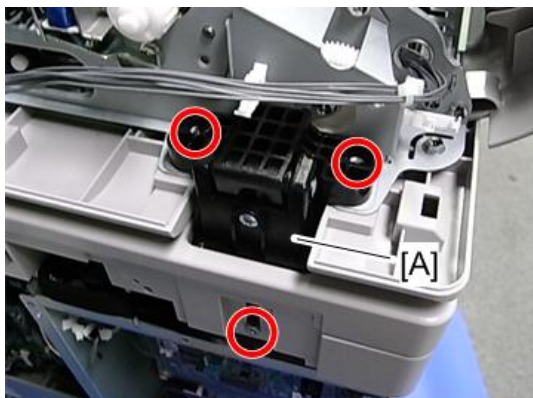

d117r833

6. Hinge [A] ( 1 x 3)

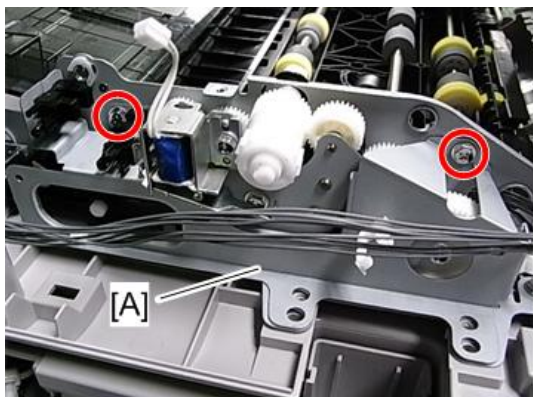

d117r834

7. Bracket [A] ( 1 x 2)

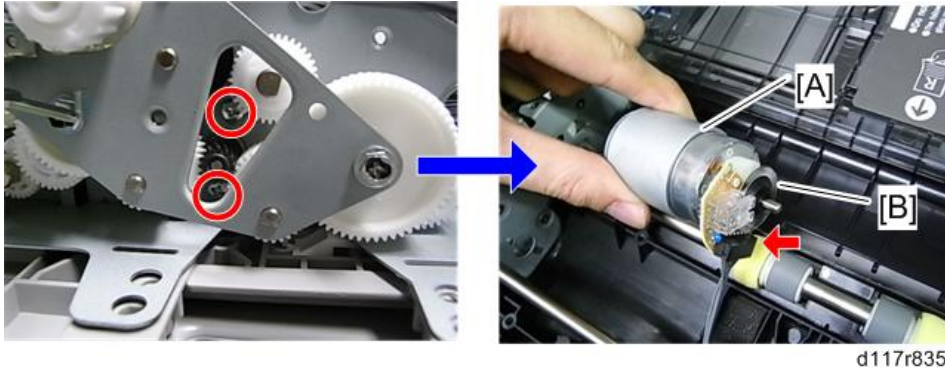

d117r835

8. ARDF drive motor [A] (  x 2,  x 1 )

**Note**

- Do not touch the encoder [B] when holding the motor.

4

## White Plate

1. Open the ARDF.

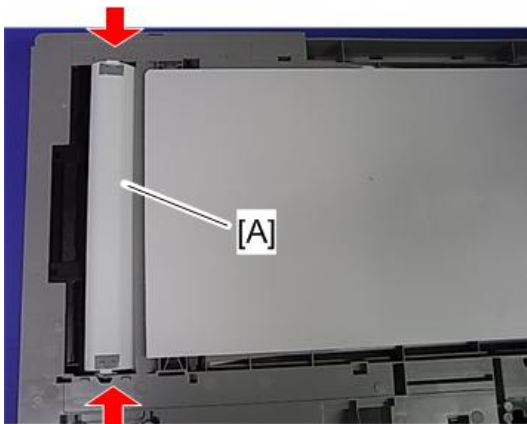

d117r823

2. White plate [A] (hook x 2)

### When installing the white plate

---

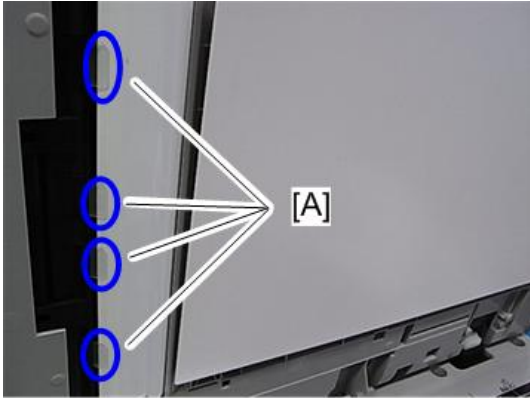

d117r839

Make sure that the mylars [A] are outside the white plate.

---

### Registration Sensor

---

1. White plate (p. 131 "White Plate")

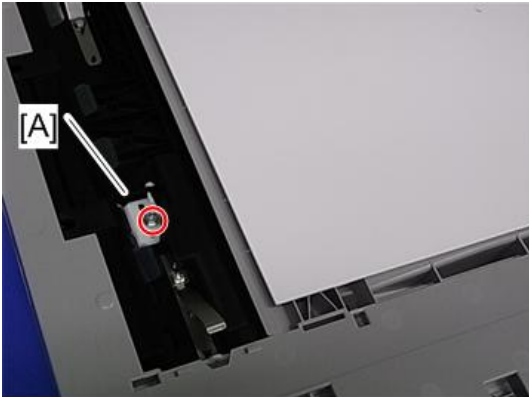

d117r824

2. Registration sensor holder [A] ( x 1)

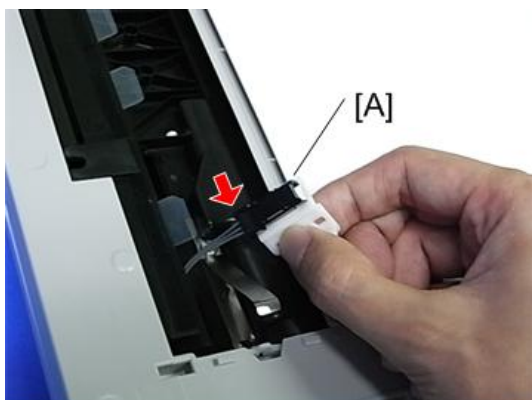

d117r825

3. Registration sensor [A] (📐 x 1, hooks)

# Adjusting Copy Image Area

Adjust the copy image area under any of the following conditions:

1. After clearing engine data (SP5-801-001 or SP5-801-002).
2. After replacing any of the following components:
  - LED unit
  - Scanner motor
  - Polygon mirror motor
  - Paper tray

4

## Printing

Make sure that the paper is correctly loaded in each paper tray before starting the adjustment procedures in this section.

## Adjusting Registration

Use the Trimming Area Pattern (SP2-109-001 > 10) for this adjustment.

1. Print out the test pattern with the paper fed from the regular paper tray.
2. Print out the test pattern with the paper fed from the by-pass tray.
3. Print out the test pattern by selecting duplex printing.

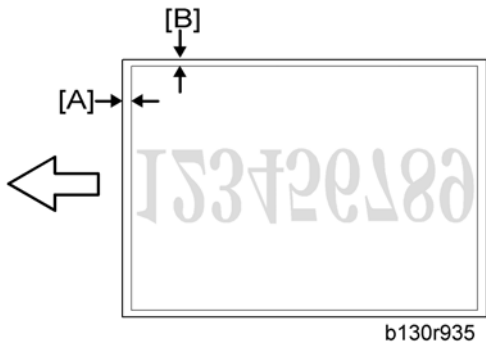

4. Measure the distance between the leading edge of the image area and the leading edge of the paper [A].

**Note**

- The diagram shows the paper on the copy tray. Note that the paper is output with the face down.



SP	Specification
SP1-001-001 (All Trays)	$0 \pm 2$ mm
SP1-001-002 (By-pass)	$0 \pm 2$ mm
SP1-001-003 (Duplex)	$0 \pm 4$ mm

- Adjust the leading edge registration (SP1-001).
- Measure the distance between the side edge of the image area and the side edge of the paper [B].

SP	Specification
SP1-002-001 (1st tray)	$0 \pm 2$ mm
SP1-002-002 (2nd tray)	$0 \pm 2$ mm
SP1-002-003 (3rd tray)	$0 \pm 2$ mm
SP1-002-004 (By-pass)	$0 \pm 4$ mm
SP1-002-005 (Duplex)	$0 \pm 4$ mm

- Adjust the side-to-side registration (SP1-002).
- Select "Cancel" in SP2-109-001 after finishing the adjustment procedure.

## Adjusting Blank Margin

Use the Trimming Area Pattern (SP2-109-001 > 10) for this adjustment.

- Print out the test pattern.

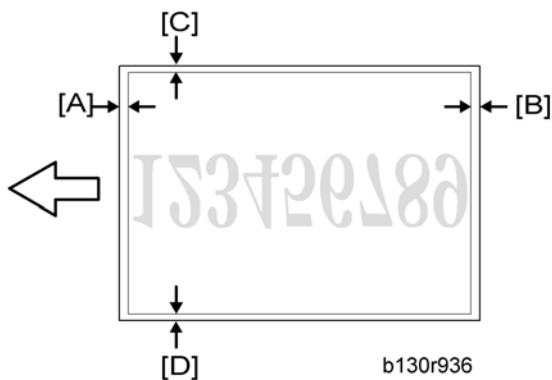

- Measure the distance between the four edges of the image area and the four edges of the paper [A][B][C][D].

**Note**

- The diagram shows the paper on the copy tray. Note that the paper is output with the face down.

3. Adjust the blank margin (SP2-103).

SP	Specification
SP2-103-001 (Leading Edge) [A]	3 +1/-3 mm
SP2-103-002 (Trailing Edge) [B]	3 +1/-3 mm
SP2-103-003 (Left Side) [C]	2 ± 2 mm
SP2-103-004 (Right Side) [D]	2 ± 2 mm

**Note**

- The "Left Side" and "Right Side" comes to your left-hand side and right-hand side respectively when you view the copied image with the leading edge upwards.

4. Select "Cancel" in SP2-109-001 after finishing the adjustment procedure.

## Adjusting Main-Scan Magnification

Use the Grid Pattern (Grid Vertical Line) (SP2-109-001 > 5) for this adjustment.

SP	Specification
SP2-102-001 (Main scan Mag.)	0 ± 0.5%

- Print out the test pattern.
- Measure the sides of squares. Each side should be 2.7-mm long.)
- Adjust the main-scan magnification (SP2-102-001: Main Scan Mag.).
- Select "Cancel" in SP2-109-001 after finishing the adjustment procedure.

## Scanning

### Preparation:

- Before adjusting scanning, adjust printing (p. 134 "Printing").
- To adjust scanning, use the A4 test chart.

## Adjusting Registration

1. Place the test chart on the exposure glass. Make sure that the test chart is aligned with the rear and left scales on the exposure glass.
2. Make a copy.

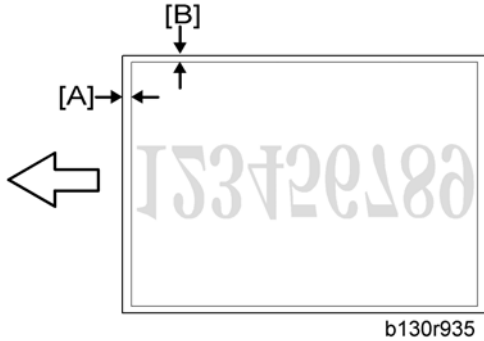

3. Measure the distance between the leading edge of the image area and the leading edge of the paper [A].

### ↓ Note

- The diagram shows the paper on the copy tray. Note that the paper is output with the face down.

4. Adjust the leading-edge scan registration. (SP4-010-001).

SP	Specification
SP4-010-001 (LE Scan Regist)	$0 \pm 2$ mm

5. Measure the distance between the side edge of the image area and the side edge of the paper [B].

6. Adjust the side-to-side registration (SP4-011-001).

SP	Specification
SP4-011-001 (S-to-S Scan Regist)	$0 \pm 2$ mm

### Adjusting Magnification



4

1. Place the test chart on the exposure glass. Make sure the test chart is aligned with the rear and left scales on the exposure glass.
2. Make a copy.
3. Compare the copy with the original.
4. Adjust the main-scan and sub-scan magnifications. The original image [A] is magnified in the main-scan direction [B] or in the sub-scan direction [C] when you specify a larger value.

**Note**

- The diagrams show the paper on the copy tray. Note that the paper is output with the face down.

SP	Specification
SP2-102-001 (Main scan Mag.)	0 ± 0.5%
SP4-008-001 (Sub Scan Mag.)	0 ± 1.0%

### DF Image Adjustment

**Note**

- Perform the adjustment procedure in this section only when the ARDF is installed on the copier.



b130r967

1. Make a temporary test chart as shown in the above diagram. Use the "A4/8.5 x 11" paper to make it.
2. Place the temporary test chart on the ARDF.
3. Make a copy.

4

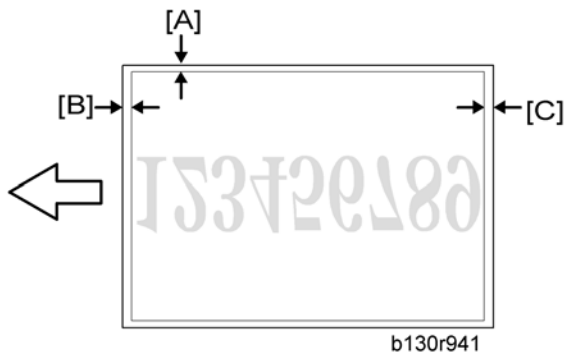

b130r941

4. Measure the distance between the side edge of the image area and the side edge of the paper [A].  
(The diagram shows the paper on the copy tray. Note that the paper is output with the face down.)
5. Adjust the side-to-side registration (S to S/Front Regist: SP6-006-001, S to S/Rear Regist: SP6-006-002). The image area moves to the rear side of the copier when you specify a larger value.
6. Measure the distance between the leading of the image area and the leading edge of the paper [B].
7. Adjust the leading edge registration (Leading Regist: SP6-006-003). The image area moves to the right side of the copier when you specify a larger value.
8. Measure the distance between the trailing edge of the image area and the trailing edge of the paper [C].
9. Adjust the erased area on the trailing edge (Trailing Erase: SP6-006-007).
10. Compare the copy with the original.

11. Adjust the sub-scan magnification (SP4-008-001). The specification is  $\pm 1.0\%$ .

# 5. System Maintenance Reference

## Service Program

**★ Important**

- Do not let the user access the SP mode or the SSP mode. Only service representatives are allowed to access these modes. The machine operation is NOT guaranteed after any person other than service representatives accesses the SP mode.

### SP Tables

See "Appendices" for the following information:

- System SP Tables
- Printer SP Tables
- Scanner SP Tables

### Using SP and SSP Modes

The following two modes are available:

- SP Mode (Service Program Mode): The SP Mode includes the programs that are necessary for standard maintenance work.
- SSP Mode (Special SP Mode): The SSP Mode includes SP-Mode programs and some special programs. You need some extra knowledge to use these special programs. For details, consult your supervisor.

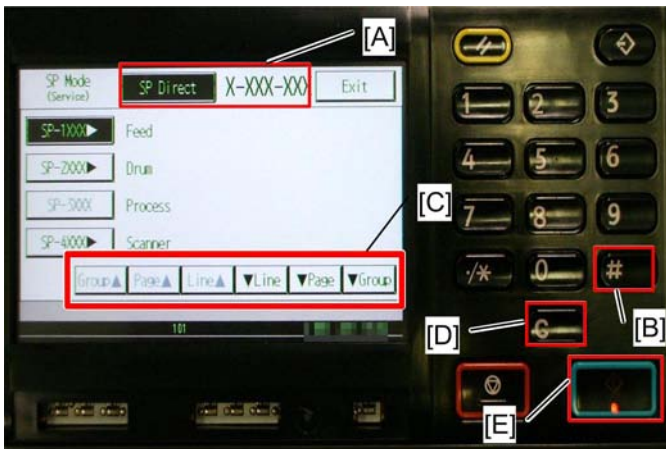

d127s903.jpg

## Starting SP Mode

---

For details, ask your supervisor.

## Selecting Programs

---

- When you want to jump to the program directly, confirm the item "SP Direct" [A] selected and put the SP number you want to operate by the keypad. Then press the "#" key [B].
- When you want to select the program in the menu, touch the signs [C] to scroll through the menu. Then touch the item you want to operate.

## Specifying Values

---



1. After locating a program, type the keypad to put the number in as the value. To switch between positive (plus) and negative (minus) values, press the  key.
2. Press the "#" key [B] to confirm the value or the "C" key [D] to cancel.

5

## Activating Copy Mode

---

You can activate the copy mode while the SP mode is running. When you do so, the copier outputs images or patterns that help you adjust the SP setting.

1. Press the  key [E]. The copy mode is activated.
2. Specify copy settings and press the  key [E].
3. To return to the SP mode, touch the item "To SP" displayed on the upper left corner on the panel.

### Note

- You cannot end the SP mode while the copy mode is activated.

## Quitting Programs/Ending (S) SP Mode

---

Touch the item "Exit" displayed on the upper right corner on the panel to quit the program or end the SP mode.

## Conventions used in the tables:

---

- Asterisk (\*): The settings are saved in the NVRAM. Most of them return to the default values when you execute SP5-801-002. CTL indicates that the data is contained in NVRAM on the controller board.
- DFU: The program is for design/factory use only. Do not change the settings.



- Brackets ([ ]): The brackets enclose the setting range, default value, and minimum step with unit ([Minimum to Maximum / **Default** / Step]).

# Using SP Mode

## NVRAM Data Upload/Download

### Uploading Content of NVRAM to an SD card

Follow this procedure to upload SP code settings from NVRAM to an SD card.

#### ↓ Note

- This data should always be uploaded to an SD card before the NVRAM is replaced.
1. Before switching the machine off, execute SP 5990-1 (SMC Print). You will need a record of the NVRAM settings if the upload fails.
  2. Turn off the main power of the copier.
  3. Remove the interface cover (  x 1).
  4. Insert the SD card into the service slot 2, then turn on the main power of the copier.
  5. Execute SP 5824-1 (NVRAM Data Upload) then press the "Execute" key.

- When uploading is finished, a file is copied to an NVRAM folder on the SD card. The file is saved to the path and filename:

**NVRAM\<<serial number>.NV**

Here is an example with Serial Number "B0700017":

NVRAM\B0700017.NV

6. In order to prevent an error during the download, be sure to mark the SD card that holds the uploaded (saved) data with the number of the machine from which the data was uploaded (saved).

#### ★ Important

- **NVRAM data from more than one machine can be uploaded (saved) to the same SD card.**
7. Turn off the main power, and then remove the SD card from the slot 2.
  8. Reassemble the machine.

### Downloading an SD Card to NVRAM

Follow this procedure to download (save) SP data from an SD card to the NVRAM in the machine.

- If the SD card with the NVRAM data is damaged, or if the connection between the controller and BICU is defective, the NVRAM data download may fail.
- If the download fails, repeat the download procedure.

- If the second attempt fails, enter the NVRAM data manually using the SMC print you created before uploading the NVRAM data. (🔧 above procedure)
1. Turn off the main power of the copier.
  2. Remove the interface cover 2 (🔧 x 1).
  3. Insert the SD card with the NVRAM data into the service slot 2.
  4. Turn on the main power of the copier.
  5. Execute SP 5825-1 (NVRAM Data Download) and press the "Execute" key.
  6. Turn off the main power of the copier, and then remove the SD card from the slot 2.
  7. Reassemble the machine.

#### ⬇ Note

- In order for the NVRAM data to download successfully, the serial number of the file on the SD card must match the serial number of the machine. If the serial numbers do not match, the download will fail.

This procedure downloads (saves) the following data to the NVRAM:

- Total Count
- C/O, P/O Count

## Firmware Update Procedure

This section illustrates how to update the firmware.

To update the firmware, you must have the new version of the firmware downloaded onto an SD (Secure Digital) Card. The SD Card is inserted into the uppermost slot on the right side of the controller box, viewed from the back of the machine.

### Before You Begin...

An SD card is a precision device, so always observe the following precautions when handling SD cards:

- Always switch the machine off before inserting an SD card. Never insert the SD card into the slot with the power on.
- When the power is switched on, never remove the SD card from the service slot.
- Never switch the machine off while the firmware is downloading from the SD card.
- Store SD cards in a safe location where they are not exposed high temperature, high humidity, or exposure to direct sunlight.
- Always handle SD cards with care to avoid bending or scratching them. Never drop an SD card or expose it to other shock or vibration.

Keep the following points in mind while you are using the firmware update software:

- "Upload" means to send data from the machine to the SD card, and "download" means to send data from the SD card to the machine.
- To select an item on the LCD screen, press the appropriate key on the operation panel, or press the appropriate number key on the 10-key pad of the operation panel.
- Before starting the firmware update procedure, always make sure that the machine is disconnected from the network to prevent a print job for arriving while the firmware update is in progress.

## Firmware Update Procedure

### ↓ Note

- Before beginning the following, first confirm which firmware version(s) are currently installed in the machine with SP7-801-255.

### -SD Card Preparation-

1. Format an SD card with, for example, SD Formatter v1.1.
2. Create a "romdata" folder on the card.
3. Create the following folders within the "romdata" folder: B121, B620, B622, B658, B681, B685
4. Download the firmware from the server and store the files in the folder with the corresponding model code on the SD card.

#### Example:

File B1215540B should be stored in the "B121" folder, whereas files B6585902B, B6585903B, and B6585905B should be stored in the "B658" folder.

### -Firmware Update-

### ↓ Note

- Do not put multiple machine firmware programs on the same SD card. Copy the only model firmware you want.
1. Turn off the main power switch.
  2. If the machine is connected to a network, disconnect the network cable from the copier.
  3. Remove the interface cover (  x 1 )
  4. With the label on the SD card facing the rear side of the machine, insert the SD card into the slot 2 on the controller box. Slowly push the SD card into the slot so it locks in place.
  5. Make sure the SD card is locked in place.  
(To remove the SD card, push it in to unlock the spring lock and then release it so it pops out of the slot.)
  6. Switch the main power switch on. After about 45 seconds, the initial version update screen appears on the LCD in English.

- On the screen, touch the button or press the corresponding number key on the operation panel to select the item in the menu that you want to update.

ROM/NEW	What it means
ROM:	Tells you the number of the module and name of the version currently installed. The first line is the module number, the second line the version name.
NEW:	Tells you the number of the module and name version on the SD card. The first line is the module number, the second line the version name.

#### ↓ Note

- Controller, engine and operation panel firmware cannot be updated at the same time. It is recommended to update firmware modules one by one.

- Touch "UpDate (#)" (or ) to start the update.

#### ↓ Note

- The progress bar does not show for the operation panel firmware after you touch "OpPanel". The power on key flashes on and off at 0.5 s intervals when the LCDC firmware is updating. The power key flashes on and off at 3 s intervals when the update is finished.

- The "Update is Done" message appears on the operation panel after completing the updating. The message differs depending on the firmware that has been updated.
- Switch the copier main power switch off when you see the "Update is Done" message or follow the procedure that is displayed on the operation panel.
- Press in the SD card to release it. Then remove it from the slot.
- Switch the copier on for normal operation.

## Error Messages

An error message shows in the first line if an error occurs during the download.

The error code consists of the letter "E" and a number. The example above shows error "E24" displayed. For details, refer to the Error Message Table (see "Handling Firmware Update Error").

## Firmware Update Error

If a firmware update error occurs, this means the update was cancelled during the update because the module selected for update was not on the SD card.

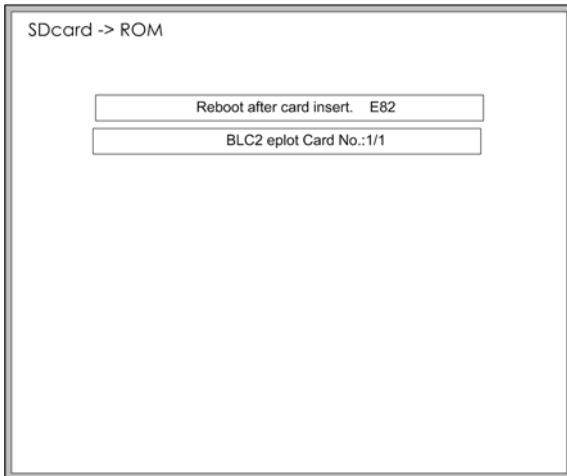

## 5

### Recovery after Power Loss

If the ROM update is interrupted as a result of accidental loss of power while the firmware is updating, then the correct operation of the machine cannot be guaranteed after the machine is switched on again. If the ROM update does not complete successfully for any reason, then in order to ensure the correct operation of the machine, the ROM update error will continue to show until the ROM is updated successfully.

In this case, insert the card again and switch on the machine to continue the firmware download automatically from the card without the menu display.

### Browser Unit Update Procedure

1. Remove the slot cover [A] for the SD card (  x 1).
2. Turn the SD-card label face [A] of the browser unit to the rear of the machine. Then push it slowly into slot 2 (lower) until you hear a click.
3. Plug in and turn on the main power switch.
4. Push the "User Tools" key.
  - If an administrator setting is registered for the machine, step 5 and 6 are required. Otherwise, skip to the step 7.
5. Push the "Login/ Logout" key.
6. Login with the administrator user name and password.
7. Touch "Extended Feature Settings" twice on the LCD.
8. Touch "Uninstall" on the LCD.
9. Touch the "Browser" line.

10. Confirmation message appears on the LCD.
11. Touch "Yes" to proceed.
12. Reconfirmation message appears on the LCD.
13. Touch "Yes" to uninstall the browser unit.
14. You will see "Uninstalling the extended feature... Please wait.", and then "Completed".
15. Touch "Exit" to go back to the setting screen.
16. Exit "User/Tools" setting, and then turn off the main power switch.
17. Remove the SD card of the browser unit from SD card slot 2 (lower).
18. Overwrite the updated program in the "sdk" folder of the browser unit application with PC.
19. Do the "Installation Procedure" to install the browser unit.

## Handling Firmware Update Errors

5

An error message shows in the first line if an error occurs during a download. The error code consists of the letter "E" and a number ("E20", for example).



### Error Message Table

Code	Meaning	Solution
20	Cannot map logical address	Make sure the SD card is inserted correctly.
21	Cannot access memory	HDD connection incorrect or replace hard disks.
22	Cannot decompress compressed data	Incorrect ROM data on the SD card, or data is corrupted.
23	Error occurred when ROM update program started	Controller program abnormal. If the second attempt fails, replace controller board.
24	SD card access error	Make sure SD card inserted correctly, or use another SD card.
30	No HDD available for stamp data download	HDD connection incorrect or replace hard disks.
31	Data incorrect for continuous download	Insert the SD card with the remaining data required for the download, the re-start the procedure.

32	Data incorrect after download interrupted	Execute the recovery procedure for the intended module download, then repeat the installation procedure.
33	Incorrect SD card version	Incorrect ROM data on the SD card, or data is corrupted.
34	Module mismatch - Correct module is not on the SD card)	SD update data is incorrect. Acquire the correct data (Japan, Overseas, OEM, etc.) then install again.
35	Module mismatch - Module on SD card is not for this machine	SD update data is incorrect. The data on the SD card is for another machine. Acquire correct update data then install again.
36	Cannot write module - Cause other than E34, E35	SD update data is incorrect. The data on the SD card is for another machine. Acquire correct update data then install again.
40	Engine module download failed	Replace the update data for the module on the SD card and try again, or replace the BICU board.
42	Operation panel module download failed	Replace the update data for the module on the SD card and try again, or replace the LCDC.
43	Stamp data module download failed	Replace the update data for the module on the SD card and try again, or replace the hard disks.
44	Controller module download failed	Replace the update data for the module on the SD card and tray again, or replace controller board.
50	Electronic confirmation check failed	SD update data is incorrect. The data on the SD card is for another machine. Acquire correct update data then install again.

## Test Pattern Print (SP2-109-001)

### Executing Test Pattern Printing

1. Touch the item you want to activate then the item "OK" displayed on the touch panel.
2. Press the  key. The copy mode is activated.
3. Specify copy settings and press the  key.
4. To return to the SP mode, Touch the item "To SP" displayed on the upper left corner on the touch panel.



## Test Patterns

No.	Pattern
0	None
1	Vertical Lines (1 Dot)
2	Vertical Lines (2 Dot)
3	Horizontal Lines (1 Dot)
4	Horizontal Lines (2 Dot)
5	Grid Vertical Line
6	Grid Horizontal Line
7	Grid Pattern Small
8	Grid Pattern Large
9	Argyle Pattern Small
10	Argyle Pattern Large
11	Independent Pattern (1 Dot)
12	Independent Pattern (2 Dot)
13	Independent pattern (4 Dot)
14	Trimming Area
15	Hound's Tooth Check
16	Hound's Tooth Check
17	Black Band (Horizontal)
18	Black Band (Vertical)
19	Checker Flag Pattern
20	Grayscale (Vertical)
21	Grayscale (Horizontal)
22	Two Beam Density Pattern

23	Full Dot Pattern
24	All White Pattern

## Memory Clear

The machine stores the engine data in the NVRAM on the BICU, and stores the other data in the NVRAM on the optional controller. To distinguish between the engine data and the other data, see SP5-801-003 through 015. This service program (SP5-801) handles the controller data. The data in the BICU NVRAM (engine data) is cleared by SP5-801-002 while the data in the controller NVRAM (controller data) is cleared by the other programs in SP5-801 (for exceptions, see "Exceptions" as described below).

Data	NVRAM	Cleared by	Remarks
Engine data	BICU	SP5-801-002	Any data other than controller data
Controller data	Controller	SP5-801-xxx	SCS, IMH, MCS, Copier application, Fax application, Printer application, Scanner application, Web service/network application, NCS, R-Fax, DCS, UCS

## Exceptions

SP5-801-002 clears most of the settings and counters stored in the NVRAM on the BICU (the values return to their default values). However, the following settings are not cleared:

- SP5-811-003 (MachineSerial [ID2 Code Display])
- SP5-812-001 (Service TEL No. Setting [Service])
- SP5-812-002 (Service TEL No. Setting [Facsimile])
- SP5-907 (Plug & Play Maker/Model Name)
- SP7 (Data Log)
- SP8 (Data Log2)

Use SP5-801-002 after you have replaced the BICU NVRAM or when the BICU NVRAM data is corrupted. When the program ends normally, the message "Completed" is displayed. When you have replaced the controller NVRAM or when the controller NVRAM data is corrupted, use SP5-801-001. The message is the same as the basic machine.

## Memory Clear Procedure

1. Print out all SMC data lists (▶ p.153 "SMC Print (SP5-990)").
2. Do SP5-801-002.
3. Press the OK key.
4. Select "Execute." The messages "Execute?" followed by "Cancel" and "Execute" are displayed.
5. Select "Execute."
6. When the program has ended normally, the message "Completed" is displayed. If the program has ended abnormally, an error message is displayed.
7. Turn the main switch off and on.
8. Adjust the printer and scanner registration and magnification (\* "Copy Adjustment" in the chapter "Replacement and Adjustment").
9. Refer to the SMC lists, and enter any values that differ from the factory settings.
10. Initialize the Developer (SP 2-801-001).
11. Check the copy quality and the paper path.

## SMC Print (SP5-990)

SP5-990 outputs machine status lists.

1. Select SP5-990.
2. Select a menu:
  - -001 All (Data List), -002 SP (Mode Data List), -003 User Program, -004 Logging Data, -005 Diagnostic Report, -006 Non-Default, -007 NIB Summary, -008 Capture Log, -021 Copier User Program, -022 Scanner SP, -023 Scanner User Program

### ↓ Note

- The output given by the menu "Big Font" is suitable for faxing.
3. Press the "Execute" key.
    - The machine status list is output.
  4. To return to the SP mode, Touch the item "To SP" displayed on the upper left corner on the touch panel.

## ID Sensor Error Analysis (SP2-220)

The image quality may become very bad when the ID sensor does not operate properly. However, there is no such SC code that indicates ID-sensor malfunction; instead, SP2-220 shows you some information on the ID sensor. Check this information when the image quality is not very good.

The table lists the information shown with SP2-220 (Vsg/Vsp/Vsdp/Vt/Vtref Dilay).

SP	Error condition	Possible cause	Remarks
SP2-220-1 Vsp (VP in the display)	$V_{sp} < 2.5V$ or $(V_{sp} - V_{sp}) < 1.00V$	<ul style="list-style-type: none"> <li>• Toner density very low</li> <li>• ID sensor pattern not created</li> </ul>	-
SP2-220-2 Vsg (VG in the display)	$V_{sp} > 2.5V$ or $(V_{sg} - V_{sg}) < 1.00V$	<ul style="list-style-type: none"> <li>• ID sensor defective</li> <li>• ID sensor dirty</li> <li>• Drum not charged</li> </ul>	-
SP2-220-3 Vsdp	No Error Conditions		-
SP2-220-4 Vt	$V_t > 4.5V$ or $V_t < 0.2V$	<ul style="list-style-type: none"> <li>• TD sensor defective</li> </ul>	-
SP2-220-5 Vtref	-	-	-

# Fax Service Tables

See "Appendices" for the following information:

- Fax System Service Mode
- Bit Switches
- NCU Parameters
- Dedicated Transmission Parameters
- Service RAM Addresses



# 6. Troubleshooting

## SC Tables

### Summary

There are four levels of service call conditions.

Level	Definition	Reset Procedure
A	To prevent possible damage, the machine does not operate until the service representative resets the SC code.	Activate the SP mode, and turn the main power switch off and on.
B	Turning the main power switch off and on resets the SC code if the error is caused by incorrect sensor detection.	Turn the main power switch off and on.
C	The machine operates as usual excluding the unit related to the service call.	Turn the main power switch off and on.
D	The SC history is updated. The machine operates as usual.	No SC code is displayed. Only the SC history is updated.

#### ↓ Note

- If a problem involves circuit boards, see if you can solve the problem by disconnecting and reconnecting all connectors before deciding to replace a circuit board.
- If a problem involves a motor lock, check the mechanical load before deciding to replace a motor or sensor.
- If working on a fax-equipped machine, switching power off and on may cause loss of data stored in the memory.

## Engine SC Code Descriptions

No. Definition		Symptom	Possible Cause
101	B	Exposure Lamp Error	
		The scanner has scanned the white plate, but cannot detect the certain white level.	<ul style="list-style-type: none"> <li>Defective exposure lamp</li> <li>Defective exposure lamp stabilizer</li> <li>Defective power source harness</li> <li>Defective signal harness</li> <li>High-voltage cable leak</li> <li>Defective darkness starting characteristic</li> </ul>
120	B	Scanner home position error 1	
		The scanner home position sensor does not detect the scanner leaving the home position.	<ul style="list-style-type: none"> <li>Defective scanner home position sensor</li> <li>Defective scanner home position sensor harness</li> <li>Defective scanner motor drive</li> <li>Defective scanner motor</li> </ul>
121	B	Scanner home position error 2	
		The scanner home position sensor does not detect the scanner coming back to the home position.	<ul style="list-style-type: none"> <li>Defective scanner home position sensor</li> <li>Defective scanner home position sensor harness</li> <li>Defective scanner motor drive</li> <li>Defective scanner motor</li> </ul>
141	B	Black level correction error	
		The automatic adjustment has failed to correct a current black level to the certain level.	<ul style="list-style-type: none"> <li>Defective SBU board</li> <li>Defective relevant harness</li> </ul>



No. Definition		Symptom	Possible Cause
142	B	White level correction error	
		The automatic adjustment has failed to correct a current white level to the certain level.	<ul style="list-style-type: none"> <li>• Dewing scanner unit</li> <li>• Defective scanner drive</li> <li>• Defective optical section</li> <li>• Defective SBU board</li> <li>• Defective relevant harness</li> </ul>
144	B	SBU Communication Error	
		Cannot correctly establish communication with the SBU.	<ul style="list-style-type: none"> <li>• Defective relevant harness</li> <li>• Defective destination device (e.g., BICU, etc)</li> <li>• Defective SBU</li> </ul>
161	IPU error		
-001	B	LSYNC error	
		Detecting an error from the result of the IPU self-check on startup.	<ul style="list-style-type: none"> <li>• Defective the IPU or the BICU (or bad connection between the ASIC and the LEO, LSYNC Abnormal, etc)</li> <li>• Cable bad connection between the SBU and the IPU (or the BICU).</li> </ul>
-002	B	RI response error	
		Detecting an error on access to the RI.	<ul style="list-style-type: none"> <li>• Defective the IPU (the BICU, the ICTL) or RI abnormal performance, etc</li> </ul>
162	IPC:PCIE error		
-001	B	PCIE Communication error	
		Doesn't occur insertion request of linking-up from the LYRA on startup. Or NOT the number of the connection lanes detected is two.	<ul style="list-style-type: none"> <li>• Defective IPU (BICU, IPU)</li> </ul>

No. Definition		Symptom	Possible Cause
165	B	Unauthorized copy protection Failed	
		Detecting the ICIB wrong or NOT attached on the copier under setting unauthorized copy protection on. Or detecting wrong with the ICIB on startup.	<ul style="list-style-type: none"> <li>• NOT the ICIB attached firmly.</li> <li>• Defective the ICIB</li> </ul>
202	B	Polygon motor error: Time out (On)	
		NOT detecting making the polygon motor be ready in certain time after start polygon motor up or change the spin speed.	<ul style="list-style-type: none"> <li>• Harness and the polygon motor driver.</li> <li>• Defective the polygon motor or the polygon motor driver.</li> <li>• Defective polygon motor drive pulse output (Around polygon control part)</li> <li>• Unable to monitor XSCRDY signal (Around polygon control parts)</li> <li>• Bad connection or disconnection between the I/F</li> </ul>
203	B	Polygon motor error: Time out (Off)	
		NOT XSCRDY signal becoming "H" (Inactive) within three seconds.	<ul style="list-style-type: none"> <li>• Harness and the polygon motor driver.</li> <li>• Defective the polygon motor or the polygon motor driver.</li> <li>• Defective polygon motor drive pulse output (Around polygon control parts)</li> <li>• Unable to monitor XSCRDY signal (Around polygon control parts)</li> <li>• Bad connection or disconnection between the I/F</li> </ul>

No. Definition		Symptom	Possible Cause
204	B	Polygon motor error: XSCRDY signal error	
		Detecting XSCRDY signal "H" (Inactive) while writing.	<ul style="list-style-type: none"> <li>• Harness and the polygon motor driver.</li> <li>• Defective the polygon motor or the polygon motor driver.</li> <li>• Bad connection or disconnection between the I/F</li> </ul>
220	B	LD synchro-detection error	
		NOT output certain synchro-detection signal within 200ms after LD lighting in steady-rotation.	<ul style="list-style-type: none"> <li>• Bad connection or disconnection between the I/F harness and the synchro-detection Unit.</li> <li>• Defective the synchro-detection</li> <li>• NOT the beam going into the photo detector</li> <li>• Defective the GAVD related parts, the LD driver, the LDB, the BICU</li> </ul>
230	B	FGATE: Fail to switch "ON"	
		NOT switching FGATE signal on within one second after writing start-timing.	<ul style="list-style-type: none"> <li>• Defective the GAVD, PCI bridge ASIC</li> <li>• BICU, the Controller board wrong or bad connection</li> <li>• Defective the harness between the BICU to the LDB</li> </ul>
231	B	FGATE: Fail to switch "OFF"	
		NOT switching FGATE signal off within nine seconds after writing end-timing.	<ul style="list-style-type: none"> <li>• BICU, the Controller board wrong or bad connection</li> <li>• Defective the harness between the BICU to the LDB</li> <li>• Defective the GAVD, PCI bridge ASIC</li> </ul>

No. Definition		Symptom	Possible Cause
240	D	LD error	
		Detecting two LD error flags in series when LD lighting after the LD initializing	<ul style="list-style-type: none"> <li>• Characteristic degradation of the LD (LD broken, electric current versus light output characteristic shift, etc)</li> <li>• Bad connection or disconnection of the harness to the LD</li> <li>• Defective the LD driver parts</li> </ul>
270	B	GAVE communication error	
		Doesn't the value you set in a certain resister accord with the value of the same resister on reading.	<ul style="list-style-type: none"> <li>• Defective the BICU</li> <li>• Defective the GAVD, the CPU</li> </ul>
302	B	High-voltage charge error	
		The maximum rate of PWM duty (50%) occurs ten fimes in series (20msec x 10) This error doesn't happen when the front door (the inter lock) opens.	<ul style="list-style-type: none"> <li>• Defective the MD</li> <li>• Defective harness connected to the HVP</li> </ul>
355	D	P sensor error	
		SC350~354 happen on normal operation. This error isn't displayed on panel but left on the history as a logging data.	<ul style="list-style-type: none"> <li>• Disconnection of the harness to P sensor</li> <li>• Bad electrical contact of P sensor CN</li> <li>• Defective the BICU</li> <li>• Defective the writing section</li> <li>• Defective developer density</li> <li>• Defective high-voltage PP</li> <li>• Uncleanness of the P sensor</li> <li>• Defective the P sensor</li> </ul>

No. Definition		Symptom	Possible Cause
389	D	T sensor error warning	
		Detected the following value T sensor output value < 0.2V T sensor output value > 4.0V 10 times in series.	<ul style="list-style-type: none"> <li>Defective the T sensor</li> <li>Bad contact of the connector to the T sensor</li> </ul>
390	B	T sensor error	
		After SC389 detection and executing SP2-992-001, This SC is displayed. In process flow, This SC occurs when two times of T sensor output value error are detected consecutively.	<ul style="list-style-type: none"> <li>Defective T sensor</li> <li>Loose connection part</li> </ul>
391	B	Development bias error	
		The maximum rate of PWM duty (50%) occurs 10 times in series (20msec x 10) This error doesn't happen when the front door (the inter lock) opens.	<ul style="list-style-type: none"> <li>Defective the MD</li> <li>Defective harness connected to the HVP</li> </ul>
392	B	Developer initialization error	
		The P sensor does not detect a correct pattern during developer initialization (SP2-801-001). When Vsp output is more than 2.5V, SC appears in the case of not removing the heat seal or an absence of developer.	<ul style="list-style-type: none"> <li>Defective P sensor</li> <li>Defective T sensor</li> <li>NOT removing heat-seal</li> <li>Defective drum operation</li> <li>Defective development roller operation</li> </ul>

No. Definition		Symptom	Possible Cause
401	B	Transfer roller leak error (positive electrode)	
		<ul style="list-style-type: none"> <li>The feedback voltage of the transfer roller has been more than the certain voltage for 200msec. (Open detecting condition)</li> <li>The feedback voltage of the transfer roller has been insufficient for 200msec. (Leak detecting condition)</li> </ul> <p>This error doesn't happen when the front door (the inter lock) opens.</p>	<ul style="list-style-type: none"> <li>Defective harness connected to HVP</li> <li>Defective the MD</li> </ul>
402	B	Transfer roller leak error (negative electrode)	
		<p>The feedback voltage of the transfer roller has been more than the certain voltage (more than 4.5V) for 200msec. This error doesn't happen when the front door (the inter lock) opens.</p>	<ul style="list-style-type: none"> <li>Defective the MD</li> <li>Defective harness connected to the HVP</li> </ul>
411	B	Separation high-voltage error	
		<p>The maximum rate of PWM duty (50%) occurs ten times in series (20msec x 10) This error doesn't happen when the front door (the inter lock) opens.</p>	<ul style="list-style-type: none"> <li>Defective the MD, HVP Connection harness.</li> </ul>
440	B	Transfer electric plus current error	
		<p>Detecting "0" (Abnormal) ten times in series (200ms) while monitoring "HVP: T +: Output error detection signal" every 20m seconds. (Reboot the machine to clear this SC)</p>	

No. Definition		Symptom	Possible Cause
460	B	Isolation voltage error	
		Detecting "0" (Abnormal) ten times in series (200ms) while monitoring "HVP: D: Output error detection signal" every 20m seconds. (Reboot the machine to clear this SC)	
490	B	Toner bottle motor overcurrent	
		Detecting "Low" for more than 200msec while the motor on. Motor locked up due to overcurrent to the drive section.	<ul style="list-style-type: none"> <li>Defective the motor drive.</li> </ul>
500	B	Main motor error	
		Detecting "High" condition twenty times in series during watching each lock signal after switching motor on.	<ul style="list-style-type: none"> <li>Overload</li> <li>Defective main motor drive</li> </ul>
541	A	Fusing thermistor disconnection	
		Detecting the temperature remains lower than 0 degrees Celsius for 5 seconds.	<ul style="list-style-type: none"> <li>Thermistor disconnection</li> <li>Defective connector part</li> </ul>
542	Fusing reload failed		
-001	A	Fusing temperature warm-up error	
		<ul style="list-style-type: none"> <li>The fusing temperature doesn't rise by more than 7 degrees for two seconds; and this happens 5 times consecutively.</li> </ul> <p>The measure is start in 3.5 seconds after activation of the heater.</p> <p>This monitoring will stop in the case of reaching the reload temperature.</p>	<ul style="list-style-type: none"> <li>Defective thermistor</li> <li>Power source is out of warranty</li> </ul>

No. Definition		Symptom	Possible Cause
-003	A	Time out error	
		(On the fusing roller inactive) NOT reaching the reload temperature in 25 seconds after starting heater control.	<ul style="list-style-type: none"> <li>• Disconnection of Heater After activation of the anti-overheat device</li> </ul>
		(On the fusing roller active) NOT reaching the reload temperature in 35 seconds after starting heater control.	
543	A	Fusing overheat error 1	
		The fusing temperature detected by the thermistor is 230°C or higher for one second.	<ul style="list-style-type: none"> <li>• Defective the triac (Semiconductor device)</li> <li>• Defective the IOB control board</li> <li>• Detective the BICU control board</li> </ul>
544	A	Fusing overheat error 2	
		The fusing temperature detected by the monitor circuit is 250°C or higher.	<ul style="list-style-type: none"> <li>• Defective the triac (Semiconductor device)</li> <li>• Defective the IOB control board</li> <li>• Defective the BICU control board</li> <li>• Uncontrollable fusing condition</li> </ul>
545	A	Fusing lamp overheat error	
		The fusing lamp remains on for 12 seconds after starting the waiting mode.	<ul style="list-style-type: none"> <li>• Defective thermistor</li> <li>• Disconnection of Heater</li> <li>• After activation of the anti-overheat device</li> </ul>
547		Zero cross signal malfunction	



No. Definition		Symptom	Possible Cause
-001	B	Detecting fusing contact meltdown	<ul style="list-style-type: none"> <li>Defective the fusing relay (Contact adhesion, Contact separation)</li> <li>Defective the drive circuit in the fusing relay</li> <li>PSU fuse (24VS) meltdown</li> <li>Unsteadiness in frequency of the commercial power source</li> </ul>
-002		Detecting wrong with fusing contact	
-003		Detecting low-frequency wave	
557	D	Over zero cross frequency	<ul style="list-style-type: none"> <li>Interruption of power source line noise.</li> </ul>
		The number of times Low-frequency wave detection is less than 1 time.	
559	A	Consecutive fusing jam	<ul style="list-style-type: none"> <li>Paper jam in the fusing unit.</li> </ul>
		The paper jam counter for the fusing unit reaches 3 times. The paper jam counter is cleared if the paper is fed correctly. This SC is activated only when SP1159-001 is set to "1" (default "0").	
620	B	ADF communication error	<ul style="list-style-type: none"> <li>Defective the ADF</li> <li>Defective the IPU board</li> <li>Bad connection of the ADF</li> </ul>
		Disconnection after connection in normal.	
622	B	Bank communication error	<ul style="list-style-type: none"> <li>Defective the bank control board</li> <li>Defective the BICU, the IOB</li> <li>Bad connection between the bank and the main machine</li> <li>Defective the bank control</li> </ul>
		<ol style="list-style-type: none"> <li>Malfunction occurs on line connection.</li> <li>Receiving a communication error notice from the URAT.</li> </ol>	

No. Definition		Symptom	Possible Cause
623	B	Second bank communication error	<ul style="list-style-type: none"> <li>• Bad connection between the first bank and the second bank</li> <li>• Defective the bank control board</li> <li>• NOT all connectors are in place</li> </ul>
		Abnormal code is send from the bank unit.	
669	B	EEPROM communication error	<ul style="list-style-type: none"> <li>• Defective the EEPROM</li> <li>• Noise</li> </ul>
		Cannot return to be normal condition after retrying three times when the error on EEPROM communication occurs.	
687	B	Cannot receive RAPI-PER	<ul style="list-style-type: none"> <li>• Defective the controller board</li> <li>• Noise</li> </ul>
		Command (Ready for image transfer) in 120 seconds after RARI-PES (Request for image transfer) occurs.	
790	B	Over the number of the banks installed error	<ul style="list-style-type: none"> <li>• More than 3 of the banks are installed. (Specific limitation for Model S-C5 is 2 at maximum)</li> </ul>
		Receiving a code other than the following cord: For Model S-C5: 01H 02H	
901	B	Mechanical total counter error	<ul style="list-style-type: none"> <li>• Defective harness between mechanical counter and BICU.</li> <li>• Defective BICU</li> <li>• Defective mechanical total counter</li> <li>• Loose connection of harness between mechanical counter and BICU.</li> <li>• Mechanical counter has been pulled out while accounting operation.</li> </ul>
		The condition of the mechanical counter on the electric hard is disconnection on activating the counter when SP mode "Anti-tampering system" is ON.	

No. Definition		Symptom	Possible Cause
995	B	Model information error	
		NOT according manufacturing number (11 digits) with product identification code.	<ul style="list-style-type: none"> <li>• Defective BICU</li> <li>• Defective NVRAM</li> <li>• Defective controller</li> </ul>

## SC Code Descriptions

### SC6xx

No. Definition		Symptom	Possible Cause/Countermeasure
632	C	MF accounting device error 1	
		The machine sends a data frame. → No normal end signal returns. → This symptom happens three times.	<ul style="list-style-type: none"> <li>• Defective or broken line between machine and device</li> </ul>
633	C	MF accounting device error 2	
		The machine is communicating with the accounting device. → The break signal returns.	<ul style="list-style-type: none"> <li>• Defective or broken line between machine and device</li> </ul>
634	C	MF accounting device error 3	
		A backup RAM error is reported from the accounting device.	<ul style="list-style-type: none"> <li>• Defective accounting device controller</li> <li>• Defective battery in the accounting device</li> </ul>
635	C	MF accounting device error 4	
		A battery voltage error is reported from the accounting device.	<ul style="list-style-type: none"> <li>• Defective accounting device controller</li> <li>• Defective battery in the accounting device</li> </ul>

No. Definition	Symptom	Possible Cause/Countermeasure
636	SD Card Error	
-001	B Expanded authentication module error There is no expanded authentication module in the machine. The SD card or the file of the expanded authentication module is broken. There is no DESS module in the machine.	1. Install the correct SD card or the file of the expanded authentication module. 2. Install the DESS module.
-002	B Version error The version of the expanded authentication module is not correct.	1. Install the correct file of the expanded authentication module.
-011	B OSM usercode file error NOT found the "usercode" file in the rootfolder, in the SD card Or cannot read the usercode file correctly. *This SC occurs only for OSM IC card.	<ul style="list-style-type: none"> <li>• No usercode file exists in the SD card</li> <li>• Irregular usercode file</li> <li>• The data in the usercode file is irregular</li> <li>• NOT coping the application with the "usercode" file to the SD card.</li> </ul> 1. Make a customer usercode by the OSM usercode setting tool (IDissuer.exe) and put it in the rootfolder where IC card module (eccm.mod) is stored.
637	Tracking APP error	
-001	B NOT found the tracking information.	<ul style="list-style-type: none"> <li>• Causes of failing to notice tracking SDK APP (e.g.: Defective tracking SDK APP, Abnormal internal communication)</li> </ul> 1. Power source OFF/ON

No. Definition		Symptom	Possible Cause/Countermeasure
-002	B	Administration server error	
		NOT found the tracking information.	<ul style="list-style-type: none"> <li>• Defective tracking administration server</li> <li>• Defective tracking SDK APP</li> <li>• Defective Network</li> </ul> <ol style="list-style-type: none"> <li>1. Power source OFF/ON</li> </ol>
640	D	Engine to controller communication error (Check Sum error)	
		Incorrect sum data.	<ul style="list-style-type: none"> <li>• Defective the PCI related hardware</li> </ul>
641	B	Engine to controller communication error (No response)	
		No response to the frame from the engine when frame sending according to RAPI protocol is done from the controller.	
650		Communication error of the remote service modem (Cumin-M)	
-001	C	Authentication error	
		The authentication for the Embedded RCG-M fails at a dial up connection.	<ol style="list-style-type: none"> <li>1. Check and set the correct user name (SP5816-156) and password (SP5816-157).</li> </ol>
-004	C	Incorrect modem setting	
		Dial up fails due to the incorrect modem setting.	<ol style="list-style-type: none"> <li>1. Check and set the correct AT command (SP5819-160).</li> </ol>
-005	C	Communication line error	
		The supplied voltage is not sufficient due to the defective communication line or defective connection.	<ol style="list-style-type: none"> <li>1. Consult with the user's local telephone company.</li> </ol>
651		Incorrect dial up connection	
		An unexpected error occurs when the modem (RCG-M) tries to call the center with a dial up connection.	

No. Definition		Symptom	Possible Cause/Countermeasure
-001	D	Program parameter error	<ul style="list-style-type: none"> <li>Software bug.</li> </ul>
-002	D	Program execution error	1. No action required because this SC does not interfere with operation of the machine.
670	B	Engine startup error	
		<p>Just after the main power is turned on or the machine is recovering from auto off mode, the engine ready signal assertion fails.</p> <p>Just after the main power is turned on, the engine does not respond.</p>	<ul style="list-style-type: none"> <li>Poor connection between the BICU and controller board</li> <li>Defective BICU</li> <li>Defective controller board</li> </ul>
672	B	Controller-to-operation panel communication error at startup	
		<p>After powering on the machine, communication between the controller and operation panel does not begin, or the communication is interrupted after a normal startup.</p>	<ul style="list-style-type: none"> <li>Controller stalled</li> <li>Controller board installed incorrectly</li> <li>Defective controller board</li> <li>Operation panel connector loose or defective</li> <li>Poor connection of DIMM and optional boards on the controller board</li> </ul> <p>1. Check the setting of SP5875-001. If the setting is set to "1 (OFF)", change it to "0 (ON)".</p>

## SC8xx

No. Definition		Symptom	Possible Cause/Countermeasure
818	B	Firmware update error	
		This error may occur while firmware update.	1. Reboot the copier and complete the undone update.

817	Monitor Error		
	B	This is a file detection and electronic file signature check error when the boot loader attempts to read the self-diagnostic module, system kernel, or root system files from the OS Flash ROM, or the items on the SD card in the controller slot are false or corrupted.	<ul style="list-style-type: none"> <li>OS Flash ROM data defective; change the controller firmware</li> <li>SD card data defective; use another SD card</li> </ul>
819	Kernel stop		
	Due to a control error, a RAM overflow occurred during system processing. One of the following messages was displayed on the operation panel.		
[5032]	B	HAIC-P2 error	<ul style="list-style-type: none"> <li>System program defective</li> <li>Controller board defective</li> <li>Optional board defective</li> </ul> <ol style="list-style-type: none"> <li>Replace controller firmware</li> </ol>
[6261]	B	init died	
[0696e]	B	Process error	
[0766d]	B	VM full error	
[554C]	B	USB error	
[----]	B	The others	
820	Self-Diagnostic Error: CPU		
	B	<ul style="list-style-type: none"> <li>[0001-0015] [000A-000D]: Detailed error code</li> </ul>	<ul style="list-style-type: none"> <li>Defective CPU device</li> <li>Defective boot monitor program or self-diagnostic program</li> </ul> <ol style="list-style-type: none"> <li>Replace the controller board.</li> <li>Reinstall the system firmware.</li> </ol>
		During the boot monitor program and self-diagnostic, any exception or cut-in are not supposed to happen. If these happen, it is defined as SC.	

		[00FF]: Detailed error code	
	B	Cache access error in the CPU	<ul style="list-style-type: none"> <li>Defective CPU</li> <li>Defective local bus</li> </ul> <ol style="list-style-type: none"> <li>Turn the main power switch off and on.</li> <li>Reinstall the system program.</li> <li>Replace the controller board.</li> </ol>
		[0601, 0602, 0605, 0606, 0607, 0609]: Detailed error code	
	B	Exceptional command does not operate even though it is executed on purpose.	<ul style="list-style-type: none"> <li>Defective CPU devices</li> </ul> <ol style="list-style-type: none"> <li>Replace the controller board.</li> </ol>
		[060A-060E]: Detailed error code	
	B	Cut-in command does not operate when it is executed.	<ul style="list-style-type: none"> <li>Defective CPU devices</li> <li>Defective ASIC devices</li> </ul> <ol style="list-style-type: none"> <li>Replace the controller board.</li> </ol>
		[0610]: Detailed error code	
	B	Timer cut-in does not operate even though it is set.	<ul style="list-style-type: none"> <li>Defective CPU devices</li> </ul> <ol style="list-style-type: none"> <li>Replace the controller board.</li> </ol>
		[0612]: Detailed error code	
	B	Cut-in in ASIC occurs.	<ul style="list-style-type: none"> <li>Defective ASIC</li> <li>Defective devices in which ASIC detects cut-in.</li> </ul> <ol style="list-style-type: none"> <li>Replace the controller board.</li> </ol>
		[06FF]: Detailed error code	
	B	The pipeline clock frequency rate is different from the prescribed value.	<ul style="list-style-type: none"> <li>Defective CPU devices</li> <li>Mode bit data error, which is used for initializing CPU.</li> </ul> <ol style="list-style-type: none"> <li>Replace the controller board.</li> </ol>



		[0702]: Detailed error code	
	B	The result when the program is executed in the command cache is different from desirable value.	<ul style="list-style-type: none"> <li>• Insufficient CPU cache</li> <li>• Insufficient memory process speed</li> </ul> <ol style="list-style-type: none"> <li>1. Replace the controller board.</li> <li>2. Replace the RAM DIMM.</li> </ol>
		[0709, 070A]: Detailed error code	
	B	Even you write the data in the only cache of memory, the data is actually written in another area (not cache) of memory.	<ul style="list-style-type: none"> <li>• Defective CPU devices</li> <li>• Incorrect SPD</li> <li>• Boot mode setting error</li> </ul> <ol style="list-style-type: none"> <li>1. Replace the controller board.</li> <li>2. Replace the RAM DIMM.</li> </ol>
		[0801, 0804, 0807, 0808, 0809, 80A]: Detailed error code	
	B	An error occurs when checking the TLB.	<ul style="list-style-type: none"> <li>• Defective CPU devices</li> </ul> <ol style="list-style-type: none"> <li>1. Replace the controller board.</li> </ol>
		[4002-4005]: Detailed error code	
	B	The calculation error in the CPU occurs.	<ul style="list-style-type: none"> <li>• Defective CPU</li> </ul> <ol style="list-style-type: none"> <li>1. Replace the CPU.</li> </ol>
821		Self-Diagnostic Error: ASIC	
		ASIC error	
[0B00]	B	The write-&-verify check error has occurred in the ASIC.	<ul style="list-style-type: none"> <li>• Defective controller board</li> </ul> <ol style="list-style-type: none"> <li>1. Replace the controller.</li> </ol>
		ASIC not detected	
[0B06]	B	The ASIC of the I/O is not detected.	<ul style="list-style-type: none"> <li>• ASIC (controller board defective)</li> <li>• Poor connection between North Bridge and PCI I/F.</li> </ul> <ol style="list-style-type: none"> <li>1. Replace controller board.</li> </ol>

[0D05]	B	Timer error between ASIC and CPU	
		The CPU checks if the ASIC timer works properly compared with the CPU timer. If the ASIC timer does not function in the specified range, this SC code is displayed.	<ul style="list-style-type: none"> <li>System firmware problem</li> <li>Defective RAM-DIMM</li> <li>Defective controller</li> <li>Reinstall the controller system firmware.</li> </ul> <ol style="list-style-type: none"> <li>Replace the RAM-DIMM.</li> <li>Replace the controller board.</li> </ol>
[50A1]	B	Video bridge device (ASIC) error 1	
		The CPU does not detect the video bridge device.	<ul style="list-style-type: none"> <li>Defective I/F between the video bridge device and controller</li> </ul> <ol style="list-style-type: none"> <li>Replace the controller board.</li> </ol>
[50A2]	B	Video bridge device (ASIC) register error 1	
		The CPU detects the video bridge device, but detects error data from the video bridge device.	<ul style="list-style-type: none"> <li>Defective I/F between the video bridge device and controller</li> </ul> <ol style="list-style-type: none"> <li>Replace the controller board.</li> </ol>
822	Self-diagnostic error: HDD (Hard Disk Drive)		
	[XXXX]: Detailed error code		
When the main switch is turned on or starting the self-diagnostic, the HDD stays busy for the specified time or more.			
[3003]	C	Timeout error	<ul style="list-style-type: none"> <li>Loose connection</li> <li>Defective HDD</li> <li>Defective controller</li> </ul> <ol style="list-style-type: none"> <li>Check that the HDD is correctly connected to the controller.</li> <li>Replace the HDD or the controller</li> </ol>
[3004]	C	Command error	
823	Self-diagnostic Error: NIB		
[6101]	C	MAC address check sum error	
		The result of the MAC address check sum does not match the check sum stored in ROM.	<ul style="list-style-type: none"> <li>Defective controller</li> </ul> <ol style="list-style-type: none"> <li>Replace the controller.</li> </ol>

[6104]	C	PHY IC error	
		The PHY IC on the controller cannot be correctly recognized.	Same as SC823-[6101]
[6105]	C	PHY IC loop-back error	
		An error occurred during the loop-back test for the PHY IC on the controller.	Same as SC823-[6101]
824 [1401]	B	Self-diagnostic Error: NVRAM	
		The controller cannot recognize the standard NVRAM installed or detects that the NVRAM is defective.	<ul style="list-style-type: none"> <li>• Loose connection</li> <li>• Defective standard NVRAM</li> <li>• Defective controller</li> </ul> <ol style="list-style-type: none"> <li>1. Check the standard NVRAM is firmly inserted into the socket.</li> <li>2. Replace the NVRAM.</li> <li>3. Replace the controller</li> </ol>
826	B	Self-diagnostic Error: RTC/Optional NVRAM	
		[1501]: Clock error	
		<ul style="list-style-type: none"> <li>• An RTC device is recognized, and the difference between the RTC device and the CPU exceeds the defined limit.</li> <li>• No RTC device is recognized.</li> </ul>	<ul style="list-style-type: none"> <li>• RTC defective</li> </ul> <ol style="list-style-type: none"> <li>1. Replace the RTC device.</li> </ol>
	B	[15FF]: RTC not detected	
The RTC device is not detected.		<ul style="list-style-type: none"> <li>• NVRAM without RTC installed</li> <li>• Backup battery discharged</li> </ul> <ol style="list-style-type: none"> <li>1. Replace the NVRAM with another NVRAM with an RTC device.</li> </ol>	
827	Self-diagnostic Error: RAM		

[0201]	B	Verification error	
		Error is detected during a write/verify check for the standard RAM (SDRAM DIMM).	<ul style="list-style-type: none"> <li>Loose connection</li> <li>Defective SDRAM DIMM</li> <li>Defective controller</li> </ul> <ol style="list-style-type: none"> <li>Replace the SDRAM DIMM.</li> <li>Replace the controller.</li> </ol>
[0202]	B	Resident memory error	
		The SPD values in all RAM DIMM are incorrect or unreadable.	<ul style="list-style-type: none"> <li>Defective RAM DIMM</li> <li>Defective SPD ROM on RAM DIMM</li> <li>Defective 12C bus</li> </ul> <ol style="list-style-type: none"> <li>Replace the RAM DIMM.</li> </ol>
828	Self-diagnostic Error: ROM		
[0101]	B	Boost lap code error	
		The boot monitor and OS program stored in the ROM DIMM is checked. If the check sum of the program is incorrect, this SC code is displayed.	<ul style="list-style-type: none"> <li>Defective ROM DIMM</li> <li>Defective controller</li> </ul> <ol style="list-style-type: none"> <li>Replace the ROM DIMM.</li> <li>Replace the controller.</li> </ol>
829	B	Self-diagnostic Error: Optional RAM	
		Verify error for optional RAM.	
		[0301] Verification error (Slot 1)	<ul style="list-style-type: none"> <li>Make sure that the resident RAM is installed in the correct slot.</li> </ul>
		[0302] Composition error (Slot 1)	<ul style="list-style-type: none"> <li>Make sure the optional RAM is installed in the correct slot (Slot 0)</li> </ul>
835	Self-diagnostic error: Centronic device		
[1102]	C	Loopback connector is connected but check results in an error.	<ul style="list-style-type: none"> <li>IEEE 1284 connector error</li> <li>Centronic loopback connector defective</li> </ul> <ol style="list-style-type: none"> <li>Replace the controller board.</li> </ol>

[110C]	C	Loopback connector is connected but check results in an error.	<ul style="list-style-type: none"> <li>• ASIC device error</li> <li>• IEEE1284 connector error</li> <li>• Centronic loopback connector defective</li> </ul> <ol style="list-style-type: none"> <li>1. Replace the controller board.</li> </ol>
[1120]	C	Centronic loopback connector is not connected for detailed self-diagnostic test.	<ul style="list-style-type: none"> <li>• Centronic loopback connector not connected correctly</li> <li>• Centronic loopback connector defective</li> <li>• ASIC device defective</li> </ul> <ol style="list-style-type: none"> <li>1. Replace the controller board.</li> </ol>
838 [2701]	B	Self-diagnostic Error: Clock Generator	
		A verify error occurred when setting data was read from the clock generator via the I2C bus.	<ul style="list-style-type: none"> <li>• Defective clock generator</li> <li>• Defective I2C bus</li> <li>• Defective I2C port on the CPU</li> </ul> <ol style="list-style-type: none"> <li>1. Replace the controller board.</li> </ol>
839	USB NAND Flash ROM error		
839	B	Serial Flash access error	
[9001]		The result of reading and writing in software status register of Serial Flash, the device for certification, came to an error.	<ul style="list-style-type: none"> <li>• Defective Serial Flash</li> </ul>
[9101]		The ID of the USB NAND Flash ROM cannot be read.	<ul style="list-style-type: none"> <li>• Defective controller board</li> </ul> <ol style="list-style-type: none"> <li>1. Replace the controller board.</li> </ol>
[9110]	The USB NAND Flash ROM is disconnected.		
840	B	EEPROM access error	
		While I/O operation to EEPROM Three times retry is ineffective after reading error Writing error occurs.	<ul style="list-style-type: none"> <li>• Defective EEPROM</li> </ul>

841	B	EEPROM reading error	
		All of the data values being read from three areas which are given EEPROM mirroring, are different from each other.	<ul style="list-style-type: none"> <li>Particular area in EEPROM has been changed by some cause</li> </ul>
842	D	Nand-Flash update VerifyError	
		SCS detected abnormal writing (verifying Error) in the module which is written in Nand-Flash on the time of ROM remote update or ROM update.	<ul style="list-style-type: none"> <li>Defective Nand-Flash</li> </ul>
853	C	Wireless card startup error	
		The machine starts up. → The IEEE802.11b card connection board is recognized. → The wireless LAN card or bluetooth card is not recognized.	<ul style="list-style-type: none"> <li>Loose connection between the wireless card and the connection board</li> </ul>
854	C	Wireless card access error	
		The machine has been reading the data from the card. → The machine loses access to the card; the wireless LAN card or bluetooth card connection board is still recognized.	<ul style="list-style-type: none"> <li>Loose connection between the wireless card and the connection board</li> </ul>
855	C	Wireless card error	
		Some illegal data is found in the card.	<ul style="list-style-type: none"> <li>Defective wireless card</li> </ul>
856	C	Wireless card connection board error	
		An error is detected in the wireless LAN card or bluetooth card connection board.	<ul style="list-style-type: none"> <li>Defective wireless card connection board</li> </ul>

857	C	USB I/F Error	
		USB interface error is detected.	<ul style="list-style-type: none"> <li>Defective controller</li> </ul> <ol style="list-style-type: none"> <li>Check the USB connections, and make sure that they are securely connected.</li> <li>Replace the controller board.</li> </ol>
858	HDD Encryption unit error 1		
	A serious error occurs when data is encrypted to update an encryption key with the HDD encryption unit.		
[0]	A	Encryption key acquisition error: The controller fails to get a new encryption key.	<ul style="list-style-type: none"> <li>Defective controller board</li> </ul> <ol style="list-style-type: none"> <li>Replace the controller board.</li> </ol>
[1]		Encryption key setting for HDD error: The controller fails to copy a new encryption key to the HDD.	<ul style="list-style-type: none"> <li>Defective SATA chip on the controller board</li> </ul> <ol style="list-style-type: none"> <li>Replace the controller board.</li> </ol>
[2]		NVRAM data encryption error 1: An error occurs while the NVRAM data is encrypted.	<ul style="list-style-type: none"> <li>Defective NVRAM on the controller board</li> </ul> <ol style="list-style-type: none"> <li>Replace the NVRAM.</li> </ol>
[30]		NVRAM data encryption error 2: An error occurs before the NVRAM data is encrypted.	<ul style="list-style-type: none"> <li>Defective controller board</li> </ul> <ol style="list-style-type: none"> <li>Replace the controller board.</li> </ol>
[31]		Other error: A serious error occurs while the data is encrypted.	<ul style="list-style-type: none"> <li>Same as SC991</li> </ul>
859	HDD Encryption unit error 2		
	A serious error occurs when the HDD data is encrypted to update an encryption key with the HDD encryption unit.		

[8]		HDD check error: The HDD is not correctly installed.	<ul style="list-style-type: none"> <li>No HDD installed</li> <li>Unformatted HDD</li> <li>The encryption key on the controller is different from the one on the HDD</li> </ul> <ol style="list-style-type: none"> <li>1. Install the HDD correctly.</li> <li>2. Initialize the HDD.</li> </ol>
[9]	C	Power failure during the data encryption: The data encryption (NVRAM and HDD) has not been completed.	<ul style="list-style-type: none"> <li>Power failure during the data encryption</li> </ul> <ol style="list-style-type: none"> <li>1. Initialize the HDD.</li> </ol>
[10]		Data read/write error: The DMAC error is detected twice or more.	<ul style="list-style-type: none"> <li>Same as SC863</li> </ul>
860	HDD: Initialization error		
	B	The controller detects that the hard disk fails.	<ul style="list-style-type: none"> <li>HDD not initialized</li> <li>Defective HDD</li> </ul> <ol style="list-style-type: none"> <li>1. Reformat the HDD.</li> <li>1. Replace the HDD.</li> </ol>
862	Bad sector number error		
	B	The number of bad sectors in the HDD (image data area) goes over 101.	<ul style="list-style-type: none"> <li>Defective HDD</li> </ul> <ol style="list-style-type: none"> <li>1. Format the HDD with SP5-832-002.</li> <li>2. Replace the HDD.</li> </ol>
863	HDD: Read error		
	C	The data stored in the HDD cannot be read correctly.	<ul style="list-style-type: none"> <li>Defective HDD</li> <li>Defective controller</li> </ul> <ol style="list-style-type: none"> <li>1. Replace the HDD.</li> <li>2. Replace the controller.</li> </ol>
864	HDD: CRC error		
	C	While reading data from the HDD or storing data in the HDD, data transmission fails.	<ul style="list-style-type: none"> <li>Defective HDD</li> </ul> <ol style="list-style-type: none"> <li>1. Replace the HDD.</li> </ol>



865	HDD: Access error		
	C	An error is detected while operating the HDD.	<ul style="list-style-type: none"> <li>Defective HDD</li> </ul> <ol style="list-style-type: none"> <li>Replace the HDD.</li> </ol>
866	SD card authentication error		
	C	A digital license error of an SD card application is detected.	<ul style="list-style-type: none"> <li>SD card data has corrupted.</li> </ul> <ol style="list-style-type: none"> <li>Store correct data in the SD card.</li> </ol>
867	SD card error		
	B	An application SD card is removed from the boot slot while an application is activated.	<ul style="list-style-type: none"> <li>An application SD card is ejected.</li> </ul>
868	SD card access error (-13 to -3: File system error, other number: Device error)		
	B	An error report is sent from the SD card reader.	<ul style="list-style-type: none"> <li>SD card not inserted correctly</li> <li>SD card defective</li> <li>Controller board defective</li> </ul> <ol style="list-style-type: none"> <li>For a file system error, format the SD card on PC.</li> <li>For a device error, turn the main switch off and on.</li> <li>Remove and re-install the SD card.</li> <li>Replace the SD card.</li> <li>Replace the controller.</li> </ol>
870	Address book data error		
	C	The address book in the hard disk is accessed. → An error is detected in the address book data; address book data is not read; or data is not written into the address book.	<ul style="list-style-type: none"> <li>Data corruption</li> <li>Defective hard disk</li> <li>Defective controller software</li> </ul> <ol style="list-style-type: none"> <li>Replace the hard disk (the user codes and counters are recovered when the main switch is turned on if those data are stored in Smart Device Monitor for Admin).</li> </ol>

		<p><b>Note</b></p> <ul style="list-style-type: none"> <li>To recover from the error, do any of the following countermeasures:</li> <li>Format the address book by using SP5-846-050 (all data in the address book—including the user codes and counters—is initialized).</li> </ul>	
872	C	HDD receiving mail data error	
		Defecting wrong with the HDD on startup.	<ul style="list-style-type: none"> <li>Defective HDD</li> <li>Turned off the power source while accessing to the HDD</li> </ul> <ol style="list-style-type: none"> <li>SP5832-007 (Format Rec Mail) to initialize the HDD</li> <li>Replace the HDD</li> </ol>
873	C	HDD sending mail data error	
		Detecting wrong with the HDD on startup.	<ul style="list-style-type: none"> <li>Defective HDD</li> <li>Turned off the power source while accessing to the HDD</li> </ul> <ol style="list-style-type: none"> <li>SP5832-008 (Format Sed Mail) to initialize the HDD</li> <li>Replace the HDD</li> </ol>
874	B	Mass erasing error (Data area erasing)	
		<p>HDD/NVRAM data erasing error was detected.</p> <p>The case you went out from the mode while operating before finishing mass erasing (HDD/NVRAM data erasing) option, this SC occurs.</p>	<ul style="list-style-type: none"> <li>HDD erasing program detected an error</li> <li>An error occurs while NVRAM data erasing</li> <li>Unset erasing program (mass erasing option)</li> </ul> <ol style="list-style-type: none"> <li>Reboot and retry the erasing operation</li> <li>If there is wrong with the HDD (e.g., defective the HDD sector), this error will happen again.</li> <li>Reset the option when the error occurs by unsetting of the mass erase option.</li> </ol>

875	B	Mass erasing error (HDD erasing)	
		<p>An error was detected before HDD erasing when HDD/Data erasing was executed.</p> <p>(The case data erasing failed, or The case HDD logic erasing failed)</p>	<ul style="list-style-type: none"> <li>Failed HDD logic erasing</li> <li>Failed to erase the data each module has</li> </ul> <ol style="list-style-type: none"> <li>Reboot the machine</li> </ol>
876	Log Data Error		
	An error was detected in the handling of the log data at power on or during machine operation. This can be caused by switching the machine off while it is operating.		
-001	C	Log Data Error 1	<ul style="list-style-type: none"> <li>Damaged log data file in the HDD</li> </ul> <ol style="list-style-type: none"> <li>Initialize the HDD with SP5832-004.</li> </ol>
-002	C	Log Data Error 2	<ul style="list-style-type: none"> <li>An encryption module not installed</li> </ul> <ol style="list-style-type: none"> <li>Disable the log encryption setting with SP9730-004 ("0" is off.)</li> <li>Install the DESS module.</li> </ol>
-003	C	Log Data Error 3	<ul style="list-style-type: none"> <li>Invalid log encryption key due to defective NVRAM data</li> </ul> <ol style="list-style-type: none"> <li>Initialize the HDD with SP5832-004.</li> <li>Disable the log encryption setting with SP9730-004 ("0" is off.)</li> </ol>
-004	C	Log Data Error 4	<ul style="list-style-type: none"> <li>Unusual log encryption function due to defective NVRAM data</li> </ul> <ol style="list-style-type: none"> <li>Initialize the HDD with SP5832-004.</li> </ol>
-005	C	Log Data Error 5	<ul style="list-style-type: none"> <li>Installed NVRAM or HDD which is used in another machine</li> </ul> <ol style="list-style-type: none"> <li>Reinstall the previous NVRAM or HDD.</li> <li>Initialize the HDD with SP5832-004.</li> </ol>
-099	C	Log Data Error 99	<ul style="list-style-type: none"> <li>Other than the above causes</li> </ul> <ol style="list-style-type: none"> <li>Ask your supervisor.</li> </ol>

877-00	C	HDD erasing error	
		Cannot operate successive erasing of the hard disc encryption unit under the condition of the successive erasing setting ON.	<ul style="list-style-type: none"> <li>SD card for the hard disc encryption unit is ejected</li> <li>Defective SD card for the hard disc encryption unit</li> </ul> <ol style="list-style-type: none"> <li>The case that the SD card is ejected, insert a normal condition SD card for the unit into the slot after the main power switch OFF.</li> <li>The case that the SD card is defective, replace the NVRAM on the machine under the condition of you preparing the new option SD card.</li> </ol>
878	TPM system authentication error		
-00	B	The system firmware is not authenticated by TPM (security chip).	<ul style="list-style-type: none"> <li>Incorrect updating for the system firmware</li> <li>Defective flash ROM on the controller board</li> </ul> <ol style="list-style-type: none"> <li>Replace the controller board.</li> </ol>
-01	B	USB Flash error	
		Defective file system of USB Flash memory.	<ul style="list-style-type: none"> <li>USB Flash file system is broken</li> </ul> <ol style="list-style-type: none"> <li>Replace the controller board</li> </ol>
-02	B	TPM error	
		Defective TPM or TPM drive	<ul style="list-style-type: none"> <li>Defective TPM</li> </ul> <ol style="list-style-type: none"> <li>Replace the controller board</li> </ol>
-03	B	TCSD error	
		Defective TPM Software Stack	<ul style="list-style-type: none"> <li>Cannot start TPM Software Stack up</li> <li>NOT found necessary files for TPM Software Stack</li> </ul> <ol style="list-style-type: none"> <li>Replace the controller board</li> </ol>

880	B	File Format Converter (MLB) error	
		A request to get access to the MLB was not answered within the specified time.	<ul style="list-style-type: none"> <li>• MLB defective</li> </ul>
881	B	Administration area error	
		Defective the software. This error occurs in the following timing: <ol style="list-style-type: none"> <li>1. Giving a job to the printer</li> <li>2. Login from the panel</li> <li>3. Accessing from WEB browser</li> </ol>	<ul style="list-style-type: none"> <li>• Caused by stored un-authentication information in the software (NOT caused by user operation)</li> </ul> <ol style="list-style-type: none"> <li>1. Reboot the machine</li> </ol>
899	B	Software operation error (Receiving signal end)	
		Abnormal operation occurs in the controller program (Hardware or Software)	<ol style="list-style-type: none"> <li>1. Reboot the machine</li> <li>2. Update the firmware.</li> <li>3. If this SC does not clear with No.1, 2 processes, replace the controller board.</li> </ol>

## SC9xx

900	B	Electronic total counter error	
		The value of the total counter is out of the normal range.	<ul style="list-style-type: none"> <li>• Defective NVRAM</li> </ul>
920	C	Printer error	
		An application error that stops the machine operation is detected.	<ul style="list-style-type: none"> <li>• Defective software</li> </ul> <ol style="list-style-type: none"> <li>1. Unexpected hardware resource (e.g., memory shortage)</li> </ol>

921	C	Printer font error	
		A necessary font is not found in the SD card when the printer application starts.	<ul style="list-style-type: none"> <li>A necessary font is not found in the SD card.</li> <li>The SD card data is corrupted.</li> </ul> <ol style="list-style-type: none"> <li>Check that the SD card stores correct data.</li> </ol>
925	C	Net file error	
		<p>The management file for net files is corrupted; net files are not normally read.</p> <p><b>Netfiles:</b> Jobs to be printed from the document server using a PC and the DeskTopBinder software</p>	<ul style="list-style-type: none"> <li>Defective hardware</li> <li>Data corruption</li> <li>Defective software</li> </ul>
990	B	Software performance error	
		<p>The software attempted to perform an unexpected operation.</p> <p> <b>Note</b></p> <ul style="list-style-type: none"> <li>When this error occurs, the file name, address, and data will be stored in NVRAM. This information can be checked by using SP7-403. See the data and the situation in which this SC occurs. Then report the data and conditions to your technical control center.</li> </ul>	<ul style="list-style-type: none"> <li>Software defective</li> <li>Internal parameter incorrect</li> <li>Insufficient working memory</li> </ul>
991	D	Software continuity error	
		The software attempted to perform an unexpected operation. However, unlike SC990, the process can keep on running.	<ul style="list-style-type: none"> <li>Logged only; the machine can continue to operate</li> </ul>
992	B	Undefined error	
		An error not controlled by the system occurred (the error does not come under any other SC code).	<ul style="list-style-type: none"> <li>Defective software program</li> </ul>

994-00	D	Over-limit OP panel administrative record error	
		The record, which composes the display items and which is controlled by the service layer, is over the certain limit.	<ul style="list-style-type: none"> <li>In using the operation panel, if operating reaches deep layer with multiple applications active, the record may go over the limitation.</li> </ul>
997	C	Application function selection error	
		The application selected by a key press on the operation panel does not start or ends abnormally.	<ul style="list-style-type: none"> <li>Software for that application is defective</li> <li>An option required by the application (RAM, DIMM, board) is not installed.</li> <li>Too complicated nest of the fax group address</li> </ul> <ol style="list-style-type: none"> <li>As for the fax operation problem, simplify the nest of the fax group address.</li> </ol>
998	B	Application start error	
		After switching the machine on, the application does not start within 60 s. (No applications start or end normally.)	<ul style="list-style-type: none"> <li>Software for that application is defective</li> <li>An option required by the application (RAM, DIMM, board) is not installed.</li> </ul> <ol style="list-style-type: none"> <li>Check the setting of SP5875-001. If the setting is set to "1 (OFF)", change it to "0 (OFF)".</li> </ol>

# Electrical Component Defects

## Sensor/Switch

Sensor	Connector	Message	Remarks
Registration Sensor	CN127	Paper jam	-
	SN		
Paper End Sensor	CN129	Load paper	-
	SN		
Bypass Paper End Sensor	CN130	(None)	The machine cannot detect paper on the bypass tray.
	SN		
Paper Path Sensor	CN128	Paper jam	-
	SN		
Exit Sensor	CN128	Paper jam	-
	SN		
Image Density (ID) Sensor	CN132	(None)	Print quality may become worse.
	SN		
Toner Density (TD) Sensor	CN123	SC901	The connector is shared with the mechanical total counter.
	PCU	Reset PCU correctly	-
Scanner HP Sensor	CN404	SC120	-
	SN	SC120	-
Platen Cover Sensor	CN404	SC120	-
	SN	(None)	The copier does not warm up when you open the platen cover.
DF Guide Open Sensor	DF CN04	Paper jam	-
	SN	(None)	-



Sensor	Connector	Message	Remarks
DF Original Set Sensor	DF CN04	Paper jam	-
	Sensor	(None)	Originals are not detected.
DF Registration Sensor	DF CN03	Paper jam	-
	SN		Originals are correctly transported.
Inverter Sensor	DF CN03	Paper jam	-
	SN	(None)	-
Exit Sensor	DF CN04	Paper jam	-
	SN		-
Front Door Switch	CN114	Front door open	-
	SW	Front door open	
Right Door Switch	CN114	Right door open	-
	SW	Right door open	-

CNxxx: The connector on the BICU board.

DF CNxxx: The connector on the DF connection board.

SN: The connector on the sensor.

SW: The connector on the switch.

PCU: The connector on the PCU.

## Blown Fuse Conditions

All of these fuses are on the power supply unit.

Fuse	Rating		At main switch ON
	100 – 127 V	250 V	
FU1	15A/250V	8A/250 V	No response
FU2	8A/250 V	4A/250 V	No response

# Card Save Function

---

## Overview

---

### Card Save:

---

- The Card Save function is used to save print jobs received by the printer on an SD card with no print output. Card Save mode is toggled using printer Bit Switch #1 bit number 4. Card Save will remain enabled until the SD card becomes full, or until all file names have been used.
- Captures are stored on the SD card in the folder /prt/cardsave. File names are assigned sequentially from PRT00000.prn to PRT99999.prn. An additional file PRT.CTL will be created. This file contains a list of all files created on the card by the card save function.
- Previously stored files on the SD card can be overwritten or left intact. Card Save SD has "Add" and "New" menu items.
  - **Card Save (Add):** Appends files to the SD Card. Does not overwrite existing files. If the card becomes full or if all file names are used, an error will be displayed on the operation panel. Subsequent jobs will not be stored.
  - **Card Save (New):** Overwrites files in the card's /prt/cardsave directory.

### Limitation:

- Card Save cannot be used with PjL Status Readback commands. PjL Status Readbacks will not work. In addition they will cause the Card Save to fail.

---

## Procedure

---

1. Turn the main power switch OFF.
2. Insert the SD card into the service slot of the controller board. Then turn the power ON.

 **Note**

- To determine which slot is the service slot, please see the service manual.
3. Enter SP mode.
  4. Select "Printer SP".
  5. Select "SP1-001-001".



d127t102.jpg

1. Use the numeric key "4" to turn bit 4 ON and be sure to press "#" button to confirm. The result should look like: 00010000 as shown above. By doing this Card Save option will appear in "List/ Test Print".
2. Exit SP Mode.
3. Press the  button.
4. Select "Printer Features".
5. Select "List/Test Print".

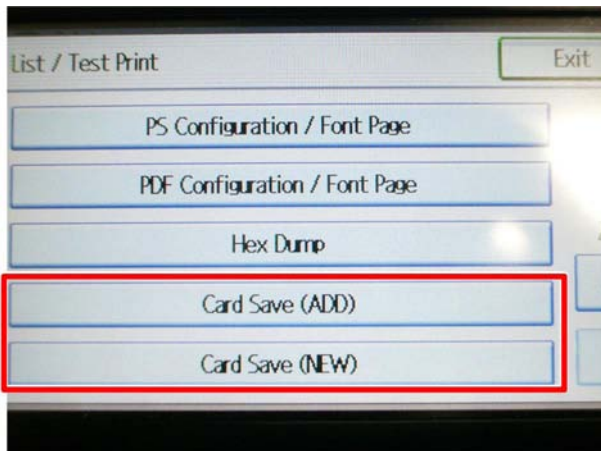

d127t103.jpg

1. Select "Card Save (ADD) or Card Save (New)".
2. Select OK to the message "Switching to Card Save mode.". Then exit the "List/Test Print" menu.
3. Send a job to the printer.
4. As soon as the printer receives the data, it will be stored on the SD card automatically with no print output. Nothing is displayed on the screen indicating that a Card Save operation was successful.

5. To exit Card Save mode, Change the Bit Switch Settings back to the default **00000000**.
6. After main power switch is turned off, remove the SD card.

## Error Messages

---

Card Save error messages:

- **Init error:** A card save process (i.e. card detection, change to kernel mode) failed to initialize.
- **Card not found:** Card cannot be detected in the slot.
- **No memory:** Insufficient working memory to process the job.
- **Write error:** Failed to write to the card.
- **Other error:** An unknown error occurred.

If an error occurs, pressing "OK" will cause the device to discard the job and return to the ready state.

# Fax Troubleshooting Guide

See "Appendices" for the following information:

- Fax Error Codes
- IFAX Troubleshooting
- IP-Fax Troubleshooting



# 7. Energy Saving

## Energy Save

### Energy Saver Modes

Customers should use energy saver modes properly, to save energy and protect the environment.

#### Power Consump.

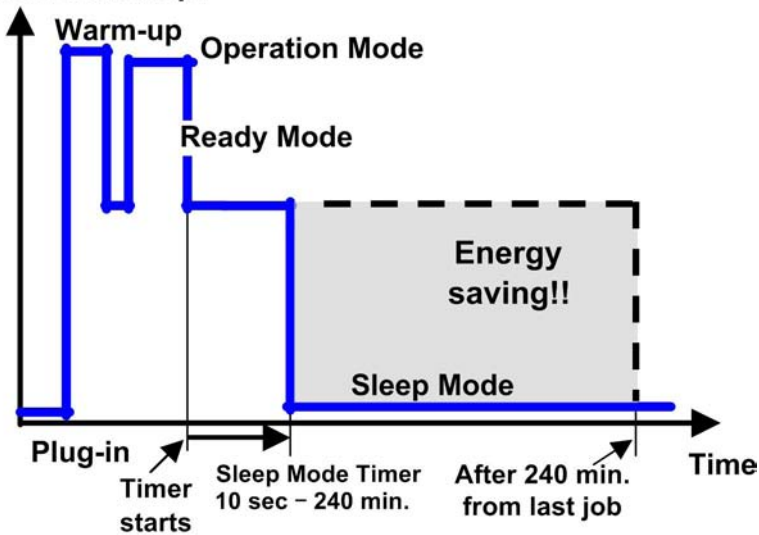

d128d911

The area shaded grey in this diagram represents the amount of energy that is saved when the timers are at the default settings. If the timers are changed, then the energy saved will be different. For example, if the timer is set to 240 min., the grey area will disappear, and no energy is saved before 240 min. expires.

### Timer Settings

#### Sleep Mode Timer

After a specified period has passed, or the [Energy Saver] key is pressed, the machine enters Sleep Mode in order to conserve energy.

Specify the time to elapse before Sleep Mode.

You can specify this setting only if [Sleep Mode] is set to [Enable] in [Administrator Tools] in [System Settings].

Default: [1 minute]

The time can be set from 10 seconds to 240 minutes, using the number keys.

Sleep Mode Timer may not work when error messages appear.

Depending on which Embedded Software Architecture application is installed on it, the machine might take longer than indicated to enter Sleep Mode.

## Recommendation

---

We recommend that the default settings should be kept.

- If the customer requests that these settings should be changed, please explain that their energy costs could increase, and that they should consider the effects on the environment of extra energy use.
- If it is necessary to change the settings, please try a shorter setting first, such as 30 min., then go to a longer one (such as 60 min.) if the customer is not satisfied.
- If the timer is set to the maximum value, the machine will not begin saving energy until 240 minutes has expired after the last job. This means that after the customer has finished using the machine for the day, energy will be consumed that could otherwise be saved.
- If you change the settings, the energy consumed can be measured using SP8941, as explained below.

---

## Energy Save Effectiveness

---

SP 8941 (Machine Status) keeps a record of the amount of time that the machine spends in each mode.

- 8941-001: Operation mode
- 8941-002: Ready mode
- 8941-005: Sleep mode

With this data, and the power consumption values from the specifications, we can estimate the amount of energy that is used by the machine.

This should only be used as a reference value, because the power consumption specifications are measured in a controlled environment with a constant power supply.

To get an exact measurement at the customers site, a watt meter must be used to measure the actual energy consumed.

To use SP8941 to calculate the energy consumed:

- At the start of the measurement period, read the values of SP8941 001 002 005.
- At the end of the measurement period, read the values of SP8941 001 002 005 again.
- Find the amount of time spent in each mode (subtract the earlier measurement from the later measurement).
- Multiply this by the power consumption spec for each mode.



- Convert the result to kWh (kilowatt hours)

Here is an example calculation.

Machine Date	Power Consumption (W): <b>Data: a</b>	SP8941: Machine Status	Start Time: (min.) <b>Data: b</b>	End Time: (min.) <b>Data: c</b>	Time Differences (Data:b - Data: c) (min.) <b>Data: d</b>	Power Consumption (Data:a x Data:d) (Wmin.) <b>Data: e</b>
① Operation mode	1081.8	001: Operating Time	21089.0	21386.0	297.0	321294.6
② Ready mode (stand by)	214.0	002: Standby Time	306163.0	308046.0	1883.0	402962.0
⑤ Sleep mode	7.0	005: Off mode Time	508776.0	520377.0	11601.0	81207.0
Total Time of Data: d (min.)					13781.0	
Total Time of Data: d/60min. (Hour)					229.68	
Total Power Consumption of Data: e (Wmin.)						805463.60
Total Power Consumption of Data: e /60min./1000W (KWH)						13.42

# Paper Save

---

## Effectiveness of Duplex/Combine Function

---

Duplexing and the combine functions reduce the amount of paper used. This means that less energy overall is used for paper production, which improves the environment.

### 1. Duplex:

---

Reduce paper volume in half!

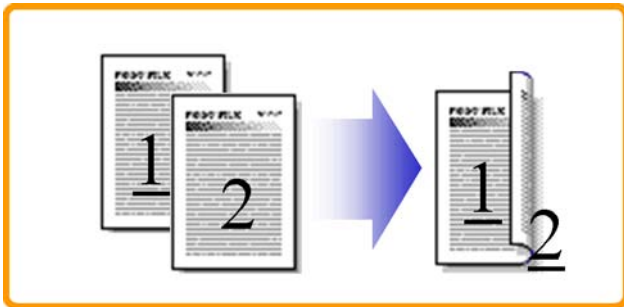

d062d102

### 2. Combine mode:

---

Reduce paper volume in half!

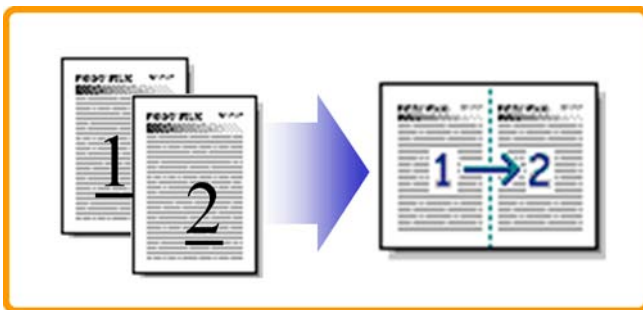

d062d100

### 3. Duplex + Combine:

---

Using both features together can further reduce paper volume by 3/4!

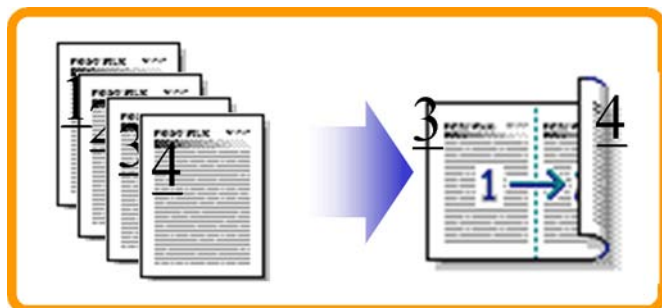

d062d101

To check the paper consumption, look at the total counter and the duplex counter.

The total counter counts all pages printed.

- For one duplex page, the total counter goes up by 2.
- For a duplex job of a three-page original, the total counter goes up by 3.

The duplex counter counts pages that have images on both sides.

- For one duplex page, the duplex counter goes up by 1.
- For a duplex job of a three-page original, the duplex counter will only increase by 1, even though two sheets are used.

7

## Recommendation

Please explain the above features to the customers, so that they can reduce their paper usage.

## Model S-C5

- Total counter: SP 8581-001
- Duplex counter: SP 8411-001
- Single-sided with combine mode: SP 8421-004
- Duplex with combine mode: SP 8421-005

The following table shows paper savings and how the counters increase for some simple examples of single-sided and duplex jobs

### Duplex mode:

Originals	Simplex Sheet used	Duplex Sheets used	Paper Saved	Total counter SP8501-001	Duplex counter SP8411-001
1	1	1	0	1	0
2	2	1	1	2	1

Originals	Simplex Sheet used	Duplex Sheets used	Paper Saved	Total counter SP8501-001	Duplex counter SP8411-001
3	3	2	1	3	1
4	4	2	2	4	2
5	5	3	2	5	2
10	10	5	5	10	5
20	20	10	10	20	10

If combine mode is used, the total and duplex counters work in the same way as explained previously. The following table shows paper savings and how the counters increase for some simple examples of duplex/combine jobs.

**2 in 1 mode:**

Originals	Simplex Sheet used	Duplex Sheets used	Paper Saved	Total counter SP8501-001	Duplex counter SP8421-004
1	1	1	0	1	1
2	2	1	1	1	1
3	3	2	1	2	2
4	4	2	2	2	2
5	5	3	2	3	2
10	10	5	5	5	5
20	20	10	10	10	10

**Duplex + 2 in 1 mode:**

Originals	Simplex Sheet used	Duplex Sheets used	Paper Saved	Total counter SP8501-001	Duplex counter SP8421-005
1	1	1	0	1	1
2	2	1	1	1	1
3	3	1	2	2	2
4	4	1	3	2	2

Originals	Simplex Sheet used	Duplex Sheets used	Paper Saved	Total counter SP8501-001	Duplex counter SP8421-005
5	5	2	<b>3</b>	3	3
6	6	2	<b>4</b>	3	3
7	7	2	<b>5</b>	4	4
8	8	2	<b>6</b>	4	4
9	9	3	<b>6</b>	5	5
10	10	3	<b>7</b>	5	5
11	11	3	<b>8</b>	6	6
12	12	3	<b>9</b>	6	6

---

MEMO

**Model S-C5**  
**Machine Code: D127/D128**

**Appendices**

26 November, 2011





# TABLE OF CONTENTS

---

## 1. Appendix: Specifications

---

Specifications.....	5
Copier.....	5
Printer.....	7
Scanner.....	8
FAX.....	9
General.....	9
IFAX Specifications.....	10
IP-FAX Specifications.....	12
Fax Unit Configuration.....	12
ARDF.....	13
Paper Tray Unit.....	13
Supported Paper Sizes.....	15
Original Paper Sizes.....	15
Paper Feed.....	16

## 2. Appendix: Preventive Maintenance Tables

---

Maintenance Tables.....	19
-------------------------	----

## 3. Appendix: SP Mode Tables

---

System Service Mode.....	21
Service Mode Tables (System SP Tables).....	21
SP1-XXX (Feed).....	21
SP2-XXX (Drum).....	27
SP4-XXX (Scanner).....	40
SP5-XXX (Mode).....	55
SP6-XXX (Peripherals).....	103
SP7-XXX (Data Log).....	105
SP8-XXX (Data Log 2).....	112
SP-9XXX (Etc).....	139
Input Check (SP5-803).....	145
Conducting Input Check.....	145
Input Check Table.....	145
Output Check (SP5-804).....	147
Conducting Output Check.....	147

---

Output Check Table.....	147
Printer Service Mode (Print SP Tables).....	149
Service Mode Table.....	149
SP Modes Related to Printer Controller.....	154
Scanner Program Mode Table (Scanner SP Tables).....	154
Service Table Key.....	154

#### 4. Appendix: Fax Troubleshooting Guide

---

Fax Error Codes.....	159
IFAX Troubleshooting.....	178
IP-Fax Troubleshooting.....	181
IP-Fax Transmission.....	181
Cannot send by IP Address/Host Name.....	181
Cannot send via VoIP Gateway.....	182
Cannot send by Alias Fax number.....	182
IP-Fax Reception.....	184
Cannot receive by IP Address/Host name.....	184
Cannot receive by VoIP Gateway.....	184
Cannot receive by Alias Fax number.....	185

#### 5. Appendix: Fax Service Program

---

System Service Mode.....	187
SP1-XXX (Bit Switches).....	187
SP2-XXX (RAM).....	188
SP3-XXX (Machine Set).....	188
SP4-XXX (ROM Version).....	189
SP5-XXX (RAM Clear).....	189
SP6-XXX (Report).....	190
SP7-XXX (Tests).....	192
Bit Switches.....	193
System Switches.....	193
I-Fax Switches .....	204
Printer Switches.....	212
Communication Switches.....	217
G3-1 Switches.....	225

---

IP Fax Switches.....	236
NCU Parameters.....	245
Dedicated Transmission Parameters.....	259
Programming Procedure.....	259
Parameters.....	259
Fax Parameters.....	259
E-mail Parameters.....	263



# 1. Appendix: Specifications

## Specifications

### Copier

Configuration:	Desktop
Copy Process:	Laser beam scanning and electro-photographic printing
Originals:	Sheet/Book/Object
Original Size:	Maximum A4 / 8 <sup>1</sup> / <sub>2</sub> " x 14" A4 / 8 <sup>1</sup> / <sub>2</sub> " x 14" (ARDF)
Copy Paper Size:	Maximum A4 SEF / 8 <sup>1</sup> / <sub>2</sub> " x 11" SEF (Copier's paper tray) A4 SEF / 8 <sup>1</sup> / <sub>2</sub> " x 14" SEF (Bypass) A4 SEF / 8 <sup>1</sup> / <sub>2</sub> " x 14" SEF (Optional paper tray) A4 SEF / 8 <sup>1</sup> / <sub>2</sub> " x 14" SEF (Duplex) Minimum A5 LEF / 8 <sup>1</sup> / <sub>2</sub> " x 5 <sup>1</sup> / <sub>2</sub> " LEF (Copier's paper tray) A6 SEF/ 8 <sup>1</sup> / <sub>2</sub> " x 5 <sup>1</sup> / <sub>2</sub> " (Bypass) A4 SEF / 8 <sup>1</sup> / <sub>2</sub> " x 11" SEF (Optional paper tray unit) A4 SEF / 8 <sup>1</sup> / <sub>2</sub> " x 11" SEF (Duplex) Custom sizes in the bypass tray: Width: 90 – 216 mm (3.5" – 8.5") Length: 139 – 600mm (5.48" – 23.62")
Copy Paper Weight:	Standard paper tray; optional paper tray: 60 – 90 g/m <sup>2</sup> , 16 – 24 lb. Bypass: 60 – 157 g/m <sup>2</sup> , 16 – 42 lb. Duplex: 64 – 90 g/m <sup>2</sup> , 20 – 24 lb.

		A4 Version	LT Version
Reproduction Ratios:	Enlargement	200%	155%
		141%	129%
	Full Size	100%	100%
	Reduction	93%	93%
71%		78%	
50%		65%	
Zoom:	50% to 200%, in 1% steps		
Power Source:	120 – 127 V / 15A, 60 Hz or 220 – 240 V / 10 A, 50/60 Hz		
Power Consumption:	Maximum:	1100 W (EU), (NA)	
	Energy Saver:	35 W or less	
	Sleep Mode:	SP: 2.8 W SPF: 3.1 W (NA) SP: 3.0 W SPF: 3.3 W (EU)	
	Off Mode:	None	
Noise Emission:	Sound Power Level		
	Standby	40 dB	
	Operating (copier only)	66.5 dB	
	Operating (full-system)	70.5 dB	
Dimensions (W x D x H)	Copier: 476 x 450 x 371 mm (19.4" x 18" x 14.8") With optional paper tray unit: 485 x 454 x 511 mm (18.4" x 17.7" x 20.1")		
Weight:	23 kg or less (26kg or less including ARDF) *The weights do not include toner bottle.		
Resolution:	600 dpi		
Copying Speed:	Memory Copy: 30 cpm (2-sided copy: 18 cpm) ARDF 1 to 1: 30cpm		
Warm-up Time:	30 seconds or less (at 20°C [68°F])		

First Copy Time:	6 seconds or less <b>Note:</b> Measurement conditions <ul style="list-style-type: none"> <li>• From the ready state, with the polygonal mirror motor spinning.</li> <li>• A4/LT SEF copying</li> <li>• From copier's paper tray</li> <li>• The time from pushing copy start button</li> </ul>
Copy Number Input:	Numeric keypad, 1 to 99 (increment, decrement)
Manual Image Density:	7 steps
Auto Off Timer	Default: 1 minute Range: 1 to 240 minutes
Energy Saver Timer:	Default: 1 minute Range: 1 to 240 minutes
Copy Paper Capacity:	Paper Tray: 250 sheets Optional Paper Tray Unit: 500 sheets x 1 Bypass Tray: 100 sheets
Copy-Tray Capacity	250 sheets
Toner Replenishment:	Cartridge replacement (230 g/cartridge)
Toner Yield	8k copies /toner bottle
Optional Equipment:	Auto reverse document feeder Paper tray unit Anti-condensation heater for paper tray unit

## Printer

Resolution:	600 dpi (PCL 6/PCL5e/PS3/RPCS) 300 dpi (PCL5e/PS3) 600 dpi (RPCS (XPS))
Printing speed:	30 cpm (A4, 8 1/2" x 11")

Interface:	USB 2.0 Type A / B Ethernet (100BASE-TX/10BASE-T) IEEE1284 ECP (option) Wireless LAN (IEEE802.11a/g) (option) Gigabit Ethernet (1000BASE-T) (option) Bluetooth V2 (option)
Network protocol:	TCP/IP (IPv4, IPv6), IPX/SPX
Printer language:	RPCS PCL5e / 6 (XL) PostScript3 Adobe PS3/PDF Media Print: JPEG / TIFF
Resident Fonts:	PCL: 45 fonts 13 International fonts PS: 136 fonts Euro Currency supported.
Memory:	1GB
OS supported	Windows XP/Vista/7/Server 2003/Server2008 or later MacOS8.6 to 9, MacOSX10.1 or later
Required network cable:	100BASE-TX/10BASE-T shielded twisted-pair (STP, Category/ Type5) cable. Gigabit Ethernet- Category6 cable

## Scanner

Scan method	Flatbed scanning
Scan speed *1	B/W: 30 pages/ min. [Scan Size: A4 SEF, compression, Resolution 200 dpi] ITU-T No.1 Chart



Maximum power consumption	Less than 900 W
Image sensor type	CCD Image Sensor
Scan types	Sheet, book
Interface	10/100BASE-TX(TCP/TP) Ethernet interface (10BASE-T or 100BASE-TX) IEEE 802.11a/b/g (Wireless LAN),
Resolution	B/W: 600 dpi
Variable range of scan resolution	Setting range: 100 dpi - 600 dpi

\*1 Scanning speeds vary according to machine operating conditions, computer (specifications, network traffic, software, etc.), and original types.

## FAX

### General

Type:	Desktop type transceiver
Circuit:	PSTN PBX
Connection:	Direct couple
Original Size:	Book (Face down): Maximum Width: 216 mm [8.5 inch] ARDF (Face up): (Single-sided document) Length: 139 - 1200 mm [5.5 - 47.2 inch] Width: 139 - 216 mm [5.5 - 8.5 inch] (Double-sided document) Length: 160 - 356 mm [6.3 - 14.0 inch] Width: 139 - 216 mm [5.5 - 8.5 inch]

Scanning Method:	Flat bed, with CCD
Resolution:	G3 8 x 3.85 lines/mm (Standard) 8 x 7.7 lines/mm (Detail) 8 x 15.4 line/mm (Fine) 200 x 100 dpi (Standard) 200 x 200 dpi (Detail)
Transmission Time:	G3: 3 at 28.8Kbps; Measured with G3 ECM using memory for an ITU-T #1 test document (Slerexe letter) at standard resolution
Data Compression:	MH, MR, MMR, JBIG
Protocol:	Group 3 with ECM
Modulation:	V.34, V.33, V.17 (TCM), V.29 (QAM), V.27ter (G3), V.8, V.21 (G3)
Data Rate:	G3: 33600/31200/28800/26400/24000/21600/ 19200/16800/14400/12000/9600/7200/4800/2400 bps Automatic fallback
I/O Rate:	With ECM: 0 ms/line Without ECM: 2.5, 5, 10, 20, or 40 ms/line
Memory Capacity:	ECM: 128 KB SAF Standard: 4 MB Page Memory: Standard: 4 MB (Print: 2 MB + Scanner: 2 MB)

## IFAX Specifications

Connectivity:	Local area network Ethernet 100base-Tx/10base-T IEEE1394 (IP over 1394) IEEE802.11b (wireless LAN)
---------------	---

Resolution:	Main scan: 400 dpi, 200 dpi Sub scan: 400 dpi, 200 dpi, 100 dpi To use 400 dpi, IFAX SW01 Bit 4 must be set to "1".
Transmission Time:	1 s (through a LAN to the server) Condition: ITU-T #1 test document (Selerexe Letter) MTF correction: OFF TTI: None Resolution: 200 x 100 dpi Communication speed: 10 Mbps Correspondent device: E-mail server Line conditions: No terminal access
Document Size:	Maximum message width is A4/LT. <b>Note</b> <ul style="list-style-type: none"> <li>To use B4 and A3 width, IFAX SW00 Bit 1 (B4) and/or Bit 2 (A3) must be set to "1".</li> </ul>
E-mail File Format:	Single/multi-part MIME conversion Image: TIFF-F (MH, MR, MMR), JBIG
Protocol:	<b>Transmission:</b> SMTP, TCP/IP <b>Reception:</b> POP3, SMTP, IMAP4, TCP/IP
Data Rate:	100 Mbps(100base-Tx) 10 Mbps (10base-T)
Authentication Method:	SMTP-AUTH POP before SMTP A-POP
Remark:	The machine must be set up as an e-mail client before installation. Any client PCs connected to the machine through a LAN must also be e-mail clients, or some features will not work (e.g. Autorouting).

## IP-FAX Specifications

Network:	Local Area Network Ethernet/10base-T, 100base-TX IEEE1394 (IP over 1394) IEEE802.11b (wireless LAN)
Scan line density:	8 x 3.85 lines/mm, 200 x 100dpi (standard characters) 8 x 7.7lines/mm, 200 x 200dpi (detailed characters)
Original size:	Maximum A3 or 11"x 17" (DLT)
Maximum scanning size:	Standard: A3, 297mm x 432mm Irregular: 297mm x 1200mm
Transmission protocol:	Recommended: T.38 Annex protocol, TCP, UDP/IP communication
Compatible machines:	IP-Fax compatible machines
IP-Fax transmission function:	Specify IP address and send fax to an IP-Fax compatible fax through a network. Also capable of sending fax from a G3 fax connected to the public telephone lines via a VoIP gateway.
IP-Fax reception function:	Receive a fax sent from an IP-Fax compatible fax through a network. Also capable of receiving fax from a G3 fax connected the public telephone lines via a VoIP gateway.

## Fax Unit Configuration

Component	Code	No.	Remarks
FCU	-	-	Option for D127 Standard for D128
MBU		-	
Speaker		-	
Handset	D645	-	NA only.

## ARDF

Original Size:	Standard:	A4 to A5; 8 <sup>1</sup> / <sub>2</sub> " x 14" to 8 <sup>1</sup> / <sub>2</sub> " x 5 <sup>1</sup> / <sub>2</sub> "
	Custom (Simplex):	Width: 139 mm to 216 mm Length: 139 mm to 1260 mm
	Custom (Duplex):	Width: 139 mm to 216 mm Length: 160 mm to 356* <sup>1</sup> mm
	* <sup>1</sup> : When you use 310 mm or more originals, originals weighing 55k (17 lb. / 64 g/m <sup>2</sup> ) or less cannot be used in duplex scanning mode.	
Original Weight:	52–128 g/m <sup>2</sup>	
Table Capacity:	50 sheets (80 g/m <sup>2</sup> , 21 lb.) 20 sheets (80 g/m <sup>2</sup> , 21 lb.)	
Original Standard Position:	Center	
Separation:	Friction pad method	
Transport:	Roller transport	
Feed Order:	Top first	
Reproduction Range:	50–200%	
Power Source:	T.B.D	
Power Consumption:	T.B.D	
Dimensions (W x D x H):	485 x 450 x 120 mm	
Weight:	3kg or less	

## Paper Tray Unit

Paper Sizes:	A4 SEF, 8 <sup>1</sup> / <sub>2</sub> " x 11" SEF, 8 <sup>1</sup> / <sub>2</sub> " x 13" SEF, 8 <sup>1</sup> / <sub>2</sub> " x 14" SEF
Paper Weight:	60 – 90 g/m <sup>2</sup> , 16 – 24 lb.
Tray Capacity:	500 sheets (80 g/m <sup>2</sup> , 21 lb. ) x 1 tray

Paper Feed System:	Feed roller and friction pad
Power Source:	24 Vdc and 5 Vdc, from copier. If optional tray heater is installed, the copier also supplies Vac (120 Vac or 220 – 240 Vac).
Power Consumption:	Maximum: 15 W (excluding optional tray heater)
Average:	14 W (excluding optional tray heater)
Weight:	Not above 6 kg (13.2. lb.)
Size (W x D x H):	430 x 414 x 140 mm (16.9" x 16.3" x 5.5")

**↓ Note**

- 2 units can be installed at maximum. When more than 3 units are installed, SC occurs and the operation doesn't work.

# Supported Paper Sizes

## Original Paper Sizes

The copier and ARDF do not detect original paper sizes. The following table lists the paper sizes that the ARDF can transport.

Paper	Size (W x L)	Book	ARDF	
			Simpl.	Dupl.
A3 SEF	297 x 420 mm	–	–	–
B4 SEF	257 x 364 mm	–	–	–
A4 SEF	210 x 297 mm	X	X	X
A4 LEF	297 x 210 mm	–		
B5 SEF	182 x 257 mm	X	X	X
B5 LEF	257 x 182 mm	–		
A5 SEF	148 x 210 mm	X	X	X
A5 LEF	210 x 148 mm	X	X	
B6 SEF	128 x 182 mm	–		
B6 LEF	182 x 128 mm	–		
A6 SEF	105 x 148 mm	–		
8K SEF	267 x 390 mm	–		
16K SEF	195 x 267 mm	X	X	X
16K LEF	267 x 195 mm	–		
DLT SEF	11.0" x 17.0"	–		
LG SEF	8.5" x 14.0"	X* <sup>1</sup>	X	X* <sup>2</sup>
LT SEF	8.5" x 11.0"	X	X	X
LT LEF	11.0" x 8.5"	–		
Executive SEF	7.25" x 10.5"	–	X	X

Paper	Size (W x L)	Book	ARDF	
			Simpl.	Dupl.
HLT SEF	5.5" x 8.5"	X	X	X
HLT LEF	8.5" x 5.5"	X	X	
F/GL (F4) SEF	8.0" x 13.0"	X*1	X	X*2
Foolscap SEF	8.5" x 13.0"	X*1	X	X*2
Folio SEF	8.25" x 13.0"	X*1	X	X*2
Government	8.25" x 14"	X*1	X	X*2
USB4 SEF	10.0" x 14.0"	–		
Eng Quarto SEF	8.0" x 10.0"	–	X	X*2
Eng Quarto LEF	10.0" x 8.0"	–		
Custom:	Width 139-216 mm Length 139-356 mm	–	X*3	X*2, 4

**Symbol meanings:**

X: Can use

–: Cannot use

\*1: Can be used when the ARDF is installed

\*2: 55k (17 lb./ 64 g/m<sup>2</sup>) or less original cannot be used.

\*3: Width: 139-216 mm, Length: 139-1260 mm

\*4: Width 139-216 mm, Length: 160-356 mm

**Paper Feed**

The copier and optional paper feed unit do not detect paper sizes. The following table lists the paper sizes that the copier and optional paper feed unit can transport.

Paper	Size (W x L)	Regular	By-pass	Duplex	Optional PFU
A3 SEF	297 x 420 mm	–	–	–	–
B4 SEF	257 x 364 mm	–	–	–	–



Paper	Size (W x L)	Regular	By-pass	Duplex	Optional PFU
A4 SEF	210 x 297 mm	X	X	X	X
A4 LEF	297 x 210 mm	-	-	-	-
B5 SEF	182 x 257 mm	X	X	X	-
B5 LEF	257 x 182 mm	-	-	-	-
A5 SEF	148 x 210 mm	-	X	-	-
A5 LEF	210 x 148 mm	X	X	-	-
B6 SEF	128 x 182 mm	-	-	-	-
B6 LEF	182 x 128 mm	-	-	-	-
A6 SEF	105 x 148 mm	-	-	-	-
8K SEF	267 x 390 mm	-	-	-	-
16K SEF	195 x 267 mm	X	X	X	-
16K LEF	267 x 195 mm	-	-	-	-
DLT SEF	11.0" x 17.0"	-	-	-	-
LG SEF	8.5" x 14.0"	-	X	X	X
LT SEF	8.5" x 11.0"	X	X	X	X
LT LEF	11.0" x 8.5"	-	-	-	-
Executive SEF	7.25" x 10.5"	-	X	-	-
HLT SEF	5.5" x 8.5"	-	X	-	-
HLT LEF	8.5" x 5.5"	X	X	-	-
F/GL (F4) SEF	8.0" x 13.0"	-	X	-	-
Foolscap SEF	8.5" x 13.0"	-	X	X	X
Folio SEF	8.25" x 13.0"	-	X	X	X
Government	8.25" x 14"	-	X	X	X
Com 10 SEF	4.124" x 9.5"	-	X	-	-
Monarch SEF	3.875" x 7.5"	-	X	-	-

Paper	Size (W x L)	Regular	By-pass	Duplex	Optional PFU
C5	162 x 229 mm	-	X	-	-
C6	114 x 162 mm	-	X	-	-
DL Env	110 x 220 mm	-	X	-	-
Custom: Leading edge 90–216 mm Side edge 139–356 mm		-	X	-	-

**Symbol meanings:**

X: Can transport

-: Cannot transport

# 2. Appendix: Preventive Maintenance Tables

## Maintenance Tables

Reset the PM counter (SP7-804-001) after doing maintenance work.

Key: AN: As necessary / C: Clean + Inspect / R: Replace

	Every 45k	Every 90k	Every 120k	AN	NOTE
<b>OPTICS</b>					
Reflector				C	Air-using clean DO NOT clean with dry cloth.
1st - 5th Mirror				C	Clean with dry optical cleaning cloth.
Platen cover	C			C	Dry cloth
Exposure glass	C			C	Ricoh contact glass cleaner Dry cloth
<b>DRUM AREA</b>					
PCU	R				Clean toner-bottle holder.
Transfer roller		R			
Discharge plate		R			
<b>PAPER FEED</b>					
Paper feed roller		R		C	Water or alcohol
Friction pad		R		C	Dry cloth
Bottom-plate pad	C			C	Water or alcohol
Registration roller	C			C	Water or alcohol
<b>FUSING UNIT</b>					

	Every 45k	Every 90k	Every 120k	AN	NOTE
Hot roller		R			
Pressure roller			R		
Hot roller bearings		R		R	
Pressure-roller bushings			C	R	
Inlet guide		C		C	Clean attached toner.
Outlet guide		C		C	
Hot roller stripper pawls		C		C	
Thermistor		C		C	

	Every 90k	AN	NOTE
<b>ARDF</b>			
ADF Separation Pad		C	Dry cloth
Pick-up roller		C	Damp cloth
Feed roller		C	Damp cloth
Torque Limiter		C	(TBA)

	Every 45k	Every 90k	AN	NOTE
<b>PAPER TRAY UNIT</b>				
Registration roller	C			Water or alcohol
Paper feed roller		R		Water or alcohol
Friction pad		R		Dry cloth
Bottom-plate pad	C			Water or alcohol

# 3. Appendix: SP Mode Tables

## System Service Mode

### Service Mode Tables (System SP Tables)

#### SP1-XXX (Feed)

<b>1001*</b>	LE Registration	[-9.0 to 9.0 / <b>0.0</b> / 0.1 mm/step]
1001 1	All Trays	Adjusts the leading-edge registration (Adjusting Copy Image Area) in the section "Replacement and Adjustment".
1001 2	By-pass	
1001 3	Duplex	

<b>1002*</b>	S-to-S Regist	[-9.0 to 9.0 / <b>0.0</b> / 0.1 mm/step]
1002 1	1st Tray	Adjusts the side-to-side registration (Adjusting Copy Image Area) in the section "Replacement and Adjustment". SP1-002-001 is applied to all trays. SP1-002-002, 003 and 005 adjusts the difference from SP1-002-001.
1002 2	2nd Tray	
1002 3	3rd Tray	
1002 4	By-pass	
1002 5	Duplex	Adjusts the side-to-side registration of the 2nd side in duplex copying. The 1st side is adjusted by SP1-002-001 through 005.

<b>1003*</b>	Paper Feed Timing	Adjusts the amount of paper buckle on the registration roller.
1003 1	1st tray	[-5 to 5 / <b>0</b> / 1 mm/step]
1003 2	Bank Trays	
1003 3	By-pass	
1003 4	Duplex	

<b>1103*</b>	Fusing Idling	
1103 1	Fusing Idling	[0 = No / 1 = Yes]
	Enables or disables the contact-release control.	
1103 2	Reload Temp: Center	[90 to 140 / <b>120</b> / 1 °C/step]
	Sets the degree at which or less reload becomes ON.	
1103 3	Threshold	[60 to 160 / <b>100</b> / 1 °C/step]
	Sets threshold-degree for switching forced reload to temperature-judging reload.	

<b>1105*</b>	Fusing Temperature Adjustment	
	Adjusts the target fusing temperature. Note that the thermistor is at the center of the hot roller.	
1105 1	Roller Center: Plain1	[120 to 200 / <b>140</b> / 1 °C/step]
1105 3	Roller Center: Plain2	
1105 5	Roller Center: M - Thick	[120 to 200 / <b>145</b> / 1 °C/step]
1105 7	Thick Paper – Roller Center	[0 to 40 / <b>10</b> / 1 °C/step]
	Sets the additional temperature to SP1105-001's degree for thick paper print. (i.e.: SP1105-001= 140, This SP= 10, 140+10= 150 degree)	
1105 9	Center Minus: Thin	[0 to 20 / <b>5</b> / 1 °C/step]
	Sets the subtractive temperature to SP1105-001's degree for thin paper print. (i.e.: SP1105-001= 140, This SP= 5, 140-5= 135 degree)	
1105 11	Energy Saver	[0 to 80 / <b>60</b> / 1 °C/step]
	Sets the fusing temperature on energy saving mode.	
1105 12	Wait Temp: Center	[140 to 160 / <b>150</b> / 1 °C/step]
1105 13	Print Ready	[140 to 180 / <b>160</b> / 1 °C/step]
1105 14	Thresh: S1	[0 to 50 / <b>16</b> / 1 °C/step]
	Sets standard temperature used for the environment judge. *About the judge, refer to SP1105-015.	

1105 15	Thresh: delta t		[0 to 50 / 0 / 1 °C/step]	
	The environment judge takes place as follows: Compared with "S1" and "S1+Delta t", the environment temp. is... (S1: SP1105-014 value / Delta t: This SP's value)			
	S1	Less or equal	Greater	Greater
	S1+Delta t	Less	Less or equal	Greater
		↓	↓	↓
<b>Judged as</b>	Low temp.	Normal temp.	High temp.	
1105 16	Low: Plain1		[0 to 30 / 5 / 1 °C/step]	
1105 17	Low: Plain2		Sets the additional degree for each paper type printing under low temperature environment. *Refer to SP1105-015 about the environment judge.	
1105 18	Low: M-Thick			
1105 19	Low: Thick		[0 to 30 / 10 / 1 °C/step] The same function as SP1105 (-017 to -18)	
1105 20	Registration Waiting: Plain1		[0 to 1 / 1 / 1 /step]	
1105 21	Registration Waiting: Plain2		(0: OFF / 1: ON)	
1105 22	Registration Waiting: M - Thick		Registration waiting means keeping fed paper in the registration part until fusing unit is ready to work.	
1105 23	Registration Waiting: Thick			
1105 24	Waiting: Center Minus: Plain 1		[0 to 60 / 30 / 1 °C/step]	
1105 26	Waiting: Center Minus: Plain2		Subtracting temp. applying to SP1105-001,002. The sum at which or less, registration waiting starts.	
1105 28	Waiting: Center Minus: M - Thick		[0 to 60 / 10 / 1 °C/step]	
1105 30	Waiting: Center Minus: Thick		The same function as SP1105 (-024, -26)	

1105 32	Waiting: Center Upper: Plain 1	[0 to 60 / <b>40</b> / 1 °C/step] Additional value to each paper type setting temp.. The sum at which or less, registration waiting starts.
1105 34	Waiting: Center Upper: Plain2	
1105 36	Waiting: Center Upper: M - Thick	
1105 38	Waiting Center Upper: Thick	

<b>1106</b>	Fusing Temperature Display	
1106 1	Roller Center	[-20 to 250 / <b>0</b> / 1 °C/step]
1106 3	In The Machine at Power On	[-20 to 250 / <b>0</b> / 1 °C/step]
	Displays the thermistor temp. at power on.	

<b>1108*</b>	Control Period Setting	
1108 1	Warming-up	[100 to 2000 / <b>100</b> / 100 msec/step]
1108 2	Print	[100 to 2000 / <b>1000</b> / 100 msec/step]
1108 3	Wait	[100 to 2000 / <b>1000</b> / 100 msec/step]
1108 4	Print Start	[100 to 2000 / <b>200</b> / 100 msec/step]
1108 5	Print Start Time	[0 to 999 / <b>5</b> / 1 sec/step]

<b>1112</b>	Image Process Temp. Correction	
1112 1	Temp.: Normal: Level 1	[-25 to 10 / <b>0</b> / 1 °C/step] Sets the additional temperature
1112 2	Temp.: Normal: Level2	

<b>1124</b>	CPM Down Setting	
1124 1	Low: Down Temp	[-50 to 0 / <b>-25</b> / 1 °C/step]
	Sets the temperature for the trigger of CPM down.	
1124 2	Low: Up Temp	[-50 to 0 / <b>-5</b> / 1 °C/step]
	Sets the temperature for the trigger of CPM up.	



1124 3	Low: 1st CPM	[10 to 100 / <b>80</b> / 1 %/step]
	Sets the rate for CPM down. (Low Temp.)	
1124 4	Low: 2nd CPM	[10 to 100 / <b>60</b> / 1 %/step]
	The same function as -003, -005	
1124 5	Low: 3rd CPM	[10 to 100 / <b>40</b> / 1 %/step]
	The same function as -003, -004	
1124 6	High: 1st CPM	[10 to 100 / <b>65</b> / 1 %/step]
	Sets the rate for CPM down. (High Temp.)	
1124 7	High: 2nd CPM	[10 to 100 / <b>50</b> / 1 %/step]
	The same function as -006, -008	
1124 8	High: 3rd CPM	[10 to 100 / <b>50</b> / 1 %/step]
	The same function as -006, -007	
1124 9	High: 1st CPM Down Time.: LT	[0 to 999 / <b>0</b> / 1 sec/step] After motor driving start, CPM (High temp.) gets one step down in SP's value sec later for each paper size. (SP-9 to -23)
1124 10	High: 2nd CPM Down Time.: LT	
1124 11	High: 3rd CPM Down Time.: LT	
1124 12	High: 1st CPM Down Time.: A4	
1124 13	High: 2nd CPM Down Time.: A4	
1124 14	High: 3rd CPM Down Time.: A4	
1124 15	High: 1st CPM Down Time.: B5	[0 to 999 / <b>120</b> / 1 sec/step]
1124 16	High: 2nd CPM Down Time.: B5	[0 to 999 / <b>1</b> / 1 sec/step]
1124 17	High: 3rd CPM Down Time.: B5	[0 to 999 / <b>0</b> / 1 sec/step]
1124 18	High: 1st CPM Down Time.: A5	[0 to 999 / <b>60</b> / 1 sec/step]
1124 19	High: 2nd CPM Down Time.: A5	[0 to 999 / <b>0</b> / 1 sec/step]
1124 20	High: 3rd CPM Down Time.: A5	[0 to 999 / <b>0</b> / 1 sec/step]
1124 21	High: 1st CPM Down Time.: A6	[0 to 999 / <b>60</b> / 1 sec/step]
1124 22	High: 2nd CPM Down Time.: A6	[0 to 999 / <b>1</b> / 1 sec/step]

1124 23	High: 3rd CPM Down Time.: A6	[0 to 999 / 0 / 1 sec/step]
1124 24	Judging Interval	[1 to 999 / 10 / 1 sec/step]
	For CPM down (Low temp.)	
1124 25	Start Timing	[1 to 999 / 10 / 1 sec/step]
	After motor driving start, CPM down judge starts in SP's value sec later. (Low temp.)	

<b>1152</b>	Fusing Nip Band Check By-pass	
1152 1	Check By-pass	
	Execution type SP	
1152 2	Pre-idling Time	[0 to 999 / 300 / 1 sec/step]
	Sets the duration of idling before the check takes place.	
1152 3	Stop Time	[0 to 100 / 20 / 1 sec/step]
	Sets the duration of the check.	

<b>1159*</b>	Fusing Jam Detection	
1159 1	SC Display	[0 = No / 1 = Yes]
	Enables or disables consecutive jam detection at the fusing unit. If this SP is set to "1" (default: 0), consecutive fusing jam alarm occurs (SC559) when the machine detects three consecutive paper jams at the fusing unit.	

<b>1902</b>	Frequency	
1902 1	Displays the fusing lamp power control frequency (as detected by the zero cross signal generator).	

<b>1907</b>	Paper Pre Feed Timing	
1907 20	F2 Tray	[-10 to 10 / 0 / 1 mm/step] The larger value set, the larger area of the paper is pre-fed for each tray.
1907 21	F3 Tray	
1907 22	F2 Tray	
1907 23	F3 Tray	

<b>1950</b>	Fan Cooling Time Set	
1950 1	Fusing Exit Fan	[0 to 900 / <b>10</b> / 1 sec/step]
	Sets the duration of the fusing exit fan on waiting and abnormal condition.	

<b>1951</b>	Fan start Time Set	
1951 1	Fusing Exit Fan	[0 to 900 / <b>60</b> / 1 sec/step]
	Sets the time before fan operates at startup.	

<b>1952</b>	Fan Control Off Mode Time Set	
1952 1	Fusing Exit Fan	[0 to 60 / <b>10</b> / 1 min/step]
	Sets the time before fan operates at startup from sleep mode.	

<b>1991</b>	Max Fusing Lamp Duty	
1991 1	Roller Center	[40 to 100 / <b>100</b> / 10%/step]
1991 3	After Warming-Up -- Center	

<b>1996</b>	Heater Forced Off	
1996 5	After Printing	[0 to 120 / <b>7</b> / 1 sec/step]
	Sets the wait time before the heater will be forced off after printing.	

### SP2-XXX (Drum)

<b>2001 *</b>	Charge Roller Bias Adjust	
2001 1	Setting (Copying)	[-2100 to -1500 / <b>-1700</b> / 10 V/step]
	Adjusts the voltage applied to the charge roller for printing. The voltage changes automatically as charge-roller voltage control works. The value here is the base value for the charge-roller voltage control. The value from -1800 V to -1600 V is preferable.	

2001 2	ID sensor pattern	[0 to 400 / <b>200</b> / 10 V/step]
	Adjusts the voltage applied to the charge roller for the ID sensor pattern (as part of charge-roller voltage correction). Setting the same value as "SP2-201-002" is preferable.	
2001 3	Temporally Input	[-2500 to 0 / <b>0</b> / 10 V/step]
	Inputs the voltage value. Too small value may cause the charge roller tainted. Too large value may cause attaching carrier particles in developer, on a printed paper. The value from - 1800 V to 1600 V is preferable.	

<b>2005*</b>	Charge Bias Correction	
2005 1	Vsdp Min	[0 to 100 / <b>90</b> / 1 %/step]
2005 2	Vsdp Max	[0 to 100 / <b>95</b> / 1 %/step]
2005 3	Charge Roller Bias Correction (Step)	[0 to 200 / <b>50</b> / 1 V/step]
	Sets correction value by one step for bias adjustment to meet SP2001-001 setting value.	

<b>2102*</b>	Main Scan Adj.	
2102 1	Magnification Adj.	[-0.5 to 0.5 / <b>0</b> / 0.1%/step]
2102 13	Beam Pitch Dot	[0 to 20 / <b>5</b> / 1 dot/step]
2005 14	Beam Pitch Subdot	[0 to 15 / <b>3</b> / 1 sub-dot/step]

<b>2103*</b>	Erase Margin Adj.	
2103 1	Leading Edge	[0 to 4 / <b>3</b> / 0.1 mm/step]
2103 2	Trailing Edge	
2103 3	Left	[0 to 4 / <b>2</b> / 0.1 mm/step]
2103 4	Right	

<b>2104*</b>	Unit LD Power Adj.	
2104 1	LD1	[60 to 140 / <b>100</b> / 0.1 %/step]
2104 2	LD2	

<b>2105*</b>	LD Power Adjustment
2105 1	[60 to 140 / <b>100</b> / 0.1 %/step]

<b>2109*</b>	Test Pattern			
2109 1	Pattern Select			
	This SP has the test patterns as below.			
	0	None	13	Independent Pattern (4dot)
	1	Vertical Line (1dot)	14	Trimming Area
	2	Vertical Line (2dot)	15	Hound's Tooth Check (Horizontal)
	3	Horizontal Line (1dot)	16	Hound's Tooth Check (Vertical)
	4	Horizontal Line (2dot)	17	Black Band (Horizontal)
	5	Grid Vertical Line	18	Black Band (vertical)
	6	Grid Horizontal Line	19	Checker Flag Pattern
	7	Grid Pattern Small	20	Grayscale (Vertical)
	8	Grid Pattern Large	21	Grayscale (Horizontal)
	9	Argyle Pattern Small	22	Two Beam Density Pattern
	10	Argyle Pattern Large	23	Full Dot Pattern
	11	Independent Pattern (1dot)	24	All White pattern
12	Independent Pattern (2dot)			
2109 2	Pattern Density	[0 to 15 / <b>15</b> / 1 /step]		
	Sets the density applying to test patterns			

<b>2152*</b>	LD Power Adj.	
	Adjusts each area LD power. Higher becomes stronger LD. Lower becomes dimmed.	
2152 1	LD1 Area 0	[75 to 125 / <b>100</b> / 0.1 %/step]
2152 2	LD1 Area 1	[75 to 125 / <b>79.9</b> / 0.1 %/step]
2152 3	LD1 Area 2	[75 to 125 / <b>79.9</b> / 0.1 %/step]

2152 4	LD1 Area 3	[75 to 125 / <b>79.9</b> / 0.1 %/step]
2152 5	LD1 Area 4	[75 to 125 / <b>82.2</b> / 0.1 %/step]
2152 6	LD1 Area 5	[75 to 125 / <b>84.3</b> / 0.1 %/step]
2152 7	LD1 Area 6	[75 to 125 / <b>86.3</b> / 0.1 %/step]
2152 8	LD1 Area 7	[75 to 125 / <b>88.2</b> / 0.1 %/step]
2152 9	LD1 Area 8	[75 to 125 / <b>89.9</b> / 0.1 %/step]
2152 10	LD1 Area 9	[75 to 125 / <b>91.5</b> / 0.1 %/step]
2152 11	LD1 Area 10	[75 to 125 / <b>93</b> / 0.1 %/step]
2152 12	LD1 Area 11	[75 to 125 / <b>94.3</b> / 0.1 %/step]
2152 13	LD1 Area 12	[75 to 125 / <b>95.5</b> / 0.1 %/step]
2152 14	LD1 Area 13	[75 to 125 / <b>96.6</b> / 0.1 %/step]
2152 15	LD1 Area 14	[75 to 125 / <b>97.5</b> / 0.1 %/step]
2152 16	LD1 Area 15	[75 to 125 / <b>98.3</b> / 0.1 %/step]
2152 17	LD1 Area 16	[75 to 125 / <b>99</b> / 0.1 %/step]
2152 18	LD1 Area 17	[75 to 125 / <b>99.6</b> / 0.1 %/step]
2152 19	LD1 Area 18	[75 to 125 / <b>100</b> / 0.1 %/step]
2152 20	LD1 Area 19	[75 to 125 / <b>100.3</b> / 0.1 %/step]
2152 21	LD1 Area 20	[75 to 125 / <b>100.4</b> / 0.1 %/step]
2152 22	LD1 Area 21	[75 to 125 / <b>100.5</b> / 0.1 %/step]
2152 23	LD1 Area 22	[75 to 125 / <b>100.4</b> / 0.1 %/step]
2152 24	LD1 Area 23	[75 to 125 / <b>100.1</b> / 0.1 %/step]
2152 25	LD1 Area 24	[75 to 125 / <b>99.8</b> / 0.1 %/step]
2152 26	LD1 Area 25	[75 to 125 / <b>99.3</b> / 0.1 %/step]
2152 27	LD1 Area 26	[75 to 125 / <b>98.6</b> / 0.1 %/step]
2152 28	LD1 Area 27	[75 to 125 / <b>97.9</b> / 0.1 %/step]
2152 29	LD1 Area 28	[75 to 125 / <b>97</b> / 0.1 %/step]

2152 30	LD1 Area 29	[75 to 125 / <b>96</b> / 0.1 %/step]
2152 31	LD1 Area 30	[75 to 125 / <b>94.8</b> / 0.1 %/step]
2152 32	LD1 Area 31	[75 to 125 / <b>93.5</b> / 0.1 %/step]
2152 33	LD2 Area 0	[75 to 125 / <b>100</b> / 0.1 %/step]
2152 34	LD2 Area 1	[75 to 125 / <b>82</b> / 0.1 %/step]
2152 35	LD2 Area 2	[75 to 125 / <b>82</b> / 0.1 %/step]
2152 36	LD2 Area 3	[75 to 125 / <b>82</b> / 0.1 %/step]
2152 37	LD2 Area 4	[75 to 125 / <b>84</b> / 0.1 %/step]
2152 38	LD2 Area 5	[75 to 125 / <b>85.8</b> / 0.1 %/step]
2152 39	LD2 Area 6	[75 to 125 / <b>87.6</b> / 0.1 %/step]
2152 40	LD2 Area 7	[75 to 125 / <b>89.2</b> / 0.1 %/step]
2152 41	LD2 Area 8	[75 to 125 / <b>90.7</b> / 0.1 %/step]
2152 42	LD2 Area 9	[75 to 125 / <b>92.1</b> / 0.1 %/step]
2152 43	LD2 Area 10	[75 to 125 / <b>93.4</b> / 0.1 %/step]
2152 44	LD2 Area 11	[75 to 125 / <b>94.7</b> / 0.1 %/step]
2152 45	LD2 Area 12	[75 to 125 / <b>95.7</b> / 0.1 %/step]
2152 46	LD2 Area 13	[75 to 125 / <b>96.7</b> / 0.1 %/step]
2152 47	LD2 Area 14	[75 to 125 / <b>97.6</b> / 0.1 %/step]
2152 48	LD2 Area 15	[75 to 125 / <b>98.4</b> / 0.1 %/step]
2152 49	LD2 Area 16	[75 to 125 / <b>99</b> / 0.1 %/step]
2152 50	LD2 Area 17	[75 to 125 / <b>99.6</b> / 0.1 %/step]
2152 51	LD2 Area 18	[75 to 125 / <b>100.1</b> / 0.1 %/step]
2152 52	LD2 Area 19	[75 to 125 / <b>100.4</b> / 0.1 %/step]
2152 53	LD2 Area 20	[75 to 125 / <b>100.6</b> / 0.1 %/step]
2152 54	LD2 Area 21	[75 to 125 / <b>100.8</b> / 0.1 %/step]
2152 55	LD2 Area 22	[75 to 125 / <b>100.8</b> / 0.1 %/step]

2152 56	LD2 Area 23	[75 to 125 / <b>100.7</b> / 0.1 %/step]
2152 57	LD2 Area 24	[75 to 125 / <b>100.5</b> / 0.1 %/step]
2152 58	LD2 Area 25	[75 to 125 / <b>100.2</b> / 0.1 %/step]
2152 59	LD2 Area 26	[75 to 125 / <b>99.8</b> / 0.1 %/step]
2152 60	LD2 Area 27	[75 to 125 / <b>99.3</b> / 0.1 %/step]
2152 61	LD2 Area 28	[75 to 125 / <b>98.7</b> / 0.1 %/step]
2152 62	LD2 Area 29	[75 to 125 / <b>97.9</b> / 0.1 %/step]
2152 63	LD2 Area 30	[75 to 125 / <b>97.1</b> / 0.1 %/step]
2152 64	LD2 Area 31	[75 to 125 / <b>96.2</b> / 0.1 %/step]

<b>2201 *</b>	Development Bias Adjust	
2201 1	Printing	[-1500 to -200 / <b>-650</b> / 10 /step = 1V]
	Adjusts the voltage applied to the development roller for printing. Image density becomes higher when you specify a smaller value (a greater absolute value). Image density becomes lower when you specify a greater value (a smaller absolute value).	
2201 2	ID sensor pattern (0:N 1:H 2:L 3:HH 4:LL)	[ 0 to 4 / <b>0</b> / 1 /step]
	Adjusts the toner density control of the developer case. [0= Normal / 1= Thick / 2= Thin / 3= More thick / 4= More thin]	
2201 3	ID sensor pattern (Temporally Input)	[-700 to -300 / <b>-420</b> / 10 V/step]

<b>2210</b>	Bias Off Time	
2210 1	Charge Bias	[10 to 150 / <b>100</b> / 10 /step]
2210 2	Development Bias	[10 to 200 / <b>80</b> 10 /step]

<b>2211</b>	PCU Reverse Interval	
2211 1	This value affects how many sheets are copied continuously before PCU reversing.	



<b>2213</b>	Copies After Toner Near End	
2213 1	After "Toner Near End" detected, this value affects how many sheets are copied before "Toner End" will occur. [0= 50 sheets / 1= 20 sheets]	

<b>2220</b>	Vsg / Vsp / Vsdp / Vt / Vtref Dilay	
2220 1	Vsp	Displays each value.
2220 2	Vsg	
2220 3	Vsdp	
2220 4	Vt	
2220 5	Vtref	

<b>2224</b>	Copies After Toner Near End Counter	
2224 1	[0 to 999 / 0 / 1 sheet/step] The counter applying to "SP2-213-1"	

<b>2301*</b>	Transfer Current Adjust	
	Adjusts the current applied to the transfer roller.	

2301 1	Thin: 1 side: Image Area	<p>[0 to 4 / 0 / 1 /step]</p> <p>Each value suggests as follows:</p> <p><b>0: -2<math>\mu</math>A (Default)</b></p> <p>1: 0<math>\mu</math>A</p> <p>2: +2<math>\mu</math>A</p> <p>3: +4<math>\mu</math>A</p>
2301 2	Thin: 1 side: Lead Edge	
2301 3	Thin: 1 side: Trail Edge	
2301 4	Thin: 2side: Image Area	
2301 5	Thin: 2side: Lead Edge	
2301 6	Thin: 2side: Trail Edge	
2301 7	Plain: 1 side: Image Area	
2301 8	Plain: 1 side: Lead Edge	
2301 9	Plain: 1 side: Trail Edge	
2301 10	Plain: 2side: Image Area	
2301 11	Plain: 2side: Lead Edge	
2301 12	Plain: 2side: Trail Edge	
2301 13	Middle: 1 side: Image Area	
2301 14	Middle: 1 side: Lead Edge	
2301 15	Middle: 1 side: Trail Edge	
2301 16	Middle: 2side: Image Area	
2301 17	Middle: 2side: Lead Edge	
2301 18	Middle: 2side: Trail Edge	
2301 19	Thick: 1 side: Image Area	
2301 20	Thick: 1 side: Lead Edge	
2301 21	Thick: 1 side: Trail Edge	
2301 22	Input: 1 side	<p>[0 to 30 / 0 / 1 <math>\mu</math>A/step]</p>
2301 23	Input: 2side	
2301 25	Temp Inside the Machine	<p>[-25 to 55 / 20 / 1 <math>\mu</math>A/step]</p> <p>This temp affects transfer current value.</p>

2301 26	Non Image Area: LL	[0 to 30 / 10 / 1 $\mu$ A/step]
	Output current under low temperature condition. * Refer to SP1 105-015 about the condition judge.	
2301 27	Non Image Area: MM	[0 to 30 / 13 / 1 $\mu$ A/step]
	Output current under normal temperature condition. * Refer to SP1 105-015 about the condition judge.	
2301 28	Non Image Area: HH	[0 to 30 / 15 / 1 $\mu$ A/step]
	Output current under high temperature condition. * Refer to SP1 105-015 about the condition judge.	

<b>2302*</b>	Transfer Current Switch Timing	
2302 1	Lead Edge	[-10 to 10 / 0 / 1 mm/step]
2302 2	Trail Edge	

<b>2303*</b>	Transfer Roller Cleaning Bias	
	Increasing positive or negative current that improves clear of the same charged toner but attracts the opposite charged one.	
2303 1	Positive	[0 to 20 / 10 / 1 $\mu$ A/step]
2303 2	Negative	

<b>2308*</b>	Transfer Voltage Upper Limiter	
2308 1	0: OFF 1: ON	
	The switch of the limiter for transfer voltage.	

<b>2801*</b>	Developer Initialization	
2801 1	Execute in the case of PCU replacement.	

<b>2802</b>	Developer Mixing	
-------------	------------------	--

2802 1	Initializes the developer and checks the TD sensor output (Vt). The machine mixes the developer for 2 minutes while reading and displaying the Vt value. The machine does not initialize the TD sensor output. If the machine has not been used for a long period, prints may have a dirty background. In a case like this, use this SP to mix the developer. The message "Completed" is displayed when the program ends normally.	
--------	--	--

<b>2803*</b>	Developer Initialization Data	Displays each value at the time of initialization completed.
2803 1	Vts	[0 to 9.99 / <b>2.4</b> / 0.01 V/step]
2803 2	ID Sensor PWM Value	[0 to 1023 / <b>0</b> / 1 /step]

<b>2901*</b>	Separation Voltage Adjust	
2901 1	1side: Lead Edge	[0 to 4000 / <b>0</b> / -100 V/step] Adjusting image area or too much value (bias setting may cause dust problem.
2901 2	1side: Image Area	
2901 3	2side: Lead Edge	
2901 4	2side: Image Area	
2901 5	Switching Timing Lead Edge	[-20 to 20 / <b>15</b> / 1 mm/step]

<b>2906*</b>	Tailing Control	
2906 1	Shift Range	[0.0 to 1.0 / <b>0.0</b> / 0.1 mm/step]
	Shifts the image position. When the copier is continuously printing vertical lines (such as in tables), the paper may not separate correctly. This SP can prevent this.	
2906 2	Number of Sheets	[1 to 10 / <b>1</b> / 1 sheet/step]
	Changes the number of sheet(s) under tailing control with the shift range specified by SP2-906-001.	

<b>2908</b>	Forced Toner Supply	
2908 1	Supplies the toner to the development unit. The processing stops under either of the following conditions: <ul style="list-style-type: none"> <li>The toner density in the development unit reaches the standard level.</li> <li>The processing has continued for two 2 minutes.</li> </ul>	

<b>2915*</b>	Polygon Motor Idling Time	
2915 1	Idling Time ADJ	[0 to 60 / <b>10</b> / 1 sec/step]
2915 2	Post Idling Time ADJ	Adjusts before or after printing polygon motor idling time.
<b>2921*</b>	Toner Supply Mode	
2921 1	[0: Normal 1 / 1: Normal 2 / 2: Fixed 1 / 3: Fixed 2] Selects the toner supply mode. Keep the default setting as long as the TD sensor is working normally. (Default= 0)	
<b>2922*</b>	Toner Supply Time	[0.1 to 5.0 / <b>0.5</b> / 0.1 sec/step]
2922 1	Adjusts the toner supply time. The toner supply motor remains on for the specified time. Specify a greater value if the user tends to make many copies having high proportions of solid black image areas.	
<b>2923*</b>	Toner Recovery Time	[1 to 60 / <b>30</b> / 1 sec/step]
2923 1	Adjusts the toner supply time under the condition of "Toner End" or "Toner Near End" detected.	
<b>2925*</b>	Toner Supply Ratio	[0 to 7 / <b>0</b> / 1 /step]
2925 1	The ratio adjustment SP available only when "SP2-921-1" setting is "2 (Fixed1)". Each value represents as follows: <b>0</b> : x1 1: x2 2: x4 3: x8 4: x12 5: x16 6: Continuously supply 7: No supply	
<b>2926*</b>	Standard Vt	[0.00 to 5.00 / <b>2.4</b> / 0.05 V/step] <b>DFU</b>

2926 1	Adjusts V <sub>ts</sub> (the V <sub>t</sub> value for new developer). The TD sensor output is adjusted to this value during the TD sensor initial setting process.	
<b>2927*</b>	ID Sensor Control	[0 = No / 1 = Yes]
2927 1	Determines whether the ID sensor signal is referenced or not for the toner density control. Keep the default value in usual operations.	
<b>2928</b>	Toner End Clear	
2928 1	<p>Clears the following messages and counters without supplying the toner:</p> <ul style="list-style-type: none"> <li>• Toner near end message</li> <li>• Toner end message</li> <li>• Copies After Toner Near End Counter (SP2-224-001)</li> </ul> <p>Do not use this SP in usual operations. When the toner in the development unit is abnormally insufficient, the drum may attract the toner carrier to its surface. The toner carrier damages the drum surface.</p>	
<b>2929*</b>	Vref Adjustment	Adjust the upper or lower Vref limit.
2929 1	Upper Limit	[0.50 to 3.50 / <b>2.40</b> / 0.05 V/step] <b>DFU</b>
2929 2	Lower Limit	[0.50 to 3.50 / <b>0.50</b> / 0.05 V/step] <b>DFU</b>
<b>2930*</b>	TD Sensor Manual Setting	[0.00 to 5.00 / <b>0.00</b> / 0.05 V/step]
2930 1	<p>Inputs V<sub>tref</sub> directly.</p> <p>"SP2-926-001" becomes invalid when this value is set.</p>	
<b>2931*</b>	TD (V/wt%) Setting	[0.01 to 1.50 / <b>0.40</b> / 0.01 /step]
2931 1	Adjusts the timing of toner supplying. The more frequently toner is supplied under the smaller value. DO NOT use this SP in usual operations.	
<b>2932*</b>	Toner Density Control Level	[0 to 4 / <b>0</b> / 1 /step]
2932 1	<p>[ 0=Normal / 1=Dark / 2=Light / 3=Darker / 4=Lighter ]</p> <p>This SP isn't valid unless "SP2-921-001" setting is 1=Normal2.</p>	

<b>2933*</b>	ID Sensor Control Correction	[0.5 to 3 / 1 / 0.1 /step]
2933 1	For Adjustment of ID sensor correction value. DO NOT use this SP in usual operations.	
<b>2934*</b>	ID Sensor PMW Setting	
2934 1	Dilay	[0 to 1023 / 200 / 1 /step]
2934 2	Upper Limit Correction	[0 to 1023 / 100 / 1 /step]
	Sets PMW upper limit.	
<b>2935*</b>	ID Sensor Initialization	
2935 1	Use this SP after ID Sensor replacement. This Operates PWM value clearing, Vsg re-adjustment, and PWM re-adjustment.	
<b>2936*</b>	ID Sensor Detection Interval Counter	
2936 1	[0 to 999 / 0 / 1 page/step]	
	The counter applying to "SP2-995-002".	
<b>2992*</b>	Copies After TD Sensor Error	
	"SP2992-002" is for "SP2992-001". SC will occur after copying the number of sheets chosen at "SP2992-001".	
2992 1	0= 100pages 1= 200pages	-
2992 2	Counter	[0 to 255 / 0 / 1 /step]
<b>2995*</b>	ID Sensor Detection Interval	
2995 1	Warming-up	[0 to 999 / 480 / 1 min/step]
	After energy saving mode activates, ID sensor warming-up will take place in this SP's value min later.	
2995 2	Number of Pages	[0 to 999 / 100 / 1 sheet/step]
	Sets the number of pages as the trigger of "SP2-995-003" setting action. (Counter: "SP2936-001")	

2995 3	JobEnd / Interrupt	-
	Sets the condition at which ID sensor control takes place.	

<b>2996*</b>	Transfer Roller Cleaning	[0 = No / 1 = Yes]
2996 1	Cleans or does not clean the transfer roller before each job. Select "1" if the backside of the paper becomes unclean when output. Note that the copier takes a longer time to output the first copy when you select "1". If you select "0", the transfer roller is never cleaned.	
2996 2	Interval	[0 to 100 / 50 / 1 /step]
	When the "SP2-996-003" counter is over this SP's value, Transfer roller cleaning is activated on the Job-End timing. If this SP's value is 0, cleaning doesn't act.	
2996 3	Counter	[0 to 255 / 0 / 1 /step]
	The counter Applying to "SP2996-002" (Interval).	

<b>2998*</b>	PCU Reverse Rotation Time	
2998 1	Wait Time	[0 to 999 / 300 / 1 /step= 30ms]
2998 2	Reverse Time	[0 to 99 / 60 / 1 /step= 6ms]
2998 3	Brake Time	[0 to 99 / 0 / 1 /step= 3ms]
	DO NOT use this SP in usual operations.	

**SP4-XXX (Scanner)**

<b>4008*</b>	SubScan Mag Adjustment	[-1.0 to +1.0 / 0.0 / 0.1 %/step]
4008 1	Adjusts the sub-scan magnification (  "Adjusting Copy Image Area" in the section "Replacement and Adjustment").	

<b>4010*</b>	L – Edge Regist Adjustment	[-1.0 to +1.0 / 0.0 / 0.1 mm/step]
4010 1	Adjusts the leading edge registration (  "Adjusting Copy Image Area" in the section "Replacement and Adjustment").	

<b>4011*</b>	S-to-S Regist Adjustment	[-2.0 to +2.0 / 0.0 / 0.1 mm/step]
--------------	--------------------------	------------------------------------



4011 1	Adjusts the side-to-side registration for scanning in platen mode (  "Adjusting Copy Image Area" in the section "Replacement and Adjustment").
--------	--

<b>4012*</b>	Scan Erase Margin: Scale	[0 to 3.0 / 0.0 / 0.1 mm/step]
4012 1	Book: Leading Edge	Adjusts the scanning margin. Generally, the scanning margin should be as little as possible.
4012 2	Book: Trailing Edge	
4012 3	Book: Left Side	
4012 4	Book: Right Side	

<b>4013</b>	Scanner Free Run	Conducts the scanner free run with the exposure lamp on.
4013 1	Lamp Off	
4013 2	Lamp On	

<b>4014</b>	Scan
4014 1	HP Detection Enable
4014 2	HP Detection Disable
4014 3	HP Detection Enable FC 600 dpi
4014 4	HP Detection Enable BW 600 dpi
4014 5	HP Detection Enable FC 1200dpi

<b>4016*</b>	DF Scan
4016 1	FC 600x300 Duplex
4016 2	BW 600x300 Duplex
4016 3	FC 600x600 Duplex
4016 4	BW 600x600 Duplex
4016 5	FC 600x200 Duplex
4016 6	FC 600x300 Simplex

4016 7	BW 600x300 Simplex
4016 8	FC 600x600 Simplex
4016 9	BW 600x600 Simplex
4016 10	FC 600x200 Simplex

<b>4020*</b>	Dust Check	
	DF dust check function	
4020 1	Dust Detect: ON / OFF	[0= OFF or 1= ON / 0 ]
4020 2	Dust Detect: Lvl	[0 to 8 / 4 / 1 /step]
	The larger value is set, the more sensitive the detection becomes.	
4020 3	Dust Reject: Lvl	[0 to 4 / 0 / 1 /step]
	0=OFF The larger value is set, the stronger the correction becomes.	

<b>4400*</b>	Scanner Erase Margin	[0 to 3 / 0 / 0.1 mm/step]
4400 1	Book Leading Edge	Adjusts the mask range against shade on each part of the original.
4400 2	Book Trailing Edge	
4400 3	Book Left	
4400 4	Book Right	
4400 5	Trailing Edge	Adjusts the mask range for ADF copying.
4400 7	Left	
4400 8	Right	

<b>4417*</b>	IPU Test Pattern		
4417 1	This SP has the test patterns as below.		
0	Scanned image	15	Gray pattern (1)
1	Gradation main scan A	16	Gray pattern (2)

2	Gradation main scan B	17	Gray pattern (3)
3	None	18	Shading pattern
4		29	Thin line pattern
5	Gradation sub scan (1)	20	Scanned+Grid pattern
6	Grid pattern (1)	21	None
7	Slant grid pattern	22	Scanned+Color patch
8	Gradation K	23	Scanned+Slant Grid C
9	None	24	None
10	Gray patch 16 (1)	25	Gray scale 18 text
11	Gray patch 16 (2)	26	Gray scale 18 photo
12	Gray patch 64	27	Gray scale 256 text
13	Grid pattern (2)	28	Gray scale 256 photo
14	Color patch K		

<b>4429</b>	Select Copy Data Security	[0 to 3 / <b>3</b> / 1 /step]
4429 1	Copying	The larger value, the stronger the density becomes for coping originals forbidden to be duplicated.
4429 2	Scanning	
4429 3	Fax Operation	

<b>4450</b>	Scan Image Pass Selection	[0 or 1 / <b>0</b> ]
4450 1	Black Subtraction ON/OFF	
4450 2	SH ON/OFF	

<b>4460</b>	Digital AE	
4460 1	Low Limit Value	[0 to 1023 / <b>364</b> / 1 /step]
	The threshold value detected on platen sheet check. The larger (lighter) value area on scanned image than this SP's value is detected as white sheet area (background).	

4460 2	Background level	[512 to 1535 / <b>932</b> / 1 /step]
4550	Scan Apli:Txt/Print	These SPs have the same lower level settings as below.
4551*	Scan Application: Txt	
4552*	Scan Application: Txt Dropout	
4553*	Scan Application: Txt/Photo	
4554*	Scan Application: Photo	
4565*	Scan Application: GrayScale	
4570*	Scan Application: Color Txt/Photo	
4571*	Scan Application: Color Gloss Photo	
4572*	Scan Application: AutoColor	
005	MTF	[0 to 15 / <b>8</b> / 1 /step] 0= (Off) 1 – 15= (Weak – Strong)
006	Smoothing	[0 to 7/ <b>4</b> / 1 /step] 0= (x1) 1 – 7= (Weak – Strong)
007	Brightness	[1 to 255 / <b>128</b> / 1 /step]
008	Contrast	
009	Ind Dot Erase (Independent Dot Erase)	[0 to 7/ <b>0</b> / 1 /step] 0= (x1) 1 – 7= (Weak – Strong)

<b>4580*</b>	Fax Application: Txt/Chart		These SPs have mostly common lower level settings as below. ("SP4581", "4584", "4585" don't have "-010")
<b>4581*</b>	Fax Application: Txt		
<b>4582*</b>	Fax Application: Txt/Photo		
<b>4583*</b>	Fax Application: Photo		
<b>4584*</b>	Fax Application: Original 1		
<b>4585*</b>	Fax Application: Original 2		
005	MTF	[0 to 15 / <b>8</b> / 1 /step] 0= (Off) 1 – 15=(Weak – Strong)	
006	Smoothing	[0 to 7 / <b>4</b> / 1 /step] 0= (x1) 1 – 7= (Weak – Strong)	
007	Brightness	[1 to 255 / <b>128</b> / 1 /step]	
008	Contrast		
009	Ind Dot Erase (Independent Dot Erase)	[0 to 7 / <b>0</b> / 1 /step] 0= (Off) 1 – 7= (Weak – Strong)	
010	Texture Erase	[0 to 2 / <b>0</b> / 1 /step] 0= (Fix)	

<b>4603*</b>	AGC Execution	
4603 1	HP Detection Enable	Execution type SP
4603 2	HP Detection Disable	

<b>4604*</b>	FGATE	
4604 1	Open/Close	[ON or OFF]

<b>4606*</b>	White Level Adjust	
4606 1	Color 600	[0 to 1024 / <b>784</b> / 1 digit/step]

<b>4607*</b>	White Level Adjust	
4607 1	Color 1200	[0 to 1024 / <b>784</b> / 1 digit/step]

<b>4608*</b>	White Level Adjust	
4608 1	BK	[0 to 1024 / <b>784</b> / 1 digit/step]

<b>4609*</b>	Gray Balance Set: R	
4609 1	Book Scan	[-512 to 511 / <b>-89</b> / 1 digit/step]
4609 2	DF Scan	

<b>4610*</b>	Gray Balance Set: G	
4610 1	Book Scan	[-512 to 511 / <b>-76</b> / 1 digit/step]
4610 2	DF Scan	
4610 3	BW Book Scan	[-512 to 511 / <b>-92</b> / 1 digit/step]
4610 4	BW DF Scan	

<b>4611*</b>	Gray Balance Set: B	
4611 1	Book Scan	[-512 to 511 / <b>-85</b> / 1 digit/step]
4611 2	DF Scan	

<b>4623*</b>	Black Level Adj. Display	
4623 1	Latest: R Color 600	[0 to 255 / <b>0</b> / 1 digit/step]
4623 2	Latest: R Color 1200	

<b>4624*</b>	Black Level Adj. Display	
--------------	--------------------------	--

4624 1	Latest: G Color 600	[0 to 255 / 0 / 1 digit/step]
4624 2	Latest: G Color 1200	
4624 1	Latest: BK E	
4624 2	Latest: BK O	

<b>4625*</b>	Black Level Adj. Display	
4625 1	Latest: B Color 600	[0 to 255 / 0 / 1 digit/step]
4625 2	Latest: B Color 1200	

<b>4631*</b>	Display Gain Adjust	
4631 1	Latest: R Color 600	[0 to 511 / 0 / 1 digit/step]
4631 2	Latest: R Color 1200	

<b>4632*</b>	Display Gain Adjust	
4632 1	Latest: G Color 600	[0 to 511 / 0 / 1 digit/step]
4632 2	Latest: G Color 1200	
4632 3	Latest: BK E	
4632 4	Latest: BK O	

<b>4633*</b>	Display Gain Adjust	
4633 1	Latest: B Color 600	[0 to 511 / 0 / 1 digit/step]
4633 2	Latest: B Color 1200	

<b>4645*</b>	Scan Adjust Error	
4645 1	White level	[0 to 65535 / 0 / 1 /step]
4645 2	Black level	

<b>4647*</b>	Scanner Hard Error	
--------------	--------------------	--

4647 1	Power - ON	[0 to 65535 / 0 / 1 /step]
--------	------------	----------------------------

<b>4654*</b>	Black Level Adj. Display	
4654 1	Last Correct Value: R Color 600	[0 to 255 / 0 / 1 digit/step]
4654 2	Last Correct Value: R Color1200	

3

<b>4655*</b>	Black Level Adj. Display	
4655 1	Last Correct Value: G Color 600	[0 to 255 / 0 / 1 digit/step]
4655 2	Last Correct Value: G Color1200	
4655 3	Last Correct Value: BK E	
4655 4	Last Correct Value: BK O	

<b>4656*</b>	Black Level Adj. Display	
4656 1	Last Correct Value: B Color 600	[0 to 255 / 0 / 1 digit/step]
4656 2	Last Correct Value: B Color1200	

<b>4661*</b>	Digital Gain Adjust	
4661 1	Last Correct Value : R Color 600	[0 to 511 / 0 / 1 digit/step]
4661 2	Last Correct Value : R Color1200	

<b>4662*</b>	Digital Gain Adjust	
4662 1	Last Correct Value: G Color 600	[0 to 511 / 0 / 1 digit/step]
4662 2	Last Correct Value: G Color1200	
4662 3	Last Correct Value: BK E	
4662 4	Last Correct Value: BK O	

<b>4663*</b>	Digital Gain Adjust	
--------------	---------------------	--



4663 1	Last Correct Value: B Color 600	[0 to 511 / 0 / 1 digit/step]
4663 2	Last Correct Value: B Color1200	

<b>4673*</b>	Black Level Adj. Display	
4673 1	Factory Setting: R Color 600	[0 to 255 / 0 / 1 digit/step]
4673 2	Factory Setting: R Color1200	

<b>4674*</b>	Black Level Adj. Display	
4674 1	Factory Setting: G Color 600	[0 to 255 / 0 / 1 digit/step]
4674 2	Factory Setting: Color1200	
4674 3	Factory Setting: BK E	
4674 4	Factory Setting: BK O	

<b>4675*</b>	Black Level Adj. Display	
4675 1	Factory Setting: B Color 600	[0 to 255 / 0 / 1 digit/step]
4675 2	Factory Setting: B Color1200	

<b>4680*</b>	Digital Gain Adjust	
4680 1	Factory setting: R Color 600	[0 to 511 / 0 / 1 digit/step]
4680 2	Factory setting: R Color1200	

<b>4681*</b>	Digital Gain Adjust	
4681 1	Factory setting: G Color 600	[0 to 511 / 0 / 1 digit/step]
4681 2	Factory setting: G Color1200	
4681 3	Factory setting: BK E	
4681 4	Factory setting: BK O	

<b>4682*</b>	Digital Gain Adjust	
--------------	---------------------	--

4682 1	Factory setting: B Color 600	[0 to 511 / 0 / 1 digit/step]
4682 2	Factory setting: B Color1200	

<b>4688*</b>	ADF Adjustment	
4688 1	Density	[50 to 150 / 100 / 1 %/step]

<b>4690*</b>	White Level Peak Read: R	
4690 1	R Color 600	[0 to 1023 / 0 / 1 digit/step]
4690 2	R Color1200	

<b>4691*</b>	White Level Peak Read: G	
4691 1	G Color 600	[0 to 1023 / 0 / 1 digit/step]
4691 2	G Color1200	
4691 3	BK E	
4691 4	BK O	

<b>4692*</b>	White Level Peak Read: B	
4692 1	B Color 600	[0 to 1023 / 0 / 1 digit/step]
4692 2	B Color1200	

<b>4693*</b>	Black Level Peak Read: R	
4693 1	R Color 600	[0 to 1023 / 0 / 1 digit/step]
4693 2	R Color1200	

<b>4694*</b>	Black Level Peak Read: G	
--------------	--------------------------	--

4694 1	G Color 600	[0 to 1023 / 0 / 1 digit/step]
4694 2	G Color1200	
4694 3	BK E	
4694 4	BK O	

<b>4695*</b>	Black Level Peak Read: B	
4695 1	B Color 600	[0 to 1023 / 0 / 1 digit/step]
4695 2	B Color1200	

<b>4802*</b>	DF Shading FreeRun	
4802 1	Lamp OFF	[0: OFF / 1: ON]
4802 2	Lamp ON	

<b>4804*</b>	Home Position	
4804 1	Home Position	Execution type SP

<b>4806*</b>	Carriage Save	
4806 1	Carriage Save	Execution type SP

<b>4808*</b>	Factory Setting Input	
4808 2	Execution Flag	[0 to 1 / 0 / 1 /step]

<b>4810*</b>	PWM Latest	
4810 1	Latest: Color 600	[0 to 4412 / 0 / 1 digit/step]
4810 2	Latest: Color 1200	
4810 3	Latest: Bk	

4810 4	Last Correct Value Color 600	[0 to 4412 / <b>3152</b> / 1 digit/step]
4810 5	Last Correct Value Color 1200	
4810 6	Last Correct Value Bk	
4810 7	Factory Setting: Color 600	[0 to 4412 / <b>0</b> / 1 digit/step]
4810 8	Factory Setting: Color 1200	
4810 9	Factory Setting: Bk	

<b>4811*</b>	LED White Level Peak Read	
4811 1	Latest: R Color 600	[0 to 1023 / <b>0</b> / 1 digit/step]
4811 2	Latest: R Color 1200	
4811 3	Latest: G Color 600	
4811 4	Latest: G Color 1200	
4811 5	Latest: BkE	
4811 6	Latest: BkO	
4811 7	Latest: B Color 600	
4811 8	Latest: B Color 1200	

<b>4812*</b>	LED White Level Peak Read	
4812 1	Factory Setting: R Color 600	[0 to 1023 / <b>0</b> / 1 digit/step]
4812 2	Factory Setting: R Color 1200	
4812 3	Factory Setting: G Color 600	
4812 4	Factory Setting: G Color 1200	
4812 5	Factory Setting: BkE	
4812 6	Factory Setting: BkO	
4812 7	Factory Setting: B Color 600	
4812 8	Factory Setting: B Color 1200	

<b>4813*</b>	LED White Level Adjust	
4813 1	Color 600	[0 to 1023 / <b>784</b> / 1 digit/step]
4813 2	Color 1200	
4813 3	Bk	[0 to 1023 / <b>540</b> / 1 digit/step]

<b>4903*</b>	Filter Setting	
4903 1	Ind Dot Erase: Text	[0 to 7 / <b>0</b> / 1 digit/step]
4903 2	Ind Dot Erase: Generation Copy	Independent Dot Erase

<b>4905*</b>	Select Gradation Level	[0 to 255 / <b>0</b> / 1 /step]
4905 1	Adjusts the gradation level applying to copy application. Default (0) is optimal parameter.	

<b>4909*</b>	Man Gamma:P ColK	
4909 1	Offset: Highlight	[0 to 30 / <b>15</b> / 1 /step]
4909 2	Offset: Middle	
4909 3	Offset: Shadow	
4909 4	Offset: IDmax	
4909 5	Option: Highlight	[0 to 255 / <b>0</b> / 1 /step]
4909 6	Option: Middle	[0 to 12 / <b>0</b> / 1 /step]
4909 7	Option: Shadow	[0 to 255 / <b>0</b> / 1 /step]
4909 8	Option: IDmax	[0 to 255 / <b>0</b> / 1 /step]

<b>4914*</b>	Man Gamma: T: ColK	
4914 1	Offset: Highlight	[0 to 30 / <b>15</b> / 1 /step]
4914 2	Offset: Middle	
4914 3	Offset: Shadow	
4914 4	Offset: IDmax	

4914 5	Option: Highlight	[0 to 255 / 0 / 1 /step]
4914 6	Option: Middle	[0 to 12 / 0 / 1 /step]
4914 7	Option: Shadow	[0 to 255 / 0 / 1 /step]
4914 8	Option: IDmax	[0 to 255 / 0 / 1 /step]

<b>4918*</b>	Man Gamma Adj	
4918 9	Touch [Change] displayed.	

<b>4954*</b>	Read/Restore Std	
4954 1	Read New Chart	Execution type SP
4954 2	Recall Prev chart	
4954 4	Set std chart	
4954 5	Chromaticity Rank	[0 to 255 / 0 / 1 /step]

<b>4991*</b>	IPU Image Pass Selection	
4991 1	RGB Frame Memory: single	[0 to 11 / 2 / 1 /step]

<b>4993*</b>	High Light Correction	
4993 1	Sensitivity Selection	[0 to 9 / 4 / 1 /step]
4993 2	Range Selection	

<b>4994*</b>	Text/Photo Detect Level Adj.	
4994 1	High Compression PDF	[0 to 2 / 1 / 1 /step]

<b>4996*</b>	White Paper Detect Level	[0 to 6 / 3 / 1 /step]
4996 1	[Dull 0 – 6 Sensitive] Adjusts the degree of white paper detection sensitivity.	

## SP5-XXX (Mode)

<b>5024*</b>	mm/inch Display Selection		
001	Selects whether mm or inches are used in the display. <div style="border: 1px solid blue; border-radius: 10px; padding: 2px; display: inline-block;"> <span style="color: blue;">↓</span> <b>Note</b> </div> <ul style="list-style-type: none"> <li>After selecting the number, you must turn the main power switch off and on.</li> </ul> Europe/Asia model: [0: mm / 1: inch] American model: [0: mm / 1: inch]		
<b>5045*</b>	Accounting Counter		
5045 1	Counter Method		Displays the number of the installed counter. [0 to 2 / 0 / 1 /step] 0: 1 counter (Total) 1: 2 counters (Total and Prints) 2: 2 counters GPC
<b>5047*</b>	Paper Display		
001	Backing Paper		[0: OFF 1: ON]
	Sets the "backing paper" button display ON/OFF on paper size selection.		
<b>5055</b>	Display IP address		
001	Display IP address	CTL	Displays or does not display the IP address on the LCD. [0 or 1 / 0 / -] 0: No (Not display), 1: Yes (Display)
<b>5062</b>	Part Replacement Alert Display		
001	D CDU: Bk	CTL	Displays or does not display the PCU yield on the LCD. [0 or 1 / 0 / -] 0: Not display, 1: Display

<b>5066</b>	PM Parts Display		
001	PM Parts Display	CTL	Displays or does not display the PM part button on the LCD. [0 or 1 / 0 / -] 0: Not display, 1: Display

<b>5112*</b>	Non-Std. Paper Sel.	[0:OFF 1:ON]
5112 1	Sets "Non-standard size setting" in usual panel operations, available or not.	

<b>5113</b>	Optional Counter Type		
001	Default Optional Counter Type	CTL	This program specifies the counter type. <b>0: None</b> 1: Key card (RK 3, 4) 2: Key card (down) 3 to 10: (Japan only) 11: Exp. Key card (Add) 12: Exp. Key card (Deduct)
002	External Optional Counter Type	CTL	This program specifies the external counter type. <b>0: None</b> 1: Expansion Device type 1 2: Expansion Device type 2 3: Expansion Device type 3

<b>5114</b>	Optional Counter I/F	CTL	[0: Not installed/ 1: Installed (scanning accounting)]
001	MF Key Card Ext. Japan use		

<b>5118</b>	Disable Copying		
001	[0: Not disable / 1: Disable] Sets copy disabled or enabled.		



<b>5120*</b>	Mode Clear Opt. Counter Removal		[0=Yes / 1=Standby only / 2=No]
5120 1	<p>Specifies the condition to reset the copy job settings when the key counter is removed.</p> <ul style="list-style-type: none"> <li>• 0: Y = Yes: The settings are cleared when the counter is removed.</li> <li>• 1: StdBy = Standby only: The settings are cleared when the counter is removed at the end of a job.</li> <li>• 2: N = No: The settings are not cleared under either condition.</li> </ul> <p>As for duplex copying, the job settings are always preserved regardless of these setting.</p>		
<b>5121*</b>	Counter Up Timing		[0 = Feed In / 1 = Exit]
5121 1	<p>Selects the count-up timing.</p> <ul style="list-style-type: none"> <li>• 0 = Feed: At each paper feed</li> <li>• 1 = Exit: At each paper exit</li> </ul>		
<b>5127</b>	APS Mode		
001	<p>[0: Not forbidden / 1: Forbidden]</p> <p>Sets APS forbidden or not.</p> <p>APS means "Auto paper size selection".</p>		
<b>5167</b>	Fax Printing Mode at Optional Counter Off		
	Enables or disables the automatic print out without an accounting device. This SP is used when the receiving fax is accounted by an external accounting device.		
001		CTL	<p>[ 0 or 1 / 0 / - ]</p> <p>0: Automatic printing</p> <p>1: No automatic printing</p>
<b>5169</b>	CE Login		
	If you change the printer bit switches, you must 'log in' to service mode with this SP before you go into the printer SP mode.		
001	CE Login	CTL	<p>[0 or 1 / 0 / - ]</p> <p>0: Disabled</p> <p>1: Enabled</p>

<b>5186*</b>	RK4: Setting	[0 or 1 / 0]
5186 1	[1: Jam 0: None] in 10 sec after put the card out.	

<b>5188</b>	Copy NV Version		
001	Copy NV Version	CTL	Displays the NVRAM version in the controller board.

3

<b>5195</b>	Limitless SW	[0 or 1 / 0]
001	Switches limitless paper feed for productivity or for paper run-out. 0: Productivity 1: Paper run-out	

<b>5212</b>	Page Numbering	[0 or 1 / 0]
003	Duplex Printout Right/Left Position	
	Horizontally positions the page numbers printed on both sides during duplexing. [-10 to 10/ 0 / 1 mm]	
004	Duplex Printout High/Low Position	
	Vertically positions the page numbers printed on both sides during duplexing. [-10 to 10/ 0 / 1 mm] 0 is center, minus is down, + is up.	

5302	Set Time		
	Adjusts the RTC (real time clock) time setting for the local time zone. Examples: For Japan (+9 GMT), enter 540 (9 hours x 60 min.) DOM: +540 (Tokyo) NA :-300 (New York) EU :+ 60 (Paris) CH :+480 (Peking) TW :+480 (Taipei) AS :+480 (Hong Kong)		
002	Time Difference	CTL #	[ -1440 to 1440 / Area / 1 min./step ]

5307	Summer Time		
001	Setting	-	[ 0 or 1 / NA, EU, ASIA / 1 /step] 0: Disabled 1: Enabled NA and EUR: 1, ASIA: 0
	Enables or disables the summer time mode. <b>Note</b> <ul style="list-style-type: none"> <li>Make sure that both SP5-307-3 and -4 are correctly set. Otherwise, this SP is not activated even if this SP is set to "1".</li> </ul>		

003	Rule Set (Start)	-	-
	<p>Specifies the start setting for the summer time mode.</p> <p>There are 8 digits in this SP. For months 1 to 9, the "0" cannot be input in the first digit, so the eight-digit setting for -2 or -3 becomes a seven-digit setting.</p> <p>1st and 2nd digits: The month. [1 to 12]</p> <p>3rd digit: The week of the month. [1 to 5]</p> <p>4th digit: The day of the week. [0 to 6 = Sunday to Saturday]</p> <p>5th and 6th digits: The hour. [00 to 23]</p> <p>7th digit: The length of the advanced time. [0 to 9 / 1 hour /step]</p> <p>8th digit: The length of the advanced time. [0 to 5 / 10 minutes /step]</p> <p>For example: 3500010 (EU default)</p> <p>The timer is advanced by 1 hour at am 0:00 on the 5th Sunday in March</p> <ul style="list-style-type: none"> <li>• The digits are counted from the left.</li> <li>• Make sure that SP5-307-1 is set to "1".</li> </ul>		
004	Rule Set (End)	-	-
	<p>Specifies the end setting for the summer time mode.</p> <p>There are 8 digits in this SP.</p> <p>1st and 2nd digits: The month. [1 to 12]</p> <p>3rd digit: The week of the month. [0 to 5]</p> <p>4th digit: The day of the week. [0 to 6 = Sunday to Saturday]</p> <p>5th and 6th digits: The hour. [00 to 23]</p> <p>The 7th and 8th digits must be set to "00".</p> <ul style="list-style-type: none"> <li>• The digits are counted from the left.</li> <li>• Make sure that SP5-307-1 is set to "1".</li> </ul>		

5401	Access Control		
	When installing the SDK application, SAS (VAS) adjusts the following settings. <b>DFU</b>		
103	Default Document ACL	CTL	

200	SDK1 Unique ID	CTL	"SDK" is the "software development kit". This data can be converted from SAS (VAS) when installed or uninstalled. (DFU)
201	SDK1 Certification Method	CTL	
210	SDK2 Unique ID	CTL	
211	SDK2 Certification Method	CTL	
220	SDK3 Unique ID	CTL	
221	SDK3 Certification Method	CTL	
240	Detail Option	CTL	<p>Enables or disables the log-out confirmation option.</p> <p>Bit0: Log-out confirmation option <b>0: Enable (default), 1: Disable</b></p> <p>Selects the automatic log-out time.</p> <p>Bit1 and 2: Automatic log-out timer reduction <b>00: 60 seconds (default), 01:10 seconds, 10: 20seconds, 11: 30 seconds</b></p>

<b>5404</b>	User Code Count Clear
001	Clears the counts for the user codes assigned by the key operator to restrict the use of the machine. Press [Execute] to clear.

<b>5411</b>	LDAP Certification
004	Simplified Authentication
	<p>Determines whether easy LDAP certification is done.</p> <p>[0 to 1/1/1]</p> <p>1: On 0: Off</p>

005	Password Null Not Permit
	<p>This SP is referenced only when SP5411-4 is set to "1" (On).</p> <p>[0 to 1/0/1]</p> <p>0: Password NULL not permitted.</p> <p>1: Password NULL permitted.</p>
006	Detail Option
	<p>Bit 0: Anonymous authorization [0: OFF 1: ON]</p> <p>*Only bit 0 is used.</p>

<b>5413</b>	Lockout Setting
001	Lockout On/Off
	<p>Switches on/off the lock on the local address book account.</p> <p>[0 to 1/0/1]</p> <p>0: Off</p> <p>1: On</p>
002	Lockout Threshold
	<p>Sets a limit on the frequency of lockouts for account lockouts.</p> <p>[1 to 10/5/1]</p>
003	Cancellation On/Off
	<p>Determines whether the system waits the prescribed time for input of a correct user ID and password after an account lockout has occurred.</p> <p>[0 to 1/0/1]</p> <p>0: Off (no wait time, lockout not cancelled)</p> <p>1: On (system waits, cancels lockout if correct user ID and password are entered).</p>
004	Cancellation Time
	<p>Determines the length of time that the system waits for correct input of the user ID and password after a lockout has occurred. This setting is used only if SP5413-3 is set to "1" (on).</p> <p>[1 to 999/60/1 min.]</p>

<b>5414</b>	Access Mitigation
001	Mitigation On/Off
	Switches on/off masking of continuously used IDs and passwords that are identical. [0 to 1/ <b>0</b> /1] 0: Off 1: On
002	Mitigation Time
	Sets the length of time for excluding continuous access for identical user IDs and passwords. [0 to 60/ <b>15</b> /1 min.]

<b>5415</b>	Password Attack
001	Permissible Number
	Sets the number of attempts to attack the system with random passwords to gain illegal access to the system. [0 to 100/ <b>30</b> /1 attempt]
002	Detect Time
	Sets the time limit to stop a password attack once such an attack has been detected. [1 to 10/ <b>5</b> /1 sec.]

<b>5416</b>	Access Information
001	Access User Max Num
	Limits the number of users used by the access exclusion and password attack detection functions. [50 to 200/ <b>200</b> /1 users]
002	Access Password Max Num
	Limits the number of passwords used by the access exclusion and password attack detection functions. [50 to 200/ <b>200</b> /1 passwords]

003	Monitor Interval
	Sets the processing time interval for referencing user ID and password information. [1 to 10/ <b>3</b> /1 sec.]

<b>5417</b>	Access Attack
001	Access Permissible Number
	Sets a limit on access attempts when an excessive number of attempts are detected for MFP features. [0 to 500/ <b>100</b> /1]
002	Attack Detect Time
	Sets the length of time for monitoring the frequency of access to MFP features. [10 to 30/ <b>10</b> /1 sec.]
003	Productivity Fall Wait
	Sets the wait time to slow down the speed of certification when an excessive number of access attempts have been detected. [0 to 9/ <b>3</b> /1 sec.]
004	Attack Max Num
	Sets a limit on the number of requests received for certification in order to slow down the certification speed when an excessive number of access attempts have been detected. [50 to 200/ <b>200</b> /1 attempt]

<b>5420</b>	User Authentication
	These settings should be done with the System Administrator. <b>Note:</b> These functions are enabled only after the user access feature has been enabled.
001	Copy
	Determines whether certification is required before a user can use the copy applications. [0 to 1/ <b>0</b> /1] 0: On 1: Off



011	Document Server	
	Determines whether certification is required before a user can use the document server. [0 to 1/0/1] 0: On 1: Off	
021	Fax	
	Determines whether certification is required before a user can use the fax application. [0 to 1/0/1] 0: On 1: Off	
031	Scanner	
	Determines whether certification is required before a user can use the scan applications. [0 to 1/0/1] 0: On 1: Off	
041	Printer	
	Determines whether certification is required before a user can use the printer applications. [0 to 1/0/1] 0: On 1: Off	
051	SDK1	[0 or 1/0/1] 0: ON. 1: OFF Determines whether certification is required before a user can use the SDK application.
061	SDK2	
071	SDK3	
5481	Authentication Error Code	
	These SP codes determine how the authentication failures are displayed.	

001	System Log Disp
	<p>Determines whether an error code appears in the system log after a user authentication failure occurs.</p> <p>[0 to 1/0/1]</p> <p>0: Off</p> <p>1: On</p>
002	Panel Disp
	<p>Determines whether an error code appears on the operation panel after a user authentication failure occurs.</p> <p>[0 to 1/1/1]</p> <p>1: On</p> <p>0: Off</p>

<b>5507</b>	Supply Alarm	CTL	-
080	Toner Call Timing	<b>0: Toner is replaced (default)</b> 1: Toner near end or end	

<b>5508*</b>	CC Call	CTL	-
001*	Jam Remains	0: Disable, 1: Enable	
	Enables/disables initiating a call for an unattended paper jam.		
002*	Continuous Jams	0: Disable, 1: Enable	
	Enables/disables initiating a call for consecutive paper jams.		
003*	Continuous Door Open	0: Disable, 1: Enable	
	Enables/disables initiating a call when the front door remains open.		

<b>5515</b>	SC/Alarm Setting	CTL	-
	With @Remote in use, these SP codes can be set to issue an SC call when an SC error occurs. If this SP is switched off, the SC call is not issued when an SC error occurs.		

001	SC Call	[0 or 1 / 1 / -] 0: Off, 1: On
002	Service Parts Near End Call	
003	Service Parts End Call	
004	User Call	
006	Communication Test Call	
007	Machine Information Notice	
008	Alarm Notice	
010	Supply Automatic Ordering call	
011	Supply Management Report call	
012	Jam/Door Open Call	[0 or 1 / 1 / -] 0: Off, 1: On

<b>5730</b>	Extended Function Setting	
010	Expiration Prior Alarm Set	
	DFU	

<b>5741</b>	Node Authentication Timeout	
	DFU	

<b>5747</b>	Browser Setting	DFU
001	Use Cache File	
002	Cache Size	
003	Cache Clear	
011	Default HTTP Request Method	
021	User Agent	
031	Use Java Script	
032	Use Extended Java Script	



041	Keep History
042	History Period
051	Use Proxy
052	Proxy Server Name
053	Proxy Port
054	Proxy User Name
055	Proxy Password
056	Hosts Not Using Proxy
061	Accept cookie
071	Show URL Bar
072	Show Horizontal Scroll
081	Homepage
181	User Permit: Homepage
182	User Permit: Bookmark
183	User Permit: Proxy
184	User Permit: History
185	User Permit: Screen Settings
201	JPEG Quality
202	Number of Common Bookmark

<b>5793</b>	ECS Debug SW
	DFU

<b>5794</b>	Browser Debug
	DFU

5801	<b>[Memory Clear]</b>		
	Before executing any of these SP codes, print an SMC Report.		
001	All Clear		
	Initializes items SP5801-002 to -014 below. Turn the main power switch off and on after executing this SP.		
002	Engine	-	-
	Clears the engine settings.		
003	SCS	-	-
	Clears the system settings.		
004	IMH Memory Clr		
	Initializes the image file system. (IMH: Image Memory Handler)		
005	MCS	-	
	Clears MCS data. <b>DFU</b>		
006	Copier application		
	Clears the copier application settings.		
007	Fax Application	-	-
	Clears the fax application settings.		
008	Printer Application	-	-
	Clears the printer application settings.		
009	Scanner Application	-	-
	Clears the scanner application settings.		
010	Memory All Clear (Web Service)	-	-
011	NCS		
	Initializes the NCS (Net Control Service) settings.		

012	R-FAX	-	-
	Initializes the job login ID, SmartNetMonitor for Admin, job history, and local storage file numbers.		
014	Clear DCS Setting	-	-
	Initializes the DCS (Delivery Control Service) settings.		
015	Clear VCS Setting		
	Initializes the UCS (User Information Control Service) settings.		
017	CCS	-	-
	Initializes the CCS (Certification and Charge-control Service) settings.		
018	SRM Memory Clr		
019	LCS	-	-
	Initializes the LCS (Log Count Service) settings.		
020	Web Apli	-	-
	Initializes Web application settings.		
021	ECS		
	Initializes ECS (Engine Control Service).		
023	AICS		
	Initializes the AICS settings.		
024	BROWSER		
	DFU		
025	Websys	-	-
	Initialization applying to the following SPs: SP5-885-020, SP5-885-050, SP5-885-051, SP5-885-100 SP5-885-101, SP5-885-200, SP5-885-201		
5803	Input Check		
	 "Input Check" in this chapter.		

<b>5804</b>	Output Check		
	 "Output Check" in this chapter.		
<b>5810</b>	SC Reset		
001	Fusing SC Reset	Resets SC of CE-Reset.	
<b>5811*</b>	Machine Serial		
002	Display		
	 "Machine No. Setting" in this section.		
<b>5812</b>	Service Tel. No. Setting		
001	Service	CTL	-
	Sets the telephone number for a service representative. This number is printed on the Counter List, which can be printed with the user's "Counter" menu. This can be up to 20 characters (both numbers and alphabetic characters can be input).		
002	Facsimile	CTL	-
	Sets the fax or telephone number for a service representative. This number is printed on the Counter List. This can be up to 20 characters (both numbers and alphabetic characters can be input).		
003	Supply	CTL	-
	Use this to input the telephone number of your supplier for consumables. Enter the number and press "StringIn" key. Press the "Clear modes" key to delete the telephone number.		
004	Operation	CTL	-
	Use this to input the telephone number of your sales agency. Enter the number and press #. Press the "Clear modes" key to delete the telephone number.		
<b>5816</b>	<b>Remote Service</b>	CTL	-
021	RCG-C Registered	[0: Unregistered 1: Registered]	

062	<p>Use Proxy</p> <p>This SP setting determines if the proxy server is used when the machine communicates with the service center.</p>
063	<p>Proxy Host</p> <p>This SP sets the address of the proxy server used for communication between embedded RCG-N and the gateway. Use this SP to set up or display the customer proxy server address. The address is necessary to set up embedded RCG-N.</p> <p><b>Note</b></p> <ul style="list-style-type: none"> <li>The address display is limited to 127 characters. Characters beyond the 127th character are ignored.</li> <li>This address is customer information and is not printed in the SMC report.</li> </ul>
064	<p>Proxy Port Number</p> <p>This SP sets the port number of the proxy server used for communication between embedded RCG N and the gateway. This setting is necessary to set up embedded RCG-N.</p> <p><b>Note</b></p> <ul style="list-style-type: none"> <li>This port number is customer information and is not printed in the SMC report.</li> </ul>
065	<p>Proxy User Name</p> <p>This SP sets the HTTP proxy authentication user name.</p> <p><b>Note</b></p> <ul style="list-style-type: none"> <li>The length of the name is limited to 31 characters. Any character beyond the 31st character is ignored.</li> <li>This name is customer information and is not printed in the SMC report.</li> </ul>
066	<p>Proxy Password</p> <p>This SP sets the HTTP proxy authentication password.</p> <p><b>Note</b></p> <ul style="list-style-type: none"> <li>The length of the password is limited to 31 characters. Any character beyond the 31st character is ignored.</li> <li>This name is customer information and is not printed in the SMC report.</li> </ul>



250	CommLog Print
	Prints the communication log.

<b>5824</b>	NVRAM Upload
5824 1	 "NVRAM Upload/Download" in this section.

<b>5825</b>	NVRAM Download
5825 1	 "NVRAM Upload/Download" in this section.

<b>5828</b>	Network Setting	CTL
001	IPv4 Address (Ethernet / IEEE802.11)	Default: 0B16212C H (011.022.033.044)
002	Subnet Mask (Ethernet / IEEE802.11)	Default: 00000000 H (000.000.000.000)
003	IPv4 Default Gateway (Ethernet / IEEE802.11)	Default: 00000000 H (000.000.000.000)
006	DHCP (Ethernet / IEEE802.11)	Determines whether DHCP IP Address Setting is used or not. [0: Not used 1: Used]
021	Active IPv4 Address	Default: 00000000 H (000.000.000.000)
022	Active IPv4 Subnet Mask	Default: 00000000 H (000.000.000.000)
023	Active IPv4 Gateway Address	Default: 00000000 H (000.000.000.000)
050	1284 Compatibility (Centro)	[0:Not permitted 1:Permitted]
052	ECP (Centro)	[0:Not permitted 1:Permitted]
065	Job Spooling	Enables/disables Job Spooling. [0 or 1 / 0 / 1 /step] 0: Disable, 1: Enable
066	Job Spooling clear: start time	Determines whether spooled job in the HDD is cleared or printed on machine start-up. [0: Clear 1: Print]

069	Job Spooling (Protocol)	Validates or invalidates the job spooling function for each protocol. <b>0</b> : Validates 1: Invalidates bit0: LPR bit1: FTP bit2: IPP bit3: SMB bit4: BMLinkS bit5: DIPRINT bit6: (Reserved) bit7: (Reserved)
-----	-------------------------	---

	@Remote Protocol Cnt		
	Represents whether each network function has been used or not. [0: Not used 1: Used]		
	<b>Bit</b>	<b>Function</b>	<b>Bit</b>
	0	IPsec	16
	1	IPv6	17
	2	IEEE 802.1X	18
	3	Wireless LAN	19
	4	Security Level Setting	20
	5	AppleTalk	21
087	6	DHCP	22
	7	DHCPv6	23
	8	telnet	24
	9	SSL	25
	10	HTTPS	26
	11	BMLinks print	27
	12	diprint printing	28
	13	LPR print	29
	14	ftp print	30
	15	rsh print	31
090	TELNET(0: OFF 1: ON)	Enables or disables the TELENET.	
091	Web (0: OFF 1: ON)	Enables or disables the Web operation. [ 0 or 1 / 1 / - ] 0: Disable, 1: Enable	

145	Active IPv6 Link Local Address	<p>These SPs are the IPv6 status addresses (1 to 5) referenced on the Ethernet or wireless LAN (802.11b) in the format:                      "Status Address" + "Prefix Length"</p> <p>The IPv6 address consists of a total of 128 bits configured in 8 blocks of 16 bits each.</p>
147	Active IPv6 Stateless Address 1	
149	Active IPv6 Stateless Address 2	
151	Active IPv6 Stateless Address 3	
153	Active IPv6 Stateless Address 4	
155	Active IPv6 Stateless Address 5	
156	IPv6 Manual Address	
158	IPv6 Gateway Address	
161	IPv6 Stateless Auto Setting	<p>Enables or disables the function.                      [0: Disable 1: Enable]</p>
236	<p>Web Item Invisible</p> <p>Determines whether each item can be set in Websys.                      [0x0000 to 0xffff/0xffff]                      Bit 1: NetRICOH                      Bit2: Vendor for consumables                      Bit2-15: Reserved</p>	<p>Web Shopping Link Invisible</p> <p>Determines whether the NetRICOH link is displayed on the Websys top page and link page.                      [0 to 1/1/1]                      1: Display                      0: No display</p>
	<p>Web Shopping Link Visible</p>	
237	Web Shopping Link Visible	[0: Invisible 1: Visible]
238	Web Supplies Link Visible	[0: Invisible 1: Visible]
239	Web Link 1 Name	Default: <b>Null</b>

240	Web Link 1 URL	Default: <b>URL1</b>
241	Web Link 1 Visible	[0: Invisible 1: Visible]
242	Web Link 2 Name	Default: <b>URL2</b>
243	Web Link 2 URL	Default: <b>URL2</b>
244	Web Link 2 Visible	[0: Invisible 1: Visible]
249	DHCPv6 DUID	-

<b>5832</b>	HDD	
	Enter the SP number for the partition to initialize, then press "Execute". When the execution ends, cycle the machine off and on.	
001	HDD Formatting (All)	
002	HDD Formatting (IMH)	
003	HDD Formatting (Thumbnail)	
004	HDD Formatting (Job Log)	
005	HDD Formatting (Printer Fonts)	
006	HDD Formatting (User Info)	
007	Mail Rx Data	
008	Mail Tx Data	
009	HDD Formatting (Data for a Design)	
010	HDD Formatting (Log)	
011	HDD Formatting (Ridoc I/F)	

<b>5836</b>	Capture Setting	
001	Capture Function (0:Off 1:On)	[0: OFF / 1: ON]
	Capture setting shows up in "user tool" menu when this SP's value is 1.	
002	Panel Setting	[0: ON / 1: OFF]
	Determines whether the capture function is available or not.	

072	Reduction for Copy B&W Text	[0 to 3, 6 / 0 / 1 /step]
073	Reduction for Copy B&W Other	Resolution conversion rate for stored document sent to the document server. Each value represents: <b>0:</b> x1 <b>1:</b> x1/2 <b>2:</b> x1/3 <b>3:</b> x1/4 <b>6:</b> x2/3
075	Reduction for Printer B&W	
082	Format for Copy B&W Text	
083	Format for Copy B&W Other	These SPs are valid only when MLB is equipped. Each of the following values represents: <b>0:</b> JFIF/JPEG <b>1:</b> TIFF/MMR <b>2:</b> TIFF/MH <b>3:</b> TIFF/MR
085	Format for Printer B&W	
091	Default for JPEG	[5 to 95 / 50 / 1 /step]
101	Primary srv IP address	[000.000.000.000 to 255.255.255.255] Default: <b>000.000.000.000</b>
	Sets IP address to make a relation with PC designed as Capture server (CS). Normally, the value is determined automatically on CS I/O device registration.	
102	Primary srv scheme	[6 letter(s) character strings]
	Normally, the value is determined automatically on CS I/O device registration.	
103	Primary srv port number	[1 to 65535 / 80 / 1 /step]
	Normally, the value is determined automatically on CS I/O device registration.	
104	Primary srv URL path	[0 to 16 letter(s)]
	Normally, the value is determined automatically on CS I/O device registration.	

111	Secondary srv IP address	[000.000.000.000 to 255.255.255.255] Default: <b>000.000.000.000</b>
	Normally, the value is determined automatically on CS I/O device registration. Only IP address designation is valid.	
112	Secondary srv scheme	[Max 6 letter(s)]
	Normally, the value is determined automatically on CS I/O device registration.	
113	Secondary srv port number	[1 to 65535 / <b>80</b> / 1 /step]
	Normally, the value is determined automatically on CS I/O device registration.	
114	Secondary srv URL path	[0 to 16 letter(s)]
	Normally, the value is determined automatically on CS I/O device registration.	
120	Default Reso Rate Switch	[0 or 1 / <b>0</b> / 1 /step]
	Normally, the value is determined automatically on CS I/O device registration.	
122	Reso: Copy (Mono)	[0 to 255 / <b>0</b> / 1 /step]
	The value affects the output resolution. See the list below. Normally, the value is determined automatically on CS I/O device registration. *When the resolution cannot be output for the machine specification limit, output is done by the nearest rate within the limitation.	
	<b>Value</b>	<b>Resolution</b>
	0	600dpi
	1	400dpi
	2	300dpi
	3	200dpi
	4	150dpi
	5	100dpi
6	75dpi	

124	Reso: Print (Mono)	[0 to 255 / 3 / 1 /step]
	<p>The value affects the resolution applying to capturing a monochrome original read by Print application. See the list below.</p> <p>Normally, the value is determined automatically on CS I/O device registration.</p> <p>*When the resolution cannot be output for the machine specification limit, output is done by the nearest rate within the limitation.</p>	
	<b>Value</b>	<b>Resolution</b>
	0	600dpi
	1	400dpi
	2	300dpi
	3	200dpi
	4	150dpi
	5	100dpi
6	75dpi	
126	Reso: Fax (Mono)	[0 to 255 / 3 / 1 /step]
	<p>The value affects the resolution applying to capturing a monochrome original read by Fax application. See the list below.</p> <p>Normally, the value is determined automatically on CS I/O device registration.</p> <p>*When the resolution cannot be output for the machine specification limit, output is done by the nearest rate within the limitation.</p>	
	<b>Value</b>	<b>Resolution</b>
	0	600dpi
	1	400dpi
	2	300dpi
	3	200dpi
	4	150dpi
	5	100dpi
6	75dpi	



127	Reso: Scanner (Color)	[0 to 255 / 4 / 1 /step]
	<p>The value affects the resolution applying to capturing a colored original read by Scanner application. See the list below.</p> <p>Normally, the value is determined automatically on CS I/O device registration.</p> <p>*When the resolution cannot be output for the machine specification limit, output is done by the nearest rate within the limitation.</p>	
	<b>Value</b>	<b>Resolution</b>
	0	600dpi
	1	400dpi
	2	300dpi
	3	200dpi
	4	150dpi
	5	100dpi
6	75dpi	
128	Reso: Scanner (Mono)	[0 to 255 / 3 / 1 /step]
	<p>The value affects the resolution applying to capturing a monochrome original read by Scanner application. See the list below.</p> <p>Normally, the value is determined automatically on CS I/O device registration.</p> <p>*When the resolution cannot be output for the machine specification limit, output is done by the nearest rate within the limitation.</p>	
	<b>Value</b>	<b>Resolution</b>
	0	600dpi
	1	400dpi
	2	300dpi
	3	200dpi
	4	150dpi
	5	100dpi
6	75dpi	

141	All Addr Info Switch	[0 or 1 / <b>0</b> / 1 /step]
142	Stand-by Doc Max Number	[10 to 10000 / <b>2000</b> / 1 /step]
	Sets how many stand-by documents sent to CS the device can hold.	

<b>5840</b>	IEEE 802.11	
006	Channel MAX	CTL [1 to 11 or 13 / <b>11</b> or <b>13</b> / 1 /step] Europe: 1 to 13, default: 13 NA/ Asia: 1 to 11, default: 11
	Sets the maximum number of channels available for data transmission via Wireless LAN. The number of channels available varies according to location. The default settings are set for the maximum end of the range for each area. Adjust the upper 4 bits to set the maximum number of channels. <b>DFU</b>	
<p><b>Note</b></p> <ul style="list-style-type: none"> <li>Do not change the setting.</li> </ul>		
007	Channel MIN	CTL [ 1 to 11 or 13 / 1 / 1 /step] Europe: 1 to 13 NA/ Asia: 1 to 11
	Sets the minimum number of channels available for data transmission via the wireless LAN. The number of channels available varies according to location. The default settings are set for the minimum end of the range for each area. Adjust the lower 4 bits to set the minimum number of channels. <b>DFU</b>	
<p><b>Note</b></p> <ul style="list-style-type: none"> <li>Do not change the setting.</li> </ul>		
008	Transmission Speed	[00 to FF h / <b>FF</b> (Auto)]
	Each value suggests as follows: FF= Auto / 11= 54M Fix / 10= 48M Fix / 0F= 36M Fix / 0E= 24M Fix 0D= 18M Fix / 0C= 12M Fix / 0B= 9M Fix / 0A= 6M Fix / 07= 11M Fix 06= 5.5M Fix / 05= 2M Fix / 08= 1M Fix / 13 to FE= Reserved / 12= 72M Fix / 09= 22M Fix / 01 to 04= Not used	

011	WEP Key Select	CTL	[00 to 11 / 00 / 1 binary] 00: Key #1 01: Key #2 (Reserved) 10: Key #3 (Reserved) 11: Key #4 (Reserved)
	Selects the WEP key.		
042	Fragment Thresh	CTL	[256 to 2346 / <b>2346</b> / 1]
	Adjusts the fragment threshold for the IEEE802.11 card. This SP is displayed only when the IEEE802.11 card is installed.		
043	11g CTS to Self	CTL	[0 to 1 / 1 / 1] 0: Off, 1: On
	Determines whether the CTS self function is turned on or off. This SP is displayed only when the IEEE802.11 card is installed.		
044	11g Slot Time	CTL	[0 to 1 / 1 / 1] 0: 20 $\mu$ m, 1: 9 $\mu$ m
	Selects the slot time for IEEE802.11.		
045	WPA Debug Lvl	CTL	[0 to 3 / <b>3</b> / 1] 1: Info, 2: Warning, 3: Error
	Selects the debug log for WPA authentication application. This SP is displayed only when the IEEE802.11 card is installed.		
<b>5842</b>	GWWS Analysis <b>DFU</b>		

001	Setting 1	CTL	
	<p>This is a debugging tool. It sets the debugging output mode of each Net File process.</p> <p>Default: Bit SW 1000 0000</p>	Bit	Groups
		0	System & other groups (LSB)
		1	Capture related
		2	Certification related
		3	Address book related
		4	Machine management related
		5	Output related (printing, delivery)
		6	Repository related
		7	Debug log output
002	Setting 2	CTL	
	<p>Default: Bit SW 0000 0000</p>	Bit	Groups
		0-6	Not used
		7	<p>Log time stamp setting</p> <p>0: Date/Hour/Minute/Second</p> <p>1: Minute/Second/Msecond</p>
<b>5844</b>	USB		
001	Transfer Rate	CTL	
	<p>Sets the speed for USB data transmission.</p> <p>[Full Speed]</p> <p><b>[Auto Change]</b></p>		
002	Vendor ID	CTL	
	<p>Sets the vendor ID:</p> <p>Initial Setting: 0x05A Ricoh Company</p> <p>[0x0000 to 0xFFFF/1] <b>DFU</b></p>		

003	Product ID	CTL	
	Sets the product ID. [0x0000 to 0xFFFF/1] <b>DFU</b>		
004	Device Release Number	CTL	
	Sets the device release number of the BCD (binary coded decimal) display. [0000 to 9999/1] <b>DFU</b> Enter as a decimal number. NCS converts the number to hexadecimal number recognized as the BCD.		
005	Fixed USB Port		[0 to 3/ 0 / 1 /step ]
	Sets the control function saving driver re-install ON/OFF. <b>0:</b> OFF 1: ON (Level 1)= ON for the same model. 2: ON (Level 2)= Depending on "SP5844 -006,-007"		
006	PnP Model Name		[20 letter(s)]
	Sets the model name for USB PnP when "SP5844-005" is "2".		
007	PnP Serial Number		[12 digit]
	Sets the serial number for USB PnP when "SP5844-005" is "2".		
100	Notify UnSupport		[0: Disabled / 1: Enabled]
	Sets banner message popup Enabled/Disabled on unsupported USB device connection.		

<b>5845</b>	Delivery Server Setting	CTL	-
	Provides items for delivery server settings.		
001	FTP Port No.		[ 0 to 65535 / <b>3670</b> / 1 /step]
	Sets the FTP port number used when image files to the Scan Router Server.		
006	Delivery Error Display Time		[0 to 999 / <b>300</b> / 1 second /step]
	Use this setting to determine the length of time the prompt message is displayed when a test error occurs during document transfer with the NetFile application and an external device.		

008	Server IP (Secondary)	Range: 000.000.000.000 to 255.255.255.255	
	Specifies the IP address assigned to the computer designated to function as the secondary delivery server of Scan Router. This SP allows only the setting of the IP address without reference to the DNS setting.		
009	Delivery Server Model	[0 to 4 / 0 / 1 /step]	
	Allows changing the model of the delivery server registered by the I/O device. 0: Unknown, 1: SG1 Provided, 2: SG1 Package, 3: SG2 Provided, 4: SG2 Package		
010	Delivery Svr. Capability	[0 to 255 / 0 / 1 /step]	
	Changes the capability of the server that is registered as an I/O device.		
			Bit7 = 1 Comment information exists
			Bit6 = 1 Direct specification of mail address possible
			Bit5 = 1 Mail RX confirmation setting possible
			Bit4 = 1 Address book automatic update function exists
			Bit3 = 1 Fax RX delivery function exists
			Bit2 = 1 Sender password function exists
Bit1 = 1 Function to link MK-1 user and Sender exists			
Bit0 = 1 Sender specification required (if set to 1, Bit6 is set to "0")			
011	Delivery Svr. Capability (Ext)	[ 0 to 255 / 0 / 1 /step]	
	Changes the capability of the server that is registered as an I/O device.		
	Bit7 = 1 Address book usage limitation (Limitation for each authorized user) Bit6 = 1 RDH authorization link Bit5 to 0: Not used		
013	Server Scheme (Primary)	-	
	Specifies the scheme of the primary delivery server.		

014	Server Port Number (Primary)	-
	Specifies the port number of the primary delivery server.	
015	Server URL Path (Primary)	-
	Specifies the URL path of the primary delivery server.	
016	Server Scheme (Sec)	-
	Specifies the scheme of the secondary delivery server.	
017	Port Number (Sec)	-
	Specifies the port number of the secondary delivery server.	
018	URL Path (Sec)	-
	Specifies the URL path of the secondary delivery server.	
022	Rapid Sending Control	[ 0 or 1 / 1 / - ] 0: Disable, 1: Enable
	Enables or disables the prevention function for the continuous data sending.	

5846	UCS Settings	CTL
	Provides items for delivery server settings.	
001	Machine ID (for Delivery Server)	Displays ID
	Displays the unique device ID in use by the delivery server directory. The value is only displayed and cannot be changed. This ID is created from the NIC MAC or IEEE 1394 EUI. The ID is displayed as either 6-byte or 8-byte binary.	
002	Machine ID Clear (for Delivery Server)	Clears ID
	Clears the unique ID of the device used as the name in the file transfer directory. Execute this SP if the connection of the device to the delivery server is unstable. After clearing the ID, the ID will be established again automatically by cycling the machine off and on.	

003	Maximum Entries	[150 to 999 / <b>150</b> / 1 /step]
	Changes the maximum number of entries that UCS can handle. If a value smaller than the present value is set, the UCS managed data is cleared, and the data (excluding user code information) is displayed.	
006	Delivery Server retry Timer	[0 to 255 / <b>0</b> / 1 /step]
	Sets the interval for retry attempts when the delivery server fails to acquire the delivery server address book.	
007	Delivery Server retry Times	[0 to 255 / <b>0</b> / 1 /step]
	Sets the number of retry attempts when the delivery server fails to acquire the delivery server address book.	
008	Delivery Server Maximum Entries	[200 to 999 / <b>200</b> / 1/step]
	Sets the maximum number account entries of the delivery server user information managed by UCS.	
010	LDAP Search Timeout	[1 to 255 / <b>60</b> / 1 /step]
	Sets the length of the timeout for the search of the LDAP server.	
020	WSD Maximum Entries	[5 to 255 / <b>250</b> / 1 /step]
	Sets the maximum entries for the address book of the WSD (SD-scanner)	
021	Folder Auth change	[0 or 1 / 0 / -] 0: Login user name 1: address book
022	Initial Value of Upper Limit Count	-



040	Addr Book Migration (USB -> HDD)	
	<p>This SP moves the address book data from the SD card or flash ROM on the controller board to the HDD. You must cycle the machine off and on after executing this SP.</p> <ol style="list-style-type: none"> <li>1. Turn the machine off.</li> <li>2. Install the HDD.</li> <li>3. Turn the machine on.</li> <li>4. Do SP5846 040.</li> <li>5. Turn the machine off/on.</li> </ol> <p><b>Note</b></p> <ul style="list-style-type: none"> <li>• Executing this SP overwrites any address book data already on the HDD with the data from the flash ROM on the controller board.</li> <li>• We recommend that you back up all directory information to an SD card with SP5846-051 before you execute this SP.</li> <li>• After the address book data is copied to HDD, all the address book data is deleted from the flash ROM. If the operation fails, the data is not erased from the flash ROM.</li> </ul>	
041	Fill Adder Book A C L Info	
	<p>This SP must be executed immediately after installation of an HDD unit in a basic machine that previously had no HDD. The first time the machine is powered on with the new HDD installed, the system automatically takes the address book from the NVRAM and writes it onto the new HDD. However, the new address book on the HDD can be accessed only by the system administrator at this stage. Executing this SP by the service technician immediately after power on grants full address book access to all users.</p>	
043	Addr Book Media	
	Displays the slot number where an address book data is in.	
046	Initialize All Setting & Addr Book	Clears the local address book information, including the user code.
047	Initialize Local Addr Book	Clears the local address book information, including the user code.
048	Initialize All Delivery Addr Book	Clears the distribution address book information, except the user code.

049	Initialize All LDAP Addr Book	Clears the LDAP address book information, except the user code.
050	Initialize All Addr Book	Clears all directory information managed by UCS, including all user codes. Turn the main power switch off and on after executing this SP.
051	Backup All Addr Book	Uploads all directory information to the SD card.
052	Restore All Addr Book	Downloads all directory information from the SD card.
053	Clear Backup Info	Deletes the address book data from the SD card in the service slot. Deletes only the files that were uploaded from this machine. This feature does not work if the card is write-protected. <b>Note:</b> After you do this SP, go out of the SP mode, and then turn the power off. Do not remove the SD card until the Power LED stops flashing.
060	Search Option	This SP uses bit switches to set up the fuzzy search options for the UCS local address book. Bit0: Checks both upper/lower case characters Bit1: Japan only Bit2 to 7: Not used
062	Complexity Option 1 <sup>(1)</sup>	Use this SP to set the conditions for password entry to access the local address book. Specifically, this SP limits the password entry to upper case and sets the length of the password. [0 to 32 / 0 / 1 /step]
063	Complexity Option 2 <sup>(1)</sup>	Use this SP to set the conditions for password entry to access the local address book. Specifically, this SP limits the password entry to lower case and defines the length of the password. [0 to 32 / 0 / 1 /step]

064	Complexity Option 3 <sup>(1)</sup>	Use this SP to set the conditions for password entry to access the local address book. Specifically, this SP limits the password entry to numbers and defines the length of the password. [0 to 32 / 0 / 1 /step]
065	Complexity Option 4 <sup>(1)</sup>	Use this SP to set the conditions for password entry to access the local address book. Specifically, this SP limits the password entry to symbols and defines the length of the password. [0 to 32 / 0 / 1 /step]
091	FTP Auth Port Setting	Specifies the FTP port for getting a distribution server address book that is used in the identification mode. [0 to 65535 / 3671 / 1 /step]
094	Encryption Stat	Shows the status of the encryption function for the address book data.

**Note (1):**

SP5846-062 to SP5846-065 do not normally require adjustment.

These SP modes are enabled only after the system administrator has set up a group password policy to control access to the address book.

<b>5847</b>	Rep Resolution Reduction		
	This SP applies to GW Repository service and NetFile page reference function. Some settings need MLB-equipment to effect.		
002	Rate for Copy B&W Text	[0 to 6 / 0 / 1 /step]	Each value represents: 0: x1, 1: 1/2, 2: 1/3, 3: 1/4, 4: 1/6, 5: 1/8, 6: 2/3
003	Rate for Copy B&W Other		
005	Rate for Printer B&W		
007	Rate for Printer B&W 1200dpi	[0 to 6 / 1 / 1 /step]	
021	Network Quality Default for JPEG	[5 to 95 / 50 / 1 /step]	

	Web Service	CTL	-
<b>5848</b>	SP5848-1 sets the 4-bit switch assignment for the access control setting. Setting of 0001 has no effect on access and delivery from Scan Router. ac: Access Control		
002	Access Ctrl: Repository (only Lower 4 Bits)	Switches access control on and off. <b>0000</b> : No access control 0001: Denies access to DeskTop Binder.	
004	Access Ctrl: U Directory (only Lower 4 bits)		
007	Access Ctrl: Log Fax (Lower 4 bits)		
009	Access Ctrl: Job Ctrl (Lower 4 bits)		
011	Access Ctrl: Device management (Lower 4 bits)		
021	Access Ctrl: Delivery (Lower 4bits)		
022	Access Ctrl: U Administration (Lower 4bits)		
099	Repository: Download Image Set	DFU	
100	Repository: Download Image Max	[1 to 1024/1 K]	
210	Log Type: Job1	Displays the log server settings. These can be adjusted with the Web Image Monitor.	
211	Log Type: Job2		
212	Log Type: Access		
213	Primary Server		
214	Secondary Server		
215	Start Time		

216	Interval Time	Specifies the transmit interval. [1 to 1000 / 1 / 1 hour/step] This SP is activated only when SP5848-217 is set to "2 (Transmit periodically)".
217	Timing	Selects the transmit timing. [0 to 2 / 0 / 1/step] 0: No Transmit, 1: Transmit one by one 2: Transmit periodically

3

<b>5849</b>	Installation Date	CTL	
	Displays or prints the installation date of the machine.		
001	Display	The "Counter Clear Day" has been changed to "Installation Date" or "Inst. Date".	
002	Switch to Print	Determines whether the installation date is printed on the printout for the total counter. [0 or 1 / 1 / 1/step] 0: Off (No Print), 1: On (Print)	
003	Total Counter	Displays the total counter when the installation date is registered to the machine.	

<b>5853</b>	Stamp Data Download
	Push [Execute] to download the fixed stamp data from the machine ROM onto the hard disk. Then these stamps can be used by the system. If this is not done, the user will not have access to the fixed stamps ("Confidential", "Secret", etc.). You must always execute this SP after replacing the HDD or after formatting the HDD. Always switch the machine off and on after executing this SP.

<b>5856</b>	Remote ROM Update
	Allows the technician to upgrade the firmware using a parallel cable when updating the remote ROM.

002	Local Port	CTL	[0 or 1 / 0 / 1/step] 0: Disallow 1: Allow
<b>5857</b>	Save Debug Log	CTL	-
001	ON/OFF	0: OFF, 1: ON	
	Switches the debug log feature on and off. The debug log cannot be captured until this feature is switched on.		
002	Target (2: HDD 3: SD)		
	Selects the destination where the debugging information generated by the event selected by SP5858 will be stored if an error is generated [2 to 3 /1] 2: HDD 3: SD Card		
005	Save to HDD		
	Specifies the decimal key number of the log to be written to the hard disk.		
006	Save to SD Card		
	Specifies the debug log number for saving to an SD card.		
009	Copy HDD to SD Card (Latest 4MB)		
	Takes the most recent 4 MB of the log written to the hard disk and copies them to the SD Card. A unique file name is generated to avoid overwriting existing file names on the SD Card. Up to 4MB can be copied to an SD Card. 4 MB segments can be copied one by one to each SD Card.		
010	Copy HDD to SD Card (Latest 4MB Any Key)		
	Takes the log of the specified key from the log on the hard disk and copies it to the SD Card. A unique file name is generated to avoid overwriting existing file names on the SD Card. Up to 4 MB can be copied to an SD Card. 4 MB segments can be copied one by one to each SD Card. This SP does not execute if there is no log on the HDD with no key specified.		

011	Erase HDD Debug Data		
	Erases all debug logs on the HDD		
012	Erase SD Card Debug Data		
	Erases SD debug logs in the SD card. Turn off and on after executing this SP.		
013	Free Space on SD Card		
	Displays the remaining space in the SD card.		
014	Copy SD to SD (Latest 4 MB)		
	Saves the debug log (latest 4 MB) in memory to the SD card. A unique file name is generated to avoid overwriting existing file names on the SD card. Up to 4MB can be copied to the SD card. 4 MB segments can be copied one by one to the SD card.		
015	Copy SD to SD (Latest 4 MB Any Key)		
	Saves the specified debug log (with SP5-857-006) in memory to the SD card. A unique file name is generated to avoid overwriting existing file names on the SD card. Up to 4MB can be copied to the SD card. 4 MB segments can be copied one by one to the SD card.		
016	Make HDD Debug		
	This SP creates a 32 MB file to store a log on the HDD.		
017	Make SD Debug		
	Executes the making of a file (4MB) for saving debug logs.		
5858	Debug Save When	CTL	-
	These SPs select the content of the debugging information to be saved to the destination selected by SP5857-2. SP5858-3 stores one SC specified by number. Refer to the chapter "Trouble Shooting" for a list of SC error codes.		

001	Engine SC Error	Turns the save function on/off for SC codes generated by copier engine errors. [0 or 1 / 0 / 1/ step] 0: OFF, 1: ON
002	Controller SC Error	Turns the save function on/off for SC codes generated by GW controller errors. [0 or 1 / 0 / 1/ step] 0: OFF, 1: ON
003	Any SC Error	[0 to 65535 / 0 / 1 /step]
004	Jam	Turns the save function on/off for jam errors. [0 or 1 / 0 / 1/ step] 0: OFF, 1: ON

<b>5859</b>	Debug Save Key No.	CTL	-
001	Key 1	These SPs allow you to set up to 10 keys for log files for functions that use common memory on the controller board. [ -9999999 to 9999999 / 0 / - ]	
002	Key 2		
003	Key 3		
004	Key 4		
005	Key 5		
006	Key 6		
007	Key 7		
008	Key 8		
009	Key 9		
010	Key 10		

<b>5860</b>	SMTP/POP3/IMAP4	CTL	-
-------------	-----------------	-----	---



020	Partial Mail Receive Timeout	[1 to 168 / <b>72</b> / 1 hour/step]
	Sets the amount of time to wait before saving mail that breaks up during reception. The received mail is discarded if the remaining portion of the mail is not received during this prescribed time.	
021	MDN Response RFC2298 Compliance	[0 to 1 / <b>1</b> / -]
	Determines whether RFC2298 compliance is switched on for MDN reply mail. 0: No, <b>1</b> : Yes	
022	SMTP Auth. From Field Replacement	[0 to 1 / <b>0</b> / -]
	Determines whether the FROM item of the mail header is switched to the validated account after the SMTP server is validated. <b>0</b> : No. "From" item not switched. <b>1</b> : Yes. "From" item switched.	
025	SMTP Auth. Direct Setting	[0 or 1 / <b>0</b> / -]
	<p>Selects the authentication method for SMTP.</p> <p><b>Bit switch:</b></p> <ul style="list-style-type: none"> <li>• Bit 0: LOGIN</li> <li>• Bit 1: PLAIN</li> <li>• Bit 2: CRAM MD5</li> <li>• Bit 3: DIGEST MD5</li> <li>• Bit 4 to 7: Not used</li> </ul> <p> <b>Note</b></p> <ul style="list-style-type: none"> <li>• This SP is activated only when SMTP authorization is enabled by UP mode.</li> </ul>	
026	S/MINE: MINE Header Setting	[0 to 2 / <b>0</b> / 1 /step]
	<p>Compliance setting for S/MINE output mail header.</p> <p><b>0</b>: Microsoft Outlook Express</p> <p><b>1</b>: Internet Draft</p> <p><b>2</b>: RFC</p>	
<b>5866</b>	E-mail Report	
005	Add Date Field	CTL [ 0 or 1 / <b>0</b> / - ] 0: Not add, 1: Add
	Adds or does not add the date field to the header of the alert mail.	

<b>5869</b>	RAM Disk Setting		
001	Mail Function	GWINIT	0: ON, 1: OFF
	Turns on or off the e-mail function.		

<b>5873</b>	SD Card Appli Move		
001	Move Exec	This SP copies the application programs from the original SD card in SD card slot 3 to an SD card in SD card slot 2.	
002	Undo Exec	This SP copies back the application programs from an SD card in the SD Card Slot 3 to the original SD card in the SD card slot 2. Use this menu when you have mistakenly copied some programs by using "Move Exec" (SP5873-1).	

<b>5875</b>	SC Auto Reboot		
002	Reboot Type	CTL	Selects the reboot method for SC. [0 or 1 / 0 / -] 0: Manual reboot, 1: Automatic reboot

<b>5876</b>	Security Clear		
001	All clear	Press "Execute" to activate.	
011	Clear NCS Security Setting		
015	Clear UCS Security Setting		

<b>5878</b>	Option Setup		
001	Data Overwrite Security	Enables the Data Overwrite Security unit. Press "EXECUTE" on the operation panel. Then turn the machine off and on.	
002	HDD Encryption		

<b>5881</b>	Fixed Phrase Block Erasing		
001	-	Deletes the fixed form sentence.	

<b>5885</b>	Set WIM Function		
-------------	------------------	--	--

	DocSvr Acc Ctrl	[0: Disabled 1: Enabled] *Reboot machine to confirm the setting.	
	<b>Bit</b>	<b>Function</b>	<b>Default</b>
020	0	All access prohibition	0
	1	All access prohibition for user mode	
	2	Print function prohibition	
	3	Fax transmitting prohibition	
	4	Scanner transmitting prohibition	
	5	DL function prohibition	
	6	Delete function prohibition	
	7	Access prohibition for guest user	
		DocSvr Format	
050	[0: Thumbnail / 1: Icon / 2: Detail] Sets the way in which files in the document box are displayed.		
	DocSvr Trans	[5 to 20 / 10 / 1/step]	
051	Sets how many files in the document box are displayed per page.		
200	Detect Mem Leak		
201	DocSvr Timeout		

<b>5887</b>	SD GetCounter SSP
001	This SP saves the counter list of the machine to an SD card in the slot 3. The folder of "SD_COUNTER" must be made in an SD card for this SP.

	Personal Information Protect
<b>5888*</b>	Selects the protection level for logs. [0 to 1 / 0 / 1] 0: No authentication, No protection for logs 1: No authentication, Protected logs (an administrator can see the logs)

<b>5893</b>	[SDK Apli Cnt Name]	*CTL	-
	Displays the counter name of each SDK application.		
001	SDK-1		
002	SDK-2		
003	SDK-3		
004	SDK-4		
005	SDK-5		
006	SDK-6		

<b>5894</b>	External Counter Setting		
001	Switch Charge Mode	[0 to 2 / 0 / 1 /step] (DFU)	

<b>5907*</b>	Plug & Play Maker / Model Name		
5907 1	<p>Selects the brand name and production name for the Plug and Play function. These names are stored in the NVRAM. When the NVRAM data is corrupted, select these names once again. Use the right-arrow or left-arrow key to scroll through the list of brand names. To select a brand name, press the OK key. An asterisk (*) indicates which manufacture is currently selected.</p>		

<b>5913</b>	Switch Permission Time		
002	Print Application Timer		
	<p>Sets the length of time to elapse before allowing another application to take control of the display when the application currently controlling the display is not operating because a key has not been pressed.</p> <p>[3 to 30 / 3 / 1 second/step]</p>		

<b>5967</b>	Copy Server: Set Function		
001	(0: ON 2: OFF)	Sets the document server function ON/OFF.	

<b>5973</b>	User Stamp Registration		
001	Frame deletion Setting	[0 to 3 / 0 / 1 mm/step]	

5985	Device Setting	
	The NIC and USB support features are built into the GW controller. Use this SP to enable and disable these features. In order to use the NIC and USB functions built into the controller board, these SP codes must be set to "1".	
001	On Board NIC	<p>[0 to 2 / 0 / 1 /step]</p> <p>0: OFF, 1: ON, 2: ON: Limited</p> <p>When the "Function limitation" is set, "On board NIC" is limited only for the @Remote or LDAP/NT authentication.</p> <p><b>Note</b></p> <ul style="list-style-type: none"> <li>Other network applications than @Remote or LDAP/NT authentication are not available when this SP is set to "2". Even if you can change the initial settings of those network applications, settings may not actually work.</li> </ul>
002	On Board USB	<p>[0 or 1 / 0 / 1/step]</p> <p>0: OFF, 1: ON</p>

5987	Mech. Counter	[0: OFF / 1: ON]
001	<p>Gives the counter list text to the SD card inserted in the service slot.</p> <p>In the SD card, the folder named "SD_COUNTER" must be placed in the root directory.</p>	

5990	SP Print Mode	SMC Print
	<p>In the SP mode, press Copy Window to move to the copy screen, select the paper size, then press Start. Select A4/LT (Sideways) or larger to ensure that all the information prints. Press SP Window to return to the SP mode, select the desired print, and press "EXECUTE".</p>	
001	All (Data List)	
002	SP (Mode Data List)	
003	User Program	
004	Logging Data	
005	Diagnostic Report	
006	Non-Default (Prints only SPs set to values other than defaults.)	

007	NIB Summary
008	Capture Log
021	Copier User Program
022	Scanner SP
023	Scanner User Program
024	SDK/J Summary
025	SDK/J Application Info
026	Printer SP

<b>5992</b>	SP Text Mode
	This SP gives the SMC print text data to SD card inserted.
001	All (Data List)
002	SP (Mode Data List)
003	User Program
004	Logging Data
005	Diagnostic Report
006	Non-Default (Prints only SPs set to values other than defaults.)
007	NIB Summary
008	Capture Log
021	Copier User Program
022	Scanner SP
023	Scanner User Program
024	SDK/J Summary
025	SDK/J Application Info
026	Printer SP

<b>5994</b>	Mirroring
-------------	-----------

001	Engine	Execution type SP (DFU)
<b>5995</b>	Factory Mode	
001	-	[0 to 1 / 0 / 1 STEP/step] (DFU)

### SP6-XXX (Peripherals)

<b>6006*</b>	ADF Adjustment (  "DF Image Adjustment" in the "Adjusting Copy Image Area") <b>NOTE:</b> Available menus depend on the machine model and its configuration.	
001	Side-to-Side Regist Adjustment Face	[-2.0 to +2.0 / 0.0 / 0.1 mm/step]
002	Side-to-Side	[-2.0 to +2.0 / 0.0 / 0.1 mm/step]
003	Leading Edge Duplex Front	[-5.0 to +5.0 / 0.0 / 0.1 mm/step]
004	Leading Edge Duplex Rear	[-5.0 to +5.0 / 0.0 / 0.1 mm/step]
007	Rear Edge Erase	[-5.0 to +5.0 / 0.0 / 0.1 mm/step]

<b>6007</b>	ADF INPUT Check	
009	Original Detection	[0 to 1 / 0 / 1 STEP/step]
	Displays ADF original sensor information. When the sensor detects an original, this SP's value becomes "1".	
013	Registration Sensor	[0 to 1 / 0 / 1 STEP/step]
	Displays ADF registration sensor information. When the sensor detects an original, this SP's value becomes "1".	
015	Feed Cover Sensor	[0 to 1 / 0 / 1 STEP/step]
	Displays ADF sensor information. When the cover opens, this SP's value becomes "1".	

<b>6008</b>	ADF OUTPUT Check	
003	Feed Motor Forward	[ON/OFF]
	Makes the paper transfer motor rotate to check ADF condition against operational load.	

004	Feed Motor Reverse	[ON/OFF]
	Makes the paper transfer motor reverse-rotate to check ADF condition against operational load.	
009	Feed Solenoid	[ON/OFF]
	Makes the paper feed solenoid intermittent-drive to check ADF condition against operational load.	
011	Inverter Solenoid	[ON/OFF]
	Makes the inverter solenoid intermittent-drive to check ADF condition against operational load.	

<b>6009</b>	ADF Free Run	
001	Simplex Mode	[0 to 1 / 0 / 1 STEP/step]
	Performs an ARDF free run at simplex scanning mode. Press "ON" to start; press "OFF" to stop.	
002	Duplex Mode	[0 to 1 / 0 / 1 STEP/step]
	Performs an ARDF free run in duplex scanning mode. Press "ON" to start; press "OFF" to stop.	

<b>6017</b>	ADF Adjustment Magnification	
001	Magnification	[-5 to 5 / 0 / 0.1 %/step]
	Adjusts vertical magnification for ADF.	

<b>6021</b>	ARDF Motor	
001	Gain Selection	[0 to 2 / 0 / 1 /step]
	The values represent: [0: Universal / 1: for GX060050 / 2: for GX060040]	

<b>6149</b>	Max. Pre-Stack Sheet	
001	[0 to 3 / 3 / 1 Sheet(s)/step]	



<b>6910</b>	ADF Adjustment Shading Time	[0 to 90 / <b>60</b> / 1 Sec/step]
001	Adjusts the interval used for the shading processing in the ARDF mode. Light and heat in the room may affect the scanner response. Reduce this setting if copy quality indicates that the white level is drifting during ARDF copy jobs.	

### SP7-XXX (Data Log)

<b>7401*</b>	Total SC	[0 to 65535 / <b>0</b> / 1/step]
001	SC Counter	
	Displays how many times SC codes are generated.	
002	Total SC Counter	
	Displays how many times SC codes are generated including the number having been reset.	

<b>7403*</b>	SC History	
001	Latest	Displays the most recent 10 service calls.
002	Latest 1	
003	Latest 2	
004	Latest 3	
005	Latest 4	
006	Latest 5	
007	Latest 6	
008	Latest 7	
009	Latest 8	
010	Latest 9	

<b>7502*</b>	Total Paper Jam	[0 to 65535 / <b>0</b> / 1/step]
001	Jam Counter	Jam Counter Displays the total number of copy paper jams.

002	Total Jam Counter	Total Jam Counter including the number having been reset.
-----	-------------------	---

<b>7503*</b>	Total Original Jam	[0 to 65535 / 0 / 1/step]
001	Original Jam Counter	Displays the total number of original jams.
002	Total Original Counter	Total Original Counter including the number having been reset.

<b>7504*</b>	Paper Jam Location	[0 to 9999 / 0 / 1/step]
	Displays the total number of the paper jams classified by timing and location.	
001	At power on	
	Paper jam occurs at power on.	
010	2nd Paper Feed SN: Late	
011	3rd Paper Feed SN: Late	
012	4th Paper Feed SN: Late	
021	LCT Paper Feed SN: Late	
022	1st Vertical Transport SN: Late	
050	2nd Vertical Transport SN: Late	
060	4th Vertical Transport SN: Late	
070	Relay SN: Late	
121	Registration SN: Late	
122	Fusing Exit SN: Late	
123	Exit Unit Entrance SN: Late	
125	Paper Exit SN: Late	

7505	Paper Jam Location (Original)	
	<p>Displays the total number of original jams by location. These jams occur when the original does not activate the sensors.</p> <p><b>Note</b></p> <ul style="list-style-type: none"> <li>• Lag: Jam occurs when the paper remains at the sensor for longer than the prescribed time.</li> <li>• Late: Jam occurs because paper fails to arrive at the prescribed time.</li> </ul>	
1	Duplex Entrance SN: Late	
4	Duplex Transport SN1: Late	
54	Duplex Transport: SN2: Late	

<b>7506</b>	Jam Count by Paper Size		
006	A5 LEF	CTL	<p>Displays the number of jams according to the paper size. [ 0 to 9999 / 0 / 1 sheet/step ]</p>
044	HLT LEF		
133	A4 SEF		
134	A5 SEF		
142	B5 SEF		
164	LG SEF		
166	LT SEF		
172	HLT SEF		
255	Others		

<b>7507*</b>	Plotter Jam History
--------------	---------------------

001	Latest	Displays the copy jam history (the most recent 10 jams) Sample Display: CODE:023 SIZE:05h TOTAL:0000334 DATE: Mon Mar 15 11:44:50 2000 CODE is the SP7504-*** number (see above.) SIZE is the ASAP paper size code in hex. TOTAL is the total jam error count (SP7502) DATE is the date the jams occurred.			
002	Latest 1				
003	Latest 2				
004	Latest 3				
005	Latest 4				
006	Latest 5				
007	Latest 6				
008	Latest 7				
009	Latest 8				
010	Latest 9				
Size	Code	Size	Code	Size	Code
A4 (S)	05	A3 (L)	84	DLT (L)	A0
A5 (S)	06	A4 (L)	85	LG (L)	A4
B5 (S)	0E	A5 (L)	86	LT (L)	A6
LT (S)	26	B4 (L)	8D	HLT (L)	AC
HLT (S)	2C	B5 (L)	8E	Others	FF
<b>7508*</b>	Original Jam History				

001	Latest	Displays the original jam history (the most recent 10 jams). Sample Display: CODE:007 SIZE:05h TOTAL:0000334 DATE: Mon Mar 15 11:44:50 2000 CODE is the SP7505*** number (see above.) SIZE is the ASAP paper size code in hex. TOTAL is the total error count (SP7503) DATE is the date the jams occurred.
002	Latest 1	
003	Latest 2	
004	Latest 3	
005	Latest 4	
006	Latest 5	
007	Latest 6	
008	Latest 7	
009	Latest 8	
010	Latest 9	

<b>7624</b>	Parts Replacement Operation ON/OFF PCDU:BK	[0 or 1 / 1]
001	[0: No / 1: Yes] Determines whether the use of PM applies to the machine or not. After selecting "Yes" (1), confirm the "SP5067" (Parts replacement operation type) setting.	

<b>7801</b>	ROM version. / Firmware Version	
255	Displays the parts number and versions of all ROMs in the machine.	

<b>7803*</b>	PM Counter Display	
001	Paper	Displays the PM counter.
002	Sheets 45k part	Displays the PM sheet Counter (45k).
003	Sheets 90k part	Displays the PM sheet Counter (90k).
004	Distance (mm) 45k	Displays the PM distance Counter (45k).
005	Distance (mm) 90k	Displays the PM distance Counter (90k).

006	Distance 45k part	[0 to 255 / 0 / 1 /step] Displays the PM distance Counter (45k) usage rate.
007	Distance 90k part	[0 to 255 / 0 / 1 /step] Displays the PM distance Counter (90k) usage rate.

<b>7804</b>	PM Count Reset	
001	Paper	Resets the PM counter (SP7-803-001). When the program ends normally, the message "Completed" is displayed.
002	45k part	PM counter (45k) clear
003	90k part	PM counter (90k) clear

<b>7807</b>	SC/Jam Counter Reset	
001	Resets the SC, paper, original, and total jam counters. When the program ends normally, the message "Completed" is displayed. SP7-807-1 does not clear the latest 10 JAM and SC logs.	

<b>7826</b>	MF Error Counter	
	Displays the number of counts requested of the card/key counter.	
001	Error Counter	A request for the count total failed at power on. This error will occur if the device is installed but disconnected.
002	Error Staple	The request for a staple count failed at power on. This error will occur if the device is installed but disconnected.

<b>7827</b>	MF Error Counter Clear	
	Press Execute to reset to 0 the values of SP7826.	

<b>7832*</b>	Self-Diagnose Result Display	
001	Displays the SC codes and the number of their occurrences. Each number is in the range of 0 to 9999.	

<b>7836</b>	Total Memory size		
	Displays the contents of the memory on the controller board.		

<b>7852*</b>	DF Glass Dust Check		
001	Dust Detection Counter	Displays each counter in the range of 0 to 65535.	
002	Dust Detection Clear Counter		

<b>7901</b>	Assert Info		
	Records the location where a problem is detected in the program. The data stored in this SP is used for problem analysis.		
001	File Name	-	-
002	Number of Lines	-	-
003	Location	-	-

<b>7906</b>	Last PM Count		
002	Sheets 45k part	Displays each of the PM sheet Counter: the last count	
003	Sheets 90k part		
004	Distance (mm) 45k part	Displays each of the PM distance Counter: the last count	
005	Distance (mm) 90k part		
006	Distance 45k	Displays each of the PM distance Counter usage rate: the last count	
007	Distance 90k		

<b>7907</b>	Before 2 PM Count		
002	Sheets 45k part	Displays each of the PM sheet Counter (90k): the second last count	
003	Sheets 90k part		
004	Distance (mm) 45k part	Displays each of the PM distance Counter: the second last count	
005	Distance (mm) 90k part		

006	Distance 45k	Displays each of the PM distance Counter usage rate: the second last count
007	Distance 90k	

<b>7908</b>	Before 3 PM Count	
002	Sheets 45k part	Displays each of the PM sheet Counter (90k): the third last count
003	Sheets 90k part	
004	Distance (mm) 45k part	Displays each of the PM distance Counter: the third last count
005	Distance (mm) 90k part	
006	Distance 45k	Displays each of the PM distance Counter usage rate: the third last count
007	Distance 90k	

**SP8-XXX (Data Log 2)**

Most of the SPs in this group are prefixed with a letter that indicates the mode of operation (the mode of operation is referred to as an "application"). Before reading the Group 8 Service Table, make sure that you understand what these prefixes mean.

Prefixes	What it means	
T:	Total: (Grand Total).	Grand total of the items counted for all applications (C, F, P, etc.)..
C:	Copy application.	Totals (pages, jobs, etc.) executed for each application when the job was not stored on the document server.
F:	Fax application.	
P:	Print application.	
S:	Scan application.	
L:	Local storage (document server)	Totals (jobs, pages, etc.) for the document server. The L: counters work differently case by case. Sometimes, they count jobs/pages stored on the document server; this can be in document server mode (from the document server window), or from another mode, such as from a printer driver or by pressing the Store File button in the Copy mode window. Sometimes, they include occasions when the user uses a file that is already on the document server. Each counter will be discussed case by case.



O:	Other applications (external network applications, for example)	Refers to network applications such as Web Image Monitor. Utilities developed with the SDK (Software Development Kit) will also be counted with this group in the future.
----	---	---

The Group 8 SP codes are limited to 17 characters, forced by the necessity of displaying them on the small LCDs of printers and faxes that also use these SPs. Read over the list of abbreviations below and refer to it again if you see the name of an SP that you do not understand.

### Key for Abbreviations

Abbreviation	What it means
/	"By", e.g. "T:Jobs/Apl" = Total Jobs "by" Application
>	More (2> "2 or more", 4> "4 or more")
AddBook	Address Book
Apl	Application
B/W	Black & White
Bk	Black
C	Cyan
ColCr	Color Create
ColMode	Color Mode
Comb	Combine
Comp	Compression
Deliv	Delivery
DesApl	Designated Application. The application (Copy, Fax, Scan, Print) used to store the job on the document server, for example.
Dev Counter	Development Count, no. of pages developed.
Dup, Duplex	Duplex, printing on both sides
Emul	Emulation
FC	Full Color
FIN	Post-print processing, i.e. finishing (punching, stapling, etc.)

Abbreviation	What it means
Full Bleed	No Margins
GenCopy	Generation Copy Mode
GPC	Get Print Counter. For jobs 10 pages or less, this counter does not count up. For jobs larger than 10 pages, this counter counts up by the number that is in excess of 10 (e.g., for an 11-page job, the counter counts up $11-10=1$ )
IFax	Internet Fax
ImgEdt	Image Edit performed on the original with the copier GUI, e.g. border removal, adding stamps, page numbers, etc.
K	Black (YMCK)
LS	Local Storage. Refers to the document server.
LSize	Large (paper) Size
Mag	Magnification
MC	One color (monochrome)
NRS	NRS (@Remote), which allows a service center to monitor machines remotely. "@Remote" is used overseas; "CSS" is used in Japan.
Org	Original for scanning
OrgJam	Original Jam
Palm 2	Print Job Manager/Desk Top Editor: A pair of utilities that allows print jobs to be distributed evenly among the printers on the network, and allows files to be moved around, combined, and converted to different formats.
PC	Personal Computer
PGS	Pages. A page is the total scanned surface of the original. Duplex pages count as two pages, and A3 simplex count as two pages if the A3/DLT counter SP is switched ON.
PJob	Print Jobs
Ppr	Paper
PrtJam	Printer (plotter) Jam

Abbreviation	What it means
PrtPGS	Print Pages
R	Red (Toner Remaining). Applies to the wide format model A2 only. This machine is under development and currently not available.
RCG	Remote Communication Gate
Rez	Resolution
SC	Service Code (Error SC code displayed)
Scn	Scan
Sim, Simplex	Simplex, printing on 1 side.
S-to-Email	Scan-to-E-mail
SMC	SMC report printed with SP5990. All of the Group 8 counters are recorded in the SMC report.
Svr	Server
TonEnd	Toner End
TonSave	Toner Save
TXJob	Send, Transmission
YMC	Yellow, Magenta, Cyan
YMCK	Yellow, Magenta, Cyan, Black

**Note**

- All of the Group 8 SPs are reset with SP5 801 1 Memory All Clear.

8 191	T:Total Scan PGS	CTL	<p>These SPs count the pages scanned by each application that uses the scanner to scan images.</p> <p>[0 to 99999999 / 0 / 1]</p>
8 192	C:Total Scan PGS		
8 193	F:Total Scan PGS		
8 195	S:Total Scan PGS		
8 196	L:Total Scan PGS		

- SP 8 191 to 8 196 count the number of scanned sides of pages, not the number of physical pages.
- These counters do not count reading user stamp data, or reading color charts to adjust color.
- Previews done with a scanner driver are not counted.
- A count is done only after all images of a job have been scanned.
- Scans made in SP mode are not counted.

**Examples**

- If 3 B5 pages and 1 A3 page are scanned with the scanner application but not stored, the S: count is 4.
- If both sides of 3 A4 sheets are copied and stored to the document server using the Store File button in the Copy mode window, the C: count is 6 and the L: count is 6.
- If both sides of 3 A4 sheets are copied but not stored, the C: count is 6.
- If you enter document server mode then scan 6 pages, the L: count is 6.

8 201	T:LSize Scan PGS	CTL	[0 to 99999999 / 0 / 1]
	<p>These SPs count the total number of large pages input with the scanner for scan and copy jobs. Large size paper (A3/DLT) scanned for fax transmission is not counted.</p> <p><b>Note</b></p> <ul style="list-style-type: none"> <li>• These counters are displayed in the SMC Report, and in the User Tools display.</li> </ul>		
8 203	F:LSize Scan PGS	CTL	[0 to 99999999 / 0 / 1]
	<p>These SPs count the number of large pages scanned by original type for Fax jobs.</p>		

8 205	S:LSize Scan PGS	CTL	[0 to 99999999 / 0 / 1]
	<p>These SPs count the total number of large pages input with the scanner for scan jobs only. Large size paper (A3/DLT) scanned for fax transmission is not counted.</p> <p><b>Note</b></p> <ul style="list-style-type: none"> <li>These counters are displayed in the SMC Report, and in the User Tools display.</li> </ul>		

8 221	ADF Org Feeds	CTL	[0 to 99999999 / 0 / 1]
	<p>These SPs count the number of pages fed through the ADF for front and back side scanning.</p>		
001	Front	<p>Number of front sides fed for scanning:</p> <p>With an ADF/ARDF that can scan both sides simultaneously, the Front side count is the same as the number of pages fed for either simplex or duplex scanning.</p> <p>With an ADF/ARDF that cannot scan both sides simultaneously, the Front side count is the same as the number of pages fed for duplex front side scanning. (The front side is determined by which side the user loads face up.)</p>	
002	Back	<p>Number of rear sides fed for scanning:</p> <p>With an ADF/ARDF that can scan both sides simultaneously, the Back count is the same as the number of pages fed for duplex scanning.</p> <p>With an ADF/ARDF that cannot scan both sides simultaneously, the Back count is the same as the number of pages fed for duplex rear-side scanning.</p>	

- When 1 sheet is fed for duplex scanning the Front count is 1 and the Back count is 1.
- If a jam occurs during the job, recovery processing is not counted to avoid double counting. Also, the pages are not counted if the jam occurs before the first sheet is output.

8 281	T:Scan PGS/TWAIN	CTL	<p>These SPs count the number of pages scanned using a TWAIN driver. These counters reveal how the TWAIN driver is used for delivery functions.</p> <p>[0 to 99999999 / 0 / 1]</p> <p><b>Note</b></p> <ul style="list-style-type: none"> <li>At the present time, these counters perform identical counts.</li> </ul>
8 285	S:Scan PGS/TWAIN	CTL	
8 291	T:Scan PGS/Stamp	CTL	<p>These SPs count the number of pages stamped with the stamp in the ADF unit.</p> <p>[0 to 99999999 / 0 / 1]</p>
8 293	F:Scan PGS/Stamp	CTL	
8 295	S:Scan PGS/Stamp	CTL	
8 301	T:Scan PGS/Size	CTL	[0 to 99999999 / 0 / 1]
	<p>These SPs count by size the total number of pages scanned by all applications. Use these totals to compare original page size (scanning) and output (printing) page size [SP 8-441].</p>		
8 302	C:Scan PGS/Size	CTL	[0 to 99999999 / 0 / 1]
	<p>These SPs count by size the total number of pages scanned by the Copy application. Use these totals to compare original page size (scanning) and output (printing) page size [SP 8-442].</p>		
8 303	F:Scan PGS/Size	CTL	[0 to 99999999 / 0 / 1]
	<p>These SPs count by size the total number of pages scanned by the Fax application. Use these totals to compare original page size (scanning) and output page size [SP 8-443].</p>		
8 305	S:Scan PGS/Size	CTL	[0 to 99999999 / 0 / 1]
	<p>These SPs count by size the total number of pages scanned by the Scan application. Use these totals to compare original page size (scanning) and output page size [SP 8-445].</p>		
8 306	L:Scan PGS/Size	CTL	[0 to 99999999 / 0 / 1]
	<p>The L: counters work differently case by case. Sometimes, they count jobs/pages stored on the document server. Sometimes, they include occasions when the user uses a file that is already on the document server.</p>		

001	A3	
002	A4	
003	A5	
004	B4	
005	B5	
006	DLT	
007	LG	
008	LT	
009	HLT	
010	Full Bleed	
254	Other (Standard)	
255	Other (Custom)	

<b>8 381</b>	T:Total PrtPGS	CTL	These SPs count the number of pages printed by the customer. The counter for the application used for storing the pages increments. [0 to 99999999 / 0 / 1]
<b>8 382</b>	C:Total PrtPGS	CTL	
<b>8 383</b>	F:Total PrtPGS	CTL	
<b>8 384</b>	P:Total PrtPGS	CTL	
<b>8 385</b>	S:Total PrtPGS	CTL	
<b>8 387</b>	O:Total PrtPGS	CTL	

- When the A3/DLT double count function is switched on with SP5104, 1 A3/DLT page is counted as 2.
- When several documents are merged for a print job, the number of pages stored is counted for the application that stored them.
- These counters are used primarily to calculate charges on use of the machine, so the following pages are not counted as printed pages:
  - Blank pages in a duplex printing job.
  - Blank pages inserted as document covers, chapter title sheets, and slip sheets.
  - Reports printed to confirm counts.

All reports done in the service mode (service summaries, engine maintenance reports, etc.)

Test prints for machine image adjustment.

Error notification reports.

Partially printed pages as the result of a copier jam.

8 391	LSize PrtPGS	CTL	[0 to 99999999 / 0 / 1]
	These SPs count pages printed on paper sizes A3/DLT and larger. <b>Note</b> <ul style="list-style-type: none"> <li>In addition to being displayed in the SMC Report, these counters are also displayed in the User Tools display on the copy machine.</li> </ul>		
8 411	Prints/Duplex	CTL	This SP counts the amount of paper (front/back counted as 1 page) used for duplex printing. Last pages printed only on one side are not counted. [0 to 99999999 / 0 / 1]
8 421	T:PrtPGS/Dup Comb	CTL	[0 to 99999999 / 0 / 1]
	These SPs count by binding and combine, and n-Up settings the number of pages processed for printing. This is the total for all applications.		
8 422	C:PrtPGS/Dup Comb	CTL	[0 to 99999999 / 0 / 1]
	These SPs count by binding and combining, and n-Up settings the number of pages processed for printing by the copier application.		
8 423	F:PrtPGS/Dup Comb	CTL	[0 to 99999999 / 0 / 1]
	These SPs count by binding and combining, and n-Up settings the number of pages processed for printing by the fax application.		
8 424	P:PrtPGS/Dup Comb	CTL	[0 to 99999999 / 0 / 1]
	These SPs count by binding and combining, and n-Up settings the number of pages processed for printing by the printer application.		
8 425	S:PrtPGS/Dup Comb	CTL	[0 to 99999999 / 0 / 1]
	These SPs count by binding and combining, and n-Up settings the number of pages processed for printing by the scanner application.		



<b>8 426</b>	L:PrtPGS/Dup Comb	CTL	[0 to 99999999 / 0 / 1]
	The L: counters work differently case by case. Sometimes, they count jobs/pages stored on the document server. Sometimes, they include occasions when the user uses a file that is already on the document server.		
<b>8 427</b>	O:PrtPGS/Dup Comb	CTL	[0 to 99999999 / 0 / 1]
	These SPs count by binding and combining, and n-Up settings the number of pages processed for printing by Other applications		
001	Simplex> Duplex	-	
002	Duplex> Duplex	-	
003	Book> Duplex	-	
004	Simplex Combine	-	
005	Duplex Combine	-	
006	2in1	2 pages on 1 side (2-Up)	
007	4in1	4 pages on 1 side (4-Up)	
008	6in1	6 pages on 1 side (6-Up)	
009	8in1	8 pages on 1 side (8-Up)	
010	9in1	9 pages on 1 side (9-Up)	
011	16in1	16 pages on 1 side (16-Up)	
012	Booklet	-	
013	Magazine	-	
014	2in1+Booklet	-	
015	4in1+Booklet	-	
016	6in1+Booklet	-	
017	8in1+Booklet	-	
018	9in1+Booklet	-	
019	2in1+Magazine	-	
020	4in1+Magazine	-	

021	6in1+Magazine	-
022	8in1+Magazine	-
023	9in1+Magazine	-
024	16in1+Magazine	-

- These counts (SP8-421 to SP8-427) are especially useful for customers who need to improve their compliance with ISO standards for the reduction of paper consumption.
- Pages that are only partially printed with the n-Up functions are counted as 1 page.
- Here is a summary of how the counters work for Booklet and Magazine modes:

Booklet		Magazine	
Original Pages	Count	Original Pages	Count
1	1	1	1
2	2	2	2
3	2	3	2
4	2	4	2
5	3	5	4
6	4	6	4
7	4	7	4
8	4	8	4

8 441	T:PrtPGS/Ppr Size	CTL	[0 to 99999999 / 0 / 1]
	These SPs count by the number of the page classified by paper size. The page is printed by all applications.		
8 442	C:PrtPGS/Ppr Size	CTL	[0 to 99999999 / 0 / 1]
	These SPs count by the number of the page classified by paper size. The page is printed by the copy application.		

<b>8 443</b>	F:PrtPGS/Ppr Size	CTL	[0 to 99999999 / 0 / 1]
	These SPs count by the number of the page classified by paper size. The page is printed by the fax application.		
<b>8 444</b>	P:PrtPGS/Ppr Size	CTL	[0 to 99999999 / 0 / 1]
	These SPs count by the number of the page classified by paper size. The page is printed by the printer applications.		
<b>8 445</b>	S:PrtPGS/Ppr Size	CTL	[0 to 99999999 / 0 / 1]
	These SPs count by the number of the page classified by paper size. The page is printed by the scanner applications.		
<b>8 446</b>	L:PrtPGS/Ppr Size	CTL	[0 to 99999999 / 0 / 1]
	The L: counters work differently case by case. Sometimes, they count jobs/pages stored on the document server Sometimes, they include occasions when the user uses a file that is already on the document server.		
<b>8 447</b>	O:PrtPGS/Ppr Size	CTL	[0 to 99999999 / 0 / 1]
	These SPs count by the number of the page classified by paper size. The page is printed by Other applications.		
001	A3		
002	A4		
003	A5		
004	B4		
005	B5		
006	DLT		
007	LG		
008	LT		
009	HLT		
010	Full Bleed		
254	Other (Standard)		
255	Other (Custom)		

- These counters do not distinguish between LEF and SEF.

<b>8 451</b>	PrtPGS/Ppr Tray	CTL	[0 to 99999999 / 0 / 1]
	These SPs count the number of sheets fed from each paper feed station.		
001	Bypass	Bypass Tray	
002	Tray 1	Copier	
003	Tray 2	Copier	
004	Tray 3	Copier	
005	Tray 4	Currently not used.	
006	Tray 5	Currently not used.	
007	Tray 6	Currently not used.	
008	Tray 7	Currently not used.	
009	Tray 8	Currently not used.	
010	Tray 9	Currently not used.	
011	Tray 10	Currently not used.	
012	Tray 11	Currently not used.	
013	Tray 12	Currently not used.	
014	Tray 13	Currently not used.	
015	Tray 14	Currently not used.	
016	Tray 15	Currently not used.	

<b>8 461</b>	T:PrtPGS/Ppr Type	CTL	[0 to 99999999 / 0 / 1]
	<p>These SPs count by paper type the number pages printed by all applications.</p> <ul style="list-style-type: none"> <li>• These counters are not the same as the PM counter. The PM counter is based on feed timing to accurately measure the service life of the feed rollers. However, these counts are based on output timing.</li> <li>• Blank sheets (covers, chapter covers, slip sheets) are also counted.</li> <li>• During duplex printing, pages printed on both sides count as 1, and a page printed on one side counts as 1.</li> </ul>		

<b>8 462</b>	C:PrtPGS/Ppr Type	CTL	[0 to 99999999 / 0 / 1]
	These SPs count by paper type the number pages printed by the copy application.		
<b>8 463</b>	F:PrtPGS/Ppr Type	CTL	[0 to 99999999 / 0 / 1]
	These SPs count by paper type the number pages printed by the fax application.		
<b>8 464</b>	P:PrtPGS/Ppr Type	CTL	[0 to 99999999 / 0 / 1]
	These SPs count by paper type the number pages printed by the printer application.		
<b>8 466</b>	L:PrtPGS/Ppr Type	CTL	[0 to 99999999 / 0 / 1]
	The L: counters work differently case by case. Sometimes, they count jobs/pages stored on the document server. Sometimes, they include occasions when the user uses a file that is already on the document server.		
001	Normal		
002	Recycled		
003	Special		
004	Thick		
005	Normal (Back)		
006	Thick (Back)		
007	OHP		
008	Other		

<b>8 511</b>	T:PrtPGS/Emul	CTL	[0 to 99999999 / 0 / 1]
	Printed by all applications.		
<b>8 514</b>	P:PrtPGS/Emul	CTL	[0 to 99999999 / 0 / 1]
	Printed by the printer application.		
001	RPCS		
002	RPDL		
003	PS3		
004	R98		

005	R16
006	GL/GL2
007	R55
008	RTIFF
009	PDF
010	PCL5e/5c
011	PCL XL
012	IPDL-C
013	BM-Links
014	Other
015	IPDS

8 521	T:PrfPGS/FIN	CTL	[0 to 99999999 / 0 / 1]
	These SPs count by finishing mode the total number of pages printed by all applications.		
8 522	C:PrfPGS/FIN	CTL	[0 to 99999999 / 0 / 1]
	These SPs count by finishing mode the total number of pages printed by the Copy application.		
8 523	F:PrfPGS/FIN	CTL	[0 to 99999999 / 0 / 1]
	These SPs count by finishing mode the total number of pages printed by the Fax application. <div style="border: 1px solid blue; border-radius: 10px; padding: 2px; display: inline-block;">  <b>Note</b> </div> <ul style="list-style-type: none"> <li>• Print finishing options for received faxes are currently not available.</li> </ul>		
8 524	P:PrfPGS/FIN	CTL	[0 to 99999999 / 0 / 1]
	These SPs count by finishing mode the total number of pages printed by the Print application.		

8 525	S:PrtPGS/FIN	CTL	[0 to 99999999 / 0 / 1]
	These SPs count by finishing mode the total number of pages printed by the Scanner application.		
8 526	L:PrtPGS/FIN	CTL	[0 to 99999999 / 0 / 1]
	The L: counters work differently case by case. Sometimes, they count jobs/pages stored on the document server. Sometimes, they include occasions when the user uses a file that is already on the document server.		
001	Sort		
002	Stack		
003	Staple		
004	Booklet		
005	Z-Fold		
006	Punch		
007	Other		
008	Inside-Fold		
009	Three-IN-Fold		
010	Three-OUT-Fold		
011	Four-Fold		
012	KANNON-Fold		
013	Perfect-Bind		
014	Ring-Bind		

**Note**

- If stapling is selected for finishing and the stack is too large for stapling, the unstapled pages are still counted.
- The counts for staple finishing are based on output to the staple tray, so jam recoveries are counted.

<b>8 531</b>	Staples
	-

<b>8 551</b>	T:PrtBooks/FIN	CTL	[0 to 99999999 / 0 / 1]
	Printed by all applications.		
<b>8 552</b>	C:PrtBooks/FIN	CTL	[0 to 99999999 / 0 / 1]
	Printed by the printer application.		
<b>8 554</b>	P:PrtBooks/FIN	CTL	[0 to 99999999 / 0 / 1]
	Printed by the printer application.		
<b>8 556</b>	L:PrtBooks/FIN	CTL	[0 to 99999999 / 0 / 1]
	The L: counters work differently case by case. Sometimes, they count jobs/pages stored on the document server Sometimes, they include occasions when the user uses a file that is already on the document server.		
001	Perfect-Bind		
002	Ring-Bind		

<b>8 561</b>	T:A Sheet Of Paper	CTL	[0 to 99999999 / 0 / 1]
	Printed by all applications.		
<b>8 562</b>	C:A Sheet Of Paper	CTL	[0 to 99999999 / 0 / 1]
	Printed by the copy application.		
<b>8 563</b>	F:A Sheet Of Paper	CTL	[0 to 99999999 / 0 / 1]
	Printed by the fax application.		
<b>8 564</b>	P:A Sheet Of Paper	CTL	[0 to 99999999 / 0 / 1]
	Printed by the printer application.		
<b>8 566</b>	L:A Sheet Of Paper	CTL	[0 to 99999999 / 0 / 1]
	The L: counters work differently case by case. Sometimes, they count jobs/pages stored on the document server Sometimes, they include occasions when the user uses a file that is already on the document server.		



<b>8 567</b>	O:A Sheet Of Paper
	Printed by Other application.
001	Total: Over A3/DLT
002	Total: Under A3/DLT
003	Duplex: Over A3/DLT
004	Duplex: Under A3/DLT

<b>8 581</b>	T:Counter	CTL	[0 to 99999999 / 0 / 1]
	This SP counts the total output broken down by color output, regardless of the application used. In addition to being displayed in the SMC Report, these counters are also displayed in the User Tools display on the copy machine.		
001	Total		

<b>8 591</b>	O:Counter	CTL	[0 to 99999999 / 0 / 1]
001	A3/DLT	These SPs count the totals for A3/DLT paper use, number of duplex pages printed, and the number of staples used. These totals are for Other (O:) applications only.	
002	Duplex		

<b>8 601</b>	T: Coverage Counter	CTL	[0 to 99999999 / 0 / 1]
001	B/W	Displays the total coverage of each mode.	
011	B/W Printing Pages	Displays the number of the printouts in each mode.	

<b>8 602</b>	C: Coverage Counter	CTL	[0 to 99999999 / 0 / 1]
001	B/W		
<b>8 603</b>	F: Coverage Counter	CTL	[0 to 99999999 / 0 / 1]
001	B/W		
<b>8 604</b>	P: Coverage Counter	CTL	[0 to 99999999 / 0 / 1]
001	B/W		

<b>8 606</b>	L: Coverage Counter	CTL	[0 to 99999999 / 0 / 1]
001	B/W		

<b>8 617</b>	SDK Apli Counter		
001 - 006	SDK-1 to -6		

<b>8 621</b>	Func Use Counter		
001 - 064	Function-001 to -064		

<b>8 631</b>	T:FAX TX PGS	CTL	[0 to 99999999 / 0 / 1]
	This SP counts by color mode the number of pages sent by fax to a telephone number.		
<b>8 633</b>	F:FAX TX PGS	CTL	[0 to 99999999 / 0 / 1]
	This SP counts by color mode the number of pages sent by fax to a telephone number.		
001	B/W		

- If a document has color and black-and-white pages mixed, the pages are counted separately as B/W or Color.
- At the present time, this feature is provided for the Fax application only so SP8631 and SP8633 are the same.
- The counts include error pages.
- If a document is sent to more than one destination with a Group transmission, the count is done for each destination.
- Polling transmissions are counted but polling RX are not.
- Relay, memory, and confidential mailbox transmissions and are counted for each destination.

<b>8 641</b>	T:IFAX TX PGS	CTL	[0 to 99999999 / 0 / 1]
	This SP counts by color mode the number of pages sent by fax to as fax images using I-Fax.		

8 643	F:IFAX TX PGS	CTL	[0 to 99999999 / 0 / 1]
	This SP counts by color mode the number of pages sent by Fax as fax images using I-Fax.		
001	B/W		

- If a document has color and black-and-white pages mixed, the pages are counted separately as B/W or Color.
- At the present time, this feature is provided for the Fax application only so SP8641 and SP8643 are the same.
- The counts include error pages.
- If a document is sent to more than one destination with a Group transmission, the count is done for each destination.
- Polling transmissions are counted but polling RX are not.
- Relay, memory, and confidential mailbox transmissions and are counted for each destination.

8 651	T:S-to-Email PGS	CTL	[0 to 99999999 / 0 / 1]
	This SP counts by color mode the total number of pages attached to an e-mail for both the Scan and document server applications.		
8 655	S:S-to-Email PGS	CTL	[0 to 99999999 / 0 / 1]
	This SP counts by color mode the total number of pages attached to an e-mail for the Scan application only.		
001	B/W		
002	Color		

#### ↓ Note

- The count for B/W and Color pages is done after the document is stored on the HDD. If the job is cancelled before it is stored, the pages are not counted.
- If Scan-to-Email is used to send a 10-page document to 5 addresses, the count is 10 (the pages are sent to the same SMTP server together).
- If Scan-to-PC is used to send a 10-page document to 5 folders, the count is 50 (the document is sent to each destination of the SMB/FTP server).
- Due to restrictions on some devices, if Scan-to-Email is used to send a 10-page document to a large number of destinations, the count may be divided and counted separately. For example, if a 10-page document is sent to 200 addresses, the count is 10 for the first 100 destinations and the count is also 10 for the second 100 destinations, for a total of 20.

8 661	T:Deliv PGS/Svr	CTL	[0 to 99999999 / 0 / 1]
	These SPs count by color mode the total number of pages sent to a Scan Router server by both Scan and LS applications.		
8 665	S:Deliv PGS/Svr	CTL	[0 to 99999999 / 0 / 1]
	These SPs count by color mode the total number of pages sent to a Scan Router server by the Scan application.		
001	B/W		
002	Color		

**Note**

- The B/W and Color counts are done after the document is stored on the HDD of the Scan Router server.
- If the job is canceled before storage on the Scan Router server finishes, the count is not done.
- The count is executed even if there is confirmation of the arrival at the Scan Router server.

8 671	T:Deliv PGS/PC	CTL	[0 to 99999999 / 0 / 1]
	These SPs count by color mode the total number of pages sent to a folder on a PC (Scan-to-PC) with the Scan and LS applications.		
8 675	S:Deliv PGS/PC	CTL	[0 to 99999999 / 0 / 1]
	These SPs count by color mode the total number of pages sent with Scan-to-PC with the Scan application.		
001	B/W		
002	Color		

**Note**

- Print jobs done with Web Image Monitor and Desk Top Binder are added to the count.
- If several documents are merged for sending, the number of pages stored is counted for the application that stored them.
- When several documents are sent by a Fax broadcast, the F: count is done for the number of pages sent to each destination.

<b>8 681</b>	T:PCFAX TXPGS	CTL	These SPs count the number of pages sent by PC Fax. These SPs are provided for the Fax application only, so the counts for SP8-681 and SP8-683 are the same.  [0 to 99999999 / 0 / 1]
<b>8 683</b>	F:PCFAX TXPGS	CTL	

- This counts pages sent from a PC using a PC fax application, from the PC through the copier to the destination.
- When sending the same message to more than one place using broadcasting, the pages are only counted once. (For example, a 10-page fax is sent to location A and location B. The counter goes up by 10, not 20.)

	TX PGS/Port	CTL	[0 to 99999999 / 0 / 1]
<b>8 701</b>	These SPs count the number of pages sent by the physical port used to send them. For example, if a 3-page original is sent to 4 destinations via ISDN G4, the count for ISDN (G3, G4) is 12.		
001	PSTN-1	-	
002	PSTN-2	-	
003	PSTN-3	-	
004	ISDN (G3,G4)	-	
005	Network	-	

<b>8 711</b>	T:Scan PGS/Comp	CTL	[0 to 99999999 / 0 / 1]
<b>8 715</b>	S:Scan PGS/Comp	CTL	[0 to 99999999 / 0 / 1]
	These SPs count the number of pages sent by each compression mode.		
-001	JPEG/JPEG2000	-	
-002	TIFF M/S (Multi/Single)	-	
-003	PDF	-	
-004	Other	-	
-005	PDF/Comp	-	
-006	PDF/A	-	

<b>8 721</b>	T:Deliv PGS/WSD	CTL	[0 to 99999999 / 0 / 1]
<b>8 725</b>	S:Deliv PGS/WSD		
<b>8 731</b>	T:Scan PGS/Media		
<b>8 735</b>	S:Scan PGS/Media		
-001	B/W	-	
-002	Color	-	

<b>8741</b>	RX PGS/Port	[0 to 99999999 / 0 / 1]
	These SPs count the number of pages received by the physical port used to receive them.	
001	PSTN-1	
002	PSTN-2	
003	PSTN-3	
004	ISDN (G3,G4)	
005	Network	

<b>8 771</b>	Dev Counter	CTL	[0 to 99999999 / 0 / 1]
	This SP counts the total number of developed images.		
001	Total		

<b>8 781</b>	Toner Bottle Info.	*BICU	[0 to 99999999 / 0 / 1]
	This SP counts the total number of developed images.		
001	BK		

8 801	Toner Remain	CTL	[0 to 100 / 0 / 1]
	<p>This SP displays the percent of toner remaining for each color. This SP allows the user to check the toner supply at any time.</p> <p><b>Note</b></p> <ul style="list-style-type: none"> <li>This precise method of measuring remaining toner supply (1% steps) is better than other machines on the market that can only measure in increments of 10 (10% steps).</li> </ul>		
001	K		

3

8 811	Eco Counter	CTL	
001	Eco Total	[0 to 99999999 / 0 / 1]	
004	Duplex		
005	Combine		
008	Duplex (%)		
009	Combine (%)		
010	Paper Cut (%)		
101	Eco Total: Last		
104	Duplex: Last		
105	Combine: Last		
108	Duplex(%):Last		
109	Combine(%):Last		
110	Paper Cut(%):Last		

8 851	Cvr Cnt:0-10%	*BICU	[0 to 99999999 / 0 / 1]
	<p>These SPs display the number of scanned sheets on which the coverage of each color is from 0% to 10%.</p>		
011	0-2%:Bk		
021	3-4%: Bk		

031	5-7%: Bk
041	8-10%: Bk

<b>8 861</b>	Cvr Cnt: 11-20%	*BICU	[0 to 99999999/ 0 / 1]
	These SPs display the number of scanned sheets on which the coverage of each color is from 11% to 20%.		
001	Bk		

<b>8 871</b>	Cvr Cnt: 21-30%	*BICU	[0 to 99999999/ 0 / 1]
	These SPs display the number of scanned sheets on which the coverage of each color is from 21% to 30%.		
001	Bk		

<b>8 881</b>	Cvr Cnt: 31%-	*BICU	[0 to 99999999/ 0 / 1]
	These SPs display the number of scanned sheets on which the coverage of each color is 31% or higher.		
001	Bk		

<b>8 891</b>	Page/Toner Bottle	*BICU	[0 to 99999999/ 0 / 1]
	This SP displays the number of sheets output by the scan application.		
001	Bk		

<b>8 901</b>	Page/Toner k Prev1	*BICU	[0 to 99999999/ 0 / 1]
	This SP displays the number of sheets output by the scan application with the previously replaced units.		
001	Bk		

<b>8 911</b>	Page/Toner k Prev2	*BICU	[0 to 99999999/ 0 / 1]
	This SP displays the number of sheets output by the scan application with the unit replaced before the previously replaced unit (two steps back from the current unit).		



001	Bk
-----	----

<b>8 921</b>	Cvr Cnt/Total	*BICU	
001	Coverage(%): BK	[0 to 2147483647 / 0 / 1]	These SPs display the total coverage percentage of sheets output by the machine.
011	Coverage/P: Bk	[0 to 99999999 / 0 / 1]	These SPs display the total coverage pages output by the machine.

	Machine Status	CTL	[0 to 99999999 / 0 / 1]
<b>8 941</b>	These SPs count the amount of time the machine spends in each operation mode. These SPs are useful for customers who need to investigate machine operation for improvement of their compliance with ISO Standards.		
001	Operation Time	Engine operation time. Does not include time while controller is saving data to HDD (while engine is not operating).	
002	Standby Time	Engine not operating. Includes time while controller saves data to HDD. Does not include time spent in Energy Save, Low Power, or Off modes.	
003	Energy Save Time	Includes time while the machine is performing background printing.	
004	Low Power Time	Includes time in Energy Save mode with Engine on. Includes time while machine is performing background printing.	
005	Off Mode Time	Includes time while machine is performing background printing. Does not include time machine remains powered off with the power switches.	
006	SC	Total down time due to SC errors.	
007	PrtJam	Total down time due to paper jams during printing.	
008	OrgJam	Total down time due to original jams during scanning.	
009	Supply PM Unit End	Total down time due to toner end.	

<b>8 961</b>	Electricity Status	CTL	[0 to 99999999 / 0 / 1]
001	Ctrl Standby Time		
002	STR Time		
003	Main Power Off Time		
004	Reading and Printing Time		
005	Printing Time		
006	Reading Time		
007	Eng Waiting Time		
008	Low Power State Time		
009	Silent State Time		

<b>8 999</b>	Admin. Counter List	CTL	[0 to 99999999 / 0 / 1]
	Displays the user setting counter for administrator.		
001	Total	-	
003	Copy: BW	-	
007	Printer: BW	-	
010	FaxP: BW	-	
013	Duplex	-	
023	Copy: BW(%)	-	
027	Printer: BW(%)	-	
030	Fax Print: BW(%)	-	
101	SedTit: FC	-	
102	SendTit: BW	-	
103	FaxSend	-	
104	FaxSend: BW	-	
105	FaxSend: BW	-	

## SP-9XXX (Etc)

9001	Right Door Detect	[0 to 1 / 0 ]
001	0: NOT SET 1: SET	Selects the right door open/close SW ON/OFF

9901	Fusing Temperature Setting	
010	Heater Force OFF Timing	[0 to 99 / 17 / 1 mm/step ]
		Sets the forced the heater OFF time after paper-through.
011	Thresh: Warming-up Low Temperature	[0 to 50 / 16 / 1 deg/step ]
		Sets the basic temperature for determination of the condition on machine-startup.
012	Disable Change Time	[0 to 999 / 5 / 1 sec/step ]
		Unused. DO NOT change the setting.
013	Total Count Clear Time	[0 to 999 / 15 / 1 sec/step ]
		When the wait time is over this SP's time, the following three items are reset: <ul style="list-style-type: none"> <li>• Control cycle on printing,</li> <li>• Repeat-temperature correction,</li> <li>• CPM-down counter</li> </ul>
014	Print Prepare Time	[0 to 999 / 60 / 1 sec/step ]
		Sets the print preparation time.

9902	Target Temp revise (Temp)	
	Sets the fusing additional temperature for the temperature correction. (Pattern A)	
001	Added Temp: T1	[0 to 50 / 5 / 1 deg/step ]
002	Added Temp: T2	[0 to 50 / 15 / 1 deg/step ]
003	Added Temp: T3	[0 to 50 / 10 / 1 deg/step ]
004	Added Temp: T4	[0 to 50 / 5 / 1 deg/step ]

005	Added Temp: T5	[0 to 50 / 1 / 1 deg/step ]
006	Added Temp: T6	[0 to 50 / 5 / 1 deg/step ]
007	Added Temp: T7	[0 to 50 / 15 / 1 deg/step ]
008	Added Temp: T8	[0 to 50 / 10 / 1 deg/step ]
009	Added Temp: T9	[0 to 50 / 5 / 1 deg/step ]
010	Added Temp: T10	[0 to 50 / 1 / 1 deg/step ]
011	Added Temp: T11	[0 to 50 / 5 / 1 deg/step ]
012	Added Temp: T12	[0 to 50 / 15 / 1 deg/step ]
013	Added Temp: T13	[0 to 50 / 10 / 1 deg/step ]
014	Added Temp: T14	[0 to 50 / 5 / 1 deg/step ]
015	Added Temp: T15	[0 to 50 / 1 / 1 deg/step ]
016	Added Temp: T16	[0 to 50 / 5 / 1 deg/step ]
017	Added Temp: T17	[0 to 50 / 15 / 1 deg/step ]
018	Added Temp: T18	[0 to 50 / 10 / 1 deg/step ]
019	Added Temp: T19	[0 to 50 / 5 / 1 deg/step ]
020	Added Temp: T20	[0 to 50 / 1 / 1 deg/step ]
021	Added Temp: T21	[0 to 50 / 45 / 1 deg/step ]
022	Added Temp: T22	[0 to 50 / 35 / 1 deg/step ]
023	Added Temp: T23	[0 to 50 / 22 / 1 deg/step ]
024	Added Temp: T24	[0 to 50 / 5 / 1 deg/step ]
025	Added Temp: T25	[0 to 50 / 1 / 1 deg/step ]
026	Added Temp: T26	[0 to 50 / 45 / 1 deg/step ]
027	Added Temp: T27	[0 to 50 / 35 / 1 deg/step ]
028	Added Temp: T28	[0 to 50 / 22 / 1 deg/step ]
029	Added Temp: T29	[0 to 50 / 5 / 1 deg/step ]
030	Added Temp: T30	[0 to 50 / 1 / 1 deg/step ]

031	Added Temp: T31	[0 to 50 / <b>40</b> / 1 deg/step ]
032	Added Temp: T32	[0 to 50 / <b>20</b> / 1 deg/step ]
033	Added Temp: T33	[0 to 50 / <b>17</b> / 1 deg/step ]
034	Added Temp: T34	[0 to 50 / <b>5</b> / 1 deg/step ]
035	Added Temp: T35	[0 to 50 / <b>1</b> / 1 deg/step ]
036	Added Temp: T36	[0 to 50 / <b>35</b> / 1 deg/step ]
037	Added Temp: T37	[0 to 50 / <b>20</b> / 1 deg/step ]
038	Added Temp: T38	[0 to 50 / <b>16</b> / 1 deg/step ]
039	Added Temp: T39	[0 to 50 / <b>5</b> / 1 deg/step ]
040	Added Temp: T40	[0 to 50 / <b>1</b> / 1 deg/step ]

<b>9903</b>	Target Temp revise (Time)	
	Sets the fusing additional time for the temperature correction. (Pattern A)	
001	Added Time: S1	[0 to 999 / <b>10</b> / 1 sec/step ]
002	Added Time: S2	[0 to 999 / <b>10</b> / 1 sec/step ]
003	Added Time: S3	[0 to 999 / <b>15</b> / 1 sec/step ]
004	Added Time: S4	[0 to 999 / <b>10</b> / 1 sec/step ]
005	Added Time: S5	[0 to 999 / <b>10</b> / 1 sec/step ]
006	Added Time: S6	[0 to 999 / <b>15</b> / 1 sec/step ]
007	Added Time: S7	[0 to 999 / <b>12</b> / 1 sec/step ]
008	Added Time: S8	[0 to 999 / <b>10</b> / 1 sec/step ]
009	Added Time: S9	[0 to 999 / <b>15</b> / 1 sec/step ]
010	Added Time: S10	[0 to 999 / <b>15</b> / 1 sec/step ]
011	Added Time: S11	[0 to 999 / <b>10</b> / 1 sec/step ]
012	Added Time: S12	[0 to 999 / <b>15</b> / 1 sec/step ]
013	Added Time: S13	[0 to 999 / <b>10</b> / 1 sec/step ]

014	Added Time: S14	[0 to 999 / 10 / 1 sec/step ]
015	Added Time: S15	[0 to 999 / 15 / 1 sec/step ]
016	Added Time: S16	[0 to 999 / 10 / 1 sec/step ]
017	Added Time: S17	[0 to 999 / 10 / 1 sec/step ]
018	Added Time: S18	[0 to 999 / 15 / 1 sec/step ]
019	Added Time: S19	[0 to 999 / 12 / 1 sec/step ]
020	Added Time: S20	[0 to 999 / 10 / 1 sec/step ]
021	Added Time: S21	[0 to 999 / 15 / 1 sec/step ]
022	Added Time: S22	[0 to 999 / 15 / 1 sec/step ]
023	Added Time: S23	[0 to 999 / 10 / 1 sec/step ]
024	Added Time: S24	[0 to 999 / 15 / 1 sec/step ]

<b>9915</b>	Fuser Reload Setting	[0 to 1 / 0 / 1 sheet/step ]
001	<b>0:</b> Normal / <b>1:</b> Force Time Sets the way of fusing reload.	

<b>9930</b>	Toner control NV Data	[0 to 65535 / 0 / 1 sheet/step ]
008	This SP's count is used as the flag of toner bottle replacement notice. When the value becomes more than 1000, the notice will occur and the value will be cleared.	

<b>9946</b>	Fusing Jam Exist	[0 to 1 / 0 / 1/step ]
001	<b>0:</b> Not fusing jam existing / <b>1:</b> Fusing jam existing This SP tells whether a fusing jam exists or not.	

<b>9947</b>	Fuser SC	
001	Number	[0 to 999 / 0 / 1/step ]
002	Detail	[0 to 99 / 0 / 1/step ]

<b>9948</b>	Fusing Jam Detection	[0 to 3 / 0 / 1/step ]
001	<p>Fusing jam succession occurring counter.</p> <p>A fusing jam is counted as +1. When paper ejection process is done normally, the counter will be reset.</p> <p>SC will occur when the counter become 3.</p>	

<b>9960</b>	Soft Start: Start	
	Soft start parameter on system start-up	
001	First duty	[0 to 100 / 15 / 0.01 %/step ]
002	Duty step	[0 to 100 / 5 / 0.01 %/step ]
003	Last duty	[0 to 100 / 50 / 0.01 %/step ]
004	Repeat count	[0 to 255 / 5 / 1/step ]

<b>9961</b>	Soft Start: Print	
	Soft start parameter on paper pass process	
001	First duty	[0 to 100 / 30 / 0.01 %/step ]
002	Duty step	[0 to 100 / 5 / 0.01 %/step ]
003	Last duty	[0 to 100 / 65 / 0.01 %/step ]
004	Repeat count	[0 to 255 / 4 / 1/step ]

<b>9962</b>	Soft Stop: Print	
	Soft stop parameter on paper pass process	
001	First duty	[0 to 100 / 60 / 0.01 %/step ]
002	Duty step	[0 to 100 / 10 / 0.01 %/step ]
003	Last duty	[0 to 100 / 30 / 0.01 %/step ]
004	Repeat count	[0 to 255 / 2 / 1/step ]

<b>9963</b>	Soft Start: Wait	
	Soft start parameter on wait time	
001	First duty	[0 to 100 / <b>15</b> / 0.01 %/step ]
002	Duty step	[0 to 100 / <b>5</b> / 0.01 %/step ]
003	Last duty	[0 to 100 / <b>50</b> / 0.01 %/step ]
004	Repeat count	[0 to 255 / <b>4</b> / 1/step ]

<b>9964</b>	Soft Stop: Wait	
	Soft stop parameter on wait time	
001	First duty	[0 to 100 / <b>60</b> / 0.01 %/step ]
002	Duty step	[0 to 100 / <b>10</b> / 0.01 %/step ]
003	Last duty	[0 to 100 / <b>30</b> / 0.01 %/step ]
004	Repeat count	[0 to 255 / <b>2</b> / 1/step ]

<b>9966</b>	Soft Start: Print	
	Soft start parameter on paper pass process	
001	First duty	[0 to 100 / <b>30</b> / 0.01 %/step ]
002	Duty step	[0 to 100 / <b>5</b> / 0.01 %/step ]
003	Last duty	[0 to 100 / <b>65</b> / 0.01 %/step ]
004	Repeat count	[0 to 255 / <b>4</b> / 1/step ]

<b>9967</b>	Soft Stop: Print	
	Soft stop parameter on paper pass process	
001	First duty	[0 to 100 / <b>60</b> / 0.01 %/step ]
002	Duty step	[0 to 100 / <b>10</b> / 0.01 %/step ]
003	Last duty	[0 to 100 / <b>30</b> / 0.01 %/step ]
004	Repeat count	[0 to 255 / <b>2</b> / 1/step ]



<b>9968</b>	Soft Start: Wait	
	Soft start parameter on wait time	
001	First duty	[0 to 100 / <b>15</b> / 0.01 %/step ]
002	Duty step	[0 to 100 / <b>5</b> / 0.01 %/step ]
003	Last duty	[0 to 100 / <b>50</b> / 0.01 %/step ]
004	Repeat count	[0 to 255 / <b>4</b> / 1/step ]

<b>9969</b>	Soft Stop: Wait	
	Soft stop parameter on wait time	
001	First duty	[0 to 100 / <b>60</b> / 0.01 %/step ]
002	Duty step	[0 to 100 / <b>10</b> / 0.01 %/step ]
003	Last duty	[0 to 100 / <b>30</b> / 0.01 %/step ]
004	Repeat count	[0 to 255 / <b>2</b> / 1/step ]

## Input Check (SP5-803)

### Conducting Input Check

1. Select SP5-803.
2. Select the number (see the table below) corresponding to the component.
3. Select "Start" The copy mode is activated.
4. The sign "01H" or "00H" is displayed (see the table below).

### Input Check Table

Num.	Sensor/Switch	1h (00000001)	0h (00000000)
009	Tray 1: Paper End Sensor	Paper detected	Not detected
016	By-pass: Paper End Sensor	Paper detected	Not detected
019	Paper Exit Sensor	Paper detected	Not detected

022	Registration Sensor	Paper detected	Not detected
023	Interchange Sensor	Paper detected	Not detected
027	Front Safety SW – 24V	Closed	Open
031	CTL Fan Lock	Locked	Not locked
033	Fan Lock	Locked	Not locked
035	Main Motor Lock	Normal	Abnormal
037	PCU Set	Set	Not Set
039	Key Card Set	Set	Not Set
040	Mechanical Counter Set	Set	Not Set
041	Key Counter Set	See the table below	
042	BCU Version	See the table below	
051	Bypass Tray Check	Set	Not Set
053	Cover Right Check	Open	Closed
087	Bank1 SNS	Paper detected	Not detected
088	Bank2 SNS	Paper detected	Not detected
092	Bank1 PE	Paper detected	Not detected
093	Bank2 PE	Paper detected	Not detected
094	Bank1 Cover	Open	Closed
095	Bank2 Cover	Open	Closed
200	Scanner HP Sensor	In Home Position	Out of Home Position
201	Platen Cover Sensor	Open	Closed

\* The items using more than 2 bits

Num.	Sensor/Switch	Bit2	Bit1	Bit0
041	Key Counter Set	-	Set Detected 1	Set Detected 2

Num.	Sensor/Switch	Bit2	Bit1	Bit0
042	BCU Version	Ver.1	Ver.2	Ver.3

## Output Check (SP5-804)

### Conducting Output Check

#### CAUTION

- To prevent mechanical or electrical damage, do not keep an electrical component on for a long time.
1. Select SP5-804.
  2. Select the number (see the table below) corresponding to the component.
  3. Select "ON."
  4. To stop the operation, select "OFF."

### Output Check Table

Num.	Component
001	Main Motor: CW: High
003	Main Motor: CCW: High
020	Toner Bottle Motor
025	Exhaust Fan Motor: High
026	Exhaust Fan Motor: Low
028	CTL Fan
032	Registration CL
033	1st Paper Feed CL
040	Fusing SOL
041	Dehumidification Heater
042	P.P.: Image Transfer: -

Num.	Component
043	P.P.: Image Transfer: +
044	P.P.: Separation Voltage
045	P.P.: Development
046	P.P.: Charge
047	P Sensor
048	Anti-static LED
049	Polygon Motor
051	LD
052	Duplex Motor CW
053	Duplex Motor CCW
055	Bypass Feed Clutch
163	Bank1 Motor
164	Bank2 Motor
169	Bank1 Clutch
170	Bank2 Clutch
202	Scanner Lamp: Color 600
203	Scanner Lamp: Color 1200
204	Scanner Lamp: Bk

When checking Fan Motor High (005) or Fan Motor Low (006) note the following:

- These motors may not respond when the fusing temperature is high.
- Selecting "ON" checks that one of these motors normally operates. Selecting "OFF" turns off the motor that you have started by selecting "ON." However, this does not guarantee that the motor normally stops during normal operation.

## Printer Service Mode (Print SP Tables)

### Service Mode Table

1001	Bit Switch			
001	Bit Switch 1		0	1
	bit 0	DFU	-	-
	bit 1	DFU	-	-
	bit 2	DFU	-	-
	bit 3	<b>No I/O Timeout</b>	0: Disable	1: Enable
		Enables/Disables MFP I/O Timeouts. Enabled: The MFP I/O Timeout setting will have no affect. I/O Timeouts will never occur.		
	bit 4	<b>SD Card Save Mode</b>	0: Disable	1: Enable
		Enabled: Print jobs will be saved to an SD Card in the GW SD slot (  "Card Save Function" in the service tables of Field Service Manual).		
	bit 5	DFU	-	-
	bit 6	DFU	-	-
bit 7	<b>[RPCS,PCL]: Printable area frame border</b>	0: Disable	1: Enable	
	Enable: The machine prints all RPCS and PCL jobs with a border on the edges of the printable area.			
1001	Bit Switch			

002	Bit Switch 2		0	1
	bit 0	DFU	-	-
	bit 1	DFU	-	-
	bit 2	Applying a collate Type	Shift Collate	Normal Collate
		<p>A collation type (shift or normal) will be applied to all jobs that do not already have a 'Collate Type' configured.</p> <p><b>Note</b></p> <ul style="list-style-type: none"> <li>If #5-0 is enabled, this Bit Switch has no effect.</li> </ul>		
	bit 3	<b>[PCL5e/c,PS]: PDL Auto Switching</b>	0: Enable	1: Disable
		<p>Disabled: The MFPs ability to change the PDL processor mid-job.</p> <p>Some host systems submit jobs that contain both PS and PCL5e/c. If Auto PDL switching is disabled, these jobs will not be printed properly.</p>		
	bit 4	DFU	-	-
	bit 5	DFU	-	-
bit 6	DFU	-	-	
bit 7	DFU	-	-	
1001	Bit Switch			

003	Bit Switch 3		0	1
	bit 0	DFU	-	-
	bit 1	DFU	-	-
	bit 2	<b>[PCL5e/c]: Legacy HP compatibility</b>	0: Disable	1: Enable
	Enabled: Uses the same left margin as older HP models such as HP4000/HP8000. In other words, the left margin defined in the job (usually "<ESC>*r0A") will be changed to "<ESC>*r1A"			
	bit 3	DFU	-	-
	bit 4	DFU	-	-
	bit 5	DFU	-	-
	bit 6	DFU	-	-
	bit 7	DFU	-	-

<b>1001</b>	<b>Bit Switch</b>		
004	Bit Switch 4 DFU	-	-

<b>1001</b>	<b>Bit Switch</b>		
-------------	-------------------	--	--

005	Bit Switch 5		0	1
	bit 0	DFU	-	-
	bit 1	Multiple copies if a paper size or type mismatch occurs	Disabled (single copy)	Enabled (multiple)
		If a paper size or type mismatch occurs during the printing of multiple copies, only a single copy is output by default. Using this BitSw, the device can be configured to print all copies even if a paper mismatch occurs.		
	bit 2	DFU	-	-
	bit 3	<b>[PS] PS Criteria</b>	Pattern3	Pattern1
		Change the number of PS criterion used by the PS interpreter to determine whether a job is PS data or not. Pattern3: includes most PS commands. Pattern1: A small number of PS tags and headers		
	bit 4	<b>Increase max number of the stored jobs to 1000 jobs.</b>	Disable (100)	Enable (1000)
		Enabled: Changes the maximum number of jobs that can be stored on the HDD via Job Type settings to 1000. The default is 100.		
	bit 5	DFU	-	-
bit 6	<b>Method for determining the image rotation for the edge to bring on</b>	Disable	Enable	
	Enabled: The image rotation will be performed as they were in the specifications of older models for the binding of pages of mixed orientation jobs. The old models are below: -PCL-: Pre-04A models			
bit 7	<b>Letterhead mode printing</b>	Disable	Enable (Duplex)	
	Routes all pages through the duplex unit. If this is disabled, simplex pages or the last page of an odd-paged duplex job, are not routed through the duplex unit. This could result in problems with letterhead / pre-printed pages.			



<b>1001</b>	<b>Bit Switch</b>		
006	Bit Switch 6 DFU	-	-

<b>1001</b>	<b>Bit Switch</b>		
007	Bit Switch 7 DFU	-	-

<b>1001</b>	<b>Bit Switch</b>			
008	Bit Switch 8		0	1
	bit 0	DFU	-	-
	bit 1	DFU	-	-
	bit 2	DFU	-	-
	bit 3	DFU	-	-
	bit 4	DFU	-	-
	bit 5	DFU	-	-
	bit 6	DFU	-	-
	bit 7	DFU	-	-

<b>1003</b>	3	Clear Setting Delete Program	-
<b>1004</b>	1	Print Summary Print Printer Summary	Prints the service summary sheet. (An error log is printed in addition to the configuration page)
<b>1005</b>	2	Display Version	Displays the version of the controller firmware.
<b>1006</b>	1	Sample/Locked print	[0: Link with Doc. srv, 1: Enable] Enables and disables the document server. When you select "0" the document server is enabled or disables in accordance with copy service mode SP5-967. When you select "1" the document server is enabled regardless of service mode SP5-967.

1110	2	Media Print Device Setting	[0: Disabled 1: Enabled] Sets I/F (USB/SD device) Enabled/Disabled on the media print function.
------	---	----------------------------	--

### SP Modes Related to Printer Controller

The following SP modes are located in the system SP mode. Refer to section 5.1 of the main unit service manual.

3

SP No.	Description	Function and Setting
5801 -001	Memory All Clear	Resets data for process control and all software counters, and returns all modes and adjustments to their defaults values.  Section "Memory Clear" in this chapter for details.
5907	Plug & Play Maker/ Model Name	Selects the brand name and the production name for Windows Plug & Play. This information is stored in NVRAM.
7832	Self-Diagnose Result Display	Displays the controller self-diagnostic result.

### Scanner Program Mode Table (Scanner SP Tables)

#### Service Table Key

Notation	What it means
[range / <b>default</b> / step]	Example: [-9 to +9 / <b>+3.0</b> / 0.1 mm step]. The setting can be adjusted in the range $\pm 9$ , value reset to +3.0 after an NVRAM reset, and the value can be changed in 0.1 mm steps with each key press.
<i>italics</i>	Comments added for your reference.
*	This value is stored in NVRAM. After a RAM reset, the default value (factory setting) is restored.
DFU	Denotes "Design or Factory Use". Do not change this value.

SP1	Mode Number		Function and [Setting]
1001*	5	Scan NV Version	Displays the scanner NV version. This shows as following: Function name _ Model name _ Version
1005*	1	Erase Margin (Remote Scan) Range from 0 to 5 mm	Creates an erase margin for all edges of the scanned image. The margin color (Black or White) depends on color-tone and invert settings. [0 to 5 / <b>0mm</b> / 1mm step]
1009*	1	Remote Scan disable	Enables or disables the network TWAIN scanner function. [0: Enable, 1: Disable]
1010*	1	Non Display ClearLight PDF	Sets the clear light PDF display ON/OFF [0: OFF 1: ON]
1011*	1	Org Count Disp	Sets the original counter display ON/OFF [0: OFF 1: ON]
1012	1	User Info Release	Clears or does not clear user information after a job. [0 or 1 / 1 / -] 0: Not clear, 1: Clear
1013	2	Scan to Media Device Setting	Sets "Scan To Multi Media" function ON/OFF. [0 or 1 / 1 / -] 0: OFF, 1: ON

SP	Number/Name	Function and [Setting]
2	Compression level (grayscale)	
0	These SP codes set the compression ratio for the grayscale or full color processing mode that can be selected with the notch settings on the operation panel.	
1	Range: 5 (lowest ratio) ↔ 95 (highest ratio)	
Comp 1: 5-95 (Middle l- Qual)	[5 to 95 / <b>20</b> / 1/step]	

SP	Number/Name	Function and [Setting]
Comp2: 5-95 2 (High I- Qual)	[5 to 95 / <b>40</b> / 1/step]	
Comp3: 5-95 3 (Low I- Qual)	[5 to 95 / <b>65</b> / 1/step]	
Comp4: 5-95 4 (Highest I- Qual)	[5 to 95 / <b>80</b> / 1/step]	
Comp5: 5-95 5 (Lowest I- Qual)	[5 to 95 / <b>95</b> / 1/step]	

SP	Number/Name	Function and [Setting]
<b>2024</b>	Compression ratio of ClearLightPDF	
	These SP codes set the compression ratio for the clear light PDF processing mode. Range: 5 (lowest ratio) ↔ 95 (highest ratio)	
1	Compression Ratio (Normal)	[5 to 95 / <b>25</b> / 1/step]
2	Compression Ratio (High)	[5 to 95 / <b>20</b> / 1/step]

SP	Number/Name	Function and [Setting]
<b>2025</b>	Compression ratio of ClearLightPDF JPEG2000	
	These SP codes set the compression ratio for the clear light PDF processing mode (For JPEG 2000). Range: 5 (lowest ratio) ↔ 95 (highest ratio)	
1	Compression Ratio (Normal) JPEG2000	[5 to 95 / <b>25</b> / 1/step]
2	Compression Ratio (High) JPEG2000	[5 to 95 / <b>20</b> / 1/step]

For the settings of the image quality, see the copier SP-mode table.



# 4. Appendix: Fax Troubleshooting Guide

## Fax Error Codes

- If an error code occurs, retry the communication. If the same problem occurs, try to fix the problem as suggested below. Note that some error codes appear only in the error code display and on the service report.

Code	Meaning	Suggested Cause/Action
0-00	DIS/NSF not detected within 40 s of Start being pressed	<ul style="list-style-type: none"> <li>• Check the line connection.</li> <li>• The machine at the other end may be incompatible.</li> <li>• Replace the NCU or FCU.</li> <li>• Check for DIS/NSF with an oscilloscope.</li> <li>• If the rx signal is weak, there may be a bad line.</li> </ul>
0-01	DCN received unexpectedly	<ul style="list-style-type: none"> <li>• The other party is out of paper or has a jammed printer.</li> <li>• The other party pressed Stop during communication.</li> </ul>
0-03	Incompatible modem at the other end	The other terminal is incompatible.
0-04	CFR or FTT not received after modem training	<ul style="list-style-type: none"> <li>• Check the line connection.</li> <li>• Try changing the tx level and/or cable equalizer settings.</li> <li>• Replace the FCU.</li> <li>• The other terminal may be faulty; try sending to another machine.</li> <li>• If the rx signal is weak or defective, there may be a bad line.</li> </ul> <p><b>Cross reference</b></p> <p>Tx level - NCU Parameter 01 (PSTN)</p> <p>Cable equalizer - G3 Switch 07 (PSTN)</p> <p>Dedicated Tx parameters in Service Program Mode</p>

Code	Meaning	Suggested Cause/Action
0-05	Modem training fails even G3 shifts down to 2400 bps.	<ul style="list-style-type: none"> <li>• Check the line connection.</li> <li>• Try adjusting the tx level and/or cable equalizer.</li> <li>• Replace the FCU.</li> <li>• Check for line problems.</li> </ul> <p><b>Cross reference</b> See error code 0-04.</p>
0-06	The other terminal did not reply to DCS	<ul style="list-style-type: none"> <li>• Check the line connection.</li> <li>• Try adjusting the tx level and/or cable equalizer settings.</li> <li>• Replace the NCU or FCU.</li> <li>• The other end may be defective or incompatible; try sending to another machine.</li> <li>• Check for line problems.</li> </ul> <p><b>Cross reference</b> See error code 0-04.</p>
0-07	No post-message response from the other end after a page was sent	<ul style="list-style-type: none"> <li>• Check the line connection.</li> <li>• Replace the NCU or FCU.</li> <li>• The other end may have jammed or run out of paper.</li> <li>• The other end user may have disconnected the call.</li> <li>• Check for a bad line.</li> <li>• The other end may be defective; try sending to another machine.</li> </ul>



Code	Meaning	Suggested Cause/Action
0-08	The other end sent RTN or PIN after receiving a page, because there were too many errors	<ul style="list-style-type: none"> <li>• Check the line connection.</li> <li>• Replace the NCU or FCU.</li> <li>• The other end may have jammed, or run out of paper or memory space.</li> <li>• Try adjusting the tx level and/or cable equalizer settings.</li> <li>• The other end may have a defective modem/NCU/FCU; try sending to another machine.</li> <li>• Check for line problems and noise.</li> </ul> <p><b>Cross reference</b></p> <ul style="list-style-type: none"> <li>• Tx level - NCU Parameter 01 (PSTN)</li> <li>• Cable equalizer - G3 Switch 07 (PSTN)</li> <li>• Dedicated Tx parameters in Service Program Mode</li> </ul>
0-14	Non-standard post message response code received	<ul style="list-style-type: none"> <li>• Incompatible or defective remote terminal; try sending to another machine.</li> <li>• Noisy line: resend.</li> <li>• Try adjusting the tx level and/or cable equalizer settings.</li> <li>• Replace the NCU or FCU.</li> </ul> <p><b>Cross reference</b></p> <p>See error code 0-08.</p>
0-15	The other terminal is not capable of specific functions.	<p>The other terminal is not capable of accepting the following functions, or the other terminal's memory is full.</p> <ul style="list-style-type: none"> <li>• Confidential rx</li> <li>• Transfer function</li> <li>• SEP/SUB/PWD/SID</li> </ul>

Code	Meaning	Suggested Cause/Action
0-16	CFR or FTT not detected after modem training in confidential or transfer mode	<ul style="list-style-type: none"> <li>• Check the line connection.</li> <li>• Replace the NCU or FCU.</li> <li>• Try adjusting the tx level and/or cable equalizer settings.</li> <li>• The other end may have disconnected, or it may be defective; try calling another machine.</li> <li>• If the rx signal level is too low, there may be a line problem.</li> </ul> <p><b>Cross reference</b> See error code 0-08.</p>
0-20	Facsimile data not received within 6 s of retraining	<ul style="list-style-type: none"> <li>• Check the line connection.</li> <li>• Replace the NCU or FCU.</li> <li>• Check for line problems.</li> <li>• Try calling another fax machine.</li> <li>• Try adjusting the reconstruction time for the first line and/or rx cable equalizer setting.</li> </ul> <p><b>Cross reference</b> Reconstruction time - G3 Switch 0A, bit 6 Rx cable equalizer - G3 Switch 07 (PSTN)</p>
0-21	EOL signal (end-of-line) from the other end not received within 5 s of the previous EOL signal	<ul style="list-style-type: none"> <li>• Check the connections between the FCU, NCU, &amp; line.</li> <li>• Check for line noise or other line problems.</li> <li>• Replace the NCU or FCU.</li> <li>• The remote machine may be defective or may have disconnected.</li> </ul> <p><b>Cross reference</b> Maximum interval between EOLs and between ECM frames - G3 Bit Switch 0A, bit 4</p>

Code	Meaning	Suggested Cause/Action
0-22	The signal from the other end was interrupted for more than the acceptable modem carrier drop time (default: 200 ms)	<ul style="list-style-type: none"> <li>• Check the line connection.</li> <li>• Replace the NCU or FCU.</li> <li>• Defective remote terminal.</li> <li>• Check for line noise or other line problems.</li> <li>• Try adjusting the acceptable modem carrier drop time.</li> </ul> <p><b>Cross reference</b> Acceptable modem carrier drop time - G3 Switch 0A, bits 0 and 1</p>
0-23	Too many errors during reception	<ul style="list-style-type: none"> <li>• Check the line connection.</li> <li>• Replace the NCU or FCU.</li> <li>• Defective remote terminal.</li> <li>• Check for line noise or other line problems.</li> <li>• Try asking the other end to adjust their tx level.</li> <li>• Try adjusting the rx cable equalizer setting and/or rx error criteria.</li> </ul> <p><b>Cross reference</b> Rx cable equalizer - G3 Switch 07 (PSTN) Rx error criteria - Communication Switch 02, bits 0 and 1</p>
0-30	The other terminal did not reply to NSS(A) in AI short protocol mode	<ul style="list-style-type: none"> <li>• Check the line connection.</li> <li>• Try adjusting the tx level and/or cable equalizer settings.</li> <li>• The other terminal may not be compatible.</li> </ul> <p><b>Cross reference</b> Dedicated tx parameters - Section 4</p>
0-32	The other terminal sent a DCS, which contained functions that the receiving machine cannot handle.	<ul style="list-style-type: none"> <li>• Check the protocol dump list.</li> <li>• Ask the other party to contact the manufacturer.</li> </ul>
0-33	The data reception (not ECM) is not completed within 10 minutes.	<ul style="list-style-type: none"> <li>• Check the line connection.</li> <li>• The other terminal may have a defective modem/NCU/FCU.</li> </ul>

Code	Meaning	Suggested Cause/Action
0-52	Polarity changed during communication	<ul style="list-style-type: none"> <li>• Check the line connection. Retry communication.</li> </ul>
0-55	FCU does not detect the SG3.	<ul style="list-style-type: none"> <li>• FCU firmware or board defective.</li> <li>• SG3 firmware or board defective.</li> </ul>
0-56	The stored message data exceeds the capacity of the mailbox in the SG3.	<ul style="list-style-type: none"> <li>• SG3 firmware or board defective.</li> </ul>
0-70	The communication mode specified in CM/JM was not available (V.8 calling and called terminal)	<ul style="list-style-type: none"> <li>• The other terminal did not have a compatible communication mode (e.g., the other terminal was a V.34 data modem and not a fax modem.)</li> <li>• A polling tx file was not ready at the other terminal when polling rx was initiated from the calling terminal.</li> </ul>
0-74	The calling terminal fell back to T.30 mode, because it could not detect ANSam after sending CI.	<ul style="list-style-type: none"> <li>• The calling terminal could not detect ANSam due to noise, etc.</li> <li>• ANSam was too short to detect.</li> <li>• Check the line connection and condition.</li> <li>• Try making a call to another V.8/V.34 fax.</li> </ul>
0-75	The called terminal fell back to T.30 mode, because it could not detect a CM in response to ANSam (ANSam timeout).	<ul style="list-style-type: none"> <li>• The terminal could not detect ANSam.</li> <li>• Check the line connection and condition.</li> <li>• Try receiving a call from another V.8/V.34 fax.</li> </ul>
0-76	The calling terminal fell back to T.30 mode, because it could not detect a JM in response to CM (CM timeout).	<ul style="list-style-type: none"> <li>• The called terminal could not detect a CM due to noise, etc.</li> <li>• Check the line connection and condition.</li> <li>• Try making a call to another V.8/V.34 fax.</li> </ul>
0-77	The called terminal fell back to T.30 mode, because it could not detect a CJ in response to JM (JM timeout).	<ul style="list-style-type: none"> <li>• The calling terminal could not detect a JM due to noise, etc.</li> <li>• A network that has narrow bandwidth cannot pass JM to the other end.</li> <li>• Check the line connection and condition.</li> <li>• Try receiving a call from another V.8/V.34 fax.</li> </ul>

Code	Meaning	Suggested Cause/Action
0-79	The called terminal detected CI while waiting for a V.21 signal.	<ul style="list-style-type: none"> <li>• Check for line noise or other line problems.</li> <li>• If this error occurs, the called terminal falls back to T.30 mode.</li> </ul>
0-80	The line was disconnected due to a timeout in V.34 phase 2 – line probing.	<ul style="list-style-type: none"> <li>• The guard timer expired while starting these phases. Serious noise, narrow bandwidth, or low signal level can cause these errors.</li> </ul>
0-81	The line was disconnected due to a timeout in V.34 phase 3 – equalizer training.	<p>If these errors happen at the transmitting terminal:</p> <ul style="list-style-type: none"> <li>• Try making a call at a later time.</li> <li>• Try using V.17 or a slower modem using dedicated tx parameters.</li> <li>• Try increasing the tx level.</li> <li>• Try adjusting the tx cable equalizer setting.</li> </ul>
0-82	The line was disconnected due to a timeout in the V.34 phase 4 – control channel start-up.	<p>If these errors happen at the receiving terminal:</p> <ul style="list-style-type: none"> <li>• Try adjusting the rx cable equalizer setting.</li> <li>• Try increasing the tx level.</li> <li>• Try using V.17 or a slower modem if the same error is frequent when receiving from multiple senders.</li> </ul>
0-83	The line was disconnected due to a timeout in the V.34 control channel restart sequence.	<ul style="list-style-type: none"> <li>• The signal did not stop within 10 s.</li> <li>• Turn off the machine, then turn it back on.</li> <li>• If the same error is frequent, replace the FCU.</li> </ul>
0-84	The line was disconnected due to abnormal signaling in V.34 phase 4 – control channel start-up.	<ul style="list-style-type: none"> <li>• The signal did not stop within 10 s.</li> <li>• Turn off the machine, then turn it back on.</li> <li>• If the same error is frequent, replace the FCU.</li> </ul>
0-85	The line was disconnected due to abnormal signaling in V.34 control channel restart.	<ul style="list-style-type: none"> <li>• The signal did not stop within 10 s.</li> <li>• Turn off the machine, then turn it back on.</li> <li>• If the same error is frequent, replace the FCU.</li> </ul>
0-86	The line was disconnected because the other terminal requested a data rate using MPh that was not available in the currently selected symbol rate.	<ul style="list-style-type: none"> <li>• The other terminal was incompatible.</li> <li>• Ask the other party to contact the manufacturer.</li> </ul>

Code	Meaning	Suggested Cause/Action
0-87	The control channel started after an unsuccessful primary channel.	<ul style="list-style-type: none"> <li>The receiving terminal restarted the control channel because data reception in the primary channel was not successful.</li> <li>This does not result in an error communication.</li> </ul>
0-88	The line was disconnected because PPR was transmitted/received 9 (default) times within the same ECM frame.	<ul style="list-style-type: none"> <li>Try using a lower data rate at the start.</li> <li>Try adjusting the cable equalizer setting.</li> </ul>
2-11	Only one V.21 connection flag was received	<ul style="list-style-type: none"> <li>Replace the FCU.</li> </ul>
2-12	Modem clock irregularity	<ul style="list-style-type: none"> <li>Replace the FCU.</li> </ul>
2-13	Modem initialization error	<ul style="list-style-type: none"> <li>Turn off the machine, then turn it back on.</li> <li>Update the modem ROM.</li> <li>Replace the FCU.</li> </ul>
2-23	JBIG compression or reconstruction error	<ul style="list-style-type: none"> <li>Turn off the machine, then turn it back on.</li> </ul>
2-24	JBIG ASIC error	<ul style="list-style-type: none"> <li>Turn off the machine, then turn it back on.</li> </ul>
2-25	JBIG data reconstruction error (BIH error)	<ul style="list-style-type: none"> <li>JBIG data error</li> <li>Check the sender's JBIG function.</li> <li>Update the MBU ROM.</li> </ul>
2-26	JBIG data reconstruction error (Float marker error)	
2-27	JBIG data reconstruction error (End marker error)	
2-28	JBIG data reconstruction error (Timeout)	
2-29	JBIG trailing edge maker error	<ul style="list-style-type: none"> <li>FCU defective</li> <li>Check the destination device.</li> </ul>
2-50	The machine resets itself for a fatal FCU system error	<ul style="list-style-type: none"> <li>If this is frequent, update the ROM, or replace the FCU.</li> </ul>

Code	Meaning	Suggested Cause/Action
2-51	The machine resets itself because of a fatal communication error	<ul style="list-style-type: none"> <li>If this is frequent, update the ROM, or replace the FCU.</li> </ul>
2-53	Snd msg() in the manual task is an error because the mailbox for the operation task is full.	<ul style="list-style-type: none"> <li>The user did the same operation many times, and this gave too much load to the machine.</li> </ul>
4-01	Line current was cut	<ul style="list-style-type: none"> <li>Check the line connector.</li> <li>Check for line problems.</li> <li>Replace the FCU or the NCU.</li> </ul>
4-10	Communication failed because of an ID Code mismatch (Closed Network) or Tel. No./CSI mismatch (Protection against Wrong Connections)	<ul style="list-style-type: none"> <li>Get the ID Codes the same and/or the CSIs programmed correctly, then resend.</li> <li>The machine at the other end may be defective.</li> </ul>
5-10	DCR timer expired	<ul style="list-style-type: none"> <li>Replace the FCU.</li> </ul>
5-20	Storage impossible because of a lack of memory	<ul style="list-style-type: none"> <li>Temporary memory shortage.</li> <li>Test the SAF memory.</li> </ul>
5-21	Memory overflow	
5-23	Print data error when printing a substitute rx or confidential rx message	<ul style="list-style-type: none"> <li>Test the SAF memory.</li> <li>Ask the other end to resend the message.</li> </ul>
5-25	SAF file access error	<ul style="list-style-type: none"> <li>Replace an SD card or HDD.</li> <li>Replace the FCU.</li> </ul>
6-00	G3 ECM - T1 time out during reception of facsimile data	<ul style="list-style-type: none"> <li>Try adjusting the rx cable equalizer.</li> <li>Replace the FCU.</li> </ul>
6-01	G3 ECM - no V.21 signal was received	
6-02	G3 ECM - EOR was received	
6-04	G3 ECM - RTC not detected	<ul style="list-style-type: none"> <li>Check the line connection.</li> <li>Check for a bad line or defective remote terminal.</li> <li>Replace the FCU.</li> </ul>

Code	Meaning	Suggested Cause/Action
6-05	G3 ECM - facsimile data frame not received within 18 s of CFR, but there was no line fail	<ul style="list-style-type: none"> <li>• Check the line connection.</li> <li>• Check for a bad line or defective remote terminal.</li> <li>• Replace the FCU.</li> <li>• Try adjusting the rx cable equalizer</li> </ul> <p><b>Cross reference</b></p> <ul style="list-style-type: none"> <li>• Rx cable equalizer - G3 Switch 07 (PSTN)</li> </ul>
6-06	G3 ECM - coding/decoding error	<ul style="list-style-type: none"> <li>• Defective FCU.</li> <li>• The other terminal may be defective.</li> </ul>
6-08	G3 ECM - PIP/PIN received in reply to PPS.NULL	<ul style="list-style-type: none"> <li>• The other end pressed Stop during communication.</li> <li>• The other terminal may be defective.</li> </ul>
6-09	G3 ECM - ERR received	<ul style="list-style-type: none"> <li>• Check for a noisy line.</li> <li>• Adjust the tx levels of the communicating machines.</li> <li>• See code 6-05.</li> </ul>
6-10	G3 ECM - error frames still received at the other end after all communication attempts at 2400 bps	<ul style="list-style-type: none"> <li>• Check for line noise.</li> <li>• Adjust the tx level (use NCU parameter 01 or the dedicated tx parameter for that address).</li> <li>• Check the line connection.</li> <li>• Defective remote terminal.</li> </ul>
6-21	V.21 flag detected during high speed modem communication	<ul style="list-style-type: none"> <li>• The other terminal may be defective or incompatible.</li> </ul>
6-22	The machine resets the sequence because of an abnormal handshake in the V.34 control channel	<ul style="list-style-type: none"> <li>• Check for line noise.</li> <li>• If the same error occurs frequently, replace the FCU.</li> <li>• Defective remote terminal.</li> </ul>
6-99	V.21 signal not stopped within 6 s	<ul style="list-style-type: none"> <li>• Replace the FCU.</li> </ul>
13-17	SIP user name registration error	<ul style="list-style-type: none"> <li>• Double registration of the SIP user name.</li> <li>• Capacity for user-name registration in the SIP server is not sufficient.</li> </ul>



Code	Meaning	Suggested Cause/Action
13-18	SIP server access error	<ul style="list-style-type: none"> <li>• Incorrect initial setting for the SIP server.</li> <li>• Defective SIP server.</li> </ul>
13-24	SIP authentication password error	<ul style="list-style-type: none"> <li>• The input password for the authentication does not match the password registered in the SIP server.</li> </ul>
14-00	SMTP Send Error	<ul style="list-style-type: none"> <li>• Error occurred during sending to the SMTP server. Occurs for any error other than 14-01 to 16. For example, the mail address of the system administrator is not registered.</li> </ul>
14-01	SMTP Connection Failed	<ul style="list-style-type: none"> <li>• Failed to connect to the SMTP server (timeout) because the server could not be found.</li> <li>• The PC is not ready to transfer files.</li> <li>• SMTP server not functioning correctly.</li> <li>• The DNS IP address is not registered.</li> <li>• Network not operating correctly.</li> <li>• Destination folder selection not correct.</li> </ul>
14-02	No Service by SMTP Service (421)	<ul style="list-style-type: none"> <li>• SMTP server operating incorrectly, or the destination for direct SMTP sending is not correct.</li> <li>• Contact the system administrator and check that the SMTP server has the correct settings and operates correctly.</li> <li>• Contact the system administrator for direct SMTP sending and check the sending destination.</li> </ul>

Code	Meaning	Suggested Cause/Action
14-03	Access to SMTP Server Denied (450)	<ul style="list-style-type: none"> <li>• Failed to access the SMTP server because the access is denied.</li> <li>• SMTP server operating incorrectly. Contact the system administrator to determine if there is a problem with the SMTP server and to check that the SMTP server settings are correct.</li> <li>• Folder send destination is incorrect. Contact the system administrator to determine that the SMTP server settings and path to the server are correct.</li> <li>• Device settings incorrect. Confirm that the user name and password settings are correct.</li> <li>• Direct SMTP destination incorrect. Contact the system administrator to determine if there is a problem at the destination at that the settings at the destination are correct.</li> </ul>
14-04	Access to SMTP Server Denied (550)	<ul style="list-style-type: none"> <li>• SMTP server operating incorrectly</li> <li>• Direct SMTP sending not operating correctly</li> </ul>
14-05	SMTP Server HDD Full (452)	<ul style="list-style-type: none"> <li>• Failed to access the SMTP server because the HDD on the server is full.</li> <li>• Insufficient free space on the HDD of the SMTP server. Contact the system administrator and check the amount of space remaining on the SMTP server HDD.</li> <li>• Insufficient free space on the HDD where the destination folder is located. Contact the system administrator and check the amount of space remaining on the HDD where the target folder is located.</li> <li>• Insufficient free space on the HDD at the target destination for SMTP direct sending. Contact the system administrator and check the amount of space remaining on the target HDD.</li> </ul>

Code	Meaning	Suggested Cause/Action
14-06	User Not Found on SMTP Server (551)	<ul style="list-style-type: none"> <li>• The designated user does not exist.</li> <li>• The designated user does not exist on the SMTP server.</li> <li>• The designated address is not for use with direct SMTP sending.</li> </ul>
14-07	Data Send to SMTP Server Failed (4XX)	<ul style="list-style-type: none"> <li>• Failed to access the SMTP server because the transmission failed.</li> <li>• PC not operating correctly.</li> <li>• SMTP server operating incorrectly</li> <li>• Network not operating correctly.</li> <li>• Destination folder setting incorrect.</li> <li>• Direct SMTP sending not operating correctly.</li> </ul>
14-08	Data Send to SMTP Server Failed (5XX)	<ul style="list-style-type: none"> <li>• Failed to access the SMTP server because the transmission failed.</li> <li>• SMTP server operating incorrectly</li> <li>• Destination folder setting incorrect.</li> <li>• Direct SMTP sending not operating correctly.</li> <li>• Software application error.</li> </ul>
14-09	Authorization Failed for Sending to SMTP Server	<ul style="list-style-type: none"> <li>• POP-Before-SMTP or SMTP authorization failed.</li> <li>• Incorrect setting for file transfer</li> </ul>
14-10	Addresses Exceeded	<ul style="list-style-type: none"> <li>• Number of broadcast addresses exceeded the limit for the SMTP server.</li> </ul>
14-11	Buffer Full	<ul style="list-style-type: none"> <li>• The send buffer is full so the transmission could not be completed. Buffer is full due to using Scan-to-Email while the buffer is being used send mail at the same time.</li> </ul>
14-12	Data Size Too Large	<ul style="list-style-type: none"> <li>• Transmission was cancelled because the detected size of the file was too large.</li> </ul>
14-13	Send Cancelled	<ul style="list-style-type: none"> <li>• Processing is interrupted because the user pressed Stop.</li> </ul>
14-14	Security Locked File Error	<ul style="list-style-type: none"> <li>• Update the software because of the defective software.</li> </ul>

Code	Meaning	Suggested Cause/Action
14-15	Mail Data Error	<ul style="list-style-type: none"> <li>The transmitting a mail is interrupted via DCS due to the incorrect data.</li> <li>Update the software because of the defective software.</li> </ul>
14-16	Maximum Division Number Error	<ul style="list-style-type: none"> <li>When a mail is divided for the mail transmission and the division number of a mail are more than the specified number, the mail transmission is interrupted.</li> <li>Update the software because of the defective software.</li> </ul>
14-17	Incorrect Ticket	<ul style="list-style-type: none"> <li>Update the software because of the defective software.</li> </ul>
14-18	Access to MCS File Error	<ul style="list-style-type: none"> <li>The access to MCS file is denied due to the no permission of access.</li> <li>Update the software because of the defective software.</li> </ul>
14-30	MCS File Creation Failed	<p>Failed to create the MCS file because:</p> <ul style="list-style-type: none"> <li>The number of files created with other applications on the Document Server has exceeded the limit.</li> <li>HDD is full or not operating correctly.</li> <li>Software error.</li> </ul>
14-31	UFS File Creation Failed	<p>UFS file could not be created:</p> <ul style="list-style-type: none"> <li>Not enough space in UFS area to handle both Scan-to-Email and IFAX transmission.</li> <li>HDD full or not operating correctly.</li> <li>Software error.</li> </ul>
14-32	Cancelled the Mail Due to Error Detected by NFAX	<ul style="list-style-type: none"> <li>Error detected with NFAX and send was cancelled due to a software error.</li> </ul>
14-33	No Mail Address For the Machine	<ul style="list-style-type: none"> <li>Neither the mail address of the machine nor the mail address of the network administrator is registered.</li> </ul>

Code	Meaning	Suggested Cause/Action
14-34	Address designated in the domain for SMTP sending does not exist	<ul style="list-style-type: none"> <li>Operational error in normal mail sending or direct SMTP sending.</li> <li>Check the address selected in the address book for SMTP sending.</li> <li>Check the domain selection.</li> </ul>
14-50	Mail Job Task Error	<p>Due to an FCU mail job task error, the send was cancelled:</p> <ul style="list-style-type: none"> <li>Address book was being edited during creation of the notification mail.</li> <li>Software error.</li> </ul>
14-51	UCS Destination Download Error	<p>Not even one return notification can be downloaded:</p> <ul style="list-style-type: none"> <li>The address book was being edited.</li> <li>The number for the specified destination does not exist (it was deleted or edited after the job was created).</li> </ul>
14-60	Send Cancel Failed	<ul style="list-style-type: none"> <li>The cancel operation by the user failed to cancel the send operation.</li> </ul>
14-61	Notification Mail Send Failed for All Destinations	<ul style="list-style-type: none"> <li>All addresses for return notification mail failed.</li> </ul>
14-62	Transmission Error due to the existence of zero line page	<ul style="list-style-type: none"> <li>When the 0 line page exists in received pages with G3 communication, the transmission is interrupted.</li> </ul>
15-01	POP3/IMAP4 Server Not Registered	<ul style="list-style-type: none"> <li>At startup, the system detected that the IP address of the POP3/IMAP4 server has not been registered in the machine.</li> </ul>
15-02	POP3/IMAP4 Mail Account Information Not Registered	<ul style="list-style-type: none"> <li>The POP3/IMAP4 mail account has not been registered.</li> </ul>
15-03	Mail Address Not Registered	<ul style="list-style-type: none"> <li>The mail address has not been registered.</li> </ul>
15-10	DCS Mail Receive Error	<ul style="list-style-type: none"> <li>Error other than 15-11 to 15-18.</li> </ul>

Code	Meaning	Suggested Cause/Action
15-11	Connection Error	<p>The DNS or POP3/IMAP4 server could not be found:</p> <ul style="list-style-type: none"> <li>• The IP address for DNS or POP3/IMAP4 server is not stored in the machine.</li> <li>• The DNS IP address is not registered.</li> <li>• Network not operating correctly.</li> </ul>
15-12	Authorization Error	<p>POP3/IMAP4 send authorization failed:</p> <ul style="list-style-type: none"> <li>• Incorrect IFAX user name or password.</li> <li>• Access was attempted by another device, such as the PC.</li> <li>• POP3/IMAP4 settings incorrect.</li> </ul>
15-13	Receive Buffer Full	<ul style="list-style-type: none"> <li>• Occurs only during manual reception. Transmission cannot be received due to insufficient buffer space. The buffer is being used for mail send or Scan-to-Email.</li> </ul>
15-14	Mail Header Format Error	<ul style="list-style-type: none"> <li>• The mail header is not standard format. For example, the Date line description is incorrect.</li> </ul>
15-15	Mail Divide Error	<ul style="list-style-type: none"> <li>• The e-mail is not in standard format. There is no boundary between parts of the e-mail, including the header.</li> </ul>
15-16	Mail Size Receive Error	<ul style="list-style-type: none"> <li>• The mail cannot be received because it is too large.</li> </ul>
15-17	Receive Timeout	<ul style="list-style-type: none"> <li>• May occur during manual receiving only because the network is not operating correctly.</li> </ul>
15-18	Incomplete Mail Received	<ul style="list-style-type: none"> <li>• Only one portion of the mail was received.</li> </ul>
15-31	Final Destination for Transfer Request Reception Format Error	<ul style="list-style-type: none"> <li>• The format of the final destination for the transfer request was incorrect.</li> </ul>
15-39	Send/Delivery Destination Error	<p>The transmission cannot be delivered to the final destination:</p> <ul style="list-style-type: none"> <li>• Destination file format is incorrect.</li> <li>• Could not create the destination for the file transmission.</li> </ul>

Code	Meaning	Suggested Cause/Action
15-41	SMTP Receive Error	<ul style="list-style-type: none"> <li>Reception rejected because the transaction exceeded the limit for the "Auth. E-mail RX" setting.</li> </ul>
15-42	Off Ramp Gateway Error	<ul style="list-style-type: none"> <li>The delivery destination address was specified with Off Ramp Gateway OFF.</li> </ul>
15-43	Address Format Error	<ul style="list-style-type: none"> <li>Format error in the address of the Off Ramp Gateway.</li> </ul>
15-44	Addresses Over	<ul style="list-style-type: none"> <li>The number of addresses for the Off Ramp Gateway exceeded the limit of 30.</li> </ul>
15-61	Attachment File Format Error	<ul style="list-style-type: none"> <li>The attached file is not TIFF format.</li> </ul>
15-62	TIFF File Compatibility Error	<p>Could not receive transmission due to:</p> <ul style="list-style-type: none"> <li>Resolution error</li> <li>Image of resolution greater than 200 dpi without extended memory.</li> <li>Resolution is not supported.</li> <li>Page size error</li> <li>The page size was larger than A3.</li> <li>Compression error</li> <li>File was compressed with other than MH, MR, or MMR.</li> </ul>
15-63	TIFF Parameter Error	<p>The TIFF file sent as the attachment could not be received because the TIFF header is incorrect:</p> <ul style="list-style-type: none"> <li>The TIFF file attachment is a type not supported.</li> <li>The TIFF file attachment is corrupted.</li> <li>Software error.</li> </ul>
15-64	TIFF Decompression Error	<p>The file received as an attachment caused the TIFF decompression error:</p> <ul style="list-style-type: none"> <li>The TIFF format of the attachment is corrupted.</li> <li>Software error.</li> </ul>
15-71	Not Binary Image Data	<ul style="list-style-type: none"> <li>The file could not be received because the attachment was not binary image data.</li> </ul>

Code	Meaning	Suggested Cause/Action
15-73	MDN Status Error	<ul style="list-style-type: none"> <li>• Could not find the Disposition line in the header of the Return Receipt, or there is a problem with the firmware.</li> </ul>
15-74	MDN Message ID Error	<ul style="list-style-type: none"> <li>• Could not find the Original Message ID line in the header of the Return Receipt, or there is a problem with the firmware.</li> </ul>
15-80	Mail Job Task Read Error	<ul style="list-style-type: none"> <li>• Could not receive the transmission because the destination buffer is full and the destination could not be created (this error may occur when receiving a transfer request or a request for notification of reception).</li> </ul>
15-81	Repeated Destination Registration Error	<ul style="list-style-type: none"> <li>• Could not repeat receive the transmission because the destination buffer is full and the destination could not be created (this error may occur when receiving a transfer request or a request for notification of reception).</li> </ul>
15-91	Send Registration Error	<p>Could not receive the file for transfer to the final destination:</p> <ul style="list-style-type: none"> <li>• The format of the final destination or the transfer destination is incorrect.</li> <li>• Destinations are full so the final and transfer destinations could not be created.</li> </ul>
15-92	Memory Overflow	<ul style="list-style-type: none"> <li>• Transmission could not be received because memory overflowed during the transaction.</li> </ul>
15-93	Memory Access Error	<ul style="list-style-type: none"> <li>• Transaction could not complete due to a malfunction of SAF memory.</li> </ul>
15-94	Incorrect ID Code	<ul style="list-style-type: none"> <li>• The machine rejected an incoming e-mail for transfer request, because the ID code in the incoming e-mail did not match the ID code registered in the machine.</li> </ul>
15-95	Transfer Station Function	<ul style="list-style-type: none"> <li>• The machine rejected an incoming e-mail for transfer because the transfer function was unavailable.</li> </ul>



Code	Meaning	Suggested Cause/Action
22-00	Original length exceeded the maximum scan length	<ul style="list-style-type: none"> <li>• Divide the original into more than one page.</li> <li>• Check the resolution used for scanning. Lower the scan resolution if possible.</li> <li>• Add optional page memory.</li> </ul>
22-01	Memory overflow while receiving	<ul style="list-style-type: none"> <li>• Wait for the files in the queue to be sent.</li> <li>• Delete unnecessary files from memory.</li> <li>• Transfer the substitute reception files to an another fax machine, if the machine's printer is busy or out of order.</li> <li>• Add an optional SAF memory card or hard disk.</li> </ul>
22-02	Tx or rx job stalled due to line disconnection at the other end	<ul style="list-style-type: none"> <li>• The job started normally but did not finish normally; data may or may not have been received fully.</li> <li>• Restart the machine.</li> </ul>
22-04	The machine cannot store received data in the SAF	<ul style="list-style-type: none"> <li>• Update the ROM</li> <li>• Replace the FCU.</li> </ul>
22-05	No G3 parameter confirmation answer	<ul style="list-style-type: none"> <li>• Defective FCU board or firmware.</li> </ul>
23-00	Data read timeout during construction	<ul style="list-style-type: none"> <li>• Restart the machine.</li> <li>• Replace the FCU.</li> </ul>
25-00	The machine software resets itself after a fatal transmission error occurred	<ul style="list-style-type: none"> <li>• Update the ROM</li> <li>• Replace the FCU.</li> </ul>
F0-xx	V.34 modem error	<ul style="list-style-type: none"> <li>• Replace the FCU.</li> </ul>
F6-xx	SG3 modem error	<ul style="list-style-type: none"> <li>• Update the SG3 modem ROM.</li> <li>• Replace the SG3 board.</li> <li>• Check for line noise or other line problems.</li> <li>• Try communicating another V.8/V.34 fax.</li> </ul>

# IFAX Troubleshooting

- Use the following procedures to determine whether the machine or another part of the network is causing the problem.

Communication Route	Item	Action [Remarks]
General LAN	1. Connection with the LAN	<ul style="list-style-type: none"> <li>• Check that the LAN cable is connected to the machine.</li> <li>• Check that the LEDs on the hub are lit.</li> </ul>
	2. LAN activity	<ul style="list-style-type: none"> <li>• Check that other devices connected to the LAN can communicate through the LAN.</li> </ul>
Between IFAX and PC	1. Network settings on the PC	<ul style="list-style-type: none"> <li>• Check the network settings on the PC.</li> </ul> <p>[Is the IP address registered in the TCP/IP properties in the network setup correct?</p> <ul style="list-style-type: none"> <li>• Check the IP address with the administrator of the network.]</li> </ul>
	2. Check that PC can connect with the machine	<ul style="list-style-type: none"> <li>• Use the "ping" command on the PC to contact the machine.</li> </ul> <p>[At the MS-DOS prompt, type ping then the IP address of the machine, then press Enter.]</p>
	3. LAN settings in the machine	<ul style="list-style-type: none"> <li>• Check the LAN parameters</li> <li>• Check if there is an IP address conflict with other PCs.</li> </ul> <p>[Use the "Network" function in the User Tools.</p> <p>If there is an IP address conflict, inform the administrator.]</p>
Between machine and e-mail server	LAN settings in the machine	<ul style="list-style-type: none"> <li>• Check the LAN parameters</li> <li>• Check if there is an IP address conflict with other PCs.</li> </ul> <p>[Use the "Network" function in the User Tools.</p> <p>If there is an IP address conflict, inform the administrator.]</p>

Communication Route	Item	Action [Remarks]
Between machine and e-mail server	1. E-mail account on the server	<ul style="list-style-type: none"> <li>• Make sure that the machine can log into the e-mail server.</li> <li>• Check that the account and password stored in the server are the same as in the machine.</li> </ul> [Ask the administrator to check.]
	2. E-mail server	<ul style="list-style-type: none"> <li>• Make sure that the client devices which have an account in the server can send/receive e-mail.</li> </ul> [Ask the administrator to check. Send a test e-mail with the machine's own number as the destination. The machine receives the returned e-mail if the communication is performed successfully.]
Between e-mail server and internet	1. E-mail account on the Server	<ul style="list-style-type: none"> <li>• Make sure that the PC can log into the e-mail server.</li> <li>• Check that the account and password stored in the server are the same as in the machine.</li> </ul> [Ask the administrator to check.]
	2. E-mail server	<ul style="list-style-type: none"> <li>• Make sure that the client devices which have an account in the server can send/receive e-mail.</li> </ul> [Ask the administrator to check. Send a test e-mail with the machine's own number as the destination. The machine receives the returned e-mail if the communication is performed successfully.]
	3. Destination e-mail address	<ul style="list-style-type: none"> <li>• Make sure that the e-mail address is actually used.</li> <li>• Check that the e-mail address contains no incorrect characters such as spaces.</li> </ul>

Communication Route	Item	Action [Remarks]
Between e-mail server and internet	Router settings	<ul style="list-style-type: none"> <li>• Use the “ping” command to contact the router.</li> <li>• Check that other devices connected to the router can send data over the router.</li> </ul> [Ask the administrator of the server to check.]
Between e-mail server and internet	Error message by e-mail from the network of the destination.	<ul style="list-style-type: none"> <li>• Check whether e-mail can be sent to another address on the same network, using the application e-mail software.</li> <li>• Check the error e-mail message.</li> </ul> [Inform the administrator of the LAN.]

# IP-Fax Troubleshooting

## IP-Fax Transmission

### Cannot send by IP Address/Host Name

Check Point		Action
1	LAN cable connected?	Check the LAN cable connection.
2	Specified IP address/host name correct?	Check the IP address/host name.
3	Firewall/NAT is installed?	Cannot breach the firewall. Send by using another method (Fax, Internet Fax)
4	Transmission sent manually?	Manual sending not supported.
5	IP address of local machine registered?	Register the IP address.
6	Remote terminal port number setting other than 1720?	Send by specifying the port number.
7	Specified port number correct?	Confirm the port number of the remote fax.
8	DNS server registered when host name specified?	Contact the network administrator.
9	Remote fax a T.38 terminal?	Check whether the remote fax is a T38 terminal.
10	Remote fax switched off or busy?	Check that the remote fax is switched on.
11	Network bandwidth too narrow?	Request the network administrator to increase the bandwidth.
		Raise the delay level. IPFAX SW 01 Bit 0 to 3
		IP-Fax bandwidth is the same as the DCS speed. Set IP-Fax SW00 Bit 6 to 1.
12	Remote fax cancelled transmission?	Check whether the remote fax cancelled the transmission.

**Cannot send via VoIP Gateway**

Check Point		Action
1	LAN cable connected?	Check the LAN cable connection.
2	VoIP Gateway T.38 standard?	Contact the network administrator.
3	VoIP Gateway installed correctly?	Contact the network administrator.
4	VoIP Gateway power switched on?	Contact the network administrator.
5	Is the IP address/host name of the specified Gateway correct?	Check the IP address/host name.
6	Number of the specified fax correct?	Check the remote fax number.
7	Firewall/NAT is installed?	Cannot breach the firewall. Send by using another method (Fax, Internet Fax)
8	Transmission sent manually?	Manual sending not supported.
9	IP address of local fax registered?	Register the IP address.
10	DNS registered when host name specified?	Contact the network administrator.
11	Remote fax a G3 fax?	Check that the remote fax is a G3 fax.
12	G3 fax is connected to VoIP gateway?	Check that G3 fax is connected.
13	Remote G3 fax turned on?	Check that G3 fax is switched on.
14	Network bandwidth too narrow?	Request the network administrator to increase the bandwidth.
		Raise the network delay level. IPFAX SW 01 Bit 0 to 3
		IP-Fax bandwidth is the same as the DCS speed. Set IP-Fax SW00 Bit 6 to 1.

**Cannot send by Alias Fax number.**

Check Point		Action
1	LAN cable connected?	Check the LAN cable connection.

2	Number of specified Alias fax correct?	Confirm the Alias of the remote fax. Error Code: 13-14
3	Firewall/NAT installed?	Cannot breach the firewall. Send by using another method (Fax, Internet Fax)
4	Transmission sent manually?	Manual sending not supported.
5	Gatekeeper installed correctly?	Contact the network administrator.
6	Gatekeeper power switched on?	Contact the network administrator.
7	IP address/host name of Gatekeeper correct?	Check the IP address/host name.
8	DNS server registered when Gatekeeper host name specified?	Contact the network administrator.
9	Enable H.323 SW is set to on?	Check the settings. See User Parameter SW 34 Bit 0
10	IP address of local fax registered?	Register the IP address of the local fax.
11	Alias number of local fax registered?	Register the Alias number of the local fax.
12	Remote fax registered in Gatekeeper?	Contact the network administrator.
13	Remote fax a T.38 terminal?	Check whether the remote fax is a T38 terminal.
14	Remote fax switched off or busy?	Contact the network administrator.
15	Network bandwidth too narrow?	Request the system administrator to increase the bandwidth.
		Raise the delay level. IPFAX SW 01 Bit 0 to 3
		Lower the modem transmission baud rate. IPFAX SW 05
16	Remote fax cancelled transmission?	Check whether the remote fax cancelled the transmission.

## IP-Fax Reception

### Cannot receive by IP Address/Host name.

Check Point		Action
1	LAN cable connected?	Check the LAN cable connection.
2	Firewall/NAT is installed?	Cannot breach the firewall. Send by using another method (Fax, Internet Fax)
3	IP address of local fax registered?	Register the IP address.
4	Port number specified at remote sender fax (if required)?	Request the sender to specify the port number.
5	Specified port number correct (if required)?	Request the sender to check the port number.
6	DNS server registered when host name specified on sender side?	<p>Contact the network administrator.</p> <p><b>Note</b></p> <ul style="list-style-type: none"> <li>The sender machine displays this error code if the sender fax is a Ricoh model.</li> </ul>
7	Network bandwidth too narrow?	Request the system administrator to increase the bandwidth.
		<p>Lower the start modem reception baud rate on the receiving side.</p> <p>IPFAX SW06</p>
8	Remote fax cancelled transmission?	Check whether the remote fax cancelled the transmission.



### Cannot receive by VoIP Gateway.

Check Point		Action
1	LAN cable connected?	Check the LAN cable connection.
2	Firewall/NAT is installed?	Cannot breach the firewall. Request the remote fax to send by using another method (Fax, Internet Fax)



3	VoIP Gateway installed correctly?	Contact the network administrator.
4	VoIP Gateway power switched on?	Contact the network administrator.
5	IP address/host name of specified VoIP Gateway correct on sender's side?	Request the remote fax to check the IP address/host name.
6	DNS server registered when host name specified on sender side?	Contact the network administrator.
7	Network bandwidth too narrow?	Request the network administrator to increase the bandwidth.
8	G3 fax connected?	Check that G3 fax is connected.
9	G3 fax power switched on?	Check that G3 fax is switched on.

### Cannot receive by Alias Fax number.

Check Point		Action
1	LAN cable connected?	Check the LAN cable connection.
2	Firewall/NAT is installed?	Cannot the breach firewall. Request the remote fax to send by using another method (Fax, Internet Fax)
3	Gatekeeper installed correctly?	Contact the network administrator.  <b>Note</b> <ul style="list-style-type: none"> <li>The sender machine displays this error code when the sender fax is a Ricoh model.</li> </ul>
4	Power to Gatekeeper switched on?	Contact the network administrator.  <b>Note</b> <ul style="list-style-type: none"> <li>The sender machine displays this error code when the sender fax is a Ricoh model.</li> </ul>
5	IP address/host name of Gatekeeper correct on the sender's side?	Request the sender to check the IP address/host name.  <b>Note</b> <ul style="list-style-type: none"> <li>The sender machine displays this error code when the sender fax is a Ricoh model.</li> </ul>

6	DNS server registered when Gatekeeper host name specified on sender's side?	<p>Contact the network administrator.</p> <p><b>Note</b></p> <ul style="list-style-type: none"> <li>The sender machine displays this error code when the sender fax is a Ricoh model.</li> </ul>
7	Enable H.323 SW is set to on?	<p>Request the sender to check the settings.</p> <p>User Parameter SW 34 Bit 0</p> <p><b>Note</b></p> <ul style="list-style-type: none"> <li>Only if the remote sender fax is a Ricoh fax.</li> </ul>
8	Local fax IP address registered?	Register the IP address.
9	Local fax Alias number registered?	Register the Alias number.
10	Network bandwidth too narrow?	Request the system administrator to increase the bandwidth.
		<p>Lower the start modem reception baud rate on the receiving side.</p> <p>IPFAX SW06</p>
11	Remote fax cancelled transmission?	Check whether the remote fax cancelled the transmission.
12	Local fax registered in Gatekeeper?	<p>Contact the network administrator.</p> <p><b>Note</b></p> <ul style="list-style-type: none"> <li>The sender machine displays this error code when the sender fax is a Ricoh model.</li> </ul>

# 5. Appendix: Fax Service Program

## System Service Mode

### SP1-XXX (Bit Switches)

☐ "p.193 "Bit Switches""

1	Mode No.		Function
101	System Switch		
	001 – 032	00 – 1F	Change the bit switches for system settings for the fax option (☐ "p.193 "Bit Switches"")
102	Ifax Switch		
	001 – 016	00 – 0F	Change the bit switches for internet fax settings for the fax option (☐ "p.193 "Bit Switches"")
103	Printer Switch		
	001 – 016	00 – 0F	Change the bit switches for printer settings for the fax option (☐ "p.193 "Bit Switches"")
104	Communication Switch		
	001 – 032	00 – 1F	Change the bit switches for communication settings for the fax option (☐ "p.193 "Bit Switches"")
105	G3-1 Switch		
	001 – 016	00 – 0F	Change the bit switches for the protocol settings of the standard G3 board (☐ "p.193 "Bit Switches"")
111	IP fax Switch		
	001 – 016	00 – 0F	Change the bit switches for optional IP fax parameters (☐ "p.193 "Bit Switches"")

**SP2-XXX (RAM)**

2	Mode No.		Function
101	RAM Read/Write		
	001	-	Change RAM data for the fax board directly.
102	Memory Dump		
	001	G3-1 Memory Dump	Print out RAM data for the fax board.
103	G3-1 NCU Parameters		
	001 – 023	CC, 01 – 22	NCU parameter settings for the standard G3 board. (p.245 "NCU Parameters")

5

**SP3-XXX (Machine Set)**

3	Mode No.		Function
101	Service Station		
	001	Fax Number	Enter the fax number of the service station.
102	Serial Number		
	000	-	Enter the fax unit's serial number.
103	PSTN-1		
	001	Select Line	Select the line type setting for the G3-1 line. If the machine is installed on a PABX line, select "PABX", "PABX(GND)" or "PABX(FLASH)".
	002	PSTN Access Number	Enter the PSTN access number for the G3-1 line.
	003	Memory Lock Disabled	If the customer does not want to receive transmissions using Memory Lock on this line, turn this SP on.

107	IPFAX Port Settings		
	001	H323 Port	-
	002	SIP Port	-
	003	RAS Port	-
	004	Gatekeeper port	-
	005	T.38 Port	-
	006	SIP Server Port	-
	007	IPFAX Protocol Priority	Select "H323" or "SIP".
201	FAX SW		
	001 – 032	00 – 1F	-

### SP4-XXX (ROM Version)

4	Mode No.		Function
101	002 – 007	FCU ROM Version	Displays the FCU ROM version.
102	002 – 065	Error Codes	Displays the latest 64 fax error codes.
103	002 – 004	G3-1 ROM Version	Displays the G3-1 modem version.

### SP5-XXX (RAM Clear)

5	Mode No.	Function
101	Initialization SRAM (Except secure)	
	001	Initializes the bit switches and user parameters, user data in the SRAM, files in the SAF memory, and clock.
102	Erase All Files	
	001	Erases all files stored in the SAF memory.

103	Reset Bit SW (Except secure)	
	001	Resets the bit switches and user parameters.
104	Factory Setting	
	001	Resets the bit switches and user parameters, user data in the SRAM and files in the SAF memory.
105	Reset All Bit Switches	
	001	Initializes all the current bit switch settings.
106	Reset Secure Bit Switches	
	001	Initializes only the security bit switches. If you select automatic output/display for the user parameter switches, the security settings are initialized.

**SP6-XXX (Report)**

6	Mode No.		Function
101	System Parameter List		
	001	-	Touch the "ON" button to print the system parameter list.
102	Service Monitor Report		
	001	-	Touch the "ON" button to print the service monitor report.
103	G3 Protocol Dump List		
	002	G3-1 (All Communications)	Prints the protocol dump list of all communications for the G3-1 line.
	003	G3-1 (1 Communication)	Prints the protocol dump list of the last communication for the G3-1 line.

105	All Files Print out		
	001	-	<p>Prints out all the user files in the SAF memory, including confidential messages.</p> <p><b>Note</b></p> <ul style="list-style-type: none"> <li>Do not use this function, unless the customer is having trouble printing confidential messages or recovering files stored using the memory lock feature.</li> </ul>
106	Journal Print out		
	001	All Journals	The machine prints all the communication records on the report.
	002	Specified Date	The machine prints all communication records after the specified date.
107	Log List Print out		
	001	All log files	These log print out functions are for designer use only.
	002	Printer	
	003	SC/TRAP Stored	
	004	Decompression	
	005	Scanner	
	006	JOB/SAF	
	007	Reconstruction	
	008	JBIG	
	009	Fax Driver	
	010	G3CCU	
	011	Fax Job	
	012	CCU	
	013	Scanner Condition	

108	IP Protocol Dump List		
	001	All Communications	Prints the protocol dump list of all communications for the IP fax line.
	002	1 Communication	Prints the protocol dump list of the last communication for the IP fax line.

---

### SP7-XXX (Tests)

---

These are the test modes for PTT approval.

101	G3-1 Modem Tests
102	G3-1 DTMF Tests
103	Ringer
104	G3-1 V34 Tests (S2400baud)
105	G3-1 V34 Tests (S2800baud)
106	G3-1 V34 Tests (S3000baud)
107	G3-1 V34 Tests (S3200baud)
108	G3-1 V34 Tests (S3429baud)
109	Recorded Message Test



## Bit Switches

### WARNING

- Do not adjust a bit switch or use a setting that is described as "Not used", as this may cause the machine to malfunction or to operate in a manner that is not accepted by local regulations. Such bits are for use only in other areas, such as Japan.

### Note

- Default settings for bit switches are not listed in this manual. Refer to the System Parameter List printed by the machine.

## System Switches

System Switch 00 [SP No. 1-101-001]		
No	FUNCTION	COMMENTS
0	Dedicated transmission parameter programming 0: Disabled, 1: Enabled	Set this bit to 1 before changing any dedicated transmission parameters. Reset this bit to 0 after programming dedicated transmission parameters.
1	<b>Not used</b>	Do not change
2	Technical data printout on the Journal 0: Disabled 1: Enabled	1: Instead of the personal name, the following data are listed on the Journal for each G3 communication.

	<p>e.g. 0000 (1) // 32 (2) V34 (3) // 288 (4) // 264 (5) // L0100 (6) 03 (7) 04 (8)</p> <p>(1): EQM value (Line quality data). A larger number means more errors.</p> <p>(2): Symbol rate (V.34 only)</p> <p>(3): Final modem type used</p> <p>(4): Starting data rate (for example, 288 means 28.8 kbps)</p> <p>(5): Final data rate</p> <p>(6): Rx level (refer to the note after this table for how to read the rx level)</p> <p>(7): Total number of error lines that occurred during non-ECM reception.</p> <p>(8): Total number of burst error lines that occurred during non-ECM reception.</p> <p><b>Note</b></p> <ul style="list-style-type: none"> <li>EQM and rx level are fixed at "FFFF" in tx mode.</li> <li>The seventh and eighth numbers are fixed at "00" for transmission records and ECM reception records.</li> </ul>	
	<p>Rx level calculation</p> <p>Example: 0000 // 32 V34 // 288/264 // L 01 00 03 04</p> <p>The four-digit hexadecimal value (N) after "L" indicates the rx level.</p> <p>The high byte is given first, followed by the low byte. Divide the decimal value of N by -16 to get the rx level.</p> <p>In the above example, the decimal value of N (= 0100 [H]) is 256.</p> <p>So, the actual rx level is <math>256 / -16 = -16</math> dB</p>	
3	<b>Not used</b>	Do not change this setting.
4	Line error mark print 0: OFF, 1: ON (print)	When "1" is selected, a line error mark is printed on the printout if a line error occurs during reception.
5	G3/G4 communication parameter display 0: Disabled 1: Enabled	This is a fault-finding aid. The LCD shows the key parameters (see below). This is normally disabled because it cancels the CSI display for the user.  Be sure to reset this bit to 0 after testing.
6	Protocol dump list output after each communication 0: Off 1: On	This is only used for communication troubleshooting. It shows the content of the transmitted facsimile protocol signals. Always reset this bit to 0 after finishing testing.  If system switch 09 bit 6 is at "1", the list is only printed if there was an error during the communication.

7	Not used	Do not change the setting.
---	----------	----------------------------

**System Switch 01 - Not used** (Do not change the factory settings.)

**System Switch 02 [SP No. 1-101-003]**

No	FUNCTION	COMMENTS
0-1	<b>Not used</b>	Do not change these settings.
2	Forced reset after transmission stall 0: Off 1: On	With this setting on, the machine resets itself automatically if a transmission stalls and fails to complete the job.
3	<b>Not used</b>	Do not change these settings.
4	Permanent undeliverable file holding function	0: Following "User SW 24 bit 1" 1: Permanent hold
5	<b>Not used</b>	Do not change these settings.
6-7	Memory read/write by RDS Bit 7: 0, Bit 6: 0 Always disabled Bit 7: 0, Bit 6: 1 User selectable Bit 7: 1, Bit 6: 0 User selectable Bit 7: 1, Bit 6: 1 Always enabled	(0,0): All RDS systems are always locked out. (0,1), (1,0): Normally, RDS systems are locked out, but the user can temporarily switch RDS on to allow RDS operations to take place. RDS will automatically be locked out again after a certain time, which is stored in System Switch 03. Note that if an RDS operation takes place, RDS will not switch off until this time limit has expired. (1,1): At any time, an RDS system can access the machine.

**System Switch 03 [SP No. 1-101-004]**

No	FUNCTION	COMMENTS
----	----------	----------

0-7	Length of time that RDS is temporarily switched on when bits 6 and 7 of System Switch 02 are set to "User selectable"	00 - 99 hours (BCD). This setting is only valid if bits 6 and 7 of System Switch 02 are set to "User selectable". The default setting is 24 hours.
-----	---	--

**System Switch 04 [SP No. 1-101-005]**

No	FUNCTION	COMMENTS
0-2	<b>Not used</b>	Do not change these settings.
3	Printing dedicated tx parameters on Quick/Speed Dial Lists 0: Disabled 1: Enabled	1: Each Quick/Speed dial number on the list is printed with the dedicated tx parameters (10 bytes each). The first 10 bytes of data are the programmed dedicated tx parameters; 34 bytes of data are printed (the other 24 bytes have no use for service technicians).
4-7	<b>Not used</b>	Do not change these settings.

**System Switch 05 - Not used** (Do not change the factory settings.)

**System Switch 06 - Not used** (Do not change the factory settings.)

**System Switch 07 - Not used** (Do not change the factory settings.)

**System Switch 08 - Not used** (Do not change the factory settings.)

**System Switch 09 [SP No. 1-101-010]**

No	FUNCTION	COMMENTS
0	Confidential image option on the result report 0: OFF 1: ON (Attached)	Selects images Attached/Not attached on the accumulation/Tx result report for confidential Tx.
1	Condition selection for admin communication report record 0: After image data Tx 1: After call connection	0: Communications that reached phase C (message tx/rx) of the T.30 protocol are listed on the Journal. 1: communications that reached phase A (call setup) of T.30 protocol are listed on the Journal. This will include telephone calls.

2	Automatic error report printout 0: Disabled 1: Enabled	0: Error reports will not be printed. 1: Error reports will be printed automatically after failed communications.
3	Printing of the error code on the error report 0: No 1: Yes	1: Error codes are printed on the error reports.
4	<b>Not used</b>	Do not change this setting.
5	Power failure report 0: Disabled 1: Enabled	1: A power failure report will be automatically printed after the power is switched on if a fax message disappeared from the memory when the power was turned off last.
6	Conditions for printing the protocol dump list 0: Print for all communications 1: Print only when there is a communication error	This switch becomes effective only when system switch 00 bit 6 is set to 1. 1: Set this bit to 1 when you wish to print a protocol dump list only for communications with errors.
7	Priority given to various types of remote terminal ID when printing reports 0: RTI > CSI > Dial label > Tel. Number 1: Dial label > Tel. number > RTI > CSI	This bit determines which set of priorities the machine uses when listing remote terminal names on reports. Dial Label: The name stored, by the user, for the Quick/Speed Dial number.

**System Switch 0A [SP No. 1-101-011]**

No	FUNCTION	COMMENTS
0-3	<b>Not used</b>	Do not change these settings.
4	Dialing on the ten-key pad when the external telephone is off-hook 0: Disabled 1: Enabled	0: Prevents dialing from the ten-key pad while the external telephone is off-hook. Use this setting when the external telephone is not by the machine, or if a wireless telephone is connected as an external telephone. 1: The user can dial on the machine's ten-key pad when the handset is off-hook.

5	On hook dial 0: Disabled 1: Enabled	0: On hook dial is disabled.
6-7	<b>Not used</b>	Do not change the factory settings.

**System Switch OB - Not used** (Do not change the factory settings.)

**System Switch OC - Not used** (Do not change the factory settings.)

**System Switch OD - Not used** (Do not change the factory settings.)

**System Switch OE [SP No. 1-101-015]**

No	FUNCTION	COMMENTS
0-1	<b>Not used</b>	Do not change the settings.
2	<b>Not used</b>	This machine does not have the capture function.
3	Memory storing while the handset used Enabled/Disabled selection [0: Disabled 1: Enabled]	Manual receive is disabled while this function is Enabled (1).
4-7	<b>Not used</b>	Do not change these settings.

**System Switch OF [SP No. 1-101-016]**

No	FUNCTION	COMMENTS
----	----------	----------

0-7	Country/area code for functional settings (Hex)		<p>This country/area code determines the factory settings of bit switches and RAM addresses. However, it has no effect on the NCU parameter settings and communication parameter RAM addresses.</p> <p><b>Cross reference</b></p> <p>NCU country code: SP No. 2-103-001 for G3-1</p>
	00: France	11: USA	
	01: Germany	12: Asia	
	02: UK	13: Japan	
	03: Italy	14: Hong Kong	
	04: Austria	15: South Africa	
	05: Belgium	16: Australia	
	06: Denmark	17: New Zealand	
	07: Finland	18: Singapore	
	08: Ireland	19: Malaysia	
	09: Norway	1A: China	
	0A: Sweden	1B: Taiwan	
	0B: Switz.	1C: Korea	
	0C: Portugal	20: Turkey	
	0D: Holland	21: Greece	
	0E: Spain	22: Hungary	
	0F: Israel	23: Czech	
10: ---	24: Poland		

**System Switch 10 [SP No. 1-101-017]**

No	FUNCTION	COMMENTS
0-7	Threshold memory level for parallel memory transmission	<p>Threshold = N x 128 KB + 256 KB</p> <p>N can be between 00 - FF(H)</p> <p>Default setting: 02(H) = 512 KB</p>

**System Switch 11 [SP No. 1-101-018]**

No	FUNCTION	COMMENTS
0	TTI printing position 0: Superimposed on the page data 1: Printed before the data leading edge	Change this bit to 1 if the TTI overprints information that the customer considers to be important (G3 transmissions).
1-2	<b>Not used</b>	Japan Only
3	TTI used for broadcasting 0: The TTIs selected for each Quick/Speed dial are used 1: The same TTI is used for all destinations	1: The TTI (TTI_1 or TTI_2) which is selected for all destinations during broadcasting. *TTI= Transmit Terminal Identification
4-7	<b>Not used</b>	Do not change the factory settings.

**System Switch 12 [SP No. 1-101-019]**

No	FUNCTION	COMMENTS
0-7	TTI printing position in the main scan direction	TTI: 08 to 92 (BCD) mm Input even numbers only.  This setting determines the print start position for the TTI from the left edge of the paper. If the TTI is moved too far to the right, it may overwrite the file number which is on the top right of the page. On an A4 page, if the TTI is moved over by more than 50 mm, it may overwrite the page number.

**System Switch 13 - Not used** (do not change these settings)

**System Switch 14 - Not used** (do not change these settings)

**System Switch 15 [SP No. 1-101-022]**

No	FUNCTION	COMMENTS
0	<b>Not used</b>	Do not change the settings.



1	Going into the Energy Saver mode automatically 0: Enabled 1: Disabled	1: The machine will restart from the Energy Saver mode quickly, because the +5V power supply is active even in the Energy Saver mode.
2-3	<b>Not used</b>	Do not change these settings.
4-5	Interval for preventing the machine from entering Energy Saver mode if there is a pending transmission file. Bit 5: 0, Bit 4: 0 1 min Bit 5: 0, Bit 4: 1 30 min Bit 5: 1, Bit 4: 0 1 hour Bit 5: 1, Bit 4: 1 24 hours	If there is a file waiting for transmission, the machine does not go to Energy Saver mode during the selected period. After transmitting the file, if there is no file waiting for transmission, the machine goes to the Energy Saver mode.
6-7	<b>Not used</b>	Do not change

**System Switch 16 [SP No. 1-101-023]**

No	FUNCTION	COMMENTS
0	Parallel Broadcasting 0: OFF 1: ON	1: The machine sends messages simultaneously using all available ports during broadcasting.
1-7	Not used	Do not change these settings.

**System Switch 17 - Not used** (do not change these settings)

**System Switch 18 - Not used** (do not change these settings)

**System Switch 19 [SP No. 1-101-026]**

No	FUNCTION	COMMENTS
----	----------	----------

0-5	<b>Not used</b>	Do not change the settings.
6	Scanner page-memory expansion (On DRAM added) 0: Not expanding 1: Expanding	Expands the 4MB page-memory to 12MB, to improve scanning possible range. This SW does not work without DRAM added.
7	Special Original mode 0: OFF 1: ON	1: If the customer frequently wishes to transmit a form or letterhead which has a colored or printed background, change this bit to "1". "Original 1" and "Original 2" can be selected in addition to the "Text", "Text/Photo" and "Photo" modes.

**System Switch 1A [SP No. 1-101-027]**

No	FUNCTION	COMMENTS
0-7	LS Rx Memory threshold value setting [00 – FF: HEX (0 – 1020 k Byte)] Default: 0x80(512k Byte)	The received document is printed automatically after the memory remaining amount becomes less than or equal to this Switch's value. Changing hex-value to decimal and then multiplying the value by 4, suggests xxx K byte. [i.e.: 80 changes to 128 in hex to decimal conversion. 128x4= 512K Byte]

**System Switch 1B - Not used** (do not change these settings)

**System Switch 1C - Not used** (do not change these settings)

**System Switch 1D [SP No. 1-101-030]**

No	FUNCTION	COMMENTS
0	RTI/CSI/CPS code display 0: Enable 1: Disable	0: RTI, CSI, CPS codes are displayed on the top line of the LCD panel during communication. 1: Codes are switched off (no display)
1-7	<b>Not used</b>	Do not change these settings.

**System Switch 1E [SP No. 1-101-031]**

No	FUNCTION	COMMENTS
0	Communication after the Journal data storage area has become full 0: Impossible 1: Possible	0: When this switch is on and the journal history becomes full, the next report prints. If the journal history is not deleted, the next transmission cannot be received. This prevents overwriting communication records before the machine can print them. 1: If the buffer memory of the communication records for the Journal is full, fax communications are still possible. But the machine will overwrite the oldest communication records. Note: This setting is effective only when Automatic Journal printout is enabled but the machine cannot print the report (e.g., no paper).
1	Action when the SAF memory has become full during scanning 0: The current page is erased. 1: The entire file is erased.	0: If the SAF memory becomes full during scanning, the successfully scanned pages are transmitted. 1: If the SAF memory becomes full during scanning, the file is erased and no pages are transmitted. This bit switch is ignored for parallel memory transmission.
2	RTI/CSI display priority 0: RTI 1: CSI	This bit determines which identifier, RTI or CSI, is displayed on the LCD while the machine is communicating in G3 non-standard mode.
3	File No. printing 0: Enabled 1: Disabled	1: File numbers are not printed on any reports.
4	Action when authorized reception is enabled but authorized RTIs/CSIs are not yet programmed 0: All fax reception is disabled 1: Faxes can be received if the sender has an RTI or CSI	If authorized reception is enabled but the user has stored no acceptable sender RTIs or CSIs, the machine will not be able to receive any fax messages. If the customer wishes to receive messages from any sender that includes an RTI or CSI, and to block messages from senders that do not include an RTI or CSI, change this bit to "1", then enable Authorized Reception. Otherwise, keep this bit at "0 (default setting)".
5-7	<b>Not used</b>	Do not change the settings

**System Switch 1F [SP No. 1-101-032]**

No	FUNCTION	COMMENTS
0	<b>Not used</b>	Do not change the settings.
1	Report printout after an original jam during SAF storage or if the SAF memory fills up 0: Enabled 1: Disabled	0: When an original jams, or the SAF memory overflows during scanning, a report will be printed. Change this bit to "1" if the customer does not want to have a report in these cases. Memory tx – Memory storage report Parallel memory tx – Transmission result report
2	<b>Not used</b>	Do not change the settings.
3	Received fax print start timing (G3 reception) 0: After receiving each page 1: After receiving all pages	0: The machine prints each page immediately after the machine receives it. 1: The machine prints the complete message after the machine receives all the pages in the memory.
4-6	<b>Not used</b>	Do not change the factory settings.
7	Action when a fax SC has occurred 0: Automatic reset 1: Fax unit stops	0: When the fax unit detects a fax SC code other than SC1201 and SC1207, the fax unit automatically resets itself. 1: When the fax unit detects any fax SC code, the fax unit stops. Cross Reference Fax SC codes - See "Troubleshooting"

### I-Fax Switches

I-fax Switch 00 [SP No. 1-102-001]		
No	FUNCTION	COMMENTS
	Original size limitation of TX Attachment File	These settings set the size applying to adjusting the transmitted original data so that the destination can receive within its capacity.

0	A4	0: Not selected 1: Selected This function can keep a transmitting operation from a destination's incapacity error for the size limitation.
1	B4	
2	A3	
3	Reserved (B4)	
4	Reserved (A2)	
5	Reserved	
6	Reserved	
7	<b>Not used</b>	Do not change the factory settings.

**I-fax Switch 01 [SP No. 1-102-002]**

No	FUNCTION	COMMENTS
	Original Line Resolution of TX Attachment File	These settings set the maximum resolution of the original that the destination can receive.
0	200x100 Standard	0: Not selected 1: Selected If more than one of these three bits is set to "1", the higher resolution has priority. For example, if both Bit 0 and Bit 2 are set to "1" then the resolution is set for "Bit 2 200 x 400.
1	200x200 Detail	
2	200x400 Fine	
3	300 x 300 Reserve	
4	400 x 400 Super Fine	
5	600 x 600 Reserve	
6	Reserve	

7	mm/inch
	<p>This setting selects mm/inch conversion for mail transmission.</p> <p>0: Off (No conversion), 1: On (Conversion)</p> <p>When on (set to "1"), the machine converts millimeters to inches for sending mail. There is no switch for converting inches to millimeters.</p> <p>Unlike G3 fax transmissions which can negotiate between sender and receiver to determine the setting, mail cannot negotiate between terminals; the mm/inch selection is determined by the sender fax.</p> <p>When this switch is Off (0):</p> <p>Images scanned in inches are sent in inches.</p> <p>Images scanned in mm are sent in mm.</p> <p>Images received in inches are transmitted in inches.</p> <p>Images received in mm are transmitted in mm.</p> <p>When this switch is On (1):</p> <p>Images scanned in inches are sent in inches.</p> <p>Images scanned in mm are converted to inches.</p> <p>Images received in inches are transmitted in inches.</p> <p>Images received in mm are converted to inches.</p>

I-fax Switch 02 [SP No. 1-102-003]		
No	FUNCTION	COMMENTS
0	RX Text Mail Header Processing	
		<p>This setting determines whether the header information is printed with text e-mails when they are received.</p> <p>0: Prints only text mail.</p> <p>1: Prints mail header information attached to text mail.</p> <p>When a text mail is received with this switch On (1), the "From" address and "Subject" address are printed as header information.</p> <p>When a mail with only binary data is received (a TIFF-F file, for example), this setting is ignored and no header is printed.</p>

1	<p>Output from Attached Document at E-mail TX Error</p> <p>This setting determines whether only the first page or all pages of an e-mail attachment are printed at the sending station when a transmission error occurs. This allows the customer to see which documents have not reached their intended destinations if sent to the wrong e-mail addresses, for example.</p> <p>0: Prints 1st page only. 1: Prints all pages.</p>
2-3	<p>Text String for Return Receipt</p> <p>This setting determines the text string output for the Return Receipt that confirms the transmission was received normally at the destination.</p> <p>00: "Dispatched" Sends from PC mail a request for a Return Receipt. Receives the Return Receipt with "dispatched" in the 2nd part: Disposition: Automatic-action/MDN-send automatically; dispatched The "dispatched" string is included in the Subject string.</p> <p>01: "Displayed" Sends from PC mail a request for a Return Receipt. Receives the Return Receipt with "displayed" in the 2nd part: Disposition: Automatic-action/MDN-send automatically; displayed The "displayed" string is included in the Subject string.</p> <p>10: Reserved 11: Reserved</p> <p>A mail requesting a Return Receipt sent from an IFAX with this switch set to "00" (for "dispatched") received by Microsoft Outlook 2000 may cause an error. If any setting other than "displayed" (01) causes a problem, change the setting to "01" to enable normal sending of the Return Receipt.</p>
4	<p>Media accept feature</p> <p>This setting adds or does not add the media accept feature to the answer mail to confirm a reception.</p> <p>0: Does not add the media accept feature to the answer mail 1: Adds the media accept feature to the answer mail.</p> <p>Use this bit switch if a problem occurs when the machine receives an answer mail, which contains the media accept feature field.</p>

5-6	<b>Not Used</b>
7	Image Resolution of RX Text Mail
	<p>This setting determines the image resolution of the received mail.</p> <p>0: 200 x 200 1: 400 x 400</p> <p>The "1" setting requires installation of the Function Upgrade Card in order to have enough SAF (Store and Forward) memory to receive images at 400 x 400 resolution.</p>

**I-fax Switch 03 - Not used (do not change the settings) [ SP No. 1-102-004]**

**I-fax Switch 04 [SP No. 1-102-005]**

5

No	FUNCTION	COMMENTS
0	Subject for Delivery TX/Memory Transfer	<p>This setting determines whether the RTI/CSI registered on this machine or the RTI/CSI of the originator is used in the subject lines of transferred documents.</p> <p>0: Puts the RTI/CSI of the originator in the Subject line. If this is used, either the RTI or CSI is used. Only one of these can be received for use in the subject line.</p> <p>1: Puts the RTI/CSI registered on this machine in the Subject line.</p> <p>When this switch is used to transfer and deliver mail to a PC, the information in the Subject line that indicates where the transmission originated can be used to determine automatically the destination folder for each e-mail.</p>
1	Subject corresponding to mail post database	<p>0: Standard subject 1: Mail post database subject</p> <p>The standard subject is replaced by the mail post database subject in the following three cases:</p> <p>1) When the service technician sets the service (software) switch. 2) When memory sending, delivery specified by F code or SMTP reception is done. 3) With relay broadcasting (1st stage without the Schmidt 4 function).</p> <p><b>Note</b></p> <ul style="list-style-type: none"> <li>This switch does not apply for condition 3) when the RX system is set up for memory sending, delivery by F-code, sending with SMTP RX and when operators are using FOL (to prevent problems when receiving transmissions).</li> </ul>



2-7	Not Used
-----	----------

I-fax Switch 05 [SP No. 1-102-006]		
No	FUNCTION	COMMENTS
0	Mail Addresses of SMTP Broadcast Recipients	
	<p>Determines whether the e-mail addresses of the destinations that receive transmissions broadcasted using SMTP protocol are recorded in the Journal.</p> <p>For example:</p> <p>"1st destination + Total number of destinations: 9" in the Journal indicates a broadcast to 9 destinations.</p> <p>0: Not recorded</p> <p>1: Recorded</p>	
1	I-Fax Automatic Re-dial Setting	Determines whether the I-fax automatically redials when an error occurs.
	0: OFF 1: ON	
2-7	Not used	

I-fax Switch 06 - Not used (do not change the settings) [SP No. 1-102-007]

I-fax Switch 07 - Not used (do not change the settings) [SP No. 1-102-008]

I-fax Switch 08 [SP No. 1-102-009]		
No	FUNCTION	COMMENTS
0-7	Memory Threshold for POP Mail Reception	
	<p>This setting determines the amount of SAF (Store and Forward) memory. (SAF stores fax messages to send later for transmission to more than one location, and also holds incoming messages if they cannot be printed.) When the amount of SAF memory available falls below this setting, mail can no longer be received; received mail is then stored on the mail server.</p> <p>00-FF (0 to 1024 KB: HEX)</p> <p><b>Note</b></p> <ul style="list-style-type: none"> <li>The hexadecimal number you enter is multiplied by 4 KB to determine the amount of memory.</li> </ul>	

I-fax Switch 09 [SP No. 1-102-010]		
No	FUNCTION	COMMENTS
0-3	Not used	Do not change the settings
4-7	Restrict TX Retries	This setting determines the number of retries when connection and transmission fails due to errors. 01-F (1-15 Hex)

I-fax Switch 0A - Not used (do not change the settings) [SP No. 1-102-011]

I-fax Switch 0B - Not used (do not change the settings) [SP No. 1-102-012]

I-fax Switch 0C - Not used (do not change the settings) [SP No. 1-102-013]

5

I-fax Switch 0D [SP No. 1-102-014]		
No	FUNCTION	COMMENTS
0-1	Not used	
2-3	Signature on Transmitting for Result Notification - Individual Settings	
	Bit SW(3,2) (0,0): Not attached (0,1): Setting forbidden (0,1): Individual settings (Initial Setting) (0,1): Attached at all times	
Signature settings on result notification mail. This function applies to the following notification mail: <ul style="list-style-type: none"> <li>• Transmitting result notification mail</li> <li>• Folder transfer result notification mail</li> <li>• Receiving result notification mail</li> <li>• Memory-near-full notification mail</li> <li>• Job-near-full notification mail</li> <li>• Memory-full notification mail</li> <li>• Job-full notification mail</li> </ul>		

4-5	Signature for Transmitted mail - Individual Settings
	Bit SW{5,4} (0,0): Not attached (0,1): Setting forbidden (0,1): Individual settings (Initial Setting) (0,1): Attached at all times
6-7	<b>Not used</b>

**I-fax Switch OE - Not used** (do not change the settings) [SP No. 1-102-015]

**I-fax Switch OF [SP No. 1-102-016]**

No	FUNCTION	COMMENTS
0	Delivery Method for SMTP RX Files	
	This setting determines whether files received with SMTP protocol are delivered or output immediately. 0: Off. Files received via SMTP are output immediately without delivery. 1: On. Files received via SMTP are delivered immediately to their destinations.	
1	Signature setting for SMTP RX Files	
	This setting determines whether the signature is attached or not on files received with SMTP protocol. 0: Off. 1: On.	
2	Encryption Setting for SMTP RX Files	
	Selects the encryption for SMTP RX files ON/OFF when the address encryption setting is "Individual Setting". 0: OFF. 1: ON.	
3-7	<b>Not used</b>	

## Printer Switches

Printer Switch 00 [SP No. 1-103-001]		
No	FUNCTION	COMMENTS
0	Select page separation marks 0: Off 1: On	<p>0: If a 2 page RX transmission is split, [*] is printed in the bottom right corner of the 1st page and only a [2] is printed in the upper right corner of the 2nd page.</p> <p>1: If a 2 page RX transmission is split into two pages, for example, [*] [2] is printed in the bottom right corner of the 1st page and only a [2] is printed in the upper right corner of the 2nd page.</p> <p><b>Note</b></p> <ul style="list-style-type: none"> <li>This helps the user to identify pages that have been split because the size of the paper is smaller than the size of the document received. (When A5 is used to print an A4 size document, for example.)</li> </ul>
1	Repetition of data when the received page is longer than the printer paper 0: Off 1: On	<p>1: Default. 10 mm of the trailing edge of the previous page are repeated at the top of the next page.</p> <p>0: The next page continues from where the previous page stopped without any repeated text.</p>
2	Prints the date and time on received fax messages 0: Disabled 1: Enabled	<p>This switch is only effective when user parameter 02 - bit 2 (printing the received date and time on received fax messages) is enabled.</p> <p>1: The machine prints the received and printed date and time at the bottom of each received page.</p>
3-7	<b>Not used</b>	Do not change the settings.

### Printer Switch 01 - Not used (do not change the settings) [SP No. 1-103-002]

Printer Switch 02 [SP No. 1-103-003]		
No	FUNCTION	COMMENTS

0	1st paper feed station usage for fax printing 0: Enabled 1: Disabled	<p>0: The paper feed station can be used to print fax messages and reports.</p> <p>1: The specified paper feed station will not be used for printing fax messages and reports.</p> <p><b>Note</b></p> <ul style="list-style-type: none"> <li>Do not disable usage for a paper feed station which has been specified by User Parameter Switch OF (15), or which is used for the Specified Cassette Selection feature.</li> </ul>
1	2nd paper feed station usage for fax printing 0: Enabled 1: Disabled	
2	3rd paper feed station usage for fax printing 0: Enabled 1: Disabled	
3	4th paper feed station usage for fax printing 0: Enabled 1: Disabled	
4	Selects LCT use Enabled/Disabled 0: Enabled 1: Disabled	
5-7	<b>Not used</b>	Do not change the settings.

#### Printer Switch 03 [SP No. 1-103-004]

No	FUNCTION	COMMENTS
0	Length reduction of received data 0: Disabled 1: Enabled	<p>0: Incoming pages are printed without length reduction. (Page separation threshold: Printer Switch 03, bits 4 to 7)</p> <p>1: Incoming page length is reduced when printing. (Maximum reducible length: Printer Switches 04, bits 0 to 4)</p>
1-3	Not used	Do not change the settings

4-7	<p>Page separation setting when sub scan compression is forbidden</p> <p>00-0F (0-15 mm: Hex)</p> <p>Default: 6 mm</p>	<p>Page separation threshold (with reduction disabled with switch 03-0 above).</p> <p>For example, if this setting is set to "10", and A4 is the selected paper size:</p> <p>If the received document is 10 mm or less longer than A4, then the 10 mm are cut and only 1 page prints.</p> <p>If the received document is 10 mm longer than A4, then the document is split into 2 pages.</p>
-----	--	---

**Printer Switch 04 SP No. 1-103-005**

No	FUNCTION	COMMENTS				
0-4	<p>Maximum reducible length when length reduction is enabled with switch 03-0 above.</p> <p>&lt;Maximum reducible length&gt; = &lt;Paper length&gt; + (N x 5mm)</p> <p>"N" is the decimal value of the binary setting of bits 0 to 4.</p>					
	Bit 4	Bit 3	Bit 2	Bit 1	Bit 0	Setting
	0	0	0	0	0	0 mm
	0	0	0	0	1	5 mm
	0	0	1	0	0	20 mm
	1	1	1	1	1	155 mm
		<p>For A5 sideways and B5 sideways paper</p> <p>&lt;Maximum reducible length&gt; = &lt;Paper length&gt; + 0.75 x (N x 5mm)</p>				
5-6	<p>Length of the duplicated image on the next page, when page separation has taken place.</p>					
	Bit 6: 0, Bit 5: 0 = 4 mm					
	Bit 6: 1, Bit 5: 0 = 10 mm					
	Bit 6: 0, Bit 5: 1 = 15 mm					
		Bit 6: 1, Bit 5: 1 = <b>Not used</b>				
7	<b>Not used.</b>	Do not change the setting.				

**Printer Switch 05 - Not used (do not change the settings)**

**Printer Switch 06 [SP No. 1-103-007]**

No	FUNCTION	COMMENTS
0	Printing while a paper cassette is pulled out, when the Just Size Printing feature is enabled. 0: Printing will not start 1: Printing will start if another cassette has a suitable size of paper, based on the paper size selection priority tables.	Cross reference Just size printing on/off – User switch 05, bit 5
1-7	<b>Not used.</b>	Do not change the settings.

**Printer Switch 07 [SP No. 1-103-008]**

No	FUNCTION	COMMENTS
0-3	<b>Not used.</b>	Do not change the settings.
4	List of destinations in the Communication Failure Report for broadcasting 0: All destinations 1: Only destinations where communication failure occurred	1: Only destinations where communication failure occurred are printed on the Communication Failure Report.
5-7	<b>Not used.</b>	Do not change the settings.

**Printer Switch 08 - Not used (do not change the settings) [SP No. 1-103-009]**
**Printer Switch 09 - Not used (do not change the settings) [SP No. 1-103-010]**
**Printer Switch 0A - Not used (do not change the settings) [SP No. 1-103-011]**
**Printer Switch 0B - Not used (do not change the settings) [SP No. 1-103-012]**
**Printer Switch 0C - Not used (do not change the settings) [SP No. 1-103-013]**
**Printer Switch 0D - Not used (do not change the settings) [SP No. 1-103-014]**
**Printer Switch 0E [SP No. 1-103-015]**

No	FUNCTION	COMMENTS
----	----------	----------

0	<p>Paper size selection priority</p> <p>0: Width</p> <p>1: Length</p>	<p>0: A paper size that has the same width as the received data is selected first.</p> <p>1: A paper size which has enough length to print all the received lines without reduction is selected first.</p>
1	<p>Paper size selected for printing A4 width fax data</p> <p>0: 8.5" x 11" size</p> <p>1: A4 size</p>	<p>This switch determines which paper size is selected for printing A4 width fax data, when the machine has both A4 and 8.5" x 11" size paper.</p>
2	<p>Page separation</p> <p>0: Enabled</p> <p>1: Disabled</p>	<p>1: If all paper sizes in the machine require page separation to print a received fax message, the machine does not print the message (Substitute Reception is used).</p> <p>After a larger size of paper is set in a cassette, the machine automatically prints the fax message.</p>
3-4	<p>Printing the sample image on reports</p> <p>Bit 4: 0, Bit 3: 0 = The upper half only</p> <p>Bit 4: 0, Bit 3: 1 = 50% reduction in sub-scan only</p> <p>Bit 4: 1, Bit 3: 0 = Same size</p> <p>Bit 4: 1, Bit 3: 1 = <b>Not used</b></p>	<p>"Same size" means the sample image is printed at 100%, even if page separation occurs.</p> <p>User Parameter Switch 19 (13H) bit 4 must be set to "0" to enable this switch.</p> <p>Refer to Detailed Section Descriptions for more on this feature.</p>
5-6	<p><b>Not used</b></p>	<p>Do not change the settings.</p>
7	<p>Equalizing the reduction ratio among separated pages</p> <p>(Page Separation)</p> <p>0: Enabled</p> <p>1: Disabled</p>	<p>0: When page separation has taken place, all the pages are reduced with the same reduction ratio.</p> <p>1: Only the last page is reduced to fit the selected paper size when page separation has taken place. Other pages are printed without reduction.</p>

Printer Switch OF [SP No. 1-103-016]		
No	FUNCTION	COMMENTS



0-1	Smoothing feature Bit 1: 0 Bit 0: 0 = Disabled Bit 1: 0 Bit 0: 1 = Disabled Bit 1: 1 Bit 0: 0 = Enabled Bit 1: 1 Bit 0: 1 = <b>Not used</b>	(0, 0) (0, 1): Disable smoothing if the machine receives halftone images from other manufacturers fax machines frequently.
2	Duplex-Print Setting 0: Disabled / 1: Enabled	This function is available only when the Duplex unit is equipped. This SW is disabled on Report/List-Output.
3	Stapling area setting for Duplex-Print	0: Left side area stapled 1: Upper side area stapled
4-7	<b>Not used</b>	Do not change the settings.

## Communication Switches

Communication Switch 00 [SP No. 1-104-001]		
No	FUNCTION	COMMENTS
0-1	Compression modes available in receive mode Bit 1: 0 Bit 0: 0 = MH only Bit 1: 0 Bit 0: 1 = MH/MR Bit 1: 1 Bit 0: 0 = MH/MR/MMR Bit 1: 1 Bit 0: 1 = MH/MR/MMR/JBIG	These bits determine the compression capabilities to be declared in phase B (handshaking) of the T.30 protocol.
2-3	Compression modes available in transmit mode Bit 3: 0 Bit 2: 0 = MH only Bit 3: 0 Bit 2: 1 = MH/MR Bit 3: 1 Bit 2: 0 = MH/MR/MMR Bit 3: 1 Bit 2: 1 = MH/MR/MMR/JBIG	These bits determine the compression capabilities to be used in the transmission and to be declared in phase B (handshaking) of the T.30 protocol.
4	<b>Not used</b>	Do not change the settings.

5	<p>JBIG compression method: Reception</p> <p>0: Only basic supported 1: Basic and optional both supported</p>	<p>Change the setting when communication problems occur using JBIG compression.</p>
6	<p>JBIG compression method: Transmission</p> <p>0: Basic mode priority 1: Optional mode priority</p>	<p>Change the setting when communication problems occur using JBIG compression.</p>
7	<p>Closed User Group (CUG) connecting ON/OFF switch (for RX)</p> <p>0: OFF 1: ON</p>	<p>0: All Fax received 1: Fax only from a sender machine that has the same polling ID as the receiver, can be received.</p>

Communication Switch 01 [SP No. 1-104-002]		
No	FUNCTION	COMMENTS
0	<p>ECM</p> <p>0: Off 1: On</p>	<p>If this bit is set to 0, ECM is switched off for all communications.</p> <p>In addition, V.8 protocol and JBIG compression are switched off automatically.</p>
1	<b>Not used</b>	Do not change the setting.
2-3	The trigger selection for the G3 misconnecting protection	<p>00: OFF</p> <p>01: All CSI digits un-corresponded</p> <p>10: The last 4 CSI digits un-corresponded</p> <p>11: CSI and RTI absence</p>
4-5	<b>Not used</b>	Do not change the setting.

6-7	<p>Maximum printable page length available</p> <p>Bit 7: 0 Bit 6: 0 = No limit</p> <p>Bit 7: 0 Bit 6: 1 = B4 (364 mm)</p> <p>Bit 7: 1 Bit 6: 0 = A4 (297 mm)</p> <p>Bit 7: 1 Bit 6: 1 = <b>Not used</b></p>	The setting determined by these bits is informed to the transmitting terminal in the pre-message protocol exchange (in the DIS/NSF frames).
-----	---	---

### Communication Switch 02 [SP No. 1-104-003]

No	FUNCTION	COMMENTS
0	G3 Burst error threshold 0: Low 1: High	If there are more consecutive error lines in the received page than the threshold, the machine will send a negative response. The Low and High threshold values depend on the sub-scan resolution, and are as follows.
		100 dpi      6(L) → 12(H)
		200 dpi      12(L) → 24(H)
		300 dpi      18(L) → 36(H)
		400 dpi      24(L) → 48(H)
1	Acceptable total error line ratio 0: 5% 1: 10%	If the error line ratio for a page exceeds the acceptable ratio, RTN will be sent to the other end.
2	Treatment of pages received with errors during G3 reception 0: Deleted from memory without printing 1: Printed	0: Pages received with errors are not printed.
3	Hang-up decision when a negative code (RTN or PIN) is received during G3 immediate transmission 0: No hang-up, 1: Hang-up	0: The next page will be sent even if RTN or PIN is received. 1: The machine will send DCN and hang up if it receives RTN or PIN. This bit is ignored for memory transmissions or if ECM is being used.
4-7	<b>Not used</b>	Do not change the settings.

Communication Switch 03 [SP No. 1-104-004]		
No	FUNCTION	COMMENTS
0-7	Maximum number of page retransmissions in a G3 memory transmission	00 - FF (Hex) times. This setting is not used if ECM is switched on. Default setting - 03(H)

Communication Switch 04 [SP No. 1-104-005]		
No	FUNCTION	COMMENTS
0	Remote switch setting for TEL mode 0: OFF 1: ON	Determines whether remote switching is ON/OFF on receiving fax transmission, in TEL mode.
1	Remote switch setting for FAX mode 0: OFF 1: ON	Determines whether remote switching is ON/OFF on auto receiving, in FAX mode.
2	Remote switch setting for AUTO mode 0: OFF 1: ON	Determines whether remote switching is ON/OFF on auto receiving, in AUTO mode.
3-7	<b>Not used</b>	Do not change the settings

Communication Switch 05 [SP No. 1-104-006]		
No	FUNCTION	COMMENTS
0-3	Number setting for remote switching	00-09 (0-9: HEX) Selects the handset number pushed to switch between TEL/FAX.
4-7	<b>Not used</b>	Do not change the settings

<b>Communication Switch 06 - Not used</b> (do not change the settings)		
<b>Communication Switch 07 - Not used</b> (do not change the settings)		
<b>Communication Switch 08 - Not used</b> (do not change the settings)		

<b>Communication Switch 09 [SP No. 1-104-010]</b>		
---	--	--

No	FUNCTION	COMMENTS
0-7	IP-Fax dial interval setting	Adjusts the interval of the IP-fax dialing. The interval of IP-fax dialing is calculated by following formula. [Interval time = specified value with this switch x 2 sec]

**Communication Switch 0A [SP No. 1-104-011]**

No	FUNCTION	COMMENTS
0	Point of resumption of memory transmission upon redialing 0: From the error page 1: From page 1	0: The transmission begins from the page where transmission failed the previous time. 1: Transmission begins from the first page, using normal memory transmission.
1-7	<b>Not used</b>	Do not change the settings.

**Communication Switch 0B [SP No. 1-104-012]**

No	FUNCTION	COMMENTS
0-3	<b>Not used</b>	(do not change the settings)
4	Received file output ON/OFF selection for multiple relayed communications. 0: OFF 1: ON	Determines whether received file(s) is printed out or not by the relaying copier on multiple relayed communications.
5-7	<b>Not used</b>	Do not change the settings.

**Communication Switch 0C – Not used** (do not change the settings)

**Communication Switch 0D [SP No. 1-104-014]**

No	FUNCTION	COMMENTS
----	----------	----------

0-7	<p>The available memory threshold, below which ringing detection (and therefore reception into memory) is disabled</p>	<p>00 to FF (Hex), unit = 4 kbytes (e.g., 06(H) = 24 kbytes) One page is about 24 kbytes.</p> <p>The machine refers to this setting before each fax reception. If the amount of remaining memory is below this threshold, the machine cannot receive any fax messages.</p> <p>If this setting is kept at 0, the machine will detect ringing signals and go into receive mode even if there is no memory available. This will result in communication failure.</p>
-----	--	---

**Communication Switch 0E [SP No. 1-104-015]**

No	FUNCTION	COMMENTS
0-7	<p>Minimum interval between automatic dialing attempts</p>	<p>06 to FF (Hex), unit = 2 s (e.g., 06(H) = 12 s)</p> <p>This value is the minimum time that the machine waits before it dials the next destination.</p>

**Communication Switch 0F – Not used** (do not change the settings.)

**Communication Switch 10 [SP No. 1-104-017]**

No	FUNCTION	COMMENTS
0-7	<p>Memory transmission: Maximum number of dialing attempts to the same destination</p>	<p>01 – FE (Hex) times</p>

**Communication Switch 11 – Not used** (do not change the settings.)

**Communication Switch 12 [SP No. 1-104-019]**

No	FUNCTION	COMMENTS
0-7	<p>Memory transmission: Interval between dialing attempts to the same destination</p>	<p>01 – FF (Hex) minutes</p>

**Communication Switch 13 – Not used** (do not change the settings.)

**Communication Switch 14 [SP No. 1-104-021]**

No	FUNCTION	COMMENTS
0	Inch-to-mm conversion during transmission 0: Disabled 1: Enabled	0: In immediate transmission, data scanned in inch format are transmitted without conversion. In memory transmission, data stored in the SAF memory in mm format are transmitted without conversion. Note: When storing the scanned data into SAF memory, the fax unit always converts the data into mm format. 1: The machine converts the scanned data or stored data in the SAF memory to the format which was specified in the set-up protocol (DIS/NSF) before transmission.
1-5	<b>Not used</b>	Do not change the factory settings.
6-7	Available unit of resolution in which fax messages are received Bit 7: 0, Bit 6: 0 = mm Bit 7: 0, Bit 6: 1 = inch Bit 7: 1, Bit 6: 0 = mm and inch (default) Bit 7: 1, Bit 6: 1 = <b>Not used</b>	For the best performance, do not change the factory settings. The setting determined by these bits is informed to the transmitting terminal in the pre-message protocol exchange (in the DIS/NSF frames).

**Communication Switch 15 – Not used** (do not change the settings)

**Communication Switch 16 – Not used** (do not change the settings)

**Communication Switch 17 [SP No. 1-104-024]**

No	FUNCTION	COMMENTS
0	SEP (Selective polling) reception Enabled/Disabled switch 0: Disabled / 1: Enabled	"Enabled" means SEP (Selective polling) is acceptable on reception.

1	SUB (password-locked data) reception Enabled/Disabled switch 0: Disabled / 1: Enabled	"Enabled" means SUB confidential transmission is acceptable on reception.
2	PWD (password) reception Enabled/Disabled switch 0: Disabled / 1: Enabled	"Enabled" means PWD (password for SEP) is acceptable on reception.
3-4	<b>Not used</b>	Do not change the settings.
5	PSTN dial-in routine Enabled/Disabled switch 0: Disabled / 1: Enabled	Determines whether PSTN dial-in routine function by which reception information is transferred to some destinations, enabled/disabled. PSTN dial-in number is 4 digits.
6	<b>Not used</b>	Do not change the settings.
7	Operating selection on not corresponding F-codebox with received SUB 0: Disconnect 1: Receive	This function also applies to SID/PWD only reception.

**Communication Switch 18 [SP No. 1-104-025]**

No	FUNCTION	COMMENTS
0-4	<b>Not used</b>	Do not change the settings
5	IP-FAX dial-in routine function Enabled/Disabled switch 0: Disable / 1: Enable	Determines whether IP-FAX dial-in routine function which has the same function as PSTN dial-in routine does on IP-FAX, enable/disable. Default is 0 (Disable).
6-7	<b>Not used</b>	Do not change the settings

**Communication Switch 19 - Not used** (do not change the settings)

**Communication Switch 1A - Not used** (do not change the settings)

**Communication Switch 1B [SP No. 1-104-028]**



No	FUNCTION	COMMENTS
0-7	Extension access code (0 to 7) to turn V.8 protocol On/Off 0: On 1: Off	If the PABX does not support V.8/V.34 protocol procedure, set this bit to "1" to disable V.8.  Example: If "0" is the PSTN access code, set bit 0 to 1. When the machine detects "0" as the first dialed number, it automatically disables V.8 protocol. (Alternatively, if "3" is the PSTN access code, set bit 3 to 1.)

#### Communication Switch 1C [SP No. 1-104-029]

No	FUNCTION	COMMENTS
0-1	Extension access code (8 and 9) to turn V.8 protocol On/Off 0: On 1: Off	Refer to communication switch 1B.  Example: If "8" is the PSTN access code, set bit 0 to 1. When the machine detects "8" as the first dialed number, it automatically disables V.8 protocol. (If "9" is the PSTN access code, use bit 1.)
2-7	<b>Not used</b>	Do not change the settings.

Communication Switch 1D - **Not used** (do not change the settings)

Communication Switch 1E - **Not used** (do not change the settings)

Communication Switch 1F - **Not used** (do not change the settings)

## G3-1 Switches

#### G3 Switch 00 [SP No. 1-105-001]

No	FUNCTION	COMMENTS
0-1	Monitor speaker during communication (tx and rx) Bit 1: 0, Bit 0: 0 = Disabled Bit 1: 0, Bit 0: 1 = Up to Phase B Bit 1: 1, Bit 0: 0 = All the time Bit 1: 1, Bit 0: 1 = Reserved	(0, 0): The monitor speaker is disabled all through the communication.  (0, 1): The monitor speaker is on up to phase B in the T.30 protocol.  (1, 0): Used for testing. The monitor speaker is on all through the communication. Make sure that you reset these bits after testing.

2	Monitor speaker during memory transmission 0: Disabled 1: Enabled	1: The monitor speaker is enabled during memory transmission.
3-5	<b>Not used</b>	Do not change the settings.
6	Private G3 FAX line enabled/ disabled switch 0: Disabled / 1:Enabled	This function is used in the situation that one fax is connected to the other directly without switching equipment.
7	<b>Not used</b>	Do not change the settings.

**G3 Switch 01 [SP No. 1-105-002]**

No	FUNCTION	COMMENTS
0-3	<b>Not used</b>	Do not change the settings.
4	DIS frame length limitation 0: OFF 1: 4 bytes	1: The bytes in the DIS frame after the 4th byte will not be transmitted (set to 1 if there are communication problems with PC-based faxes which cannot receive the extended DIS frames).
5	<b>Not used</b>	Do not change the setting.
6	Forbid CED/AMsam output 0: Off 1: On (Forbid output)	Do not change this setting (Default: 0: Off), unless communication problem is caused by a CED or ANSam transmission.
7	<b>Not used</b>	Do not change the setting.

**G3 Switch 02 [SP No. 1-105-003]**

No	FUNCTION	COMMENTS
0	G3 protocol mode used 0: Standard and non-standard 1: Standard only	Change this bit to 1 only when the other end can only communicate with machines that send T.30-standard frames only.  1: Disables NSF/NSS signals (these are used in non-standard mode communication)
1-6	<b>Not used</b>	Do not change the settings.

7	Short preamble 0: Disabled 1: Enabled	Refer to Appendix B in the Group 3 Facsimile Manual for details about Short Preamble.
---	--	---

G3 Switch 03 [SP No. 1-105-004]		
No	FUNCTION	COMMENTS
0	DIS detection number (Echo countermeasure) 0: 1 1: 2	0: The machine will hang up if it receives the same DIS frame twice. 1: Before sending DCS, the machine will wait for the second DIS which is caused by echo on the line.
1	<b>Not Used</b>	Do not change the settings.
2	V.8 protocol 0: Disabled 1: Enabled	0: V.8/V.34 communications will not be possible. Note: Do not set to 0 unless the line condition is always bad enough to slow down the data rate to 14.4 kbps or lower.
3	ECM frame size 0: 256 bytes 1: 64 bytes	Keep this bit at "0" in most cases.
4	CTC transmission conditions 0: After one PPR signal received 1: After four PPR signals received (ITU-T standard)	0: When using ECM in non-standard (NSF/NSS) mode, the machine sends a CTC to drop back the modem rate after receiving a PPR, if the following condition is met in communications at 14.4, 12.0, 9.6, and 7.2 kbps. $\sqrt{N_{\text{Transmit}} \leq N_{\text{Resend}}}$ N <sub>Transmit</sub> - Number of transmitted frames N <sub>Resend</sub> - Number of frames to be retransmitted 1: When using ECM, the machine sends a CTC to drop back the modem rate after receiving four PPRs. PPR, CTC: These are ECM protocol signals. This bit is not effective in V.34 communications.

5	Modem rate used for the next page after receiving a negative code (RTN or PIN) 0: No change 1: Fallback	1: The machine's tx modem rate will fall back before sending the next page if a negative code is received. This bit is ignored if ECM is being used.
6	<b>Not Used</b>	Do not change the settings
7	Select detection of reverse polarity in ringing 0: Off 1: On	This switch is used to prevent reverse polarity in ringing on the phone line (applied to PSTN-G3 ringing). Do not change this setting 0: No detection ⇒ Outside Japan 1: Detection ⇒ Inside Japan only

5

G3 Switch 04 [SP No. 1-105-005]		
No	FUNCTION	COMMENTS
0-3	Training error detection threshold	0 - F (Hex); 0 - 15 bits If the number of error bits in the received TCF is below this threshold, the machine informs the sender that training has succeeded.
4-7	<b>Not used</b>	Do not change the settings.

G3 Switch 05 [SP No. 1-105-006]		
No	FUNCTION	COMMENTS

0-3	Initial Tx modem rate					<p>These bits set the initial starting modem rate for transmission.</p> <p>Use the dedicated transmission parameters if you need to change this for specific receivers.</p> <p>If a modem rate 14.4 kbps or slower is selected, V.8 protocol should be disabled manually.</p> <p>Cross reference V.8 protocol on/off - G3 switch 03, bit2</p>
	Bit 3	Bit 2	Bit 1	Bit 0	bps	
	0	0	0	1	2.4k	
	0	0	1	0	4.8k	
	0	0	1	1	7.2k	
	0	1	0	0	9.6k	
	0	1	0	1	12.0k	
	0	1	1	0	14.4k	
	0	1	1	1	16.8k	
	1	0	0	0	19.2k	
	1	0	0	1	21.6k	
	1	0	1	0	24.0k	
	1	0	1	1	26.4k	
	1	1	0	0	28.8k	
	1	1	0	1	31.2k	
1	1	1	0	33.6k		
	Other settings - <b>Not used</b>					
4-5	<p>Initial modem type for 9.6 k or 7.2 kbps.</p> <p>Bit 5: 0, Bit 4: 0 = V.29</p> <p>Bit 5: 0, Bit 4: 1 = V.17</p> <p>Bit 5: 1, Bit 4: 0 = V.34</p> <p>Bit 5: 1, Bit 4: 1 = Reserved</p>					<p>These bits set the initial modem type for 9.6 and 7.2 kbps, if the initial modem rate is set at these speeds.</p>
6-7	<b>Not used</b>					Do not change the settings.

## G3 Switch 06 [SP No. 1-105-007]

No	FUNCTION	COMMENTS
----	----------	----------

Initial Rx modem rate					<ul style="list-style-type: none"> <li>• These bits set the initial starting modem rate for reception.</li> <li>• Use a lower setting if high speeds pose problems during reception.</li> <li>• If a modem rate 14.4 kbps or slower is selected, V.8 protocol should be disabled manually.</li> </ul> <p>Cross reference: V.8 protocol on/off - G3 switch 03, bit2</p>
Bit 3	Bit 2	Bit 1	Bit 0	bps	
0	0	0	1	2.4k	
0	0	1	0	4.8k	
0	0	1	1	7.2k	
0	1	0	0	9.6k	
0	1	0	1	12.0k	
0	1	1	0	14.4k	
0	1	1	1	16.8k	
1	0	0	0	19.2k	
1	0	0	1	21.6k	
1	0	1	0	24.0k	
1	0	1	1	26.4k	
1	1	0	0	28.8k	
1	1	0	1	31.2k	
1	1	1	0	33.6k	
Other settings - <b>Not used</b>					

4-7	Modem types available for reception					<ul style="list-style-type: none"> <li>The setting of these bits is used to inform the transmitting terminal of the available modem type for the machine in receive mode.</li> <li>If V.34 is not selected, V.8 protocol must be disabled manually.</li> </ul> <p>Cross reference: V.8 protocol on/off - G3 switch 03, bit2</p>
	Bit 7	Bit 6	Bit 5	Bit 4	Setting	
	0	0	0	1	V.27ter	
	0	0	1	0	V.27ter, V.29	
	0	0	1	1	V.27ter, V.29	
	0	1	0	0	V.27ter, V.29, V.17	
	0	1	0	1	V.27ter, V.29, V.17, V.34	
Other settings - <b>Not used</b>						

G3 Switch 07 [SP No. 1-105-008]		
No	FUNCTION	COMMENTS
0-1	PSTN cable equalizer (tx mode: Internal) Bit 1: 0, Bit 0: 0 = None Bit 1: 0, Bit 0: 1 = Low Bit 1: 1, Bit 0: 0 = Medium Bit 1: 1, Bit 0: 1 = High	Use a higher setting if there is signal loss at higher frequencies because of the length of wire between the modem and the telephone exchange. Use the dedicated transmission parameters for specific receivers. Also, try using the cable equalizer if one or more of the following symptoms occurs. Communication error Modem rate fallback occurs frequently. <div style="border: 1px solid blue; border-radius: 10px; padding: 2px; display: inline-block;"> <span style="color: blue;">↓</span> <b>Note</b> </div> <ul style="list-style-type: none"> <li>This setting is not effective in V.34 communications.</li> </ul>

2-3	<p>PSTN cable equalizer (rx mode: Internal)</p> <p>Bit 3: 0, Bit 2: 0 = None Bit 3: 0, Bit 2: 1 = Low Bit 3: 1, Bit 2: 0 = Medium Bit 3: 1, Bit 2: 1 = High</p>	<p>Use a higher setting if there is signal loss at higher frequencies because of the length of wire between the modem and the telephone exchange.</p> <p>Also, try using the cable equalizer if one or more of the following symptoms occurs.</p> <p>Communication error with error codes such as 0-20, 0-23, etc.</p> <p>Modem rate fallback occurs frequently.</p> <p><b>Note</b></p> <ul style="list-style-type: none"> <li>This setting is not effective in V.34 communication</li> </ul>
4	<p>PSTN cable equalizer (V.8/V.17 rx mode: External)</p> <p>0: Disabled 1: Enabled</p>	<p>Keep this bit at "1".</p>
5	<p><b>Not used</b></p>	<p>Do not change the settings.</p>
6	<p>Parameter selection for dial tone detection</p> <p>0: Normal parameter 1: Specific parameter</p>	<p>0: This uses the fixed table in the ROM for dial tone detection.</p> <p>1: This uses the specific parameter adjusted with SRAM (69ECBEH - 69ECDEH). Select this if the dial tone cannot be detected when the "Normal parameter: 0" is selected.</p>
7	<p><b>Not used</b></p>	<p>Do not change the settings.</p>

**G3 Switch 08 - Not used** (do not change the settings)

**G3 Switch 09 [SP No. 1-105-008]**

No	FUNCTION	COMMENTS
----	----------	----------



0-1	<p>ISDN cable equalizer (tx mode: Internal)</p> <p>Bit 1: 0, Bit 0: 0 = None Bit 1: 0, Bit 0: 1 = Low Bit 1: 1, Bit 0: 0 = Medium Bit 1: 1, Bit 0: 1 = High</p>	<p>Use a higher setting if there is signal loss at higher frequencies because of the length of wire between the modem and the telephone exchange.</p> <p>Use the dedicated transmission parameters for specific receivers.</p> <p>Also, try using the cable equalizer if one or more of the following symptoms occurs.</p> <p>Communication error Modem rate fallback occurs frequently.</p> <p><b>Note</b></p> <ul style="list-style-type: none"> <li>This setting is not effective in V.34 communications.</li> </ul>
2-3	<p>ISDN cable equalizer (rx mode: Internal)</p> <p>Bit 3: 0, Bit 2: 0 = None Bit 3: 0, Bit 2: 1 = Low Bit 3: 1, Bit 2: 0 = Medium Bit 3: 1, Bit 2: 1 = High</p>	<p>Use a higher setting if there is signal loss at higher frequencies because of the length of wire between the modem and the telephone exchange.</p> <p>Also, try using the cable equalizer if one or more of the following symptoms occurs.</p> <p>Communication error with error codes such as 0-20, 0-23, etc.</p> <p>Modem rate fallback occurs frequently.</p> <p><b>Note</b></p> <ul style="list-style-type: none"> <li>This setting is not effective in V.34 communications.</li> </ul>
4	<p>ISDN cable equalizer (V.8/V.17 rx mode: External)</p> <p>0: Disabled 1: Enabled</p>	<p>Keep this bit at "1".</p>
5-7	<b>Not used</b>	Do not change the settings.

## G3 Switch 0A [SP No. 1-105-011]

No	FUNCTION	COMMENTS
----	----------	----------

0-1	<p>Maximum allowable carrier drop during image data reception (ms)</p> <p>Bit 1: 0, Bit 0: 0 = 200</p> <p>Bit 1: 0, Bit 0: 1 = 400</p> <p>Bit 1: 1, Bit 0: 0 = 800</p> <p>Bit 1: 1, Bit 0: 1 = Reserved</p>	<p>These bits set the acceptable modem carrier drop time.</p> <p>Try using a longer setting if error code 0-22 is frequent.</p>
2	<p>Select cancellation of high-speed RX if carrier signal lost while receiving</p> <p>0: Off</p> <p>1: On</p>	<p>This switch setting determines if high-speed receiving ends if the carrier signal is lost when receiving during non-ECM mode</p>
3	<b>Not used</b>	Do not change the settings
4	<p>Maximum allowable frame interval during image data reception.</p> <p>0: 5 sec 1: 13 sec</p>	<p>This bit set the maximum interval between EOL (end-of-line) signals and the maximum interval between ECM frames from the other end.</p> <p>Try using a longer setting if error code 0-21 is frequent.</p>
5	Not used	Do not change the settings.
6	<p>Reconstruction time for the first line in receive mode</p> <p>0: 6 sec 1: 12 sec</p>	<p>When the sending terminal is controlled by a computer, there may be a delay in receiving page data after the local machine accepts set-up data and sends CFR. This is outside the T.30 recommendation. But, if this delay occurs, set this bit to 1 to give the sending machine more time to send data.</p> <p>Refer to error code 0-20.</p> <p>ITU-T T.30 recommendation: The first line should come within 5 s of CFR.</p>
7	<b>Not used</b>	Do not change the settings.

**G3 Switch 0B Not used** (do not change the settings).

**G3 Switch 0C [SP No. 1-105-013]**

No	FUNCTION	COMMENTS
0-3	<b>Not used</b>	Do not change the settings

4-5	DTMF/DP fixed detection method selection for remote switching <ul style="list-style-type: none"> <li>• Bit4: 0 / Bit5: 0 = Simultaneous detection of DTMF+PSTN external line choice</li> <li>• Bit4: 0 / Bit5: 1 = DTMF fixed</li> <li>• Bit4: 1 / Bit5: 0 = DP (10PPS) fixed</li> <li>• Bit4: 1 / Bit5: 1 = DP(20PPS) fixed</li> </ul>	Sets the signal from the handset as a trigger for remote switching
6-7	<b>Not used</b>	Do not change the settings

**G3 Switch OD Not used** (do not change the settings).

### G3 Switch OE [SP No 1-105-015]

0-7	Set CNG send time interval Some machines on the receiving side may not be able to automatically switch the 3-second CNG interval.	
	High order bit	3000-2250ms: 3000-50xNms 3000 – 50 x Nms 0F (3000 ms) < N < FF (2250 ms)
	Low order bit	00-0E(3000-3700ms: 3000+50xNms 3000 – 50 x Nms 0F (3000 ms) < N < 0F (3700 ms)

### G3 Switch OF [SP No. 1-105-016]

No	FUNCTION	COMMENTS
0	Alarm when an error occurred in Phase C or later 0: Disabled 1: Enabled	If the customer wants to hear an alarm after each error communication, change this bit to "1".
1	Alarm when the handset is off-hook at the end of communication 0: Disabled 1: Enabled	If the customer wants to hear an alarm if the handset is off-hook at the end of fax communication, change this bit to "1".
2-3	<b>Not used</b>	Do not change the settings.

4	Sidaa manual calibration setting 0: Off 1: On	1: manually calibrates for communication with a line, whose current change occurs such as an optical fiber line.
5-7	<b>Not used</b>	Do not change the settings.

## IP Fax Switches

IP Fax Switch 00 [SP No. 1-111-001]		
No.	FUNCTION	COMMENTS
0	<b>Not used</b>	Do not change this setting.
1	IP Fax Transport 0: TCP, 1: UDP	Selects TCP or UDP protocol for IP-Fax
2	IP Fax single port selection 0: OFF, 1: ON (enable)	Selects single data port.
3	IP Fax double ports (single data port) selection 0: OFF, 1: ON (enable)	Selects whether IP-Fax uses a double port.
4	IP Fax Gatekeeper 0: OFF, 1: ON (enable)	Enables/disables the communication via the gatekeeper for IP-Fax.
5	IP Fax T30 bit signal reverse 0: LSB first, 1: MSB first	Reverses the T30 bit signal.
6	IP Fax max bit rate setting 0: Not affected, 1: Affected	When "0" is selected, the max bit rate does not affect the value of the DIS/DCS. When "1" is selected, the max bit rate affects the value of the DIS/DCS.

7	IP Fax received telephone number confirmation 0: No confirmation, 1: Confirmation	When "0" is selected, fax data is received without checking the telephone number.  When "1" is selected, fax data is received only when confirming that the telephone number from the sender matches the registered telephone number in this machine. If this confirmation fails, the line is disconnected.
---	---	---

#### IP-Fax Switch 01

No.	FUNCTION	COMMENTS				
0-3	Select IP FAX Delay Level					Raise the level by selecting a higher setting if too many transmission errors are occurring on the network.  If TCP/UDP is enabled on the network, raise this setting on the T.30 machine. Increasing the delay time allows the recovery of more lost packets.  If only UDP is enabled, increase the number of redundant packets.  Level 1 to 2: 3 Redundant packets Level 3: 4 Redundant packets
	Bit3	Bit2	Bit1	Bit0	Setting	
	0	0	0	0	Level 0	
	0	0	0	1	Level 1	
	0	0	1	0	Level 2	
	0	0	1	1	Level 3	
4-7	IP Fax preamble wait time setting	Selects the preamble wait time. [00 to 0F]  There are 16 values in this 4-bit binary switch combination.  Waiting time: set value level x 100 ms Max: 0F (1500 ms) Min: 00 (No wait time)  The default is "0000" (00H).				

#### IP Fax Switch 02 [SP No. 1-111-003]

No.	FUNCTION	COMMENTS
-----	----------	----------

0	<p>IP Fax bit signal reverse setting</p> <p>0: Maker code setting</p> <p>1: Internal bit switch setting</p>	<p>When "0" is selected, the bit signal reverse method is decided by the maker code.</p> <p>When "1" is selected, the bit signal reverse method is decided by the internal bit switch.</p> <p>(When communicating between IP Fax devices, LSB first is selected.)</p>
1	<p>IP Fax transmission speed setting</p> <p>0: Modem speed</p> <p>1: No limitation</p>	<p>Selects the transmit speed for IP Fax communication.</p>
2	<p>SIP transport setting</p> <p>0: TCP</p> <p>1: UDP</p>	<p>This bit switch sets the transport that has priority for receiving IP Fax data.</p> <p>This function is activated only when the sender has both TCP and UDP.</p>
3	<p>CCM connection</p> <p>0: No CCM connection</p> <p>1: CCM connection</p>	<p>When "1" is selected, only the connection call message with H.323 or no tunneled H.245 is transmitted via CCM.</p>
4	<p>Message reception selection from non-registered SIP server</p> <p>0: Answer</p> <p>1: Not answer</p>	<p>0: This answers the INVITE message from the SIP server not registered for the machine.</p> <p>1: This does not receive the INVITE message from the SIP server not registered for the machine and send a refusal message.</p>
5	<p>ECM communication setting</p> <p>0: No limit for image compression</p> <p>1: Limit for image compression</p>	<p>0: This does not limit the type of the image compression with ECM communication.</p> <p>1: When the other end machine is Cisco, this permits the image compression other than JBIG or MMR with ECM communication.</p>
6-7	<b>Not used</b>	Do not change these settings.

IP Fax Switch 03 [SP No. 1-111-004]		
No.	FUNCTION	COMMENTS
0	<p>Effective field limitation for G3 standard function information</p> <p>0: OFF, 1: 4byte (DIS)</p>	<p>Limits the effective field for standard G3 function information.</p>

1	Switching between G3 standard and G3 non standard 0: Enable switching 1: G3 standard only	Enables/disables switching between G3 standard and G3 non-standard.
2	Not used.	Do not change this setting.
3	ECM frame size selection at transmitting 0: 256byte, 1: 64byte	Selects the ECM frame size for sending.
4	DIS detection times for echo prevention 0: 1 time, 1: 2 times	Sets the number of times for DIS to detect echoes.
5	CTC transmission selection 0: PPRx1 1: PPRx4	When "0" is selected, the transmission condition is decided by error frame numbers. When "1" is selected, the transmission condition is based on the ITU-T method.
6	Shift down setting at receiving negative code 0: OFF, 1: ON	Selects whether to shift down when negative codes are received.
7	<b>Not used</b>	Do not change this setting.

**IP Fax Switch 04 [SP No. 1-111-005]**

No.	FUNCTION	COMMENTS
0-3	TCF error threshold	Sets the TCF error threshold level. [00 to 0F] The default is "1111" (0F H).
4-7	<b>Not used</b>	Do not change these settings.

**IP Fax Switch 05 [SP No. 1-111-006]**

No.	FUNCTION	COMMENTS
-----	----------	----------

0-3	Modem bit rate setting for transmission Sets the modem bit rate for transmission. The default is "0110" (14.4K bps).				
	Bit 4	Bit 3	Bit 2	Bit 1	
	0	0	0	1	2400 bps
	0	0	1	1	4800 bps
	0	0	1	1	7200 bps
	0	1	0	0	9600 bps
	0	1	0	1	12.0 Kbps
	0	1	1	0	14.4 Kbps
	0	1	1	1	<b>Not Used</b>
	1	0	0	0	<b>Not Used</b>
	1	0	0	1	<b>Not Used</b>
	1	0	1	0	<b>Not Used</b>
	1	0	1	1	<b>Not Used</b>
	1	1	0	0	<b>Not Used</b>
1	1	0	1	<b>Not Used</b>	
1	1	1	0	<b>Not Used</b>	
4-5	Modem setting for transmission Sets the modem for transmission. The default is "00" (V29). Bit 5: 0, Bit 4: 0 = V29 Bit 5: 0, Bit 4: 1 = V17 Bit 5: 1, Bit 4: 0 = <b>Not used</b> Bit 5: 1, Bit 4: 1 = <b>Not used</b> *V34 is not supported for IP-Fax communication.				
6-7	<b>Not used</b>		Do not change these settings.		

IP Fax Switch 06 [SP No. 1-111-007]



No.	FUNCTION				COMMENTS
0-3	Modem bit rate setting for reception				
	Sets the modem bit rate for reception. The default is "0110" (14.4K bps).				
	Bit 3	Bit 2	Bit 1	Bit 0	
	0	0	0	1	2400 bps
	0	0	1	0	4800 bps
	0	0	1	1	7200 bps
	0	1	0	0	9600 bps
	0	1	0	1	12.0 Kbps
	0	1	1	0	14.4 Kbps
	0	1	1	1	<b>Not Used</b>
	1	0	0	0	<b>Not Used</b>
	1	0	0	1	<b>Not Used</b>
	1	0	1	0	<b>Not Used</b>
	1	0	1	1	<b>Not Used</b>
	1	1	0	0	<b>Not Used</b>
	1	1	0	1	<b>Not Used</b>
	1	1	1	0	<b>Not Used</b>

4-7	Modem setting for reception Sets the modem type for reception. The default is "0100" (V27ter, V29, V17).				
	Bit 7	Bit 6	Bit 5	Bit 4	
	0	0	0	1	V27ter
	0	0	1	0	V27ter, V29
	0	0	1	1	V27ter, V29, V33 (invalid)
	0	1	0	0	V27ter, V29, V17
	0	1	0	1	<b>Not Used</b>
*V34 is not supported for IP-Fax communication.					

IP Fax Switch 07 [SP No. 1-111-008]		
No.	FUNCTION	COMMENTS
0	TSI information 0: Not added, 1: Added	Adds or does not add TSI information to NSS(S).
1	DCN transmission setting at T1 timeout 0: Not transmitted, 1: Transmitted	Transmits or does not transmit DCN at T1 timeout.
2	<b>Not used</b>	Do not change this setting.
3	Hang up setting at DIS reception disabled 0: No hang up 1: Hang up after transmitting DCN	Sets whether the machine disconnects after DIS reception.
4	Number of times for training 0: 1 time, 1: 2 times	Selects the number of times training is done at the same bit rate.
5	Space CSI transmission setting at no CSI registration 0: Not transmitted, 1: Transmitted	When "0" is selected, frame data is enabled. When "1" is selected, the transmitted data is all spaces.

6-7	<b>Not used</b>	Do not change these settings.
-----	-----------------	-------------------------------

**IP Fax Switch 08 [SP No. 1-111-009]**

No.	FUNCTION	COMMENTS
0-1	T1 timer adjustment Adjusts the T1 timer. The default is "00" (35 seconds). Bit 1: 0, Bit 0: 0 = 35 sec Bit 1: 0, Bit 0: 1 = 40 sec Bit 1: 1, Bit 0: 0 = 50 sec Bit 1: 1, Bit 0: 1 = 60 sec	-
2-3	T4 timer adjustment Adjust the T4 timer. The default is "00" (3 seconds). Bit 3: 0, Bit 2: 0 = 3 sec Bit 3: 0, Bit 2: 1 = 3.5 sec Bit 3: 1, Bit 2: 0 = 4 sec Bit 3: 1, Bit 2: 1 = 5 sec	-
4-5	T0 timer adjustment Bit 5: 0, Bit 4: 0 = 75 sec Bit 5: 0, Bit 4: 1 = 120 sec Bit 5: 1, Bit 4: 0 = 180 sec Bit 5: 1, Bit 4: 1 = 240 sec	Adjusts the fail safe timer. This timer sets the interval between "setup" data transmission and T.38 phase decision. If your destination return is late on the network or G3 fax return is late, adjust the longer interval timer.  The default is "00" (75 seconds).
6-7	<b>Not used</b>	Do not change these settings.

**IP Fax Switch 09 [SP No. 1-111-010]**

No.	FUNCTION	COMMENTS
0	Setting IPv4 or IPv6 for SIP call connection 0: IPv4 (Default) 1: IPv6	This function is used to make SIP connection suited to the user network environment.

1	Setting the way to choose the method with which FAX data communication is done 0: The same method as the call connection 1: Automatic setting			Sets selection way of network I/F method Automatic setting (1) means negotiating with call connection before determining IPv4 or IPv6.
2	Record-route using 1: Enabled 2: Disabled			"Enabled" is for Record-route acceptable SIP server
3-4	Delay time between ACK-message reception and re-INVITE transmitting			Set this function more than "1 sec" when SIP connection is done via HiPath8000/4000 (Siemen Co.)
	Bit 3	Bit 4		
	0	0	No delay	
	1	0	1 sec	
	0	1	2 sec	
	1	1	3 sec	
5-7	<b>Not used</b>			Do not change these settings.

<b>IP Fax Switch OA Not Used</b> (do not change the settings)
<b>IP Fax Switch OB Not Used</b> (do not change the settings)
<b>IP Fax Switch OC Not Used</b> (do not change the settings)
<b>IP Fax Switch OD Not Used</b> (do not change the settings)

## NCU Parameters

- The following tables give the RAM addresses and the parameter calculation units that the machine uses for ringing signal detection and automatic dialing. The factory settings for each country are also given. Most of these must be changed by RAM read/write (SP2-101), but some can be changed using NCU Parameter programming (SP2-103); if SP2-103 can be used, this will be indicated in the Remarks column. The RAM is programmed in hex code unless (BCD) is included in the Unit column.

Address	Function						
680500	Country/Area code for NCU parameters						
	Use the Hex value to program the country/area code directly into this address, or use the decimal value to program it using SP2-103-001						
		<b>Country /Area</b>	<b>Decimal</b>	<b>Hex</b>	<b>Country /Area</b>	<b>Decimal</b>	<b>Hex</b>
		France	00	00	USA	17	11
		Germany	01	01	Asia	18	12
		UK	02	02	Japan	19	13
					Hong Kong	20	14
		Italy	03	03	South Africa	21	15
		Austria	04	04	Australia	22	16
		Belgium	05	05	New Zealand	23	17
		Denmark	06	06	Singapore	24	18
		Finland	07	07	Malaysia	25	19
		Ireland	08	08	China	26	1A
		Norway	09	09	Taiwan	27	1B
		Sweden	10	0A	Korea	28	1C
		Switzerland	11	0B	Brazil	29	1D
					Turkey	32	20
		Portugal	12	0C	Greece	33	21
	Holland	13	0D	Hungary	34	22	
	Spain	14	0E	Czech	35	23	
	Israel	15	0F	Poland	36	24	

Address	Function	Unit	Remarks
680501	Line current detection time	20 ms	Line current detection is disabled. Line current is not detected if 680501 contains FF.
680502	Line current wait time		
680503	Line current drop detect time		
680504	PSTN dial tone frequency upper limit (high byte)	Hz (BCD)	If both addresses contain FF(H), tone detection is disabled.
680505	PSTN dial tone frequency upper limit (low byte)		
680506	PSTN dial tone frequency lower limit (high byte)	Hz (BCD)	If both addresses contain FF(H), tone detection is disabled.
680507	PSTN dial tone frequency lower limit (low byte)		
680508	PSTN dial tone detection time	20 ms	If 680508 contains FF(H), the machine pauses for the pause time (address 68050D / 68050E). Italy: See Note 2.
680509	PSTN dial tone reset time (LOW)		
68050A	PSTN dial tone reset time (HIGH)		
68050B	PSTN dial tone continuous tone time		
68050C	PSTN dial tone permissible drop time		
68050D	PSTN wait interval (LOW)		
68050E	PSTN wait interval (HIGH)	-	
68050F	PSTN ring-back tone detection time	20 ms	Detection is disabled if this contains FF.
680510	PSTN ring-back tone off detection time	20 ms	-
680511	PSTN detection time for silent period after ring-back tone detected (LOW)	20 ms	-
680512	PSTN detection time for silent period after ring-back tone detected (HIGH)	20 ms	-

Address	Function	Unit	Remarks
680513	PSTN busy tone frequency upper limit (high byte)	Hz (BCD)	If both addresses contain FF(H), tone detection is disabled.
680514	PSTN busy tone frequency upper limit (low byte)		
680515	PSTN busy tone frequency lower limit (high byte)	Hz (BCD)	If both addresses contain FF(H), tone detection is disabled.
680516	PSTN busy tone frequency lower limit (low byte)		
680517	PABX dial tone frequency upper limit (high byte)	Hz (BCD)	If both addresses contain FF(H), tone detection is disabled.
680518	PABX dial tone frequency upper limit (low byte)		
680519	PABX dial tone frequency lower limit (high byte)	Hz (BCD)	If both addresses contain FF(H), tone detection is disabled.
68051A	PABX dial tone frequency lower limit (low byte)		
68051B	PABX dial tone detection time	20 ms	If 68051B contains FF, the machine pauses for the pause time (680520 / 680521).
68051C	PABX dial tone reset time (LOW)		
68051D	PABX dial tone reset time (HIGH)		
68051E	PABX dial tone continuous tone time		
68051F	PABX dial tone permissible drop time		
680520	PABX wait interval (LOW)		
680521	PABX wait interval (HIGH)	-	
680522	PABX ringback tone detection time	20 ms	If both addresses contain FF(H), tone detection is disabled.
680523	PABX ringback tone off detection time	20 ms	



Address	Function	Unit	Remarks
680524	PABX detection time for silent period after ringback tone detected (LOW)	20 ms	If both addresses contain FF(H), tone detection is disabled.
680525	PABX detection time for silent period after ringback tone detected (HIGH)	20 ms	
680526	PABX busy tone frequency upper limit (high byte)	Hz (BCD)	If both addresses contain FF(H), tone detection is disabled.
680527	PABX busy tone frequency upper limit (low byte)		
680528	PABX busy tone frequency lower limit (high byte)	Hz (BCD)	If both addresses contain FF(H), tone detection is disabled.
680529	PABX busy tone frequency lower limit (low byte)		
68052A	Busy tone ON time: range 1	20 ms	-
68052B	Busy tone OFF time: range 1		
68052C	Busy tone ON time: range 2		
68052D	Busy tone OFF time: range 2		
68052E	Busy tone ON time: range 3	20 ms	
68052F	Busy tone OFF time: range 3		
680530	Busy tone ON time: range 4		
680531	Busy tone OFF time: range 4		
680532	Busy tone continuous tone detection time		

Address	Function	Unit	Remarks		
680533	<p>Busy tone signal state time tolerance for all ranges, and number of cycles required for detection (a setting of 4 cycles means that ON-OFF-ON or OFF-ON-OFF must be detected twice).</p> <p>Tolerance (<math>\pm</math>)</p> <p>Bit 1: 0, Bit 0: 0 = 75% Bits 2 and 3 must always be kept at 0.</p> <p>Bit 1: 0, Bit 0: 0 = 50% Bits 2 and 3 must always be kept at 0.</p> <p>Bit 1: 0, Bit 0: 0 = 25%</p> <p>Bit 1: 0, Bit 0: 0 = 12.5%</p> <p>Bits 7, 6, 5, 4 - number of cycles required for cadence detection</p>				
680534	International dial tone frequency upper limit (high byte)	Hz (BCD)	If both addresses contain FF(H), tone detection is disabled.		
680535	International dial tone frequency upper limit (low byte)				
680536	International dial tone frequency lower limit (high byte)	Hz (BCD)	If both addresses contain FF(H), tone detection is disabled.		
680537	International dial tone frequency lower limit (low byte)				
680538	International dial tone detection time	20 ms	<p>If 680538 contains FF, the machine pauses for the pause time (68053D / 68053E).</p> <p>Belgium: See Note 2.</p>		
680539	International dial tone reset time (LOW)				
68053A	International dial tone reset time (HIGH)				
68053B	International dial tone continuous tone time				
68053C	International dial tone permissible drop time				
68053D	International dial wait interval (LOW)				
68053E	International dial wait interval (HIGH)				
					-

Address	Function	Unit	Remarks
68053F	Country dial tone upper frequency limit (HIGH)	Hz (BCD)	If both addresses contain FF(H), tone detection is disabled.
680540	Country dial tone upper frequency limit (LOW)		
680541	Country dial tone lower frequency limit (HIGH)		If both addresses contain FF(H), tone detection is disabled.
680542	Country dial tone lower frequency limit (LOW)		
680543	Country dial tone detection time	20 ms	If 680543 contains FF, the machine pauses for the pause time (680548 / 680549).
680544	Country dial tone reset time (LOW)		
680545	Country dial tone reset time (HIGH)		
680546	Country dial tone continuous tone time	-	-
680547	Country dial tone permissible drop time	20 ms	-
680548	Country dial wait interval (LOW)		
680549	Country dial wait interval (HIGH)		
68054A	Time between opening or closing the DO relay and opening the OHDI relay	1 ms	See Notes 3, 6 and 8. SP2-103-012 (parameter 11).
68054B	Break time for pulse dialing	1 ms	See Note 3. SP2-103-013 (parameter 12).
68054C	Make time for pulse dialing	1 ms	See Note 3. SP2-103-014 (parameter 13).
68054D	Time between final OHDI relay closure and DO relay opening or closing	1 ms	See Notes 3, 6 and 8. SP2-103-015 (parameter 14). This parameter is only valid in Europe.

Address	Function	Unit	Remarks
68054E	Minimum pause between dialed digits (pulse dial mode)	20 ms	See Note 3 and 8. SP2-103-016 (parameter 15).
68054F	Time waited when a pause is entered at the operation panel		SP2-103-017 (parameter 16). See Note 3.
680550	DTMF tone on time	1 ms	SP2-103-018 (parameter 17).
680551	DTMF tone off time		SP2-103-019 (parameter 18).
680552	Tone attenuation level of DTMF signals while dialing	-N x 0.5 –3.5 dBm	SP2-103-020 (parameter 19). See Note 5.
680553	Tone attenuation value difference between high frequency tone and low frequency tone in DTMF signals	-dBm x 0.5	SP2-103-021 (parameter 20). The setting must be less than –5dBm, and should not exceed the setting at 680552h above. See Note 5.
680554	PSTN: DTMF tone attenuation level after dialling	-N x 0.5 –3.5 dBm	SP2-103-022 (parameter 21). See Note 5.
680555	ISDN: DTMF tone attenuation level after dialling	-dBm x 0.5	See Note 5
680556	Not used	-	Do not change the settings.
680557	Time between 68054Dh (NCU parameter 14) and 68054Eh (NCU parameter 15)	1 ms	This parameter takes effect when the country code is set to France.
680558	Not used	-	Do not change the setting.
680559	Grounding time (ground start mode)	20 ms	The Gs relay is closed for this interval.
68055A	Break time (flash start mode)	1 ms	The OHDI relay is open for this interval.

Address	Function	Unit	Remarks
68055B	International dial access code (High)	BCD	For a code of 100: 68055B - F1 68055C - 00
68055C	International dial access code (Low)		
68055D	PSTN access pause time	20 ms	This time is waited for each pause input after the PSTN access code. If this address contains FF[H], the pause time stored in address 68054F is used.  Do not set a number more than 7 in the UK.
68055E	Progress tone detection level, and cadence detection enable flags	Bit 7: 0, Bit 6: 0, Bit 5: 0 = -25.0 dBm Bit 7: 0, Bit 6: 0, Bit 5: 1 = -35.0 dBm Bit 7: 0, Bit 6: 1, Bit 5: 0 = -30.0 dBm Bit 7: 1, Bit 6: 0, Bit 5: 0 = -40.0 dBm Bit 7: 1, Bit 6: 1, Bit 5: 0 = -49.0 dBm Bits 2, 0 - See Note 2.	
68055F To 680564	<b>Not used</b>	-	Do not change the settings.
680565	Long distance call prefix (HIGH)	BCD	For a code of 0: 680565 - FF 680566 - FF
680566	Long distance call prefix (LOW)	BCD	
680567 to 680571	<b>Not used</b>	-	Do not change the settings.

Address	Function	Unit	Remarks
680572	Acceptable ringing signal frequency: range 1, upper limit	1000/ N (Hz).	SP2-103-003 (parameter 02).
680573	Acceptable ringing signal frequency: range 1, lower limit		SP2-103-004 (parameter 03).
680574	Acceptable ringing signal frequency: range 2, upper limit		SP2-103-005 (parameter 04).
680575	Acceptable ringing signal frequency: range 2, lower limit		SP2-103-006 (parameter 05).
680576	Number of rings until a call is detected	1	SP2-103-007 (parameter 06). The setting must not be zero.
680577	Minimum required length of the first ring	20 ms	See Note 4. SP2-103-008 (parameter 07).
680578	Minimum required length of the second and subsequent rings	20 ms	SP2-103-009 (parameter 08).
680579	Ringing signal detection reset time (LOW)	20 ms	SP2-103-010 (parameter 09).
68057A	Ringing signal detection reset time (HIGH)		SP2-103-011 (parameter 10).
68057B to 680580	<b>Not used</b>	-	Do not change the settings.
680581	Interval between dialing the last digit and switching the Oh relay over to the external telephone when dialing from the operation panel in handset mode.	20 ms	Factory setting: 500 ms

Address	Function	Unit	Remarks
680582	Bits 0 and 1 - Handset off-hook detection time Bit 1:0, Bit 0: 0 = 200 ms Bit 1:0, Bit 0: 1 = 800 ms Other Not used Bits 2 and 3 - Handset on-hook detection time Bit 3: 0, Bit 2: 0 = 200 ms Bit 3: 0, Bit 2: 1 = 800 ms Other Not used Bits 4 to 7 - <b>Not used</b>		-
680583 To 6805A0	<b>Not used</b>	-	Do not change the settings.
6805A1	Acceptable CED detection frequency upper limit (high byte)	BCD (Hz)	If both addresses contain FF(H), tone detection is disabled.
6805A2	Acceptable CED detection frequency upper limit (low byte)		
6805A3	Acceptable CED detection frequency lower limit (high byte)	BCD (Hz)	If both addresses contain FF(H), tone detection is disabled.
6805A4	Acceptable CED detection frequency lower limit (low byte)		
6805A5	CED detection time	20 ms ± 20 ms	Factory setting: 200 ms
6805A6	Acceptable CNG detection frequency upper limit (high byte)	BCD (Hz)	If both addresses contain FF(H), tone detection is disabled.
6805A7	Acceptable CNG detection frequency upper limit (low byte)		
6805A8	Acceptable CNG detection frequency lower limit (high byte)	BCD (Hz)	If both addresses contain FF(H), tone detection is disabled.
6805A9	Acceptable CNG detection frequency lower limit (low byte)		
6805AA	<b>Not used</b>	-	Do not change the setting.

Address	Function	Unit	Remarks
6805AB	CNG on time	20 ms	Factory setting: 500 ms
6805AC	CNG off time	20 ms	Factory setting: 3000 ms
6805AD	Number of CNG cycles required for detection	-	The data is coded in the same way as address 680533.
6805AE	<b>Not used</b>	-	Do not change the settings.
6805AF	Acceptable AI short protocol tone (800Hz) detection frequency upper limit (high byte)	Hz (BCD)	If both addresses contain FF(H), tone detection is disabled.
6805B0	Acceptable AI short protocol tone (800Hz) detection frequency upper limit (low byte)		
6805B1	Acceptable AI short protocol tone (800Hz) detection frequency lower limit (high byte)	Hz(BCD)	If both addresses contain FF(H), tone detection is disabled.
6805B2	Acceptable AI short protocol tone (800Hz) detection frequency lower limit (low byte)		
6805B3	Detection time for 800 Hz AI short protocol tone	20 ms	Factory setting: 360 ms
6805B4	PSTN: Tx level from the modem	-N – 3 dBm	SP2-103-002 (parameter 01).
6805B5	PSTN: 1100 Hz tone transmission level	- N 6805B4 - 0.5N 6805B5 –3.5 (dB) See Note 7.	
6805B6	PSTN: 2100 Hz tone transmission level	- N6805B4 - 0.5N 6805B6 –3 (dB) See Note 7.	
6805B7	PABX: Tx level from the modem	- dBm	
6805B8	PABX: 1100 Hz tone transmission level	- N 6805B7 - 0.5N 6805B8 (dB)	
6805B9	PABX: 2100 Hz tone transmission level	- N 6805B7 - 0.5N 6805B9 (dB)	



Address	Function	Unit	Remarks										
6805BD	Modem turn-on level (incoming signal detection level)	-37-0.5N (dBm)											
6805BE to 6805C6	<b>Not used</b>	-	Do not change the settings.										
6805C7	Bits 0 to 3 – <b>Not used</b> Bit 4 = V.34 protocol dump 0: Simple, 1: Detailed (default) Bits 5 to 7 – <b>Not used.</b>												
6805C8 to 6805D9	<b>Not used</b>	-	Do not change the settings.										
6805DA	T.30 T1 timer	1 s											
6805E0 bit 3	Maximum wait time for post message	0: 12 s 1: 30 s	1: Maximum wait time for post message (EOP/EOM/MPS) can be changed to 30 s. Change this bit to "1" if communication errors occur frequently during V.17 reception.										
6805E4	Bit 2 sets the level of the call signal, Bit 3 sets the call signal impedance	<table border="1"> <tr> <td rowspan="2">Bit 2</td> <td>0</td> <td>RT=0 (Low)</td> </tr> <tr> <td>1</td> <td>RT=1 (High)</td> </tr> <tr> <td rowspan="2">Bit 3</td> <td>0</td> <td>RZ=0 (High)</td> </tr> <tr> <td>1</td> <td>RZ=1 (Composite)</td> </tr> </table>	Bit 2	0	RT=0 (Low)	1	RT=1 (High)	Bit 3	0	RZ=0 (High)	1	RZ=1 (Composite)	-
Bit 2	0	RT=0 (Low)											
	1	RT=1 (High)											
Bit 3	0	RZ=0 (High)											
	1	RZ=1 (Composite)											
6805E5	Bit 0 sets the ring detection method, Bit 1 sets the ring detection method when fixed.	<table border="1"> <tr> <td rowspan="2">Bit 0</td> <td>0</td> <td>Auto</td> </tr> <tr> <td>1</td> <td>Fixed</td> </tr> <tr> <td rowspan="2">Bit 1</td> <td>0</td> <td>Use RDTP</td> </tr> <tr> <td>1</td> <td>Use RDTN</td> </tr> </table>	Bit 0	0	Auto	1	Fixed	Bit 1	0	Use RDTP	1	Use RDTN	If any setting is changed, select a setting that is higher than the default setting.
Bit 0	0	Auto											
	1	Fixed											
Bit 1	0	Use RDTP											
	1	Use RDTN											
	Bits 2 to 7: Not used												

## NOTES

1. If a setting is not required, store FF in the address.

2. Italy and Belgium only

RAM address 68055E: the lower four bits have the following meaning.

Bit 2 - 1: International dial tone cadence detection enabled (Belgium)

Bit 1 - Not used

Bit 0 - 1: PSTN dial tone cadence detection enabled (Italy)

If bit 0 or bit 2 is set to 1, the functions of the following RAM addresses are changed.

680508 (if bit 0 = 1) or 680538 (if bit 2 = 1): tolerance for on or off state

duration (%), and number of cycles required for detection, coded as in address 680533.

68050B (if bit 0 = 1) or 68053B (if bit 2 = 1): on time, hex code (unit = 20 ms)

68050C (if bit 0 = 1) or 68053C (if bit 2 = 1): off time, hex code (unit = 20 ms)

3. Pulse dial parameters (addresses 68054A to 68054F) are the values for 10 pps. If 20 pps is used, the machine automatically compensates.

4. The first ring may not be detected until 1 to 2.5 wavelengths after the time specified by this parameter.

5. The calculated level must be between 0 and 10.

The attenuation levels calculated from RAM data are:

High frequency tone:

- $-0.5 \times N_{680552/680554} - 3.5$  dBm
- $-0.5 \times N_{680555}$  dBm

Low frequency tone:

- $-0.5 \times (N_{680552/680554} + N_{680553}) - 3.5$  dBm
- $-0.5 \times (N_{680555} + N_{680553})$  dBm

**Note**

- $N_{680552}$ , for example, means the value stored in address 680552(H)

6. 68054A: Europe - Between Ds opening and Di opening, France - Between Ds closing and Di opening

68054D: Europe - Between Ds closing and Di closing, France - Between Ds opening and Di closing

7. Tone signals which frequency is lower than 1500Hz (e.g., 800Hz tone for AI short protocol) refer to the setting at 6805B5h. Tones which frequency is higher than 1500Hz refer to the setting at 6805B6h.

8. 68054A, 68054D, 68054E: The actual inter-digit pause (pulse dial mode) is the sum of the period specified by the RAM addresses 68054A, 68054D, and 68054E.

# Dedicated Transmission Parameters

There are two sets of transmission parameters: Fax and E-mail

Each Quick Dial Key and Speed Dial Code has eight bytes of programmable parameters allocated to it. If transmissions to a particular machine often experience problems, store that terminal's fax number as a Quick Dial or Speed Dial, and adjust the parameters allocated to that number.

The programming procedure will be explained first. Then, the eight bytes will be described.

## Programming Procedure

1. Set the bit 0 of System Bit Switch 00 to 1 (01H).
2. Enter Address Book Management mode ([User Tools] > Address Book Management).
3. Select "New program" (To create the new address book) or "Change" (To change already created address book).
4. Press the "Fax Dest." or "Email", and select "Fax Dest." for the fax parameter or select "Email" for E-mail.
5. Press "Start" key. Make sure that the Start button lamp is blue. (If the system bit switch is not changed, the button lamp is red.)
6. Select the switch you want to change by pressing "Next" and "Previous" button.
7. Press the "Bit No." displayed below that you wish to change.
8. After the setting is changed, press "OK" displayed upper above of the panel.
9. Reset bit 0 of System Bit Switch 00 to 0 (00H).

## Parameters

### Fax Parameters

The initial settings of the following fax parameters are all FF(H) - all the parameters are disabled.

Switch 00
FUNCTION AND COMMENTS

ITU-T T1 time (for PSTN G3 mode)

If the connection time to a particular terminal is longer than the NCU parameter setting, adjust this byte. The T1 time is the value stored in this byte (in hex code), multiplied by 1 second.

**Range:**

0 to 120 s (00h to 78h)

FFh - The local NCU parameter factory setting is used.

Do not program a value between 79h and FEh.

**Switch 01**

No	FUNCTION						COMMENTS
0-4	Tx level						If communication with a particular remote terminal often contains errors, the signal level may be inappropriate. Adjust the Tx level for communications with that terminal until the results are better.
	Bit4	Bit3	Bit2	Bit1	Bit0		
	0	0	0	0	0	0	
	0	1	0	0	0	-8	
	0	1	1	1	1	-15	
	1	1	1	1	1	Disabled	<p><b>Note</b></p> <ul style="list-style-type: none"> <li>Do not use settings other than listed on the left.</li> </ul>

5-7	<p>Cable equalizer</p> <p>Bit 7: 0, Bit 6: 0, Bit 5: 0 = None</p> <p>Bit 7: 0, Bit 6: 0, Bit 5: 1 = Low</p> <p>Bit 7: 0, Bit 6: 1, Bit 5: 0 = Medium</p> <p>Bit 7: 0, Bit 6: 1, Bit 5: 1 = High</p> <p>Bit 7: 1, Bit 6: 1, Bit 5: 1 = Disabled</p>	<p>Use a higher setting if there is signal loss at higher frequencies because of the length of wire between the modem and the telephone exchange when calling the number stored in this Quick/Speed Dial.</p> <p>Also, try using the cable equalizer if one or more of the following symptoms occurs.</p> <p>Communication error with error codes such as 0-20, 0-23, etc.</p> <p>Modem rate fallback occurs frequently.</p> <p><b>Note</b></p> <ul style="list-style-type: none"> <li>Do not use settings other than listed on the left.</li> </ul> <p>If the setting is "Disabled", the bit switch setting is used.</p>
-----	--	---

## Switch 02

No	FUNCTION	COMMENTS
----	----------	----------

		Initial Tx modem rate					<p>If training with a particular remote terminal always takes too long, the initial modem rate may be too high. Reduce the initial Tx modem rate using these bits.</p> <p>For the settings 14.4 or kbps slower, Switch 04 bit 4 must be changed to 0.</p> <p><b>Note</b></p> <ul style="list-style-type: none"> <li>Do not use settings other than listed on the left. If the setting is "Disabled", the bit switch setting is used.</li> </ul>
		Bit3	Bit2	Bit1	Bit0	bps	
0-3		0	0	0	0	Not used	
		0	0	0	1	2400	
		0	0	1	0	4800	
		0	0	1	1	7200	
		0	1	0	0	9600	
		0	1	0	1	12000	
		0	1	1	0	14400	
		1	1	0	1	31200	
		1	1	1	0	33600	
		1	1	1	1	Disabled	
Other settings: <b>Not used</b>							
4-7	<b>Not used</b>						Do not change the settings.

Switch 03		
No	FUNCTION	COMMENTS
0-1	<p>Inch-mm conversion before tx</p> <p>Bit 1: 0, Bit 0: 0 = Inch-mm conversion available</p> <p>Bit 1: 0, Bit 0: 1 = Inch only</p> <p>Bit 1: 1, Bit 0: 0 = Not used</p> <p>Bit 1: 1, Bit 0: 1 = Disabled</p>	<p>The machine uses inch-based resolutions for scanning. If "inch only" is selected, the printed copy may be slightly distorted at the other end if that machine uses mm-based resolutions.</p> <p>If the setting is "Disabled", the bit switch setting is used.</p>
2-3	<p>DIS/NSF detection method</p> <p>Bit 3: 0, Bit 2: 0 = First DIS or NSF</p> <p>Bit 3: 0, Bit 2: 1 = Second DIS or NSF</p> <p>Bit 3: 1, Bit 2: 0 = Not used</p> <p>Bit 3: 1, Bit 2: 1 = Disabled</p>	<p>(0, 1): Use this setting if echoes on the line are interfering with the set-up protocol at the start of transmission. The machine will then wait for the second DIS or NSF before sending DCS or NSS.</p> <p>If the setting is "Disabled", the bit switch setting is used.</p>

4	V.8 protocol 0: Off 1: Disabled	If transmissions to a specific destination always end at a lower modem rate (14,400 bps or lower), disable V.8 protocol so as not to use V.34 protocol. 0: V.34 communication will not be possible. If the setting is "Disabled", the bit switch setting is used.
5	Compression modes available in transmit mode 0: MH only 1: Disabled	This bit determines the capabilities that are informed to the other terminal during transmission. If the setting is "Disabled", the bit switch setting is used.
6-7	ECM during transmission Bit 7: 0, Bit 6: 0 = Off Bit 7: 0, Bit 6: 1 = On Bit 7: 1, Bit 6: 0 = Not used Bit 7: 1, Bit 6: 1 = Disabled	For example, if ECM is switched on but is not wanted when sending to a particular terminal, use the (0, 0) setting. <b>Note</b> <ul style="list-style-type: none"> <li>V.8/V.34 protocol and JBIG compression are automatically disabled if ECM is disabled.</li> <li>If the setting is "Disabled", the bit switch setting is used.</li> </ul>

**Switch 04 - Not used** (do not change the settings)

**Switch 05 - Not used** (do not change the settings)

**Switch 06 - Not used** (do not change the settings)

**Switch 07 - Not used** (do not change the settings)

**Switch 08 - Not used** (do not change the settings)

**Switch 09 - Not used** (do not change the settings)

## E-mail Parameters

The initial settings of the following e-mail parameters are all "0" (all parameters disabled).

Switch 00		
No	FUNCTION	COMMENTS

0	MH Compression mode for e-mail attachments 0: Off 1: On	Switches MH compression on and off for files attached to e-mails for sending.
1	MR Compression mode for e-mail attachments 0: Off 1: On	Switches MR compression on and off for files attached to e-mails for sending.
2	MMR Compression mode for e-mail attachments 0: Off 1: On	Switches MMR compression on and off for files attached to e-mails for sending.
3-6	<b>Not used</b>	Do not change these settings.
7	Designates the bits to reference for compression method of e-mail attachments 0: Registered (Bit 0 to 6) 1: No registration.	The "0" selection (default) references the settings for Bits 00, 01, 02 above. The "1" selection ignores the selections of Bits 00, 01, 02.

Switch 01		
No	FUNCTION	COMMENTS
0	Original width of e-mail attachment: A4 0: Off 1: On	Sets the original width of the e-mail attachment as A4.
1	Original width of e-mail attachment: B4 0: Off 1: On	Sets the original width of the e-mail attachment as B4.



2	Original width of e-mail attachment: A3 0: Off 1: On	Sets the original width of the e-mail attachment as A3.
3-6	<b>Not used</b>	Do not change these settings.
7	Designates the bits to reference for original size of e-mail attachments 0: Registered (Bit 0 to 6) 1: No registration.	The "0" selection (default) references the settings for Bits 00, 01, 02 above. The "1" selection ignores the selections of Bits 00, 01, 02.

**Switch 02**

No	FUNCTION	COMMENTS
0	Line resolution of e-mail attachment: 200 x 100 0: Off 1: On	Sets the line resolution of the e-mail attachment as 200 x 100.
1	Line resolution of e-mail attachment: 200 x 200 0: Off 1: On	Sets the line resolution of the e-mail attachment as 200 x 200.
2	Line resolution of e-mail attachment: 200 x 400 0: Off 1: On	Sets the line resolution of the e-mail attachment as 200 x 400.
3	<b>Not used</b>	Do not change these settings.
4	Line resolution of e-mail attachment: 400 x 400 0: Off 1: On	Sets the line resolution of the e-mail attachment as 400 x 400.
5-6	<b>Not used</b>	Do not change these settings.

7	Designates the bits to reference for original size of e-mail attachments <b>0:</b> Registered (Bit 0 to 6) <b>1:</b> No registration.	The "0" selection (default) references the settings for Bits 00, 01, 02, 04 above. The "1" selection ignores the selections of Bits 00, 01, 02, 04.
---	---	---

**Switch 03 - Not used** (do not change the settings)

**Switch 04**

No	FUNCTION	COMMENTS
0	Full mode address selection <b>0:</b> Full mode address <b>1:</b> No full mode (simple mode)	If the other ends have the addresses, which have the full mode function flag ("0"), this machine determines them as full mode standard machines. <ul style="list-style-type: none"> <li>• This machine attaches the "demand of reception confirmation" to a message when transmitting.</li> <li>• This machine updates the reception capability to the address book when receiving.</li> </ul>
1-7	<b>Not used</b>	Do not change these settings.

**Switch 05**

No	FUNCTION	COMMENTS
0	Direct transmission selection to SMTP server <b>0:</b> ON <b>1:</b> OFF	Allows or does not allow the direct transmission to SMTP server.
1-7	Not used	Do not change these settings.

**Switch 06 - Not used** (do not change the settings)

**Switch 07 - Not used** (do not change the settings)

**Switch 08 - Not used** (do not change the settings)

**Switch 09 - Not used** (do not change the settings)