

MB760 / MB770
MPS5502
Maintenance Manual
(2 of 2) Controller Manual

70913A

Copyright © 2013 by Oki Data. All Rights Reserved

Oki Data America's, Inc. ("Oki Data"), authorizes you to view, copy, and print documents published by Oki Data for noncommercial use within your organization only. In consideration of this authorization, you agree and acknowledge that any copy of these documents shall retain all copyright and proprietary rights contained herein. Each document published by Oki Data may contain additional copyright information and proprietary notification relating to that individual document.

Nothing contained herein shall be construed as conferring by estoppel, implication or otherwise any license or right under any patent or trademark of Oki Data, Oki Electric Industry Co., Ltd. ("Oki Electric"), or any third party. Except as provided above nothing contained herein shall be construed as conferring any license or right under any Oki Data copyright.

Oki Data has taken care to insure that the information which follows is complete, accurate and up-to-date. However, Oki Data assumes no responsibility for errors or omissions which may occur. All the information provided is subject to change from time to time at the sole discretion of Oki Data.

All publications may include technical inaccuracies or typographical errors. We reserve the right to make periodic changes, additions, and deletions to publications without notice.

The most up-to-date drivers and manuals are available from the web site:
<http://www.okiprintingsolutions.com>

TRADEMARKS

- The official name of Windows 8 is Microsoft Windows 8 Operating System.
- The official name of Windows 7 is Microsoft Windows 7 Operating System.
- The official name of Windows Vista is Microsoft Windows Vista Operating System.
- The official name of Windows XP is Microsoft Windows XP Operating System.
- Microsoft, Windows, Windows NT, Windows Vista and the brand names and product names of other Microsoft products are trademarks or registered trademarks of Microsoft Corporation in the U.S. and/or other countries.
- Apple, AppleTalk, Macintosh, and Mac are trademarks of Apple Inc. in the U.S. and other countries.
- PostScript is a trademark of Adobe Systems Incorporated.
- NOVELL, NetWare, and NDS are trademarks or registered trademarks of Novell, Inc.
- FLOIL is a registered trademark of Kanto Kasei Ltd. CORPORATION.
- Molykote is a registered trademark of Dow Corning Corporation.
- Web Page is a trademark of OKI DATA Corporation.
- Other company names and product names in this manual are the trademarks of their respective companies.

© 2013 OKI DATA CORPORATION All rights reserved

Under the copyright laws, this manual cannot be reproduced in any form without prior written permission of OKI DATA CORPORATION.

GENERAL PRECAUTIONS REGARDING THE SERVICE FOR THIS EQUIPMENT

The installation and service shall be done by a qualified service technician.

1. Transportation/Installation

- When transporting/installing the equipment, employ two or more persons and be sure to hold the positions as shown in the figure. The equipment is quite heavy and weighs approximately 55 kg (121.23 lb.) (including the finisher), therefore pay full attention when handling it.



- Be sure not to hold the movable parts or units (e.g. the control panel, ADU or RADF) when transporting the equipment.
- Be sure to use a dedicated outlet with AC 110V/15A, 120V/12A, 220-240V/8A for its power source.
- The equipment must be grounded for safety.
- Select a suitable place for installation. Avoid excessive heat, high humidity, dust, vibration and direct sunlight.
- To insure adequate working space for the copying operation, keep a minimum clearance of 30 cm (12") on the left, 30 cm (12") on the right and 60 cm (24") on the rear.
- The equipment shall be installed near the socket outlet and shall be accessible.
- Be sure to fix and plug in the power cable securely after the installation so that no one trips over it.
- If the unpacking place and where the equipment is to be installed differ, perform image quality adjustment (automatic gamma adjustment) according to the temperature and humidity of the place of installation and the paper to be used.
- If the equipment has casters, lock them after the installation.

2. General Precautions at Service

- Be sure to turn the power OFF and unplug the power cable during service (except for the service should be done with the power turned ON).
- Unplug the power cable and clean the area around the prongs of the plug and socket outlet once a year or more. A fire may occur when dust lies on this area.
- When the parts are disassembled, reassembly is the reverse of disassembly unless otherwise noted in this manual or other related documents. Be careful not to install small parts such as screws, washers, pins, E-rings, star washers, harnesses in the wrong places.
- Basically, the equipment should not be operated with any parts removed or disassembled.
- The PC board must be stored in an anti-electrostatic bag and handled carefully using an antistatic wrist strap since the ICs on it may be damaged due to static electricity.

Caution: Before using the antistatic wrist strap, unplug the power cable of the equipment and make sure that there are no charged objects which are not insulated in the vicinity.

- Be sure not to touch high-temperature sections such as the fuser unit and areas around them.
- Be sure not to touch high-voltage sections such as the chargers, transfer belt, developer, high-voltage transformer, and power supply unit. Especially, the board of these components should not be touched since the electric charge may remain in the capacitors, etc. on them even after the power is turned OFF.
- Make sure that the equipment will not operate before touching potentially dangerous places (e.g. rotating/operating sections such as gears, belts pulleys, and fans).
- Be careful when removing the covers since there might be the parts with very sharp edges underneath.
- When servicing the equipment with the power turned ON, be sure not to touch live sections and rotating/operating sections.
- Use designated jigs and tools.
- Use recommended measuring instruments or equivalents.
- Return the equipment to the original state and check the operation when the service is finished.
- Be very careful to treat the touch panel gently and never hit it. Breaking the surface could cause malfunctions.

3. Important Service Parts for Safety

- The door switch, fuse, thermostat, thermofuse, thermistor, batteries, IC-RAMs including lithium batteries, etc. are particularly important for safety. Be sure to handle/install them properly. If these parts are short-circuited and their functions become ineffective, they may result in fatal accidents such as a burnout. Avoid short-circuiting and do not use parts not recommended by OKI DATA Corporation.

4. Cautionary Labels

- During servicing, be sure to check the rating plate and cautionary labels to see if there is any dirt on their surface and if they are properly stuck to the equipment.

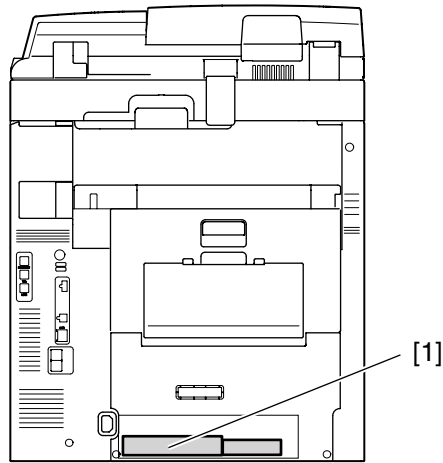

[1] Identification label

5. Disposal of the Equipment, Supplies, Packing Materials, Used Batteries and IC-RAMs

- Regarding the recovery and disposal of the equipment, supplies, packing materials, used batteries and IC-RAMs including lithium batteries, follow the relevant local regulations or rules.
- Never attempt to incinerate a used transfer belt unit. This could cause an explosion and burn you since the toner inside would be scattered.

Caution:

Dispose of used batteries and IC-RAMs including lithium batteries according to this manual.

Attention:

Se débarrasser de batteries et IC-RAMs usés y compris les batteries en lithium selon ce manuel.

Vorsicht:

Entsorgung der gebrauchten Batterien und IC-RAMs (inclusive der Lithium-Batterie) nach diesem Handbuch.

ALLEGEMEINE SICHERHEITSMASSNAHMEN IN BEZUG AUF DIE WARTUNG

Die Installation und die Wartung sind von einem qualifizierten Service-Techniker durchzuführen.

1. Transport/Installation

- Das Tragen oder Installieren des Gerätes braucht wenigstens zwei Menschen. Die angezeigten Stellen sind wie in der Abbildung festzuhalten. Das Gerät ist ziemlich schwer und wiegt ungefähr 55 kg (mit dem Finisher); deshalb wenn Sie es hochheben oder tragen, passen Sie besonders auf.



- Beim Transportieren des Geräts nicht an den beweglichen Teilen oder Einheiten (z.B. das Bedienungsfeld, die Duplexeinheit oder die automatische Dokumentenzuführung) halten.
- Eine spezielle Steckdose mit Stromversorgung von AC 110V/15A, 120V/12A, 220-240V/8A als Stromquelle verwenden.
- Das Gerät ist aus Sicherheitsgründen zu erden.
- Einen geeigneten Standort für die Installation wählen. Standorte mit zuviel Hitze, hoher Luftfeuchtigkeit, Staub, Vibrieren und direkter Sonneneinstrahlung sind zu vermeiden.
- Um einen optimalen Kopierbetrieb zu gewährleisten, muss ein Abstand von mindestens 30 cm links, 30 cm rechts und 60 cm dahinter eingehalten werden.
- Das Gerät ist in der Nähe der Steckdose zu installieren; diese muss leicht zu erreichen sein.
- Nach der Installation muss das Netzkabel richtig hineingesteckt und befestigt werden, damit niemand darüber stolpern kann.
- Falls der Auspackungsstandort und der Installationsstandort des Geräts verschieden sind, die Bildqualitätsjustierung (automatische Gammajustierung) je nach der Temperatur und Luftfeuchtigkeit des Installationsstandorts und der Papiersorte, die verwendet wird, durchführen.
- Wenn das Gerät Rollen hat, sind sie nach der Installation zu verriegeln.

2. Allgemeine Sicherheitsmassnahmen in bezug auf die Wartung

- Während der Wartung das Gerät ausschalten und das Netzkabel herausziehen (ausser Wartung, die bei einem eingeschalteten Gerät, durchgeführt werden muss).
- Das Netzkabel herausziehen und den Bereich um die Steckerpole und die Steckdose die Umgebung in der Nähe von den Steckerzacken und der Steckdose wenigstens einmal im Jahr reinigen. Wenn Staub sich in dieser Gegend ansammelt, kann dies ein Feuer verursachen.
- Wenn die Teile auseinandergenommen werden, wenn nicht anders in diesem Handbuch usw erklärt, ist das Zusammenbauen in umgekehrter Reihenfolge durchzuführen. Aufpassen, dass kleine Teile wie Schrauben, Dichtungsringe, Bolzen, E-Ringe, Stern-Dichtungsringe, Kabelbäume nicht an den verkehrten Stellen eingebaut werden.
- Grundsätzlich darf das Gerät mit entfernten oder auseinandergenommenen Teilen nicht in Betrieb genommen werden.
- Das PC-Board muss in einer Anti-elektrostatischen Hülle gelagert werden. Nur Mit einer Manschette bei Betätigung eines Armbandes anfassen, sonst könnte es sein, dass die integrierten Schaltkreise durch statische Elektrizität beschädigt werden.

Vorsicht: Vor Benutzung der Manschette der Betätigung des Armbandes, das Netzkabel des Gerätes herausziehen und prüfen, dass es in der Nähe keine geladenen Gegenstände, die nicht isoliert sind, gibt.

- Auf keinen Fall Hochtemperaturbereiche, wie die Fixiereinheit und die umliegenden Bereiche, berühren.
- Auf keinen Fall Hochspannungsbereiche, wie die Ladeeinheiten, das Transferband, die Entwicklereinheit, den Hochspannungstransformator und das Netzgerät, berühren. Insbesondere sollten die Platinen dieser Komponenten nicht berührt werden, da die Kondensatoren usw. auch nach dem Ausschalten des Geräts noch elektrisch geladen sein können.
- Vor dem Berühren potenziell gefährlicher Bereiche (z. B. drehbare oder betriebsrelevante Bereiche, wie Zahnräder, Riemen, Riemenscheiben und Lüfter) sicherstellen, dass das Gerät sich nicht bedienen lässt.
- Beim Entfernen von Abdeckungen vorsichtig vorgehen, da sich darunter scharfkantige Komponenten befinden können.
- Bei Wartungsarbeiten am eingeschalteten Gerät dürfen keine unter Strom stehenden, drehbaren oder betriebsrelevanten Bereiche berührt werden.
- Ausschließlich vorgesehene Werkzeuge und Hilfsmittel verwenden.
- Empfohlene oder gleichwertige Messgeräte verwenden.
- Nach Abschluss der Wartungsarbeiten das Gerät in den ursprünglichen Zustand zurück versetzen und den einwandfreien Betrieb überprüfen.
- Das berührungsempfindliche Bedienungsfeld stets vorsichtig handhaben und keinen Stößen aussetzen. Wenn die Oberfläche beschädigt wird, kann dies zu Funktionsstörungen führen.

3. Sicherheitsrelevante Wartungsteile

- Der Türschalter, die Sicherung, der Thermostat, die Thermosicherung, der Thermistor, die IC- RAMs einschließlich der Lithiumakkus usw. sind besonders sicherheitsrelevant. Sie müssen unbedingt korrekt gehandhabt und installiert werden. Wenn diese Teile kurzgeschlossen und funktionsunfähig werden, kann dies zu schwerwiegenden Schäden, wie einem Abbrand, führen. Kurzschlüsse sind zu vermeiden, und es sind ausschließlich Teile zu verwenden, die von der OKI DATA Corporation empfohlen sind.

4. Warnetiketten

- Im Rahmen der Wartung unbedingt das Leistungsschild und die Etiketten mit Warnhinweisen überprüfen [z. B. „Unplug the power cable during service“ („Netz kabel vor Beginn der Wartungsarbeiten abziehen“), „CAUTION. HOT“ („VORSICHT, HEISS“), „CAUTION. HIGH VOLTAGE“ („VORSICHT, HOCHSPANNUNG“), „CAUTION. LASER BEAM“ („VORSICHT, LASER“) usw.], um sicherzustellen, dass sie nicht verschmutzt sind und korrekt am Gerät angebracht sind.

5. Entsorgung des Geräts, der Verbrauchs- und Verpackungsmaterialien, alter Akkus und IC-RAMs

- In Bezug auf die Entsorgung und Wiederverwertung des Geräts, der Verbrauchs- und Verpackungsmaterialien, alter Akkus und IC-RAMs, einschließlich Lithiumakkus, sind die einschlägigen nationalen oder regionalen Vorschriften zu befolgen.
- Eine benutzte Transportriemeneinheit darf niemals verbrannt werden. Dies könnte eine Explosion verursachen und sie brennen, da der Toner innerhalb der Einheit verstreut wird.

Caution:

Dispose of used batteries and IC-RAMs including lithium batteries according to this manual.

Attention:

Se débarrasser de batteries et IC-RAMs usés y compris les batteries en lithium selon ce manuel.

Vorsicht:

Entsorgung der gebrauchten Batterien und IC-RAMs (inclusive der Lithium-Batterie) nach diesem Handbuch.

CONTENTS

1.	SPECIFICATIONS/SYSTEM LIST.....	1-1
1.1	Specifications.....	1-1
1.1.1	General.....	1-1
1.1.2	HDD Memory Map.....	1-2
1.2	System List.....	1-3
2.	DISASSEMBLY AND REPLACEMENT	2-1
2.1	Removal and Installation of Options	2-1
2.1.1	MJ-1038 (Inner finisher).....	2-1
2.1.2	GD-1340 (Fax unit)	2-3
2.1.3	MY-1046 (Paper feed pedestal)	2-3
2.1.4	GR-1170 (Caster)	2-4
2.1.5	GR-1160 (Spacer)	2-5
2.1.6	MJ-1039 (Offline stapler)	2-6
3.	SELF-DIAGNOSTIC MODE	3-1
3.1	Overview	3-1
3.2	Service UI	3-5
3.2.1	Overview.....	3-5
3.2.2	Login procedure.....	3-5
3.2.3	[SERVICE MODE] Screen.....	3-6
3.2.4	Setting/Changing password.....	3-6
3.3	Input check (Test mode 03).....	3-7
3.4	Output check (test mode 03).....	3-8
3.5	Test print mode (test mode 04)	3-9
3.6	Operation Procedure in Adjustment Mode (05)	3-10
3.7	Test print pattern in Adjustment Mode (05).....	3-12
3.8	Operation Procedure in Setting Mode (08).....	3-13
3.9	Assist Mode (3C)	3-15
3.9.1	General description.....	3-15
3.9.2	Operating Procedure.....	3-15
3.9.3	Functions	3-15
3.10	HDD Assist Mode (4C)	3-18
3.10.1	General description.....	3-18
3.10.2	Operation procedure.....	3-18
3.10.3	Functions	3-20
3.11	File System Recovery Mode (5C).....	3-22
3.11.1	Overview.....	3-22
3.11.2	Operation procedure.....	3-22
3.11.3	Functions	3-23
3.12	SRAM Clear Mode (6C).....	3-27
3.12.1	General description.....	3-27
3.12.2	Operation procedure.....	3-27
3.12.3	Functions	3-28

- 3.13 List print mode (9S) 3-29
 - 3.13.1 Operation procedure 3-29
 - 3.13.2 List Printing 3-30
- 4. SETTING / ADJUSTMENT 4-1**
 - 4.1 Image Related Adjustment 4-1
 - 4.1.1 Adjustment Order 4-1
 - 4.1.2 Image Dimensional Adjustment 4-2
 - 4.1.3 Image dimensional adjustment in the copy/printer/fax function 4-3
 - 4.2 Image Quality Adjustment (Copying Function) 4-4
 - 4.2.1 Automatic gamma adjustment 4-4
 - 4.2.2 Density adjustment 4-5
 - 4.2.3 Gamma balance adjustment 4-6
 - 4.2.4 Background adjustment 4-7
 - 4.2.5 Judgment threshold for ACS (common for copy and scan) 4-7
 - 4.2.6 Sharpness adjustment 4-8
 - 4.2.7 Setting range correction 4-8
 - 4.2.8 Adjustment of smudged/faint text 4-9
 - 4.2.9 Judgment threshold adjustment for blank originals
(common for copy and scan) 4-9
 - 4.2.10 Background offsetting adjustment for RADF
(common for copy, scan and fax) 4-10
 - 4.3 Image Quality Adjustment (Printing Function) 4-11
 - 4.3.1 Gamma balance adjustment (Black Mode) 4-11
 - 4.3.2 Upper limit value in the Toner Saving Mode 4-12
 - 4.3.3 Thin line width lower limit adjustment 4-12
 - 4.3.4 Density adjustment of graphic lines (1200 dpi) 4-13
 - 4.4 Image Quality Adjustment (Scanning Function) 4-14
 - 4.4.1 Gamma balance adjustment 4-14
 - 4.4.2 Density adjustment 4-15
 - 4.4.3 Background adjustment (Color Mode) 4-16
 - 4.4.4 Background adjustment (Black/Grayscale) 4-16
 - 4.4.5 Judgment threshold for ACS (common for copy and network scan) 4-17
 - 4.4.6 Sharpness adjustment 4-17
 - 4.4.7 Fine adjustment of black density 4-18
 - 4.4.8 RGB conversion method selection 4-18
 - 4.4.9 Adjustment of saturation 4-19
 - 4.4.10 Background offsetting adjustment for RADF
(common for copy, scan and fax) 4-19
 - 4.4.11 Adjustment of the capacity and image quality of SlimPDF 4-20
 - 4.4.12 Surrounding void amount adjustment 4-20
 - 4.4.13 Judgment threshold adjustment for blank originals
(common for copy and scan) 4-21
 - 4.4.14 JPEG compression level adjustment 4-21
 - 4.4.15 Color conversion table selection 4-22
 - 4.5 Image Quality Adjustment (FAX Function) 4-23
 - 4.5.1 Density adjustment 4-23
 - 4.5.2 Background offsetting adjustment for RADF
(common for copy, scan and fax) 4-24

5.	ERROR CODE AND TROUBLESHOOTING	5-1
5.1	General Descriptions	5-1
5.1.1	If a problem continues even after performing all troubleshooting.....	5-1
5.1.2	Collection of debug logs with a USB device	5-2
5.2	Error Code List.....	5-4
5.2.1	Jam	5-4
5.2.2	Service call	5-5
5.2.3	Error in Internet FAX / Scanning Function	5-8
5.2.4	Printer function error	5-17
5.2.5	Web Page related error/Communication error with external application.....	5-19
5.2.6	MFP access error	5-20
5.2.7	Maintenance error.....	5-21
5.2.8	Network error	5-22
5.2.9	Error history	5-25
5.3	Diagnosis and Prescription for Each Error Code	5-27
5.3.1	Check item.....	5-27
5.3.2	Paper jam in finisher section.....	5-28
5.3.3	Finisher related service call	5-32
5.3.4	Communication related service call	5-40
5.3.5	Scanner related service call.....	5-42
5.3.6	Circuit related service call.....	5-43
5.3.7	Other service call	5-44
5.3.8	Error in Internet FAX / Scanning Function	5-67
5.3.9	Printer function error	5-79
5.3.10	Web Page related error/Communication error with external application.....	5-82
5.3.11	MFP access error	5-86
5.3.12	Maintenance error.....	5-88
5.3.13	Network error	5-93
5.4	Other errors	5-103
5.4.1	Equipment operation disabled after the installation of option(s)	5-103
5.4.2	Wireless LAN connection disabled	5-103
5.4.3	“Invalid Department Code” is displayed	5-103
5.4.4	Ethernet disabled in half-duplex communication	5-103
6.	REPLACEMENT OF PC BOARDS/HDD.....	6-1
6.1	Removal and Installation of PC Boards/HDD	6-1
6.1.1	Right side cover	6-1
6.1.2	SYS Board cover	6-4
6.1.3	SYS board	6-5
6.1.4	Hard disk (HDD)	6-6
6.1.5	SRAM board <for SYS board>.....	6-8
6.1.6	FAX unit	6-9
6.2	Precautions, Procedures and Settings for Replacing PC Boards and HDD.....	6-10
6.2.1	Precautions when replacing PC boards.....	6-10
6.2.2	HDD fault diagnosis	6-11
6.2.3	Precautions and procedures when replacing the HDD	6-13

6.2.4	Precautions and Procedures when replacing the SYS board.....	6-18
6.2.5	Precautions and procedure when replacing the SRAM board (for the SYS board).....	6-22
6.2.6	Precautions and Procedures when replacing the PU board.....	6-28
6.2.7	Precautions and Procedures when replacing the SU board.....	6-28
6.2.8	Firmware confirmation after the PC board/HDD replacement.....	6-28
6.2.9	License re-registration using the one-time dongle.....	6-29
6.3	Precautions for Installation of GP-1070 and Disposal of HDD/ Board ..	6-31
6.3.1	Precautions for Installation of GP-1070.....	6-31
6.3.2	Precautions when disposing of HDD.....	6-31
6.3.3	Precautions when disposing of the SYS board.....	6-31
6.3.4	Precautions when disposing of the SRAM board (for SYS board).....	6-31
7.	REMOTE SERVICE	7-1
7.1	Auto Supply Order	7-1
7.1.1	Outline	7-1
7.1.2	Setting Item.....	7-1
7.1.3	Setting procedure	7-4
7.1.4	Order Sheet Format.....	7-13
7.2	Service Notification.....	7-17
7.2.1	Outline	7-17
7.2.2	Setting.....	7-17
7.2.3	Items to be notified	7-23
8.	FIRMWARE UPDATING	8-1
8.1	Overview.....	8-1
8.2	Firmware Updating with USB Device.....	8-3
8.2.1	Firmware type and data file name for updating.....	8-3
8.2.2	Update procedure	8-5
8.3	Patch Updating with USB Device.....	8-13
8.3.1	Firmware type and data file name for patch updating.....	8-13
8.3.2	Update procedure	8-15
8.4	Firmware Updating with PWA-DWNLD-JIG2	8-20
8.4.1	Writing the data to the download jig (PWA-DWNLD-JIG2).....	8-21
8.4.2	System firmware	8-23
8.5	Firmware Updating with K-PWA-DLM-320	8-25
8.5.1	FAX unit firmware (GD-1340).....	8-26
8.6	Confirmation of the updated data	8-28
8.7	When Firmware Updating Fails.....	8-29
8.7.1	Procedure	8-29
8.7.2	Flow chart for correcting USB update failure	8-30
9.	BACKUP FUNCTION	9-1
9.1	Data Cloning	9-1
9.1.1	General description.....	9-1
9.1.2	Precautions.....	9-1

9.1.3	Backup files.....	9-2
9.1.4	Cloning procedure	9-2
9.2	AES Data Encryption Function Setting	9-5
9.2.1	General description	9-5
9.2.2	Precautions	9-5
9.2.3	Setting procedure	9-6
9.2.4	Procedure for disabling data encryption function.....	9-10
9.2.5	Procedure for discarding HDD when data encryption function is enabled....	9-10
9.3	High Security Mode	9-11
9.3.1	General description.....	9-11
9.3.2	Prior confirmation.....	9-11
9.3.3	Procedure for entering the High Security Mode.....	9-11
9.3.4	Precautions.....	9-12
10.	EXTERNAL COUNTERS	10-1
10.1	Outline	10-1
10.2	Signal.....	10-1
10.2.1	Pin Layout.....	10-1
10.2.2	Details of the signals.....	10-3
10.3	Notices.....	10-5
10.3.1	Setting code.....	10-5
10.3.2	Setting value change and restrictions when using the coin controller	10-5
11.	SELF-DIAGNOSIS CODE (03/05/08 CODE)	11-1
Test mode (03)		11-1
Adjustment Mode (05) Codes		11-3
Setting Mode (08) Codes		11-19

1. SPECIFICATIONS/SYSTEM LIST

Notes: In this document, a model name is replaced with an alias as follows:

Model name	Alias
MB760	H-290
MB770, ES7170MFP, MPS5502mb	H-291

1.1 Specifications

1.1.1 General

Memory (RAM)	Main memory	2 GB
	Page Memory	None
HDD		160 GB
Account Codes		10000 codes
Department Codes		1000 codes
Machine version		OEL, ODA, AOS

1.1.2 HDD Memory Map

Category	Item	Unit	HDD	
HDD	HDD	GB	160	
Copy	Memory copy	GB	30	
	Box	e-Filing	GB	80 (Shared with e-filing/Storage file)
		Public box	Box	1
		User box	Box	200
		Folders per box	Folder	100
		Documents per box	Document	400
		Pages per document	Page	200
		Number of maximum jobs	Job	899
	Scan	Scan to File	GB	80
		Pages per job	Page	1000
		Number of maximum jobs	Job	899 (Except Print/FAX/interrupt)
	FAX	FAX Transmission	GB	1 (Shared with Rx and Tx)
		FAX Reception	GB	1 (Shared with Rx and Tx)
	Print	Printer Data Spool	GB	25
		Pages per job	Job	Storage full
			Job	1000
		Job area	GB	80 (Shared with e-filing/Storage file)
		Pages per job	Job	Storage full
			Job	1000

1.2 System List

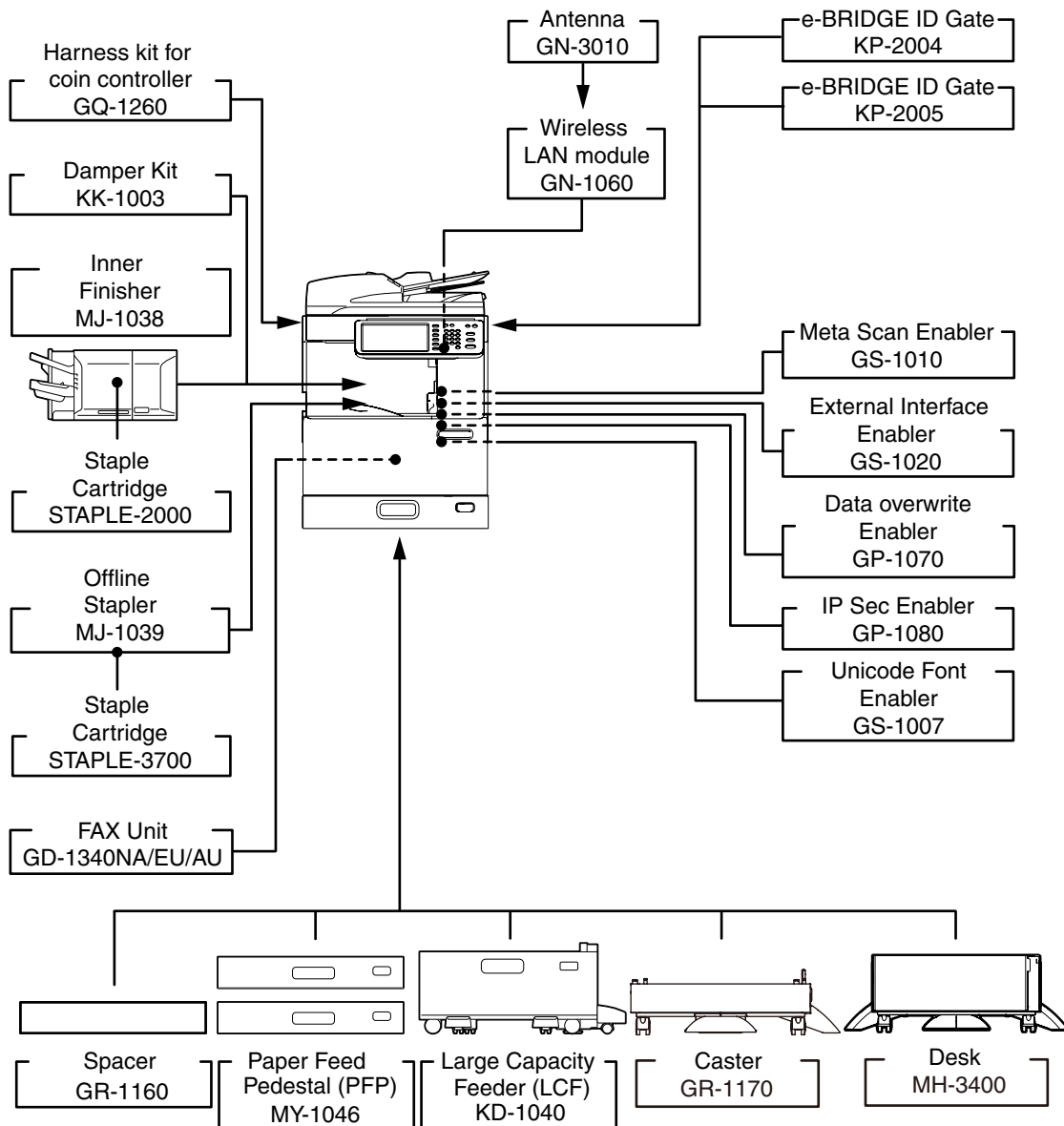

Fig. 1-1

Notes:

- The antenna (GN-3010) is necessary to enable the wireless LAN module (GN-1060/C).

2. DISASSEMBLY AND REPLACEMENT

2.1 Removal and Installation of Options

Important:

- Before installing or removing options, turn the main power switch off and disconnect the 2 power cable from the outlet.

2.1.1 MJ-1038 (Inner finisher)

- (1) Press the [Power] button on the control panel to shut it down.
- (2) Turn the main power switch of the equipment off.
- (3) Disconnect the power cable.
- (4) Open the scanner.



Fig. 2-1

- (5) Remove 2 screws and take off the stacker tray.

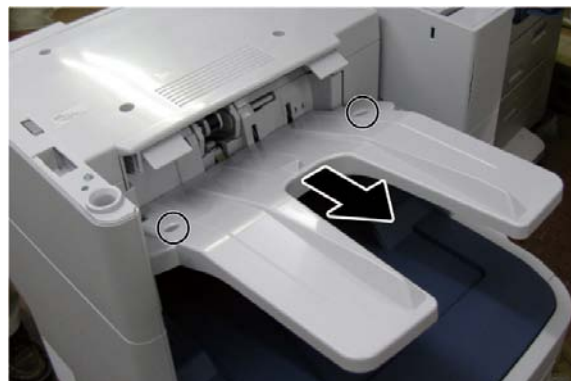

Fig. 2-2

(6) Take off the connector cover.

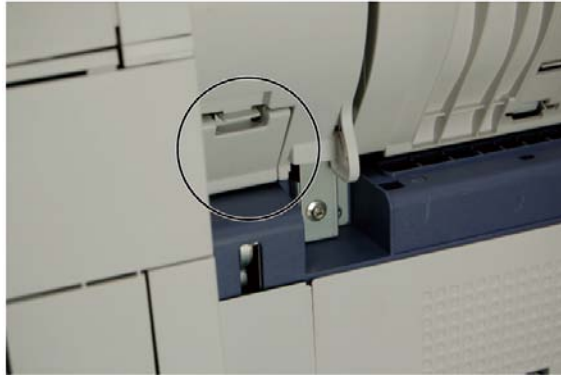

Fig. 2-3

(7) Disconnect the connector.



Fig. 2-4

(8) Remove 2 screws and take off the finisher.

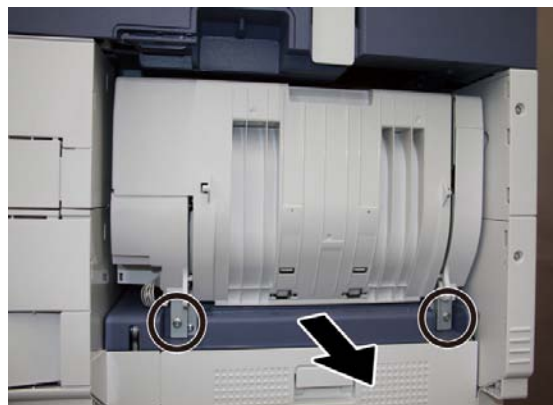



Fig. 2-5

2.1.2 GD-1340 (Fax unit)

Refer to  P. 6-9 “6.1.6 FAX unit”.

2.1.3 MY-1046 (Paper feed pedestal)

- (1) Press the [Power] button on the control panel to shut it down.
- (2) Turn the main power switch of the equipment off.
- (3) Disconnect the power cable.
- (4) Remove 2 screws and take off 2 fixing brackets.

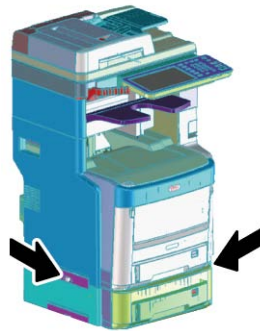

Fig. 2-6

- (5) Lift the equipment up and remove the paper feed pedestal.

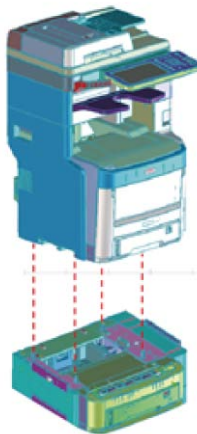

Fig. 2-7

2.1.4 GR-1170 (Caster)

- (1) Press the [Power] button on the control panel to shut it down.
- (2) Turn the main power switch of the equipment off.
- (3) Disconnect the power cable.
- (4) Release the lock.

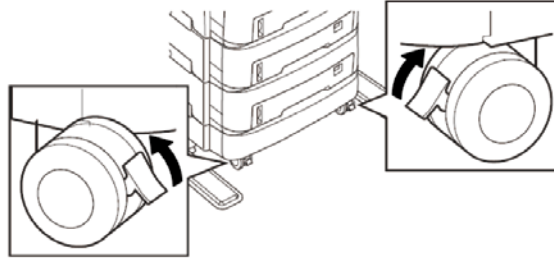

Fig. 2-8

- (5) Remove 2 screws and take off 2 fixing brackets.

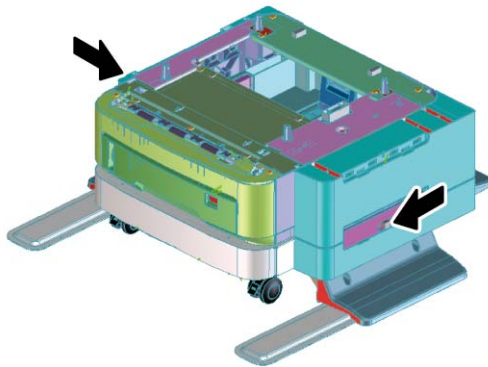

Fig. 2-9

- (6) Lift the equipment up and remove the caster.

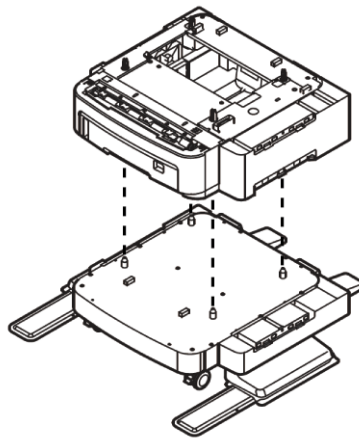

Fig. 2-10

2.1.5 GR-1160 (Spacer)

- (1) Press the [Power] button on the control panel to shut it down.
- (2) Turn the main power switch of the equipment off.
- (3) Disconnect the power cable.
- (4) Remove 2 screws and take off 2 fixing brackets.

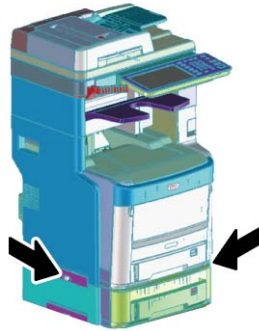

Fig. 2-11

- (5) Lift the equipment up and remove the spacer.

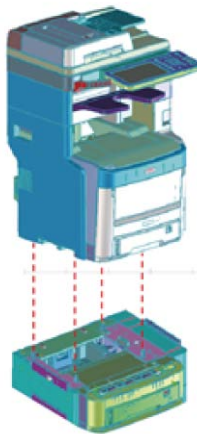

Fig. 2-12

2.1.6 MJ-1039 (Offline stapler)

- (1) Press the [Power] button on the control panel to shut it down.
- (2) Turn the main power switch of the equipment off.
- (3) Disconnect the power cable.
- (4) Take off the right side cover.
P. 6-1 “6.1.1 Right side cover”
- (5) Take off the SYS board cover.
P. 6-4 “6.1.2 SYS Board cover”
- (6) Disconnect the connector.

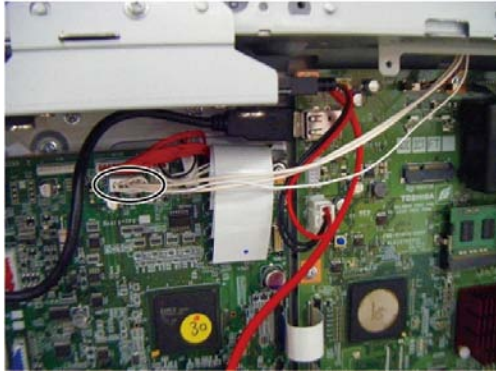

Fig. 2-13

- (7) Remove 2 screws and take off the offline stapler.

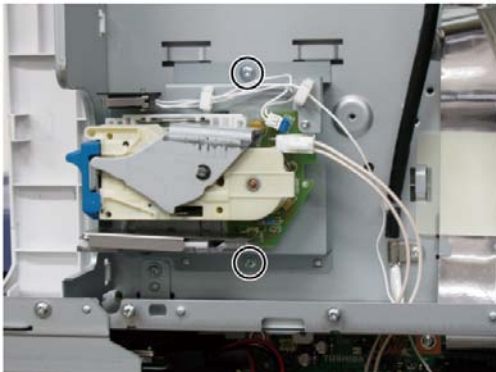

Fig. 2-14

3. SELF-DIAGNOSTIC MODE

3.1 Overview

[A] Starting each mode

To enter the desired mode, turn the power ON while pressing two digital keys designated to each mode (e.g. [0] and [5]) simultaneously. Hold the two keys until the [PRINT DATA] lamp is lit.

On the authentication screen displayed after starting up each mode, enter the service password, and then press [OK]. The password is not set by default.

Refer to “Appendix” for the codes in Test mode (03), Test print mode (04), Adjustment mode (05), and Setting mode (08).

[B] Exiting from each mode

Shut down the equipment. When the power should be turned OFF, be sure to shut down the equipment by pressing the [ON/OFF] button for a few seconds.

[C] List of modes

Mode	For start	Contents	For exit	Display
Control panel check mode	[0] + [1] + [POWER]	All LEDs on the control panel are lit, and all the LCD pixels blink.	[POWER] OFF/ON	-
Test mode	[0] + [3] + [POWER]	Checks the status of input/output signals.	[POWER] OFF/ON	100% C TEST MODE
Test print mode	[0] + [4] + [POWER]	Outputs the test patterns.	[POWER] OFF/ON	100% P A4 TEST PRINT
Adjustment mode	[0] + [5] + [POWER]	Adjusts various items.	[POWER] OFF/ON	100% A A4 TEST MODE
Setting mode	[0] + [8] + [POWER]	Sets various items.	[POWER] OFF/ON	100% D TEST MODE
Maintenance mode	[6]+[8]+ [POWER]	Maintains the scanner unit (SU) and printer unit (PU)	[POWER] OFF/ON	-
Assist mode	[3]+[C]+ [POWER]	Clears error flags or SRAM, or safely deletes data in the HDD or SRAM to support the replacement of the SYS board, SRAM or HDD.	[POWER] OFF/ON	-
HDD assist mode	[4]+[CLEAR]+ [POWER]	Assists the ADI-HDD by checking the type of the mounted HDD, reverting the HDD to a factory default or removing keys.	[POWER] OFF/ON	-
File system recovery mode	[5] + [C] + [POWER]	Checks, recovers or initializes the file system (HDD).	[POWER] OFF/ON	-
SRAM clear mode	[6]+[CLEAR]+ [POWER]	Recovers the equipment from particular errors such as F800 or F900.	[POWER] OFF/ON	-
List print mode	[9] + [START] + [POWER]	Prints various lists or outputs them in a CSV format.	[POWER] OFF/ON	100% L A4 LIST PRINT
Firmware update mode	[4] + [9] + [POWER]	Performs firmware update with USB device.	[POWER] OFF/ON	-
	[8] + [9] + [POWER]	Performs firmware update with download jig.	[POWER] OFF/ON	-
Password reset mode	[4] + [8] + [9] + [POWER]	Resets the administrator password and service password.	[POWER] OFF/ON	-
SRAM data cloning mode	[5] + [9] + [POWER]	Backs up the SRAM data to USB device.	[POWER] OFF/ON	-

Note:

Do not enter any of the modes shown below since they are provided only for production. If you do so, the equipment may not be restarted.

- [2]+[CLEAR]+[POWER]
- [7]+[CLEAR]+[POWER]
- [8]+[CLEAR]+[POWER]
- [9]+[CLEAR]+[POWER]

[D] State transition diagram of self-diagnosis modes

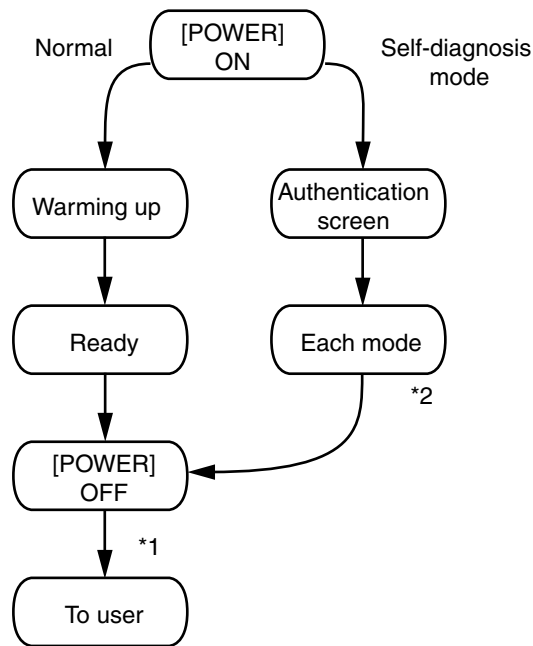

Fig. 3-1

*1 If you have used a self-diagnostic mode, turn the power OFF before the customer starts using the equipment

*2 Mode shown in the table “[C] List of modes”

[E] About each mode

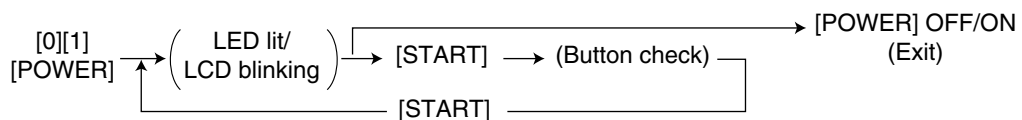

- Control panel check mode (01)

Operation procedure





Notes:

- A mode can be cancelled by [POWER] OFF/ON when the LED is lit and the LCD is blinking.
- Button Check
 - Buttons with LED: Press to turn OFF the LED.
 - Buttons without LED: Press to display the message on the control panel.
 - Button on touch panel: Press to display the initial screen displayed at power-ON. Press [execution] on the touch panel and then the [CLEAR] button on the control panel. The screen then returns to the Button Check menu.

- Test mode (03)
Refer to  P. 3-7 “3.3 Input check (Test mode 03)” and  P. 3-9 “3.4 Output check (test mode 03)”.

- Test print mode (04)
Refer to  P. 3-9 “3.5 Test print mode (test mode 04)”.

- Adjustment mode (05)
Refer to  P. 3-10 “3.6 Operation Procedure in Adjustment Mode (05)”,  P. 3-12 “3.7 Test print pattern in Adjustment Mode (05)”, and “Appendix” - “Adjustment Code (05).”
Notes:
When the power should be turned OFF, be sure to shut down the equipment by pressing the [ON/OFF] button for a few seconds.
Remarks:
 - In “RAM”, the SRAM of the board in which the data of each code is stored is indicated. “PU” stands for the PU board and “SYS” stands for the SYS board.

- Setting mode (08)
Refer to  P. 3-13 “3.8 Operation Procedure in Setting Mode (08)” and “Appendix” - “Setting Code (08).”
Notes:
When the power should be turned OFF, be sure to shut down the equipment by pressing the [ON/OFF] button for a few seconds.
Remarks:
 - In “RAM”, the SRAM of the board in which the data of each code is stored is indicated. “PU” stands for the PU board, “SYS”, “NIC” or “UTY” stands for the SYS board.

- Maintenance mode (68)
Refer to “5.2 Maintenance menu functions” in the Hardware Guide.

- Assist mode (3C)
Refer to  P. 3-15 “3.9 Assist Mode (3C)”.

- HDD assist mode (4C)
Refer to  P. 3-18 “3.10 HDD Assist Mode (4C)”.

- File system recovery mode (5C)
Refer to  P. 3-23 “3.11 File System Recovery Mode (5C)”.

- SRAM clear mode (6C)
Refer to  P. 3-27 “3.12 SRAM Clear Mode (6C)”.

- List print mode (9S)
Refer to  P. 3-29 “3.13 List print mode (9S)”.

- Firmware update mode (49/89)
Refer to  P. 8-1 “8. FIRMWARE UPDATING”.

- Password reset mode (489)

This mode resets the administrator password and service password. The user data is erased when resetting the passwords.

Operation procedure

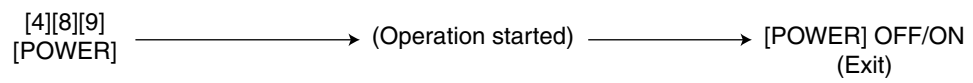

- SRAM data cloning mode (59)

Refer to  P. 9-1 “9.1 Data Cloning”.

3.2 Service UI

3.2.1 Overview

The following self-diagnostic modes can be used with Service UI on the touch panel of the control panel.

- 05 ADJUSTMENT MODE
- 08 SETTING MODE
- FAX LIST PRINT MODE

3.2.2 Login procedure

[1] In the normal mode

- (1) Turn the power ON.
- (2) Press the [USER FUNCTIONS] button.
- (3) With the [USER FUNCTIONS] menu displayed, enter the Service Mode password provided during product training.

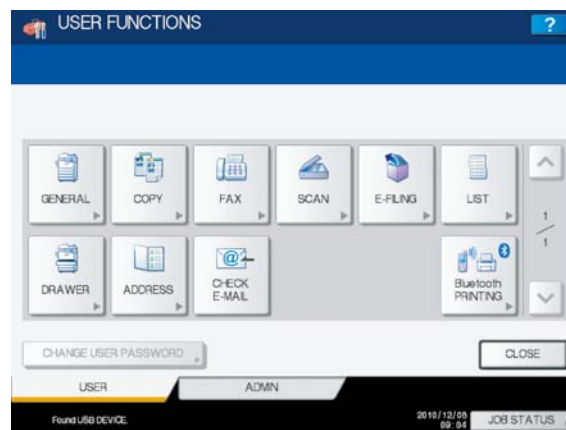

Fig. 3-2

- (4) Enter the user name and password on the SERVICE TECHNICIAN PASSWORD screen, then press [OK]. They are set by default as follows:

User Name	Service
Password	None

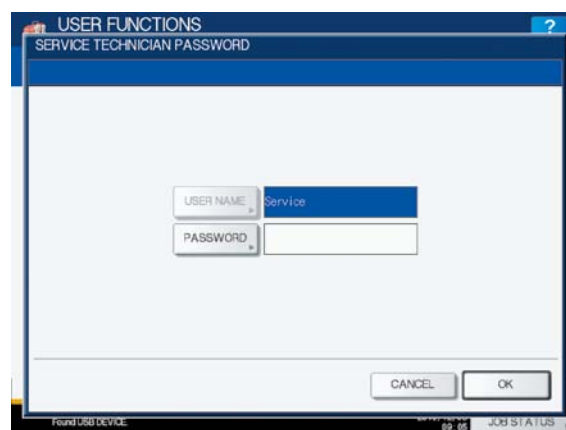

Fig. 3-3

The SERVICE MODE screen is displayed.

[2] In the security mode

If the security mode (the value of 08-8911 is “3”) is set, log into Service UI following the steps below.

- (1) Turn the power ON.
- (2) Enter the user name and password on the USER AUTHENTICATION screen. The password needs to be changed to log in for the first time.

Notes:

In case the password is forgotten, ask the administrator to reset the service password. In case both the service password and administrator password are forgotten, the passwords can be reset in the password reset mode. Note that the user data are deleted at that time.

- (3) Press the [USER FUNCTIONS] button.
- (4) Enter the password for Service UI on the USER FUNCTIONS screen. The SERVICE MODE screen is displayed.

3.2.3 [SERVICE MODE] Screen

After selecting the mode and pressing the [NEXT] button, the screen is switched to the selected mode.

3.2.4 Setting/Changing password

- (1) Press the [SETTINGS] button on the SERVICE MODE screen to display the SETTINGS screen.

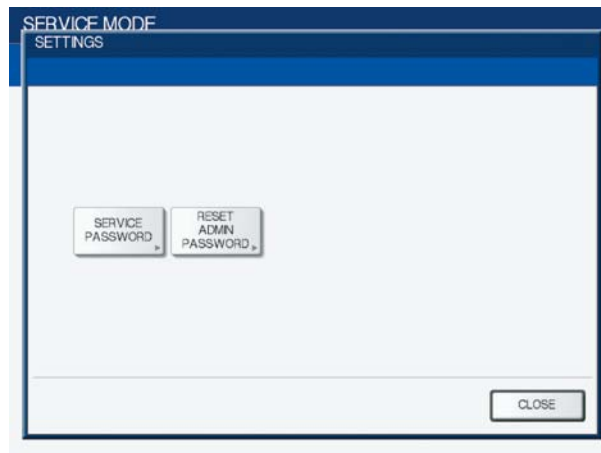

Fig. 3-4

- (2) Press the [SERVICE PASSWORD] button to change the service password, or [RESET ADMIN PASSWORD] to reset the administrator password.

3.3 Input check (Test mode 03)

The status of each input signal can be checked by pressing the [FAX] button, [COPY] button, [SCAN] button and the digital keys in the test mode (03).

<Operation procedure>

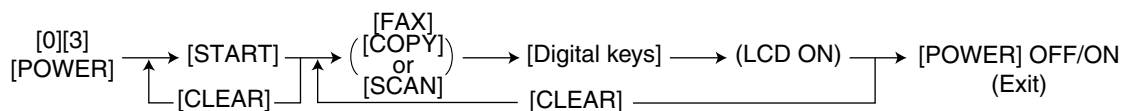

Notes:

- Initialization is performed before the equipment enters the test mode.
- The PRINT DATA lamp blinks when the input check is running.

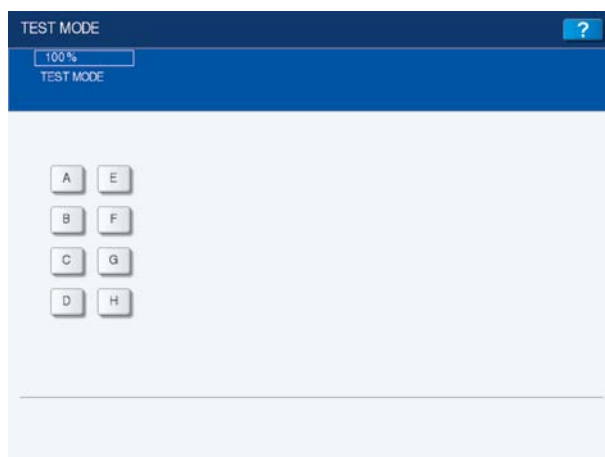

Fig. 3-5 Example of display during input check

Refer to “Appendix” in this manual for the items to be checked and the condition of the equipment when the buttons [A] to [H] are highlighted.

3.4 Output check (test mode 03)

Status of the output signals can be checked in the test mode 03.

<Operation procedure>

Procedure 1

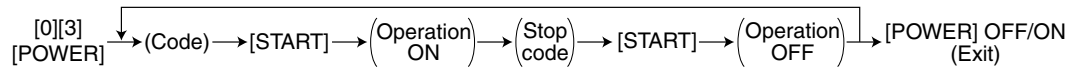

Procedure 2

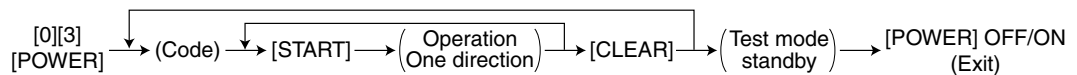

Procedure 3

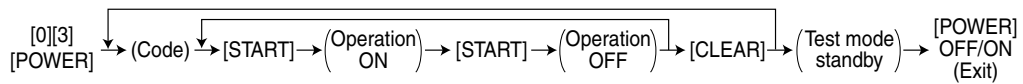

Procedure 4

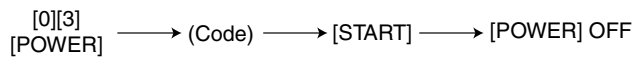

Refer to “Appendix” in this manual for the codes available in the test mode 03.

3.5 Test print mode (test mode 04)

The embedded test pattern can be printed out in the test print mode (04).

<Procedure 1>

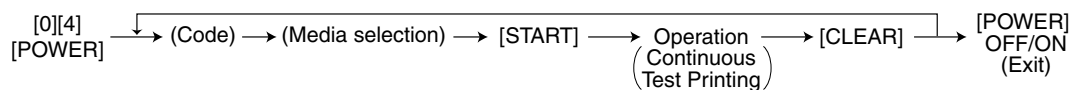

Notes:

- When an error occurs, it is indicated on the panel, but the recovery operation is not performed.
Turn OFF the power and then back ON to clear the error.
- During test printing, the [CLEAR] button is disabled when “Wait adding toner” is displayed.

Refer to “Appendix” in this manual for the codes available in the test print mode.

3.6 Operation Procedure in Adjustment Mode (05)

Procedure 1

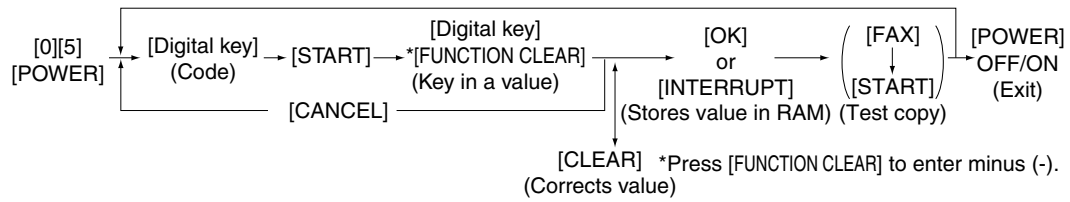

Procedure 2

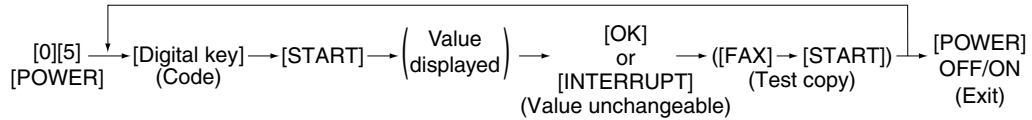

Procedure 3

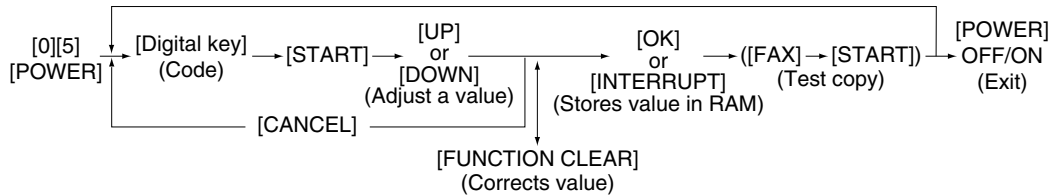

Procedure 4

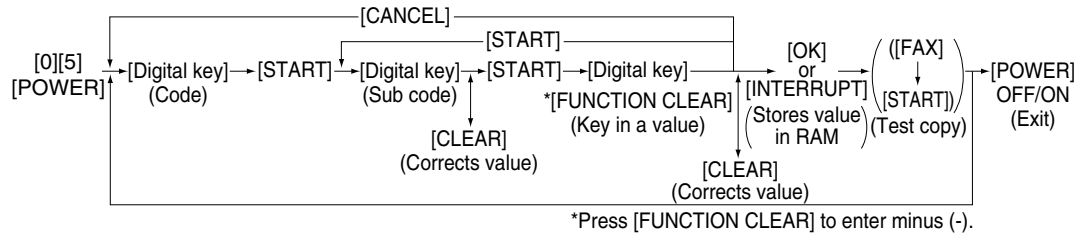

Procedure 5

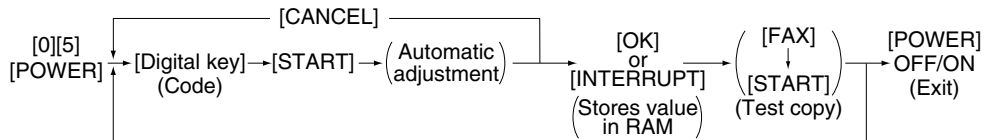

Procedure 6

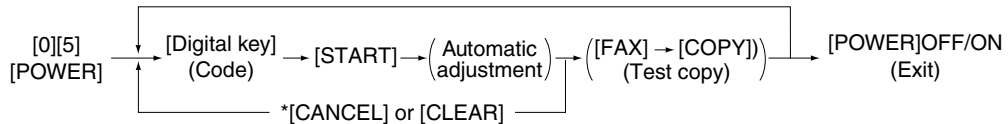

* When the automatic adjustment ends abnormally, an error message is displayed.

* Return to standby screen by pressing the [CANCEL] or [CLEAR] button.

Procedure 7

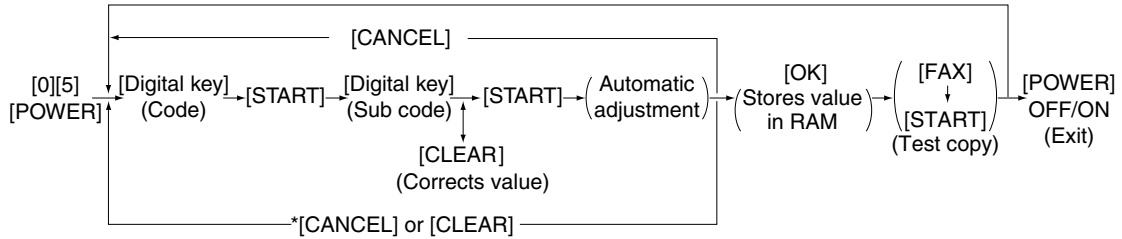

- * When the automatic adjustment ends abnormally, an error message is displayed.
- * Return to standby screen by pressing the [CANCEL] or [CLEAR] button.

Procedure 10

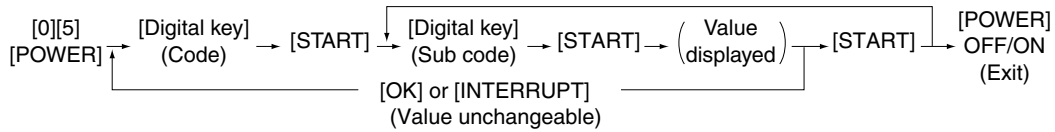

Procedure 12

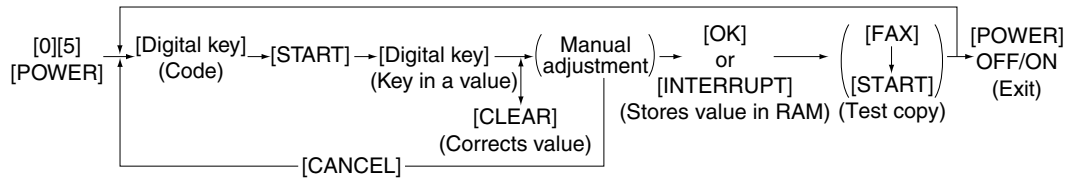

Procedure 14

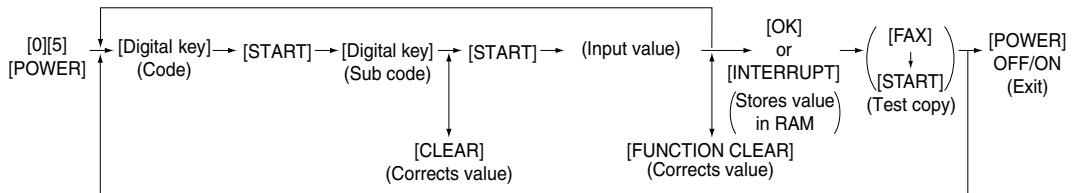

Notes:

The fuser belt temperature control at the adjustment mode is different from that at the normal state. Therefore, the problem of fusing efficiency may be occurred in the test copy at the adjustment mode. In that case, turn ON the power normally, leave the equipment for approx. 3 minutes after it has become ready state and then start up the adjustment mode again.

3.7 Test print pattern in Adjustment Mode (05)

Operation:

One test print is printed out when the [FAX] button is pressed after the code is keyed in at Standby Screen.

Code	Types of test pattern	Remarks
6	Copier gamma confirmation pattern (Black / All media types)	For confirming the reproduction of gradatin
10	Copier gamma adjustment pattern (Black / All media types)	Refer to 4.2.1 Automatic gamma adjustment

3.8 Operation Procedure in Setting Mode (08)

Procedure 1

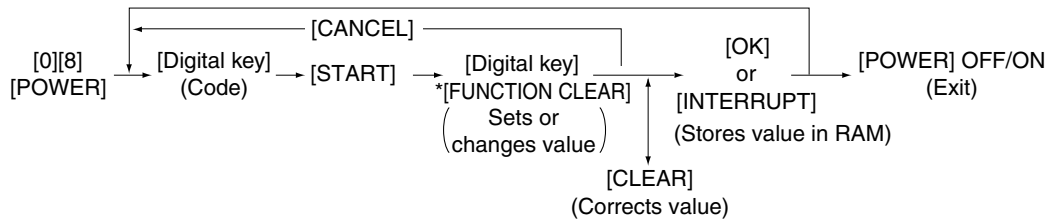

* Press [RESET] to enter minus (-).

Procedure 2

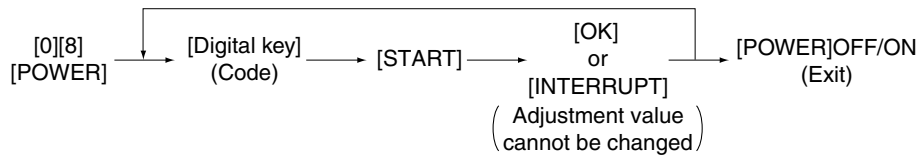

Procedure 3

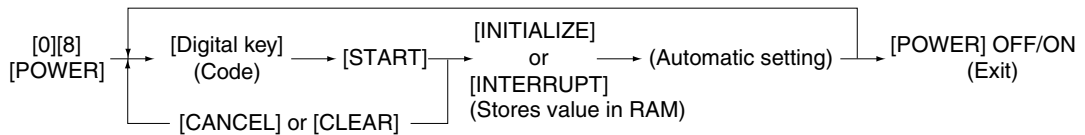

Procedure 4

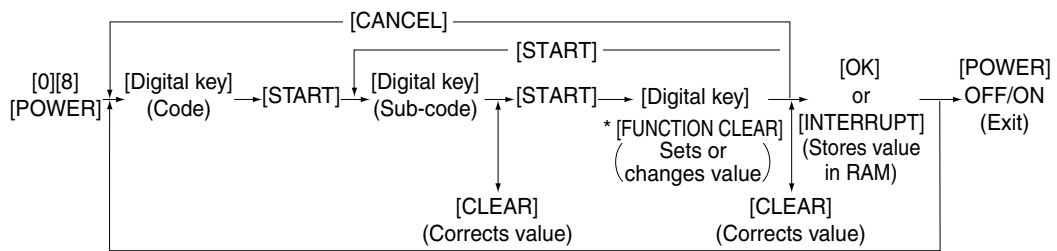

* Press [RESET] to enter minus (-).

Procedure 5

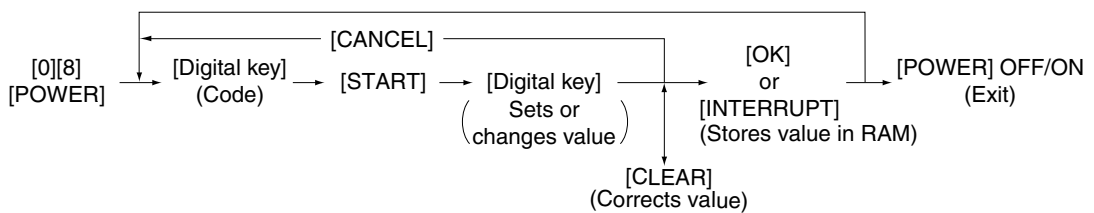

Procedure 9

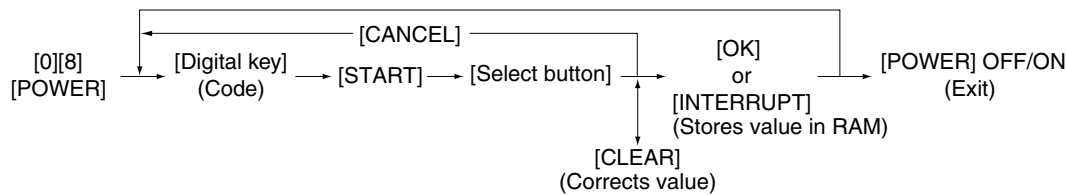

Procedure 10

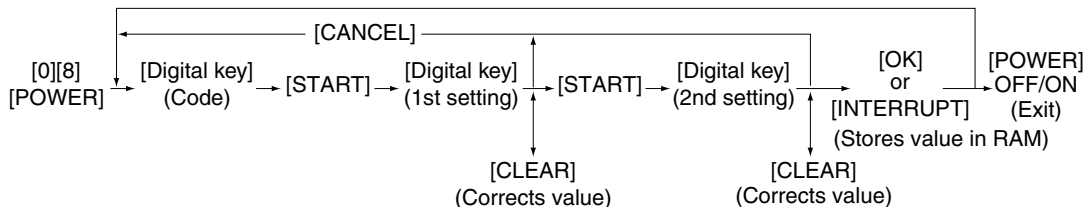

Procedure 11 and 12

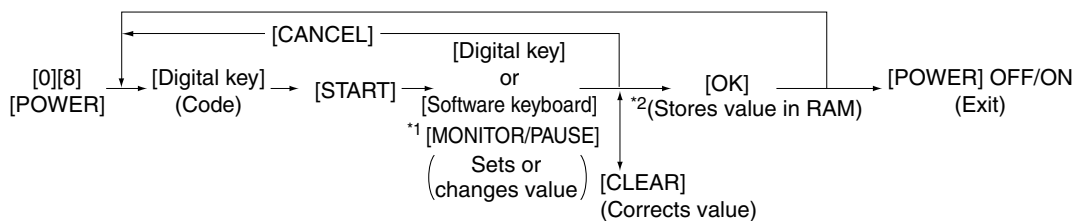

* Press [MONITOR/PAUSE] to enter "-", when entering telephone number.

* The data are stored in SYS-RAM in procedure 11 and stored in NIC-RAM in procedure 12.

Procedure 14

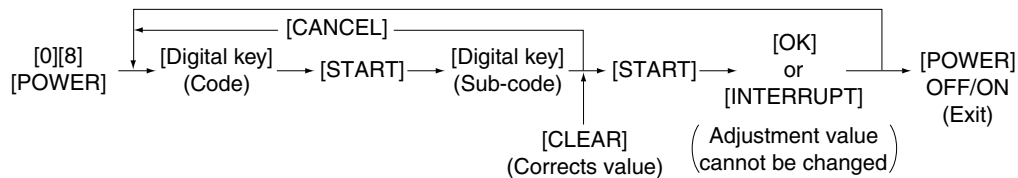

3.9 Assist Mode (3C)

3.9.1 General description

This is a mode to operate the partitions of HDD, initialize the SRAM data, erase the HDD/SRAM data, back up/restore the encryption key and licences.

Functions:

- Clearing update error flag (Clear Error Flag in Software Installation)
- Formatting data storage partition (Format Root Partition)
- Creating HDD partition (Format HDD)
- Formatting SRAM data (Clear SRAM)
- Backing up/restoring encryption key and license (Key Backup Restore)
- Erasing HDD securely (Erase HDD Securely)
- Erasing SRAM securely (Erase SRAM Securely)
- Clearing service tech password (Clear Service Tech)

3.9.2 Operating Procedure

- (1) Turn ON the power while [3] button and [CLEAR] button are pressed simultaneously.

The following screen is displayed.

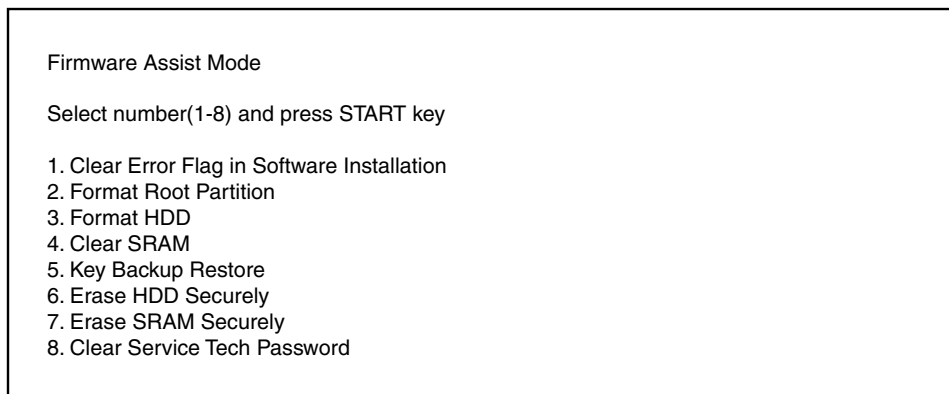

Fig. 3-6

- (2) Select the item with the digital keys and press the [START] button.

3.9.3 Functions

[A] Clearing update error flag (Clear Error Flag in Software Installation)

Even if the firmware downloading has been completed normally, the Recovery Mode may accidentally start up and an F600 error occurs when the power is turned ON again. In this case, clear the Update Error flags used in the download process with this function. (Normally, the flags are automatically cleared in the download process.)

Also in the case the Recovery Mode accidentally starts up after the replacement of SRAM on the SYS board, the flags are cleared with this function.

[B] Formatting data storage partition (Format Root Partition)

When a defect occurs on the UI data, etc. which are stored in the HDD, the partition with the stored UI data, etc. is formatted with this function.

Do not use this function since it is not normally necessary. HDD data must be installed after performing this function.

[C] Creating HDD partition (Format HDD)

When the HDD is replaced or UI data, etc. are downloaded using the USB storage, it is necessary to format a partition in the HDD before downloading. In this case, the partition is created in the HDD with this function.

Notes:

- When downloading with a download jig, it is not necessary to format a partition in advance.
- Perform the HDD partition formatting only when a new HDD is installed since all data in the current HDD are erased by this operation.

[D] Formatting SRAM data (Clear SRAM)

When SRAM is replaced with a new one, abnormal values may be written in the new SRAM. SRAM data must be formatted with this function for such case.

Notes:

- This function is required only when a new SRAM is installed.
- Do not perform this function in cases other than the installation of a new SRAM because all data in the SRAM will be deleted with this function.

[E] Backing up/restoring encryption key and license (Key Backup Restore)

When the SRAM board (for the SYS board) or the SYS board is replaced or initialized, the encryption key and license are erased. Therefore, they need to be backed up or restored with this function.

Configurations and functions of the “5.Key Backup Restore” menu.

1. Key SRAM to FROM
Restore the encryption key from SRAM to FROM.
2. Key FROM to SRAM
Back up the encryption key from FROM to SRAM.
3. License SRAM to FROM
Restore the license from SRAM to FROM.
4. License FROM to SRAM
Back up the license from FROM to SRAM.
5. ADIKey SRAM to FROM
Restore the ADIKey from SRAM to FROM.
6. ADIKey FROM to SRAM
Back up the ADIKey from FROM to SRAM.

[F] Erasing HDD securely (Erase HDD Securely)

This function is used when installing Data Overwrite Enabler (GP-1070) or before discarding the HDD. It overwrites all the used areas on the HDD with the selected data, and makes it unusable.

After selecting this function, specify the level below to be overwritten.

- 1: LOW (Normally use this setting.)
This is the standard overwriting method.
- 2: MEDIUM
This overwriting method is more secure than LOW. The erasing time is between LOW and HIGH.
- 3: HIGH
This is the most secure overwriting method. It takes the longest time to erase data.
- 4: SIMPLE
This is the simple overwriting method. It takes the shortest time to erase data.

Key in the level number to display "<" next to it.

(At this time, if "0" is entered, the screen returns to the initial one of the Assist Mode.)

Press the [START] button to display the reconfirmation screen, and then press the [START] button again to start overwriting.

[G] Erasing SRAM securely (Erase SRAM Securely)

This function is used before discarding the SRAM board (for the SYS board).

It overwrites all the used areas on the SRAM board with the selected data, and makes it unusable. Immediately after selecting this function, the processing starts and is completed.

[H] Clearing service tech password (Clear Service Tech)

This function is needed after the HDD is replaced.

When the HDD is replaced, the service tech password stored in the new one is set as a blank. Therefore, its password is copied to the SRAM board so that both passwords become the same with this function. The setting is enabled when the equipment is started up in the normal mode after performing this function.

3.10 HDD Assist Mode (4C)

3.10.1 General description

This mode is available only when the security HDD (ADI-HDD) is mounted in the equipment. It enables you to check the type of the mounted HDD, revert the ADI-HDD to the factory default or remove keys.

Functions

- Checks the type (ADI or SATA) of the mounted HDD.
- Disposes of ADI-HDD data safely without any of leakage.
- Deletes image data when reusing a used ADI-HDD.

3.10.2 Operation procedure

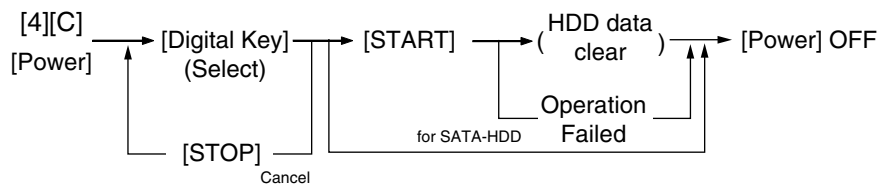

Turn the power ON while pressing the [4] and the [CLEAR] button simultaneously. Then the type of the mounted HDD is checked and either of the following screens is displayed.

- When the security HDD is mounted

HDD Assist Mode Current HDD type: ADI HDD	System Firmware Version : xxx(x.x.x.x) Update Mode : 4c Mode
Select number (1-2) and press START key	
1. Revert factory initial status HDD 2. Remove key	

Fig. 3-7

- When a normal HDD is mounted

HDD Assist Mode Current HDD type: SATA HDD	System Firmware Version : xxxx(x.x.x.x) Update Mode : 4c Mode
Select number (1-2) and press START key	
<ol style="list-style-type: none"> 1. Revert factory initial status HDD 2. Remove key 	

Fig. 3-8

Remarks:

If the HDD type cannot be identified, “Unknown HDD” may appear on the screen.
Refer to  P. 5-54 “ [F106_1] ADI-HDD error: HDD type detection error”

Note:

When “SATA HDD” (normal HDD) is displayed, items 1 and 2 are not selectable.
If you select any of 1 and 2 and press the [START] button, the error message below appears.

HDD Assist Mode Current HDD type: SATA HDD	System Firmware Version : xxxx(x.x.x.x) Update Mode : 4c Mode
Select number (1-2) and press START key	
=> <ol style="list-style-type: none"> 1. Revert factory initial status HDD 2. Remove key 	
Operation Failed. Press SoftPower Key to Switch Off	

Fig. 3-9

3.10.3 Functions

[A] 1. Revert factory initial status HDD

Select this to dispose of the ADI-HDD as well as the equipment.

When this item is selected, all data in the HDD are deleted and the HDD is reverted to its initial status at the factory shipment.

This operation requires only a few seconds; however, you must create the partition in the HDD in the 3C mode (Format HDD) and reinstall the HDD data in the 49 mode to make the HDD reusable.

When "1" is selected and then [START] button is pressed, the menu below appears. To start, press the [START] button.

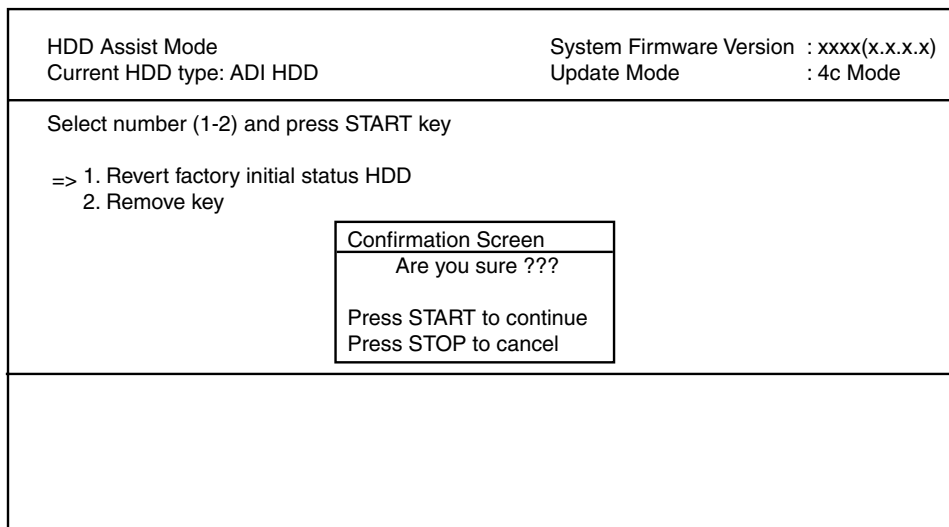

Fig. 3-10

When the operation is finished, the result appears on the menu.

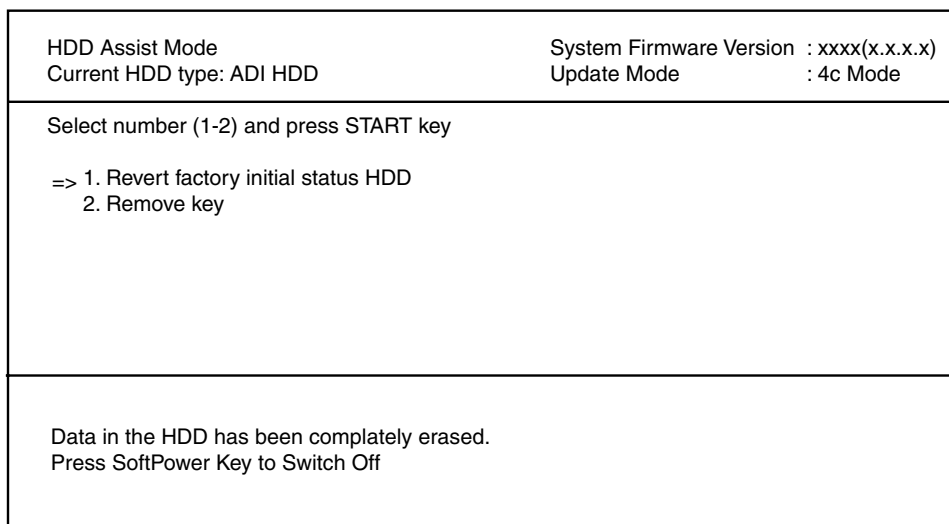

Fig.5-1

Note:

If the equipment is started in the normal mode with this condition, an HDD mounting error occurs.

[B] 2. Remove Key

Select this to reuse the ADI-HDD as well as the equipment.

When this item is selected, all image data in the HDD are deleted.

This operation requires approx. 20 minutes since the partition must be rebuilt.

When “2” is selected and then [START] button is pressed, the menu below appears.

To start, press the [START] button.

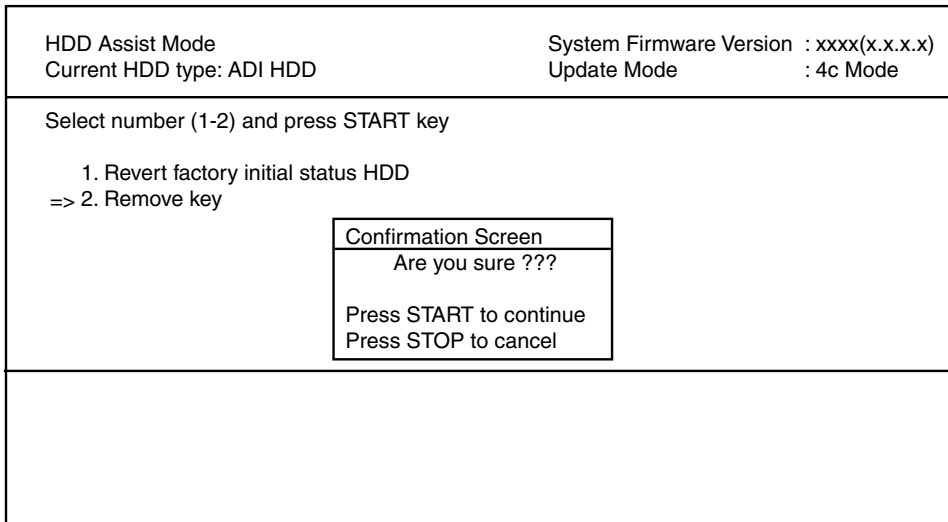

Fig. 3-11

When the operation is finished, the result appears on the menu.

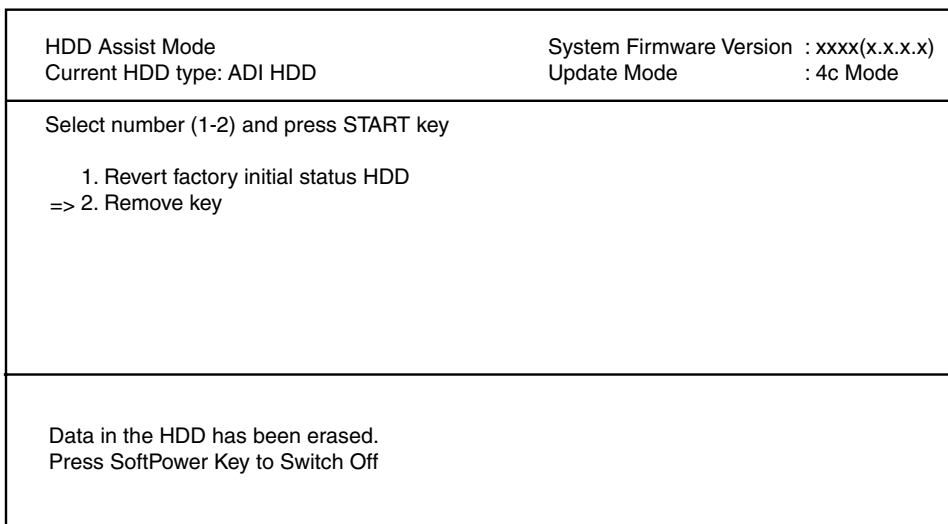

Fig. 3-12

Note:

After this operation, the equipment becomes reusable without reinstalling the firmware.

3.11 File System Recovery Mode (5C)

3.11.1 Overview

This is a mode to check if there is any damage to the file system (HDD) and recover it if necessary. Use this mode only in the following cases:

- There is a possibility of damage to the file system (HDD).
- There is an apparent damage to the file system (HDD), requiring recovery or initialization.

This mode enables you to have the following functions:

- Check F/S: Checks the file system.
- Recovery F/S: Recovers the file system.
- Initialize HDD: Initializes partitions in the HDD.
- Initialize DB: Initializes database (LDAP DB/log DB/language DB).
- SMART Info: Displays the various information in the HDD.
- DISK Info: Displays the usage rate of HDD.
- HDD Utility: Initializes log files.

3.11.2 Operation procedure

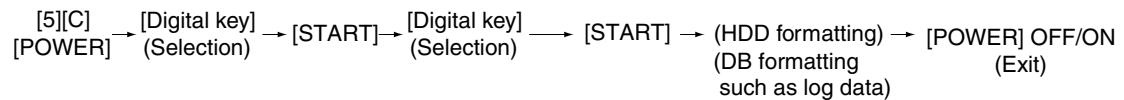

Notes:

- Do not turn the main power switch OFF after you select a menu and processing has started (during processing).
- After the processing is completed, a beep sounds 4 times and either “Completed” or “Failed” appears on the screen.

Turn ON the power while pressing the [5] and [CLEAR] button simultaneously. The following screen is displayed.

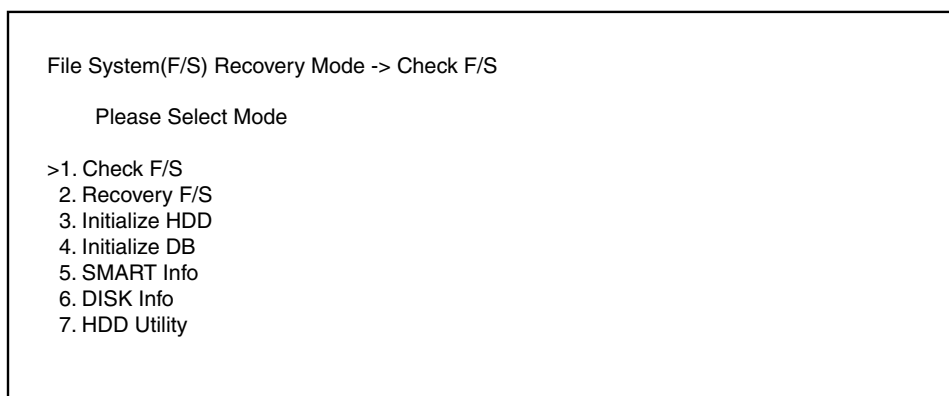

Fig. 3-13

Remark:

When the mode is started, “1. Check F/S” is selected by default. (“>” is displayed on the left of the selected number.)

3.11.3 Functions

[A] Check of the File System (Check F/S)

In case that particular service calls occur or there is a possibility of damage to the file system, the status of each partition in the HDD can be checked.

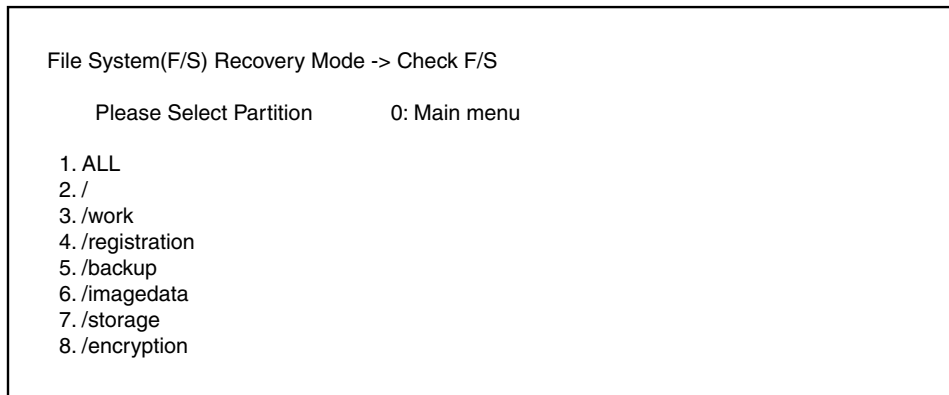

Fig. 3-14

Explanation for each item

- 1: Checks all partitions.
- 2: Checks root partition only.
- 3-8: Checks each partition shown above.

Note:

More than one partition can be selected. (“>” is displayed on the left of the selected number.)

- If damage is discovered, recover or initialize the file system (HDD).

[B] Recovery of the File System (Recovery F/S)

In case that an error occurs during the file system check, each partition can be recovered.

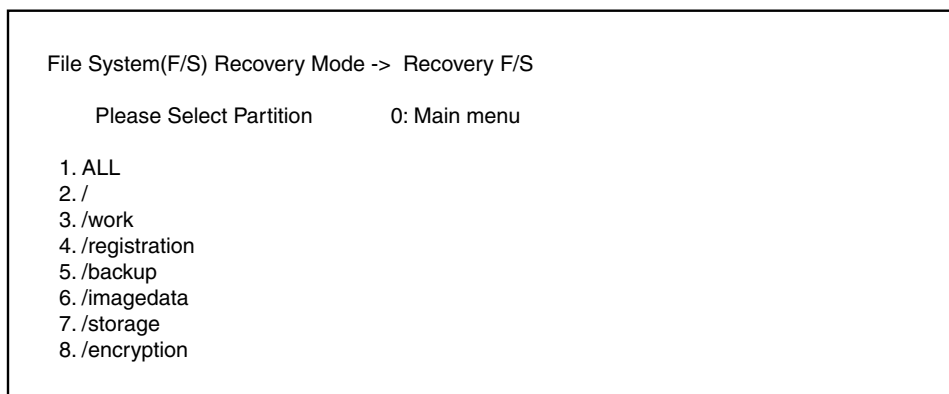

Fig. 3-15

Explanation for each item

- 1: Recovers all partitions.
- 2: Recovers root partition only.
- 3-8: Recovers each partition shown above.

Note:

More than one partition can be selected. (“>” is displayed on the left of the selected number.)

- If an error occurs during recovery, initialize the file system (HDD).

[C] Initialize the File System (Initialize HDD)

In case that an error occurs during the file system check and the partition cannot be recovered with the recovery, each partition can be initialized.

It is recommended to export the user information such as address book before performing this function.

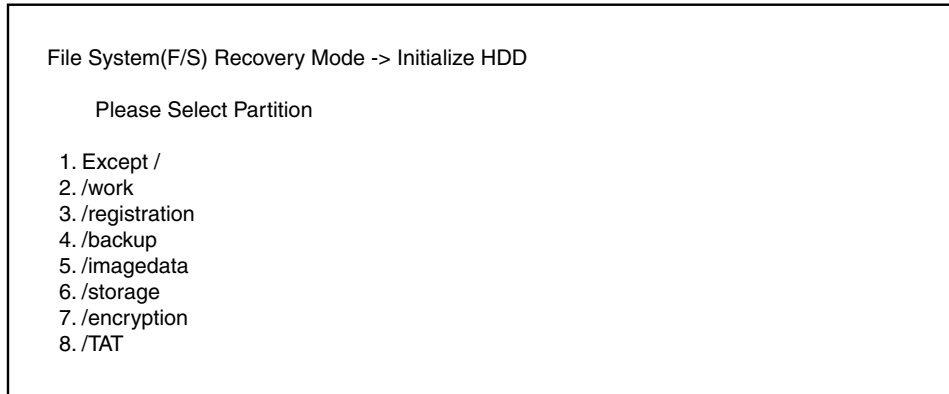
**Fig. 3-16**

Explanation for each item

- 1: Initializes partitions other than root one and creates initial files.
- 2: Initializes a partition (/work) and creates an initial file.
- 3: Initializes a partition (/registration) and creates an initial file.
- 4: Initializes a partition (/backup) and creates an initial file.
- 5: Initializes a partition (/imagedata) and creates an initial file.
- 6: Initializes a partition (/storage) and creates an initial file.
- 7: Initializes a partition (/encryption) and creates an initial file.
- 8: Initializes a partition (/TAT) and creates an initial file.

Remark:

More than one partition can be selected. (“>” is displayed on the left of the selected number.)

Notes:

- If [1. Except /] is selected, minimal data necessary for normal startup are automatically recovered.
- If [1. Except /] is selected, log database is also initialized. Back up the data before initializing if necessary.

[D] Initialize the DB (Initialize DB)

In case that particular service calls occur or there is a possibility of damage to the databases, each one can be initialized.

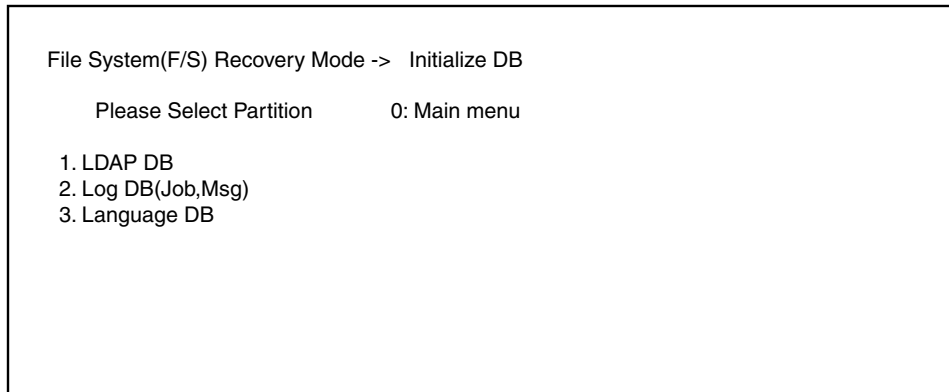
**Fig. 3-17**

Explanation for each item

- 1: Initializes address book data and the user information database.
- 2: Initializes job log data and the message database.
- 3: Initializes the language database.

Notes:

The selected databases are initialized and recreated in the next normal startup.

[E] Displaying various data in the HDD (SMART Info)

Various data in the HDD can be displayed. (Data equivalent to the setting contents of 08-9065 are displayed.)

When this item is selected, data in the HDD embedded in the equipment are displayed. "---" is displayed for the items not supported.

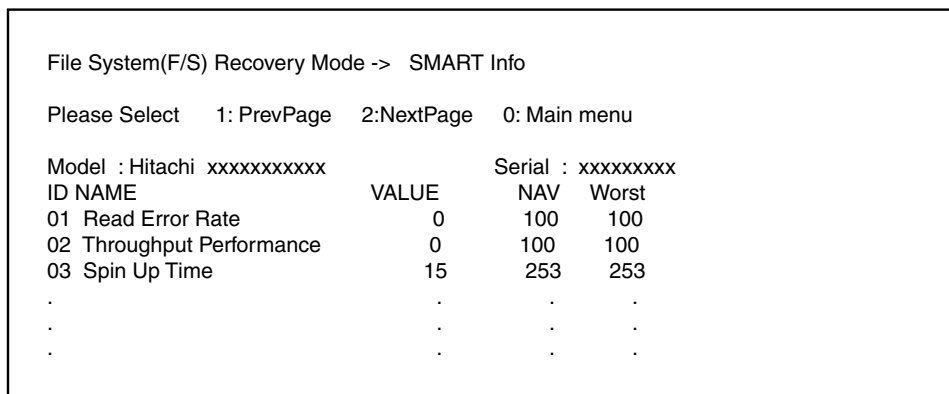
**Fig. 3-18****Remark:**

- NAV: Normalized Attribute Value
Indicates the value of the specified HDD condition as compared to the manufacturer's optimum value.
- Worst: Worst Ever Normalized Attribute Value
Indicates the worst value of NAV permitted by the manufacturer.

Notes:

The values of NAV and Worst should be treated as a rough reference since their basis may differ depending on the specification of HDD manufacturers.

[F] Displaying usage rate of each partition (DISK Info)

The usage rate of each partition can be checked.

When this item is selected, the usage rate of each partition is displayed.

File System(F/S) Recovery Mode -> DISK Info				
0: Main menu				
Partition name	ALL(Mbyte)	FREE(Mbyte)	USE(%)	
/	8737	5401	33.1%	MT:OK
/work	10326	9563	2.3%	MT:OK
/registration	3099	2861	2.6%	MT:OK
/backup	1036	949	3.3%	MT:OK
/imagedata	24778	23343	0.7%	MT:OK
/storage	26873	25332	0.7%	MT:OK
/encryption	--- encrypted partition ---			

Fig. 3-19

Remark:

The disk information of a partition indicated as “Encrypted Partition” is not displayed as it is encrypted.

[G] Initialization of log file (HDD Utility)

Normally it is not necessary to use this menu.

3.12 SRAM Clear Mode (6C)

3.12.1 General description

This is a mode in which you can clear particular errors such as F800 or F900 without entering a Service Technician password.

For example, when SYS-SRAM is in an abnormal status or needs replacement but service technicians cannot log into the 3C mode, SRAM can be initialized by entering the SRAM clear mode (6C) and selecting item 1 below.

The content of item 1 in this mode is the same as that of item 4 in the 3C mode (Clear SRAM).

Use this mode to clear the SRAM data when a particular error occurs or service technicians cannot log in with their password and therefore cannot use the 3C mode.

Functions

- Sets the serial number of this equipment.
- Clears SRAM data when the 3C mode cannot be used.
- Clears F800 error.
- Clears F900 error.

3.12.2 Operation procedure

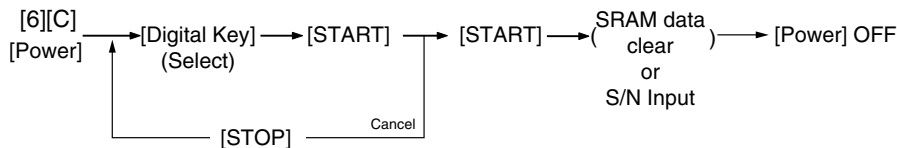

Turn the power ON while pressing the [6] and the [CLEAR] button simultaneously. Then the following screen is displayed.

Key in the desired item number and then press the [START] button.

SRAM Clear Mode	System Firmware Version : xxxx(x.x.x.x) Update Mode : 6c Mode
0. Set Serial Number 1. Clear SRAM 2. Reset Date and Time 3. SRAM Re-Initialize Support	

Fig. 3-20

Notes:

- When “0” is keyed in and the [START] button is pressed, the menu to key in the serial number appears. Key in the serial number of this equipment and then press [OK] to determine the setting.
- Items 1 and 2 can be canceled while 0 and 3 cannot.
- When “3” is keyed in and the [START] button is pressed, the operation starts.

3.12.3 Functions

[A] 0. Set Serial Number

When replacing SYS-SRAM, select this to set the serial number of the equipment since it must be done in advance of recovery from SRAM backup data.

- Clear SRAM first and then set the serial number in this mode.
- Recover from SRAM backup data after setting the serial number.
Refer to  P. 9-2 “9.1.4 Cloning procedure”

Select “0” and then press the [START] button. Then key in the serial number of this equipment. The keyed in serial number appears on the menu.

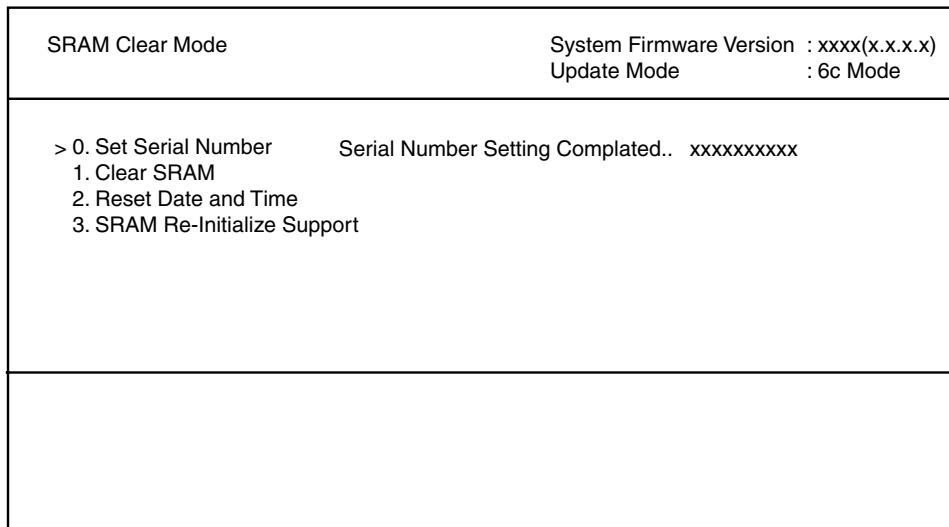



Fig. 3-21

[B] 1. Clear SRAM

Select this to clear all SRAM data when replacing SYS-SRAM.

- Replace the SRAM board and then clear the SRAM data.
- After clearing the SRAM data, initialize SRAM following its replacement procedure.
Refer to  P. 6-22 “6.2.5 Precautions and procedure when replacing the SRAM board (for the SYS board)”.

[C] 2. Reset Date and Time

Select this to clear an F800 error which occurred when the date and time were set as after the end of the year 2037 or when the actual end of the year 2037 has come.

- After selecting this, start the equipment in the normal mode to reset the date and time.

[D] 3. SRAM Re-Initialize Support

When the SRAM board (for the SYS board) and the SYS board are replaced at the same time, or an F900 error occurs, the machine information needs to be reset with this function.

After the resetting is completed, initialize SRAM following its replacement procedure.

 P. 6-22 “6.2.5 Precautions and procedure when replacing the SRAM board (for the SYS board)”

3.13 List print mode (9S)

3.13.1 Operation procedure

[1] Print out

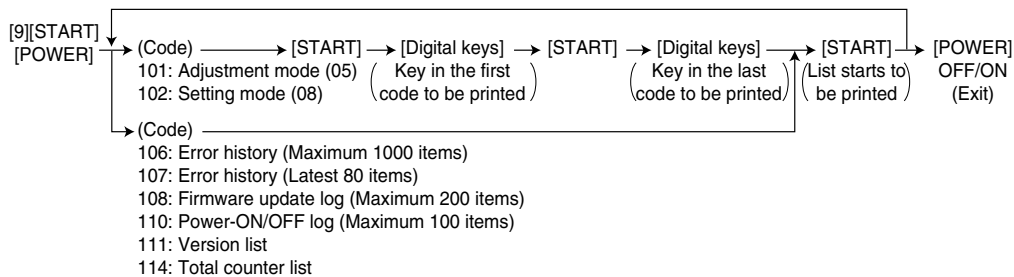

[2] CSV output (USB)

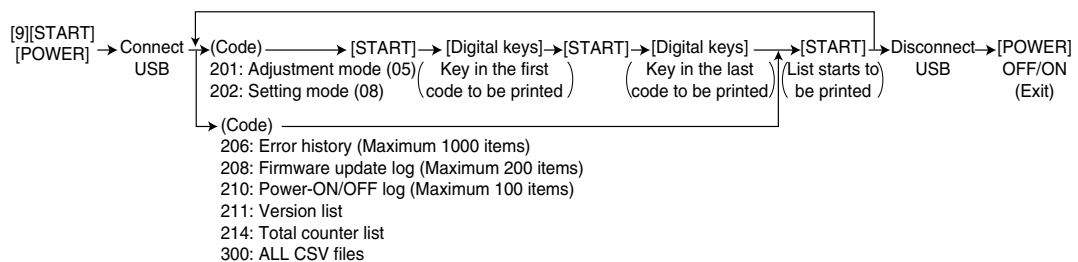

Notes:

Precautions when storing information into USB device

- When storing the setting information of the equipment into a USB device, be sure to obtain permission from a user in advance.
- When storing the setting information of the equipment into a USB device, the information is printed out in a CSV format. Handle and manage the information with extra care.
- Do not lose or leak the setting information of the equipment.
- Do not use the setting information of the equipment for purposes other than maintenance or product services.
- Provide the information promptly if a user requires so.
- The buttons on the control panel keep blinking while data are being stored in the USB device.

Do not disconnect the USB device while data are being stored.

Remarks:

In the USB storage procedure above, lists are stored in a CSV format. The names of the CSV files are shown below.

201: ADJUSTMENT_LIST_serial_date and time(YYYYMMDDHHMMSS).csv

202: SETTING_LIST_serial_date and time(YYYYMMDDHHMMSS).csv

206: ERROR_LOG_serial_date and time(YYYYMMDDHHMMSS).csv

208: FW_UPGRADE_LOG_serial_date and time(YYYYMMDDHHMMSS).csv

210: POWER_ONOFF_LOG_serial_date and time(YYYYMMDDHHMMSS).csv

211: VERSION_LIST_serial_date and time(YYYYMMDDHHMMSS).csv

214: TOTAL_COUNTER_LIST_serial_date and time(YYYYMMDDHHMMSS).csv

3.13.2 List Printing

Lists below are output in the list print mode.

List data are printed out or output in a CSV format by storing them in a USB device. Paper sizes available for this printing are A4 or LT or larger. This section introduces a sample of each list.

To start the list print mode, turn the power on while pressing [9] + [START] button.

Lists	List code	
	Printout	CSV file output
Adjustment mode (05) data list	101	201
Setting mode (08) data list	102	202
Error history list	106 (Maximum 1000 items)	206 (Maximum 1000 items)
Error history list	107 (Latest 80 items)	-
Firmware upgrade log	108 (Maximum 200 items)	208 (Maximum 200 items)
Power ON/OFF log	110 (Maximum 100 items)	210 (Maximum 100 items)
Version list	111	211
Total counter list	114	214
Output all CSV files	-	300
Toner replacement log	812 (Maximum 1024 items)	912 (Maximum 1024 items)

- Adjustment mode (05)

05 ADJUSTMENT MODE DATA LIST							
				S/N: xxxxxxxx	TOTAL:	999999	
20xx-xx-xx xx:xx				OKI MBxxx	DF TOTAL:	999999	
CODE	DATA	CODE	DATA	CODE	DATA	CODE	DATA
2000	128	3860	88	4830	128	5920	128
.
.
.
.
.
.
.
.
.
.
.
.

Fig. 3-22

The selected adjustment codes and the current adjustment value for each code are output in a list. See the following page for the adjustment code (05):

Refer to “Appendix” - “Adjustment Code (05).”

- Setting mode (08)

08 SETTING MODE DATA LIST				S/N: xxxxxxxx		TOTAL: 9999999	
20xx-xx-xx xx:xx				OKI MBxxx		DF TOTAL: 9999999	
CODE	DATA	CODE	DATA	CODE	DATA	CODE	DATA
2010	2	2880	12	3040	0	3070	0
.
.
.
.
.
.
.
.
.
.
.
.

Fig. 3-23

The selected setting codes and the current setting value for each code are output in a list. See the following page for the setting code (08):

Refer to “Appendix” - “Setting Code (08)”

- Error history

ERROR HISTORY LIST						
				S/N: xxxxxxxx	TOTAL:	9999999
				OKIMBxxx	DF TOTAL:	9999999
20xx-xx-xx xx:xx						
CODE	COUNTER	DATE	TIME	ZOOM_XY	ABCD	EFHI JLOP QR
F110	00000000	xxxx-xx-xx	xx:xx:xx	000 000	0000_0000_0000_0	000000000000
F110	00000000	xxxx-xx-xx	xx:xx:xx	000 000	0000_0000_0000_0	000000000000
F110	00000000	xxxx-xx-xx	xx:xx:xx	000 000	0000_0000_0000_0	000000000000
F110	00000000	xxxx-xx-xx	xx:xx:xx	000 000	0000_0000_0000_0	000000000000
F110	00000000	xxxx-xx-xx	xx:xx:xx	000 000	0000_0000_0000_0	000000000000
EAD0	00000000	xxxx-xx-xx	xx:xx:xx	000 000	0000_0000_0000_0	000000000000
E860	00000000	xxxx-xx-xx	xx:xx:xx	000 000	0000_0000_0000_0	000000000000
E731	00000000	xxxx-xx-xx	xx:xx:xx	000 000	0000_0000_0000_0	000000000000
E090	00000000	xxxx-xx-xx	xx:xx:xx	000 000	0000_0000_0000_0	000000000000
E870	00000000	xxxx-xx-xx	xx:xx:xx	000 000	0000_0000_0000_0	000000000000
E724	00000000	xxxx-xx-xx	xx:xx:xx	000 000	0000_0000_0000_0	000000000000

Fig. 3-24

The error history is output. See the following page for the parameters for each error:

 P. 5-17 “5.2.4 Printer function error”

• Firmware update log

```

FW UPGRADE LOG
                                     S/N: xxxxxxxx      TOTAL:      9999999
xx-xx-xx xx:xx                       OKI MBxxx       DF TOTAL:   9999999

USER ROM/VERSION DATE  TOTAL  COPY(B) COPY(2) COPY(C) PRINT(B) PRINT(2) PRINT(C) LIST  FAX  STATUS
Service Txxxxxx-xxxx 20xx-xx-xx 99999999 99999999 0 0 99999999 0 0 99999999 99999999 OK
Service Txxxxxx-xxxx 20xx-xx-xx 99999999 99999999 0 0 99999999 0 0 99999999 99999999 OK
Service Txxxxxx-xxxx 20xx-xx-xx 99999999 99999999 0 0 99999999 0 0 99999999 99999999 OK

. . . . .
. . . . .
. . . . .
. . . . .
. . . . .
. . . . .

```

Fig. 3-25

Firmware update logs are output.

- Only the versions of ROMs updated with USB device are output.

Item	Content
USER	User who updated firmware
ROM/VERSION	Version of firmware
DATE	Date that firmware was updated
TOTAL	Total counter data when firmware was updated
COPY (B)	Copier counter data (black) when firmware was updated
COPY (2)	Since this function is unavailable for the machine, "0" always appears.
COPY (C)	Since this function is unavailable for the machine, "0" always appears.
PRINT (B)	Printer counter data (black) when firmware was updated
PRINT (2)	Since this function is unavailable for the machine, "0" always appears.
PRINT (C)	Since this function is unavailable for the machine, "0" always appears.
LIST	List print counter data when firmware was updated
FAX	Fax print counter data when firmware was updated
STATUS	Result of update

• Power-ON/OFF log

```

POWER ON/OFF LOG
S/N: xxxxxxxx          TOTAL: 9999999
OKI MBxxx             DFTOTAL: 9999999

20xx-xx-xx xx:xx

DATE    TIME    FUNCTION    TOTAL    DATE    TIME    FUNCTION    TOTAL
xxxx-xx-xx  xx:xx:xx  ON          99999999  xxxx-xx-xx  xx:xx:xx  ON          99999999
xxxx-xx-xx  xx:xx:xx  OFF         99999999  xxxx-xx-xx  xx:xx:xx  OFF         99999999
xxxx-xx-xx  xx:xx:xx  ON          99999999  xxxx-xx-xx  xx:xx:xx  ON          99999999
xxxx-xx-xx  xx:xx:xx  OFF         99999999  xxxx-xx-xx  xx:xx:xx  OFF         99999999
xxxx-xx-xx  xx:xx:xx  ON          99999999  xxxx-xx-xx  xx:xx:xx  RMT_OFF    99999999
xxxx-xx-xx  xx:xx:xx  OFF         99999999
xxxx-xx-xx  xx:xx:xx  ON          99999999
xxxx-xx-xx  xx:xx:xx  OFF         99999999
xxxx-xx-xx  xx:xx:xx  RMT_OFF    99999999
xxxx-xx-xx  xx:xx:xx  OFF         99999999
.          .          .          .
.          .          .          .
.          .          .          .
    
```

Fig. 3-26

Power ON/OFF logs are output.

- Note that cases that the power was turned OFF with the main switch (not with the [ON/OFF] button on the control panel) will not be displayed.

Item	Content
DATE	Date that the power was turned ON or OFF
TIME	Time that the power was turned ON or OFF
FUNCTION	Whether the power was turned ON or OFF, or if it was turned ON or OFF with a remote reset function
TOTAL	Total counter data when the power was turned OFF and then back ON

- Version list

```

VERSION LIST
S/N: xxxxxxxx          TOTAL:      9999999
OKI MBxxx             DF TOTAL:  9999999

'xx-xx-xx xx:xx

SYSTEM FIRMWARE ROM VERSION           : Txxxxxxxxxxx
SYSTEM FIRMWARE INTERNAL ROM VERSION  : Vxxxx.xxx
PRINTER ROM VERSION                    : xx.xx.xx
PRINTER LOADER ROM VERSION             : xx.xx.xx
PRINTER OPTION TRAY ROM VERSION (TRAY2): xx.xx.xx
PRINTER OPTION TRAY ROM VERSION (TRAY3): xx.xx.xx
PRINTER OPTION TRAY ROM VERSION (TRAY4): xx.xx.xx
SCANNER ROM VERSION                    : xx.xx.xx
SCANNER LOADER ROM VERSION             : xx.xx.xx
SCANNER RECOVERY FW ROM VERSION        : xx.xx.xx
FINISHER STACKER ROM VERSION           : xx.xx.xx
FAX BOARD FIRMWARE ROM VERSION         : Fxxx-xxx
SYSTEM FIRMWARE INTERNAL OS VERSION     : xxxx-xx
HDD DATA VERSION                      : Txxxxxxxxxxx
SYSTEM FIRMWARE OS VERSION             : Txxxxxxxxxxx
LANGUAGE VERSION
  English(US)                          : xxx.xxx  xxx xxx xx xx:xx:xx xxxx
  .                                      .
  .                                      .
  .                                      .

CAPACITY OF HDD                        : xx.x GB
DEVICE INFORMATION OF HDD               : xxx xxxxxx-xxxxxx
SERIAL NUMBER OF HDD                    : xx-xxxxxxxxxxx
MEMORY SIZE                             : xxxx MB / xxxx MB
INSTALLED ELK NAME                      : IPsec enabler
                                         Meta scan enabler
                                         .
                                         .
                                         .

```

Fig. 3-27

The list of versions is output.

Notes:

Some of the characters in the fonts that are used to print the version list are not supported. As a result, the language names under LANGUAGE VERSION may not be printed correctly when printing the version list.

- Total counter list

TOTAL COUNTER LIST	S/N:xxxxxxx	TOTAL:	9999999
'xx-xx-xx xx:xx	OKI MBxxx	DF TOTAL:	9999999
PRINT COUNTER			
	<u>COPY</u>	<u>FAX</u>	<u>PRINTER</u>
<u>SMALL</u>	xxxxxxxx	xxxxxxxx	xxxxxxxx
<u>LARGE</u>	xxxxxxxx	xxxxxxxx	xxxxxxxx
<u>TOTAL</u>	xxxxxxxx	xxxxxxxx	xxxxxxxx
SCAN COUNTER			
TOTAL	<u>FULL COLOR</u>	<u>BLACK</u>	<u>TOTAL</u>
COPY	0	xxxxxxxx	xxxxxxxx
FAX	0	xxxxxxxx	xxxxxxxx
NETWORK	xxxxxxxx	xxxxxxxx	xxxxxxxx
<u>TOTAL</u>	xxxxxxxx	xxxxxxxx	xxxxxxxx
COPY	<u>FULL COLOR</u>	<u>BLACK</u>	<u>TOTAL</u>
SMALL	0	xxxxxxxx	xxxxxxxx
LARGE	0	xxxxxxxx	xxxxxxxx
<u>TOTAL</u>	0	xxxxxxxx	xxxxxxxx
FAX	<u>FULL COLOR</u>	<u>BLACK</u>	<u>TOTAL</u>
SMALL	0	xxxxxxxx	xxxxxxxx
LARGE	0	xxxxxxxx	xxxxxxxx
<u>TOTAL</u>	0	xxxxxxxx	xxxxxxxx
NETWORK	<u>FULL COLOR</u>	<u>BLACK</u>	<u>TOTAL</u>
SMALL	xxxxxxxx	xxxxxxxx	xxxxxxxx
LARGE	xxxxxxxx	xxxxxxxx	xxxxxxxx
<u>TOTAL</u>	xxxxxxxx	xxxxxxxx	xxxxxxxx
CALIBRATION COUNTER : xx			

Fig. 3-28

The list of total counter is output.

4. SETTING / ADJUSTMENT

4.1 Image Related Adjustment

4.1.1 Adjustment Order

This chapter mainly explains the procedures for image related adjustment. In the following diagram, the solid lines with arrow lead to essential adjustments, while the dotted lines lead to adjustments to be performed if necessary.

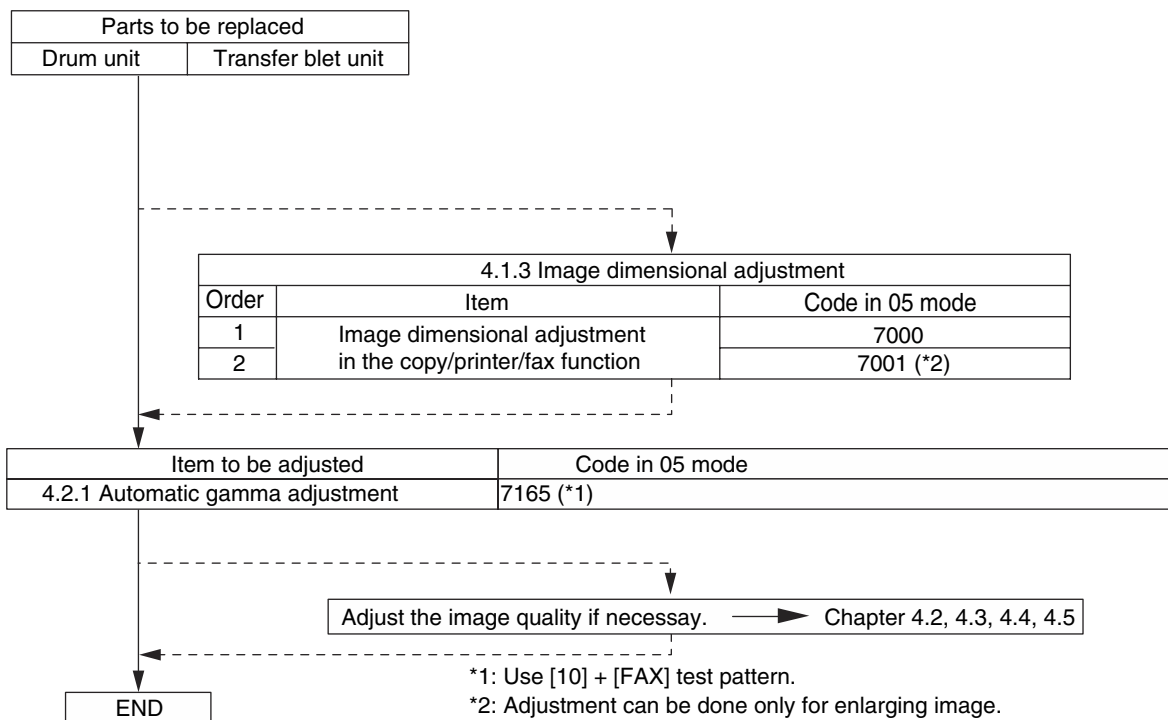

Fig. 4-1

4.1.2 Image Dimensional Adjustment

There are several adjustment items in the image dimensional adjustment, as listed below.

Item to be adjusted		Code in mode 05
Image dimensional adjustment in the copy/printer/fax function	Reproduction ratio adjustment of primary scanning direction (PPC)	7000
	Reproduction ratio adjustment of primary scanning direction (PRT/FAX)	7001*1

*1: Adjustment can be done only for enlarging image.

[Procedure to key in adjustment values]

In accordance with the procedure described below, make adjustment of each adjustment item so that the measured values obtained from test copies satisfy the specification. By pressing the [FAX] button, immediately after starting the Adjustment Mode (05), single-sided test copying can be performed (normal copy mode).

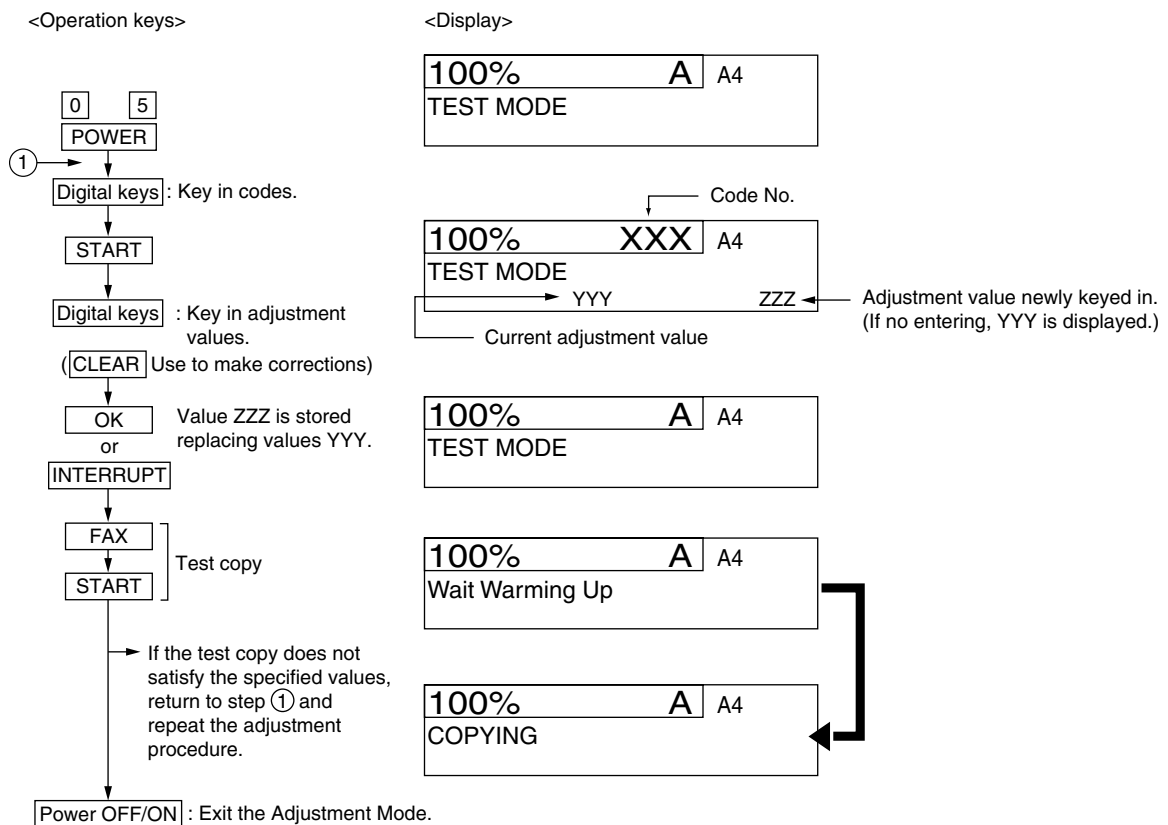

Fig.6-1

4.1.3 Image dimensional adjustment in the copy/printer/fax function

[1] Reproduction ratio adjustment of primary scanning direction

The reproduction ratio in the primary scanning direction of the printed image can be adjusted as follows:

<Adjustment Mode (05)>

Code	Function	Remarks
7000	PPC	The larger the value is, the larger the reproduction ratio in the primary scanning direction becomes. (0.1%/step) Acceptable values: 0 to 255 (Default: 128)
7001	PRT/FAX	The larger the value is, the larger the reproduction ratio in the primary scanning direction becomes. (0.1%/step) Acceptable values: 128 to 255 (Default: 128)

Make a test copy and compare the image obtained with the current settings; if necessary, make adjustments according to the following procedure:

Notes:

- Since the reproduction ratio may vary due to expansion and contraction of the paper immediately after the image is printed out, it is recommended to measure its dimension after at least 3 minutes have passed.
- This adjustment may cause image troubles such as moire, disappearance or breaking of thin lines on the printed image. Therefore check if there is no such image trouble while you are performing the adjustment.

<Procedure>

- (1) While pressing [0] and [5] simultaneously, turn the power ON.
- (2) Key in a code and press the [START] button.
- (3) Key in the adjustment value. (To correct a value, press the [CLEAR] button.)
- (4) Press the [OK] or [INTERRUPT] button to store the value. -> The equipment goes back to the ready state.
- (5) Make a test copy and check the image copied. To check the printed image, turn off the power and then back on, and then print the image. If the image is not in the desired reproduction ratio, repeat steps (2) to (4).

4.2 Image Quality Adjustment (Copying Function)

4.2.1 Automatic gamma adjustment

When the reproduction of gradation is not appropriate, the gradation reproducibility can be corrected by performing this automatic gamma adjustment. In case the gradation reproduction of the image checked is not satisfactory, make this adjustment as described below at parts replacement.

When unpacking or any of the following parts has been replaced, be sure to make this adjustment:

- Drum unit
- Transfer belt unit
- SRAM board (SYS board)
- PU board
- HDD

Notes:

Be sure that this adjustment be made after performing the image adjustment in  P. 4-2 "4.1.2 Image Dimensional Adjustment".

<Procedure>

- (1) While pressing [0] and [5] simultaneously, turn the power ON. → Adjustment Mode
- (2) Select the A4/LT drawer. Key in the pattern number and press the [FAX] button to output a "Patch chart for gamma adjustment".

<Adjustment Mode (05)>

Pattern No.	Pattern No.	Remark	Paper type
10	Black	When performing code 05-7165	All paper types

- (3) Place the patch chart for adjustment printed in step (2) face down on the original glass. Place the chart aligning its side with a black square against the original scale.
- (4) Key in a code and press the [START] button.
→ The scanner reads the chart automatically and performs automatic gamma adjustment calculation (approx.30 sec.).

<Adjustment Mode (05)>

Code	Item to be adjusted	Contents
7165	Automatic gamma adjustment	When the reproduction of gradation is not appropriate, the gradation reproducibility can be corrected by performing this automatic gamma adjustment. The result of 7165 is applied to all paper types.

- (5) When the adjustment has finished normally, press the [OK] button to have the adjustment results reflected.

(To cancel the reflection of adjustment results, press the [CANCEL] button.)
In the case of an abnormal ending, "ADJUSTMENT ERROR" is shown.

Press the [CANCEL] button to clear the error display. When it is cleared, the control panel display will return to the ready state. Then, check if the patch chart on the original glass is placed in the wrong direction or if it is placed inclined on the original glass, and then repeat step (3) and afterward.

4.2.2 Density adjustment

The center density and the density variation controlled by density adjustment keys can be adjusted as follows.

<Adjustment Mode (05)>

Color mode	Original mode				Item to be adjusted	Remarks
	Text/Photo	Text	Photo	Custom Mode		
Black	7114	7115	7116	7134	Manual density mode center value	The larger the value is, the darker the image becomes. Acceptable values: 0 to 255 (Default: 128)
	7123	7124	7125	7137	Automatic density mode	
	7117	7118	7119	7135	Manual density mode lightness value	The larger the value is, the lighter the image becomes. Acceptable values: 0 to 255 (Default: 20)
	7120	7121	7122	7136	Manual density mode darkness value	The larger the value is, the darker the image becomes. Acceptable values: 0 to 255 (Default: 20)

Make a test copy and compare the image obtained with the current settings; if necessary, make adjustments according to the following procedure.

Notes:

Be sure that this adjustment is made after performing  P. 4-4 “4.2.1 Automatic gamma adjustment”.

<Procedure>

- (1) While pressing [0] and [5] simultaneously, turn the power ON.
- (2) Key in a code and press the [START] button.
- (3) Key in an adjustment value.
(To correct the value once keyed in, press the [CLEAR] button.)
- (4) Press the [OK] or [INTERRUPT] button to store the value. → The equipment goes back to the ready state.
- (5) Press the [FAX] button and then press the [START] button to make a test copy.
If the original mode is Custom, restart the equipment and check if the desired image quality is attained.
- (6) If the desired image quality has not been attained, repeat step (2) to (5).
If the original mode is Custom, repeat step (1) to (5).

4.2.3 Gamma balance adjustment

The density adjustment at the Black Mode is performed by selecting its density area from the following: low density, medium density and high density.

<Adjustment Mode (05)>

Color mode	Original mode				Item to be adjusted	Remarks
	Text/Photo	Text	Photo	Custom Mode		
Black	7190-0	7191-0	7192-0	7276-0	Low density	The larger the value is, the density of the item to be adjusted becomes darker. Acceptable values: 0 to 255 (Default: 128)
	7190-1	7191-1	7192-1	7276-1	Medium density	
	7190-2	7191-2	7192-2	7276-2	High density	

Make a test copy and compare the image obtained with the current settings; if necessary, make adjustments according to the following procedure.

Notes:

Be sure that this adjustment is made after performing  P. 4-4 “4.2.1 Automatic gamma adjustment”.

<Procedure>

- (1) While pressing [0] and [5] simultaneously, turn the power ON.
- (2) Key in the code of the mode to be adjusted (original mode) and press the [START] button.
- (3) Select the density area to be adjusted with digital keys (0, 1 or 2), and press the [START] button.
 - 0: Low density
 - 1: Medium density
 - 2: High density
- (4) Key in an adjustment value. (To correct the value once keyed in, press the [CLEAR] button.)
- (5) Press the [OK] or [INTERRUPT] button to store the value in memory.
→ The equipment goes back to the ready state.
- (6) For resetting the value, repeat step (2) to (5).
- (7) Press the [FAX] button and then press the [START] button to make a test copy.
If the original mode is Custom, restart the equipment and check if the desired image quality is attained.
- (8) If the desired image quality has not been attained, repeat step (2) to (7).
If the original mode is Custom, repeat step (1) to (7).

4.2.4 Background adjustment

The density of the background can be adjusted as follows.

<Adjustment Mode (05)>

Color mode	Original mode				Remarks
	Text/Photo	Text	Photo	Custom Mode	
Black	7100	7101	7102	7106	The larger the value is, the darker the background becomes. Acceptable values: 0 to 255 (Default: 128)

Make a test copy and compare the image obtained with the current settings; if necessary, make adjustment using the following procedure.

<Procedure>

The procedure is the same as that of & P. 4-5 “4.2.2 Density adjustment”.

4.2.5 Judgment threshold for ACS (common for copy and scan)

Judgment levels for automatically identifying whether an original is color or black are adjusted. This adjustment is for judgment levels when “Auto Color” is selected as a color mode. The same adjustment value is simultaneously applied to all cases of originals on the original glass for copier functions and network scanning functions, and those placed on the RADF.

<Adjustment Mode (05)>

Code	Item to be adjusted	Contents
7630	Judgment threshold for ACS	The larger the value is, the more an original tends to be judged as black . The smaller value is, the more it tends to be judged as color. Acceptable values: 0 to 255 (Default: 70)

Make a test copy and compare the image obtained with the current settings; if necessary and make adjustment.

<Procedure>

- (1) While pressing [0] and [5] simultaneously, turn the power ON.
- (2) Key in a code and press the [START] button.
- (3) Key in a sub-code and press the [START] button.
- (4) Key in an adjustment value.
(To correct a value once keyed in, press the [CLEAR] button.)
- (5) Press the [OK] or [INTERRUPT] button to store the value. → The equipment goes back to the ready state.
- (6) Turn the power OFF and back ON in the normal mode, and then make a copy.
- (7) If the desired image quality has not been attained, repeat step (1) to (6).

4.2.6 Sharpness adjustment

If you want to make copy images look softer or sharper, perform the following adjustment. The adjustment can be made for each of the original modes independently.

<Adjustment Mode (05)>

Code	Color mode	Original mode	Contents
7056	Black	Text/Photo	The larger the value is, the sharper the image becomes; while the smaller the value is, the softer the image becomes.
7057		Text	
7058		Photo	The smaller the value is, the less moire tends to appear. Acceptable values: 0 to 255 (Default: 128)
7249		Custom mode	

Make a test copy and compare the image obtained with the current settings; if necessary, make adjustment.

Notes:

You have to make adjustment by balancing between moire and sharpness.

<Procedure>

The procedure is the same as that of  P. 4-5 “4.2.2 Density adjustment”.

4.2.7 Setting range correction

The values of the background peak/text peak in the range correction at the Black Mode can be switched to “varied” or “fixed” in the following codes.

If they are fixed, the range correction is performed with standard values.

The values of the background peak affects the reproduction of the background density, and the values of the text peak affects that of the text density.

<Adjustment Mode (05)>

Color mode	Original mode			Item to be adjusted	Remarks
	Text/Photo	Text	User Custom		
Black	7283	7284	7236	Auto density mode	0: Background peak / fixed 1: Background peak / varied (Default: 1)
	7286	7287	7237	Manual density mode	

Make a test copy and compare the image obtained with the current settings; if necessary, make adjustment.

<Procedure>

The procedure is the same as that of  P. 4-5 “4.2.2 Density adjustment”.

4.2.8 Adjustment of smudged/faint text

The smudge/faint text at a Black Mode can be set at the following codes.

<Adjustment Mode (05)>

Color mode	Original mode			Item to be adjusted	Remarks
	Text/Photo	Text	Custom mode		
Black	7097	7098	7252	Adjustment of smudged/ faint text	When the value decreases, the faint text is improved. When the value increases, the smudged text is improved. Acceptable values: 0 to 4 (Default: 2)

Make a test copy and compare the image obtained with the current settings; if necessary, make adjustment.

Notes:

Remember the image specifications and life span of the replacing parts may not meet the standard when the setting value is changed from the default value.

<Procedure>

The procedure is the same as that of  P. 4-5 “4.2.2 Density adjustment”.

4.2.9 Judgment threshold adjustment for blank originals (common for copy and scan)

The judgment level is adjusted for automatic identification of whether the original set is blank or not. This adjustment is made when “OMIT BLANK PAGE” is selected on the control panel.

The adjustment value is simultaneously applied to all modes at PPC and scanning.

<Adjustment Mode (05)>

Code	Item to be adjusted	Contents
7618	Judgment threshold adjustment for blank original	The larger the value is, the more an original tends to be judged as a bank sheet. Acceptable values: 0 to 255 (Default: 128)

<Procedure>

The procedure is the same as that of  P. 4-7 “4.2.5 Judgment threshold for ACS (common for copy and scan)”.

4.2.10 Background offsetting adjustment for RADF (common for copy, scan and fax)

The background level for scanning originals with the RADF is adjusted when the background fogging at the scanning of a manually-set original and an original used with the RADF is different. This is to adjust the level of the background image removed when the scanning of the originals with the RADF is performed.

<Adjustment Mode (05)>

Color mode	Code	Remarks
Color	7026	The larger the value is, the darker the background density becomes. Acceptable values: 0 to 255 (Default: 128)
Black	7025	

<Procedure>

The procedure is the same as that of  P. 4-5 "4.2.2 Density adjustment".

4.3 Image Quality Adjustment (Printing Function)

4.3.1 Gamma balance adjustment (Black Mode)

The gamma balance is adjusted by adjusting the density at the Black Mode. The adjustment is performed by selecting its density area from the following: low density, medium density, and high density.

When "Black" (600 dpi) is set for the color mode and "Auto" is selected for the halftone setting, the gamma balance can be adjusted in each area of Text, Graphics and Image.

<Adjustment Mode (05)>

Color mode	Smooth	Detail	Smooth	Detail	Smooth	Detail	Remarks
	(PS)	(PS)	(PCL)	(PCL)	(XPS)	(XPS)	
Black (600dpi)	7315-0	7316-0	7317-0	7318-0	7319-0	7320-0	The larger the value is, the density of the item to be adjusted becomes darker. Acceptable values: 0 to 255 (Default: 128)
	7315-1	7316-1	7317-1	7318-1	7319-1	7320-1	
	7315-2	7316-2	7317-2	7318-2	7319-2	7320-2	
Black (1200dpi)	7309-0	7310-0	-	-	-	-	The larger the value is, the density of the item to be adjusted becomes darker. Acceptable values: 0 to 255 (Default: 128)
	7309-1	7310-1	-	-	-	-	
	7309-2	7310-2	-	-	-	-	

Color mode	Auto (PS)			Auto (XPS)			Remarks
	Text	Graphics	Image	Text	Graphics	Image	
Black (600dpi)	7360-0	7361-0	7362-0	7366-0	7367-0	7368-0	The larger the value is, the density of the item to be adjusted becomes darker. Acceptable values: 0 to 255 (Default: 128)
	7360-1	7361-1	7362-1	7366-1	7367-1	7368-1	
	7360-2	7361-2	7362-2	7366-2	7367-2	7368-2	

Notes:

- Be sure that this adjustment is made after performing  P. 4-4 "4.2.1 Automatic gamma adjustment".
- Changing the adjustment setting influences the adjacent density area slightly.
E.g.: When the value of the medium density is larger, the adjacent areas in the low density and high density range will become slightly darker.

<Procedure>

- (1) While pressing [0] and [5] simultaneously, turn the power ON.
- (2) Key in the codes to be adjusted (language and screen) and press the [START] button.
- (3) Key in the value corresponding to the density area to be adjusted (0, 1 or 2) and press the [START] button.
0: Low density 1: Medium density 2: High density/Highest density
- (4) Key in the adjustment value. (To correct the value once keyed in, press the [CLEAR] button.)
- (5) Press the [OK] or [INTERRUPT] button to store the value in memory. → The equipment goes back to the ready state.
- (6) For resetting the value, repeat step (2) to (5).
- (7) Let the equipment restart and perform the printing job.
- (8) If the image density has not been attained, repeat step (1) to (7)

4.3.2 Upper limit value in the Toner Saving Mode

The upper limit value of the density when “Toner save” is selected in the Custom tab of the printer driver can be adjusted.

<Adjustment Mode (05)>

Color	PS	PCL	XPS	1200dpi	Remarks
Black mode	7307-0	7307-1	7307-2	7302	The smaller the value is, the lighter the density of image becomes. Acceptable values: 0 to 255 (Default: 176)

<Procedure>

The procedure is the same as that of  P. 4-11 “4.3.1 Gamma balance adjustment (Black Mode)”.

4.3.3 Thin line width lower limit adjustment

<Adjustment Mode (05)>

Code	Remarks
8240 (600dpi)	Sets the lower limit value of the thin line width when “Distinguish Thin Lines” is selected in the screen selecting menu of the printer driver. The larger the value is, the thicker (darker) the thin line becomes. Acceptable values: 1 to 9 (Default: 1 for 8240 / 4 for 8241)
8241 (1200dpi)	

<Procedure>

- (1) While pressing [0] and [5] simultaneously, turn the power ON.
- (2) Key in the codes to be adjusted and press the [START] button.
- (3) Key in the adjustment value. (To correct the value once keyed in, press the [CLEAR] button.)
- (4) Press the [OK] or [INTERRUPT] button to store the value in memory. → The equipment goes back to the ready state.
- (5) For resetting the value, repeat step (2) to (4).
- (6) Let the equipment restart and perform the printing job.
- (7) If the desired image has not been attained, repeat step (1) to (6).

4.3.4 Density adjustment of graphic lines (1200 dpi)

This adjustment is available regardless of whether “Distinguish Thin Lines” of the printer driver is selected or not.

<Adjustment Mode (05)>

Color mode	Code	Remarks
Black	8242-0	The density of the line in Black in the line density range specified by “05-8243-0” or “05-8243-1” can be adjusted. The larger the value is, the darker the line density becomes. Acceptable value: 0 to 5 (Default: 4)

Color mode	Code	Remarks	
Black	8243-0	The effective range (lower limit) of the density adjustment for the line in Black can be set. Acceptable value: 0 to 255 (Default: 1)	The density range selected in the upper and lower limit is adjusted with 05-8242-0.
	8243-1	The effective range (upper limit) of the density adjustment for the line in Black can be set. Acceptable value: 0 to 255 (Default: 200)	

Notes:

Be sure to set the values of the upper and lower limit properly so that they are not set in reverse.

<Procedure>

The procedure is the same as that of  P. 4-11 “4.3.1 Gamma balance adjustment (Black Mode)”.

4.4 Image Quality Adjustment (Scanning Function)

4.4.1 Gamma balance adjustment

The gamma balance at the Black Mode is adjusted by adjusting the density. The adjustment is performed by selecting its density area from the following: low density, medium density and high density.

<Adjustment Mode (05)>

Black				Gray Scale	Item to be adjusted	Remarks
Original mode						
Text/ Photo	Text	Photo	Custom mode			
7485-0	7486-0	7487-0	7480-0	7488-0	Low density	The larger the value is, the density of the item to be adjusted becomes darker. Acceptable values: 0 to 255 (Default: 128)
7485-1	7486-1	7487-1	7480-1	7488-1	Medium density	
7485-2	7486-2	7487-2	7480-2	7488-2	High density	

<Procedure>

- (1) While pressing [0] and [5] simultaneously, turn the power ON.
- (2) Key in the code corresponding to the desired original mode and press the [START] button.
- (3) Key in the value corresponding to the density area to be adjusted (0, 1 or 2) and press the [START] button.
0: Low density (L), 1: Medium density (M), 2: High density (H)
- (4) Key in the adjustment value. (To correct the value once keyed in, press the [CLEAR] button.)
- (5) Press the [OK] or [INTERRUPT] button to store the value in memory.
→ The equipment goes back to the ready state.
- (6) For resetting the value, repeat step (2) to (5).
- (7) Let the equipment restart and perform the scanning job.
- (8) If the desired image has not been attained, repeat step (1) to (7).

4.4.2 Density adjustment

Adjusts the center density.

<Adjustment Mode (05)>

Color Mode	Original mode				Item to be adjusted	Remarks
	Text/Photo	Text	Photo	Custom mode		
Color	8339	8340	8341	8380	Manual density center value	The larger the value is, the darker the image becomes. Acceptable values: 0 to 255 (Default: 128)

<Adjustment Mode (05)>

Mode	Original mode				Gray Scale	Item to be adjusted	Remarks
	Text/Photo	Text	Photo	Custom mode			
Black	7444	7445	7446	7475	7447	Manual density center value	The larger the value is, the darker the image becomes. Acceptable values: 0 to 255 (Default: 128)
	7456	7457	7458	7478	7459	Automatic density	

<Procedure>

- (1) While pressing [0] and [5] simultaneously, turn the power ON.
- (2) Key in a code and press the [START] button.
- (3) Key in an adjustment value (acceptable values: 0 to 255).
(To correct a value once keyed in, press the [CLEAR] button.)
- (4) Press the [OK] or [INTERRUPT] button to store the value in memory.
→ The equipment goes back to the ready state.
- (5) Let the equipment restart and perform the scanning.
- (6) If the desired image quality has not been attained, repeat step (1) to (5).

4.4.3 Background adjustment (Color Mode)

The adjustment level of background center value is adjusted. The control value of background adjustment button is automatically adjusted to the same level as the adjusted center value.

For example, when the control value of background adjustment key ranges from 0 to 6, the background center value (-2 to +2) is used to be the range from 6 to 14 accordingly.

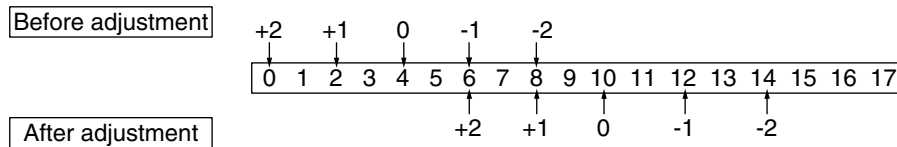

Fig 6-2

<Adjustment Mode (05)>

Code	Original mode	Remarks
8309	Text/Photo	The smaller the value is, the background becomes lighter. Acceptable values: 0 to 255 (Default: 128)
8310	Text	
8311	Photo	
8370	Custom mode	

<Procedure>

- (1) While pressing [0] and [5] simultaneously, turn the power ON.
- (2) Key in the codes and press the [START] button.
- (3) Key in the adjustment values. Acceptable values: 0 to 255. (To correct the value once keyed in, press the [CLEAR] button.)
- (4) Press the [OK] or [INTERRUPT] button to store the value in memory.
→ The equipment goes back to the ready state.
- (5) Let the equipment restart and perform the scanning job.
- (6) If the desired image has not been attained, repeat step (1) to (5).

4.4.4 Background adjustment (Black/Grayscale)

The density of background can be adjusted as follows.

<Adjustment Mode (05)>

Code	Color mode	Original mode	Remarks
7436	Black	Text/Photo	The smaller the value is, the background becomes lighter. Acceptable values: 0 to 255 (Default: 128)
7437		Text	
7438		Photo	
7441		Custom mode	
7439	Grayscale	-	

<Procedure>

The procedure is the same as that of P. 4-15 “4.4.2 Density adjustment”.

4.4.5 Judgment threshold for ACS (common for copy and network scan)

The judgment level is adjusted for the automatic identification of whether the original set on the glass is black or color. Namely, this is to adjust the judgment level used when "Auto Color" is selected at color modes. The same adjustment value is simultaneously applied to all cases of originals on the original glass for copier functions and network scanning functions, and those placed on the RADF.

<Adjustment Mode (05)>

Code	Item to be adjusted	Contents
7630	Judgment threshold for ACS	The larger the value is, the more an original tends to be judged as black even at the Auto Color Mode. The smaller the value is, the more it tends to be judged as color. Acceptable values: 0 to 255 (Default: 70)

<Procedure>:

The procedure is the same as that of  P. 4-15 "4.4.2 Density adjustment".

4.4.6 Sharpness adjustment

If you want to make scan images look softer or sharper, perform the following adjustment. The adjustment can be made for each of the color modes and original modes independently.

<Adjustment Mode (05)>

Code	Color mode	Original mode	Contents
8354	Full Color	Text/Photo	The larger the value is, the sharper the image becomes; while the smaller the value is, the softer the image becomes. The smaller the value is, the less moire tends to appear. The acceptable values are 0 to 255. The center value is 128.
8335		Text	
8336		Photo	
8375		Custom mode	
7430	Black	Text/Photo	
7431		Text	
7432		Photo	
7470		Custom mode	
7433	Gray Scale	–	

Notes:

You have to make adjustment by balancing between moire and sharpness.

<Procedure>

The procedure is the same as that of  P. 4-15 "4.4.2 Density adjustment".

4.4.7 Fine adjustment of black density

The density of black side on scanned image is adjusted at color-scanning.

<Adjustment Mode (05)>

Code	Original mode	Remarks
8314	Text/Photo	The larger the value is, the black side of the image becomes darker. Acceptable values: 0 to 4 (Default: 1)
8315	Text	The larger the value is, the black side of the image becomes darker. Acceptable values: 0 to 4 (Default: 0)
8316	Photo	
8371	Custom mode	

Notes:

Be careful for the value not to be too large since the gradation is reproduced worse in darker side.

<Procedure>

- (1) While pressing [0] and [5] simultaneously, turn the power ON.
- (2) Key in the codes and press the [START] button.
- (3) Key in the adjustment values. Acceptable values: 0 to 4. (To correct the value once keyed in, press the [CLEAR] button.)
- (4) Press the [OK] or [INTERRUPT] button to store the value in memory. → The equipment goes back to the ready state.
- (5) Let the equipment restart and perform the scanning job.
- (6) If the desired image has not been attained, repeat step (1) to (5).

4.4.8 RGB conversion method selection

The color space conversion method of image is decided at color-scanning.

<Adjustment Mode (05)>

Code	Original mode	Remarks
8319	Text/Photo	0: sRGB, 1: AppleRGB, 2: ROMMRGB, 3: AdobeRGB (Default: 0)
8320	Text	
8321	Photo	
8372	Custom mode	

<Procedure>

- (1) While pressing [0] and [5] simultaneously, turn the power ON.
- (2) Key in the codes and press the [START] button.
- (3) Key in the adjustment values. Acceptable values: 0 to 3. (To correct the value once keyed in, press the [CLEAR] button.)
- (4) Press the [OK] or [INTERRUPT] button to store the value in memory. → The equipment goes back to the ready state.
- (5) Let the equipment restart and perform the scanning job.
- (6) If the desired image has not been attained, repeat step (1) to (5).

4.4.9 Adjustment of saturation

The saturation of the scanned image is adjusted for color-scanning.

<Adjustment Mode (05)>

Code	Original mode	Remarks
8324	Text/Photo	The larger the value is, the brighter the image becomes. The smaller the value is, the duller the image becomes. Acceptable values: 0 to 255 (Default: 128)
8325	Text	
8326	Photo	
8373	Custom mode	

<Procedure>

- (1) While pressing [0] and [5] simultaneously, turn the power ON.
- (2) Key in the codes and press the [START] button.
- (3) Key in the adjustment values. Acceptable values: 0 to 255.
(To correct the value once keyed in, press the [CLEAR] button.)
- (4) Press the [OK] or [INTERRUPT] button to store the value in the memory. → The equipment goes back to the ready state.
- (5) Let the equipment restart and perform the scanning job.
- (6) If the desired image has not been attained, repeat step (1) to (5).

4.4.10 Background offsetting adjustment for RADF (common for copy, scan and fax)

The background level for scanning originals with the RADF is adjusted when the background fogging at the scanning of a manually-set original and an original used with the RADF is different. This is to adjust the level of the background image removed when the scanning of the originals with the RADF is performed.

<Adjustment Mode (05)>

Color mode	Code	Remarks
Color	7026	The larger the value is, the darker the background density becomes. Acceptable values: 0 to 255 (Default: 128)
Black	7025	

<Procedure>

The procedure is the same as that of  P. 4-15 "4.4.2 Density adjustment".

4.4.11 Adjustment of the capacity and image quality of SlimPDF

The compression quality or the resolution is adjusted to reduce the file capacity of a SlimPDF or improve its quality.

<Adjustment Mode (05)>

Code	Item to be adjusted	Remarks
9104	Compression quality of SlimPDF background processing	The smaller the value, the less the file capacity and the lower the image quality becomes. The larger the value, the greater the file capacity and the higher the image quality becomes. Acceptable values: 0 to 10 (Default: 5)
9107	Resolution of SlimPDF background processing	The smaller the value, the less the file capacity and the lower the image quality becomes. The larger the value, the greater the file capacity and the higher the image quality becomes. 0: 75dpi 1: 100dpi 2: 150dpi 3: 200dpi Acceptable values: 0 to 3 (Default: 1)

<Procedure>

- (1) While pressing [0] and [5] simultaneously, turn the power ON.
- (2) Key in the codes to be adjusted and press the [START] button.
- (3) Key in the adjustment value. (To correct a value once keyed in, press the [CLEAR] button.)
- (4) Press the [OK] or [INTERRUPT] button to store the value in memory. → The equipment goes back to the ready state.
- (5) Let the equipment restart. Acquire the SlimPDF file and check it.
- (6) If the desired image quality has not been attained, repeat step (1) to (5).

4.4.12 Surrounding void amount adjustment

The void amount around the network scanned image is adjusted.

In network scanning, since the void amount is very small in stored images, a shadow may appear around the scanned image due to the subtle difference in the original sizes. This shadow can be eliminated by adjusting the setting value.

The setting value is applied to all resolutions and color modes.

<Adjustment Mode (05)>

Code	Item to be adjusted	Remarks
7489	Surrounding void amount adjustment	When the value increases, the blank area around the scanned image becomes wider, and the data on the image decrease. Acceptable values: 0 to 255 (Default: 0) The setting value "1" is equal to 1 dot with 600 dpi. (The value "24" is equal to approx. 1 mm.)

<Procedure>

The procedure is the same as that of  P. 4-15 "4.4.2 Density adjustment".

4.4.13 Judgment threshold adjustment for blank originals (common for copy and scan)

The judgment level is adjusted for automatic identification of whether the original set is blank or not. This adjustment is made when "OMIT BLANK PAGE" is selected on the control panel.

The adjustment value is simultaneously applied to all modes at PPC and scanning.

<Adjustment Mode (05)>

Code	Item to be adjusted	Remarks
7618	Judgment threshold adjustment for blank original	The larger the value is, the more an original tends to be judged as a bank sheet. Acceptable values: 0 to 255 (Default: 128)

<Procedure>

The procedure is the same as that of  P. 4-15 "4.4.2 Density adjustment".

4.4.14 JPEG compression level adjustment

The compression level for saving the scanned data in the JPEG format can be adjusted as follows.

<Adjustment Mode (05)>

Code	Item to be adjusted	Remarks
8304-0	High quality	The larger the value is, the better the quality becomes, and the larger the size of file becomes. Acceptable values: 0 to 255 (Default: 128)
8304-1	Standard	
8304-2	Low quality	

<Procedure>

The procedure is the same as that of  P. 4-15 "4.4.2 Density adjustment".

4.4.15 Color conversion table selection

The color conversion table for each original mode at color scanning can be selected as follows.

<Adjustment Mode (05)>

Code	Original mode	Item to be adjusted	Remarks
8305	Text/Photo	Color conversion table	0: Color conversion for text or photo 1: Color conversion for text/photo 2: For reproduction of pure color * "For reproduction of pure color" increases the color reproduction of the pure color patch for CMY.
8308	Custom mode		

Notes:

When "For reproduction of pure color" is selected, the colors other than pure colors of CMY might change.

<Procedure>

- (1) While pressing [0] and [5] simultaneously, turn the power ON.
- (2) Key in the codes to be adjusted and press the [START] button.
- (3) Key in the adjustment value.
(To correct a value once keyed in, press the [CLEAR] button.)
- (4) Press the [OK] or [INTERRUPT] button to store the value in memory. → The equipment goes back to the ready state.
- (5) Let the equipment restart and perform the scanning job.
- (6) If the desired image has not been attained, repeat step (2) to (5).

4.5 Image Quality Adjustment (FAX Function)

4.5.1 Density adjustment

The center density and the density variation controlled by density adjustment keys can be adjusted as follows.

<Adjustment Mode (05)>

Color mode	Original mode			Item to be adjusted	Remarks
	Text/Photo	Text *	Photo		
Black	7533	7534	7535	Manual density center value	[TEXT/PHOTO], [PHOTO]: The larger the value is, the darker the image becomes. [Text]: The larger the value is, the lighter the image becomes. Acceptable values: 0 to 255 (Default: 128)
	7542	–	7543	Automatic density mode	The larger the value is, the darker the image becomes. Acceptable values: 0 to 255 (Default: 128)

* Since the gradation in this mode is reproduced in a binary image (black and white), this adjustment should be a simple binary threshold adjustment.

<Procedure>

- (1) While pressing [0] and [5] simultaneously, turn the power ON.
- (2) Key in a code and press the [START] button.
- (3) Key in an adjustment value.
(To correct the value once keyed in, press the [CLEAR] button.)
- (4) Press the [OK] or [INTERRUPT] button to store the value. → The equipment goes back to the ready state.
- (5) Turn the power OFF.

<Confirmation>

If possible, perform a Fax transmission and check the adjusted density with the image on the recipient's side.

4.5.2 Background offsetting adjustment for RADF (common for copy, scan and fax)

The background level for scanning originals with the RADF is adjusted when the background fogging at the scanning of a manually-set original and an original used with the RADF is different. This is to adjust the level of the background image removed when the scanning of the originals with the RADF is performed.

<Adjustment Mode (05)>

Color mode	Code	Remarks
Black	7025	The larger the value is, the darker the background density becomes. Acceptable values: 0 to 255 (Default: 128)



<Procedure>

The procedure is the same as that of  P. 4-5 “4.2.2 Density adjustment”.

5. ERROR CODE AND TROUBLESHOOTING

5.1 General Descriptions

This chapter explains the procedures for solving troubles occurring in the equipment.

When a trouble occurs, check if an error code is displayed on the LCD screen of the control panel first. If displayed, refer to “ P. 5-4 “5.2 Error Code List”” to figure out the classification and contents of the error, and then refer to “ P. 5-27 “5.3 Diagnosis and Prescription for Each Error Code”” to remove its cause.

If not displayed and the equipment does not operate properly or images are not printed properly, refer to “ P. 5-103 “5.4 Other errors”” to remove its cause.

Note:

If unusual odor is detected or if smoke or fire comes out of the equipment, immediately turn the power OFF.

Even in the cases other than the above, fully observe safety precautions.

If any PC board or HDD shall be replaced, refer to “6.3 Precautions for Installation of GP-1070 and Disposal of HDD/Board”.

5.1.1 If a problem continues even after performing all troubleshooting.

If a problem continues even after performing all troubleshooting and technical tips, report the problem to the appropriate service center along with the following information. This information will help the service center understand your problem and take quick action to find the solution.

1. Serial Number

2. List Print

Refer to the appropriate Service Manual / Service Handbook for the detailed procedure to obtain a List Print.

A. Enter the value given below to obtain a List Print by CSV file.

9S-300: All CSV files

B. Enter the value given below to obtain a List Print by printing it out.

9S-101: 05 code

9S-102: 08 code

9S-106: Error history (1000 cases max)

9S-108: Firmware update log (200 cases max)

9S-110: Power on/off log (100 cases max)

3. For image-related problems, collect image samples with the problem areas and the feeding direction marked first. Then provide information about the media type and weight, and the print data / spool files for duplicating the problem.

4. For abnormal acoustic noise, describe the situation in as much detail as possible.

5. For hardware-related problems, provide photos of any broken parts, paper jams, etc. In case of paper jams, include the type of paper and its manufacturer.

6. For software-related problems, provide list prints, Web Page Logs and the detailed procedure needed to duplicate the problem.

* This is the minimum information required to report a complaint. It would be appreciated if you could obtain additional information.

* Follow the directions of the service center if they request additional information as each issue is unique to some degree.

5.1.2 Collection of debug logs with a USB device

[1] General description

The purpose of collecting the debug logs is to acquire the information for analyzing problems which occurred during the MFP's operation. In such a case, you can collect the debug logs by inserting a USB device into the MFP. Even if the power has to be turned OFF with the main power switch after a problem occurs, the debug logs will be saved in the MFP (up to 3 logs). If the debug logs have already been saved in the MFP, they also can be collected.

The following information is included in the USB debug logs.

Internal operation, Job history, HDD/memory usage status, etc. (Personal/Corporate information (address book) not included)

When the debug logs are collected, also do so for the following information. since it may be difficult to investigate only using the debug log.

- List print mode ([9] + [START]) [300: All CSV files]
- Job logs below in Web Page -> [Logs] -> [Export Logs]
 - Print Job Log Export
 - Fax Transmission Journal Export
 - Fax Reception Journal Export
 - Scan Log Export
 - Messages Log Export
- Problem occurrence time
Or the time when the customer called if it is difficult to work out when it occurred.
- Status of when you collected the debug log
As in the example below, check the status to know if the problem occurred at the debug log collection or how the customer recovered it.
- E.g.
 - You checked the problem and connected a USB device to the equipment.
 - No problem occurred when an attempt to collect the debug log was made; however the customer did turn the main power switch OFF when the problem occurred, so the log can be collected.

[2] Collection procedure

1. Note

When collecting a log, be sure to obtain consent from the user in advance and get the dedicated script file from the service center.

2. About USB devices

Be sure to format the USB device with FAT16/32 beforehand. (Recommend size: 2GB or more)

3. Advance preparation of collection

Store the dedicated script file to the root directory of the USB device.

4. Procedure for collecting debug logs

1. Insert USB device, in which the dedicated script file is stored, into the MFP while the power is ON.
2. The LED in the MFP starts blinking after the USB device has been inserted.
3. When the collection of the debug logs is finished, beeping is heard.
4. After the beeping has stopped, remove the USB device.

Notes:

- Do not remove the USB device while the LED in the MFP is blinking.
- If the LED does not start blinking after the USB device is inserted and a few minutes have passed, try the procedure from step 1 again.
- If there is no beeping after the LED starts blinking (about 20 minutes), try procedure from step 1 again.
- If the USB device is inserted when the MFP is not ready, the debug logs cannot be collected.

5. Collected debug logs

- When the collection of the debug logs is completed, the compressed file of the collected logs is stored in the root directory of the USB device.

File name: XXXX.YYYYMMDDHHmmSS

(XXXX= Serial number of the equipment, YYYY= year, MM= month, DD= day, HH= hour, mm= minute, SS= second)

- After the debug logs have been collected, be sure to send them to the service center together with a report.

5.2 Error Code List

The following error codes is displayed at the upper right of the screen when the “CLEAR PAPER” or “CALL SERVICE” symbol is blinking.

Notes:

For the error codes not described in this guide, refer to the Hardware Guide.

5.2.1 Jam

Error code	Classification	Contents	Troubleshooting
EA10	Finisher jam	Paper not detected: Paper was not detected at the finisher within the set period after the paper was fed by the main unit.	P. 5-28
EA20		Early arrival jam: A piece of paper is fed and then the next piece of paper is fed at an interval shorter than the specified time.	P. 5-28
EA26		Paper transport jam (stop command request): Main unit requested finisher to stop operating while finisher was feeding paper.	P. 5-29
EA2A		Paper transport jam (Between entrance transport and exit transport): Leading edge of paper in finisher transport path passed entrance transport sensor, but did not arrive at exit transport sensor.	P. 5-29
EA2B		Paper transport jam (Exit transport sensor): Paper stayed for longer than set period at exit transport sensor while being transported in finisher transport path.	P. 5-30
EA31		Power-ON jam: Paper was detected at either the entrance transport sensor or the exit transport sensor while the power was on and the finisher's side cover was closed.	P. 5-30
EA40		Side cover open jam: Jam occurred because finisher's side cover was opened while finisher was transporting paper.	P. 5-31
EA50		Stapling jam: Staple jam occurred at stapler.	P. 5-31

5.2.2 Service call

Error code	Classification	Contents	Troubleshooting
CB30	Finisher related service call	Stacker motor abnormality	P. 5-32
CB40		Rear alignment HP abnormality	P. 5-32
CB50		Stapler motor HP abnormality	P. 5-33
CC03		Download abnormality	P. 5-33
CC80		Front alignment HP abnormality	P. 5-33
CC91		Ejector abnormality	P. 5-34
CC95		Paper support HP abnormality	P. 5-34
CC96		Lever path abnormality	P. 5-35
CDE0		Paddle HP abnormality	P. 5-35
EAF2		Stapler motor HP abnormality	P. 5-36
EAF3		Ejector abnormality	P. 5-36
EAF4		Paper support HP abnormality	P. 5-37
EAF5		Lever path HP abnormality	P. 5-37
EAF6		Front alignment HP abnormality	P. 5-38
EAF7		Rear alignment HP abnormality	P. 5-38
EAF8		Stacker motor position detection error	P. 5-39
ED15		Paddle HP abnormality	P. 5-39
F070		Communication related service call	Communication error between SYS board and PU board
F071	Communication initialization error between SYS board and PU board		P. 5-40
F090	Circuit related service call	SRAM abnormality on the SYS board	P. 5-43
F100_0	Other service call	HDD format error: Operation of HDD key data fails.	P. 5-44
F100_1		HDD format error: Encryption key data of either the SYS board or the SRAM board for the SYS board are damaged.	P. 5-44
F100_2		HDD format error: Encryption key data of both the SYS board and the SRAM board for the SYS board are damaged.	P. 5-45
F101_0		HDD connection error (HDD connection cannot be detected.)	P. 5-46
F101_1		Root partition mount error (HDD formatting fails.): The HDD cannot be connected (mounted) caused by damage to the areas in which the program is mainly stored.	P. 5-46
F101_2		Partition mount error: The HDD cannot be connected (mounted) caused by damage to areas other than those described in the F101_1 and F101_4 to F101_9 errors.	P. 5-46
F101_3		Partition mount error: The HDD cannot be connected (mounted) caused by damage to areas other than those described in the F101_1 and F101_4 to F101_9 errors.	P. 5-46
F101_4		Partition mount error: The HDD cannot be connected (mounted) caused by damage to the "/work" partition.	P. 5-47

Error code	Classification	Contents	Troubleshooting
F101_5	Other service call	Partition mount error: The HDD cannot be connected (mounted) caused by damage to the “/registration” partition.	P. 5-48
F101_6		Partition mount error: The HDD cannot be connected (mounted) caused by damage to the “/backup” partition.	P. 5-49
F101_7		Partition mount error: The HDD cannot be connected (mounted) caused by damage to the “/imagedata” partition.	P. 5-50
F101_8		Partition mount error: The HDD cannot be connected (mounted) caused by damage to the “/storage” partition.	P. 5-51
F101_9		Partition mount error: The HDD cannot be connected (mounted) caused by damage to the “/encryption” partition.	P. 5-52
F102		HDD start error: HDD cannot become ‘Ready’ state.	P. 5-53
F103		HDD transfer time-out: Reading/writing cannot be performed in the specified period of time.	P. 5-53
F104		HDD data error: Abnormality is detected in the data of HDD.	P. 5-53
F105		HDD other error	P. 5-53
F106_0	Communication related service call	ADI-HDD error: Illegal disk replacement detected (ADI-HDD Exchange to SATA-HDD)	P. 5-53
F106_1		ADI-HDD error: HDD type detection error	P. 5-54
F106_2		ADI-HDD error: ADI encryption key download operation error	P. 5-54
F106_3		ADI-HDD error: ADI authentication Admin Password generation error	P. 5-55
F106_4		ADI-HDD error: Authentication random number generation error	P. 5-55
F106_5		ADI-HDD error: Authentication data transmission error	P. 5-55
F109_0		Key consistency error: Consistency check operation error.	P. 5-56
F109_1		Key consistency error: SRAM encryption AES key data damage.	P. 5-56
F109_2		Key consistency error: Signature Check public key damage.	P. 5-56
F109_3		Key consistency error: HDD encryption parameter damage.	P. 5-57
F109_4	Key consistency error: license data damage.	P. 5-58	
F109_5	Key consistency error: Encryption key for ADI- HDD is damaged.	P. 5-59	
F109_6	Key consistency error: Administrator password error for ADI-HDD authentication.	P. 5-60	
F110	Communication related service call	Communication error between System-CPU and Scanner-CPU	P. 5-41
F111		Scanner response abnormality	P. 5-41
F112		Communication error between System-CPU and Scanner-CPU detected by Scanner-CPU	P.5-42

Error code	Classification	Contents	Troubleshooting	
F113	Communication related service call	Scanner software error	P.5-42	
F114		Scanner CPU exception	P.5-42	
F120	Other service call	Database abnormality: Database is not operating normally.	P. 5-61	
F121		Database abnormality (user information management database)	P. 5-62	
F122		Database abnormality (Message/Job log management database)	P. 5-62	
F124		Database abnormality: Database is not operating normally. (Language management database)	P. 5-62	
F130		Invalid MAC address	P. 5-63	
F131		Error due to damage to filtering setting file	P. 5-63	
F140		ASIC format error: ASIC formatting fails or memory acquiring fails when software is formatted	P. 5-63	
F200		Data Overwrite option (GP-1070) disabled	P. 5-64	
F400		Circuit related service call	SYS board abnormality	P. 5-43
F500		Other service call	HD partition damage	P. 5-64
F510	Application start error		P. 5-64	
F520	Operating system start error		P. 5-65	
F521	Integrity check error		P. 5-65	
F550	Encryption partition error		P. 5-65	
F600	Software update error		P. 5-65	
F700	Overwrite error		P. 5-66	
F800	Date error		P. 5-66	
F900	Machine information alignment error		P. 5-66	

5.2.3 Error in Internet FAX / Scanning Function

1. Internet FAX related error

Error code	Classification	Troubleshooting
1C10	System access abnormality	P. 5-67
1C11	Insufficient memory	P. 5-67
1C12	Message reception error	P. 5-67
1C13	Message transmission error	P. 5-67
1C14	Invalid parameter	P. 5-67
1C15	Exceeding file capacity	P. 5-67
1C30	Directory creation failure	P. 5-67
1C31	File creation failure	P. 5-67
1C32	File deletion failure	P. 5-67
1C33	File access failure	P. 5-67
1C40	Image conversion abnormality	P. 5-67
1C60	HDD full failure during processing	P. 5-67
1C61	Address Book reading failure	P. 5-67
1C63	Terminal IP address unset	P. 5-68
1C64	Terminal mail address unset	P. 5-68
1C65	SMTP address unset	P. 5-68
1C66	Server time time-out error	P. 5-68
1C69	SMTP server connection error	P. 5-68
1C6B	Terminal mail address error	P. 5-68
1C6C	Destination mail address error	P. 5-68
1C6D	System error	P. 5-68
1C70	SMTP client OFF	P. 5-68
1C71	SMTP authentication error	P. 5-68
1C72	POP before SMTP error	P. 5-68
1CC0	Job canceling	-
1CC1	Power failure	P. 5-68

2. RFC related error

Error code	Message displayed in the Web Page screen	Contents	Troubleshooting
2500	Syntax error, command unrecognized	HOST NAME error (RFC: 500) Destination mail address error (RFC: 500) Terminal mail address error (RFC: 500)	P. 5-69
2501	Syntax error in parameters or arguments	HOST NAME error (RFC: 501) Destination mail address error (RFC: 501) Terminal mail address error (RFC: 501)	P. 5-69
2503	Bad sequence of commands	Destination mail address error (RFC: 503)	P. 5-69
2504	Command parameter not implemented	HOST NAME error (RFC: 504)	P. 5-69
2550	Mailbox unavailable	Destination mail address error (RFC: 550)	P. 5-69
2551	User not local	Destination mail address error (RFC: 551)	P. 5-69
2552	Insufficient system storage	Terminal/Destination mail address error (RFC: 552)	P. 5-69
2553	Mailbox name not allowed	Destination mail address error (RFC: 553)	P. 5-69

3. Electronic Filing related error

Error code	Message displayed in the Web Page screen	Contents	Troubleshooting
2B11	Job status failed.	JOB status abnormality	P. 5-69
2B20	Failed to access file.	File library function error	P. 5-69
2B30	Insufficient disk space.	Insufficient disk space in /BOX partition	P. 5-69
2B31	Failed to access Electronic Filing.	Status of specified Electronic Filing or folder is undefined or being created/ deleted	P. 5-69
2B50	Failed to process image.	Image library error	P. 5-69
2B51	Failed to print images from the document box	List library error	P. 5-70
2B71	Document(s) expire(s) in a few days	Documents expiring in a few days exist	-
2B80	Hard Disk space for Electronic Filing nearly full.	Hard disk space in /BOX partition is nearly full (90%).	-
2B90	Insufficient Memory.	Insufficient memory capacity	P. 5-69
2BA0	Invalid Box password specified.	Invalid Box password	P. 5-70
2BA1	Incorrect paper size / invalid color mode / invalid resolution	The specified paper size, color mode or resolution is not available.	P. 5-70
2BB0	Job canceled	Job canceling	-
2BB1	Power failure occurred	Power failure	P. 5-70
2BC0	System fatal error.	Fatal failure occurred	P. 5-69
2BD0	Power failure occurred during e- Filing restoring.	Power failure occurred during restoring of Electronic Filing	P. 5-70
2BE0	Failed to get machine parameter.	Machine parameter reading failure	P. 5-70
2BF0	Maximum number of page range is reached.	Exceeding maximum number of pages	P. 5-70
2BF1	Maximum number of document range is reached.	Exceeding maximum number of documents	P. 5-70
2BF2	Maximum number of folder range is reached.	Exceeding maximum number of folders	P. 5-70

4. Remote scanning related error

Error code	Message displayed in the Web Page screen	Contents	Troubleshooting
2A20	Failed to acquire resource	System management module resource acquiring failure	P. 5-70
2A31	WS Scan function is not available	Disabled WS Scan	P. 5-70
2A40	System fatal error	System error	P. 5-70
2A50	Job canceling	Job canceling	-
2A51	Power failure	Power failure	P. 5-70
2A60	Authentication for WS Scan failed	WS Scan user authentication failure	P. 5-71
2A70	Insufficient permission to execute RemoteScan	Remote Scan privilege check error	P. 5-71
2A71	Insufficient permission to execute WS Scan	WS Scan privilege check error	P. 5-71
2A72	Insufficient permission to access e-Filing box using scan utility.	e-Filing data access privilege check error (Scan Utility)	P. 5-71

5. E-mail related error

Error code	Message displayed in the Web Page screen	Contents	Troubleshooting
2C10	Illegal Job status	System access abnormality	P. 5-71
2C11	Not enough memory	Insufficient memory	P. 5-71
2C12	Illegal Job status	Message reception error	P. 5-71
2C13	Illegal Job status	Message transmission error	P. 5-71
2C14	Invalid parameter specified	Invalid parameter	P. 5-71
2C15	Email size exceeded limit or maximum size	Exceeding file capacity	P. 5-71
2C20	Illegal Job status	System management module access abnormality	P. 5-71
2C21	Illegal Job status	Job control module access abnormality	P. 5-71
2C22	Illegal Job status	Job control module access abnormality	P. 5-71
2C30	Failed to create directory	Directory creation failure	P. 5-72
2C31	Failed to create file	File creation failure	P. 5-72
2C32	Failed to delete file	File deletion failure	P. 5-71
2C33	Failed to create file	File access failure	P. 5-72
2C40	Failed to convert image file format	Image conversion abnormality	P. 5-72
2C43	Encryption error. Failed to create file	Encryption error	P. 5-72
2C44	Creating the image file was not permitted.	Encryption PDF enforced mode error	P. 5-72
2C45	Failed in making meta data.	Meta data creation error (Scan to Email)	P. 5-72
2C60	Failed to process your Job. Insufficient disk space.	HDD full failure during processing	P. 5-72
2C61	Failed to read AddressBook	Address Book reading failure	P. 5-72
2C62	Not enough memory	Memory acquiring failure	P. 5-72
2C63	Invalid Domain Address	Terminal IP address unset	P. 5-72
2C64	Invalid Domain Address	Terminal mail address unset	P. 5-72
2C65	Failed to connect to SMTP server	SMTP address unset	P. 5-72
2C66	Failed to connect to SMTP server	Server time time-out error	P. 5-72
2C69	Failed to connect to SMTP server	SMTP server connection error	P. 5-72
2C6A	Failed to send E-Mail message	HOST NAME error (No RFC error)	P. 5-73
2C6B	Invalid address specified in From: field	Terminal mail address error	P. 5-73
2C6C	Invalid address specified in To: field	Destination mail address error (No RFC error)	P. 5-73
2C70	SMTP service is not available	SMTP client OFF	P. 5-73
2C71	Failed SMTP Authentication	SMTP authentication error	P. 5-73
2C72	POP Before SMTP Authentication Failed	POP before SMTP error	P. 5-73
2CC0	Job canceled	Job canceling	-
2CC1	Power failure occurred	Power failure	P. 5-73

6. File sharing related error

Error code	Message displayed in the Web Page screen	Contents	Troubleshooting
2D10	Illegal Job status	System access abnormality	P. 5-73
2D11	Not enough memory	Insufficient memory	P. 5-73
2D12	Illegal Job status	Message reception error	P. 5-73
2D13	Illegal Job status	Message transmission error	P. 5-73
2D14	Invalid parameter specified	Invalid parameter	P. 5-74
2D15	Document size exceeded limit or maximum size.	Exceeding the maximum size for file sharing	P. 5-74
2D30	Failed to create directory	Directory creation failure	P. 5-74
2D31	Failed to create file	File creation failure	P. 5-74
2D32	Failed to delete file	File deletion failure	P. 5-73
2D33	Failed to create file	File access failure	P. 5-74
2D40	Failed to convert image file format	Image conversion abnormality	P. 5-74
2D43	Encryption error. Failed to create file	Encryption error	P. 5-74
2D44	Creating the image file was not permitted.	Encryption PDF enforced mode error	P. 5-74
2D45	Failed in making meta data.	Meta data creation error (Scan to File)	P. 5-74
2D62	Failed to connect to network destination. Check destination path	File server connection error	P. 5-74
2D63	Specified network path is invalid. Check destination path	Invalid network path	P. 5-74
2D64	Logon to file server failed. Check username and password	Login failure	P. 5-74
2D65	There are too many documents in the folder. Failed in creating new document.	Exceeding documents in folder: Creating new document is failed.	P. 5-74
2D66	Failed To Process your Job. Insufficient Storage space.	Storage capacity full failure during processing	P. 5-74
2D67	FTP service is not available	FTP service not available	P. 5-75
2D68	File Sharing service is not available	File sharing service not available	P. 5-75
2D69	NetWare service is not available	NetWare service not available	P. 5-75
2DA0	Expired scan documents deleted from share folder.	Periodical deletion of scanned documents completed properly.	-
2DA1	Expired Sent Fax documents deleted from shared folder.	Periodical deletion of transmitted FAX documents completed properly.	-
2DA2	Expired Received Fax documents deleted from shared folder.	Periodical deletion of received FAX documents completed properly.	-
2DA3	Scanned documents in shared folder deleted upon user's request.	Manual deletion of scanned documents completed properly.	-

Error code	Message displayed in the Web Page screen	Contents	Troubleshooting
2DA4	Sent Fax Documents in shared folder deleted upon user's request.	Manual deletion of transmitted FAX documents completed properly.	-
2DA5	Received Fax Documents in shared folder deleted upon user's request.	Manual deletion of received FAX documents completed properly.	-
2DA6	Failed to delete file.	File deletion failure	P. 5-73
2DA7	Failed to acquire resource.	Resource acquiring failure	P. 5-73
2DC0	Job canceled	Job canceling	-
2DC1	Power failure occurred	Power failure	P. 5-75
2E10	Failed to store document(s) in USB folder.	USB storage system access abnormality	P. 5-75
2E11	Failed to store document(s) in USB folder.	Insufficient memory capacity for USB storage	P. 5-75
2E12	Failed to store document(s) in USB folder.	Message reception error in USB storage	P. 5-75
2E13	Failed to store document(s) in USB folder.	Message transmission error in USB storage	P. 5-75
2E14	Failed to store document(s) in USB folder.	Invalid parameter for USB storage	P. 5-75
2E15	Document size exceeded limit or maximum size	Exceeding the maximum size for file sharing	P. 5-75
2E30	Failed to store document(s) in USB folder.	Creation of a directory failed.	P. 5-75
2E31	Failed to store document(s) in USB folder.	File creation failure in USB storage	P. 5-75
2E32	Failed to store document(s) in USB folder.	File deletion failure in USB storage	P. 5-75
2E33	Failed to store document(s) in USB folder.	File access failure in USB storage	P. 5-75
2E40	Failed to convert image file format	Image conversion abnormality in USB storage	P. 5-76
2E43	Encryption error. Failed to create file.	Encryption failure in USB storage	P. 5-76
2E44	Creating the image file was not permitted.	Encryption PDF enforced mode error in USB storage	P. 5-76
2E45	Failed in making meta data.	Meta data creation error in USB storage (Scan to File)	P. 5-76
2E65	There are too many documents in folders. Failed in creating new document.	File creation error due to insufficient USB folder capacity	P. 5-76
2E66	Failed To Process your Job. Insufficient Storage space.	HDD full failure during USB storage	P. 5-76
2EC0	Job canceled	Job canceling	-
2EC1	Power Failure Job Aborted	Power failure in USB storage	P. 5-76

7. E-mail reception related error

Error code	Message displayed in the Web Page screen	Contents	Troubleshooting
3A10	MIME Error has been detected in the received mail.	E-mail MIME error	P. 5-76
3A20	Analyze Error has been detected in the received mail.	E-mail analysis error	P. 5-76
3A30	Whole partial mails were not reached by timeout.	Partial mail time-out error	P. 5-76
3A40	Partial Mail Error has been detected in the received mail.	Partial mail related error	P. 5-76
3A50	HDD Full Error has been occurred in this mail.	Insufficient HDD capacity error	P. 5-77
3A70	Receiving partial mail was aborted since the partial mail setting has been changed to Disable.	Warning of partial mail interruption	P. 5-77
3A80	Partial mail was received during the partial mail setting is disabled.	Partial mail reception setting OFF	P. 5-77
3B10	Format Error has been detected in the received mail.	E-mail format error	P. 5-76
3B20	Content-Type Error has been detected in the received mail.	Content-Type error	P. 5-77
3B40	Decode Error has been detected in the received mail.	E-mail decode error	P. 5-76
3C10	Tiff Analyze Error has been detected in the received mail.	TIFF analysis error	P. 5-77
3C13	Tiff Analyze Error has been detected in the received mail.		P. 5-77
3C20	Tiff Compression Error has been detected in the received mail.	TIFF compression error	P. 5-77
3C30	Tiff Resolution Error has been detected in the received mail.	TIFF resolution error	P. 5-77
3C40	Tiff Paper Size Error has been detected in the received mail.	TIFF paper size error	P. 5-77
3C50	Offramp Destination Error has been detected in the received mail.	Offramp destination error	P. 5-77
3C60	Offramp Security Error has been detected in the received mail.	Offramp security error	P. 5-77
3C70	Power Failure has been occurred in Email receiving.	Power failure error	P. 5-78
3C90	OffRamp Fax transmission disable error has been detected in the received mail.	OffRamp Fax transmission disable error	P. 5-78

Error code	Message displayed in the Web Page screen	Contents	Troubleshooting
3D10	SMTP Destination Error has been detected in the received mail. This mail was deleted.	Destination address error	P. 5-78
3D20	Offramp Destination limitation Error has been detected in the received mail.	Offramp destination limitation error	P. 5-78
3D30	Fax Board Error has been occurred in the received mail.	FAX board error	P. 5-78
3E10	POP3 Connection Error has been occurred in the received mail.	POP3 server connection error	P. 5-78
3E20	POP3 Connection Timeout Error has been occurred in the received mail.	POP3 server connection time-out error	P. 5-78
3E30	POP3 Login Error has been occurred in the received mail.	POP3 login error	P. 5-78
3E40	POP3 Login Error occurred in the received mail.	POP3 login method error	P. 5-78
3F10	File I/O Error has been occurred in this mail. The mail could not be received until File I/O is recovered.	File I/O error	P. 5-78
3F20			P. 5-78

5.2.4 Printer function error

Following codes are displayed at the end of the user name on the print job log screen.

Error code	Contents	Troubleshooting
4011	Print job cancellation - Print job (copy, list print, network print) is deleted from the print job screen.	P. 5-79
4021	Print job power failure - The power of the equipment is turned OFF during print job (copy, list print, network print).	P. 5-79
4031	HDD full during print - Large quantity image data by private print or invalid network print are saved in HDD.	P. 5-79
4041	User authentication error: The user who intended to print a document is not registered as a user.	P. 5-79
4042	Department authentication error? A department whose code is specified for a print job is not registered.	P. 5-79
4045	Problem in LDAP server connection or LDAP server authorization settings	P. 5-79
4111	Quota over error (The number of the assigned pages set by department and user management has reached 0.): The numbers of output pages have exceeded those specified with both of the department code and the user code at the same time.	P. 5-79
4112	Quota over error (The number of the assigned pages set by user management has reached 0.): The number of output pages has exceeded the one specified with the user code.	P. 5-79
4113	Quota over error (The number of the assigned pages set by department management has reached 0.): The number of output pages has exceeded the one specified with the department code.	P. 5-79
4121	Job canceling due to external counter error	P. 5-79
4211	Printing data storing limitation error: Printing with its data being stored to the HDD temporarily (Proof print, Private print, Scheduled print, etc.) cannot be performed.	P. 5-79
4212	e-Filing storing limitation error: Printing with its data being stored to the HDD (print and e-Filing, print to e-Filing, etc.) cannot be performed.	P. 5-79
4213	File storing limitation error: The file storing function is set to "disabled".	P. 5-80
4214	Fax/Internet Fax transmission limitation error: Fax / Internet Fax transmission function or Network Fax/Internet Fax function is disabled.	P. 5-80
4221	Private-print-only error: Jobs other than Private print jobs cannot be performed.	P. 5-80
4231	Hardcopy security printing error: hardcopy security printing job is performed when the function is restricted.	P. 5-80
4311	Not being authorized to perform JOB	P. 5-80
4312	Not authorized to store a file	P. 5-80
4313	No privilege for e-Filing storage: No privilege to store e-Filing data is given. (e-Filing storage permission)	P. 5-80
4314	No privilege for Fax / Internet Fax transmission: No privilege to send Fax or Internet Fax jobs is given. (Fax / Internet Fax transmission permission)	P. 5-80
4321	No privilege for print settings: No privilege to print with the specified settings is given. (Print setting permission)	P. 5-80
4411	Image data creation failure: Data that you tried to print may be corrupted. <ul style="list-style-type: none"> • Network print: Data are corrupted or invalid. • Direct print: A file is corrupted or not in a supported format. 	P. 5-80

Error code	Contents	Troubleshooting
4412	Double-sign encoding error: A double-sign encoding error occurred because the PDF file is encrypted in a forbidden language or in a language not supported.	P. 5-80
4611	Font download failure (exceeding maximum number of registrations): A new font cannot be registered because the number of fonts registered in this equipment has reached the limit.	P. 5-80
4612	Font download failure (HDD full): A new font cannot be registered because there is not sufficient space in the font storage area of this equipment.	P. 5-80
4613	Font download failure (others): A new font cannot be registered due to other abnormality.	P. 5-80
4621	Font deletion failure: A font cannot be deleted because the specified font does not exist, the specified font is undeletable or any other abnormality occurred.	P. 5-80
4F10	Printing was not performed successfully due to other abnormalities.	P. 5-81

5.2.5 Web Page related error/Communication error with external application

Error code	Message displayed in the Web Page screen	Contents	Troubleshooting
5010	-	Internal setting error: There is a print job, a proof print job, a private print job, a print job without a set department code, a scan job or a fax job remaining in this equipment.	P. 5-82
5012	Invalid temporary password and permanent password	Authentication error: A temporary password downloaded from e- Bridge and entered in this equipment is not valid, or the permanent password set in the e- Bridge is not valid.	P. 5-82
5013	e-Bridge communication error	e-Bridge communication error: Communication is attempted while the e-Bridge is enabled for some reason such as version upgrade.	P. 5-82
5014	No SSL certificate	No SSL certificate: There is no SSL certificate or the certificate is not in a correct file format.	P. 5-82
5015	Invalid SSL certificate	Invalid SSL certificate: SSL certificate is not valid.	P. 5-82
5016	Expired SSL certificateIncorrect time in MFP	Expired SSL certificate: SSL certificate is expired.	P. 5-83
5017	Other SSL certificate related error	Other SSL certificate related error: SSL certificate is invalid.	P. 5-83
5018	Invalid DNS error	Invalid DNS error: DNS address is invalid.	P. 5-83
5019	Connection error	Connection error: Settings for initial URL and proxy are incorrect.	P. 5-83
501A	Proxy error	Proxy error: IP address or port for proxy setting is invalid.	P. 5-83
501B	No URL (host/port) or invalid path	No URL (host/port) or invalid path: Initial URL is invalid.	P. 5-84
5030	HTTP communication error	An error in the HTTP communication	P. 5-84
50FF	eBR2 internal error	A fatal error occurred in the MFP	P. 5-84
5110	Toner Not Recognized - Please Check Toner.	Toner cartridge detection error.	P. 5-84
5212	Time for Slit Glass and Main Charger Cleaning - Please Clean Slit Glass and Main Charger.	Appears when the time for main charger cleaning comes (at every output of approx. 10,000 sheets)	P. 5-84
5BD0	Power failure occurred during restore	Power supply is cut off during the restoration of database sent from Web Page	P. 5-85
5C10	FAX Unit is not attached.	Network FAX is disabled because the FAX Unit is not attached	P. 5-85
5C11	Security error on Address Book.	The network FAX job failed because the specified address is not registered in the Address Book	P. 5-85

5.2.6 MFP access error

Error code	Message displayed in the Web Page screen	Contents	Troubleshooting
6007	Failed user login	Unsuccessful User Login to MFP: User authentication cannot be done because connection to the authentication server has failed.	P. 5-86
6008	Failed to connect on External LDAP server for Role Base Access Control	Failed to connect on External Role Base Access Control (LDAP) Server: User authentication cannot be done because connection to an external RBAC server has failed.	P. 5-86
6032	Illegal period.	Card related error: Expired card: The card cannot be used because it has expired.	P. 5-86
6033	No entering record.	Card related error: Invalid flag data (no room-entry data): The card cannot be used because no room-entry data are recorded in it.	P. 5-86
6034	Illegal entering record.	Card related error: Invalid flag data (invalid card data): The card cannot be used because the data required for the use of the card are not correctly set.	P. 5-86
6041	Card Authentication Failed because of Card Reading Error	Card authentication: Card related error: Card data cannot be obtained correctly.	P. 5-87
6042	Card Authentication Failed because of setting Error	Card authentication: Card setting error: The self-diagnostic code required for card authentication is not set in this equipment correctly.	P. 5-87
6121	SecureErase fails	Automatic Secure Erase failure	P. 5-87
6131	SNTP server synchronization failure	Synchronization with the SNTP server failed.	P. 5-87

5.2.7 Maintenance error

Error code	Message displayed in the Web Page screen	Contents	Troubleshooting
7101	Failed to update Copier Firmware	System firmware installation failure	P. 5-88
7103	Failed to update Copier Main ROM	Engine firmware installation failure	P. 5-88
7105	Failed to update Copier Scanner ROM	Scanner firmware installation failure	P. 5-88
7109	Failed to update Printer Driver	Printer driver upload failure	P. 5-88
710B	Failed to update Point And Print	Point and Print data upload failure	P. 5-88
710F	Failed to install Language Pack	Failed to install Language Pack Language Pack installation failure	P. 5-88
7111	Failed to install Patch	Patch installation failure	P. 5-88
7113	Failed to install Plugin	Plug-in installation failure	P. 5-88
7115	Failed to update HDD Data	HDD data installation failure	P. 5-88
711D	Failed to remove License Key	License key returning failure	P. 5-89
711F	Failed to install License Key	License key installation failure	P. 5-89
71A4	Failed in consistency confirmation of cryptographic key	Cryptographic key consistency confirmation failure	P. 5-89
71AA	Invalid Error Occurd while getting Certificate from SCEP server	Invalid Error Occurd while getting Certificate from SCEP server	P. 5-89
71AB	Timeout Error Occurd while getting Certificate from SCEP server	Timeout Error Occurd while getting Certificate from SCEP server	P. 5-89
71AC	File Save Error Occurd while getting Certificate from SCEP server	File Save Error Occurd while getting Certificate from SCEP server	P. 5-90
71B0	Failed to decrypt Software Package	Software package file decryption failure	P. 5-90
71B5	Failed to update Finisher ROM	Finisher firmware installation failure	P. 5-90
7261	Failed to update SU FW	SU firmware installation failure	P. 5-90
7263	Failed to update SU Loader	SU Loader installation failure	P. 5-90
7265	Failed to update SU Recovery	SU Recovery installation failure	P. 5-91
7267	Failed to update PU FW	PU firmware installation failure	P. 5-91
7269	Failed to update PU Loader	PU Loader installation failure	P. 5-91
726B	Failed to update Option Tray	Option Tray installation failure	P. 5-91
726D	Failed to update LCF	LCF installation failure	P. 5-91
726F	Failed to update Finisher	Finisher installation failure	P. 5-91
7271	Failed to update Duplex	Duplex installation failure	P. 5-92

5.2.8 Network error

Error code	Message displayed in the Web Page screen	Contents	Troubleshooting
8000	Static IPv4 duplicated address detected	IPv4 address overlaps.	P. 5-93
8011	Link Local address of IPv6 was duplicated.	Linklocal Address Conflict	P. 5-93
8012	Manual address of IPv6 was duplicated.	Manual IPv6 Address Conflict	P. 5-93
8013	Stateless address of IPv6 was duplicated.	Stateless Address Conflict	P. 5-93
8014	Stateful address of IPv6 was duplicated.	Stateful Address Conflict	P. 5-93
8022	Authentication Failure	Failed in 802.1X authentication.	P. 5-93
8023	Can not contact Authentication Server/Switch	Failed in connection to authentication server and switch.	P. 5-94
8024	Certificate verification Failure	Failed in verification of certificate.	P. 5-94
8031	No IKE proposal chosen	Ipssec error for ikev1 certification failed	P. 5-94
8032	IKE Certificate Authentication failed	Ipssec error for wrong proposal choosen	P. 5-94
8033	IKE Pre-shared key Authentication failed	Ipssec error if auth for shared key failed	P. 5-94
8034	Invalid Certificate	Ipssec error if invalid certificate uploaded	P. 5-95
8035	Certificate Type unsupported	Ipssec error if certificate not supported	P. 5-95
8036	Invalid certificate authority	Ipssec error if invalid certificate authentication	P. 5-95
8037	Certificate unavailable	Ipssec error if certificate are not avialable	P. 5-95
8038	No ISAKMP SA established	Ipssec error for SA is not present	P. 5-95
8039	Invalid Signature	Ipssec error for invalid signaturer for certificate	P. 5-96
803A	No IKEv2 proposal chosen	Ipssec error is proposal choosen is wrong	P. 5-96
803B	IKEv2 Certificate Authentication failed	Ipssec error for ikev2 certification failed	P. 5-96
803C	IKEv2 Secret key Authentication failed	Ipssec error for ikev2 if secret key auth failed	P. 5-96
803D	Falling Back to IKEv1	Ipssec error if peer dosent support IKEv2 and falling back to IKEv1	P. 5-96
803E	ISAKMP SA unusable (deleted)	Ipssec error if ISAKMP SA is not created of destroyed due to some uncertain condition	P. 5-97
803F	Crypto operation failed	Ipssec error for ikev2 if crypto operation failed	P. 5-97
8040	Invalid key information	Ipssec error for ikev2 if key info is invalid	P. 5-97
8041	CA not trusted	Ipssec error for ikev2 if CA is not trusted	P. 5-97
8042	Authentication Method mismatch	Ipssec error if auth method is not matching	P. 5-97
8043	IKE Version mismatch	Ipssec error if ike version is not matching	P. 5-98
8044	Encapsulation mode mismatch	Ipssec error for encaptulation is not matching	P. 5-98

Error code	Message displayed in the Web Page screen	Contents	Troubleshooting
8045	Peer IP Address mismatch	Ipsec error for peer ip mismatch	P. 5-98
8046	Local IP Address mismatch	Ipsec error for local ip mismatch	P. 5-98
8047	Local ID mismatch	Ipsec error for local id mismatch	P. 5-98
8048	Remote ID mismatch	Ipsec error for remote id mismatch	P. 5-98
8049	IPsec Remote IP mismatch	Ipsec error for remote ip mismatch	P. 5-99
804A	IKEv1/IKEv2 Timed out	Ipsec error for ike timeout	P. 5-99
804B	Invalid manual key data	Ipsec error id manual key is not valid	P. 5-99
8061	Secure Update to Primary IPv4 DDNS failed.	Secure primary DDNS update error	P. 5-99
8062	Secure Update to Secondary IPv4 DDNS failed	Secure secondary DDNS update error	P. 5-99
8063	Secure Update to Primary IPv6 DDNS failed.	Secure primary DDNS update error	P. 5-99
8064	Secure Update to Secondary IPv6 DDNS failed	Secure secondary DDNS update error	P. 5-99
8065	IPv6 Update to Primary DDNS failed.	IPv6 primary DDNS update error	P. 5-99
8066	IPv6 Update to Secondary DDNS failed.	IPv6 secondary DDNS update error	P. 5-99
8067	IPv4 Update to Primary DDNS failed.	IPv4 primary DDNS update error	P. 5-99
8068	IPv4 Update to Secondary DDNS failed.	IPv4 secondary DDNS update error	P. 5-99
8069	Invalid TSIG/SIG(0) Key file uploaded	This message is displayed when the key file for SIG(0) or TSIG is invalid	P. 5-100
8101	Wireless association with Access point failure	Wireless association with Access point failure	P. 5-100
8102	Unable to contact Access point	MFP not able to contact the Access point with the specified SSID	P. 5-100
8103	Certificate verification Failure	Wireless Certificate verification failure	P. 5-100
8121	Domain - General Failure during Authentication	Domain - General Failure during Authentication	P. 5-100
8122	Domain - Invalid Username or Password	Domain - Invalid Username or Password	P. 5-101
8123	Domain - Server not present in Network	Domain - Server not present in Network	P. 5-101
8124	Domain - User account is disabled on Server	Domain - User account is disabled on Server	P. 5-101
8125	Domain - User account has expired and cannot be used for logon	Domain - User account has expired and cannot be used for logon	P. 5-101
8126	Domain - User account is locked and cannot be used for logon	Domain - User account is locked and cannot be used for logon	P. 5-101
8127	Domain - Invalid logon hours for the User	Domain - Invalid logon hours for the User	P. 5-102
8128	Active Directory Domain - Clock Skew error due to difference in Time between Server and MFP	Active Directory Domain - Clock Skew error due to difference in Time between Server and MFP	P. 5-102

Error code	Message displayed in the Web Page screen	Contents	Troubleshooting
8129	Active Directory Domain - Kerberos Ticket has expired and cannot be used for Authentication	Active Directory Domain - Kerberos Ticket has expired and cannot be used for Authentication	P. 5-102
812A	Active Directory Domain - Verification of the Ticket has failed	Active Directory Domain - Verification of the Ticket has failed	P. 5-102
812B	Active Directory Domain- The Domain specified could not be found	Active Directory Domain-The Domain specified could not be found	P. 5-102

5.2.9 Error history

In the setting mode (08-9703), the latest twenty groups of error data will be displayed.

Display example

```
EA10      99999999      2013 04 14 17 57 32 064      064      2362_1000_0000_0
                                                _XXXXXXXXXX
Error code  Total counter  YYYY MM DD HH MM SS  MMM  NNN  ABCD_EFHI_JLOP_Q
                                                _R
4 digits      8 digits      14 digits      3 digits  3 digits  23 digits
```

A	Paper source
	0: Not selected 1: Bypass feed 2: LCF 3: 1st drawer 4: 2nd drawer 5: PFP upper drawer 6: PFP lower drawer 7: Unused 8: Unused
B	Paper size code (Only the codes of the supported papers will be displayed.)
	0: A5/ST 1: A5-R 2: ST-R 3: LT 4: A4 5: B5-R 6: LT-R 7: A4-R 8: OTHER/UNIV 9: B5 A: FOLIO/COMP B: LG C: B4 D: LD E: A3 F: 13"LG G: 13.5 inch-R H: A6-R I: J Post card, J Double post card J: 8.5"SQ K: A3-wide L: LD wide M: 8K N: 16K-R O: 16K P: Envelope (Com10, Com9) Q: Envelope(DL) R: Envelope(Monarch) S: Envelope(Cho-3, Cho-4) T: Envelope(You-4, C5-R) U: Exective-R V: IndexCard-R Z: Not selected
C	Sort mode/staple mode
	0: Non-sort/Non-staple 1: Group 2: Sort 7: Front staple 8: Double staple 9: Rear staple A: Saddle stitch
D	ADF mode
	0: Unused 1: AUTO FEED (SADF) 2: STACK FEED
E	APS/AMS mode
	0: Not selected 1: APS 2: AMS
F	Duplex mode
	0: Not selected 1: Book 2: Double-sided/Single-sided 4: Double-sided/Duplex copying 8: Single-sided/Duplex copying
G	Unused
H	Image shift
	0: Unused 1: Book 2: Left 3: Right 4: Top 5: Bottom 6: Book+Top 7: Book+Bottom 8: Left+Top 9: Left+Bottom A: Right+Top B: Right+Bottom
I	Editing
	0: Unused 1: Masking 2: Trimming 3: Mirror image 4: Unused 5: NEG/POS
J	Edge erase/Dual-page
	0: Unused 1: Edge erase 2: Dual-page 3: Edge erase & Dual-page
K	Unused
L	Function
	0: Unused 1: Copying 2: FAX/Internet FAX transmission 3: FAX/Internet FAX/E-mail reception printing 4: Unused 5: Printing/List print 6: Scan/E-mail transmission
MMM	Primary scanning reproduction ratio (Display in hexadecimal)
	(Mx256)+(Mx16)+M
NNN	Secondary scanning reproduction ratio (Display in hexadecimal)
	(Mx256)+(Mx16)+N

O	Color mode
	0: Auto color 1: Full color 2: Black 3: Unused 4: Twin color copy 5: Gray scale 6: Unused 7: Image smoothing
P	Media type
	0: Plain 1: Thick1 2: Thick2 3: Thick3 4: Thick4 5: Thick5 6: Thin 7: Special1_Label1 8: Special2_Label2 9: Special3_Transparency A: Special4_Glossy1 B: Special5_Glossy2 C: Special6_Glossy3 D: Envelope E: Envelope2 F: Envelope3 G: Envelope4 H: UserType1 I: UserType2 J: UserType3 K: UserType4 L: UserType5 Z: Unused
Q	RADF size mixed
	0: Unused 1: Size mixed 2: Single-size document
R	Workflow ID: 10-digit ID

5.3 Diagnosis and Prescription for Each Error Code

5.3.1 Check item

Check item	Contents
Sensor check	<ul style="list-style-type: none">• Check the sensor in the test mode.• Check that there is no dust on the sensor.• Check that the actuator is correctly operated.
Connector check	<ul style="list-style-type: none">• Check that the connector is not disconnected.• Check that the pins are not deformed and do not come off.• Disconnect and reconnect the connector.
Harness check	<ul style="list-style-type: none">• Check if the harnesses are open circuited.
Motor check	<ul style="list-style-type: none">• Check the motor in the test mode.• Check that there is no abnormality in the driving section.• Check that there is no abnormality in the roller.
Board check	<ul style="list-style-type: none">• Check if the board is short circuited or open circuited.

5.3.2 Paper jam in finisher section

[EA10] Paper not detected

Classification	Error content
Paper jam in finisher section	Paper was not detected at the finisher within the set period after the paper was fed by the main unit.

Check item	Measures
Entrance transport sensor	<ul style="list-style-type: none"> • Sensor check (S1) • Connector check (P7-2) • Harness check
Finisher control PC board	<ul style="list-style-type: none"> • Board check • Connector check (J7) • Harness check

Parts to be replaced	Remark
Entrance transport sensor	
Finisher control PC board	

[EA20] Early arrival jam

Classification	Error content
Paper jam in finisher section	A sheet of paper is fed and then the next sheet of paper is fed at an interval shorter than the specified time.

Check item	Measures
Transport path	If there is paper in the paper transport path, remove the paper.
Entrance transport sensor	<ul style="list-style-type: none"> • Sensor check (S1) • Connector check (P7-2) • Harness check
Exit transport sensor	<ul style="list-style-type: none"> • Sensor check (S2) • Connector check (P8-1) • Harness check
Finisher control PC board	<ul style="list-style-type: none"> • Board check • Connector check (J7, J8) J7: input, J8: output • Harness check

Parts to be replaced	Remark
Entrance transport sensor	
Exit transport sensor	
Finisher control PC board	

[EA26] Paper transport jam (stop command request)

Classification	Error content
Paper jam in finisher section	Main unit requested finisher to stop operating while finisher was feeding paper.

Check item	Measures
Transport path	If there is paper in the paper transport path, remove the paper.
Entrance transport sensor	<ul style="list-style-type: none"> • Sensor check (S1) • Connector check (P7-2) • Harness check
Exit transport sensor	<ul style="list-style-type: none"> • Sensor check (S2) • Connector check (P8-1) • Harness check
Finisher control PC board	<ul style="list-style-type: none"> • Board check • Connector check (J7, J8) J7: input, J8: output • Harness check

Parts to be replaced	Remark
Entrance transport sensor	
Exit transport sensor	
Finisher control PC board	

[EA2A] Paper transport jam (Between entrance transport and exit transport)

Classification	Error content
Paper jam in finisher section	Leading edge of paper in finisher transport path passed entrance transport sensor, but did not arrive at exit transport sensor.

Check item	Measures
Transport path	If there is paper in the paper transport path, remove the paper.
Entrance transport sensor	<ul style="list-style-type: none"> • Sensor check (S1) • Connector check (P7-2) • Harness check
Exit transport sensor	<ul style="list-style-type: none"> • Sensor check (S2) • Connector check (P8-1) • Harness check
Finisher control PC board	<ul style="list-style-type: none"> • Board check • Connector check (J7, J8) J7: input, J8: output • Harness check

Parts to be replaced	Remark
Entrance transport sensor	
Exit transport sensor	
Finisher control PC board	

[EA2B] Paper transport jam (Exit transport sensor)

Classification	Error content
Paper jam in finisher section	Paper stayed for longer than set period at exit transport sensor while being transported in finisher transport path.

Check item	Measures
Transport path	If there is paper in the paper transport path, remove the paper.
Exit transport sensor	<ul style="list-style-type: none"> • Sensor check (S2) • Connector check (P8-1) • Harness check
Finisher control PC board	<ul style="list-style-type: none"> • Board check • Connector check (J7, J8) • Harness check

Parts to be replaced	Remark
Exit transport sensor	
Finisher control PC board	

[EA31] Power-ON jam

Classification	Error content
Paper jam in finisher section	Paper was detected at either the entrance transport sensor or the exit transport sensor when the power was on or the finisher's side cover was closed.

Check item	Measures
Transport path	If there is paper in the paper transport path, remove the paper.
Entrance transport sensor	<ul style="list-style-type: none"> • Sensor check (S1) • Connector check (P7-2) • Harness check
Exit transport sensor	<ul style="list-style-type: none"> • Sensor check (S2) • Connector check (P8-1) • Harness check
Finisher control PC board	<ul style="list-style-type: none"> • Board check • Connector check (J7, J8) • Harness check

Parts to be replaced	Remark
Entrance transport sensor	
Exit transport sensor	
Finisher control PC board	

[EA40] Side cover open jam

Classification	Error content
Paper jam in finisher section	Jam occurred because finisher's side cover was opened while finisher was transporting paper.

Check item	Measures
Transport path	If there is paper in the paper transport path, remove the paper.
Side cover	Close the cover if it is open.
Door switch	<ul style="list-style-type: none"> • Switch check (SW2) • Connector check (P2-12, P2-13) • Harness check
Finisher control PC board	<ul style="list-style-type: none"> • Board check • Connector check (J2) • Harness check

Parts to be replaced	Remark
Door switch	
Finisher control PC board	

[EA50] Stapling jam

Classification	Error content
Paper jam in finisher section	Staple jam occurred at stapler.

Check item	Measures
Stapler	<ul style="list-style-type: none"> • Remove the staple cartridge, remove any jammed staples, install the staple cartridge. • Connector check (P9-1, P10-1) • Harness check
Finisher control PC board	<ul style="list-style-type: none"> • Board check • Connector check (J9, J10) • Harness check

Parts to be replaced	Remark
Stapler	
Finisher control PC board	

5.3.3 Finisher related service call

[CB30] Stacker motor abnormality

* If [EAF8] occurs two times consecutively, it becomes a [CB30] error.

Classification	Error content
Finisher related service call	Stacker motor position detection error

Check item	Measures
Stack home position sensor	<ul style="list-style-type: none"> • Sensor check (S9) • Connector check (P7-11) • Harness check
Stacker motor	<ul style="list-style-type: none"> • Motor check (M8) • Connector check (P14-3) • Harness check
Finisher control PC board	<ul style="list-style-type: none"> • Board check • Connector check (J7, J14) • Harness check

Parts to be replaced	Remark
Stack home position sensor	
Stacker motor	
Finisher control PC board	

[CB40] Rear alignment HP abnormality

* If [EAF7] occurs two times consecutively, it becomes a [CB40] error.

Classification	Error content
Finisher related service call	Rear alignment HP abnormality

Check item	Measures
Rear alignment plate home position sensor	<ul style="list-style-type: none"> • Sensor check (S5) • Connector check (P7-5) • Harness check
Rear alignment motor	<ul style="list-style-type: none"> • Motor check (M5) • Connector check (P5-13) • Harness check
Finisher control PC board	<ul style="list-style-type: none"> • Board check • Connector check (J5, J7) • Harness check

Parts to be replaced	Remark
Rear alignment plate home position sensor	
Rear alignment motor	
Finisher control PC board	

[CB50] Stapler motor HP abnormality

* If [EAF2] occurs two times consecutively, it becomes a [CB50] error.

Classification	Error content
Finisher related service call	Stapler motor HP abnormality

Check item	Measures
Stapler	<ul style="list-style-type: none"> • Connector check (P9-1) • Harness check
Stapler motor	<ul style="list-style-type: none"> • Motor check (M9) • Connector check (P9-1) • Harness check
Finisher control PC board	<ul style="list-style-type: none"> • Board check • Connector check (J9, J10) • Harness check

Parts to be replaced	Remark
Stapler home position sensor	
Stapler motor	
Finisher control PC board	

[CC03] Download abnormality

Classification	Error content
Finisher related service call	Download abnormality

Check item	Measures
Setting	Update the firmware again.

[CC80] Front alignment HP abnormality

* If [EAF6] occurs two times consecutively, it becomes a [CC80] error.

Classification	Error content
Finisher related service call	Front alignment HP abnormality

Check item	Measures
Front alignment plate home position sensor	<ul style="list-style-type: none"> • Sensor check (S4) • Connector check (P8-3) • Harness check
Front alignment motor	<ul style="list-style-type: none"> • Motor check (M4) • Connector check (P6-12) • Harness check
Finisher control PC board	<ul style="list-style-type: none"> • Board check • Connector check (J6, J8) • Harness check

Parts to be replaced	Remark
Front alignment plate home position sensor	
Front alignment motor	
Finisher control PC board	

[CC91] Ejector abnormality

* If [EAF3] occurs two times consecutively, it becomes a [CC91] error.

Classification	Error content
Finisher related service call	Ejector abnormality

Check item	Measures
Ejector home position sensor	<ul style="list-style-type: none"> • Sensor check (S7) • Connector check (P7-16) • Harness check
Ejector encoder sensor	<ul style="list-style-type: none"> • Sensor check (S8) • Connector check (P13-1) • Harness check
Ejector motor	<ul style="list-style-type: none"> • Motor check (M7) • Connector check (P6-3) • Harness check
Finisher control PC board	<ul style="list-style-type: none"> • Board check • Connector check (J7, J13) • Harness check

Parts to be replaced	Remark
Ejector home position sensor	
Ejector encoder sensor	
Ejector motor	
Finisher control PC board	

[CC95] Paper support HP abnormality

* If [EAF4] occurs two times consecutively, it becomes a [CC95] error.

Classification	Error content
Finisher related service call	Paper support HP abnormality

Check item	Measures
Paper support home position sensor	<ul style="list-style-type: none"> • Sensor check (S6) • Connector check (P7-13) • Harness check
Paper support motor	<ul style="list-style-type: none"> • Motor check (M6) • Connector check (P6-1) • Harness check
Finisher control PC board	<ul style="list-style-type: none"> • Board check • Connector check (J6, J7) • Harness check

Parts to be replaced	Remark
Paper support home position sensor	
Paper support motor	
Finisher control PC board	

[CC96] Lever path HP abnormality

* If [EAF5] occurs two times consecutively, it becomes a [CC96] error.

Classification	Error content
Finisher related service call	Lever path HP abnormality

Check item	Measures
Lever path home position sensor	<ul style="list-style-type: none"> • Sensor check (S15) • Connector check (P7-4) • Harness check
Lever path motor	<ul style="list-style-type: none"> • Motor check (M10) • Connector check (P18-1) • Harness check
Finisher control PC board	<ul style="list-style-type: none"> • Board check • Connector check (J7, J18) • Harness check

Parts to be replaced	Remark
Lever path home position sensor	
Lever path motor	
Finisher control PC board	

[CDE0] Paddle HP abnormality

* If [ED15] occurs two times consecutively, it becomes a [CDE0] error.

Classification	Error content
Finisher related service call	Paddle HP abnormality

Check item	Measures
Paddle home position sensor	<ul style="list-style-type: none"> • Sensor check (S3) • Connector check (P8-4) • Harness check
Paddle motor	<ul style="list-style-type: none"> • Motor check (M3) • Connector check (P5-4) • Harness check
Finisher control PC board	<ul style="list-style-type: none"> • Board check • Connector check (J5, J8) • Harness check

Parts to be replaced	Remark
Paddle home position sensor	
Paddle motor	
Finisher control PC board	

[EAF2] Stapler motor HP abnormality

Classification	Error content
Finisher related service call	Stapler motor HP abnormality

Check item	Measures
Stapler	<ul style="list-style-type: none"> • Connector check (P9-1) • Harness check
Stapler motor	<ul style="list-style-type: none"> • Motor check (M9) • Connector check (P9-1) • Harness check
Finisher control PC board	<ul style="list-style-type: none"> • Board check • Connector check (J9, J10) • Harness check

Parts to be replaced	Remark
Stapler home position sensor	
Stapler motor	
Finisher control PC board	

[EAF3] Ejector abnormality

Classification	Error content
Finisher related service call	Ejector abnormality

Check item	Measures
Ejector home position sensor	<ul style="list-style-type: none"> • Sensor check (S7) • Connector check (P7-16) • Harness check
Ejector encoder sensor	<ul style="list-style-type: none"> • Sensor check (S8) • Connector check (P13-1) • Harness check
Ejector motor	<ul style="list-style-type: none"> • Motor check (M7) • Connector check (P6-3) • Harness check
Finisher control PC board	<ul style="list-style-type: none"> • Board check • Connector check (J7, J13) • Harness check

Parts to be replaced	Remark
Ejector home position sensor	
Ejector encoder sensor	
Ejector motor	
Finisher control PC board	

[EAF4] Paper support HP abnormality

Classification	Error content
Finisher related service call	Paper support HP abnormality

Check item	Measures
Paper support home position sensor	<ul style="list-style-type: none"> • Sensor check (S6) • Connector check (P7-13) • Harness check
Paper support motor	<ul style="list-style-type: none"> • Motor check (M6) • Connector check (P6-1) • Harness check
Finisher control PC board	<ul style="list-style-type: none"> • Board check • Connector check (J6, J7) • Harness check

Parts to be replaced	Remark
Paper support home position sensor	
Paper support motor	
Finisher control PC board	

[EAF5] Lever path HP abnormality

Classification	Error content
Finisher related service call	Lever path HP abnormality

Check item	Measures
Lever path home position sensor	<ul style="list-style-type: none"> • Sensor check (S15) • Connector check (P7-4) • Harness check
Lever path motor	<ul style="list-style-type: none"> • Motor check (M10) • Connector check (P18-1) • Harness check
Finisher control PC board	<ul style="list-style-type: none"> • Board check • Connector check (J7, J18) • Harness check

Parts to be replaced	Remark
Lever path home position sensor	
Lever path motor	
Finisher control PC board	

[EAF6] Front alignment HP abnormality

Classification	Error content
Finisher related service call	Front alignment HP abnormality

Check item	Measures
Front alignment plate home position sensor	<ul style="list-style-type: none"> • Sensor check (S4) • Connector check (P8-3) • Harness check
Front alignment motor	<ul style="list-style-type: none"> • Motor check (M4) • Connector check (P6-12) • Harness check
Finisher control PC board	<ul style="list-style-type: none"> • Board check • Connector check (J6, J8) • Harness check

Parts to be replaced	Remark
Front alignment plate home position sensor	
Front alignment motor	
Finisher control PC board	

[EAF7] Rear alignment HP abnormality

Classification	Error content
Finisher related service call	Rear alignment HP abnormality

Check item	Measures
Rear alignment plate home position sensor	<ul style="list-style-type: none"> • Sensor check (S5) • Connector check (P7-5) • Harness check
Rear alignment motor	<ul style="list-style-type: none"> • Motor check (M5) • Connector check (P5-13) • Harness check
Finisher control PC board	<ul style="list-style-type: none"> • Board check • Connector check (J5, J7) • Harness check

Parts to be replaced	Remark
Rear alignment plate home position sensor	
Rear alignment motor	
Finisher control PC board	

[EAF8] Stacker motor position detection error

Classification	Error content
Finisher related service call	Stacker motor position detection error

Check item	Measures
Stack home position sensor	<ul style="list-style-type: none"> • Sensor check (S9) • Connector check (P7-11) • Harness check
Stacker motor	<ul style="list-style-type: none"> • Motor check (M8) • Connector check (P14-3) • Harness check
Finisher control PC board	<ul style="list-style-type: none"> • Board check • Connector check (J7, J14) • Harness check

Parts to be replaced	Remark
Stack home position sensor	
Stacker motor	
Finisher control PC board	

[ED15] Paddle HP abnormality

Classification	Error content
Finisher related service call	Paddle HP abnormality

Check item	Measures
Paddle home position sensor	<ul style="list-style-type: none"> • Sensor check (S3) • Connector check (P8-4) • Harness check
Paddle motor	<ul style="list-style-type: none"> • Motor check (M3) • Connector check (P5-4) • Harness check
Finisher control PC board	<ul style="list-style-type: none"> • Board check • Connector check (J5, J8) • Harness check

Parts to be replaced	Remark
Paddle home position sensor	
Paddle motor	
Finisher control PC board	

5.3.4 Communication related service call

[F070] Communication error between SYS board and PU board

Classification	Error content
Communication related service call	Communication error between SYS board and PU board

Check item	Measures
Error code	<ul style="list-style-type: none"> Turn the power OFF and then back ON using the main power switch, and then check if the error code changes to another one. If it changes to another one, follow the procedure for the changed error code.
Check firmware version	<ul style="list-style-type: none"> Check the version of the system firmware on the SYS board. Check the version of the PU firmware on the PU board.
Board check	<ul style="list-style-type: none"> Check if the connector CN118, CN119 on the SYS board and the connector CUIF0, CUIF1 on the PU board are completely inserted. Check if the connector pin between the SYS board (connector CN118, CN119) and the PU board (CUIF0, CUIF1) is disconnected. Check if the connectors HEAD0K, HEAD1Y, HEAD2M, and HEAD3C of the LED head are completely inserted, and the harness is disconnected or open circuited. Check if the conductor patterns on the PU board and SYS board are short circuited or open circuited

Parts to be replaced	Remark
SYS board	
PU board	
LED head	

[F071] Communication initialization error between SYS board and PU board

Classification	Error content
Communication related service call	Communication initialization error between SYS board and PU board

Proce- dure	Check item	Measures
1	LED head, harness	<p>1-1. Disconnect all the harnesses of the LED heads, and then turn the power ON. Check if the error changes to another service call. (HEAD0K, HEAD1Y, HEAD2M, HEAD3C)</p> <p>1-2. If the error does not change to another service call in step 1-1, go to step 2. If the error changes to another service call, follow the steps below.</p> <p>1-3. Connect the harnesses of the LED head to the PU board single color at a time, and then turn the power ON to identify the LED head in error. Check if F071 occurs. Place the parts causing the error.</p> <p>Y color: HEAD1Y M color: HEAD2M C color: HEAD3C K color: HEAD0K</p>
2	Check firmware version	<ul style="list-style-type: none"> Check the version of the system firmware on the SYS board. Check the version of the PU firmware on the PU board.

Procedure	Check item	Measures
3	Board check	<ul style="list-style-type: none"> • Check if the connector CN118, CN119 on the SYS board and the connector CUIF0, CUIF1 on the PU board are completely inserted. • Check if the connector pin between the SYS board (connector CN118, CN119) and the PU board (connector CUIF0, CUIF1) is disconnected. • Check if the connectors HEAD0K, HEAD1Y, HEAD2M, and HEAD3C of the LED head are completely inserted, and the harness is disconnected or open circuited. • Check if the conductor patterns on the PU board and SYS board are short circuited or open circuited

Parts to be replaced	Remark
PU board	
SYS board	
LED head	
Harness of LED head	

[F110] Communication error between System-CPU and Scanner-CPU

[F111] Scanner response abnormality

Classification	Error content
Communication related service call	[F110] Communication error between System-CPU and Scanner- CPU [F111] Scanner response abnormality

Check item	Measures
SU board	<ul style="list-style-type: none"> • Check if the harness connecting the SU board and SYS board is disconnected or open circuited. • Check if the conductor pattern on the SU board is short circuited or open circuited.
SYS board	Check if the conductor pattern on the SYS board is short circuited or open circuited.

Parts to be replaced	Remark
SU board	
SYS board	

5.3.5 Scanner related service call

[F112] Communication error between System-CPU and Scanner-CPU detected by Scanner-CPU

[F113] Scanner software error

[F114] Scanner CPU exception

Classification	Error content
Scanner related service call	[F112] Communication error between System-CPU and Scanner-CPU detected by Scanner-CPU [F113] Scanner software error [F114] Scanner CPU exception

Check item	Measures
Debug log	<ul style="list-style-type: none"> To get the debug logs with a USB device and request the research. It is possible that the firmware is troubling. Don't turn off the MFP until collecting the debug logs with USB, when occurred the troubling.
Check firmware version	<ul style="list-style-type: none"> Check the version of the system firmware on the SYS board. Check the version of the SU firmware on the SU board.

5.3.6 Circuit related service call

[F090] SRAM abnormality on the SYS board

Classification	Contents
Circuit related service call	SRAM abnormality on the SYS board

Check item	Measure
SRAM	Check the connection of SRAM
	<ol style="list-style-type: none"> 1. Turn the power OFF, and start up the Setting Mode (08). 2. When "SRAM REQUIRES INITIALIZATION" is displayed on the LCD, check the destination and then press the [START] button. If the destination is not correct, key in the correct one and then press the [START] button. (SRAM is initialized.) 3. After the confirmation message is displayed, press the [INTERRUPT] button. 4. Perform the panel calibration (08-9050). 5. Enter the serial number (08-9601). Match it with the serial number on the label attached to the rear cover of the equipment. 6. Initialize the NIC information (08-9083). 7. Turn the power OFF and then start up with the Adjustment mode (05). 8. Perform "Automatic gamma adjustment" <PPC> (05-7869). (using [4] [FAX] test pattern) 9. Perform "Automatic gamma adjustment" <PRT> (05-8008, 8009). (using [70][FAX] test pattern) 10. Turn the power OFF and then back ON.
SYS board	Board check

Replacement part	Measure
SRAM on the SYS board	
SYS board	

[F400] SYS board abnormality

Classification	Contents
Circuit related service call	SYS board abnormality

Check item	Measures
SYS board	Board check

Replacement part	Measure
SYS board	

5.3.7 Other service call

[F100_0] HDD format error (Operation failure of key data)

Classification	Contents
Other service call	HDD format error: Operation of HDD key data fails.

Check item	Measures
Setting	Reboot the equipment. If it cannot be recovered, reinstall the software in the following procedure. 1. Install the system firmware. ⓘ P. 8-3 “8.2 Firmware Updating with USB Device”

[F100_1] HDD format error (HDD encryption key data damaged - one board)

Classification	Contents
Other service call	HDD format error: Encryption key data of either the SYS board or the SRAM board for the SYS board are damaged.

Check item	Measures
Encryption key status	Check the displayed message. ([3] + [C] + [POWER] → 5. Key Backup Restore)

Take appropriate countermeasures shown in the table below according to the messages displayed in “SRAM Key Status” and “FROM Key Status”.

Remarks:

If the error is not cleared, reinstallation of the system firmware, system software and application is needed. ([4]+[9] → Power-ON)

ⓘ P. 8-3 “8.2 Firmware Updating with USB Device”

SRAM Key Status	FROM Key Status	Measure
OK	AccessFailed	Replace the SYS board. ⓘ P. 6-18 “6.2.4 Precautions and Procedures when replacing the SYS board” (all steps)
OK	KeyNull	Recover the encryption key on the SYS board. ⓘ P. 6-18 “6.2.4 Precautions and Procedures when replacing the SYS board” ([D]Restore encryption key)
	KeyBroken	
AccessFailed	OK	Replace the SRAM board (for the SYS board). (USB backup data are not used) ⓘ P. 6-22 “6.2.5 Precautions and procedure when replacing the SRAM board (for the SYS board)” (all steps)
KeyNull	OK	Recover the encryption key on the SRAM board. ⓘ P. 6-22 “6.2.5 Precautions and procedure when replacing the SRAM board (for the SYS board)” ([H]Backup encryption key)
KeyBroken		
Keymismatch	Keymismatch	<The error occurs when the SYS board is replaced> Recover the encryption key on the CU board. ⓘ P. 6-18 “6.2.4 Precautions and Procedures when replacing the SYS board” ([D]Restore encryption key) <The error occurs except when the SYS board is replaced> Replace the SRAM board (for the SYS board). ⓘ P. 6-22 “6.2.5 Precautions and procedure when replacing the SRAM board (for the SYS board)” (all steps)

[F100_2] HDD format error (HDD encryption key data damaged - both boards)

Classification	Contents
Other service call	HDD format error: Encryption key data of both the SYS board and the SRAM board for the SYS board are damaged.
Check item	Measures
Encryption key status	Check the displayed message. ([3] + [C] + [POWER] → 5. Key Backup Restore)

Take appropriate countermeasures shown in the table below according to the messages displayed in “SRAM Key Status” and “FROM Key Status”.

Remarks:

If the error is not cleared, reinstallation of the system firmware / system software and application is needed. ([4]+[9] → Power-ON)

SRAM Key Status	FROM Key Status	Measure
*	AccessFailed	Replace the SYS board. 📖 P. 6-18 “6.2.4 Precautions and Procedures when replacing the SYS board” (all steps) <With USB backup data: All key data recovery> 1. Recover all the data on the SRAM board. [5] + [9] + [POWER] → 2. Restore SRAM Data from USB (For details, see “9.1.4 Cloning procedure [B]Restore procedure”) 2. Recover the encryption key/license on the SYS board. Follow the procedures below noted in “6.2.4 Precautions and Procedures when replacing the SYS board”. [C] Restore ADI key (only when ADI-HDD is installed) [D] Restore encryption key [E] Restore license
AccessFailed	*	Replace the SYS board. 📖 P. 6-22 “6.2.5 Precautions and procedure when replacing the SRAM board (for the SYS board)” (for the SYS board, all steps)
KeyNull/ KeyBroken	KeyNull/ KeyBroken	<No USB backup data> 1. Reinstall the system software. 📖 P. 8-4 “8.2 Firmware Updating with USB Device” <With USB backup data: All key data recovery> 1. Recover all the data on the SRAM board. [5] + [9] + [POWER] → 2. Restore SRAM Data from USB (For details, see “9.1.4 Cloning procedure [B]Restore procedure”) 2. Recover the encryption key/license on the SYS board. Follow the procedures below noted in “6.2.4 Precautions and Procedures when replacing the SYS board”. [C] Restore ADI key (only when ADI-HDD is installed) [D] Restore encryption key [E] Restore license

* AccessFailed, KeyNull or KeyBroken

[F101_0] HDD connection error (HDD connection cannot be detected.)

[F101_1] Root partition mount error (HDD formatting fails.)

[F101_2][F101_3] Partition mount error (The HDD cannot be connected (mounted) caused by damage to areas other than those described in the F101_1 and F101_4 to F101_9 errors.)

Classification	Contents
Other service call	HDD unmounted: Connection of HDD cannot be detected. Sub-code 0: HDD connection error (HDD connection cannot be detected.) Sub-code 1: Root partition mount error (HDD formatting fails.) Sub-code 2, 3: Partition mount error (The areas other than those described in the F101_1 and F101_4 to F101_9 errors are damaged.)

Check item	Measures
HDD, SYS board, Setting	<ol style="list-style-type: none"> 1. Turn the power of the equipment OFF and check the connection of the HDD. <ul style="list-style-type: none"> - Connector and harness check - Check if the connector pins of the HDD are bent. - Check if HDD for other equipment is not installed. - Check if SRAM for other equipment is not installed. 2. If the error still occurs after step 1, perform the following. <ul style="list-style-type: none"> - Perform [3C] - [5] (Key Backup Restore) and check that each Key Status is "OK". - If not, recover the key (copy "SRAM Key Status" to "FROM Key Status" or vice versa). 3. If the error still persists after step 2, perform the following. <ul style="list-style-type: none"> - Perform [3C] - [3] (Format HDD), and then install "System Software (HD data)" with [49] - [4]. <p>Notes:</p> <p>The following items will be deleted by performing [3C] - [3] (Format HDD).</p> <ul style="list-style-type: none"> • Message Log • Job Log • Spool Data (Print, Email reception) • Template <p>If F101_1 occurs with ADI-HDD or the error persists after performing step 3, perform step 3 after performing [4]+[C]+[POWER] → 1. Revert factory initial status HDD.</p> 4. If the error persists even after step 3, replace the HDD.

Replacement part	Measure
HDD	
SYS board	

[F101_4] Partition mount error (The HDD cannot be connected (mounted) caused by damage to the “/work” partition.)

Classification	Contents
Other service call	HDD unmounted: Connection of HDD cannot be detected. Sub-code 4: Partition mount error (The “/work” partition is damaged.)

Check item	Measures
HDD, SYS board, Setting	<ol style="list-style-type: none"> 1. Turn the power of the equipment OFF and check the connection of the HDD. <ul style="list-style-type: none"> - Connector and harness check - Check if the connector pins of the HDD are bent. - Check if HDD for other equipment is not installed. - Check if SRAM for other equipment is not installed. 2. If the error still occurs after step 1, perform the following. <ul style="list-style-type: none"> - Perform [3C] - [5] (Key Backup Restore) and check that each Key Status is “OK”. - If not, recover the key (copy “SRAM Key Status” to “FROM Key Status” or vice versa). 3. If the error persists after step 2, perform [5]+[C]+[POWER] → 2. Recovery F/S → 3. /work, and then restart the equipment. 4. If the error persists after step 3, perform [5]+[C]+[POWER] → 3. Initialize HDD → 2. /work, and then restart the equipment. 5. If the error still persists after step 4, perform the following. <ul style="list-style-type: none"> - Perform [3C] - [3] (Format HDD), and then install “System Software (HD data)” with [49] - [4]. <p>Notes: The following items will be deleted by performing [3C] - [3] (Format HDD).</p> <ul style="list-style-type: none"> • Message Log • Job Log • Spool Data (Print, Email reception) • Template <p>If the error persists after performing step 5, perform step 5 after performing [4]+[C]+[POWER] → 1. Revert factory initial status HDD.</p> 6. If the error persists even after step 5, replace the HDD.

Replacement part	Measure
HDD	
SYS board	

[F101_5] Partition mount error (The HDD cannot be connected (mounted) caused by damage to the “/registration” partition.)

Classification	Contents
Other service call	HDD unmounted: Connection of HDD cannot be detected. Sub-code 5: Partition mount error (The “/registration” partition is damaged.)

Check item	Measures
HDD, SYS board, Setting	<ol style="list-style-type: none"> 1. Turn the power of the equipment OFF and check the connection of the HDD. <ul style="list-style-type: none"> - Connector and harness check - Check if the connector pins of the HDD are bent. - Check if HDD for other equipment is not installed. - Check if SRAM for other equipment is not installed. 2. If the error still occurs after step 1, perform the following. <ul style="list-style-type: none"> - Perform [3C] - [5] (Key Backup Restore) and check that each Key Status is “OK”. - If not, recover the key (copy “SRAM Key Status” to “FROM Key Status” or vice versa). 3. If the error persists after step 2, perform [5]+[C]+[POWER] → 2. Recovery F/S → 4. /registration, and then restart the equipment. 4. If the error persists after step 3, perform [5]+[C]+[POWER] → 3. Initialize HDD → 3. /registration, and then restart the equipment. 5. If the error still persists after step 4, perform the following. <ul style="list-style-type: none"> - Perform [3C] - [3] (Format HDD), and then install “System Software (HD data)” with [49] - [4]. <p>Notes: The following items will be deleted by performing [3C] - [3] (Format HDD).</p> <ul style="list-style-type: none"> • Message Log • Job Log • Spool Data (Print, Email reception) • Template <p>If the error persists after performing step 5, perform step 5 after performing [4]+[C]+[POWER] → 1. Revert factory initial status HDD.</p> 6. If the error persists even after step 5, replace the HDD.

Replacement part	Measure
HDD	
SYS board	

[F101_6] Partition mount error (The HDD cannot be connected (mounted) caused by damage to the “/backup” partition.)

Classification	Contents
Other service call	HDD unmounted: Connection of HDD cannot be detected. Sub-code 6: Partition mount error (The “/backup” partition is damaged.)

Check item	Measures
HDD, SYS board, Setting	<ol style="list-style-type: none"> 1. Turn the power of the equipment OFF and check the connection of the HDD. <ul style="list-style-type: none"> - Connector and harness check - Check if the connector pins of the HDD are bent. - Check if HDD for other equipment is not installed. - Check if SRAM for other equipment is not installed. 2. If the error still occurs after step 1, perform the following. <ul style="list-style-type: none"> - Perform [3C] - [5] (Key Backup Restore) and check that each Key Status is “OK”. - If not, recover the key (copy “SRAM Key Status” to “FROM Key Status” or vice versa). 3. If the error persists after step 2, perform [5]+[C]+[POWER] → 2. Recovery F/S → 5. /backup, and then restart the equipment. 4. If the error persists after step 3, perform [5]+[C]+[POWER] → 3. Initialize HDD → 4. /backup, and then restart the equipment. 5. If the error still persists after step 4, perform the following. <ul style="list-style-type: none"> - Perform [3C] - [3] (Format HDD), and then install “System Software (HD data)” with [49] - [4]. <p>Notes: The following items will be deleted by performing [3C] - [3] (Format HDD).</p> <ul style="list-style-type: none"> • Message Log • Job Log • Spool Data (Print, Email reception) • Template <p>If the error persists after performing step 5, perform step 5 after performing [4]+[C]+[POWER] → 1. Revert factory initial status HDD.</p> 6. If the error persists even after step 5, replace the HDD.

Replacement part	Measure
HDD	
SYS board	

[F101_7] Partition mount error (The HDD cannot be connected (mounted) caused by damage to the "/imagedata" partition.)

Classification	Contents
Other service call	HDD unmounted: Connection of HDD cannot be detected. Sub-code 7: Partition mount error (The "/imagedata" partition is damaged.)

Check item	Measures
HDD, SYS board, Setting	<ol style="list-style-type: none"> 1. Turn the power of the equipment OFF and check the connection of the HDD. <ul style="list-style-type: none"> - Connector and harness check - Check if the connector pins of the HDD are bent. - Check if HDD for other equipment is not installed. - Check if SRAM for other equipment is not installed. 2. If the error still occurs after step 1, perform the following. <ul style="list-style-type: none"> - Perform [3C] - [5] (Key Backup Restore) and check that each Key Status is "OK". - If not, recover the key (copy "SRAM Key Status" to "FROM Key Status" or vice versa). 3. If the error persists after step 2, perform [5]+[C]+[POWER] → 2. Recovery F/S → 6. /imagedata, and then restart the equipment. 4. If the error persists after step 3, perform [5]+[C]+[POWER] → 3. Initialize HDD → 5. /imagedata, and then restart the equipment. 5. If the error still persists after step 4, perform the following. <ul style="list-style-type: none"> - Perform [3C] - [3] (Format HDD), and then install "System Software (HD data)" with [49] - [4]. <p>Notes: The following items will be deleted by performing [3C] - [3] (Format HDD).</p> <ul style="list-style-type: none"> • Message Log • Job Log • Spool Data (Print, Email reception) • Template <p>If the error persists after performing step 5, perform step 5 after performing [4]+[C]+[POWER] → 1. Revert factory initial status HDD.</p> 6. If the error persists even after step 5, replace the HDD.

Replacement part	Measure
HDD	
SYS board	

[F101_8] Partition mount error (The HDD cannot be connected (mounted) caused by damage to the “/storage” partition.)

Classification	Contents
Other service call	HDD unmounted: Connection of HDD cannot be detected. Sub-code 8: Partition mount error (The “/storage” partition is damaged.)

Check item	Measures
HDD, SYS board, Setting	<ol style="list-style-type: none"> 1. Turn the power of the equipment OFF and check the connection of the HDD. <ul style="list-style-type: none"> - Connector and harness check - Check if the connector pins of the HDD are bent. - Check if HDD for other equipment is not installed. - Check if SRAM for other equipment is not installed. 2. If the error still occurs after step 1, perform the following. <ul style="list-style-type: none"> - Perform [3C] - [5] (Key Backup Restore) and check that each Key Status is “OK”. - If not, recover the key (copy “SRAM Key Status” to “FROM Key Status” or vice versa). 3. If the error persists after step 2, perform [5]+[C]+[POWER] → 2. Recovery F/S → 7. /storage, and then restart the equipment. 4. If the error persists after step 3, perform [5]+[C]+[POWER] → 3. Initialize HDD → 6. /storage, and then restart the equipment. 5. If the error still persists after step 4, perform the following. <ul style="list-style-type: none"> - Perform [3C] - [3] (Format HDD), and then install “System Software (HD data)” with [49] - [4]. <p>Notes: The following items will be deleted by performing [3C] - [3] (Format HDD).</p> <ul style="list-style-type: none"> • Message Log • Job Log • Spool Data (Print, Email reception) • Template <p>If the error persists after performing step 5, perform step 5 after performing [4]+[C]+[POWER] → 1. Revert factory initial status HDD.</p> 6. If the error persists even after step 5, replace the HDD.

Replacement part	Measure
HDD	
SYS board	

[F101_9] Partition mount error (The HDD cannot be connected (mounted) caused by damage to the “/encryption” partition.)

Classification	Contents
Other service call	HDD unmounted: Connection of HDD cannot be detected. Sub-code 9: Partition mount error (The “/encryption” partition is damaged.)

Check item	Measures
HDD, SYS board, Setting	<ol style="list-style-type: none"> 1. Turn the power of the equipment OFF and check the connection of the HDD. <ul style="list-style-type: none"> - Connector and harness check - Check if the connector pins of the HDD are bent. - Check if HDD for other equipment is not installed. - Check if SRAM for other equipment is not installed. 2. If the error still occurs after step 1, perform the following. <ul style="list-style-type: none"> - Perform [3C] - [5] (Key Backup Restore) and check that each Key Status is “OK”. - If not, recover the key (copy “SRAM Key Status” to “FROM Key Status” or vice versa). 3. If the error persists after step 2, perform [5]+[C]+[POWER] → 2. Recovery F/S → 8. /encryption, and then restart the equipment. 4. If the error persists after step 3, perform [5]+[C]+[POWER] → 3. Initialize HDD → 7. /encryption, and then restart the equipment. 5. If the error still persists after step 4, perform the following. <ul style="list-style-type: none"> - Perform [3C] - [3] (Format HDD), and then install “System Software (HD data)” with [49] - [4]. <p>Notes: The following items will be deleted by performing [3C] - [3] (Format HDD).</p> <ul style="list-style-type: none"> • Message Log • Job Log • Spool Data (Print, Email reception) • Template <p>If the error persists after performing step 5, perform step 5 after performing [4]+[C]+[POWER] → 1. Revert factory initial status HDD.</p> 6. If the error persists even after step 5, replace the HDD.

Replacement part	Measure
HDD	
SYS board	

[F102] HDD start error**[F103] HDD transfer time-out****[F104] HDD data error****[F105] HDD other error**

Classification	Contents
Other service call	HDD start error: HDD cannot become "Ready" state. HDD transfer time-out: Reading/writing cannot be performed in the specified period of time. HDD data error: Abnormality is detected in the data of HDD. HDD other error

Check item	Measures
HDD	<ul style="list-style-type: none"> • Connector and harness check • Check if the connector pins of the HDD are bent. • Perform the bad sector check (08-9072). If the check result is OK, recover the data in the HDD. If the check result is failed, replace the HDD.

Replacement part	Measure
HDD	
SYS board	

[F106_0] ADI-HDD error: Illegal disk replacement detected (ADI-HDD Exchange to SATA-HDD)

Classification	Error item
Other service call	ADI-HDD error: The ADI-HDD has been replaced illegally to SATA-HDD (normal type).

Check item	Measures
Setting	<p>Check if the HDD has been replaced with a SATA-HDD (normal type).</p> <ol style="list-style-type: none"> 1. Start the equipment in the 4C mode: [4] + [C] + [POWER] 2. Check the type of the HDD shown on the top left of the control panel display "Current HDD type". <ol style="list-style-type: none"> 2a. In case of "SATA-HDD" (normal type), replace it with the original ADI-HDD or a new ADI-HDD. <p>Notes:</p> <p>To replace with the original ADI-HDD, start the equipment in the normal mode and then reinstall system software only if any abnormality occurs.</p> <ol style="list-style-type: none"> 2b. In case of "ADI-HDD" <ol style="list-style-type: none"> Check each item in the Measures field for the HDD below. If the error still occurs, reinstall the system software.
HDD	<ul style="list-style-type: none"> • Connector check • Harness check <p>Follow the procedure below if no abnormality is found in the check items above.</p> <ol style="list-style-type: none"> 1. Start the equipment in the 4C mode: [4] + [C] + [POWER] → 1. Revert factory initial status HDD 2. Reinstall the system software.

[F106_1] ADI-HDD error: HDD type detection error

Classification	Error item
Other service call	ADI-HDD error: HDD type detection fails.
Check item	Measures
Setting	If the error is not recovered after rebooting the equipment or no abnormality is found on any check items for the HDD, reinstall the system software.
HDD	<ul style="list-style-type: none"> • Connector check • Harness check • Start the equipment in the 5C mode: [5] + [C] + [POWER] Check the file system and recover it if necessary. If the recovery fails, replace the HDD. If the equipment does not start in the 5C mode, also replace the HDD. • Check that either the ADI-HDD or SATA-HDD (normal type) is mounted. <ol style="list-style-type: none"> 1. Start the equipment in the 4C mode: [4] + [C] + [POWER] 2. Check the type of the HDD shown on the top left of the control panel display "Current HDD type". Normal status: ADI-HDD or SATA-HDD Abnormal status: Unknown HDD If "Unknown HDD" is displayed, reinstall the system software.

[F106_2] ADI-HDD error: ADI encryption key download operation error

Classification	Error item
Other service call	ADI-HDD error: Downloading of or consistency check for ADI- HDD encryption key fails.
Check item	Measures
Setting	<p>Checking of ADI-HDD encryption key status</p> <ol style="list-style-type: none"> 1. Start the equipment in the 3C mode: [3] + [C] + [POWER] 2. The authentication menu is displayed. Press [OK]. (Not required in the default setting) 3. Select "5. Key Backup Restore" and then press the [START] button. 4. Check the status of the ADI-HDD encryption key on the Key Backup Restore Mode menu. 5. After the operation is completed, shut down the equipment by pressing the [POWER] button. <ul style="list-style-type: none"> • In case both the SRAM ADIKey and FROM ADIKey status are OK Reinstall the system firmware. • In case either the SRAM ADIKey or FROM ADIKey status is other than OK. Restore the ADI-HDD encryption key. • In case both of the SRAM ADIKey or FROM ADIKey status are other than OK. Reinstall the system software.

[F106_3] ADI-HDD error: ADI authentication Admin Password generation error

Classification	Error item
Other service call	ADI-HDD error: The generation of ADI authentication Admin Password fails.
Check item	Measures
Setting	Reinstall the system firmware. Reinstall the system software.

[F106_4] ADI-HDD error: Authentication random number generation error



Classification	Error item
Other service call	ADI-HDD error: The generation of a random number for authentication data fails.
Check item	Measures
Setting	Reinstall the system firmware. Reinstall the system software.

[F106_5] ADI-HDD error: Authentication data transmission error

Classification	Error item
Other service call	ADI-HDD error: The transmission of authentication data fails.
Check item	Measures
Setting	<p>Reinstall the system firmware. Reinstall the system software.</p> <ul style="list-style-type: none"> • In case this error occurred after returning SRAM data for SRAM cloning: <ul style="list-style-type: none"> Copy the ADI-HDD encryption key from FROM to SRAM. 1. Start the equipment in the 3C mode: [3] + [C] + [POWER] 2. The authentication menu is displayed. Press [OK]. (Not required in the default setting) 3. Select "5. Key Backup Restore" and then press the [START] button. 4. Select "6. ADIKey FROM to SRAM" and then press the [START] button. 5. After the restoring of the encryption key has completed, "Operation Complete" is displayed. 6. After the operation has completed, shut down the equipment by pressing the [POWER] button.

[F109_0] Key consistency error (Consistency check operation error)

Classification	Contents
Other service call	Key consistency error - Key consistency check on each key data fails.

Check item	Measures
Setting	Reboot the equipment. If it cannot be recovered, reinstall the software in the following procedure. 1. Install the system firmware. 2. If the error cannot be solved after installing the system firmware, reinstall the system software and application program.  P. 8-15 "8.3.2 Update procedure"([A] Update procedure)
SRAM board (for SYS board)	If the error is not cleared after the software reinstallation, replace the SRAM board.  P. 6-22 "6.2.5 Precautions and procedure when replacing the SRAM board (for the SYS board)"
SYS board	If the error is not cleared after this (see above), replace the SYS board.  P. 6-18 "6.2.4 Precautions and Procedures when replacing the SYS board"

Replacement part	Measure
SRAM board	
CU board	

[F109_1] Key consistency error (SRAM encryption AES key data damage)

Classification	Contents
Other service call	Key consistency error - AES key data used for SRAM encryption are damaged.

Check item	Measures
Setting	Reboot the equipment. If it cannot be recovered, reinstall the software in the following procedure. 1. Install the system firmware. 2. If the error cannot be solved after installing the system firmware, reinstall the system software and application program.  P. 8-15 "8.3.2 Update procedure"([A] Update procedure)

[F109_2] Key consistency error (Signature Check public key damage)

Classification	Contents
Other service call	Key consistency error - Public key data used for Integrity Check are damaged.

Check item	Measures
Setting	Reboot the equipment If it cannot be recovered, reinstall the software in the following procedure. 1. Install the system firmware. 2. If the error cannot be solved after installing the system firmware, reinstall the system software and application program.  P. 8-15 "8.3.2 Update procedure"([A] Update procedure)

[F109_3] Key consistency error (HDD encryption parameter damage)

Classification	Contents
Other service call	Key consistency error - Parameter used for HDD partition encryption are damaged.

Check item	Measures
Encryption key status confirmation	Check the message displayed by [3] + [C] + [POWER] → 5. Key Backup Restore.

Take measures given in the following table according to the messages displayed in the SRAM Key Status and FROM Key Status fields.

Remarks:

If the error is not cleared, reinstallation of the system firmware, system software and application is needed. ([4]+[9] → Power-ON)

SRAM Key Status	FROM Key Status	Measure
*	AccessFailed	Replace the SYS board. ☞ P. 6-18 “6.2.4 Precautions and Procedures when replacing the SYS board” (all steps) <With USB backup data: All key data recovery> 1. Recover all the data on the SRAM board. [5] + [9] + [POWER] → 2. Restore SRAM Data from USB (For details, see “9.1.4 Cloning procedure [B]Restore procedure”) 2. Recover the encryption key/license on the SYS board. Follow the procedures below noted in “6.2.4 Precautions and Procedures when replacing the SYS board”. [C] Restore ADI key (only when ADI-HDD is installed) [D] Restore encryption key [E] Restore license
AccessFailed	*	Replace the SYS board. ☞ P. 6-22 “6.2.5 Precautions and procedure when replacing the SRAM board (for the SYS board)” (for the SYS board, all steps)
OK	KeyNull/ KeyBroken	Recover the encryption key on the SYS board. ☞ P. 6-18 “6.2.4 Precautions and Procedures when replacing the SYS board” ([D]Restore encryption key)
AccessFailed	OK	Replace the SRAM board (for the SYS board). ☞ P. 6-22 “6.2.5 Precautions and procedure when replacing the SRAM board (for the SYS board)” (all steps)
KeyNull/ KeyBroken	OK	Recover the encryption key on the SRAM board. ☞ P. 6-22 “6.2.5 Precautions and procedure when replacing the SRAM board (for the SYS board)” (for the SYS board, [H] Backup encryption key)
KeyNull/ KeyBroken	KeyNull/ KeyBroken	<No USB backup data> 1. Reinstall the system software. ☞ P. 8-3 “8.2 Firmware Updating with USB Device” <With USB backup data: All key data recovery> 1. Recover all the data on the SRAM board. [5] + [9] + [POWER] → 2. Restore SRAM Data from USB (For details, see “9.1.4 Cloning procedure [B] Restore procedure”) 2. Recover the encryption key/license on the SYS board. Follow the procedures below noted in “6.2.4 Precautions and Procedures when replacing the SYS board”. [C] Restore ADI key (only when ADI-HDD is installed) [D] Restore encryption key [E] Restore license

* AccessFailed, KeyNull or KeyBroken

[F109_4] Key consistency error (license data damage)





Classification	Contents
Other service call	Key consistency error - The license data are damaged.

Check item	Measures
Encryption key status confirmation	Check the message displayed by [3] + [C] + [POWER] → 5. Key Backup Restore.

Take measures given in the following table according to the messages displayed in the SRAM Licence Status and FROM Licence Status fields.

Remarks:

If the error is not cleared, reinstallation of the system firmware, system software and application is needed. ([4]+[9] → Power-ON)

SRAM Licence Status	FROM Licence Status	Measure
*	AccessFailed	<p>Replace the SYS board.  P. 6-18 “6.2.4 Precautions and Procedures when replacing the SYS board” (all steps)</p> <p><With USB backup data: All key data recovery></p> <ol style="list-style-type: none"> 1. Recover all the data on the SRAM board. [5] + [9] + [POWER] → 2. Restore SRAM Data from USB (For details, see “9.1.4 Cloning procedure [B] Restore procedure”) 2. Recover the encryption key/license on the SYS board. Follow the procedures below noted in “6.2.4 Precautions and Procedures when replacing the SYS board”. [C] Restore ADI key (only when ADI-HDD is installed) [D] Restore encryption key [E] Restore license
AccessFailed	*	<p>Replace the SYS board.  P. 6-22 “6.2.5 Precautions and procedure when replacing the SRAM board (for the SYS board)” (all steps)</p>
KeyMismatch	KeyMismatch	<p><The error occurs when the SYS board is replaced> Recover the license on the SYS board. (Transfer the license from SYS-SRAM to SYS-FROM.)  P. 6-18 “6.2.4 Precautions and Procedures when replacing the SYS board”([E] Restore license)</p> <p><The error occurs except when the SYS board is replaced> Recover the license on the SRAM board. (Transfer the license from SYS-FROM to SYS-SRAM.)  P. 6-22 “6.2.5 Precautions and procedure when replacing the SRAM board (for the SYS board)”([I]Backup license)</p>

* AccessFailed or KeyMismatch

[F109_5] Key consistency error (encryption key for ADI-HDD is damaged)

Classification	Contents
Other service call	Key consistency error - Encryption key for ADI-HDD is damaged.



Check item	Measures
Encryption key status confirmation	Check the message displayed by [3] + [C] + [POWER] → 5. Key Backup Restore.

Take measures given in the following table according to the messages displayed in the SRAM Key Status and FROM Key Status fields.

Remarks:

If the error is not cleared, reinstallation of the system firmware, system software and application is needed. ([4]+[9] → Power-ON)

SRAM Key Status	FROM Key Status	Measure
*	AccessFailed	<p>Replace the SYS board.</p> <p>📖 P. 6-18 “6.2.4 Precautions and Procedures when replacing the SYS board” (all steps)</p> <p><With USB backup data: All key data recovery></p> <ol style="list-style-type: none"> 1. Recover all the data on the SRAM board. [5] + [9] + [POWER] → 2. Restore SRAM Data from USB (For details, see “9.1.4 Cloning procedure [B] Restore procedure”) 2. Recover the encryption key/license on the SYS board. Follow the procedures below noted in “6.2.4 Precautions and Procedures when replacing the SYS board”. [C] Restore ADI key (only when ADI-HDD is installed) [D] Restore encryption key [E] Restore license
AccessFailed	*	<p>Replace the SRAM board (for the SYS board).</p> <p>📖 P. 6-22 “6.2.5 Precautions and procedure when replacing the SRAM board (for the SYS board)” (all steps)</p>
OK	KeyNull/ KeyBroken	<p>Recover the ADI key on the SYS board.</p> <p>📖 P. 6-18 “6.2.4 Precautions and Procedures when replacing the SYS board” ([C] Restore ADI key)</p>
KeyNull/ KeyBroken	OK	<p>Recover the encryption key on the SRAM board.</p> <p>📖 P. 6-22 “6.2.5 Precautions and procedure when replacing the SRAM board (for the SYS board)” ([G] Backup ADI key)</p>
KeyNull/ KeyBroken	KeyNull/ KeyBroken	<p><No USB backup data></p> <ol style="list-style-type: none"> 1. Create the partition in the HDD, and reinstall the system software. 📖 P. 6-13 “6.2.3 Precautions and procedures when replacing the HDD”(Perform step 3 or later in “[E] Replace / Format HDD”) <p><With USB backup data: All key data recovery></p> <ol style="list-style-type: none"> 1. Recover all the data on the SRAM board. [5] + [9] + [POWER] @ 2. Restore SRAM Data from USB (For details, see “9.1.4 Cloning procedure [B] Restore procedure”) 2. Recover the encryption key/license on the SYS board. Follow the procedures below noted in “6.2.4 Precautions and Procedures when replacing the SYS board”. [C] Restore ADI key (only when ADI-HDD is installed) [D] Restore encryption key [E] Restore license

SRAM Key Status	FROM Key Status	Measure
KeyMismatch	KeyMismatch	<p><The error occurs when the SYS board is replaced> Recover the encryption key on the SYS board. (Transfer the license from SYS-SRAM to SYS-FROM.)  P. 6-18 “6.2.4 Precautions and Procedures when replacing the SYS board”([C] Restore ADI key)</p> <p><The error occurs except when the SYS board is replaced> Recover the encryption key on the SRAM board. (Transfer the license from SYS-FROM to SYS-SRAM.)  P. 6-22 “6.2.5 Precautions and procedure when replacing the SRAM board (for the SYS board)”([G] Backup ADI key)</p>

* AccessFailed or KeyMismatch

[F109_6] Key consistency error (administrator password error for ADI-HDD authentication)





Classification	Content
Other service call	Key consistency error - Administrator password error for ADI- HDD authentication.

Check item	Measures
Encryption key status confirmation	Check the message displayed by [3] + [C] + [POWER] → 5. Key Backup Restore.

Take measures given in the following table according to the messages displayed in the SRAM Key Status and FROM Key Status fields.

Remarks:

If the error is not cleared, reinstallation of the system firmware, system software and application is needed. ([4]+[9] → Power-ON)

SRAM Key Status	FROM Key Status	Measure
*	AccessFailed	<p>Replace the SYS board.  P. 6-18 “6.2.4 Precautions and Procedures when replacing the SYS board” (all steps)</p> <p><With USB backup data: All key data recovery> 1. Recover all the data on the SRAM board. [5] + [9] + [POWER] → 2. Restore SRAM Data from USB (For details, see “9.1.4 Cloning procedure [B] Restore procedure”) 2. Recover the encryption key/license on the SYS board. Follow the procedures below noted in “6.2.4 Precautions and Procedures when replacing the SYS board”. [C] Restore ADI key (only when ADI-HDD is installed) [D] Restore encryption key [E] Restore license</p>
AccessFailed	*	<p>Replace the SRAM board (for the SYS board).  P. 6-22 “6.2.5 Precautions and procedure when replacing the SRAM board (for the SYS board)” (all steps)</p>
OK	KeyNull/ KeyBroken	<p>Recover the ADI key on the SYS board.  P. 6-18 “6.2.4 Precautions and Procedures when replacing the SYS board” ([C] Restore ADI key)</p>
KeyNull/ KeyBroken	OK	<p>Recover the encryption key on the SRAM board.  P. 6-22 “6.2.5 Precautions and procedure when replacing the SRAM board (for the SYS board)” ([G] Backup ADI key)</p>

SRAM Key Status	FROM Key Status	Measure
KeyNull/ KeyBroken	KeyNull/ KeyBroken	<p><No USB backup data></p> <p>1. Create the partition in the HDD, and reinstall the system software. <small>☞</small> P. 6-13 “6.2.3 Precautions and procedures when replacing the HDD”(Perform step 3 or later in “[E] Replace / Format HDD”)</p> <p><With USB backup data: All key data recovery></p> <p>1. Recover all the data on the SRAM board. [5] + [9] + [POWER] → 2. Restore SRAM Data from USB (For details, see “9.1.4 Cloning procedure [B] Restore procedure”)</p> <p>2. Recover the encryption key/license on the SYS board. Follow the procedures below noted in “6.2.4 Precautions and Procedures when replacing the SYS board”.</p> <p>[C] Restore ADI key (only when ADI-HDD is installed) [D] Restore encryption key [E] Restore license</p>
KeyMismatch	KeyMismatch	<p><The error occurs when the SYS board is replaced></p> <p>Recover the encryption key on the SYS board. (Transfer the license from SYS-SRAM to SYS-FROM.) <small>☞</small> P. 6-18 “6.2.4 Precautions and Procedures when replacing the SYS board”([C] Restore ADI key)</p> <p><The error occurs except when the SYS board is replaced></p> <p>Recover the encryption key on the SRAM board. (Transfer the license from SYS-FROM to SYS-SRAM.) <small>☞</small> P. 6-22 “6.2.5 Precautions and procedure when replacing the SRAM board (for the SYS board)”([G] Backup ADI key)</p>

* AccessFailed or KeyMismatch

[F120] Database abnormality

Classification	Error item
Other service call	Database abnormality: Database is not operating normally.

Check item	Measures
Setting	<p>1. Check that no jobs remain and rebuild the databases. ([5] + [C] + [POWER] → 4. Initialize database → 1. LDAP DB and 2. Log DB (Job, Msg).</p> <p>2. If the error is not recovered, reinstall the system software. ([4] + [9] + [POWER] → 4. System Software(HD data))</p> <p>Notes:</p> <ul style="list-style-type: none"> • If you rebuild the databases with a job remaining, delete it after finishing. • When “Rebuilding all databases” is performed, all data including log/user/role/group/department information and address book data are deleted. If you back up the data in advance, they will be recovered by restoring them after rebuilding the database.

[F121] Database abnormality (user information management database)

Classification	Error item
Other service call	Login after the startup fails in any starting mode because user management database is corrupted.

Check item	Measures
Setting	<p>1. Delete the log in the following procedure:[5] + [C] + [POWER] → 4. Initialize database → 1. LDAP database (to delete user database) (Note that all user, role, group and accounting data will be deleted.)</p> <p>2. If the error is not recovered, reinstall the system software. ([4] + [9] + [POWER] → 4. System Software (HD data))</p> <p>Notes:</p> <ul style="list-style-type: none"> • If you rebuild the databases with a job remaining, delete it after finishing. • When “Rebuilding all databases” is performed, all data including log/user/role/group/department information and address book data are deleted. If you back up the data in advance, they will be recovered by restoring them after rebuilding the database.

[F122] Database abnormality (message/job log management database)

Classification	Error item
Other service call	Login after the startup fails in any starting mode because log management database is corrupted.

Check item	Measures
Setting	<p>1. Delete the log in the following procedure: [5] + [C] + [POWER] → 4. Initialize database → 2. Log database (jobs and messages) (Note that all job and message logs will be deleted.)</p> <p>2. If the error is not recovered, reinstall the system software. ([4] + [9] + [POWER] → 4. System Software (HD data))</p> <p>Notes:</p> <ul style="list-style-type: none"> • If you rebuild the databases with a job remaining, delete it after finishing. • When “Rebuilding all databases” is performed, all data including log/user/role/group/department information and address book data are deleted. If you back up the data in advance, they will be recovered by restoring them after rebuilding the database.

[F124] Language DB damage error

Classification	Error item
Other service call	Login after the startup fails in any starting mode because language management database is corrupted.

Check item	Measures
Setting	<p>Delete the journal file: [5] + [C] + [START] → 4. Initialize DB → 3. Language DB</p> <p>If the recovery is still not completed, reinstall the system software and application program.  P. 8-15 “8.3.2 Update procedure”</p>

[F130] Invalid MAC address

Classification	Contents
Other service call	Invalid MAC address

Check item	Measures
Setting	Compare the serial number of the equipment with a number displayed with 08-9601. If they are different, enter the correct serial number at 08-9601, 08-9083.

[F131] Error due to damage to filtering setting file

Classification	Contents
Other service call	The filtering function is not working properly due to the damage to the file for the filtering setting.

Check item	Measures
Setting	<ol style="list-style-type: none"> 1. Check the bad sector of the HDD (08-9072). If the result is "NG", replace the HDD. Notes: It may take more than 30 minutes to finish the checking. 2. Perform [3] + [C] + [POWER] → [3], and then reinstall the HDD software. Notes: User data will be deleted when [3] + [C] + [POWER] → [3] is performed.

Parts to be replaced	Remarks
HDD	

[F140] ASIC format error

Classification	Contents
Other service call	ASIC formatting fails or memory acquiring fails when software is formatted

Check item	Measures
SYS board	<ul style="list-style-type: none"> • Connector check • Board check
Main memory	<ul style="list-style-type: none"> • Check the installation • Main memory check

Replace parts	Remarks
Main memory	
SYS board	

[F200] Data Overwrite option (GP-1070) disabled

Classification	Contents
Other service call	Data Overwrite option (GP-1070) disabled
Check item	Measures
Setting	Perform firmware installation (all firmware: OS, HDD, SYS, Engine Main Firmware, and Scanner Firmware) with the USB device. * When the function of the Data Overwrite option (GP-1070) is deleted from the equipment, the service call "F200" occurs.
	Perform 08-3840 to install the Data Overwrite Enabler (GP-1070). * If F200 occurs while High ("3") is set for the security level (08-8911), it cannot be released by installing the firmware using the USB device. Install the Data Overwrite Enabler (GP-1070) by 08-384.

[F500] HD partition damage

Classification	Error item
Other service call	The file system is abnormal.
Check item	Measures
Setting	<ul style="list-style-type: none"> • Diagnose the file system with [5] + [C] + [POWER] → 1. • Check F/S, and then recover the problem partition with [5] + [C] + [POWER] → 2. Recovery F/S. • If it is not recovered, reinstall the software after the HDD format.
Replace parts	Remarks

[F510] Application start error

Classification	Error item
Other service call	The application fails to start.
Check item	Measures
Setting	<ol style="list-style-type: none"> 1. Reboot. 2. If it has still not recovered, reinstall the system software. 3. If it still persists after step 2, perform [3] + [C] + [POWER] → 3, and then reinstall the system software. <p>Notes: User data will be deleted when [3] + [C] + [POWER] → 3 is performed.</p>

[F520] Operating system start error

Classification	Error item
Other service call	The operating system fails to start.
Check item	Measures
Setting	<ol style="list-style-type: none"> 1. Reboot. 2. If it has still not recovered, reinstall the system software. 3. If it still persists after step 2, perform [3] + [C] + [POWER] → 3, and then reinstall the system software. <p>Notes: User data will be deleted when [3] + [C] + [POWER] → 3 is performed.</p>

[F521] Integrity check error

Classification	Error item
Other service call	The program data fails to be authenticated.
Check item	Measures
Setting	<p>Restart the equipment. If the error is not recovered after restarting the equipment, reinstall software following the procedure below.</p> <ol style="list-style-type: none"> 1. Reinstall the system software and application program.  P. 6-13 "6.2.3 Precautions and procedures when replacing the HDD"

[F550] Encryption partition error

Classification	Error item
Other service call	The encryption partition fails to be read and written.
Check item	Measures
Setting	<ul style="list-style-type: none"> • Recover the encryption key with [3] + [C] + [POWER] → 5.

[F600] F/W update error

Classification	Error item
Other service call	The firmware fails to be updated.
Check item	Measures
Setting	<ol style="list-style-type: none"> 1. Perform [3] + [C] + [POWER] → [1] → [START] for "Clear Error Flag in Software Installation". 2. Reinstall the firmware in error displayed on the F600 error screen.

[F700] Overwrite error

Classification	Error item
Other service call	Overwriting fails.
Check item	Measures
Setting	<ul style="list-style-type: none"> If a service call occurs again after the reboot, replace the HDD.

[F800] Date error

Classification	Error item
Other service call	The year 2038 problem
Check item	Measures
Setting	<p>Reset the date, and request the administrator to set the date and time.</p> <ol style="list-style-type: none"> Turn the power on while pressing the [6] and [CLEAR] button. Select [2] key, and then press the [START] button. Press the [START] button on the confirmation screen displayed. (The date is set to January 1st, 2011.) Request the administrator to set the date and time.

[F900] Model information error

Classification	Error item
Other service call	Machine information alignment error. The machine information is damaged.
Check item	Measures
Setting	<p>Recover the machine information by means of the following procedure.</p> <p><Machine information recovery></p> <ol style="list-style-type: none"> Turn the power ON while pressing [6] and the [CLEAR] button simultaneously. Key in [3] to select "3. SRAM Re-Initialize Support", and then press the [START] button. Select the proper machine information with 1 or 2 key, and then press the [START] button. Shut down the equipment by pressing the [ON/OFF] button. Turn the power ON by pressing the [ON/OFF] button. <p>* If it is not recovered, initialize the SRAM by performing the following procedure.</p> <p> P. 6-22 "6.2.5 Precautions and procedure when replacing the SRAM board (for the SYS board)"</p>

5.3.8 Error in Internet FAX / Scanning Function

Notes:

- When formatting the HDD ([5] + [C] + [POWER] ON → [3] → [1]), all data in the shared folder, Electronic Filing, Address Book, template, etc. are erased. Back up these data before the initialization. Note that some of data cannot be backed up
 P. 6-13 “6.2.3 Precautions and procedures when replacing the HDD”

[1] Internet FAX related error

[1C10] System access abnormality

[1C32] File deletion failure

Turn the power OFF and then back ON. Perform the job in error again.

If the error still occurs, first, check if there are no jobs existing and then perform the HDD formatting ([5] + [C] + [POWER] ON → [3] → [1]).

[1C11] Insufficient memory

When there are running jobs, perform the job in error again after the completion of the running jobs.

If the error still occurs, turn the power OFF and then back ON, and perform the job again.

[1C12] Message reception error

[1C13] Message transmission error

Turn the power OFF and then back ON. Perform the job in error again.

[1C14] Invalid parameter

When a template is used, form the template again.

If the error still occurs, turn the power OFF and then back ON, and perform the job again.

[1C15] Exceeding file capacity

Reset and extend the “Maximum send to E-mail/iFAX size” or reduce the number of pages and perform the job again.

[1C30] Directory creation failure

[1C31] File creation failure

[1C33] File access failure

Check if the access privilege to the storage directory is writable.

Check if the server or local disk has a sufficient space in disk capacity.

[1C40] Image conversion abnormality

Turn the power OFF and then back ON. Perform the job in error again.

Replace the main memory and perform the job again.

[1C60] HDD full failure during processing

Delete the job in progress or being set or in the HOLD/PRIVATE/PROOF/INVALID, and perform it again.

Check if the server or local disk has a sufficient space in disk capacity.

[1C61] Address Book reading failure

Turn the power OFF and then back ON. Perform the job in error again.

Reset the data in the Address Book and perform the job again.

[1C63] Terminal IP address unset

Reset the Terminal IP address.

Turn the power OFF and then back ON. Perform the job in error again.

[1C64] Terminal mail address unset

Reset the Terminal mail address.

Turn the power OFF and then back ON. Perform the job in error again.

[1C65] SMTP address unset

Reset the SMTP address and perform the job.

Turn the power OFF and then back ON. Perform the job in error again.

[1C66] Server time-out error

Check if the SMTP server is operating properly.

[1C69] SMTP server connection error

Reset the login name or password of SMTP server and perform the job again.

Check if the SMTP server is operating properly.

[1C6B] Terminal mail address error

Check the SMTP Authentication method.

Check if there is an illegal character in the Terminal mail address.

Set the correct SMTP Authentication method or delete the illegal character and reset the appropriate Terminal mail address, then perform the job again.

[1C6C] Destination mail address error

Check if there is an illegal character in the Destination mail address.

Delete the illegal character and reset the appropriate Destination mail address, then perform the job again.

[1C6D] System error

Turn the power OFF and then back ON. Perform the job in error again.

If the error still occurs, replace the SYS board.

[1C70] SMTP client OFF

Set the SMTP valid and perform the job again.

[1C71] SMTP authentication error

Check that SMTP authentication method, login name and password are correct, then perform authentication again.

[1C72] POP Before SMTP error

Check that both the POP Before SMTP setting and POP3 setting are correct, then perform authentication again.

[1CC1] Power failure

Check if the power cable is connected properly and it is inserted securely.

Check if the power voltage is unstable.

[2] RFC related error**[2500] HOST NAME error (RFC: 500) / Destination mail address error (RFC: 500) / Terminal mail address error (RFC: 500)****[2501] HOST NAME error (RFC: 501) / Destination mail address error (RFC: 501) / Terminal mail address error (RFC: 501)**

Check if the Terminal mail address and Destination mail address are correct.

Check if the mail server is operating properly.

Turn the power OFF and then back ON. Perform the job in error again.

[2503] Destination mail address error (RFC: 503)**[2504] HOST NAME error (RFC: 504)****[2551] Destination mail address error (RFC: 551)**

Check if the mail server is operating properly.

Turn the power OFF and then back ON. Perform the job in error again.

If the error still occurs, replace the SYS board.

[2550] Destination mail address error (RFC: 550)

Check the state of the mail box in the mail server.

[2552] Terminal/Destination mail address error (RFC: 552)

Confirm the size on the mail server.

Transmit again in text mode or with lower resolution or divide the document and transmit again.

If the error still occurs, turn the power OFF and then back ON. Perform the job in error again.

[2553] Destination mail address error (RFC: 553)

Check if there is an illegal character in the mail box in the mail server.

[3] Electronic Filing related error**[2B11] JOB status abnormality****[2B20] File library function error****[2B30] Insufficient disk space in BOX partition****[2BC0] Fatal failure occurred**

Erase some data in the Electronic Filing or the shared folder and perform the job in error again (in case of [2B30]).

Ask the administrator if e-Filing has been disabled. (In case of [2CC1])

Turn the power OFF and then back ON. Perform the job in error again.

Check if there are no other running jobs and perform the HDD formatting ([5] + [C] + [POWER] ON → [3] → [1]).

If the recovery is still not completed, replace the SYS board.

[2B31] Status of specified Electronic Filing or folder is undefined or being created/deleted

Check if the specified Electronic Filing or folder exists. (If no, this error would not occur.)

Delete the specified Electronic Filing or folder.

Perform the job in error again.

[2B50] Image library error**[2B90] Insufficient memory capacity**

Turn the power OFF and then back ON. Perform the job in error again.

If the error still occurs, replace the main memory.

Delete the job in progress or being set or in the HOLD/PRIVATE/PROOF/INVALID, and retry the job in error.

[2B51] List library error

Check if the Function list can be printed.

If it can be printed, retry the job in error.

If it cannot, replace the main memory.

If it still cannot be printed, initialize the HDD ([5] + [C] + [POWER] ON → [3] → [1])

[2BA0] Invalid Box password

Check if the password is correct.

Reset the password.

When this error occurs when printing the data in the Electronic Filing, perform the printing with the administrator's password.

[2BA1]Invalid paper size/color mode/resolution.

The specified paper size, color mode or resolution cannot be used. Check the setting.

[2BB1] Power failure**[2BD0] Power failure occurred during restoring of Electronic Filing**

Check if the power cable is connected properly and it is inserted securely.

Check if the power voltage is unstable.

[2BE0] Machine parameter reading error

Turn the power OFF and then back ON. Perform the job in error again.

[2BF0] Exceeding maximum number of pages

Reduce the number of the pages of the job in error, and retry the job.

[2BF1] Exceeding maximum number of documents

Backup the documents in the box or folder to PC or delete them.

[2BF2] Exceeding maximum number of folders

Backup the folders in the box or folder to PC or delete them.

[4] Remote scanning related error**[2A20] System management module resource acquiring failure**

Retry the job in error.

If the error still occurs, turn the power OFF and then back ON, then retry the job in error.

[2A31] Disabled WS Scan

Check if the WS Scan function is disabled.

Or, check if the forcible encryption setting of the secure PDF is enabled.

[2A40] System error

Turn the power OFF and then back ON, then retry the job in error.

[2A51] Power failure

Check if the power cable is properly connected.

Check if the power supply voltage is inconstant.

[2A60] WS Scan user authentication failure

- When “1” (TTEC’s WIA driver) is set for 08-9749 and also Windows Fax&Scan is used
Check if the user name that you used to log in Windows is a name registered as a user.
- When MFP panel or EWB Scan is used
Check if the login user name is a name registered as a user.

[2A70] Remote Scan privilege check error

Check if correct privilege is given to the user.

[2A71] WS Scan privilege check error

Check if correct privilege is given to the user.

[2A72] e-Filing data access privilege check error (Scan Utility)

Check if correct privilege is given to the user.

[5] E-mail related error**[2C10] System access abnormality****[2C32] File deletion failure**

Turn the power OFF and then back ON. Perform the job in error again.

If the error still occurs, first, check if there are no jobs existing and then perform the HDD formatting ([5] + [C] + [POWER] ON → [3] → [1]).

[2C11] Insufficient memory

When there are running jobs, perform the job in error again after the completion of the running jobs.

If the error still occurs, turn the power OFF and then back ON, and perform the job again.

[2C12] Message reception error**[2C13] Message transmission error**

Turn the power OFF and then back ON. Perform the job in error again.

[2C14] Invalid parameter

When a template is used, form the template again.

If the error still occurs, turn the power OFF and then back ON, and perform the job again.

[2C15] Exceeding file capacity

Reset and extend the “Maximum send to E-mail/iFAX size” or reduce the number of pages and perform the job again.

[2C20] System management module access abnormality**[2C21] Job control module access abnormality****[2C22] Job control module access abnormality**

Turn the power OFF and then back ON. Perform the job in error again.

Check if there are no other running jobs and perform the HDD formatting ([5] + [C] + [POWER] ON → [3] → [1]).

If the recovery is still not completed, replace the SYS board.

[2C30] Directory creation failure**[2C31] File creation failure****[2C33] File access failure**

Check if the access privilege to the storage directory is writable.

Check if the server or local disk has a sufficient space in disk capacity.

[2C40] Image conversion abnormality**[2C62] Memory acquiring failure**

Turn the power OFF and then back ON. Perform the job in error again.

Replace the main memory and perform the job again.

[2C43] Encryption error

Turn the power OFF and then back ON. Perform the job in error again.

[2C44] Encryption PDF enforced mode error

Reset the encryption and perform the job in error again.

If an image file not encrypted is created, consult your administrators.

[2C45] Meta data creation error (Scan to Email)

Check the template settings. Perform the job in error again. If the error still occurs, turn the power OFF and then back ON, and then perform the job in error again.

[2C60] HDD full failure during processing

Delete the job in progress or being set or in the HOLD/PRIVATE/PROOF/INVALID, and perform it again.

Check if the server or local disk has a sufficient space in disk capacity.

Check that there is enough space in the server or local disk.

[2C61] Address Book reading failure

Turn the power OFF and then back ON. Perform the job in error again.

Reset the data in the Address Book and perform the job again.

[2C63] Terminal IP address unset

Reset the Terminal IP address.

Turn the power OFF and then back ON. Perform the job in error again.

[2C64] Terminal mail address unset

Reset the Terminal mail address.

Turn the power OFF and then back ON. Perform the job in error again.

[2C65] SMTP address unset

Reset the SMTP address and perform the job.

Turn the power OFF and then back ON. Perform the job in error again.

[2C66] Server time-out error

Check if the SMTP server is operating properly.

[2C69] SMTP server connection error

Reset the login name and password of SMTP server and perform the job again.

Check if the SMTP server is operating properly.

[2C6A] HOST NAME error (No RFC error)

Check if there is an illegal character in the device name.
Delete the illegal character and reset the appropriate device name.

[2C6B] Terminal mail address error

Check the SMTP Authentication method.
Check if there is an illegal character in the Terminal mail address.
Set the correct SMTP Authentication method or delete the illegal character and reset the appropriate Terminal mail address, then perform the job again.

[2C6C] Destination mail address error (No RFC error)

Check if there is an illegal character in the Destination mail address.
Delete the illegal character and reset the appropriate Destination mail address, then perform the job again.

[2C70] SMTP client OFF

Set the SMTP valid and perform the job again.

[2C71] SMTP authentication error

Check that SMTP authentication method, login name and password are correct, then perform authentication again.

[2C72] POP Before SMTP error

Check that both the POP Before SMTP setting and POP3 setting are correct, then perform authentication again.

[2CC1] Power failure

Check if the power cable is connected properly and it is inserted securely.
Check if the power voltage is unstable.

[6] File sharing related error**[2D10] System access abnormality****[2D32] File deletion failure****[2DA6] File deletion failure****[2DA7] Resource acquiring failure**

Delete some files in the shared folder by using Explorer because of automatic/manual file deletion failure (in case of [2DA6])

Turn the power OFF and then back ON. Perform the job in error again.

If the error still occurs, first, check if there are no jobs existing and then perform the HDD formatting ([5] + [C] + [POWER] ON → [3] → [1]).

[2D11] Insufficient memory

When there are running jobs, perform the job in error again after the completion of the running jobs. If the error still occurs, turn the power OFF and then back ON, and perform the job again.

[2D12] Message reception error**[2D13] Message transmission error**

Turn the power OFF and then back ON. Perform the job in error again.

[2D14] Invalid parameter

When a template is used, form the template again.

If the error still occurs, turn the power OFF and then back ON, and perform the job again.

[2D15] Exceeding the maximum size for file sharing

Divide the file in error into several files and retry. Or retry the job in a single-page format.

[2D30] Directory creation failure**[2D31] File creation failure****[2D33] File access failure**

Check if the access privilege to the storage directory is writable.

Check if the server or local disk has a sufficient space in disk capacity.

[2D40] Image conversion abnormality

Turn the power OFF and then back ON. Perform the job in error again.

Replace the main memory and perform the job again.

[2D43] Encryption error

Turn the power OFF and then back ON. Perform the job in error again.

[2D44] Encryption PDF enforced mode error

Reset the encryption and perform the job in error again.

If an image file not encrypted is created, consult your administrators.

[2D45] Meta data creation error (Scan to File)

Check the template settings. Perform the job in error again. If the error still occurs, turn the power OFF and then back ON, and then perform the job in error again.

[2D62] File server connection error

Check the IP address or path of the server.

Check if the server is operating properly.

[2D63] Invalid network path

Check the network path.

If the path is correct, turn the power OFF and then back ON, and perform the job again.

[2D64] Login failure

Reset the login name and password. Perform the job.

Check if the account of the server is properly set up.

[2D65] Exceeding documents in folder: Creating new document is failed

Delete some documents in the folder.

[2D66] Storage capacity full failure during processing

Delete the job in progress or being set or in the HOLD/PRIVATE/PROOF/INVALID, and perform it again.

Check if the server or local disk has a sufficient space in disk capacity.

Check that there is enough space in the server or local disk.

[2D67] FTP service not available

Check if the setting of FTP service is valid.

[2D68] File sharing service not available

Check if the setting of SMB is valid.

[2D69] NetWare service not available

Check if the Netware setting is enabled.

[2DC1] Power failure

Check if the power cable is connected properly and it is inserted securely.

Check if the power voltage is unstable.

[2E10] USB storage system access abnormality

Turn the power OFF and then back ON. Perform the job in error again. If the error still occurs, first, check if there are no jobs existing and then perform HDD formatting ([5] + [C] + [POWER] ON → [3] → [1]).

[2E11] Insufficient memory capacity for USB storage

If there is a job in progress, perform the job in error again after the job in progress is finished. If the error still occurs, turn the power OFF and then back ON, and then perform the job in error again.

[2E12] Message reception error in USB storage**[2E13] Message transmission error in USB storage**

Turn the power OFF and then back ON. Perform the job in error again.

[2E14] Invalid parameter for USB storage

If a template is being used, recreate the template. If the error still occurs, turn the power OFF and then back ON. Perform the job in error again.

[2E15] Exceeding maximum file capacity

Delete some files in the folder. Perform the job in error again.

[2E30] Directory creation failure in USB storage

Check if access privilege to the storage directory is writable. Check if the server or local disk has sufficient space in its disk capacity.

[2E31] File creation failure in USB storage

Check if access privilege to the storage directory is writable. Check if the server or local disk has sufficient space in its disk capacity.

[2E32] File deletion failure in USB storage

Turn the power OFF and then back ON. Perform the job in error again. If the error still occurs, first, check if there are no jobs existing and then perform HDD formatting ([5] + [C] + [POWER] ON → [3] → [1]).

[2E33] File access failure in USB storage

Check if access privilege to the storage directory is writable. Check if the server or local disk has sufficient space in its disk capacity.

[2E40] Image conversion abnormality in USB storage

Turn the power OFF and then back ON. Perform the job in error again. Replace the main memory and then perform the job in error again.

[2E43] Encryption failure in USB storage

Turn the power OFF and then back ON. Perform the job in error again.

[2E44] Encryption PDF enforced mode error in USB storage

Reset the encryption and perform the job in error again. To create an image file not encrypted, consult your administrator.

[2E45] Meta data creation error in USB storage (Scan to File)

Check the template settings. Perform the job in error again. If the error still occurs, turn the power OFF and then back ON, and then perform the job in error again.

[2E65] File creation error due to insufficient USB folder capacity

Delete unnecessary files in the folder.

[2E66] HDD full failure in USB storage

Delete the job in progress or being set or in the HOLD/PRIVATE/PROOF/INVALID, and perform it again.

Check if the server or local disk has a sufficient space in disk capacity.

Check that there is enough space in the USB memory.

[2EC1] Power failure in USB storage

Check if the power cable is connected properly and inserted securely. Check if the power voltage is unstable.

[7] E-mail reception related error**[3A10] E-mail MIME error**

The format of the mail is not corresponding to MIME 1.0.

Request the sender to retransmit the mail in the format corresponding to MIME 1.0.

[3A20] E-mail analysis error**[3B10] E-mail format error****[3B40] E-mail decode error**

These errors occur when the mail data is damaged from the transmission to the reception of the mail.

Request the sender to retransmit the mail.

[3A30] Partial mail time-out error

The partial mail is not received in a specified period of time.

Request the sender to retransmit the partial mail, or set the time-out period of the partial mail longer.

[3A40] Partial mail related error

The format of the partial mail is not corresponding to this equipment.

Request the sender to remake and retransmit the partial mail in RFC2046 format.

[3A50] Insufficient HDD capacity error

These errors occur when the HDD capacity is not sufficient for a temporary concentration of the jobs, etc.

Request the sender to retransmit after a certain period of time, or divide the mail into more than one. Insufficient HDD capacity error also occurs when printing is disabled for no printing paper.

In this case, supply the printing paper.

[3A70] Warning of partial mail interruption

This error occurs when the partial mail reception setting becomes OFF during the partial mail reception.

Reset the partial mail reception setting ON and then request the sender to retransmit the mail.

[3A80] Partial mail reception setting OFF

Reset the partial mail reception setting ON and then request the sender to retransmit the mail.

[3B20] Content-Type error

The format of the attached file is not supported by this equipment (TIFF-FX).

Request the sender to retransmit the file in TIFF-FX.

[3C10] [3C13] TIFF analysis error

These errors occur when the mail data is damaged from the transmission to the reception of the mail, or when the format of the attached file is not supported by this equipment (TIFF-FX). Request the sender to retransmit the mail.

[3C20] TIFF compression error

The compression method of the TIFF file is not acceptable for this equipment. (Acceptable: MH/MR/ MMR/JBIG)

Request the sender to retransmit the file in the acceptable compression method.

[3C30] TIFF resolution error

The resolution of the TIFF file is not acceptable for this equipment. (Acceptable: 200 x 100, 200 x 200, 200 x 400, 400 x 400, 300 x 300 or equivalent)

Request the sender to retransmit the file in the acceptable resolution.

[3C40] TIFF paper size error

The paper size of the TIFF file is not acceptable for this equipment. (Acceptable: A4, B4, A3, B5, LT, LG, LD or ST)

Request the sender to retransmit the file in the acceptable paper size.

[3C50] Offramp destination error

These errors occur when the FAX number of the offramp destination is incorrect.

Request the sender to correct the FAX number of offramp destination and then retransmit the mail.

[3C60] Offramp security error

These errors occur when the FAX number of the offramp destination is not on the Address Book.

Check if the FAX number of the offramp destination is correctly entered or the number has not been changed.

[3C70] Power failure error

Check if the mail is recovered after turning ON the power again.
Request the sender to retransmit the mail if it is not recovered.

[3C90] OffRamp Fax transmission disable error

OffRamp Fax transmission disable error has been detected in the received mail.
Confirm if the Fax Send Function of MFP setting is disable or not.

[3D10] Destination address error

Check if the setting of the server or DNS is correct. Correct if any of the setting is incorrect.
When the content of the setting is correct, confirm the sender if the destination is correct.

[3D20] Offramp destination limitation error

Inform the sender that the transfer of the FAX data over 40 is not supported.

[3D30] FAX board error

This error occurs when the FAX board is not installed or the FAX board has an abnormality.
Check if the FAX board is correctly connected.

[3E10] POP3 server connection error

Check if the IP address or domain name of the POP3 server set for this equipment is correct,
or check if POP3 server to be connected is operating properly.

[3E20] POP3 server connection time-out error

Check if POP3 server to be connected is operating properly.
Check if the LAN cable is correctly connected.

[3E30] POP3 login error

Check if the POP3 server login name and password set for this equipment are correct.

[3E40] POP3 Login Type error

Check that the login type (Auto, POP3 or APOP) to the POP3 server is correct.

[3F10] [3F20] File I/O error

These errors occur when the mail data is not transferred properly to the HDD.
Request the sender to retransmit the mail.
Replace the HDD if the error still occurs after retransmission.

5.3.9 Printer function error

[4011] Print job cancellation

This message appears when deleting the job on the screen.

[4021] Print job power failure

When there are running jobs, perform the job in error again after the completion of the running jobs.

If the error still occurs, turn the power OFF and then back ON, and perform the job again.

[4031] HDD full error

Delete unnecessary private print jobs and invalid department print jobs.

[4041] User authentication error

Perform the authentication or register as a user, and then perform the printing again.

[4042] Department authentication error

Check department information registered in this equipment.

[4045] Problem in LDAP server connection or LDAP server authorization settings

Confirm the administrator for the LDAP server connection or LDAP server authorization settings.

[4111] Quota over error (The number of the assigned pages set by department and user management has reached 0.)

The number of the assigned pages set by the department and the number of those assigned by user management have both reached 0. Assign the number of the pages again or perform initialization.

[4112] Quota over error (The number of the assigned pages set by user management has reached 0.)

The number of the assigned pages set by the user management has reached 0. Assign the number of the pages again or perform initialization.

[4113] Quota over error (The number of the assigned pages set by department management has reached 0.)

The number of the assigned pages set by the department management has reached 0. Assign the number of the pages again or perform initialization.

[4121] Job canceling due to external counter error

1. Drop a coin in. Perform the print job in error again.
2. Insert a key card and then perform the print job in error again, or consult your administrator.
3. Insert a key copy counter and then perform the print job in error again.
4. Reset the scheduled print job and then perform the print job in error again.

[4211] Printing data storing limitation error

Select "Normal Print", and then perform the printing again.

[4212] e-Filing storing limitation error

Select "Normal Print", and then perform the printing again.

[4213] File storing limitation error

The file storing function is set to “disabled”. Check the settings of the equipment.

[4214] Fax/Internet Fax transmission limitation error

Check the settings of this equipment.

[4221] Private-print-only error

Select “Private print”, and then perform the printing again.

[4231] Hardcopy security printing error

Hardcopy security printing cannot be performed because the function is restricted in the self-diagnosis mode.

[4311] Printing not permitted

Confirm the administrator for the JOB authorization.

[4312] Not authorized to store a file

The user has not been authorized to perform this operation. Ask your administrator.

[4313] No privilege for e-Filing storage**[4314] No privilege for Fax / Internet Fax transmission****[4321] No privilege for print settings**

Check the privilege given, or request the administrator to add the necessary privilege.

[4411] Image data creation failure

Check if the file to be printed is broken. Perform printing again or use another printer driver.

- Network print: Perform the print job in error again, or use another printer driver (e.g.; PS3, Universal).
- Direct print: Check if the file is corrupted (e.g. checking if the file is displayed on your PC monitor), or check if the file format is supported by this equipment.

[4412] Double-sign encoding error

Printing using this function cannot be performed due to a decoding process error which occurs because the PDF file is encrypted incorrectly or encrypted in a language not supported.

[4611] Font download failure (reached the registration limit)**[4612] Font download failure (HDD full)**

Delete one or more font already registered.

[4613] Font download failure (others)

Reattempt the downloading. Recreate font data and reattempt the downloading.

[4621] Font deletion failure

Check if the font to be deleted is registered (or pre-registered) in this equipment.

[4F10] System abnormality

- (1) Perform the job in error again. If the error still occurs, turn the power OFF and then back ON, and perform the job again.
- (2) Collect the debug log with USB device.
 P. 5-2 “5.1.2 Collection of debug logs with a USB device”
- (3) Initialize HDD.
Refer to step 3 and later in “[E] Replace / Format HDD” in “6.2.3 Precautions and procedures when replacing the HDD”.

5.3.10 Web Page related error/Communication error with external application

[5010] Internal setting error

Classification	Error item
Communication error with external application	There is a print job, a proof print job, a private print job, a print job without a set department code, a scan job or a fax job remaining in this equipment.
Check item	Measures
Setting	Delete the remaining jobs. Turn the power OFF and then back ON. Until the initial registration is begun, do not press any button on the control panel or start any print or fax job.

[5012] Authentication error

Classification	Error item
Communication error with external application	A temporary password downloaded from e-Bridge and entered in this equipment is not valid, or the permanent password set in the e-Bridge is not valid.
Check item	Measures
Setting	Perform the job again at a later date.

[5013] e-Bridge communication error

Classification	Error item
Communication error with external application	Communication is attempted while the e-Bridge is enabled for some reason such as version upgrade.
Check item	Measures
Setting	Check if the MFP is connected to the eBR2 server.

[5014] No SSL certificate

Classification	Error item
Communication error with external application	There is no SSL certificate or the certificate is not in a correct file format.
Check item	Measures
Setting	Install the correct SSL certificate.

[5015] Invalid SSL certificate

Classification	Error item
Communication error with external application	SSL certificate is not valid.
Check item	Measures
Setting	Install the correct SSL certificate.

[5016] Expired SSL certificate

Classification	Error item
Communication error with external application	SSL certificate is expired.

Check item	Measures
Setting	Set the correct time.

[5017] Other SSL certificate related error

Classification	Error item
Communication error with external application	SSL certificate is invalid.

Check item	Measures
Setting	Install the correct SSL certificate.

[5018] Invalid DNS error

Classification	Error item
Communication error with external application	DNS address is invalid.

Check item	Measures
Setting	Set the correct DNS address. If any setting is needed in DNS, consult your administrators.

[5019] Connection error

Classification	Error item
Communication error with external application	Settings for initial URL and proxy are incorrect.

Check item	Measures
Setting	Perform the correct settings for initial URL and proxy.

[501A] Proxy error

Classification	Error item
Communication error with external application	IP address or port for proxy setting is invalid.

Check item	Measures
Setting	Set the correct IP address or port for the proxy setting. If any setting is needed in proxy, consult your administrators.

[501B] No URL (host/port) or invalid path

Classification	Error item
Communication error with external application	Initial URL is invalid.
Check item	Measures
Setting	Set the correct initial URL.

[5030] HTTP communication error

Classification	Error item
Communication error with external application	An error in the HTTP communication
Check item	Measures
Setting	Check the URL for communication. Check that the valid IP address is assigned to connect to the server.

[50FF] eBR2 internal error

Classification	Error item
MFP internal error	A fatal error occurred in the MFP
Check item	Measures
Setting	Restart the MFP, and then try again.

[5110] Toner cartridge detection error

Classification	Error item
Web Page related error	
Check item	Measures
Setting	<ul style="list-style-type: none"> • Check if the toner cartridge is installed properly. • Check if the toner cartridge detection sensor operates properly.

[5212] Time for cleaning of the slit glass and main charger

Classification	Error item
Web Page related error	
Check item	Measures
Setting	<ul style="list-style-type: none"> • Clean the LED head and main charger. • If the message is not cleared after the cleaning, check if there is any detection error, breakage or poor connection of the needle electrode cleaner detection sensor.

[5BD0] Power failure during restoration

Classification	Error item
Web Page related error	

Check item	Measures
Setting	<ul style="list-style-type: none"> • Check if the power cable is connected properly and is inserted securely. • Check if the power voltage is unstable. • Reattempt the restoration of the database (Address Book, templates, F-code (Mailbox) or user information).

[5C10] FAX Unit attachment error

Classification	Error item
Web Page related error	

Check item	Measures
Setting	<ul style="list-style-type: none"> • Check if the FAX Unit is attached. • Check if there is any damage or abnormality on the FAX board. • Check if the connector on the FAX board is connected properly.

[5C11] Network FAX transmission error

Classification	Error item
Web Page related error	

Check item	Measures
Setting	The address specified for the network FAX is not registered on the Address Book. Register it.

5.3.11 MFP access error

[6007] Unsuccessful User Login to MFP

Classification	Error item
MFP access error	User authentication cannot be done because connection to the authentication server has failed.

Check item	Measures
Setting	Check if the operating status of the server and connection from an MFP have been confirmed.

[6008] Failed to connect on External Role Base Access Control (LDAP) Server

Classification	Error item
MFP access error	User authentication cannot be done because connection to an external RBAC server has failed.

Check item	Measures
Setting	Check if the operating status of the server and connection from the MFP have been confirmed.

[6032] Card related error: Expired card

Classification	Error item
MFP access error	The card cannot be used because it has expired.

Check item	Measures
Setting	Use a card with a valid expiration.

[6033] Card related error: Invalid flag data (no room-entry data)

Classification	Error item
MFP access error	The card cannot be used because no room-entry data are recorded in it.

Check item	Measures
Setting	Use a correct card that has been used for entering the room.

[6034] Card related error: Invalid flag data (invalid card data)

Classification	Error item
MFP access error	The card cannot be used because the data required for the use of the card are not correctly set.

Check item	Measures
Setting	Use a valid card.

[6041] Card authentication: Card related error

Classification	Error item
MFP access error	Card data cannot be obtained correctly.
Check item	Measures
Setting	Reattempt scanning. If the error still occurs after reattempting scanning for several times, card data may be corrupted or the card reader may be out of order.

[6042] Card authentication: Card setting error

Classification	Error item
MFP access error	The self-diagnostic code required for card authentication is not set in this equipment correctly.
Check item	Measures
Setting	Set the correct self-diagnostic code.

[6121] Automatic Secure Erase failure

Classification	Error item
MFP access error	The automatic secure erase fails.
Check item	Measures
Setting	Data overwriting failed for some reason. If the error still occurs after rebooting the equipment, start up using the following procedure:[3] + [C] + [POWER] → 3. HDD formatting → Reinstallation of software or HDD replacement.

[6131] MFP fail to verify clock with Time Server

Classification	Error item
MFP access error	The MFP is not synchronized with the SNTP server.
Check item	Measures
Setting	<ul style="list-style-type: none"> • Check that the SNTP server is operating correctly. • Check that the path to the SNTP server is operating correctly. • Check that the settings are correct in Web Page → [Administrator] → [Setup] → [General] → [SNTP Service].

5.3.12 Maintenance error

[7101] System firmware installation failure**[7103] Engine firmware installation failure****[7105] Scanner firmware installation failure****[7111] Patch installation failure****[7113] Plug-in installation failure****[7115] HDD data installation failure****[7119] PFC firmware installation failure**

Classification	Error item
Maintenance error	System firmware installation failed. ([7101]) Engine firmware installation failed. ([7103]) Scanner firmware installation failed. ([7105]) Patch installation failed. ([7111]) Plug-in installation failed. ([7113]) HDD data installation failed. ([7115]) PFC firmware installation failed. ([7119])

Check item	Measures
Setting	Software package file may have a problem or may be corrupted. Check the software package file and then reattempt the installation.

Replace parts	Remarks

[7109] Printer driver update failure

Classification	Error item
Maintenance error	Printer driver upload failed.

Check item	Measures
Setting	Printer driver file may have a problem or may be corrupted. Check the package file and then reattempt the upload.

[710B] Point and Print data installation failure

Classification	Error item
Maintenance error	Point and Print data upload failed.

Check item	Measures
Setting	Point and Print data may have a problem or may be corrupted. Check the package file and then reattempt the upload.

[710F] Language Pack installation failure

Classification	Error item
Maintenance error	Language Pack installation failed.

Check item	Measures
Setting	Language Pack file may have a problem or may be corrupted. Check the package file and then reattempt the installation.

[711D] License key returning failure

Classification	Error item
Maintenance error	The one-time dongle license fails to be returned to USB device.
Check item	Measures
Setting	Return the license to the USB device used for installing the license. Check that the USB device is correctly installed. Notes: The GP-1080 IPsec Enabler cannot return to the USB device due to license problem. The GP-1070 Overwrite Enabler cannot return to the USB device in the high security (08-8911: 3).

[711F] License key installation failure

Classification	Error item
Maintenance error	The one-time dongle license fails to be installed.
Check item	Measures
Setting	Check that the USB device is correctly installed.

[71A4] Cryptographic key consistency confirmation failure

Classification	Error item
Maintenance error	Cryptographic key consistency confirmation failed.
Check item	Measures
Setting	Start up the equipment in the following procedure: [3] + [C] + [POWER] → 5. Key Backup Restore Then overwrite the corrupted license key with a normal one.

[71AA] Unidentified error during certificate acquisition from SCEP server

Classification	Error item
Maintenance error	Unidentified error occurred during certificate acquisition from SCEP server.
Check item	Measures
Setting	Check SCEP server and the SCEP setting (automatic) on the Web Page screen as follows: Web Page Administration → Security → Certificate Management

[71AB] Timeout error during certificate acquisition from SCEP server

Classification	Error item
Maintenance error	Timeout error occurred during certificate acquisition from SCEP server.
Check item	Measures
Setting	Check SCEP server and the SCEP setting (automatic) on the Web Page screen in the following procedure: Web Page Administration → Security → Certificate Management

[71AC] File save error during certificate acquisition from SCEP server

Classification	Error item
Maintenance error	File save error occurred during certificate acquisition from SCEP server.
Check item	Measures
Setting	File saving failed for some reason. If the error still occurs after rebooting the equipment, start up using the following procedure: [3] + [C] + [POWER] → 3. HDD formatting → Reinstallation of software or HDD replacement

[71B0] Software package file decryption failure

Classification	Error item
Maintenance error	Software package file decryption failed.
Check item	Measures
Setting	Software package file may have a problem or may be corrupted. Check the software package file and then reattempt the installation.

[71B5] Finisher firmware installation failure

Classification	Error item
Maintenance error	Finisher firmware installation failure
Check item	Measures
Setting	Finisher firmware installation failed. Reinstall the firmware.

[7261] SU firmware installation failure

Classification	Error item
Maintenance error	SU firmware installation failure
Check item	Measures
Setting	SU firmware installation failed. Reinstall the firmware.

[7263] SU Loader installation failure

Classification	Error item
Maintenance error	SU Loader installation failure
Check item	Measures
Setting	SU Loader installation failed. Reinstall the firmware.

[7265] SU Recovery installation failure

Classification	Error item
Maintenance error	SU Recovery installation failure
Check item	Measures
Setting	SU Recovery installation failed. Reinstall the firmware.

[7267] PU firmware installation failure

Classification	Error item
Maintenance error	PU firmware installation failure
Check item	Measures
Setting	PU firmware installation failed. Reinstall the firmware.

[7269] PU Loader installation failure

Classification	Error item
Maintenance error	PU Loader installation failure
Check item	Measures
Setting	PU Loader installation failed. Reinstall the firmware.

[726B] Option Tray installation failure

Classification	Error item
Maintenance error	Option Tray installation failure
Check item	Measures
Setting	Option Tray installation failed. Reinstall the firmware.

[726D] LCF installation failure

Classification	Error item
Maintenance error	LCF installation failure
Check item	Measures
Setting	LCF installation failed. Reinstall the firmware.

[726F] Finisher installation failure

Classification	Error item
Maintenance error	Finisher installation failure
Check item	Measures
Setting	Finisher installation failed. Reinstall the firmware.

[7271] Duplex installation failure

Classification	Error item
Maintenance error	Duplex installation failure

Check item	Measures
Setting	Duplex installation failed. Reinstall the firmware.

5.3.13 Network error

[8000] Static IPv4 address conflict

Classification	Error item
Network error	IPv4 address overlaps.
Check item	Measures
Setting	Check if the same IP address is not used by other machine.

[8011] Linklocal Address Conflict

Classification	Error item
Network error	Linklocal Address Conflict
Check item	Measures
Setting	Check if the same IP address is not used by other machine.

[8012] Manual Address Conflict

Classification	Error item
Network error	Manual IPv6 Address Conflict
Check item	Measures
Setting	Check if the same IP address is not used by other machine.

[8013] Stateless Address Conflict

Classification	Error item
Network error	Stateless Address Conflict
Check item	Measures
Setting	Check if the same IP address is not used by other machine.

[8014] Stateful Address Conflict

Classification	Error item
Network error	Stateful Address Conflict
Check item	Measures
Setting	Check if the same IP address is not used by other machine.

[8022] Authentication Failure

Classification	Error item
Network error	Failed in 802.1X authentication.
Check item	Measures
Setting	Check the user credential.

[8023] Can not contact Authentication Server/Switch

Classification	Error item
Network error	Failed in connection to authentication server and switch.

Check item	Measures
Setting	Check connectivity to switch or server.

[8024] Certificate verification Failure

Classification	Error item
Network error	Failed in verification of certificate.

Check item	Measures
Setting	Check if a valid certificate is installed.

[8031] IKEv1 certification failed

Classification	Error item
Network error	Ipsec error for ikev1 certification failed

Check item	Measures
Setting	Check <ol style="list-style-type: none"> 1. CA and user certificate in both MFP and remote peer - certificate timestamp and IPsec Certificate template should be valid. 2. CRL DP server name is mapped in MFP's host table or DNS entry. 3. Certificate against CRL.

[8032] IKEv1 wrong proposal choosen

Classification	Error item
Network error	Ipsec error for wrong proposal choosen

Check item	Measures
Setting	Check the IKEv1 IPsec proposal parameters (like encryption/ authentication algorithms, DH group, authentication methods) in MFP and peer machine.

[8033] IKEv1 shared key authentication failed

Classification	Error item
Network error	Ipsec error if auth for shared key failed

Check item	Measures
Setting	Mismatch in IKEv1 Pre Shared Key. Check the PSK in MFP and remote machine.

[8034] IKEv1 invalid certificate

Classification	Error item
Network error	Ipsec error if invalid certificate uploaded
Check item	Measures
Setting	Check the CA and User certificate in MFP and peer machine.

[8035] IKEv1 certificate not supported

Classification	Error item
Network error	Ipsec error if certificate not supported
Check item	Measures
Setting	Check the User certificate type.

[8036] IKEv1 invalid certificate authentication

Classification	Error item
Network error	Ipsec error if invalid certificate authentication
Check item	Measures
Setting	Check the CA certificate in MFP and Peer machine.

[8037] IKEv1 certificate unavaliable

Classification	Error item
Network error	Ipsec error if certificate are not avialable
Check item	Measures
Setting	Certificate has been deleted from Certificate store. Re-upload the corresponding certificates.

[8038] IKEv1 no SA established

Classification	Error item
Network error	Ipsec error for SA is not present
Check item	Measures
Setting	Check the IKEv1/IPsec proposal parameters (like encryption/ authentication algorithms, DH group, authentication methods) in MFP and peer machine. Check 1. CA and user certificate in both MFP and remote peer - certificate timestamp and IPsec Certificatetem.

[8039] IKEv1 invalid signature

Classification	Error item
Network error	Ipsec error for invalid signaturer for certificate
Check item	Measures
Setting	Mismatch in Signature payload (MAC or IV). Check the CA and user certificate in MFP and peer machine.

[803A] IKEv2 wrong proposal choosen

Classification	Error item
Network error	Ipsec error is proposal choosen is wrong
Check item	Measures
Setting	Check the IKEv2/IPsec proposal parameters (encryption/ authentication algorithms, DH group, authentication methods) in MFP and peer machine.

[803B] IKEv2 Certificate failed

Classification	Error item
Network error	Ipsec error for ikev2 certification failed
Check item	Measures
Setting	Check <ol style="list-style-type: none"> 1. CA and user certificate in both MFP and remote peer - certificate timestamp and IPsec Certificate template should be valid. 2. CRL DP server name is mapped in MFP's host table or DNS entry. 3. Certificate against CRL.

[803C] IKEv2 secret key authentication failed

Classification	Error item
Network error	Ipsec error for ikev2 if secret key auth failed
Check item	Measures
Setting	Mismatch in IKEv2 Pre Shared Key. Check the PSK in MFP and peer machine.

[803D] IKEv2 falling back to IKEv1

Classification	Error item
Network error	Ipsec error if peer dosent support IKEv2 and falling back to IKEv1
Check item	Measures
Setting	Remote machine is not supporting IKEv2. Going back to use IKEv1.

[803E] IKEv2 ISAKMP SA unavialable

Classification	Error item
Network error	Ipsec error if ISAKMP SA is not created of destroyed due to some uncertain condition

Check item	Measures
Setting	Restart IPsec service on Peer and retry.

[803F] IKEv2 cryptographic operation failed

Classification	Error item
Network error	Ipsec error for ikev2 if crypto operation failed

Check item	Measures
Setting	If Certificates are being used, re-upload the corresponding certificates using Security Services. Restart IPsec Service on MFP.

[8040] IKEv2 invalid key information

Classification	Error item
Network error	Ipsec error for ikev2 if key info is invalid

Check item	Measures
Setting	Check IKE settings in MFP and peer.

[8041] IKEv2 CA not trusted

Classification	Error item
Network error	Ipsec error for ikev2 if CA is not trusted

Check item	Measures
Setting	Check the CA certificate in MFP and peer machine. Check the CA certificate timestamp.

[8042] IKEv2 Authentication method mismatch

Classification	Error item
Network error	Ipsec error if auth method is not matching

Check item	Measures
Setting	Mismatch in IKE authentication type. Check the Authentication type in MFP and peer.

[8043] IPsec IKE version mismatch

Classification	Error item
Network error	Ipsec error if ike version is not matching
Check item	Measures
Setting	Mismatch in IKE version. Check the IKE version in MFP and peer.

[8044] IPsec encapsulation mismatch

Classification	Error item
Network error	IPsec error for encapsulation is not matching
Check item	Measures
Setting	Check the IPsec mode (Transport/Tunnel) in MFP and peer.

[8045] IPsec Peer IP mismatch

Classification	Error item
Network error	IPsec error for peer IP mismatch
Check item	Measures
Setting	Remote Traffic selector mismatch. Check the destination address/port in IPsec filter.

[8046] IPsec local IP mismatch

Classification	Error item
Network error	IPsec error for local IP mismatch
Check item	Measures
Setting	Local traffic selector mismatch. Check the source address/port in IPsec filter.

[8047] IPsec local ID mismatch

Classification	Error item
Network error	IPsec error for local ID mismatch
Check item	Measures
Setting	Check the user certificate in MFP

[8048] IPsec Remote ID mismatch

Classification	Error item
Network error	IPsec error for remote ID mismatch
Check item	Measures
Setting	Check the user certificate in peer machine.

[8049] IPsec Remote IP mismatch

Classification	Error item
Network error	IPsec error for remote IP mismatch
Check item	Measures
Setting	Remote traffic selector mismatch. Check the source address/port in IPsec filter.

[804A] IPsec IKE timeout

Classification	Error item
Network error	IPsec error for IKE timeout
Check item	Measures
Setting	Check the network connectivity between MFP and peer machine. Select the Flush Connections Option and retry.

[804B] IPsec invalid manual key

Classification	Error item
Network error	IPsec error ID manual key is not valid
Check item	Measures
Setting	Check the Inbound and Outbound (ESP Encryption/ Authentication and AH Authentication) keys in MFP and Remote PC.

[8061] Secure update to primary IPv4 server failed**[8062] Secure update to secondary IPv4 server failed****[8063] Secure update to primary IPv6 server failed****[8064] Secure update to secondary IPv6 server failed****[8065] IPv6 primary DDNS update error****[8066] IPv6 secondary DDNS update error****[8067] IPv4 primary DDNS update error****[8068] IPv4 secondary DDNS update error**

Classification	Error item
Network error	Secure update to primary IPv4 server failed. ([8061]) Secure update to secondary IPv4 server failed. ([8062]) Secure update to primary IPv6 server failed. ([8063]) Secure update to secondary IPv6 server failed. ([8064]) IPv6 primary DDNS update error. ([8065]) IPv6 secondary DDNS update error. ([8066]) IPv4 primary DDNS update error. ([8067]) IPv4 secondary DDNS update error. ([8068])
Check item	Measures
Setting	Check if there is any problem with DNS or DDNS settings.

[8069] Invalid TSIG/SIG(0) Key file

Classification	Error item
Network error	This message is displayed when the key file for SIG(0) or TSIG is invalid.
Check item	Measures
Setting	Verify the TSIG/SIG(0) key files used.

[8101] Wireless association with Access point failure

Classification	Error item
Network error	Wireless association with Access point failure
Check item	Measures
Setting	Verify the credentials used for association with Access point.

[8102] MFP not able to contact the Access point with the specified SSID

Classification	Error item
Network error	MFP not able to contact the Access point with the specified SSID
Check item	Measures
Setting	Verify the access point name setting and mechanism used for association same as Access Point setting.

[8103] Wireless Certificate verification failure

Classification	Error item
Network error	Wireless Certificate verification failure
Check item	Measures
Setting	Verify the certificate settings used for association.

[8121] Domain - General Failure during Authentication

Classification	Error item
Network error	An unknown domain authentication error occurs when connecting to the domain controller.
Check item	Measures
Setting	Check the network settings of the equipment, and retry connecting to the domain controller.

[8122] Domain - Invalid Username or Password

Classification	Error item
Network error	The user name or password of the domain authentication is not valid and the user cannot log on.

Check item	Measures
Setting	Check if the user name or password is correctly entered. Enter them by specifying the upper and lower case letters correctly.

[8123] Domain - Server not present in Network

Classification	Error item
Network error	The server cannot be detected at domain authentication.

Check item	Measures
Setting	Check if the server fails. Check the network settings of the equipment. If name resolution is used, check the settings of the DNS and DDNS.

[8124] Domain - User account is disabled on Server

Classification	Error item
Network error	The user account is invalid at domain authentication and it cannot be used to log on.

Check item	Measures
Setting	Check if the setting of the user account in "Active Directory User and Computer" is disabled.

[8125] Domain - User account has expired and cannot be used for logon

Classification	Error item
Network error	The user account has expired at domain authentication and it cannot be used to log on.

Check item	Measures
Setting	Check if the setting of the user account in "Active Directory User and Computer" has expired.

[8126] Domain - User account is locked and cannot be used for logon

Classification	Error item
Network error	The user account is locked at domain authentication and it cannot be used to log on.

Check item	Measures
Setting	Check the setting of the account lock-out on the server.

[8127] Domain - Invalid logon hours for the User

Classification	Error item
Network error	The user log-on time is invalid at domain authentication and the user cannot log-on.
Check item	Measures
Setting	Check the log-on time setting of the user account in "Active Directory User and Computer".

[8128] Active Directory Domain - Clock Skew error due to difference in Time between Server and MFP

Classification	Error item
Network error	The difference between the time set in the equipment and that set in the server is more than five minutes at domain authentication of the Active Directory and the user cannot log on.
Check item	Measures
Setting	Match the time of the equipment and domain controller, or if an SNTP server is in the network, recommend the use of SNTP.

[8129] Active Directory Domain - Kerberos Ticket has expired and cannot be used for Authentication

Classification	Error item
Network error	A Kerberos ticket has expired at the domain authentication of the Active Directory and the user cannot log on.
Check item	Measures
Setting	Check if the Kerberos ticket on the Kerberos server has expired.

[812A] Active Directory Domain - Verification of the Ticket has failed

Classification	Error item
Network error	A Kerberos ticket authentication error of the Active Directory domain authentication occurs and the user cannot log on.
Check item	Measures
Setting	Check if the user name or password is correctly entered. If this problem still persists, contact your Window server administrator.

[812B] Active Directory Domain-The Domain specified could not be found

Classification	Error item
Network error	The Realm name for the domain authentication of the Active Directory is invalid and the user cannot log on.
Check item	Measures
Setting	Check if the Realm name of the Active Directory server of the equipment is wrong. If this problem still persists, contact your Window server administrator.

5.4 Other errors

5.4.1 Equipment operation disabled after the installation of option(s)

Check if the optional board is installed properly.

5.4.2 Wireless LAN connection disabled

The connection state and settings of the Wireless LAN can be checked with [USER FUNCTIONS] → [ADMIN] → [WIRELESS LAN] → [SETTING CHECK].

Confirm the settings with the administrator.

- “NIC INITIALIZING” does not disappear at the time of the power being turned ON and it disappears after 6 minutes with the NIC initializing time-out. In this case, the connection to the Wireless LAN did not succeed even though “NIC INITIALIZING” disappears.
- The connection to the Wireless LAN cannot be made if the Access Point to be connected is not found or security settings are not correct.

5.4.3 “Invalid Department Code” is displayed

Log in to Web Page as an administrator, select [Authentication] on the [User Management] tab, and then check whether Department Setting is enabled or disabled.

Department Setting is enabled:

- Log in to Web Page as an administrator, select [Authentication] on the [User Management] tab, and then check User Management Setting.
- Confirm the settings of 08-3805 in the setting mode.

Department Setting is disabled:

- Log in to Web Page as an administrator, select [Authentication] on the [User Management] tab, and then check User Management Setting.

5.4.4 Ethernet disabled in half-duplex communication

The Ethernet of this equipment does not support half-duplex communication.

When the port setting of the switch is fixed at half-duplex communication, use any of 10/100/1000 Mbps, full-duplex fixed communication mode or auto-negotiation function.

In addition, select the setting of the equipment corresponding to that of the switch.

([ADMIN] > [NETWORK] > [ETHERNET])

Check the set communication speed as follows if required:

[ADMIN] > [NETWORK] > [ETHERNET]

6. REPLACEMENT OF PC BOARDS/HDD

6.1 Removal and Installation of PC Boards/HDD

Refer to the Hardware Guide for the removal and installation procedures of the PC boards other than the SYS board, HDD, and SRAM board <for SYS board>.

Notes:

When the PC board/HDD is replaced, refer to the respective Notes and Cautions of “Replacement of PC boards and HDD” in  P. 6-10 “6.2 Precautions, Procedures and Settings for Replacing PC Boards and HDD”.

6.1.1 Right side cover

- (1) Remove two screws.



Fig.6-3

- (2) Remove the screw located at the bottom of the right side cover.



Fig.6-4

- (3) Open the front cover and remove two screws.



Fig.6-5

- (4) Release 2 latches.

As shown in the figure, insert a flathead screwdriver into the groove and push it in the direction of the arrow to release the latches.

Notes:

When using tools, be sure not to put your face and hands in the direction in which force will be applied; otherwise this could result in injury. In addition, be sure not to damage the cover.



Fig.6-6

- (5) Release 2 latches.

As shown in the figure, insert a flathead screwdriver into the groove and push it in the direction of the arrow to release the latches.

Notes:

When using tools, be sure not to put your face and hands in the direction in which force will be applied; otherwise this could result in injury. In addition, be sure not to damage the cover.



Fig.6-7

- (6) Release the latches (I) and (II).

As shown in the figure, insert a flathead screwdriver into the groove and push it in the direction of the arrow to release the latches.

Notes:

When using tools, be sure not to put your face and hands in the direction in which force will be applied; otherwise this could result in injury. In addition, be sure not to damage the cover.



Fig.6-8

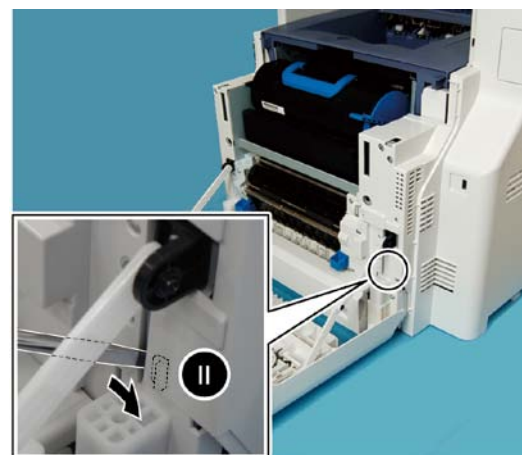

Fig.6-9

- (7) Pull the bottom of the cover outward, release the latch, and remove the cover.



Fig.6-10

6.1.2 SYS Board cover

- (1) Take off the right side cover.
 📖 P. 6-1 "6.1.1 Right side cover"
- (2) Remove 15 screws, and take off the SYS board cover.

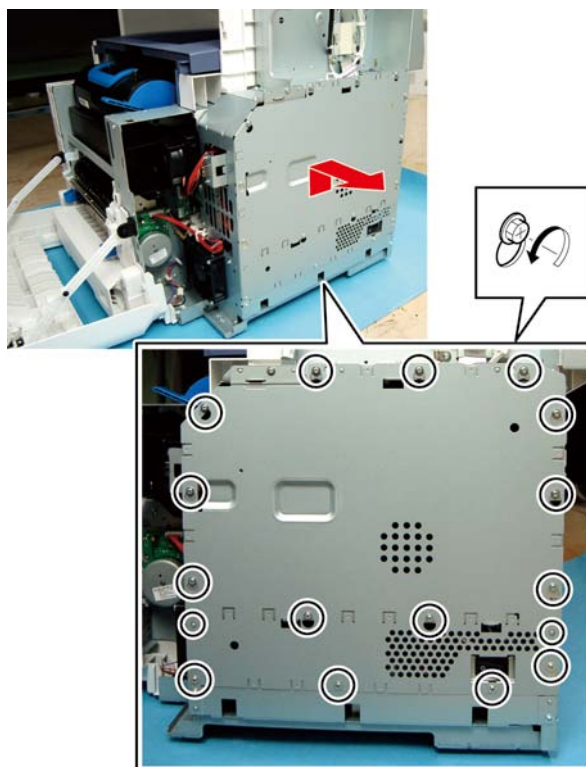

Fig.6-11

6.1.3 SYS board

- (1) Take off the right side cover.
📖 P. 6-1 “6.1.1 Right side cover”
- (2) Take off the SYS board cover.
📖 P. 6-4 “6.1.2 SYS Board cover”
- (3) Take off the fax unit if it's installed.
📖 P. 6-9 “6.1.6 FAX unit”
- (4) Unplug all the connectors and cable connected to the SYS board, and then take out the connectors and cable from the SYS board case.



Fig.6-12

- (5) Remove 2 screws.



Fig.6-13

- (6) Remove 8 screws, and then take off the SYS board.

Notes:

When removing the SYS board, do not apply pressure to the heat sink, memory or SRAM board by holding them too firmly.

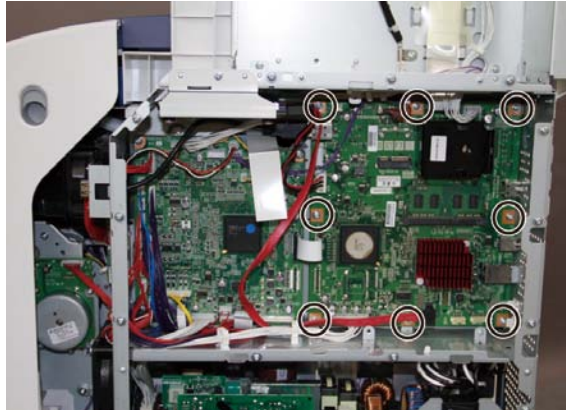

Fig.6-14

6.1.4 Hard disk (HDD)

- (1) Take off the right side cover.
☞ P. 6-1 “6.1.1 Right side cover”
- (2) Take off the SYS board cover.
☞ P. 6-4 “6.1.2 SYS Board cover”
- (3) Take off the fax unit if it's installed.
☞ P. 6-9 “6.1.6 FAX unit”
- (4) Unplug the connector connected to the hard disk.



Fig.6-15

(5) Remove 3 screws.



Fig.6-16

(6) Remove 4 screws and take off the hard disk.



Fig.6-17

6.1.5 SRAM board <for SYS board>

- (1) Take off the right side cover.
📖 P. 6-1 “6.1.1 Right side cover”
- (2) Take off the SYS board cover.
📖 P. 6-4 “6.1.2 SYS Board cover”
- (3) Take off the fax unit if it's installed.
📖 P. 6-9 “6.1.6 FAX unit”
- (4) Release 2 latches and take off the SRAM board for the SYS board[1] with the case.

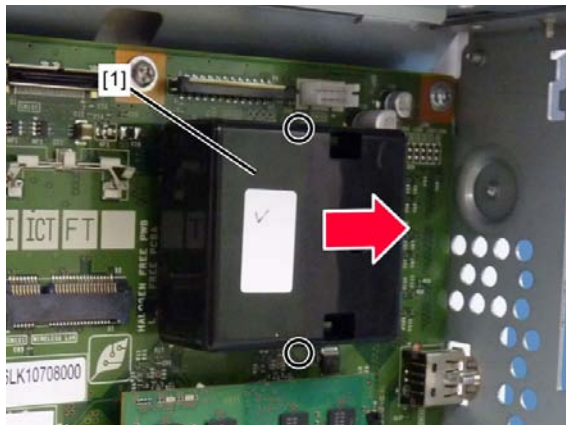

Fig.6-18

- (5) Release 2 latches[1] and take off the SRAM board for SYS board[2] from the case.

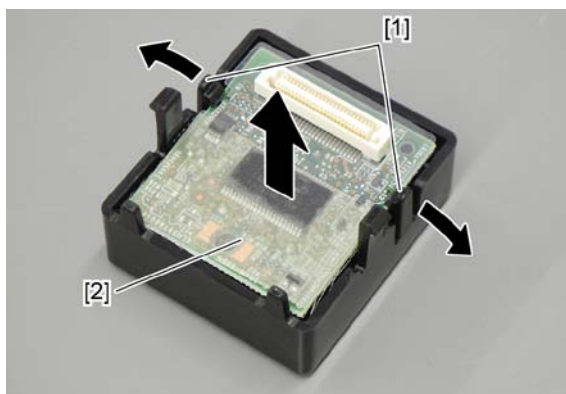

Fig.6-19

6.1.6 FAX unit

- (1) Take off the right side cover.
📖 P. 6-1 “6.1.1 Right side cover”
- (2) Take off the SYS board cover.
📖 P. 6-4 “6.1.2 SYS Board cover”
- (3) Remove 2 screws.



Fig.6-20

- (4) Unplug the connectors and cable connected to the SYS board.



Fig.6-21

- (5) Remove 2 screws, and then take off the fax unit.



Fig.6-22

6.2 Precautions, Procedures and Settings for Replacing PC Boards and HDD

6.2.1 Precautions when replacing PC boards

- The ID for each equipment is registered on the PU board, the SYS board and SU board. So, if their replacement is required, be sure to replace only one board at a time. Do not replace the SYS board and the SRAM board (for the SYS board) together.
- If both the PU board and SYS board require replacement, replace them in the following procedure.
 1. First, replace one of the board to be replaced.
 2. Turn the power ON and confirm that “READY” is displayed.
 3. Turn the power OFF.
 4. Replace another board that requires replacement.
- When the HDD requires replacement, see “6.2.3 Precautions and procedures when replacing the HDD”.
- When the SYS board requires replacement, see “6.2.4 Precautions and Procedures when replacing the SYS board”.
- When SRAM board requires replacement, see “6.2.5 Precautions and procedure when replacing the SRAM board (for the SYS board)”.

6.2.2 HDD fault diagnosis

This code displays the HDD operation history, which is recorded in the HDD, on the control panel. HDD failure can be diagnosed or predicted with the information displayed.

1. Display

The following screen is displayed with setting code 08-9065. You can also refer to the same information by pressing the [ON/OFF] button while pressing [5] and [C] simultaneously and then selecting "5. SMART Info".

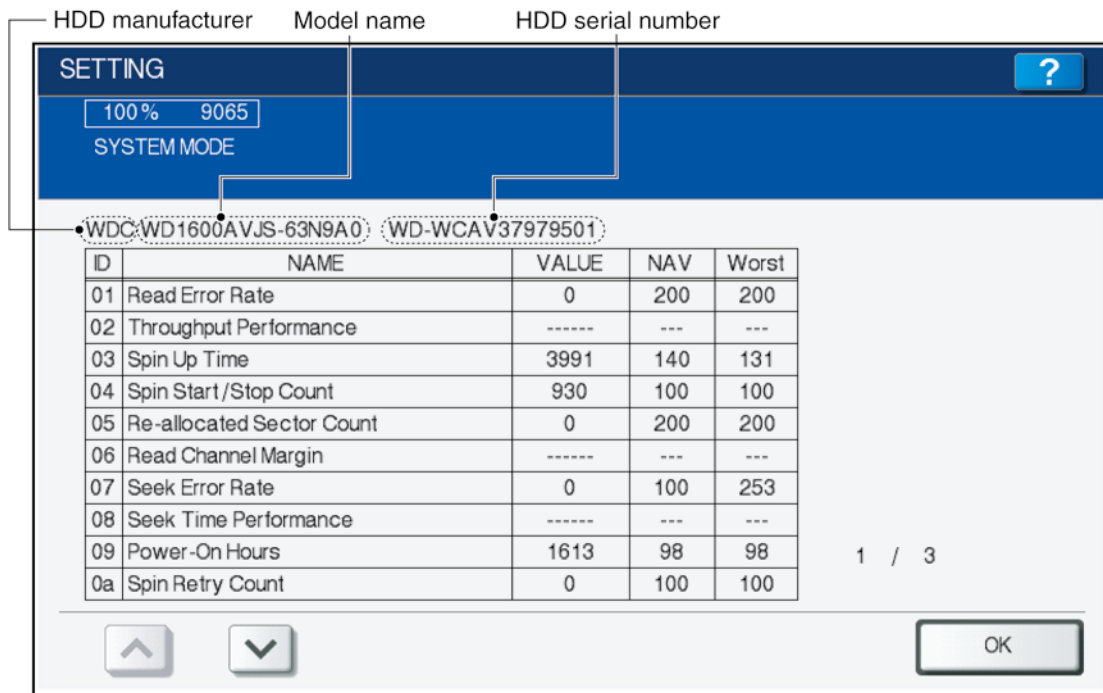

Fig. 9-1

- Items supported differ depending on the HDD manufacturer.
- "----" is displayed on the VALUE, NAV and Worst columns if items are not supported.

2. Usage

The combination of the values of ID=05 and c5 is used to diagnose whether or not the HDD has a physical failure when HDD failure is suspected (service call F100 - F109 or F120 or F124 occurred).

Result		Description	Diagnosis
ID	VALUE		
05	0	Low possibility of physical failure	HDD replacement is not required.
c5	0		
05	From 1 to 999	Defective sector has been reassigned and HDD is recovered.	HDD replacement is not required.
c5	0		
05	Any value	High possibility of defective sector existence. (There will be a possibility of physical failure depending on the use of HDD.)	HDD replacement is required.
c5	1 or more		
05	Either one is at least 1000.	High possibility of physical failure	HDD replacement is recommended.
c5			
05	All values are displayed as "-----".	High possibility of physical failure (A HDD connector, harness or SYS board may be one of the causes.)	HDD replacement is recommended.
c5			

3. ID=05 and c5

ID	Name	Description	Remarkd
05	Re-allocated Sector Count	The number of sectors reassigned	This value tends to increase at HDD failure.
c5	Current Pending Sector Count	The number of candidate sectors to be reassigned	This value tends to increase at HDD failure.

4. Description of each ID

ID	Name	Meaning
01	Read Error Rate	This attribute is a measure of the read error rate.
02	Throughput Performance	This attribute is a measure of the throughput performance.
03	Spin Up Time	This attribute is a measure of how quickly the drive is able to spin up from a spun down condition.
04	Spin Start/Stop Count	This attribute is a measure of the total number of spin ups from a spun down condition.
05	Re-allocated Sector Count	This attribute is a measure of the total number of reallocated sectors.
07	Seek Error Rate	This is a measure of the seek error rate.
08	Seek Time Performance	This attribute is a measure of a drive's seek performance during normal online operations.
09	Power-On Hours	This attribute is a measure of the total time (hours or minutes depending on disk manufacturer) the drive has been on.
0a	Spin Retry Count	This attribute is a measure of the total number of spin retries.
0c	Power Cycle Count	This attribute is a measure of the number of times the drive has been turned on.
c0	Power off Retract Count	This attribute is a measure of the total number of emergency unloads.
c1	Load Cycle Count	This attribute is a measure of the total number of load/unloads.
c2	Temperature	This attribute is a measure of the temperature in the HDD.
c3	ECC On the Fly Count	This attribute is a measure of the total number of the ECC On the Fly.
c4	Reallocation Event Count	This attribute is a measure of the total number of the reallocation events.
c5	Current Pending Sector Count	This attribute is a measure of the total number of candidate sectors to be reallocated.
c6	Off-Line Scan Uncorrectable Sector Count	This attribute is a measure of the total number of uncorrectable sectors found during the off-line scan.
c7	Ultra DMA CRC Error Count (Rate)	This attribute is a measure of the total number of errors found in data transfer in the Ultra-DMA mode.
c8	Write Error Rate	This attribute is a measure of the write error rate.

Notes:

“Over-range” is displayed if the number of digits acquired from the HDD exceeds the maximum digits which can be displayed on the control panel; however, this does not indicate an error.

6.2.3 Precautions and procedures when replacing the HDD

Notes:

- When the HDD is replaced, it is necessary to back up the data in the HDD before replacing and to recover them after replacing.
- To maintain the security, ask users to perform the backup/restore for users' data/information in the HDD. The service technician can perform them only when users permit it.
- Some data in the HDD cannot be backed up and can be kept only on the paper.
- Do not replace the HDD and the SRAM board (for the SYS board) together.

A procedure for replacing the HDD is shown below.

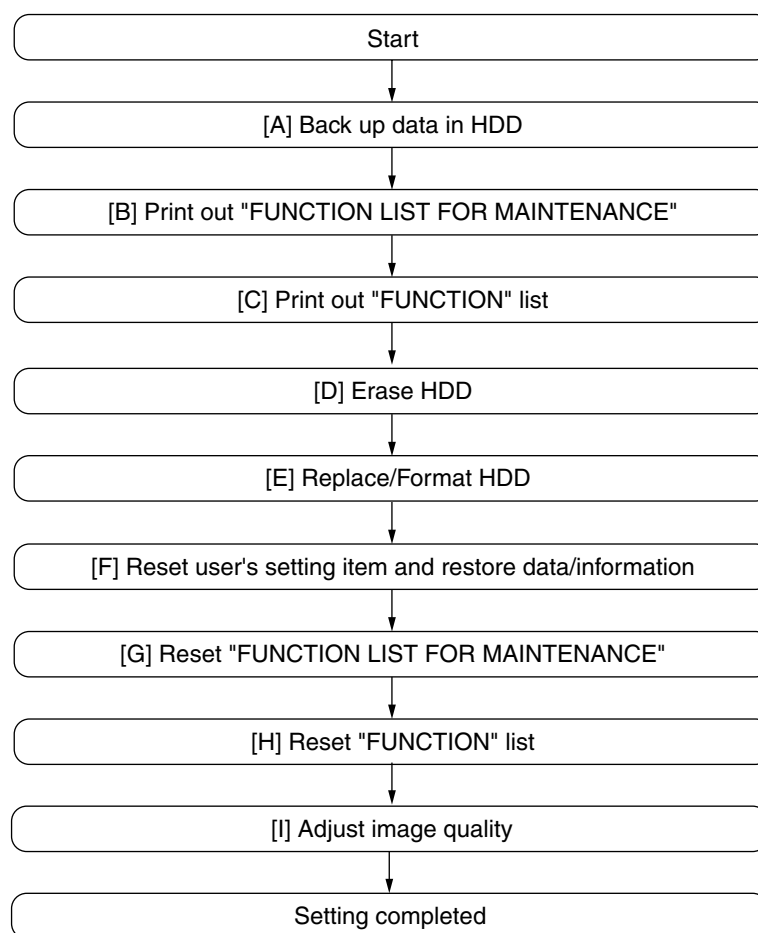

Fig.6-23

[A] Back up in HDD

Ask the user (machine administrator) to back up the data in the HDD. Refer to the table below for the type of data, availability and method of backup.

Type of data in HDD	Availability	Backup method
Image data in the e-Filing	Available	Archive them in the “e-Filing” of Web Page. As for the backup in Box data, all data (selectable by the box) can be backed up / restored in one go by using “e-Filing Backup/Restore Utility”.
F-code information, Template registration information, Address book data	Available	Back them up in the “Administrator” menu of Web Page.
Department management data	Available	Export them in “Administrator” menu of Web Page.
Log data (Print, Scan, FAX (Transmission/Reception))	Available	Export them in the “Administrator” menu of Web Page. (Import cannot be performed.)
Data in the shared folder (Scanned data, Saved data of copy / FAX transmission)	Available	Copy them to the client computer via the network. (The data which have been copied to the client computer cannot be copied to the shared folder.)
Print waiting data (Copying data and FAX reception data that are waiting to be printed due to the paper run-out and jam, etc.)	Not available	Finish printing them after supplying paper or releasing the jam, etc. (The data cannot be left.)
Print job (Private print data, Schedule print data)	Not available	If any jobs are left, print them. (The data cannot be backed up.)
FAX saved data (Confidential / Bulletin board data)	Not available	Print them. (The data cannot be backed up.)
Registration data for FAX transmission (Delayed transmission / Recovery transmission)	Not available	Print them. (The data cannot be backed up.)

[B] Print out “FUNCTION LIST FOR MAINTENANCE”

- (1) Enter the Service Mode. “3.2 Service UI”
- (2) Select “FAX LIST PRINT MODE” and then press [NEXT].
- (3) Select “Function list for Maintenance” and then press [PRINT].

[C] Print out “FUNCTION” list

- (1) Press the [USER FUNCTIONS] button.
- (2) Press the [ADMIN] button, enter the password, and then press the [ENTER] button.

Notes:

Explain the procedure to the user (machine administrator) and ask him/her to enter his/her password.

- (3) Press the [LIST/REPORT] button and then the [LIST] button.
- (4) Press the [FUNCTION] button. The “FUNCTION LIST FOR MAINTENANCE” is printed out.

[D] Erase HDD

In case of the ADI-HDD:

- (1) Turn the power ON while pressing [4] and the [CLEAR] button simultaneously.
- (2) Key in [1] to select "1: Revert factory install status HDD." and then press the [START] button.
- (3) Turn the power OFF.

[E] Replace / Format HDD

- (1) Confirm that the power is turned OFF.
- (2) Replace the HDD.
(Refer to  P. 6-6 "6.1.4 Hard disk (HDD)".)
- (3) Create the partitions on the HDD.
 1. Turn the power ON while pressing [3] and [CLEAR] button simultaneously.
 2. When "Firmware Assist Mode" appears on the LCD, key in [3] to select "3: Format HDD" and then press the [START] button.
 3. When "Operation Complete" is displayed on the LCD, creating of the partitions is completed.
- (4) Turn the power OFF.
- (5) Format the service tech password.
 1. Turn the power ON while pressing [3] and the [CLEAR] button simultaneously.
 2. When "Firmware Assist Mode" appears on the LCD, key in [8] to select "8. Clear Service Tech Password" and then press the [START] button.
 3. When "Reset Complete" is displayed on the LCD, formatting of the service tech password is completed.
- (6) Turn the power OFF.
- (7) Update the system software using the USB device.
See "8.2 Firmware Updating with USB Device" for details.
- (8) Turn the power OFF.
- (9) When the Fax Unit (GD-1340) is installed, perform "Fax Set Up" (1*-100) and "Clearing the image data" (1*-102). Then turn the power OFF.
- (10) Start up with the Setting mode (08).
- (11) Perform the panel calibration (08-9050).
 1. Touch the center of "+" mark displayed on the upper left of the LCD.
 2. Touch the center of "+" mark displayed on the upper right of the LCD.
 3. Touch the center of "+" mark displayed on the lower left of the LCD.
 4. Touch the center of "+" mark displayed on the lower right of the LCD.
- (12) Check the system software version (08-8952).
Confirm the version displayed on the LCD, and then press the [OK] button.
- (13) Initialization of NIC information (08-9083).
- (14) Turn the power OFF.

[F] Reset user's setting items and restore data/information

Ask the user (machine administrator) to reset the user's setting items and to restore data or information. Refer to the following for the reset and restore:

Items to reset/restore	Method
Printer driver	Upload them in the "Administrator" menu of Web Page.
F-code information, Template registering information, Address book data	Restore them in the "Administrator" menu of Web Page
Department management data	Import them in the "Administrator" menu of Web Page.
Image data in the Electronic Filing	Upload them in the "e-Filing" of Web Page.

- When the SSL is enabled, perform the setting of the following items again with "Self-signed certificate" of Web Page.
 - Country Name
 - State or Province Name
 - Locality Name
 - Organization Name
 - Organizational Unit Name
 - Common Name
 - Email Address
- When wireless LAN is used, perform the setting again on the LCD panel. (only when security with a certificate is used) Also, upload the following certificate file with "Install Certificate for Wireless LAN" of Web Page.
 - CA certificate
 - User certificate

[G] Reset "FUNCTION LIST FOR MAINTENANCE"

- (1) Print out the "FUNCTION LIST FOR MAINTENANCE" list after the formatting. For how to print it out, refer to [B] Print out "FUNCTION LIST FOR MAINTENANCE".
- (2) While pressing [1] and [3] simultaneously, turn the power ON. (Fax Function Mode)
- (3) Compare the lists which were printed before and after the formatting to check the setting items having the different setting values. Set the value which was set before the formatting.
- (4) Turn the power OFF.

[H] Reset "FUNCTION" list

Reset the fax function by referring to the "function list" that was printed out in [C] Print out "FUNCTION" list.

- (1) Press the [USER FUNCTIONS] button.
- (2) Press the [ADMIN] button, enter the password, and then press the [ENTER] button.

Notes:

Explain the user (machine administrator) about the next operation and ask him/her to enter his/her password.

- (3) Press the [FAX] button and then the [TERMINAL ID] button to set each item.
- (4) Press the [INITIAL SETUP] button to set each item.

[I] Adjust image quality

- (1) Start up with the Adjustment mode (05).
- (2) Enter the password, and then press the [OK] button.
(If the password is not set for Service, press the [ENTER] button without entering anything.)
- (3) Perform “Automatic gamma adjustment” (05-7165).
 P. 4-4 “4.2.1 Automatic gamma adjustment”
- (4) Turn the power OFF.

6.2.4 Precautions and Procedures when replacing the SYS board

A procedure for SYS board replacement is shown below.

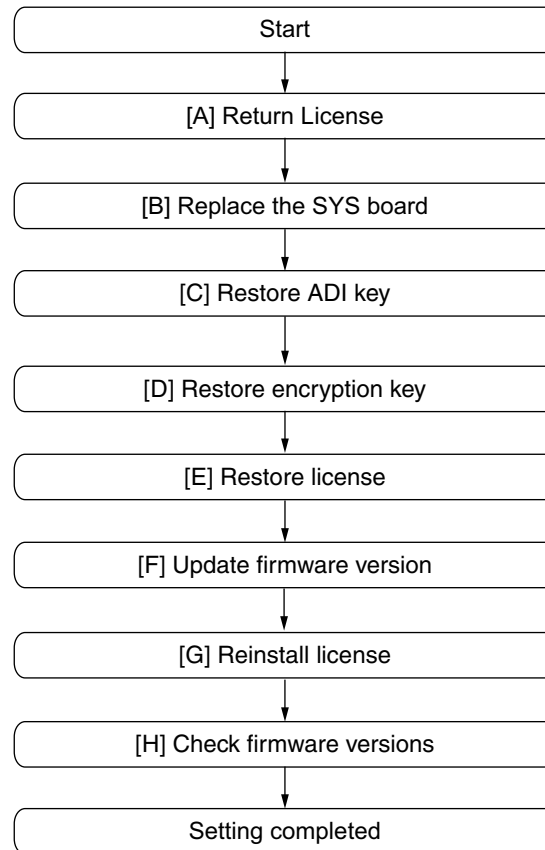

Fig.6-24

[A] Return License

Notes:

- If the Setting Mode (08) is not started up, “[A] Return License” can be omitted. In that case, reinstall the license with “[1] Re-registration when the board is replaced” if it is cleared since “[G] Reinstallation of License” cannot be performed.
- When installing the Data Overwrite Enabler (GP-1070) and security mode is setting High Security, set the security mode level to “1” (Low level). Then restart the equipment.

- (1) Start up with the Setting Mode (08).
- (2) Enter the password, and then press the [OK] button.
(If the password is not set for Service, press the [ENTER] button without entering anything.)
- (3) Key in [3840], and then press the [ENTER] button.
- (4) Select the license to be returned, and then press the [REMOVE] button.
- (5) Install the one-time dongle, which you used for uploading the selected license, in the equipment, and then press the [OK] button.
- (6) The Remove screen is displayed, then press the [YES] button. If this screen is not displayed, check whether the one-time dongle is installed in the equipment properly.

- (7) After 10 to 40 seconds passes, the screen for notifying the success of performance is displayed.
Then press the [OK] button. If this screen is not displayed or the screen for notifying the failure of performance is displayed, quit this operation by pressing the [NO]/[CLOSE] button. Then, check whether the one-time dongle, which you used for uploading the selected license, is installed in the equipment.
- (8) Check that the returned license is not displayed on the screen.

Remarks:

If there are any other licenses to be returned, repeat from step (4).

If there is no more licenses to be returned, press the [CLOSE] button, and then turn the power OFF.

[B] Replace the SYS board**Notes:**

Before replacing the SYS board, perform the following procedure.

 P. 6-10 “6.2.1 Precautions when replacing PC boards”

- (1) Confirm that the power is turned OFF.
- (2) Replace the SYS board.
- (3) Install DIMM (main memory) to the new SYS board (from the old SYS board).
- (4) Install SRAM board to the new SYS board (from the old SYS board).
- (5) Install HDD to the new SYS board (from the old SYS board).

[C] Restore ADI key

If the ADI-HDD is installed, follow the steps below. To confirm the type of device, start up the equipment in the 4C mode.

Notes:

If turning the power ON while pressing [3] and the [CLEAR] button simultaneously or restoring the key is not possible, update the system firmware using the download jig, and then perform this procedure again.

 P. 8-20 “8.4 Firmware Updating with PWA-DWNLD-JIG2”

- (1) Turn the power ON while pressing [3] and the [CLEAR] button simultaneously.
- (2) Enter the password, and then press the [OK] button. (If the password is not set for Service, press the [OK] button without entering anything.)
- (3) Key in [5] to select “5. Key Backup Restore”, and then press the [START] button.
- (4) Key in [5] to select “5. ADI Key SRAM to FROM”, and then press the [START] button.
- (5) Wait until the restoring of the encryption key is completed. “Operation Complete” is displayed.
- (6) Turn the power OFF.

[D] Restore encryption key**Notes:**

If turning the power ON while pressing [3] and the [CLEAR] button simultaneously or restoring the key is not possible, update the system firmware using the download jig, and then perform this procedure again.

 P. 8-20 “8.4 Firmware Updating with PWA-DWNLD-JIG2”

- (1) Turn the power ON while pressing [3] and the [CLEAR] button simultaneously.
- (2) Enter the password, and then press the [OK] button. (If the password is not set for Service, press the [OK] button without entering anything.)
- (3) Key in [5] to select “5. Key Backup Restore”, and then press the [START] button.
- (4) Key in [1] to select “1. Key SRAM to FROM”, and then press the [START] button.
- (5) Wait until the restoring of the encryption key is completed. “Operation Complete” is displayed.
- (6) Restart the equipment after the restoring is completed. If you want to perform the restoring of the license, do not restart the equipment but perform from (4) in “[H] Restore license”.

[E] Restore license**Notes:**

If turning the power ON while pressing [3] and the [CLEAR] button simultaneously or restoring the license is not possible, update the system firmware using the download jig, and then perform this procedure again.

 P. 8-20 “8.4 Firmware Updating with PWA-DWNLD-JIG2”

- (1) Turn the power ON while pressing [3] and the [CLEAR] button simultaneously.
- (2) Enter the password, and then press the [OK] button. (If the password is not set for Service, press the [OK] button without entering anything.)
- (3) Key in [5] to select “5. Key Backup Restore”, and then press the [START] button.
- (4) Key in [3] to select “3. License SRAM to FROM”, and then press the [START] button.
- (5) Wait until the restoring of the license is completed. “Operation Complete” is displayed.
- (6) After the restoring is completed, check that “OK” is indicated in “SRAM License STATUS” and “FROM License Status”. Then, restart the equipment.
- (7) If “4. License FROM to SRAM” is performed by mistake, carry out the following procedure.

 P. 6-29 “[1] Re-registration when the board is replaced”

[F] Update firmware version

- (1) Update the version of system firmware using the USB device.

 P. 8-3 “8.2 Firmware Updating with USB Device”

[G] Reinstall license

If the license was returned in “[A] Return License”, reinstall it with the following procedure.

- (1) Turn the power ON while pressing [0] and [8] simultaneously.
- (2) Enter the password, and then press the [OK] button.
(If the password is not set for Service, press the [ENTER] button without entering anything.)
- (3) Key in [3840], and then press the [START] button.
- (4) Press the [INSTALL] button.
- (5) Install the one-time dongle in the equipment (the one which you used for returning the selected license before replacing the equipment). Then press the [OK] button.
- (6) Select the license to be installed, and then press the [INSTALL] button.
- (7) The screen for notifying that the installation will be started is displayed. Then press the [YES] button.
- (8) After 10 to 40 seconds have passed, the screen for notifying the success of the performance is displayed. Then press the [OK] button. If the screen for notifying a failure of the performance is displayed, quit this operation by pressing the [NO] button. Then check that the one-time dongle is installed properly in the equipment.
- (9) Check that the installed license is displayed on the license list.

Remarks:

If there are any other licenses to be installed, repeat from step (4). If there are no other licenses to be installed, press the [CLOSE] button, and then turn the power OFF.

[H] Check firmware versions

- System firmware version (08-9930)

Notes:

If the security mode is changed from High Security to Low Security in the step “[A] Return License”, set the value of 08-8911 to “3” (High Security).

6.2.5 Precautions and procedure when replacing the SRAM board (for the SYS board)

Notes:

Do not replace the HDD and the SRAM board (for the SYS board) together.
Be careful not to damage the board when replacing the SRAM board.

A procedure for replacing the SRAM board is shown below.

When disposing of the SRAM board, perform the items in  P. 6-31 “6.3.4 Precautions when disposing of the SRAM board (for SYS board)”.

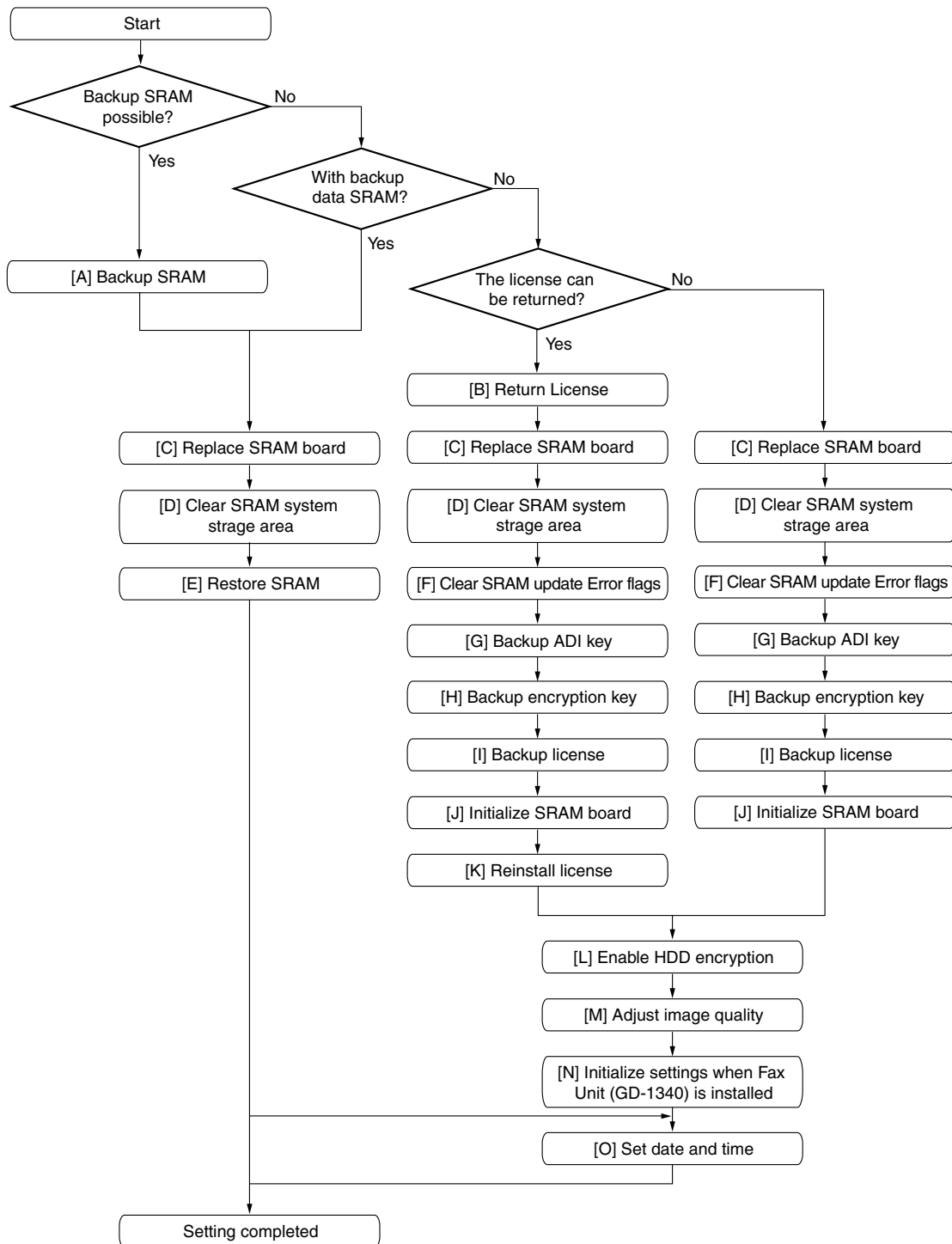

Fig. 9-2

Notes:

“[G] Backup ADI key” is required only for the equipment in which the ADI-HDD has been installed. Other procedures are the same as those for installing the SATA-HDD.

[A] Backup SRAM**Notes:**

If “[A] Backup SRAM” fails, proceed to “[B] Return License”.

If “[A] Backup SRAM” succeeds, proceed to “[C] Replace SRAM board”.

- (1) Turn the power ON while pressing [6] and the [CLEAR] button simultaneously.
- (2) When “SRAM Clear Mode” appears on the LCD, key in [0] to select “0. Set Serial Number” and then press the [START] button.
- (3) Key in the serial number on the label attached to the rear cover of the equipment, and then press the [OK] button.
- (4) “Serial Number Setting completed” is displayed.
- (5) Turn the power OFF.
- (6) Install the USB device in the equipment, and then turn the power ON while pressing [5] and [9] buttons simultaneously.
- (7) Key in [1] to select “1. Backup SRAM Data to USB”, and then press the [START] button.
- (8) Enter a password (max. 15 characters) to be set for the backup data.
- (9) Restart the equipment after the backup is completed.
- (10) Turn the power OFF.

[B] Return License**Notes:**

When installing the Data Overwrite Enabler (GP-1070) and security mode is setting High Security, set the security mode level to “1” (Low level). Then restart the equipment.

- (1) Start up with the Setting Mode (08).
- (2) Enter the password, and then press the [OK] button.
(If the password is not set for Service, press the [ENTER] button without entering anything.)
- (3) Key in [3840], and then press the [ENTER] button.
- (4) Select the license to be returned, and then press the [REMOVE] button.
- (5) Install the one-time dongle, which you used for uploading the selected license, in the equipment, and then press the [OK] button.
- (6) The Remove screen is displayed, then press the [YES] button. If this screen is not displayed, check whether the one-time dongle is installed in the equipment properly.
- (7) After 10 to 40 seconds passes, the screen for notifying the success of performance is displayed.
Then press the [OK] button. If this screen is not displayed or the screen for notifying the failure of performance is displayed, quit this operation by pressing the [NO]/[CLOSE] button. Then, check whether the one-time dongle, which you used for uploading the selected license, is installed in the equipment.
- (8) Check that the returned license is not displayed on the screen.

Remarks:

If there are any other licenses to be returned, repeat from step (4).

If there is no more licenses to be returned, press the [CLOSE] button, and then turn the power OFF.

[C] Replace SRAM board

- (1) Confirm that the power is turned OFF.
- (2) Take off the Fax Unit (GD-1340) if it is installed.
- (3) Replace the SRAM board (for the SYS board).
 P. 6-8 “6.1.5 SRAM board <for SYS board>”

[D] Clear SRAM system storage area

- (1) Turn the power ON while pressing [6] and [CLEAR] simultaneously.
- (2) When “SRAM Clear Mode” appears on the LCD, key in [1] to select “1. Clear SRAM” and then press the [START] button.
- (3) When “SRAM Format Completed” is displayed on the LCD, initializing is completed.
- (4) Turn the power OFF.

[E] Restore SRAM

If there is SRAM backup data, perform the following steps.

- (1) Turn the power ON while pressing [6] and the [CLEAR] button simultaneously.
- (2) When “SRAM Clear Mode” appears on the LCD, key in [0] to select “0. Set Serial Number” and then press the [START] button.
- (3) Key in the serial number on the label attached to the rear cover of the equipment, and then press the [OK] button.
- (4) “Serial Number Setting completed” is displayed.
- (5) Turn the power OFF.
- (6) Install the USB device in the equipment, and then turn the power ON while pressing [5] and [9] simultaneously.
- (7) Key in [2] to select “2. Restore SRAM Data from USB” and then press the [START] button.
- (8) Enter the password set for the backup data.
- (9) Enter the serial number of the backup file.
- (10) Turn the power OFF after the restoring of SRAM is completed.

Remarks:

When the restoration is completed successfully, do not perform “[F] Clear SRAM update error flags” or later procedures.

End this procedure here and finish replacing the SRAM board (for SYS board).

- (11) Reinstall the GD-1340 Fax Unit if used.

[F] Clear SRAM update Error flags

- (1) Turn the power ON while pressing [3] and the [CLEAR] button simultaneously.
- (2) Enter the password, and then press the [OK] button. (If the password is not set for Service, press the [ENTER] button without entering anything.)
- (3) After “Firmware Assist Mode” is displayed on the LCD, check that “1: Clear Error Flag in Software Installation.” is marked and press the [START] button.
If not, key in [1] and then press the [START] button.
- (4) When “Operation Complete” is displayed on the LCD, clearing the flag is completed.
- (5) Turn the power OFF.

[G] Backup ADI key

If the ADI-HDD is installed, follow the steps below. To confirm the type of device, start up the equipment in the 4C mode.

- (1) Turn the power ON while pressing [3] and the [CLEAR] button simultaneously.
- (2) Enter the password, and then press the [OK] button. (If the password is not set for Service, press the [OK] button without entering anything.)
- (3) Key in [5] to select "5. Key Backup Restore", and then press the [START] button.
- (4) Key in [6] to select "6. ADIKey FROM to SRAM", and then press the [START] button.
- (5) Wait until the backup of the ADI key is completed. "Operation Complete" is displayed.
- (6) Restart the equipment after the backup is completed.
If you want to perform the backup of the license, do not restart the equipment but perform from (4) in "[H] Backup encryption key".

[H] Backup encryption key

- (1) Turn the power ON while pressing [3] and the [CLEAR] button simultaneously.
- (2) Enter the password, and then press the [OK] button. (If the password is not set for Service, press the [ENTER] button without entering anything.)
- (3) Key in [5] to select "5. Key Backup Restore", and then press the [START] button.
- (4) Key in [2] to select "2. Key FROM to SRAM", and then press the [START] button.
- (5) Wait until the backup of the encryption key is completed. "Operation Complete" is displayed.
- (6) Restart the equipment after the backup is completed. If you want to perform the backup of the license, do not restart the equipment but perform from (4) in "[I] Backup license".
- (7) Turn the power OFF.

[I] Backup license**Notes:**

If "3. License SRAM to FROM" is performed by mistake, carry out the following procedure.

 P. 6-29 "[1] Re-registration when the board is replaced"

- (1) Turn the power ON while pressing [3] and the [CLEAR] button simultaneously.
- (2) Enter the password, and then press the [OK] button. (If the password is not set for Service, press the [ENTER] button without entering anything.)
- (3) Key in [5] to select "5. Key Backup Restore", and then press the [START] button.
- (4) Key in [4] to select "4. License FROM to SRAM", and then press the [START] button.
- (5) Wait until the backup of the license is completed. "Operation Complete" is displayed.
- (6) Restart the equipment after the backup is completed.
- (7) Turn the power OFF.

[J] Initialize SRAM board

- (1) Start up with the Setting Mode (08).
- (2) Initialize the SRAM error.
 1. When “SRAM REQUIRES INITIALIZATION” is displayed on the LCD, check the destination and then press the [START] button.
If the destination is not correct, key in the correct one and then press the [START] button.
 2. After the confirmation message is displayed, press the [INTERRUPT] button.
- (3) Perform the panel calibration (08-9050).
 1. Touch the center of “+” mark displayed on the upper left of the LCD.
 2. Touch the center of “+” mark displayed on the upper right of the LCD.
 3. Touch the center of “+” mark displayed on the lower left of the LCD.
 4. Touch the center of “+” mark displayed on the lower right of the LCD.
- (4) Set the line mode to OFF by setting the value of 08-9010 to “0”.
- (5) Perform the initialization at the software version upgrade (08-9030).
- (6) Initialize the NIC information (08-9083).
- (7) Enter the serial number (08-9601).
Key in the serial number on the label attached to the rear cover of the equipment, and then press the [OK] button.
- (8) Turn the power off.

[K] Reinstall license

If the license was returned in “[B] Return License”, reinstall it with the following procedure.

- (1) Turn the power ON while pressing [0] and [8] simultaneously.
- (2) Enter the password, and then press the [OK] button.
(If the password is not set for Service, press the [ENTER] button without entering anything.)
- (3) Key in [3840], and then press the [START] button.
- (4) Press the [INSTALL] button.
- (5) Install the one-time dongle in the equipment (the one which you used for returning the selected license before replacing the equipment). Then press the [OK] button.
- (6) Select the license to be installed, and then press the [INSTALL] button.
- (7) The screen for notifying that the installation will be started is displayed. Then press the [YES] button.
- (8) After 10 to 40 seconds have passed, the screen for notifying the success of the performance is displayed. Then press the [OK] button. If the screen for notifying a failure of the performance is displayed, quit this operation by pressing the [NO] button. Then check that the one-time dongle is installed properly in the equipment.
- (9) Check that the installed license is displayed on the license list.

Remarks:

- If there are any other licenses to be installed, repeat from step (4).
- If there are no other licenses to be installed, press the [CLOSE] button, and then turn the power OFF.

[L] Enable HDD encryption

If the HDD encryption function is used, follow the procedure below.

- (1) Start up with the Setting mode (08).
- (2) Enter the password, and then press the [OK] button.
(If the password is not set for Service, press the [ENTER] button without entering anything.)
- (3) Enable the encryption function.
 - For high security mode
Set the value of 08-8911 to "3".
 - For enabling HDD encryption only
Set the value of 08-8911 to "1", and then set the value of 08-9379 to "1" (Security priority) or "2" (Performance priority).
- (4) Turn the power OFF.

[M] Adjust image quality

- (1) Start up with the Adjustment mode (05).
- (2) Enter the password, and then press the [OK] button.
(If the password is not set for Service, press the [ENTER] button without entering anything.)
- (3) Perform "Automatic gamma adjustment" (05-7165).
 P. 4-4 "4.2.1 Automatic gamma adjustment"
- (4) Turn the power OFF.

[N] Initialize settings when FAX Unit (GD-1340) is installed

- (1) Reinstall the FAX Unit (GD-1340).
- (2) Start up with the Setting mode (08).
- (3) Enter the password, and then press the [OK] button.
(If the password is not set for Service, press the [ENTER] button without entering anything.)
- (4) Set the destination of FAX (08-9001).
- (5) Turn the power OFF.
- (6) Start up with the FAX Clearing Mode (1*).
- (7) Perform the FAX Set Up (1*-100).
- (8) Turn the power OFF and then back ON.
- (9) Set the dial type according to these buttons: [USER FUNCTIONS] → [ADMIN] → [FAX] → [INITIAL SETUP]

[O] Set date and time

Set the date and time according to these buttons.

[USER FUNCTIONS] → [ADMIN] → [GENERAL] → [CLOCK] → [DATE/TIME]

6.2.6 Precautions and Procedures when replacing the PU board

Refer to the Hardware Guide for the replacement procedure of the PU board.

6.2.7 Precautions and Procedures when replacing the SU board

Refer to the Hardware Guide for the replacement procedure of the SU board.

6.2.8 Firmware confirmation after the PC board/HDD replacement

After replacing the PC board/HDD, check the firmware version in the setting mode (08) and confirm if the firmware combination is correct.

Firmware	Code	Remarks
System firmware (OS data)	08-9930	System firmware version
PU firmware	08-9901	PU firmware version
SU firmware	08-9902	SU firmware version
System firmware (HDD program data)	08-8952	HD data external version
	08-9900	System software version
Finisher firmware	08-9904	Finisher firmware version
FAX firmware	08-9905	FAX firmware version

6.2.9 License re-registration using the one-time dongle

[1] Re-registration when the board is replaced

The license registered using the one-time dongle can be re-registered only in the same equipment. When the SYS board or SRAM board (for SYS board) is replaced, follow the procedures for re-registration given below.

- (1) Start up with the Setting Mode (08).
- (2) Enter the password, and then press the [OK] button.
(If the password is not set for Service, press the [ENTER] button without entering anything.)
- (3) Key in [3840], and then press the [START] button.
- (4) Press the [INSTALL] button.
- (5) Install the one-time dongle in the equipment (the one which you used for registering the selected license), and then press the [OK] button.
- (6) Select the license to be installed, and then press the [INSTALL] button.
- (7) The screen for notifying that the installation will be started is displayed. Then press the [YES] button.
- (8) After 10 to 40 seconds have passed, the screen for notifying the success of the performance is displayed. Then press the [OK] button. If the screen for notifying a failure of the performance is displayed, quit this operation by pressing the [CLOSE] button. Then check that the one-time dongle, which you used for uploading the selected license, is installed in the equipment.
- (9) Check that the installed license is displayed on the license list.

Remarks:

If there are any other licenses to be returned, repeat from step (4). If there are no other licenses to be returned, press the [CLOSE] button, and then turn the power OFF.

Notes:

This procedure is available only with the one-time dongle used for the previous registration, since the model information registered in it is utilized. Use the same one-time dongle and the equipment when registering the license.

[2] Re-registration when the equipment is replaced due to malfunction

When the equipment has to be replaced due to a malfunction, return the license registered in the equipment to the one-time dongle and register it to the new equipment following the procedure below.

Notes:

The license of the IPSec Enabler (GP-1080) cannot be reinstalled. The one-time dongle to be used is the one for the previous registration of the license. The license is deleted from the equipment and is stored in the one-time dongle.

Do not perform the deletion of PDF/A Converter since it is deleted without any return to the one-time dongle.

- (1) Start up with the Setting Mode (08).
- (2) Enter the password, and then press the [OK] button.
(If the password is not set for Service, press the [ENTER] button without entering anything.)
- (3) Key in [3840], and then press the [START] button.
- (4) Select the license to be returned, and then press the [REMOVE] button.
- (5) Install the one-time dongle in the equipment (the one which you used for uploading the selected license), and then press the [OK] button.

- (6) The Remove screen is displayed. Then press the [YES] button.
If this screen is not displayed, check that the one-time dongle is installed in the equipment properly.
- (7) After 10 to 40 seconds have passed, the screen for notifying the success of the performance is displayed. Then press the [OK] button.
If the screen for notifying a failure of the performance is displayed, quit this operation by pressing the [CLOSE] button. Then check that the one-time dongle, which you used for uploading the selected license, is installed in the equipment.
- (8) Check that the returned license is not displayed on the screen.

Remarks:

If there are any other licenses to be returned, repeat from step (4).

If there are no other licenses to be returned, press the [CLOSE] button, and then turn the power OFF.

- (9) Replace the equipment.
- (10) Turn the power ON while pressing [0] and [8] simultaneously.
- (11) Enter the password, and then press the [OK] button.
(If the password is not set for Service, press the [ENTER] button without entering anything.)
- (12) Key in [3840], and then press the [START] button.
- (13) Press the [INSTALL] button.
- (14) Install the one-time dongle in the equipment (the one which you used for returning the selected license before replacing the equipment). Then press the [OK] button.
- (15) Select the license to be installed, and then press the [INSTALL] button.
- (16) The screen for notifying that the installation will be started is displayed. Then press the [YES] button.
- (17) After 10 to 40 seconds have passed, the screen for notifying the success of the performance is displayed. Then press the [OK] button. If the screen for notifying a failure of the performance is displayed, quit this operation by pressing the [NO] button. Then check that the one-time dongle is installed properly in the equipment.
- (18) Check that the installed license is displayed on the license list.

Remarks:

If there are any other licenses to be installed, repeat from step (13). If there are no other licenses to be installed, press the [CLOSE] button, and then turn the power OFF.

6.3 Precautions for Installation of GP-1070 and Disposal of HDD/ Board

6.3.1 Precautions for Installation of GP-1070

When installing the Data Overwrite Enabler (GP-1070), perform the following setting:

3C→6. Erase HDD Securely : HDD securely erasing

This setting is the overwriting method complying with DoD 5220.22-M.

- 1: LOW: This is the normal overwriting method. (This setting is used normally.)
- 2: MEDIUM: This overwriting method is more secure than LOW. The erasing time is between LOW and HIGH.
- 3: HIGH: This is the most secure overwriting method. It takes the longest time to erase data
- 4:SIMPLE: This is the simple overwriting method. It takes the shortest time to erase data.

6.3.2 Precautions when disposing of HDD

[1] When disposing of ADI-HDD

When disposing of ADI-HDD, perform the following setting:

4C → 1. Revert factory initial status HDD

[2] When disposing of SATA-HDD

When disposing of SATA-HDD, perform the following setting:

3C → 6. Erase HDD Securely (HDD securely erasing)

This setting is the overwriting method complying with DoD 5220.22-M.

- 1: LOW: This is the normal overwriting method. (This setting is used normally.)
- 2: MEDIUM: This overwriting method is more secure than LOW. The erasing time is between LOW and HIGH.
- 3: HIGH: This is the most secure overwriting method. It takes the longest time to erase data.
- 4:SIMPLE: This is the simple overwriting method. It takes the shortest time to erase data.

6.3.3 Precautions when disposing of the SYS board

When disposing of the SYS board, data clearing is not required since important data, such as user information, etc. are stored in the SRAM board.

6.3.4 Precautions when disposing of the SRAM board (for SYS board)

When disposing of the SRAM board (for SYS board), perform 3C → 7:Erase SRAM Securely (SRAM securely erasing) for security reasons.

Notes:

If this is performed, the equipment cannot be started up.

7. REMOTE SERVICE

There are following functions as Remote Service.

1. Auto Supply Order
Automatically orders the toner by FAX or E-mail.
2. Service Notification
Notifies the status of the equipment to the service technician by E-mail or FAX.

7.1 Auto Supply Order

7.1.1 Outline

Automatically orders the toner.

(1) Placing an Order

There are two ways to place an order.

- FAX
Installation of the FAX board is required.
If the FAX board has not been installed, it is regarded as OFF setting.
- E-mail (E-mail body + TIFF image)

(2) Order Intervals

When the toner empty occurs, the number of occurrences is counted. And when it reaches the specified number for CONDITION, the order is placed automatically.

The number of the CONDITION can be set respectively for the toner.

(3) If Order Failure Occurs

If some problems occur and the order cannot be placed after registering an order as a job, refer to the standard countermeasure for the FAX/E-mail transmission failure.

7.1.2 Setting Item

To enable Auto Supply Order, the following settings are required.

Notes:

When selecting E-mail to place an order, it is required that sending and receiving E-mails are available. Confirm the details to the administrator.

(1) Self-diagnosis (08) Setting

As the default setting, the Auto Supply Order setting screen is not displayed on the touch panel. To display it, switching the Valid/Invalid setting (08-9783) is required.

- 0: Valid (FAX/Internet FAX)
- 1: Valid (FAX/Internet FAX/HTTP)*
- 2: Invalid (Default)

When changing the setting value from "2" (default) to "0", the Auto Supply Order setting screen is displayed. (* HTTP has not been supported yet.)

(2) Touch Panel Setting

Each item is set from the Auto Supply Order screen on the touch panel.

Entering the password and customer information is required because the setting is made from the ADMIN screen. Setting it with the administrator is a must.

- Basic setting
[ADMIN] > [SERVICE] > [SUPPLY ORDER SETUP] > [ORDER INFORMATION]

AUTO SUPPLY ORDER	Ordered by: [FAX], [MAIL], [HTTP] (*1)
FAX NUMBER	FAX number of supplier (*2)
E-MAIL	E-mail address of supplier (*3)
CUSTOMER	Customer information
NAME	
TEL NUMBER	
E-MAIL	
ADDRESS	
SUPPLIER	Supplier information
NAME	
ADDRESS	
SERVICE TECNICIAN	Service technician information
NUMBER	
NAME	
TEL NUMBER	
E-MAIL	

*1 HTTP has not been supported yet.

*2 Even when "FAX" is selected, the order is not placed without entering the FAX number.

*3 Even when "MAIL" is selected, the order is not placed without entering the E-mail address.

- Detailed setting for the order
[ADMIN] > [SERVICE] > [SUPPLY ORDER SETUP] > [TONER ORDERING]

***** TONER ORDER	Order information (TONER)
PART NUMBER	Part number to be ordered
CONDITIOIN	The number of conditions (*)
QUANTITY	The quantity to be ordered
AUTO ORDER	ON/OFF setting of order for each part

* The order is placed when the number of replacement reaches the number specified for the CONDITION.

- FAX number of this equipment (common information)
[ADMIN] > [FAX] > [TERMINAL ID]

ID NAME	ID name of this equipment
FAX NUMBER	FAX number of this equipment

- E-mail information of this equipment (common information)
[ADMIN] > [E-MAIL]

FROM ADDRESS	E-mail address of this equipment (*)
FROM NAME	E-mail username of this equipment

* When sending an E-mail, validity of the address is checked. If the address is invalid, it is not sent.

(3) Output of setting list of the Auto Supply Order.

1. Enter the Service UI Mode.  P. 3-5 “3.2 Service UI”
2. Select “FAX LIST PRINT MODE” and then press [NEXT].
3. Select “SUPPLY ORDER LIST” and then press [PRINT].

7.1.3 Setting procedure

- (1) Start up the self-diagnosis setting mode 08-9783, and then change the setting value to "0".
- (2) Turn the power OFF, and then ON.
- (3) Press the [USER FUNCTIONS] button to enter the user function screen.
- (4) Press the [ADMIN] button.

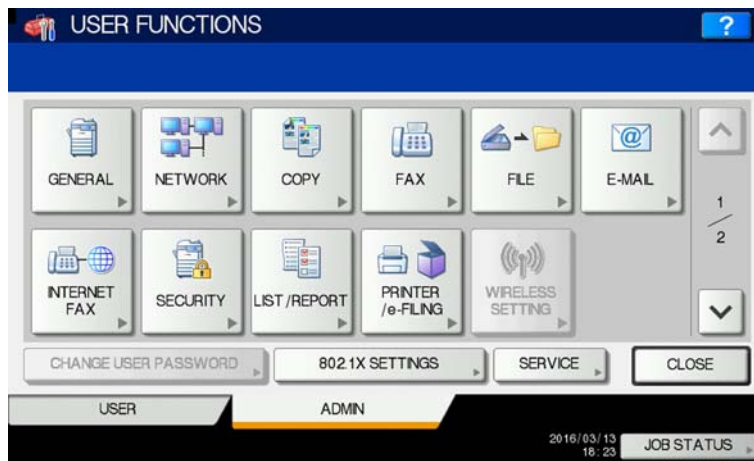

Fig.7-1

When the Administrator Password has been set, ADMINISTRATOR PASSWORD screen is displayed.

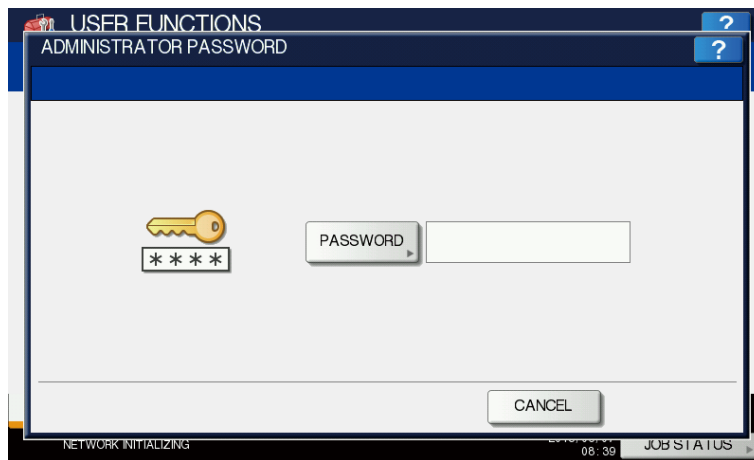

Fig. 7-2

- (5) Press the [PASSWORD] button and the screen is switched to a full keyboard. Then key in the Administrator Password and press the [OK] button.
 - * Confirm the password to the administrator.
- (6) Press the [SERVICE] button in the ADMIN screen.

(7) The SERVICE screen is displayed.

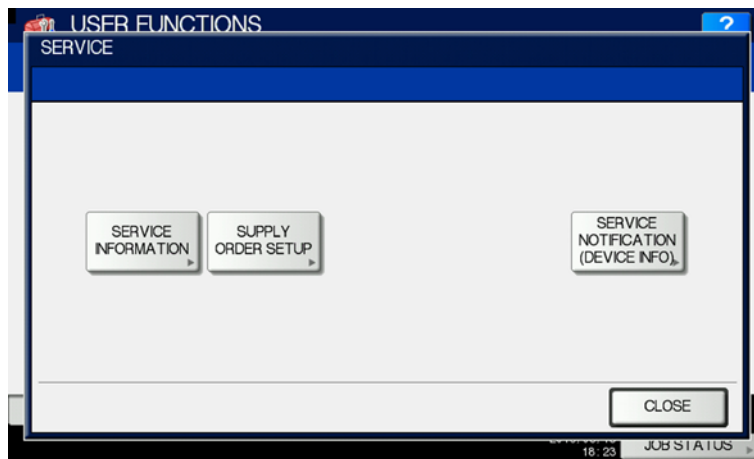

Fig. 7-3

(8) Press the [SUPPLY ORDER SETUP] button.

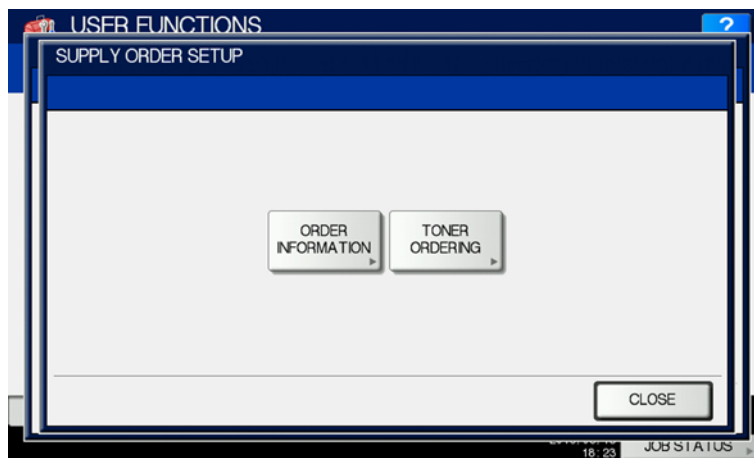

Fig. 7-4

(9) Press the [ORDER INFORMATION] button.

(10) The ORDER INFORMATION screen is displayed.

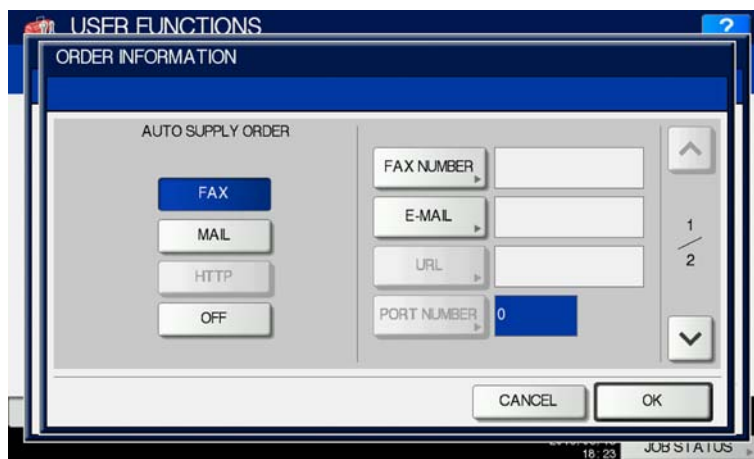

Fig. 7-5

(11) Press the buttons on the screen of ORDER INFORMATION to set the required item.

- [FAX]/[MAIL]/ [OFF] Select the [FAX] or the [MAIL] button for the transmitting way of order.
(HTTP has not been supported yet.)
[OFF]: Turn off the AUTO SUPPLY ORDER function.
- [FAX NUMBER] Input the FAX number of supplier.
(To transmit by FAX, the order cannot be placed automatically if you do not input the number.)
- [E-MAIL] Input the E-mail address of supplier.
(To transmit by E-mail, the order cannot be placed automatically if you do not input the address.)

(12) Press the scroll button.

(Press the [OK] button to register, and then the screen returns to the (7) SERVICE screen.
Press the [CANCEL] button to cancel this register, and then the screen returns to the (7) SERVICE screen.)

(13) The SUPPLIER screen is displayed.

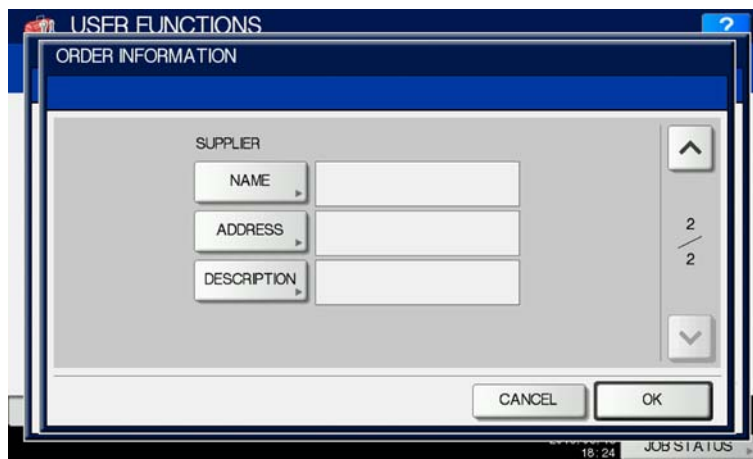

Fig. 7-6

(14) Press the buttons of the screen of SUPPLIER to set the required item.

- [NAME] Input the name of supplier.
- [ADDRESS] Input the address of supplier.

(15) Press the [OK] button.

(16) The SERVICE screen is displayed.

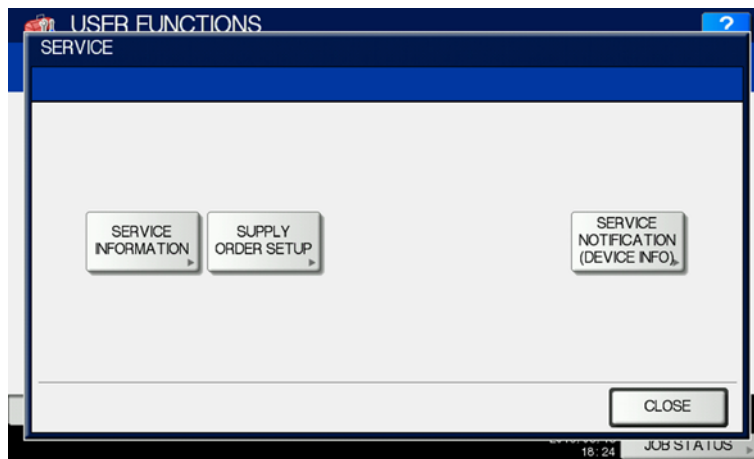

Fig. 7-7

(17) Press the [SERVICE INFORMATION] button.

(18) The CUSTOMER/SERVICE TECHNICIAN screen is displayed.

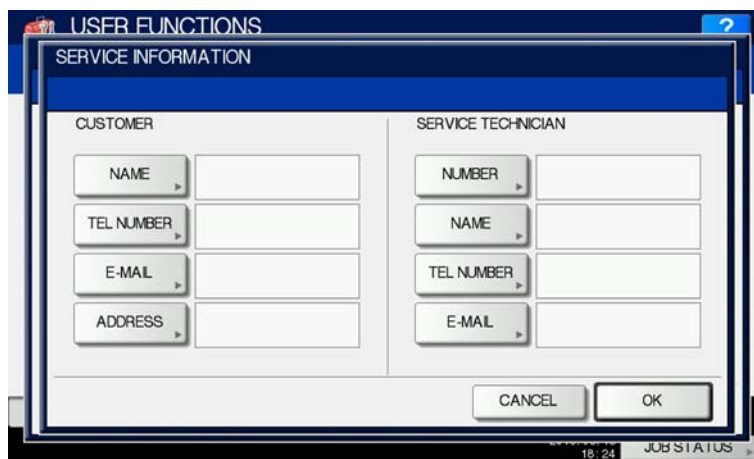

Fig. 7-8

(19) Press the buttons of the screen of CUSTOMER/SERVICE TECHNICIAN to set the required item.

CUSTOMER

- | | |
|--------------|---|
| [NAME] | Input the name of customer. |
| [TEL NUMBER] | Input the telephone number of customer. |
| [E-MAIL] | Input the E-mail address of customer. |
| [ADDRESS] | Input the address of customer. |

SERVICE TECHNICIAN

- | | |
|--------------|---|
| [NUMBER] | Input the number of SERVICE TECHNICIAN. |
| [NAME] | Input the name of SERVICE TECHNICIAN. |
| [TEL NUMBER] | Input the telephone number of SERVICE TECHNICIAN. |
| [E-MAIL] | Input the E-mail address of SERVICE TECHNICIAN. |

(20) Press the [OK] button to register and complete the order information setting.

(21) The SERVICE screen is returned.

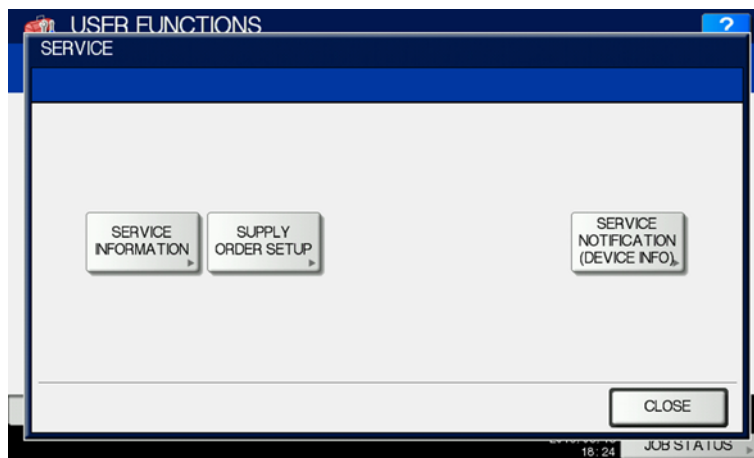

Fig. 7-9

(22) Press the [SUPPLY ORDER SETUP] button.

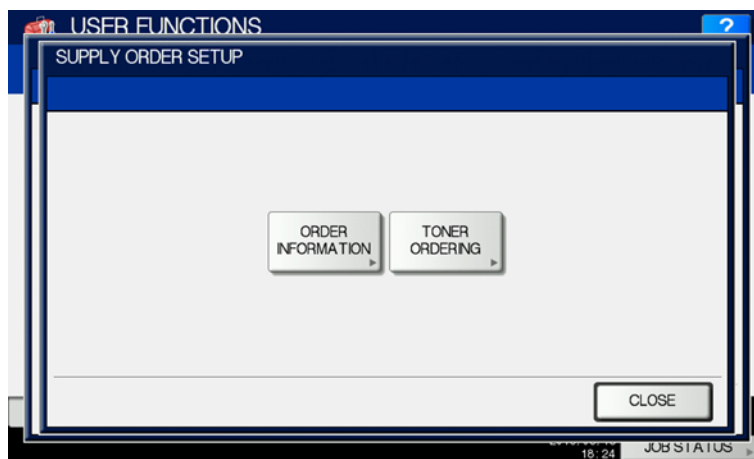

Fig. 7-10

(23) Press the [TONER ORDERING] button.

(24) The TONER ORDERING screen is displayed.

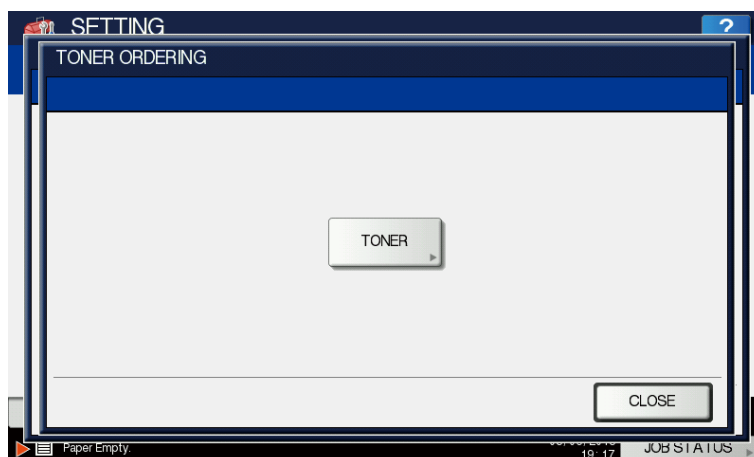

Fig. 7-11

(25) Press the [TONER] button.

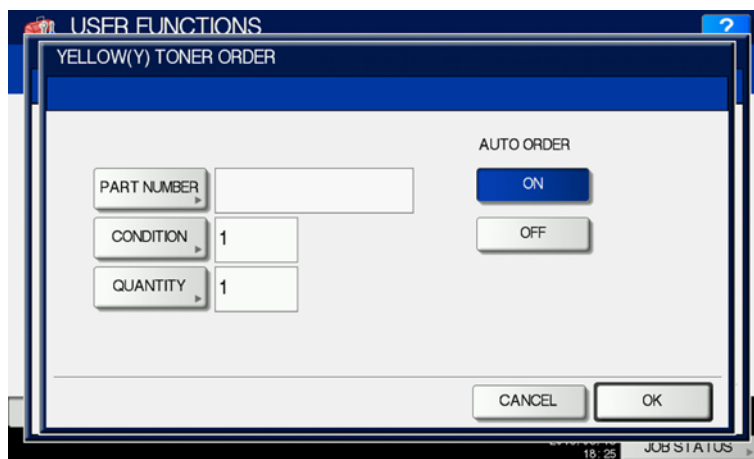

Fig. 7-12

(26) Input the order information of TONER.

- [PART NUMBER] Toner number
- [CONDITION] The order is placed when the number of toner empty reaches the number specified for the CONDITION.
- [QUANTITY] Quantity to be ordered

AUTO ORDER

- [ON]/[OFF] Allows you to select whether each part to be ordered is placed automatically or not.

(27) Press the [OK] button to register the setting of toner order.

(28) The TONER ORDERING screen is displayed.

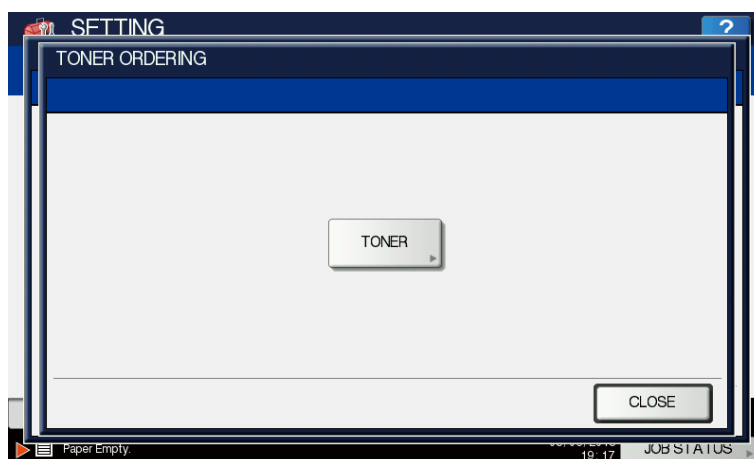

Fig. 7-13

(29) Press the [CLOSE] button.

Notes:

Auto Supply Order setting is also available from the following setting mode (08).

Items	08 code	Contents
The transmitting way of order [FAX]/[MAIL] /[OFF]	9750	0: Ordered by FAX 1: Ordered by E-mail 2: Ordered by HTTP 3: OFF
SUPPLIER [FAX NUMBER]	9751	Maximum 32 digits
SUPPLIER [E-MAIL]	9752	Maximum 192 letters
CUSTOMER [NAME]	9756	Maximum 50 letters
CUSTOMER [TEL NUMBER]	9757	Maximum 32 digits
CUSTOMER [E-MAIL]	9758	Maximum 192 letters
CUSTOMER [ADDRESS]	9759	Maximum 100 letters
SUPPLIER [NAME]	9764	Maximum 50 letters
SUPPLIER [ADDRESS]	9765	Maximum 100 letters
SERVICE TECHNICIAN [NUMBER]	9760	Maximum 5 digits
SERVICE TECHNICIAN [NAME]	9761	Maximum 50 letters
SERVICE TECHNICIAN [TEL NUMBER]	9762	Maximum 32 digits
SERVICE TECHNICIAN [E-MAIL]	9763	Maximum 192 letters
Remarks [DESCRIPTION]	9766	Maximum 128 letters
RESULT PRINTING [OFF] / [ALWAYS] / [ON ERROR]	9782	0: OFF 1: Always 2: ON Error
BLACK TONER [PART NUMBER]	9776	Maximum 20 digits
BLACK TONER [CONDITION]	9778	1-99
BLACK TONER [QUANTITY]	9777	1-99

(30) The SERVICE screen is returned.

(31) Press the [SERVICE NOTIFICATION (DEVICE INFO)] button.

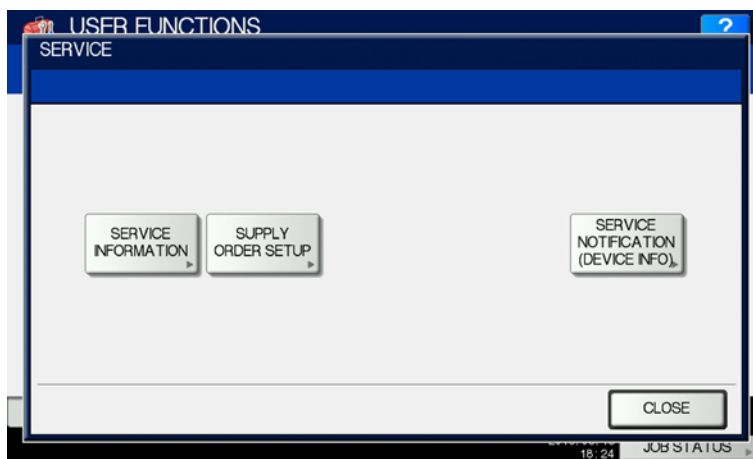

(32) Press the [ON] or [OFF] button in "Service Notification (Device Info)".

When the [OFF] button is pressed, all functions related Service Notification (Device Info) become ineffective.

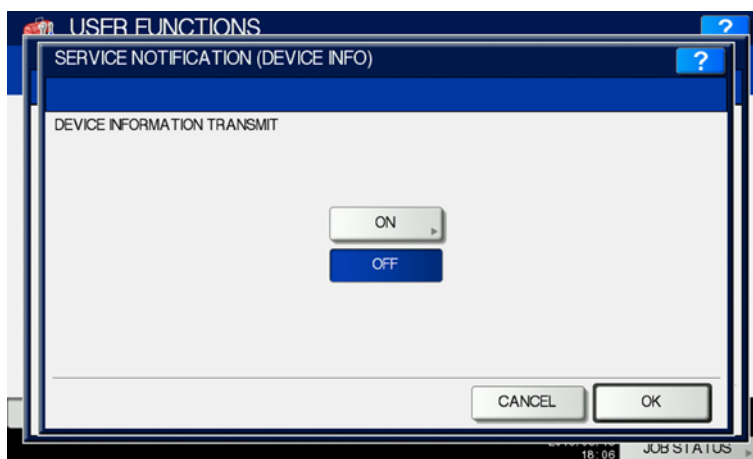

Fig. 7-14

(33) When Service Notification (Device Info) is set to ON, the screen to set the notification date is displayed.

Then set the notification date with the following procedure.

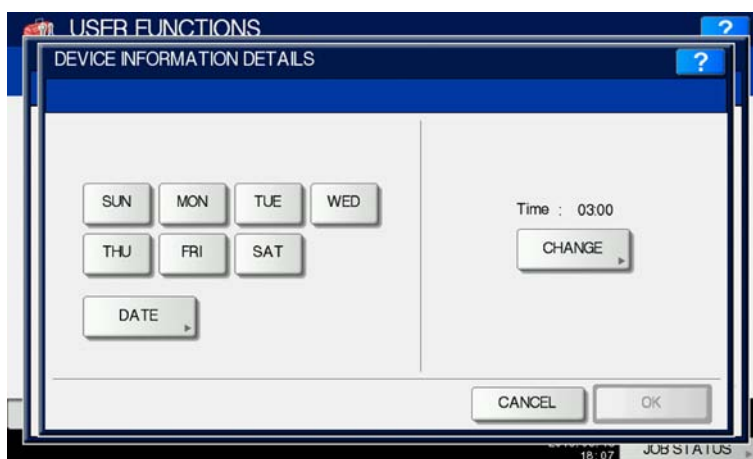

Fig. 7-15

Set the date and time of the Total Counter.

The following 3 items can be specified for the date setting, and more than one day of the week also can be selected.

- Day of the week (More than one day can be selected.)
- Notify Date 1
- Notify Date 2

- **Day of the week ([SUN] to [SAT] buttons)**
 Pressing the buttons ([Sunday] to [Saturday]) of the desired day makes transmission on every specified day. More than one day can be selected.
 * This does not affect the settings of “Notify Date 1” and “Notify Date 2”.
- **Notify Date 1 and Notify Date 2 ([DATE] button)**
 Pressing the [DATE] button sets up to 2 dates on which you want to send data.
 * This is not affected by the specified day of the week.

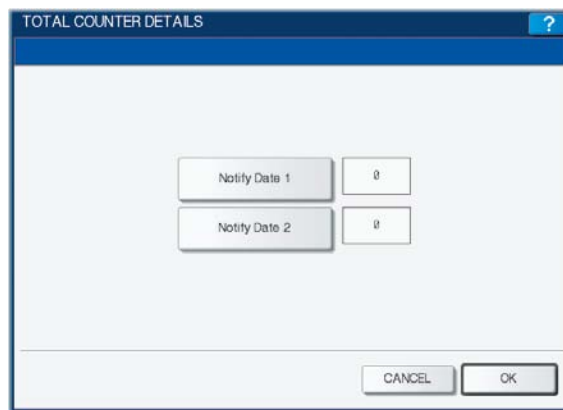

Fig. 7-16

Key in the date (acceptable values: 0-31) in “Notify Date 1” or “Notify Date 2” and press the [OK] button.

- **Time setting ([CHANGE] button)**
 Pressing the [CHANGE] button sets the time at which you want to send data.
 This is the time when data are sent with “Day of the week”, “Notify Date 1” and “Notify Date 2”.

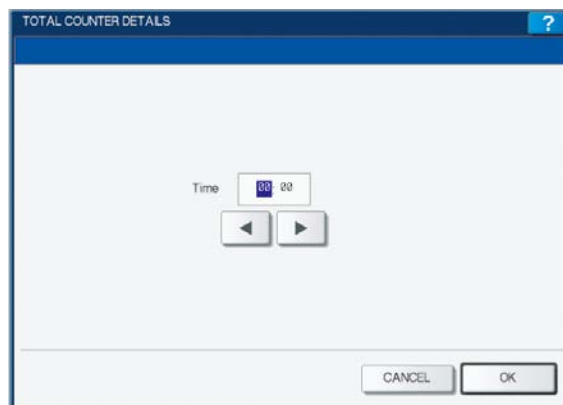

Fig. 7-17

Key in the time (acceptable values: 00:00-23:59) in “Time”.

Key in the time in the hour column of “Time”, press the scroll button, key in the time in the minute column of “Time”.

After all the settings are completed, press the [OK] button.

(34) Press the [CLOSE] button. The setting completes.

7.1.4 Order Sheet Format

The sample of order sheet is as follows.

(1) FAX (This format is the same as that of TIFF image attached E-mail.)

```

DATE & TIME                :99-99-'99 99:99
CUSTOMER NAME              :XXXXXXXXXXXXXXXXXXXXXXXXXXXXXXXXXXXX
CUSTOMER ADDRESS          :XXXXXXXXXXXXXXXXXXXXXXXXXXXXXXXXXXXX
CUSTOMER TEL NUMBER       :XXXXXXXXXXXXXXXXXXXXXXXXXXXXXXXXXXXX
CUSTOMER E-MAIL ADDRESS   :XXXXXXXXXXXXXXXXXXXXXXXXXXXXXXXXXXXX
SERVICE TECHNICIAN NUMBER :XXXXXXXXXXXXXXXXXXXXXXXXXXXXXXXXXXXX
SERVICE TECHNICIAN NAME  :XXXXXXXXXXXXXXXXXXXXXXXXXXXXXXXXXXXX
SERVICE TECHNICIAN TEL NUMBER :XXXXXXXXXXXXXXXXXXXXXXXXXXXXXXXXXXXX
SERVICE TECHNICIAN E-MAIL :XXXXXXXXXXXXXXXXXXXXXXXXXXXXXXXXXXXX
SUPPLIER NAME             :XXXXXXXXXXXXXXXXXXXXXXXXXXXXXXXXXXXX
SUPPLIER ADDRESS         :XXXXXXXXXXXXXXXXXXXXXXXXXXXXXXXXXXXX
-----
TONER CARTRIDGE          PART NUMBER      QUANTITY
BLACK                   :XXXXXXXXXXXXX      99
-----
DESCRIPTION AREA .....
.....

DEVICE DESCRIPTION       :XXXXXXXXXXXXXXXXXXXXXXXXXXXX
SERIAL NUMBER           :XXXXXXXXXXXXXXXXXXXXXXXXXXXX
DEVICE FAX NUMBER       :XXXXXXXXXXXXXXXXXXXXXXXXXXXX
DEVICE E-MAIL ADDRESS   :XXXXXXXXXXXXXXXXXXXXXXXXXXXX

PRINT COUNTER          TOTAL      BLACK      FULL COLOR
999999999             999999999 999999999 -----
SCAN COUNTER          999999999 999999999 999999999

TONER INFORMATION

BLACK REMAINING QUANTITY (%) : 0000062
    
```

Fig. 7-18

DATE & TIME:	Order date and time
Customer Information:	Name, address, TEL number, E-mail address
Service Technician Information:	Number, name, TEL number, E-mail address
Supplier Information:	Name, address
Toner cartridge ordered:	Part number, quantity
DESCRIPTION AREA:	Remarks
DEVICE DESCRIPTION:	Model name
SERIAL NUMBER:	Serial number
DEVICE FAX NUMBER:	Fax number
DEVICE E-MAIL ADDRESS:	E-mail address
Counter Information:	Print counter, scan counter
TONER INFORMATION:	Toner remaining quantity (Black)

(2) E-MAIL (TIFF image attached with the E-mail is the same format with that of the FAX order sheet.)

SUBJECT: SUPPLY ORDER FORM

Date & Time	:99-99-'99 99:99
Customer Name	:XX
Customer Address	:XX
Customer Tel Number	:XX
Customer E-Mail Address	:XX
Service Technician Number	:XX
Service Technician Name	:XX
Service Technician Tel Number	:XX
Service Technician E-Mail	:XX
Supplier Name	:XX
Supplier Address	:XX

	Part Number	Quantity
Toner Cartridge		
Black	:XXXXXXXXXXXX	99

Description Area

.....

Device Description	:XXXXXXXXXXXXXXXXXXXXXXXXXXXX
Serial Number	:XXXXXXXXXXXXXXXXXXXXXXXXXXXX
Device FAX Number	:XXXXXXXXXXXXXXXXXXXXXXXXXXXX
Device E-Mail Address	:XXXXXXXXXXXXXXXXXXXXXXXXXXXX

	Total	Black	Full Color
Print Counter	999999999	999999999	-----
Scan Counter	999999999	999999999	999999999

Toner Information

 Black Remaining Quantity (%) : 0000062

Fig. 7-19

DATE & TIME:	Order date and time
Customer Information:	Name, address, TEL number, E-mail address
Service Technician Information:	Number, name, TEL number, E-mail address
Supplier Information:	Name, address
Toner cartridge ordered:	Part number, quantity
Description Area:	Remarks
Device Description:	Model name
Serial Number:	Serial number
Device FAX Number:	Fax number
Device E-Mail Address:	E-mail address
Counter Information:	Print counter, scan counter
Toner Information:	Toner remaining quantity (Black)

(3) Result list

```

ORDER XXXXXXXXX
DATE & TIME           :99-99-'99 99:99
CUSTOMER NAME        :XXXXXXXXXXXXXXXXXXXXXXXXXXXXXXXXXXXX
CUSTOMER ADDRESS     :XXXXXXXXXXXXXXXXXXXXXXXXXXXXXXXXXXXX
CUSTOMER TEL NUMBER  :XXXXXXXXXXXXXXXXXXXXXXXXXXXXXXXXXXXX
CUSTOMER E-MAIL ADDRESS :XXXXXXXXXXXXXXXXXXXXXXXXXXXXXXXXXXXX
SERVICE TECHNICIAN NUMBER :XXXXXXXXXXXXXXXXXXXXXXXXXXXXXXXXXXXX
SERVICE TECHNICIAN NAME :XXXXXXXXXXXXXXXXXXXXXXXXXXXXXXXXXXXX
SERVICE TECHNICIAN TEL NUMBER :XXXXXXXXXXXXXXXXXXXXXXXXXXXXXXXXXXXX
SERVICE TECHNICIAN E-MAIL :XXXXXXXXXXXXXXXXXXXXXXXXXXXXXXXXXXXX
SUPPLIER NAME        :XXXXXXXXXXXXXXXXXXXXXXXXXXXXXXXXXXXX
SUPPLIER ADDRESS     :XXXXXXXXXXXXXXXXXXXXXXXXXXXXXXXXXXXX

-----
TONER CARTRIDGE      PART NUMBER      QUANTITY
BLACK                 : XXXXXXXXXX      99

-----
DESCRIPTION AREA .....
.....

DEVICE DESCRIPTION   :XXXXXXXXXXXXXXXXXXXXXXXXXXXX
SERIAL NUMBER        :XXXXXXXXXXXXXXXXXXXXXXXXXXXX
DEVICE FAX NUMBER    :XXXXXXXXXXXXXXXXXXXXXXXXXXXX
DEVICE E-MAIL ADDRESS :XXXXXXXXXXXXXXXXXXXXXXXXXXXX

PRINT COUNTER      TOTAL      BLACK      FULL COLOR
999999999          999999999  999999999  -----
SCAN COUNTER       999999999  999999999  999999999

TONER INFORMATION

BLACK REMAINING QUANTITY (%) : 00000059
    
```

Fig. 7-19

- ORDER SUCCESSFUL/FAILURE: Automatic supply ordering: transmission success or failure
- DATE & TIME: Order date and time
- CUSTOMER NAME: Customer name
- CUSTOMER ADDRESS: Customer address
- CUSTOMER TEL NUMBER: Customer telephone number
- CUSTOMER E-MAIL ADDRESS: Customer E-mail address
- SERVICE TECHNICIAN NUMBER: Service technician number
- SERVICE TECHNICIAN NAME: Service technician name
- SERVICE TECHNICIAN TEL NUMBER: Service technician telephone number
- SERVICE TECHNICIAN E-MAIL: Service technician E-mail address
- SUPPLIER NAME: Supplier name
- SUPPLIER ADDRESS: Supplier address
- PART NUMBER: Order part number

QUANTITY:	Order quantity
TONER CARTRIDGE:	Toner cartridge
DESCRIPTION AREA:	Remarks
DEVICE DESCRIPTION:	Model name (MFP model name)
SERIAL NUMBER:	Serial number
DEVICE FAX NUMBER:	Fax number
DEVICE E-MAIL ADDRESS:	E-mail address
PRINT COUNTER:	Print count
SCAN COUNTER:	Scan count
TOTAL:	Total
BLACK:	Black
FULL COLOR:	Full color
BLACK REMAINING QUANTITY (%)	Toner remaining quantity (Black)

7.2 Service Notification

7.2.1 Outline

This function automatically notifies the status of the equipment to the service technician by E-mail or FAX. The following three are the items to be notified.

- Total counter notification
When this function is effective, it notifies each counter information periodically (on the set date and time every month).
- Service call notification (E-mail only)
When this function is effective, it notifies the corresponding error code and such at a service call error.
- Toner near empty notification
When this function is effective, it notifies each counter information and toner cartridge information if toner near empty occurs.

7.2.2 Setting

Notes:

When using this function, it is required that sending and receiving E-mails or FAXes are available. Confirm the details to the administrator.

[1] Preparation

The screen to set this function is not displayed at the default setting.

Set this screen to be displayed with the following code (08).

08-9604 Setting of notification display

0: Invalid (Default)

1: Valid

[2] Setting procedure

- (1) Press the [USER FUNCTIONS] button and select the [ADMIN] button. Then enter the password and press the [OK] button.

Confirm the password to the administrator.

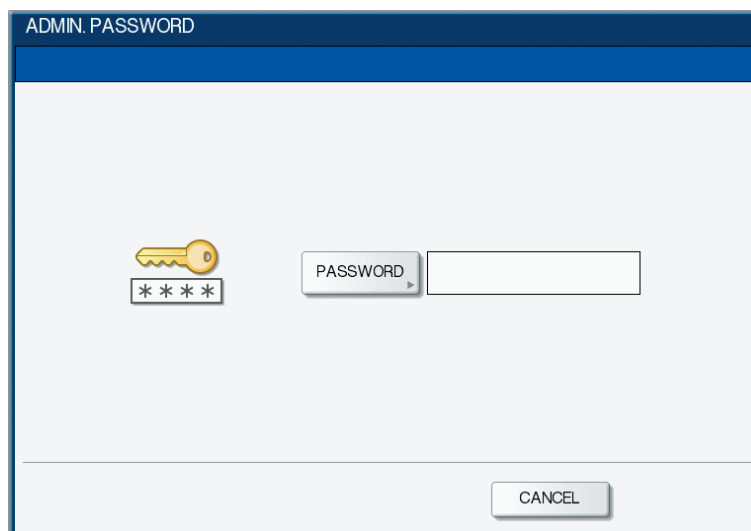

Fig. 7-21

(2) Press the [SERVICE] button.



Fig. 7-22

(3) Press the [SERVICE NOTIFICATION] button.

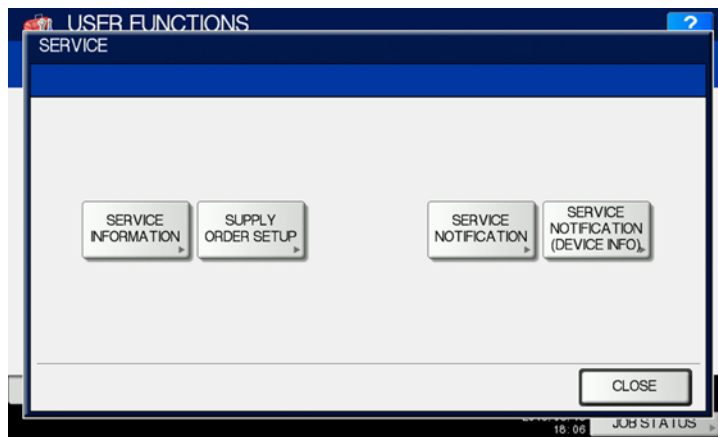

Fig. 7-23

(4) Press the [E-MAIL] or [FAX] button in “SERVICE NOTIFICATION”.

When the [OFF] button is pressed, all functions related Service Notification become ineffective.

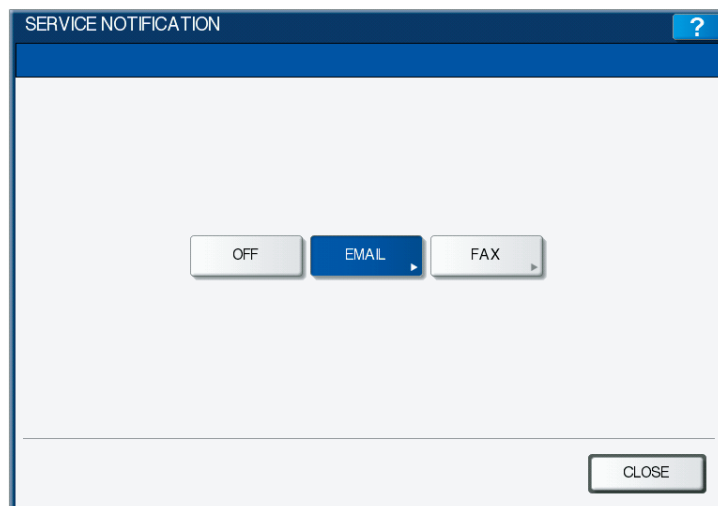

Fig. 7-24

- (5) Enter the E-mail address or FAX number of the destination.

When pressing the [E-MAIL] button, the screen is switched to a full keyboard. Then enter the E-mail addresses and press the [OK] button. (Maximum 3 addresses can be set.)

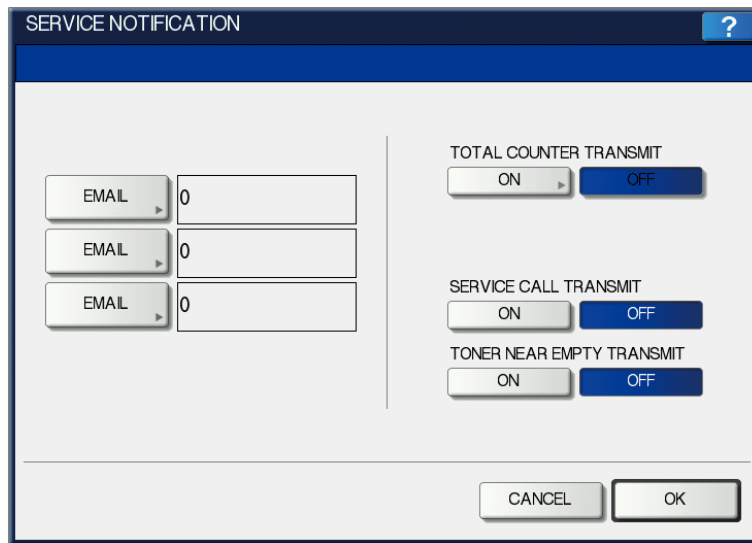

Fig. 7-25

Press the [FAX NUMBER] button, key in the FAX number and then press the [OK] button.

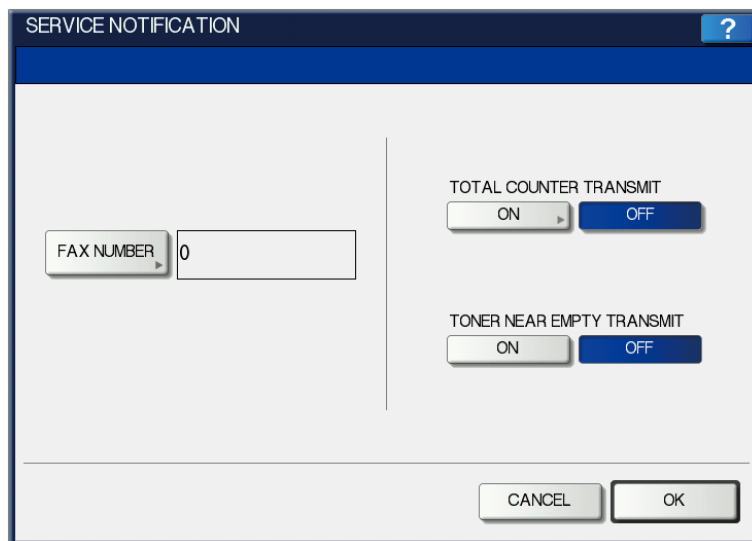

Fig. 7-26

- (6) Press the [ON] button to notify or the [OFF] button not to notify each item for E-mail and FAX.

When Total Count Transmit is set to ON, the screen to set the notification date is displayed.

Then set the notification date with the following procedure.

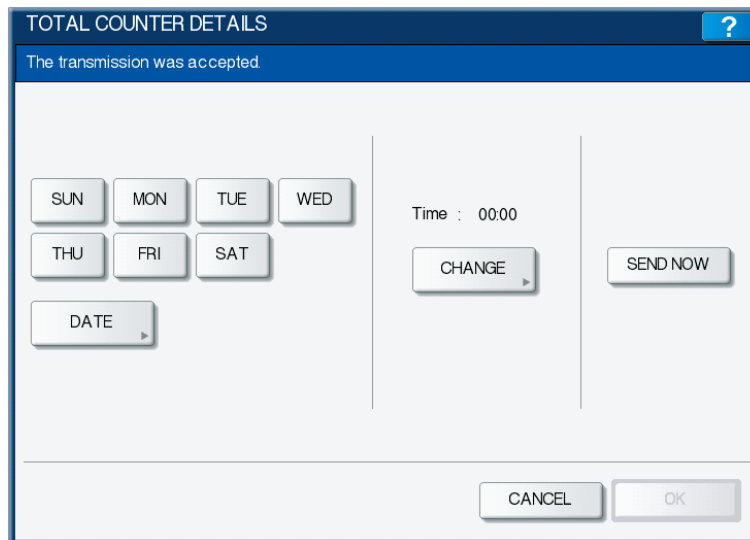

Fig. 7-27

Set the date and time of the Total Counter.

The following 3 items can be specified for the date setting, and more than one day of the week also can be selected.

- Day of the week (More than one day can be selected.)
- Notify Date 1
- Notify Date 2

You can send the Total Counter immediately without the above settings by pressing the [SEND NOW] button.

- **Day of the week ([SUN] to [SAT] buttons)**

Pressing the buttons ([Sunday] to [Saturday]) of the desired day makes transmission on every specified day. More than one day can be selected.

- * This does not affect the settings of "Notify Date 1" and "Notify Date 2".

- **Notify Date 1 and Notify Date 2 ([DATE] button)**

Pressing the [DATE] button sets up to 2 dates on which you want to send data.

* This is not affected by the specified day of the week.

The screenshot shows a window titled 'TOTAL COUNTER DETAILS' with a question mark icon in the top right corner. The main area contains two rows of controls. The first row has a button labeled 'Notify Date 1' followed by a text input field containing the digit '0'. The second row has a button labeled 'Notify Date 2' followed by a text input field containing the digit '0'. At the bottom right of the window, there are two buttons: 'CANCEL' and 'OK'.

Fig. 7-28

Key in the date (acceptable values: 0-31) in “Notify Date 1” or “Notify Date 2” and press the [OK] button.

- **Time setting ([CHANGE] button)**

Pressing the [CHANGE] button sets the time at which you want to send data.

This is the time when data are sent with “Day of the week”, “Notify Date 1” and “Notify Date 2”.

The screenshot shows a window titled 'TOTAL COUNTER DETAILS' with a question mark icon in the top right corner. The main area contains a label 'Time' followed by a time input field showing '00:00'. Below the input field are two arrow buttons (left and right) for navigating between digits. At the bottom right of the window, there are two buttons: 'CANCEL' and 'OK'.

Fig. 7-29

Key in the time (acceptable values: 00:00-23:59) in “Time”.

Key in the time in the hour column of “Time”, press the scroll button, key in the time in the minute column of “Time”.

After all the settings are completed, press the [OK] button. The display returns to the screen in step (5).

(7) Press the [OK] button. The setting completes.

Notes:

Service Notification setting is also available from the following setting mode (08).

Items	08 code	Contents
Service Notification setting	9793	0: OFF (Invalid) 1:E-mail 2:FAX
E-mail address 1	9794	Maximum 192 letters
E-mail address 2	9607	Maximum 192 letters
E-mail address 3	9608	Maximum 192 letters
FAX number	9784	Maximum 32 digits
Total Counter Transmit setting	9795	0: OFF (Invalid) 1: ON (Valid)
Total counter transmission date setting	9796	0 to 31
Total counter transmission date setting(2)	9880	0 to 31
Day of total counter data transmission	9881	1 byte 00000000(0)-01111111(127) From the 2nd bit - Sunday, Monday, Tuesday, Wednesday, Thursday, Friday, Saturday
Total counter transmission interval setting (Hour/Minute/Minute)	9606	00:00-23:59
Service Call Transmit setting	9605	0: OFF (Invalid) 1: ON (Valid)

7.2.3 Items to be notified

The items to be notified are shown below.

1. Total Counter Transmit by E-mail

Subject: Counter Notification

```

① Date : 04/26/2013 12:34
② Machine Model : OKI MBxxxx
③ SerialNumber : 1234567890
④ Total Counter : 00004787
⑤ Supplier:
  Name : SUPPLIER_NAME
  Tel Number : 1122334455
  E-Mail : Supplier_emailaddress@cccc.xxx
  Address : SUPPLIER_ADDRESS
⑥ Customer:
  Name : CUSTOMER_NAME
  Tel Number : 1234567890
  E-Mail : customer_emailaddress@dddd.xxx
  Address : CUSTOMER_ADDRESS
⑦ Service Technician:
  Number : svc12
  Name : SERVICE_TECHNICIAN_NAME
  Tel Number : 0987654321
  E-Mail : svc@oki.com
⑧ ChargeCounterFormat:
  LargeSizeChargeCount 1
⑨ LargeSizeChargePaperDefinition 1
  Charge Counter:
    <Print Counter>
      Large Small
⑩ Copy 00000000 00000000
⑪ Print 00000000 00000000
⑫ List 00000000 00000000
⑬ FAX 00000000 00000000
  <Scan Counter>
  Full Color -----
⑭ Net Scan 00000000 00000000
  Black -----
⑮ Copy Scan 00000000 00000000
⑯ FAX Scan 00000000 00000000
⑰ Net Scan 00000000 00000000
  <FAX Counter>
⑱ Transmit 00000000 00000000
  Receive 00000000 00000000
  
```

Fig. 7-30

```

⑳ Printer Error History:
  Date Time ErrorCode Counter
  -----
  04/13/2013 16:44 F110 00000000
  04/12/2013 22:28 F110 00000000
  04/12/2013 22:23 F110 00000000
  03/15/2013 22:23 F110 00000000
  02/25/2013 11:12 F110 00000000
  Toner Information
  Toner Remaining Quantity (%)
  -----
㉑ Black 00000000
  
```

Fig. 7-31

- ① Date
- ② Machine model name
- ③ Serial number
- ④ Total counter value
- ⑤ Supplier information
- ⑥ Customer information
- ⑦ Service technician information
- ⑧ Count setting of large-sized paper (Fee charging system counter)
- ⑨ Definition setting of large-sized paper (Fee charging system counter)
- ⑩ Number of output pages in the Copier Function (BLACK)
- ⑪ Number of output pages in the Printer Function (BLACK)
- ⑫ Number of output pages at the List Print Mode (BLACK)
- ⑬ Number of output pages in the FAX Function (BLACK)
- ⑭ Number of scanning pages in the Network Scanning Function (FULL COLOR)
- ⑮ Number of scanning pages in the Copier Function (BLACK)
- ⑯ Number of scanning pages in the FAX Function (BLACK)
- ⑰ Number of scanning pages in the Network Scanning Function (BLACK)
- ⑱ Number of transmitted pages in the FAX Function (BLACK)
- ⑲ Number of received pages in the FAX Function (BLACK)
- ⑳ Error history
*1 The latest 20 errors are displayed.
- ㉑ Toner remaining quantity (Black)

2. Total Counter Transmit by FAX

Sheet 1

COUNTER NOTIFICATION	
①	DATE : 12/04/14 13:47
②	MACHINE MODEL : OKI MBxxx
③	SERIAL NUMBER : 1234567890
④	TOTAL COUNTER : 00004787
[
⑤	CUSTOMER NAME : CUSTOMER_NAME
	CUSTOMER ADDRESS : CUSTOMER_ADDRESS
	CUSTOMER TEL NUMBER : 1234567890
	CUSTOMER E-MAIL ADDRESS : customer_emailaddress@dddd.xxx
[
⑥	SERVICE TECHNICIAN NUMBER : svc12
	SERVICE TECHNICIAN NAME : SERVICE_TECHNICIAN_NAME
	SERVICE TECHNICIAN TEL NUMBER : 0987654321
	SERVICE TECHNICIAN E-MAIL : svc@oki.com
[
⑦	SUPPLIER NAME : SUPPLIER_NAME
	SUPPLIER ADDRESS : SUPPLIER_ADDRESS
	SUPPLIER FAX NUMBER : 5544332211
	SUPPLIER E-MAIL ADDRESS : supplier_emailaddress@cccc.xxx

Fig. 7-32

Sheet 2

COUNTER NOTIFICATION	
CHARGE COUNTER FORMAT	
⑧	LARGE SIZE CHARGE COUNT : 1
⑨	LARGE SIZE CHARGE PAPER DEFINITION : 1
CHARGE COUNTER	
<PRINT COUNTER>	
	BLACK LARGE SMALL
⑩	COPY 00000000 00000000
⑪	PRINT 00000000 00000000
⑫	LIST 00000000 00000000
⑬	FAX 00000000 00000000
<SCAN COUNTER>	
	FULL COLOR LARGE SMALL
⑭	NET SCAN 00000000 00000000
	BLACK LARGE SMALL
⑮	COPY SCAN 00000000 00000000
⑯	FAX SCAN 00000000 00000000
⑰	NET SCAN 00000000 00000000
<FAX COUNTER>	
	LARGE SMALL
⑱	TRANSMIT 00000000 00000000
⑲	RECEIVE 00000000 00000000

Fig. 7-33

Sheet 3

COUNTER NOTIFICATION							
⑳ PRINTER ERROR HISTORY							
DATE	TIME	ERROR CODE	COUNTER	DATE	TIME	ERROR CODE	COUNTER
13/04/13	16:44	F110	00000000	08/04/13	16:44	F110	00000000
13/04/12	22:28	F110	00000000	08/04/13	16:44	F110	00000000
13/04/12	22:23	F110	00000000	08/04/13	16:44	F110	00000000
13/03/15	22:23	F110	00000000	08/04/13	16:44	F110	00000000
13/02/25	11:12	F110	00000000	08/04/13	16:44	F110	00000000
<div style="text-align: right;">} (*1)</div>							
TONER INFORMATION							
㉑ BLACK REMAINING QUANTITY (%)			: 00000059				

Fig. 7-34

- ① Date
- ② Machine model name
- ③ Serial number
- ④ Total counter value
- ⑤ Customer information
- ⑥ Service technician information
- ⑦ Supplier information
- ⑧ Count setting of large-sized paper (Fee charging system counter)
- ⑨ Definition setting of large-sized paper (Fee charging system counter)
- ⑩ Number of output pages in the Copier Function (BLACK)
- ⑪ Number of output pages in the Printer Function (BLACK)
- ⑫ Number of output pages at the List Print Mode (BLACK)
- ⑬ Number of output pages in the FAX Function (BLACK)
- ⑭ Number of scanning pages in the Network Scanning Function (FULL COLOR)
- ⑮ Number of scanning pages in the Copier Function (BLACK)
- ⑯ Number of scanning pages in the FAX Function (BLACK)
- ⑰ Number of scanning pages in the Network Scanning Function (BLACK)
- ⑱ Number of transmitted pages in the FAX Function (BLACK)
- ⑲ Number of received pages in the FAX Function (BLACK)
- ⑳ History of error
*1 The latest 20 errors are displayed.
- ㉑ Toner remaining quantity (Black)

3. Toner near-empty notification by e-mail

Subject: Toner Near-Empty Notification

```

1  Date       : 04/26/2013 12:34
2  Machine Model : OKI MBxxx
3  SerialNumber : 1234567890
4  Total Counter : 00004787
5  Supplier:
   Name       : SUPPLIER_NAME
   Tel Number : 1122334455
   E-Mail     : Supplier_emailaddress@cccc.xxx
   Address    : SUPPLIER_ADDRESS
6  Customer:
   Name       : CUSTOMER_NAME
   Tel Number : 1234567890
   E-Mail     : customer_emailaddress@dddd.xxx
   Address    : CUSTOMER_ADDRESS
7  Service Technician:
   Number    : svc12
   Name      : SERVICE_TECHNICIAN_NAME
   Tel Number : 0987654321
   E-Mail    : svc@oki.com
   ChargeCounterFormat:
8  LargeSizeChargeCount      1
9  LargeSizeChargePaperDefinition  1

   Charge Counter:
           Large      Small
   <Print Counter>
   Black -----
10  Copy      00000000  00000000
11  Print     00000000  00000000
12  List      00000000  00000000
13  FAX       00000000  00000000
   <Scan Counter>
   Full Color -----
14  Net Scan  00000000  00000000
   Black -----
15  Copy Scan 00000000  00000000
16  FAX Scan  00000000  00000000
17  Net Scan  00000000  00000000
   <FAX Counter>
18  Transmit  00000000  00000000
19  Receive   00000000  00000000
    
```

Fig. 7-35

```

20  Printer Error History:
    Date      Time      ErrorCode Counter
    -----
    04/13/2008 16:44   F110      00000000
    04/12/2008 22:28   F110      00000000
    04/12/2008 22:23   F110      00000000
    03/15/2008 22:23   F110      00000000
    02/25/2008 11:12   F110      00000000
    (*1)
21  Toner Cartridge Information:
22  Color Code           Black
23  Toner Near-Empty Counter
24  Setting              00000000
25  Current              00000000
26  Toner Near-Empty Sensed  0
27  Point Of Destination  non
   Used History
   Developer Counter      00000056
   Developer Driving Time 00000057
   Drum Driving Time      00000058

   Toner Information
28  Toner      Remaining Quantity (%)
   -----
   Black      00000062
    
```

Fig. 7-36

1. Date
2. Machine model name
3. Serial number
4. Total counter value
5. Supplier information
6. Customer information
7. Service technician information
8. Count setting of large-sized paper (Fee charging system counter)
9. Definition setting of large-sized paper (Fee charging system counter)
10. Number of output pages in the Copier Function (BLACK)
11. Number of output pages in the Printer Function (BLACK)
12. Number of output pages at the List Print Mode (BLACK)
13. Number of output pages in the FAX Function (BLACK)
14. Number of scanning pages in the Network Scanning Function (Full color)
15. Number of scanning pages in the Copier Function (BLACK)
16. Number of scanning pages in the FAX Function (BLACK)
17. Number of scanning pages in the Network Scanning Function (BLACK)
18. Number of transmitted pages in the FAX Function (BLACK)
19. Number of received pages in the FAX Function (BLACK)
20. History of error
*1 The latest 20 errors are displayed.
21. Toner cartridge information
22. Color of toner cartridge
23. Toner near-empty counter
24. Setting value of toner cartridge rotation time counter
25. Current value of toner cartridge rotation time counter
26. Toner near-empty sensed
27. Destination setting of toner cartridge
28. Toner remaining quantity (Black)

4. Toner near-empty notification by FAX

Sheet 1

TONER NEAR-EMPTY NOTIFICATION	
1	DATE : 13/04/14 13:47
2	MACHINE MODEL : OKI MBxxx
3	SERIAL NUMBER : 1234567890
4	TOTAL COUNTER : 00004787
5	CUSTOMER NAME : CUSTOMER_NAME
	CUSTOMER ADDRESS : CUSTOMER_ADDRESS
	CUSTOMER TEL NUMBER : 1234567890
	CUSTOMER E-MAIL ADDRESS : customer_emailaddress@dddd.xxx
6	SERVICE TECHNICIAN NUMBER : svc12
	SERVICE TECHNICIAN NAME : SERVICE_TECHNICIAN_NAME
	SERVICE TECHNICIAN TEL NUMBER : 0987654321
	SERVICE TECHNICIAN E-MAIL : svc@oki.com
7	SUPPLIER NAME : SUPPLIER_NAME
	SUPPLIER ADDRESS : SUPPLIER_ADDRESS
	SUPPLIER FAX NUMBER : 5544332211
	SUPPLIER E-MAIL ADDRESS : supplier_emailaddress@cccc.xxx

Fig.7-37

Sheet 2

TONER NEAR-EMPTY NOTIFICATION						
CHARGE COUNTER FORMAT						
8	LARGE SIZE CHARGE COUNT		: 1			
9	LARGE SIZE CHARGE PAPER DEFINITION		: 1			
CHARGE COUNTER						
<PRINT COUNTER>			<SCAN COUNTER>			
	BLACK	LARGE	SMALL	FULL COLOR	LARGE	SMALL
10	COPY	00000000	00000000	14	NET SCAN	00000000 00000000
11	PRINT	00000000	00000000		BLACK	LARGE SMALL
12	LIST	00000000	00000000	15	COPY SCAN	00000000 00000000
13	FAX	00000000	00000000	16	FAX SCAN	00000000 00000000
				17	NET SCAN	00000000 00000000
<FAX COUNTER>			LARGE	SMALL		
18	TRANSMIT	00000000	00000000			
19	RECEIVE	00000000	00000000			

Fig.7-38

Sheet 3

TONER NEAR-EMPTY NOTIFICATION								
20	PRINTER ERROR HISTORY							
	DATE	TIME	ERROR CODE	COUNTER	DATE	TIME	ERROR CODE	COUNTER
	08/04/13	16:44	F110	00000000	08/04/13	16:44	F110	00000000
	08/04/12	22:28	F110	00000000	08/04/13	16:44	F110	00000000
	08/04/12	22:23	F110	00000000	08/04/13	16:44	F110	00000000
	08/03/15	22:23	F110	00000000	08/04/13	16:44	F110	00000000
	08/02/25	11:12	F110	00000000	08/04/13	16:44	F110	00000000
21	TONER CARTRIDGE INFORMATION							
22	COLOR CODE			1				
23	TONER NEAR-EMPTY COUNTER							
24	SETTING			00000000				
25	CURRENT			00000000				
26	TONER NEAR-EMPTY SENSED			1				
27	POINT OF DESTINATION			0				
	USED HISTORY							
	DEVELOPER COUNTER			00000056				
	DEVELOPER DRIVING TIME			00000057				
	DRUM DRIVING TIME			00000058				
28	TONER INFORMATION							
	BLACK REMAINING QUANTITY (%):			00000062				

Fig.7-39

1. Date
2. Machine model name
3. Serial number
4. Total counter value
5. Customer information
6. Service technician information
7. Supplier information
8. Count setting of large-sized paper (Fee charging system counter)
9. Definition setting of large-sized paper (Fee charging system counter)
10. Number of output pages in the Copier Function (BLACK)
11. Number of output pages in the Printer Function (BLACK)
12. Number of output pages at the List Print Mode (BLACK)
13. Number of output pages in the FAX Function (BLACK)
14. Number of scanning pages in the Network Scanning Function (Full color)
15. Number of scanning pages in the Copier Function (BLACK)
16. Number of scanning pages in the FAX Function (BLACK)
17. Number of scanning pages in the Network Scanning Function (BLACK)
18. Number of transmitted pages in the FAX Function (BLACK)
19. Number of received pages in the FAX Function (BLACK)
20. History of error
*1 The latest 20 errors are displayed.
21. Toner cartridge information

- 22. Color of toner cartridge
1: Black
- 23. Toner near-empty counter
- 24. Setting value of toner cartridge rotation time counter
- 25. Current value of toner cartridge rotation time counter
- 26. Toner near-empty sensed
- 27. Destination setting of toner cartridge
- 28. Toner remaining quantity (Black)

- ① Date (When an error occurs)
- ② Machine model name
- ③ Serial number
- ④ Function: Fixed at "Printer"
- ⑤ Severity: Fixed at "Error"
- ⑥ Error code
- ⑦ Error message: The content of error is displayed.
- ⑧ Supplier information
- ⑨ Customer information
- ⑩ Service technician information
- ⑪ History of error
*1 The latest 20 errors are displayed.
- ⑫ Toner remaining quantity (Black)

8. FIRMWARE UPDATING

8.1 Overview

When you want to update the firmware to the latest one or the equipment becomes inoperable due to some defect in the firmware, updating can be performed as follows.

Equipment

Firmware	Updating method
System firmware	USB device
	Download jig (PWA-DWNLD-JIG2)
PU firmware	USB device
SU firmware	
System software	

Options

Model name	Firmware	Updating method
FAX Unit (GD-1340)	FAX firmware	Download jig (K-PWA-DLM-320)
Finisher (MJ-1038)	PU firmware	USB device

A.



Fig.8-1

A	<ul style="list-style-type: none"> • System firmware • PU firmware • SU firmware • System software 	P. 8-5
---	--	--------

B.

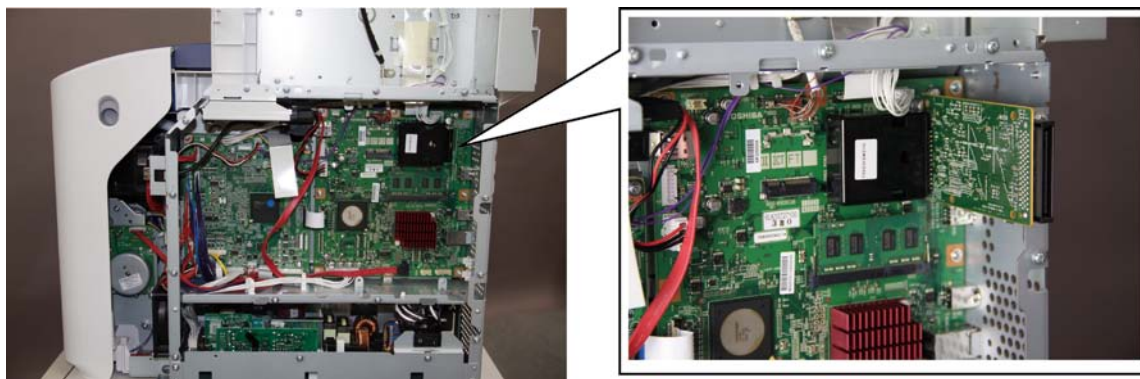

Fig.8-2

B	System firmware	P. 8-23
---	-----------------	---------

C.



Fig.8-3

C	FAX firmware (GD-1340)	P. 8-26
---	------------------------	---------

Notes:

- Written firmware varies depending on the kinds of the boards provided as service parts. For updating, only the minimum firmware is installed on the system control PC board, logic PC board, and scanning section control PC board. No firmware is installed on the FAX board. The latest version of the firmware at the time of delivery is written on the RADF control PC board and finisher control PC board. When any of above boards is replaced with a new one in the field, check the other firmware version used and then update with a corresponding suitable version.
- “Can’t fetch Ver.” is displayed in the Installed Version field when the version of the installed firmware cannot be acquired properly. If a normal power on is not performed after the firmware is updated and the [ON/OFF] button is pressed while simultaneously holding down the [4] and [9] buttons, “Can’t fetch Ver.” may be displayed on the control panel for some firmwares. A normal power on must be performed.

8.2 Firmware Updating with USB Device

To update firmware, store update program and firmware data files in the USB device.

The update program is “signatures.sig”, and it needs to be stored in the USB device. It is necessary for updating firmware except that of the System firmware.

For the data file for each firmware, refer to the following tables.

Notes:

When performing the update, use the latest program.

8.2.1 Firmware type and data file name for updating

Equipment

Firmware	Stored	Data file name	Display
System firmware	System control PC board (SYS board)	O290SF0Wxxxx.tar * xxxx is version.	SYSTEM FIRMWARE (OS Data)
PU firmware	PU PC board	H291PUPWW.xxxx * xxx is version.	ENGINE FIRMWARE
SU firmware	SU PC board	H282SUPWW.xxxx * xxx is version.	SCANNER FIRMWARE
System software	HDD	O290HD0Wxxxx.tar * xxxx is version.	SYSTEM SOFTWARE (HD Data)

Store the data file for updating in the model specific folder. This configuration is an example. The number of files differs depending on the installed option.

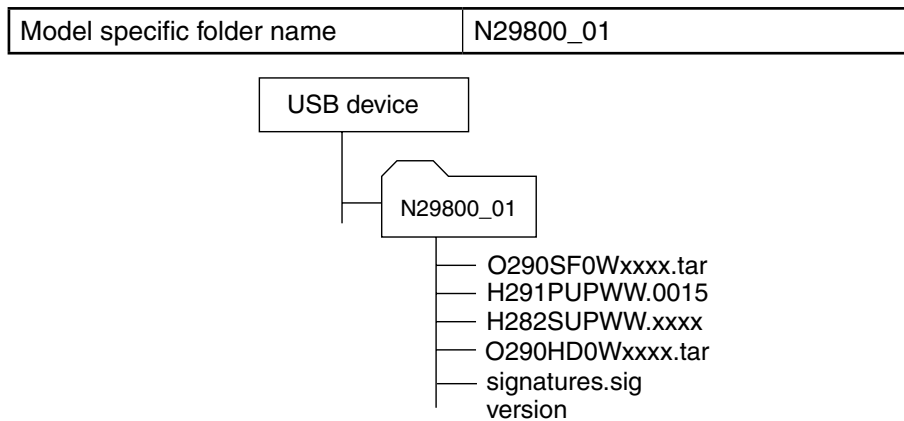

Fig.8-4

Notes:

- Since the date and time set in the equipment are recorded in the firmware update log, make sure that they are correct before updating the firmware.
- Never change the model specific folder name, since it is used for identifying the data file when the data files used for updating multiple models are stored in the USB device.

Important:

- Only the USB devices which meet the following conditions should be used for updating. Be careful since updating with any device other than the above is never guaranteed.
 - A combination USB device with a flash memory (to be connected directly to the USB port) and its capacity is 2GB or more.
 - Operation of the USB device used for updating has been confirmed at the input check of this equipment (Test mode 03). (& P. 3-7 “3.3 Input check (Test mode 03)”)
 - USB devices which comply with the following standards regulated by USB-IF (USB Implementers Forum)
 - Class number: 8 (=08h) (Mass-storage class)
 - Sub-class number: 6 (=06h) (SCSI transfer command set)
 - Protocol number: 80 (=50h) (Bulk-Only)
- * Most common USB devices comply with the specification above and can be used for updating. However, the operation in all the Multi Functional Digital Color Systems and Multi Functional Digital Systems is not necessarily guaranteed since the most of these devices are developed based on use in a PC environment (Windows or Macintosh). Therefore, check thoroughly that the device is operational in the equipment for which the updating will be performed when purchasing it.
- The USB devices complying with USB2.0 can be used for updating.
- Do not update the firmware by any storage device other than a flash memory (such as a USB connection type memory card reader, CD/DVD drive or hard disk), since it is never guaranteed.
- It is possible to store the model specific update program and the data file for updating directly in the root directory when you store the updating data file for one specific model in the USB device.
However, if the model specific folder for the same model as that of the data file stored in the root directory already exists, this will have priority.

8.2.2 Update procedure

Important:

- The file system of USB device should be formatted in the FAT or FAT32 format. Be careful since the devices formatted in NTFS or other format will not be able to be operated. The file system can be confirmed on the device properties in applications such as Explorer of Windows.
- Never shut down the equipment during the update. Firmware data and the following option data (if installed) could be damaged and may not be able to be operated properly.
 - Data Overwrite Enabler (GP-1070)
 - Meta Scan Enabler (GS-1010)
 - External Interface Enabler (GS-1020)
 - IPsec Enabler (GP-1080)
 - Unicode Font Enabler (GS-1007)

[A] Update procedure

- (1) Connect the USB device to the PC and write the model specific folder in which the data file is stored.
Store the data file for updating in the model specific folder.
- (2) Press the [ON/OFF] button to shut down the equipment.
- (3) Connect the USB device [1] to the USB port [2] on the right upper cover.

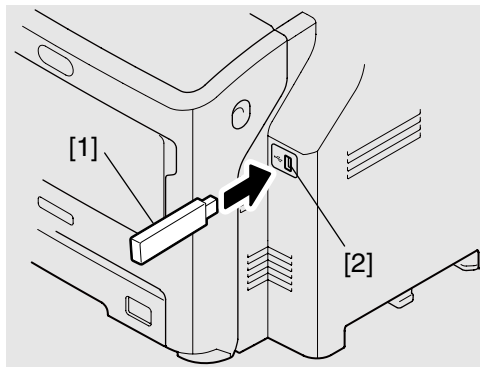

Fig.8-5

- (4) Press the [ON/OFF] button while simultaneously holding down the [4] and [9] buttons.
Data in the USB device are checked and the checking status is displayed on the screen.

- (5) Enter the password, and then press the [OK] button.
 (If the password is not set for Service, press the [OK] button without entering anything.)

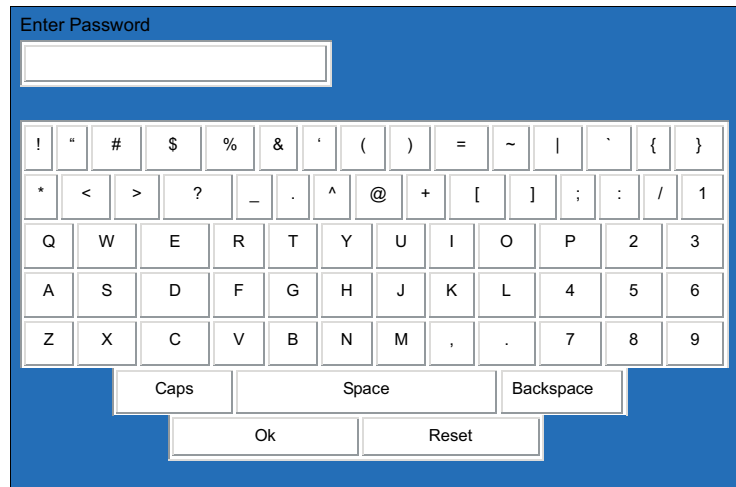

Fig.11-1

The screen for selecting items to be updated is displayed after approx. 3 minutes.
 On this screen, the current firmware version of this equipment and the firmware version of data to be updated are displayed.

Firmware Update Mode	System Firmware Version : xxxx(x.x.x.x)
	Update Mode : USB Update
Select Firmwares	Updater Version Installed Version
1. SYSTEM FIRMWARE (OS Data)	xxxxxxxxxxxx xxxxxxxxxxxxxx
2. ENGINE FIRMWARE	xxxxxxxxxxxx xxxxxxxxxxxxxx
* PU LOADER FIRMWARE	
* PU FIRMWARE	
* OPTION TRAY FIRMWARE	
* LCF FIRMWARE	
* FINISHER FIRMWARE	
* DUPLEX FIRMWARE	
3. SCANNER FIRMWARE	xxxxxxxxxxxx xxxxxxxxxxxxxx
* SU LOADER FIRMWARE	
* SU RECOVERY FIRMWARE	
* SU FIRMWARE	
4. SYSTEM SOFTWARE (HD Data)	
* FILE SYSTEM SOFTWARE	
* APPLICATION SOFTWARE	

Fig.8-6

Notes:

- The display of items on this screen varies depending on the types of data written on the USB device.

Each item is displayed only when each data file is written on the USB device in the following conditions.

Item	Condition
1. SYSTEM FIRMWARE (OS Data)	O290SF0Wxxxx.tar is written. (xxxx is version.)
2. ENGINE FIRMWARE	H291PUPWW.xxxx is written. (xxxx is version.)
3. SCANNER FIRMWARE	H282SUPWW.xxxx is written. (xxxx is version.)
4. SYSTEM SOFTWARE (HD Data)	O290HD0Wxxxx.tar is written. (xxxx is version.)

- If the USB device is not recognized properly, "USB device Not detected" message is displayed. In this case, disconnect the USB device and connect again within 3 minutes, or shut down the equipment and connect the device properly. Then repeat the procedure from (4).
- If any of the error messages below is displayed, confirm if the data file in the USB device is correct.

Then repeat the procedure from (4).

Error number	Error message	Cause
01	Error Loadmodule	Module loading failed.
02	Machine Model Get Error	Model information was not downloaded.
03	Copy Data with valid signature in USB Storage	Checking of data file failed.
04	Other models ROMDATA TXXXXXXXXX * The version name comes at "xxx.xxx.x".	Master data of other model are stored.
05	Copy Signature File in USB Storage	Data files are not stored in the USB device.
06	Patch and Normal package in one folder of USB Storage	When both the system and patch update packages are in the USB device

- (6) Select the item with the digital keys.
 "*" is displayed next to the selected item. Display or delete the "*" by pressing the number of the item.

Item	Remarks
1. SYSTEM FIRMWARE(OS Data)	Updating System firmware
2. ENGINE FIRMWARE	Updating PU firmware
3. SCANNER FIRMWARE	Updating SU firmware
4. SYSTEM SOFTWARE (HD Data)	Updating System software

- (7) Press the [START] button.
 Updating starts and the processing status is displayed on the LCD screen.

Status display during update	Status display when update is completed
SYSTEM FIRMWARE(OS Data) update in progress	SYSTEM FIRMWARE(OS Data) Completed
ENGINE FIRMWARE update in progress	ENGINE FIRMWARE Completed
SCANNER FIRMWARE update in progress	SCANNER FIRMWARE Completed
SYSTEM SOFTWARE (HD Data) update in progress	SYSTEM SOFTWARE (HD Data) Completed

- (8) "Update successfully completed Restart the MFP" is displayed at the bottom of the LCD screen after the updating is completed properly.

Firmware Update Mode	System Firmware Version : xxx(x.x.x.x)
	Update Mode : USB Update
Update Status	
* 1. SYSTEM FIRMWARE (OS Data)	Completed
* 2. ENGINE FIRMWARE	Completed
* PU LOADER FIRMWARE	Completed
* PU FIRMWARE	Completed
* OPTION TRAY FIRMWARE	Completed
* LCF FIRMWARE	Completed
* FINISHER FIRMWARE	Completed
* DUPLEX FIRMWARE	Completed
* 3. SCANNER FIRMWARE	Completed
* SU LOADER FIRMWARE	Completed
* SU RECOVERY FIRMWARE	Completed
* SU FIRMWARE	Completed
* 4. SYSTEM SOFTWARE (HD Data)	Completed
* FILE SYSTEM SOFTWARE	Completed
* APPLICATION SOFTWARE	Completed
<div style="border: 1px solid black; border-radius: 15px; padding: 5px; display: inline-block;"> Update successfully completed Restart the MFP </div>	

Fig.8-7

Notes:

- “Update Failed.” is displayed at the bottom of the LCD screen when the updating is not completed properly. “Failed” appears next to the failed item on the status display. Even though an update fails, do not turn the power OFF until other updates are finished. If “Update Failed” appears at the bottom of the screen, turn OFF the power and then check the following items. After confirming and clearing the problems, restart updating from the beginning.
 - Does the USB device meet the conditions to be used for updating?
 - Is the data file written properly on the USB device?
 - Is the USB device installed properly?
 - Do the USB device and equipment operate properly?
- The integrity check system is automatically operated before firmware updating. During this operation, “Verifying Signature...” and “Progress: **%” are displayed on the control panel. When the check is completed properly, no message for notifying the success will appear and the firmware updating will start. If it fails, “Invalid Signature” and “Copy Data with >valid signature in USB” will be shown. In that case, firmware updating cannot be performed, so turn the power OFF and disconnect the USB device. Check that there is no abnormality in the firmware data, and reperform the update.
- When an system firmware (OS Data) update error or system software (HD Data) update error occurs, “Update Failed” or “Failed” appears on the screen and the error number appears next to the message.

For details of each error, refer to the following tables.

System firmware update Error	
Error number	Error content
O01	FROM writing failed
O02	FROM verification error
O03	File operation error
O04	SRAM flag set error
O05	Electronic key data backup error
O06	Device error

System software update Error	
Error number	Error content
H01	File creation error
H02	File decompression error (Out of free disk space on the HDD at file extraction)
H03	Partition mount error
H00	Other errors

- When a PU firmware update error or SU firmware update error occurs, “Update Failed” or “Failed” appears on the screen and the error number and error message appear next to the message. For details of each error, refer to the following tables.

PU firmware update Error		
Error number	Error message	Error content
PU01	Time out (When the download is requested)	Communication timeout (When the download is requested)
PU02	Time out (When the download is written)	Communication timeout (When the download is written)
PU03	Time out (When the download is finished)	Communication timeout (When the download is finished)
PU04	Reception failed (When the download is requested)	Downloading request was denied. (When the download is requested)
PU05	Deletion error (When the download is written)	Deletion error (When the download is written)
PU06	Writing error (When the download is written)	Writing error (When the download is written)
PU07	Checksum error (When the download is finished)	Checksum error (When the download is finished)
PU08	Reception status code abnormality (When the download is requested)	Reception status code abnormality (When the download is requested)
PU09	Reception status code abnormality (When the download is written)	Reception status code abnormality (When the download is written)
PU10	Reception status code abnormality (When the download is finished)	Reception status code abnormality (When the download is finished)
PU00	Other error	Other error

SU firmware update Error		
Error number	Error message	Error content
SU01	Time out (When the download is requested)	Communication timeout (When the download is requested)
SU02	Time out (When the download is written)	Communication timeout (When the download is written)
SU03	Time out (When the download is finished)	Communication timeout (When the download is finished)
SU05	Deletion error (When the download is written)	Deletion error (When the download is written)
SU06	Writing error (When the download is written)	Writing error (When the download is written)
SU08	Reception status code abnormality (When the download is requested)	Reception status code abnormality (When the download is requested)
SU09	Reception status code abnormality (When the download is written)	Reception status code abnormality (When the download is written)
SU10	Reception status code abnormality (When the download is finished)	Reception status code abnormality (When the download is finished)
SU00	Other error	Other error

- (9) Press the [ON/OFF] button to shut down the equipment, and then remove the USB device.
- (10) Perform the initialization of the updating data.
 - Press the [ON/OFF] button while simultaneously holding down the [0] and [8] buttons.
 - Key in “9030”, and then press the [START] button.
 - Press the [INITIALIZE] button.

[B] Confirmation of the updated data

After the updating is completed, check each data version in the Setting Mode (08) to confirm that the data were overwritten properly.

📖 P. 8-23 “8.6 Confirmation of the updated data”

[C] Adjustment

Perform the adjustment of the equipment.

- Automatic gamma adjustment (05-7165) (using [10] [FAX] test pattern):

📖 P. 4-4 “4.2.1 Automatic gamma adjustment”

[D] Display during the update

Update is performed in parallel as shown in the transition diagram below.

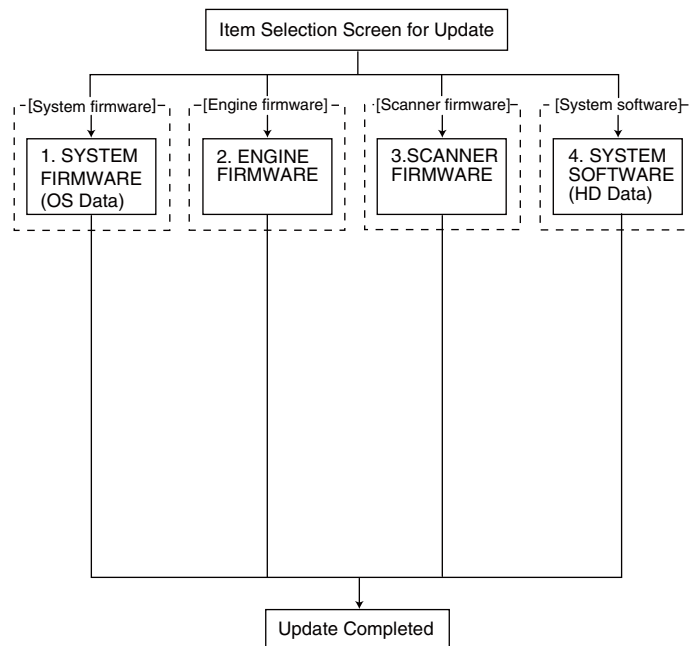

During the update, "Update in progress" is displayed on the right of each item. After it is completed, "Completed" is displayed there. Example screens of the system firmware update are as follows, and these are the same for other firmware.

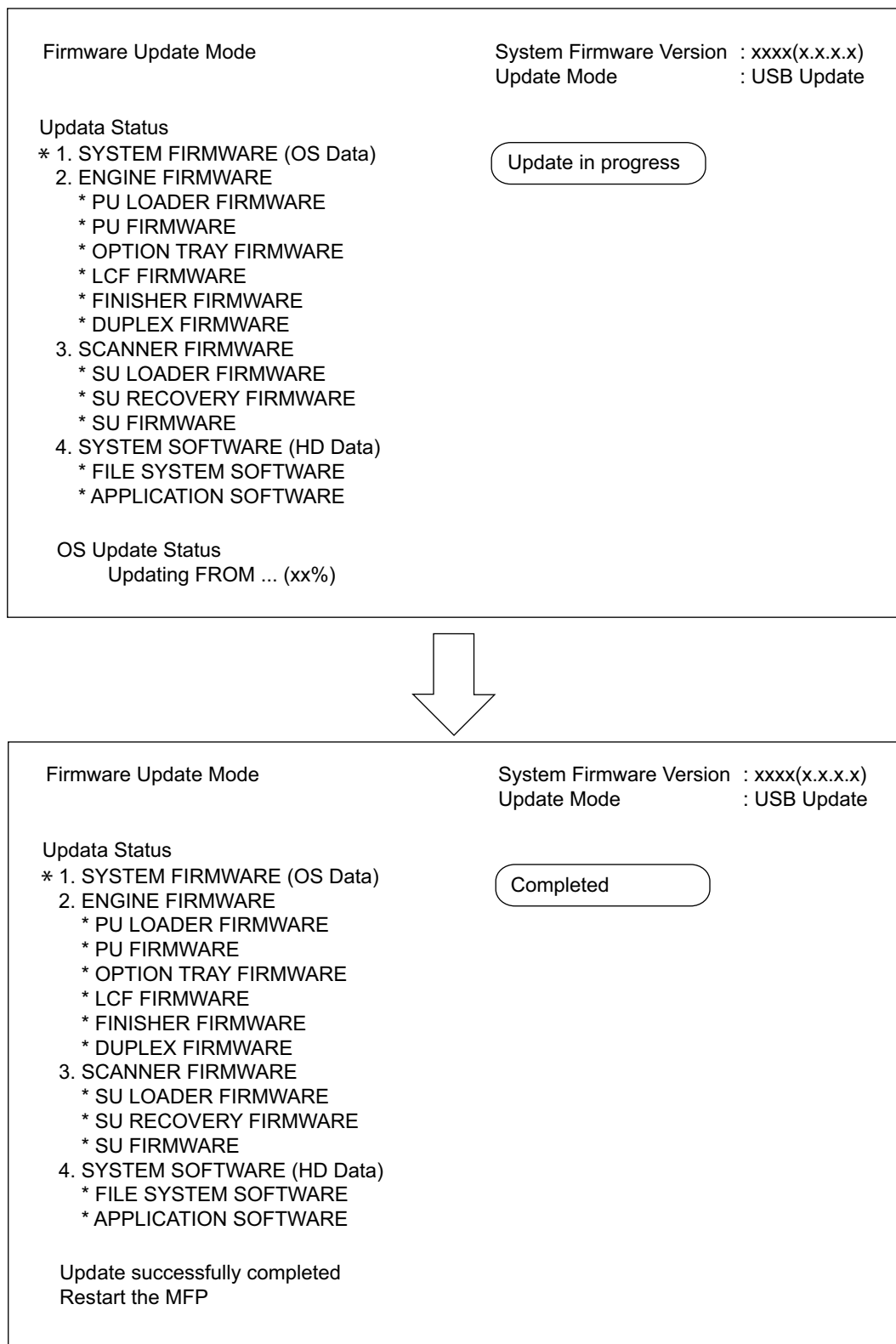

Fig.8-8

8.3 Patch Updating with USB Device

System firmware and System software can be updated in a shorter time than normal update using the data file for the patch update.

Notes:

When performing the update, use the latest program.

8.3.1 Firmware type and data file name for patch updating

Equipment

Firmware	Stored	Data file name	Display
System firmware	System control PC board (SYS board)	O290SFPWxxxx.tar * xxxx is version.	SYSTEM FIRMWARE(OS Data)
System software	HDD	O290HDPWxxxx.tar * xxxx is version.	SYSTEM SOFTWARE (HD Data)

Store the data file for patch updating in the model specific folder.

Model specific folder name	N29800_01
----------------------------	-----------

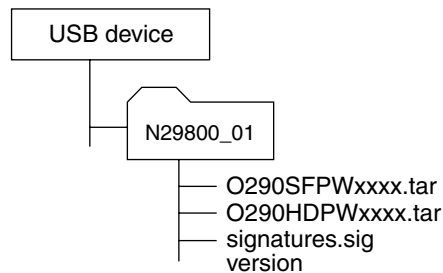

Fig.8-9

Notes:

- Since the date and time set in the equipment are recorded in the firmware update log, make sure that they are correct before updating the firmware.
- Never change the model specific folder name, since it is used for identifying the data file when the data files used for updating multiple models are stored in the USB device.

Important:

- Only the USB devices which meet the following conditions should be used for updating. Be careful since updating with any device other than the above is never guaranteed.
 - A combination USB device with a flash memory (to be connected directly to the USB port) and its capacity is 1GB or more.
 - Operation of the USB device used for updating has been confirmed at the input check of this equipment (Test mode 03). (☞ P. 3-7 “3.3 Input check (Test mode 03)”)
 - USB devices which comply with the following standards regulated by USB-IF (USB Implementers Forum)
 - Class number: 8 (=08h) (Mass-storage class)
 - Sub-class number: 6 (=06h) (SCSI transfer command set)
 - Protocol number: 80 (=50h) (Bulk-Only)
- * Most common USB devices comply with the specification above and can be used for updating. However, the operation in all the Multi Functional Digital Color Systems and Multi Functional Digital Systems is not necessarily guaranteed since the most of these devices are developed based on use in a PC environment (Windows or Macintosh). Therefore, check thoroughly that the device is operational in the equipment for which the updating will be performed when purchasing it.
- The USB devices complying with USB2.0 can be used for updating.
- Do not update the firmware by any storage device other than a flash memory (such as a USB connection type memory card reader, CD/DVD drive or hard disk), since it is never guaranteed.
- It is possible to store the model specific update program and the data file for updating directly in the root directory when you store the updating data file for one specific model in the USB device. However, if the model specific folder for the same model as that of the data file stored in the root directory already exists, this will have priority.

8.3.2 Update procedure

Important:

- The file system of USB device should be formatted in the FAT or FAT32 format. Be careful since the devices formatted in NTFS or other format will not be able to be operated. The file system can be confirmed on the device properties in applications such as Explorer of Windows.
- Never shut down the equipment during the update. Firmware data and the following option data (if installed) could be damaged and may not be able to be operated properly.
 - Data Overwrite Enabler (GP-1070)
 - Meta Scan Enabler (GS-1010)
 - External Interface Enabler (GS-1020)
 - IPsec Enabler (GP-1080)
 - Unicode Font Enabler (GS-1007)

[A] Update procedure

- (1) Connect the USB device to the PC and write the model specific folder in which the data file is stored.
Store the data file for updating in the model specific folder.
- (2) Press the [ON/OFF] button on the control panel to shut down the equipment.
- (3) Connect the USB device [1] to the USB port [2] on the right upper cover.

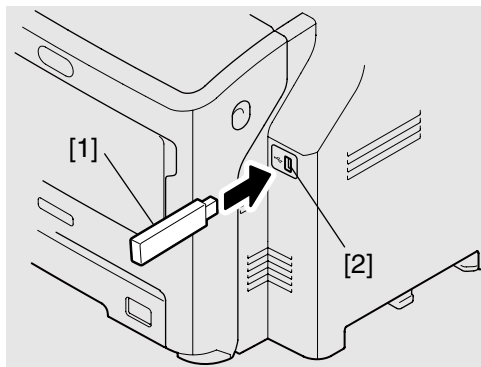

Fig.8-10

- (4) Press the [ON/OFF] button while simultaneously holding down the [4] and [9] buttons.
Data in the USB device are checked and the checking status is displayed on the screen.

- (5) Enter the password, and then press the [OK] button.
 (If the password is not set for Service, press the [OK] button without entering anything.)

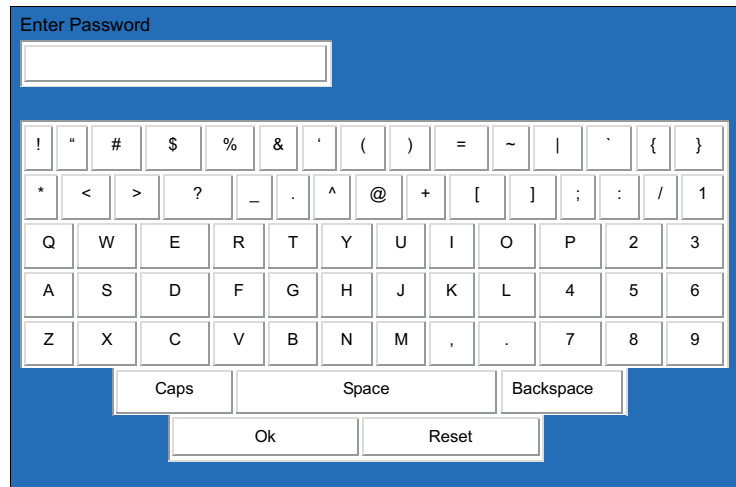

Fig.11-2

The screen for selecting items to be updated is displayed after approx. 3 minutes.

On this screen, the current firmware version of this equipment and the firmware version of data to be updated are displayed.

Firmware Update Mode	System Firmware Version : x.x.x.x	
	Update Mode : USB Update	
Update Status	Updater Version	Installed Version
1. SYSTEM FIRMWARE (OS Data)	O290SFPWxxxx.tar	O290SFPWxxxx.tar
2. SYSTEM SOFTWARE (HD Data)	O290HDPWxxxx.tar	O290HDPWxxxx.tar

Fig.8-11

Notes:

- The display of items on this screen varies depending on the types of data written on the USB device.

Each item is displayed only when each data file is written on the USB device in the following conditions.

Item	Condition
1. SYSTEM FIRMWARE(OS Data)	O290SFPWxxxx.tar is written. (xxxx is version.)
2. SYSTEM SOFTWARE (HD Data)	O290HDPWxxxx.tar is written. (xxxx is version.)

- If the USB device is not recognized properly, "USB device Not detected" message is displayed. In this case, disconnect the USB device and connect again within 3 minutes, or shut down the equipment and connect the device properly. Then repeat the procedure from (4).
- If any of the error messages below is displayed, confirm if the data file in the USB device is correct.

Then repeat the procedure from (4).

Error number	Error message	Cause
01	Error Loadmodule	Module loading failed.
02	Machine Model Get Error	Model information was not downloaded.
03	Copy Data with valid signature in USB Storage	Checking of data file failed.
04	Other models ROMDATA TXXXXXXXXX * The version name comes at "xxxx.xxx.x".	System software of other model are stored.
05	Copy Signature File in USB Storage	Data files are not stored in the USB device.
06	Patch and Normal package in one folder of USB Storage	When both the system and patch update packages are in the USB device

- (6) Select the item with the digital keys.

"**" is displayed next to the selected item. Display or delete the "**" by pressing the number of the item.

Item	Remarks
1. SYSTEM FIRMWARE(OS Data)	Updating System firmware (OS Data).
2. SYSTEM SOFTWARE (HD Data)	Updating System software (HD Data).

(7) Press the [START] button.

Updating starts and the processing status is displayed on the LCD screen.

The follow screen shows the display when selecting “1. SYSTEM FIRMWARE (OS Data)” in the update selection menu. “Update in progress” is displayed on the right side of the selected item, and then “Verifying Signature...” appears.

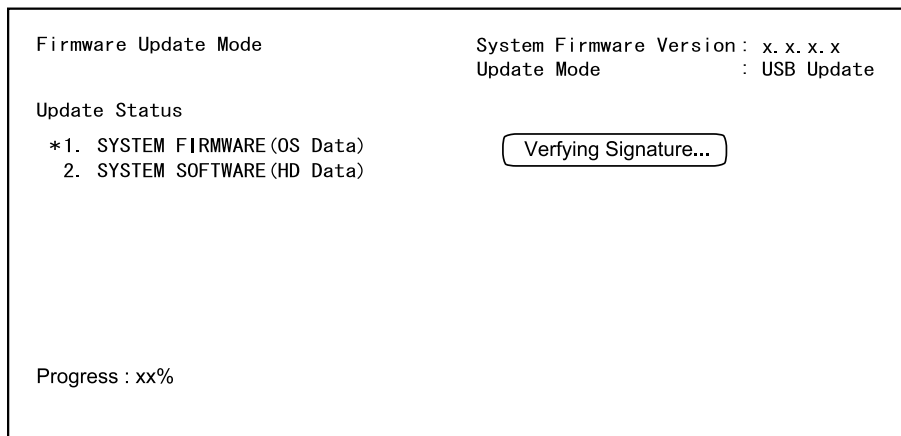
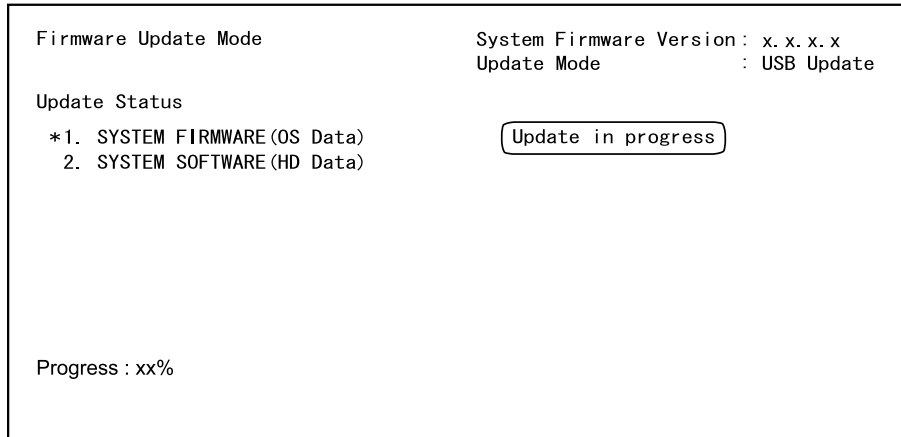

Fig.8-12

(8) “Patch Update Successful Restart the MFP” is displayed at the bottom of the LCD screen after the updating is completed properly.

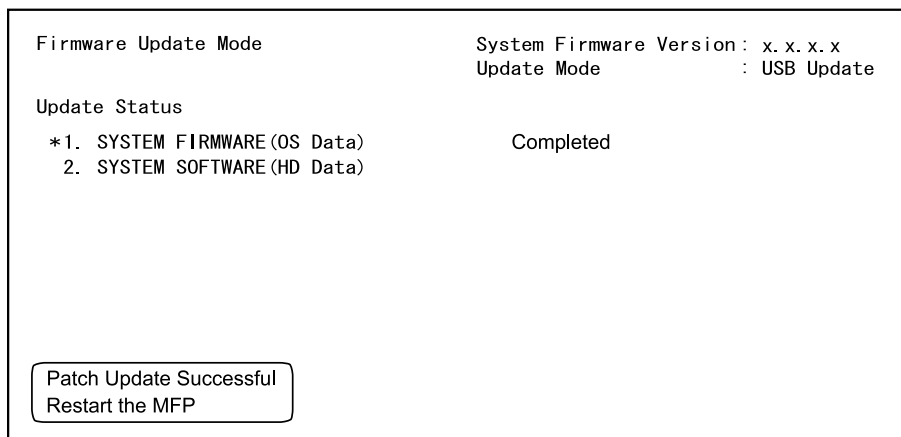

Fig.8-13

Notes:

- “Update Failed.” is displayed at the bottom of the LCD screen when the updating is not completed properly. “Failed” appears next to the failed item on the status display. Even though an update fails, do not turn the power OFF until other updates are finished. If “Update Failed” appears at the bottom of the screen, turn OFF the power and then check the following items. After confirming and clearing the problems, restart updating from the beginning.
 - Does the USB device meet the conditions to be used for updating?
 - Is the data file written properly on the USB device?
 - Is the USB device installed properly?
 - Do the USB device and equipment operate properly?
- When an System firmware (OS Data) update error or System software (HD Data) update error occurs, “Update Failed” or “Failed” appears on the screen and the error number appears next to the message.

For details of each error, refer to the following tables.

System firmware (OS Data) update Error	
Error number	Error content
O01	FROM writing failed
O02	FROM verification error
O03	File operation error
O04	SRAM flag set error
O05	Electronic key data backup error
O06	Device error

System software (HD Data) update Error	
Error number	Error content
H01	File creation error
H02	File decompression error
H03	Partition mount error
H00	Other errors

- (9) Press the [ON/OFF] button to shut down the equipment, and then remove the USB device.

[B] Confirmation of the updated data

After the updating is completed, check each data version in the Setting Mode (08) to confirm that the data were overwritten properly.

 P. 8-28 “8.6 Confirmation of the updated data”

8.4 Firmware Updating with PWA-DWNLD-JIG2

The data to be overwritten by this update are as follows.

When the SYS board is replaced, update the ROM data written on SYS board as necessary.

Equipment

Firmware	Stored
System firmware	System control PC board (SYS board)

PWA-DWNLD-JIG2 (48MB)

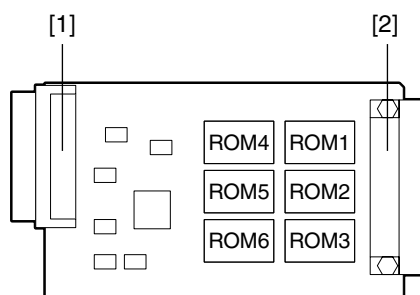

Fig.8-14

[1] Connector (for SYS board connection)

[2] Connector (for ROM writer adapter connection)

Important:

The download jig (PWA-DWNLD-JIG2) is the jig in which the Flash ROM is mounted on the board directly. Therefore, ROM writer adapter (PWA-DL-ADP-350) is required to write the data to these Flash ROMs. Refer to the following to write the data.

Remarks: Useable jigs

Download jigs for this equipment are as follows:

No	Type of jig	ROM capacity	Remarks
1	PWA-DWNLD-JIG1	16MB	
2	PWA-DWNLD-JIG2	48MB	

8.4.1 Writing the data to the download jig (PWA-DWNLD-JIG2)

The download jig (PWA-DWNLD-JIG2) is that in which the Flash ROM is mounted on the board directly. The ROM writer adapter (PWA-DL-ADP-350) is required to write data to these Flash ROMs. Connect the download jig with the ROM writer via ROM writer adapter to write data. For the procedure to write data, refer to the downloading procedure, instruction manual of each ROM writer, or other sources.

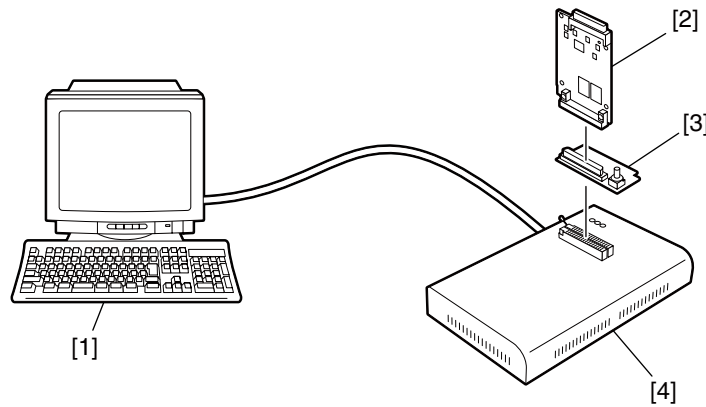

Fig.11-3

- [1] PC
- [2] Download jig (PWA-DWNLD-JIG2)
- [3] ROM writer adapter (PWA-DL-ADP-350)
- [4] ROM writer

Notes:

There are two types of the ROM writer adapter. Use the proper one according to the ROM writer to be used. Applicable type of the adapter for the ROM writer can be confirmed by the model name indicated on the board. Confirm that the adapter is available for the ROM writer to be used before connecting them. If an unapplied adapter is connected, the application of the ROM writer judges it as an error and writing the data cannot be implemented. Applicable combinations of the ROM writer and adapter are as follows.

ROM writer	ROM writer adapter
Minato Electronics MODEL 1881XP/1881UXP (or equivalent)	PWA-DL-ADP-350-1881 (model 1881)
Minato Electronics MODEL 1893/1895/1931/1940 (or equivalent)	PWA-DL-ADP-350-1931-LV640 (model 1931)

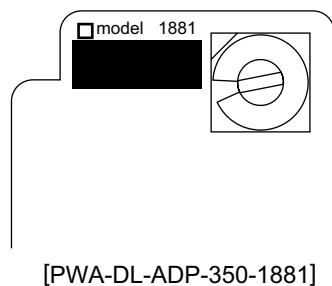

Fig.8-15

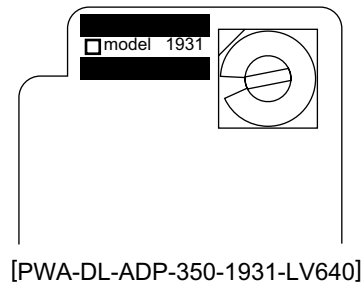

Fig.8-16

[A] Precautions when writing the System firmware data

- Set the writing voltage (VID) to 3.3 V.
When an error appears while the data are being written to the download jig, set the writing voltage (VID) to 12 V and then write them.
- When writing the data, set the address from 0 to 3FFFFFF. The data may not be written correctly if it is not set.
- Load the data file into the buffer by means of the following settings.

Auto Format Detected	Binary
From File	Normal
To Buffer	Normal
From File Address	0
To Buffer Address	0
Buffer Size	800100
Clear Buffer Before Loading the file	Clear buffer with blank state

[A-1] System firmware

System firmware		
Rotary Switch	File Name	Flash ROM
1	mosel_OKI_jig_1.bin	ROM1
2	mosel_OKI_jig_2.bin	ROM2
3	N/A	ROM3
4	N/A	ROM4
5	N/A	ROM5
6	N/A	ROM6

Notes:

Be sure not to confuse different ROM Versions since the file name is identical although the ROM version is different.



8.4.2 System firmware

The system firmware can be updated individually by using PWA-DWNLD-JIG2.

Important:

- Be sure to shut down the equipment before installing and removing the download jig.
- Do not shut down the equipment during the update. The data could be damaged and not be able to be operated properly.

[A] Update procedure

- (1) Write the ROM data to be updated to the download jig (PWA-DWNLD-JIG2).
- (2) Press the [ON/OFF] button to shut down the equipment.
- (3) Take off the right side cover.
 P. 6-1 "6.1.1 Right side cover"
- (4) Take off the SYS board cover.
 P. 6-4 "6.1.2 SYS Board cover"
- (5) Connect the download jig with the jig connector (CN105) on the SYS board.
- (6) Turn the power ON by pressing the [ON/OFF] button while simultaneously holding down the [8] and [9] keys.
- (7) Press the [Firmware Update] button, then press the [1] key to select "1.SYSTEM FIRMWARE(OS Data)".
- (8) Confirm the item to be updated.
 "=>" is displayed next to the selected item. Display or delete the "=>" by pressing the number of the item.
- (9) Press the [START] button. Updating starts and the processing status is displayed on the LCD screen.
- (10) "Update successfully completed." is displayed on the LCD screen after the updating is completed properly. Turn the power OFF by pressing the [ON/OFF] button.

Notes:

"Update Failed." is displayed at the bottom of the LCD screen when the updating is not completed properly. "Failed" appears next to the failed item on the status display. In this case, shut down the equipment and check the following items. Then clear the problems and restart updating from the beginning.

- Is the download jig connected properly?
- Is the updating data written to the download jig properly?
- Do the download jig and the equipment operate properly?

- (11) Turn the power OFF using the main power switch, remove the download jig, and then install the SYS board cover and rear cover.
- (12) Turn the power ON using the main power switch while holding down the [3] and [C] keys simultaneously.
- (13) Press the [5] key to select "5. Key Backup Restore", then press the [START] button.

(14) Restore the key and license data by following the steps below.

- Restore the key data by pressing the [1] key to select “1. Key SRAM to FROM”, then press the [START] button.
- If the state of “FROM Licence Status” is “KeyMismatch”, restore the license data by pressing the [3] key to select “3. License SRAM to FROM “, then press the [START] button.
- If ADI-HDD is installed, restore the encryption key data by pressing the [5] key to select “5. ADIKey SRAM to FROM”, then press the [START] button.

(15) Press the [ON/OFF] button to shut down the equipment.

(16) Initialize the updated data by following the steps below.

- Turn the power ON by pressing the [ON/OFF] button while holding down the [0] and [8] keys simultaneously.
- Key in “9030”, and then press the [START] button.
- Press the [INITIALIZE] button.

[B] Confirmation of the updated data

After the updating is completed, check each data version in the Setting Mode (08) to confirm that the data was overwritten properly.

 P. 8-28 “8.6 Confirmation of the updated data”

8.5 Firmware Updating with K-PWA-DLM-320

The firmware of the option (FAX ROM) can be updated individually by using K-PWA-DLM-320F. Update the ROM data written on each board according to the need such as the case of replacing the board.

Options

Model name	Firmware	Stored
FAX Unit (GD-1340)	FAX firmware	FAX board

K-PWA-DLM-320F

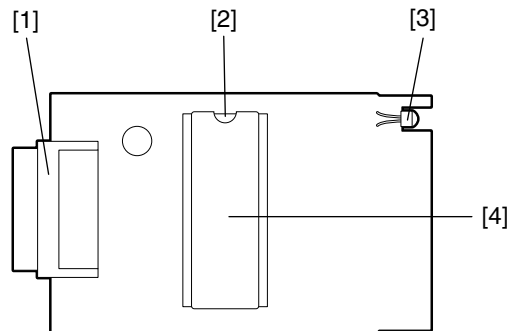

Fig.8-17

- [1] Connector
- [2] Mark for ROM installation direction
- [3] LED
- [4] ROM

Important:

Pay attention to the direction of the ROM.

Remarks: Useable jigs

Download jigs for this equipment are as follows:

No	Type of jig	Remarks
1	K-PWA-DLM-320	

8.5.1 FAX unit firmware (GD-1340)

Important:

- Before updating the FAX firmware, make sure to print out the current Function list for maintenance, Function list (ADMIN), Address book list and Group number information. In case the updating is failed and the registered information of the users is lost for some reason, re-register the user information referring to the lists and recover it.
- Confirm the following items before turning OFF the power of the equipment. Turning OFF the power may clear the data below.
 - Confirm that the “MEMORY RX” LED is OFF and there are no memory reception data.
 - Press the [JOB STATUS] button to display the screen and then confirm that there are no memory transmission data.
 - Print the “Mailbox/Relay box report” and then confirm that there are no F code data.

[A] Update Procedure

- (1) Install the ROM to the download jig (K-PWA-DLM-320).
Make sure the direction is correct.
- (2) Press the [ON/OFF] button to shut down the equipment.
- (3) Take off the right side cover.
 P. 6-1 “6.1.1 Right side cover”
- (4) Connect the download jig [1] with the jig connector [2] on the FAX board.

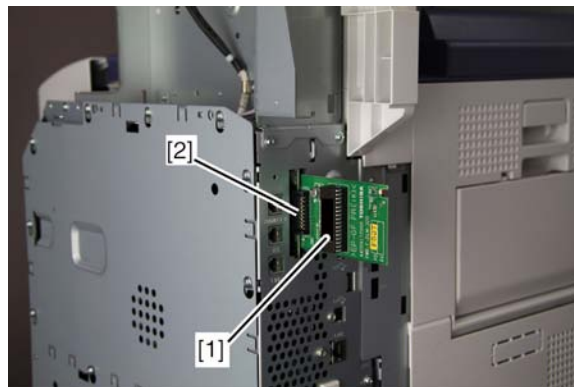

Fig.8-18

- (5) Press the [ON/OFF] button while simultaneously holding down the [0] and [8] buttons. Updating starts automatically and the LED on the download jig lights.
- (6) After the update is completed properly, the LED on the download jig blinks. The LED starts blinking approx. 30 sec. after the update starts. It is assumed that the update has failed if it does not start blinking even though 1 min. has passed. In this case, shut down the equipment and check the following items. Then clear the problems and restart updating from the beginning.
 - Is the download jig connected properly?
 - Is the ROM installed to the download jig properly?
 - Is the updating data written on the ROM of the download jig properly?
 - Do the download jig and the equipment operate properly?

- (7) Turn the power OFF using the main power switch of the equipment, remove the download jig, and then install the right side cover.
- (8) In the FAX Clearing Mode, perform the “FAX Set Up”.
 - Confirm the destination setting is correct in the Setting Mode (08).
 - 08-9000: Destination setting of the equipment
 - 08-9001: Destination setting of the FAX machine
 - Turn ON the power while [1] button and [*] button are pressed simultaneously.
 - Key in “100”.
 - Press the [START] button.

Notes:

If the equipment does not work properly after the operation (8), follow the procedure below and then perform the “Clearing the image data” in the FAX Clearing Mode to erase the image data in the memory.

- Confirm the destination setting is correct in the Setting Mode (08).
 - 08-9000: Destination setting of the equipment
 - 08-9001: Destination setting of the FAX machine
- Turn ON the power while [1] button and [*] button are pressed simultaneously.
- Key in “102”.
- Press the [START] button.

[B] Confirmation of the updated data

After the updating is completed, check each data version in Setting Mode (08) to confirm that the data were overwritten properly.

 P. 8-28 “8.6 Confirmation of the updated data”

8.6 Confirmation of the updated data

After the updating is completed, check each data version in Setting Mode (08) to confirm that the data were overwritten properly.

Firmware	Code	Remarks
Updating System firmware	08-9930	System firmware version
Updating PU firmware	08-9901	PU firmware version
Updating SU firmware	08-9902	SU firmware version
Updating System software	08-8952	HD data external version
	08-9900	System software version
Updating Finisher firmware	08-9904	Finisher firmware version
Updating FAX firmware	08-9905	FAX firmware version

8.7 When Firmware Updating Fails

When the equipment was shut down during firmware updating or it could not be started after updating for some reason, perform firmware updating again following the procedure below.

8.7.1 Procedure

- (1) Update “System firmware” of the system control PC board (SYS board) using the download jig (PWA-DWNLD-JIG2).

Updating with the USB device becomes possible only after the “System firmware” has been updated.

See the updating procedure below for details.

 P. 8-20 “8.4 Firmware Updating with PWA-DWNLD-JIG2”

- (2) Update the following firmware using the USB device.

See the updating procedure below for details.

 P. 8-3 “8.2 Firmware Updating with USB Device”

- System firmware
- PU firmware
- SU firmware
- System software

Important:

If the equipment cannot be started even when the above update has been performed, check that there is no damage to the “SYS board”, or “LGC board”. Replace them if necessary.

8.7.2 Flow chart for correcting USB update failure

[A] When the update of the System firmware failed

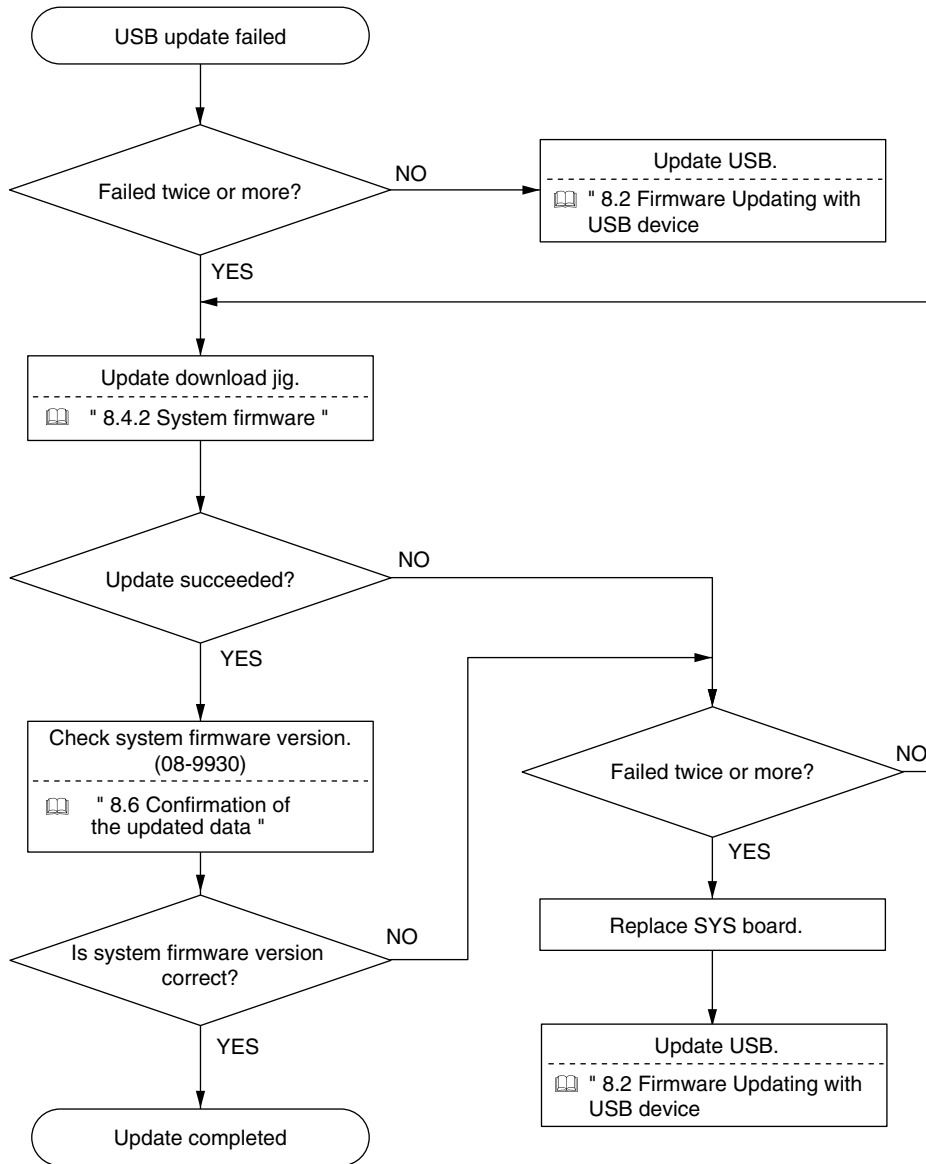

[B] When the update of system software failed

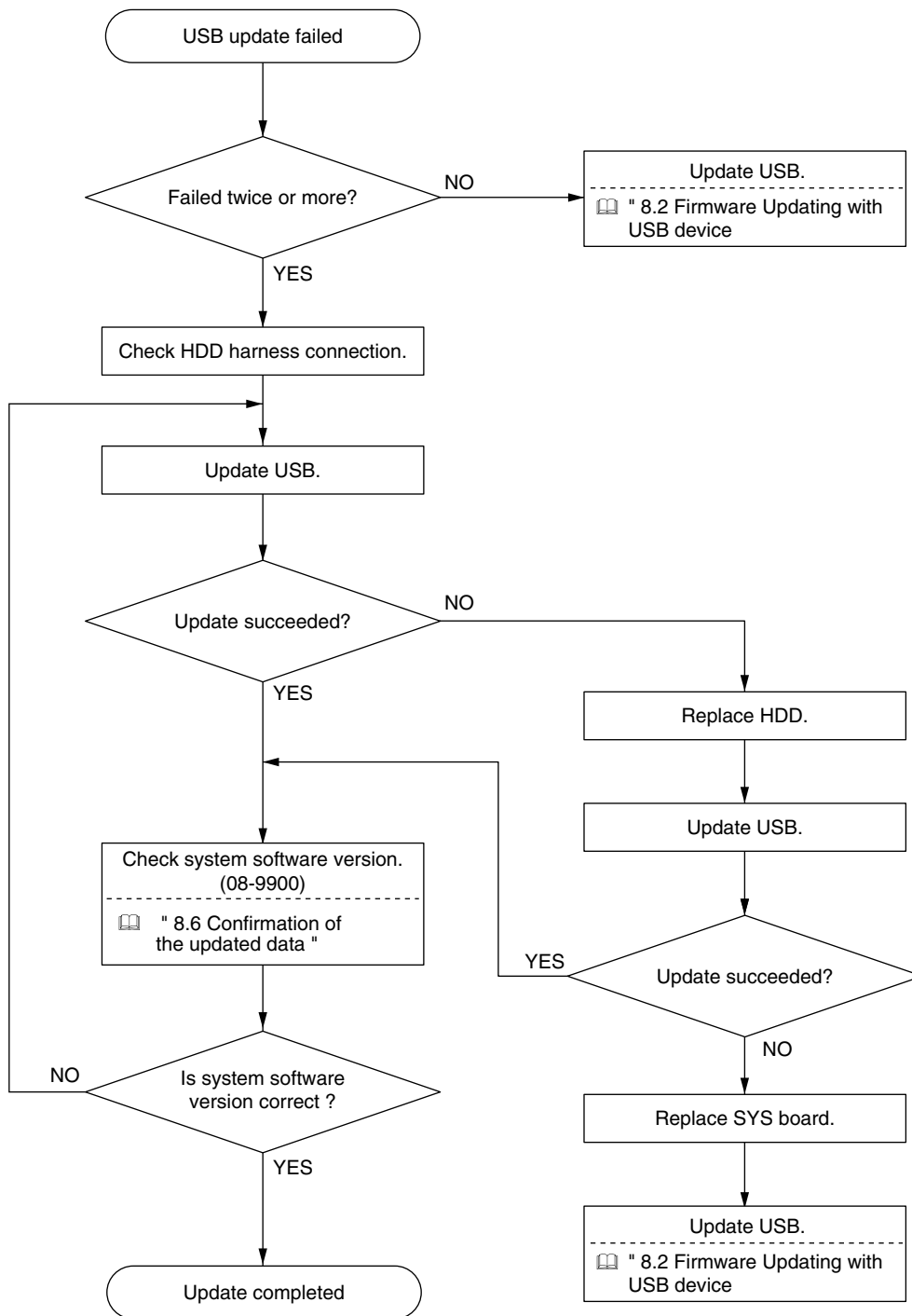

9. BACKUP FUNCTION

9.1 Data Cloning

9.1.1 General description

Data cloning is a function that backs up user data, setting data and SRAM data into a USB device and also restores these data into the equipment.

This function backs up or restores the data of the same equipment (same serial number), and is performed in the following cases.

- When the SYS board and the SRAM board are mistakenly replaced at the same time
- When the SRAM board is replaced

Notes:

The SYS board and SRAM board should never be replaced together.

9.1.2 Precautions

- When the ADI-HDD is initialized or replaced, back up the SRAM data afterwards.
- It is assumed that data cloning is to be performed when equipment is installed or options are installed. If the address book has been registered, do not perform restore. Registered / set data are lost.
- The USB device for the data cloning must meet the following conditions. A data cloning operation with any devices other than the following will not be guaranteed.
 - A combination USB device with a flash memory (to be connected directly to the USB port) and its capacity is 1GB or more.
 - A device compliant with the following specifications established by USB-IF (USB Implementers Forum)

Class number:	8 (=08h)	(Mass storage class)
Sub-Class number:	6 (=06h)	(SCSI transfer command set)
Protocol number:	80 (=50h)	(Bulk-only)

The USB device should be formatted in the FAT or FAT32. (Correct operation cannot be guaranteed if it is formatted in NTFS/exFAT.)

 - Most of the common USB device are compliant with the above specifications and are therefore applicable to this data cloning. However, most of these devices were originally developed to be used in an environment for PCs (e.g. Windows or Macintosh) and thus operations exclusively with this equipment have not been fully guaranteed. Therefore, the user must thoroughly check in advance whether there will be any problem in operating with this equipment when adopting one of these devices.
- The USB device compliant with both USB 1.1 and USB 2.0 can be used for this data cloning.
- Data cloning with any storage devices other than a flash memory (e.g. USB-connectable memory card reader, CD/DVD drive, hard disk) will never be guaranteed. Therefore never use them for this operation.
- Be sure to unplug the LAN cable and Fax line before data are backed up / restored. Also, do not use the RADF and open the cover, drawer, etc. during the data cloning.
- Data can be backed up / restored only for the same model and version. If the version is different, update the firmware and back up / restore data in the same version.
- Restore data to equipment which has the same options as when the data are backed up.
- Delete the backed up data in the USB device after the data cloning.

9.1.3 Backup files

The following files are saved in the root directory of the USB device by backing up.

Filename	Remark
Modelname_MFPSerialNo_yyyy-MM-dd_hh-mm	E.g.: When backup was performed at 13:59 on October 1st, 2010. T290_CUK911379_2010-10-01_13-59

9.1.4 Cloning procedure

[A] Backup procedure

- (1) Press the [ON/OFF] button to shut down the equipment.
- (2) Connect the USB device [1] to the USB port [2] on the right upper cover.

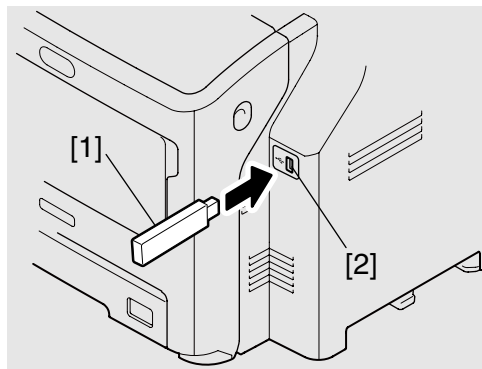

Fig. 9-3

Notes:

Backing up cannot be performed with multiple USB device [1] connected at the same time.

- (3) Turn the power ON while pressing [6] and the [CLEAR] button simultaneously.
- (4) When "SRAM Clear Mode" appears on the LCD, key in [0] to select "0. Set Serial Number" and then press the [START] button.
- (5) Key in the serial number on the label attached to the rear cover of the equipment, and then press the [OK] button.
- (6) "Serial Number Setting completed" is displayed.
- (7) Turn the power OFF.
- (8) Turn the power ON while pressing the [5] and [9] buttons simultaneously.
- (9) Enter the password, and then press the [OK] button.
(If the password is not set for Service, press the [ENTER] button without entering anything.)
- (10) Select "1. Backup SRAM Data to USB", and then press the [START] button.
- (11) Enter a password (max. 15 characters) set for the backup data.
- (12) "Backup Successfully done Restore the MFP" is displayed on the LCD screen when the backup has been properly completed.
- (13) Press the [ON/OFF] button to shut down the equipment.

[B] Restore procedure

- (1) Press the [ON/OFF] button to shut down the equipment.
- (2) Connect the USB device [1] to the USB port [2] on the right upper cover.

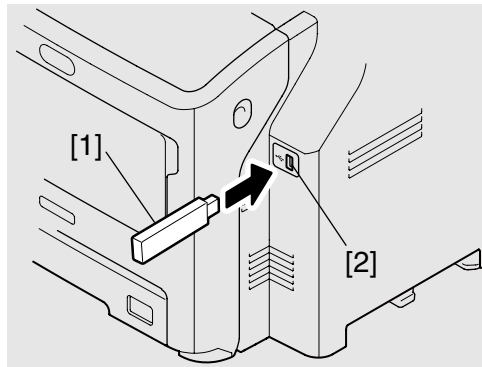
**Fig. 9-4****Notes:**

Backing up cannot be performed with multiple USB device [1] connected at the same time.

- (3) Turn the power ON while pressing the [5] and [9] buttons simultaneously.
- (4) If "3" is set for 08-8911, enter the password.
- (5) Select "2. Restore SRAM Data from USB", and then press the [START] button.
- (6) Enter the password (max. 15 characters) which has been set in (6) of "[A] Backup procedure".
- (7) Enter the serial number for the backup file.
- (8) "Restore successfully done Restart the MFP" is displayed on the LCD screen when the restoring has been properly completed.
- (9) Press the [ON/OFF] button to shut down the equipment.

Notes:

To perform cloning with the SRAM data backed up before the ADI-HDD is initialized or replaced, follow the procedure below after the restoration is finished.

- (1) Turn the power ON while pressing [3] and the [CLEAR] button simultaneously.
- (2) Enter the password, and then press the [OK] button.
(If no password is set for Service, press the [OK] button without entering anything.)
- (3) Key in [5] to select "5. Key Backup Restore", and then press the [START] button.
- (4) Key in [6] to select "6. ADIKey FROM to SRAM", and then press the [START] button.
- (5) Wait until the restoring of the encryption key is completed. "Operation Complete" is displayed.
- (6) Then turn the power OFF.

[C] Confirmation of the error

“Backup Failed” or “Restore Failed” is displayed on the lower left part of the LCD screen when the data have not been properly backed up or restored.

Moreover, details of an error are displayed under the above message.

(The following is an example screen when “USB device not detected” is displayed.)

SRAM Data Cloning Mode	Firmware Version : x. x. x. x Update Mode : 59 Mode
Select number (1-2) and press START key	
→ 1: Backup SRAM Data from USB 2: Restore SRAM Data from USB	
Backup Failed USB device not detected	

Fig.12-1

In this case, turn the power OFF and then check the following items. After confirming and solving the problem, back up / restore the data again from the beginning.

- Does the USB device meet the conditions being used for this cloning?
- Is the updated program file written on the USB device properly?
- Is the USB device installed properly?
- Is the USB device or the equipment damaged?

Backup	
Display content	Error content
USB device not detected	The USB device has not been installed.
SRAM Device Not Connected	The SRAM board (for the SYS board) has not been installed.
Backup not created	Creation of the Backup file of data of the SRAM board (for the SYS board) has been failed.
Encryption Failed	An encryption of the backup file has been failed.
password Not Appended to Backup	Addition of the encryption password has been failed.
MFP Serial Number Not Set	Acquisition of the MFP Serial No. has been failed.

Restore	
Display content	Error content
USB device not detected	The USB device has not been installed.
SRAM Device Not Connected	The SRAM board (for the SYS board) has not been installed.
Invalid Backup File	The SYS board has not been recognized.
No Backup File Exists	Backup file has not existed in the USB device.
Invalid password	An incorrect password has been entered.
Decryption Failed	Decoding of the backup file has been failed.
Invalid MFP Serial Number: xxxxxxxx	An incorrect MFP Serial No. has been entered.
MFP Serial Number Not Set	Acquisition of the MFP Serial No. has been failed.
Backup File Corrupted	A backup file has been damaged.

9.2 AES Data Encryption Function Setting

9.2.1 General description

Data encryption is a function that encrypts data in the HDD to enhance the security. Note that this function may affect the equipment performance.

9.2.2 Precautions

When the data encryption function is set enabled, data currently stored in the HDD will not be retrieved. Therefore when data encryption function needs to be enabled after the installation of the equipment, it is necessary to back up the data in the HDD before setting this function and then recover them after the setting.

- To ensure security, ask the user (machine administrator) to back up or restore the user's data and information in the HDD. A service technician can back up or restore them only when the user (machine administrator) permits it.
- Some data in the HDD cannot be backed up and can be left only on printouts.

When the data encryption function is enabled, the following items are restricted.

- 08-9112 (Auto Shut Off Mode timer setting (Sleep Mode)) is automatically set to "20: Not used".
- 08-9113 (Screen setting for automatic energy saver/automatic power OFF) is automatically set to "0: OFF".
- When the [POWER SAVE] button is pressed on the control panel, the equipment does not enter the sleep mode.
- Since the energy saver mode cannot be set using the control panel, set it in Web Page. However, the setting of "Sleep/Auto Shut Off" cannot be changed in Web Page and "Disable" is displayed.

9.2.3 Setting procedure

A procedure for setting the data encryption function is shown below.

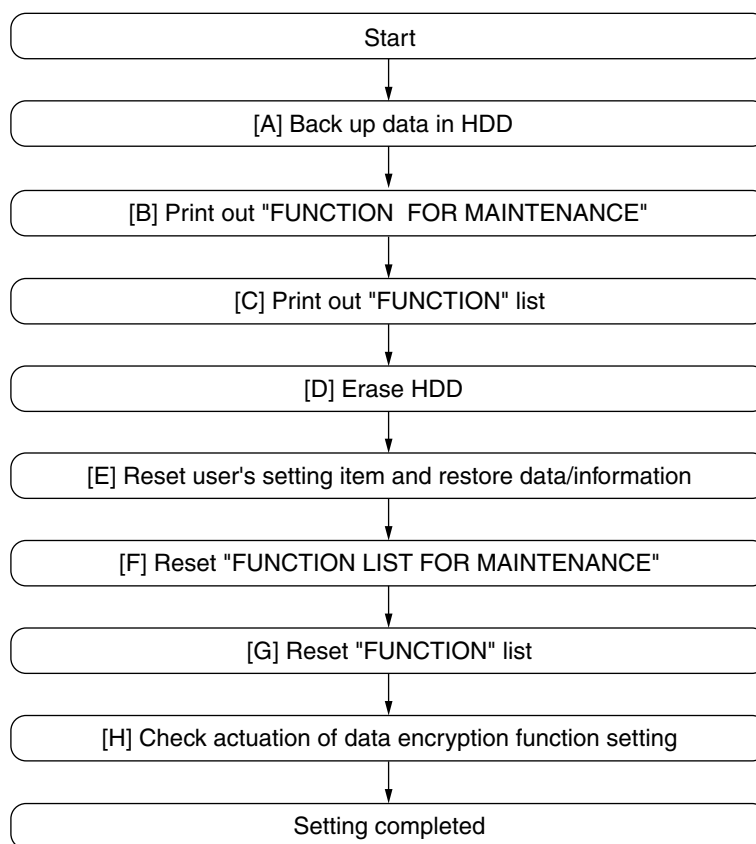



Fig. 9-5

[A] Back up in HDD

Ask the user (machine administrator) to back up the data in the HDD. Refer to the table below for the type of data, availability and method of backup.

Type of data in HDD	Availability	Backup method
Image data in the e-Filing	Available	Archive them in the “e-Filing” of Web Page. As for the backup in Box data, all data (selectable by the box) can be backed up / restored in one go by using “e-Filing Backup/Restore Utility”.
F-code information, Template registration information, Address book data	Available	Export them up in the “Administrator” menu of Web Page.
Department management data	Available	Export them in “Administrator” menu of Web Page.
Log data (Print, Scan, FAX (Transmission/Reception) / Message Log	Available	Export them in the “Log” menu of Web Page. (Import cannot be performed.)
Data in the shared folder (Scanned data, Saved data of copy / FAX transmission)	Available	Copy them to the client computer via the network. (The data which have been copied to the client computer cannot be copied to the shared folder.)
Role information	Available	Export role information on the Web Page menus. [User Management] tab > [Export]
Print waiting data (Copying data and FAX reception data that are waiting to be printed due to the paper run-out and jam, etc.)	Not available	Finish printing them after the paper supply and the jam release, etc. (The data cannot be kept.)
Print job (Private print data, Schedule print data)	Not available	If any jobs are left, print them. (The data cannot be backed up.)
FAX saved data (Confidential / Bulletin board data)	Not available	Print them. (The data cannot be backed up.)
Registration data for FAX transmission (Delayed transmission / Recovery transmission)	Not available	Print them. (The data cannot be backed up.)

[B] Print out “FUNCTION LIST FOR MAINTENANCE”

- (1) Enter the Service UI Mode.  P. 3-5 “3.2 Service UI”
- (2) Select “FAX LIST PRINT MODE” and then press [NEXT].
- (3) Select “Function list for Maintenance” and then press [PRINT].

[C] Print out “FUNCTION” list

- (1) Press the [USER FUNCTIONS] button.
- (2) Press the [ADMIN] button, enter the password, and then press the [ENTER] button.
- (3) Press the [LIST/REPORT] button and then the [LIST] button.
- (4) Press the [FUNCTION] button. The “FUNCTION” list is printed out.

Notes:

Explain the procedure to the user (machine administrator) and ask him/her to enter his/her password.

[D] Enable data encryption function

Perform the setting of the data encryption function in the code 08-9379. The setting values are shown below.

- 0: Encryption disabled
- 1: Encryption enabled (Security priority)
- 2: Encryption enabled (Performance priority)

Security priority: All user data are encrypted.

Performance priority: Encryption data are generated only in a copying or a printing process temporarily.

All user data except files which are deleted in a corresponding process are encrypted.

[E] Reset user’s setting items and restore data/information

Ask the user (machine administrator) to reset the user’s setting items and to restore data or information. Refer to the following for the reset and restore:

Items to reset/restore	Method
Printer driver	Upload them in the “Administrator” menu of Web Page.
F-code information, Template registering information, Address book data	Restore them in the “Administrator” menu of Web Page.
Department management data	Import them in the “Administrator” menu of Web Page.
Image data in the e-Filing	Restore them in the “e-Filing” of the Web Page.
Role information	Import role information on the Web Page menus. [User Management] tab > [User Confirm/Create/Modify] > [Role Information]

Notes:

- When the SSL is enabled, perform the setting of the following items again with “Create self-certificate” of Web Page.
 - Country Name
 - State or Province Name
 - Locality Name
 - Organization Name
 - Organizational Unit Name
 - Common Name
 - Email Address
- When wireless LAN is used, perform the setting again on the LCD panel. (only when security with a certificate is used) Also, upload the following certificate file with “Install Certificate for Wireless LAN” of Web Page.
 - CA certificate
 - User certificate

[F] Reset “FUNCTION LIST FOR MAINTENANCE”

- (1) Print out the “FUNCTION LIST FOR MAINTENANCE” list after the formatting.
- (2) While pressing [1] and [3] simultaneously, turn the power ON. (Function Mode)
- (3) Compare the lists which were printed before and after the formatting to check the setting items having the different setting values. Set the value which was set before the formatting
Turn the power OFF.
- (4) Turn the power OFF.

[G] Reset “FUNCTION” list

Reset the fax function by referring to the “function list” that was printed out in  P. 9-8 “[C] Print out “FUNCTION” list”.

- (1) Press the [USER FUNCTIONS] button.
- (2) Press the [ADMIN] button, enter the password, and then press the [ENTER] button.
- (3) Press the [FAX] button and then the [TERMINAL ID] button to set each item.
- (4) Press the [INITIAL SETUP] button to set each item.

Notes:

Explain to the user (machine administrator) about the next operation and ask him/her to enter his/her password.

[H] Check actuation of data encryption function setting

Check if the data encryption function is in operation.

Press the [COUNTER] button on the control panel. If a key-shaped icon is displayed at the top right of the screen, the data encryption function is in operation.

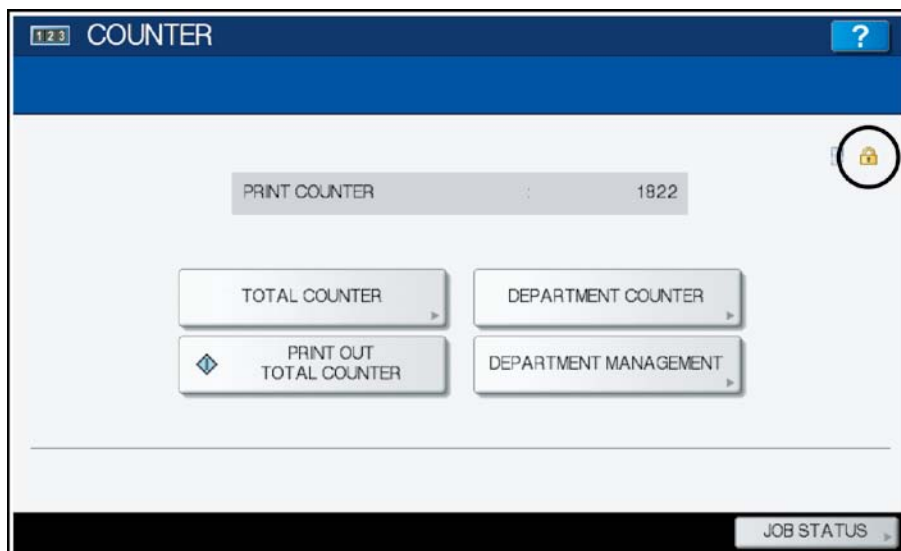



Fig.12-2

9.2.4 Procedure for disabling data encryption function

The basic procedure is the same as the one for enabling this function. To disable it, set "0 (Invalid)" in the code 08-9379 at step  P. 9-8 "[D] Enable data encryption function".

9.2.5 Procedure for discarding HDD when data encryption function is enabled

Set the data encryption function disabled following the procedure shown in  P. 9-10 "9.2.4 Procedure for disabling data encryption function". Then perform the code 3C->6 : Erase HDD Securely (HDD securely erasing) to completely erase the data in the HDD.

9.3 High Security Mode

9.3.1 General description

The High Security Mode is a security mode complying with the IEEE2600.1 Security Standards Requirement. To have the equipment enter this mode, follow the procedure and the precautions below.

9.3.2 Prior confirmation

- Confirm that the administrator for the equipment is authorized and ask him/her to observe the installation.
- To have the equipment enter the High Security Mode, the Data Overwrite Enabler GP-1070 (optional) is required. Confirm that this option is installed in advance. Follow the Unpacking Instructions to install it.
- To avoid physical security problems, such as hardware removal or inappropriate disassembly at the installation site, take all necessary measures, such as checking who enters and leaves the site.
- Confirm that no received fax data or print jobs in progress exist. If there are any, be sure to print them all out before entering the High Security Mode.
- The HDD is initialized in the High Security Mode. Be sure first to back up user data such as documents, Address Book, templates or fax settings using the export function or the backup/restore utility of the Web Page. Refer to items noted in  P. 9-5 "9.2 AES Data Encryption Function Setting".
- Make a note of the settings on the Administration tab page of the Web Page in advance.
- Compatibility of cloning data is lost between the High Security Mode and the normal mode; therefore, cloning data cannot be imported.

Downloaded from	Downloaded to	Compatibility of cloning data
Normal mode	Normal mode	Yes
Normal mode	High Security Mode	No
High Security Mode	Normal mode	No
High Security Mode	High Security Mode	Yes

9.3.3 Procedure for entering the High Security Mode

- (1) Set the value of the code 08-8911 (Security mode level setting) to "3" (High). Then restart the equipment.
- (2) A key-shaped icon appears at the bottom of the touch panel, indicating that it is now in the High Security Mode.
- (3) Press [COUNTER] button on the control panel. If a key-shaped icon, indicating that the HDD data are being encrypted, a paper-shaped icon indicating that the Data Overwrite Enabler is operating normally and the version name of the installed system ROM (SYS V1.0) are displayed on the top right of the counter menu, this means the mode is operating normally.
- (4) Reset the user data backed up in advance.

9.3.4 Precautions

- In the High Security Mode, an integrity check system is operated at every restart. If F521 (integrity check error) is displayed, take the necessary measures following the troubleshooting procedure.
- When a self-diagnostic mode is started in the High Security Mode, an authentication screen appears. Enter the default user name and password as follows:

Default user name: service

Default password: #1048#

- If a password change screen appears, reset the password according to the rules below.
 - It must not include the user name.
 - It must be a combination of letters of the alphabet and numbers.
 - It must be 6 characters or more. (Maximum 64 characters)
 - The same character must not be repeated 4 times within the new password.
 - The old and the new passwords must not be the same.
- In the High Security Mode, restrictions are set to the following self-diagnostic codes:

Code	Contents
08-8910	The setting value is changed to "2". "0" is not settable.
08-8911	The setting value is changed to "3".
08-8924	The setting value is changed to "1". Values other than "1" are not settable.
08-9110	"0" is not settable.
08-9193	If "0" is set for the value, the setting will not comply with IEEE2600.1 Security Standards Requirement.
08-9379	The setting value is changed to "1".
08-9819	The setting value is changed to "1". If "0" is set for the value, the setting will not comply with IEEE2600.1 Security Standards Requirement.

- In the above case, the password is not reset. The password setting can be changed with the code 08-8919.
- The HDD is initialized (and the saved user data are deleted) when the equipment returns to the normal mode from the High Security Mode. Be sure to back up user data before having it do so.
- After the equipment enters the High Security Mode, ask the administrator for the equipment to select [FULL] and perform the Integrity check manually.

10. EXTERNAL COUNTERS

10.1 Outline

This chapter describes the interface between the equipment and coin controller. This equipment does not support card controller and mechanical counter.

10.2 Signal

Notes:

- Use 24V supplied from the main equipment as power for the output signals (KCTRON) from the transistor.
- Do not connect inductive loads, such as a mechanical counter or a relay coil, to CTRON.

10.2.1 Pin Layout

1. Connector on the PU board: COIN (JST-made B20B-CZHK-B-1(LF)(SN)(V)) (Coin Controller)

Pin No.	I/O	Signal name	Function	Voltage level	Remarks	GQ-1260
1	GND	SG	Signal Ground	0V		-
2	In	CTRCNT	Copy permission Signal 1	L=0V, H=DC3.3V		-
3	Power	+24V	24V line	DC24V+10%, -5%		-
4	Out	KCTRON	Mechanical Counter On Signal	Open Collector	L: ON	-
5	Power	+24V	24V line	DC24V+10%, -5%		-
6	Out	CTRON	Total Counter On Signal	Open Collector	L: ON	In use
7	In	CTRCNT	Copy permission Signal 1	L=0V, H=DC3.3V	L: Allowed	In use
8	Out	MCRUN	Ready to Copy Signal	Open Collector	L: Operating	In use
9	Out	EXTCTR	Exit Sensor On Signal	Open Collector	L: Operating	In use
10	GND	PG	Power ground	0V		In use
11	Out	BKCTR	Black mode Counter Signal	Open Collector	L: Operating	-
12	Out	MNCTR	Mono color mode Counter Signal	Open Collector	L: Operating	-
13	Out	FLCTR	Full color mode Counter On Signal	Open Collector	L: Operating	-
14	GND	SG	Signal Ground	0V		-
15	Out	SIZE3	Paper size Signal 3	Open Collector	L: Operating	-
16	Out	SIZE2	Paper size Signal 2	Open Collector	L: Operating	-
17	Out	SIZE1	Paper size Signal 1	Open Collector	L: Operating	-
18	Out	SIZE0	Paper size Signal 0	Open Collector	L: Operating	-
19	Power	+5V (Sleep)	5V line	DC5.1V	At the sleep mode: OFF	In use
20	-	N.C.	-	-		-

2. Connector on the SYS board: CN110 (JST-made B7B-PH-SM4) (Coin Controller)

Pin No.	I/O	Signal name	Function	Voltage level	Remarks	GQ-1260
1	Out	LARGE / SMALL	Paper size Signal	Open Collector	L: Large size	In use
2	Out	FULL COLOR	Full color mode Signal	Open Collector	L: Full color	In use
3	Out	TWN/ MON COLOR	Twin color / Mono color Mode Signal	Open Collector	L: Twin colors	In use
4	Out	B/W	Black mode Signal	Open Collector	L: Black	In use
5	Power	N.C. (5VA)	5V line	DC5.0V	At the sleep mode: ON	-
6	GND	GND	Signal Ground	-		In use
7	-	N.C.	-	-		-

10.2.2 Details of the signals

1. CTRON signal (output signals)

These signals are synchronized with electronic counter of the equipment and they become "Low" when one sheet of paper is counted up. They are the signals for coin controller, and output from the LGC board.

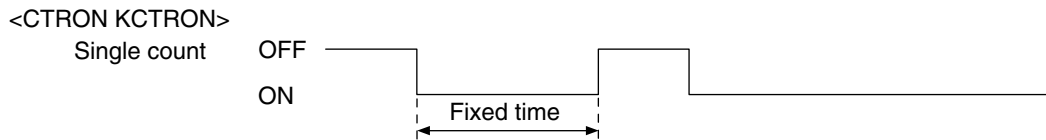

Fig.10-1

2. CTCRNT signal (input signals)

The CTCRNT signal enables to accept copies when the coin controller is connected, and copies can be accepted with "Low". In case of "High", "Set Key Counter" appears and copies cannot be made.

3. MCRUN signal (output signal)

The MCRUN signal is changed to "Low" during copying. It becomes "Low" at 30 ms or more before the CTRON signal is turned ON, and "High" at 50 ms or more after the EXTCTR signal goes OFF. However, if copying is interrupted due to forced toner supply or similar, this signal is "High" until copying is made possible again. This is the signal for the coin controller.

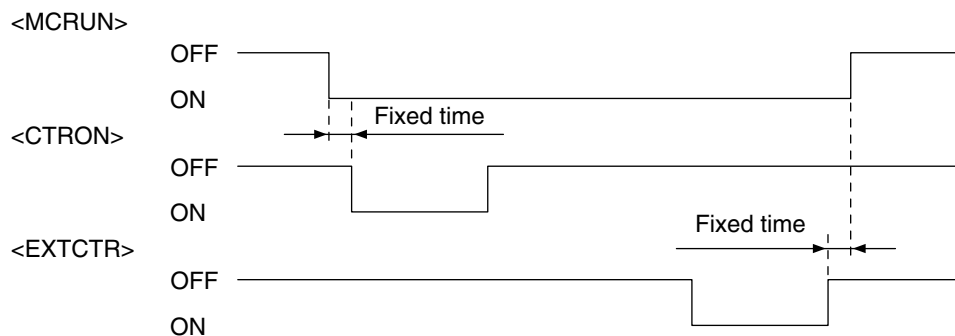

Fig.10-2

4. EXTCTR signal (output signal)

The EXTCTR signal is synchronized with "Exit sensor ON" and becomes "Low" (ON) for 200 ms. The coin controller counts the number of times with this signal.

This is the signal only for the coin controller.

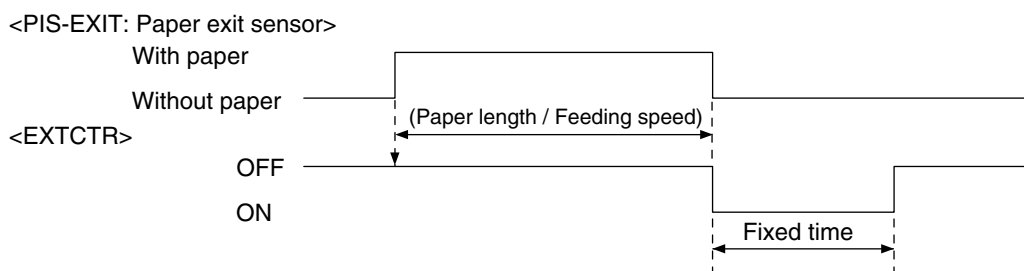

Fig.13-1

5. BKCTR signal, MNCTR signal, FLCTR signal (output signals)

These signals become “Low” (ON) synchronizing with the CTRON signal according to the copying mode used. The pulse width corresponds to the fixed time. Though the CTRON signal is set to “Double count”, they are not outputted synchronizing with the second count signal.

6. SIZE3, SIZE2, SIZE1 and SIZE0 signals (output signals)

These 4 signals are outputted in the combination of 4 sizes for the paper to be copied. They are the signals for the coin controller, and are outputted from the LGC board.

7. LARGE/SMALL signal (output signal)

When large size paper (A3 / A3 wide / LD) is selected or paper size is not specified with the manual feeding, it outputs “Low” in real time. In other cases, it outputs “High”. The setting change for large size paper is performed with F/W.

This is the signal only for the coin controller.

8. FULL COLOR signal (output signal)

If the full color mode is selected, it outputs “Low” in real time. In other cases, it outputs “High”. By default, it outputs “Low” since it is set as full color mode.

This is the signal only for the coin controller.

9. TWN / MON COLOR signal (output signal)

If the twin color or mono color mode is selected, it outputs “Low” in real time. In other cases, it outputs “High”. This is the signal only for the coin controller.

10. B/W signal (output signal)

If the black mode is selected, it outputs “Low” in real time. In other cases, it outputs “High”. This is the signal only for the coin controller.

11. KCTRON signal (output signal)

These signals are synchronized with the electronic counter of the equipment and they become “Low” when the counter is turned ON. They are the signals for driving a mechanical counter, and output from the LGC board.

They can drive inductive loads, such as a solenoid, using 24V supplied from the equipment. The interval between when they are turned ON and when this happens next must be at least 100 ms. “Single count” or “Double count” can be switched according to the paper size by setting “1” or “2” for 08-6010.

10.3 Notices

10.3.1 Setting code

Each signal will be enabled by configuring the setting code "08-9016" (Counter installed externally).

08-9016

0: No external counter (Default)

1: Coin controller

5: Coin controller supporting ACS

10.3.2 Setting value change and restrictions when using the coin controller

1. Setting value

- 08-9016 (Counter installed externally): Set to "1" (Coin controller). The coin controller supporting ACS (Auto Color Selection) can be connected by setting to "5" (Coin controller supporting ACS/ mixed-size). However, operation is not guaranteed unless the specification for the ACS timing is met.
- 08-9017 (Setting for counter installed externally): It should be charged precisely according to the usage.
Example: To charge only when copies are made, set to "1".
- 08-6011 (Definition setting of large sized paper):
 - Setting value "0": Set this value to regard A3, LD, undefined, and custom size that exceeds 415 mm as large size.
 - Setting value "1": Set this value to regard A3, LD, undefined, B4, Folio, 14"LG, 13.5"LG, 13"LG, Computer and custom size that exceeds 325 mm as large size.
 - Setting value "2": Set this value to regard B4 and custom size that exceeds 325 mm as large size.

11. SELF-DIAGNOSIS CODE (03/05/08 CODE)



Test mode (03)

Input check (Test mode 03)

Items to be checked and the condition of the equipment when the buttons [A] to [H] are highlighted are listed on the following pages.

[FAX] button: OFF/[COPY] button: ON/[SCAN] button OFF

("C%" is displayed.)

Digital key	Button	Items to check	Contents	
			Highlighted display e.g. 	Normal display e.g. 
[0]	A	-	-	-
	B	-	-	-
	C	-	-	-
	D	Security enabler	Connectable	Not connectable
	E	Judgement for acceptable USB storage device (*1)	Acceptable	Not acceptable
	F	-	-	-
	G	-	-	-
	H	-	-	-

*1

- Be sure to install the USB storage device to the equipment and check if the device can be used with this code.
- Be sure to turn OFF the write protection (the function to prevent data from erasure by the accidental recording or deleting) of the USB storage device before performing the check, otherwise this code cannot be used.
- It may take some time (2 sec. to 10 sec.) before this check is completed depending on the USB storage device.

Output check (test mode 03)

Code	Function	Procedure
301	Modem test 2100Hz	2
302	Modem test 14.4KBPS(V17)	2
303	Modem test 9.6KBPS(V29)	2
304	Modem test 4.8KBPS(V27)	2
305	Modem test 300BPS	2
306	Modem test 1850Hz	2
307	Modem test 1650Hz	2
308	Modem test 1100Hz	2
309	Modem test 462Hz	2
310	Modem test 1300Hz	2
311	Modem test 33.6KBPS(V.34)	2
312	Modem test 28.8KBPS(V.34)	2
313	Modem test 24.0KBPS(V.34)	2
314	Modem test 16.8KBPS(V.34)	2
315	Dial test 10PPS	5
316	Dial test 20PPS	5
317	Dial test PB	5
318	Modem test 12.0KBPS(V.17)	2
319	Modem test 7.2KBPS(V.29)	2
320	Modem test 2.4KBPS(V.27ter)	2
321	FAX image memory test	2
322	CML relay ON	2

Adjustment Mode (05) Codes

05/08	Mode	Element	Sub element	Item	Subitem	Code	Sub-code	Details	Default value	Acceptable value	RAM	Contents	Procedure
05	Adjustment mode	Printer	Feeding system/ Paper transport	Setting method of drawer size		4800	0	1st drawer	1	0~1	SYS	0: Manual 1: Automatic	4
05	Adjustment mode	Printer	Feeding system/ Paper transport	Setting method of drawer size		4800	1	2nd drawer	1	0~1	SYS	0: Manual 1: Automatic	4
05	Adjustment mode	Printer	Feeding system/ Paper transport	Setting method of drawer size		4800	2	3rd drawer	1	0~1	SYS	0: Manual 1: Automatic	4
05	Adjustment mode	Printer	Feeding system/ Paper transport	Setting method of drawer size		4800	3	4th drawer	1	0~1	SYS	0: Manual 1: Automatic	4
05	Adjustment mode	Printer	Feeding system/ Paper transport	Setting method of drawer size		4800	4	LCF	1	0~1	SYS	0: Manual 1: Automatic	4
05	Adjustment mode	Printer	Image control	Density correction	Fine adjustment of density correction	4903	3	Black	16	13~19	PU	13: -3 14: -2 15: -1 16: 0 17: 1 18: 2 19: 3	4
05	Adjustment mode	Printer	Maintenance			4907		Setting of measure against curl	0	0~1	PU	0: Off 1: On	1
05	Adjustment mode	Printer	Image control	Fine adjustment for printing plain paper		4908	0	Black	3	0~6	PU	0: -3 1: -2 2: -1 3: 0 4: 1 5: 2 6: 3	4
05	Adjustment mode	Printer	Image control	Fine adjustment for printing transparencies		4909	0	Black	3	0~6	PU	0: -3 1: -2 2: -1 3: 0 4: 1 5: 2 6: 3	4
05	Adjustment mode	Printer	Image control	Print deviation correction		4910	0	Unevenness of print quality	3	0~6	PU	0: -3 1: -2 2: -1 3: 0 4: 1 5: 2 6: 3	4

05/08	Mode	Element	Sub element	Item	Subitem	Code	Sub-code	Details	Default value	Acceptable value	RAM	Contents	Procedure
05	Adjustment mode	Printer	Image control	Print deviation correction		4910	1	Background	3	0~6	PU	0: -3 1: -2 2: -1 3: 0 4: 1 5: 2 6: 3	4
05	Adjustment mode	Printer	Maintenance			4911		Drum cleaning mode	0	0~1	PU	0: Disabled 1: Enabled	1
05	Adjustment mode	Image Processing	Reproduction ratio adjustment	Primary scanning direction		7000		PPC	128	0-255	SYS	When the value increases by "1", the reproduction ratio in the primary scanning direction increases by approx. 0.1%.	1
05	Adjustment mode	Image Processing	Reproduction ratio adjustment	Primary scanning direction		7001		PRT/FAX	128	128-255	SYS	When the value increases by "1", the reproduction ratio in the primary scanning direction increases by approx. 0.1%.	1
05	Adjustment mode	Image Processing	Background offset adjustment	PPC/SCN(black)		7025		ADF	128	0-255	SYS	The larger the adjustment value, the darker the background becomes. The smaller the adjustment value, the lighter the background becomes.	1
05	Adjustment mode	Image Processing	Background offset adjustment	SCN(color)		7026		ADF	128	0-255	SYS	The larger the adjustment value, the darker the background becomes. The smaller the adjustment value, the lighter the background becomes.	1
05	Adjustment mode	Image Processing	Sharpness adjustment	PPC(black)		7056		Text/Photo	128	0-255	SYS	The larger the value, the sharper the image becomes. The smaller the value, the softer the image becomes and the less moire appears.	1
05	Adjustment mode	Image Processing	Sharpness adjustment	PPC(black)		7057		Text	128	0-255	SYS	The larger the value, the sharper the image becomes. The smaller the value, the softer the image becomes and the less moire appears.	1
05	Adjustment mode	Image Processing	Sharpness adjustment	PPC(black)		7058		Photo	128	0-255	SYS	The larger the value, the sharper the image becomes. The smaller the value, the softer the image becomes and the less moire appears.	1
05	Adjustment mode	Image Processing	Smudged/faint text adjustment	PPC(black)		7097		Text/Photo	2	0-4	SYS	0: Faint text is suppressed most. 4: Smudged text is suppressed most.	1
05	Adjustment mode	Image Processing	Smudged/faint text adjustment	PPC(black)		7098		Text	2	0-4	SYS	0: Faint text is suppressed most. 4: Smudged text is suppressed most.	1
05	Adjustment mode	Image Processing	Background adjustment	PPC(black)		7100		Text/Photo	128	0-255	SYS	The larger the value, the darker the background becomes. The smaller the value, the lighter the background becomes.	1
05	Adjustment mode	Image Processing	Background adjustment	PPC(black)		7101		Text	128	0-255	SYS	The larger the value, the darker the background becomes. The smaller the value, the lighter the background becomes.	1

05/08	Mode	Element	Sub element	Item	Subitem	Code	Sub-code	Details	Default value	Acceptable value	RAM	Contents	Procedure
05	Adjustment mode	Image Processing	Background adjustment	PPC(black)		7102		Photo	128	0-255	SYS	The larger the value, the darker the background becomes. The smaller the value, the lighter the background becomes.	1
05	Adjustment mode	Image Processing	Background adjustment	PPC(black)		7106		User custom	128	0-255	SYS	The larger the value, the darker the background becomes. The smaller the value, the lighter the background becomes.	1
05	Adjustment mode	Image Processing	Density adjustment	PPC(black)	Manual adjustment/ Center value	7114		Text/Photo	128	0-255	SYS	The larger the value, the darker the image at the center value becomes.	1
05	Adjustment mode	Image Processing	Density adjustment	PPC(black)	Manual adjustment/ Center value	7115		Text	128	0-255	SYS	The larger the value, the darker the image at the center value becomes.	1
05	Adjustment mode	Image Processing	Density adjustment	PPC(black)	Manual adjustment/ Center value	7116		Photo	128	0-255	SYS	The larger the value, the darker the image at the center value becomes.	1
05	Adjustment mode	Image Processing	Density adjustment	PPC(black)	Automatic density adjustment	7123		Text/Photo	128	0-255	SYS	The larger the value, the darker the image becomes.	1
05	Adjustment mode	Image Processing	Density adjustment	PPC(black)	Automatic density adjustment	7124		Text	128	0-255	SYS	The larger the value, the darker the image becomes.	1
05	Adjustment mode	Image Processing	Density adjustment	PPC(black)	Automatic density adjustment	7125		Photo	128	0-255	SYS	The larger the value, the darker the image becomes.	1
05	Adjustment mode	Image Processing	Density adjustment	PPC(black)	Manual adjustment/ Center value	7134		User custom	128	0-255	SYS	The larger the value, the darker the image of the center value becomes.	1
05	Adjustment mode	Image Processing	Density adjustment	PPC(black)	Automatic density adjustment	7137		User custom	128	0-255	SYS	The larger the value, the darker the image becomes.	1
05	Adjustment mode	Image Processing	Automatic gamma adjustment	PPC(black)		7165		All media types	-	-	-	When color deviation is found in gradation reproduction, the gradation reproduction of color K can be corrected with the automatic gamma adjustment. The result of the correction above will be applied to all media types.	7
05	Adjustment mode	Image Processing	Gamma balance adjustment	PPC(black)	Text/Photo	7190	0	Low density	128	0-255	SYS	The larger the value, the darker the image of the area surrounding the target area becomes.	4
05	Adjustment mode	Image Processing	Gamma balance adjustment	PPC(black)	Text/Photo	7190	1	Medium density	128	0-255	SYS	The larger the value, the darker the image of the area surrounding the target area becomes.	4
05	Adjustment mode	Image Processing	Gamma balance adjustment	PPC(black)	Text/Photo	7190	2	High density	128	0-255	SYS	The larger the value, the darker the image of the area surrounding the target area becomes.	4

05/08	Mode	Element	Sub element	Item	Subitem	Code	Sub-code	Details	Default value	Acceptable value	RAM	Contents	Procedure
05	Adjustment mode	Image Processing	Gamma balance adjustment	PPC(black)	Text	7191	0	Low density	128	0-255	SYS	The larger the value, the darker the image of the area surrounding the target area becomes.	4
05	Adjustment mode	Image Processing	Gamma balance adjustment	PPC(black)	Text	7191	1	Medium density	128	0-255	SYS	The larger the value, the darker the image of the area surrounding the target area becomes.	4
05	Adjustment mode	Image Processing	Gamma balance adjustment	PPC(black)	Text	7191	2	High density	128	0-255	SYS	The larger the value, the darker the image of the area surrounding the target area becomes.	4
05	Adjustment mode	Image Processing	Gamma balance adjustment	PPC(black)	Photo	7192	0	Low density	128	0-255	SYS	The larger the value, the darker the image of the area surrounding the target area becomes.	4
05	Adjustment mode	Image Processing	Gamma balance adjustment	PPC(black)	Photo	7192	1	Medium density	128	0-255	SYS	The larger the value, the darker the image of the area surrounding the target area becomes.	4
05	Adjustment mode	Image Processing	Gamma balance adjustment	PPC(black)	Photo	7192	2	High density	128	0-255	SYS	The larger the value, the darker the image of the area surrounding the target area becomes.	4
05	Adjustment mode	Image Processing	Range correction adjustment	PPC(black)	Black/Manual density adjustment	7237		User custom	1	0-1	SYS	0: Background peak - Fixed 1: Background peak - Varied	1
05	Adjustment mode	Image Processing	Sharpness adjustment	PPC(black)		7249		User custom	128	0-255	SYS	The larger the value, the sharper the image becomes. The smaller the value, the softer the image becomes and the less moire appears.	1
05	Adjustment mode	Image Processing	Smudged/faint text adjustment	PPC(black)		7252		User custom	2	0-4	SYS	0: Faint text is suppressed most. 4: Smudged text is suppressed most.	1
05	Adjustment mode	Image Processing	Gamma balance adjustment	PPC(black)	User custom	7276	0	Low density	128	0-255	SYS	The larger the value, the darker the image of the area surrounding the target area becomes.	4
05	Adjustment mode	Image Processing	Gamma balance adjustment	PPC(black)	User custom	7276	1	Medium density	128	0-255	SYS	The larger the value, the darker the image of the area surrounding the target area becomes.	4
05	Adjustment mode	Image Processing	Gamma balance adjustment	PPC(black)	User custom	7276	2	High density	128	0-255	SYS	The larger the value, the darker the image of the area surrounding the target area becomes.	4
05	Adjustment mode	Image Processing	Range correction adjustment	PPC(black)	Black/Manual density adjustment	7286		Text/Photo	1	0-1	SYS	0: Background peak - Fixed 1: Background peak - Varied	1
05	Adjustment mode	Image Processing	Range correction adjustment	PPC(black)	Black/Manual density adjustment	7287		Text	1	0-1	SYS	0: Background peak - Fixed 1: Background peak - Varied	1

05/08	Mode	Element	Sub element	Item	Subitem	Code	Sub-code	Details	Default value	Acceptable value	RAM	Contents	Procedure
05	Adjustment mode	Image Processing	Upper limit value in toner saving mode	PRT(black/1200dpi)		7302		PS	176	0-255	SYS	The smaller the value, the lighter the printed image becomes.	1
05	Adjustment mode	Image Processing	Upper limit value in toner saving mode	PRT(black/600dpi)		7307	0	PS	176	0-255	SYS	The smaller the value, the lighter the printed image becomes.	4
05	Adjustment mode	Image Processing	Upper limit value in toner saving mode	PRT(black/600dpi)		7307	1	PCL	176	0-255	SYS	The smaller the value, the lighter the printed image becomes.	4
05	Adjustment mode	Image Processing	Upper limit value in toner saving mode	PRT(black/600dpi)		7307	2	XPS	176	0-255	SYS	The smaller the value, the lighter the printed image becomes.	4
05	Adjustment mode	Image Processing	Gamma balance adjustment	PRT(black)	PS/Smooth/1200dpi	7309	0	Low density	128	0-255	SYS	When the value increases, the density in the target area becomes higher.	4
05	Adjustment mode	Image Processing	Gamma balance adjustment	PRT(black)	PS/Smooth/1200dpi	7309	1	Medium density	128	0-255	SYS	When the value increases, the density in the target area becomes higher.	4
05	Adjustment mode	Image Processing	Gamma balance adjustment	PRT(black)	PS/Smooth/1200dpi	7309	2	High density	128	0-255	SYS	When the value increases, the density in the target area becomes higher.	4
05	Adjustment mode	Image Processing	Gamma balance adjustment	PRT(black)	PS/Detail/1200dpi	7310	0	Low density	128	0-255	SYS	When the value increases, the density in the target area becomes higher.	4
05	Adjustment mode	Image Processing	Gamma balance adjustment	PRT(black)	PS/Detail/1200dpi	7310	1	Medium density	128	0-255	SYS	When the value increases, the density in the target area becomes higher.	4
05	Adjustment mode	Image Processing	Gamma balance adjustment	PRT(black)	PS/Detail/1200dpi	7310	2	High density	128	0-255	SYS	When the value increases, the density in the target area becomes higher.	4
05	Adjustment mode	Image Processing	Gamma balance adjustment	PRT(black)	PS/Smooth/600dpi	7315	0	Low density	128	0-255	SYS	When the value increases, the density in the target area becomes higher.	4
05	Adjustment mode	Image Processing	Gamma balance adjustment	PRT(black)	PS/Smooth/600dpi	7315	1	Medium density	128	0-255	SYS	When the value increases, the density in the target area becomes higher.	4
05	Adjustment mode	Image Processing	Gamma balance adjustment	PRT(black)	PS/Smooth/600dpi	7315	2	High density	128	0-255	SYS	When the value increases, the density in the target area becomes higher.	4

05/08	Mode	Element	Sub element	Item	Subitem	Code	Sub-code	Details	Default value	Acceptable value	RAM	Contents	Procedure
05	Adjustment mode	Image Processing	Gamma balance adjustment	PRT(black)	PS/Detail/600dpi	7316	0	Low density	128	0-255	SYS	When the value increases, the density in the target area becomes higher.	4
05	Adjustment mode	Image Processing	Gamma balance adjustment	PRT(black)	PS/Detail/600dpi	7316	1	Medium density	128	0-255	SYS	When the value increases, the density in the target area becomes higher.	4
05	Adjustment mode	Image Processing	Gamma balance adjustment	PRT(black)	PS/Detail/600dpi	7316	2	High density	128	0-255	SYS	When the value increases, the density in the target area becomes higher.	4
05	Adjustment mode	Image Processing	Gamma balance adjustment	PRT(black)	PCL/Smooth/600dpi	7317	0	Low density	128	0-255	SYS	When the value increases, the density in the target area becomes higher.	4
05	Adjustment mode	Image Processing	Gamma balance adjustment	PRT(black)	PCL/Smooth/600dpi	7317	1	Medium density	128	0-255	SYS	When the value increases, the density in the target area becomes higher.	4
05	Adjustment mode	Image Processing	Gamma balance adjustment	PRT(black)	PCL/Smooth/600dpi	7317	2	High density	128	0-255	SYS	When the value increases, the density in the target area becomes higher.	4
05	Adjustment mode	Image Processing	Gamma balance adjustment	PRT(black)	PCL/Detail/600dpi	7318	0	Low density	128	0-255	SYS	When the value increases, the density in the target area becomes higher.	4
05	Adjustment mode	Image Processing	Gamma balance adjustment	PRT(black)	PCL/Detail/600dpi	7318	1	Medium density	128	0-255	SYS	When the value increases, the density in the target area becomes higher.	4
05	Adjustment mode	Image Processing	Gamma balance adjustment	PRT(black)	PCL/Detail/600dpi	7318	2	High density	128	0-255	SYS	When the value increases, the density in the target area becomes higher.	4
05	Adjustment mode	Image Processing	Gamma balance adjustment	PRT(black)	XPS/Smooth/600dpi	7319	0	Low density	128	0-255	SYS	When the value increases, the density in the target area becomes higher.	4
05	Adjustment mode	Image Processing	Gamma balance adjustment	PRT(black)	XPS/Smooth/600dpi	7319	1	Medium density	128	0-255	SYS	When the value increases, the density in the target area becomes higher.	4
05	Adjustment mode	Image Processing	Gamma balance adjustment	PRT(black)	XPS/Smooth/600dpi	7319	2	High density	128	0-255	SYS	When the value increases, the density in the target area becomes higher.	4
05	Adjustment mode	Image Processing	Gamma balance adjustment	PRT(black)	XPS/Detail/600dpi	7320	0	Low density	128	0-255	SYS	When the value increases, the density in the target area becomes higher.	4
05	Adjustment mode	Image Processing	Gamma balance adjustment	PRT(black)	XPS/Detail/600dpi	7320	1	Medium density	128	0-255	SYS	When the value increases, the density in the target area becomes higher.	4

05/08	Mode	Element	Sub element	Item	Subitem	Code	Sub-code	Details	Default value	Acceptable value	RAM	Contents	Procedure
05	Adjustment mode	Image Processing	Gamma balance adjustment	PRT(black)	XPS/Detail/600dpi	7320	2	High density	128	0-255	SYS	When the value increases, the density in the target area becomes higher.	4
05	Adjustment mode	Image Processing	Smoothing processing	PRT(black)		7325		PS	1	0-2	SYS	The smaller the value, the more faint text is suppressed. The larger the value, the more smudged text is suppressed.	1
05	Adjustment mode	Image Processing	Smoothing processing	PRT(black)		7326		PCL	1	0-2	SYS	The smaller the value, the more faint text is suppressed. The larger the value, the more smudged text is suppressed.	1
05	Adjustment mode	Image Processing	Smoothing processing	PRT(black)		7327		XPS	1	0-2	SYS	The smaller the value, the more faint text is suppressed. The larger the value, the more smudged text is suppressed.	1
05	Adjustment mode	Image Processing	Gamma balance adjustment	Monochrome/600dpi/ Auto	PS/Text	7360	0	Low density	128	0-255	SYS	When the value increases, the density in the target area becomes higher.	4
05	Adjustment mode	Image Processing	Gamma balance adjustment	Monochrome/600dpi/ Auto	PS/Text	7360	1	Medium density	128	0-255	SYS	When the value increases, the density in the target area becomes higher.	4
05	Adjustment mode	Image Processing	Gamma balance adjustment	Monochrome/600dpi/ Auto	PS/Text	7360	2	High density	128	0-255	SYS	When the value increases, the density in the target area becomes higher.	4
05	Adjustment mode	Image Processing	Gamma balance adjustment	Monochrome/600dpi/ Auto	PS/Graphics	7361	0	Low density	128	0-255	SYS	When the value increases, the density in the target area becomes higher.	4
05	Adjustment mode	Image Processing	Gamma balance adjustment	Monochrome/600dpi/ Auto	PS/Graphics	7361	1	Medium density	128	0-255	SYS	When the value increases, the density in the target area becomes higher.	4
05	Adjustment mode	Image Processing	Gamma balance adjustment	Monochrome/600dpi/ Auto	PS/Graphics	7361	2	High density	128	0-255	SYS	When the value increases, the density in the target area becomes higher.	4
05	Adjustment mode	Image Processing	Gamma balance adjustment	Monochrome/600dpi/ Auto	PS/Image	7362	0	Low density	128	0-255	SYS	When the value increases, the density in the target area becomes higher.	4
05	Adjustment mode	Image Processing	Gamma balance adjustment	Monochrome/600dpi/ Auto	PS/Image	7362	1	Medium density	128	0-255	SYS	When the value increases, the density in the target area becomes higher.	4
05	Adjustment mode	Image Processing	Gamma balance adjustment	Monochrome/600dpi/ Auto	PS/Image	7362	2	High density	128	0-255	SYS	When the value increases, the density in the target area becomes higher.	4
05	Adjustment mode	Image Processing	Gamma balance adjustment	Monochrome/600dpi/ Auto	XPS/Text	7366	0	Low density	128	0-255	SYS	When the value increases, the density in the target area becomes higher.	4

05/08	Mode	Element	Sub element	Item	Subitem	Code	Sub-code	Details	Default value	Acceptable value	RAM	Contents	Procedure
05	Adjustment mode	Image Processing	Gamma balance adjustment	Monochrome/600dpi/ Auto	XPS/Text	7366	1	Medium density	128	0-255	SYS	When the value increases, the density in the target area becomes higher.	4
05	Adjustment mode	Image Processing	Gamma balance adjustment	Monochrome/600dpi/ Auto	XPS/Text	7366	2	High density	128	0-255	SYS	When the value increases, the density in the target area becomes higher.	4
05	Adjustment mode	Image Processing	Gamma balance adjustment	Monochrome/600dpi/ Auto	XPS/Graphics	7367	0	Low density	128	0-255	SYS	When the value increases, the density in the target area becomes higher.	4
05	Adjustment mode	Image Processing	Gamma balance adjustment	Monochrome/600dpi/ Auto	XPS/Graphics	7367	1	Medium density	128	0-255	SYS	When the value increases, the density in the target area becomes higher.	4
05	Adjustment mode	Image Processing	Gamma balance adjustment	Monochrome/600dpi/ Auto	XPS/Graphics	7367	2	High density	128	0-255	SYS	When the value increases, the density in the target area becomes higher.	4
05	Adjustment mode	Image Processing	Gamma balance adjustment	Monochrome/600dpi/ Auto	XPS/Image	7368	0	Low density	128	0-255	SYS	When the value increases, the density in the target area becomes higher.	4
05	Adjustment mode	Image Processing	Gamma balance adjustment	Monochrome/600dpi/ Auto	XPS/Image	7368	1	Medium density	128	0-255	SYS	When the value increases, the density in the target area becomes higher.	4
05	Adjustment mode	Image Processing	Gamma balance adjustment	Monochrome/600dpi/ Auto	XPS/Image	7368	2	High density	128	0-255	SYS	When the value increases, the density in the target area becomes higher.	4
05	Adjustment mode	Image Processing	Sharpness adjustment	SCN(black)		7430		Text/Photo	128	0-255	SYS	The larger the value, the sharper the image becomes. The smaller the value, the softer the image becomes and the less moire appears.	1
05	Adjustment mode	Image Processing	Sharpness adjustment	SCN(black)		7431		Text	128	0-255	SYS	The larger the value, the sharper the image becomes. The smaller the value, the softer the image becomes and the less moire appears.	1
05	Adjustment mode	Image Processing	Sharpness adjustment	SCN(black)		7432		Photo	128	0-255	SYS	The larger the value, the sharper the image becomes. The smaller the value, the softer the image becomes and the less moire appears.	1
05	Adjustment mode	Image Processing	Sharpness adjustment	SCN(black)		7433		Gray scale	128	0-255	SYS	The larger the value, the sharper the image becomes. The smaller the value, the softer the image becomes and the less moire appears.	1
05	Adjustment mode	Image Processing	Background adjustment	SCN(black)		7436		Text/Photo	128	0-255	SYS	The smaller the value, the lighter the background becomes.	1
05	Adjustment mode	Image Processing	Background adjustment	SCN(black)		7437		Text	128	0-255	SYS	The smaller the value, the lighter the background becomes.	1
05	Adjustment mode	Image Processing	Background adjustment	SCN(black)		7438		Photo	128	0-255	SYS	The smaller the value, the lighter the background becomes.	1

05/08	Mode	Element	Sub element	Item	Subitem	Code	Sub-code	Details	Default value	Acceptable value	RAM	Contents	Procedure
05	Adjustment mode	Image Processing	Background adjustment	SCN(black)		7439		Gray scale	128	0-255	SYS	The smaller the value, the lighter the background becomes.	1
05	Adjustment mode	Image Processing	Background adjustment	SCN(black)		7441		User custom	128	0-255	SYS	The smaller the value, the lighter the background becomes.	1
05	Adjustment mode	Image Processing	Density adjustment	SCN(black)	Manual adjustment/ Center value	7444		Text/Photo	128	0-255	SYS	The larger the value, the darker the image at the center value becomes.	1
05	Adjustment mode	Image Processing	Density adjustment	SCN(black)	Manual adjustment/ Center value	7445		Text	128	0-255	SYS	The larger the value, the darker the image at the center value becomes.	1
05	Adjustment mode	Image Processing	Density adjustment	SCN(black)	Manual adjustment/ Center value	7446		Photo	128	0-255	SYS	The larger the value, the darker the image at the center value becomes.	1
05	Adjustment mode	Image Processing	Density adjustment	SCN(black)	Manual adjustment/ Center value	7447		Gray scale	128	0-255	SYS	The larger the value, the darker the image at the center value becomes.	1
05	Adjustment mode	Image Processing	Density adjustment	SCN(black)	Automatic density adjustment	7456		Text/Photo	128	0-255	SYS	The larger the value, the darker the image at the center value becomes.	1
05	Adjustment mode	Image Processing	Density adjustment	SCN(black)	Automatic density adjustment	7457		Text	128	0-255	SYS	The larger the value, the darker the image at the center value becomes.	1
05	Adjustment mode	Image Processing	Density adjustment	SCN(black)	Automatic density adjustment	7458		Photo	128	0-255	SYS	The larger the value, the darker the image at the center value becomes.	1
05	Adjustment mode	Image Processing	Density adjustment	SCN(black)	Automatic density adjustment	7459		Gray scale	128	0-255	SYS	The larger the value, the darker the image at the center value becomes.	1
05	Adjustment mode	Image Processing	Sharpness adjustment	SCN(black)		7470		User custom	128	0-255	SYS	The larger the value, the sharper the image becomes. The smaller the value, the softer the image becomes and the less moire appears.	1
05	Adjustment mode	Image Processing	Density adjustment	SCN(black)	Manual adjustment/ Center value	7475		User custom	128	0-255	SYS	The larger the value, the darker the image at the center value becomes.	1
05	Adjustment mode	Image Processing	Density adjustment	SCN(black)	Automatic density adjustment	7478		User custom	128	0-255	SYS	The larger the value, the darker the image at the center value becomes.	1
05	Adjustment mode	Image Processing	Gamma balance adjustment	SCN(black)	User custom	7480	0	Low density	128	0-255	SYS	The larger the value, the darker the image of the area surrounding the target area becomes.	4
05	Adjustment mode	Image Processing	Gamma balance adjustment	SCN(black)	User custom	7480	1	Medium density	128	0-255	SYS	The larger the value, the darker the image of the area surrounding the target area becomes.	4

05/08	Mode	Element	Sub element	Item	Subitem	Code	Sub-code	Details	Default value	Acceptable value	RAM	Contents	Procedure
05	Adjustment mode	Image Processing	Gamma balance adjustment	SCN(black)	User custom	7480	2	High density	128	0-255	SYS	The larger the value, the darker the image of the area surrounding the target area becomes.	4
05	Adjustment mode	Image Processing	Gamma balance adjustment	SCN(black)	Text/Photo	7485	0	Low density	128	0-255	SYS	The larger the value, the darker the image of the area surrounding the target area becomes.	4
05	Adjustment mode	Image Processing	Gamma balance adjustment	SCN(black)	Text/Photo	7485	1	Medium density	128	0-255	SYS	The larger the value, the darker the image of the area surrounding the target area becomes.	4
05	Adjustment mode	Image Processing	Gamma balance adjustment	SCN(black)	Text/Photo	7485	2	High density	128	0-255	SYS	The larger the value, the darker the image of the area surrounding the target area becomes.	4
05	Adjustment mode	Image Processing	Gamma balance adjustment	SCN(black)	Text	7486	0	Low density	128	0-255	SYS	The larger the value, the darker the image of the area surrounding the target area becomes.	4
05	Adjustment mode	Image Processing	Gamma balance adjustment	SCN(black)	Text	7486	1	Medium density	128	0-255	SYS	The larger the value, the darker the image of the area surrounding the target area becomes.	4
05	Adjustment mode	Image Processing	Gamma balance adjustment	SCN(black)	Text	7486	2	High density	128	0-255	SYS	The larger the value, the darker the image of the area surrounding the target area becomes.	4
05	Adjustment mode	Image Processing	Gamma balance adjustment	SCN(black)	Photo	7487	0	Low density	128	0-255	SYS	The larger the value, the darker the image of the area surrounding the target area becomes.	4
05	Adjustment mode	Image Processing	Gamma balance adjustment	SCN(black)	Photo	7487	1	Medium density	128	0-255	SYS	The larger the value, the darker the image of the area surrounding the target area becomes.	4
05	Adjustment mode	Image Processing	Gamma balance adjustment	SCN(black)	Photo	7487	2	High density	128	0-255	SYS	The larger the value, the darker the image of the area surrounding the target area becomes.	4
05	Adjustment mode	Image Processing	Gamma balance adjustment	SCN(black)	Gray scale	7488	0	Low density	128	0-255	SYS	The larger the value, the darker the image of the area surrounding the target area becomes.	4
05	Adjustment mode	Image Processing	Gamma balance adjustment	SCN(black)	Gray scale	7488	1	Medium density	128	0-255	SYS	The larger the value, the darker the image of the area surrounding the target area becomes.	4
05	Adjustment mode	Image Processing	Gamma balance adjustment	SCN(black)	Gray scale	7488	2	High density	128	0-255	SYS	The larger the value, the darker the image of the area surrounding the target area becomes.	4
05	Adjustment mode	Image Processing	Image	NW scanning		7489		Amount of surrounding void	0	0-255	SYS	When the value increases, the blank area around the scanned image becomes wider. (e.g.: In network scanning with 600 dpi, if the setting value is "1", the blank area increases by 1 dot.)	1

05/08	Mode	Element	Sub element	Item	Subitem	Code	Sub-code	Details	Default value	Acceptable value	RAM	Contents	Procedure
05	Adjustment mode	Image Processing	Density adjustment	FAX(black)	Manual adjustment/Center value	7533		Text/Photo	128	0-255	SYS	The larger the value, the darker the image at the center value becomes.	1
05	Adjustment mode	Image Processing	Density adjustment	FAX(black)	Manual adjustment/Center value	7534		Text	128	0-255	SYS	The larger the value, the lighter the image at the center value becomes.	1
05	Adjustment mode	Image Processing	Density adjustment	FAX(black)	Manual adjustment/Center value	7535		Photo	128	0-255	SYS	The larger the value, the darker the image at the center value becomes.	1
05	Adjustment mode	Image Processing	Density adjustment	FAX(black)	Automatic density adjustment	7542		Text/Photo	128	0-255	SYS	The larger the value, the darker the image becomes.	1
05	Adjustment mode	Image Processing	Density adjustment	FAX(black)	Automatic density adjustment	7543		Photo	128	0-255	SYS	The larger the value, the darker the image becomes.	1
05	Adjustment mode	Image Processing	Blank page judgment threshold adjustment			7618		PPC/SCN	128	0-255	SYS	The larger the value, the more the original tends to be judged as a blank page.	1
05	Adjustment mode	Image Processing	ACS judgment threshold			7630		PPC/SCN	70	0-255	SYS	The larger the value, the more the original tends to be judged as black even in the auto color mode. The smaller value, the more it tends to be judged as color.	1
05	Adjustment mode	Image Processing	Stroke adjustment	PS/PDF automatic stroke adjustment	600dpi	8239	0	Default setting	1	0-3	SYS	This code is used to change the width of fine lines in PS and PDF printing. Automatic stroke adjustment is the function that prevents the width from changing according to the position. This code sets whether automatic stroke adjustment is enabled or disabled if it is not included in the print data. If this setting is disabled, there will be an increase in cases in which the width of fine lines becomes thicker by 1 dot when they are printed. 0: Disabled 1: Enabled 2: Forcibly disabled (Ignores command in printing data) 3: Forcibly enabled (Ignores command in printing data)	4

05/08	Mode	Element	Sub element	Item	Subitem	Code	Sub-code	Details	Default value	Acceptable value	RAM	Contents	Procedure
05	Adjustment mode	Image Processing	Stroke adjustment	PS/PDF automatic stroke adjustment	600dpi	8239	1	Minimum stroke width when disabled	1	1-2	SYS	This code is used to change the width of fine lines in PS and PDF printing. Automatic stroke adjustment is the function that prevents the width from changing according to the position. This code sets the minimum width of fine lines when the automatic stroke adjustment is disabled. For example, if automatic stroke adjustment is disabled and the width of fine lines is set to "0" in the PS command, the width of the lines becomes 1 dot if the value of this code is set to "1"; equally, if it is set to "2", the width of the lines becomes 2 dots. 1: 1 dot 2: 2 dots	4
05	Adjustment mode	Image Processing	Stroke adjustment	PS/PDF automatic stroke adjustment	1200dpi	8239	2	Default setting	1	0-3	SYS	This code is used to change the width of fine lines in PS and PDF printing. Automatic stroke adjustment is the function that prevents the width from changing according to the position. This code sets whether automatic stroke adjustment is enabled or disabled if it is not included in the print data. If this setting is disabled, there will be an increase in cases in which the width of fine lines becomes thicker by 1 dot when they are printed. 0: Disabled 1: Enabled 2: Forcibly disabled (Ignores command in printing data) 3: Forcibly enabled (Ignores command in printing data)	4
05	Adjustment mode	Image Processing	Stroke adjustment	PS/PDF automatic stroke adjustment	1200dpi	8239	3	Minimum stroke width when disabled	1	1-2	SYS	This code is used to change the width of fine lines in PS and PDF printing. Automatic stroke adjustment is the function that prevents the width from changing according to the position. This code sets the minimum width of fine lines when the automatic stroke adjustment is disabled. For example, if automatic stroke adjustment is disabled and the width of fine lines is set to "0" in the PS command, the width of the lines becomes 1 dot if the value of this code is set to "1"; equally, if it is set to "2", the width of the lines becomes 2 dots. 1: 1 dot 2: 2 dots	4

05/08	Mode	Element	Sub element	Item	Subitem	Code	Sub-code	Details	Default value	Acceptable value	RAM	Contents	Procedure
05	Adjustment mode	Image Processing	Line width minimum value adjustment	NW PRT		8240		600dpi	1	1-9	SYS	The larger the value, the darker the fine lines become.	1
05	Adjustment mode	Image Processing	Line width minimum value adjustment	PRT(color)		8241		1200dpi	4	1-9	SYS	The larger the value, the darker the fine lines become.	1
05	Adjustment mode	Image Processing	Line density adjustment	NW PRT	1200dpi	8242	0	Gray (K)	4	0-5	SYS	The larger the value, the darker the fine line becomes.	4
05	Adjustment mode	Image Processing	Line density adjustment	PRT(color)	1200dpi	8243	0	Gray (K) lower limit value	1	0-255	SYS	Specifies the effective density range of 05-8242 from 0 to 255.	4
05	Adjustment mode	Image Processing	Line density adjustment	PRT(color)	1200dpi	8243	1	Gray (K) upper limit value	200	0-255	SYS	Specifies the effective density range of 05-8242 from 0 to 255.	4
05	Adjustment mode	Image Processing	JPEG compression level	NW SCN(color)		8304	0	High quality	128	0-255	SYS	When the value increases, the quality gets better, and the file size gets larger.	4
05	Adjustment mode	Image Processing	JPEG compression level	NW SCN(color)		8304	1	Standard	128	0-255	SYS	When the value increases, the quality gets better, and the file size gets larger.	4
05	Adjustment mode	Image Processing	JPEG compression level	NW SCN(color)		8304	2	Low quality	128	0-255	SYS	When the value increases, the quality gets better, and the file size gets larger.	4
05	Adjustment mode	Image Processing	Color conversion table selection	NW SCN(color)		8305		Text/Photo	1	0-2	SYS	0: Text, Photo 1: Text/Photo 2: For reproduction of pure color	1
05	Adjustment mode	Image Processing	Color conversion table selection	NW SCN(color)		8308		User custom	0	0-2	SYS	0: Text, Photo 1: Text/Photo 2: For reproduction of pure color	1
05	Adjustment mode	Image Processing	Background adjustment	SCN(color)		8309		Text/Photo	128	0-255	SYS	The smaller the value, the lighter the background becomes.	1
05	Adjustment mode	Image Processing	Background adjustment	SCN(color)		8310		Text	128	0-255	SYS	The smaller the value, the lighter the background becomes.	1
05	Adjustment mode	Image Processing	Background adjustment	SCN(color)		8311		Photo	128	0-255	SYS	The smaller the value, the lighter the background becomes.	1
05	Adjustment mode	Image Processing	Fine adjustment of black density	SCN(color)		8314		Text/Photo	1	0-4	SYS	The larger the value, the darker the black side of the image becomes.	1

05/08	Mode	Element	Sub element	Item	Subitem	Code	Sub-code	Details	Default value	Acceptable value	RAM	Contents	Procedure
05	Adjustment mode	Image Processing	Fine adjustment of black density	SCN(color)		8315		Text	0	0-4	SYS	The larger the value, the darker the black side of the image becomes.	1
05	Adjustment mode	Image Processing	Fine adjustment of black density	SCN(color)		8316		Photo	0	0-4	SYS	The larger the value, the darker the black side of the image becomes.	1
05	Adjustment mode	Image Processing	RGB conversion method selection	SCN(color)		8319		Text/Photo	0	0-3	SYS	Sets the color space format of the output image. 0: sRGB 1: AppleRGB 2: ROMMRGB 3: AdobeRGB	1
05	Adjustment mode	Image Processing	RGB conversion method selection	SCN(color)		8320		Text	0	0-3	SYS	Sets the color space format of the output image. 0: sRGB 1: AppleRGB 2: ROMMRGB 3: AdobeRGB	1
05	Adjustment mode	Image Processing	RGB conversion method selection	SCN(color)		8321		Photo	0	0-3	SYS	Sets the color space format of the output image. 0: sRGB 1: AppleRGB 2: ROMMRGB 3: AdobeRGB	1
05	Adjustment mode	Image Processing	Saturation adjustment	SCN(color)		8324		Text/Photo	128	0-255	SYS	The larger the value, the brighter the image becomes. The smaller the value, the duller the image becomes.	1
05	Adjustment mode	Image Processing	Saturation adjustment	SCN(color)		8325		Text	128	0-255	SYS	The larger the value, the brighter the image becomes. The smaller the value, the duller the image becomes.	1
05	Adjustment mode	Image Processing	Saturation adjustment	SCN(color)		8326		Photo	128	0-255	SYS	The larger the value, the brighter the image becomes. The smaller the value, the duller the image becomes.	1
05	Adjustment mode	Image Processing	Sharpness adjustment	SCN(color)	Full color	8335		Text	128	0-255	SYS	The larger the value, the sharper the image becomes. The smaller the value, the softer the image becomes and the less moire appears.	1
05	Adjustment mode	Image Processing	Sharpness adjustment	SCN(color)	Full color	8336		Photo	128	0-255	SYS	The larger the value, the sharper the image becomes. The smaller the value, the softer the image becomes and the less moire appears.	1
05	Adjustment mode	Image Processing	Density adjustment	SCN(color)	Manual adjustment/ Center value	8339		Text/Photo	128	0-255	SYS	The larger the value, the darker the image becomes.	1

05/08	Mode	Element	Sub element	Item	Subitem	Code	Sub-code	Details	Default value	Acceptable value	RAM	Contents	Procedure
05	Adjustment mode	Image Processing	Density adjustment	SCN(color)	Manual adjustment/ Center value	8340		Text	128	0-255	SYS	The larger the value, the darker the image becomes.	1
05	Adjustment mode	Image Processing	Density adjustment	SCN(color)	Manual adjustment/ Center value	8341		Photo	128	0-255	SYS	The larger the value, the darker the image becomes.	1
05	Adjustment mode	Image Processing	Sharpness adjustment	SCN(color)	Full color	8354		Text/Photo	128	0-255	SYS	The larger the value, the sharper the image becomes. The smaller the value, the softer the image becomes and the less moire appears.	1
05	Adjustment mode	Image Processing	Background adjustment	SCN(color)		8370		User custom	128	0-255	SYS	When the value increases, the background becomes darker.	1
05	Adjustment mode	Image Processing	Fine adjustment of black density	SCN(color)		8371		User custom	0	0-4	SYS	The larger the value, the darker the black side of the image becomes.	1
05	Adjustment mode	Image Processing	RGB conversion method selection	SCN(color)		8372		User custom	0	0-3	SYS	Sets the color space format of the output image. 0: sRGB 1: AppleRGB 2: ROMMRGB 3: AdobeRGB	1
05	Adjustment mode	Image Processing	Saturation adjustment	SCN(color)		8373		User custom	128	0-255	SYS	The larger the value, the brighter the image becomes. The smaller the value, the duller the image becomes.	1
05	Adjustment mode	Image Processing	Sharpness adjustment	SCN(color)	Full color	8375		User custom	128	0-255	SYS	The larger the value, the sharper the image becomes. The smaller the value, the softer the image becomes and the less moire appears.	1
05	Adjustment mode	Image Processing	Density adjustment	SCN(color)	Manual adjustment/ Center value	8380		User custom	128	0-255	SYS	The larger the value, the darker the image becomes.	1
05	Adjustment mode	System	Maintenance			9043		Equipment number (serial number) display	-	-	SYS	If this code is performed, 08-9601 is performed. 7 digits out of 9 digits can be entered except for upper 2 digits (fixed digits).	1
05	Adjustment mode	System	Image			9104		Compression quality of SLIM PDF background processing	5	0-10	SYS	0-10 0: High compression, low image quality 10: Low compression, high image quality	1
05	Adjustment mode	System	Image			9107		Resolution of SLIM PDF background processing	1	0-3	SYS	0: 75dpi 1: 100dpi 2: 150dpi 3: 200dpi	1

05/08	Mode	Element	Sub element	Item	Subitem	Code	Sub-code	Details	Default value	Acceptable value	RAM	Contents	Procedure
05	Adjustment mode	FAX	FAX			9850		Volume adjustment of pseudo ring for TEL/FAX	4	0-7	SYS	Tone is output to speaker with set sound volume. 0 to 7 can be input. When the code is input, the speaker rings with set sound volume (setting value). The sound volume is set by pressing the INTERRUPT button.	12
05	Adjustment mode	System	Maintenance			9960		Display of equipment information (SRAM)	Refer to contents	0-2	SYS	Displays the equipment information in SRAM. 0: Not set 1: H-290/291 2: H-290/291 for ODA <Default value> ODA: 2 Others: 1	2

Setting Mode (08) Codes

05/08	Mode	Element	Sub element	Item	Subitem	Code	Sub-code	Details	Default value	Acceptable value	RAM	Contents	Procedure
08	Setting Mode	System	User interface	Card reading device		3500		Device setting	0006 0001	0- 42949 67295	SYS	To enable the e-Bridge ID Gate, a card reading device should be set in the order of "ABYYZZZZ". (Enter the corresponding values to "A", "B", "YY" and "ZZZZ".) - AB: Special setting - A: Debugging NIC 0: Not used 1: Used - B: Interface 0: USB connection 1: Serial connection (KP-2003 only) - YY: Authentication 00: No authentication using card 02: FeliCa (KP-2003 only) 03: Mifare (KP-2005 only) 04: HID (KP-2004 only) 06: RFIdeas 07: USB keyboard emulation authentication device 08: Q-tag 09: Magnetic card I/F 10: NFC (Common setting for Felica/Mifare) 11: NFC (Separate setting for Felica/Mifare) 12: NFC (Dedicated setting for Felica) 13: NFC (Dedicated setting for Mifare) - ZZZZ: Sub-code (Specifies the usage type of card ID) 0000: No authentication using card 0001: IDm (Felica/NFC-Felica) and (or) UID (Mifare/NFC-Mifare) 0002: Data (Felica/NFC-Felica/Mifare/NFC-Mifare) 0003: SSFC mode	5
08	Setting Mode	System	User interface	Card reading device		3501		Card reader format information -1	0	0- 42949 67295	SYS	To access the data in the noncontact IC card, the Key Information "LLLL" and the Sector Number "MMMM" should be set. The "LLLL" should be set first, and then "MMMM". KP-2003: LLLL: System code (hexadecimal number) MMMM: Service code (hexadecimal number) KP-2005: LLLL: Key information MMMM: Sector number (hexadecimal number)	5

05/08	Mode	Element	Sub element	Item	Subitem	Code	Sub-code	Details	Default value	Acceptable value	RAM	Contents	Procedure
08	Setting Mode	System	User interface	Card reading device		3502		Card reader format information -2	0	0-4294967295	SYS	The data of the block number in the noncontact IC is set. KP-2003: <PPQRSSTU (hexadecimal number)> PP: 1st block Q: 1st block beginning byte R: 1st block ending byte SS: 2nd block T: 2nd block beginning byte U: 2nd block ending byte KP-2005: <RRBSEbse (hexadecimal number)> RR: 00 (Fixed) B: 1st area block number S: 1st area beginning byte offset E: 1st area ending byte offset b: 2nd area block number s: 2nd area beginning byte offset e: 2nd area ending byte offset * If the 2nd block/area is not used, set the SSTU to "FFFF" (hexadecimal number), the bse to "FFF" (hexadecimal number).	5
08	Setting Mode	System	User interface	Card reading device		3503		Card reader format information -3	0	Refer to contents	SYS	Security key "KKKKKKKKKKKK" (12 digits) <hexadecimal number> in the [Key Information] of the [Sector Number] set in the code 08-3501 should be entered. <Acceptable value> 0-0xFFFFFFFFFFFFFFFF	5
08	Setting Mode	System	User interface	Card reading device		3504		Card authentication LDAP server	0	0-100	SYS	LDAP server number for the card authentication when a noncontact IC card is used should be set.	1
08	Setting mode	System	General	List print USB storage setting		3615		List print USB storage setting	0	0-1	SYS	0: Enable (USB storage available) 1: Disable (USB storage not available)	1
08	Setting mode	System	General	Real time log notification function		3623		Job filtering setting	0	0-65535	SYS	Changes the target type of jobs for notification in real time log notification function.	1
08	Setting mode	System	General	Real time log notification function		3624		Log item filtering setting	2147483921	0-4294967295	SYS	Changes the target type of logs for notification in real time log notification function.	5
08	Setting Mode	System	General	Real time log notification function		3626		Department information transmission setting	0	0-1	SYS	Sets whether the department information (number, name, code) is transmitted or not in the real time log notification function. 0: Department number, department name, department code 1: Department number, department name	1
08	Setting mode	System	General			3629		Enable/Disable setting of standard EWB function	1	0-1	SYS	0: Disabled 1: Enabled	1

05/08	Mode	Element	Sub element	Item	Subitem	Code	Sub-code	Details	Default value	Acceptable value	RAM	Contents	Procedure
08	Setting Mode	System	Network			3631		Remote Access (SNMP)	1	0-1	SYS	0: Disabled 1: Enabled	1
08	Setting mode	System	User interface			3635		Trial copy function	1	0-1	SYS	0: Disabled 1: Enabled	1
08	Setting mode	System	Network			3702		Logon User Name of Windows Domain Authentication	MFP's serial number	-	-	Maximum 128 letters "MFP's serial number" is set as default. Perform 08-9083 to set the default value.	12
08	Setting mode	System	Network			3703		Logon User Name Password of Windows Domain Authentication	-	-	NIC	Maximum 128 letters	12
08	Setting mode	System	Network			3704		PDC2 of user authentication	-	-	UTY	Maximum 128 letters	12
08	Setting mode	System	Network			3705		BDC2 of user authentication	-	-	UTY	Maximum 128 letters	12
08	Setting mode	System	Network			3706		PDC3 of user authentication	-	-	UTY	Maximum 128 letters	12
08	Setting mode	System	Network			3707		BDC3 of user authentication	-	-	UTY	Maximum 128 letters	12
08	Setting mode	System	Network			3708		PDC of Windows Domain Authentication	-	-	NIC	Maximum 128 letters	12
08	Setting mode	System	Network			3709		BDC of device authentication	-	-	NIC	Maximum 128 letters	12
08	Setting mode	System	Network			3718		Domain name of Windows Domain Authentication	-	-	NIC	Maximum 128 letters	12
08	Setting mode	System	Network			3719		Windows domain No. 2 of user authentication	-	-	UTY	Maximum 128 letters	12
08	Setting mode	System	Network			3720		Windows domain No.3 of user authentication	-	-	UTY	Maximum 128 letters	12
08	Setting mode	System	Network			3721		AppleTalk device name	MFP's serial number	-	-	Maximum 32 letters "MFP's serial number" is set as default. Perform 08-9083 to set the default value.	12
08	Setting mode	System	Network			3722		PDC/BDC timeout value of Windows Domain Authentication (Unit: Seconds)	60	1-180	NIC	Applied to the device authentication	12

05/08	Mode	Element	Sub element	Item	Subitem	Code	Sub-code	Details	Default value	Acceptable value	RAM	Contents	Procedure
08	Setting mode	System	Network			3723		User authentication PDC/BDC time-out period (Unit: Seconds)	30	1-180	NIC	Applied to the user authentication	12
08	Setting mode	System	Network			3724		Windows Domain Authentication method of Windows Domain/Scan to SMB/User Authentication	1	1-4	NIC	1: Auto 2: Kerberos 3: NTLMv2 4: NTLMv1	12
08	Setting mode	System	Network			3725		IPP max connection	16	1-16	NIC		12
08	Setting mode	System	Network			3726		IPP active connection	10	1-16	NIC		12
08	Setting mode	System	Network			3727		LPD max connection	10	1-16	NIC		12
08	Setting mode	System	Network			3728		LPD active connection	10	1-16	NIC		12
08	Setting mode	System	Network			3729		ATalk PS max Connection	10	1-16	NIC		12
08	Setting mode	System	Network			3730		ATalk PS active Connection	10	1-16	NIC		12
08	Setting mode	System	Network			3731		Raw TCP max Connection	10	1-16	NIC		12
08	Setting mode	System	Network			3732		Raw TCP active connection	10	1-16	NIC		12
08	Setting mode	System	Network			3736		DNS client TimeOut	5	1-180	NIC	Use when a timeout occurred at DNS client connection	12
08	Setting mode	System	Network			3739		FTP Client TimeOut (SCAN)	30	1-180	NIC	Use when a timeout occurred at FTP client connection	12
08	Setting mode	System	Network			3743		LDAP client TimeOut	5	1-180	NIC	Use when a timeout occurred at LDAP client connection	12
08	Setting mode	System	Network	DPWS		3754		Switching printer setting	1	1-2	NIC	DPWS printer function is switched. 1: Enabled 2: Disabled	12
08	Setting mode	System	Network	DPWS		3755		Switching scanner setting	1	1-2	NIC	DPWS scanner function is switched. 1: Enabled 2: Disabled	12
08	Setting mode	System	Network	DPWS		3757		Discovery Port Number	3702	1-65535	NIC	Port number used for DPWS Discovery	12

05/08	Mode	Element	Sub element	Item	Subitem	Code	Sub-code	Details	Default value	Acceptable value	RAM	Contents	Procedure
08	Setting mode	System	Network	DPWS		3758		Metadata Exchange Port Number	50081	1-65535	NIC	Port number used for DPWS Metadata Exchange	12
08	Setting mode	System	Network	DPWS		3759		Print Port Number	50082	1-65535	NIC	Port number used for DPWS Print	12
08	Setting mode	System	Network	DPWS		3760		Scan Port Number	50083	1-65535	NIC	Port number used for DPWS Scan	12
08	Setting mode	System	Network	DPWS		3765		Print Max numbers of connection	10	1-20	NIC	Maximum numbers received from more than one connection request in the DPWS print	12
08	Setting mode	System	Network	DPWS		3766		Print Max numbers of reception	10	1-20	NIC	Maximum numbers of data received from more than one clients in the DPWS print	12
08	Setting mode	System	Network	IPv6		3767		Switching IPv6 setting	2	1-2	NIC	IPv6 function is switched. 1: Enabled 2: Disabled	12
08	Setting mode	System	Network	IPv6		3768		Switching address acquisition	2	1-3	NIC	IP (IPv6) address acquisition setting is switched. 1: Manual 2: Stateless 3: Stateful	12
08	Setting mode	System	Network	IPv6		3770		IPv6 Address	-	-	-	Displays IPv6 address. Maximum 40 characters (byte).	12
08	Setting mode	System	Network	IPv6		3771		Prefix display setting	-	-	-	Sets the length of the displayed prefix. Maximum 3 characters (byte).	12
08	Setting mode	System	Network	IPv6		3772		Default Gateway setting	-	-	-	Sets the default gateway for IPv6 address. Maximum 40 characters (byte).	12
08	Setting mode	System	Network			3774		DHCPv6 Option setting	2	1-2	NIC	DHCPv6 Option is switched when the Manual is set. 1: Enabled 2: Disabled	12
08	Setting mode	System	Network			3777		Stateless Address setting	2	1-2	NIC	IP Address is acquired by both Stateless and State full Address. 1: Enabled 2: Disabled	12
08	Setting mode	System	Network			3778		Acquiring DHCPv6 Option	2	1-2	NIC	When Stateless Address is selected, an option is acquired from DHCPv6 server. 1: Enabled 2: Disabled	12
08	Setting mode	System	Network			3779		State full Address setting	1	1-2	NIC	IP Address is acquired from DHCPv6 server. 1: Enabled 2: Disabled	12
08	Setting mode	System	Network			3780		State full Option setting	1	1-2	NIC	An option is acquired from DHCPv6 server. 1: Enabled 2: Disabled	12

05/08	Mode	Element	Sub element	Item	Subitem	Code	Sub-code	Details	Default value	Acceptable value	RAM	Contents	Procedure
08	Setting mode	System	Network	IPv6		3781		Primary DNS Server Address Registration	-	-	-	Registration of Primary DNS Server Address. Maximum 40 characters (byte).	12
08	Setting mode	System	Network	IPv6		3782		Secondary DNS Server Address Registration	-	-	-	Registration of Secondary DNS Server Address. Maximum 40 characters (byte).	12
08	Setting mode	System	Network			3793		LLTD function setting	1	1-2	NIC	Sets the LLTD function. 1: Enabled 2: Disabled	12
08	Setting Mode	Counter	Extra long size paper count	Count switching setting		3800	0	461-800 mm	2	1-30	SYS	Sets the number of multiples. A sheet is counted as N sheets when extra long size paper is used for printing.	4
08	Setting Mode	Counter	Extra long size paper count	Count switching setting		3800	1	801-1320 mm	3	1-30	SYS	Sets the number of multiples. A sheet is counted as N sheets when extra long size paper is used for printing.	4
08	Setting mode	System	General	USB media direct printing		3802		Paper size	Refer to contents	1,2,6,7, 10-13	SYS	1: legal 2: letter 6: A4 7: A5 10: B5 11: Folio 12: Legal13" 13: LetterSquare <Default value> ODA: 2 Others: 6	1
08	Setting mode	System	General	USB media direct printing		3803		Enable/disable setting	1	0-1	SYS	Sets the USB media direct printing function. 0: Disabled 1: Enabled	1
08	Setting mode	System	Scanner			3805		Department Management setting by Remote Scan	3	0-3	SYS	Sets the department management with remote scanning as follows: 0: w/o GUI OFF, w/ GUI OFF 1: w/o GUI ON, w/ GUI OFF 2: w/o GUI OFF, w/ GUI ON 3: w/o GUI ON, w/ GUI ON w/o GUI: Remote scanning is operated on SSOP application of eCOPY Inc. w/ GUI: Remote scanning is operated on MFP-specific GUI. This setting is only for department management with remote scanning. When GUI is set ON, a department code dialog is displayed at the start-up of remote scanning. This code is valid only when the code 08-9120 is set "1 (Valid)".	1

05/08	Mode	Element	Sub element	Item	Subitem	Code	Sub-code	Details	Default value	Acceptable value	RAM	Contents	Procedure
08	Setting Mode	System	Network	Direct SMTP		3810		Communication setting	0	0-1	SYS	When an Internet Fax is sent, Direct SMTP communication is set. 0: Disabled 1: Enabled When "0: Disabled" is set, an Internet Fax is sent using an SMTP server. When "1: Enabled" is set, direct SMTP communication is enabled and an Internet Fax is sent to MFPs If "1: Enabled" is set in 08-3810, set "1: Enabled" in 08-3812 as well.	1
08	Setting Mode	System	Network	Direct SMTP		3811		Image encrypting at the Direct SMTP	0	0-1	SYS	When Direct SMTP communication is performed, an attached image is encrypted. 0: Disabled 1: Enabled	1
08	Setting Mode	System	Network	Internet Fax		3812		Dummy full mode at transmission	0	0-1	SYS	When an Internet Fax is sent, the resolution ratio and the paper size of an attached image are set to the full mode. 0: Disabled 1: Enabled If "1: Enabled" is set in 08-3810, set "1: Enabled" in 08-3812 as well.	1
08	Setting mode	System	Scanner	XPS file		3815		Thumbnail addition	1	0-1	SYS	Thumbnail is added to the XPS file produced by the Scan function. 0: Not added 1: Only the top page added	1
08	Setting mode	System	Scanner	XPS file		3816		Paper size setting	1	0-1	SYS	The paper size of the XPS file produced by the Scan function is set. 0: Scanned image size 1: Standard size	1
08	Setting mode	System	Scanner	PDF file		3817		Version setting	4	0, 1, 4	SYS	The version of PDF file produced by the Scan function is set. 0: PDF V1.3 1: PDF V1.4 4: PDF V1.7	1
08	Setting mode	System	General			3833		Home directory function	0	0-1	SYS	Function to store a file in the user's home directory 0: Disabled 1: Enabled	1
08	Setting mode	System	General			3837		Display switching for the machine name shown in the notification	0	0-1	SYS	The display method of the machine name shown in the event related notification is switched. 0: IP address 1: NetBIOS name	1
08	Setting mode	System	General	License control		3840		Registration/deletion	-	-	-	Registers electronic keys for setting related optional items (e.g. when the equipment is delivered). Returns the license file having the same ID as that in the one-time dongle. Displays all the electronic keys stored in a USB media connected to the equipment in a list. Displays electronic keys registered in the equipment.	3

05/08	Mode	Element	Sub element	Item	Subitem	Code	Sub-code	Details	Default value	Acceptable value	RAM	Contents	Procedure
08	Setting Mode	System	Option	FAX		3847		FAX mis-transmission prevention	0	0-1	SYS	FAX mis-transmission prevention function is switched. 0: OFF (Disabled) 1: ON (Enabled)	1
08	Setting Mode	System	Option	FAX		3848		Restriction on Address Book destination	0	0-1	SYS	Sets whether the address in the address book is selectable or not for the FAX mis-transmission prevention function. 0: OFF (Disabled) 1: ON (Enabled)	1
08	Setting Mode	System	Option	FAX		3849		Restriction on destination direct entry	0	0-1	SYS	Sets whether the direct entry of the FAX number is available or not for the FAX mis-transmission prevention function. 0: OFF (Disabled) 1: ON (Enabled)	1
08	Setting mode	System	General			3851		Template display	0	0-1	SYS	0: ID number order 1: Alphabetical order	1
08	Setting mode	System	General	Summer time		3852		Summer time Automatic change function	Refer to contents	0-1	SYS	0: Disabled 1: Enabled <Default value> JP: 0 Others: 1	1
08	Setting mode	System	General	Summer time		3853		Time to shift	2	0-7	SYS	0: +2:00 1: +1:30 2: +1:00 3: +0:30 4: -0:30 5: -1:00 6: -1:30 7: -2:00	1
08	Setting mode	System	General	Summer time	Start	3854		Month	3	1-12	SYS	1: Jan 2: Feb 3: Mar 4: Apr 5: May 6: Jun 7: Jul 8: Aug 9: Sep 10: Oct 11: Nov 12: Dec	1
08	Setting mode	System	General	Summer time	Start	3855		Week	Refer to contents	1-5	SYS	1: 1st 2: 2nd 3: 3rd 4: 4th 5: Last <Default value> ODA: 2 Others: 5	1
08	Setting mode	System	General	Summer time	Start	3856		Day of the week	0	0-6	SYS	0: Sun 1: Mon 2: Tue 3: Wed 4: Thu 5: Fri 6: Sat	1
08	Setting mode	System	General	Summer time	Start	3857		Hours	2	0-23	SYS	0 to 23	1
08	Setting mode	System	General	Summer time	Start	3858		Minutes	0	0-59	SYS	0 to 59	1
08	Setting mode	System	General	Summer time	End	3859		Month	Refer to contents	1-12	SYS	1: Jan 2: Feb 3: Mar 4: Apr 5: May 6: Jun 7: Jul 8: Aug 9: Sep 10: Oct 11: Nov 12: Dec <Default value> ODA: 11 JP: 1 Others: 10	1

05/08	Mode	Element	Sub element	Item	Subitem	Code	Sub-code	Details	Default value	Acceptable value	RAM	Contents	Procedure
08	Setting mode	System	General	Summer time	End	3860		Week	Refer to contents	1-5	SYS	1: 1st 2: 2nd 3: 3rd 4: 4th 5: Last <Default value> ODA/JP: 1 Others: 5	1
08	Setting mode	System	General	Summer time	End	3861		Day of the week	0	0-6	SYS	0: Sun 1: Mon 2: Tue 3: Wed 4: Thu 5: Fri 6: Sat	1
08	Setting mode	System	General	Summer time	End	3862		Hours	Refer to contents	0-23	SYS	0 to 23 <Default value> ODA: 2 Others: 3	1
08	Setting mode	System	General	Summer time	End	3863		Minutes	0	0-59	SYS	0 to 59	1
08	Setting mode	System	Network			3864		Disclosure of telnet function	0	0-1	SYS	0: Not disclosed 1: Disclosed When this value is set at "0", the value of code 08-3865 must be "2".	1
08	Setting mode	System	Network			3865		Availability of telnet server	2	1-2	NIC	1: Enable 2: Disable	12
08	Setting mode	Printer	Paper feeding	Default setting of paper source	PPC	4010		Default setting of paper source	0	0-5	SYS	0: A4/LT 1: LCF 2: 1st tray 3: 2nd tray 4: 3rd tray 5: 4th tray	1
08	Setting Mode	Printer	Paper feeding	Automatic change of paper source	When a drawer is specified	4016	0	PPC	0	0-1	SYS	Sets whether the automatic change of paper source is performed or not if the drawer is specified as the paper source and the paper in the specified drawer runs out when coping. 0: Does not change the paper source automatically 1: Changes the paper source automatically	4
08	Setting Mode	Printer	Paper feeding	Automatic change of paper source	When a drawer is specified	4016	1	Printing/BOX printing	0	0-1	SYS	Sets whether the automatic change of paper source is performed or not if the drawer is specified as the paper source and the paper in the specified drawer runs out when printing/BOX printing. 0: Does not change the paper source automatically 1: Changes the paper source automatically	4
08	Setting mode	Printer	Paper feeding	Paper size setting		4100		1st tray	Refer to contents	0-255	SYS	Press the button on the LCD to select the size. This code is reset every time a paper size is detected automatically. 20: A4-R 80: LT-R <Default value> ODA: 80 Others: 20	9

05/08	Mode	Element	Sub element	Item	Subitem	Code	Sub-code	Details	Default value	Acceptable value	RAM	Contents	Procedure
08	Setting mode	Printer	Paper feeding	Paper size setting		4101		2nd tray	Refer to contents	0-255	SYS	Press the button on the LCD to select the size. This code is reset every time a paper size is detected automatically. 20: A4-R 80: LT-R <Default value> ODA: 80 Others: 20	9
08	Setting mode	Printer	Paper feeding	Paper size setting		4102		3rd tray	Refer to contents	0-255	SYS	Press the button on the LCD to select the size. This code is reset every time a paper size is detected automatically. 20: A4-R 80: LT-R <Default value> ODA: 80 Others: 20	9
08	Setting mode	Printer	Paper feeding	Paper size setting		4103		4th tray	Refer to contents	0-255	SYS	Press the button on the LCD to select the size. This code is reset every time a paper size is detected automatically. 20: A4-R 80: LT-R <Default value> ODA: 80 Others: 20	9
08	Setting mode	Printer	Paper feeding	Paper size setting		4104		LCF	Refer to contents	0-255	SYS	Press the button on the LCD to select the size. This code is reset every time a paper size is detected automatically. 20: A4-R 80: LT-R <Default value> ODA: 80 Others: 20	9
08	Setting mode	Printer	Paper feeding	Paper size setting	PPC	4140		MP tray	Refer to contents	0-153	SYS	Press the button on the LCD to select the size. 255: UNDEF <Default value> ODA: 80 (LT-R) Others: 20 (A4-R)	9
08	Setting mode	Printer	General			4160		Silent control setting	0	0-1	PU	Switches ON/OFF of low speed printing mode to reduce the printing noise. 0: OFF 1: ON	1
08	Setting mode	Printer	General			4161		Nearly end setting of drum	4	1-6	PU	Sets the occurrence timing of nearly end of drum (replacement timing is close). Set the available number of sheets prior to replacement timing (end of life). 1: 0.5K 2: 1K 3: 2K 4: 3K 5: 4K 6: 5K	1

05/08	Mode	Element	Sub element	Item	Subitem	Code	Sub-code	Details	Default value	Acceptable value	RAM	Contents	Procedure
08	Setting Mode	Counter	Double count	For fee charging	Paper size	6010		Large-sized paper	1	0-1	SYS	Sets whether LargeCounter is counted as 1 or 2 when printing large-sized paper. 0: Counted as 1 1: Counted as 2 * This code is a special code which has areas in both SYS-SRAM and PU. The default value in SYS-SRAM is applied to the PU area at initialization. <Default value> JP: 0 Others: 1	1
08	Setting Mode	Counter	Double count	For fee charging	Paper size	6011		Definition setting of large sized paper	0	0-2	SYS	Sizes that classified into Large. 0: A3, LD, Undefined, Custom size that exceeds 415 mm (including Long-a, Long-b) 1: In addition to the paper sizes listed in "0", B4 (364mm), Folio (330 mm), 14"LG (356 mm), 13.5"LG (343 mm), 13"LG (330 mm), Computer (356mm), Custom size that exceeds 325 mm 2: B4 (364mm), Custom size that exceeds 356 mm (including Long-a, Long-b) * This code is a special code which has areas in both SYS-SRAM and PU. The default value in SYS-SRAM is applied to the PU area at initialization.	1
08	Setting mode	Counter	Copy	Print	Black	6063	0	Large	0	8 digits	SYS	Counts the number of output pages at the Black Mode in the Copier Function according to its size (large/small). Large: Number of output pages of large-sized paper defined at 08-6011 Small: Number of output pages other than set as large-sized paper	14
08	Setting mode	Counter	Copy	Print	Black	6063	1	Small	0	8 digits	SYS	Counts the number of output pages at the Black Mode in the Copier Function according to its size (large/small). Large: Number of output pages of large-sized paper defined at 08-6011 Small: Number of output pages other than set as large-sized paper	14
08	Setting mode	Counter	Printer	Black		6064	0	Large	0	8 digits	SYS	Counts the number of output pages at the Black Mode in the Printer Function according to its size (large/small). Large: Number of output pages of large-sized paper defined at 08-6011 Small: Number of output pages other than set as large-sized paper	14

05/08	Mode	Element	Sub element	Item	Subitem	Code	Sub-code	Details	Default value	Acceptable value	RAM	Contents	Procedure
08	Setting mode	Counter	Printer	Black		6064	1	Small	0	8 digits	SYS	Counts the number of output pages at the Black Mode in the Printer Function according to its size (large/small). Large: Number of output pages of large-sized paper defined at 08-6011 Small: Number of output pages other than set as large-sized paper	14
08	Setting mode	Counter	List print	Black		6065	0	Large	0	8 digits	SYS	Counts the number of output pages at the List Print Mode Function according to its size (large/small). Large: Number of output pages of large-sized paper defined at 08-6011 Small: Number of output pages other than set as large-sized paper	14
08	Setting mode	Counter	List print	Black		6065	1	Small	0	8 digits	SYS	Counts the number of output pages at the List Print Mode Function according to its size (large/small). Large: Number of output pages of large-sized paper defined at 08-6011 Small: Number of output pages other than set as large-sized paper	14
08	Setting mode	Counter	FAX	Print	Black	6066	0	Large	0	8 digits	SYS	Counts the number of output pages in the FAX Function according to its size (large/small). Large: Number of output pages of large-sized paper defined at 08-6011 Small: Number of output pages other than set as large-sized paper	14
08	Setting mode	Counter	FAX	Print	Black	6066	1	Small	0	8 digits	SYS	Counts the number of output pages in the FAX Function according to its size (large/small). Large: Number of output pages of large-sized paper defined at 08-6011 Small: Number of output pages other than set as large-sized paper	14
08	Setting mode	Counter	NW Scanning	Full color		6068	0	Large	0	8 digits	SYS	Counts the number of scanning pages at the Full Color Mode in the Scanning Function according to its size (large/small). Large: Number of output pages of large-sized paper defined at 08-6011 Small: Number of output pages other than set as large-sized paper	14

05/08	Mode	Element	Sub element	Item	Subitem	Code	Sub-code	Details	Default value	Acceptable value	RAM	Contents	Procedure
08	Setting mode	Counter	NW Scanning	Full color		6068	1	Small	0	8 digits	SYS	Counts the number of scanning pages at the Full Color Mode in the Scanning Function according to its size (large/small). Large: Number of output pages of large-sized paper defined at 08-6011 Small: Number of output pages other than set as large-sized paper	14
08	Setting mode	Counter	Copy	Scanning	Black	6070	0	Large	0	8 digits	SYS	Counts the number of scanning pages at the Black Mode in the Copier Function according to its size (large/small). Large: Number of output pages of large-sized paper defined at 08-6011 Small: Number of output pages other than set as large-sized paper	14
08	Setting mode	Counter	Copy	Scanning	Black	6070	1	Small	0	8 digits	SYS	Counts the number of scanning pages at the Black Mode in the Copier Function according to its size (large/small). Large: Number of output pages of large-sized paper defined at 08-6011 Small: Number of output pages other than set as large-sized paper	14
08	Setting mode	Counter	FAX	Scanning	Black	6071	0	Large	0	8 digits	SYS	Counts the number of scanning pages in the FAX Function according to its size (large/small). Large: Number of output pages of large-sized paper defined at 08-6011 Small: Number of output pages other than set as large-sized paper	14
08	Setting mode	Counter	FAX	Scanning	Black	6071	1	Small	0	8 digits	SYS	Counts the number of scanning pages in the FAX Function according to its size (large/small). Large: Number of output pages of large-sized paper defined at 08-6011 Small: Number of output pages other than set as large-sized paper	14
08	Setting mode	Counter	NW Scanning	Black		6072	0	Large	0	8 digits	SYS	Counts the number of scanning pages in the Scanning Function according to its size (large/small). Large: Number of output pages of large-sized paper defined at 08-6011 Small: Number of output pages other than set as large-sized paper	14

05/08	Mode	Element	Sub element	Item	Subitem	Code	Sub-code	Details	Default value	Acceptable value	RAM	Contents	Procedure
08	Setting mode	Counter	NW Scanning	Black		6072	1	Small	0	8 digits	SYS	Counts the number of scanning pages in the Scanning Function according to its size (large/small). Large: Number of output pages of large-sized paper defined at 08-6011 Small: Number of output pages other than set as large-sized paper	14
08	Setting mode	Counter	FAX	Transmission	Black	6073	0	Large	0	8 digits	SYS	Counts the number of transmitted pages in the FAX Function according to its size (large/small). Large: Number of output pages of large-sized paper defined at 08-6011 Small: Number of output pages other than set as large-sized paper	14
08	Setting mode	Counter	FAX	Transmission	Black	6073	1	Small	0	8 digits	SYS	Counts the number of transmitted pages in the FAX Function according to its size (large/small). Large: Number of output pages of large-sized paper defined at 08-6011 Small: Number of output pages other than set as large-sized paper	14
08	Setting mode	Counter	FAX	Reception	Black	6074	0	Large	0	8 digits	SYS	Counts the number of received pages in the FAX Function according to its size (large/small). Large: Number of output pages of large-sized paper defined at 08-6011 Small: Number of output pages other than set as large-sized paper	14
08	Setting mode	Counter	FAX	Reception	Black	6074	1	Small	0	8 digits	SYS	Counts the number of received pages in the FAX Function according to its size (large/small). Large: Number of output pages of large-sized paper defined at 08-6011 Small: Number of output pages other than set as large-sized paper	14
08	Setting Mode	Counter	Custom counter			6080		On/Off of charge for scanning	0	0-1	SYS	Sets whether custom counter is output or not. Since the count is calculated based on the existing Large/Small counter, the count before changing this setting is also included in the count. 0: OFF (Don't charge the scan counter.) 1: ON (Charge the scan counter.)	1

05/08	Mode	Element	Sub element	Item	Subitem	Code	Sub-code	Details	Default value	Acceptable value	RAM	Contents	Procedure
08	Setting Mode	Counter	Custom counter	Quota control	Weighting/Scanning	6081	0	Black/Gray	100	0-9999	SYS	Weights addition of Scan Counter to Custom Counter. Since the count is calculated based on the existing Large/ Small counter, the count before changing this setting is also included in the count. 0 (weight: 0.00) – 9999 (weight: 99.99)	4
08	Setting Mode	Counter	Custom counter	Quota control	Weighting/Scanning	6081	1	Full Color	100	0-9999	SYS	Weights addition of Scan Counter to Custom Counter. Since the count is calculated based on the existing Large/ Small counter, the count before changing this setting is also included in the count. 0 (weight: 0.00) – 9999 (weight: 99.99)	4
08	Setting Mode	Counter	Double count	For charging	Paper type	6083	1	Thick1/2/3/4/5	0	0-1	SYS	Sets the weight of fee charging count for printing per page. Scan counter and fax counter are not influenced. 0: Single 1: Double	4
08	Setting Mode	Counter	Double count	For charging	Paper type	6083	2	Special1(Label1) / Special2(Label2) / Special3(Transparency) / Special4(Glossy1) / Special5(Glossy2) / Special6(Glossy3)	0	0-1	SYS	Sets the weight of fee charging count for printing per page. Scan counter and fax counter are not influenced. 0: Single 1: Double	4
08	Setting Mode	Counter	Double count	For charging	Paper type	6083	4	Envelope1/2/3/4	0	0-1	SYS	Sets the weight of fee charging count for printing per page. Scan counter and fax counter are not influenced. 0: Single 1: Double	4
08	Setting Mode	Counter	Double count	For charging	Paper type	6083	6	UserType1/2/3/4/5	0	0-1	SYS	Sets the weight of fee charging count for printing per page. Scan counter and fax counter are not influenced. 0: Single 1: Double	4
08	Setting Mode	Counter	Custom counter	Quota control		6084		Print weight and Quota type	0	0-1	SYS	Sets the type of Quota. When the value of this code is set to "1", the value of 08-9116 is set to "0" (Black free function is OFF). 0: Color/Black Quota 1: Job Quota	1
08	Setting Mode	Counter	Custom counter	Quota control	Weighting/Print	6085	0	Black/Small	100	0-9999	SYS	Weights addition of print to Custom Counter and Job Quota. 0 (weight: 0.00) – 9999 (weight: 99.99)	4
08	Setting Mode	Counter	Custom counter	Quota control	Weighting/Print	6085	1	Black/Large	100	0-9999	SYS	Weights addition of print to Custom Counter and Job Quota. 0 (weight: 0.00) – 9999 (weight: 99.99)	4
08	Setting Mode	Counter	Custom counter	Counter Settings		6086		Display in Web Page	0	0-1	SYS	Sets whether the counter settings (screen of weighting setting of custom counter) are displayed in Web Page for administrator, or set by code 08-6081 and 6085 only. 0: OFF (Not displayed in Web Page) 1: ON (Displayed in Web Page)	1

05/08	Mode	Element	Sub element	Item	Subitem	Code	Sub-code	Details	Default value	Acceptable value	RAM	Contents	Procedure
08	Setting Mode	Counter	Counter of Paper feed			6117		RADF	0	8 digits	SYS	Counts the number of originals fed from RADF.	2
08	Setting mode	Counter	PM counter	Pickup roller (RADF)		6382	0	Present number of output pages	0	8 digits	SYS		4
08	Setting mode	Counter	PM counter	Pickup roller (RADF)		6382	1	Recommended number of output pages for replacement	120000	8 digits	SYS		4
08	Setting mode	Counter	PM counter	Pickup roller (RADF)		6382	2	Number of output pages at the last replacement	0	8 digits	SYS		4
08	Setting mode	Counter	PM counter	Pickup roller (RADF)		6382	8	Number of times replaced	0	8 digits	SYS		4
08	Setting mode	Counter	PM counter	Pickup roller (RADF)		6383		Date of previous replacement	0	8 digits	SYS		2
08	Setting mode	Counter	PM counter	Feed roller (RADF)		6384	0	Present number of output pages	0	8 digits	SYS		4
08	Setting mode	Counter	PM counter	Feed roller (RADF)		6384	1	Recommended number of output pages for replacement	120000	8 digits	SYS		4
08	Setting mode	Counter	PM counter	Feed roller (RADF)		6384	2	Number of output pages at the last replacement	0	8 digits	SYS		4
08	Setting mode	Counter	PM counter	Feed roller (RADF)		6384	8	Number of times replaced	0	8 digits	SYS		4
08	Setting mode	Counter	PM counter	Feed roller (RADF)		6385		Date of previous replacement	0	8 digits	SYS		2
08	Setting mode	Counter	PM counter	Separation roller (RADF)		6386	0	Present number of output pages	0	8 digits	SYS		4
08	Setting mode	Counter	PM counter	Separation roller (RADF)		6386	1	Recommended number of output pages for replacement	120000	8 digits	SYS		4
08	Setting mode	Counter	PM counter	Separation roller (RADF)		6386	2	Number of output pages at the last replacement	0	8 digits	SYS		4
08	Setting mode	Counter	PM counter	Separation roller (RADF)		6386	8	Number of times replaced	0	8 digits	SYS		4
08	Setting mode	Counter	PM counter	Separation roller (RADF)		6387		Date of previous replacement	0	8 digits	SYS		2

05/08	Mode	Element	Sub element	Item	Subitem	Code	Sub-code	Details	Default value	Acceptable value	RAM	Contents	Procedure
08	Setting mode	Counter				6817		Calibration counter	0	8 digits	SYS	Displays the number of times a calibration chart is printed. When "0" is set for this code, and also when in the line adjustment mode or when the fee charging counter is reset, this counter is reset. The counter value goes up every time a calibration chart is printed, regardless of the setting value of the code 08-9894 (Calibration chart charging method).	1
08	Setting mode	Image Processing	Image	All clearing	Adjustment values of all 05/08 image process codes	7000		PPC related codes	-	-	SYS	Clears the following codes and the PPC related areas of the HDD. 05-7025 to 7287 05-7618 to 7630 08-7014 to 7051	3
08	Setting mode	Image Processing	Image	All clearing	Gamma correction table	7001		PPC related codes	-	-	SYS	Clears PPC related areas of the HDD.	3
08	Setting mode	Image Processing	Image	Error diffusion and dither setting		7014		Photo mode	1	0-1	SYS	Switches the image processing method in the photo mode. 0: Error diffusion 1: Dither	1
08	Setting mode	Image Processing	Image	Error diffusion and dither setting		7015		Photo mode (Custom Mode)	1	0-1	SYS	Switches the image processing method in the photo mode (custom mode). 0: Error diffusion 1: Dither	1
08	Setting mode	Image Processing	User interface	User custom mode setting	Monochrome PPC	7034		Black	0	0-3	SYS	0: Unused 1: Text/Photo base 2: Text base 3: Photo base	1
08	Setting Mode	Image Processing	Automatic tone correction data	Last updated date and time	Monochrome PPC	7051		Plain paper1	0	0-4212312359	SYS	Last updated date and time of automatic tone correction data. YYMMDDHHMM YY: year, MM: month, DD: day, HH: hour, MM: minute	2
08	Setting mode	Image Processing	Image	All clearing	Adjustment values of all 05/08 image process codes	7300		NW PRT related codes	-	-	SYS	Clears the values of the following codes and the PPC related areas of the HDD. 05-7302 to 7368 05-8239 to 8243	3
08	Setting mode	Image Processing	Image	All clearing	Adjustment values of all 05/08 image process codes	7400		NW SCN related codes	-	-	SYS	Clears the values of the following codes: 05-7430 to 7489 05-8304 to 8380 08-7401, 8303	3
08	Setting mode	Image Processing	User interface	User custom mode setting	NW SCN	7401		Black	0	0-3	SYS	0: Unused 1: Black TEXT/PHOTO base 2: Black TEXT base 3: Black PHOTO base	1
08	Setting mode	Image Processing	Image	All clearing	Adjustment values of all 05 image process codes	7500		FAX related codes	-	-	SYS	Clears the values of the following codes: 05-7533 to 7543	3

05/08	Mode	Element	Sub element	Item	Subitem	Code	Sub-code	Details	Default value	Acceptable value	RAM	Contents	Procedure
08	Setting mode	Image Processing	Image	FAX (black)	Image quality switchover	7501	0	Primary scanning direction	1	0-1	SYS	0: Suppresses graininess 1: Suppresses smudge	4
08	Setting mode	Image Processing	Image	FAX (black)	Image quality switchover	7501	1	Secondary scanning direction	1	0-1	SYS	0: Suppresses graininess 1: Dimensional accuracy priority	4
08	Setting mode	Image Processing	User interface	User custom mode setting	NW SCN	8303		Color	0	0-4	SYS	0: Unused 1: Text/Photo base 2: Text base 3: Photo base 4: e-document base * e-document: This is the mode that corresponds to the law in Japan. This mode is used to clarify area where changes were made with such as a correction fluid.	1
08	Setting mode	System	General			8504		Feeding method of odd page number in duplex printing (Raw print)	0	0-1	SYS	0: One side 1: Both sides	1
08	Setting mode	System	General	Wide A4 Mode (for PCL)	PRT	8511		Wide A4 Mode (for PCL)	0	0-1	SYS	0: Disable 1: Enable	1
08	Setting mode	System	General			8512		Number of jobs in batch processing	10	2-10	SYS	2-10: From 2 to jobs can be specified	1
08	Setting mode	System	General			8514		Threshold value setting for RIP standard paper judgment	20	5-30	SYS	This code is used for changing the range in which non-standard paper sizes are judged as standard ones. If the page size data are within the standard paper size \pm the setting value, the page size is judged as a standard paper size in PS/PDF printing. If the page size data are out of the range, the page size is judged as a non-standard paper size. The unit for the setting value is PS points. 1 PS point is approx. 0.35 mm.	1
08	Setting mode	System	General	Outside erase Judgment threshold (Default)		8515		PPC	0	-3-3	SYS	The larger the value, area to be erased increases. The smaller the value, area to be erased decreases.	1
08	Setting mode	System	General	Outside erase Judgment threshold (Default)		8516		SCN	0	-3-3	SYS	The larger the value, area to be erased increases. The smaller the value, area to be erased decreases.	1
08	Setting mode	System	General			8517		Remote Scan User authentication automatic login	1	0-1	SYS	0: OFF (A user always enters manually (current method)) 1: ON (Previous authentication information will be used)	1
08	Setting mode	System	General			8518		Overwriting mode for scanned files	0	0-3	SYS	0: Always OFF 1: Meta Scan function ON / Normal scan function OFF 2: Meta Scan function OFF / Normal scan function ON 3: Always ON	1
08	Setting mode	System	General			8519		Scan PDF file Paper size	1	0-1	SYS	0: Equivalent to scan image size 1: Fitted into any standard size	1

05/08	Mode	Element	Sub element	Item	Subitem	Code	Sub-code	Details	Default value	Acceptable value	RAM	Contents	Procedure
08	Setting mode	System	General			8520		Underscore conversion of prohibited character in filename	1	0-1	SYS	Sets the prohibited characters in filename to covert to underscore. 0: \ / > < , " ? * ; = [] + 1: \ / > < " ? * ; * 0: Existing model standard 1: Windows standard Since setting the value to "1" allows some prohibited characters, filename might not be processed in external application or server.	1
08	Setting mode	System	General			8521		Switchover of output format of Service Notification attachment	0	0-1	SYS	Switches the output format of date in attachment of Service Notification. 0: YYYY.MM.DD 1: YYYY-MM-DDTHH:MM:SS	1
08	Setting Mode	System	User interface	Display setting		8523		Nearly end display of supplies	0	0-1	SYS	Switches ON/OFF of nearly end display (replacement timing is close) of supplies. 0: ON 1: OFF	1
08	Setting mode	System	User interface	Display setting		8524		No paper message	0	0-1	SYS	0: ON 1: OFF	1
08	Setting mode	System	User interface			8526		Scan Preview Default setting	0	0-1	SYS	0: OFF 1: ON	1
08	Setting mode	System	General			8527		Scan Preview Default display type	0	0-1	SYS	0: Page Fit 1: Width Fit	1
08	Setting mode	System	General			8532		Control panel Brightness level adjustment	4	1-7	SYS	1-7: Brightness level	1
08	Setting mode	System	General	Sorting method for displaying private print jobs	PRT	8537		Sorting method for displaying private print jobs	0	0-1	SYS	Changes the sorting order for print jobs on the private print list. 0: Descending order 1: Ascending order	1
08	Setting mode	System	User interface			8538		Toner near empty notification setting	0	0-1	SYS	0: Disabled 1: Enabled	1
08	Setting mode	System	User interface	Scanning		8540		Date/time format in the Meta Scan XML file	1	0-1	SYS	0: YYYY/MM/DDhh:mm:ss.mmm 1: YYYY-MMDDThh:mm:ss.mmmTZD	1
08	Setting mode	System	User interface			8543		Switching to the low power consumption mode in the Sleep mode	1	0-1	SYS	0: Not switched 1: Switched under certain conditions	1
08	Setting mode	System	User interface			8544		Tolerance for switching to Super Sleep mode	5	5-600	SYS	Sets the range of tolerance in which the equipment returns to the Super Sleep mode after the system is started during that mode. Unit: Second	1

05/08	Mode	Element	Sub element	Item	Subitem	Code	Sub-code	Details	Default value	Acceptable value	RAM	Contents	Procedure
08	Setting mode	System	User interface			8546		Input setting of minus value for image shift when copying	0	0-1	SYS	0: Inputting a minus value is disabled. 1: Inputting a minus value is enabled.	1
08	Setting mode	System	User interface	Paper feeding		8548		Operation of drawer size change when printing is interrupted by size mismatch	0	0-1	SYS	0: Operation of cassette size change is disabled. 1: Operation of cassette size change is enabled.	1
08	Setting mode	System	User interface	Counter		8549		Hardware key control when external counter is installed	0	0-1	SYS	0: No control 1: Mode switch key is disabled.	1
08	Setting Mode	System	Network			8585		Edit setting of e-mail subject	1	0-1	SYS	0: Not allowed 1: Allowed	1
08	Setting Mode	System	Network			8586		Addition of date and time to email subject	1	0-1	SYS	0: Not added 1: Added	1
08	Setting Mode	System	Network			8587		Character string of email subject	0	0-1	SYS	Switches the default character string of subject. 0: Character string at the shipment 1: Character string specified by users	1
08	Setting Mode	System	User control	LDAP authentication	Attribute value setting	8592		Sender address	mail	-	SYS	Sets the default attribute value of sender address. Maximum 34 characters (ASCII).	11
08	Setting Mode	System	User control	LDAP authentication	Attribute value setting	8593		Sender name	uid	-	SYS	Sets the default attribute value of sender name. Maximum 34 characters (ASCII).	11
08	Setting Mode	System	User interface			8597		Automatic update of private/hold print job list	0	0-1	SYS	0: Disabled 1: Enabled	1
08	Setting mode	System	User interface			8598		Template icon layout on the control panel	0	0-1	SYS	0: Pattern 1 (1) (2) (3) (4) (5) (6) (7) (8) (9) (10) (11) (12) (13) (14) (15) (16) 1: Pattern 2 (1) (2) (9) (10) (3) (4) (11) (12) (5) (6) (13) (14) (7) (8) (15) (16)	1
08	Setting Mode	System	General	Outside erase		8600		Change of default value	0	0-1	SYS	0: Disabled 1: Enabled	1
08	Setting Mode	System	User interface			8603		Special usage of external options I/F	0	0-2	SYS	0: None 1: Usage 1 2: Usage 2	1

05/08	Mode	Element	Sub element	Item	Subitem	Code	Sub-code	Details	Default value	Acceptable value	RAM	Contents	Procedure
08	Setting Mode	System	Network	Prioritized authentication server		8608		Windows	0	0-100	SYS	Sets the prioritized authentication server to be searched (0 to 100). The servers displayed on the screen accessed by Web Page -> Administration -> Maintenance -> Directory Service are numbered beginning at the top (0 to 100).	1
08	Setting Mode	System	Network	Prioritized authentication server		8609		LDAP	0	0-100	SYS	Sets the prioritized authentication server to be searched (0 to 100). The servers displayed on the screen accessed by Web Page -> Administration -> Maintenance -> Directory Service are numbered beginning at the top (0 to 100).	1
08	Setting Mode	System	Network	Prioritized authentication server		8610		Card	0	0-100	SYS	Sets the prioritized authentication server to be searched (0 to 100). The servers displayed on the screen accessed by Web Page -> Administration -> Maintenance -> Directory Service are numbered beginning at the top (0 to 100).	1
08	Setting Mode	System	User interface			8622		Date and time addition setting to file name of scan to file/e-mail	1	0-1	SYS	0: Not added 1: Added	1
08	Setting Mode	System	User interface			8623	0	RIP function setting	1	0-1	SYS	Enables/Disables the function related to Excel boarder rendering of PCL6. The function is to prevent missing lines when scaling down and inconsistent line width when scaling up. 0: Disabled (No correction. Compliant with PCL6 language) 1: Enabled	4
08	Setting Mode	System	User interface			8624		Switchover of filename display method	3	0-3	SYS	Switches the display method of filename. 0: Displays the filename from the beginning 1: Displays the trailing characters 2: Displays the beginning and trailing characters 3: Displays the filename without abbreviation	1
08	Setting mode	System	User interface			8628		Job operation on the COPY screen when the coin controller is connected	0	0-1	SYS	This setting enables user to move from the COPY screen to JOB STATUS screen, and then operate jobs during printing when the coin controller is connected. This code is valid when the value of 08-9016 is "1". 0: Disabled 1: Enabled	1
08	Setting Mode	System	FAX			8631		Filename creation at fax reception and forwarding	0	0-1	SYS	0: Use address name (family-name/first-name) as filename if multiple names are found by address book search of TSI (sender information). 1: Use address name (family-name/first-name) as filename only when single name is found by address book search of TSI (sender information).	1
08	Setting mode	System	User interface			8640		Job build operation when the coin controller is connected	0	0-1	SYS	This setting enables user to use the job build function when the coin controller is connected. This code is valid when the value of 08-9016 is "1". 0: Disabled 1: Enabled	1

05/08	Mode	Element	Sub element	Item	Subitem	Code	Sub-code	Details	Default value	Acceptable value	RAM	Contents	Procedure
08	Setting Mode	System	General			8641		Notification setting for job cancel	1	0-1	SYS	Sets the notification setting for job cancel. This setting is effective for the following codes: 1CC0, 2BB0, 2CC0, 2DC0, 2EC0 0: Disabled (Not notified) 1: Enabled (Notified)	1
08	Setting Mode	System	Output			8665		Paper size setting for output to face-up tray	0	0-1	SYS	Sets the paper size for output to the face-up tray. Output is interrupted if the face-up tray is not opened. 0: Paper size not allowed to output to inner tray (Index card, custom size paper which is 147 mm or shorter) 1: Paper size recommended to output to face-up tray (A6, postcard, double postcard, envelope, long-size paper which is 356 mm or longer, index card, custom size paper which is 147 mm or shorter)	1
08	Setting Mode	System	FAX			8700		Secret reception setting	0	0-2	SYS	When the value of 08-8924 is "0", the value of this code can be set to "1" or "2". 0: Always Off 1: Always On 2: Scheduled reception	1
08	Setting Mode	System	User interface			8704		Email/FAX address restriction	0	0-1	SYS	0: No restriction 1: Search for external LDAP only Use this code to restrict address of email/fax to specified LDAP server. If the value of this code is set to "1", the addresses of email/fax are restricted to the LDAP server specified with Web Page, and the direct input of addresses and selecting addresses from the local address book are not available. If the value of this code is set to "1", this setting is given priority over the setting value of 08-9299, 08-3848, 08-3849.	1
08	Setting Mode	System	User interface			8709		Display setting of Service Notification	1	0-1	SYS	Sets whether the [SERVICE NOTIFICATION] button is displayed on the screen accessed by [USER FUNCTIONS] -> [ADMIN] -> [SERVICE]. 0: Disabled 1: Enabled	1
08	Setting Mode	System	Scanning			8710		Japanese character code of ScanToFTP	0	0-2	SYS	0: Automatic selection 1: UTF8 2: Shift-JIS	1
08	Setting Mode	System	General	Hardcopy security printing		8711		Enable/Disable setting of watermark information tracking application	1	0-1	SYS	Set this code to "1: Disabled" to disable the watermark information tracking application at hardcopy security printing. When this code is set to "1: Disabled", a license error occurs even if the license for hardcopy security printing is enabled. If this error occurs, hardcopy security printing is available, but copy prohibition function and tracking application are not available. 0: Disabled 1: Enabled	1

05/08	Mode	Element	Sub element	Item	Subitem	Code	Sub-code	Details	Default value	Acceptable value	RAM	Contents	Procedure
08	Setting Mode	System	User interface			8712		Display setting of the drawer setting button	1	0-1	SYS	Sets whether the drawer button in USER FUNCTIONS is displayed or not. 0: Not displayed 1: Displayed	1
08	Setting Mode	System	User interface			8713		Setting of web upload/web printing	1	0-1	SYS	Sets whether the web upload and web printing function is enabled or disabled. - Web upload is a function which uploads the image data created on the equipment to the web page displayed on EWB. - Web printing is a function which prints the web page displayed on EWB or the PDF file included in the web page displayed on EWB. 0: Disabled 1: Enabled	1
08	Setting Mode	System	User interface	Service notification information		8715		Password for zip file with password	#1048109	-	SYS	Password for zip file with password of service notification information. Minimum number of digits: 0, maximum number of digits: 20 Available character: alphanumeric characters and symbols	11
08	Setting Mode	System	General			8717		Shutdown when Super Sleep is enabled	0	0-1	SYS	Sets the operation when the power button is pressed for a few seconds if Super Sleep is enabled. 0: Hibernation 1: Super Sleep	1
08	Setting Mode	System	User interface			8718		Selection for caching the screen of control panel at start-up	0	0-17	SYS	Use this code to shorten the time to switch the function on the control panel for the first time immediately after start-up. However, the start-up time becomes longer (about 1 to 3 seconds per screen). When selecting multiple screens, enter the total value. 0: Disabled 1: Copy 16: Fax	1
08	Setting Mode	System	Network			8719		MTU setting of network communication	1500	576-1500	NIC	Normally there's no need to change the MTU value. However, set the proper MTU value when MFP is connected to the Internet using broadband router and so on.	12
08	Setting Mode	System	User interface			8720		Department code display with asterisk	0	0-1	SYS	0: Displays department code with asterisk when inputting it. 1: Displays department code as it is when inputting it.	1
08	Setting Mode	System	FAX			8721		Automatic FAX sending at AutoClear when scanning original put on the glass	0	0-1	SYS	Sets whether the job is sent or canceled when AutoClear is executed on the interruption screen to confirm the next original displayed after scanning the original put on the glass. Use this code to cancel job when the equipment is left unattended while the interruption screen is displayed. 0: Sends job 1: Cancels job	1

05/08	Mode	Element	Sub element	Item	Subitem	Code	Sub-code	Details	Default value	Acceptable value	RAM	Contents	Procedure
08	Setting Mode	System	User interface			8722		Display method of "Cannot find the Home Directory" on the control panel	0	0-1	SYS	Sets the display method of error if the Home Directory for user cannot be obtained from the server when setting the Home Directory for scanning. Use this code to disable the pop-up display when the Home Directory cannot be obtained depending on the user. 0: Displays the pop-up dialogue when user logs in 1: Displays the message in the guidance area when the Scan to File screen is displayed	1
08	Setting Mode	System	User interface			8723		Pop-up display of logging out of user authentication and department management on the control panel	1	0-1	SYS	Sets whether the pop-up dialog of confirmation for logging out is displayed when user or department logs out by pressing [FUNCTION CLEAR] button twice or pressing [ACCESS] button. 0: Logs out without displaying pop-up dialog 1: Displays pop-up dialog when logging out	1
08	Setting Mode	System	User interface			8724		Display setting of Edit From Address button for Scan to email	1	0-1	SYS	0: Not displayed (From Address cannot be edited) 1: Displayed (From Address can be edited)	1
08	Setting Mode	System	User interface			8725		Display setting of [USER FUNCTIONS]-> CHANGE LANGUAGE button	1	0-1	SYS	Sets whether the [CHANGE LANGUAGE] button accessed from [USER FUNCTIONS] button is displayed or not. Use this code to prohibit users from changing the language displayed on the control panel. Administrators can change the language. 0: Not displayed 1: Displayed	1
08	Setting Mode	System	General			8726		Job deletion on the Job Status screen	0	0-1	SYS	Use this code to enable the job deletion on the [Job Status] screen. When "3: High level" is set for code 08-8911, be sure to disable this setting. 0: Disabled 1: Enabled	1
08	Setting Mode	System	User interface	Card reading device		8727		Display of dedicated screen for card authentication	0	0-1	SYS	Switches whether the message to hold a card over the card reader is displayed on the login screen when the card authentication is enabled. 0: Disabled 1: Enabled	1
08	Setting Mode	System	General			8737		Restart behavior when the out of paper is solved (bypass feeding)	1	0-1	SYS	0: Automatically restarted 1: Restarted by pressing the [START] button	1
08	Setting Mode	System	User interface	Display setting		8738		E-mail address direct input button	1	0-1	SYS	Switches the display setting of the [INPUT @] button. 0: Not displayed 1: Displayed	1
08	Setting Mode	System	User interface	Display setting		8744		Switchover of pop-up display during scanning	1	0-1	SYS	Switches the pop-up display during scanning 0: Not displayed 1: Displayed	1

05/08	Mode	Element	Sub element	Item	Subitem	Code	Sub-code	Details	Default value	Acceptable value	RAM	Contents	Procedure
08	Setting Mode	System	User interface			8745		Enable/Disable setting of EWB history	0	0-1	SYS	Sets whether part of the cookie, password, and form data of user who logs in to EWB is saved or not. 0: Disabled 1: Enabled	1
08	Setting Mode	System	Network			8746		Port number setting of destination 10 for sending trap	162	1-65535	NIC	Sets the port number of destination 10 for sending SNMP trap. If the port is used when using the real time log notification function, change the port number.	12
08	Setting Mode	System	User interface			8748		Input of department code at user authentication	0	0-1	SYS	0: Not required 1: Required	1
08	Setting Mode	System	Network			8749		User authentication by logon information to domain (external authentication)	0	0-1	SYS	0: Disabled 1: Enabled	1
08	Setting Mode	System	General			8750		Time to wait for print image	0	0-1	SYS	Sets whether the drum idling is executed or not when the waiting for print image occurred. If there is the stain on the back side of the paper, set the value of this code to "1". When the value is set to "1", the number of times the equipment stops printing may increase. 0: Waiting is enabled (8 sec.) 1: Waiting is disabled (0 sec.)	1
08	Setting Mode	System	Maintenance	Notification of remaining amount of toner		8755		Enable/Disable setting	0	0-1	SYS	0: Disabled 1: Enabled	1
08	Setting Mode	System	Maintenance	Notification of remaining amount of toner		8756	0	Remaining amount at first notification	25	0-100	SYS	0 to 100%	4
08	Setting Mode	System	Maintenance	Notification of remaining amount of toner		8756	1	Notification interval	10	1-25	SYS	1 to 25%	4
08	Setting Mode	System	User interface	Card reading device		8758		Overwriting of login at authentication	0	0-1	SYS	Switches the enable/disable setting for the function to overwrite the login information at the card authentication. 0: Disabled 1: Enabled	1
08	Setting Mode	System	General			8761		Retention of print (spooling) data	0	0-1	SYS	Use this code to retain and obtain the print data (spooling data) if problem occurs. After obtaining the data, be sure to disable the setting. 0: Disabled (print data is deleted) 1: Enabled (print data is retained)	1
08	Setting Mode	System	Maintenance	Display of remaining life (for RDMS/MMDT)	Toner	8762	0	K	0	0-100	SYS	0 ~ 100%. The small value indicates that the remaining life is short.	14

05/08	Mode	Element	Sub element	Item	Subitem	Code	Sub-code	Details	Default value	Acceptable value	RAM	Contents	Procedure
08	Setting Mode	System	Maintenance	Display of remaining life (for RDMS/MMDT)	Drum	8762	4	K	0	0-100	SYS	0 ~ 100%. The small value indicates that the remaining life is short.	14
08	Setting Mode	System	Maintenance	Display of remaining life (for RDMS/MMDT)	Drum	8762	8	Fuser unit	0	0-100	SYS	0 ~ 100%. The small value indicates that the remaining life is short.	14
08	Setting Mode	System	Scanning			8767		Default value of original size when scanning original put on the glass	Refer to contents	0-1	SYS	Sets the default value of original size for the network scanning and fax/Internet Fax transmission when scanning original put on the glass. 0: A4 1: Letter <Default value> ODA: 1 Others: 0	1
08	Setting mode	System	Network			8774		Password authentication of print job	0	0-1	SYS	Sets whether the user authentication for network printing/ FAX/InternetFAX using the user information and password input on the printer driver is enabled or disabled. When this setting is enabled, the setting of 08-8749 is automatically disabled. 0: Disabled 1: Enabled	1
08	Setting mode	System	Network		PIN code	8775		PIN code authentication setting at user authentication	0	0-2	SYS	0: Disabled 1: PIN code 2: Card+PIN code	1
08	Setting mode	System	Network		PIN code	8776		Logging setting of PIN code	1	0-1	SYS	0: Disabled 1: Enabled	1
08	Setting mode	System	Network		PIN code	8777		Attribute value setting of LDAP PIN authentication server 1	eBM UserPIN	-	SYS	Attribute name of PIN code	11
08	Setting mode	System	Network		PIN code	8778		Attribute value setting of LDAP PIN authentication server 2	eBM UserPIN	-	SYS	Attribute name of PIN code	11
08	Setting mode	System	Network		PIN code	8779		Attribute value setting of LDAP PIN authentication server 3	eBM UserPIN	-	SYS	Attribute name of PIN code	11
08	Setting mode	System	Network		PIN code	8780		Prioritized authentication server	1	1-3	SYS	Sets the prioritized authentication server to be searched.	1

05/08	Mode	Element	Sub element	Item	Subitem	Code	Sub-code	Details	Default value	Acceptable value	RAM	Contents	Procedure
08	Setting mode	System	User interface	Display setting		8781		Default setting of print screen when USB is inserted	0	0-1	SYS	0: Disabled (The setting of 08-9236 is used) 1: USB print screen	1
08	Setting mode	System	General	Interval setting	Transition to Super Sleep	8782		For fax	15	15~600	SYS	Sets the interval to shift to Super Sleep again after recovery from Super Sleep. (Unit: seconds)	1
08	Setting mode	System	General			8783		Switchover of document sorting order of e-Filing Box	1	0-1	SYS	0: Sorted by saved date 1: Sorted by document name	1
08	Setting mode	System	Network	IEEE802.1X		8800		Enable/Disable setting	2	1-2	NIC	1: Enabled 2: Disabled	12
08	Setting mode	System	Network	IPsec		8802		Enable/Disable setting	2	1-2	NIC	1: Enabled 2: Disabled	12
08	Setting mode	System	Network	SNMPv3		8803		Enable/Disable setting	2	1-2	NIC	1: Enabled 2: Disabled	12
08	Setting mode	System	Network	IP Filtering		8804		Enable/Disable setting	2	1-2	SYS	1: Enabled 2: Disabled	1
08	Setting mode	System	Network	MAC Address Filtering		8805		Enable/Disable setting	2	1-2	SYS	1: Enabled 2: Disabled	1
08	Setting mode	System	Network	IPsec	NAT-Traversal	8820		Enable/Disable setting	1	1-3	NIC	1: Default (IKEv1: Disabled, IKEv2: Enabled) 2: Enable IKEv1 & IKEv2 3: Disable IKEv1 & IKEv2	12
08	Setting mode	System	Network	IPsec	CRL	8821		Enable/Disable setting	2	1-2	NIC	1: Enable CRL 2: Disable CRL	12
08	Setting mode	System	Network			8824		FTP client mode	0	0-2	NIC	Sets the FTP transfer mode when FTP is selected for "FILE" to save the scanned data. 0: Automatic 1: Passive mode 2: Active mode	12
08	Setting mode	System	Network			8825		Sending host announcement in Super Sleep mode	1	1~2	NIC	Sets whether sending host announcement in the super sleep mode is enabled or not. Enable this setting to always display the MFP in the browse-list since MFP is deleted by the master browser of the Windows network if MFP is in the super sleep mode for 36 minutes or more. 1: Enabled 2: Disabled	12
08	Setting mode	System	General	Registration number for workflow		8900	0	Total	2000	1000-2000	SYS	Changes the maximum number for workflow that is registrable.	4
08	Setting mode	System	General	Registration number for workflow		8900	1	Number of interrupt copy	1	1	SYS	Changes the maximum number for workflow that is registrable.	4

05/08	Mode	Element	Sub element	Item	Subitem	Code	Sub-code	Details	Default value	Acceptable value	RAM	Contents	Procedure
08	Setting mode	System	General	Registration number for workflow		8900	2	Number of transmission and calling of Fax/ InternetFax	100	10-100	SYS	Changes the maximum number for workflow that is registrable.	4
08	Setting mode	System	General	Registration number for workflow		8900	3	Number of printing	1000	150-1000	SYS	Changes the maximum number for workflow that is registrable.	4
08	Setting Mode	System	Preview	Fax		8901		Default setting	0	0-1	SYS	Sets whether the preview function is enabled or disabled by default when using the Fax function. 0: OFF 1: ON	1
08	Setting Mode	System	Preview	Fax		8902		Default display method	0	0-1	SYS	Sets the default display method on the preview screen when using the Fax function. 0: Fit to page 1: Fit to width	1
08	Setting mode	System	Printer			8904		Job jump instruction setting	0	0-1	SYS	0: Disabled 1: Enabled	1
08	Setting mode	System				8905		Forcible printing against unacceptable paper error	0	0-1	SYS	0: OFF (printing not continued) 1: ON (printing continued by automatically selecting the available exit tray)	1
08	Setting Mode	System	General			8910		Time to auto-clearing when in the self- diagnostic mode	0	0-5	SYS	0: None 1: 1 min. 2: 5 min. 3: 10 min. 4: 30 min. 5: 99 min.	1
08	Setting Mode	System	Security			8911		Security mode (level) setting	1	1-4	SYS	Level setting for security function 1: Low level 2: - 3: High level 4: -	1
08	Setting Mode	System	Maintenance	General		8913		Warning display for password expiration	15	0-30	SYS	0: None 1-30: Remaining days until the password expiration for warning start.	1
08	Setting mode	System	MFP function setting			8914	0	Copy	1	0-1	SYS	Sets whether the Copier function is enabled or disabled. 0: Disabled 1: Enabled	4
08	Setting Mode	System	MFP function setting			8914	1	e-Filing	1	0-1	SYS	Sets whether the filing function is enabled or disabled. 0: Disabled 1: Enabled	4
08	Setting Mode	System	MFP function setting			8914	2	Fax	1	0-1	SYS	Sets whether the Fax function is enabled or disabled. 0: Disabled 1: Enabled	4

05/08	Mode	Element	Sub element	Item	Subitem	Code	Sub-code	Details	Default value	Acceptable value	RAM	Contents	Procedure
08	Setting Mode	System	MFP function setting			8914	3	InternetFAX	1	0-1	SYS	Sets whether the InternetFAX function is enabled or disabled. 0: Disabled 1: Enabled	4
08	Setting Mode	System	MFP function setting			8914	4	Email	1	0-1	SYS	Sets whether the email function is enabled or disabled. 0: Disabled 1: Enabled	4
08	Setting Mode	System	MFP function setting			8914	5	Save as Local HDD	1	0-1	SYS	Sets whether the function that saves data to HDD in the equipment is enabled or disabled. 0: Disabled 1: Enabled	4
08	Setting Mode	System	MFP function setting			8914	6	Save as Local HDD from Print	1	0-1	SYS	Sets whether the function that saves data to HDD in the equipment using print function is enabled or disabled. 0: Disabled 1: Enabled	4
08	Setting Mode	System	MFP function setting			8914	7	Save as Local HDD from Fax	1	0-1	SYS	Sets whether the function that saves data to HDD in the equipment using Fax function is enabled or disabled. 0: Disabled 1: Enabled	4
08	Setting Mode	System	MFP function setting			8914	8	Save to USB Media	1	0-1	SYS	Sets whether the function that saves scanned data of originals to USB media is enabled or disabled. 0: Disabled 1: Enabled	4
08	Setting Mode	System	MFP function setting			8914	9	Save as FTP	1	0-1	SYS	Sets whether the function that saves scanned data of originals to FTP server is enabled or disabled. 0: Disabled 1: Enabled	4
08	Setting Mode	System	MFP function setting			8914	10	Save as FTPS	1	0-1	SYS	Sets whether the function that saves scanned data of originals to FTP server using SSL is enabled or disabled. 0: Disabled 1: Enabled	4
08	Setting Mode	System	MFP function setting			8914	11	Save as SMB	1	0-1	SYS	Sets whether the function that saves scanned data of originals to the SMB server is enabled or disabled. 0: Disabled 1: Enabled	4
08	Setting Mode	System	MFP function setting			8914	12	Save as Netware	1	0-1	SYS	Sets whether the function that saves scanned data of originals to the Netware server is enabled or disabled. 0: Disabled 1: Enabled	4
08	Setting Mode	System	MFP function setting			8914	13	Web Service Scanning (WS Scan)	1	0-1	SYS	Sets whether the WS scanning function is enabled or disabled. 0: Disabled 1: Enabled	4

05/08	Mode	Element	Sub element	Item	Subitem	Code	Sub-code	Details	Default value	Acceptable value	RAM	Contents	Procedure
08	Setting Mode	System	MFP function setting			8914	14	Twain Scanning (Remote Scan)	1	0-1	SYS	Sets whether the remote scanning function is enabled or disabled. 0: Disabled 1: Enabled	4
08	Setting Mode	System	MFP function setting			8914	15	Send to External Controller	1	0-1	SYS	Sets whether the function that saves data to the external server is enabled or disabled. 0: Disabled 1: Enabled	4
08	Setting mode	System	MFP function setting			8914	16	Network Fax	1	0-1	SYS	Sets whether the Network Fax function is enabled or disabled. 0: Disabled 1: Enabled	4
08	Setting mode	System	MFP function setting			8914	17	Network InternetFAX	1	0-1	SYS	Sets whether the Network InternetFAX function is enabled or disabled. 0: Disabled 1: Enabled	4
08	Setting Mode	System	Network			8915		Automatic output of jobs at login	0	0-1	SYS	Sets whether jobs registered in the hold queue of user are automatically output or not when the user logs in. 0: Disabled 1: Enabled	1
08	Setting Mode	System	Security			8919		Service password	-	-	SYS	Sets the password to log into the self-diagnostic mode and Service UI.	11
08	Setting Mode	System	Option	FAX		8920		Output tray for FAX/InternetFAX/e-mail printing	0	0-2	SYS	Selects the tray onto which the received document is output. 0: Face down stacker 1: Finisher receiving tray (When finisher is installed) 2: Finisher receiving tray (When finisher is installed)	1
08	Setting mode	System	Department management			8921		Clearing of the user/department counter	1	0-1	SYS	0: Not allowed 1: Allowed	1
08	Setting mode	System	User interface	Email		8922		Email header print setting	0	0-1	SYS	Sets whether the header of an Email or an Internet Fax is printed or not as they are received. 0: Not printed 1: Printed	1
08	Setting mode	System	User interface	Email		8923		Email body print setting	1	0-1	SYS	Sets whether the body of an Email or an Internet Fax is printed or not as they are received. 0: Not printed 1: Printed	1
08	Setting mode	System	User interface			8924		Registration of the received FAX/Internet Fax / Email jobs to hold queue	0	0-1	SYS	Registers the received Fax / Internet Fax / Email jobs to the hold queue instead of printing immediately. Data in the hold queue are not printed unless the user allows printing by means of the control panel. 0: Not registered (normal printing) 1: Registered	1

05/08	Mode	Element	Sub element	Item	Subitem	Code	Sub-code	Details	Default value	Acceptable value	RAM	Contents	Procedure
08	Setting mode	System				8925		Data tampering checking at start-up	0	0-1	SYS	Sets whether data tampering is checked or not at startup. 0: Not checked 1: Checked * When the value of 08-8911 is set to "3" (Security mode: High level), the value of this code is automatically set to "1."	1
08	Setting mode	System	Department management			8926		Clearing of all department counters	-	-	SYS	In cases when the administrator has prohibited the clearing of department counter data using code 08-8921, a service technician can clear the data using this code.	3
08	Setting mode	System	Department management			8927		Clearing of all user counter	-	-	SYS	In cases when the administrator has prohibited the clearing of user counter data using code 08-8921, a service technician can clear the data using this code.	3
08	Setting mode	System	Password			8929		Administrator password reset	-	-	SYS	The default password is set. When "3: High level" is set for code 08-8911, the default password is set as a temporary password.	3
08	Setting mode	System	User interface	Off Device Customization Architecture		8931		Output Management Service setting	1	0-1	SYS	0: Disabled 1: Enabled	1
08	Setting mode	System	User interface			8932		Availability of Netware	2	1-2	NIC	1: Enabled 2: Disabled	12
08	Setting mode	System	User interface	SSL		8933		SSL SMTP Client	2	1-3	NIC	1: Enabled (accepts all server certificates) 2: Disabled 3: Enabled (uses the imported CA certificate)	12
08	Setting mode	System	User interface	SSL		8934		SMTP Client SSL/TLS	1	1-2	NIC	1: STARTTLS 2: Over SSL	12
08	Setting mode	System	User interface	Remote Scan		8935		Enable/Disable setting	1	0-1	NIC	0: Disabled 1: Enabled	12
08	Setting mode	System	User interface	Remote Scan		8936		Remote scanning with SSL	0	0-1	NIC	0: Disabled 1: Enabled	12
08	Setting mode	System	User interface	Remote Scan		8937		Port number	20080	0-65535	NIC		12
08	Setting mode	System	User interface	Remote Scan		8938		SSL port number	20443	0-65535	NIC		12
08	Setting mode	System				8942		Debug level setting	2	0, 2	-	Sets the output volume of debug log. When the value is set to "0", the performance may decrease. 0: Debug log level – high 2: Debug log level - normal	1
08	Setting mode	System	User interface	Card reading device		8947		Automatic user registration for card authentication	0	0-1	SYS	0: Disabled 1: Enabled	1

05/08	Mode	Element	Sub element	Item	Subitem	Code	Sub-code	Details	Default value	Acceptable value	RAM	Contents	Procedure
08	Setting Mode	System	User interface			8948		Language package information	-	-	-	Displays the information of the installed language package.	2
08	Setting Mode	System	Version			8952		External version of HD data	-	-	-	External version of file system for system software	2
08	Setting Mode	System	User interface	General	Language package information	8968		Panel Help	-	-	-	Displays the language package information of the installed Panel Help.	2
08	Setting Mode	System	User interface	General	Language package information	8969		WebHelp	-	-	-	Displays the language package information of the installed WebHelp.	2
08	Setting Mode	System	User interface	General	Language package information	8970		Service UI	-	-	-	Displays the language package information of the installed Service UI.	2
08	Setting Mode	System	User interface	General		8971		Installation of language package	-	-	-	Installs the language package.	3
08	Setting Mode	System	General	Self-certificate		8973		Length of public key	1	0-1	SYS	0: 1024 bit 1: 2048 bit	1
08	Setting Mode	System	General	Self-certificate		8974		Signature algorithm	0	0-4	SYS	0: SHA1 1: SHA224 2: SHA256 3: SHA384 4: SHA512	1
08	Setting Mode	System	Network			8975		Data clearing of Point and Print	-	-	SYS	Point and Print in the equipment is deleted when this code is performed. Perform this code when a trouble occurs such as when uploading Point and Print is not possible. After performing this code, upload Point and Print from [Maintenance] menu in the [Administration] menu of Web Page.	3
08	Setting Mode	System	General	Detection of originals prohibited from duplication		8977	0	Copy	1	0-1	SYS	Sets whether the originals that are prohibited from duplication are detected or not. 0: Detection disabled 1: Detection enabled	4
08	Setting Mode	System	General	Detection of originals prohibited from duplication		8977	1	Scan	1	0-1	SYS	Sets whether the originals that are prohibited from duplication are detected or not. 0: Detection disabled 1: Detection enabled	4
08	Setting Mode	System	General	Detection of originals prohibited from duplication		8977	2	FAX	1	0-1	SYS	Sets whether the originals that are prohibited from duplication are detected or not. 0: Detection disabled 1: Detection enabled	4

05/08	Mode	Element	Sub element	Item	Subitem	Code	Sub-code	Details	Default value	Acceptable value	RAM	Contents	Procedure
08	Setting Mode	System	Scanning			8980		Execution of Remote Scan while control panel is operated	0	0-1	NIC	Sets whether the remote scanning is enabled or disabled if the user is logged in using the control panel when user authentication or department management is enabled. 0: Disabled 1: Enabled	12
08	Setting Mode	System	General	Scheduled automatic reboot		8981		Day of the week	0	0-255	SYS	Sets the condition and day of the week for scheduled automatic reboot. Input the condition and day of the week to each bit as follows (0: disabled, 1: enabled) bit8: Set the condition of reboot 0: Reboots when in the sleep or super sleep mode 1: Reboots regardless of the sleep mode bit7: Sunday, bit6: Saturday, bit5: Friday, bit4: Thursday, bit3: Wednesday, bit2: Tuesday, bit1: Monday <Input value> Reboots when in the sleep or super sleep mode: 0 Reboots regardless of the sleep mode: 128 Monday: 1 Tuesday: 2 Wednesday: 4 Thursday: 8 Friday: 16 Saturday: 32 Sunday: 64 e.g.) Monday: 1 Monday, Tuesday, Wednesday, Thursday, Friday, Saturday, Sunday: 127 (1+2+4+8+16+32+64=127)	1
08	Setting Mode	System	General	Scheduled automatic reboot		8982		Time (Hour)	0	0-23	SYS	Sets time (hour) for scheduled automatic reboot.	1
08	Setting Mode	System	General	Scheduled automatic reboot		8983		Time (Minute)	0	0-59	SYS	Sets time (minute) for scheduled automatic reboot.	1
08	Setting Mode	System	User interface	NFC reader		8986		Usage type	0	0-4294967295	SYS	0011ZZZZ (First 4 digits are fixed) -ZZZZ: Sub code 0000: No authentication using card 0001: IDm (Felica/NFC-FeliCa) and (or) UID (Mifare/NFC-Mifare) are used 0002: Data (Felica/NFC-FeliCa/Mifare/NFC-Mifare) 0003: SSFC mode	5
08	Setting Mode	System	User interface	NFC reader		8987		Format information 1	0	0-4294967295	SYS	000ASSSS (hexadecimal, first 3 digits are fixed) -A: 0: A key 1: B key -SSSS: Sector number (first 2 digits are fixed to "0")	5

05/08	Mode	Element	Sub element	Item	Subitem	Code	Sub-code	Details	Default value	Acceptable value	RAM	Contents	Procedure
08	Setting Mode	System	User interface	NFC reader		8988		Format information 2	0	0-4294967295	SYS	00BSEbse (hexadecimal, first 2 digits are fixed) -B: Block number of first block -S: Starting offset of first block -E: Ending offset of first block -b: Block number of second block -s: Starting offset of second block -e: Ending offset of second block	5
08	Setting Mode	System	User interface	NFC reader		8989		Format information 3	0	0-0xFFFFFFFFFFFFFFFF	SYS	0000KKKKKKKKKKKK (hexadecimal, first 4 digits are fixed) -KKKKKKKKKKKK: key (12 digits)	5
08	Setting Mode	System	Maintenance	Notification of equipment information		8991		Notification setting	0	0-1	SYS	0: Disabled 1: Enabled	2
08	Setting Mode	System	Maintenance	Notification of equipment information		8992		Notification day 1	0	0-31	SYS	1st to 31th. Input "0" to disable this setting.	1
08	Setting Mode	System	Maintenance	Notification of equipment information		8993		Notification day 2	0	0-31	SYS	1st to 31th. Input "0" to disable this setting.	1
08	Setting Mode	System	Maintenance	Notification of equipment information		8994		Notification day of the week	0	0-127	SYS	Input the value which corresponds to the day of the week. Input "0" to disable this setting. Sunday: 64 Monday: 32 Tuesday: 16 Wednesday: 8 Thursday: 4 Friday: 2 Saturday: 1 e.g.) Monday: 32 Sunday, Monday, Tuesday, Wednesday, Thursday, Friday, Saturday: 127 (64+32+16+8+4+2+1=127)	1
08	Setting Mode	System	Maintenance	Notification of equipment information		8995		Notification time	300	0-2359	SYS	(Hour/Hour/Minute/Minute)	1
08	Setting Mode	System	Maintenance	Notification of equipment information		8996		Email address 1 for notification	-	-	SYS	Maximum 192 characters.	11
08	Setting Mode	System	Maintenance	Notification of equipment information		8997		Email address 2 for notification	-	-	SYS	Maximum 192 characters.	11

05/08	Mode	Element	Sub element	Item	Subitem	Code	Sub-code	Details	Default value	Acceptable value	RAM	Contents	Procedure
08	Setting Mode	System	Maintenance	Notification of equipment information		8998		Email address 3 for notification	-	-	SYS	Maximum 192 characters.	11
08	Setting Mode	System	Maintenance	Notification of equipment information		8999	1	Adjustment mode (05) data list	0	0-1	SYS	0: Disabled 1: Enabled	4
08	Setting Mode	System	Maintenance	Notification of equipment information		8999	2	Setting mode (08) data list	0	0-1	SYS	0: Disabled 1: Enabled	4
08	Setting Mode	System	Maintenance	Notification of equipment information	Error history list	8999	6	Maximum 1000 items	0	0-1	SYS	0: Disabled 1: Enabled	4
08	Setting Mode	System	Maintenance	Notification of equipment information	Error history list	8999	7	Latest 80 items	0	0-1	SYS	0: Disabled 1: Enabled	4
08	Setting Mode	System	Maintenance	Notification of equipment information	Firmware upgrade log	8999	8	Maximum 200 items	0	0-1	SYS	0: Disabled 1: Enabled	4
08	Setting Mode	System	Maintenance	Notification of equipment information		8999	9	Power ON/OFF log	0	0-1	SYS	0: Disabled 1: Enabled	4
08	Setting Mode	System	Maintenance	Notification of equipment information		8999	10	Version list	0	0-1	SYS	0: Disabled 1: Enabled	4
08	Setting Mode	System	Maintenance	Notification of equipment information		8999	12	Total counter list	0	0-1	SYS	0: Disabled 1: Enabled	4
08	Setting Mode	System	Maintenance	Notification of equipment information		8999	13	Supplies exchange log	0	0-1	SYS	0: Disabled 1: Enabled	4
08	Setting mode	System	General			9000		Destination selection	Refer to contents	0-3	SYS	0: Europe 1: North America 2: Japan 3: Others <Default value> ODA: 1 JP: 2 Others: 0	1

05/08	Mode	Element	Sub element	Item	Subitem	Code	Sub-code	Details	Default value	Acceptable value	RAM	Contents	Procedure
08	Setting Mode	System	Option	FAX		9001		Destination setting	Refer to contents	0-27	SYS	0: Japan 1: Asia 2: Australia 3: Hong Kong 4: U.S.A./Canada 5: Germany 6: U.K. 7: Italy 8: Belgium 9: Netherlands 10: Finland 11: Spain 12: Austria 13: Switzerland 14: Sweden 15: Denmark 16: Norway 17: Portugal 18: France 19: Greece 20: Poland 21: Hungary 22: Czech 23: Turkey 24: South Africa 25: Taiwan 26: Russia 27: Brazil <Default value> ODA: 4 JP: 0 Others: 5	1
08	Setting mode	System	General			9003		OEM identification code destination	1	0-1	SYS	0: Reserve 1: OKI	2
08	Setting mode	System	General			9010		Line adjustment mode	0	0-1	SYS	0: For factory shipment 1: For line Field: "0" must be selected	1
08	Setting mode	System	General			9012		Language selection to be displayed at power-ON	English	-	SYS	en_US: English de_DE: German fr_FR: French es_ES: Spanish it_IT: Italian ja_JP: Japanese en_GB: English (British) zh_CN: Simplified Chinese zh_TW: Traditional Chinese ko_KR: Korean <Default value> ODA: English JP: Japanese Others: English (British)	11
08	Setting mode	System	User interface			9016		Externally installed counter	0	0, 1, 5	SYS	0: No external counter 1: Coin controller 5: Coin controller supporting ACS/mixed-size * This code is a special code which has areas in both SYS-SRAM and PU. The default value in SYS-SRAM is applied to the PU area at initialization.	1
08	Setting mode	System	Counter			9017		Setting for counter installed externally	1	0, 1, 4, 5	SYS	Selects the job to count up for the external counter. 0: Not selected 1: Copier 4: Printer 5: Copier/Printer * This code is a special code which has areas in both SYS-SRAM and PU. The default value in SYS-SRAM is applied to the PU area at initialization.	1

05/08	Mode	Element	Sub element	Item	Subitem	Code	Sub-code	Details	Default value	Acceptable value	RAM	Contents	Procedure
08	Setting Mode	System	General	Memory		9020		Size information of memory	-	-	SYS	Displays the sizes of the main memory and page memory. Enables to check if each memory is properly recognized.	2
08	Setting Mode	System	Initialization			9030		Initialization after software version up	-	-	SYS	Perform this code when the software in this equipment has been upgraded.	3
08	Setting Mode	System	User interface	Counter installed externally		9037		Job handling-short paid-coin controller	1	0-1	SYS	Sets whether pause or stop the printing job when it is short paid using a coin controller. 0: Pause the job 1: Stop the job	1
08	Setting mode	System	Finisher	Finisher tray operating mode		9048	0	Operating mode 1	0	0-1	SYS	For plain paper, thick 1, LG. For non-sort mode and sort mode. Do not change this setting unless otherwise instructed. 0: Disabled 1: Enabled	4
08	Setting mode	System	Finisher	Finisher tray operating mode		9048	1	Operating mode 2	0	0-1	SYS	For thick 2. Do not change this setting unless otherwise instructed. 0: Disabled 1: Enabled	4
08	Setting mode	System	Finisher	Finisher tray operating mode		9048	2	Operating mode 3	0	0-1	SYS	For thick 3. Do not change this setting unless otherwise instructed. 0: Disabled 1: Enabled	4
08	Setting mode	System	Finisher	Finisher tray operating mode		9048	3	Operating mode 4	0	0-1	SYS	For thick 4. Do not change this setting unless otherwise instructed. 0: Disabled 1: Enabled	4
08	Setting mode	System	Finisher	Finisher tray operating mode		9048	4	Operating mode 5	0	0-1	SYS	For LG. For Single-sided stapling. Do not change this setting unless otherwise instructed. 0: Disabled 1: Enabled	4
08	Setting mode	System	Finisher	Finisher tray operating mode		9048	5	Operating mode 6	0	0-1	SYS	For single-sided stapling. Do not change this setting unless otherwise instructed. 0: Disabled 1: Enabled	4
08	Setting mode	System	Scanning			9049		Scanning operating mode	0	0-1	SYS	Do not change this setting unless otherwise instructed. 0: Operating mode 1 1: Operating mode 2	1
08	Setting Mode	System	Maintenance	General		9050		Performing panel calibration	-	-	SYS	Performs the calibration of the pressing position on the touch panel (LCD screen). The calibration is performed by pressing 4 reference positions after this code is started up.	1
08	Setting Mode	System	User interface	Display setting		9051		Panel calibration setting value	0	0-1	SYS	Switches whether the screen for displaying panel calibration setting values is displayed or not. 0: Disabled (screen not displayed) 1: Enabled (screen displayed)	1

05/08	Mode	Element	Sub element	Item	Subitem	Code	Sub-code	Details	Default value	Acceptable value	RAM	Contents	Procedure
08	Setting mode	System				9060		Destination display at SRAM initialization	Refer to contents	0-255	SYS	20: ODA (ODC-IT) 21: OEL (ODC-IT) 22: AOS (ODC-IT) 23: JP (ODC-IT) 30: ODA (ODC-OA) 31: OEL (ODC-OA) 32: AOS (ODC-OA) 33: JP (ODC-OA) <Default value> ODA: 20 OEL: 21 AOS: 22 JP: 23 * When the default value of 08-9845 is "0", the default value of this code is "ODA: 30 OEL: 31 AOS: 32 JP: 33".	2
08	Setting Mode	System	HDD			9065		HDD diagnostic menu display	-	-	SYS	Displays the HDD information.	2
08	Setting Mode	System	HDD			9072		Performing HDD testing	-	-	SYS	Checks the bad sector. It may take more than 30 minutes to finish the checking.	3
08	Setting mode	System	General			9081		Initialization of department management information	-	-	SYS	Initializing of the department management information Enter the code with the digital keys and press the [INITIALIZE] button to perform the initialization. If the area storing the department management information is destroyed for some reason, "Enter Department Code" is displayed on the control panel even if the department management function is not set on. In this case, initialize the area with this code. This area is normally initialized at the factory.	3
08	Setting Mode	System	Initialization			9083		Initialization of NIC information	-	-	SYS	Returns the value to the factory shipping default value.	3
08	Setting mode	System	General			9100		Date and time setting	-	13 digits	-	Year/month/date/day/hour/minute/second Example: 03 07 01 3 13 27 48 "Day" - "0" is for "Sunday". Proceeds Monday through Saturday from "1" to "6".	5
08	Setting mode	System	User interface			9102		Date display format	Refer to contents	0-2	SYS	0: YYYY.MM.DD 1: DD.MM.YYYY 2: MM.DD.YYYY <Default value> ODA: 2 JP: 0 Others: 1	1

05/08	Mode	Element	Sub element	Item	Subitem	Code	Sub-code	Details	Default value	Acceptable value	RAM	Contents	Procedure
08	Setting mode	System	General			9103		Time differences	Refer to contents	0-47	SYS	0: +12.0h 1: +11.5h 2: +11.0h 3: +10.5h 4: +10.0h 5: +9.5h 6: +9.0h 7: +8.5h 8: +8.0h 9: +7.5h 10: +7.0h 11: +6.5h 12: +6.0h 13: +5.5h 14: +5.0h 15: +4.5h 16: +4.0h 17: +3.5h 18: +3.0h 19: +2.5h 20: +2.0h 21: +1.5h 22: +1.0h 23: +0.5h 24: 0.0h 25: -0.5h 26: -1.0h 27: -1.5h 28: -2.0h 29: -2.5h 30: -3.0h 31: -3.5h 32: -4.0h 33: -4.5h 34: -5.0h 35: -5.5h 36: -6.0h 37: -6.5h 38: -7.0h 39: -7.5h 40: -8.0h 41: -8.5h 42: -9.0h 43: -9.5h 44: -10.0h 45: -10.5h 46: -11.0h 47: -11.5h <Default value> ODA: 40 JP: 6 Others: 24	1
08	Setting mode	System	User interface			9110		Auto-clear timer setting	3	0-10	SYS	Timer to return the equipment to the default settings when the [START] button is not pressed after the function and the mode are set 0: Not cleared 1 to 10: Set number x 15 sec.	1
08	Setting Mode	System	User interface			9111		Power save mode timer setting	4	0, 4, 6-15	SYS	Timer to automatically switch to the auto power save mode when the equipment has not been used 0: Invalid 4: 1 min. 6: 3 min. 7: 4 min. 8: 5 min. 9: 7 min. 10: 10 min. 11: 15 min. 12: 20 min. 13: 30 min. 14: 45 min. 15: 60 min.	1
08	Setting Mode	System	User interface			9112		Shut Off timer setting (Sleep Mode)	21	0-21	SYS	Timer to automatically switch to the auto sleep mode when the equipment has not been used 0: 3 min. 1: 5 min. 2: 10 min. 3: 15 min. 4: 20 min. 5: 25 min. 6: 30 min. 7: 40 min. 8: 50 min. 9: 60 min. 10: 70 min. 11: 80 min. 12: 90 min. 13: 100 min. 14: 110 min. 15: 120 min. 16: 150 min. 17: 180 min. 18: 210 min. 19: 240 min. 20: Invalid 21: 1 min.	1

05/08	Mode	Element	Sub element	Item	Subitem	Code	Sub-code	Details	Default value	Acceptable value	RAM	Contents	Procedure
08	Setting Mode	System	User interface	Power save		9113		Setting for turning the screen OFF for Power Save mode or the Shut Off mode	1	0-1	SYS	0: OFF 1: ON	1
08	Setting Mode	System	User interface	Power save		9114		Energy saving mode	1	0-2	SYS	0: Off mode 1: Sleep mode 2: Auto mode	1
08	Setting mode	System	General	Raw printing job		9117		Blank page print	0	0-1	SYS	0: OFF 1: ON	1
08	Setting Mode	System	User interface	Department setting		9120		Enable/Disable setting	0	0-1	SYS	0: Invalid 1: Valid	1
08	Setting Mode	System	User interface	Department setting		9121		Print setting without department code	1	0-2	SYS	0: Printed forcibly 1: Not printed 2: Deleted forcibly	1
08	Setting Mode	System	User interface	Department setting		9122		Copy	1	0-1	SYS	0: Disabled 1: Enabled	1
08	Setting Mode	System	User interface	Department setting		9123		FAX	1	0-1	SYS	0: Disabled 1: Enabled	1
08	Setting Mode	System	User interface	Department setting		9124		Printer/e-Filing	1	0-1	SYS	0: Disabled 1: Enabled	1
08	Setting Mode	System	User interface	Department setting		9125		Scanning	1	0-1	SYS	0: Disabled 1: Enabled	1
08	Setting Mode	System	User interface	Department setting		9126		List print	1	0-1	SYS	0: Disabled 1: Enabled	1
08	Setting Mode	System	User interface	External counter	Coin controller	9129		Duplex print setting	1	0-1	SYS	Sets whether duplex printing is allowed or not (only permitting single printing) when a coin controller is used. 0: Invalid (printing only one side) 1: Valid (printing both sides)	1
08	Setting mode	System	User interface			9130		Highlighting display on LCD	0	0-1	SYS	0: Black letter on white background 1: White letter on black background	1

05/08	Mode	Element	Sub element	Item	Subitem	Code	Sub-code	Details	Default value	Acceptable value	RAM	Contents	Procedure
08	Setting Mode	System	User interface	Default mode setting	Default setting	9132		Default setting of screen (Function)	0	0-99	SYS	Sets the screen to be displayed after the auto-clear time has passed or it has recovered from the energy saving mode or sleep mode. 0: Copier 1: Fax 2: Scan 3: Box 4: Print 5: Template 6: Menu 7: Job status 99: EWB * Only 0 to 7 and 99 can be entered.	1
08	Setting mode	System	User interface			9133		Default setting for APS/AMS	0	0-2	SYS	0: APS (Automatic Paper Selection) 1: AMS (Automatic Magnification Selection) 2: Not selected	1
08	Setting Mode	System	User interface	Default setting of RADF mode		9134		Default setting	0	0-1	SYS	0: Continuous feeding (by pressing the [START] button) 1: Single feeding (by setting original on the tray)	1
08	Setting mode	System	User interface	Maximum number of copy volume	PPC	9136		Maximum number of copy volume	1	1-3	SYS	1: 999 2: 99 3: 9	1
08	Setting Mode	System	User interface	Default mode setting	Default setting	9137		Setting for automatic duplexing mode	0	0-3	SYS	0: Invalid 1: Single-sided to duplex copying 2: Two-sided to duplex copying 3: User selection	1
08	Setting mode	System	User interface	Paper size selection for [OTHER] button	PPC	9140		Paper size selection for [OTHER] key	Refer to contents	0-153	SYS	Press the icon on the LCD to select the size. <Default value> JP: A5-R Others: FOLIO	9
08	Setting Mode	System	User interface	Default setting of RADF mode		9142		Default setting of RADF original size	0	0-1	SYS	0: Same size originals 1: Mixed size originals	1
08	Setting mode	System	Paper feeding			9143		Time lag before auto- start of MPT feeding	4	0-10	SYS	Sets the time taken to add paper feeding when paper in the MP tray has run out during the MPT feed copying. 0: Paper is not drawn in unless the [START] button is pressed. 1-10: Setting value x 0.5sec.	1
08	Setting Mode	System	User interface	Rotation printing		9146		Rotation printing at the non-sorting	0	0-1	SYS	0: Not rotating 1: Rotating	1
08	Setting mode	System	User interface	Direction priority of original image	PPC	9147		Direction priority of original image	0	0, 2	SYS	0: Automatic 2: Landscape	1
08	Setting mode	System	User interface			9148		Face down stacker priority at Non-sort Mode	0	0-1	SYS	0: Normal 1: Face down stacker	1

05/08	Mode	Element	Sub element	Item	Subitem	Code	Sub-code	Details	Default value	Acceptable value	RAM	Contents	Procedure
08	Setting mode	System	User interface	Width setting for image shift copying (linkage of front side and back side)	PPC	9149		Width setting for image shift copying (linkage of front side and back side)	0	0-1	SYS	0: ON 1: OFF	1
08	Setting mode	System	User interface	Automatic Sorting Mode setting (RADF)	PPC	9150		Automatic Sorting Mode setting (RADF)	2	0-4	SYS	0: Invalid 1: STAPLE 2: SORT 3: GROUP	1
08	Setting mode	System	User interface	Default setting of Sorter Mode	PPC	9151		Default setting of Sorter Mode	0	0-4	SYS	0: NON-SORT 1: STAPLE 2: SORT 3: GROUP	1
08	Setting mode	System	User interface	Correction of reproduction ratio in editing copy	PPC	9152		Correction of reproduction ratio in editing copy	10	0-10	SYS	Sets the reproduction ratio for the "X in 1" printing (including magazine sort) to the "Reproduction ratio x Correction ratio". 0: 90% 1: 91% 2: 92% 3: 93% 4: 94% 5: 95% 6: 96% 7: 97% 8: 98% 9: 99% 10: 100%	1
08	Setting mode	System	User interface			9153		Image position in editing	2	0-3	SYS	Sets the page pasted position for "X in 1" to the upper left corner/center. 0: Cornering (PPC)/Cornering (PRT) 1: Centering (PPC)/Cornering (PRT) 2: Cornering (PPC)/Centering (PRT) 3: Centering (PPC)/Centering (PRT)	1
08	Setting mode	System	User interface			9155		Magazine sort setting	0	0-1	SYS	0: Left page to right page 1: Right page to left page	1
08	Setting mode	System	User interface	2 in 1/4 in 1 page allocating order setting	PPC	9156		2 in 1 / 4 in 1 page allocating order setting	0	0-1	SYS	0: Horizontal 1: Vertical	1
08	Setting mode	System	User interface	Printing format setting for Time Stamp and Page Number	PPC	9157		Printing format setting for Time Stamp and Page Number	0	0-1	SYS	Hyphen 0: OFF 1: ON Note: Hyphen printing format ON: -1- OFF: 1	1
08	Setting mode	System	User interface	Cascade operation setting	PPC / FAX	9158	0	Enable/Disable setting	0	0-1	SYS	0: Disabled 1: Enabled	4
08	Setting mode	System	User interface	Cascade operation setting	PPC / FAX	9158	1	Operation setting	0	0	SYS	0: Once(Stop)	4
08	Setting mode	System	User interface	Cascade operation setting	Printer/Box	9159	0	Enable/Disable setting	0	0-1	SYS	0: Disabled 1: Enabled	4

05/08	Mode	Element	Sub element	Item	Subitem	Code	Sub-code	Details	Default value	Acceptable value	RAM	Contents	Procedure
08	Setting mode	System	User interface	Cascade operation setting	Printer/Box	9159	1	Operation setting	0	0	SYS	0: Once(Stop)	4
08	Setting mode	System	User interface			9163		Default setting of printing direction for Time Stamp and Page Number	0	0-1	SYS	0: Short edge 1: Long edge	1
08	Setting Mode	System	User interface	Paper Feed	Auto-start setting for bypass feed printing	9164		Remote	0	0-1	SYS	Sets whether or not feeding a paper automatically into the copier when it is placed on the bypass tray. 0: OFF (Press the [START] button to start feeding.) 1: ON (Automatic feeding)	1
08	Setting mode	System	User interface	Paper Feed	Auto-start setting for bypass feed printing	9165		Local	1	0-1	SYS	Sets whether or not feeding a paper automatically into the copier when it is placed on the bypass tray. 0: OFF (Press the [START] button to start feeding.) 1: ON (Automatic feeding)	1
08	Setting Mode	System	Option	FAX		9183		Application of paper source	0	0-1	SYS	0: Not subjected for APS judgment 1: Subjected for APS judgment	1
08	Setting mode	System	User interface			9184		Centering printing of primary/secondary direction at AMS	1	0-1	SYS	0: Invalid 1: Valid	1
08	Setting mode	System	User interface	Feeding paper media		9185	0	Copier	17	1, 17	SYS	Sets a media type for APS drawer searching in the copier functions. Acceptable value (decimal number): 1, 17 Each bit 0: Excluded from feeding target media Each bit 1: Feeding target media bit 0: Plain paper bit 1: N/A (Always set "0") bit 2: N/A (Always set "0") bit 3: N/A (Always set "0") bit 4: Plain (Thin) * Do not set the paper type that is not supported.	4
08	Setting mode	System	User interface	Feeding paper media		9185	1	Printer/Box	1	1	SYS	Sets a media type to print on plain paper in the printer/box functions. This setting is used for drawer searching or media type inconsistency judgment. The setting result does not affect other media types, other than plain paper. Acceptable value (decimal number): 1 only Each bit 0: Excluded from feeding target media Each bit 1: Feeding target media bit 0: Plain paper bit 1: N/A (Always set "0") bit 2: N/A (Always set "0") bit 3: N/A (Always set "0") bit 4: N/A (Always set "0")	4

05/08	Mode	Element	Sub element	Item	Subitem	Code	Sub-code	Details	Default value	Acceptable value	RAM	Contents	Procedure
08	Setting Mode	System	Network	Retention period		9193		Web data retention period	10	0-999	SYS	When a certain period of time has passed without operation after accessing Web Page, the data being registered is automatically reset. This period is set at this code. (Unit: minute)	1
08	Setting Mode	System	Network	Retention period		9200		File retention period	30	0-999	SYS	0: No limits 1 to 999: 1 to 999 days	1
08	Setting Mode	System	Network	E-mail		9201		Max. size in email/ InternetFAX transmission	30	2-100	SYS	2 to 100 M bytes	1
08	Setting mode	System	Electronic filing			9203		e-Filing document guarantee mode	1	0-1	SYS	Sets the file retention level during edition in e-Filing (when the document cut/save command is used) 0: Not retained (Documents could be lost due to We session timeout / electricity cutoff during document cut/ save.) 1: Full retained - Documents are retained until cut/save command completion. When "1" is set, documents are not lost even if disk full occurs during command execution.	1
08	Setting mode	System	User interface	When judging as black in the ACS Mode		9204		Binarizing level selection	3	1-5	SYS	1: Step -2 2: Step -1 3: Step 0 (center) 4: Step 1 5: Step 2 The binarizing level of each step is set at 08-9230.	1
08	Setting mode	System	Electronic filing			9207		Default setting of user box retention period	0	0-999	SYS	Sets the data retention period when creating a user box. 0: Not deleted 1 to 999: Retention period (Unit: Day)	1
08	Setting Mode	System	HDD			9208		Warning notification- File Share/e-Filing	90	0-100	SYS	Sets the percentage of HDD partition filled when warning notification is sent. 0 to 100: 0 to 100% * Checks the remaining amount of HDD with the searching interval set at 08-9225.	1
08	Setting mode	System	Scanning	E-mail		9209		Notification setting of E-mail saving time limit	3	0-99	SYS	Sets the days left the notification of E-mail saving time limit appears 0 to 99: 0 to 99 days	1
08	Setting mode	System	Scanning	E-mail		9210		Default setting of partial size when transmitting E-mail	0	0-6	SYS	Sets the default value for the partial size of E-mail to be transmitted when creating a template. 0: Not divided 1: 64 2: 128 3: 256 4: 512 5: 1024 6: 2048 (Unit: KB)	1

05/08	Mode	Element	Sub element	Item	Subitem	Code	Sub-code	Details	Default value	Acceptable value	RAM	Contents	Procedure
08	Setting Mode	System	Option	FAX		9211		Default setting of page by page-I FAX	0	0-4	SYS	Sets the default value for the page by page of Internet FAX to be transmitted when creating a template. 0: Not divided 1: 256 2: 512 3: 1024 4: 2048 (Unit: KB)	1
08	Setting Mode	System	User interface	Default mode setting	Default setting (SCN)	9213		Default set of density adjust (Black)	0	0-11	SYS	0: Automatic density 1: Step -5 2: Step -4 3: Step -3 4: Step -2 5: Step -1 6: Step 0 (center) 7: Step +1 8: Step +2 9: Step +3 10: Step +4 11: Step +5 (1 to 11: Manual density)	1
08	Setting mode	System	User interface	Default mode setting	Default setting of background adjustment	9214		Full Color	5	1-9	SYS	1: Step -4 2: Step -3 3: Step -2 4: Step -1 5: Step 0 (center) 6: Step +1 7: Step +2 8: Step +3 9: Step +4	1
08	Setting Mode	System	User interface	Default mode setting	Default setting (SCN)	9215		Color mode	0	0-4	SYS	0: Black 1: Gray Scale 2: Unused 3: Full Color 4: Auto Color	1
08	Setting Mode	System	User interface	Default mode setting	Default setting of resolution (SCN)	9216		Full Color	2	0-5	SYS	0: 100 dpi 1: 150 dpi 2: 200 dpi 3: 300 dpi 4: 400 dpi 5: 600 dpi	1
08	Setting Mode	System	User interface	Default mode setting	Default setting of resolution (SCN)	9217		Gray Scale	2	0-5	SYS	0: 100 dpi 1: 150 dpi 2: 200 dpi 3: 300 dpi 4: 400 dpi 5: 600 dpi	1

05/08	Mode	Element	Sub element	Item	Subitem	Code	Sub-code	Details	Default value	Acceptable value	RAM	Contents	Procedure
08	Setting Mode	System	User interface	Default mode setting	Default setting of resolution (SCN)	9218		Black	1	0-5	SYS	0: 150 dpi 1: 200 dpi 2: 300 dpi 3: 400 dpi 4: 600 dpi 5: 100 dpi	1
08	Setting Mode	System	User interface	Default mode setting	Default setting (SCN)	9219		Original mode (Full color)	0	0-3	SYS	0: Text 1: Text/Photo 2: Photo 3: Custom (Valid only when a setting other than "0" is set for 08-8303)	1
08	Setting Mode	System	User interface	Default mode setting	Default setting (SCN)	9220		Original mode (Black)	0	0-3	SYS	0: Text 1: Text/Photo 2: Photo 3: Custom The value other than "0" needs to be set for 08-7401 to select "3: Custom."	1
08	Setting mode	System	User interface	Default mode setting		9221		Default setting of scanning mode	0	0-2	SYS	0: Single 1: Book 2: Tablet	1
08	Setting mode	System	User interface	Default mode setting		9222		Default setting of rotation mode	1	0-3	SYS	0: 0 degree 1: 90 degrees 2: 180 degrees 3: 270 degrees	1
08	Setting mode	System	User interface	Default mode setting		9223		Default setting of original paper size	0	Refer to contents	SYS	0: Automatic 5: A4-R 6: A5-R 7: LT-R 8: LG 11: ST-R 13: B5-R 14: FOLIO 15: 13"LG 16: 8.5"x 8.5" 18: A6-R 19: Size mixed 22: 16K-R 23: 13.5"LG-R 24: EXECUTIVE-R 27: Postcard 28: Double Postcard <Acceptable value> 0, 5-8, 11, 13-16, 18, 19, 22-24, 27, 28	1
08	Setting mode	System	General			9225		Searching interval of deleting expired files and checking capacity of HDD partitions	12	1-24	SYS	Sets the search interval of deleting expired files and checking capacity of HDD partitions. (Unit: Hour) Related code 08-9208	1
08	Setting mode	System	User interface	Default mode setting		9226		Default setting of background adjustment (Gray Scale)	5	1-9	SYS	1: Step -4 2: Step -3 3: Step -2 4: Step -1 5: Step 0 (Center) 6: Step +1 7: Step +2 8: Step +3 9: Step +4	1

05/08	Mode	Element	Sub element	Item	Subitem	Code	Sub-code	Details	Default value	Acceptable value	RAM	Contents	Procedure
08	Setting Mode	System	User interface	Default setting of filing format	E-mail	9227		Black	1	0-6	SYS	0: TIFF (Multi) 1: PDF (Multi) 2: Not used 3: TIFF (Single) 4: PDF (Single) 5: XPS (Multi) 6: XPS (Single)	1
08	Setting Mode	System	User interface	Default setting of filing format	Storing files	9228		Color/ACS	1	0-8	SYS	0: TIFF (Multi) 1: PDF (Multi) 2: JPG 3: TIFF (Single) 4: PDF (Single) 5: SLIM PDF (Multi) 6: SLIM PDF (Single) 7: XPS (Multi) 8: XPS (Single)	1
08	Setting Mode	System	User interface	Default setting of filing format	Storing files	9229		Black	Refer to contents	0-6	SYS	0: TIFF (Multi) 1: PDF (Multi) 2: Not used 3: TIFF (Single) 4: PDF (Single) 5: XPS (Multi) 6: XPS (Single) <Default value> ODA: 0 Others: 1	1
08	Setting mode	System	Image	Binarizing level setting (When judging as black in the ACS Mode)		9230	0	Step -2	115	0-255	SYS	Sets the binarizing level of each step. When the value increases, the image becomes darker. When the value decreases, the image becomes lighter. Refer to 08-9204.	4
08	Setting mode	System	Image	Binarizing level setting (When judging as black in the ACS Mode)		9230	1	Step -1	145	0-255	SYS	Sets the binarizing level of each step. When the value increases, the image becomes darker. When the value decreases, the image becomes lighter. Refer to 08-9204.	4
08	Setting mode	System	Image	Binarizing level setting (When judging as black in the ACS Mode)		9230	2	Step 0 (center)	175	0-255	SYS	Sets the binarizing level of each step. When the value increases, the image becomes darker. When the value decreases, the image becomes lighter. Refer to 08-9204.	4
08	Setting mode	System	Image	Binarizing level setting (When judging as black in the ACS Mode)		9230	3	Step +1	205	0-255	SYS	Sets the binarizing level of each step. When the value increases, the image becomes darker. When the value decreases, the image becomes lighter. Refer to 08-9204.	4

05/08	Mode	Element	Sub element	Item	Subitem	Code	Sub-code	Details	Default value	Acceptable value	RAM	Contents	Procedure
08	Setting mode	System	Image	Binarizing level setting (When judging as black in the ACS Mode)		9230	4	Step +2	235	0-255	SYS	Sets the binarizing level of each step. When the value increases, the image becomes darker. When the value decreases, the image becomes lighter. Refer to 08-9204.	4
08	Setting mode	System	Scanning			9233		Equipment name and user name setting to a folder when saving files	0	0-2	SYS	Sets whether or not adding the equipment name and user name to the folder when saving files. 0: Not added 1: Add the equipment name 2: Add the user name	1
08	Setting mode	System mode	User interface	Default screen setting		9236		Default setting of print screen	1	1-4	SYS	1: Private print screen (Job list of log-in user is displayed if user authentication is enabled.) 2: Hold print screen (Job list of log-in user is displayed if user authentication is enabled.) 3: Private print screen (If the private print screen is displayed when user authentication is enabled, user list is displayed if user logs in as GUEST, and job list of log-in user is displayed if user logs in as general user.) 4: Hold print screen (If the private print screen is displayed when user authentication is enabled, user list is displayed if user logs in as GUEST, and job list of log-in user is displayed if user logs in as general user.) * If user data department management (08-9264) is changed from OFF to ON, the value in this code changes from "1" to "2", and "3" to "4". The value does not change if it is "2" or "4". Reset this value as necessary when changing user data department management (08-9264) from OFF to ON.	1
08	Setting mode	System	Data overwrite enabler			9240		HDD data overwriting type setting	3	0-3	SYS	Select the type of the overwriting level for deleting HDD data. (This setting is enabled only when the GP-1070 is installed.) 0: LOW Standard overwriting method. 1: MEDIUM More secure overwriting method than LOW. The overwriting time is between LOW and HIGH. 2: HIGH The most secure overwriting method. The overwriting time is the longest. 3: SIMPLE Simple overwriting method. The time for overwriting is the shortest.	1
08	Setting mode	System	User interface			9251		Access code entry for Electronic Filing printing	0	0-1	SYS	0: Renewed automatically 1: Enter every time	1

05/08	Mode	Element	Sub element	Item	Subitem	Code	Sub-code	Details	Default value	Acceptable value	RAM	Contents	Procedure
08	Setting mode	System	User interface			9252		Clearing timing for files and Electronic Filing Agent	1	0-1	SYS	0: Immediately after the completion of scanning 1: Cleared by Auto Clear	1
08	Setting mode	System	User interface			9261		Maximum number of time job build performed	1000	5-1000	SYS	Sets the maximum number of time a job build has been performed. 5-1000: 5 to 1000 times	1
08	Setting mode	System	General			9264		User data department management	0	0-1	SYS	0: Disabled 1: Enabled	1
08	Setting Mode	System	Option	FAX		9268		Inbound FAX function (Forwarding by TSI)	1	0-1	SYS	0: OFF (Function disabled) 1: ON (Function enabled)	1
08	Setting Mode	System	Option	FAX		9269		Tab/cover sheet-FAX Printing stop function	0	0-1	SYS	Sets ON or OFF of the printing function of special sheets such as tab or cover sheet of FAX, Email or list print. 0: Function OFF 1: Function ON	1
08	Setting mode	System	Network			9271		Authentication method of "Scan to Email"	0	0-2	SYS	0: Disabled 1: SMTP authentication 2: LDAP authentication	1
08	Setting mode	System	Network			9272		Setting whether use of the Internet FAX is permitted at the time of authentication	0	0-1	SYS	0: Not permitted 1: Permitted	1
08	Setting mode	System	Network			9274		"From" address assignment method at the time of authentication	0	0-2	SYS	0: User name + @ + Domain name 1: LDAP searching 2: Use the address registered at "From" field of E-mail setting	1
08	Setting mode	System	Network			9276		Setting for "From" address edit at "Scan to Email"	0	0-1	SYS	0: Not permitted 1: Permitted	1
08	Setting mode	System	Network	E-mail		9278		Domain name	-	-	SYS	96 + 2 (delimiter) character ASCII sequence only	11
08	Setting Mode	System	User interface	Sound		9280		Error sound	1	0-1	SYS	0: OFF 1: ON	1
08	Setting Mode	System	User interface	Sound		9281		Sound setting -- Energy Saving	1	0-1	SYS	0: OFF 1: ON	1
08	Setting mode	System	General			9293		User authentication method	0	0-2	SYS	0: Local authentication 1: Windows domain authentication 2: LDAP authentication	1

05/08	Mode	Element	Sub element	Item	Subitem	Code	Sub-code	Details	Default value	Acceptable value	RAM	Contents	Procedure
08	Setting mode	System	General			9294		Automatic user registration for external authentication	1	0-1	SYS	0: Disabled 1: Enabled	1
08	Setting mode	System	General			9295		User data management limitation setting	0	0-1	SYS	0: Disabled 1: Enabled	1
08	Setting mode	System	General			9296		User data management limitation Setting by number of printouts	0	7 digits	SYS	0-9,999,999: 0-9,999,999 sheets	1
08	Setting mode	System	Network			9298		Restriction on Address book operation by administrator	0	0-1	SYS	Some restrictions can be given on the administrator for operating the Address book. 0: No restriction 1: Can be operated only under the administrator's authorization	1
08	Setting mode	System	Network			9299		Restriction on "To" ("cc") address	0	0-3	SYS	0: No restriction 1: Can be set from both of the Address book and LDAP server 2: Can be set only from the Address book 3: Can be set only from the LDAP server	1
08	Setting mode	System	Paper feeding	Paper information		9300		Drawer 1	0	Refer to contents	SYS	0: Plain paper 1: Thick paper 1 2: Thick paper 2 3: Thick paper 3 4: Thick paper 4 11: Plain paper (Thin) 80: UserType paper 1 81: UserType paper 2 82: UserType paper 3 83: UserType paper 4 84: UserType paper 5 * Do not set the paper type that is not supported. <Acceptable value> 0-4, 11, 80-84	1

05/08	Mode	Element	Sub element	Item	Subitem	Code	Sub-code	Details	Default value	Acceptable value	RAM	Contents	Procedure
08	Setting mode	System	Paper feeding	Paper information		9301		Drawer 2	0	Refer to contents	SYS	0: Plain paper 1: Thick paper 1 2: Thick paper 2 3: Thick paper 3 4: Thick paper 4 11: Plain paper (Thin) 80: UserType paper 1 81: UserType paper 2 82: UserType paper 3 83: UserType paper 4 84: UserType paper 5 * Do not set the paper type that is not supported. <Acceptable value> 0-4, 11, 80-84	1
08	Setting mode	System	Paper feeding	Paper information		9302		PFP 1	0	Refer to contents	SYS	0: Plain paper 1: Thick paper 1 2: Thick paper 2 3: Thick paper 3 4: Thick paper 4 11: Plain paper (Thin) 80: UserType paper 1 81: UserType paper 2 82: UserType paper 3 83: UserType paper 4 84: UserType paper 5 * Do not set the paper type that is not supported. <Acceptable value> 0-4, 11, 80-84	1
08	Setting mode	System	Paper feeding	Paper information		9303		PFP 2	0	Refer to contents	SYS	0: Plain paper 1: Thick paper 1 2: Thick paper 2 3: Thick paper 3 4: Thick paper 4 11: Plain paper (Thin) 80: UserType paper 1 81: UserType paper 2 82: UserType paper 3 83: UserType paper 4 84: UserType paper 5 * Do not set the paper type that is not supported. <Acceptable value> 0-4, 11, 80-84	1

05/08	Mode	Element	Sub element	Item	Subitem	Code	Sub-code	Details	Default value	Acceptable value	RAM	Contents	Procedure
08	Setting mode	System	Paper feeding	Paper information		9304		LCF	0	Refer to contents	SYS	0: Plain paper 1: Thick paper 1 2: Thick paper 2 3: Thick paper 3 4: Thick paper 4 11: Plain paper (Thin) 80: UserType paper 1 81: UserType paper 2 82: UserType paper 3 83: UserType paper 4 84: UserType paper 5 * Do not set the paper type that is not supported. <Acceptable value> 0-4, 11, 80-84	1
08	Setting mode	System	Paper feeding	Paper information		9305		Bypass tray	0	Refer to contents	SYS	0: Plain paper 1: Thick paper 1 2: Thick paper 2 3: Thick paper 3 4: Thick paper 4 11: Plain paper (Thin) 13: Thick paper 5 18: Special paper 3(Transparency) 32: Envelop paper 1 33: Envelop paper 2 34: Envelop paper 3 35: Envelop paper 4 64: Special paper 1(Label1) 65: Special paper 2(Label2) 80: UserType paper 1 81: UserType paper 2 82: UserType paper 3 83: UserType paper 4 84: UserType paper 5 * Do not set the paper type that is not supported. <Acceptable value> 0-4, 11, 13, 18, 32-35, 64-65, 80-84	1
08	Setting mode	System	Paper feeding	Size conversion		9306		LT <-> A4 / LD <-> A3	0	0-1	SYS	Sets whether the data is printed on the different but similar size paper or not when the paper of corresponding size is not available. 0: Valid (The data is printed on A4/A3 when LT/LD is selected or vice versa.) 1: Invalid (The message to use the selected paper size is displayed.)	1
08	Setting Mode	System	Network	Print	Retention period	9307		Storage period at trail and private	14	0-53	SYS	0: No limits 1 to 30: 1 to 30 days 31: 1 hour 32: 2 hours 33: 4 hours 34: 8 hours 35: 12 hours 50: 5 min. 51: 10 min. 52: 15 min. 53: 30 min.	1
08	Setting mode	System	Network	Print	Raw printing job	9308		Duplex	1	0-1	SYS	0: Valid 1: Invalid	1

05/08	Mode	Element	Sub element	Item	Subitem	Code	Sub-code	Details	Default value	Acceptable value	RAM	Contents	Procedure
08	Setting mode	System	Network	Print	Raw printing job	9309		Paper size	Refer to contents	Refer to contents	SYS	1: LG 2: LT 4: ST 6: A4 7: A5 8: A6 10: B5 11: FOLIO 12: 13"LG 13: 8.5" x 8.5" 14: Postcard <Default value> ODA: 2 Others: 6 <Acceptable value> 1-2, 4, 6-8, 10-14	1
08	Setting mode	System	Network	Print	Raw printing job	9310		Paper type	0	Refer to contents	SYS	0: Plain paper 1: Thick paper 1 2: Thick paper 2 3: Thick paper 3 5: Thick paper 4 6: Plain paper(Thin) 10: Thick paper 5 <Acceptable value> 0-3, 5-6, 10	1
08	Setting mode	System	Network	Print	Raw printing job	9311		Paper direction	0	0-1	SYS	0: Portrait 1: Landscape	1
08	Setting mode	System	Network	Print	Raw printing job	9312		Staple	1	0-1	SYS	0: Valid 1: Invalid	1
08	Setting mode	System	Network	Print	Raw printing job	9313		Exit tray	0	0-6	SYS	0: Face down stacker 1: Finisher receiving tray 2: Finisher receiving tray 3: Unused 4: Unused 5: Unused 6: Unused	1
08	Setting mode	System	Network	Print	Raw printing job	9314		Number of form lines	1200	500-12800	SYS	Sets the number of form lines from 5 to 128. (A hundredfold of the number of form lines is defined as the setting value.)	1
08	Setting mode	System	Network	Print	Raw printing job	9315		PCL font pitch	1000	44-9999	SYS	Sets the font pitch from 0.44 to 99.99. (A hundredfold of the font pitch is defined as the setting value.)	1
08	Setting mode	System	Network	Print	Raw printing job	9316		PCL font size	1200	400-99975	SYS	Sets the font size from 4 to 999.75. (A hundredfold of the font size is defined as the setting value.)	1
08	Setting mode	System	Network	Print	Raw printing job	9317		PCL font number	0	0-9999	SYS	Sets the PCL font number.	1
08	Setting mode	System	Paper feeding	Paper size (bypass feeding/non-standard type)		9318		Memory 1	127/64	127-356/64-216	SYS	Registers the paper size of bypass feed (non-standard type) into [MEMORY 1]. Feeding/Widthwise direction.	10
08	Setting mode	System	Paper feeding	Paper size (bypass feeding/non-standard type)		9319		Memory 2	127/64	127-356/64-216	SYS	Registers the paper size of bypass feed (non-standard type) into [MEMORY 2]. Feeding/Widthwise direction.	10

05/08	Mode	Element	Sub element	Item	Subitem	Code	Sub-code	Details	Default value	Acceptable value	RAM	Contents	Procedure
08	Setting mode	System	Paper feeding	Paper size (bypass feeding/non-standard type)		9320		Memory 3	127/64	127-356/64-216	SYS	Registers the paper size of bypass feed (non-standard type) into [MEMORY 3]. Feeding/Widthwise direction.	10
08	Setting mode	System	Paper feeding	Paper size (bypass feeding/non-standard type)		9321		Memory 4	127/64	127-356/64-216	SYS	Registers the paper size of bypass feed (non-standard type) into [MEMORY 4]. Feeding/Widthwise direction.	10
08	Setting Mode	System	User interface	Sound		9325		Key touch sound of control panel	1	0-1	SYS	0: OFF 1: ON	1
08	Setting mode	System	General	Banner advertising		9327		Setting of banner advertising display	0	0-1	SYS	Sets whether or not displaying the banner advertising. The setting contents of 08-9328 and 9329 are displayed at the time display section on the right top of the screen. When both are set, each content is displayed alternately. 0: Not displayed 1: Displayed	1
08	Setting mode	System	General	Banner advertising		9328		Banner advertising display 1	-	-	SYS	Maximum 27 letters (one-byte character)	11
08	Setting mode	System	General	Banner advertising		9329		Banner advertising display 2	-	-	SYS	Maximum 27 letters (one-byte character)	11
08	Setting mode	System	General	Banner advertising		9330		Display of [BANNER MESSAGE] button	0	0-1	SYS	0: Not displayed 1: Displayed This button enables the entry of "Banner advertising display 1 (08-9328)" and "Banner advertising display 2 (08-9329)" on the control panel.	1
08	Setting mode	System	Network			9331		Local I/F time-out period	6	1-50	SYS	Sets the period of time when the job is judged as completed in local I/F printing (USB or parallel). 1: 1.0 sec. 2: 1.5 sec. 50: 25.5 sec. (in increments of 0.5 sec.)	1
08	Setting mode	System	User interface			9332		Original counter display	Refer to contents	0-4	SYS	Sets whether the original counter is displayed or not. 0: Not displayed 2: Displayed 4: Displayed (Double sized original is counted as 2.) <Default value> ODA/JP: 0 Others: 2	1
08	Setting mode	System	Network	Print		9334		PCL line feed code setting	0	0-3	SYS	Sets the PCL line feed code. 0: Automatic setting 1: CR=CR, LF=LF 2: CR=CR+LF, LF=LF 3: CR=CR, LF=CR+LF	1

05/08	Mode	Element	Sub element	Item	Subitem	Code	Sub-code	Details	Default value	Acceptable value	RAM	Contents	Procedure
08	Setting mode	System	Paper feeding			9336		Default setting of drawers (Printer/BOX)	1	1-5	SYS	1: LCF 2: 1st tray 3: 2nd tray 4: 3rd tray 5: 4th tray	1
08	Setting mode	System	User interface			9337		Restriction of the template function with the administrator privilege	0	0-1	SYS	Selects the restriction of the template function usage setting. 0: No restriction 1: Only available with the administrator privilege.	1
08	Setting mode	System	Network	Print	Raw printing job	9338		Paper feeding drawer	0	0-5	SYS	0: AUTO 1: 1st tray 2: 2nd tray 3: 3rd tray 4: 4th tray 5: LCF	1
08	Setting mode	System	Network	Print	Raw printing job	9339		PCL symbol set	0	0-39	SYS	0: Roman-8 1: ISO 8859/1 Latin 1 2: ISO 8859/2 Latin 2 3: ISO 8859/9 Latin 5 4: PC-8, Code Page 437 5: PC-8 D/N, Danish/Norwegian 6: PC-850, Multilingual 7: PC-852, Latin2 8: PC-8 Turkish 9: Windows 3.1 Latin 1 10: Windows 3.1 Latin 2 11: Windows 3.1 Latin 5 12: DeskTop 13: PS Text 14: Ventura International 15: Ventura US 16: Microsoft Publishing 17: Math-8 18: PS Math 19: Ventura Math 20: Pi Font 21: Legal 22: ISO 4: United Kingdom 23: ISO 6: ASCII 24: ISO 11 25: ISO 15: Italian 26: ISO17 27: ISO 21: German 28: ISO 60: Danish/Norwegian 29: ISO 69: French 30: Windows 3.0 Latin 1 31: MC Text 32: PC Cyrillic 33: ITC Zapf Dingbats 34: ISO 8859/10 Latin 6 35: PC-775 36: PC-1004 37: Symbol 38: Windows Baltic 39: Wingdings	1
08	Setting mode	System	User interface	Copy	Binding margin setting	9341	0	Left binding front (Right binding back)	7	0-100	SYS	Sets the binding margin displayed as default on the setting screen for the top/bottom/left/right binding function when copying.	4
08	Setting mode	System	User interface	Copy	Binding margin setting	9341	1	Left binding back (Right binding front)	7	0-100	SYS	Sets the binding margin displayed as default on the setting screen for the top/bottom/left/right binding function when copying.	4
08	Setting mode	System	User interface	Copy	Binding margin setting	9341	2	Top binding front (Bottom binding back)	7	0-100	SYS	Sets the binding margin displayed as default on the setting screen for the top/bottom/left/right binding function when copying.	4
08	Setting mode	System	User interface	Copy	Binding margin setting	9341	3	Top binding back (Bottom binding front)	7	0-100	SYS	Sets the binding margin displayed as default on the setting screen for the top/bottom/left/right binding function when copying.	4

05/08	Mode	Element	Sub element	Item	Subitem	Code	Sub-code	Details	Default value	Acceptable value	RAM	Contents	Procedure
08	Setting mode	System	Network	Print		9344		Private-print-only mode	0	0-3	SYS	0: Normal 1: Private-print-only mode 2: Hold-print-only mode 3: Private/Hold-print-only mode	1
08	Setting mode	System	General	Print		9357		Enhanced bold for PCL6	0	0-1	SYS	0: OFF 1: ON (Enhanced bold for PCL6.)	1
08	Setting Mode	System	User interface	Paper Feed setting		9359		Printing resume after jam releasing	1	0-1	SYS	0: Auto resume 1: Resume by users	1
08	Setting mode	System	User interface	Security		9379		AES data encryption function setting	0	0-2	SYS	0: Encryption invalid 1: Encryption valid (Security priority) Encrypts all of the user's data. 2: Encryption valid (Performance priority) Encrypts the user's data except the files temporarily created and deleted in the image processing such as copying or printing. * If the setting is changed, the data including user's data are erased.	1
08	Setting mode	System	User interface	Email		9380		Converting 1-byte katakana into 2 byte-katakana at e-mail transmission	1	0-1	SYS	0: Non-conversion 1: With conversion	1
08	Setting Mode	System	User interface	Default setting of filing format	E-mail	9384		Color/ACS	1	0-8	SYS	0: TIFF (Multi) 1: PDF (Multi) 2: JPG 3: TIFF (Single) 4: PDF (Single) 5: SLIM PDF (Multi) 6: SLIM PDF (Single) 7: XPS (Multi) 8: XPS (Single)	1
08	Setting mode	System	Network	Notification of scan job		9386	0	When job completed	0	0-1	SYS	Sets the notification method of scan job completion. 0: Invalid 1: Valid	4
08	Setting mode	System	Network	Notification of scan job		9386	1	On error	0	0-1	SYS	Sets the notification method of scan job completion. 0: Invalid 1: Valid	4

05/08	Mode	Element	Sub element	Item	Subitem	Code	Sub-code	Details	Default value	Acceptable value	RAM	Contents	Procedure
08	Setting mode	System	Network	Scanning		9387		File name format of "Save as file" and Email transmission	0	0-6	SYS	Sets the file naming method for "Save as file" and Email transmission. 0: [FileName]-[Data]-[Page] 1: [FileName]-[Page]-[Data] 2: [Data]-[FileName]-[Page] 3: [Data]-[Page]-[File-Name] 4: [Page]-[FileName]-[Data] 5: [Page]-[Data]-[File-Name] 6: [HostName]_[Data]-[Page]	1
08	Setting mode	System	Network	Scanning		9388		Date display format of the file name of "Save as file" and Email transmission	0	0-5	SYS	Sets the data display format of the file for "Save as file" and Email transmission. 0: [YYYY][MM][DD][HH][mm][SS] 1: [YY][MM][DD][HH][mm][SS] 2: [YYYY][MM][DD] 3: [YY][MM][DD] 4: [HH][mm][SS] 5: [YYYY][MM][DD][HH][mm][SS][mm0] The order of [YY], [MM] and [DD] varies depending on the setting of the code 08-9102 (Data display format).	1
08	Setting mode	System	Network	Scanning		9389		Single page data saving directory at "Save as file"	0	0-1	SYS	Sets the directory where the file of "Save as file" is saved. 0: Save it under a subfolder 1: Save it without creating a subfolder	1
08	Setting mode	System	Network	Scanning		9390		Page number display format of the file of "Save as file" and Email transmission	4	3-6	SYS	Sets the digit of a page number attached on the file. 3-6: 3-6 digits	1
08	Setting mode	System	Network	Scanning		9391		Extension (suffix) format of the file of "Save as file"	3	3-6	SYS	Sets the extension digits of the file to be saved. 3: Auto 4: 4 digits 5: 5 digits 6: 6 digits	1
08	Setting mode	System	Network	Scanning		9394		Single-page option for storing File and sending Email	0	0-1	SYS	0: Sets 1 page as 1 file 1: Makes a file based on the original	1
08	Setting mode	System	User interface	LDAP authentication		9397		Execution of user authentication when the user ID is not entered	2	0-2	SYS	0: Forcible execution 1: Execution impossible (pooled in the invalid queue) 2: Forcible deletion	1
08	Setting Mode	System	User interface	Card reading device	LDAP authentication	9398		LDAP attribute name settings	eBM User Card	-	SYS	Maximum 32 letters	11

05/08	Mode	Element	Sub element	Item	Subitem	Code	Sub-code	Details	Default value	Acceptable value	RAM	Contents	Procedure
08	Setting mode	System	User interface	LDAP authentication		9399		Role Based Access LDAP search index	0	0-4294967295	SYS	This code is used to specify the ID for the LDAP server to implement Role-Based Access Control.	5
08	Setting mode	System	Network	Ethernet		9403		Communication speed and settings of Ethernet	1	1-7	-	1: Auto 2: - 3: 10MBPS Full Duplex 4: - 5: 100MBPS Full Duplex 6: - 7: 1000MBPS Full Duplex	12
08	Setting Mode	System	Network	TCP/IP		9406		Method of acquiring IP address	2	1-3	NIC	1: Fixed IP address 2: Dynamic IP address 3: Dynamic IP address without Auto IP	12
08	Setting mode	System	Network			9407		Domain name	-	-	NIC	Maximum 96 letters	12
08	Setting Mode	System	Network	TCP/IP		9408		IP address	Refer to contents	Refer to contents	NIC	<Default value> 0.0.0.0 <Acceptable value> 0.0.0.0-255.255.255.255	12
08	Setting Mode	System	Network	TCP/IP		9409		Subnet mask	Refer to contents	Refer to contents	NIC	<Default value> 0.0.0.0 <Acceptable value> 0.0.0.0-255.255.255.255	12
08	Setting Mode	System	Network	TCP/IP		9410		Gateway	Refer to contents	Refer to contents	NIC	<Default value> 0.0.0.0 <Acceptable value> 0.0.0.0-255.255.255.255	12
08	Setting mode	System	Network	IPX/SPX		9411		Enable/disable setting of IPX/SPX	2	1-2	NIC	1: Enabled 2: Disabled	12
08	Setting mode	System	Network	AppleTalk		9414		Availability of AppleTalk	2	1-2	NIC	1: Enabled 2: Disabled	12
08	Setting mode	System	Network	LDAP		9416		Availability of LDAP	1	1-2	NIC	1: Available 2: Not available	12
08	Setting Mode	System	Network	DNS		9417		Availability of DNS	1	1-2	NIC	1: Available 2: Not available	12
08	Setting Mode	System	Network	DNS		9418		IP address to DNS server (Primary)	-	Refer to contents	NIC	<Acceptable value> 0.0.0.0-255.255.255.255	12
08	Setting Mode	System	Network	DNS		9419		IP address to DNS server (Secondary)	-	Refer to contents	NIC	<Acceptable value> 0.0.0.0-255.255.255.255	12
08	Setting mode	System	Network	NetWare		9421		Availability of SLP	1	1-2	NIC	Sets the availability of SLP on NetWare. 1: Enabled 2: Disabled	12

05/08	Mode	Element	Sub element	Item	Subitem	Code	Sub-code	Details	Default value	Acceptable value	RAM	Contents	Procedure
08	Setting mode	System	Network			9423		NetBios name	MFP_serial	-	NIC	Maximum 15 letters The network-related serial number of the equipment appears at "serial"	12
08	Setting mode	System	Network			9424		Name of WINS server or IP address (Primary)	-	-	NIC	000.000.000.000-255.255.255.255 (Default value 000.000.000.000)	12
08	Setting mode	System	Network			9425		Name of WINS server or IP address (Secondary)	-	-	NIC	000.000.000.000-255.255.255.255 (Default value 000.000.000.000)	12
08	Setting mode	System	Network	NetWare		9426		Availability of Bindery	1	1-2	NIC	1: Available 2: Not available	12
08	Setting mode	System	Network	NetWare		9427		Availability of NDS	1	1-2	NIC	1: Available 2: Not available	12
08	Setting mode	System	Network	HTTP		9430		Availability of HTTP server	1	1-2	NIC	1: Available 2: Not available	12
08	Setting mode	System	Network	SMTP		9437		Availability of SMTP client	1	1-2	NIC	1: Available 2: Not available	12
08	Setting mode	System	Network	SMTP		9438		FQDN or IP address to SMTP server	-	-	NIC	Maximum 128 Bytes	12
08	Setting mode	System	Network	SMTP		9440		Availability of SMTP server	1	1-2	UTY	1: Available 2: Not available	12
08	Setting mode	System	Network	POP3		9446		Availability of POP3 clients	1	1-2	NIC	1: Available 2: Not available	12
08	Setting mode	System	Network			9459		Availability of FTP server	1	1-2	NIC	1: Available 2: Not available	12
08	Setting mode	System	Network	SNMP		9463		Availability of MIB function	1	1-2	NIC	1: Valid 2: Invalid	12
08	Setting mode	System	Network	Raw TCP		9473		Availability of Raw/TCP	1	1-2	NIC	1: Valid 2: Invalid	12
08	Setting mode	System	Network	LPD		9475		Availability of LPD client	1	1-2	NIC	1: Valid 2: Invalid	12
08	Setting mode	System	Network	IPP		9478		Availability of IPP	1	1-2	NIC	1: Valid 2: Invalid	12
08	Setting mode	System	Network	IPP		9481		IPP printer name	MFP_serial	-	NIC	Maximum 127 letters The network-related serial number of the equipment appears at "serial"	12
08	Setting mode	System	Network	IPP		9486		IPP printer "Make and Model"	Refer to contents	-	NIC	Maximum 127 characters <Default value> mfp model name	12

05/08	Mode	Element	Sub element	Item	Subitem	Code	Sub-code	Details	Default value	Acceptable value	RAM	Contents	Procedure
08	Setting mode	System	Network	IPP		9487		IPP printer information (more) MFGR	-	-	NIC	Maximum 127 characters	12
08	Setting mode	System	Network	IPP		9488		IPP message from operator	-	-	NIC	Maximum 127 characters	12
08	Setting mode	System	Network	FTP		9489		Availability of FTP print	1	1-2	NIC	1: Available 2: Not available	12
08	Setting mode	System	Network	Email		9499		Page number limitation for printing text of received Email	5	1-99	SYS		1
08	Setting mode	System	Network			9505		Bonjour setting	1	1-2	NIC	1: Valid 2: Invalid	12
08	Setting mode	System	Network			9514		Host name	MFP_serial	-	NIC	Maximum 63 letters The network-related serial number of the equipment appears at "serial"	12
08	Setting mode	System	Network	Windows authentication		9515		Windows domain No.1 of user authentication	-	-	UTY	Maximum 128 letters	12
08	Setting mode	System	Network	Windows authentication		9516		PDC (Primary Domain Controller) name No.1 of authentication	-	-	UTY	Maximum 128 letters	12
08	Setting mode	System	Network	Windows authentication		9517		BDC (Backup Domain Controller) name No.1 of authentication	-	-	UTY	Maximum 128 letters	12
08	Setting mode	System	Network	Windows authentication		9518		Windows domain of device authentication	4	3-4	NIC	3: ON (Domain selected) 4: OFF (Work group selected)	12
08	Setting Mode	System	Network			9519		Workgroup name	Work-group	15 letters	NIC	Maximum 15 letters	12
08	Setting Mode	System	Network			9525		Display of MAC address	-	-	SYS	(**.*.*.*.*.*.*) The address is displayed as above. 6-byte data is divided by colon.	2
08	Setting mode	System	Network	SSL		9548		HTTP server OFF/ON	2	1-2	-	1: Enabled 2: Disabled	12
08	Setting mode	System	Network	SSL		9550		IPP server OFF/ON setting	2	1-2	-	1: Enabled 2: Disabled	12
08	Setting mode	System	Network	SSL		9552		SSL ftp server OFF/ON	2	1-2	-	OFF/ON 1: Valid 2: Invalid	12

05/08	Mode	Element	Sub element	Item	Subitem	Code	Sub-code	Details	Default value	Acceptable value	RAM	Contents	Procedure
08	Setting mode	System	Network	SSL		9556		SSL POP3 Client OFF/ON	2	1-3	-	OFF/ON 1: Valid (Accepts all the certification of the server) 2: Invalid 3: Use the imported certification.	12
08	Setting mode	System	Network	TCP/IP		9563		IP Conflict Detect	1	1-2	-	OFF/ON 1: Valid 2: Invalid	12
08	Setting mode	System	Network	SNTP		9564		SNTP Enable	2	1-2	-	OFF/ON 1: Valid 2: Invalid	12
08	Setting mode	System	Network	DHCP		9580		Enabling server's IP address acquired by DHCP	1	1-2	-	Domain Name Server option (6) 1: Enabled 2: Disabled This value is used only when DHCP is enabled.	12
08	Setting mode	System	Network	DHCP		9581		Enabling server's IP address acquired by DHCP	1	1-2	-	NetBIOS over TCP/IP Name Server option (44) = Primary and Secondary Wins NAME 1: Enabled 2: Disabled This value is used only when DHCP is enabled.	12
08	Setting mode	System	Network	SMTP		9584		SMTP Server Option (69) Simple Mail Server Address	2	1-2	-	OFF/ON 1: Valid 2: Invalid	12
08	Setting mode	System	Network	POP3		9585		POP3 Server Option (70) Post Office Server Address	2	1-2	-	OFF/ON 1: Valid 2: Invalid	12
08	Setting mode	System	Network	DHCP		9587		Enabling server's IP address acquired by DHCP	2	1-2	-	SNTP Server Option (42) NTP Server Address 1: Enabled 2: Disabled This value is used only when DHCP is enabled.	12
08	Setting mode	System	Network	SMB		9599		Samba server ON/OFF setting	1	1-4	NIC	1: Samba enabled 2: Samba disabled 3: Print Share disabled 4: File Share disabled	12
08	Setting Mode	System	Maintenance	General		9601		Equipment number (serial number) display	-	9 digits	SYS	First digit: Production country (fixed) Second digit: Model (fixed) Third digit: Month (variable) Fourth to ninth digit: serial number (variable) This can be also entered with 05-9043.	11
08	Setting mode	System	Maintenance			9602		Dealer's name	-	-	SYS	Maximum 100 letters Needed at initial registration	11
08	Setting Mode	System	Maintenance	RDMS		9603		Login name	-	20 letters	SYS	Maximum 20 letters Needed at initial registration	11

05/08	Mode	Element	Sub element	Item	Subitem	Code	Sub-code	Details	Default value	Acceptable value	RAM	Contents	Procedure
08	Setting Mode	System	Maintenance	Remote-controlled service	Call /Display function	9604		Display set of Service Notification button	Refer to contents	0-1	SYS	0: Not displayed 1: Displayed <Default value> JP: 0 Others: 1	1
08	Setting mode	System	Maintenance	RDMS		9605		Sending error contents of equipment	0	0-1	SYS	0: Invalid 1: Valid	1
08	Setting mode	System	Maintenance	Remote-controlled service		9606		Setting total counter transmission interval	-	-	SYS	(Hour/Hour/Minute/Minute)	1
08	Setting mode	System	Maintenance	Remote-controlled service		9607		Destination E-mail address 2	-	-	SYS	Maximum 192 letters	11
08	Setting mode	System	Maintenance	Remote-controlled service		9608		Destination E-mail address 3	-	-	SYS	Maximum 192 letters	11
08	Setting mode	System	Maintenance	RDMS		9610		Polling day selection Day-1	0	0-31	SYS	0: OFF 1 to 31: 1st to 31st of a month	1
08	Setting mode	System	Maintenance	RDMS		9611		Polling day selection Day-2	0	0-31	SYS	0: OFF 1 to 31: 1st to 31st of a month	1
08	Setting mode	System	Maintenance	RDMS		9612		Polling day selection Day-3	0	0-31	SYS	0: OFF 1 to 31: 1st to 31st of a month	1
08	Setting mode	System	Maintenance	RDMS		9613		Polling day selection Day-4	0	0-31	SYS	0: OFF 1 to 31: 1st to 31st of a month	1
08	Setting Mode	System	Maintenance	RDMS	Remote-controlled service polling day	9614		Sunday	1	0-1	SYS	0: Invalid 1: Valid	1
08	Setting Mode	System	Maintenance	RDMS	Remote-controlled service polling day	9615		Monday	1	0-1	SYS	0: Invalid 1: Valid	1
08	Setting Mode	System	Maintenance	RDMS	Remote-controlled service polling day	9616		Tuesday	1	0-1	SYS	0: Invalid 1: Valid	1
08	Setting Mode	System	Maintenance	RDMS	Remote-controlled service polling day	9617		Wednesday	1	0-1	SYS	0: Invalid 1: Valid	1
08	Setting Mode	System	Maintenance	RDMS	Remote-controlled service polling day	9618		Thursday	1	0-1	SYS	0: Invalid 1: Valid	1
08	Setting Mode	System	Maintenance	RDMS	Remote-controlled service polling day	9619		Friday	1	0-1	SYS	0: Invalid 1: Valid	1
08	Setting Mode	System	Maintenance	RDMS	Remote-controlled service polling day	9620		Saturday	1	0-1	SYS	0: Invalid 1: Valid	1
08	Setting mode	System	Maintenance	Remote-controlled service	Information of supplies	9624		Setting of toner cartridge K	0	0-1	SYS	0: Invalid 1: Valid	1

05/08	Mode	Element	Sub element	Item	Subitem	Code	Sub-code	Details	Default value	Acceptable value	RAM	Contents	Procedure
08	Setting mode	System	Maintenance	RDMS	Long interval polling	9626		Setting of polling at the end of month	0	0-1	SYS	0: Invalid 1: Valid	1
08	Setting mode	System	Network	InternetFAX		9627		Sending mail text of Internet FAX	1	0-1	SYS	0: Invalid 1: Valid	1
08	Setting mode	System	Network	SMTP		9628		From Name Creation setting in SMTP authentication	0	0-2	SYS	0: Not edited 1: Account name of From Address +Device name 2: LDAP searching	1
08	Setting mode	System	Wireless LAN			9649		Wireless LAN setting	2	1-2	NIC	Sets whether the wireless LAN connection is enabled or disabled. 1: Enabled 2: Disabled	12
08	Setting mode	System	Network	DHCP		9694		Enabling server's IP address acquired by DHCP	1	1-2	-	DNS domain name Option (15) DNS domain name of the client 1: Enabled 2: Disabled This value is used only when DHCP is enabled.	12
08	Setting Mode	System	Maintenance	General		9700		Service technician telephone number	0	32 digits	SYS	A telephone number can be entered up to 32 digits. Use the [MONITOR/PAUSE] button to enter a hyphen(-).	11
08	Setting mode	System	User interface			9702		Automatic calibration disclosure level	1	0-2	SYS	Sets the disclosing level of automatic calibration. 0: Service technician 1: Administrator 2: User	1
08	Setting Mode	System	Maintenance	General		9703		Error history display	-	-	SYS	Displays the latest 20 errors data	2
08	Setting mode	System	Network	Scanning		9709		Default data saving directory of "Scan to File"	0	0-2	SYS	0: Local directory 1: REMOTE 1 2: REMOTE 2	1
08	Setting Mode	System	Maintenance	RDMS	General	9710		Remote-controlled service function	2	0-2	SYS	0: Valid (Remote-controlled server) 1: Valid (L2) 2: Invalid	1
08	Setting Mode	System	Maintenance	RDMS	HTTP	9711		Remote-controlled service URL setting	-	-	SYS	Maximum 256 letters	11
08	Setting Mode	System	Maintenance	RDMS	HTTP	9715		Initially-registered server URL setting	Refer to contents	-	SYS	Maximum 256 letters <Default value> https://device.mfp-support.com:443/device/firstregist.ashx	11
08	Setting mode	System	Maintenance (Remote)	RDMS		9718		Short time interval setting of recovery from Emergency Mode	24	1-48	SYS	Sets the time interval to recover from the Emergency Mode to the Normal Mode. (Unit: Hour)	1

05/08	Mode	Element	Sub element	Item	Subitem	Code	Sub-code	Details	Default value	Acceptable value	RAM	Contents	Procedure
08	Setting mode	System	Maintenance	RDMS		9719		Short time interval setting of Emergency Mode	60	30-360	SYS	Unit: Minute	1
08	Setting Mode	System	Maintenance	RDMS	General	9723		Periodical polling timing	1530	0-2359	SYS	(Hour/Hour/Minute/Minute) 0 (0:00) to 2359 (23:59)	1
08	Setting Mode	System	Maintenance	RDMS	General	9724		Writing data of self-diagnostic code	0	0-1	SYS	0: Prohibited 1: Accepted	1
08	Setting Mode	System	Maintenance	RDMS	General	9726		Remote-service initial registration	0	0-3	SYS	0: OFF 1: Start 2: Only certification is scanned 3: RDMS communication starts	1
08	Setting Mode	System	Maintenance	RDMS	General	9727		Remote-controlled service tentative password	-	10 letters	SYS	Maximum 10 letters	11
08	Setting Mode	System	Maintenance	RDMS	General	9729		Status of remote-service initial regist	0	0-1	SYS	0: Not registered 1: Registered	2
08	Setting Mode	System	Maintenance	RDMS	Call /Display function	9730		Service center call function	1	0-2	SYS	0: OFF 1: Notifies all service calls 2: Notifies all but paper jams	1
08	Setting Mode	System	Maintenance	RDMS	HTTP	9732		Service center call HTTP server URL setting	-	-	SYS	Maximum 256 letters	11
08	Setting mode	System	Counter	External counter		9736		Interrupt copying	0	0-1	SYS	0: Invalid 1: Valid	1
08	Setting Mode	System	Maintenance	RDMS	Call /Display function	9739		Toner-end notification	0	0-2	SYS	0: RDMS toner empty notified immediately 1: RDMS toner empty notified once a day 2: RDMS toner empty not notified	1
08	Setting Mode	System	Maintenance	RDMS	HTTP	9740		HTTP proxy setting	1	0-1	SYS	0: Valid 1: Invalid	1
08	Setting Mode	System	Maintenance	RDMS	HTTP	9741		HTTP proxy IP address setting	Refer to contents	-	SYS	Input IP address or FQDN. <Default value> 0.0.0.0	11
08	Setting Mode	System	Maintenance	RDMS	HTTP	9742		HTTP proxy port number setting	0	0-65535	SYS		1
08	Setting Mode	System	Maintenance	RDMS	HTTP	9743		HTTP proxy ID setting	-	-	SYS	Maximum 30 letters	11
08	Setting Mode	System	Maintenance	RDMS	HTTP	9744		HTTP proxy password setting	-	-	SYS	Maximum 30 letters	11
08	Setting Mode	System	Maintenance	RDMS	HTTP	9745		HTTP proxy panel display	1	0-1	SYS	0: Valid 1: Invalid	1

05/08	Mode	Element	Sub element	Item	Subitem	Code	Sub-code	Details	Default value	Acceptable value	RAM	Contents	Procedure
08	Setting mode	System	Network	Security		9746		802.1X/Dynamic WEP selecting button display	1	0-1	SYS	Switches whether a selecting button for Security mode 802.1X/Dynamic WEP is displayed or not. 0: Not displayed 1: Displayed	1
08	Setting mode	System	Network	Scanning		9749		WIA Scan Driver	1	1-2	NIC	Selects WIA Scan Driver. 1: SPECIFIC 2: Microsoft	12
08	Setting mode	System	Maintenance	Remote-controlled service	Automatic ordering function of supplies	9750		Ordering method	3	0-3	SYS	0: Ordered by FAX 1: Ordered by E-mail 2: Ordered by HTTP 3: OFF	1
08	Setting mode	System	Maintenance	Remote-controlled service	Automatic ordering function of supplies	9751		FAX number	-	-	SYS	Maximum 32 digits Enter hyphen with the [Monitor/Pause] button	11
08	Setting mode	System	Maintenance	Remote-controlled service	Automatic ordering function of supplies	9752		E-mail address	-	-	SYS	Maximum 192 letters List: 256 digits	11
08	Setting mode	System	Maintenance	Remote-controlled service	Automatic ordering function of supplies	9756		User's name	-	-	SYS	Maximum 50 letters	11
08	Setting mode	System	Maintenance	Remote-controlled service	Automatic ordering function of supplies	9757		User's telephone number	-	-	SYS	Maximum 32 digits Enter hyphen with the [Monitor/Pause] button	11
08	Setting mode	System	Maintenance	Remote-controlled service	Automatic ordering function of supplies	9758		User's E-mail address	-	-	SYS	Maximum 192 letters List: 256 digits	11
08	Setting mode	System	Maintenance	Remote-controlled service	Automatic ordering function of supplies	9759		User's address	-	-	SYS	Maximum 100 letters	11
08	Setting mode	System	Maintenance	Remote-controlled service	Automatic ordering function of supplies	9760		Service number	-	-	SYS	Maximum 5 digits	11
08	Setting mode	System	Maintenance	Remote-controlled service	Automatic ordering function of supplies	9761		Service technician's name	-	-	SYS	Maximum 50 letters	11
08	Setting mode	System	Maintenance	Remote-controlled service	Automatic ordering function of supplies	9762		Service technician's telephone number	-	-	SYS	Maximum 32 digits Enter hyphen with the [Monitor/Pause] button	11
08	Setting mode	System	Maintenance	Remote-controlled service	Automatic ordering function of supplies	9763		Service technician's E-mail address	-	-	SYS	Maximum 192 letters List: 256 digits	11

05/08	Mode	Element	Sub element	Item	Subitem	Code	Sub-code	Details	Default value	Acceptable value	RAM	Contents	Procedure
08	Setting mode	System	Maintenance	Remote-controlled service	Automatic ordering function of supplies	9764		Supplier's name	-	-	SYS	Maximum 50 letters	11
08	Setting mode	System	Maintenance	Remote-controlled service	Automatic ordering function of supplies	9765		Supplier's address	-	-	SYS	Maximum 100 letters	11
08	Setting mode	System	Maintenance	Remote-controlled service	Automatic ordering function of supplies	9766		Notes	-	-	SYS	Maximum 128 letters	11
08	Setting mode	System	Maintenance	Remote-controlled service	Information about supplies	9776		Part number of toner cartridge K	-	-	SYS	Maximum 20 digits	11
08	Setting mode	System	Maintenance	Remote-controlled service	Information about supplies	9777		Order quantity of toner cartridge K	1	1-99	SYS		1
08	Setting mode	System	Maintenance	Remote-controlled service	Information about supplies	9778		Condition number of toner cartridge K	1	1-99	SYS		1
08	Setting mode	System	Maintenance	Remote-controlled service	Automatic supply ordering	9782		Result table printout	1	0-2	SYS	0: OFF 1: Always 2: ON Error	1
08	Setting Mode	System	Maintenance	Remote-controlled service	Automatic supply ordering	9783		Call /Display function	Refer to contents	0-2	SYS	0: Valid (FAX/Internet FAX) 1: Valid (FAX/Internet FAX/HTTP) 2: Invalid <Default value> ODA: 0 Others: 2	1
08	Setting mode	System	Maintenance	Remote-controlled service	Automatic supply ordering	9784		Counter notification Remote FAX setting	-	-	SYS	Maximum 32 digits Enter a hyphen with the [MONITOR/PAUSE] button.	11
08	Setting Mode	System	Counter			9787		Suspend when quota is empty	0	0-1	SYS	Sets whether the process is suspended immediately or suspended after the job is completed if quota is used up. 0: Suspended immediately 1: Suspended after the job is finished	1

05/08	Mode	Element	Sub element	Item	Subitem	Code	Sub-code	Details	Default value	Acceptable value	RAM	Contents	Procedure
08	Setting mode	System	Maintenance			9788		Service call checking period setting	6	0-12	SYS	0: No checking period specified (= Calls service technician immediately) 1: 10 minutes 2: 30 minutes 3: 1 hour 4: 6 hours 5: 12 hours 6: 24 hours 7: 48 hours 8: 7 days 9: 1 month 10: 1 year 11: 5 years 12: Not limited (= Calls service technician if such error has occurred in the past even once or more)	1
08	Setting mode	System	Maintenance	Remote-controlled service		9793		Service Notification setting	0	0-2	SYS	Enables to set up to 3 E-mail addresses to be sent. (08-9794, 9607, 9608) 0: Invalid 1: Valid (E-mail) 2: Valid (FAX)	1
08	Setting mode	System	Maintenance	Remote-controlled service		9794		Destination E-mail address 1	-	-	SYS	Maximum 192 letters	11
08	Setting mode	System	Maintenance	Remote-controlled service		9795		Total counter information transmission setting	0	0-1	SYS	0: Invalid 1: Valid	1
08	Setting mode	System	Maintenance	Remote-controlled service		9796		Total counter transmission date setting	0	0-31	SYS	0 to 31	1
08	Setting mode	System	Network			9798		Temporary communication password setting	99999	-	SYS	Sets a temporary communication password. The password can be entered in alphanumeric characters (A to Z, a to z, 0 to 9) up to 10 digits. The entered password is displayed with "*" on the touch panel and the self-diagnostic lists. (Maximum 10 digits, minimum 5 digits)	11
08	Setting mode	System	User management	Local authentication		9799		Switchover of mode	0	0-1	SYS	Sets the authentication mode when "0: (Internal authentication)" is selected in the code 08-9293. 0: Card ID differs from the User ID 1: Card ID is the same as the User ID	1
08	Setting mode	System	Image processing			9804		Forcible mode change in toner empty status	0	0-2	SYS	0: SLEEP MODE 1: AUTO POWER SAVE 2: READY	1

05/08	Mode	Element	Sub element	Item	Subitem	Code	Sub-code	Details	Default value	Acceptable value	RAM	Contents	Procedure
08	Setting Mode	System	Version	Printer		9806		Firmware version of printer loader section	-	-	-		2
08	Setting Mode	System	Version	Printer	ROM version of printer optional tray	9807	0	Tray2	-	00.00.00~FF.FF.FF	-		14
08	Setting Mode	System	Version	Printer	ROM version of printer optional tray	9807	1	Tray3	-	00.00.00~FF.FF.FF	-		14
08	Setting Mode	System	Version	Printer	ROM version of printer optional tray	9807	2	Tray4	-	00.00.00~FF.FF.FF	-		14
08	Setting Mode	System	Version	Printer		9808		Firmware version of LCF	-	-	-		2
08	Setting mode	System	Finisher	Interruption of stapling operation (no staple)		9810	0	Copying	1	0-1	SYS	When staple runs out while printing in the stapling mode, sets whether printing is interrupted or printing is continued by switching to sorting. This code is valid only when printing in the stapling mode. However, printing is always interrupted when staple for saddle stitch runs out. 0: Continues printing by switching to sort setting 1: Interrupts printing	4
08	Setting mode	System	Finisher	Interruption of stapling operation (no staple)		9810	1	Printing / BOX printing	0	0-1	SYS	When staple runs out while printing in the stapling mode, sets whether printing is interrupted or printing is continued by switching to sorting. This code is valid only when printing in the stapling mode. However, printing is always interrupted when staple for saddle stitch runs out. 0: Continues printing by switching to sort setting 1: Interrupts printing	4
08	Setting mode	System	Finisher	Stapling setting: Maximum number of sheets acceptable exceeding upper limit	Long size	9811	0	Plain/Recycled	0	-50-50	SYS	-50 to 50	4
08	Setting mode	System	Finisher	Stapling setting: Maximum number of sheets acceptable exceeding upper limit	Long size	9811	1	Thick1	0	-50-50	SYS	-50 to 50	4

05/08	Mode	Element	Sub element	Item	Subitem	Code	Sub-code	Details	Default value	Acceptable value	RAM	Contents	Procedure
08	Setting mode	System	Finisher	Stapling setting: Maximum number of sheets acceptable exceeding upper limit	Long size	9811	2	Thick2	0	-50-50	SYS	-50 to 50	4
08	Setting mode	System	Finisher	Stapling setting: Maximum number of sheets acceptable exceeding upper limit	Long size	9811	3	Thick3	0	-50-50	SYS	-50 to 50	4
08	Setting mode	System	General			9816		Addition of the page number to the multi- page file name of File	0	0-1	SYS	Only when job is executed with TimeStamp enabled for file storage, page number is added with the format set at 08-9387. 0: Invalid (Page number not added) 1: Valid (Page number added)	1
08	Setting mode	System	General			9817		Maximum number of decimals in the extension fields	2	0-6	SYS	0 to 6 digits	1
08	Setting mode	System	General			9818		The default value of the stored/ attached file name of a File/Email	0	0-1	SYS	0: DOCYYMMDD 1: NetBios name	1
08	Setting mode	System	User interface	Off Device Customization Architecture		9819		STAGE SSL	0	0-1	SYS	Sets whether SSL communication is enabled or disabled for remote scanning. 0: Disabled 1: Enabled	1
08	Setting mode	System	User interface	Off Device Customization Architecture		9820		STAGE I/F	1	0-1	SYS	Sets whether interface is enabled or disabled for remote scanning. 0: Disabled 1: Enabled	1
08	Setting mode	System	User interface	Off Device Customization Architecture		9821		Port number	49629	0-65535	SYS	Sets a port number for the remote scanning.	1
08	Setting mode	System	User interface	Off Device Customization Architecture		9822		SSL port number	49630	0-65535	SYS	Sets an SSL port number for remote scanning using SSL communication.	1

05/08	Mode	Element	Sub element	Item	Subitem	Code	Sub-code	Details	Default value	Acceptable value	RAM	Contents	Procedure
08	Setting mode	System	Network			9823		User name and password at user authentication or "Save as file"	0	0-2	SYS	0: User name and password of the device 1: User name and password at the user authentication (Template registration information comes first when a template is retrieved.) 2: User name and password at the user authentication (User information of the authentication comes first when a template is retrieved.)	1
08	Setting mode	System	Image			9825		Image quality of the black part in the ACS mode	0	0-1	SYS	0: Black 1: Gray scale	1
08	Setting mode	System	General	Department management		9829		Limitation setting	0	0-1	SYS	Decide the default limitation setting when the new department code is created. 0: No limit 1: Limited only in the black mode	1
08	Setting mode	System	Maintenance	General		9843		Serial number display	-	-	SYS	Displays the serial number of PU board.	2
08	Setting mode	System	Paper feeding	Paper size setting		9844		Paper size series setting	Refer to contents	0-1	SYS	0: AB-series 1: LT-series <Default value> ODA: 1 Others: 0	1
08	Setting mode	System	Maintenance	General		9845		Sales channel setting	Refer to contents	0-1	SYS	0: OA (dealer) 1: IT (sellout) <Default value> ODC-OA: 0 ODC-IT: 1	1
08	Setting mode	System	General	Remote-controlled service	Automatic ordering function of supplies	9880		Total counter data transmission date 2	0	0-31	SYS	0 to 31	1
08	Setting mode	System	General	Remote-controlled service	Automatic ordering function of supplies	9881		Day of the total counter data transmission	0	0-127	SYS	1 byte 00000000(0)-01111111(127) From the 2nd bit - Sunday, Monday, Tuesday, Wednesday, Thursday, Friday, Saturday	1
08	Setting mode	System	Paper feeding	LG size for automatic size detection		9885	0	Drawer 1	0	0-3	SYS	0: Legal14 1: Legal13.5 2: Legal13 3: Folio * This setting is not applied to LCF and bypass feeding.	4
08	Setting mode	System	Paper feeding	LG size for automatic size detection		9885	1	Drawer 2	0	0-3	SYS	0: Legal14 1: Legal13.5 2: Legal13 3: Folio * This setting is not applied to LCF and bypass feeding.	4
08	Setting mode	System	Paper feeding	LG size for automatic size detection		9885	2	Drawer 3	0	0-3	SYS	0: Legal14 1: Legal13.5 2: Legal13 3: Folio * This setting is not applied to LCF and bypass feeding.	4

05/08	Mode	Element	Sub element	Item	Subitem	Code	Sub-code	Details	Default value	Acceptable value	RAM	Contents	Procedure
08	Setting mode	System	Paper feeding	LG size for automatic size detection		9885	3	Drawer 4	0	0-3	SYS	0: Legal14 1: Legal13.5 2: Legal13 3: Folio * This setting is not applied to LCF and bypass feeding.	4
08	Setting mode	System	General			9886		Decimal point indication for Enhanced Scan Template	Refer to contents	0-1	SYS	0: Comma 1: Full stop <Default value> ODA/JP: 1 Others: 0	1
08	Setting mode	System	General			9888		Permission setting for changing the scan parameter when recalling an extension	0	0-1	SYS	0: Prohibited 1: Accepted	1
08	Setting Mode	System	General	Data cloning		9889		Status display for USB cloning	0	0-1	SYS	0: Accepted 1: Prohibited	2
08	Setting Mode	System	User interface	Display setting		9891		Warning message when PM time has come	1	0-1	SYS	0: No warning notification 1: Warning notification	1
08	Setting mode	System	General			9894		Calibration chart charging method	0	0-1	SYS	Decide whether the calibration chart printing is charged or not 0: No charge 1: Charge	1
08	Setting mode	System	Image	Default value setting	Background peak adjustment	9897		Black	5	1-9	SYS	1: -4 2: -3 3: -2 4: -1 5: 0 6: +1 7: +2 8: +3 9: +4	1
08	Setting mode	System	Image	Default value setting	Density in the scan mode	9898		Color	6	0-11	SYS	0: Auto 1: -5 2: -4 3: -3 4: -2 5: -1 6: 0 7: +1 8: +2 9: +3 10: +4 11: +5	1
08	Setting mode	System	Image	Default value setting	Density in the scan mode	9899		Grayscale	6	0-11	SYS	0: Auto 1: -5 2: -4 3: -3 4: -2 5: -1 6: 0 7: +1 8: +2 9: +3 10: +4 11: +5	1
08	Setting Mode	System	Version	System		9900		System software ROM version	-	-	-	TXXSY0WXXXX	2
08	Setting Mode	System	Version	Engine		9901		PU firmware version	-	-	-	Displays the PU firmware version.	2
08	Setting Mode	System	Version	System		9902		SU firmware version	-	-	-	Displays the SU firmware version.	2
08	Setting Mode	System	Version	Finisher		9904		Finisher firmware version	-	-	-	Displays the finisher firmware version. (xx xx xx)	2
08	Setting Mode	System	Version	FAX		9905		FAX firmware version	-	-	-	Displays the fax firmware version.	2
08	Setting Mode	System	Version	SU		9927		SU Loader firmware version	-	-	-	Displays the ROM version of SU Loader.	2
08	Setting Mode	System	Version	SU		9928		SU Recovery firmware version	-	-	-	Displays the ROM version of SU Recovery FW.	2

05/08	Mode	Element	Sub element	Item	Subitem	Code	Sub-code	Details	Default value	Acceptable value	RAM	Contents	Procedure
08	Setting Mode	System	Version	System		9930		System firmware version	-	-	-	TXXSF0WXXXX	2
08	Setting mode	System	Network	LDAP authentication		9933		Domain participation confirmation of printing when LDAP authentication is used	1	0-1	SYS	Sets whether domain participation of a client computer for print job authentication is confirmed or not when LDAP is selected as the authentication method for user authentication. This function is enabled only when department management is enabled. 0: Disabled 1: Enabled	1
08	Setting mode	System	Finisher	Stapling setting Acceptable number of sheets exceeding upper limit	Short size	9937	0	Plain/Recycled	0	-100-100	SYS	-100 to 100	4
08	Setting mode	System	Finisher	Stapling setting Acceptable number of sheets exceeding upper limit	Short size	9937	1	Thick1	0	-100-100	SYS	-100 to 100	4
08	Setting mode	System	Finisher	Stapling setting Acceptable number of sheets exceeding upper limit	Short size	9937	2	Thick2	0	-100-100	SYS	-100 to 100	4
08	Setting mode	System	Finisher	Stapling setting Acceptable number of sheets exceeding upper limit	Short size	9937	3	Thick3	0	-100-100	SYS	-100 to 100	4
08	Setting Mode	System	Network	E-mail		9946		Number of Email transmission retries	3	0-14	SYS	0 to 14 times	1
08	Setting Mode	System	Network	E-mail		9947		E-mail transmission retry interval	1	0-15	SYS	0 to 15 min.	1
08	Setting mode	System	User interface			9955		Name of [EXTENSION] button	EXTENSION	-	SYS	Sets the name of " EXTENSION" button displayed on the MENU screen. Maximum 10 characters with alphameric characters and symbols.	11
08	Setting mode	System	Network	E-mail		9958		Bcc address display ON/OFF setting (Job Log / Job Status)	0	0-1	SYS	Sets whether the Bcc address is displayed or not on the Job Log or Job Status when "1: To/Bcc" is selected in the code 08-9957. 0: OFF (Bcc address not displayed) 1: ON (Bcc address displayed)	1

05/08	Mode	Element	Sub element	Item	Subitem	Code	Sub-code	Details	Default value	Acceptable value	RAM	Contents	Procedure
08	Setting mode	System	Network	E-mail		9959		Bcc address display ON/OFF setting (Job Notification)	1	0-1	SYS	Sets whether the Bcc address is displayed or not on all the Job Notifications except for the administrator when "1: To/Bcc" is selected in the code 08-9957. 0: OFF (Bcc address not displayed) 1: ON (Bcc address displayed)	1
08	Setting Mode	System	Maintenance			9960		Display of equipment information (SRAM)	Refer to contents	0-2	SYS	Displays the equipment information in SRAM. 0: Not set 1: H-290/291 2: H-290/291 for ODA <Default value> ODA: 2 Others: 1	2
08	Setting Mode	System	User interface	Default mode setting	Default setting (PPC)	9970		Original mode (Black)	0	0-4	SYS	0: Text/Photo 1: Text 2: Photo 3: Gray Scale 4: User custom mode	1
08	Setting mode	System	General	Default setting	Image quality density	9971		PPC (black)	0	0-1	SYS	0: Auto 1: Manual	1
08	Setting mode	System	General	Default setting	Blank page judgment: Default setting	9972		PPC	0	-3-3	SYS	The larger the value, the more the paper is judged as a blank page. The smaller the value, the less the paper is judged as a blank page.	1
08	Setting mode	System	User interface	Default setting	Blank page judgment: Default setting	9973		SCN	0	-3-3	SYS	The larger the value, the more the paper is judged as a blank page. The smaller the value, the less the paper is judged as a blank page.	1
08	Setting mode	System	User interface	Default setting	ACS judgment adjustment: Default setting	9975		SCN	2	-3-3	SYS	The larger the value, the more the original is judged as color data. The smaller the value, the less the original is judged as black data.	1
08	Setting mode	System	Network	Email		9980		Receiver's address fixing function at authentication	0	0-4	SYS	Sets address of TO/CC/BCC when the user authentication and E-mail authentication are enabled. When the value of this code is set to "1", the address specified as From Address is input to TO destination field. TO/CC/BCC field cannot be edited. When the value of this code is set to "2 to 4", the address specified as From Address is input to each field. TO/CC/BCC field can be edited by pressing the TO/CC/BCC button. 0: Disabled 1: Fixed to TO field. 2: Added to TO field. 3: Added to CC field. 4: Added to BCC field.	1

05/08	Mode	Element	Sub element	Item	Subitem	Code	Sub-code	Details	Default value	Acceptable value	RAM	Contents	Procedure
08	Setting mode	System	Network	Email		9981		Sending body text of email	1	0-1	SYS	Sets whether the job information is output in the body of e-mail when executing e-mail send job. 0: Disabled 1: Enabled	1
08	Setting mode	System	User interface			9982		Switch of display attribute of [EXTENSION] icon	0	0-1	SYS	0: Touch is invalid when authentication is not completed. 1: Touch is valid when authentication is not completed.	1
08	Setting Mode	System	User interface			9984		Document or file name display form for the PRINT screen, JOB STATUS screen, Job Status tab and Logs tab	0	0-1	SYS	0: Displays with the document or file name 1: Does not display the document or file name	1
08	Setting Mode	System	User interface			9985		Screen displayed by pressing MENU button	0	0-1	SYS	0: MENU screen 1: EWB screen	1
08	Setting Mode	System	Fax			9987		Retention of fax sending settings	0	0-3	SYS	Sets whether the fax sending settings are retained or not. 0: Clears all settings (The authentication screen is displayed if user authentication or department management is enabled.) 1: Clears all 2: Clears only addresses 3: Retains all settings	1
08	Setting Mode	System	Paper feeding	Custom size (1st drawer)		9991		Value of feeding/widthwise direction	Refer to contents	210~356/ 148~216	SYS	<Default value> ODA: 279/216 Others: 297/210	10
08	Setting Mode	System	Paper feeding	Custom size (2nd drawer)		9992		Value of feeding/widthwise direction	Refer to contents	210~356/ 148~216	SYS	<Default value> ODA: 279/216 Others: 297/210	10
08	Setting Mode	System	Paper feeding	Custom size (PFP 1st drawer)		9993		Value of feeding/widthwise direction	Refer to contents	210~356/ 148~216	SYS	<Default value> ODA: 279/216 Others: 297/210	10
08	Setting Mode	System	Paper feeding	Custom size (PFP 2nd drawer)		9994		Value of feeding/widthwise direction	Refer to contents	210~356/ 148~216	SYS	<Default value> ODA: 279/216 Others: 297/210	10