

OKI

MULTIFUNCTIONAL DIGITAL COLOR SYSTEMS /
MULTIFUNCTIONAL DIGITAL SYSTEMS

Operator's Manual for FAX Unit

GD-1320/GD-1260

for ES9455 MFP
ES9465 MFP/ES9475 MFP

Preface

Thank you for purchasing the Oki FAX Unit GD-1320/GD-1260.



This Operator's Manual describes how to use the fax functions, troubleshooting and its maintenance, etc. Before using the fax functions, thoroughly read and understand this Operator's Manual. To ensure that the fax functions are used in optimum working conditions, keep this Operator's Manual in a handy place for future reference.

Before Reading This Manual



■ How to read this manual

□ Symbols in this manual

In this manual, some important items are described with the symbols shown below. Be sure to read these items before using this equipment.

-  **WARNING** Indicates a potentially hazardous situation which, if not avoided, could result in death, serious injury, or serious damage, or fire in the equipment or surrounding objects.
-  **CAUTION** Indicates a potentially hazardous situation which, if not avoided, may result in minor or moderate injury, partial damage to the equipment or surrounding objects, or loss of data.
-  **Note** Indicates information to which you should pay attention when operating the equipment.

Other than the above, this manual also describes information that may be useful for the operation of this equipment with the following signage:

-  **Tip** Describes handy information that is useful to know when operating the equipment.
-  Pages describing items related to what you are currently doing. See these pages as required.

□ Model and series names in this manual

In this manual, each model name is replaced with the series name as shown below.

Model name	Series name in this manual
ES9455 MFP	ES9455 MFP
ES9465 MFP / ES9475 MFP	ES9475 MFP Series

□ Explanation for control panel and touch panel

- The details on the touch panel menus may differ depending on the operating environment such as whether options are installed.
- The illustration screens used in this manual are for paper in the A/B format. If you use paper in the LT format, the display or the order of buttons in the illustrations may differ from that of your equipment.

□ Options

For the available options, refer to “Options” in the **Quick Start Guide** for your equipment.

□ Description of original/paper direction

Paper or originals of A4, B5 or LT size can be placed either in a portrait direction or in a landscape direction. In this manual, “-R” is added to this paper size when this size of paper or original is placed in a landscape direction.

Example: A4 size original on the original glass

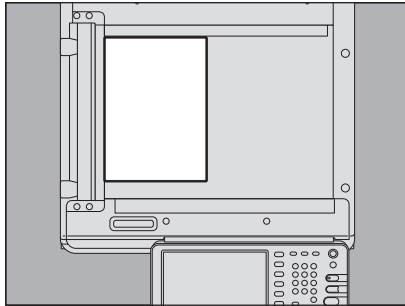

Placed in a portrait direction: A4

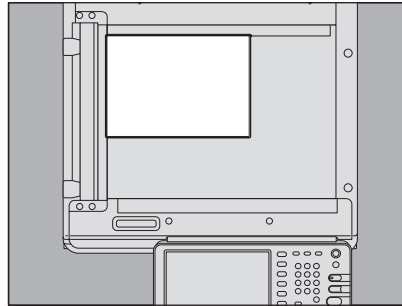

Placed in a landscape direction: A4-R

Paper or originals of A3, B4, LD or LG can only be placed in a landscape direction, therefore “-R” is not added to these sizes.

□ Trademarks

The company names and product names in this manual are the trademarks of their respective companies.

■ Accessories

Accessories Provided for GD-1320

- Modular cable: 1
- Operator's Manual: 1

General Precautions

■ Disclaimer notice

The following notice sets out the exclusions and limitations of liability of Oki Data Corporation (including its employees, agents and sub-contractors) to any purchaser or user (hereafter "User") of the ES9455 MFP/ES9465 MFP/ES9475 MFP, including its accessories, options and bundled software (hereafter "Product").

1. The exclusion and limitations of liability referred to in this notice shall be effective to the fullest extent permissible at law. For the avoidance of doubt, nothing in this notice shall be taken to exclude or limit Oki Data Corporation's liability for death or personal injury caused by Oki Data Corporation's negligence or Oki Data Corporation's fraudulent misrepresentation.
2. All warranties, conditions and other terms implied by law are, to the fullest extent permitted by law, excluded and no such implied warranties are given or apply in relation to the Products.
3. Oki Data Corporation shall not be liable for any loss, cost, expense, claim or damage whatsoever caused by any of the following:
 - use of handling of the Product otherwise than in accordance with the manuals, including but not limited to the Operator's Manual, User's Guide, and/or incorrect or careless handling or use of the Product;
 - any cause which prevents the Product from operating or functioning correctly which arises from or is attributable to either acts, omissions, events or accidents beyond the reasonable control of Oki Data Corporation including without limitation acts of God, war, riot, civil commotion, malicious or deliberate damage, fire, flood, or storm, natural calamity, earthquakes, abnormal voltage or other disasters;
 - additions, modifications, disassembly, transportation, or repairs by any person other than service technicians authorized by Oki Data Corporation; or
 - use of paper, supplies or parts other than those recommended by Oki Data Corporation.
4. Subject to paragraph 1, Oki Data Corporation shall not be liable to Customer for:
 - loss of profits, loss of sales or turnover; loss of or damage to reputation; loss of production; loss of anticipated savings; loss of goodwill or business opportunities; loss of customers; loss of, or loss of use of, any software or data; loss under or in relation to any contract; or
 - any special, incidental, consequential or indirect loss or damage, costs, expenses, financial loss or claims for consequential compensation;

whatsoever and howsoever caused which arise out of or in connection with the Product or the use of handling of the Product even if Oki Data Corporation is advised of the possibility of such damages.

Oki Data Corporation shall not be liable for any loss, cost, expense, claim or damage caused by any inability to use (including, but not limited to failure, malfunction, hang-up, virus infection or other problems) which arises from use of the Product with hardware, goods or software which Oki Data Corporation has not directly or indirectly supplied.

CONTENTS

Preface.....	1
Before Reading This Manual	2
General Precautions.....	4

Chapter 1 BEFORE USING FAX

Description of Each Component.....	8
Control panel.....	8
Touch panel.....	10
Options	11
Connecting Cables	12

Chapter 2 SENDING/RECEIVING A FAX

Sending a Fax	14
Basic procedures.....	14
Handling an original.....	17
Setting the transmission conditions.....	21
Specifying the recipient	25
Other transmissions.....	32
Receiving a Fax	35
Reception mode	35
Originals and paper	37

Chapter 3 CHECKING AND CANCELING THE COMMUNICATIONS

Checking Communications	42
Checking reserved transmissions.....	42
Checking communication status (log).....	43
Canceling the Transmission.....	45
Canceling the memory transmission	45
Canceling direct transmissions.....	47
Canceling reserved transmissions.....	48

Chapter 4 ADVANCED FUNCTIONS

Transmitting 2-Sided Originals	50
Priority Transmission.....	52
Polling Communication	53
Polling transmission.....	53
Polling reception	54
Mailbox Transmission.....	55
Registering/printing/deleting an original	56
Sending/retrieving an original	60
Creating/modifying/deleting a mailbox.....	63
Chain Dial Communication.....	68
Delayed Transmission Reservation.....	69
Recovery Transmission	70

Onramp Gateway	71
Offramp Gateway	72
Save as File	73
Printing SECURE RECEIVE fax jobs.....	75

Chapter 5 PRINTING LISTS AND REPORTS

Printing Lists & Reports Manually	78
Journal (transmission journal/reception journal).....	78
Reservation list.....	79
Mailbox/relay box report	80
Printing Lists & Reports Automatically.....	81
Lists/Reports Samples.....	82
Transmission journal	82
Reception journal.....	83
Reservation list.....	83
Mailbox/relay box report	84
Memory transmission report.....	85
Transmission report.....	86
Multi transmission report	86
Multi polling report	87
Relay TX orig. terminal report.....	87
Relay TX relay station report.....	88
Relay TX end terminal report.....	88
Relay station report	89
Mailbox reception report.....	89

Chapter 6 SETTING ITEMS

User Settings	92
Fax settings	92
Administrator Settings.....	95
Registering the terminal ID	97
Setting the initial setup	98
Setting RX printing.....	100
Setting recovery transmission	102
Setting 2nd Line for FAX Unit.....	103
SECURE RECEIVE.....	104

Chapter 7 TROUBLESHOOTING AND SPECIFICATIONS

Troubleshooting	108
Error codes.....	108
Error messages	108
Transmission/reception trouble	109
Specifications of GD-1320/GD-1260.....	110

INDEX	111
--------------------	------------

BEFORE USING FAX

This chapter describes the basics of this equipment you should learn before you start using it.

Description of Each Component	8
Control panel	8
Touch panel	10
Options	11
Connecting Cables	12

Description of Each Component

■ Control panel

This section describes the buttons on the control panel used for the fax functions. For any details of the control panel not covered in this document, refer to the **Quick Start Guide**.

ES9455 MFP / ES9475 MFP Series

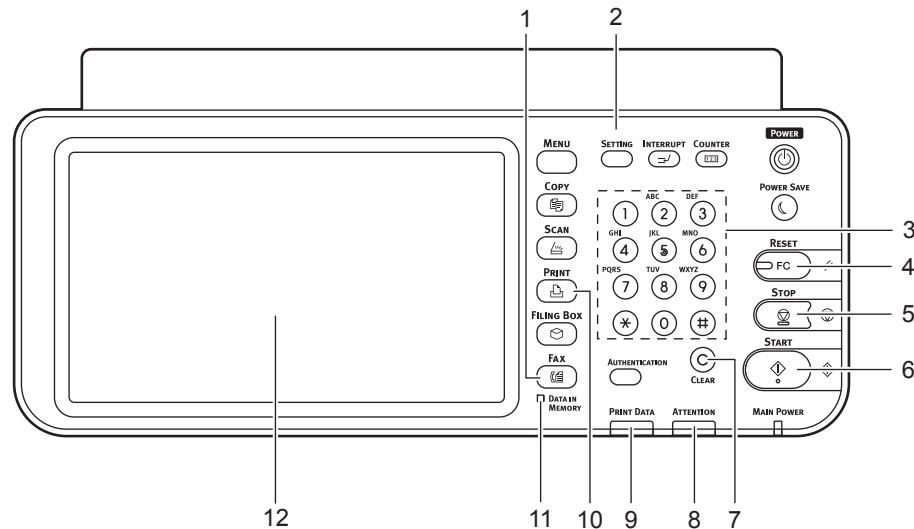

1. [FAX] button

Use this button to display the fax screen when you use the fax function.

Tip

When you use the Internet Fax function, you also press this button. For details of the Internet Fax function, refer to the **Scanning Guide**.

2. [SETTING] button

Use this button when you register/make settings such as initial setting for the fax function.

3. Digital keys

Use these keys to enter fax numbers, etc.

4. [RESET] button

Use this button to clear all current selected functions and return to the default settings.

5. [STOP] button

Use this button to stop any scanning in progress.

6. [START] button

Use this button to start scanning a document for fax transmission.

7. [CLEAR] button

Use this button to cancel entered numbers.

8. ATTENTION lamp

This lamp lights when an error occurs and this equipment needs some actions to be taken.

9. DATA lamp

This lamp lights when there is a received SECURE RECEIVE fax job.

10. [PRINT] button

Use this button to print a SECURE RECEIVE fax job.

11. DATA IN MEMORY

This lamp lights when there is a received fax which is not printed yet and its data are still in the memory.

12. Touch panel

📖 P.10 "Touch panel"

Tip

This lamp does not light when the equipment is in the Super Sleep mode.

■ Touch panel

This section describes the fax screen on the touch panel. For any details of the touch panel not covered in this document, refer to the **Quick Start Guide**.

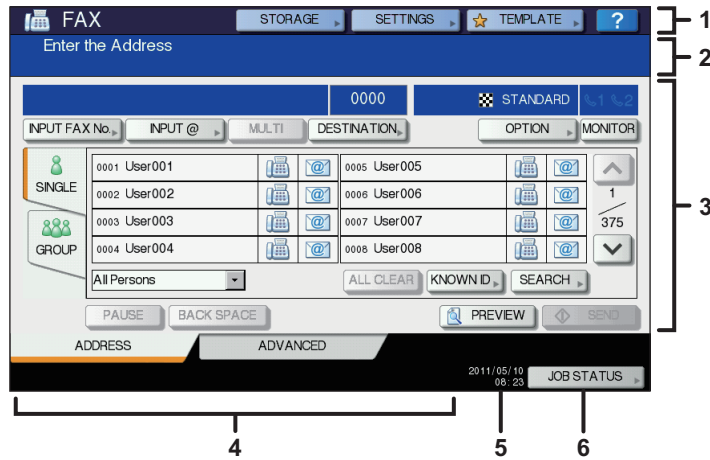

1. Header area

The name of the currently selected function and buttons related to the current status of this equipment are shown here.

2. Message indication area

Various messages such as the status of this equipment and operating instructions are shown here.

3. Operation object area

Operation-related buttons and text boxes are shown here.

4. Alert message indication area

Messages are shown here to inform you of various alerts such as the replacement time of toner cartridges and waste toner boxes, or the existence of a received SECURE RECEIVE fax job.

5. Date and time

The current date and time are shown here.

6. [JOB STATUS] button

Use this button to view the job status or its history.

Tip

When this equipment is managed under the department management or user management, key in user information such as the department code, user name and password to display the operation screen. For details of the operation, refer to the **Quick Start Guide**.

■ Options

This section describes the options related to the fax function.

- **FAX Unit**
This unit enables the use of the fax function.
- **2nd Line for FAX Unit (GD-1260)**
This board enables the use of 2 lines for sending and receiving faxes.

Connecting Cables

Be sure that the power of this equipment is turned OFF before connecting the cables.

ES9455 MFP

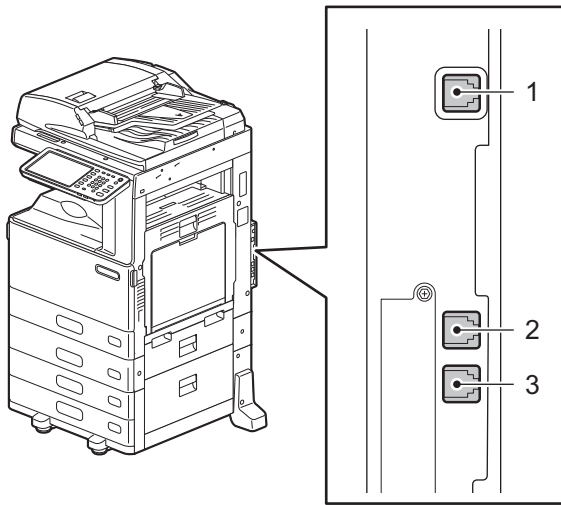

ES9475 MFP Series

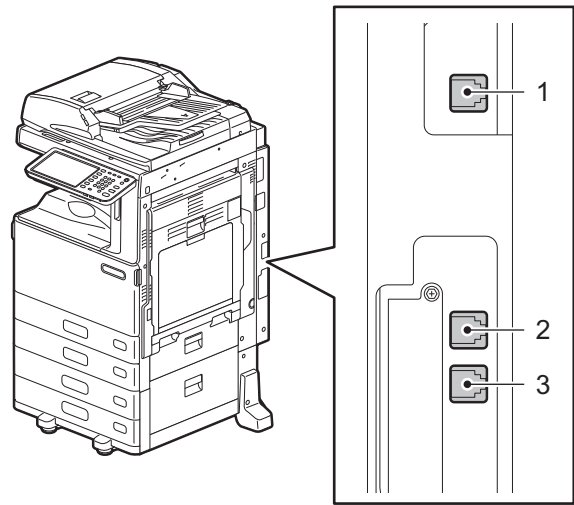

1. **LINE2**
Connect a telephone line when the 2nd Line for FAX Unit is installed.
2. **LINE**
Connect a telephone line.
3. **TEL**
Connect an external telephone.

Notes

- Do not connect this equipment and the external telephone to a telephone connector in parallel.
- Use the external telephone without an answerphone (or with the function off) to be connected with the TEL.

SENDING/RECEIVING A FAX

This chapter describes how to send and receive a fax.

Sending a Fax	14
Basic procedures	14
Handling an original	17
Setting the transmission conditions	21
Specifying the recipient	25
Other transmissions	32
Receiving a Fax	35
Reception mode	35
Originals and paper	37

Sending a Fax

Basic procedures

This section describes the basic procedures to send a fax. For details of in-depth operations, see the page under each procedure as required.

Besides the basic sending functions described in this page, there are various useful ways to send a fax. These procedures are described in the following pages.

📖 P.32 “Other transmissions”

📖 P.49 “ADVANCED FUNCTIONS”

1 Place the original(s).

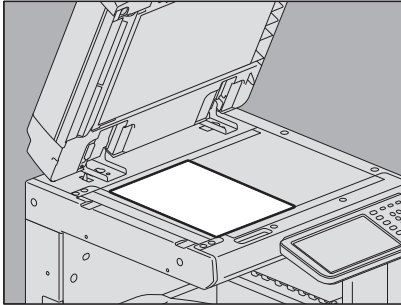

Check the original size and scanning range, etc. Place the original(s) on the original glass or RADF (Reversing Automatic Document Feeder) in the correct direction. (The illustration above shows the original placed on the original glass.)

📖 P.17 “Handling an original”

2 Press the [FAX] button on the control panel.

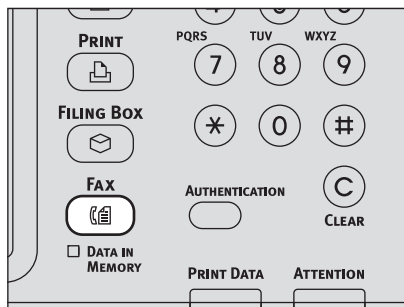

The fax screen is displayed. If you leave the screen unattended for the period of the auto clear setting time (45 sec. by manufacturer default), the screen returns to the default one automatically.

3 Press [OPTION] and set the transmission conditions.



The transmission condition setting screen is displayed. Set the transmission conditions such as resolution, original mode, exposure and transmission mode, as required.

📖 P.21 “Setting the transmission conditions”

4 Specify the recipient.



To specify the recipient, dial the number using the digital keys on the control panel or use the address book.
 📖 P.25 “Specifying the recipient”

5 To display the preview screen, press [PREVIEW].



This feature is available when the hard disk is installed in the equipment.
 📖 P.33 “Displaying the preview”

6 Press [SEND].



The fax is sent or reserved.

Tips

- Alternatively, you can press the [START] button on the control panel.
- In the memory transmission mode, the original is scanned into memory. Once a connection has been made, this equipment automatically starts sending the scanned document. In the direct transmission mode, the fax number is dialed immediately, and the scanned document will be sent. (Transmission conditions can be set in the transmission condition setting screen.)
- If memory becomes full during scanning in the memory transmission mode, that original will not be stored in memory. When that happens, reduce the number of originals you are sending, or try sending them in the direct transmission mode.
- You can check the status of the current sending. You can also cancel the transmission (deletes the job).
 📖 P.41 “CHECKING AND CANCELING THE COMMUNICATIONS”

Redial function

In the memory transmission mode, if the fax cannot be sent due to a busy-line, the fax number is redialed automatically to send the fax. By default, this equipment redials 3 times at 1-minute intervals.

Batch transmission function

If there are multiple transmission jobs to the same recipient in memory, you can send them at once using this function, resulting in reduction of communication costs. However, if their recipients are the same but their transmission conditions vary or if users or departments are different when this equipment is managed under the department management or user management, this function is not applied to those reserved jobs.

Sending the next original

If an original is placed on the original glass and its scanning is completed, the confirmation screen for the next original is displayed. If you want to continue scanning of the next original, place it on the original glass, and then press the [START] button on the control panel. Once all the originals are scanned, press [JOB FINISH]. If you place an original on the RADF (Reversing Automatic Document Feeder) and press the [CONTINUE] button during scanning, the confirmation screen for the next original can be displayed after the scanning is completed.

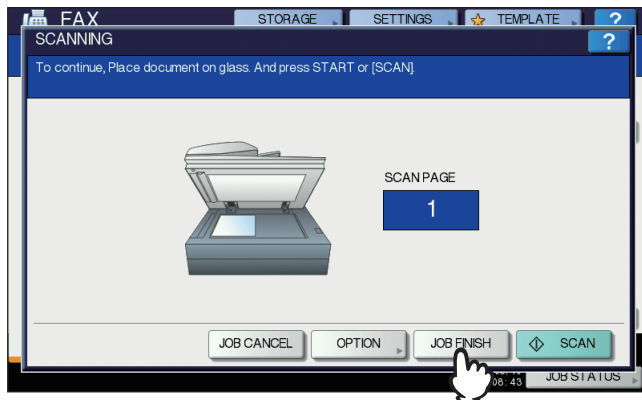

- If you leave the screen unattended for a period of the auto clearance setting time (45 sec. by manufacturer default), a copy of the scanned originals is sent.
- To cancel the transmission in the memory transmission mode, press [JOB CANCEL].
 📖 P.45 "Canceling the memory transmission"
- To change the transmission conditions for each page, press [OPTION].
 📖 P.24 "Changing the settings for each page"

■ Handling an original

□ Originals that can be sent

This equipment can send a fax of the following originals.

You can place 1-sided or 2-sided originals of the media types, such as standard paper, recycled paper and paper having holes (2, 3 or 4 holes) for filing, on the RADF (Reversing Automatic Document Feeder). On the original glass, you can place 1-sided originals of the above media types as well as OHP film, tracing paper, booklets and three-dimensional objects.

Location	Maximum size	Paper weight	Original size
Original glass	Length: 297 mm (11.69") Width: 432 mm (17.01")	—	North American format: LD, LG, LT, LT-R, ST, ST-R, COMP A/B format: A3, A4, A4-R, A5, A5-R, B4, B5, B5-R, FOLIO
RADF	Length: 297 mm (11.69") Width: 432 mm (17.01")	1-sided originals 35 - 157 g/m ² (9.3 - 41.8 lb.) 2-sided originals 50 - 157 g/m ² (13.3 - 41.8 lb.)	North American format: LD, LG, LT, LT-R, ST-R, COMP A/B format: A3, A4, A4-R, A5-R, B4, B5, B5-R, FOLIO (ST/A5 is not available)

Notes

- Do not place any heavy objects (4 kg/9 lb. or over) on the original glass and do not press on it with force.
- If the original is any of the following sizes, it is automatically rotated and sent as described below.
A4 → A4-R
A5-R → A5
B5-R → B5
LT → LT-R
ST-R → ST

□ Original scanning range

The following figures show the original scanning area. Any information in the shaded area is not printed on the paper.

1. LD, LG, LT-R, ST-R, COMP, A3, A4-R, A5-R, B4, B5-R, FOLIO
2. LT, ST, A4, A5, B5

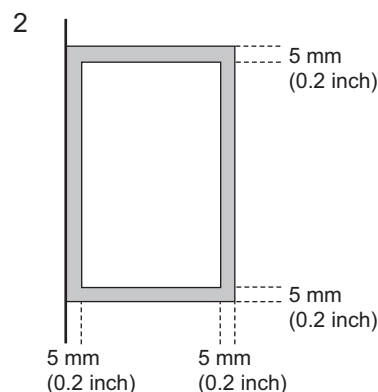
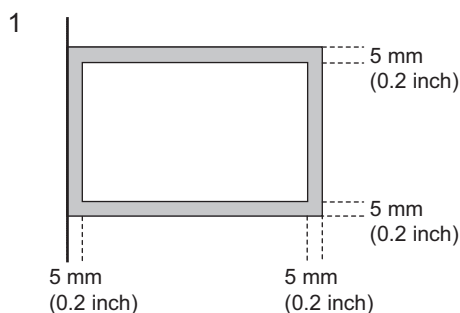

□ Placing the original(s) on the original glass

This section describes how to set an original on the original glass. Originals are sent in the order they are placed on the original glass.

⚠ CAUTION

Do not place any heavy objects (4 kg/9 lb. or over) on the original glass and do not press on it with force. Breaking the glass could injure you.

- 1 Raise the Original Cover or RADF (Reversing Automatic Document Feeder), and place the original with its face down on the glass.**

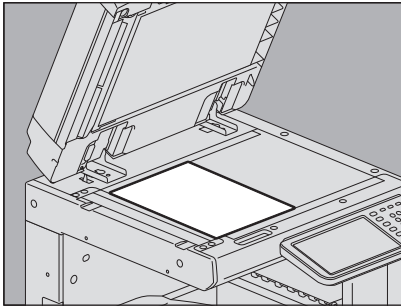

Raise it 60 degrees or more for the detection of the original.

- 2 Align the original against the left inner corner of the glass.**

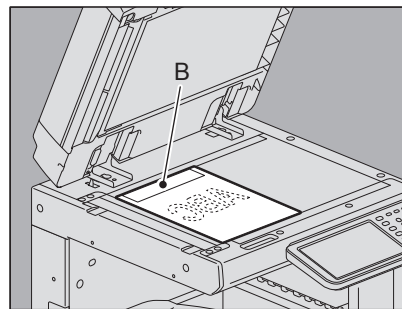
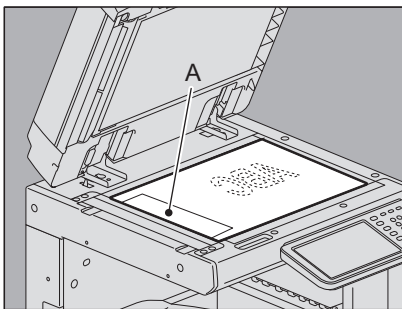

- Different size originals can also be sent in one transmission.
- When an original of any size other than LT/A4 is placed in the direction shown in the above left figure, transmission to a recipient is carried out so that the pre-entered sender information is printed in position A in the figure.
- When an original of LT/A4 size is placed in the direction shown in the above right figure, transmission to a recipient is carried out so that the pre-entered sender information is printed in position B in the figure.
- The pre-entered sender information shows what is registered in the Terminal ID.
 □ P.97 "Registering the terminal ID"

- 3 Lower the Original Cover or RADF slowly.**

□ Placing the original(s) on the RADF

This section describes how to set the original(s) on the RADF (Reversing Automatic Document Feeder). When the originals are placed on the RADF, the uppermost page is the first to be scanned and sent.

- 1** After aligning the originals, place them with their face up and slide the guides to rest against the edges of the originals.

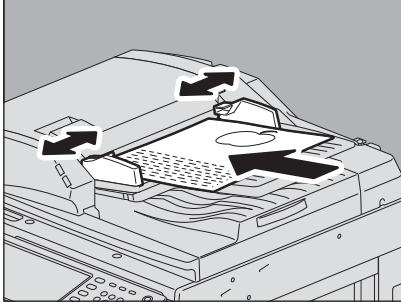

- Regardless of their sizes, originals are acceptable up to 100 sheets (35 to 80 g/m² (9.3 to 20 lb.)) or 16 mm (0.62") in height.
- 2-sided originals can be set and sent.
 □ P.50 "Transmitting 2-Sided Originals"

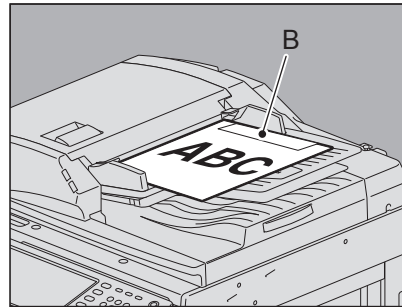
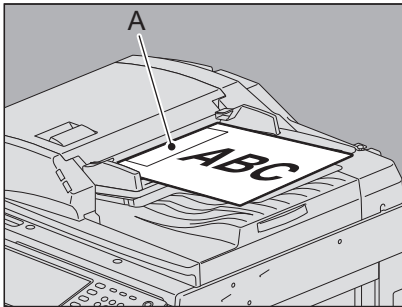

- When an original of any size other than LT/A4 is placed in the direction shown in the above left figure, transmission to a recipient is carried out so that the pre-entered sender information is printed in position A in the figure.
- When an original of LT/A4 size is placed in the direction shown in the above right figure, transmission to a recipient is carried out so that the pre-entered sender information is printed in position B in the figure.
- The pre-entered sender information shows what is registered in the Terminal ID.
 □ P.97 "Registering the terminal ID"

Sending different width originals

To set different width originals, adjust the side guides to the widest original size, and then align the original against the front side. Available combinations of the original size are as follows.

- A/B format: A3, A4, B4, B5, A4-R, FOLIO
- North American format: LD, LT, COMP, LG, LT-R

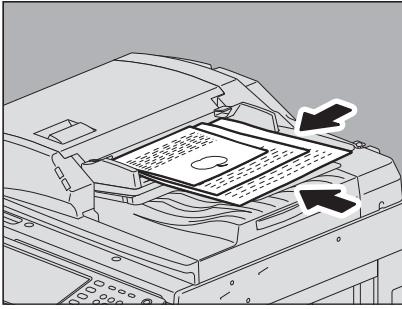





Tip

To send different width originals, you need to enable "DIFFERENT WIDTH" as a transmission condition.



P.21 "Setting the transmission conditions"

Precautions for using the RADF

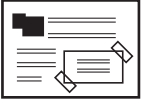
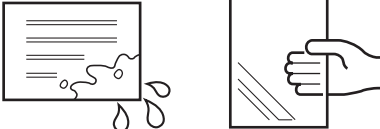
Do not use the following originals as they may misfeed or become damaged:

<p>(1) Badly wrinkled or folded originals. In particular, originals whose leading edge are curled may fail to be fed.</p> 	<p>(4) Clipped or stapled originals</p> 
<p>(2) Originals with carbon paper</p> 	<p>(5) Originals with holes or torn originals</p> 
<p>(3) Taped, pasted or clipped (cut out) originals</p> 	<p>(6) Damp originals (7) OHP film originals</p> 

The following originals should be handled carefully:

<p>(1) Folded or curled originals should be smoothed out before being used.</p>	
<p>(2) Originals sticking to each other, or originals that are surface-treated may fail to separate properly.</p>	

■ Setting the transmission conditions

You can set the fax transmission conditions.



Tips

- The transmission conditions are only applied to the current transmission. They return to the default settings after the transmission.
- Each default setting of resolution, original mode, exposure, transmission mode and ECM is adjustable.
 P.92 "Fax settings"

□ Making settings

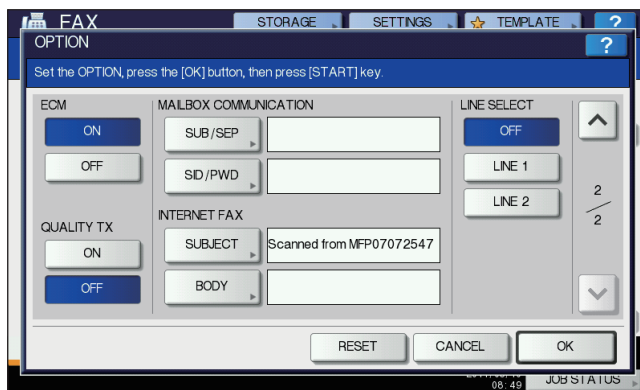
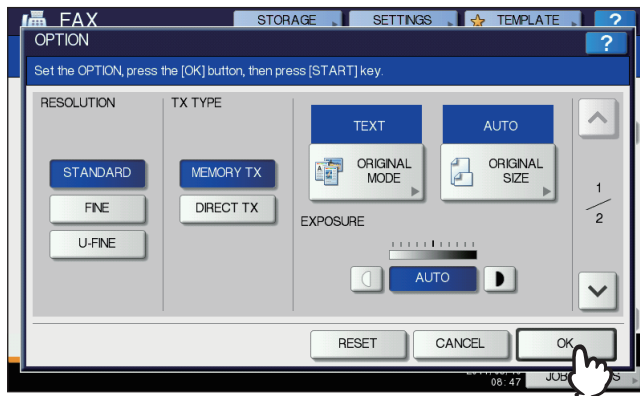
Pressing [OPTION] on the fax screen will display the transmission condition setting screen as shown below. Set each setting item, and then press [OK].



- Press  or  to switch the pages.
- To cancel the operation and return to the previous screen, press [RESET].

RESOLUTION

Set the resolution based on the fineness of the original.

- STANDARD: This is suitable for an original with regular size text.
 FINE: This is suitable for an original with small size text and fine illustrations.
 U-FINE: This is suitable for an original with ultra-fine illustrations.

Tip

If the recipient's fax machine is not capable of receiving originals at the same resolution, the resolution is automatically converted before being sent to the recipient. The higher the resolution is, the longer it takes to send an original.

TX TYPE

Set the fax transmission mode.

- MEMORY TX: Send the original after the scanned data are saved in the memory. Up to 100 transmissions of up to 1000 pages per 1 transmission can be reserved, or up to 50 transmissions when the hard disk is not installed.
 DIRECT TX: Send the original directly as it is being scanned. Once a page has been scanned and sent, the next page is scanned and sent. Therefore, it takes longer to scan and send all pages. However, you can confirm on the fly that each page is sent to the recipient.

ORIGINAL MODE

Set the scanning mode based on the type of the original.

- TEXT: This is suitable for an original with text and line drawings.
 TEXT/PHOTO: This is suitable for an original with a mixture of text and photos.
 PHOTO: This is suitable for an original with photos.

Tip

In the TEXT/PHOTO mode or PHOTO mode, transmission time may be longer than that in the TEXT mode.

ORIGINAL SIZE

Set the scan size of the original.

- AUTO: The size of the original is automatically determined before the original is scanned.
 DIFFERENT WIDTH: Select this function to load the originals with different width into the RADF (Reversing Automatic Document Feeder).
 Specified size: The original is scanned at the preset size regardless of its actual size.

Tip

If the recipient's fax machine is not capable of receiving originals of B5/B5-R size, this equipment may reduce that size before sending it. To avoid this, when the original to be set is B5 and B5-R size, specify A4 and A4-R size respectively.

EXPOSURE

Set the density at which the original is to be scanned.

- AUTO: This equipment automatically detects the contrast of the original, and scans it with the optimum density.
 Manual: Press or to set the desired contrast.

ECM

Switch the ECM (Error Correction Mode) communication ON or OFF. ECM is an internationally standardized communication mode that automatically corrects errors that occur during fax transmissions. With this setting option ON, even when the transmitted data have been affected by noise during communication, this mode allows good communication without image distortion by automatically resending the parts that have been affected.

Notes

- Both the sender and the receiver must have the ECM function to make ECM communication available.
- When affected by noise during communication, communication time is slightly longer than usual. Even when the ECM communication is used, an error may occur depending on the line status.
- The ECM communication is not available for voice communication.

QUALITY TX

Switch Quality TX ON or OFF. When this mode is set to ON, originals are sent at a slower speed than usual and the chances of errors occurring decrease.

MAIL BOX COMMUNICATION

For the communication compatible with ITU-T (International Telecommunications Union-Telecommunications) standards, specify a subaddress or password to be sent to the recipient's fax machine. (Up to 20 digits can be entered.)

SUB (Subaddress):	Information to send data of the original to the fax machine.
SEP (Selective Polling):	Information to retrieve data of the original from the fax machine.
SID (Sender Identification):	Password for SUB.
PWD (Password):	Password for SEP.

Tip

To use this function, the recipient's fax machine must be capable of setting an ITU-T compatible subaddress or password.

INTERNET FAX

SUBJECT: The subject of the Internet Fax
 BODY: The body of the Internet Fax

This is not used for sending a standard fax.

LINE SELECT

Specify the line to be used for sending a fax when the 2nd Line for FAX Unit is installed.

 P.103 "Setting 2nd Line for FAX Unit"

AUTO: The line is switched automatically.
 LINE 1: The 1st line is used.
 LINE 2: The 2nd line is used.

□ Changing the settings for each page

You can change the scanning conditions (RESOLUTION, MODE, EXPOSURE and ORIGINAL) for each page.

- 1 Specify the recipients and press [SEND] to start scanning a document. When the scanning of the original is completed, the confirmation screen for the next original is displayed. Press [OPTION].

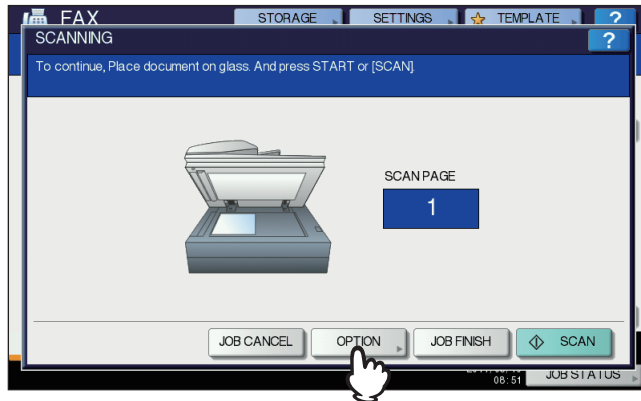

The illustration above shows the original placed on the original glass. If you place an original on the RADF (Reversing Automatic Document Feeder) and press the [CONTINUE] button during scanning, the confirmation screen for the next original is displayed after the scanning is completed. If you press the [STOP] button during scanning, the scanning halts and the confirmation screen for the next original can be displayed.

- 2 The setting screen for the scanning conditions is displayed. Change the setting, and then press [OK].

📖 P.21 "Making settings"

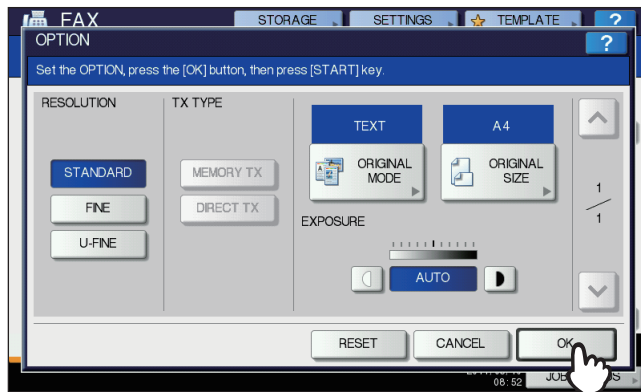

■ Specifying the recipient

There are various ways to specify the recipient, such as Direct entry with the control panel and Address book entry.

Tip

To use the address book, you need to register recipients' fax numbers to the book in advance. For details of the operation, refer to the *MFP Management Guide* or *TopAccess Guide*.

□ Direct entry with digital keys

You can specify the recipient by entering its fax number on the control panel.

1 Press [INPUT FAX No].



2 Key in the recipient's fax number and press [OK].

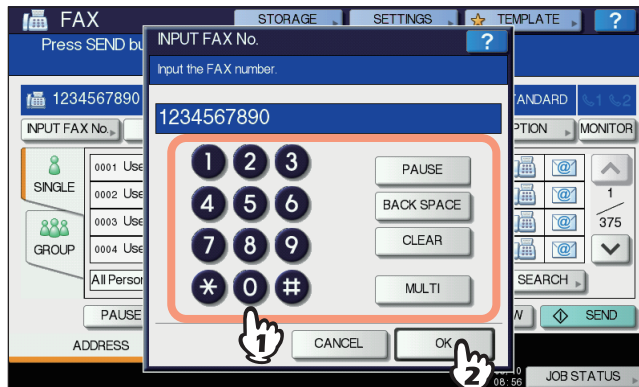

- You can also enter the recipient's address with the digital key on the control panel.
- To delete the entered fax number one number at a time, press [BACK SPACE].
- To delete the entire entered fax number in one go, press the [CLEAR] button.

3 Confirm the fax number displayed on the fax screen.

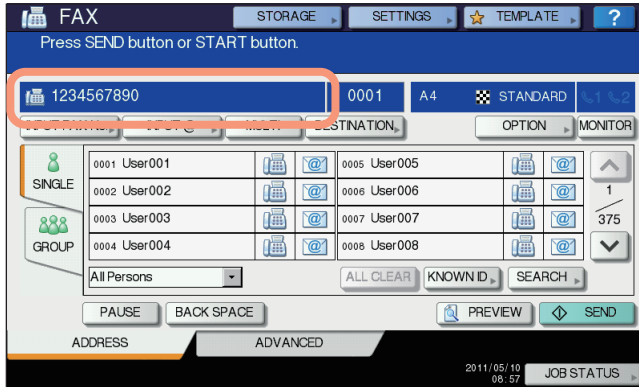

- To delete each entered value, press [BACK SPACE].
- To delete all the entered values at once, press the [CLEAR] button on the control panel.
- In the memory transmission mode, you can specify multiple recipients to send the same document at once. Press [MULTI], and enter the recipient's fax number. Repeat this operation until all the recipients are specified. You can also specify the recipients' fax numbers by combining with other entry methods. The number of recipients you can simultaneously specify is limited to 400.
- To confirm all the selected recipients or delete unnecessary recipients, press [DESTINATION].
 ⓘ P.31 "Confirming the recipients"

□ Specifying the recipient in the address book

In the address book, you can specify the recipient.

1 Press [SINGLE] tab to display the list of the addresses, and then press the recipient's FAX icon (☎).

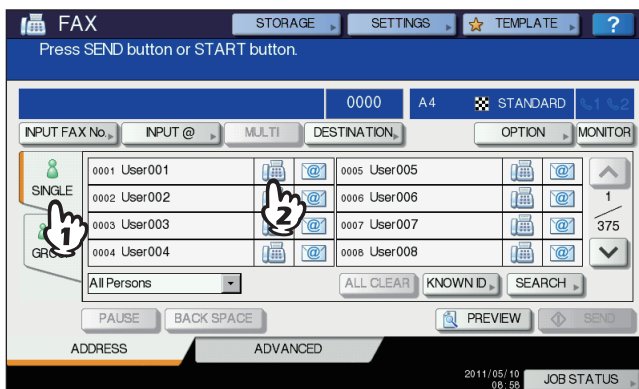

- Press or to switch the pages.
- Alternatively, you can select the recipient by pressing the address name box. In such case, if a fax number and an E-mail address have been registered to the recipient's address, both of them are selected.
- To cancel the selected recipient, press it again.
- In the memory transmission mode, you can specify multiple recipients to send the same document at once. Repeat the recipient selection operation until all the recipients are selected. For the multi-address transmission, you can also specify recipients by combining with other entry methods. The number of recipients you can simultaneously specify is limited to 400.
- To confirm all the selected recipients or delete unnecessary recipients, press [DESTINATION].
 ⓘ P.31 "Confirming the recipients"
- To refine your search only for items including specified characters, press the pull-up menu.
- A list of recipients can be displayed using 11 to 15 characters per name.

□ Group entry

In the address book, you can specify the group to which you want to send a fax.

1 Press [GROUP] tab to display the list of the groups, and then press the group name.

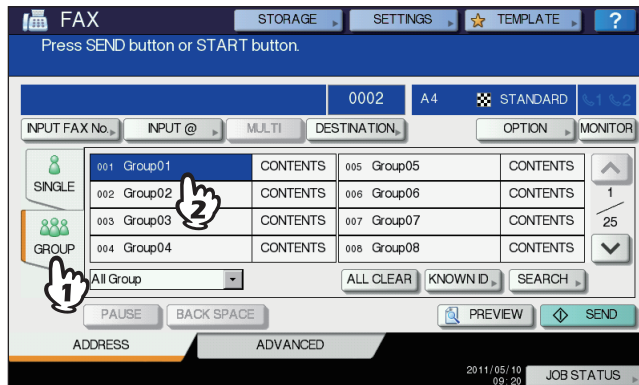

- Press \uparrow or \downarrow to switch the pages.
- To cancel the selected group, press it again.
- To confirm the addresses registered in that group, press [CONTENTS].
- In the memory transmission mode, you can specify multiple groups to send the same document at once. Repeat the recipient selection operation until all the recipients are selected. For the multi-address transmission, you can also specify recipients by combining with other entry methods. The number of groups you can simultaneously specify is limited to 200 groups of up to 400 recipients per 1 group. When the hard disk is not installed, the number of groups you can simultaneously specify is limited to 40 groups of up to 80 recipients per 1 group.
- To pause all the selected recipients or delete unnecessary recipients, press [DESTINATION].
 □ P.31 "Confirming the recipients"
- To refine your search only for items including specified characters, press the pull-up menu.

□ Searching by ID number

You can search for a specific recipient from the address book using the ID number.

1 Press [KNOWN ID].



- 2** Key in the desired ID number (1 to 1000) using the digital keys on the control panel, and then press [OK].

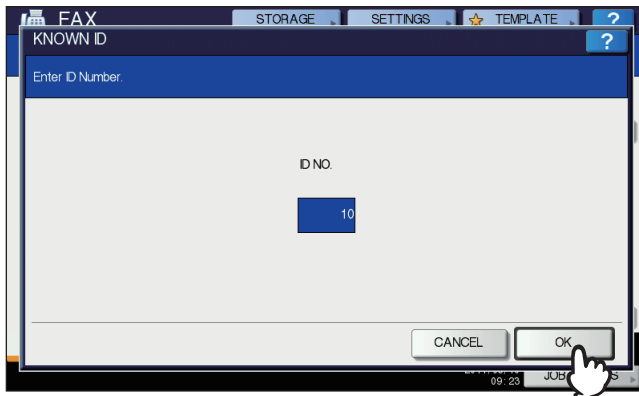

The ID number is the one shown in the destination name box. The number ranges from 001 to 1000.

- 3** The page including the entered ID number is displayed. Press the FAX icon (☎).

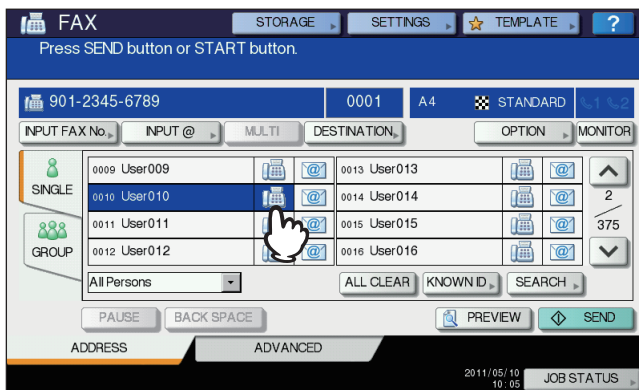

- Press or to switch the pages.
- Alternatively, you can select the recipient by pressing the address name box. In such case, if a fax number and an E-mail address have been registered to the recipient's address, both of them are selected.
- To cancel the selected recipient, press it again.
- In the memory transmission mode, you can specify multiple recipients to send the same document at once. Repeat the recipient selection operation until all the recipients are selected. For the multi-address transmission, you can also specify recipients by combining with other entry methods. The number of recipients you can simultaneously specify is limited to 400.
- To confirm all the selected recipients or delete unnecessary recipients, press [DESTINATION].
 ☰ P.31 "Confirming the recipients"

□ Searching for the recipient's fax number

You can search for the recipient's fax number from the address book and LDAP server.

Tip

To search for the recipient's fax number from the LDAP (Lightweight Directory Access Protocol) server, the name of the LDAP server to be connected is required to be registered to this equipment in advance. For details of the LDAP server, ask your network administrator.

1 Press [SEARCH].



- To display the recipient search menu, press [SEARCH] while the address list is displayed. Perform this operation when you want to search the LDAP server.
- To display the group search menu, press [SEARCH] while the group list is displayed.

2 Press the button of the keyword category you want to search. Enter the keyword. Press [SEARCH].

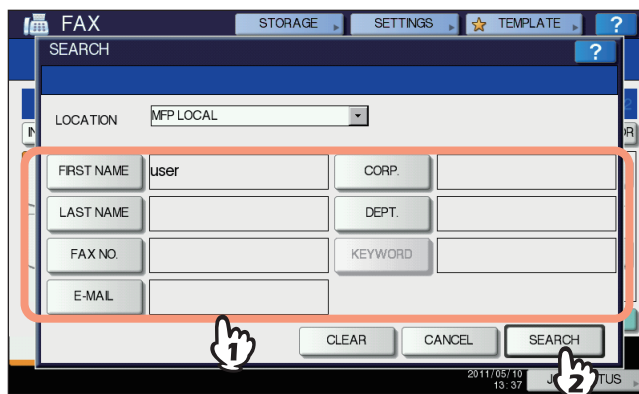

- For details of the operation to enter characters, refer to the **Quick Start Guide**.
- To cancel the entered keyword, press [CLEAR].
- You can search for the desired recipient's fax number by specifying multiple keywords.

Selecting the LDAP server

To search for the recipient's fax number in the LDAP server, press the pull-down menu in the recipient search menu. The list of the LDAP servers is displayed. Press the LDAP server name you want to search, and then press [OK].

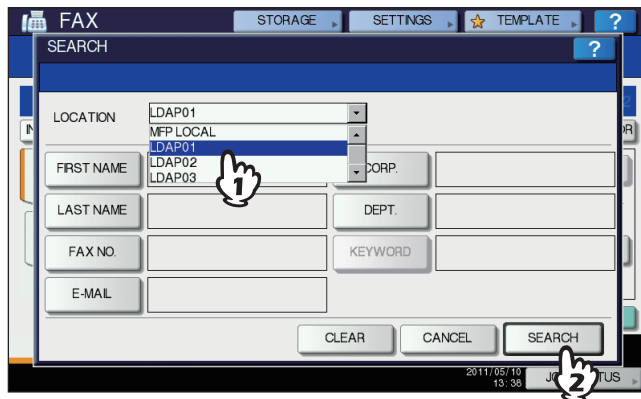

3 The search result is displayed. Press the desired FAX icon (📠), and then press [OK].

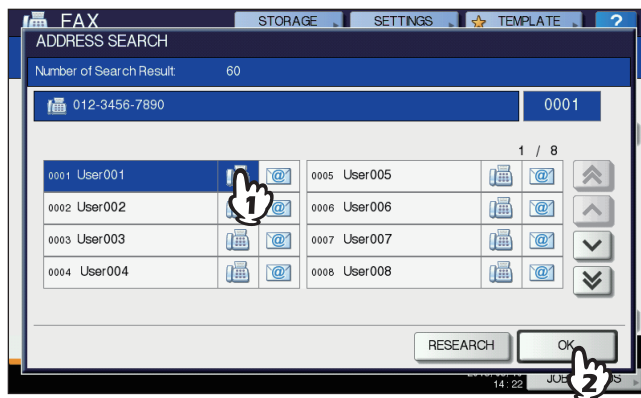

- Press or to switch the pages. Pressing or allows you to skip 5 pages.
- Alternatively, you can select the recipient by pressing the address name box. In such case, if a fax number and an E-mail address have been registered to the recipient's address, both of them are selected.
- To cancel the selected recipient, press it again.
- In the memory transmission mode, you can specify multiple recipients to send the same document at once. Repeat the recipient selection operation until all the recipients are selected. For the multi-address transmission, you can also specify recipients by combining with other entry methods. The number of recipients you can simultaneously specify is limited to 400.
- To confirm all the selected recipients or delete unnecessary recipients, press [DESTINATION].
 P.31 "Confirming the recipients"
- If you want to change the results of the search, press [CHANGE]. You will be returned to the Step 2 screen. Specify the search string again.

□ Confirming the recipients

You can confirm the recipients which you specified or delete unnecessary recipients.

1 Press [DESTINATION].



2 The recipient list screen is displayed. Select the recipient you want to delete, and then press [DELETE].

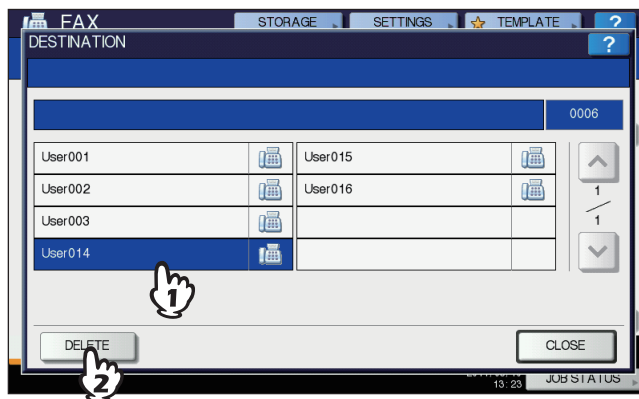



- Press or to switch the pages.
- Press [CLOSE] to return to the previous screen.

Other transmissions

On-hook transmission

In this mode, you can dial and perform direct fax transmission without picking up the handset of the external telephone. On-hook Transmission is available when  on the upper right of the screen is OFF.

- 1 Place the original(s).**
 P.17 “Handling an original”
- 2 Press the [FAX] button on the control panel.**
 P.14 “Basic procedures”
- 3 Press [OPTION] and set the transmission conditions.**
 P.21 “Setting the transmission conditions”
- 4 Press [MONITOR].**



- Make sure that you hear the dial tone from the built-in speaker.
- To cancel the operation, press [MONITOR] again.

Note

To use the [SEARCH] to specify the recipients, you must specify the recipient in advance by following the procedures below. Specify the recipients, and then press [MONITOR].

- 5 Specify the recipients.**
 P.25 “Specifying the recipient”

Notes

- For direct entry, each press of a digital key on the control panel dials a number. If you make a mistake when dialing the fax number, press [MONITOR] to cut the line, and then press it again to redial.
- If you specified the recipient with the [SEARCH], press [MONITOR], and then [DIAL].





- 6 When you hear the answer tone (short high-pitched tone) through the built-in speaker indicating the connection has been made with the recipient's machine, press [SEND].**
 P.14 “Basic procedures”

Note

When you hear the other party's voice answering the call before pressing [SEND], pick up the handset of the external telephone. Then ask him/her to perform operation of the fax reception.

□ Off-hook transmission

In this mode, you can pick up the handset of the external telephone to dial and perform direct fax transmission. Off-hook Transmission is available when  on the upper right of the screen is OFF.

- 1 Place the original(s).**
 P.17 "Handling an original"
- 2 Press the [FAX] button on the control panel.**
 P.14 "Basic procedures"
- 3 Press [OPTION] and set the transmission conditions.**
 P.21 "Setting the transmission conditions"
- 4 Pick up the handset of the external telephone.**
- 5 Use the external telephone to dial the fax number.**
 P.25 "Specifying the recipient"

Note

When you use the external telephone to dial, the machine dials each number you enter. If you make a mistake when dialing the fax number, replace the handset to cut the line, and then pick up the handset again to redial.

- 6 When you hear the answer tone (short high-pitched tone) through the built-in speaker indicating the connection has been made with the recipient's machine, press [SEND].**
 P.14 "Basic procedures"

Note

When you hear the other party's voice answering the call before pressing [SEND], ask him/her to perform operation of the fax reception.

- 7 Replace the handset of the external telephone.**

□ Displaying the preview

Before sending a fax, you can check the image on the touch panel with this preview function. This feature is available when the hard disk is installed in the equipment.

- 1 Press [PREVIEW] on the fax menu.**



- To use the preview function, specify the recipient and then press [PREVIEW].

2 Press [SEND].



3 Check the fax image after the preview is displayed. Press [OK] if you send it without any change. The fax will then be sent.

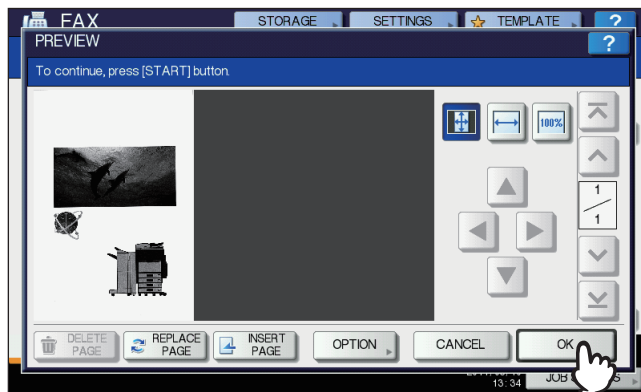

- To send another original, place it on the original glass or RADF (Reversing Automatic Document Feeder), and then press the [START] button on the control panel.
 - To delete the page being previewed, press [DELETE PAGE].
 - To replace the page being previewed with another page, press [REPLACE PAGE].
 - To insert another scan before the page being previewed, press [INSERT PAGE].
 - Press [OPTION] to change the setting.
- 📖 P.21 "Setting the transmission conditions"

Receiving a Fax

■ Reception mode

This section describes how to receive a fax. Refer to the appropriate section for your current reception mode. The reception mode can be set on the ADMIN menu. For details of the current setting, ask your administrator. Besides the receiving methods described in this page, there are various useful ways to receive a fax. These procedures are described in the following pages.

📖 P.53 “Polling Communication”

📖 P.55 “Mailbox Transmission”

□ AUTO reception

Faxes are automatically received during an incoming call. Users do not have to do anything when receiving a fax.

Tip

When the 2nd Line for FAX Unit is installed, the reception mode of the 2nd line is limited to “AUTO reception”.

□ MANUAL reception

Faxes are manually received by using an external telephone when you have an incoming call.

- 1 Pick up the handset of the external telephone when you have an incoming call.**
If the incoming call is a telephone call, you can start talking.
- 2 If you hear a tone (fax signal) through the handset of the external telephone, press the [FAX] button on the control panel.**
📖 P.14 “Basic procedures”
- 3 Press the [ADVANCED] tab, and then press [MANUAL RECEIVE].**

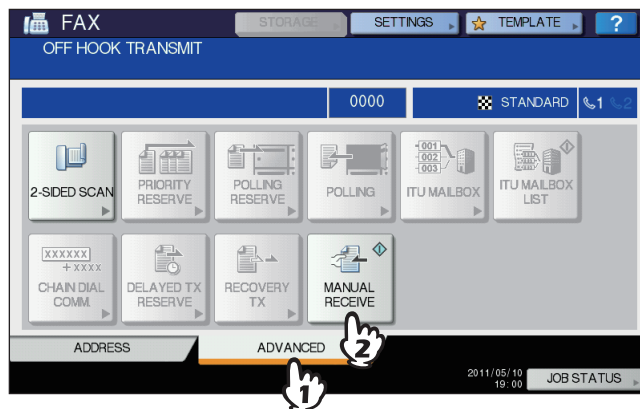

- 4 When a message appears indicating that you can send a fax, press the [START] button on the control panel and replace the handset of the external telephone.**

□ Memory reception

In the following conditions, faxes cannot be printed. If this happens, received fax data are stored in the memory, and printing is resumed as soon as this equipment is ready. As the memory reception function is always enabled, you do not need to make any setting.

- During copying or printing
- During printing of received copy of the originals
- During printing of lists and reports
- When paper has run out
- When a paper misfeed occurs
- When toner has run out

■ Originals and paper

□ Acceptable size of paper

A3, B4, A4, B5, A5, FOLIO, LD, LG, LT, ST and COMP sized paper are available.

The printing range of each size of paper is as follows: As shown in the figures below, if an original document contains any information in the shaded area, it is not printed on the paper.

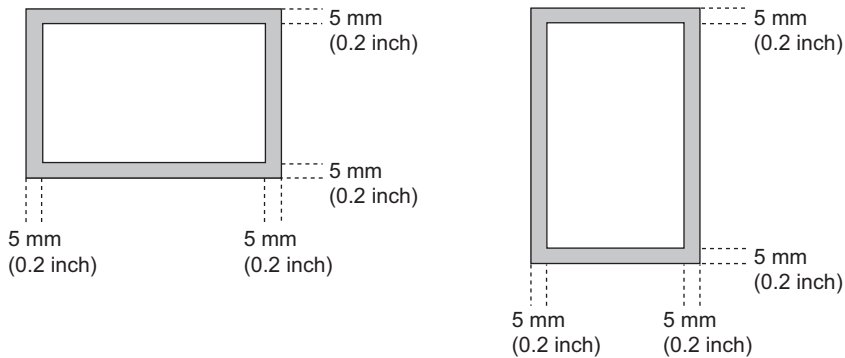

Tips

- Set the paper in the trays or the Large Capacity Feeder. The MPT is not available.
- Regardless of whether or not the Finisher is installed, paper exits on the receiving tray.
- Trays can be set for fax use only. For details of the operation, refer to the **Copying Guide**.

□ Default setting for RX printing

To print the received fax, the paper with the same width as the original is used. Depending on the length of the original, "RX reduction printing" or "Discard printing" (both of them are set to ON by manufacturer default) are applied.

📖 P.100 "Setting RX printing"

When an original is shorter or the same as the paper printing area

It is printed in the original size.

When an original is longer than the paper printing area

It is printed according to the following priority:



























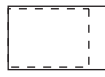

- When an original is up to 10 mm (0.4 inch) longer than the printing area: the part of the originals that exceeds the paper printing area is discarded.
- When an original exceeds the printing area by more than 10 mm (0.4 inch): the original image is reduced to 75 % (reduction printing). If the image still cannot be fitted into the printing area, paper larger than the original is selected. In case there is no larger paper available, the original is printed with the image divided.

□ Paper priority when there is no same size paper

When both “RX reduction printing” and “Discard printing” are set to ON, paper is selected according to the following priority:

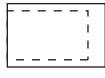
1. Paper of the same size and the same orientation as the original
2. Paper of the same size but with a different orientation to the original
3. Paper of the same orientation but larger than the original

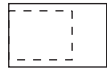



































North American format

Size of Original being Received \ Priority	Ledger	Legal	Letter	Letter	Statement	COMP
1	 Ledger	 Legal	 Letter	 Letter	 Statement	 COMP
2	 Ledger	 Legal	 Letter	 Letter	 Statement	 COMP
3		 Letter Reduced to 75%	 Letter	 Letter	 Letter	 Ledger
4		 Letter Reduced to 75%	 Ledger	 Legal	 Letter	
5		 COMP	 Legal	 COMP	 Legal	
6		 Ledger	 COMP	 Ledger	 COMP	
7					 Ledger	

Notes

- When the corresponding paper size is not available, in most cases, the scanned original is printed on paper of a larger size. However, the sender’s fax machine may reduce the scanned original to fit the paper size available in the recipient’s fax machine (this equipment). (Ex. LD → LT)
- The paper priority varies according to the “RX reduction printing” and “Discard printing” settings. For details, contact your service technician.

A/B format

Size of Original being Received Priority	 A3	 B4	 A4	 A4	 B5	 A5	 FOLIO
1	 A3	 B4	 A4	 A4	 B5	 A5	 FOLIO
2		 A3	 A4	 A4	 B5	 A4	 B4
3			 A3	 B4	 B4	 A4	 A3
4			 B4	 A3	 A4	 B5	 A4 Reduced to 75%
5					 A4	 B5	 A4 Reduced to 75%
6					 A3	 B4	
7						 A3	

Notes

- When the corresponding paper size is not available, in most cases, the scanned original is printed on paper of a larger size. However, the sender's fax machine may reduce the scanned original to fit the paper size available in the recipient's fax machine (this equipment). (Ex. A3 → A4)
- The paper priority varies according to the "RX reduction printing" and "Discard printing" settings. For details, contact your service technician.

CHECKING AND CANCELING THE COMMUNICATIONS

This chapter describes how to check and cancel fax communications.

Checking Communications	42
Checking reserved transmissions	42
Checking communication status (log).....	43
Canceling the Transmission	45
Canceling the memory transmission	45
Canceling direct transmissions.....	47
Canceling reserved transmissions	48

Checking Communications

■ Checking reserved transmissions

You can check reserved fax transmissions.

1 Press [JOB STATUS].



2 Select [FAX].

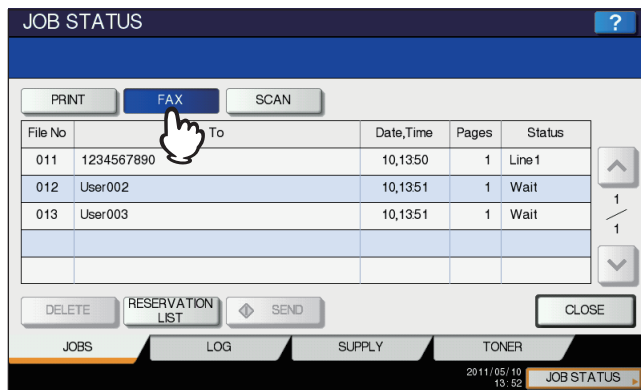

- Reserved transmission jobs are listed in the reversed chronological order from top to bottom.
- Press or to switch the pages.
- To print the list of the reserved transmissions jobs, press [RESERVATION LIST].
- In the "Status" column, the status of each job is indicated as follows:
 - Line1: Sending on the 1st line.
 - Line2: Sending on the 2nd line.
 - Network: Reserved for sending via Internet Fax.
 - Delayed: Reserved with the time to send specified.
 - Wait: Communication is in the standby queue.
 - Invalid: Under standby due to an invalid department code (Network Fax). For details of Network Fax function, refer to the **Network Fax Guide**.

■ Checking communication status (log)

You can check the log of fax transmissions and receptions.

1 Press [JOB STATUS].



2 Select the [LOG] tab, and then press [SEND] or [RECEIVE].

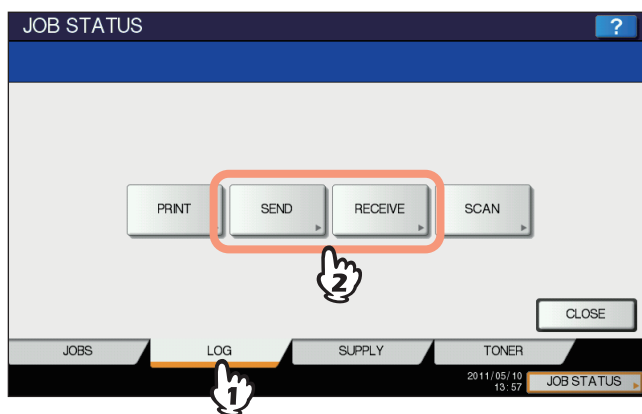

3 The list of the communication status is displayed.

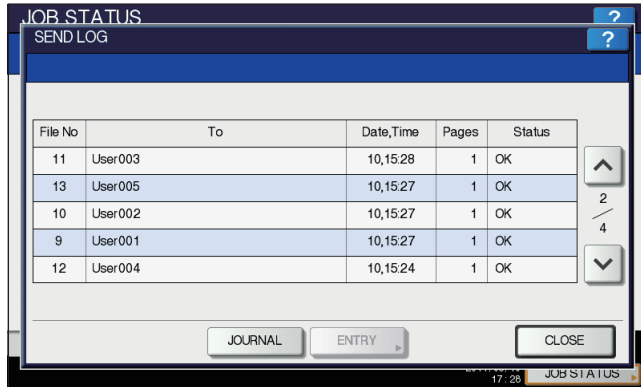

- Transmissions or receptions are listed in the reversed chronological order from top to bottom.
- Press or to switch the pages.
- Up to the latest 40 or 120 transmission/reception records can be listed on the log. The maximum number can be set on the ADMIN menu. For details of the operation, refer to the **MFP Management Guide**.
- To print the log of transmissions or receptions, press [JOURNAL].
 P.78 "Journal (transmission journal/reception journal)"
- In the "Status" column, the status is indicated as follows:
 - OK: Transmission or reception succeeded.
 - 4-digit error code: Transmission or reception failed.
 P.108 "Error codes"

Registering recipients' fax numbers to the address book

To register recipient's fax numbers in the address book from the send/receive log screen, select a record in the send or receive log, and then press [ENTRY]. For details of the registration to the address book, refer to the **MFP Management Guide**.

Notes

- Fax and E-mail transmissions whose recipients are specified with direct entry or entry using the LDAP server can be registered to the address book from the Send log.
- Polling and E-mail receptions whose recipients are specified with direct entry or entry using the LDAP server can be registered to the address book from the Receive log.

Canceling the Transmission

■ Canceling the memory transmission

You can cancel the memory transmission during scanning.

□ When using the original glass

This section describes how to cancel the memory transmission when an original is placed on the original glass.

- 1 When scanning is completed, the confirmation screen for the next original is displayed. Press [JOB CANCEL].**

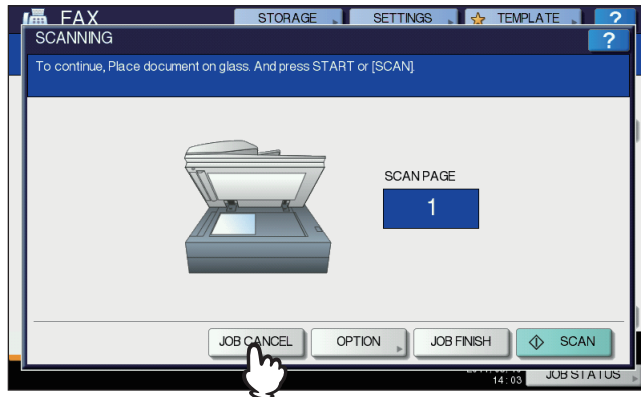

If you leave the screen unattended for a period of the auto clearance setting time (45 sec. by manufacturer default) after the confirmation screen for the next original is displayed, a copy of the scanned originals is sent.

- 2 The confirmation screen for the deletion is displayed. Press [YES].**

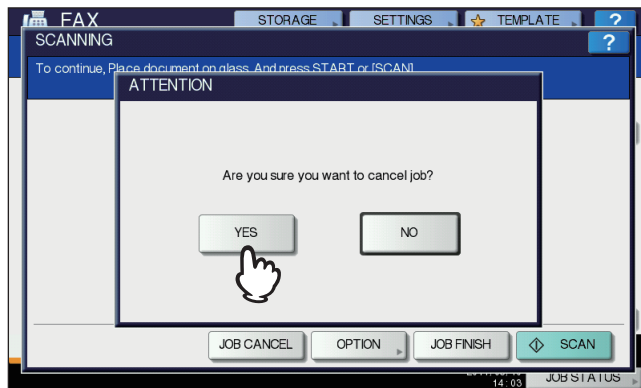

□ When using the RADF (Reversing Automatic Document Feeder)

This section describes how to cancel the memory transmission when an original is placed on the RADF.

- 1 Press the [STOP] button on the control panel while the originals are being scanned.

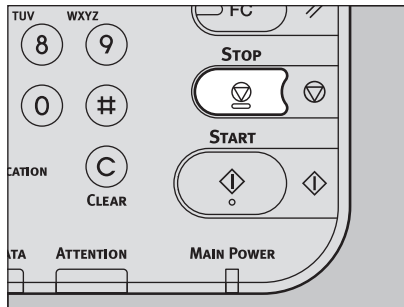

Scanning is paused.

- 2 The confirmation screen for the next original is displayed. Press [JOB CANCEL].

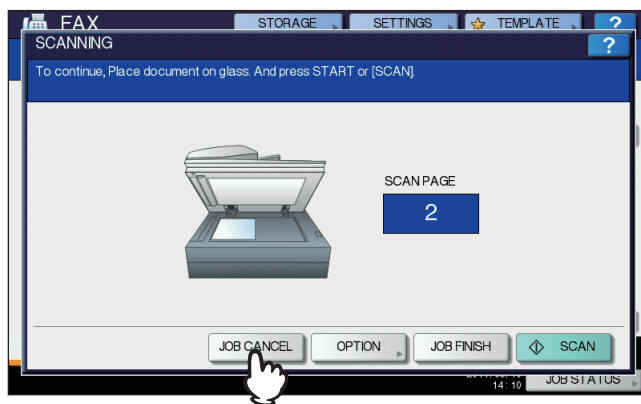

- If you press [JOB FINISH], the scanned originals are sent.
- If you leave the screen for the next original unattended for the period of the auto clear setting time (45 sec. by manufacturer default) after it appears, the memory transmission is canceled.

- 3 The confirmation screen for the deletion is displayed. Press [YES].



■ Canceling direct transmissions

You can cancel the direct transmission during scanning.

Note

Even if you cancel transmission in the direct TX mode, the part of the original that was scanned before transmission is canceled has been sent.

- 1 Press the [STOP] button on the control panel while the original is being scanned.

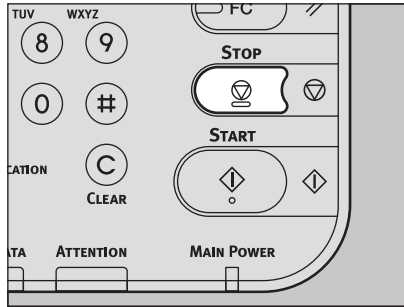

The scanning and transmission are stopped.

■ Canceling reserved transmissions

You can display the list of the reserved transmissions, and cancel the reserved transmissions that are in the queue or in progress.

1 Press [JOB STATUS], and then select the [FAX] tab.

The list of the reserved transmissions is displayed. This step is the same as that for checking the reserved transmission.

 P.42 “Checking reserved transmissions”

2 Select the reserved transmission you want to delete, and then press [DELETE].

More than one job can be selected.

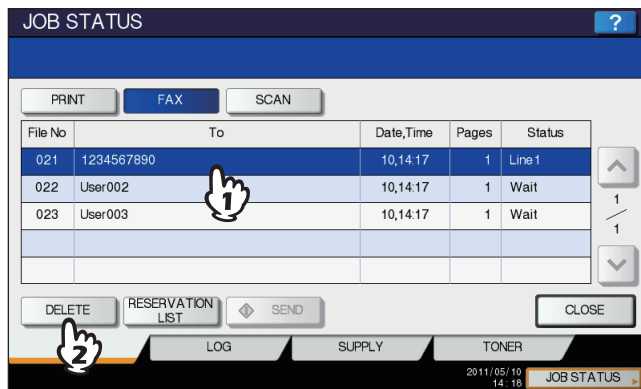

In the “Status” column, you can check the status of the reservation. “Wait” indicates that the data are waiting to be sent. “Line1” or “Line2” indicates that the data are being sent. Delayed transmission reservation and polling transmission/reception can be canceled.

3 The confirmation screen for the deletion is displayed. Press [DELETE].

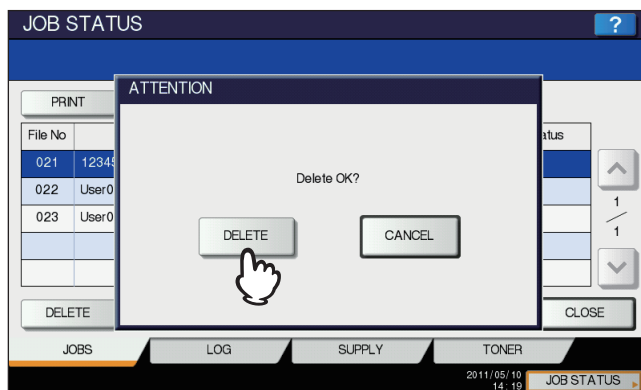

ADVANCED FUNCTIONS

This chapter describes useful functions of this equipment.

Transmitting 2-Sided Originals	50
Priority Transmission.....	52
Polling Communication	53
Polling transmission	53
Polling reception.....	54
Mailbox Transmission.....	55
Registering/printing/deleting an original	56
Sending/retrieving an original.....	60
Creating/modifying/deleting a mailbox	63
Chain Dial Communication.....	68
Delayed Transmission Reservation.....	69
Recovery Transmission	70
Onramp Gateway.....	71
Offramp Gateway.....	72
Save as File.....	73
Printing SECURE RECEIVE fax jobs	75

Transmitting 2-Sided Originals

You can send a copy of 2-sided originals by fax using the RADF (Reversing Automatic Document Feeder).

Tip

Note that each setting will automatically return to its default setting when transmission is completed.

1 Place the original(s) on the RADF.

P.17 "Handling an original"

When you place a 2-sided original of the LT/A4 size, change the direction of the original depending on its bound position as follows:

1. Right-to-left (book-type) original
2. Top-to-bottom (tablet-type) original

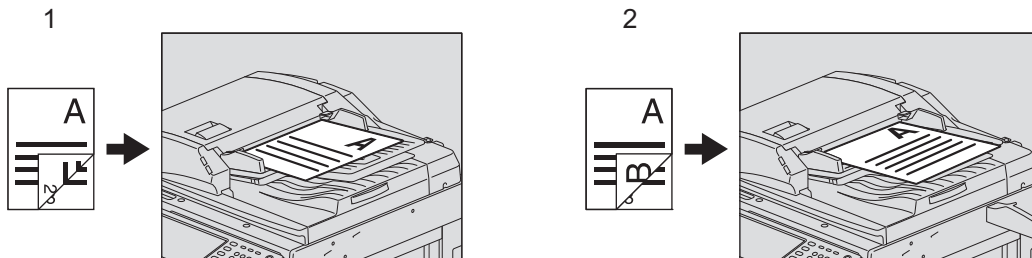

2 Press the [FAX] button on the control panel.

P.14 "Basic procedures"

3 Press [OPTION] and set the transmission conditions.

P.21 "Setting the transmission conditions"

4 Select the [ADVANCED] tab, and then press [2-SIDED SCAN].

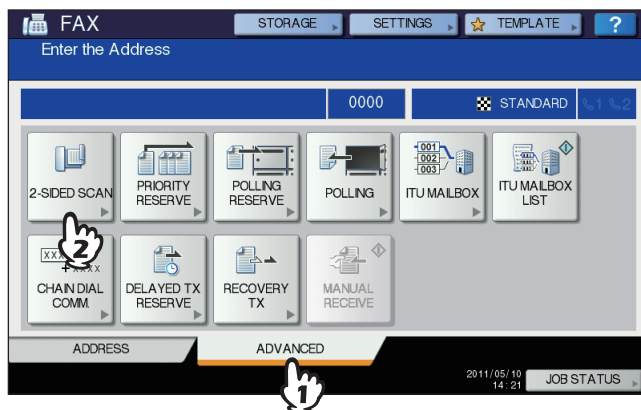

5 Press [BOOK] or [TABLET] depending on the bound position of the original(s), and then press [OK].



6 Specify the recipient's fax number.

 P.25 "Specifying the recipient"

7 Press [SEND].

 P.14 "Basic procedures"

Priority Transmission

You can send a fax prior to other reserved transmissions (including redial standby).

Tip

Note that each setting will automatically return to its default setting when transmission is completed.

- 1 Place the original(s).**
 ⓘ P.17 “Handling an original”
- 2 Press the [FAX] button on the control panel.**
 ⓘ P.14 “Basic procedures”
- 3 Press [OPTION] and set the transmission conditions.**
 ⓘ P.21 “Setting the transmission conditions”
- 4 Press the [ADVANCED] tab, and then press [PRIORITY RESERVE].**

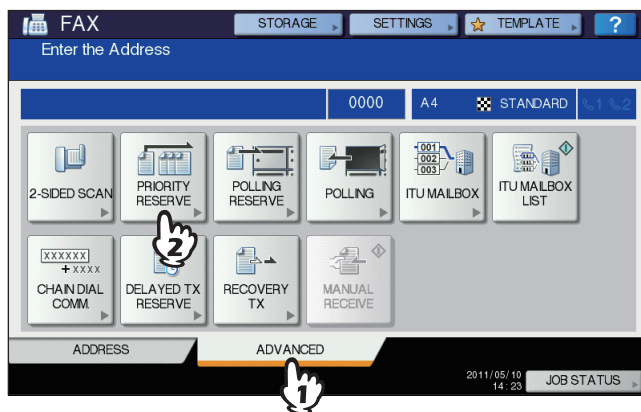

- 5 Press [OK].**



- 6 Specify the recipient's fax number.**
 ⓘ P.25 “Specifying the recipient”

Tip

In the priority transmission mode, you cannot specify multiple recipients' fax numbers.

- 7 Press [SEND].**
 ⓘ P.14 “Basic procedures”

Polling Communication

The polling communication function allows you to receive pending originals in the sender's fax machine by manually operating the receiving fax machine. In this document, the operation in which this equipment is used as the sender's fax machine is called "polling transmission" while that in which it is used as the recipient's fax machine is called "polling reception".

■ Polling transmission

Upon request of a recipient's fax machine, this equipment sends an original document stored into the memory to the recipient. By setting a password and/or a recipient's fax number to an original stored into the memory, you can permit specific recipients to receive the original using the polling transmission.

Note

To use the polling communication function with the password verification applied, the fax machines of both the sender and recipient have to be Oki Fax machines (MFP).

- 1 Place the original(s).**
 P.17 "Handling an original"
- 2 Press the [FAX] button on the control panel.**
 P.14 "Basic procedures"
- 3 Press [OPTION] and set the transmission conditions.**
 P.21 "Setting the transmission conditions"
- 4 Press the [ADVANCED] tab, and then press [POLLING RESERVE].**

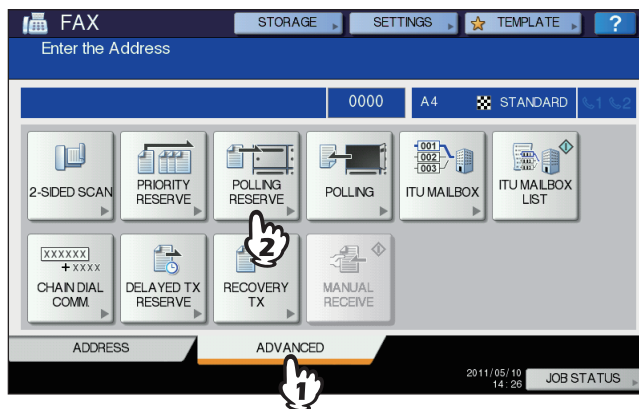

- 5 To set the password and/or fax number (the recipient's telephone number), press the [PASSWORD] and/or [FAX NUMBER] button. On the entry screen that appears, key in the password (4 digits) and/or fax number (a maximum of 20 digits), and then press [OK].**

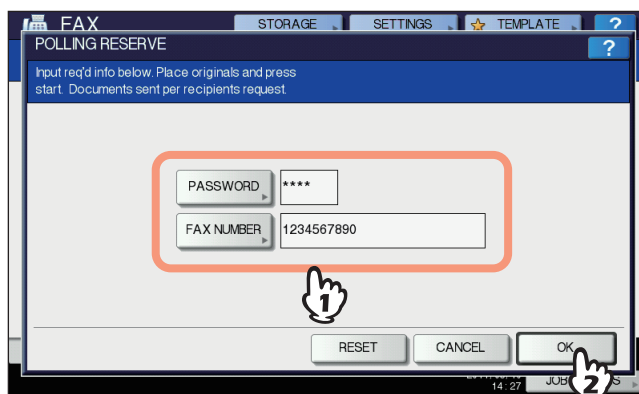

- You do not have to set both the password and the fax number.
- If you have to set neither a password nor a fax number, leave both blank and press [OK].

6 Press the [START] button on the control panel.

- Upon request of the recipient's fax machine, the data of the original stored into memory are sent automatically. Once they are sent, they are deleted from memory.
- You can delete the data of the original from memory by canceling the polling transmission.
 P.48 "Canceling reserved transmissions"

■ Polling reception

This equipment requests the sender's fax machine to send the data of the original.

1 Press the [FAX] button on the control panel.

 P.14 "Basic procedures"

2 Press the [ADVANCED] tab, and then press [POLLING].

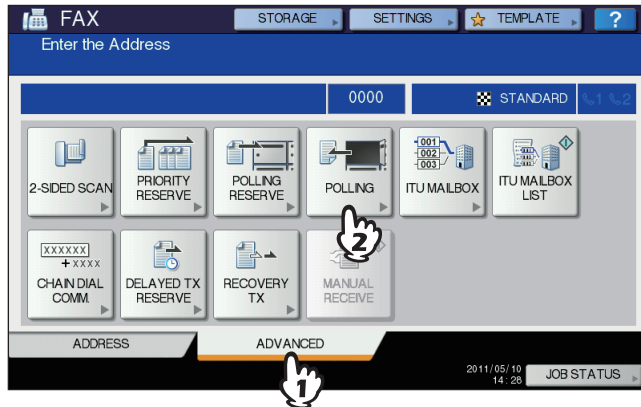

3 If the password is set to the data of the original in the sender's fax machine, press [PASSWORD] to display the entry screen. Key in the password, and then press [OK].

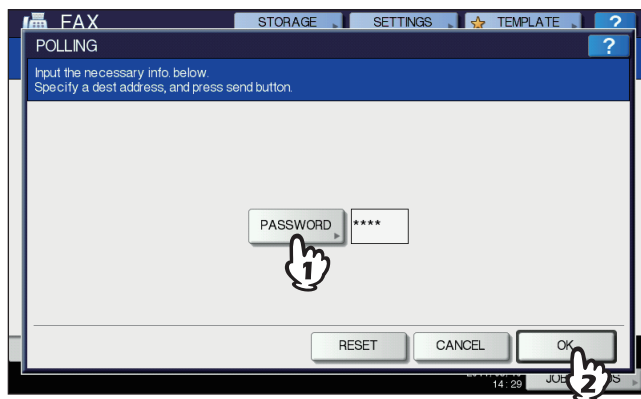

If you do not have to key in the password, leave this entry box blank, and then press [OK].

4 Specify the sender's fax number.

 P.25 "Specifying the recipient"

Tip

This equipment supports two types of receptions: Individual polling reception in which you specify a recipient's fax number and Multi-polling reception in which you specify multiple recipients' fax numbers.

5 Press [SEND].

 P.14 "Basic procedures"

Tip

With the delayed transmission reservation, you can perform the polling reception on a specific date and time. To do that, set the date and time before pressing [SEND].

 P.69 "Delayed Transmission Reservation"

Mailbox Transmission

This function is used to communicate between fax machines compatible with a mailbox function (ITU-T compatible). The owners of these fax machines can input or retrieve the data of the originals in the mailbox.

There are 3 types of mailbox: confidential mailbox, bulletin board mailbox and relay station mailbox. To perform mailbox communication, the mailboxes must be created in advance. An individual password for each box can be set for security protection.

📖 P.63 “Creating/modifying/deleting a mailbox”

Confidential mailbox

Once data of an original are retrieved from this mailbox, these data will be deleted. This mailbox is suitable for registering an original you want to send to a specific recipient. If a new original is registered in this mailbox in which another original exists, the mailbox will contain both of the originals.

Bulletin board mailbox

No matter how many times an original is retrieved from this mailbox, the original will not be deleted. This mailbox is suitable for registering an original you want to send to multiple recipients. If a new original is registered in this mailbox in which another original exists, the existing original will be replaced with the new original and the new one will be stored in the mailbox.

Relay station mailbox

Using this mailbox, an original sent from a fax machine is relayed to pre-registered multiple recipients. To inform a user of the result of the relay, a report called RELAY TX END TERMINAL REPORT can be sent to a specific recipient. A copy of the original can be printed out (regularly or when an error occurs).

<Example of how to use the relay station mailbox>

If you want to send a copy of an original from an office in Los Angeles to multiple offices in New York, you first send it from the one in Los Angeles to one of the offices in New York where the relay station mailbox is set up, so that it is relayed to the other offices in New York. This will reduce communication costs.

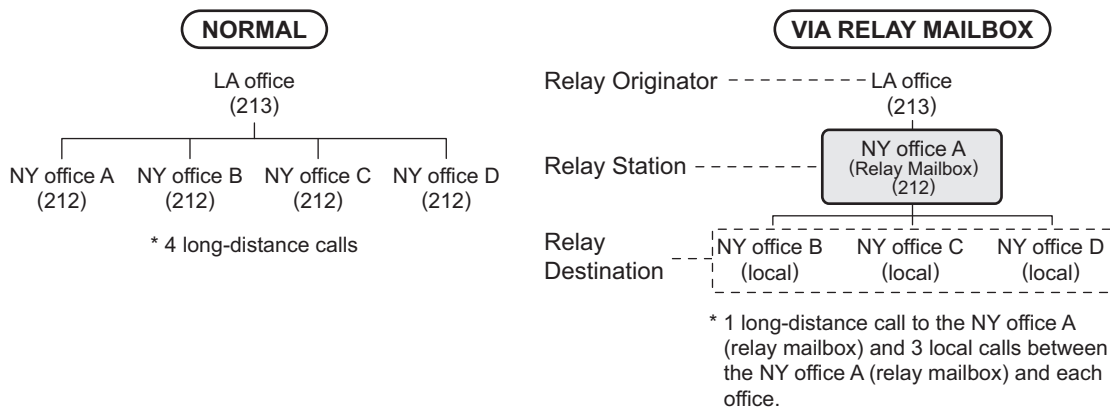

Tip

If you create a forward mailbox whose number is the fax number of the sender, you can use the TSI function. Using this function, this equipment forwards the original sent from the sender whose fax number is set to the mailbox number, based on the pre-set agent (Save as file / Email / Store to e-Filing). This can be set from TopAccess. For details of the operation, refer to the **TopAccess Guide**.

■ Registering/printing/deleting an original

This section describes the operations of the mailbox in this equipment.

□ Registering an original

You can register an original to the confidential or bulletin board mailbox in this equipment.

Tip

To register the originals to confidential or bulletin board mailbox, the confidential or bulletin board mailbox must be created in advance.

📖 P.63 “Creating/modifying/deleting a mailbox”

- 1 Place the original(s).**
📖 P.17 “Handling an original”
- 2 Press the [FAX] button on the control panel.**
📖 P.14 “Basic procedures”
- 3 Press [OPTION] and set the transmission conditions.**
📖 P.21 “Setting the transmission conditions”
- 4 Press the [ADVANCED] tab, and then press [ITU MAILBOX].**

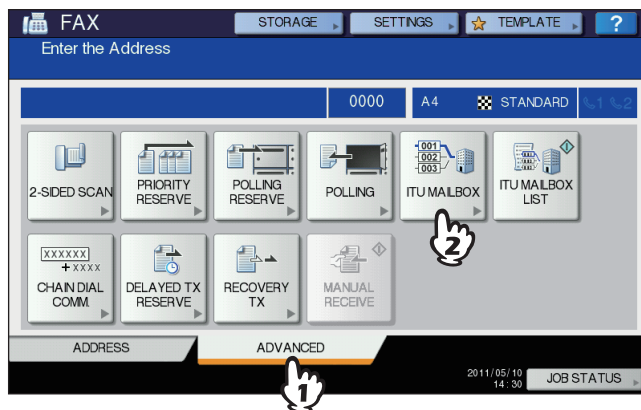

- 5 In the “BOX TYPE” group, press [CONFIDENTIAL] or [BULLETIN BD]. In the “MODE” group, press [INPUT], and then [OK].**

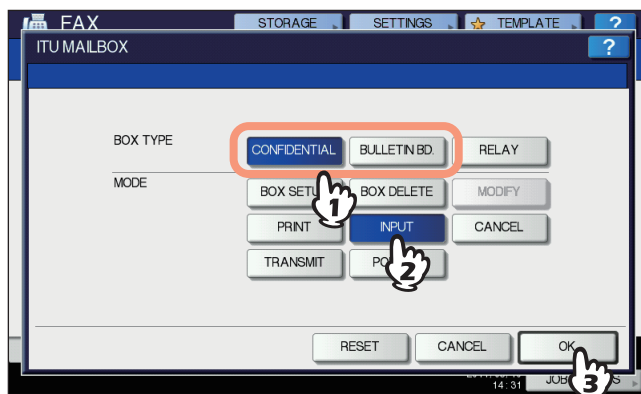

If the selected mailbox has not been set, an error message is displayed and you are unable to proceed.

6 Press [BOX NUMBER] to display the entry screen. Key in the box number, and then press [OK].

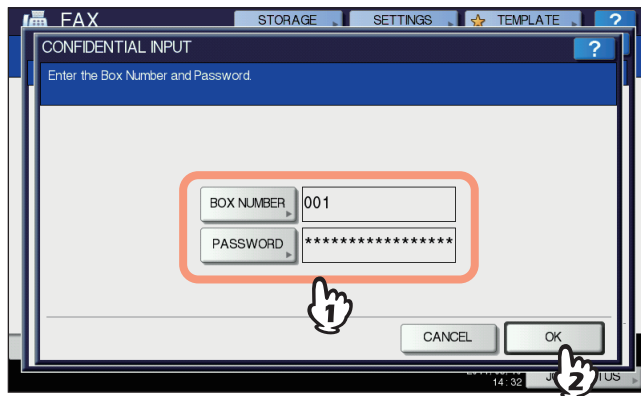

- If a password has been set to the selected bulletin board mailbox, key in the password in the same way as the box number. If you have selected the confidential mailbox, it is not necessary to key in a password since it is not verified.
- If the box number or password is incorrect, an error message is displayed and you are unable to proceed.

7 Press the [START] button on the control panel.

When you cancel the registration, press the [STOP] button on the control panel, and then [JOB CANCEL] on the touch panel.

□ Printing an original

You can print the original registered in the confidential or bulletin board mailbox in this equipment.

1 Press the [FAX] button on the control panel.

📖 P.14 “Basic procedures”

2 Press the [ADVANCED] tab, and then press [ITU MAILBOX].

This screen is the same as the one you see when you register the original.

📖 P.56 “Registering an original”

3 In the “BOX TYPE” group, press [CONFIDENTIAL] or [BULLETIN BD]. In the “MODE” group, press [PRINT], and then [OK].

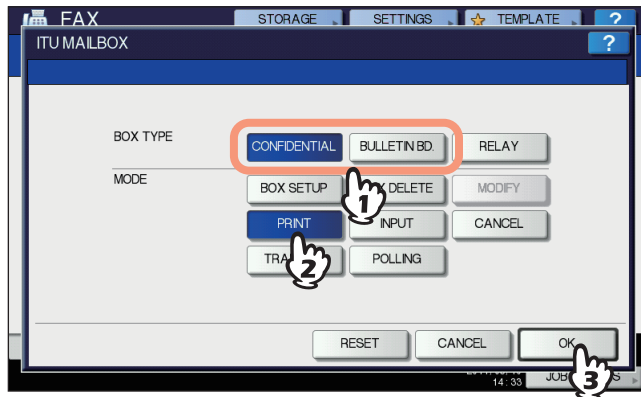

If the selected mailbox has not been set, an error message is displayed and you are unable to proceed.

4 Press [BOX NUMBER] to display the entry screen and key in the box number.

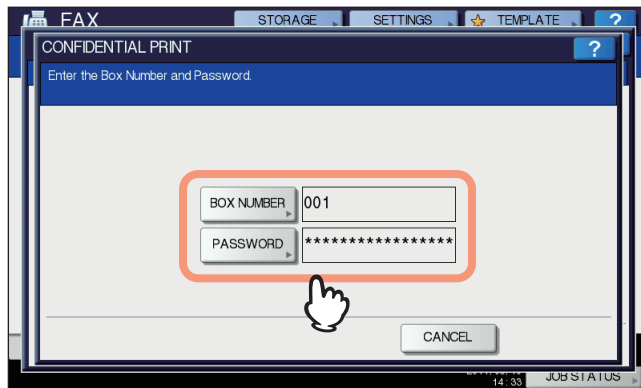

If a password has been set to the selected confidential mailbox, key in the password in the same way as the box number. If you have selected the bulletin board mailbox, it is not necessary to key in a password since it is not verified.

5 Press the [START] button on the control panel.

If the box number or password is incorrect, an error message is displayed and you are unable to proceed.

□ Deleting an original

You can delete the original registered in the confidential or bulletin board mailbox in this equipment.

1 Press the [FAX] button on the control panel.

P.14 “Basic procedures”

2 Press the [ADVANCED] tab, and then press [ITU MAILBOX].

This screen is the same as the one you see when you register the original.

P.56 “Registering an original”

3 In the “BOX TYPE” group, press [CONFIDENTIAL] or [BULLETIN BD]. In the “MODE” group, press [CANCEL], and then [OK].

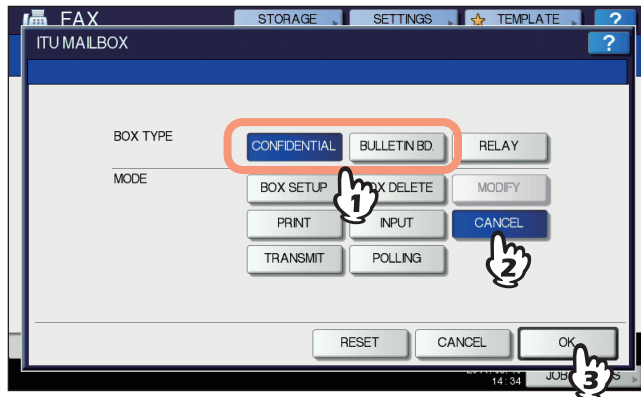

If the selected mailbox has not been set, an error message is displayed and you are unable to proceed.

4 Press [BOX NUMBER] to display the entry screen. Key in the box number, and then press [OK].

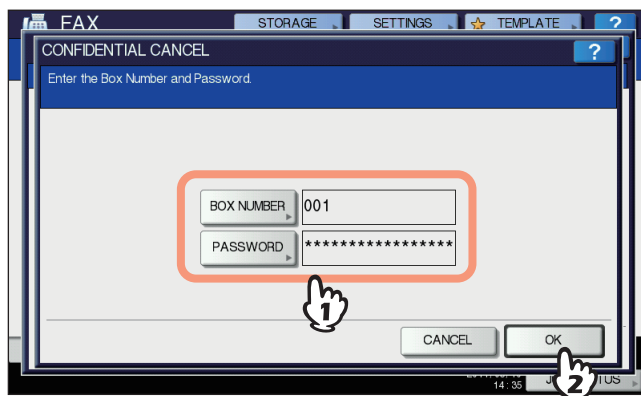

If a password has been set to the selected mailbox, key in the password in the same way as the box number.

5 The confirmation screen for the deletion is displayed. Press [YES].

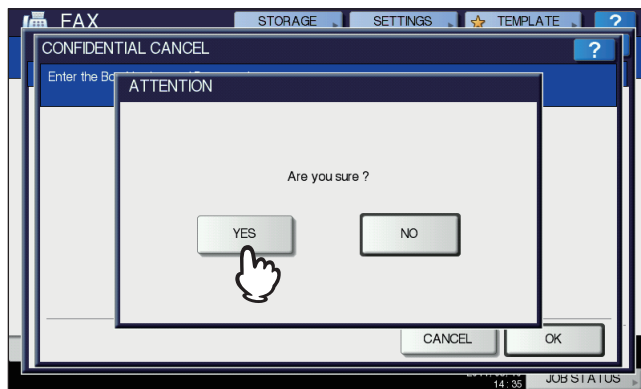

If the box number or password is incorrect, an error message is displayed and you are unable to proceed.

■ Sending/retrieving an original

This section describes the operations of the mailbox in the recipient's fax machine.

□ Sending an original

You can send an original to the confidential/bulletin board/relay station mailbox in this equipment.

- 1 Place the original(s).**
 ⓘ P.17 "Handling an original"
- 2 Press the [FAX] button on the control panel.**
 ⓘ P.14 "Basic procedures"
- 3 Press [OPTION] and set the transmission conditions.**
 ⓘ P.21 "Setting the transmission conditions"
- 4 Press the [ADVANCED] tab, and then press [ITU MAILBOX].**

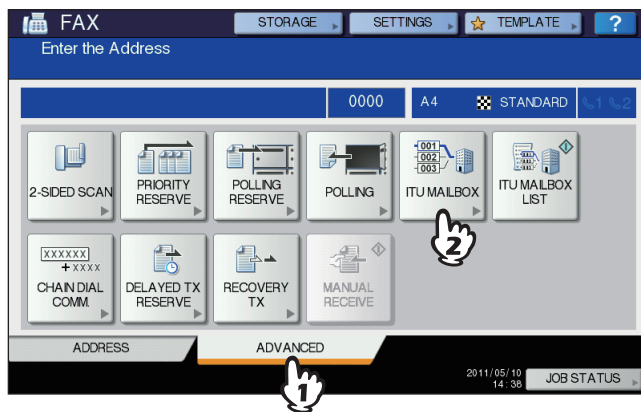

- 5 In the "BOX TYPE" group, press [CONFIDENTIAL], [BULLETIN BD] or [RELAY]. In the "MODE" group, press [TRANSMIT], and then [OK].**

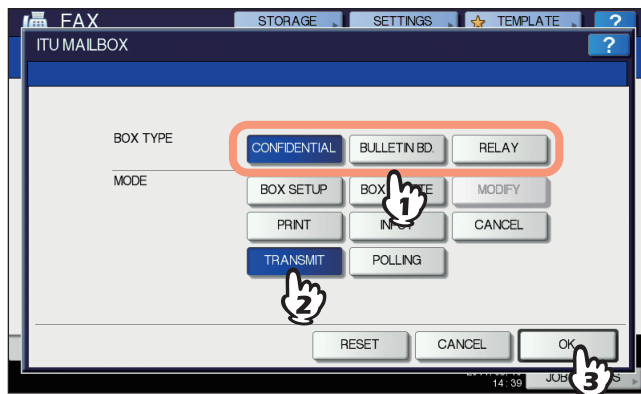

- 6 Press [BOX NUMBER] to display the entry screen. Key in the box number, and then press [OK].**

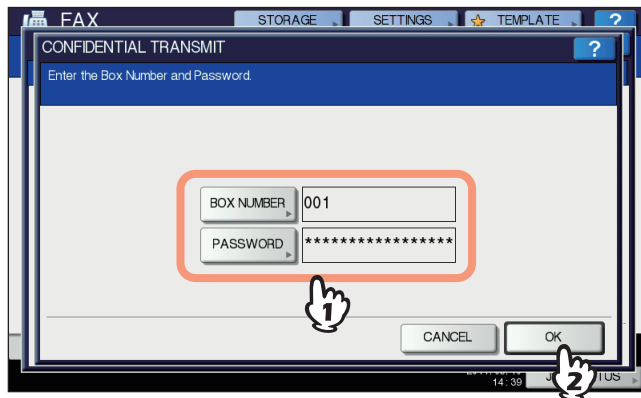

If a password has been set to the selected mailbox, key in the password in the same way as the box number.

Tip

The box number and the password you specified here are sent to the recipient's fax machine as SUD (box number) and SID (password) of the command compatible with the ITU-T standards.

- 7 Specify the recipient's fax number.**

P.25 "Specifying the recipient"

- 8 Press [SEND].**

P.14 "Basic procedures"

You can cancel the transmission of the original.

P.45 "Canceling the Transmission"

Retrieving an original

You can retrieve an original from the confidential or bulletin board mailbox in the recipient's fax machine.

- 1 Press the [FAX] button on the control panel.**

P.14 "Basic procedures"

- 2 Press the [ADVANCED] tab, and then press [ITU MAILBOX].**

This screen is the same as the one you see when you send the original.

P.60 "Sending an original"

- 3 In the "BOX TYPE" group, press [CONFIDENTIAL] or [BULLETIN BD]. In the "MODE" group, press [POLLING], and then [OK].**

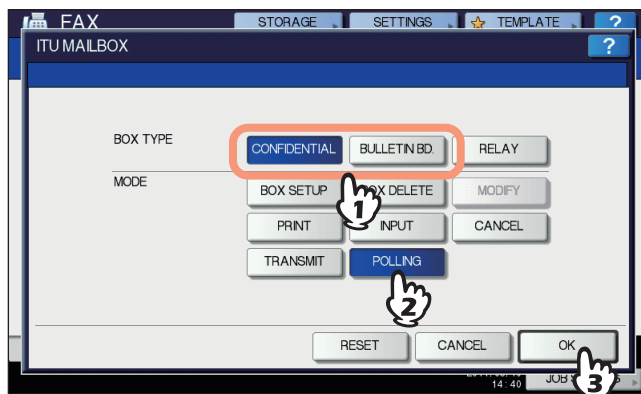

- 4** Press [BOX NUMBER] to display the entry screen. Key in the box number, and then press [OK].

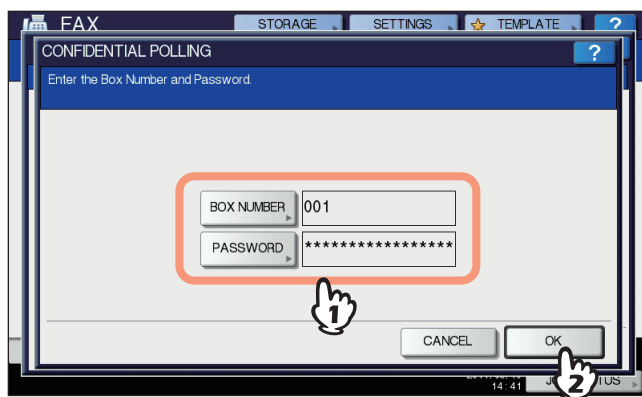

If a password has been set to the selected mailbox, key in the password in the same way as the box number.

Tip

The box number and the password you specified here are sent to the recipient's fax machine as SUD (box number) and SID (password) of the command compatible with the ITU-T standards.

- 5** Specify the recipient's fax number.

 P.25 "Specifying the recipient"

- 6** Press [SEND].

 P.14 "Basic procedures"

■ Creating/modifying/deleting a mailbox

This section describes how to manage the mailbox in this equipment.

Tip

In the list, you can view the status of the mailbox registered to this equipment.

📖 P.80 “Mailbox/relay box report”

□ Creating the confidential or bulletin board mailbox

You can create the confidential or bulletin board mailbox in this equipment.

- 1 Press the [FAX] button on the control panel.
📖 P.14 “Basic procedures”
- 2 Press the [ADVANCED] tab, and then press [ITU MAILBOX].

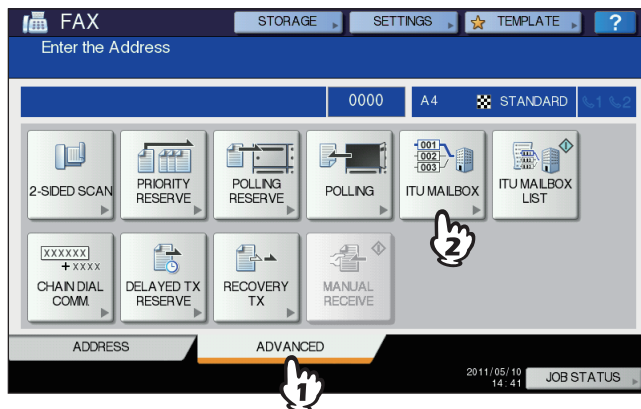

- 3 In the “BOX TYPE” group, press [CONFIDENTIAL] or [BULLETIN BD]. In the “MODE” group, press [BOX SETUP], and then [OK].

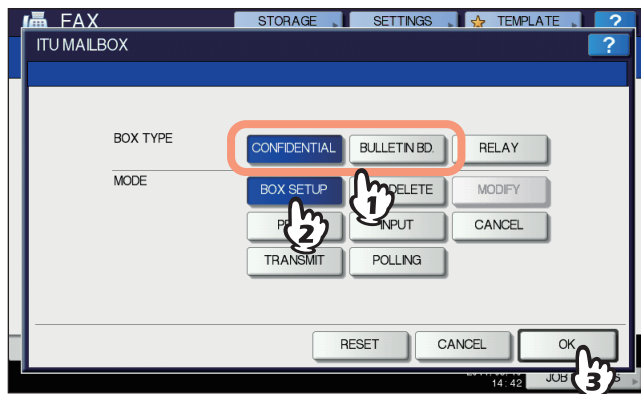

- 4 Press [BOX NUMBER] to display the entry screen, key in the box number(s) (a maximum of 20 digits), and then press [OK].**

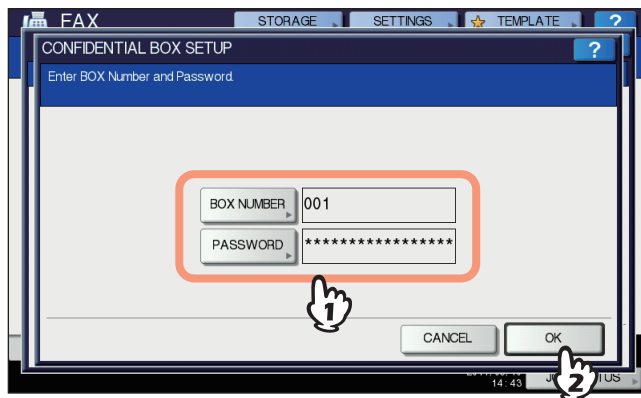

- If you want to set a password (a maximum of 20 digits), key in the password in the same way as the box number.
- If the box number or password keyed in has already been registered, an error message is displayed and you are unable to proceed.

□ Creating/modifying a relay station mailbox

You can create or modify the relay station mailbox.

- 1 Press the [FAX] button on the control panel.**

P.14 “Basic procedures”

- 2 Press the [ADVANCED] tab, and then press [ITU MAILBOX].**

This screen is the same as the one you see when you create the confidential/bulletin board mailbox.

P.63 “Creating the confidential or bulletin board mailbox”

- 3 In the “BOX TYPE” group, press [RELAY]. In the “MODE” group, press [BOX SETUP] or [MODIFY], and then [OK].**

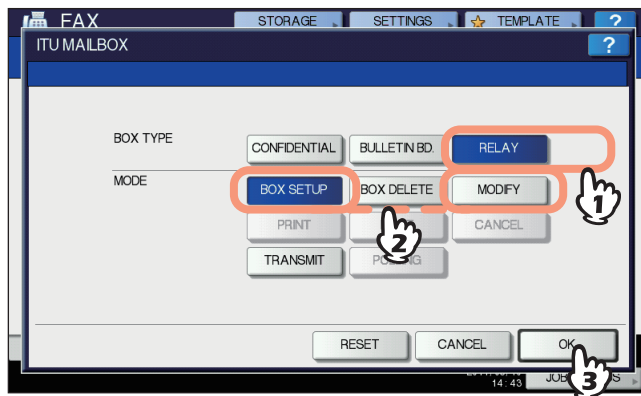

If the selected mailbox is not set at the time of modification, an error message is displayed and you are unable to proceed.

- 4 Press [BOX NUMBER] to display the entry screen. Key in the box number(s) (a maximum of 20 digits), and then press [OK].**

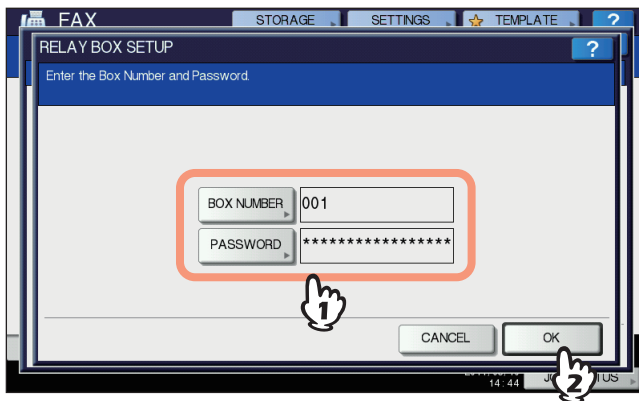

- If you want to set a password (a maximum of 20 digits), key in the password in the same way as the box number.
- If the box number or password is incorrect, an error message is displayed and you are unable to proceed.

- 5 Specify the recipient to be registered, and then press [OK].**

P.25 "Specifying the recipient"

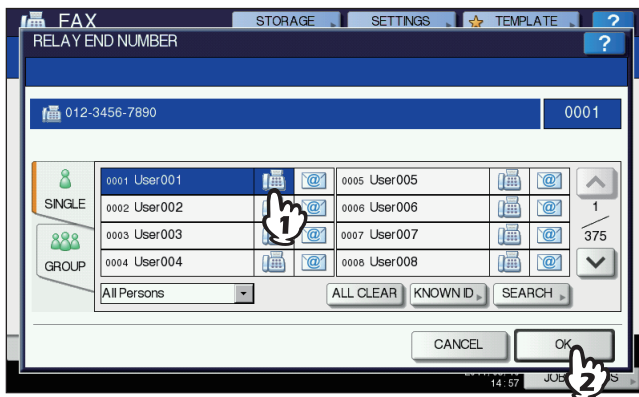

Specify the recipient from the address book because this cannot be done with direct dialing.

- 6 The confirmation screen for sending a relay transmission report is displayed. If you want to send the report, select [YES]. If not, select [NO].**

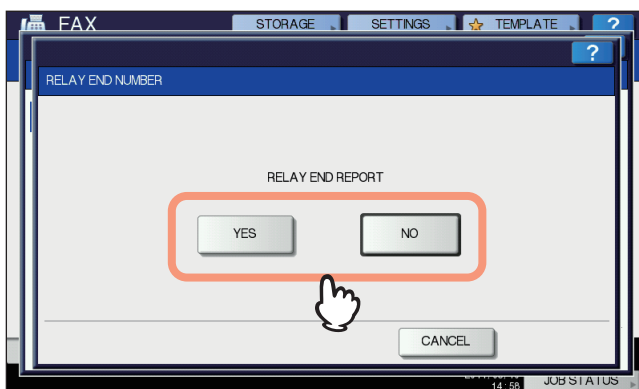

Tip

By default, the relay transmission end terminal report is sent when a communication error occurs. On the ADMIN menu, you can make setting so that the report can be sent automatically. For details of the operation, refer to the *MFP Management Guide*.

7 Specify the recipient to which you want to send the report, and then press [OK].

P.25 “Specifying the recipient”

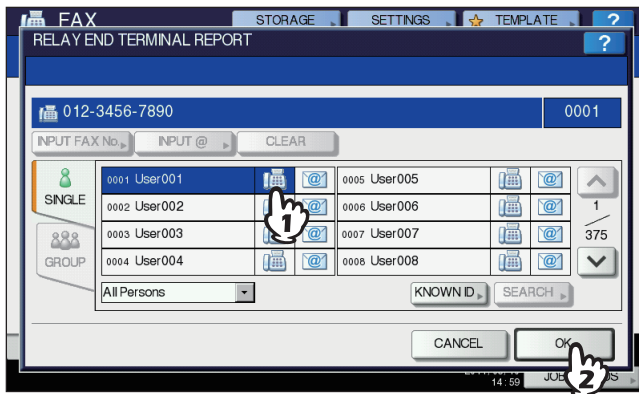

Only one recipient can be specified.

8 The confirmation screen for printing the received copy of the original is displayed. If you want to print it out whenever a copy of the original is delivered, press [ALWAYS]. If you want to print it out only when an error occurs, press the [ON ERROR].

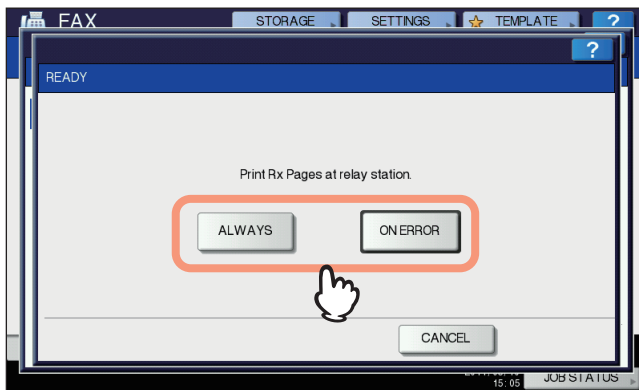

Deleting a mailbox

You can delete the confidential/bulletin board/relay station mailbox registered in this equipment.

Tip

The confidential and bulletin board mailbox in which the original is registered cannot be deleted. To delete the mailbox, delete the original in advance.

P.59 “Deleting an original”

1 Press the [FAX] button on the control panel.

P.14 “Basic procedures”

2 Press the [ADVANCED] tab, and then press [ITU MAILBOX].

This screen is the same as the one you see when you create the confidential/bulletin board mailbox.

P.63 “Creating the confidential or bulletin board mailbox”

- 3** In the “BOX TYPE” group, press [CONFIDENTIAL], [BULLETIN BD] or [RELAY]. In the “MODE” group, press [BOX DELETE], and then [OK].

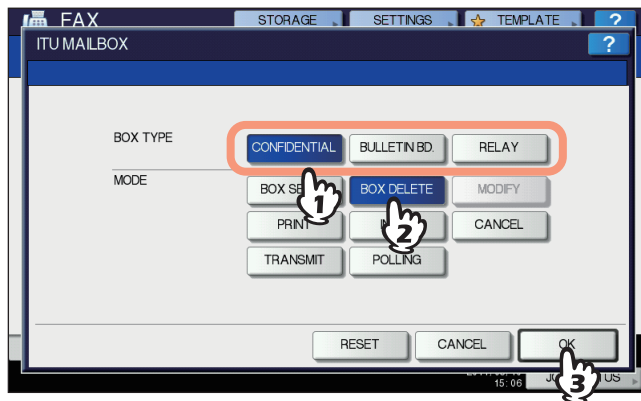

If the selected mailbox has not been set, an error message is displayed and you are unable to proceed.

- 4** Press [BOX NUMBER] to display the entry screen. Key in the box number, and then press [OK].

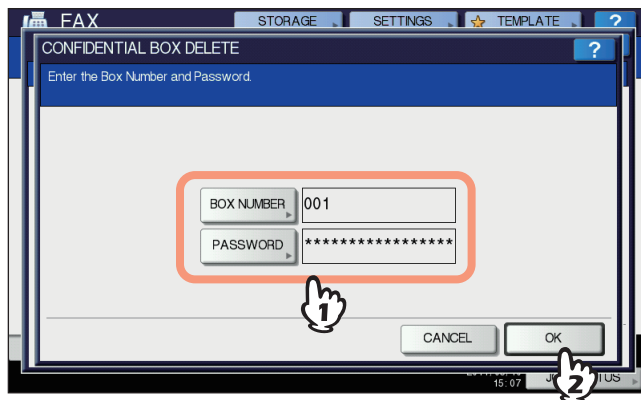

If a password has been set to the selected mailbox, key in the password in the same way as the box number.

- 5** The confirmation screen for the deletion is displayed. Press [YES].

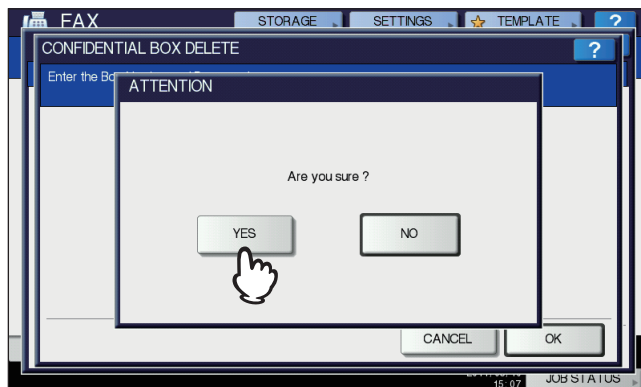

If the box number or password is incorrect, an error message is displayed and you are unable to proceed.

Chain Dial Communication

You can chain pre-registered sets of numbers to form a dialing string. For example, you can form the desired number by specifying sets of numbers registered in the address book sequentially such as region code, area code and fax numbers.

- 1 Place the original(s).**
 ⓘ P.17 "Handling an original"
- 2 Press the [FAX] button on the control panel.**
 ⓘ P.14 "Basic procedures"
- 3 Press [OPTION] and set the transmission conditions.**
 ⓘ P.21 "Setting the transmission conditions"
- 4 Press the [ADVANCED] tab, and then press [CHAIN DIAL COMM.].**

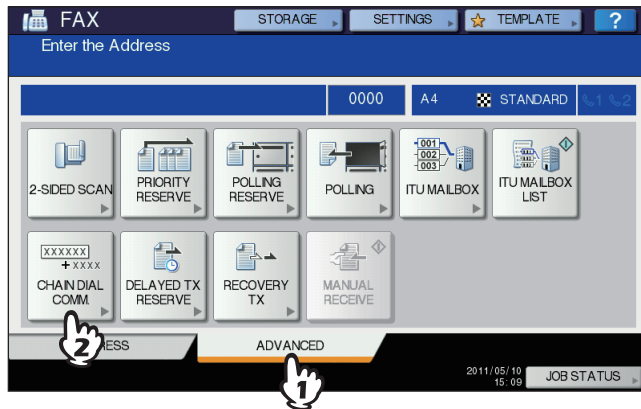

- 5 Repeat this operation until the desired number is formed.**
 ⓘ P.25 "Specifying the recipient"

You can form the dialing number which is up to 128 digits in length. The numbers are chained in the order you specify them.

- 6 Press [SEND].**
 ⓘ P.14 "Basic procedures"

Delayed Transmission Reservation

You can send a fax at a specified date and time. It is useful when you want to make use of off-peak discounts (e.g. nighttime) or you want to send a fax to a country which has a time difference.

- 1 Place the original(s).**
 ⓘ P.17 "Handling an original"
- 2 Press the [FAX] button on the control panel.**
 ⓘ P.14 "Basic procedures"
- 3 Press [OPTION] and set the transmission conditions.**
 ⓘ P.21 "Setting the transmission conditions"
- 4 Press the [ADVANCED] tab, and then press [DELAYED TX RESERVE].**

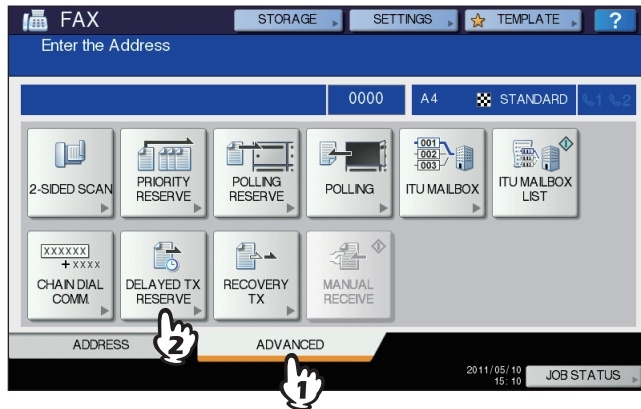

- 5 Key in the date, hour, and minute using the digital keys on the control panel, and then press [OK].**

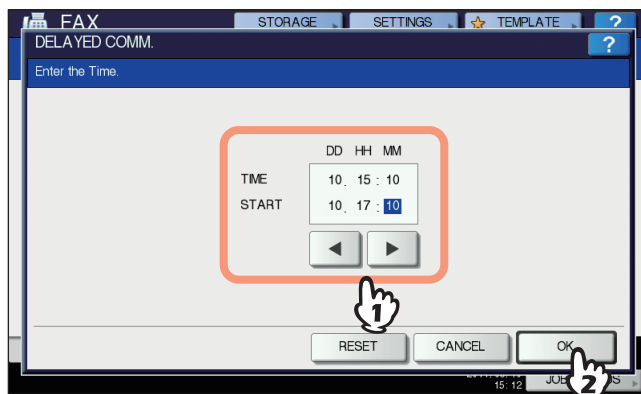

- The acceptable range of reservation is up to one month later.
- Press ◀ and ▶ to move the cursor.
- Specify the time on a 24-hour basis.
- To correct the entry, press the [RESET] button on the control panel, and then key in the correct number.

- 6 Specify the recipient's fax number.**

ⓘ P.25 "Specifying the recipient"

- 7 Press [SEND].**

ⓘ P.14 "Basic procedures"

Canceling delayed transmission reservation

You can cancel the delayed transmission reservation and send a fax in a normal manner. On the reserved transmission confirmation screen, select the transmissions job, and then press [SEND].

ⓘ P.42 "Checking reserved transmissions"

Recovery Transmission

You can save the data of originals, which were not sent after redialing a specified number of times, in the memory and resend them without placing the originals. Enabling or disabling this function or a period of time for the data to be retained can be set on the ADMIN menu. For the details of the current setting, ask your administrator.

📖 P.102 “Setting recovery transmission”

- 1 Press the [FAX] button on the control panel.**
📖 P.14 “Basic procedures”
- 2 Press [OPTION] and set the transmission conditions.**
📖 P.21 “Setting the transmission conditions”
- 3 Press the [ADVANCED] tab, and then press [RECOVERY TX].**

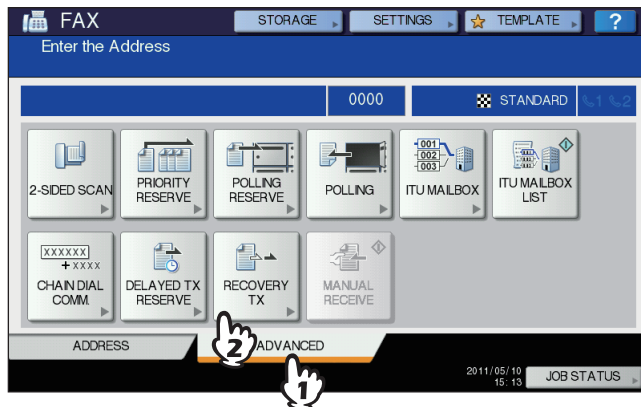

- 4 Select the transmission job, and then press [SEND].**

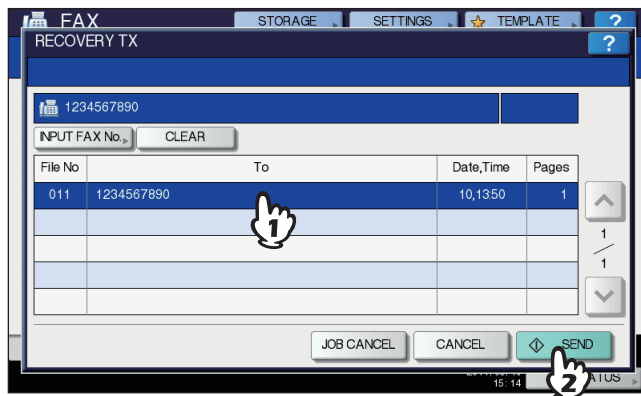

- You can change the fax number which is specified with the direct entry method.
- To delete the selected transmission job, press [JOB CANCEL].

Onramp Gateway

The onramp gateway function allows for an original sent from another mailbox-supported fax machine to be converted into E-mail data, which will be sent to a pre-registered E-mail address, via the mailbox (relay station) in this equipment.

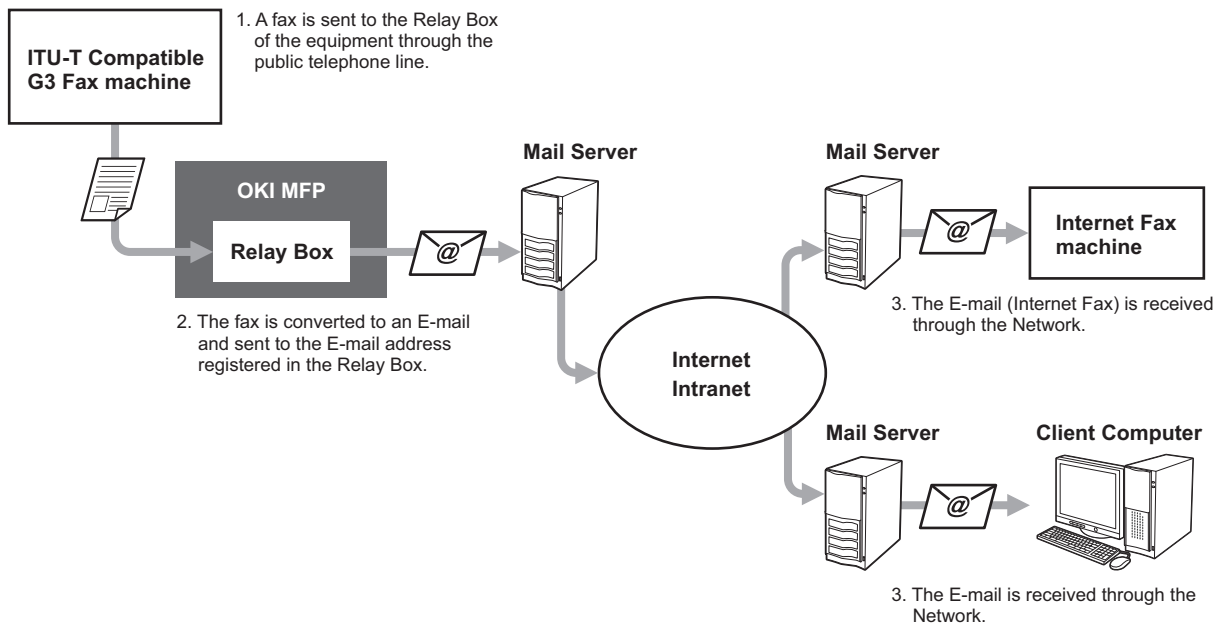

Fax numbers and E-mail addresses can be registered to the mailbox used for an onramp gateway transmission. That mailbox is the same as the one used for the mailbox transmission. For details of how to create/modify/delete a relay station mailbox, see the following section.

📖 P.63 "Creating/modifying/deleting a mailbox"

Tip

To use the onramp gateway, you need to set an E-mail address and Internet Fax to this equipment. For details of the operation, refer to the **TopAccess Guide**.

Offramp Gateway

The offramp gateway function allows for E-mail or Internet Fax sent from another device to be converted into standard fax data via this equipment, which will be sent to the recipient specified by the sender via a public telephone line. This is useful in reducing communication costs by using a combination of both the Internet and public telephone lines. For example, when sending documents long distances, such as overseas, the Internet can be used to send the document to a machine in the country of destination and then it will be forwarded to a target fax machine as fax data via a public telephone line.

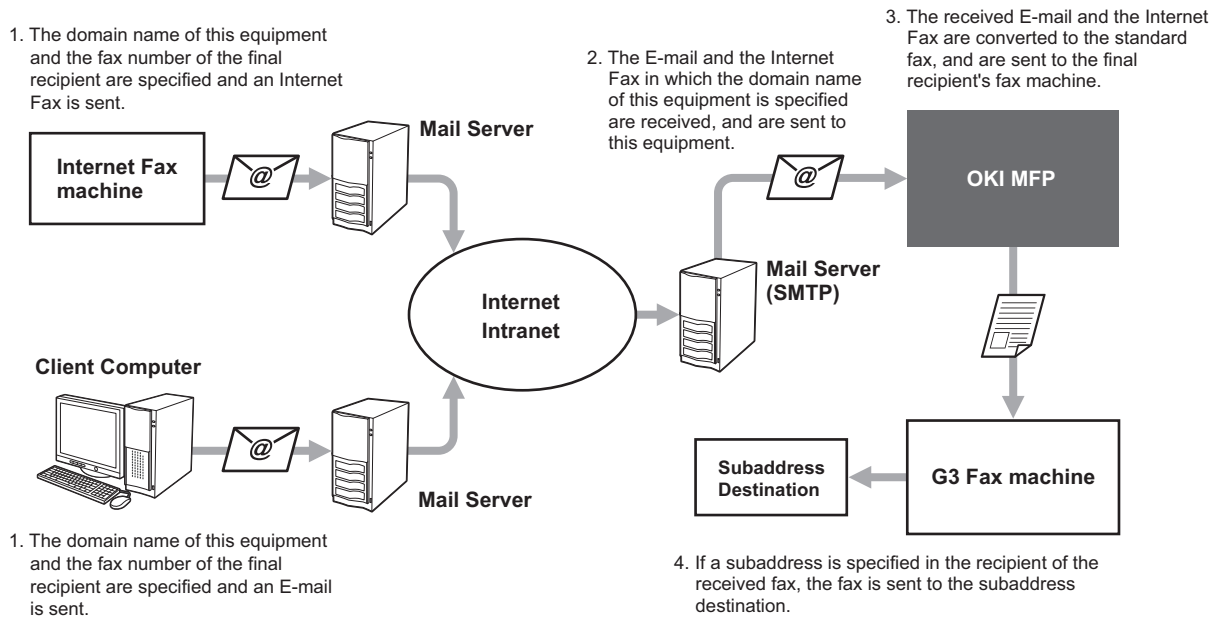

Specifying an E-mail address

When you want to use this equipment as a relay station to perform an offramp gateway transmission, ask the sender to specify an E-mail address as follows.

- FAX=xxxxxxx@FQDN

The fax number of the final recipient is specified in "xxxxxxx".

e.g.: In case that the fax number is "1234567890" and the domain name of this equipment (FQDN) is "host1.oki-ifax.com", the fax should be sent to

FAX=1234567890@host1.oki-ifax.com

Sending to a subaddress

- FAX=xxxxxxx/T33S=yyyy@FQDN

The fax number of the final recipient is specified in "xxxxxxx" and the subaddress in "yyyy".

e.g.: In case that the fax number is "1234567890", the subaddress is "1234", and the domain name of this equipment (FQDN) is "host1.oki-ifax.com", the fax should be sent to

FAX=1234567890/T33S=1234@host1.oki-ifax.com

Setting up the SMTP server

SMTP is a server protocol for sending and receiving E-mails. To use the offramp gateway function, you need to set up the SMTP server so that this equipment can receive E-mails and Internet Fax using SMTP. For details of the operation, refer to the *TopAccess Guide*.

Save as File

While sending a fax, you can save the fax as a file to a shared folder in this equipment or in a client computer. That file can be accessed from client computers on a network. To save a fax as a file into a shared folder in a client computer, you must make the “Save as file” setting of this equipment in advance. For details of the operation, refer to the **TopAccess Guide**.

Notes

- Save as File to a shared folder in this equipment is available only when the hard disk is installed.
 - Be sure to back up the files in the shared folder to protect them from unexpected data loss events.
 - If the forced encryption function for PDF security* is enabled, this function is not available. For the details of the security settings, refer to the **MFP Management Guide**.
- * The PDF security may not be available depending on the equipment.

- 1 Place the original(s).**
 P.17 “Handling an original”
- 2 Press the [FAX] button on the control panel.**
 P.14 “Basic procedures”
- 3 Press [STORAGE].**



- 4 Press [FILE NAME], and then enter the file name (a maximum of 45 characters).**

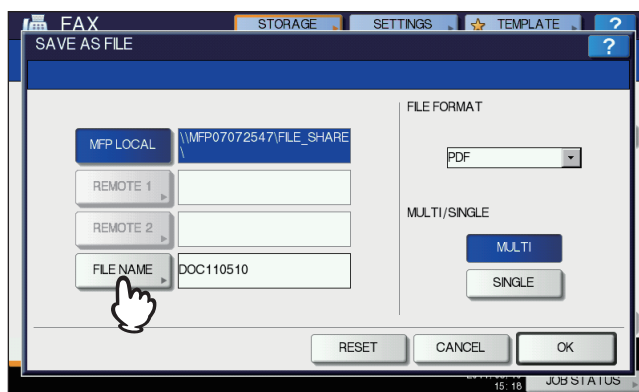

If you press [FILE NAME], the on-screen keyboard appears. For details of the operation to enter characters, refer to the **Quick Start Guide**.

5 Select the location where you want to save the file and the file format, and then press [OK].

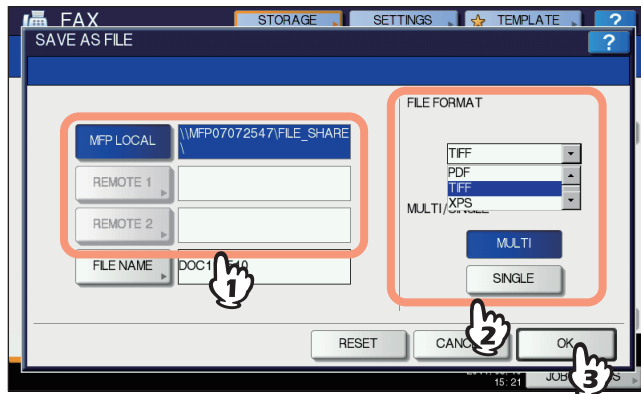

- When PDF-MULTI, TIFF-MULTI, or XPS-MULTI is selected, the file should be saved as a multiple-page file. When PDF-SINGLE, TIFF-SINGLE, or XPS-SINGLE is selected, the file should be saved as a single-page file.
- Select the file format in the [FILE FORMAT] box.

Tip

When a file is saved in the shared folder of the hard disk in this equipment, it is saved in the "TXFAX" folder under the "FILE_SHARE" folder. When PDF-SINGLE, TIFF-SINGLE, or XPS-SINGLE is selected, another folder with the same file name is automatically created in the "TXFAX" folder in which the file is saved.

6 Specify the recipient's fax number.

P.25 "Specifying the recipient"

7 Press [SEND].

P.14 "Basic procedures"

Tip

When fax transmission is completed, storing of the data of the original is also completed. However, if a fax cannot be sent after redialing a specified number of times, only the storing of the data of the original is completed.

Printing SECURE RECEIVE fax jobs

When the DATA lamp on the control panel is lit, there is a received SECURE RECEIVE fax job. You can print the fax data by entering your PRINT PASSWORD.

Tip

This lamp does not light when the equipment is in the Super Sleep mode.

1 Press the [PRINT] button on the control panel.

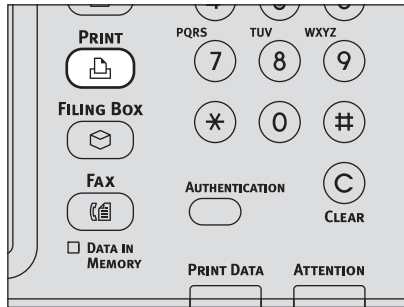

- The print screen is displayed. If you leave the screen unattended for the auto clear setting time (45 sec. by manufacturer default), the screen returns to the default one automatically.

2 Select [SECURE RX (LINE 1)] or [SECURE RX (LINE 2)] in the pull-down menu.

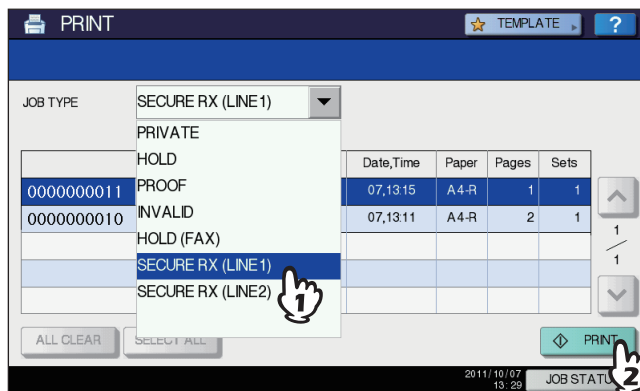

- If the equipment is running in the High Security mode, [SECURE RX (LINE 1)] and [SECURE RX (LINE 2)] are not displayed.

3 Select the desired fax job on the touch panel, and then press [PRINT].

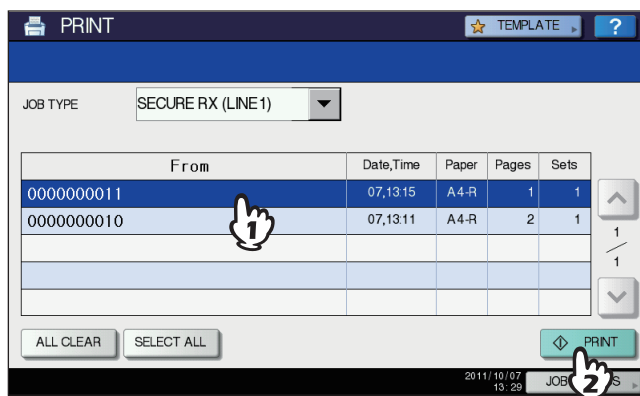

- You can select and print multiple fax jobs at once.

4 Press [PASSWORD].

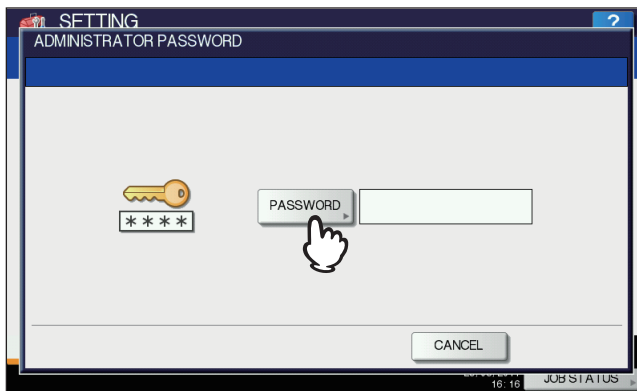

5 Enter the password for printing a received SECURE RECEIVE fax, and then press [OK] to start printing.

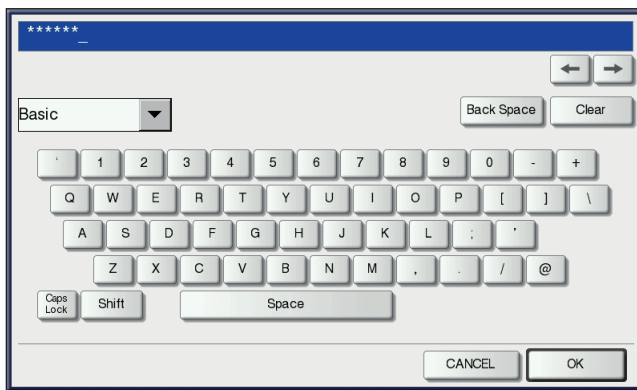

- Use the password set by your administrator for each line.

PRINTING LISTS AND REPORTS

This chapter explains how to print lists and reports.

Printing Lists & Reports Manually	78
Journal (transmission journal/reception journal).....	78
Reservation list.....	79
Mailbox/relay box report	80
Printing Lists & Reports Automatically.....	81
Lists/Reports Samples.....	82
Transmission journal	82
Reception journal	83
Reservation list.....	83
Mailbox/relay box report	84
Memory transmission report.....	85
Transmission report.....	86
Multi transmission report	86
Multi polling report	87
Relay TX orig. terminal report	87
Relay TX relay station report.....	88
Relay TX end terminal report	88
Relay station report	89
Mailbox reception report.....	89

Printing Lists & Reports Manually

You can print lists and reports (journals) manually. For samples of lists and reports, see the following section.

📖 P.82 “Lists/Reports Samples”

Tips

- Lists and reports are printed on LT/A4-size paper. If this equipment has run out of LT/A4-size paper, lists and reports will be printed on larger sized paper.
- In addition to the lists described in this section, the following lists can be printed manually: For details of the operation, refer to the **MFP Management Guide**.

ADDRESS BOOK INFORMATION: List of recipients registered in the address book.

GROUP NUMBER INFORMATION: List of recipients registered in the address book as a group.

FUNCTION LIST:

List of the user settings.

Journal (transmission journal/reception journal)

You can print a list of transmissions and receptions.

Tip

This equipment logs up to the latest 40 or 120 transmission/reception records. This number can be set on the ADMIN menu. For details of the operation, refer to the **MFP Management Guide**.

1 Press [JOB STATUS].



2 Select the [LOG] tab, and then press [SEND] or [RECEIVE].

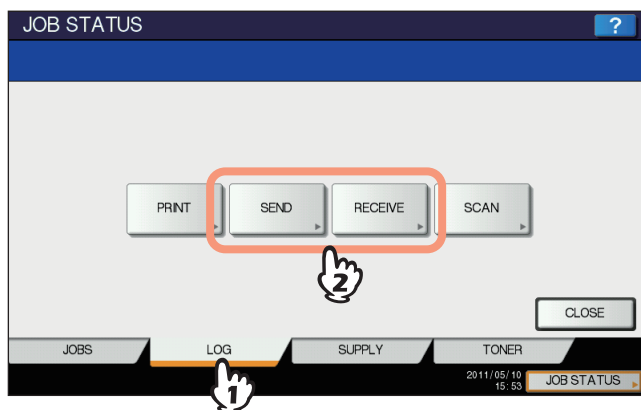

3 Press [JOURNAL].

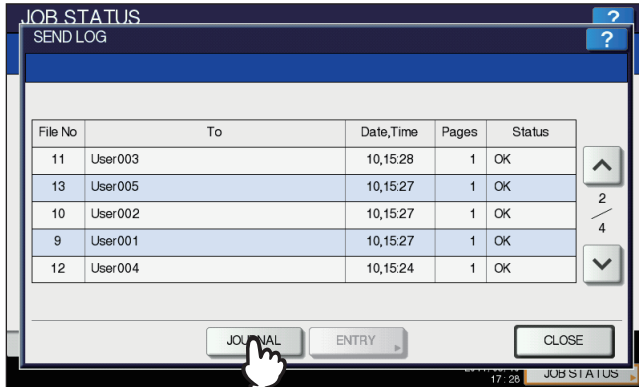

If [JOURNAL] is pressed with the transmission/reception records selected, the journal of the selected file is printed.

5

Reservation list

You can print a list of the reserved transmissions.

1 Press [JOB STATUS].



2 Press the [FAX], and then press [RESERVATION LIST].

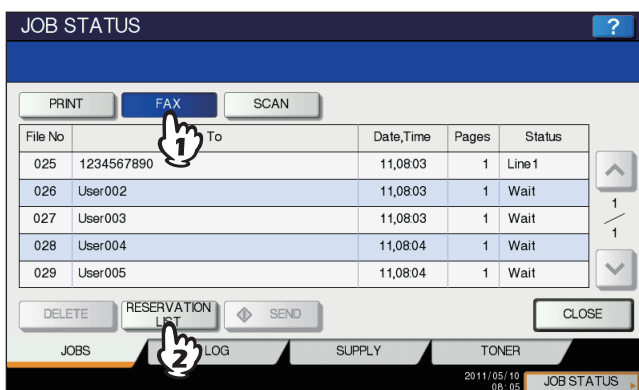

■ Mailbox/relay box report

You can print a list of the current status of the mailboxes registered to this equipment.

- 1 Press the [FAX] button on the control panel.**
P.14 “Basic procedures”
- 2 Press the [ADVANCED] tab, and then press [ITU MAILBOX LIST].**

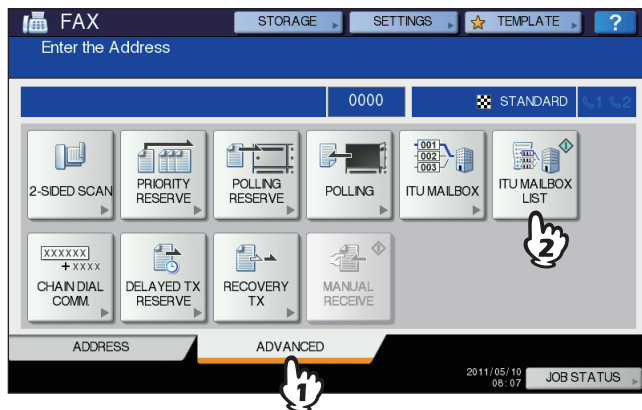

Printing Lists & Reports Automatically

You can print lists and reports automatically. For samples of lists and reports, see the following section.

 P.82 “Lists/Reports Samples”

Tip

Lists and reports are automatically printed according to the settings that the administrator made, so no user operation is required. For details of the setting operation, refer to the *MFP Management Guide*.

The available lists/reports to be printed automatically are as follows:

TRANSMISSION JOURNAL

When this equipment completes 40 or 120 transmission jobs, the transmission journal is printed.

RECEPTION JOURNAL

When this equipment completes 40 or 120 reception jobs, the reception journal is printed.

MEMORY TRANSMISSION REPORT

When the memory transmission is completed, the report is printed. (You have an option to add a reduced image of the transmitted document.)

TRANSMISSION REPORT

When the direct transmission is completed, the report is printed.

MULTI TRANSMISSION REPORT

When the multi-address transmission is completed, the report is printed. (You have an option to add a reduced image of the transmitted document.)

MULTI POLLING REPORT

When a multi-polling RX is completed, the report is printed.

RELAY TX ORIG. TERMINAL REPORT

When the document transmission from an originator terminal to a relay station is completed during the mailbox transmissions, the report is printed. (You have an option to add a reduced image of the transmitted document.)

RELAY TX RELAY STATION REPORT

When a document transmission from a relay station to an end terminal is completed during the mailbox transmissions, the report is printed. (You have an option to add a reduced image of the transmitted document.)

RELAY TX END TERMINAL REPORT

When the document transmission from a relay station to an end terminal is completed during the mailbox transmissions, the report is sent to an originator terminal. (You have an option to add a reduced image of the transmitted document.)

RELAY STATION REPORT

When a relay station in this equipment receives an original during the mailbox transmissions, the report is printed.

MAILBOX RECEPTION REPORT

When the confidential or bulletin board mailbox in this equipment receives an original during the mailbox receptions, the report is printed.

Lists/Reports Samples

Transmission journal

Terminal ID _____
 Sender's Fax number (Line2) _____
 Sender's Fax number (Line1) _____
 Journal (or list) outputting date and time _____

ROM version _____
 TRANSMISSION JOURNAL XXXXXXXXXXXX XXXX-XXX

TIME : 05-10-2012 17:55
 FAX NO.1 : 2131234567
 FAX NO.2 : 2131235678
 NAME : Aaabbb L.A.

NO.	FILE NO.	DATE TIME	DURATION	PGS	TO	DEPT	MODE	STATUS
001	002	05.10 16:59	00:23	1	◆ Redfield HS		◆ EC 603	OK
002	010	05.10 17:33	00:00	0	2123456789		P	00B5

Serial number for communication

File number of communication

Date and time when starting communication

Communicating period of time

The number of pages for the communication

Fax name or telephone number

Department code (blank if not controlled with department code)

Communication mode

EC: ECM communication

G3: G3 communication

ML: Email communication

	1 st (bps)	2 nd (Resolution)	3 rd (Mode)
0	2,400	8 x 3.85	MH
1	4,800	8 x 7.7	MR
2	7,200	8 x 15.4	MMR
3	9,600		JBIG
4	12,000	16 x 15.4	
5	14,400		
6	V.34		
8		300 dpi	
B		600 dpi	
D		150 dpi	

Special communication mode

P: Polling communication

SB: Mailbox communication

SR,R: Relay mailbox communication

SF,F: Forward mailbox communication

ML: Internet Fax communication

I: Network Fax communication

O: Offramp Gateway communication

Communication result and error code

OK: Succeeded

4-digit error code: Failed

Tips

- The mark ◆ in the "TO" column indicates that the 2ND FAX registered in the address book is used.
- The mark ◆ in the "MODE" column indicates that the 2nd line is used.
- For error codes in the "STATUS" column, see the following section.
P.108 "Error codes"

■ Reception journal

RECEPTION JOURNAL		XXXXXXXXXX	XXXX-XXX					
			TIME : 05-10-2012 17:55					
			FAX NO.1 : 2131234567					
			FAX NO.2 : 2131235678					
			NAME : Aaabbb L.A.					
NO.	FILE NO.	DATE TIME	DURATION	PGS	FROM	DEPT	MODE	STATUS
001	003	05.10 14:23	00:00	0	Aaabbb USA HQ		◆	NG 00B1
002	007	05.10 17:20	00:32	1	3109998888		EC 603	OK

5

Tips

- What is included in this journal is the same as in the transmission journal.
- For error codes in the "STATUS" column, see the following section.
 P.108 "Error codes"

■ Reservation list

RESERVATION LIST			
			TIME : 05-10-2012 18:41
			FAX NO.1 : 2131234567
			FAX NO.2 : 2131235678
			NAME : Aaabbb L.A.
TX / RX			
FILE NO.	DATE TIME	FUNCTION	PGS TO DELAY TIME
017	05.10 18:41	MULTI TX	1 G ABC EXPRESS
RECOVERY TX			
FILE NO.	DATE TIME	FUNCTION	PGS TO
013	05.10 18:01	MULTI TX	1 ☎ 2153334444
PC JOB			
FILE NO.	DATE TIME	FUNCTION	PGS TO DELAY TIME
003	05.10 17:40	MULTI TX	2 Cccddd CORPORATION

Tips

- The mark ☎ in the "TO" column indicates that the recipient is specified with the direct entry method.
- The mark G in the "TO" column indicates that the recipient is specified with the group entry method.

■ Mailbox/relay box report

MAILBOX/RELAY BOX REPORT						
					TIME	: 05-10-2012 18:00
					FAX NO.1	: 2131234567
					FAX NO.2	: 2131235678
					NAME	: Aaabbb L.A.
MAIL BOX						
BOX NO.	BOX TYPE	PGS	FILE NO.	DATE TIME	FROM	
11222	BULLETIN BD					
11231	CONFIDENTIAL	1	008	05.10 17:24	LOCAL	
RELAY						
BOX NO.	END STATION					REPLY TO NUMBER
12345	ADDRESS	001	002	003	004	005
	GROUP	001	002			
FORWARD/INBOUND FAX(TSI)						
BOX NO.	AGENT	DESTINATION				
22222	E-MAIL	To:	ADDRESS: <input checked="" type="checkbox"/> 001			
			GROUP : <input checked="" type="checkbox"/> 001			
		Cc:	ADDRESS: <input checked="" type="checkbox"/> 002 <input checked="" type="checkbox"/> 003			
			GROUP : <input checked="" type="checkbox"/> 002			

Tip

"END STATION" field indicates an E-mail address by a 4-digit number and the ID of a group by a 3-digit number.

■ Memory transmission report

MEMORY TRANSMISSION REPORT	
	TIME : 05-10-2012 17:48
	FAX NO.1 : 2131234567
	FAX NO.2 : 2131235678
	NAME : Aaabbb L.A.
FILE NO.	: 004
DATE	: 05.10 17:11
TO	: ◆ ABC EXPRESS
DOCUMENT PAGES	: 1
START TIME	: 05.10 17:13
END TIME	: 05.10 17:14 (STORED TIME : 05.10 23:14)
PAGES SENT	: 0
STATUS	: 0050
*** TX FAILURE NOTICE ***	
FILE NO.	: 005 (ITU MAILBOX : 12345)
DATE	: 05.10 17:25
TO	: ☎ 2221234555
DOCUMENT PAGES	: 1
START TIME	: 05.10 17:30
END TIME	: 05.10 17:31 (STORED TIME : 05.10 23:31)
PAGES SENT	: 1
STATUS	: OK

Tips

- The mark ◆ in the "TO" column indicates that the 2ND FAX registered in the address book is used.
- The mark ☎ in the "TO" column indicates that the recipient is specified with the direct entry method.
- For error codes in the "STATUS" column, see the following section.
 P.108 "Error codes"

■ Transmission report

TRANSMISSION REPORT		XXXXXXXXXX	XXXX-XXX					
			TIME : 05-10-2012 17:55					
			FAX NO.1 : 2131234567					
			FAX NO.2 : 2131235678					
			NAME : Aaabbb L.A.					
NO.	FILE NO.	DATE TIME	DURATION	PGS	TO	DEPT	MODE	STATUS
002	007	05.10 17:20	00:32	1	3109998888		EC 603	OK

Tip

For the error codes displayed in the "STATUS" column, see the following section.

📖 P.108 "Error codes"

■ Multi transmission report

MULTI TRANSMISSION REPORT		XXXXXXXXXX	XXXX-XXX
			TIME : 05-10-2012 18:17
			FAX NO.1 : 2131234567
			FAX NO.2 : 2131235678
			NAME : Aaabbb L.A.
FILE NO.	: 013		
DATE	: 05.10 18:01		
DOCUMENT PAGES	: 1		
START TIME	: 05.10 18:01		
END TIME	: 05.10 18:17 (STORED TIME : 05.11 00:17)		
SUCCESSFUL			
ADDRESS BOOK			
001	◆ Aaabbb ADMIN		
UNSUCCESSFUL			
FAX NUMBER	☎ 3109998888	PAGES SENT	0

Tips

- The mark ◆ in the "ADDRESS BOOK" column indicates that the 2ND FAX registered in the address book is used.
- The mark ☎ in the "FAX NUMBER" column indicates that the recipient is specified with the direct entry method.

■ Multi polling report

MULTI POLLING REPORT	
	TIME : 05-10-2012 18:18
	FAX NO.1 : 2131234567
	FAX NO.2 : 2131235678
	NAME : Aaabbb L.A.
FILE NO.	: 014
DATE	: 05.10 18:02
START TIME	: 05.10 18:17
END TIME	: 05.10 18:18
SUCCESSFUL	
ADDRESS BOOK	
001	Cccddd ADMIN
UNSUCCESSFUL	
FAX NUMBER	
	☎2139998888

5

Tip

The mark ☎ in the "FAX NUMBER" column indicates that the recipient is specified with the direct entry method.

■ Relay TX orig. terminal report

RELAY TX ORIG. TERMINAL REPORT	
	TIME : 05-10-2012 18:22
	FAX NO.1 : 2131234567
	FAX NO.2 : 2131235678
	NAME : Aaabbb L.A.
FILE NO.	: 016
DATE	: 05.10 18:22
TO	: ☎2139998888
RELAY BOX	: 12345
DOCUMENT PAGES	: 1
START TIME	: 05.10 18:22
END TIME	: 05.10 18:22
PAGES SENT	: 1
STATUS	: OK

Tip

The mark ☎ in the "TO" column indicates that the recipient is specified with the direct entry method.

■ Relay TX relay station report

```

RELAY TX RELAY STATION REPORT

                                     TIME           : 05-10-2012 14:46
                                     FAX NO.1       : 2131234567
                                     FAX NO.2       : 2131235678
                                     NAME           : Aaabbb L.A.

FILE NO.          : 013
DATE              : 05.10 14:45
DOCUMENT PAGES   : 3
FROM              : 7141234567
START TIME       : 05.10 14:45
END TIME         : 05.10 14:46
RELAY BOX        : 12345
SUCCESSFUL
GROUP NUMBER
  002 USA 1      ADDRESS BOOK ◆001
  005 ASIA 1
UNSUCCESSFUL
ADDRESS BOOK
  001 Cccddd ADMIN
                                     PAGE SENT
                                     0

```

Tip

The mark ◆ in the "ADDRESS BOOK" column is appended when the 2ND FAX registered in the address book is used for transmission.

■ Relay TX end terminal report

```

RELAY TX END TERMINAL REPORT

                                     TIME           : 05-10-2012 14:46
                                     FAX NO.1       : 2131234567
                                     FAX NO.2       : 2131235678
                                     NAME           : Aaabbb L.A.

FILE NO.          : 013
DATE              : 05.10 14:45
DOCUMENT PAGES   : 3
FROM              : 7141234567
START TIME       : 05.10 14:45
END TIME         : 05.10 14:46
RELAY BOX        : 12345
SUCCESSFUL
ADDRESS BOOK
  005 XYZ CORPORATION
UNSUCCESSFUL
ADDRESS BOOK
  001 Cccddd ADMIN
                                     PAGES SENT
                                     0

```

■ Relay station report

RELAY STATION REPORT	
TIME	: 05-10-2012 13:33
FAX NO.1	: 2131234567
NAME	: Aaabbb L.A.
FILE NO.	: 734
DATE	: 05.10 13:33
RELAY BOX	: 777
DOCUMENT PAGES	: 1
FROM	: 214

5

■ Mailbox reception report

MAILBOX RECEPTION REPORT	
TIME	: 05-10-2012 18:22
FAX NO.1	: 2131234567
FAX NO.2	: 2131235678
NAME	: Aaabbb L.A.
FILE NO.	: 016
DATE	: 05.10 18:22
BOX NUMBER	: 12345
BOX TYPE	: CONFIDENTIAL
DOCUMENT PAGES	: 1 (TOTAL 2)
FROM	: LOCAL

SETTING ITEMS

This chapter describes the user and administrator settings related to the fax function.

User Settings	92
Fax settings	92
Administrator Settings	95
Registering the terminal ID	97
Setting the initial setup	98
Setting RX printing	100
Setting recovery transmission	102
Setting 2nd Line for FAX Unit	103
SECURE RECEIVE	104

User Settings

■ Fax settings

Set the initial settings for the fax transmission functions.

- 1 Press the [RESET] button on the control panel.

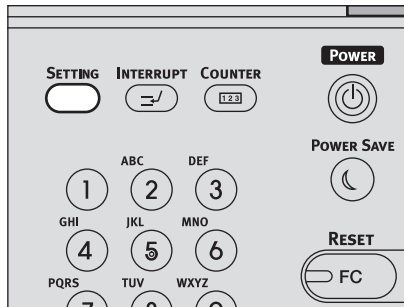

- 2 Press [FAX].

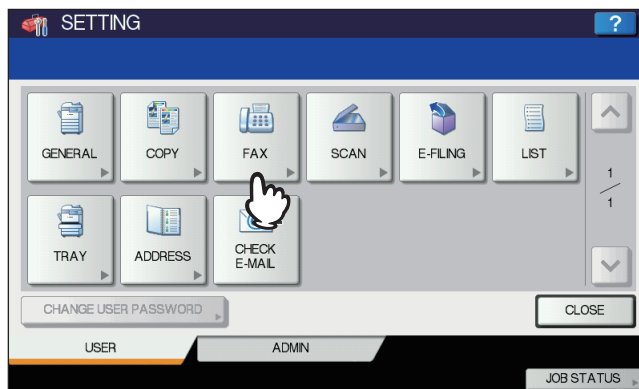

3 Set each setting item, and then press [OK].

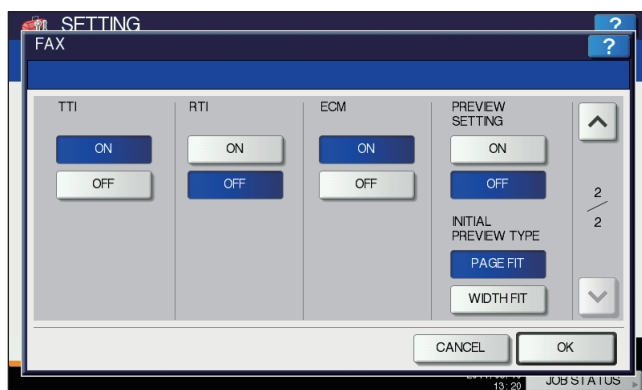
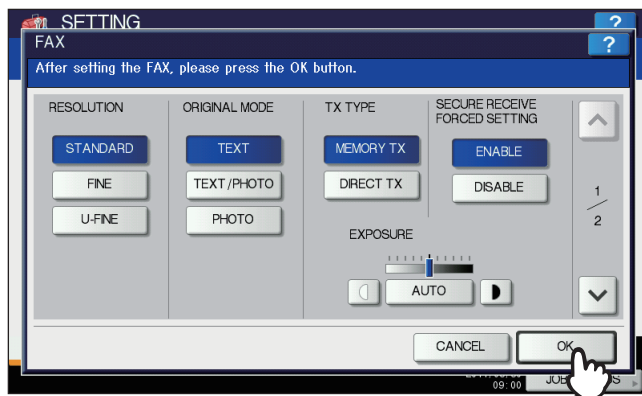

Press or to switch the pages.

RESOLUTION

Set the resolution based on the fineness of the original.

- STANDARD: This is suitable for an original with regular size text.
- FINE: This is suitable for an original with small size text and detailed illustrations.
- U-FINE: This is suitable for an original with ultra-detailed illustrations.

Tip

If the recipient's fax machine is not capable of receiving originals at the same resolution, the resolution is automatically converted before being sent it to the recipient. The higher the resolution is, the longer it takes to send an original.

ORIGINAL MODE

Set the scanning mode based on the type of the original.

- TEXT: This is suitable for an original with text and line drawings.
- TEXT/PHOTO: This is suitable for an original with a mixture of text and photos.
- PHOTO: This is suitable for an original with photos.

Tip

In the TEXT/PHOTO mode or PHOTO mode, transmission time may be longer than in the TEXT mode.

TX TYPE

Set the fax transmission mode.

- MEMORY TX: Send the original after the scanned data are saved in the memory. Up to 100 transmissions of up to 1000 pages per 1 transmission can be reserved, or up to 50 transmissions when the hard disk is not installed.
- DIRECT TX: Send the original directly as it is being scanned. Once a page has been scanned and sent, the next page is scanned and sent. Therefore, it takes longer to scan and send all pages. However, you can confirm on the fly that each page is sent to the recipient.

EXPOSURE

Set the density at which the original is to be scanned.

AUTO: This equipment automatically detects the contrast of the original, and scans it with the optimum contrast.

MANUAL: Press  or  to set the desired contrast.

TTI

Switch the TTI recording ON or OFF. To enable this feature, the Terminal ID must be registered to this equipment in advance.

 P.97 "Registering the terminal ID"

Tip

Setting this item may not be required since it may not be displayed on the screen (it depends on your country or region).

RTI

Switch the RTI recording ON or OFF. To enable this feature, the Terminal ID must be registered to this equipment in advance.

 P.97 "Registering the terminal ID"

ECM

Switch the ECM (Error Correction Mode) communication ON or OFF.

ECM is an internationally standardized communication mode that automatically corrects errors that occur during fax transmissions. With this setting option ON, even when the transmitted data have been affected by noise during communication, this mode allows good communication without image distortion by automatically resending the part that have been affected.

Tips

- Both the sender and the receiver must have the ECM function to make ECM communication available.
- When affected by noise during communication, communication time is slightly longer than usual. Even when the ECM communication is used, an error may occur depending on the line status.
- The ECM communication is not available for voice communication.

PREVIEW SETTING

Switch the preview setting ON or OFF.

This feature is available when the hard disk is installed in the equipment.

INITIAL PREVIEW TYPE

Set the preview type to be displayed as an initial

This feature is available when the hard disk is installed in the equipment.

SECURE RECEIVE FORCED SETTING

You can enable or disable the SECURE RECEIVE function.

This is available only when the WEEKLY SCHEDULE function is set.

ON: This enables the SECURE RECEIVE function.

Tip

It becomes disabled at the time set by WEEKLY SCHEDULE.

OFF: This disables the SECURE RECEIVE function.

Tips

- It becomes enabled at the time set by WEEKLY SCHEDULE.
- An administrator password is required.

Administrator Settings

This section describes the FAX menu managed by the administrator. Follow the procedures below to display the menu you want to operate.

1 Press the [RESET] button on the control panel.

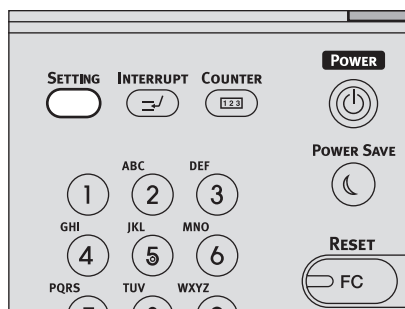

2 Press [ADMIN] tab, and then press [PASSWORD].

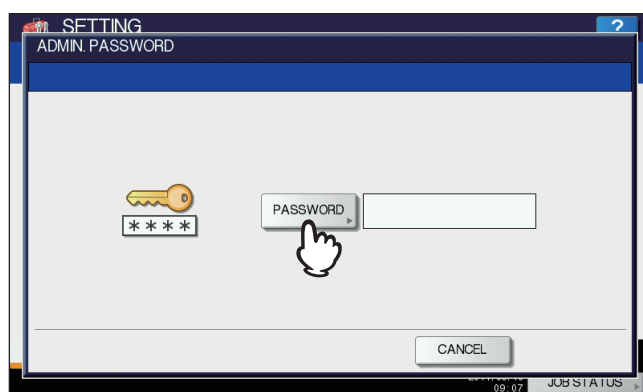

3 Enter the administrator password, and then press [OK].

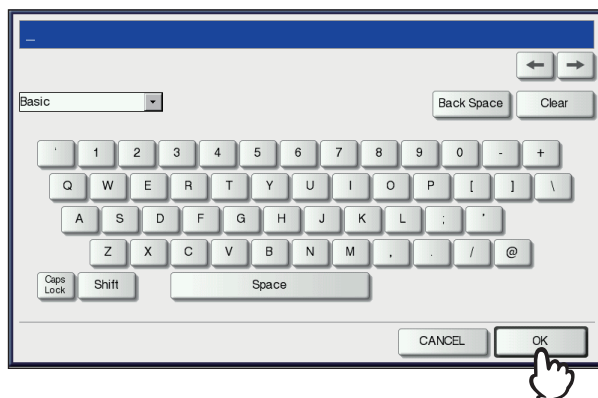

4 Press [FAX].



The FAX menu is displayed.

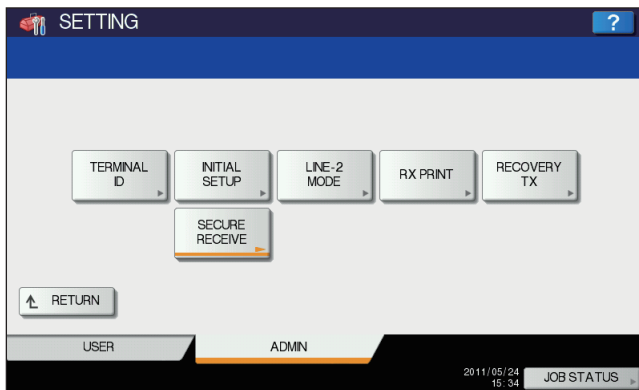

The following section describes each menu.

■ Registering the terminal ID

This section describes how to register the terminal ID of this equipment. If the terminal ID is registered in advance, sender information can be printed on the leading edge on the transmitted original, and receiver information on the trailing edge on the received fax.

📖 P.92 “Fax settings”

1 Press [TERMINAL ID].

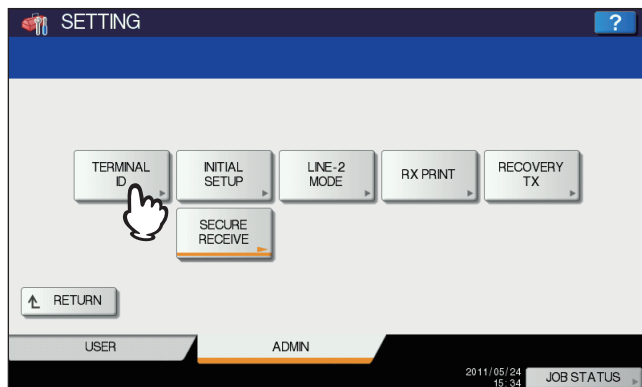

2 Set each setting option, and then press [OK].

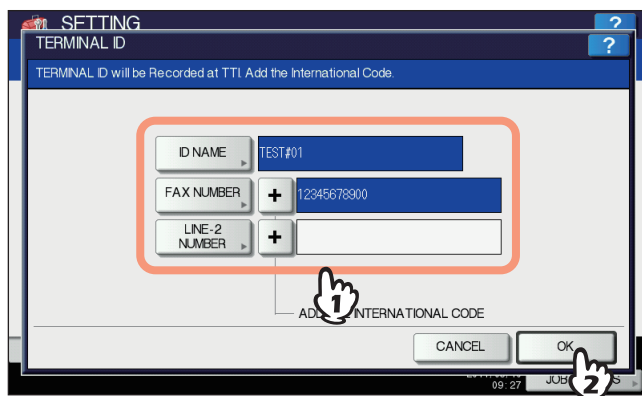

- You can enter up to 20 characters in the ID NAME, but whether they can all be displayed or not depends on their size.
- When you add an international code, press [+]. To enter a pause “ - ”, press [Pause].
- [LINE2 NUMBER] is displayed only when the 2nd Line for FAX Unit is installed.

Example of how sender information is printed on paper

Sender information is printed about 5 mm (0.2 inch) from the top edge of the transmitted copy of the original.

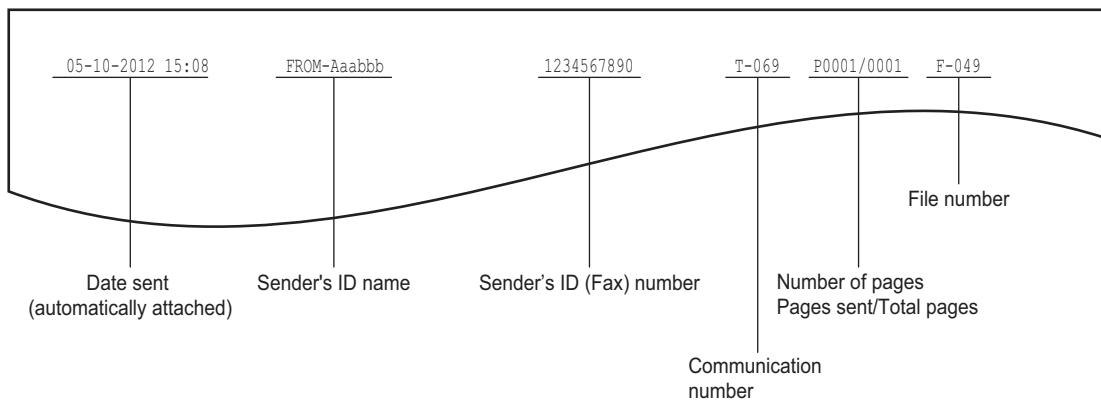

Example of how receiver information is printed on originals you receive

Receiver information is printed about 5 mm (0.2 inch) from the bottom edge of the received copy of the original.

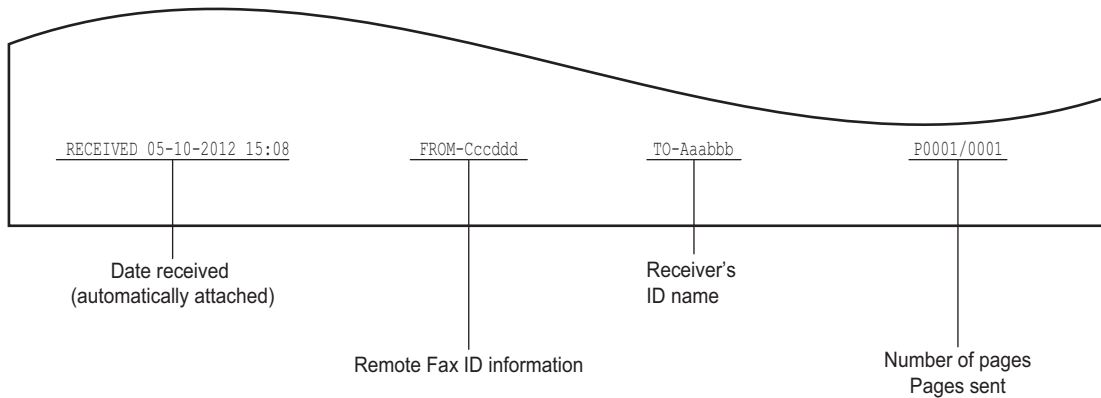

■ Setting the initial setup

You can set the initial settings for the fax functions.

1 Press [INITIAL SETUP].

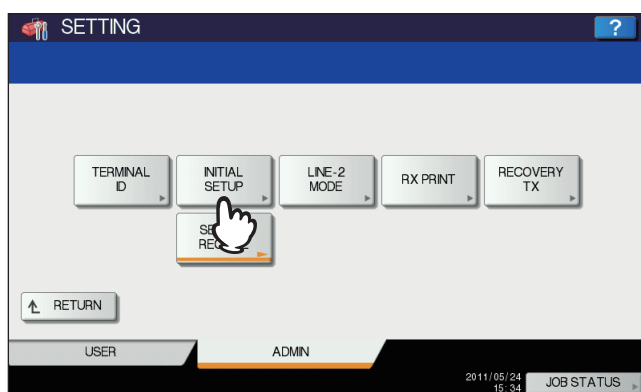

2 Set each option, and then press [OK].

Tip

Setting these items may not be required since they may not be displayed on the screen (it depends on your country or region).

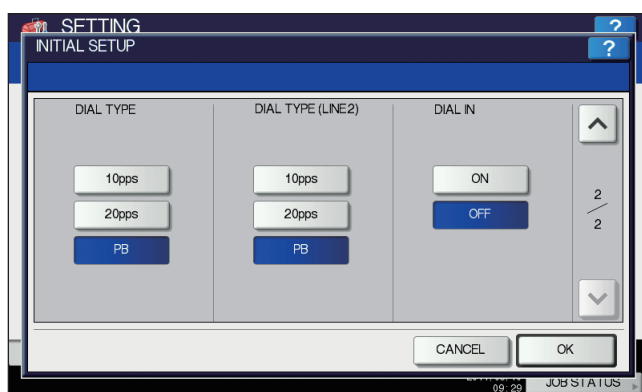
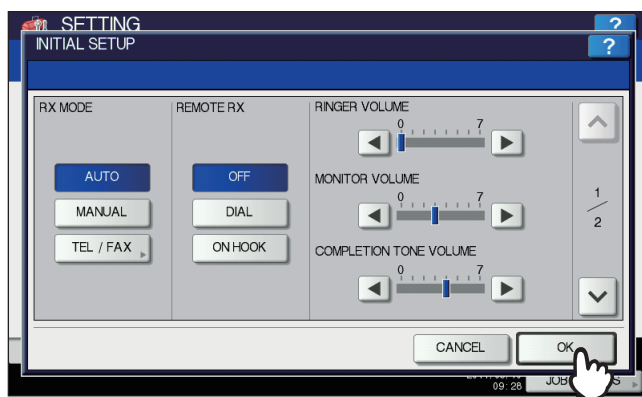

Press or to switch the pages.

RX MODE

Set the fax reception mode.

AUTO: This equipment receives an incoming fax automatically.

MANUAL: This equipment receives an incoming fax manually.

Tips

- To receive a fax in the manual mode, an external telephone is required.
- When the 2nd Line for FAX Unit is installed, the reception mode of the 2nd lines limited to "AUTO reception".

MONITOR VOLUME / COMPLETION TONE VOLUME

Monitor tone volume (line tone when on-hook) and Reception completion tone volume (You hear this tone when reception is completed). Each volume can be set in 8 levels (0: tone Off).

DIAL TYPE / DIAL TYPE (LINE2)

There are 2 types of telephone lines. When you first install this equipment or you change the connected telephone line, set this according to the telephone line type.

DP: Dial pulse lines.

MF: Multi frequency lines.

Tip

"DIAL TYPE (LINE2)" can be set when the 2nd Line for FAX Unit is installed.

■ Setting RX printing

You can set up options to print a received fax.

Tip

In the Administrator's Function List, you can view the status of the options. For details of the operation to print the list, refer to the *MFP Management Guide*.

1 Press [RX PRINT].

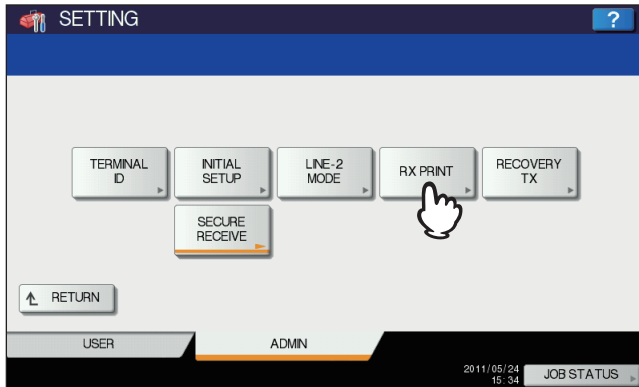

2 Set each option, and then press [OK].

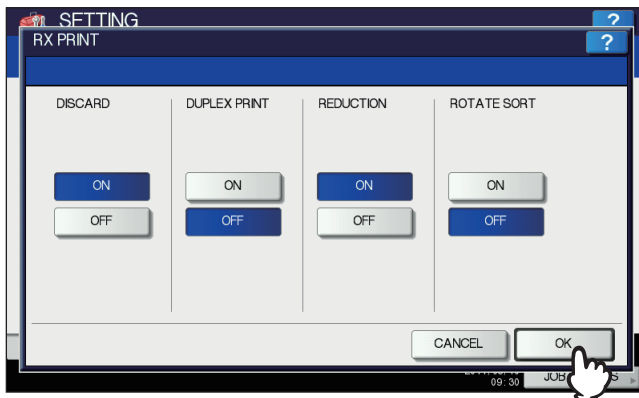

DISCARD

You can switch discard printing ON or OFF. With it being set to ON, if an original is up to 10 mm (0.4 inch) longer than the printing area, the part that exceeds the paper printing area is discarded.

📖 P.37 "Default setting for RX printing"

DUPLEX PRINT

You can switch duplex printing ON or OFF. With it being set to ON, received documents are printed on both sides of paper.

Tips

- Duplex printing is available only if the received fax sizes and resolution are the same.
- When paper has run out during duplex printing, the rest of the documents are printed on another size paper.
- When the received fax is printed on 2 sheets of paper because it exceeds the printing area, duplex printing is not available.
- Documents received using the batch transmission function are printed on both sides of the paper as one continuous document. Pay attention to the separation of the individual documents particularly those consisting of an odd number of pages.
- Even when duplex printing is set to ON, the document printed using the reception forward function is printed on a single side of paper.
- Duplex printing direction differs depending on the received document size, as shown in the figures below. Received LD, LG, LT, A3, A4, or B4-sized documents are printed so that they can be bound along the long edge of the direction. (Figure 1)
Received ST, A5 or B5-sized documents are printed so that they can be bound along the short edge of the direction. (Figure 2)

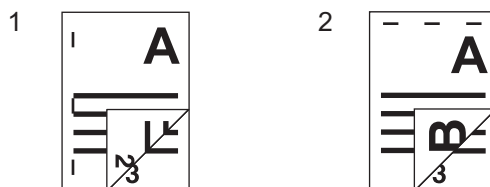

REDUCTION

You can switch RX reduction printing ON or OFF. With it being set to ON, if an original exceeds the printing area by more than 10 mm (0.4 inch), it is reduced by 90% of the original size when printing.

P.37 “Default setting for RX printing”

ROTATE SORT

You can switch the rotate sort function ON or OFF. With this being set to ON, received faxes are alternately sorted horizontally and vertically for each fax job.

Tips

- Rotate Sort is available only for LT/A4-sized paper. Set the LT and LT-R, or A4 and A4-R trays.
- If paper runs out during Rotate Sort, the rest of the documents are printed on the remaining paper. If no copy paper remains, printing is performed on a larger size than A4/A4-R or LT/LT-R.
- When the rotate sort function is set to ON, the attribute cannot be set to “FAX”.

■ Setting recovery transmission

You can set a period of time to retain original data in the memory for the recovery transmission function, or whether enabling or disabling this function.

1 Press [RECOVERY TX].

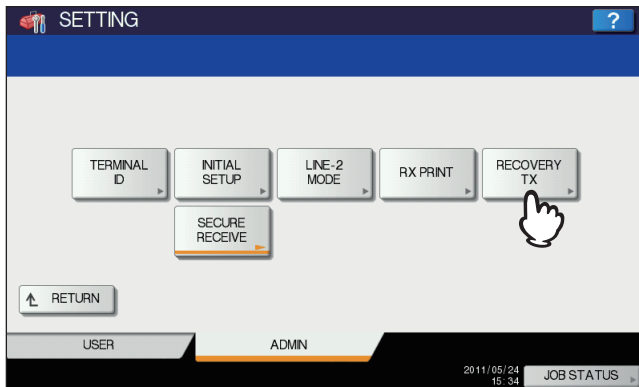

2 Press [▲ 24H] or [▼ 1H] to set the document-stored time, and then press [OK].

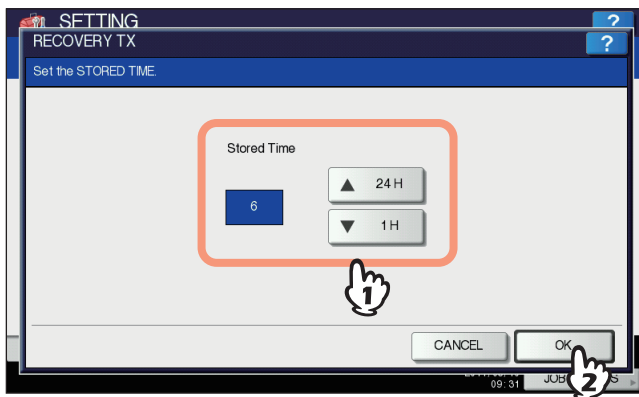



Note

When the screen is returned to the one shown in step 1 above, make sure that an orange line is marked on [RECOVERY TX]. This line indicates that the recovery transmission function is ON. If you press [RECOVERY TX] again, the orange line disappears, that is, the function is OFF.

■ Setting 2nd Line for FAX Unit

You can make settings so that two lines can be used at the same time using the 2nd Line for FAX Unit installed. In addition to the settings described below, you need to:

- Register the terminal ID.
 P.97 "Registering the terminal ID"
- Set the dial type.
 P.98 "Setting the initial setup"

1 Press [LINE-2 MODE].

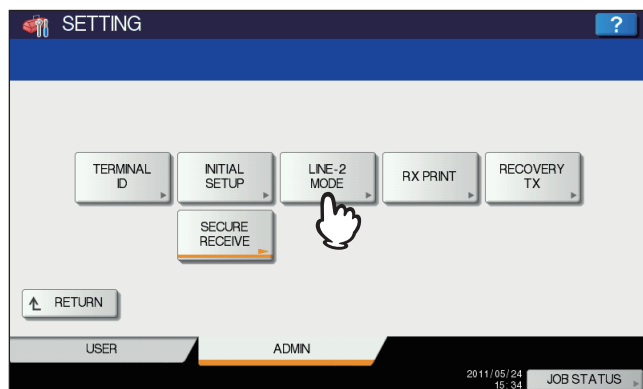

2 Set how you want to use the 2nd line, and then press [OK].

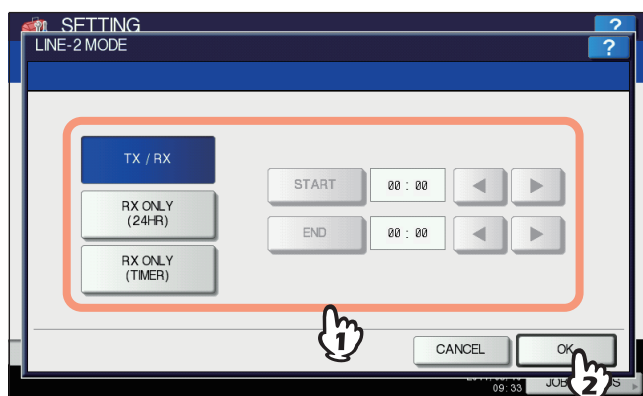

TX / RX

The 2nd line is used for both transmission and reception.

RX ONLY (24HR)

The 2nd line is used only for reception.

RX ONLY (TIMER)

The 2nd line is used only for reception during a specified period of time. To move the cursor, use ◀ or ▶. Specify the time period on a 24-hour basis using the digital keys on the control panel.

Tip

The automatic reception is only available for the 2nd line.

■ SECURE RECEIVE

The SECURE RECEIVE function allows you to store received fax jobs in the equipment without printing them. With this function, you can prevent the leaking of confidential information in a fax received when no people are present in your office, such as nighttime or holidays, or when an unspecified number of people visit your office.

The SECURE RECEIVE setting consists of a manual POWER setting and a scheduled POWER setting for each day of the week (WEEKLY SCHEDULE) by administrators.

The SECURE RECEIVE function can be manually enabled/disabled, or automatically enabled/disabled at a specified time and day of the week.

Notes

- If the equipment is being used in the High Security mode, the SECURE RECEIVE function is not available.
- The data lamp does not light when the equipment is in the Super Sleep mode.

Tip

In [FAX] in the [USER] tab, you can enable or disable the SECURE RECEIVE function earlier than the time set by WEEKLY SCHEDULE.

□ Setting SECURE RECEIVE

You can set how you receive a SECURE RECEIVE fax.

1 Press [SECURE RECEIVE].

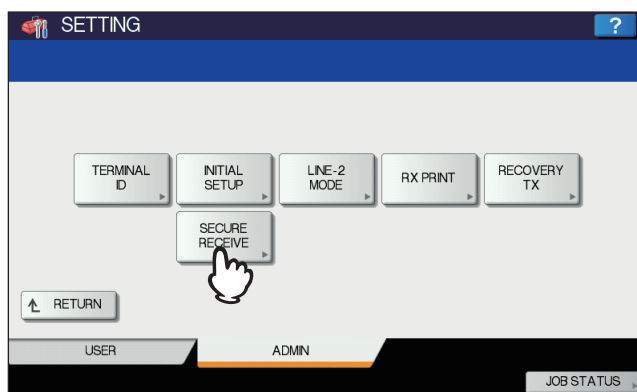

2 Select [WEEKLY SCHEDULE] or [ENABLE] for SECURE RECEIVE.

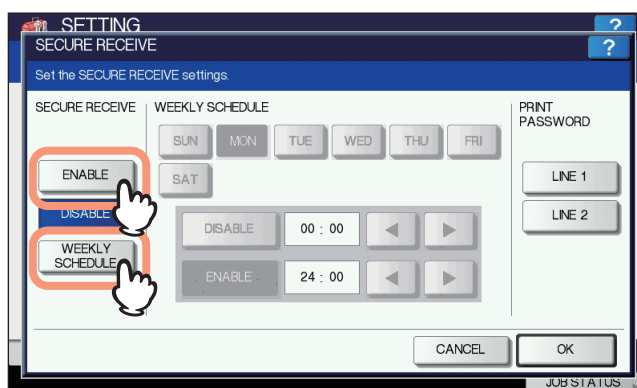

[ENABLE]

You can enable the SECURE RECEIVE function.

[WEEKLY SCHEDULE]

You can set the time for each day of the week for automatically enabling or disabling the SECURE RECEIVE function.

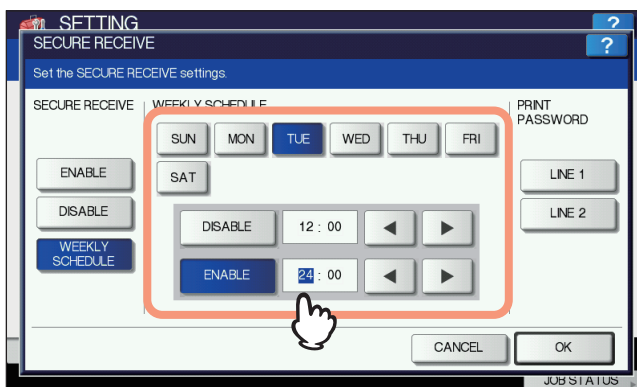

- Time is displayed in 24-hour format.
 - To enable the function throughout the day, set [DISABLE]/[ENABLE] to 00:00/00:00.
 - To disable the function throughout the day, set [DISABLE]/[ENABLE] to 00:00/24:00.
- To clear the entered time, press the [Clear] button on the control panel.

□ Setting a password for printing

You can set a password for printing a received SECURE RECEIVE fax.

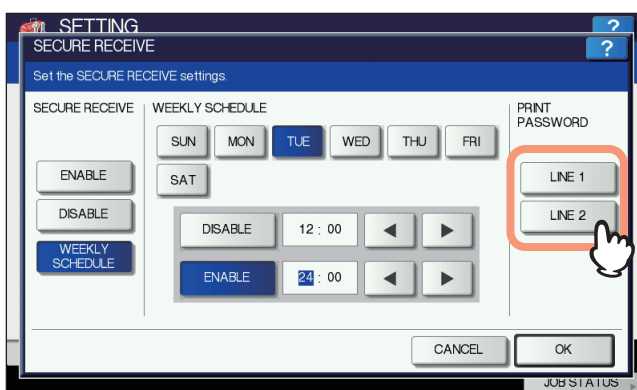
1 Select [LINE 1] or [LINE 2].

- A password for printing can be set for each line.

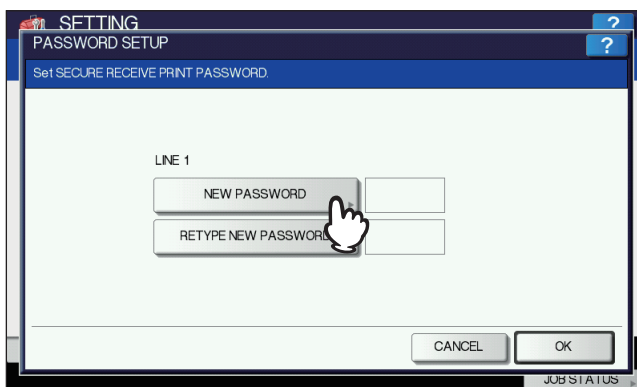
2 Press [NEW PASSWORD].

3 Enter the password and press [OK].

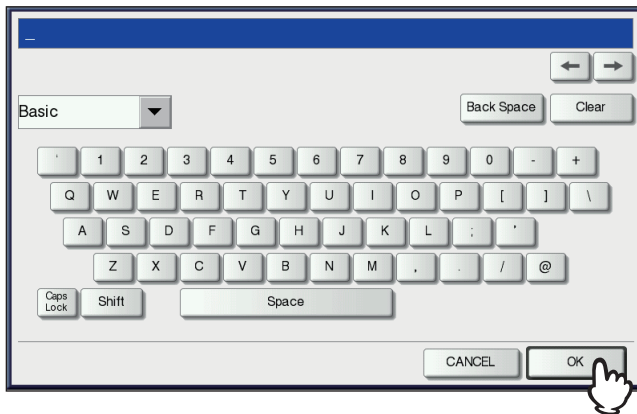

4 Press [RETYPE NEW PASSWORD], enter the same password again, and then press [OK].



- Up to 20 alphanumeric characters (including the following symbols) can be entered for the password. You can use alphanumerics and the following symbols.
\$ () * + , - . / : ; = ? @ \ ^ _ ` { | } ~

5 Press [OK].

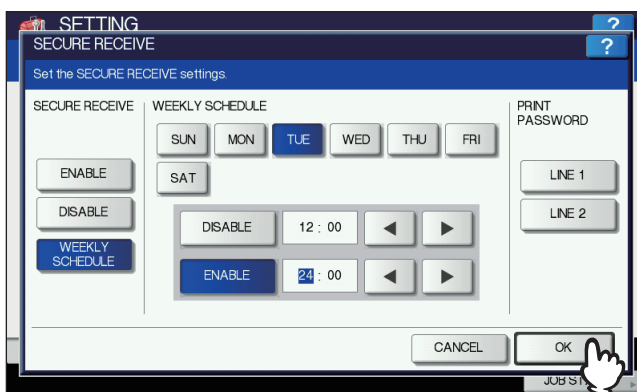

Tip

It can be set also on the TopAccess menu.

TROUBLESHOOTING AND SPECIFICATIONS

This chapter describes troubleshooting and specifications of GD-1320/GD-1260.

Troubleshooting	108
Error codes	108
Error messages	108
Transmission/reception trouble	109
Specifications of GD-1320/GD-1260	110

Troubleshooting

■ Error codes

Below is a list of error codes that you might see in the lists or reports.

Error Code	Description	Remedy
0012	Original misfeed	Clear the misfed original.
0013	Door open	Firmly close the open door.
0020	Power interruption	Check the power interruption report.
0030	Reset	Transmission is cancelled. (The transmission is terminated by the misfed printing paper during the direct transmission.)
0033	Polling Error	Check polling options setup (Security code, etc.), and check if the polling document exists.
0042	Memory full	Make sure that there is sufficient memory before making the call again.
0050	Line busy	Retry communications.
0053	Security mismatch in relay or mail box transmission	Confirm the remote party's security code, system password, and your setup.
00B0 - 00E8	Communication Error	Retry communications.

Tip

If you see an error code not listed here, retry the communication. If this error still occurs, contact your service technician or service representative.

■ Error messages

Below is a list of error messages that might appear on the touch panel. When any message in the list appears on the touch panel, press [RESET] on the control panel to clear it, and then take action suggested in the "Remedy" column.

Message	Cause	Remedy
Memory overflow	Memory overflowed when scanning documents to the memory.	Either wait for memory to be cleared, or check the jobs and delete reserved jobs to clear memory.
Communication error	Communication error occurred during direct TX.	Retry communications.
Job reservation full	The number of reserved jobs exceeded the maximum.	Either wait for job reservations to be completed, or check the jobs and delete reserved jobs.
Job memory full	The total number of destinations for reserved jobs exceeded the maximum.	Either wait for job reservations to be completed, or check the jobs and delete reserved jobs.
Sorry not possible	On-hook or direct TX was attempted during communications.	Wait for communications to end and retry communications.
Not allowed now	Further polling transmission reservation was attempted even though polling transmission was already reserved.	Either wait for polling transmission jobs to be completed, or check the jobs and delete reserved jobs.
Too Many Tel # Digits	128 digits or more were registered for a chain dial communication.	Confirm the number of digits dialed and register the numbers again.

⚠ WARNING

Never attempt to repair, disassemble or modify the equipment by yourself.

You could cause a fire or get an electric shock. Always contact your service representative for maintenance or repair of the internal parts of the equipment.

Tip

For error messages not listed above and their solutions, refer to the **Troubleshooting Guide**.

■ Transmission/reception trouble

Below is a list of trouble you might encounter during the transmission/reception.

Transmission troubles

Trouble	Check Point
TRANSMIT is not displayed even if the [START] button is pressed.	<ul style="list-style-type: none"> • Did you replace the handset before you pressed the [START] button? When you are making a call on the handset to send a Fax, do not replace the handset until you press the [START] button. • Is the modular cord disconnected? • Is the power plug unplugged from the power outlet? • Can you receive telephone calls? • Is there any problem at the remote Fax? Check this with the party trying to receive the original.
Originals are fed diagonally.	<ul style="list-style-type: none"> • Are the document feeder slides adjusted to the width of the original that you are sending? • Does the original that you are sending match the conditions of the original that is available for sending?
2 originals are fed together.	<ul style="list-style-type: none"> • Have you placed more than the maximum number of originals that can be placed at one time? • Does the original that you are sending match the conditions of the original that is available for sending? • Have you pushed the originals into the feeder too hard?
The original is not being printed on the paper of the remote Fax even though it has been sent.	Was the original placed correctly facing up? When placing the original on the original glass, specify the original size.
Black lines are shown in the image that was sent.	Is the scanning area of the Reversing Automatic Document Feeder clean? Clean it with a soft cloth.
Originals are not sent even if operations are carried out normally.	Is the remote Fax compatible with your system? This system supports G3 communications but not G2 or G4 communications.
Originals cannot be sent overseas.	Specify Quality TX and resend. 📖 P.21 "Setting the transmission conditions"

Reception troubles

Trouble	Check Point
Originals cannot be received even if "RECEIVE" is displayed and the [START] button is pressed.	<ul style="list-style-type: none"> • Did you replace the handset before you pressed the [START] button? When you answer a call on the handset to receive a Fax, do not replace the handset until you press the [START] button. • Is the modular cord disconnected? • Is there a problem at the remote Fax? Check this with the party trying to send the original.
Paper is not output.	Is the equipment out of paper?
The received original is printed dark and is illegible or black stripes are printed on the original.	<ul style="list-style-type: none"> • Make a local copy and confirm proper printing. • Is the original being sent a dirty copy? Check this with the party trying to send the original. • Is the trouble due to a problem or operation error at the remote Fax? Check this with the party trying to send the original.
Paper is output but not printed.	<ul style="list-style-type: none"> • Is there enough toner? • Is the original placed correctly on the remote Fax? Check this with the party trying to send the original.
Paper often misfeeds.	<ul style="list-style-type: none"> • Is the paper tray size setting correct? • Is the paper tray properly inserted? • Is the specified paper type being use?

Tip

If the suggested action does not solve the trouble or you encounter trouble not listed above, contact your service technician or service representative.

Specifications of GD-1320/GD-1260

Model Name	GD-1320
Size of Original (North America)	LD, LG, LT, LT-R, ST, ST-R, COMP
Size of Original (A/B format)	A3, A4, A4-R, A5, A5-R, B4, B5, B5-R, FOLIO
Recording Paper Size (North America)	11" x 17" (LD), 8.5" x 14" (LG), 8.5" x 11" (LT), 5.5" x 8.5" (ST), 10. 1/8" x 14" (COMP)
Recording Paper Size (A/B format)	297 mm x 420 mm (A3), 210 mm x 297 mm (A4), 148 mm x 210 mm (A5), 257 mm x 364 mm (B4), 182 mm x 257 mm (B5), 210 mm x 330 mm (FOLIO)
Compatibility Communication Modes	Exclusive Mode, ECM, G3
Communication Resolution	Horizontal: 8 dots/mm, 16 dots/mm, 300 dots/inch
	Vertical: 3.85 lines/mm, 7.7 lines/mm, 15.4 lines/mm, 300 dots/inch
Transmission Rate	33,600/31,200/28,800/26,400/24,000/21,600/19,200/16,800/14,400/12,000/9,600/7,200/4,800/2,400 bps
Encoding Systems	JBIG/MMR/MR/MH
Memory Capacity	Transmission/Reception: 1GB *1
Unit Type	Desktop type, transmitting/receiving dual type
Applicable Network	Public Switched Telephone Network (PSTN)

*1 For hard drives, MB means 1 million bytes. (Total hard drive accessible capacity may vary depending on operating environment.)

When the total time that the power is turned off for 12 hours a day becomes about 5 years, the battery will expire. If the battery is run down, ask your service technician. (Repair and replacement will be charged.)

* Specifications and appearance are subject to change without notice in the interest of product improvement.

* If trouble occurs, call service for assistance.

Options

2nd Line for FAX Unit: GD-1260

INDEX

Numerics

2nd Line for FAX Unit	12, 103
2-Sided originals	50

A

Administrator settings	95
ATTENTION lamp	8

B

Batch transmission function	16
Bulletin board mailbox	55

C

Canceling direct transmissions	47
Canceling reserved transmissions	48
Canceling the memory transmission	45
Chain dial communication	68
[CLEAR] button	8
Communication status	43
COMPLETION TONE VOLUME	99
Confidential mailbox	55
Connecting cables	12
Control panel	8

D

DATA IN MEMORY	8
DATA lamp	8
Delayed transmission reservation	69
Department management	10
DIAL TYPE	99
DIAL TYPE (LINE2)	99
Different width originals	20
Digital keys	8
DIRECT TX	22, 93
DISCARD	100
DUPLEX PRINT	101

E

ECM	23, 94
E-mail	71, 72
E-mail address	71, 72
Error codes	108
Error messages	108
EXPOSURE	22, 94
External telephone	12, 32, 33, 35

F

[FAX] button	8
--------------------	---

I

INITIAL PREVIEW TYPE	94
Initial setup	98
INTERNET FAX	23
Internet Fax	42, 72
ITU-T	23, 55

J

[JOB STATUS]	10
--------------------	----

L

LINE SELECT	23
-------------------	----

M

MAIL BOX COMMUNICATION	23
------------------------------	----

Mailbox Transmission

creating the confidential or bulletin board mailbox	63
creating/modifying a relay station mailbox	64
deleting a mailbox	66
deleting an original	59
printing an original	58
registering an original	56
retrieving an original	61
sending an original	60
MEMORY TX	22, 93
MONITOR VOLUME	99

N

Network Fax	42
Next original	16

O

Off-hook transmission	33
Offramp gateway	72
On-hook transmission	32
Onramp gateway	71
[OPTION]	14, 21, 24
Options	11
Original	
original scanning range	17
originals that can be sent	17
placing the original(s) on the original glass	18
placing the original(s) on the RADF	19
ORIGINAL MODE	22, 93
ORIGINAL SIZE	22

P

Paper	
acceptable size of paper	37
default setting for RX printing	37
paper priority when there is no same size paper	38
[Pause]	97
Polling Communication	53
[PREVIEW]	15, 33
PREVIEW SETTING	94
[PRINT] button	8
Printing lists & reports	
automatically	81
manually	78
samples	82
Priority transmission	52

Q

QUALITY TX	23
------------------	----

R

Receiver information	97, 98
Receiving	
AUTO reception	35
MANUAL reception	35
Memory reception	36
Recipient	
confirming the recipients	31
direct entry with digital keys	25
group entry	27
searching for by ID number	27
searching for the recipient's fax number	29
specifying the recipient in the address book	26
Recovery transmission	70, 102
Redial function	16
REDUCTION	101

Relay station mailbox	55
Reserved transmissions	42
[RESET] button	8
RESOLUTION	22, 93
ROTATE SORT	101
RTI	94
RX MODE	99
RX ONLY (24HR)	103
RX ONLY (TIMER)	103
RX printing	100

S

Save as File	73
SECURE RECEIVE FORCED SETTING	94
Sender information	97, 98
Sending	14
[SETTING] button	8
SMTP server	72
Specifications	110
[START] button	8
[STOP] button	8

T

Telephone line	12
Terminal ID	97
Touch panel	10
Transmission conditions	
changing the settings for each page	24
making settings	21
Trouble	109
TTI	94
TX / RX	103
TX TYPE	22, 93

U

User management	10
User Settings	92

Oki Data Corporation
4-11-22 Shibaura, Minato-ku, Tokyo
108-8551, Japan

www.okiprintingsolutions.com

