



## *Service Manual*

**Lexmark™ E350d, E352dn**

---

**4512-420**

**4512-430**

- ***Table of contents***
- ***Start diagnostics***
- ***Safety and notices***
- ***Trademarks***
- ***Index***

**LEXMARK™**

*Lexmark and Lexmark with diamond design are trademarks of Lexmark International, Inc., registered in the United States and/or other countries.*

**Edition: July 2, 2008**

**The following paragraph does not apply to any country where such provisions are inconsistent with local law:** LEXMARK INTERNATIONAL, INC. PROVIDES THIS PUBLICATION "AS IS" WITHOUT WARRANTY OF ANY KIND, EITHER EXPRESS OR IMPLIED, INCLUDING, BUT NOT LIMITED TO, THE IMPLIED WARRANTIES OF MERCHANTABILITY OR FITNESS FOR A PARTICULAR PURPOSE. Some states do not allow disclaimer of express or implied warranties in certain transactions; therefore, this statement may not apply to you.

This publication could include technical inaccuracies or typographical errors. Changes are periodically made to the information herein; these changes will be incorporated in later editions. Improvements or changes in the products or the programs described may be made at any time.

Comments may be addressed to Lexmark International, Inc., Department D22A/032-2, 740 West New Circle Road, Lexington, Kentucky 40550, U.S.A or e-mail at ServiceInfoAndTraining@Lexmark.com. Lexmark may use or distribute any of the information you supply in any way it believes appropriate without incurring any obligation to you.

References in this publication to products, programs, or services do not imply that the manufacturer intends to make these available in all countries in which it operates. Any reference to a product, program, or service is not intended to state or imply that only that product, program, or service may be used. Any functionally equivalent product, program, or service that does not infringe any existing intellectual property right may be used instead. Evaluation and verification of operation in conjunction with other products, programs, or services, except those expressly designated by the manufacturer, are the user's responsibility.

Lexmark, Lexmark with diamond design, MarkNet, and MarkVision are trademarks of Lexmark International, Inc., registered in the United States and/or other countries.

PictureGrade is a trademark of Lexmark International, Inc.

PCL® is a registered trademark of the Hewlett-Packard Company.

All other trademarks are the property of their respective owners.

**© 2006 Lexmark International, Inc.  
All rights reserved.**

#### **UNITED STATES GOVERNMENT RIGHTS**

This software and any accompanying documentation provided under this agreement are commercial computer software and documentation developed exclusively at private expense.

# Table of Contents

<b>Table of Contents</b> .....	<b>iii</b>
<b>Notices and safety information</b> .....	<b>v</b>
Laser notice .....	v
Safety information .....	ix
<b>Preface</b> .....	<b>xii</b>
Definitions .....	xii
<b>General information</b> .....	<b>1-1</b>
Model .....	1-1
Maintenance approach .....	1-1
Overview of the operator panel .....	1-2
Specifications .....	1-3
Memory .....	1-3
Print speed .....	1-3
Print quality .....	1-3
Media trays and supply capacity .....	1-4
Connectivity and compatibility .....	1-5
Types of print media .....	1-6
Tips on preventing jams .....	1-7
Paper path .....	1-7
Tools .....	1-8
Acronyms .....	1-9
<b>Diagnostics information</b> .....	<b>2-1</b>
Start .....	2-1
Overview of the operator panel and menus .....	2-2
Indicator light .....	2-2
Buttons .....	2-3
Diagram of the printer menus .....	2-4
Messages and error codes .....	2-5
User attendance messages .....	2-5
Cartridge error messages .....	2-8
Paper jam error codes (200-series) .....	2-8
Service error codes .....	2-12
Symptom tables .....	2-15
POST symptom table .....	2-15
Printer symptom table .....	2-16
Service checks .....	2-17
Controller card service check .....	2-17
Cooling fan service check .....	2-18
Cover interlock switch service check .....	2-18
Dead machine service check .....	2-19
Fuser service check .....	2-19
LVPS/HVPS service check .....	2-20
Main motor service check .....	2-20
Operator panel service check .....	2-21
Paper feed service checks .....	2-21
Parallel or USB port service check .....	2-23
Print quality service checks .....	2-24
Printhead service check .....	2-31
Transfer roll service check .....	2-31

<b>Diagnostic aids</b> .....	<b>3-1</b>
<b>Accessing service menus</b> .....	<b>3-1</b>
Printing menus .....	3-1
<b>Configuration menu (CONFIG MENU)</b> .....	<b>3-2</b>
Entering Configuration Menu .....	3-2
Available menus .....	3-2
Maint Cnt Value .....	3-2
Reset Maint Count .....	3-2
Reset PC Cnt .....	3-2
Print quality pages (Prt Quality Pgs) .....	3-3
Panel Menus .....	3-3
PPDS Emulation .....	3-3
Demo Mode .....	3-3
Factory Defaults .....	3-3
Energy Conserve .....	3-3
Event Log .....	3-3
Reduced Curl .....	3-4
USB Speed .....	3-4
Exit Config Menu .....	3-4
<b>Diagnostics mode</b> .....	<b>3-5</b>
Entering Diagnostics Mode .....	3-5
Available tests .....	3-5
Registration .....	3-7
Print tests .....	3-14
Hardware tests .....	3-15
Duplex tests .....	3-16
Input tray tests .....	3-17
Base sensor test .....	3-18
Printer setup .....	3-19
EP setup .....	3-21
Event log .....	3-21
Exit Diagnostics .....	3-22
<b>Repair information</b> .....	<b>4-1</b>
Handling ESD-sensitive parts .....	4-1
Removal procedures .....	4-1
<b>Locations and connections</b> .....	<b>5-1</b>
<b>Locations</b> .....	<b>5-1</b>
Front view .....	5-1
Rear view .....	5-1
Controller card connector pin values .....	5-2
<b>Connectors</b> .....	<b>5-4</b>
<b>Preventive maintenance</b> .....	<b>6-1</b>
Safety inspection guide .....	6-1
Lubrication specifications .....	6-1
Maintenance kits .....	6-1
<b>Parts catalog</b> .....	<b>7-1</b>
How to use this parts catalog .....	7-1
<b>Index</b> .....	<b>I-1</b>
<b>Part number index</b> .....	<b>I-5</b>

---

## Notices and safety information

The following laser notice labels may be affixed to this printer as shown:

---

### Laser notice

The printer is certified in the U.S. to conform to the requirements of DHHS 21 CFR Subchapter J for Class I (1) laser products, and elsewhere is certified as a Class I laser product conforming to the requirements of IEC 60825-1.

Class I laser products are not considered to be hazardous. The printer contains internally a Class IIIb (3b) laser that is nominally a 5 milliwatt gallium arsenide laser operating in the wavelength region of 770-795 nanometers. The laser system and printer are designed so there is never any human access to laser radiation above a Class I level during normal operation, user maintenance, or prescribed service condition.

---

### Laser

Der Drucker erfüllt gemäß amtlicher Bestätigung der USA die Anforderungen der Bestimmung DHHS (Department of Health and Human Services) 21 CFR Teil J für Laserprodukte der Klasse I (1). In anderen Ländern gilt der Drucker als Laserprodukt der Klasse I, der die Anforderungen der IEC (International Electrotechnical Commission) 60825-1 gemäß amtlicher Bestätigung erfüllt.

Laserprodukte der Klasse I gelten als unschädlich. Im Inneren des Druckers befindet sich ein Laser der Klasse IIIb (3b), bei dem es sich um einen Galliumarsenlaser mit 5 Milliwatt handelt, der Wellen der Länge 770-795 Nanometer ausstrahlt. Das Lasersystem und der Drucker sind so konzipiert, daß im Normalbetrieb, bei der Wartung durch den Benutzer oder bei ordnungsgemäßer Wartung durch den Kundendienst Laserbestrahlung, die Klasse I übersteigen würde, Menschen keinesfalls erreicht.

---

### Avis relatif à l'utilisation de laser

Pour les Etats-Unis : cette imprimante est certifiée conforme aux provisions DHHS 21 CFR alinéa J concernant les produits laser de Classe I (1). Pour les autres pays : cette imprimante répond aux normes IEC 60825-1 relatives aux produits laser de Classe I.

Les produits laser de Classe I sont considérés comme des produits non dangereux. Cette imprimante est équipée d'un laser de Classe IIIb (3b) (arséniure de gallium d'une puissance nominale de 5 milliwatts) émettant sur des longueurs d'onde comprises entre 770 et 795 nanomètres. L'imprimante et son système laser sont conçus pour impossible, dans des conditions normales d'utilisation, d'entretien par l'utilisateur ou de révision, l'exposition à des rayonnements laser supérieurs à des rayonnements de Classe I.

---

### Avvertenze sui prodotti laser

Questa stampante è certificata negli Stati Uniti per essere conforme ai requisiti del DHHS 21 CFR Sottocapitolo J per i prodotti laser di classe 1 ed è certificata negli altri Paesi come prodotto laser di classe 1 conforme ai requisiti della norma CEI 60825-1.

I prodotti laser di classe non sono considerati pericolosi. La stampante contiene al suo interno un laser di classe IIIb (3b) all'arseniuro di gallio della potenza di 5mW che opera sulla lunghezza d'onda compresa tra 770 e 795 nanometri. Il sistema laser e la stampante sono stati progettati in modo tale che le persone a contatto con la stampante, durante il normale funzionamento, le operazioni di servizio o quelle di assistenza tecnica, non ricevano radiazioni laser superiori al livello della classe 1.

---

## Avisos sobre el láser

Se certifica que, en los EE.UU., esta impresora cumple los requisitos para los productos láser de Clase I (1) establecidos en el subcapítulo J de la norma CFR 21 del DHHS (Departamento de Sanidad y Servicios) y, en los demás países, reúne todas las condiciones expuestas en la norma IEC 60825-1 para productos láser de Clase I (1).

Los productos láser de Clase I no se consideran peligrosos. La impresora contiene en su interior un láser de Clase IIIb (3b) de arseniuro de galio de funcionamiento nominal a 5 milivatios en una longitud de onda de 770 a 795 nanómetros. El sistema láser y la impresora están diseñados de forma que ninguna persona pueda verse afectada por ningún tipo de radiación láser superior al nivel de la Clase I durante su uso normal, el mantenimiento realizado por el usuario o cualquier otra situación de servicio técnico.

---

## Declaração sobre Laser

A impressora está certificada nos E.U.A. em conformidade com os requisitos da regulamentação DHHS 21 CFR Subcapítulo J para a Classe I (1) de produtos laser. Em outros locais, está certificada como um produto laser da Classe I, em conformidade com os requisitos da norma IEC 60825-1.

Os produtos laser da Classe I não são considerados perigosos. Internamente, a impressora contém um produto laser da Classe IIIb (3b), designado laser de arseneto de potássio, de 5 milliwatts, operando numa faixa de comprimento de onda entre 770 e 795 nanómetros. O sistema e a impressora laser foram concebidos de forma a nunca existir qualquer possibilidade de acesso humano a radiação laser superior a um nível de Classe I durante a operação normal, a manutenção feita pelo utilizador ou condições de assistência prescritas.

---

## Laserinformatie

De printer voldoet aan de eisen die gesteld worden aan een laserprodukt van klasse I. Voor de Verenigde Staten zijn deze eisen vastgelegd in DHHS 21 CFR Subchapter J, voor andere landen in IEC 60825-1.

Laserprodukten van klasse I worden niet als ongevaarlijk aangemerkt. De printer is voorzien van een laser van klasse IIIb (3b), dat wil zeggen een gallium arsenide-laser van 5 milliwatt met een golflengte van 770-795 nanometer. Het lasergedeelte en de printer zijn zo ontworpen dat bij normaal gebruik, bij onderhoud of reparatie conform de voorschriften, nooit blootstelling mogelijk is aan laserstraling boven een niveau zoals voorgeschreven is voor klasse 1.

---

## Lasermeddelelse

Printeren er godkendt som et Klasse I-laserprodukt, i overensstemmelse med kravene i IEC 60825-1.

Klasse I-laserprodukter betragtes ikke som farlige. Printeren indeholder internt en Klasse IIIB (3b)-laser, der nominelt er en 5 milliwatt galliumarsenid laser, som arbejder på bølgelængdeområdet 770-795 nanometer. Lasersystemet og printeren er udformet således, at mennesker aldrig udsættes for en laserstråling over Klasse I-niveau ved normal drift, brugervedligeholdelse eller obligatoriske servicebetingelser.

---

## Huomautus laserlaitteesta

Tämä kirjoitin on Yhdysvalloissa luokan I (1) laserlaitteiden DHHS 21 CFR Subchapter J -määrityksen mukainen ja muualla luokan I laserlaitteiden IEC 60825-1 -määrityksen mukainen.

Luokan I laserlaitteiden ei katsota olevan vaarallisia käyttäjälle. Kirjoittimessa on sisäinen luokan IIIb (3b) 5 milliwatin galliumarsenidilaser, joka toimii aaltoalueella 770 - 795 nanometriä. Laserjärjestelmä ja kirjoitin on suunniteltu siten, että käyttäjä ei altistu luokan I määräytyksiä voimakkaammalle säteilylle kirjoittimen normaalin toiminnan, käyttäjän tekemien huoltotoimien tai muiden huoltotoimien yhteydessä.

VARO! Avattaessa ja suojalukitus ohitettaessa olet alttiina näkymättömälle lasersäteilylle. Älä katso säteeseen.

VARNING! Osynlig laserstrålning när denna del är öppnad och spärren är urkopplad. Betrakta ej strålen.

---

## Laser-notis

Denna skrivare är i USA certifierad att motsvara kraven i DHHS 21 CFR, underparagraf J för laserprodukter av Klass I (1). I andra länder uppfyller skrivaren kraven för laserprodukter av Klass I enligt kraven i IEC 60825-1.

Laserprodukter i Klass I anses ej hälsovådliga. Skrivaren har en inbyggd laser av Klass IIIb (3b) som består av en laserenhet av gallium-arsenid på 5 milliwatt som arbetar i våglängdsområdet 770-795 nanometer.

Lasersystemet och skrivaren är utformade så att det aldrig finns risk för att någon person utsätts för laserstrålning över Klass I-nivå vid normal användning, underhåll som utförs av användaren eller annan föreskriven serviceåtgärd.

---

## Laser-melding

Skriveren er godkjent i USA etter kravene i DHHS 21 CFR, underkapittel J, for klasse I (1) laserprodukter, og er i andre land godkjent som et Klasse I-laserprodukt i samsvar med kravene i IEC 60825-1.

Klasse I-laserprodukter er ikke å betrakte som farlige. Skriveren inneholder internt en klasse IIIb (3b)-laser, som består av en gallium-arsenlaserenhet som avgir stråling i bølglengdeområdet 770-795 nanometer.

Lasersystemet og skriveren er utformet slik at personer aldri utsettes for laserstråling ut over klasse I-nivå under vanlig bruk, vedlikehold som utføres av brukeren, eller foreskrevne serviceoperasjoner.

---

## Avís sobre el Làser

Segons ha estat certificat als Estats Units, aquesta impressora compleix els requisits de DHHS 21 CFR, apartat J, pels productes làser de classe I (1), i segons ha estat certificat en altres llocs, és un producte làser de classe I que compleix els requisits d'IEC 60825-1.

Els productes làser de classe I no es consideren perillosos. Aquesta impressora conté un làser de classe IIIb (3b) d'arseniür de gal.li, nominalment de 5 mil.liwats, i funciona a la regió de longitud d'ona de 770-795 nanòmetres. El sistema làser i la impressora han sigut concebuts de manera que mai hi hagi exposició a la radiació làser per sobre d'un nivell de classe I durant una operació normal, durant les tasques de manteniment d'usuari ni durant els serveis que satisfacin les condicions prescrites.

---

#### レーザーに関するお知らせ

このプリンターは、米国ではDHHS 21 CFRサブチャプターJのクラスI(1)の基準を満たしたレーザー製品であることが証明されています。また米国以外ではIEC 825の基準を満たしたクラスIのレーザー製品であることが証明されています。

クラスIのレーザー製品には危険性はないと考えられています。このプリンターはクラスIII b(3b)のレーザーを内蔵しています。このレーザーは、波長が770 ~ 795ナノメートルの範囲で、通常5ミリワットのガリウム砒化物を放射するレーザーです。このレーザーシステムとプリンターは、通常の操作、ユーザのメンテナンス、規定された修理においては、人体がクラスIのレベル以上のレーザー放射に晒されることのないよう設計されています。

---

#### 注意：

本打印机被美国认证合乎 DHHS 21 CFR Subchapter I 对分类 I (1) 激光产品的标准，而在其他地区则被认证合乎 IEC 825 的标准。

分类 I 激光产品一般认为不具危险性，本打印机内部含有分类 IIIb (3b) 的激光，在操作过程中会产生 5 毫瓦含镓及砷的微量激光，其波长范围在 770-795 nm 之间。本激光系统及打印机的设计，在一般操作、使用者维护或规定内的维修情况下，不会使人体接触分类 I 以上等级的辐射。

---

본프린터는 1등급 레이저 제품들에 대한 DHHS 21 CFR Subchapter 3의 규정을 준수하고 있음을 미국에서 인증받았으며, 그외의 나라에서도 IEC 825 규정을 준수하는 1등급 레이저 제품으로서 인증을 받았습니다.

1등급 레이저 제품들은 안전한 것으로 간주됩니다. 본 프린터는 5 밀리วัต 갈륨 아르세나이드 레이저로서 770-795 나노미터의 파장대에서 활동하는 Class III (3b) 레이저를 내부에 갖고 있습니다. 본 레이저 시스템과 프린터는 정상 작동 중이나 유지 보수 중 또는 규정된 서비스 상태에서 상기의 Class I 수준의 레이저 방출에 사람이 절대 접근할 수 없도록 설계되어 있습니다.



---

## Safety information

- The safety of this product is based on testing and approvals of the original design and specific components. The manufacturer is not responsible for safety in the event of use of unauthorized replacement parts.
- The maintenance information for this product has been prepared for use by a professional service person and is not intended to be used by others.
- There may be an increased risk of electric shock and personal injury during disassembly and servicing of this product. Professional service personnel should understand this and take necessary precautions.
-  **CAUTION:** When you see this symbol, there is a danger from hazardous voltage in the area of the product where you are working. Unplug the product before you begin, or use caution if the product must receive power in order to perform the task.

---

## Consignes de sécurité

- La sécurité de ce produit repose sur des tests et des agrégations portant sur sa conception d'origine et sur des composants particuliers. Le fabricant n'assume aucune responsabilité concernant la sécurité en cas d'utilisation de pièces de rechange non agréées.
- Les consignes d'entretien et de réparation de ce produit s'adressent uniquement à un personnel de maintenance qualifié.
- Le démontage et l'entretien de ce produit pouvant présenter certains risques électriques, le personnel d'entretien qualifié devra prendre toutes les précautions nécessaires.
-  **ATTENTION :** Ce symbole indique la présence d'une tension dangereuse dans la partie du produit sur laquelle vous travaillez. Débranchez le produit avant de commencer ou faites preuve de vigilance si l'exécution de la tâche exige que le produit reste sous tension.

---

## Norme di sicurezza

- La sicurezza del prodotto si basa sui test e sull'approvazione del progetto originale e dei componenti specifici. Il produttore non è responsabile per la sicurezza in caso di sostituzione non autorizzata delle parti.
- Le informazioni riguardanti la manutenzione di questo prodotto sono indirizzate soltanto al personale di assistenza autorizzato.
- Durante lo smontaggio e la manutenzione di questo prodotto, il rischio di subire scosse elettriche e danni alla persona è più elevato. Il personale di assistenza autorizzato deve, quindi, adottare le precauzioni necessarie.
-  **ATTENZIONE:** Questo simbolo indica la presenza di tensione pericolosa nell'area del prodotto. Scollegare il prodotto prima di iniziare o usare cautela se il prodotto deve essere alimentato per eseguire l'intervento.

---

## Sicherheitshinweise

- Die Sicherheit dieses Produkts basiert auf Tests und Zulassungen des ursprünglichen Modells und bestimmter Bauteile. Bei Verwendung nicht genehmigter Ersatzteile wird vom Hersteller keine Verantwortung oder Haftung für die Sicherheit übernommen.
- Die Wartungsinformationen für dieses Produkt sind ausschließlich für die Verwendung durch einen Wartungsfachmann bestimmt.
- Während des Auseinandernehmens und der Wartung des Geräts besteht ein zusätzliches Risiko eines elektrischen Schlags und körperlicher Verletzung. Das zuständige Fachpersonal sollte entsprechende Vorsichtsmaßnahmen treffen.
-  **ACHTUNG:** Dieses Symbol weist auf eine gefährliche elektrische Spannung hin, die in diesem Bereich des Produkts auftreten kann. Ziehen Sie vor den Arbeiten am Gerät den Netzstecker des Geräts, bzw. arbeiten Sie mit großer Vorsicht, wenn das Produkt für die Ausführung der Arbeiten an den Strom angeschlossen sein muß.

---

## Pautas de Seguridad

- La seguridad de este producto se basa en pruebas y aprobaciones del diseño original y componentes específicos. El fabricante no es responsable de la seguridad en caso de uso de piezas de repuesto no autorizadas.
- La información sobre el mantenimiento de este producto está dirigida exclusivamente al personal cualificado de mantenimiento.
- Existe mayor riesgo de descarga eléctrica y de daños personales durante el desmontaje y la reparación de la máquina. El personal cualificado debe ser consciente de este peligro y tomar las precauciones necesarias.
-  **PRECAUCIÓN:** este símbolo indica que el voltaje de la parte del equipo con la que está trabajando es peligroso. Antes de empezar, desenchufe el equipo o tenga cuidado si, para trabajar con él, debe conectarlo.

---

## Informações de Segurança

- A segurança deste produto baseia-se em testes e aprovações do modelo original e de componentes específicos. O fabricante não é responsável pela segurança, no caso de uso de peças de substituição não autorizadas.
- As informações de segurança relativas a este produto destinam-se a profissionais destes serviços e não devem ser utilizadas por outras pessoas.
- Risco de choques eléctricos e ferimentos graves durante a desmontagem e manutenção deste produto. Os profissionais destes serviços devem estar avisados deste facto e tomar os cuidados necessários.
-  **CUIDADO:** Quando vir este símbolo, existe a possível presença de uma potencial tensão perigosa na zona do produto em que está a trabalhar. Antes de começar, desligue o produto da tomada eléctrica ou seja cuidadoso caso o produto tenha de estar ligado à corrente eléctrica para realizar a tarefa necessária.

## Informació de Seguretat

- La seguretat d'aquest producte es basa en l'avaluació i aprovació del disseny original i els components específics.  
El fabricant no es fa responsable de les qüestions de seguretat si s'utilitzen peces de recanvi no autoritzades.
- La informació pel manteniment d'aquest producte està orientada exclusivament a professionals i no està destinada a ningú que no ho sigui.
- El risc de xoc elèctric i de danys personals pot augmentar durant el procés de desmuntatge i de servei d'aquest producte. El personal professional ha d'estar-ne assabentat i prendre les mesures convenients.
-  **PRECAUCIÓ:** aquest símbol indica que el voltatge de la part de l'equip amb la qual esteu treballant és perillós. Abans de començar, desendolleu l'equip o extremeu les precaucions si, per treballar amb l'equip, l'heu de connectar.

## 안전 사항

- 본 제품은 원래 설계 및 특정 구성품에 대한 테스트 결과로 안정성이 입증된 것입니다. 따라서 무허가 교체부품을 사용하는 경우에는 제조업체에서 안전에 대한 책임을 지지 않습니다.
- 본 제품에 관한 유지 보수 설명서는 전문 서비스 기술자용으로 작성된 것이므로, 비전문가는 사용할 수 없습니다.
- 본 제품을 해체하거나 정비할 경우, 전기적인 충격을 받거나 상처를 입을 위험이 커집니다. 전문 서비스 기술자는 이 사실을 숙지하고, 필요한 예방 조치를 취하도록 하십시오.
-  **주의:** 이 표시는 해당영역에서 고압전류가 흐른다는 위험 표시입니다. 시작전에 플러그를 뽑으시거나, 주의를 기울여 주시기 바랍니다.

## 安全信息

- 本产品的安全性以原来设计和特定产品的测试结果和认证为基础。万一使用未经许可的替换部件，制造商不对安全性负责。
- 本产品的维护信息仅供专业服务人员使用，并不打算让其他人使用。
- 本产品在拆卸、维修时，遭受电击或人员受伤的危险性会增高，专业服务人员对这点必须有所了解，并采取必要的预防措施。
-  **切记:** 当您看到此符号时，说明在您工作的产品区域有危险电压的存在。请在开始操作前拔掉产品的电源线，或者在产品必须使用电源来执行任务时，小心从事。

## Preface

This manual contains maintenance procedures for service personnel. It is divided into the following chapters:

1. **General information** contains a general description of the printer and the maintenance approach used to repair it. Special tools and test equipment are, as well as general environmental and safety instructions.
  2. **Diagnostic information** contains an error indicator table, symptom tables, and service checks used to isolate failing field replaceable units (FRUs).
  3. **Diagnostic aids** contains tests and checks used to locate or repeat symptoms of printer problems.
  4. **Repair information** provides instructions for making printer adjustments and removing and installing FRUs.
  5. **Connector locations** uses illustrations to identify the connector locations and test points on the printer.
  6. **Preventive maintenance** contains the lubrication specifications and recommendations to prevent problems.
  7. **Parts catalog** contains illustrations and part numbers for individual FRUs.
- Appendix A** contains service tips and information.  
**Appendix B** contains representative print samples.

---

## Definitions

**Note:** A note provides additional information.

**Warning:** A warning identifies something that might damage the product hardware or software.

**CAUTION:** A caution identifies something that might cause a servicer harm.



**CAUTION:** When you see this symbol, there is a danger from hazardous voltage in the area of the product where you are working. Unplug the product before you begin, or use caution if the product must receive power in order to perform the task.

---

## 1. General information

The Lexmark™ E350d and E352dn are monochrome laser printers designed for single users or small workgroups. This book contains information on E350d and E352dn. For information on E250d and E250dn, see the 4512-220,-230 service manual.

---

### Model

There are two models: E350d and E352dn. Both models have 32MB memory standard, a parallel USB connector, INA, ENA option support via USB and/or parallel ports, and prints 35 pages per minute on letter-size media (34 ppm on A4, 29 ppm on legal).

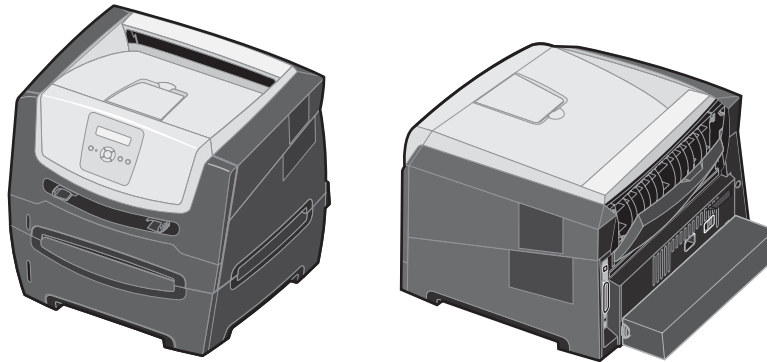

---

### Maintenance approach

The diagnostic information in this manual leads to the correct field replaceable unit (FRU) or part. Use the error code charts, symptom index, and service checks to determine the symptom and repair the failure. See **“Diagnostics information” on page 2-1** for more information. See **“Repair information” on page 4-1** to help identify parts. After completing the repair, perform tests as needed to verify the repair.

## Overview of the operator panel

The operator panel consists of these items:

- A 2-line liquid crystal display (LCD) that shows text
- Six buttons: Stop (⊗), Menu (with Left Menu ◀, Select (✓), and Right Menu ▶), Back (↶), and Go (▶)
- An indicator light

A label located on the inside front door shows the operator panel buttons. An additional translated label is included in the printer box.

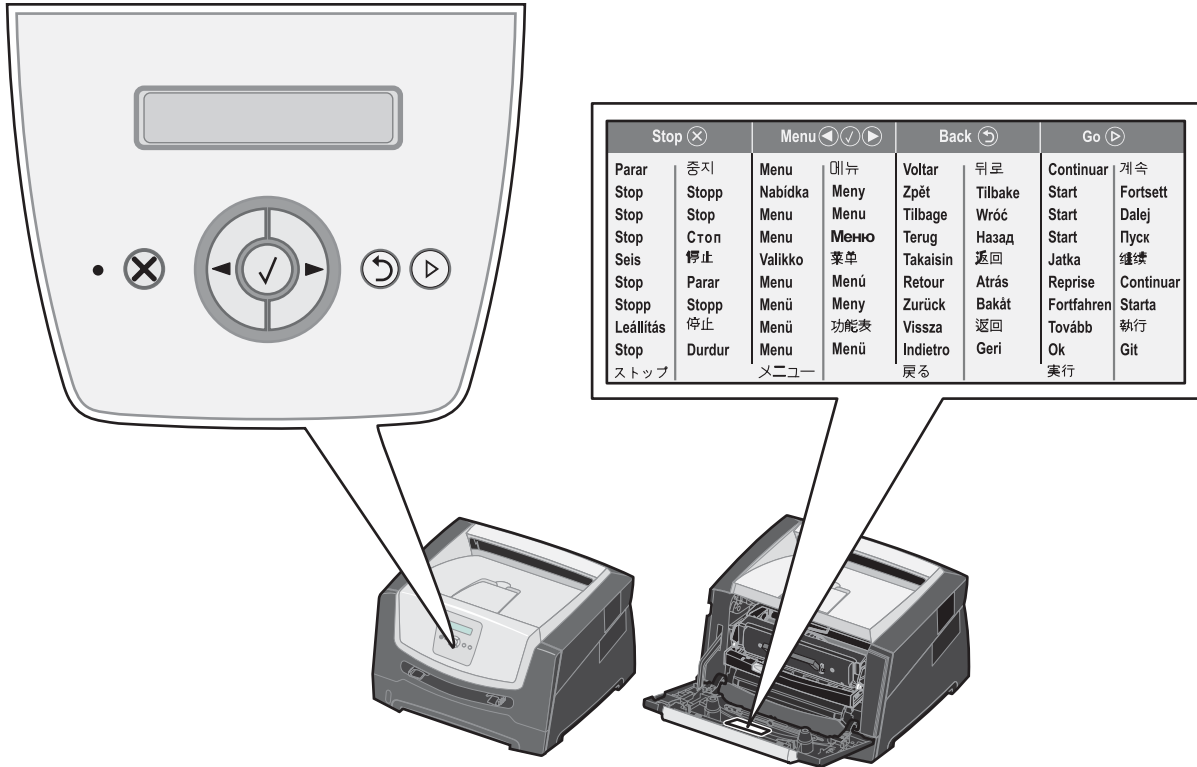

## Specifications

### Memory

Item	4512-420 Lexmark E350d	4512-430 Lexmark E352dn
Standard DRAM	32MB	32MB
Optional SDRAM 32MB	✓	✓
Optional SDRAM 64MB	✓	✓
Optional SDRAM 128MB	✓	✓
Optional SDRAM 256MB	n/a	n/a
Maximum DRAM	160MB	160MB
Optional flash memory 32MB	✓	✓
Optional font cards (DBCS)	✓	✓

### Print speed

Media Size	4512-420 Lexmark E350d	4512-430 Lexmark E352dn
Letter– 8.5 x 11 in.	35 ppm	35 ppm
A4– 210 x 297 mm	34 ppm	34 ppm
Legal– 8.5 x 14 in.	29ppm	29ppm
Speed measured on media from tray 1, simplex, and at 600 x 600 dpi.		

### Print quality

Resolution	4512-420 Lexmark E350d	4512-430 Lexmark E352dn
1200 Image quality <sup>1</sup>	✓	✓
2400 Image quality <sup>2</sup>	✓	✓
1200 x 1200 dpi <sup>3</sup>	✓	✓
600 x 600 dpi	✓	✓
<sup>1</sup> 1200 Image quality defined as 600 dpi with 2 bit IET (image enhancement technology) default mode for all models		
<sup>2</sup> 2400 Image quality defined as 600 and 4 bit IET		
<sup>3</sup> True 1200 dpi at ½ rated speed.		

**Media trays and supply capacity**

Item	4512-420 Lexmark E350d	4512-430 Lexmark E352dn
<b>Available input trays</b>		
250-sheet tray	✓	✓
550-sheet option drawer	✓	✓
550-sheet tray	✓	✓
Dust cover	✓	✓
<b>Toner and photoconductor</b>		
Toner cartridge	1,500 standard pages SWE <sup>1</sup> 3,500 standard pages SWE <sup>1</sup>	2,500 standard pages SWE <sup>1</sup> 3,500 standard pages SWE <sup>1</sup>
High toner cartridge	9,000 standard pages <sup>1</sup>	9,000 standard pages <sup>1</sup>
Photoconductor kit	Up to 30,000 <sup>2</sup>	Up to 30,000 <sup>2</sup>
<sup>1</sup> Declared value in accordance with ISO/IEC 19752		
<sup>2</sup> Based on approximately 5% coverage, actual yield may vary		



**Connectivity and compatibility**

Item	4512-420 Lexmark E350d	4512-430 Lexmark E352dn
<b>Data stream emulations</b>		
PCL 6	✓	✓
PostScript 3	✓	✓
HBP	✓	✓
PPDS	✓	✓
Compatibility	Windows/Macintosh/Linux	Windows/Macintosh/Linux
<b>Standard local connections</b>		
Parallel (IEE 1284 Bi-Di)	✓	✓
USB*	✓	✓
<b>Standard network connections</b>		
Ethernet (10/100 Base TX)	n/a	✓
<b>Optional local connections</b>		
External print server support	✓	✓
<b>Option slots</b>		
Memory slots (100-pin DIMM)	1	1
Flash memory / option card	2	2
* The E 350d and E352dn products are USB 2.0 certified devices supporting hi-speed (480MB/sec.) data transfer.		

## Types of print media

Ensure trays are properly loaded. Never mix media types within a tray.

Source	Sizes	Types	Weight	Input capacity* (sheets)
Input tray 1 (250-sheet tray)	A4, A5, A6 (grain long only), JIS B5, letter, legal, executive, folio, statement, Universal <sup>1</sup>	Plain paper, bind, letterhead, transparencies, paper labels (single sided only)	60–90 g/m <sup>2</sup> (16–24 lb)	<ul style="list-style-type: none"> <li>• 250 paper</li> <li>• 50 labels**</li> <li>• 50 transparencies</li> </ul>
2nd Drawer option (550-sheet drawer)	A4, A5, JIS B5, letter, legal, executive, folio, statement, Universal <sup>1</sup>	Plain paper, bond, letterhead, transparencies, paper tables (single-sided only)	60–90 g/m <sup>2</sup> (16–24 lb)	<ul style="list-style-type: none"> <li>• 550 paper</li> <li>• 50 tables**</li> <li>• 50 transparencies</li> </ul>
Manual feeder	A4, A5, A6 (grain long only), JIS B5, letter, legal, executive, folio, statement, Universal <sup>1</sup>	Plain paper, transparencies, paper labels (single-sided only)	60–463 g/m <sup>2</sup> (16–43 lb)	1
		Card stock <sup>2</sup>	<ul style="list-style-type: none"> <li>• 120–463 g/m<sup>2</sup> (16–43 lb) Index Bristol</li> <li>• 75–463 g/m<sup>2</sup> (46–100 lb) Tag</li> </ul>	
	7 3/4, 9, 10, DL, C5, B5	Envelopes	75 g/m <sup>2</sup> (20 lb)	
<p>* Capacity for 20 lb print media, unless otherwise noted.  ** Use for occasional printing only.  <sup>1</sup> Universal size ranges:  —<b>Manual feeder:</b> 76–216 x 127–356 mm (3.0–8.5 x 5.0–14.0 in.) (includes 3 x 5 in. cards)  <sup>2</sup> Grain short is recommended. Use rear exit for best results.</p>				

## Tips on preventing jams

### Paper path

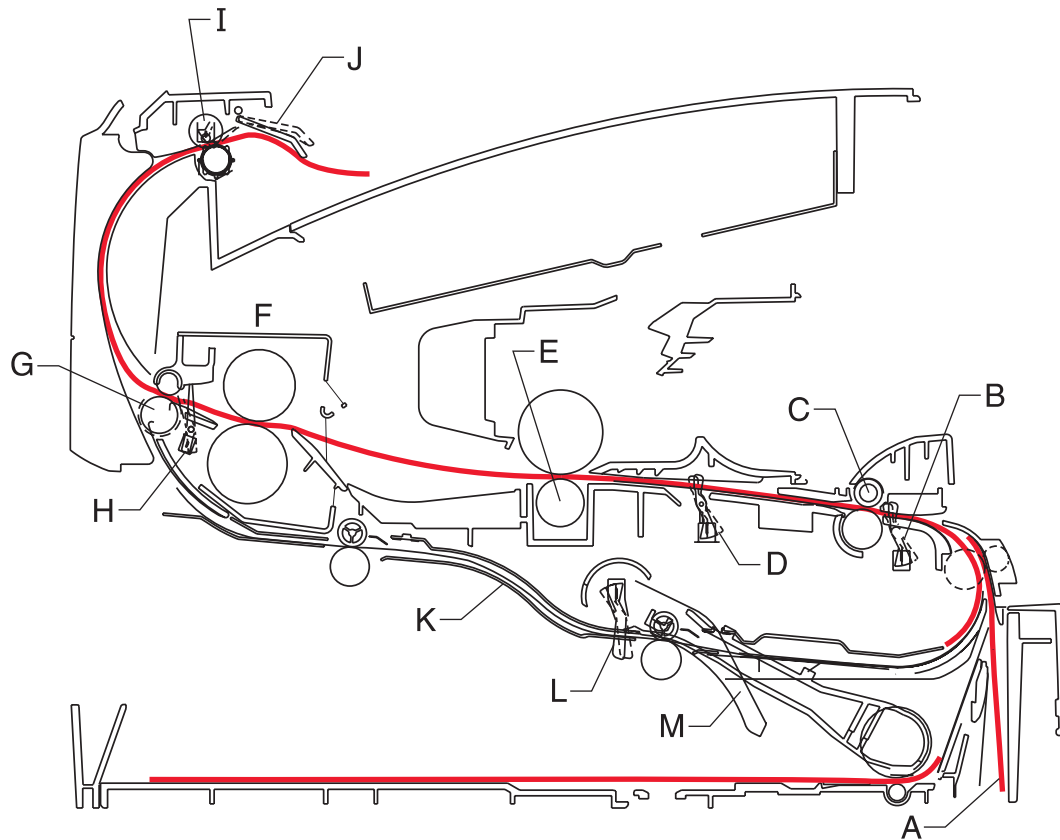

\*Measurements are approximate paper lengths (millimeters)

\*\*Sensors are measured at rotation/position which they are tripped

A	Paper path	A-B	117.8
B	Manual feed sensor	B-C	9.6
C	Upper end feed rolls	C-D	60.5
D	Input sensor	D-E	49.0
E	Transfer roll	E-F	110.7
F	Fuser	F-G	26.9
G	Fuser exit rolls	G-H	6.2
H	Fuser exit sensor	H-I	127.2
I	Exit rolls	I-J	26.4
J	Exit sensor	I-K	217.4
K	Duplex unit	K-L	102.5
L	Duplex sensor	L-M	16.2
M	Auto compensator	M-B	178.9

Most paper jams can be avoided by correctly loading paper and specialty media in the printer.

The following hints can help prevent paper jams:

- Use only the recommended print media.
- Do not overload the print media sources. Make sure the stack height does not exceed the maximum height indicated by the stack line on the labels in the sources.
- Do not load wrinkled, creased, damp, or curled print media.
- Flex, fan, and straighten print media before loading it. If jams do occur with the print media, try feeding one sheet at a time through the manual feeder.

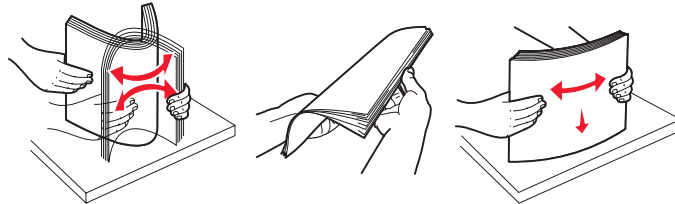

- Do not mix print media sizes, weights, or types in the same print media source.
- Push all trays in firmly after loading them.

**Note:** Make sure the media stack is below the maximum media fill indicators on the 250-sheet tray before pushing the tray into the printer.

- Make sure paper guides are positioned before loading the paper or specialty media.
- Do not remove trays while a job is printing.
- Before loading transparencies, fan the stack to prevent sheets from sticking together.
- Do not use envelopes that:
  - Have excessive curl
  - Are stuck together
  - Are damaged in any way
  - Contain windows, holes, perforations, cutouts, or embossments
  - Have metal clasps, string ties, or metal folding bars
  - Have postage stamps attached
  - Have any exposed adhesive when the flap is in the sealed position
- Use only recommended media. Refer to the *Card Stock & Label Guide* available on the Lexmark Web site at [www.lexmark.com](http://www.lexmark.com) for more information about which media provides optimum results for the current printing environment.

---

## Tools

The removal and adjustment procedures require the following tools and equipment:

- Spring hook
- Needle nose pliers
- Volt-ohmmeter
- #1 and #2 Phillips screwdriver
- Slotted screwdriver

---

## Acronyms

ACM	Autocompensator Mechanism (or paper feed)
ADC	Analog-to-digital Converter
ASIC	Application Specific Integrated Circuit
CBM	Complete Bill Of Material
DEV	Development Roll (of print cartridge/photoconductor system)
DIMM	Dual In-Line Memory Module
ENA	External Network Adapter
FRU	Field Replaceable Unit
HBP	Host Based Printing
HVPS	High Voltage Power Supply
LCD	Liquid Crystal Diode
LED	Light Emitting Diode
LSU	Laser Scanning Unit
LVPS	Low Voltage Power Supply
NVRAM	Nonvolatile Random Access Memory
PC	Photoconductor
PCL	Printer Control Language
POR	Power-On Reset
POST	Power-On Self Test
PPDS	Personal Printer Data Stream
PRC	People's Republic of China
TAR	Toner Add Roll
SDR	Synchronous Dynamic RAM
SWE	Shipped With Equipment
USB	Universal Serial Bus
V ac	Volts alternating current
V dc	Volts direct current



## 2. Diagnostics information

### Start



**CAUTION:** Unplug power from the printer before connecting or disconnecting any cable, assembly, or electronic card. This is a precaution for personal safety and to prevent damage to the printer.

This chapter contains the codes and diagnostic tools to aid in providing corrective action for a malfunctioning printer. To determine the corrective action to repair a printer, look for the following information:

- A description of a problem, see **“Symptom tables” on page 2-15.**
- Information from the operator panel of the printer.
  - **Models E350d and E352dn** have an operator panel with messages. See **“Overview of the operator panel and menus” on page 2-2.**

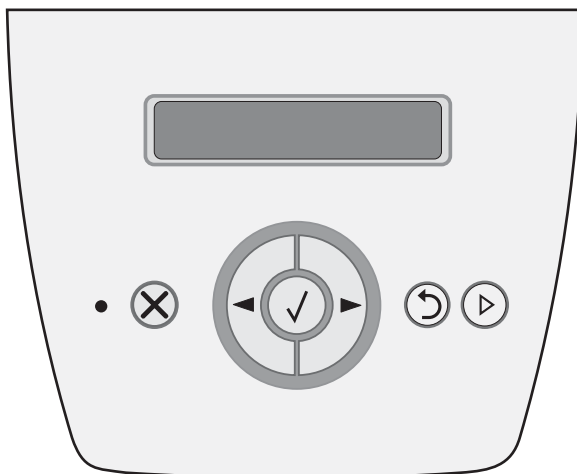

### Power-On Self Test (POST) sequence

The following is an example of the events that occur during the POR sequence when the printer is turned on.

1. Diamonds are displayed on the operator panel.
2. While code is being loaded into DRAM, dots scroll across the operator panel.
3. A screen is displayed with the memory and processor speed. A typical example of this message is:

*	32 Mb	366 Mhz
---	-------	---------

4. Performing Self Test is displayed.
5. Busy is displayed.
6. Close Door will be displayed if the cover is open.
7. Any cartridge errors, such as Defective Cartridge, are displayed.
8. Applicable maintenance messages are displayed.
9. Applicable toner low messages are displayed.
10. The printer displays Ready.

## Overview of the operator panel and menus

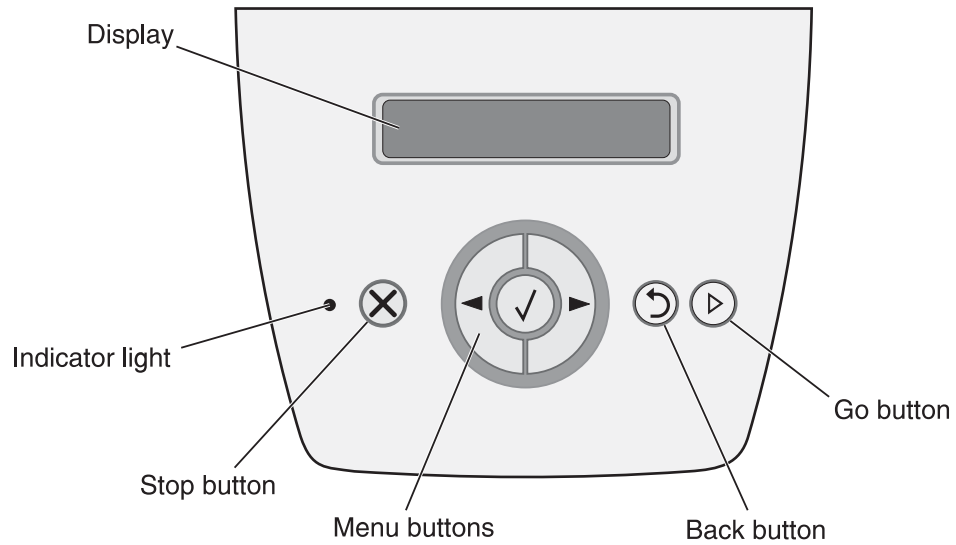

### ***Indicator light***

The indicator light gives information about the status of the printer.

If the light is	The printer is
Off	Off
On	On, but idle
Blinking	On and busy





## Buttons

Use the six operator panel buttons to open a menu, scroll through a list of values, change printer settings, and respond to printer messages.

**Note:** Buttons act on the information displayed on the second line of the operator panel.

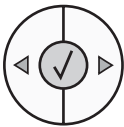
The use of the buttons and the layout of the display are described in the following table:

Button or control panel item	Function								
Display	<p>The display shows messages describing the current state of the printer and indicating possible printer problems that must be resolved.</p> <p>The top line of the display is the header line. It will display the current status and the Supplies (Warnings) status. This is where printer status, supplies messages, and show-me screens are viewed.</p>								
Indicator light	<p>A green LED is used on the display, including the printer status.</p> <table border="1"> <thead> <tr> <th>If the light is</th> <th>The printer is</th> </tr> </thead> <tbody> <tr> <td>Off</td> <td>Off</td> </tr> <tr> <td>On</td> <td>On, but idle</td> </tr> <tr> <td>Flashing</td> <td>On and busy</td> </tr> </tbody> </table>	If the light is	The printer is	Off	Off	On	On, but idle	Flashing	On and busy
If the light is	The printer is								
Off	Off								
On	On, but idle								
Flashing	On and busy								
Stop ✕	Press and release ✕ to stop the mechanical operation of the printer. The <b>Not Ready</b> message will appear. Operation will resume when ▶ is pressed.								
Menu buttons 	<p> The ▶ and ◀ buttons are used to enter a menu group. Once a menu group is active, press and release ▶ to step to the next selection, or press and release ◀ to step to the previous selection.</p> <p>These buttons can also be used to automatically increase ▶ or decrease ◀ the desired number of copies.</p> <p>✓ Press and release ✓ to initiate action on a selection.</p> <p>✓ Selects the menu selection displayed on the second line of the display. If a menu is displayed such as <b>Paper Menu</b>, then ✓ opens the menu and displays the first printer setting contained in the menu.</p> <p>If a menu item such as <b>Paper Source</b> is displayed, then ✓ opens the item and displays the default setting.</p> <p>If a menu item such as <b>Manual Feeder</b> is displayed, then ✓ saves the selection as the new default setting for Paper Source. The printer will display the <i>Saved</i> message momentarily and then return to the menu item level.</p>								
Back ↶	Press and release ↶ to return to the previous menu group. If at the top of the menu group, the button functions as a <b>Go</b> button.								
Go ▶	Press and release ▶ to place the printer in the Ready state after an off line situation (to exit menus, to clear most messages).								

## Diagram of the printer menus

Not all menus or selections will be available on all models or in all situations. These are accessed through the driver.

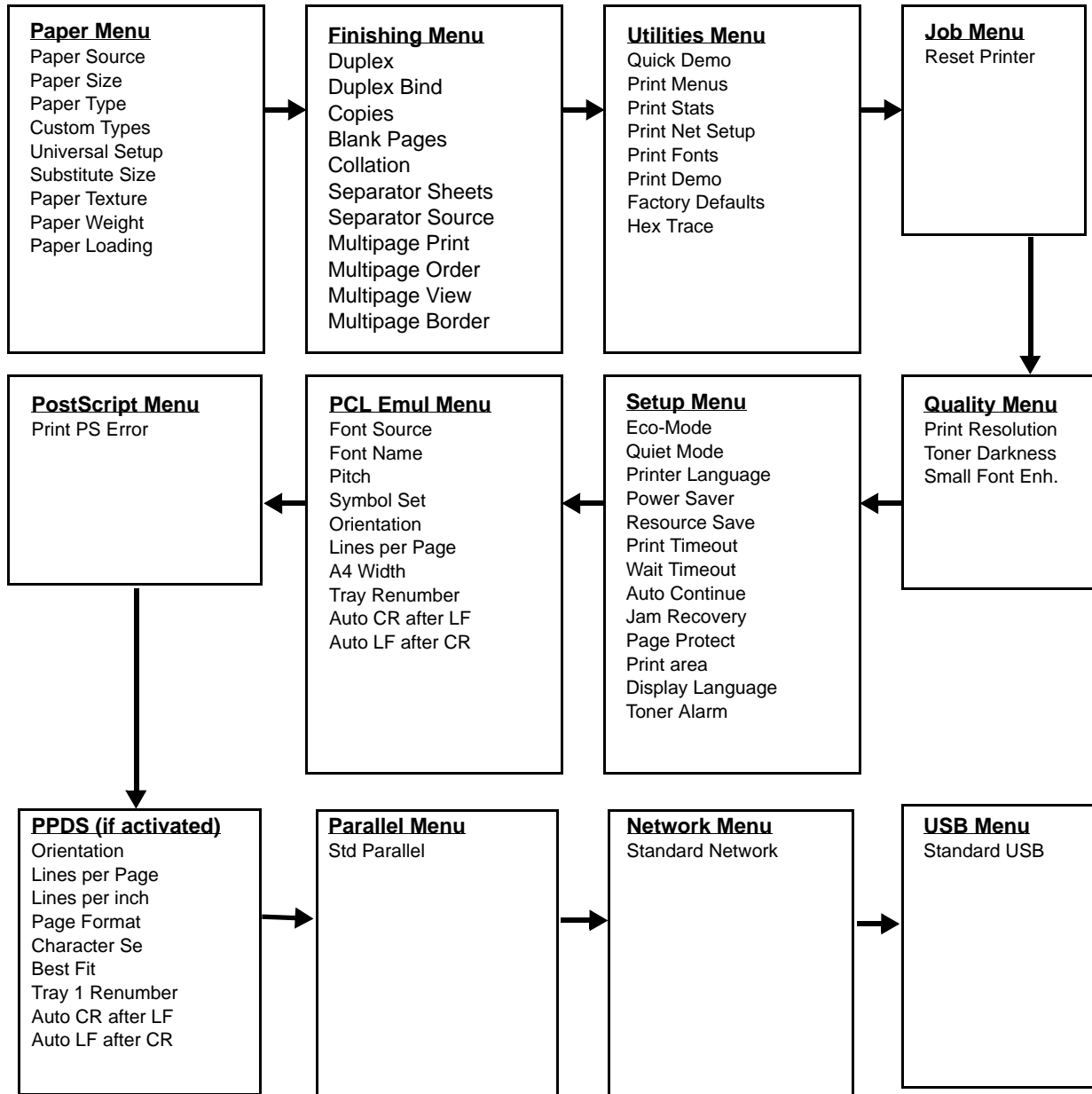

## Messages and error codes

### User attendance messages

The printer control panel displays messages describing the current state of the printer and indicates possible printer problems that must be resolved. This topic provides a list of all printer messages, explains what they mean, and tells how to clear the messages.

The following table lists the messages in alphanumerical order. A message can also be located using the index.

### User attendance messages

Message	Action
Activating Demo Mode	Wait for the message to clear.
Activating Menu Changes	Wait for the message to clear.
Activating/Deactivating PPDS	Wait for the message to clear.
Busy	Wait for the message to clear, or cancel the print job.
Cancelling Job	Wait for the message to clear.
Change Cartridge Invalid Refill	The printer has detected an unsupported refilled cartridge. Remove the indicated print cartridge, and install a new one.
Close door	Close the specified door to clear the message.
Deactivating Demo Mode	Wait for the message to clear.
Defragmenting Flash DO NOT POWER OFF	<b>Warning:</b> Do not turn the printer off while this message is displayed. Wait for the message to clear.
Disabling Menus	Wait for the message to clear. <b>Note:</b> The printer settings cannot be changed from the control panel while the menus are disabled.
Enabling Menus	Wait for the message to clear.
Flushing Buffer	Wait for the message to clear.
Formatting Flash DO NOT POWER OFF	<b>Warning:</b> Do not turn the printer off while this message is displayed. Wait for the message to clear.
Invalid Engine Code	Download valid engine code to the printer.
Invalid Standard Network Code	The code in an internal print server is not valid. The printer cannot receive and process jobs until valid code is programmed into the internal print server. Download valid code to the internal print server. <b>Note:</b> The network code can be downloaded while this message is displayed.
Load manual feeder with <Custom Type>	<ul style="list-style-type: none"> <li>• Load the specified media in the manual feed tray or multipurpose feeder.</li> <li>• To ignore the manual feed request and print on media already installed in one of the input sources, press ▷.</li> </ul> <p>If the printer finds a tray that has media with the correct media type and size, it feeds media from that tray. If the printer cannot find a tray with the correct media type and size, it prints on whatever media is installed in the default input source.</p> <ul style="list-style-type: none"> <li>• Cancel the current job.</li> </ul>
Load manual feeder with <Custom String>	
Load manual feeder with <size>	
Load manual feeder with <size> <type>	

### User attendance messages (Continued)

Message	Action
Load <src> with <Custom Type Name>	<ul style="list-style-type: none"> <li>• Load the input source with the correct type and size media.</li> <li>• Cancel the current job.</li> </ul>
Load <src> with <Custom String>	
Load <src> <size>	
Load <src> <type> <size>	
Maintenance	Replace the maintenance items and, if necessary, reset the printer maintenance counter.
Menus Disabled	<p>The printer menus are disabled. The printer settings cannot be changed from the control panel.</p> <p><b>Note:</b> A job can still be canceled.</p> <p>Contact a system support person.</p>
Network	A network interface is the active communication link.
Network Card Busy	An internal print server (also called an internal network adapter or INA) is being reset. Wait for the message to clear.
Not Ready	The printer is not ready to receive or process data. Someone pressed X to take the printer offline. Press ▶ to make the printer ready to receive jobs.
Parallel	A parallel interface is the active communication link.
Performing Self Test	The printer is running the series of start-up tests it performs after it is turned on. Wait for the message to clear.
Power Saver	<ul style="list-style-type: none"> <li>• Send a job to print.</li> <li>• Press ▶ to warm the printer to normal operating temperature and display the Ready message.</li> </ul>
Printing Directory List	The printer is processing or printing a directory of all files stored in flash memory. Wait for the message to clear.
Printing Font List	The printer is processing or printing a list of all available fonts for the specified printer language. Wait for the message to clear.
Printing Menu Settings	The printer is processing or printing the menu settings page. Wait for the message to clear.
Printing Device Statistics	The printer is printing statistical information about the printer. Wait for the message to clear.
Printing Quality Test Pages	The printer is formatting and printing the Print Quality Test, which consists of 4 pages. Page 1 contains a mixture of graphics and text, pages 2 and 3 contain only graphics, and page 4 is a blank page. If Duplex is turned on, then the pages are duplexed; otherwise they are simplex. Wait for the message to clear.
Prog Engine Code DO NOT POWER OFF	<p>The printer is programming new engine code. Wait for the message to clear and the printer to reset.</p> <p><b>Warning:</b> Do not turn the printer off while this message is displayed.</p>
Program Flash DO NOT POWER OFF	<p>The printer is storing resources, such as fonts or macros, in flash memory. Wait for the message to clear.</p> <p><b>Warning:</b> Do not turn the printer off while this message is displayed.</p>

### User attendance messages (Continued)

Message	Action
Prog System Code DO NOT POWER OFF	The printer is programming new system code. Wait for the message to clear and the printer to reset. <b>Warning:</b> Do not turn the printer off while this message is displayed.
Ready	Send a job to print.
Remove Paper Standard Bin	The standard output bin is full.
Resetting Maint Cnt Valu	The printer is resetting the counter that tracks wear on the fuser.
Resetting PC Cnt Value	The printer is resetting the counter that tracks wear on the photoconductor.
Resetting the Printer	Wait for the message to clear.
Res Reduced	The printer is reducing the resolution of a page in the current job from 600 dots per inch (dpi) to 300 dpi to prevent a 38 Memory Full error. Res Reduced remains on the display while the job prints.
Restoring Factory Defaults	Wait for the message to clear. <b>Note:</b> When factory default settings are restored: <ul style="list-style-type: none"> <li>• All downloaded resources (fonts, macros, symbol sets) in the printer memory are deleted.</li> <li>• All menu settings return to the factory default <i>except</i>: <ul style="list-style-type: none"> <li>— The Display Language setting in the Setup Menu</li> <li>— All settings in the Parallel Menu, Network Menu, and USB Menu</li> </ul> </li> </ul>
Std Bin Full	The standard bin is full.
Toner Low	<ul style="list-style-type: none"> <li>• Replace the toner cartridge.</li> <li>• Press <math>\blacktriangleright</math> to clear the message and continue printing.</li> </ul>
Tray <x> Missing	Insert the tray into the printer.
USM	The printer is processing data through the specified USB port.
Waiting	The printer has received a page of data to print, but is waiting for an End of Job command, a Form Feed command, or additional data. <ul style="list-style-type: none"> <li>• Press <math>\blacktriangleright</math> to print the contents of the buffer.</li> <li>• Cancel the current job.</li> </ul>

## Cartridge error messages

Error	Description
31	Defective cartridge
32	Unsupported print cartridge
33	Invalid refill

## Paper jam error codes (200-series)

**Note:** The Event log (See **“Event log”** on page 3-21) will list any of these errors that have occurred.

Repeating jams or jam messages can be caused by any of the following:

- Faulty/contaminated pick solenoids or worn cams of the solenoids.
- Faulty/contaminated flags or springs.
- Debris in the paper path.
- Media not of the specified length.

## Paper jam error codes (200-series)

Error	Description
200.00	Paper jam around input sensor.
200.01	Classic input jam. The media is too long over the input sensor. Possible causes include multi-sheet feed, tray size sensing problem, and media slippage.
200.02	The main input sensor never became uncovered from the sheet ahead.
200.03	The video never started on the page at the input sensor within two inches after hitting the input sensor
200.04	The media at the input sensor before interrupt occurred - not enough time elapsed since the printhead started to expect the printhead mirror motor lock. Possible causes include bouncy sensor or exceptionally fast pick - perhaps due to media pre-staged in the source tray.
200.06	Imaged page not expected page (bouncy passthru sensor)
200.08	Media reached the input sensor before the EP was ready
200.09	Transfer servo never started
200.12	Media detected at manual feeder sensor when not expected. Possible causes include user insert of media when motor is running or pre-staged media in the tray.
200.13	The input sensor is covered when the media is not expected (media in machine during warm-up)
200.14	Trailing edge cleared manual feed, but did not successfully debounce the sensor. Potential causes are a small gap or a bouncy manual feed sensor.
200.15	UNRECOVERABLE NO GAP JAM. Engine detected no gap at the manual feeder sensor, attempted to open the gap by stopping the feed rolls, but no trailing edge was ever seen at the input sensor.
200.16	Transport motor error detected
200.17	Took too long to ramp up transport motor
200.18	Manual feeder sensor never became uncovered from the sheet ahead.
200.19	The media never reached the input sensor, but was detected at manual feeder sensor.

**Paper jam error codes (200-series) (Continued)**

<b>Error</b>	<b>Description</b>
200.20	The media is too long over the manual feeder sensor. Possible causes include multi-sheet feed, media size (length) problem, pre-staged media in the tray.
200.22	FAILED SMALL GAP OR NO GAP JAM RECOVERY. Engine detected small gap or no gap at the manual feeder sensor, opened the gap by stopping the feed rolls, but never saw the leading edge of the second page at the input sensor.
200.23	Laser Servo never started due to potential conflict with the transfer servo. Possible causes: slow or missing transport motor positional feedback, or the media is transferred too quickly to the input sensor.
200.24	The measured gap at the input sensor is too small to meet the video delivery requirements. (There is not enough time since prior image finished to start new image)
200.26	The trailing edge never cleared the input sensor when feeding out the media that was detected during warm-up.
200.27	Printhead Driver: Mirror motor fell out of lock condition after the media at the input sensor - more time elapsed since the printhead than the expected stable lock time, but less than the printhead jitter-stable specification. Mirror motor fell out of lock condition after media at the input sensor - more time elapsed since the printhead than expected stable lock time, but less than the printhead jitter-stable specification.
200.28	First writing line of a page at the developer nip, but laser servo cleanup is not complete. Likely pre staged media or a fast paper feed.
200.29	Printhead drive control out of range due to an external event beyond what the control is designed to handle. Probable causes: ESD or noise on hsync signal.
200.30	Narrow media sensor covered during warm-up.
200.32	Media more than 14 inches too long over the manual feeder sensor. Possible causes include multi-sheet feed or pre-staged media in the tray.
200.33	Page from tray 1 did not reach the input sensor after multiple attempts. Page did make it out of the tray at least as far as the manual feeder sensor. Possible cause is that the page stalled at the alignment gate.
200.34	Timed out waiting for page from tray 1 to reach the input sensor after multiple pick attempts, but the page was later detected at the input sensor while waiting for any page(s) ahead to clear the paper path. Possible cause is that the page is delayed at the alignment gate.
200.35	Failed to create hsync during auto alignment
200.36	Lost hsyncs during auto alignment
200.37	Timeout on data collection during auto alignment
200.38	Interpage servo gap is smaller than expected for printhead offset target evaluation
201.00	Paper jam between input and exit sensor
201.01	Transport motor identification failed to identify either motor after two tries.
201.02	Exit sensor never made by leading edge of page. Also known as internal jam.
201.03	Video never started on the page at the input sensor within two inches after hitting the input sensor
201.05	Restart attempted after an internal jam without the cover open/close event. It is likely that the jam was never cleared.
201.25	Exit sensor never made by leading edge of media when feeding out the media that was detected during warm-up.
201.26	Page at fuser nip before fuser started ramping toward desired temperature. Indicates code may be receiving more hall interrupts than intended

**Paper jam error codes (200-series) (Continued)**

<b>Error</b>	<b>Description</b>
201.27	Page at fuser nip before fuser reached acceptable operating temperature. Page arrived at fuser earlier than expected, so it was probably staged
202.00	Paper jam around exit sensor.
202.01	Exit sensor never broke on the trailing edge of the sheet at the exit sensor.
202.02	Exit sensor never broke from sheet ahead of page heading toward the exit sensor.
202.06	Exit sensor bounced
202.13	Exit sensor covered, media not expected (media not in machine during warm-up)
202.25	Exit sensor never broke from the sheet ahead of the page heading toward the exit sensor when feeding out the media detected during warm-up.
202.26	Trailing edge never cleared exit sensor when feeding out media that was detected during warm-up.
202.32	Long media or shingled multi feed stopped before sending to duplex.
231.00	Duplex jam while reversing into the device
231.01	Duplex sensor never made by leading edge reversing into the duplex.
231.02	Bouncy duplex sensor never made.
232.00	Duplex jam while staging in the device
232.01	Duplex sensor never broke by the sheet ahead after reversing into the duplex.
232.02	Page in duplex ahead of current reversing page never staged.
233.00	Duplex jam while picking from the device
233.01	Page in duplex never picked.
233.02	Feed error picking from the duplex.
233.03	Paper never reached the input sensor, but was detected at the manual feed sensor.
234.01	Duplex sensor covered during warm-up.
235.01	Invalid duplex media
241.00	Paper jam near tray 1.
241.10	Second pick attempt failed from Tray 1
241.12	Second pick from manual feeder, tray 1, or feeder failed when the media was in the source while other sheets were committed to the paper path.
241.16	Failed to feed from tray 1. Pages in the paper path have been flushed to the output bin.
241.17	MISIDENTIFIED SMALL GAP JAM. Engine detected small gap at the manual feeder sensor, attempted to open the gap by stopping the feed rolls, trailing edge was seen at the input sensor, manual feeder sensor is no longer covered.
241.18	MISIDENTIFIED NO GAP JAM. Engine detected no gap at the manual feeder sensor, attempted to open the gap by stopping the feed rolls, trailing edge was seen at the input sensor, manual feeder sensor is no longer covered.
241.19	Second pick attempted failed from Tray 1, no pages printed since calling a 241.10 or a prior 241.19.
242.00	Paper jam near tray 2.



**Paper jam error codes (200-series) (Continued)**

<b>Error</b>	<b>Description</b>
242.01	Took too long to ramp up dc feed motor
242.08	Received lots of dc feed interrupts before losing them
242.10	Second pick attempt failed from Tray 2
242.12	Second pick from manual feeder, tray 1, or feeder failed when media was in the source, other sheets were committed to the paper path.
242.16	Failed to feed from tray 2. Pages in the paper path have been flushed to the output bin.
251.00	Paper jam near the manual feeder.
251.10	Second pick attempt failed from manual feeder.
251.11	Failed to feed from manual feeder. Pages in the paper path have been flushed to the output bin.
251.12	Second pick from manual feeder, tray 1, or feeder failed when media was in the source while the other sheets were committed to the paper path.
251.19	Media never reached the input sensor from the manual feeder.

## Service error codes

Service error codes are generally non-recoverable except in an intermittent condition when the printer can be put into POR to temporarily recover from the error condition.

### Service error codes (9xx)

Error	Description
<b>Engine software service errors</b>	
902.xx	Engine software error
<b>Transfer service errors</b>	
917.00	Transfer service error
917.01	Transfer servo result too low.
<b>Fuser service errors</b>	
920.00	Under temperature during steady state control.
920.01	Fuser took too long to heat up after transitioning to new enhanced mode.
920.02	Fuser fell too far below desired temperature while printing.
920.03	Fuser too cool while checking for slope change.
920.04	Fuser too cool when heating to desired temperature after slope change.
920.05	Fuser under temperature while printing
920.06	Fuser under temperature while printing
920.07	Fuser under temperature while printing
920.08	Fuser temperature did not increase after IR recovery.
920.20	Belt fuser under temperature during steady state control. This can occur in printing or standby modes.
921.00	Under temperature during standby control.
921.01	Fuser temperature did not reach standby temperature after two attempts
922.00	Fuser failed to ramp to target temperature
922.01	Fuser did not reach standby temperature in time (standby control)
922.07	Media reached fuser nip and fuser is under temperature
922.08	Fuser warm-up failure (motor start condition)
922.09	Fuser warm-up failure (compression set)
922.20	Belt fuser failed to reach the preheat temperature for the motor to start during warm-up.
922.21	Belt fuser was under temperature when the media reached the fuser nip.
923.00	Fuser is over temperature.
923.01	Fuser is over temperature. This applies to the fuser and belt fusers.
924.00	Open thermistor check.
924.01	Open thermistor check failure. This applies to the fuser and belt fusers.

**Service error codes (9xx) (Continued)**

<b>Error</b>	<b>Description</b>
924.02	Open thermistor check failure. The ADC failed to converge. Possible noisy thermistor signal. This applies to the fuser and belt fusers.
<b>Fan service errors</b>	
927.00	Service fan error
927.03	Main fan took too long to ramp up
927.04	Main fan is under speed or stalled during speed adjustment state
927.05	Main fan overspeed during speed adjustment state.
927.06	Main fan capture data is invalid and speed control is at maximum in fan control idle state
927.07	Main fan capture data is invalid and speed control is at maximum in fan control adjustment state.
<b>Printhead service errors</b>	
931.00	No first hsync
931.01	No first hsync
932.00	Lost hsyncs
932.01	Lost hsyncs
933.00	Printhead boost signal failure
935.10	Printhead sweep error, swept through Hz range without finding the resonant frequency
935.11	Printhead sweep error, autosweep hw state
935.12	Printhead sweep error, coarse sweep state
935.13	Printhead sweep error, init fine sweep state
935.14	Printhead sweep error, fine sweep state
935.15	Printhead sweep error, check prelim amp state
935.16	Printhead sweep error, enable amp Kp state
935.17	Printhead sweep error, amp Kp failed to converge
935.18	Printhead sweep error, enable amp Ki state
935.19	Printhead sweep error, amp Ki failed to converge
935.20	Printhead sweep error, enable offset controller state
935.21	Printhead sweep error, load scan regs state
935.22	Printhead sweep error, fwd and rev capture times differ by too much
935.23	Printhead sweep error, check sweep accuracy state
935.24	Printhead sweep error, reserved
935.25	Printhead sweep error, detected resonant frequency out of expected range
935.26	Printhead sweep error, timed out waiting for end of sweep
<b>Transport motor service errors</b>	

**Service error codes (9xx) (Continued)**

<b>Error</b>	<b>Description</b>
936.01	No lock detected at normal motor start
936.02	No lock detected at motor start for motor ID
936.03	No halls detected at motor start
936.04	Failed to stop within timeout
936.05	Stall detected during speed control
937.00	Main transport motor lost lock
937.01	Main transport motor lost lock, detected by engine control
937.02	Overspeed detected during position control
937.03	Overspeed detected during speed control
<b>Power supply service errors</b>	
940.00	LVPS service error
940.01	Line frequency outside allowed range of 45Hz-64Hz
940.02	Line frequency below 43Hz
940.03	No zero cross detected on belt fuser model

## Symptom tables

### *POST symptom table*

Symptom	Action
The main motor, cooling fan, and fuser do not come on.	See <b>“Cover interlock switch service check” on page 2-18.</b>
POST completes, but the LCD does not come on.	See <b>“Operator panel service check” on page 2-21.</b>
Main motor does not come on.	See <b>“Main motor service check” on page 2-20.</b>
Fan does not come on.	See <b>“Cooling fan service check” on page 2-18.</b>
Fuser does not cycle.	See <b>“Fuser service check” on page 2-19.</b>
Fuser does not turn on and off.	See <b>“Fuser service check” on page 2-19.</b>
The paper feed picks and tries to feed media.	See <b>“Paper feed service checks” on page 2-21.</b>

**Note:** Investigate any displayed codes before proceeding with these symptoms. For example, a missing toner cartridge will prevent POST from completing.

**Printer symptom table**

Symptom	Action
Fan noisy or fan not working.	See <b>“Cooling fan service check” on page 2-18.</b>
Fuser parts melted.	See <b>“LVPS/HVPS service check” on page 2-20.</b>
Toner not fused to the media.	See <b>“Fuser service check” on page 2-19</b> or <b>“Solving print quality problems” on page 3-28.</b>
Paper jams.	See <b>“Paper feed service checks” on page 2-21.</b>
Main motor noisy or not moving.	See <b>“Main motor service check” on page 2-20.</b>
Media skew.	See <b>“Paper feed service checks” on page 2-21.</b>
Printer not communicating with host.	See <b>“Parallel or USB port service check” on page 2-23.</b>
Front access cover will not close.	See <b>“Cover interlock switch service check” on page 2-18.</b>
Operator panel button not responding.	See <b>“Operator panel service check” on page 2-21.</b>
Operator panel lights are off or very dim.	See <b>“Operator panel service check” on page 2-21.</b>
Blank page.	See <b>“Blank page” on page 2-24.</b>
Black page.	See <b>“Black page” on page 2-25.</b>
Heavy background.	See <b>“Heavy background” on page 2-25.</b>
Light print.	See <b>“Light print” on page 2-27.</b>
White or black lines or bands.	See <b>“White or black lines or bands” on page 2-27.</b>
Toner on back of page.	See <b>“Toner on back of page” on page 2-27.</b>
Media never picks.	See <b>“Media never picks” on page 2-22.</b>
Media feeds continuously.	See <b>“Media picks during POST and/or continuously” on page 2-21.</b>
Media wrinkled or bent.	See <b>“Media “trees,” wrinkles, stacks poorly, or curls” on page 2-23.</b>
Dead machine (no power).	See <b>“Dead machine service check” on page 2-19.</b>
Print quality problems <ul style="list-style-type: none"> <li>• Light print</li> <li>• Blurred characters</li> <li>• Toner on both sides of media</li> <li>• Toner not fused</li> <li>• Streaks</li> <li>• Blank pages</li> </ul>	See <b>“Solving print quality problems” on page 3-28.</b>

## Service checks



Service checks which involve measuring voltages on the LVPS/HVPS (low voltage power supply/high voltage power supply board) should be performed with the printer positioned on its back side.

**Note:** When making voltage readings, always use frame ground unless another ground is specified. See the wiring diagram in the back of the book for more information.

### Controller card service check

#### Controller card service check

FRU	Action
Controller card assembly <b>Warning:</b> Do not replace the operator panel and controller card at the same time. Each card contains the printer settings. When either of these cards is new, it obtains some of the settings from the other card. Settings are lost when both are new and replaced at the same time.	<p><b>POST (Power-On Self Test)</b></p> <p><b>Note:</b> The printer should complete POST in approximately 30 seconds.</p> <p>If the printer fails to display lights or activate the drive motor, fuser or fan, check the following order:</p> <ol style="list-style-type: none"> <li>1. Power to the LVPS/HVPS</li> <li>2. Power from the LVPS/HVPS to the controller card</li> <li>3. Cables are plugged in correctly, especially for the operator panel. The printer will not power-up without a functioning operator panel.</li> <li>4. The controller card assembly.</li> <li>5. The operator panel. See <b>“Operator panel service check” on page 3-21.</b></li> </ol>
	<p>Verify +24 V dc input from the LVPS/HVPS.</p> <ol style="list-style-type: none"> <li>1. Turn the printer off.</li> <li>2. Disconnect the LVPS/HVPS cable from the controller card at J19.</li> <li>3. Turn the printer on.</li> <li>4. Verify +24 V dc on positions 8 and 9 of the cable connector.</li> <li>5. If voltage is correct, check the continuity in the other conductors of the cable. If the cable is good, check the connectors to the controller board.</li> <li>6. Verify that pins 7 and 12 on both the cable and the card connector are grounded.</li> <li>7. If grounds are not correct on the cable, but the cable possesses continuity otherwise, check the LVPS/HVPS.</li> <li>8. If the grounds are not correct on the controller card, replace the controller card. (Check with one probe on the connector pin and the other on the card's ground plane found at each screw head.)</li> </ol>
	<p>Controller card voltage outputs</p> <p>Turn the printer off, and plug the LVPS/HVPS cable into J19 of the controller card. See the wiring diagram at the end of the book which identifies the voltages and grounds for a good controller card.</p> <p>Turn the printer off before plugging or unplugging any connectors.</p>

**Controller card service check (Continued)**

FRU	Action								
LVPS/HVPS	<p><b>Verify main power to controller card</b></p> <p>With the printer off, unplug the LPS/HVPS cable at J19 on the controller card. Verify grounds on pins 7, 12, and 14 for both the cable and the controller card. If any of these grounds are incorrect, check the cable for continuity. Replace the cable or the respective card as necessary.</p> <p>Turn the printer on with the cable still unplugged, and verify the following on the cable (controller card will not be powered):</p> <table border="1" data-bbox="743 510 1117 680"> <thead> <tr> <th>Pins</th> <th>Voltage</th> </tr> </thead> <tbody> <tr> <td>J19-8</td> <td>+24 V dc</td> </tr> <tr> <td>J19-9</td> <td>+24 V dc</td> </tr> <tr> <td>J19-13</td> <td>+5 V dc</td> </tr> </tbody> </table> <p>If any of the voltages are incorrect, replace the LVPS/HVPS. See <b>“Dead machine service check” on page 2-19.</b></p>	Pins	Voltage	J19-8	+24 V dc	J19-9	+24 V dc	J19-13	+5 V dc
Pins	Voltage								
J19-8	+24 V dc								
J19-9	+24 V dc								
J19-13	+5 V dc								

**Cooling fan service check**

FRU	Action
Cooling fan	<p>Make sure the fan cable plug is properly seated at J4 (controller card).</p> <p>Turn the printer off, and disconnect the cooling fan cable from the controller card.</p> <p>Turn the printer on. Within a few seconds, the controller card assembly should apply +24 V dc to pin 2.</p> <ul style="list-style-type: none"> <li>• If voltage is present and the fan is not turning, replace the cooling fan. If the fan still doesn't function, replace the controller card.</li> <li>• If voltage is not present, check the controller card.</li> </ul>

**Cover interlock switch service check**

**Note:** Make sure a print cartridge assembly is installed and the cover closes all the way, engaging the cover open switch lever.

FRU	Action
Cover interlock switch	<p>Disconnect the cover interlock cable from the controller card at J6.</p> <p>With the printer turned off, verify continuity between cable pin 1 and pin 2 with the door closed and discontinuity with the door open.</p> <p>Verify continuity between cable pin 1 and pin 3 with the door open and discontinuity with the door closed.</p> <p>Verify discontinuity between cable pins 2 and 3 whether the door is open or closed.</p> <ul style="list-style-type: none"> <li>• If either fails, replace the cover interlock switch.</li> <li>• If both pass continuity, turn the printer on, and measure +5 V dc on pin 2 at J6 on the controller card.</li> <li>• Verify pin 3 at J6 is ground.</li> <li>• If voltage or ground is not present, see <b>“Controller card service check” on page 2-17</b> for more information.</li> </ul>



## Dead machine service check



**CAUTION:** Check the AC line voltage. The voltage should be within the following limits:

- 100 V ac (volts alternating current) —127 V ac for the 110 V printer
- 200 V ac —240 V ac for the 220 V printer

FRU	Action
 LVPS/HVPS	<p>Unplug the printer. Remove the LVPS/HVPS, and check the fuses for continuity.</p> <ul style="list-style-type: none"> <li>• If open, replace the LVPS/HVPS.</li> <li>• If not open, check the switch continuity across its conductors with the switch on. Turn the switch off. Plug the AC line into the LVPS/HVPS and switch unit on.</li> </ul> <p><b>Note:</b> Voltages may be exposed at several places on the board. Do these verifications, and then unplug the card:</p> <ul style="list-style-type: none"> <li>• Verify 24 V dc on pins 8, 9, and 10 at PCN1.</li> <li>• Verify approximately 3V on pins 1–3.</li> <li>• Verify approximately 5V on pins 4 and 13.</li> <li>• If voltages are not correct, replace the LVPS/HVPS.</li> <li>• If voltages are correct, check the controller card. See <b>“Controller card service check” on page 2-17.</b></li> </ul>

## Fuser service check

When toner is partially fused to the media, it is usually caused by low fuser temperature.

The line voltage to the printer must be within the following limits:

- 100 V ac—127 V ac for the 110 V model printer
- 200 V ac—240 V ac for the 220 V model printer



This printer uses a belt fuser and therefore does not have a lamp.

Fuser service check

FRU	Action
 Fuser power cable LVPS/HVPS Fuser	<p>Unplug the printer, and disconnect the fuser cable plug from the LVPS/HVPS board connector at PCN5.</p> <p>Check for continuity across the fuser by checking across the connector pins.</p> <ul style="list-style-type: none"> <li>• If there is continuity, check the LVPS/HVPS. See <b>“LVPS/HVPS service check” on page 3-20.</b></li> <li>• If there is no continuity, disconnect the fuser power cable at both ends and check each conductor for continuity. Replace cable if necessary.</li> <li>• If the cable tests good, replace the fuser.</li> </ul> <p>Make sure the fuser thermistor is correctly connected to the controller board at J13. If the problem persists, disconnect the thermistor cable and check for less than +5 V dc on pin 1. Pin 2 should be ground. If line voltage is incorrect on pin 1, see <b>“Controller card service check” on page 2-17</b> for more information.</p>
 Fuser	<p>Disconnect the thermistor cable from J13 on the controller card.</p> <p>Measure the resistance across the ends of the thermistor cable.</p> <p>Replace the fuser assembly if the resistance is lower than 1K ohm or shorted.</p> <p><b>Note:</b> Resistance measures approximately 400K ohms when cool and 1K ohms hot.</p>

### LVPS/HVPS service check

FRU	Action
 LVPS/HVPS	<p><b>LVPS portion of board</b> Fuses that open typically indicate a faulty LVPS/HVPS.</p> <p>Disconnect the power cable, and open the LVPS/HVPS enough to test the switch. The switch will show continuity across the conductors with a meter when the switch is on. If the switch is good, see <b>“Dead machine service check” on page 2-19</b> for more diagnostics.</p> <p><b>HVPS portion of board</b> Problems with the HVPS are exhibited in the print quality. See <b>“Print quality service checks” on page 2-24</b> for more information.</p>

### Main motor service check

FRU	Action								
 Main gear drive Main motor cable LVPS/HVPS Controller card  <b>Warning:</b> Do not replace the operator panel and controller card at the same time. Each card contains the printer settings. When either of these cards is new, it obtains the settings from the other card. Settings are lost when both are new and replaced at the same time.	<p>Turn off the printer, and unplug the main motor cable at J17. Turn on the printer, and check for the following voltages at J17:</p> <table border="1" data-bbox="719 825 1133 989"> <thead> <tr> <th>J17 pins</th> <th>Voltages</th> </tr> </thead> <tbody> <tr> <td>Pins 1–4</td> <td>Approx. +3.3 V dc</td> </tr> <tr> <td>Pin 6</td> <td>Approx. +5 V dc</td> </tr> <tr> <td>Pins 7–9</td> <td>10 V dc–24 V dc</td> </tr> </tbody> </table> <p>Verify ground at pin 5 for both the card and cable.</p> <ul style="list-style-type: none"> <li>If these voltages are correct, check the main motor cable for continuity.                         <ul style="list-style-type: none"> <li>Remove the left side cover to access the connector on the motor.</li> <li>If continuity exists on each wire, replace the main gear drive which includes the motor.</li> <li>If continuity does not exist on one or more of the wires, replace the motor cable.</li> </ul> </li> <li>If these voltages are not correct, see <b>“Controller card connector pin values” on page 5-2</b>, or replace the controller card. See <b>“Controller card removal” on page 4-13</b>.</li> </ul>	J17 pins	Voltages	Pins 1–4	Approx. +3.3 V dc	Pin 6	Approx. +5 V dc	Pins 7–9	10 V dc–24 V dc
J17 pins	Voltages								
Pins 1–4	Approx. +3.3 V dc								
Pin 6	Approx. +5 V dc								
Pins 7–9	10 V dc–24 V dc								

## Operator panel service check

Inspect the operator panel cable for damage. Make sure the cable is plugged in securely. Run POST and check each light for proper operation. See **“Power-On Self Test (POST) sequence” on page 2-1.**

### LCD Operator panel service check

FRU	Action
Operator panel (LCD) Controller card  <b>Warning:</b> Do not replace the operator panel and controller card at the same time. Each card contains the printer settings. When either of these cards is new, it obtains the settings from the other card. Settings are lost when both are new and replaced at the same time.	<p><b>Lights</b></p> <p>If the LCD does not come on, open the controller card cage and locate the operator panel connector at J3. Make sure the cable is properly connected to the controller card and the controller card has input voltage to it.</p> <p>With the printer on, verify the following without disconnecting the cable:</p> <ul style="list-style-type: none"> <li>• Pins 1, 3, 5, and 6– 3.3 v</li> <li>• Pin 2– 5 v</li> <li>• Pins 4 and 7– GND</li> </ul> <p>If these are correct and the operator panel is not functioning, replace the operator panel.</p> <p>If any are incorrect, see <b>“Controller card service check” on page 3-17.</b></p>
	<p><b>Buttons</b></p> <p>If the buttons do not respond, replace the operator panel. There is no test or repair for the faulty switches.</p>

## Paper feed service checks

### Paper jam error indication during POST

FRU	Action
Fuser (exit sensor)	If the exit sensor flag, which is visible at the back of the fuser, is in any position other than vertical, the printer will display a paper jam. Make sure the flag is operating freely. Replace the fuser if the sensor is damaged.
Input/duplex sensor Manual feed sensor	Make sure the input paper feed sensors are working properly. A stuck or incorrectly installed sensor causes a paper jam indication.

### Media picks during POST and/or continuously

FRU	Action
ACM Manual feed clutch	<p>Check the ACM clutch for wear. The solenoid interacts with the clutch to control the motion of the pick tires.</p> <p>If the ratchet teeth of the ACM clutch assembly are worn or broken, the solenoid may not stop the ACM from rotating. Replace the ACM clutch assembly if necessary.</p> <p>Check the manual feed clutch for damage.</p>

### Media picks but stops halfway through the printer

FRU	Action
Input/duplex sensors (under print cartridge assembly) Input sensor (manual)	<p>Make sure the input sensors are working properly.</p> <p>Check for a broken or stuck flag on the input sensors.</p> <p>Make sure the cables are seated on the controller card at J23 (Tray 1 input) and J20 (manual input).</p> <p>Check for about +5 V dc on pin 6 at J23 (Input/duplex sensor) and pin 3 at J20 (Input sensor).</p> <ul style="list-style-type: none"> <li>• If correct, replace the input paper feed sensor.</li> <li>• If these voltages are not correct, replace the controller card.</li> </ul>

### Media never picks

FRU	Action
Paper feed (pick tires) tray 1 Paper feed (pick tires) tray 2 Media drive ASM Media feed clutch ASM Manual feed clutch ASM P/U and manual feed solenoid ACM drive shaft	<p>Open the left cover, and verify that the solenoids and clutches are functioning when an attempt is made to feed the media.</p> <p>Make sure the rubber tires on the ACM are installed and clean.</p> <p>Replace the tires, ACM drive, clutch assemblies, solenoids, or drive shaft as necessary.</p>

### Media occasionally mispicks or picks multiple sheets at once

FRU	Action
Tray 1 Tray 2 (option)	<p>Check tray for media catch points.</p> <p>If the sheet being fed stops momentarily, the ACM applies additional vertical force, causing additional sheets to feed.</p> <p>Do not mix media types in one tray.</p>
Paper pick tires (Tray 1 or tray 2)	<p>Check the tires in the ACM assembly for signs of wear or damage.</p> <p>Replace the tires as necessary.</p>
ACM clutch complete bill of material (CBM) Manual feed clutch CBM Media feed clutch ASM (tray 1 only) Manual feed clutch ASM	<p>Open left cover, and observe the solenoid and clutch actions at the ACM and manual feed shafts as a print job is attempted.</p> <p>Replace the faulty part.</p>
Controller card P/U and manual feed solenoid ASM.	<p>Disconnect the solenoid cable at J21 on the controller card.</p> <p>Measure the resistance across cable pins 1 and 2 and then pins 3 and 4.</p> <ul style="list-style-type: none"> <li>• The resistance should be 180–250 ohms.</li> <li>• If it is not, replace the solenoid assembly.</li> <li>• If the resistance is 180–250 ohms, check the controller card. See <b>“Controller card service check” on page 2-17</b> for more information.</li> </ul> <p>Replace controller card as necessary.</p>

### Media skews

FRU	Action
Paper feed (pick tires) tray 1 Paper feed (pick tires) tray 2 Tray 1 Tray 2 (option)	Check tires for debris. If tires are new, try reversing each on its hub.  Check side guides on Tray 1 and Tray 2. Guides set for a full stack of media may be too wide when the stack is short.

### Media “trees,” wrinkles, stacks poorly, or curls

FRU	Action
Fuser	<p>This problem is most likely due to a worn backup roll. It causes the printer to run hotter than required for the media being printed. Excessive heat can cause media treeing problems, poor stacking, or curl.</p> <p>Print the menu sheet found under Utilities.</p> <p>Look at the media settings. Some, such as card stock or rough texture, may require a higher fuser temperature, which leads to more of these problems (except stacking) in plain paper.</p> <ul style="list-style-type: none"> <li>• Change settings using the printer driver.</li> <li>• Use the local printer setup utility (included on the CD) to change the NVRAM settings.</li> </ul> <p>Try a different ream of paper. Moist media has a higher tendency to crease (treeing) and curl.</p>

### ***Parallel or USB port service check***

1. Perform a print test to make sure the printer prints correctly. Verify that the indicator light is on, then print the menu settings by selecting Print Menu under Utilities.
2. Be sure the printer parallel cable is designed for bidirectional printing.
3. Be sure the user's application is set up correctly.
4. If the internal print test page prints correctly, the user's application/printer driver is set up correctly, and the correct bidirectional parallel cable is installed, but the printer still fails to print on command from the host computer, replace the controller card.
5. Check the USB cable for continuity.

## Print quality service checks

**Note:** Ensure the cover closes tightly. A gap in the opening may allow light to expose the photoconductor resulting in a 'dirty' print. Extreme environmental conditions, temperatures, and humidity will affect the print quality.

### Using print quality test pages

To help isolate print quality problems, like streaking, print test pages using the print quality test pages. To print the print quality test pages:

1. Enter Configuration Menu.
  - a. Turn off the printer.
  - b. Turn on the printer while pressing and holding ✓ and ↶.
  - c. Release the buttons when Performing Self Test displays.
  - d. The message CONFIG MENU displays.
  - e. Press ▶ to Prt Quality Pgs.
  - f. Press ✓ to print the pages.  
Four pages print to help evaluate print quality. The first page has various fonts and a graphic, the second page is gray with graphics, the third page is black, and the last page is blank.
2. Use the test pages to isolate problems such as light or toner streaks. See **“POST symptom table” on page 2-15** for solutions to these problems.
3. Press ▶ to Exit Config Menu and press ✓.

To exit configuration, turn the printer off.

**Note:** Refer to the print defects guide at the end of the manual for repeating defects.

### Blank page

FRU	Action
Toner cartridge (not a FRU)	Remove the toner cartridge, and gently shake it to evenly distribute the toner. Check for cartridge damage.
 Printhead LVPS/HVPS Controller card	Blank pages can be caused by a defective printhead assembly, LVPS/HVPS, or controller card. <ul style="list-style-type: none"> <li>• Printhead errors typically result in printer service errors unless there is blockage of the beam or dust on the lens.</li> <li>• Blank pages typically are caused by the PC roll not being properly charged. Try a different PC kit.</li> </ul> Unplug the printer, and check the cable continuity between the LVPS/HVPS connector marked OPC (at PCN 2) and the corresponding wire form (spring) found about 14 mm above and to the right of the transfer roll gear. <ul style="list-style-type: none"> <li>• If there is not continuity, call the next level of service.</li> </ul> Try a different toner cartridge and PC kit. <ul style="list-style-type: none"> <li>• If those fail, replace the LVPS/HVPS, controller card, or the printhead in that order.</li> </ul> Also, see <b>“Solving print quality problems” on page 3-28.</b>

## Black page

**Note:** Incorrect laser exposure or incorrect charging of the photoconductor causes an all black page. Always verify the same results from a different print cartridge assembly and developer before proceeding.

FRU	Action
Toner electrodes (not a FRU)	<p>Check the three rearward electrodes below the print cartridge assembly for contamination or damage. Correct as necessary.</p> <p>Check continuity between the cable (DEV, TAR, and doctor blade) connection PCN3 and on the contact tips below the print cartridge assembly.</p> <ul style="list-style-type: none"> <li>• If continuity fails, call the next level of service.</li> </ul>
 <p>LVPS/HVPS board Controller card Miscellaneous cables</p>	<p>With the printer off, disconnect the LVPS/HVPS cable from J19 on the controller card.</p> <p>Turn the printer on, and verify +24 V dc on pins 8 and 9 of the cable.</p> <p>Verify ground on pins 7, 12, and 14.</p> <ul style="list-style-type: none"> <li>• If the voltage is incorrect, replace LVPS/HVPS board.</li> <li>• If grounds are incorrect, check ground paths.</li> <li>• Check continuity in the cable. Replace the cable if necessary.</li> <li>• If voltage is correct and the toner electrodes are good, replace the controller card.</li> <li>• See the <b>“LVPS/HVPS service check” on page 2-20</b> and the <b>“Controller card service check” on page 2-17</b>, if necessary.</li> </ul>

## Heavy background

Poor development or poorly charged toner particles cause excessive background. This is more noticeable as the toner cartridge nears end-of-life.

FRU	Action
Toner cartridge (not a FRU) PC Kit (not a FRU)	<p>Check the toner darkness setting in the driver. Try a lower setting.</p> <p>Make sure the toner cartridge and PC Kit are correctly installed and the high voltage contacts are clean.</p> <p>If the toner cartridge and PC Kit are installed correctly, try a new PC Kit first and then toner cartridge.</p>
 <p>LVPS/HVPS Controller card</p>	<p>Check the contacts for correct installation and contamination where contact is made between the print cartridge assembly and spring contacts which connect to the LVPS/HVPS board at PCN3. Clean as necessary.</p> <p>If this does not correct the problem, replace the following FRUs one at a time in the order shown:</p> <ul style="list-style-type: none"> <li>• LVPS/HVPS board (See <b>“Black page” on page 3-25</b> for pin values.)</li> <li>• Controller card</li> </ul>

**Partial blank image/white spots (no repeating pattern)**

FRU	Action
Toner cartridge (not a FRU)	Remove the toner cartridge assembly and gently shake the assembly to evenly distribute the toner. Check to make sure that the laser light path is not blocked. If toner cartridge is low, try a new one.
Paper (not a FRU)	Make sure recommended media is being used. Check the media settings in the printer driver. A heavier media may require higher heat to properly fuse.

**Variation in image density horizontally across page**

FRU	Action
PC Kit (not a FRU)	The charge roll may have an unbalanced force against the PC (photoconductor) drum. Try a new PC Kit.
Transfer roll	<b>Note:</b> Do not touch the transfer roll except at its ends. Place a sheet of paper over the roll to prevent damage from finger oils or hand lotion. Check the springs in the left and right transfer roll bearings. The bearing assemblies should support the transfer roll, applying evenly distributed forces to the PC drum. Replace the transfer roll assembly if the springs or bearings show signs of damage or fatigue. Inspect the transfer roll for signs of wear, damage or contamination. Replace as necessary.

**Poor fusing of image**

FRU	Action
Fuser	The fuser may not be operating at the proper temperature to fuse the toner to the paper. See " <b>LVPS/HVPS service check</b> " on page 2-20 for more information. Try changing the setting to heavier paper or even card stock.
Media (not a FRU)	Make sure recommended media is being used. Check the media settings in the printer driver.



### Light print

FRU	Action
Toner cartridge (not a FRU)	<p>Make sure the toner cartridge and PC Kit are installed correctly and that the toner cartridge is not low on toner.</p> <p>If the problem continues, install a new toner cartridge.</p> <p>Recheck condition before replacing PC Kit, if necessary.</p>
 Transfer roll LVPS/HVPS card	<p>Check the transfer roll for signs of toner buildup and contamination.</p> <p>Inspect the HVPS contact (transfer roll) for contamination.</p> <p>Verify the high voltage cable is plugged into the LVPS/HVPS.</p> <p>If all components appear free of contamination, replace the following FRUs one at a time in the order shown:</p> <ul style="list-style-type: none"> <li>• Transfer roll</li> <li>• LVPS/HVPS card</li> </ul>

### White or black lines or bands

FRU	Action
Print cartridge assembly (not a FRU) Developer drive coupling assembly Main gear drive	<p>Banding appears as light or dark horizontal lines on a uniformly gray page or on a page with a large area of graphics. Banding is primarily due to a variation in the speed of the media as it feeds through the printer, especially in the developer and transfer process. It may also be a result of overly dry or moist environments.</p> <p>With the printer off, check to make sure that the laser beam is not blocked.</p> <p>Inspect the toner cartridge and paper feed components, especially the drive coupler and drive gears for debris, binds, or damage.</p>

### Toner on back of page

FRU	Action
PC Kit (not a FRU)	<p>Print a menu page found under Utilities, and check settings for media type.</p> <p>Inspect the overall paper path for signs of spilled toner.</p> <p>Gently clean the contaminated areas with a soft cloth.</p>
Fuser	<p>Inspect the fuser for signs of contamination.</p> <p>Replace the fuser as necessary.</p>
Transfer roll	<p>A transfer roll contaminated with toner can cause toner to transfer to the back of pages.</p> <p>Inspect the transfer roll for contamination, and replace as necessary.</p>

## Solving print quality problems

**Note:** Refer to the print defects guide at the end of the manual for repeating defects.

### Print quality problems

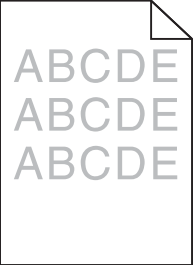
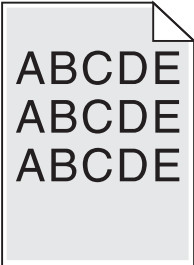
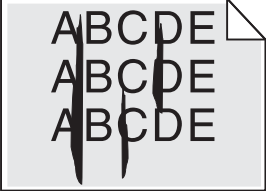
Problem	Cause / action
<p>Light or blurred characters.</p> 	<p><b>Light print</b> See <b>“Light print” on page 2-27.</b></p> <p>The toner cartridge may be getting low on toner:</p> <ul style="list-style-type: none"> <li>• Remove the toner cartridge and print cartridge assembly.</li> <li>• Shake it from side to side to redistribute the toner.</li> <li>• Reinstall it and recheck for condition.</li> <li>• Make sure to use the recommended print media (see media types and sizes in the <i>User's Reference</i>).</li> <li>• Use MarkVision™ to define the custom type setting for media type, media texture, or media weight.</li> <li>• The toner cartridge or PC Kit may be defective. Replace the PC Kit first and recheck.</li> </ul> <p><b>Blurred characters</b> Blurred images, including characters, are usually caused by a defective printhead.</p> <p><b>Vertical white lines</b> See <b>“Vertical streaks</b> below.</p> <p>Vertical white lines may be caused by the laser beam, which may be partially blocked. With the printer off, clear the path or clean the lens. The toner cartridge or fuser may be defective. Try a different toner cartridge. Inspect the fuser at its entry for debris.</p>
<p>Toner smudges appear on the front or back of the page.</p> 	<ul style="list-style-type: none"> <li>• Make sure the media is straight and unwrinkled.</li> <li>• Replace the PC Kit, and recheck before replacing the toner cartridge. See <b>“Toner on back of page” on page 2-27</b> for more information.</li> </ul>
<p>Vertical or horizontal streaks appear on the page</p> 	<p><b>Vertical streaks</b> Something could be caught between the PC kit and the fuser. Check the paper path around the fuser entry. Try a different toner cartridge.</p> <p>Vertical white lines may be caused by the laser beam, which may be partially blocked. With the printer off, clear the path or clean the lens. The toner cartridge or fuser may be defective. Try a different toner cartridge. Inspect the fuser at its entry for debris.</p> <p><b>Horizontal streaks</b> The toner cartridge or the fuser may be the cause due to excessive page count or defect. Replace as needed.</p> <p>If the lines are parallel and match the two intended ghost images, the Form Type may be incorrectly set. Check those settings.</p> <p>The PC cleaner sump may be full. Replace the PC kit.</p>

## Print quality problems (Continued)

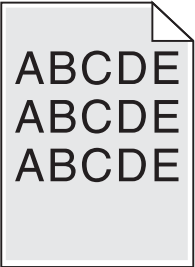
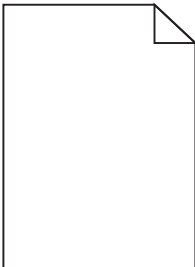
Problem	Cause / action
<p>Toner smears or rubs off the page.</p> 	<ul style="list-style-type: none"> <li>• Toner is not being fused to the paper. Replace the fuser.</li> <li>• Change the media texture setting in the driver. If special media is being used, such as card stock or labels, be sure to select the correct media type.</li> <li>• Try a different kind of paper. Paper designed for copiers gives the best quality fusing.</li> </ul>
<p>The print is getting light, but the printer has not indicated it is low on toner.</p>	<ul style="list-style-type: none"> <li>• Toner is becoming low in the cartridge.</li> <li>• The Toner Low message does not display if the 1,500 page toner cartridge is installed.</li> <li>• Remove the toner cartridge, and gently shake it from side to side to redistribute the toner.</li> <li>• Replace the toner cartridge.</li> </ul>
<p>The Toner Low message displays.</p>	<ul style="list-style-type: none"> <li>• Remove the toner cartridge, and gently shake it from side to side to redistribute the toner.</li> <li>• Replace the toner cartridge.</li> </ul>
<p>Solid black areas on transparencies</p>	<ul style="list-style-type: none"> <li>• There is a mismatch in the transparency and what the software is expecting.</li> <li>• Choose a different fill pattern in the software program.</li> <li>• Remove the toner cartridge, and gently shake it from side to side to redistribute the toner.</li> <li>• Try a different type of transparency.</li> <li>• Replace the toner cartridge.</li> </ul>
<p>Faint images or repetitive spots appear on the page.</p>	<ul style="list-style-type: none"> <li>• Select a different media type or form type setting from the printer driver.</li> <li>• Try a different type of paper. Media designed for copiers gives the best quality.</li> <li>• Replace the toner cartridge.</li> </ul>
<p>Pages are blank.</p> 	<ul style="list-style-type: none"> <li>• The print cartridge may be out of toner or defective. Replace the cartridge.</li> <li>• There may be a software error. Re-initialize the printer by turning it off and back on.</li> <li>• With the printer off, check the printhead beam path. If clear, check for a printhead error on POR. See <b>“Printhead service check” on page 2-31.</b></li> <li>• Also, see <b>“Blank page” on page 3-24.</b></li> </ul>

## Print quality problems (Continued)

Problem	Cause / action
The printer is on and indicates ready, but nothing prints.	<ul style="list-style-type: none"> <li>• Make sure the parallel or USB cable is not damaged and is firmly plugged into the connector on the back of the printer.</li> <li>• Make sure the toner cartridge assembly is installed properly.</li> <li>• Print the menu page found under Utilities.               <ul style="list-style-type: none"> <li>- If a menu settings page cannot be printed, contact the next level of support.</li> <li>- If a menu settings page can be printed, the problem is one of the following:                   <ul style="list-style-type: none"> <li>• Computer</li> <li>• Software program</li> <li>• Cable</li> <li>• (USB only) A failed controller card. Replace card.</li> </ul> </li> </ul> </li> </ul> <p><b>Note:</b> Test by unplugging USB and plugging it with the printer on. If the computer indicates "unknown device," replace the controller card.</p>
Toner Low light is on and printing stops.	If a 3.5K or more page toner cartridge is being used and the Toner Low alarm is set to on, the printer stops printing until the toner cartridge is replaced.
The Error light alone is on.	Make sure the front printer cover is closed.
The Toner Low light is blinking, and the Error light is on.	<ul style="list-style-type: none"> <li>• Make sure the toner cartridge is installed correctly.</li> <li>• Install a new toner cartridge.</li> </ul>
The media skews or buckles.	<ul style="list-style-type: none"> <li>• Tray is overfilled or media is too loose.</li> <li>• Don't overfill Tray 1 or the optional Tray 2 (see media capacities in the media types and sizes table in the <i>User's Guide</i>).</li> <li>• Make sure the paper guides are flush against the edges of the media.</li> </ul>
The media sticks together, resulting in the printer feeding multiple sheets.	<ul style="list-style-type: none"> <li>• The friction between sheets is too high.</li> <li>• Remove the media from Tray 1 or Tray 2, and fan it.</li> <li>• Don't overfill Tray 1 or the optional Tray 2 (see media capacities in the media types and sizes chart in the <i>User's Reference</i>).</li> </ul>
The media fails to feed from Tray 1.	<ul style="list-style-type: none"> <li>• Frictional force between tires and media is less than resisting force.</li> <li>• Remove the media from Tray 1, and fan it.</li> <li>• Make sure Tray 1 is selected from the printer driver. Do not overfill the tray.</li> <li>• Check the condition of the rubber on the paper feed rolls. Replace if worn or contaminated.</li> <li>• Verify that the ACM clutch is functioning correctly.</li> </ul>
The media fails to feed from the optional Tray 2.	<ul style="list-style-type: none"> <li>• Incorrect tray selection or inadequate picking force by tires.</li> <li>• Make sure the correct tray and media type are selected from the driver.</li> <li>• Make sure the tray is pushed all the way in.</li> <li>• Remove the media from the optional Tray 2, fan it, and reload.</li> <li>• Check the rubber on the paper feed tires for dirt or any other debris. Replace as necessary.</li> <li>• Check the paper path in the tray for burrs or debris that may hinder media movement.</li> <li>• Make sure the media does not exceed the stack height indicator.</li> </ul>
Load Paper displays even though there is media loaded in the optional Tray 2.	<ul style="list-style-type: none"> <li>• The input sensor does not sense media after picking.</li> <li>• Make sure the tray is pushed all the way in.</li> <li>• Press ▷.</li> <li>• Check the feed tires. (See two preceding actions.)</li> </ul>
The printer does not print after a paper jam has been cleared.	<ul style="list-style-type: none"> <li>• The printer is waiting on the next command.</li> <li>• Clear all jams.</li> <li>• Press and release ▷, or open and close the printer cover to restart the printer.</li> <li>• Make sure the print cartridge assembly is installed properly.</li> </ul>

**Print quality problems (Continued)**

Problem	Cause / action
Unexpected characters print or characters are missing.	<ul style="list-style-type: none"> <li>• Ensure correct printer driver is being used.</li> <li>• Select hex trace mode to determine what the problem is.</li> <li>• Restore factory defaults.</li> <li>• Make sure the parallel cable or USB cable is firmly plugged in at the back of the printer.</li> </ul>
Jobs are not printing, and an error message is displayed.	<ul style="list-style-type: none"> <li>• The printer is waiting for an appropriate command.</li> <li>• Make sure the print cartridge assembly is installed properly.</li> <li>• Make sure the printer front cover is closed.</li> </ul>
While in PostScript 3 emulation, the printer is flushing data (an error message is displayed).	<ul style="list-style-type: none"> <li>• Ensure the correct PostScript driver is being used.</li> <li>• The printer doesn't have enough memory to print the job. Install more memory.</li> </ul>

**Printhead service check**

FRU	Action
 <p>Printhead</p> <p><b>Note:</b> New printhead must be aligned. See <b>“Printhead assembly electronic adjustment” on page 3-8.</b></p>	<p>Turn the printer off.</p> <p>Disconnect the printhead cables from J8 and J15 on the controller card.</p> <p>Turn the printer on with the front door closed.</p> <p>On the controller card, verify +5 V dc on pin 10 at J8 and +5 V dc on pins 1 and 2 at J15.</p> <p>Verify grounds on pins 2, 4, and 7 at J8 and on pin 4 at J15.</p> <ul style="list-style-type: none"> <li>• If voltages or grounds are incorrect, check the controller card. See <b>“Controller card service check” on page 2-17</b> for more information.</li> <li>• If voltages are correct, replace the printhead (comes with cables).</li> </ul>

**Transfer roll service check**

FRU	Action
 <p>Transfer roll</p>	<p><b>Note:</b> Do not touch the transfer roll except at its ends. Place a sheet of paper over the roll to prevent damage from finger oils or hand lotion.</p> <p>Check the springs in the left and right transfer roll bearings. Do not try to move the left spring. The bearing assemblies should support the transfer roll, applying evenly distributed forces to the PC drum.</p> <p>Replace the transfer roll assembly if the springs or bearings show signs of damage or fatigue.</p> <p>Inspect the transfer roll for signs of wear, damage or contamination.</p> <p>Replace as necessary.</p>



## 3. Diagnostic aids

### Accessing service menus

There are two different test menus that can be accessed during POR to identify problems with the printer.

Configuration Menu	<ol style="list-style-type: none"> <li>1. Turn off the printer.</li> <li>2. Press and hold <b>✓</b> and <b>Back</b> ↵ .</li> <li>3. Turn on the printer.</li> <li>4. Release the buttons when Performing Self Test displays.</li> <li>5. The message CONFIG MENU displays on the top line of the operator panel.</li> </ol>	<p>The Configuration menu group contains a set of menus, settings and operations which are infrequently required by a user. Generally, the options made available in this menu group are used to configure a printer for operation.</p> <p>See <b>“Available menus” on page 3-2.</b></p>
Diagnostics Mode	<ol style="list-style-type: none"> <li>1. Turn off the printer.</li> <li>2. Press and hold <b>Go</b> ▶ and <b>Back</b> ↵ .</li> <li>3. Turn on the printer.</li> <li>4. Release the buttons when Performing Self Test displays.</li> </ol>	<p>The Diagnostic menu group contains the settings and operations used while manufacturing and servicing the printer.</p> <p>See <b>“Available tests” on page 3-5.</b></p>

### Printing menus

To print a listing of the states and settings of the printer:

1. At the Ready prompt, press ▶ under **Menu** until Utilities appears.
2. Press **✓**.
3. Press ▶ until Print Menus appear.
4. Press **✓**.

## Configuration menu (CONFIG MENU)

### Entering Configuration Menu

1. Turn off the printer.
2. Press and hold **✓** and **Back** ⏪.
3. Turn on the printer.
4. Release the buttons when Performing Self Test displays.  
The message CONFIG MENU displays on the top line of the operator panel.

### Available menus

Maint Cnt Value	<b>“Maint Cnt Value” on page 3-2.</b>
Reset Maint Count	<b>“Reset Maint Count” on page 3-2.</b>
Reset PC Count	<b>“Reset PC Cnt” on page 3-2.</b>
Prt Quality Pgs	<b>“Print quality pages (Prt Quality Pgs)” on page 3-3.</b>
Panel Menus	<b>“Panel Menus” on page 3-3.</b>
PPDS Emulation	<b>“PPDS Emulation” on page 3-3.</b>
Demo Mode	<b>“Demo Mode” on page 3-3.</b>
Factory Defaults	<b>“Factory Defaults” on page 3-3.</b>
Energy Conserve	<b>“Energy Conserve” on page 3-3.</b>
Event Log	<b>“Event Log” on page 3-3.</b>
Reduced Curl	<b>“Reduced Curl” on page 3-4.</b>
USB Speed	<b>“USB Speed” on page 3-4.</b>
Exit Config Menu	<b>“Exit Config Menu” on page 3-4.</b>

Menus may vary depending on the features and options of the printer.

### Maint Cnt Value

This value represents the number of printed sides (duplexed=2 sides). It can be reset via **Reset Maint Count**.

### Reset Maint Count

To reset the **Maint Cnt Value**:

1. Select **Reset Maint Count** from the **CONFIG MENU**.
2. Press **✓** to reset the counter.

### Reset PC Cnt

When you install a new photoconductor, this number should be reset.

To reset the counter:

1. Select **Reset PC Cnt** from the **CONFIG MENU**.
2. Press **✓** to reset the counter to zero.

**Note:** Permanent page count is not affected by this operation.



## ***Print quality pages (Prt Quality Pgs)***

To print the Print Quality Pages:

1. Select **Prt Quality Pgs** from **CONFIG MENU**.
2. Press **✓**.  
Four pages print. Additional button presses are ignored until the pages have printed. If duplex is selected, the pages print front and back.  
The first page is a mix of graphics and text. The second two pages are graphics, and the last page is blank.

The Print Quality Pages can also be printed from the Diagnostics Mode.

## ***Panel Menus***

If no password is set, Panel Menus lets you restrict access to the Ready Menu Group. When a password is set by an administrator, this menu item does not appear.

1. Select **Panel Menus** from the **CONFIG MENU**.
2. Select **Disable** to make menus in the Ready Menu Group inaccessible.

To change the setting, select **Panel Menus**, and select **Enable** to make the menus available.

## ***PPDS Emulation***

This menu lets you turn on PPDS emulation, if desired.

1. Select **PPDS Emulation** from **CONFIG MENU**.
2. Select **Activate** to enable PPDS emulation and **Deactivate** to turn it off.

## ***Demo Mode***

This menu item lets you turn demo mode on or off.

1. Select **Demo Mode** from **CONFIG MENU**.
2. Select **Activate** to turn the demo mode on or **Deactivate** to turn demo mode off.

## ***Factory Defaults***

This menu lets you restore the printer settings to their factory default values.

1. Select **Factory Defaults** from the Configuration Menu.
2. Select either **Restore Base** or **Restore Network**. Restore Network is only available if an integrated network adapter is installed.

## ***Energy Conserve***

Select **On** to allow access to the Power Saver menu. If you select **Off**, an additional item appears in the Power Saver menu. **Disable** lets you enable or disable Power Saver from the customer menu.

## ***Event Log***

Selecting **EVENT LOG** provides a history of printer errors. The most recent error displays in position 1, and the oldest error displays in position 10 (if 10 errors have occurred). If an error occurs after the log is full, the oldest error is discarded. Identical errors in consecutive positions in the log are entered. All 2xx and 9xx error messages are stored in the event log. See **“Event log” on page 3-21** for more information.

## ***Reduced Curl***

Select **Reduced Curl** from the **CONFIG MENU** to help reduce the curl of media. Select **On** to activate Reduced Curl, or select **Off** (default) to deactivate Reduced Curl. Reduced Curl lowers the fuser temperature.

## ***USB Speed***

To change the speed of the USB:

1. Select USB Speed from the **CONFIG MENU**.
2. Select **Auto** (default) or **Full**.
3. Press ✓ to save the desired speed.

## ***Exit Config Menu***

Select **Exit Config Menu** to exit the Configuration Menu and return to normal mode.

## Diagnostics mode

### Entering Diagnostics Mode

1. Turn off the printer.
2. Press and hold **Go** ▶ and **Back** ⏪.
3. Turn on the printer.
4. Release the buttons when Performing Self Test displays.

### Available tests

The tests display on the operator panel in the order shown:

#### Diagnostics mode tests

<b>REGISTRATION</b>	
Margins (top margin, bottom margin, left margin)	See <b>"Margins"</b> on page 3-7.
Quick Test	See <b>"Quick Test"</b> on page 3-14.
Printhead	See <b>"Printhead assembly electronic adjustment"</b> on page 3-8.
<b>PRINT TESTS</b>	
Tray 1	See <b>"Input source tests"</b> on page 3-14.
Tray 2 (if installed)	See <b>"Input source tests"</b> on page 3-14.
Prt Quality Pgs	See <b>"Print quality pages (Prt Quality Pgs)"</b> on page 3-14.
<b>HARDWARE TESTS</b>	
LCD Test	See <b>"LCD Test"</b> on page 3-15.
Button Test	See <b>"Button Test"</b> on page 3-15.
DRAM Test	See <b>"DRAM Test"</b> on page 3-15.
<b>DUPLEX TESTS</b>	
Quick Test	See <b>"Quick Test"</b> on page 3-16.
Top margin	See <b>"Top Margin"</b> on page 3-16.
Left Margin	See <b>"Left Margin"</b> on page 3-16.
Sensor Test	See <b>"Sensor Test"</b> on page 3-16.
Duplex Feed 1	See <b>"Duplex Feed 1"</b> on page 3-17.
<b>INPUT TRAY TESTS</b>	
Feed Tests	See <b>"Feed Tests (input tray)"</b> on page 3-17.
Sensor Test	See <b>"Sensor Test (input tray)"</b> on page 3-18.
<b>BASE SENSOR TEST</b>	
Front Door	See <b>"Front Door (front access door sensor)"</b> on page 3-18.
Input	See <b>"Input (input sensor)"</b> on page 3-18.
Output	See <b>"Output (exit sensor)"</b> on page 3-18.
<b>PRINTER SETUP</b>	
Defaults	See <b>"Defaults"</b> on page 3-19.
Page Count	See <b>"Page Count"</b> on page 3-19.
Perm Page Count	See <b>"Perm Page Count (permanent page count)"</b> on page 3-19.
Serial Number	See <b>"Serial Number"</b> on page 3-20.

**Diagnostics mode tests (Continued)**

Engine Setting 1 through 4	See <b>“Engine Setting 1 through 4”</b> on page 3-20.
Model Name	See <b>“Model Name”</b> on page 3-20.
Configuration ID	See <b>“Configuration ID”</b> on page 3-20.
Edge to Edge	See <b>“Edge to Edge”</b> on page 3-20.
Par S Strobe Adj	See <b>“Par S Strobe Adj (parallel strobe adjustment)”</b> on page 3-20.
<b>EP SETUP</b>	
EP Defaults	See <b>“EP Defaults”</b> on page 3-21.
Fuser Temp	See <b>“Fuser Temperature (Fuser Temp)”</b> on page 3-21.
Transfer	See <b>“Transfer”</b> on page 3-21.
Print Contrast	See <b>“Print Contrast”</b> on page 3-21.
Charge Roll	See <b>“Charge Roll”</b> on page 3-21.
Gap Adjust	See <b>“Gap Adjust”</b> on page 3-21.
<b>EVENT LOG</b>	
Display Log	See <b>“Display Log”</b> on page 3-21.
Print Log	See <b>“Print Log”</b> on page 3-22.
Clear Log	See <b>“Clear Log”</b> on page 3-22.
<b>EXIT DIAGNOSTICS</b>	See <b>“Exit Diagnostics”</b> on page 3-22.

## Registration

### Margins

To set print registration:

1. Select **REGISTRATION** from the Diagnostics menu.
2. Select **Margins** from the **REGISTRATION** menu.

The Top margin sign/value pair *blinks*. This indicates it is the margin value being changed.

T=sxx*	B=-sxx*
L=sxx*	

3. To select the margin value to be changed, press  $\checkmark$  until the margin value pair you want to change is blinking.

The print registration range is:

Variable	Description	Value
s	sign	blank for positive values, "-" for negative values
B=	Bottom margin	-20 to +20– Each increment causes approximately 0.55 mm shift in the bottom margin.
T=	Top margin	-16 to +16
L=	Left margin	-25 to +25

4. To change the margin value, press  $\blacktriangleleft$   $\blacktriangleright$ . When the value you want displays, press  $\checkmark$  to save the value. To verify the margin values are correct, you must print the Quick Test page. Press **Go** to print the test page. While printing, *Quick Test Printing* displays. Once the Quick Test page completes printing, the registration screen displays again.
5. To exit, press **Return**.
6. To Test the setting by printing the Quick Test page for all the sources, see **“Quick Test” on page 3-14**. Select all the available sources.

Print the Quick Test Page on letter or A4 paper.

## Printhead assembly electronic adjustment

A step-by-step process to align a new printhead.

**Note:** Before aligning the printhead electronically, first align the printhead mechanically, if needed. See **“Printhead assembly mechanical adjustment” on page 3-12.**

1. Press **Go** to print Step 1 test page.

### Step 1 printout (sample only; use actual sheet)

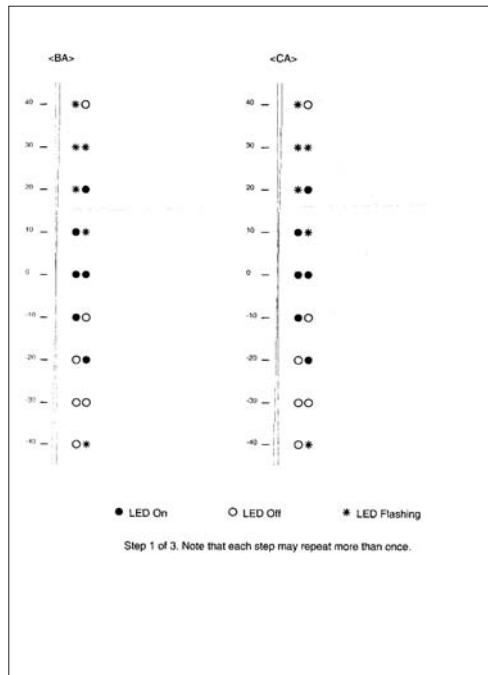

2. In column <BA> of Step 1 test page, look for the position where the vertical lines are the closest to each other. Press **▶** to select the corresponding number (new setting).
3. Press and release **✓** to move to the <CA> pattern on the right side of Step 1 test page.
4. Press **▶** to select the <CA> setting.

- Press **Go** to print Step 2 test page.

**Step 2 printout**  
(sample only; use actual sheet)

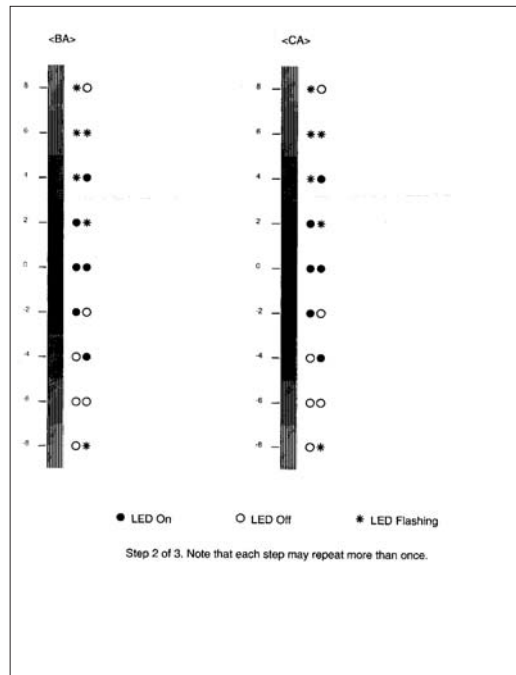

- Press **▶** to change the <BA> settings to the number beside the darkest portion of the vertical bar.
- Press and release **✓** to move to the <CA> settings on the right side of Step 2 test page.
- Press **▶** to change the <CA> settings to the number beside the darkest portion of the vertical bar.

9. Press **Go** to print Step 3 test page.

**Step 3 printout**  
(sample only; use actual sheet)

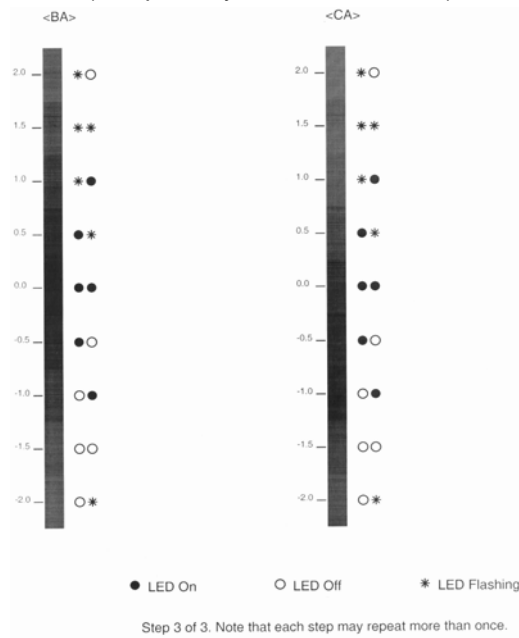

10. Press **▶** to change the <BA> setting to the number beside the darkest portion of the vertical bar.
11. Press and release **✓** to move to the <CA> settings on the right side of Step 3 test page.
12. Press **▶** to change the <CA> settings to the number beside the darkest portion of the vertical bar.



13. Press **Go** to print Visual alignment page.

**Visual alignment printout**  
(sample only; use actual sheet)

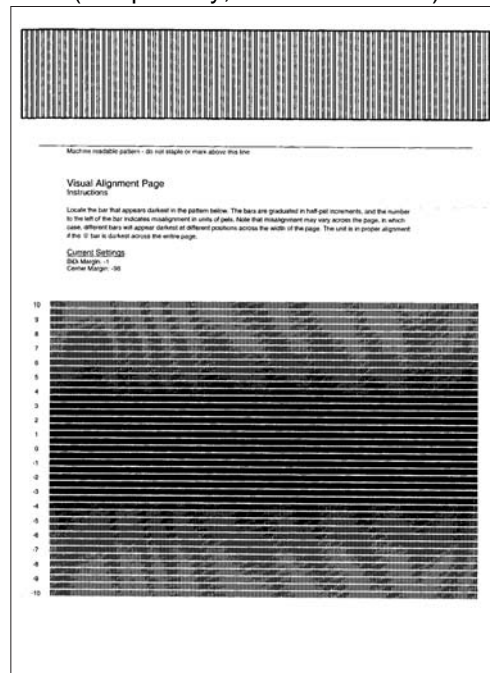

14. Verify that the overall darkest line across the page is "0." If not, then run the alignment again.  
15. Turn the printer off to exit the printer alignment menu.

## Printhead assembly mechanical adjustment

A printhead needs to be correctly positioned after it has been removed. Align it to the frame or use the same position as the removed printhead. An indicator is located at the front right-hand screw for reference.

**Note:** Skew is caused by a sheet being fed through the printer while misaligned. The entire image is rotated relative to the sheet edges. However, a mechanically misaligned printhead causes the horizontal lines to appear skewed while the vertical lines remain parallel to the vertical edges.

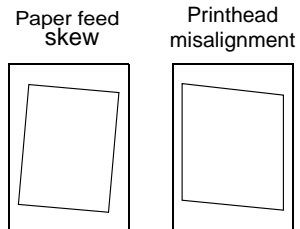

There are no adjustments for skew. Check the pick roll (paper pick assembly) for wear, the paper path for obstructions, the fuser for proper setting, and the tray paper guides for fit to the media.

### To adjust the printhead:

1. Enter the Diagnostics Menu. See **“Entering Diagnostics Mode” on page 3-5.**
2. Select PRINT TESTS.
3. Select Tray 1.
4. Select Single.
5. Fold the printed test page on the left side so that a few millimeters of grid lines wrap around the outside of the fold. See photo below.
6. Fold a second vertical fold near the center so that the left side top edge aligns with the right side top edge.

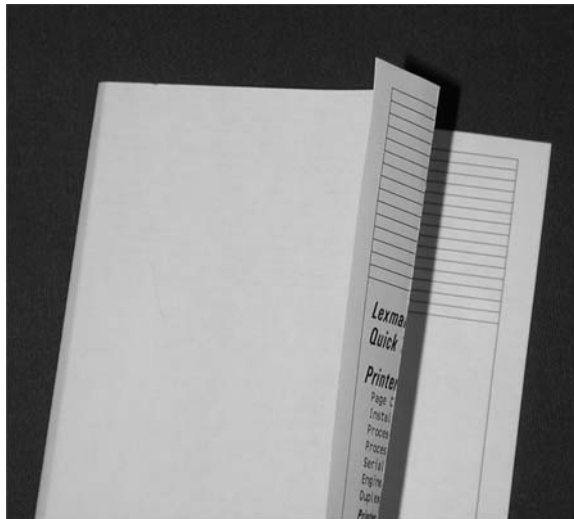

7. If the grid lines of the right flap align below the corresponding lines on the left flap, adjust the printhead clockwise relative to the printer and recheck. (See the left side of the figure below.) If the grid lines of the left flap align below the corresponding lines of the right side, adjust the printhead counterclockwise. (See the right side of the figure below.)

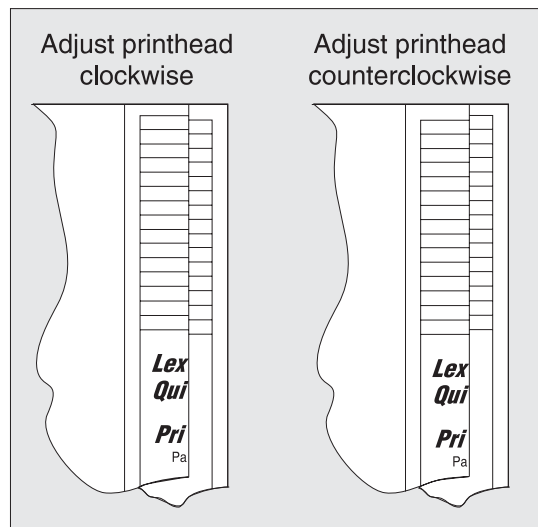

8. After obtaining a properly adjusted image on the paper, tighten all three screws.

**Note:** The printhead **must** be aligned electronically. See **"Printhead assembly electronic adjustment"** on **page 3-8**.

## Quick Test

The Quick Test contains the following information:

- Print registration settings
- Alignment diamonds at the top and bottom
- Horizontal lines to check for skew
- General printer information, including current page count, installed memory, serial number, and code level.

To print the Quick Test page:

**Note:** Print the Quick Test Page on letter or A4 paper.

1. Select **REGISTRATION** from the Diagnostics menu.
2. Press **Go**.

Once the Quick Test Page completes printing, the Registration screen displays again.

## Print tests

### Input source tests

Input source print tests can verify that the printer can print on media from the installed input sources. Only installed sources appear in the menu.

To run the input source test:

1. Select **PRINT TESTS** from Diagnostics Mode.
2. Select the input source from the sources displayed on the menu. All installed sources are listed.

Menu selections	Description
Tray 1	Standard tray
Tray 2*	Optional tray
* If installed	

3. Select either **Single** (feeds one sheet of blank media from the selected source) or **Continuous** (continues feeding blank media from the selected source until **Return** or **Stop** is pressed) by using ◀ ▶ .

Press **Return** or **Stop** to exit the test.

### Print quality pages (Prt Quality Pgs)

To print the Print Quality pages:

1. Select **PRINT TESTS** from Diagnostics Mode.
2. Select **Prt Quality Pgs**.
3. Press ✓ .

Four pages print. Additional button presses are ignored until the pages have printed.

The first page is a mix of graphics and text. The second two pages are graphics, and the last page is blank.

The Print Quality pages can also be printed from the Configuration Menu.

## Hardware tests

Select the following selections from HARDWARE TESTS:

- LCD Panel
- Buttons
- Op Panel
- DRAM
- Parallel Port

### LCD Test

This test continuously executes a pattern.

1. Select **LCD Test** from Diagnostics Mode. The test continually executes.
2. Press **Return** or **Stop** to cancel the test.

### Button Test

1. Select **Button Test** from Diagnostics Mode.  
With no buttons pressed, several occurrences of OP (Open) appear on the display.

OP	OP	OP	OP	OP
----	----	----	----	----

2. To test the proper operation of each button, press each button on the operator panel one at a time, and a CL (Closed) displays in place of an OP.
3. Press **Return** or **Stop** to cancel the test.

### DRAM Test

The purpose of this test is to check the validity of DRAM, both standard and optional. The test writes patterns of data to SDRAM to verify that each bit in memory can be set and read correctly.

To run the SDRAM Memory Test:

1. Select **DRAM Test** from the menu. The power indicator *blinks*, indicating the test is in progress.

DRAM Test	xxxMb
P:#####	F:#####

xxxMB represents the amount of installed DRAM memory in MB.

P:##### represents the number of times the memory test has passed and finished successfully. Initially, 000000 displays with the maximum pass count being 999,999.

F:##### represents the number of times the memory test has failed and finished with errors. Initially, 000000 displays with the maximum fail count being 99,999.

2. Once the maximum pass count or fail count is reached, the test stops, the power indicator is turned on solid, and the final results display. If the test fails, the message DRAM Error displays for approximately three seconds and the failure count increases by 1.
3. To stop the test before it completes, turn off the printer. The test does not terminate.

## Duplex tests

- Quick Test
- Top Margin
- Left Margin
- Sensor Test
- Duplex Feed 1

These tests are used to determine if the duplex is working correctly.

### Quick Test

The Quick Test contains the following information on a duplexed page:

- Print registration settings
- Alignment diamonds at the top and bottom
- Horizontal lines to check for skew
- General printer information, including current page count, installed memory, serial number, and code level.

To print the duplexed Quick Test page:

1. Select **Quick Test** from the **DUPLEX TESTS** menu.
2. Select **Single** or **Continuous** by using ◀ ▶.
3. Press ✓ to print the page.

### Top Margin

1. Select **Top Margin** from the **DUPLEX TESTS** menu.
2. To change the margin value, press ◀ to increase the value or ▶ to decrease the value.
3. Press ✓ to save the desired margin value.

### Left Margin

1. Select **Left Margin** from the **DUPLEX TESTS** menu.
2. To change the margin value, press ◀ to decrease the value or ▶ to increase the value.
3. Press ✓ to save the desired margin value.

### Sensor Test

This test is used to determine if the input sensor is operating correctly.

- If the sensor is operating correctly, **OP (Open)** will appear on the display:

Sensor Test
Input=OP

- Press **Back** to return to the **DUPLEX TESTS** menu.

## Duplex Feed 1

1. Select **Duplex Feed 1** from the **DUPLEX TESTS** menu. The following will appear on the display:

```
Duplex Feed 1
Feeding...
```

2. A blank page will feed through the printer. The following will appear on the display:

```
Duplex Feed 1
Clear Paper...
```

3. Remove the blank page from the printer, and press **Back** to return to the **DUPLEX TESTS** menu.

## Input tray tests

### Feed Tests (input tray)

These tests are used to determine if the input tray sensors are working correctly. Observe the paper path as blank media is being fed through the printer. The front access door cannot be opened during the feed test. To observe the paper path, open the door cover to access the manual feeder. Any media that meets the specifications for the printer can be used for this test.

To run the Input Tray Feed Test:

1. Open the manual feeder door.  
**Note:** Do not open the front cover.
2. Select the **Feed Test** from the INPUT TRAY TESTS menu.
3. Select the input source. Only installed sources display, but may include **Tray 1**, **Tray 2**, and **Manual Feeder**.
4. Select **Single** to feed a single blank sheet or **Continuous** to feed blank sheets until you press **Return** or **Stop**.

The selected input source appears on the display:

```
<input source>
Feeding...
```

### Sensor Test (input tray)

This test is used to determine if the input tray sensors are working correctly.

1. Select the **Sensor Test** from the Input Tray Test menu.
2. Select the input source. Only installed sources display, but may include **Tray 1**, **Tray 2**, and **Manual Feeder**.

<input source>  
Testing...

3. A list of sensors appears, depending upon the input source selected. For example, if tray 2 were selected:

Tray 2  
TP=OP                      P=OP

TP refers to tray present sensor.  
P refers to pass thru sensor.  
OP indicates the sensor is open.  
CL indicates the sensor is closed.

Not all sources have the same set of sensors. The table below indicates which sources should display which sensors.

Source	Tray present (TP)	Pass thru sensor (P)
Tray 1	No	No
Tray 2	No	No*
Manual feeder	Yes	No
* Only available if tray is a 550-sheet drawer.		

4. Press **Return** or **Stop** to exit the test.

### Base sensor test

Base sensor test is used to determine if the sensors inside the printer are working correctly.

To run the Base Sensor Test:

1. Select **BASE SENSOR TEST** from the Diagnostics Mode.
2. Select the sensor to test. The following sensors may be tested:
  - Input** (input sensor)
  - Output** (exit sensor)
  - Front Door** (front access door sensor)

The selected sensor is displayed with **OP** for open or **CL** for closed. You can actuate the sensors to toggle between open and closed.



## Printer setup

### Defaults

Selections are **U.S.** or **Non-U.S.** This selection affects the following defaults:

Printer setting	U.S. value	Non-U.S. value
Default paper size*	Letter	A4
Envelope size*	10 Envelope	DL Envelope
Fax paper size	Letter	A4
PCL Symbol Set	PC-8	PC-850
PPDS code page	437	850
Units of measure	Inches	Millimeters

\* Where input sources do not have size-sensing capabilities.

**Warning:** Changing this setting resets the printer to factory defaults, and data may be lost. It cannot be undone.

### Page Count

Reset the page count when an engine card is replaced.

To reset the page count:

1. Select **Page Count** from the **PRINTER SETUP** menu.

Page Count =1234567*
-------------------------

2. The leftmost number *blinks*. Use **Menu** to increase or decrease the number, and press  $\checkmark$  to move to the next digit to the right. Continue until the correct number displays. To skip a number without changing it, press  $\checkmark$ .

When  $\checkmark$  is pressed after the last digit, the number is saved.

### Perm Page Count (permanent page count)

The permanent page count can only be viewed and cannot be changed.

To view the permanent page count:

1. Select **Perm Page Count** from **PRINTER SETUP**.
2. Press **Return** to return to **PRINTER SETUP**.

## Serial Number

The serial number can only be viewed and cannot be changed.

To view the serial number:

1. Select **Serial number** from **PRINTER SETUP**.
2. Press **Return** to return to **PRINTER SETUP**.

## Service Tag (only on some printers)

The service tag number can only be viewed and cannot be changed.

1. Select **Service Tag** from the **PRINTER SETUP** menu.
2. Press **Back** to return to **PRINTER SETUP**.

## Engine Setting 1 through 4

**Warning:** Do not change these settings unless requested to do so by your next level of support.

## Model Name

The serial number can only be viewed and cannot be changed.

## Configuration ID

The configuration ID is used to communicate characteristics of certain areas of the printer that cannot be determined by hardware sensors. The configuration ID was originally set when the printer was manufactured and is located on the printer label.

## Edge to Edge

When Edge to Edge is set to **On**, text and graphics are printed with all margins set to the physical edges of the page. This feature does not work in PPDS emulation.

## Par S Strobe Adj (parallel strobe adjustment)

This setting adjusts the factory setting for the amount of time the strobe is sampled to determine that valid data is available on the parallel port. Incrementing this value by one means the strobe is sampled 50 nanoseconds longer. The range of values are between -4 and +6, in increments of one. A value of zero indicates no change is made from the factory setting.

## EP setup

### EP Defaults

Restores all EP settings to factory default values. Selections are **Restore** and **Do Not Restore**.

### Fuser Temperature (Fuser Temp)

Changing this setting can reduce media curl or melting of some letterhead images. Selections are **Normal** (default), **Lower**, and **Lowest**.

### Transfer

The transfer can be adjusted to **Low**, **Medium**, or **High**. The default setting is Medium.

### Print Contrast

The print contrast can be adjusted to **Low**, **Medium**, or **High**. The default setting is Medium.

### Charge Roll

The charge roll can be adjusted to **Low**, **Medium**, or **High**. The default setting is Medium.

### Gap Adjust

Adjusts the minimum gap between sheets during printing. This setting reduces speed (pages per minute), but can be used to reduce curl of printed media and improve stacking in the output bin.

Range is 0 (default) to 255. Adjusting by one results in 9 mm of increased gap.

## Event log

### Display Log

Selecting **EVENT LOG** provides a history of printer errors. The most recent error displays in position 1, and the oldest error displays in position 10 (if 10 errors have occurred). If an error occurs after the log is full, the oldest error is discarded. Identical errors in consecutive positions in the log are entered. All 2xx and 9xx error messages are stored in the event log as well as the PC kit and maintenance counter resets and NVRAM resets initiated by the **Factory Defaults** setting in the UTILITIES menu.

To view the display log:

1. Select **Display Log** from the **EVENT LOG** menu.

The error log is displayed one error per display screen. For example:

```
Event 1/6
936 Svc Error
```

This error is the first of six errors (it is also the latest error). This error was a 936 service error. To see the second service error, press **▶**. Pressing **◀** will display the sixth error as shown:

```
Event 6/6
202.01 Paper Jam
```

2. Press **Back** once to exit the Display log, or press twice to exit the **EVENT LOG**.

## Print Log

Additional diagnostic information is available when you print the error log. Some of the additional information includes:

- Detailed printer information, including model and serial number
- Time and date stamps
- Page counts for each error

The printed error log can be faxed to Lexmark or your next level of support for verification or diagnosis. This report can also be printed from the Configuration Menu. Because you can clear error logs, the contents of this log may not match the contents when you view the error log.

To print the error log:

1. Press **✓** to enter **Print Log** from the **EVENT LOG** menu.
2. Press **Back** to exit the **EVENT LOG** menu.

## Clear Log

1. Select **Clear Log** from the Error Log menu.

```
Clear Log
=Yes
```

2. Select **No** to exit without clearing the log. Press **Yes** to confirm. The log is immediately erased, and the display indicates **No Events Logged**.
3. Press **Return** to exit the Clear Log menu after clearing the log.

## Exit Diagnostics

Selecting **EXIT DIAGNOSTICS** exits the Diagnostics mode, and **Resetting the Printer** displays. The printer performs a POR, and the printer returns to normal mode.

## 4. Repair information

**Warning:** Read the following before handling electronic parts.

---

### Handling ESD-sensitive parts

Many electronic products use parts that are known to be sensitive to electrostatic discharge (ESD). To prevent damage to ESD-sensitive parts, follow the instructions below in addition to all the usual precautions, such as turning off power before removing logic cards:

- Keep the ESD-sensitive part in its original shipping container (a special “ESD bag”) until the part is ready to be installed into the printer.
- Make the least-possible body movements to prevent an increase of static electricity from clothing fibers, carpets, and furniture.
- Put the ESD wrist strap on your wrist. Connect the wrist band to the system ground point. This discharges any static electricity in your body to the printer.
- Hold the ESD-sensitive part by its edge connector shroud (cover); do not touch its pins. If a pluggable module is being removed, use the correct tool.
- Do not place the ESD-sensitive part on the MFP cover or on a metal table; if the ESD-sensitive part needs to be put down for any reason, first put it into its special bag.
- Machine covers and metal tables are electrical grounds. They increase the risk of damage because they make a discharge path from your body through the ESD-sensitive part. (Large metal objects can be discharge paths without being grounded.)
- Prevent ESD-sensitive parts from being accidentally touched by other personnel. Install machine covers when the machine is not being worked on, and do not put unprotected ESD-sensitive parts on a table.
- If possible, keep all ESD-sensitive parts in a grounded metal cabinet (case).
- Be extra careful in working with ESD-sensitive parts when cold-weather heating is used, because low humidity increases static electricity.

---

### Removal procedures

**Note:**

1. Remove the toner cartridge and media tray before removing other printer parts. The toner cartridge should be protected from light while out of the printer.
2. We recommend disconnecting all external cables from the printer to prevent damage during service.
3. Unless otherwise stated, reinstall the parts in reverse order of removal.
4. When reinstalling a part held with several screws, start all screws before final tightening.

### Front access cover removal

1. Remove Tray 1.
2. Open the front access cover.
3. Open the rear door and the right side cover.
4. Loosen the four screws, and remove the controller card cover.
5. Disconnect the operator panel cable (A) from J3 on the controller card.

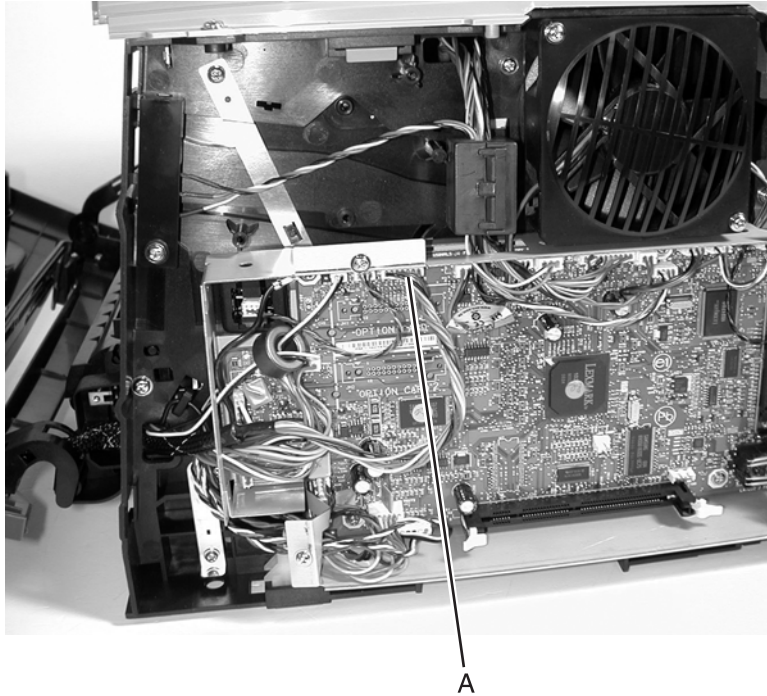

6. Extract the cable, and unhook the access cover by pressing the right hinge to the right until it can be lifted up and away from its pivot. Relax the hinge above the pivot.
7. In the same manner, move the left hinge from its pivot point.



8. Tilt the front cover down, and disconnect it on the left side from the link.

**Warning:** Make sure that the link is not bent or pulled out farther than normal. Otherwise, the toner cartridge coupler may become dislodged.

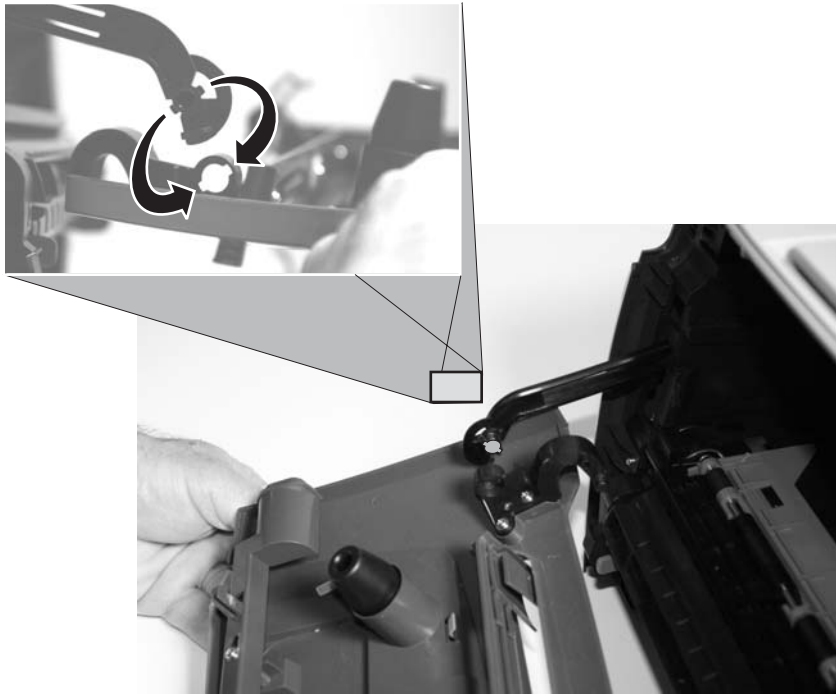

9. Remove the front access cover.

### Left side cover removal

1. Remove Tray 1.
2. Open the front access cover.
3. Open the rear door.
4. Remove the screw (A).
5. Unlatch the cover from the latches (B).

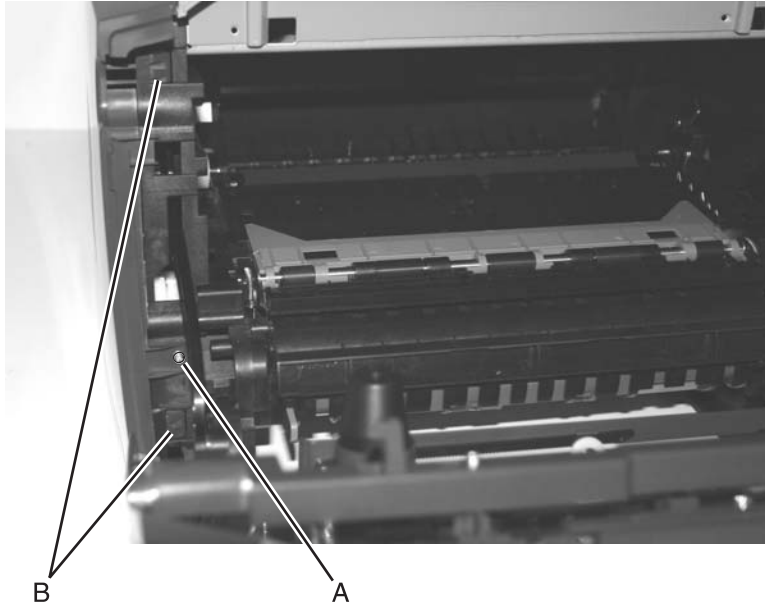

6. Position the printer with the left rear corner hanging over the edge of the table.
7. Swing the cover open.



8. Lift the top rear of the cover over the pivot point, and drop the cover away from the printer.



## Right side cover removal

1. Remove Tray 1.
2. Open the front access cover.
3. Open the rear door.
4. Release the latches (A), and swing the cover open.



5. Position the printer with the right rear corner hanging over the edge of the table.

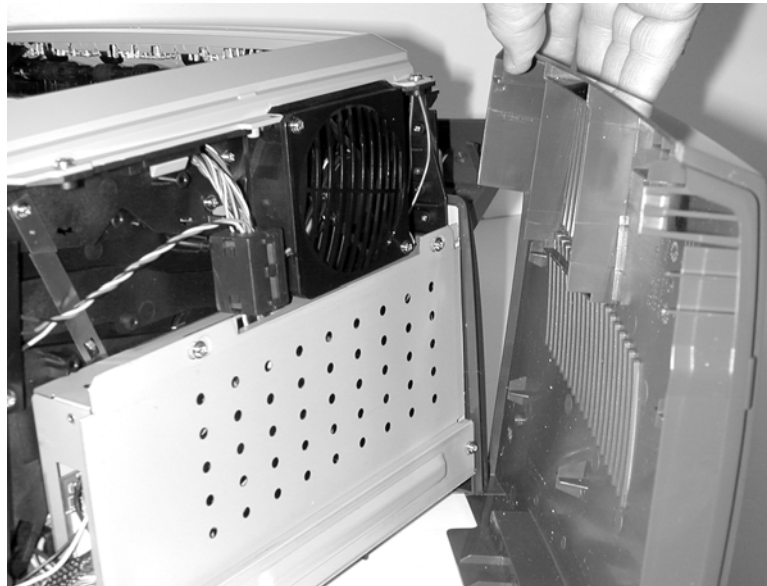

6. Lift the top rear of the cover over the pivot point, and drop the cover away from the printer.

## Rear cover removal

1. Remove the right side cover. See **“Right side cover removal”** on page 4-5.
2. Remove the left side cover. See **“Left side cover removal”** on page 4-4.
3. Remove the two screws (A).

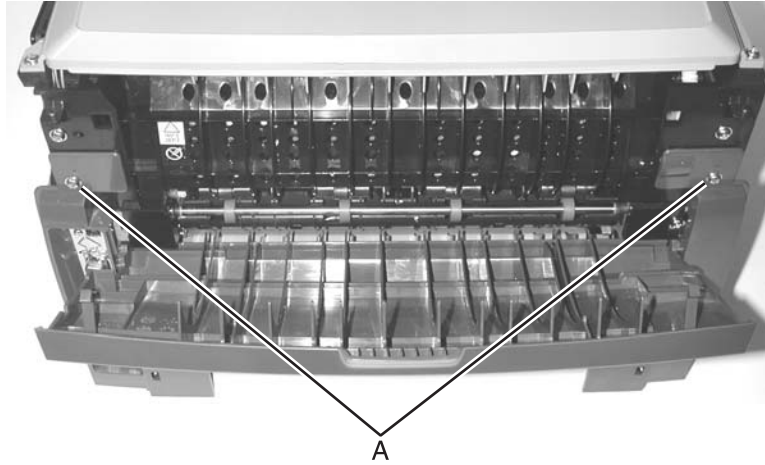

4. Open the rear cover.
5. Lift the rear cover, unhooking it from the frame at the bottom, and remove.

**Note:** In re-installation, check to make sure that the fuser ground cable is routed out of the way and is not pinched or damaged.

## Top cover removal

1. Remove the right side cover. See **“Right side cover removal”** on page 4-5.
2. Remove the left side cover. See **“Left side cover removal”** on page 4-4.
3. Open the rear door.
4. Remove the two screws (A) from the two front corners on the top cover, the two screws (B) from the two rear corners on the top cover, and the screw (C) on the left side.

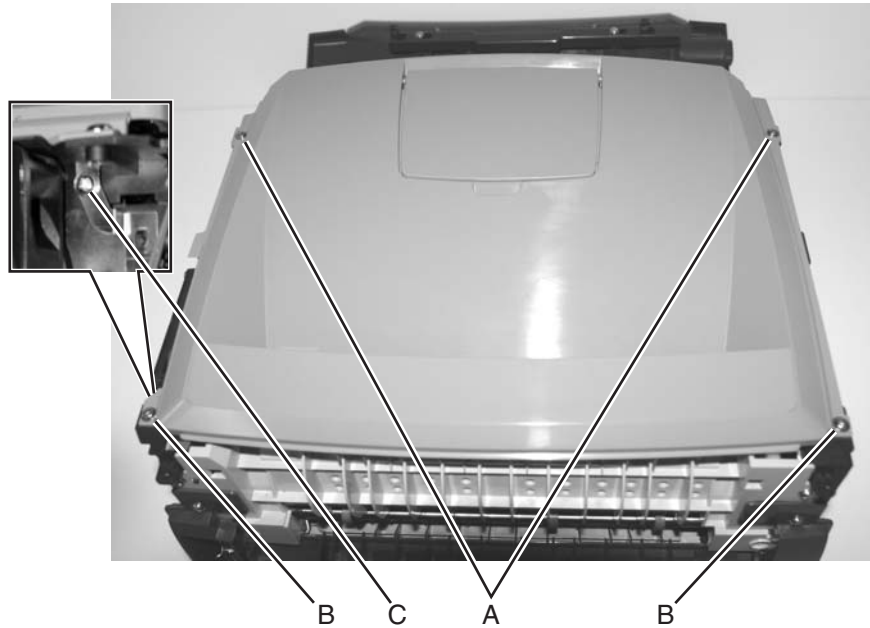

5. Open the front cover.
6. Remove the two screws (D).

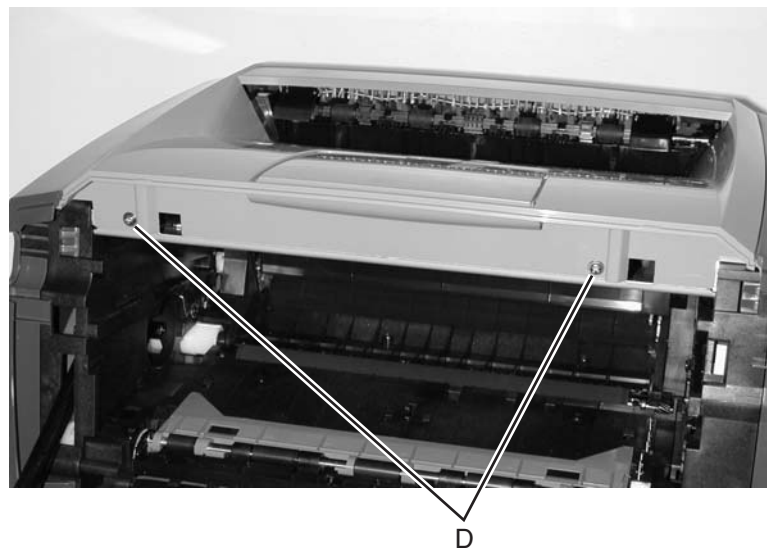

7. Remove the controller card cover.

8. Disconnect the cable (E) of the narrow media sensor from J10 on the controller card.

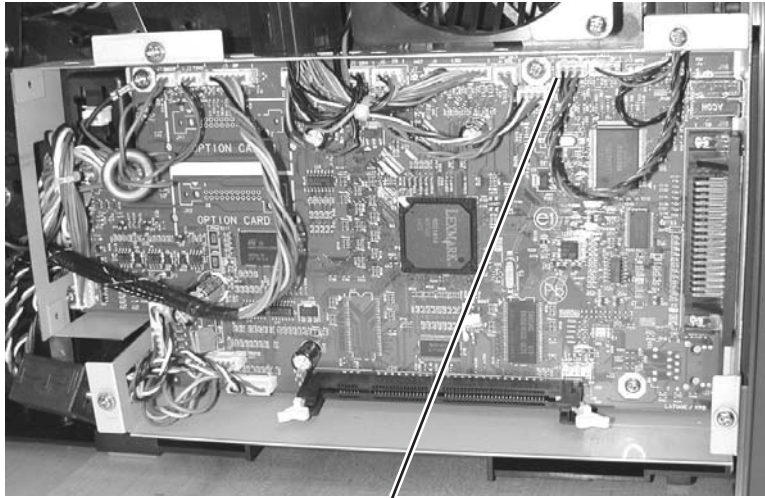

E

9. Free the cable while noting which top frame opening it goes through.
10. Release the latches (F) on both sides to unhook the top cover.

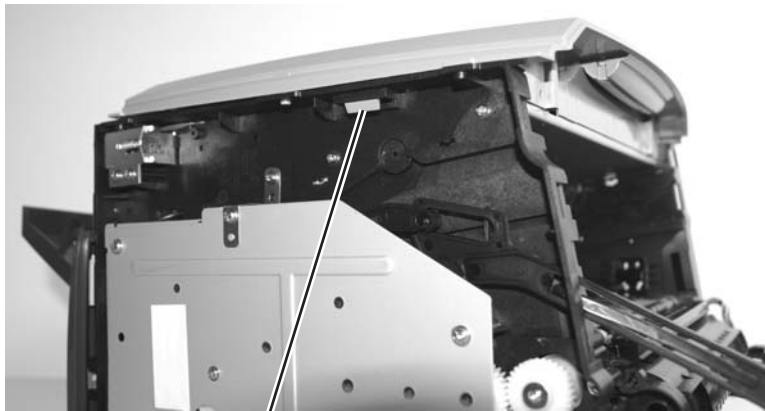

F

11. Lift and remove the top cover.

**Installation note:**

- Be sure to re-route the cable back through the same hole.
- Be sure that the ground strap aligns at screw (C).
- Verify the proper alignment of the top cover with the paper exit guide along the mating edges at the rear of the exit tray.
- Verify that the rollers in the top cover contact the exit guide rollers at the top rear. There are arrows under the top cover to verify the location of the rollers.

## Auto comp removal

1. Remove the duplex. See **"Duplex removal"** on page 4-18.
2. Remove the auto comp clutch. See **"Auto comp clutch removal"** on page 4-10.
3. Use a spring hook or a small screwdriver to rotate the latch toward the bottom of the printer until it is pointing downward.

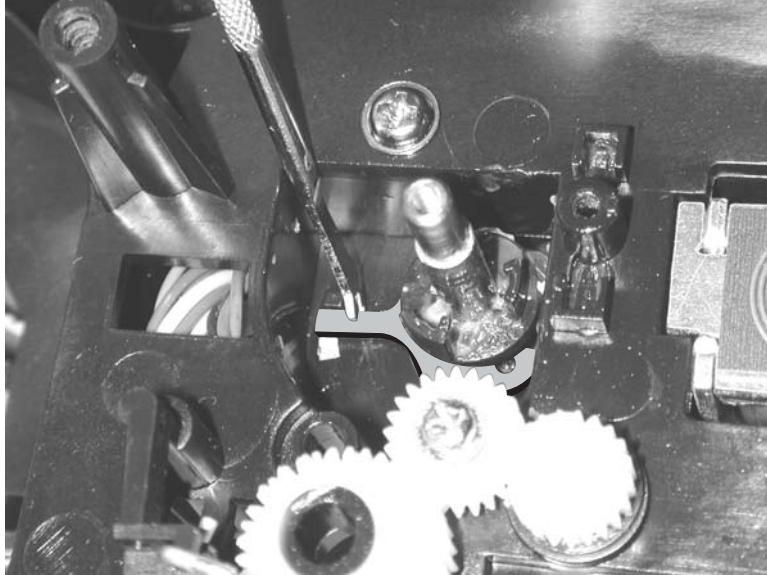

4. Lay the printer on its top. Be sure to protect it from marring.
5. Raise the auto comp, and unhook the counter balance spring (A).

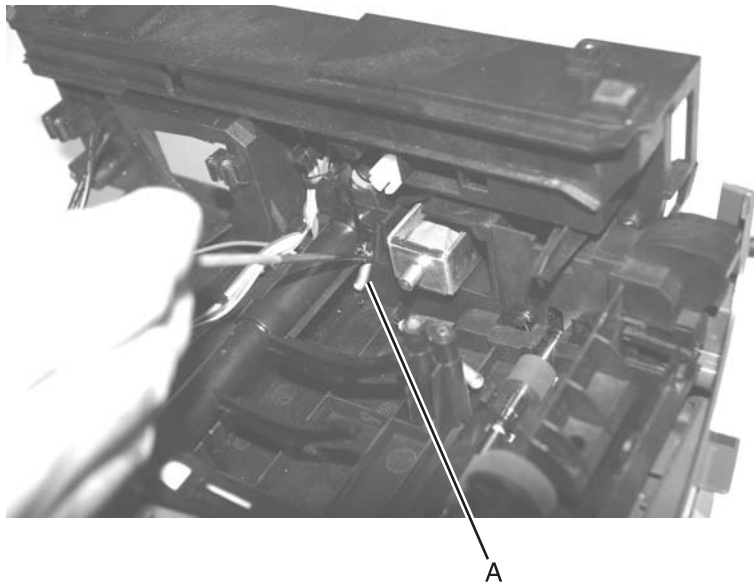

6. Rotate the arm, and pull to remove the auto comp.



### Auto comp clutch removal

1. Remove the left side cover. See **“Left side cover removal”** on page 4-4.
2. Remove the main motor drive. See **“Main motor drive removal”** on page 4-28.
3. Remove the screws (A).

**Note:** Resistance to loosening the screw may have to be applied to the shaft. Use a finger or small screwdriver against the coupler behind the clutch.

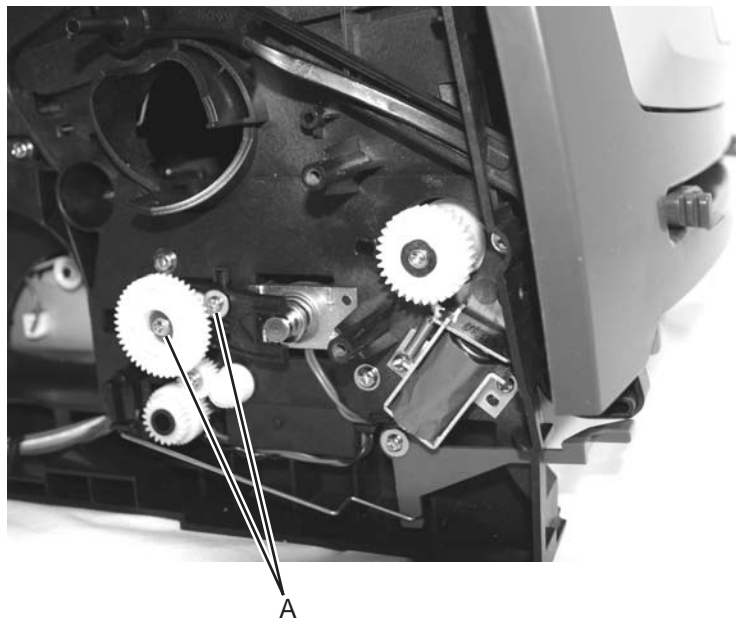

4. Remove the auto comp clutch.

## Auto comp drive shaft assembly removal

1. Remove the auto comp clutch. See **“Auto comp clutch removal”** on page 4-10.
2. Use a spring hook or a small screwdriver to dislodge the arm of the shaft bushing, and rotate the arm counterclockwise as far as it will go.

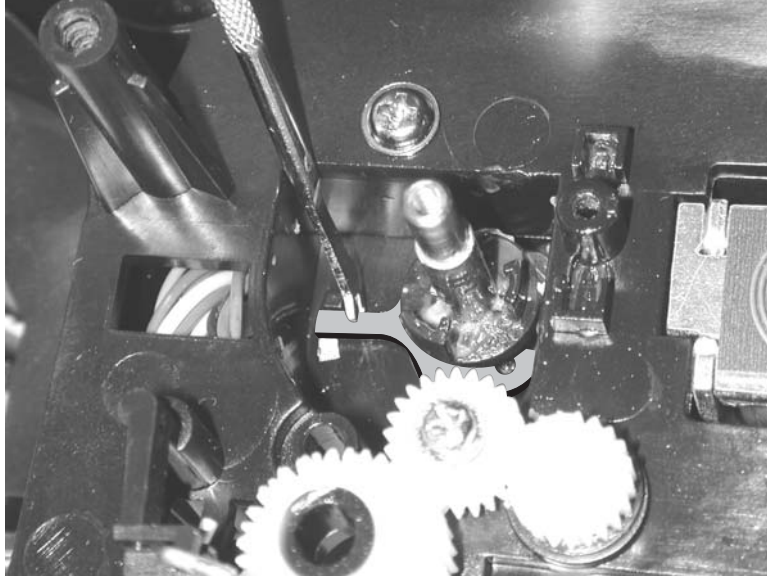

3. With the bushing aligned with the frame opening for clearance, unsnap the shaft from the ACM.
4. Remove the auto comp drive shaft assembly.
5. Use a screwdriver to align the ACM with the shaft bearing to help in installation.

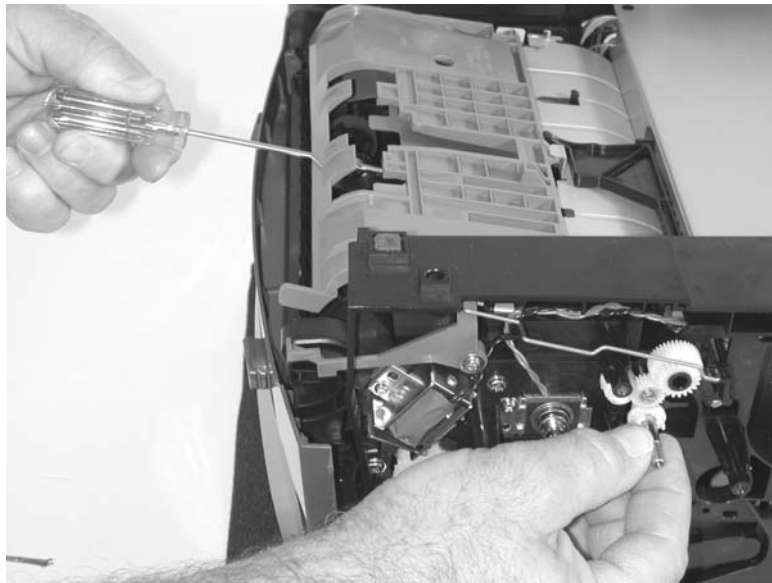

## Bezel removal

1. Open the front access cover.
2. Remove the two screws (A).

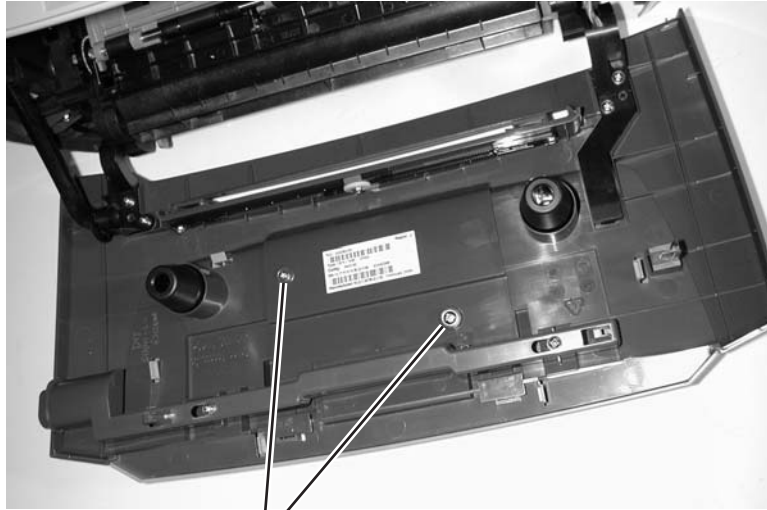

A

3. Lift the lower edge of the shield, slide it to the right, and remove.
4. Release the four inner latches (B).

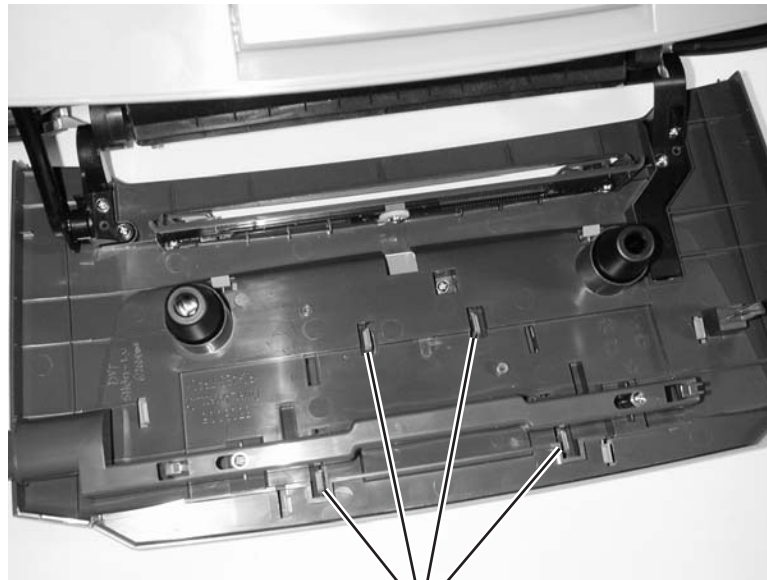

B

5. Remove the bezel and lens while the door remains open.



## Controller card removal

### Warning:

- Always touch a ground before touching the card.
- Handle the card carefully by the edges.
- Never replace the operator panel and controller card at the same time without a successful POR in between.

1. Remove the right side cover. See **“Right side cover removal”** on page 4-5.
2. Remove the controller card cover.
3. Disconnect all the cables from the controller card, and remove cables from the shield housing.

**Warning:** *Do not* replace the controller card and the operator panel at the same time. Each card contains the printer settings. When either of these cards is new, it obtains its settings from the other card. Critical factory settings are lost when both are new and replaced at the same time.

4. Remove the four screws (A) that are securing the controller card.

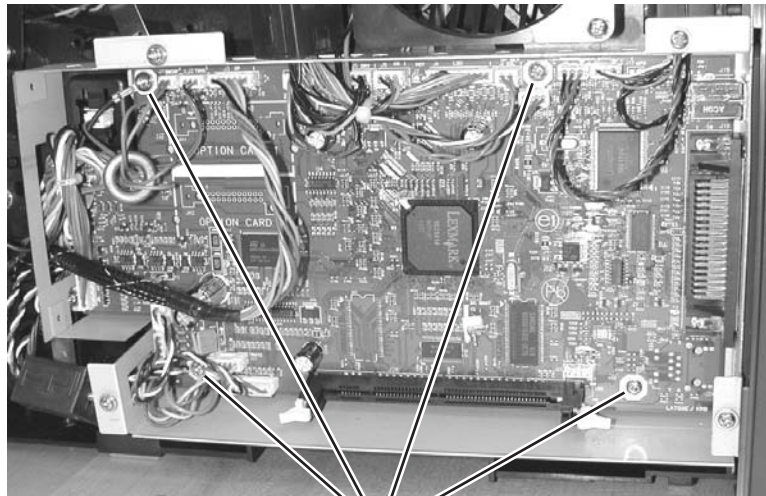

A

5. Remove the three screws (B) securing the USB port and the parallel ports.

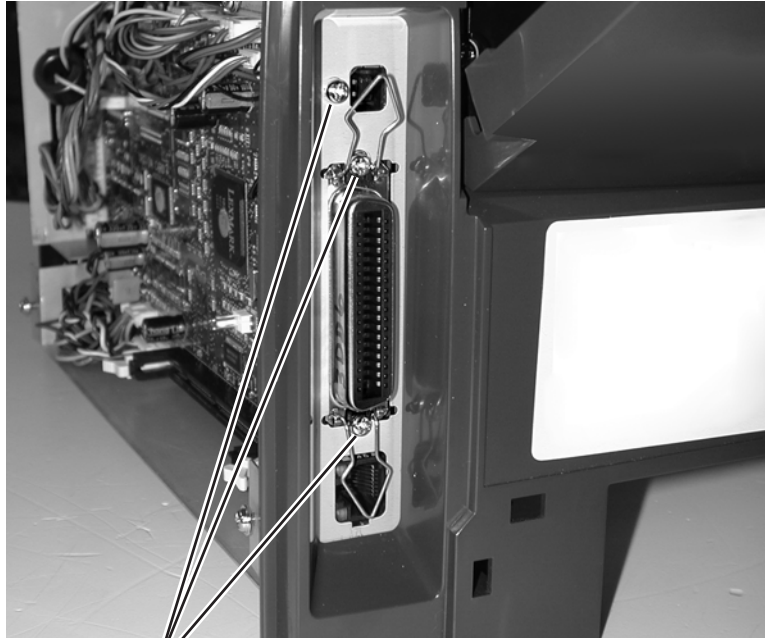

B

6. Lift and remove the card.

**Re-installation note:** When replacing the controller card, make sure to route all of the cables through the correct shield opening. Make sure that the ground wire that is being held by the front, upper screw is in the correct location before installing.

## Cover open sensor removal

1. Remove Tray 1.
2. Open the front cover.
3. Open the right side cover. See steps 1 and 2 of **“Right side cover removal”** on page 4-5.
4. Remove the controller card cover.
5. Loosen the one screw (A) from the shield that protects the sensor.



A

6. Disconnect the cable from J6 on the controller card.

**Note:** The cable has a toroid. Be sure to remove the toroid before removing the cable.

7. Use a small Phillips screwdriver to remove the screw (B) holding the sensor.

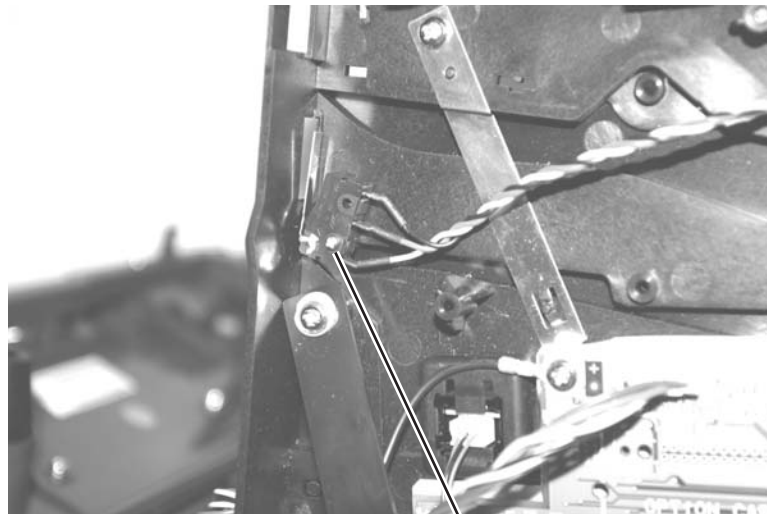

B

8. Remove the sensor.

### Reinstallation note:

- Be sure to re-route the cable back through its retainer.
- Be sure to place the toroid back over the cable.

## Developer drive coupling assembly removal

1. Remove the left side cover. See **“Left side cover removal”** on page 4-4.
2. Place the machine on its right side.

**Note:** Be sure to protect the machine from marring.

3. Remove the six screws (A), the machine screw (B), and the ground cable screw (C).

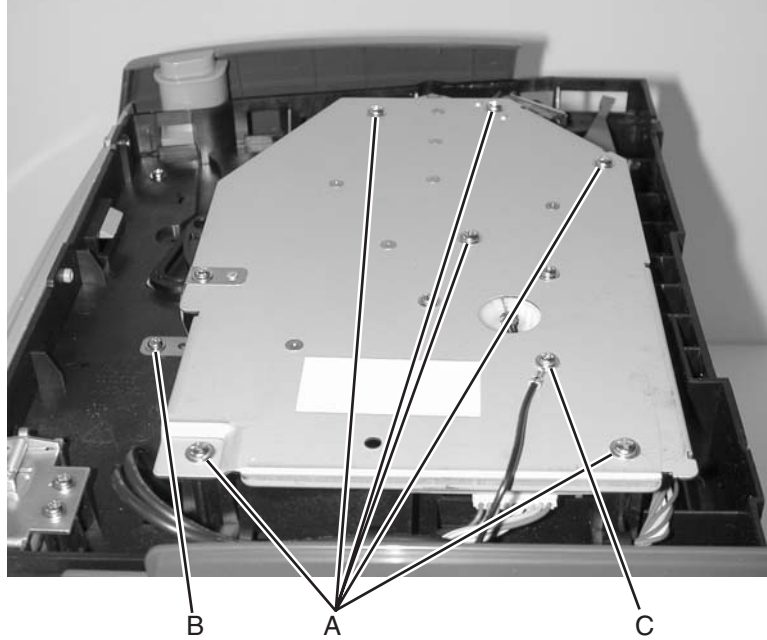

4. Lift the main motor drive, and disconnect the motor cable (D).

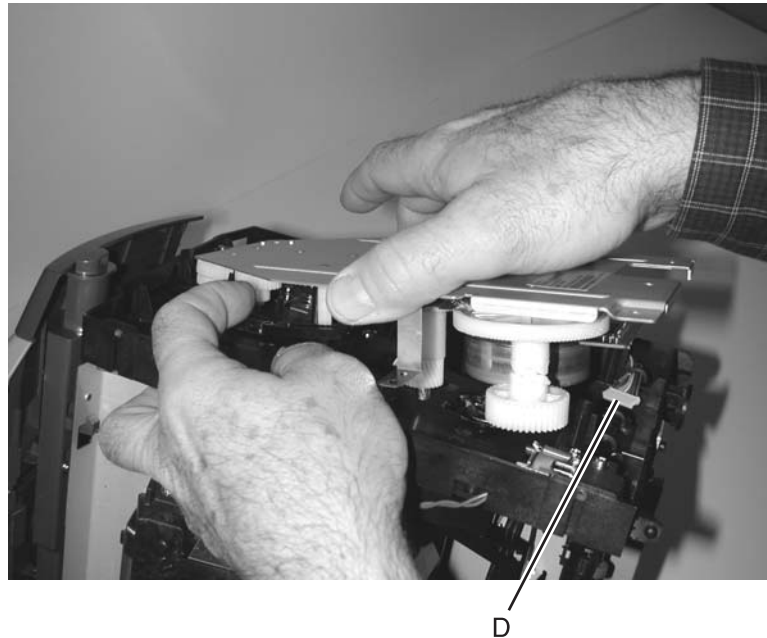

5. Remove the coupling spring (E).

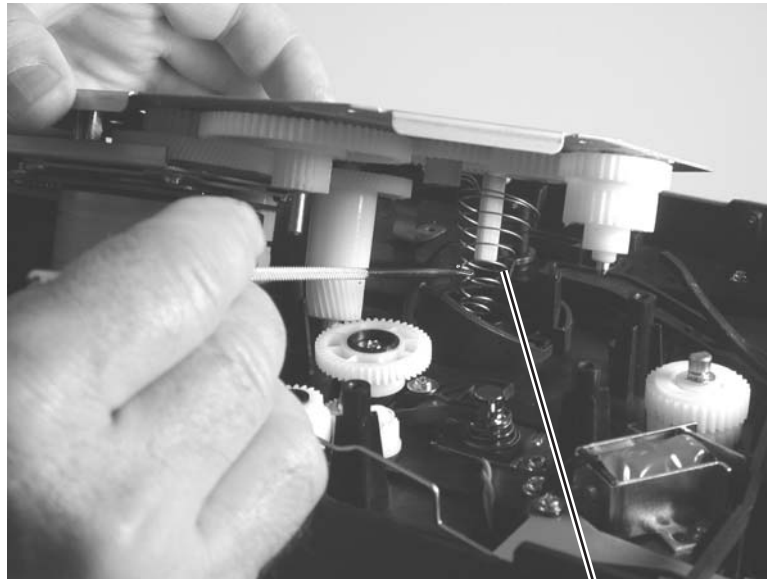

E

6. Remove the developer drive coupling (F).

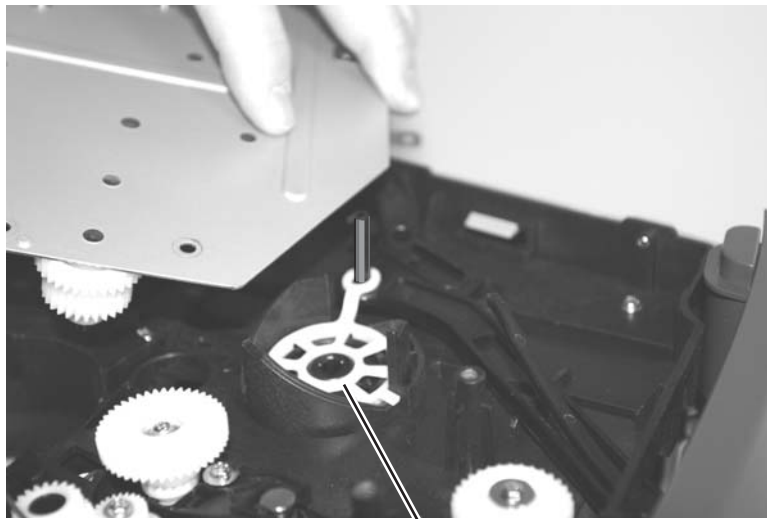

F

## Duplex removal

1. Remove the right side cover. See **“Right side cover removal”** on page 4-5.
2. Remove the left side cover. See **“Left side cover removal”** on page 4-4.
3. Remove the top cover. See **“Top cover removal”** on page 4-7.
4. Remove the controller card. See **“Controller card removal”** on page 4-13.
5. Remove the LVPS/HVPS card assembly. See **“LVPS/HVPS card assembly removal”** on page 4-26.
6. Unhook the media level indicator. See **“Media level indicator removal”** on page 4-33.
7. Remove the top LVPS/HVPS shield:
  - a. Remove the screw (A) and the screw (B) at the controller shield.
  - b. Remove the screw (C) opposite from screw (B) on the other side of the printer.

**Note:** The ground cable is attached to screw (C). When re-installing, be sure to reconnect the ground cable.

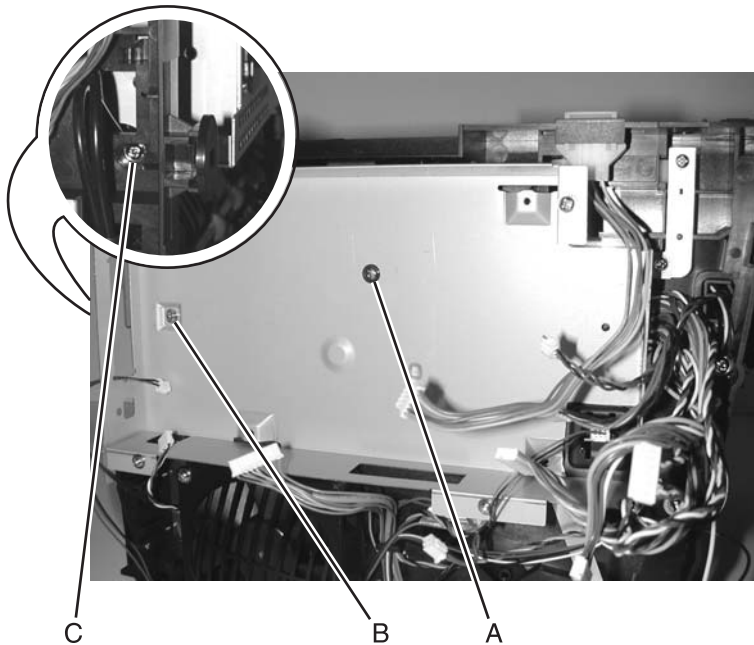

8. Remove the media level indicator. See **“Media level indicator removal”** on page 4-33.

9. Remove the six screws (D).

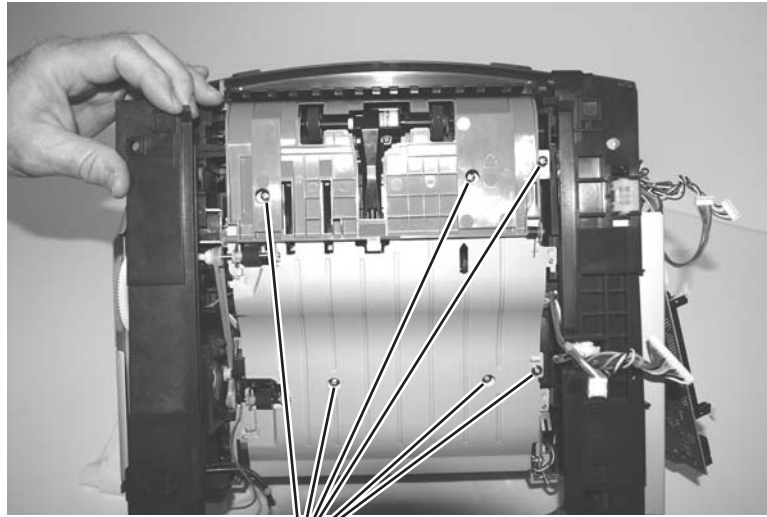

D

10. Lift the right side (opposite the coupler) and remove the duplex.

**Note:** At re-installation, before tightening the screws, locate the duplex unit against the left side frame. (Left side relative to the picture above.)

## Duplex gear drive

1. Remove the main motor drive. See **“Main motor drive removal”** on page 4-28.
2. Remove the duplex. See **“Duplex removal”** on page 4-18.
3. Remove the duplex coupling and gears (A) (the screw and plastic retainer).



A

4. Remove the duplex coupling (B) and mating link.

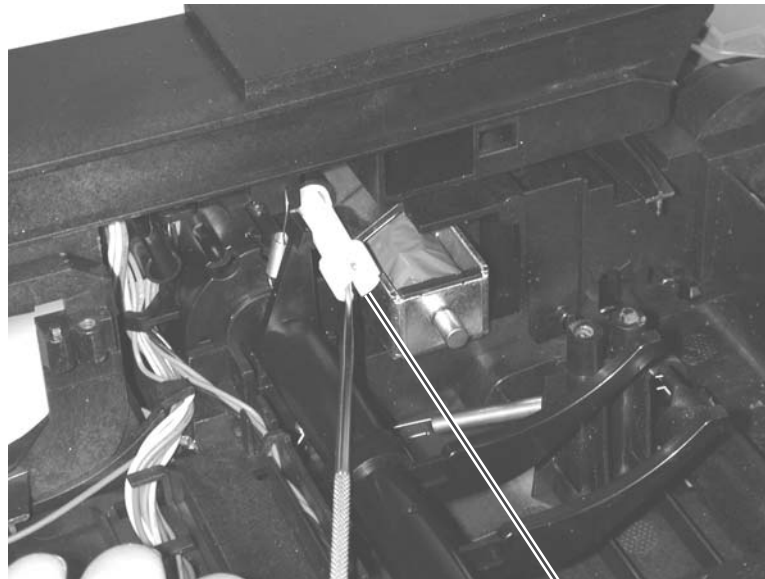

B

**Note:** The link (not shown) that connects the duplex and duplex coupling is part of this FRU as well as the duplex FRU.



## Fan removal

1. Open the right side cover. See steps 2 through 4 of **“Right side cover removal”** on page 4-5.
2. Remove the two screws (A) holding the fan to the side frame.

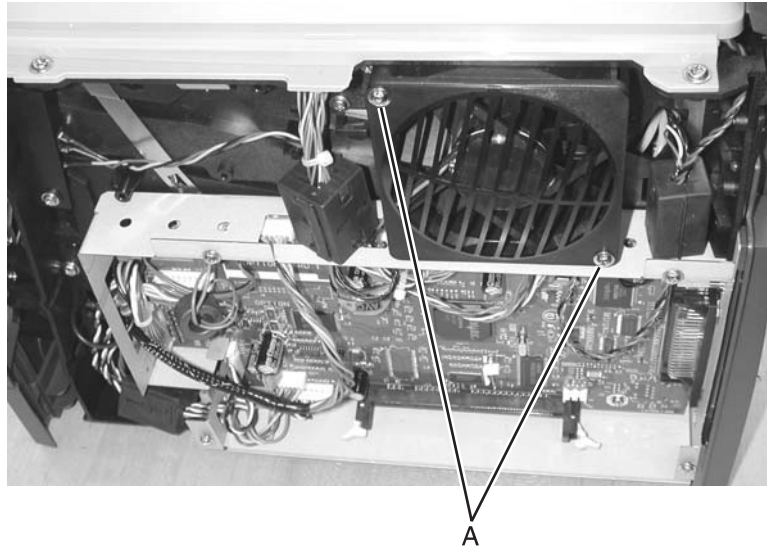

3. Unplug the cable from J4 on the controller card.

**Note:** Be sure to remove the toroid before removing the cables. When re-installing, be sure to place the toroid back over the same cables.

4. Remove the cable from its retainer.
5. Remove the fan.

## Flag removal (top cover right)

1. Remove the top cover. See **“Top cover removal”** on page 4-7.
2. Turn the top cover upside down.
3. While lifting the flag with your thumb to align the shaft flats with the holder, use the spring hook to slide the flag out of place, and remove.

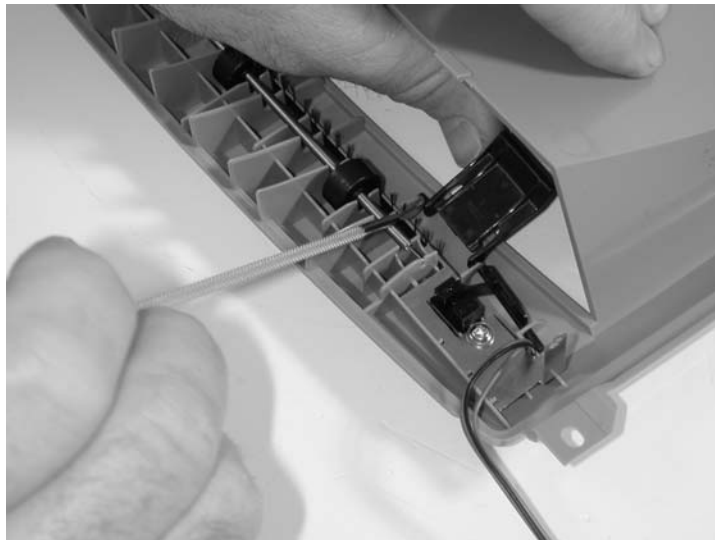

**Note:** The left flag was found to be not needed and has been removed from the FRU list.

## Fuser removal



1. Remove the left side cover. See **“Left side cover removal” on page 4-4.**
2. Remove the right side cover. See **“Right side cover removal” on page 4-5.**
3. Remove the rear cover. See **“Rear cover removal” on page 4-6.**
4. Loosen the top cover by removing the one rear screw above the reverse solenoid. Release the side latches, and lift the rear of the top cover.
5. Remove the paper exit guide assembly. The gears of the exit guide must clear the fuser bracket without touching it. See **“Paper exit guide assembly removal” on page 4-37** for more information.
6. Remove the two screws (A) and the one machine screw (B) that secures the ground cable.

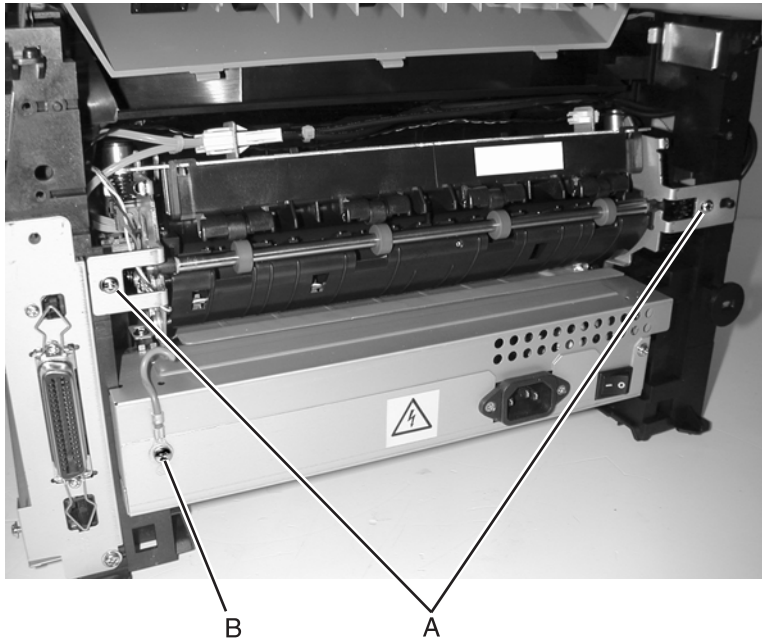

7. Disconnect the thermistor cable above the fuser.
8. Remove the controller card cover.
9. Disconnect the exit sensor cable from J11 on the controller card.
10. Disconnect the fuser power cable above the fuser.

11. Unlatch the fuser (see (A) and (B) in the second photo below), and remove.

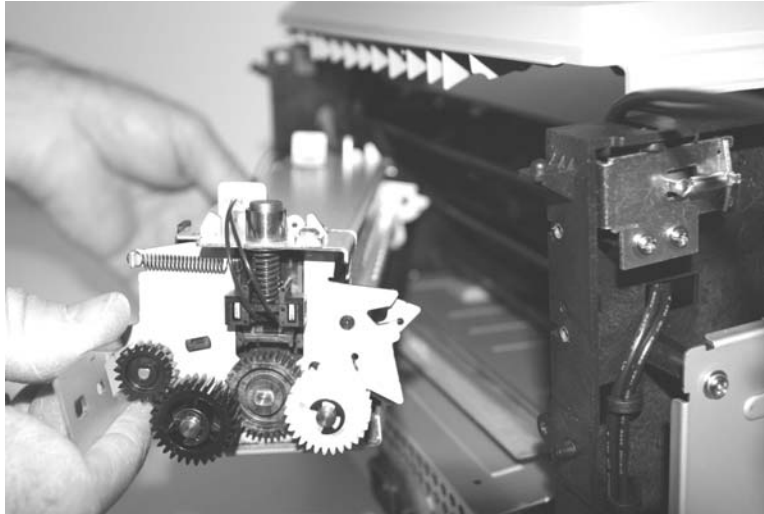

**Reinstallation note:**

- Be sure to reroute the cables back through their retainers.
- If the printer has been moved following the removal of the fuser, verify that the cross shaft behind the fuser is in place.
- Place the fuser into the opening, and push levers (A) to open the latches (B). Push the fuser into the final position on the release levers. Alternatively, the fuser may be tilted to drop the latches (B) below the shaft for the final few millimeters.
- Check to make sure that the ground cable is routed out of the way and will not be pinched or damaged by the rear cover.

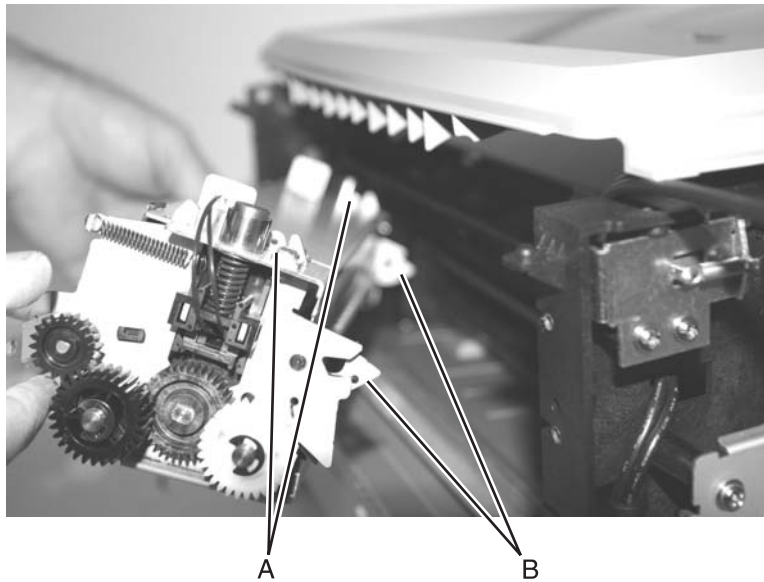

## Fuser power cable removal



1. Remove the paper exit guide assembly. See **“Paper exit guide assembly removal” on page 4-37.**
2. Remove the fuser. See **“Fuser removal” on page 4-22.**
3. Disconnect the power cable from the fuser, and pull the cable through the opening in the side frame.
4. Place the printer on its top with the back and bottom in view.

**Note:** Be careful not to mar the finish of the printer.

5. Remove the four screws (A), the machine screw (flange head) (B), and the machine screw (button head) (C).

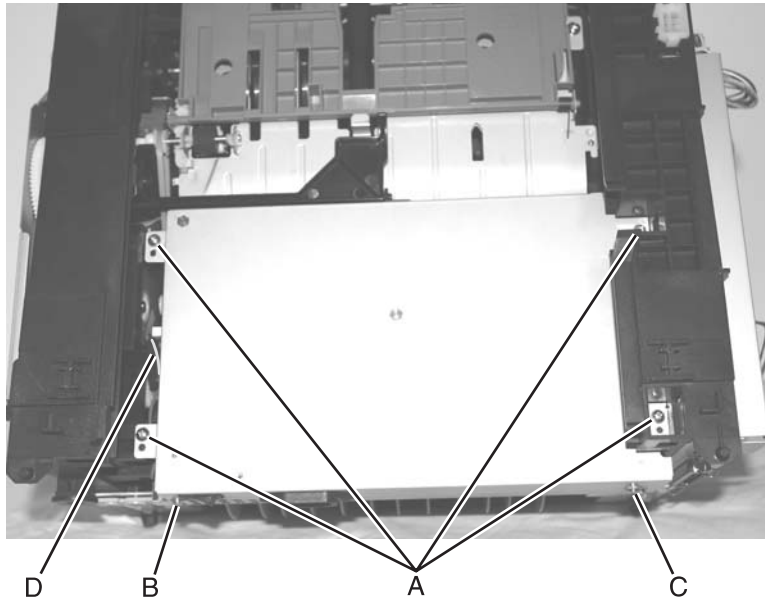

6. Use the hook end of a spring hook to disconnect the fuser power cable from the LVPS/HVPS side.

**Note:** The connector latch (D) is toward the side frame as shown.

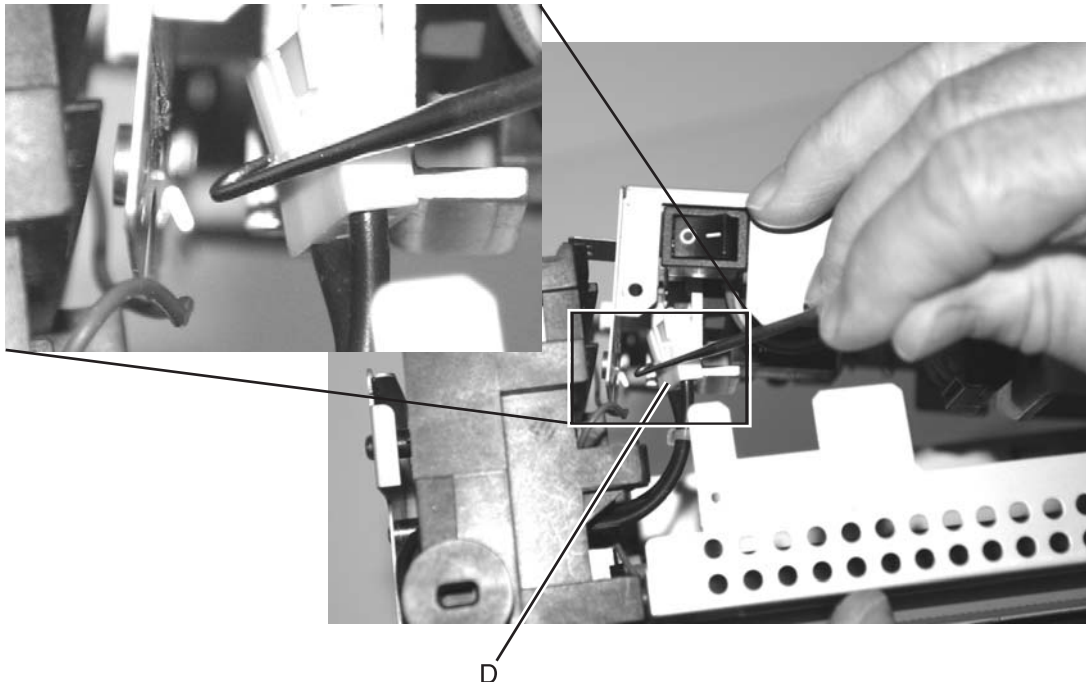

## Link developer drive and access door removal

1. Remove the main motor drive. See **“Main motor drive removal”** on page 4-28.
2. Remove the coupling assembly. See **“Developer drive coupling assembly removal”** on page 4-16.
3. Disconnect the front access door from its hinges. See **“Front access cover removal”** on page 4-2.

**Note:** The cover does not need to be electrically disconnected.

- 4.
5. Disconnect the link and door.

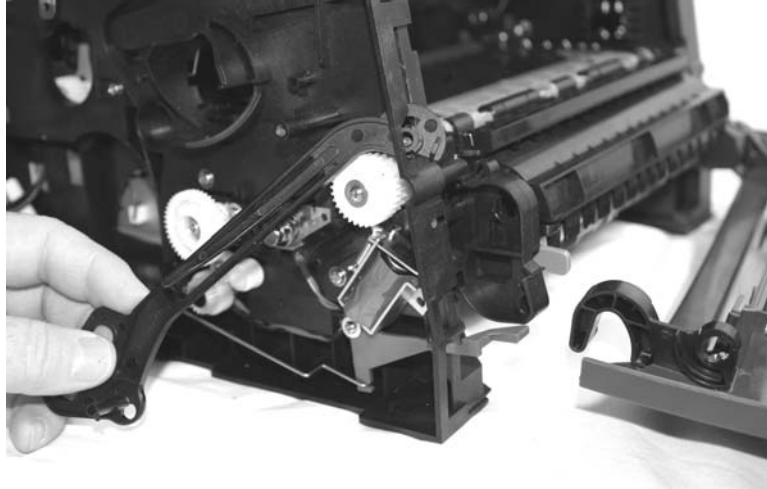

6. Remove the developer link.

## LVPS/HVPS card assembly removal



1. Remove the rear cover. See **“Rear cover removal” on page 4-6.**
2. Place the printer onto its top with the back and bottom in view.

**Note:** Be careful not to mar the finish of the printer.

3. Remove the four screws (A), the machine screw (B) and the machine screw (C).
4. Unhook the red cable (D) located in the left side frame.

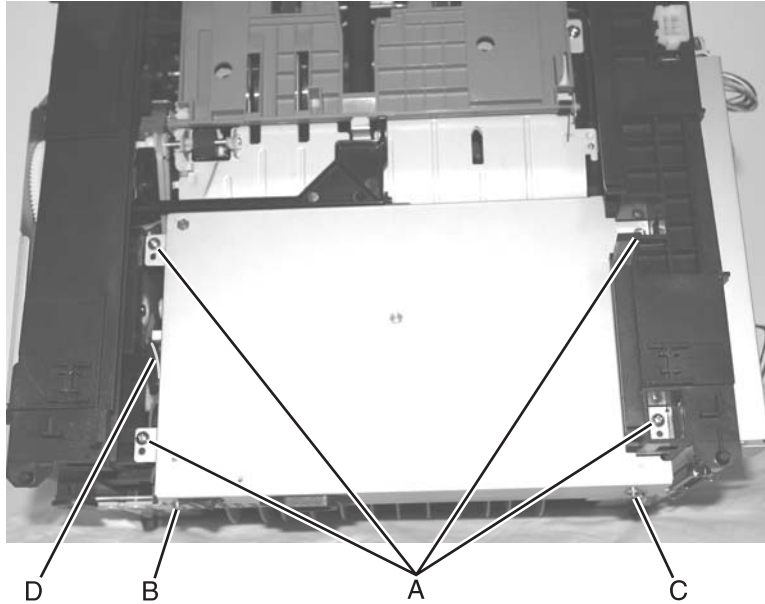

5. Lift the metal cover so the connecting cables (E) and (F) can be unplugged on the side shown.

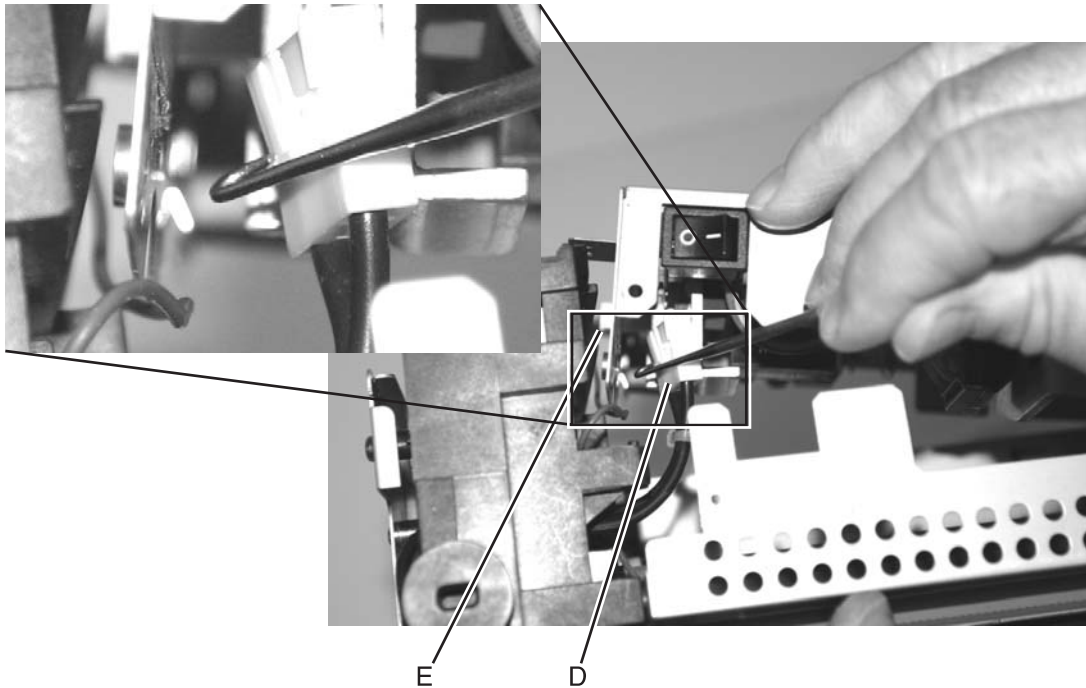

6. Rotate the assembly, and unplug the remaining cables.

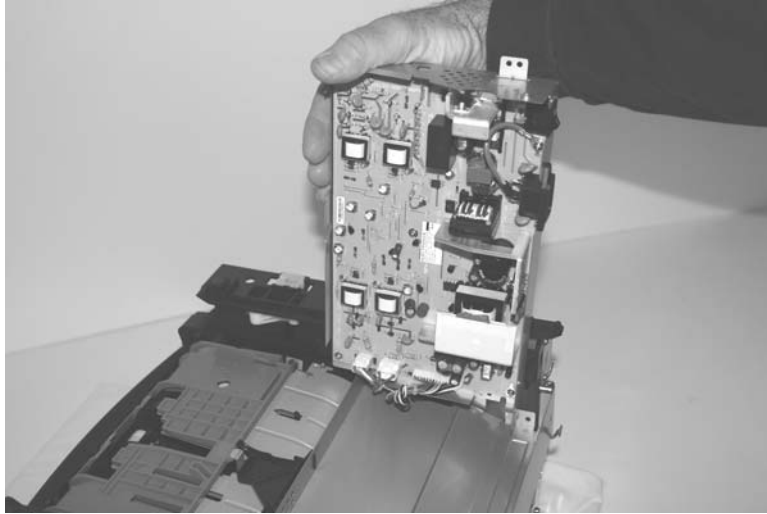

7. Remove the assembly.

**Re-installation note:**

When re-installing the LVPS/HVPS assembly:

- Be sure to locate the rear flange of the card bracket inside of the shield prior to rotating the card assembly into final position.



**CAUTION:** Make sure that the mylar card is located inside the overlapping flanges to avoid damage to the printer.

- It is easy for the cables to become pinched during re-installation. Make sure that the cables are free during re-installation.

## Main motor drive removal

1. Open the left side cover. See **“Left side cover removal”** on page 4-4 for more information.
2. Tilt the printer onto its right side, and remove the six screws (A), the screw (B), and the ground cable screw (C).

**IMPORTANT:** The ground strap (held by screw B) is not included in the main motor drive FRU. Be sure to remove this strap, and install it in the new drive.

3. Lift the motor end, and disconnect the main motor cable (D).

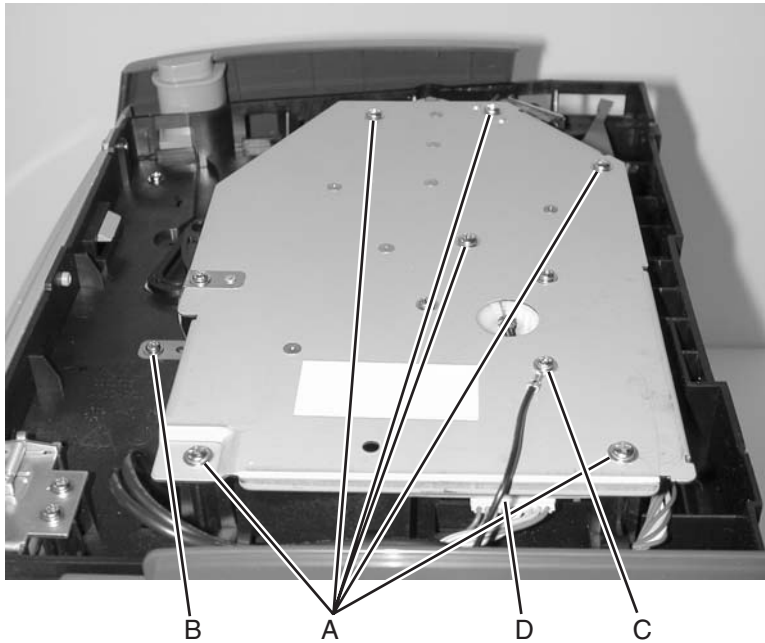

4. Lift the gear assembly, and remove the developer drive spring (E).

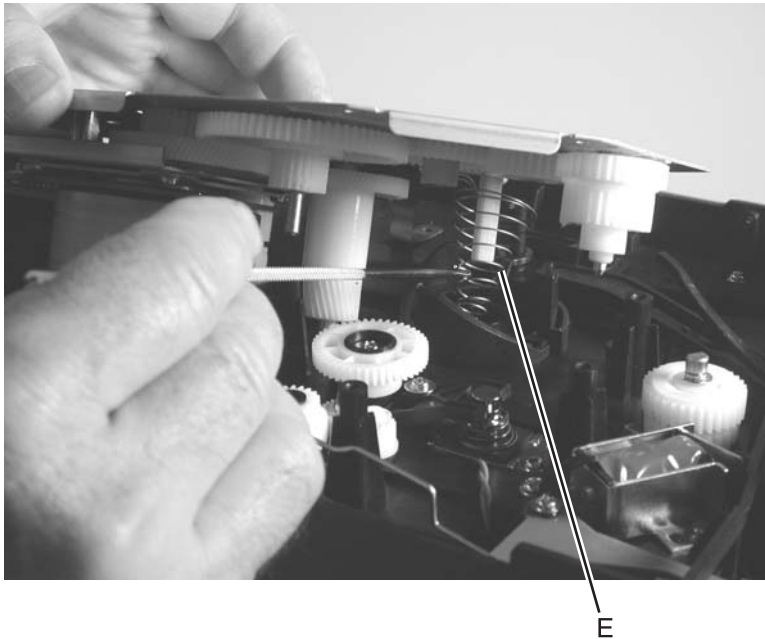



5. Rotate the motor drive counterclockwise until the two plastic links can be separated.



6. Remove the main motor drive.

## Manual feed sensor removal

1. Remove the right side cover. See **“Right side cover removal”** on page 4-5.
2. Remove the controller card cover by loosening the four screws and sliding the cover free from the screws.
3. Disconnect the sensor from J20 (MPF SNS) on the controller card, and free it back through the opening of the side frame.
4. Place the machine on its top.

**Note:** Be careful not to mar the finish of the printer.

5. Lift the door on the duplex and auto comp.
6. Remove the screw (A).

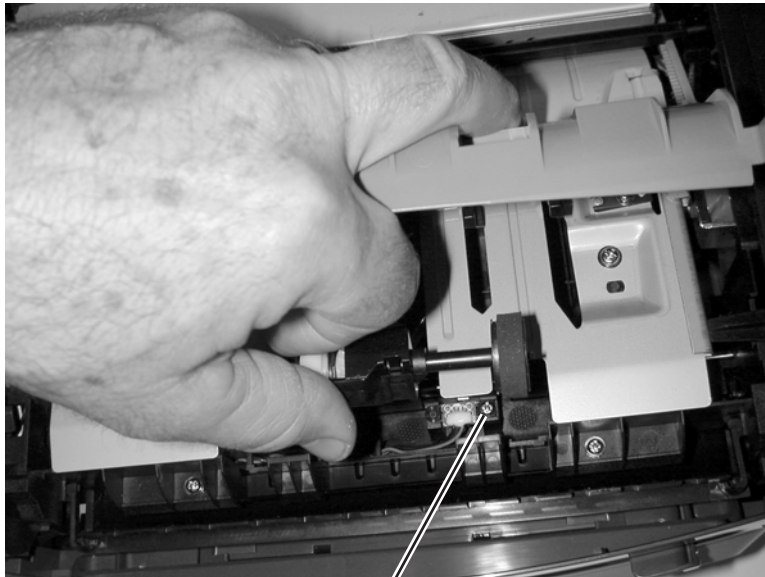

A

7. Free the cable from its retainer, and pull it through the opening toward the sensor mount.

### Re-installation note:

- Insert the hook end of the spring hook through the frame opening from the controller card side. Extend the hook until the sensor connector can be hooked.
- Hook the spring hook to the connector, and pull it through the opening.
- Place the sensor into position, and reconnect the cable on the controller card.
- Using the spring hook, be sure to reroute the cable through the three retainers between the sensor and side frame.

## Manual paper feed clutch

1. Open the left side cover. See **“Left side cover removal”** on page 4-4 for more information.
2. Tilt the printer onto its right side, and remove the six screws (A), the screw (B), and the ground cable screw (C).
3. Lift the motor end, and disconnect the main motor cable (D).

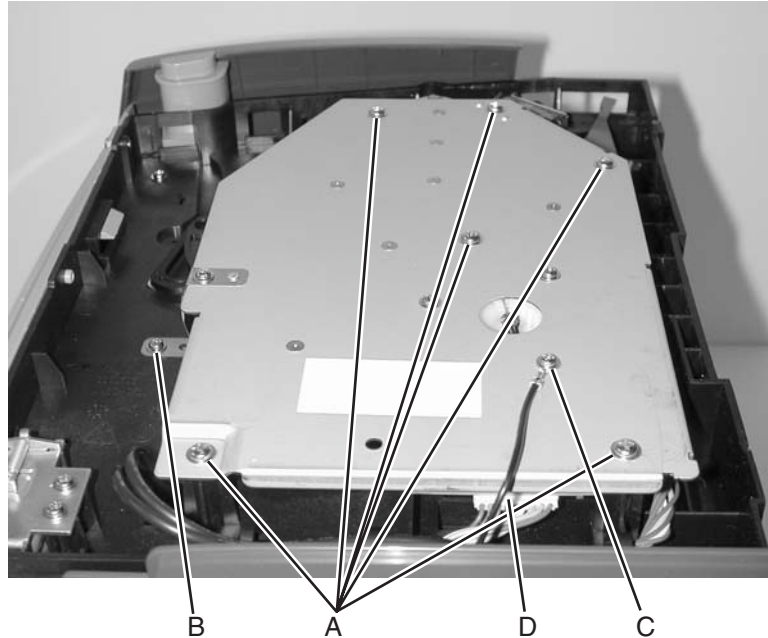

4. Lift the main motor drive enough to clear.

**Note:** The main motor drive does not have to be completely removed. See **“Main motor drive removal”** on page 4-28 for more information.

5. Use a thin screw driver to remove the clip (E).

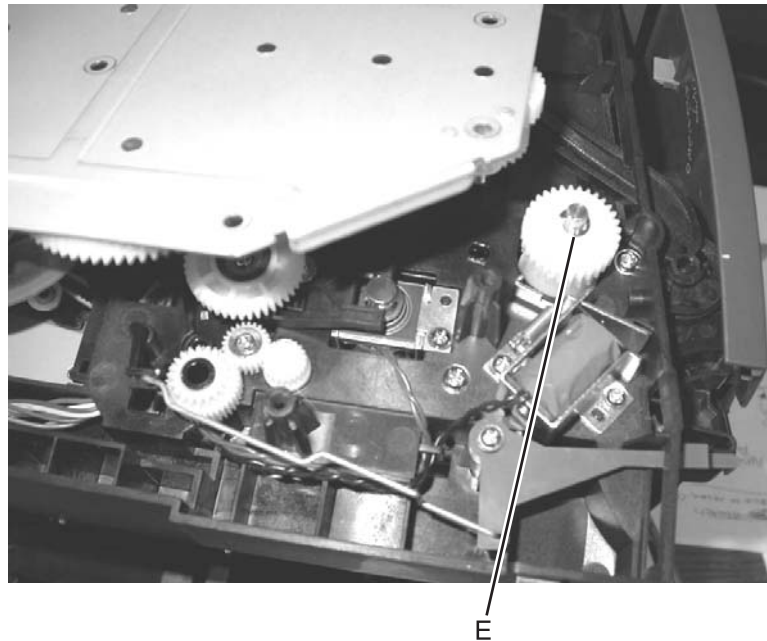

6. Remove the manual paper feed clutch.

## Manual feed solenoids

1. Remove the duplex unit. See **“Duplex removal” on page 4-18.**
2. Extract the solenoid cable to a point close to the left side as possible.
3. Remove the main motor drive. See **“Main motor drive removal” on page 4-28.**
4. Remove the auto comp clutch. See **“Auto comp clutch removal” on page 4-10.**
5. Remove the three screws (A).

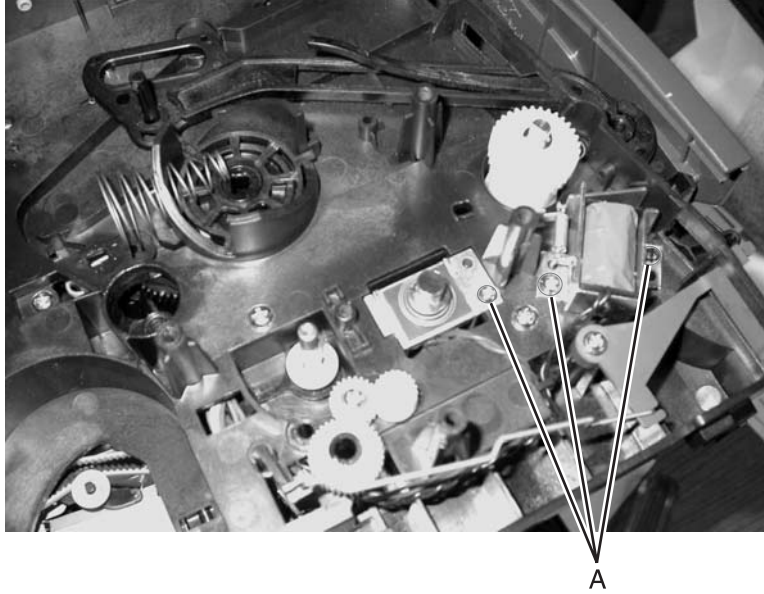

6. Remove the manual feed solenoids.

## Media level indicator removal

1. Remove the left side cover. See **“Left side cover removal”** on page 4-4.
2. Turn the printer onto its top. (Be careful to protect the covers.)
3. Unhook and remove the spring (A).



A

4. Unhook the link (B) from the indicator level.



B

5. Rotate the link, and turn it to separate it from the plastic shaft (C). Be careful to not damage the adjacent gear.

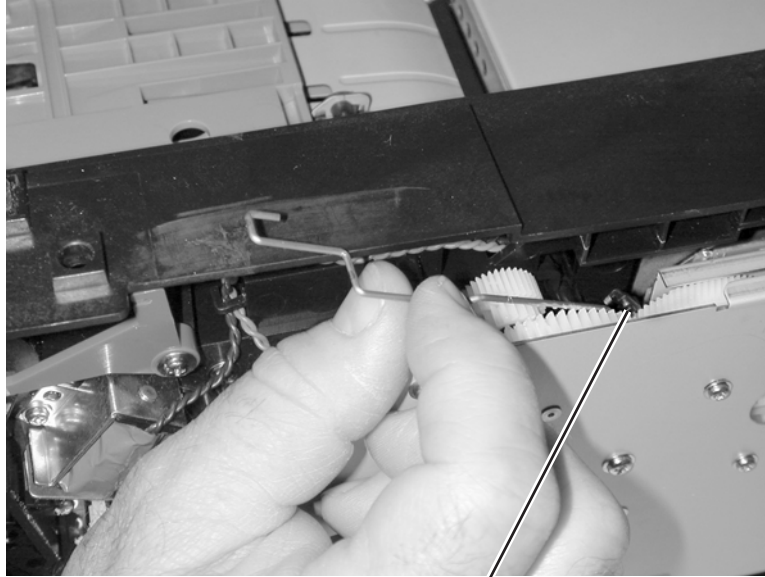

C

6. Unsnap the shaft from its pivot, which is attached to the back of the LVPS/HVPS shield (D).
7. Align the link end of the shaft with the opening in the side frame, and remove the shaft and spring anchor (E).

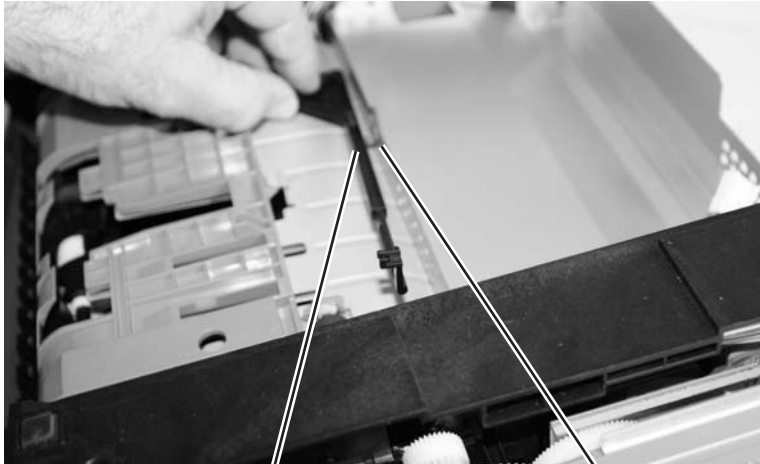

E

D

### Narrow media sensor removal

1. Remove the top cover. See **“Top cover removal”** on page 4-7.
2. Turn the top cover upside down.
3. Remove the ground strap screw (A) and the ground strap.

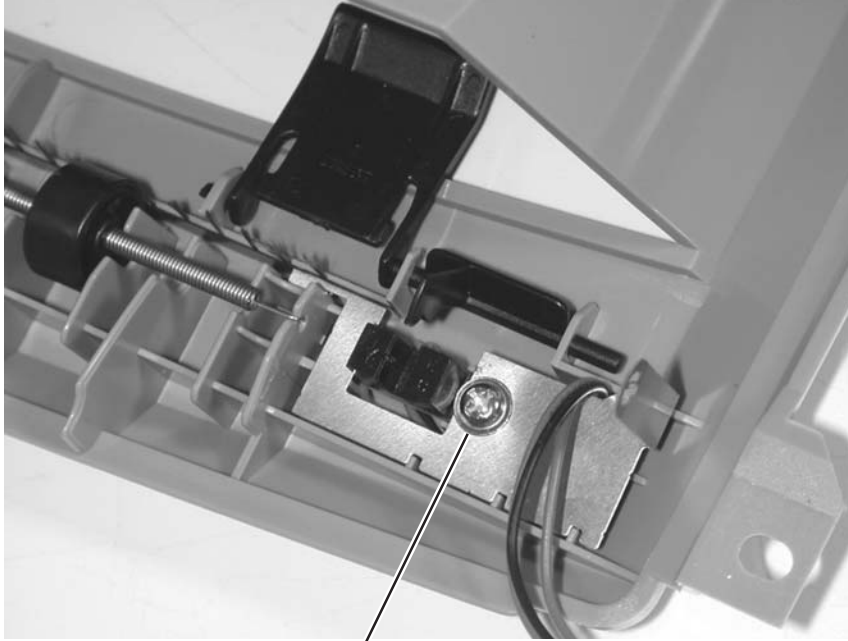

4. Remove the narrow media sensor.

## Operator panel removal

1. Open the front cover.
2. Remove the bezel. See **“Bezel removal”** on page 4-12.
3. Remove the screw (A).
4. Remove the face plate which surrounds the bezel by unlatching the four tabs (B).

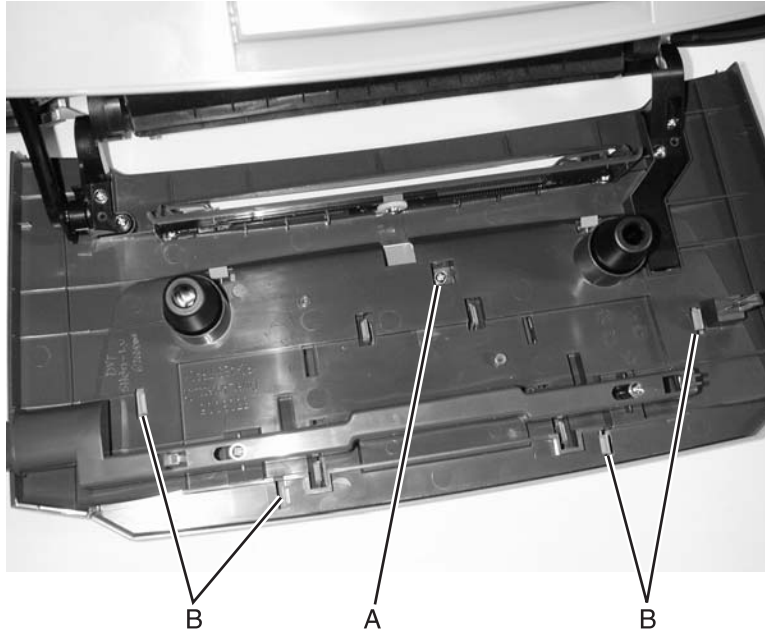

5. Close the front cover.
6. Disconnect the cable (C). (The LED operator panel connects the same as the LCD panel as shown.)

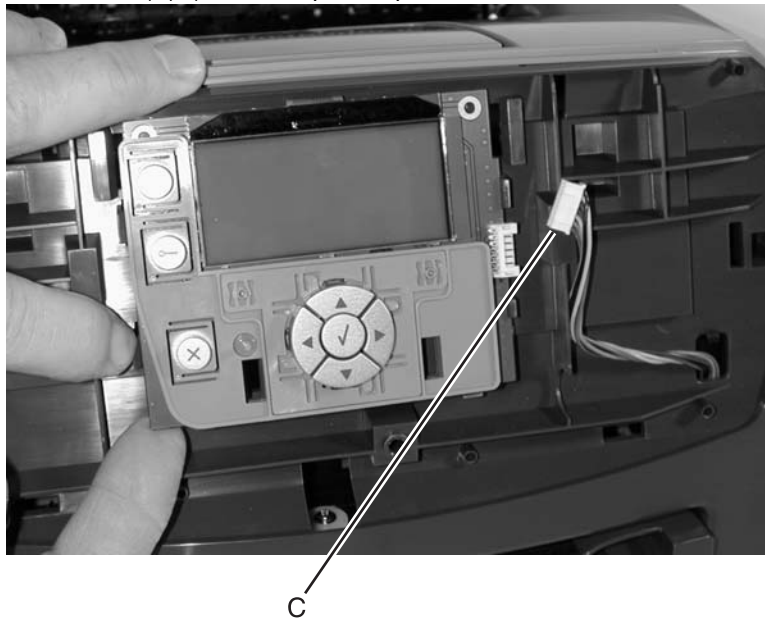

7. Unlatch the four latches on the panel cover.
8. Pull the bottom edge out until it slides in a downward motion out of its retainers.
9. Slide the card out from the latches on top.
10. Remove the operator panel.

**Warning:** Do not replace the operator panel and the controller card at the same time. Each card contains the printer settings. When either of these cards is new, it obtains its settings from the other card. Critical factory settings are lost when both are new and replaced at the same time.



## Paper exit guide assembly removal

1. Remove the rear cover. See **"Rear cover removal"** on page 4-6.
2. Remove the one screw above the reversing solenoid. See **"Top cover removal"** on page 4-7.
3. Remove the three screws (A).

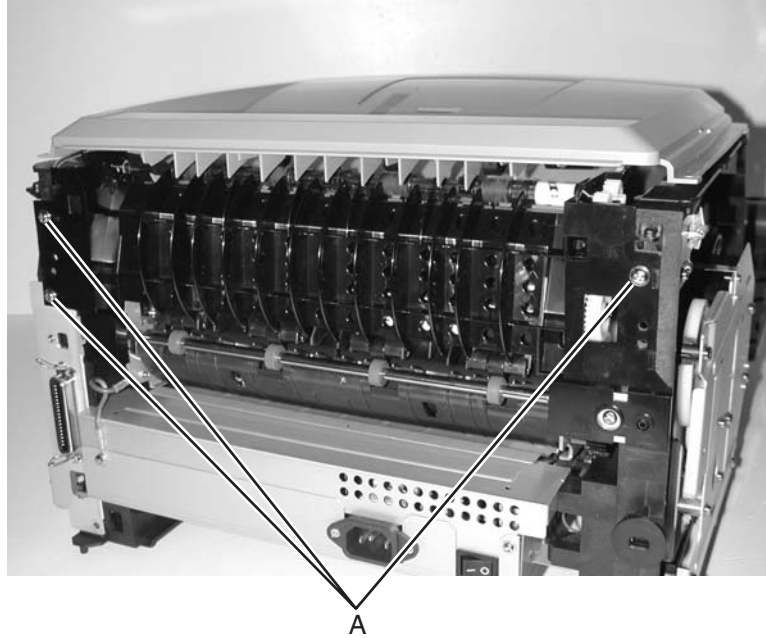

4. Lift the back of the top cover (right side in photo) to prevent the gears on the assembly from touching other items while removing, especially the fuser mounting bracket.
5. Remove the paper exit guide assembly.

### Paper feed rollers (autocompensator tires) removal

1. Remove Tray 1.
2. Open or lower the duplex door.
3. Lower the ACM.
4. Remove the rubber paper feed rollers.

**Note:** Remove the tire from the hub. Do not attempt to remove the hub.

5. Pinch the new rubber roller into a tight radius to determine the orientation of the tire relative to the hub. Notice the direction of the points on the edge. Those points should be directed in the paper feed direction as shown.

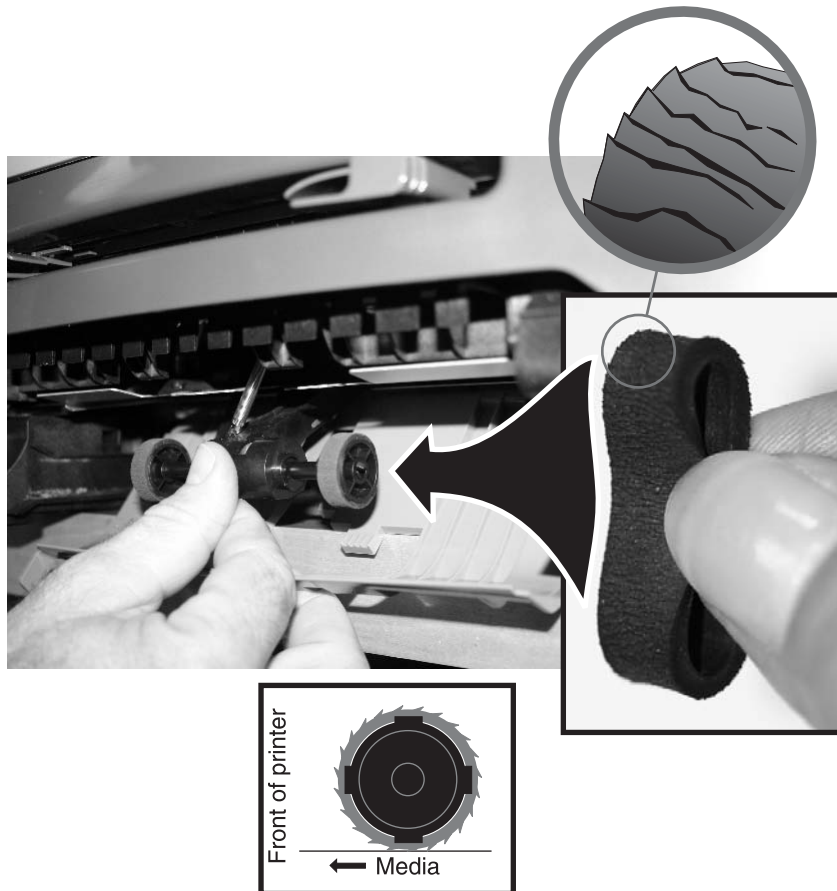

6. Make sure the new paper feed rollers are captured between the rims of the plastic hub.
7. If the orientation is questionable, run Print Quality sheets, and check for skew.

## Paper input and duplex sensor removal

1. Remove the duplex unit. See **“Duplex removal”** on page 4-18.
2. Remove screws (A) holding the two sensors.

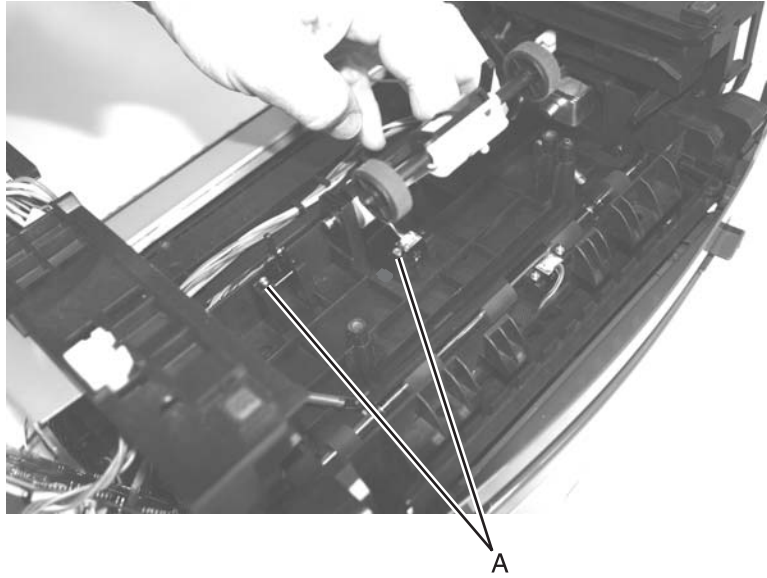

3. Remove the sensor assembly.

**Note:** Be sure to secure cables in retainers when installing the new assembly. The solenoid cable should be installed on top of the sensor cables.

## Printhead removal

1. Remove the top cover. See **“Top cover removal”** on page 4-7 for more information.
2. Remove the right side cover. See **“Right side cover removal”** on page 4-5.
3. Remove the controller card cover.
4. Disconnect the cables J5 DRV (A), J8 LXX LSU (B), and J15 (C) from the controller card.

**Note:** Be sure to remove the toroid before disconnecting the cables.

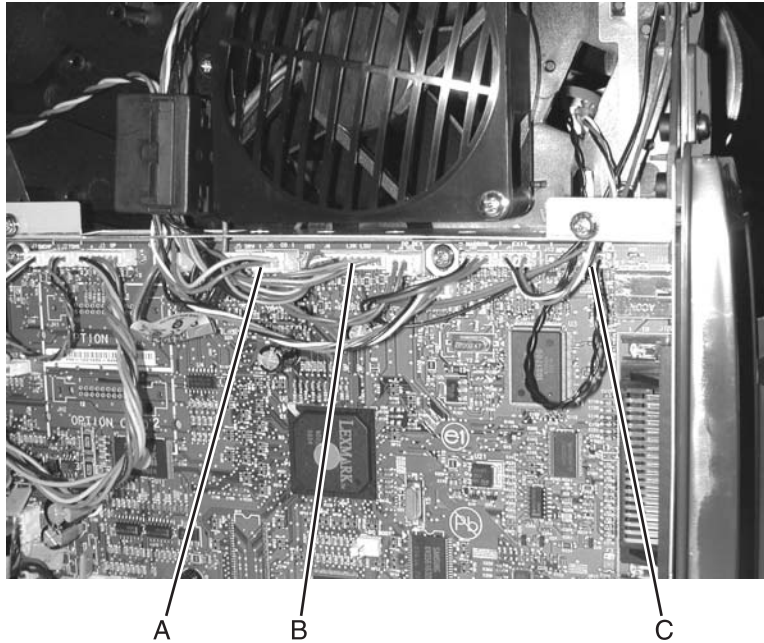

5. Remove three screws (D) securing the printhead.

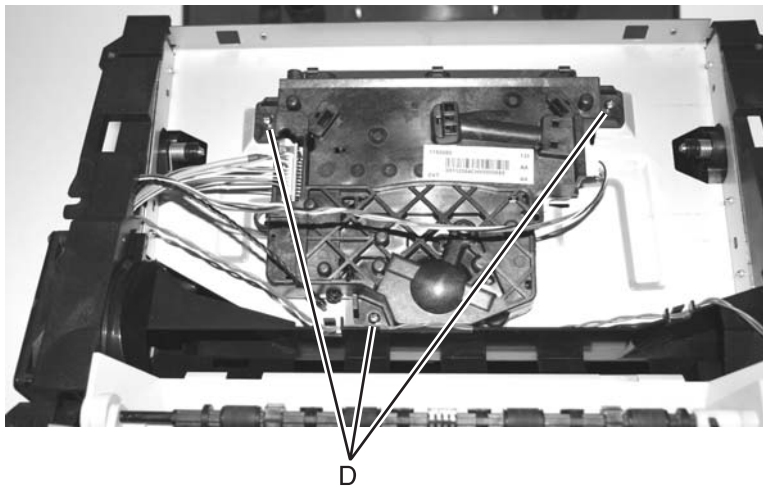

6. Remove the printhead.

### Reinstallation note:

- Install the new printhead by lining up the alignment knob with the indicator located at the front right-hand screw.
- Be sure to place the toroid back over the cables.
- Mechanically adjust the printhead, if necessary. See **“Printhead assembly mechanical adjustment”** on page 4-13.
- Electronically adjust the printhead. This is a necessary step. See **“Printhead assembly electronic adjustment”** on page 4-8.

## Reversing solenoid removal

1. Remove the top cover. See **“Top cover removal” on page 4-7.**
2. Remove the controller card shield. (Loosen the four screws, and slide.) See **“Right side cover removal” on page 4-5.**
3. Disconnect the cable from J9 (DP REV SOL) on the controller card.
4. Remove the two screws (A).



A

5. Remove the reversing solenoid.

## Toner level sensor removal

1. Remove Tray 1.
2. Open the front access cover.
3. Open the right side cover.
4. Unplug the toner level sensor cable.
5. Unsnap the toner level sensor (A) from the frame, and remove it through the inside of the printer.

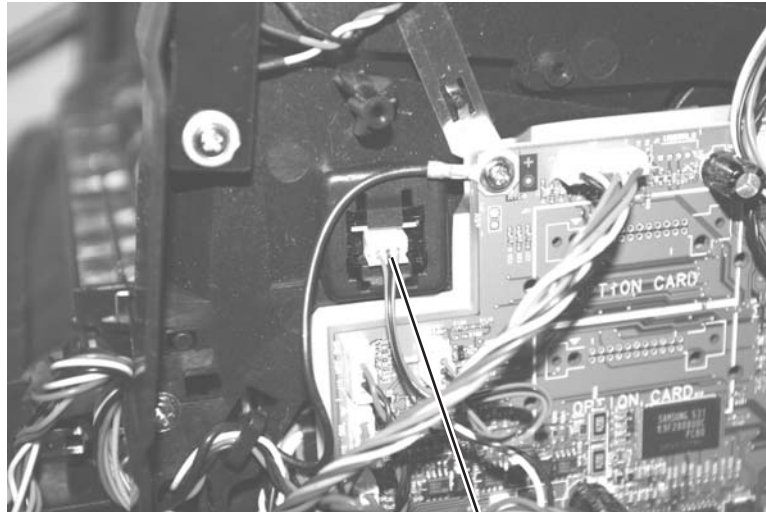

A

## Transfer roll removal

**Note:** A flashlight may be required to remove the transfer roll.

1. Open the front access cover.
2. Place a clean piece of paper around the transfer roll to protect it from finger oils.

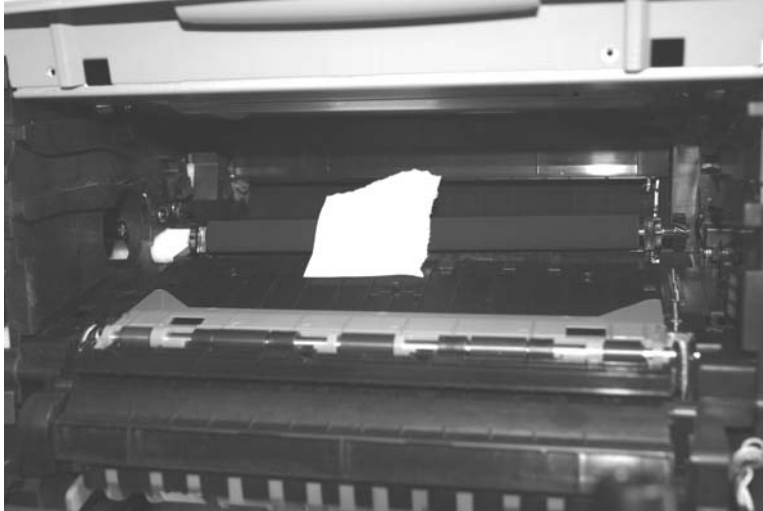

**Note:** *Do not* touch the transfer roll with bare hands. Contaminants can damage the roll.

3. At the right side of the transfer roll, squeeze the holder arms with the left hand while lifting. Stop when the holder is unlatched.
4. At the left side of the transfer roll, squeeze the holder arms with the right hand while lifting with the left hand. Stop when the left holder is unlatched.
5. With a hand at each end, lift the transfer roll out.

**Note:** Do not try removing the spring on the left; it is not removeable but can be dislodged. The spring included with the FRU is to be used only if the old right-side spring is damaged or lost. Both springs must be positioned on posts that cannot be seen. If the old springs are moved, feel the base of the springs to assure that they are on the posts. The top of the springs must be captured in the bearings of the transfer roll.

## Tray 2 auto comp tire removal

Gently pull the rubber tire loose from the wheel, and replace it with a new tire.

**Note:** Look at the nap of the tire, and orient the tire for highest friction when picking the paper.

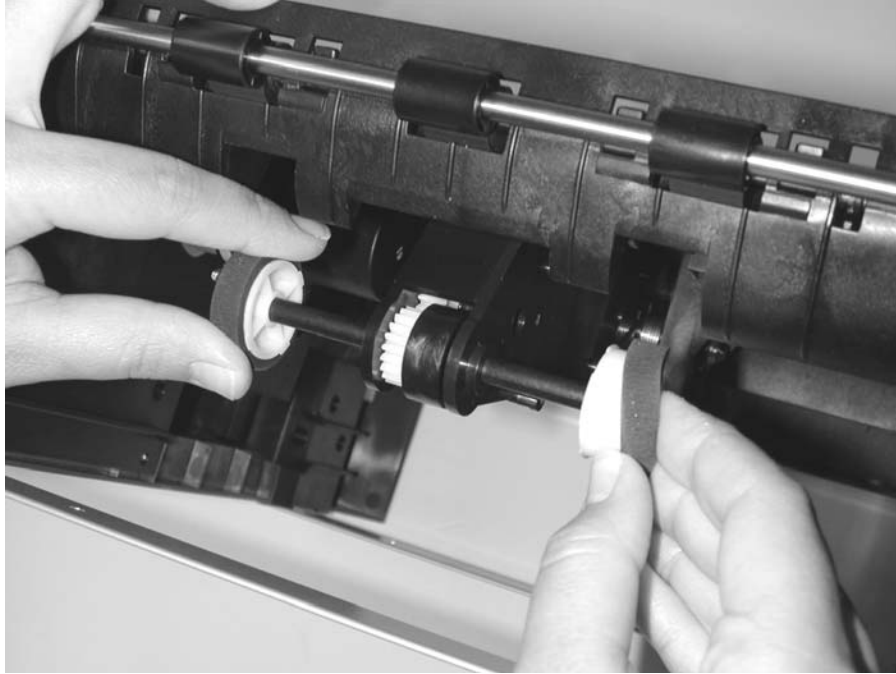

## Upper front frame group removal

1. Open the front cover.
2. Unhook the front end of the springs (A) on the right and left sides of the upper frame.

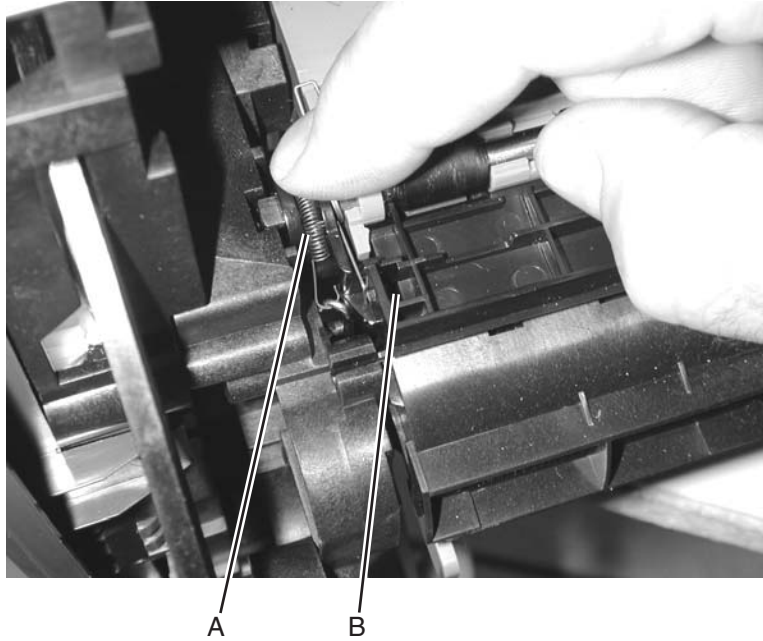

3. Insert the flat end of the spring hook through the front corner opening (B).
4. Push out on the latch by moving the top of the spring hook to the right and while lifting the corner.
5. Repeat for the right side, and remove the assembly.
6. Unlatch the left and right sides of the front cover guide (C) with a flat blade screwdriver or spring hook (D).
7. Lift the right side to align the flat on the guide shaft with the opening.
8. Slide the shaft through the opening.

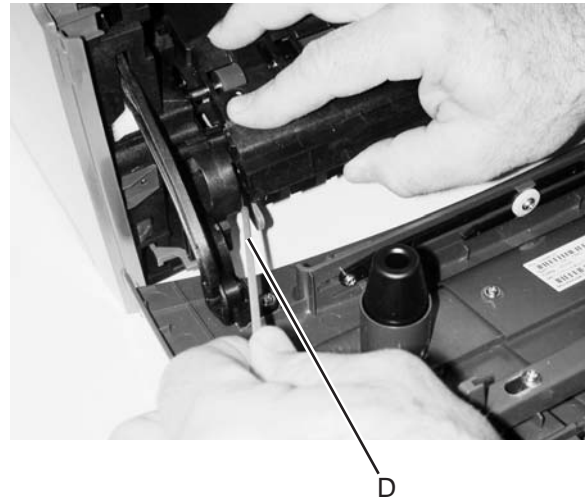
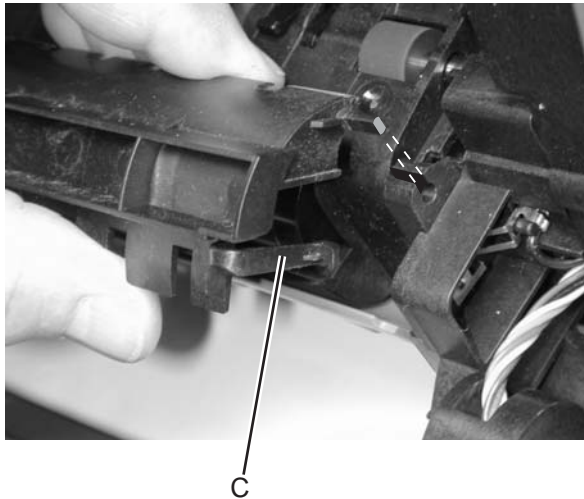

9. Slide the cover to the right to free the left side, and remove the front cover guide.



**Installation note:** Move the printer so the front hangs over the front edge of the work surface. Anchor the left spring on its rear post and maintain tension on it while snapping the assembly into position on the left side. Use the spring hook from below the printer to anchor the front of the spring.

Carefully position the unsnapped right side so the right spring can be anchored at the rear. While maintaining tension on the spring, snap the right side into position. Use the spring hook from below the printer to anchor the front of the spring.



### Wear strip removal (tray 1)

1. Hold the tray with the bottom up.
2. Use a spring hook to unfasten each of the anchors on the back of each strip.



3. Remove the strip from inside the tray.

### Wear strip removal (tray 2)

1. Pull up the strip with the spring hook to free it at the top.

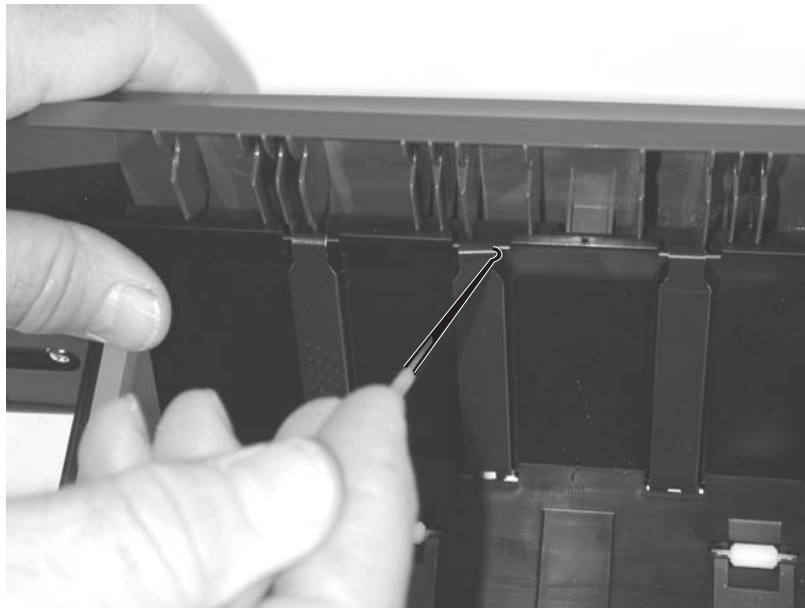

2. Lift the strip out.

**Note:** When replacing the strip:

- Push the strip up with your thumb to make sure that the strip is in place.



- Turn the tray over so that you are looking at the bottom of the strip. Using the spring hook, check to make sure that the end of the strip is secure and the strip is fastened tightly.





## 5. Locations and connections

### Locations

#### Front view

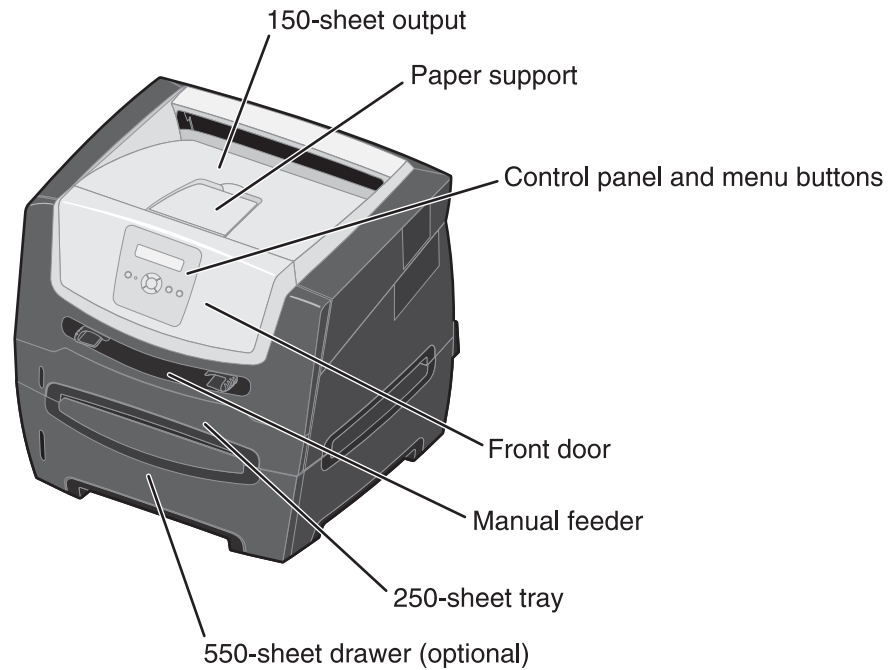

#### Rear view

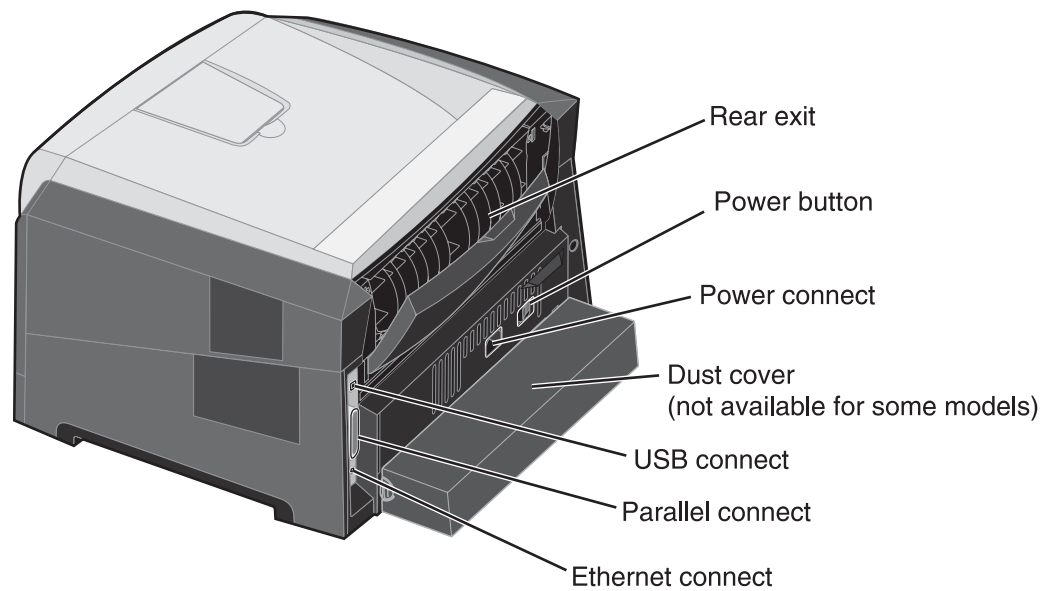

## Controller card connector pin values

**Note:** See the wiring diagram at back of book.

These values were measured with all connections made (plugged) or with only one connector at a time unplugged to expose the pins. Always disconnect and connect with the printer power off. Otherwise, the values below may not match.

Connector	Pin #	Value cableplugged	Value cable unplugged (if different)	Comments
J1	1	Signal		Smart chip
	2	Ground		
J2	1	Less than 5 V dc		Toner level sensor
	2	Ground		
	3	Signal		
J3	1, 3, 5	Signal		Operator panel
	2	5 V dc		
	4, 7	Ground		
	6	3.3 V dc		
J4	1	Ground		Cooling fan
	2	24 V dc		
J5	1, 3	Signal		LSU drive
	2	Ground		
J6	1, 2	5 V dc	Less than 1 V dc	Front cover open switch
	3	Ground		Cover closed
	1	0 V dc		Cover open
	2	5v		
	3	Ground		
J8	2, 4, 7	Ground		LSU
	10	5 V dc		
	1, 3, 5, 6, 8, 9	Signal		
J9	1, 2	24 V dc		Reversing solenoid
	2		Less than 1 V dc	
J10	1	Less than 5 V dc		Narrow media sensor
	2	5 V dc		
	3	Ground		
J11	1	Less than 5 V dc		Exit sensor
	2	5 V dc		
	3	Ground		
J13	1	5 V dc		Thermistor
	2	Ground		

Connector	Pin #	Value cableplugged	Value cable unplugged (if different)	Comments
J15	1	5 V dc		LSU (HSYNC)
	2, 3	Signal		
	4	Ground		
J17	1-4	Signal	3.2 V dc	Main motor
	5	Ground		
	6	5 V dc		
	7-9	24 V dc	Less than 24 V dc	
J19	1-6	Signal		LVPS/HVPS
	7	Ground		
	8, 9	24 V dc		
	10, 11, 15	Signal		
	12, 14	Ground		
	13	5 V dc		
J20	1	Less than 5 V dc	5 V dc	Manual feed sensor
	2	5 V dc	5 V dc	
	3	Ground		
J21	1-4	24 V dc		Manual feed solenoids
	1, 3		24 V dc	
	2, 4		0 V dc	
J22	1, 4, 5	Signal		Tray 2
	2, 3	24 V dc		
	6	Ground		
J25	1	Less than 5 V dc	5 V dc	Paper feed and duplex sensors
	2	5 V dc	5 V dc	
	4	Less than V dc	5 V dc	
	5	5 V dc	5 V dc	
	3, 6	Ground		

---

## Connectors

### System board

Connector	Pin no.	Signal
J1 USB Port	G1	Ground
	1	USB +5 V dc
	2	USB D-
	3	USB D+
	4	Ground
	G2	Ground



## 6. Preventive maintenance

This chapter describes procedures for printer preventive maintenance. Follow these recommendations to help prevent problems and maintain optimum performance.

---

### Safety inspection guide

The purpose of this inspection guide is to aid you in identifying unsafe conditions.

If any unsafe conditions exist, find out how serious the hazard could be and if you can continue before you correct the hazard.

Check the following items:

- Damaged, missing, or altered parts, especially in the area of the On/Off switch and the power supply
- Damaged, missing, or altered covers, especially in the area of the top cover and the power supply cover
- Possible safety exposure from any non-Lexmark attachments

---

### Lubrication specifications

FRUs are typically lubricated as needed from the factory. If not, lubricate only when parts are replaced or as needed, not on a scheduled basis. Use of lubricants other than those specified can cause premature failure. Some unauthorized lubricants may chemically attack parts. Use P/N 99A0394 (Nyogel 744) to lubricate appropriate areas. Lubricate gears that were lubricated in the original part.

---

### Maintenance kits

Maintenance kits include:

- Fuser (P/N 40X2800, 40X2801, or 40X2802)
- Exit guide (P/N 40X2834)
- Tray 1 ACM feed tires (P/N 56P1820)
- Transfer roll (P/N 40X2822)

#### Maintenance kits

Description	Part number
110 V maintenance kit	40X2847
220 V maintenance kit	40X2848
100 V maintenance kit	40X2849



## 7. Parts catalog

### How to use this parts catalog

The following legend is used in the parts catalog:

Asm-Index	Part number	Units/mach	Units/FRU	Description
-----------	-------------	------------	-----------	-------------

- **Asm-index:** identifies the assembly and the item in the diagram. For example 3-1 indicates assembly 3 and the item number 1.
- **Part number:** identifies the unique number that identifies this FRU.
- **Units/mach:** refers to the number of units actually used in the machine or product.
- **Units/FRU:** refers to the number of units packaged together and identified by the part number.
- **NS:** (Not shown) in the Asm-Index column indicates that the part is procurable but is not pictured in the illustration.
- **PP:** (Parts Packet) in the parts description column indicates the part is contained in a parts packet.
- Model information used in the parts catalog.

Machine type and model	Description
4512-420	Lexmark E350d
4512-430	Lexmark E352dn

## Assembly 1: Covers

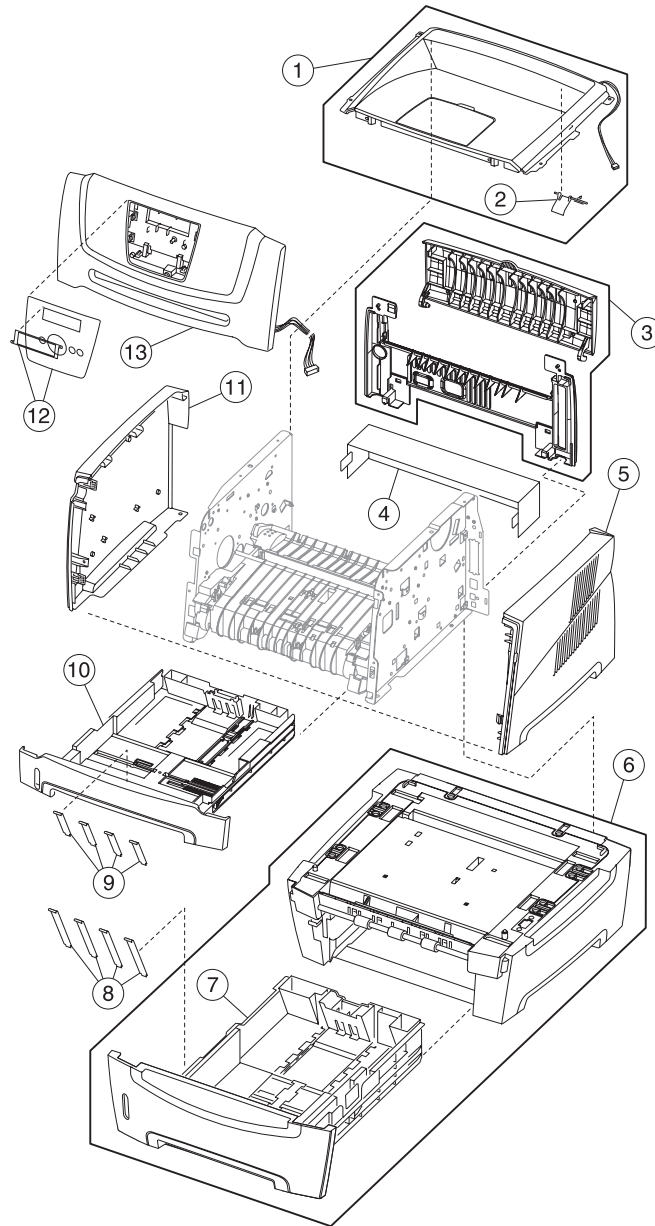

## Assembly 1: Covers

Asm-Index	Part number	Units/mach	Units/FRU	Description
1- 1	40X5069	1	1	Top cover assembly (includes narrow media sensor)
2	40X5068	1	1	Top cover right flag
3	40X2839	1	1	Rear upper and lower cover assembly
4	40X2858	1	1	Legal extender dust cover
5	40X2837	1	1	Right side cover
6	40X2843	1	1	Optional media drawer assembly
7	40X2844	1	1	Tray 2 assembly
8	40X2855	1	4	Tray 2 wear strips
9	40X2854	1	4	Tray 1 wear strips
10	40X2842	1	1	Main tray
11	40X2836	1	1	Left side cover
12	40X2815	1	1	LCD bezel cover, E350d
12	40X2816	1	1	LCD bezel cover, E352dn
13	40X2840	1	1	Front access cover assembly

## Assembly 2: Electronics

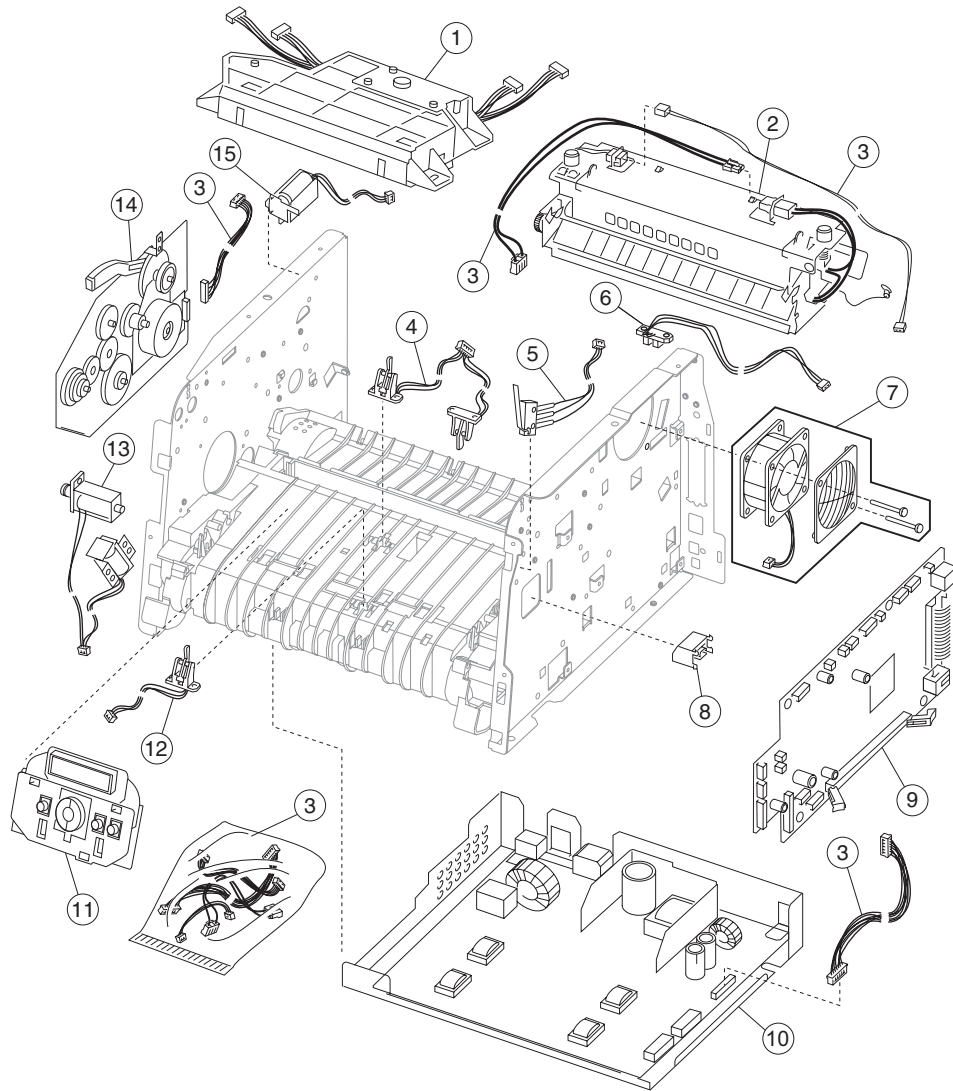

**Assembly 2: Electronics**

Asm-Index	Part number	Units/mach	Units/FRU	Description
2-4	40X2803	1		LSU, E350d/E352dn (printhead)
2	40X2800	1		Fuser assembly, 110 V
2	40X2801	1		Fuser assembly, 220 V
2	40X2802	1		Fuser assembly, 100 V
3	40X2833	1		Miscellaneous cable assemblies
			1	Thermistor
			1	LVPS/HVPS to controller card
			1	Main drive gear assembly (motor to controller card)
			1	Fuser power (LVPS to fuser)
4	40X2823	1	1	Duplex and media sensor assembly
5	40X2813	1	1	Cover open sensor assembly
6	40X2856	1	1	Narrow media sensor
7	40X2828	1	1	Cooling fan
8	56P2076	1	1	Toner low sensor (RO)
9	40X2806	1	1	Controller card, E350d
9	40X2807	1	1	Controller card, E352dn
10	40X2819	1		LVPS/HVPS card assembly, 110 V
10	40X2820	1		LVPS/HVPS card assembly, 220 V
11	40X2810	1		LCD operator panel assembly, E350d/E352dn
12	40X2824	1	1	Manual input sensor assembly
13	40X2845	1	1	Pickup and manual feed solenoids
14	40X2826	1	1	Main drive gear assembly
15	40X2846	1	1	Reversing solenoid

### Assembly 3: Frame

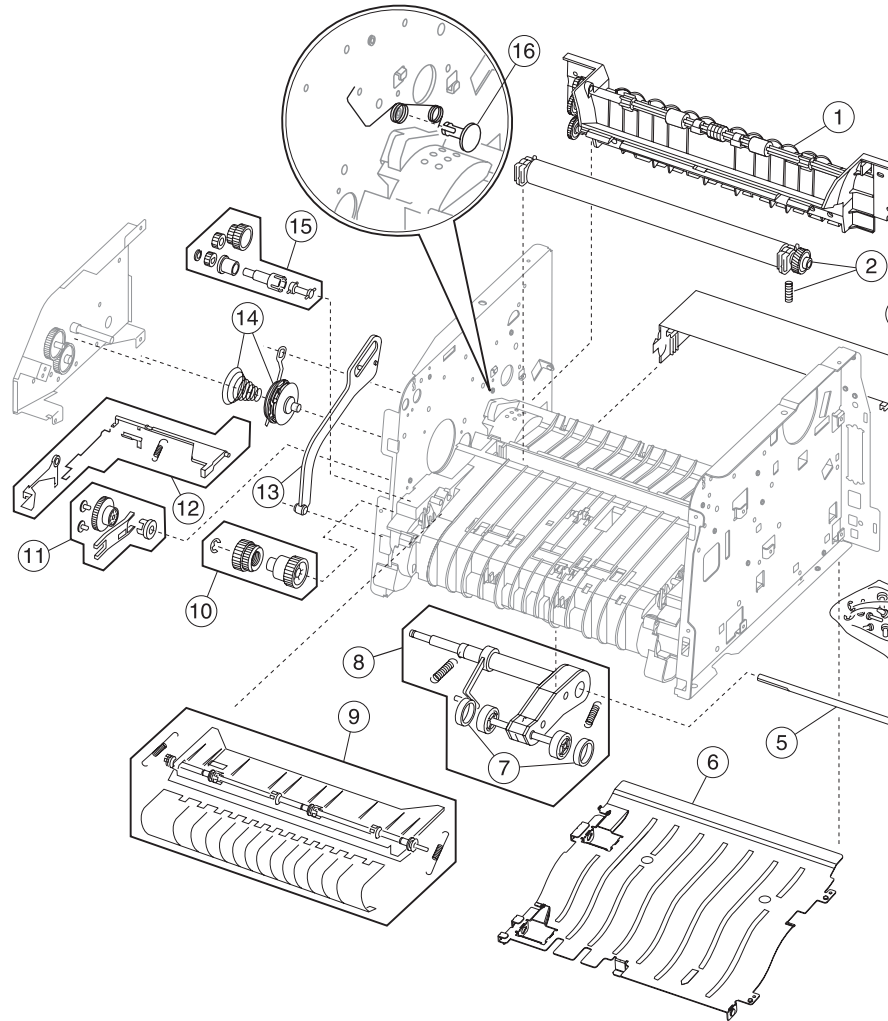



### Assembly 3: Frame

Asm-Index	Part number	Units/mach	Units/FRU	Description
3-4	40X2834	1		Media exit guide assembly
2	40X2822	1		Transfer roll, bearings, gear, spring (CBM)
3	40X2858	1	1	Legal extender dust cover
4	40X2850	N/A		Screws, miscellaneous
			4	TP2NCX3X6PF-Ni
			4	TP2C-4.0+8PF-Ni
			4	M3.0*0.5+6PF-Ni
			2	M3.0*0.5+4PF-Ni
			2	M3.5*0.6+6P-Ni
5	40X2853	1	1	ACM drive shaft assembly
6	40X2841	1	1	Complete duplex assembly
7	56P1820	2		Paper feed, ACM tires (RO)
8	40X2838	1	1	Media (ACM) drive assembly
9	40X2857	1	1	Upper front frame assembly
10	40X2830	1	1	Manual feed clutch CBM
11	40X5930	1	1	Media feed ACM clutch CBM
12	40X2832	1	1	Media level indicator CBM
13	40X2825	1	1	Developer drive/access door link
14	40X2829	1	1	Developer drive coupling assembly
15	40X2821	1	1	Duplex drive gear CBM
NS	40X2847	1	1	110 V maintenance kit
NS	40X2848	1	1	220 V maintenance kit
NS	40X2849	1	1	100 V maintenance kit
				<b>Note:</b> Kit contains the following: Fuser (40X2800, 40X2801, or 40X2802) Exit guide (40X2834) Tray 1 ACM feed tires (56P1820) Transfer roll CBM (40X2822)
NS	7377298	1		Field location package assembly
NS	40X2817	1	2	Tray 2 paper feed tire

## Assembly 4: Options

Asm-Index	Part number	Units/mach	Units/FRU	Description
NS	40X1512	1		Japanese font card assembly
NS	40X1513	1		Simplified Chinese font card assembly
NS	40X1514	1		Traditional Chinese font card assembly
NS	40X1515	1		Korean font card assembly
NS	40X1364	1		32MB SDR DIMM
NS	40X1365	1		64MB SDR DIMM
NS	40X1366	1		128 MB SDR DIMM
NS	40X1454	1		32 MB flash card assembly
NS	40X1367	1		Parallel cable, packaged (3 m)
NS	40X1368	1		USB cable, packaged (2 m)

## Assembly 5: Power cords

Asm-Index	Part number	Units/mach	Units/FRU	Description
NS	40X0289	1		Power cord, 1.8M (straight)– USA, Canada
NS	40X0278	1		Power cord, 6 foot (straight)– Europe and others
NS	40X0288	1		Power cord, 8 foot (straight)– Argentina
NS	40X0271	1		Power cord, 8 foot (straight)– United Kingdom
NS	40X0275	1		Power cord, 6 foot (straight)– Israel
NS	40X0274	1		Power cord, 6 foot (straight)– Switzerland
NS	40X0276	1		Power cord, 6 foot (straight)– South Africa
NS	40X0287	1		Power cord, 6 foot (straight)– Traditional Italy
NS	40X0279	1		Power cord, 6 foot (straight)– Denmark
NS	40X0277	1		Power cord, 6 foot (straight)– Brazil
NS	40X0282	1		Power cord, 1.8M (straight)– PRC
NS	40X0270	1		Power cord, 2.5M (straight)– Japan
NS	40X0280	1		Power cord, 1.8M (straight)– Korea
NS	40X0281	1		Power cord, 1.8M (straight)– Taiwan
NS	40X0296	1		Power cord, 1.8M (straight)– Australia



# Index

## A

abbreviations **1-9**  
 acronyms **1-9**  
 autocompensator tires **4-38**

## C

cables  
   fuser power cable **4-24**  
 Charge Roll, diagnostics mode **3-21**  
 compatibility **1-5**  
 configuration ID **3-20**  
 configuration menu—  
   accessing **3-1**  
   Demo Mode **3-3**  
   Energy Conserve **3-3**  
   entering **3-2**  
   Exit Config Menu **3-4**  
   Factory Defaults **3-3**  
   menus **3-2**  
   Panel Menus **3-3**  
   PPDS Emulation **3-3**  
   Prt Quality Pgs **3-3**  
   Reset PC Cnt **3-2**  
 control panel **1-2**  
 controller card  
   removal **4-13**  
   service check **2-17**

## D

Defaults  
   US/Non-US defaults **3-19**  
 Demo Mode **3-3**  
 diagnostic information **2-1**  
 diagnostics mode— **3-1**  
   available tests **3-5**  
   Base Sensor Test **3-18**  
 EP Setup  
   Charge Roll **3-21**  
   EP Defaults **3-21**  
   Fuser Temp **3-21**  
   Gap Adjust **3-21**  
   Print Contrast **3-21**  
   Transfer **3-21**  
 Event Log  
   Clear Log **3-22**  
   Display Log **3-21**  
   Print Log **3-22**  
 Exit Diagnostics **3-22**  
 exiting **3-6**  
 Hardware Tests  
   Button Test **3-15**  
   DRAM Test **3-15**  
   LCD Test **3-15**

Input Tray Tests  
   Feed Tests **3-17**  
   Sensor Test **3-18**  
 menu list **3-5**  
 Print Tests  
   input source **3-14**  
   input source tests **3-14**  
   Prt Quality Pgs **3-14**  
 Printer Setup  
   Configuration ID **3-20**  
   Defaults **3-19**  
   Edge to Edge **3-20**  
   Engine Settings **3-20**  
   Model Name **3-20**  
   Page Count **3-19**  
   Par S Strobe Adj **3-20**  
   Perm Page Count **3-19**  
   Serial Number **3-20**  
 Registration **3-7**  
   Quick Test **3-14**  
 DRAM Test **3-15**

## E

Edge to Edge **3-20**  
 Energy Conserve **3-3**  
 EP Defaults **3-21**  
 error log  
   clear log (diagnostics mode) **3-22**  
   display log (diagnostics mode) **3-21**  
   Print Log **3-22**  
 error messages  
   service error codes **2-12**  
   user attendance messages **2-5**  
 ESD-sensitive parts **4-1**

## F

Factory Defaults **3-3**  
 fan  
   parts catalog **7-5**  
   removal **4-21**  
   service check **2-18**  
 frame, parts catalog **7-6**  
 fuser  
   parts catalog **7-5**  
   removal **4-22**  
   service check **2-19**  
 Fuser Temp **3-21**

## G

Gap Adjust **3-21**

## H

handling ESD-sensitive parts **4-1**  
 History  
   *see error log* **3-22**

**I**

input feed tests **3-17**  
input source tests **3-14**

**L**

LCD operator panel **4-36**  
locations  
  front views **5-1**  
  rear views **5-1**  
lubrication specifications **6-1**  
LVPS/HVPS  
  parts catalog **7-5**  
  removal **4-26**  
  service check **2-20**

**M**

maintenance kits **6-1**  
manual feed  
  print media types and sizes **1-6**  
messages  
  service error codes **2-12**  
  user attendance messages **2-5**  
Model Name **3-20**  
models  
  comparison **1-1**  
  diagrams **5-1**  
  operator panels **1-2**  
  service menus **3-1**  
  trays available **1-4**

**O**

operator panel  
  LCD— **2-2**  
  LED—  
    service check **2-21**  
overview **1-2**

**P**

Page Count **3-19**  
Panel Menus **3-3**  
panel, control **1-2**  
paper exit guide, removal **4-37**  
paper jams  
  tips on preventing **1-7**  
parallel port service check **2-23**  
parts catalog  
  covers **7-2**  
  electronics **7-4**  
  frame **7-6**  
  options **7-8**  
permanent page count **3-19**  
power-on self test (POST) **2-1**  
  symptoms **2-15**  
PPDS emulation **3-3**  
Print Contrast **3-21**  
print media  
  preventing jams **1-7**  
  trays by model **1-4**  
  types and sizes **1-6**

print quality pages **3-3, 3-14**  
  using **2-24**  
print quality problems  
  print media **1-7**  
  service check **2-24**  
  solving **2-28**  
printer symptom table **2-16**  
printhead  
  removal **4-40**  
  service check **2-31**

**Q**

Quick Test **3-7, 3-14**

**R**

registration **3-7**  
removals  
  controller card **4-13**  
  cover open sensor **4-15**  
  covers  
    front access cover **4-2**  
    left side cover **4-4**  
    right side cover **4-5**  
    top cover **4-7**  
  developer drive coupling assembly **4-16**  
  fan **4-21**  
  fuser **4-22**  
  fuser power cable **4-24**  
  LVPS/HVPS card assembly **4-26**  
  paper exit guide assembly **4-37**  
  paper feed rollers **4-38**  
  printhead **4-40**  
  procedures **4-1**  
  toner level sensor— **4-41**  
  transfer roll **4-42**  
Reset Factory Defaults **3-19**  
Reset PC Counter **3-2**

**S**

safety information **ix**  
safety inspection guide **6-1**  
sensors  
  cover open **4-15**  
Serial Number **3-20**  
service checks **2-17**  
  controller card **2-17**  
  cooling fan **2-18**  
  cover interlock switch **2-18**  
  dead machine **2-19**  
  fuser **2-19**  
  LVPS/HVPS **2-20**  
  main motor **2-20**  
  operator panel **2-21**  
  paper feed **2-21**  
    paper jam during POST **2-21**  
    paper never picks **2-22**  
    paper picks but stops **2-22**  
    paper picks during POST **2-21**  
    paper picks sheets **2-22**  
    paper trees, curls **2-23**

- parallel port **2-23**
- print quality **2-24**
  - black page **2-25**
  - blank page **2-24**
  - heavy background **2-25**
  - image density **2-26**
  - light print **2-27**
  - partial blank image **2-26**
  - poor fusing of image **2-26**
  - toner on back of page **2-27**
  - white or black lines **2-27**
- printhead **2-31**
- transfer roll **2-31**
- service error codes **2-12**
- service menus **3-1**
- special tools **1-8**
- specifications
  - connectivity **1-5**
  - input trays **1-4**
  - memory **1-3**
  - operating systems **1-5**
  - photoconductor capacity **1-4**
  - print media **1-6**
  - print speed **1-3**
  - toner capacity **1-4**
- start **2-1**
- strobe adjustment **3-20**
- symptom tables **2-15**
  - POST **2-15**
  - printer **2-16**

## T

- test pages
  - Print Quality Pages **3-14**
  - Quick Test **3-7**
- tires, removal **4-38**
- tools **1-8**
- Top Margin **3-7**
- Transfer **3-21**
- transfer roll
  - parts catalog **7-7**
  - removal **4-42**
  - service check **2-31**
- translated label **1-2**

## U

- user attendance messages **2-5**





## Part number index

40X0270	Power cord, 1.77M (straight)– Japan	7-9
40X0271	Power cord, 6 foot– United Kingdom	7-9
40X0274	Power cord, 6 foot– Switzerland	7-9
40X0275	Power cord, 6 foot (straight)– Israel	7-9
40X0276	Power cord, 6 foot– South Africa	7-9
40X0277	Power cord, 6 foot (straight)– Brazil	7-9
40X0278	Power cord, 6 foot (straight)– Europe and others	7-9
40X0279	Power cord, 6 foot (straight)– Denmark	7-9
40X0280	Power cord, 1.77M (straight)– Korea	7-9
40X0281	Power cord, 1.77M (straight)– Taiwan	7-9
40X0282	Power cord, 1.77M (straight)– PRC	7-9
40X0287	Power cord, 6 foot (straight)– Traditional Italy	7-9
40X0288	Power cord, 6 foot– Argentina	7-9
40X0289	Power cord, 1.77M (straight)– USA, Canada	7-9
40X0296	Power cord, 1.8M (straight)– Australia	7-9
40X1300	Fuser assembly, 110 V	7-5
40X1323	Duplex and media sensor assembly	7-5
40X1328	Cooling fan	7-5
40X1333	Cable assembly, misc - fuser power	7-5
40X1333	Cable assembly, misc - main drive motor	7-5
40X1333	Cable assembly, misc.- LVPS/HVPS to controller	7-5
40X1333	Cable assembly, misc.- toner sensor	7-5
40X1364	32MB SDR DIMM	7-8
40X1365	64MB SDR DIMM	7-8
40X1366	128 MB SDR DIMM	7-8
40X1367	Parallel cable, packaged (3 m)	7-8
40X1368	USB cable, packaged (2 m)	7-8
40X1454	32 MB flash card assembly	7-8
40X1512	Japanese font card assembly	7-8
40X1513	Simplified Chinese font card assembly	7-8
40X1514	Traditional Chinese font card assembly	7-8
40X1515	Korean font card assembly	7-8
40X2801	Fuser assembly, 220 V	7-5
40X2802	Fuser assembly, 100 V	7-5
40X2803	LSU, E350d/E352dn (printhead)	7-5
40X2806	Controller card, E350d	7-5
40X2807	Controller card, E352dn	7-5
40X2810	LCD operator panel assembly, E350d/E352dn	7-5
40X2813	Cover open sensor assembly	7-5
40X2815	LCD bezel cover, E350d	7-3
40X2816	LCD bezel cover, E352dn	7-3
40X2817	Tray 2 paper feed tire	7-7
40X2819	LVPS/HVPS card assembly, 110 V	7-5
40X2820	LVPS/HVPS card assembly, 220 V	7-5
40X2821	Duplex drive gear CBM	7-7
40X2822	Transfer roll, bearings, gear, spring (CBM)	7-7
40X2824	Manual input sensor assembly	7-5
40X2825	Developer drive/access door link	7-7
40X2826	Main drive gear assembly	7-5
40X2829	Developer drive coupling assembly	7-7
40X2830	Manual feed clutch CBM	7-7
40X2832	Media level indicator CBM	7-7
40X2833	Miscellaneous cable assemblies	7-5
40X2834	Media exit guide assembly	7-7
40X2836	Left side cover	7-3

40X2837	Right side cover	7-3
40X2838	Media (ACM) drive assembly	7-7
40X2839	Rear upper and lower cover assembly	7-3
40X2840	Front access cover assembly	7-3
40X2841	Complete duplex assembly	7-7
40X2842	Main tray	7-3
40X2843	Optional media drawer assembly	7-3
40X2844	Tray 2 assembly	7-3
40X2845	Pickup and manual feed solenoids	7-5
40X2846	Reversing solenoid	7-5
40X2847	110 V maintenance kit	6-1, 7-7
40X2848	220 V maintenance kit	6-1, 7-7
40X2849	100 V maintenance kit	6-1, 7-7
40X2850	Screws, miscellaneous	7-7
40X2853	ACM drive shaft assembly	7-7
40X2854	Tray 1 wear strips	7-3
40X2855	Tray 2 wear strips	7-3
40X2856	Narrow media sensor	7-5
40X2857	Upper front frame assembly	7-7
40X2858	Legal extender dust cover	7-3, 7-7
40X5068	Top cover right flag	7-3
40X5069	Top cover assembly (includes narrow media sensor)	7-3
40X5930	Media feed ACM clutch CBM	7-7
56P1820	Paper feed, ACM tires (RO)	7-7
56P2076	Toner low sensor (RO)	7-5
7377298	Field location package assembly	7-7

# E350d/E350dn Wiring Diagram

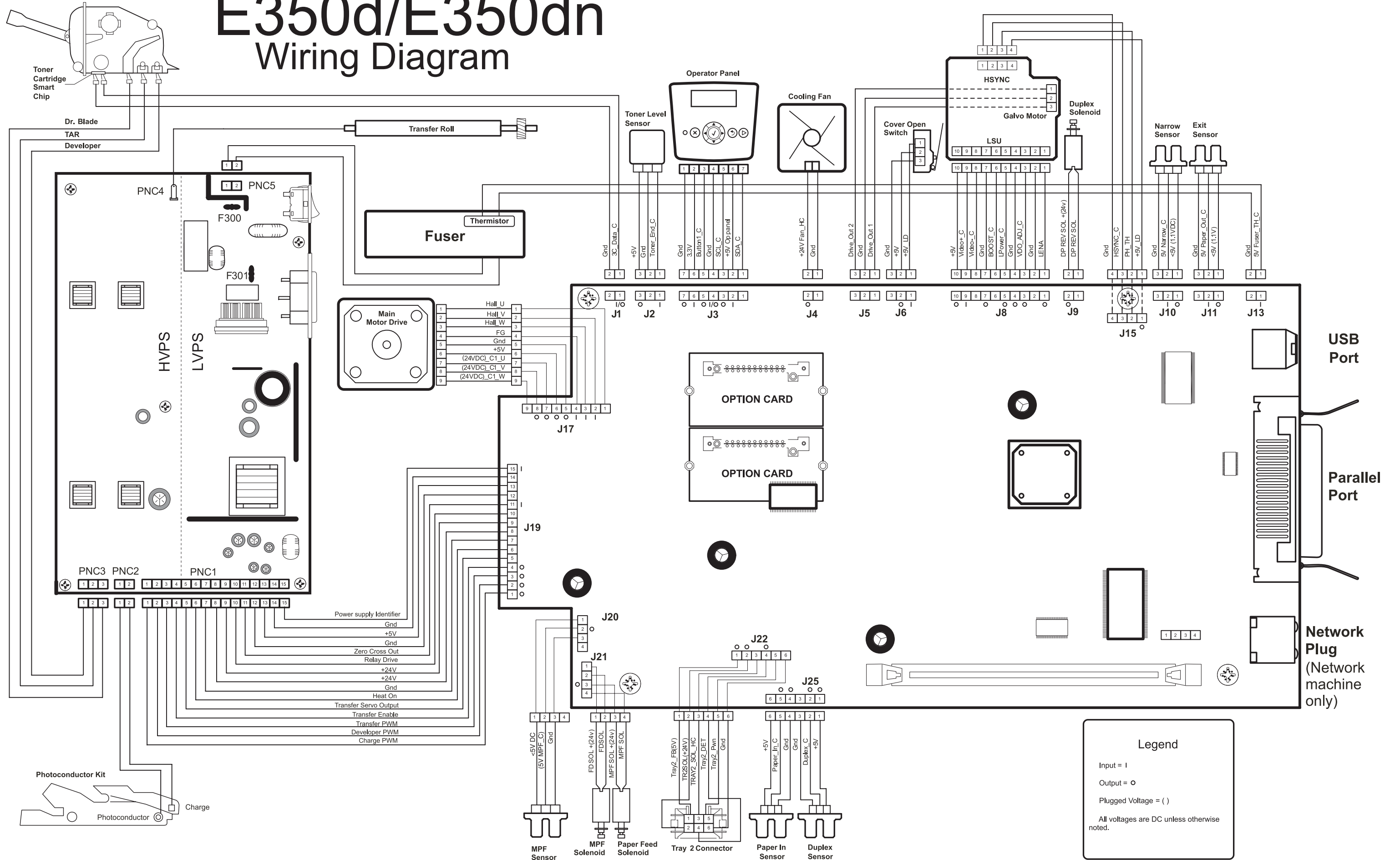

# Print defects guide

Defects often repeat down a page. In such cases, matching the defect frequency to one of the sets of vertical lines below can help identify the particular part that may be causing the defect.

For example, the distance between these two marks represents a repeating defect caused by the toner cartridge.

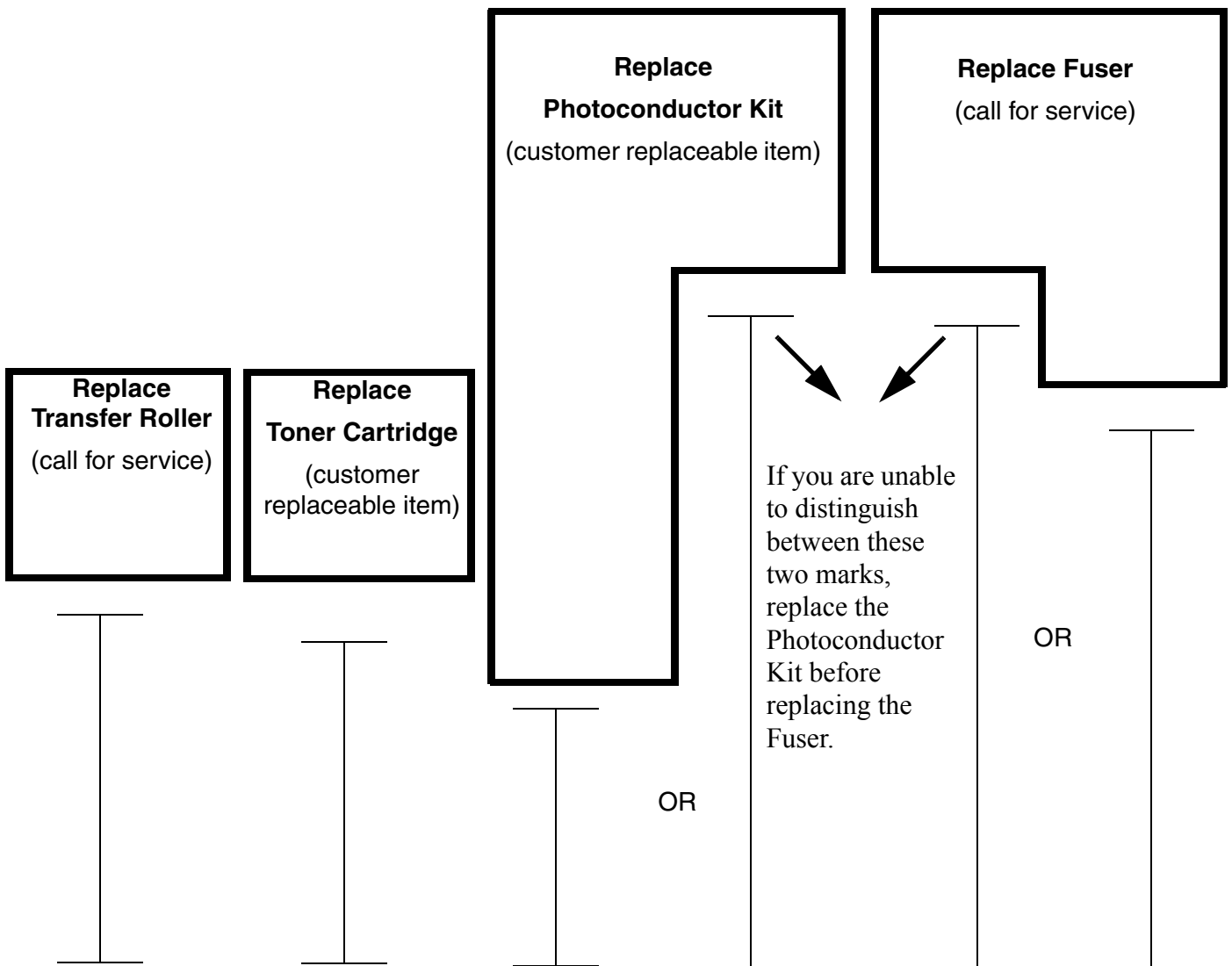
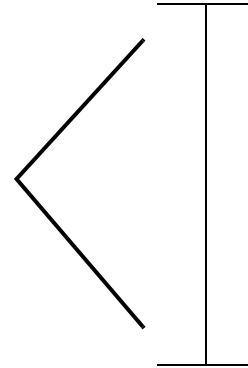

**Replace Transfer Roller**  
(call for service)

**Replace Toner Cartridge**  
(customer replaceable item)

**Replace Photoconductor Kit**  
(customer replaceable item)

**Replace Fuser**  
(call for service)

If you are unable to distinguish between these two marks, replace the Photoconductor Kit before replacing the Fuser.

OR

OR