



## *Service Manual*

Lexmark™ E120, E120n

4506-1xx

- *Table of contents*
- *Start diagnostics*
- *Safety and notices*
- *Trademarks*
- *Index*

**LEXMARK**™

Lexmark and Lexmark with diamond design are trademarks of Lexmark International, Inc., registered in the United States and/or other countries.

**Edition: March 24, 2006**

**The following paragraph does not apply to any country where such provisions are inconsistent with local law:**  
LEXMARK INTERNATIONAL, INC. PROVIDES THIS PUBLICATION "AS IS" WITHOUT WARRANTY OF ANY KIND, EITHER EXPRESS OR IMPLIED, INCLUDING, BUT NOT LIMITED TO, THE IMPLIED WARRANTIES OF MERCHANTABILITY OR FITNESS FOR A PARTICULAR PURPOSE. Some states do not allow disclaimer of express or implied warranties in certain transactions; therefore, this statement may not apply to you.

This publication could include technical inaccuracies or typographical errors. Changes are periodically made to the information herein; these changes will be incorporated in later editions. Improvements or changes in the products or the programs described may be made at any time.

Comments may be addressed to Lexmark International, Inc., Department D22A/032-2, 740 West New Circle Road, Lexington, Kentucky 40550, U.S.A or e-mail at [ServiceInfoAndTraining@Lexmark.com](mailto:ServiceInfoAndTraining@Lexmark.com). Lexmark may use or distribute any of the information you supply in any way it believes appropriate without incurring any obligation to you.

References in this publication to products, programs, or services do not imply that the manufacturer intends to make these available in all countries in which it operates. Any reference to a product, program, or service is not intended to state or imply that only that product, program, or service may be used. Any functionally equivalent product, program, or service that does not infringe any existing intellectual property right may be used instead. Evaluation and verification of operation in conjunction with other products, programs, or services, except those expressly designated by the manufacturer, are the user's responsibility.

Lexmark and Lexmark with diamond design are trademarks of Lexmark International, Inc., registered in the United States and/or other countries.

All other trademarks are the property of their respective owners.

**© 2006 Lexmark International, Inc.  
All rights reserved.**

#### **UNITED STATES GOVERNMENT RIGHTS**

This software and any accompanying documentation provided under this agreement are commercial computer software and documentation developed exclusively at private expense.

# Table of contents

<b>Table of contents</b> .....	<b>iii</b>
<b>Notices and safety information</b> .....	<b>vi</b>
Laser notice .....	vi
Safety information .....	x
<b>Preface</b> .....	<b>xiii</b>
Definitions .....	xiii
<b>General information</b> .....	<b>1-1</b>
Maintenance approach .....	1-1
Models .....	1-1
Overview of the printer .....	1-1
E120 operator panel .....	1-1
E120n operator panel .....	1-1
Front view .....	1-2
Rear view .....	1-2
Specifications .....	1-3
Types of print media .....	1-3
Choosing appropriate print media .....	1-3
Paper .....	1-3
Preprinted forms and letterhead .....	1-4
Transparencies .....	1-4
Envelopes .....	1-4
Labels .....	1-4
Card stock .....	1-5
Storing print media .....	1-5
Tips on preventing jams .....	1-5
Tools .....	1-6
Acronyms .....	1-6
<b>Diagnostic information</b> .....	<b>2-1</b>
Start .....	2-1
Power-On Self Test (POST) sequence .....	2-2
Overview of the operator panel—E120 .....	2-2
Light patterns and error messages .....	2-3
Primary, secondary, and tertiary light patterns .....	2-4
Power-On Self Test (POST) sequence .....	2-8
Overview of the operator panel—E120n .....	2-9
Common primary and secondary light patterns .....	2-9
Common primary light patterns—E120n .....	2-9
Additional information—primary codes .....	2-11
Additional information—secondary light patterns .....	2-14
Service codes .....	2-17
Service primary code .....	2-18
Service secondary error codes .....	2-18
Service tertiary error codes .....	2-18
Controller software .....	2-19
Transfer roll .....	2-19
Fuser .....	2-20
Printhead, transport motor, or RIP/engine communication error .....	2-20
LVPS/HVPS failure .....	2-21

NVRAM failure	2-21
RAM memory error	2-22
Network error	2-22
<b>Symptom tables</b>	<b>2-22</b>
<b>POST symptom table</b>	<b>2-22</b>
<b>Printer symptom table</b>	<b>2-23</b>
<b>Service checks</b>	<b>2-24</b>
<b>Controller card service check</b>	<b>2-24</b>
<b>Operator Panel Service Check</b>	<b>2-25</b>
<b>Dead machine service check</b>	<b>2-25</b>
<b>Fuser service check</b>	<b>2-26</b>
Cold fuser service check	2-27
Hot fuser service check	2-27
<b>LVPS/HVPS service check</b>	<b>2-28</b>
<b>Main motor service check</b>	<b>2-28</b>
<b>Paper feed service checks</b>	<b>2-29</b>
Paper jam error indication during POST	2-29
Paper picks during POST and/or continuously	2-29
Paper picks but stops halfway through the printer	2-29
Paper never picks	2-30
Paper occasionally mispicks or picks multiple sheets at once	2-30
Paper “trees,” wrinkles, stacks poorly, or curls	2-31
<b>Print quality service checks</b>	<b>2-31</b>
<b>Using print quality test pages</b>	2-31
Blank page	2-32
Black page	2-33
Heavy background	2-33
Partial blank image/white spots (no periodic pattern)	2-34
Variation in image density horizontally across page	2-34
Poor fusing of image	2-34
Light print	2-35
White or black lines or bands	2-35
Toner on back of page	2-36
Solving print quality problems	2-36
<b>Printhead service check</b>	<b>2-40</b>
<b>Transfer roll service check</b>	<b>2-41</b>
<b>Diagnostic aids</b>	<b>3-1</b>
<b>Service menus—E120</b>	<b>3-1</b>
<b>Printing menus</b>	<b>3-1</b>
<b>Moving around the menu</b>	<b>3-1</b>
<b>Diagnostics mode printout sample</b>	<b>3-2</b>
<b>Diagnostics mode descriptions</b>	<b>3-3</b>
Development	3-3
<b>Service menus—E120n</b>	<b>3-3</b>
<b>Printing menus</b>	<b>3-3</b>
Diagnostics mode	3-3
Configuration menu	3-3
<b>Moving around the menu</b>	<b>3-3</b>
<b>Diagnostics mode printout sample</b>	<b>3-4</b>
<b>Diagnostics mode descriptions</b>	<b>3-5</b>
Development	3-5
Network	3-6
<b>Configuration menu printout sample</b>	<b>3-7</b>
<b>Configuration menu descriptions</b>	<b>3-8</b>
Utilities	3-8
Setup	3-9
USB	3-9
Network	3-10

<b>Repair information</b> .....	<b>4-1</b>
Handling ESD-sensitive parts .....	4-1
Adjustment procedures .....	4-2
Printhead assembly adjustment .....	4-2
Removal procedures .....	4-4
Extender cover removal .....	4-4
Tray cover removal .....	4-4
Main tray removal .....	4-5
Left cover removal .....	4-5
Right cover removal .....	4-7
Front door assembly removal .....	4-8
Top cover assembly removal .....	4-9
Printhead removal .....	4-12
Transfer roll assembly .....	4-12
Rear door assembly .....	4-13
Transfer card and input sensor assembly removal .....	4-14
Paper pick assembly removal .....	4-15
Controller card removal .....	4-17
Operator panel removal (all models) .....	4-18
LVPS/HVPS removal .....	4-19
Fuser removal .....	4-20
<b>Locations and connections</b> .....	<b>5-1</b>
Locations .....	5-1
Front view .....	5-1
Rear view .....	5-1
Connectors .....	5-2
Controller card .....	5-2
LVPS/HVPS card .....	5-4
<b>Preventive maintenance</b> .....	<b>6-1</b>
<b>Parts catalog</b> .....	<b>7-1</b>
How to use this parts catalog .....	7-1
Assembly 1: Covers .....	7-2
Assembly 2: Electronics .....	7-4
Assembly 3: Frame .....	7-6
Assembly 4: Miscellaneous .....	7-8
<b>Index</b> .....	<b>I-1</b>
<b>Part number index</b> .....	<b>I-5</b>

---

## Notices and safety information

The following laser notice labels may be affixed to this printer as shown:

---

### Laser notice

The printer is certified in the U.S. to conform to the requirements of DHHS 21 CFR Subchapter J for Class I (1) laser products, and elsewhere is certified as a Class I laser product conforming to the requirements of IEC 60825-1.

Class I laser products are not considered to be hazardous. The printer contains internally a Class IIIb (3b) laser that is nominally a 5 milliwatt gallium arsenide laser operating in the wavelength region of 770-795 nanometers. The laser system and printer are designed so there is never any human access to laser radiation above a Class I level during normal operation, user maintenance, or prescribed service condition.

---

### Laser

Der Drucker erfüllt gemäß amtlicher Bestätigung der USA die Anforderungen der Bestimmung DHHS (Department of Health and Human Services) 21 CFR Teil J für Laserprodukte der Klasse I (1). In anderen Ländern gilt der Drucker als Laserprodukt der Klasse I, der die Anforderungen der IEC (International Electrotechnical Commission) 60825-1 gemäß amtlicher Bestätigung erfüllt.

Laserprodukte der Klasse I gelten als unschädlich. Im Inneren des Druckers befindet sich ein Laser der Klasse IIIb (3b), bei dem es sich um einen Galliumarsenlaser mit 5 Milliwatt handelt, der Wellen der Länge 770-795 Nanometer ausstrahlt. Das Lasersystem und der Drucker sind so konzipiert, daß im Normalbetrieb, bei der Wartung durch den Benutzer oder bei ordnungsgemäßer Wartung durch den Kundendienst Laserbestrahlung, die Klasse I übersteigen würde, Menschen keinesfalls erreicht.

---

### Avis relatif à l'utilisation de laser

Pour les Etats-Unis : cette imprimante est certifiée conforme aux provisions DHHS 21 CFR alinéa J concernant les produits laser de Classe I (1). Pour les autres pays : cette imprimante répond aux normes IEC 60825-1 relatives aux produits laser de Classe I.

Les produits laser de Classe I sont considérés comme des produits non dangereux. Cette imprimante est équipée d'un laser de Classe IIIb (3b) (arséniure de gallium d'une puissance nominale de 5 milliwatts) émettant sur des longueurs d'onde comprises entre 770 et 795 nanomètres. L'imprimante et son système laser sont conçus pour impossible, dans des conditions normales d'utilisation, d'entretien par l'utilisateur ou de révision, l'exposition à des rayonnements laser supérieurs à des rayonnements de Classe I.

---

### Avvertenze sui prodotti laser

Questa stampante è certificata negli Stati Uniti per essere conforme ai requisiti del DHHS 21 CFR Sottocapitolo J per i prodotti laser di classe 1 ed è certificata negli altri Paesi come prodotto laser di classe 1 conforme ai requisiti della norma CEI 60825-1.

I prodotti laser di classe non sono considerati pericolosi. La stampante contiene al suo interno un laser di classe IIIb (3b) all'arseniuro di gallio della potenza di 5mW che opera sulla lunghezza d'onda compresa tra 770 e 795 nanometri. Il sistema laser e la stampante sono stati progettati in modo tale che le persone a contatto con la stampante, durante il normale funzionamento, le operazioni di servizio o quelle di assistenza tecnica, non ricevano radiazioni laser superiori al livello della classe 1.

---

## Avisos sobre el láser

Se certifica que, en los EE.UU., esta impresora cumple los requisitos para los productos láser de Clase I (1) establecidos en el subcapítulo J de la norma CFR 21 del DHHS (Departamento de Sanidad y Servicios) y, en los demás países, reúne todas las condiciones expuestas en la norma IEC 60825-1 para productos láser de Clase I (1).

Los productos láser de Clase I no se consideran peligrosos. La impresora contiene en su interior un láser de Clase IIIb (3b) de arseniuro de galio de funcionamiento nominal a 5 milivatios en una longitud de onda de 770 a 795 nanómetros. El sistema láser y la impresora están diseñados de forma que ninguna persona pueda verse afectada por ningún tipo de radiación láser superior al nivel de la Clase I durante su uso normal, el mantenimiento realizado por el usuario o cualquier otra situación de servicio técnico.

---

## Declaração sobre Laser

A impressora está certificada nos E.U.A. em conformidade com os requisitos da regulamentação DHHS 21 CFR Subcapítulo J para a Classe I (1) de produtos laser. Em outros locais, está certificada como um produto laser da Classe I, em conformidade com os requisitos da norma IEC 60825-1.

Os produtos laser da Classe I não são considerados perigosos. Internamente, a impressora contém um produto laser da Classe IIIb (3b), designado laser de arseneto de potássio, de 5 milliwatts, operando numa faixa de comprimento de onda entre 770 e 795 nanómetros. O sistema e a impressora laser foram concebidos de forma a nunca existir qualquer possibilidade de acesso humano a radiação laser superior a um nível de Classe I durante a operação normal, a manutenção feita pelo utilizador ou condições de assistência prescritas.

---

## Laserinformatie

De printer voldoet aan de eisen die gesteld worden aan een laserprodukt van klasse I. Voor de Verenigde Staten zijn deze eisen vastgelegd in DHHS 21 CFR Subchapter J, voor andere landen in IEC 60825-1.

Laserprodukten van klasse I worden niet als ongevaarlijk aangemerkt. De printer is voorzien van een laser van klasse IIIb (3b), dat wil zeggen een gallium arsenide-laser van 5 milliwatt met een golflengte van 770-795 nanometer. Het lasergedeelte en de printer zijn zo ontworpen dat bij normaal gebruik, bij onderhoud of reparatie conform de voorschriften, nooit blootstelling mogelijk is aan laserstraling boven een niveau zoals voorgeschreven is voor klasse 1.

---

## Lasermeddelelse

Printeren er godkendt som et Klasse I-laserprodukt, i overensstemmelse med kravene i IEC 60825-1.

Klasse I-laserprodukter betragtes ikke som farlige. Printeren indeholder internt en Klasse IIIB (3b)-laser, der nominelt er en 5 milliwatt galliumarsenid laser, som arbejder på bølgelængdeområdet 770-795 nanometer. Lasersystemet og printeren er udformet således, at mennesker aldrig udsættes for en laserstråling over Klasse I-niveau ved normal drift, brugervedligeholdelse eller obligatoriske servicebetingelser.

---

## Huomautus laserlaitteesta

Tämä kirjoitin on Yhdysvalloissa luokan I (1) laserlaitteiden DHHS 21 CFR Subchapter J -määrityksen mukainen ja muualla luokan I laserlaitteiden IEC 60825-1 -määrityksen mukainen.

Luokan I laserlaitteiden ei katsota olevan vaarallisia käyttäjälle. Kirjoittimessa on sisäinen luokan IIIb (3b) 5 milliwatin galliumarsenidilaser, joka toimii aaltoalueella 770 - 795 nanometriä. Laserjärjestelmä ja kirjoitin on suunniteltu siten, että käyttäjä ei altistu luokan I määräytyksiä voimakkaammalle säteilylle kirjoittimen normaalin toiminnan, käyttäjän tekemien huoltotoimien tai muiden huoltotoimien yhteydessä.

VARO! Avattaessa ja suojalukitus ohitettaessa olet alltiina näkymättömälle lasersäteilylle. Älä katso säteeseen.

WARNING! Osynlig laserstrålning när denna del är öppnad och spårren är urkopplad. Betrakta ej strålen.

---

## Laser-notis

Denna skrivare är i USA certifierad att motsvara kraven i DHHS 21 CFR, underparagraf J för laserprodukter av Klass I (1). I andra länder uppfyller skrivaren kraven för laserprodukter av Klass I enligt kraven i IEC 60825-1.

Laserprodukter i Klass I anses ej hälsovådliga. Skrivaren har en inbyggd laser av Klass IIIb (3b) som består av en laserenhet av gallium-arsenid på 5 milliwatt som arbetar i våglängdsområdet 770-795 nanometer. Lasersystemet och skrivaren är utformade så att det aldrig finns risk för att någon person utsätts för laserstrålning över Klass I-nivå vid normal användning, underhåll som utförs av användaren eller annan föreskriven serviceåtgärd.

---

## Laser-melding

Skriveren er godkjent i USA etter kravene i DHHS 21 CFR, underkapittel J, for klasse I (1) laserprodukter, og er i andre land godkjent som et Klasse I-laserprodukt i samsvar med kravene i IEC 60825-1.

Klasse I-laserprodukter er ikke å betrakte som farlige. Skriveren inneholder internt en klasse IIIb (3b)-laser, som består av en gallium-arsenlaserenhet som avgir stråling i bølglengdeområdet 770-795 nanometer.

Lasersystemet og skriveren er utformet slik at personer aldri utsettes for laserstråling ut over klasse I-nivå under vanlig bruk, vedlikehold som utføres av brukeren, eller foreskrevne serviceoperasjoner.

---

## Avís sobre el Làser

Segons ha estat certificat als Estats Units, aquesta impressora compleix els requisits de DHHS 21 CFR, apartat J, pels productes làser de classe I (1), i segons ha estat certificat en altres llocs, és un producte làser de classe I que compleix els requisits d'IEC 60825-1.

Els productes làser de classe I no es consideren perillosos. Aquesta impressora conté un làser de classe IIIb (3b) d'arseniür de gal.li, nominalment de 5 mil.liwats, i funciona a la regió de longitud d'ona de 770-795 nanòmetres. El sistema làser i la impressora han sigut concebuts de manera que mai hi hagi exposició a la radiació làser per sobre d'un nivell de classe I durant una operació normal, durant les tasques de manteniment d'usuari ni durant els serveis que satisfacin les condicions prescrites.



---

#### レーザーに関するお知らせ

このプリンターは、米国ではDHHS 21 CFRサブチャプターJのクラスI (1)の基準を満たしたレーザー製品であることが証明されています。また米国以外ではIEC 825の基準を満たしたクラスIのレーザー製品であることが証明されています。

クラスIのレーザー製品には危険性はないと考えられています。このプリンターはクラスIII b (3 b)のレーザーを内蔵しています。このレーザーは、波長が770 ~ 795ナノメートルの範囲で、通常5ミリワットのガリウム砒化物を放射するレーザーです。このレーザーシステムとプリンターは、通常の操作、ユーザのメンテナンス、規定された修理においては、人体がクラスIのレベル以上のレーザー放射に晒されることのないよう設計されています。

---

#### 注意：

本打印机被美国认证合乎 DHHS 21 CFR Subchapter I 对分类 I (1) 激光产品的标准，而在其他地区则被认证合乎 IEC 825 的标准。

分类 I 激光产品一般认为不具危险性，本打印机内部含有分类 IIIb (3b) 的激光，在操作过程中会产生 5 毫瓦含镓及砷的微量激光，其波长范围在 770-795 nm 之间。本激光系统及打印机的设计，在一般操作、使用者维护或规定内的维修情况下，不会使人体接触分类 I 以上等级的辐射。

---

본프린터는 1등급 레이저 제품들에 대한 DHHS 21 CFR Subchapter 3의 규정을 준수하고 있음을 미국에서 인증받았으며, 그외의 나라에서도 IEC 825 규정을 준수하는 1등급 레이저 제품으로서 인증을 받았습니다.

1등급 레이저 제품들은 안전한 것으로 간주됩니다. 본 프린터는 5 밀리วัต 갈륨 아르세나이드 레이저로서 770-795 나노미터의 파장대에서 활동하는 Class III (3b) 레이저를 내부에 갖고 있습니다. 본 레이저 시스템과 프린터는 정상 작동 중이나 유지 보수 중 또는 규정된 서비스 상태에서 상기의 Class I 수준의 레이저 방출에 사람이 절대 접근할 수 없도록 설계되어 있습니다.

---

## Safety information

- The safety of this product is based on testing and approvals of the original design and specific components. The manufacturer is not responsible for safety in the event of use of unauthorized replacement parts.
- The maintenance information for this product has been prepared for use by a professional service person and is not intended to be used by others.
- There may be an increased risk of electric shock and personal injury during disassembly and servicing of this product. Professional service personnel should understand this and take necessary precautions.
-  **CAUTION:** When you see this symbol, there is a danger from hazardous voltage in the area of the product where you are working. Unplug the product before you begin, or use caution if the product must receive power in order to perform the task.

---

## Consignes de sécurité

- La sécurité de ce produit repose sur des tests et des agréments portant sur sa conception d'origine et sur des composants particuliers. Le fabricant n'assume aucune responsabilité concernant la sécurité en cas d'utilisation de pièces de rechange non agréées.
- Les consignes d'entretien et de réparation de ce produit s'adressent uniquement à un personnel de maintenance qualifié.
- Le démontage et l'entretien de ce produit pouvant présenter certains risques électriques, le personnel d'entretien qualifié devra prendre toutes les précautions nécessaires.
-  **ATTENTION :** Ce symbole indique la présence d'une tension dangereuse dans la partie du produit sur laquelle vous travaillez. Débranchez le produit avant de commencer ou faites preuve de vigilance si l'exécution de la tâche exige que le produit reste sous tension.

---

## Norme di sicurezza

- La sicurezza del prodotto si basa sui test e sull'approvazione del progetto originale e dei componenti specifici. Il produttore non è responsabile per la sicurezza in caso di sostituzione non autorizzata delle parti.
- Le informazioni riguardanti la manutenzione di questo prodotto sono indirizzate soltanto al personale di assistenza autorizzato.
- Durante lo smontaggio e la manutenzione di questo prodotto, il rischio di subire scosse elettriche e danni alla persona è più elevato. Il personale di assistenza autorizzato deve, quindi, adottare le precauzioni necessarie.
-  **ATTENZIONE:** Questo simbolo indica la presenza di tensione pericolosa nell'area del prodotto. Scollegare il prodotto prima di iniziare o usare cautela se il prodotto deve essere alimentato per eseguire l'intervento.

---

## Sicherheitshinweise

- Die Sicherheit dieses Produkts basiert auf Tests und Zulassungen des ursprünglichen Modells und bestimmter Bauteile. Bei Verwendung nicht genehmigter Ersatzteile wird vom Hersteller keine Verantwortung oder Haftung für die Sicherheit übernommen.
- Die Wartungsinformationen für dieses Produkt sind ausschließlich für die Verwendung durch einen Wartungsfachmann bestimmt.
- Während des Auseinandernehmens und der Wartung des Geräts besteht ein zusätzliches Risiko eines elektrischen Schlags und körperlicher Verletzung. Das zuständige Fachpersonal sollte entsprechende Vorsichtsmaßnahmen treffen.
-  **ACHTUNG:** Dieses Symbol weist auf eine gefährliche elektrische Spannung hin, die in diesem Bereich des Produkts auftreten kann. Ziehen Sie vor den Arbeiten am Gerät den Netzstecker des Geräts, bzw. arbeiten Sie mit großer Vorsicht, wenn das Produkt für die Ausführung der Arbeiten an den Strom angeschlossen sein muß.

---

## Pautas de Seguridad

- La seguridad de este producto se basa en pruebas y aprobaciones del diseño original y componentes específicos. El fabricante no es responsable de la seguridad en caso de uso de piezas de repuesto no autorizadas.
- La información sobre el mantenimiento de este producto está dirigida exclusivamente al personal cualificado de mantenimiento.
- Existe mayor riesgo de descarga eléctrica y de daños personales durante el desmontaje y la reparación de la máquina. El personal cualificado debe ser consciente de este peligro y tomar las precauciones necesarias.
-  **PRECAUCIÓN:** este símbolo indica que el voltaje de la parte del equipo con la que está trabajando es peligroso. Antes de empezar, desenchufe el equipo o tenga cuidado si, para trabajar con él, debe conectarlo.

---

## Informações de Segurança

- A segurança deste produto baseia-se em testes e aprovações do modelo original e de componentes específicos. O fabricante não é responsável pela segurança, no caso de uso de peças de substituição não autorizadas.
- As informações de segurança relativas a este produto destinam-se a profissionais destes serviços e não devem ser utilizadas por outras pessoas.
- Risco de choques eléctricos e ferimentos graves durante a desmontagem e manutenção deste produto. Os profissionais destes serviços devem estar avisados deste facto e tomar os cuidados necessários.
-  **CUIDADO:** Quando vir este símbolo, existe a possível presença de uma potencial tensão perigosa na zona do produto em que está a trabalhar. Antes de começar, desligue o produto da tomada eléctrica ou seja cuidadoso caso o produto tenha de estar ligado à corrente eléctrica para realizar a tarefa necessária.

## Informació de Seguretat

- La seguretat d'aquest producte es basa en l'avaluació i aprovació del disseny original i els components específics.  
El fabricant no es fa responsable de les qüestions de seguretat si s'utilitzen peces de recanvi no autoritzades.
- La informació pel manteniment d'aquest producte està orientada exclusivament a professionals i no està destinada a ningú que no ho sigui.
- El risc de xoc elèctric i de danys personals pot augmentar durant el procés de desmuntatge i de servei d'aquest producte. El personal professional ha d'estar-ne assabentat i prendre les mesures convenients.
-  **PRECAUCIÓ:** aquest símbol indica que el voltatge de la part de l'equip amb la qual esteu treballant és perillós. Abans de començar, desendolieu l'equip o extremeu les precaucions si, per treballar amb l'equip, l'heu de connectar.

## 안전 사항

- 본 제품은 원래 설계 및 특정 구성품에 대한 테스트 결과로 안정성이 입증된 것입니다. 따라서 무허가 교체부품을 사용하는 경우에는 제조업체에서 안전에 대한 책임을 지지 않습니다.
- 본 제품에 관한 유지 보수 설명서는 전문 서비스 기술자용으로 작성된 것이므로, 비전문가는 사용할 수 없습니다.
- 본 제품을 해체하거나 정비할 경우, 전기적인 충격을 받거나 상처를 입을 위험이 커집니다. 전문 서비스 기술자는 이 사실을 숙지하고, 필요한 예방 조치를 취하도록 하십시오.
-  **주의:** 이 표시는 해당영역에서 고압전류가 흐른다는 위험 표시입니다. 시작전에 플러그를 뽑으시거나, 주의를 기울여 주시기 바랍니다.

## 安全信息

- 本产品的安全性以原来设计和特定产品的测试结果和认证为基础。万一使用未经许可的替换部件，制造商不对安全性负责。
- 本产品的维护信息仅供专业服务人员使用，并不打算让其他人使用。
- 本产品在拆卸、维修时，遭受电击或人员受伤的危险性会增高，专业服务人员对这点必须有所了解，并采取必要的预防措施。
-  **切记:** 当您看到此符号时，说明在您工作的产品区域有危险电压的存在。请在开始操作前拔掉产品的电源线，或者在产品必须使用电源来执行任务时，小心从事。

---

## Preface

This manual contains maintenance procedures for service personnel. It is divided into the following chapters:

1. **General information** contains a general description of the printer and the maintenance approach used to repair it. Special tools and test equipment are, as well as general environmental and safety instructions.
  2. **Diagnostic information** contains an error indicator table, symptom tables, and service checks used to isolate failing field replaceable units (FRUs).
  3. **Diagnostic aids** contains tests and checks used to locate or repeat symptoms of printer problems.
  4. **Repair information** provides instructions for making printer adjustments and removing and installing FRUs.
  5. **Connector locations** uses illustrations to identify the connector locations and test points on the printer.
  6. **Preventive maintenance** contains the lubrication specifications and recommendations to prevent problems.
  7. **Parts catalog** contains illustrations and part numbers for individual FRUs.
- Appendix A** contains service tips and information.  
**Appendix B** contains representative print samples.

---

## Definitions

**Note:** A note provides additional information.

**Warning:** A warning identifies something that might damage the product hardware or software.

**CAUTION:** A caution identifies something that might cause a servicer harm.



**CAUTION:** When you see this symbol, there is a danger from hazardous voltage in the area of the product where you are working. Unplug the product before you begin, or use caution if the product must receive power in order to perform the task.

## 1. General information

The Lexmark™ E120 and E120n printers are monochrome laser printers designed for single users or small workgroups.

### Maintenance approach

The diagnostic information in this manual leads to the correct field replaceable unit (FRU) or part. Use the error code charts, symptom index, and service checks to determine the symptom and repair the failure. See **“Diagnostic information” on page 2-1** for more information. See **“Repair information” on page 4-1** for the steps to replace FRUs. After completing the repair, perform tests as needed to verify the repair. See **“Parts catalog” on page 7-1** to help identify part numbers if parts need to be replaced.

### Models

There are two models:

- Lexmark E120—ENA support, host-based printing in a Windows environment, an 8,000 page per month maximum duty cycle (one time only), and a two button, two light operator panel.
- Lexmark E120n—Built-in 10/100 BaseTX Ethernet, host-based printing in Windows (PCL) or Macintosh (PostScript emulation) environment, a 10,000 page per month maximum duty cycle (one time only), and a two button, six light operator panel.

The differences between the models are listed in the following table.

Item	Lexmark E120 (4506-100)	Lexmark E120n (4506-110)
Base memory	8MB	16MB
Maximum memory	8MB	16MB
Paper inputs	Primary tray (tray 1), Priority feeder (manual feeder)	
Emulations	PCL	PostScript emulation (Mac only), PCL, XL
Compatibility	Windows	Windows, Macintosh
Connectivity	USB 2.0	USB 2.0, Ethernet
Photoconductor kit yield*	25,000 pages	
* Photoconductor yield based on approximately 5% coverage of pages.		

### Overview of the printer

There are two available operator panels.

#### *E120 operator panel*

This model has two lights and two buttons. See **“Diagnostics—E120” on page 2-2** for more information.

#### *E120n operator panel*

This model has six lights, two buttons, and an internal network adapter. See page **“Diagnostics—E120n” on page 2-8**.

**Front view**

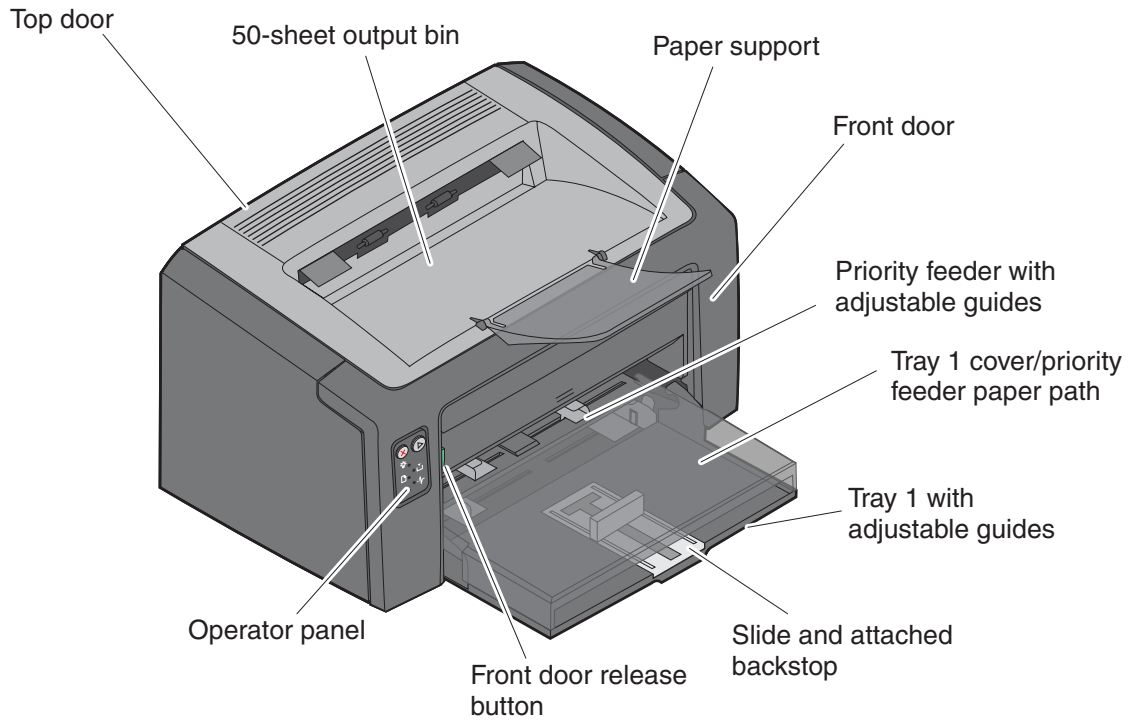

**Rear view**

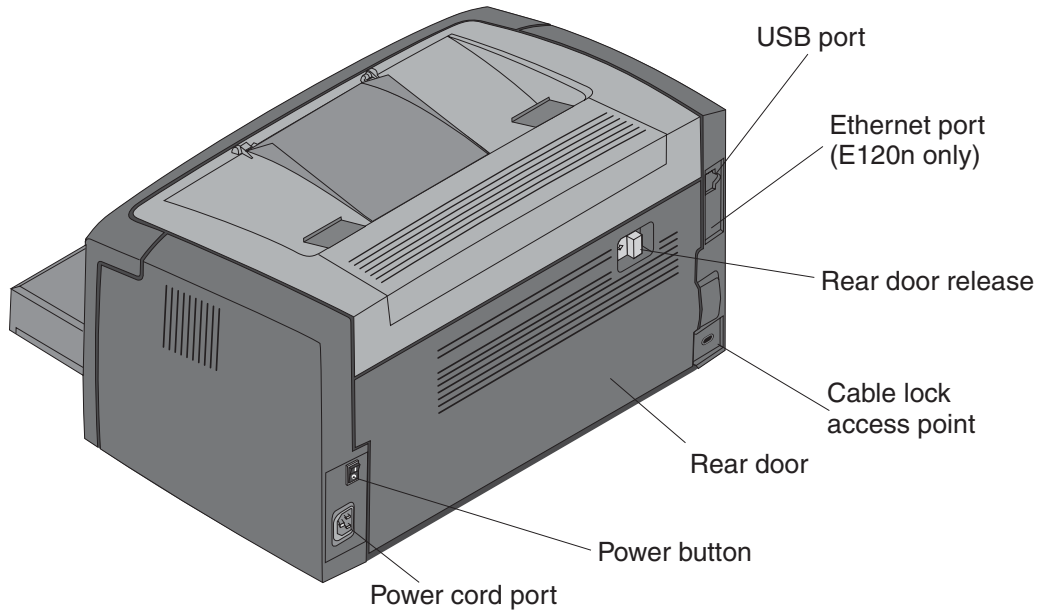

## Specifications

### Types of print media

Receive optimal use from the printer by properly loading trays. Never mix media types within a tray.

Source	Sizes	Types	Weight	Capacity <sup>1</sup> (sheets)
Primary Tray (tray 1)	A4, A5, JIS-B5, letter, legal, executive, folio, statement, universal <sup>2</sup>	Plain paper, bond paper, transparency, label	60–105 g/m <sup>2</sup> (16–28 lb)	<ul style="list-style-type: none"> <li>• 150 sheets</li> <li>• 5 transparencies</li> <li>• 5 labels</li> </ul>
	3 x 5 inch, other	Card stock	135–163 g/m <sup>2</sup> (36–43 lb) bond	5 cards
	7¼, 9, 10, DL, C5, B5, other	Envelope	105 g/m <sup>2</sup> (28 lb) max	5 envelopes
Priority feeder (manual feeder)	A4, A5, JIS-B5, letter, legal, executive, folio, statement, universal <sup>†</sup>	Plain paper, bond paper, transparency, label,	60–163 g/m <sup>2</sup> (16–43 lb)	<ul style="list-style-type: none"> <li>• 15 sheets</li> <li>• 5 transparencies</li> <li>• 5 labels</li> </ul>
	A6 (long grain only)	Plain paper, bond paper	60–163 g/m <sup>2</sup> (16–43 lb)	30 sheets
	3 x 5 inch, other	Card stock	135–163 g/m <sup>2</sup> (36–43 lb) bond	5 cards
	7¼, 9, 10, DL, C5, B5, other	Envelopes	105 g/m <sup>2</sup> (28 lb) max	3 envelopes
<sup>1</sup> Capacity for 20 lb print media, unless otherwise noted. <sup>2</sup> Universal size ranges: <ul style="list-style-type: none"> <li>• <b>Tray 1:</b> 76–216 x 190–356 mm (3.0–8.5 x 7.5–14.0 in.) (includes 3 x 5 in. cards)</li> <li>• <b>Priority feeder:</b> 76–216 x 190–356 mm (3.0–8.5 x 7.5–14.0 in.) (includes 3 x 5 in. cards)</li> </ul>				

### Choosing appropriate print media

To reduce printing problems and to receive the best print quality, try a sample of the media you are considering before buying large quantities.

Refer to the *Card Stock & Label Guide* available on the Lexmark Web site at [www.lexmark.com](http://www.lexmark.com) for more information about which print media provides optimum results.

#### Paper

- For the best print quality, use 20 lb (75 g/m<sup>2</sup>) xerographic, grain long paper. The printer can automatically feed paper weights from 16 to 28 lb bond (60 to 105 g/m<sup>2</sup>) grain long and (64 to 105 g/m<sup>2</sup>) grain short. Paper lighter than 16 lb (60 g/m<sup>2</sup>) might not be stiff enough to feed properly, causing jams.
- The laser printing process heats paper to high temperatures of 206°C (403°F). Use only paper able to withstand these temperatures without discoloring, bleeding, or releasing hazardous emissions. Check with the manufacturer or vendor to determine whether the chosen paper is acceptable for laser printers.



## Preprinted forms and letterhead

- Use only forms and letterhead printed using an offset lithographic or engraved printing process.
- Choose forms and letterhead types that absorb ink, but do not bleed.
- Avoid rough or heavily textured surfaces.  
Use media printed with heat-resistant inks designed for use in xerographic copiers. The ink must withstand temperatures of 200°C (392°F) without melting or releasing hazardous emissions. Use inks that are not affected by the resin in toner. Inks that are oxidation-set or oil-based should meet these requirements; latex inks might not. If in doubt, contact the supplier.

## Transparencies

- Use transparencies designed specifically for laser printers. Transparencies must be able to withstand temperatures of 185°C (365°F) without melting, discoloring, offsetting, or releasing hazardous emissions. We recommend Lexmark laser printer transparencies, part number 70X7240 for letter size transparencies; part number 12A5010 for A4 size transparencies.
- To prevent print quality problems, avoid getting fingerprints on transparencies.

## Envelopes

- Use envelopes made from 24 lb (90 g/m<sup>2</sup>) bond paper, or up to a maximum weight of 28 lb (105 g/m<sup>2</sup>).
- Use envelopes that can withstand temperatures of 185°C (365°F) without:
  - Sealing
  - Excessive curling
  - Wrinkling
  - Releasing hazardous emissions
- Do not use envelopes that:
  - Have excessive curl
  - Are stuck together
  - Are damaged in any way
  - Contain windows, holes, perforations, cutouts, or embossments
  - Have metal clasps, string ties, or metal folding bars
  - Have postage stamps attached
  - Have exposed adhesive when the flap is in the sealed position
  - Are self-sealing

If uncertain about the envelopes being considered for use, check with the supplier.
- A combination of high humidity (over 60%) and high printing temperatures may seal envelopes.

## Labels

- Use labels that can withstand temperatures of 185°C (365°F) without sealing, excessive curling, wrinkling, or releasing hazardous emissions. Label adhesives, face sheet (printable stock), and topcoats must also be able to withstand 25 pounds per square inch (psi) (172 kilopascals) of pressure.
- Do not use labels with exposed adhesive.
- Do not print a large number of labels continuously.
- Do not use vinyl labels.

## Card stock

- Use card stock that can withstand temperatures of 225°C (437°C).
- Use card stock up to a maximum weight of 43 lb (163 g/m<sup>2</sup>) bond and down to a minimum size of 76 x 127 mm (3 x 5 inch).
- Do not preprint, perforate, or crease card stock. This can significantly affect print quality and cause media handling or jamming problems.
- Avoid using card stock that may release hazardous emissions when heated.
- Do not use preprinted card stock manufactured with chemicals that may contaminate the printer. Preprinting introduces semi-liquid and volatile components into the printer.

## Storing print media

Use the following guidelines to avoid print media feeding problems and uneven print quality.

- Store all print media in an environment where temperature is approximately 21°C (70°F) and relative humidity is 40%.
- Store cartons of paper on a pallet or shelf rather than directly on the floor surface.
- If storing individual packages of paper out of the original carton, make sure they rest on a flat surface so edges do not buckle, curl, or become damaged.
- Do not place anything on top of paper packages.
- Store transparencies and envelopes in their original boxes.

---

## Tips on preventing jams

Most paper jams can be avoided by correctly loading paper and specialty media.

The following hints can help to avoid paper jams:

- Do not load wrinkled, creased, or damp paper.
- Never mix media types within a tray.
- Flex, fan, and straighten paper before loading it.
- Do not exceed the maximum stack height.
- Adjust all edge guides after loading media.
- Make sure the guides in the tray are positioned snugly against the paper or specialty media.
- Do not remove paper stacks while a job is printing. Wait for a **Load Paper** or **Ready** light sequence or message before loading the tray.
- Before loading transparencies, fan the stack to prevent sheets from sticking together.
- Do not use envelopes that:
  - Have excessive curl
  - Are stuck together
  - Are damaged in any way
  - Contain windows, holes, perforations, cutouts, or embossing
  - Have metal clasps, string ties, or metal folding bars
  - Have postage stamps attached
  - Have any exposed adhesive when the flap is in the sealed position
- Use only recommended paper. Refer to the *Card Stock & Label Guide* available on the Lexmark Web site at [www.lexmark.com](http://www.lexmark.com) for more information about which paper provides optimum results for the current printing environment.

---

## Tools

The removal and adjustment procedures require the following tools and equipment:

- Magnetic tip Phillips screwdrivers, large and small
- Volt-ohmmeter

---

## Acronyms

ASIC	Application Specific Integrated Circuit
CRC	Cyclic Redundancy Check
DEV	Developer Roll (of toner cartridge/photoconductor system)
DIMM	Dual In-Line Memory Module
EEPROM	Erasable Electrically Programmable Read-Only Memory
ENA	External Network Adapter
FRU	Field Replaceable Unit
HVPS	High Voltage Power Supply
LED	Light Emitting Diode
LVPS	Low Voltage Power Supply (110 V or 220 Vac)
NVRAM	Nonvolatile Random Access Memory
PC	Photoconductor
PCL	Printer Control Language
PCU	PC/Cleaner Unit
POR	Power-On Reset
POST	Power-On Self Test
PPDS	Personal Printer Data Stream
RIP	Raster Image Processor
TAR	Toner Add Roll
TU	Toner
USB	Universal Serial Bus
V ac	Volts alternating current
V dc	Volts direct current

## 2. Diagnostic information

### Start



**CAUTION:** Unplug power from the printer before connecting or disconnecting any other cable, assembly, or electronic card. This is a precaution for personal safety and to prevent damage to the printer.

This chapter contains the codes and diagnostic tools to aid in providing corrective action for a malfunctioning printer. To determine the corrective action to repair a printer, look for the following information:

- A description of a problem. See **“Symptom tables” on page 2-22.**
- Information from the operator panel of the printer
  - **Lexmark E120**—This model has an operator panel containing two lights and two buttons. For diagnostic information specific to these modes, see **“Diagnostics—E120” on page 2-2.**

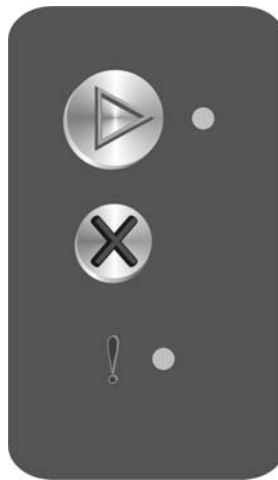

- **Lexmark E120n**—This model has an operator panel with six lights and two buttons. For diagnostic information specific to these models, see **“Diagnostics—E120n” on page 2-8.**

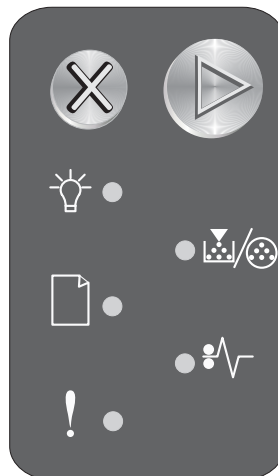

## Diagnostics—E120

### Power-On Self Test (POST) sequence

When you turn the printer on, it performs a POST. Check for correct POST functioning of the base printer by observing the following process:

1. All operator panel lights turn on momentarily.
2. Lights then flash on and off sequentially.
3. After the lights quit flashing, the Ready/Data light flashes until the fuser comes up to temperature (5–20 additional seconds, depending on the initial temperature of the fuser) and then stays on.
4. The motor drive and fan come on.
5. If there is a problem in the printer such as a paper jam, the panel lights indicate the problem. See “” on page 2-3 for more information.
6. The printer cycles down into standby mode, and the Ready/Data light comes on solid.

### Overview of the operator panel—E120

The printer operator panel has two buttons and two lights. Lights indicate the status of the printer. Buttons are used to continue or cancel the current print job.

When the printer is turned on, both lights cycle as a self test is performed. Also, when the printer is reset, or when a printer setting is changed in the menus, both lights cycle.

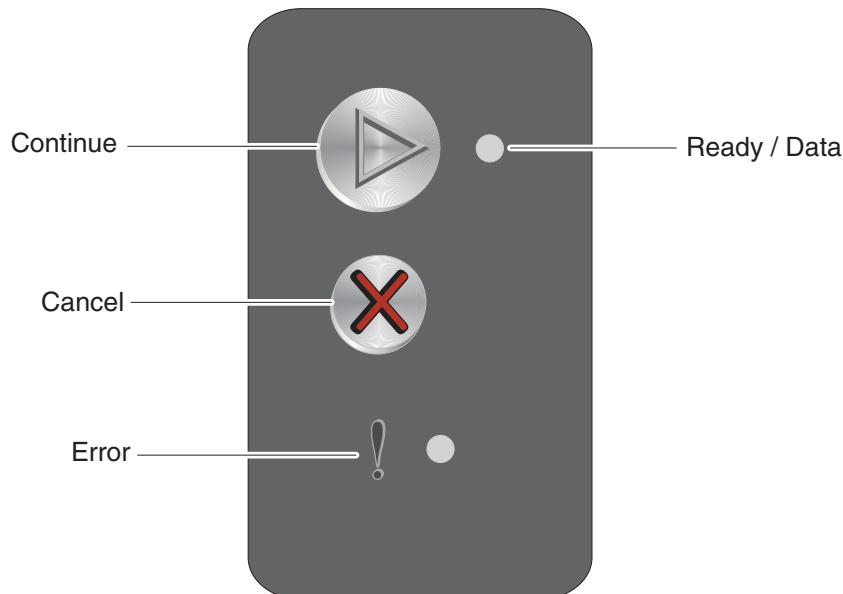

To learn more about the panel lights or to determine the status of the printer when lights are on, see “Light patterns and error messages” on page 2-3.



- Press and release **Continue** (▶) to resume printing.
- Press and release **Continue** (▶) twice quickly to display the secondary light sequence.
- Press and release **Continue** (▶) twice quickly to display the tertiary light sequences if present.
- Press and release **Continue** (▶) from the Ready state to print the menu settings page.
- Press and release **Cancel** (⊗) to cancel current job.
- Press and hold **Cancel** (⊗) until all lights come on to reset.

---

## Light patterns and error messages

User attendance messages, paper jam errors, and service errors display an initial light pattern. This may be all the information you need. However, if you double-click  on the panel, a second pattern may appear with more detailed information. If you double-click  again, a tertiary light pattern may appear. If there is not a tertiary pattern, the initial pattern reappears. Not all initial level light patterns have secondary patterns; when you double-click , the pattern does not change.

All service errors are indicated by all lights flashing as the primary notification or code. The secondary code indicates an area or function which has the error. Additional tertiary codes used for service (see **“Service codes” on page 2-6**) indicate specific errors. See **“” on page 2-3**.

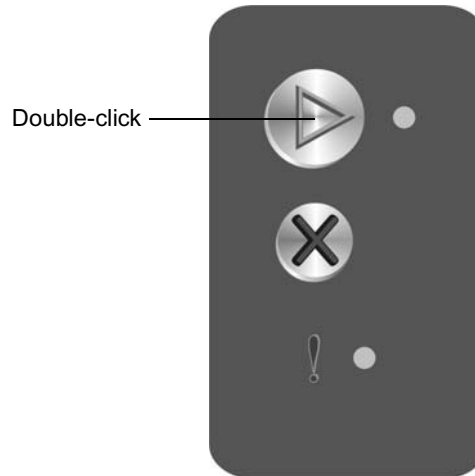



















**Note:** If you send data to the printer and all lights flash immediately, and double-clicking does not change the display, there may be a code problem. Call the next level of support.

### Primary, secondary, and tertiary light patterns

The table below uses the following symbols to indicate solid, or blinking light patterns. When a number accompanies the blinking symbol, it refers to the number of times the light turns off and on.

●	Light continuously on
	Light off
*	Light blinks continuously
3*	Light blinks three times, pauses and repeats pattern
x	Light blinking slowly

Primary		Secondary		Tertiary		Description	Action
Ready/ Data	!	Ready/ Data	!	Ready/ Data	!		
●						Ready/Power Saver	
x						Hex Trace Ready or Demo Mode ready	
*						Busy, printing job, printing font list, printing menu settings, printing the print quality test page.	
						Resolution reduced (no pattern displays)	
●	●					Flushing buffer, resolution reduced while cancelling job, resetting printer	
	*					Waiting or Not Ready (printer offline)	
	●					Close door	
*	*					Service error. Double-click  to display additional secondary and tertiary light patterns.	
	●	1*			1*	Close door (front door, rear door, or top cover door)	<ol style="list-style-type: none"> <li>1. Make sure the top cover door, front door and rear doors are closed.</li> <li>2. Make sure the front and rear door posts which close the switches are not damaged. Replace the door if the part is damaged.</li> <li>3. Check the switches of the front and rear doors. With the door closed, the outermost pins (1 and 5) of J14 or J11 should indicate continuity when checked with a meter. If a switch has failed, replace the printer.</li> </ol>
	●	1*			3*	13 Invalid engine code or the code is not programmed. Code must be successfully downloaded to continue.	If the printer has had a code update just prior to this message, reload the code. Otherwise, replace the controller card.
	●	3*			1*	31 Defective toner cartridge or missing cartridge	<ol style="list-style-type: none"> <li>1. Verify that the toner cartridge and PC kit are correctly installed.</li> <li>2. Wait 10–20 seconds for the printer to verify the units.</li> <li>3. Replace the toner cartridge or PC kit if necessary.</li> </ol>
	●	3*			2*	32 Unsupported toner cartridge	Replace the toner cartridge with one that is supported.
	●	3*			3*	33 Change cartridge or invalid refill	Install a new toner cartridge.

Primary		Secondary		Tertiary		Description	Action
Ready/ Data	!	Ready/ Data	!	Ready/ Data	!		
	●	3*			5*	35 Resource Save off; insufficient memory	<ol style="list-style-type: none"> <li>Briefly press  to temporarily disable Resource Save.</li> <li>Set Link Buffer to Auto.</li> </ol>
	●	4*			2*	42 Cartridge region mismatch	<p>While the message is displayed, the following steps may be taken:</p> <ol style="list-style-type: none"> <li>Go to the Diagnostics menu (see <b>“Diagnostic aids” on page 3-1</b>) and print the print quality test pages. The first page shows the regions under “Cartridge Information.”</li> <li>Change the cartridge to one corresponding to the region where the printer was purchased.</li> <li>Call the next level of support.</li> </ol>
	*	1*			2*	12 Load media, load the manual feeder, or load the tray to complete side two of the manual duplex.	<ol style="list-style-type: none"> <li>Load paper in the main tray.</li> <li>Check the driver for incorrect paper selections.</li> <li>Load paper for the manual duplex.</li> </ol>
	*	1*			4*	14 Not Ready	<ul style="list-style-type: none"> <li>Briefly press  to return to the Ready state.</li> <li>Briefly press  to return to the Ready state.</li> <li>Hold  longer to reset the printer.</li> </ul>
	*	3*			4*	34 Short paper	<ul style="list-style-type: none"> <li>Verify the actual paper size matches the selected size in the driver or application.</li> <li>Briefly press  to cancel the job.</li> <li>Briefly press  to clear the message and continue printing.</li> <li>Hold  longer to reset the printer.</li> </ul>
	*	3*			7*	37 Insufficient collation area, memory too full	<ul style="list-style-type: none"> <li>Set Collation to Off in driver.</li> <li>Briefly press  to cancel the job.</li> <li>Briefly press  to clear memory and continue printing the remainder of the job. Some data will be lost.</li> <li>Hold  longer to reset the printer.</li> </ul>
	*	3*			8*	38 Memory full	<ul style="list-style-type: none"> <li>Delete fonts, macros, and other data in RAM.</li> <li>Simplify the print job.</li> <li>Briefly press  to cancel the job.</li> <li>Briefly press  to clear the message and continue printing. Some data may be lost.</li> <li>Hold  longer to reset the printer.</li> </ul>
	*	3*			9*	39 Complex page	<ul style="list-style-type: none"> <li>Try simplifying the job.</li> <li>Briefly press  to cancel job.</li> <li>Briefly press  to clear message and continue printing.</li> <li>Hold  longer to reset the printer.</li> </ul>
	*	5*			4*	54 ENA connection lost during POR	<ul style="list-style-type: none"> <li>Check the connections to the ENA and POR the printer.</li> <li>Briefly press  to clear the message.</li> </ul>
	*	8*			4*	84 Photoconductor near full	<ul style="list-style-type: none"> <li>Customer should make plans to replace the PC kit.</li> <li>Briefly press  to clear the message and continue printing.</li> </ul>



Primary		Secondary		Tertiary		Description	Action
Ready/ Data	!	Ready/ Data	!	Ready/ Data	!		
	*	8*			8*	88 Toner low	<ol style="list-style-type: none"> <li>1. Replace the toner cartridge.</li> <li>2. Briefly press  to clear the message and continue printing.</li> </ol>
	*	10*	●	●	1*	201 Paper jam between input sensor and exit sensor	<ol style="list-style-type: none"> <li>1. Open the rear and top doors, remove the PC kit if necessary and clear the paper jam.</li> <li>2. Check the paper path for the cause of the jam and repair as necessary.</li> </ol>
	*	10*	●	●	2*	202 Paper jam at the exit sensor	<ol style="list-style-type: none"> <li>1. Open the rear and top doors and remove the paper jam.</li> <li>2. Check the paper path for the cause of the jam and repair as necessary.</li> </ol>
	*	10*	●	●	10*	200 Paper jam at the input sensor	<ol style="list-style-type: none"> <li>1. Open the front and rear covers, remove the toner cartridge and PC kit if necessary. Remove the paper jam.</li> <li>2. Check the paper path for the cause of the jam and repair as necessary.</li> </ol>
<b>Service codes</b>							
*	*	10*			10*	900	Reprogram or replace the controller card. See <b>“Controller card removal” on page 4-17.</b>
*	*	10*			1*	901 Service—Engine flash error	Flash memory if faulty. Replace the controller card. See <b>“Controller card removal” on page 4-17.</b>
*	*	10*			2*	902 Engine service errors	Replace the controller card. See <b>“Controller card removal” on page 4-17.</b>
*	*	10*			3*	903 Engine service errors	
*	*	10*			4*	904 Engine service errors	
*	*	10*			5*	905 Engine service errors	
*	*	10*			6*	906 Engine service errors	
*	*	1*			7*	917 Transfer roll	Check the circuitry. See <b>“Transfer roll service check” on page 2-41.</b>
*	*	2*			10*	920 Fuser is below temperature.	<ul style="list-style-type: none"> <li>• Check all connectors to the fuser assembly.</li> <li>• Replace the fuser. See <b>“Fuser removal” on page 4-20.</b></li> </ul>
*	*	2*			1*	921 Fuser is below standby temperature.	
*	*	2*			2*	922 Fuser failed to reach standby temperature.	
*	*	2*			3*	923 Fuser is too hot during printing or at idle.	
*	*	2*			4*	924 The thermistor has an open circuit.	
*	*	2*			5*	925 Incorrect fuser lamp	



Primary		Secondary		Tertiary		Description	Action
Ready/ Data	!	Ready/ Data	!	Ready/ Data	!		
*	*	3*			10*	930 Wrong printhead installed	<ul style="list-style-type: none"> <li>• Check all connections to the printhead.</li> <li>• Replace the printhead. See <b>“Printhead removal” on page 4-12.</b></li> </ul>
*	*	3*			1*	931 No first HYSNC	
*	*	3*			2*	932 Lost HYSNC	
*	*	3*			3*	933 Mirror motor locked	
*	*	3*			4*	934 Mirror motor lost lock.	
*	*	3*			5*	935 Mirror motor unable to reach operating speed	
*	*	3*			6*	936 Transport motor initial lock failed	<ul style="list-style-type: none"> <li>• Check the connection to the main motor.</li> <li>• Verify continuity in the cable.</li> <li>• Call the next level of support.</li> </ul>
*	*	3*			7*	937 Transport motor lost lock	
*	*	3*			9*	939 RIP to engine communications error	Replace the controller card. See <b>“Controller card removal” on page 4-17.</b>
*	*	4*			10*	940 Zero crossing failure	<ul style="list-style-type: none"> <li>• Check the connections on the LVPS card.</li> <li>• Replace the LVPS. See <b>“LVPS/HVPS removal” on page 4-19.</b></li> </ul>
*	*	5*			10*	950 Controller card failure—Data mismatch between secure EEPROM and NVRAM	<p>If either the operator panel or controller card were replaced proceeding the error message, then either an incorrect card was installed or the printer was improperly powered on.</p> <p><b>Note:</b> The controller card and operator panel cannot be replaced at the same time without a POR in between. Printer settings on each FRU are obtained from the other. The settings are lost if both are installed and powered on at the same time.</p>
*	*	5*			1*	951 Controller card failure—Secure EEPROM failure	
*	*	5*			2*	952 NVRAM CRC failure	<ul style="list-style-type: none"> <li>• Check all the connections on the controller card.</li> <li>• Replace the controller card. See <b>“Controller card removal” on page 4-17.</b></li> </ul>
*	*	5*			4*	954 NVRAM chip failure	
*	*	5*			5*	955 Code ROM/NAND failure	<p>Replace the controller card. See <b>“Controller card removal” on page 4-17.</b></p>
*	*	5*			6*	956 Controller card failure	
*	*	5*			7*	957 Controller card failure	
*	*	5*			9*	959 Controller card failure	
*	*	5*			8*	958 NAND failure	
*	*	6*			10*	960 RAM memory errors	
							Replace the controller card. See <b>“Controller card removal” on page 4-17.</b>

Primary		Secondary		Tertiary		Description	Action
Ready/ Data	!	Ready/ Data	!	Ready/ Data	!		
*	*	8*			10*	980 Engine is experiencing unreliable communications with the specified device.	Replace the controller card. See <b>“Controller card removal” on page 4-17.</b>
*	*	8*			1*	981 Engine protocol violation is detected by the device.	
*	*	8*			2*	982 Communication error is detected by the specified device.	
*	*	8*			3*	983 Invalid command is received by the specified device.	
*	*	8*			4*	984 Invalid command parameter is received by the specified device.	
*	*	9*			10*	990 Device equipment check	Replace the controller card. See <b>“Controller card removal” on page 4-17.</b>
*	*	9*			1*	991 Device system card failure	Replace the controller card. See <b>“Controller card removal” on page 4-17.</b>

## Diagnostics—E120n

### Power-On Self Test (POST) sequence

When you turn the printer on, it performs a POST. Check for correct POST functioning of the base printer by observing the following process:

1. All operator panel lights turn on momentarily.
2. Lights then flash on and off sequentially.
3. After the lights quit flashing, the  light flashes until the fuser comes up to temperature (5–20 additional seconds, depending on the initial temperature of the fuser) and then stays on.
4. The motor drive and fan come on.
5. If there is a problem in the printer such as a paper jam, the panel lights indicate the problem. See **“Common primary light patterns—E120n” on page 2-9** for more information.
6. The printer cycles down into standby mode, and  lights solid.

## Overview of the operator panel—E120n

The printer operator panel has two buttons and six lights (the Continue button is both a light and button). Lights indicate the status of the printer. Buttons are used to continue or cancel the current print job.

When the printer is turned on, all lights cycle as a self test is performed. Also, when the printer is reset, or when a printer setting is changed in the menus, all lights cycle.

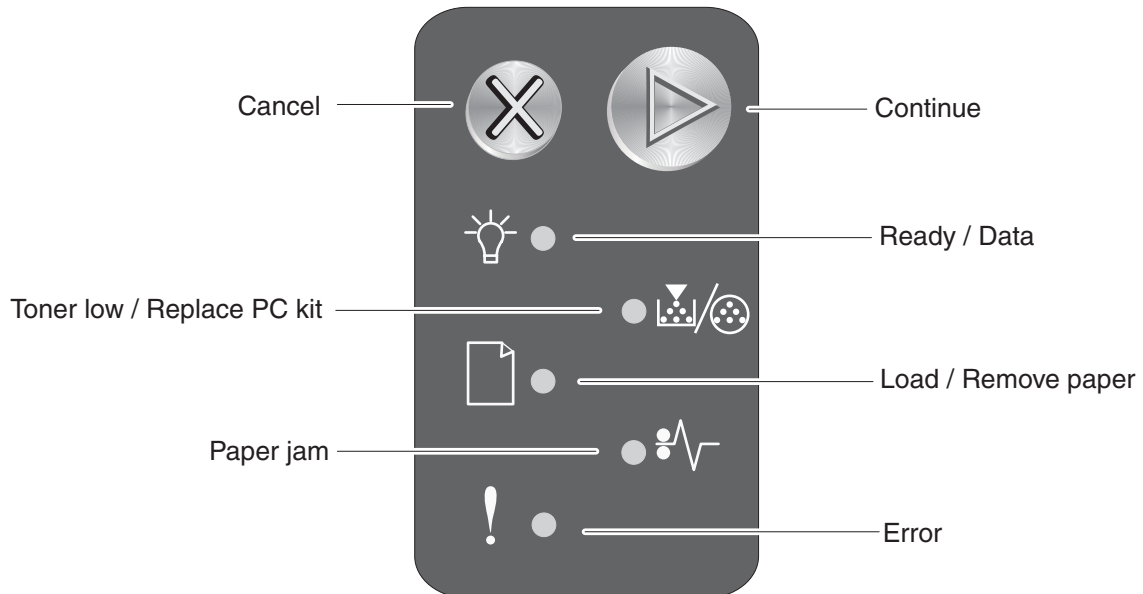

- Press and release **Continue** (▶) to resume printing.
- Press and release **Continue** (▶) from the Ready state to print the menu pages.
- Press and release **Continue** (▶) twice quickly to display the secondary light sequence.
- Press and release **Continue** (▶) twice quickly to display the tertiary light sequence.
- Press and release **Cancel** (⊗) to cancel the current job.
- Press and hold **Cancel** (⊗) until all of the lights come on to reset the printer.

## Common primary and secondary light patterns

### Common primary light patterns—E120n

The table below uses the following symbols to indicate solid or blinking light patterns.

●	Light on
	Light off
*	Light blinking
x	Light blinking slowly

In the table below, white rows are primary codes, and secondary codes are in gray.











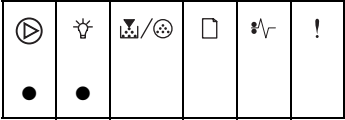







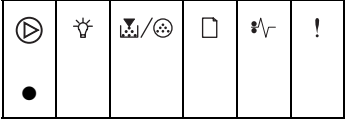

The secondary light pattern is related to the primary light pattern immediately preceding it.

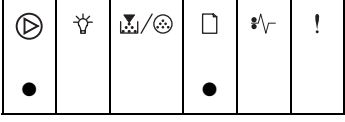

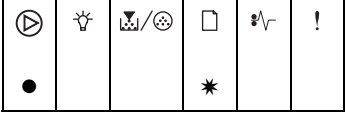

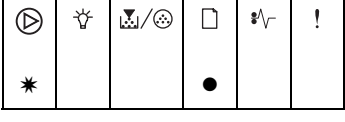



						Description/action
	●					Ready/Power Saver. See <b>“Ready/Power Saver” on page 2-11.</b>
	*					Busy (processing or printing). See <b>“Busy” on page 2-11.</b>
	x					Hex Trace Ready. See <b>“Hex Trace Ready” on page 2-11.</b>
●	●					Waiting. See <b>“Waiting” on page 2-12</b>
	*				*	Flushing/Resolution reduced. See <b>“Flushing / Resolution reduced” on page 2-12.</b>
●						Not Ready (printer offline). See <b>“Not ready” on page 2-12.</b>
					●	Close door. See <b>“Close door / Insert cartridge” on page 2-12.</b>
●			●			Load media. See <b>“Load media” on page 2-12.</b>
●			*			Load manual feeder. See <b>“Load manual feeder” on page 2-12.</b>
*			●			Print side two of a duplex job. See <b>“Print side two of duplex job” on page 2-12.</b>
		●				Toner low. See <b>“Toner low” on page 2-13.</b>
●		*				Replace the photoconductor. See <b>“Replace the photoconductor kit” on page 2-13.</b>
●				●		Paper jam. Press and release  twice briefly to display secondary error codes.
●	●			●		200 Paper jam input sensor. See <b>“200 Paper jam at the input sensor” on page 2-14.</b>
●		●		●		201 Paper jam between input and exit sensors. See <b>“201 Paper jams between the input sensor and exit sensor” on page 2-14.</b>
●			●	●		202 Paper jam exit sensor. See <b>“202 Paper jams as a printed job exits the printer.” on page 2-15.</b>
		●			●	Cartridge errors. Press and release  twice briefly to display secondary error codes.
		●	*		●	42 Cartridge region mismatch. Install the correct cartridge.
		●		*	●	33 Change cartridge/invalid refill. Install a new cartridge.
		●		●	●	31 Defective cartridge/missing cartridge
		●	●		●	32 Unsupported toner cartridge
	●				●	Invalid engine code/Invalid network code
	●		●		●	Invalid engine code
	●		*		●	Invalid network code
	●	●	●			Programming engine code/Programming system code
●	●	●	●	●	●	Cancel job/Reset printer
●					●	Printer error. Press and release  twice briefly to display secondary error codes.
●				●	●	Standard network software error in the manual feeder
●	●				●	Complex page. See <b>“Complex page” on page 2-15.</b>
●	*				●	Insufficient printer memory
●		●			●	Insufficient collation area

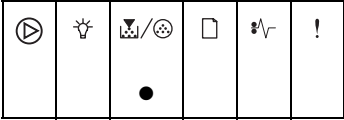

**Primary codes—additional information (continued)**

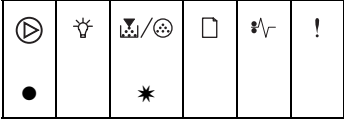

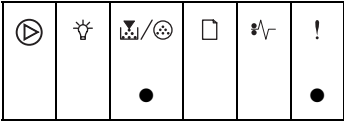
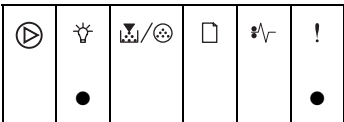

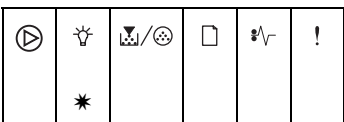
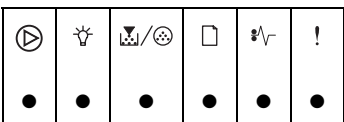
Description/ Light pattern	Meaning	Action
<p>Waiting</p> 	<p>Printer is waiting until a print timeout occurs, or until it receives additional data.</p>	<ul style="list-style-type: none"> <li>• Press and release  to print the contents of the print buffer.</li> <li>• Press and release  to cancel the print job.</li> <li>• Press and hold  to reset the printer.</li> </ul>
<p>Flushing / Resolution reduced</p> 	<ul style="list-style-type: none"> <li>• Printer is flushing corrupted print data.</li> <li>• Printer is processing data or printing pages, but the resolution of a page in the current print job is reduced from 600 dots per inch (dpi) to 300 dpi to prevent a memory full error.</li> </ul>	<ul style="list-style-type: none"> <li>• Wait until  is on to print other jobs.</li> <li>• Press and release  to cancel print job.</li> <li>• Press and hold  to reset printer.</li> </ul>
<p>Not ready</p> 	<p>Printer is not ready to receive or process data, or the printer ports are offline.</p>	<ul style="list-style-type: none"> <li>• Press  to return to the Ready or Busy state.</li> <li>• Press and release  to cancel the print job.</li> <li>• Press and hold  to reset the printer.</li> </ul>
<p>Close door / Insert cartridge</p> 	<p>The printer door is open.</p>	<ul style="list-style-type: none"> <li>• Close the door.</li> <li>• Check the switches and cables under the left cover.</li> </ul>
<p>Load media</p> 	<p>The printer is out of media, or the media did not feed properly, thereby not making it to the input sensor in the allotted time.</p>	<ul style="list-style-type: none"> <li>• Load media into tray 1 and press  to resume printing.</li> <li>• Check that the media is loaded correctly in tray 1. (Do not overfill.)</li> <li>• Press  to cancel the print job.</li> </ul>
<p>Load manual feeder</p> 	<p>Printer prompts to load a single sheet of media in the manual feeder.</p>	<ul style="list-style-type: none"> <li>• Load media in the manual feeder with the side to be printed facing up.</li> <li>• Press  to resume printing.</li> <li>• Press and hold  to reset the printer.</li> </ul>
<p>Print side two of duplex job</p> 	<p>Print the other side of a duplex print job.</p>	<ul style="list-style-type: none"> <li>• Reinsert the print job in tray 1 using the instructions in the driver pop-up menu to orient the pages correctly (printed side up, loading edge to front of the printer).</li> <li>• Press  to resume printing.</li> <li>• Press and hold  to reset the printer.</li> </ul>

## Primary codes—additional information (continued)



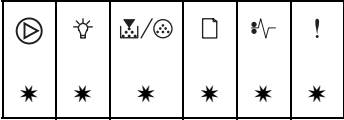



Description/ Light pattern	Meaning	Action
<p>Toner low</p> 	<p>The toner in the toner cartridge is getting low.</p>	<ul style="list-style-type: none"> <li>• Send a print job.</li> <li>• Press  to print the menu settings page for a list of current settings.</li> <li>• Remove the toner cartridge, and shake it to extend the life of the cartridge.</li> <li>• Replace the toner cartridge.</li> <li>• Press and hold  to reset the printer.</li> </ul> <p><b>Note:</b> The  light may not come on if the starter toner cartridge is installed in a base model.</p>
<p>Replace the photoconductor kit</p> 	<p>The photoconductor kit drum is full and needs to be replaced.</p>	<ul style="list-style-type: none"> <li>• Press  to resume printing.</li> <li>• Replace the photoconductor kit.</li> <li>• Reset the counter.</li> </ul>
<p>toner cartridge error / toner cartridge is not installed</p> 	<p>The toner cartridge is not installed, or the printer detects a toner cartridge error.</p> <p>The error is caused by a defective cartridge, an unsupported cartridge, an invalid refill, or a cartridge meant to be used in another geographic region.</p>	<ul style="list-style-type: none"> <li>• If the toner cartridge is not installed, install it.</li> <li>• If the toner cartridge is installed, remove it and install a new toner cartridge.</li> </ul>
<p>Invalid engine code / Invalid network code</p> 	<p>The code in an internal print server has not been programmed, or the programmed code is not valid.</p>	<ul style="list-style-type: none"> <li>• Download valid network code to the internal print server.</li> <li>• Press  twice quickly to see the secondary error code.</li> </ul>
<p>Programming engine code / Programming system code</p> 	<p>New code is being loaded into the engine or firmware code flash.</p>	<p>Wait for the message to clear. When the printer has finished loading the code, it performs a soft reset.</p>
<p>Cancel job / Reset printer</p> 	<ul style="list-style-type: none"> <li>• The current print job is canceled.</li> <li>• The printer is resetting to the user default settings. <ul style="list-style-type: none"> <li>– Any active print jobs are canceled.</li> <li>– A user default setting remains in effect until changed or until the printer is restored to factory default settings.</li> </ul> </li> </ul>	<p>Wait for the message to clear.</p>



**Primary codes—additional information (continued)**

Description/ Light pattern	Meaning	Action
<p>Service error</p> 	<p>The printer has a service error, and printing has stopped.</p>	<p>Turn the printer off and back on.</p> <p>If the lights are still blinking, contact the next level of support.</p> <p>Press and release  twice quickly to view the secondary message. See <b>“Service primary code” on page 2-18.</b></p>
<p>Printer error</p> 	<p>The printer has one of the following errors:</p> <ul style="list-style-type: none"> <li>• Memory is full, insufficient to save what is in the buffer, or insufficient to defragment flash memory.</li> <li>• A page is too complex to print or is shorter than the set page margins.</li> <li>• Resolution of a formatted page is reduced to 300 dpi.</li> <li>• A font error occurred.</li> <li>• Communication with the host computer is lost.</li> </ul>	<ul style="list-style-type: none"> <li>• Press  twice quickly to see the secondary error code. See <b>“Additional information—secondary light patterns” on page 2-14</b> for more information.</li> <li>• Press  to clear the secondary message.</li> </ul>

**Additional information—secondary light patterns**

- When the  and  lights are both on, a secondary error has occurred.
- When the  and  lights are both on, a paper jam secondary error has occurred.
- When the  and  lights are both on, a toner cartridge error has occurred.



Press and release  twice to display the secondary error code light pattern.

The following tables show what these light patterns mean and what to do.

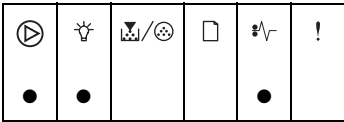
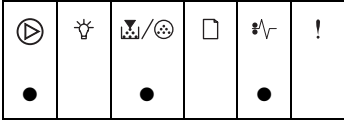



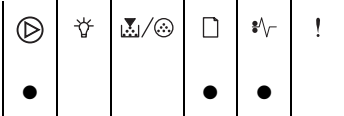
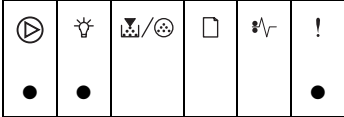

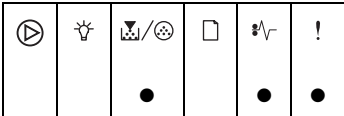
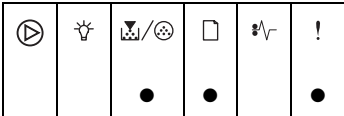
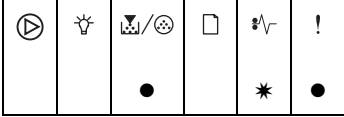
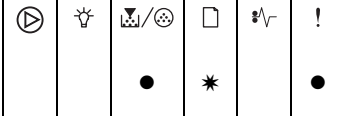



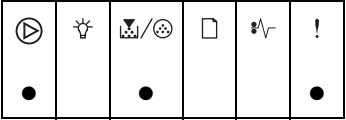

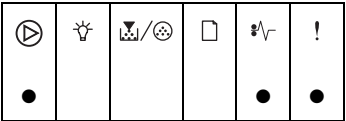

**Secondary light patterns—additional information**

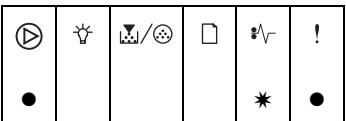
Description/ Light pattern	Meaning	Action
<p>200 Paper jam at the input sensor</p> 	<p>Media has stopped over the input sensor.</p>	<p>Open the front and rear covers and remove the toner cartridge to access the area. Check for obstructions and remove them.</p>
<p>201 Paper jams between the input sensor and exit sensor</p> 	<p>Paper has cleared the input sensor but not made it to the exit sensor.</p>	<p>Open the front and rear doors and check the paper path for obstacles. The fuser should be inspected.</p>

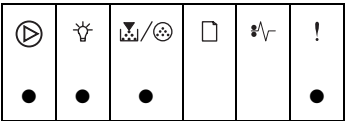
## Secondary light patterns—additional information (continued)

Description/ Light pattern	Meaning	Action
<p>202 Paper jams as a printed job exits the printer.</p> 	A paper jam has occurred as the paper is exiting the printer.	Open the rear and top doors and clear the paper jam.
<p>Complex page</p> 	The page may not print correctly because the print information on the page is too complex (that is, too large for the printer memory).	<ul style="list-style-type: none"> <li>• Press  to clear the message and continue processing the print job (some of the print data may be lost).</li> <li>• To avoid this error in the future: <ul style="list-style-type: none"> <li>– Reduce the complexity of the page by reducing the amount of text or graphics on the page and deleting unnecessary downloaded fonts or macros.</li> <li>– Set <b>Page Protect</b> to on in the Local Printer Setup Utility.</li> </ul> </li> <li>• Install additional printer memory.</li> </ul>
<p>31 toner cartridge missing or defective</p> 	The toner cartridge is either missing or defective.	<ul style="list-style-type: none"> <li>• Install the correct toner cartridge and PC kit.</li> <li>• Check the toner cartridge and PC kit contacts at the upper left side.</li> </ul>
<p>32 Unsupported toner cartridge</p> 	The toner cartridge is unsupported.	Replace the cartridge.
<p>33 Invalid refill</p> 	The toner cartridge has an invalid refill.	Replace the cartridge.
<p>42 Region mismatch</p> 	The toner cartridge was manufactured for a different geographic region than the printer.	<p>Replace the cartridge with a cartridge from the same region as the printer.</p> <p>Go to the Diagnostics menu (see <b>“Diagnostic aids” on page 3-1</b>) and print the print quality test pages. The first page shows the regions under “Cartridge Information.”</p> <p>If the printer has been moved from a different geographic location, call the next level of support.</p>

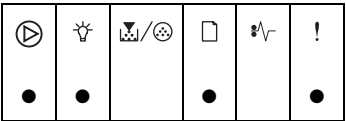

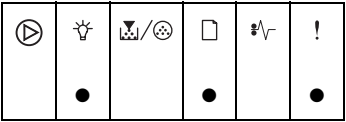
**Secondary light patterns—additional information (continued)**

Description/ Light pattern	Meaning	Action
<p>37 Insufficient collation area</p> 	<p>The printer memory does not have the free space necessary to collate the print job. This may happen due to one of these errors:</p> <ul style="list-style-type: none"> <li>• Memory is full.</li> <li>• A page is too complex to print.</li> <li>• A page is shorter than the set page margins.</li> <li>• Memory is insufficient to save what is in the buffer.</li> </ul>	<ul style="list-style-type: none"> <li>• Press  to clear the message and continue printing the job (the job may not print correctly).</li> <li>• Press and release  to cancel the print job.</li> <li>• Press and hold  to reset the printer.</li> <li>• To avoid this error in the future: <ul style="list-style-type: none"> <li>– Simplify the print job. Reduce the complexity of the page by reducing the amount of text or graphics on the page and deleting unnecessary downloaded fonts or macros.</li> <li>– Install additional printer memory.</li> </ul> </li> </ul>
<p>Network interface errors</p> 	<p>The printer cannot establish communication with the network.</p>	<p>Press  to clear the message and continue printing (the job may not print correctly).</p>
<p>54 Network or ENA connection lost</p> 	<p>The printer has lost the connection to an external print server (also called an external network adapter or ENA).</p> <p>This light pattern is displayed if your printer is connected to the network, but it cannot detect the print server when you turn on the printer.</p>	<ul style="list-style-type: none"> <li>• Make sure the cable connecting the ENA and the printer is securely attached.</li> <li>• Turn the printer off and then on to reset the printer.</li> <li>• Press and hold  to reset the printer.</li> </ul>
<p>Memory full</p> 	<p>The printer is processing data, but the memory used to store pages is full.</p>	<ul style="list-style-type: none"> <li>• Press  to clear the message and continue printing the job (the job may not print correctly).</li> <li>• Press and release  to cancel the print job.</li> <li>• Press and hold  to reset the printer.</li> <li>• To avoid this error in the future: <ul style="list-style-type: none"> <li>Simplify the print job. Reduce the complexity of the page by reducing the amount of text or graphics on the page and deleting unnecessary downloaded fonts or macros.</li> </ul> </li> </ul>
<p>Short paper</p> 	<p>The paper length is too short to print the formatted data. This occurs when the printer does not know the media size loaded in the tray, or there is a problem feeding the media.</p>	<ul style="list-style-type: none"> <li>• Make sure the print media you loaded is large enough.</li> <li>• Open the front cover, clear the paper path, and close the cover to resume printing.</li> <li>• Press  to clear the message and continue printing the job.</li> <li>• Press  to cancel the print job.</li> </ul>
<p>Invalid engine code</p> 	<p>The code in an internal print server has not been programmed, or the programmed code is not valid.</p>	<p>Download valid engine code to the internal print server.</p>

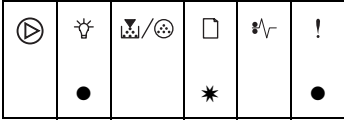

## Secondary light patterns—additional information (continued)

Description/ Light pattern	Meaning	Action
Invalid network code 	The code in an internal print server has not been programmed, or the programmed code is not valid.	Download valid network code to the internal print server.

## Service codes

All service errors are indicated by all lights flashing as the primary notification or code. The secondary light pattern indicates an area or function which has the error. Tertiary codes (shown on the following pages) indicate specific device errors. When all lights flash, double-click  to see the secondary code. Double-click  again to see the tertiary code. If you double-click again, you return to the primary light pattern.

In the following example:

- The primary light pattern indicates a service error (all flashing). Double-click  for more information.
- The secondary light pattern indicates a fuser or toner sensor error. Double-click  for more information.
- The tertiary light pattern indicates that the fuser is below temperature when printing. If you double-click again, the original primary light pattern will appear.

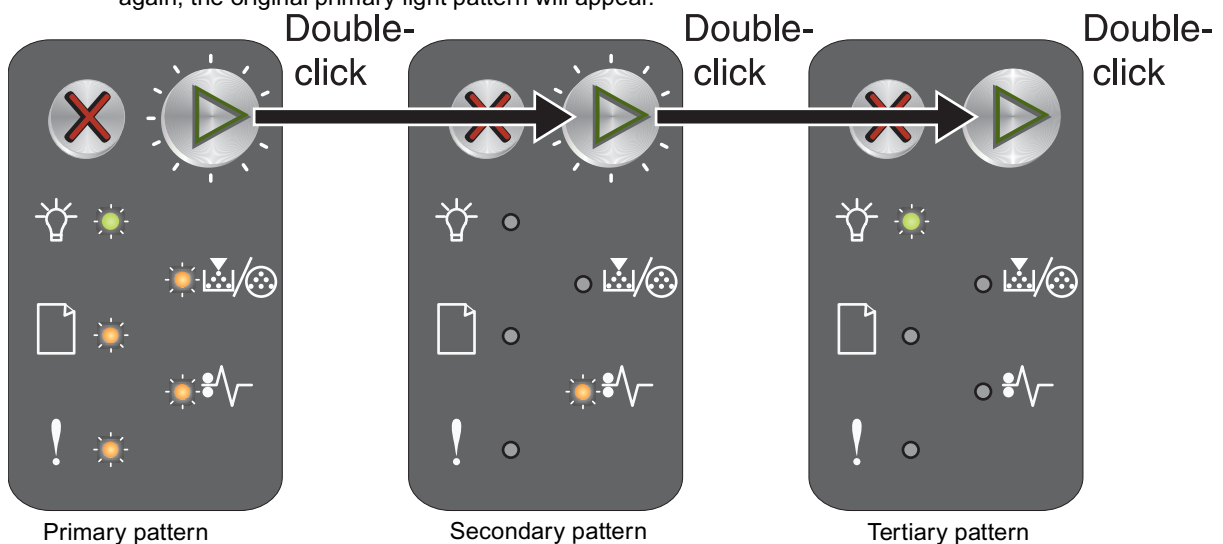





**Note:** If you send data to the printer and all lights flash simultaneously, and double-clicking  does not produce a secondary code, you may have a code problem. Call the next level of support.

### Service primary code

When this code appears, double-click  to reveal the secondary codes.





●	Light on
	Light off
*	Light blinking
x	Light blinking slowly

					!	Description/action
*	*	*	*	*	*	This service primary code indicates that a secondary code is available.

### Service secondary error codes

						Secondary light pattern
--	--	--	--	--	--	-------------------------

### Service secondary light patterns

					!	Description/action
*						90x Software
*					*	91x DC motor or transfer roll
*				*		92x Fuser or toner sensor
*				*	*	93x Printhead, drive motor, RIP to engine
*			*			94x RIP to engine communications, engine electronics
*			*		*	95x Controller card (NVRAM, ROM, or NAND)
*			*	*		96x RAM memory
*			*	*	*	97x Network
*		*				98x Paper port communications
*		*		*		Programming error
*		*	*	*	*	Unsupported firmware/controller card

### Service tertiary error codes







Service error codes are generally non-recoverable except in an intermittent condition when you can POR (power-on reset) the printer to temporarily recover from the error.

**Note:** All service errors are initially communicated by all lights flashing which is the primary indication or code. For brevity, this indication is not repeated in the following codes.

## Controller software

Controller software errors are in the 90x group/illegal trap (90x).

### Service tertiary light patterns—controller software (90x)

						Description/action	
*						When this secondary code is received, one of the following tertiary light patterns is available.	
	*					900 RIP error	Replace the controller card or reload the engine code. See <b>“Controller card removal” on page 4-17.</b>
	*				*	901 Engine error	
	*			*		902	
	*			*	*	903	
	*		*			904	
	*		*		*	905	
	*		*	*		906	







## Transfer roll



**CAUTION:** When you see this symbol, there is a danger from hazardous voltage in the area of the product where you are working. Unplug the product before you begin, or use caution if the product must receive power in order to perform the task.

Code 917 indicates a problem in the transfer roll circuitry.

### Service tertiary light patterns—transfer roll (91x)

						Description/action	
*					*	When this secondary code is received, one of the following tertiary light patterns is available.	
	*		*	*	*	917 Transfer roll circuitry	Check the continuity from the cable connection on the HVPS (high voltage power supply) to the right side of the transfer roll.

### Fuser

Codes 920 through 925 indicate a problem in the fuser (see **“Fuser service check”** on page 2-26 for more information) or toner cartridge.

#### Service tertiary light patterns—fuser (92x)

						Description/action	
*				*		When this secondary code is received, one of the following tertiary light patterns is available.	
	*					920 Fuser below temperature when printing	Replace the fuser.
	*			*		921 Fuser below standby temperature (see <b>“Fuser service check”</b> on page 2-26 for more information)	
	*			*		922 Fuser failed to reach standby temperature	
	*			*	*	923 Fuser too hot during printing or idle	
	*		*			924 Open circuit in thermistor path	
	*		*		*	925 Incorrect fuser lamp installed.	Check the AC voltage. Change the fuser to match the voltage.

### Printhead, transport motor, or RIP/engine communication error

Codes 930 through 935 indicate a problem with the printhead. Check cables to the printhead. Replace the printhead as necessary.

Codes 936 and 937 indicate a problem in the drive system.

Code 939 indicates a communication failure between the RIP and engine processors.

#### Service tertiary light patterns—printhead, transport motor, or RIP/engine communication error (93x)

						Description/action	
*				*	*	When this secondary code is received, one of the following tertiary light patterns is available.	
	*					930 Wrong printhead	Check connectors. Replace the printhead.
	*			*		931 No first HYSNC	
	*			*		932 Printhead lost HYSNC	
	*			*	*	933 Mirror motor locked but no HYSNC	
	*		*			934 Mirror motor lost lock	
	*		*		*	935 Mirror motor not at operating speed.	

### Service tertiary light patterns—printhead, transport motor, or RIP/engine communication error (93x)

	*		*	*		936	Transport motor initial lock failure	Replace the printer or call the next level of support.
	*		*	*	*	937	Transport motor lost lock	
	*	*			*	939	RIP/engine communication error	

### LVPS/HVPS failure

### Service tertiary light patterns—printhead, transport motor, or RIP/engine communication error (94x)

						Description/action	
*			*			Zero signal for fuser control has failed on LVPS.	
	*					940	Replace the LVPS/HVPS. See <b>“LVPS/HVPS removal” on page 4-19.</b>

### NVRAM failure

Error codes 950–954 indicate a problem in the NVRAM (nonvolatile random access memory). Replace the operator panel assembly. Codes 955–959 indicate a failed controller card. Replace the controller card. See **“Controller card removal” on page 4-17.**

**Note:** NVRAM is on the operator panel printed circuit board while secure NVRAM is on the controller card. Check margin alignments after replacing the operator panel assembly. If margin errors are unacceptable, corrections can only be made through software. Contact the next level of support.

### Service tertiary light patterns—NVRAM failure (95x)

						Description/action		
*			*		*	When this secondary code is received, one of the following tertiary light patterns is available.		
	*					950	Secure EEPROM data does not match NVRAM.	Check the connectors for the operator panel.
	*				*	951	Secure EEPROM failure	Replace the operator panel, if necessary.
	*			*		952	NVRAM CRC failure	
	*		*			954	NVRAM chip failure	
	*		*		*	955	Code ROM or NAND failed CRC	Check the connectors for the controller card.
	*		*	*		956	Processor failure	Replace controller card, if necessary.
	*		*	*	*	957	ASIC failure	
	*	*				958	NAND failure	
	*	*			*	959	SRAM failure	



### RAM memory error

This error indicates RAM failure.

#### Service tertiary light patterns—RAM memory error (96x)

						Description/action	
*			*	*		When this secondary code is received, the following tertiary light pattern is available.	
	*					960 RAM soldered on the board is bad	<ul style="list-style-type: none"> <li>• POR the printer.</li> <li>• Replace the controller card.</li> </ul>

### Network error

Indicates an error in the network circuitry.

#### Service tertiary light patterns—Network error (97x)

						Description/action	
*			*	*	*	When this secondary code is received, one of the following tertiary light patterns is available.	
	*		*		*	975 Unrecognizable network port	Replace the controller card. See <b>“Controller card removal”</b> on page 4-17.
	*		*	*		976 Unrecoverable software error in network port.	
	*	*				978 Bad checksum while programming port	
	*	*			*	979 Flash parts failed while programming port	

## Symptom tables

### POST symptom table

Symptom	Action
The main motor, cooling fan, and fuser do not come on.	See <b>“Main motor service check”</b> on page 2-28.
POST completes, except one or more lights do not come on.	See <b>“Operator Panel Service Check”</b> on page 2-25.
None of the lights come on.	See <b>“Controller card service check”</b> on page 2-24.
Main motor does not come on.	See <b>“Main motor service check”</b> on page 2-28.
Fan does not come on.	See <b>“Fan noisy or not working.”</b> on page 2-23.
The paper feed picks and tries to feed paper.	See <b>“Paper feed service checks”</b> on page 2-29.

**Printer symptom table**

Symptom	Action
Dead machine (no power).	See <b>“Dead machine service check” on page 2-25.</b>
Fan noisy or not working.	Unplug the fan at CN404 on the LVPS/HVPS. Turn the printer on and verify +24 V dc on pin 1. If the voltage is not correct, replace the LVPS/HVPS. If it is correct, the most likely failure is the fan. Contact the next level of support.
Fuser parts melted.	See <b>“Hot fuser service check” on page 2-27.</b>
Fuser lamp does not light.	See <b>“Fuser service check” on page 2-26.</b>
Fuser lamp never turns off.	See <b>“Hot fuser service check” on page 2-27.</b>
Toner is not fused to the paper.	See <b>“Fuser service check” on page 2-26.</b>
Paper jams.	See <b>“Paper feed service checks” on page 2-29.</b>
Main motor is noisy or not moving.	See <b>“Main motor service check” on page 2-28.</b>
Paper skews.	See <b>“Paper feed service checks” on page 2-29.</b>
Operator panel button is not responding.	See <b>“Controller card service check” on page 2-24.</b>
Operator panel lights are off or very dim.	See <b>“Controller card service check” on page 2-24.</b>
Blank page	See <b>“Blank page” on page 2-32.</b>
Black page	See <b>“Black page” on page 2-33.</b>
Heavy background	See <b>“Heavy background” on page 2-33.</b>
Light print	See <b>“Light print” on page 2-35.</b>
White or black lines or bands	See <b>“White or black lines or bands” on page 2-35.</b>
Toner on back of page	See <b>“Toner on back of page” on page 2-36.</b>
Paper never picks.	See <b>“Paper never picks” on page 2-30.</b>
Paper feeds continuously.	See <b>“Paper picks during POST and/or continuously” on page 2-29.</b>
Paper is wrinkled or bent.	See <b>“Paper “trees,” wrinkles, stacks poorly, or curls” on page 2-31.</b>

## Service checks



Service checks which involve measuring voltages on the LVPS/HVPS (low voltage power supply/ high voltage power supply board) should be performed with the printer positioned on its back side.



**Note:** When you make voltage readings, always use frame ground unless another ground is specified. See the wiring diagram in the back of the book for more information.

### Controller card service check

FRU	Action
<p>Controller card assembly</p> <p><b>Warning:</b> <i>Do not</i> replace the operator panel and controller card at the same time. Each card contains the printer settings. When either of these cards is new, it obtains some of the settings from the other card. Settings are lost when both are new and replaced at the same time.</p>	<p><b>POST (Power-On Self Test)</b></p> <p><b>Note:</b> The printer should complete POST in approximately 30 seconds.</p> <p>If the printer fails to display lights or activate the drive motor, fuser or fan, check the following in order:</p> <ol style="list-style-type: none"> <li>1. Power to the LVPS/HVPS</li> <li>2. Power from the LVPS/HVPS to the controller card</li> <li>3. Cables are plugged in correctly, especially for the operator panel. The printer will not power-up without a functioning operator panel.</li> <li>4. The controller card assembly.</li> <li>5. The operator panel. See <b>“Operator Panel Service Check” on page 2-25.</b></li> </ol>

FRU	Action																																																																																																																																																						
Controller card assembly	<p>Check input voltages to the controller card from the LVPS/HVPS.</p> <p><b>Warning:</b> Check the following at CN402 on the LVPS/HVPS with the flat cable <i>unplugged</i> and the printer on. Do not check voltages on a flat cable due to potential damage to electrical components.</p> <ul style="list-style-type: none"> <li>• 24 V dc at pins 18, 16, 15, 14, 13, and 12 If any of these voltages are incorrect, replace the LVPS/HVPS. See <b>“LVPS/HVPS removal” on page 4-19.</b></li> <li>• With the cable unplugged on both ends, check the continuity of the cable. If the cable is damaged, replace it.</li> </ul> <p>Check the output voltage of the controller card with all cables disconnected on the controller card except the thermistor at J2 and the LVPS/HVPS at J6. The measurements should be as follows: (all dc)</p> <table border="1" data-bbox="610 611 1463 1150"> <thead> <tr> <th rowspan="2">Connectors</th> <th colspan="10">Pins (voltage measured in V dc)</th> </tr> <tr> <th>1</th> <th>2</th> <th>3</th> <th>4</th> <th>5</th> <th>6</th> <th>7</th> <th>8</th> <th>16</th> </tr> </thead> <tbody> <tr> <td>J1 (Exit sensor)</td> <td>+5 V</td> <td>GND</td> <td>+5 V</td> <td>GND</td> <td></td> <td></td> <td></td> <td></td> <td></td> </tr> <tr> <td>J2 (Thermistor)</td> <td></td> <td>GND</td> <td></td> <td></td> <td></td> <td></td> <td></td> <td></td> <td></td> </tr> <tr> <td>J3 (Cartridge)</td> <td>+5 V</td> <td></td> <td></td> <td></td> <td></td> <td></td> <td></td> <td></td> <td></td> </tr> <tr> <td>J4 (Main mtr)</td> <td>+5 V</td> <td>+5 V</td> <td>+5 V</td> <td>+5 V</td> <td>GND</td> <td>+5 V</td> <td></td> <td></td> <td></td> </tr> <tr> <td>J5 (USB)</td> <td></td> <td></td> <td></td> <td></td> <td></td> <td></td> <td></td> <td></td> <td></td> </tr> <tr> <td>J6 (LVPS/HVPS)</td> <td></td> <td></td> <td></td> <td></td> <td></td> <td></td> <td></td> <td></td> <td>+5 V</td> </tr> <tr> <td>J9 (Transfer)</td> <td>+5 V</td> <td></td> <td></td> <td></td> <td>+5 V</td> <td>GND</td> <td>+24 V</td> <td></td> <td></td> </tr> <tr> <td>J10 (Solenoid)</td> <td>+24 V</td> <td></td> <td></td> <td></td> <td></td> <td></td> <td></td> <td></td> <td></td> </tr> <tr> <td>J11 (Rear cvr)</td> <td></td> <td>GND</td> <td>GND</td> <td>GND</td> <td></td> <td></td> <td></td> <td></td> <td></td> </tr> <tr> <td>J12 (Mirror mtr)</td> <td></td> <td></td> <td></td> <td>GND</td> <td>+24 V</td> <td></td> <td></td> <td></td> <td></td> </tr> <tr> <td>J13 (LSU)</td> <td>GND</td> <td></td> <td></td> <td></td> <td></td> <td>GND</td> <td></td> <td>+5 V</td> <td></td> </tr> <tr> <td>J14 (Front cvr)</td> <td>+5 V</td> <td>GND</td> <td>GND</td> <td>GND</td> <td></td> <td></td> <td></td> <td></td> <td></td> </tr> <tr> <td>J15 (Op panel)</td> <td>+5 V</td> <td>+5 V</td> <td>+5 V</td> <td>GND</td> <td></td> <td>+5 V</td> <td>+5 V</td> <td>+5 V</td> <td></td> </tr> </tbody> </table>	Connectors	Pins (voltage measured in V dc)										1	2	3	4	5	6	7	8	16	J1 (Exit sensor)	+5 V	GND	+5 V	GND						J2 (Thermistor)		GND								J3 (Cartridge)	+5 V									J4 (Main mtr)	+5 V	+5 V	+5 V	+5 V	GND	+5 V				J5 (USB)										J6 (LVPS/HVPS)									+5 V	J9 (Transfer)	+5 V				+5 V	GND	+24 V			J10 (Solenoid)	+24 V									J11 (Rear cvr)		GND	GND	GND						J12 (Mirror mtr)				GND	+24 V					J13 (LSU)	GND					GND		+5 V		J14 (Front cvr)	+5 V	GND	GND	GND						J15 (Op panel)	+5 V	+5 V	+5 V	GND		+5 V	+5 V	+5 V	
Connectors	Pins (voltage measured in V dc)																																																																																																																																																						
	1	2	3	4	5	6	7	8	16																																																																																																																																														
J1 (Exit sensor)	+5 V	GND	+5 V	GND																																																																																																																																																			
J2 (Thermistor)		GND																																																																																																																																																					
J3 (Cartridge)	+5 V																																																																																																																																																						
J4 (Main mtr)	+5 V	+5 V	+5 V	+5 V	GND	+5 V																																																																																																																																																	
J5 (USB)																																																																																																																																																							
J6 (LVPS/HVPS)									+5 V																																																																																																																																														
J9 (Transfer)	+5 V				+5 V	GND	+24 V																																																																																																																																																
J10 (Solenoid)	+24 V																																																																																																																																																						
J11 (Rear cvr)		GND	GND	GND																																																																																																																																																			
J12 (Mirror mtr)				GND	+24 V																																																																																																																																																		
J13 (LSU)	GND					GND		+5 V																																																																																																																																															
J14 (Front cvr)	+5 V	GND	GND	GND																																																																																																																																																			
J15 (Op panel)	+5 V	+5 V	+5 V	GND		+5 V	+5 V	+5 V																																																																																																																																															
Controller card assembly (continued)	<p>Turn off the printer and connect the front and rear door switches to the controller card. Close the doors, turn the printer on, and check the following:</p> <table border="1" data-bbox="594 1255 1471 1392"> <thead> <tr> <th rowspan="2">Connectors</th> <th colspan="8">Pins</th> </tr> <tr> <th>1</th> <th>2</th> <th>3</th> <th>4</th> <th>5</th> <th>6</th> <th>7</th> <th>8</th> </tr> </thead> <tbody> <tr> <td>J11 (Rear cover)</td> <td>+5 V dc</td> <td>GND</td> <td>GND</td> <td>GND</td> <td></td> <td></td> <td></td> <td></td> </tr> <tr> <td>J13 (LSU)</td> <td>GND</td> <td></td> <td>+5 V dc</td> <td></td> <td></td> <td>GND</td> <td>+5 V dc</td> <td>+5 V dc</td> </tr> </tbody> </table>	Connectors	Pins								1	2	3	4	5	6	7	8	J11 (Rear cover)	+5 V dc	GND	GND	GND					J13 (LSU)	GND		+5 V dc			GND	+5 V dc	+5 V dc																																																																																																																			
Connectors	Pins																																																																																																																																																						
	1	2	3	4	5	6	7	8																																																																																																																																															
J11 (Rear cover)	+5 V dc	GND	GND	GND																																																																																																																																																			
J13 (LSU)	GND		+5 V dc			GND	+5 V dc	+5 V dc																																																																																																																																															

## Operator Panel Service Check

<p>Operator panel (2 LED and 6 LED)</p> <p><b>Warning:</b> <i>Do not</i> replace the operator panel and controller card at the same time. Each card contains the printer settings. When either of these cards is new, it obtains some of the settings from the other card. Settings are lost when both are new and replaced at the same time.</p>	<p>Check the switches (buttons) with the printer off and operator panel cables disconnected.</p> <ul style="list-style-type: none"> <li>• Check continuity between the ground and pin 6 (pins numbered from top) of J40 (operator panel card) while pressing . Check continuity between ground and pin 7 while pressing .</li> <li>• If either fail continuity, replace the operator panel. See <b>“Operator panel removal (all models)” on page 4-18.</b></li> <li>• Connect the operator panel cable and turn the printer on. Verify +5 V dc on pin 1 of J40. If this fails, verify +5 V dc on pin 1 of J15 on the controller card. Replace the cable if the voltage is verified on the controller card but not on the operator panel.</li> <li>• Disconnect the cable at both ends to perform a continuity check.</li> </ul>
---	---

## Dead machine service check



**CAUTION:** Check the AC line voltage. The voltage should be within the following limits:

- 100 V ac (volts alternating current) – 127 V ac for the 110 V printer
- 200 V ac – 240 V ac for the 220 V printer

For information about the LVPS/HVPS, see **“LVPS portion of the LVPS/HVPS” on page 2-28.**

## Fuser service check

When toner is partially fused to the paper, it is usually caused by a low fuser temperature.

**Warning:** Avoid handling the lamp as much as possible, as it is easily broken. Be careful not to touch the glass housing with bare hands because skin acids can weaken the glass.

**Note:** The lamp is not a service part.



The line voltage to the printer must be within the following limits:

- 100 V ac–127 V ac for the 110 V model printer
- 200 V ac–240 V ac for the 220 V model printer

Turn the printer off, and wait a few minutes for the fuser lamp to cool. Turn the printer on, and observe the lamp turning on during POST. In the Ready state (not Power Saver), the lamp will cycle on and off at approximately 15 second cycles.



You can see the light from the lamp by opening the right side cover and observing the rear opening through which the fuser power cables pass.

FRU	Action
 <p>Fuser power cable LVPS/HVPS Fuser</p>	<p>Unplug the printer, and disconnect the fuser lamp cable plug from the LVPS/HVPS board connector at CN403 (100/110 V ac) or CN401 (220 V ac).</p> <p>Check for continuity across the fuser lamp by checking across the cable connector pins.</p> <ul style="list-style-type: none"> <li>• If there is continuity, turn the printer on with only the fuser power disconnected at CN403/CN401. Measure the voltage at connector CN102 on the LVPS/HVPS. It should match the line voltage. If line voltage is not present, see <b>“Main motor service check” on page 2-28</b> for more information. Make sure the fuser thermistor is correctly connected to the controller board. If the problem persists, disconnect the thermistor cable at J2, and check for approximately +5 V dc on pin 1. Pin 2 should be grounded. If voltage is incorrect on pin 1, see <b>“Controller card service check” on page 2-24</b> for more information.</li> <li>• If there is no continuity, replace the fuser. See <b>“Fuser removal” on page 4-20</b>.</li> </ul>
 <p>Fuser (continued)</p>	<p>Disconnect the thermistor cable from J2 on the controller card. Measure the resistance across the ends of the thermistor cable. Replace the fuser assembly if the resistance is lower than 7K ohm.</p> <p><b>Note:</b> Resistance measures approximately 450K ohms when cool and 1K ohms when hot.</p>

### Cold fuser service check

Make sure the correct voltage lamp is installed. The voltage rating is stamped on one of the lamp contacts.

FRU	Action
 <p data-bbox="272 531 407 579">LVPS/HVPS Fuser</p>	<p data-bbox="561 384 1406 457">If the fuser lamp comes on and a fuser failure light error code displays, be sure the thermistor is contacting the hot roll, and the thermistor cable is firmly seated in connector J2 on the controller card.</p> <p data-bbox="561 468 1365 516">Check for excessive toner buildup on the surface of the thermistor. Clean as necessary.</p> <p data-bbox="561 527 1349 575">With the printer unplugged, disconnect the thermistor cable from J2 on the controller card.</p> <p data-bbox="561 585 1406 684">Measure the resistance of the thermistor. The resistance measures from approximately 7K ohms immediately after printing or POR to approximately 450K ohms when the thermistor reaches room temperature. (It may take 30 minutes to cool.)</p> <p data-bbox="561 695 1008 722">Replace the fuser assembly as necessary.</p>

### Hot fuser service check

**Note:** Ensure the correct lamp is installed.

FRU	Action
 <p data-bbox="272 1102 407 1150">LVPS/HVPS Fuser</p>	<p data-bbox="561 970 1357 1068">Measure the resistance of the thermistor. The resistance measures from approximately 7K ohms immediately after printing or POR to approximately 450K ohms when the thermistor reaches room temperature. (It may take 30 minutes to cool.)</p> <p data-bbox="561 1079 1008 1106">Replace the fuser assembly as necessary.</p>

## LVPS/HVPS service check

<p>LVPS/HVPS</p> 	<p><b>LVPS portion of the LVPS/HVPS</b></p> <p>Use the voltage meter to verify the appropriate voltage at the printer end of the power cable. Disconnect the power cable from the printer and the fuser cable (CN403) and check the following:</p> <ul style="list-style-type: none"> <li>• Continuity across the power switch when it is on. Leave the power switch turned on.</li> <li>• Continuity from the lower blade of the 110/220 V ac receptacle (designated “L” on the controller card) to the following: <ul style="list-style-type: none"> <li>- Each end of the two fuses</li> <li>- Pin 1 of the fuser connector (CN403)</li> </ul> </li> </ul> <p>If any of these fail, replace the LVPS/HVPS. See <b>“LVPS/HVPS removal” on page 4-19</b>.</p> <p>Disconnect the cable from the controller card (CN402) and the fan (CN404). Reconnect the fuser, turn the power switch off and reconnect the power cord into the printer. Turn the printer on and verify the following:</p> <ul style="list-style-type: none"> <li>• +24 V dc at pins 12, 13, 14, 15, 16, and 18 on CN402 (pins 12, 13, 14, 15, and 16 are interconnected)</li> <li>• +24 V dc at pin 1 on CN404</li> </ul> <p>Turn the printer off and verify grounds on pins 2, 4, 6, 8, and 17 of CN402. If any of these voltages or grounds fail, replace the LVPS/HVPS. See <b>“LVPS/HVPS removal” on page 4-19</b>.</p> <p><b>HVPS portion of the LVPS/HVPS</b></p> <p>Remove the LVPS/HVPS to inspect the HVPS contacts. Clean the contacts, both springs and pads, if necessary.</p> <p><b>Note:</b> The voltage for the transfer roll is created on the transfer card and input sensor assembly. See <b>“Transfer roll service check” on page 2-41</b>.</p>
--	---

## Main motor service check

FRU	Action						
<p>Main motor (not a FRU)</p>  <p>Controller card</p> <p><b>Warning:</b> Do not replace the operator panel and controller card at the same time. Each card contains the printer settings. When either of these cards is new, it obtains some of the settings from the other card. Settings are lost when both are new and replaced at the same time.</p>	<p>Turn off the printer, and unplug the main motor cable at J4. Turn on the printer, and check for +5 V dc on pins 1, 2, 3, 4, and 6. Pin 5 should be grounded:</p> <table border="1" data-bbox="812 1249 1258 1375"> <thead> <tr> <th>J4 pins</th> <th>Voltages</th> </tr> </thead> <tbody> <tr> <td>Pins 1, 2, 3, 4, and 6</td> <td>Approx. +5 V dc</td> </tr> <tr> <td>Pin 5</td> <td>Ground</td> </tr> </tbody> </table> <ul style="list-style-type: none"> <li>• If these voltages are correct, call the next level of support.</li> <li>• If these voltages are not correct, see <b>“LVPS/HVPS card” on page 5-4</b>, or replace the controller card. See <b>“Controller card removal” on page 4-17</b>.</li> </ul> <p><b>Note:</b> The main motor is not a service part.</p>	J4 pins	Voltages	Pins 1, 2, 3, 4, and 6	Approx. +5 V dc	Pin 5	Ground
J4 pins	Voltages						
Pins 1, 2, 3, 4, and 6	Approx. +5 V dc						
Pin 5	Ground						



## Paper feed service checks

### Paper jam error indication during POST

FRU	Action
Fuser (exit sensor) Paper pick assembly (input sensor)	If the exit sensor flag is not resting within the paper exit sensor during POST, the printer displays a paper jam message. Make sure the flag is operating freely and is correctly installed. Make sure the wire spring in the top cover is properly positioned relative to the sensor. See the photo on <a href="#">page 4-11</a> .
Paper pick assembly (Input sensor) Fuser (exit sensor)	Make sure the paper sensors are working properly. A stuck or incorrectly installed sensor causes this error.

### Paper picks during POST and/or continuously

FRU	Action
Paper pick assembly	Check the clutch area. Verify the solenoid spring which holds the lever in place is attached properly. Replace the assembly as necessary.

### Paper picks but stops halfway through the printer

FRU	Action
Transfer card and input sensor assembly Paper pick assembly Fuser Miscellaneous cable assembly	<ul style="list-style-type: none"> <li>The printer indicates where the jam occurs.                             <ul style="list-style-type: none"> <li>A 200 paper jam (see <a href="#">“200 Paper jam at the input sensor” on page 2-14</a>) indicates the paper did not activate the input sensor. Access this jam through the front and rear doors.</li> <li>A 201 jam (see <a href="#">“201 Paper jams between the input sensor and exit sensor” on page 2-14</a>) indicates the paper activated the input sensor, but did not make it to the exit sensor. Access this jam through the rear and top doors.</li> <li>A 202 jam (see <a href="#">“202 Paper jams as a printed job exits the printer.” on page 2-15</a>) indicates the paper has not cleared the exit sensor. Access this jam through the rear and top cover doors.</li> </ul> </li> <li>Check the paper path for any obstruction that could cause a jam.</li> <li>Inspect the input sensor and exit sensor mechanisms.</li> </ul> <p><b>Note:</b> The input sensor is soldered on the transfer card and input sensor assembly. The flag for this sensor is part of the paper picking assembly. The cable connecting the card to the controller card is available in the miscellaneous cable assembly.</p> <p>The exit sensor and flag are part of the fuser assembly and are not service items alone. The cable for the exit sensor is part of the miscellaneous cable assembly.</p>

### Paper never picks

FRU	Action
Paper pick assembly	<p>Open the left cover, and verify the solenoid and clutch are functioning when an attempt is made to feed the paper.</p> <ul style="list-style-type: none"> <li>• If the shaft of the assembly rotates and paper does not move, remove the picking assembly and inspect the pick roll and pad. Replace the assembly if necessary.</li> <li>• If the shaft does not rotate, observe the solenoid when a paper pick is requested. If the solenoid does not function, do the following:            With the printer off, disconnect the solenoid at J10 on the controller card. Turn the printer on and verify +24 V dc on pin 1 of the card connector.           <ul style="list-style-type: none"> <li>- If the voltage fails, check the controller card. See <b>“Controller card service check” on page 2-24.</b></li> <li>- If the voltage is correct, replace the paper pick assembly. See <b>“Paper pick assembly removal” on page 4-15.</b></li> <li>- If the solenoid is functioning, remove the assembly and check for blockage. Replace the assembly if necessary. See <b>“Paper pick assembly removal” on page 4-15.</b></li> </ul> </li> </ul>

### Paper occasionally mispicks or picks multiple sheets at once

FRU	Action
Tray	<p>Check the tray for paper catch points.</p> <p>Do not mix paper types in the tray.</p>
Paper pick assembly	<p>Remove the left side cover and observe the solenoid when a paper pick is requested.</p> <p>If the solenoid does not function, do the following:</p> <p>With the printer off, disconnect the solenoid at J10 on the controller card. Turn the printer on and verify +24 V dc on pin 1 of the card connector.</p> <ul style="list-style-type: none"> <li>• If the voltage fails, check the controller card. See <b>“Controller card service check” on page 2-24.</b></li> <li>• If the voltage is correct, replace the paper pick assembly. See <b>“Paper pick assembly removal” on page 4-15.</b></li> <li>• Occasional mispicks (pick without a request) is typically caused by a faulty clutch assembly. Replace the paper pick assembly. See <b>“Paper pick assembly removal” on page 4-15.</b></li> <li>• Multiple-sheet feeds following a request is a failure of the paper separation pad. Remove the assembly to inspect the pads and paper path. Replace the assembly if necessary.</li> </ul>

## Paper “trees,” wrinkles, stacks poorly, or curls

FRU	Action
Fuser	<p>This problem is most likely due to a worn backup roll. It causes the printer to run hotter than required for the media being printed. Excessive heat can cause paper treeing problems, poor stacking, or curl. Replace the fuser. See “<b>Fuser removal</b>” on page 4-20.</p> <p>Print the menu sheet (press and release  with the printer in ready mode).</p> <p>Look at the paper settings. Some, such as card stock or rough texture may require a higher fuser temperature, which leads to more of these problems (except stacking) in plain paper.</p> <ul style="list-style-type: none"> <li>• Change settings using the printer driver.</li> <li>• Use the local printer setup utility (included on the CD) to change the NVRAM settings.</li> </ul> <p>Try a different ream of paper. Moist paper has a higher tendency to crease (treeing) and curl.</p> <p>A contaminated thermistor can cause the fuser temperature to be elevated. The fuser has to be removed to determine contamination. A worn or damaged hot roll can also cause the media to experience a higher temperature than appropriate for the selected media. Try settings for lower temperature media (light weight, smooth finish) before replacing the fuser.</p>

## Print quality service checks



**Note:** Ensure the covers are in place. An opening may allow light to expose the photoconductor, resulting in a ‘dirty’ print. Extreme environmental conditions, temperatures, and humidity will affect the print quality.

### Using print quality test pages

To help isolate print quality problems, like streaking, print test pages using the print quality test pages.

#### Model E120

To print the print quality test pages:

1. Enter Diagnostics mode:
  - a. Turn off the printer.
  - b. Open the front access cover.
  - c. Turn on the printer while pressing and holding .
  - d. When the ! light stays on, close the cover.
  - e. Wait (approximately 10 seconds) until the printer drive activates.
2. Press and release .
3. Press and hold  until all the lights flash to initiate printing the quality test pages. The error log (history) will also print.
 







The first four pages print to help you evaluate print quality. The first page has various fonts, the second page is gray, the third page is black, and the last page is blank. The following pages list errors and other printer information.

Use the test pages to isolate problems such as light or toner streaks. The following pages identify solutions for most print quality problems.

To exit print quality test pages, turn the printer off.

**Model E120n**

To print the print quality test pages:

1. Enter the Configuration menu.
  - a. Turn off the printer.
  - b. Open the front access cover.
  - c. Turn on the printer while pressing and holding  .
  - d. When the  light stays on, close the cover.
  - e. Wait (approximately 10 seconds) until the printer drive activates.
2. Slowly press and release  three times until the  and  lights come on.
3. Press and hold  until all the lights flash to initiate printing the quality test pages.  
Three pages print to help you evaluate print quality. The first page has various fonts, the second page is gray, and the third page is black. Once the paper exits into the output bin, the printer returns to the home state (four top lights on).

Use the test pages to isolate problems such as light or toner streaks. See **“POST symptom table” on page 2-22** for solutions to these problems.

To exit the Configuration menu, turn the printer off.

**Blank page**

FRU	Action
Toner cartridge (not a FRU)	Remove the toner cartridge, and gently shake it to evenly distribute the toner. Check the cartridge for damage or contamination. Straighten or clean it as necessary. Try a different toner cartridge.
 Printhead LVPS/HVPS Controller card	Blank pages can be caused by a defective printhead assembly, LVPS/HVPS, or controller card. <b>Note:</b> Printhead errors typically result in printer service errors. A blocked or absent laser beam will result in a blank page. Check for blockage of the beam or dust on the lens. If these steps fail, replace the LVPS/HVPS, controller, or printhead in that order.

### Black page

**Note:** Incorrect laser exposure or incorrect charging of the photoconductor causes an all black page. Always verify the same results from a different toner cartridge assembly and developer before proceeding.

FRU	Action
PC kit (not a FRU) Toner electrodes (not a FRU)	Check the three electrical contacts at the right rear of the toner cartridge assembly for contamination or damage. Correct them as necessary.  Check continuity between the spring behind the LVPS/HVPS (DEV, TAR, and doctor blade) contact tips for the toner cartridge assembly. If continuity fails, call the next level of service.  Check the contact for the PC kit. No charge on the charge roll will result in a black page. Try a different PC kit.
 LVPS/HVPS board Controller card	With the printer off, disconnect the cable from CN402 on the LVPS/HVPS card. Turn the printer on, and verify +24 V dc on pins 18, 16, 15, 14, 13, and 12 on the connector.  With the printer off, verify the ground on pins 2, 4, 6, 8, and 17. <ul style="list-style-type: none"> <li>• If the voltage is incorrect, replace the LVPS/HVPS board. See <b>“LVPS/HVPS removal” on page 4-19.</b></li> <li>• If voltage is correct and the toner electrodes are good, check continuity on the cable. Replace the cable if necessary.                          As much as possible, check the cable while in plugged position but not plugged. Flat cables open when bent but close when straightened.</li> <li>• If voltages are correct and the cable is good, check the controller card. See <b>“Controller card service check” on page 2-24.</b></li> </ul>

### Heavy background

Poor development or poorly charged toner particles cause excessive background. This is more noticeable as the toner cartridge nears end-of-life.

FRU	Action
Toner cartridge (not a FRU) PC Kit (not a FRU)	Check the toner darkness setting in the driver. Try a lower setting.  Make sure the toner cartridge and PC Kit are correctly installed and the high voltage contacts are clean.  If the toner cartridge and PC Kit are installed correctly, try a new PC Kit first and then try a new toner cartridge. Check the darkness setting.
 LVPS/HVPS Controller card	Check the contacts for correct installation and contamination where contact is made between the toner cartridge assembly and the LVPS/HVPS board. Clean the contacts as necessary.  If this does not correct the problem, replace the following FRUs one at a time in the order shown: <ul style="list-style-type: none"> <li>• LVPS/HVPS board</li> <li>• Controller card</li> </ul>

**Partial blank image/white spots (no periodic pattern)**

FRU	Action
Toner cartridge (not a FRU)	<p>Remove the toner cartridge assembly, and gently shake the assembly to evenly distribute the toner.</p> <p>Check to make sure the dust cover is in place and in use. If the dust cover is not in place, spotting can result.</p> <p>Check to make sure the laser light path is not blocked.</p> <p>If the toner cartridge is low, try a new one.</p>
Paper (not a FRU)	Make sure recommended paper is being used.



**Variation in image density horizontally across page**

FRU	Action
PC Kit (not a FRU)	<p>The charge roll may have an unbalanced pressure against the PC (photoconductor) drum.</p> <p>Try a new PC Kit.</p>
Transfer roll	<p><b>Warning:</b> Do not touch the black portion of the transfer roll.</p> <p>Check the springs in the left and right transfer roll bearings. The bearing assemblies should support the transfer roll, applying even pressure to the PC drum.</p> <p>Replace the transfer roll assembly if the springs or bearing show signs of damage or fatigue.</p> <p>Inspect the transfer roll for signs of wear, damage, or contamination.</p> <p>Replace the transfer roll as necessary.</p>
Rear door	<p>Check pivots.</p> <p>Check for spring damage.</p> <p>Check for interferences.</p> <p>Check the latching operation.</p>

**Poor fusing of image**

FRU	Action
Fuser	The fuser may not be operating at the proper temperature to fuse the toner to the paper. See " <b>Hot fuser service check</b> " on page 2-27 for more information.
Paper (not a FRU)	Make sure recommended paper is being used.

## Light print

FRU	Action
Toner cartridge (not a FRU)	<p>Print a menu page (press and release  when the printer is in the ready state) and check for the correct media type setting.</p> <p>Check darkness in the printer driver.</p> <p>Make sure the toner cartridge and PC kit are installed correctly and that the toner cartridge is not low on toner.</p> <p>If the problem continues, install a new toner cartridge.</p> <p>Recheck the condition of the PC Kit before replacing it (if necessary).</p>
 Transfer roll LVPS/HVPS board	<p>Check the transfer roll for signs of toner buildup and contamination.</p> <p>Inspect the HVPS contact (transfer roll) for contamination.</p> <p>Verify the high voltage cable is plugged into the LVPS/HVPS.</p> <p>If all components appear free of contamination, replace the following FRUs one at a time in the order shown:</p> <ul style="list-style-type: none"> <li>• Transfer roll</li> <li>• LVPS/HVPS board</li> </ul>

## White or black lines or bands

FRU	Action
Toner cartridge (not a FRU)	<p>Banding appears as light or dark horizontal lines on a uniformly gray page or on a page with a large area of graphics. Banding is primarily due to a variation in the speed of the paper as it feeds through the printer, especially in the developer and transfer process. It can also be a result of overly moist or dry environments.</p> <p>Check to make sure the laser light is not blocked while the printer is turned off.</p> <p>Inspect the toner cartridge, paper feed components, the drive coupler, and drive gears for debris, binds, or damage. (The coupler retracts when the front door is opened.) Close the door and inspect the previously mentioned areas from the rear of the printer. Try a new ream of paper.</p>
PC Kit (not a FRU)	<p>Check the charge roll for a discoloration pattern that matches the row pattern on the pages. If the pattern is present, try a different PCU.</p>

## Toner on back of page

FRU	Action
PC Kit (not a FRU)	<p>Print a menu page (press and release  when the printer is in the ready state) and check settings for the correct media type.</p> <p>Inspect the overall paper path for signs of spilled toner.</p> <p>Gently clean the contaminated areas with a soft cloth.</p>
Fuser	<p>The fuser hot roll can cause toner deposits on the back of the paper if toner is building up on the hot roll. This buildup may transfer to the backup roll, later transferring to the back of the paper.</p> <p>Inspect the hot roll and backup roller for signs of contamination.</p> <p>Replace the fuser as necessary.</p>
Transfer roll	<p>Check to make sure that the paper size being used is large enough for the image settings in the driver. Printing the images off of the paper will transfer the toner to the transfer roll, and then to the back of the page. Correct the paper size or the settings and run test pages to clear up the roll.</p> <p>A transfer roll contaminated with toner can cause toner to transfer to the back of printed pages.</p> <p>Inspect the transfer roll for contamination, and replace it as necessary.</p>

## Solving print quality problems

To solve many print quality problems, replace supply or maintenance items that have reached the end of their intended life. Use the following table for solutions. For defects repeating down the page at a fixed distance, see the chart at the back of the book to determine the cause.

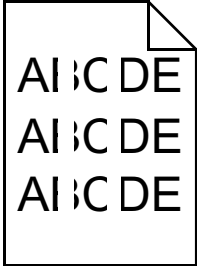
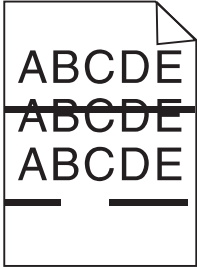
Symptom	Cause	Solution
<p>White lines</p> 	<ul style="list-style-type: none"> <li>The toner cartridge or the fuser may be defective.</li> <li>The laser beam's path may be blocked in a certain area of the lens.</li> </ul>	<ul style="list-style-type: none"> <li>Replace the toner cartridge or the fuser, as needed.</li> <li>Check the lens opening (above the toner cartridge) for debris. Remove particles.</li> </ul>
<p>Streaked horizontal lines</p> 	<p>If the lines are parallel to lines that are supposed to be there, see <b>"Ghost images" on page 2-38.</b></p> <p>The toner cartridge or the fuser may be defective, empty, or worn.</p>	<p>Replace the toner cartridge or the fuser, as needed.</p>

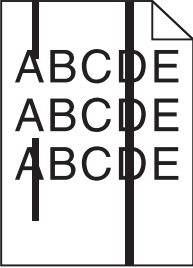
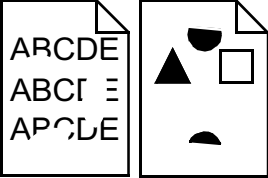

Symptom	Cause	Solution
Streaked vertical lines 	<ul style="list-style-type: none"> <li>The toner is smeared before fusing to the paper.</li> <li>The toner cartridge is defective.</li> <li>The PCU cleaner is full.</li> </ul>	<ul style="list-style-type: none"> <li>If paper is stiff, try feeding from the priority feeder.</li> <li>Replace the toner cartridge.</li> <li>Replace the PCU kit.</li> </ul>
Print irregularities 	<ul style="list-style-type: none"> <li>The paper has absorbed moisture due to high humidity.</li> <li>The paper may not meet printer specifications.</li> <li>The fuser is worn or defective.</li> </ul>	<ul style="list-style-type: none"> <li>Load paper from a fresh package.</li> <li>Avoid textured paper with rough finishes.</li> <li>Check to make sure that the dust cover is in place and in use. (Absence of the dust cover will cause spotting.)</li> <li>Make sure the printer driver paper type setting matches the type of paper being used.</li> <li>Replace the fuser.</li> </ul>
Light print	<ul style="list-style-type: none"> <li>The Toner Darkness setting is too light.</li> <li>The paper may not meet printer specifications.</li> <li>The toner cartridge is low.</li> <li>The toner cartridge is defective.</li> </ul>	<ul style="list-style-type: none"> <li>Select a different Toner Darkness setting from the printer driver before sending the job to print.</li> <li>Try paper from a new package.</li> <li>Avoid textured paper with rough finishes.</li> <li>Make sure paper loaded in the tray is not damp.</li> <li>Replace the toner cartridge.</li> </ul>
Dark print	<ul style="list-style-type: none"> <li>The Toner Darkness setting is too dark (check driver)</li> <li>The toner cartridge is defective.</li> </ul>	<ul style="list-style-type: none"> <li>Select a different Toner Darkness setting from the printer driver before sending the job to print.</li> <li>Replace the toner cartridge.</li> </ul>
Poor transparency print quality (Print has inappropriate light or dark spots, toner is smeared, or horizontal or vertical light bands appear.)	<ul style="list-style-type: none"> <li>The transparencies may not meet printer specifications.</li> <li>The Form Type setting in the printer driver is set to a media other than transparency.</li> </ul>	<ul style="list-style-type: none"> <li>Use only transparencies recommended by the printer manufacturer (use care not to touch transparency surfaces with your fingers).</li> <li>Make sure the Form Type setting is set to transparency.</li> </ul>
Toner specks	<ul style="list-style-type: none"> <li>The toner cartridge is defective.</li> <li>The fuser is worn or defective.</li> <li>Toner is in the paper path.</li> <li>The long-life photoconductor kit is exhausted.</li> </ul>	<ul style="list-style-type: none"> <li>Replace the toner cartridge.</li> <li>Replace the fuser.</li> <li>Remove toner.</li> <li>Replace the long-life photoconductor kit.</li> </ul>

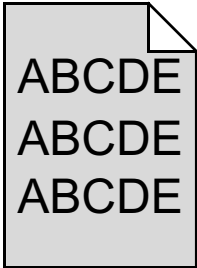
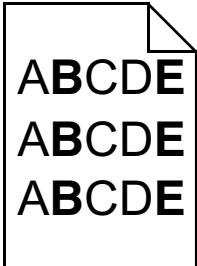
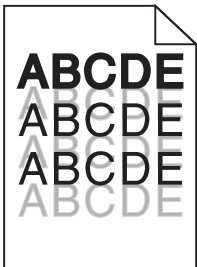
Symptom	Cause	Solution
<p>Toner rubs off paper easily when sheets are handled</p>	<ul style="list-style-type: none"> <li>• The Paper Texture setting is wrong for the type of paper or specialty media being used.</li> <li>• The Paper Weight setting is wrong for the type of paper or specialty media being used.</li> <li>• The fuser is worn or defective.</li> </ul>	<ul style="list-style-type: none"> <li>• Change the Paper Texture from Normal to Smooth or Rough. This setting can be changed using the Local Printer Setup Utility (Windows), or through Printer Settings (Macintosh). See the <i>Software and Documentation CD</i> for additional information.</li> <li>• Change the Paper Weight from Plain to Card Stock (or another appropriate weight).</li> <li>• Replace the fuser.</li> </ul>
<p>Gray background</p> 	<ul style="list-style-type: none"> <li>• The Toner Darkness setting is too dark or too light.</li> <li>• The toner cartridge is defective.</li> <li>• The long-life photoconductor kit is exhausted.</li> </ul>	<ul style="list-style-type: none"> <li>• Select a different Toner Darkness setting from the printer driver before sending the job to print.</li> <li>• First, remove and reset the toner cartridge. If the problem persists, replace the toner cartridge.</li> <li>• Replace the long-life photoconductor kit.</li> </ul>
<p>Uneven print density</p> 	<p>The toner cartridge is running low on toner.</p> <p>The toner cartridge is defective.</p>	<p>Remove the toner cartridge and shake it gently left to right to redistribute the remaining toner. Reprint the pages.</p> <p>Remove and reset the toner cartridge. If the problem persists, replace the toner cartridge.</p> <p>Check the springs on the front door which push on the cartridge when the front door is closed.</p>
<p>Ghost images</p> 	<p>The Form Type setting in the printer driver is incorrectly set.</p>	<p>Make sure the Form Type setting is correct for the paper or specialty media used.</p>

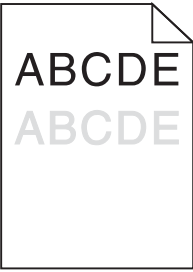
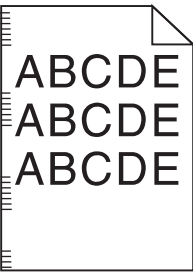
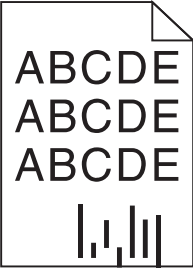
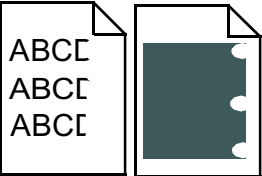
Symptom	Cause	Solution
<p>Specifically located ghost images</p> 	<p>The long-life photoconductor kit is exhausted.</p> <p><b>Note:</b> From the top of the image to the top of the ghost is 71mm.</p>	<p>Replace the long-life photoconductor kit.</p>
<p>Grouped streaks along the left or right (not shown) side of the printed page</p> 	<p>The long-life photoconductor kit is exhausted.</p> <p><b>Note:</b> Streaks repeat at 71mm intervals.</p>	<p>Replace the long-life photoconductor kit.</p>
<p>Streaks appear on the page.</p> 	<p>The long-life photoconductor kit is exhausted.</p>	<p>Replace the long-life photoconductor kit.</p>
<p>Uneven printing</p>  <p>(Print voids occur on the right hand side of the page.)</p>	<p>The toner cartridge is not properly installed.</p> <p><b>Note:</b> Unevenness reoccurs at 71mm intervals.</p>	<ul style="list-style-type: none"> <li>• Remove and then reinsert the toner cartridge.</li> <li>• Check the springs on the front door which push against the cartridge when the door is closed.</li> </ul>
<p>Incorrect margins</p>	<p>The Form Size setting in the printer driver is different from the paper size loaded in the tray. For example, A4 size paper is loaded into the tray, but the Form Size setting is not set to A4.</p>	<p>Change the Form Size setting to the appropriate size.</p>

Symptom	Cause	Solution
Skewed print (Print is inappropriately slanted.)	<ul style="list-style-type: none"> <li>The tray guide is not in the correct position.</li> <li>The priority feeder guides are not in the correct position for the paper size loaded in the feeder.</li> <li>Contaminated pick roll and/or separator pad</li> </ul>	<ul style="list-style-type: none"> <li>Reposition the guide to fit lightly against the paper stack.</li> <li>Reposition the priority feeder guides to fit lightly against the print media.</li> <li>Check the transfer roll springs for free operation.</li> <li>Check the rear door latching.</li> <li>Remove debris from the pick roll and/or separator pad.</li> <li>Remove and clean the paper pick assembly. See <b>"Paper pick assembly removal"</b> on page 4-15 for more information.</li> </ul>
Blank pages	<p>The toner cartridge is defective or empty.</p> <p>Contacts are blocked</p> <p>Laser light is blocked or not present</p>	<ul style="list-style-type: none"> <li>First, remove and reset the toner cartridge. If problem persists, replace the toner cartridge.</li> <li>Check and clear contacts.</li> </ul> <p>See <b>"Blank page"</b> on page 2-32 for more information.</p>
Solid black pages	<ul style="list-style-type: none"> <li>The toner cartridge is defective.</li> <li>The printer requires service.</li> <li>The long-life photoconductor kit is defective.</li> </ul>	<ul style="list-style-type: none"> <li>First, remove and reset the toner cartridge. If problem persists, replace the toner cartridge.</li> <li>Check the PC contacts</li> <li>Replace the long-life photoconductor kit.</li> </ul> <p>See <b>"Black page"</b> on page 2-33 for more information.</p>
Paper (except card stock) curls badly as it exits the bin.	The Paper Texture setting is wrong for the type of paper or specialty media being used.	<p>Change the Paper Texture from Rough to Normal or Smooth.</p> <p>This setting can be changed using the Local Printer Setup Utility (Windows) or through Printer Settings (Macintosh). See the <i>Software and Documentation</i> CD for additional information.</p>

## Printhead service check

FRU	Action
 <p>Printhead</p>	<ol style="list-style-type: none"> <li>Unplug the printer.</li> <li>Disconnect the printhead cables from J12 and J13 on the controller card. Turn the printer on.</li> <li>On the controller card, verify +24 V dc on pin 5 at J12 and +5 V dc on pin 5 at J13. Be sure the front and rear doors are closed when checking.</li> <li>Verify grounds on pin 4 at J12 and on pin 6 at J13. <ul style="list-style-type: none"> <li>If voltages or grounds are incorrect, check the controller card. See <b>"Controller card service check"</b> on page 2-24 for more information.</li> <li>If voltages are correct, replace the printhead (comes with cables). See <b>"Printhead removal"</b> on page 4-12.</li> <li>A faulty printhead will typically be indicated in a service error.</li> </ul> </li> </ol>

**Transfer roll service check**

FRU	Action
 Transfer roll	<p>Check the transfer roll area for debris, and clean the area as necessary.</p> <p>Verify continuity between the spring below the left side (facing the rear of the printer) bearing and the conical compression spring on the left side of the door.</p> <p>Verify continuity in the spring and the cable connection on the LVPS/HVPS.</p> <p>Inspect the roll for signs of wear or damage and replace it if necessary.</p>
Transfer roll Rear door assembly	<p>See <b>“Paper “trees,” wrinkles, stacks poorly, or curls” on page 2-31</b> for symptoms of transfer roll problems.</p> <p><b>Warning:</b> The transfer roll should not be touched except on gear and metal shaft.</p> <p>The conical shaped spring on the left side of the rear door (facing the rear of the printer) contacts the transfer card and input sensor assembly when the door is closed.</p> <ul style="list-style-type: none"> <li>• Make sure the contacts are clean.</li> <li>• Inspect the spring (cone-shaped on one end and cylinder-shaped on the other end) Clean and remove any debris from the spring and contact with the bearing of the transfer roll.</li> </ul> <p><b>Note:</b> The spring does not directly contact the transfer roll shaft. Therefore a continuity check cannot be made between the shaft and spring.</p> <p>Check continuity between the left side of the anti-static brush base and the semicircular wire form on the right side of the door. Clean the contact as necessary including the one made between the wire form and frame as the door is closed. This is only a grounding circuit, not part of the high voltage circuit.</p> <p>Push the ends of the transfer roll against the springs. The bearings should move up and down smoothly. Rotate the roll using the gear. It should rotate uniformly and freely. Inspect the transfer roll for contamination. Replace it as necessary.</p> <p>Inspect the rear door assembly for any damage and replace it as necessary.</p>

---

## 3. Diagnostic aids



This chapter explains the tests and procedures to identify printer failures and to verify that repairs have corrected the problem.

There are different test menus that can be accessed during POR to identify problems with the printer.

---

### Service menus—E120



#### *Printing menus*

To enter Diagnostics mode, turn off the printer, open the front access cover, press and hold  while turning on the printer. Close the cover when the  light displays.

Print menus by pressing and holding  until the lights flash. See **“Diagnostics mode printout sample” on page 3-2.**

#### *Moving around the menu*

The menu items are designated by the non-indented items listed along the left edge of the page (bottom as printed from the printer). These items are also un-shaded.

- Press and release  to move sequentially from one menu item to another.
- Press and hold  to jump to home state (top four lights on).
- Press and release  to move through the menu settings.

This action rotates only through the possible settings of the selected menu item.

## Diagnostics mode printout sample

### Printer Diagnostics

This page explains how to access the printer menus and change values. Menus are represented by Ready/Data light sequences. Menu items and their values are indicated by Error light sequences.

Use the illustration to help you find the menu and value you want to change. The Error light shows the current value of the menu item.

- 1 Press and release Cancel to advance through the menus and menu items to the one you need.
- 2 Press and release Continue to advance to the value you need.
- 3 Press and hold Continue until both of the lights cycle to perform the function or to save the value.
- 4 Press and hold Cancel until both of the lights cycle to return to the home menu.
- 5 Turn the printer off to exit the menus.

Menus, menu items, and values



## Diagnostics mode descriptions

### Development



Menu item	Use setting to	Value
Print quality pages	<p>Print the print quality test pages and history information by pressing and holding  until the lights flash.</p> <p>Help isolate print quality problems, such as streaking. Four or more pages print:</p> <ul style="list-style-type: none"> <li>• A text page with printer information, cartridge information, current margin settings, and a graphic</li> <li>• Two pages with graphics</li> <li>• A blank page</li> <li>• An error log (history)</li> </ul> <p><b>Note:</b> The cartridge lockout function is disabled.</p>	
Defaults	Change default media sizes and designations from U.S. to non-U.S. to metric.	U.S. (default) Non-U.S.

---

## Service menus—E120n



### Printing menus

#### Diagnostics mode

To enter Diagnostics mode, turn off the printer, open the front access cover, and press and hold  while turning on the printer. Close the cover when the  light displays.

Print menus by pressing and holding  until the lights flash. See **“Diagnostics mode printout sample” on page 3-4.**





#### Configuration menu

To enter Configuration menu, turn off the printer, open the front access cover, turn on the printer while pressing and holding , and close the cover once the  light displays.

Print menus by pressing and holding  until the lights flash. See **“Configuration menu printout sample” on page 3-7**

### Moving around the menu

The menu items are designated by the non-indented items listed along the left edge of the page (bottom as printed from the printer). These items are also un-shaded.

- Press and release  to move sequentially from one menu item to another.
- Press and hold  to jump to the home state (top four lights on).
- Press and release  to move through the menu settings (indicated by the  and  lights).

This action rotates only through the possible settings of the selected menu item.



## Diagnostics mode printout sample

### Printer Diagnostics

This page explains how to access the printer menus and change values. Menus are represented by Continue, Ready/Data, Toner Low, and Load/Remove Paper Light sequences. Menu items and their values are indicated by Paper Jam and Error Light sequences.

Use the illustration to help you find the menu and value you want to change. The Paper Jam and Error Lights show the current value of the menu item.

- 1 Press and release Cancel to advance through the menus and menu items to the one you need.
- 2 Press and release Continue to advance to the value you need.
- 3 Press and hold Continue until all of the lights cycle to perform the function or to save the value.
- 4 Press and hold Cancel until all of the lights cycle to return to the Home menu.
- 5 Turn the printer off to exit the menus.



Menus, menu items, and values

	Press Continue	Ready/Data	Toner Low	Load Paper	Paper Jam	Error
Print Diag Inst	●	○	○	○	○	○
Prt Quality Pgs	○	○	○	○	○	○
Defaults = U.S.	○	○	○	○	○	○
U.S.	○	○	○	○	○	○
Non-U.S.	○	○	○	○	○	○
Edge to Edge = Off	○	○	○	○	○	○
Off	○	○	○	○	○	○
On	○	○	○	○	○	○
Cont Prt Simplex Tray 1	○	○	○	○	○	○
Print History	○	○	○	○	○	○
Configuration ID = 400001	○	○	○	○	○	○
400001	○	○	○	○	○	○
400089	○	○	○	○	○	○
History	○	○	○	○	○	○
Mark History = Do Not Mark	○	○	○	○	○	○
Mark	○	○	○	○	○	○
Do Not Mark	○	○	○	○	○	○
History Mode = Modified	○	○	○	○	○	○
Modified	○	○	○	○	○	○
Every Time	○	○	○	○	○	○
Dump NVRAM	○	○	○	○	○	○
Reinit NVRAM	○	○	○	○	○	○
Optra Forms Mode = Off	○	○	○	○	○	○
On	○	○	○	○	○	○
Off	○	○	○	○	○	○
Meditech Mode = No	○	○	○	○	○	○
Yes	○	○	○	○	○	○
No	○	○	○	○	○	○

- Light On
- Light Off
- ◐ Light Blinking
- ◑ Value



## Diagnostics mode descriptions

To enter Diagnostics mode, do the following:



1. Turn the printer off.
2. Open the front access cover.
3. Press and hold  while turning the printer on.
4. Close the cover when the  light displays.

Print menus by pressing and holding  until the lights flash.

## Development

Menu item	Use this setting to	Value
Print quality pages	Print test pages by pressing and holding  until the lights flash.  Help isolate print quality problems, such as streaking. The three pages print: <ul style="list-style-type: none"> <li>• A text page with printer information, cartridge information, current margin settings, and a graphic</li> <li>• The two pages with graphics.</li> </ul> <b>Note:</b> The cartridge lockout function is disabled.	
Defaults	Change sizes and designations to metric.	U.S. (default) Non-U.S.
Edge to Edge	Allow a shift of all four margins (top, bottom, right, and left) to the physical edge of the page (printable area of supported paper).	Off (default) On
Continuous print— simplex Tray 1	Continuously print pages containing cross lines, printer information, and margin settings.  Press and hold  until the lights flash to begin.  Place the desired number of pages in the tray to limit the printing.	
Print History	Print a history of errors.  Press and hold  until the lights flash to print.	
Configuration ID	Allow the printer ID to match the label ID after the controller card is replaced.	0x400D01 (default) 0x400D89

## Network

Menu item	Use this setting to	Value
History	Print a history of errors. (same as Print History) Press and hold  until the lights flash to print.	
Mark History	Append a tag to the history report to indicate the most recent crashes.	Mark Do not mark (default)
History Mode	Post the 976 error code to the user each time it occurs. The default (modified) internally resets the posting but records it in the history. A substantial number of consecutive errors result in posting 976.	Modified (default) Every time
Dump NVRAM	Print a hex dump of the network NVRAM partition. Press and hold  until the lights flash to initiate this action.	
Reinit NVRAM	Reset the network NVRAM to factory defaults. Press and hold  until the lights flash to initiate this action.	
Meditech Mode	Prevent the network card from accepting more than one 9100 mode connection at a time.	Yes No (default)

## Configuration menu printout sample

### Printer Settings Configuration

This page explains how to access the printer menus and change values. Menus are represented by Continue, Ready/Data, Toner Low, and Load/Remove Paper Light sequences. Menu items and their values are indicated by Paper Jam and Error Light sequences.

Use the illustration to help you find the menu and value you want to change. The Paper Jam and Error Lights show the current value of the menu item.

- 1 Press and release Cancel to advance through the menus and menu items to the one you need.
  - 2 Press and release Continue to advance to the value you need.
  - 3 Press and hold Continue until all of the lights cycle to perform the function or to save the value.
  - 4 Press and hold Cancel until all of the lights cycle to return to the Home menu.
  - 5 Turn the printer off to exit the menus.
- Menus, menu items, and values

	Press Continue	Ready/Data	Toner Low	Load Paper	Paper Jam	Error
Print Configuration Mode Instructions	●	○	○	○	○	○
Reset Factory Defaults	○	○	○	○	○	○
Hex Trace = Off	○	○	○	○	○	○
Off	○	○	○	○	○	○
On	○	○	○	○	○	○
Print Quality Test Pages	○	○	○	○	○	○
Reset Photoconductor Counter	○	○	○	○	○	○
Demo Mode = Deactivate	○	○	○	○	○	○
Deactivate	○	○	○	○	○	○
Activate	○	○	○	○	○	○
Auto CR after LF = Off	○	○	○	○	○	○
Off	○	○	○	○	○	○
On	○	○	○	○	○	○
Auto LF after CR = Off	○	○	○	○	○	○
Off	○	○	○	○	○	○
On	○	○	○	○	○	○
Energy Conserve = Off	○	○	○	○	○	○
Off	○	○	○	○	○	○
On	○	○	○	○	○	○
NPA Mode = Auto	○	○	○	○	○	○
On	○	○	○	○	○	○
Off	○	○	○	○	○	○
Auto	○	○	○	○	○	○
MAC Binary PS = Auto	○	○	○	○	○	○
On	○	○	○	○	○	○
Off	○	○	○	○	○	○
Auto	○	○	○	○	○	○
NPA Mode = Auto	○	○	○	○	○	○
Off	○	○	○	○	○	○
Auto	○	○	○	○	○	○
MAC Binary PS = Auto	○	○	○	○	○	○
On	○	○	○	○	○	○
Off	○	○	○	○	○	○
Auto	○	○	○	○	○	○
Set Card Speed = Auto	○	○	○	○	○	○
Auto	○	○	○	○	○	○
10 Mbps, Half Duplex	○	○	○	○	○	○
10 Mbps, Full Duplex	○	○	○	○	○	○
100 Mbps, Half Duplex	○	○	○	○	○	○
100 Mbps, Full Duplex	○	○	○	○	○	○

●	Light On
○	Light Off
◐	Light Blinking
◑	Value

## Configuration menu descriptions

To enter the Configuration menu, turn off the printer, open the front access cover, turn on the printer while pressing and holding , and close the cover once the ! light displays.

Print menus by pressing and holding  until the lights flash.

### Utilities

Use the Utilities menu to troubleshoot printer problems.

Menu Item	Use this setting to	Values
Reset Factory Defaults	<p>Return the printer settings to factory default values.</p> <p>Sometimes resetting the printer to the original settings solves formatting problems.</p> <p>All menu items are reset to the factory default values except:</p> <ul style="list-style-type: none"> <li>• All settings in the Parallel, Network, LocalTalk, and USB menus.</li> <li>• All downloaded resources (fonts, macros, and symbol sets) in printer memory (RAM) are deleted.</li> </ul> <p>Resources in flash memory are unaffected.</p>	
Hex Trace	<p>Help isolate printing problems when unexpected characters print or characters are missing.</p> <p>Hex Trace helps determine if there is a problem with the language interpreter or the cable by providing information about what the printer is receiving.</p> <p>To exit Hex Trace, turn off the printer.</p>	<p>Off (default)</p> <p>On</p>
Print Quality Test Pages	<p>Help isolate print quality problems, such as streaking. Four pages print to help evaluate print quality:</p> <ul style="list-style-type: none"> <li>• A text page with printer information, cartridge information, current margin settings, and a graphic.</li> <li>• Two pages with graphics.</li> <li>• A blank page.</li> </ul>	
Reset Photoconductor Counter	<p>Return the photoconductor counter to zero.</p> <p>The replace photoconductor message should be cleared <i>only</i> when the photoconductor kit has been replaced.</p>	

## Setup

Use the Setup menu to configure how the printer formats the end of a line depending on the computer system being used.

Menu item	Use this setting to	Values
Demo Mode	Put the printer into demo mode where internal sheets print with each press of  . To deactivate, turn the printer off, and re-enter the configuration group. Set to Deactivate.	Deactivate (default) Activate
Auto CR After LF	Specify whether the printer automatically performs a carriage return after a line feed control command.	Off (default) On
Auto LF after CR	Specify whether the printer automatically performs a line feed after a carriage return control command.	Off (default) On
Energy Conserve		On Off (default)

## USB

Use the USB menu to change printer settings on jobs sent through a USB port.

Menu item	Use setting to	Values
NPA Mode	Send print jobs to the printer and query printer status information simultaneously.	Off On Auto (default)
MAC Binary PS	Configure the printer to process Macintosh binary PostScript print jobs.	Off—The printer filters PostScript print jobs using Standard protocol. On—The printer processes raw binary PostScript print jobs from computers using the Macintosh operating system. This setting often causes Windows print jobs to fail. Auto (default)—The printer processes print jobs from computers using either Windows or Macintosh operating systems.

## Network

Use the network menu to change printer settings on jobs sent through a network port (either standard network or network opt <x>).

Menu item	Use setting to	Values
NPA Mode	Send print jobs to the printer and query printer status information simultaneously.	Off Auto (default)
MAC Binary PS	Configure the printer to process Macintosh binary PostScript print jobs.	Off—The printer filters PostScript print jobs using Standard protocol. On—The printer processes raw binary PostScript print jobs from computers using the Macintosh operating system. This setting often causes Windows print jobs to fail. Auto (default)—The printer processes print jobs from computers using either Windows or Macintosh operating systems.
Set Card Speed	Automatically detect the connection speed of your network. This setting can be disabled to set the speed manually.	Auto (default)—The printer detects the current network speed. 10Mbps, half duplex—Forces the printer to try to connect to the network only at 10Mbps, half duplex. 10Mbps, full duplex—Forces the printer to try to connect to the network only at 10Mbps, full duplex. 100Mbps, half duplex—Forces the printer to try to connect to the network only at 100Mbps, half duplex. 100Mbps, full duple—Forces the printer to try to connect to the network only at 100Mbps, full duplex.

---

## 4. Repair information

**Warning:** Read the following before handling electronic parts.

---

### Handling ESD-sensitive parts

Many electronic products use parts that are known to be sensitive to electrostatic discharge (ESD). To prevent damage to ESD-sensitive parts, use the following instructions in addition to all the usual precautions, such as turning off power before removing logic boards:

- Keep the ESD-sensitive part in its original shipping container (a special “ESD bag”) until you are ready to install the part into the printer.
- Make the least-possible movements with your body to prevent an increase of static electricity from clothing fibers, carpets, and furniture.
- Put the ESD wrist strap on your wrist. Connect the wrist band to the system ground point. This discharges any static electricity in your body to the printer.
- Hold the ESD-sensitive part by its edge connector shroud (cover); do not touch its pins. If you are removing a pluggable module, use the correct tool.
- Do not place the ESD-sensitive part on the printer cover or on a metal table; if you need to put down the ESD-sensitive part for any reason, first put it into its special bag.
- Printer covers and metal tables can be electrical grounds. They increase the risk of damage because they make a discharge path from your body through the ESD-sensitive part. (Large metal objects can be discharge paths without being grounded.)
- Prevent ESD-sensitive parts from being accidentally touched by other personnel. Install covers when you leave the printer unattended and do not put unprotected ESD-sensitive parts on a table.
- If possible, keep all ESD-sensitive parts in a grounded metal cabinet (case).
- Be extra careful in working with ESD-sensitive parts when cold-weather heating is used because low humidity increases static electricity.



## Adjustment procedures

### *Printhead assembly adjustment*

A printhead needs to be correctly positioned after it has been removed. Align it to the frame or use the same position as the removed printhead.

Skew is caused by a sheet being fed through the printer while misaligned. The entire image is rotated relative to the sheet edges. However, a misaligned printhead causes the horizontal lines to appear skewed while the vertical lines remain parallel to the vertical edges.

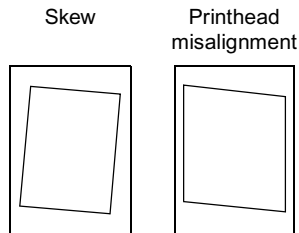

There are no adjustments for skew. Check the pick roll (paper pick assembly) for wear, the paper path for obstructions, the fuser for proper setting, and the tray paper guides for fit to the media.

To align the printhead:

1. **For the E120n model**—Enter the Diagnostics Menu. See **“Service menus—E120n” on page 3-3**, and print the **Cont Prt Simplex Tray 1** (Quick Test).

**Note:** In order to limit the number of printouts, place only one sheet at a time in the main tray.

**For the E120 model**—The E120 can be adjusted in the same manner as the E120n. However, this model does not print the same sheet. You may have to find or create a page with lines going horizontally across the page. Otherwise, follow the same procedure to adjust the printhead.

2. Fold the printed test page on the left side so that a few millimeters of grid lines wrap around the outside of the fold.
3. Fold a second vertical fold near the center so that the left side top edge aligns with the right side top edge.



4. If the top margin of the grid lines of the right flap is greater than the top margin of the grid lines on the left flap, adjust the printhead clockwise relative to the printer and recheck. See the left side of the figure below. Adjust the printhead counterclockwise if the left side grid lines extend below the right side. See the right side of the figure below.

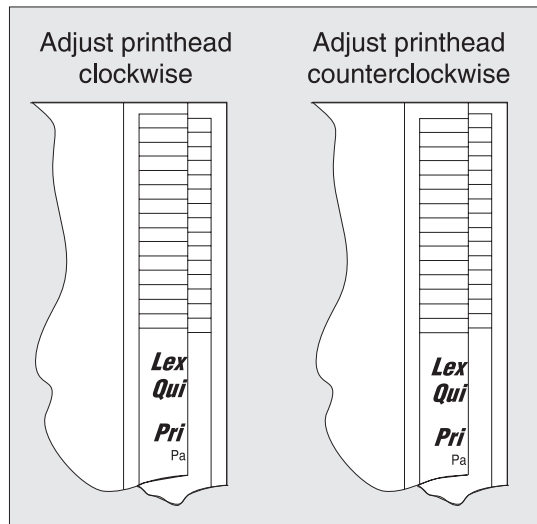

5. After obtaining a properly adjusted image on the paper, tighten all three screws.

---

## Removal procedures



**CAUTION:** Remove the power cord from the printer or electrical outlet before you connect or disconnect any cable, electronic board, or assembly for personal safety and to prevent damage to the printer. Disconnect any connections between the printer and PCs/peripherals.

**Note:** Some removal procedures may require removing cable ties. If so, you must replace the cable ties during reassembly to avoid pinching wires, obstructing the paper path, or restricting mechanical movement.

**Note:** Before beginning any removal, remove the toner cartridge and PC kit.

**Warning:** Cover the PC kit to block light to the PC drum. It can be damaged by excessive light.

### ***Extender cover removal***

1. Rotate the extender cover (A) toward the front of the printer.



A

2. Pinch the pivot on the extender cover and remove it.

### ***Tray cover removal***

Lift and pull out the tray cover.



### ***Main tray removal***

1. Remove the tray cover. See **“Tray cover removal” on page 4-4.**
2. Align the front of the printer with the front edge of the table.
3. Put pressure with your thumb in the center of the tray and pull out.



### ***Left cover removal***

1. Open the rear door and remove the screw (A).



A

2. Remove the screw (B).



B

3. Pull the cover away from the printer and lift to remove it.

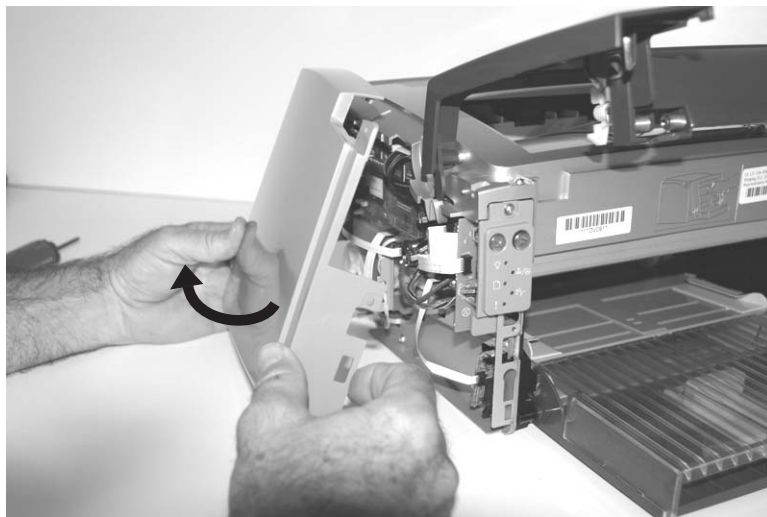

## Right cover removal

1. Open the rear door and remove the lower right screw (A).



2. Open the front door and remove the screw (B).



3. Pull the front of the cover to unlatch (B), pull the bottom out, and lift the cover to remove it.

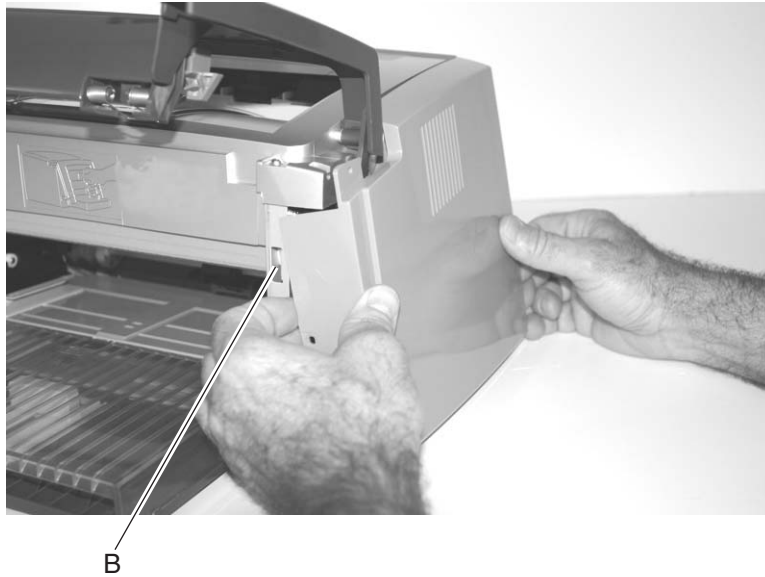

### ***Front door assembly removal***

1. Remove the left cover. See **“Left cover removal”** on page 4-5.
2. Remove the right cover. See **“Right cover removal”** on page 4-7.
3. Grasp the right pivot and remove it from the pivot shaft (A).
4. Gently slide the front door toward the left side while lifting to the right side.
5. Once the left pivot is separated, lift the front door away from the printer.

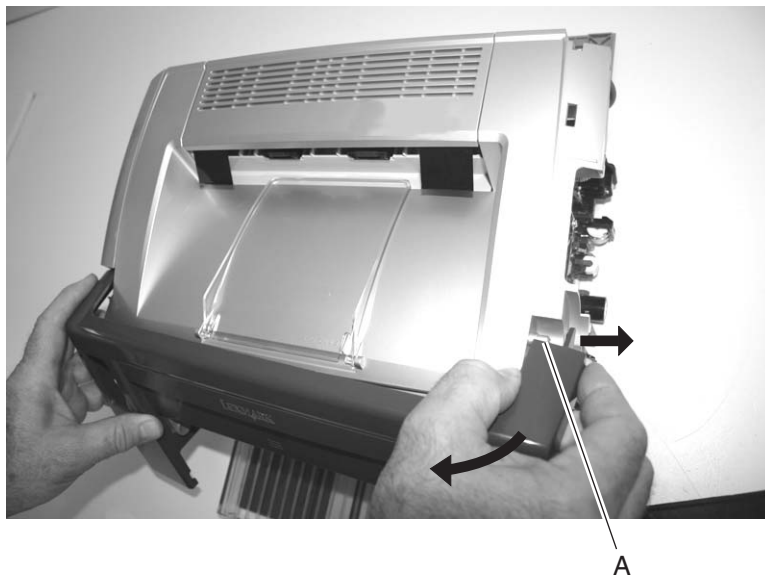

### ***Top cover assembly removal***

1. Remove the front door assembly. See **“Front door assembly removal”** on page 4-8.
2. Remove the two screws (A) from the front of the printer.



A

3. Remove the two screws (B) from the back of the printer.



B



4. Lift the front of the cover and unhook the rear.



**Reinstallation note:** Close the top door before reinstalling the top cover. When the top cover is in place, open the top door and press vertically on the front leg of the flag. It should rotate downward and return by the force of the cantilever spring in the cover.

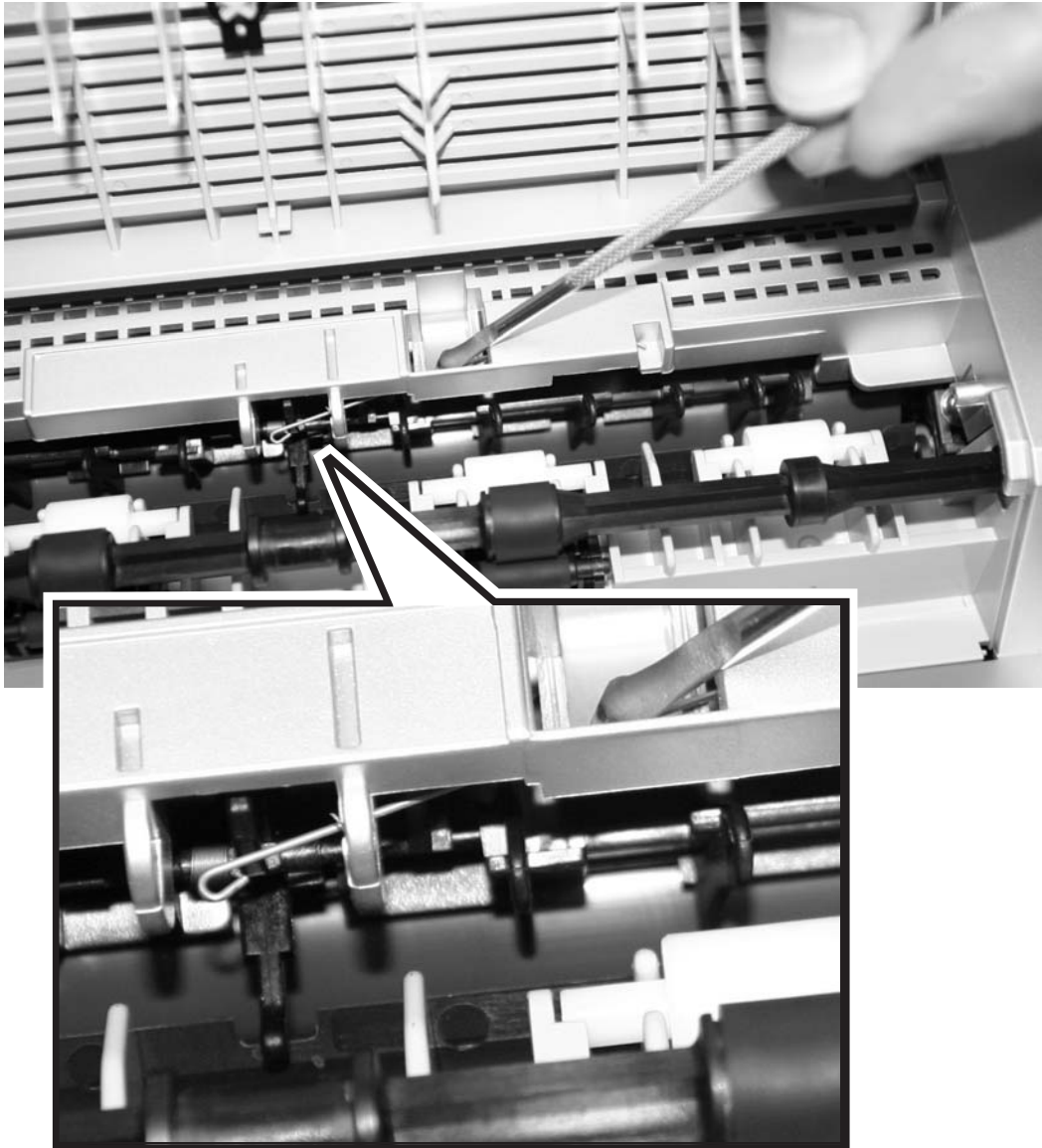

## Printhead removal

1. Remove the top cover. See **“Top cover assembly removal”** on page 4-9.
2. Remove the three screws (A).

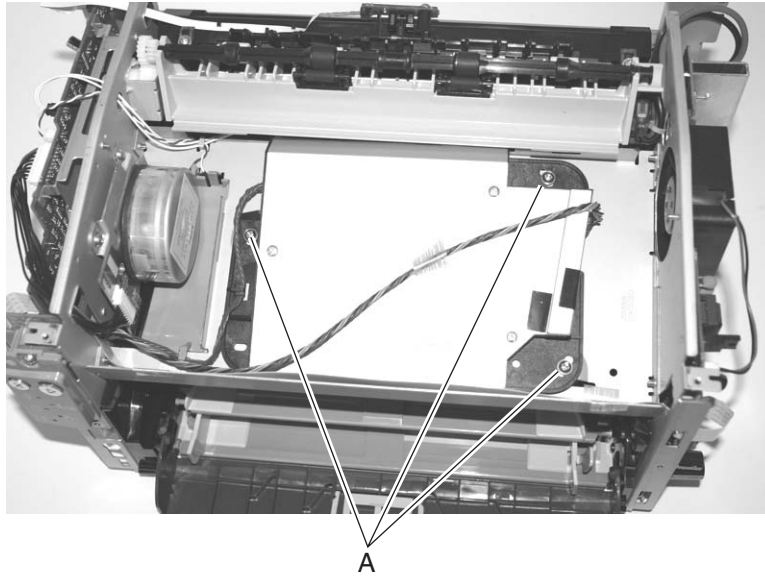

3. Disconnect the printhead cables at J12 and J13 on the controller card.
4. Remove the printhead.

**Note:** After reinstalling the printhead, check the alignment. If necessary, perform the **“Printhead assembly adjustment”** on page 4-2 before the final reinstallation of the top cover.

## Transfer roll assembly

1. Turn the back of the printer to face you.
2. Open the back door.
3. Lift the right side of the transfer roll until the shaft unsnaps from the bearing (A).
4. Pull the roll to the right and slide the left end of the shaft from the bearing.

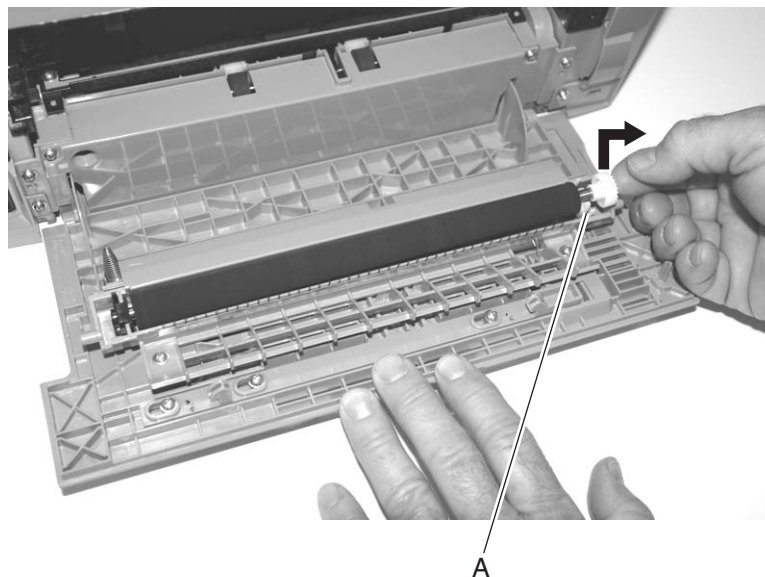

## Rear door assembly

**Note:** Be careful not to touch the transfer roll during this removal.

1. Open the rear door.
2. Remove the two screws (A).
3. Remove the transfer card cover (B).

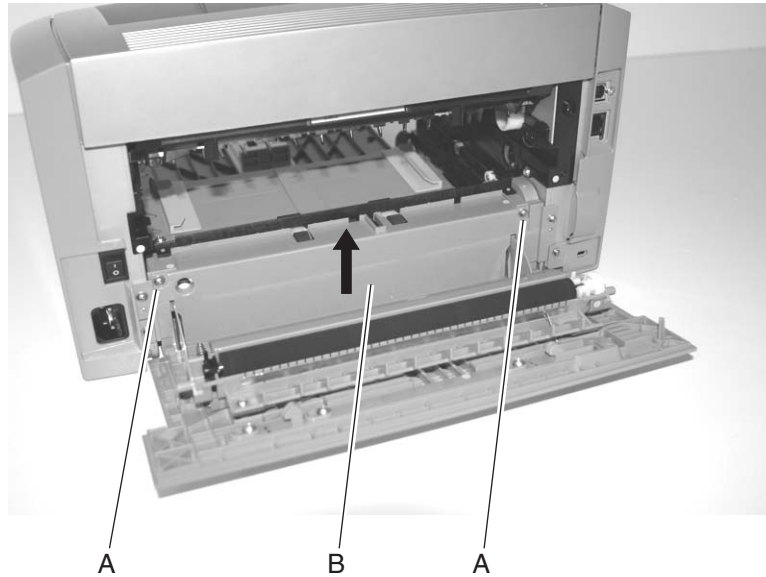

4. Press the right side door stop (C) to the left and rotate the cover slightly to free the stop.
5. Detach the right hinge from its pivot (D) with a short, quick motion.

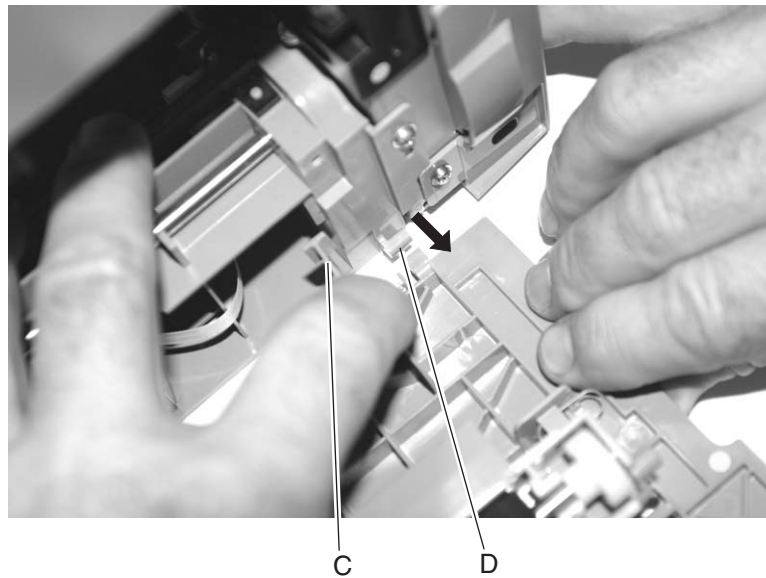

6. Press the left side door stop (E) to free it from the printer.
7. Pull out the left side of the rear door.

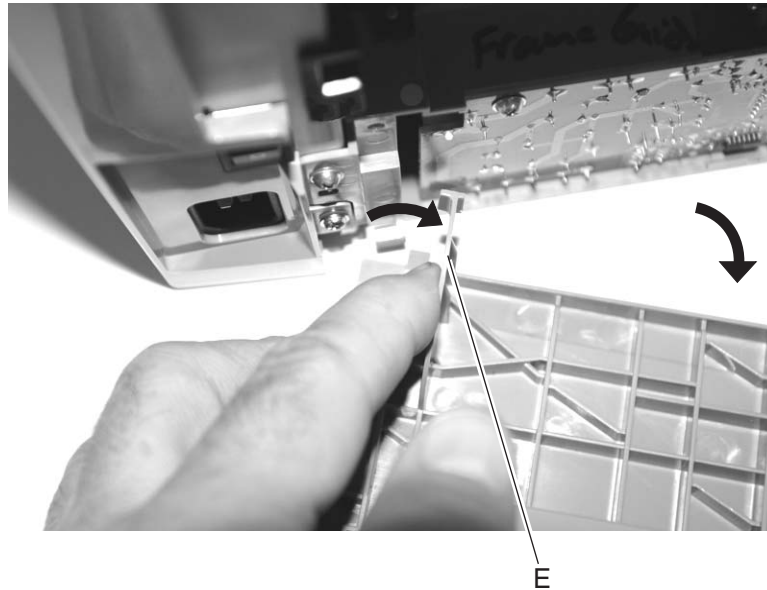

### ***Transfer card and input sensor assembly removal***

1. Remove the left cover. See **“Left cover removal”** on page 4-5.
2. Remove the rear door assembly. See **“Rear door assembly”** on page 4-13.
3. Remove the three screws (A).

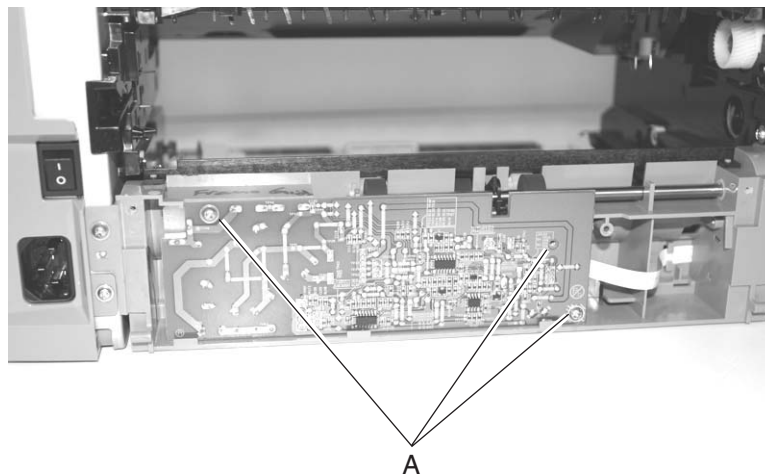

4. Disconnect the cable (B) from the controller card at J9.
5. Remove the card and cable assembly carefully by sliding the cable through the retainer (C).

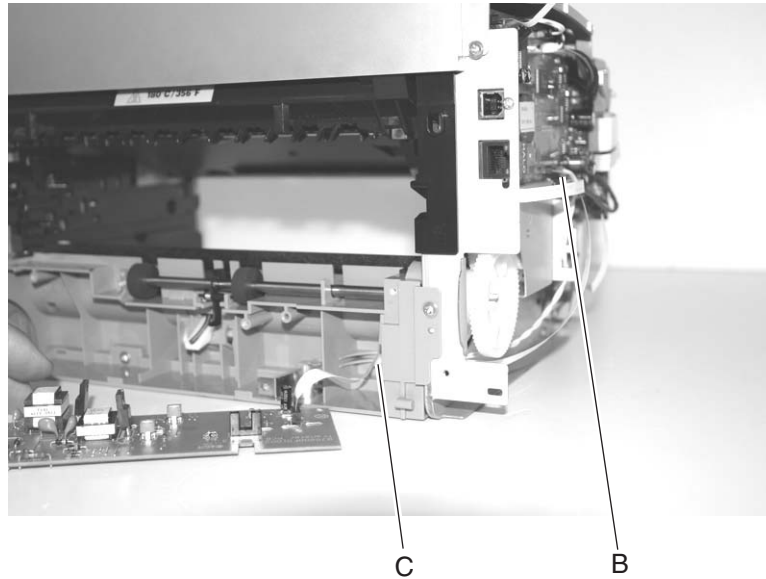

### ***Paper pick assembly removal***

1. Remove the transfer card and input sensor assembly. See **“Transfer card and input sensor assembly removal” on page 4-14.**
2. Remove the four screws (A).

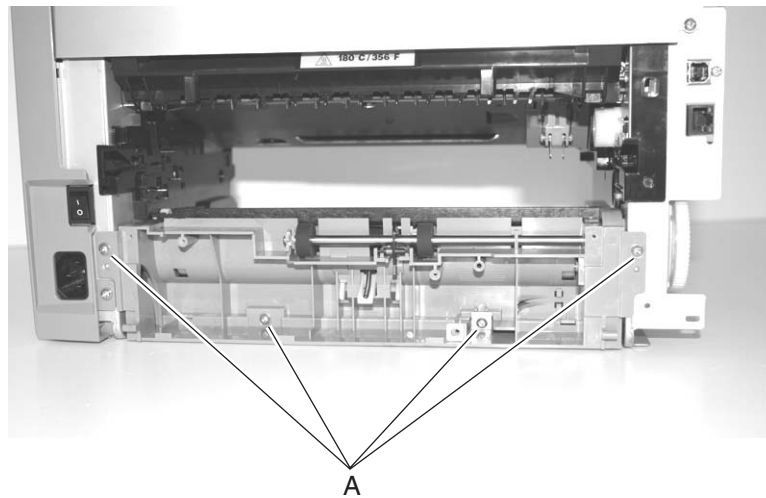

3. Press the locking tab (B) on the gear hub while sliding the gear from the shaft.

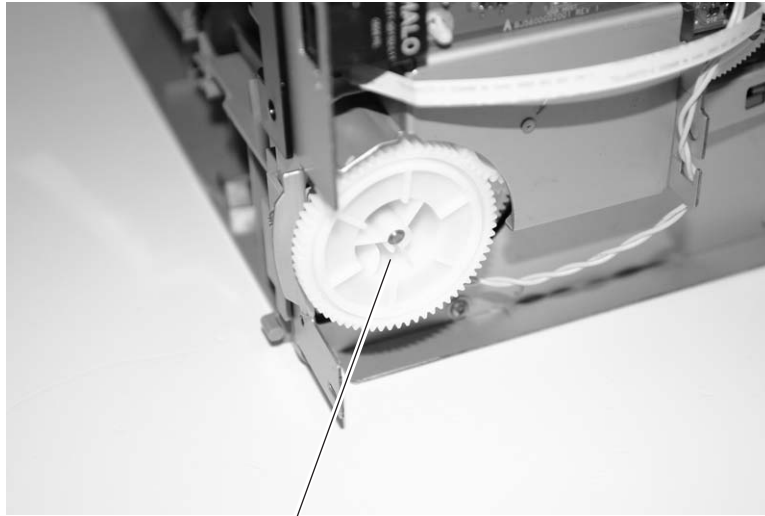

B

4. Remove the gears and spring (C) from the shaft.
5. Disconnect the cable (D) from the controller card at J10.

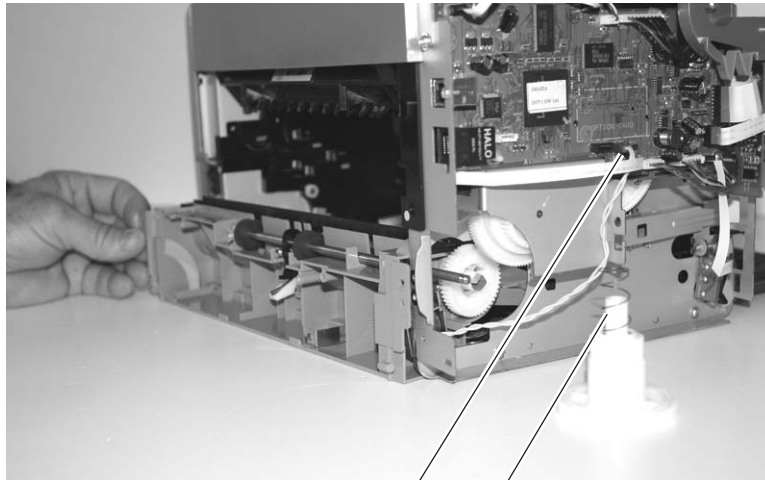

D

C

6. Remove the paper pick assembly.

## Controller card removal

**Warning:** Do not replace the operator panel and controller card at the same time. Each card contains the printer settings. When either of these cards is new, it obtains some of the settings from the other card. Settings are lost when both are new and replaced at the same time.

1. Remove the left cover. See **“Left cover removal” on page 4-5.**
2. Disconnect all of the cables.
3. Remove the four screws (A).
4. Push the latch in the plastic standoff (B) using a screwdriver or spring hook while gently pulling the bottom of the card away from the printer.

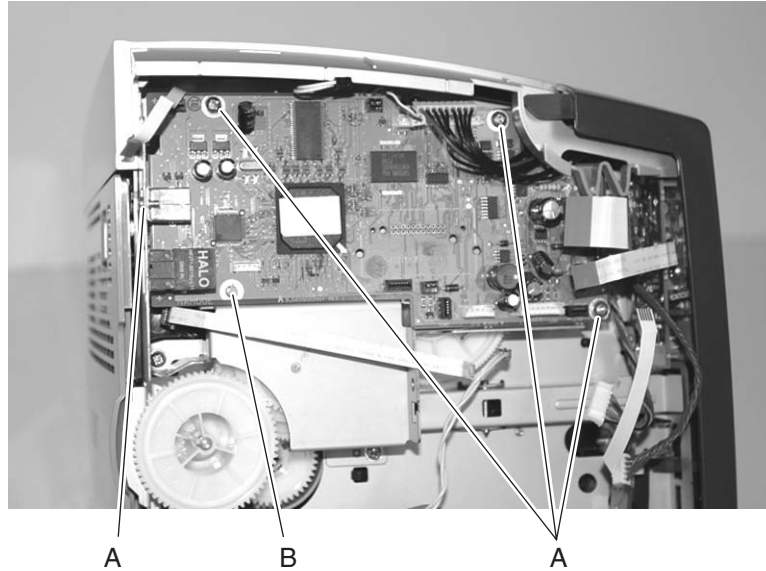

5. Remove the card.
6. When re-installing, be sure the printhead cable is routed through the upper right side of the controller card cutout.



## Operator panel removal (all models)

**Warning:** Do not replace the operator panel and controller card at the same time. Each card contains the printer settings. When either of these cards is new, it obtains some of the settings from the other card. Settings are lost when both are new and replaced at the same time.

1. Remove the left cover. See **“Left cover removal” on page 4-5.**
2. Disconnect the cable from the controller card at J16.
3. Remove the two screws (A).



A

4. Remove the card assembly.

**Warning:** Do not change the operator panel at the same time as you change a controller card. Special settings will be lost.

## LVPS/HVPS removal



1. Remove the right cover. See **“Right cover removal”** on page 4-7.
2. Disconnect the three cables (A) connected to the LVPS/HVPS card.

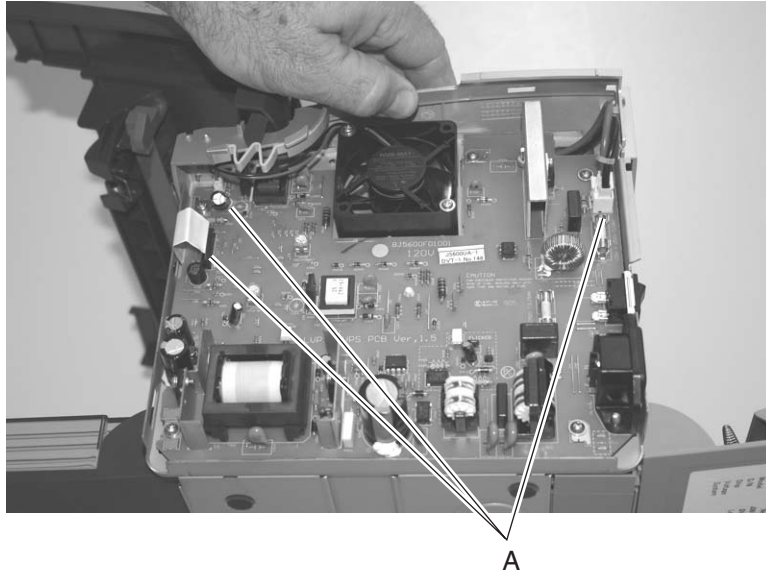

3. Remove the four common screws (B) and the unique screw (C).
4. Squeeze the latch (D) to free the card.

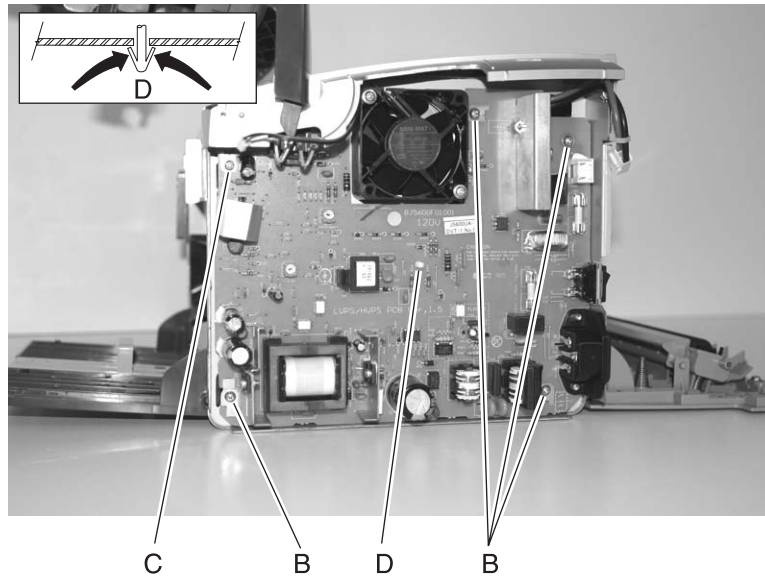

## Fuser removal



1. Remove the top cover assembly. See **“Top cover assembly removal”** on page 4-9.
2. Remove the two screws (A).

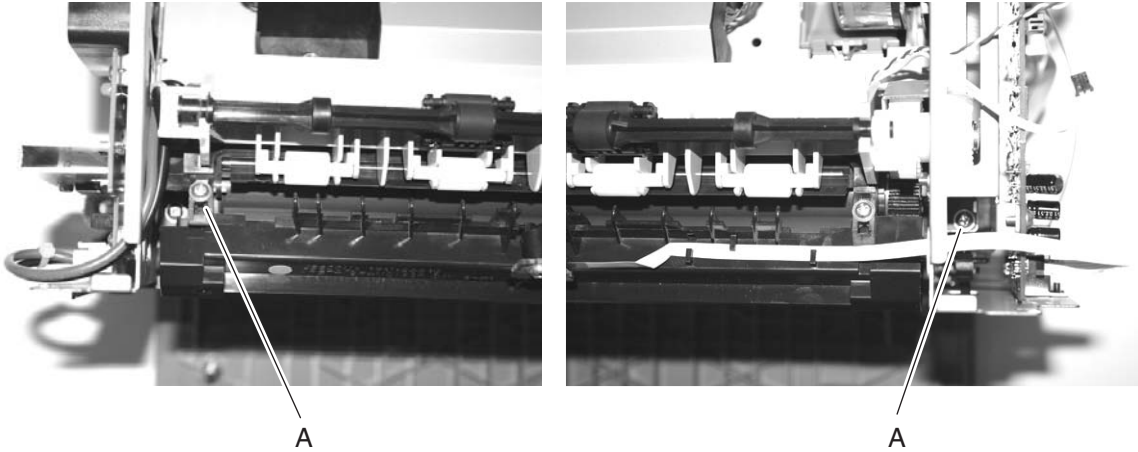

3. Disconnect the cables from the LVPS/HVPS (CN403) and the controller card (J1 and J2).
4. Remove the fuser along with the sensor and cables.

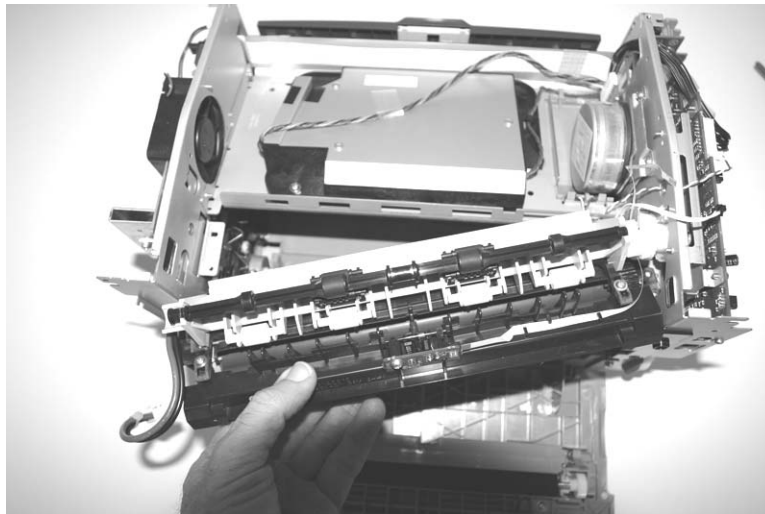

## 5. Locations and connections

### Locations

#### Front view

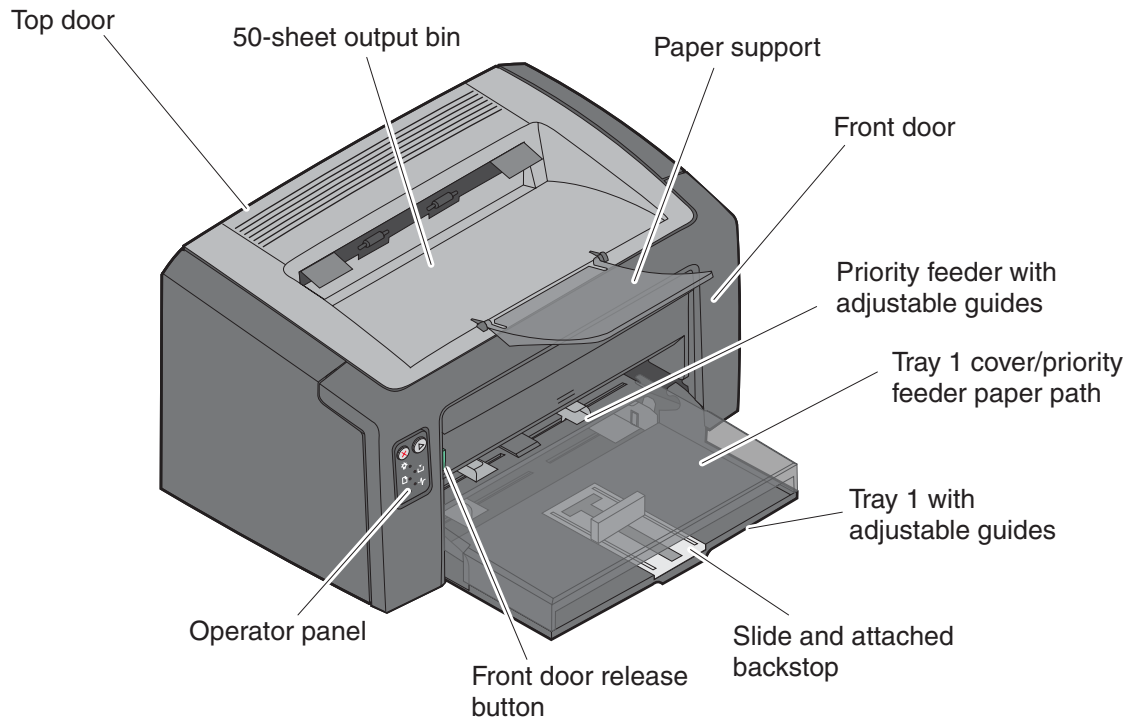

#### Rear view

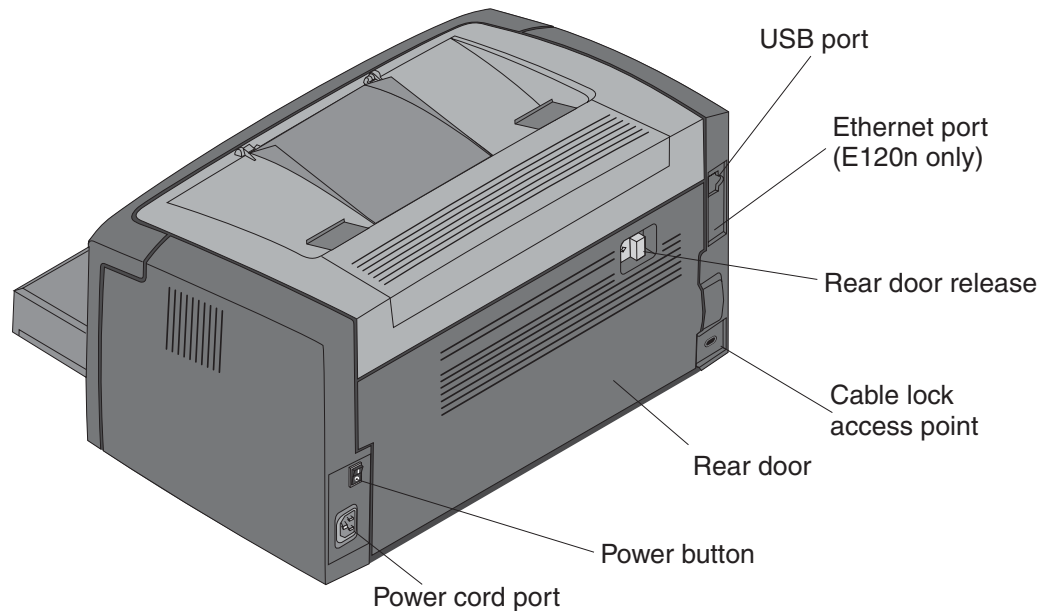

# Connectors

## Controller card

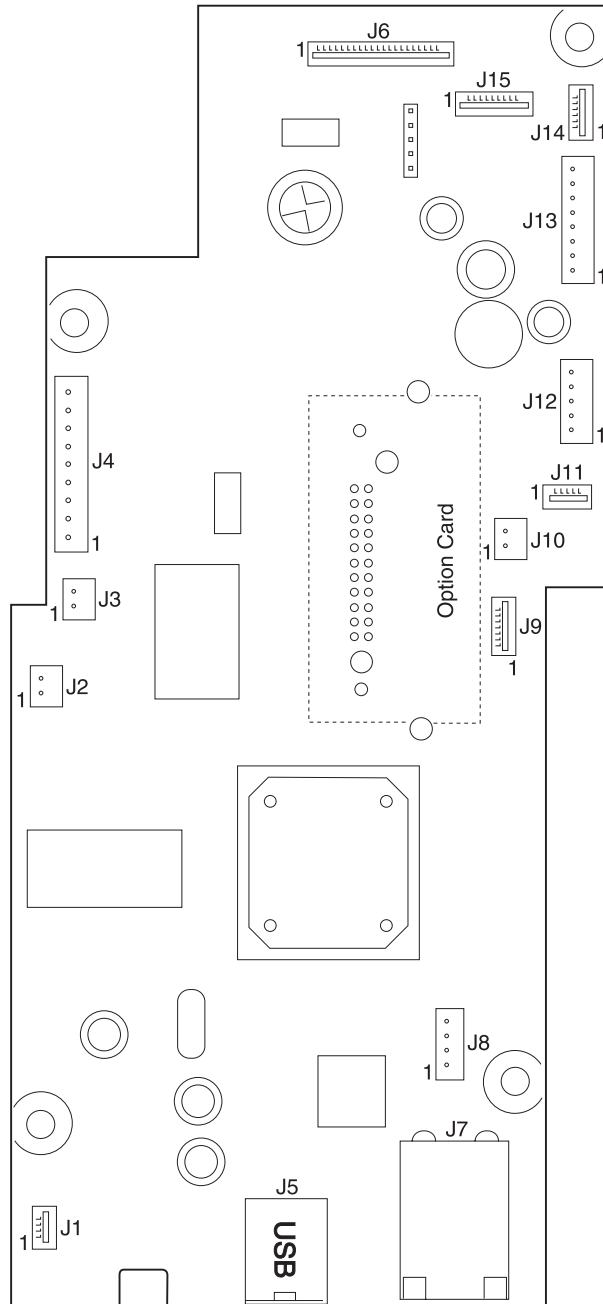

**Controller card connector pin values (only J2, thermistor, and J6 LVPS/HVPS connected)**

Connector	Pin #	Value
J1 Exit sensor	1	+5 V dc
	2	Ground
	3	+5 V dc
	4	Ground
J2 Thermistor	2	Ground
J3 toner cartridge	1	+5 V dc
J4 Main motor	2	+5 V dc
	3	+5 V dc
	4	+5 V dc
	5	Ground
	6	+5 V dc
J5 USB		
J6 LVPS/HVPS	16	+5 V dc
J9 Transfer	1	+5 V dc
	5	+5 V dc
	6	Ground
	7	+24 V dc
J10 Solenoid	1	+24 V dc
J11 Rear cover	2	Ground
	3	Ground
	4	Ground
J12 Mirror motor	4	Ground
	5	+24 V dc
J13 LSU	1	Ground
	6	Ground
	8	+5 V dc
J14 Front cover	1	+5 V dc
	2	Ground
	3	Ground
	4	Ground
J15 Operator panel	1	+5 V dc
	2	+5 V dc
	3	+5 V dc
	4	Ground
	6	+5 V dc
	7	+5 V dc
	8	+5 V dc

**LVPS/HVPS card**

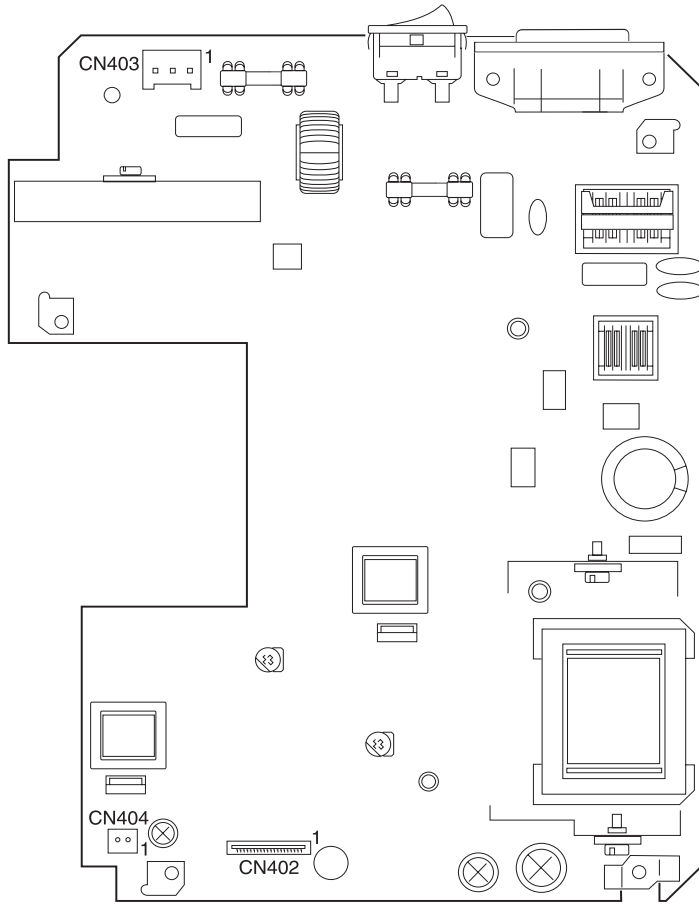



**LVPS/HVPS pin values (turn the switch on and unplug the cables except for the AC input)**

Connector	Pin #	Value
CN402	12	+24 V dc
	13	+24 V dc
	14	+24 V dc
	15	+24 V dc
	16	+24 V dc
	18 (F403Fused)	+24 V dc
	2	Ground
	4	Ground
	6	Ground
	8	Ground
	17	Ground
CN403	1	110/220 V ac
CN404	1	+24 V dc





---

## 6. Preventive maintenance

The E120 and E120n do not require preventive maintenance.



## 7. Parts catalog

### How to use this parts catalog

The following legend is used in the parts catalog:

Asm-index	Part number	Units/mach	Units/FRU	Description
-----------	-------------	------------	-----------	-------------

- **Asm-index:** Identifies the assembly and the item in the diagram. For example, 3-1 indicates Assembly 3 and item number 1 in the table.
- **Part number:** Identifies the unique number that identifies this FRU.
- **Units/mach:** Refers to the number of units actually used in the base printer.
- **Units/FRU:** Refers to the number of units packaged together and identified by the part number.
- **NS:** (Not shown) in the Asm-Index column indicates that the part is procurable but is not pictured in the illustration.
- **PP:** (Parts Packet) in the parts description column indicates the part is contained in a parts packet.
- Model information used in the parts catalog:

Abbreviation used	Machine type and model	Description	Network capability
E120	4506-100	Lexmark E120	Non-network
E120n	4506-110	Lexmark E120n	Network

## Assembly 1: Covers

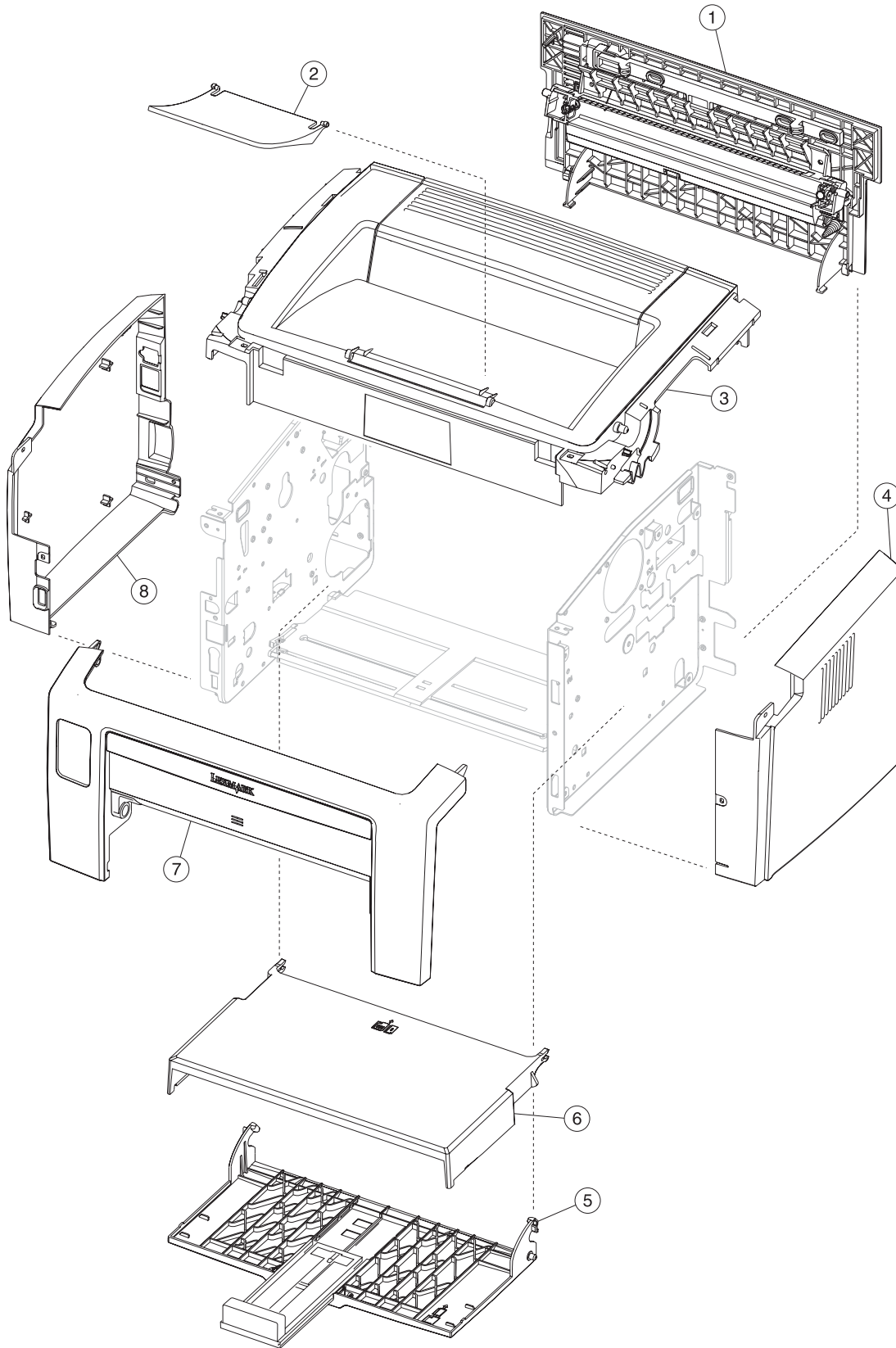

<b>Asm-index</b>	<b>Part number</b>	<b>Units/mach</b>	<b>Units/FRU</b>	<b>Description</b>
1—1	40X1293	1	1	Rear door assembly
2	40X1295	1	1	Output tray extender
3	40X1290	1	1	Top cover assembly
4	40X1289	1	1	Right cover
5	40X1294	1	1	Main tray assembly
6	40X1291	1	1	Tray cover
7	40X1292	1	1	Front door assembly
8	40X1288	1	1	Left cover

## Assembly 2: Electronics

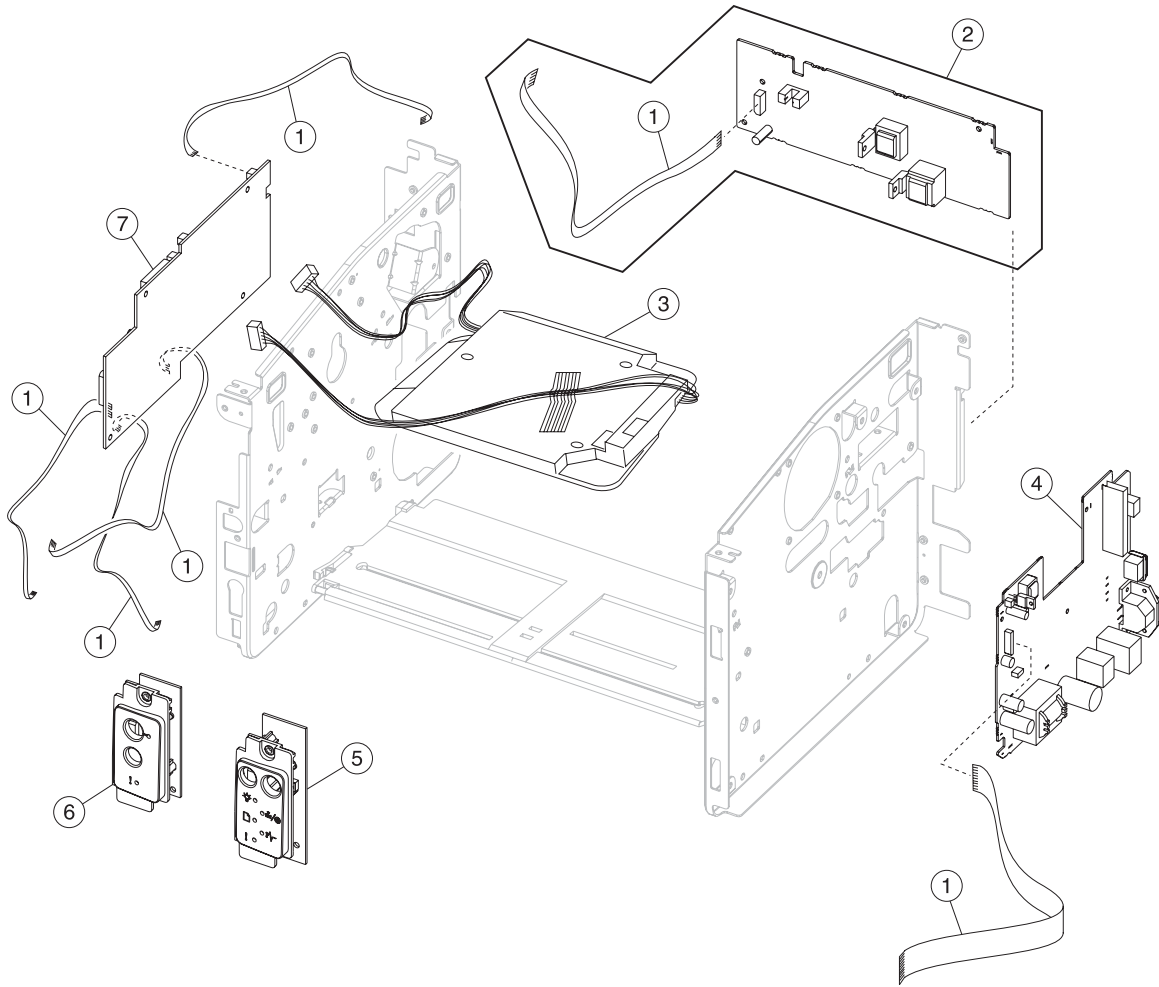

Asm-index	Part number	Units/mach	Units/FRU	Description
2—1	40X1296	1	1	Miscellaneous flat cables
2	40X1297	1	1	Transfer card and input sensor
3	40X1284	1	1	Printhead assembly, including cables
4	40X1278	1	1	LVPS/HVPS, 110 V
4	40X1279	1	1	LVPS/HVPS, 220 V
5	40X1282	1	1	Operator panel (2 button, 6 light), E120n
6	40X1283	1	1	Operator panel (2 button, 2 light), E120
7	40X1280	1	1	Controller card, E120
7	40X1281	1	1	Controller card, E120n



### Assembly 3: Frame

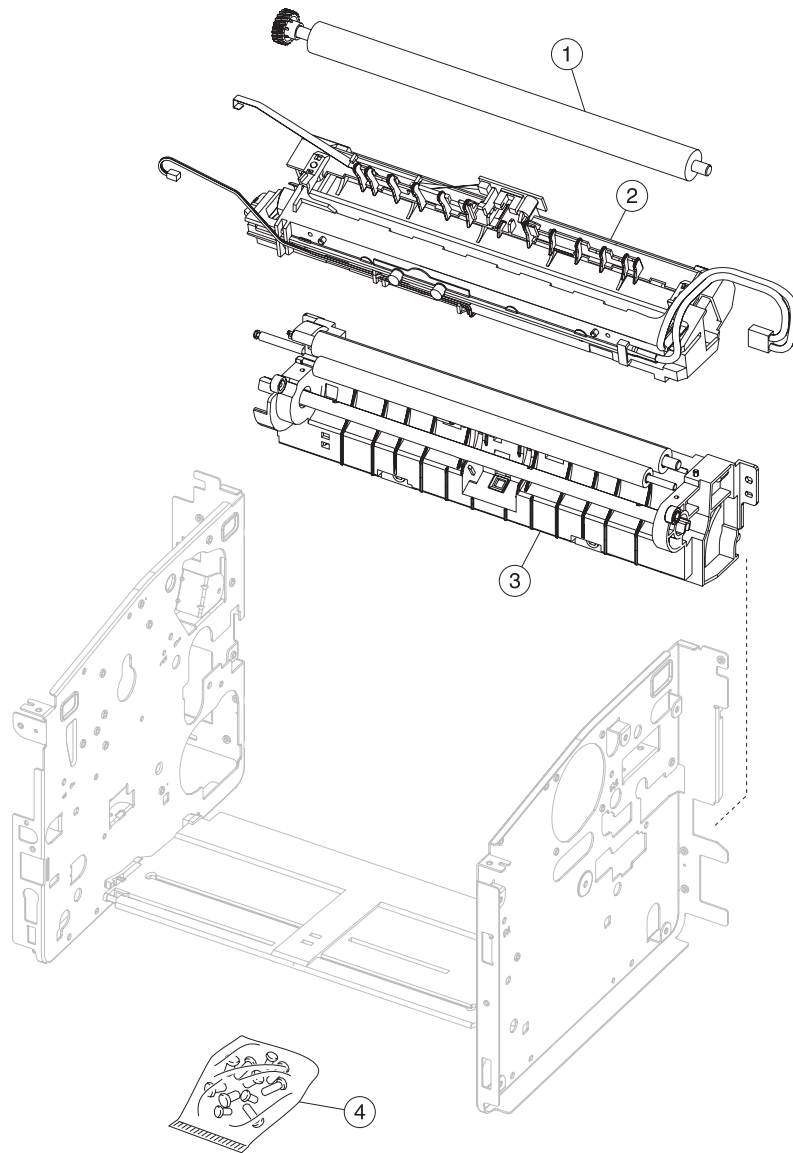

<b>Asm-index</b>	<b>Part number</b>	<b>Units/mach</b>	<b>Units/FRU</b>	<b>Description</b>
3—1	40X1287	1	1	Transfer roll assembly
2	40X1276	1	1	Fuser assembly, 110 V
2	40X1277	1	1	Fuser assembly, 220 V
2	40X1298	1	1	Fuser assembly, 100 V
3	40X1285	1	1	Paper pick assembly
4	40X1299			Screws, parts packet

**Assembly 4: Miscellaneous**

<b>Asm-index</b>	<b>Part number</b>	<b>Units/mach</b>	<b>Units/FRU</b>	<b>Description</b>
NS	40X0289	1	1	Power cord—U.S.A. and Canada
NS	40X0271	1	1	Power cord, 8 ft.—United Kingdom
NS	40X0274	1	1	Power cord, 6 ft.—Switzerland
NS	40X0275	1	1	Power cord, 6 ft.—Israel
NS	40X0276	1	1	Power cord, 6 ft., straight—South Africa
NS	40X0277	1	1	Power cord, 6 ft., straight—Brazil
NS	40X0278	1	1	Power cord, HV 6 ft., straight—Austria
NS	40X0279	1	1	Power cord, 6 ft., straight—Denmark
NS	40X0280	1	1	Power cord—Korea
NS	40X0281	1	1	Power cord, 1.8M, straight—Taiwan
NS	40X0282	1	1	Power cord, 6 ft., straight—PRC
NS	40X0287	1	1	Power cord—Italy
NS	40X0288	1	1	Power cord—Argentina
NS	40X0296	1	1	Power cord—Australia
NS	7375411	1	1	Relocation packaging kit

# Index

## A

- abbreviations **1-6**
- acronyms **1-6**
- adjustments, printhead assembly **4-2**
- alignment, printhead **4-2**
- Auto CR After LF, E120n **3-9**
- Auto LF After CR, E120n **3-9**

## B

- buttons **2-9**

## C

- card stock **1-5, 2-31**
- configuration ID—E120n **3-5**
- configuration menu
  - table of light patterns
    - E120 **2-3**
    - E120n **2-9**
- configuration menu—E120n
  - menus **3-8**
  - Network
    - Mac Binary PS **3-10**
    - NPA Mode **3-10**
    - Set Card Speed **3-10**
  - printout sample **3-7**
  - Setup
    - Auto CR After LF **3-9**
    - Auto LF After CR **3-9**
    - Demo Mode **3-9**
    - Energy Conserve **3-9**
  - USB
    - Mac Binary PS **3-9**
    - NPA Mode **3-9**
  - Utilities
    - Hex Trace **3-8**
    - Print Quality Pages **3-8**
    - Reset Factory Defaults **3-8**
    - Reset Photoconductor Counter **3-8**
- connections
  - controller card **5-2**
  - LVPS/HVPS card **5-4**
- controller card
  - connections **5-2**
  - error codes
    - E120 **2-6, 2-7**
    - E120n **2-18**
  - parts catalog **7-5**
  - removal **4-17**
  - service check **2-24**

## D

- Defaults
  - E120 **3-3**
  - E120n **3-5**
- Demo Mode—E120n **3-9**

- diagnostic information **2-1**
- diagnostics mode—E120
  - Defaults **3-3**
  - menus **3-3**
  - Print Quality Pages **3-3**
  - printing menu **3-2**
  - printout sample **3-2**
  - table of light patterns **3-2**
- diagnostics mode—E120n
  - Development
    - Configuration ID **3-5**
    - Continuous Print, simplex **3-5**
    - Defaults **3-5**
    - Edge to Edge **3-5**
    - Print History **3-5**
    - Print Quality Pages **3-5**
  - menus **3-5**
  - Network
    - Dump NVRAM **3-6**
    - History **3-6**
    - History Mode **3-6**
    - Mark History **3-6**
    - Reinit NVRAM **3-6**
  - printout sample **3-4**
  - table of light patterns **3-4**
- Dump NVRAM, E120n **3-6**

## E

- Edge to Edge—E120n **3-5**
- Energy Conserve—E120n **3-9**
- envelopes **1-4**
- error log, E120n—*see History* **3-6**
- error messages
  - E120
    - primary light patterns **2-3**
    - user attendance messages **2-3**
  - E120n
    - additional information **2-11, 2-14**
    - service error codes **2-17**
- ESD-sensitive parts **4-1**

## F

- front door assembly removal **4-8**
- fuser **2-36, 2-37**
  - error codes
    - E120 **2-6**
    - E120n **2-18, 2-20**
  - parts catalog **7-7**
  - removal **4-20**
  - service check **2-26**
    - cold **2-27**
    - hot **2-27**
  - symptom tables **2-23**

**H**

Hex Trace—E120n **3-8**  
 History—E120n **3-6**

**L**

labels **1-4**  
 left cover removal **4-5**  
 letterhead **1-4**  
 light patterns, E120  
   additional information—primary codes **2-11**  
   description **2-3**  
 light patterns, E120n—service codes **2-17**  
 locations  
   front views **1-2, 5-1**  
   rear views **1-2, 5-1**  
 LVPS/HVPS  
   connections **5-4**  
   parts catalog **7-5**  
   removal **4-19**  
   service check **2-28**

**M**

Macintosh **2-38, 2-40**  
 main motor  
   connections **5-3**  
   service check **2-28**  
   symptom tables **2-22**  
 main tray removal **4-5**  
 maintenance approach **1-1**  
 Mark History—E120n **3-6**  
 menus  
   E120  
     diagnostics mode **3-3**  
     printing **3-1**  
   E120n  
     configuration mode **3-8**  
     diagnostics mode **3-5**  
     printing **3-3**  
 messages, E120n—service error codes **2-17**  
 models **1-1**  
   diagrams **1-2, 5-1**

**O**

operator panel  
   E120  
     diagram **2-2**  
     overview **2-2**  
     primary, secondary, tertiary **2-4**  
   E120n  
     diagram **2-9**  
     overview **2-9**  
     primary light patterns **2-11**  
     secondary light patterns **2-14**  
   model differences **1-1**  
   parts catalog **7-5**  
 Operator Panel Service Check **2-24, 2-25**

**P**

paper **1-3**  
 paper jams  
   E120n **2-14**  
   paper feed service check **2-29**  
   tips on preventing **1-5**  
 paper recommendations **1-3**  
 parts catalog  
   covers **7-2**  
   electronics **7-4**  
   frame **7-6**  
 power-on self test (POST)  
   E120 **2-2**  
   E120n **2-8**  
   symptoms **2-22**  
 preprinted forms **1-4**  
 print history, E120n **3-5**  
 print media **1-3**  
 print quality pages  
   E120n **3-5, 3-8**  
   using **2-31**  
 Print Quality Pages—E120 **3-3**  
 print quality problems, solving **2-36**  
 printer symptom table **2-23**  
 printhead  
   adjustment **4-2**  
   error code—E120n **2-18**  
   error codes—E120 **2-7**  
   parts catalog **7-5**  
   removal **4-12**  
   service check **2-40**

**R**

Reinit NVRAM—E120n **3-6**  
 removals  
   controller card **4-17**  
   extender cover **4-4**  
   front door assembly **4-8**  
   fuser **4-20**  
   left cover **4-5**  
   LVPS/HVPS **4-19**  
   main tray **4-5**  
   operator panel (all models) **4-18**  
   paper pick assembly **4-14, 4-15**  
   printhead **4-12**  
   rear door assembly **4-13**  
   right cover **4-7**  
   top cover assembly **4-9**  
   transfer card and input sensor assembly **4-14**  
   transfer roll assembly **4-12**  
   tray cover **4-4**  
 Reset Factory Defaults—E120n **3-8**  
 reset maintenance page counter—E120n **3-8**  
 Reset PC Counter—E120n **3-8**  
 right cover removal **4-7**

**S**

- safety information **x**
- secondary error codes
  - complex page **2-15**
  - error communicating with the host computer **2-16**
  - insufficient collation area **2-16**
  - invalid engine code **2-16**
  - invalid network code **2-17**
  - memory full **2-16**
  - network interface errors **2-16**
  - short paper **2-16**
- service checks **2-24**
  - controller card **2-24**
  - dead machine **2-25**
  - fuser **2-26**
    - cold **2-27**
    - hot **2-27**
  - LVPS/HVPS **2-28**
  - main motor **2-28**
  - operator panel **2-25**
  - paper feed **2-29**
    - paper jam during POST **2-29**
    - paper never picks **2-30**
    - paper picks but stops **2-29**
    - paper picks during POST **2-29**
    - paper picks sheets **2-30**
    - paper trees, curls **2-31**
  - print quality **2-31**
    - black page **2-33**
    - blank page **2-32**
    - heavy background **2-33**
    - image density **2-34**
    - light print **2-35**
    - partial blank image **2-34**
    - poor fusing of image **2-34**
    - toner on back of page **2-36**
    - white or black lines **2-35**
  - printhead **2-40**
  - transfer roll **2-41**
- service error codes
  - E120 **2-6**
  - E120n
    - accessing **2-17**
    - secondary light patterns **2-18**
    - tertiary light patterns **2-18**
- service menus
  - E120 **3-1**
  - E120n **3-3**
- special tools **1-6**
- start **2-1**
- symptom tables **2-22**
  - POST **2-22**
  - printer **2-23**

**T**

- tools **1-6**
- top cover assembly removal **4-9**
- Transfer **2-19, 2-34**
- transfer card and input sensor—parts catalog **7-5**

- Transfer roll **2-34**
  - error codes
    - E120 **2-6**
    - E120n **2-18, 2-19**
  - parts catalog **7-7**
  - removal **4-12**
  - service check **2-41**
- transparencies **1-3, 1-4**
- tray cover removal **4-4**

**W**

- Windows **2-38, 2-40**



## Part number index

P/N	Description	Page
40X0271	Power cord, 8 ft.—United Kingdom -----	7-8
40X0274	Power cord, 6 ft.—Switzerland -----	7-8
40X0275	Power cord, 6 ft.—Israel -----	7-8
40X0276	Power cord, 6 ft., straight—South Africa -----	7-8
40X0277	Power cord, 6 ft., straight—Brazil -----	7-8
40X0278	Power cord, HV 6 ft., straight—Austria -----	7-8
40X0279	Power cord, 6 ft., straight—Denmark -----	7-8
40X0280	Power cord—Korea -----	7-8
40X0281	Power cord, 1.8M, straight—Taiwan -----	7-8
40X0282	Power cord, 6 ft., straight—PRC -----	7-8
40X0287	Power cord—Italy -----	7-8
40X0288	Power cord—Argentina -----	7-8
40X0289	Power cord—U.S.A. and Canada -----	7-8
40X0296	Power cord—Australia -----	7-8
40X1276	Fuser assembly, 110 V -----	7-7
40X1277	Fuser assembly, 220 V -----	7-7
40X1278	LVPS/HVPS, 110 V -----	7-5
40X1279	LVPS/HVPS, 220 V -----	7-5
40X1280	Controller card, E120 -----	7-5
40X1281	Controller card, E120n -----	7-5
40X1282	Operator panel (2 button, 6 light), E120n -----	7-5
40X1283	Operator panel (2 button, 2 light), E120 -----	7-5
40X1284	Printhead assembly -----	7-5
40X1285	Paper pick assembly -----	7-7
40X1287	Transfer roll assembly -----	7-7
40X1288	Left cover -----	7-3
40X1289	Right cover -----	7-3
40X1290	Top cover assembly -----	7-3
40X1291	Tray cover -----	7-3
40X1292	Front door assembly -----	7-3
40X1293	Rear door assembly -----	7-3
40X1294	Main tray assembly -----	7-3
40X1295	Output tray extender -----	7-3
40X1296	Miscellaneous flat cables -----	7-5
40X1297	Transfer card and input sensor -----	7-5
40X1298	Fuser assembly, 100 V -----	7-7
40X1299	Screws, parts packet -----	7-7
7375411	Relocation packaging kit -----	7-8



4506-1xx

# Print defects guide

Match a set of repeating defects on a print job to the marks on one of the vertical lines. The line that best matches the defect on the print job indicates which particular part may be causing the defect.

**Notes:** Defects in graphics will be spaced very slightly further apart for the print cartridge and PC kit but the difference will not be noticed between two adjacent defects.  
 Some components can be cleaned with a clear, dry, and lint-free cloth. Otherwise a new FRU will have to be used.  
 If the defect appears on the printed side of a single-sided print job, replace the toner cartridge before replacing the fuser.

For example, the distance between these two marks represents a repeating defect that occurs every 29.0 mm (1.14 in.), which means the charge roll may need to be replaced.

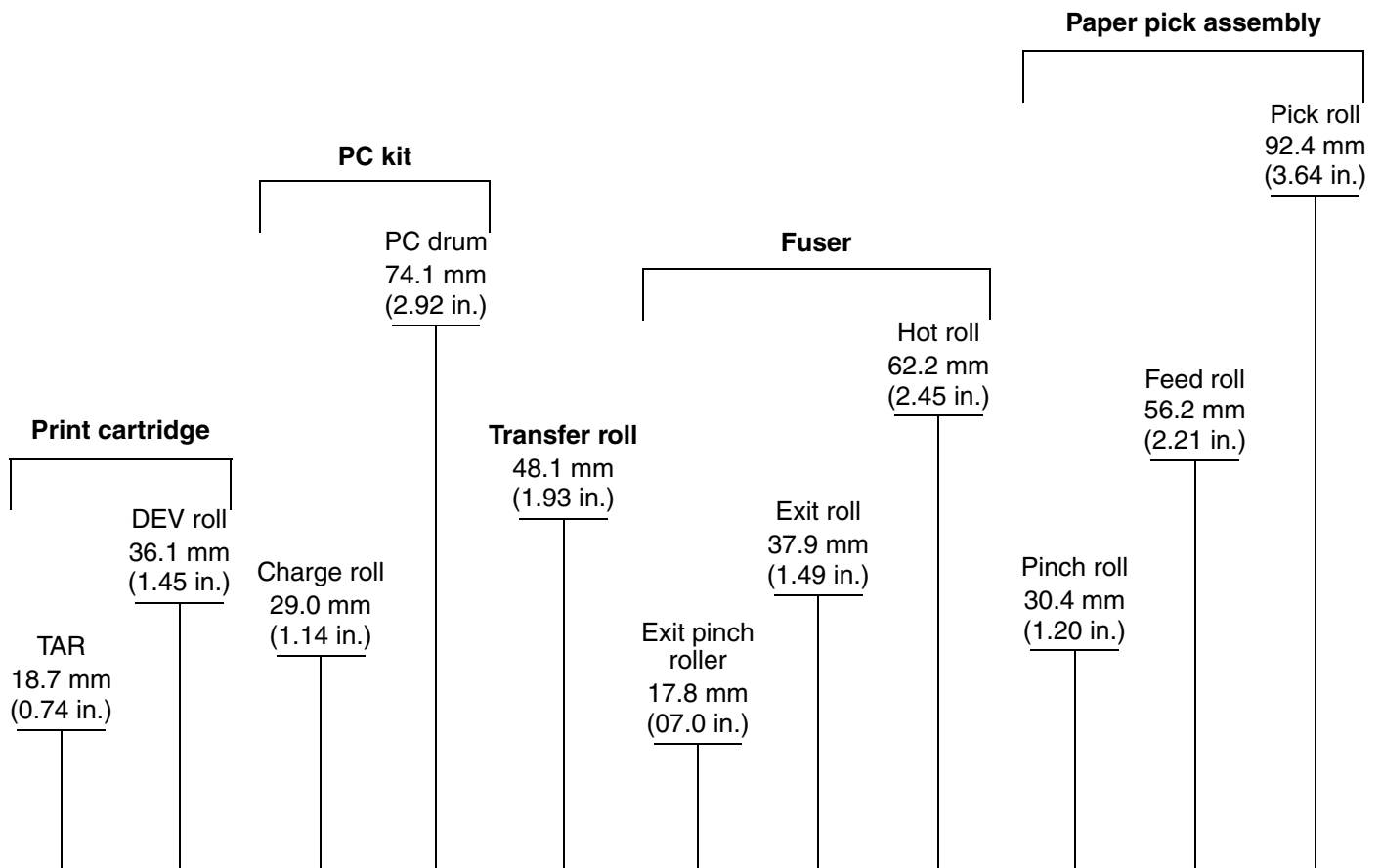
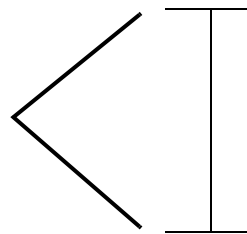

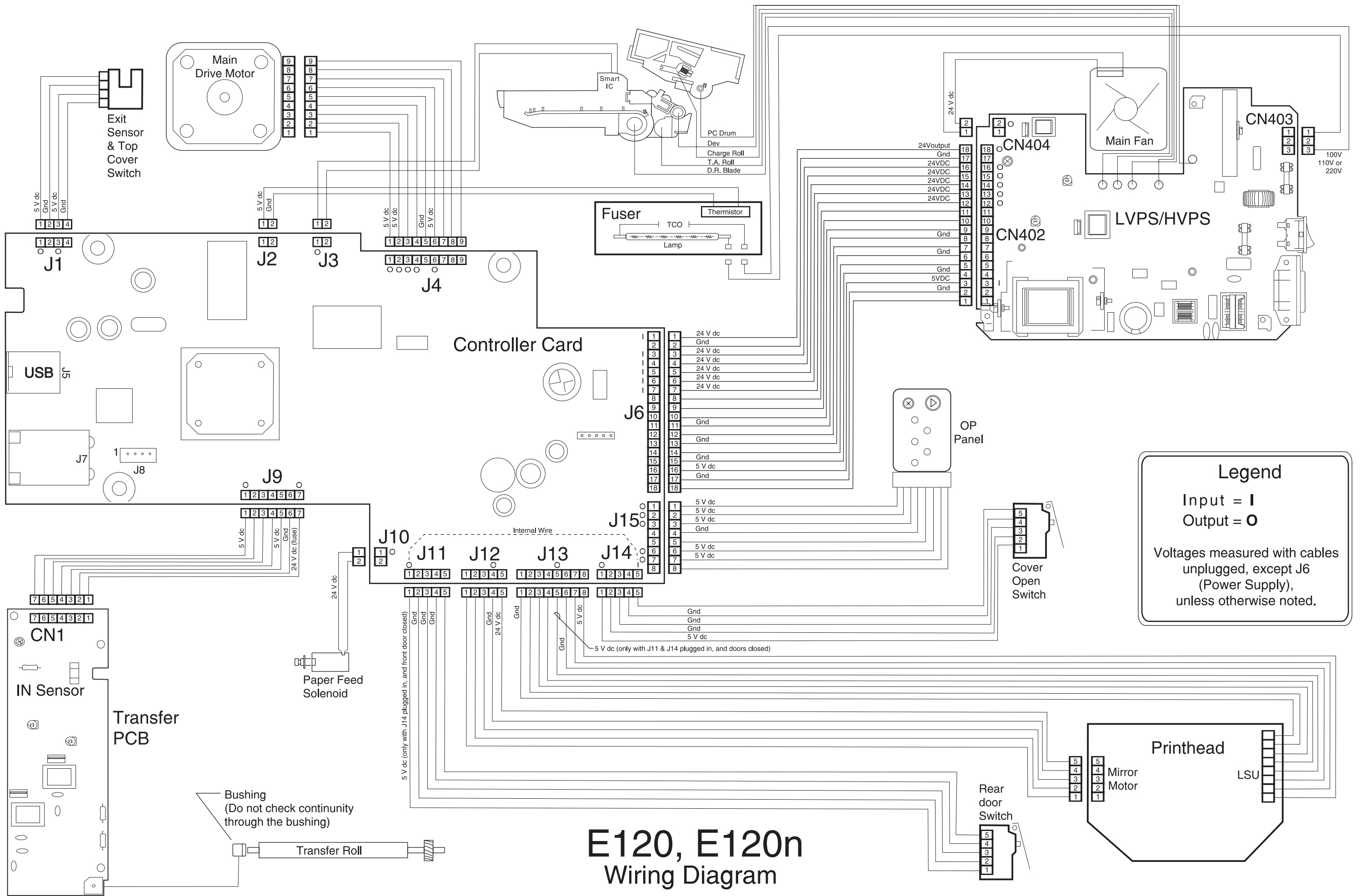

**E120, E120n**  
 Wiring Diagram