

OPERATION GUIDE

FS-C8600DN
FS-C8650DN



Introduction

Thank you for your purchase of FS-C8600DN/FS-C8650DN

This Operation Guide is intended to help you operate the machine correctly, perform routine maintenance and take a simple troubleshooting action as necessary, so that you can always use the machine in good condition.

Please read this Operation Guide before you start using the machine.

We recommend the use of our own brand supplies. We will not be liable for any damage caused by the use of third party supplies in this machine.

A label shown in the illustration assures that the supplies are our own brand.

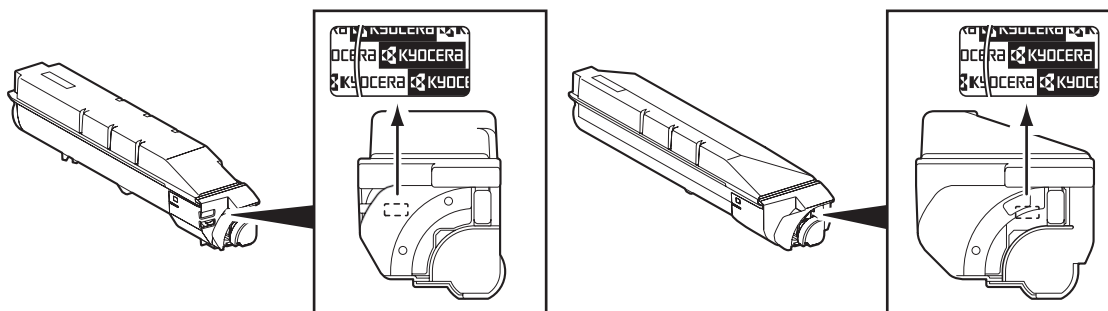

Included Guides

The following guides are supplied with the machine. Refer to them as necessary.

Quick Installation Guide	Describes the procedures for installation of the machine.
Safety Guide	Provides safety and cautionary information for the installation and use of the machine. Be sure to read this guide before using the machine.
Safety Guide (FS-C8600DN/ FS-C8650DN)	Describes the machine installation space, cautionary space, and other information. Be sure to read this guide before using the machine.

Product Library disc

Operation Guide (This Guide)	Describes how to load paper, basic print operations, and troubleshooting.
Data Security Kit (E) Operation Guide	Explains the installation and setting methods for the Data Security Kit.
Card Authentication Kit (B) Operation Guide	Describes how to authenticate to the machine using the ID card.
Command Center RX User Guide	Describes how to access the machine from a computer via a Web browser to check and change settings.
Printer Driver User Guide	Describes how to install the printer driver and use printer functionality.
KYOCERA Net Direct Print Operation Guide	Describes how to use functionality for printing PDF files without launching Adobe Acrobat or Reader.
KYOCERA Net Viewer User Guide	Describes how to monitor the network printing system with KYOCERA Net Viewer.
PRESCRIBE Commands Technical Reference	Describes the native printer language (PRESCRIBE commands).
PRESCRIBE Commands Command Reference	Describes PRESCRIBE command functionality and control for each type of emulation.

Safety Conventions in This Guide

The sections of this guide and parts of the machine marked with symbols are safety warnings meant to protect the user, other individuals and surrounding objects, and ensure correct and safe usage of the machine. The symbols and their meanings are indicated below.



WARNING: Indicates that serious injury or even death may result from insufficient attention to or incorrect compliance with the related points.



CAUTION: Indicates that personal injury or mechanical damage may result from insufficient attention to or incorrect compliance with the related points.

Symbols

The \triangle symbol indicates that the related section includes safety warnings. Specific points of attention are indicated inside the symbol.



... [General warning]



... [Warning of high temperature]

The \circledR symbol indicates that the related section includes information on prohibited actions. Specifics of the prohibited action are indicated inside the symbol.



... [Warning of prohibited action]



... [Disassembly prohibited]

The \bullet symbol indicates that the related section includes information on actions which must be performed. Specifics of the required action are indicated inside the symbol.



... [Alert of required action]



... [Remove the power plug from the outlet]



... [Always connect the machine to an outlet with a ground connection]

Please contact your service representative to order a replacement if the safety warnings in this Operation Guide are illegible or if the guide itself is missing (fee required).



Note An original which resembles a bank note closely may not be copied properly in some rare cases because this machine is equipped with a counterfeiting prevention function.

Contents

Legal and Safety Information

1 Part Names

Exterior / Cassettes	1-2
Interior/Connectors	1-3
When options are installed	1-4
Operation Panel	1-5

2 Preparation before Use

Power On/Off	2-2
Changing Network Interface Parameters	2-3
Printing a Status Page	2-7
Installing Software	2-8
Status Monitor	2-14
Uninstalling Software (Windows)	2-17
Command Center RX	2-18
Loading Paper	2-20
Registering a page size	2-36
Energy Saver Function	2-37
Operation Panel	2-38
Keys	2-40
Using the Menu Selection System	2-43
Setting a Mode Selection Menu	2-45

3 Printing

Printing - Printing from Applications	3-2
Loading Envelopes	3-5
Banner printing	3-8
Secure Pull Printing (Optional Feature)	3-12

4 Document Box

Document Box	4-2
Custom Box	4-3
Job Box	4-24

5 Status Menu

Displaying the Status Menu Screen	5-2
Job Status	5-2
Job Log	5-4
USB Keyboard	5-5
Wireless Network	5-6

6 Operation Panel

Report Print	6-2
USB Memory (USB memory selection)	6-7
Counter (Viewing the counter value)	6-16
Paper Settings	6-18
Print Settings	6-28
Network (Network settings)	6-40
Optional network (Optional Network settings)	6-48
Device Common (Selecting/Setting the common device)	6-59
Security (Security function setting)	6-84
User/Job Account (User Login Setting/Job Account setting)	6-98
Adjust/Maint. (Adjust/Maintenance selection/setting)	6-119
Op Functions (Optional application settings)	6-129
Shut down (Shutting down the machine)	6-133

7 Maintenance	
Toner Container Replacement	7-2
Waste Toner Box Replacement	7-5
Replacing Staples	7-8
Emptying the Punch Waste Box (Option)	7-13
Cleaning	7-15
8 Troubleshooting	
General Guidelines	8-2
Print Quality Problems	8-3
Error Messages	8-6
Clearing Paper Jams	8-16
Appendix	
Optional Equipment	A-2
Character Entry Method	A-6
Paper	A-9
Specifications	A-17
Glossary	A-24
Index	

Legal and Safety Information



CAUTION NO LIABILITY IS ASSUMED FOR ANY DAMAGE CAUSED BY IMPROPER INSTALLATION.

Notice on Software

SOFTWARE USED WITH THIS PRINTER MUST SUPPORT THE PRINTER'S EMULATION MODE. The printer is factory-set to emulate the PCL.

Notice

The information in this guide is subject to change without notification. Additional pages may be inserted in future editions. The user is asked to excuse any technical inaccuracies or typographical errors in the present edition.

No responsibility is assumed if accidents occur while the user is following the instructions in this guide. No responsibility is assumed for defects in the printer's firmware (contents of its read-only memory).

This guide, any copyrightable subject matter sold or provided with or in connection with the sale of the page printer, are protected by copyright. All rights are reserved. Copying or other reproduction of all or part of this guide, any copyrightable subject matter without the prior written consent of KYOCERA Document Solutions Inc. is prohibited. Any copies made of all or part of this guide, any copyrightable subject must contain the same copyright notice as the material from which the copying is done.

Regarding Trade Names

- PRESCRIBE, KPDL and ECOSYS are trademarks of Kyocera Corporation.
- Microsoft, Windows, Windows XP, Windows Server 2003, Windows Vista, Windows Server 2008, Windows 7 and Internet Explorer are registered trademarks or trademarks of Microsoft Corporation in the U.S.A. and/or other countries.
- PCL is a trademark of Hewlett-Packard Company.
- Adobe Acrobat, Adobe Reader and PostScript are trademarks of Adobe Systems, Incorporated.
- Ethernet is a registered trademark of Xerox Corporation.
- Novell is registered trademarks of Novell, Inc.
- IBM and IBM PC/AT are registered trademarks of International Business Machines Corporation.
- Bonjour, Macintosh, and Mac OS are trademarks of Apple Inc., registered in the U.S. and other countries.
- All European language fonts installed in this machine are used under licensing agreement with Monotype Imaging Inc.
- Helvetica, Palatino and Times are registered trademarks of Linotype GmbH.
- ITC Avant Garde Gothic, ITC Bookman, ITC ZapfChancery and ITC ZapfDingbats are registered trademarks of International Typeface Corporation.
- UFST™ MicroType® fonts by Monotype Imaging Inc. are installed in this machine.
- ThinPrint is a trademark of Cortado AG in Germany and other countries.

All other brands and product names are registered trademarks or trademarks of their respective companies. The designations ™ and ® will not be used in this Operation Guide.

License Agreements

GPL/LGPL

This product contains GPL (<http://www.gnu.org/licenses/gpl.html>) and/or LGPL (<http://www.gnu.org/licenses/lgpl.html>) software as part of its firmware. You can get the source code, and you are permitted to copy, redistribute and modify it under the terms of GPL/LGPL.

For further information including availability of the source code, visit <http://www.kyoceradocumentsolutions.com/gpl/>.

Open SSL License

Copyright © 1998-2006 The OpenSSL Project. All rights reserved.

Redistribution and use in source and binary forms, with or without modification, are permitted provided that the following conditions are met:

- 1 Redistributions of source code must retain the above copyright notice, this list of conditions and the following disclaimer.
- 2 Redistributions in binary form must reproduce the above copyright notice, this list of conditions and the following disclaimer in the documentation and/or other materials provided with the distribution.
- 3 All advertising materials mentioning features or use of this software must display the following acknowledgment: "This product includes software developed by the OpenSSL Project for use in the OpenSSL Toolkit. (<http://www.openssl.org/>)"
- 4 The names "OpenSSL Toolkit" and "OpenSSL Project" must not be used to endorse or promote products derived from this software without prior written permission.
For written permission, please contact openssl-core@openssl.org.
- 5 Products derived from this software may not be called "OpenSSL" nor may "OpenSSL" appear in their names without prior written permission of the OpenSSL Project.
- 6 Redistributions of any form whatsoever must retain the following acknowledgment: "This product includes software developed by the OpenSSL Project for use in the OpenSSL Toolkit (<http://www.openssl.org/>)"

THIS SOFTWARE IS PROVIDED BY THE OpenSSL PROJECT "AS IS" AND ANY EXPRESSED OR IMPLIED WARRANTIES, INCLUDING, BUT NOT LIMITED TO, THE IMPLIED WARRANTIES OF MERCHANTABILITY AND FITNESS FOR A PARTICULAR PURPOSE ARE DISCLAIMED. IN NO EVENT SHALL THE OpenSSL PROJECT OR ITS CONTRIBUTORS BE LIABLE FOR ANY DIRECT, INDIRECT, INCIDENTAL, SPECIAL, EXEMPLARY, OR CONSEQUENTIAL DAMAGES (INCLUDING, BUT NOT LIMITED TO, PROCUREMENT OF SUBSTITUTE GOODS OR SERVICES; LOSS OF USE, DATA, OR PROFITS; OR BUSINESS INTERRUPTION) HOWEVER CAUSED AND ON ANY THEORY OF LIABILITY, WHETHER IN CONTRACT, STRICT LIABILITY, OR TORT (INCLUDING NEGLIGENCE OR OTHERWISE) ARISING IN ANY WAY OUT OF THE USE OF THIS SOFTWARE, EVEN IF ADVISED OF THE POSSIBILITY OF SUCH DAMAGE.

Original SSLeay License

Copyright © 1995-1998 Eric Young (eay@cryptsoft.com) All rights reserved.

This package is an SSL implementation written by Eric Young (eay@cryptsoft.com). The implementation was written so as to conform with Netscapes SSL.

This library is free for commercial and non-commercial use as long as the following conditions are adhered to. The following conditions apply to all code found in this distribution, be it the RC4, RSA, lhash, DES, etc., code; not just the SSL code. The SSL documentation included with this distribution is covered by the same copyright terms except that the holder is Tim Hudson (tjh@cryptsoft.com).

Copyright remains Eric Young's, and as such any Copyright notices in the code are not to be removed.

If this package is used in a product, Eric Young should be given attribution as the author of the parts of the library used.

This can be in the form of a textual message at program startup or in documentation (online or textual) provided with the package.

Redistribution and use in source and binary forms, with or without modification, are permitted provided that the following conditions are met:

- 1 Redistributions of source code must retain the copyright notice, this list of conditions and the following disclaimer.
- 2 Redistributions in binary form must reproduce the above copyright notice, this list of conditions and the following disclaimer in the documentation and/or other materials provided with the distribution.
- 3 All advertising materials mentioning features or use of this software must display the following acknowledgement:
"This product includes cryptographic software written by Eric Young (eay@cryptsoft.com)"
The word 'cryptographic' can be left out if the routines from the library being used are not cryptographic related :-).
- 4 If you include any Windows specific code (or a derivative thereof) from the apps directory (application code) you must include an acknowledgement:
"This product includes software written by Tim Hudson (tjh@cryptsoft.com)"

THIS SOFTWARE IS PROVIDED BY ERIC YOUNG "AS IS" AND ANY EXPRESS OR IMPLIED WARRANTIES, INCLUDING, BUT NOT LIMITED TO, THE IMPLIED WARRANTIES OF MERCHANTABILITY AND FITNESS FOR A PARTICULAR PURPOSE ARE DISCLAIMED. IN NO EVENT SHALL THE AUTHOR OR CONTRIBUTORS BE LIABLE FOR ANY DIRECT, INDIRECT, INCIDENTAL, SPECIAL, EXEMPLARY, OR CONSEQUENTIAL DAMAGES (INCLUDING, BUT NOT LIMITED TO, PROCUREMENT OF SUBSTITUTE GOODS OR SERVICES; LOSS OF USE, DATA, OR PROFITS; OR BUSINESS INTERRUPTION) HOWEVER CAUSED AND ON ANY THEORY OF LIABILITY, WHETHER IN CONTRACT, STRICT LIABILITY, OR TORT (INCLUDING NEGLIGENCE OR OTHERWISE) ARISING IN ANY WAY OUT OF THE USE OF THIS SOFTWARE, EVEN IF ADVISED OF THE POSSIBILITY OF SUCH DAMAGE.

The licence and distribution terms for any publically available version or derivative of this code cannot be changed. i.e. this code cannot simply be copied and put under another distribution licence [including the GNU Public Licence.]

Monotype Imaging License Agreement

- 1 Software shall mean the digitally encoded, machine readable, scalable outline data as encoded in a special format as well as the UFST Software.
- 2 You agree to accept a non-exclusive license to use the Software to reproduce and display weights, styles and versions of letters, numerals, characters and symbols (Typefaces) solely for your own customary business or personal purposes at the address stated on the registration card you return to Monotype Imaging. Under the terms of this License Agreement, you have the right to use the Fonts on up to three printers. If you need to have access to the fonts on more than three printers, you need to acquire a multi-user license agreement which can be obtained from Monotype Imaging. Monotype Imaging retains all rights, title and interest to the Software and Typefaces and no rights are granted to you other than a License to use the Software on the terms expressly set forth in this Agreement.
- 3 To protect proprietary rights of Monotype Imaging, you agree to maintain the Software and other proprietary information concerning the Typefaces in strict confidence and to establish reasonable procedures regulating access to and use of the Software and Typefaces.
- 4 You agree not to duplicate or copy the Software or Typefaces, except that you may make one backup copy. You agree that any such copy shall contain the same proprietary notices as those appearing on the original.
- 5 This License shall continue until the last use of the Software and Typefaces, unless sooner terminated. This License may be terminated by Monotype Imaging if you fail to comply with the terms of this License and such failure is not remedied within thirty (30) days after notice from Monotype Imaging. When this License expires or is terminated, you shall either return to Monotype Imaging or destroy all copies of the Software and Typefaces and documentation as requested.
- 6 You agree that you will not modify, alter, disassemble, decrypt, reverse engineer or decompile the Software.
- 7 Monotype Imaging warrants that for ninety (90) days after delivery, the Software will perform in accordance with Monotype Imaging-published specifications, and the diskette will be free from defects in material and workmanship. Monotype Imaging does not warrant that the Software is free from all bugs, errors and omissions.

The parties agree that all other warranties, expressed or implied, including warranties of fitness for a particular purpose and merchantability, are excluded.

- 8 Your exclusive remedy and the sole liability of Monotype Imaging in connection with the Software and Typefaces is repair or replacement of defective parts, upon their return to Monotype Imaging.

In no event will Monotype Imaging be liable for lost profits, lost data, or any other incidental or consequential damages, or any damages caused by abuse or misapplication of the Software and Typefaces.

- 9 Massachusetts U.S.A. law governs this Agreement.
- 10 You shall not sublicense, sell, lease, or otherwise transfer the Software and/or Typefaces without the prior written consent of Monotype Imaging.
- 11 Use, duplication or disclosure by the Government is subject to restrictions as set forth in the Rights in Technical Data and Computer Software clause at FAR 252-227-7013, subdivision (b)(3)(ii) or subparagraph (c)(1)(ii), as appropriate. Further use, duplication or disclosure is subject to restrictions applicable to restricted rights software as set forth in FAR 52.227-19 (c)(2).
- 12 You acknowledge that you have read this Agreement, understand it, and agree to be bound by its terms and conditions. Neither party shall be bound by any statement or representation not contained in this Agreement. No change in this Agreement is effective unless written and signed by properly authorized representatives of each party. By opening this diskette package, you agree to accept the terms and conditions of this Agreement.

Compliance and Conformity

This equipment has been tested and found to comply with the limits for a Class B digital device, pursuant to Part 15 and Part 18 of the FCC Rules. These limits are designed to provide reasonable protection against harmful interference in a residential installation. This equipment generates, uses and can radiate radio frequency energy and, if not installed and used in accordance with the instructions, may cause harmful interference to radio communications. However, there is no guarantee that interference will not occur in a particular installation. If this equipment does cause harmful interference to radio or television reception, which can be determined by turning the equipment off and on, the user is encouraged to try to correct the interference by one or more of the following measures:

- Reorient or relocate the receiving antenna.
- Increase the separation between the equipment and receiver.
- Connect the equipment into an outlet on a circuit different from that to which the receiver is connected.
- Consult the dealer or an experienced radio/TV technician for help.
- The use of a non-shielded interface cable with the referenced device is prohibited.

CAUTION — The changes or modifications not expressly approved by the party responsible for compliance could void the user's authority to operate the equipment.

This device complies with Part 15 of FCC Rules and RSS-Gen of IC Rules.

Operation is subject to the following two conditions; (1) this device may not cause interference, and (2) this device must accept any interference, including interference that may cause undesired operation of the device.

* The above warning is valid only in the United States of America.

Interface connectors

IMPORTANT Be sure to power off the printer before connecting or disconnecting an interface cable. For protection against static electricity discharge to the printer's internal electronics through the interface connector(s), cover any interface connector that is not in use with the protective cap supplied.



Note Use shielded interface cables.

Canadian Department of Communications Compliance Statement

This Class B digital apparatus complies with Canadian ICES-003.

Avis de conformité aux normes du ministère des Communications du Canada

Cet appareil numérique de la classe B est conforme à la norme NMB-003 du Canada.

Energy Saving Control Function

The device comes equipped with a **Low Power Mode** where energy consumption is reduced after a certain amount of time elapses since the device was last used, as well as a **Sleep** where printer and fax functions remain in a waiting state but power consumption is still reduced to a minimum when there is no activity with the device within a set amount of time.

Sleep

The device automatically enters Sleep when 60 minutes have passed since the device was last used. The amount of time of no activity that must pass before Sleep is activated may be lengthened. For more information refer to *Sleep* section.

Low Power Mode

The device automatically enters Low Power Mode when 3 minutes (for FS-C8600DN) or 5 minutes (for FS-C8650DN) have passed since the device was last used. The amount of time of no activity that must pass before Low Power Mode is activated may be lengthened. For more information refer to *Low Power Mode* section.

Automatic 2-Sided Print Function

This device includes 2-sided copying as a standard function. For example, by copying two 1-sided originals onto a single sheet of paper as a 2-sided copy, it is possible to lower the amount of paper used. For more information refer to *Duplex (Setting the duplex printing) on page 6-30*.

Printing in duplex mode reduces paper consumption and contributes to the conservation of forest resources. Duplex mode also reduces the amount of paper that must be purchased, and thereby reduces cost. It is recommended that machines capable of duplex printing be set to use duplex mode by default.

Resource Saving - Paper

For the preservation and sustainable use of forest resources, it is recommended that recycled as well as virgin paper certified under environmental stewardship initiatives or carrying recognised ecolabels, which meet EN 12281:2002*¹ or an equivalent quality standard, be used.

This machine also supports printing on 64 g/m² paper. Using such paper containing less raw materials can lead to further saving of forest resources.

*1: EN12281:2002 "Printing and business paper - Requirements for copy paper for dry toner imaging processes"

Your sales or service representative can provide information about recommended paper types.

Environmental benefits of "Power Management"

To reduce power consumption when idle, this machine is equipped with a power management function that automatically activates energy-saving mode when the machine is idle for a certain period of time.

Although it takes the machine a slight amount of time to return to READY mode when in energy-saving mode, a significant reduction in energy consumption is possible. It is recommended that the machine be used with the activation time for energy-saving mode set to the default setting.

Energy Star (ENERGY STAR®) Program



We have determined as a participating company in the International Energy Star Program that this product is compliant with the standards laid out in the International Energy Star Program.

ENERGY STAR® is a voluntary energy efficiency program with the goal of developing and promoting the use of products with high energy efficiency in order to help prevent global warming. By purchasing

ENERGY STAR® qualified products, customers can help reduce emissions of greenhouse gases during product use and cut energy-related costs.

Environment

The service environmental conditions are as follows:

- Temperature: 50 to 90.5 °F (10 to 32.5 °C)
- Humidity: 15 to 80 %

However, adverse environmental conditions may affect the image quality. It is recommended to use the machine at a temperature: around 60.8 to 80.6 °F or less (16 to 27 °C), humidity: around 36 to 65%. Avoid the following locations when selecting a site for the machine.

- Avoid locations near a window or with exposure to direct sunlight.
- Avoid locations with vibrations.
- Avoid locations with drastic temperature fluctuations.
- Avoid locations with direct exposure to hot or cold air.
- Avoid poorly ventilated locations.

If the floor is delicate against casters, when this machine is moved after installation, the floor material may be damaged.

During printing, some ozone is released, but the amount does not cause any ill effect to one's health. If, however, the machine is used over a long period of time in a poorly ventilated room or when printing an extremely large number of copies, the smell may become unpleasant. To maintain the appropriate environment for print work, it is suggested that the room be properly ventilated.

Cautions when Handling Consumables

Do not attempt to incinerate the toner container or unit. Dangerous sparks may cause burns.

Keep the toner container and unit out of the reach of children.

If toner happens to spill from the toner container or unit, avoid inhalation and ingestion, as well as contact with your eyes and skin.

- If you do happen to inhale toner, move to a place with fresh air and gargle thoroughly with a large amount of water. If coughing develops, contact a physician.
- If you do happen to ingest toner, rinse your mouth out with water and drink 1 or 2 cups of water to dilute the contents of your stomach. If necessary, contact a physician.
- If you do happen to get toner in your eyes, flush them thoroughly with water. If there is any remaining tenderness, contact a physician.
- If toner does happen to get on your skin, wash with soap and water.

Do not attempt to force open or destroy the toner container or unit.

Other precautions

Return the exhausted toner container and waste toner box to your dealer or service representative. The collected toner container and waste toner box will be recycled or disposed in accordance with the relevant regulations.

Store the machine while avoiding exposure to direct sunlight.

Store the machine in a place where the temperature stays below 40°C while avoiding sharp changes of temperature and humidity.

If the machine will not be used for an extended period of time, remove the paper from the cassette and the Multi Purpose (MP) Tray, return it to its original package and reseal it.

SAFETY OF LASER BEAM (USA)

1. Safety of laser beam

This machine has been certified by the manufacturer to Class 1 level under the radiation performance standards established by the U.S.DHHS (Department of Health and Human Services) in 1968. This indicates that the product is safe to use during normal operation and maintenance. The laser optical system, enclosed in a protective housing and sealed within the external covers, never permits the laser beam to escape.

2. The CDRH Act

A laser-product-related act was implemented on Aug. 2, 1976, by the Center for Devices and Radiological Health (CDRH) of the U.S. Food and Drug Administration (FDA). This act prohibits the sale of laser products in the U.S. without certification, and applies to laser products manufactured after Aug. 1, 1976. The label shown below indicates compliance with the CDRH regulations and must be attached to laser products marketed in the United States. On this machine, the label is on the right.

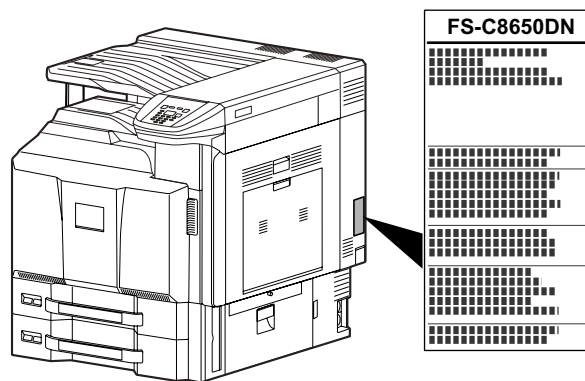

3. Optical unit

When checking the optical unit, avoid direct exposure to the laser beam, which is invisible. Shown at below is the label located on the cover of the optical unit.

	DANGER · CLASS 3B LASER RADIATION WHEN OPEN, AVOID DIRECT EXPOSURE TO BEAM. ATTENTION · CLASSE 3B RAYONNEMENT LASER EN CAS D'OUVERTURE. EXPOSITION DANGEREUSE AU FAISCEAU. VORSICHT · KLASSE 3B LASERSTRAHLUNG, WENN ABDECKUNG GEOFFNET, NICHT DEM STRAHL AUSSETZEN.	ATTENZIONE · CLASSE 3B RADIAZIONE LASER IN CASO DI APERTURA, EVITARE L'ESPOSIZIONE AL FASCIO. PRECAUCION · CLASSE 3B RADIAZIONE LASER CUANDO SE ABRE, EVITAR EXPONERSE AL RAYO. PERIGO · RADIAÇÃO DE LASER CLASSE 3B QUANDO ABERTO EVITAR EXPOSIÇÃO DIRETA. NO FEIXE.	WAARSCHUWING · KLASSE 3B LASERSTRAAL INDIEN GEOPEND, VERMIJD DIRECTE BLOOTSTELLING AAN DE STRAAL. Внимание · Когда устройство открыто, присутствует лазерное излучение класса 3B. Избегайте прямого попадания лазерного луча.	警告 · 该产品为3B类激光产品, 打开盖子后有激光辐射, 请避免光束照射。 警告 · 该产品为3B类激光产品, 打开盖子后有激光辐射, 请避免光束照射。 위험 · CLASS 3B 가시 레이저광선을 직접 보지마십시오. 警告 · ここを開くとクラス3Bレーザー光が ビームを直接見たり、触れないでください。
---	---	--	--	---

4. Maintenance

For safety of the service personnel, follow the maintenance instructions in the other section of this manual.

5. Safety switch

The power to the laser unit is cut off when the right cover is opened.

Safety Instructions Regarding the Disconnection of Power

Caution: The power plug is the main isolation device! Other switches on the equipment are only functional switches and are not suitable for isolating the equipment from the power source.

Attention: Le débranchement de la fiche secteur est le seul moyen de mettre l'appareil hors tension. Les interrupteurs sur l'appareil ne sont que des interrupteurs de fonctionnement: ils ne mettent pas l'appareil hors tension.

WARNING

This equipment has been tested and found to comply with the limits for a Class B digital device, pursuant to Part 15 and Part 18 of the FCC Rules. These limits are designed to provide reasonable protection against harmful interference in a residential installation. This equipment generates, uses and can radiate radio frequency energy and, if not installed and used in accordance with the instructions, may cause harmful interference to radio communications. However, there is no guarantee that interference will not occur in a particular installation. If this equipment does cause harmful interference to radio or television reception, which can be determined by turning the equipment off and on, the user is encouraged to try to correct the interference by one or more of the following measures:

- Reorient or relocate the receiving antenna.
- Increase the separation between the equipment and receiver.
- Connect the equipment into an outlet on a circuit different from that to which the receiver is connected.
- Consult the dealer or an experienced radio/TV technician for help.
- The use of a non-shielded interface cable with the referenced device is prohibited.

CAUTION — The changes or modifications not expressly approved by the party responsible for compliance could void the user's authority to operate the equipment.

This device contains the module, which complies with Part 15 of FCC Rules and RSS-Gen of IC Rules.

Operation is subject to the following two conditions; (1) this device may not cause interference, and (2) this device must accept any interference, including interference that may cause undesired operation of the device.

Radio Tag Technology

In some countries the radio tag technology used in this equipment to identify the toner container may be subject to authorization and the use of this equipment may consequently be restricted.

Other precautions (for users in California, the United States)

This product contains a CR Coin Lithium Battery which contains Perchlorate Material - special handling may apply. See www.dtsc.ca.gov/hazardouswaste/perchlorate.

Laser Safety (Europe)

Laser radiation could be hazardous to the human body. For this reason, laser radiation emitted inside this machine is hermetically sealed within the protective housing and external cover. In the normal operation of the product by user, no radiation can leak from the machine.

This machine is classified as Class 1 laser product under IEC/EN 60825-1:2007.

Caution: Performance of procedures other than those specified in this manual may result in hazardous radiation exposure.

These labels are attached to the laser scanner unit inside the machine and are not in a user access area.

	DANGER · CLASS 3B LASER RADIATION WHEN OPEN, AVOID DIRECT EXPOSURE TO BEAM.	ATTENZIONE · CLASSE 3B RADIAZIONE LASER IN CASO DI APERTURA. EVITARE L'ESPOSIZIONE AL FASCIO.	WAARSCHUWING · KLASSE 3B LASERSTRAAL INDIEN GEOPEND. VERMIJD DIRECTE BLOOTSTELLING AAN DE STRAAL.	警告 · 该产品为3B类激光产品。 打开盖子后会有激光辐射。请避免光束照射。
	ATTENTION · CLASSE 3B RAYONNEMENT LASER EN CAS D'OUVERTURE. EXPOSITION DANGEREUSE AU FAISCEAU.	PRECAUCION · CLASSE 3B RADIAZIONE LASER CUANDO SE ABRE. EVITAR EXPONERSE AL RAYO.		警告 · 该产品为3B类激光产品。 打开盖子后会有激光辐射。请避免光束照射。
	VORSICHT · KLASSE 3B LASERSTRAHLUNG, WENN ABDECKUNG GEOFFNET, NICHT DEM STRAHL AUSSETZEN.	PERIGO · RADIAÇÃO DE LASER CLASSE 3B QUANDO ABERTO EVITAR EXPOSIÇÃO DIRETA NO FEIXE	Внимание. · Когда устройство открыто, присутствует лазерное излучение класса 3B. Избегайте прямого попадания лазерного луча.	위험 · CLASS 3B 기시 레이저 광선을 직접 보지마십시오. 警告 · ここを開くとクラス3Bレーザー光がでます。 ビームを直接見たり、触れないでください。

The label shown below is attached on the right side of the machine.

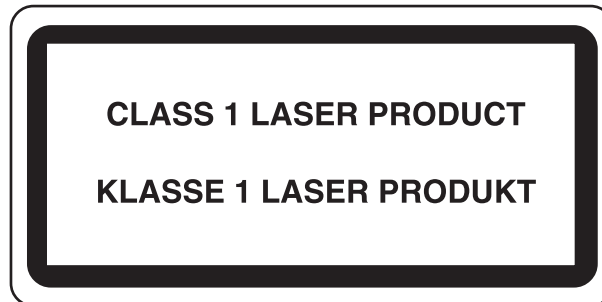

About the Operation Guide

This Operation Guide has the following chapters:

Chapter 1 - Part Names

This chapter explains the names of parts.

Chapter 2 - Preparation before Use

This chapter explains the preparations and settings necessary before use and the method for loading paper.

Chapter 3 - Printing

This chapter explains the method for printing from a computer.

Chapter 4 - Document Box

This chapter explains about the Document Box function.

Chapter 5- Status Menu

This chapter explains how to check the job status and job history.

Chapter 6 - Operation Panel

This chapter explains how to use the operation panel to configure the printer.

Chapter 7 - Maintenance

This chapter explains about the replacement of toner container and the cleaning of the printer.

Chapter 8 - Troubleshooting



This chapter explains how to handle error messages, paper jams and other problems.

Appendix

This section explains the method for entering characters, an introduction to optional products and the printer specifications.

Conventions

This manual uses the following conventions.

Convention	Description	Example
Italic Typeface	Used to emphasize a key word, phrase or reference to additional information.	To replace the toner container, refer to <i>Toner Container Replacement on page 7-27</i> .
Bold	Used to denote buttons on the software.	To start printing, click OK .
Bracket Bold	Used to denote operation panel keys.	Press [OK] to resume printing.
Note	Used to provide additional or useful information about a function or feature.	 Note Check with your network administrator for the network address settings.
Important	Used to provide important information.	IMPORTANT Ensure paper is not folded, curled, or damaged.
Caution	Indicates what must be observed to prevent injury or machine breakdown and how to deal with it.	 CAUTION The fuser unit inside the printer is hot. Do not touch it with your hands as it may result in burn injury.
Warning	Used to alert users to the possibility of <i>personal</i> injury.	 WARNING If you ship the printer, remove and pack the developer unit in a plastic bag and ship them separately from the printer.

1 Part Names

This chapter identifies the machine parts and operation panel keys.

Exterior / Cassettes	1-2
Interior/Connectors	1-3
When options are installed	1-4
Operation Panel	1-5

Exterior / Cassettes

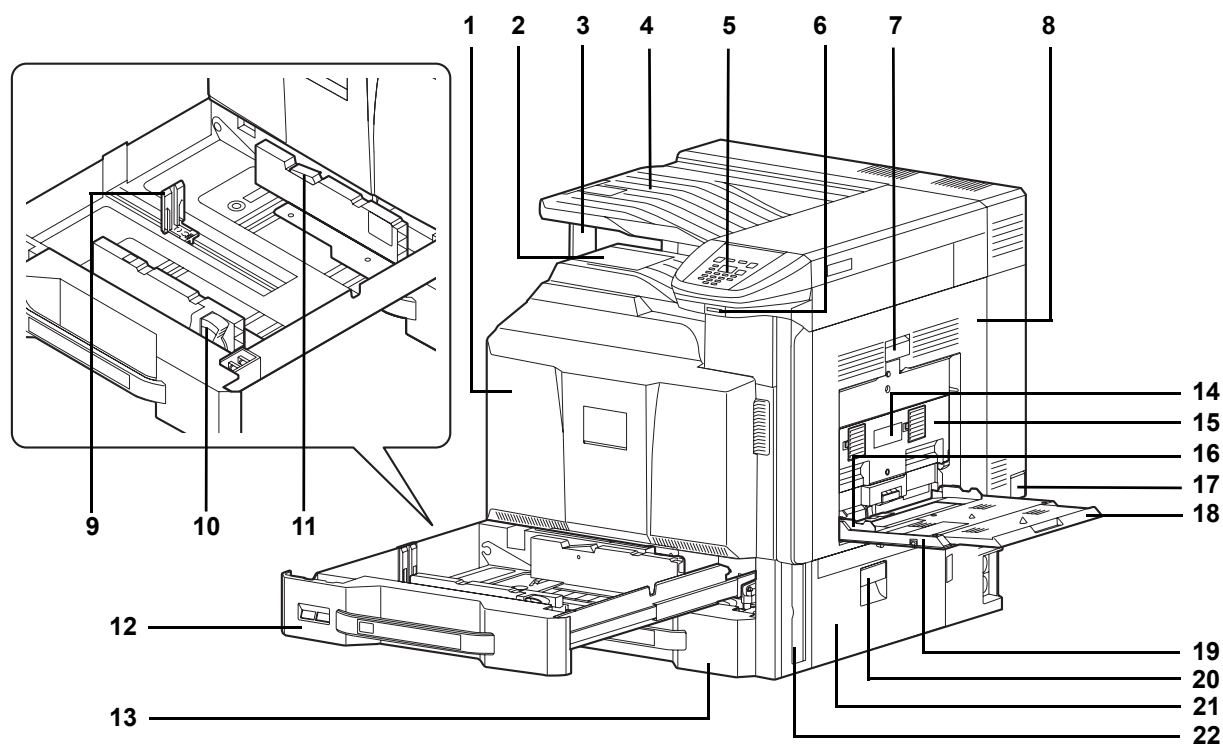

- 1 Front Cover
- 2 Main Tray
- 3 Paper stopper
- 4 Job Separator
- 5 Operation Panel
- 6 USB Memory Slot (A1)
- 7 Right Cover 1 Lever
- 8 Right Cover 1
- 9 Paper Length Guide
- 10 Paper Width Adjusting Tab
- 11 ((Paper Width Guide) Lock
- 12 Cassette 1
- 13 Cassette 2
- 14 Right Cover 2 Lever
- 15 Right Cover 2
- 16 Paper Width Guide
- 17 Main Power Switch
- 18 Multi Purpose Tray
- 19 Support Tray Section of the Multi Purpose Tray
- 20 Right Cover 3 Lever
- 21 Right Cover 3
- 22 Handles

Interior/Connectors

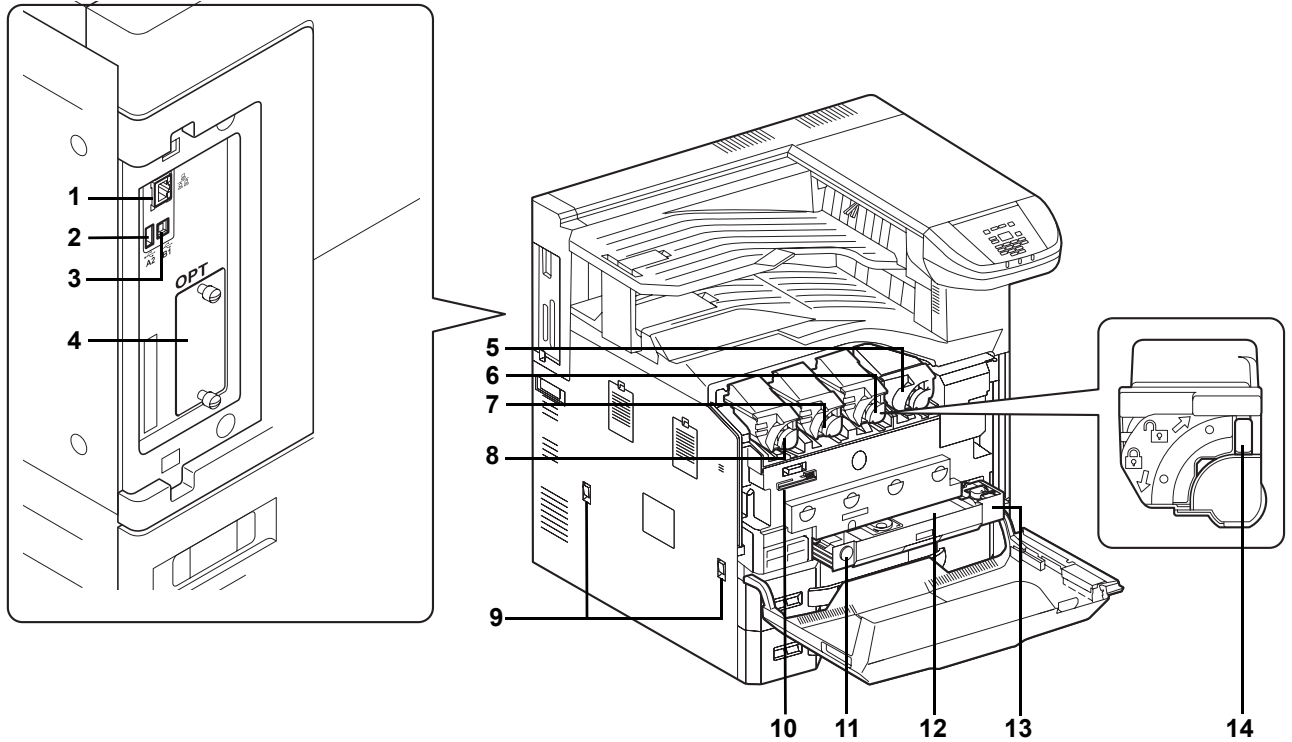

- 1 Network Interface Connector
- 2 USB Port (A2)
- 3 USB Interface Connector (B1)
- 4 Option Interface
- 5 Toner Container (Black)
- 6 Toner Container (Magenta)
- 7 Toner Container (Cyan)
- 8 Toner Container (Yellow)
- 9 Handles
- 10 Cleaning Brush
- 11 Release key
- 12 Waste Toner Box
- 13 Waste Toner Tray
- 14 Toner Container Release Lever

When options are installed

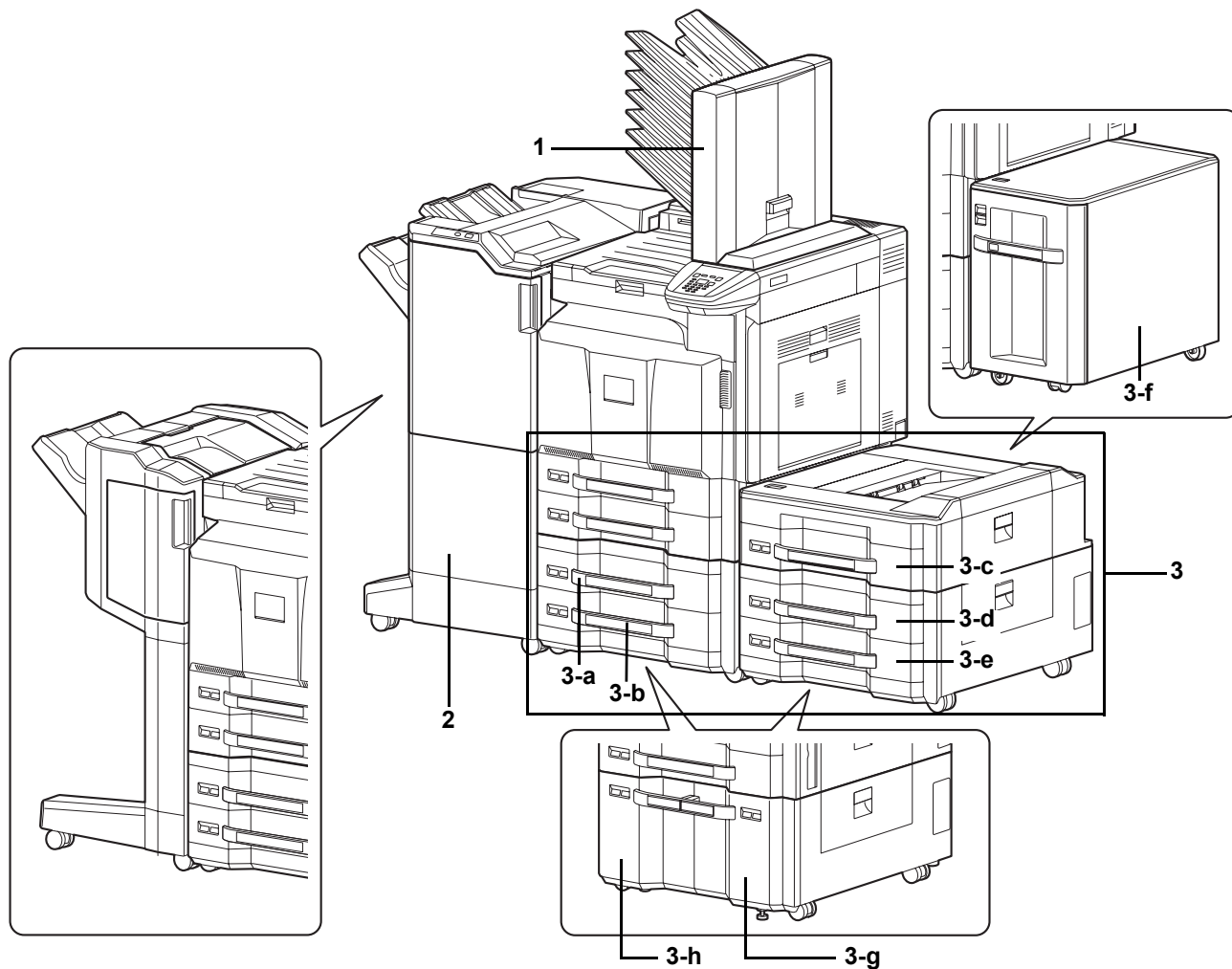

- 1 Mailbox
- 2 Document Finisher
- 3 Cassette 3 to 7
 - 3-a: Cassette 3
 - 3-b: Cassette 4
 - 3-c: Cassette 5
 - 3-d: Cassette 6
 - 3-e: Cassette 7
 - 3-f: Cassette 5
 - 3-g: Cassette 3 or 6
 - 3-h: Cassette 4 or 7

Operation Panel

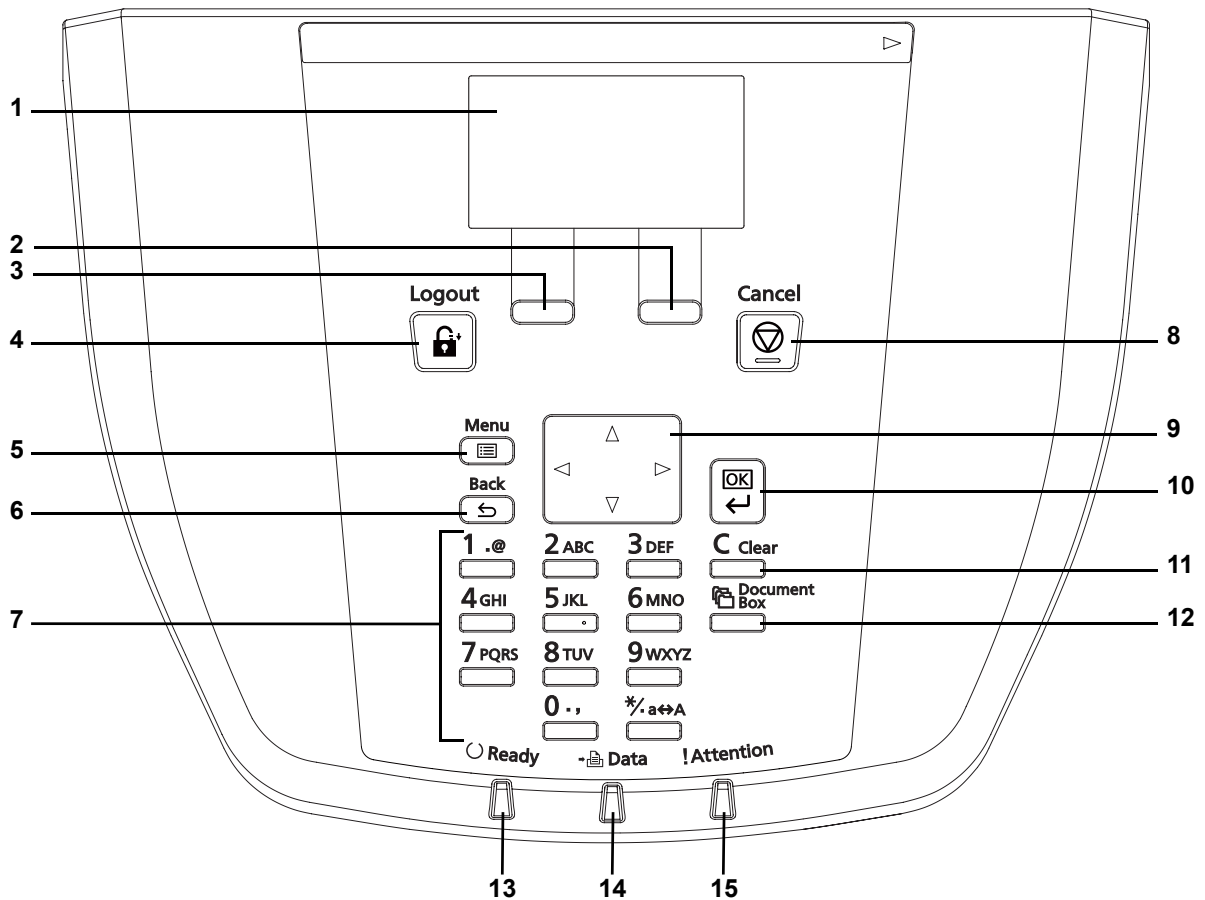

- 1 Message Display
- 2 [Right Select] Key
- 3 [Left Select] Key
- 4 [Logout] Key
- 5 [Menu] Key
- 6 [Back] Key
- 7 Numeric Keys
- 8 [Cancel] Key
- 9 Arrow Keys
- 10 [OK] Key
- 11 [Clear] Key
- 12 [Document Box] Key
- 13 Ready Indicator
- 14 Data Indicator
- 15 Attention Indicator

2 Preparation before Use

This chapter contains explanations on the following topics:

Power On/Off	2-2
Changing Network Interface Parameters	2-3
Printing a Status Page	2-7
Installing Software	2-8
Status Monitor	2-14
Uninstalling Software (Windows)	2-17
Command Center RX	2-18
Loading Paper	2-20
Energy Saver Function	2-37
Operation Panel	2-38

Power On/Off

Power On

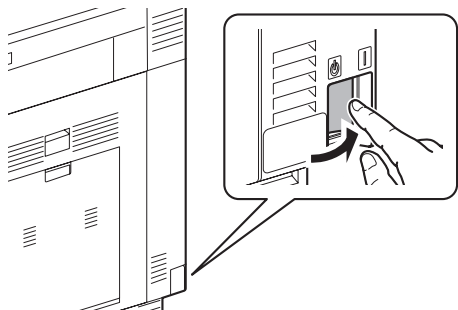

Turn the main power switch on.

IMPORTANT When turning off the main power switch, do not turn on the main power switch again immediately. Wait more than 5 seconds, and then turn on the main power switch.

Power Off

CAUTION The hard disk may be operating when the Data indicator is lit or blinking. Turning off the main power switch while the hard disk is operating may cause damage. Note that when the main power switch is turned off, the machine will be unable to automatically receive print data from computers.

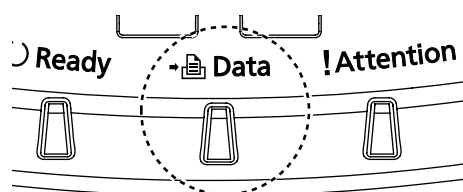

- 1 Make sure that the Data indicator off.
- 2 Press **[Menu]**.
- 3 Press Δ or ∇ to select Shut down.

Shut down.
Are you sure?

[Yes] [No]

Completed.
Turn the main power
switch off.

- 4 Press **[OK]**. A confirmation screen appears.

- 5 Press **[Yes]** (**[Left Select]**). The display will show "Completed. Turn the main power switch off."

- 6 Switch off the main power switch.



Changing Network Interface Parameters

This printer supports TCP/IP, TCP/IP (IPv6), IPP, SSL Server and the IPSec protocols and Security Level.

The table below shows the items required for each of the settings.

Configure the printer's network parameters as appropriate for your PC and your network environment.

Menu	Submenu		Setting	
Network	TCP/IP Settings	TCP/IP	On/Off	
		IPv4 Setting	DHCP	On/Off
			Auto-IP	On/Off
			IP Address	IP address
			Subnet Mask	Mask value
			Default Gateway	Gateway address
			Bonjour	On/Off
			IPv6 Setting	TCP/IP(IPv6)
		RA(Stateless)		On/Off
		DHCPv6		On/Off
		Protocol Detail	NetBEUI	On/Off
			SNMPv3	On/Off
			FTP(Server)	On/Off
			SNMP	On/Off
			SMTP	On/Off
			POP3	On/Off
			RAW Port	On/Off
			LPD	On/Off
			HTTP	On/Off
	LDAP	On/Off		
	Restart Network	Yes/No		

Menu	Submenu	Setting			
Security	Network Security	WSD-PRINT	On/Off		
		Enhanced WSD	On/Off		
		EnhancedWSD(SSL)	On/Off		
		IPP	On/Off		
		SSL Setting	SSL	Off/On	On/Off
				Encryption	AES/DES/3DES
			IPP over SSL		On/Off
			HTTPS		On/Off
		IPSec		On/Off	
		Thin Print	Off/On	On/Off	
			Thin Print over SSL	On/Off	
		LAN Interface		Auto/10BASE-Half/ 10BASE-Full/ 100BASE-Half/ 100BASE-Full/ 1000BASE-T	

 **Note** After all network related settings have been done, turn the machine **OFF** and **ON** again. This is mandatory to make the settings effective!

Network Settings

This section explains the settings for when DHCP is used or when an IP Address is entered while TCP(IPv4) is selected. For details of the settings, refer to *Network (Network settings) on page 6-40*. Also, for how to use the Menu Selection System, refer to *Using the Menu Selection System on page 2-43*.

 **Note** When entering an IP Address manually, check the IP Address, Subnet Mask and Default Gateway with the system administrator.

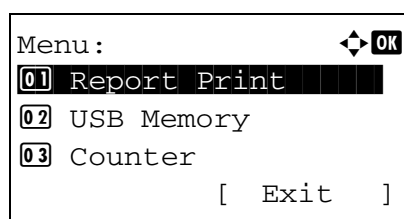

1 While the printer displays *Ready to print.*, *Please wait.*, *Sleeping.* and *Processing.*, press **[Menu]**. The Mode Selection Menu is displayed.

2 Press Δ or ∇ to select *Network*.

3 Press **[OK]**. The *Network* menu screen appears.

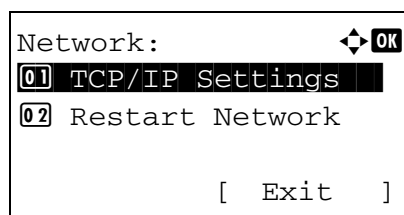

Checking that TCP/IP is On

This is an explanation of the method for setting for IPv4, but TCP/IP should also be On when setting for IPv6.

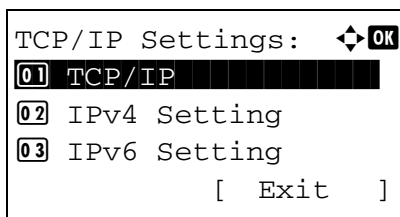

- 4 Select **TCP/IP Settings** and press **[OK]**. The **TCP/IP Settings** menu screen appears.

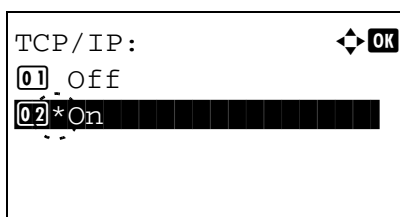

- 5 Press Δ or ∇ to select **TCP/IP**.
- 6 Press **[OK]**. The **TCP/IP** screen appears.

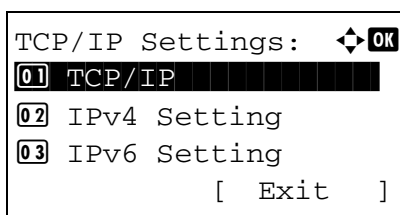

- 7 Check that **On** is selected. If **Off** is selected, then press Δ or ∇ to select **On**.



Note "*" is displayed for the setting which has been selected.

- 8 Press **[OK]**. The **TCP/IP** setting is set and the **TCP/IP Setting** menu reappears.

Switching DHCP to Off or On

Select **On** when using a DHCP server to automatically obtain an IP Address. Select **Off** to enter an IP Address.

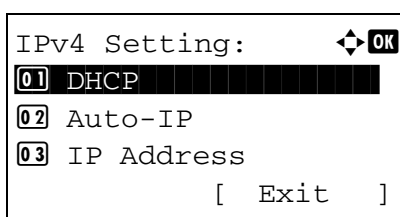

- 9 Press Δ or ∇ to select **IPv4 Setting**.
- 10 Press **[OK]**. The **IPv4 Setting** menu screen appears.

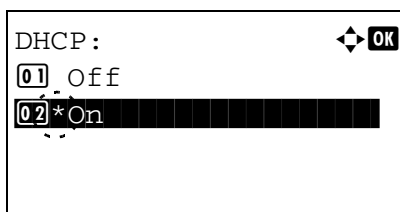

- 11 Press Δ or ∇ to select **DHCP**.
- 12 Press **[OK]**. The **DHCP** screen appears.

- 13 Press Δ or ∇ to select **Off** or **On**.

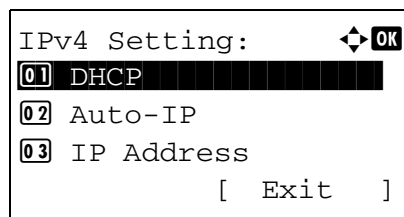

- 14** Press **[OK]**. The DHCP setting is set and the IPv4 Setting menu reappears.



Note DHCP becomes effective when `On` is selected. Press **[Menu]** to end the Mode Selection Menu.

When `Off` is set, continue on to enter the IP Address.

Entering the IP address

If DHCP is set to `Off`, enter the IP Address manually.

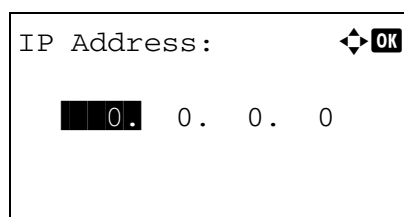

- 15** Press Δ or ∇ to select `IP Address`.
- 16** Press **[OK]**. The `IP Address` screen appears.

- 17** Use the numeric keys to set the IP address.

You can set any value between 000 and 255.

Increase or reduce the figures by pressing Δ or ∇ .

Use \triangleleft and \triangleright to move the position being entered, which is shown highlighted.

- 18** Press **[OK]**. The IP address is stored and the IPv4 Setting menu reappears.

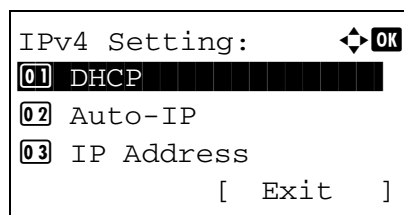

Entering the Subnet Mask

When DHCP is set to `Off`, enter the Subnet Mask manually.

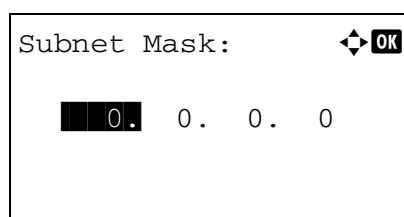

- 19** Press Δ or ∇ to select `Subnet Mask`.
- 20** Press **[OK]**. The `Subnet Mask` screen appears.

- 21** Use the numeric keys to set the subnet mask.

You can set any value between 000 and 255.

The method for entering is the same as for the IP Address.

- 22** Press **[OK]**. The subnet mask setting is stored and the IPv4 Setting menu reappears.

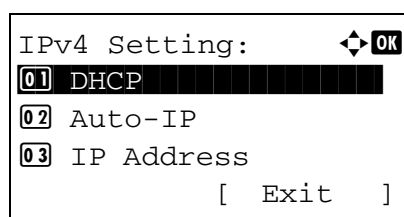

Entering the Default Gateway

When DHCP is set to Off, enter the Default Gateway manually.

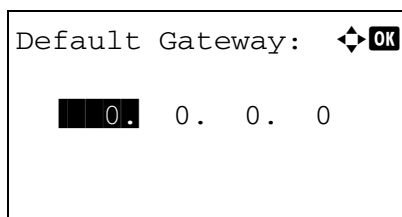

- 23 Press Δ or ∇ to select Default Gateway.
- 24 Press **[OK]**. The Default Gateway screen appears.

- 25 Use the numeric keys to set the default gateway.
You can set any value between 000 and 255.
The method for entering is the same as for the IP Address.
- 26 Press **[OK]**. The default gateway is stored and the IPv4 Setting menu reappears.

This completes the network settings. Press **[Menu]** and end the Mode Selection Menu.



Note When the network settings have been changed, the machine must be switched OFF then back ON again to make the changes effective.

Printing a Status Page

After completing the network settings, print a status page. The status page allows you to confirm a range of information, including network addresses and network protocols.

To print a status page, select *Status Page* from the Report Print menu. Refer to *Report Print on page 6-2* for detailed information.

Installing Software

If you are connecting this machine to a Windows PC, follow the next steps to install the software. The example shows you how to connect your machine to a Windows 7 PC.

The following softwares are supported:

Software on CD-ROM (Windows)

Express Mode or Custom Mode can be selected for the installation method. The software that can be installed and the printer port selection method vary depending on which method is selected.

Software	Function	Description	Installation Method	
			Express Mode	Custom Mode
KX driver	Print	This driver enables files on a computer to be printed by the machine. Multiple page description languages (PCL XL, KPD, etc.) are supported by a single driver. This printer driver allows you to take full advantage of the features of the machine. Use this driver to print PDF files.	●	●*
KX (XPS) printer driver		This printer driver supports the XPS (XML Paper Specification) format developed by Microsoft Corporation.	—	○
Mini printer driver (PCL/KPDL)		This is a Microsoft MiniDriver that supports PCL and KPDL. There are some restrictions on the machine features and option features that can be used with this driver.	—	○
KYOCERA Net Direct Print	Utility	This makes it possible to print a PDF file without starting Adobe Acrobat/Reader.	—	○
KYOCERA Net Viewer		This is a utility that enables monitoring of the machine on the network.	—	○
Font	—	These are display fonts that enable the machine's built-in fonts to be used in a software application.	●	●*

- Standard installation.
- Allows selection of the components to be installed.
- * Selected by default.

 **Note** Plug and Play is disabled on this device when in Sleep. Wake the device from Sleep before continuing. Refer to *Sleep on page 2-37*.

Installing Printer Driver in Windows

-  **Note** Installation on Windows must be done by a user logged on with administrator privileges.
 If the **Welcome to the Found New Hardware Wizard** dialog box displays, select **Cancel**.
 If the autorun screen is displayed, click **Run Setup.exe**.
 If the user account management window appears, click **Allow**.

You can use either Express Mode or Custom Mode to install the software. Express Mode automatically detects connected machines and installs the required software. Use Custom Mode if you want to specify the printer port and select the software to be installed. For details, refer to Custom Installation in the *Printer Driver User Guide* on the CD-ROM.

-  **Note** In Windows operating systems, you must be logged on with administrator rights to install the printer driver.

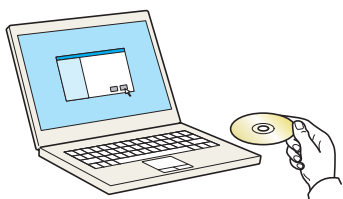

- 1 Insert the CD-ROM.



- 2 Click **View License Agreement** and read the License Agreement. Click **Accept**.



- 3 Click **Install Software**.

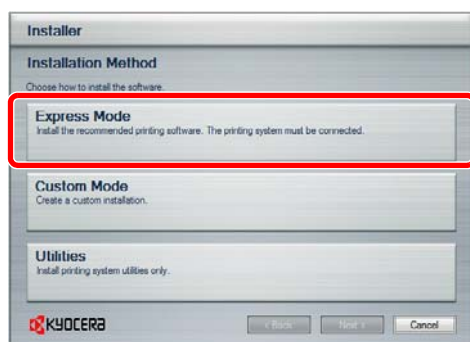

- 4 Click **Express Mode**.

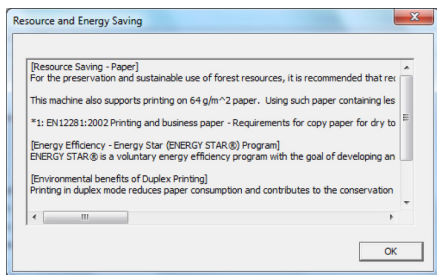

5 Click **OK**.

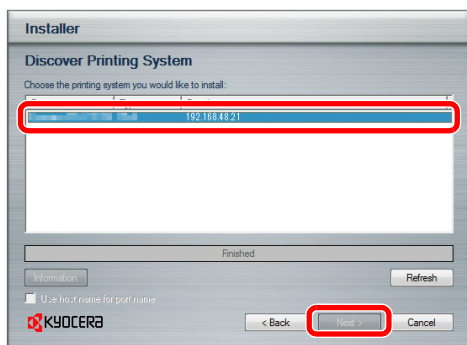

6 Select the print system to be installed and click **Next**.



Note If the print system detection window appears and the installer fails to detect the machine, verify that it is connected to the computer via a network or USB cable and that it is turned on and click **Reload**.

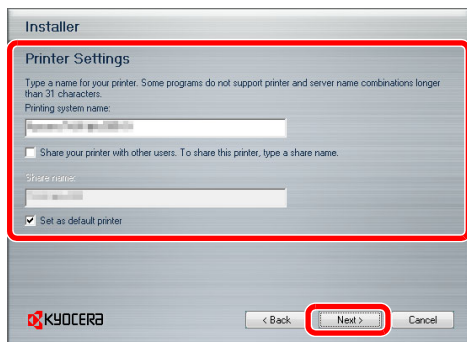

7 Select installation settings. Follow the instructions on the screen to select the settings, and click **Next**.

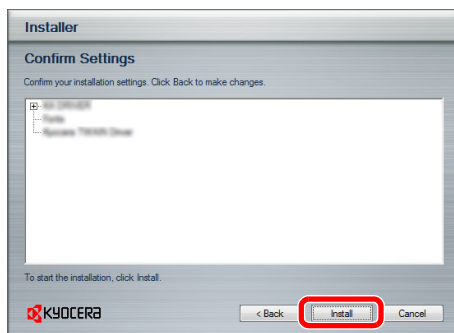

8 Click **Install**.



Note If the Windows security window appears, click **Install this driver software anyway**.

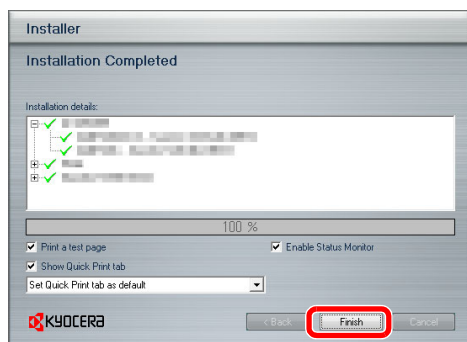

9 A message appears saying that the printer has been installed successfully. Click **Finish**.

This completes the printer driver installation procedure. Follow the on-screen instructions to restart the system, if required.

Installing Printer Driver in Macintosh

The example shows you how to connect your machine to a Macintosh running MAC OS X v10.6.



Note Installation on MAC OS must be done by a user logged on with administrator privileges. When printing from a Macintosh computer, set the machine's emulation to [KPDL] or [KPDL(Auto)]. For details about the configuration method, refer to *Network (Network settings) on page 6-40*. If connecting by Bonjour, enable Bonjour in the machine's network settings. For details, refer to *Bonjour (Bonjour setting) on page 6-43*. In the Authenticate screen, enter the name and password used to log in to the operating system.

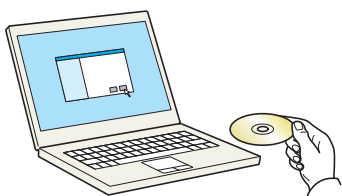

- 1 Insert the CD-ROM.

Double-click the Kyocera icon.

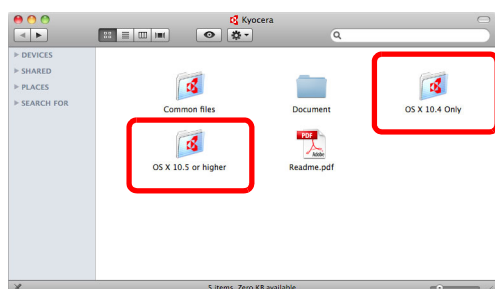

- 2 Double-click either **OS X 10.4 Only** or **OS X 10.5 or higher** depending on your Mac OS version.

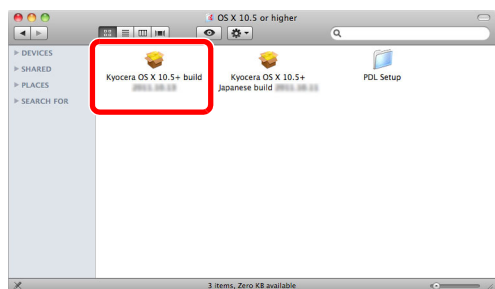

- 3 Double-click **Kyocera OS X vx.x**.

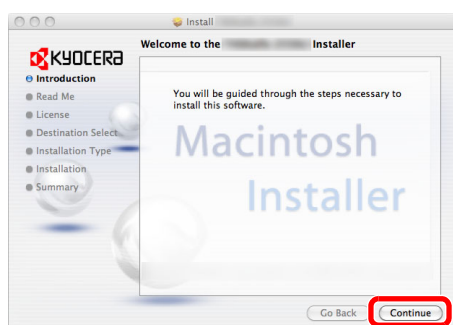

- 4 Install the printer driver as directed by the instructions in the installation software.

This completes the printer driver installation.

Next, specify the print settings. If an IP or AppleTalk connection is used, the settings below are required. If a USB connection is used, the machine is automatically recognized and connected.

5 Open **System Preferences** and click **Print & Fax**.

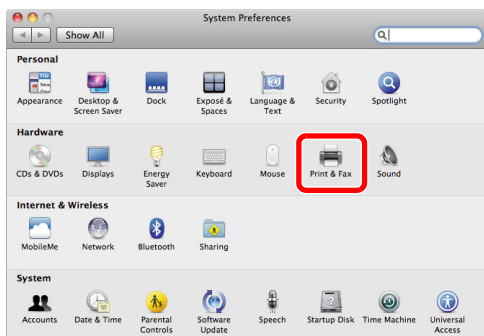

6 Click the plus symbol (+).

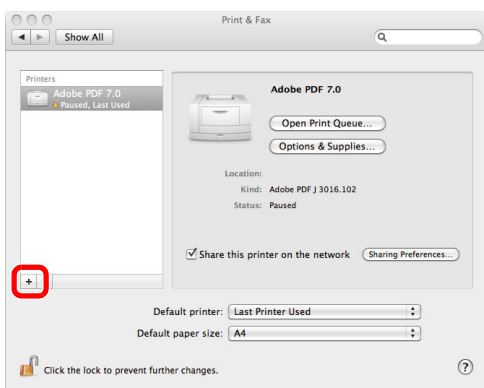

7 Click the IP icon for an IP connection or the AppleTalk icon for an AppleTalk connection and then enter the IP address and printer name. Click **Add**.



Note When using a Bonjour connection, select [Default] and click the item that appears in "Printer Name". The driver with the same name as the machine automatically appears in "Driver".

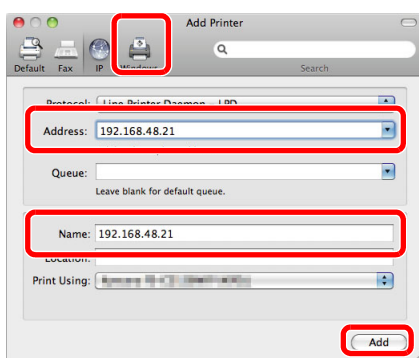

8 Select the options available for the machine and click **Continue**

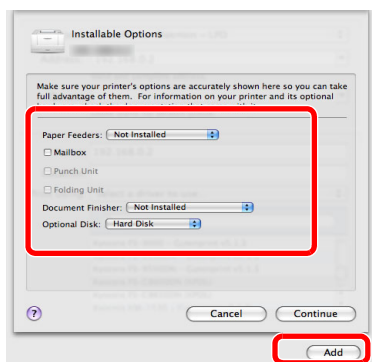

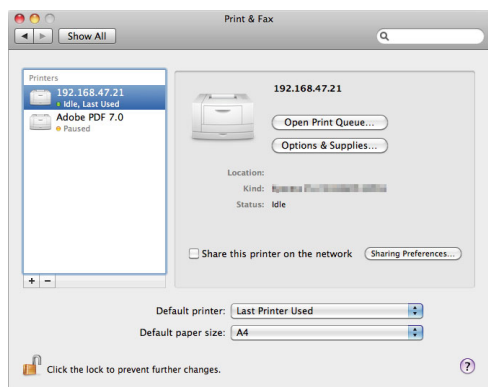

9 The selected printer is added. This completes the print settings.

Status Monitor

The Status Monitor shows a print system status message at the bottom right of the printing screen. You can also start Command Center RX to check and change printer settings.

The Status Monitor is installed automatically during KX driver installation.

Accessing the Status Monitor

Use either of the methods listed below to launch the Status Monitor.

- Launch when printing starts:
When you specify a printer and start a print job, one Status Monitor is launched for each printer name. If Status Monitor startup is requested from multiple printers, Status Monitors are launched for each printer that issues the request.
- Launch from the KX driver properties:
Click the **Status Monitor** button in the Advanced tab. Then click **Open Status Monitor** button in the Status Monitor dialog box to launch the Status Monitor.

Exiting the Status Monitor

Use either of the methods listed below to exit the Status Monitor.

- Exit manually:
Right-click the Status Monitor icon in the taskbar and select **Exit** in the menu to exit the Status Monitor.
- Exit automatically:
The Status Monitor automatically shuts down after 5 minutes if it is not being used.

Screen Overview

The screen overview of the Status Monitor is as follows.

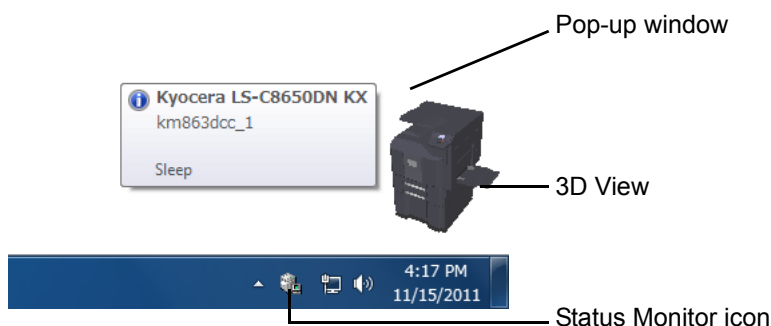

Pop-up window

If an information notification event occurs, a pop-up window appears. This window only appears when the 3D View is open on the desktop.

3D View

This shows the status of the monitored printer as a 3D image. You can choose whether to show or hide the 3D view from the menu displayed when you right-click the Status Monitor icon.

If an information notification event occurs, the 3D view and an alert sound are used to notify you. For information on the sound notification settings, refer to *Notification Settings on page 2-16*.

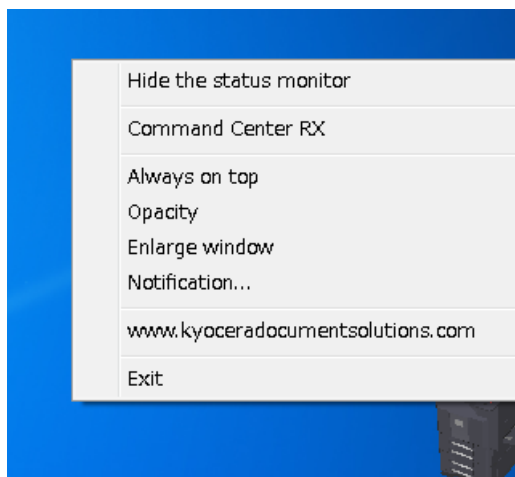

Status Monitor icon

While the **Status Monitor** is running, its icon is displayed in the taskbar notification area. When you position the cursor over the icon, the printer name appears. Right-clicking the **Status Monitor icon** allows you to set the options below.

Show/Hide the status monitor

Displays or hides the **Status Monitor icon**.

Command Center RX

If the printer is connected to a TCP/IP network and has its own IP address, use a web browser to access the Command Center RX to modify or confirm the network settings. For more information, refer to the *Command Center RX User Guide*.

Always on top

Positions the Status Monitor in front of other active windows.

Opacity

Adjusts the Status Monitor to let a variable amount of background to show through the image. Select a percentage between 20 to 100.

Enlarge window

Doubles the size of the Status Monitor window.

Notification...

Specify the **Notification** setting for the Status Monitor. For details, refer to *Notification Settings on page 2-16*.

www.kyoceradocumentsolutions.com

Accesses the KYOCERA Document Solutions global website.

Exit

Exits the **Status Monitor**.

Notification Settings

Use the **Notification** option to set up the Status Monitor.

The **Notification** tab contains the following items.

IMPORTANT To confirm the settings on **Notification** tab, the computer requires the sound capabilities such as sound card and speaker.

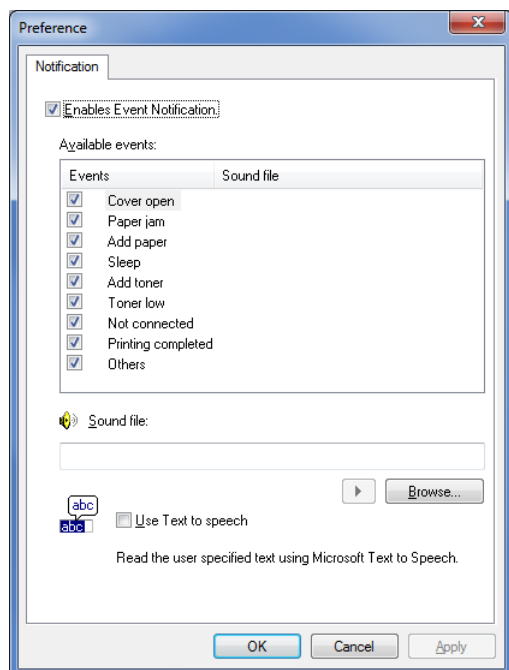

Enables Event Notification

Select to enable or disable monitoring the events in Available events.

Sound file

A sound file can be selected if you require an audible notification. Click **Browse** to search for the sound file.

Use Text to speech

Select this check box to enter text you would like to hear played for events. Although a sound file is unnecessary, this function is applicable for Windows XP or later.

To use this function, follow these steps.

- 1** Select **Enables Event Notification** checkbox.
- 2** Select an event to use with the text to speech function in Available events.
- 3** To use a sound file for notification of events, remove the checkmark from the **Use Text to speech** checkbox. The **Sound file** text box will be enabled.
- 4** Enter the location of the sound file (.wav), or click **Browse...** to select a sound file saved on your computer.



Note The available file format is WAV.

Select **Use Text to speech** checkbox to speech the text entered in Text to speech box when an event occurred.

- 5** Click **Play** to confirm the sound or text is played correctly.

Uninstalling Software (Windows)

The software can be uninstalled (removed) using the *Product Library* disc supplied with the printer.

IMPORTANT On Macintosh computers, because the printer settings are specified using a PPD (PostScript Printer Description) file, the software cannot be uninstalled using the *Product Library* disc.

- 1 Exit all active software applications.
- 2 Insert the *Product Library* disc supplied with the printer into the optical drive.
- 3 Following the procedure used to install the printer driver, click **Remove Software**. The Software Remove wizard appears.
- 4 Select the software package to remove.
- 5 Click **Uninstall**.



Note In Windows Vista, the **Remove Driver and Package** screen appears. Select **Remove driver and driver package**, and click **OK**. When KYOCERA Net Viewer or KYOCERA Net Direct Print is installed, separate uninstallers are launched for each application. Proceed with the uninstallation steps for each application as directed by the on-screen instructions.

The uninstaller starts.

- 6 When Uninstall complete screen appears, click **Next**.
- 7 Select whether you restart your computer or not, click **Finish**.



Note The software can be uninstalled from the Program menu.
(In the case of Windows XP)
Start the uninstaller by clicking **start > All Programs > Kyocera > Kyocera Uninstaller**, and uninstall the software.

Command Center RX

Command Center RX is a tool used for tasks such as verifying the operating status of the machine on the web and changing the settings for security, network printing and advanced networking.

If the E-mail settings are made then it is possible to send notification by E-mail when a job is completed.

 **Note** To change settings in Command Center RX, you must log in as an administrator of the machine. The default factory settings are set as shown below.

Login User Name: Admin

Login Password: Admin

The operation procedure for accessing Command Center RX is as follows.

- 1 Start the web browser.
- 2 In the Address or Location bar, enter the machine's IP address.
e.g.) http://10.183.51.41/

The web page displays basic information about the machine and Command Center RX as well as their current status.

- 3 Select an item from the navigation bar on the left of the screen. The settings must be configured separately depending on the items.
If restrictions have been set for Command Center RX, enter the correct user name and password to access pages other than the startup page.

For more information, refer to the *Command Center RX User Guide*.

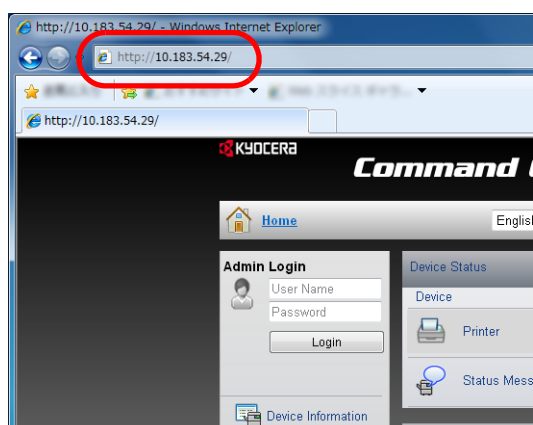

E-mail Setting

Specifying the SMTP settings allows you to send notification of the end of a Job via E-mail.

To use this function, this machine must be connected to a mail server using the SMTP protocol.

Also, check the following:

- The network environment used to connect this machine to the mail server
A full-time connection via a LAN is recommended.
- SMTP Settings
Use Command Center RX to register the IP address or host name of the SMTP server.
- If limits have been set on the size of E-mail messages, it may not be possible to send large volume E-mails.

The procedure for specifying the SMTP settings is explained below.

- 1 Click **Settings** -> **Advanced** -> **SMTP** -> **General**.

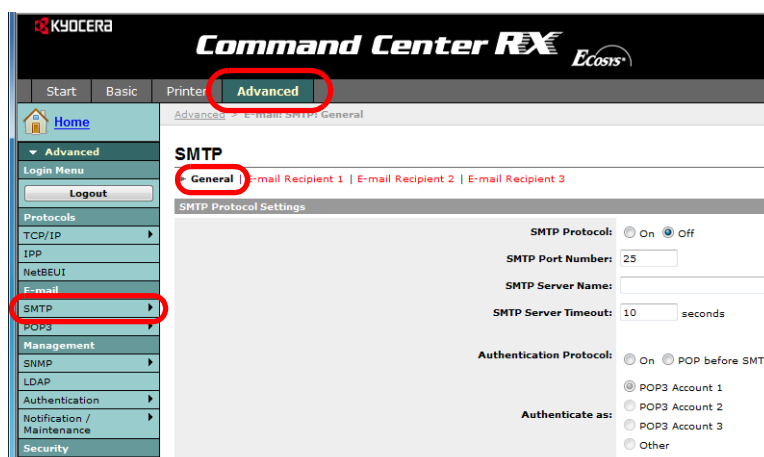

2 Enter the correct settings in each field.

The settings to be specified in the SMTP settings screen are shown below.

Item	Description
SMTP Protocol	Enables or disables SMTP protocol. To use E-mail, this protocol must be enabled.
SMTP Port Number	Set the SMTP Port Number. Normally use the port No. 25.
SMTP Server Name	Enter the SMTP server IP address or its name. The maximum length of the SMTP server name and IP address is 64 characters. If entering the server name, an IP address of DNS server must also be configured. The DNS server address can be entered on the TCP/IP setting screen.
SMTP Server Timeout	Set the amount of time to wait before time-out in seconds.
Authentication Protocol	Enables or disables the SMTP authentication protocol or sets POP before SMTP as the protocol. The SMTP authentication supports Microsoft Exchange 2000.
Authenticate as	Authentication can be set from three POP3 accounts or you can choose a different account.
Login User Name	When Other is selected for Authentication, the login user name entered here will be used for SMTP authentication. The maximum length of the login user name is 64 characters.
Login Password	When Other is selected for Authentication, the password entered here will be used for authentication. The maximum length of the login password is 64 characters.
SMTP Security	Enables or disables the SMTP Security. When this protocol is enabled, either SSL/TLS or STARTTLS must be selected. To enable SMTP security, the SMTP port number may have to be changed according to the server settings. Typically, 465 for SSL/TLS and 25 or 587 for STARTTLS are used for SMTP ports.
POP before SMTP Timeout	Set the amount of time to wait before time-out in seconds when you have selected POP before SMTP as the Authentication Protocol.
Test	This will test if the SMTP connection can be successfully established.
E-mail Size Limit	Enter the maximum size of E-mail that can be sent in kilobytes. When the value is 0, the limitation for E-mail size is disabled.
Sender Address	Enter the E-mail address of the person responsible for the machine, such as the machine administrator, so that a reply or non-delivery report will go to a person rather than to the machine. The sender address must be entered correctly for SMTP authentication. The maximum length of the sender address is 128 characters.
Signature	Enter the signature. The signature is free form text that will appear at the end of the E-mail body. It is occasionally used for further identification of the print system. The maximum length of the signature is 512 characters.
Domain Restriction	Enter the domain names that can be permitted or rejected. The maximum length of the domain name is 32 characters. You can also specify the E-mail addresses.

Dynamic Domain Name System (DDNS)

This printer supports DDNS through DHCP. To use this system, you have to set the **DHCP/BOOTP** option to **On** first. Set the **DDNS** to **On** to use the DDNS service to update the correspondence of the host names and IP addresses. Refer to the *Command Center RX User Guide* for the method for setting this.

Loading Paper

Paper can be loaded in the two standard cassettes and the multi purpose tray. Paper feeders are also available as an option (refer to *Optional Equipment on page A-2*).

For the paper feed methods for each cassette, refer to the page below.

Cassette		Name	Page
Standard	Cassette 1, Cassette 2	Standard cassettes	2-22
	Multi Purpose Tray	Multi Purpose Tray	2-28
Option	Cassette 3, Cassette 4	Paper Feeder (500-sheet x 2)*	2-22
		Large Capacity Feeder (1,500-sheet x 2)	2-25
	Cassette 5	Side Feeder (3,000-sheet)	2-27
		Side Feeder (500-sheet x 3)*	2-22
		Large Capacity Side Feeder (500*, 1,500-sheet x 2**)	2-22
	Cassette 6 Cassette 7	Side Feeder (500-sheet x 3)*	2-22
Large Capacity Side Feeder (500*, 1,500-sheet x 2**)		2-25	

* The paper feed method is the same as standard cassettes 1 and 2.

** The paper feed method is the same as the Large Capacity Feeder (1,500-sheet x 2).

IMPORTANT Cautions when setting the Energy Saver mode

- The number of sheets that can be held varies depending on your environment.
- To obtain clearer color prints, use special paper for color printing.
You should not use inkjet printer paper or any paper with a special surface coating. (Such paper may cause paper jams or other faults.)

Before Loading Paper

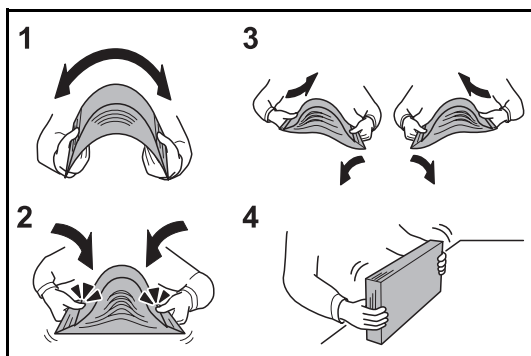

When you open a new package of paper, fan the sheets to separate them slightly prior to loading in the following steps.

- 1** Bend the whole set of sheets to swell them in the middle.
- 2** Hold the stack at both ends and stretch it while keeping the entire stack risen.
- 3** Raise the right and left hands alternately to create a gap and feed air between the paper.
- 4** Finally, align the paper on a level, flat table.
If the paper is curled or folded, straighten it before loading. Paper that is curled or folded may cause a jam.



CAUTION If you copy onto used paper (paper already used for printing), do not use paper that is stapled or clipped together. This may damage the machine or cause poor image quality.

Avoid exposing opened paper to high temperatures and high humidity as dampness can be a cause of problems. Seal any remaining paper after loading in the multi purpose tray or cassettes back in the paper storage bag.

If the machine will not be used for a prolonged period, protect all paper from humidity by removing it from the cassettes and sealing it in the paper storage bag.



Note Note that some paper types have a tendency to curl and may jam in the paper eject unit.

If the output paper scatters or stacks unevenly, turn the paper over in the cassette, or change the orientation (vertical/horizontal) of the paper in the cassette.

If you use special paper such as letterhead, paper with holes or paper with pre-prints like logo or company name, refer to *the Paper on A-9*.

Loading Paper in the Cassettes

The standard cassettes

The 2 standard cassettes will each hold plain paper, recycled paper or color paper.

Cassette 1 and 2 hold up to 500 sheets of plain paper (80 g/m²) (or up to 550 sheets of 64 g/m² plain paper).

The following paper sizes are supported: A3, B4, A4, A4-R, B5, B5-R, A5-R, Ledger, Legal, Oficio II, 12 × 18", Letter, Letter-R, Statement-R, Folio, 8K, 16K, 16K-R and 216 × 340 mm.

IMPORTANT

- When using media types other than plain paper (such as recycled or colored paper), always specify the media type and paper weight settings. (Refer to *Specifying Paper Size and Media Type for the Cassettes* on page 2-30, *Media Type Set. (Paper type settings)* on page 6-23.)

The cassettes can hold paper with weights between 60 and 256 g/m². If you are using a paper weight between 106 and 256 g/m², set the media type to *Thick* and set the weight of the paper you are using.

- Do not load thick paper that is heavier than 256 g/m² in the cassettes. Use the multi purpose tray for paper that is heavier than 256 g/m².
- If you wish to use 330 × 210 mm to 356 × 220 mm paper, contact a service technician.

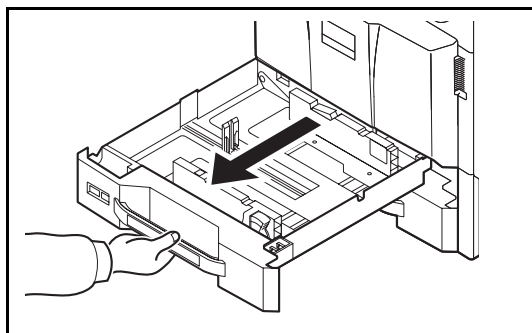

- 1 Pull the cassette out toward you until it stops.



Note Do not pull out more than one cassette at a time.

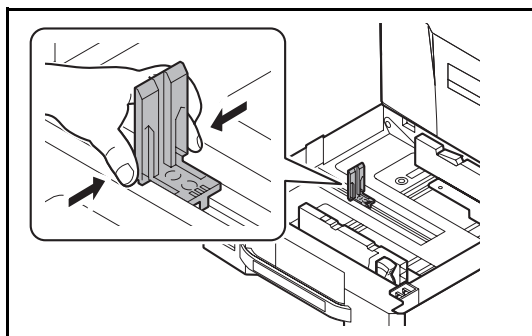

- 2 Squeeze the ends of the bottom of the paper length guide and move the guide to fit the length of the paper.



Note Paper sizes are marked on the cassette.

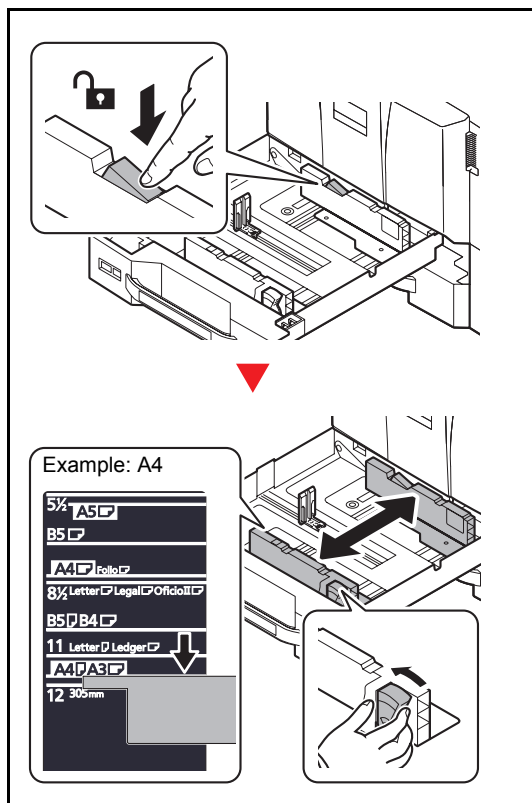

- 3** Press the (Paper Width Guide) Lock to release the lock. Grasp the paper width adjusting tab and move the paper width guides to fit the paper.

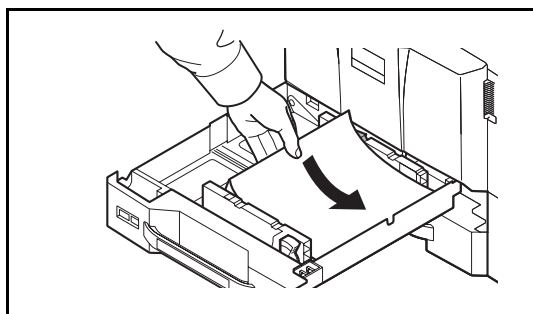

- 4** Align the paper flush against the right side of the cassette. After removing new paper from its packaging, fan the paper before loading it in the cassette. (Refer to *Before Loading Paper* on page 2-21)

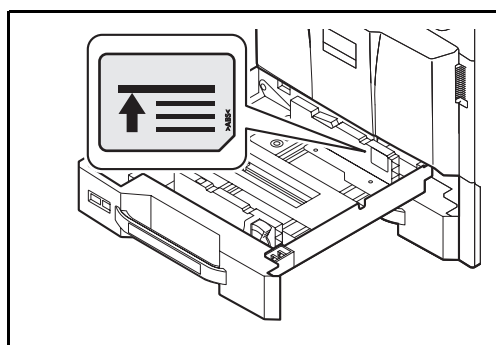

IMPORTANT

- Before loading the paper, be sure that it is not curled or folded. Paper that is curled or folded may cause paper jams.
- Ensure that the loaded paper does not exceed the level indicator (see illustration on the left).
- When loading the paper, keep the side that was closest to the package seal facing up.
- The paper length and width guides must be adjusted to the paper size. Loading the paper without adjusting these guides may cause skewed feeding and paper jams.

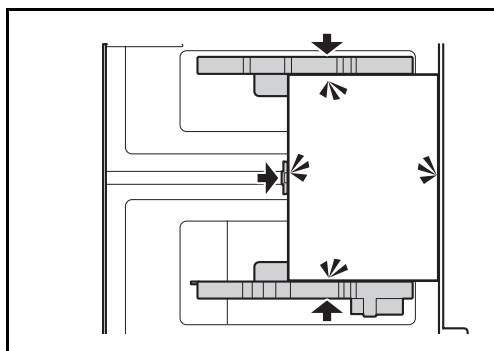

- 5** Be sure that the paper length and width guides rest securely against the paper. If there is a gap, readjust the guides to fit the paper.

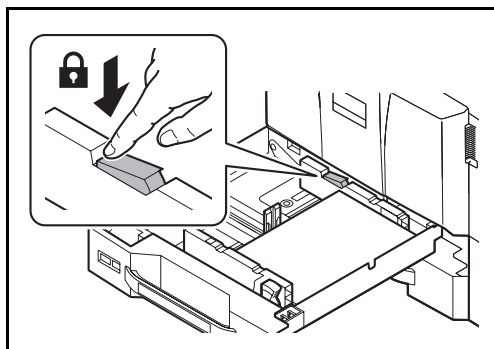

- 6** Press the (Paper Width Guide) Lock to lock.

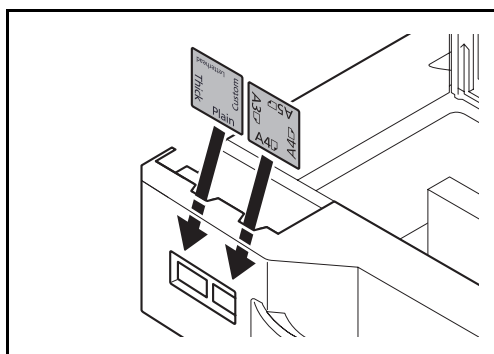

- 7** Insert the indication on the sheet so as to match the size and type of paper to be placed. (The indication is printed on both sides of the sheet.)

- 8** Gently push the cassette back in.



Note If the machine will not be used for a prolonged period, protect all paper from humidity by removing it from the cassettes and sealing it in the paper storage bag.

- 9** Select the media type (plain, recycled, etc.) loaded in the cassette. (Refer to *Specifying Paper Size and Media Type for the Cassettes* on page 2-30.)

The Large Capacity Feeder (1,500-sheet x 2) (Option)

The Optional cassettes will each hold plain paper, recycled paper or color paper.

The Large Capacity Feeder (1,500-sheet x 2) holds up to 3,000 sheets (1,500-sheet x 2) of plain paper (80 g/m²) (or up to 3,500 sheets (1,750-sheet x 2) of 64 g/m² plain paper).

The following paper sizes are supported: A4, B5 and Letter.

IMPORTANT

- When using media types other than plain paper (such as recycled or colored paper), always specify the media type and paper weight settings. (Refer to *Specifying Paper Size and Media Type for the Cassettes on page 2-30, Media Type Set. (Paper type settings) on page 6-23.*)

The cassettes can hold paper with weights up to 256 g/m². If you are using a paper weight between 106 and 256 g/m², set the media type to *Thick* and set the weight of the paper you are using.

- Do not load thick paper that is heavier than 256 g/m² in the cassettes. Use the multi purpose tray for paper that is heavier than 256 g/m².

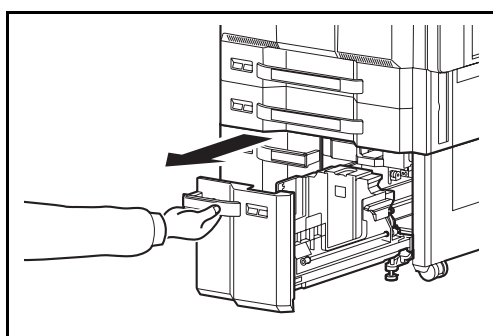

- 1 Pull the cassette out toward you until it stops.

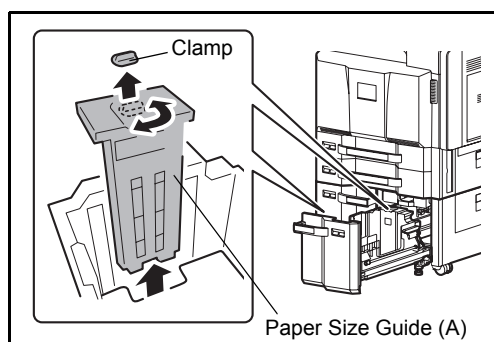

- 2 Rotate the Paper Size Guide (A) clamp and remove. Pull the Paper Size Guide (A) up and out.

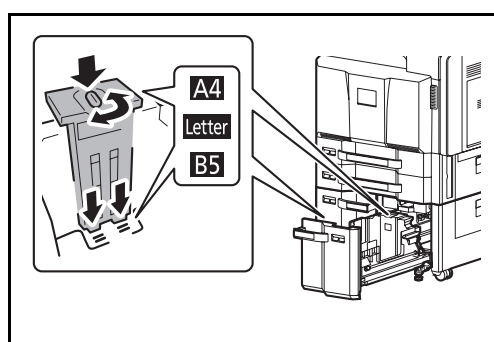

- 3 Insert the Paper Size Guide (A) into the slot (bottom of cassette) for the paper size to be used.

Make sure that the top of the paper size guide (A) matches the paper size to be used, attach the clamp, and rotate the clamp to lock it.

Gently try moving the Paper Size Guide (A) to verify that it is fixed.

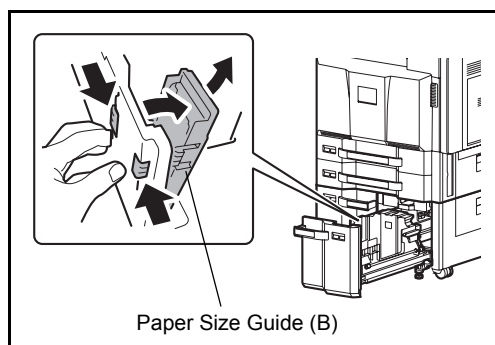

- 4** With the bottom of the cassette pressed all the way down, press the hook on the side of the Paper Size Guide (B) to release it and pull out the Paper Size Guide (B).

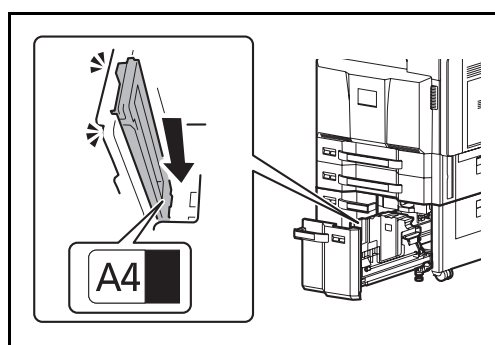

- 5** Adjust the Paper Size Guide (B) to the paper size.

A4

Insert the Paper Size Guide (B) into the slot marked A4 (on the bottom of the cassette), and lock the hook (it will make a "click" sound).

Gently try moving the Paper Size Guide (B) to verify that it is fixed.

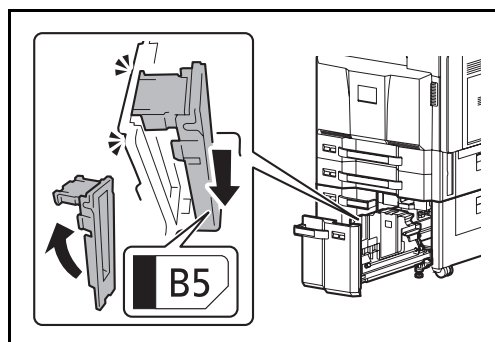

B5

Open the Paper Size Guide (B) as shown, insert into the slot marked B5 (on the bottom of the cassette), and lock the hook (it will make a "click" sound).

Gently try moving the Paper Size Guide (B) to verify that it is fixed.

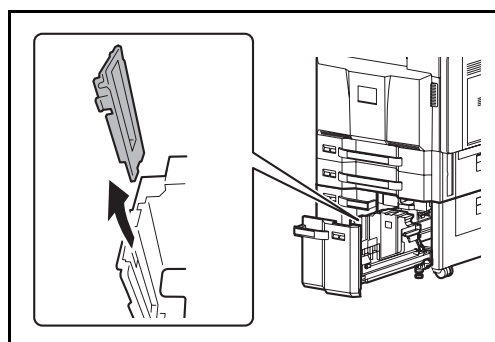

Letter

The Paper Size Guide (B) is not attached.

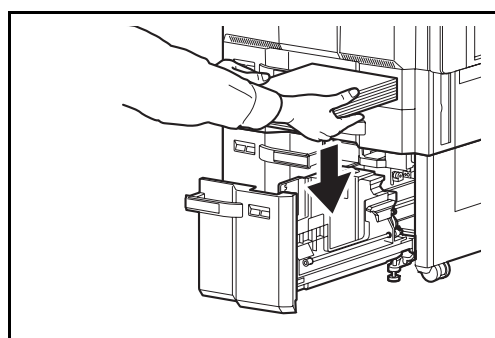

- 6** Insert the paper into the cassette.

After removing new paper from its packaging, fan the paper before loading it in the cassette.

(Refer to *Before Loading Paper* on page 2-21)

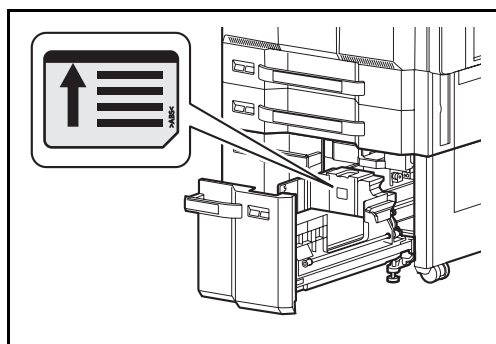
**IMPORTANT**

- Before loading the paper, be sure that it is not curled or folded. Paper that is curled or folded may cause paper jams.
- Ensure that the loaded paper does not exceed the level indicator (see illustration below).
- When loading the paper, keep the print side facing up.

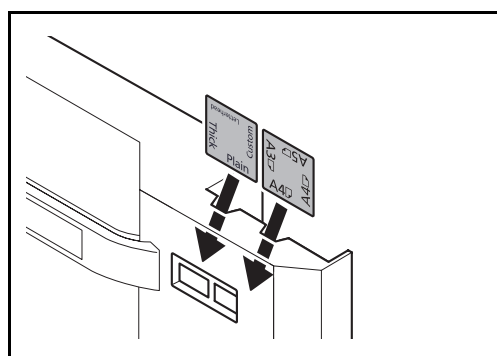

- 7** Insert the indication on the sheet so as to match the size and type of paper to be placed. (The indication is printed on both sides of the sheet.)

- 8** Gently push the cassette back in.



Note If the machine will not be used for a prolonged period, protect all paper from humidity by removing it from the cassettes and sealing it in the paper storage bag.

- 9** Select the media type (plain, recycled, etc.) loaded in the cassette. (Refer to *Specifying Paper Size and Media Type for the Cassettes* on page 2-30.)

Side Feeder (3,000-sheet) (Option)

The optional side feeder hold up to 3,000 sheets of plain paper (80 g/m²). The following paper sizes are supported: A4, B5, Letter.

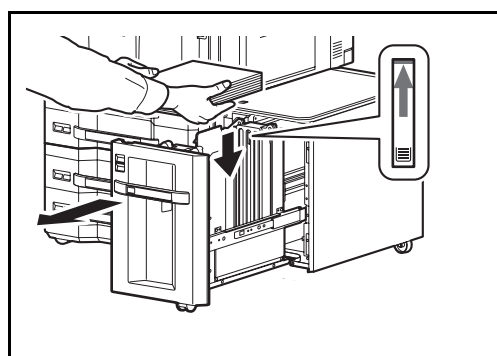

Pull the cassette out toward you until it stops and insert the paper into the cassette. After loading paper, gently push the cassette back in.



Note The default paper size setting is A4. If you need the paper size changed to B5 or Letter, contact your service representative.

IMPORTANT

- Before loading the paper, be sure that it is not curled or folded. Paper that is curled or folded may cause paper jams.
- Ensure that the loaded paper does not exceed the level indicator (see illustration below).
- When loading the paper, keep the print side facing down.

Loading Paper in the Multi Purpose Tray

The multi purpose tray will hold up to 150 sheets of A4 or smaller plain paper (80 g/m²) (or up to 165 sheets of 64 g/m² plain paper) or up to 50 sheets of plain paper (80 g/m²) (or up to 55 sheets of 64 g/m² plain paper) larger than A4.

The multi purpose tray accepts paper sizes 12×18" and from A3 to A6-R and Hagaki and from Ledger to Statement-R, 8K, 16K and 16K-R. Be sure to use the multi purpose tray when you print on any special paper.

IMPORTANT When using media types other than plain paper (such as recycled or colored paper), always specify the media type and paper weight settings. (Refer to *Specifying Paper Size and Media Type for the Multi Purpose Tray (MP Tray Setting)* on page 2-33, *Media Type Set. (Paper type settings)* on page 6-23.) If you are using a paper weight of 106 g/m² or more, set the media type to *Thick* and set the weight of the paper you are using.

The capacity of the multi purpose tray is as follows.

- A4 or smaller plain paper (80 g/m²), recycled paper or color paper: 150 sheets
(64 g/m² plain paper :165 sheets)
- B4 or larger plain paper (80 g/m²), recycled paper or color paper: 50 sheets
(64 g/m² plain paper :55 sheets)
- Hagaki: 30 sheets
- OHP film: 10 sheets
- Envelope DL, Envelope C4, Envelope C5, Envelope #10 (Commercial #10), Envelope #9 (Commercial #9), Envelope #6 (Commercial #6), Monarch, Youkei 4, Youkei 2: 10 sheets
- Banner paper: 470.1 mm (18.51") to a maximum of 1220.0 mm (48"):
1 sheet (manual feed), 10 sheets (when optional banner tray is attached)

 **Note** When you load custom size paper, enter the paper size by referring to *Specifying Paper Size and Media Type for the Multi Purpose Tray (MP Tray Setting)* on page 2-33.

When you use special paper such as transparencies or thick paper, select the media type by referring to *Specifying Paper Size and Media Type for the Multi Purpose Tray (MP Tray Setting)* on page 2-33.

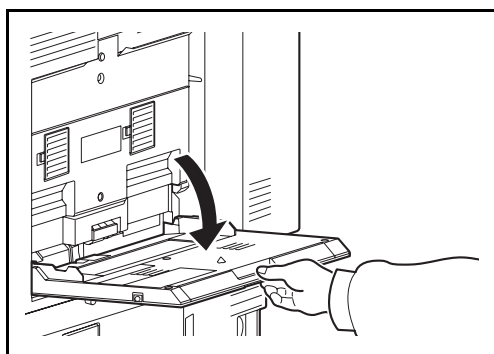

- 1** Open the Multi Purpose tray until it stops.

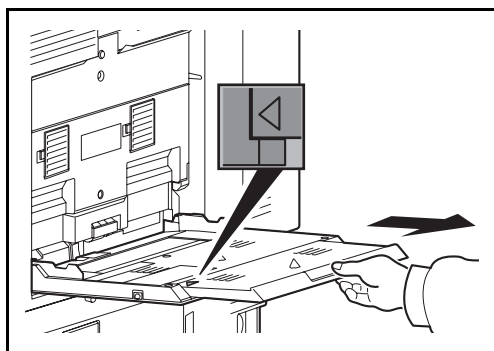

- 2** When loading paper sizes 12×18" and from A3 to B4 and Ledger to Legal, extend the support tray section of the multi purpose tray until the mark "Δ" is fully appeared.

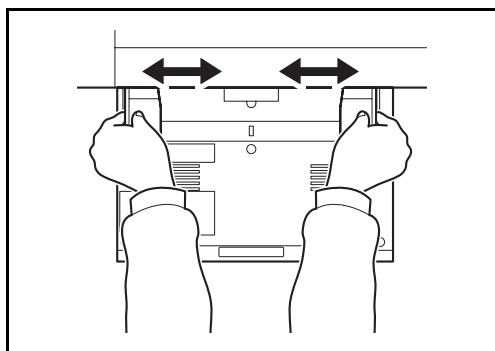

3 Adjust the paper width guides to the width of the paper.

After removing new paper from its packaging, fan the paper before loading it in the multi-purpose tray.

(Refer to *Before Loading Paper* on page 2-21)

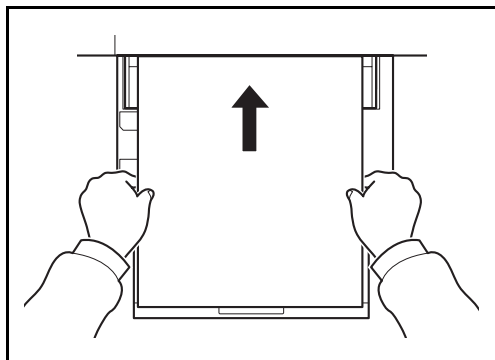

4 Insert the paper along the paper width guides into the tray until it stops.

IMPORTANT Keep the print side facing down.

Curled paper must be uncurled before use.

Straighten the top edge if it is curled.

When loading paper into the multi purpose tray, check that there is no paper left over in the tray from a previous job before loading the paper. If there is just a small amount of paper left over in the multi purpose tray and you want to add more, first remove the left-over paper from the tray and include it with the new paper before loading the paper back into the tray.

If there is a gap between the paper and the paper width guides, readjust the guides to fit the paper in order to prevent skewed feeding and paper jams.

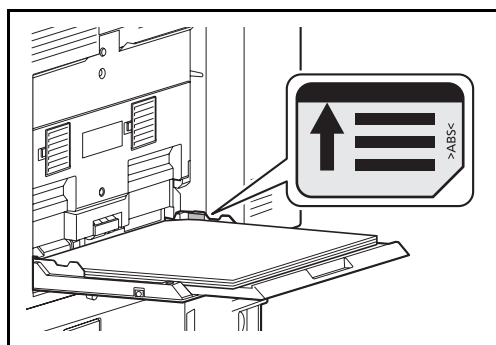

IMPORTANT Ensure that the loaded paper does not exceed the level indicator (see illustration).



Note When you load envelopes in the multi purpose tray, select the envelope type by referring to *Specifying Paper Size and Media Type for the Multi Purpose Tray (MP Tray Setting)* on page 2-33.

Specifying Paper Size and Media (Cassette Setting)

The default paper size setting for cassettes 1 and 2, for the multi purpose tray and for the optional paper feeder (cassettes 3 to 7) is [Auto], and the default media type setting is [Plain].

To fix the type of paper to be used in cassettes, specify the paper size and media type setting. (Refer to *Specifying Paper Size and Media Type for the Cassettes* on page 2-30.)

To fix the type of paper to be used in multi purpose tray, specify the paper size setting. (Refer to *Specifying Paper Size and Media Type for the Multi Purpose Tray (MP Tray Setting)* on page 2-33.)

Specifying Paper Size and Media Type for the Cassettes

To fix the type of paper to be used in cassettes 1 or 2 or the optional paper feeders (cassettes 3 to 7), specify the paper size. Also, if you use a media type other than plain paper, specify the media type setting. To change to a media type other than Plain, refer to *Media Type Set. (Paper type settings)* on page 6-23.

Selection Item	Selectable Size/Type
Standard Sizes *	Select from the standard sizes. Selectable paper sizes are as follows. Letter-R, Letter, Legal, A4-R, A4, B5-R, B5, A3, B4, Ledger, A5, Oficio II, 216×340 mm, 12×18", 8K, 16K-R, 16K, Statement, Folio
Media Type	Plain, Preprinted**, Bond, Recycled, Vellum**, Rough**, Letterhead**, Color**, Prepunched, Thick**, High Quality and Custom 1~8**

* Only A4, Letter, and B5 can be specified when the optional Large Capacity Feeder (1,500-sheet x 2) and the optional Large Capacity Side Feeder (500, 1,500-sheet x 2) are used.

** This cannot be selected when the cassette paper weight is Heavy 5 or Extra heavy. Select at the Multi Purpose Tray.

Cassette (1 to 7) Set. (Settings for the cassettes)

When loading paper in the printer's paper cassette, follow the steps below to set the paper size and paper type.

If the optional paper feeder is installed, use the same procedure to set the cassette paper size and paper type.

Cassette (1 to 7) Size (Setting the cassette paper size)

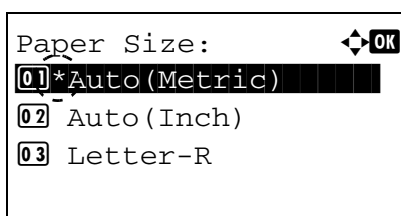
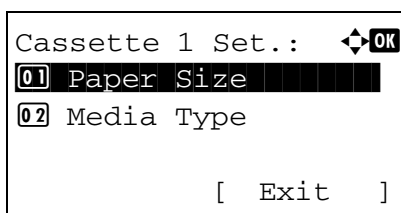

1 In the Paper Settings menu, press Δ or ∇ to select the paper cassette you want to set.

2 Press **[OK]**. The `Cassette # Set.` menu screen appears.

3 Press Δ or ∇ to select `Paper Size`.

4 Press **[OK]**. The `Paper Size` screen appears listing the paper sizes that can be used with the selected cassette.

The available paper sizes are as follows:

Auto (Metric)
 Auto (Inch)
 Letter-R
 Letter
 Legal
 A4-R
 A4
 B5-R
 B5
 A3
 B4
 Ledger
 A5
 Oficio II
 216x340mm
 12x18"
 8K
 16K-R
 16K
 Statement
 Folio



Note To have the paper size automatically selected from metric sizes or inch sizes, select `Auto (Metric)` or `Auto (Inch)`.

5 Press Δ or ∇ to select the desired paper size.

6 Press **[OK]**. The paper size for the cassette is set and the `Paper Settings` menu screen reappears.

Cassette (1 to 7) Type (Setting the cassette paper type)

By setting a paper type (plain, recycled, etc.) for the paper cassette, you can automatically select the paper in the paper cassette according to the paper type you command on the printer driver. The default setting is plain paper for all paper cassettes.

For more information about paper types that you can feed from the paper cassette, refer to *Basic Paper Specifications on page A-10*.

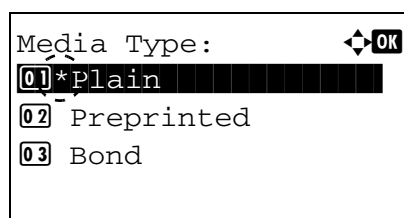
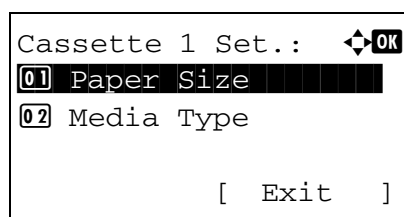

1 In the Paper Settings menu, press Δ or ∇ to select the cassette you want to set.

2 Press **[OK]**. The Cassette # Set. menu screen appears.
shows the number of the cassette installed in the printer (1 to 7).

3 Press Δ or ∇ to select Media Type.

4 Press **[OK]**. The Media Type screen appears listing the media types that can be used with the selected cassette.

The available Media Types are as follows:

Plain
Preprinted
Bond
Recycled
Vellum
Rough
Letterhead
Color
Prepunched
Thick
HighQuality
CUSTOM1 to 8

5 Press Δ or ∇ to select the desired media type.

6 Press **[OK]**. The media type for the cassette is set and the Paper Settings menu screen reappears.

Specifying Paper Size and Media Type for the Multi Purpose Tray (MP Tray Setting)

To fix the type of paper to be used in the multi purpose tray, specify the paper size. When using other than a plain paper, specify the media type.

Item	Description
Paper Size	Select from the standard sizes. Selectable paper sizes are as follows. Envelope Monarch, Envelope #10 (Commercial #10), Envelope DL, Envelope C5, Executive, Letter-R, Letter, Legal, A4-R, A4, B5-R, B5, A3, B4, Ledger, A5, A6, B6, Envelope #9 (Commercial #9), Envelope #6 (Commercial #6 3/4), ISO B5, Custom*, Envelope C4, Hagaki, Oufuku hagaki, Oficio II, 216×340 mm, 12×18", 8K, 16K-R, 16K, Statement, Folio, Youkei 2, Youkei 4
Media Type	Selectable media types are as follows. Plain, Transparency, Preprinted, Labels, Bond, Recycled, Vellum, Rough, Letterhead, Color, Prepunched, Envelope, Cardstock, Coated, Thick, High Quality and Custom 1~8**

* Refer to *Registering a page size on page 2-36* for selecting Custom for Custom Paper Size.

** Refer to *Media Type Set. (Paper type settings) on page 6-23* for selecting Custom 1- 8 from Media Type.



Note To change to a media type other than Plain, refer to *Media Type Set. (Paper type settings) on page 6-23*.

MP Tray Set. (MP tray settings)

To print correctly on paper supplied from the MP tray, use the procedure below to set the paper size and media type.

 **Note** Feeding the paper having a paper size which does not match the current paper size from the MP tray can cause paper jam.

When the paper size and/or paper type is set in the driver, the driver settings are given priority.

Paper Size (Paper size setting for MP tray)

You can use this to set the paper size that can be supplied from the MP tray. The default setting is Letter size for the U.S. and Canada and A4 for other countries.

For more information about the paper sizes that you can feed from the MP tray, refer to *Basic Paper Specifications on page A-10*.

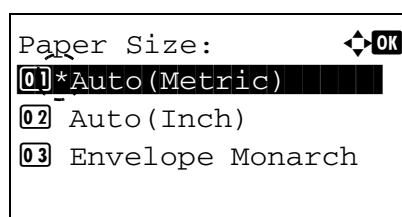
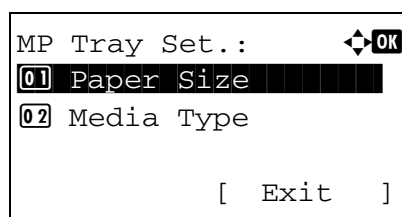

- 1 In the Paper Settings menu, press Δ or ∇ to select MP Tray Set..
- 2 Press [OK]. The MP Tray Set. menu screen appears.

- 3 Press Δ or ∇ to select Paper Size.
- 4 Press [OK]. The Paper Size screen appears listing the paper sizes that can be supplied from the MP tray.

The available paper sizes are as follows:

Auto (Metric)	B6
Auto (Inch)	Envelope #9
Envelope Monarch	Envelope #6
Envelope #10	ISO B5
Envelope DL	Custom
Envelope C5	Envelope C4
Executive	Hagaki
Letter-R	Oufuku Hagaki
Letter	Oficio II
Legal	216x340mm
A4-R	12x18"
A4	8K
B5-R	16K-R
B5	16K
A3	Statement
B4	Folio
Ledger	Youkei 2
A5	Youkei 4
A6	

 **Note** To have the paper size automatically selected from metric sizes or inch sizes, select Auto (Metric) or Auto (Inch).

- 5 Press Δ or ∇ to select the desired paper size.
- 6 Press [OK]. The paper size for the MP tray is set and the Paper Settings menu screen reappears.

Media Type (Paper type setting for MP tray)

You can use this to set the paper type that can be supplied from the MP tray. The default setting is Plain.

For more information about paper types that you can feed from the MP tray, refer to *Basic Paper Specifications on page A-10*.

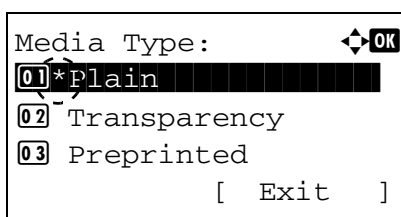
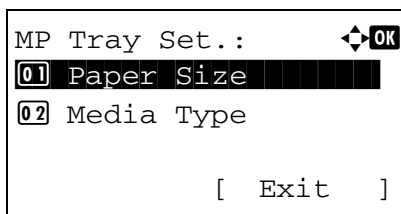

- 1 In the Paper Settings menu, press Δ or ∇ to select MP Tray Set..
- 2 Press [OK]. The MP Tray Set. menu screen appears.

- 3 Press Δ or ∇ to select Media Type.
- 4 Press [OK]. The Media Type screen appears listing the media types that can be supplied from the MP tray.

The available paper types are as follows:

Plain
 Transparency
 Preprinted
 Labels
 Bond
 Recycled
 Vellum
 Rough
 Letterhead
 Color
 Prepunched
 Envelope
 Cardstock
 Coated
 Thick
 HighQuality
 CUSTOM1 to 8

- 5 Press Δ or ∇ to select the desired media type.
- 6 Press [OK]. The media type for the MP tray is set and the Paper Settings menu screen reappears.

Registering a page size

To use a paper size that is not in the machine's paper sizes, register the paper size on the **Basic** tab of the print settings screen of the printer driver.

Once registered, the paper size can be selected from the **Page Size** menu.

 **Note** To print without using the printer driver, set the paper size and type as explained in Specifying Paper Size and Media Type for the *MP Tray Set*. (*MP tray settings*) on page 2-34.

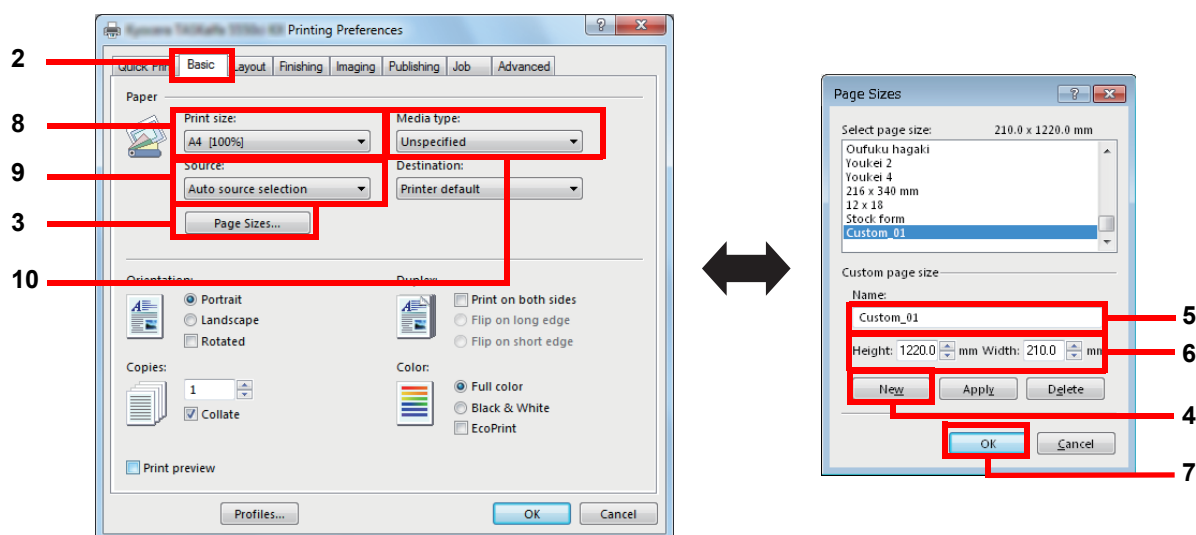

- 1 Display the print settings screen.
- 2 Click the **Basic** tab.
- 3 Click the **Page Sizes...** button to register the size.
- 4 Click the **New** button.
- 5 Enter the name of the paper.
- 6 Enter the paper size.
To print using a paper size of 470.1 mm or longer (18.51" or longer), up to a maximum length of 1220.0 mm (48"), refer to *Banner printing on page 3-8*.
- 7 Click the **OK** button.
- 8 Select the page size (name) registered in steps 4 to 7.
- 9 Select **MP Tray**.
- 10 Select the media type.

Energy Saver Function

Low Power Mode

When the machine is left idle for a certain period of time, the message display turns off and power consumption is reduced. This status is referred to as Low Power Mode.

The default preset time is 3 minutes (for FS-C8600DN) or 5 minutes (for FS-C8650DN).

If print data is received during Low Power Mode, the message display lights up and printing starts.

To resume, press OK key. The printer will be ready to operate within 25 seconds.

Note that ambient environmental conditions, such as ventilation, may cause the machine to respond more slowly.

Sleep

When the machine is left idle for a certain period of time in Low Power Mode, the message display turns off and power consumption is minimized. This status is referred to as Sleep.

If print data is received during Sleep, the message display lights up and printing starts.

To resume, press the **OK** key. FS-C8600DN will be ready within 41 seconds, or FS-C8650DN will be ready within 45 seconds.

Note that ambient environmental conditions, such as ventilation, may cause the machine to respond more slowly.

In case of not using the machine for an extended period of time



CAUTION If this machine will be left unused for an extended period (e.g. overnight), turn it off at the main power switch. If the machine will not be used for an even longer period of time (e.g. vacation), remove the power plug from the outlet as a safety precaution.

CAUTION Remove paper from the cassettes and seal it in the paper storage bag to protect it from humidity.

Operation Panel

Message Display

Messages indicating the status of the various printer operations are displayed on the message display.

Status Information

Message	Meaning
Please wait.	The printer is warming up and is not ready. When the printer is switched on for the first time, this message will take several minutes.
Please wait. Loading paper...	Appears while paper is being loaded.
Please wait. Adding toner...	Toner is currently being replenished. This message may be displayed during continuous printing of a large volume of pages which require a large amount of toner such as with photographs, etc.
Please wait. Performing Color Calibration...	The color calibration function is being performed automatically as you powered on the printer. You can also execute this function manually on the operation panel. For details, refer to <i>ColorCalibration on page 6-120</i> .
Ready to print.	The printer is ready to print.
Processing.	The printer is receiving data to print. This is also shown when the printer is reading a USB memory or hard disk.
Sleeping.	The printer is in Auto Sleep. The printer wakes from Auto Sleep whenever a print job is received. The printer then warms up and goes on-line. For details on Auto Sleep, refer to <i>Sleep on page 2-37</i> .
Canceling...	Jobs inside the printer are being canceled. To cancel a job, refer to <i>Canceling a Printing Job on page 2-40</i> .

Error Codes

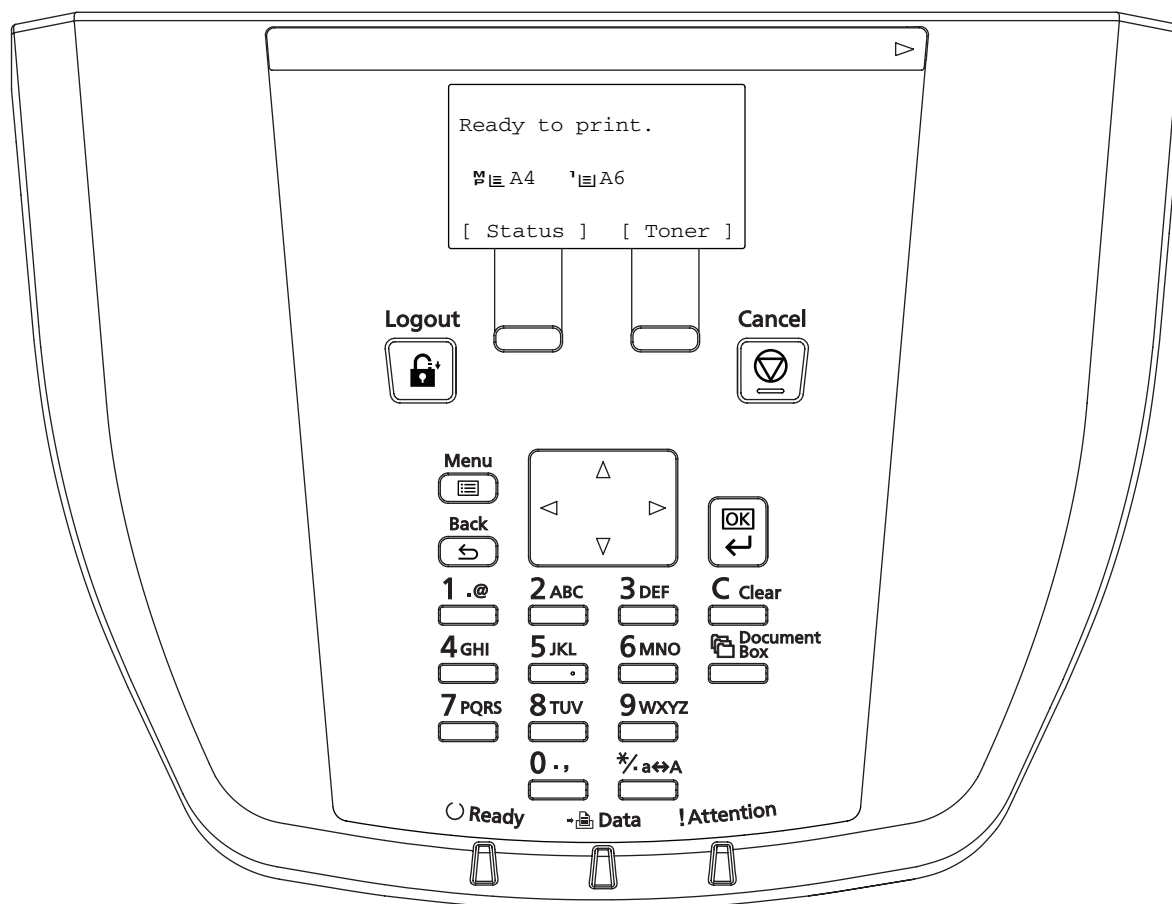

For information on error code and errors where the printer requires the operator's attention, refer to *Error Messages on page 8-6*.

Indicators in Message Display



Ready, Data, and Attention Indicators

The following indicators light during normal operation and whenever the printer needs attention. Depending on the status of lighting, each indicator has the following meaning:

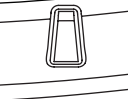
Indicator	Description
	<p>Flashing. Indicates an error that you can resolve. For details, refer to <i>Troubleshooting on page 8-1</i>. Or, the printer is in Auto Sleep. The printer wakes from Auto Sleep whenever a print job is received. The printer then warms up and goes on-line. For details on Auto Sleep, refer to <i>Sleep Timer (Sleep timer timeout time) on page 6-74</i>.</p> <p>On. Indicates that the printer is ready and on-line. The printer prints the data it receives.</p> <p>Off. Indicates that the printer is off-line because printing is manually stopped or automatically stopped due to an error condition. Data can be received but will not be printed. For details, refer to <i>Error Messages on page 8-6</i> if printing is automatically stopped when an error condition has occurred.</p>
	<p>Flashing. Indicates that a data is being received.</p> <p>On. Indicates either that data received is being processed before printing starts, or that the hard disk or memory card is being accessed.</p>
	<p>Flashing. If <code>Please wait</code> is displayed, the printer is warming up. Or, the printer cannot print for some reason (e.g. there is no paper in the cassette). Check the message display and carry out the required action. For details, refer to <i>Error Messages on page 8-6</i>.</p> <p>On. The printer cannot print due to an error. Check the message display and carry out the required action. For details, refer to <i>Error Messages on page 8-6</i>.</p>

Keys

The operation panel keys are used to configure the printer operation. Note that certain keys have a secondary function.

Cancel Key

Cancel



- Cancel a printing job.
- Stop the alarm sound.

Canceling a Printing Job

- 1 While the printer displays `Processing.`, press **[Cancel]**.

The `Job Cancel List` appears, showing the list of current print jobs.

- 2 Press \triangle or ∇ to display the desired job and then press **[OK]**.

When the `Job will be canceled. Are you sure?` message appears, press `[Yes]` (**[Left Select]**) to cancel the job or `[No]` (**[Right Select]**) to cancel this operation and continue printing.

When you cancel a job, `Canceling...` appears on the message display and printing stops after the page currently printing has been fed out.

Logout Key

Logout



- If user control is set then please log out by pressing **[Logout]** after operations are completed.

Menu Key

Menu



- **[MENU]** lets you enter the menu system to change the setup and printing environment of the printer.

Back Key

Back



- Cancels the menu setting currently displayed and returns to the menu for the previous step.

Arrow Keys

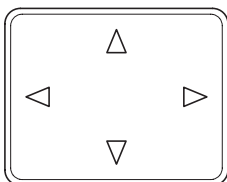

- The four arrow keys are used in the menu system to access an item or enter numeric values.

OK Key



- Finalize settings of numeric values and other selections.

Numeric Keys

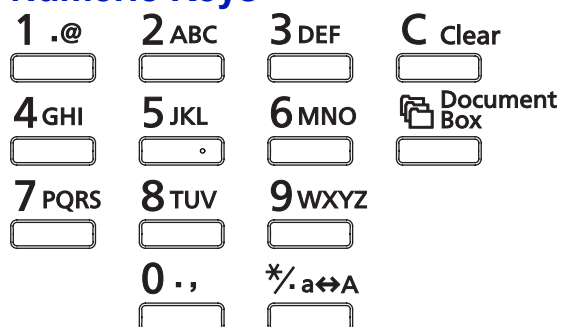

- Enter numbers and symbols.

Clear Key



- Clears entered numbers and characters.

Document Box Key



- Press this key when using Document Box. For details, refer to *Document Box on page 4-2*.

Left Select Key / Right Select Key



- These keys only function when the respective key tabs are shown in the message display. Pressing the key executes the function shown in the message display.

Pressing the key executes the function shown in the message display.

E.g.:

When the menu shown below is displayed, pressing **[Left Select]** ([Yes]) prints the file selected. Pressing **[Right Select]** ([No]) stop printing and returns to the menu for the previous step.

```
Print.  
Are you sure?  
  
[ Yes ] [ No ]
```

- These keys only function when the paper jam message has appeared on the message display. A help message will then appear to facilitate jam clearing in the location.

Using the Menu Selection System

Menu Selection System

This section explains how to use the menu selection system.

[Menu] on the operation panel allows you to use the menu to configure the printer settings to your specific needs. Settings can be made when *Ready to print.*, *Please wait.* or *Processing.* is indicated on the printer message display.

 **Note** Settings that are received from application software and the printer driver will take priority over settings made in the operation panel.

Entering the Mode Selection Menu

Press **[Menu]** when *Ready to print.* is indicated on the printer message display.

The mode selection menu is displayed.

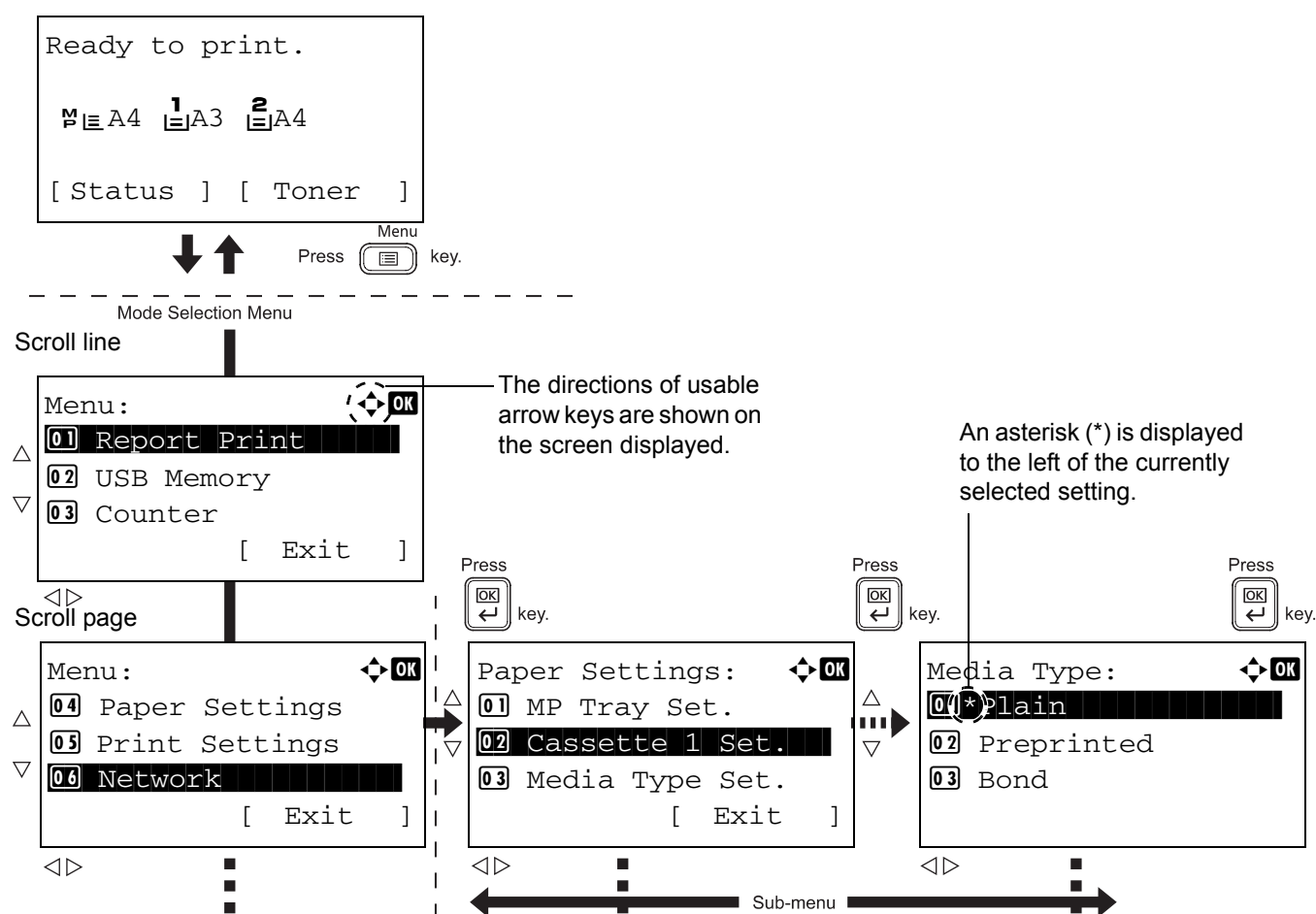

 **Note** Only when USB memory is installed, USB Memory is displayed.

Selecting a Menu

The mode selection menu is hierarchical. Press Δ , ∇ , \triangleleft or \triangleright to display the desired menu.

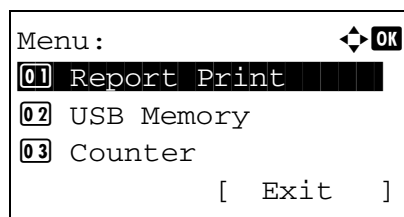

- If [\blacklozenge] appears in the top-right of the screen, you can use the Δ and ∇ to scroll up and down through the menu options one line at a time, and the \triangleleft and \triangleright to move between menu options one page at a time.

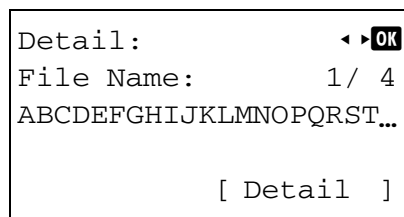

- If [\blacktriangleleft] appears in the top-right of the screen, you can use the \triangleleft and \triangleright to switch between pages.

To return to the menu one level up, press **[Back]**.

Setting a Menu

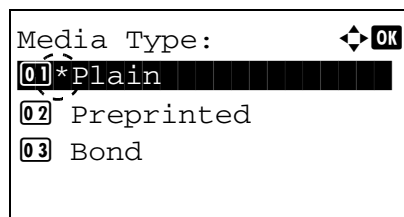

Select the desired menu and press **[OK]**. You can now select options in the menu. press Δ , ∇ , \triangleleft or \triangleright to select or enter the desired setting and then press **[OK]** to confirm your selection.

If you are choosing from a list of settings, an asterisk (*) is displayed to the left of the currently selected setting.

Canceling Menu Selection

If you press **[Menu]** when a menu is selected, the message display returns to Ready to print.

Setting a Mode Selection Menu

This section explains the setting procedures used for each menu item in the mode selection menu.

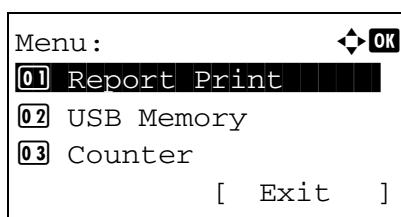

1 While the printer displays `Ready to print.`, `Please wait.`, `Sleeping.` and `Processing.`, press **[MENU]**. The Mode Selection Menu is displayed.

2 Each time you press Δ or ∇ , the selection changes.

- Report Print...6-2
- USB Memory...6-7
- Counter...6-16
- Paper Settings...6-18
- Print Settings...6-28
- Network...6-40
- Device Common...6-59
- Security...6-84
- User/Job Account...6-98
- Adjust/Maint. ...6-119
- Op Functions...6-129
- Shut down...6-133



Note `Optional network` is only displayed when a network interface card or Wireless Network Interface Kit is installed as an option.

3 Printing

This chapter contains explanations on the following topics:

Printing - Printing from Applications	3-2
Loading Envelopes	3-5
Banner printing	3-8
Secure Pull Printing (Optional Feature).....	3-12

Printing - Printing from Applications

Follow the steps below to print documents from applications.

 **Note** To print the document from applications, install the printer driver on your computer from the supplied CD-ROM (Product Library).

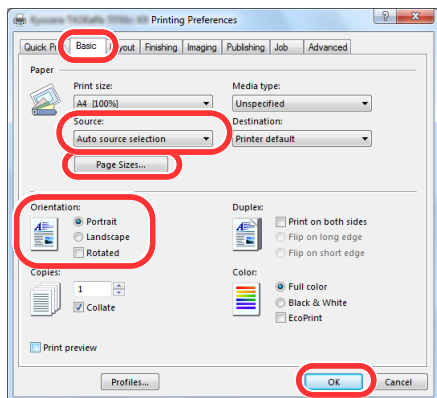
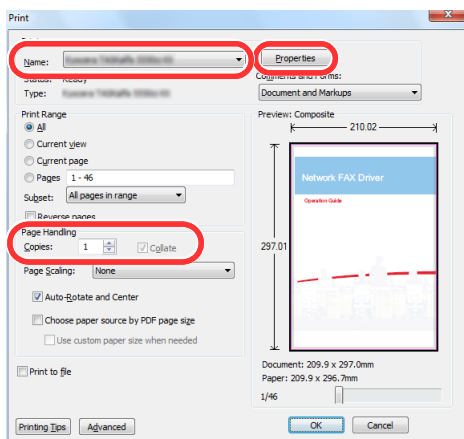

- 1 Create a document using an application.
- 2 Click **File** and select **Print** in the application. The **Print** dialog box appears.
- 3 Click the ▼ button next to the Name field and select this machine from the list.
- 4 Enter the desired print quantity in the **Number of copies** box. Enter any number up to 999. Enter any number up to 9999.
When there is more than one page, select **Collate** to print out one by one in the sequence of the page numbers.
- 5 Click the **Properties** button. The **Properties** dialog box appears.
- 6 Select the **Basic** tab and click the **Page Size** button to select the paper size.
To print on the special paper such as thick paper or transparency, click the **Media Type** menu and select the media type.
To print using a paper size of 470.1 mm or longer (18.51" or longer), up to a maximum length of 1220.0 mm (48"), refer to *Banner printing on page 3-8*.
- 7 Click **Source** and select the paper source.
 **Note** If you choose **Auto Select**, paper is supplied automatically from the paper source loaded with paper of optimum size and type. To print on special paper such as envelope or thick paper, place it on the multi purpose tray and select **MP Tray**.
- 8 Select paper orientation, either **Portrait** or **Landscape**, to match the orientation of the document.
Selecting **Rotate 180°** will print the document rotated 180°.
- 9 Click the **OK** button to return to the **Print** dialog box.
- 10 Click the **OK** button to start printing.

Printer driver print settings screen

The printer driver print settings screen allows you to configure a variety of print-related settings. For more information, refer to the Printer Driver User Guide on the CD-ROM.

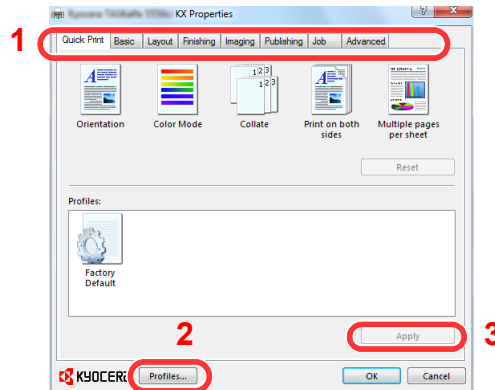

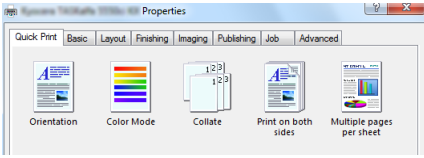
No.	Description
1	<p>Quick Print Provides icons that can be used to easily configure frequently used functions. Each time you click an icon, it changes to an image resembling the print results and applies the settings.</p>  <p>Basic This tab groups basic functions that are frequently used. You can use it to configure the paper size, destination, and duplex printing, and color mode.</p> <p>Layout This tab lets you configure settings for printing various layouts, including booklet printing, combine mode, poster printing, and scaling.</p> <p>Finishing This tab lets you configure settings related to finishing of printed media, including binding and stapling.</p> <p>Imaging This tab lets you configure settings related to the quality and color mode of the print results.</p> <p>Publishing This tab lets you create covers and inserts for print jobs and put inserts between sheets of OHP film.</p> <p>Job This tab lets you configure settings for saving print data from the computer to the machine. Regularly used documents and other data can be saved to the machine for easy printing later. Since saved documents can be printed directly from the machine, this function is also convenient when you wish to print a document that you don't want others to see.</p> <p>Advanced This tab lets you configure settings for adding text pages or watermarks to print data. It also provides simple color adjustment functionality.</p>
2	<p>Profiles Printer driver settings can be saved as a profile. Saved profiles can be recalled at any time, so it's a convenient practice to save frequently used settings.</p>
3	<p>Reset Click to revert settings to their initial values.</p>

Printer Driver Help

The printer driver includes Help. To learn about print settings, open the printer driver print settings screen and display Help as explained below.

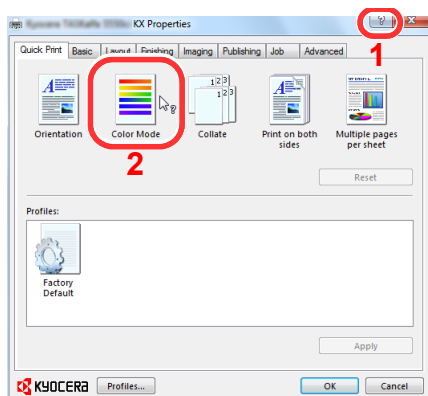

- 1 Click the ? button in the upper right corner of the screen.
- 2 Click the item you want to know about.

Changing the default printer driver settings (Windows 7)

The default printer driver settings can be changed. By selecting frequently used settings, you can omit steps when printing. The procedure is as follows.

- 1 Click the **start** button, and then click **Devices and Printers**.
- 2 Right-click the printer driver icon of the machine, and click the **Properties** menu of the printer driver.
- 3 Click the **Printing Preferences** button on the **General** tab.
- 4 Select the default settings and click the **OK** button.

For the settings, refer to *Printer driver print settings screen on page 3-3*.

Loading Envelopes

Up to 10 envelopes may be loaded in the multi purpose tray.

Acceptable envelope sizes are as follows.

Acceptable Envelope	Size
Monarch	3 7/8"×7 1/2"
Envelope #10 (Commercial #10)	4 1/8"×9 1/2"
Envelope #9 (Commercial #9)	3 7/8"×8 7/8"
Envelope #6 (Commercial #6)	3 5/8"×6 1/2"
Envelope DL	110×220 (mm)
Envelope C4	229×324 (mm)
Envelope C5	162×229 (mm)
Youkei 2	162×114 (mm)
Youkei 4	235×105 (mm)

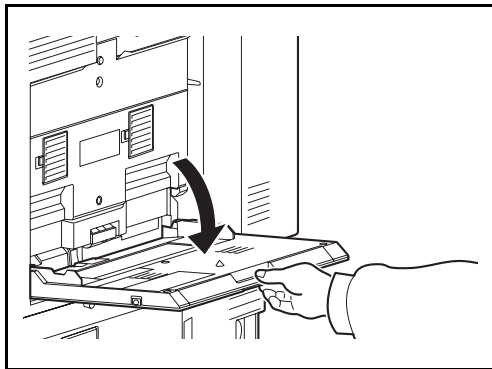

1 Open the multi purpose tray.

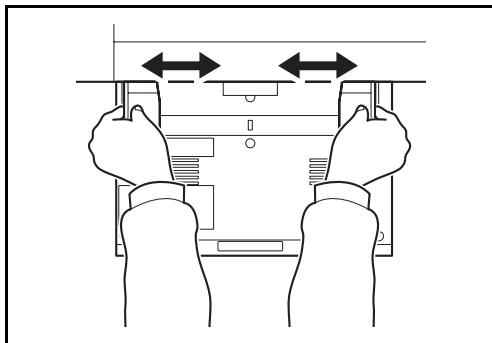

2 Adjust the paper width guides to the width of the envelope.

- 3 Insert along the paper width guide all the way in as shown.

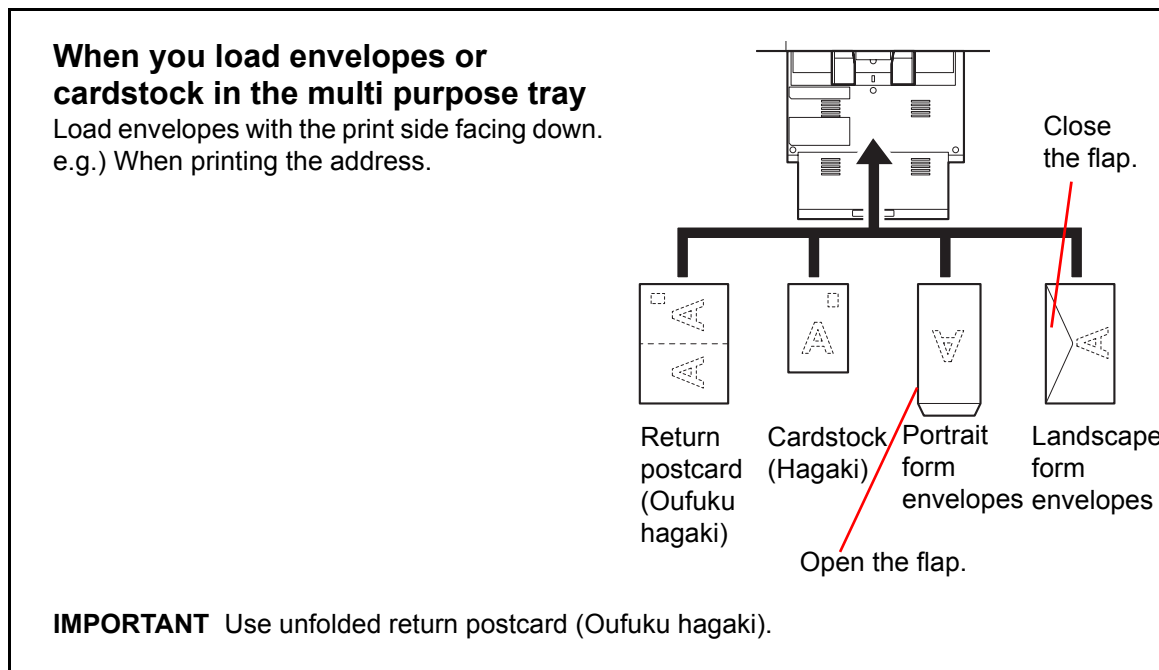

IMPORTANT How to load envelopes (orientation and facing) will differ depending on the type of envelope. Be sure to load it in correctly, otherwise printing may be done in the wrong direction or on the wrong face.

- 4 On the machine, set the size and type of the postcard or envelope that you placed.
 For details, refer to *Specifying Paper Size and Media Type for the Multi Purpose Tray (MP Tray Setting)* on page 2-33.

Registering a page size

When cardstock or an envelope is loaded in the Multi Purpose Tray, set the paper size and type and then register the paper size on the **Basic** tab of the print settings screen in the printer driver.

Once registered, the paper size can be selected from the **Page Size** menu.

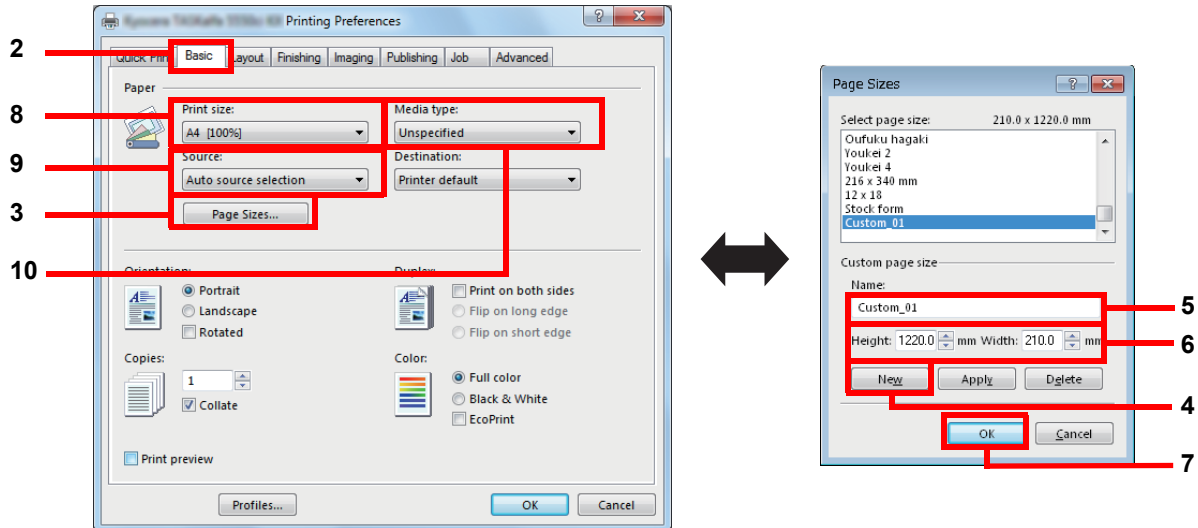

- 1 Display the print settings screen.
- 2 Click the **Basic** tab.
- 3 Click the **Page Sizes...** button to register the size.
- 4 Click the **New** button.
- 5 Enter the name of the paper.
- 6 Enter the paper size.
- 7 Click the **OK** button.
- 8 Select the page size (name) registered in steps 4 to 7.
- 9 Select **MP Tray**.
- 10 Select **Cardstock** or **Envelope**.

Banner printing

When a document length from 470.1 mm (18.51") to a maximum of 1220.0 mm (48") is specified for printing, the print job is treated as banner printing.

Max. number of sheets	1 sheet (manual feed), 10 sheets (when optional banner tray is attached*)
Paper width	210 (8.26") to 304.8 (12") mm
Paper length	Max. 1220 (48") mm
Paper weight	136 to 163 g/m ²
Paper type	Heavy 2
Destination	Job separator tray

* When the banner tray (option) is used, up to 10 sheets of banner paper can be fed continuously . (Refer to *Using the Banner Tray (Option) on page 3-10.*)

Follow the steps below to set banner paper in the printer driver.

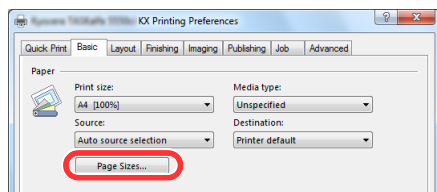

1 Click the **Basic** tab and then click the **Page Sizes** button.

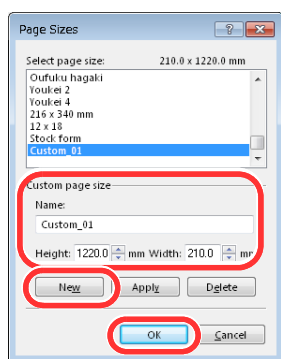

2 Click the **New** button, enter the name, length (470.1 mm or longer), and width of the custom paper size being registered, and click the **OK** button.

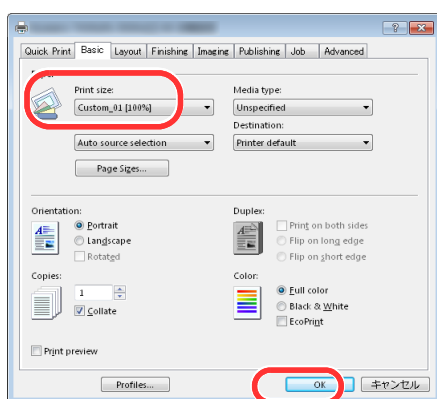

3 Click **Print size**, select the custom paper size that you registered, and click the **OK** button.

 **Note** When KPD L is used for PDL Settings of the printer driver, a length setting of 470.5 mm (18.53") or longer is handled as banner print.

When you execute printing in this case, a message appears on the machine's operation panel. Place the paper in the multipurpose tray, continue to support it so that it does not fall, and press [Continue] (Right Select Key). To cancel printing, press [Cancel].

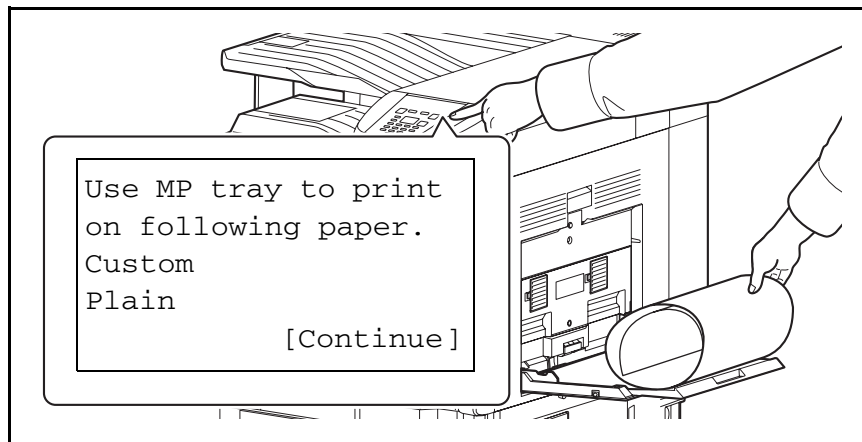

IMPORTANT If an output tray that cannot be used for banner printing such as Mailbox (option) is selected in the printer driver, the output tray automatically changes to the Job Separator Tray.

To print on multiple sheets manually (not using the banner tray), place each sheet after the previous sheet is printed, and press [Continue] (Right Select Key).

After pressing [Continue] (Right Select Key), support the paper with both hands so that it feeds in correctly.

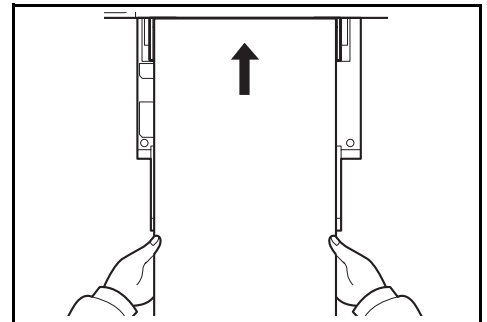

After printing starts, catch the paper when it is output so that it does not fall. Do not stand up the stopper. Standing up the stopper may cause paper jams.

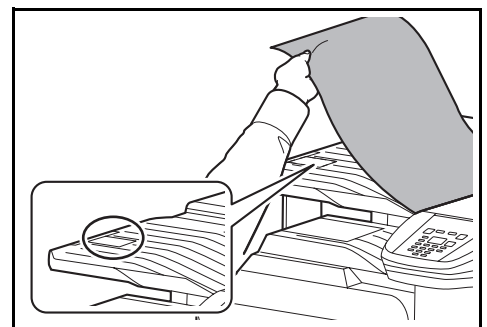

Using the Banner Tray (Option)

When the banner tray (option) is used, up to 10 sheets of banner paper can be fed continuously.

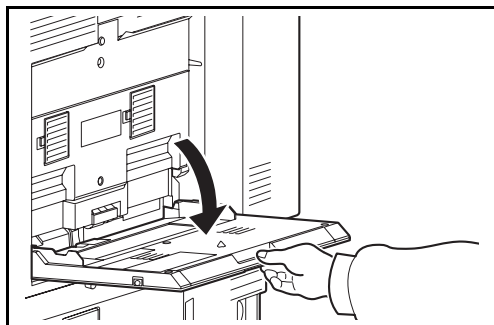

- 1** Open the Multi Purpose tray until it stops.
Do not extend the multi purpose auxiliary tray.

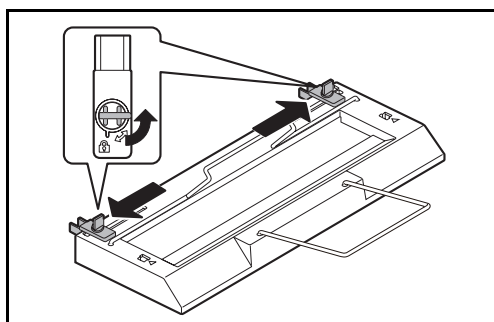

- 2** Release the paper width guide lock on the banner tray and open to the maximum width.

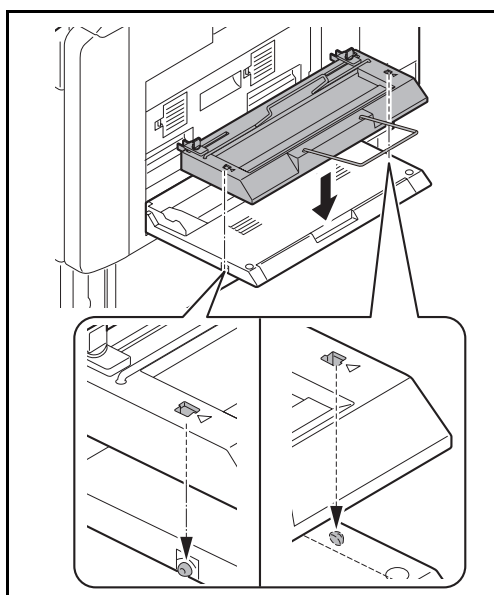

- 3** Attach the banner tray to the multi purpose tray.
Fit the openings on the sides of the banner tray onto the tabs on the sides of the multi purpose tray, and press into place.

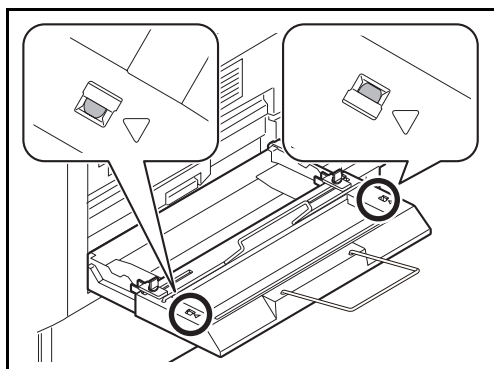

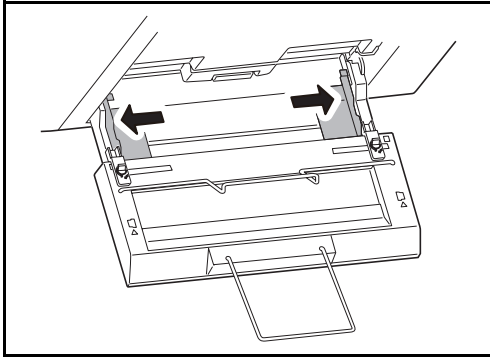

- 4** Open the paper width guides on the multi purpose tray to the maximum width.
 Make sure that the banner tray is attached so that the paper width guides on the banner tray are outside the paper width guides on the multi purpose tray.

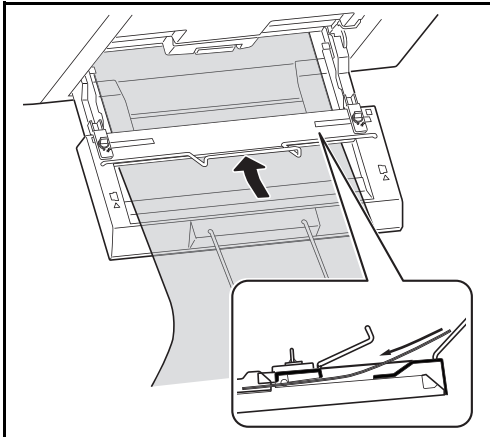

- 5** Load banner paper so that it passes under the paper clamp bar.

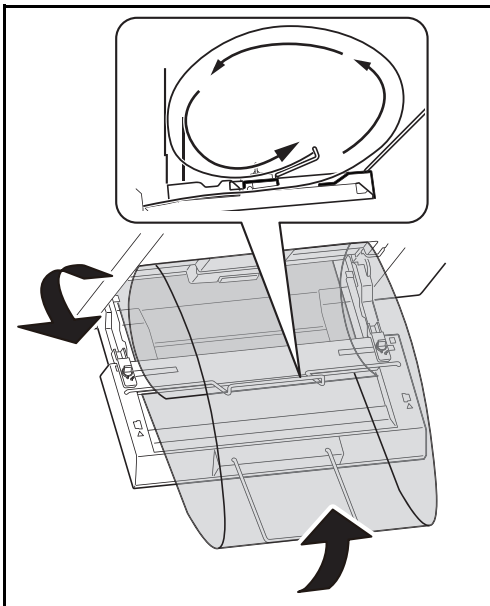

- 6** Loop the banner paper back and place the end on the paper support.

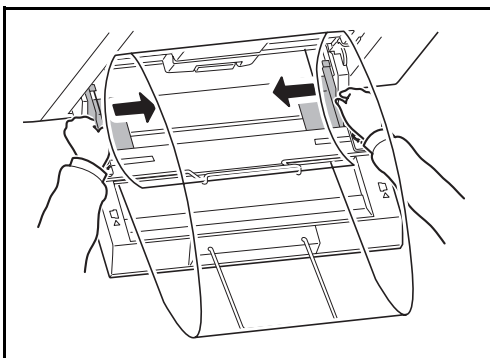

- 7** Adjust the paper width guides to the width of the paper.

IMPORTANT If there is a gap between the paper and the paper width guides, readjust the guides to fit the paper in order to prevent skewed feeding and paper jams.

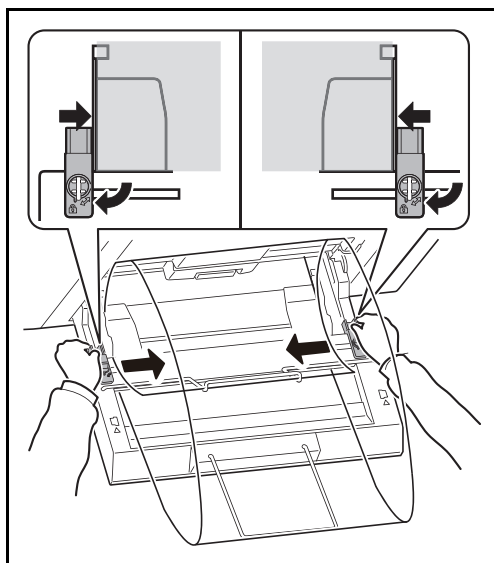

- 8** Adjust the paper width guides on the banner tray to the same width as the paper width guides on the multi purpose tray and lock.

IMPORTANT Remove the paper when you are not performing banner printing.

 **Note** The print confirmation screen can be set in the system menu to not appear when the banner tray is attached. This will allow continuous printing on multiple sheets. (Refer to *Msg Banner Print (Preview screen setting for Banner Printing)* on page 6-82.)

Secure Pull Printing (Optional Feature)

Secure Pull Printing is a printing feature where a user pulls the print job to an afterward selected printer. To use this feature, the following system environments are required.

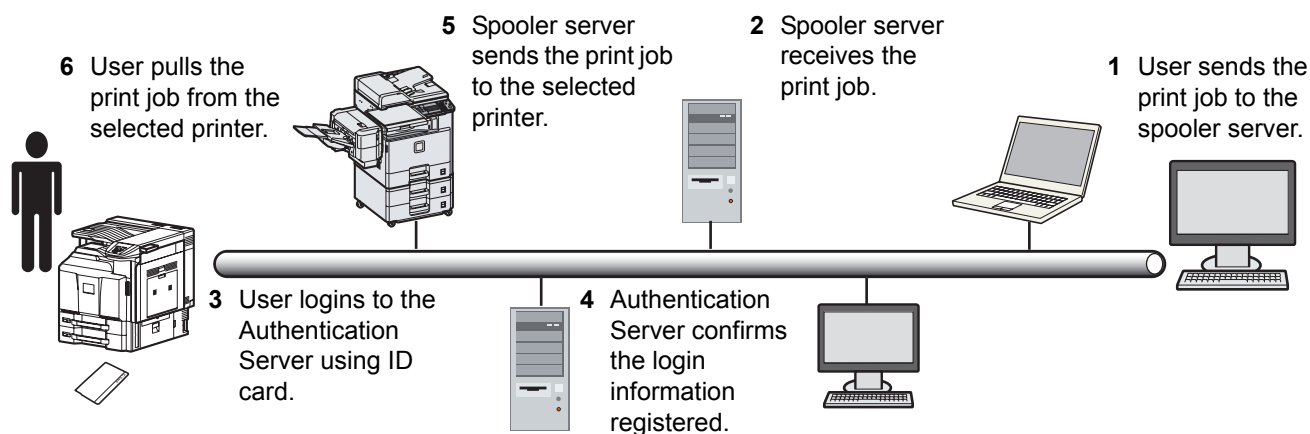

Authentication server: it has to install the KYOCERA Net Policy Manager (Option).

ID card and ID card reader: they are used to register and authenticate a user.

Spooler server: it pulls the print job to an afterward selected printer if user required.

For more details, contact your dealer or service representative.

4 Document Box

This chapter contains explanations on the following topics:

Document Box	4-2
Custom Box	4-3
Job Box	4-24

Document Box

The Document Box is a function for saving print data from a computer onto the HDD on the machine and then printing it by operating the operation panel.

Press [**Document Box**] to display the Document Box menu.

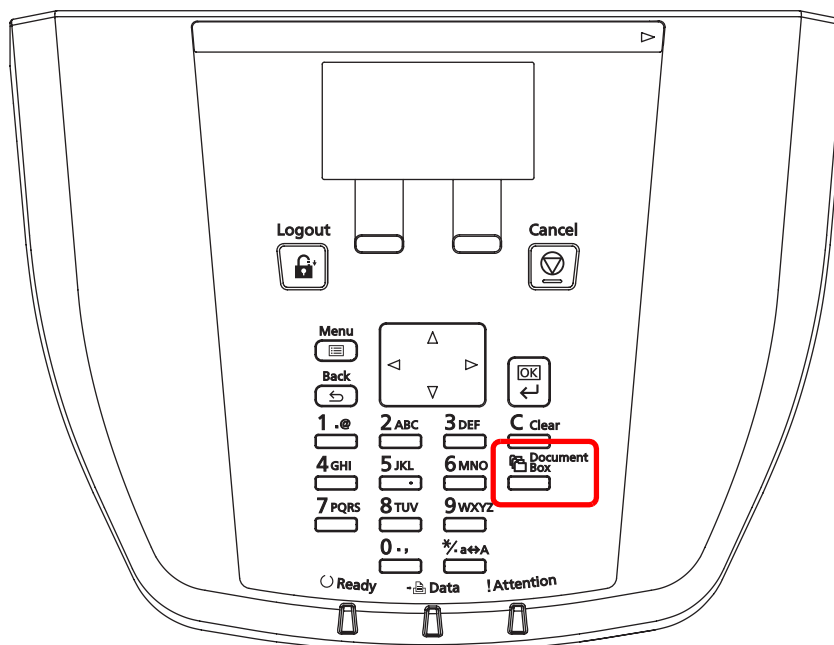

Document Box has the following functions.

- Custom Box...4-3
- Job Box...4-24

Custom Box

The Custom Box is a general-purpose box which allows the user to save print data on the printer's HDD and then re-use it whenever necessary.

The transmission of data to save in the box is done with the printer driver. For more information, refer to the *Printer Driver User Guide*.

Use the printer's operation panel to print the print data stored in a Custom Box.

Procedure for printing using Custom Box

Follow the work flow below when using Custom Box.

Registering the Custom Box (*page 4-4*)



Specifying the Custom Box from a computer and sending the print job (*page 3-2*)



Using the operation panel to specify a file within a Box and printing it (*page 4-15*)



Note After pressing **[Document Box]**, it is possible to display either the Custom Box list screen or the Job Box menu screen or to set them. Refer to *Def. Screen(Box) (Document Box default screen settings.)* on page 6-60.

If the Job Box menu screen is displayed, follow the procedure below to display the Custom Box list screen.

- 1 Press **[Back]**.
- 2 Press Δ or ∇ to select *Custom Box*.
- 3 Press **[OK]**. Custom Box list screen appears.

Operation panel display

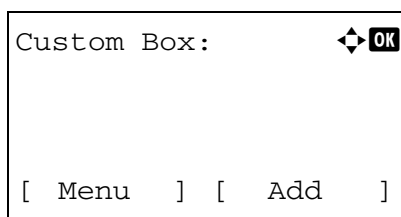

- 1 Press **[Document Box]**. Either the Custom Box list screen or the Job Box menu screen is displayed.



Note After pressing **[Document Box]**, it is possible to display either the Custom Box list screen or the Job Box menu screen or to set them. Refer to *Def. Screen(Box) (Document Box default screen settings.)* on page 6-60.

If the Job Box menu screen is displayed, follow the procedure below to display the Custom Box list screen.

- 1 Press **[Back]**.
- 2 Press Δ or ∇ to select *Custom Box*.
- 3 Press **[OK]**. Custom Box list screen appears.

The options available in Custom Box are as follows:

- Custom Box operation (Box creation, editing and deletion)...4-4
- File operations (Printing, deleting and moving files)...4-15

Custom Box operation (Box creation, editing and deletion)

It is possible to create Custom Boxes and change Box settings.

The following operations are possible:

- Custom Box creation...4-4
- Editing and Deleting Custom Boxes...4-11
- Sorting the Custom Box list...4-12
- Searching Custom Boxes...4-13
- Setting automatic document deletion for Custom Boxes...4-14

 **Note** The creation and setting of Custom Boxes is also possible from Command Center RX. For more information, refer to the *Command Center RX User Guide*.

Custom Box creation

Create a Custom Box. Enter the Box Name and Box Number then it is possible to continue on and set the details of the Box.

 **Note** When user login administration is enabled, log in as a user with administrator authority.

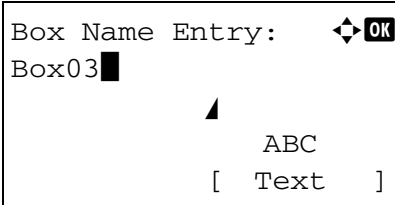

- 1** In the Custom Box list screen, press [Add] ([Right Select]). The Box Name Entry screen appears.

- 2** Enter the Box Name using the numeric keys.

 **Note** Up to 32 characters can be entered. For details on entering characters, refer to *Character Entry Method* on page A-6.

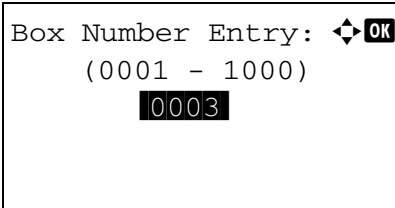

- 3** Press [OK]. The Box Number Entry screen appears.

- 4** Enter the Box Number using the numeric keys.

 **Note** Enter the Box Number as a four-digit number from 0001 - 1000.

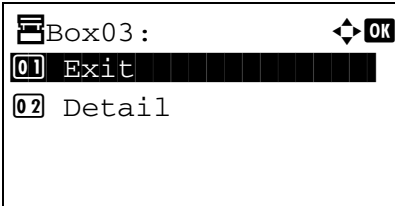

- 5** Press [OK].

- 6 Press Δ or ∇ to select `Detail` or `Exit` then press **[OK]**.

To set the details of the Box, select `Detail` and proceed to *Detailed box settings on page 4-5*.

If the details of the Box will not be set then select `Exit` and finish the operation.

Detailed box settings

Set the details of the Box when necessary. The items to set are different between when user login administration is not enabled, when user login administration is enabled and the user is logged in with administrator authority and when user login administration is enabled and the user is logged in with user authority.

```

Detail:          ⬅️ OK
Box Name:       1/9
Box03
                [ Edit ]
  
```

The detailed settings for the Box are as below.

Yes: The setting can be changed. No: The setting cannot be changed. -: No setting

Setting	User login Off	User login On		Reference Page
		Administrator	User	
Box Name	Yes	Yes	Yes	Box Name (Change the Box name)...4-6
Owner	-	Yes	No	Owner (Owner settings)...4-6
Permission	-	Yes	Yes	Permission (settings for the sharing of a Box)...4-7
Box Password	Yes	Yes	Yes	Box Password (Box password setting)...4-7
Box Number	Yes	Yes	Yes	Box Number (Change of the Box number)...4-8
Usage Restrict.	Yes	Yes	No	Usage Restrict. (Setting for maximum possible capacity usage)...4-9
Auto File Del.	Yes	Yes	Yes	Auto File Del. (Setting for automatic file deletion)...4-9
Overwrite Set.	Yes	Yes	Yes	Overwrite Set. (Setting of overwrite storage)...4-10
Del. afterPrint	Yes	Yes	Yes	Del. afterPrint (Setting for file deletion after printing)...4-10

Box Name (Change the Box name)

Change the Box name.

```

Detail:          ⬅️⬆️ OK
Box Name:       1/9
Box03
[ Edit ]

```

- 1 In the Detail menu screen, press ◀ or ▶ to select Box Name.

```

Box Name Entry: ⬅️⬆️ OK
Box03█
          ▲
          ABC
[ Text ]

```

- 2 Press [Edit] ([Right Select]). The Box Name Entry screen appears.

- 3 Enter the Box Name using the numeric keys.



Note Up to 32 characters can be entered.

Refer to *Character Entry Method* on page A-6 for details on entering characters.

- 4 Press [OK]. The Detail menu screen reappears.

Owner (Owner settings)

When user login administration is enabled, set the owner of the Box. If the owner is not set then the owner name is displayed as [----].

```

Detail:          ⬅️⬆️ OK
Owner:          2/9
Smith
[ Change ]

```

- 1 In the Detail menu screen, press ◀ or ▶ to select Owner.

```

User setting:   ⬅️⬆️ OK
01 Network User
02 None

```

- 2 Press [Change] ([Right Select]). The User setting screen appears.

- 3 Press ▲ or ▼ to select Network User.



Note If the owner will not be set then select None and press [OK].

- 4 Press [OK]. The Login User Name screen appears.

```

Login User Name: ⬅️⬆️ OK
█
          ABC
[ Text ]

```

- 5 Enter the Login User Name using the numeric keys.



Note Up to 64 characters can be entered.

Refer to *Character Entry Method on page A-6* for details on entering characters.

- 6 Press [OK]. The Detail menu screen reappears.

Permission (settings for the sharing of a Box)

When user login administration is enabled, this setting determines whether or not a Box will be shared with other users.

- 1 In the Detail menu screen, press < or > to select Permission.

- 2 Press [Change] ([Right Select]). The Permission screen appears.

- 3 Press Δ or ∇ to select Shared or Private.

- 4 Press [OK]. The Detail menu screen reappears.

Box Password (Box password setting)

It is possible to set a password for a box and restrict the users who have access to it. Enter one if necessary.



Note This setting is not displayed when user login administration is enabled and the *Permission (settings for the sharing of a Box) on page 4-7* has been set to Private.

- 1 In the Detail menu screen, press < or > to select Box Password.

- 2 Press [Edit] ([Right Select]). The New Password input menu screen appears.

- 3 Enter the new password using the numeric keys.



Note Up to 16 characters can be entered. For details on entering characters, refer to *Character Entry Method on page A-6*.

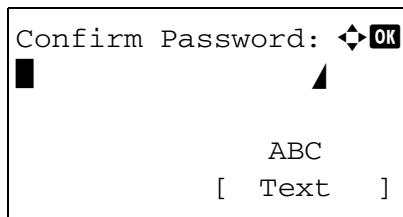

4 Press **[OK]**. The `Confirm Password` input menu screen appears.

5 To confirm, re-enter the security password to be registered. Enter the password with the numeric keys.

6 Press **[OK]**. If the password is correct, the setting is changed to the new password and the `Detail` menu screen reappears.

If the password is not correct, the display shows `Incorrect password.` and returns to the `New Password` screen, so enter again from the new password.

Box Number (Change of the Box number)

Change the Box number.

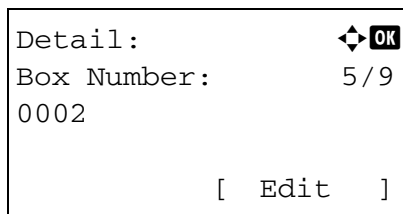

1 In the `Detail` menu screen, press `<` or `>` to select `Box Number`.

2 Press `[Edit]` (**[Right Select]**). The `Box Name Entry` screen appears.

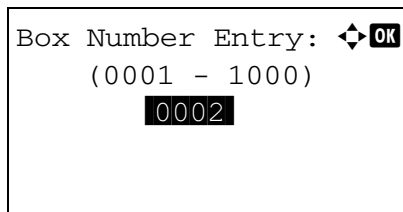

3 Enter the Box Number using the numeric keys.



Note Enter the Box Number as a four-digit number from 0001 - 1000.

If the display shows `This box number is already registered.` then this Box number is already in use. Register a different Box number.

4 Press **[OK]**. The `Detail` menu screen reappears.

Usage Restrict. (Setting for maximum possible capacity usage)

It is possible to restrict the capacity of Boxes in order to preserve the HDD capacity. To limit the usage capacity, enter the maximum value (MB) with the numeric keys. The limit value will vary depending on the number of user Boxes that are created, but it is possible to enter the maximum between 1 and 30,000 (MB).

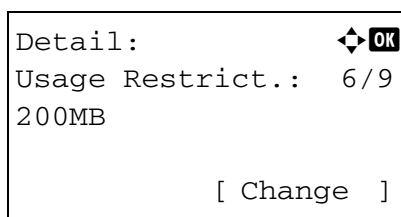

1 In the Detail menu screen, press ◀ or ▶ to select Usage Restrict..

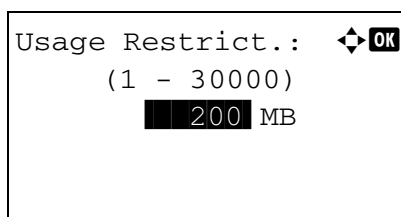

2 Press [Change] ([Right Select]). The Usage Restrict. screen appears.

3 Enter the limit value using the numeric keys.

4 Press [OK]. The Detail menu screen reappears.

Auto File Del. (Setting for automatic file deletion)

This automatically deletes the documents that have been saved after a fixed period. Set to On for the automatic deletion and then enter the number of days that the documents will be stored. Between 1 and 31 (days) can be entered. Set to Off if automatic deletion will not be used.

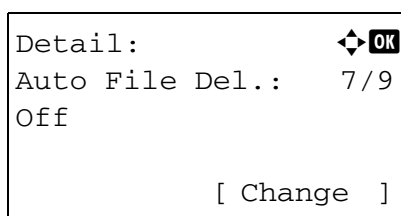

1 In the Detail menu screen, press ◀ or ▶ to select Auto File Del..



2 Press [Change] ([Right Select]). The Auto File Del. menu screen appears.

3 Press ▲ or ▼ to select Off/On.

4 Press [OK]. The Off/On screen reappears.

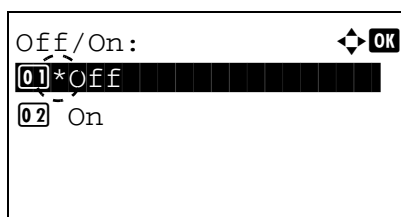

5 Press ▲ or ▼ to select On or Off.

```

Auto File Del.:  ⏏ OK
01 Off/On
02 Period

```

```

Period:  ⏏ OK
(1 - 31)
  7 day(s)

```

6 Press **[OK]**. The Auto File Del. menu screen reappears.



Note If On has been selected, set the number of days for storage as the Period. Period is only displayed if it has been set to On.

7 Press Δ or ∇ to select Period.

8 Press **[OK]**. The Period screen reappears.

9 Enter the number of days for storage using the numeric keys.

10 Press **[OK]**. The Detail menu screen reappears.

Overwrite Set. (Setting of overwrite storage)

This setting is used to permit or prohibit the overwriting of old documents that have been stored for the storage of new documents.

```

Detail:  ⏏ OK
Overwrite Set.:  8/9
Permit

[ Change ]

```

1 In the Detail menu screen, press \triangleleft or \triangleright to select Overwrite Set..

```

Overwrite Set.:  ⏏ OK
01 *Permit
02 Prohibit

```

2 Press [Change] (**[Right Select]**). The Overwrite Set. screen appears.

3 Press Δ or ∇ to select Permit or Prohibit.

4 Press **[OK]**. The Detail menu screen reappears.

Del. afterPrint (Setting for file deletion after printing)

This automatically deletes the documents from the Boxes when the printing is complete.

```

Detail:  ⏏ OK
Del. afterPrint:  9/9
Off

[ Change ]

```

1 In the Detail menu screen, press \triangleleft or \triangleright to select Del. afterPrint.

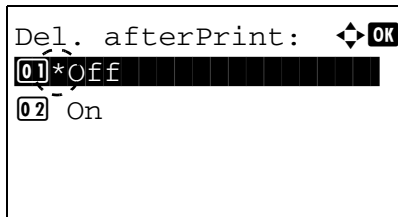

- 2 Press [Change] ([Right Select]). The Del. afterPrint screen appears.
- 3 Press Δ or ∇ to select On or Off.
- 4 Press [OK]. The Detail menu screen reappears.

Editing and Deleting Custom Boxes

It is possible to change the detailed settings of the Custom Boxes and to delete Boxes.

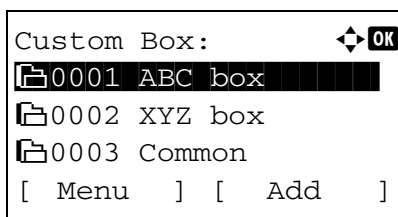

- 1 In the Custom Box list screen, press Δ or ∇ to select the Box to edit or delete.

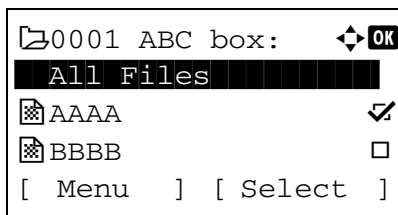

- 2 Press [OK]. The file list screen for the Box selected is displayed.

 **Note** If the screen for entering a password is displayed then enter the password using the numeric keys and then press [OK].

Refer to *Character Entry Method on page A-6* for details on entering characters.

The following operations are possible:

- Editing Custom Boxes...4-11
- Deleting Custom Boxes...4-12

Editing Custom Boxes

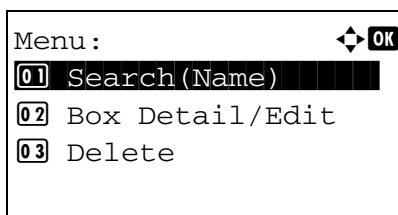

- 1 In the file list screen, press [Menu] ([Left Select]). The Menu screen appears.

- 2 Press Δ or ∇ to select Box Detail/Edit.

- 3 Press [OK]. The Detail screen appears.

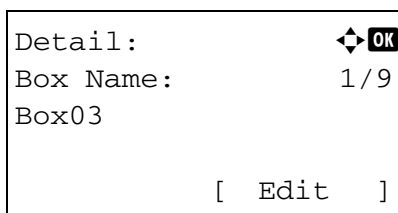

- 4 Press \triangleleft or \triangleright to check each of the settings and make changes.

 **Note** For the method for making changes, refer to *Detailed box settings on page 4-5*.

- 5 When the editing is completed press [OK]. The file list screen reappears.

Deleting Custom Boxes

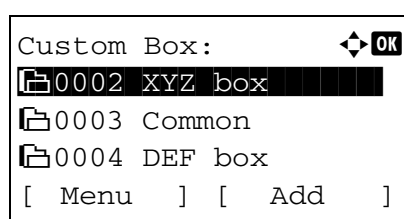
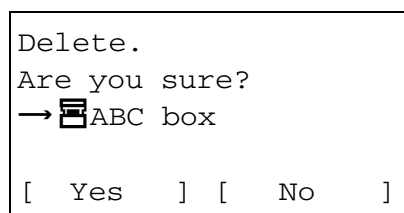
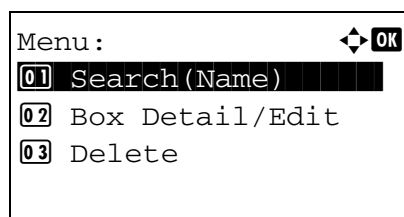

1 In the file list screen, press [Menu] (**[Left Select]**). The Menu screen appears.

2 Press Δ or ∇ to select Delete.

3 Press [OK]. A confirmation screen appears.

4 To proceed with deleting the custom box, press [Yes] (**[Left Select]**). Completed. appears and the custom box is deleted. The Once deleting of the custom box ends, the Custom Box list screen reappears.

Pressing [No] (**[Right Select]**) returns you to the file list screen without deleting the custom box.

Sorting the Custom Box list

When user login administration is enabled, it is possible to sort the list display into either Box Number order or Box Owner order.

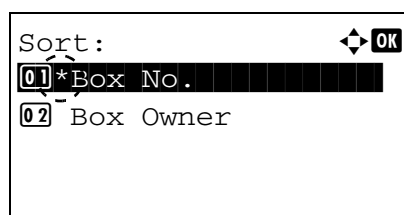
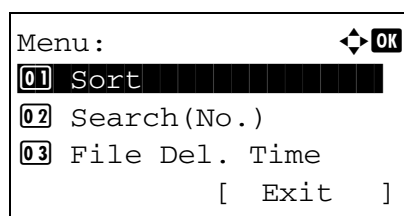

1 In the Custom Box list screen, press [Menu] (**[Left Select]**). The Menu screen appears.

2 Press Δ or ∇ to select Sort.

3 Press [OK]. The Sort screen appears.

4 Press Δ or ∇ to select Box No. or Box Owner.

5 Press [OK]. The Menu screen reappears.

Searching Custom Boxes

It is possible to search for a Custom Box using either the Box number or Box name.

```

Menu:                                ⬅️ OK
01 Sort
02 Search (No.)
03 File Del. Time
      [ Exit ]

```

```

Search (No.) :                       ⬅️ OK
      (0001 - 1000)
      0003
[ Menu ]

```

1 In the Custom Box list screen, press [Menu] (**[Left Select]**). The Menu screen appears.

2 Press Δ or ∇ to select Search (No.) or Search (Name).

3 Press **[OK]**. The Search (No.) screen or the Search (Name) screen appears.

Searching is possible using the methods below:

- Searching with Box numbers...4-13
- Searching with Box names...4-13

Searching with Box numbers

```

Menu:                                ⬅️ OK
01 *Search (No.)
02 Search (Name)

```

```

Search (No.) :                       ⬅️ OK
      (0001 - 1000)
      0003
[ Menu ]

```

1 In the Search (No.), press [Menu] (**[Left Select]**). The Menu screen appears.

2 Press Δ or ∇ to select Search (No.).

3 Press **[OK]**. The Search (No.) screen appears.

4 Enter the Box number to be found and press **[OK]**. A search is done for the Box number entered.

Searching with Box names

```

Menu:                                ⬅️ OK
01 *Search (No.)
02 Search (Name)

```

1 In the Search (No.), press [Menu] (**[Left Select]**). The Menu screen appears.

2 Press Δ or ∇ to select Search (Name).

```

Search (Name) :   [OK]
Box03
                ABC
[ Menu ] [ Text ]

```

3 Press **[OK]**. The Search (Name) screen appears.

4 Enter the Box name to be found and press **[OK]**. A search is done for the Box name entered.



Note Refer to *Character Entry Method* on page A-6 for details on entering characters.

Setting automatic document deletion for Custom Boxes

Set the time for documents stored in Custom Boxes to be automatically deleted.

```

Menu :           [OK]
[01] Sort
[02] Search (No.)
[03] File Del. Time
                [ Exit ]

```

1 In the Custom Box list screen, press **[Menu]** (**[Left Select]**). The Menu screen appears.

2 Press Δ or ∇ to select File Del. Time.

3 Press **[OK]**. The File Del. Time screen appears.

```

File Del. Time: [OK]
Hour   Min.
  00   :   00

```

4 Enter the hours and minutes using the numeric keys.

Press Δ or ∇ to increase or decrease the figures.

Use \triangleleft and \triangleright to move the position being entered, which is shown highlighted.

5 Press **[OK]**. The Menu screen reappears.

File operations (Printing, deleting and moving files)

It is possible to print files stored in a Custom Box, to delete them or to move them to a different Custom Box.

The following operations are possible:

- Box number/Box name (Select a File)...4-15
- Select/Deselect All Files...4-15
- Print a File...4-16
- Print a File (Changes to the print settings)...4-17
- Delete a File...4-22
- Moving files...4-22
- Check File Details...4-23

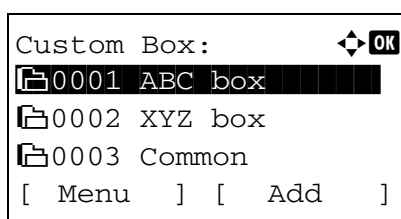

- 1 In the Custom Box list screen, press Δ or ∇ to select a Custom Box.

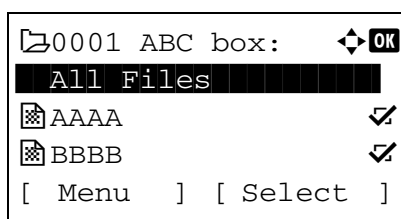

- 2 Press **[OK]**. The printer displays a list of files stored in the Custom Box.



Note If the screen for entering a password is displayed then enter the password using the numeric keys and then press **[OK]**.

Refer to *Character Entry Method* on page A-6 for details on entering characters.

Box number/Box name (Select a File)

To print/delete a file in the Custom Box, first select the file to be printed or deleted.

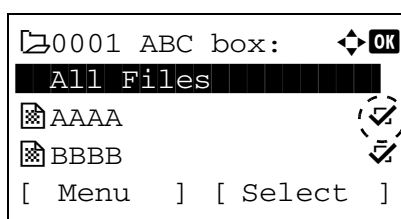

- 1 Press Δ or ∇ to select the file to be printed/deleted.
- 2 When **[Select]** (**[Right Select]**) is pressed, the file is selected. A checkmark will be placed on the right of the selected file. Select the checkmarked file and press **[Select]** (**[Right Select]**) again to cancel the selection.



Note To select all files, follow the steps of *Select/Deselect All Files* on page 4-15.

Select/Deselect All Files

All files in the Custom Box are selected.

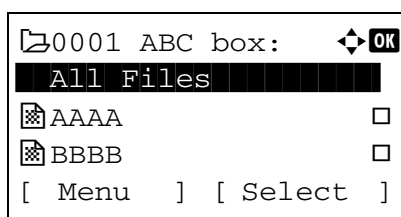

- 1 In the file list screen, press Δ or ∇ to select All Files.

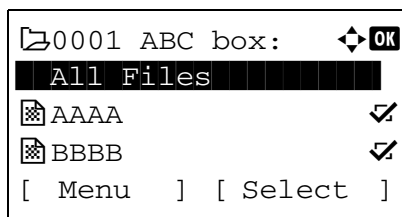

2 Press [Select] ([Right Select]).

When there is a file not checked in the Custom Box, all files will be checkmarked.

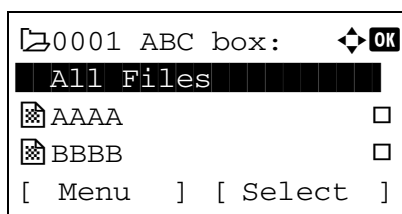

When all files in the Custom Box are checked, all checkmarked files are deselected.

Print a File

Print the file(s) selected in the Custom Box.

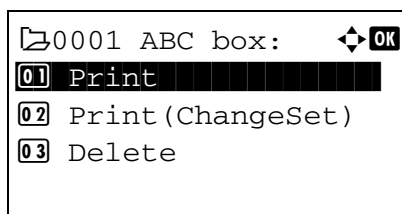

1 In the file list screen, select the item and press [OK]. The Print/Delete menu screen appears.

2 Press Δ or ∇ to select Print.

3 Press [OK]. The Copies menu screen appears.

If you want to change the number of remaining copies to be printed, use the numeric keys to set the number of copies to be printed.



Note If Job Accounting is enabled, enter the account ID in the login screen that appears. The Copies menu screen appears after login.

--- is displayed first, and it means it according to the set number of copies when the data of each file is preserved. In this setting, each set number of copies is printed.

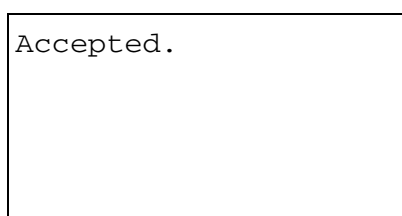
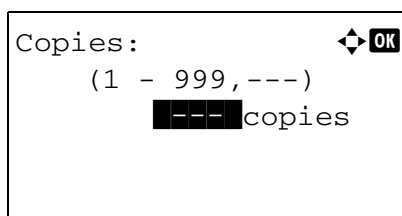

4 Press [OK]. The message Accepted. appears and printing begins. When On is selected in the Del. afterPrint (Setting for file deletion after printing) on page 4-10, the selected file will be deleted from the Custom Box after it is printed.

Print a File (Changes to the print settings)

To change the print settings for a file selected in a Custom Box and print it.

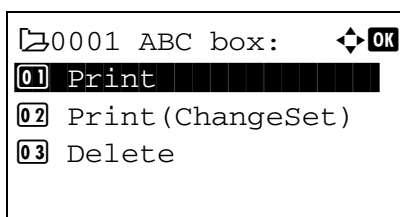

- 1 In the file list screen, select the item and press **[OK]**. The **Print/Delete** menu screen appears.

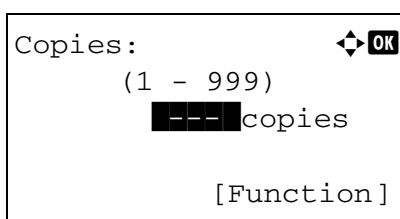

- 2 Press **△** or **▽** to select **Print (ChangeSet)**.
- 3 Press **[OK]**. The **Copies** menu screen appears.

If you want to change the number of remaining copies to be printed, use the numeric keys to set the number of copies to be printed.



Note If Job Accounting is enabled, enter the account ID in the login screen that appears. The **Copies** menu screen appears after login.

[Function] (**[Right Select]**) can be pressed to change the print settings. For details, refer to *Print Function Settings on page 4-17*.

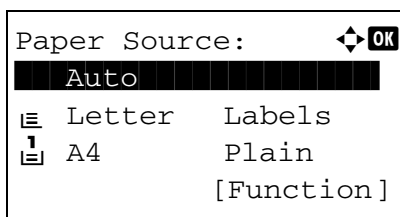

- 4 Press **[OK]**. The **Paper Source** menu screen appears.

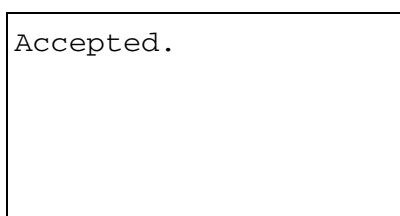

- 5 Press **△** or **▽** to select the tray containing the paper you want to use.
- 6 Press **[OK]**. The message **Accepted.** appears and printing begins. When **On** is selected, the selected file will be deleted from the Custom Box after it is printed.

Print Function Settings

When printing, the print settings can be changed.

Options available in Print Function Settings are as follows:

- Paper Output (Output location selection)...4-18
- Collate (Collate Setting)...4-18
- Offset (Offset Setting)...4-19
- Duplex (Setting the duplex printing)...4-19
- Eco Print (Selecting the EcoPrint mode)...4-20
- File Name Entry (entering a file name)...4-20
- JobFinish Notice (Settings for notification when jobs are finished)...4-21
- Del. after Print (Delete data after printing setting)...4-21

Paper Output (Output location selection)

Select the output location. For details, refer to *Paper Output (Selecting the Paper Output Location)* on page 6-31.

 **Note** The screen varies depending on the installed options.

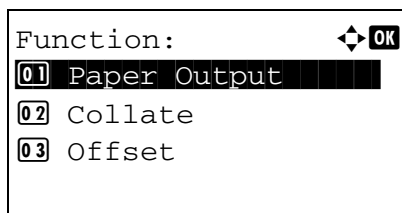

1 In the Copies menu or the Paper Selection menu, press [Function] ([**Right Select**]). The Function menu appears.

2 Press Δ or ∇ to select Paper Output.

3 Press [**OK**]. The Paper Output menu appears showing the available output locations.

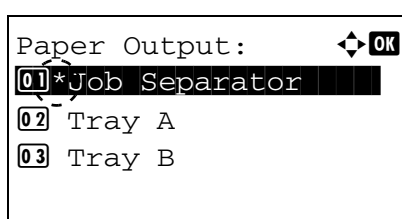

 **Note** The screen shown appears when a 4,000-sheet Finisher is installed.

4 Press Δ or ∇ to select the desired output location.

5 Press [**OK**]. The selected output location is stored and the Function menu reappears.

Collate (Collate Setting)

Select the collate setting.

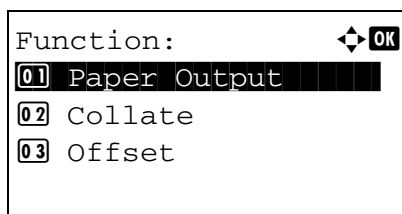

1 In the Copies menu or the Paper Selection menu, press [Function] ([**Right Select**]). The Function menu appears.

2 Press Δ or ∇ to select Collate.

3 Press [**OK**]. The Collate screen appears.

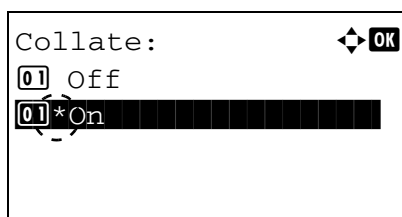

4 Press Δ or ∇ to select On or Off.

5 Press [**OK**]. The selected mode is set and you return to the function menu.

Offset (Offset Setting)

Set whether each set of printed output is offset from the previous set.

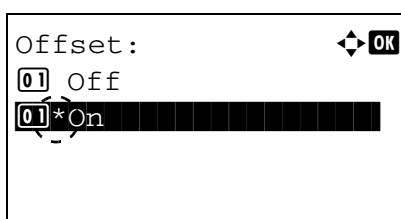
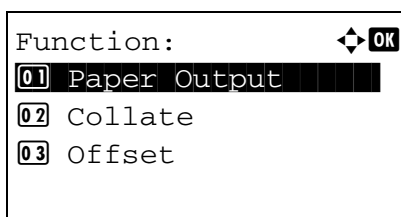

- 1 In the Copies menu or the Paper Selection menu, press [Function] ([Right Select]). The Function menu appears.
- 2 Press Δ or ∇ to select Offset.
- 3 Press [OK]. The Offset screen appears.
- 4 Press Δ or ∇ to select On or Off.
- 5 Press [OK].
The selected mode is set and you return to the function menu.

Duplex (Setting the duplex printing)

Set duplex printing. For details, refer to *Duplex (Setting the duplex printing)* on page 6-30.

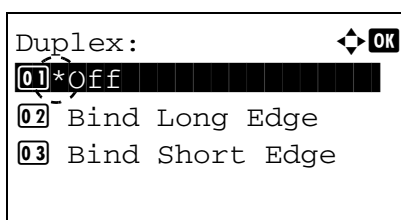
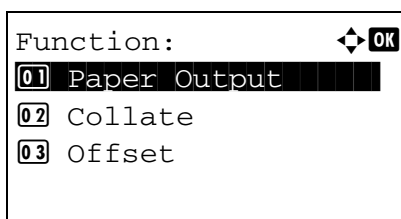

- 1 In the Copies menu or the Paper Selection menu, press [Function] ([Right Select]). The Function menu appears.
- 2 Press Δ or ∇ to select Duplex.
- 3 Press [OK]. The Duplex screen appears showing the list of available duplex printing modes.
- 4 Press Δ or ∇ to select the desired duplex printing mode.
The message display toggles through the following:
Off (default)
Bind Long Edge
Bind Short Edge
Selecting Off disables duplex printing.
- 5 Press [OK]. The duplex printing mode is set and the Function menu reappears.

Eco Print (Selecting the EcoPrint mode)

Set EcoPrint mode. For details, refer to *EcoPrint (Selecting the EcoPrint mode)* on page 6-35.

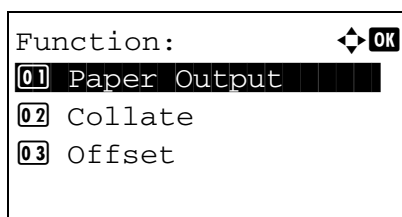

1 In the Copies menu or the Paper Selection menu, press [Function] ([Right Select]). The Function menu appears.

2 Press Δ or ∇ to select Eco Print.

3 Press [OK]. The Eco Print screen appears.

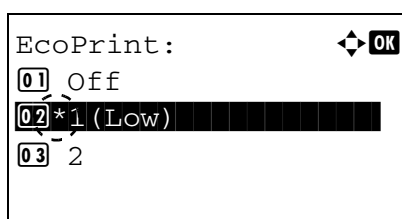

4 Press Δ or ∇ to select the EcoPrint mode.

5 Press [OK]. The EcoPrint mode is set and the Function menu reappears.

File Name Entry (entering a file name)

Enter the file name. The file name entered is displayed as the Job Name in the Job Status and Job Log.

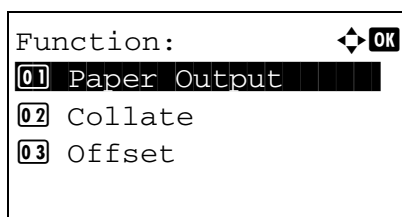

1 In the Copies menu or the Paper Selection menu, press [Function] ([Right Select]). The Function menu appears.

2 Press Δ or ∇ to select File Name Entry.

3 Press [OK]. The File Name Entry screen appears.

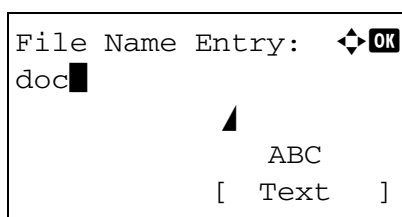

4 Enter the file name using the numeric keys.



Note Up to 32 characters can be entered.

Refer to *Character Entry Method* on page A-6 for details on entering characters.

5 Press [OK]. Register the file name and the Function menu reappears.

JobFinish Notice (Settings for notification when jobs are finished)

The end of a job is notified using E-mail.

 **Note** To send E-mail on this machine, set the SMTP and POP3 settings to On. For details, refer to *Protocol Detail (Detailed settings for the network protocol)* on page 6-46.

A mail server must be registered. For the method for setting a server, refer to the *Command Center RX User Guide*.

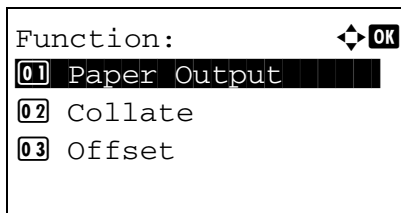

- 1 In the Copies menu or the Paper Selection menu, press [Function] (**[Right Select]**). The Function menu appears.

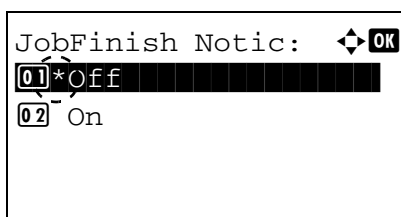

- 2 Press Δ or ∇ to select JobFinish Notice.
- 3 Press **[OK]**. The JobFinish Notice screen appears.

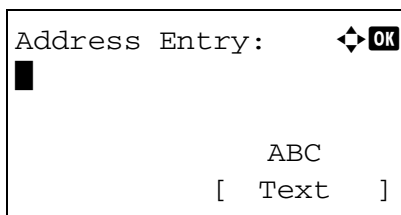

- 4 Press Δ or ∇ to select On.
- 5 Press **[OK]**. The Address Entry screen appears.

- 6 Enter the E-Mail address to be notified.

 **Note** Up to 128 characters can be entered.
Refer to *Character Entry Method* on page A-6 for details on entering characters.

When user login administration is set, the address of the logged in user is entered.

- 7 Press **[OK]**. Register the address and the Function menu reappears.

Del. after Print (Delete data after printing setting)

Use this setting to specify whether or not the file data is deleted after printing.

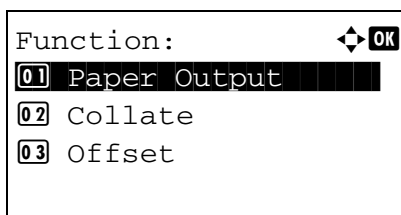

- 1 In the Copies menu or the Paper Selection menu, press [Function] (**[Right Select]**). The Function menu appears.

- 2 Press Δ or ∇ to select Del. after Print.

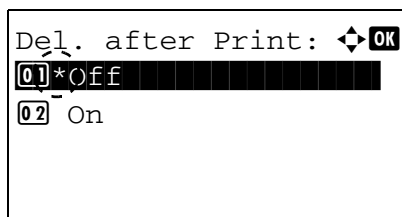

3 Press **[OK]**. The Del. after Print screen appears.

4 Press Δ or ∇ to select the Del. after Print setting.

5 Press **[OK]**. The Del. after Print setting is set and the Function menu reappears.

Delete a File

Delete the file(s) selected in the Custom Box.

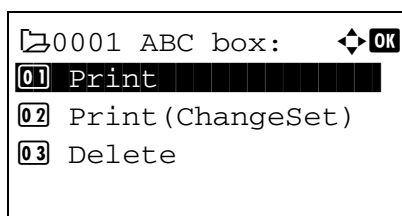

1 In the file list screen, select the item and press **[OK]**. The Print/Delete menu screen appears.

2 Press Δ or ∇ to select Delete.

3 Press **[OK]**. A confirmation screen appears.

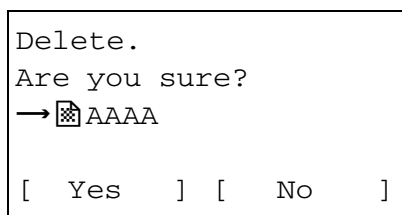

4 Press **[Yes]** (**[Left Select]**). The message Completed. appears and the selected file(s) are deleted.

Pressing **[No]** (**[Right Select]**) returns you to the Print/Delete menu screen without deleting the file.

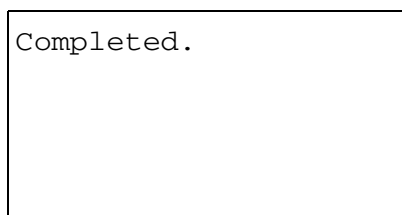

Moving files

A file can be moved to a different Custom Box.

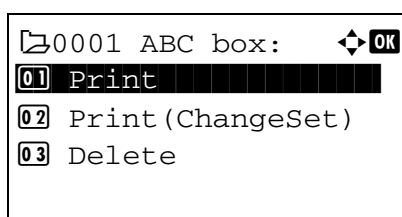

1 In the file list screen, select the item and press **[OK]**. The Print/Delete menu screen appears.

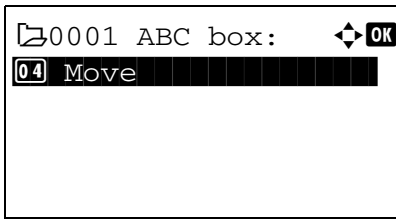

2 Press Δ or ∇ to select Move.

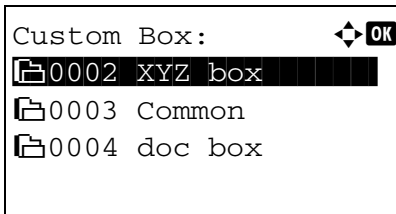

3 Press [OK]. The Custom Box list screen appears.

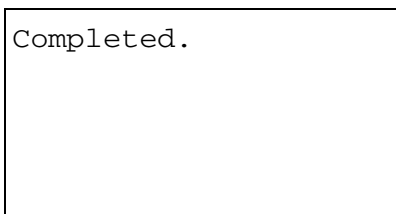

4 Press Δ or ∇ to select the destination Box.

5 The message `Completed.` appears and the selected file(s) is/are moved. Press [OK].



Note If the screen for entering a password is displayed then enter the password using the numeric keys and then press [OK].

Refer to *Character Entry Method on page A-6* for details on entering characters.

Check File Details

Details for the file that is selected with the cursor will appear.

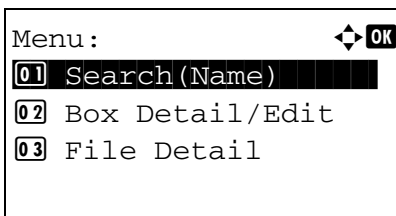

1 In the file list screen, press [Menu] ([Left Select]).

2 Press Δ or ∇ to select File Detail.

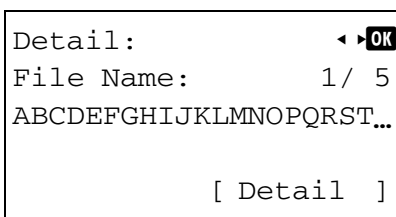

3 Press [OK]. Details for the file that is selected with the cursor appears.

The details for the file covers 6 pages in all. Press \triangleright to view to the next page or \triangleleft to return to the previous page.

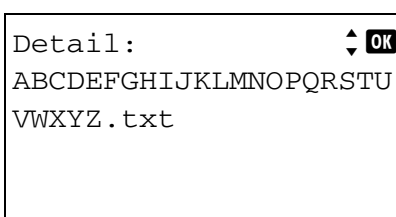

In the File Name screen, if the file name is abbreviated because it cannot be displayed on one line, press [Detail] ([Right Select]) to change the display to three lines. If the file name cannot be displayed in three lines, use Δ or ∇ to scroll up and down the display.

Pressing [OK] in three lines display returns you to one line display.

4 Pressing [OK] while the file details are displayed returns you to the file list screen.

Job Box

Job Box is a print function that makes the Job Retention function possible. The settings are specified from the printer driver. Refer to *Printer driver print settings screen on page 3-3* or the *Printer Driver User Guide*.

Job Retention

Job Retention has four modes as summarized below. These modes are selected from the printer driver through the application software:

	Quick Copy	Proof-and-Hold	Private Print	Stored Job
Primary function	To later print additional copies	To proof the first copy before printing multiple copies	To hold the document in printer to prevent unauthorized access	To electronically store documents such as fax cover pages
On terminating print setting from application software	Prints simultaneously	Prints one copy simultaneously	Does not print	Does not print
Retrieved by	Operation panel	Operation panel	Operation panel	Operation panel
Default number of copies printed at retrieval	Same as storing (can be changed)	One less (can be changed)	Same as storing (can be changed)	One (can be changed)
Maximum number of jobs stored *	32, expandable to 300	32, expandable to 300	Depends on the HDD capacity (the job is automatically deleted after printing)	Depends on the HDD capacity
PIN security	No	No	Yes	Yes (if necessary)
Data after printing	Stored	Stored	Deleted	Stored
Data at power off	Deleted	Deleted	Deleted	Stored

* Jobs in excess will cause the earlier ones to be deleted.



Note Refer to the *Printer Driver User Guide* for the driver settings and print (save) procedures.

After pressing **[Document Box]**, it is possible to display either the Job Box list screen or the Custom Box menu screen or to set them. Refer to *Def. Screen(Box) (Document Box default screen settings.) on page 6-60*.

If the Custom Box menu screen is displayed, follow the procedure below to display the Job Box list screen.

- 1 Press **[Back]**.
- 2 Press Δ or ∇ to select **Job Box**.
- 3 Press **[OK]**. Job Box list screen appears.

Procedure for printing using Job Box

Follow the work flow below when using Job Box.

Specifying the Custom Box from a computer and sending the print job (page 3-2)



Using the operation panel to specify a file within a Box and printing it

- Quick Copy (page 4-25)
- Proof-and-Hold (page 4-29)
- Private Print (page 4-31)
- Stored Job (page 4-31)

Operation panel display

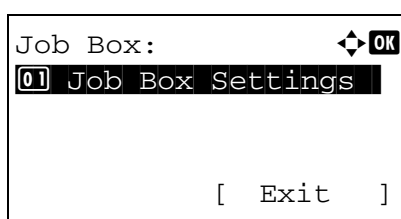

- 1 Press **[Document Box]**. Either the Custom Box list screen or the Job Box menu screen is displayed.



Note After pressing **[Document Box]**, it is possible to display either the Custom Box list screen or the Job Box menu screen or to set them. Refer to *Def. Screen(Box) (Document Box default screen settings.)* on page 6-60.

If the Job Box menu screen is displayed, follow the procedure below to display the Custom Box list screen.

- 1 Press **[Back]**.
- 2 Press Δ or ∇ to select **Job Box**.
- 3 Press **[OK]**. Job Box menu screen appears.

The options available in Job Box are as follows:

- Quick Copy (Using Quick Copy)...4-25
- Using Proof-and-Hold...4-29
- Private/Stored (Printing a Private Print/Stored Job)...4-31
- Job Box Settings (Job Box Configuration)...4-35

Quick Copy is only displayed if there are any jobs that were saved to the HDD in Quick Copy mode.

Private/Stored is only displayed if there are any jobs that were saved to the HDD.

Quick Copy (Using Quick Copy)

This mode enables you to print the requested number of copies of a job, simultaneously storing the job on the HDD. When additional copies are required, you can reprint the required number of copies from the printer operation panel. To print a job as a quick copy job, refer to *Printer Driver User Guide*.

The default number of print jobs that can be stored on the HDD is 32. This value can be increased to up to 300. For details, refer to *Job Box Settings (Job Box Configuration)* on page 4-35. When the number of jobs reaches the limit, the oldest job will be overwritten by the new one.

When the printer is turned off, all stored jobs will be deleted.



Note Refer to the *Printer Driver User Guide* for the driver settings.

The following operations are possible:

- Printing Additional Copies using Quick Copy...4-26
- Select/Deselect All Files...4-26
- Print a File...4-27
- Deleting a Quick Copy Job...4-27
- Delete a File...4-28

Printing Additional Copies using Quick Copy

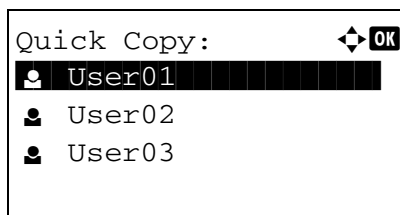

- 1 In the Job Box menu, press Δ or ∇ to select `Quick Copy`.
- 2 Press **[OK]**. The `Quick Copy` screen appears listing the user names for stored jobs.

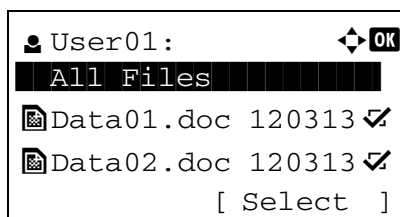

- 3 Press Δ or ∇ to select the user name you entered in the printer driver.
- 4 Press **[OK]**. The printer displays a list of the jobs stored under the selected user name.

- 5 Press Δ or ∇ to scroll to the desired job title.

When `[Select]` (**[Right Select]**) is pressed, the file is selected. A checkmark will be placed on the right of the selected file.

Select the checkmarked file and press `[Select]` (**[Right Select]**) again to cancel the selection.



Note To select all files, follow the steps of *Select/Deselect All Files* on page 4-26

Select/Deselect All Files

All files in the Job Box are selected.

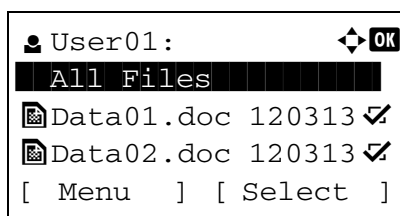

- 1 In the file list screen, press Δ or ∇ to select `All Files`.

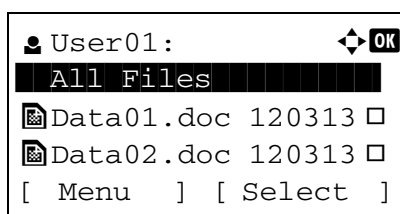

- 2 Press `[Select]` (**[Right Select]**).

When all files in the Job Box are checked, all checkmarked files are deselected.

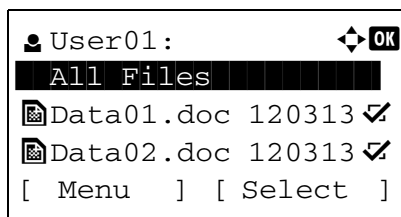

When there is a file not checked in the Job Box, all files will be checkmarked.

Print a File

Print the file(s) selected in the Job Box.

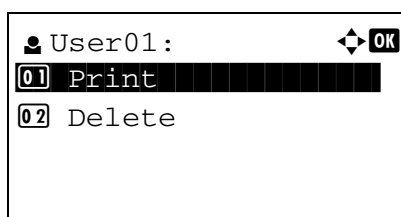

- 1 In the file list screen, select the item and press **[OK]**. The *Print/Delete* menu screen appears.

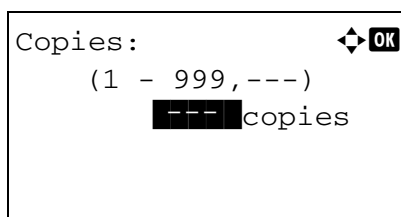

- 2 Press Δ or ∇ to select *Print* and press **[OK]**. The *Copies* menu screen appears.
To print 2 or more copies, use the numeric keys to set the number of copies to be printed.

 **Note** --- is displayed first, and it means it according to the set number of copies when the data of each file is preserved. In this setting, each set number of copies is printed.

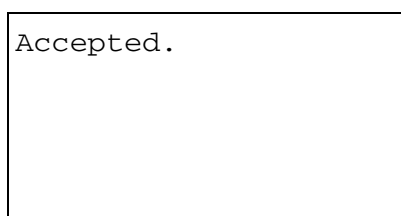

- 3 Press **[OK]**. The message *Accepted.* appears and the printer prints the selected job.

Deleting a Quick Copy Job

Jobs saved using Quick Copy are automatically deleted when you turn the printer off, but you can also use this procedure to delete jobs individually.

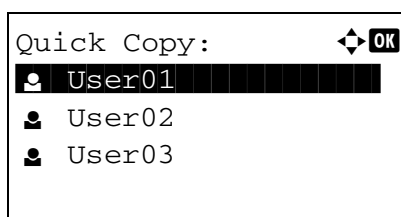

- 1 In the Job Box menu, press Δ or ∇ to select *Quick Copy*.
- 2 Press **[OK]**. The *Quick Copy* screen appears listing the user names for stored jobs.

- 3 Press Δ or ∇ to select the user name you entered in the printer driver.

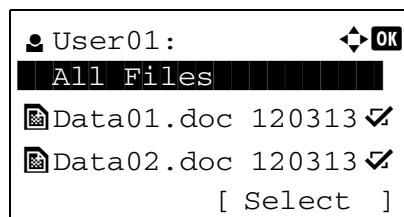

- Press **[OK]**. The printer displays a list of the jobs stored under the selected user name.

- Press Δ or ∇ to select the name of the job to be deleted.

When **[Select]** (**[Right Select]**) is pressed, the file is selected. A checkmark will be placed on the right of the selected file.

Select the checkmarked file and press **[Select]** (**[Right Select]**) again to cancel the selection.



Note To select all files, follow the steps of *Select/Deselect All Files* on page 4-26

Delete a File

Delete the file(s) selected in the Job Box.

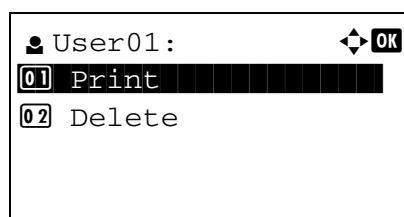

- In the file list screen, select the item and press **[OK]**. The *Print/Delete* menu screen appears.

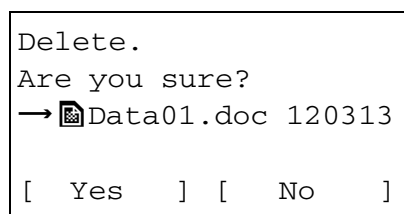

- Press Δ or ∇ to select **Delete** and press **[OK]**. A confirmation message is appears.

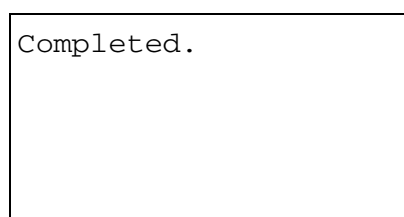

- Press **[Yes]** (**[Left Select]**). The message *Completed.* appears and the printer deletes the selected job. Pressing **[No]** (**[Right Select]**) returns you to return to the previous screen.

Using Proof-and-Hold

When you print multiple copies, this mode first prints one copy so that you can proof it before continuing to print the remaining copies. Since you can proof the printouts before printing the remaining copies, wastage of paper can be reduced.

The printer prints one copy and, at the same time, saves the print job on the HDD. You can also change the number of copies when resuming printing from the operation panel.

When the printer is turned off, all stored jobs will be deleted.

The following operations are possible:

- Printing Remaining Copies of a Proof-and-Hold Job...4-29
- Print a File...4-30
- Deleting a Proof-and-Hold Job...4-30
- Delete a File...4-31

Printing Remaining Copies of a Proof-and-Hold Job

Refer to *Printer Driver User Guide* for the driver settings.

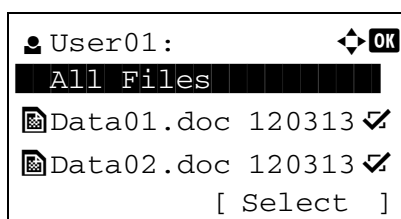
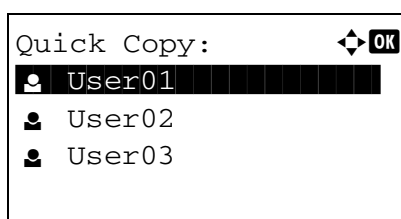

- 1 In the Job Box menu, press Δ or ∇ to select **Quick Copy**.
- 2 Press **[OK]**. The **Quick Copy** screen appears listing the user names for stored jobs.
- 3 Press Δ or ∇ to select the user name you entered in the printer driver.
- 4 Press **[OK]**. The printer displays a list of the jobs stored under the selected user name.
- 5 Press Δ or ∇ to select the name of the job to be printed.
When **[Select]** (**[Right Select]**) is pressed, the file is selected. A checkmark will be placed on the right of the selected file.
Select the checkmarked file and press **[Select]** (**[Right Select]**) again to cancel the selection.

 **Note** To select all files, follow the steps of *Select/Deselect All Files* on page 4-26

Print a File

Print the file(s) selected in the Job Box.

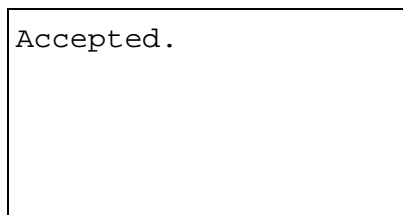
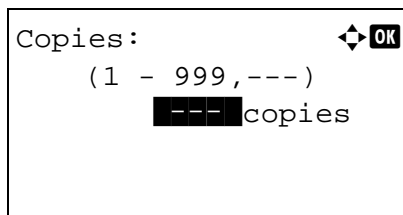
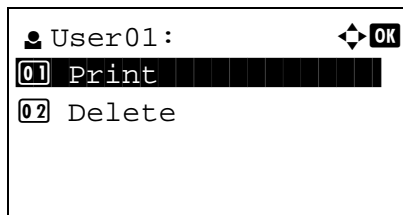

1 In the file list screen, select the item and press **[OK]**. The *Print/Delete* menu screen appears.

2 Press Δ or ∇ to select *Print* and press **[OK]**. The *Copies* menu screen appears.

If you want to change the number of remaining copies to be printed, use the numeric keys to set the number of copies to be printed.

 **Note** --- is displayed first, and it means it according to the set number of copies when the data of each file is preserved. In this setting, each set number of copies is printed.

If Job Accounting is enabled, enter the account ID in the login screen that appears. The *Copies* menu screen appears after login.

 **Note** When the access code is set to the document selected in the check box, *Incorrect ID* is displayed for the disagreement.

3 Press **[OK]**. The message *Accepted.* appears and the printer prints the selected job.

Deleting a Proof-and-Hold Job

Saved jobs are automatically deleted when you turn the printer off, but you can also use this procedure to delete jobs individually.

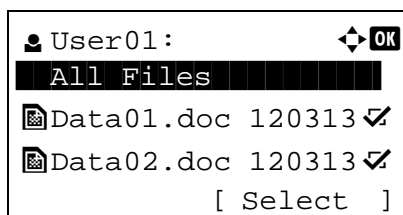
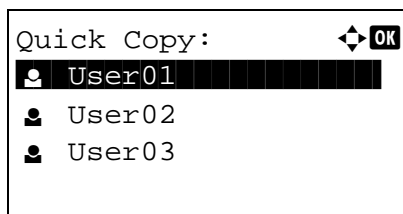

1 In the Job Box menu, press Δ or ∇ to select *Quick Copy*.

2 Press **[OK]**. The *Quick Copy* screen appears listing the user names for stored jobs.

3 Press Δ or ∇ to select the user name you entered in the printer driver.

4 Press **[OK]**. The printer displays a list of the jobs stored under the selected user name.

- 5 Press Δ or ∇ to select the name of the job to be deleted.

When [Select] (**[Right Select]**) is pressed, the file is selected. A checkmark will be placed on the right of the selected file.

Select the checkmarked file and press [Select] (**[Right Select]**) again to cancel the selection.



Note To select all files, follow the steps of *Select/Deselect All Files* on page 4-26

Delete a File

Delete the file(s) selected in the Job Box.

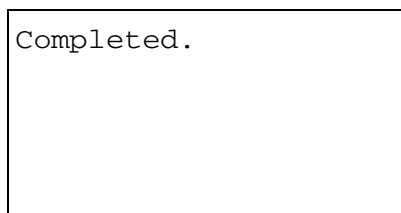
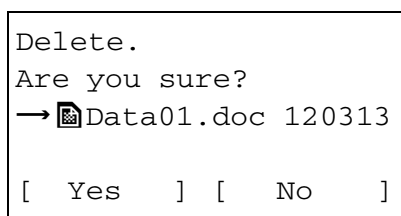
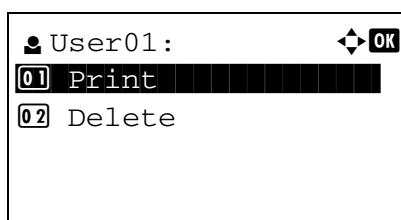

- 1 In the file list screen, select the item and press **[OK]**. The Print/Delete menu screen appears.

- 2 Press Δ or ∇ to select Delete and press **[OK]**. A confirmation message is appears.

- 3 Press [Yes] (**[Left Select]**). The message Completed. appears and the selected job is deleted.
Pressing [No] (**[Right Select]**) returns you to return to the previous screen.

Private/Stored (Printing a Private Print/Stored Job)

In private printing, you can specify that a job is not printed until you release the job from the operation panel. When sending the job from the application software, specify a 4-digit access code in the printer driver. The job is released for printing by entering the access code on the operation panel ensuring confidentiality of the print job.

In the stored job mode, access codes are not mandatory, but can be set on the printer driver if printing with PIN security is required. Then, the access code must be entered on the operation panel to print a stored job. Print data will be stored in the HDD after printing.

Refer to *Printer Driver User Guide* for the driver settings.

The following operations are possible:

- Printing a Private/Stored Job...4-32
- Print a File...4-32
- Deleting a Private/Stored Job...4-33
- Delete a File...4-34

Printing a Private/Stored Job

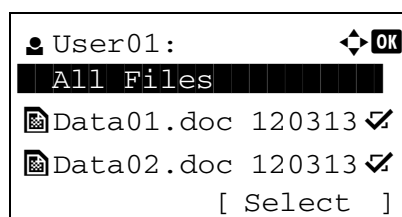
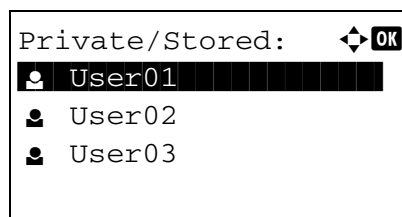

- 1 In the Job Box menu, press Δ or ∇ to select `Private/Stored`.
- 2 Press **[OK]**. The `Private/Stored` screen appears listing the user names for stored jobs.
- 3 Press Δ or ∇ to select the user name you entered in the printer driver.
- 4 Press **[OK]**. The printer displays a list of the jobs stored under the selected user name.
- 5 Press Δ or ∇ to select the name of the job to be printed.
When `[Select]` (**[Right Select]**) is pressed, the file is selected. A checkmark will be placed on the right of the selected file.
Select the checkmarked file and press `[Select]` (**[Right Select]**) again to cancel the selection.



Note To select all files, follow the steps of *Select/Deselect All Files* on page 4-26

Print a File

Print the file(s) selected in the Job Box.

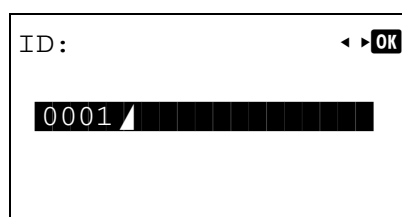
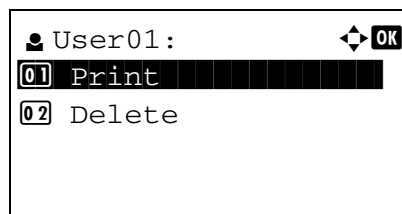

- 1 In the file list screen, select the item and press **[OK]**. The `Print/Delete` menu screen appears.
- 2 Press Δ or ∇ to select `Print` and press **[OK]**. If the selected job was saved as a Private Print job, its `ID` is displayed. If the job was saved in stored job mode, the number of direct copies is displayed.
- 3 Use the numeric keys to enter the access code entered in the printer driver. Press **[OK]**. If the entered access code is correct, the `Copies` menu screen appears.
If the entered access code is incorrect, the `ID` menu screen reappears.



Note When the access code is set to the document selected in the check box, `Incorrect ID` is displayed for the disagreement.

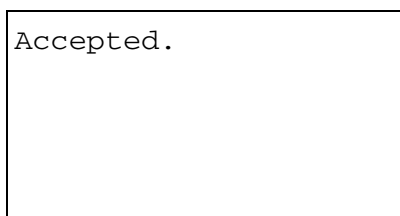
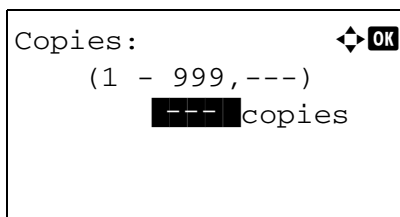

- 4 To print 2 or more copies, use the numeric keys to set the number of copies to be printed.

 **Note** --- is displayed first, and it means it according to the set number of copies when the data of each file is preserved. In this setting, each set number of copies is printed.

- 5 Press [OK]. The message `Accepted.` appears and the printer prints the selected job.

Deleting a Private/Stored Job

You can individually delete stored jobs by performing the following procedure. Jobs saved using Private Print will be automatically deleted if you turn the power off after printing, but jobs saved using Stored Job will not be deleted automatically.

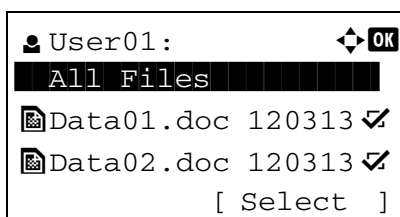
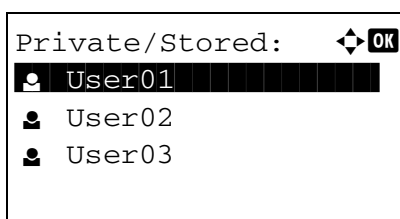

- 1 In the Job Box menu, press Δ or ∇ to select `Private/Stored`.
- 2 Press [OK]. The `Private/Stored` screen appears listing the user names for stored jobs.

- 3 Press Δ or ∇ to select the user name you entered in the printer driver.

- 4 Press [OK]. The printer displays a list of the jobs stored under the selected user name.

- 5 Press Δ or ∇ to select the name of the job to be printed.

When [Select] ([Right Select]) is pressed, the file is selected. A checkmark will be placed on the right of the selected file.

Select the checkmarked file and press [Select] ([Right Select]) again to cancel the selection.

 **Note** To select all files, follow the steps of *Select/Deselect All Files* on page 4-26

Delete a File

Delete the file(s) selected in the Job Box.

- 1 In the file list screen, select the item and press **[OK]**. The Print/Delete menu screen appears.
- 2 Press Δ or ∇ to select `Delete` and press **[OK]**. The ID is displayed.
- 3 Use the numeric keys to enter the access code entered in the printer driver.
- 4 Press `[Enter]` (**[Right Select]**). If the entered access code is correct, the Delete menu screen appears. If the entered access code is incorrect, the ID menu screen reappears.

 **Note** When the access code is set to the document selected in the check box, ID error is displayed for the disagreement.
- 5 Press `[Yes]` (**[Left Select]**). `Complete.` appears and the printer deletes the selected job. Pressing `[No]` (**[Right Select]**) returns you to return to the previous screen.

Job Box Settings (Job Box Configuration)

Change Job Box settings, such as the maximum number of storable documents in the HDD, and automatic delete settings, and select the storage media.

The following items are available in the Job Box detail settings.

- Changing the Maximum Number of Quick Copy jobs...4-35
- Set Automatic Delete times for Temporary Jobs...4-35

Changing the Maximum Number of Quick Copy jobs

This changes maximum number of Quick Copy jobs to a value between 0 and 300. The default is 32.

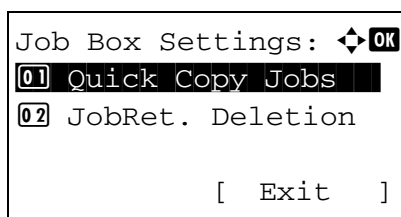

- 1 In the Job Box menu, press Δ or ∇ to select Job Box Settings.
- 2 Press [OK]. The Job Box Settings screen appears.

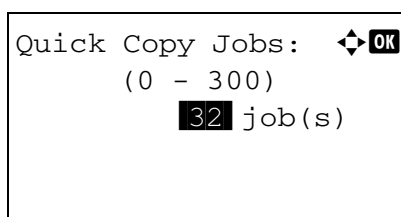

- 3 Select Quick Copy Jobs and press [OK]. The Quick Copy Jobs screen appears.
- 4 Use the numeric keys to set the maximum number of Quick Copy jobs.

- 5 Press [OK]. The setting is stored and the Job Box Settings menu reappears.

Set Automatic Delete times for Temporary Jobs

When the set period passes, the temporary jobs are automatically deleted.

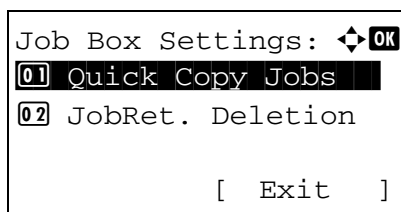

- 1 In the Job Box menu, press Δ or ∇ to select Job Box Settings.
- 2 Press [OK]. The Job Box Settings screen appears.

- 3 Select JobRet. Deletion and press [OK]. The JobRet. Deletion screen appears.

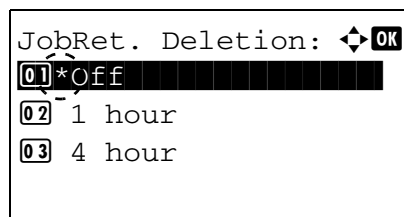

- 4** Press Δ or ∇ to select the desired Automatic Delete time. The list shows the following times:
 - Off (automatic delete is not performed)
 - 1 hour (deleted in 1 hour)
 - 4 hours (deleted in 4 hours)
 - 1 day (deleted on the next day)
 - 1 week (deleted after one week)
- 5** Press **[OK]**. The setting is stored and the Job Box Settings menu reappears.

5 Status Menu

This chapter contains explanations on the following topics:

Displaying the Status Menu Screen	5-2
Job Status.....	5-2
Job Log.....	5-4
USB Keyboard.....	5-5
Wireless Network.....	5-6

Displaying the Status Menu Screen

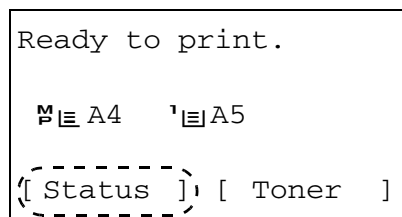

If **Status** is displayed at the left of the bottom row of the message display whilst the machine is printing or awaiting printing, it is possible to display the Status menu screen.

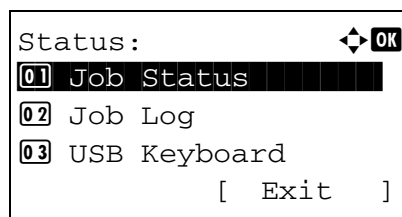

Press [Status] (**Left Select**). The Status menu screen appears.

The following operations are possible on the Status menu screen:

- Job Status
- Job Log
- USB Keyboard
- Wireless Network

Note USB Keyboard is only displayed when a USB keyboard is connected.

Job Status

It is possible to check the status of jobs printing or awaiting printing.

In addition to the jobs printed from computers, it is also possible to check reports such as status pages and jobs printed directly from USB memory.

The information available in the Job Status is listed below.

Item	Content	Results Displayed		
		Display	Icon	Description
Job Name	Job name	Job name		Job name
Status	Job status	Processing		Printing
		Pause		Printing suspended
		Canceling		Job canceled.
Job Type	Job type	Printer		Printed from a PC
		Report		Report
		USB		Printed from USB memory
		Box		Printed from Job Box
Accepted Time	Job reception time	Year/Month/Day Hour: Minute		
User Name	Printed user name	User name		
Printed Pages	Pages printed	***Page(s)		No. of pages
		***/**		Pages completed/Pages specified
Color/B & W	Printing type	Color		Color printing
		Black & White		Black & White printing
		Mixed		Mixed Color and Black & White printing
		-----		Nothing printed

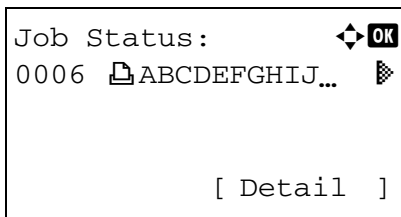

- 1 In the Status menu, press Δ or ∇ to select Job Status.
- 2 Press **[OK]**. Job Status is displayed and a list is displayed of the job numbers and job names of the jobs currently being printed or awaiting printing. Also, the type of job and results are indicated for each job using icons.

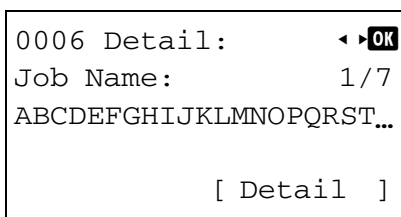

- 3 Press Δ or ∇ to select the name of the job whose details you want to view.
- 4 Press [Detail] (**[Right Select]**). The Job Status details screen appears.

The detailed job status covers 6 pages in all. Press \triangleleft to view to the next page or \triangleright to return to the previous page.

Pressing **[OK]** while file or folder details are displayed returns you to the Job Status menu.

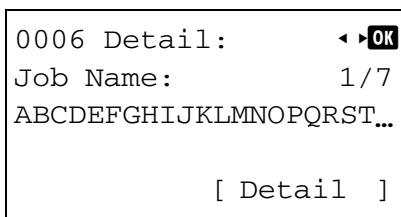

If the entire name shown as the Job Name will not fit on one line, pressing [Detail] (**[Right Select]**) changes to a 3-line name display. If the name is 3 or more lines long, you can scroll up or down by pressing Δ or ∇ .

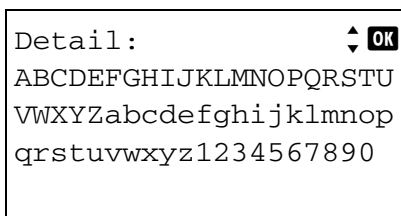

Pressing **[OK]** during 3-line name display returns you to single-line name display.

Job Log

You can use the Job Log to check the history of jobs that have already finished printing.

As well as jobs printed from PCs, this log shows the outcomes for jobs printed directly from USB memory and reports such as status pages.

It is possible to check the log of the 100 most recent jobs.

The information available in the Job Log is listed below.

Item	Content	Results Displayed		
		Display	Icon	Description
Job Name	Job name	Job name		Job name
Result	Job status	OK	OK	Completed normally
		Error		Error occurred.
		Cancel		Job canceled.
Job Type	Job type	Printer		Printed from a PC
		Report		Report
		USB		Printed from USB memory
		Box		Printed from Job Box
Accepted Time	Job reception time	Year/Month/Day Hour: Minute		
User Name	Printed user name	User name		
Printed Pages	Pages printed	***Page(s)		No. of pages
		***/**		Pages completed/Pages specified
Color/B & W	Printing type	Color		Color printing
		Black & White		Black & White printing
		Mixed		Mixed Color and Black & White printing
		-----		Nothing printed

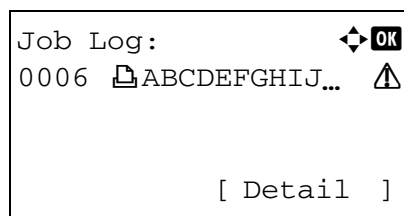

- 1 In the Status menu, press Δ or ∇ to select Job Log.
- 2 Press **[OK]**. Job Log is displayed, along with the job numbers of completed jobs and a list of the job names. The job type and result for each job are also shown as icons.
- 3 Press Δ or ∇ to select the name of the job whose details you want to view.

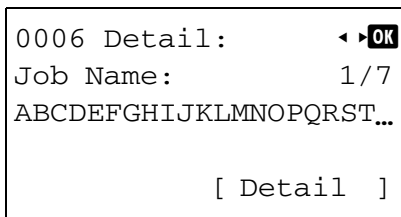

- 4 Press [Detail] ([Right Select]). The Job Log details screen appears.
The detailed job log covers 7 pages in all. Press < to view to the next page or > to return to the previous page.

Pressing [OK] while file or folder details are displayed returns you to the Job Log menu.

If the entire name shown as the Job Name will not fit on one line, pressing [Detail] ([Right Select]) changes to a 3-line name display. If the name is 3 or more lines long, you can scroll up or down by pressing Δ or ∇.

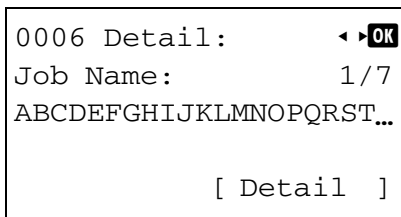

Pressing [OK] during 3-line name display returns you to single-line name display.

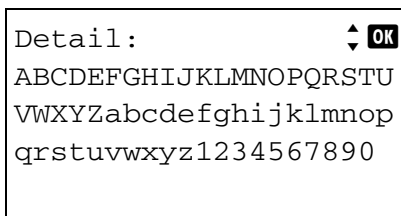

USB Keyboard

When a USB keyboard is attached, it is possible to check whether the USB keyboard can be used.

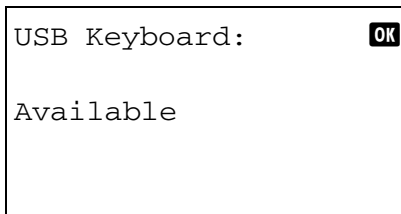

- 1 In the Status menu, press Δ or ∇ to select USB Keyboard.
- 2 Press [OK]. If the USB keyboard is available for use, Available is displayed.

Wireless Network

When the optional Wireless Network Interface Kit (IB-51) is installed, it is possible to check the status of the wireless LAN.



Note Wireless Network is only displayed when the optional Wireless Network Interface Kit (IB-51) is installed.

```
Wireless network: ◀ ▶OK
Status:          1/2
Connected
```

```
Wireless network: ◀ ▶OK
NetwkName(SSID): 2/2
AAAA
[ Detail ]
```

```
Detail:          ⬆ ⬇OK
ABCDEFGHIJKLMN
OPQRSTUVWXYZ
abcdefghijklmnop
qrstuvwxyz1234567890
```

- 1 In the Status menu, press Δ or ∇ to select Wireless network.
- 2 Press **[OK]**. The status of the wireless LAN is displayed.

- 3 Press \triangleleft or \triangleright . The NetwkName(SSID) is displayed.



Note If some of the NetwkName(SSID) are not displayed, press [Detail] (**[Right Select]**) and all the Names will be displayed.

If the entire name shown as the NetwkName(SSID) will not fit on one line, pressing [Detail] (**[Right Select]**) changes to a 3-line name display.

6 Operation Panel

This chapter contains explanations on the following topics:

Report Print	6-2
USB Memory (USB memory selection)	6-7
Counter (Viewing the counter value)	6-16
Paper Settings	6-18
Print Settings	6-28
Network (Network settings)	6-40
Optional network (Optional Network settings)	6-48
Device Common (Selecting/Setting the common device)	6-59
Security (Security function setting)	6-84
User/Job Account (User Login Setting/Job Account setting)	6-98
Adjust/Maint. (Adjust/Maintenance selection/setting)	6-119
Op Functions (Optional application settings)	6-129
Shut down (Shutting down the machine)	6-133

Report Print

Prints a report. The options available in the Report Print menu are as follows:

- Menu Map (Printing a menu map)...6-2
- Status Page (Printing a printer's status page)...6-4
- Font List (Printing a list of the printer's fonts)...6-6
- HDD File List (Printing a list of the files on the hard disk)...6-6

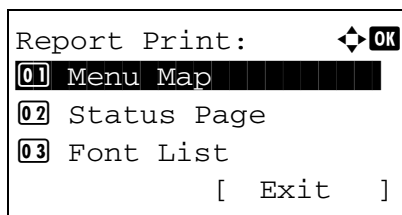

- 1 Press **[MENU]**.
- 2 Press Δ or ∇ to select `Report Print`.
- 3 Press **[OK]**. The `Report Print` menu appears showing a list of the types of report that can be printed. Note that report types shown may vary depending on which optional units are installed in the printer.

Menu Map (Printing a menu map)

The printer prints a full list of the menu selection system menu map.

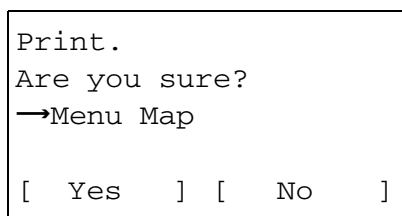

- 1 In the Report Print menu, press Δ or ∇ to select `Menu Map`.
- 2 Press **[OK]**. A confirmation message is displayed.
 -  **Note** When Job Accounting is set but user login is not set, the screen for entering Job Accounting information is displayed. Enter the Account ID and press **[OK]**.
- 3 Press **[Yes] ([Left Select])**. The message `Accepted.` appears and the printer prints the menu map. Pressing **[No] ([Right Select])** returns you to the Report Print menu without printing the menu map.

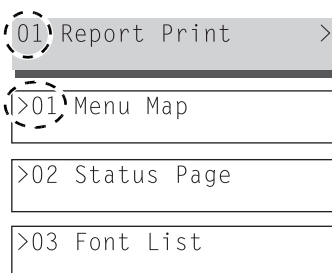

-  **Note** The Menu numbers are printed on the Menu Map outputted. It is possible to use the numeric keys to enter the Menu number and display the settings required.

Example: Displaying the Menu Map printing menu

- 1 Press **[Menu]**.
- 2 Press **[1]** on the Numeric Keys. The `Report Print` menu appears.
- 3 Press **[1]** on the Numeric Keys. A confirmation message is displayed.

Menu Map Sample

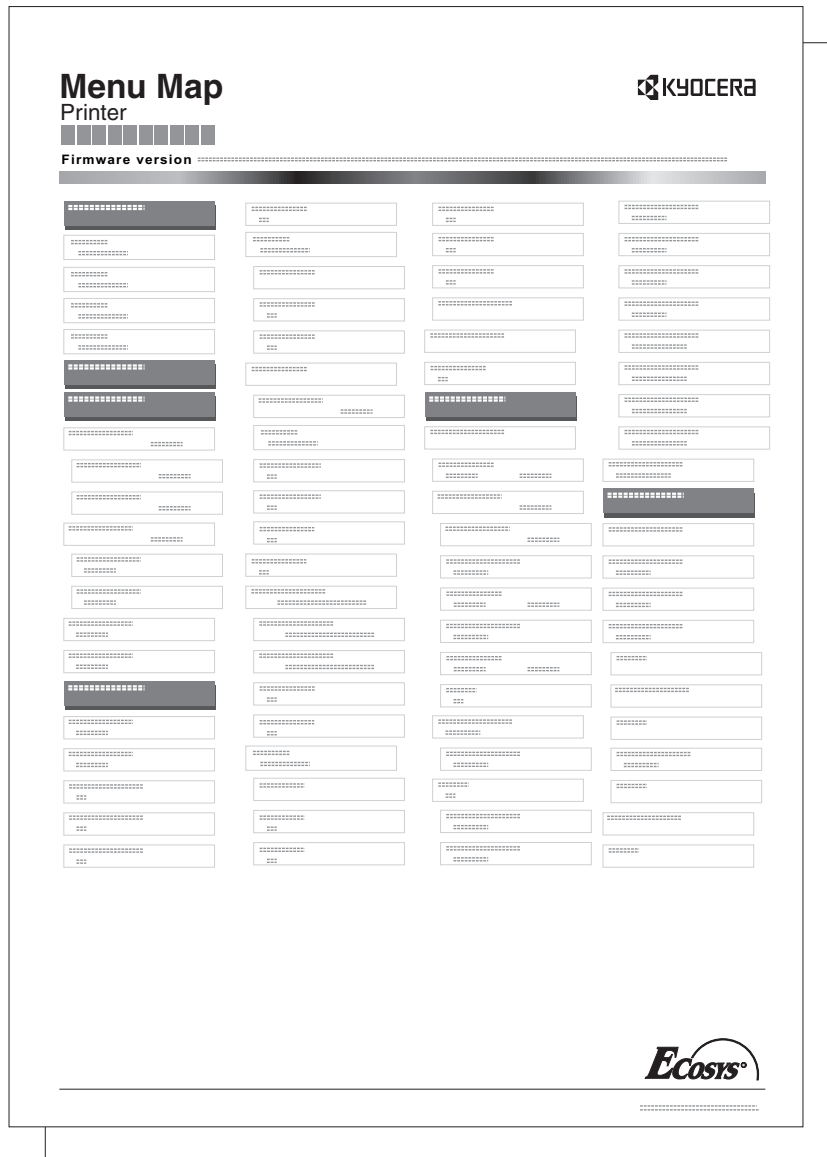

Status Page (Printing a printer's status page)

You can check the printer's current status and option settings by printing a status page.

- 1 In the Report Print menu, press Δ or ∇ to select *Status Page*.
- 2 Press **[OK]**. A confirmation message is displayed.



Note When Job Accounting is set but user login is not set, the screen for entering Job Accounting information is displayed. Enter the Account ID and press **[OK]**.

- 3 Press **[Yes]** (**[Left Select]**). The message *Accepted.* appears and the printer prints the status page.

Pressing **[No]** (**[Right Select]**) returns you to the Report Print menu without printing the status page.

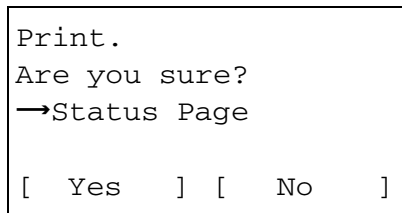

Understanding the Status Page

The numbers in the following diagram refer the items explained below the diagram. The items and values on the status page may vary depending on the printer's firmware version.

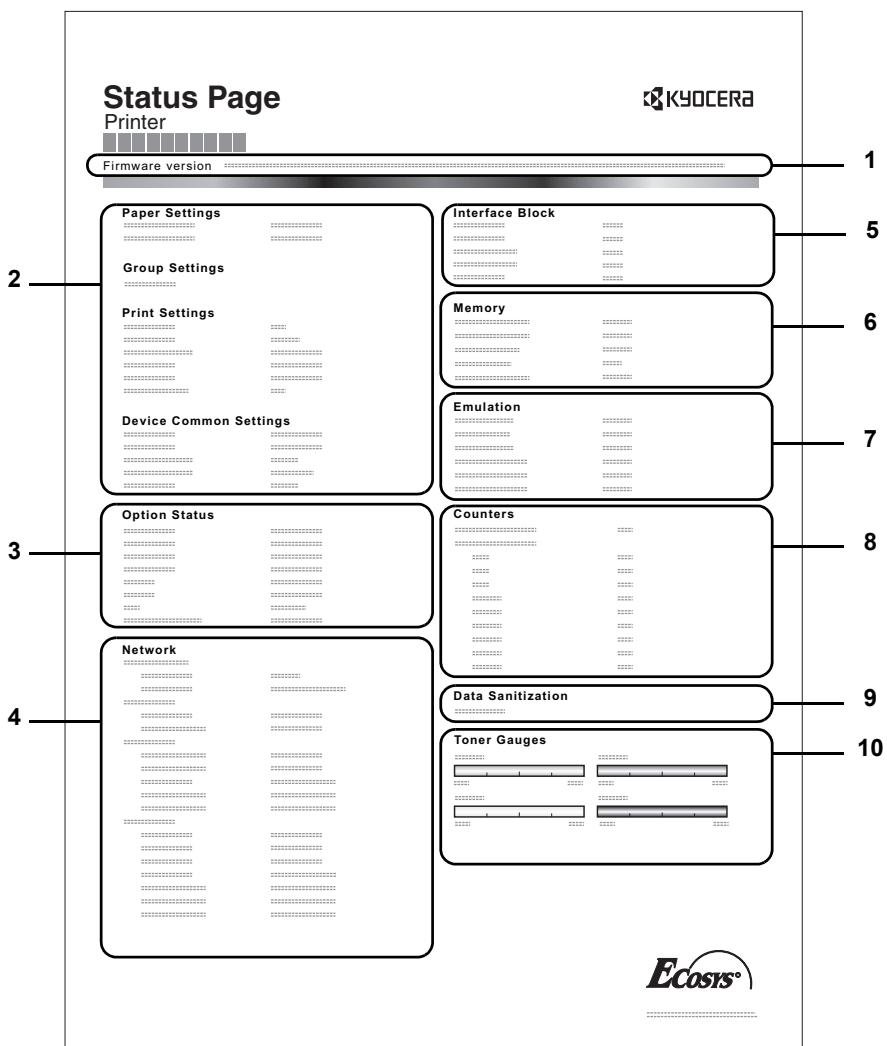

1 Firmware Version

This item shows the version and release date of the printer firmware.

2 Printer Settings Information

This item shows various printer settings for hardware-related items:

- MP tray paper size and type
- Paper cassette size and type
- Copies
- EcoPrint
- Default Media Type
- Sleep time
- Formfeed timeout time

3 Installed Options

This item shows the options installed in the printer:

- Paper Feeder
- Side Feeder
- Finisher
- Mail Box
- IC Card kit (B)
- Security Kit(E)

4 Network Status

This item shows the IP address, subnet mask address, and default gateway address for the network interface card in the printer.

5 Interface Information

This information shows the block status for items including the USB memory slot and USB interface. When connected by network interface card (NIC), block status is shown for an optional interface.

6 Memory

This item shows:

- Standard memory in the printer
- Option memory slot status in megabytes
- Total memory in the printer

7 Emulation

This item shows all available emulations of the printer. The KPD (AUTO) or PCL 6 emulation is set as the default when the printer is shipped from the factory. The emulations are:

- PCL 6
- KPD
- IBM Proprinter
- DIABLO630
- EPSON LQ-850

8 Page Information

This shows counter information. Total printed page count and total page count of each paper size are shown, and are itemized by color/monochrome/total for each counter.

9 Data Sanitization

The status of the Data Sanitization implementation is displayed.

10 Consumable Status

This item shows the approximate level of remaining toner. When the value is 100, the toner container is full. The closer to 0, the smaller the amount of remaining toner.

Font List (Printing a list of the printer's fonts)

To help you decide in selecting a font, you can printout lists of the internal fonts or the optional fonts.

1 In the Report Print menu, press Δ or ∇ to select Font List.

2 Press **[OK]**. A confirmation message is displayed.

 **Note** When Job Accounting is set but user login is not set, the screen for entering Job Accounting information is displayed. Enter the Account ID and press **[OK]**.

3 Press **[Yes] ([Left Select])**. The message Accepted. appears and the printer prints the font list.

Pressing **[No] ([Right Select])** returns you to the Report Print menu without printing the font list.

```
Print.
Are you sure?
→Font List

[ Yes ] [ No ]
```

Font List Sample

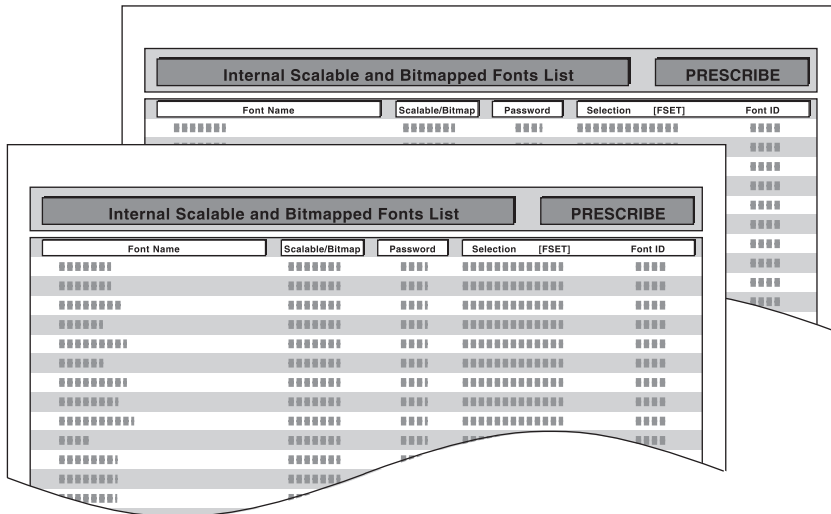

HDD File List (Printing a list of the files on the hard disk)

This allows you to print a list of the files on the hard disk.

1 In the Report Print menu, press Δ or ∇ to select HDD File List.

2 Press **[OK]**. A confirmation message is displayed.

3 Press **[Yes] ([Left Select])**. The message Accepted. appears and the printer prints a list of the files held on the hard disk.

Pressing **[No] ([Right Select])** returns you to the Report Print menu without printing the hard disk file list.

```
Print.
Are you sure?
→Hard Disk File List

[ Yes ] [ No ]
```

USB Memory (USB memory selection)

A USB memory can be connected to the machine to print a file saved in the USB memory, and the USB memory can be removed.

The **USB Memory** menu automatically appears when you install the USB memory.

IMPORTANT This message is only displayed when the USB host block and USB Storage block are set to **Unblock**. For more information, please refer to *I/F Block Set. (External interface block setting)* on page 6-92.

The options available in the USB Memory menu are as follows:

- Print File (Printing and checking the files in the USB memory)...6-7
 - Display of File List...6-7
 - Print File (Prints the selected file)...6-8
 - Print Function Settings...6-9
 - Paper Output (Output location selection)...6-9
 - Collate (Collate Setting)...6-9
 - Offset (Offset Setting)...6-10
 - Duplex (Setting the duplex printing)...6-10
 - Eco Print (Selecting the EcoPrint mode)...6-11
 - File Name Entry (entering a file name)...6-11
 - JobFinish Notice (Setting for notification when jobs are finished.)...6-12
 - Encrypted PDF (PDF password entry)...6-13
 - TIFF/JPEG Size (Adjusting the TIFF/JPEG file print out size)...6-13
 - XPS FitTo Page (Adjusting the XPS file print out size)...6-14
 - Detail (Shows the details of the selected file)...6-14
- Remove Memory (Removing the USB memory)...6-15

- 1 Press **[MENU]**.
- 2 Press Δ or ∇ to select **USB Memory**.
- 3 Press **[OK]**. The **USB Memory** menu appears showing a list of available actions.

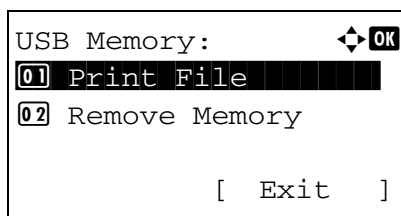

Print File (Printing and checking the files in the USB memory)

This displays a list of the files and folders in the USB memory. You can print the select file. You can also view the details of the selected file or folder.

The options available in the Print File menu are as follows:

- Display of File List...6-7
- Print File (Prints the selected file)...6-8

Display of File List

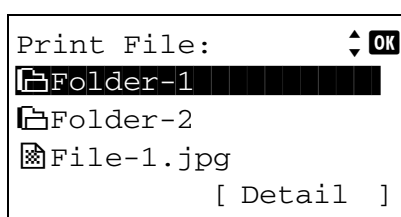

- 1 In the USB Memory menu, press Δ or ∇ to select **Print File**.
- 2 Press **[OK]**. File List appears showing a list of the files and folders in the USB memory.
If there are 3 or more files and folders, pressing Δ or ∇ repeatedly scrolls up or down through the list.

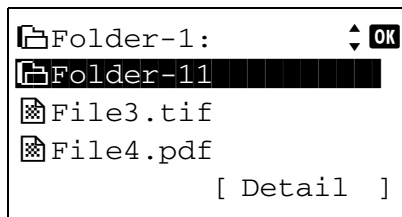

Press Δ or ∇ to select a folder and then press **[OK]**.
The folders and files in the selected folder are displayed.

IMPORTANT Print File only shows the PDF, TIFF, JPEG and XPS files in the USB memory. Up to 4 folder levels can be displayed. Depending on the USB memory capacity and the number of files, the list may take some time to appear.

Print File (Prints the selected file)

You can use this to specify printing for files in the USB memory.

- 1 Use the procedure described in *Print File (Printing and checking the files in the USB memory)* on page 6-7 to display a list of the files in the folder containing the file you want to print.
- 2 Press Δ or ∇ to select the file you want to print.
- 3 Press **[OK]**. The **Copies** menu screen appears.



Note When Job Accounting is set but user login is not set, the screen for entering Job Accounting information is displayed. Enter the Account ID and press **[OK]**.

- 4 To print 2 or more copies, use the numeric keys to set the number of copies to be printed.



Note **[Function]** (**[Right Select]**) can be pressed to change the print settings. For details, refer to *Print Function Settings* on page 6-9.

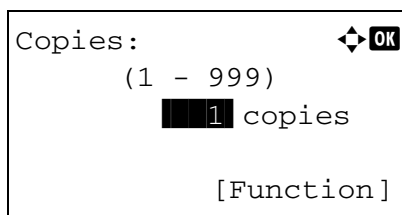

- 5 Press **[OK]**. The **Paper Source** menu screen appears.



Note **[Function]** (**[Right Select]**) can be pressed to change the print settings. For details, refer to *Print Function Settings* on page 6-9.

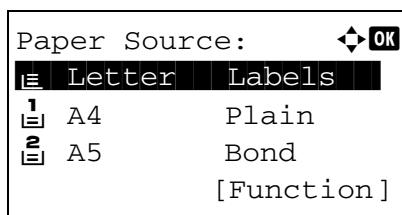

- 6 Press Δ or ∇ to select the tray containing the paper you want to use.
- 7 Press **[OK]**. The message **Accepted.** appears and printing begins.

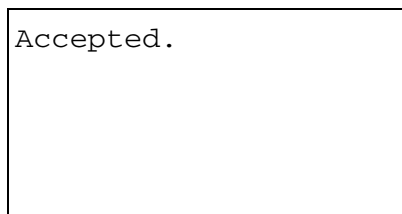

Print Function Settings

When printing, the print settings can be changed.

Options available in Print Function Settings are as follows:

- Paper Output (Output location selection)...6-9
- Collate (Collate Setting)...6-9
- Offset (Offset Setting)...6-10
- Duplex (Setting the duplex printing)...6-10
- Eco Print (Selecting the EcoPrint mode)...6-11
- File Name Entry (entering a file name)...6-11
- JobFinish Notice (Setting for notification when jobs are finished.)...6-12
- Encrypted PDF (PDF password entry)...6-13
- TIFF/JPEG Size (Adjusting the TIFF/JPEG file print out size)...6-13
- XPS FitTo Page (Adjusting the XPS file print out size)...6-14

Paper Output (Output location selection)

Select the output location. For details, refer to *Paper Output (Selecting the Paper Output Location)* on page 6-31.



Note The screen varies depending on the installed options.

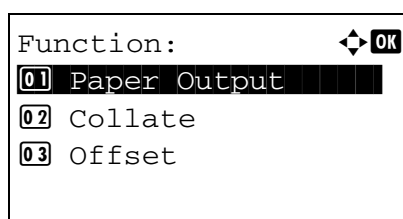

- 1** In the Copies menu or the Paper Selection menu, press [Function] (**[Right Select]**). The Function menu appears.

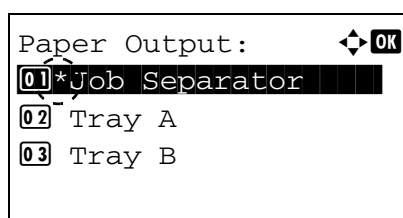

- 2** Press Δ or ∇ to select Paper Output.
- 3** Press **[OK]**. The Paper Output menu appears showing the available output locations.



Note The screen shown appears when a 4,000-sheet Finisher is installed.

- 4** Press Δ or ∇ to select the desired output location.
- 5** Press **[OK]**. The selected output location is stored and the Function menu reappears.

Collate (Collate Setting)

Select the collate setting.

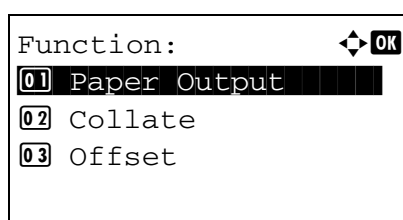

- 1** In the Copies menu or the Paper Selection menu, press [Function] (**[Right Select]**). The Function menu appears.

- 2** Press Δ or ∇ to select Collate.

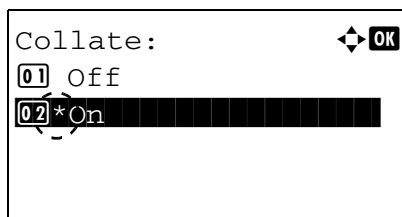

3 Press **[OK]**. The `Collate` screen appears.

4 Press Δ or ∇ to select whether `Collate` mode is enabled.

5 Press **[OK]**.
The selected mode is set and you return to the function menu.

Offset (Offset Setting)

Set whether each set of printed output is offset from the previous set.

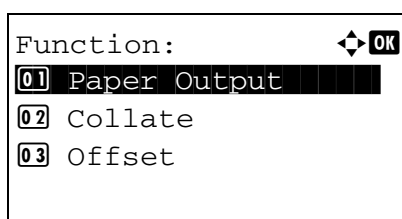

1 In the Copies menu or the Paper Selection menu, press **[Function]** (**[Right Select]**). The `Function` menu appears.

2 Press Δ or ∇ to select `Offset`.

3 Press **[OK]**. The `Offset` screen appears.

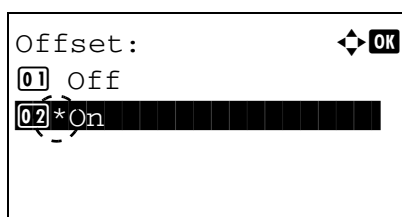

4 Press Δ or ∇ to select whether `Offset` mode is enabled.

5 Press **[OK]**.
The selected mode is set and you return to the function menu.

Duplex (Setting the duplex printing)

Set duplex printing. For details, refer to *Duplex (Setting the duplex printing)* on page 6-30.

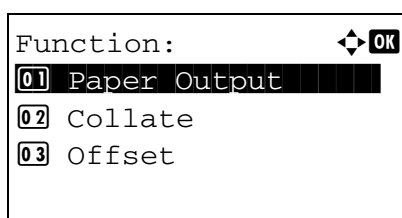

1 In the Copies menu or the Paper Selection menu, press **[Function]** (**[Right Select]**). The `Function` menu appears.

2 Press Δ or ∇ to select `Duplex`.

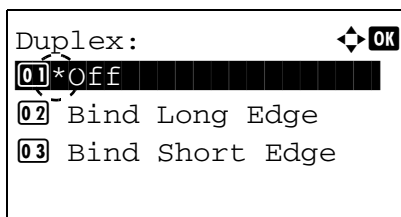

3 Press **[OK]**. The Duplex screen appears showing the list of available duplex printing modes.

4 Press Δ or ∇ to select the desired duplex printing mode.

The message display toggles through the following:

Off (default)

Bind Long Edge

Bind Short Edge

Selecting Off disables duplex printing.

5 Press **[OK]**. The duplex printing mode is set and the Function menu reappears.

Eco Print (Selecting the EcoPrint mode)

Set EcoPrint mode. For details, refer to *EcoPrint (Selecting the EcoPrint mode)* on page 6-35.

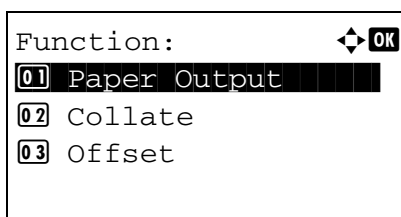

1 In the Copies menu or the Paper Selection menu, press [Function] (**[Right Select]**). The Function menu appears.

2 Press Δ or ∇ to select Eco Print.

3 Press **[OK]**. The Eco Print screen appears.

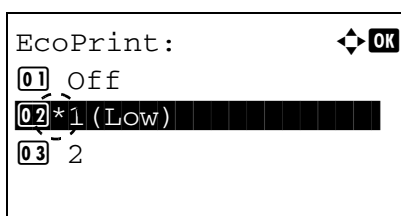

4 Press Δ or ∇ to select the EcoPrint mode.

5 Press **[OK]**. The EcoPrint mode is set and the Function menu reappears.

File Name Entry (entering a file name)

Enter the file name. The file name entered is displayed as the Job Name in the Job Status and Job Log.

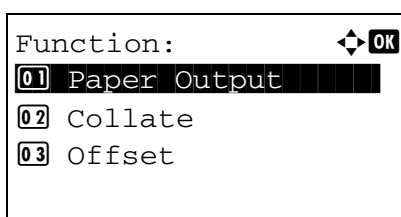

1 In the Copies menu or the Paper Selection menu, press [Function] (**[Right Select]**). The Function menu appears.

2 Press Δ or ∇ to select File Name Entry.

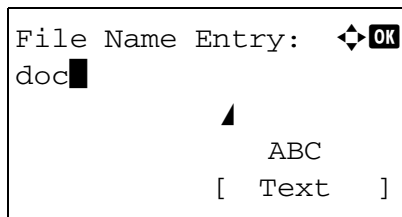

3 Press **[OK]**. The File Name Entry screen appears.

4 Enter the file name using the numeric keys.



Note Up to 32 characters can be entered. For details on entering characters, refer to *Character Entry Method* on page A-6.

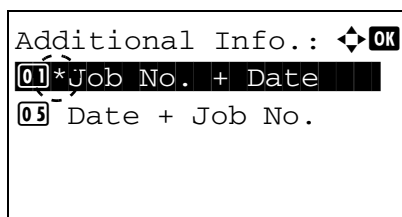

5 Press **[OK]**. The Additional Info. screen appears.

6 Press Δ or ∇ to select from the additional information that can be set for the file name.

The following settings can be selected.

- None (No additional information is added.)
- Date (To add the date.)
- Job No. (To add the Job Number.)
- Job No. + Date (To add the Job Number and date.)
- Date + Job No. (To add the date and Job Number.)

7 Press **[OK]**. Register the file name and the Function menu reappears.

JobFinish Notice (Setting for notification when jobs are finished.)

Notification that a job has finished is sent by E-Mail.

 **Note** To send E-mail from this machine, set the SMTP and POP3 settings to On. For details, refer to the *Protocol Detail (Detailed settings for the network protocol)* on page 6-46.

It is necessary to register a mail server. For the method for setting the server, refer to the section on *Command Center RX* on page 2-18.

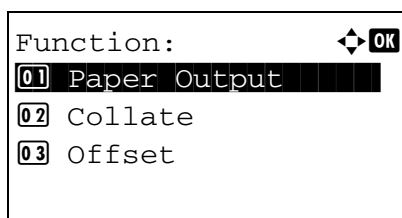

1 In the Copies menu or the Paper Selection menu, press [Function] (**[Right Select]**). The Function menu appears.

2 Press Δ or ∇ to select JobFinish Notice.

3 Press **[OK]**. The JobFinish Notice screen appears.

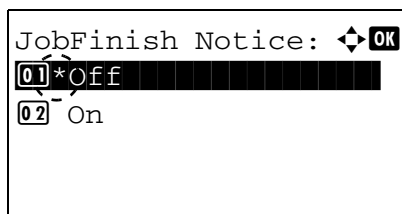

4 Press Δ or ∇ to select On.

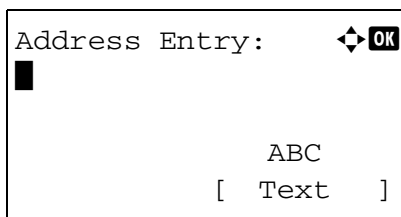

- 5 Press **[OK]**. The Address Entry screen appears.

- 6 Enter the address to be notified.



Note Up to 128 characters can be entered. For details on entering characters, refer to *Character Entry Method on page A-6*.

When user login administration is enabled, the address of the logged in user is entered.

- 7 Press **[OK]**. Register the address and the Function menu reappears.

Encrypted PDF (PDF password entry)

The password of a PDF file can be entered.

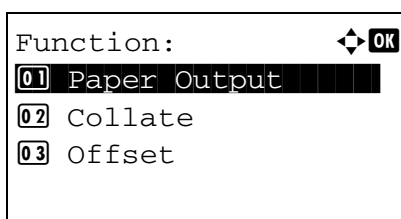

- 1 In the Copies menu or the Paper Selection menu, press **[Function] ([Right Select])**. The Function menu appears.

- 2 Press Δ or ∇ to select Encrypted PDF.

- 3 Press **[OK]**. The Password input menu screen appears.

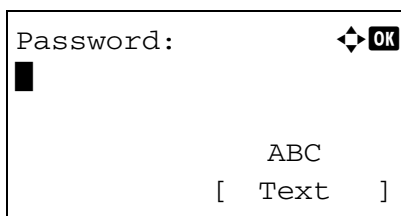

- 4 Enter the password for the PDF file.



Note Up to 256 characters can be entered. For details on entering characters, refer to *Character Entry Method on page A-6*.

- 5 Press **[OK]** to enter the password and the Function menu reappears.

TIFF/JPEG Size (Adjusting the TIFF/JPEG file print out size)

Use this setting to select the printing method used when TIFF or JPEG files are printed directly.

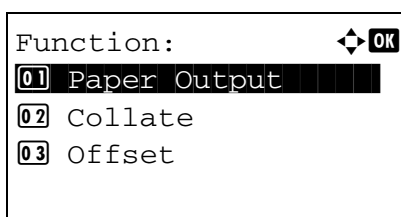

- 1 In the Copies menu or the Paper Selection menu, press **[Function] ([Right Select])**. The Function menu appears.

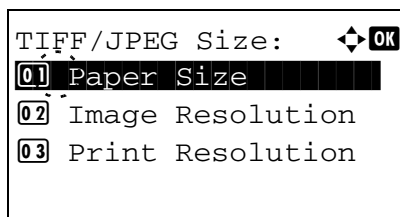

2 Press Δ or ∇ to select **TIFF/JPEG Size**.

3 Press **[OK]**. The **TIFF/JPEG Size** screen appears.

The options available in **TIFF/JPEG Size** are as follows:

- **Paper Size (default)**
Images are resized so that they fill the paper size when printed.
- **Image Resolution**
Image files are printed at the resolution specified in the resolution information. Images with no resolution information are printed using the Paper Size setting.
- **Print Resolution**
Images are printed using a 1-to-1 correspondence between the image file pixels and printed dots. For example, the printed size of a 600 x 300-pixel image file is 1 inch x 1/2 inch.

4 Press Δ or ∇ to select whether **TIFF/JPEG Size** mode is enabled.

5 Press **[OK]**. The **TIFF/JPEG Size** setting is set and the **Function** menu reappears.



Note Images are automatically rotated during printing to provide a closer match between the aspect ratios of the image file and the paper used for printing.

XPS FitTo Page (Adjusting the XPS file print out size)

Reduces or enlarges the image size to fit to the selected paper size when printing XPS file.

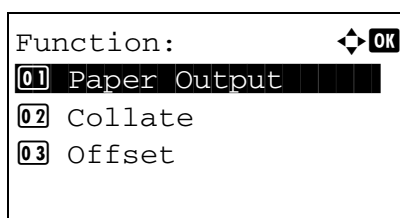

1 In the **Copies** menu or the **Paper Selection** menu, press **[Function]** (**[Right Select]**). The **Function** menu appears.

2 Press Δ or ∇ to select **XPS FitTo Page**.

3 Press **[OK]**. The **XPS FitTo Page** screen appears.

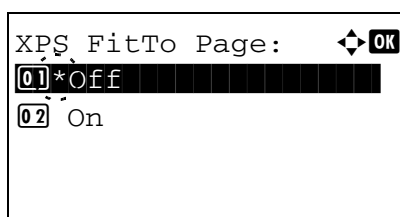

4 Press Δ or ∇ to select whether **XPS FitTo Page** mode is enabled.

5 Press **[OK]**. The **XPS FitTo Page** setting is set and the **Function** menu reappears.

Detail (Shows the details of the selected file)

Use this to view detailed information on the files and folders in the USB memory.

1 Use the procedure described in *Print File (Printing and checking the files in the USB memory)* on page 6-7 to display a list of the files or folders you want to check.

2 Press Δ or ∇ to select the folder or file you want to check.

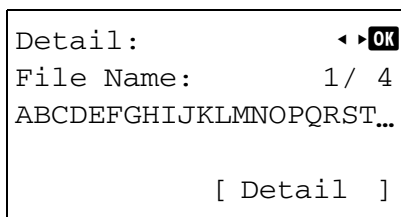

- 3 Press [Detail] (**[Right Select]**). The Detail screen appears. If you selected a file, there are 4 Detail screens. Press ◀ or ▶ to move between the screens.

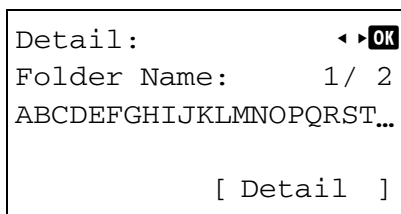

If you selected a folder, there are 2 Detail screens. Press ◀ or ▶ to move between the screens.

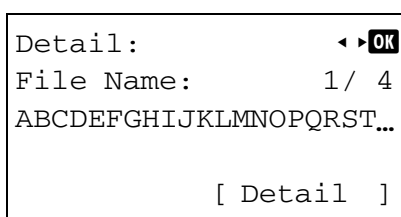

If the entire name shown as the File Name or Folder Name will not fit on one line, pressing [Detail] (**[Right Select]**) changes to a 3-line name display. If the name is 3 or more lines long, you can scroll up or down by pressing ▲ or ▼.

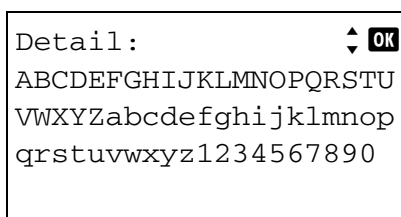

Pressing **[OK]** twice while file or folder details are displayed returns you to the Print File menu.

Remove Memory (Removing the USB memory)

Allows you to remove a USB memory device.

IMPORTANT If the correct procedure is not followed to remove a USB memory device, the data may be corrupted or the device may be damaged.

- 1 In the USB Memory menu, press ▲ or ▼ to select *Remove Memory*.
- 2 Press **[OK]**. The printer is now ready for the USB memory to be removed and the Mode Selection menu screen appears.

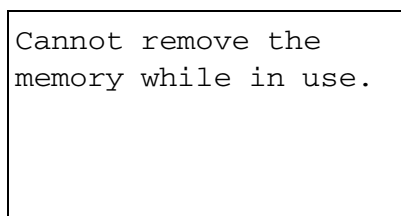

IMPORTANT If the screen on the left appears, the USB memory is still being used. Wait until the relevant job (e.g. printing from the USB memory) has ended and then repeat the Remove Memory procedure.

Counter (Viewing the counter value)

Displays the number of pages printed.

The options available in Counter are as follows:

- Total (Displaying the total printed pages)...6-16
- Color (Displaying the color printed pages)...6-17
- Black & White (Displaying the monochrome printed pages)...6-17

- 1 Press **[MENU]**.
- 2 Press Δ or ∇ to select Counter.
- 3 Press **[OK]**. The Counter menu appears.
- 4 Select **[All]**.

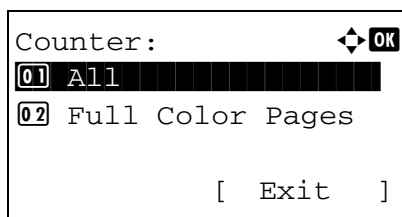

- 5 Press **[OK]**. The All menu appears showing a list of available options.

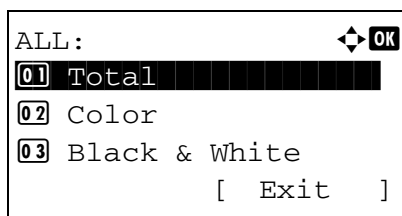

Total (Displaying the total printed pages)

This only displays the total number of pages printed. You cannot change the displayed number.

- 1 In the Counter menu screen, press Δ or ∇ to select Total.
- 2 Press **[OK]**. The Total screen appears showing the total number of pages printed.

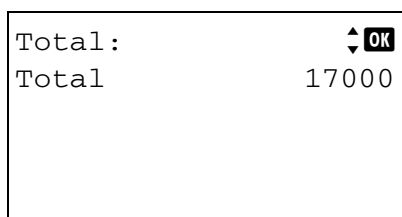

Color (Displaying the color printed pages)

This allows you to check the total number of color pages printed and the number of color pages printed in each of the 12 paper sizes.

You cannot change the displayed number.

Color:	↕	OK
Total	17000	
A3	2000	
A4	1000	

- 1 In the Counter menu screen, press Δ or ∇ to select **Color**.
- 2 Press **[OK]**. The **Color** screen appears showing the total number of color pages printed and the number of color pages printed in 2 paper sizes.

Press Δ or ∇ to view the number of color pages printed in other paper sizes.

Pressing **[OK]** returns you to the Counter menu.

Black & White (Displaying the monochrome printed pages)

This allows you to check the total number of monochrome pages printed and the number of monochrome pages printed in each of the 12 paper sizes.

You cannot change the displayed number.

Black & White:	↕	OK
Total	17000	
A3	2000	
A4	1000	

- 1 In the Counter menu screen, press Δ or ∇ to select **Black & White**.
- 2 Press **[OK]**. The **Black & White** screen appears showing the total number of monochrome pages printed and the number of monochrome pages printed in 2 paper sizes.

Press Δ or ∇ to view the number of monochrome pages printed in other paper sizes.

Pressing **[OK]** returns you to the Counter menu.

Paper Settings

This sets the paper size and type for the MP tray and cassettes from which paper is supplied.

The options available in Paper Settings are as follows:

- MP Tray Set. (MP tray settings)...6-19
 - Paper Size (Paper size setting for MP tray)...6-19
 - Media Type (Paper type setting for MP tray)...6-21
- Cassette (1 to 7) Set. (Settings for the cassettes)...6-22
 - Cassette (1 to 7) Size (Setting the cassette paper size)...6-22
 - Cassette (1 to 7) Type (Setting the cassette paper type)...6-23
- Media Type Set. (Paper type settings)...6-23
- Reset Type Adj. (Resets customized settings)...6-27

1 Press **[MENU]**.

2 Press Δ or ∇ to select Paper Settings.

3 Press **[OK]**. The Paper Settings menu appears showing a list of available options.

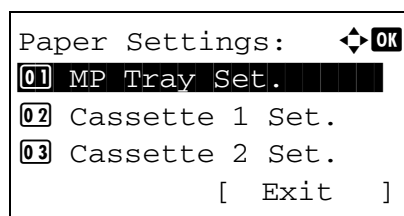

Media Type Set.

Set the type of paper used in the paper cassette and Multi Purpose Tray. This will allow you to select the paper type in the printer driver when you print.

In addition to paper types registered in the machine, you can set custom paper types. For details, refer to *Media Type Set. (Paper type settings)* on page 6-23.

Paper types that can be set vary depending on the paper source. Refer to the table below. For details, refer to *Paper* on page A-9.

Paper type (message display)	Paper Source	
	MP tray	Cassette
Plain (60 to 105 g/m ²)	Y	Y
Transparency	Y	N
Preprinted	Y	Y*
Labels	Y	N
Bond (60 to 256 g/m ²)	Y	Y
Recycled (60 to 105 g/m ²)	Y	Y
Rough	Y	Y*
Vellum	Y	Y*
Letterhead	Y	Y*
Color	Y	Y*
Prepunched (60 to 105 g/m ²)	Y	Y
Envelope (106 to 300 g/m ²)	Y	N

Paper type (message display)	Paper Source	
	MP tray	Cassette
Cardstock (106 to 300 g/m ²)	Y	N
Coated	Y	N
Thick (106 to 300 g/m ²)	Y	Y*
HighQuality (60 to 163 g/m ²)	Y	Y
CUSTOM#	Y	Y*

* Paper of weight up to 256 g/m² can be used in the paper cassette.

Y: Paper type can be set. N: Paper type cannot be set.

MP Tray Set. (MP tray settings)

To print correctly on paper supplied from the MP tray, use the procedure below to set the paper size and media type.

 **Note** Feeding the paper having a paper size which does not match the current paper size from the MP tray can cause paper jam.

The options available in MP Tray Set. menu are as follows:

- Paper Size (Paper size setting for MP tray)...6-19
- Media Type (Paper type setting for MP tray)...6-21

Paper Size (Paper size setting for MP tray)

You can use this to set the paper size that can be supplied from the MP tray. The default setting is Letter size for the U.S. and Canada and A4 for other countries.

For more information about the paper sizes that you can feed from the MP tray, refer to *Paper on page A-9*.

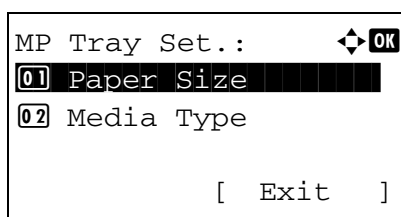

- 1 In the Paper Settings menu, press Δ or ∇ to select MP Tray Set..
- 2 Press [OK]. The MP Tray Set. menu screen appears.
- 3 Press Δ or ∇ to select Paper Size.

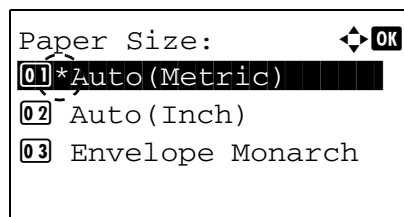

- 4** Press **[OK]**. The Paper Size screen appears listing the paper sizes that can be supplied from the MP tray.

The available paper sizes are as follows:

Auto (Metric)	Envelope #9
Auto (Inch)	Envelope #6
Envelope Monarch	ISO B5
Envelope #10	Custom
Envelope DL	Envelope C4
Envelope C5	Hagaki
Executive	Oufuku Hagaki
Letter-R	Oficio II
Letter	216x340mm
Legal	12x18"
A4-R	8K
A4	16K-R
B5-R	16K
B5	Statement
A3	Folio
B4	Youkei 2
Ledger	Youkei 4
A5	
A6	
B6	



Note To have the paper size automatically selected from metric sizes or inch sizes, select `Auto (Metric)` or `Auto (Inch)`.

- 5** Press Δ or ∇ to select the desired paper size.
- 6** Press **[OK]**. The paper size for the MP tray is set and the Paper Settings menu screen reappears.

Media Type (Paper type setting for MP tray)

You can use this to set the paper type that can be supplied from the MP tray. The default setting is PLAIN.

For more information about paper types that you can feed from the MP tray, refer to *Paper on page A-9*.

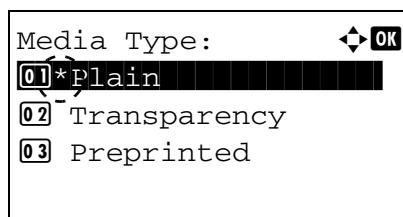
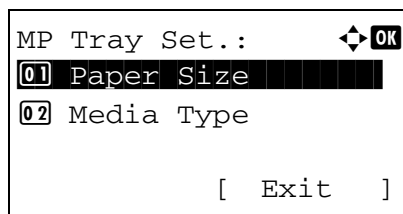

- 1 In the Paper Settings menu, press Δ or ∇ to select MP Tray Set..
- 2 Press [OK]. The MP Tray Set. menu screen appears.

- 3 Press Δ or ∇ to select Media Type.
- 4 Press [OK]. The Media Type screen appears listing the media types that can be supplied from the MP tray.

The available paper sizes are as follows:

Plain
 Transparency
 Preprinted
 Labels
 Bond
 Recycled
 Vellum
 Rough
 Letterhead
 Color
 Prepunched
 Envelope
 Cardstock
 Coated
 Thick
 HighQuality
 CUSTOM 1 to 8

- 5 Press Δ or ∇ to select the desired media type.
- 6 Press [OK]. The media type for the MP tray is set and the Paper Settings menu screen reappears.

Cassette (1 to 7) Set. (Settings for the cassettes)

When loading paper in the printer's paper cassette, follow the steps below to set the paper size and paper type.

If the optional paper feeder is installed, use the same procedure to set the cassette paper size and paper type.

Cassette (1 to 7) Size (Setting the cassette paper size)

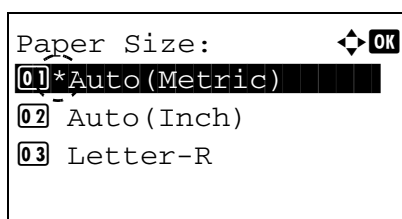
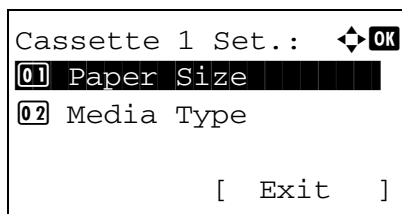

1 In the Paper Settings menu, press Δ or ∇ to select the paper cassette you want to set.

2 Press **[OK]**. The `Cassette # Set.` menu screen appears.

3 Press Δ or ∇ to select `Paper Size`.

4 Press **[OK]**. The `Paper Size` screen appears listing the paper sizes that can be used with the selected cassette.

The available paper sizes are as follows:

Auto (Metric)
 Auto (Inch)
 Letter-R
 Letter
 Legal
 A4-R
 A4
 B5-R
 B5
 A3
 B4
 Ledger
 A5
 Oficio II
 216x340mm
 12x18"
 8K
 16K-R
 16K
 Statement
 Folio



Note To have the paper size automatically selected from metric sizes or inch sizes, select `Auto (Metric)` or `Auto (Inch)`.

5 Press Δ or ∇ to select the desired paper size.

6 Press **[OK]**. The paper size for the cassette is set and the `Paper Settings` menu screen reappears.

Cassette (1 to 7) Type (Setting the cassette paper type)

By setting a paper type (plain, recycled, etc.) for the paper cassette, you can automatically select the paper in the paper cassette according to the paper type you command on the printer driver. The default setting is plain paper for all paper cassettes.

For more information about paper types that you can feed from the paper cassette, refer to *Paper* on page A-9.

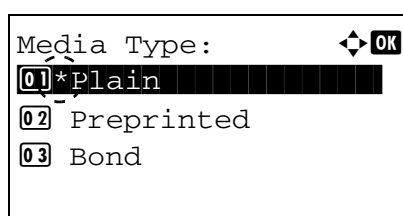
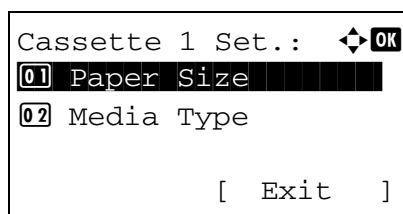

- 1 In the Paper Settings menu, press Δ or ∇ to select the cassette you want to set.
- 2 Press **[OK]**. The Cassette # Set. menu screen appears.
shows the number of the cassette installed in the printer (1 to 7).

- 3 Press Δ or ∇ to select Media Type.
- 4 Press **[OK]**. The Media Type screen appears listing the media types that can be used with the selected cassette.

The available Media Types are as follows:

Plain
Preprinted
Bond
Recycled
Vellum
Rough
Letterhead
Color
Prepunched
Thick
HighQuality
CUSTOM1 to 8

- 5 Press Δ or ∇ to select the desired media type.
- 6 Press **[OK]**. The media type for the cassette is set and the Paper Settings menu screen reappears.

Media Type Set. (Paper type settings)

You set the paper thickness by selecting a paper weight. This allows you to set the paper thickness for each of the media types that can be used on the printer. And for custom paper registered in the printer (up to 8), you can specify paper thickness and whether duplex printing is permitted.

For normal settings, refer to *Setting the Paper Thickness* on page 6-24. For custom paper settings, refer to *Custom Paper Settings* on page 6-25.

Setting the Paper Thickness

You set the paper thickness by selecting a paper weight.

The available paper weights are as follows (grammages are provided as a guide)

Extra Heavy (OHP)

Heavy 5 (257 to 300 g/m²)

Heavy 4 (221 to 256 g/m²)

Heavy 3 (164 to 220 g/m²)

Heavy 2 (136 to 163 g/m²)

Heavy 1 (105 to 135 g/m²)

Normal 3 (91 to 105 g/m²)

Normal 2 (75 to 90 g/m²)

Normal 1 (60 to 74 g/m²)

Light (52 to 59 g/m²)

Change the weight of each media type so that the optimum print result is obtained. The default setting for each media type is shown below.

Media Type	Paper Weight
Plain	Normal 2
Transparency	Extra Heavy
Preprinted	Normal 2
Labels	Heavy 2
Bond	Normal 3
Recycled	Normal 2
Vellum	Heavy 1
Rough	Normal 3
Letterhead	Normal 2
Color	Normal 3
Prepunched	Normal 2
Envelope	Heavy 2
Cardstock	Heavy 4
Coated	Heavy 1
Thick	Heavy 1
HighQuality	Normal 2
CUSTOM1 to 8	Normal 2

Use the procedure below to set the paper weight.

(For the procedure for setting weights for custom paper (CUSTOM 1 to 8), refer to *Custom Paper Settings on page 6-25*.)

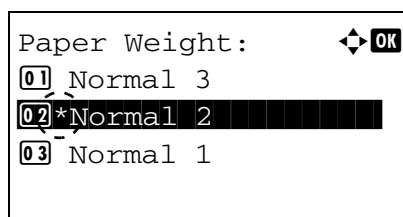
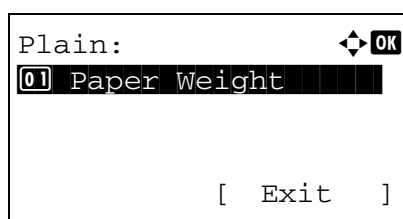
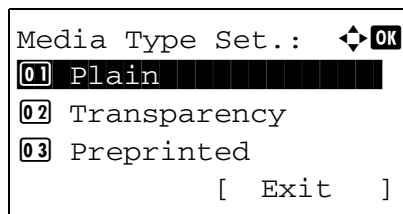

1 In the Paper Settings menu, press Δ or ∇ to select `Media Type Set..`

2 Press **[OK]**. The `Media Type Set.` screen appears listing the media types that can used with the printer.

3 Press Δ or ∇ to select the media type for which you want to set the paper weight.

4 Press **[OK]**. A menu for the selected media is displayed.

5 Press Δ or ∇ to select `Paper Weight`.

6 Press **[OK]**. The `Paper Weight` screen appears listing the paper weights that can used with the printer.

7 Press Δ or ∇ to select the desired paper weight.

8 Press **[OK]**. The paper weight is set and the `Media Type Set.` screen reappears.

Custom Paper Settings

This setting specifies the paper weight of the selected custom paper and whether duplex printing is permitted.

Use the procedure below to set the custom paper weight.

1 In the Paper Settings menu, press Δ or ∇ to select `Media Type Set..`

2 Press **[OK]**. The `Media Type Set.` screen appears listing the media types that can used with the printer.

3 Press Δ or ∇ to select the custom paper (CUSTOM 1 to 8) for which you want to set the paper weight.

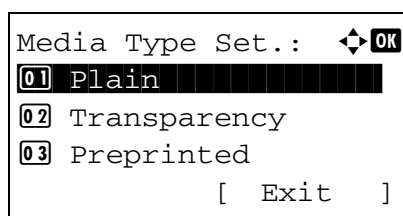

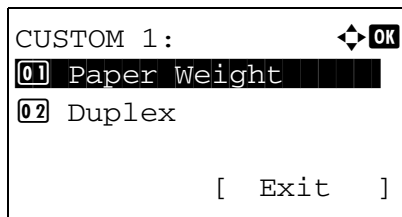

4 Press **[OK]**. A menu for the selected media is displayed.

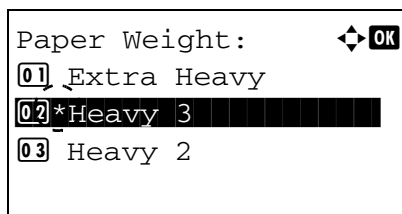

5 Press Δ or ∇ to select Paper Weight.

6 Press **[OK]**. The Paper Weight screen appears listing the paper weights that can used with the printer.

7 Press Δ or ∇ to select the desired paper weight.

8 Press **[OK]**. The paper weight is set and the Media Type Set. screen reappears.

Use the procedure below to specify whether duplex printing is permitted with custom paper.

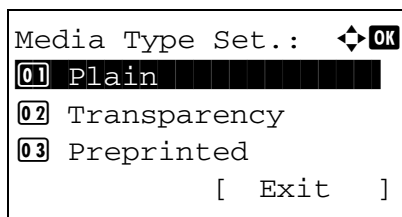

1 In the Paper Settings menu, press Δ or ∇ to select Media Type Set..

2 Press **[OK]**. The Media Type Set. screen appears listing the media types that can used with the printer.

3 Press Δ or ∇ to select the custom paper (CUSTOM 1 to 8) for which you want to set the duplex printing permission.

4 Press **[OK]**. A menu for the selected media is displayed.

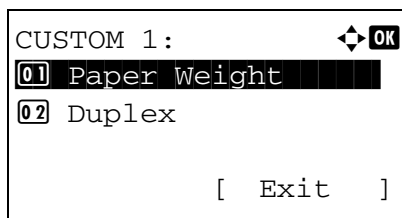

5 Press Δ or ∇ to select Duplex.

6 Press **[OK]**. The Duplex screen appears listing the paper weights that can used with the printer.

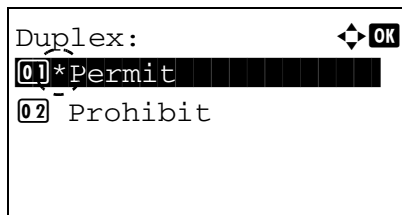

7 Press Δ or ∇ to specify whether duplex printing is permitted.

8 Press **[OK]**. The duplex printing permission is set and the Media Type Set. screen reappears.

Reset Type Adj. (Resets customized settings)

This resets all the settings specified in *Media Type Set. (Paper type settings)* on page 6-23.

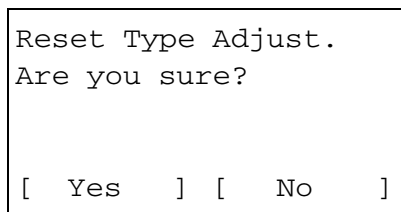

- 1** In the Paper Settings menu, press \triangle or ∇ to select `Reset Type Adj..`
- 2** Press **[OK]**. A confirmation screen appears.
- 3** Press `[Yes]` (**[Left Select]**). The message `Completed.` appears and the Paper Settings menu reappears.
Pressing `[No]` (**[Right Select]**) returns you to the Paper Settings menu without resetting the customized settings.

Print Settings

These settings specify the following printing parameters: paper feed source, paper feed mode, duplex printing, override A4/LTR, emulation mode, color mode, print quality, and setting pagination.

The options available in Print Settings are as follows:

- Paper Source (Selecting the paper feed source)...6-28
- MP Tray Priority (the settings for priority paper feed from the MP tray)...6-29
- Paper Feed Mode (Setting the paper feed source)...6-29
- Duplex (Setting the duplex printing)...6-30
- Paper Output (Selecting the Paper Output Location)...6-31
- Override A4/LTR (Overriding difference between A4 and Letter)...6-32
- Emulation (Setting the emulation)...6-32
- Color Mode (Selecting color or black & white printing)...6-34
- Print Quality (Setting print quality)...6-34
- Page Setting (Setting pagination)...6-36
- Offset 1PageDoc. (Offset One Page Documents)...6-38
- User Name (The User Name display settings)...6-39
- Job Name (The Job Name display settings)...6-39

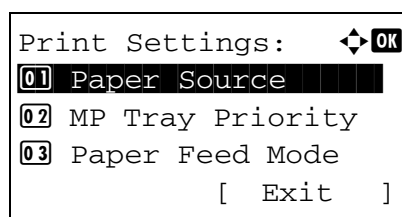

- 1** Press **[Menu]**.
- 2** Press Δ or ∇ to select **Print Settings**.
- 3** Press **[OK]**. The **Print Settings** menu appears showing a list of available options.

Paper Source (Selecting the paper feed source)

You can select the paper source from which the printer feeds paper as the default. If an optional paper feeder(s) is installed, it can also be set the default paper source.

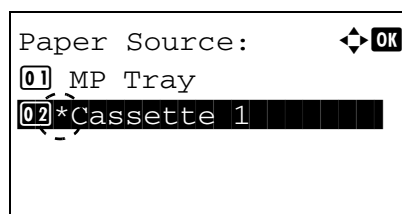

- 1** In the **Print Settings** menu, press Δ or ∇ to select **Paper Source**.
- 2** Press **[OK]**. The **Paper Source** screen appears showing a list of the available paper sources.
The available paper sources are as follows:
MP Tray
Cassette 1 (printer's standard paper cassette)
Cassette 2 to 5 (optional paper feeders (only installed paper feeders are shown))
Cassette 5 to 7 (optional side feeders (only installed side feeders are shown))
- 3** Press Δ or ∇ to select the desired paper source.
- 4** Press **[OK]**. The paper source is set and the **Print Settings** menu reappears.

MP Tray Priority (the settings for priority paper feed from the MP tray)

If paper is set in the MP Tray then it is possible for priority to be given to that MP tray in the paper feed.

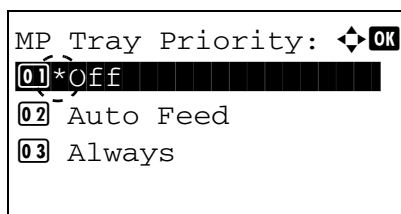

- 1 In the Print Settings menu, press Δ or ∇ to select `Paper Selection`.
- 2 Press **[OK]**. The `MP Tray Priority` screen appears showing the available MP tray priority mode options.
 - `Off` (The printer driver settings are followed.)
 - `Auto Feed` (If `Auto` is selected in the printer driver and there is paper in the MP tray then the paper feed will be from the MP tray.)
 - `Always` (If there is paper in the MP tray then the paper feed will be from the MP tray regardless of what is set in the printer driver.)
- 3 Press Δ or ∇ to select the desired MP tray priority mode.
- 4 Press **[OK]**. The MP tray priority mode is set and the Print Settings menu reappears.

Paper Feed Mode (Setting the paper feed source)

This mode specifies how the paper should be fed once the paper feed source and paper type have been chosen. If `Auto` is selected, the printer searches for a paper feed source that matches the paper size and type, and paper is then delivered from that source. If `Fixed` is selected and there is no matching paper feed source, handling proceeds as specified by `Paper Mismatch for Error Handling`. For details on paper feeding when `Fixed` is selected, refer to *Paper Mismatch (Detection settings for paper size/type errors when the paper source is fixed)* on page 6-69. The default setting is `Auto`. To change the settings, follow the steps described below.

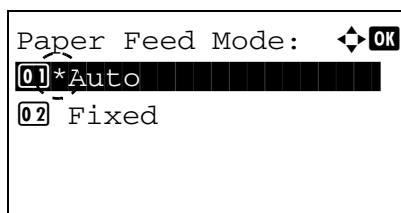

- 1 In the Print Settings menu, press Δ or ∇ to select `Paper Feed Mode`.
- 2 Press **[OK]**. The `Paper Feed Mode` screen appears showing the available paper feed options.
- 3 Press Δ or ∇ to select the desired paper feed mode.
- 4 Press **[OK]**. The paper feed mode is set and the Print Settings menu reappears.

When the Paper Runs Out During Printing

When `Paper Feed Mode` is set to `Fixed`, if the paper in the cassette runs out during printing, `Add paper in cassette 1.` is displayed and the printer stands by. In this event, either replenish the paper in the empty cassette or use the procedure below to print from another paper source.

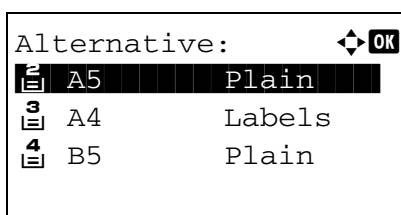

- 1 While `Add paper in cassette 1.` is displayed, press **[Alt.] ([Left Select])**. The `Alternative` menu screen appears.
- 2 Press Δ or ∇ to select the desired paper feed source and paper size. Each time you press Δ or ∇ , another optional cassette or the paper size that can currently be fed from the MP tray appears.
- 3 Press **[OK]**. Printing continues.

Duplex (Setting the duplex printing)

Paper types that can be used for duplex printing are types that can be fed from the paper cassette.

 **Note** Transparencies, labels, vellum, envelopes, cardstock, coated, and Heavy 5 (257 g/m²) or heavier paper cannot be used for duplex printing. (Refer to *Media Type Set* on page 6-18.)

Binding Modes

Binding refers to the manner in which printed pages of paper are joined together (by gluing, stitching, etc.) in book form. The two possible types of binding are: Bind Long Edge, in which pages are joined together along their long edge; and Bind Short Edge, in which they are joined together along their short edge. In selecting a binding type, you must also consider the orientation of the printed page. You can use Bind Long Edge or Bind Short Edge with either landscape or portrait printing.

Depending on the binding type and print orientation, the duplexer provides four types of binding. These are: (1) portrait, Bind Long Edge, (2) portrait, Bind Short Edge, (3) landscape, Bind Long Edge, and (4) landscape, Bind Short Edge. The figure below shows these binding methods.

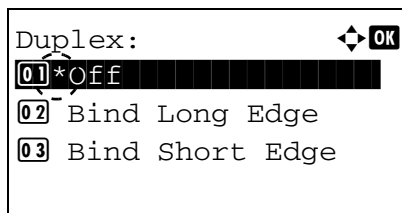
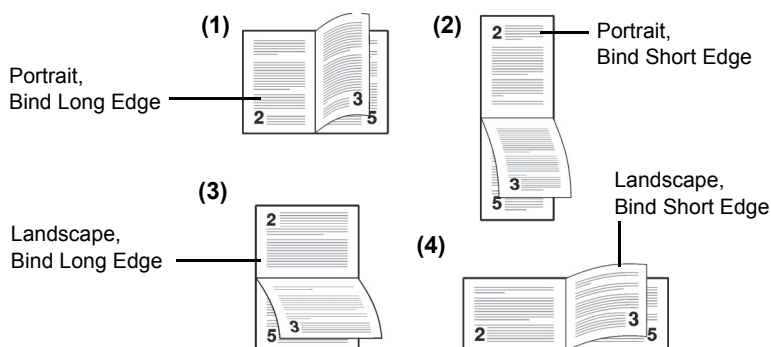

- 1 In the Print Settings menu, press Δ or ∇ to select Duplex.
- 2 Press [OK]. The Duplex screen appears showing the list of available duplex printing modes.
- 3 Press Δ or ∇ to select the desired duplex printing mode. The message display toggles through the following:
 - Off (default)
 - Bind Long Edge
 - Bind Short Edge
 Selecting Off disables duplex printing.
- 4 Press [OK]. The duplex printing mode is set and the Print Settings menu reappears.

Paper Output (Selecting the Paper Output Location)

This setting can be specified when an optional document finisher is installed.

You can select whether print jobs are output to the top tray of the printer, or to the optional document finisher or mail box.



Note The screen varies depending on the installed options.

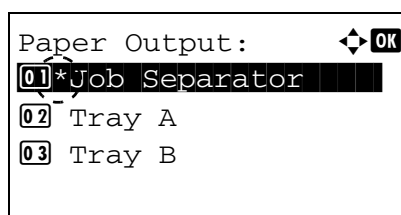

- 1 In the Print Settings menu, press Δ or ∇ to select Paper Output.
- 2 Press [OK]. The Paper Output screen appears showing the available output locations.



Note The screen shown appears when a 4,000-Sheet Finisher is installed.

- 3 Press Δ or ∇ to select the desired output location.

The available output locations are as follows:

4,000-Sheet Finisher installed

Job Separator
 Tray A
 Tray B
 Tray 1*
 Tray 2*
 Tray 3*
 Tray 4*
 Tray 5*
 Tray 6*
 Tray 7*
 *Tray of optional mail box

1,000-Sheet Finisher installed

Job Separator
 Left Tray

- 4 Press [OK]. The selected output location is stored and the Print Settings menu reappears.

Override A4/LTR (Overriding difference between A4 and Letter)

When the `Override A4/LTR` is turned `On` using the operation panel, the printer ignores the difference between A4 and Letter paper sizes. Printing is performed without an error message even if the actual paper size in the current cassette differs from the paper size formatting the job.

By default, this feature is `On`.

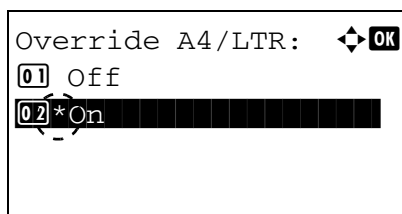

- 1 In the Print Settings menu, press Δ or ∇ to select `Override A4/LTR`.
- 2 Press **[OK]**. The `Override A4/LTR` screen appears showing the shared paper feed mode settings.

- 3 Press Δ or ∇ to select the desired shared paper feed mode.
- 4 Press **[OK]**. The shared paper feed mode is set and the Print Settings menu reappears.

Emulation (Setting the emulation)

You can change the emulation mode for the current interface. Use the procedure below to select the mode.

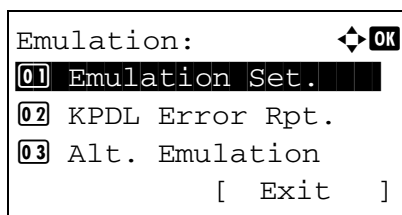

- 1 In the Print Settings menu, press Δ or ∇ to select `Emulation`.
- 2 Press **[OK]**. The `Emulation` menu screen appears.

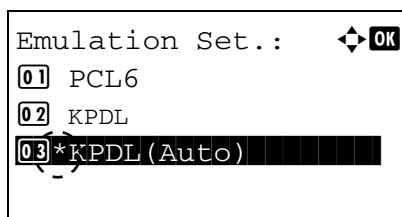

- 3 Press Δ or ∇ to select `Emulation Set..`
- 4 Press **[OK]**. The `Emulation Set.` screen appears showing a list of the available emulations. The defaults differ depending on the delivery destination.

The available emulations are as follows:

PCL6
 IBM Proprinter*
 DIABLO 630*
 EPSON LQ-850*
 KPDL
 KPDL (Auto)

*This appears when the Emulation Option is installed.

- 5 Press Δ or ∇ to select the desired emulation.
- 6 Press **[OK]**. The emulation is set and the Print Settings menu reappears.

KPDL Error Rpt. (Printing KPDL errors)

The printer can print error descriptions when printing error occurs during KPDL emulation. The default is On — the printer does not print KPDL errors.

IMPORTANT This setting only appears when KPDL or KPDL (Auto) is selected for the emulation.

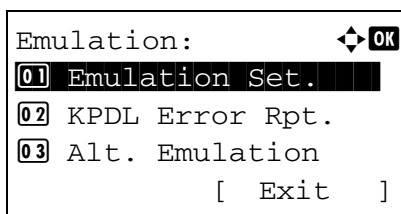

- 1 In the Print Settings menu, press Δ or ∇ to select Emulation Set..
- 2 Press [OK]. The Emulation menu screen appears.

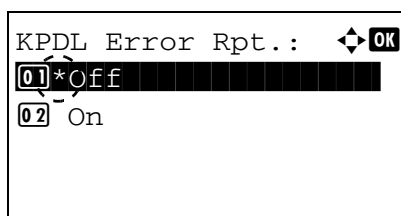

- 3 Press Δ or ∇ to select KPDL Error Rpt..
- 4 Press [OK]. The KPDL Error Rpt. screen appears.

- 5 Press Δ or ∇ to select whether error reports are printed.
- 6 Press [OK]. The error report print setting is set and the Print Settings menu reappears.

Alt. Emulation (Alternative Emulation for KPDL Emulation)

KPDL is Kyocera's implementation of the PostScript language. The KPDL (AUTO) emulation enables the printer to automatically change the emulation mode according to the data received when printing.

In addition to KPDL (AUTO) emulation, you can use the operation panel to set another emulation mode that is used very often. The default setting is PCL 6.

IMPORTANT This setting only appears when KPDL (Auto) is selected for the emulation.

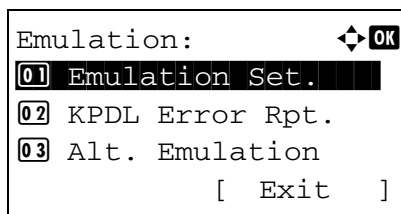

- 1 In the Print Settings menu, press Δ or ∇ to select Emulation.
- 2 Press [OK]. The Emulation menu screen appears.

- 3 Press Δ or ∇ to select Alt. Emulation.

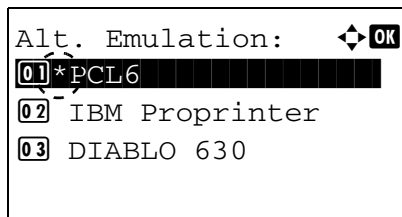

- 4 Press **[OK]**. The `Alt. Emulation` screen appears showing a list of the available alternative emulations.

The available alternative emulations are as follows:

PCL6
 IBM Proprinter*
 DIABLO 630*
 EPSON LQ-850*

*This appears when the Emulation Option is installed.

- 5 Press Δ or ∇ to select the desired alternative emulation.
- 6 Press **[OK]**. The alternative emulation is set and the `Print Settings` menu reappears.

Color Mode (Selecting color or black & white printing)

When executing printing at the printer, you can select Color mode or Black & White mode. By default, the printer is set to print in color mode.

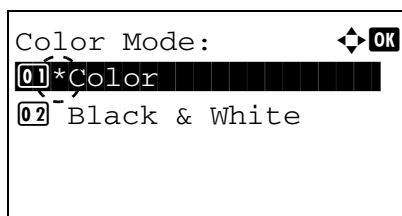

- 1 In the `Print Settings` menu, press Δ or ∇ to select `Color Mode`.
- 2 Press **[OK]**. The `Color Mode` screen appears.

- 3 Press Δ or ∇ to select the desired color mode.
- 4 Press **[OK]**. The color mode is set and the `Print Settings` menu reappears.

Print Quality (Setting print quality)

In `Print Quality` menus, you can set the `EcoPrint` mode, `Toner SaveLevel`, and `Gloss Mode`.

The options available in `Print Quality` are as follows:

- `EcoPrint` (Selecting the `EcoPrint` mode)...6-35
- `Toner SaveLevel` (Selecting the `Toner SaveLevel`)...6-35
- `Gloss Mode` (Setting gloss mode)...6-35

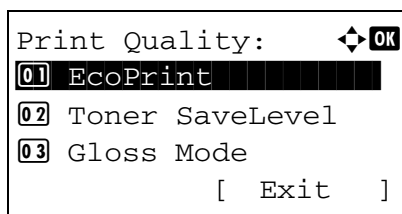

- 1 In the `Print Settings` menu, press Δ or ∇ to select `Print Quality`.
- 2 Press **[OK]**. The `Print Quality` menu screen appears.

EcoPrint (Selecting the EcoPrint mode)

By enabling EcoPrint mode, you can minimize the amount of toner used during printing. Because images printed in this mode may be slightly coarser than those printed in standard resolution, you should use EcoPrint for test prints or other situations where high-quality prints are not required.

Use the procedure below to select EcoPrint mode. The default setting is `Off`.

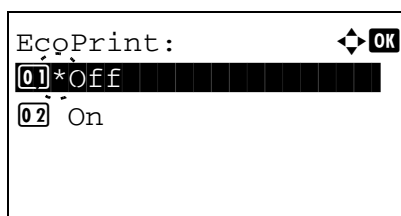

- 1 In the Print Quality menu, press Δ or ∇ to select `EcoPrint`.
- 2 Press **[OK]**. The `EcoPrint` screen appears.
- 3 Press Δ or ∇ to select the EcoPrint mode.
- 4 Press **[OK]**. The EcoPrint mode is set and the `Print Quality` menu screen reappears.

Toner SaveLevel (Selecting the Toner SaveLevel)

Select the default Toner SaveLevel. One of five levels [1] - [5] can be set.



Note Raising the level reduces toner consumption, but image quality falls.

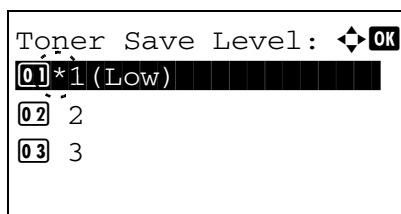

- 1 In the Print Quality menu, press Δ or ∇ to select `Toner Save Level`.
- 2 Press **[OK]**. The `Toner Save Level` screen appears.
- 3 Press Δ or ∇ to select the Toner SaveLevel mode.
- 4 Press **[OK]**. The Toner SaveLevel mode is set and the `Print Quality` menu screen reappears.

Gloss Mode (Setting gloss mode)

This feature can be used to set the glossiness of printed matter.

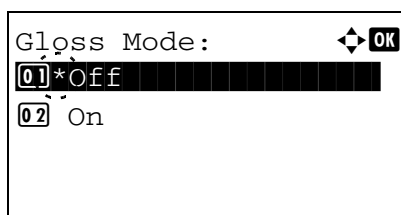

- 1 In the Print Quality menu, press Δ or ∇ to select `Gloss Mode`.
- 2 Press **[OK]**. The `Gloss Mode` screen appears.
- 3 Press Δ or ∇ to select whether Gloss Mode is enabled.
- 4 Press **[OK]**. The Gloss mode is set and the `Print Quality` menu screen reappears.

Page Setting (Setting pagination)

You can use the Page Setting menu to set the number of copies, the page orientation and other pagination settings.

The options available in Page Setting are as follows:

- Copies (Number of copies)...6-36
- Orientation (Print orientation)...6-36
- Wide A4 (Wide A4 pitch)...6-37
- XPS FitTo Page (Adjusting the XPS file print out size)...6-37
- TIFF/JPEG Size (Adjusting the TIFF/JPEG file print out size)...6-38

- 1 In the Print Settings menu, press Δ or ∇ to select Page Setting.
- 2 Press [OK]. The Page Setting menu screen appears.

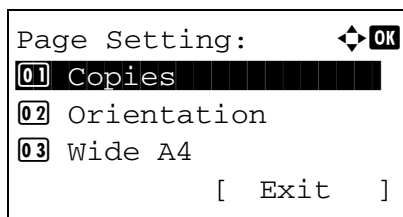

Copies (Number of copies)

You can set the number of copies of each page to be printed for the current interface.

- 1 In the Page Setting menu, press Δ or ∇ to select Copies.
- 2 Press [OK]. The Copies screen appears.

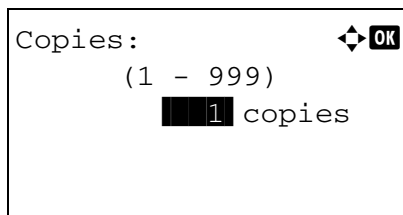

- 3 Use the numeric keys to set the number of copies.
- 4 Press [OK]. The setting is stored and the Page Setting menu reappears.

Orientation (Print orientation)

You can select portrait (upright) or landscape (sideways) page orientation.

Portrait Orientation

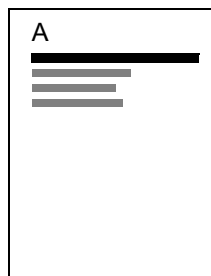

Landscape Orientation

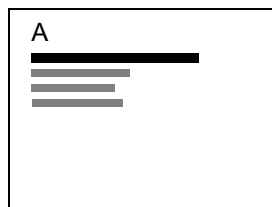

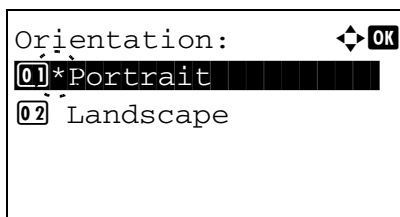

- 1 In the Page Setting menu, press Δ or ∇ to select Orientation.
- 2 Press [OK]. The Orientation screen appears.

- 3 Press Δ or ∇ to select the desired Orientation.
- 4 Press [OK]. The orientation is set and the Page Setting menu reappears.

Wide A4 (Wide A4 pitch)

Turn this to On to increase the maximum number of characters that can be printed in a line for an A4 page (78 characters at 10 pitch) and Letter size page (80 characters at 10 pitch). This setting is only effective in PCL 6 emulation.

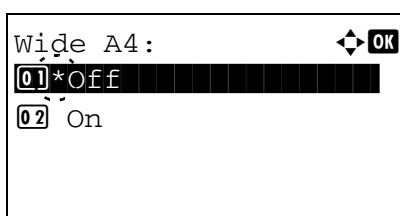

- 1 In the Page Setting menu, press Δ or ∇ to select Wide A4.
- 2 Press [OK]. The Wide A4 screen appears.

- 3 Press Δ or ∇ to select whether Wide A4 mode is enabled.
- 4 Press [OK]. The wide mode setting is set and the Page Setting menu reappears.

XPS FitTo Page (Adjusting the XPS file print out size)

Select On in this setting to enlarge or reduce XPS files to fit the printable area during printing.

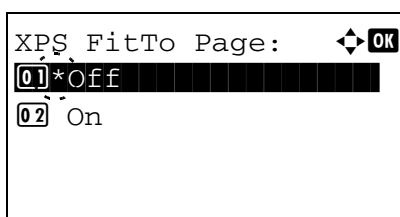

- 1 In the Page Setting menu, press Δ or ∇ to select XPS FitTo Page.
- 2 Press [OK]. The XPS FitTo Page screen appears.

- 3 Press Δ or ∇ to select whether XPS FitTo Page mode is enabled.
- 4 Press [OK]. The XPS FitTo Page setting is set and the Page Setting menu reappears.

TIFF/JPEG Size (Adjusting the TIFF/JPEG file print out size)

Use this setting to select the printing method used when TIFF or JPEG files are printed directly.

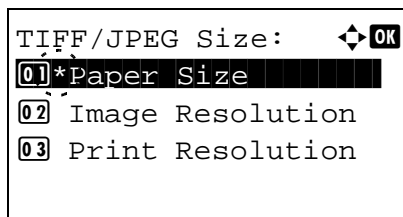

- 1 In the Page Setting menu, press Δ or ∇ to select **TIFF/JPEG Size**.
- 2 Press **[OK]**. The **TIFF/JPEG Size** screen appears.

The options available in **TIFF/JPEG Size** are as follows:

- **Paper Size (default)**
Images are resized so that they fill the paper size when printed.
- **Image Resolution**
Image files are printed at the resolution specified in the resolution information. Images with no resolution information are printed using the Paper Size setting.
- **Print Resolution**
Images are printed using a 1-to-1 correspondence between the image file pixels and printed dots. For example, the printed size of a 600 x 300-pixel image file is 1 inch x 1/2 inch.

- 3 Press Δ or ∇ to select whether **TIFF/JPEG Size** mode is enabled.
- 4 Press **[OK]**. The **TIFF/JPEG Size** setting is set and the **Page Setting** menu reappears.



Note Images are automatically rotated during printing to provide a closer match between the aspect ratios of the image file and the paper used for printing.

Offset 1PageDoc. (Offset One Page Documents)

Set whether one-page documents are sorted.

 **Note** This setting is displayed when an optional 1,000-sheet finisher or 4,000-sheet finisher is installed.

Item	Description
Off	Does not sort one-page documents.
On	Sorts one-page documents.

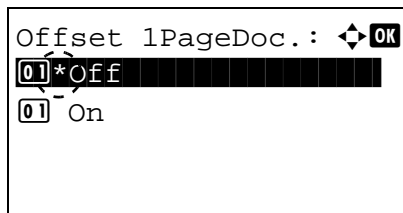

- 1 In the Print Settings menu, press Δ or ∇ to select **Offset 1PageDoc..**
- 2 Press **[OK]**. The **Offset 1PageDoc.** screen appears.

- 3 Press Δ or ∇ to select **On** or **Off**.
- 4 Press **[OK]**. The **Offset 1PageDoc.** setting is set and the **Print Settings** menu reappears.

User Name (The User Name display settings)

Set whether the job name set in the printer driver is displayed.

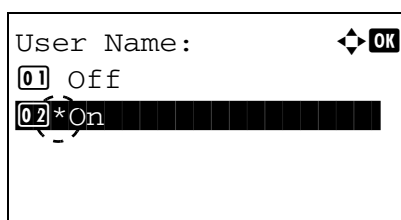

- 1 In the Print Settings menu, press Δ or ∇ to select `User Name`.
- 2 Press **[OK]**. The `User Name` screen appears.

- 3 Press Δ or ∇ to select `On` or `Off`.
- 4 Press **[OK]**. The `User Name` setting is set and the Print Settings menu reappears.

Job Name (The Job Name display settings)

Set whether the user name set in the printer driver is displayed.

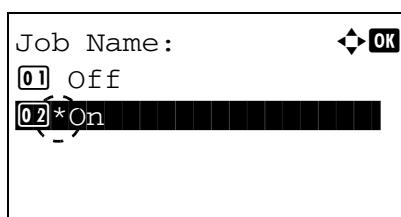

- 1 In the Print Settings menu, press Δ or ∇ to select `Job Name`.
- 2 Press **[OK]**. The `Job Name` screen appears.

- 3 Press Δ or ∇ to select `On` or `Off`.
- 4 Press **[OK]**. The `Job Name` setting is set and the Print Settings menu reappears.

Network (Network settings)

This printer supports TCP/IP and TCP/IP (IPv6) protocols.

IP is an abbreviation for Internet Protocol. This printer routinely uses the TCP/IP (IPv4) protocol, but provides a separate setting for the next-generation IP, IPv6.

TCP/IP (IPv4) uses 32-bit IP addresses, but the rapid growth in the number of Internet users has resulted in a shortage of IP addresses. IPv6 was developed to expand the range of available IP addresses by using 128-bit IP addresses.

The options available in the Network settings are as follows:

- TCP/IP (Enable/Disable TCP/IP)...6-40
- IPv4 Setting (TCP/IP IPv4 settings)...6-41
- IPv6 Setting (TCP/IP IPv6 settings)...6-44
- Protocol Detail (Detailed settings for the network protocol)...6-46
- Restart Network (Restarting the network card)...6-47

 **Note** Check with your network administrator when selecting the network setting. After all network related settings have been done, restart the network. Refer to *Restart Network (Restarting the network card)* on page 6-47. This is mandatory to make the settings effective!

When Command Center RX is used, network parameters and security settings can be conveniently changed and checked from your PC. For more information, refer to the *Command Center RX User Guide*.

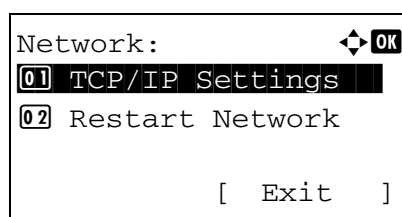

1 In the Print Settings menu, press Δ or ∇ to select *Network*.

2 Press **[OK]**. The *Network* menu screen appears.

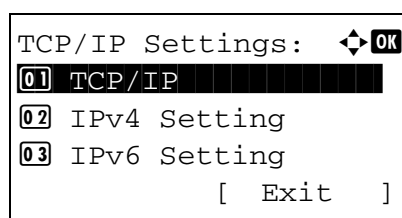

3 Select *TCP/IP Settings* and press **[OK]**. The *TCP/IP Settings* menu screen appears.

TCP/IP (Enable/Disable TCP/IP)

Select whether or not to use TCP/IP. The default setting is On.

IMPORTANT After changing the setting, restart the network, or turn the machine OFF and then ON. For detailed information on restarting the network, refer to *Restart Network (Restarting the network card)* on page 6-47.

1 In the TCP/IP Settings menu, press Δ or ∇ to select *TCP/IP*.

2 Press **[OK]**. The *TCP/IP* screen appears.

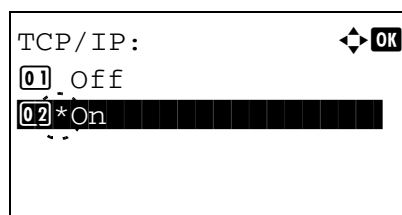

3 Press Δ or ∇ to select whether TCP/IP is enabled.

4 Press **[OK]**. The TCP/IP setting is set and the *TCP/IP Set.* menu reappears.

IPv4 Setting (TCP/IP IPv4 settings)

This selects the settings for TCP/IP (IPv4).

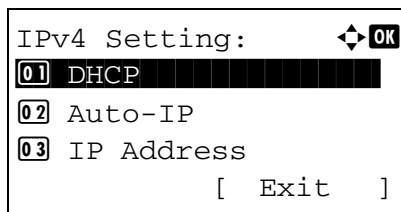

- 1 In the TCP/IP Settings menu, press Δ or ∇ to select IPv4 Setting.
- 2 Press **[OK]**. The IPv4 Setting menu screen appears.

The options available in the TCP/IP (IPv4) settings are as follows:

- DHCP (DHCP setting)...6-41
- Auto-IP (Auto-IP setting)...6-41
- IP Address (IP address setting)...6-42
- Subnet Mask (Subnet mask setting)...6-42
- Default Gateway (Gateway setting)...6-43
- Bonjour (Bonjour setting)...6-43

IMPORTANT The DHCP, Auto-IP, IP address, subnet mask, gateway and Bonjour menu options for TCP/IP (IPv4 settings) are displayed when TCP/IP is enabled.

DHCP (DHCP setting)

Select whether or not to use the DHCP server. The default setting is On.

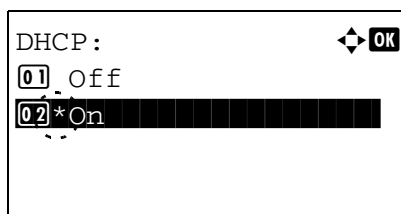

- 1 In the IPv4 Setting menu, press Δ or ∇ to select DHCP.
- 2 Press **[OK]**. The DHCP screen appears.

- 3 Press Δ or ∇ to select whether DHCP is enabled.
- 4 Press **[OK]**. The DHCP setting is set and the IPv4 Setting menu reappears.

Auto-IP (Auto-IP setting)

Select whether or not to use Auto-IP. The default setting is On.

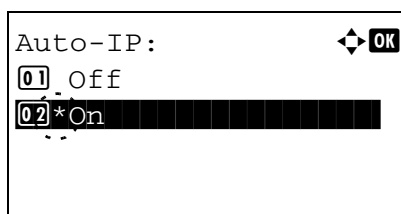

- 1 In the IPv4 Setting menu, press Δ or ∇ to select Auto-IP.
- 2 Press **[OK]**. The Auto-IP screen appears.

- 3 Press Δ or ∇ to select whether Auto-IP is enabled.
- 4 Press **[OK]**. The DHCP setting is set and the IPv4 Setting menu reappears.

IP Address (IP address setting)

Set the IP addresses.

 **Note** When you enter the IP address, be sure to set the DHCP setting to Off.

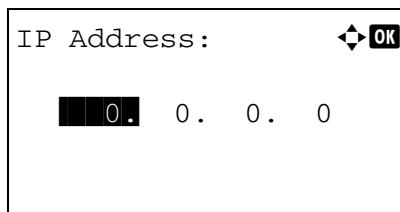

- 1 In the IPv4 Setting menu, press Δ or ∇ to select IP Address.
- 2 Press [OK]. The IP Address screen appears.

- 3 Use the numeric keys to set the IP address.
You can set any value between 000 and 255.
Increase or reduce the figures by pressing Δ or ∇ .
Use \triangleleft and \triangleright to move the position being entered, which is shown highlighted.
- 4 Press [OK]. The IP address is stored and the IPv4 Setting menu reappears.

Subnet Mask (Subnet mask setting)

Set the IP subnet mask.

 **Note** When you enter the subnet mask, be sure to set the DHCP setting to Off.

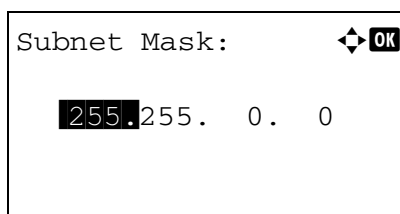

- 1 In the IPv4 Setting menu, press Δ or ∇ to select Subnet Mask.
- 2 Press [OK]. The Subnet Mask screen appears.

- 3 Use the numeric keys to set the subnet mask.
You can set any value between 000 and 255.
Increase or reduce the figures by pressing Δ or ∇ .
Use \triangleleft and \triangleright to move the position being entered, which is shown highlighted.
- 4 Press [OK]. The subnet mask setting is stored and the IPv4 Setting menu reappears.

Default Gateway (Gateway setting)

Set the IP gateway addresses.

 **Note** Before you input the gateway, be sure to set the DHCP setting to Off.

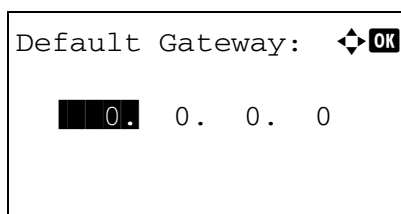

- 1 In the IPv4 Setting menu, press Δ or ∇ to select Default Gateway.
- 2 Press [OK]. The Default Gateway screen appears.

- 3 Use the numeric keys to set the default gateway.
You can set any value between 000 and 255.
Increase or reduce the figures by pressing Δ or ∇ .
Use \triangleleft and \triangleright to move the position being entered, which is shown highlighted.
- 4 Press [OK]. The default gateway is stored and the IPv4 Setting menu reappears.

Bonjour (Bonjour setting)

Select whether or not to use Bonjour. The default setting is On.

IMPORTANT After changing the setting, restart the network, or turn the machine OFF and then ON. For detailed information on restarting the network, refer to *Restart Network (Restarting the network card)* on page 6-47.

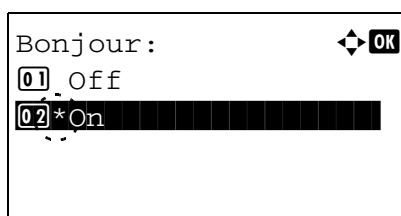

- 1 In the IPv4 Setting menu, press Δ or ∇ to select Bonjour.
- 2 Press [OK]. The Bonjour screen appears.

- 3 Press Δ or ∇ to select whether automatic detection is enabled.
- 4 Press [OK]. The automatic detection setting is set and the IPv4 Setting menu reappears.

IPv6 Setting (TCP/IP IPv6 settings)

Set up TCP/IP (IPv6) to connect to the network. The default settings are "TCP/IP Protocol: On, TCP/IP (IPv6): Off".

IMPORTANT After changing the setting, restart the network, or turn the machine OFF and then ON. For detailed information on restarting the network, refer to *Restart Network (Restarting the network card) on page 6-47*.

The options available in the TCP/IP (IPv6) settings are as follows:

- TCP/IP (IPv6) (Enable/disable TCP/IP (IPv6))...6-44
- RA (Stateless) (RA (Stateless) setting)...6-45
- DHCPv6 (DHCPv6 setting)...6-45

IMPORTANT The RA (Stateless) and DHCPv6 menu options for TCP/IP (IPv6) are displayed when TCP/IP (IPv6) is enabled.

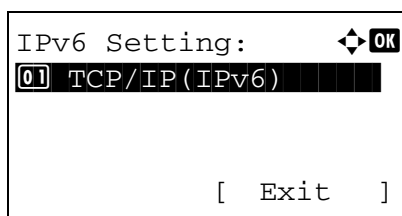

- 1 In the TCP/IP Settings menu, press Δ or ∇ to select IPv6 Setting.
- 2 Press **[OK]**. The IPv6 Setting menu screen appears.

TCP/IP (IPv6) (Enable/disable TCP/IP (IPv6))

This specifies whether TCP/IP (IPv6) is used.

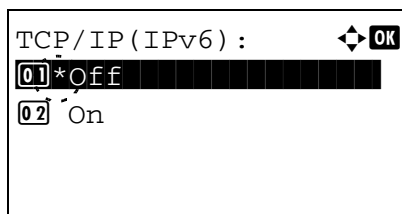

- 1 In the IPv6 Setting menu, press Δ or ∇ to select TCP/IP (IPv6).
- 2 Press **[OK]**. The TCP/IP (IPv6) screen appears.

- 3 Press Δ or ∇ to select whether TCP/IP (IPv6) is enabled.
- 4 Press **[OK]**. The TCP/IP (IPv6) setting is set and the IPv6 Setting menu reappears.

RA (Stateless) (RA (Stateless) setting)

Select whether or not to use RA (Stateless). The RA (Stateless) settings are available when selecting On for TCP/IP (IPv6). The default setting is On.

IMPORTANT After changing the setting, restart the network, or turn the machine OFF and then ON. For detailed information on restarting the network, refer to *Restart Network (Restarting the network card)* on page 6-47.

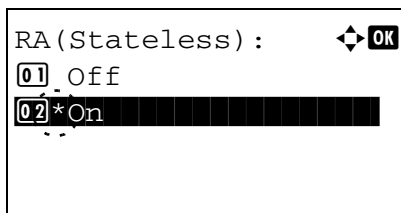

- 1 In the IPv6 Setting menu, press Δ or ∇ to select RA (Stateless).
- 2 Press **[OK]**. The RA (Stateless) screen appears.
- 3 Press Δ or ∇ to select whether RA (Stateless) is enabled.
- 4 Press **[OK]**. The RA (Stateless) setting is set and the IPv6 Setting menu reappears.

DHCPv6 (DHCPv6 setting)

Select whether or not to use the DHCP (IPv6) server. The DHCP (IPv6) Settings are available when selecting On for TCP/IP (IPv6). The default setting is On.

IMPORTANT After changing the setting, restart the network, or turn the machine OFF and then ON. For detailed information on restarting the network, refer to *Restart Network (Restarting the network card)* on page 6-47.

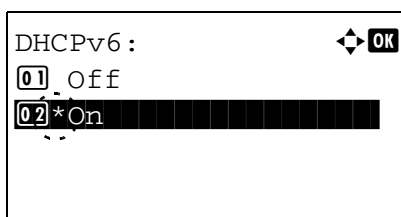

- 1 In the IPv6 Setting menu, press Δ or ∇ to select DHCPv6.
- 2 Press **[OK]**. The DHCPv6 screen appears.
- 3 Press Δ or ∇ to select whether DHCPv6 is enabled.
- 4 Press **[OK]**. The DHCPv6 setting is set and the IPv6 Setting menu reappears.

Protocol Detail (Detailed settings for the network protocol)

This selects the settings for Protocol Detail.

Item	Description	Default Setting	Restarting the System*
NetBEUI	Selects whether or not to receive documents using NetBEUI.	On	×
SNMPv3	Set SNMPv3.	Off	●
FTP (Server)	Select whether or not to receive documents using FTP.	On	●
SNMP	Select whether or not to communicate using SNMP.	On	●
SMTP (E-mail TX)	Select whether or not to send e-mail using SMTP.	Off	×
POP3 (E-mail RX)	Select whether or not to receive e-mail using POP3.	Off	×
RAW Port	Select whether or not to communicate using RAW Port.	On	●
LPD	Select whether or not to receive documents using LPD as the network protocol.	On	●
HTTP	Select whether or not to communicate using HTTP.	On	●
LDAP	Select whether or not to use LDAP.	Off	×

* ●: The machine must be restarted after the setting is changed.

×: The machine does not need to be restarted after the setting is changed.

Use the procedure below.

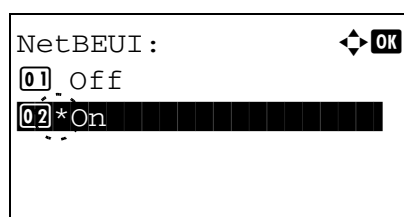
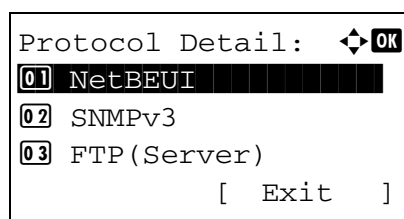

1 In the TCP/IP Settings menu, press Δ or ∇ to select Protocol Detail.

2 Press [OK]. The Protocol Detail menu screen appears.

3 Press Δ or ∇ to select the item for which you want to make settings.

4 Press [OK]. This displays the setting screen for the item selected in step 3.

The screen shown is the one when NetBEUI is selected.

5 Press Δ or ∇ to select On or Off.

6 Press [OK]. The Protocol Detail menu reappears.

Restart Network (Restarting the network card)

To restart the network card of the device.

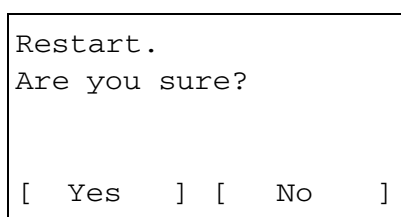
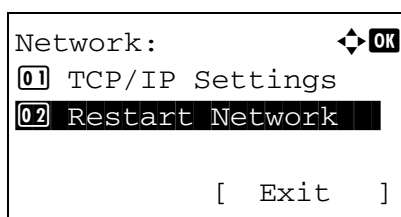

- 1 In the Print Settings menu, press Δ or ∇ to select `Network`.
- 2 Press **[OK]**. A confirmation message is displayed.
- 3 Press `[Yes]` (**[Left Select]**). The message `Restarting...` appears and the network is restarted.
Pressing `[No]` (**[Right Select]**) returns you to the `Network` menu without restarting the network.

Optional network (Optional Network settings)

This selects the settings for the optional Network Interface Kit (IB-50) or Wireless Network Interface Kit (IB-51).

 **Note** This is only displayed when a Network Interface Kit (IB-50) or Wireless Network Interface Kit (IB-51) is installed as an option.

The options available in the Optional Network settings are as follows:

- Wireless Network (Wireless network settings)...6-49
- Basic (Basic settings for the optional network interface card)...6-55
- Communication (Select the network interface to use)...6-58

 **Note** Check with your network administrator when selecting the network setting. After all network related settings have been done, restart the network. Refer to *Restart Network (Restarting the network card)* on page 6-47. This is mandatory to make the settings effective!

When Command Center RX is used, network parameters and security settings can be conveniently changed and checked from your PC. For more information, refer to the *Command Center RX User Guide*.

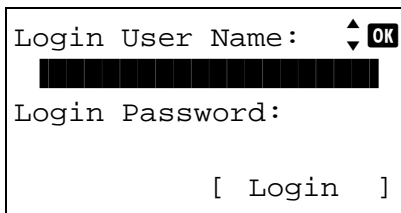
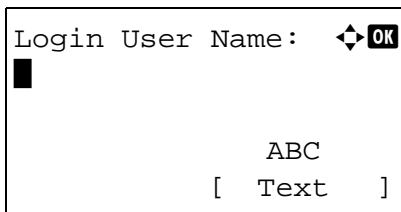
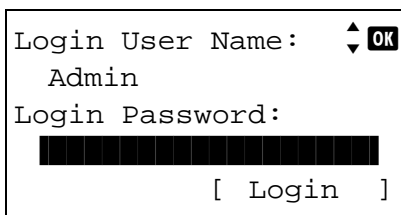
- 1 Press **[Menu]** .
- 2 Press Δ or ∇ to select `Optional network`.
- 3 Press **[OK]**. The Login screen appears.

 **Note** When user login administration is set:

- When logged in as an administrator, the log in screen is not displayed and the `Optional Network` menu screen is displayed.
- The setting is not possible when logged in as anyone other than an administrator. Log in again as an administrator.

- 4 With the `Login User Name` entry field selected, press **[OK]**. The `Login User Name` entry screen is displayed.

- 5 Enter the Login User Name using the numeric keys then press **[OK]**. The log in screen reappears.

 **Note** The initial setting for the administrator's Login User Name is "Admin".

For details on entering characters, refer to *Character Entry Method* on page A-6.

- 6 Press Δ or ∇ to select the `Login Password` entry field.

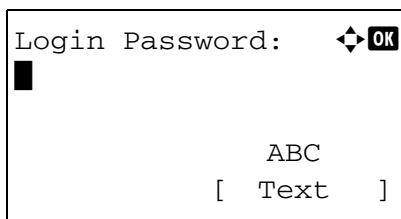

7 Press **[OK]**. The Login Password entry screen is displayed.

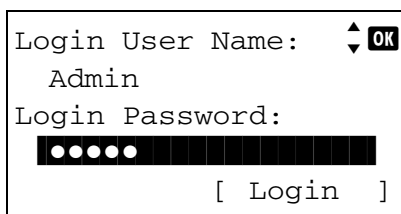

8 Enter the Login Password with the numeric keys then press **[OK]**. The login screen reappears.



Note The initial setting for the administrator's Login Password is "Admin".

For details on entering characters, refer to *Character Entry Method* on page A-6.

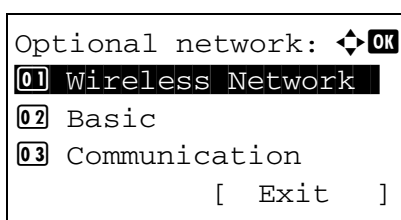

9 Pressing **[Login]** (**[Right Select]**). If the entered Login User Name and Login Password are correct, the Optional network menu appears showing a list of available options.

Wireless Network (Wireless network settings)

This selects the settings for Wireless network.



Note Wireless Network is only displayed when the optional Wireless Network Interface Kit (IB-51) is installed.

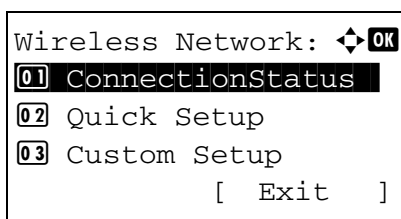

1 In the Optional network menu, press Δ or ∇ to select `Wireless network`.

2 Press **[OK]**. The `Wireless network` menu screen appears.

The following operations are possible:

- `ConnectionStatus` (Wireless network connection status check)...6-49
- `Quick Setup` (Quick setup for the wireless LAN)...6-50
- `Custom Setup` (Detailed settings for the wireless LAN)...6-52

ConnectionStatus (Wireless network connection status check)

When the optional Wireless Network Interface Kit (IB-51) is installed, it is possible to check the status of the wireless LAN.

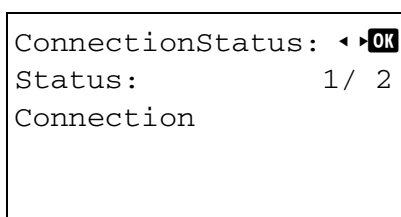

1 In the Wireless network menu, press Δ or ∇ to select `ConnectionStatus`.

2 Press **[OK]**. The `ConnectionStatus` screen appears.

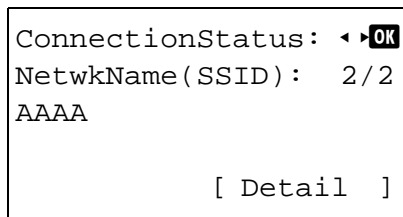

3 Press < or >. The NetwkName (SSID) is displayed.



Note If some of the NetwkName (SSID) are not displayed, press [Detail] ([Right Select]) and all the Names will be displayed.

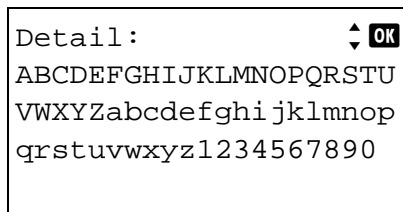

If the entire name shown as the NetwkName (SSID) will not fit on one line, pressing [Detail] ([Right Select]) changes to a 3-line name display.

Quick Setup (Quick setup for the wireless LAN)

When connecting to an access point which supports the automatic wireless LAN setup, you can select the connection settings using Quick Setup.

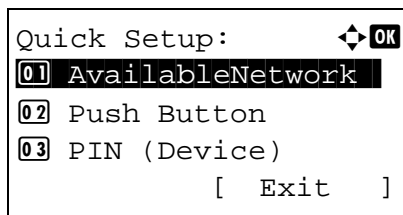

1 In the Wireless Network menu, press Δ or ∇ to select Quick Setup.

2 Press [OK]. The Quick Setup menu screen appears.

The following operations are possible:

- AvailableNetwork (Display the access points)
- Push Button (Connect using Push Button)
- PIN (Device) (Connect using a PIN code (for the Wireless Network Interface Kit))
- PIN (Terminal) (Connect using a PIN code (for the access point))

AvailableNetwork (Display the access points)

Displays the access points which can be connected to.

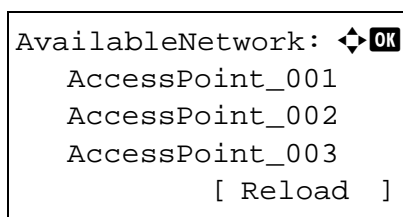

1 In the Quick Setup menu, press Δ or ∇ to AvailableNetwork.

2 Press [OK]. The AvailableNetwork screen appears.



Note Press [Reload] ([Left Select]) to update the information.

3 Press Δ or ∇ to select the access point to connect to.

4 Press [OK]. The connection with the access point is started.

When it is necessary to enter an encryption key, the WEP Key entry screen or Preshared Key entry screen appears.

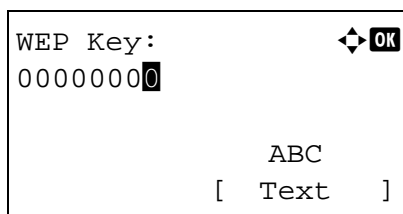

When a WEP Key must be entered:

Enter the WEP Key using the numeric keys and press [OK].



Note Up to 26 characters can be entered. For details on entering characters, refer to *Character Entry Method* on page A-6.

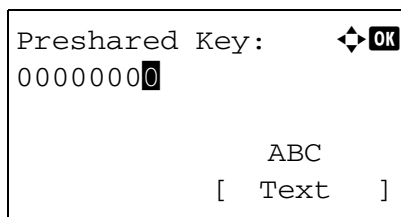

When a Preshared Key must be entered:

Enter the Preshared Key using the numeric keys and press **[OK]**.



Note The number of characters is between 8 and 64. For details on entering characters, refer to *Character Entry Method* on page A-6.

Push Button (Connect using Push Button)

When the access point supports the automatic wireless LAN setup button, you can configure the wireless settings automatically using the button and the panel operation of the printer.

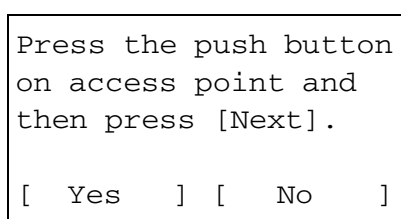

- 1 In the Quick Setup menu, press Δ or ∇ to select `Push Button`.
- 2 Press **[OK]**. A confirmation message is displayed.

- 3 Press the automatic wireless LAN setup button on the access point.
- 4 Press `[Yes]` (**[Left Select]**). The message `Connecting...` appears and the connection with the access point starts.

PIN (Device) (Connect using a PIN code (for the Wireless Network Interface Kit))

The connection is started using the PIN code for the machine. The PIN code displayed should be entered at the access point. The PIN code for the machine is generated automatically.

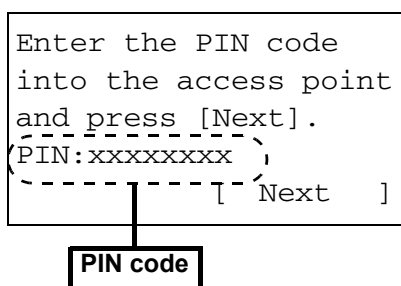

- 1 In the Quick Setup menu, press Δ or ∇ to select `PIN (Device)`.
- 2 Press **[OK]**. A PIN code is displayed on the Message display.

- 3 Register the PIN code displayed on the Message display at the access point.
- 4 Press `[Next]` (**[Left Select]**). The message `Connecting...` appears and the connection with the access point starts.

PIN (Terminal) (Connect using a PIN code (for the access point))

The connection is started using the PIN code for the access point. Enter the PIN code for the access point. For details of the PIN code for the access point, refer to the Operation Guide of the access point.

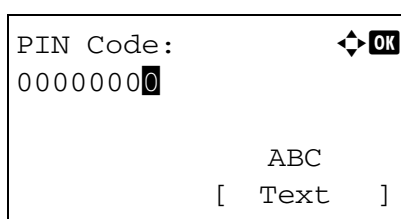

- 1 In the Quick Setup menu, press Δ or ∇ to select `PIN (Terminal)`.
- 2 Press **[OK]**. The `PIN code` entry screen appears.

- 3 Enter the PIN Code using the numeric keys.



Note Up to 8 characters can be entered. For details on entering characters, refer to *Character Entry Method on page A-6*.

- 4 Press **[OK]**. The message `Connecting...` appears and the connection with the access point starts.

Custom Setup (Detailed settings for the wireless LAN)

It is possible to change the detailed settings of the wireless LAN.

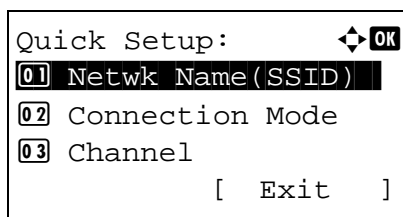

- 1 In the Wireless network menu, press Δ or ∇ to select `Custom Setup`.
- 2 Press **[OK]**. The `Custom Setup` menu screen appears.
The following operations are possible:
 - Netwk Name (SSID) (Registration of the access point's SSID)
 - Connection mode (Switch between connection modes)
 - Channel (Channel settings)
 - Netwk Authentic. (Network Authentication setting)
 - Encryption (Encryption settings)

Netwk Name (SSID) (Registration of the access point's SSID)

This sets the SSID (Service Set Identifier) for the wireless LAN access point the machine will be connected to.

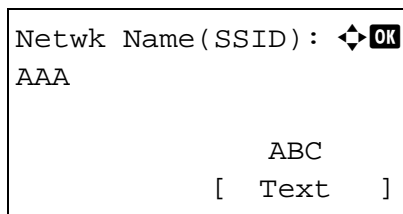

- 1 In the `Custom Setup` menu, press Δ or ∇ to select `Netwk Name (SSID)`.
- 2 Press **[OK]**. The `Netwk Name (SSID)` entry screen appears.
 -  **Note** Up to 32 characters can be entered. For details on entering characters, refer to *Character Entry Method on page A-6*.
- 3 Press **[OK]**. The `Custom Setup` menu reappears.

Connection mode (Switch between connection modes)

This selects the method for connecting to the wireless LAN. Set `Ad Hoc` when machines will be connected directly with each other, without going through an access point.

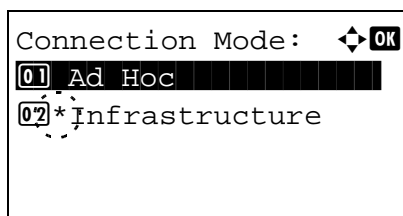

- 1 In the `Custom Setup` menu, press Δ or ∇ to select `Connection Mode`.
- 2 Press **[OK]**. The `Connection Mode` screen appears.
The available `Connection Mode` are as follows:
`Ad Hoc` (Connect without going through access points)
`Infrastructure` (Connect via an access point)
- 3 Press Δ or ∇ to select the connection mode.
- 4 Press **[OK]**. The `Custom Setup` menu reappears.

Channel (Channel settings)

This sets the Channel to be used in the wireless LAN.

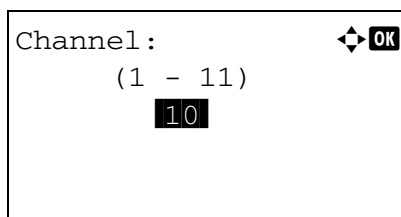

- 1 In the Custom Setup menu, press Δ or ∇ to select Channel.
- 2 Press [OK]. The Channel screen appears.

- 3 Enter the Channel number using the numeric keys, Δ or ∇ .



Note The Channel can be set between 1 and 11.

- 4 Press [OK]. The Custom Setup menu reappears.

Netwk Authentic. (Network Authentication setting)

This sets the authentication method to be used when connecting to an access point.

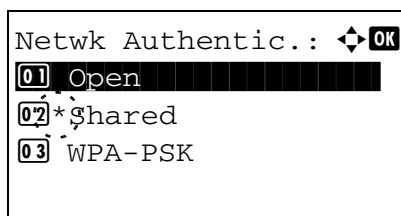

- 1 In the Custom Setup menu, press Δ or ∇ to select Netwk Authentic..

- 2 Press [OK]. The Netwk Authentic. screen appears.

The available authentication methods are as follows:

Open
Shared
WPA-PSK
WPA2-PSK



Note WPA-PSK and WPA2-PSK are only displayed when Infrastructure has been set as the Connection mode (Switch between connection modes) on page 6-52.

- 3 Press Δ or ∇ to select the desired authentication method.
- 4 Press [OK]. The Custom Setup menu reappears.

Encryption (Encryption settings)

This selects the encryption settings.



Note This setting is not displayed when the setting for *Netwk Authentic. (Network Authentication setting)* on page 6-53 is set to use an authentication method other than Open, Shared, WPA-PSK and WPA2-PSK, using Utility.

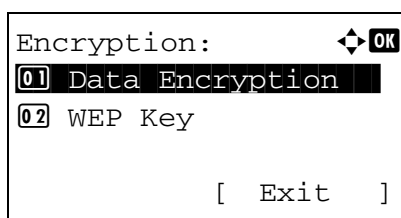

- 1 In the Custom Setup menu, press Δ or ∇ to select Encryption.
- 2 Press [OK]. The Encryption screen appears.

The following operations are possible:

- Data Encryption (Data Encryption setting)...6-54
- WEP Key (WEP Key settings)...6-54
- Preshared Key (Preshared Key settings)...6-55



Note WEP Key is displayed when *Netwk Authentic. (Network Authentication setting)* on page 6-53 is set to Open or Shared.

Preshared Key is displayed when *Netwk Authentic. (Network Authentication setting)* on page 6-53 is set to WPA-PSK or WPA2-PSK.

Data Encryption (Data Encryption setting)

This sets the encryption method.

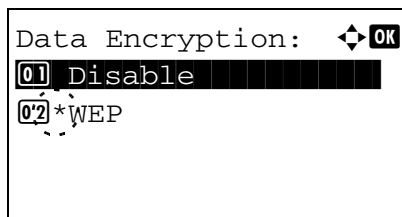

- 1 In the Encryption menu, press Δ or ∇ to select Data Encryption.
- 2 Press [OK]. The Data Encryption screen appears.



Note The encryption methods that can be selected vary depending on the authentication method set in *Netwk Authentic.* (*Network Authentication setting*) on page 6-53.

Disable or WEP can be selected when Open or Shared is set.

TKIP, AES or Auto can be selected when PA-PSK or WPA2-PSK is set.

- 3 Press Δ or ∇ to select the desired encryption method.
- 4 Press [OK]. The Encryption menu reappears.

WEP Key (WEP Key settings)

This registers the WEP Key.

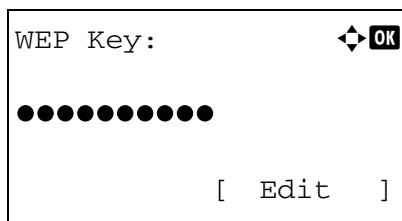

- 1 In the Encryption menu, press Δ or ∇ to select WEP Key.
- 2 Press [OK]. The WEP Key screen appears.

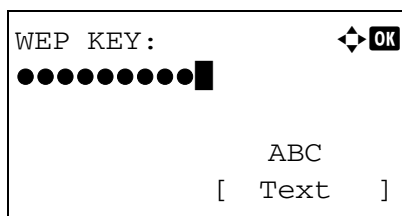

- 3 Press [Edit] ([Right Select]). The WEP Key entry screen appears.

- 4 Enter the WEP Key using the numeric keys.



Note Up to 26 characters can be entered. For details on entering characters, refer to *Character Entry Method* on page A-6.

- 5 Press [OK]. The Encryption menu reappears.

Preshared Key (Preshared Key settings)

This registers the Preshared Key.

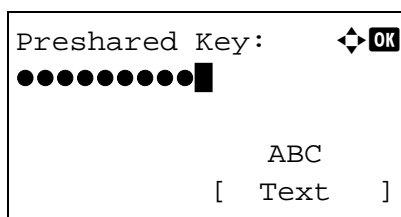
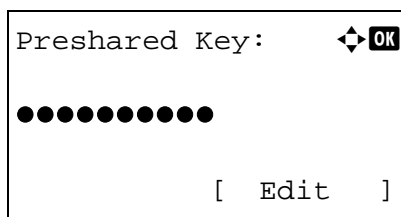

- 1 In the Encryption menu, press Δ or ∇ to select **Preshared Key**.
- 2 Press **[OK]**. The **Preshared Key** screen appears.

- 3 Press **[Edit]** (**[Right Select]**). The **Preshared Key** screen appears.

- 4 Enter the Preshared Key using the numeric keys.



Note The number of characters is between 8 and 64. For details on entering characters, refer to *Character Entry Method* on page A-6

- 5 Press **[OK]**. The **Encryption** menu reappears.

Basic (Basic settings for the optional network interface card)

This selects the basic settings for the optional network interface card (IB-50) or optional Wireless Network Interface Kit (IB-51) network.

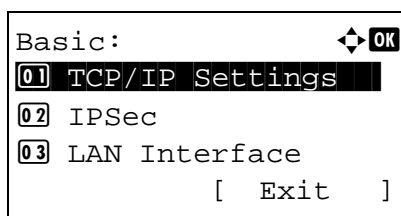

- 1 In the Optional network menu, press Δ or ∇ to select **Basic**.

- 2 Press **[OK]**. The **Basic** menu screen appears.

The following operations are possible:

- TCP/IP Settings (optional network interface card TCP/IP Settings)...6-56
- IPsec (IPsec setting)...6-56
- LAN Interface (LAN Interface setting)...6-57
- MACAddressFilter (MAC address filtering setting)...6-57
- Restart Network (Restarting the optional network interface card)...6-58

TCP/IP Settings (optional network interface card TCP/IP Settings)

This selects the TCP/IP settings.

The options available in the TCP/IP Settings are as follows:

- TCP/IP (Enable/Disable TCP/IP)
- IPv4 Setting (TCP/IP IPv4 settings)
- IPv6 Setting (TCP/IP IPv6 settings)

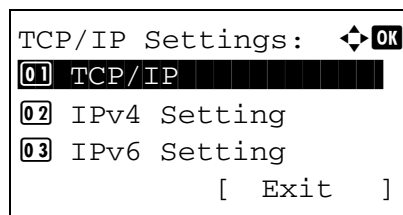

- 1 In the Network Settings menu, press Δ or ∇ to select TCP/IP Settings.
- 2 Press [OK]. The TCP/IP Settings menu screen appears.

TCP/IP (Enable/Disable TCP/IP)

This specified whether TCP/IP is used.

The method for setting is the same as for the standard Network settings. For details, refer to *TCP/IP (Enable/Disable TCP/IP) on page 6-40*.

IPv4 Setting (TCP/IP IPv4 settings)

This selects the settings for TCP/IP (IPv4). The method for setting is the same as for the standard Network settings. For details, refer to *IPv4 Setting (TCP/IP IPv4 settings) on page 6-41*.

IPv6 Setting (TCP/IP IPv6 settings)

This selects the settings for TCP/IP (IPv6). The method for setting is the same as for the standard Network settings. For details, refer to *IPv6 Setting (TCP/IP IPv6 settings) on page 6-44*.

IPSec (IPSec setting)

IPSec (IP Security Protocol) is a security protocol adopted as the standard by the IETF for authentication and encryption in the third network layer (IP layer).

It can be used with both IPv4 and IPv6.

 **Note** IPv4 uses 32-bit IP addresses and IPv6 uses 128-bit IP addresses.

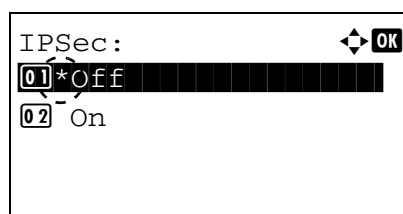

- 1 In the Basic menu, press Δ or ∇ to select IPSec.
- 2 Press [OK]. The IPSec screen appears.

- 3 Press Δ or ∇ to select whether IPSec is enabled.
- 4 Press [OK]. The IPSec setting is set and the Basic menu reappears.

LAN Interface (LAN Interface setting)

Specify the settings for the LAN interface to be used. The default setting is Auto.

 **Note** LAN Interface is only displayed when the optional network interface card (IB-50) is installed.

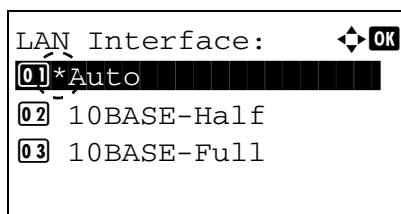

1 In the Basic menu, press Δ or ∇ to select LAN Interface.

2 Press **[OK]**. The LAN Interface screen appears.

The available LAN Interface are as follows:

Auto
10BASE-Half
10BASE-Full
100BASE-Half
100BASE-Full
1000BASE-T

3 Press Δ or ∇ to select the desired LAN Interface.

4 Press **[OK]**. The LAN Interface is set and the Basic menu reappears.

MACAddressFilter (MAC address filtering setting)

This sets whether or not to enable MAC address filtering.

 **Note** The detailed settings for MAC address filtering are selected using the optional network interface card utility software.

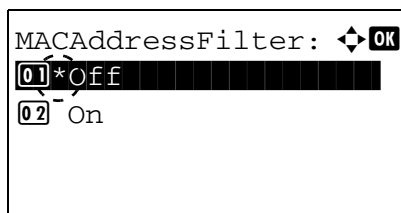

1 In the Basic menu, press Δ or ∇ to select MACAddressFilter.

2 Press **[OK]**. The MACAddressFilter screen appears.

3 Press Δ or ∇ to select whether MAC address filtering is enabled.

4 Press **[OK]**. The MAC address filtering setting is set and the Basic menu reappears.

Restart Network (Restarting the optional network interface card)

To restart the optional network interface card of the device.

```
Restart.
Are you sure?

[ Yes ] [ No ]
```

- 1 In the `Basic` menu, press Δ or ∇ to select `Network`.
- 2 Press **[OK]**. A confirmation message is displayed.

- 3 Press `[Yes]` (**[Left Select]**). The message `Restarting...` appears and the network is restarted.

Pressing `[No]` (**[Right Select]**) returns to the `Basic` menu without restarting the network.

Communication (Select the network interface to use)

This selects the interface to use for network connection.

```
Communication: ↕ OK
01*Standard NIC
02 Option NIC
```

- 1 In the `Optional Network` menu, press Δ or ∇ to select `Communication`.
- 2 Press **[OK]**. The `Communication` screen appears.

- 3 Press Δ or ∇ to select the desired NIC.

Press **[OK]**. The NIC is set and the `Optional Network` menu reappears.

Device Common (Selecting/Setting the common device)

Selects/sets all the functions in this printer.

The options available in Device Common are as follows:

- Language (Selecting the message language)...6-59
- Def. Screen(Box) (Document Box default screen settings)...6-60
- Date Setting (Date and time settings)...6-61
- Buzzer (Alarm (Buzzer) setting)...6-64
- Display Bright. (Display brightness setting)...6-66
- Disp. Backlight (Display backlight setting)...6-66
- Error Handling (Error detection setting)...6-66
- ColorToner Empty (Setting when color toner runs out)...6-71
- Timer Setting...6-71
- USB Keyboard Type (USB keyboard type selection)...6-77
- Manual Staple (Manual Staple setting)...6-77
- TonerAlert Level (Setting for the alert level for toner addition)...6-79
- Display Jobs Log...6-81
- Msg Banner Print (Preview screen setting for Banner Printing)...6-82

- 1** Press **[MENU]**.
- 2** Press Δ or ∇ to select Device Common.
- 3** Press **[OK]**. The Device Common menu appears showing a list of available options.

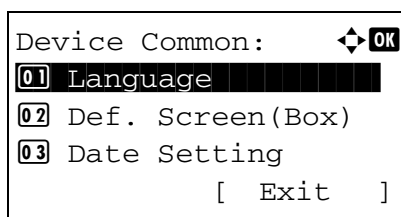

Language (Selecting the message language)

You can select the language of the message display by following the procedure given below. You can optionally download messages in other languages. Contact your service technician for information.

- 1** In the Device Common menu, press Δ or ∇ to select Language.
- 2** Press **[OK]**. The Language screen appears showing the list of languages.

The available languages are as follows:

English
 Deutsch
 Français
 Español
 Italiano
 Nederlands
 Русский
 Português

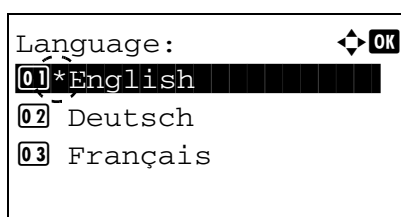

The optional languages are as follows:

Optional language	Message display
Turkish	Türkçe
Greek	Ελληνικά
Polish	Polski
Czech	Česky
Hungarian	Magyar
Finnish	Suomi
Hebrew	עברית
Arabic	عربي
Swedish	Svenska
Danish	Dansk
Norwegian	Norsk
Romanian	Română

If you are using one of the optional languages, it is displayed in place of *Português*.

- 3** Press Δ or ∇ to select the desired language.
- 4** Press **[OK]**. The language is set and the Device Common menu reappears.

Def. Screen(Box) (Document Box default screen settings.)

Select the screen to be displayed when **[Document Box]** is pressed.

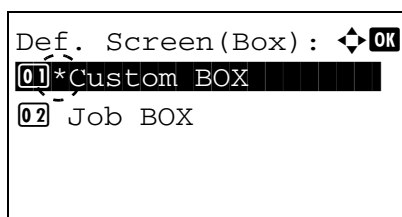

- 1** In the Device Common menu screen, press Δ or ∇ to select *Def. Screen(Box)*.
- 2** Press **[OK]**. The *Def. Screen(Box)* screen appears.
- 3** Press Δ or ∇ to select either *Custom BOX* or *Job BOX* as the default screen.
- 4** Press **[OK]**. The default screen is set and the Device Common menu reappears.

Date Setting (Date and time settings)

Set the date and time.

IMPORTANT To change the Date Setting, the administrator's Login User Name and Login Password must be entered. For details of the administrator settings, refer to *Local User List* on page 6-102.

If you change the date/time while using an application, you will no longer be able to use the application.

The date and time settings consist of the following items:

- Date (date setting)...6-62
- Time (time setting)...6-62
- Date Format (date format selection)...6-63
- Time Zone (time difference setting)...6-63
- Summer Time (summer time setting)...6-63

1 In the Device Common menu, press Δ or ∇ to select Date Setting.

2 Press **[OK]**. The Login screen appears.



Note When user login administration is set:

- When logged in as an administrator, the log in screen is not displayed and the Date Setting menu screen is displayed.
- The setting is not possible when logged in as anyone other than an administrator. Log in again as an administrator.

3 With the Login User Name entry field selected, press **[OK]**. The Login User Name entry screen is displayed.

4 Enter the Login User Name using the numeric keys then press **[OK]**. The log in screen reappears.



Note The initial setting for the administrator's Login User Name is "Admin".

For details on entering characters, refer to *Character Entry Method* on page A-6.

5 Press Δ or ∇ to select the Login Password entry field.

6 Press **[OK]**. The Login Password entry screen is displayed.

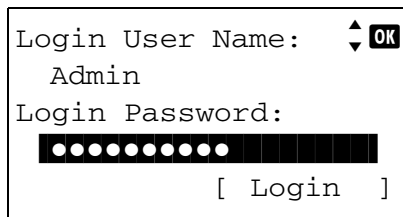

- 7 Enter the Login Password with the numeric keys then press **[OK]**. The login screen reappears.



Note The initial setting for the administrator's Login Password is "Admin".

For details on entering characters, refer to *Character Entry Method* on page A-6.

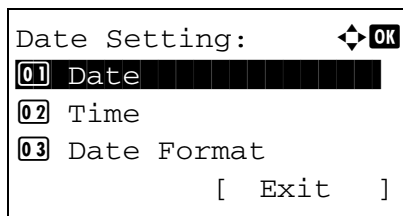

- 8 Pressing **[Login]** (**[Right Select]**). If the entered Login User Name and Login Password are correct, the Date Setting menu appears showing a list of available options.

Date (date setting)

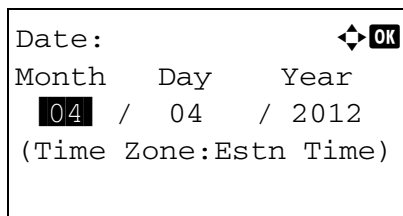

- 1 In the Date Setting menu, press Δ or ∇ to select **Date**.
- 2 Press **[OK]**. The Date screen appears.

- 3 Use the numeric keys to set the year, month, and day. Use \triangleleft and \triangleright to move the cursor right and left.
- 4 Press **[OK]**. The date is set and the Date Setting menu reappears.

Time (time setting)

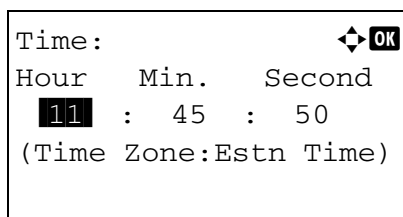

- 1 In the Date Setting menu, press Δ or ∇ to select **Time**.
- 2 Press **[OK]**. The Time screen appears.

- 3 Use the numeric keys to set the hour, minute, and second. Use \triangleleft and \triangleright to move the cursor right and left.
- 4 Press **[OK]**. The time is set and the Date Setting menu reappears.

Date Format (date format selection)

One of three formats can be selected for the date format.

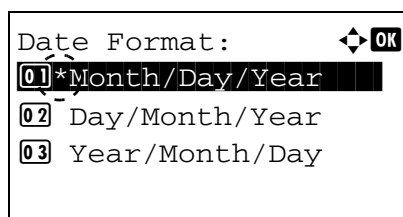

- 1 In the Date Setting menu, press Δ or ∇ to select `Date Format`.
- 2 Press **[OK]**. The `Date Format` screen appears.

- 3 Press Δ or ∇ to select the desired date format.

The following date formats can be selected:

Month/Day/Year

Day/Month/Year

Year/Month/Day

- 4 Press **[OK]**. The date format is set and the Date Setting menu reappears.

Time Zone (time difference setting)

Set the time difference from GMT.

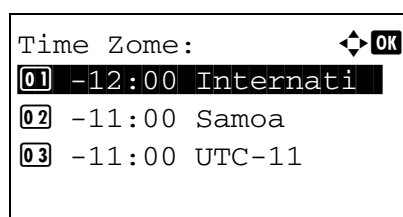

- 1 In the Date Setting menu, press Δ or ∇ to select `Time Zone`.
- 2 Press **[OK]**. The `Time Zone` screen appears.

- 3 Press Δ or ∇ to select the location.

- 4 Press **[OK]**. The time zone is set and the Date Setting menu reappears.

 **Note** If you select a region that does not utilize summer time, the summer time setting will not appear.

Summer Time (summer time setting)

Set summer time.

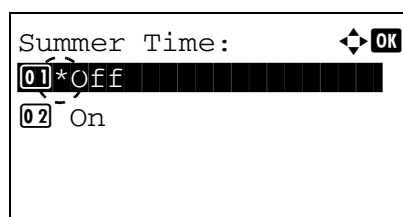

- 1 In the Date Setting menu, press Δ or ∇ to select `Summer Time`.
- 2 Press **[OK]**. The `Summer Time` screen appears.

- 3 Press Δ or ∇ to select whether the summer time is enabled.

- 4 Press **[OK]**. The summer time is set and the Date Setting menu reappears.

Buzzer (Alarm (Buzzer) setting)

This function uses tones to notify the user of printer operations and the printer status. This setting is useful, for example, when the printer is located some distance from the user.

The options available in Buzzer are as follows:

- Key Confirmation (Key confirmation tone setting)...6-64
- Job Finish (Job completed tone setting)...6-64
- Ready (Preparation completed tone setting)...6-65
- Error (Error tone setting)...6-65
- Keyboard Confirm (Keyboard confirmation tone setting)...6-65

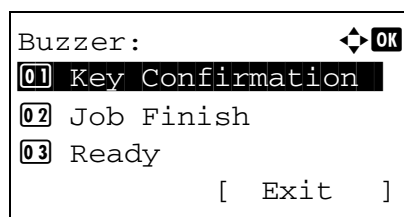

1 In the Device Common menu, press Δ or ∇ to select `Buzzer`.

2 Press **[OK]**. The `Buzzer` screen appears.

Key Confirmation (Key confirmation tone setting)

When `On` is selected in this setting, a tone sounds each time a key is used. The default setting is `On`.

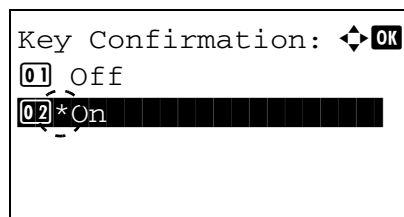

1 In the Buzzer menu screen, press Δ or ∇ to select `Key Confirmation`.

2 Press **[OK]**. The `Key Confirmation` screen appears.

3 Press Δ or ∇ to select whether the key confirmation tone is enabled.

4 Press **[OK]**. The key confirmation tone setting is set and the Buzzer menu reappears.

Job Finish (Job completed tone setting)

When `On` is selected in this setting, a tone sounds when printing ends. The default setting is `Off`.

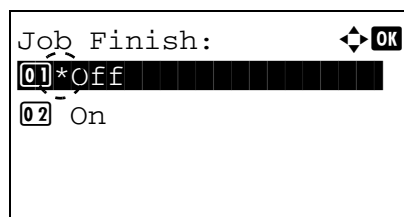

1 In the Buzzer menu screen, press Δ or ∇ to select `Job Finish`.

2 Press **[OK]**. The `Job Finish` screen appears.

3 Press Δ or ∇ to select whether the printing completed tone is enabled.

4 Press **[OK]**. The printing completed tone setting is set and the Buzzer menu reappears.

Ready (Preparation completed tone setting)

When **On** is selected in this setting, a tone sounds when print preparation has been completed. The default setting is **Off**.

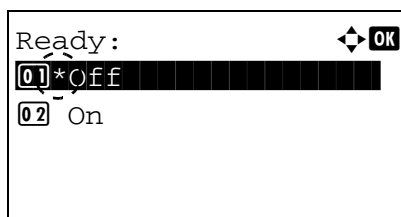

- 1 In the Buzzer menu screen, press Δ or ∇ to select **Ready**.
- 2 Press **[OK]**. The **Ready** screen appears.

- 3 Press Δ or ∇ to select whether the preparation completed tone is enabled.
- 4 Press **[OK]**. The preparation completed tone setting is set and the Buzzer menu reappears.

Error (Error tone setting)

When **On** is selected in this setting, a tone sounds when a problem such as running out of paper or a paper jam occurs during printing. The default setting is **On**.

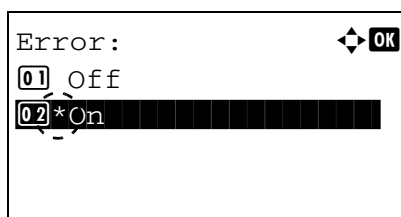

- 1 In the Buzzer menu screen, press Δ or ∇ to select **Error**.
- 2 Press **[OK]**. The **Error** screen appears.

- 3 Press Δ or ∇ to select whether the warning tone is enabled.
- 4 Press **[OK]**. The warning tone setting is set and the Buzzer menu reappears.

Keyboard Confirm (Keyboard confirmation tone setting)

When **On** is selected in this setting, a tone sounds each time a USB keyboard is used. The default setting is **Off**.

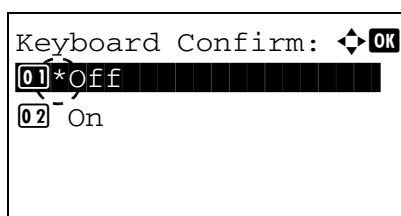

- 1 In the Buzzer menu screen, press Δ or ∇ to select **Keyboard Confirm**.
- 2 Press **[OK]**. The **Keyboard Confirm** screen appears.

- 3 Press Δ or ∇ to select whether the keyboard confirmation tone is enabled.
- 4 Press **[OK]**. The Keyboard Confirm tone setting is set and the Buzzer menu reappears.

Display Bright. (Display brightness setting)

Sets the brightness of the message display.

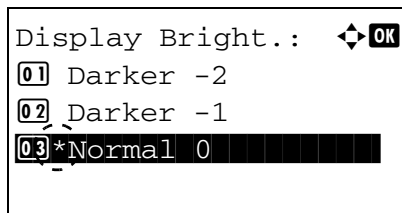

- 1** In the Device Common menu, press Δ or ∇ to select Display Bright..
- 2** Press **[OK]**. The Display Bright. screen appears showing the available brightness settings.
The list shows the following brightness settings:
Darker -2
Darker -1
Normal 0
Lighter +1
Lighter +2
- 3** Press Δ or ∇ to select the desired brightness.
- 4** Press **[OK]**. The brightness is set and the Device Common menu reappears.

Disp. Backlight (Display backlight setting)

Set the backlight for the message display.

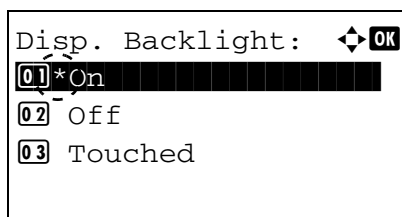

- 1** In the Device Common menu, press Δ or ∇ to select Disp. Backlight.
- 2** Press **[OK]**. The Disp. Backlight screen appears.
The list shows the following display backlight settings:
On (Standard)
Off (No backlight)
Touched (Backlight lights up during operation)
- 3** Press Δ or ∇ to select the desired backlight setting.
- 4** Press **[OK]**. The backlight setting is set and the Device Common menu reappears.

Error Handling (Error detection setting)

This specifies the settings for the detection methods used for duplex printing errors and for paper size and paper type errors when the paper source is fixed.

The options available in Error Handling are as follows:

- DuplexPaperError (Duplex printing error detection setting)...6-67
- Finishing Error (Setting when a finishing error occurs)...6-67
- No Staple Error (Setting when the staples run out)...6-68
- Stapling Limit (Setting when the number of sheets exceeds the stapling limit)...6-68
- Punch Waste Full (Setting when the punch waste box is full)...6-69
- Paper Mismatch (Detection settings for paper size/type errors when the paper source is fixed)...6-69
- MP Tray Empty (Warning when the MP tray is empty)...6-70
- Jam before Staple (Operation when stapling paper jam occurs)...6-70

- 1 In the Device Common menu, press Δ or ∇ to select **Error Handling**.
- 2 Press **[OK]**. The **Error Handling** menu screen appears.

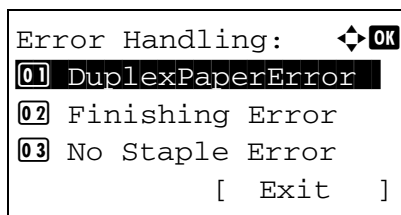

DuplexPaperError (Duplex printing error detection setting)

If the error detection setting for duplex printing has been turned **Display Error**, and you attempt to print onto a paper size and paper type that cannot be used for duplex printing, the **Duplex disabled** error message will be displayed and printing will stop.

Display Error	<ul style="list-style-type: none"> • To print onto one-side of the paper only when this message is displayed, press [OK]. • Press [Cancel] to cancel the printing itself.
1-sided	<ul style="list-style-type: none"> • To print onto one-side of the paper.

- 1 In the **Error Handling** menu, press Δ or ∇ to select **DuplexPaperError**.
- 2 Press **[OK]**. The **DuplexPaperError** screen appears.

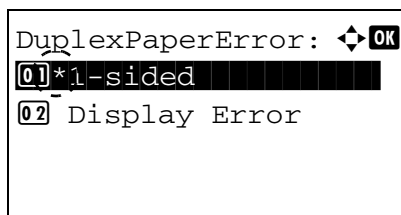

- 3 Press Δ or ∇ to select the setting for handling duplex paper errors.
- 4 Press **[OK]**. The handling of duplex paper errors is set and the **Error Handling** menu screen reappears.

Finishing Error (Setting when a finishing error occurs)

Select the setting when finishing (stapling, punching, sorting, or auto image rotation) is not possible for the selected paper size or type.

Display Error	<ul style="list-style-type: none"> • A message is displayed and printing stops.
Ignore	<ul style="list-style-type: none"> • A message is not displayed and printing continues without finishing.

1 In the Error Handling menu, press Δ or ∇ to select `Finishing Error`.

2 Press **[OK]**. The `Finishing Error` screen appears.

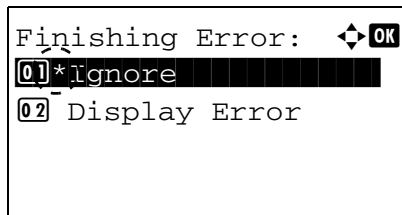

3 Press Δ or ∇ to select the setting for handling finishing error.

4 Press **[OK]**. The handling of finishing error is set and the Error Handling menu screen reappears.

No Staple Error (Setting when the staples run out)

This setting can be specified when an optional document finisher is installed.

Select the setting when the staples run out and the `Add staples.` message is displayed during stapling.

Display Error	• A message is displayed and printing stops. Printing automatically resumes when staples are added.
Ignore	• A message is displayed, however, printing continues without stapling.

1 In the Error Handling menu, press Δ or ∇ to select `No Staple Error`.

2 Press **[OK]**. The `No Staple Error` screen appears.

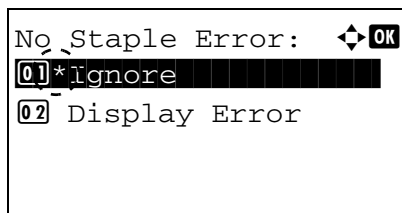

3 Press Δ or ∇ to select the setting for handling no staple error.

4 Press **[OK]**. The handling of no staple error is set and the Error Handling menu screen reappears.

Stapling Limit (Setting when the number of sheets exceeds the stapling limit)

Select the setting when the number of printed sheets exceeds the number of sheets that can be stapled.

Display Error	• A message is displayed and printing stops.
Ignore	• A message is not displayed and printing continues without stapling.

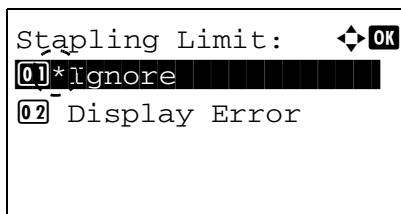

1 In the Error Handling menu, press Δ or ∇ to select `Stapling Limit`.

2 Press **[OK]**. The `Stapling Limit` screen appears.

3 Press Δ or ∇ to select the setting for handling staple limit errors.

4 Press **[OK]**. The handling of staple limit errors is set and the Error Handling menu screen reappears.

Punch Waste Full (Setting when the punch waste box is full)

This setting can be specified when a punch unit is installed on the optional Document Finisher. Select the setting when the punch waste box becomes full and the message `Empty the punch waste box.` is displayed during punching.

Display Error	<ul style="list-style-type: none"> A message is displayed and printing stops. Printing automatically resumes when the punch waste is discarded and the punch waste box is replaced in the punch unit.
Ignore	<ul style="list-style-type: none"> A message is displayed, however, printing continues without punching.

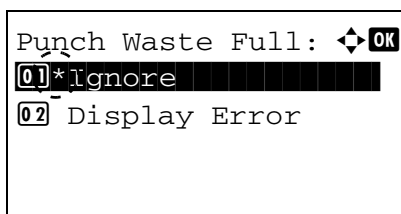

1 In the Error Handling menu, press Δ or ∇ to select `Punch Waste Full`.

2 Press **[OK]**. The `Punch Waste Full` screen appears.

3 Press Δ or ∇ to select the setting for handling punch waste full.

4 Press **[OK]**. The handling of punch waste full is set and the Error Handling menu screen reappears.

Paper Mismatch (Detection settings for paper size/type errors when the paper source is fixed)

Select `Continue` in this setting if you want to continue printing even if the paper size or type you specified is different from the fixed paper source, or select `Display Error` to have the paper feed error displayed.

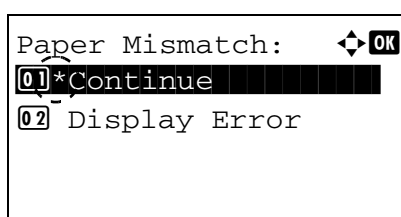

1 In the Error Handling menu, press Δ or ∇ to select `Paper Mismatch`.

2 Press **[OK]**. The `Paper Mismatch` screen appears.

- 3 Press Δ or ∇ to select the setting for handling paper mismatch errors.
- 4 Press **[OK]**. The handling of paper mismatch errors is set and the `Error Handling` menu screen reappears.

MP Tray Empty (Warning when the MP tray is empty)

Turn this setting to `On` if you want the error displayed when the MP tray is configured as the default paper source, and there is no paper in the MP tray, or turn it to `Off` not to have the error displayed.

The setting `On` enables the paper-empty message to display when the MP tray is empty.

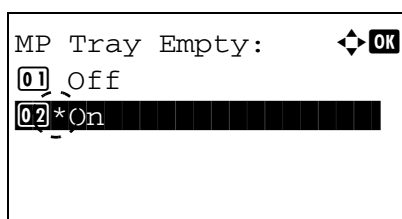

- 1 In the `Error Handling` menu, press Δ or ∇ to select `MP Tray Empty`.
- 2 Press **[OK]**. The `MP Tray Empty` screen appears.

- 3 Press Δ or ∇ to select the setting for the paper-empty message to display.
- 4 Press **[OK]**. The display of `MP Tray Empty` is set and the `Error Handling` menu screen reappears.

Jam before Staple (Operation when stapling paper jam occurs)

The page from which printing is resumed when a paper jam occurs during a job with stapling can be selected.

Item	Description
Top of Page	Resume printing from the first page of the document.
Jammed Page	Resume printing from the page where the jam occurred.

 **Note** This setting is displayed when an optional document finisher is installed.

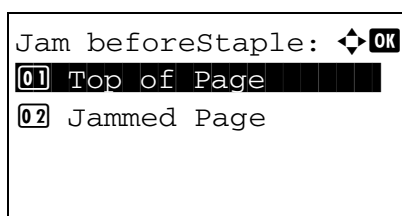

- 1 In the `Error Handling` menu, press Δ or ∇ to select `Jam beforeStaple`.
- 2 Press **[OK]**. The `Jam beforeStaple` appears.

- 3 Press Δ or ∇ to select the operation when a stapling paper jam occurs.
- 4 Press **[OK]**. The operation when a stapling paper jam occurs is set and you return to the error settings menu.

ColorToner Empty (Setting when color toner runs out)

Select whether printing is prohibited or the Print in Black and White setting is used for printing once the color toner runs out.

Stop Printing	Printing stops until the toner is replaced.
Print in B & W	When cyan, magenta, or yellow color toner runs out, the printer displays the message <code>Replace the toner. [C][M][Y]</code> . If not, press [OK]. The job is canceled, and stops printing. Printing resumes when the color toner is replaced. After [OK] is pressed and the current job is canceled, printing will take place in black and white mode from the next job.

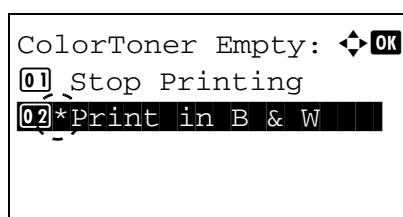

- 1 In the Device Common menu, press Δ or ∇ to select `ColorToner Empty`.
- 2 Press [OK]. The `ColorToner Empty` screen appears.
- 3 Press Δ or ∇ to select the setting for handling when a color toner runs out.
- 4 Press [OK]. The handling when color toner runs out is set and the Device Common menu reappears.

Timer Setting

This specifies timer-related settings such as the automatic form-feed timeout and the timeout settings for Auto Sleep.

IMPORTANT To change the Timer Setting, the administrator's Login User Name and Login Password must be entered. For details of the administrator settings, refer to *Local User List on page 6-102*.

The options available in Timer Setting are as follows:

- Auto Panel Reset (Auto panel reset setting)...6-73
- PanelReset Timer (Setting the panel reset timer)...6-73
- Low Power Timer (Low Power Mode timer timeout time)...6-73
- Sleep Timer (Sleep timer timeout time)...6-74
- Auto Err. Clear (Auto error clear setting)...6-74
- Err. Clear Timer (Setting the error clear time)...6-75
- Error Job Skip...6-75
- Job Skip Timer (Job Skip Timer setting)...6-76
- FormFeed TimeOut (Automatic form feed timeout setting)...6-76

- 1 In the Device Common menu, press Δ or ∇ to select `Timer Setting`.

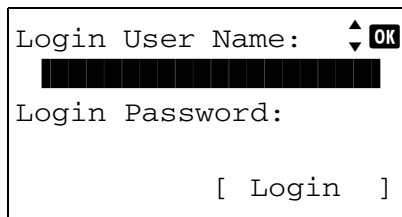

2 Press **[OK]**. The Login screen appears.



Note When user login administration is set:

- When logged in as an administrator, the log in screen is not displayed and the `Timer Setting` menu screen is displayed.
- The setting is not possible when logged in as anyone other than an administrator. Log in again as an administrator.

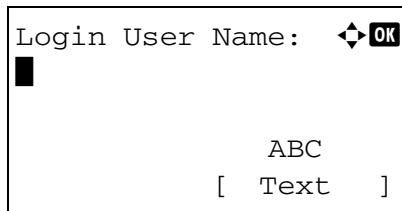

3 With the `Login User Name` entry field selected, press **[OK]**. The `Login User Name` entry screen is displayed.

4 Enter the Login User Name using the numeric keys then press **[OK]**. The log in screen reappears.



Note The initial setting for the administrator's Login User Name is "Admin".

For details on entering characters, refer to *Character Entry Method* on page A-6.

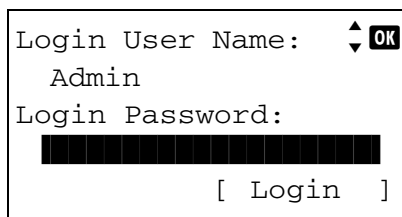

5 Press Δ or ∇ to select the `Login Password` entry field.

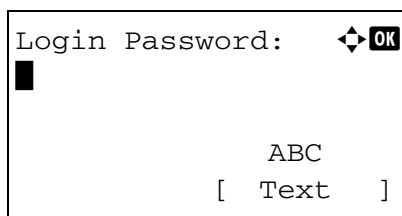

6 Press **[OK]**. The `Login Password` entry screen is displayed.

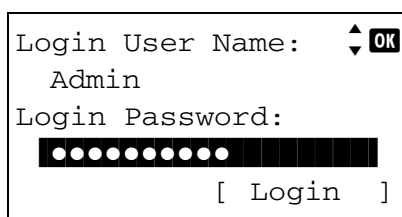

7 Enter the Login Password with the numeric keys then press **[OK]**. The login screen reappears.



Note The initial setting for the administrator's Login Password is "Admin".

For details on entering characters, refer to *Character Entry Method* on page A-6.

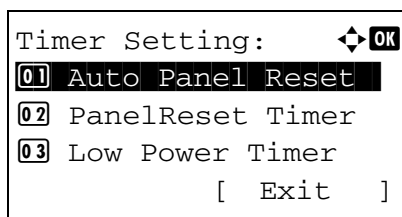

8 Pressing `[Login]` (**[Right Select]**). If the entered Login User Name and Login Password are correct, the `Timer Setting` menu appears showing a list of available options.

Auto Panel Reset (Auto panel reset setting)

The Auto Panel Reset function automatically restores the default settings if the panel is not used for a set time. The default setting is On.

For setting the time until the panel is automatically reset, refer to *PanelReset Timer (Setting the panel reset timer)* on page 6-73.

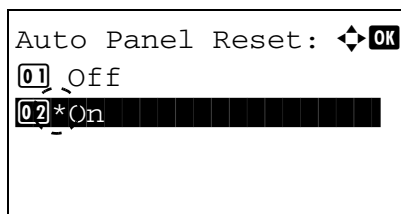

- 1 In the Timer Setting menu, press Δ or ∇ to select `Auto Panel Reset`.
- 2 Press **[OK]**. The `Auto Panel Reset` screen appears.
- 3 Press Δ or ∇ to select whether Auto Panel Reset is enabled.
- 4 Press **[OK]**. The Auto Panel Reset setting is set and the Timer Setting menu reappears.

PanelReset Timer (Setting the panel reset timer)

When `Auto Panel Reset` is set to `On`, this sets the time until the panel is automatically reset after the user stops using the panel. The default setting is 90 seconds.

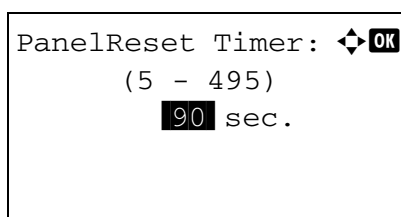

- 1 In the Timer Setting menu, press Δ or ∇ to select `PanelReset Timer`.
- 2 Press **[OK]**. The `PanelReset Timer` screen appears.
- 3 Use the numeric keys to set the panel reset time.
- 4 Press **[OK]**. The panel reset time setting is stored and the Timer Setting menu reappears.

Low Power Timer (Low Power Mode timer timeout time)

You can adjust the length of time the printer waits before entering Low Power Mode in the absence of a print job. The printer reverts to normal operation mode when the printer receives a print job or any button is pressed on the operation panel. The default time is 3 minutes (for FS-C8600DN) or 5 minutes (for FS-C8650DN).

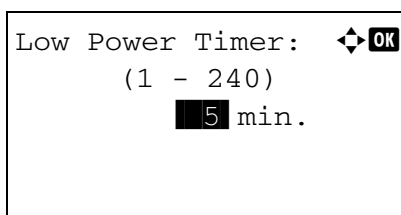

- 1 In the Timer Setting menu, press Δ or ∇ to select `Low Power Timer`.
- 2 Press **[OK]**. The `Low Power Timer` screen appears.
- 3 Use the numeric keys to set the low power time.
- 4 Press **[OK]**. The low power time setting is stored and the Timer Setting menu reappears.

Sleep Timer (Sleep timer timeout time)

You can adjust the length of time the printer waits before entering Auto Sleep in the absence of data. The printer reverts to normal operation mode when the printer receives a print job, **[OK]** is pressed or one of the exterior covers is opened. The default time is 60 minutes.

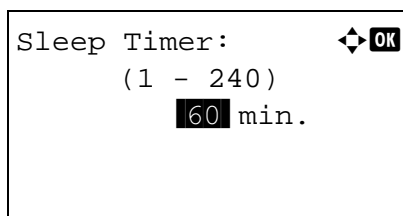

- 1 In the Timer Setting menu, press Δ or ∇ to select Sleep Timer.
- 2 Press **[OK]**. The Sleep Timer screen appears.
- 3 Use the numeric keys to set the sleep time.
- 4 Press **[OK]**. The sleep time setting is stored and the Timer Setting menu reappears.

Auto Err. Clear (Auto error clear setting)

If an error that still allows you to continue printing occurs, the next received data is automatically printed after a set period of time elapses.

For example, if the printer is shared over a network as a network printer and one person causes one of the above errors, after the set period of time elapses, the data sent from the next person is printed. The default setting is `Off` (Auto Error Clear disabled).

The auto clear errors are:

Print overrun.

KPDL error.

Hard disk error.

Incorrect account ID.

Account error.

Cannot duplex print on this paper.

Job Accounting restriction exceeded.

No multi copies.

USB memory error.

Restricted by Job Accounting.

Job not stored.

For the procedure for setting the automatic error recovery time, refer to *Err. Clear Timer (Setting the error clear time)* on page 6-75.

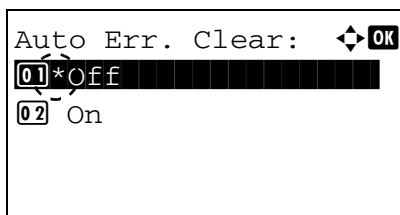

- 1 In the Timer Setting menu, press Δ or ∇ to select Auto Err. Clear.
- 2 Press [OK]. The Auto Err. Clear screen appears.

- 3 Press Δ or ∇ to select whether automatic error recovery is enabled.
- 4 Press [OK]. The automatic error recovery setting is set and the Timer Setting menu reappears.

Err. Clear Timer (Setting the error clear time)

If Auto Err. Clear is set to On and a non-fatal error (an error that allows printing to continue) occurs, this setting specifies the time until the error is recovered and printing resumes. The default setting is 30 seconds.

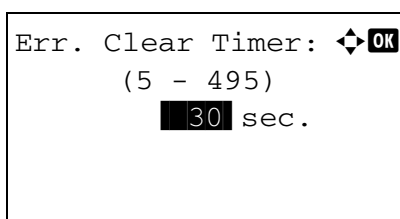

- 1 In the Timer Setting menu, press Δ or ∇ to select Err. Clear Timer.
- 2 Press [OK]. The Err. Clear Timer screen appears.

- 3 Use the numeric keys to set the recovery time.
- 4 Press [OK]. The recovery time setting is stored and the Timer Setting menu reappears.

Error Job Skip

Set whether a job for which a "Add paper in cassette #" or "Add paper in Multi Purpose tray" error occurred when the job was started is automatically skipped after a set period of time elapses.



Note When a job is skipped, it is moved to the end of the job queue.

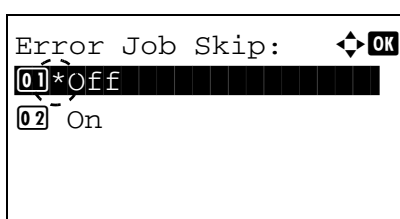

- 1 In the Timer Setting menu, press Δ or ∇ to select Error Job Skip.
- 2 Press [OK]. The Error Job Skip screen appears.

- 3 Press Δ or ∇ to select whether error job skip is enabled.
- 4 Press [OK]. The error job skip setting is set and the Timer Setting menu reappears.

Job Skip Timer (Job Skip Timer setting)

When Error Job Skip is set to "On", you can set the wait time until an error job is skipped. The default setting is 30 seconds.

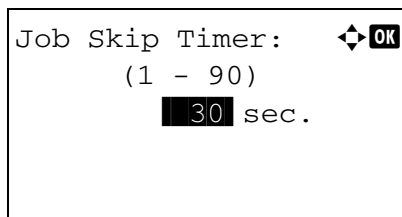

- 1 In the Timer Setting menu, press Δ or ∇ to select Job Skip Timer.
- 2 Press [OK]. The Job Skip Timer screen appears.

- 3 Use the numeric keys to set the job skip time.
- 4 Press [OK]. The job skip time setting is stored and the Timer Setting menu reappears.

FormFeed TimeOut (Automatic form feed timeout setting)

If the printer receives no data for a set period, it times out and releases the current interface. It then prints whatever data it has in its buffer and feeds out the printed page. The default setting is 30 seconds.

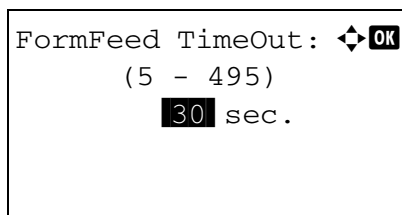

- 1 In the Timer Setting menu, press Δ or ∇ to select FormFeed TimeOut.
- 2 Press [OK]. The FormFeed TimeOut screen appears.

- 3 Use the numeric keys to set the form feed timeout delay.
- 4 Press [OK]. The form feed timeout setting is stored and the Timer Setting menu reappears.

USB Keyboard Type (USB keyboard type selection)

Select the type of USB keyboard that you want to use.

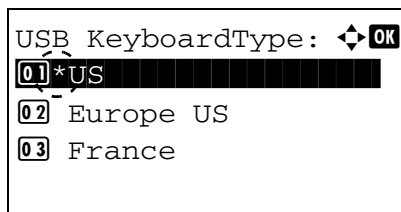

- 1 In the Device Common menu, press Δ or ∇ to select USB KeyboardType.
- 2 Press **[OK]**. The USB KeyboardType screen appears. The available USB keyboard type are as follows:
 - US
 - Europe US
 - France
 - Germany
- 3 Press Δ or ∇ to select the desired USB keyboard type.
- 4 Press **[OK]**. The USB keyboard type is set and the Device Common menu reappears.

Manual Staple (Manual Staple setting)

The following settings can be configured in the manual staple settings.

- Off/On...6-78
- Clear Timer...6-79
- Staple Position...6-79



Note When a 4,000-sheet finisher is not installed, these settings cannot be configured.

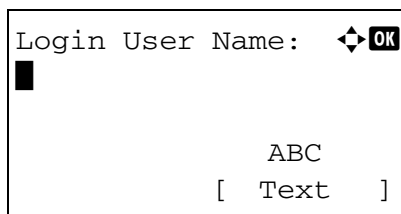
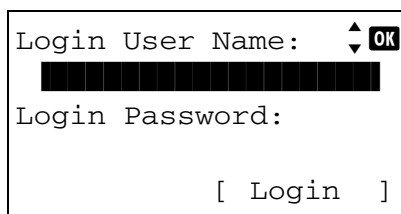

- 1 In the Device Common menu, press Δ or ∇ to select Manual Staple.
- 2 Press **[OK]**. The Login screen appears.
 -  **Note** When user login administration is set:
 - When logged in as an administrator, the log in screen is not displayed and the Manual Staple menu screen is displayed.
 - The setting is not possible when logged in as anyone other than an administrator. Log in again as an administrator.
- 3 With the Login User Name entry field selected, press **[OK]**. The Login User Name entry screen is displayed.
- 4 Enter the Login User Name using the numeric keys then press **[OK]**. The log in screen reappears.



Note The initial setting for the administrator's Login User Name is "Admin".

For details on entering characters, refer to *Character Entry Method* on page A-6.

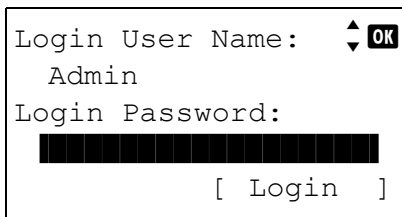

5 Press Δ or ∇ to select the Login Password entry field.

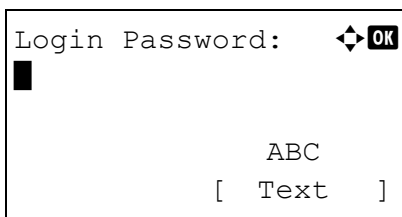

6 Press [OK]. The Login Password entry screen is displayed.

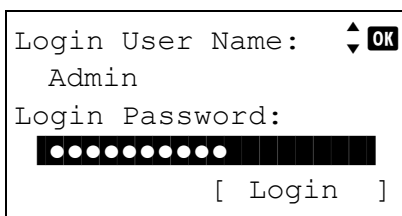

7 Enter the Login Password with the numeric keys then press [OK]. The login screen reappears.



Note The initial setting for the administrator's Login Password is "Admin".

For details on entering characters, refer to *Character Entry Method* on page A-6.

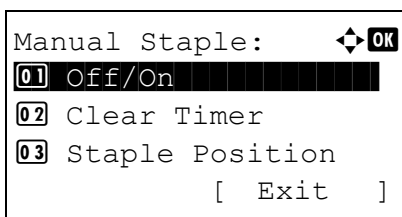

8 Pressing [Login] (**[Right Select]**). If the entered Login User Name and Login Password are correct, the Manual Staple menu screen appears.

Off/On

Select whether or not to set the setting for Manual Staple.

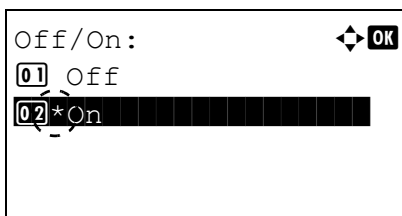

1 In the Manual Staple menu, press Δ or ∇ to select Off/On.

2 Press [OK]. The Off/On screen appears.

3 Press Δ or ∇ to select whether Manual Staple setting is enabled.

4 Press [OK]. The Manual Staple setting is set and the Manual Staple menu reappears.

Clear Timer

Set the time until manual stapling mode is automatically cancelled.

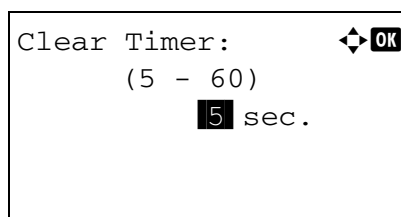

- 1 In the Manual Staple menu, press Δ or ∇ to select `Clear Timer`.
- 2 Press **[OK]**. The `Clear Timer` screen appears.
- 3 Use the numeric keys to set the clear time.
The setting range is 5 to 60 seconds (5-second increments).
- 4 Press **[OK]**. The clear time setting is stored and the `Manual Staple` menu reappears.

Staple Position

Set the default Staple Position.

A4 Long Edge	Staple on the long side of A4 size.
Letter Long Edge	Staple on the long side of letter size.

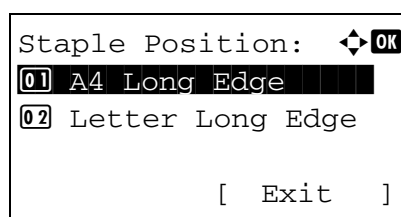

- 1 In the Manual Staple menu, press Δ or ∇ to select `Staple Position`.
- 2 Press **[OK]**. The `Staple Position` screen appears.
- 3 Press Δ or ∇ to select the desired staple position.
- 4 Press **[OK]**. The Staple Position is set and the `Manual Staple` menu reappears.

TonerAlert Level (Setting for the alert level for toner addition)

This sets the toner addition alert level displayed.

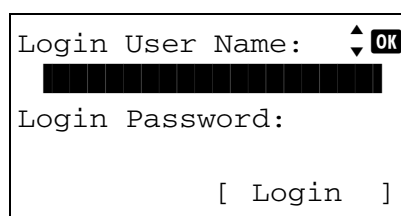

- 1 In the Device Common menu, press Δ or ∇ to select `TonerAlert Level`.
- 2 Press **[OK]**. The Login screen appears.



Note When user login administration is set:

- When logged in as an administrator, the log in screen is not displayed and the `TonerAlert Level` menu screen is displayed.
- The setting is not possible when logged in as anyone other than an administrator. Log in again as an administrator.

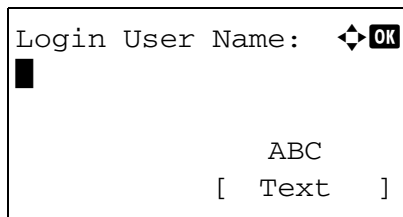

3 With the Login User Name entry field selected, press **[OK]**. The Login User Name entry screen is displayed.

4 Enter the Login User Name using the numeric keys then press **[OK]**. The log in screen reappears.



Note The initial setting for the administrator's Login User Name is "Admin".

For details on entering characters, refer to *Character Entry Method* on page A-6.

5 Press Δ or ∇ to select the Login Password entry field.

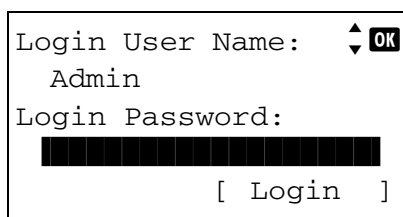

6 Press **[OK]**. The Login Password entry screen is displayed.

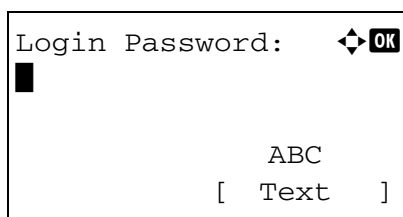

7 Enter the Login Password with the numeric keys then press **[OK]**. The login screen reappears.



Note The initial setting for the administrator's Login Password is "Admin".

For details on entering characters, refer to *Character Entry Method* on page A-6.

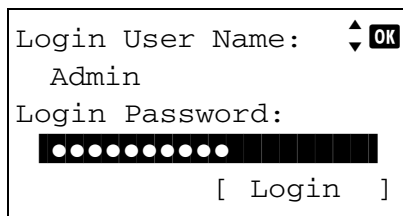

8 Pressing [Login] (**[Right Select]**). If the entered Login User Name and Login Password are correct, the TonerAlert Level menu screen appears.

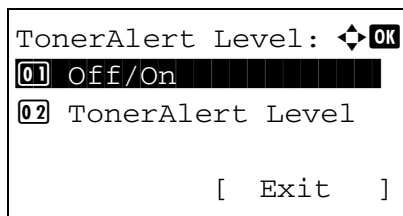

9 Press Δ or ∇ to select Off/On.

10 Press **[OK]**. The Off/On screen appears.

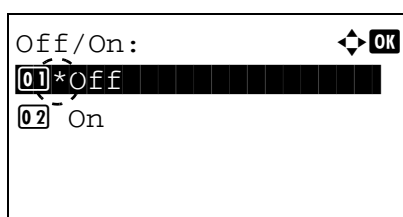

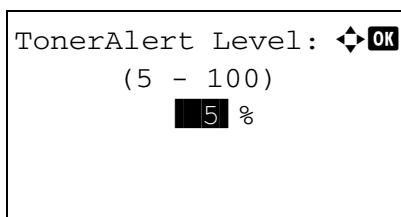
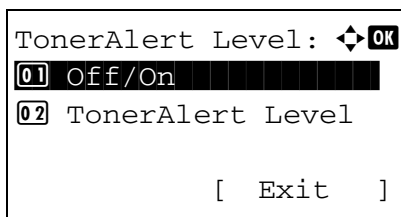

- 11 Press Δ or ∇ to select whether Toner Alert Level is enabled.
- 12 Press **[OK]**. The TonerAlert Level screen appears.

- 13 Press Δ or ∇ to select TonerAlert Level.
- 14 Press **[OK]**. The TonerAlert Level screen appears.

- 15 Set the level at which an alert will be displayed using the numeric keys, Δ or ∇ . The setting is possible between 5 and 100%.
- 16 Press **[OK]**. The Toner Alert Level is set and the TonerAlert Level menu reappears.

Display Jobs Log

Set Display Jobs Log.

Show All	All users can view the job log.
Hide All	Only users with administrator privileges can view the job log.

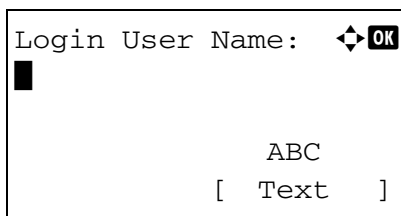
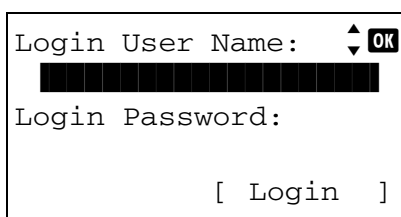

- 1 In the Device Common menu, press Δ or ∇ to select Display Jobs Log.

- 2 Press **[OK]**. The Login screen appears.



Note When user login administration is set:

- When logged in as an administrator, the log in screen is not displayed and the Display Jobs Log menu screen is displayed.
- The setting is not possible when logged in as anyone other than an administrator. Log in again as an administrator.

- 3 With the Login User Name entry field selected, press **[OK]**. The Login User Name entry screen is displayed.

- 4 Enter the Login User Name using the numeric keys then press **[OK]**. The log in screen reappears.



Note The initial setting for the administrator's Login User Name is "Admin".

For details on entering characters, refer to *Character Entry Method* on page A-6.

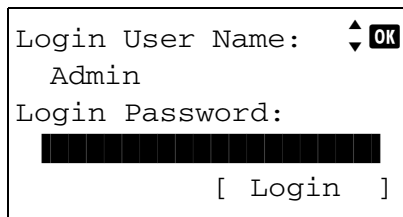

5 Press Δ or ∇ to select the Login Password entry field.

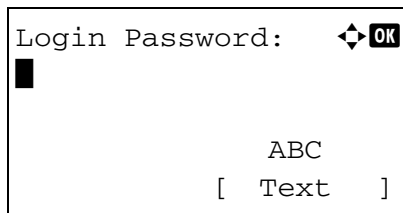

6 Press [OK]. The Login Password entry screen is displayed.

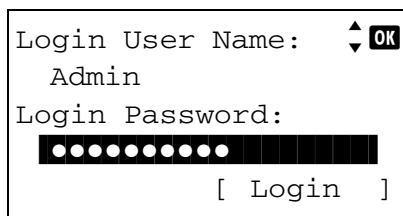

7 Enter the Login Password with the numeric keys then press [OK]. The login screen reappears.



Note The initial setting for the administrator's Login Password is "Admin".

For details on entering characters, refer to *Character Entry Method* on page A-6.

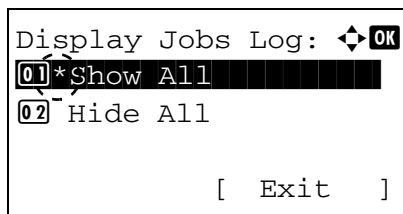

8 Pressing [Login] ([Right Select]). If the entered Login User Name and Login Password are correct, the Display Jobs Log menu screen appears.

9 Press Δ or ∇ to select the display setting.

10 Press [OK]. The Device Common screen appears.

Msg Banner Print (Preview screen setting for Banner Printing)

This sets whether or not the confirmation screen appears before each sheet is printed when printing multiple banner sheets.



Note Select this setting when the optional banner tray is attached.

The table below shows the available settings.

Off	The confirmation screen is not displayed. (Paper is fed continuously.)
On	The confirmation screen is displayed before each sheet is printed.

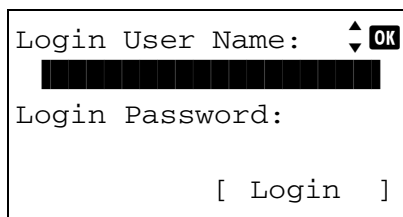

1 In the Device Common menu, press Δ or ∇ to select Msg Banner Print.

2 Press [OK]. The Login screen appears.



Note When user login administration is set:

- When logged in as an administrator, the log in screen is not displayed and the Msg Banner Print menu screen is displayed.
- The setting is not possible when logged in as anyone other than an administrator. Log in again as an administrator.

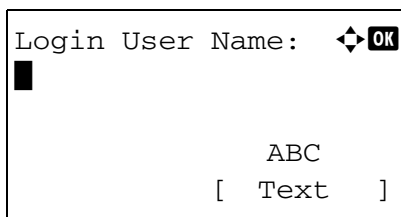

3 With the Login User Name entry field selected, press **[OK]**. The Login User Name entry screen is displayed.

4 Enter the Login User Name using the numeric keys then press **[OK]**. The log in screen reappears.



Note The initial setting for the administrator's Login User Name is "Admin".

For details on entering characters, refer to *Character Entry Method* on page A-6.

5 Press Δ or ∇ to select the Login Password entry field.

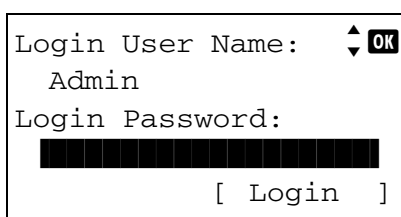

6 Press **[OK]**. The Login Password entry screen is displayed.

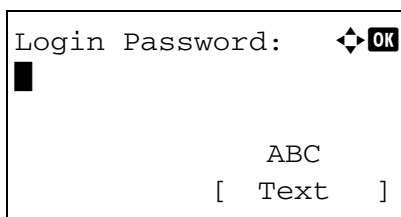

7 Enter the Login Password with the numeric keys then press **[OK]**. The login screen reappears.



Note The initial setting for the administrator's Login Password is "Admin".

For details on entering characters, refer to *Character Entry Method* on page A-6.

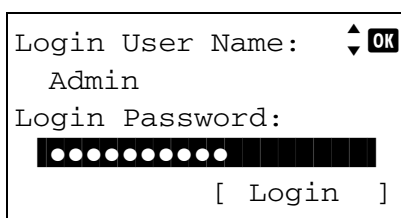

8 Pressing **[Login] ([Right Select])**. If the entered Login User Name and Login Password are correct, the Msg Banner Print menu screen appears.

9 Press Δ or ∇ to select whether the Msg Banner Print is enabled.

10 Press **[OK]**. The Device Common screen appears.

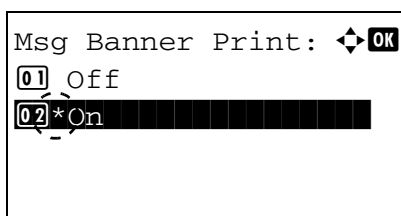

Security (Security function setting)

The security functions can be set up to protect printer operation and the print data.

IMPORTANT To change the Security function settings, the administrator's Login User Name and Login Password must be entered. For details of the administrator settings, refer to *Local User List on page 6-102*.

The options available in Security are as follows:

- Network Security (Network security setting)...6-85
- I/F Block Set. (External interface block setting)...6-92
- Security Level...6-93
- Data Security (Data Security setting)...6-94

- 1 Press **[MENU]**.
- 2 Press Δ or ∇ to select *Security*.
- 3 Press **[OK]**. The Login screen appears.



Note When user login administration is set:

- When logged in as an administrator, the log in screen is not displayed and the *Security* menu screen is displayed.
- The setting is not possible when logged in as anyone other than an administrator. Log in again as an administrator.

- 4 With the *Login User Name* entry field selected, press **[OK]**. The *Login User Name* entry screen is displayed.

- 5 Enter the *Login User Name* using the numeric keys then press **[OK]**. The log in screen reappears.



Note The initial setting for the administrator's *Login User Name* is "Admin".

For details on entering characters, refer to *Character Entry Method on page A-6*.

- 6 Press Δ or ∇ to select the *Login Password* entry field.

```

Login Password:  [OK]
█
                ABC
                [ Text ]

```

7 Press **[OK]**. The Login Password entry screen is displayed.

```

Login User Name:  [OK]
Admin
Login Password:
●●●●●●●●●●
                [ Login ]

```

8 Enter the Login Password with the numeric keys then press **[OK]**. The login screen reappears.



Note The initial setting for the administrator's Login Password is "Admin".

For details on entering characters, refer to *Character Entry Method* on page A-6.

```

Security:  [OK]
[01] Network Security
[02] I/F Block Set.
[03] Security Level
                [ Exit ]

```

9 Pressing [Login] (**[Right Select]**). If the entered Login User Name and Login Password are correct, the Security menu screen appears.

Network Security (Network security setting)

Use this procedure to specify the security settings for each of the network protocols used.

IMPORTANT Check with your network administrator when selecting network settings.

The options available in Network Security are as follows:

- WSD-PRINT (WSD-PRINT setting)...6-86
- Enhanced WSD (Enhanced WSD setting)...6-86
- EnhancedWSD(SSL) (EnhancedWSD(SSL) setting)...6-86
- IPP (IPP setting)...6-87
- SSL Setting (SSL Server setting)...6-87
- IPSec (IPSec setting)...6-90
- ThinPrint (ThinPrint setting)...6-90
- LAN Interface (LAN Interface setting)...6-91

1 In the Security menu, press Δ or ∇ to select Network Security.

2 Press **[OK]**. The Network Security menu screen appears.

```

Network Security:  [OK]
[01] WSD-PRINT
[02] Enhanced WSD
[03] EnhancedWSD(SSL)
                [ Exit ]

```

WSD-PRINT (WSD-PRINT setting)

Select whether or not to use WSD Print. The default setting is On.

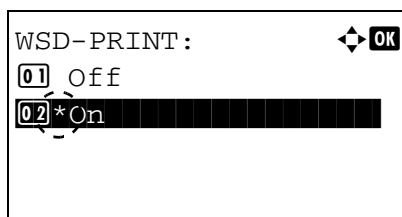

- 1 Network Security menu, press Δ or ∇ to select WSD-PRINT.
- 2 Press **[OK]**. The WSD-PRINT screen appears.

- 3 Press Δ or ∇ to select whether WSD-PRINT is enabled.
- 4 Press **[OK]**. The WSD-PRINT setting is set and the Network Security menu reappears.

Enhanced WSD (Enhanced WSD setting)

Set whether to use our proprietary web services. Network driver use this Enhanced WSD Web service. The default setting is On.

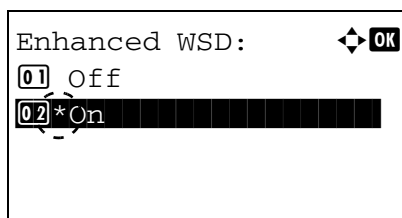

- 1 Network Security menu, press Δ or ∇ to select Enhanced WSD.
- 2 Press **[OK]**. The Enhanced WSD screen appears.

- 3 Press Δ or ∇ to select whether Enhanced WSD is enabled.
- 4 Press **[OK]**. The Enhanced WSD setting is set and the Network Security menu reappears.

EnhancedWSD(SSL) (EnhancedWSD(SSL) setting)

Set whether to use our proprietary web services over SSL. SSL must be set to "On" in SSL (SSL Server setting) on page 6-87. The default setting is On.

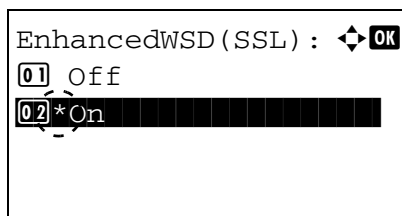

- 1 Network Security menu, press Δ or ∇ to select EnhancedWSD(SSL).
- 2 Press **[OK]**. The EnhancedWSD(SSL) screen appears.

- 3 Press Δ or ∇ to select EnhancedWSD(SSL) is enabled.
- 4 Press **[OK]**. The EnhancedWSD(SSL) setting is set and the Network Security menu reappears.

IPP (IPP setting)

IPP (Internet Printing Protocol) is a standard that uses TCP/IP networks such as the Internet to enable print jobs to be sent between remote computers and printers.

IPP is an extension of the HTTP protocol used to view websites and enables printing to be carried out via routers on printers in remote locations. It also supports the HTTP authentication mechanisms along with SSL server and client authentication as well as encryption. The default setting is `Off`.

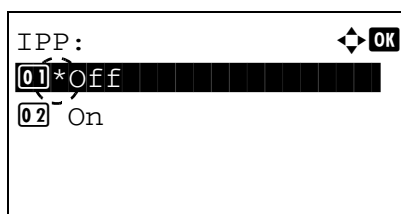

- 1 In the Network Security menu, press Δ or ∇ to select `IPP`.
- 2 Press **[OK]**. The `IPP` screen appears.

- 3 Press Δ or ∇ to select whether IPP is enabled.
- 4 Press **[OK]**. The IPP setting is set and the Network Security menu reappears.

SSL Setting (SSL Server setting)

SSL (Secure Sockets Layer) refers to a protocol used to encrypt information sent and received over a network. SSL can currently be used to encrypt data such as the WWW or FTP files widely used on the Internet so that privacy-related information, credit card numbers, corporate secrets and other confidential information can be sent and received safely.

SSL servers use this protocol to authenticate servers and clients.

The options available in SSL Setting are as follows:

- SSL (SSL Server setting)...6-87
- IPP over SSL (SSL Server IPP over SSL setting)...6-89
- HTTPS (SSL Server HTTPS setting)...6-90

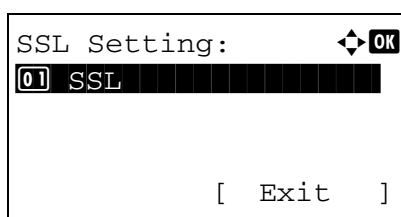

- 1 In the Network Security menu, press Δ or ∇ to select `SSL Setting`.
- 2 Press **[OK]**. The `SSL Setting` menu screen appears.

SSL (SSL Server setting)

Select the SSL server settings.

The options available in SSL are as follows:

- Off/On (SSL operation setting)...6-88
- Encryption (Encryption setting)...6-88

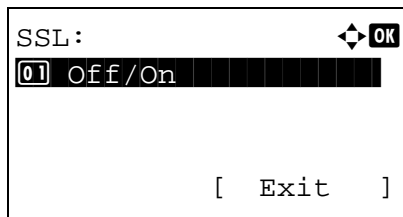

- 1 In the SSL Setting menu, press Δ or ∇ to select SSL.
- 2 Press **[OK]**. The SSL menu screen appears.

Off/On (SSL operation setting)

Select whether or not to use the SSL server. The default setting is OFF.

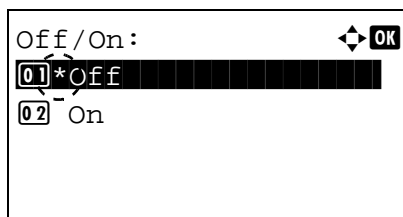

- 1 In the SSL menu, press Δ or ∇ to select Off/On.
- 2 Press **[OK]**. The Off/On screen appears.

- 3 Press Δ or ∇ to select whether to use the SSL server.
- 4 Press **[OK]**. The SSL server setting is set and the SSL menu reappears.

Encryption (Encryption setting)

Select the encryption method used on the SSL server.

 **Note** This setting is only displayed when the *SSL Setting (SSL Server setting)* on page 6-87 is set to On.

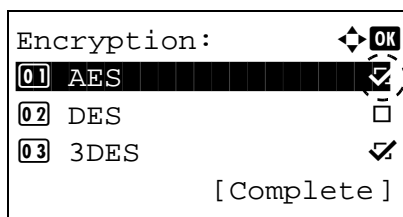

- 1 In the SSL menu, press Δ or ∇ to select Encryption.
- 2 Press **[OK]**. The Encryption screen appears.

- 3 Press Δ or ∇ to move the cursor to the encryption method to be used and then press **[OK]**.

The options available in Encryption are as follows:

- AES (SSL Server AES setting)
 AES (Advanced Encryption Standard) was developed to replace DES as the standard encryption as the safety of DES has declined. AES is a block encryption system that uses 128-bit blocks and an SPN structure (a typical structure for repeated encryption) with three selectable key lengths of 128, 192 and 256 bits.

- DES
DES (Data Encryption Standard) is a typical symmetric-key cryptographic algorithm that divides data in to 64-bit blocks and then encrypts each block using a 56-bit key.

IMPORTANT Symmetric-key cryptography, because it uses the same key for both encryption and decryption, uses the same key in both directions when encrypted data is exchanged. Accordingly, to prevent the key from being divulged, key transfer and storage must be very strictly managed.

- 3DES
3DES (Triple Data Encryption Standard) is a high level of encryption in which DES encryption is repeated threefold.

A hash symbol (✓) appears to the right of the selected encryption method.

- 4 After completing the selection, press [Complete] (**[Right Select]**). The selected encryption method is set and the SSL menu reappears.

Once you have set an encryption method, and asterisk (*) appears in front of this menu option.

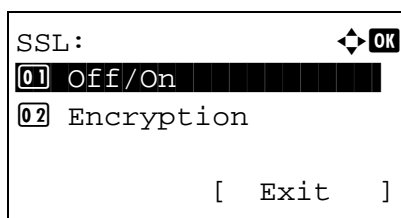

IPP over SSL (SSL Server IPP over SSL setting)

IPP over SSL is an encryption function that uses SSL for communications between users and servers in network printing. To use IPP over SSL, both server and client must support the protocol. The default setting is *Off*.

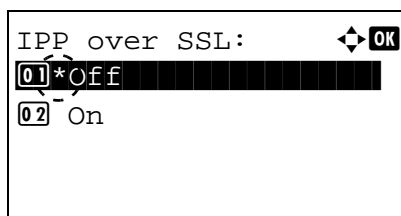

- 1 In the SSL Setting menu, press Δ or ∇ to select *IPP over SSL*.
- 2 Press **[OK]**. The *IPP over SSL* screen appears.

- 3 Press Δ or ∇ to select whether IPP over SSL is enabled.
- 4 Press **[OK]**. The IPP over SSL setting is set and the SSL Setting menu reappears.

HTTPS (SSL Server HTTPS setting)

HTTPS (HyperText Transfer Protocol Secure) is a protocol that adds SSL data encryption, message authentication and a digital signature function to the HTTP protocol used for data transfer between WWW servers and clients.

S-HTTP is a similar protocol, but HTTPS differs in that it uses SSL. The default setting is `On`.

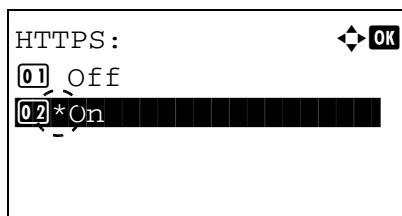

- 1 In the SSL Setting menu, press Δ or ∇ to select `HTTPS`.
- 2 Press **[OK]**. The `HTTPS` screen appears.

- 3 Press Δ or ∇ to select whether HTTPS is enabled.
- 4 Press **[OK]**. The HTTPS setting is set and the SSL Setting menu reappears.

IPSec (IPSec setting)

IPSec (IP Security Protocol) is a security protocol adopted as the standard by the IETF for authentication and encryption in the third network layer (IP layer).

It can be used with both IPv4 and IPv6.

 **Note** IPv4 uses 32-bit IP addresses and IPv6 uses 128-bit IP addresses.

The default setting is `Off`.

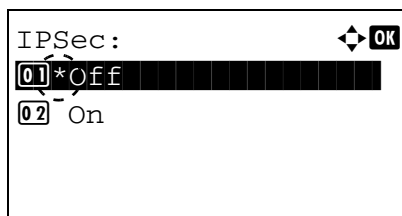

- 1 In the Network Security menu, press Δ or ∇ to select `IPSec`.
- 2 Press **[OK]**. The `IPSec` screen appears.

- 3 Press Δ or ∇ to select whether IPSec is enabled.
- 4 Press **[OK]**. The IPSec setting is set and the Network Security menu reappears.

ThinPrint (ThinPrint setting)

Select whether or not to communicate using ThinPrint. SSL settings can also be selected. The default setting is `On`.

 **Note** Thin Print is only displayed when the optional UG-33 has been activated. Thin Print is only supported in Europe.

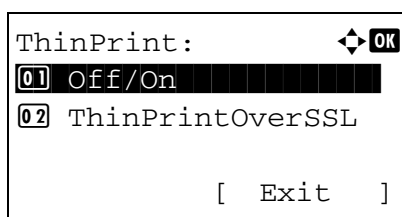

- 1 In the Network Security menu, press Δ or ∇ to select `ThinPrint`.
- 2 Press **[OK]**. The `ThinPrint` menu screen appears.

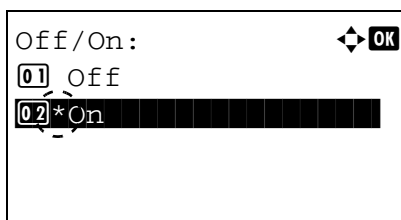

- 3 Press Δ or ∇ to select Off/On.
- 4 Press **[OK]**. The Off/On screen appears.

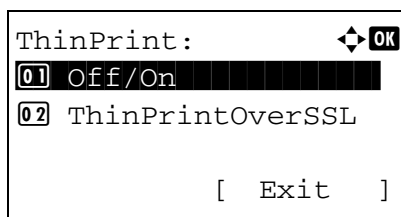

- 5 Press Δ or ∇ to select whether Thin Print is enabled.
- 6 Press **[OK]**. The Thin Print is set and the ThinPrint menu reappears. When Thin Print is set to On, the settings for Thin Print over SSL are displayed, so continue on and set these.

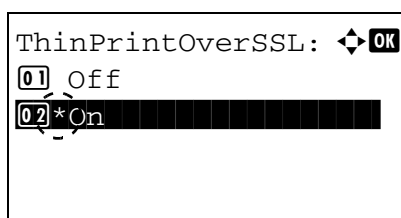

- 7 Press Δ or ∇ to select ThinPrintOverSSL.
- 8 Press **[OK]**. The ThinPrintOverSSL screen appears.

- 9 Press Δ or ∇ to select whether Thin Print over SSL is enabled.
- 10 Press **[OK]**. The Thin Print is set and the ThinPrint menu reappears.

LAN Interface (LAN Interface setting)

Specify the settings for the LAN interface to be used. The default setting is Auto.

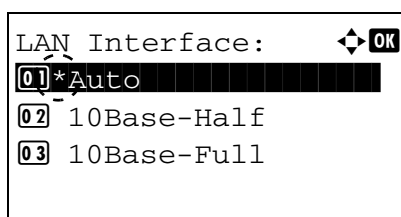

- 1 In the Network Security menu, press Δ or ∇ to select LAN Interface.
- 2 Press **[OK]**. The LAN Interface screen appears.

The available LAN Interface are as follows:

Auto
 10Base-Half
 10Base-Full
 100Base-Half
 100Base-Full
 1000Base-T

- 3 Press Δ or ∇ to select the desired LAN Interface.
- 4 Press **[OK]**. The LAN Interface is set and the Network Security menu reappears.

I/F Block Set. (External interface block setting)

You can use this to lock and thereby protect the interface.

The options available in I/F Block Set. are as follows:

- USB Host (USB Port setting)...6-92
- USB Device (USB interface setting)...6-92
- Option I/F (Network interface card (NIC) setting)...6-93
- USB Storage (USB memory setting)...6-93

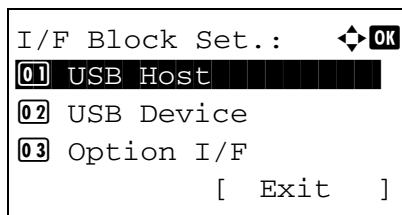

- 1 In the Security menu, press Δ or ∇ to select I/F Block Set..
- 2 Press **[OK]**. The I/F Block Set. menu screen appears.

USB Host (USB Port setting)

This locks and protects the USB Port (USB Host). The default setting is Unblock.

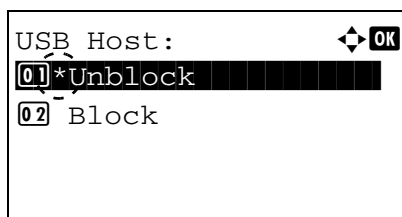

- 1 In the I/F Block Set. menu, press Δ or ∇ to select USB Host.
- 2 Press **[OK]**. The USB Host screen appears.

- 3 Press Δ or ∇ to select whether a USB host is used.
- 4 Press **[OK]**. The USB Host setting is set and the I/F Block Set. menu reappears.

USB Device (USB interface setting)

This locks and protects the USB interface. The default setting is Unblock.

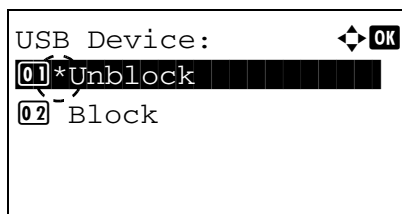

- 1 In the I/F Block Set. menu, press Δ or ∇ to select USB Device.
- 2 Press **[OK]**. The USB Device screen appears.

- 3 Press Δ or ∇ to select whether a USB device is used.
- 4 Press **[OK]**. The USB Device setting is set and the I/F Block Set. menu reappears.

Option I/F (Network interface card (NIC) setting)

This locks and protects the network interface card (NIC). The default setting is Unblock.

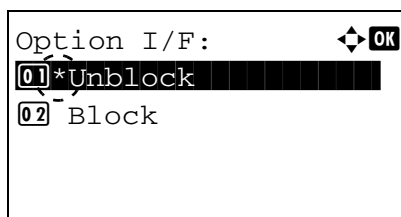

- 1 In the I/F Block Set. menu, press Δ or ∇ to select Option I/F.
- 2 Press **[OK]**. The Option I/F screen appears.

- 3 Press Δ or ∇ to select whether an optional interface is used.
- 4 Press **[OK]**. The Optional I/F setting is set and the I/F Block Set. menu reappears.

USB Storage (USB memory setting)

This locks and protects the USB storage (USB memory). The default setting is Unblock.

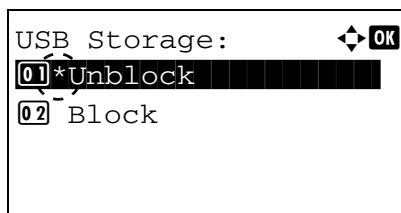

- 1 In the I/F Block Set. menu, press Δ or ∇ to select USB Storage.
- 2 Press **[OK]**. The USB Storage screen appears.

- 3 Press Δ or ∇ to select whether a USB memory is used.
- 4 Press **[OK]**. The USB memory setting is set and the I/F Block Set. menu reappears.

Security Level

The Security Level setting is primarily a menu option used by service personnel for maintenance work. There is no need for customers to use this menu.

Data Security (Data Security setting)

This is to change the Security Password, perform HDD initialization and perform data sanitization.

- HDD Initializ. (Hard Disk Initialization)...6-94
- DataSanitization (Sanitizing the stored data)...6-97

 **Note** HDD Initializ. is displayed only when the optional Data Security Kit is installed on the printer.

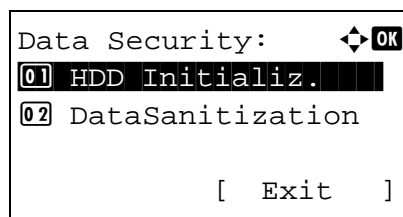

- 1 In the Security menu, press Δ or ∇ to select Data Security.
- 2 Press **[OK]**. The Data Security menu screen appears.

HDD Initializ. (Hard Disk Initialization)

This is to change the Security Password and initialize on HDD.

- Data Overwrite (data overwrite setting)...6-95
- SecurityPassword (Change the Security Password)...6-95
- Initialization (Initialize on HDD)...6-96

 **Note** The HDD Initializ. menu is used with the optional Data Security Kit (E). For details, refer to *Data Security Kit (E) Operation Guide*.

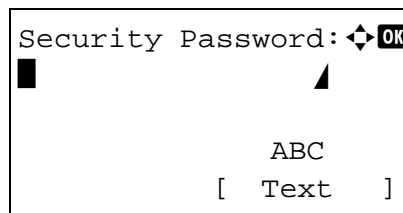

- 1 In the Data Security menu, press Δ or ∇ to select HDD Initializ..
- 2 Press **[OK]**. The Security Password input menu screen appears.

- 3 Enter the Security Password using the numeric keys.

 **Note** The initial setting for the Security Password is "000000". For details on entering characters, refer to *Character Entry Method on page A-6*.

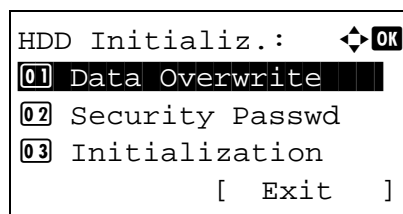

- 4 Press **[OK]**. If the Security Password entered is correct, the HDD Initializ. menu screen appears. If the Security Password entered was not correct, Incorrect password is displayed and the SecurityPassword screen reappears. Enter the correct Security Password.

Data Overwrite (data overwrite setting)

Set the method for erasing the printed data from the machine's hard disk after printing is finished.

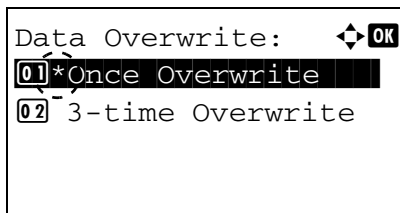

- 1 In the HDD Initializ. menu, press Δ or ∇ to select Data Overwrite.
- 2 Press [OK]. The Data Overwrite menu screen appears.

- 3 Press Δ or ∇ to select the Data Overwrite setting.
- 4 Press [OK]. Data Overwrite is set and you return to the HDD initialization menu.

SecurityPassword (Change the Security Password)

Change the Security Password.

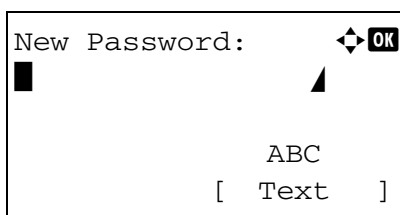

- 1 In the HDD Initializ. menu, press Δ or ∇ to select Security Passwd.
- 2 Press [OK]. The New Password input menu screen appears.

- 3 Enter the new Security Password using the numeric keys.



Note The Security Password must be between 6 and 16 characters. For details on entering characters, refer to *Character Entry Method* on page A-6.

- 4 Press [OK]. The Confirm Password input menu screen appears.

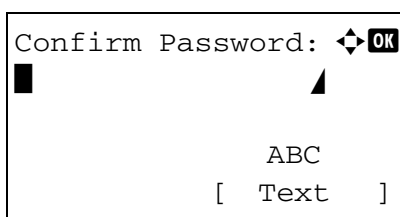

- 5 To confirm, re-enter the security password to be registered. Enter the new Security Password using the numeric keys.
- 6 Press [OK]. If the Security Password entered matches then the password is changed to the new password and the HDD Initializ. menu reappears.

If the password does not match, *Incorrect password* is displayed and the *New Password* screen reappears. Enter again from the new Security Password.

Initialization (Initialize on HDD)

Overwrite all the data stored in the HDD when disposing of the printer.

IMPORTANT If you accidentally turn the power switch off during initialization, the HDD might possibly crash or initialization might fail.

```
System Initialization
will start.
Are you sure?

[ Yes ] [ No ]
```

- 1** In the HDD Initializ. menu, press Δ or ∇ to select Initialization.
- 2** Press **[OK]**. A confirmation message is displayed.
- 3** Press **[Yes]** (**[Left Select]**). Initialization starts.
If you do not wish to initialize, press **[No]** (**[Right Select]**). The HDD Initializ. menu reappears.

```
Completed.
Turn the main power
switch off.
```

- 4** When the initialization is finished Completed. is displayed. Press **[OK]** (**[Right Select]**) and turn the power switch off.

DataSanitization (Sanitizing the stored data)

This is to completely delete the address information registered on the machine and the stored image data .

IMPORTANT About 8 hours are required to complete this processing, depending on the amount of data. Once started, the processing cannot be canceled.

Before performing this task, disconnect the modular cable, network cable, and any other cables.

Do not turn off the main power during sanitization. If the main power is turned off, sanitization will automatically resume when the power is turned on, but complete sanitization cannot be guaranteed.

The data deleted is as listed below.

- Job settings
- Machine settings (Network settings)
- Certificates
- User settings (user lists, document boxes)
- Machine administration (job logs, job accounting)



Note It is possible to check the status of data sanitization implementation on the Status page. For details, refer to *Status Page (Printing a printer's status page)* on page 6-4.

- 1 In the Data Security menu, press \triangle or ∇ to select DataSanitization.
- 2 Press **[OK]**. A confirmation message is displayed.

```
Sanitize the data.
Are you sure?
* This process will
take a while.
[ Yes ] [ No ]
```

- 3 Press **[Yes] ([Left Select])**. The message Sanitizing the data. appears and the data sanitization begins. Pressing **[No] ([Right Select])** returns you to the Data Security menu without sanitizing the data.

```
Sanitize the data.
Main Memory :Comple
Internal Mem.:Comple

[ OK ]
```

- 4 When the data sanitization is finished "Comple" is displayed. Press **[OK] ([Right Select])** and turn the power switch off.



Note It is possible to check the result of data sanitization on the Status page. For details, refer to *Status Page (Printing a printer's status page)* on page 6-4.

User/Job Account (User Login Setting/Job Account setting)

It is possible to set User Login Administration and Job Accounting on this machine.

User/ Job Account has the following items.

- User Login Set. (User login setting)...6-98
- Job Account.Set. (Job Account setting)...6-110

User Login Set. (User login setting)

User Login Administration is a function which makes it possible to specify the users who can use the machine and to manage the users. If the login user name and password entered match those already registered then the user is authenticated and can log in to the machine.

Users are classified into "User," "Administrator" or "DeviceAdmin," depending on their authority. The setting of security levels can only be done by DeviceAdmin.

The authentication for this machine uses a network authentication server. The registration of users is done on the server.

In the local user list for the machine, 1 user with administrator authority and 1 user with device administrator authority are registered. To change the administrator information, refer to *Local User List on page 6-102*.

When the optional Card Authentication Kit is activated, it is possible to log in using an IC card.

First User Login Administration

Follow these steps for the first user login administration.

Enable user login administration. (*page 6-100*)



Log out. (*page 6-108*)



The registered user logs in for operations. (*page 6-108*)

Login User Name :	▲	▼	OK
[REDACTED]			
Login Password :			
[Login]			

- 1 Press **[Menu]**.
- 2 Press Δ or ∇ to select **User/Job Account**.
- 3 Press **[OK]**. The Login screen appears.



Note When user login administration is set:

- When logged in as an administrator, the log in screen is not displayed and the **User/Job Account** menu screen is displayed.
- The setting is not possible when logged in as anyone other than an administrator. Log in again as an administrator.

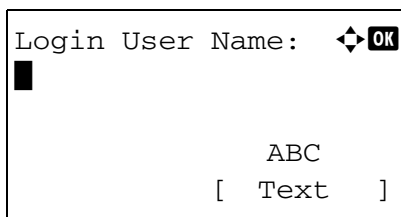

4 With the Login User Name entry field selected, press **[OK]**. The Login User Name entry screen is displayed.

5 Enter the Login User Name using the numeric keys then press **[OK]**. The log in screen reappears.



Note The initial setting for the administrator's Login User Name is "Admin".

For details on entering characters, refer to *Character Entry Method* on page A-6.

6 Press Δ or ∇ to select the Login Password entry field.

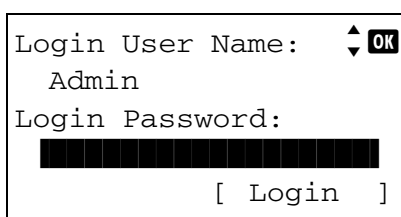

7 Press **[OK]**. The Login Password entry screen is displayed.

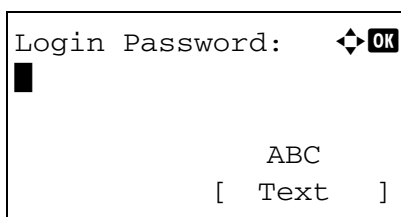

8 Enter the Login Password with the numeric keys then press **[OK]**. The login screen reappears.



Note The initial setting for the administrator's Login Password is "Admin".

For details on entering characters, refer to *Character Entry Method* on page A-6.

9 Pressing [Login] (**[Right Select]**). If the entered Login User Name and Login Password are correct, the User/Job Account menu screen appears.

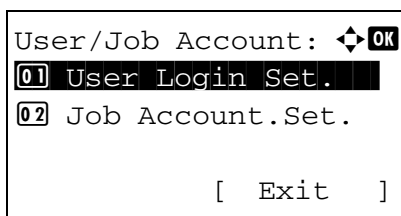

10 Press Δ or ∇ to select User Login Set..

11 Press **[OK]**. The User Login Set. menu appears.

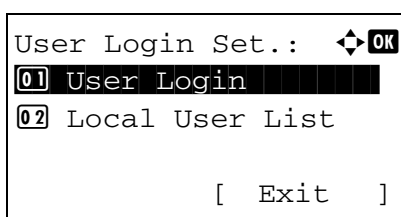

User Login

This switches the User Login Administration On/Off and sets the authentication network server.

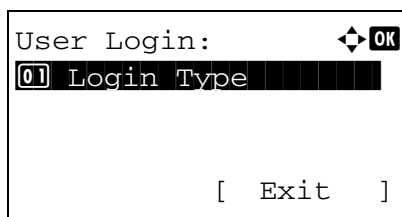

- 1 In the User Login Set. menu, press Δ or ∇ to select User Login.
- 2 Press **[OK]**. The User Login menu screen appears.

Login Type (Enabling of User Login Administration)

Select `Netwk Authentic.` to enable User Login Administration.

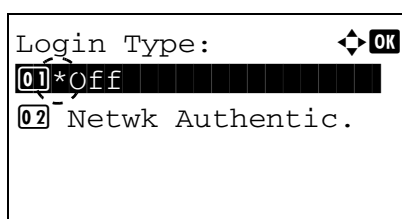

- 1 In the User Login menu, press Δ or ∇ to select Login Type.
- 2 Press **[OK]**. The Login Type screen appears.

- 3 Press Δ or ∇ to select `Netwk Authentic.` or `Off`.
- 4 Press **[OK]**. The User Login menu reappears.



Note When `Netwk Authentic.` is selected, set the network authentication server.

Netwk Auth. Set (Netwk authentication setting)

Set the network authentication server.



Note These settings are only displayed when `Netwk Authentic.` has been set as the *Login Type (Enabling of User Login Administration)* on page 6-100.

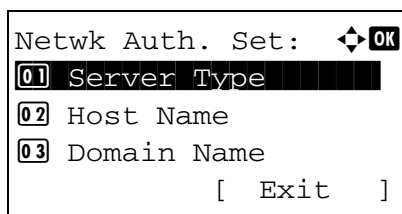

- 1 In the User Login menu, press Δ or ∇ to select Netwk Auth. Set.
- 2 Press **[OK]**. The Netwk Auth. Set menu screen appears.

The options available in `Netwk Auth. Set` are as follows:

- Server Type (Server type selection)...6-101
- Host Name (Entering of Host Name)...6-101
- Port (Port number setting)...6-101
- Domain Name (Entering of Domain Name)...6-102

Server Type (Server type selection)

- Select the type of server for the authentication server.

- In the *Netwk Auth. Set* menu, press Δ or ∇ to select *Server Type*.
- Press **[OK]**. The *Server Type. Set* screen appears. The available server types are as follows:
NTLM
Kerberos
Ext.
- Press Δ or ∇ to select the desired server type.
- Press **[OK]**. The server type is set and the *Netwk Auth. Set* menu reappears.

Host Name (Entering of Host Name)

Enter the Host Name for the authentication server.

- In the *Netwk Auth. Set* menu, press Δ or ∇ to select *Host Name*.
- Press **[OK]**. The *Host Name* screen appears.
- Enter the Host Name using the numeric keys.



Note Up to 64 characters can be entered. For details on entering characters, refer to *Character Entry Method* on page A-6.

- Press **[OK]**. Register the Host Name and the *Netwk Auth. Set* menu reappears.

Port (Port number setting)

Set the Port number for the authentication server.



Note This setting is only displayed when *Ext.* has been set as the *Server Type (Server type selection)* on page 6-101.

- In the *Netwk Auth. Set* menu, press Δ or ∇ to select *Port*.
- Press **[OK]**. The *Port* screen appears.

- Enter the Port number with the numeric keys.



Note If the Port is registered as a blank field, the default Port number will be enabled.

- Press **[OK]**. Register the Port number and the *Netwk Auth. Set* menu reappears.

Domain Name (Entering of Domain Name)

Enter the Domain Name for the authentication server.

 **Note** This setting is only displayed when NTLM or Kerberos has been set as the *Server Type (Server type selection)* on page 6-101.

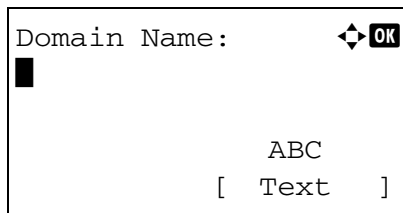

- 1 In the *Netwk Auth. Set* menu, press Δ or ∇ to select *Domain Name*.
- 2 Press **[OK]**. The *Domain Name* screen appears.

- 3 Enter the Domain Name using the numeric keys.

 **Note** Up to 256 characters can be entered. For details on entering characters, refer to *Character Entry Method* on page A-6.

- 4 Press **[OK]**. Register the Domain Name and the *Netwk Auth. Set* menu reappears.

Local User List

User information registered in the machine can be viewed and changed.

In the local user list for the machine, 1 user with administrator authority and 1 user with device administrator authority are registered.

Each user's properties are:

Machine Administrator		Administrator	
User Name:	DeviceAdmin	User Name:	Admin
Login User Name:	FS-C8600DN: 4500 FS-C8650DN: 5500	Login User Name:	Admin
Login Password:	FS-C8600DN: 4500 FS-C8650DN: 5500	Login Password:	Admin
Access Level:	Machine Administrator	Access Level:	Administrator

Use the procedure below to change the details registered.

 **Note** Log in as DeviceAdmin to change the administrator information. When logged in as Admin., it is only possible to check the administrator information.

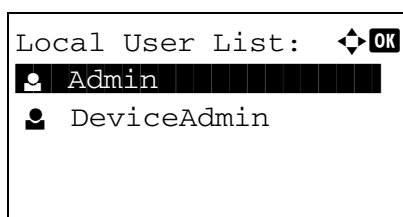

- 1 In the *User Login Set.* menu, press Δ or ∇ to select *Local User List*.
- 2 Press **[OK]**. The *Local User List* screen appears.

```

Detail:                ◀ ▶ OK
User Name:             1/ 5
Admin
    
```

- 3 Press Δ or ∇ to select the administrator to change.
- 4 Press **[OK]**. The detailed information for the user is displayed.

To change the Login User Name

```

Detail:                ◀ ▶ OK
Login User Name:      2/ 5
Admin
                        [ Edit ]
    
```

- 5 Press \triangleleft or \triangleright to select Login User Name.

```

Login User Name:     ◀ ▶ OK
Admin█
                        ABC
                        [ Text ]
    
```

- 6 Pressing **[Edit]** (**[Right Select]**). The screen for editing the Login User Name appears.

- 7 Change the Login User Name with the numeric keys and press **[OK]**. The Login User Name screen reappears.



Note Up to 32 characters can be entered. For details on entering characters, refer to *Character Entry Method* on page A-6.

To change the Login Password

```

Detail:                ◀ ▶ OK
Login Password:      3/ 5
●●●●●●●●●●
                        [ Edit ]
    
```

- 8 Press \triangleleft or \triangleright to select Login Password.

```

New Password:        ◀ ▶ OK
█
                        ABC
                        [ Text ]
    
```

- 9 Pressing **[Edit]** (**[Right Select]**). The New Password screen appears.

Confirm Password: 

█

ABC

[Text]

- 10** Enter the new password with the numeric keys and press **[OK]**. The Confirm Password screen reappears.



Note Up to 64 characters can be entered. For details on entering characters, refer to *Character Entry Method on page A-6*.

- 11** To confirm, re-enter the password to be registered. Enter the Password using the numeric keys.
- 12** Press **[OK]**. If the Password matches then the password is changed to the new one and the Login Password screen reappears.
- If the password does not match, *Incorrect password* is displayed and the *New Password* screen reappears. Enter again from the new Password.

To change the E-mail Address

Detail: 

 E-mailAddress: 4/ 5

[Edit]

- 13** Press **<** or **>** to select E-mailAddress.

Address Entry: 

█

ABC

[Text]

- 14** Pressing **[Edit]** (**[Right Select]**). The Address Entry screen appears.

- 15** Change the address with the numeric keys and press **[OK]**. The E-mailAddress screen reappears.



Note Up to 128 characters can be entered. For details on entering characters, refer to *Character Entry Method on page A-6*.

To change the Account ID



Note This item is only displayed when Job Account is set.

Detail: 

Account ID: 5/ 5

 OTHER

[Change]

- 16** Press **<** or **>** to select Account ID.

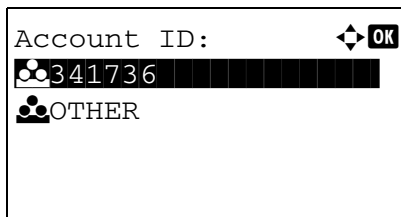

17 Pressing [Change] (**[Right Select]**). The Account ID screen appears.

18 Press Δ or ∇ to select the Account ID and press **[OK]**. The Account ID screen reappears.



Note For other accounts, select OTHER.

ID Card Setting

This sets the login method when the optional Card Authentication Kit is used and users are managed using ID cards.

 **Note** This item is only displayed when the optional Card Authentication Kit is activated. For details of the Card Authentication Kit, refer to *Card Authentication Kit (B) Operation Guide for Printer*.

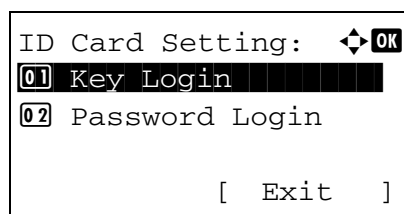

- 1 In the User Login Set. menu, press Δ or ∇ to select ID Card Setting.
- 2 Press [OK]. The ID Card Setting menu screen appears.

The options available in ID Card Setting are as follows:

- Key Login (Setting for key login permission)...6-106
- Password Login (Password Login setting)...6-106

Key Login (Setting for key login permission)

This setting also permits logging in using the numeric keys on the ID card login screen. When `Permit` is set, `KeyLogin` is displayed on the login screen and it is possible to log in by entering the Login User Name and Login Password using the numeric keys. When `Prohibit` is set, it is not possible to log in using the numeric keys.

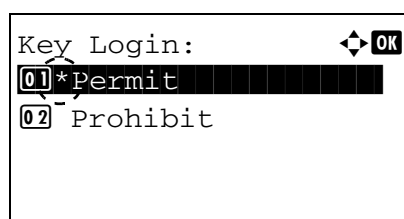

- 1 In the ID Card Setting menu, press Δ or ∇ to select Key Login.
- 2 Press [OK]. The Key Login screen appears.

- 3 Press Δ or ∇ to select `Permit` or `Prohibit`.
- 4 Press [OK]. Set the Key Login and the The ID Card Setting menu reappears.

Password Login (Password Login setting)

This sets whether or not to require the entry of a Login Password after authentication using an ID card. When set to `On`, the Login Password entry screen is displayed after the ID card is authenticated.

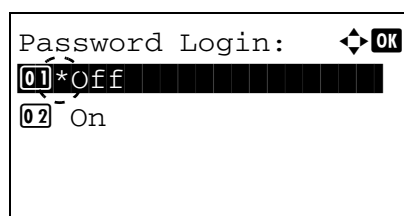

- 1 In the ID Card Setting menu, press Δ or ∇ to select Password Login.
- 2 Press [OK]. The Password Login screen appears.

- 3 Press Δ or ∇ to select `Off` or `On`.
- 4 Press [OK]. Set the Password Login and the The ID Card Setting menu reappears.

NW User Property (Obtain the network user property)

This setting is to acquire user information from the LDAP server.

 **Note** This setting is only displayed when `Netwk Authentic.` has been set as the *Login Type (Enabling of User Login Administration)* on page 6-100 and `NTLM` or `Kerberos` has been set as the *Server Type (Server type selection)* on page 6-101.

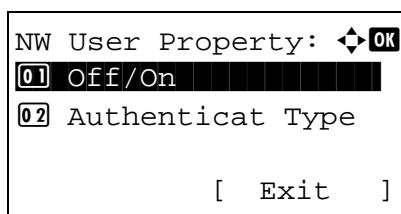

1 In the User Login Set. menu, press Δ or ∇ to select `NW User Property`.

2 Press **[OK]**. The NW User Property menu screen appears.

The options available in `NW User Property` are as follows:

- `Off/On` (Switching network user property acquisition On/Off)...6-107
- `Authenticat Type` (Authenticat type setting)...6-107

 **Note** `Authenticat Type` is only displayed when `Kerberos` has been set as the *Server Type (Server type selection)* on page 6-101.

Off/On (Switching network user property acquisition On/Off)

Set the NW User Property to On/Off.

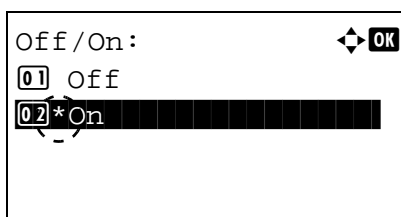

1 In the NW User Property menu, press Δ or ∇ to select `Off/On`.

2 Press **[OK]**. The Off/On screen appears.

3 Press Δ or ∇ to select `On` or `Off`.

4 Press **[OK]**. Set the NW User Property and the The NW User Property menu reappears.

Authenticat Type (Authenticat type setting)

Set the authentication method.

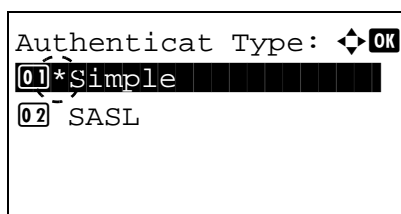

1 In the NW User Property menu, press Δ or ∇ to select `Authenticat Type`.

2 Press **[OK]**. The Authenticat Type screen appears.

3 Press Δ or ∇ to select `Simple` or `SASL`.

4 Press **[OK]**. Set the Authenticat Type and the The NW User Property menu reappears.

Login/Logout

Once you enable user login administration, a login user name and password entry screen appears each time you use this machine. Enter the user information registered on the network authentication server as the login user name and password. Register new users from the KYOCERA Net Policy Manager. For details, refer to the *KYOCERA Net Policy Manager User Guide*.

Login

Use the procedure below to login.

- 1 With the Login User Name entry field selected, press **[OK]**. The Login User Name entry screen is displayed.

- 2 Enter the Login User Name using the numeric keys then press **[OK]**. The log in screen reappears.

 **Note** For details on entering characters, refer to *Character Entry Method* on page A-6.

- 3 Press Δ or ∇ to select the Login Password entry field.

- 4 Press **[OK]**. The Login Password entry screen is displayed.

- 5 Enter the Login Password with the numeric keys then press **[OK]**. The login screen reappears.

 **Note** For details on entering characters, refer to *Character Entry Method* on page A-6.

- 6 Check that the correct login user name and password have been entered then press **[Login]** (**[Right Select]**).

 **Note** When Job Accounting is set, it is possible to press **[Menu]** (**[Left Select]**) then select Counter on the menu displayed and press **[OK]** to see the number of pages printed.

Logout

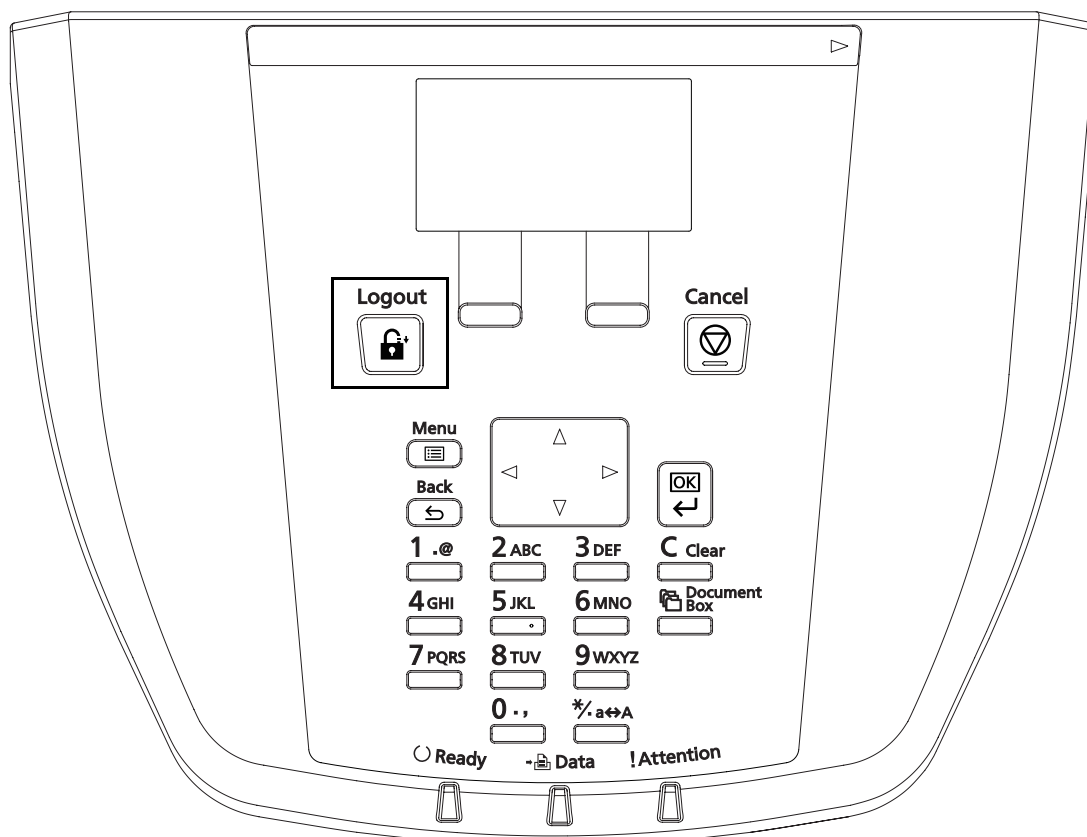

When the operations are finished, press **[Logout]**. The login screen reappears.

Auto Logout

Logout is automatically executed in the following cases:

- When the power supply is cut
- When auto sleep is activated
- When auto panel reset is activated

Job Account.Set. (Job Account setting)

Job Accounting is a function that allows the number of pages used by each department to be managed through the use of entered account IDs. To specify the Job Accounting settings, it is necessary to log in with an administrator's Login User Name and Login Password. For details of User Login Administration, refer to *User Login Set. (User login setting)* on page 6-98.

Job accounting on this machine offers the following features:

- Support for up to 100 departments
- Account IDs up to 8 digits long from 1 to 99999999
- Collective print management for the same account ID
- Totaling of the number of pages used for each department
- Specifiable limits (1 to 9,999,999) on the number of pages used

The options available in the Job Account.Set menu are as follows:

- Job Accounting (Job Accounting settings)...6-112
- Account. Report (Account report printing)...6-112
- Each Job Account (Totals display by account)...6-112
- Account. List (Account List operation)...6-114
- Apply Limit (Operation settings when limits are exceeded)...6-118
- Unknown ID Job (Operation settings for unknown account IDs)...6-118

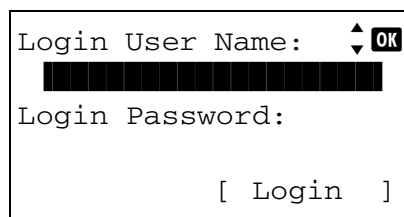

Login User Name: ▲ ▼ OK
 Login Password:
[Login]

- 1 Press **[Menu]**.
- 2 Press Δ or ∇ to select *User/Job Account*.
- 3 Press **[OK]**. The Login screen appears.



Note When user login administration is set:

- When logged in as an administrator, the log in screen is not displayed and the *User/Job Account* menu screen is displayed.
- The setting is not possible when logged in as anyone other than an administrator. Log in again as an administrator.

```

Login User Name:  ⬆️⬆️⬆️ OK
█
                                     ABC
                               [  Text  ]
    
```

4 With the Login User Name entry field selected, press [OK]. The Login User Name entry screen is displayed.

5 Enter the Login User Name using the numeric keys then press [OK]. The log in screen reappears.



Note The initial setting for the administrator's Login User Name is "Admin".

For details on entering characters, refer to *Character Entry Method* on page A-6.

6 Press Δ or ∇ to select the Login Password entry field.

```

Login User Name:  ▲ OK
  Admin
Login Password:
████████████████████
                               [  Login  ]
    
```

7 Press [OK]. The Login Password entry screen is displayed.

```

Login Password:  ⬆️⬆️⬆️ OK
█
                                     ABC
                               [  Text  ]
    
```

8 Enter the Login Password with the numeric keys then press [OK]. The login screen reappears.



Note The initial setting for the administrator's Login Password is "Admin".

For details on entering characters, refer to *Character Entry Method* on page A-6.

```

Login User Name:  ▲ OK
  Admin
Login Password:
●●●●●●●●●●
                               [  Login  ]
    
```

9 Pressing [Login] ([Right Select]). If the entered Login User Name and Login Password are correct, the User/Job Account menu screen appears.

```

User/Job Account: ⬆️⬆️⬆️ OK
01 User Login Set.
02 Job Account.Set.
                               [  Exit  ]
    
```

10 Press Δ or ∇ to select Job Account.Set..

11 Press [OK]. The Job Account.Set. menu appears.

```

Job Account.Set.: ⬆️⬆️⬆️ OK
01 Job Accounting
02 Account. Report
02 Each Job Account
                               [  Exit  ]
    
```

Job Accounting (Job Accounting settings)

This allows you to turn the Job Accounting function On and Off.

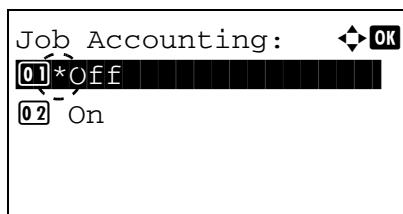

1 In the Job Account.Set. selection menu, press Δ or ∇ to select Job Accounting.

2 Press **[OK]**. The Job Accounting screen appears.

3 Press Δ or ∇ to select On or Off and then press **[OK]**. The Job Account.Set. menu reappears.

Account. Report (Account report printing)

This enables you to print the total number of pages for all accounts as a Job Accounting list.

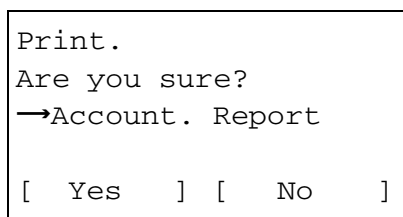

1 In the Job Account.Set. selection menu, press Δ or ∇ to select Account. Report.

2 Press **[OK]**. A confirmation screen appears.

Press **[Yes]** (**[Left Select]**). Accepted. appears and the printer prints the job accounting list.

Pressing **[No]** (**[Right Select]**) returns you to the Job Account.Set. menu without printing the job accounting list.

Each Job Account (Totals display by account)

Displays the number of pages printed for each of the currently selected accounts.

This enables you to check the following numbers for printed pages:

- Total
- Color
- Black & White
- Combine (None)
- Combine (2in1)
- Combine (4in1)
- Duplex (1side)
- Duplex (2side)

 **Note** Before carrying out this operation, register the Account in the *Account. List (Account List operation)* on page 6-114.

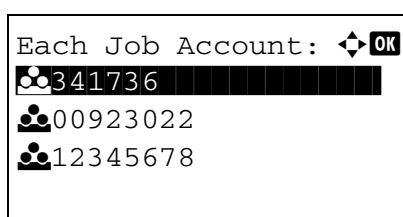

1 In the Job Account.Set. selection menu, press Δ or ∇ to select Each Job Account.

2 Press **[OK]**. The Each Job Account menu appears with the accounts with the highest numbers listed first.

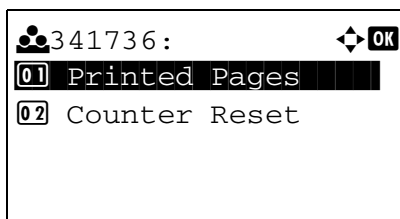

3 Press Δ or ∇ to select an account and then press **[OK]**. The Printed Pages/Counter Reset menu screen appears.

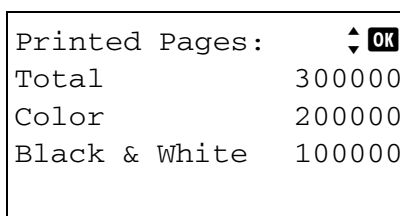

4 Press Δ or ∇ to select Printed Pages.

5 Press **[OK]**. The Printed Pages menu list screen appears.

6 Press Δ or ∇ to check the required counter display.

7 Press **[OK]**. The Printed Pages/Counter Reset menu screen reappears.

Each Job Account Counter Reset (Totals reset by account)

Resets the number of pages printed for each of the accounts currently set.



Note Before carrying out this operation, register the Account in the *Account List* (Account List operation) on page 6-114.

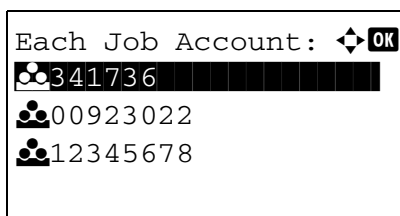

1 In the Job Account.Set. selection menu, press Δ or ∇ to select Each Job Account.

2 Press **[OK]**. The Each Job Account menu appears with the accounts with the highest numbers listed first.

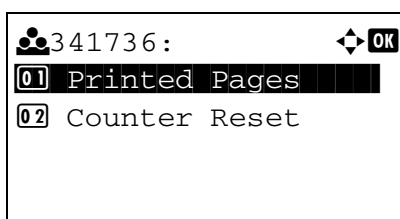

3 Press Δ or ∇ to select an account and then press **[OK]**. The Printed Pages/Counter Reset menu screen appears.

4 Press Δ or ∇ to select Counter Reset.

5 Press **[OK]**. The reset confirmation menu screen appears.

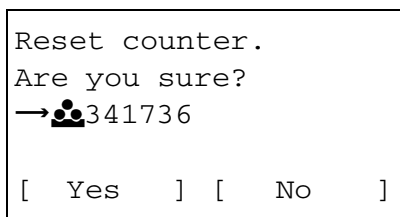

To proceed with resetting the counter, press **[Yes]** (**[Left Select]**). Completed. appears, the counter is reset and the Printed Pages/Counter Reset menu reappears.

Pressing **[No]** (**[Right Select]**) returns you to the Printed Pages/Counter Reset menu screen without resetting the counter.

Account. List (Account List operation)

This specifies the setting for the department to be used for setting Job Accounting.

Add (Account registration)

Use this procedure to add a new account.



Note Because account IDs are managed as numeric strings, "1" and "001" are handled as different accounts. Also, once Job Accounting is enabled, no jobs are printed unless information is attached showing the accounts from which the jobs are being printed.

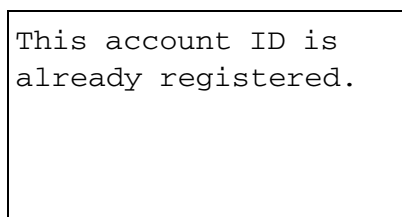
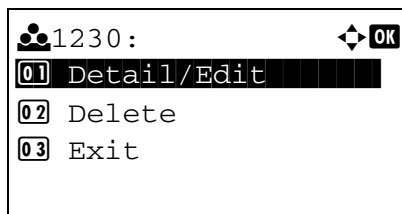
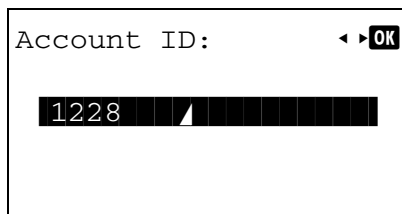
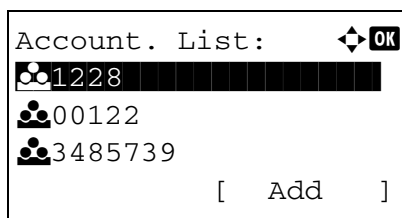

- 1 In the Job Account.Set. selection menu, press Δ or ∇ to select Account. List.
- 2 Press [OK]. The Account. List menu appears showing a list of the registered accounts in ascending order.
- 3 Press [Add] ([Right Select]). The Account ID menu screen appears.
- 4 Use the numeric keys to enter the account ID to be added.
- 5 Press [OK]. Once the account has been added, a list of selection options appears.

This message appears if the account ID has already been registered.

Detail/Edit (Checking/editing registered account ID settings)

This procedure allows you to check or edit registered accounts.

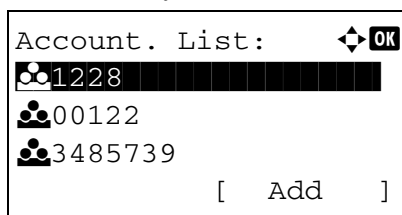

- 1 In the Job Account.Set. selection menu, press Δ or ∇ to select Account. List.
- 2 Press [OK]. The Account. List menu appears showing a list of the registered accounts in ascending order.

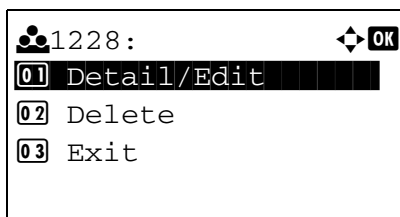

3 Press Δ or ∇ to select an account to check or edit and then press [OK]. A list of selection options appears.

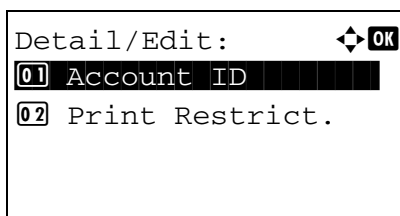

4 Press Δ or ∇ to select `Detail/Edit` and then press [OK]. The `Detail/Edit` menu screen appears.

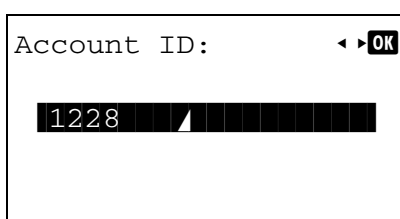

5 To edit an account ID, press Δ or ∇ to select `Account ID` and then press [OK]. The `Account ID` menu screen appears.

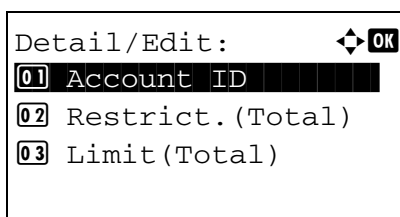

6 Use the numeric keys to enter the new account ID.

7 Press [OK]. When account ID editing ends, you are returned to the `Detail/Edit` menu.

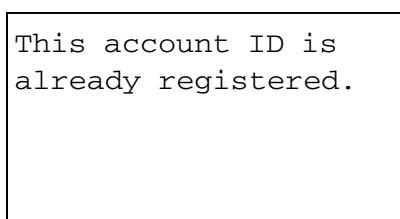

This message appears if the account ID has already been registered.

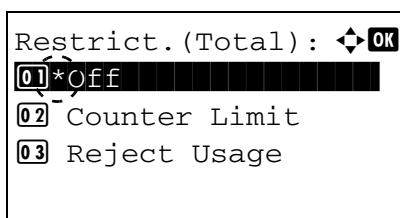

8 To place printing restrictions on this account, press Δ or ∇ to select `Print Restrict.` and then press [OK]. The `Print Restrict.` screen appears.

- Off
- Counter Limit
- Reject Usage

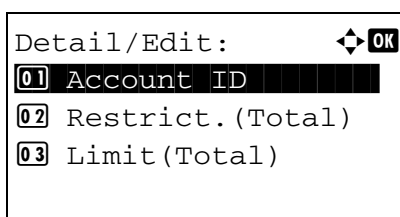

9 Press Δ or ∇ to select a setting and then press [OK]. When the setting has been completed, the `Detail/Edit` menu screen appears.

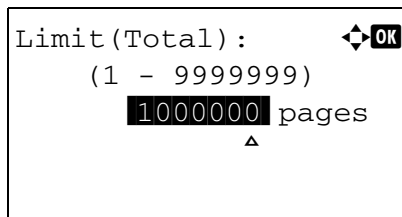

10 When Counter Limit is set for Restrict. (Total) in step 9, set the limit on the total number of pages that can be printed using this account. Press Δ or ∇ to select Limit (Total) and then press [OK]. The Limit (Total) menu screen appears.

IMPORTANT Limit (Total) is displayed when Counter Limit is set for Restrict. (Total).

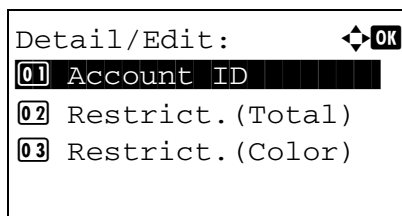

11 Use the numeric keys to enter the limit you want to set for this account.

After you have entered the limit on the number of pages, press [OK]. The setting is stored and the Detail/Edit menu reappears.

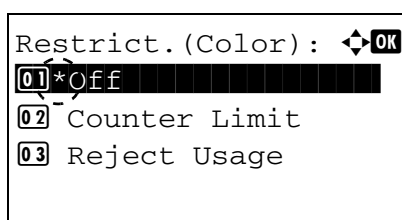

12 To place color printing restrictions on this account, press Δ or ∇ to select Restrict. (Color) and then press [OK]. The Restrict. (Color) screen appears.

- Off
- Counter Limit
- Reject Usage

13 Press Δ or ∇ to select a setting and then press [OK]. When the setting has been completed, the Detail/Edit menu screen appears.

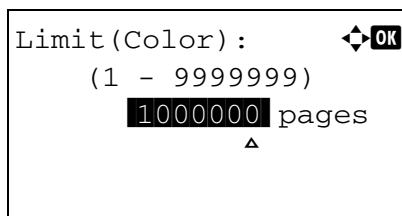
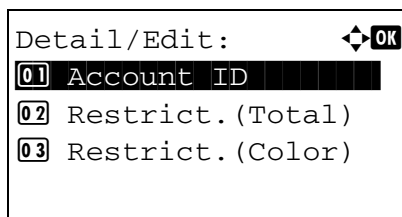

14 When Counter Limit is set for Restrict. (Color) in step 13, set the limit on the total number of color pages that can be printed using this account. Press Δ or ∇ to select Limit (Color) and then press [OK]. The Limit (Color) screen appears.

IMPORTANT Limit (Color) is displayed when Counter Limit is set for Restrict. (Color).

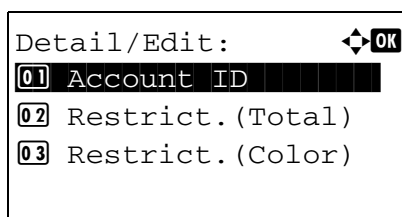

15 Use the numeric keys to enter the color printing limit you want to set for this account.

After you have entered the limit on the number of pages, press [OK]. The setting is stored and the Detail/Edit menu reappears.

Delete (Deleting registered accounts)

You can use this procedure to delete a registered account ID.

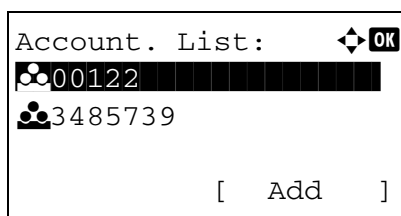
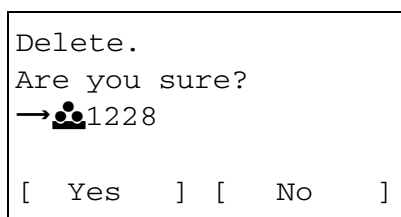
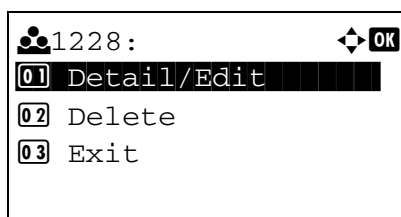
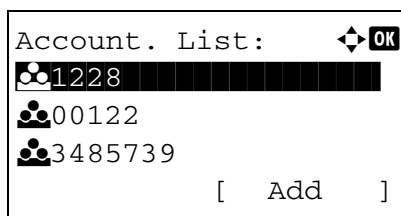

- 1 In the Job Account.Set. selection menu, press Δ or ∇ to select Account. List.
- 2 Press **[OK]**. The Account. List menu appears showing a list of the registered accounts in ascending order.
- 3 Press Δ or ∇ to select the ID of the account to be deleted.
- 4 Press **[OK]**. A list of selection options appears.
- 5 Press Δ or ∇ to select Delete and then press **[OK]**. A confirmation screen appears.
- 6 To proceed with deleting the account, press [Yes] (**[Left Select]**). Completed. appears and the account is deleted. The Once deleting of the account ends, the Account. List screen reappears. Pressing [No] (**[Right Select]**) returns you to the Account. List menu screen without deleting the account.

Apply Limit (Operation settings when limits are exceeded)

Use this to specify the action taken when a department exceeds its printing limits.

```

Apply Limit:  ⏏ OK
01 Immediately
02 *Subsequently
  
```

```

Job Account.Set.: ⏏ OK
04 Account.List
05 Apply Limit
06 Unknown ID Job
      [ Exit ]
  
```

- 1 In the Job Account.Set. selection menu, press Δ or ∇ to select Apply Limit.
- 2 Press **[OK]**. The Apply Limit screen appears.
 - Immediately (prohibit printing from this job onwards)
 - Subsequently (prohibit printing from the next job onwards)
- 3 Press Δ or ∇ to select a setting and then press **[OK]**. The Job Account.Set. selection menu list reappears.

Unknown ID Job (Operation settings for unknown account IDs)

Use this procedure to specify whether print jobs from departments with unknown account IDs are permitted.

```

Unknown ID Job: ⏏ OK
01 *Reject
02 Permit
  
```

```

Job Account.Set.: ⏏ OK
04 Account.List
05 Apply Limit
06 Unknown ID Job
      [ Exit ]
  
```

- 1 In the Job Account.Set. selection menu, press Δ or ∇ to select Unknown ID Job.
- 2 Press **[OK]**. The Unknown ID Job screen appears.
 - Reject (Not printed)
 - Permit (Printed)
- 3 Press Δ or ∇ to select a setting and then press **[OK]**. The Job Account.Set. selection menu list reappears.

Adjust/Maint. (Adjust/Maintenance selection/setting)

Adjust/Maintenance is used to adjust the print quality and to carry out printer maintenance.

The options available in Adjust/Maintenance are as follows:

- ColorCalib.Cycle (Automatic color adjustment cycle setting)...6-119
- ColorCalibration...6-120
- Color Regist. (Color registration [Standard])...6-120
- Color Regist. (Color registration [Detailed])...6-123
- Restart (Restart Printer)...6-127
- Service Setting (for Maintenance)...6-128

IMPORTANT Service Setting is primarily a menu used by service personnel for maintenance work. There is no need for customers to use this menu.

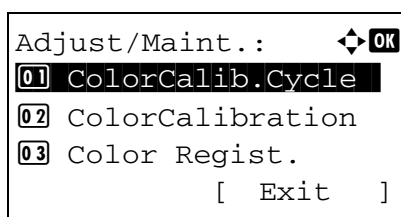

- 1 Press **[Menu]**.
- 2 Press Δ or ∇ to select Adjust/Maint..
- 3 Press **[OK]**. The Adjust/Maint. menu appears showing a list of available options.

ColorCalib.Cycle (Automatic color adjustment cycle setting)

The cycle for automatic execution of color calibration can be selected. The following cycles can be set:

Auto	Automatic judging and adjustment.
Short	Gives priority to image quality. The color adjustment cycle is shorter than Standard.
Standard	Gives equal priority to image quality and printing processing.
Long	Gives priority to printing processing. The color adjustment cycle is longer than Standard.

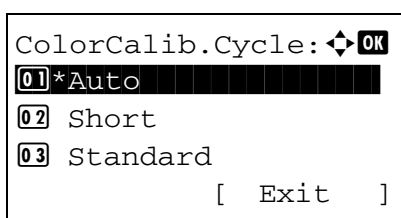

- 1 In the Adjust/Maint. menu screen, press Δ or ∇ to select ColorCalib.Cycle.
- 2 Press **[OK]**. The ColorCalib.Cycle screen appears.
- 3 Press Δ or ∇ to select the color adjustment cycle.
- 4 Press **[OK]**. The color adjustment cycle is set and the Adjust/Maint. menu screen reappears.

ColorCalibration

This printer contains a calibration function that automatically makes adjustments to compensate for changes that occur over time due to variations in the ambient temperature and humidity. So that the highest quality color printing can be maintained, this color calibration operation is carried out automatically each time the power to the printer is turned on. The color calibration operation may be carried out automatically during recovery from the Auto Sleep or during printing.

```
Start the color
calibration.
Are you sure?

[ Yes ] [ No ]
```

- 1 In the Adjust/Maint. menu screen, press Δ or ∇ to select ColorCalibration.
- 2 Press [OK]. A confirmation screen appears.
Press [Yes] ([Left Select]). Color calibration is carried out, after which you return to the standby screen.
Pressing [No] ([Right Select]) returns you to the Adjust/Maint. menu without carrying out color calibration.

Color Regist. (Color registration [Standard])

When using the printer for the first time after set-up or after having moved it, or if printout of any color (magenta, cyan or yellow) is skewed, use this mode to correct the color registration on the operation panel.

The options available in Registration Normal (Color registration [standard]) are as follows:

- Print Chart (Printing the color registration correction chart)
- Adjust Magenta (Magenta correction)
- Adjust Cyan (Cyan correction)
- Adjust Yellow (Yellow correction)

Print Chart (Printing the color registration correction chart)

You can use this option to print a color registration correction chart for use in correcting the color registration.

```
Color Regist.: ↕ OK
01 Normal
02 Detail

[ Exit ]
```

```
Normal: ↕ OK
01 Print Chart
02 Adjust Magenta
03 Adjust Cyan

[ Exit ]
```

- 1 In the Adjust/Maint. menu screen, press Δ or ∇ to select Color Regist..
- 2 Press [OK]. The Color Regist. menu screen appears.
Press [Exit] ([Right Select]) to return to the standby screen.
- 3 Press Δ or ∇ to select Normal.
- 4 Press [OK]. The Color Regist. Normal menu screen appears.
Press [Exit] ([Right Select]) to return to the standby screen.
- 5 Press Δ or ∇ to select Print Chart.

```

Print.
Are you sure?
→Registration chart
[ Yes ] [ No ]
    
```

- Press **[OK]**. A confirmation screen appears.
 If Job Accounting is enabled, enter the account ID in the login screen that appears. A confirmation screen appears after login.
 Press **[Yes]** (**[Left Select]**). A confirmation screen appears.
 Pressing **[No]** (**[Right Select]**) returns you to the Color Regist. Normal menu screen without printing the registration chart.

The printed chart is the color registration correction chart shown below.

The printed color registration correction chart includes front (F), vertical (V) and rear (R) registration charts for each color (cyan, magenta and yellow).

Sample Color Registration Correction Chart [Normal]

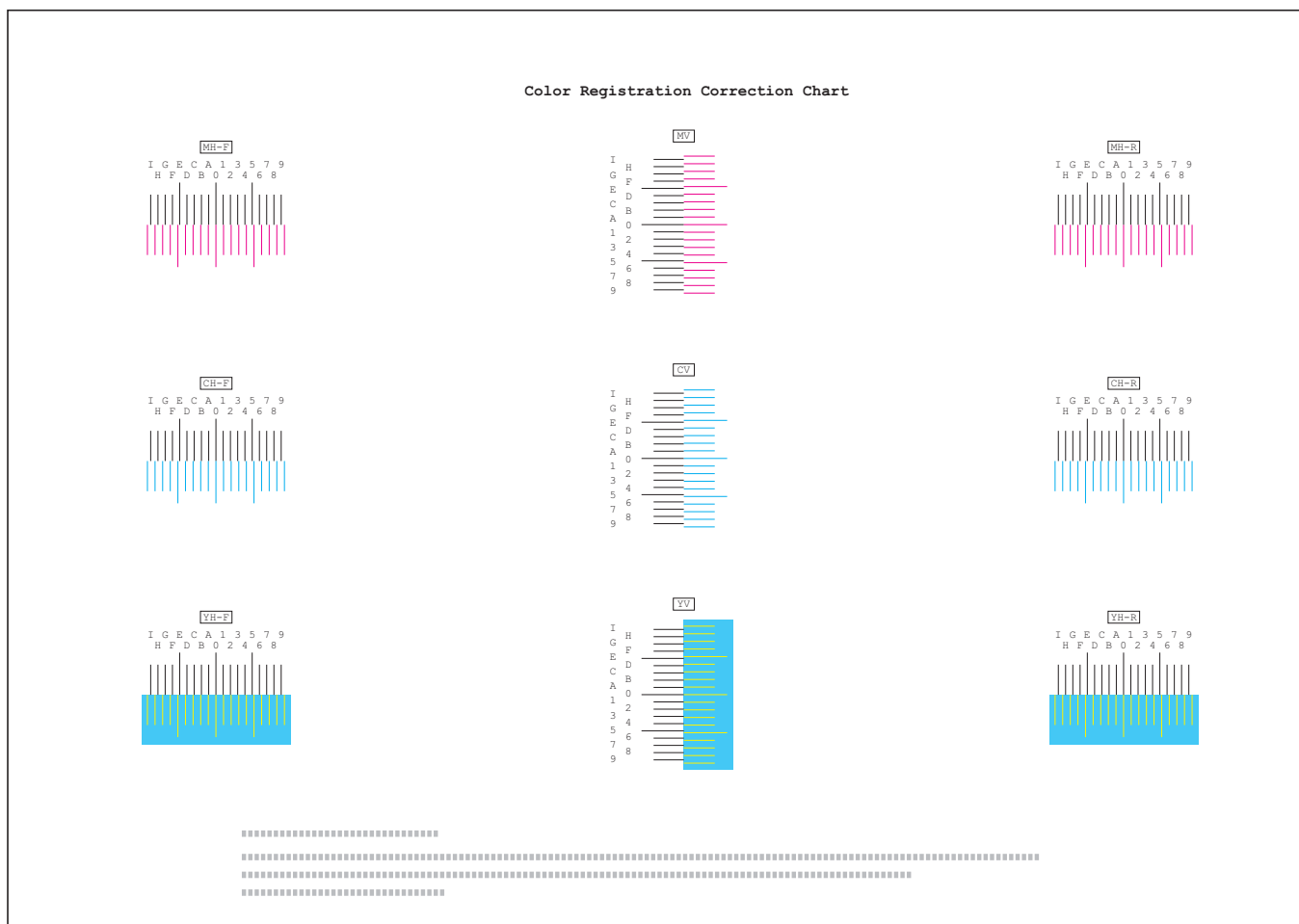

Adjust Magenta (Magenta correction)

Corrects the registration for magenta (red).

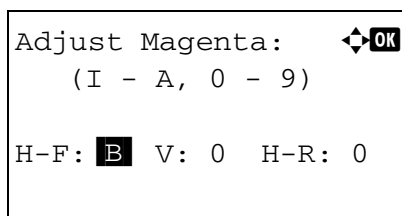
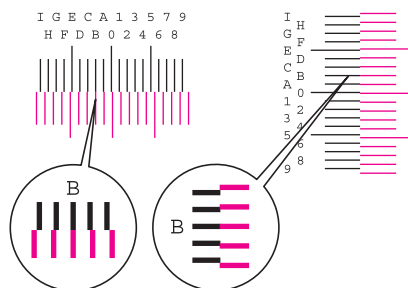
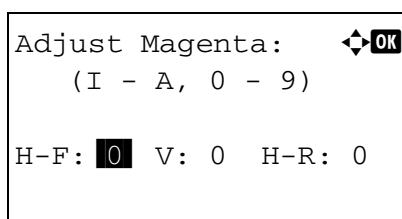
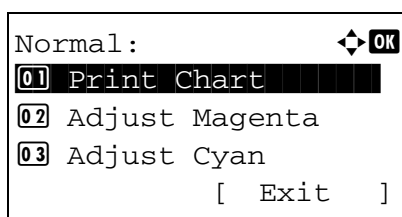
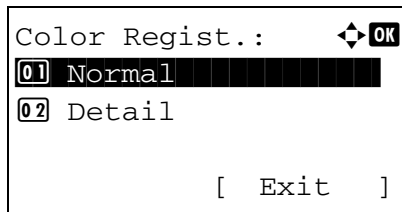

- 1 In the Adjust/Maint. menu screen, press Δ or ∇ to select Color Regist..
- 2 Press **[OK]**. The Color Regist. menu screen appears. Press **[Exit]** (**[Right Select]**) to return to the standby screen.
- 3 Press Δ or ∇ to select Normal.
- 4 Press **[OK]**. The Color Regist. Normal menu screen appears. Press **[Exit]** (**[Right Select]**) to return to the standby screen.
- 5 Press Δ or ∇ to select Adjust Magenta.
- 6 Press **[OK]**. The Adjust Magenta screen appears. 0 is displayed for the H-F, V and H-R values and the cursor () flashes under the F value.
- 7 In the F chart for magenta printed in Print Chart above, note the values where the lines are closest to forming a single straight line. This would be B in this figure.
- 8 Press Δ or ∇ until that value is displayed.
- 9 Press \triangleleft or \triangleright to move the cursor right or left. Using the same procedure as for the H-F value, display the V and H-R values identified in the color registration correction chart. When you have completed all the values, press **[OK]**. The setting is saved and you are returned to the Color Regist. Normal menu screen.

Adjust Cyan (Cyan correction) and Adjust Yellow (Yellow correction)

These options correct the registration for cyan (blue) and yellow.

```
Adjust Cyan:      ⬅️➡️OK
  (I - A, 0 - 9)

H-F: 0 V: 0 H-R: 0
```

```
Adjust Yellow:   ⬅️➡️OK
  (I - A, 0 - 9)

H-F: 0 V: 0 H-R: 0
```

- 1 In the Color Regist. Normal menu screen, press Δ or ∇ to select Adjust Cyan or Adjust Yellow.
- 2 Press [OK]. The Adjust Cyan or Adjust Yellow screen appears.

Using the same procedure as for magenta, identify the cyan and yellow values in the color registration correction chart and set them in the printer.

 **Note** As confirmation, try printing the color registration correction chart again. If the section where the lines most closely coincide as a single straight line is not 0, redo the adjustment again from Magenta.

IMPORTANT If the problem of skewed-color printout still persists even after correcting the color registration, call for service.

Color Regist. (Color registration [Detailed])

This allows you to make fine horizontal and vertical adjustments to the color registration corrections.

The options available in Color Regist. Details (Color registration [detailed]) are as follows:

- Print Chart (Printing the color registration correction chart)
- Adjust Magenta (Magenta correction)
- Adjust cyan (Cyan correction)
- Adjust yellow (Yellow correction)

Print Chart (Printing the color registration correction chart)

You can use this option to print a color registration correction chart for use in correcting the color registration.

```
Color Regist.:  ⬅️➡️OK
01 Normal
02 Detail

[ Exit ]
```

- 1 In the Adjust/Maint. menu screen, press Δ or ∇ to select Color Regist..
- 2 Press [OK]. The Color Regist. menu screen appears. Press [Exit] ([Right Select]) to return to the standby screen.
- 3 Press Δ or ∇ to select Detail.

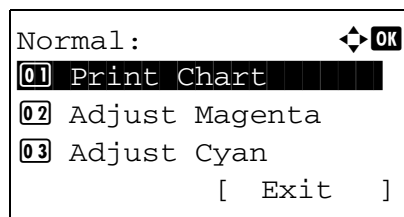

- 4** Press **[OK]**. The Color Regist. Detail menu screen appears.
Press **[Exit]** (**[Right Select]**) to return to the standby screen.

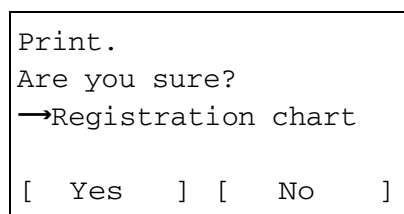

- 5** Press Δ or ∇ to select Print Chart.
- 6** Press **[OK]**. A confirmation screen appears.
Press **[Yes]** (**[Left Select]**). Completed appears and printing begins.
Pressing **[No]** (**[Right Select]**) returns you to the Color Regist. Detail menu screen without printing the registration chart.
If Job Accounting is enabled, a confirmation screen appears after department login.

If Job Accounting is enabled, also enter the account ID.

The printed chart is the color registration correction chart shown on the next page.

There are H-1 to H-7 (upper part) and V-1 to V-5 (lower part) registration charts for each color (cyan, magenta and yellow) included on the color registration correction chart.

Sample Color Registration Correction Chart [Detail]

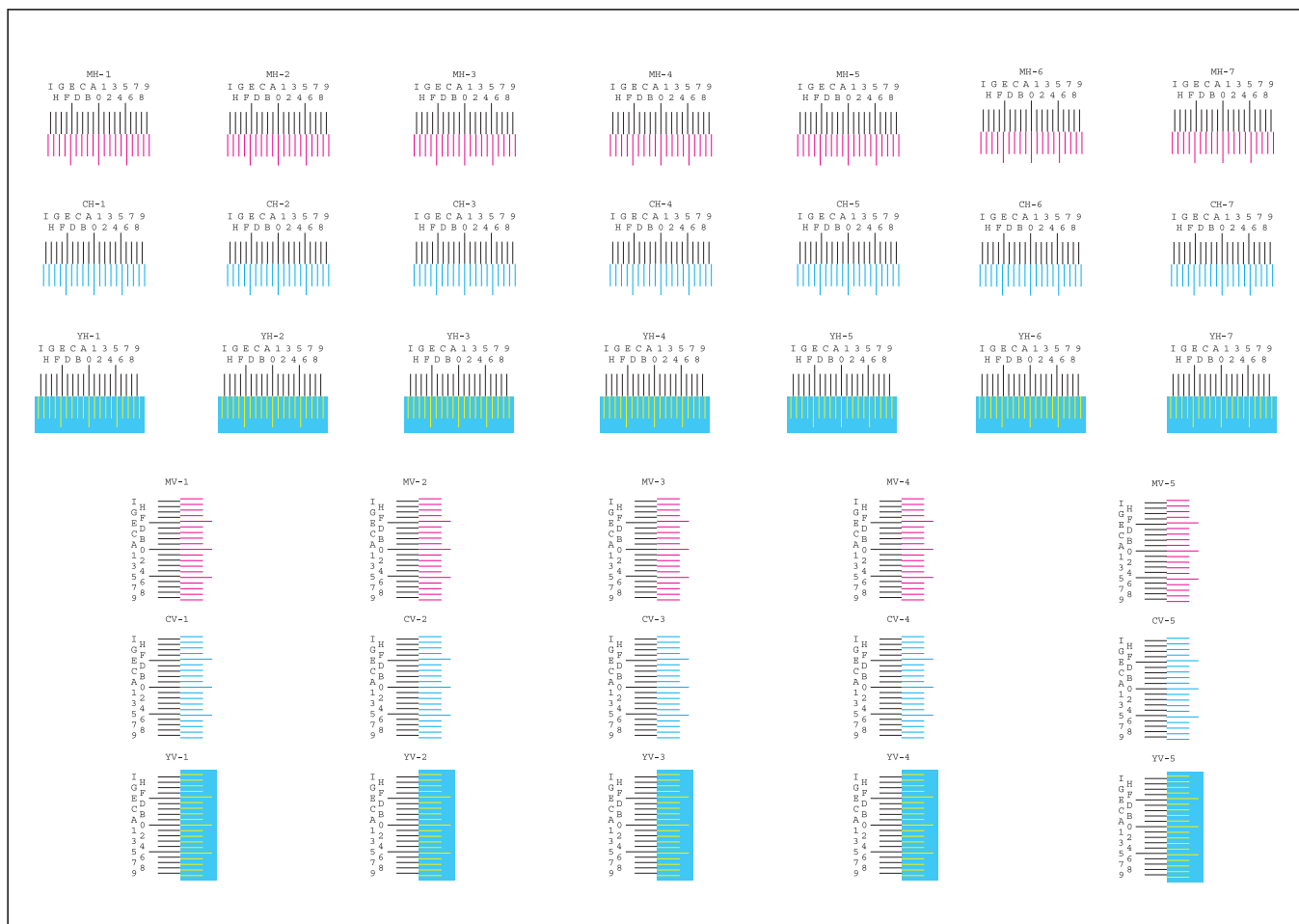

Adjust Magenta (Magenta correction)

Makes detailed corrections to the registration for magenta (red).

- 1 In the Adjust/Maint. menu screen, press Δ or ∇ to select Color Regist..
- 2 Press [OK]. The Color Regist. menu screen appears.
Press [Exit] ([Right Select]) to return to the standby screen.
- 3 Press Δ or ∇ to select Detail.
- 4 Press [OK]. The Color Regist. Detail menu screen appears.
Press [Exit] ([Right Select]) to return to the standby screen.

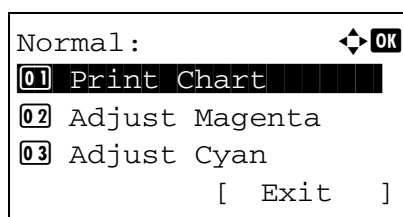
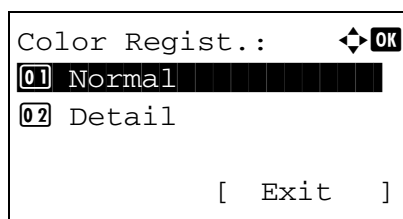

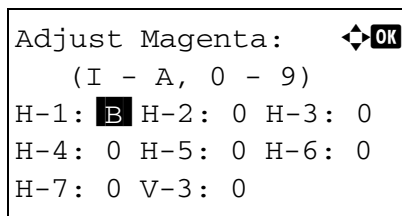
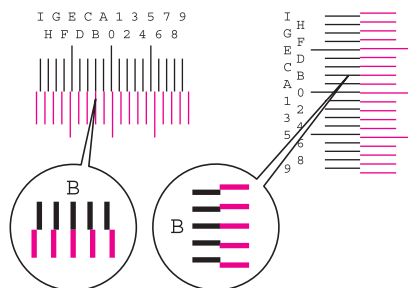
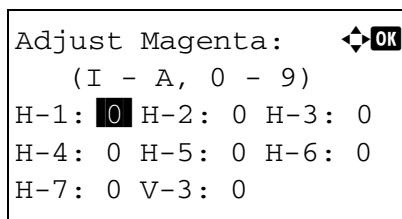

- 5 Press Δ or ∇ to select Adjust Magenta.
- 6 Press **[OK]**. The Adjust Magenta screen appears.
Values corrected are H-1, H-2, H-3, H-4, H-5, H-6, H-7, V-3.

- 7 In the H and V charts for magenta printed in Print Chart above, note the values where the lines are closest to forming a single straight line. This would be B in this figure.

- 8 Press Δ or ∇ until that value is displayed.

- 9 Press \triangleleft or \triangleright to move the cursor right or left.
Using the same procedure as for the H-1 value, display the other values identified in the color registration correction chart. When you have completed all the values, press **[OK]**. The setting is saved and you are returned to the Color Regist. Detail menu screen.

Adjust Cyan (Cyan correction) and Adjust Yellow (Yellow correction)

These options make detailed corrections to the registration for cyan (blue) and yellow.

```
Adjust Cyan: 
(I - A, 0 - 9)
H-1: 0 H-2: 0 H-3: 0
H-4: 0 H-5: 0 H-6: 0
H-7: 0 V-3: 0
```

```
Adjust Yellow: 
(I - A, 0 - 9)
H-1: 0 H-2: 0 H-3: 0
H-4: 0 H-5: 0 H-6: 0
H-7: 0 V-3: 0
```

- 1 In the Color Regist. Detail menu screen, press Δ or ∇ to select Adjust Cyan or Adjust Yellow.
- 2 Press [OK]. The Adjust Cyan or Adjust Yellow screen appears.

Using the same procedure as for magenta above, identify the cyan and yellow values in the color registration correction chart and set them in the printer.



Note As confirmation, try printing the color registration correction chart again. If the section where the lines most closely coincide as a single straight line is not 0, redo the adjustment again from Magenta.

IMPORTANT If the problem of skewed-color printout still persists even after correcting the color registration, call for service.

Restart (Restart Printer)

The procedure described below resets the printer's temporary conditions, such as the current page orientation, font, etc., set by commands to their default values. Downloaded fonts and macros are deleted from the printer's memory.

```
Restart.
Are you sure?

[ Yes ] [ No ]
```

- 1 In the Adjust/Maint. menu screen, press Δ or ∇ to select Restart..
- 2 Press [OK]. A confirmation screen appears.
Press [Yes] ([Left Select]). The printer is restarted.
Pressing [No] ([Right Select]) returns you to the Adjust/Maint. menu screen without restarting the printer.

Service Setting (for Maintenance)

IMPORTANT Service Setting is primarily a menu used by service personnel for maintenance work.

Item	Description	Value
Service Status	The service status page contains printer settings information that is more detailed than the standard status page and is therefore mostly for service purposes. However, there is a great deal of information on the service status page that may be useful to you.	Yes, No
Network Status	The network status page contains detailed information on the network settings. This is primarily used for maintenance by service personnel, but it contains information that may also be useful to you.	Yes, No
Test Page	The test page is printed to check the effectiveness of printer adjustments. This is primarily used for maintenance by service personnel, but it contains information that may also be useful to you.	Yes, No
DEV-CLN	This sets the refresh mode for the developer. When the printing quality declines, refreshing the developer can restore the printing quality.	Yes, No
Auto DrumRefresh	An automatic drum refresh is sometimes carried out when the power supply is switched on or when the machine recovers from sleep mode. In order to maintain the image quality, the automatic drum refresh is implemented automatically after observing the surrounding temperature and humidity. Here, the time for carrying out the automatic drum refresh is set.	Off, Short, Standard, Long
Drum	This sets the refresh mode for the drum. When the printing quality declines, refreshing the drum can restore the printing quality. This is primarily used for maintenance by service personnel.	Yes, No
LSU	This sets the cleaning mode for the LSU. When the printing quality declines, cleaning the LSU can restore the printing quality.	Yes, No
Silent Mode	Make the machine run more quietly. Select this mode when the running noise is uncomfortable. Use the procedure below to set Silent mode.	Off, On
First Print Pos.	Using this function speeds up either of the first print time of black and white printing or color printing by changing the default start position of the first print. In addition, the machine can automatically detect the appropriate position depending on your usage.	Standard, B & W Priority, Color Priority, Auto
Write Data	This writes data to USB memory. Note This menu only appears when USB memory is inserted.	Yes, No

Op Functions (Optional application settings)

You can use the optional applications installed on this machine.

Application

The applications listed below are installed on this machine.

You can use these applications for a limited period on a trial basis.

- DATA SECURITY (Data Security Kit(E))
- ID CARD (Card Authentication Kit(B))
- UG-33 (ThinPrint)
- UG-34 (Emulation)



Note Restrictions such as the number of times the application can be used during the trial period differ depending on the application.

The option available in Op Functions menu are as follows:

- Starting Application Use...6-129
- Checking Application Details...6-132

Starting Application Use

Use the procedure below to start using an application.

- 1 Press **[Menu]**.
- 2 Press Δ or ∇ to select Op Functions.
- 3 Press **[OK]**. The Login screen appears.



Note When user login administration is set:

- When logged in as an administrator, the log in screen is not displayed and the Op Functions menu screen is displayed.
- The setting is not possible when logged in as anyone other than an administrator. Log in again as an administrator.

- 4 With the Login User Name entry field selected, press **[OK]**. The Login User Name entry screen is displayed.

- 5 Enter the Login User Name using the numeric keys then press **[OK]**. The log in screen reappears.



Note The initial setting for the administrator's Login User Name is "Admin".

For details on entering characters, refer to *Character Entry Method* on page A-6.

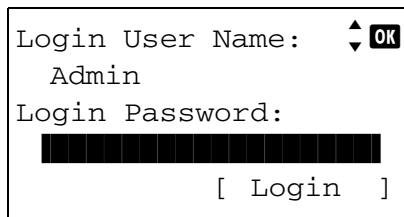

6 Press Δ or ∇ to select the Login Password entry field.

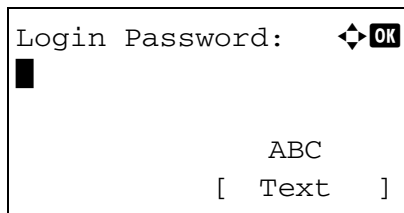

7 Press **[OK]**. The Login Password entry screen is displayed.

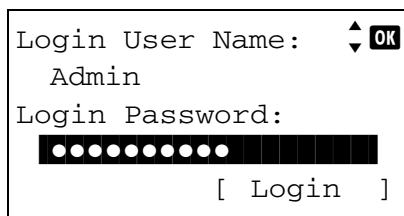

8 Enter the Login Password with the numeric keys then press **[OK]**. The login screen reappears.



Note The initial setting for the administrator's Login Password is "Admin".

For details on entering characters, refer to *Character Entry Method* on page A-6.

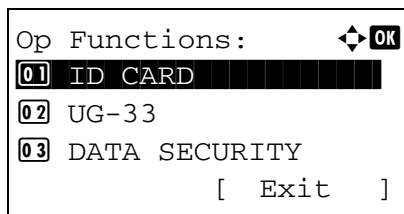

9 Pressing **[Login]** (**[Right Select]**). If the entered Login User Name and Login Password are correct, the Op Functions menu appears.

10 Press Δ or ∇ to select the desired application.

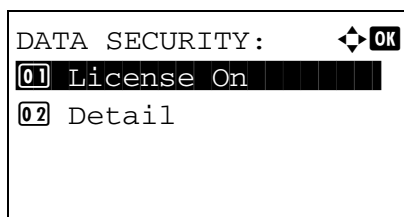

11 Press **[OK]**.

12 Press Δ or ∇ to select License On.



Note You can view detailed information on the selected application by selecting Detail.

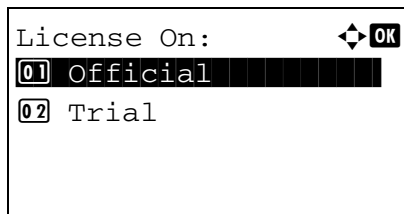

13 Press **[OK]**.

- 14 Press Δ or ∇ to select **Official**.



Note To use the application as a trial, select **Trial** and press **[OK]**. The confirmation screen is displayed so press **[Yes]** (**[Left Select]**).

```
License key:   
(0000 - 9999)  
0000 - 0000 -
```

- 15 Press **[OK]**.

- 16 Enter the License key using the numeric keys.



Note Some applications do not require you to enter a license key.

```
License key:   
(0000 - 9999)  
1234 - 5678 -
```

- 17 Press **[OK]**.

- 18 When the confirmation screen appears, press **[Yes]** (**[Left Select]**).

IMPORTANT If you change the date/time while using an application, you will no longer be able to use the application.



Note If a message prompting a restart is displayed after changes have been made then obey the message and switch the machine OFF and ON again.

Checking Application Details

Use the procedure below to check the details of an application.

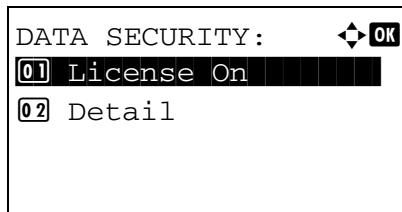

- 1 In the Op Functions menu, press Δ or ∇ to select the application to check the details of.
- 2 Press [OK].

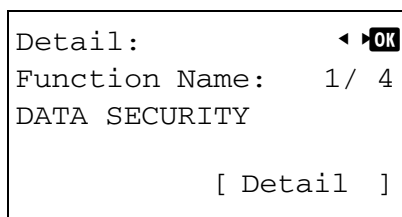

- 3 Press Δ or ∇ to select Detail.
- 4 Press [OK]. You can now view detailed information on the selected application.

Shut down (Shutting down the machine)

Before switching off the machine's power switch, follow the steps below.

CAUTION Before performing shutdown, make sure the data lamp is off.

```
Shut down.  
Are you sure?  
  
[ Yes ] [ No ]
```

```
Completed.  
Turn the main power  
switch off.
```

- 1** Press **[Menu]**.
- 2** Press Δ or ∇ to select Shut down.
- 3** Press **[OK]**. A confirmation screen appears.
- 4** Press **[Yes]** (**[Left Select]**). The display will show "Completed. Turn the main power switch off." Switch off the main power switch.
To return to the menu screen without performing shutdown, press **[No]** (**[Right Select]**).

7 Maintenance

This chapter contains explanations on the following topics:

Toner Container Replacement	7-2
Waste Toner Box Replacement.....	7-5
Replacing Staples	7-8
Emptying the Punch Waste Box (Option).....	7-13
Cleaning.....	7-15

Toner Container Replacement

When toner runs low, *Toner is running out* appears in the message display. Make sure you have a new toner container available for replacement.

When the message display shows *Toner is empty.*, replace the toner.

Every time you replace the toner container, be sure to clean the parts as instructed below. Dirty parts may deteriorate output quality.



Note

- For the toner container, always use a genuine toner container. Using a toner container that is not genuine may cause image defects and product failure.
- The memory chip in the toner container of this product stores information necessary for improving customer convenience, operation of the recycling system for used toner containers, and planning and development of new products. The stored information does not include information that makes it possible to identify individuals, and is only used anonymously for the above purposes.



CAUTION Do not attempt to incinerate the toner container or unit. Dangerous sparks may cause burns.

Installation procedures of the toner container is same for every color. The procedures here represent the yellow toner container.

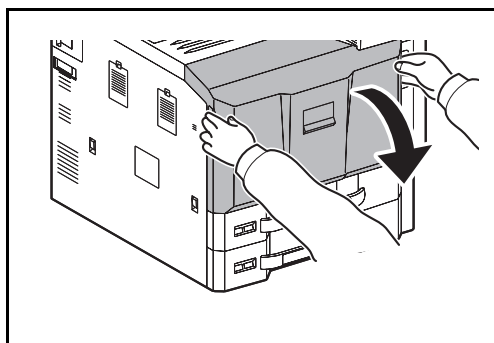

1 Open the front cover.

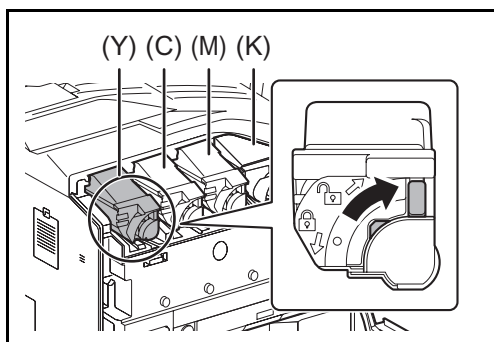

2 Turn the toner container release lever to the vertical position.

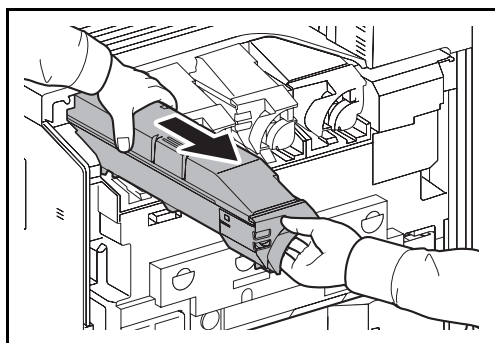

- 3** Remove the toner container and insert it into the provided plastic disposal bag.

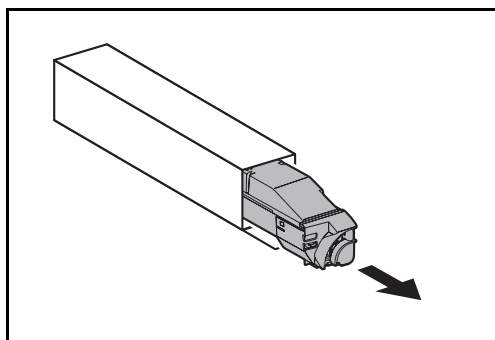
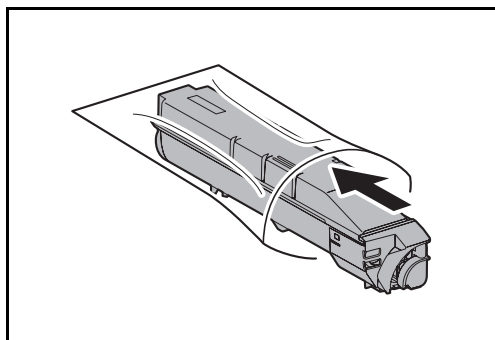

- 4** Remove the new toner container from the box.

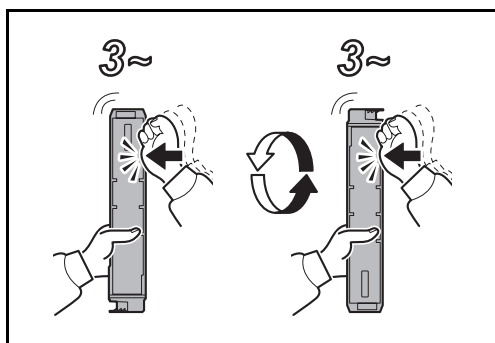

- 5** Hold the toner container vertically and hit the upper part about 3 times. Invert the toner container so that the other end is up, and hit in the same way.

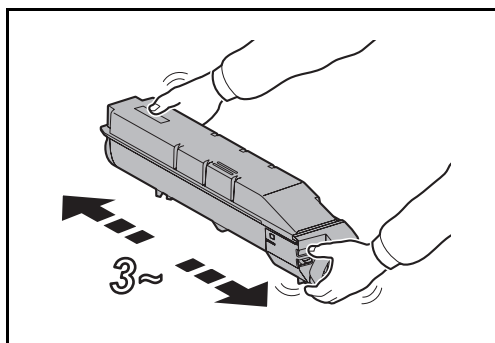

- 6** Hold the toner container horizontally and shake from side to side about 3 times.

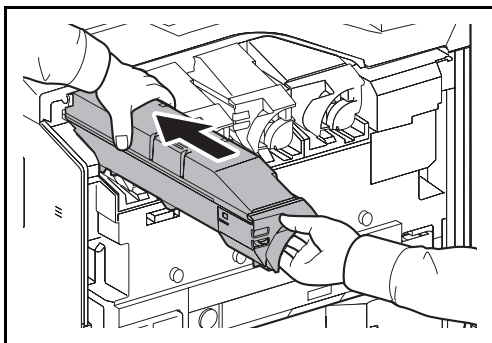

- 7** Hold the toner container with both hands and gently push it all the way in.

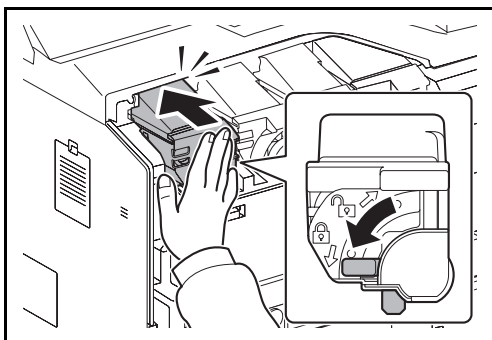

- 8** After pushing the toner container all the way in, turn the toner container release lever to the horizontal position.

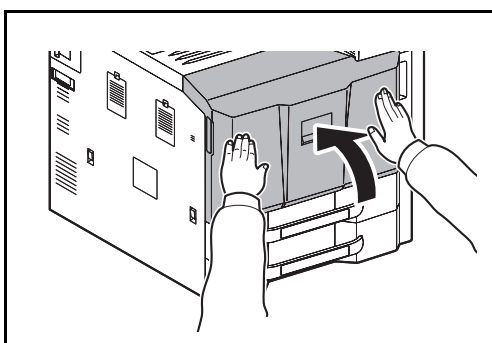

- 9** Close the front cover.

 **Note** Return the exhausted toner container and waste toner box to your dealer or service representative. The collected toner container and waste toner box will be recycled or disposed in accordance with the relevant regulations

Waste Toner Box Replacement

When the message display shows `Check waste toner box.`, immediately replace the waste toner box.



CAUTION Do not attempt to incinerate the toner container or unit. Dangerous sparks may cause burns.

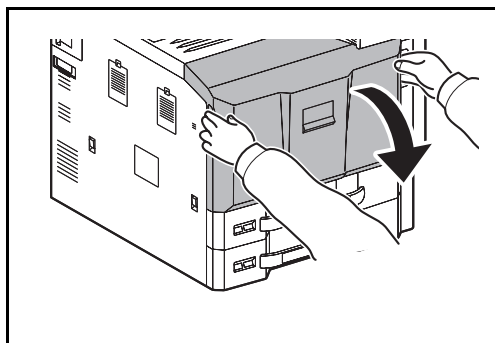

1 Open the front cover.

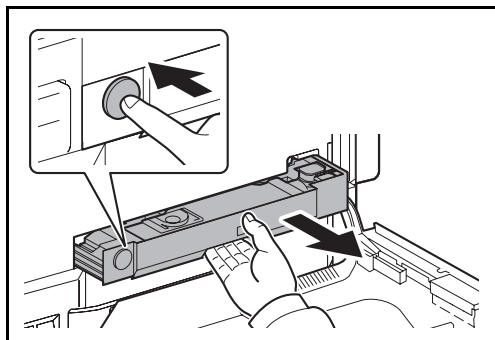

2 Press the release key (1) and pull out the waste toner tray (2).

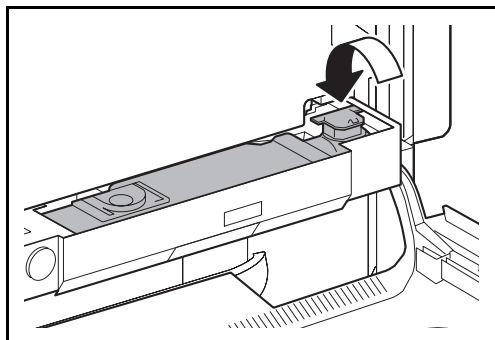

3 Close the cap and remove the old waste toner box diagonally upward.

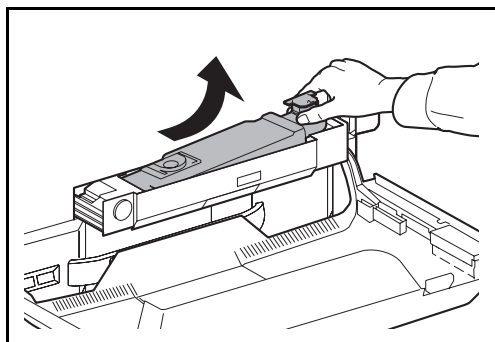

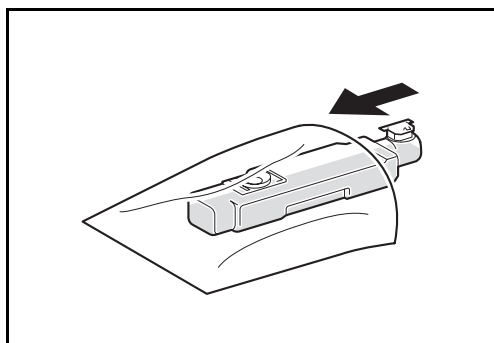

4 Insert into the provided plastic disposal bag.

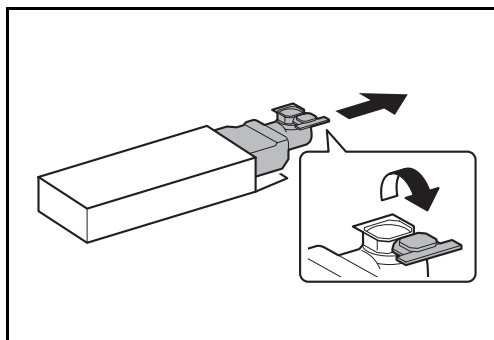

5 Gently remove the new waste toner box from its packaging and open the cap.

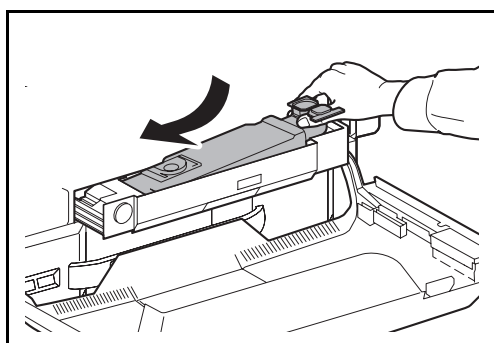

6 Install a new waste toner box.

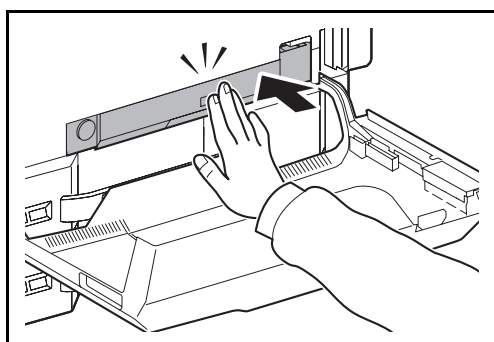
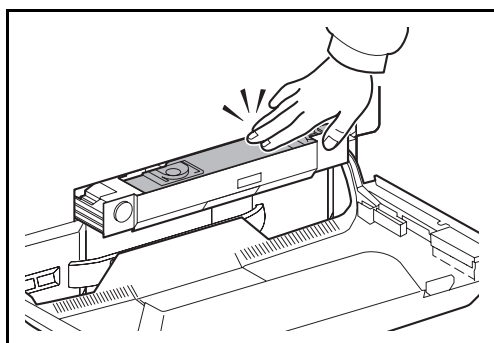

7 Press the specified position to close the waste toner tray. When the tray reaches the correct position, it locks in place with a clicking sound.

8 Close the front cover.

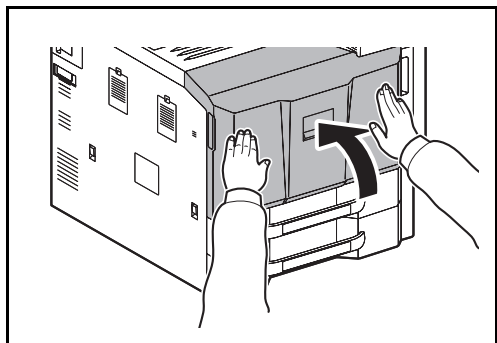

Note Return the exhausted toner container and waste toner box to your dealer or service representative. The collected toner container and waste toner box will be recycled or disposed in accordance with the relevant regulations

Replacing Staples

A staple cartridge is installed in the optional 1,000-sheet finisher, 4,000-sheet finisher, and center-fold unit.

If a message displays indicating that staples have run out, the staple cartridge holder need to be replenished with staples.

 **Note** If the Staple Unit runs out of staples, contact your service representative or the place of purchase.

Follow the steps below to refill staples.

1,000-sheet Finisher (Option)

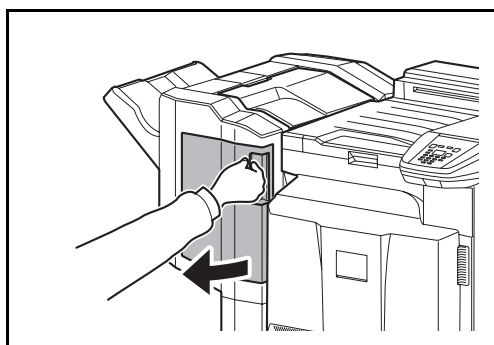

1 Open the front cover.

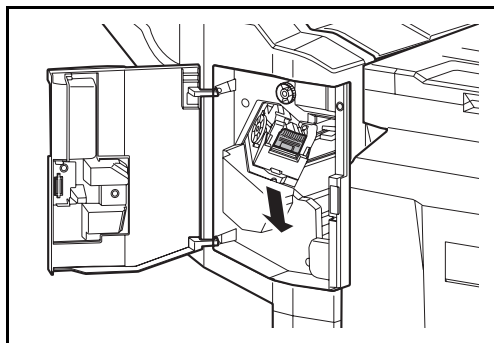

2 Remove the staple cartridge holder.

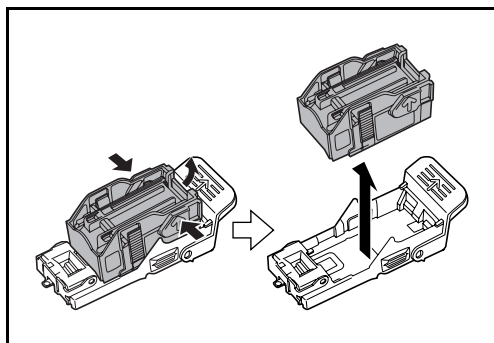

3 Remove the empty staple cartridge from the staple cartridge holder.

 **Note** The staple cartridge can only be removed when it contains no more staples.

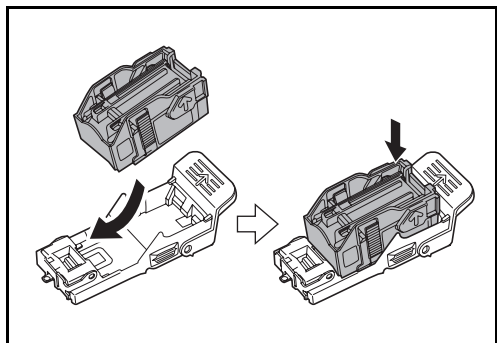

4 Insert the new staple cartridge into the staple cartridge holder.

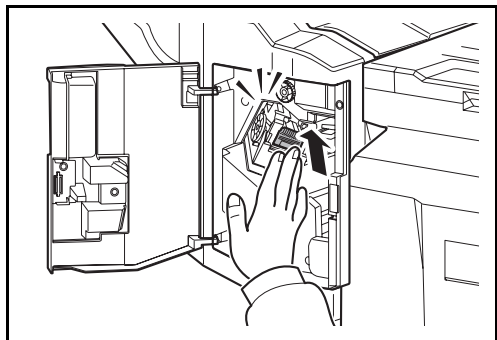

5 Re-install the staple cartridge holder. The staple cartridge holder will click into place when it has been inserted correctly.

6 Close the front cover.

4,000-sheet Finisher (Option)

The 4,000-sheet finisher contains staple cartridge holder A.

The optional folding unit contains staple cartridge holders B and C. The refill procedure for staple cartridge holders B and C are the same as for staple cartridge holder A.

Refilling Staple Cartridge Holder A



Note See page 7-11 to refill staple cartridge holder B/C of the optional folding unit.

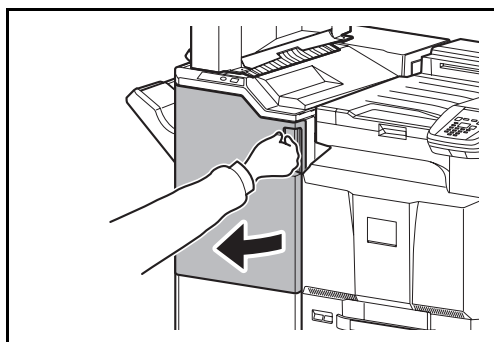

1 Open the front cover 1.

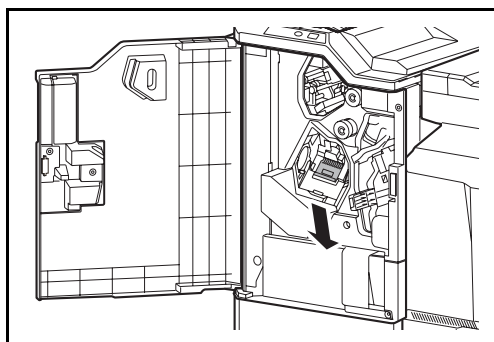

2 Remove the staple cartridge holder.

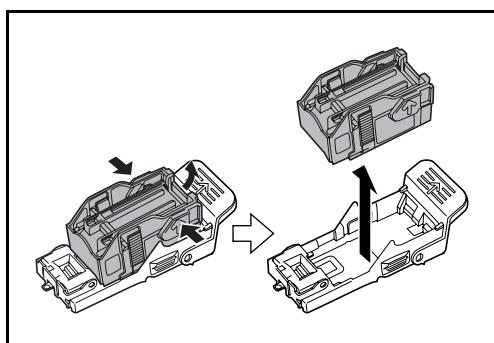

3 Remove the empty staple cartridge from the staple cartridge holder.



Note The staple cartridge can only be removed when it contains no more staples.

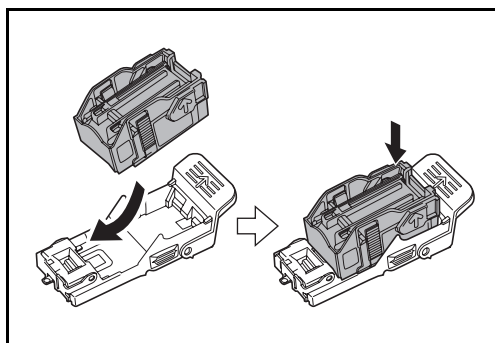

4 Insert the new staple cartridge into the staple cartridge holder.

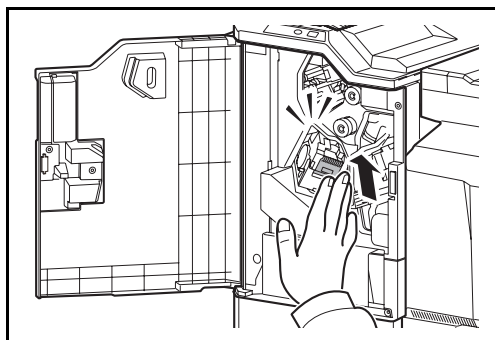

5 Re-install the staple cartridge holder. The staple cartridge holder will click into place when it has been inserted correctly.

6 Close the front cover 1.

Refilling Staple Cartridge Holders B/C (Option)

Follow the steps below to refill staples for the optional folding unit. Follow the same procedure to refill staple cartridge holders B and C.

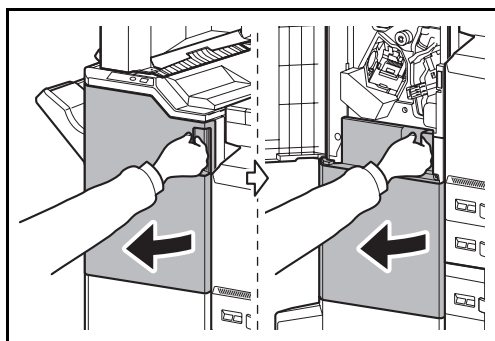

1 Open the front cover 1 and 2.

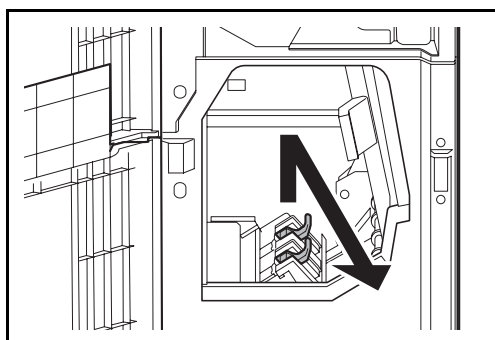

2 Remove the staple cartridge holder B or C.

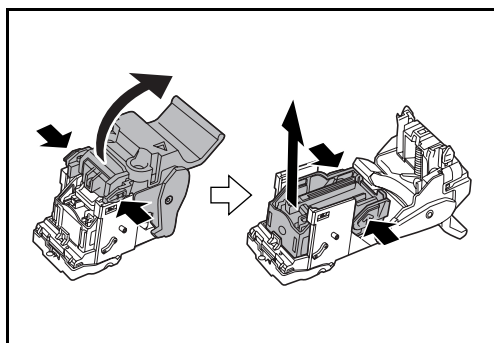

- 3** Open the stopper and remove the empty staple cartridge.



Note The staple cartridge can only be removed when it contains no more staples.

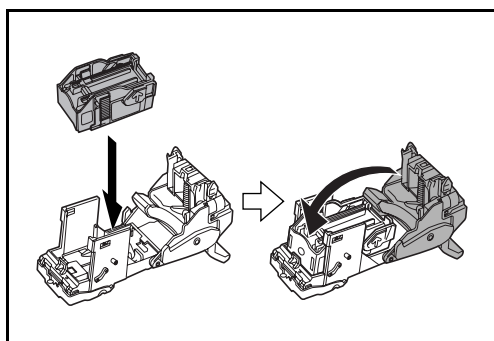

- 4** Insert the new staple cartridge into the staple cartridge holder and close the stopper.

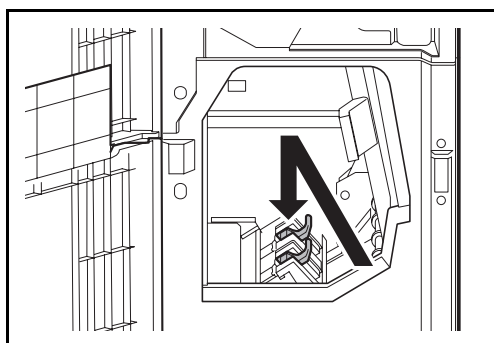

- 5** Re-install the staple cartridge holder.

When re-installing, align the triangle marks on the staple cartridge holder and the staple unit. The staple cartridge holder will click into place when it has been inserted correctly.

- 6** Close the front cover 1 and 2.

Emptying the Punch Waste Box (Option)

If a message is displayed on the machine operation panel indicating that the waste punch box is full, be sure to empty the scraps in the punch waste box.

Leave the main power switch on the machine switched ON (|) while performing this procedure.

1,000-sheet Finisher (Option)

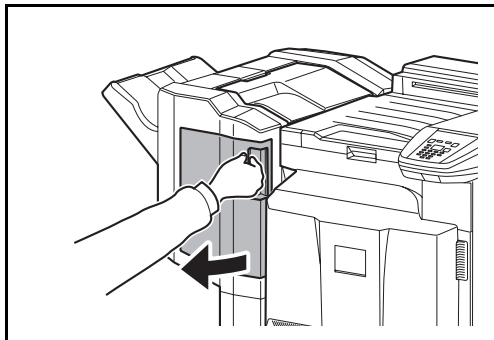

- 1** Open the front cover.

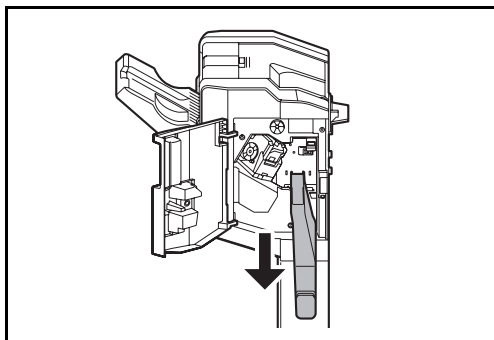

- 2** Grasp the punch waste box handle and remove the box from the Document Finisher.

 **Note** The staple cartridge can only be removed when it contains no more staples.

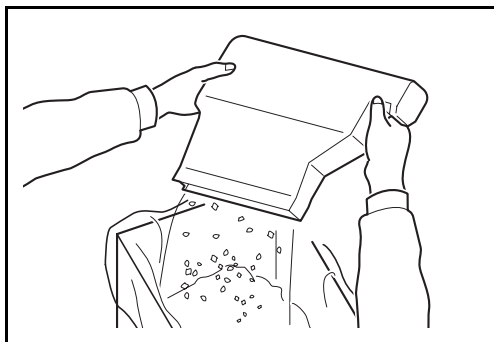

- 3** Dispose of the hole punch scraps appropriately.

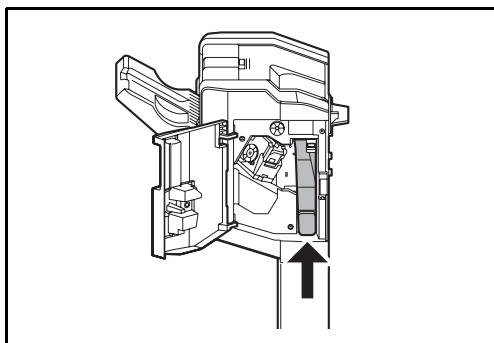

- 4** Re-install the punch waste box. Align it with the guides in the Document Finisher.

- 5** Close the front cover.

4,000-sheet Finisher (Option)

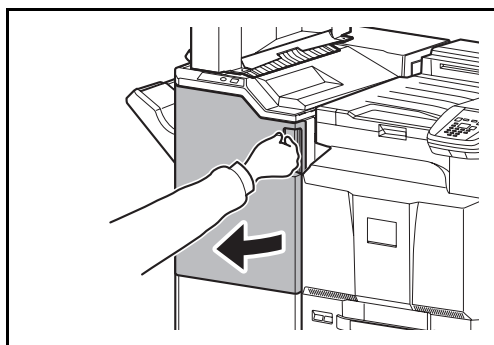

1 Open the front cover 1.

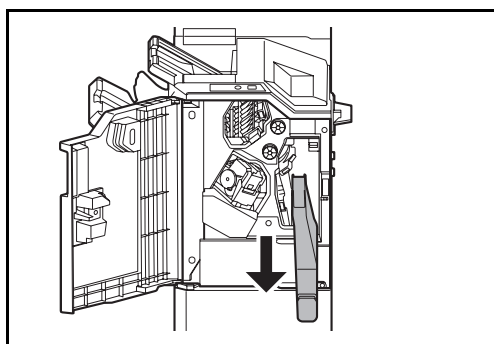

2 Grasp the punch waste box handle and remove the box from the Document Finisher.



Note Take care not to spill the waste hole punch scraps when removing the container.

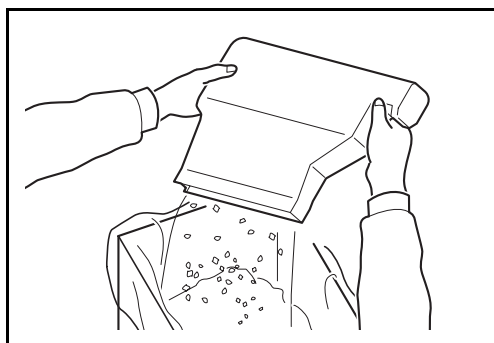

3 Dispose of the hole punch scraps appropriately.

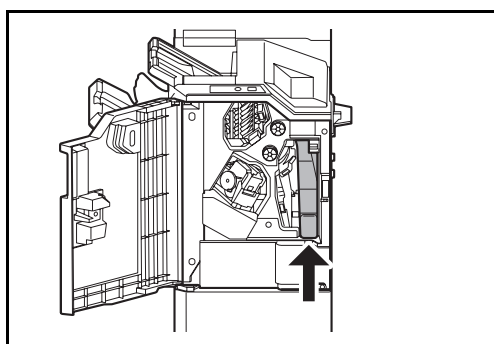

4 Re-install the punch waste box. Align it with the guides in the Document Finisher.

5 Close the front cover 1.

Cleaning

Clean the machine regularly to ensure optimum output quality.



CAUTION For safety, always unplug the power cord before cleaning the machine.

Separator

Clean the separator regularly (at least monthly) to ensure optimum output quality.

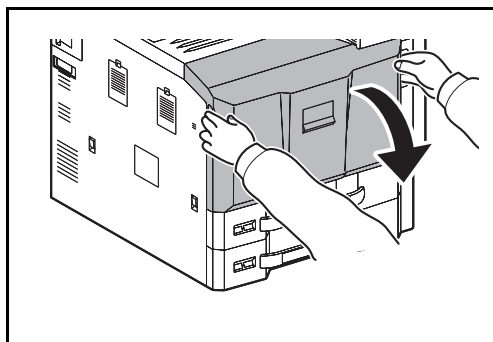

1 Open the front cover.

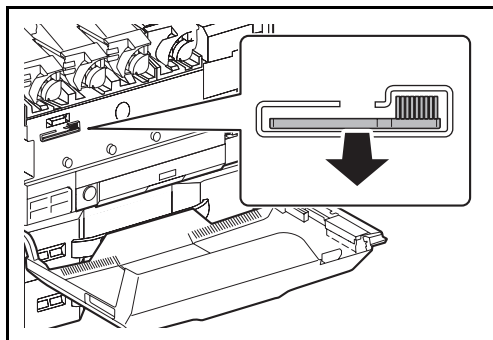

2 Remove the cleaning brush (blue colored).

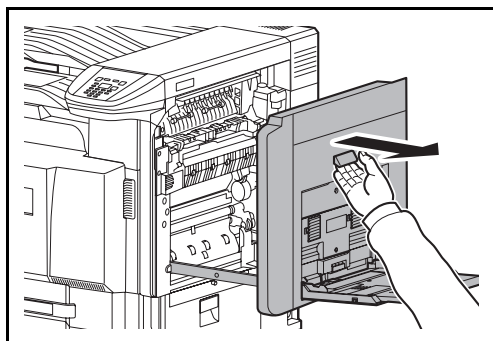

3 Pull up the lever and open the right cover 1.

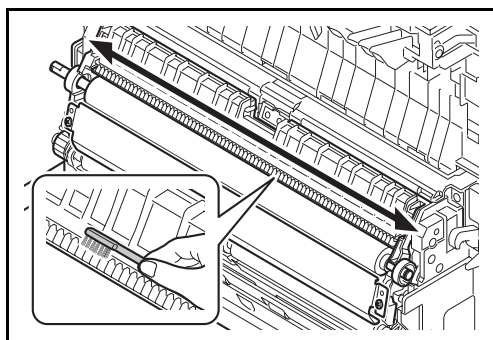

4 As shown in the figure, clean dirt from the separator by moving the brush from side to side along the separator.

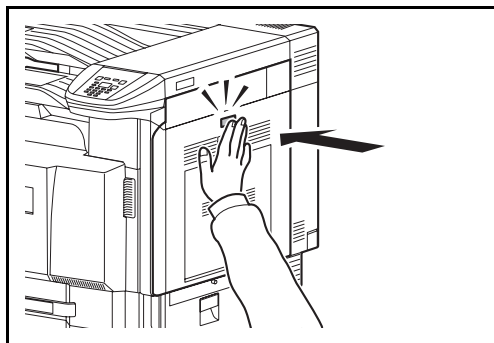

5 Press the specified position of the right cover 1 to close.

6 Put away the cleaning brush and close the front cover.

Transfer Roller

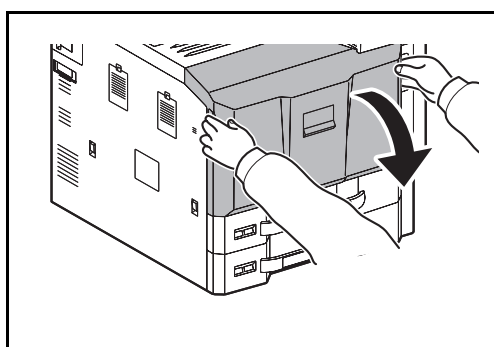

1 Open the front cover.

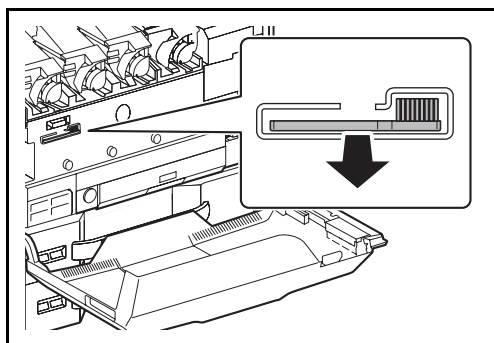

2 Remove the cleaning brush (blue colored).

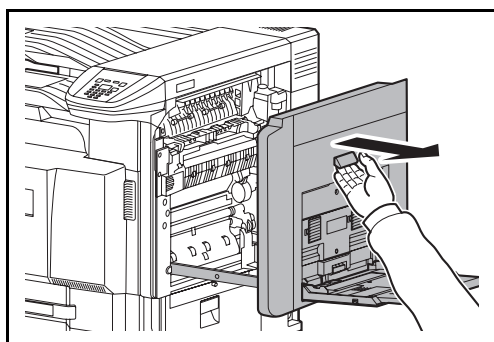

3 Pull up the lever and open the right cover 1.

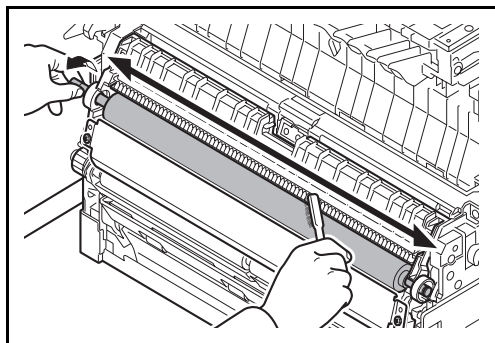

- 4** As shown in the figure, clean dirt from the transfer roller by moving the brush from side to side along the roller while rotating the roller by turning the gear at the right end of the roller.

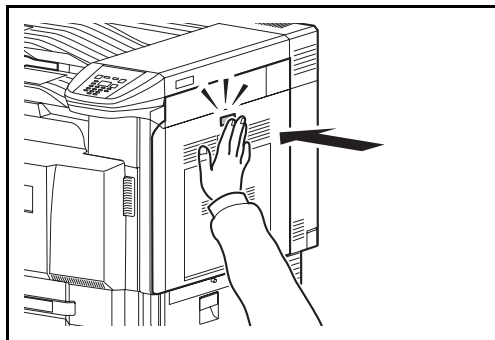

- 5** Press the specified position of the right cover 1 to close.

- 6** Put away the cleaning brush and close the front cover.

8 Troubleshooting

This chapter contains explanations on the following topics:

General Guidelines	8-2
Print Quality Problems	8-3
Error Messages	8-6
Clearing Paper Jams	8-16

If a problem cannot be corrected, contact your service technician.

General Guidelines

The table below provides basic solutions for problems you may encounter with the printer. We suggest you consult this table to troubleshoot the problems before calling for service.

Symptom	Check Items	Corrective Action	Reference Page
An application does not start.	Is the Auto Panel Reset time short?	Set the Auto Panel Reset time to 30 seconds or more.	6-73
The screen does not respond when the main power switch is turned on.	Is the machine plugged in?	Plug the power cord into an AC outlet.	—
Paper often jams.	Is the paper loaded correctly?	Load the paper correctly.	2-22 2-28
	—	Turn the orientation 180 degrees around in which the paper is positioned.	
	Is the paper of the supported type? Is it in good condition?	Remove the paper, turn it over, and reload it.	
	Is the paper curled, folded or wrinkled?	Replace the paper with new paper.	
	Are there any loose scraps or jammed paper in the machine?	Remove any jammed paper.	8-16
Cannot print.	Is the machine plugged in?	Plug the power cord into an AC outlet.	—
	Is the machine powered on?	Turn on the main power switch.	—
	Are the printer cable and network cable connected?	Connect the correct printer cable and network cable securely.	—
	Was the machine powered on before the printer cable was connected?	Power on the machine after connecting the printer cable.	—
	Is the print job paused?	Resume printing.	2-40
Cannot print with USB memory. USB memory not recognized.	Is the USB host blocked?	Select [Unblock] in the USB host settings.	6-92
	—	Check that the USB memory is securely plugged into the machine.	—
The color toner is empty.	Do you want to continue printing in black and white?	If the black toner is remained, the machine continues printing in black and white by selecting [Print in B & W] of <i>ColorToner Empty</i> .	6-71

Tips



Printer problems may be solved easily by following the tips below. When you have encountered a problem that following the above guidelines will not solve, try the following:





- Turn the printer power off and wait for several seconds. Then, turn on the printer.
- Reboot the computer which sends the print jobs to the printer.
- Obtain and use the latest version of the printer driver. The latest versions of printer drivers and utilities are available at: <http://www.kyoceradocumentsolutions.com>.
- Make sure that the procedures for printing are correctly followed in the application software. Consult the documentation supplied with the application software.

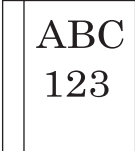
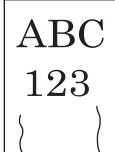

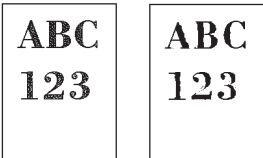
Print Quality Problems

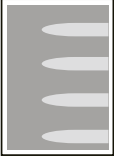
The tables and diagrams in the following sections define print quality problems and the corrective action you can conduct to solve the problems. Some solutions may require cleaning or replacing parts of the printer.

If the suggested corrective action will not solve the problem, call for service.

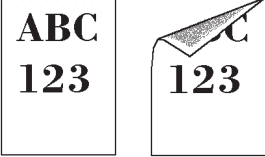
Printed Results	Corrective Action	Reference Page
<p>Blank sheets are ejected.</p> 	Check that the settings of the application software.	—
<p>2 or more sheets are overlaps when ejected. (multi feed)</p> 	Load the paper correctly.	2-22 2-28
<p>Printouts are wrinkled.</p> 	Clean the paper separator.	7-15
	Turn the orientation 180 degrees around in which the paper is positioned.	2-22 2-28
	Replace the paper with new paper.	
<p>Printouts are curled.</p> 	Turn the orientation 180 degrees around in which the paper is positioned.	2-22 2-28
	Replace the paper with new paper.	
<p>Printouts are totally too light.</p> 	Replace the paper with new paper.	2-22 2-28
	Select appropriate density level.	—
	Shake the toner container from side to side several times.	7-2
	Replace the toner container.	
	Disable EcoPrint mode.	6-11
	Run [Drum] to refresh the drum unit.	6-128
	Make sure the paper type setting is correct for the paper being used.	6-21 6-23

Printed Results	Corrective Action	Reference Page
<p>Part of the image is periodically faint or shows white lines.</p> 	<p>Run [Drum] to refresh the drum unit.</p>	<p>6-128</p>
<p>Printouts are fuzzy.</p> 	<p>Use in an environment that has suitable humidity.</p> <p>Run [Drum] to refresh the drum unit.</p>	<p>x</p> <p>6-128</p>
<p>Texts are not clearly printed.</p> 	<p>Select appropriate image quality.</p>	<p>3-3</p>
<p>Printouts are too dark even though the background of the scanned original is white.</p> 	<p>Select appropriate density level.</p> <p>Run [ColorCalibration].</p>	<p>—</p> <p>6-120</p>
<p>White dots appear on the image.</p> 	<p>Run [ColorCalibration].</p>	<p>6-120</p>
<p>Dirt on the top edge or back of the paper.</p> 	<p>Open the right cover. If the machine interior is dirty with toner, clean it using soft, dry, lint-free cloth.</p>	<p>7-15</p>

Printed Results	Corrective Action	Reference Page
<p>Images are skewed.</p> 	<p>Check the position of the paper width guides.</p>	<p>2-22 2-28</p>
<p>Skewed-color printout.</p> 	<p>Run [ColorCalibration].</p> <p>Run [Color Regist.].</p>	<p>6-120</p> <p>6-120</p>
<p>Colors appear different than you anticipated.</p>	<p>Load color copy paper into the paper tray.</p>	<p>—</p>
	<p>Run [ColorCalibration].</p>	<p>6-120</p>
	<p>Adjust the color using the printer driver.</p>	<p>3-3</p>

Error Messages

The following table lists errors and maintenance messages that you can be dealt with by yourself. If `Machine failure. Call service.` appears, turn off the printer, disconnect the power cord, and contact your service technician.

If `Machine failure. Call service. Or Error occurred.` Turn the main power switch off and on. `is` displayed, turn off the printer then turn it back on to see if the printer has recovered. If the printer has not recovered, turn off the printer, disconnect the power cord, and contact your service representative or authorized service center.

Some errors cause the alarm to sound. To stop the alarm, press **[Cancel]**.

Message	Corrective Action
<pre>Access denied. You cannot login.</pre>	<p>The Log in operation failed for the specified number of times so it is no longer possible to attempt to log in. Contact a system administrator.</p>
<pre>Access point was not detected.</pre>	<p>It was not possible to connect to the network with the optional wireless LAN interface. Check the settings of the wireless LAN interface. For details, refer to <i>Op Functions (Optional application settings)</i> on page 6-129.</p>
<pre>Account error. Press [OK].</pre>	<p>This message is displayed when the Job Accounting function is enabled and an attempt to specify job accounting settings or to register or delete an account fails. To return the printer to the print-ready status, press [OK].</p>
<pre>Add paper in casset.#</pre>	<p>The paper has run out in the paper source displayed. Supply paper according to the paper source displayed (paper cassettes, MP tray, or optional paper feeders). This message is displayed alternately with messages indicating the printer status, such as, <code>Ready to print.</code>, <code>Please wait.</code>, and <code>Processing..</code></p>
<pre>Add paper in MP tray.</pre>	<p>The paper has run out in the paper source displayed. Supply paper according to the paper source displayed (paper cassettes, MP tray, or optional paper feeders). This message is displayed alternately with messages indicating the printer status, such as, <code>Ready to print.</code>, <code>Please wait.</code>, and <code>Processing..</code></p>

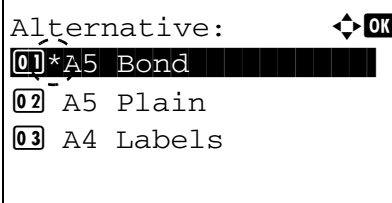
Message	Corrective Action
<p>Add staples.</p>	<p>Add staples to the 1,000-sheet Finisher. For detail, refer to <i>Replacing Staples on page 7-8</i>.</p>
<p>Add staples to Unit #.</p>	<p>Add staples to the staple cartridge holder # of 4,000-sheet Finisher. For detail, refer to <i>Replacing Staples on page 7-8</i>.</p>
	<p>When the cassette does not contain any paper that matches the print data paper size and type), this message allows you to specify an alternative cassette to use instead. A paper source number is only displayed when an optional paper feeder is installed. To print from a different paper source, refer to <i>Paper Feed Mode (Setting the paper feed source) on page 6-29</i>.</p>
<p>A machine administrator right is required.</p>	<p>You can only change the settings selected when logged in as a user with machine administrator privileges.</p>
<p>Box limit exceeded.</p>	<p>The box capacity is full. Either delete files or change the capacity of the box. For details, refer to <i>Custom Box operation (Box creation, editing and deletion) on page 4-4</i>.</p>
<p>Canceling...</p>	<p>Displayed when data is being canceled.</p>
<p>Cannot connect.</p>	<p>It was not possible to connect to the network with the optional network interface. Check the settings of the network interface. For details, refer to <i>Optional network (Optional Network settings) on page 6-48</i>.</p>

Message	Corrective Action
<p>Cannot connect. Multiple access points are enabled.</p>	<p>Multiple access points were detected with the optional wireless LAN interface. Check the settings of the wireless LAN interface. For details, refer to <i>Op Functions (Optional application settings)</i> on page 6-129.</p>
<p>Cannot connect to Authentication Server Check the domain name.</p>	<p>Press [OK] and check the following items:</p> <ul style="list-style-type: none"> • Registration to Authentication Server • Password and computer address for Authentication Server • Connection of Network <p>For details, refer to <i>Netwk Auth. Set (Netwk authentication setting)</i> on page 6-100.</p>
<p>Cannot duplex print on this paper.</p>	<p>You attempted to print with a paper size and paper type that cannot be used for duplex printing. Press [OK] to print onto one-side of the paper only.</p>
<p>Cannot execute this job. Restricted by Authorization settings.</p>	<p>This message is shown when operations are restricted in the account when job accounting is effective. To change the account settings, refer to <i>Detail/Edit (Checking/editing registered account ID settings)</i> on page 6-114.</p>
<p>Cannot remove the memory while in use.</p>	<p>This message is displayed when Remove Memory was selected while a USB memory was being used. The previous screen is displayed again 1 or 2 seconds.</p>
<p>Cassette# not loaded.</p>	<p>The corresponding paper cassette is not installed. Install the cassette.</p>
<p>Check cassette #.</p>	<p>This message is displayed when a paper lift error has occurred in the paper source's cassette. Pull out the cassette for the paper source displayed (either the paper cassettes or optional paper feeders) and check if the paper is loaded correctly.</p>

Message	Corrective Action
<p>Check the side feeder. Attach the side feeder.</p>	<p>The side feeder is not installed correctly. Attach the side feeder.</p>
<p>Check waste toner box.</p>	<p>This message warns following two cases. Install the new waste toner box. The waste toner box is not installed. The waste toner box is full. For details, refer to <i>Toner Container Replacement on page 7-2</i>.</p>
<p>Close the folding unit.</p>	<p>Close the folding unit.</p>
<p>Enclose the IPv6 address in brackets [].</p>	<p>The IPv6 address entered in the host name is not enclosed in brackets []. To enter the IPv6 address, enclose the (e.g.[ae3:9a0:cd05:b1d2:28a:1fc0:a1:10ae]:140)</p>
<p>Error occurred. Turn the main power switch off and on. #####</p>	<p>Turn the power switch off and then back on again. If this message still remains, turn the power switch off, and contact your service representative.</p>
<p>Failed to get the network user information.</p>	<p>An error occurred when obtaining user information after the authentication. Log in again.</p>
<p>Finisher left tray is full of Paper.</p>	<p>Remove the paper. Printing then resumes.</p>

Message	Corrective Action
<p>Finisher tray # is full of Paper.</p>	<p>Remove the paper. Printing then resumes.</p>
<p>Hard disk error. Press [OK]. ##</p>	<p>An error has occurred on the hard disk. Job is canceled. Press [OK]. The possible error codes and their descriptions are as follows. 01: The amount of data that can be saved at once has been exceeded. Restart the system or turn the power OFF/ON. If the error still occurs, divide the file into smaller files. If the error occurs after the file is divided, the hard disk is damaged. Execute [HDD Initializ.]. 04: Insufficient space on the hard disk to complete this operation. Move data or delete unneeded data.</p>
<p>Incorrect account ID.</p>	<p>The Account ID does not match. Check the registered Account ID. For more information, refer to <i>Job Account.Set. (Job Account setting)</i> on page 6-110.</p>
<p>Incorrect account ID. Press [OK].</p>	<p>This message is displayed when the Job Accounting function is enabled and no account is set for a transmitted print job or the specified account is not registered (the incorrect account is set). To return the printer to the print-ready status, press [OK]. For detail, refer to <i>Job Account.Set. (Job Account setting)</i> on page 6-110.</p>
<p>Incorrect ID.</p>	<p>The user ID entered for a Private/Stored Job is not correct. Check the Access code that you specified on the printer driver. For detail, refer to <i>Private/Stored (Printing a Private Print/Stored Job)</i> on page 4-31.</p>
<p>Incorrect Login User Name or Password.</p>	<p>Enter correct login user name or password.</p>
<p>Incorrect login user name or password. Job is canceled.</p>	<p>Enter correct login user name or password.</p>

Message	Corrective Action
<p>Incorrect password.</p>	<p>Enter the correct password.</p>
<p>Job Accounting restriction exceeded. Press [OK].</p>	<p>This message is displayed when the Job Accounting function is enabled and an attempt has been made to exceed the print limit set for each account. To return the printer to the print-ready status, press [OK]. For more information, refer to <i>Job Account Set. (Job Account setting) on page 6-110</i>.</p>
<p>Job not stored. Press [OK].</p>	<p>Printing using the Job Box function failed because there was insufficient space available on the hard disk. To print an error report and return the printer to the print-ready status, press [OK].</p>
<p>Job separator tray is full of paper.</p>	<p>Remove the paper. Printing then resumes.</p>
<p>KPDL error. Press [OK].</p>	<p>Current print processing cannot continue because of occurrence of KPDL error which is categorized by ##. To print out an error report, display KPDL Error Rpt. from the menu system, and select On. Press [OK] to resume printing. You can abandon printing by pressing [Cancel]. If Auto Error Clear is set to On, printing will be automatically resumed after a preset period of time. For more information, refer to <i>KPDL Error Rpt. (Printing KPDL errors) on page 6-33</i>.</p>
<p>Limit exceeded. You cannot add any more.</p>	<p>The box capacity is full. Either delete files or change the capacity of the box. For details, refer to <i>Custom Box operation (Box creation, editing and deletion) on page 4-4</i>.</p>

Message	Corrective Action
<p>Load paper in MP tray. Different paper size is set. Check paper size.</p>	<p>The size of the paper in the MP tray and the paper size setting are not the same. Check the paper size.</p>
<p>Low security</p>	<p>This message is displayed when Low was selected in Security Level.</p>
<p>Machine failure. Call service.</p> <p style="text-align: right;">####</p>	<p>#### represents a mechanical error (#=0, 1, 2, ...). Call for service. The printer does not operate when this message is displayed. The total number of pages printed is also indicated, e.g. 0123456.</p>
<p>Mailbox tray # is full of Paper.</p>	<p>Remove the paper. Printing then resumes.</p>
<p>Main tray is full of paper. Remove the paper.</p>	<p>Remove the paper. Printing then resumes.</p>
<p>Memory is full.</p>	<p>The process cannot be performed due to insufficient memory. If only [OK] is available, press [OK]. The job will be canceled.</p>

Message	Corrective Action
<p>Memory is full. Print job cannot be processed completely.</p>	<p>The total amount of data received by the printer exceeds the printer's internal memory. Try adding more memory. Press [OK] to resume printing. You can abandon printing by pressing [Cancel]. If Auto Error Clear is set to On, printing will be automatically resumed after a preset period of time. For more information, refer to <i>Auto Err. Clear (Auto error clear setting)</i> on page 6-74.</p>
<p>Non-genuine Toner. Press [Help].</p>	<p>This message is displayed if the installed toner container is nongenuine. The manufacturer assumes no responsibility for damage caused by a nongenuine toner. We recommend that you only use genuine toner containers. When you want to use the toner container currently installed, press [OK] and [Cancel] simultaneously for 3 seconds or more.</p>
<p>Paper jammed in #####.</p>	<p>A paper jam has occurred. The location of the paper jam is indicated in place of the #'s. For details, refer to <i>Clearing Paper Jams</i> on page 8-16.</p>
<p>Please wait. Adding toner...</p>	<p>Toner is currently being replenished. This message may be displayed during continuous printing of a large volume of pages which require a large amount of toner such as with photographs, etc.</p>
<p>Please wait. Cleaning...</p>	<p>The machine is under the adjustment to maintain its quality. Please wait.</p>
<p>Please wait. Performing Color Calibration...</p>	<p>The machine is under the adjustment to maintain its quality. Please wait.</p>
<p>Please wait. Regulating the temperature...</p>	<p>The machine is under the adjustment to maintain its quality. Please wait.</p>

Message	Corrective Action
<p>Print overrun.</p>	<p>The data transferred to the printer was too complex to print on a page. Press [OK] to resume printing.</p>
<p>Replace the toner. [C][M][Y][K] Clean the printer.</p>	<p>Replace the toner container to our specified toner container. After cleaning the inside of the printer, press [OK] and the printer will be ready for printing.</p> <p> Note If the color toner is empty but the black toner is remained, the machine continues printing in black and white by selecting [Print in B & W] of ColorToner Empty.</p>
<p>Registered numbers exceeded. Cannot add.</p>	<p>There are already 100 accounts registered so it is not possible to register any new accounts.</p>
<p>Restricted by Job Accounting. Press [OK].</p>	<p>This message is displayed when printing was attempted, despite the Job Account function being on with Restriction applied as the job limit for each job account. To return the printer to the print-ready status, press [OK]. For more information, refer to <i>Job Account.Set. (Job Account setting) on page 6-110.</i></p>
<p>Set the folding tray.</p>	<p>Set the folding tray.</p>
<p>Set the punch waste box.</p>	<p>Follow the instructions on the panel. and install the punch waste box.</p>
<p>Staple jam.</p>	<p>If a staple jam occurs, the machine will stop and the location of the jam will be indicated on the panel. Leave the machine on and follow the instructions to remove the jammed staple.</p>

Message	Corrective Action
<p>The file name already exists. You cannot copy.</p>	<p>Copying is not possible because data with the same file name exists at the destination. Delete the data with the same file name at the destination before copying.</p>
<p>The user name is not registered.</p>	<p>The login user name entered is not registered or wrong. Check the login user name.</p>
<p>This account ID is already registered.</p>	<p>The account ID set has already been registered. Set a different account ID.</p>
<p>This login user name already registered.</p>	<p>The changed login user name has already been registered. Set a different login user name.</p>
<p>Toner is running out. ↓ ↑ [C] [M] [Y] [K]</p>	<p>Two messages are displayed alternately. The toner in the displayed color (C: Cyan, M: Magenta, Y: Yellow or K:Black) has run low. Ensure that a new toner container is available without delay. For details, <i>Toner Container Replacement on page 7-2.</i></p>
<p>Unknown toner installed. PC [C] [M] [Y] [K]</p>	<p>This message is displayed if the installed toner container's regional specification does not match the machine's. Install the specified toner container.</p>
<p>USB memory error. Press [OK]. ##</p>	<p>An error occurred in the USB memory. The job stopped. Press [OK]. The possible error codes and their descriptions are as follows. 01:The amount of data that can be saved at once has been exceeded. Restart the system or turn the power OFF/ON. If the error still occurs, the USB memory is not compatible with the machine. Use the USB memory formatted by this machine. If the USB memory cannot be formatted, it is damaged. Connect a compatible USB memory.</p>

Clearing Paper Jams

If paper jams in the paper transport system, or no paper sheets are fed at all, the Paper jam message appears and the location of the paper jam (the component where the paper jam has occurred) is also indicated. Status Monitor or Command Center RX can indicate the location of the paper jam (the component where the paper jam has occurred). Remove the paper jam. After removing the paper jam, the printer will resume printing.

Possible Paper Jam Locations

The figure below shows the printer's paper paths including the optional paper feeder. The locations where paper jams might occur are also shown here, with each location explained in the table below. Paper jams can occur in more than one component on the paper paths.

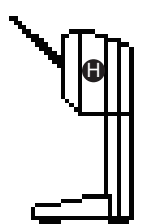
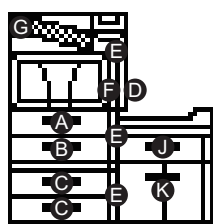

1,000-sheet Finisher

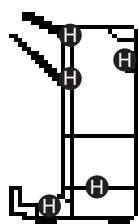

4,000-sheet Finisher

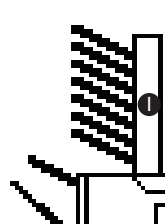

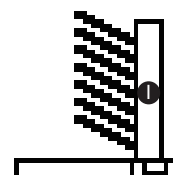

Mailbox (Installed on the 4,000-sheet Finisher)

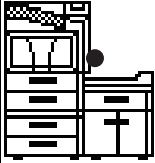
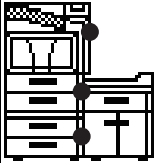

Mailbox (Installed on the machine)

Paper Jam Message	Paper jam location	Description	Reference Page
	A	Paper is jammed at the paper cassette (1).	page 8-19
	B	Paper is jammed at the paper cassette (2).	page 8-20
	C	Paper is jammed at the optional paper feeder cassette (3, 4).	page 8-21

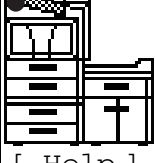
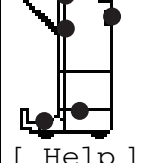
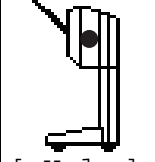
Paper Jam Message	Paper jam location	Description	Reference Page
 <p>Paper jammed at MP tray.</p> <p>[Help]</p>	D	Paper is jammed at the MP tray or inside the printer.	<i>page 8-25</i>
 <p>Paper jammed in right cover #.</p> <p>[Help]</p>	E	Paper is jammed in the right cover section.	<i>page 8-26</i>
 <p>Paper jammed in the duplex unit.</p> <p>[Help]</p>	F	Paper is jammed at the duplex unit.	<i>page 8-29</i> <i>page 8-30</i>
 <p>Paper jammed in the bridge unit.</p> <p>[Help]</p>	G	Paper is jammed at the bridge unit.	<i>page 8-32</i>
 <p>Paper jammed in the finisher.</p> <p>[Help]</p>  <p>Paper jammed in the finisher.</p> <p>[Help]</p>	H	Paper is jammed at the optional document finisher.	<i>page 8-32</i> <i>page 8-34</i> <i>page 8-39</i>

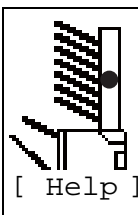
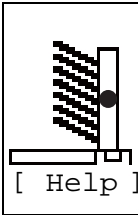
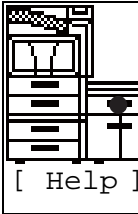
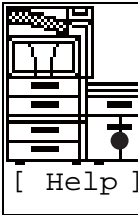
Paper Jam Message	Paper jam location	Description	Reference Page
 <p>Paper jammed in the mailbox. [Help]</p>	I	Paper is jammed at the mailbox.	page 8-38
 <p>Paper jammed in the mailbox. [Help]</p>			
 <p>Paper jammed in cassette 5. [Help]</p>	J	Paper is jammed at the paper cassette (5).	page 8-41
 <p>Paper jammed in cassette 6. [Help]</p>	K	Paper is jammed at the optional paper feeder cassette (6, 7).	page 8-43

General Considerations for Clearing Jams

Bear in mind the following considerations when attempting paper jam removal:

 **CAUTION** When pulling the paper, pull it gently so as not to tear it. Torn pieces of paper are difficult to remove and may be easily overlooked, deterring the paper jam recovery.

- If paper jams occur frequently, try using a different type of paper, replace the paper with paper from another ream, or flip the paper stack over. The printer may have problems if paper jams recur after the paper is replaced.
- Whether or not the jammed pages are reproduced normally after printing is resumed, depends on the location of the paper jam.

Utilizing Online Help Messages

When Paper Jam is displayed, press [Help] ([Left Select]) to display the procedure to clear the jam. Press ∇ to display the next step or press \triangle to display the previous step. Press the OK key to exit the online help message display.

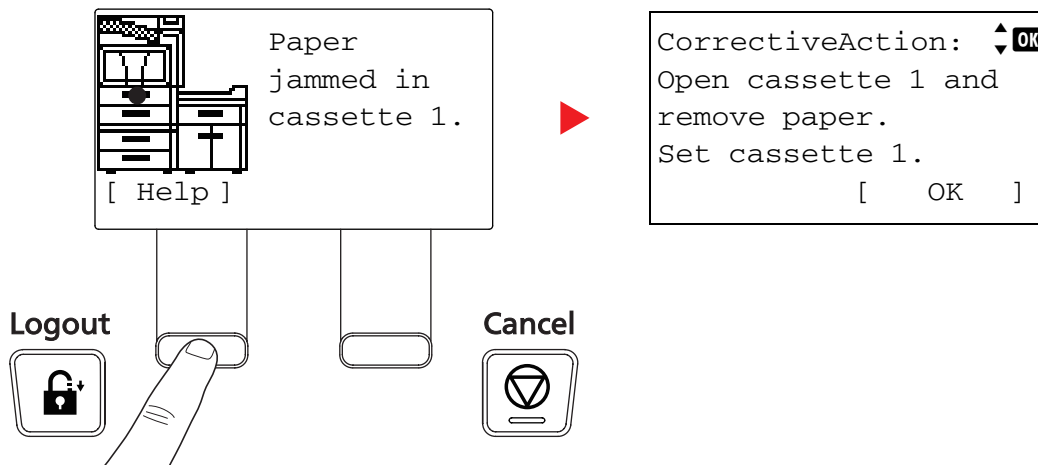

Cassette 1

Follow the steps below to clear paper jams in cassette 1.

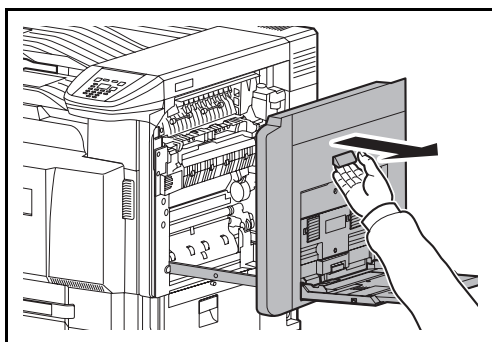

- 1 Pull up right cover 1 lever and open the right cover 1.

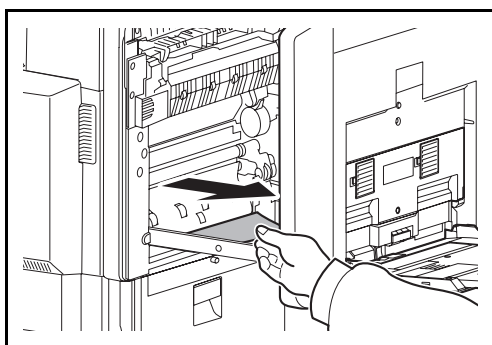

- 2 Remove the jammed paper.

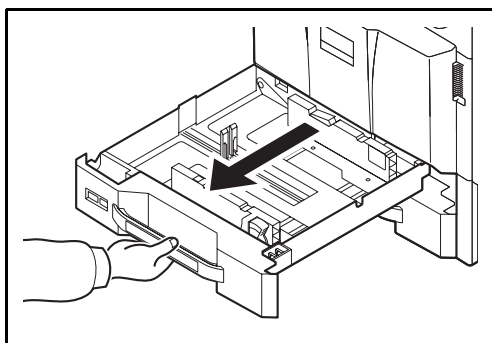

- 3 Pull out cassette 1.

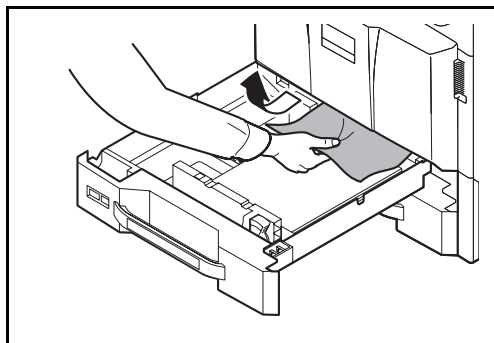

- 4** Remove the jammed paper.
If the paper tears, remove every loose scrap from inside the machine.

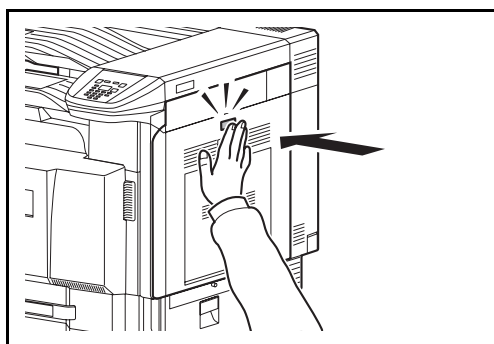

- 5** Push cassette 1 back in place securely.
6 Press the specified position to close right cover 1.

Cassette 2

Follow the steps below to clear paper jams in cassette 2.

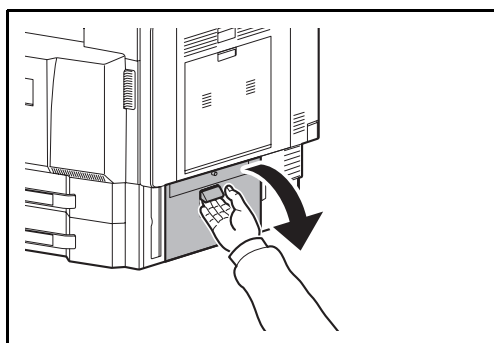

- 1** Open right cover 3.

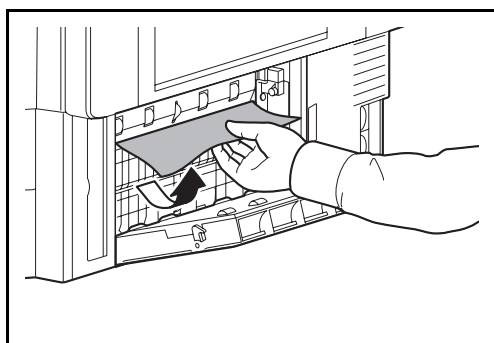

- 2** Remove the jammed paper.

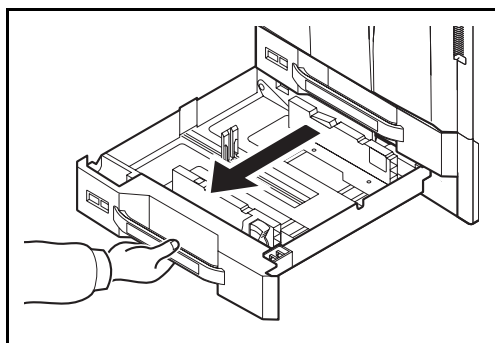

3 Pull out cassette 2.

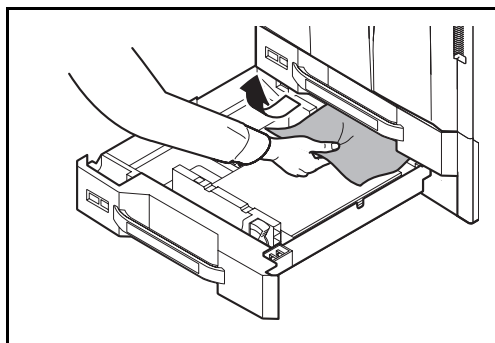

4 Remove the jammed paper.
If the paper tears, remove every loose scrap from inside the machine.

5 Push cassette 2 back in place securely.

6 Close right cover 3.

Optional Cassettes 3 and 4

Follow the steps below to clear paper jams in cassettes 3 or 4 when using the optional paper feeder.

Paper Feeder (500-sheet x 2)

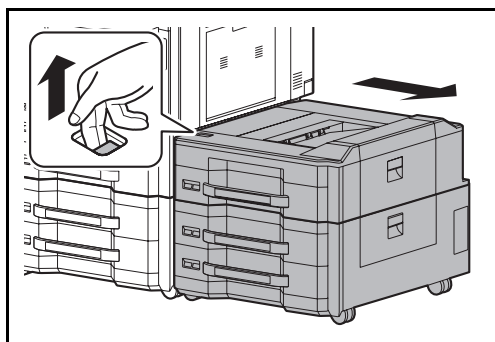

1 If you are using the optional side feeder, pull up the release lever and separate the side feeder from the multifunction machine.

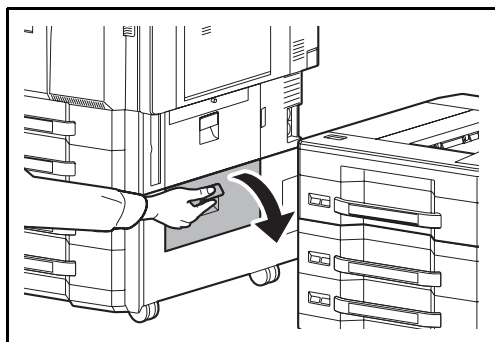

2 Open right cover 4.

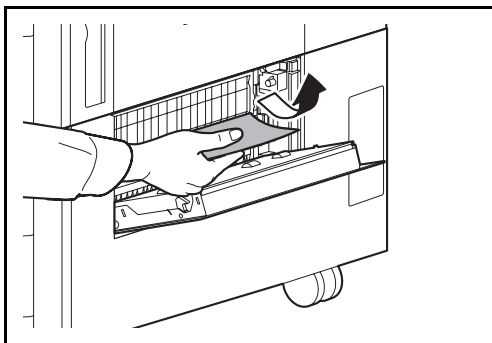

- 3** Remove the jammed paper.
If the paper tears, remove every loose scrap from inside the machine.

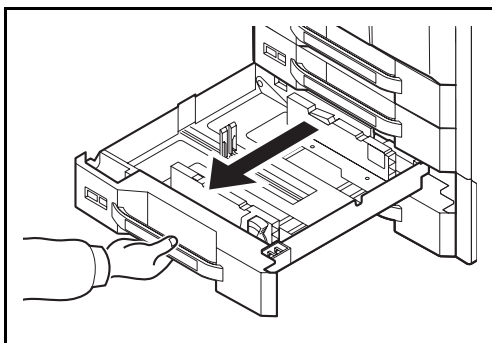

- 4** Pull out the cassette in use.

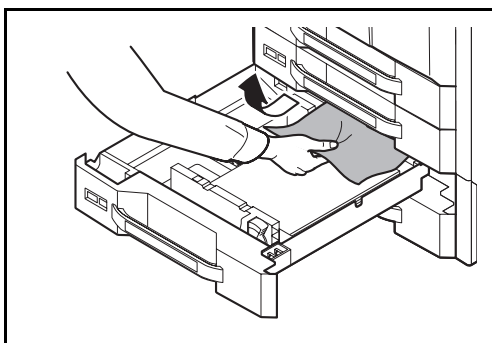

- 5** Remove the jammed paper.

- 6** Push the cassette back in place securely.

- 7** Close right cover 4.

Large Capacity Feeder (1,500-sheet x 2)

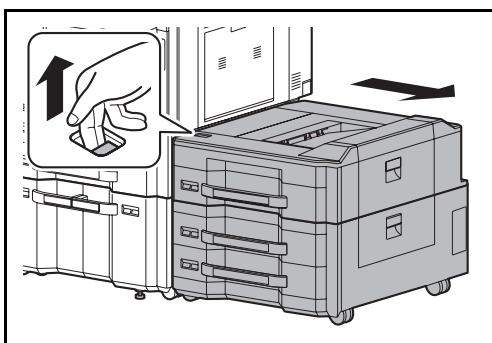

- 1** If you are using the optional side feeder, pull up the release lever and separate the side feeder from the multifunction machine.

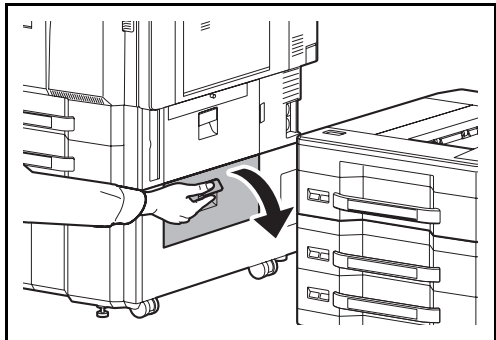

2 Open right cover 4.

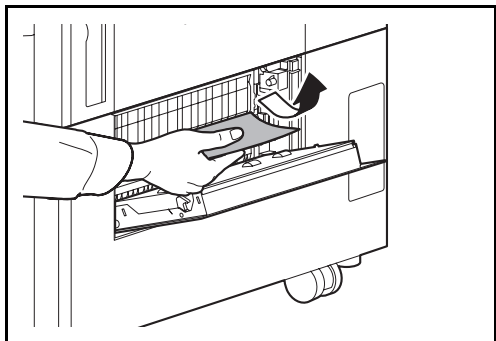

3 Remove the jammed paper.
If the paper tears, remove every loose scrap from inside the machine.

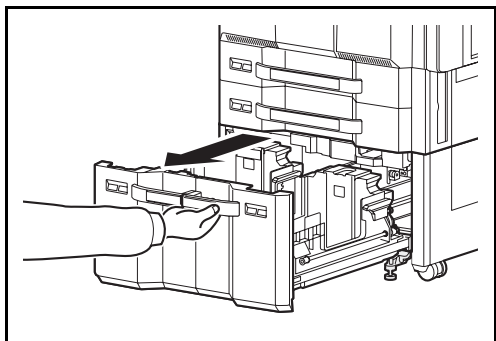

4 Pull out cassettes 3 and 4.

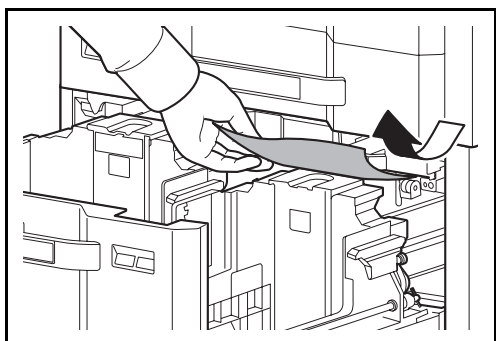

5 Remove the jammed paper.

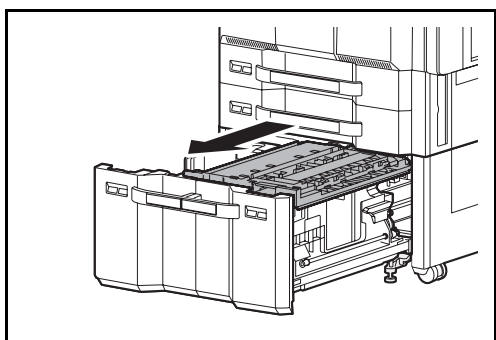

6 Pull out the paper feed unit (B1).

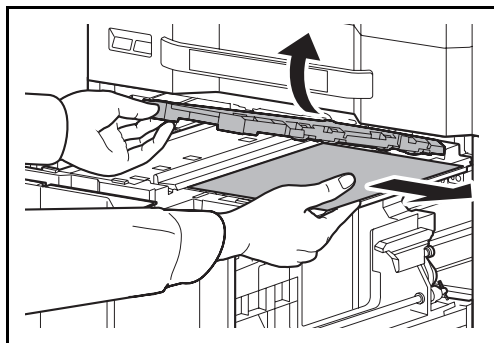

7 Open the paper feed unit cover (B2) and remove the jammed paper.

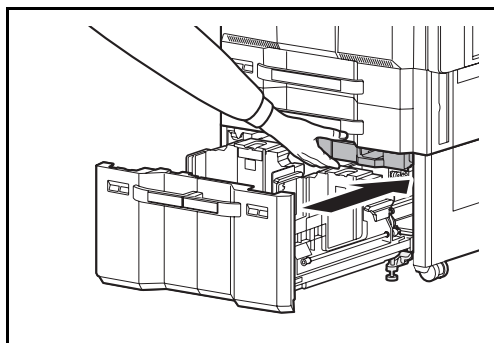

8 Close the paper feed unit cover (B2) and push the paper feed unit all the way back in.

9 Push the cassette back in place securely.

10 Close right cover 4.

Multi Purpose Tray

Follow the steps below to clear paper jams in the multi purpose tray.

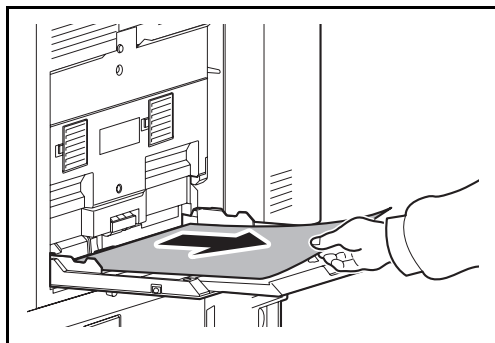

- 1** Remove all sheets of paper from the multi purpose tray.

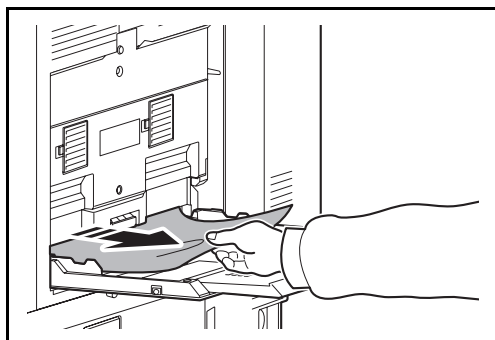

- 2** If paper is jammed inside, pull the paper toward you to remove.

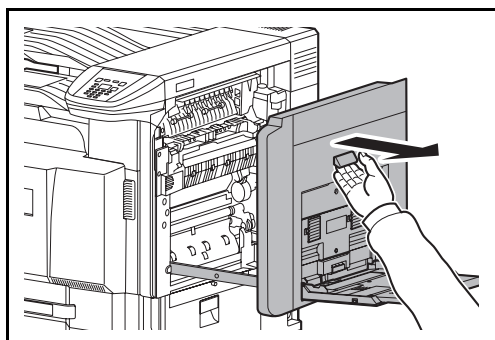

- 3** Pull up right cover 1 lever and open the right cover 1.

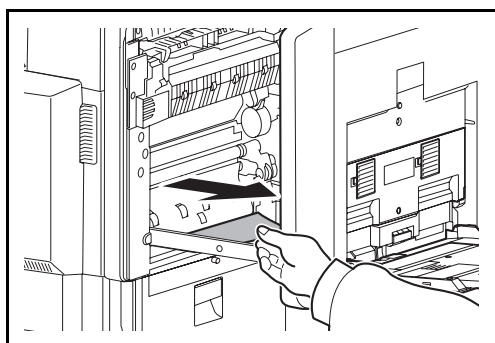

- 4** Remove the jammed paper.
If the paper tears, remove every loose scrap from inside the machine.

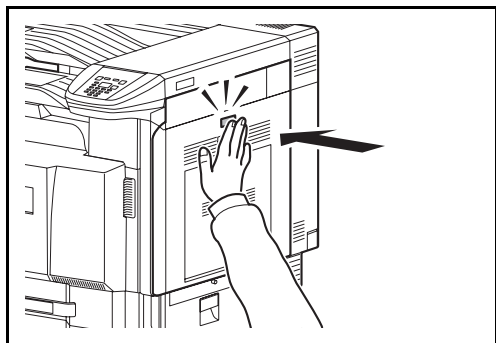

- 5** Press the specified position to close right cover 1.

Inside the Right Covers 1, 3 and 4

Follow the steps below to clear paper jams inside right cover 1, 3 or 4 when using the optional paper feeder.

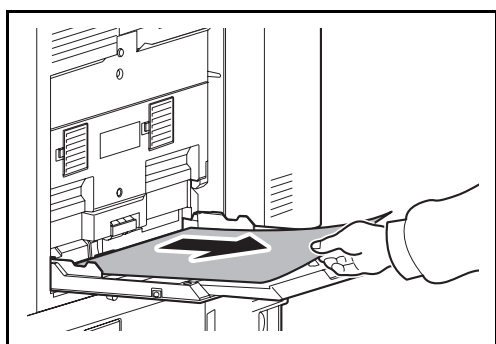

- 1** Remove all sheets of paper from the multi purpose tray.

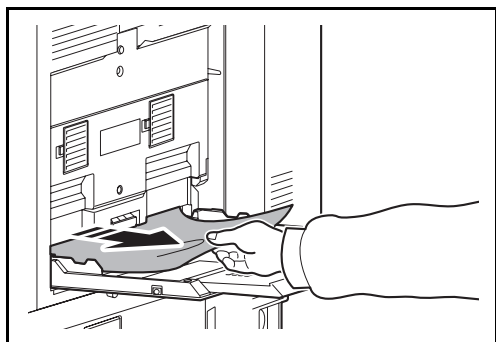

- 2** If paper is jammed inside, pull the paper toward you to remove.

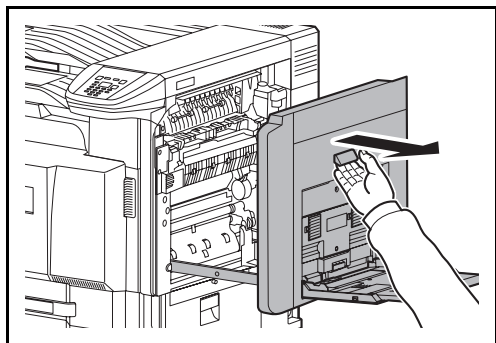

- 3** Open the right cover where the paper is jammed inside.

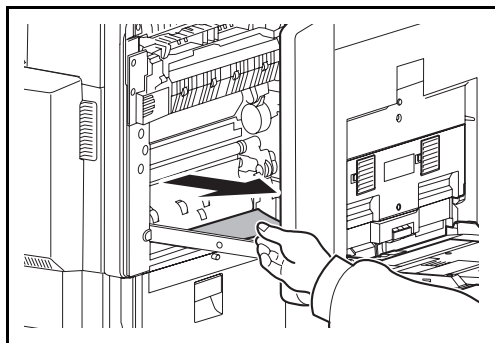

- 4** Remove the jammed paper.
If the paper tears, remove every loose scrap from inside the machine.

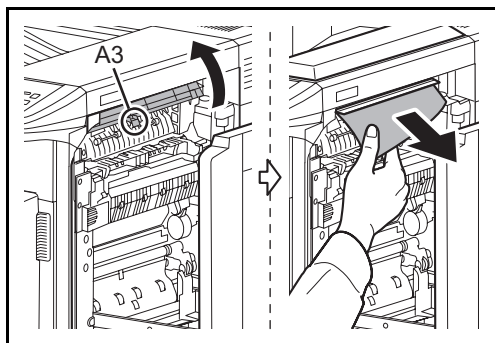

- 5** Open the Conveyor Guide (A3) and remove the jammed paper.
6 Close the Conveyor Guide (A3).

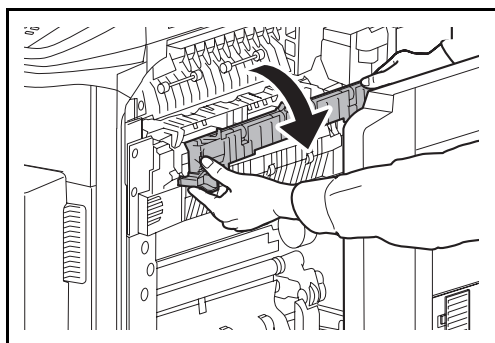

- 7** Open the fuser cover.



CAUTION The fixing unit is extremely hot. Take sufficient care when working in this area, as there is a danger of getting burned.

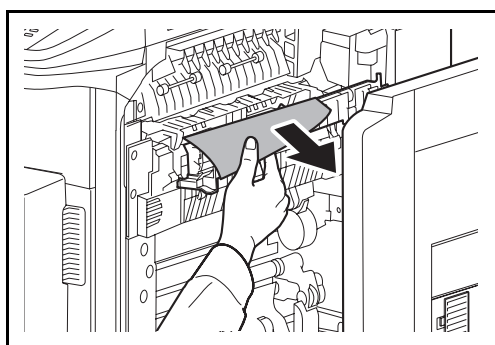

- 8** Remove the jammed paper.
If the paper tears, remove every loose scrap from inside the machine.

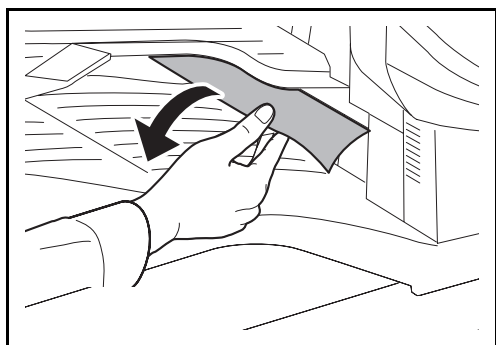

- 9** If jammed paper is seen through the paper ejection slot, pull it toward your side to remove it.

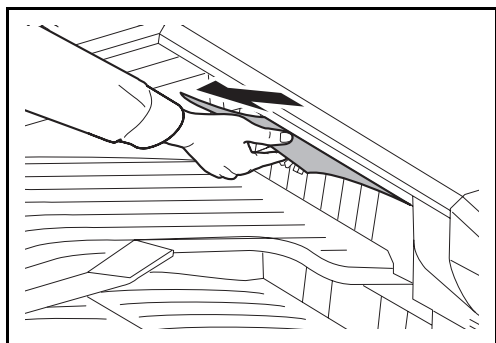

- 10** If you are using the optional document finisher, follow step on page 8-32 to remove jammed paper in the optional bridge unit.

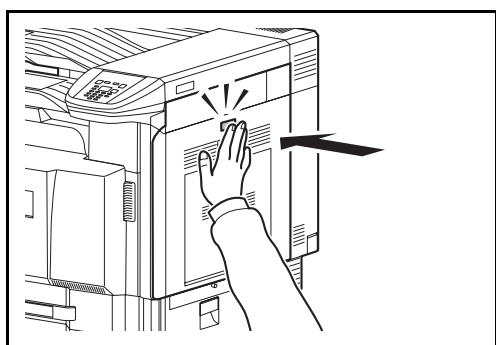

- 11** Close the right cover.

Duplex unit

Follow the steps below to clear paper jams in the duplex unit.

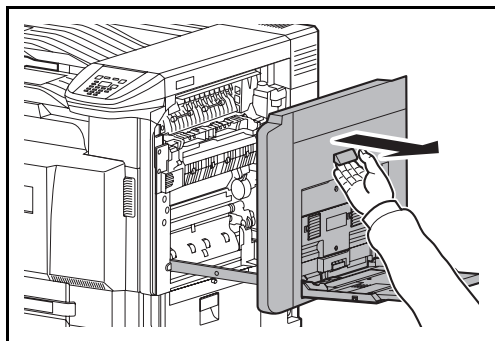

- 1 Pull up right cover 1 lever and open the right cover 1.

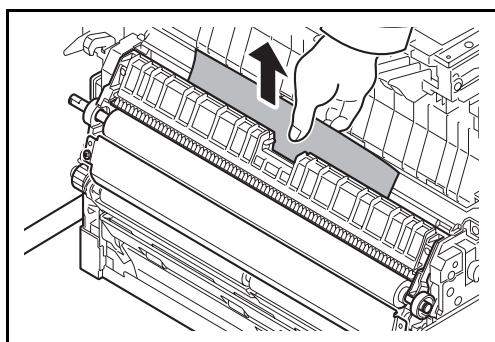

- 2 Remove the jammed paper.

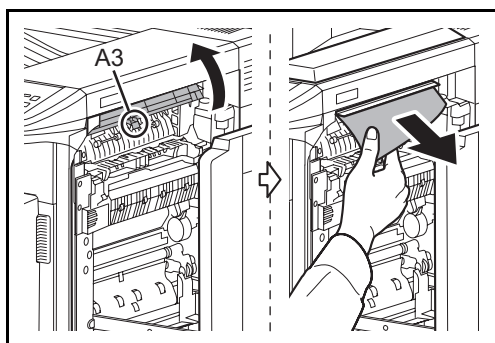
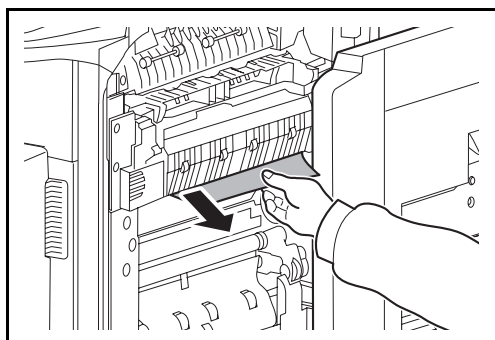

- 3 Open the Conveyor Guide (A3) and remove the jammed paper.

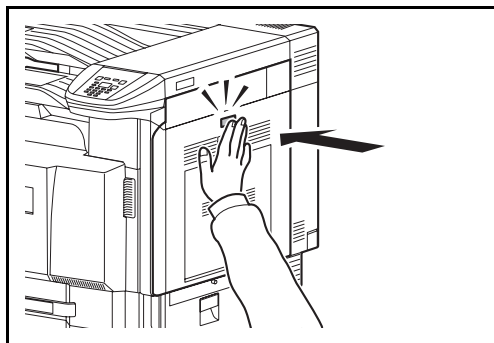

- 4** Replace the Conveyor Guide (A3), press the indicated part, and close Right Cover 1.

Duplex Unit and Cassette 1

Follow the steps below to clear paper jams in duplex unit and cassette 1.

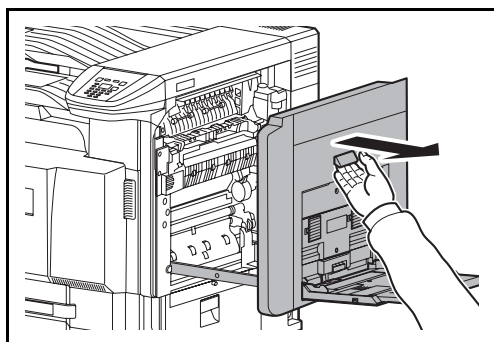

- 1** Pull up right cover 1 lever and open the right cover 1.

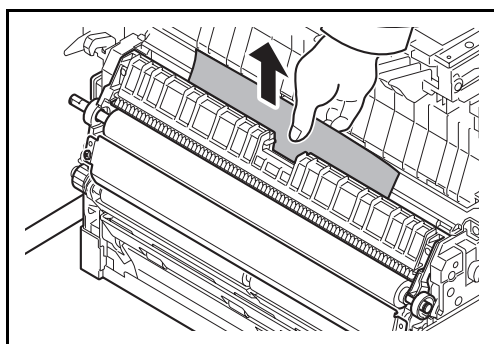

- 2** Remove the jammed paper.

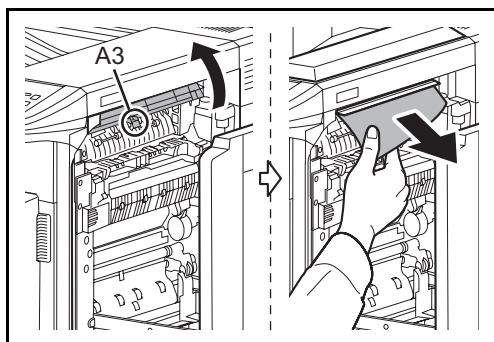

- 3** Open the Conveyor Guide (A3) and remove the jammed paper.

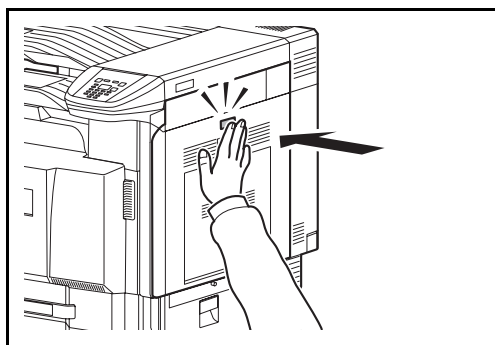

4 Replace the Conveyor Guide (A3), press the indicated part, and close Right Cover 1.

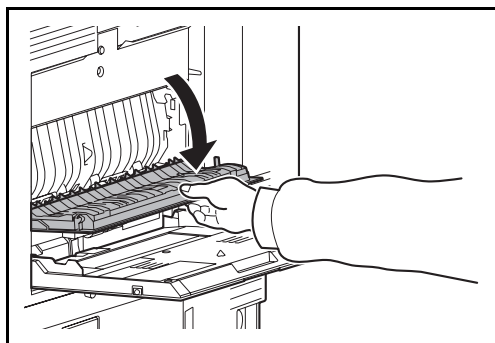

5 Open the right cover 2.

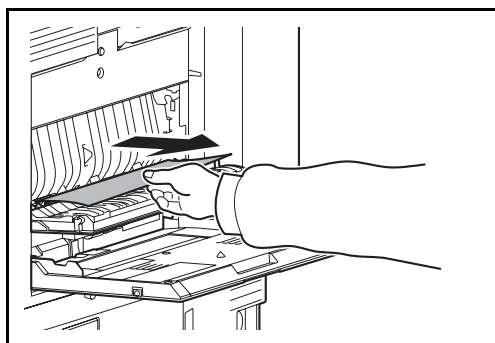

6 Remove the jammed paper.
If the paper tears, remove every loose scrap from inside the machine.

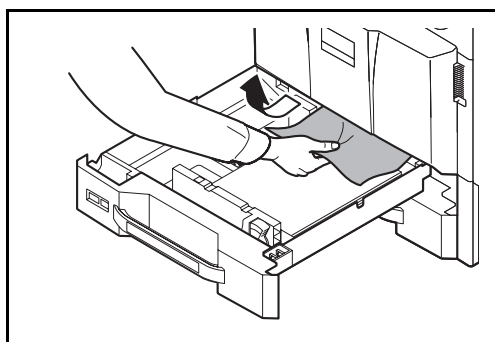

7 Close the right cover 2.
8 Pull out cassette 1 and remove the jammed paper.
If the paper tears, remove every loose scrap from inside the machine.

9 Push cassette 1 back in place securely.

Bridge Unit (Option)

If a paper jam occurs in the optional bridge unit, follow the steps below to remove the jam.

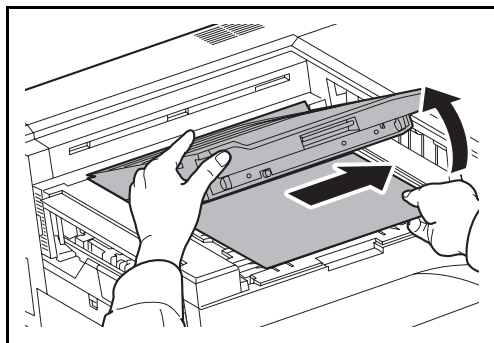

- 1 Open the relay unit cover and remove the jammed paper.

1,000-sheet Finisher (Option)

If a paper jam occurs in the optional 1,000-sheet finisher, follow the steps below to remove the jam.

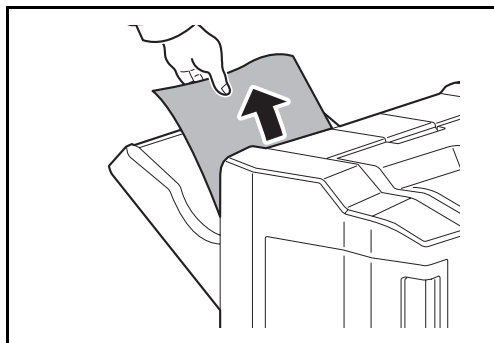

- 1 If jammed paper is seen through the paper ejection slot, pull it toward your side to remove it.

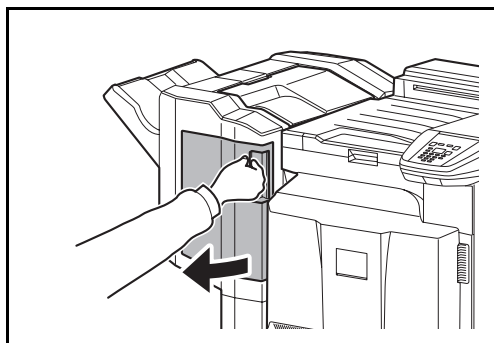

- 2 Open the front cover.

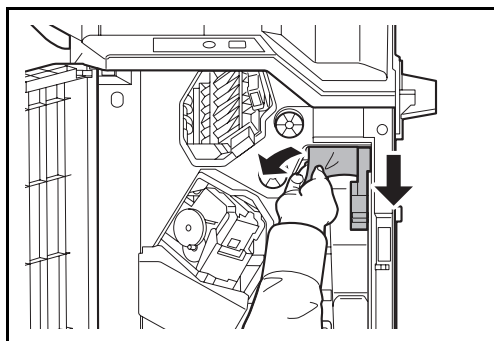

- 3 Open feed guide D1 and remove the jammed paper.

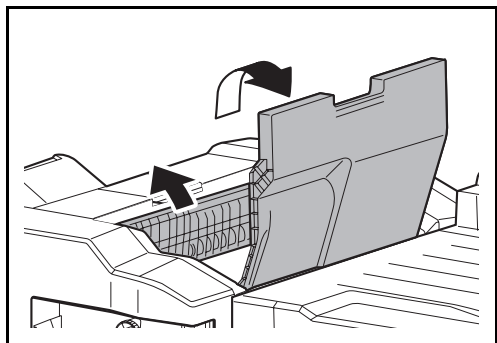

4 Open the top tray and then open feed guide D2.

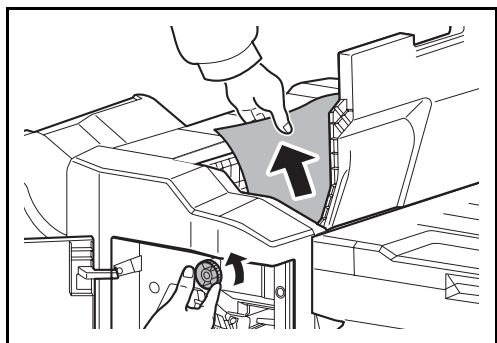

5 Turn the conveyor knob to the left to feed the paper along to enable easy removal.

6 Close the open feed guides, and close the top and front covers.

4,000-sheet Finisher (Option)

If a paper jam occurs in the optional 4,000-sheet finisher, follow the steps below to remove the jam.

Coupling Section

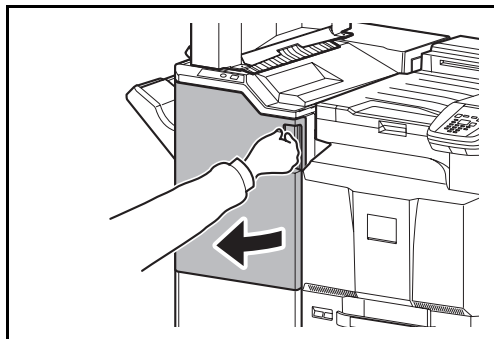

1 Open the front cover 1.

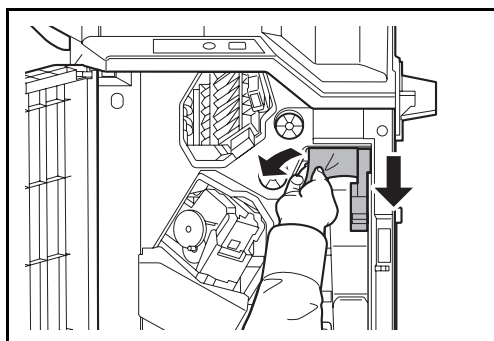

2 Open conveyor guide (D1) and remove the jammed paper.

3 Close the conveyor guide (D1) and front cover 1.

Tray A

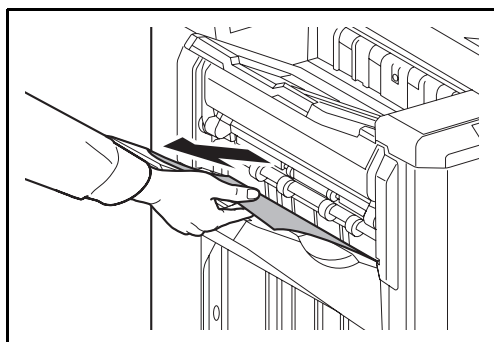

1 If jammed paper is seen through the paper ejection slot, pull it toward your side to remove it.

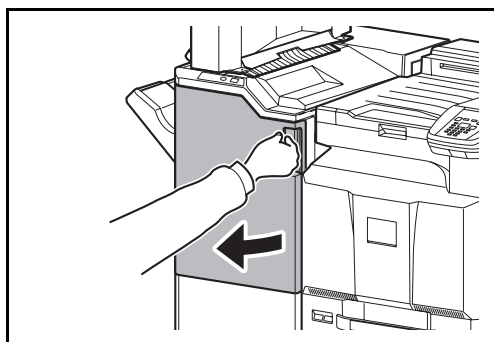

2 Open the front cover 1.

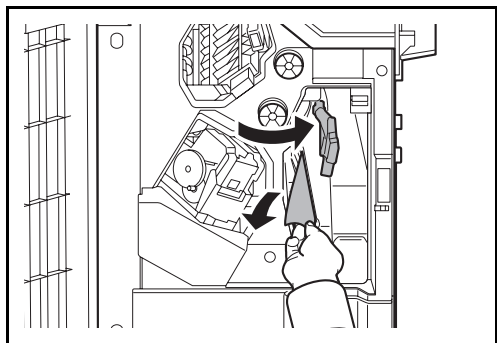

3 Open the conveyor guide (D6) and remove the jammed paper.



4 Close the conveyor guide (D6).

5 Open the conveyor guide (D4) and remove the jammed paper.

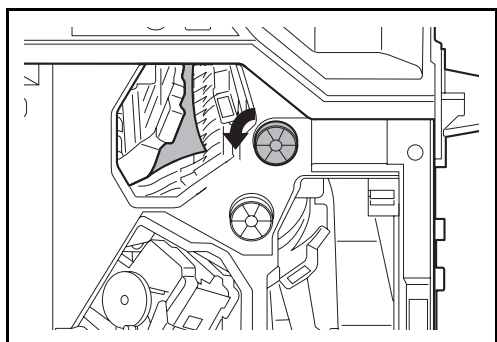

Note If it is difficult to remove the jammed paper, turn feed knob D3 until the jammed paper is in a location where it is easy to remove.

6 Close the conveyor guide (D4) and front cover 1.

Tray B

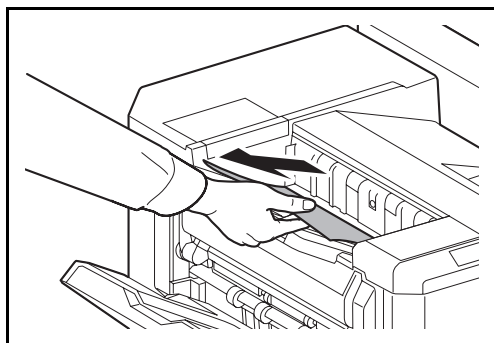

- 1 If jammed paper is seen through the paper ejection slot, pull it toward your side to remove it.

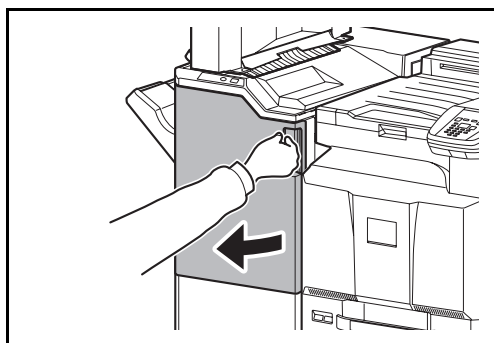

- 2 Open the front cover 1.

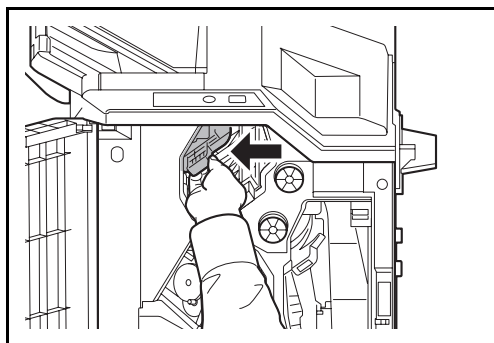

- 3 Open the conveyor guide (D2).

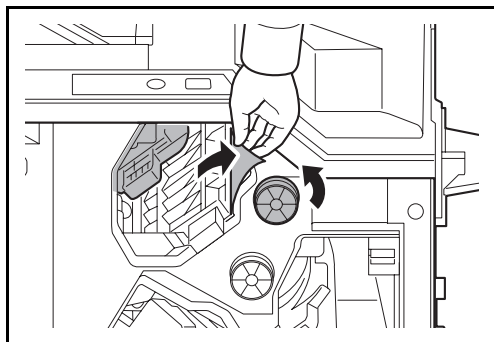

- 4 Turn the conveyor knob (D3) to the left to feed the paper along to enable easy removal.

- 5 Close the conveyor guide (D2) and front cover 1.

Conveyor / Inner Tray

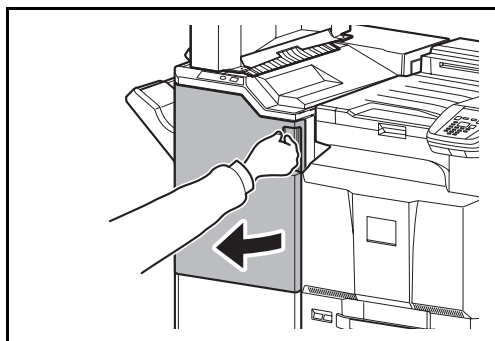

1 Open the front cover 1.

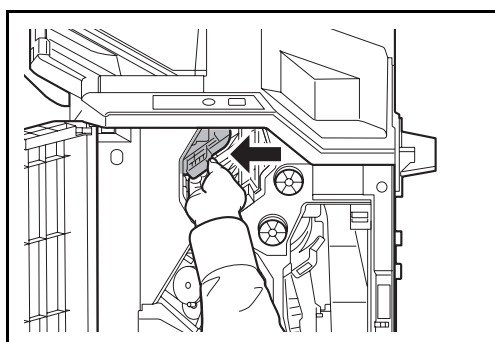

2 Open the conveyor guide (D2).

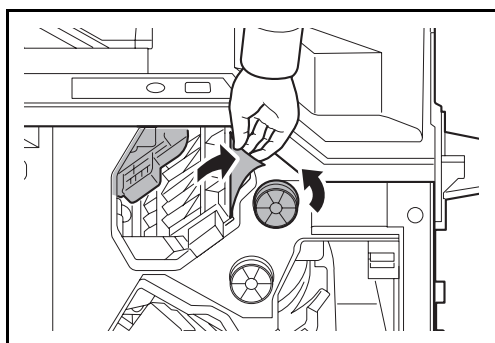

3 Turn the conveyor knob (D3) to the left to feed the paper along to enable easy removal.

4 Follow step 3 onward on *page 8-35* to remove jammed paper.

Mailbox (Option)

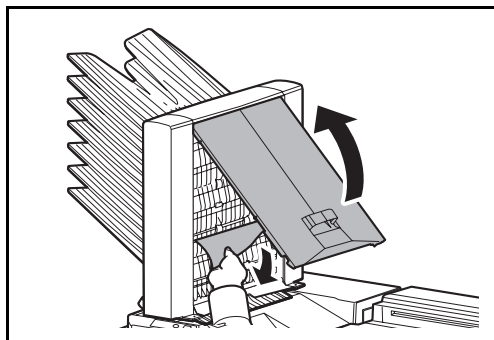

- 1 Open the mailbox cover and remove the jammed paper.

- 2 Close the mailbox cover.

If a mailbox is connected to the machine, perform the following steps.

- 3 Pull up right cover 1 lever and open the right cover 1.

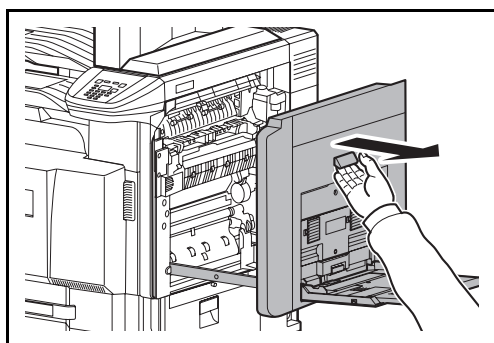

- 4 Open the Conveyor Guide (A3) and remove the jammed paper.

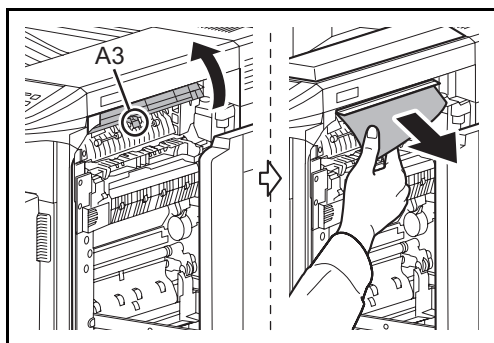

- 5 Replace the Conveyor Guide (A3), press the indicated part, and close Right Cover 1.

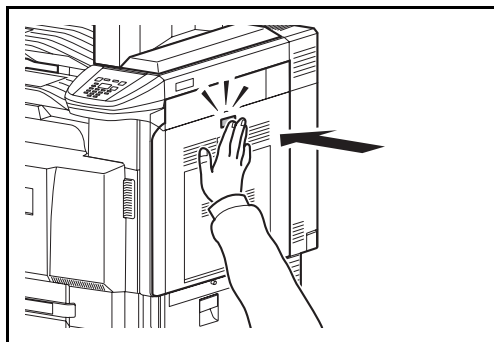

Center-Folding Unit (Option)

Ejection Section

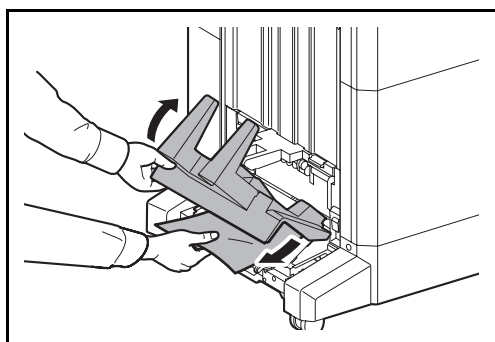

- 1 Lift up the folding tray and remove any jammed paper.

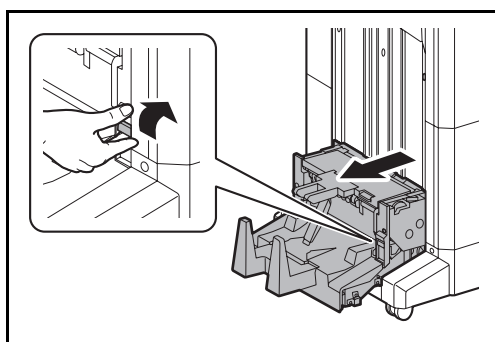

- 2 Push the folding unit release lever and pull out the folding unit.

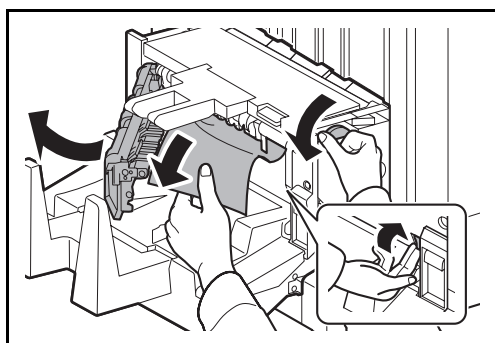

- 3 Press the release lever, open the left cover of the center fold unit, and remove the jammed paper.

- 4 Turn feed knob D9 until the jammed paper is in a location where it is easy to remove.

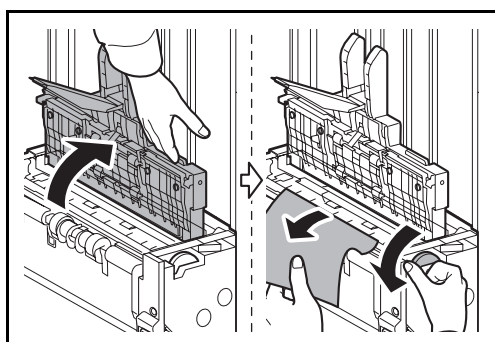

- 5 Close the folding unit left cover.

- 6 Open the folding unit top cover and remove the paper jam.

- 7 Turn feed knob D9 until the jammed paper is in a location where it is easy to remove.

- 8 Close the folding unit top cover, and return the folding unit to its original position.

Conveyor Section

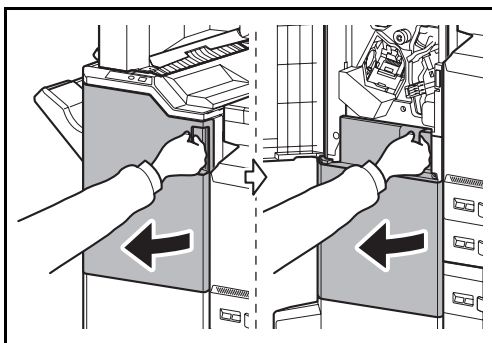

- 1** Open the front cover 1 and 2.

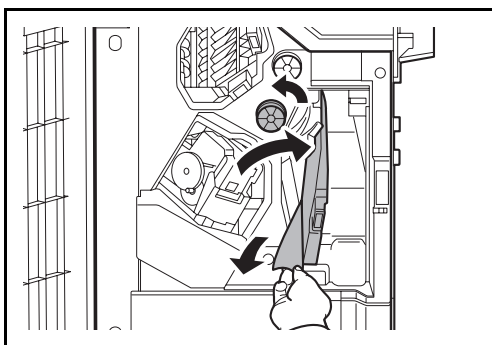

- 2** Open the conveyor guide (D7) and remove the jammed paper.
- 3** Turn feed knob D5 until the jammed paper is in a location where it is easy to remove.
If there is no paper jam in the conveyor guide (D7), proceed to the following step.

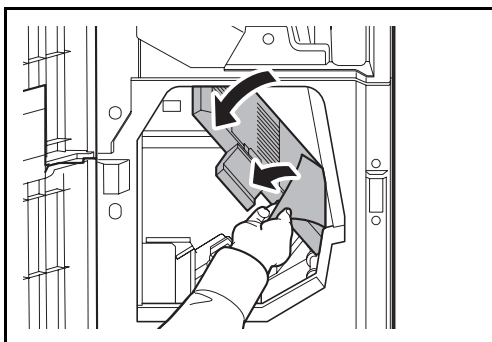

- 4** Close the conveyor guide (D7).
- 5** Open the conveyor guide (D8) and remove the jammed paper.

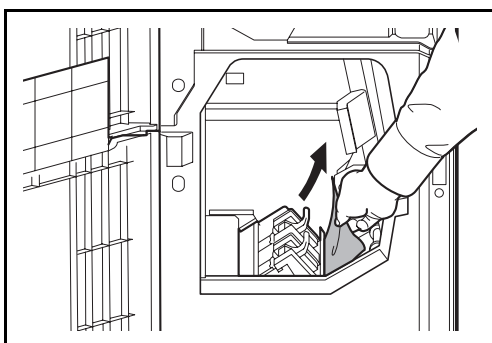

- 6** Close the conveyor guide (D8).
- 7** Remove the paper jammed in the center folding unit.

- 8** Close the front cover 1 and 2.

Cassette 5 (Option)

If a paper jam occurs in cassette 5 when you are using the optional side feeder (3,000-sheet), side feeder (500-sheet x 3), or large capacity side feeder (500, 1,500-sheet x 2), follow the steps below to remove the jam.

Side Feeder (3,000-sheet)

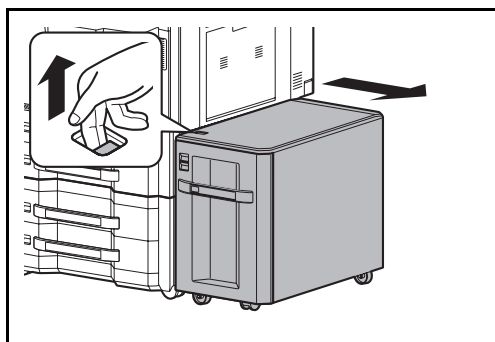

- 1** Pull up the release lever and separate the side feeder from the multifunction machine.

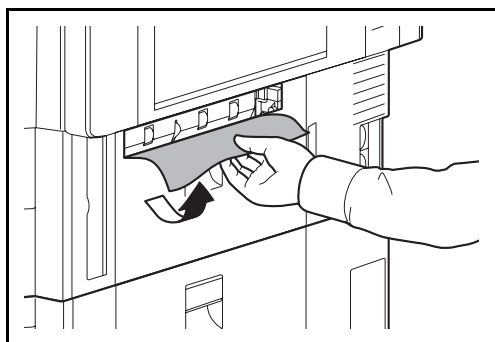

- 2** Remove the paper from the connection port.

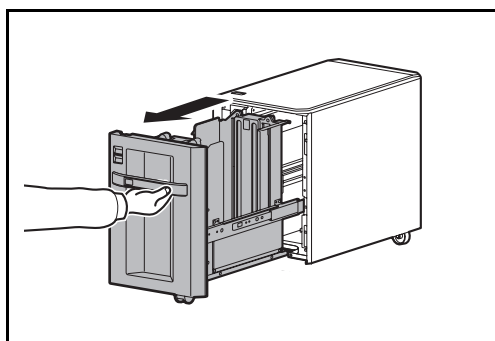

- 3** Pull out cassette 5.

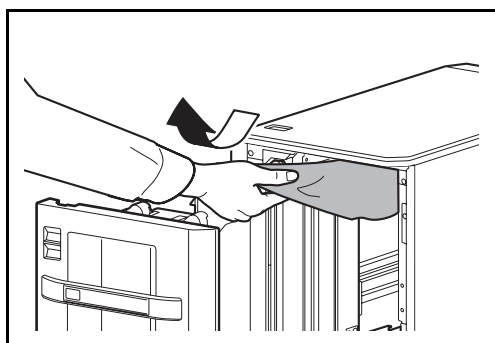

- 4** Remove the jammed paper.

- 5** Push the cassette back in place securely.

- 6** Connect to the multifunction machine.

Side Feeder (500-sheet x 3) or Large Capacity Side Feeder (500, 1,500-sheet x2)

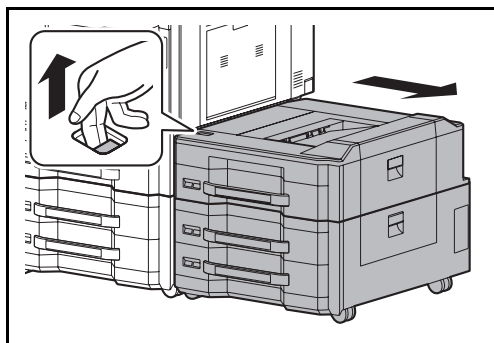

- 1** Pull up the release lever and separate the side feeder from the multifunction machine.

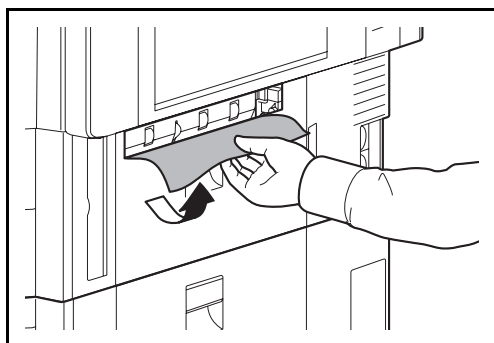

- 2** Remove the paper from the connection port.

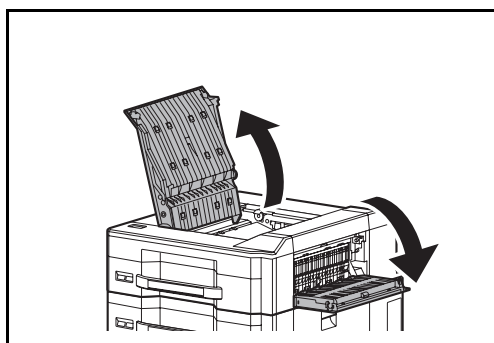

- 3** Open the top cover and right cover 1.

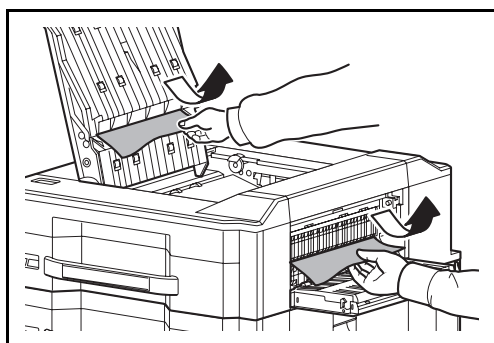

- 4** Remove the jammed paper.

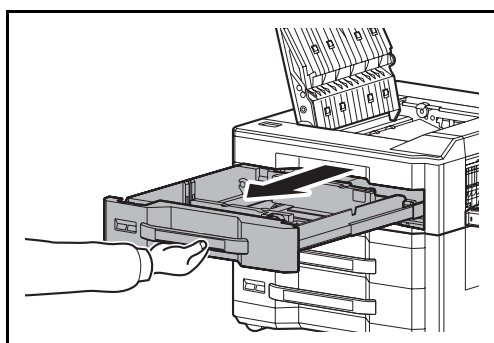

- 5** Pull out cassette 5.

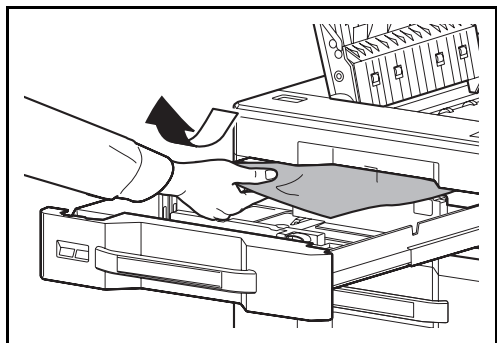

6 Remove the jammed paper.

7 Push the cassette back in place securely.

8 Close the top cover and right cover 1.

9 Connect to the multifunction machine.

Cassette 6,7 (Option)

If a paper jam occurs in cassette 6 or 7 when you are using the optional side feeder (500-sheet x 3) or large capacity side feeder (500, 1,500-sheet x 2), follow the steps below to remove the jam.

Side Feeder (500-sheet x3)

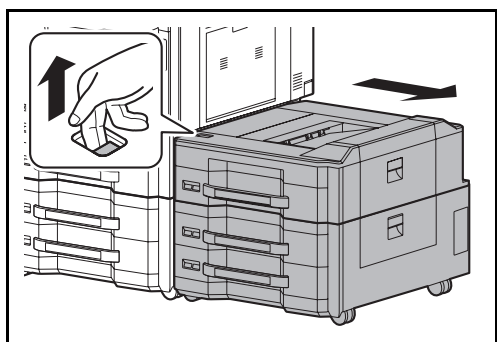

1 Pull up the release lever and separate the side feeder from the multifunction machine.

2 Follow steps 2 to 5 on *page 8-42* to remove the jammed paper.

3 Open the right cover 2.

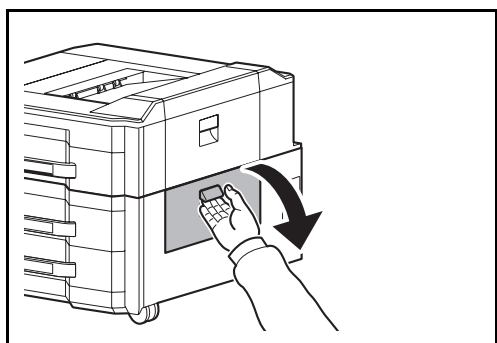

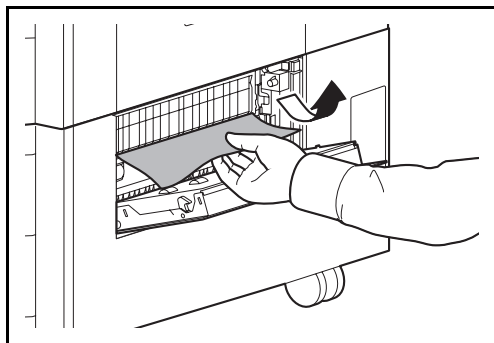

4 Remove the jammed paper.

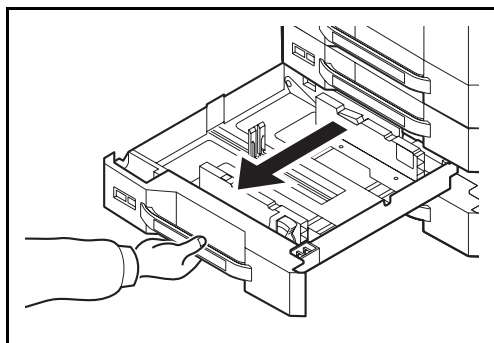

5 Pull out the cassette in use.

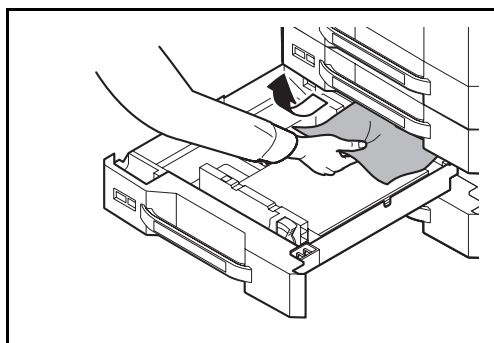

6 Remove the jammed paper.

7 Push the cassette back in place securely.

8 Close the right cover 2.

9 Connect to the multifunction machine.

Large Capacity Side Feeder (500, 1,500-sheet x2)

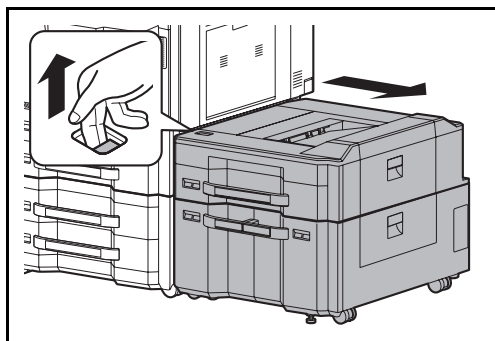

- 1** Pull up the release lever and separate the side feeder from the multifunction machine.

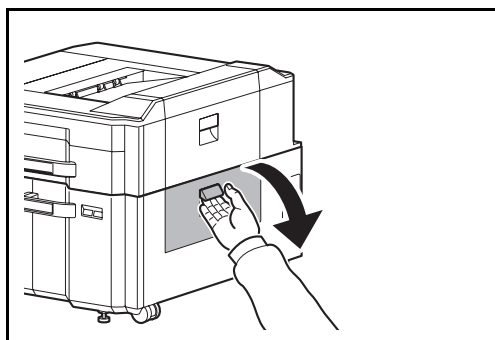

- 2** Follow steps 2 to 5 on *page 8-42* to remove the jammed paper.
- 3** Open the right cover 2.

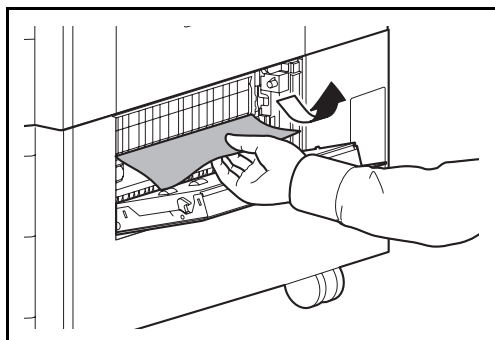

- 4** Remove the jammed paper.

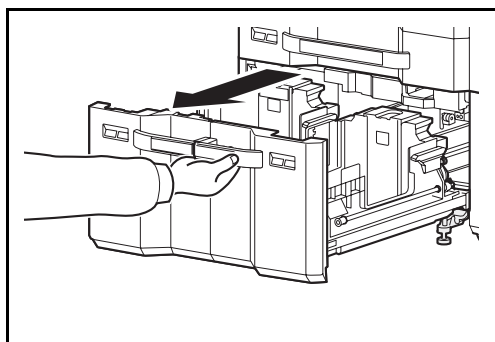

- 5** Pull out cassettes 6 and 7.

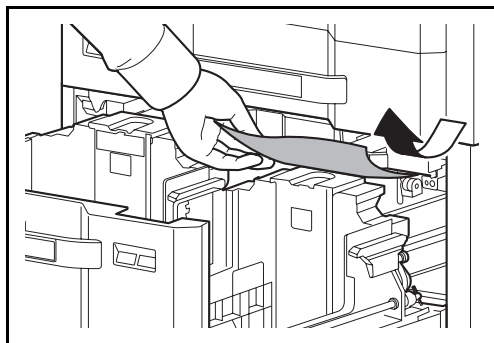

6 Remove the jammed paper.

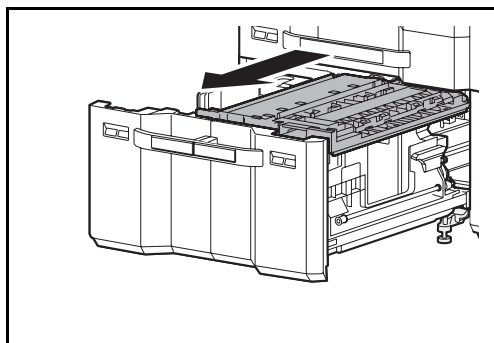

7 Pull out the paper feed unit (B1).

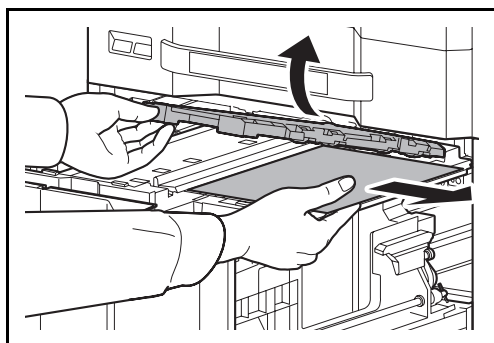

8 Open the paper feed unit cover (B2) and remove the jammed paper.

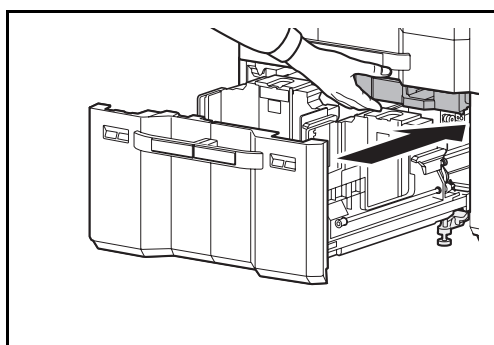

9 Close the paper feed unit cover (B2) and push the paper feed unit all the way back in.

10 Push the cassette back in place securely.

11 Close the right cover 2.

12 Connect to the multifunction machine.

Clearing a Staple Jam

If a message indicating a staple jam is displayed on the machine's operation panel, remove the jammed staples. Follow the steps below to remove jammed staples.

1,000-sheet Finisher

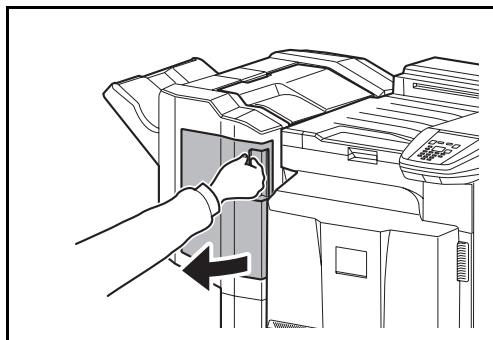

- 1 Open the front cover.

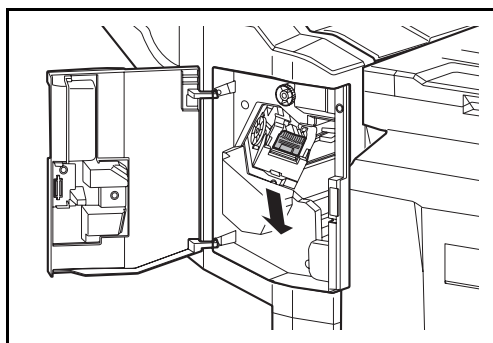

- 2 Remove the staple cartridge holder.

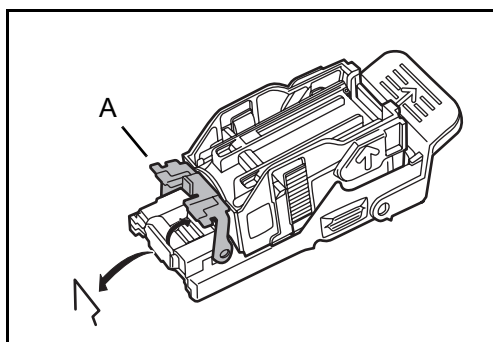

- 3 Open the cover plate (A) of the staple cartridge holder and remove any jammed staples.

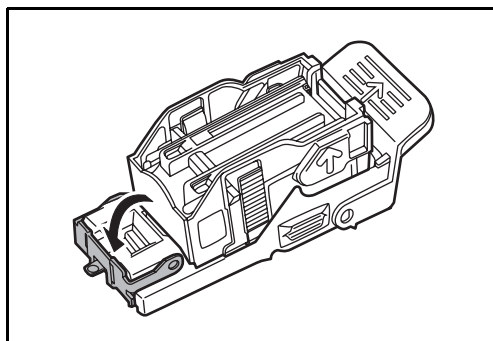

- 4 Close the cover (A) plate of the staple cartridge holder into its original position.

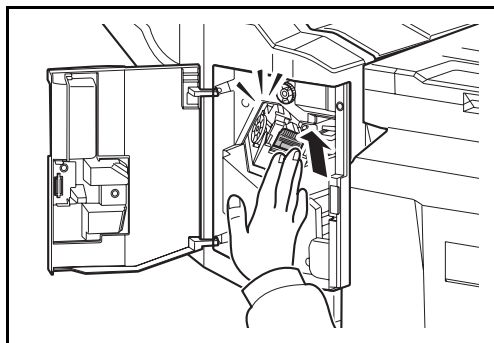

5 Re-install the staple cartridge holder. The staple cartridge holder will click into place when it has been inserted correctly.

6 Close the front cover.

4,000-sheet Finisher

◆Staple cartridge holder A

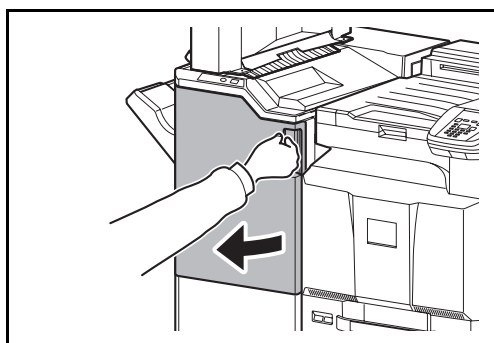

1 Open the front cover 1.

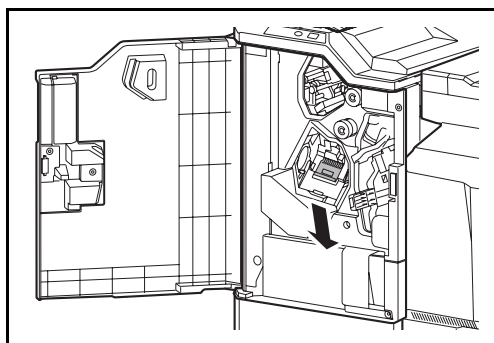

2 Remove the staple cartridge holder A.

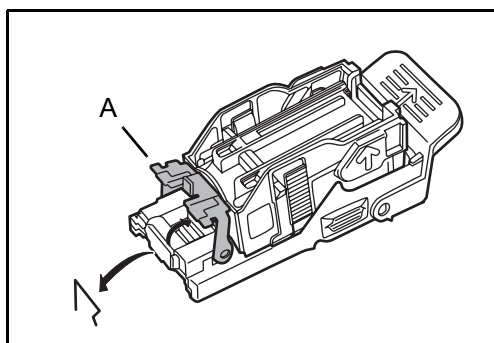

3 Open the cover plate (A) of the staple cartridge holder A and remove any jammed staples.

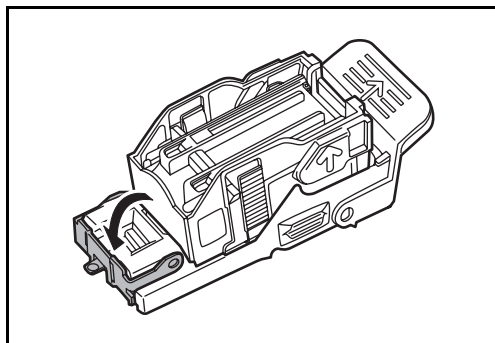

- 4 Close the cover plate (A) of the staple cartridge holder into its original position.

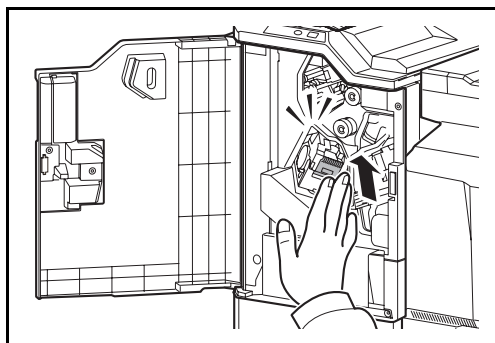

- 5 Re-install the staple cartridge holder. The staple cartridge holder will click into place when it has been inserted correctly.

- 6 Close the front cover 1.

◆ **Staple cartridge holder B/C**

Follow the steps below to remove jammed staples from the optional folding unit.

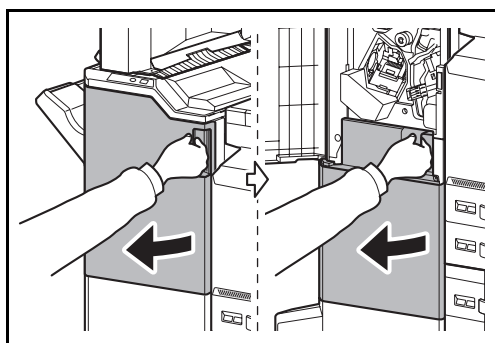

- 1 Open the front cover 1 and 2.

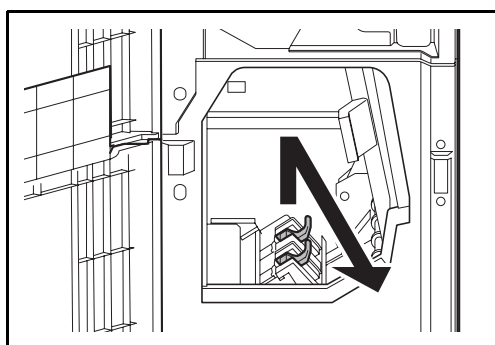

- 2 Remove staple cartridge holder B or C.

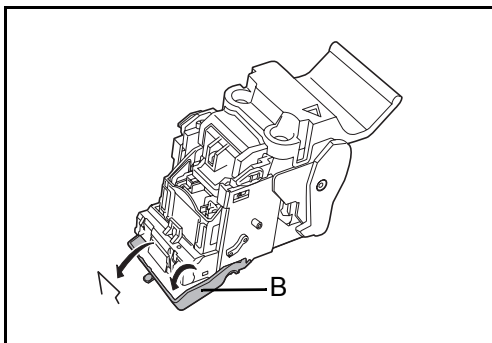

3 Open the cover plate (B) of the staple cartridge holder and remove any jammed staples.

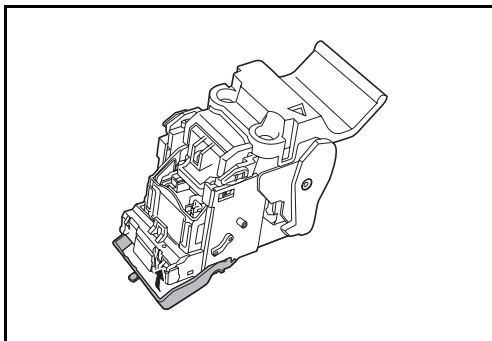

4 Close the cover (B) plate of the staple cartridge holder into its original position.

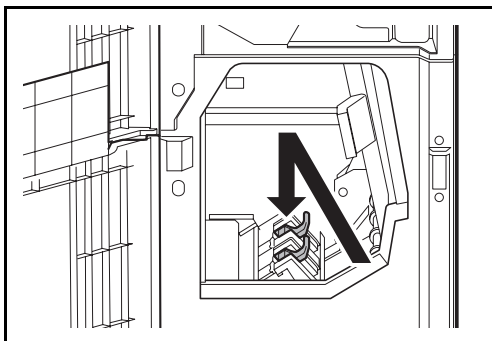

5 Re-install the staple cartridge holder.

When re-installing, align the triangle marks on the staple cartridge holder and the staple unit. The staple cartridge holder will click into place when it has been inserted correctly.

6 Close the front cover 1 and 2.

Appendix

This chapter lists the provides details of the available interfaces and describes the optional hardware that can be installed on the printer and shows the printer's specifications.

Optional Equipment	A-2
Character Entry Method	A-6
Paper	A-9
Specifications	A-17
Glossary	A-24

For availability of the options, consult your service technician.

Optional Equipment

Overview of Optional Equipment

The following optional equipment is available for the machine.

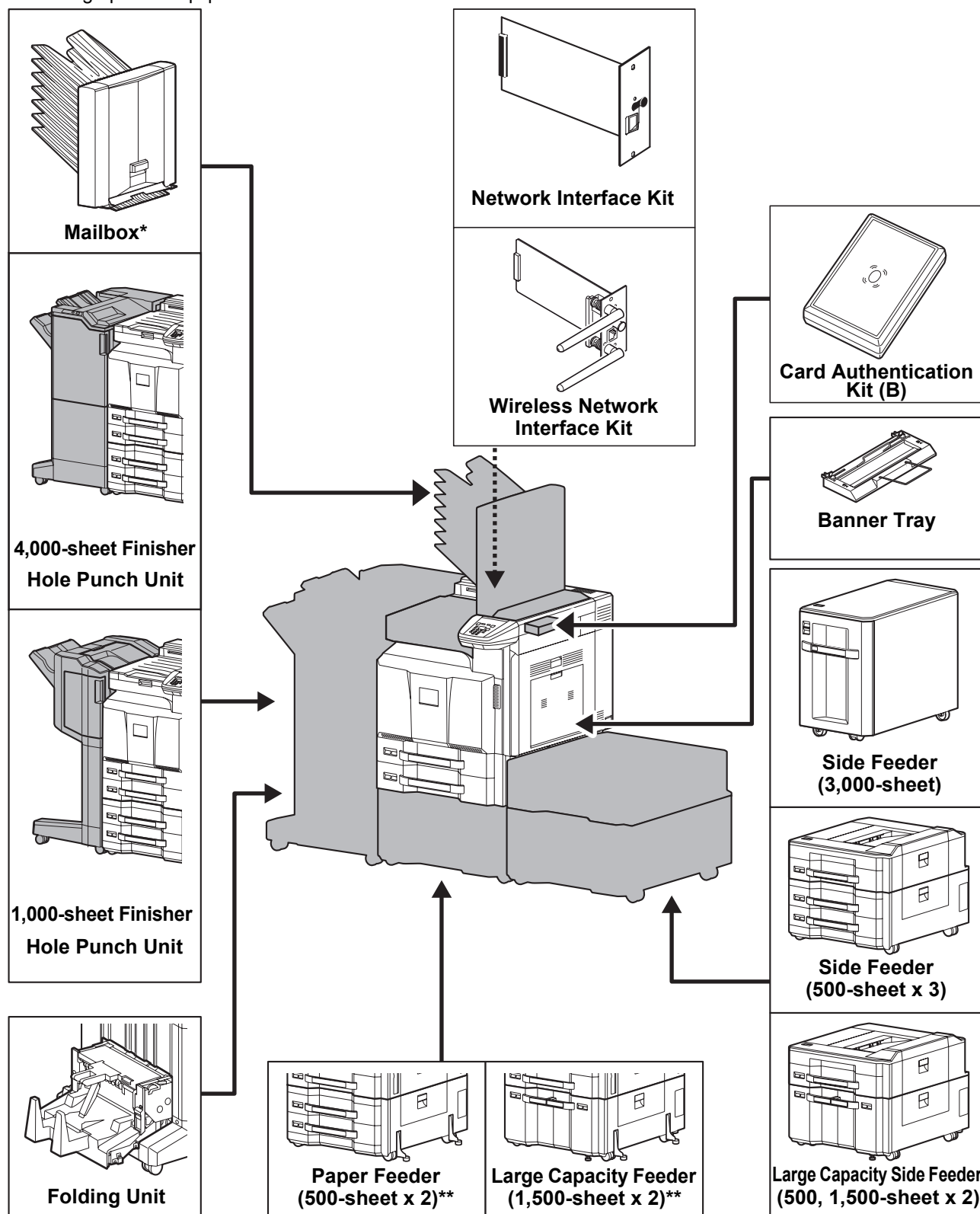

* The Mailbox can either be installed on the machine or the 4000-sheet Finisher Hole Punch Unit.

** If neither a document finisher nor a side feeder is installed, the toppling prevention kit must be installed.

Paper Feeder (500-sheet x2)

Two additional cassettes identical to the printer's cassette can be installed in the printer. Paper capacity and loading method are the same as the standard cassettes. Refer to *The standard cassettes on page 2-22* for loading paper.

Large Capacity Feeder (1,500-sheet x 2)

In addition to the printer's cassettes, you can also install an optional large capacity feeder (1,500-sheet x 2) capable of holding up to 3,000 sheets of A4, B5 or Letter paper. Refer to *The Large Capacity Feeder (1,500-sheet x 2) (Option) on page 2-25* for loading paper.

Side Feeder (3,000-sheet)

In addition to the printer's cassettes, you can also install an optional side feeder (3,000-sheet) capable of holding up to 3,000 sheets of A4, B5 or Letter paper. Refer to *Side Feeder (3,000-sheet) (Option) on page 2-27* for loading paper.

Side Feeder (500-sheet x 3)

Three additional cassettes identical to cassette 1 can be installed in the printer. Paper capacity and loading method are the same as cassette 1.

Large Capacity Side Feeder (500, 1,500-sheet x 2)

In addition to the printer's cassettes, you can also install the additional cassette identical to cassette 1 and an optional feeder (3,500-sheet) capable of holding up to 3,500 sheets of A4, B5 or Letter paper.

1,000-sheet Finisher

This is a document finisher capable of holding large print runs and of separating and offsetting multiple copies of a printout into individual copies. It can also staple or hole-punch (optional) the offset printouts.

4,000-sheet Finisher

This is a large-capacity document finisher capable of holding large print runs and of separating and offsetting multiple copies of a printout into individual copies. It can also staple or hole-punch (optional) the offset printouts.

User can select manual staple by operation button. A mail box and folding unit are also available as options.

Manual staple mode

You can staple copied paper manually without any copying operation. It is useful when you have forgotten to set the staple sort mode before starting copying, or when you want to staple originals.



Note Manual stapling cannot be executed when the machine is in operation.

If there are no staples when manual stapling is performed, the stapling position lamps and stapling position key LEDs all blink. Add staples. For details, refer to *Replacing Staples on page 7-8*

Maximum number of sheets available for manual stapling

Paper size	Paper weight	
	- 90 g/m ² (- 24.0 lb. Bond)	91 - 105 g/m ² (24.3 - 28.0 lb. Bond)
A4, A4-R, B5, Letter, 16K	65 sheets	50 sheets
A3, B4, Folio	30 sheets	30 sheets

Use the buttons on the stapling control section of the Finisher (optional) for manual stapling.

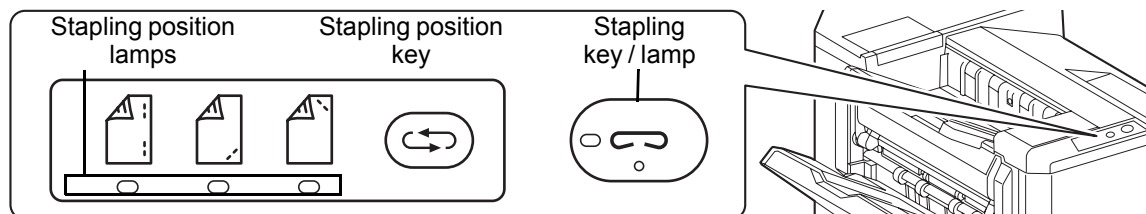

- 1 Press the stapling position key on the stapling control section.
The shutter of the paper exit area is opened and this equipment enters into the manual staple mode.
- 2 Press the stapling position key to select the stapling position (Back / Front / 2 Points).
Operation is not possible while the stapling position lamps are blinking. Operate after the lamps light solidly.

- 3 Straighten the edges of the paper well and place the paper front side down in the shutter opening of the output unit.

If the near side of the paper () will be stapled, place the paper against the front guide (A).

If the far side of the paper () will be stapled, place the paper against the back guide (B).

If the edge of the paper () will be stapled at two points, place the paper with the center aligned to the center point between the two side guides (A and B).

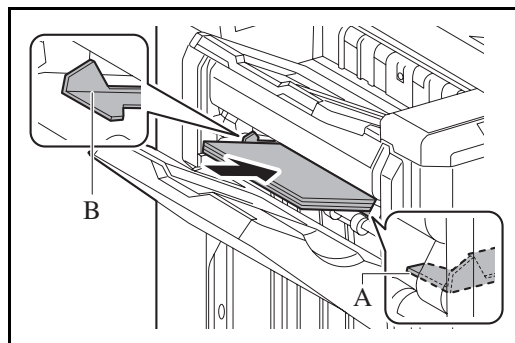

CAUTION Do not insert your hand inside the open shutter.

Note Press the stapling position key before you place the paper. Once the paper is placed, the stapling position key cannot be used.
The stapling lamp lights when the paper is properly placed. If it does not light, replace the paper.

- 4 Let go of the paper, and then press the stapling key.
Stapling starts. Stapling finishes and the output is delivered to tray A.

CAUTION Be sure that your hands are away from the paper while stapling is in progress.

Finishing the manual staple mode

Press the stapling position button several times until the stapling position lamps turn off. The shutter of the paper exit area closes. It means that manual stapling is finished. If no operation is performed for approx. 10 seconds, the manual staple mode will be automatically finished.

Note The time after which manual staple mode is automatically exited can be changed. For details, refer to *Manual Staple (Manual Staple setting)* on page 6-77.

Mailbox

Makes it easy to sort output into separate trays. Installing this option adds 7 output trays. When multiple computer users share the printer, each user can print to a specified tray.

This can be installed on the machine or the 4,000-sheet Finisher.



Note To deliver output to the mail box, change the Paper Output selection on the operation panel or in the printer driver, or change in the default settings. (For details, refer to *Paper Output (Selecting the Paper Output Location)* on page 6-31.)

Folding Unit

Folds printed output at the center or in tri-fold to enable the creation of simple booklets. Installs on the 4,000-sheet finisher.

Banner Tray

This tray enables continuous feeding of banner paper. Up to 10 sheets of banner paper can be loaded. To attach the tray and load paper, refer to *Using the Banner Tray (Option)* on page 3-10.

Network Interface Kit

The Network Interface Kit provides a high-speed connection for the Gigabit-per-second interface. Since the kit was designed to work with TCP/IP and NetBEUI protocols, it fulfills the network printing demands on Windows, Macintosh, and UNIX environments. This expansion kit is also compatible with ThinPrint.

Wireless Network Interface Kit

This is a wireless LAN interface card which supports the wireless LAN specifications IEEE802.11n (Max 300 Mbps) and 11 g/b. With the utilities supplied, settings are possible for a variety of OS and network protocols.

Data Security Kit

The Data Security Kit overwrites all unnecessary data in the storage area of the hard disk so that it cannot be retrieved. The Data Security Kit encrypts data before storing it in the hard disk. It guarantees higher security because no data cannot be decoded by ordinary output or operations.

ThinPrint Option

This application allows print data to be printed directly without a print driver.

Emulation Option

Enables emulation whereby the machine operates using commands for other printers. Installing this option enables IBM Proprinter, DIABLO 630, and EPSON LQ-850 emulation.

Card Authentication Kit (B)

It is possible to perform user authentication with an IC card. To perform authentication with an IC card, it is necessary to first register the IC card information in the list of registered users. For the method for registration, refer to the *Card Authentication Kit (B) Operation Guide*.

USB Keyboard

A USB keyboard can be used to enter information into the text fields on the operation panel. A special mount is also available to install the keyboard on the MFP. Please contact your dealer or service representative for information on keyboards that are compatible with your MFP before you purchase one.

Character Entry Method

In character entry screens, use the procedure below to enter characters.

Keys Used

Use the following keys to enter characters.

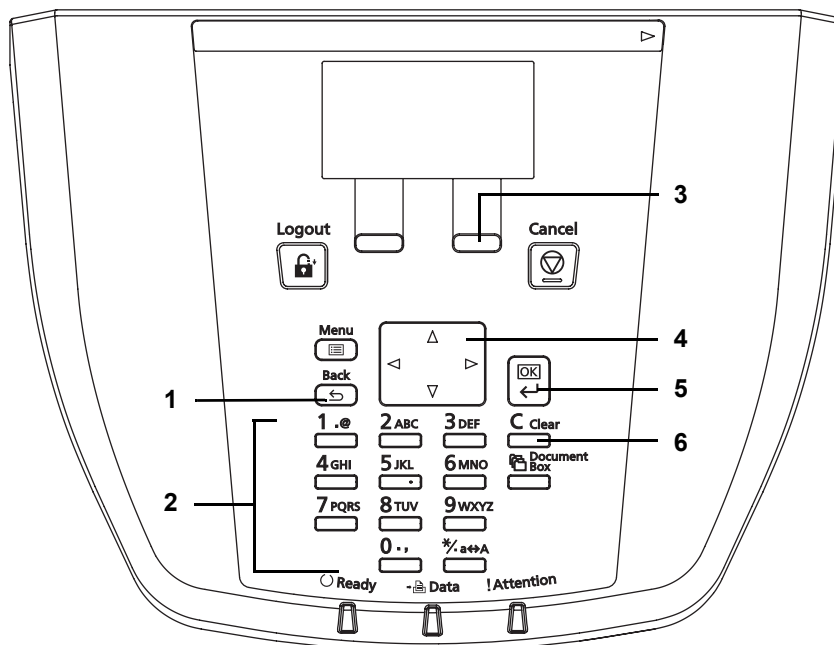

- 1 **[Back]** Key: Press this key to return to the screen from which you invoked the character entry screen.
- 2 **Numeric Keys:** Use these keys to select the character you want to enter.
- 3 **[Right Select]** Key: Press this key to select the type of characters you want to enter. (When [Text] is displayed)
- 4 **Arrow Keys:** Use these to select the entry position, or select a character from the character list.
- 5 **[OK]** Key: Press this key to finalize the entered character(s).
- 6 **[Clear]** Key: Press this key to delete the character at the cursor position. If the cursor is at the end of the line, the character to the left of it is deleted.

Selecting Type of Characters

To enter characters, the following three types are available:

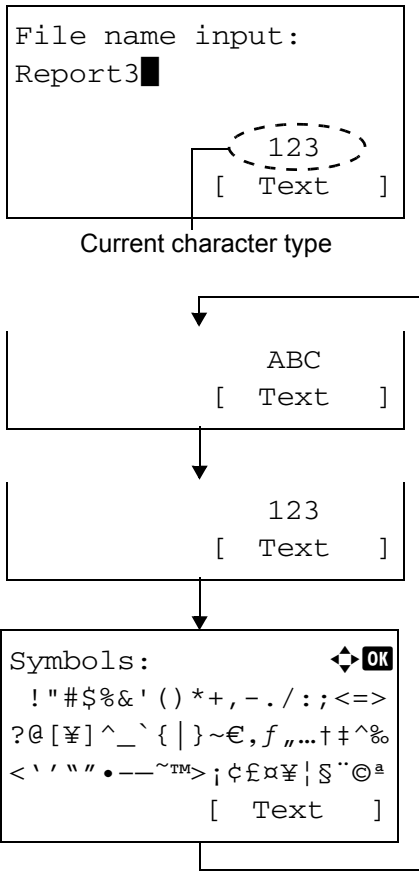

Types	Description
ABC	To enter alphabets.
123	To enter numerals.
Symbols	To enter symbols.

In a character entry screen, press [Text] (**[Right Select]**) to select the type of characters you want to enter. Each time you press [Text] (**[Right Select]**), the character type switches as follows: ABC, 123, Symbol, ABC ...







Entering Characters

After selecting a character type, use the procedure below to enter characters.

Entering Alphabets and Numerals

Referring to the table below, press the key corresponding to the character you want to enter until it is displayed.

Key	Entry mode	Available characters
1 .@ 	Alphabetic/Symbol	. @ - _ / : ? 1
	Numeric	1
2 ABC 	Alphabetic/Symbol	a b c A B C 2
	Numeric	2
3 DEF 	Alphabetic/Symbol	d e f D E F 3
	Numeric	3
4 GHI 	Alphabetic/Symbol	g h i G H I 4
	Numeric	4

Key	Entry mode	Available characters
5 JKL 	Alphabetic/Symbol	j k l J K L 5
	Numeric	5
6 MNO 	Alphabetic/Symbol	m n o M N O 6
	Numeric	6
7 PQRS 	Alphabetic/Symbol	p q r s P Q R S 7
	Numeric	7
8 TUV 	Alphabetic/Symbol	t u v T U V 8
	Numeric	8
9 WXYZ 	Alphabetic/Symbol	w x y z W X Y Z 9
	Numeric	9
0 -, 	Alphabetic/Symbol	., - _ ' ! ? (space) 0
	Numeric	0
*/_ a ↔ A 	Alphabetic/Symbol	Switch between upper-/lowercase
	Numeric	* or . (decimal point)*

* '*' is entered when [123] is selected in the character type selection, or '.' is entered when only numerals are entered and no character type is selected.

Characters associated with different keys can be entered consecutively. To enter a character associated with the same key after another, use cursor keys to move the cursor to the next entry position before entering it.

If you use cursor keys to move the cursor to an entry position apart from the end of the line and enter a character there, spaces are automatically entered in between.

Entering Symbols

Press [Text] ([Right Select]) to display the Symbols screen. Use cursor keys to select the symbol you want to enter and then press [OK].

```

Symbols:      ◀▶OK
! "# $ % & ' ( ) * + , - . / : ; < = >
? @ [ \ ] ^ _ ` { | } ~ € , f „ … † ‡ ^ %
< ' ' " • --- ~™> ; ç £ ¤ ¥ ¦ § ¨ © º
          [ Text ]

```

Paper

This section explains the paper sizes and types that can be used in the paper source.

Cassettes 1

Supported paper sizes	No. of sheets
A3, B4, A4, A4-R, B5, B5-R, A5-R, Ledger, Legal, Oficio II, 12 × 18", Letter, Letter-R, Statement-R, Folio, 8K, 16K, 16K-R 216 × 340 mm	550 (64 g/m ²) 500 (80 g/m ²)

Cassettes 2 and the optional paper feeder (500-sheet x 2)

Supported paper sizes	No. of sheets
A3, B4, A4, A4-R, B5, B5-R, A5-R, Ledger, Legal, Oficio II, 12 × 18", Letter, Letter-R, Statement-R, Folio, 8K, 16K, 16K-R 216 × 340 mm	550 (64 g/m ²) 500 (80 g/m ²)

Optional large capacity feeder (1,500-sheet x 2)

Supported paper sizes	No. of sheets
A4, B5, Letter	3,500 (64 g/m ²) 3,000 (80 g/m ²)

Multi Purpose tray (MP tray)

Supported paper sizes	No. of sheets
A4, A4-R, B5, B5-R, A5-R, B6-R, A6-R, Letter, Letter-R, Executive-R, Statement, Folio, 16K, 16K-R Other sizes: Portrait - 3 7/8 to 11 5/8" or 98 to 297 mm Landscape - 5 7/8 to 17" or 148 to 432 mm	165 (64 g/m ²) 150 (80 g/m ²)
A3, B4, Ledger, Legal, Oficio II, 12 × 18", 8K	55 (64 g/m ²) 50 (80 g/m ²)
Postcards (100 × 148 mm) Return postcard (148 × 200 mm)	30
Envelope DL, Envelope C5, Envelope C4, Envelope #10 (Commercial #10), Envelope #9 (Commercial #9), Envelope #6 (Commercial #6 3/4), Monarch, ISO B5, Youkei 2, Youkei 4 Other sizes: Portrait - 3 7/8 to 11 5/8" or 98 to 297 mm Landscape - 5 7/8 to 17" or 148 to 432 mm	10
Transparency (OHP film) (A4, A4-R, Letter, Letter-R)	10

Basic Paper Specifications

This machine is designed to print on standard copy paper as used in regular ('dry') copiers and page printers such as laser printers. It also supports a variety of other types of paper that conform to the specifications given in this appendix.

Be careful when choosing paper. Paper unsuitable for the machine may cause jams or may be wrinkled.

Supported Paper

Use standard copy paper for regular copiers or laser printers. The printing quality will be affected by the quality of paper. Poor quality paper may result in unsatisfactory output.

Basic Paper Specifications

The following table lists the specifications of paper that is supported with this machine. Refer to the subsequent sections for further details.

Criteria	Specifications
Weight	Cassettes: 60 to 256 g/m ²
	Multi purpose tray: 60 to 300 g/m ²
Thickness	0.086 to 0.110 mm
Dimensional accuracy	±0.7 mm
Squareness of corners	90° ±0.2°
Moisture content	4 to 6%
Pulp content	80% or more



Note Some recycled paper does not meet requirements for use with this machine as listed in the Basic Paper Specifications shown below, such as moisture or pulp content. For this reason, we recommend purchasing a small amount of recycled paper as a sample for testing prior to use. Choose recycled paper that gives the best printing results and contains low levels of paper dust.

We are not responsible for the problems occurred from the use of paper that does not conform to our specifications.

Choosing the Appropriate Paper

This section describes guidelines for choosing paper.

Condition

Avoid using paper with bent corners or that is curled, dirty, or torn. Do not use paper that has a rough surface or paper fiber lint, or that is especially delicate. Use of paper in any of these conditions will not only deliver poor copies but may also cause jams and shorten the useful life of the machine. Choose paper with a smooth and even surface; however, avoid coated paper or paper with a treated surface as it may damage the drum or fusing unit.

Ingredients

Do not use paper such as paper that has been coated or surface-treated or paper that contains plastic or carbon. Those types of paper may produce harmful fumes from the heat of printing and may damage the drum.

Be sure to use the standard paper that contains at least 80% pulp, i.e., not more than 20% of the total paper content consists of cotton or other fibers.

Supported Paper Sizes

Paper of the following sizes is supported by the machine.

Measurements in the table take into account a ±0.7 mm dimensional accuracy for length and width. Corner angles must be 90° ± 0.2°.

Multi Purpose Tray	Cassette or Multi Purpose Tray
A6-R (105 × 148 mm)	A3 (297 × 420 mm)
B6-R (128 × 182 mm)	B4 (257 × 364 mm)
Hagaki (100×148mm)	A4 (297 × 210 mm)
Oufuku hagaki (148 × 200 mm)	A4-R (210 × 297 mm)
Executive (7 1/4 × 10 1/2")	B5 (257 × 182 mm)
Envelope DL (110 × 220 mm)	B5-R (182 × 257 mm)
Envelope C5 (162 × 229mm)	A5-R (148 × 210 mm)
Envelope C4 (229 × 324mm)	Folio (210 × 330 mm)
ISO B5 (176 × 250 mm)	Ledger
Envelope #10 (Commercial #10) (4 1/8 × 9 1/2")	Legal
Envelope #9 (Commercial #9) (3 7/8 × 8 7/8")	Letter
Envelope #6 (Commercial #6 3/4) (3 5/8 × 6 1/2")	Letter-R
Envelope Monarch (3 7/8 × 7 1/2")	Statement-R
Youkei 2 (114 × 162 mm)	Oficio II
Youkei 4 (105 × 235 mm)	12 × 18"
Size Entry (98 × 148 to 297 × 1,220 mm)	8K (273 × 394 mm)
	16K (273 × 197 mm)
	16K-R (197 × 273 mm)
	216 × 340 mm

Smoothness

The paper surface should be smooth, but it must be uncoated. With paper that is too smooth and slippery, several sheets may accidentally be supplied at once, causing jams.

Basis Weight

In countries that use the metric system, basis weight is the weight in grams of one sheet of paper one square meter in area. In the United States, basis weight is the weight in pounds of one ream (500 sheets) of paper cut to the standard size (or trade size) for a specific grade of paper. Paper that is too heavy or too light may be supplied incorrectly or cause paper jams, which may cause excessive wear of the machine. Mixed paper weight (i.e., thickness) may cause several sheets to be supplied at once accidentally and may also cause blurring or other printing problems if the toner fails to adhere correctly.

Thickness

Avoid using paper that is too thick or thin. Signs that paper may be thin include frequent problems with paper jams or with several sheets being supplied at once. Paper jams may also indicate that the paper is too thick. The proper thickness is between 0.086 and 0.110 mm.

Moisture Content

Paper moisture content is the ratio of moisture to dryness expressed as a percentage. Moisture affects how the paper is supplied, the electrostatic chargeability of the paper, and how the toner adheres.

Paper moisture content varies depending on the relative humidity in the room. High relative humidity causes paper to become damp, making the edges expand so it appears wavy. Low relative humidity causes paper to lose moisture, making the edges tighten and weakening print contrast.

Wavy or tight edges may cause the paper to slip when it is supplied. Try to keep the moisture content between 4 to 6%.

To maintain the right level of moisture content, bear in mind the following considerations.

- Store paper in a cool, well-ventilated place.
- Store paper flat and unopened in the package. Once the package is opened, reseal it if the paper is not to be used for a while.
- Store paper sealed in the original package and box. Put a pallet under the carton to keep it raised above the floor. Especially during rainy seasons keep the paper a sufficient distance away from wooden or concrete floors.
- Before using paper that has been stored, keep it at the proper moisture level for at least 48 hours.
- Do not store paper where it is exposed to heat, sunlight, or dampness.

Other Paper Specifications

Porosity: The density of the paper fibers.

Stiffness: Paper must be stiff enough or it may buckle in the machine, causing jams.

Curl: Most paper naturally tends to curl after the package is opened. When paper passes through the fixing unit, it curls upward slightly. To deliver flat printouts, load the paper so that the curl faces towards the bottom of the paper tray.

Static electricity: During printing, paper is electrostatically charged so that the toner adheres. Choose paper that can be discharged quickly so that copies do not cling together.

Whiteness: Paper whiteness affects print contrast. Use whiter paper for sharper, brighter copies.

Quality: Machine problems may occur if sheet sizes are not uniform or if corners are not square, edges are rough, sheets are uncut, or edges or corners are crushed. In order to prevent these problems, be especially careful when you cut the paper yourself.

Packaging: Choose paper that is properly packaged and stacked in boxes. Ideally, the packaging itself should have been treated with a coating to inhibit moisture.

Specially treated paper: We do not recommend printing onto the following types of paper, even if it conforms to the basic specifications. When you use these kinds of paper, purchase a small amount first as a sample to test.

- Glossy paper
- Watermarked paper
- Paper with an uneven surface
- Perforated paper

Special Paper

This section describes printing onto special paper and print media.

The following paper and media can be used.

- Transparencies
- Preprinted paper
- Bond paper
- Recycled paper
- Thin paper (from 60 g/m² to 105 g/m² or less)
- Letterhead
- Colored paper
- Prepunched paper
- Envelopes
- Cardstocks (Hagaki)
- Thick paper (from 106 g/m² to 300 g/m² or less)
- Labels
- Coated paper
- High-quality paper

When using these paper and media, choose those that are designed specifically for copiers or page printers (such as laser printers). Use the multi purpose tray for transparencies, thick paper, envelopes, cardstocks, and label paper.

Choosing Special Paper

Although special paper that meets the following requirements can be used with the machine, print quality will vary considerably due to differences in the construction and quality of special paper. Thus, special paper is more likely than regular paper to cause printing problems. Before purchasing special paper in volume, try testing a sample to ensure the print quality is satisfactory. General precautions when printing onto special paper are given below. Note that we are not responsible for any harm to the user or damage to the machine caused by moisture or specifications of special paper.

Select a cassette or multi purpose tray for special paper.

Transparencies

Transparencies must be able to withstand the heat of printing. Transparencies must meet the following conditions.

Criteria	Specifications
Heat resistance	Must withstand at least 190°C
Thickness	0.100 to 0.110 mm
Material	Polyester
Dimensional accuracy	±0.7 mm
Squareness of corners	90° ±0.2°

To avoid problems, use the multi purpose tray for transparencies and load transparencies with the long side facing the machine.

If transparencies jam frequently at output, try pulling the leading edge of sheets gently as they are ejected.

Hagaki

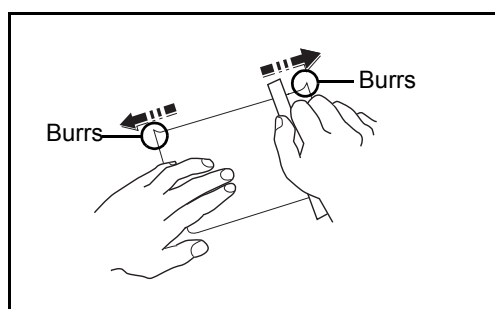

Before loading Hagaki into the multi purpose tray, fan them and align the edges. If the Hagaki paper is curled, straighten it before loading. Printing onto curled Hagaki may cause jams.

Use unfolded Oufuku hagaki (available at post offices). Some Hagaki may still have rough edges developed by a paper cutter on the back side. Remove any such rough edges by placing the Hagaki on a flat surface and rubbing the edges gently a few times with a ruler.

Envelopes

Use the multi purpose tray for envelopes.

Due to the structure of envelopes, printing evenly over the entire surface may not be possible in some cases. Thin envelopes in particular may be wrinkled by the machine in some cases as they pass through. Before purchasing envelopes in volume, try testing a sample to ensure the print quality.

Storing envelopes for a long period may cause them to become wrinkled. Thus, keep the package sealed until you are ready to use them.

Keep the following points in mind.

Do not use envelopes with exposed adhesive. In addition, do not use the type of envelope in which the adhesive is exposed after the top layer is peeled off. Serious damage may be caused if the paper covering the adhesive comes off in the machine.

Do not use envelopes with certain special features. For example, do not use envelopes with a grommet for winding a string to close the flap or envelopes with an open or film-covered window.

If paper jams occur, load fewer envelopes at once.

To prevent paper jams when printing onto multiple envelopes, do not allow more than ten envelopes to remain in the output tray at once.

Thick Paper

Before loading thick paper in the multi purpose tray, fan it and align the edges. Some thick paper may still have rough edges developed by a paper cutter on the back side. Remove any such rough edges just as with Hagaki by placing the paper on a flat surface and rubbing the edges gently a few times with a ruler. Printing onto paper with rough edges may cause jams.



Note If the paper is not supplied correctly even after it is smoothed, load the paper in the multi purpose tray with the leading edge raised a few millimeters.

Label

Be sure to feed labels from the multi purpose tray.

For selecting labels, use extreme care so that the adhesive may not come in direct contact with any part of the machine and that the labels are not easily peeled from the carrier sheet. Adhesives that stick to the drum or rollers and peeled labels remaining in the machine may cause a failure.

When printing onto labels, you must be liable for the print quality and possible trouble.

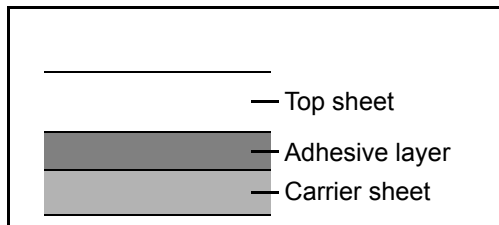

Labels consist of three layers as shown in the illustration. The adhesive layer contains materials that are easily affected by the force applied in the machine. The carrier sheet bears the top sheet until the label is used. This composition of labels may cause more problems.

The label surface must be covered completely with the top sheet. Gaps between labels may cause peeling of labels, resulting in a serious failure.

Some label paper has large margins on the top sheet. When using such paper, do not peel these margins from the carrier sheet before completing output.

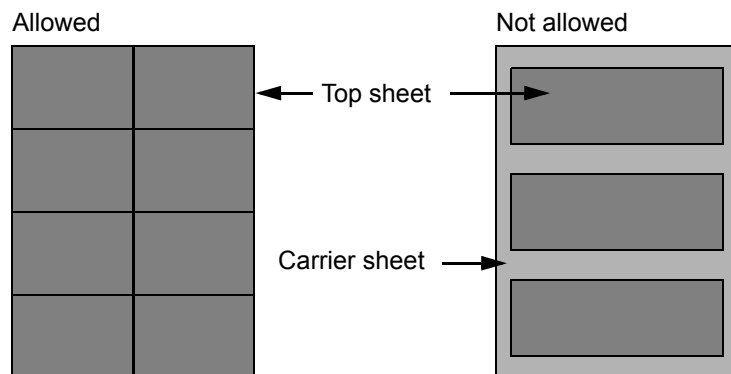

Use label paper that conforms to the following specifications.

Item	Specifications
Top sheet weight	44 to 74 g/m ²
Basis weight (overall paper weight)	104 to 151 g/m ²
Top sheet thickness	0.086 to 0.107 mm
Overall paper thickness	0.115 to 0.145 mm
Moisture content	4 to 6 % (composite)

Colored Paper

Colored paper must conform to the specifications listed on page A-10. In addition, the pigments in the paper must be able to withstand the heat of printing (up to 200°C or 392°F).

Preprinted Paper

Preprinted paper must conform to the specifications listed on page A-10. The colored ink must be able to withstand the heat of printing. It must be resistant to silicone oil as well. Do not use paper with a treated surface such as glossy paper used for calendars.

Recycled Paper

Recycled paper must conform to the specifications listed on page A-10; however, its whiteness may be considered separately.

 **Note** Before purchasing recycled paper in volume, try testing a sample to ensure satisfactory print quality.

Specifications

IMPORTANT: Specifications are subject to change without notice.

Common functions

Item	Description	
Type	Desktop	
Printing Method	Electrophotography by semiconductor laser, tandem drum system	
Paper Weight	Cassette 1, 2	60 to 256 g/m ²
	Multi Purpose Tray	60 to 300 g/m ²
Paper Type	Cassette 1, 2	Plain, Preprinted, Bond, Recycled, Vellum, Rough, Letterhead, Color (Colour), Prepunched, Thick, High quality, Custom 1 to 8 (Duplex: Same as Simplex)
	Multi Purpose Tray	Plain, Transparency (OHP film), Preprinted, Labels, Bond, Recycled, Vellum, Rough, Letterhead, Color (Colour), Prepunched, Envelope, Cardstock, Coated, Thick, High quality, Custom 1 to 8
Paper Size	Cassette 1, 2	Maximum: 12 × 18"/A3 (Duplex: 12 × 18"/A3) Minimum: Statement-R/A5-R (Duplex: Statement-R/A5-R)
	Multi Purpose Tray	Maximum: 12 × 48"/304.8 × 1220.0 mm Minimum: Statement-R/A6-R
Warm-up Time (22°C/71.6°F, 60%)	Power on	FS-C8600DN: 30 seconds or less FS-C8650DN: 30 seconds or less
	Low Power	FS-C8600DN: 20 seconds or less FS-C8650DN: 20 seconds or less
	Sleep	FS-C8600DN: 30 seconds or less FS-C8650DN: 30 seconds or less
Paper Capacity	Cassette 1	500 sheets (80 g/m ²)
	Cassette 2	500 sheets (80 g/m ²)
	Multi Purpose Tray	A4/Letter or less 150 sheets (80 g/m ²) More than A4/Letter 50 sheets (80 g/m ²)
Output Tray Capacity	Main tray	500 sheets (80 g/m ²)
	Job separator	250 sheets (80 g/m ²) (When the Documents Finisher is installed, 100 sheets.)
Image Write System	Semiconductor laser and electrophotography	
Main Memory	Standard	1024 MB
	Maximum	2048 MB
Hard Disk	160GB (standard)	
Interface	Standard	USB Interface Connector: 1 (Hi-Speed USB) USBPort: 2 (Hi-Speed USB) Network interface: 1 (10 BASE-T/100 BASE-TX/1000 BASE-T)
	Option	Network interface: 1 (10 BASE-T/100 BASE-TX/1000 BASE-T)

Item		Description		
Operating Environment	Temperature	10 to 32.5°C/50 to 90.5°F		
	Humidity	15 to 80 %		
	Altitude	2,500 m/8,202 ft maximum		
	Brightness	1,500 lux maximum		
Dimension (W × D × H) (Main unit only)		26 19/32 × 30 63/64 × 29 13/32" 668 × 787 × 747 mm		
Weight (with toner container)		235.8 lb/107 kg		
Space Required (W × D) (Using multi purpose tray)		38 29/64 × 30 63/64" 977 × 787 mm		
Power Source		120 V Specification Model: 120 V AC 60 Hz 12.0 A 230 V Specification Model: 220 to 240 V AC 50/60 Hz 7.2 A		
Options		Paper Feeder (500-sheet x2), Large Capacity Feeder (1,500-sheet x 2), 1,000-sheet Finisher, 4,000-sheet Finisher, Data Security Kit, Folding Unit, Mailbox, Side Feeder (3,000-sheet), Side Feeder (500-sheet x 3), Network Interface Kit, Large Capacity Side Feeder (500, 1,500-sheet x2), Emulation Option, Hole Punch Unit, USB Keyboard, Banner Tray, Wireless Network Interface Kit		
Printing Speed	FS-C8600DN		Black and White copying	Full color copying
	FS-C8650DN			
		A4/Letter	45 sheets/min	45 sheets/min
		A3/Ledger	22 sheets/min	22 sheets/min
		A4/Letter	55 sheets/min	50 sheets/min
		A3/Ledger	27 sheets/min	25 sheets/min
First Print Time (A4, feed from Cassette)	Black and White	FS-C8600DN:	5.4 seconds or less	
		FS-C8650DN:	4.9 seconds or less	
	Full color	FS-C8600DN:	6.6 seconds or less	
		FS-C8650DN:	6.2 seconds or less	
Resolution		600 × 600 dpi		
Operating System		Windows XP, Windows Server 2003/R2, Windows Vista, Windows 7, Windows Server 2008/R2, Mac OS 10.4 or higher		
Page Description Language		PRESCRIBE		
Emulation		PCL6(PCL5c, PCL-XL), KPDL3 (PostScript3 compatible)		

Paper Feeder (500-sheet x 2) (Option)

Item	Description
Paper Supply Method	Feed & reverse roller method (No. Sheets: 500, 80 g/m ² , 2 cassettes/No. Sheets: 550, 64 g/m ² , 2 cassettes)
Paper Size	A3, B4, A4, A4-R, B5-R, A5-R, Ledger, Legal, Oficio II, 12 × 18", Letter, Letter-R, Statement-R, Folio, 8K, 16K, 16K-R, 216 × 340 mm
Supported Paper	Paper weight: 60 - 256 g/m ² Media types: standard, recycled, Thick
Dimensions (W) × (D) × (H)	23 35/64 × 27 35/64 × 12 13/32" 598 × 699.6 × 315 mm
Weight	Approx. 66.1 lbs. / Approx. 30 kg

Large Capacity Feeder (1,500-sheet x 2) (Option)

Item	Description
Paper Supply Method	Feed & reverse roller method (No. Sheets: 3,000 (80 g/m ²)/No. Sheets: 3,500 (64 g/m ²))
Paper Size	A4, B5, Letter
Supported Paper	Paper weight: 60 - 256 g/m ² Media types: standard, recycled, Thick
Dimensions (W) × (D) × (H)	23 35/64 × 27 52/64 × 12 26/64" 598 × 706.6 × 315 mm
Weight	Approx. 63.93 lbs / Approx. 29 kg

Side Feeder (500-sheet x 3) (Option)

Item	Description
Paper Supply Method	Feed & reverse roller method (No. Sheets: 500, 80 g/m ² , 3 cassettes/No. Sheets: 550, 64 g/m ² , 3 cassettes)
Paper Size	A3, B4, A4, A4-R, B5-R, A5-R, Ledger, Legal, Oficio II, 12 × 18", Letter, Letter-R, Statement-R, Folio, 8K, 16K, 16K-R, 216 × 340 mm
Supported Paper	Paper weight: 60 - 256 g/m ² Media types: standard, recycled, Thick
Dimensions (W) × (D) × (H)	23 35/64 × 28 11/32 × 21 7/64" 598 × 720 × 536 mm
Weight	Approx. 114.6 lbs. / Approx. 52 kg

Large Capacity Side Feeder (500, 1,500-sheet x 2) (Option)

Item	Description	
Paper Supply Method	Feed & reverse roller method (No. Sheets: 500 sheets (80 g/m ²) × 1 cassette, 1,500 sheets (80 g/m ²) × 2 cassettes/No. Sheets: 550 sheets (64 g/m ²) × 1 cassette, 1,750 sheets (64 g/m ²) × 2 cassettes)	
Paper Size	Tray 5	A3, B4, A4, A4-R, B5-R, A5-R, Ledger, Legal, Oficio II, 12 × 18", Letter, Letter-R, Statement-R, Folio, 8K, 16K, 16K-R, 216 × 340 mm
	Tray 6, 7	A4, B5, Letter
Supported Paper	Paper weight: 60 - 256 g/m ² Media types: standard, recycled, Thick	
Dimensions (W) × (D) × (H)	23 35/64 × 28 11/32 × 21 7/64" 598 × 720 × 536 mm	
Weight	Approx. 112.4 lbs / Approx. 51 kg	

Side Feeder (3,000-sheet) (Option)

Item	Description
Paper Supply Method	Feed & reverse roller method (No. Sheets: 3,000, 80 g/m ² /No. Sheets: 3,500 64 g/m ²)
Paper Size	A4, B5, Letter
Supported Paper	Paper weight: 60 - 300 g/m ² Media types: standard, recycled, Thick
Dimensions (W) × (D) × (H)	12 41/64 × 24 13/32 × 19 27/32" 321 × 620 × 504 mm
Weight	Approx. 55.1 lbs. / Approx. 25 kg

1,000-sheet Finisher (Option)

Item		Description	
Number of Trays		1 tray	
Paper Size (80 g/m²)	Left Tray (Non-stapling)	A3, B4, Ledger, Legal, Oficio II, 12 × 18", 8K: 500 sheets A4, A4-R, B5, B5-R, Letter, Letter-R, 16K: 1,000 sheets	
Supported Paper Weight		Stapling: 90 g/m ² or less	
Stapling	Number of Sheets	A3, B4, B5-R, Ledger, Legal, Oficio II, 12 × 18", 216 × 340 mm, Folio, 8K, 16K-R	30 sheets (60 to 90 g/m ²) 20 sheets (91 to 105 g/m ²) 2 cover sheet only (106 g/m ² to 135 g/m ²)
		A4, A4-R, B5, Letter, Letter-R, 16K	50 sheets (60 to 90 g/m ²) 40 sheets (91 to 105 g/m ²) 2 cover sheet only (106 g/m ² to 135 g/m ²)
	Media types	Plain, Recycled, Prepunched	
Dimensions (W) × (D) × (H)		26 7/32 × 24 11 × 32 × 41 21/64" 666 × 618.5 × 1,050 mm	
Weight		Approx. 66.1 lbs. or less / Approx. 30 kg or less	

4,000-sheet Finisher (Option)

Item		Description	
Number of Trays		2 trays	
Paper Size (80 g/m²)	Tray A (Non-Stapling)	A3, B4, B5-R, Ledger, Legal, 8K: 1,500 sheets A4, A4-R, B5, Letter, Letter-R, 16K, 16K-R, Folio: 4,000 sheets*, ** A5, B6, Statement-R: 500 sheets	
	Tray B	A4, A4-R, B5, B5-R, A5, A5-R, Folio, Ledger, Legal, 12 × 18", A3, B4, 8K, Letter, Letter-R, Statement-R, 16K, 16K-R: 200 sheets	
Stapling	Maximum Number	A3, B4, B5-R, Ledger, Legal, Oficio II, 12 × 18", 216 × 340 mm, Folio, 8K, 16K-R	30 sheets (52 to 90 g/m ²) 20 sheets (91 to 105 g/m ²) 2 cover sheet only (106 g/m ² to 135 g/m ²)
		A4, A4-R, B5, Letter, Letter-R, 16K	65 sheets (52 to 90 g/m ²) 55 sheets (91 to 105 g/m ²) 2 cover sheet only (106 g/m ² to 135 g/m ²)
	Media types	Plain, Recycled, Prepunched	
Dimensions (W) × (D) × (H)		23 29/32 × 26 5/16 × 41 25/32" 607.2 × 668.5 × 1,061.3 mm	
Weight		Approx. 88.2 lbs or less / Approx. 40 kg or less	

* When the Folding Unit is installed, 3000 sheets.

** 2000 sheets when output is on the tray.

Hole Punch Unit (Option)

Item	Description	
Paper Size	A3, B4, A4, A4-R, B5, Folio, 8K, 16K, Letter-R, Legal, 12 × 18", Statement-R, A5-R, B5-R, 16K-R	
Paper Weight	45 - 300 g/m ²	
Media types	4,000-sheet Finisher	Plain, Transparency, Preprinted, Bond, Recycled, Rough, Letterhead, Color (Colour), Prepunched, Thick, Coated, High Quality
	1,000-sheet Finisher	Plain, Transparency, Preprinted, Bond, Recycled, Letterhead, Color (Colour), Prepunched, Thick, Coated, High Quality

Mailbox (Option)

Item	Description
Number of Trays	7
Paper Size (80 g/m²)	A3, B4, Ledger, Legal: 50 sheets A4, A4-R, B5, B5-R, A5-R, Letter, Letter-R, 216 × 340 mm, Executive, Folio, 8K, 16K, 16K-R, Statement-R, Oficio II: 100 sheets
Dimensions (W) × (D) × (H)	20 1/16 × 15 3/4 × 18 1/2" 510 mm × 400 mm × 470 mm
Weight	Approx. 22 lbs. / Approx. 10 kg

Center-Folding Unit (Option)

Item	Description	
Sizes	Bi-Fold	A3, B4, A4-R, Ledger, Legal, Letter-R, Oficio II, 8K
	Saddle Stitch	A3, B4, A4-R, Ledger, Legal, Letter-R, Oficio II, 8K
	Tri-Fold	A4-R, Letter-R
Number of Sheets	Bi-Fold	5 sheets (60 to 90 g/m ²) 3 sheets (91 to 120 g/m ²) 1 sheet (121 to 256 g/m ²)
	Saddle Stitch	16 sheets (60 to 90 g/m ²) 13 sheets (91 to 105 g/m ²) 1 cover sheet only (106 g/m ² or heavier)
	Tri-Fold	5 sheets (60 to 90 g/m ²) 3 sheets (91 to 120 g/m ²)
Maximum Number for Storage (80 g/m²)	Bi-Fold	5 sheets or less per set: 30 sets or more 6 to 10 sheets per set: 20 sets or more 11 to 16 sheets per set: 10 sets or more.
	Saddle Stitch	5 sheets or less per set: 30 sets or more 6 to 10 sheets per set: 20 sets or more 11 to 16 sheets per set: 10 sets or more.
	Tri-Fold	1 sheet per set: 30 sets or more 2 to 5 sheets per set: 5 sets or more
Media types	Bi-Fold	Plain, Bond, Recycled, Prepunched, High Quality
	Saddle Stitch	Plain, Recycled, Prepunched
	Tri-Fold	Plain, Recycled, Prepunched

Banner Tray (Option)

Item	Description
Max. number of sheets	10 sheets (Multi Purpose tray)
Paper length	210 (8.26") to 304.8 (12") mm
Paper weight	Max. 1220 (48") mm
Paper Type	Paper weight: 136 to 163 g/m ² Paper type: Heavy 2
Dimensions (W) × (D) × (H)	9 27/32 × 14 23/32 × 5 63/64" 250 × 374 × 152 mm
Weight	Approx. 0.78 lbs. / Approx. 0.352 kg



Note Consult your dealer or service representative for recommended paper types.

Glossary

Auto Form Feed Timeout

During data transmission, the machine may sometimes have to wait until receiving the next data. This is the auto form feed timeout. When the preset timeout passes, the machine automatically prints output. However, no output is performed if the last page has no data to be printed.

Auto-IP

Auto-IP is a module that enables dynamic IPv4 addresses to be assigned to a device on startup. However, DHCP requires a DHCP server. Auto-IP is a server-less method of choosing an IP address. IP addresses between 169.254.0.0 to 169.254.255.255 are reserved for Auto-IP and assigned automatically.

Auto Paper Selection

A function to automatically select paper in the same size as originals when printing.

Auto Sleep

A mode designed for electrical power saving, activated when the machine is left unused or there is no data transfer for a specific period. In Sleep mode, power consumption is kept to a minimum.

Bonjour

Bonjour, also known as zero-configuration networking, is a service that automatically detects computers, devices and services on an IP network. Bonjour, because an industry-standard IP protocol is used, allows devices to automatically recognize each other without an IP address being specified or DNS server being set. Bonjour also sends and receives network packets by UDP port 5353. If a firewall is enabled, the user must check that UDP port 5353 is left open so that Bonjour will run correctly. Some firewalls are set up so as to reject only certain Bonjour packets. If Bonjour does not run stably, check the firewall settings and ensure that Bonjour is registered on the exceptions list and that Bonjour packets are accepted. If you install Bonjour on Windows XP Service Pack 2 or later, the Windows firewall will be set up correctly for Bonjour.

Default Gateway

This indicates the device, such as a computer or router, that serves as the entrance/exit (gateway) for accessing computers outside the network that you are on. When no specific gateway is designated for a destination IP address, data is sent to the host designated as the Default Gateway.

DHCP (Dynamic Host Configuration Protocol)

Dynamic Host Configuration Protocol (DHCP) that automatically resolves IP addresses, subnet masks, and gateway addresses on a TCP/IP network. DHCP minimizes the load of network management employing a large number of client computers because it relieves individual clients including printers from the IP address being assigned.

DHCP (IPv6)

DHCP (IPv6) is the next-generation of the Internet's Dynamic Host Configuration Protocol and supports IPv6. It extends the BOOTP startup protocol that defines the protocols used for transferring configuration information to hosts on the network. DHCP (IPv6) permits the DHCP server to use its expanded functionality to send configuration parameters to an IPv6 node. Because the network addresses that can be used are allocated automatically, the IPv6 node management workload is reduced in systems where the administrator has to exercise close control over IP address allocation.

dpi(dots per inch)

A unit for resolution, representing the number of dots printed per inch (25.4 mm).

EcoPrint Mode

A printing mode that helps save toner. Copies made in this mode are thus lighter than normal.

Emulation

The function to interpret and execute other printers' page description languages. The machine emulates operation of PCL6, KPDL3 (PostScript 3 compatible).

FTP(File Transfer Protocol)

A protocol to transfer files on the TCP/IP network, whether the Internet or an intranet. Along with HTTP and SMTP/POP, FTP is now frequently used on the Internet.

Grayscale

A computer color expression. Displayed images of this sort are typically composed of shades of gray, varying from black at the weakest intensity to white at the strongest, without any other colors. Gray levels are displayed in numerical levels: that is, white and black only for 1 bit; 256 gray levels (including white and black) for 8 bits; and 65,536 gray levels for 16 bits.

Help

A **Help** key is provided on this machine's operation panel. If you are unsure of how to operate the machine, would like more information on its functions or are having problems getting the machine to work properly, press the **Help** key to view a detailed explanation on the panel.

IP Address

An Internet protocol address is a unique number that represents a specific computer or related device on the network. The format of an IP address is four sets of numbers separated by dots, e.g. 192.168.110.171. Each number should be between 0 and 255.

IPP

IPP (Internet Printing Protocol) is a standard that uses TCP/IP networks such as the Internet to enable print jobs to be sent between remote computers and printers. IPP is an extension of the HTTP protocol used to view websites and enables printing to be carried out via routers on printers in remote locations. It also supports the HTTP authentication mechanisms along with SSL server and client authentication as well as encryption.

KPDL (Kyocera Page Description Language)

Kyocera's PostScript page description language compatible with Adobe PostScript Level 3.

Multi Purpose (MP) Tray

The paper supply tray on the right side of the machine. Use this tray instead of the cassettes when printing onto envelopes, Hagaki, transparencies, or labels.

NetBEUI (NetBIOS Extended User Interface)

An interface, developed by IBM in 1985, as an update from NetBIOS. It enables more advanced functions on smaller networks than other protocols such as TCP/IP, etc. It is not suitable for larger networks due to lack of routing capabilities to choose the most appropriate routes. NetBEUI has been adopted by IBM for its OS/2 and Microsoft for its Windows as a standard protocol for file sharing and printing services.

PDF/A

This is "ISO 19005-1. Document management - Electronic document file format for long-term preservation - Part 1: Use of PDF (PDF/A)", and is a file format based on PDF 1.4. It has been standardized as ISO 19005-1, and is a specialization of PDF, which has been mainly used for printing, for long-term storage. A new part, ISO 19005-2 (PDF/A-2), is currently being prepared.

POP3 (Post Office Protocol 3)

A standard protocol to receive E-mail from the server in which the mail is stored on the Internet or an intranet.

PostScript

A page description language developed by Adobe Systems. It enables flexible font functions and highly-functional graphics, allowing higher quality printing. The first version called Level 1 was launched in 1985, followed by Level 2 that enabled color printing and two-byte languages (e.g. Japanese) in 1990. In 1996, Level 3 was released as an update for the Internet access and PDF format as well as gradual improvements in implementation technologies.

PPM (prints per minute)

This indicates the number of A4 size printouts made in one minute.

Printer Driver

The software to enable you to print data created on any application software. The printer driver for the machine is contained in the CD-ROM enclosed in the package. Install the printer driver on the computer connected to the machine.

RA(Stateless)

The IPv6 router communicates (transmits) information such as the global address prefix using ICMPv6. This information is the Router Advertisement (RA). ICMPv6 stands for Internet Control Message Protocol, and is a IPv6 standard defined in the RFC 2463 "Internet Control Message Protocol (ICMPv6) for the Internet Protocol Version 6 (IPv6) Specification".

Send as E-mail

A function to send the image data stored in the machine as an E-mail attachment. E-mail addresses can be selected from the list or entered at each time.

SMTP (Simple Mail Transfer Protocol)

A protocol for E-mail transmission over the Internet or an intranet. It is used for transferring mail between mail servers as well as for sending mail from clients to their servers.

Status Page

The page lists machine conditions, such as the memory capacity, total number of prints and scans, and paper source settings.

Subnet Mask

The subnet mask is a way of augmenting the network address section of an IP address. A subnet mask represents all network address sections as 1 and all host address sections as 0. The number of bits in the prefix indicates the length of the network address. The term "prefix" refers to something added to the beginning and, in this context, indicates the first section of the IP address. When an IP address is written, the length of the network address is indicated by the prefix length after a forward slash (/). For example, "24" in the address "133.210.2.0/24". In this way, "133.210.2.0/24" denotes the IP address "133.210.2.0" with a 24-bit prefix (network section). This new network address section (originally part of the host address) made possible by the subnet mask is referred to as the subnet address. When you enter the subnet mask, be sure to set the *DHCP* setting to *Off*.

TCP/IP (Transmission Control Protocol/Internet Protocol)

TCP/IP is a suite of protocols designed to define the way computers and other devices communicate with each other over a network.

TCP/IP (IPv6)

TCP/IP (IPv6) is based on the current Internet protocol, TCP/IP (IPv4). IPv6 is the next-generation Internet protocol and expands the available address space, which resolves the problem of the lack of addresses under IPv4, while also introducing other improvements such as additional security functionality and the capacity to prioritize data transmission.

USB (Universal Serial Bus)2.0

A USB interface standard for Hi-Speed USB 2.0. The maximum transfer rate is 480 Mbps. This machine is equipped with USB 2.0 for high-speed data transfer.

Index

Symbols

(Paper Width Guide) Lock 1-2

Numerics

1,000-sheet Finisher A-3
Staple Jam 8-47
4,000-sheet Finisher A-3
Staple Jam 8-48
4,000-sheet Finisher (Option)
Paper Jams 8-34

A

Alternative Emulation 6-33
Appendix A-1
Auto Paper Selection A-24
Auto Sleep A-24

B

Banner Tray A-5
Bonjour A-24
Buzzer 6-64

C

Canceling a Printing Job 2-40
Cassette
Loading Paper 2-22
Cassette (1 to 4) Settings
Media Type 2-32, 6-23
Paper Size 2-31, 6-22
Paper Weight 6-23
Cassette 1 1-2
Cassette 2 1-2
Cassette 3 to 7 1-4
Cassette 5 (Option)
Paper Jams 8-41
Cassette 6,7 (Option)
Paper Jams 8-43
Center-Folding Unit (Option)
Paper Jams 8-39
Cleaning
Platen Cover / Glass Platen 7-15
Separator 7-15
Slit Glass 7-15
Transfer Roller 7-16
Document processor 8-3
Cleaning Brush 1-3
Color Mode 6-34
Common Settings
Display Jobs Log 6-81
Message Banner Print 6-82
Counter 6-16
Custom Paper Size
Duplex Printing 6-26

Paper Weight 6-25

D

Daily Maintenance
Emptying the Punch Waste Box (Option) 7-13
Replacing Staples 7-8
Toner Container Replacement 7-2
Waste Toner Box Replacement 7-5
Data Security 6-94
Data Sanitization 6-94
Data Security Kit A-5
Date/Timer
Error Job Skip 6-75, 6-76
Default Gateway A-24
DHCP A-24
DHCP (IPv6) A-24
Display Bright 6-66
Document Finisher 1-4
dpi A-25
Duplex Printing 6-30
Binding Modes 6-30
Permitted with Custom Paper 6-26
Duplex unit 8-29
Duplex Unit and Cassette 1 8-30

E

EcoPrint Mode A-25
Emptying the Punch Waste Box (Option)
1,000-sheet Finisher (Option) 7-13
4,000-sheet Finisher (Option) 7-14
Emulation A-25
Error Report 6-33
Status Page 6-5
Emulation Option A-5
Energy Star Program ix
Error Detection
Paper mismatch 6-70
Error Handling 6-66
Paper Jam before Staple 6-70
Error Job Skip 6-75, 6-76
Error Messages 8-6

F

Folding Unit A-5
Font 6-39
Front Cover 1-2
FTP A-25

G

Grayscale A-25

H

Handles 1-2, 1-3

Help A-25

I

Indicator
 Attention 2-39
 Data 2-39
 Ready 2-39
Installing
 Macintosh 2-11
Installing the Printer Driver 2-8
 Windows 2-9
Interface 6-5, 6-40, 6-56, 6-92
IP Address A-25
IPP A-25

J

Job Account setting 6-98
Job Box
 Settings 4-35
Job Name 6-39
Job Retention
 Function 4-24
 Private Print 4-31
 Proof-and-Hold 4-29
 Quick Copy 4-25
Job Separator 1-2

K

Key
 [Back] Key 2-40
 [Clear] Key 2-41
 [Document Box] Key 2-41
 [Left Select] Key 2-42
 [MENU] Key 2-40
 [OK] Key 2-41
 [Right Select] Key 2-42
 Arrow Keys 2-41
 Numeric keys 2-41
KPD L A-25

L

Label A-15
Language 6-59
Large Capacity Feeder (1,500-sheet x 2) A-3

M

Machine Parts 1-1
Mailbox 1-4, A-5
Main Power Switch 1-2
Main Tray 1-2
Maintenance 6-119, 7-1
 Automatic Color Adjustment Cycle Setting 6-119
 Color Calibration 6-120
 Color Registration 6-120, 6-123
 Restart 6-127
Manual staple mode A-3
Memory

Status Page 6-5
Message Display
 Language 6-59
 Status Information 2-38
Message display
 Online help messages 8-19
Mode Selection Menu 2-45
MP (Multi-Purpose) Tray
 Media Type 2-35, 6-21
 Paper Selection 6-28
 Paper Size 2-34, 6-19
MP Tray Priority 6-29
Multi Purpose (MP) Tray A-25
 Paper Size and Media 2-33
Multi Purpose Tray 1-2

N

NetBEUI A-25
Network Interface Connector 1-3
Network Interface Kit A-5
Network Settings 2-2

O

Online help messages
 for clearing paper jams 8-19
Operation Panel 1-2, 1-5
Option
 1,000-sheet Finisher A-3
 4,000-sheet Finisher A-3
 Data Security Kit A-5
 Document Processor A-3
 Emulation Option A-5
 Folding Unit A-5
 Key Counter A-5
 Large Capacity Feeder (1,500-sheet x 2) A-3
 Large Capacity Side Feeder (500, 1,500-sheet x 2) A-3
 Mailbox A-5
 Network Interface Kit A-5
 Overview A-2
 Paper Feeder (500-sheet x2) A-3
 Side Feeder (3,000-sheet) A-3
 Side Feeder (500-sheet x 3) A-3
 ThinPrint Option A-5
 USB Keyboard A-5
 Wireless Network Interface Kit A-5
Option Interface 1-3

P

Page Setting 6-36
Paper
 Appropriate Paper A-10
 Before Loading 2-21
 Loading Envelopes 3-5
 Loading in the Cassettes 2-22
 Loading in the Multi Purpose Tray 2-28
 Media Type 2-32, 2-35, 6-21, 6-23
 Paper Sizes 2-31, 2-34, 6-19, 6-22
 Paper Thickness 6-24, 6-25
 Resets Customized settings 6-27
 Size and Media 2-30, A-9

Special Paper	A-13
Specifications	A-10
Paper Cassette	
Media Type	2-32, 6-23
Paper Selection	6-28
Paper Size	2-31, 6-22
Paper Feed Mode	6-29
Paper Feeder	
Media Type	2-32, 6-23
Paper Feed source	6-28
Paper Size	2-31, 6-22
Paper Feeder (500-sheet x2)	A-3
Paper Jam	
Bridge Unit (Option)	8-32
Cassette 1	8-19
Cassette 2	8-20
Cassettes 3 and 4	8-21
Inside the Right Covers 1, 3 and 4	8-26
Multi Purpose Tray	8-25
Paper Jams	8-16
4,000-sheet Finisher (Option)	8-34
Cassette 5 (Option)	8-41
Cassette 6,7 (Option)	8-43
Center-Folding Unit (Option)	8-39
Locations	8-16
Message	8-16
Paper Length Guide	1-2, 2-22
Paper Output	6-31, 6-39
Paper stopper	1-2
Paper Width Adjusting Tab	1-2
Paper Width Guide	1-2
Paper Width Guides	2-23
PDF/A	A-26
POP3	A-26
PostScript	A-26
PPM	A-26
Print	
Copies	6-36
Counter	6-16
Orientation	6-36
Print Quality	6-34
Problems	8-3
Print quality problems	
troubleshooting	8-3
Printer Driver	2-8, A-26
Windows	2-9
Printing Operation	2-1

R

RA (Stateless)	A-26
Release key	1-3
Replacing Staples	
1,000-sheet Finisher (Option)	7-8
4,000-sheet Finisher (Option)	7-10
Resolution	A-18
Right Cover 1	1-2
Right Cover 1 Lever	1-2
Right Cover 2	1-2
Right Cover 2 Lever	1-2
Right Cover 3	1-2
Right Cover 3 Lever	1-2

S

Security	6-84
I/F Block	6-92
Network	6-85
Separator	
Cleaning	7-15
Slit Glass	
Cleaning	7-15
SMTP	A-26
Specifications	A-17
1,000-sheet Finisher	A-21
4,000-sheet Finisher	A-21
Banner Tray	A-23
Center-Folding Unit	A-23
Common functions	A-17
Hole Punch Unit	A-22
Large Capacity Feeder	A-19
Large Capacity Side Feeder (500, 1,500-sheet x 2)	A-20
Mailbox	A-22
Paper Feeder	A-19
Side Feeder (3,000-sheet)	A-20
Side Feeder (500-sheet x 3)	A-19
Staple Jam	8-47
1,000-sheet Finisher	8-47
4,000-sheet Finisher	8-48
Status Page	6-4, A-26
Contents	6-4
Subnet Mask	A-26
Support Tray Section of the Multi Purpose Tray	1-2
Symbols	1-4

T

TCP/IP	A-27
TCP/IP (IPv6)	A-24
ThinPrint Option	A-5
TIFF/JPEG Size	6-38
Timer Setting	6-71
Toner Container	
Setting When Color Toner Runs Out	6-71
Toner Container (Black)	1-3
Toner Container (Cyan)	1-3
Toner Container (Magenta)	1-3
Toner Container (Yellow)	1-3
Toner Container Release Lever	1-3
Transfer Roller	
Cleaning	7-16
Troubleshooting	8-1
print quality problems	8-3

U

USB	A-27
USB Interface Connector (B1)	1-3
USB Keyboard	A-5
USB Memory	
Print	6-7
Remove	6-15
USB Memory Slot (A1)	1-2
USB Port (A2)	1-3
User Name	6-39

W

Waste Toner Box	1-3
Waste Toner Tray	1-3
Wide A4	6-37
Wireless Network Interface Kit.....	A-5

X

XPS Fit to Page	6-37
-----------------------	------

**QUALITY
CERTIFICATE**

This machine has passed
all quality controls and
final inspection

PASSIONATE PEOPLE. FROM ALL OVER THE WORLD.

**KYOCERA Document Solutions Europe B.V.**

Bloemlaan 4, 2132 NP Hoofddorp,
The Netherlands
Phone: +31-20-654-0000
Fax: +31-20-653-1256

KYOCERA Document Solutions Nederland B.V.

Beechavenue 25, 1119 RA Schiphol-Rijk,
The Netherlands
Phone: +31-20-5877200
Fax: +31-20-5877260

**KYOCERA Document Solutions (U.K.) Limited**

8 Beacontree Plaza,
Gillette Way Reading, Berkshire RG2 OBS,
United Kingdom
Phone: +44-118-931-1500
Fax: +44-118-931-1108

**KYOCERA Document Solutions Italia S.p.A.**

Via Verdi, 89/91 20063 Cernusco s/N.(MI),
Italy
Phone: +39-02-921791
Fax: +39-02-92179-600

**KYOCERA Document Solutions Belgium N.V.**

Sint-Martinusweg 199-201 1930 Zaventem,
Belgium
Phone: +32-2-7209270
Fax: +32-2-7208748

**KYOCERA Document Solutions France S.A.S.**

Espace Technologique de St Aubin
Route de l'Orme 91195 Gif-sur-Yvette CEDEX,
France
Phone: +33-1-69852600
Fax: +33-1-69853409

**KYOCERA Document Solutions Espana, S.A.**

Edificio Kyocera, Avda. de Manacor No.2,
28290 Las Matas (Madrid), Spain
Phone: +34-91-6318392
Fax: +34-91-6318219

**KYOCERA Document Solutions Finland Oy**

Atomitie 5C, 00370 Helsinki,
Finland
Phone: +358-9-47805200
Fax: +358-9-47805390

**KYOCERA Document Solutions Europe B.V., Amsterdam (NL) Zürich Branch**

Hohlstrasse 614, 8048 Zürich,
Switzerland
Phone: +41-44-9084949
Fax: +41-44-9084950

**KYOCERA Document Solutions Deutschland GmbH**

Otto-Hahn-Strasse 12, 40670 Meerbusch,
Germany
Phone: +49-2159-9180
Fax: +49-2159-918100

**KYOCERA Document Solutions Austria GmbH**

Eduard-Kittenberger-Gasse 95, 1230 Vienna,
Austria
Phone: +43-1-863380
Fax: +43-1-86338-400

**KYOCERA Document Solutions Nordic AB**

Esbogatan 16B 164 75 Kista,
Sweden
Phone: +46-8-546-550-00
Fax: +46-8-546-550-10

**KYOCERA Document Solutions Norge NUF**

Postboks 150 Oppsal, 0619 Oslo,
Norway
Phone: +47-22-62-73-00
Fax: +47-22-62-72-00

**KYOCERA Document Solutions Danmark A/S**

Ejby Industrivej 60, DK-2600 Glostrup,
Denmark
Phone: +45-70223880
Fax: +45-45765850

**KYOCERA Document Solutions Portugal Lda.**

Rua do Centro Cultural, 41 (Alvalade) 1700-106 Lisboa,
Portugal
Phone: +351-21-843-6780
Fax: +351-21-849-3312

**KYOCERA Document Solutions South Africa (Pty) Ltd.**

49 Kyalami Boulevard,
Kyalami Business Park 1685 Midrand, South Africa
Phone: +27-11-540-2600
Fax: +27-11-466-3050

**KYOCERA Document Solutions Russia LLC**

Botanichesky pereulok 5, Moscow, 129090,
Russia
Phone: +7(495)741-0004
Fax: +7(495)741-0018

**KYOCERA Document Solutions Middle East**

Dubai Internet City, Bldg. 17,
Office 157 P.O. Box 500817, Dubai,
United Arab Emirates
Phone: +971-04-433-0412

**KYOCERA Document Solutions Inc.**

2-28, 1-chome, Tamatsukuri, Chuo-ku
Osaka 540-8585, Japan
Phone: +81-6-6764-3555
<http://www.kyoceradocumentsolutions.com>

