



FS-C8520MFP FS-C8525MFP

OPERATION GUIDE



Introduction

Thank you for your purchase of FS-C8520MFP/FS-C8525MFP.

This Operation Guide is intended to help you operate the machine correctly, perform routine maintenance and take a simple troubleshooting action as necessary, so that you can always use the machine in good condition.

Please read this Operation Guide before you start using the machine.

We recommend the use of our own brand supplies. We will not be liable for any damage caused by the use of third party supplies in this machine.

A label shown in the illustration assures that the supplies are our own brand.

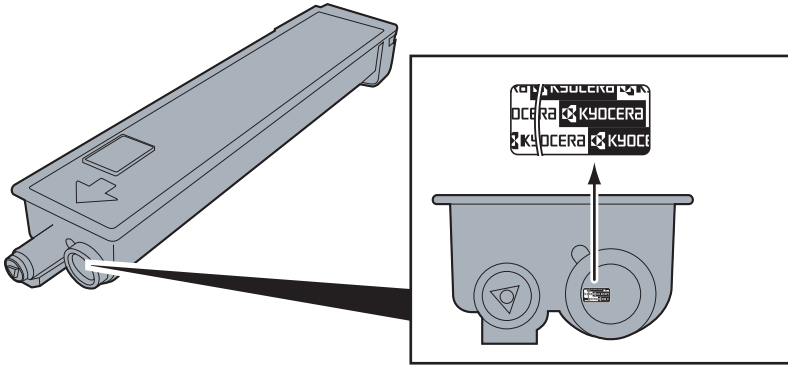

Included Guides

The following guides are supplied with the machine. Refer to them as necessary.

The contents of this manual are subject to change without notice for the purpose of improvement of machine performance.

Quick Installation Guide	Describes the procedures for installation of the machine, frequently-used operations, routine maintenance, and troubleshooting action.
Safety Guide	Provides safety and cautionary information for the installation and use of the machine. Be sure to read this guide before using the machine.
Safety Guide (FS-C8520MFP/ FS-C8525MFP)	Describes the machine installation space, cautionary space, and other information. Be sure to read this guide before using the machine.

DVD (Product Library)

Operation Guide (This Guide)	Describes how to load paper, basic copy, print and scan operations, and troubleshooting.
FAX Operation Guide	Describes how to install and use the Network FAX driver in order to use the FAX function and Network FAX transmission function.
Card Authentication Kit (B) Operation Guide	Describes how to authenticate to the machine using the ID card.
Command Center RX User Guide	Describes how to access the machine from a computer via a Web browser to check and change settings.
Printer Driver User Guide	Describes how to install the printer driver and use printer functionality.
KYOCERA Net Direct Print Operation Guide	Describes how to use functionality for printing PDF files without launching Adobe Acrobat or Reader.
KYOCERA Net Viewer User Guide	Describes how to monitor the network printing system with KYOCERA Net Viewer.
File Management Utility User Guide	Describes how to distribute scanned documents over the network.
PRESCRIBE Commands Technical Reference	Describes the native printer language (PRESCRIBE commands).
PRESCRIBE Commands Command Reference	Describes PRESCRIBE command functionality and control for each type of emulation.

Contents

1	Preface	1-1
	Notice	1-2
	Safety Conventions in This Guide	1-2
	Environment	1-3
	Precautions for Use	1-3
	Legal Restriction on Copying/Scanning	1-8
	Legal and Safety Information	1-9
	Legal Information	1-9
	Energy Saving Control Function	1-12
	Automatic 2-Sided Copy Function	1-12
	Resource Saving - Paper	1-12
	Environmental benefits of "Power Management"	1-12
	Energy Star (ENERGY STAR®) Program	1-13
	About this Operation Guide	1-14
	Conventions in This Guide	1-14
	Originals and Paper Sizes	1-16
2	Preparation before Use	2-1
	Part Names	2-2
	Machine	2-2
	Operation Panel	2-6
	Touch Panel	2-7
	Determining the Connection Method and Preparing Cables	2-8
	Connection Example	2-8
	Preparing Necessary Cables	2-9
	Connecting Cables	2-10
	Connecting LAN Cable	2-10
	Connecting USB Cable	2-11
	Connecting the Power Cable	2-11
	Power On/Off	2-12
	Power On	2-12
	Power Off	2-12
	Installing Software	2-14
	Software on DVD (Windows)	2-14
	Installing Printer Driver in Windows	2-15
	Uninstalling the Software	2-17
	Installing Printer Driver in Macintosh	2-18
	Setting TWAIN Driver	2-20
	Setting WIA Driver	2-21
	Energy Saver function	2-22
	Low Power Mode and Auto Low Power Mode	2-22
	Sleep and Auto Sleep	2-23
	Machine Setup Wizard	2-24
	Command Center RX (Settings for E-mail)	2-25
	Sending E-mail	2-26
3	Common Operations	3-1
	Loading Paper	3-2
	Before Loading Paper	3-2
	Loading Paper in the Cassettes	3-3
	Loading Paper in the Multi Purpose Tray	3-5
	Loading Originals	3-7
	Placing Originals on the Platen	3-7
	Loading Originals in the Document Processor	3-8

Checking the Equipment's Serial Number	3-10
Checking the Counter	3-11
Login/Logout	3-12
Login	3-12
Logout	3-13
Favorites	3-14
Registering Favorites	3-14
Editing and Deleting Favorites	3-18
Using Favorites	3-20
Application	3-21
Shortcuts	3-22
Registering Shortcuts	3-22
Editing and Deleting Shortcuts	3-24
Using Shortcuts	3-25
Quick Setup Wizard	3-26
Help Screen	3-28
Canceling Jobs	3-29
Using Various Functions	3-30
Common Functionality	3-31
Original Size	3-32
Original Orientation	3-34
Mixed Size Originals	3-35
2-sided/Book Original	3-37
Continuous Scan	3-40
Paper Selection	3-42
Paper Output	3-43
Collate/Offset	3-44
Margin	3-46
Staple	3-49
Density	3-51
Scan Resolution	3-52
Original Image	3-53
Sharpness	3-54
Background Density Adjust	3-55
Prevent Bleed-through	3-56
Zoom	3-57
File Format	3-58
Color Selection	3-60
Job Finish Notice	3-61
File Name Entry	3-63
Priority Override	3-64

4 Copying4-1

Basic Operation	4-2
Copying Functions	4-4
Zoom	4-5
Duplex	4-8
Combine	4-12
EcoPrint	4-15
Hue Adjustment	4-16
Color Balance	4-17
Saturation	4-18
Auto Image Rotation	4-19

	Interrupt Copy	4-20
5	Printing	5-1
	Printing from Applications	5-2
	Printing Data Saved on the Printer	5-7
	Private Print	5-7
	Proof and Hold	5-9
	Automatic Delete Setting for Temporary Documents	5-12
6	Sending	6-1
	Basic Operation	6-2
	Preparation for Sending a Document to a PC	6-5
	Making a note of the computer name and full computer name	6-5
	Making a note of the user name and domain name	6-6
	Creating a Shared Folder, Making a Note of a Shared Folder	6-7
	Configuring Windows Firewall (for Windows 7)	6-10
	Register the shared folder in the address book	6-14
	Specifying Destination	6-17
	Choosing from the Address Book	6-17
	Choosing by One Touch Key	6-19
	Entering a New E-mail Address	6-20
	Specifying a New PC Folder	6-21
	Checking and Editing Destinations	6-25
	Sending to Different Types of Destinations (Multi Sending)	6-26
	Registering Destinations in the Address Book	6-27
	Adding a Contact	6-27
	Adding a Group	6-31
	Editing and Deleting Address Book Entries	6-34
	Adding a Destination on One Touch Key	6-36
	Adding a Destination	6-36
	Editing and Deleting One Touch Key	6-38
	Sending Functions	6-39
	Sending Size	6-40
	File Separation	6-42
	E-mail Subject/Body	6-43
	FTP Encrypted TX	6-44
	WSD Scan	6-45
	Scanning using TWAIN	6-48
7	Document Box	7-1
	What is Document Box?	7-2
	Printing Documents Stored in Removable USB Memory	7-3
	Saving Documents to USB Memory (Scan to USB)	7-6
	Removing USB Memory	7-9
	Functions for Document Box	7-10
	Duplex	7-11
	Encrypted PDF Password	7-12
	JPEG/TIFF Print	7-13
	XPS Fit to Page	7-14
	Storing Size	7-15
8	Status / Job Cancel	8-1
	Checking Job Status	8-2
	Details of the Status Screens	8-3

Checking Job History	8-6
Sending the Log History	8-7
Setting the Destination	8-8
Automatic Log History Transmission	8-9
Manual Log History Transmission	8-9
Setting E-mail Subject	8-10
Check of Device Status	8-11
Checking the Remaining Amount of Toner and Paper	8-13

9 Setup, Registration, and User Management9-1

System Menu	9-2
Operation Method	9-2
System Menu Settings	9-3
Language	9-5
Report	9-5
User Property	9-7
Cassette/MP Tray Settings	9-8
Common Settings	9-9
Copy	9-15
Send	9-16
Favorites/Application	9-16
Internet	9-17
Printer	9-17
System	9-19
Date/Timer	9-24
Adjustment/Maintenance	9-26
Color Registration Procedure	9-28
User Login Administration	9-34
First User Login Administration	9-34
User Login Settings	9-35
Enabling/Disabling User Login Administration	9-36
Adding a User	9-38
Local User Authorization	9-42
My Panel	9-43
Editing and Deleting Users	9-44
Simple Login	9-47
Group Authorization	9-53
Obtain Network User Property	9-57
Job Accounting	9-59
First Job Accounting Setup	9-59
Job Accounting Settings	9-61
Enabling/Disabling Job Accounting	9-62
Login/Logout	9-63
Adding an Account	9-64
Editing and Deleting Accounts	9-66
Restricting the Use of the Machine	9-68
Counting the Number of Pages Printed	9-70
Printing an Accounting Report	9-72
Job Accounting Default Setting	9-74
Unknown Login User Name Job	9-76

10 Troubleshooting10-1

Toner Container Replacement	10-2
Waste Toner Box Replacement	10-4
Replacing Staples	10-5
Cleaning	10-6
Glass Platen	10-6
Document Processor	10-6

Solving Malfunctions	10-8
Responding to Messages	10-14
Clearing Paper Jams	10-26
Jam Location Indicators	10-26
Multi Purpose Tray	10-27
Inside the Right Cover 1	10-27
Cassette 1	10-28
Inside the Right Cover 3	10-28
Cassette 2 or 3	10-29
Optional Document Finisher	10-29
Optional Document Finisher Staple Jam	10-30
Bridge Unit	10-30
Document Processor	10-31

11 Appendix 11-1

Optional Equipment	11-2
Overview of Optional Equipment	11-2
PF-470 Paper Feeder (single cassette)	11-3
PF-471 Paper Feeder (double cassette)	11-3
DF-470 Document Finisher	11-3
FAX System (U) FAX Kit	11-3
Expansion Memory	11-3
Card Authentication Kit (B)	11-4
IB-50 Gigabit Ethernet Board	11-5
USB Keyboard	11-5
Optional Function	11-5
Character Entry Method	11-7
Entry Screens	11-7
Entering Characters	11-9
Paper	11-10
Basic Paper Specifications	11-11
Choosing the Appropriate Paper	11-11
Special Paper	11-14
Specifications	11-18
Common functions	11-18
Copy functions	11-19
Printer functions	11-20
Scanner	11-20
Document Processor	11-21
Paper Feeder (single cassette) (option)	11-21
Paper Feeder (double cassette) (option)	11-21
Document Finisher (option)	11-22
Environmental Specifications	11-22
Glossary	11-23
Index	Index-1



Quick Guide

Be sure to read *Precautions for Use* before using this machine.



To make copies

Simply press the **Start** key to make copies. You can also fine-tune the copy settings by changing the paper size, adjusting the density, etc.



To print

You can print via a network or print a PDF file directly from USB memory.

Administrator tasks

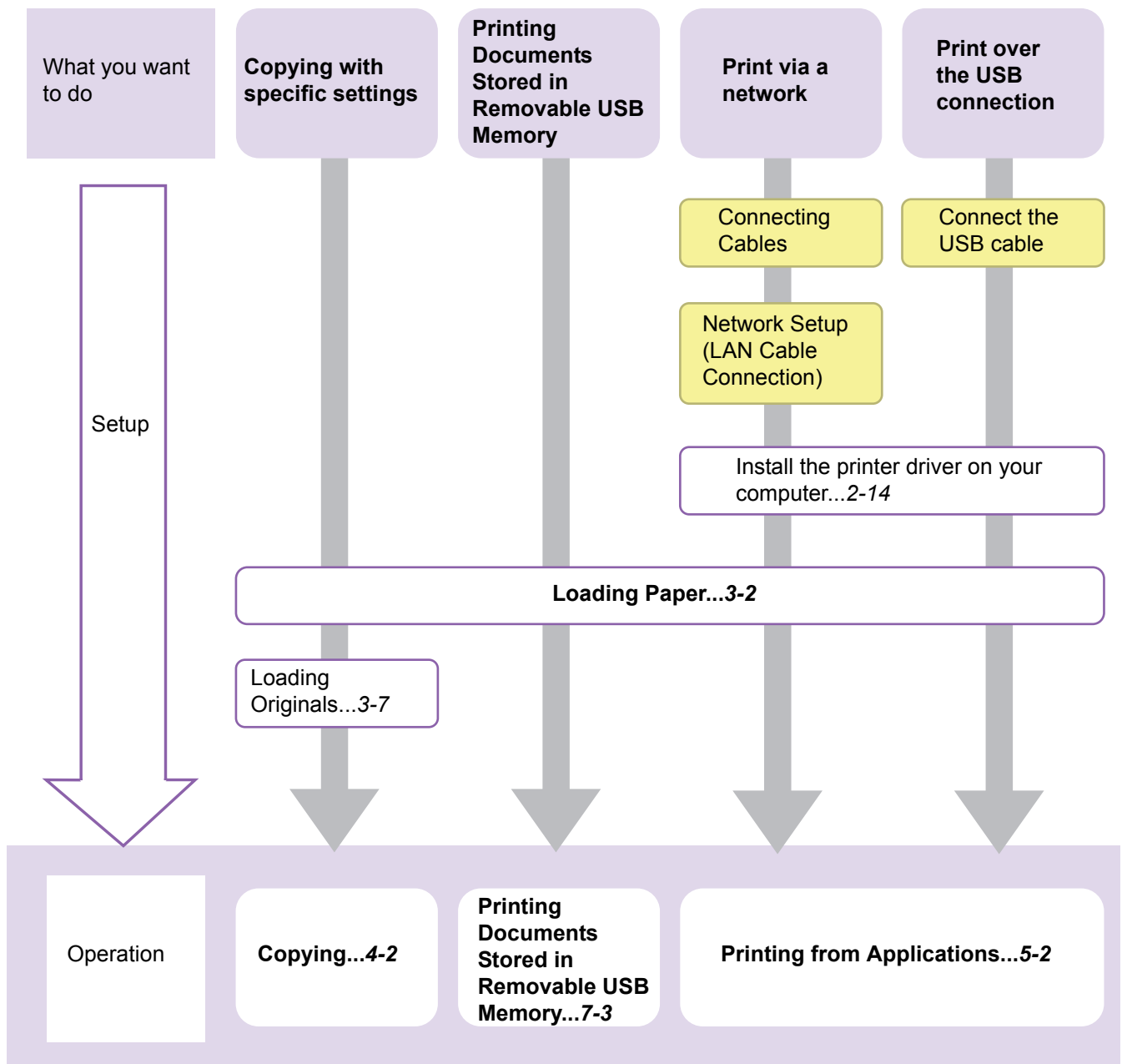



To send documents

You can send scanned images via a network. Or, you can also store scanned images in USB memory.

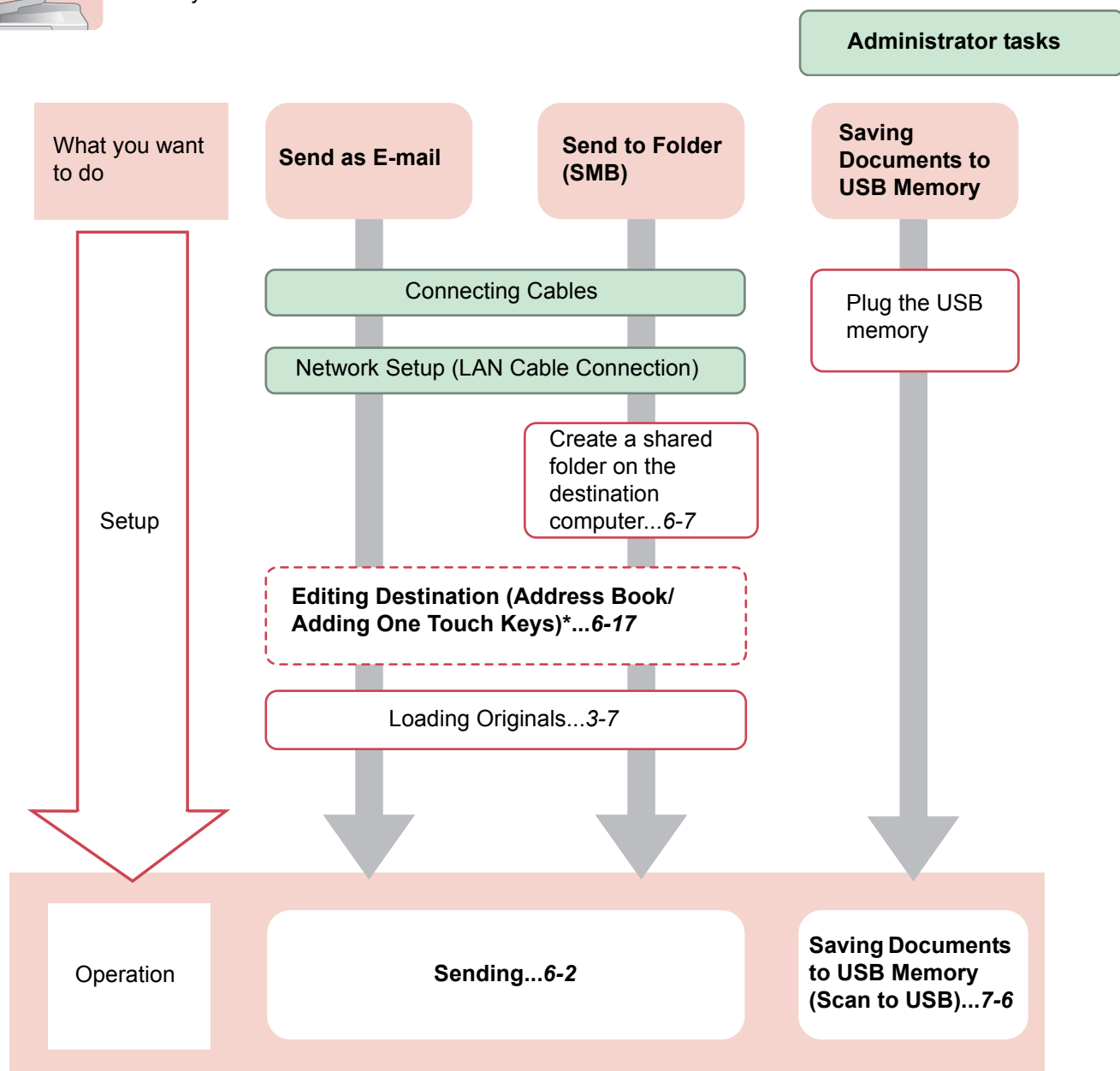

* If the destination is not stored in the address book, you can send by entering the address directly.



To send a FAX

As well as sending a FAX via the telephone lines, you can also send a FAX via a network.



NOTE

For more information on setting up and sending a FAX, refer to the *FAX Operation Guide*.

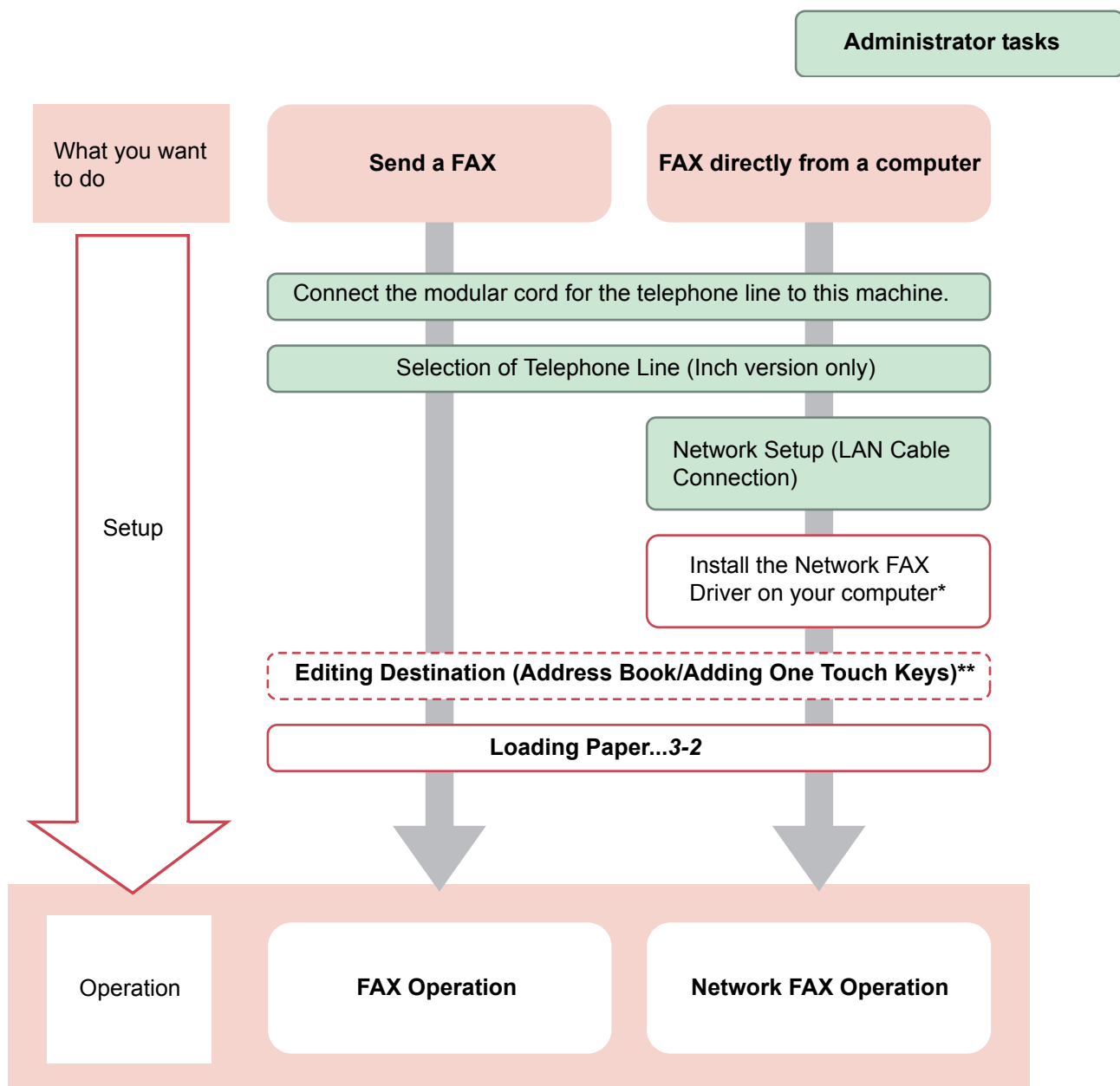

* For more information, refer to the *FAX Operation Guide*.

** If the destination is not stored in the address book, you can send the FAX by entering the address directly.

Menu Map

Copy



Copies (page 4-3)	
Paper Selection (page 3-42)	
Zoom (page 4-5)	
Density (page 3-51)	
Duplex (page 4-8)	
Combine (page 4-12)	
Collate/Offset (page 3-44)	
Functions	Original Size (page 3-32)
	Original Orientation (page 3-34)
	Mixed Size Originals (page 3-35)
	Paper Output (page 3-43)
	Staple (page 3-49)
	Color Selection (page 3-60)
	Original Image (page 3-53)
	EcoPrint (page 4-15)
	Hue Adjustment (page 4-16)
	Color Balance (page 4-17)
	Sharpness (page 3-54)
	Background Density Adj. (page 3-55)
	Prevent Bleed-through (page 3-56)
	Saturation (page 4-18)
	Margin (page 3-46)
	Continuous Scan (page 3-40)
	Auto Image Rotation (page 4-19)
	Job Finish Notice (page 3-61)
	File Name Entry (page 3-63)
	Priority Override (page 3-64)
Add/Edit Shortcut (page 3-22)	

Send



One Touch Key (page 6-19)	
Address Book (page 6-17)	
Ext. Address Book (refer to <i>Command Center RX User Guide</i> .)	
E-mail (page 6-20)	
Folder (page 6-21)	
FAX (refer to <i>Fax Operation Guide</i>)	
WSD Scan (page 6-45)	
Functions	File Format (page 3-58)
	Original Size (page 3-32)
	Original Orientation (page 3-34)
	Mixed Size Originals (page 3-35)
	2-sided/Book Original (page 3-37)
	Sending Size (page 6-40)
	File Separation (page 6-42)
	Scan Resolution (page 3-52)
	Density (page 3-51)
	Color Selection (page 3-60)
	Original Image (page 3-53)
	Sharpness (page 3-54)
	Background Density Adj. (page 3-55)
	Prevent Bleed-through (page 3-56)
	FAX TX Resolution (refer to <i>Fax Operation Guide</i>)
	Zoom (page 3-57)
	Continuous Scan (page 3-40)
	File Name Entry (page 3-63)
	E-mail Subject/Body (page 6-43)
	Job Finish Notice (page 3-61)
FTP Encrypted TX (page 6-44)	
FAX Delayed Transmission (refer to <i>Fax Operation Guide</i>)	
FAX Direct Transmission (refer to <i>Fax Operation Guide</i>)	
FAX Polling RX (refer to <i>Fax Operation Guide</i>)	
Add/Edit Shortcut (page 3-22)	

Document Box



Job Box (page 5-7)				
Removable Memory	Menu	Store File	File Format (page 3-58)	
			2-sided/Book Original (page 3-37)	
			Scan Resolution (page 3-52)	
			Density (page 3-51)	
			File Name Entry (page 3-63)	
			Functions	Original Size (page 3-32)
				Original Orientation (page 3-34)
				Mixed Size Originals (page 3-35)
				Storing Size (page 7-15)
				Color Selection (page 3-60)
				Original Image (page 3-53)
				Sharpness (page 3-54)
				Background Density Adj. (page 3-55)
	Prevent Bleed-through (page 3-56)			
	Zoom (page 3-57)			
	Continuous Scan (page 3-40)			
	Job Finish Notice (page 3-61)			
	Add/Edit Shortcut (page 3-22)			
	Print	Copies (page 7-4)	Paper Selection (page 3-42)	
			Collate/Offset (page 3-44)	
Duplex (page 7-11)				
Functions			Paper Output (page 3-43)	
		Staple (page 3-49)		
		Color Selection (page 3-60)		
		Margin (page 3-46)		
		Job Finish Notice (page 3-61)		
		Priority Override (page 3-64)		
Encrypted PDF Password (page 7-12)				
JPEG/TIFF Print (page 7-13)				
XPS Fit to Page (page 7-14)				
Add/Edit Shortcut (page 3-22)				
Sub Address Box (refer to <i>Fax Operation Guide</i>)				
Polling Box (refer to <i>Fax Operation Guide</i>)				

Status/
Job Cancel



Print Job Status (page 8-3)
Send Job Status (page 8-4)
Store Job Status (page 8-5)
Scheduled Job (page 8-5)
Print Job Log (page 8-6)
Send Job Log (page 8-6)
Store Job Log (page 8-6)
Scanner (page 8-11)
Printer (page 8-12)
FAX (page 8-12)
Removable Memory (page 8-12)
Toner Status (page 8-13)
Paper Status (page 8-13)
Staple (page 8-14)

◆ System Menu / Counter



Quick Setup Wizard (page 3-26)	FAX Setup (page 3-26)	
	Energy Saver Setup (page 3-26)	
	Network Setup (page 3-26)	
Language (page 9-5)		
Report (page 9-5)	Report Print (page 9-5)	Status Page (page 9-5)
		Font List (page 9-5)
		Network Status (page 9-5)
		Service Status (page 9-6)
		Accounting Report (page 9-6)
		Sub Address Box List (refer to <i>Fax Operation Guide</i>)
		FAX List (Index) (refer to <i>Fax Operation Guide</i>)
		FAX List (No.) (refer to <i>Fax Operation Guide</i>)
		Outgoing FAX Report (refer to <i>Fax Operation Guide</i>)
		Incoming FAX Report (refer to <i>Fax Operation Guide</i>)
	Admin Report Settings (refer to <i>Fax Operation Guide</i>)	
	Result Report Setting (page 9-6)	Send Result Report (page 9-6)
		RX Result Report (refer to <i>Fax Operation Guide</i>)
		Job Finish Notice Setting (page 9-6)
	Sending Log History (page 8-7)	Send Log History (page 8-9)
		Auto Sending (page 8-9)
		Destination (page 8-8)
		Job Log Subject (page 8-10)
	Counter	Printed Pages (page 3-11)
Scanned Pages (page 3-11)		
User Property (page 9-7)	User Name (page 9-7)	
	Login User Name (page 9-7)	
	Login Password (page 9-7)	
	Access Level (page 9-7)	
	Account Name (page 9-7)	
	E-mail Address (page 9-7)	
	Simple Login (page 9-7)	
	My Panel (page 9-7)	
	Group Name (page 9-7)	
	Group ID (page 9-7)	

Cassette/MP Tray Settings (page 9-8)	Cassette 1 (to 3) (page 9-8)	Paper Size (page 9-8)	
		Media Type (page 9-8)	
	Multi Purpose Tray (page 9-8)	Paper Size (page 9-8)	
		Media Type (page 9-8)	
Common Settings (page 9-9)	Default Screen (page 9-9)		
	Sound (page 9-9)	Buzzer (page 9-9)	Volume (page 9-9)
			Key Confirmation (page 9-9)
			Job Finish (page 9-9)
			Ready (page 9-9)
			Warning (page 9-9)
			Key Confirmation (USB Keyboard) (page 9-9)
		FAX Speaker Volume (refer to <i>Fax Operation Guide</i>)	
		FAX Monitor Volume (refer to <i>Fax Operation Guide</i>)	
	Original Settings (page 9-9)	Custom Original Size (page 9-9)	
		Original Auto Detect (page 9-9)	
	Paper Settings (page 9-10)	Custom Paper Size (page 9-10)	
		Media Type Settings (page 9-10)	
		Default Paper Source (page 9-10)	
		Paper Selection (page 9-10)	
		Media for Auto (Color) (page 9-10)	
		Media for Auto (B & W) (page 9-10)	
Special Paper Action (page 9-10)			

	Function Defaults (page 9-12)	File Format (page 9-12)	
		Original Orientation (page 9-12)	
		Collate/Offset (page 9-12)	
		File Separation (page 9-12)	
		Scan Resolution (page 9-12)	
		Color Selection (Copy) (page 9-12)	
		Color Select.(Send/Store) (page 9-12)	
		Original Image (page 9-12)	
		Background Density Adj. (page 9-12)	
		EcoPrint (page 9-12)	
		Prevent Bleed-through (page 9-12)	
		FAX TX Resolution (refer to <i>Fax Operation Guide</i>)	
		Zoom (page 9-12)	
		Margin (page 9-12)	
		Continuous Scan (page 9-12)	
		Auto Image Rotation (page 9-12)	
		File Name Entry (page 9-12)	
		E-mail Subject/Body (page 9-13)	
		FTP Encrypted TX (page 9-13)	
		JPEG/TIFF Print (page 9-13)	
		XPS Fit to Page (page 9-13)	
	Detail Settings (page 9-13)		Image Quality (page 9-13)
			PDF/A (page 9-13)
	Paper Output (page 9-13)	Copy/Document Box (page 9-13)	
		Printer (page 9-13)	
		FAX (refer to <i>Fax Operation Guide</i>)	
	Preset Limit (page 9-13)		
	Error Handling (page 9-14)	Duplexing Error (page 9-14)	
		Finishing Error (page 9-14)	
No Staple Error (page 9-14)			
Stapling Limit Error (page 9-14)			
Paper Mismatch Error (page 9-14)			
Inserted Paper Mismatch (page 9-14)			
Color Toner Empty Action (page 9-14)			
Measurement (page 9-14)			
Keyboard Layout (page 9-15)			
USB Keyboard Type (page 9-15)			
Offset One Page Documents (page 9-15)			

Copy (page 9-15)	Auto Paper Selection (page 9-15)		
	Auto % Priority (page 9-15)		
	Reserve Next Priority (page 9-15)		
	Auto Image Rotation Action (page 9-15)		
Send (page 9-16)	Dest. Check before Send (page 9-16)		
	Entry Check for New Dest. (page 9-16)		
	Send and Forward (page 9-16)	Forward (page 9-16)	
		Destination (page 9-16)	
	Color TIFF Compression (page 9-16)		
	Default Screen (page 9-16)		
Document Box	Sub Address Box (refer to <i>Fax Operation Guide</i>)		
	Job Box (page 5-7)	Quick Copy Job Retention (page 5-9)	
		Deletion of Job Retention (page 5-12)	
	Polling Box (refer to <i>Fax Operation Guide</i>)		
FAX (refer to <i>Fax Operation Guide</i>)			
Favorites/Application	Default Screen (page 9-16)		
	Application (page 9-16)		
Internet	Proxy (page 9-17)		
Address Book/One Touch	Address Book (page 6-27)		
	One Touch Key (page 6-36)		
	Address Book Defaults	Sort	
	Print List (refer to <i>Fax Operation Guide</i>)		

User Login/Job Accounting	User Login Settings (page 9-34)	User Login (page 9-36)	
		Local User List (page 9-38)	
		Simple login settings (page 9-47)	Simple Login (page 9-47)
			Simple Login Setup (page 9-47)
		Local User Authorization (page 9-42)	
		Group Authorization Set. (page 9-53)	Group Authorization (page 9-53)
			Group List (page 9-53)
	Obtain NW User Property (page 9-57)		
	Job Accounting Settings (page 9-59)	Job Accounting (page 9-62)	
		Print Accounting Report (page 9-72)	
		Total Job Accounting (page 9-70)	Printed Pages (page 9-70)
			Scanned Pages (page 9-70)
			FAX TX Pages (page 9-70)
			FAX TX Time (page 9-70)
			Counter Reset (page 9-70)
		Each Job Accounting (page 9-70)	
		Accounting List (page 9-64)	
		Default Setting (page 9-74)	Apply Limit (page 9-74)
			Copier/Printer Count (page 9-74)
	Default Counter Limit (page 9-74)		
	Count by Paper Size (page 9-75)		
Unknown ID Job (page 9-76)			
Printer (page 9-17)	Emulation (page 9-17)		
	Color Setting (page 9-17)		
	EcoPrint (page 9-18)		
	Override A4/Letter (page 9-18)		
	Duplex (page 9-18)		
	Copies (page 9-18)		
	Orientation (page 9-18)		
	Wide A4 (page 9-18)		
	Form Feed TimeOut (page 9-18)		
	LF Action (page 9-18)		
	CR Action (page 9-18)		
	Job Name (page 9-18)		
	User Name (page 9-18)		
	Paper Feed Mode (page 9-18)		
Gloss Mode (page 9-18)			

System (page 9-19)	Network (page 9-19)	Host Name (page 9-19)	
		TCP/IP (page 9-19)	TCP/IP (page 9-19)
			IPv4 Settings (page 9-19)
			IPv6 Settings (page 9-20)
			Protocol Detail (page 9-21)
		WSD Scan (page 9-22)	
		WSD Print (page 9-22)	
		Enhanced WSD (page 9-22)	
		Enhanced WSD (SSL) (page 9-22)	
		IPSec (page 9-22)	
		Secure Protocol (page 9-22)	SSL (page 9-22)
			IPP Security (page 9-22)
			HTTP Security (page 9-22)
			LDAP Security (Ext. Address Book) (page 9-22)
			LDAP Security (User Property) (page 9-22)
			SMTP Security (page 9-23)
			POP3 Security (User 1) (page 9-23)
			POP3 Security (User 2) (page 9-23)
		POP3 Security (User 3) (page 9-23)	
	LAN Interface (page 9-23)		
	Interface Block Setting (page 9-23)	USB Host (page 9-23)	
		USB Device (page 9-23)	
		USB Storage (page 9-23)	
		Optional Interface 1 (page 9-23)	
		Optional Interface 2 (page 9-23)	
	Security Level (page 9-4)		
	Restart (page 9-4)		
	RAM Disk Setting (page 9-23)		
	Main Memory (page 9-24)		
	Optional Function (page 11-5)		

Date/Timer (page 9-24)	Date/Time (page 9-24)	
	Date Format (page 9-24)	
	Time Zone (page 9-24)	
	Auto Panel Reset (page 9-24)	
	Panel Reset Timer (page 9-24)	
	Low Power Timer (page 9-24)	
	Auto Sleep (page 9-24)	
	Sleep Level (page 9-25)	
	Sleep Timer (page 9-25)	
	Auto Error Clear (page 9-25)	
	Error Clear Timer (page 9-25)	
	Interrupt Clear Timer (page 9-25)	
	Unusable Time (refer to <i>Fax Operation Guide</i>)	
Adjustment/ Maintenance (page 9-26)	Density Adjustment (page 9-26)	Copy (page 9-26)
		Send/Box (page 9-26)
	Background Density Adj. (page 9-26)	Copy (Auto) (page 9-26)
		Send/Box (Auto) (page 9-26)
	Toner Save Level (EcoPrint) (page 9-26)	Copy (page 9-26)
		Printer (page 9-26)
	Auto Color Correction (page 9-26)	
	Correcting Black Line (page 9-26)	
	Display Brightness (page 9-26)	
	Color Registration (page 9-26)	
	Tone Curve Adjustment (page 9-27)	
	Drum Refresh (page 9-27)	
	Calibration (page 9-27)	
	Laser Scanner Cleaning (page 9-27)	
DP Adjustment (page 9-27)		

1 Preface

This chapter explains the following topics:

Notice	1-2
Safety Conventions in This Guide	1-2
Environment	1-3
Precautions for Use	1-3
Legal and Safety Information	1-9
Legal Information	1-9
Energy Saving Control Function	1-12
Automatic 2-Sided Copy Function	1-12
Resource Saving - Paper	1-12
Environmental benefits of "Power Management"	1-12
Energy Star (ENERGY STAR®) Program	1-13
About this Operation Guide	1-14
Conventions in This Guide	1-14
Originals and Paper Sizes	1-16

Notice

Safety Conventions in This Guide

The sections of this guide and parts of the machine marked with symbols are safety warnings meant to protect the user, other individuals and surrounding objects, and ensure correct and safe usage of the machine. The symbols and their meanings are indicated below.

 **WARNING:** Indicates that serious injury or even death may result from insufficient attention to or incorrect compliance with the related points.

 **CAUTION:** Indicates that personal injury or mechanical damage may result from insufficient attention to or incorrect compliance with the related points.

Symbols

The \triangle symbol indicates that the related section includes safety warnings. Specific points of attention are indicated inside the symbol.

 ... [General warning]

 ... [Warning of high temperature]

The \circ symbol indicates that the related section includes information on prohibited actions. Specifics of the prohibited action are indicated inside the symbol.

 ... [Warning of prohibited action]

 ... [Disassembly prohibited]

The \bullet symbol indicates that the related section includes information on actions which must be performed. Specifics of the required action are indicated inside the symbol.

 ... [Alert of required action]

 ... [Remove the power plug from the outlet]

 ... [Always connect the machine to an outlet with a ground connection]

Please contact your service representative to order a replacement if the safety warnings in this Operation Guide are illegible or if the guide itself is missing (fee required).

NOTE

An original which resembles a bank note closely may not be copied properly in some rare cases because this machine is equipped with a counterfeiting prevention function.

Environment

The service environmental conditions are as follows:

- Temperature: 50 to 90.5 °F (10 to 32.5 °C)
- Humidity: 15 to 80 %

However, adverse environmental conditions may affect the image quality. It is recommended to use the machine at a temperature: around 60.8 to 80.6 °F or less (16 to 27 °C), humidity: around 36 to 65%. In addition, Avoid the following locations when selecting a site for the machine.

- Avoid locations near a window or with exposure to direct sunlight.
- Avoid locations with vibrations.
- Avoid locations with drastic temperature fluctuations.
- Avoid locations with direct exposure to hot or cold air.
- Avoid poorly ventilated locations.

If the floor is delicate against casters, when this machine is moved after installation, the floor material may be damaged.

During copying, some ozone is released, but the amount does not cause any ill effect to one's health. If, however, the machine is used over a long period of time in a poorly ventilated room or when making an extremely large number of copies, the smell may become unpleasant. To maintain the appropriate environment for copy work, it is suggested that the room be properly ventilated.

Precautions for Use

Cautions when handling consumables

CAUTION

Do not attempt to incinerate the toner container or unit. Dangerous sparks may cause burns.

Keep the toner container and unit out of the reach of children.

If toner happens to spill from the toner container or unit, avoid inhalation and ingestion, as well as contact with your eyes and skin.

- If you do happen to inhale toner, move to a place with fresh air and gargle thoroughly with a large amount of water. If coughing develops, contact a physician.
- If you do happen to ingest toner, rinse your mouth with water and drink 1 or 2 cups of water to dilute the contents of your stomach. If necessary, contact a physician.
- If you do happen to get toner in your eyes, flush them thoroughly with water. If there is any remaining tenderness, contact a physician.
- If toner does happen to get on your skin, wash with soap and water.

Do not attempt to force open or destroy the toner container or unit.

Other precautions

Return the exhausted toner container and waste toner box to your dealer or service representative. The collected toner container and waste toner box will be recycled or disposed in accordance with the relevant regulations.

Store the machine while avoiding exposure to direct sunlight.

Store the machine in a place where the temperature stays below 40 °C while avoiding sharp changes of temperature and humidity.

If the machine will not be used for an extended period of time, remove the paper from the cassette and the Multi Purpose (MP) Tray, return it to its original package and reseal it.

Laser Safety (Europe)

Laser radiation could be hazardous to the human body. For this reason, laser radiation emitted inside this machine is hermetically sealed within the protective housing and external cover. In the normal operation of the product by user, no radiation can leak from the machine.

This machine is classified as Class 1 laser product under IEC/EN 60825-1:2007.

Caution: Performance of procedures other than those specified in this manual may result in hazardous radiation exposure.

These labels are attached to the laser scanner unit inside the machine and are not in a user access area.

	<p>DANGER · CLASS 3B INVISIBLE LASER RADIATION WHEN OPEN. AVOID DIRECT EXPOSURE TO BEAM.</p> <p>ATTENTION · CLASSE 3B RAYONNEMENT LASER INVISIBLE EN CAS D'OUVERTURE. EXPOSITION DANGEREUSE AU FAISCEAU.</p> <p>VORSICHT · KLASSE 3B UNSICHTBARE LASERSTRAHLUNG, WENN ABDECKUNG GEÖFFNET. NICHT DEM STRAHL AUSSETZEN.</p>	<p>ATTENZIONE · CLASSE 3B RADIAZIONE LASER INVISIBLE IN CASO DI APERTURA. EVITARE L'ESPOSIZIONE AL FASCIO.</p> <p>PRECAUCION · CLASSE 3B RADIACIONE LASER INVISIBLE CUANDO SE ABRE. EVITAR EXPONERSE AL RAYO.</p> <p>PERIGO · RADIAÇÃO DE LASER INVISÍVEL CLASSE 3B QUANDO ABERTO EVITAR EXPOSIÇÃO DIRETA NO FEIXE</p>	<p>WAARSCHUWING · NIET ZICHTBARE KLASSE 3B LASERSTRAAL INDIEN GEOPEND. VERMIJD DIRECTE BLOOTSTELLING AAN DE STRAAL.</p> <p>Внимание · Когда устройство открыто, присутствует невидимое лазерное излучение класса 3B. Избегайте прямого попадания лазерного луча.</p>	<p>警告 · 该产品为3B类不可见激光产品，打开盖子后会有激光辐射，请避免光束照射。</p> <p>警告 · 該產品為3B類不可見激光產品，打開蓋子後會有激光輻射，請避免光束照射。</p> <p>위험 · CLASS 3B 불가시 레이저광선을 직접 보지마십시오.</p> <p>警告 · ここを開くとクラス3B不可視レーザー光がでます。ビームを直接見たり、触れないでください。</p>
---	--	---	--	---

The label shown below is attached on the right side of the machine.

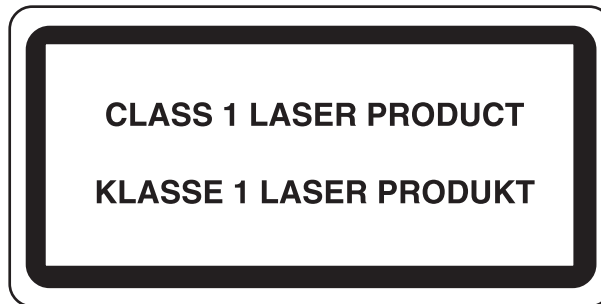

SAFETY OF LASER BEAM (USA)

1. Safety of laser beam

This machine has been certified by the manufacturer to Class 1 level under the radiation performance standards established by the U.S.DHHS (Department of Health and Human Services) in 1968. This indicates that the product is safe to use during normal operation and maintenance. The laser optical system, enclosed in a protective housing and sealed within the external covers, never permits the laser beam to escape.

2. The CDRH Act

A laser-product-related act was implemented on Aug. 2, 1976, by the Center for Devices and Radiological Health (CDRH) of the U.S. Food and Drug Administration (FDA). This act prohibits the sale of laser products in the U.S. without certification, and applies to laser products manufactured after Aug. 1, 1976. The label shown below indicates compliance with the CDRH regulations and must be attached to laser products marketed in the United States. On this machine, the label is on the right.

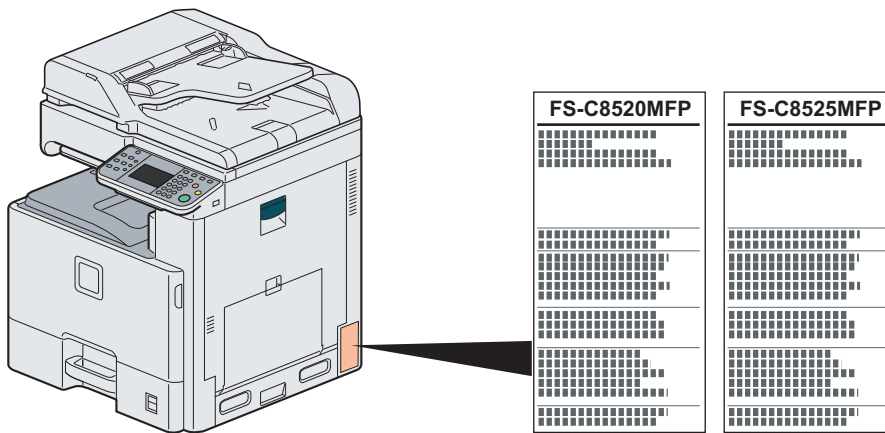

3. Optical unit

When checking the optical unit, avoid direct exposure to the laser beam, which is invisible. Shown at below is the label located on the cover of the optical unit.

 <p>DANGER · CLASS 3B INVISIBLE LASER RADIATION WHEN OPEN. AVOID DIRECT EXPOSURE TO BEAM. ATTENTION · CLASSE 3B RAYONNEMENT LASER INVISIBLE EN CAS D'OUVERTURE. EXPOSITION DANGEREUSE AU FAISCEAU. VORSICHT · KLASSE 3B UNSICHTBARE LASERSTRAHLUNG, WENN ABDECKUNG GEÖFFNET. NICHT DEM STRAHL AUSSETZEN.</p>	<p>ATTENZIONE · CLASSE 3B RADIAZIONE LASER INVISIBLE IN CASO DI APERTURA. EVITARE L'ESPOSIZIONE AL FASCIO. PRECAUCION · CLASSE 3B RADIAZIONE LASER INVISIBLE CUANDO SE ABRE. EVITAR EXPONERSE AL RAYO. PERIGO · RADIAÇÃO DE LASER INVISÍVEL CLASSE 3B QUANDO ABERTO EVITAR EXPOSIÇÃO DIRETA NO FEIXE</p>	<p>WAARSCHUWING · NIET ZICHTBARE KLASSE 3B LASERSTRAAL INDIEN GEOPEND. VERMIJD DIRECTE BLOOTSTELLING AAN DE STRAAL. Внимание · Когда устройство открыто, присутствует невидимое лазерное излучение класса 3B. Избегайте прямого попадания лазерного луча.</p>	<p>警告 · 该产品为3B类不可见激光产品，打开盖子后有激光辐射，请避免光束照射。 警告 · 該產品為3B類不可見激光產品，打開蓋子後會有激光輻射，請避免光束照射。 위험 · CLASS 3B 불가시 레이저광선을 직접 보지마십시오. 警告 · ここを開くとクラス3B不可視レーザー光がでます。ビームを直接見たり、触れないでください。</p>
--	---	--	---

4. Maintenance

For safety of the service personnel, follow the maintenance instructions in the other section of this manual.

5. Safety switch

The power to the laser unit is cut off when the front cover is opened.

Safety Instructions Regarding the Disconnection of Power

Caution: The power plug is the main isolation device! Other switches on the equipment are only functional switches and are not suitable for isolating the equipment from the power source.

Attention: Le débranchement de la fiche secteur est le seul moyen de mettre l'appareil hors tension. Les interrupteurs sur l'appareil ne sont que des interrupteurs de fonctionnement: ils ne mettent pas l'appareil hors tension.

WARNING

This equipment has been tested and found to comply with the limits for a Class B digital device, pursuant to Part 15 and Part 18 of the FCC Rules. These limits are designed to provide reasonable protection against harmful interference in a residential installation. This equipment generates, uses and can radiate radio frequency energy and, if not installed and used in accordance with the instructions, may cause harmful interference to radio communications. However, there is no guarantee that interference will not occur in a particular installation. If this equipment does cause harmful interference to radio or television reception, which can be determined by turning the equipment off and on, the user is encouraged to try to correct the interference by one or more of the following measures:

- Reorient or relocate the receiving antenna.
- Increase the separation between the equipment and receiver.
- Connect the equipment into an outlet on a circuit different from that to which the receiver is connected.
- Consult the dealer or an experienced radio/TV technician for help.
- The use of a non-shielded interface cable with the referenced device is prohibited.

CAUTION — The changes or modifications not expressly approved by the party responsible for compliance could void the user's authority to operate the equipment.

This device contains the module (FCC ID: E522K0A0540, IC: 1059B-2K0A0540), which complies with Part 15 of FCC Rules and RSS-Gen of IC Rules.

Operation is subject to the following two conditions; (1) this device may not cause interference, and (2) this device must accept any interference, including interference that may cause undesired operation of the device.

Radio Tag Technology

In some countries the radio tag technology used in this equipment to identify the toner container may be subject to authorization and the use of this equipment may consequently be restricted.

Other precautions (for users in California, the United States)

Perchlorate Material - special handling may apply. See www.dtsc.ca.gov/hazardouswaste/perchlorate.

Warranty (the United States)

FS-C8520MFP/FS-C8525MFP MULTIFUNCTIONAL PRODUCT LIMITED WARRANTY

KYOCERA Document Solutions America, Inc. and KYOCERA Document Solutions Canada, Ltd. (both referred to as "Kyocera") warrant the Customer's new Multifunctional Product (referred to as "MFP"), and the new accessories installed with the initial installation of the MFP, against any defects in material and workmanship for a period of one (1) year, or 200,000 copies/prints from date of installation, whichever first occurs. In the event the MFP or an accessory is found to be defective within the warranty period, Kyocera's only obligation and the Customer's exclusive remedy shall be replacement of any defective parts. Kyocera shall have no obligation to furnish labor.

This warranty covers Maintenance Kits and the components of Maintenance Kits included with the original MFP for a period of one year or 200,000 copies/prints, whichever first occurs. Maintenance Kits consist of the developing unit, the drum unit, the transfer belt, and the fixing unit. Replacement Maintenance Kits have a 90 day Limited Warranty.

This warranty is valid only for the original retail purchaser (referred to as the "Customer") of a new Kyocera MFP in the United States of America or Canada, based upon the country of purchase.

In order to obtain performance of this warranty, the Customer must immediately notify the Authorized Kyocera Dealer from whom the product was purchased. If the Kyocera Dealer is not able to provide service, write to Kyocera at the address below for the name and address of the Authorized Kyocera Dealer in your area, or check Kyocera's website at <http://www.kyoceradocumentsolutions.com>.

This warranty does not cover MFPs or accessories which: (a) have become damaged due to operator negligence, misuse, accidents, improper storage or unusual physical or electrical stress, (b) have used parts or supplies which are not genuine Kyocera brand parts or supplies, (c) have been installed or serviced by a technician not employed by Kyocera or an Authorized Kyocera Dealer, or (d) have had the serial number modified, altered, or removed.

This warranty gives the Customer specific legal rights. The Customer may also have other rights, which vary from state to state, or province to province. Neither the seller, nor any other person, is authorized to extend the time period or expand this warranty on behalf of Kyocera.

THIS WARRANTY IS MADE IN LIEU OF ALL OTHER WARRANTIES AND CONDITIONS, EXPRESS OR IMPLIED, AND KYOCERA SPECIFICALLY DISCLAIMS ANY IMPLIED WARRANTY OR CONDITION OF MERCHANTABILITY OR FITNESS FOR A PARTICULAR PURPOSE. THIS WARRANTY SHALL NOT EXTEND TO, AND KYOCERA SHALL NOT BE LIABLE FOR, ANY INCIDENTAL OR CONSEQUENTIAL DAMAGES WHICH MAY ARISE OUT OF THE USE OF, OR INABILITY TO USE, THE MFP.

KYOCERA Document Solutions America, Inc.

225 Sand Road,
Fairfield, New Jersey 07004-0008, USA

KYOCERA Document Solutions Canada, Ltd.

6120 Kestrel Rd., Mississauga, ON L5T 1S8,
Canada

Legal Restriction on Copying/Scanning

It may be prohibited to copy/scan copyrighted material without permission of the copyright owner.

Copying/Scanning the following items is prohibited and may be penalized by law. It may not be limited to these items. Do not knowingly copy/scan the items that are not to be copied/scanned.

- Paper money
- Bank note
- Securities
- Stamp
- Passport
- Certificate

Local laws and regulations may prohibit or restrict copying/scanning of other items not mentioned above.

Legal and Safety Information

Legal Information

Copying or other reproduction of all or part of this guide without the prior written consent of KYOCERA Document Solutions Inc. is prohibited.

Regarding Trade Names

- PRESCRIBE and ECOSYS are trademarks of Kyocera Corporation.
- KPDL is a trademark of Kyocera Corporation.
- Microsoft, Windows, Windows XP, Windows Server 2003, Windows Vista, Windows Server 2008, Windows 7 and Internet Explorer are registered trademarks or trademarks of Microsoft Corporation in the U.S.A. and/or other countries.
- PCL is a trademark of Hewlett-Packard Company.
- Adobe Acrobat, Adobe Reader and PostScript are trademarks of Adobe Systems, Incorporated.
- Ethernet is a registered trademark of Xerox Corporation.
- IBM and IBM PC/AT are trademarks of International Business Machines Corporation.
- Power PC is a trademark of IBM in the U.S.A. and/or other countries.
- Bonjour, Macintosh, and Mac OS are trademarks of Apple Inc., registered in the U.S. and other countries.
- All fonts installed in this machine are used under licensing agreement with Monotype Imaging Inc.
- Helvetica, Palatino and Times are registered trademarks of Linotype GmbH.
- ITC Avant Garde Gothic, ITC Bookman, ITC ZapfChancery and ITC ZapfDingbats are registered trademarks of International Typeface Corporation.
- UFST™ MicroType® fonts by Monotype Imaging Inc. are installed in this machine.
- This machine contains the software having modules developed by Independent JPEG Group.
- ThinPrint is a trademark of ThinPrint GmbH in Germany and other countries.
- This machine contains the NF module developed by ACCESS Co., Ltd.
- This product contains NetFront Browser of ACCESS CO., LTD.
- ACCESS, ACCESS logo and NetFront are trademarks or registered trademarks of ACCESS CO., LTD. in the United States, Japan and other countries.
- © 2011 ACCESS CO., LTD. All rights reserved.
- Java is a registered trademark of Oracle and/or its affiliates.

ACCESS™
NetFront™ Browser



All other brands and product names are registered trademarks or trademarks designations ™ and ® will not be used in this Operation Guide.

GPL/LGPL

This product contains GPL (<http://www.gnu.org/licenses/gpl.html>) and/or LGPL (<http://www.gnu.org/licenses/lgpl.html>) software as part of its firmware. You can get the source code, and you are permitted to copy, redistribute and modify it under the terms of GPL/LGPL. For further information including availability of the source code, visit <http://www.kyoceradocumentsolutions.com/gpl/>

Open SSL License

Copyright (c) 1998-2006 The OpenSSL Project. All rights reserved.

Redistribution and use in source and binary forms, with or without modification, are permitted provided that the following conditions are met:

1. Redistributions of source code must retain the above copyright notice, this list of conditions and the following disclaimer.
2. Redistributions in binary form must reproduce the above copyright notice, this list of conditions and the following disclaimer in the documentation and/or other materials provided with the distribution.
3. All advertising materials mentioning features or use of this software must display the following acknowledgment: "This product includes software developed by the OpenSSL Project for use in the OpenSSL Toolkit. (<http://www.openssl.org/>)"
4. The names "OpenSSL Toolkit" and "OpenSSL Project" must not be used to endorse or promote products derived from this software without prior written permission. For written permission, please contact openssl-core@openssl.org.
5. Products derived from this software may not be called "OpenSSL" nor may "OpenSSL" appear in their names without prior written permission of the OpenSSL Project.
6. Redistributions of any form whatsoever must retain the following acknowledgment: "This product includes software developed by the OpenSSL Project for use in the OpenSSL Toolkit (<http://www.openssl.org/>)"

THIS SOFTWARE IS PROVIDED BY THE OpenSSL PROJECT "AS IS" AND ANY EXPRESSED OR IMPLIED WARRANTIES, INCLUDING, BUT NOT LIMITED TO, THE IMPLIED WARRANTIES OF MERCHANTABILITY AND FITNESS FOR A PARTICULAR PURPOSE ARE DISCLAIMED. IN NO EVENT SHALL THE OpenSSL PROJECT OR ITS CONTRIBUTORS BE LIABLE FOR ANY DIRECT, INDIRECT, INCIDENTAL, SPECIAL, EXEMPLARY, OR CONSEQUENTIAL DAMAGES (INCLUDING, BUT NOT LIMITED TO, PROCUREMENT OF SUBSTITUTE GOODS OR SERVICES; LOSS OF USE, DATA, OR PROFITS; OR BUSINESS INTERRUPTION) HOWEVER CAUSED AND ON ANY THEORY OF LIABILITY, WHETHER IN CONTRACT, STRICT LIABILITY, OR TORT (INCLUDING NEGLIGENCE OR OTHERWISE) ARISING IN ANY WAY OUT OF THE USE OF THIS SOFTWARE, EVEN IF ADVISED OF THE POSSIBILITY OF SUCH DAMAGE.

Original SSLeay License

Copyright (C) 1995-1998 Eric Young (eay@cryptsoft.com) All rights reserved.

This package is an SSL implementation written by Eric Young (eay@cryptsoft.com). The implementation was written so as to conform with Netscapes SSL.

This library is free for commercial and non-commercial use as long as the following conditions are adhered to. The following conditions apply to all code found in this distribution, be it the RC4, RSA, lhash, DES, etc., code; not just the SSL code. The SSL documentation included with this distribution is covered by the same copyright terms except that the holder is Tim Hudson (tjh@cryptsoft.com).

Copyright remains Eric Young's, and as such any Copyright notices in the code are not to be removed.

If this package is used in a product, Eric Young should be given attribution as the author of the parts of the library used.

This can be in the form of a textual message at program startup or in documentation (online or textual) provided with the package.

Redistribution and use in source and binary forms, with or without modification, are permitted provided that the following conditions are met:

1. Redistributions of source code must retain the copyright notice, this list of conditions and the following disclaimer.
2. Redistributions in binary form must reproduce the above copyright notice, this list of conditions and the following disclaimer in the documentation and/or other materials provided with the distribution.
3. All advertising materials mentioning features or use of this software must display the following acknowledgement: "This product includes cryptographic software written by Eric Young (eay@cryptsoft.com)"
The word 'cryptographic' can be left out if the routines from the library being used are not cryptographic related :-).

4. If you include any Windows specific code (or a derivative thereof) from the apps directory (application code) you must include an acknowledgement: "This product includes software written by Tim Hudson (tjh@cryptsoft.com)"

THIS SOFTWARE IS PROVIDED BY ERIC YOUNG "AS IS" AND ANY EXPRESS OR IMPLIED WARRANTIES, INCLUDING, BUT NOT LIMITED TO, THE IMPLIED WARRANTIES OF MERCHANTABILITY AND FITNESS FOR A PARTICULAR PURPOSE ARE DISCLAIMED. IN NO EVENT SHALL THE AUTHOR OR CONTRIBUTORS BE LIABLE FOR ANY DIRECT, INDIRECT, INCIDENTAL, SPECIAL, EXEMPLARY, OR CONSEQUENTIAL DAMAGES (INCLUDING, BUT NOT LIMITED TO, PROCUREMENT OF SUBSTITUTE GOODS OR SERVICES; LOSS OF USE, DATA, OR PROFITS; OR BUSINESS INTERRUPTION) HOWEVER CAUSED AND ON ANY THEORY OF LIABILITY, WHETHER IN CONTRACT, STRICT LIABILITY, OR TORT (INCLUDING NEGLIGENCE OR OTHERWISE) ARISING IN ANY WAY OUT OF THE USE OF THIS SOFTWARE, EVEN IF ADVISED OF THE POSSIBILITY OF SUCH DAMAGE.

The licence and distribution terms for any publically available version or derivative of this code cannot be changed. i.e. this code cannot simply be copied and put under another distribution licence [including the GNU Public Licence.]

Monotype Imaging License Agreement

- 1 *Software* shall mean the digitally encoded, machine readable, scalable outline data as encoded in a special format as well as the UFST Software.
- 2 You agree to accept a non-exclusive license to use the Software to reproduce and display weights, styles and versions of letters, numerals, characters and symbols (*Typefaces*) solely for your own customary business or personal purposes at the address stated on the registration card you return to Monotype Imaging. Under the terms of this License Agreement, you have the right to use the Fonts on up to three printers. If you need to have access to the fonts on more than three printers, you need to acquire a multiuser license agreement which can be obtained from Monotype Imaging. Monotype Imaging retains all rights, title and interest to the Software and Typefaces and no rights are granted to you other than a License to use the Software on the terms expressly set forth in this Agreement.
- 3 To protect proprietary rights of Monotype Imaging, you agree to maintain the Software and other proprietary information concerning the Typefaces in strict confidence and to establish reasonable procedures regulating access to and use of the Software and Typefaces.
- 4 You agree not to duplicate or copy the Software or Typefaces, except that you may make one backup copy. You agree that any such copy shall contain the same proprietary notices as those appearing on the original.
- 5 This License shall continue until the last use of the Software and Typefaces, unless sooner terminated. This License may be terminated by Monotype Imaging if you fail to comply with the terms of this License and such failure is not remedied within thirty (30) days after notice from Monotype Imaging. When this License expires or is terminated, you shall either return to Monotype Imaging or destroy all copies of the Software and Typefaces and documentation as requested.
- 6 You agree that you will not modify, alter, disassemble, decrypt, reverse engineer or decompile the Software.
- 7 Monotype Imaging warrants that for ninety (90) days after delivery, the Software will perform in accordance with Monotype Imaging-published specifications, and the diskette will be free from defects in material and workmanship. Monotype Imaging does not warrant that the Software is free from all bugs, errors and omissions.

The parties agree that all other warranties, expressed or implied, including warranties of fitness for a particular purpose and merchantability, are excluded.
- 8 Your exclusive remedy and the sole liability of Monotype Imaging in connection with the Software and Typefaces is repair or replacement of defective parts, upon their return to Monotype Imaging.

In no event will Monotype Imaging be liable for lost profits, lost data, or any other incidental or consequential damages, or any damages caused by abuse or misapplication of the Software and Typefaces.
- 9 Massachusetts U.S.A. law governs this Agreement.
- 10 You shall not sublicense, sell, lease, or otherwise transfer the Software and/or Typefaces without the prior written consent of Monotype Imaging.
- 11 Use, duplication or disclosure by the Government is subject to restrictions as set forth in the Rights in Technical Data and Computer Software clause at FAR 252-227-7013, subdivision (b)(3)(ii) or subparagraph (c)(1)(ii), as appropriate. Further use, duplication or disclosure is subject to restrictions applicable to restricted rights software as set forth in FAR 52.227-19 (c)(2).

12 You acknowledge that you have read this Agreement, understand it, and agree to be bound by its terms and conditions. Neither party shall be bound by any statement or representation not contained in this Agreement. No change in this Agreement is effective unless written and signed by properly authorized representatives of each party. By opening this diskette package, you agree to accept the terms and conditions of this Agreement.

Energy Saving Control Function

The device comes equipped with a **Low Power Mode** where energy consumption is reduced after a certain amount of time elapses since the device was last used, as well as a **Sleep** where printer and fax functions remain in a waiting state but power consumption is still reduced to a minimum when there is no activity with the device within a set amount of time.

Sleep

The device automatically enters Sleep when 20 minutes (for FS-C8520MFP) or 30 minutes (for FS-C8525MFP) have passed since the device was last used. The amount of time of no activity that must pass before Sleep is activated may be lengthened. For more information refer to *Sleep and Auto Sleep on page 2-23*.

Low Power Mode

The device automatically enters Low Power Mode when 3 minutes have passed since the device was last used. The amount of time of no activity that must pass before Low Power Mode is activated may be lengthened. For more information refer to *Low Power Mode and Auto Low Power Mode on page 2-22*.

Automatic 2-Sided Copy Function

This device includes 2-sided copying as a standard function. For example, by copying two 1-sided originals onto a single sheet of paper as a 2-sided copy, it is possible to lower the amount of paper used. For more information refer to *Duplex on page 4-8*.

Printing in duplex mode reduces paper consumption and contributes to the conservation of forest resources. Duplex mode also reduces the amount of paper that must be purchased, and thereby reduces cost. It is recommended that machines capable of duplex printing be set to use duplex mode by default.

Resource Saving - Paper

For the preservation and sustainable use of forest resources, it is recommended that recycled as well as virgin paper certified under environmental stewardship initiatives or carrying recognised ecolabels, which meet EN 12281:2002*¹ or an equivalent quality standard, be used.

This machine also supports printing on 64 g/m² paper. Using such paper containing less raw materials can lead to further saving of forest resources.

*1: EN12281:2002 "Printing and business paper - Requirements for copy paper for dry toner imaging processes"

Your sales or service representative can provide information about recommended paper types.

Environmental benefits of "Power Management"

To reduce power consumption when idle, this machine is equipped with a power management function that automatically activates energy-saving mode when the machine is idle for a certain period of time.

Although it takes the machine a slight amount of time to return to READY mode when in energy-saving mode, a significant reduction in energy consumption is possible. It is recommended that the machine be used with the activation time for energy-saving mode set to the default setting.

Energy Star (ENERGY STAR[®]) Program



We have determined as a participating company in the International Energy Star Program that this product is compliant with the standards laid out in the International Energy Star Program.

ENERGY STAR[®] is a voluntary energy efficiency program with the goal of developing and promoting the use of products with high energy efficiency in order to help prevent global warming. By purchasing

ENERGY STAR[®] qualified products, customers can help reduce emissions of greenhouse gases during product use and cut energy-related costs.



About this Operation Guide

This Operation Guide contains the following chapters.







Chapter		Contents
1	Preface	Includes information about operating precautions, trademarks, and this manual.
2	Preparation before Use	Provides information about part names, connecting cables, and setting up and configuring the machine.
3	Common Operations	Explains overall machine operation, including loading paper and originals and logging in and out.
4	Copying	Describes the functions you can use when copying.
5	Printing	Provides information about functionality that is available when using the machine as a printer.
6	Sending	Describes the functions you can use when sending originals.
7	Document Box	Provides a basic guide to using document boxes.
8	Status / Job Cancel	Explains how to check the job status and job history and how to cancel jobs being printed or waiting to print. Also explains how to check the remaining paper and device status and how to cancel fax transmission.
9	Setup, Registration, and User Management	Explains system menu functionality related to overall machine operation, job accounting, and user management.
10	Troubleshooting	Explains how to respond to error indications such as when the machine runs out of toner and problems such as paper jams.
11	Appendix	Introduces the convenient optional equipment available for this machine. Provides information on media types and paper sizes. Also includes a glossary of terms. Explains how to enter characters, and lists the machine specifications.

Conventions in This Guide

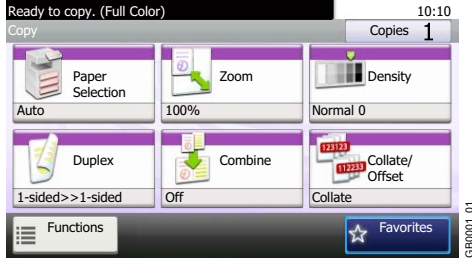
The following conventions are used depending on the nature of the description.

Convention	Description	Example
Bold	Indicates the operation panel keys or a computer screen.	Press the Start key.
[Regular]	Indicates the touch panel keys.	Press [OK].
<i>Italic</i>	Indicates a message displayed on the touch panel.	<i>Ready to copy</i> is displayed.
	Used to emphasize a key word, phrase or references to additional information.	For more information refer to <i>Sleep and Auto Sleep</i> on page 2-23.
NOTE	Indicates supplemental information or operations for reference.	 NOTE
IMPORTANT	Indicates items that are required or prohibited so as to avoid problems.	 IMPORTANT
Caution	Indicates what must be observed to prevent injury or machine breakdown and how to deal with it.	 Caution

Job types for which each function can be set are shown with icons.

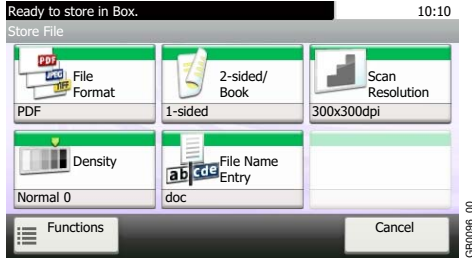
Icon	Description	Icon	Description
	<p>This function can be set while copying a document.</p>  <p><i>Copy Screen</i></p>		<p>This function can be set while printing from USB memory.</p>  <p><i>Print Screen</i></p>
	<p>This function can be set while sending a document.</p>  <p><i>Send Screen</i></p>		<p>This function can be set while saving a file to USB memory.</p>  <p><i>Store File Screen</i></p>

In this guide, steps where touch panel keys are used are outlined in red.

E.g.) Select [Zoom].

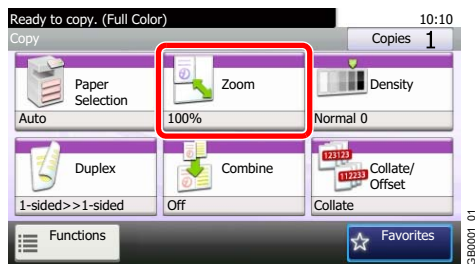

Procedures consisting of a series of operation panel and/or touch panel operations are numbered as follows:

E.g.) Select [Functions] and then [EcoPrint].



Originals and Paper Sizes



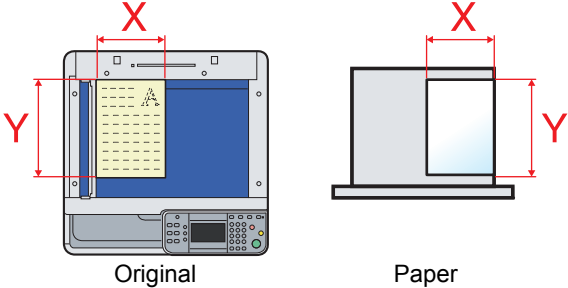
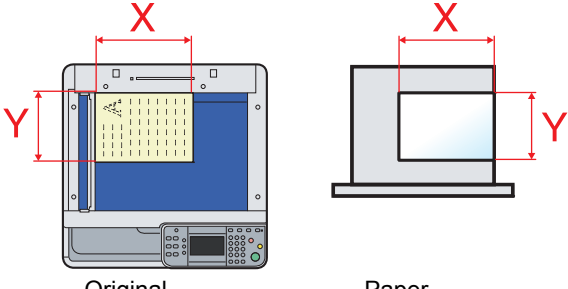

This section explains the notation used in this guide when referring to sizes of originals or paper sizes. As with A4, B5 and Letter, which may be used either in the horizontal or vertical direction, horizontal direction is indicated by an additional letter R in order to indicate the orientation of the original/paper.

	Placement direction	Indicated size*
Vertical direction	 <p style="text-align: center;">Original Paper</p> <p style="text-align: center;">For the originals/paper, dimension Y is longer than X.</p>	A4, B5, A5, Letter, Statement
Horizontal direction	 <p style="text-align: center;">Original Paper</p> <p style="text-align: center;">For the originals/paper, dimension Y is shorter than X.</p>	A4-R, B5-R, A5-R, Letter-R, Statement-R

* The size of the original/paper that can be used depends on the function and source tray. For further details, refer to the page detailing that function or source tray.

Icons on the Touch Panel

The following icons are used to indicate originals and paper placement directions on the touch panel.

Placement direction	Originals	Paper
Vertical direction		
Horizontal direction		

2 Preparation before Use

This chapter explains the following topics:

Part Names	2-2
Machine	2-2
Operation Panel	2-6
Touch Panel	2-7
Determining the Connection Method and Preparing Cables	2-8
Connection Example	2-8
Preparing Necessary Cables	2-9
Connecting Cables	2-10
Connecting LAN Cable	2-10
Connecting USB Cable	2-11
Connecting the Power Cable	2-11
Power On/Off	2-12
Power On	2-12
Power Off	2-12
Installing Software	2-14
Software on DVD (Windows)	2-14
Installing Printer Driver in Windows	2-15
Uninstalling the Software	2-17
Installing Printer Driver in Macintosh	2-18
Setting TWAIN Driver	2-20
Setting WIA Driver	2-21
Energy Saver function	2-22
Low Power Mode and Auto Low Power Mode	2-22
Sleep and Auto Sleep	2-23
Machine Setup Wizard	2-24
Command Center RX (Settings for E-mail)	2-25
Sending E-mail	2-26

Part Names

Machine

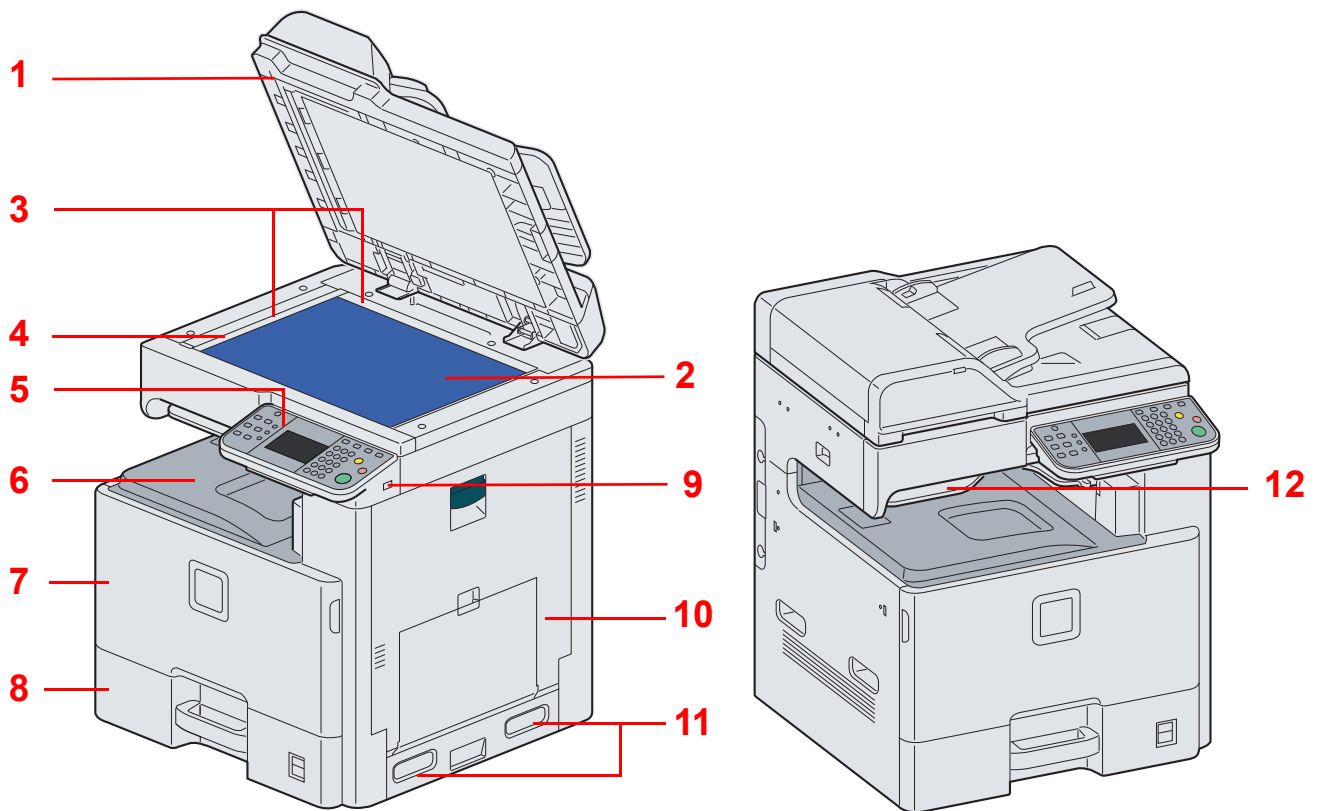

- 1 Document Processor
- 2 Platen
- 3 Original Size Indicator Plates
- 4 Slit Glass
- 5 Operation Panel
- 6 Inner Tray
- 7 Front Cover
- 8 Cassette 1
- 9 USB Memory Slot (A1)
- 10 Right Cover 1
- 11 Handles
- 12 Job Separator Tray

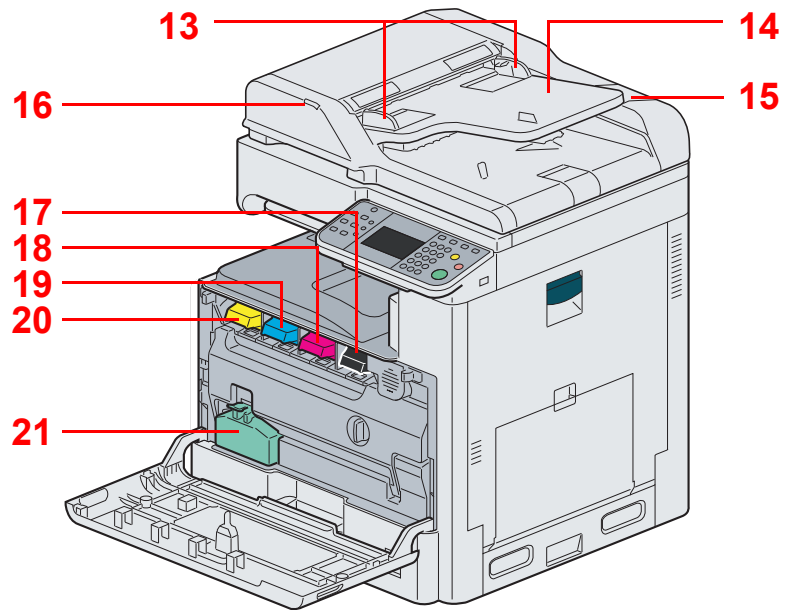

- 13 Original Width Guides
- 14 Original Table
- 15 Cleaning Cloth Compartment
- 16 Original Loaded Indicator
- 17 Toner Container (Black)
- 18 Toner Container (Magenta)
- 19 Toner Container (Cyan)
- 20 Toner Container (Yellow)
- 21 Waste Toner Box

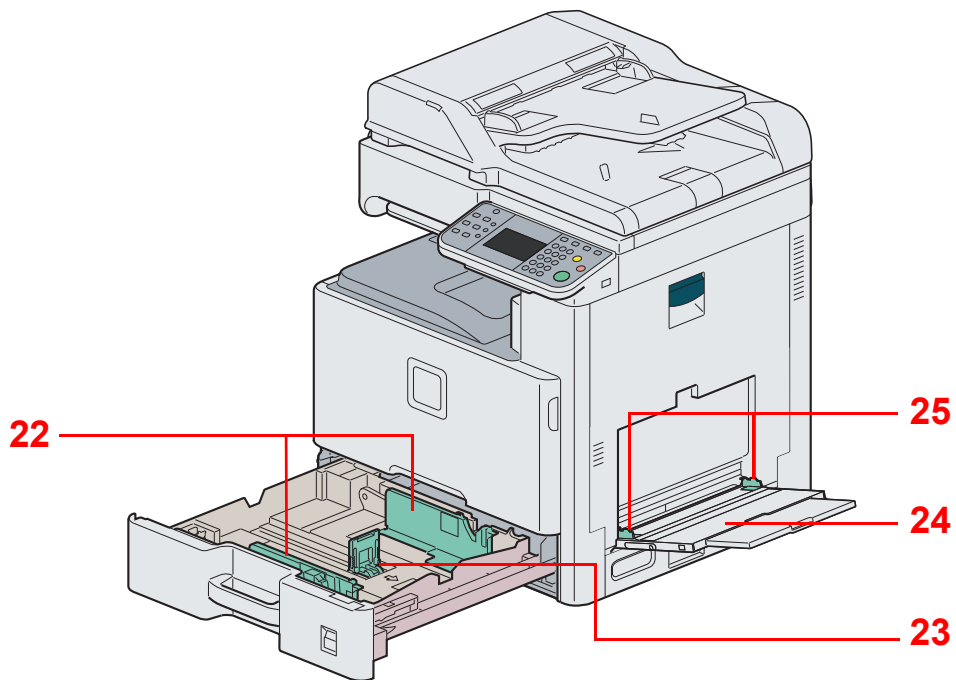

- 22 Paper Width Guide
- 23 Paper Length Guide
- 24 Multi Purpose Tray
- 25 Paper Width Guide

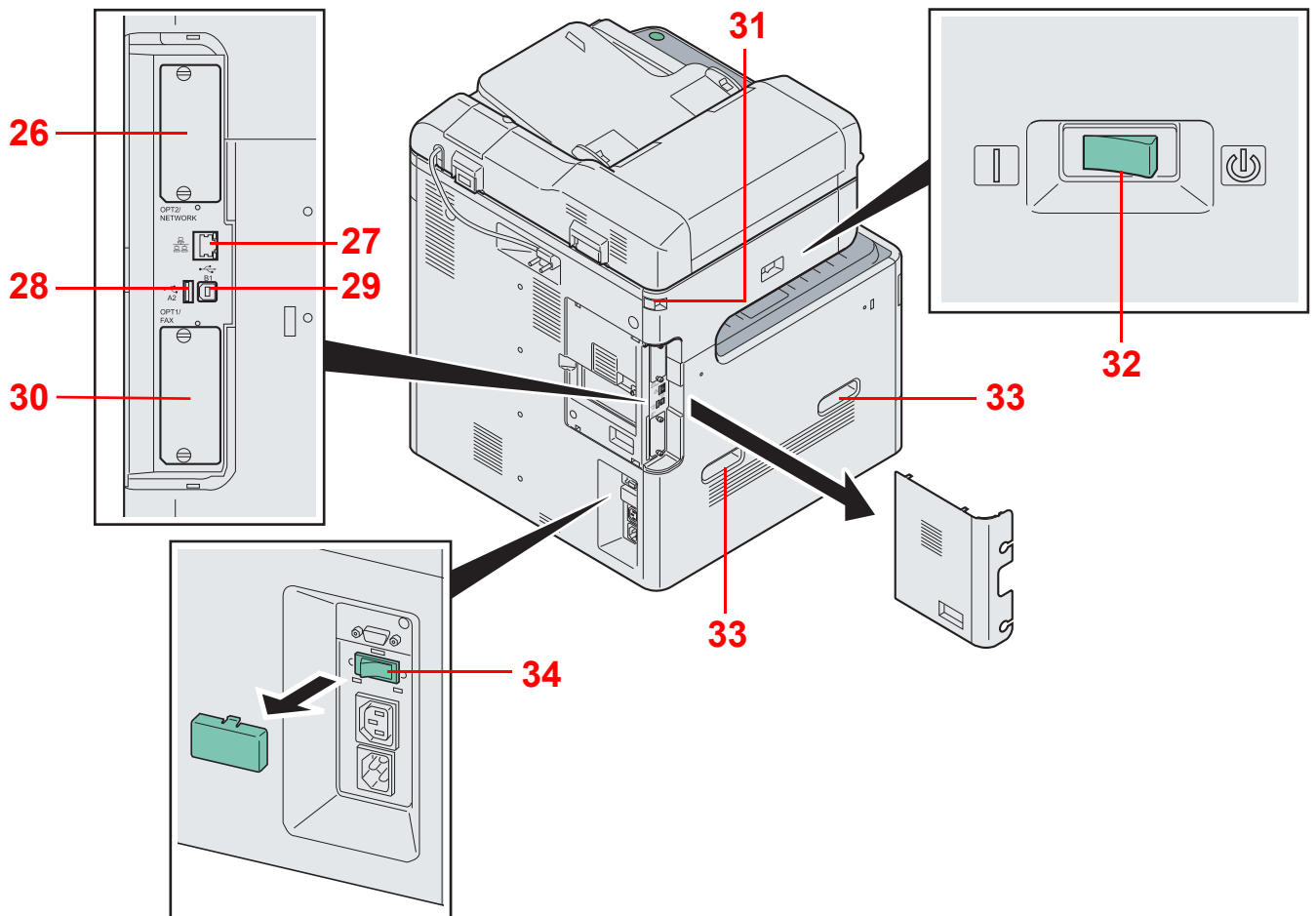



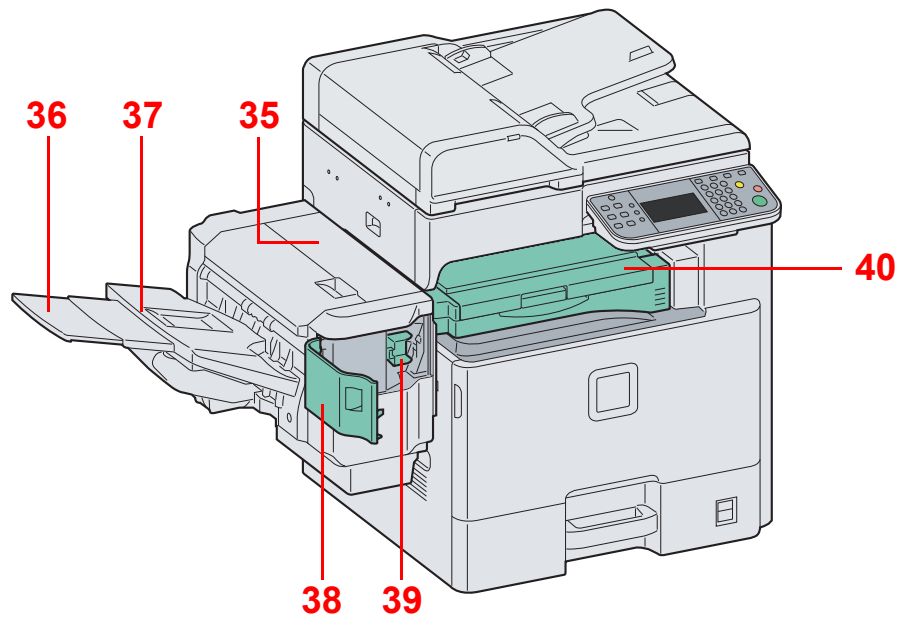









- 26** Option Interface Slot 2
- 27** Network Interface Connector
- 28** USB Interface Connector (A2)
- 29** USB Port (B1)
- 30** Option Interface Slot 1
- 31** Scanner Lock
- 32** Main Power Switch
- 33** Handles
- 34** Cassette Heater Switch



- 35** Top Cover
- 36** Tray Extension
- 37** Document Finisher Tray
- 38** Staple Cover
- 39** Staple Cartridge Holder
- 40** Bridge Unit Cover

Operation Panel

 System Menu / Counter Displays the System Menu/Counter screen.		 Copy Displays the Copy screen.		 Interrupt Displays the Interrupt Copy screen.
 Status/Job Cancel Displays the Status/Job Cancel screen.	 Send Displays the screen for sending.	 Logout Ends operation (logs out) on the Administration screen.	 Energy Saver Puts the machine into Low Power Mode.	
 Favorites / Application Displays the Favorites / Application screen.	 FAX Displays the FAX screen.	 Power Puts the machine into Sleep Mode. Recovers from Sleep if in Sleep Mode.	 Lit when the machine's main power is on.	
 Document Box Displays the Document Box screen.	Select the color mode. Auto Color: Automatically recognizes whether a document is color or black & white and then scans the document. Full Color: Scans all documents in full color. Black & White: Scans all documents in black & white.			

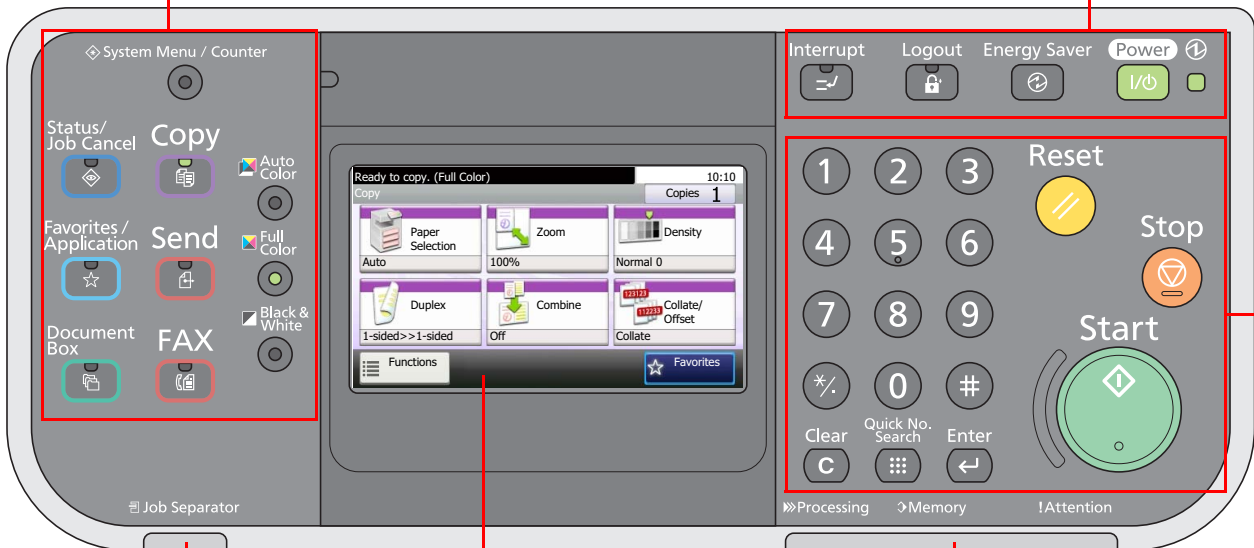







Lights when there is paper in the job separator tray.

Touch panel. Displays buttons for configuring machine settings.

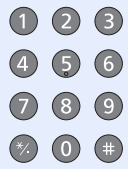
Processing: Blinks while printing or sending.

Memory: Blinks while the machine is accessing the fax memory or USB memory (generalpurpose item).

Attention: Lights or blinks when an error occurs and a job is stopped.

 Numeric keys. Enter numbers and symbols.	 Clear Clears entered numbers and characters.	 Reset Returns settings to their default states.
	 Quick No. Search Specifies registered information such as address numbers and user IDs by number.	 Stop Cancels or pauses the printing job in progress.
	 Enter Finalizes numeric key entry, and finalizes screen during setting of functions. Operates linked with the on-screen [OK].	 Start Starts copying and scanning operations and processing for setting operations.

Touch Panel

Displays the status of the equipment as well as necessary operation messages.

Displays available functions.

Configures more advanced function settings.

Displays Favorites.

Displays shortcuts.

Displays the status of the equipment as well as necessary operation messages.

Displays available functions and settings.

Return to the previous screen.

Displays the time and number of copies.

Registers functions as shortcuts.

Scrolls up and down when the list of values cannot be displayed in its entirety on a single screen.

Determining the Connection Method and Preparing Cables

Check the method to connect the equipment to a PC or network, and prepare the necessary cables for your environment.

Connection Example

Determine the method to connect the equipment to a PC or network by referring to the illustration below.

Connecting a scanner to your PC network with a network cable (1000BASE-T, 100BASE-TX or 10BASE-T)

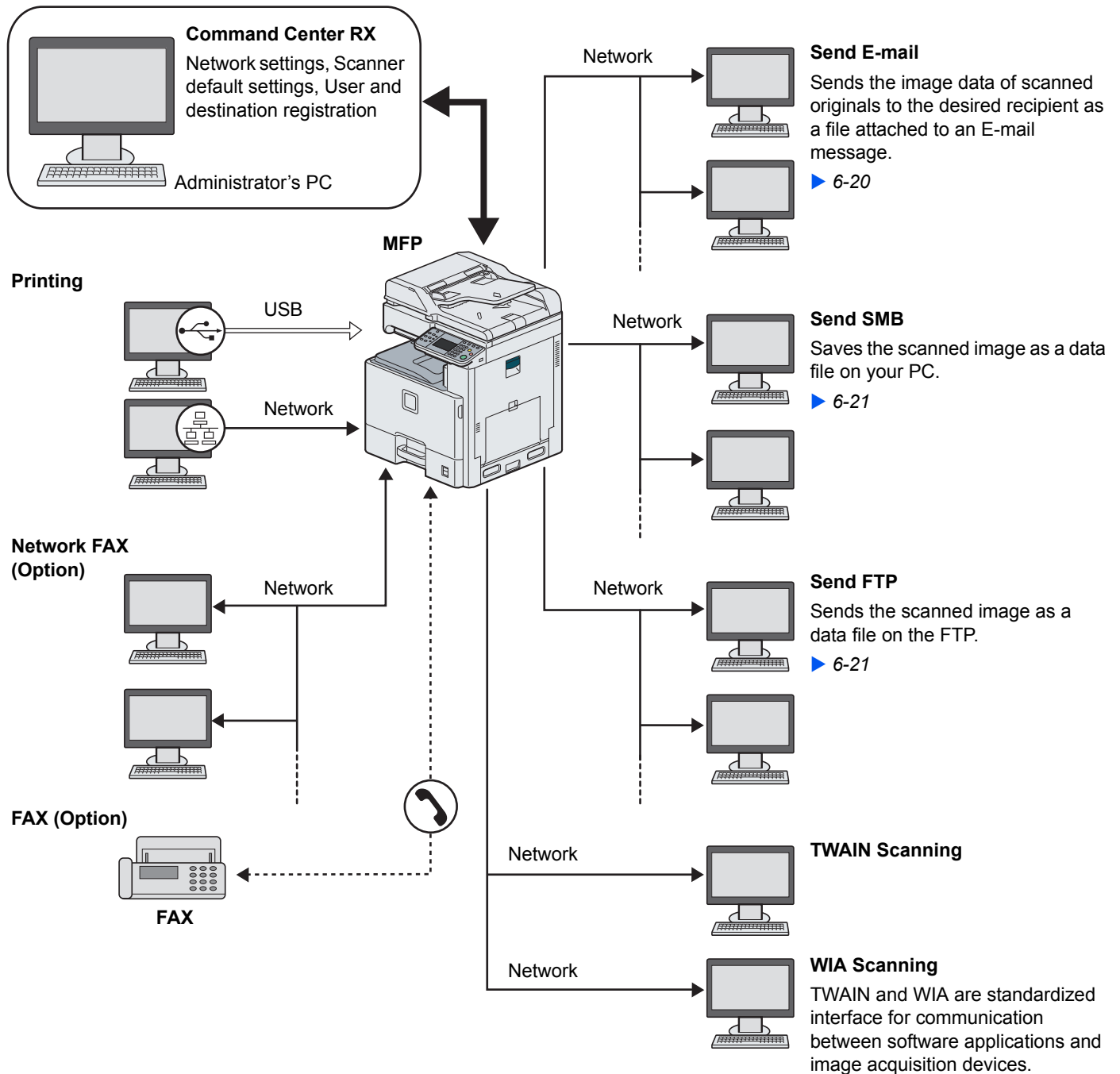

Preparing Necessary Cables

Prepare the necessary cables according to the interface you use.

Connection Environment	Function	Necessary Cable
Connect a LAN cable to the machine.	Printer/Scanner/Scanner (TWAIN/WIA)	LAN (10Base-T, 100Base-TX, or 1000BASE-T Shielded)
Connect a USB cable to the machine.	Printer	USB2.0 compatible cable (Hi-Speed USB compliant, Max. 5.0 m, Shielded)

Connecting Cables

Connecting LAN Cable

The equipment can be connected with a network cable and used as a network printer or network scanner.

1 Power Off.

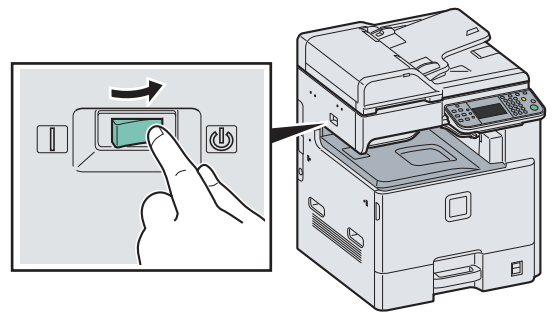
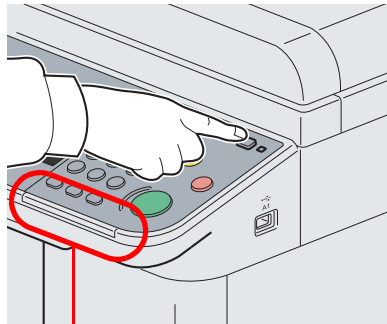

Check that the indicators are off.

2 Connect the machine.

1 Connect the LAN cable to the network interface located on left side of the body.

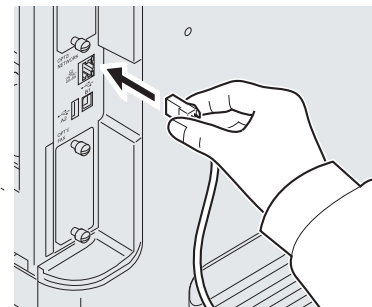
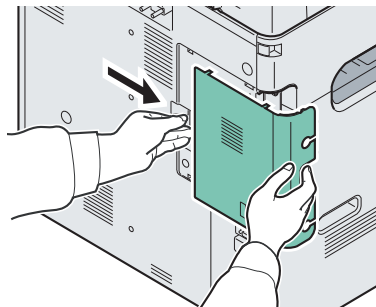

2 Connect the other end of the cable to the hub.

3 Set up the machine.

Configure the network settings.



For details, refer to *Machine Setup Wizard* on page 2-24.

Connecting USB Cable

The equipment can be connected with a USB cable and used as a printer in an environment where there is no network.

1 Power Off.

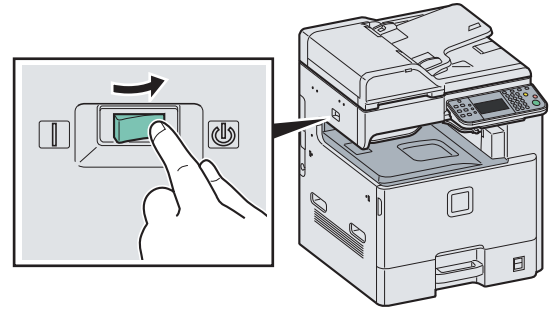
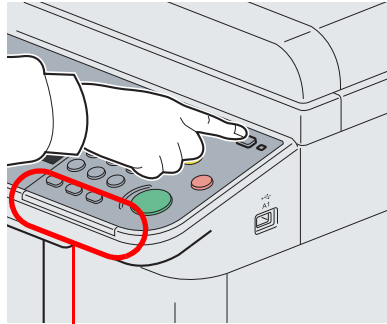

Check that the indicators are off.

2 Connect the machine.

- 1 Connect the USB cable to the appropriate interface located on the left side of the body.

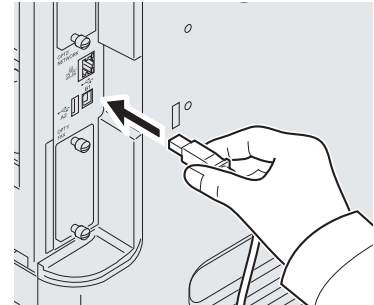
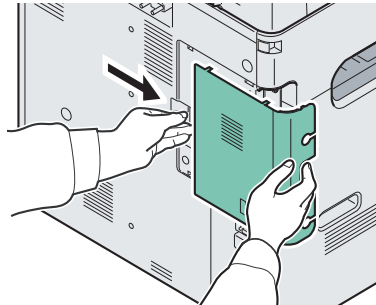

- 2 Connect the other end of the cable to the PC.

Connecting the Power Cable

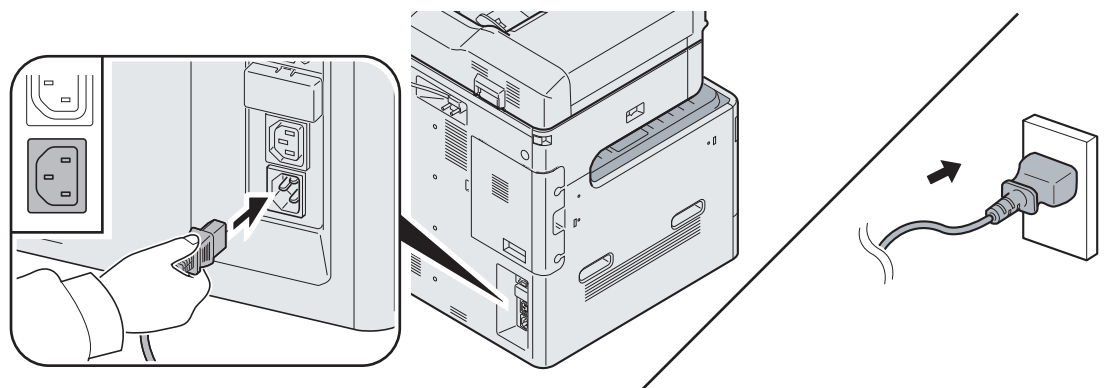

Connect one end of the supplied power cable to the machine and the other end to a power outlet.

 **IMPORTANT**

Only use the power cable that comes with the machine.

Power On/Off

Power On

When the main power indicator is lit... (Recovery from sleep)

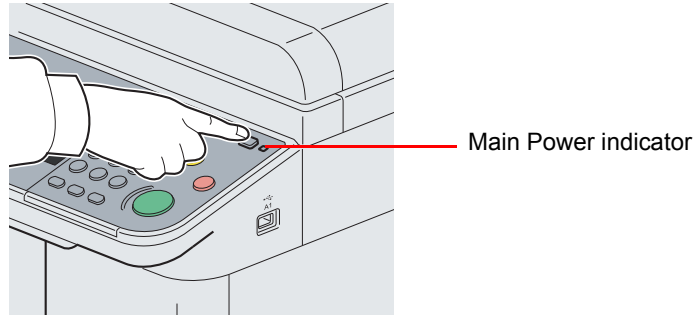

Press the **Power** key.

When the main power indicator is off...

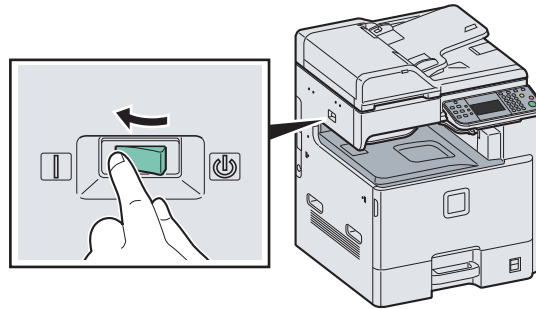

Turn the main power switch on.

✔ IMPORTANT

When turning off the main power switch, do not turn on the main power switch again immediately. Wait more than 5 seconds, and then turn on the main power switch.

Power Off

When not turning off the main power switch (sleep)

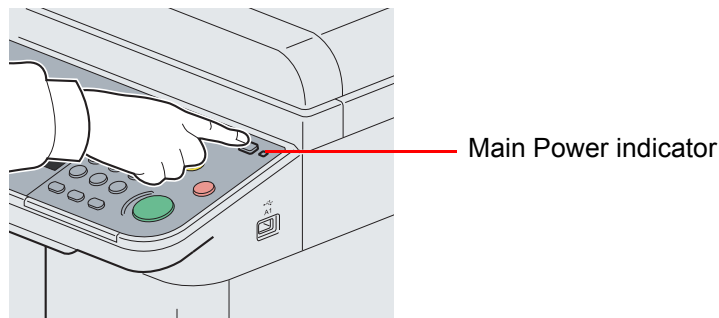

Press the **Power** key. The **Power** key light will go out, and the Main Power indicator will light up.

When turning off the main power switch

Note that when the main power switch is turned off, the machine will be unable to automatically receive print data from computers or faxes.

1 Press the Power key.

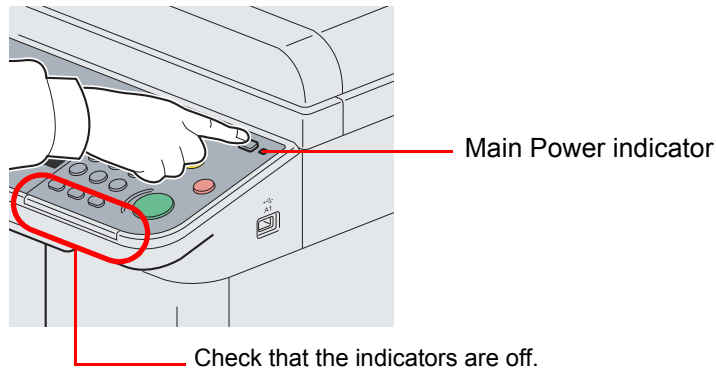

Verify that the **Power** key light has gone out and that the Main Power indicator is lit up.

2 Turn the main power switch off.

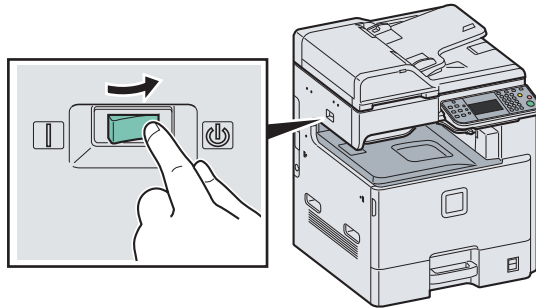

NOTE

When the **Processing** indicator or **Memory** indicator is lit up, the machine is operating. Turning off the main power switch while the machine is operating may cause it to malfunction.

In case of not using the machine for an extended period of time



CAUTION

If this machine will be left unused for an extended period (e.g. overnight), turn it off at the main power switch. If the machine will not be used for an even longer period of time (e.g. vacation), remove the power plug from the outlet as a safety precaution. If the optional Fax kit is installed, note that turning the machine off at the main power switch disables fax transmission and reception.



IMPORTANT

Remove paper from the cassettes and seal it in the paper storage bag to protect it from humidity.

Installing Software

Install appropriate software on your PC from the included DVD (Product Library) if you want to use the printer function of this machine or perform TWAIN / WIA transmission or Network FAX transmission from your PC.

Software on DVD (Windows)

Express Mode or Custom Mode can be selected for the installation method. The software that can be installed and the printer port selection method vary depending on which method is selected.

Software	Function	Description	Installation method	
			Express Mode	Custom Mode
KX driver	Print	This driver enables files on a computer to be printed by the machine. Multiple page description languages (PCL XL, KPDL, etc.) are supported by a single driver. This printer driver allows you to take full advantage of the features of the machine. Use this driver to print PDF files.	●	●*
KX (XPS) printer driver		This printer driver supports the XPS (XML Paper Specification) format developed by Microsoft Corporation.	—	○
Mini printer driver (PCL/KPDL)		This is a Microsoft MiniDriver that supports PCL and KPDL. There are some restrictions on the machine features and option features that can be used with this driver.	—	○
TWAIN driver	Scan	This driver enables scanning on the machine using a TWAIN-compliant software application. The machine has two types of TWAIN drivers: one for scanning a document placed in the machine, and one for reading document data stored in a user box.	●	●*
WIA driver		WIA (Windows Imaging Acquisition) is a function of Windows that enables reciprocal communication between an imaging device such as a scanner and an image processing software application. An image can be acquired using a WIA-compliant software application, which is convenient when a TWAIN-compliant software application is not installed in the computer.	—	○
Network FAX driver	FAX	This makes it possible to send a document created in a computer software application as a fax via the machine.	—	○
File Management Utility	Utility	This makes it possible to send and save a scanned document to a specified network folder.	—	○
KYOCERA Net Direct Print		This makes it possible to print a PDF file without starting Adobe Acrobat/Reader.	—	○
KYOCERA Net Viewer		This is a utility that enables monitoring of the machine on the network.	—	○
Font	—	These are display fonts that enable the machine's built-in fonts to be used in a software application.	●	●*

● Standard installation.

○ Allows selection of the components to be installed.

* Selected by default.

 **NOTE**

Installation on Windows must be done by a user logged on with administrator privileges.

Plug and Play is disabled on this device when in Sleep. Wake the device from Low Power Mode or Sleep before continuing. Refer to *Low Power Mode and Auto Low Power Mode on page 2-22* and *Sleep and Auto Sleep on page 2-23*.

The optional Fax Kit is required in order to make use of fax functionality.

WIA driver cannot be installed on Windows XP.

Installing Printer Driver in Windows

If you are connecting this machine to a Windows PC, follow the next steps to install the printer driver. The example shows you how to connect your machine to a Windows 7 PC.

 **NOTE**

Installation on Windows must be done by a user logged on with administrator privileges.

If the **Welcome to the Found New Hardware Wizard** dialog box displays, select **Cancel**.

If the autorun screen is displayed, click **Run Setup.exe**.

If the user account management window appears, click **Allow**.

You can use either Express Mode or Custom Mode to install the software. Express Mode automatically detects connected machines and installs the required software. Use Custom Mode if you want to specify the printer port and select the software to be installed. For details, refer to Custom Installation in the *Printer Driver User Guide* on the DVD.

1 Insert the DVD.

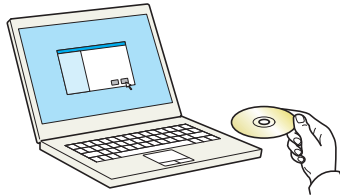

2 Display the screen.

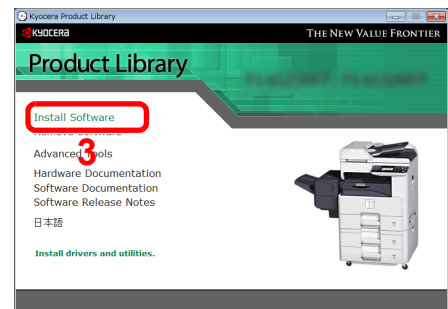
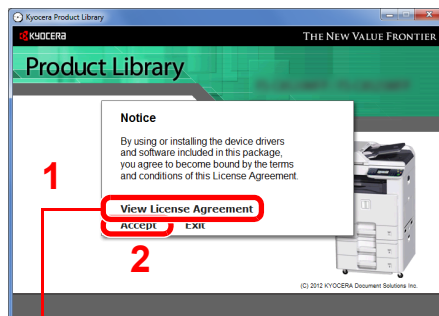

Click **View License Agreement** and read the License Agreement.

3 Install using Express Mode.

- 1 Select the print system to be installed. If the machine is set to acquire an IP address automatically, select the “Use host name for port name” checkbox.

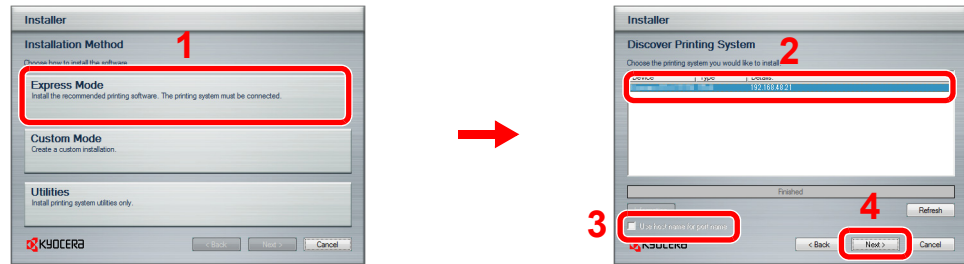

- 2 Customize the print system name if the print system is connected via a network.

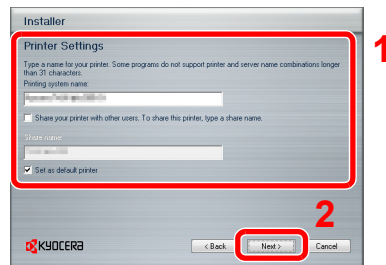

- 3 Start installing.

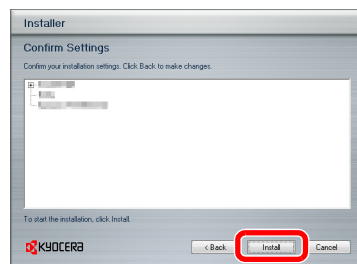

NOTE

The machine cannot be detected unless it is on. If the computer fails to detect the machine, verify that it is connected to the computer via a network or USB cable and that it is turned on and click **Reload**.

If the Windows security window appears, click **Install this driver software anyway**.

4 Finish the installation.

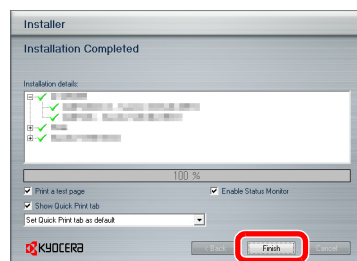

Follow the on-screen instructions to restart the system, if required. This completes the printer driver installation procedure.

The TWAIN driver and WIA driver can be installed if the machine and computer are connected via a network. You can install the WIA driver using Custom Mode.

If you are installing the TWAIN driver or WIA driver, continue by configuring the TWAIN driver (2-20) or WIA driver (2-21).

Uninstalling the Software

Perform the following procedure to delete the Software from your computer.



NOTE

Uninstallation on Windows must be done by a user logged on with administrator privileges.

1 Display the screen.

Click on the **Start** in the Task Bar and then select **All Programs, Kyocera, and Uninstall Kyocera Product Library** to display the Uninstall Wizard.

2 Uninstall the software.

Place a check in the check box of the software to be deleted.

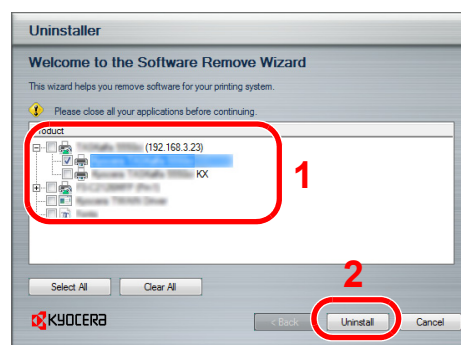

3 Finish uninstalling.

If a system restart message appears, restart the computer by following the screen prompts. This completes the software uninstallation procedure.

Installing Printer Driver in Macintosh

The machine's printer functionality can be used by a Macintosh computer.

NOTE

Installation on MAC OS must be done by a user logged on with administrator privileges.

When printing from a Macintosh computer, set the machine's emulation to "KPD L" or "KPD L(Auto)". For details about the configuration method, refer to *Printer on page 9-17*.

If connecting by Bonjour, enable Bonjour in the machine's network settings. For details, refer to *Network on page 9-19*.

In the Authenticate screen, enter the name and password used to log in to the operating system.

1 Insert the DVD.

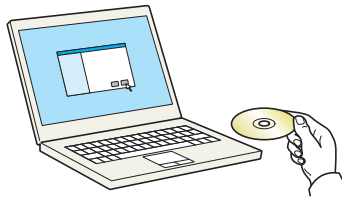

Double-click the Kyocera icon.

2 Display the screen.

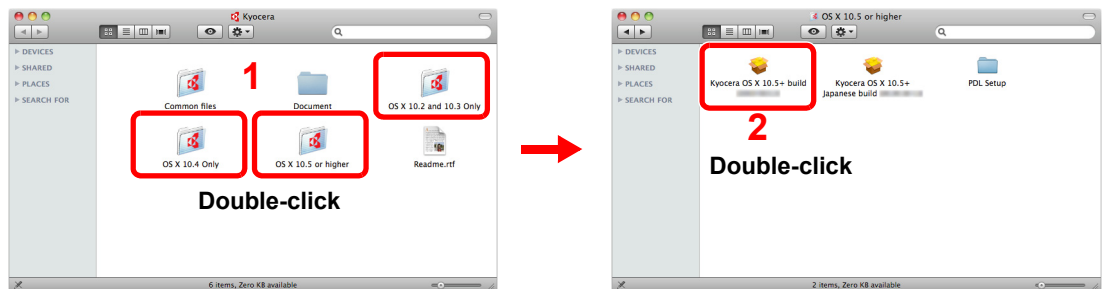

Double-click either **OS X 10.2 and 10.3 Only**, **OS X 10.4 Only** or **OS X 10.5 or higher** depending on your Mac OS version.

3 Install Printer Driver.

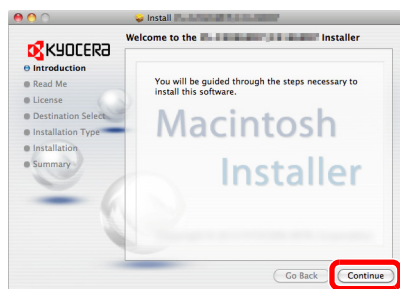

Install the printer driver as directed by the instructions in the installation software.

This completes the printer driver installation.

Next, specify the print settings. If an IP connection is used, the settings below are required. If a USB connection is used, the machine is automatically recognized and connected.

4 Configure the printer.

1 Display the window.

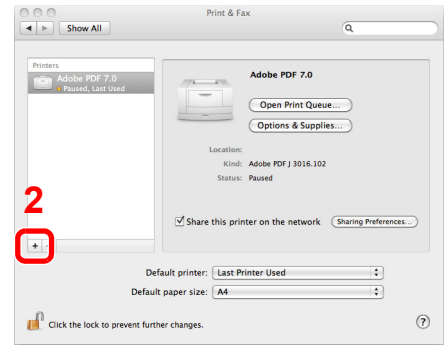
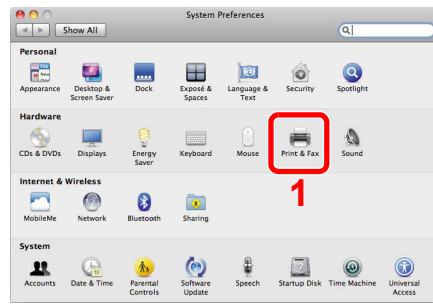

2 Click the IP icon for an IP connection and then enter the IP address and printer name.

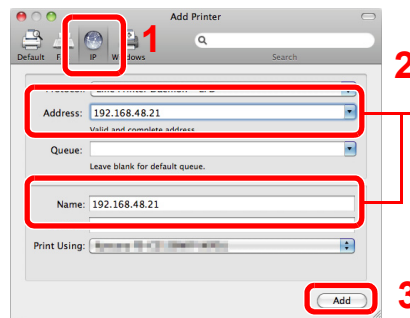

The number entered in "Address" will automatically appear in "Name". Change if needed.

3 Select the options available for the machine and click Continue.

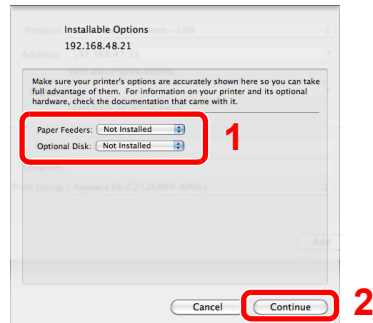

4 The selected machine is added.

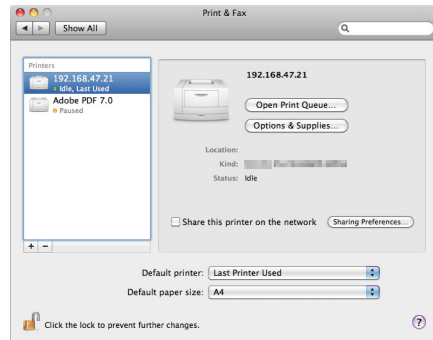

Setting TWAIN Driver

Register this machine to the TWAIN Driver.

1 Display the screen.

- 1 Select **Start** button of the Windows display, **All Programs**, **Kyocera** and then **TWAIN Driver Setting**. TWAIN Driver screen appears.

2 Click Add.

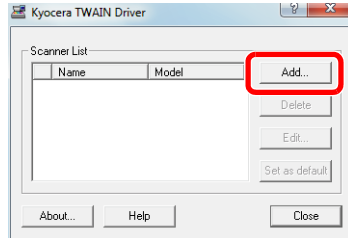

2 Configure TWAIN Driver.

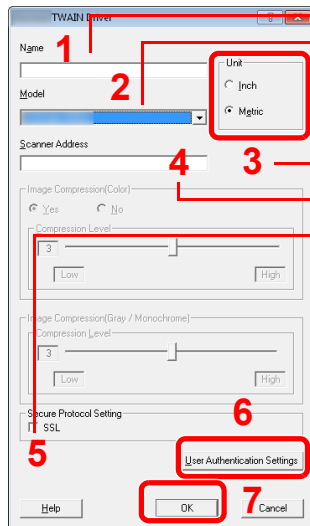

- 1 Enter the machine name.
- 2 Select this machine from the list.

3 Set units of measurement.

4 Enter the machine's IP address or host name.

5 When using SSL, select the checkbox beside **SSL**.

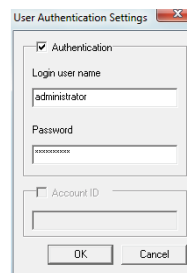

When user login administration is enabled, select the checkbox beside **Authentication**, and enter Login User Name (up to 321 characters) and Password (up to 64 characters).

When job accounting is enabled, select the checkbox beside **Account ID**, and enter the account ID as many as eight digits.



NOTE

When the machine's IP address is unknown, contact Administrator.

3 Finish registering.

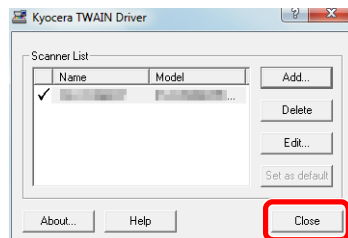

NOTE

Click **Delete** to delete the added machine. Click **Edit** to change names.

Setting WIA Driver

Register this machine to the WIA Driver. Instructions are based on interface elements as they appear in Windows 7.

1 Display the screen.

- 1 Click the Windows **Start** button and enter **Scanner** in **Program and File Search**. Click **View scanners and cameras** in the search list. The Scanners and Cameras screen appears.
- 2 Select the same name as this machine from WIA Drivers, and press the **Properties**.

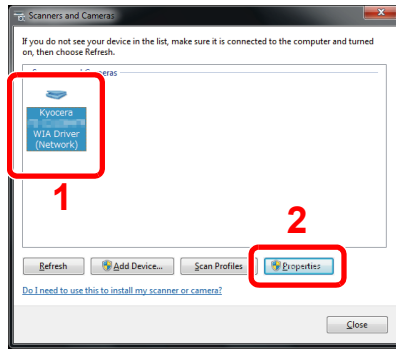

2 Configure WIA Driver.

Enter the machine name.

When using SSL, select the checkbox beside **SSL**.

Set units of measurement.

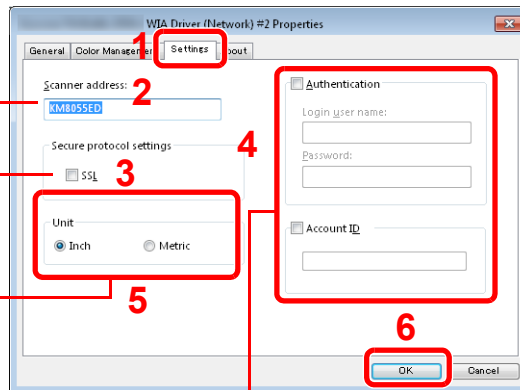

When user login administration is enabled, select the checkbox beside **Authentication**, and enter Login User Name (up to 321 characters) and Password (up to 64 characters).

When job accounting is enabled, select the checkbox beside **Account ID**, and enter the account ID as many as eight digits.

Energy Saver function

Low Power Mode and Auto Low Power Mode



Low Power Mode

To activate Low Power Mode, press the **Energy Saver** key. Touch panel and all indicators on the operation panel will go out to save power except the **Energy Saver**, **Power**, and Main Power indicators. This status is referred to as Low Power Mode.

If print data is received during Low Power Mode, the machine automatically wakes up and starts printing. Also when fax data arrives while the machine is in Low Power Mode when using the optional fax, the machine automatically wakes up and starts printing.

To resume, perform one of the following actions. The machine will be ready to operate within 10 seconds.

- Press any key on the operation panel.
- Open the document processor.
- Place originals in the document processor.

Note that ambient environmental conditions, such as ventilation, may cause the machine to respond more slowly.

Auto Low Power Mode

Auto Low Power Mode automatically switches the machine into Low Power Mode if left idle for a preset time. The default preset time is 3 minutes.



For more information about configuring settings, refer to *Low Power Timer* on page 9-24.

Sleep and Auto Sleep

Sleep

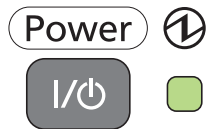

To enter Sleep, press the **Power** key. Touch panel and all indicators on the operation panel will go out to save a maximum amount of power except the Main Power indicator. This status is referred to as Sleep.

If print data is received during Sleep, the touch panel lights up and printing starts.

When using the optional fax, received data is printed out while the operation panel remains unlit.

To resume, press the **Power** key. The machine will be ready to use within 23 seconds.

Note that ambient environmental conditions, such as ventilation, may cause the machine to respond more slowly.

Auto Sleep

Auto Sleep automatically switches the machine into Sleep if left idle for a preset time in the Low Power Mode. The default preset time is 20 minutes (for FS-C8520MFP) and 30 minutes (for FS-C8525MFP).



For more information about configuring settings, refer to *Sleep Timer on page 9-25*.

Energy Saver

This mode reduces power consumption even more than normal Sleep mode, and allows Sleep Mode to be set separately for each function. Printing from a computer connected with a USB cable is not available while the machine is asleep.

To use the machine, press the **Power** key. The time required for the machine to wake up from power save mode and resume normal operation will be longer than for normal Sleep Mode.



NOTE

If the optional Gigabit Ethernet Board is installed, Energy Saver cannot be specified.



For more information on Energy Saver Mode settings, refer to *Sleep Level on page 9-25*.

Machine Setup Wizard

The Machine Setup Wizard is launched when the equipment is turned on for the first time after being installed.

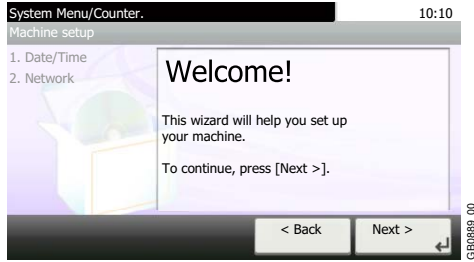

Following the instructions on the screen to configure the following settings:

Date/Time settings	Time Zone
	Summer Time
	Date
	Time
Network settings	Obtain IP Address
	IP Address
	Subnet Mask
	Default Gateway



For details about settings, refer to the help information displayed on the touch panel. To make changes after this initial configuration, refer to *Date/Timer* on page 9-24 and *System* on page 9-19.

Command Center RX (Settings for E-mail)

Command Center RX is a tool used for tasks such as verifying the operating status of the machine and changing the settings for security, network printing, E-mail transmission and advanced networking.

This section explains how to access Command Center RX and configure e-mail settings. For details on Command Center RX, refer to the *Command Center RX User Guide*.



NOTE

Here, information on the FAX settings has been omitted. For more information on using the FAX, refer to *the Fax System (U) Operation Guide*.

The optional Fax Kit is required in order to make use of fax functionality.

To fully access the features of the Command Center RX pages, enter the User Name and Password and click Login. Entering the predefined administrator password allows the user to access all pages, including Document Box, Address Book, and Settings on the navigation menu.

The factory default setting for the default user with administrator privileges is shown below.

Login User Name: Admin

Login Password: Admin

*** Upper case and lower case letters are distinguished (case sensitive).**

The procedure for accessing Command Center RX is explained below.

1 Display the screen.

1 Launch your Web browser.

2 In the Address or Location bar, enter the machine's IP address.

E.g.) `http://192.168.48.21/`

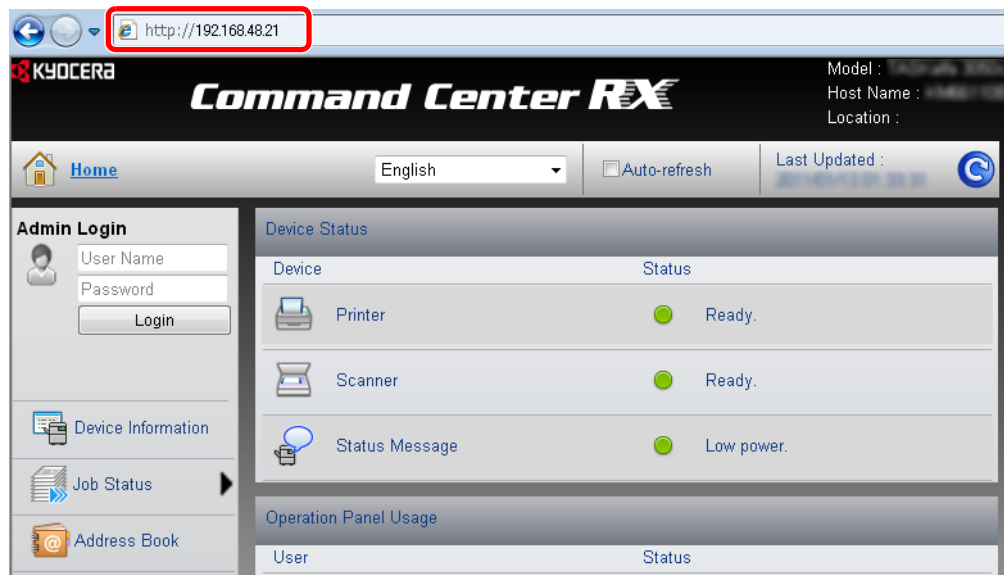

The web page displays basic information about the machine and Command Center RX as well as their current status.

2 Configure the function.

Select a category from the navigation bar on the left of the screen. When you log in to the machine as an administrator, Settings appear.

Sending E-mail

Specifying the SMTP settings allows you to send images loaded onto this machine as E-mail attachments. To use this function, this machine must be connected to a mail server using the SMTP protocol. Before sending images loaded onto this machine as E-mail attachments, check the following:

- The network environment used to connect this machine to the mail server: A full-time connection via a LAN is recommended.
- SMTP Settings: Use Command Center RX to register the IP address or host name of the SMTP server.
- If limits have been set on the size of E-mail messages, it may not be possible to send very large E-mails.

The procedure for specifying the SMTP settings is explained below.

1 Display the screen.

Click Settings -> Advanced -> SMTP -> General.



2 Configure the function.

Enter the correct settings in each field.

Item	Description
SMTP Protocol	Enables or disables SMTP protocol. To use E-mail, this protocol must be enabled.
SMTP Port Number	Set the SMTP Port Number or use the SMTP default port 25.
SMTP Server Name	Enter the SMTP server IP address or its name. The maximum length of the SMTP server name and IP address is 64 characters. If entering the name, a DNS server address must also be configured. The DNS server address may be entered on the TCP/IP General tab.
SMTP Server Timeout	Set the amount of time to wait before time-out in seconds.
Authentication Protocol	Enables or disables the SMTP authentication protocol or sets POP before SMTP as the protocol. The SMTP authentication supports Microsoft Exchange 2000.
Authenticate as	Authentication can be set from three POP3 accounts or you can choose a different account.
Login User Name	When Other is selected for Authenticate, the login user name set here will be used for SMTP authentication. The maximum length of the login user name is 64 characters.

Item	Description
Login Password	When Other is selected for Authenticate, the password set here will be used for authentication. The maximum length of the login password is 64 characters.
SMTP Security	Enables or disables the SMTP Security. When this protocol is enabled, either SSL/TLS or STARTTLS must be selected. To enable SMTP security, the SMTP port may have to be changed according to the server settings. Typically, 465 for SSL/TLS and 25 or 587 for STARTTLS are well-known SMTP ports.
POP before SMTP Timeout	Set the amount of time to wait before time-out in seconds when you have selected POP before SMTP as the Authentication Protocol.
Test	Tests to confirm that the settings on this page are correct. When the Test button is pressed, this machine tries to connect to the SMTP server.
E-mail Size Limit	Enter the maximum size of E-mail that can be sent in kilobytes. When the value is 0, no maximum size is set.
Sender Address	Enter the E-mail address of the person responsible for the machine, such as the machine administrator, so that a reply or non-delivery report will go to a person rather than to the machine. The sender address must be entered correctly for SMTP authentication. The maximum length of the sender address is 128 characters.
Signature	Enter the signature. The signature is free form text that will appear at the end of the E-mail body. It is often used for further identification of the machine. The maximum length of the signature is 512 characters.
Domain Restriction	Enter the domain names that can be permitted or rejected. The maximum length of the domain name is 32 characters. You can also specify E-mail addresses.

3 Click [Submit].

3 Common Operations

This chapter explains the following topics:

Loading Paper	3-2
Before Loading Paper	3-2
Loading Paper in the Cassettes	3-3
Loading Paper in the Multi Purpose Tray	3-5
Loading Originals	3-7
Placing Originals on the Platen	3-7
Loading Originals in the Document Processor	3-8
Checking the Equipment's Serial Number	3-10
Checking the Counter	3-11
Login/Logout	3-12
Favorites	3-14
Registering Favorites	3-14
Editing and Deleting Favorites	3-18
Using Favorites	3-20
Application	3-21
Shortcuts	3-22
Registering Shortcuts	3-22
Editing and Deleting Shortcuts	3-24
Using Shortcuts	3-25
Quick Setup Wizard	3-26
Help Screen	3-28
Canceling Jobs	3-29
Using Various Functions	3-30
Original Size	3-32
Original Orientation	3-34
Mixed Size Originals	3-35
2-sided/Book Original	3-37
Continuous Scan	3-40
Paper Selection	3-42
Paper Output	3-43
Collate/Offset	3-44
Margin	3-46
Staple	3-49
Density	3-51
Scan Resolution	3-52
Original Image	3-53
Sharpness	3-54
Background Density Adjust	3-55
Prevent Bleed-through	3-56
Zoom	3-57
File Format	3-58
Color Selection	3-60
Job Finish Notice	3-61
File Name Entry	3-63
Priority Override	3-64

Loading Paper

Paper can be loaded standardly in the cassette and the multi purpose tray. A paper feeder is also available as an option (refer to *Optional Equipment on page 11-2*).

Before Loading Paper

When you open a new package of paper, fan the sheets to separate them slightly prior to loading in the following steps.

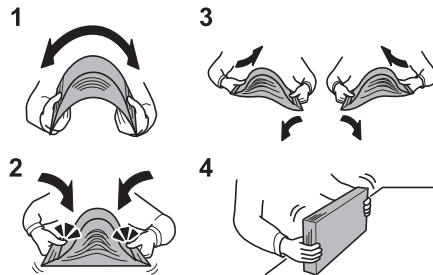

- 1 Bend the whole set of sheets to swell them in the middle.
- 2 Hold the stack at both ends and stretch it while keeping the entire stack swelled.
- 3 Raise the right and left hands alternately to create a gap and feed air between the papers.
- 4 Finally, align the papers on a level, flat table.

If the paper is curled or folded, straighten it before loading. Paper that is curled or folded may cause a jam.

 **IMPORTANT**

If you copy onto used paper (paper already used for copying), do not use paper that is stapled or clipped together. This may damage the machine or cause poor image quality.

 **NOTE**

If printouts are curled or not neatly stapled, turn the stack in the cassette upside down.

If you use special paper such as letterhead, paper with holes or paper with pre-prints like logo or company name, refer to *Paper on page 11-10*.

Avoid exposing opened paper to high temperatures and high humidity as dampness can be a cause of problems. Seal any remaining paper after loading in the multi purpose tray or cassettes back in the paper storage bag.

If the machine will not be used for a prolonged period, protect all paper from humidity by removing it from the cassettes and sealing it in the paper storage bag.

Loading Paper in the Cassettes

The standard cassette will each hold plain paper, recycled paper or color paper. The standard cassette holds up to 500 sheets of plain paper (80 g/m²).

The following paper sizes are supported: Ledger, Letter-R, Letter, Legal, Statement-R, Oficio II, A3, B4, A4, A4-R, A5-R, B5, B5-R, Folio, 216 × 340 mm, 8K, 16K-R, and 16K.

NOTE

You should not use inkjet printer paper or any paper with a special surface coating. (Such paper may cause paper jams or other faults.)

For clearer and brighter color copies, use the special color paper.

When using media types other than plain paper (such as recycled or colored paper), always specify the media type setting. (Refer to *Media Type* on page 9-8) The cassettes can hold paper with weights up to 256 g/m². If you are using a paper weight between 106 and 256 g/m², set the media type to *Thick*.

If the machine will not be used for a prolonged period, protect all paper from humidity by removing it from the cassettes and sealing it in the paper storage bag.

1 Adjust the cassette size.

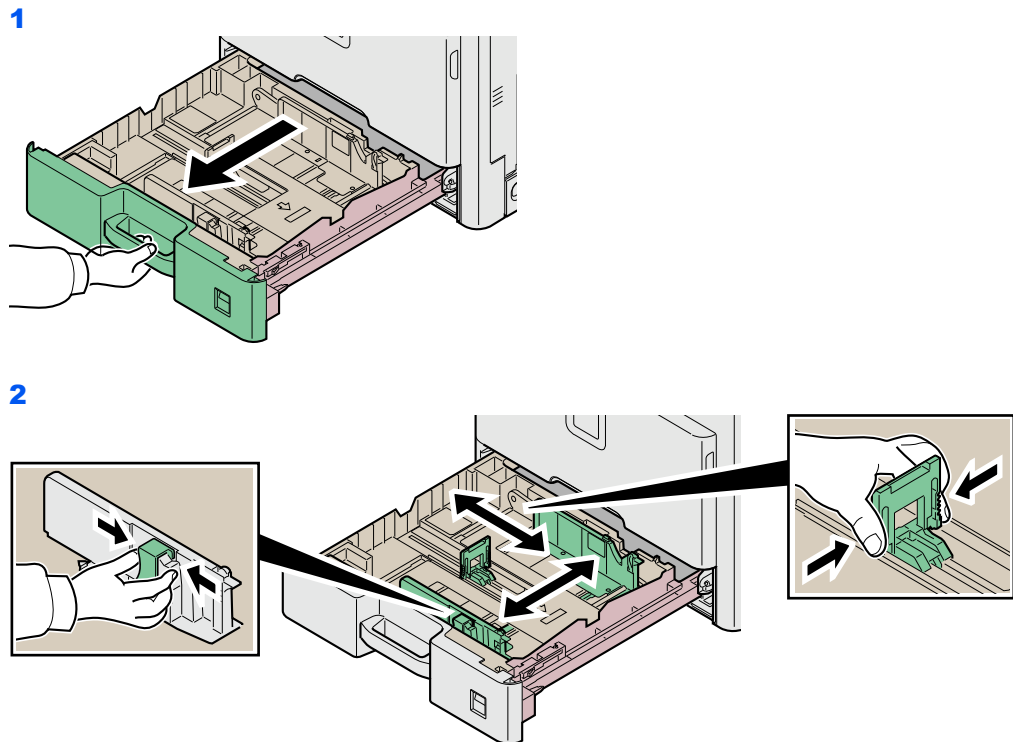

Adjust the cassette size to reflect the size of paper being loaded. Paper sizes are marked on the cassette.

NOTE

When using 11 × 17" (ledger) paper, lay the paper length guide down flat.

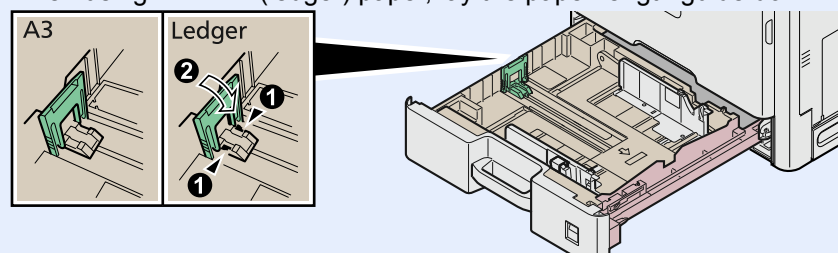

2 Load paper.

1

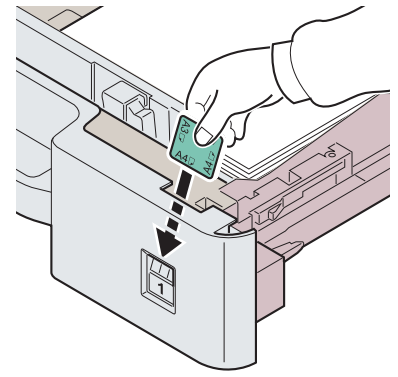
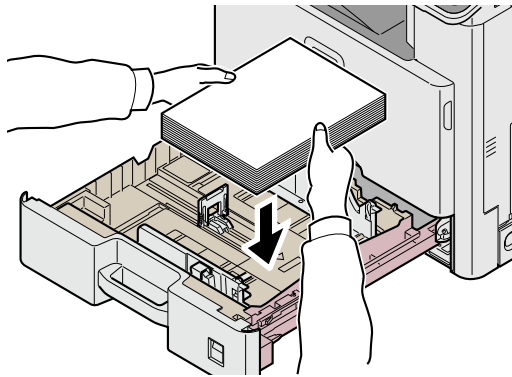

2

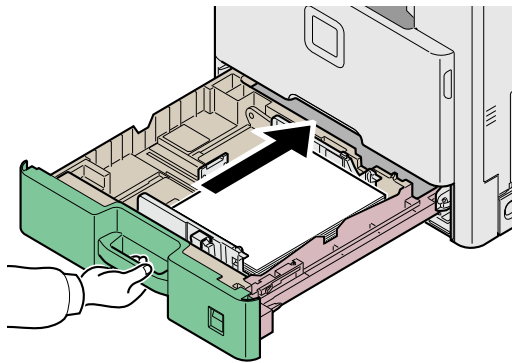

✔ IMPORTANT

Load the paper with the print side facing up.

Before loading the paper, be sure that it is not curled or folded. Paper that is curled or folded may cause paper jams.

Ensure that the loaded paper does not exceed the level indicator (see the figure).

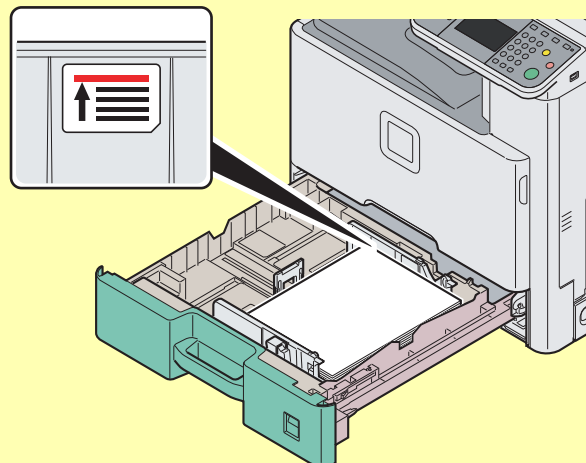

When loading the paper, keep the side that was closest the package seal facing up.

The paper length and width guides must be adjusted to the paper size. Loading the paper without adjusting these guides may cause skewed feeding and paper jams.

Be sure that the paper length and width guides rest securely against the paper. If there is a gap, readjust the guides to fit the paper.

Loading Paper in the Multi Purpose Tray

The multi purpose tray will hold up to 100 sheets of A4 or smaller plain paper (80 g/m²) or up to 25 sheets of plain paper (80 g/m²) larger than A4.

The multi purpose tray accepts paper sizes from A3 to A6 and Hagaki and from Ledger to Statement-R, 8K, 16K-R and 16K. Be sure to use the multi purpose tray when you print on any special paper.

✔ IMPORTANT

When using media types other than plain paper (such as recycled or colored paper), always specify the media type setting. (Refer to *Cassette/MP Tray Settings* on page 9-8.) If you are using a paper weight of 106 g/m² or more, set the media type to *Thick*.

The capacity of the multi purpose tray is as follows.

- A4 or smaller plain paper (80 g/m²), recycled paper or color paper: 100 sheets
- B4 or larger plain paper (80 g/m²), recycled paper or color paper: 25 sheets
- Hagaki: 20 sheet
- Envelope DL, Envelope C5, Envelope #10 (Commercial #10), Monarch, Youkei 4, Youkei 2: 5 sheets
- Heavy paper (106 to 256 g/m²): 10 sheets (when using heavy paper with a weight of 164 g/m² or greater, only A4/ Letter or smaller sheets can be loaded)

🧠 NOTE

When you load custom size paper, enter the paper size by referring to *Paper Size* on page 9-8.

When you use special paper such as thick paper, select the media type by referring to *Media Type* on page 9-8.

1 Adjust the multi purpose tray size.

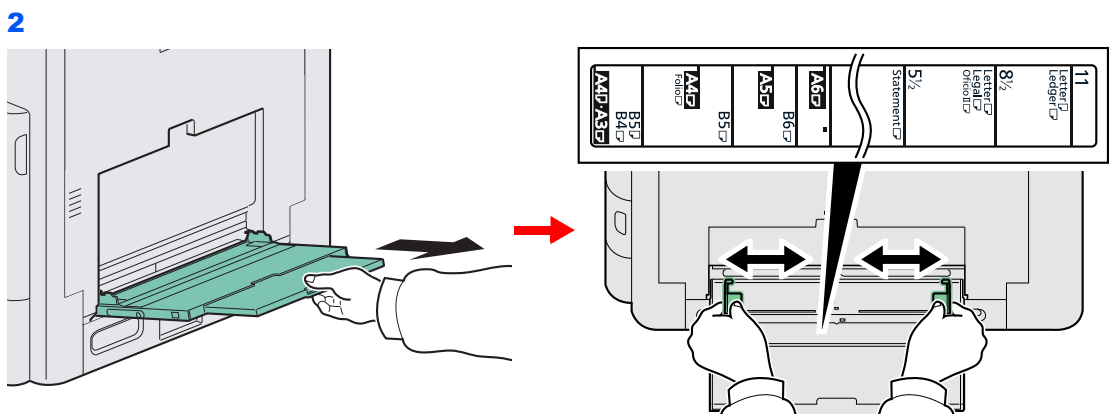
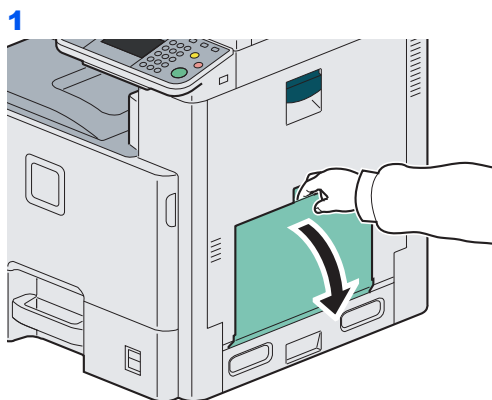

When loading paper sizes from A3 to B4 and Ledger to Legal, extend the support tray section of the multi purpose tray.

2 Load paper.

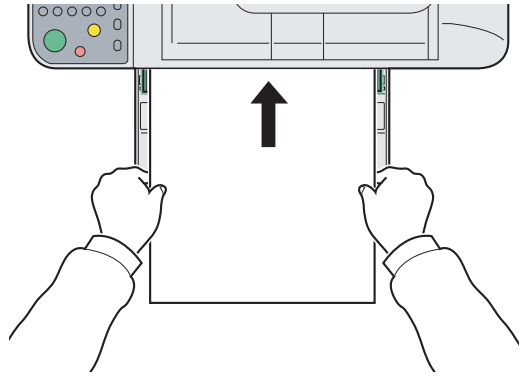

Insert the paper along the paper width guides into the tray until it stops.

✔ IMPORTANT

Load the paper with the print side facing down.

Curled paper must be uncurled before use.

Straighten the top edge if it is curled.

When loading paper into the multi purpose tray, check that there is no paper left over in the tray from a previous job before loading the paper. If there is just a small amount of paper left over in the multi purpose tray and you want to add more, first remove the left-over paper from the tray and include it with the new paper before loading the paper back into the tray.

When you load envelopes or cardstock in the multi purpose tray

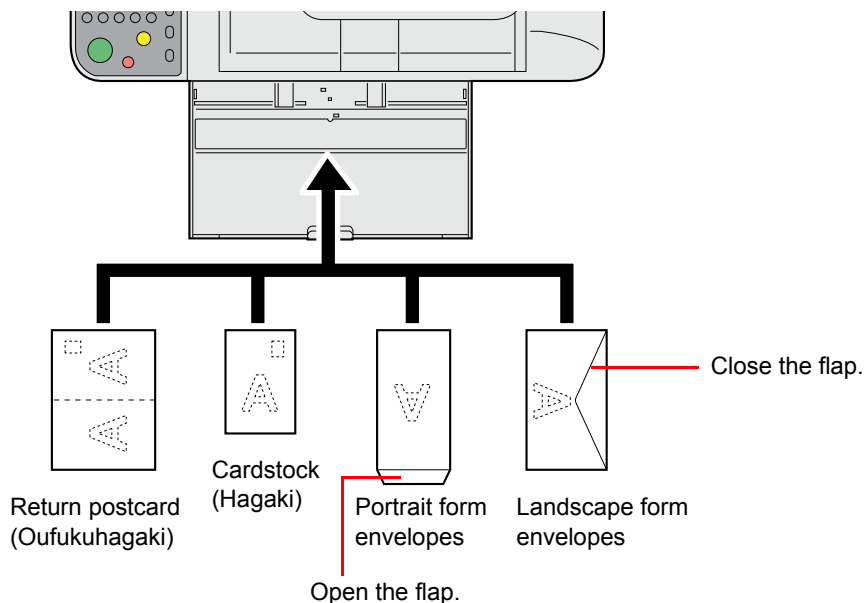

Load envelope with the print side facing down.

✔ IMPORTANT

Use unfolded return postcard (Oufukuhagaki).

How to load envelopes (orientation and facing) will differ depending on the type of envelope. Be sure to load it in correctly, otherwise printing may be done in the wrong direction or on the wrong face.

Loading Originals

Placing Originals on the Platen

You may place books or magazines on the platen in addition to ordinary sheet originals.

 **NOTE**

Before opening the document processor, be sure that there are no originals left on the original table or on the original eject table. Originals left on the original table or on the original eject table may fall off when the document processor is opened.

Shadows may be produced around the edges and in the middle of open-faced originals.

Align it flush against the original size indicator plates with the back left corner as the reference point.

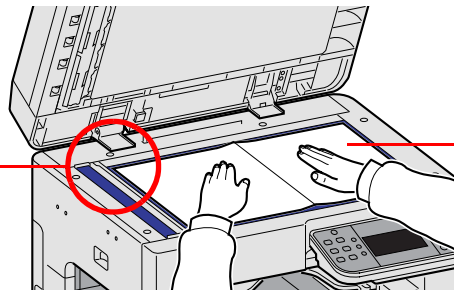

Put the scanning side facedown.

Open the document processor, and place the original.

 **CAUTION**

Do not leave the document processor open as there is a danger of personal injury.

 **IMPORTANT**

Do not push the document processor forcefully when you close it. Excessive pressure may crack the platen glass.

When placing books or magazines on the machine, do so with the document processor in the open position.

Loading Originals in the Document Processor

The document processor automatically scans each sheet of multiple originals. Both sides of two-sided originals are scanned.

Originals Supported by the Document Processor

Weight	45 to 160 g/m ² (duplex: 50 to 120 g/m ²)
Size	Maximum A3 to Minimum A5-R Maximum Ledger to Minimum Statement-R
Capacity	Plain paper (80 g/m ²), Colored paper, Recycled paper, High quality paper: 50 sheets (Mixed size originals: 30 sheets) Thick paper (157 g/m ²): 25 sheets Thick paper (120 g/m ²): 33 sheets Art paper: 1 sheet

Originals Not Supported by the Document Processor

- Soft originals such as vinyl sheets
- Transparencies such as OHP film
- Carbon paper
- Originals with very slippery surfaces
- Originals with adhesive tape or glue
- Wet originals
- Originals with correction fluid which is not dried
- Irregularly shaped (non-rectangular) originals
- Originals with cut-out sections
- Crumpled paper
- Originals with folds (Straighten the folds before loading. Failure to do so may cause the originals to jam).
- Originals bound with clips or staples (Remove the clips or staples and straighten curls, wrinkles or creases before loading. Failure to do so may cause the originals to jam).

How to Load Originals

✔ IMPORTANT

- Do not make an impact on the document processor top cover, such as aligning the originals on the top cover. It may cause an error in the document processor.
- Before loading originals, be sure that there are no originals left on the original eject table. Originals left on the original eject table may cause the new originals to jam.

1 Adjust the original table size.

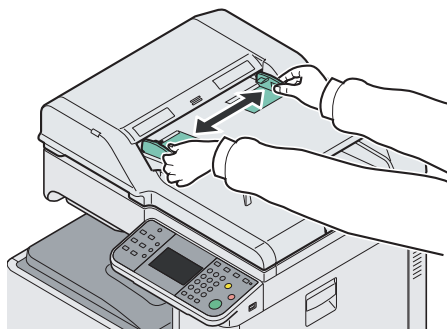

2 Load Originals.

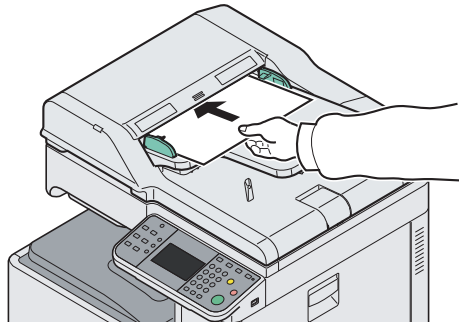

With the side to be scanned face up, insert the leading edge of the original all the way into the document processor. If the original is two-sided, insert with the front side face up.

✔ IMPORTANT

Ensure that loaded originals do not exceed the level indicator. Exceeding the maximum level may cause the originals to jam (see the figure).

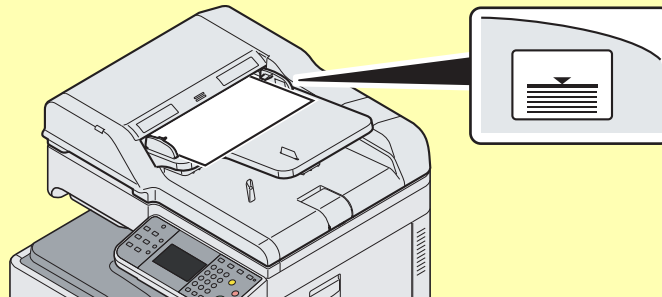

Confirm that the original width guides exactly fit the originals. If there is a gap, readjust the original width guides. The gap may cause the originals to jam.

Originals with punched holes or perforated lines should be placed in such a way that the holes or perforations will be scanned last (not first).

Original Loaded Indicator

The original loaded indicator lights depending on how originals are placed.

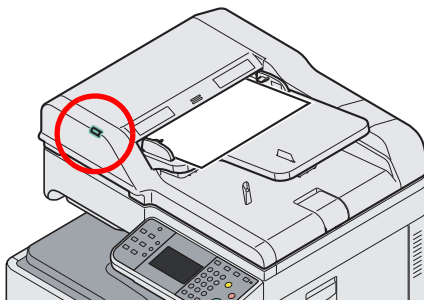

- Green (left indicator) lit: Original is placed properly.

Checking the Equipment's Serial Number

The equipment's serial number is printed in the location shown in the figure.

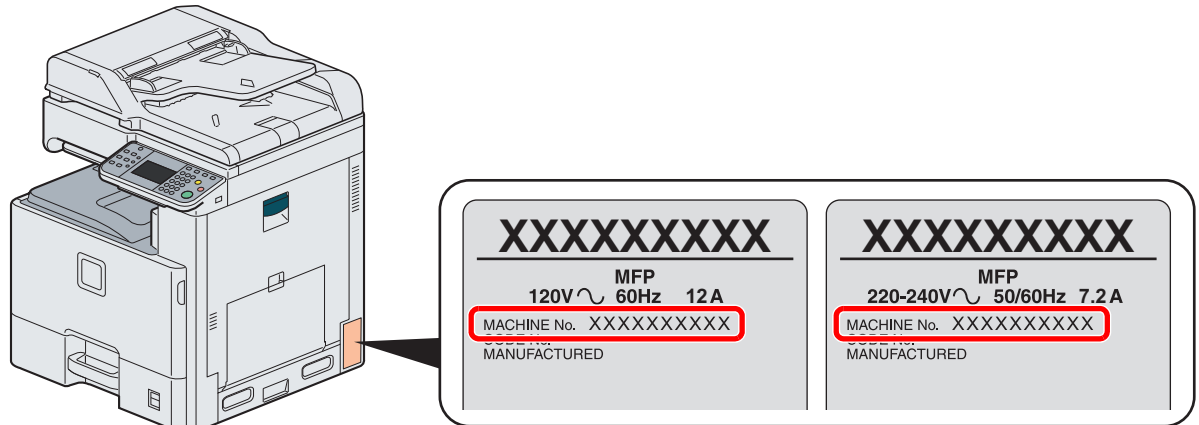

NOTE

You'll need the equipment's serial number when contacting your Service Representative. Please check the number before contacting your Service Representative.

Checking the Counter

Check the number of pages printed and scanned.

1 Display the screen.

◆ System Menu / Counter

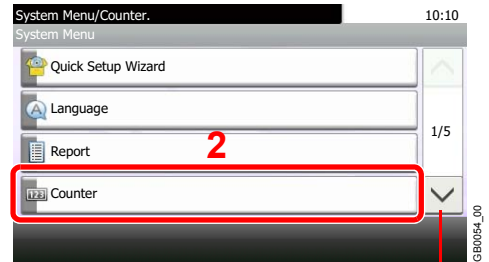
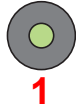

Use [∨] or [∧] to scroll up and down.

2 Check the counter.

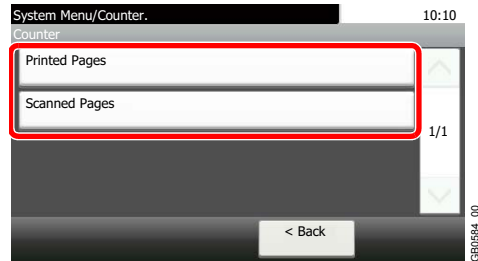

Select the job you wish to check.

[Printed Pages]

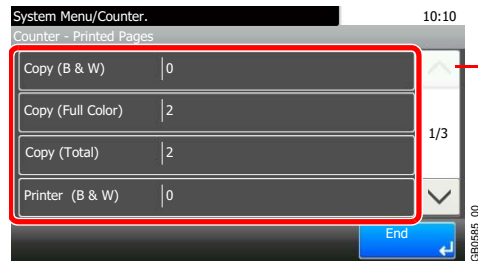

Use [∨] or [∧] to scroll up and down.

Scroll the screen to check the number of pages. Pressing [Count by Paper Size] and then [Black & White] allows you to check the number of pages by paper size.

[Scanned Pages]

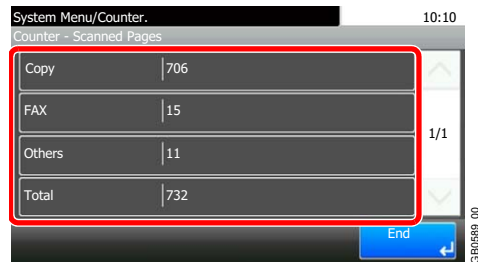

Login/Logout

If you are setting a function that requires administrator rights, or if user login administration is enabled, you must enter your login user name and login password.



NOTE

The factory default login user name and login password are set as shown below.

Model Name	Login User Name	Login Password
FS-C8520MFP	2000	2000
FS-C8525MFP	2500	2500

You will be unable to login if you forget your login user name or login password. In this event, login with administrator privileges and change your login user name or login password.

Login

Normal login

1 Enter the login user name.

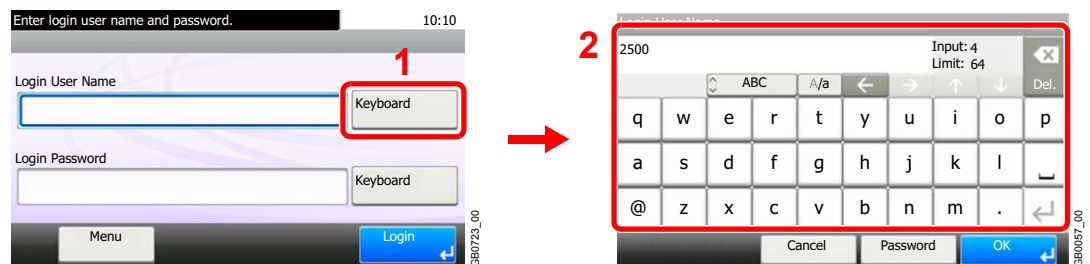

If this screen is displayed during operations, press [Keyboard] to enter the login user name. The name can also be entered using the numeric keypad.



Refer to *Character Entry Method* on page 11-7 for details on entering characters.

2 Enter the login password.

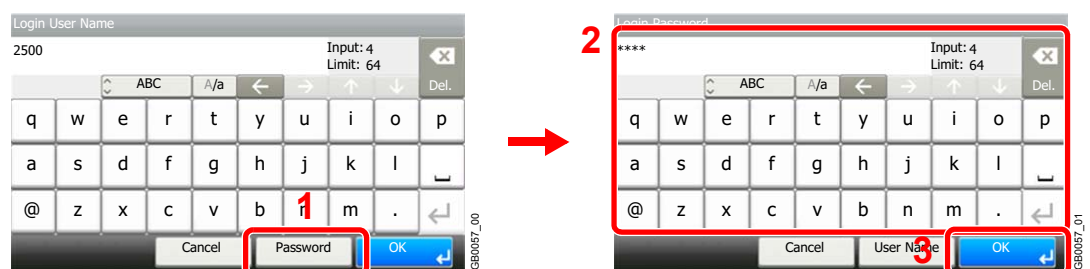

Press [Password] to enter the login password.

3 Log in.



NOTE

If *Network Authentication* is selected as the user authentication method, either Local or Network can be selected as the authentication destination.

Simple Login

If this screen is displayed during operations, select a user and log in.



NOTE

If a user password is required, an input screen will be displayed.



Refer to *Simple Login* on page 9-47.

Logout

To logout from the machine, press the Logout key to return to the login user name/password entry screen.

Logout



Users are automatically logged out in the following circumstances:

- When the machine is put to Sleep by pressing the **Power** key.
- When the Auto Sleep function is activated.
- When the auto panel reset function is activated.
- When Auto Low Power Mode is activated.
- When the machine is placed in Low Power Mode by pressing the **Energy Saver** key.

Favorites

Frequently used functions can be registered as favorites so that they can be called up easily.

The following functions are pre-registered on this machine. You can delete these functions as well as register new functions. The functions created by the external software, such as File Management Utility, are also displayed here.

- ID Card Copy
- Paper Saving Copy
- Scan to PC (Address Entry)
- Scan to PC (Address Book)
- Scan to E-mail (Address Entry)
- Scan to E-mail (Address Book)

Registering Favorites

When registering a favorite, you can choose from two methods for calling it up:

- *Wizard* mode (Interactive selection form): Registered settings are called up in order and configured as you check or change each one.
- *Program* mode: Settings are called up immediately when you press the key to which they are registered.

Transmission is explained as an example below.



NOTE

Up to 20 settings can be registered as favorites.

1 Configure the function.



If Program mode is selected, set the copy function, send function, FAX function (option), and destinations to be registered.

If Wizard mode is selected, go to step 2.

2 Display the screen.

Favorites /
Application

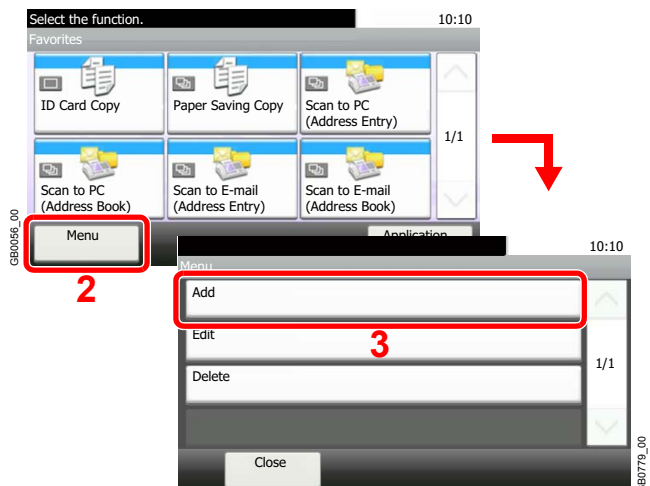



NOTE

Press [Favorites] in the Application screen to return to the Favorites screen.



3 Select the job type.

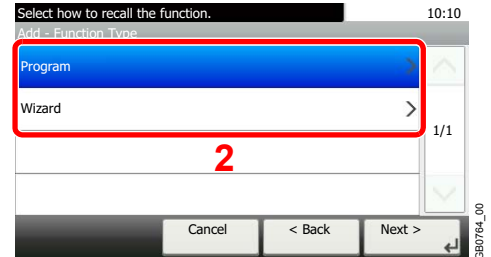
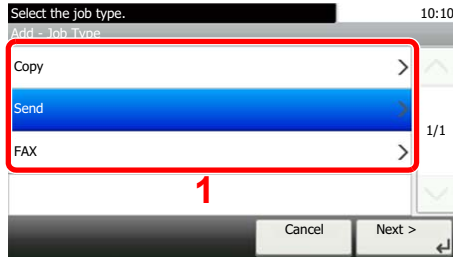

When you select the wizard mode

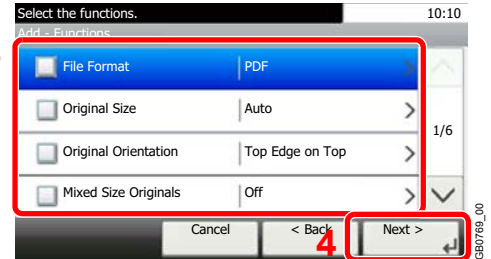
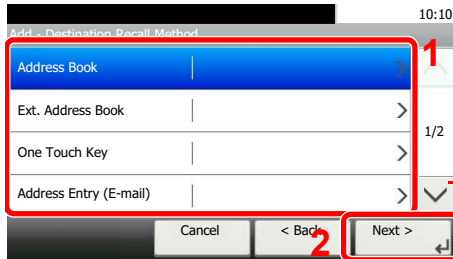

Use [∨] or [∧] to scroll up and down.

Select the function. Checked items will be shown as part of the wizard.



NOTE

When the job type is *Copy*, the Destination Recall Method screen will not be displayed.

4 Enter a name.

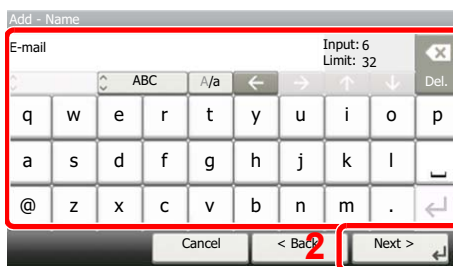

Refer to *Character Entry Method* on page 11-7 for details on entering characters.

5 Check the settings.

Check the settings and change or add information as needed.

[Name]

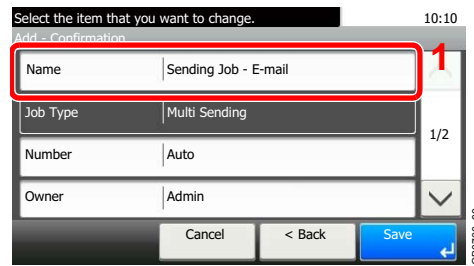

[Number]

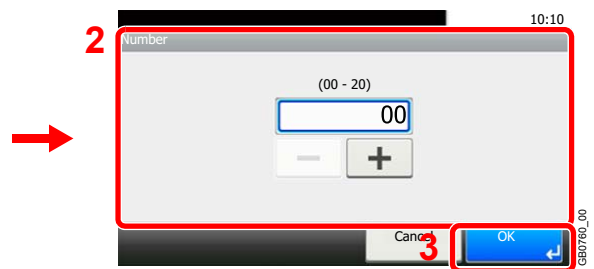
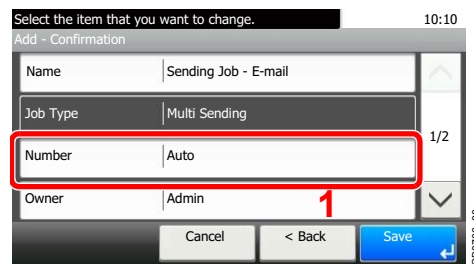

[Permission]

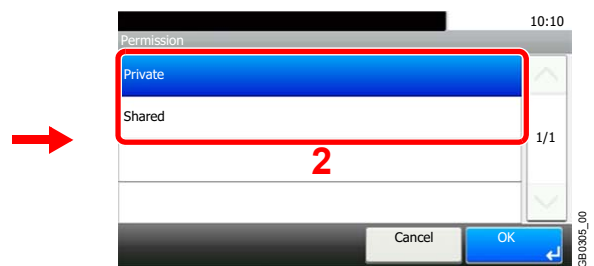
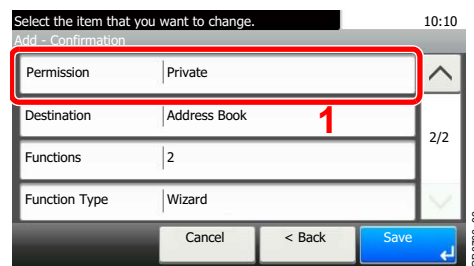

Configures permission settings for favorites to determine how they are shared with other users.

[Destination]

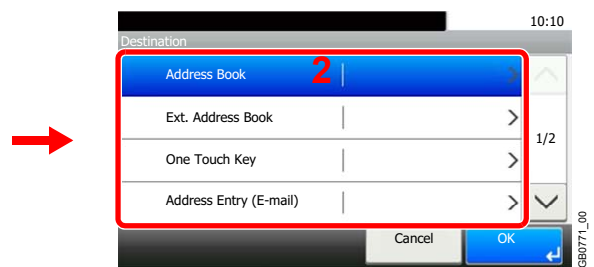
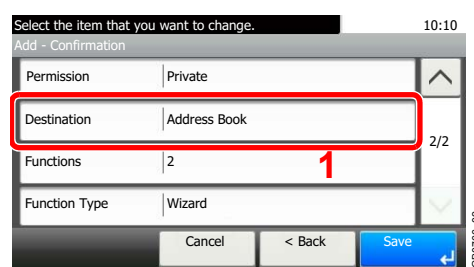

When the job type is [Send] or [FAX], selects the Destination Recall Method.

[Functions]

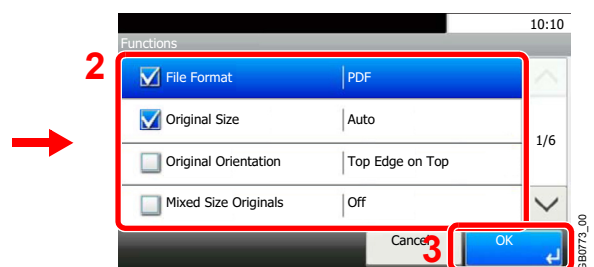
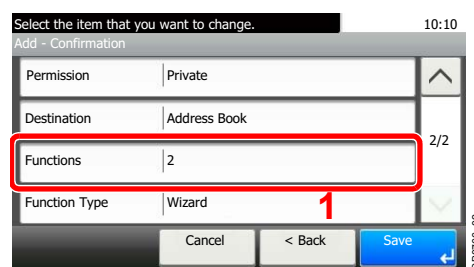

If you selected wizard mode, check the function and make changes as necessary.

[Function Type]

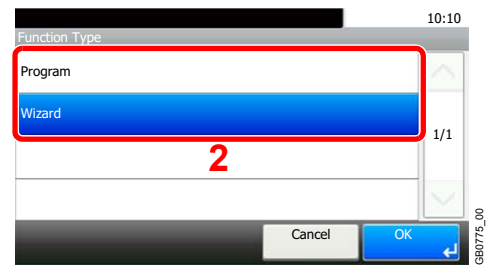
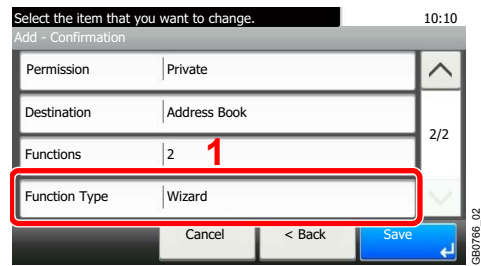

6 Register the favorite.

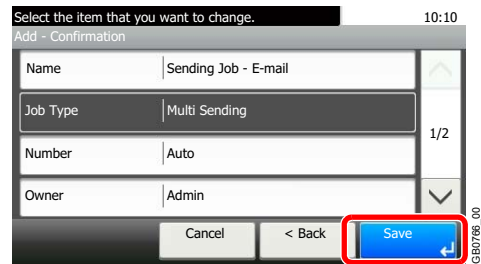

Editing and Deleting Favorites

This section describes how to edit name and permission of the registered favorites and how to delete favorites.

1 Display the screen.

Favorites /
Application

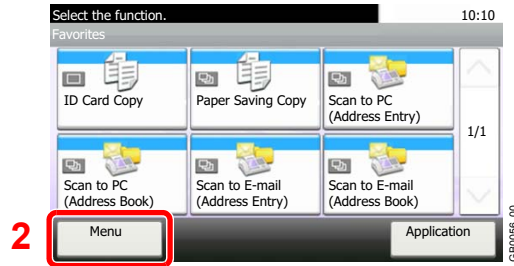

2 Edit or delete a favorite.

To edit a favorite

1 Select the favorite you wish to edit.

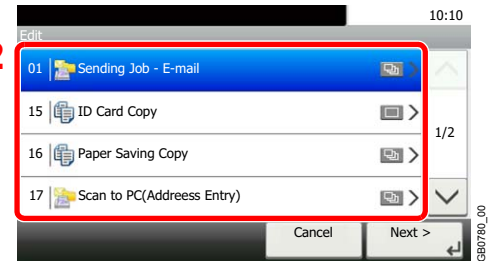
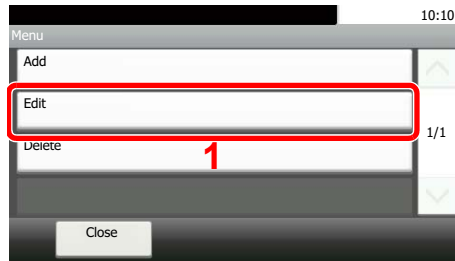

2 Edit the favorite.

[Name]

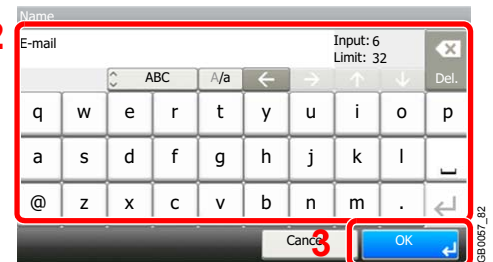
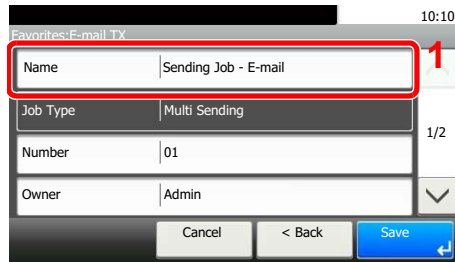

[Number]

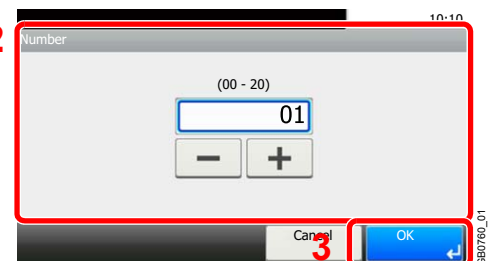
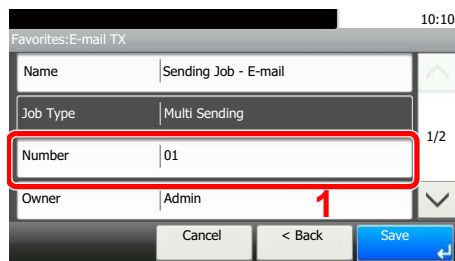

[Permission]

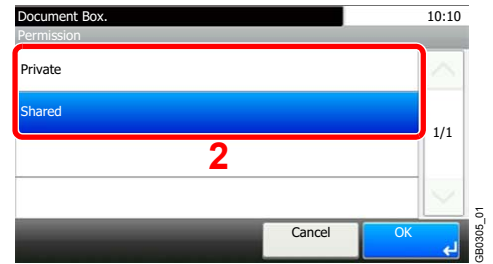
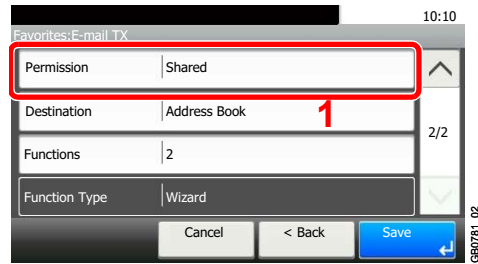

Configures permission settings for favorites to determine how they are shared with other users.

3 Register the favorite.

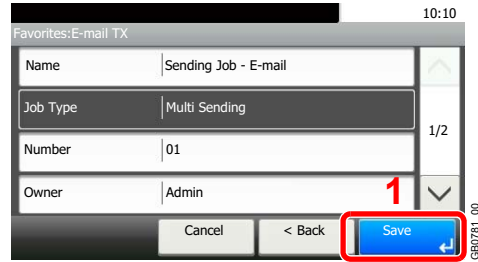

To delete

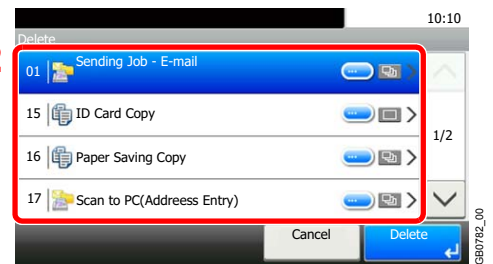
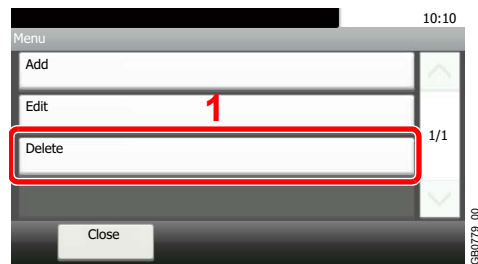

Select the favorite you wish to delete.

Using Favorites

Call up settings from a favorite.

1 Display the screen.

Favorites /
Application



2 Select a favorite.

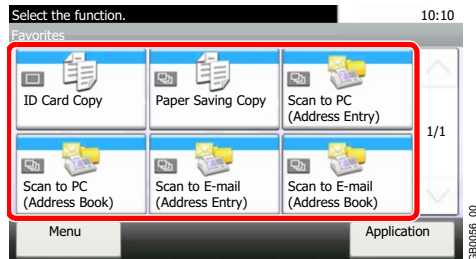

When using the wizard mode

1 The registered screens are displayed in order. Make the desired settings.

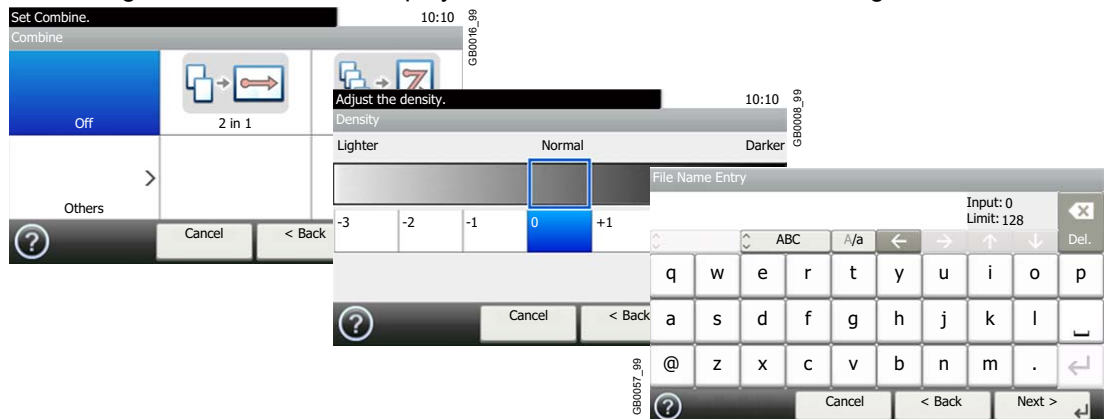

2 Confirm the settings and start the job.

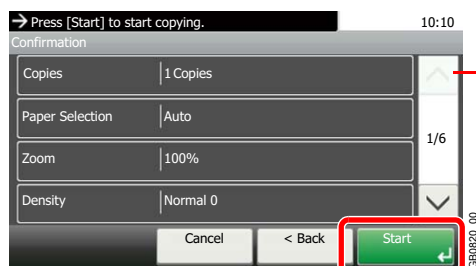

Use [∨] or [∧] to scroll up and down.



NOTE

To edit the settings, press [<Back] and make changes as desired.

When using the program mode

Select a favorite to call up registered settings.

Press the **Start** key to start the job.

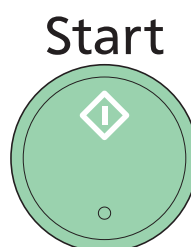

Application

The functionality of the machine can be expanded by installing applications.

Applications that help you perform your daily more efficiently such as a scan feature and an authentication feature are available.

For details, consult your sales representative or dealer.

 For application settings, refer to *Favorites/Application* on page 9-16.

1 Display the screen.

Favorites /
Application

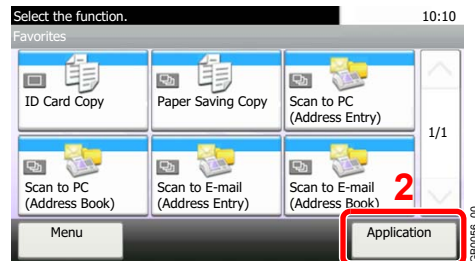

2 Select the application.

Shortcuts

Frequently used function screens can be registered as shortcuts so that they can be called up easily.

Registering Shortcuts

You can register up to 2 shortcuts for copying functions, sending functions, and functions set for document box.

The following types of shortcuts are available:

Private Shortcut	Private shortcuts are only available for use by the logged in user. They can only be set while using user login administration.
Shared Shortcut	Shared shortcuts can be used by all machine users. When using user login administration, shared shortcuts can only be set by users who have logged in as administrators.

1 Display the screen.

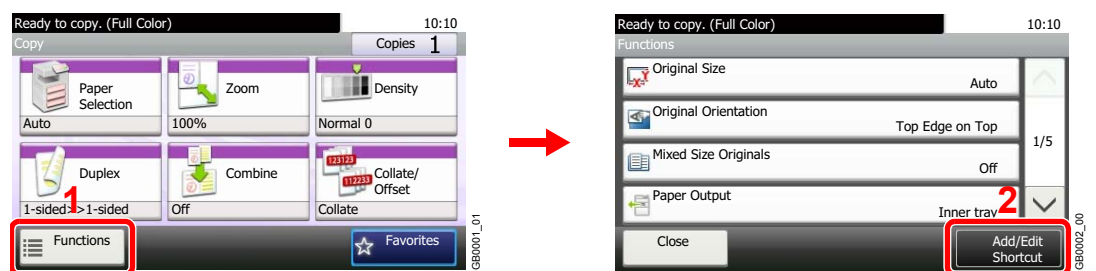

Press [Functions] on the Copy, Send, or Document Box screen and then [Add/Edit Shortcut].

2 Select [Add].

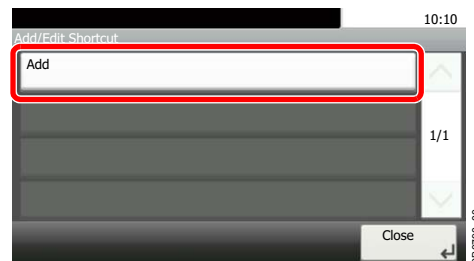

3 Select the key.

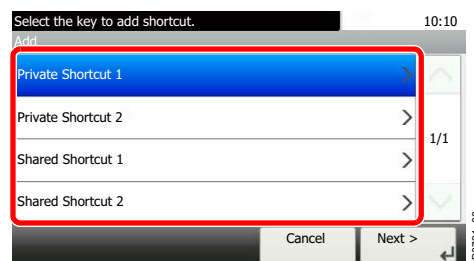

Select the key to which you wish to register the shortcut.



NOTE

If you select a shortcut number already registered, the currently registered shortcut can be replaced with a new one.

4 Select the function.

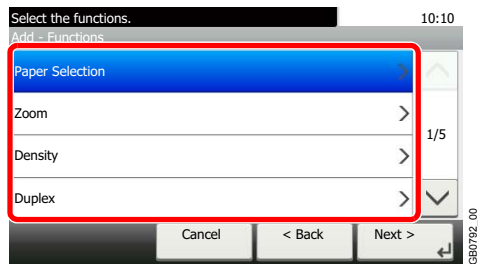

Select the function screen to display with the shortcut.

5 Enter the shortcut name.

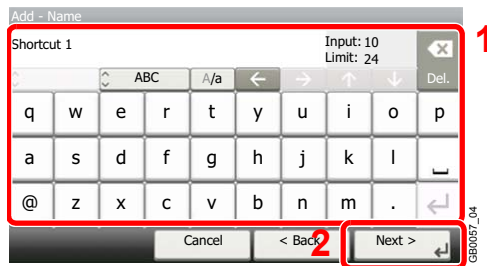

Up to 24 characters can be entered.



Refer to *Character Entry Method* on page 11-7 for details on entering characters.

6 Register the shortcut.

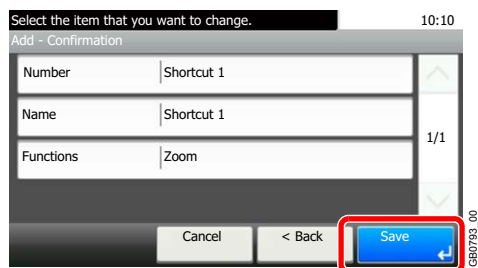

Confirm the settings and press [Save]

Editing and Deleting Shortcuts

Change shortcut number/name or delete shortcut.

1 Display the screen.

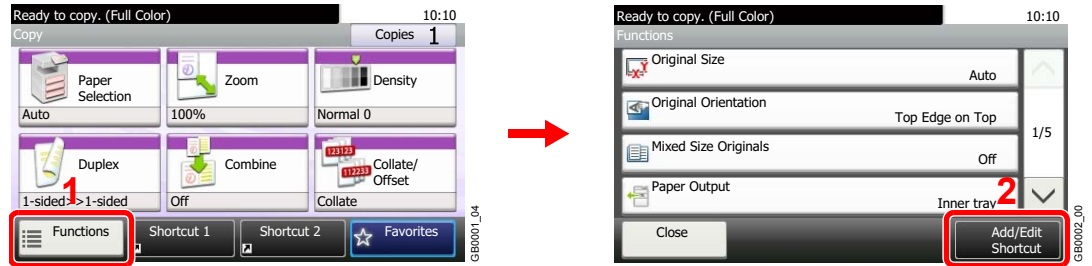

Press [Functions] on the Copy, Send, or Document Box screen and then [Add/Edit Shortcut].

2 Edit or delete a shortcut.

To edit a shortcut

1 Select the shortcut type and number you wish to edit.

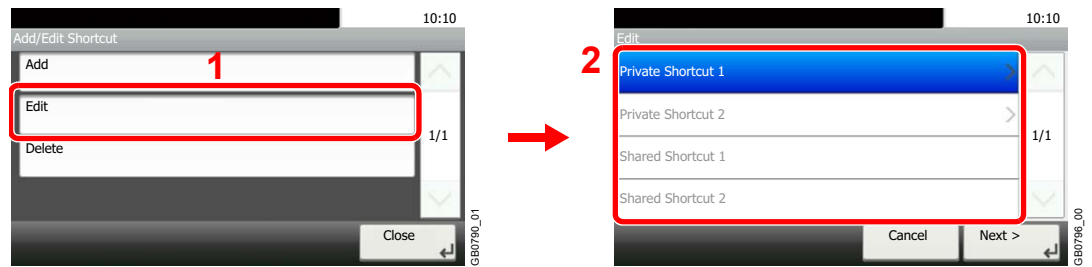

2 Edit the shortcut.

[No.]

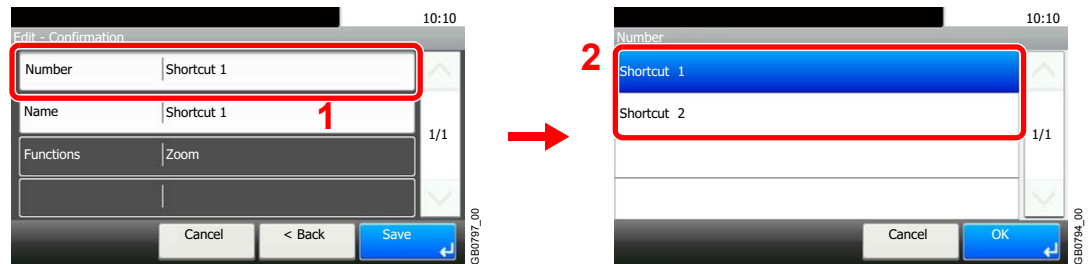

[Name]

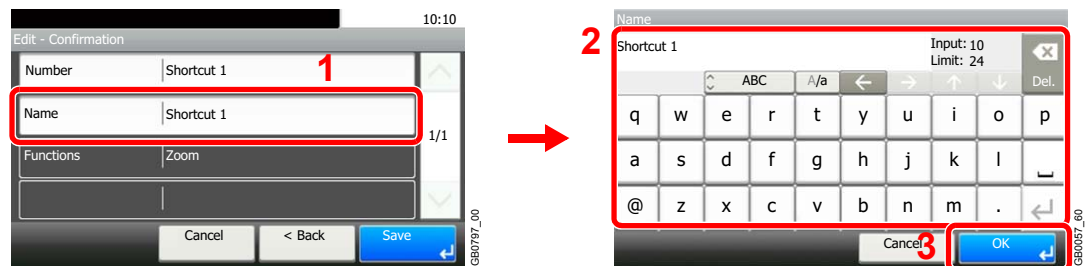

3 Register the shortcut.

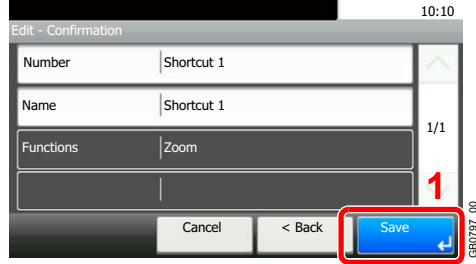

To delete

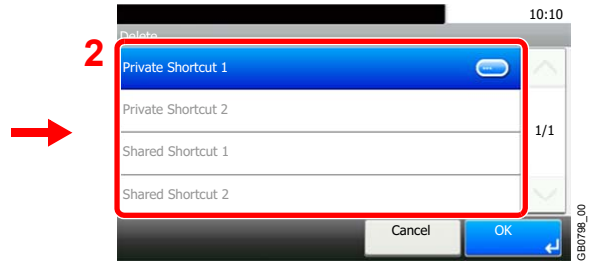

Select the shortcut you wish to delete.

Using Shortcuts

The registered shortcut will be displayed on the Copy, Send, FAX*, Print from USB Memory, or Save to USB Memory or Polling Box* initial screen. Pressing [Shortcut] will switch to the registered function's screen.

* Requires the optional fax kit.

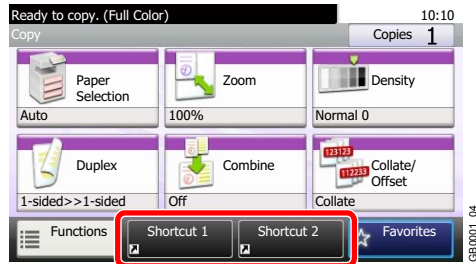

Quick Setup Wizard

Make the following basic settings as instructed by the Wizard:

Energy Saver Setup	Configures sleep mode and low-power mode.	
	1. Sleep Mode	Sleep Mode - Auto Sleep, Sleep Mode - Sleep Timer, Sleep Mode - Sleep Level
	2. Low Power Mode	Low Power Mode - Low Power Timer
Network Setup	Configure network settings.	
	1. Network	Network - Obtain IP Address
		Network - IP Address
		Network - Subnet Mask
Network - Default Gateway		
FAX Setup*	Configures basic fax settings.	
	1. Dialing/RX Mode	Dialing/RX Mode - Dialing Mode, Dialing/RX Mode - Reception Mode, Dialing/RX Mode - Auto (DRD)
	2. Local FAX Info.	Local FAX Info. - Local FAX Name, Local FAX Info. - Local FAX Number, Local FAX Info. - Local FAX ID, Local FAX Info. - Print Position
	3. Sound Volume	Sound Volume - Confirmation, Speaker Volume, Monitor Volume
	4. Rings	Rings - Confirmation, Answering Machine, FAX/TEL Switch
	5. Output	Output - Paper Output, Output - Reduced RX Size
	6. Redial	Redial - Retry Times

* This function is displayed when the optional fax is installed.

 **NOTE**

If the user authentication screen appears, enter your login user name and login password and press [Login]. The factory default login user name and login password are set as shown below.

Model Name	Login User Name	Login Password
FS-C8520MFP	2000	2000
FS-C8525MFP	2500	2500

1 Display the screen.

◆ System Menu / Counter



1

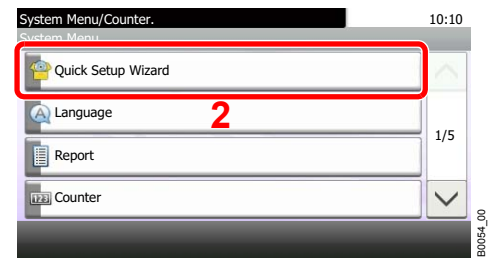

2 Select a function.

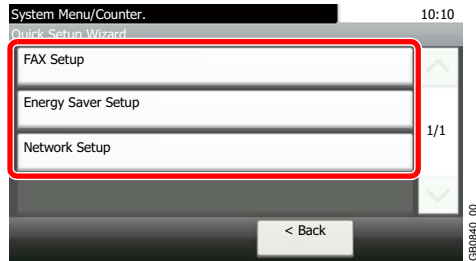

3 Configure the function.

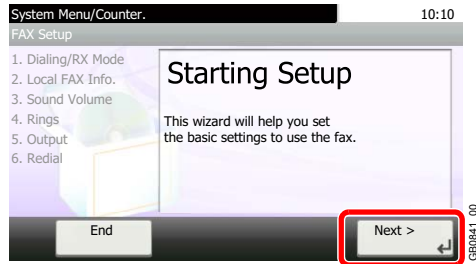

Start the wizard. Follow the instructions on the screen to configure settings.

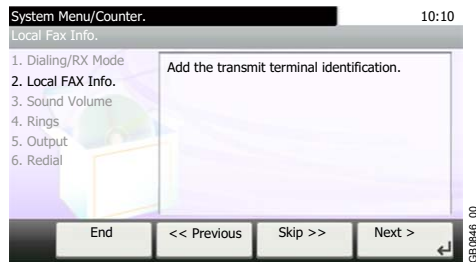

NOTE

If you experience difficulty configuring the settings, refer to *Help Screen on page 3-28*.

End	Exits the wizard. Settings configured so far are applied.
<< Previous	Returns to the previous item.
Skip >>	Advances to the next item without setting the current item.
Next >	Advances to the next screen.
< Back	Returns to the previous screen.
Complete	Register the settings and exit the wizard.

Help Screen

If you have difficulty operating the machine, you can check how to operate it using the touch panel. When the [?] (help) is displayed on the touch panel, you can press it to display the Help screen.

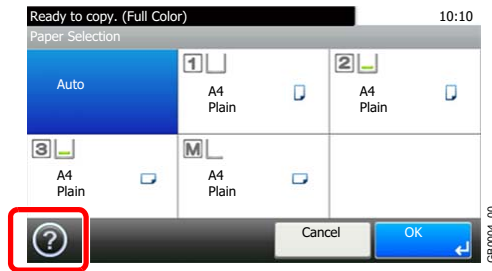

How to read the screen

A screenshot of the 'Paper Selection' help screen. The screen title is 'Ready to copy. (Full Color)' and the time is '10:10'. The screen displays the following text: 'Paper Selection', 'Select the cassette or multi-purpose tray with the desired paper size.', 'Auto: Automatically selects the appropriate paper size.', 'Cassette 1: Selects the paper in cassette 1.', 'Cassette 2: Selects the paper in cassette 2.', and 'Cassette 3: Selects the paper in cassette 3.'. At the bottom left, there is a close button (an 'X' in a circle). At the bottom right, there is a scroll bar with up and down arrows and the text '1/2'. Red lines connect annotations to these elements.

Help titles

Displays information about functions and machine operation.

Closes the Help screen and returns to the original screen.

Scrolls up and down when the help text cannot be displayed in its entirety on a single screen.

Canceling Jobs

Cancel any print or send job being executed.

1 Press the Stop key.

Stop



2 Cancel a job.

When there is a job is being scanned

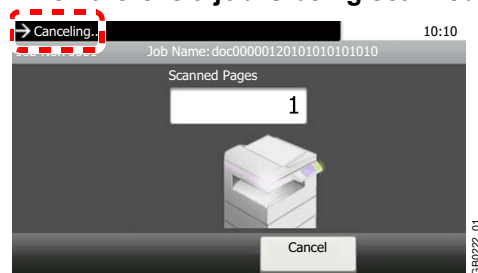

Canceling... will be displayed, and the current job will be canceled.

When there is a job printing or on standby

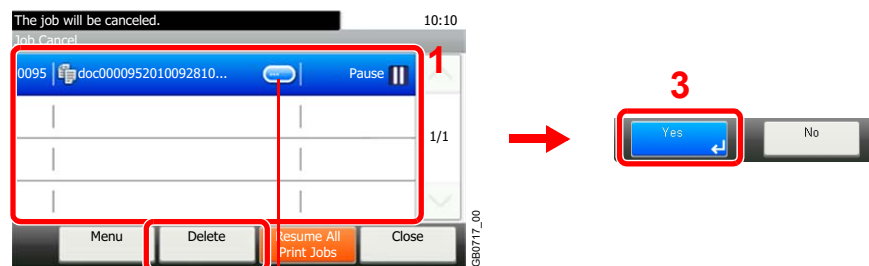

2 Displays details for individual jobs.

Select the job you wish to cancel and press [Delete].



NOTE

If printing has started, press the Stop key on the operation panel with the copy screen or transmission screen displayed to cancel the operation.

The current print job is temporarily interrupted. Continues without temporarily interrupting jobs being sent.

You can also cancel executing jobs and jobs on standby after checking their status. Refer to *Status / Job Cancel* on page 8-1.

Canceling printing from a computer

To cancel a print job executed using the printer driver before the printer begins printing, do the following:

- 1** Double-click the printer icon () displayed on the taskbar at the bottom right of the Windows desktop to display a dialog box for the printer.
- 2** Click the file for which you wish to cancel printing and select **Cancel** from the **Document** menu.

Using Various Functions

This section describes common functionality that can be configured for copying, sending, and the document box.

1 Display the screen.

Copy



Send



Press the key of each function.

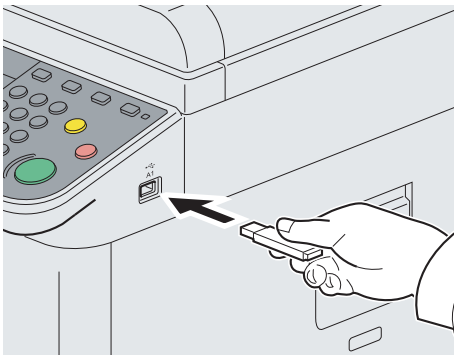

When using USB memory, plug it into the USB memory slot (A1).

Press [Yes] on the displayed screen.

When printing from USB memory, select the file to be printed and press [Print].

When storing a document to USB memory, select the folder where the file will be stored and press [Menu] and then [Store File].



For details, refer to *Printing Documents Stored in Removable USB Memory* on page 7-3 or *Saving Documents to USB Memory (Scan to USB)* on page 7-6.



NOTE

If the screen does not appear, press the **Document Box** key and then [Removable Memory].

If the touch panel is turned off, press the **Energy Saver** key or the **Power** key and wait for the machine to warm up.

2 Select the functions.

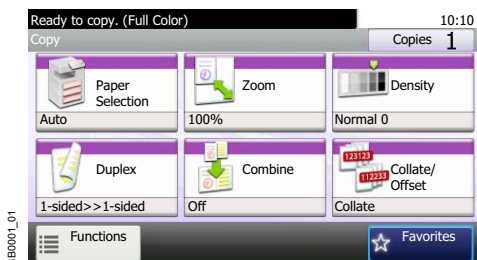

Select the functions to use.

Press [Functions] to display all the functions.



Refer to *Common Functionality* on page 3-31.

Common Functionality

Functionality related to originals

What do you want to do?	Reference Page
Specify the original size.	Original Size ► page 3-32
Specify the original orientation to scan in the correct direction.	Original Orientation ► page 3-34
Scan mixed size originals.	Mixed Size Originals ► page 3-35
Automatically scan 2-sided originals.	2-sided/Book Original ► page 3-37
Scan a large number of originals separately and then produce as one job.	Continuous Scan ► page 3-40

Functionality related to document quality

What do you want to do?	Reference Page
Specify the paper size and type.	Paper Selection ► page 3-42
Change the paper output.	Paper Output ► page 3-43
Collate the output documents in page order. Offset the output documents by set.	Collate/Offset ► page 3-44
Add margins (white space).	Margin ► page 3-46
Staple in the output documents.	Staple ► page 3-49
Adjust the density.	Density ► page 3-51
Set the resolution at which to scan originals.	Scan Resolution ► page 3-52
Select original image type for best results.	Original Image ► page 3-53
Emphasize the outline of texts or lines. Blur the image outline.	Sharpness ► page 3-54
Darken or lighten the background (i.e., the area with no text or images) of originals.	Background Density Adjust ► page 3-55
Prevent bleed-through for 2-sided originals.	Prevent Bleed-through ► page 3-56
Enlarge or shrink originals according to the sending or storing size.	Zoom ► page 3-57
Select the file format for images being sent or stored.	File Format ► page 3-58
Change the color mode.	Color Selection ► page 3-60
Send notice by e-mail when a job is complete.	Job Finish Notice ► page 3-61
Add a file name to the job to easily check its status.	File Name Entry ► page 3-63
Suspend the current job and override it to give a new job top priority.	Priority Override ► page 3-64

Original Size



Specify the original size to be scanned.

Auto	Automatically detects the size of the original.
Metric	Select from A3, A4-R, A4, A5-R, A5, A6-R, B4, B5-R, B5, B6-R, B6, Folio, or 216 × 340 mm.
Inch	Select from Ledger, Letter-R, Letter, Legal, Statement-R, Statement, 11 × 15", or Oficio II.
Others	Select from 8K, 16K-R, 16K, Hagaki, Oufukuhagaki, or Custom*
Size Entry	Enter the size. Inch models — Horizontal: 2 to 17" (in 0.01" increments), Vertical: 2 to 11.69" (in 0.01" increments) Metric models — Horizontal: 50 to 432 mm (in 1 mm increments), Vertical: 50 to 297 mm (in 1 mm increments)

* For instructions on how to specify the custom original size, refer to *Custom Original Size on page 9-9*. If you select [Off] for Custom Original Size, this does not appear.

NOTE

Be sure to always specify the original size when using custom size originals.

1 Display the screen.

- Referring to *Using Various Functions on page 3-30*, display the screen.
- Press [Functions] and then [Original Size].

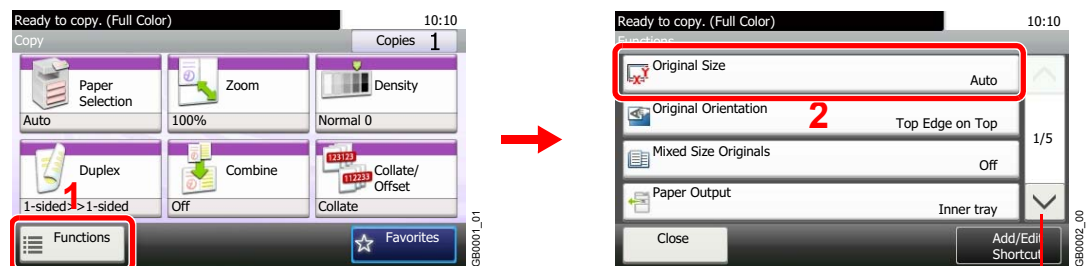

Use [∨] or [∧] to scroll up and down.

2 Select the original size.

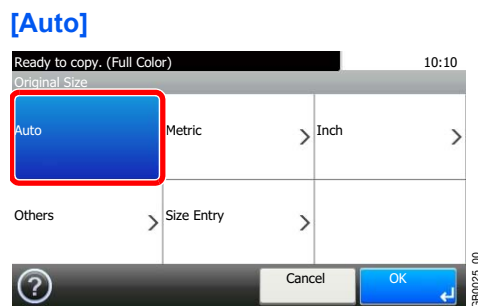

[Metric], [Inch], or [Others]

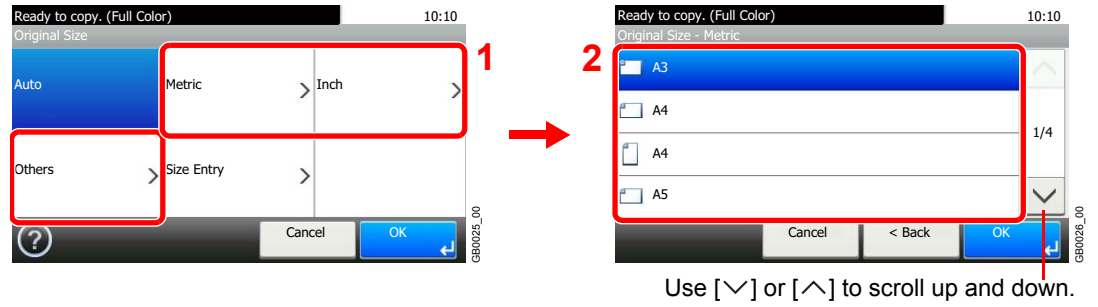

Select the original size.

[Size Entry]

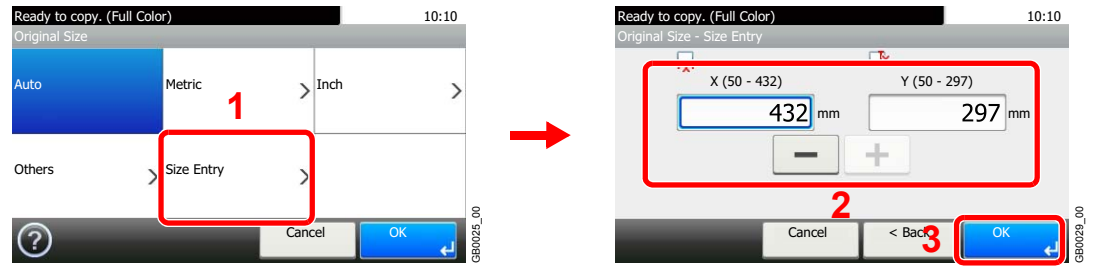

Press the text box displaying the numbers and use [-]/[+] or the numeric keypad to enter a value.

Original Orientation



Select the orientation of the original document top edge to scan correct direction.

To use any of the following functions, the document's original orientation must be set.

- Duplex
- Margin
- Combine
- Staple (option)

When placing originals on the platen

Top Edge on Top

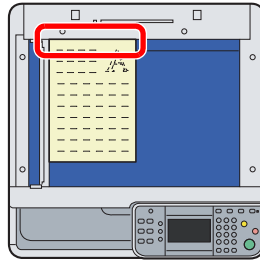

Top Edge on Left

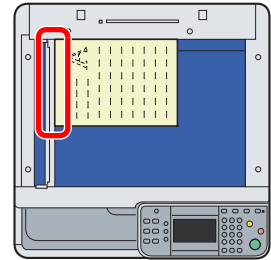

When placing originals on the document processor

Top Edge on Top

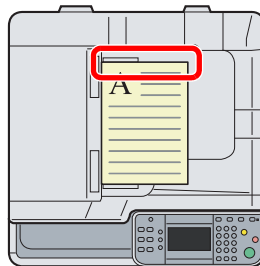

Top Edge on Left

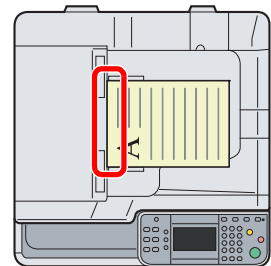

1 Display the screen.

1 Referring to *Using Various Functions* on page 3-30, display the screen.

2 Press [Functions] and then [Original Orientation].

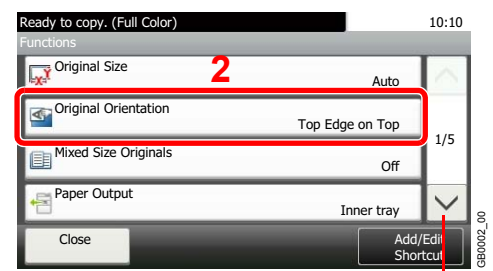
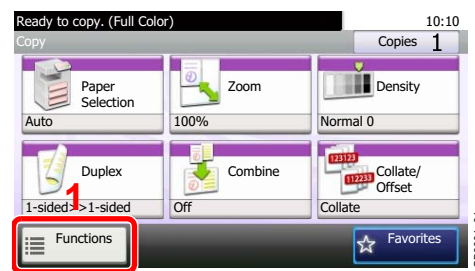

Use [∨] or [∧] to scroll up and down.

2 Select the function.

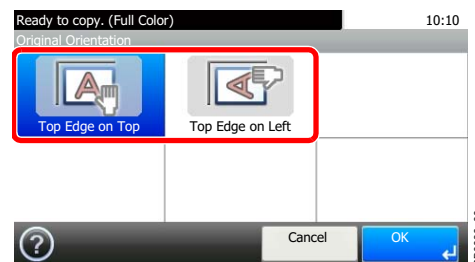

Select the original orientation.

Mixed Size Originals



Scans all sheets in the document processor, even if they are of different sizes.

Supported Combinations of Originals

- B4 and B5

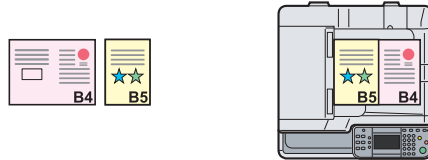

- Ledger and Letter (A3 and A4)

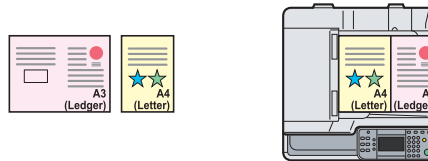

- Ledger and Letter-R (Folio and A4-R)

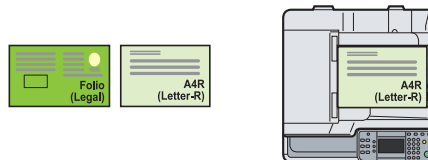

NOTE

When mixing the original sizes as using the following combination: Folio and A4-R, make sure to set *Original Auto Detect* to [On] for [Folio]. For more information, refer to *Original Auto Detect* on page 9-9.

Up to 30 sheets can be placed in the document processor for mixed size originals.

1 Display the screen.

1 Referring to *Using Various Functions* on page 3-30, display the screen.

2 Press [Functions] and then [Mixed Size Originals].

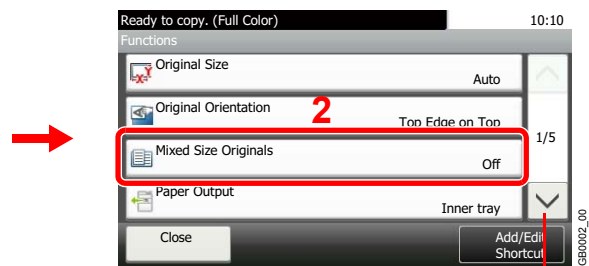
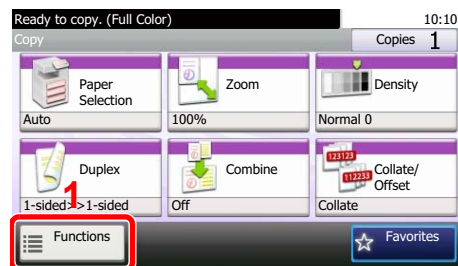

Use [∨] or [∧] to scroll up and down.

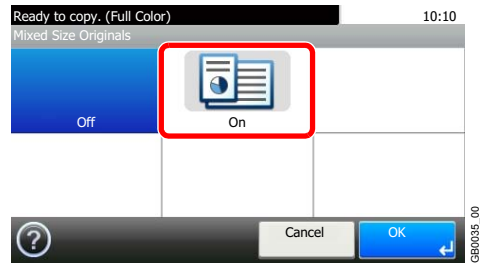

2 Select the function.



2-sided/Book Original



Select the type and orientation of the binding based on the original.

1-sided			Set when using a 1-sided sheet original.
2-sided			Set when using a 2-sided sheet original that will be bound on the left or right.
Book			Set when using a book original such as a magazine or book that is bound on the left.
Other Settings	2-sided/ Book Original	1-sided	Set when using a 1-sided sheet original.
		2-sided (Binding Left/Right)	Set when using a 2-sided sheet original that will be bound on the left or right.
		2-sided (Binding Top)	Set when using a 2-sided sheet original that will be bound at the top.
		Book (Binding Left)	Set when using a book original such as a magazine or book that is bound on the left.
		Book (Binding Right)	Set when using a book original such as a magazine or book that is bound on the right.
	Original Orientation*	Select the orientation of the original document top edge to scan correct direction.	

* This function is displayed when [2-sided (Binding Left/Right)] or [2-sided (Binding Top)] is selected.

1 Display the screen.

1 Referring to *Using Various Functions* on page 3-30, display the screen.

2 Send

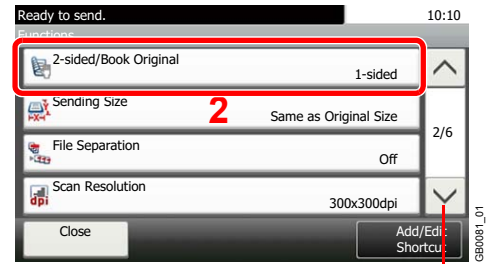

Use [∨] or [^] to scroll up and down.

Scan to USB

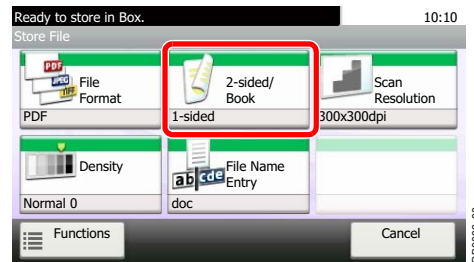

2 Select the type of original.

[2-sided] or [Book]

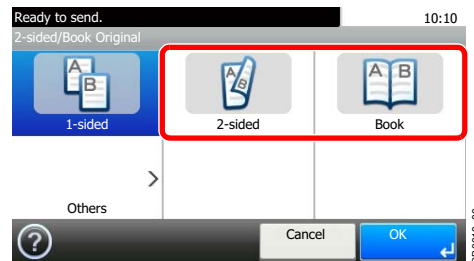

[Others]

1

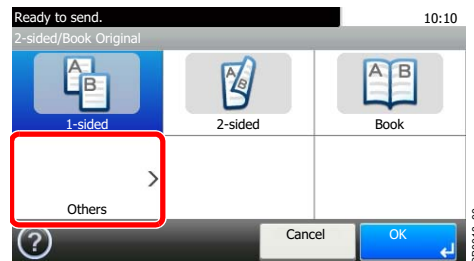

2 Select the type of original.

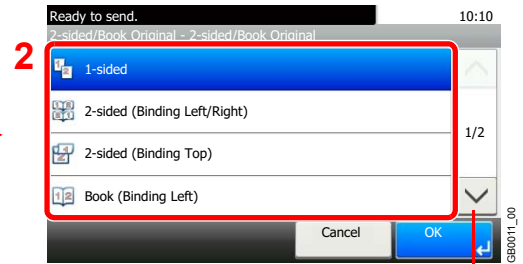
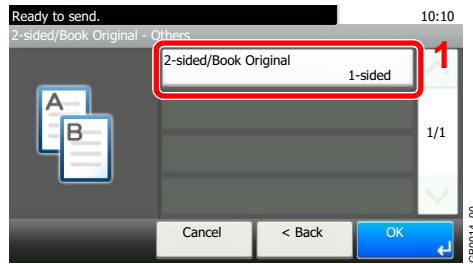

Use [∨] or [∧] to scroll up and down.

3 Select the original orientation.

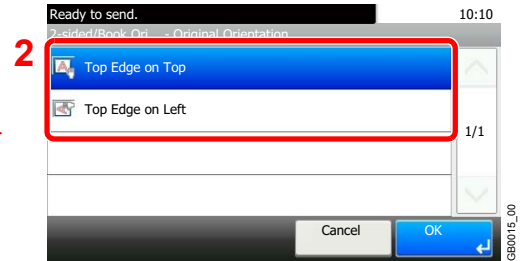
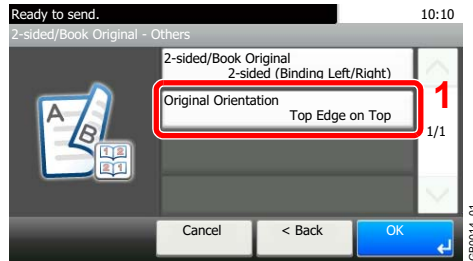

Continuous Scan



Scan a large number of originals in separate batches and then produce as one job. Originals will be scanned continuously until you press [Finish Scan].

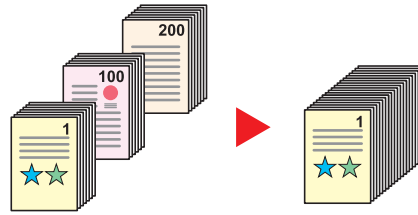

1 Display the screen.

1 Referring to *Using Various Functions* on page 3-30, display the screen.

2 Press [Functions] and then [Continuous Scan].

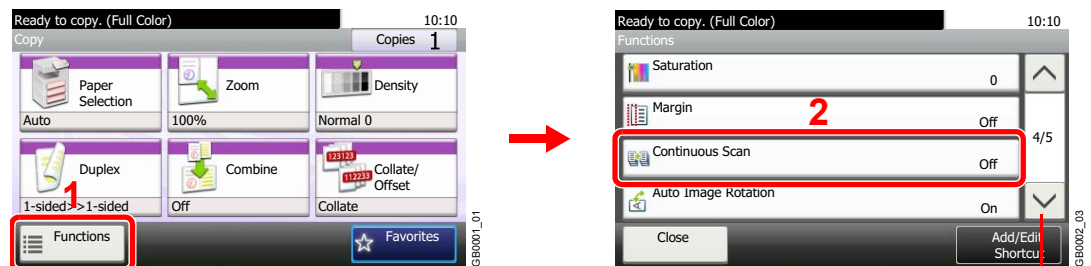

Use [∨] or [∧] to scroll up and down.

2 Select the function.

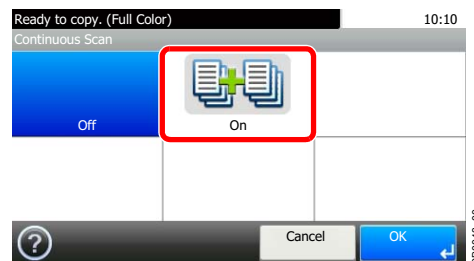

3 Scan the originals.

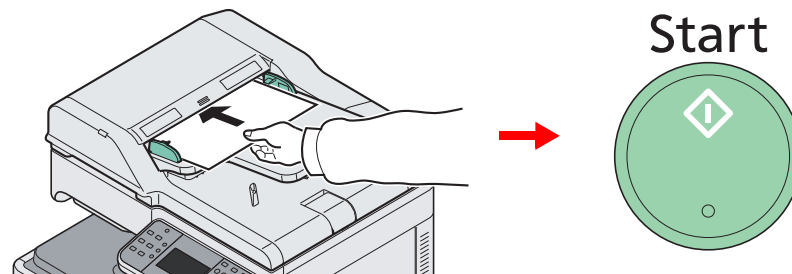

Load the original and press the **Start** key to start scanning.

Once the original has been scanned, load the next original and press the **Start** key. Use the same procedure to scan any remaining originals.

4 Finish scanning.

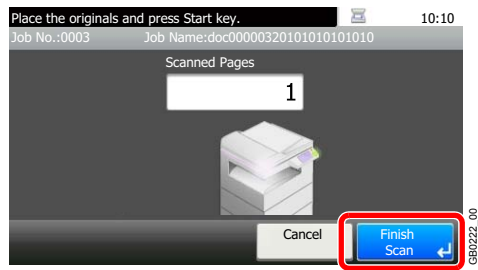

Start copying, sending, or storing.

Paper Selection



Select the cassette or multi-purpose tray that contains the required paper size.

NOTE

Specify in advance the size and type of the paper loaded in the cassette (refer to *Cassette/MP Tray Settings* on page 9-8).

1 Display the screen.

1 Referring to *Using Various Functions* on page 3-30, display the screen.

2 Press [Paper Selection].

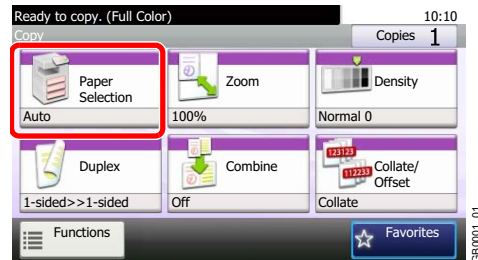

2 Select the paper source.

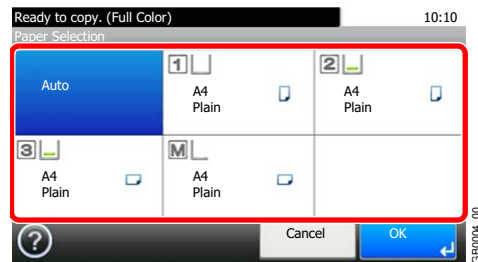

If [Auto] is selected, the paper matching the size of the original is selected automatically.

[2] (Cassette 2) and [3] (Cassette 3) are displayed when the optional paper feeder is installed. [M] indicates the MP tray.

When selecting MP tray, specify the paper size and the media type. The available paper sizes and media types are shown in the table below.

Paper Size	<p>Metric: Select from A3, A4-R, A4, A5-R, A6-R, B4, B5-R, B5, B6-R, Folio or 216 × 340 mm.</p> <p>Inch: Select from Ledger, Letter-R, Letter, Legal, Statement-R, Executive or Oficio II.</p> <p>others: Select from 8K, 16K-R, 16K, ISO B5, Envelope #10, Envelope #9, Envelope #6, Envelope Monarch, Envelope DL, Envelope C5, Envelope C4, Hagaki, Oufukuhagaki, Youkei 4, Youkei 2 or Custom.</p> <p>Size Entry: Enter a size not displayed in the standard sizes.</p> <p>Inch models – X: 5.83 to 17" (in 0.01" increments), Y: 3.86 to 11.69" (in 0.01" increments)</p> <p>Metric models – X: 148 to 432 mm (in 1 mm increments), Y: 98 to 297 mm (in 1 mm increments)</p>
Media Type	<p>Plain (105 g/m² or less), Transparency, Rough, Vellum (59 g/m² or less), Labels, Recycled, Preprinted, Bond, Cardstock, Color, Prepunched, Letterhead, Envelope, Thick (106 g/m² and more), Coated, High Quality, Custom 1-8</p>

Paper Output



Set paper output to document finisher or job separator tray.

Inner Tray*	Places pages face down in the inner tray.
Finisher Tray*	Places pages face down in the optional document finisher tray.
Job Separator Tray	Places pages face down in the job separator tray.

* If the optional document finisher has been installed, [Inner Tray] will change to [Finisher Tray].

NOTE

To change default destination, refer to *Paper Output* on page 9-13 for details.

1 Display the screen.

1 Referring to *Using Various Functions* on page 3-30, display the screen.

2 Press [Functions] and then [Paper Output].

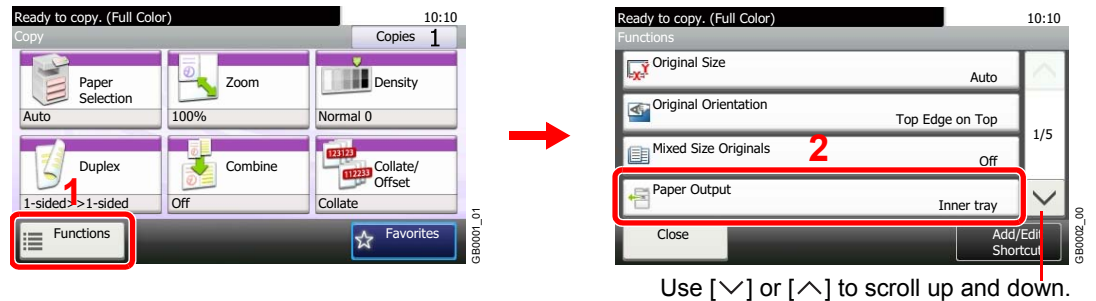

2 Select the output destination.

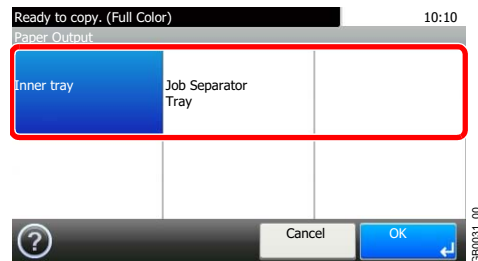

Collate/Offset



Offset the output by page or set.

Collate

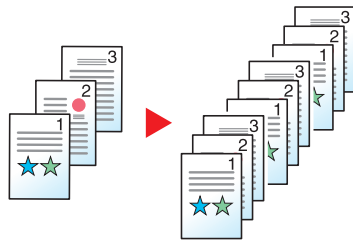

Scan multiple originals and deliver complete sets of copies as required according to page number.

Offset

Without Document Finisher (Option)

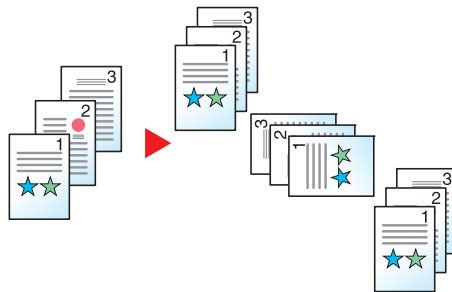

When you use offsetting, printed copies are produced after rotating each set (or page) by 90°.



NOTE

To offset without a document finisher, load the same size paper into a second paper source with a different orientation.

The paper sizes supported in Offset are A4, B5, Letter and 16K.

With Document Finisher (Option)



When you use offsetting, printed copies are segregated after each set of copies (or after each page).

1 Display the screen.

1 Referring to *Using Various Functions* on page 3-30, display the screen.

2 Press [Collate/Offset].

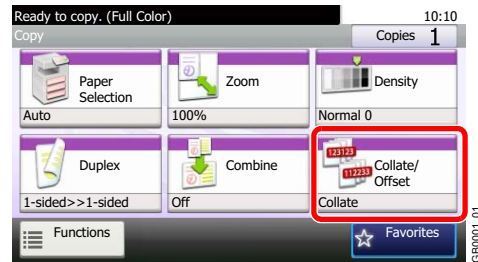

2 Select the function.

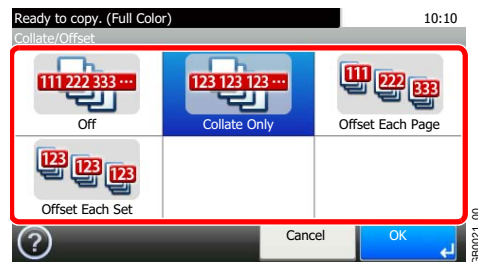

Margin



Add margins (white space). In addition, you can set the margin width and the back page margin.

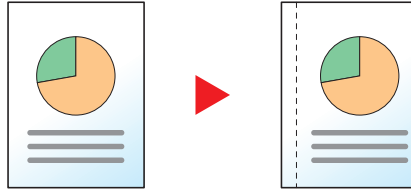

Margin Width

Input units	Margin Width
Inch Models	-0.75 to 0.75" (in 0.01" increments)
Metric Models	-18 mm to 18 mm (in 1-mm increments)

Margin on the Back Side

When duplex copying, you can also specify the margin on the back side.

Auto

When [Auto] is selected, an appropriate margin is applied automatically on the rear page depending on a margin specified for the front page and a binding orientation.

Manual

Enables you to specify the front and back settings separately.



NOTE

You can set the default margin width. Refer to *Margin on page 9-12* for details.

1 Display the screen.

1 Referring to *Using Various Functions on page 3-30*, display the screen.

2 Press [Functions] and then [Margin].

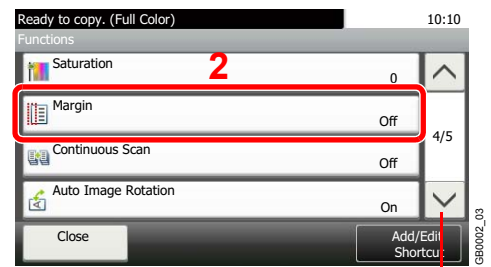
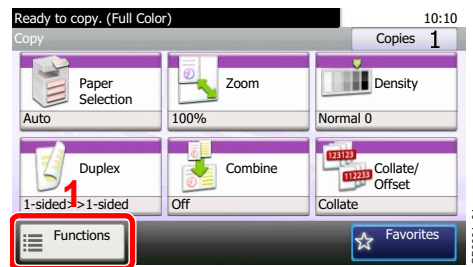

Use [∨] or [∧] to scroll up and down.

2 Enter the margin width.

1

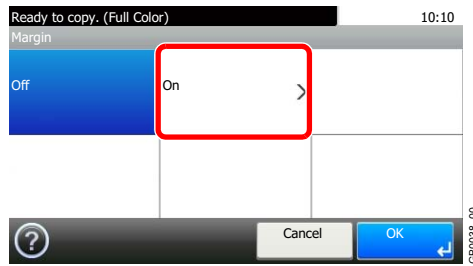

2

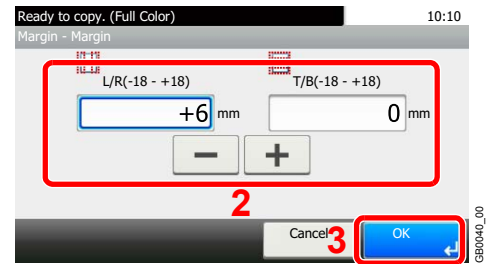
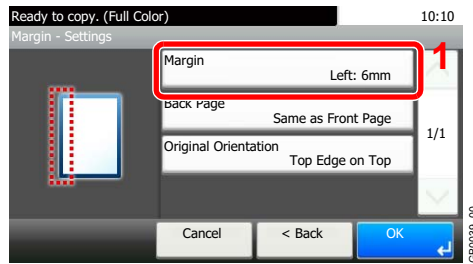

Press the text box and use [-]/[+] to enter a value.

3 Specify the margin on the back side.

1

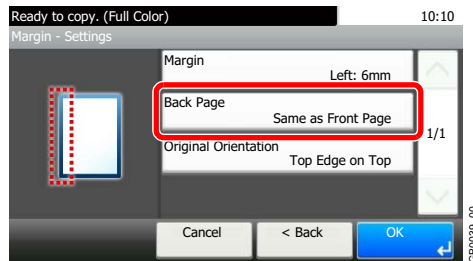

NOTE

[Original Orientation] is not displayed when printing a document from USB memory.

[Auto]

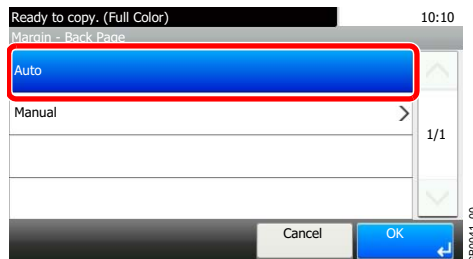

[Manual]

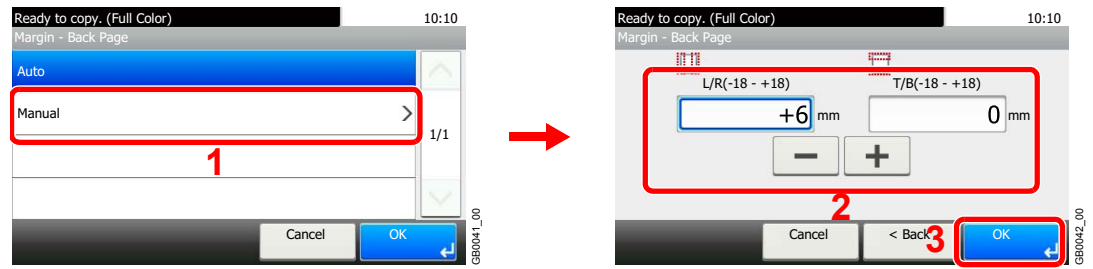

Press the text box and use [-]/[+] to enter a value.

4 Select the original orientation.

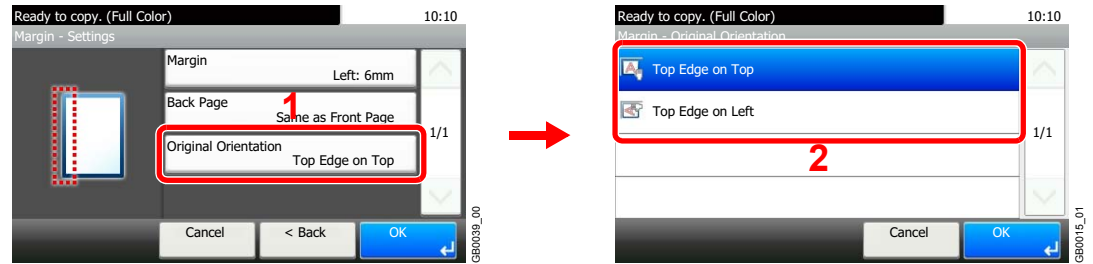

NOTE

[Original Orientation] is not displayed when printing a document from USB memory.

Staple



Staple documents. In addition, you can specify the staple position.

NOTE

Stapling requires the document finisher.

The following stapling options and orientations are available.

	Original Orientation: Top Edge (Back Edge)		Original Orientation: Left Top Edge (Left top corner)	
Cassette Paper Load Direction 				
Cassette Paper Load Direction 				

1 Display the screen.

1 Referring to *Using Various Functions on page 3-30*, display the screen.

2 Press [Functions] and then [Staple].

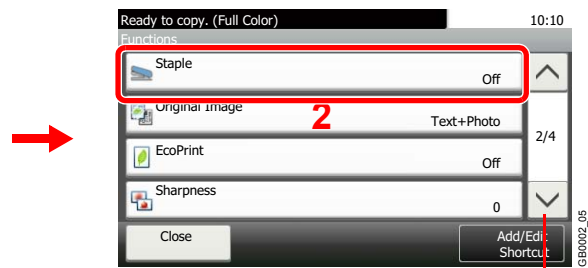
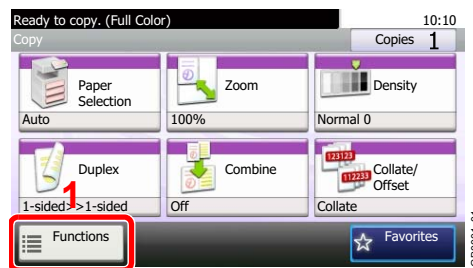

Use [∨] or [∧] to scroll up and down.

2 Select the staple position.

[1 staple] or [2 staples]

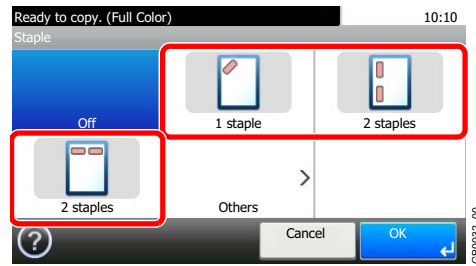

[Others]

1

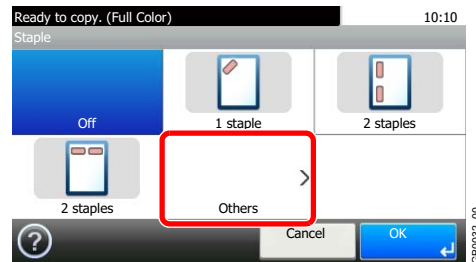

2 Select the staple position.

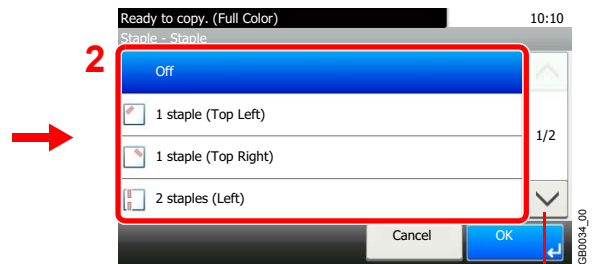
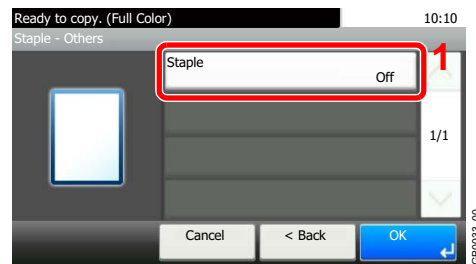

Use [∨] or [∧] to scroll up and down.

3 Select the original orientation.

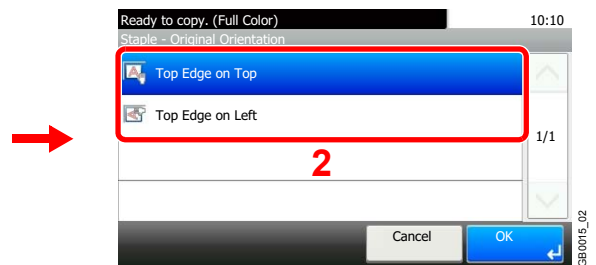
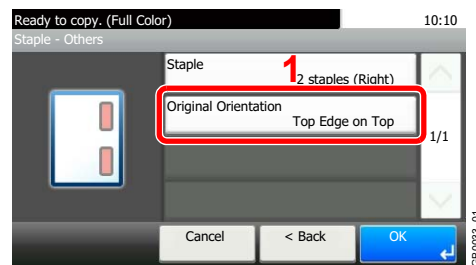

NOTE

[Original Orientation] is not displayed when printing a document from USB memory.

Density

Adjust density using 7 levels.



1 Display the screen.

1 Referring to *Using Various Functions* on page 3-30, display the screen.

2

Copy

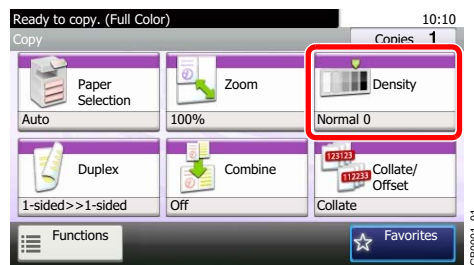

Scan to USB

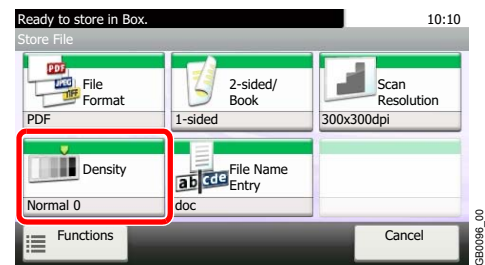

Send

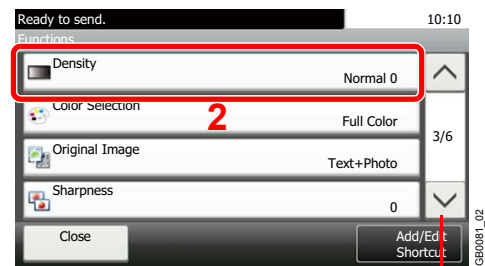

Use [∨] or [∧] to scroll up and down.

2 Adjust density.

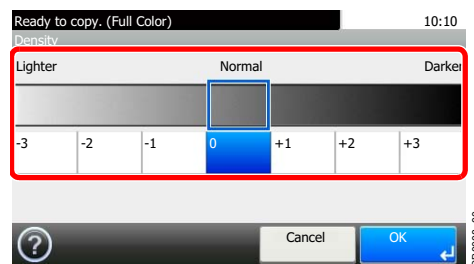

Press [-3] to [+3] (*Lighter - Darker*) to adjust density.

Scan Resolution



Select fineness of scanning resolution.

The selectable resolution is [200x100dpi Normal], [200x200dpi Fine], [200x400dpi Super], [300x300dpi], [400x400dpi Ultra], or [600x600dpi].

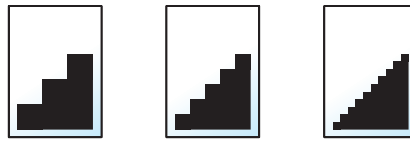

NOTE

The larger the number, the better the image resolution. However, better resolution also means larger file sizes and longer send times.

1 Display the screen.

1 Referring to *Using Various Functions on page 3-30*, display the screen.

2

Send

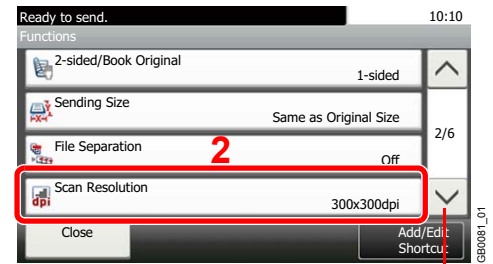
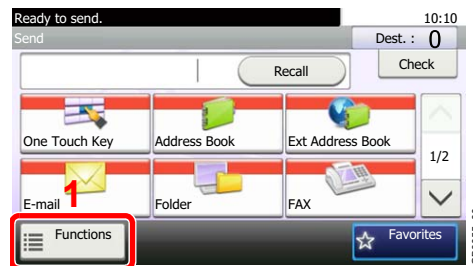

Use [∨] or [∧] to scroll up and down.

Scan to USB

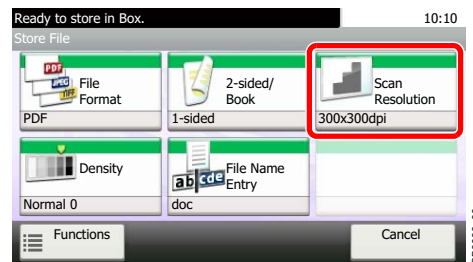

2 Select the resolution.

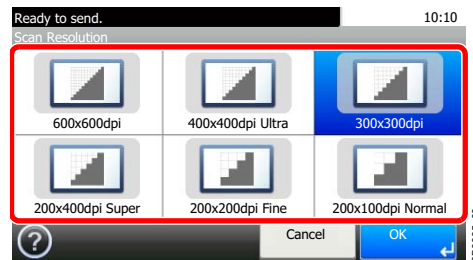

Original Image



Select original image type for best results.

Text+Photo		Best for originals which contain a mixture of text and photos.
Photo		Best for photographs.
Text		Sharply renders pencil text and fine lines.
Graphic/Map*		Best for graphics and maps.
Printer Output*		Best for documents printed on this machine originally.
Text (for OCR)**		For documents to be read by OCR.

* This function is displayed while copying.

** This function is displayed when the color mode is [Auto (Color/B & W)] or [Black & White] (when sending or storing).

1 Display the screen.

1 Referring to *Using Various Functions on page 3-30*, display the screen.

2 Press [Functions] and then [Original Image].

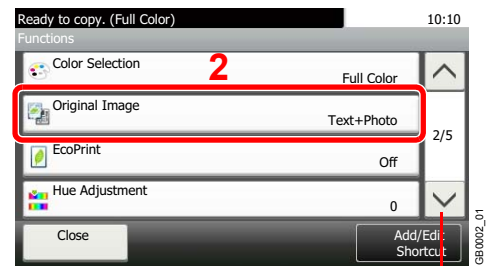
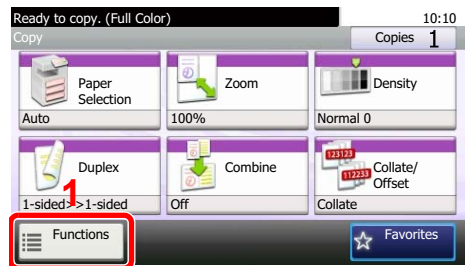

Use [∨] or [∧] to scroll up and down.

2 Select the image quality.

Copy

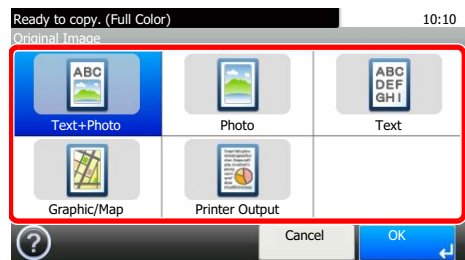

Send/Scan to USB

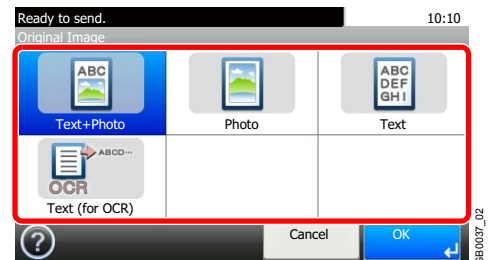

Sharpness



Adjust the sharpness of the image.

When copying penciled originals with rough or broken lines, clear copies can be taken by adjusting sharpness toward [Sharpen]. When copying images made up of patterned dots such as magazine photos, in which moire* patterns appear, edge softening and weakening of the moire effect can be obtained by setting the sharpness toward [Blur].

* Patterns that are created by irregular distribution of halftone dots.

Less Sharp



Original



More Sharp



1 Display the screen.

1 Referring to *Using Various Functions on page 3-30*, display the screen.

2 Press [Functions] and then [Sharpness].

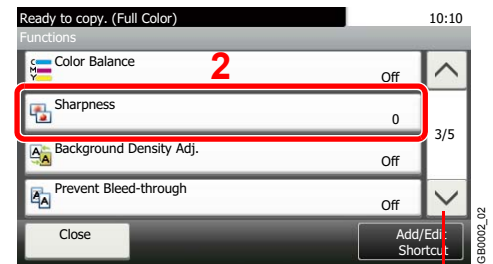
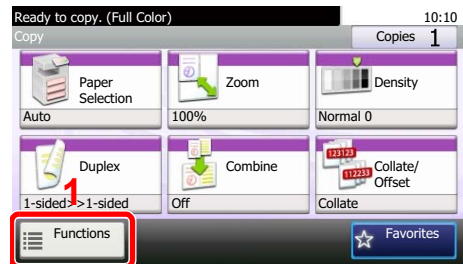

Use [∨] or [∧] to scroll up and down.

2 Adjust the sharpness.

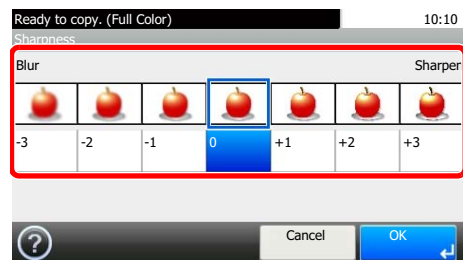

Press [-3] to [+3] (*Blur - Sharpen*) to adjust the sharpness.

Background Density Adjust



Remove dark background from originals, such as newspapers. This feature is used with full color and auto color. Background Density Adjust is disabled if Auto Color detects black and white originals.

Off	Do not use this function.
Auto	Adjusts the density automatically based on the original.
Manual	Manually adjust the density.

1 Display the screen.

1 Referring to *Using Various Functions* on page 3-30, display the screen.

2 Press [Functions] and then [Background Density Adj.].

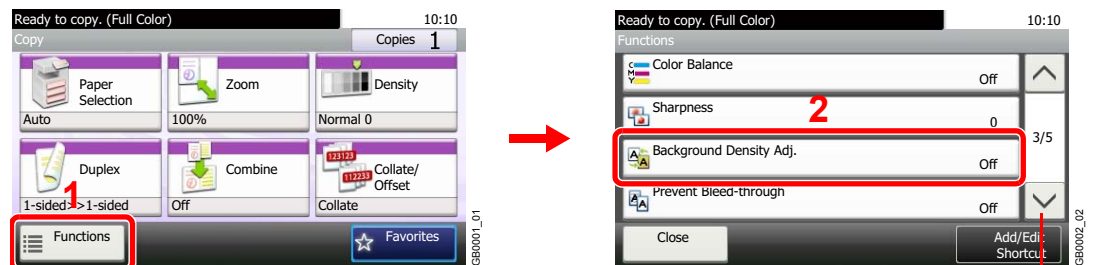

Use [∨] or [∧] to scroll up and down.

2 Adjusts the background density.

[Auto]

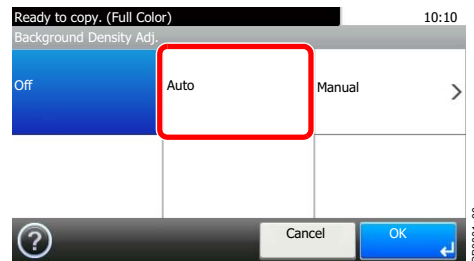

[Manual]

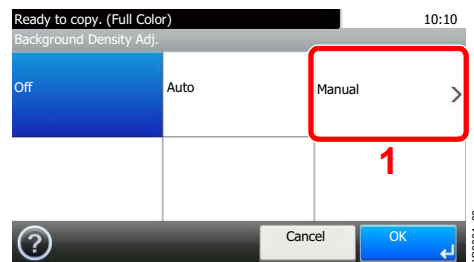

Press [1] to [5] (*Lighter - Darker*) to adjust the background density.

Prevent Bleed-through



Hide background colors and image bleed-through when scanning thin original.



1 Display the screen.

1 Referring to *Using Various Functions* on page 3-30, display the screen.

2 Press [Functions] and then [Prevent Bleed-through].

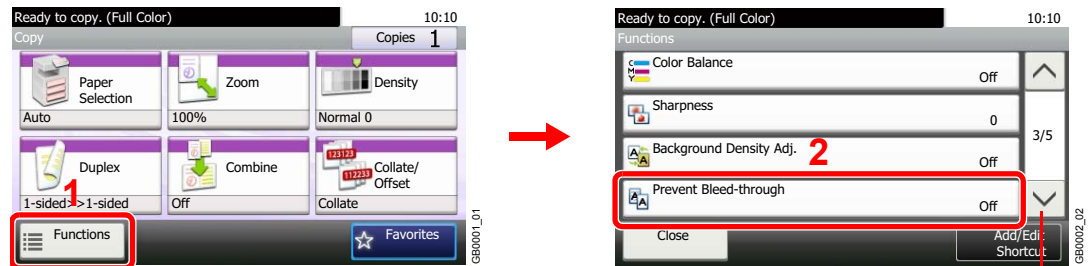

Use [∨] or [∧] to scroll up and down.

2 Select the function.

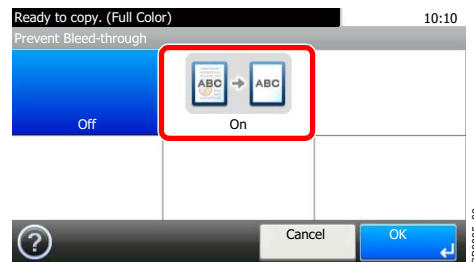

Zoom



Reduce or enlarge original to send or store size.

100%	Reproduces the original size.
Auto	Adjust the image to match the send or store size.

NOTE

Select Sending / Storing Size, when you reduce or enlarge original.

Refer to *Sending Size* on page 6-40 and *Storing Size* on page 7-15.

1 Display the screen.

1 Referring to *Using Various Functions* on page 3-30, display the screen.

2 Press [Functions] and then [Zoom].

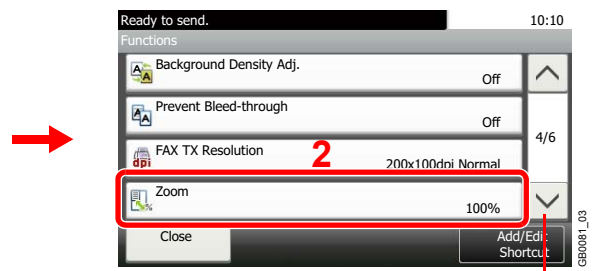

Use [∨] or [∧] to scroll up and down.

2 Select the function.

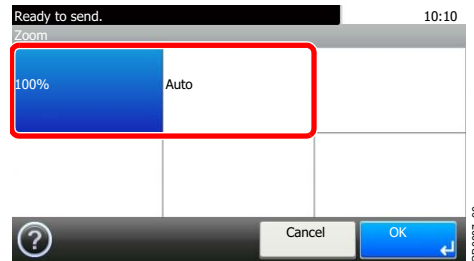

File Format



Specify the image file format. In addition, you can adjust the image quality level.

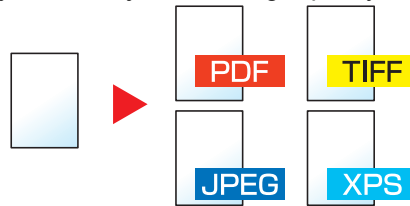

PDF		Saves or sends a PDF file. You can specify the format that comply with PDF/A.
TIFF		Saves or sends a TIFF file.
JPEG		Saves or sends a JPEG file. Each page will be saved individually.
XPS		Saves or sends a file in XPS.
Others	File Format	Select from PDF, TIFF, JPEG, and XPS.
	Image Quality	Set the image quality from [1] to [5] (<i>Low Quality - High Quality</i>).
	PDF/A*	Set PDF/A from [PDF/A-1a] and [PDF/A-1b].

* This setting is displayed only when [PDF] has been selected as the file format.

1 Display the screen.

1 Referring to *Using Various Functions on page 3-30*, display the screen.

2 Send

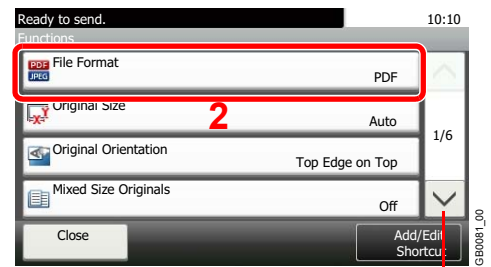
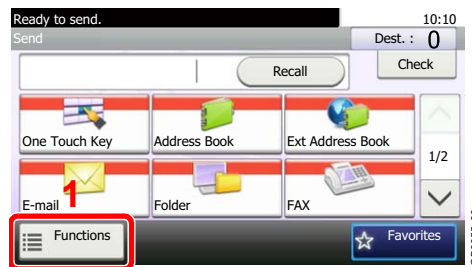

Use [∨] or [∧] to scroll up and down.

Scan to USB

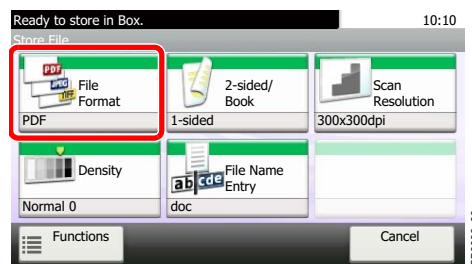

2 Select the file format.

[PDF], [TIFF], [JPEG], or [XPS]

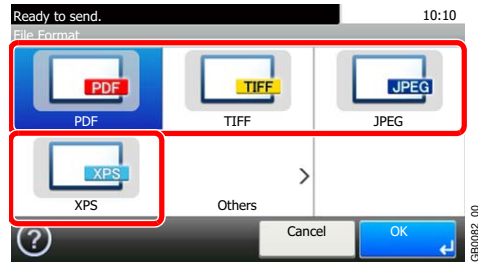

[Others]

1

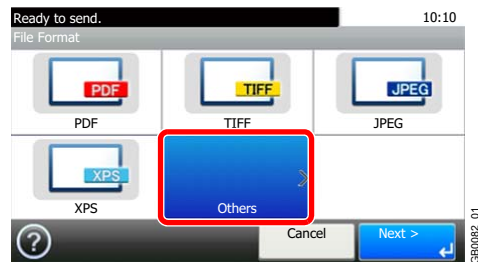

2 Select the file format.

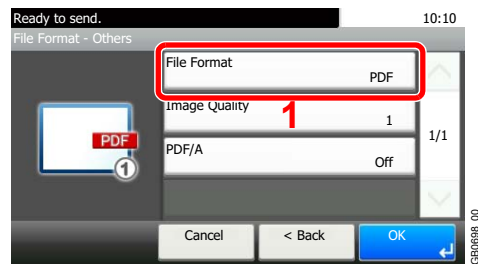

2

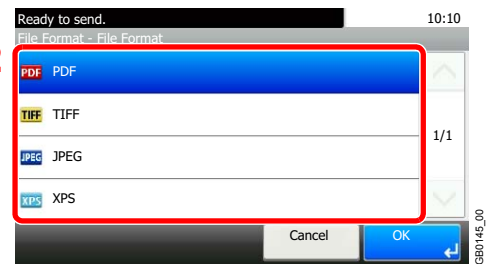

3 Set the image quality.

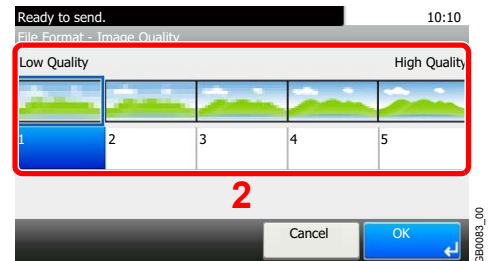
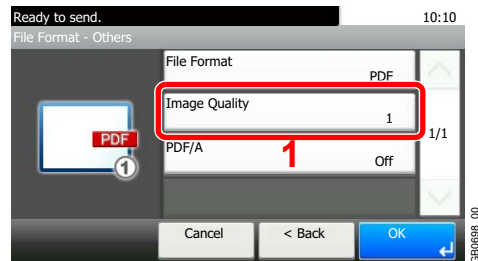

4 Set PDF/A.

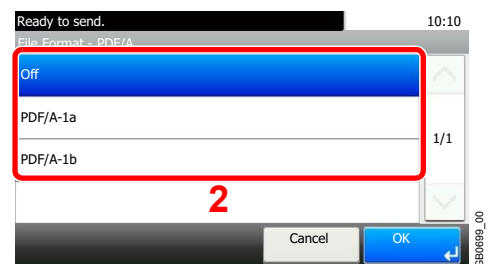
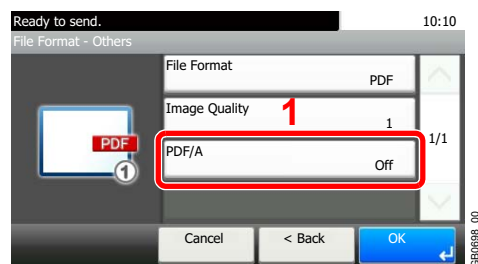

Color Selection



Select the color mode setting.

Auto Color*	Automatically recognizes whether a document is color or black and white, and then scans the document.
Auto (Color/Gray)**	Automatically detects whether the document is color or black and white, and scan color documents in Full Color and black and white documents in Grayscale.
Auto (Color/B & W)**	Automatically recognize whether the document is color or black and white, and scan color documents in Full Color and black and white documents in Black and White.
Full Color	Scan document in full color.
Grayscale**	Scan document in Grayscale for smoother and finer finish.
Black & White	Scan document in black and white. File size is smaller than Full Color or Grayscale.

* This function is displayed while copying or printing.

** This function is displayed while sending or storing.

1 Display the screen.

1 Referring to *Using Various Functions* on page 3-30, display the screen.

2 Press [Functions] and then [Color Selection].

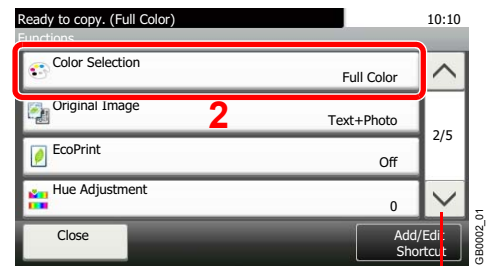
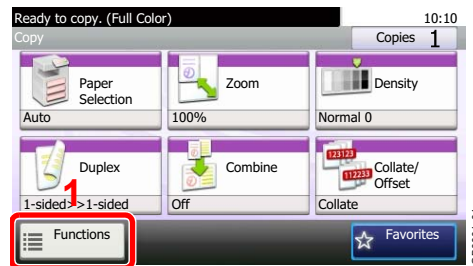

Use [∨] or [∧] to scroll up and down.

2 Select the color mode.

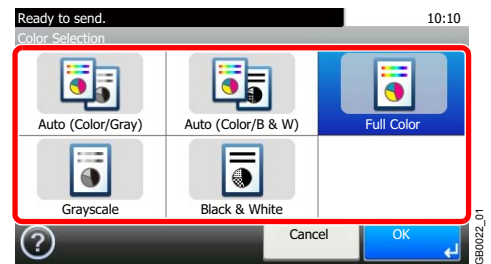
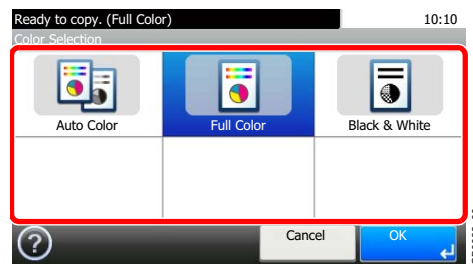

Job Finish Notice



Send e-mail notice when a job is complete.

User can be notified of the completion of a copy job while working at a remote desk, saving the time spent waiting beside the machine for copying to finish.



NOTE

PC should be configured in advance so that E-mail can be used.

Email can be sent to a single destination.

1 Display the screen.

1 Referring to *Using Various Functions* on page 3-30, display the screen.

2 Press [Functions] and then [Job Finish Notice].

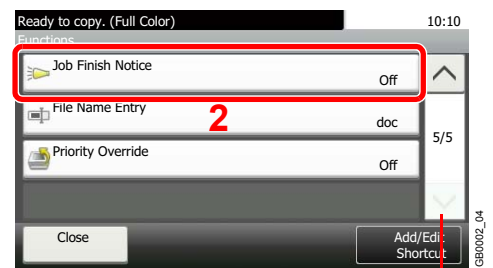
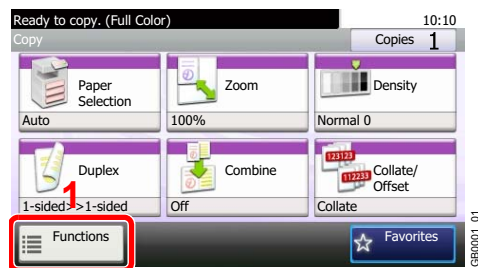

Use [∨] or [∧] to scroll up and down.

2 Select the function.

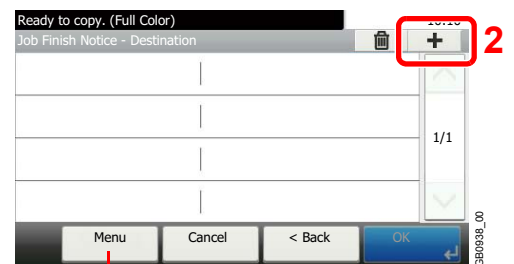
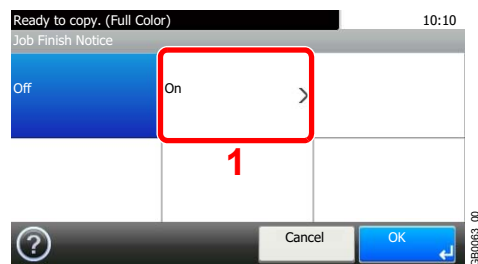

Allows you to add, edit, or delete a destination.

3 Select the destination.

Select an e-mail address from the address book.

Searches by destination name.

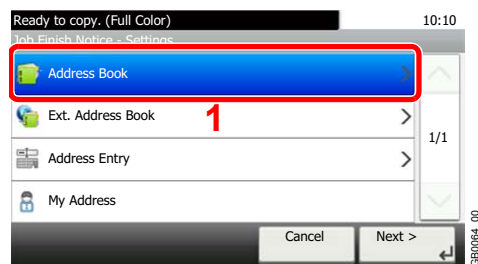

Allows you to search for and sort destinations.

Displays details for individual destinations.

Select the e-mail address from an external address book.

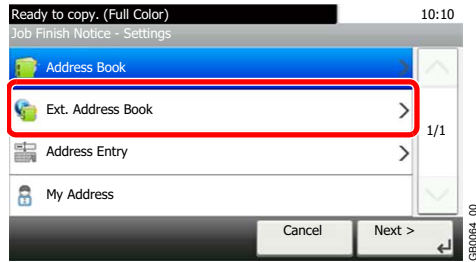

For details on the External Address Book, refer to *Command Center RX User Guide*.

Enter the e-mail address directly.

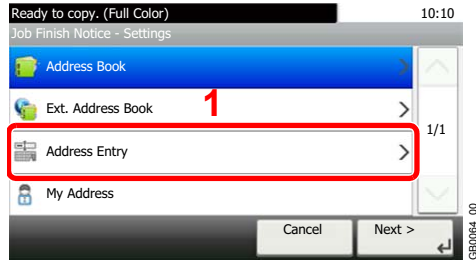

Up to 128 characters can be entered.

Refer to *Character Entry Method on page 11-7* for details on entering characters.

Uses the e-mail address of the logged in user.

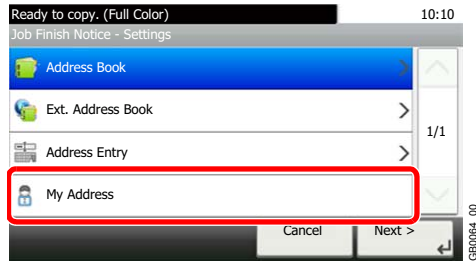

This setting is displayed when using user login administration.

4 Accept the destinations.

Press [OK].

File Name Entry



Add a file name. Additional information such as Job No. and Date and Time can also be set. You can check a job history or job status using the job name, date and time, or job number specified here.

1 Display the screen.

1 Referring to *Using Various Functions on page 3-30*, display the screen.

2 Copy/Send

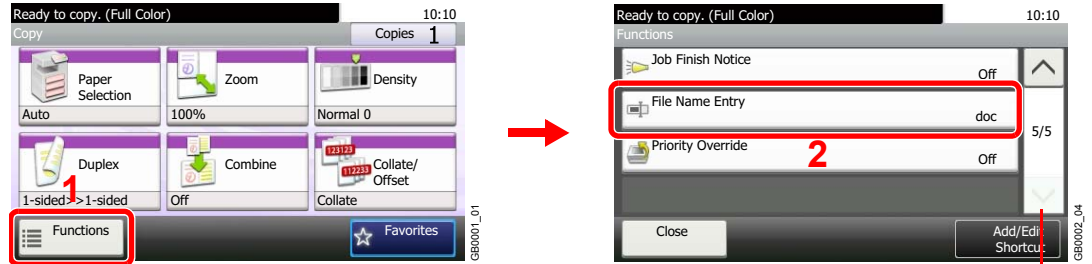

Use [∨] or [∧] to scroll up and down.

Scan to USB

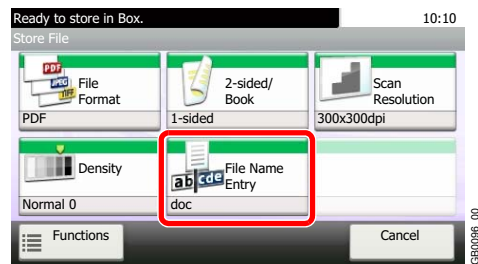

2 Enter the name.

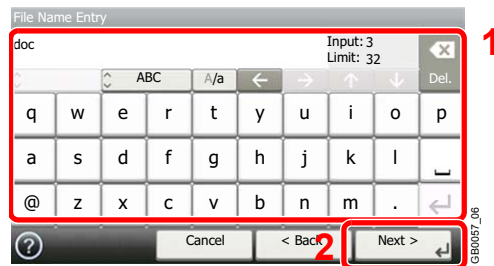

Up to 32 characters can be entered.

 Refer to *Character Entry Method on page 11-7* for details on entering characters.

3 Add other information.

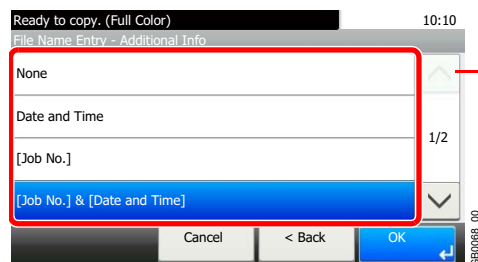

Use [∨] or [∧] to scroll up and down.

Priority Override



Suspend the current job and give a new job top priority. The suspended job resumes after the other job is finished.

NOTE

This function is not available if current job was an override.

Priority override may not be available depending on the status of the current print job and memory usage.

1 Display the screen.

1 Referring to *Using Various Functions* on page 3-30, display the screen.

2 Press [Functions] and then [Priority Override].

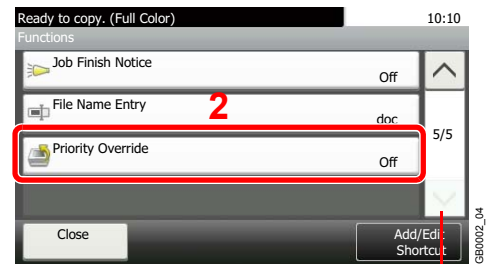
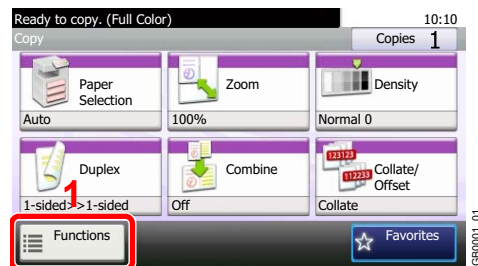

Use [∨] or [∧] to scroll up and down.

2 Select the function.

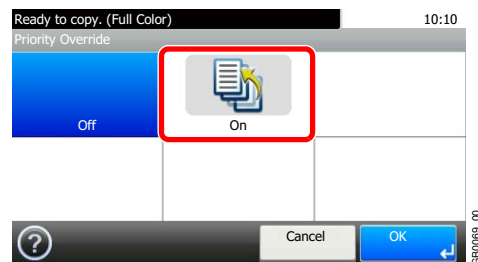

4 Copying

This chapter explains the following topics:

Basic Operation	4-2
Copying Functions	4-4
Zoom	4-5
Duplex	4-8
Combine	4-12
EcoPrint	4-15
Hue Adjustment	4-16
Color Balance	4-17
Saturation	4-18
Auto Image Rotation	4-19
Interrupt Copy	4-20

Basic Operation

1 Press the Copy key



NOTE

If the touch panel is turned off, press the **Energy Saver** key or the **Power** key and wait for the machine to warm up.

2 Place the originals

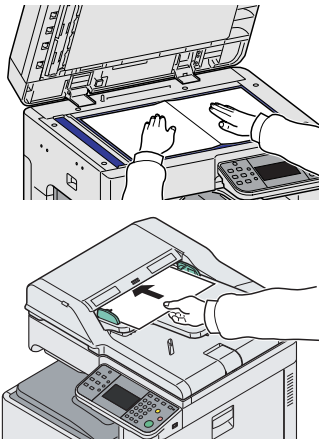

For details, refer to *Loading Originals* on page 3-7.

3 Selecting color mode



Auto Color	Automatically recognizes whether a document is color or black & white and then scans the document.
Full Color	Scans all documents in full color.
Black & White	Scans all documents in black & white.

4 Selecting the functions

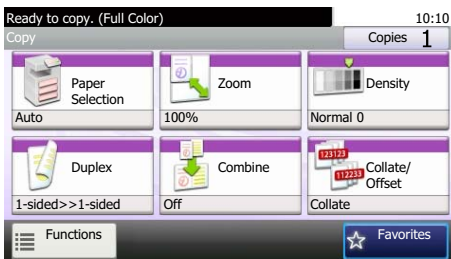

Select the copier's functions to use.

Press [Functions] to display other functions.



Refer to *Copying Functions* on page 4-4.

5 Entering the copy quantity

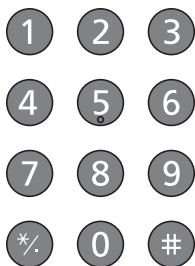

NOTE

Press the **Clear** key to change the copy quantity.

6 Start copying

Start

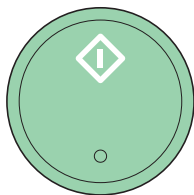

Press the **Start** key to start copying.

Copying Functions

Copy screen shows the commonly used functions. By pressing [Functions], other selectable functions will be shown as a list. Use [v] or [^] to select the function.

What do you want to do?	Reference Page
Specify the paper size and type.	Paper Selection ▶ page 3-42
Reduce or enlarge the original.	Zoom ▶ page 4-5
Adjust the density.	Density ▶ page 3-51
Copy on both sides of the paper.	Duplex ▶ page 4-8
Combine 2 or 4 originals into 1 sheet.	Combine ▶ page 4-12
Collate the output documents in page order. Offset the output documents by set.	Collate/Offset ▶ page 3-44
Specify the original size.	Original Size ▶ page 3-32
Specify the original orientation to scan in the correct direction.	Original Orientation ▶ page 3-34
Copy mixed size originals.	Mixed Size Originals ▶ page 3-35
Change the paper output.	Paper Output ▶ page 3-43
Staple in the output documents.	Staple ▶ page 3-49
Change the color mode.	Color Selection ▶ page 3-60
Select original image type for best results.	Original Image ▶ page 3-53
Save toner when printing.	EcoPrint ▶ page 4-15
Make a copy after changing the appearance of the original's colors.	Hue Adjustment ▶ page 4-16
Adjust colors, for example by strengthening cyan or magenta tones.	Color Balance ▶ page 4-17
Emphasize the outline of texts or lines. Blur the image outline.	Sharpness ▶ page 3-54
Darken or lighten the background (i.e., the area with no text or images) of originals.	Background Density Adjust ▶ page 3-55
Prevent bleed-through for 2-sided originals.	Prevent Bleed-through ▶ page 3-56
Make a copy with more vivid colors.	Saturation ▶ page 4-18
Add margins (white space).	Margin ▶ page 3-46
Scan a large number of originals separately and then produce as one job.	Continuous Scan ▶ page 3-40
Automatically rotate the scanned image to match the paper orientation.	Auto Image Rotation ▶ page 4-19
Send notice by e-mail when a job is complete.	Job Finish Notice ▶ page 3-61
Add a file name to the job to easily check its status.	File Name Entry ▶ page 3-63
Suspend the current job and override it to give a new job top priority.	Priority Override ▶ page 3-64
Pause the current jobs and make copies immediately.	Interrupt Copy ▶ page 4-20

Zoom

Adjust the zoom to reduce or enlarge the image.

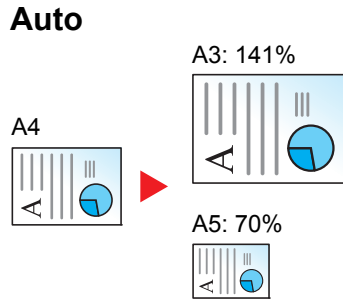

Adjusts the image to match the paper size.

Standard Zoom

Adjusts the image to match present sizes.

Model	Zoom Level (Original Copy)	Model	Zoom Level (Original Copy)
Inch Models	Auto 400% (Max.) 200% (STMT >> Ledger) 154% (STMT >> Legal) 129% (Letter >> Ledger) 121% (Legal >> Ledger) 100% 78% (Legal >> Letter) 77% (Ledger >> Legal) 64% (Ledger >> Letter) 50% (Ledger >> STMT) 25% (Min.)	Metric Models	Auto 400% (Max.) 200% (A5 >> A3) 141% (A4 >> A3, A5 >> A4) 127% (Folio >> A3) 106% (11×15" >> A3) 100% 90% (Folio >> A4) 75% (11×15" >> A4) 70% (A3 >> A4, A4 >> A5) 50% 25% (Min.)
		Metric Models (Asia Pacific)	Auto 400% (Max.) 200% (A5 >> A3) 141% (A4 >> A3, B5 >> B4) 122% (A4 >> B4, A5 >> B5) 115% (B4 >> A3, B5 >> A4) 100% 86% (A3 >> B4, A4 >> B5) 81% (B4 >> A4, B5 >> A5) 70% (A3 >> A4, B4 >> B5) 50% 25% (Min.)

Zoom Entry

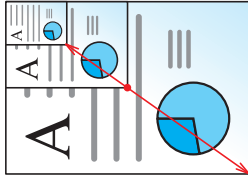

Specify the image size in 1% increment between 25% - 400% of the original.

1 Display the screen.

1 Referring to *Basic Operation on page 4-2*, display the screen.

2

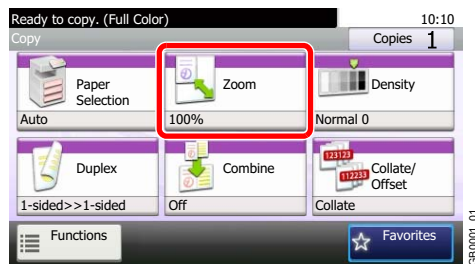

2 Select the function.

[Auto]

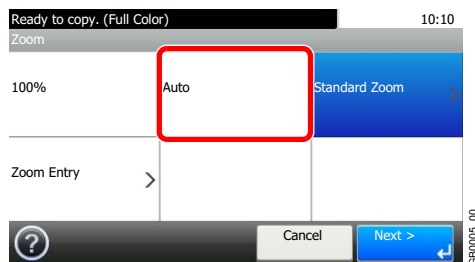

[Standard Zoom]

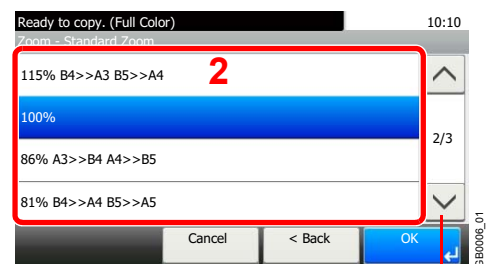
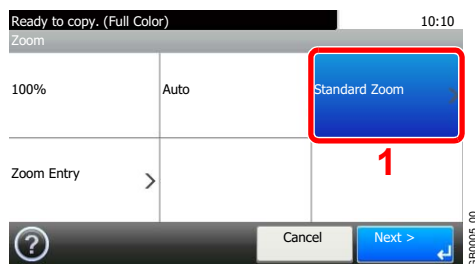

Use [∨] or [∧] to scroll up and down.

Select the zoom level.

[Zoom Entry]

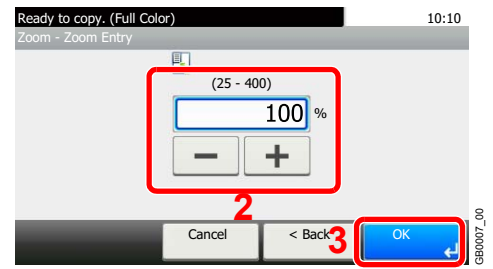
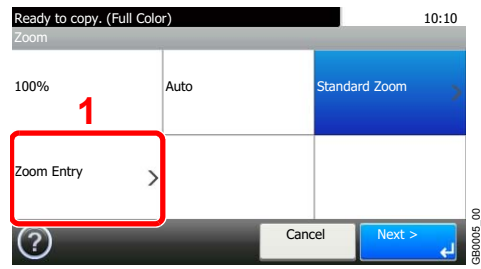

Enter the magnification.

Duplex

Print 1-sided or open book originals to 2-sided, or 2-sided or open book originals to 1-sided. Select the original binding orientation and desired final binding orientation.

1-sided>>1-sided		Prints 1-sided to 1-sided.	
1-sided>>2-sided		Prints 1-sided to 2-sided.	
2-sided>>1-sided		Prints 2-sided to 1-sided.	
2-sided>>2-sided		Prints 2-sided to 2-sided.	
Others	Duplex	1-sided>>1-sided	Prints 1-sided to 1-sided.
		1-sided>>2-sided	Prints 1-sided to 2-sided.
		2-sided>>1-sided	Prints 2-sided to 1-sided.
		2-sided>>2-sided	Prints 2-sided to 2-sided.
	Book>>1-sided	Prints open book originals to 1-sided.	
	Book>>2-sided	Prints open book originals to 2-sided.	
	Binding in Original	If you choose a 2-sided sheet original, select the binding edge of the originals.	
	Binding in Finishing	If you choose a 2-sided copy, select the binding edge of the finished copies. If you choose a 2-sided copy of a book, select the setting for duplex.	
Original Orientation*	Select the orientation of the original document top edge to scan correct direction.		

* This item is not displayed when [1-sided>>1-sided], [Book>>1-sided] or [Book>>2-sided] is selected.

NOTE

The paper sizes supported in 2-sided to 2-sided are Ledger, Letter-R, Letter, Legal, Executive, Statement-R, Oficio II, A3, A4-R, A4, A5-R, B4, B5-R, B5, Folio and 216 × 340 mm.

The following sizes of originals and paper are supported in Book to 2-sided mode. Original: Ledger, Letter-R, A3, A4-R, A5-R, B4, B5-R and 8K. Paper: Letter, A4 and B5.

The following sizes of originals and paper are supported in 2-sided to 1-sided and Book to 1-sided. Original: Ledger, Letter-R, A3, A4-R, A5-R, B4, B5-R and 8K. Paper: Letter, A4, B5 and 16K. You may change paper size and reduce or enlarge copy to match that size.

1 Display the screen.

1 Referring to *Basic Operation on page 4-2*, display the screen.

2

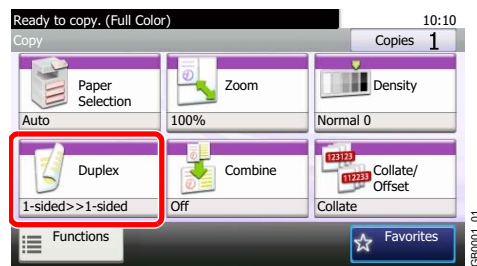

2 Select the function.

[1-sided>>1-sided], [1-sided>>2-sided], [2-sided>>1-sided], or [2-sided>>2-sided]

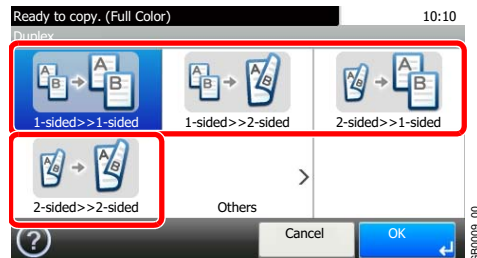

[Others]

1

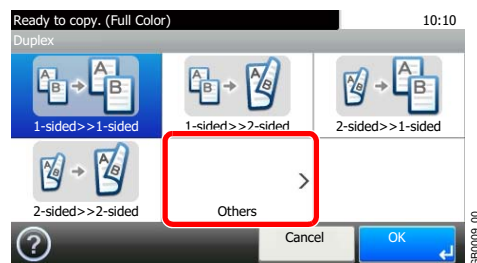

2 Select the desired Duplex option.

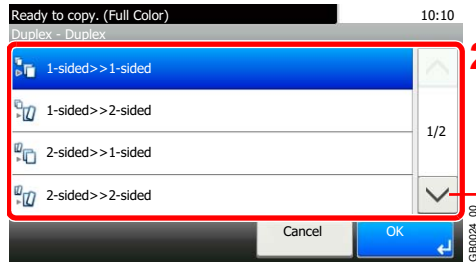
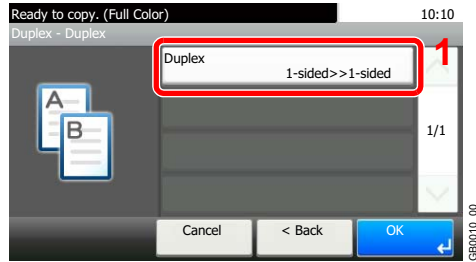

Use [∨] or [∧] to scroll up and down.

If you choose a 2-sided sheet or book, proceed to Step 3. If you choose duplex, proceed to Step 4. If you choose [Book >> 2-sided], proceed to Step 5.

3 Select the binding edge of the originals.

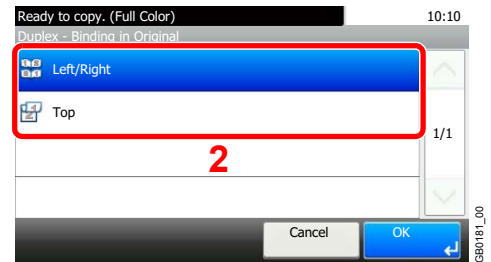
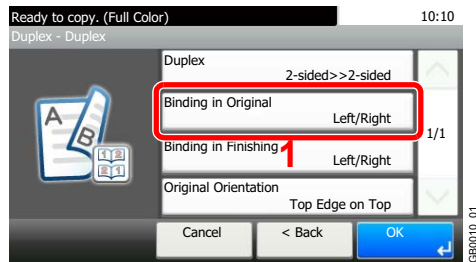

4 Select the binding edge of the finished copies.

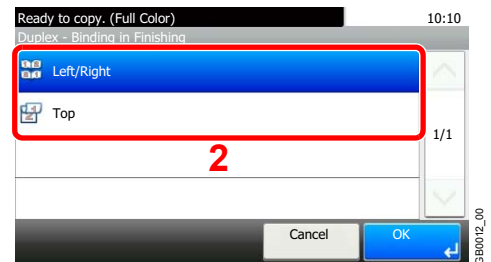
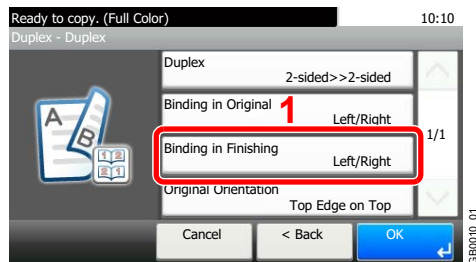

5 Select the binding edge of the finished copies.

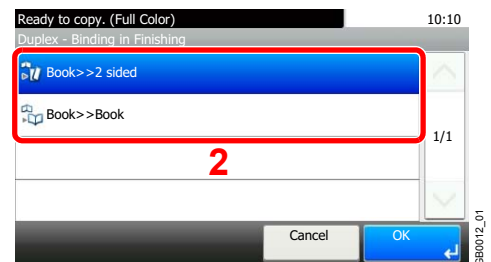
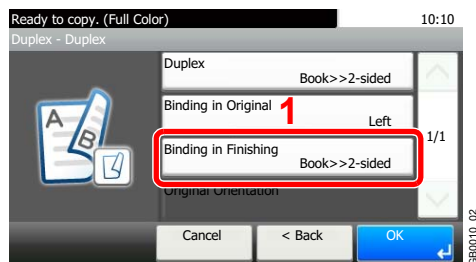



6 Select the original orientation.



If the original is placed on the platen, replace the original and press the **Start** key.
After scanning all originals, press [Finish Scan] to start copying.

Combine

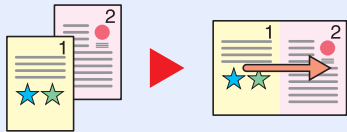
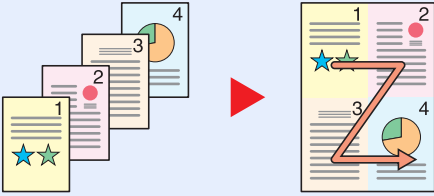
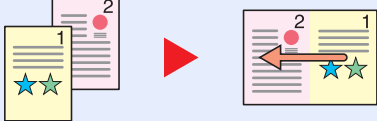
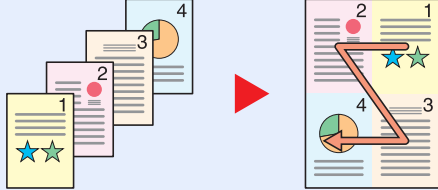
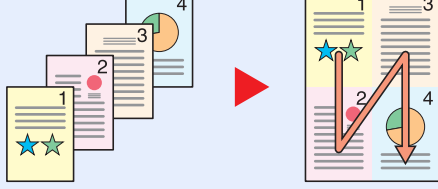
Combine 2 or 4 original sheets into 1 copied page. You can select the page layout or the type of boundary lines around the pages.

2 in 1		Copies 2 originals onto each page.
4 in 1		Copies 4 originals onto each page.
Other Settings	Combine	Copies 2 originals onto each page.
	2 in 1 (L to R/T to B)	
	2 in 1 (R to L/B to T)	
		
	4 in 1 (Right then Down)	Copies 4 originals onto each page.
	4 in 1 (Left then Down)	
		
4 in 1 (Down then Right)		
		
4 in 1 (Down then Left)		
		
Border Line	Sets the boundary line type to a solid line, dotted line, or positioning mark.	
Original Orientation	Select the orientation of the original document top edge to scan correct direction.	



NOTE

Combine mode is available for the copy paper sizes of A3, A4-R, A4, A5-R, B4, B5-R, B5, Folio, 216 × 340 mm, Ledger, Letter-R, Letter, Legal, Statement-R, Oficio II, 8K, 16K-R and 16K.

When placing the original on the platen, be sure to copy the originals in page order.

1 Display the screen.

1 Referring to *Basic Operation on page 4-2*, display the screen.

2

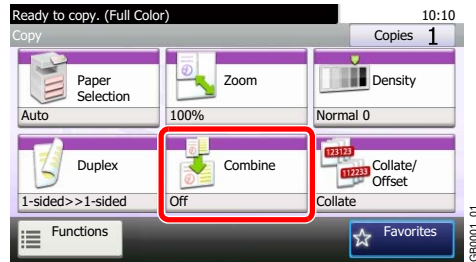

2 Select the function.

[2 in 1] or [4 in 1]

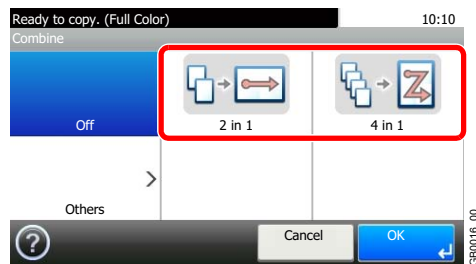

[Others]

1

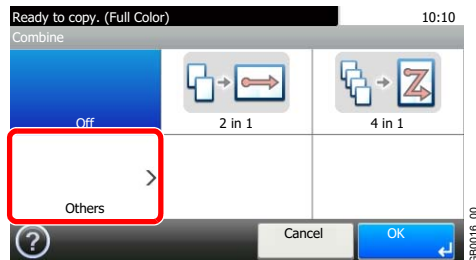

2 Select the desired Combine option.

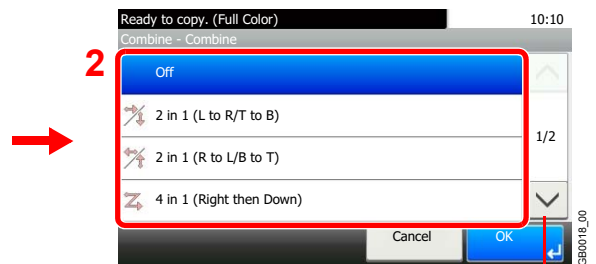
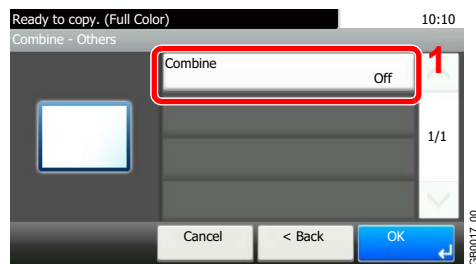

Use [∨] or [∧] to scroll up and down.

3 Sets the boundary line type.

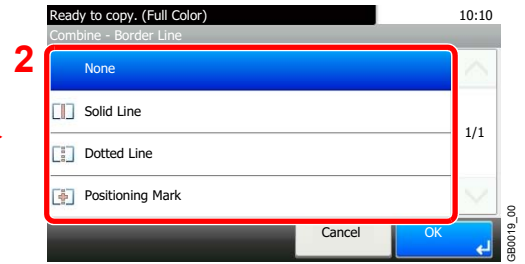
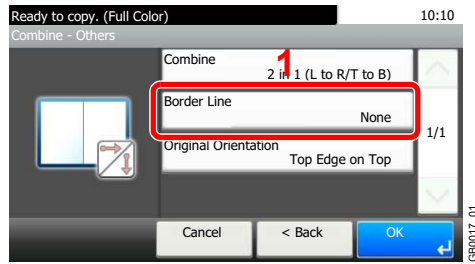

4 Select the original orientation.

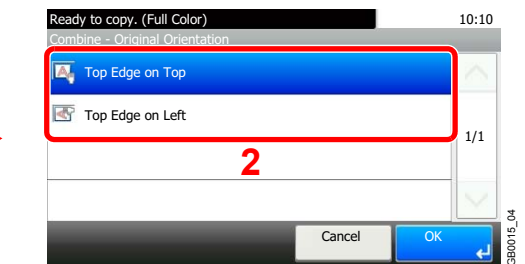
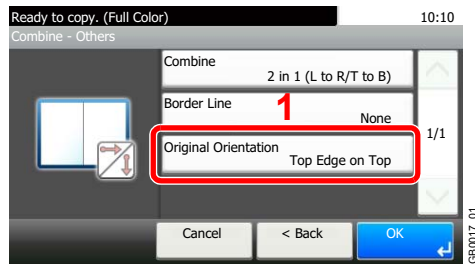

If the original is placed on the platen, replace the original and press the **Start** key.
After scanning all originals, press [Finish Scan] to start copying.

EcoPrint

Use EcoPrint to save toner when printing. Use this function for test copies or any other occasion when high quality print is not required.

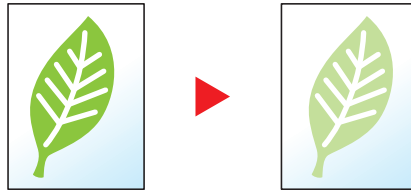

1 Display the screen.

1 Referring to *Basic Operation on page 4-2*, display the screen.

2

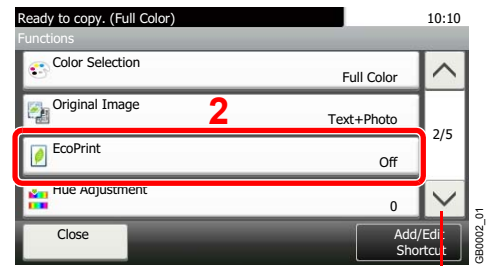
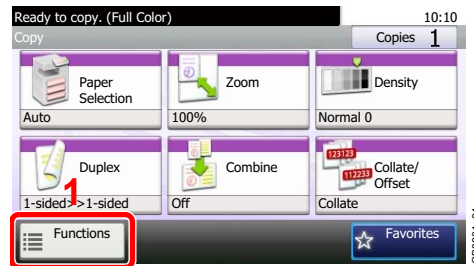

Use [∨] or [∧] to scroll up and down.

2 Select the function.

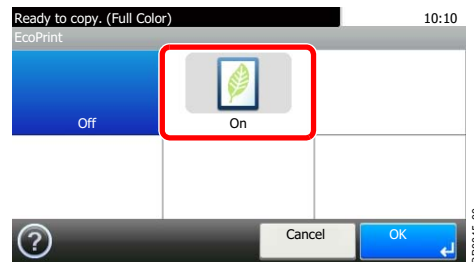

Hue Adjustment

Adjust the color (hue) of images. Make adjustments such as adjusting red to a strong yellow-red or yellow to a strong green-yellow to make more creative copies.

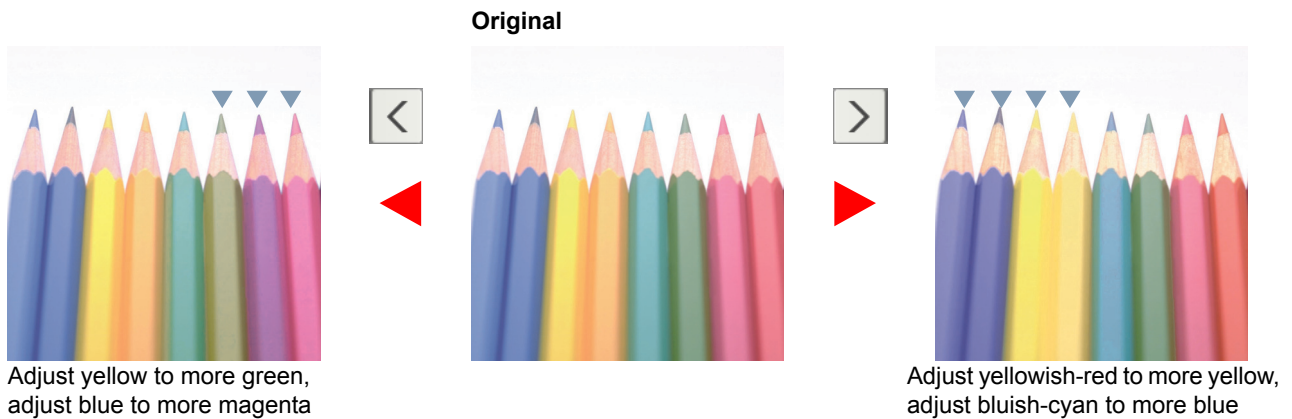

NOTE

This feature is used with full color and auto color copying.
These adjustments are especially useful on rich color images.

1 Display the screen.

1 Referring to *Basic Operation* on page 4-2, display the screen.

2

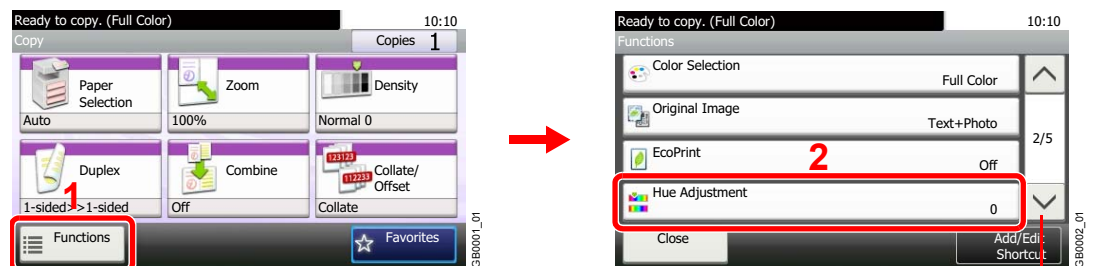

Use [∇] or [\wedge] to scroll up and down.

2 Select the function.



Press [$<$] or [$>$] to make the adjustment.

Color Balance

Adjust the strength of cyan, magenta, yellow, and black.

Less Magenta



Original



More Magenta



NOTE

This feature is used with full color and auto color copying.

1 Display the screen.

1 Referring to *Basic Operation on page 4-2*, display the screen.

2

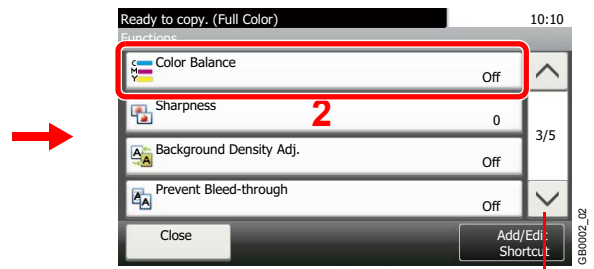
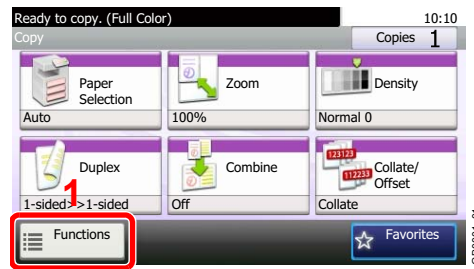

Use [∨] or [∧] to scroll up and down.

2 Select the function.

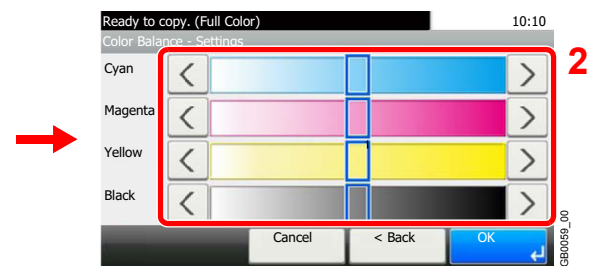
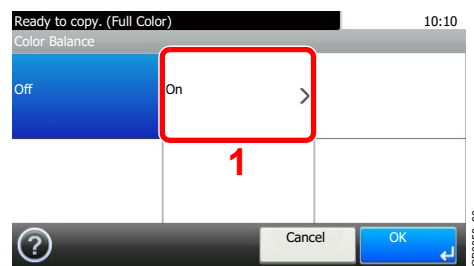

Press [<] or [>] on each side of the color to be adjusted (Cyan, Magenta, Yellow, Black) to adjust each color.

Saturation

Adjust the color saturation of the image.

Grayish



Results in paler color.

Original



Vivid



Results in more vivid color.



NOTE

This feature is used with full color and auto color copying.

1 Display the screen.

1 Referring to *Basic Operation on page 4-2*, display the screen.

2

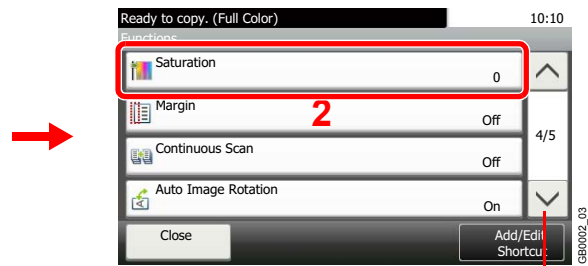
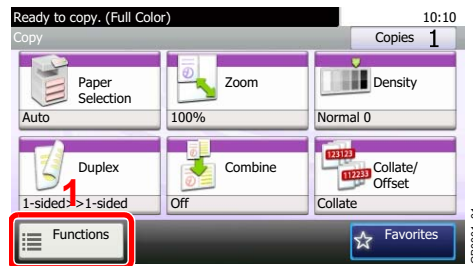

Use [∨] or [∧] to scroll up and down.

2 Select the function.

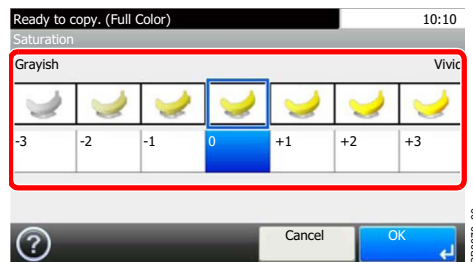

Press [-3] or [+3] (Grayish - Vivid) to adjust the color saturation.

Auto Image Rotation

When original and paper source size are the same, but their orientation is different, rotate image 90 degrees.

1 Display the screen.

1 Referring to *Basic Operation on page 4-2*, display the screen.

2

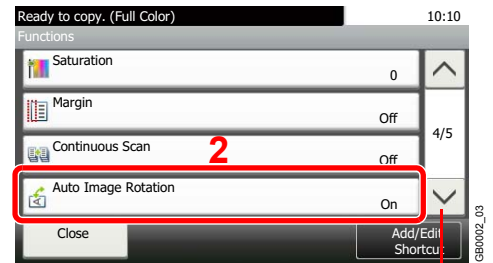
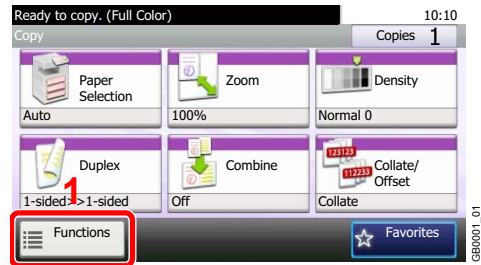

Use [∨] or [∧] to scroll up and down.

2 Select the function.

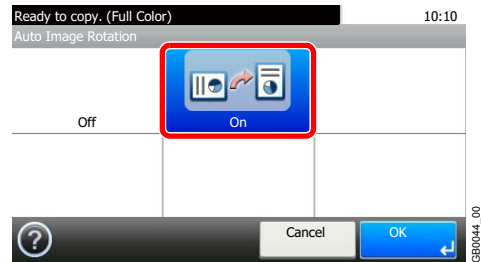

Interrupt Copy

This function allows you to pause the current jobs in progress when you need to make copies immediately. When interruption copy ends, the machine resumes the paused print jobs.

 **NOTE**

If the machine is left unused for 60 seconds in interrupt copy mode, interrupt copying is automatically cancelled and printing resumes. You can change the delay until interrupt copying is cancelled. Change the delay as required. For more information, refer to *Interrupt Clear Timer on page 9-25*.

The interrupt copy function may be unavailable due to insufficient memory depending on the manner in which the equipment is being utilized.

1 Press the Interrupt key.

Interrupt

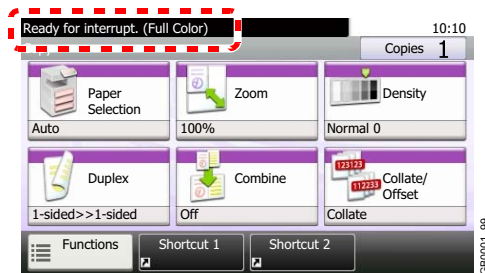

The current print job is temporarily interrupted.

2 Make an interrupt copy.

- 1 Place the originals onto the machine for interrupt copy, and configure the copy settings.
- 2 Press the **Start** key to start interrupt copying.

Start

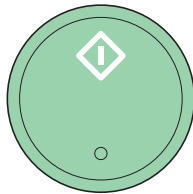

3 End the interrupt copy.

Interrupt



When interrupt copying ends, press the **Interrupt** key. The machine resumes the paused print jobs.

5 Printing

This chapter explains the following topics:

Printing from Applications	5-2
Printing Data Saved on the Printer	5-7
Private Print	5-7
Proof and Hold	5-9
Automatic Delete Setting for Temporary Documents	5-12

Printing from Applications

This section provides basic instructions for printing documents. Instructions are based on interface elements as they appear in Windows 7.

You can print documents created on your computer once you install the printer driver from the included DVD (Product Library).

 Refer to *Installing Software* on page 2-14.

For more information about how to configure advanced printer driver settings and print documents, refer to the *Printer Driver User Guide* on the DVD.

1 Display the window.

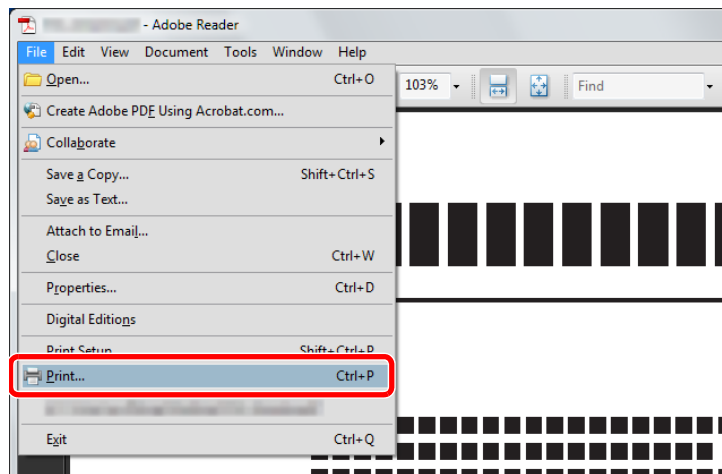

Click **File** and select **Print** in the application.

2 Configure the printer.

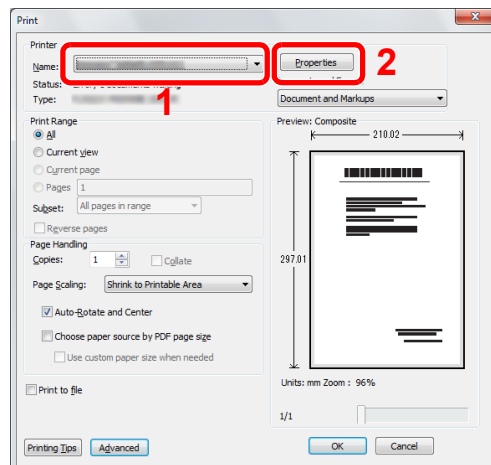

1 Select the printer.

2 Click **Properties** button.

3 Select the **Basic** tab.

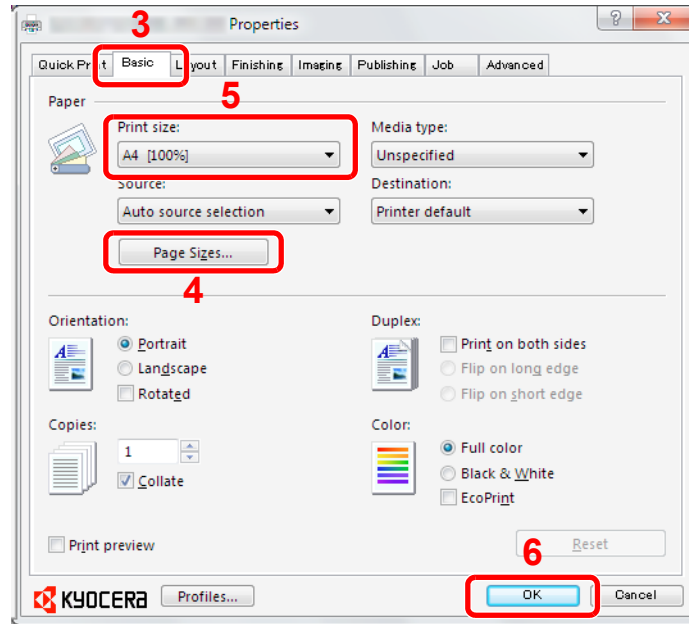

- 4** Click the **Page Sizes** button to select the paper size for the document data.
- 5** Click **Print size** and select the paper size to use for printing.
- 6** Click **OK** button to return to the **Print** dialog box.

3 **Start printing.**

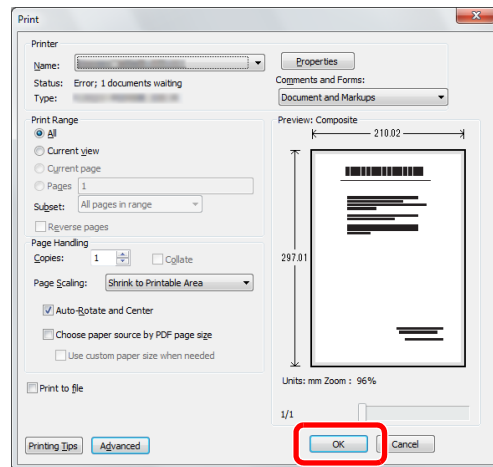

Click **OK** button.



NOTE

Click the tabs on the print settings screen and configure the print settings as necessary. For more information, refer to the *Printer Driver User Guide*.

Changing the default printer driver settings (Windows 7)

The default printer driver settings can be changed. By selecting frequently used settings, you can omit steps when printing.

The procedure is as follows.

- 1 Click the **start** button, and then click **Devices and Printers**.
- 2 Right-click the printer driver icon of the machine, and click the **Printer properties** menu of the printer driver.
- 3 Click the **Printing Preferences** button on the **General** tab.
- 4 Select the default settings and click the **OK** button.

For the settings, refer to *Printer driver User Guide*.

Printer driver print settings screen

The printer driver print settings screen allows you to configure a variety of print-related settings. For more information, refer to the *Printer Driver User Guide* on the DVD.

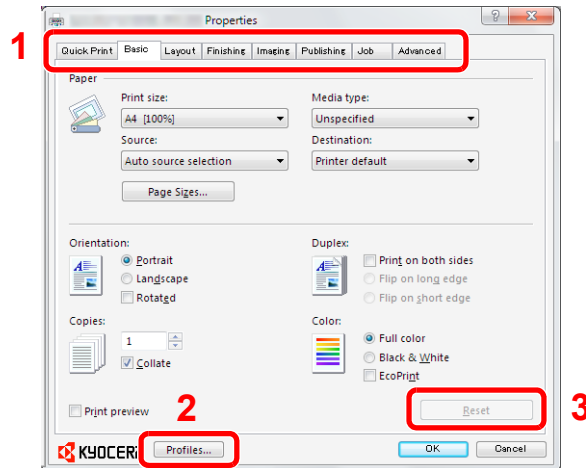

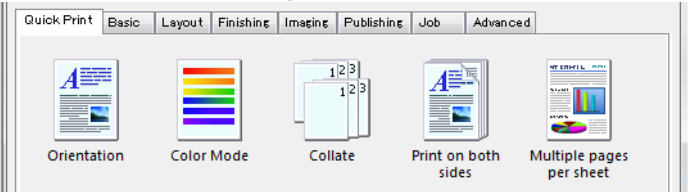
No.	Description
1	<p>Quick Print</p> <p>Provides icons that can be used to easily configure frequently used functions. Each time you click an icon, it changes to an image resembling the print results and applies the settings.</p>  <p>Basic This tab groups basic functions that are frequently used. You can use it to configure the paper size, destination, duplex printing, and color mode.</p> <p>Layout This tab lets you configure settings for printing various layouts, including booklet printing, combine mode, poster printing, and scaling.</p> <p>Finishing This tab lets you configure settings related to finishing of printed media, including binding and stapling.</p> <p>Imaging This tab lets you configure settings related to the quality and color mode of the print results.</p> <p>Publishing This tab lets you create cover sheets and insert and add OHP film for print jobs.</p> <p>Job This tab lets you configure settings for saving print data from the computer to the machine. Regularly used documents and other data can be saved to the machine for easy printing later. Since saved documents can be printed directly from the machine, this function is also convenient when you wish to print a document that you don't want others to see.</p> <p>Advanced This tab lets you configure settings for adding text pages or watermarks to print data. It also provides simple color adjustment functionality.</p>
2	<p>Profiles</p> <p>Printer driver settings can be saved as a profile. Saved profiles can be recalled at any time, so it's a convenient practice to save frequently used settings.</p>
3	<p>Reset</p> <p>Click to revert settings to their initial values.</p>

Printer Driver Help

The printer driver includes Help. To learn more about print settings, display the printer driver print settings screen and display Help using either of the methods explained below.

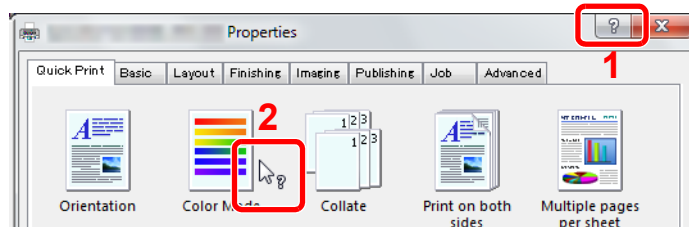

- Click the ? button in the upper right corner of the screen and then click the item you want to know about.
- Click the item you want to know about and press the [F1] key on your keyboard.

Printing Data Saved on the Printer

Print data can be saved in the machine's Job Box and printed when needed.

Private Print

Private Print stores the print data which is printed by using the printer driver as a Private Print. Refer to the *Printer Driver User Guide* on how to print a job as Private Print using the printer driver.



NOTE

RAM disk mode must be enabled.



For details, refer to *RAM Disk Setting* on page 9-23.

1 Display the screen.

Document Box



1

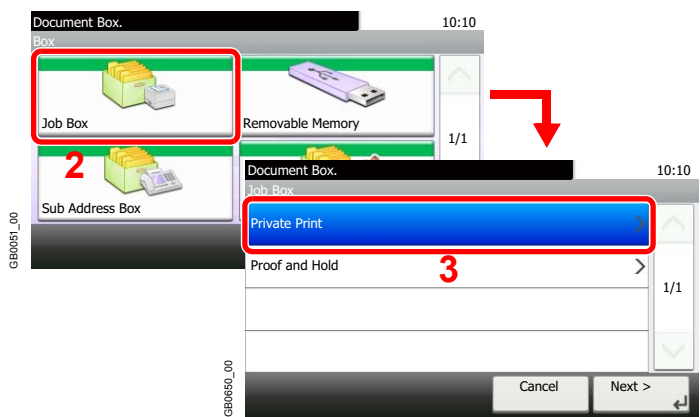

2 Select the creator of the document to print.

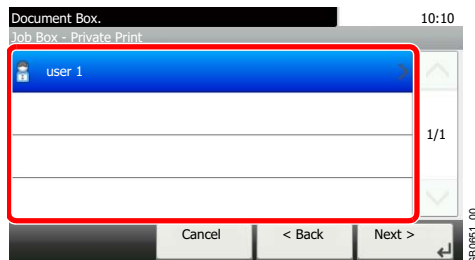

3 Select the document.

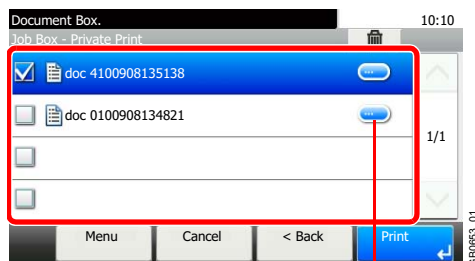

Displays details for individual documents.

4 Print and delete the document.

To print the document

1

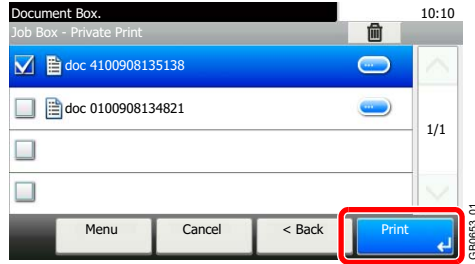

NOTE

The password entry screen will be displayed. Enter the password using the numeric keys.

2

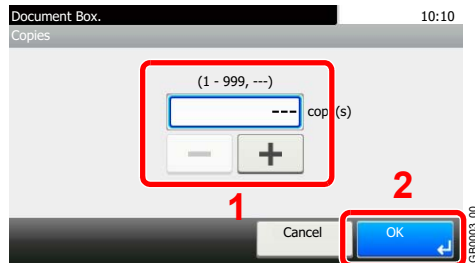

Specify the number of copies to print as desired. When using the number of copies specified with print job, select “---”.

Upon completion of printing, the Private Print job is automatically deleted.

To delete

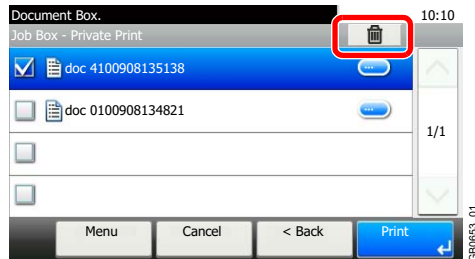

NOTE

The password entry screen will be displayed. Enter the password using the numeric keys.

Proof and Hold

Proof and Hold stores the print data which is printed by using the printer driver as a Proof and Hold Print job. Refer to the *Printer Driver User Guide* on how to print a job as Proof and Hold Print job using the printer driver.

NOTE

RAM disk mode must be enabled.

 For details, refer to *RAM Disk Setting* on page 9-23.

Setting the Number of Stored Jobs

To maintain free space on the RAM disk, you can set the maximum number of stored jobs.

1 Display the screen.

◆ System Menu / Counter

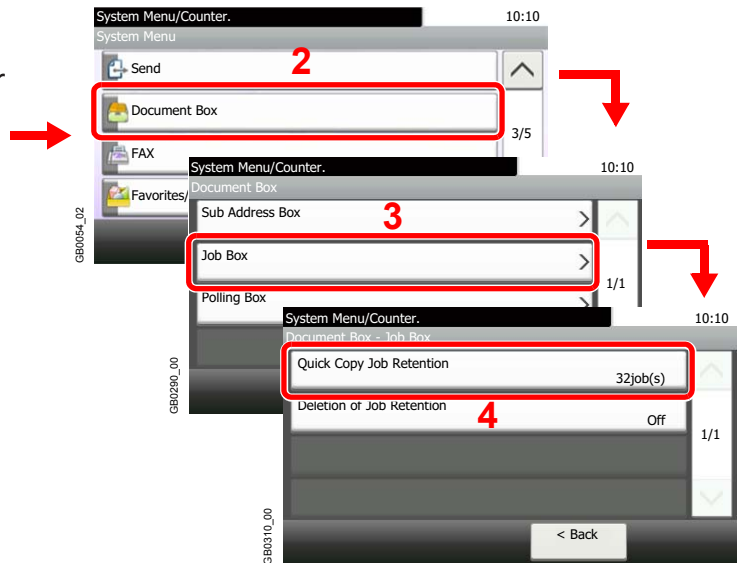
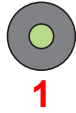

2 Enter the maximum number of stored jobs.

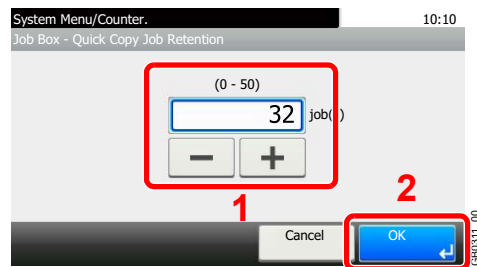

You can enter any number between 0 and 50.

NOTE

If you enter a value of 0 (zero), you cannot use the Proof and Hold function.

Printing and Deleting the Document

You can print and delete documents stored in the Proof and Hold box.

1 Display the screen.

Document Box

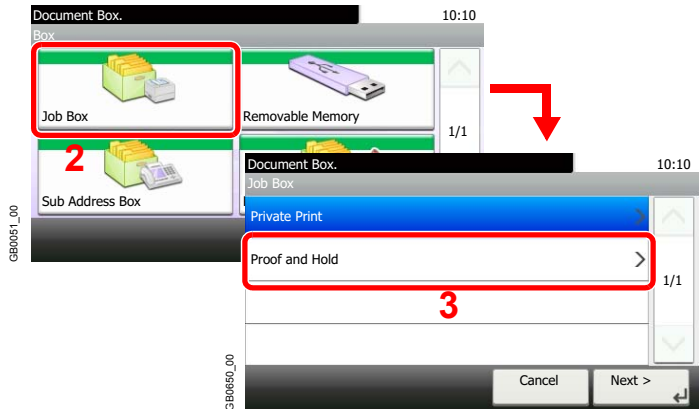

2 Select the creator of the document.

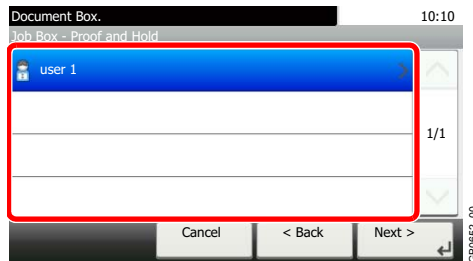

3 Select the document.

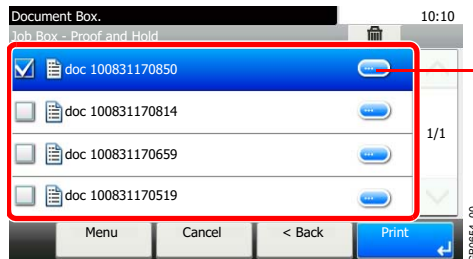

Displays details for individual documents.

4 Print and delete the document.

To print the document

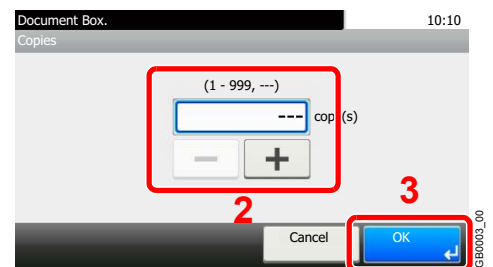
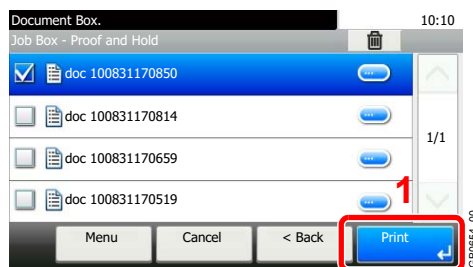

Specify the number of copies to print as desired. When using the number of copies specified with print job, select “---”.

To delete

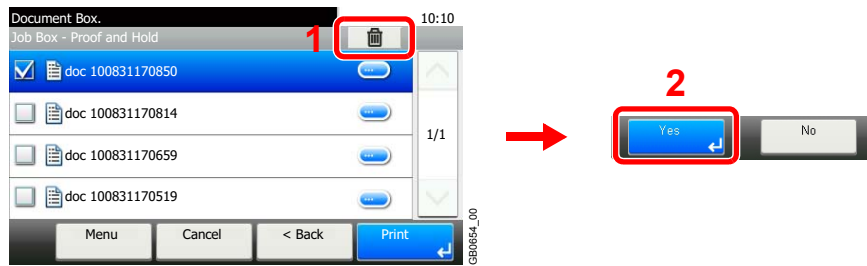

Automatic Delete Setting for Temporary Documents

This setting specifies that documents, such as Private Printing, or Proof and Hold Printing, saved temporarily in the job box are automatically deleted after they have been saved for a set time.

Off	Temporary documents are not automatically deleted.
1 hour	Documents are deleted after 1 hour.
4 hours	Documents are deleted after 4 hours.
1 day	Documents are deleted after 1 day.
1 week	Documents are deleted after 1 week.



NOTE

This function is valid for documents saved after the function is set.

Regardless of this function setting, temporary documents are deleted when the main power switch is turned off.

1 Display the screen.

◆ System Menu / Counter



1

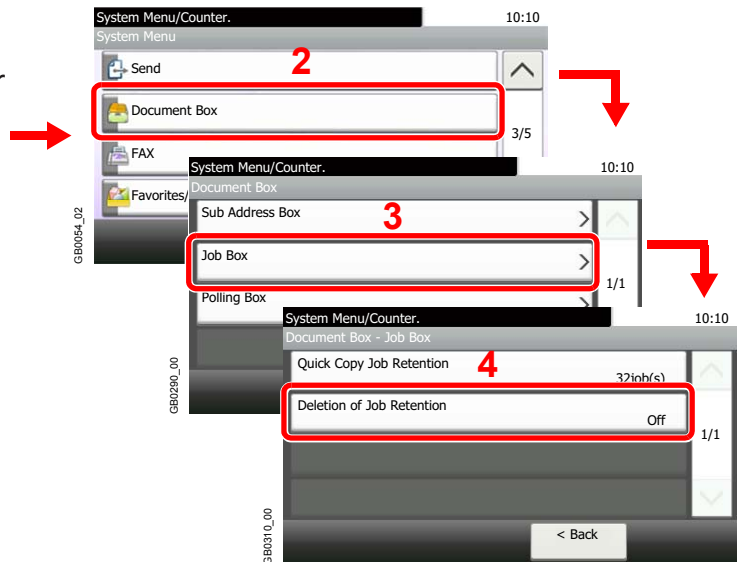

2 Select the time.

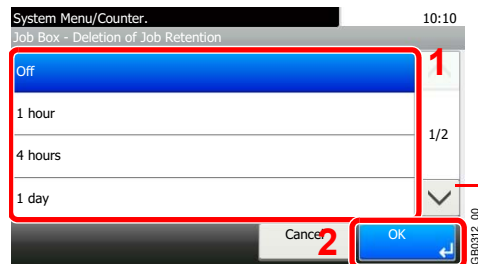

Use [V] or [^] to scroll up and down.

6 Sending

This chapter explains the following topics:

Basic Operation	6-2
Preparation for Sending a Document to a PC	6-5
Making a note of the computer name and full computer name	6-5
Making a note of the user name and domain name	6-6
Creating a Shared Folder, Making a Note of a Shared Folder	6-7
Configuring Windows Firewall (for Windows 7)	6-10
Register the shared folder in the address book	6-14
Specifying Destination	6-17
Choosing from the Address Book	6-17
Choosing by One Touch Key	6-19
Entering a New E-mail Address	6-20
Specifying a New PC Folder	6-21
Checking and Editing Destinations	6-25
Sending to Different Types of Destinations (Multi Sending)	6-26
Registering Destinations in the Address Book	6-27
Adding a Contact	6-27
Adding a Group	6-31
Editing and Deleting Address Book Entries	6-34
Adding a Destination on One Touch Key	6-36
Adding a Destination	6-36
Editing and Deleting One Touch Key	6-38
Sending Functions	6-39
Sending Size	6-40
File Separation	6-42
E-mail Subject/Body	6-43
FTP Encrypted TX	6-44
WSD Scan	6-45
Scanning using TWAIN	6-48

Basic Operation

This machine can send a scanned image as an attachment to an E-mail message or to a PC linked to the network. In order to do this, it is necessary to register the sender and destination (recipient) address on the network.

A network environment which enables the machine to connect to a mail server is required in order to send e-mail. It is recommended that a Local Area Network (LAN) be used to assist with transmission speed and security issues.

To use the transmission function, verify the following:

- Program the settings, including the E-mail setting on the machine.
- Use Command Center RX (the internal HTML web page) to register the IP address, the host name of the SMTP server, and the recipient.
- Register the destination in the Address Book or One Touch keys.
- Create a share folder in the destination computer, when a folder (SMB/FTP) is selected as the destination. Consult your network administrator concerning destination folder sharing settings.

Basic Sending

Send as E-mail

Sends a scanned original image as an E-mail attachment. (page 6-20)

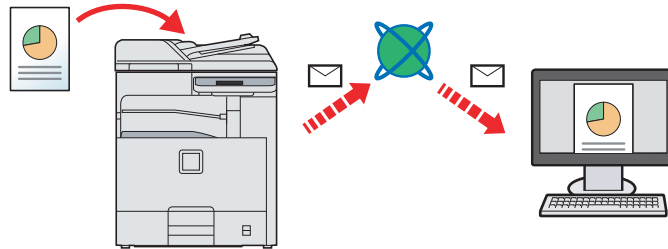

Send to Folder (SMB)

Stores a scanned original image in a shared folder of any PC. (page 6-21)

Send to Folder (FTP)

Stores a scanned original image in a folder of an FTP server. (page 6-21)

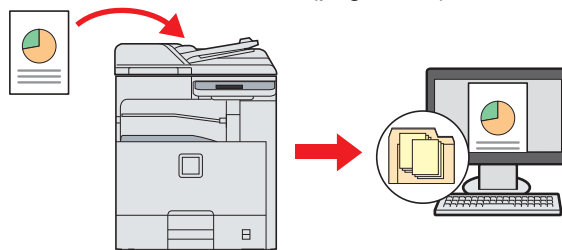



Image Data Scanning with TWAIN/WIA

Scan the document using a TWAIN or WIA compatible application program. (page 6-48)

 **NOTE**
Different sending options can be specified in combination. Refer to *Sending to Different Types of Destinations (Multi Sending)* on page 6-26.
The fax function can be used when the optional fax kit has been installed. For details about this function, refer to the *FAX Operation Guide*.

1 Press the Send key

Send



NOTE

If the touch panel is turned off, press the **Energy Saver** key or the **Power** key and wait for the machine to warm up.

2 Place the originals

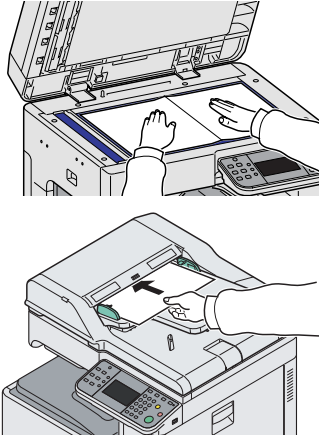

For details, refer to *Loading Originals* on page 3-7.

3 Selecting color mode



Auto Color



Full Color



Black & White



Auto Color	Automatically recognizes whether a document is color or black & white and then scans the document.
Full Color	Scans all documents in full color.
Black & White	Scans all documents in black & white.



To make more detailed settings, refer to *Color Selection* on page 3-60.

4 Specifying destination



Select the destination to which to send an image.



For details, refer to *Specifying Destination* on page 6-17.

5 Selecting the functions

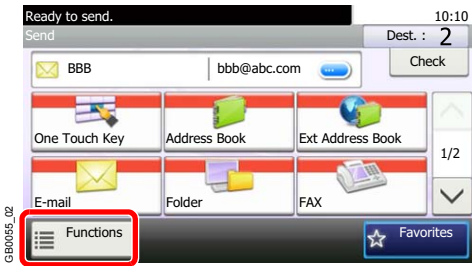

Press [Functions] to display the sending functions to use.



For details, refer to *Sending Functions* on page 6-39.

6 Start sending

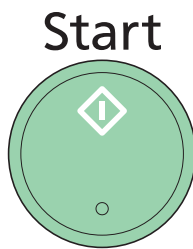

Press the **Start** key to start sending.

Preparation for Sending a Document to a PC

Check the information that needs to be set on the machine and create a folder to receive the document on your computer. Screens of Windows 7 are used in the following explanation. The details of the screens will vary in other versions of Windows.



NOTE

Log on to Windows with administrator privileges.

Making a note of the computer name and full computer name

Check the name of the computer name and full computer name.

1 Display the window.

From the Start menu, select **Computer** and then **System Properties**.

In Windows XP, right-click **My Computer** and select **Properties**. The **System Properties** dialog box appears. Click the **Computer Name** tab in the window that appears.

2 Check the computer name.



Check the computer name and full computer name.

Screen example:

Computer name: PC001

Full computer name: PC001.abcdnet.com

Windows XP:

If the full computer name does not have a dot (.), the full computer name and the computer name are the same.

If the full computer name has a dot (.), the text string in front of the dot (.) in the full computer name is the computer name.

Example: PC001.abcdnet.com

PC001 is the computer name

PC001.abcdnet.com is the full computer name

After checking the computer name, click the  (Close) button to close the **System Properties** screen.

In Windows XP, after checking the computer name, click the **Cancel** button to close the **System Properties** screen.

Making a note of the user name and domain name

Check the domain name and user name for logging onto Windows.

1 Display the window.

From the Start menu, select **All Programs** (or **Programs**), **Accessories** and then **Command Prompt**.

The **Command Prompt** window appears.

2 Check the domain name and user name.

At the Command Prompt, enter "net config workstation" and then press [Enter].

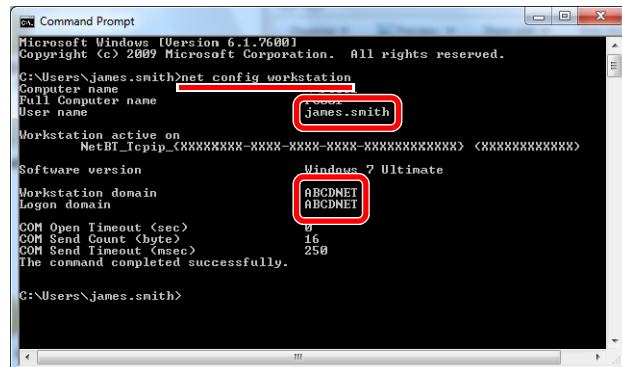

```
Microsoft Windows [Version 6.1.7600]
Copyright (c) 2009 Microsoft Corporation. All rights reserved.

C:\Users\james.smith>net config workstation
Computer name
Full Computer name
User name
james.smith
Workstation active on
NetBI_Tcpip_{XXXXXXXX-XXXX-XXXX-XXXXXXXXXXXX} <XXXXXXXXXXXX>
Software version
Windows 7 Ultimate
Workstation domain
Logon domain
ABCDNET
ABCDNET
COM Open Timeout (sec)
0
COM Send Count (byte)
16
COM Send Timeout (msec)
250
The command completed successfully.

C:\Users\james.smith>
```

Check the user name and domain name.

Screen example: user name "james.smith" and domain name "ABCDNET"

Creating a Shared Folder, Making a Note of a Shared Folder

Create a shared folder to receive the document in the destination computer.

NOTE

If there is a workgroup in System Properties, configure the settings below to limit folder access to a specific user or group.

- 1 From the Start menu, select **Control Panel, Appearance and Personalization**, and then **Folder Options**.

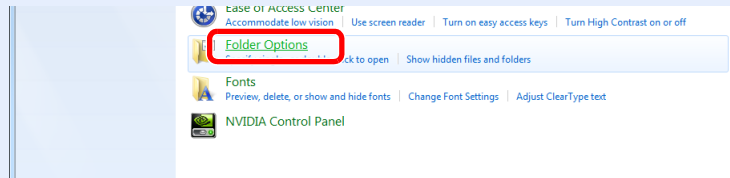

Windows XP, click **My Computer** and select **Folder Options** in Tools.

2

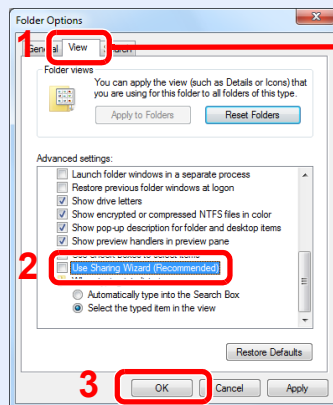

Make sure that the **View** tab is selected.

Remove the checkmark from **Use Sharing Wizard (Recommended)** in **Advanced settings**.

In Windows XP, click the **View** tab and remove the checkmark from **Use Simple File Sharing (Recommended)** in **Advanced settings**.

1 Create a folder.

- 1 Create a folder on your computer.

For example, create a folder with the name "scannerdata" on the desktop.

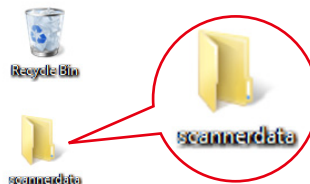

- 2 Right-click the scannerdata folder and click **Share** and **Advanced** sharing. Click the **Advanced Sharing** button.

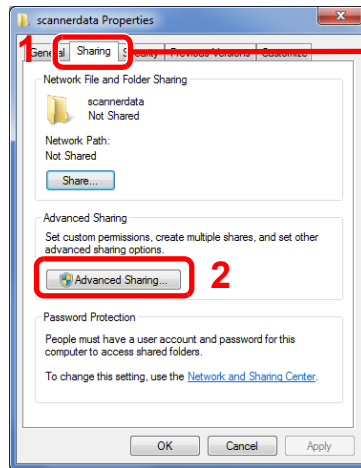

Make sure that the **Sharing** tab is selected.

In Windows XP, right-click the scannerdata folder and select **Sharing and Security...** (or **Sharing**).

2 Configures permission settings.

- 1 Select the **Share this folder** checkbox and click the **Permissions** button.

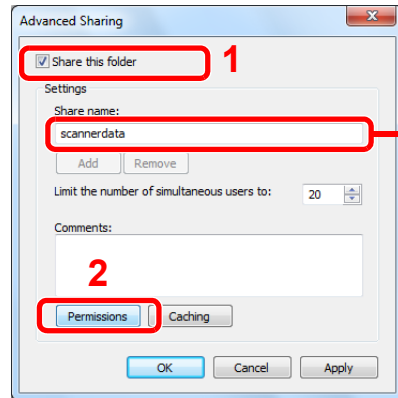

Make a note of the "Share name".

In Windows XP, select **Share this folder** and click the **Permissions** button.

- 2 Click the **Add** button.

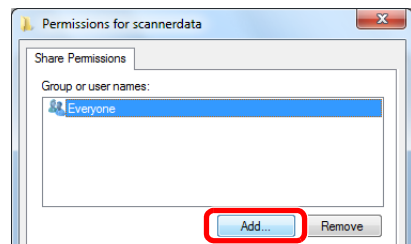

3

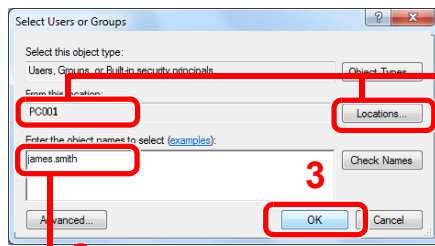

1 If the computer name that you made a note of on page 6-5 is the same as the domain name: If the computer name is not shown in [From this location], click the **Locations** button, select the computer name, and click the **OK** button. Example: PC001

2 Enter the user name that you made a note of on page 6-5 in the text box, and click the **OK** button.

If the computer name that you made a note of on page 6-5 is not the same as the domain name: If the text after the first dot (.) in the full computer name that you made a note of does not appear in [From this location], click the **Locations** button, select the text after the dot (.), and click the **OK** button. Example: abcdnet.com

4

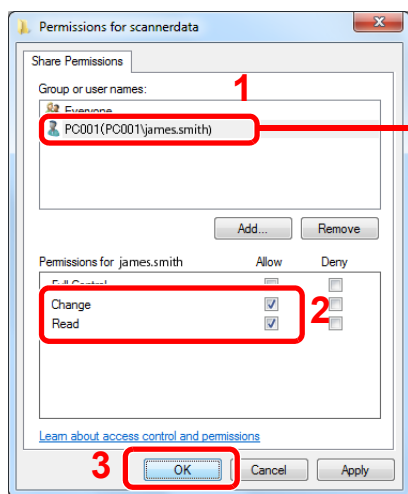

Select the user you entered.

Select the entered user, select the **Change** and **Read** permissions.

In Windows XP, go to step 6.



NOTE

"Everyone" gives sharing permission to everyone on the network. To strengthen security, it is recommended that you select Everyone and remove the **Read** permission checkmark.

5 Click the **OK** button in the **Advanced Sharing** screen to close the screen.

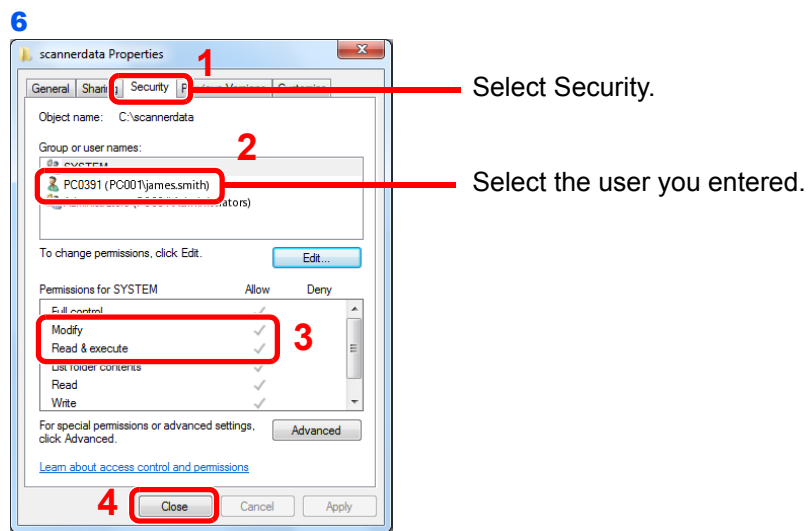

Make sure that checkmarks appear for the **Modify** and **Read & execute permissions**, and click the **Close** button.

In Windows XP, click the **Security** tab and then click the **OK** button.

Configuring Windows Firewall (for Windows 7)

Permit sharing of files and printers and set the port used for SMB transmission.



NOTE

Log on to Windows with administrator privileges.

1 Check file and printer sharing.

- 1 From the Start menu, select **Control Panel**, **System and Security**, and **Allow a program through Windows Firewall**.

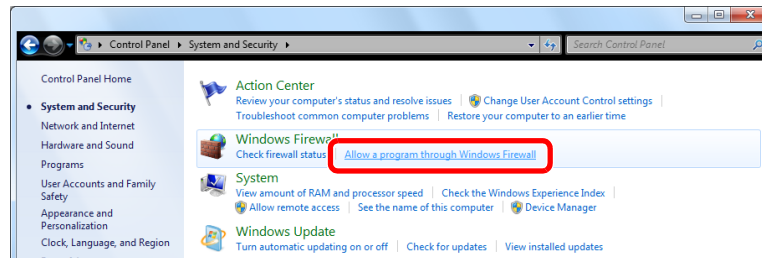

NOTE

If the **User Account Control** dialog box appears, click the **Continue** button.

2

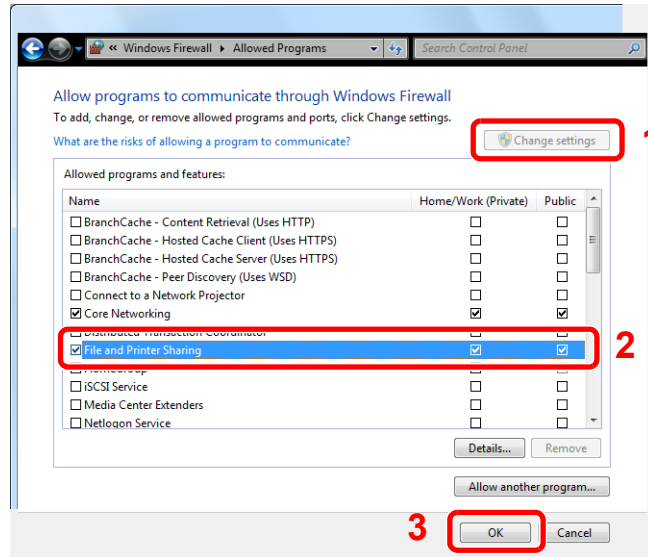

Select the **File and Printer Sharing** checkbox.

2 Add a port.

1 From the Start menu, select **Control Panel, System and Security, and Check firewall status.**

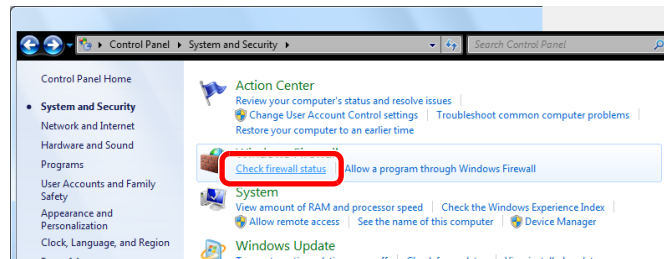

2

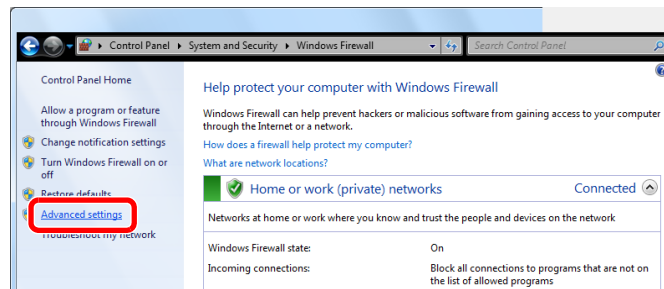

3

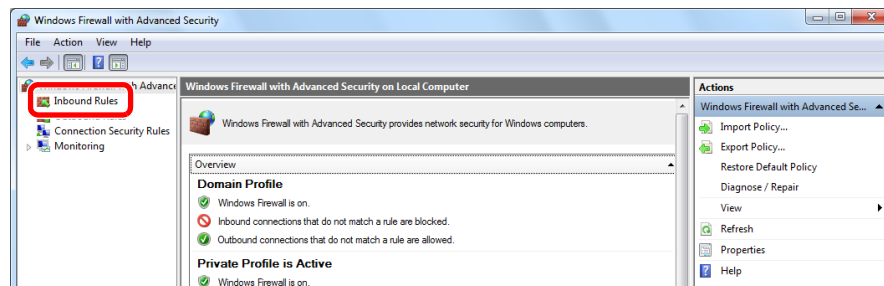

4

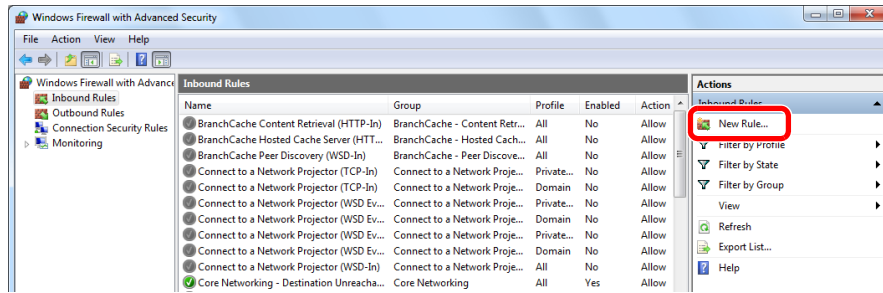

5

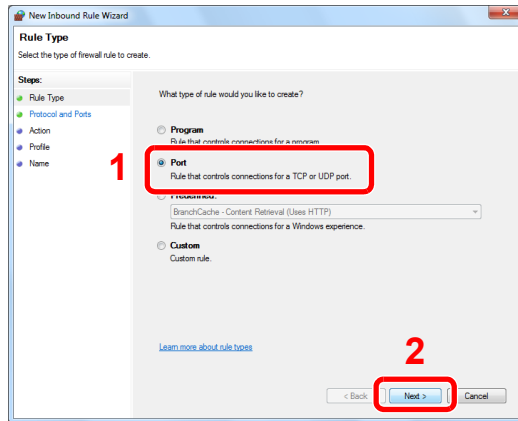

6

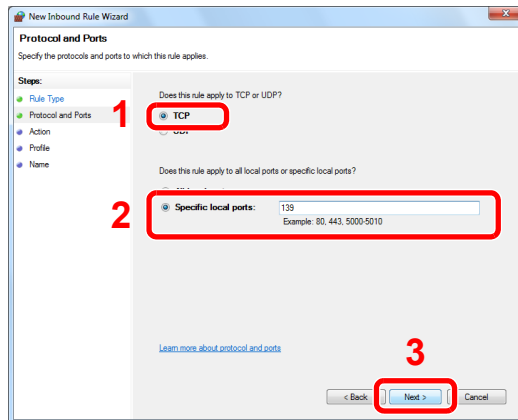

Select **Specific local ports**, and enter "139".

7

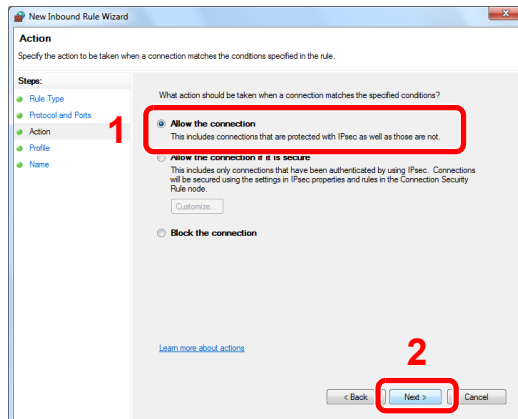

8

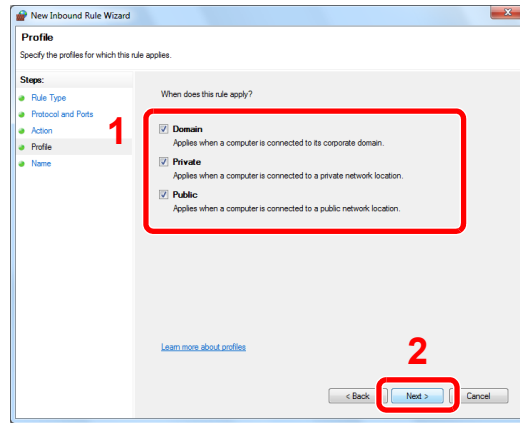

Make sure all checkboxes are selected.

9

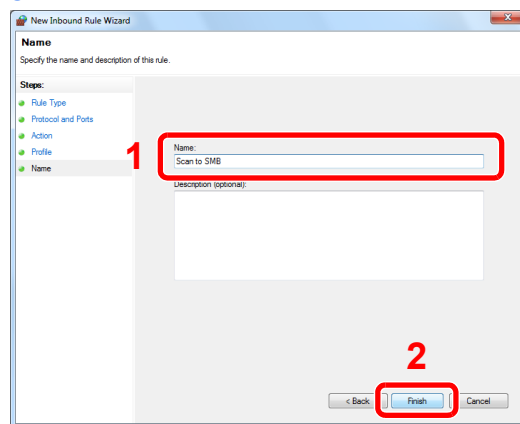

Enter "Scan to SMB" in "Name" and click **Finish**.

In Windows XP or Windows Vista

- 1 From the Start menu, select **Control Panel, System and Security** (or **Security Center**), and then **Check Firewall Status** (or **Windows Firewall**).
If the **User Account Control** dialog box appears, click the **Continue** button.
- 2 Click the **Exceptions** tab and then the **Add port...** button.
- 3 Specify **Add a Port** settings.
Enter any name in "Name" (example: Scan to SMB). This will be the name of the new port.
Enter "139" in "Port Number". Select **TCP** for "Protocol".
- 4 Click the **OK** button to close the **Add a Port** dialog box.

Register the shared folder in the address book

1 Display the screen.

Send



1

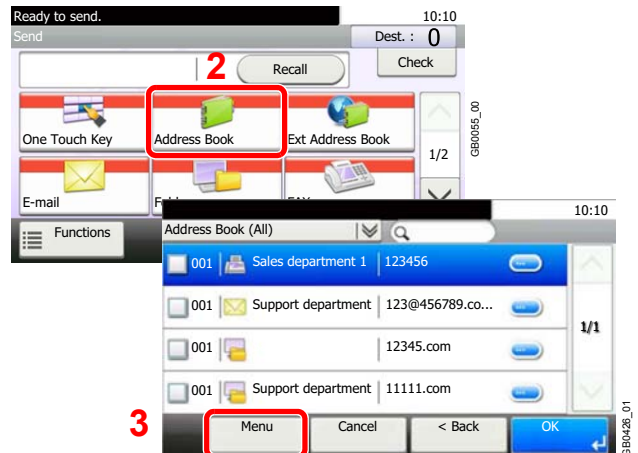

2 Adds a new destination.

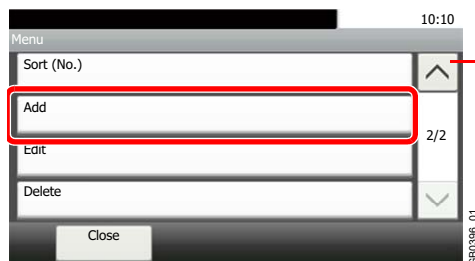

Use [∨] or [∧] to scroll up and down.

3 Select the registration method.

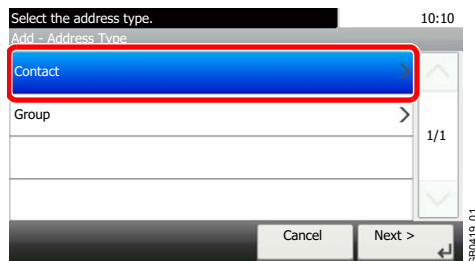

4 Enter the destination name.

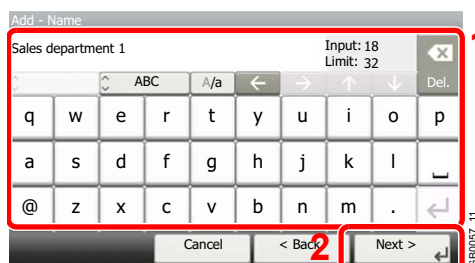

Up to 32 characters can be entered.



Refer to *Character Entry Method* on page 11-7 for details on entering characters.

5 Enter the destination.

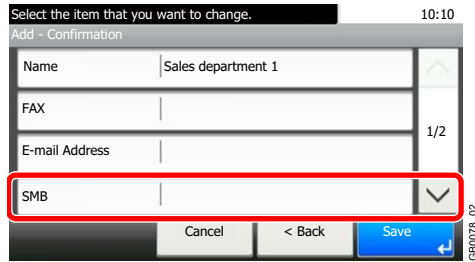

Select [SMB].

1 Enter the destination information.

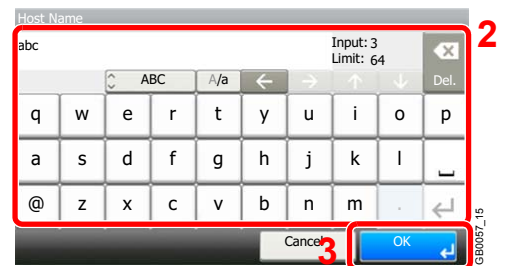
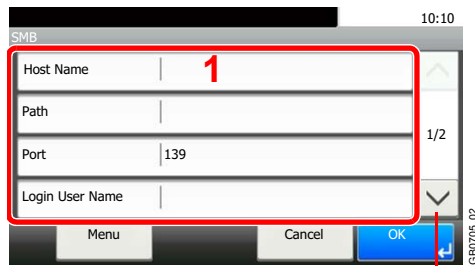

Use [∨] or [∧] to scroll up and down.

Enter the next information. Once you have entered one item, press [Next] to advance to the next item.

Item	Data to be entered	Max. characters
Host Name	The computer name that you made a note of. For example: PC001	Up to 64 characters
Path	The share name that you made a note of. For example: scannerdata If saving in a folder in the shared folder: share name\folder name in shared folder	Up to 128 characters
Port	Normally 139. In Windows Vista/7, if 139 is not used, set to 445.	1 - 65535
Login User Name	If the computer name and domain name that you made a note of are the same: The user name that you made a note of. For example: james.smith If the computer name and domain name that you made a note of are different: Domain name that you made a note of \ User name that you made a note of For example: abcdnet\james.smith	Up to 64 characters
Login Password	Windows logon password (Not case sensitive.)	Up to 64 characters



NOTE

If you change the date/time while using the trial version of an application, you will no longer be able to use the application.



Refer to *Character Entry Method* on page 11-7 for details on entering characters.

2 Confirm the connection status.

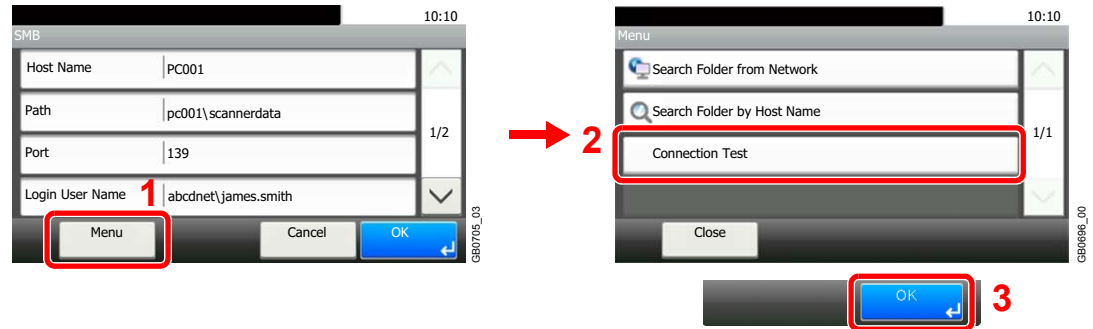

Connected. appears when connection to the destination is correctly established. If *Cannot connect.* appears, review the entry.

3

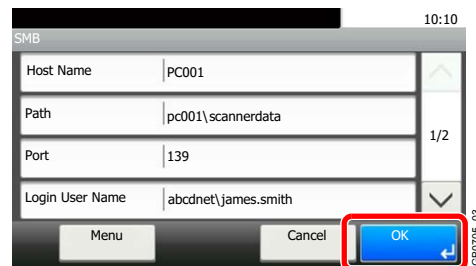

6 Enter the address number.

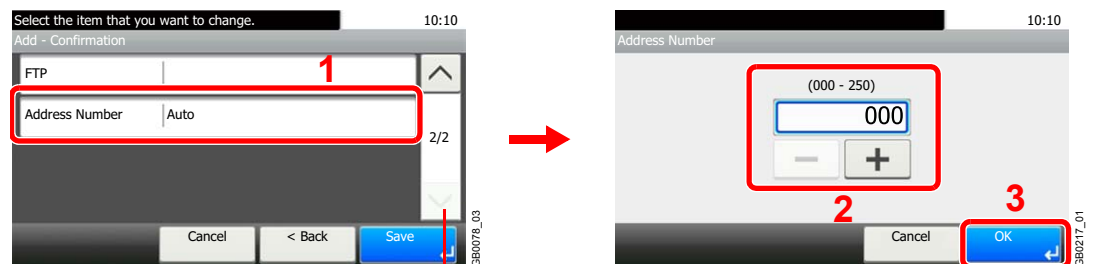

Use [∨] or [∧] to scroll up and down.

Press [+], [-] or numeric keys to enter a particular Address Number (1-250).

Address Number is an ID for a destination. You can select any available number out of 200 numbers for contacts and 50 numbers for groups.

If you set “000” as the address number, the address is registered under the lowest available number.

7 Register the destination.

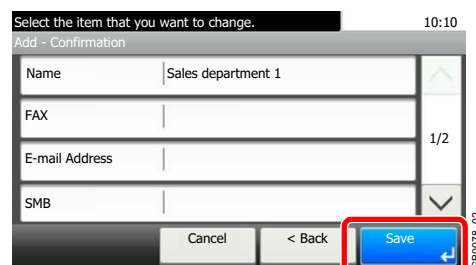

Specifying Destination

Select the destination to which to send an image.

Select the destination using either of the following methods.

- *Choosing from the Address Book* (page 6-17)
- *Choosing by One Touch Key* (page 6-19)
- *Entering a New E-mail Address* (page 6-20)
- *Specifying a New PC Folder* (page 6-21)

NOTE
When the optional fax kit has been installed, you can specify the fax destination. Enter the other party's number using the numeric keypad.

Choosing from the Address Book

Select a destination registered in the Address Book.

NOTE
For more information about how to register destinations in the Address Book, refer to *Registering Destinations in the Address Book* on page 6-27.
For details on the External Address Book, refer to *Command Center RX User Guide*.

1 Display the screen.

- 1 Referring to *Basic Operation* on page 6-2, display the screen.

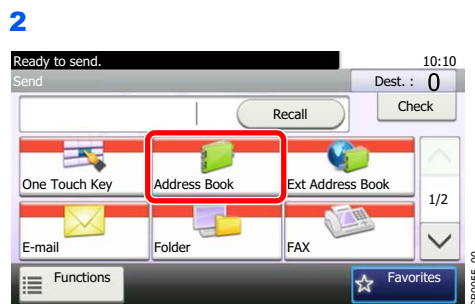

2 Select the destination.

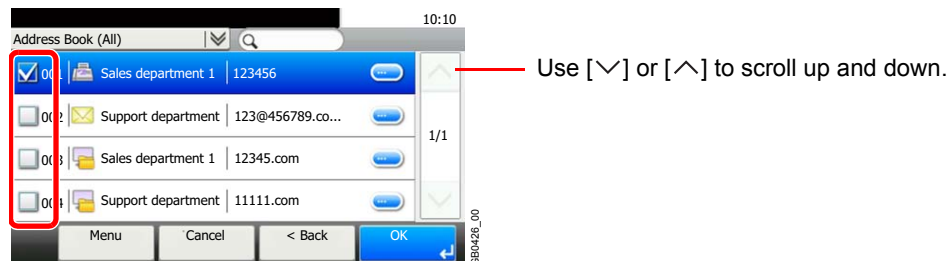

Press the checkbox to select the desired destination from the list. The selected destinations are indicated by a checkmark in the check box.

Destination Search

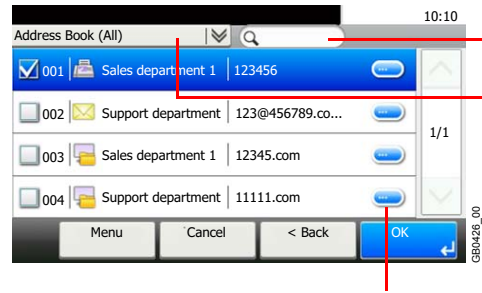

Searches by destination name.

Advanced search by type of registered destination (E-mail, Folder (SMB/FTP), FAX or Group).

Displays details for individual destinations.

You can specify a destination by address number by pressing the **Quick No. Search** key.

You can also press [Menu] to perform a more detailed search.

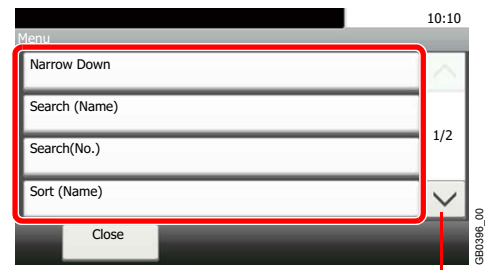
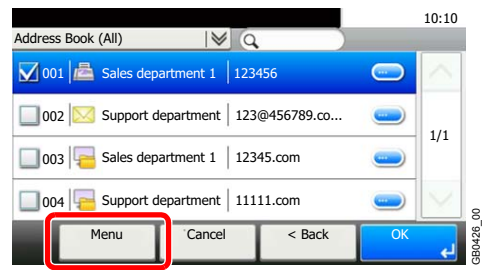

Use [∨] or [∧] to scroll up and down.

Narrow Down: Advanced search by type of registered destination (E-mail, Folder (SMB/FTP), FAX or Group).

Search (Name) and **Search (No.):** Searches by destination name or address number.

Sort (Name) and **Sort (No.):** Sorts the list by destination name or address number.



NOTE

You may choose multiple destinations.

To cancel a selection, press the corresponding checkbox to clear the check mark.

3 Accept the destinations.

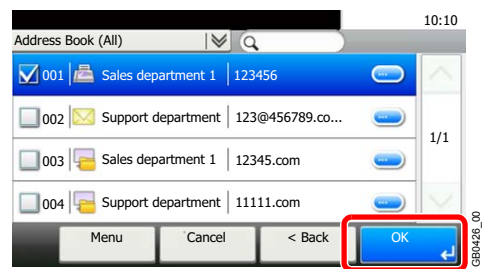

Destinations can be changed later. Refer to *Checking and Editing Destinations* on page 6-25.

Choosing by One Touch Key

Select the destination using the One Touch Keys.

 **NOTE**

For more information on adding One Touch keys, refer to *Adding a Destination on One Touch Key on page 6-36*.

1 Display the screen.

1 Referring to *Basic Operation on page 6-2*, display the screen.

2



2 Select the destination.

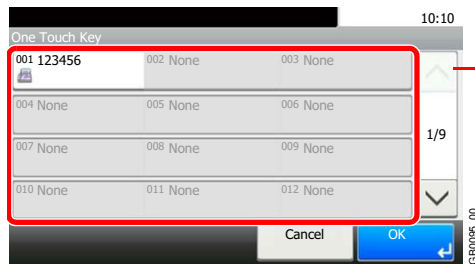

Use [∨] or [∧] to scroll up and down.

Press the One Touch Keys where the destination is registered. Multiple One Touch Keys can be selected.

You can specify a one-touch key by one-touch number by pressing the **Quick No. Search** key.

3 Accept the destination.

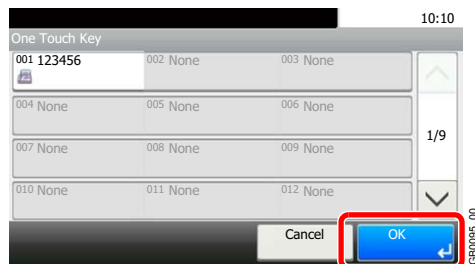

Destinations can be changed later. Refer to *Checking and Editing Destinations on page 6-25*.

Entering a New E-mail Address

Enter the desired e-mail address.

 **NOTE**
 Access the Command Center RX beforehand and specify the settings required for sending e-mail. For details, refer to *Command Center RX (Settings for E-mail) on page 2-25*.

1 Display the screen.

1 Referring to *Basic Operation on page 6-2*, display the screen.

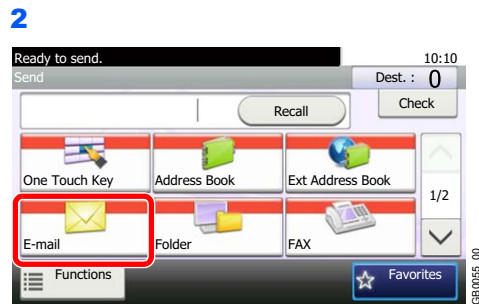

2 Enter destination E-mail address.

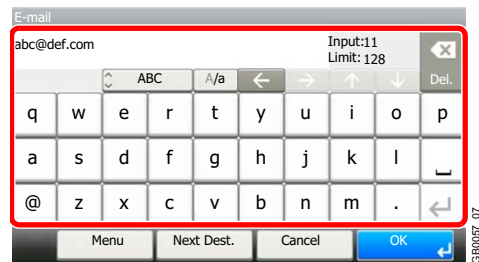

Up to 128 characters can be entered.

 Refer to *Character Entry Method on page 11-7* for details on entering characters.

To enter multiple destinations, press [Next Destination] and enter the next destination. Up to 100 E-mail addresses can be specified.

You can register the entered email address in the Address Book by pressing [Menu] and then [Add to Address Book]. You can also replace the information for a previously registered destination.

3 Accept the destinations.

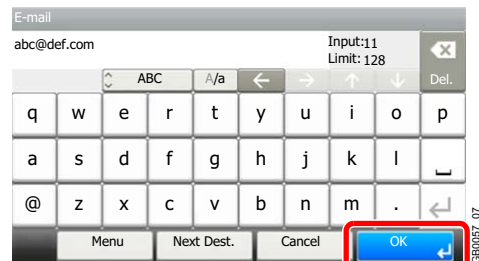

 Destinations can be changed later. Refer to *Checking and Editing Destinations on page 6-25*.

Specifying a New PC Folder

Specify either the desired shared folder on a computer or an FTP server as the destination.

NOTE

Refer to *Creating a Shared Folder, Making a Note of a Shared Folder* on page 6-7 for details on how to share a folder. Be sure that **SMB Protocol** or **FTP** in the Command Center RX is On. For details, refer to the *Command Center RX User Guide*.

1 Display the screen.

1 Referring to *Basic Operation* on page 6-2, display the screen.

2



2 Select the folder type.

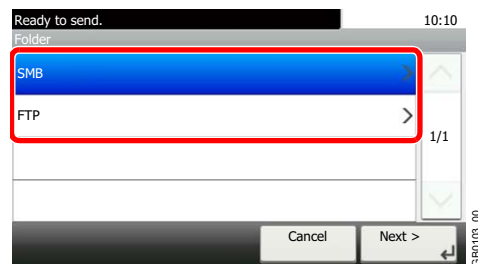

If you selected [FTP], go to step 4.

3 Select the folder specification method.

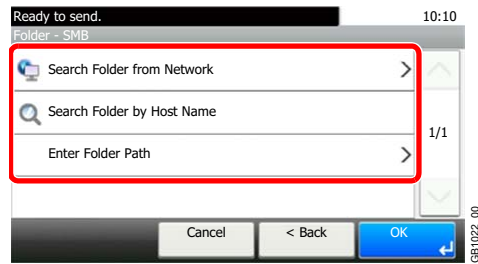

To search for a folder on a PC on the network, press [Search Folder from Network] or [Search Folder by Host Name].

If you pressed [Search Folder from Network], you can enter the *Domain/Workgroup*, and *Host Name* to search PCs on the network for the destination.

If you pressed [Search Folder by Host Name], you can search all PCs on the network for a destination.

A maximum of 500 addresses can be displayed. Select the host name (PC name) that you want to specify in the screen that appears, and press [Next]. The login user name and login password entry screen appears.

After you enter the login user name and login password name of the destination PC, the shared folders appear. Select the folder that you want to specify and press [Next]. The address of the selected shared folder is set.



NOTE

Refer to the *Character Entry Method on page 11-7* for details on entering characters.

Press [Connection Test] to check the connection to the computer you chose. If the connection fails, check the entries you made.

Select the folder from the Search Results list, and go to step 6.
If you selected [Enter Folder Path], go to step 4.

4 Enter the destination information.

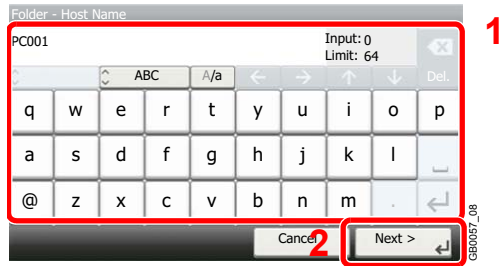

Enter the next information. Once you have entered one item, press [Next] to advance to the next item.

For send to folder (SMB)

Item	Data to be entered	Max. characters
Host Name	Host name or IP address of the PC to receive the data.	Up to 64 characters
Path	Path to the receiving folder such as follows. For example, <i>\User\scannerdata</i> .	Up to 128 characters
Port	Normally 139. In Windows Vista/7, if 139 is not used, set to 445.	1 - 65535
Login User Name	User name to access the PC Domain name\User name For example, <i>abcdnetjames.smith</i> . User name@Domain name For example, <i>james.smith@abcdnet</i>	Up to 64 characters
Login Password	Password to access the PC	Up to 64 characters

For send to folder (FTP)

Item	Data to be entered	Max. characters
Host Name	Host name or IP address of FTP server	Up to 64 characters
Path	Path to the receiving folder. For example, <i>\User\ScanData</i> . Otherwise the data will be saved in the home directory.	Up to 128 characters
Login User Name	FTP server login user name	Up to 64 characters
Login Password	FTP server login password	Up to 64 characters



Refer to *Character Entry Method* on page 11-7 for details on entering characters.

5 Confirm the information.

Check the information. Change the information as needed by pressing the item in question.

Use [∨] or [∧] to scroll up and down.

When specifying a computer or server port number as the destination, press [Port] and enter the port number. You can enter a number from 1 to 65,535 with a maximum of 5 digits.

Confirm the connection status.

Connected. appears when connection to the destination is correctly established. If *Cannot connect.* appears, review the entry.

To enter multiple destinations, press [Next Destination] and enter the next destination. You can specify a combined total of up to 5 FTP and SMB destination folders.

You can register the entered information in the Address Book by pressing [Menu] and then [Add to Address Book].

6 Accept the destinations.

 Destinations can be changed later. Refer to *Checking and Editing Destinations* on page 6-25.

Checking and Editing Destinations

Check and edit a selected destination.

1 Display the screen.

1 Referring to *Specifying Destination on page 6-17*, specify the destination.

2

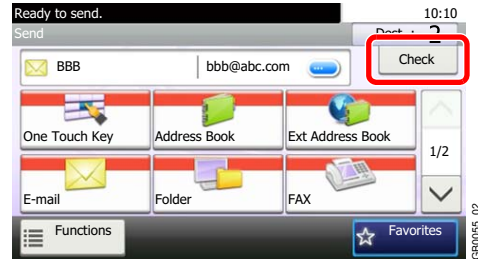

2 Check and edit the destination.

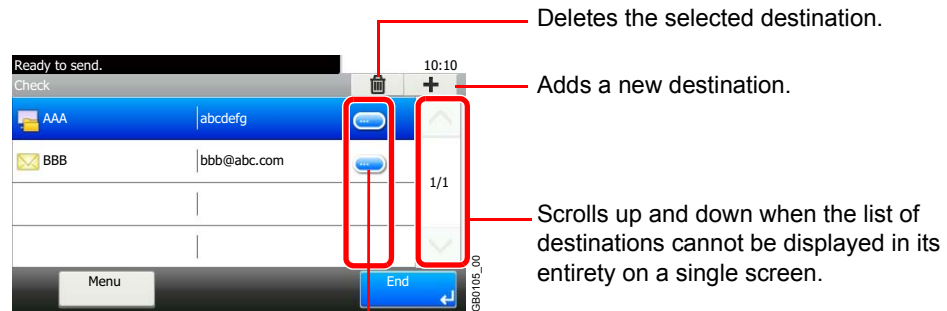

Displays details for the destinations. New E-mail addresses and PC folders can be edited if they have been specified.

Sending to Different Types of Destinations (Multi Sending)

You can specify destinations that combine e-mail addresses, folders (SMB or FTP) and fax numbers*. This is referred to as *Multi Sending*. This is useful for sending to different types of destination (e-mail addresses, folders, etc.) in a single operation.

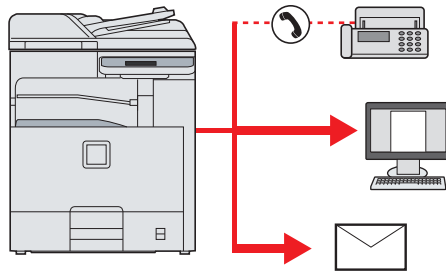

* Requires the optional fax kit.

No. of broadcast items

E-mail: Up to 100

Folders (SMB, FTP): Total of 5 SMB and FTP

FAX: Up to 100

Also, depending on the settings, you can send and print at the same time.

Procedures are the same as used in specifying the destinations of respective types. Continue to enter E-mail address or folder path so that they appear in the destination list. Press the **Start** key to launch transmission to all destinations at one time.



NOTE

If the destinations include a fax, the images sent to all destinations will be black and white.

Registering Destinations in the Address Book

Add a new destination to the Address Book. There are two registering methods, contacts and groups. When adding a group, enter the group name and select group members from the Address Book.

Adding a Contact

A maximum of 200 contact addresses can be registered. Each address can include the information such as destination name, E-mail address, FTP server folder path, computer folder path, and FAX No. (optional).



NOTE

If user login administration is enabled, you can only edit destinations in the Address Book by logging in with administrator privileges.

Contact addresses can also be registered in the system menu.

1 Display the screen.

Send

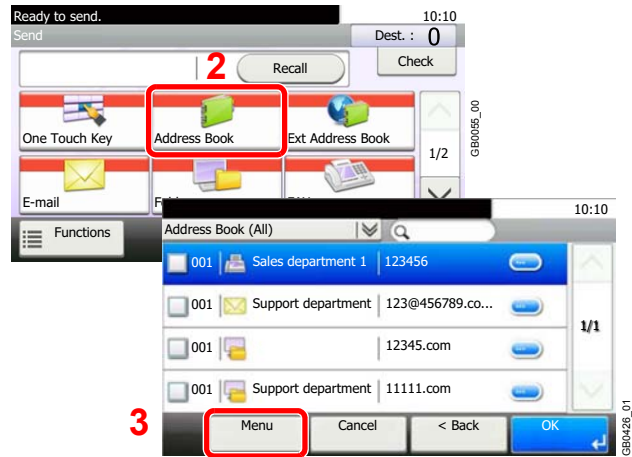

2 Adds a new destination.

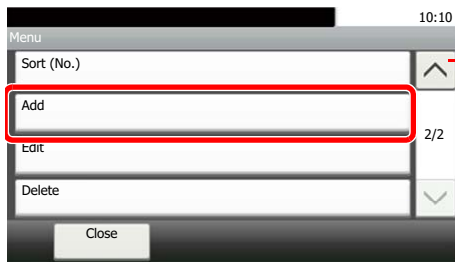

Use [v] or [^] to scroll up and down.

3 Select the registration method.

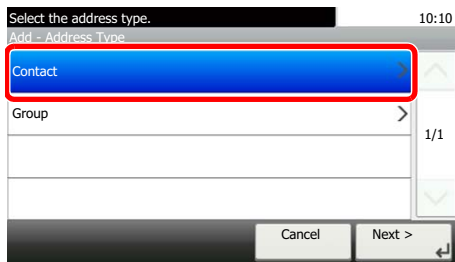

4 Enter the destination name.

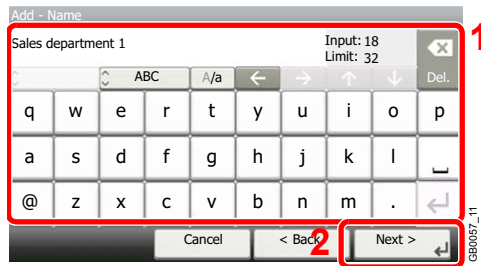

Up to 32 characters can be entered.

Refer to *Character Entry Method* on page 11-7 for details on entering characters.

5 Enter the destination.

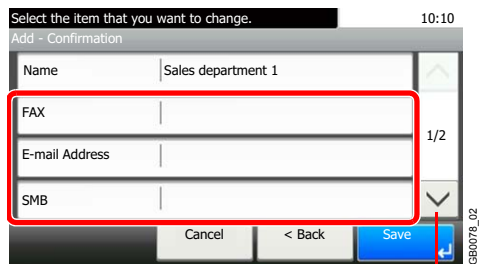

Use [∨] or [∧] to scroll up and down.

Select the type of destination to register.

For details on FAX, refer to *FAX Operation Guide*.

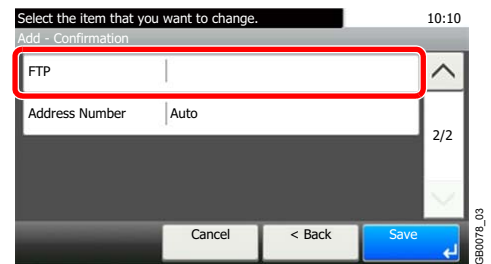

E-mail Address

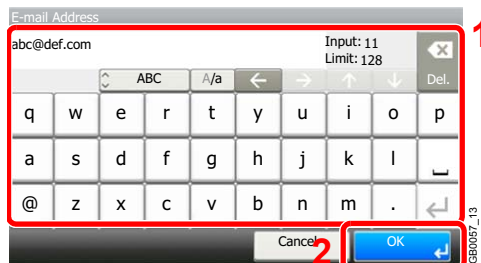

Enter the E-mail address. Up to 128 characters can be entered.

Refer to *Character Entry Method* on page 11-7 for details on entering characters.

The Folder (SMB) Address

1 Enter *Host Name*, *Path*, *Port*, *Login User Name* and *Login Password*.

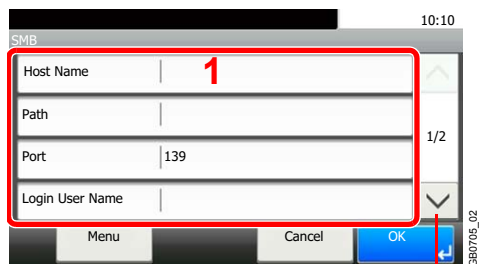

Use [∨] or [∧] to scroll up and down.

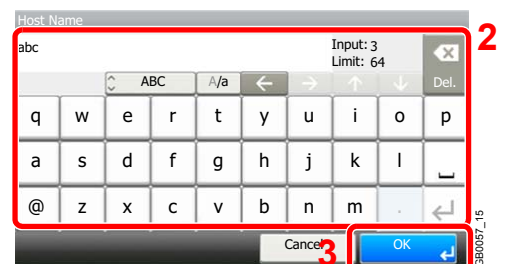

For more information, refer to *Specifying a New PC Folder* on page 6-21.

2 Confirm the connection status.

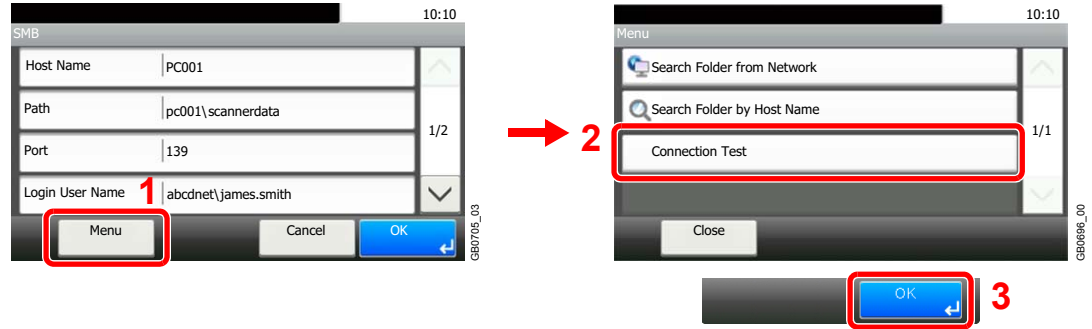

Connected. appears when connection to the destination is correctly established. If *Cannot connect.* appears, review the entry.

3

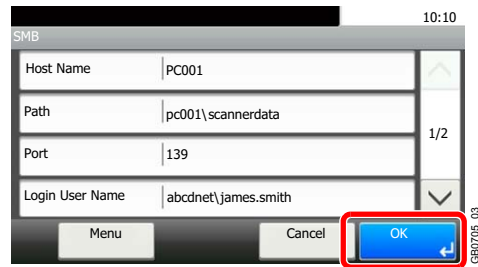

The Folder (FTP) Address

1 Enter *Host Name*, *Path*, *Port*, *Login User Name* and *Login Password*.

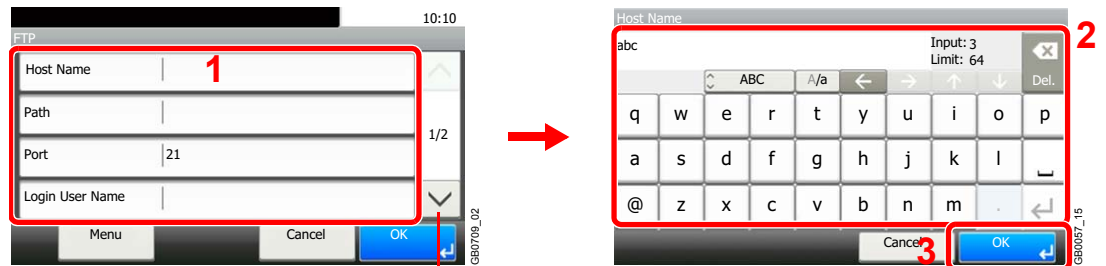

Use [∨] or [∧] to scroll up and down.

 For more information, refer to *Specifying a New PC Folder* on page 6-21.

2 Confirm the connection status.

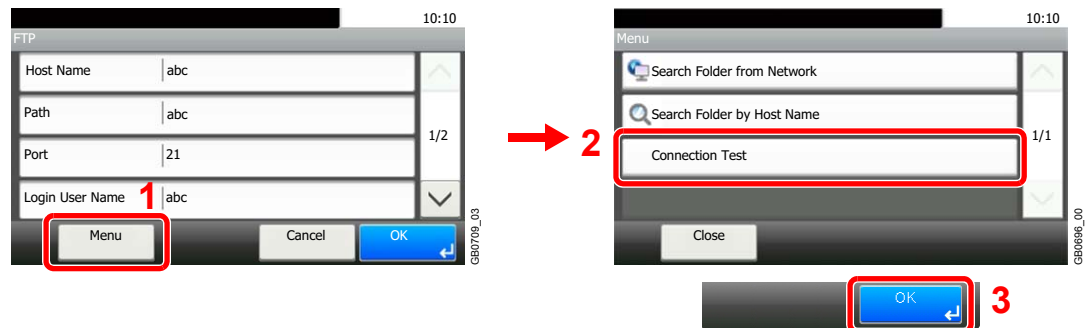

Connected. appears when connection to the destination is correctly established. If *Cannot connect.* appears, review the entry.

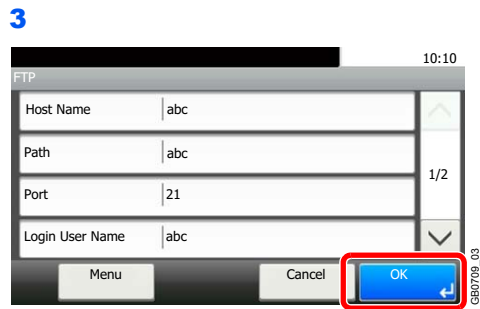

6 Enter the address number.

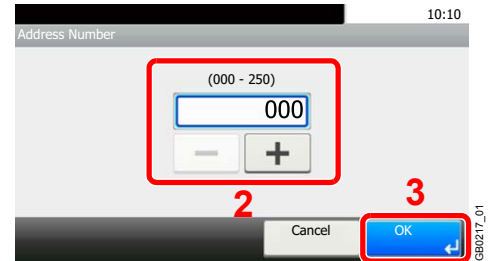
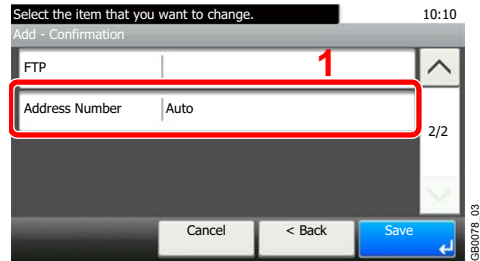

Press [+], [-] or numeric keys to enter a particular Address Number (1-250).

Address Number is an ID for a destination. You can select any available number out of 200 numbers for contacts and 50 numbers for groups.

If you set "000" as the address number, the address is registered under the lowest available number.

7 Register the destination.

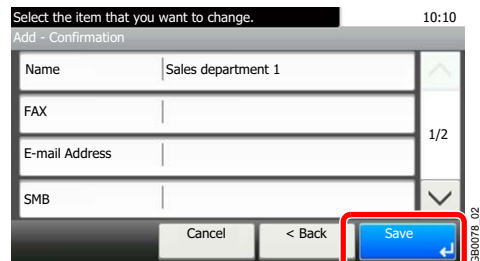

Adding a Group

Compile two or more contacts into a group. Designations in the group can be added at the same time. When adding a group, a maximum of 50 groups can be added in the Address Book.

Before adding a group in the Address Book, the contacts to be included in the group must be added first.

NOTE

If user login administration is enabled, you can only edit destinations in the Address Book by logging in with administrator privileges.

Designations in the group can also be registered in the system menu.

1 Display the screen.

Send



1

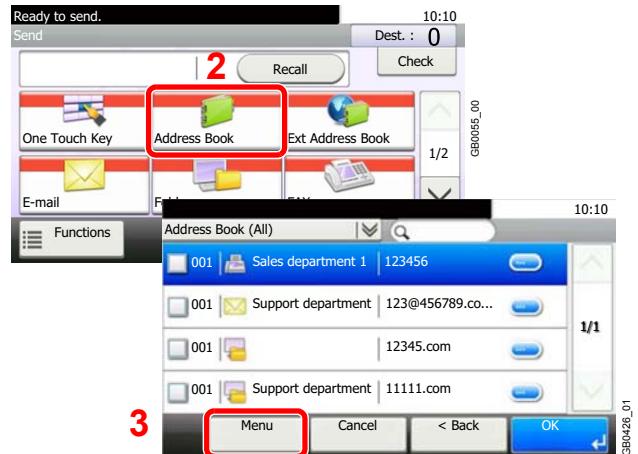

2 Adds a new destination.

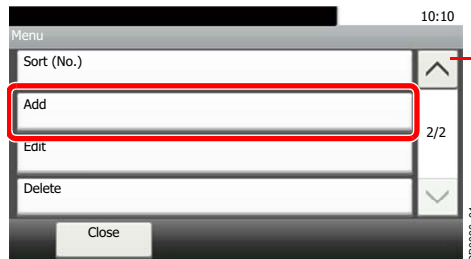

Use [∨] or [∧] to scroll up and down.

3 Select the registration method.

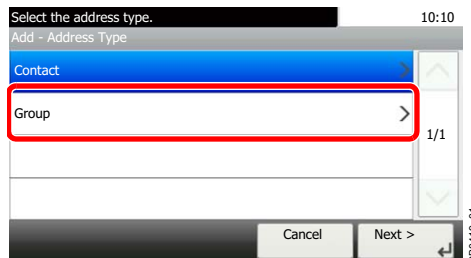

4 Enter the group name.

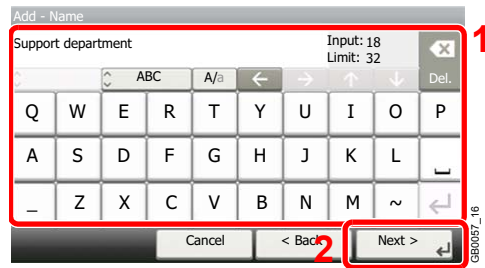

Up to 32 characters can be entered.

 Refer to *Character Entry Method* on page 11-7 for details on entering characters.

5 Select the members (destinations).

1 Display the screen.

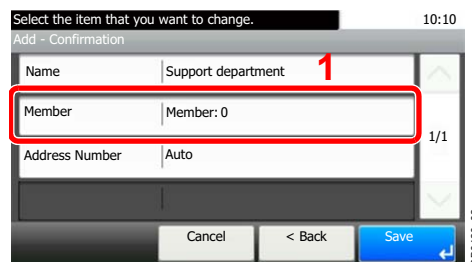

2 Press the checkbox to select the desired destination from the list. The selected destinations are indicated by a checkmark in the check box.

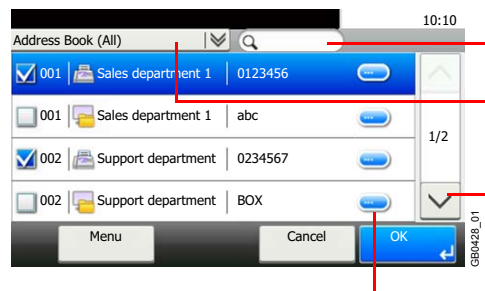

Searches by destination name.

Advanced search by type of registered destination (E-mail, Folder (SMB/FTP) or FAX).

Use [∨] or [∧] to scroll up and down.

Displays details for individual destinations.

You can specify a destination by address number by pressing the **Quick No. Search** key.

You can also press [Menu] to perform a more detailed search.

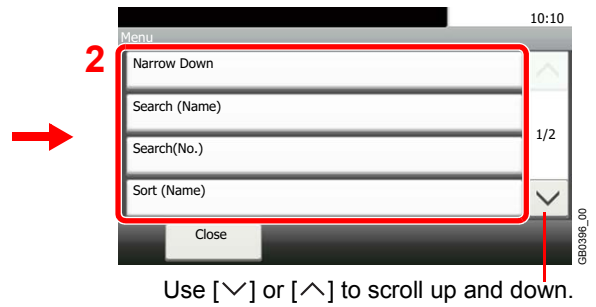
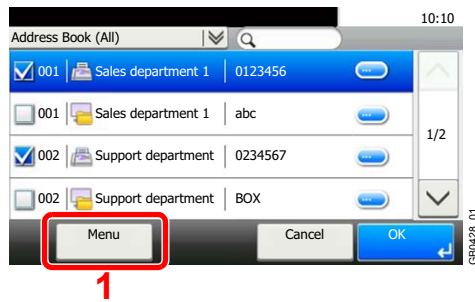

Narrow Down: Advanced search by type of registered destination (E-mail, Folder (SMB/FTP) or FAX).

Search (Name) and Search (No.): Searches by destination name or address number.

Sort (Name) and Sort (No.): Sorts the list by destination name or address number.



NOTE

To cancel a selection, press the corresponding checkbox to clear the check mark.

6 Accept the members.

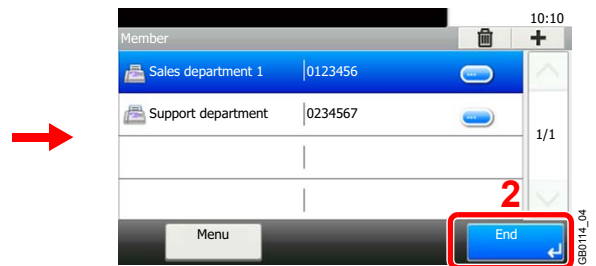
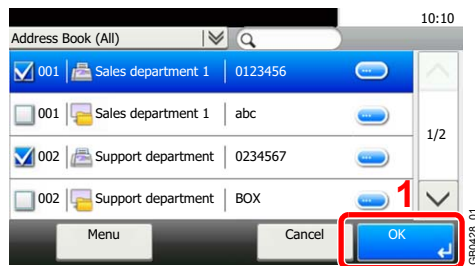

7 Enter the address number.

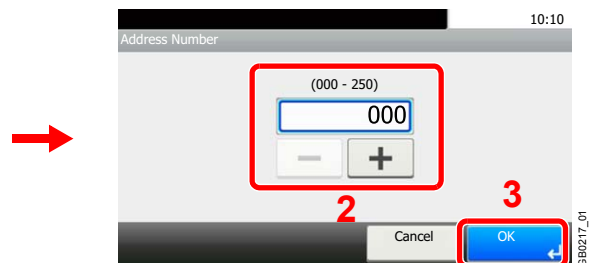
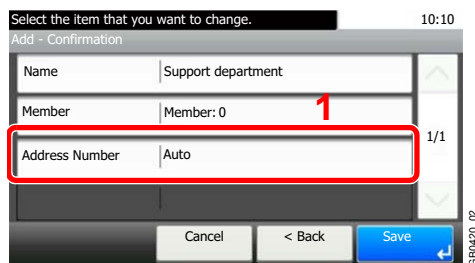

Press [+], [-] or numeric keys to enter a particular Address Number (1-250).

Address Number is an ID for a destination. You can select any available number out of 200 numbers for contacts and 50 numbers for groups.

If you set "000" as the address number, the address is registered under the lowest available number.

8 Register the group.

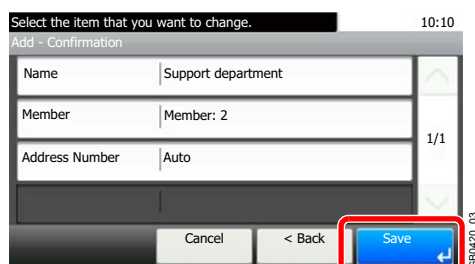

Editing and Deleting Address Book Entries

Edit and delete the destinations (contacts) you added to the Address Book.

1 Display the screen.

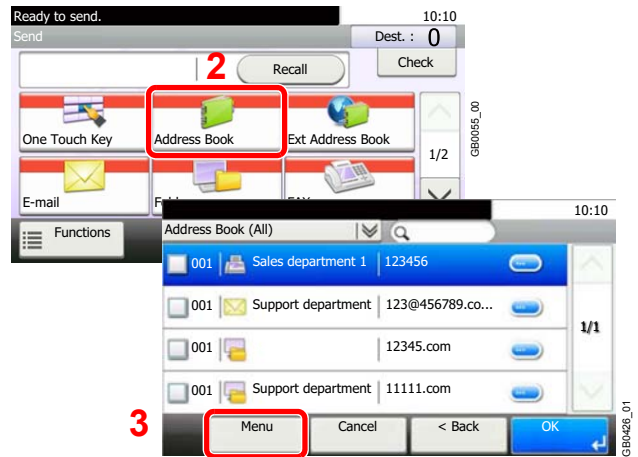

2 Edit or delete the destination.

To edit the destination

1

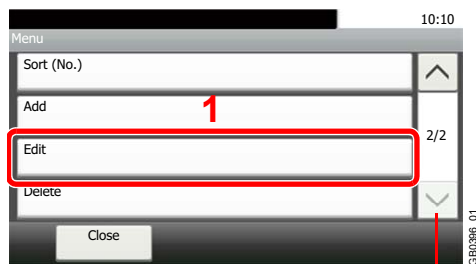

Use [∨] or [∧] to scroll up and down.

2

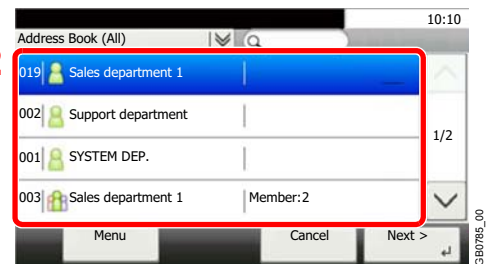

Select the destination (contacts) or group to edit.

You can specify a destination by address number by pressing the **Quick No. Search** key.

2

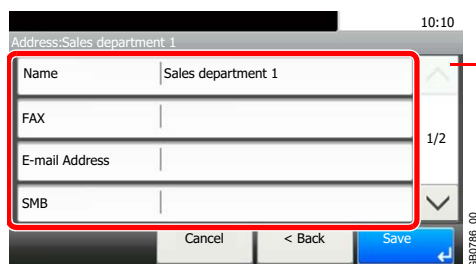

Use [∨] or [∧] to scroll up and down.

Change the information as needed by pressing the item in question.

3

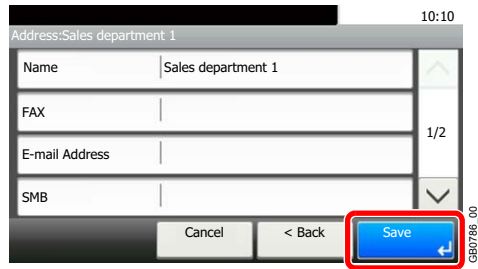

To delete a member (group)

To delete a member from a group, select the destination you wish to delete and press [(Delete)] (the trash can icon).

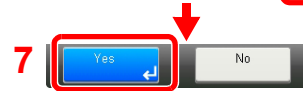
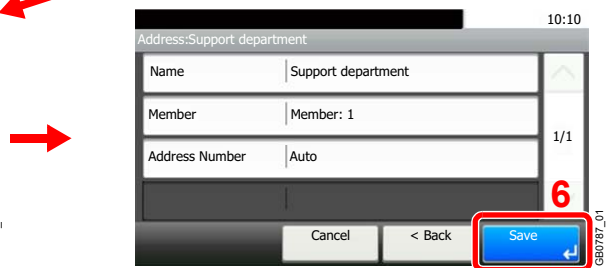
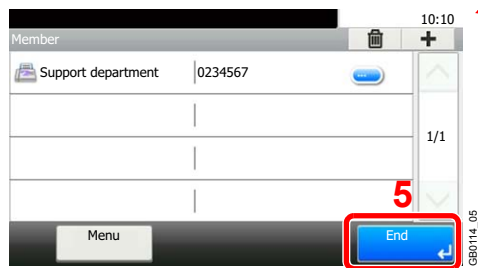
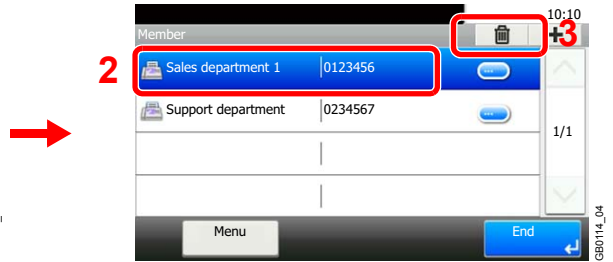
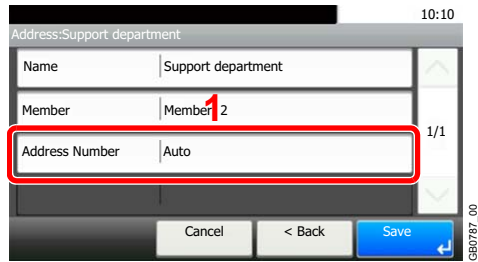

To delete

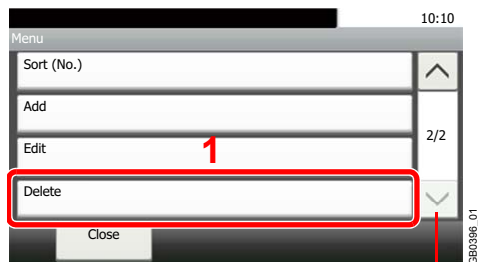

Use [∨] or [∧] to scroll up and down.

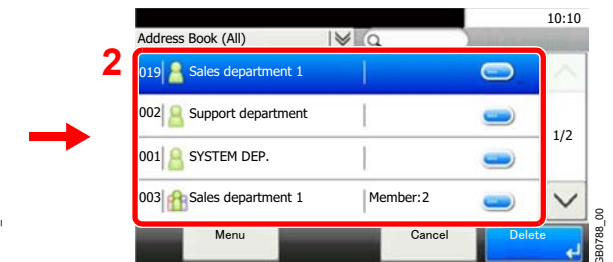

Select the destination (contacts) or group to delete.

Adding a Destination on One Touch Key

Add a new destination (contact or group) on One Touch Key.

Adding a Destination

Add a new destination (contact or group). A maximum of 100 destinations can be registered.

To register a destination to a One Touch Key, it must first be registered in the Address Book. Register one or more destinations as needed before proceeding.

1 Display the screen.

◆ System Menu / Counter



1

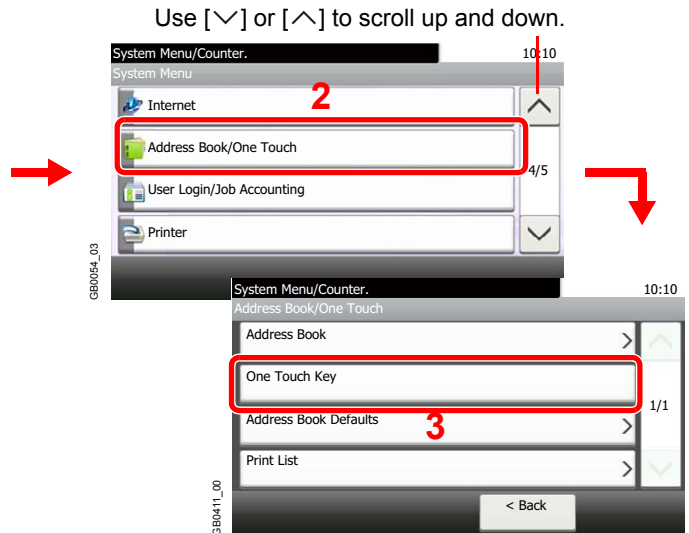

2 Add a One-Touch Key.

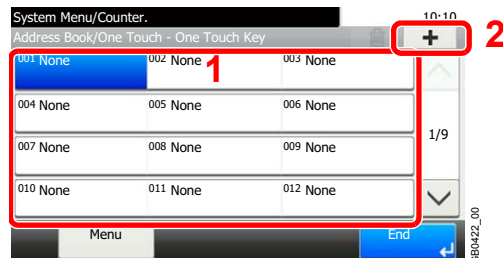

Select a One Touch Key with no registered destination, and press [+].

3 Select the destinations.

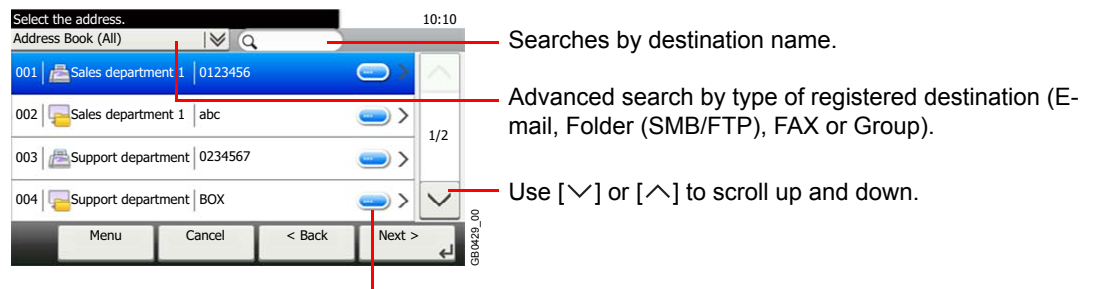

Displays details for individual destinations.

Select one destination (contact or group) from the Address Book.

You can specify a destination by address number by pressing the **Quick No. Search** key.

You can also press [Menu] to perform a more detailed search.

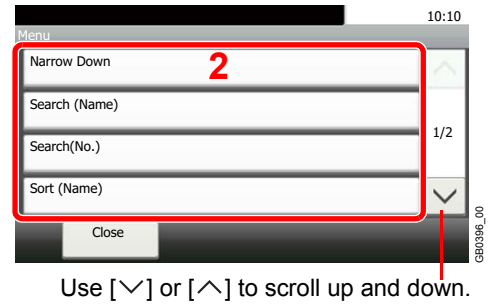
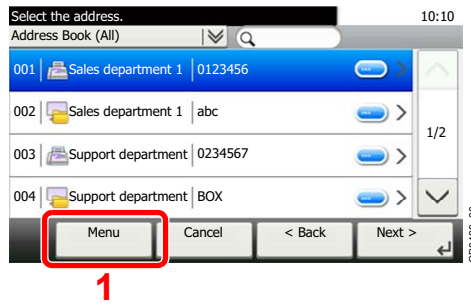

Use [∨] or [∧] to scroll up and down.

Narrow Down: Advanced search by type of registered destination (E-mail, Folder (SMB/FTP), FAX or Group).

Search (Name) and Search (No.): Searches by destination name or address number.

Sort (Name) and Sort (No.): Sorts the list by destination name or address number.

4 Enter the One Touch Key name.

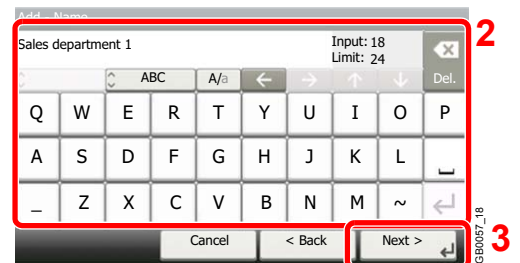
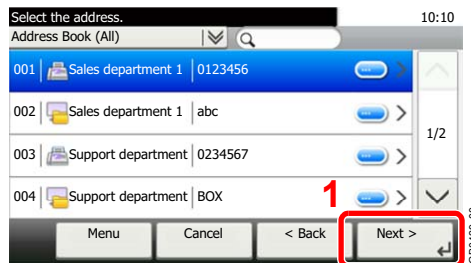

Up to 24 characters can be entered.



Refer to *Character Entry Method* on page 11-7 for details on entering characters.

5 Register the destination.

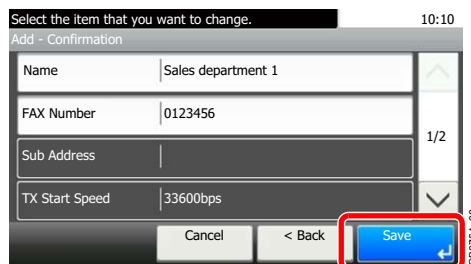

Editing and Deleting One Touch Key

Edit and delete the destinations you added to One Touch Key.

1 Display the screen.

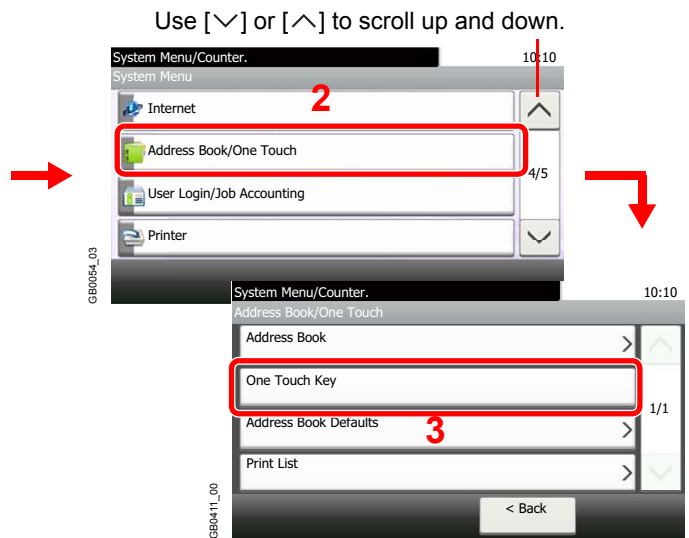
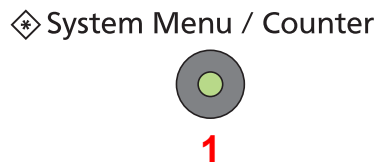

2 Edit or delete the destination.

To edit the destination

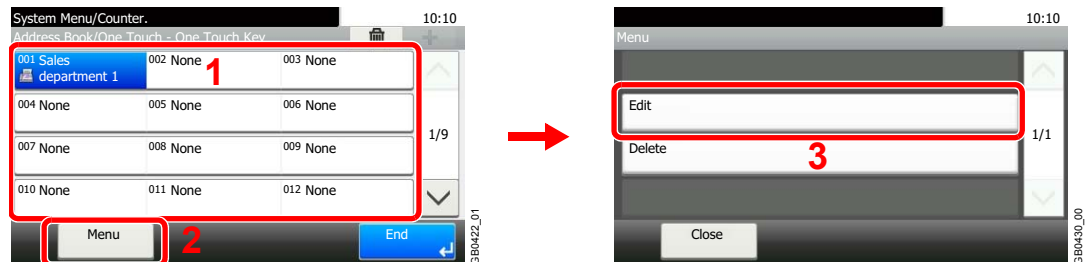

Select the One Touch Key you wish to edit and press [Menu] followed by [Edit].

To delete

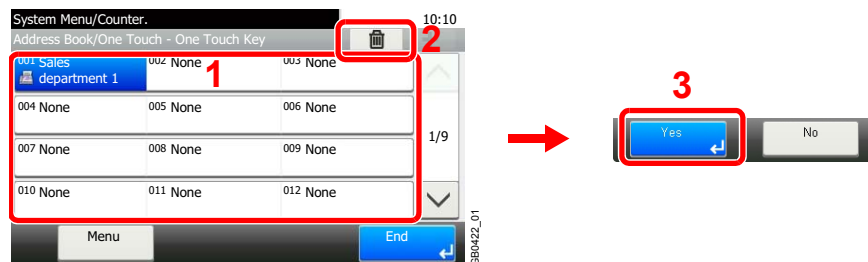

Select the One Touch Key you wish to delete and press [(Delete)] (the trash can icon).

Sending Functions

Send screen shows the commonly used functions. By pressing [Functions], other selectable functions will be shown as a list. Use [∨] or [^] to select the function.

What do you want to do?	Reference Page
Select the file format for images being sent.	File Format ▶ page 3-58
Specify the original size.	Original Size ▶ page 3-32
Specify the original orientation to scan in the correct direction.	Original Orientation ▶ page 3-34
Send mixed size originals.	Mixed Size Originals ▶ page 3-35
Automatically scan 2-sided originals.	2-sided/Book Original ▶ page 3-37
Change the size of the image being sent.	Sending Size ▶ page 6-40
Send each page in a separate file.	File Separation ▶ page 6-42
Set the resolution at which to scan originals.	Scan Resolution ▶ page 3-52
Adjust the density.	Density ▶ page 3-51
Change the color mode for images being sent.	Color Selection ▶ page 3-60
Select original image type for best results.	Original Image ▶ page 3-53
Emphasize the outline of texts or lines. Blur the image outline.	Sharpness ▶ page 3-54
Darken or lighten the background (i.e., the area with no text or images) of originals.	Background Density Adjust ▶ page 3-55
Prevent bleed-through for 2-sided originals.	Prevent Bleed-through ▶ page 3-56
Enlarge or shrink originals according to the sending size.	Zoom ▶ page 3-57
Scan a large number of originals separately and then produce as one job.	Continuous Scan ▶ page 3-40
Add a file name to the scanned images.	File Name Entry ▶ page 3-63
Add an E-mail subject and body (when sending E-mail).	E-mail Subject/Body ▶ page 6-43
Send notice by e-mail when a job is complete.	Job Finish Notice ▶ page 3-61
Encrypt your message.	FTP Encrypted TX ▶ page 6-44
Send a image to a WSD-compatible computer.	WSD Scan ▶ page 6-45



NOTE

This section does not include fax settings. For details on fax operation, refer to the *FAX Operation Guide*. Fax functionality requires the optional fax kit.

Sending Size

Select size of image to be sent.

Same as Original Size	Automatically sends the same size as the original.
Metric	Select from A3, A4, A5, A6, B4, B5, B6, Folio or 216 × 340 mm.
Inch	Select from Ledger, Letter, Legal, Statement, 11 × 15", or Oficio II.
Others	Select from 8K, 16K, Hagaki or Oufukuhagaki.

Relationship between Original Size, Sending Size, and Zoom

Original Size (page 3-32), Sending Size, and Zoom (page 3-57) are related to each other. Refer to the following table.

Original Size and the size you wish to send as are	the same	different
Original Size	Specify as necessary.	Specify as necessary.
Sending Size	Select [Same as Original].	Select the required size.
Zoom	Select [100%] (or [Auto]).	Select [Auto].

NOTE
When you select Sending Size that is different from Original Size, and select the Zoom [100%], you can send the image as the actual size (No Zoom).

1 Display the screen.

1 Referring to *Basic Operation* on page 6-2, display the screen.

2

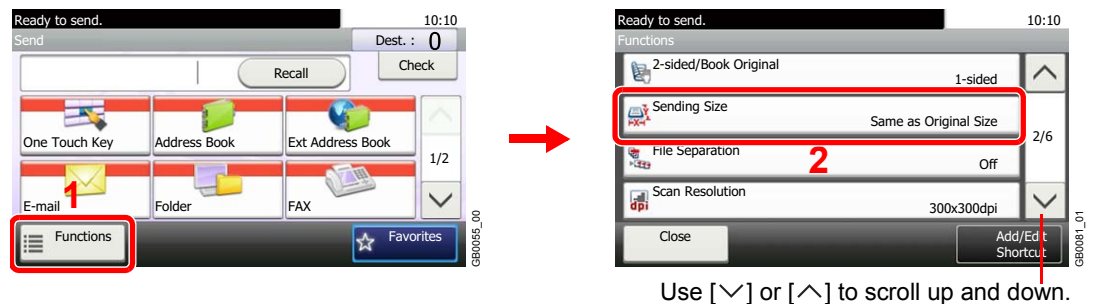

2 Select the sending size.

[Same as Original Size]

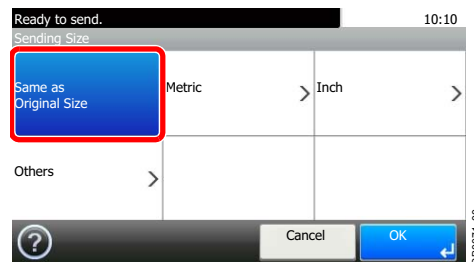

[Metric], [Inch] or [Others]

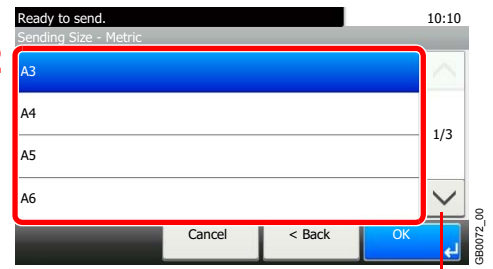
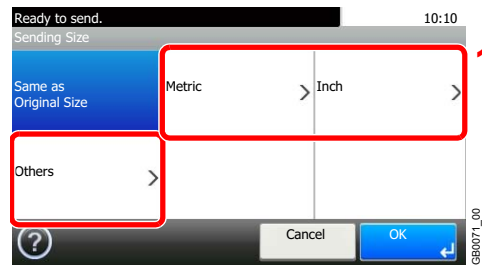

Use [∨] or [^] to scroll up and down.

Select the desired size.

File Separation

Create several files by dividing scanned original data page by page, and send the files.

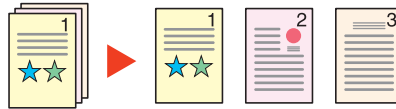

NOTE

Three-digit serial number such as abc_001.pdf, abc_002.pdf... is attached to the end of the file name.

1 Display the screen.

1 Referring to *Basic Operation on page 6-2*, display the screen.

2

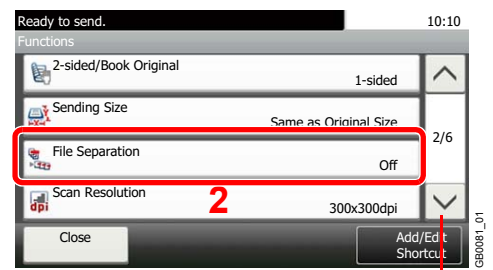

Use [∨] or [∧] to scroll up and down.

2 Select the function.

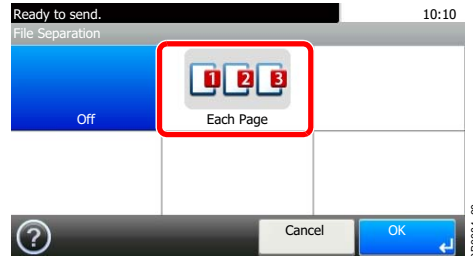

E-mail Subject/Body

Add subject and body when sending a document.

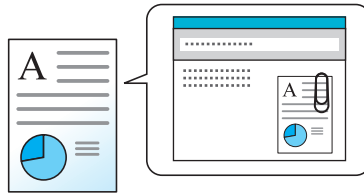

NOTE

The subject can include up to 60 characters, and the body can include up to 500 characters.

1 Display the screen.

1 Referring to *Basic Operation* on page 6-2, display the screen.

2

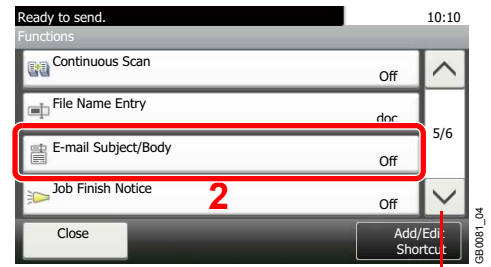

Use [∨] or [∧] to scroll up and down.

2 Enter the subject.

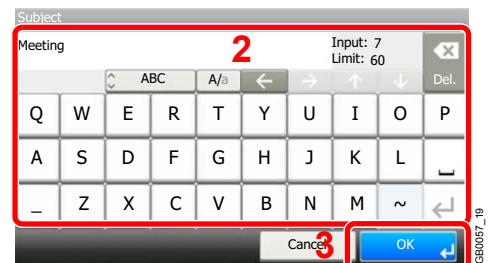
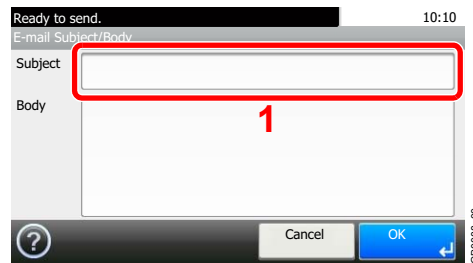

Refer to *Character Entry Method* on page 11-7 for details on entering characters.

3 Enter the body.

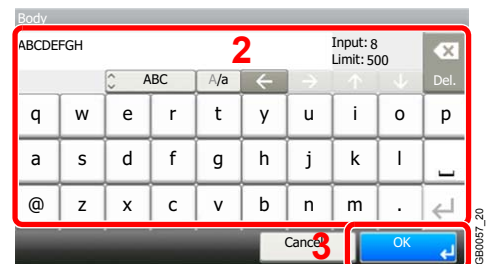
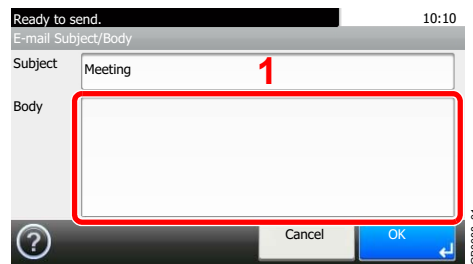

4 Press [OK].

FTP Encrypted TX

Encrypt images when using FTP. Encryption secures the document transmission.

NOTE
To use FTP encryption, set SSL to [On] in the Secure Protocol settings. For details, refer to *Secure Protocol on page 9-22*.

1 Display the screen.

1 Referring to *Basic Operation on page 6-2*, display the screen.

2

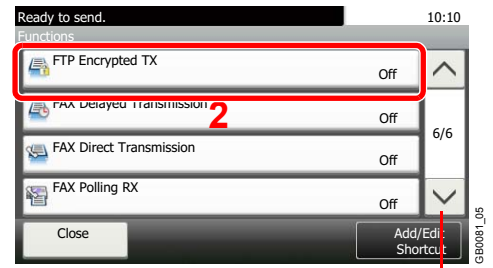

Use [∨] or [∧] to scroll up and down.

2 Select the function.

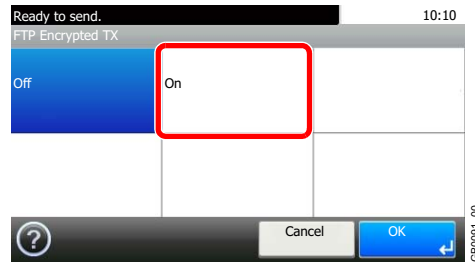

WSD Scan

WSD Scan saves images of originals scanned on this machine as files on a WSD-compatible computer.

NOTE

To use WSD Scan, confirm that the computer used for WSD scanning and the machine is network-connected, and *WSD Scan* (page 9-22) is set to [On] in the network settings.

For information on operating the computer, refer to the computer's help or the operation guide of your software.

Installing Driver Software (for Windows 7)

1 Display the window.

From the Start menu, select **Network**.

2 Install the driver.

Right-click the machine's icon (Kyocera: XXX:XXX) and then click **Install**.

NOTE

If the **User Account Control** window appears, click **Continue**.

If the **Found New Hardware** window appears, click **Cancel**.

During the installation, double-click the icon shown on the task bar to display the **Driver Software Installation** screen. When **Your devices are ready to use** is displayed on the screen, the installation is completed.

Using WSD

1 Press the Send key.

Send



2 Place the originals.

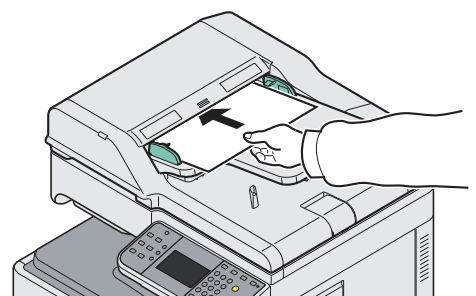
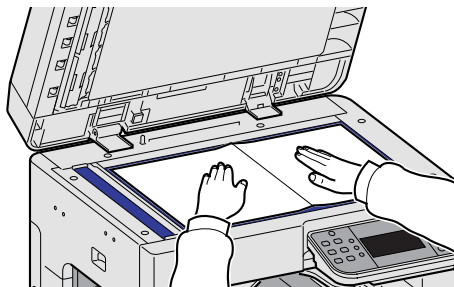

For details, refer to *Loading Originals* on page 3-7.

3 Display the screen.

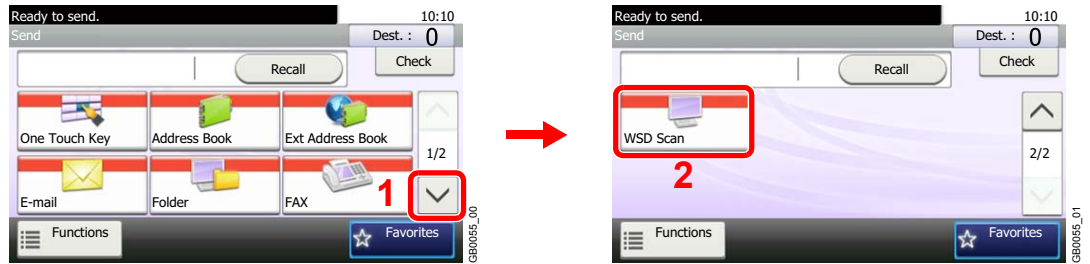

4 Scan the originals.

Procedure using this machine

1

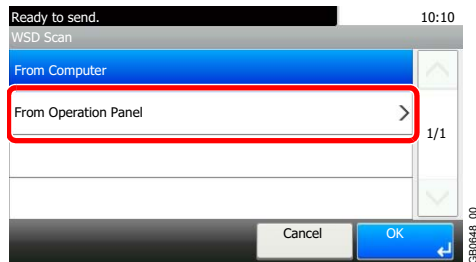

2 Select the destination computer.

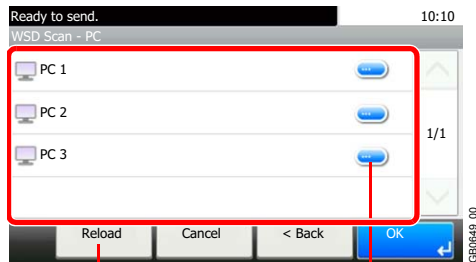

Updates the list.

Displays information for individual destination computers.

3 Press the **Start** key.

Start

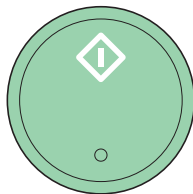

Sending begins and the software installed on the computer is activated.

Procedure from Your Computer

1

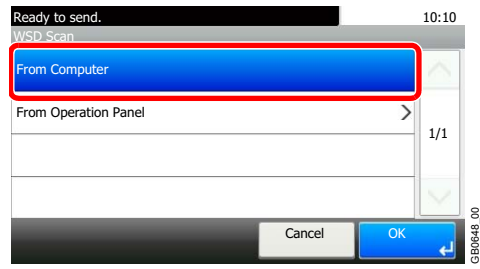

2 Use the software installed on the computer to send the images.

Scanning using TWAIN

This section explains how to scan an original using TWAIN.

The procedure for scanning using the TWAIN driver is explained as an example. The WIA driver is used in the same way.

1 Display the window.

- 1 Activate the TWAIN compatible application software.
- 2 Select the machine using the application software and display the TWAIN dialog box.



NOTE

For selecting the machine, see the Operation Guide or Help for each application software.

2 Configure the function.

Select scanning settings in the TWAIN dialog box that opens.

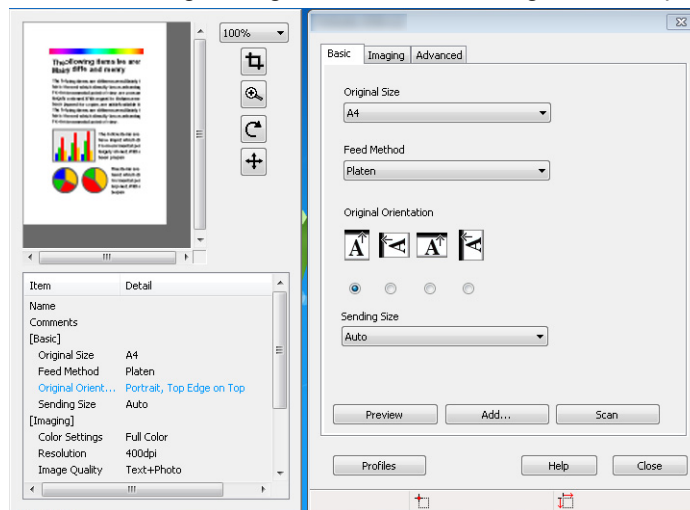



The settings that appear in the TWAIN dialog box are as follows.

Item		Detail
Basic	Original Size	This setting sets the size of the scan area.
	Feed Method	This setting specifies the feed method of the original. Select the feed method from the list.
	Original Orientation	This setting specifies the orientation of the original.
	Sending Size	This setting specifies the image size.

Item		Detail
Imaging	Color Settings	This setting specifies the type of color for the image.
	Resolution	This setting specifies the dpi (dots per inch), or sharpness, for the image.
	Image Quality	This setting specifies the overall image quality. Make sure your selection matches the original that you are scanning.
	Exposure Level	This setting specifies the sharpness and clarity of the image. If the Auto check box is selected, then the slider bar and edit box are unavailable, and the exposure level is automatically set to the default setting.
	Contrast	This setting specifies the contrast between light and dark areas of the image. This feature cannot be used when Black & White is selected in the Color Settings .
Advanced	Reverse Image	This setting prints images like a photo negative, reversing the black and white areas of the image.
	Prevent Bleed-through	This setting prevents the image on one side of the paper from showing through to the other side when printed.
Scan Profiles		This is used to check current settings and store frequently used settings. When the Configuration button is clicked, a setting screen opens with buttons for Add , Edit , and Delete .
Add		The current settings can be saved as a Scan Profile.
Edit		The name and comments of the selected Scan Profile can be changed.
Delete		Delete saved Scan Profiles.

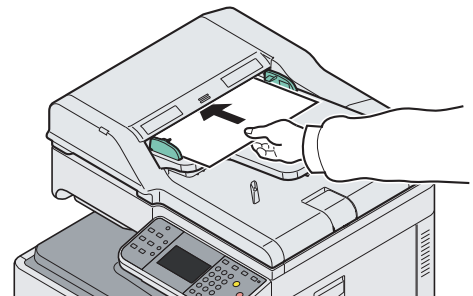
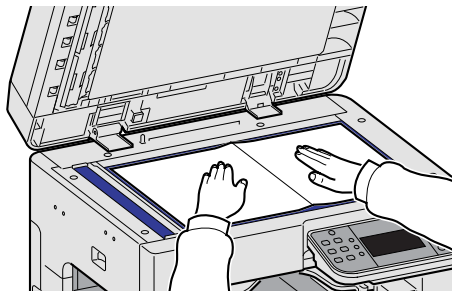
3 Place the originals.



 For details, refer to *Loading Originals* on page 3-7.

4 Scan the originals.

Click the **Scan** button. The document data is scanned.

7 Document Box

This chapter explains the following topics:

What is Document Box?	7-2
Printing Documents Stored in Removable USB Memory	7-3
Saving Documents to USB Memory (Scan to USB)	7-6
Removing USB Memory	7-9
Functions for Document Box	7-10
Duplex	7-11
Encrypted PDF Password	7-12
JPEG/TIFF Print	7-13
XPS Fit to Page	7-14
Storing Size	7-15

What is Document Box?

A document box is a place in machine memory that can be used to store document data scanned from the machine, a print job from a computer, or fax data.

The following types of document boxes are available.

Removable Memory Box

A USB memory stick can be connected to the USB port (A1) on the machine to print a saved PDF file. You can print PDF data directly from the USB memory without a PC. Image files scanned using this machine can also be saved to USB memory in the PDF, TIFF, JPEG or XPS format (Scan to USB).



Refer to *Printing Documents Stored in Removable USB Memory* on page 7-3.

Refer to *Saving Documents to USB Memory (Scan to USB)* on page 7-6.

Job Box

A print job can be saved in a job box in the machine and printed when needed.



Refer to *Printing Data Saved on the Printer* on page 5-7.

Sub Address Box, Polling Box

Fax data can be saved in Sub Address Box or Polling Box. For details, refer to the Operation Guide supplied with the fax kit.

Printing Documents Stored in Removable USB Memory

Plugging USB memory directly into the machine enables you to quickly and easily print the files stored in the USB memory without having to use a computer.

The following file types can be printed:

- PDF file (Version 1.5)
- TIFF file (TIFF V6/TTN2 format)
- JPEG file
- XPS file
- Encrypted PDF file

PDF files you wish to print should have an extension (.pdf).

Files to be printed should be saved no further down than the top 3 folder levels.

Use USB memory properly formatted by this machine.

Plug the USB memory directly into the USB memory slot (A1). We do not guarantee that USB memory printing is error free if a USB hub is used.

1 Plug the USB memory.

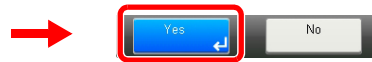
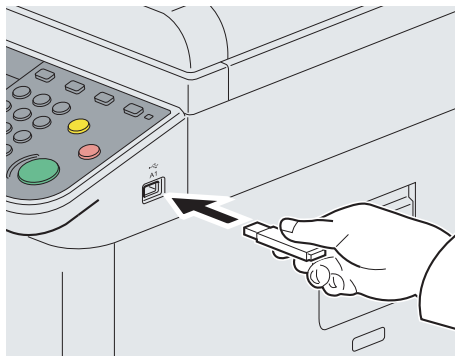

Plug the USB memory into the USB memory slot (A1).

When the message *Removable Memory is recognized. Displaying files. Are you sure?* is displayed, press [Yes].



IMPORTANT

Use USB memory formatted by this machine. If a USB memory formatted by any other device is used, *The removable memory is not formatted.* may appear.



Refer to *Check of Device Status* on page 8-11.

2 Display the screen.

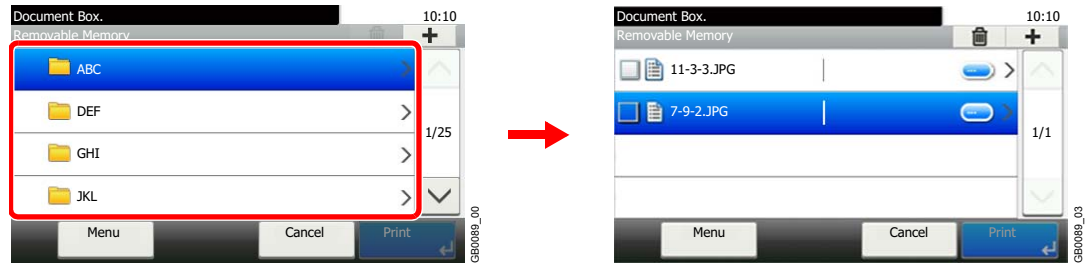

1 When the machine reads the USB memory, *Removable Memory* screen may appear.



NOTE

If the screen does not appear, press the **Document Box** key and then [Removable Memory].

2 Select and open the folder in which the file you wish to print is stored.

The machine will display documents in the top 3 folder levels, including the root folder. To return to a higher level folder, press [< Back].

3 Select the file.



Displays details for individual files.

Select the file to be printed and press [Print].

4 Enter the quantity.

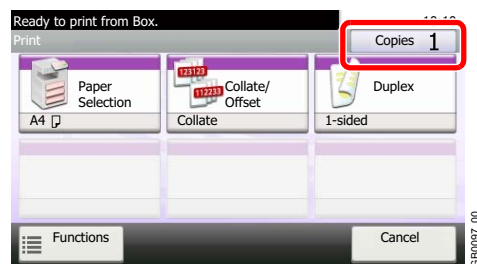

NOTE

Press the **Clear** key to change the copy quantity.

5 Select the functions.



Select the function to use for Document Box.

Press [Functions] to display other functions.

 For details, refer to *Functions for Document Box* on page 7-10.

6 Start printing.

Start

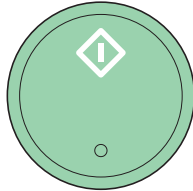

Press the **Start** key to start printing.

Remove the USB memory.

 For details, refer to *Removing USB Memory* on page 7-9.

Saving Documents to USB Memory (Scan to USB)

This function allows you to store scanned image files in USB memory connected to the machine. You can store files in PDF, TIFF, JPEG or XPS format.

1 Place the originals.

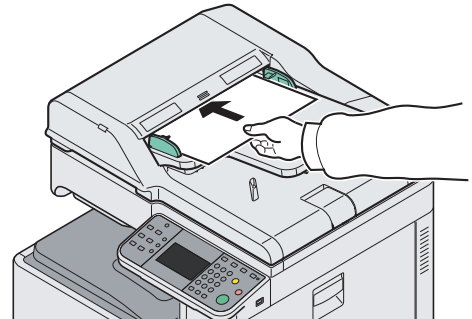
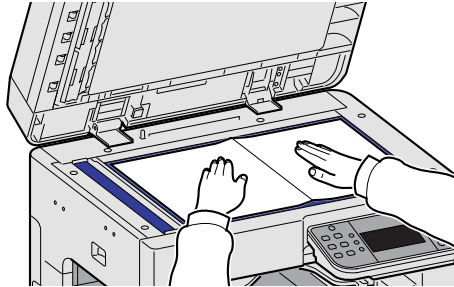

For details, refer to *Loading Originals* on page 3-7.

2 Plug the USB memory.

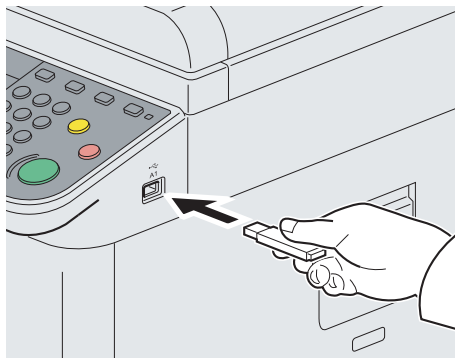

Plug the USB memory into the USB memory slot (A1).

When the message *Removable Memory is recognized. Displaying files. Are you sure?* is displayed, press [Yes].



IMPORTANT

Use USB memory formatted by this machine. If a USB memory formatted by any other device is used, *The removable memory is not formatted.* may appear.



Refer to *Check of Device Status* on page 8-11.

3 Display the screen.



When the machine reads the USB memory, *Removable Memory* screen may appear.



NOTE

If the screen does not appear, press the **Document Box** key and then [Removable Memory].

4 Select the folder.

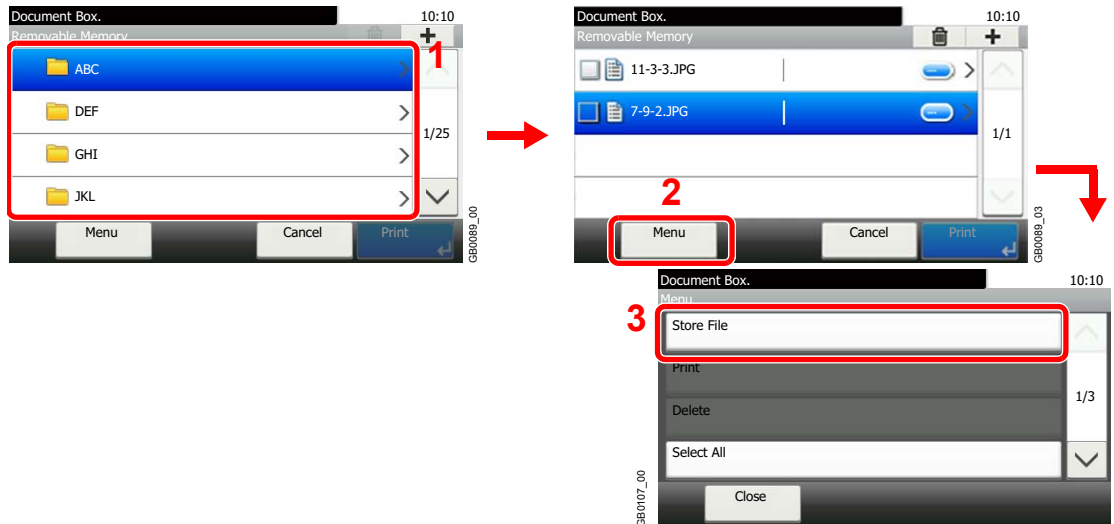

Select the folder where the file will be stored and press [Menu] and then [Store File]. The machine will display the top 3 folder levels, including the root folder. To return to a higher level folder, press [< Back].



NOTE

Up to 100 documents and folders can be displayed for each directory. If the number of documents and folders in a directory exceeds 100, you will be unable to save additional documents.

5 Select the functions.

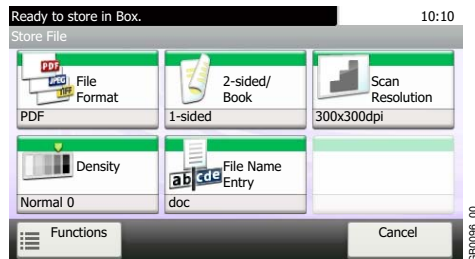

Select the function to use for Document Box. Press [Functions] to display other functions.



For details, refer to *Functions for Document Box* on page 7-10.

6 Start storing.

Start

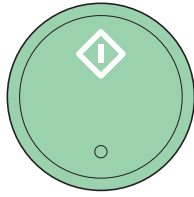

Press the **Start** key to start storing.

Remove the USB memory.



For details, refer to *Removing USB Memory on page 7-9*.

Removing USB Memory

Certain operations must be performed on the screen before USB memory can be removed.



IMPORTANT

Be sure to follow the proper procedure to avoid damaging the data or USB memory.

1 Display the screen.

Document Box

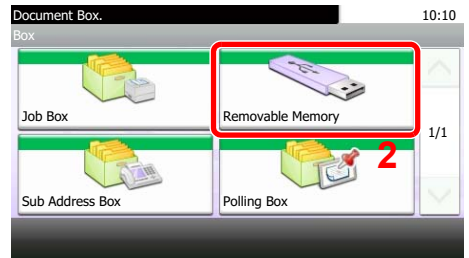

2 Select [Remove Memory].

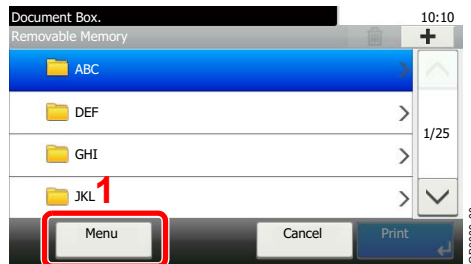

Use [∨] or [∧] to scroll up and down.

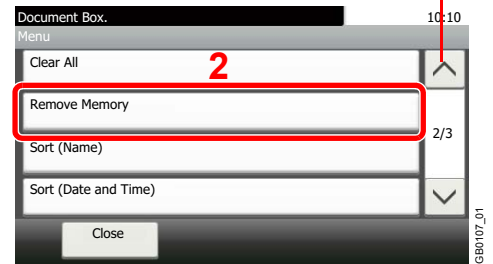

3 Remove the USB memory.

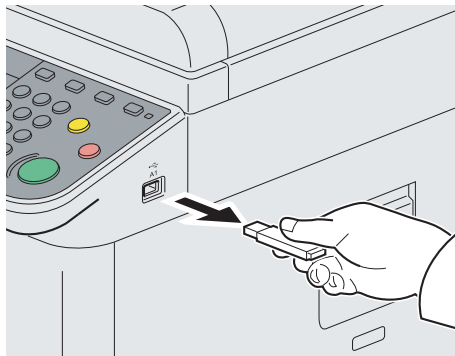

After *Removable Memory can be safely removed.* is displayed, press [OK] and remove the USB memory.



NOTE

USB memory can also be removed after checking the status of the device.



For details, refer to *Check of Device Status on page 8-11.*

Functions for Document Box

Print or Store file screen in Document Box shows the commonly used functions. By pressing [Functions], other selectable functions will be shown as a list. Use [∨] or [^] to select the function.

When printing from USB memory



What do you want to do?	Reference Page
Specify the paper size and type.	Paper Selection ▶ page 3-42
Collate the output documents in page order. / Offset the output documents by set.	Collate/Offset ▶ page 3-44
Print on both sides of the paper.	Duplex ▶ page 7-11
Change the paper output.	Paper Output ▶ page 3-43
Staple in the output documents.	Staple ▶ page 3-49
Change the color mode.	Color Selection ▶ page 3-60
Add margins (white space).	Margin ▶ page 3-46
Send notice by e-mail when a job is complete.	Job Finish Notice ▶ page 3-61
Suspend the current job and override it to give a new job top priority.	Priority Override ▶ page 3-64
Password-protect a PDF file.	Encrypted PDF Password ▶ page 7-12
Set the image size (resolution) when printing a JPEG or TIFF file.	JPEG/TIFF Print ▶ page 7-13
Print an XPS file so that it fits the paper size.	XPS Fit to Page ▶ page 7-14

When storing a document to USB memory

What do you want to do?	Reference Page
Select the file format for images being stored.	File Format ▶ page 3-58
Automatically scan 2-sided originals.	2-sided/Book Original ▶ page 3-37
Set the resolution at which to scan originals.	Scan Resolution ▶ page 3-52
Adjust the density.	Density ▶ page 3-51
Add a file name to the scanned images.	File Name Entry ▶ page 3-63
Specify the original size.	Original Size ▶ page 3-32
Specify the original orientation to scan in the correct direction.	Original Orientation ▶ page 3-34
Scan mixed size originals.	Mixed Size Originals ▶ page 3-35
Change the size at which to store an image	Storing Size ▶ page 7-15
Change the color mode for images being stored.	Color Selection ▶ page 3-60
Select original image type for best results.	Original Image ▶ page 3-53
Emphasize the outline of texts or lines. / Blur the image outline.	Sharpness ▶ page 3-54
Darken or lighten the background (i.e., the area with no text or images) of originals.	Background Density Adjust ▶ page 3-55
Prevent bleed-through for 2-sided originals.	Prevent Bleed-through ▶ page 3-56
Enlarge or shrink originals according to the storing size.	Zoom ▶ page 3-57
Scan a large number of originals separately and then produce as one job.	Continuous Scan ▶ page 3-40
Send notice by e-mail when a job is complete.	Job Finish Notice ▶ page 3-61

Duplex

Print a document 1-sided or 2-sided. Select the original binding orientation and desired final binding orientation.

 <p>2-sided</p>	<p>Print a 2-sided document so that the sheets are aligned properly for binding on the left or right</p>
 <p>2-sided</p>	<p>Print a 2-sided document so that the sheets are aligned properly for binding on the top.</p>

1 Display the screen.

- 1 Referring to *Printing Documents Stored in Removable USB Memory on page 7-3*, display the screen.

2

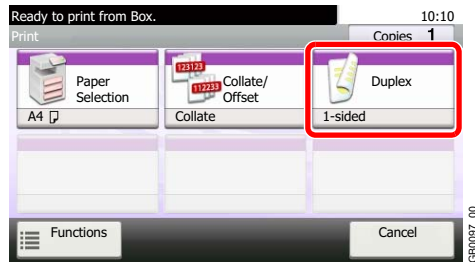

2 Select the function.

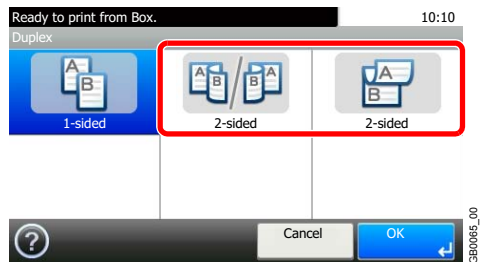

Encrypted PDF Password

Enter the preassigned password to print the PDF data.

1 Display the screen.

1 Referring to *Printing Documents Stored in Removable USB Memory on page 7-3*, display the screen.

2

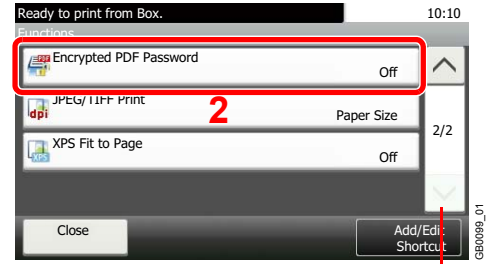

Use [∨] or [∧] to scroll up and down.

2 Enter the password.

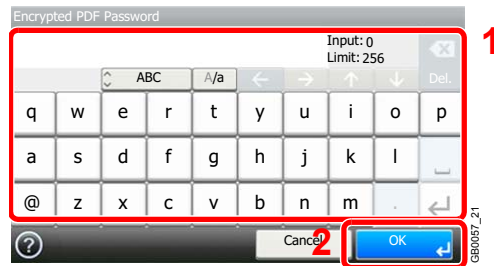

Up to 256 characters can be entered.

 Refer to *Character Entry Method on page 11-7* for details on entering characters.

JPEG/TIFF Print

Select the image size when printing JPEG or TIFF files.

Paper Size	Fit the image size to the selected paper size.
Image Resolution	Print at resolution of the actual image.
Print Resolution	Fit the image size to the print resolution.

1 Display the screen.

1 Referring to *Printing Documents Stored in Removable USB Memory on page 7-3*, display the screen.

2

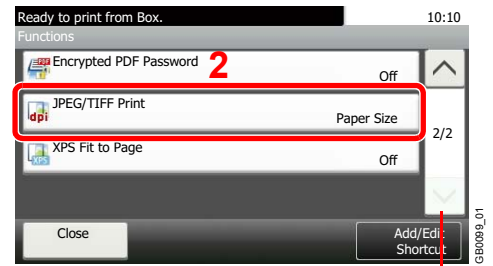
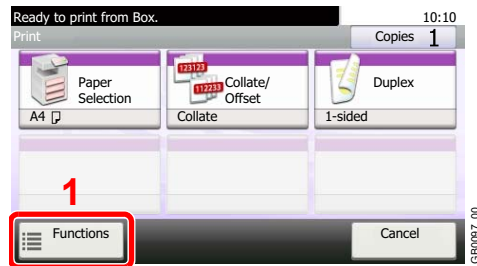

Use [∨] or [∧] to scroll up and down.

2 Select the function.

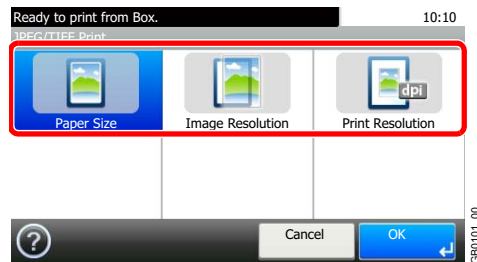

XPS Fit to Page

Reduces or enlarges the image size to fit to the selected paper size when printing XPS files.

1 Display the screen.

- 1 Referring to *Printing Documents Stored in Removable USB Memory on page 7-3*, display the screen.

2

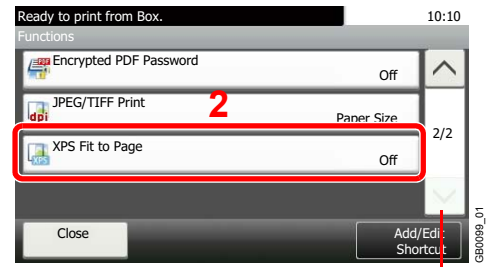

Use [∨] or [∧] to scroll up and down.

2 Select the function.

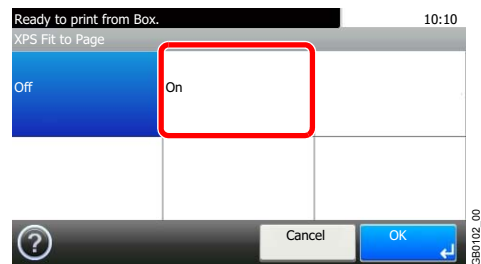

Storing Size

Select size of image to be stored.

Same as Original Size	Store an image the same size as the original.
Metric	Select from A3, A4, A5, A6, B4, B5, B6, Folio or 216 × 340 mm.
Inch	Select from Ledger, Letter, Legal, Statement, 11 × 15" or Oficio II.
Others	Select from 8K, 16K, Hagaki or Oufukuhagaki.

Relationship between Original Size, Storing Size, and Zoom

Original Size (page 3-32), Storing Size, and Zoom (page 3-57) are related to each other. Refer to the following table.

Original Size and the size you wish to store as are	the same	different
Original Size	Specify as necessary.	Specify as necessary.
Storing Size	Select [Same as Original].	Select the required size.
Zoom	Select [100%] (or [Auto]).	Select [Auto].

NOTE
When you select Storing Size that is different from Original Size, and select the Zoom [100%], you can store the image as the actual size (No Zoom).

1 Display the screen.

1 Referring to *Saving Documents to USB Memory (Scan to USB)* on page 7-6, display the screen.

2

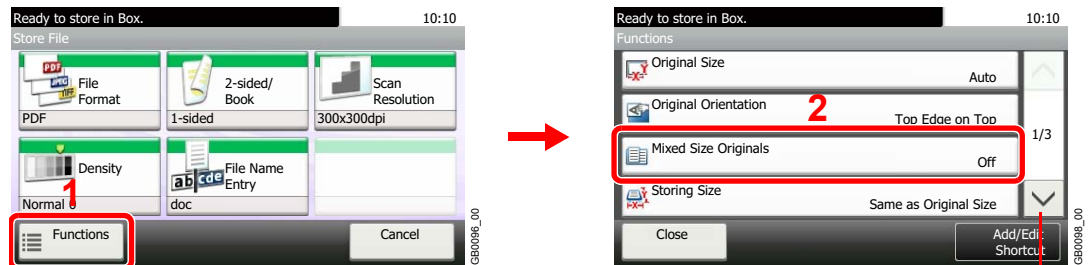

Use [∨] or [∧] to scroll up and down.

2 Select the storing size.

[Same as Original Size]

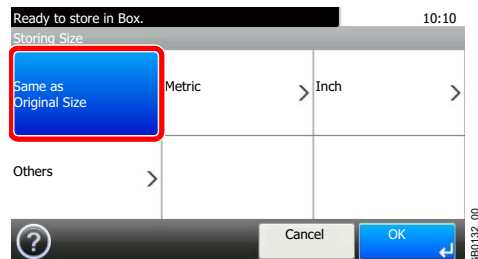

[Metric], [Inch] or [Others]

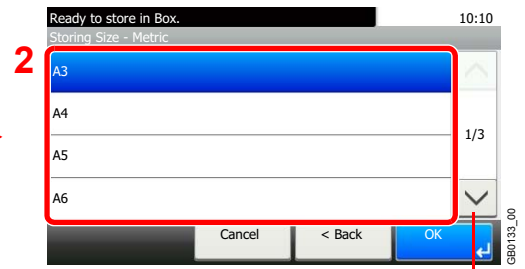
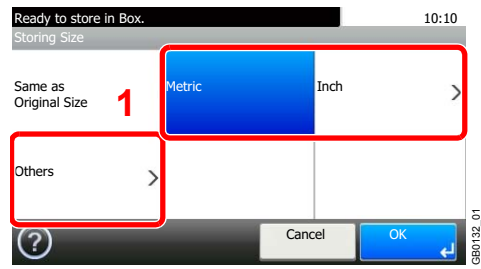

Use [∨] or [^] to scroll up and down.

Select the desired size.

8 Status / Job Cancel

This chapter explains the following topics:

Checking Job Status	8-2
Details of the Status Screens	8-3
Checking Job History	8-6
Sending the Log History	8-7
Setting the Destination	8-8
Automatic Log History Transmission	8-9
Manual Log History Transmission	8-9
Setting E-mail Subject	8-10
Check of Device Status	8-11
Checking the Remaining Amount of Toner and Paper	8-13

Checking Job Status

Check the status of jobs being processed or waiting to be printed.

Available Status Screens

The processing and waiting statuses of jobs are displayed as a list on the touch panel in four different screens - Printing Jobs, Sending Jobs, Storing Jobs, and Scheduled Jobs. The following job statuses are available.

Print Job Status	Copy Printer Printing from Document Box FAX reception E-mail reception Job Report /List Printing data from removable memory
Send Job Status	FAX transmission Folder (SMB/FTP) transmission E-mail Application Mixed (Multiple destination)
Store Job Status	Scan FAX Printer
Scheduled Job	Sending Job FAX using Delayed transmission

1 Display the screen.

Status/
Job Cancel



1



Press either of [Print Job Status], [Send Job Status], [Store Job Status] or [Scheduled Job] to check the status.

2 Check the status.

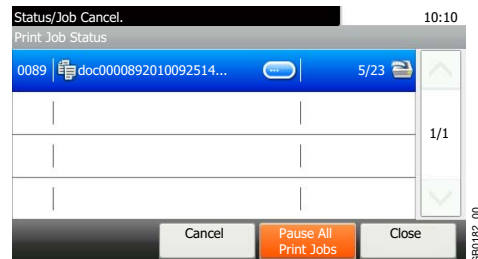

Refer to *Print Job Status Screen* on page 8-3, *Send Job Status screen* on page 8-4, *Store Job Status screen* on page 8-5, and *Scheduled Job screen* on page 8-5.

Details of the Status Screens

Print Job Status Screen

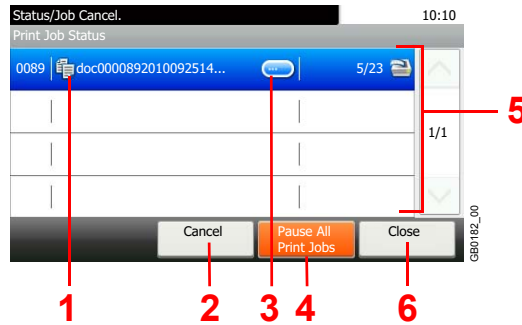

No.	Item/Key	Detail
1	—	<p>Icons that indicate the job type</p> <ul style="list-style-type: none"> Copy job Printer job Job from Document Box FAX reception E-mail reception Report/List Data from removable memory
2	[Cancel]	Select the job to be canceled from the list, and press this key.
3	[...]	Press [...] for the job for which you wish to display detailed information.
4	[Pause All Print Jobs]	Pauses all the printing jobs. By pressing this key again, the printing jobs will be resumed.
5	—	<p>Status of job</p> <ul style="list-style-type: none"> Printing Printing (priority override) Printing (interrupt copying) Print Waiting Print Waiting (priority override) Print Waiting (interrupt copying) Pausing print job or error Canceling the job The status before starting to print. The status before starting to print. (priority override) The status before starting to print. (interrupt copying) Printing has been suspended due to priority override or interrupt copy operation.
6	[Close]	Closes the Print Job Status screen.

Send Job Status screen

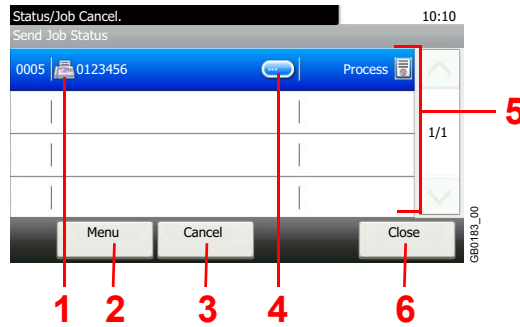

No.	Display/Key	Detail
1	—	Icons that indicate the job type Sending Job FAX Sending Job Folder (SMB/FTP) Sending Job E-mail Sending Job Application Sending Job Mixed (Multiple)
2	[Menu]*	Pressing this key displays [Priority Override]. This function allows you to give a particular fax job priority. Select the fax job you wish to send immediately and then press [Menu], followed by [Priority Override].
3	[Cancel]	Select the job you want to cancel from the list, and press this key.
4	[...]	Press [...] for the job for which you wish to display detailed information.
5	—	Status of job Sending Sending Waiting A job for which immediate transmission was specified is waiting for transmission to start. Pausing the job or error Canceling the job The status before starting sending such as during scanning originals
6	[Close]	Closes the Send Job Status screen.

* This function is displayed when the optional fax is installed.

Store Job Status screen

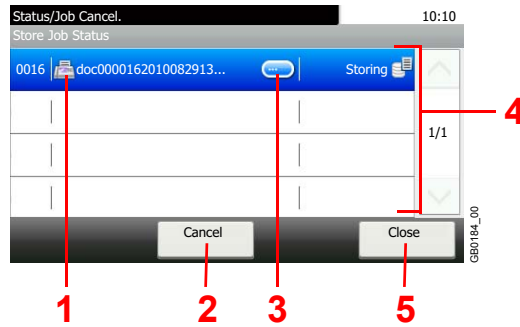

No.	Display/Key	Details
1	—	Icons that indicate the job type Storing Job Scan Storing Job Printer Storing Job FAX
2	[Cancel]	Select the job you want to cancel from the list, and press this key.
3	[...]	Press [...] for the job for which you wish to display detailed information.
4	—	Status of job Storing Data Pausing the job or error Canceling the job The status before starting to save such as during scanning originals
5	[Close]	Closes the Store Job Status screen.

Scheduled Job screen

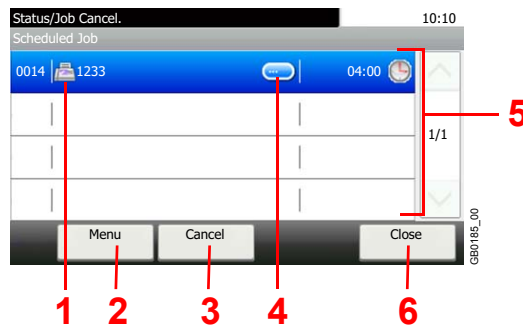

No.	Display/Key	Details
1	—	Icons that indicate the job type Sending Job FAX
2	[Menu]	Pressing this key displays [Start Now]. Select the job you wish to send immediately and then press [Menu], followed by [Start Now].
3	[Cancel]	Select the job you want to cancel from the list, and press this key.
4	[...]	Press [...] for the job for which you wish to display detailed information.
5	—	Status of job Sending Waiting
6	[Close]	Closes the Scheduled Job screen.

Checking Job History

Check the history of completed jobs.

Available Job History Screens

The job histories are displayed separately in three screens - Printing Jobs, Sending Jobs, and Storing Jobs. The following job histories are available.

Print Job Log	Copy	Send Job Log	FAX
	Printer		Folder (SMB/FTP)
	FAX reception		E-mail
	E-mail reception		Application
	Printing from Document Box		Mixed (Multiple destination)
	Job Report/List	Store Job Log	Scan
	Printing data from removable memory		FAX
			Printer

1 Display the screen.

Status/
Job Cancel



1

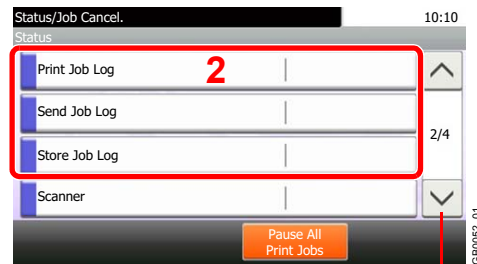

Use [∨] or [∧] to scroll up and down.

Press either of [Print Job Log], [Send Job Log], or [Store Job Log] to check the log.

2 Check the log.

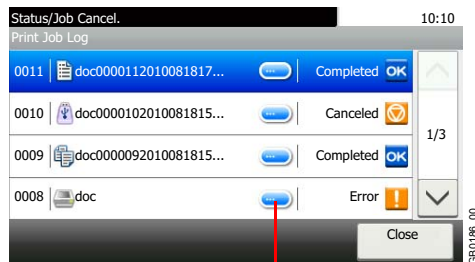

Displays details for individual jobs.

Press [Close] to exit the screen.



NOTE

The job history can be sent by E-mail.



For details, refer to *Sending the Log History* on page 8-7.

Sending the Log History

You can send the log history by e-mail. You can either send it manually as needed or have it sent automatically whenever a set number of jobs is reached.

1 Display the screen.

◆ System Menu / Counter



1

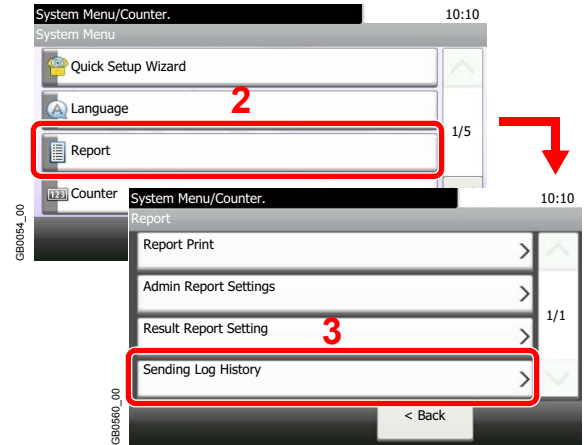

NOTE

If user login administration is enabled, you can only change the settings by logging in with administrator privileges.

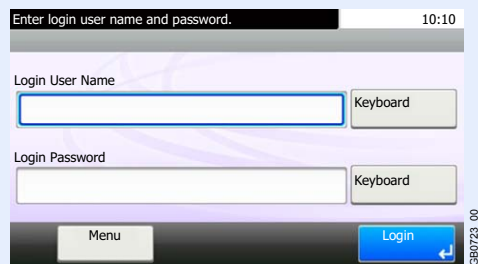

2 Configure the function.



Refer to *Setting the Destination* on page 8-8, *Automatic Log History Transmission* on page 8-9, *Manual Log History Transmission* on page 8-9 and *Setting E-mail Subject* on page 8-10.

Setting the Destination

Set the destination to which log histories are sent.

1 Display the screen.

1 Referring to *Sending the Log History* on page 8-7, display the screen.

2



2 Select the destination.

Select from the Address Book.

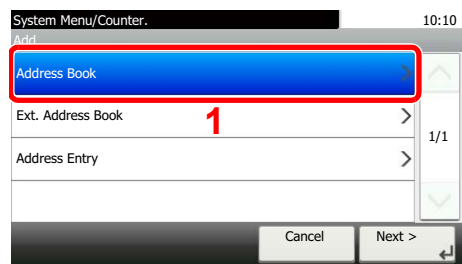

Searches by destination name.

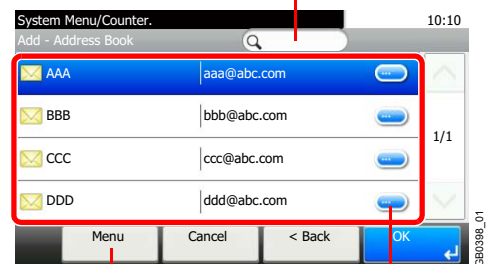

Allows you to search for and sort destinations.

Displays details for individual destinations.

Enter a new e-mail address.

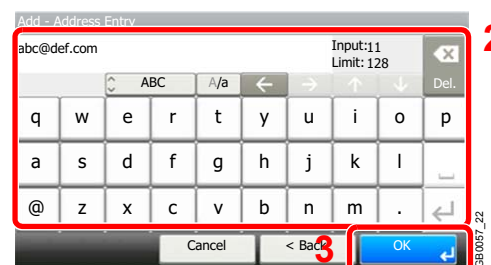
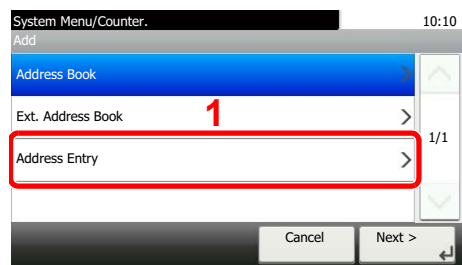

Up to 128 characters can be entered.

 Refer to *Character Entry Method* on page 11-7 for details on entering characters.

3 Accept the destination.

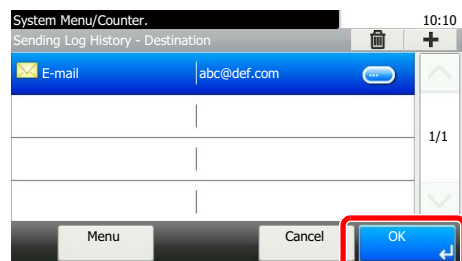

Automatic Log History Transmission

This function automatically sends the log history to the specified destinations whenever a set number of jobs has been logged.

1 Display the screen.

1 Referring to *Sending the Log History* on page 8-7, display the screen.

2

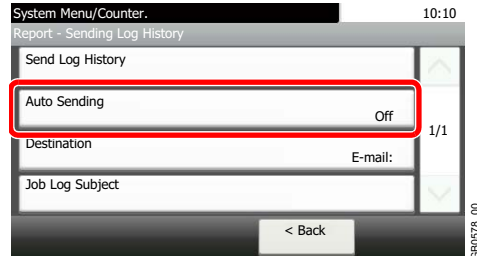

2 Select the function.

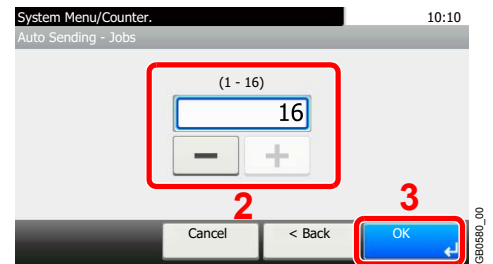
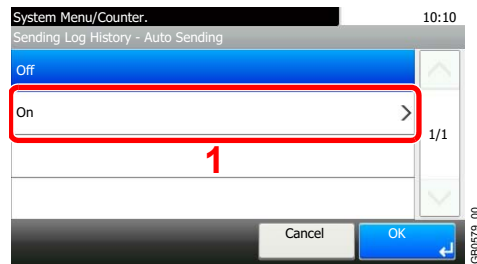

Press [On] and enter the number of jobs in the log history print. You can enter any number between 1 and 16.

Manual Log History Transmission

You can also send the log history to the specified destinations manually.

1 Display the screen.

Referring to *Sending the Log History* on page 8-7, display the screen.

2 Send the log history.

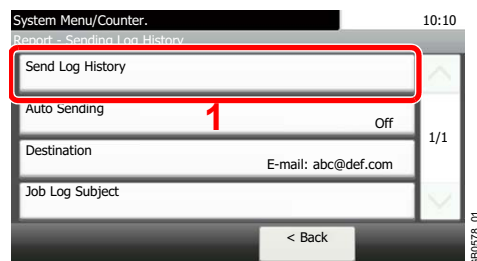

Setting E-mail Subject

Set the subject automatically entered when sending log histories by E-mail.

1 Display the screen.

1 Referring to *Sending the Log History on page 8-7*, display the screen.

2

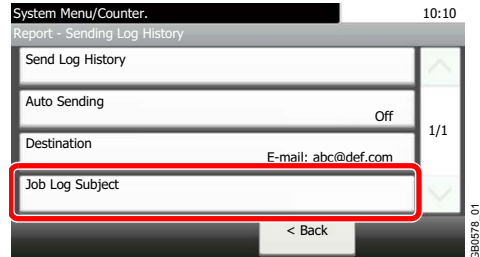

2 Enter an E-mail subject.

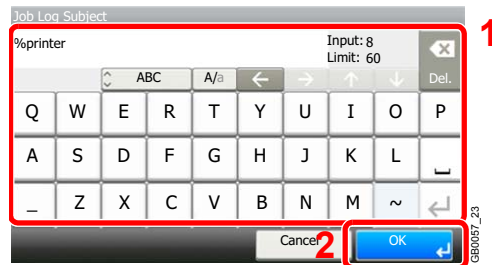

Up to 60 characters can be entered.

 Refer to *Character Entry Method on page 11-7* for details on entering characters.

Check of Device Status

Configure the devices/lines installed or connected to this machine or check their status. You can also control devices depending on their status.

1 Display the screen.

Status/
Job Cancel

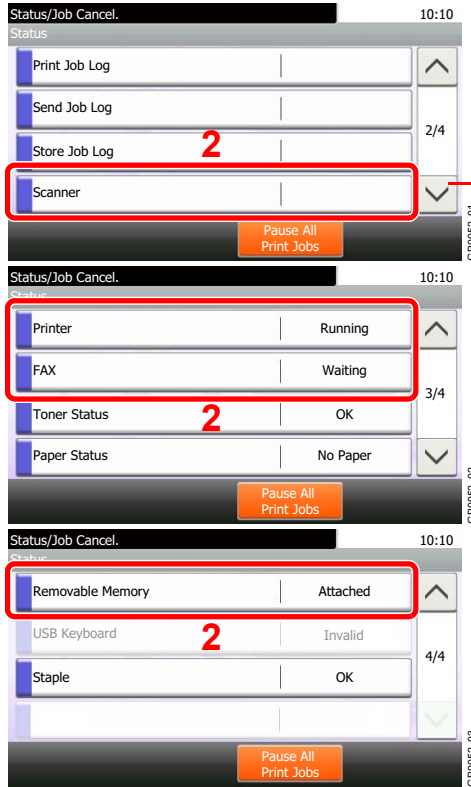

Use [∨] or [∧] to scroll up and down.

Select the device you wish to check.

2 Check the status.

Scanner



The status of an original scanning in the document processor or the error information (paper jam, opened cover, etc.) is displayed.

Printer



Error information such as paper jam, out of toner, or out of paper, and status such as waiting or printing are displayed.

FAX (Option)



- The information such as sending/receiving and dialing is displayed.
- Press [Line Off] to cancel a fax in sending/receiving.

For details, refer to the *FAX Operation Guide*.

Removable Memory

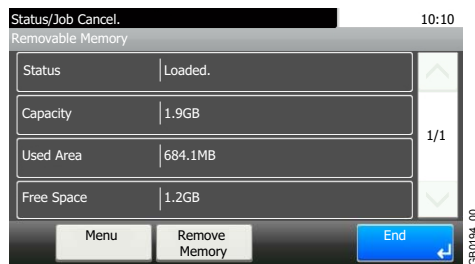

- The usage and capacity of the external media connected to this machine are displayed.
- Press [Menu] and then [Format] to format external media.
- Press [Remove Memory] to safely remove the external media. This operation is the same as that for *Removing USB Memory on page 7-9*.

Checking the Remaining Amount of Toner and Paper

Check the remaining amount of toner, paper, and staples on the touch panel.

1 Display the screen.

Status/
Job Cancel

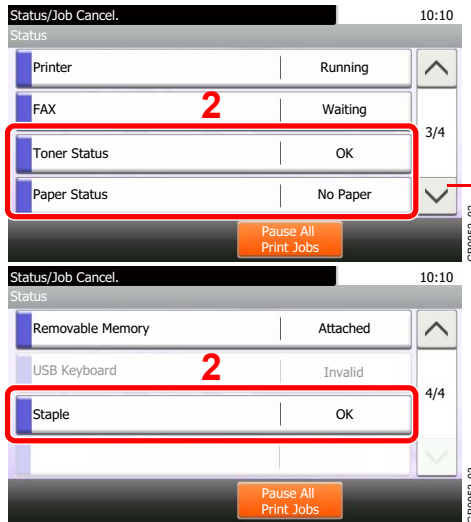

Use [v] or [^] to scroll up and down.

Select the consumable you wish to check.

2 Check the status.

Toner Status

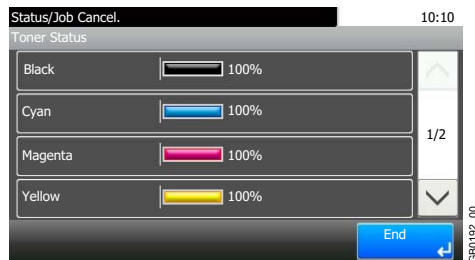

You can check the remaining amount of each color toner as one of 11 levels from 100 to 0%, and check the status of waste toner box.

Paper Status



The remaining amount of paper is shown by four levels as 100%, 70%, 30%, and 0% (none), however, the paper in the multi purpose tray is shown by two levels as 100% and 0%. If there is no paper in either cassette, the paper status will be shown as *No Paper*.

Staple Status

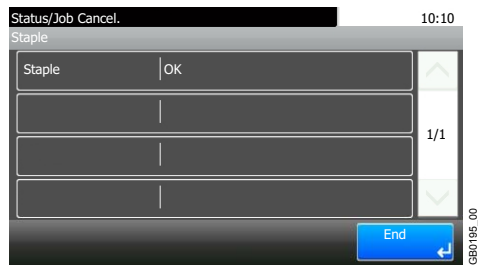

You can check the status of staples

9 Setup, Registration, and User Management

This chapter explains the following topics:

System Menu	9-2
Operation Method	9-2
System Menu Settings	9-3
Report	9-5
User Property	9-7
Cassette/MP Tray Settings	9-8
Common Settings	9-9
Copy	9-15
Send	9-16
Favorites/Application	9-16
Internet	9-17
Printer	9-17
System	9-19
Date/Timer	9-24
Adjustment/Maintenance	9-26
Color Registration Procedure	9-28
User Login Administration	9-34
First User Login Administration	9-34
User Login Settings	9-35
Enabling/Disabling User Login Administration	9-36
Adding a User	9-38
Local User Authorization	9-42
My Panel	9-43
Editing and Deleting Users	9-44
Simple Login	9-47
Group Authorization	9-53
Obtain Network User Property	9-57
Job Accounting	9-59
First Job Accounting Setup	9-59
Job Accounting Settings	9-61
Enabling/Disabling Job Accounting	9-62
Login/Logout	9-63
Adding an Account	9-64
Editing and Deleting Accounts	9-66
Restricting the Use of the Machine	9-68
Counting the Number of Pages Printed	9-70
Printing an Accounting Report	9-72
Job Accounting Default Setting	9-74
Unknown Login User Name Job	9-76

System Menu

Configure settings related to overall machine operation.

Operation Method

The system menu is operated as follows:

1 Display the screen.

◆ System Menu / Counter



2 Configure the function.

Displays available functions.

Scrolls up and down when the list of values cannot be displayed in its entirety on a single screen.

Displays available functions.

Return to the previous screen.

Selecting a value it to be accepted.

Returns to the original screen without making any changes.

Accepts the settings and exits.



NOTE

In order to change settings that require administrator privileges, you must log in with administrator privileges.

The factory default login user name and login password are set as shown below.

Model Name	Login User Name	Login Password
FS-C8520MFP	2000	2000
FS-C8525MFP	2500	2500

Refer to *System Menu Settings* on the following page and configure as needed.

System Menu Settings

System Menu include;

Item	Description	Reference Page
Quick Setup Wizard	The Quick Setup Wizard configures Fax, Network and Energy Saver settings.	3-26
Language	Select the language displayed on the touch panel.	9-5
Report	Print reports to check the machine settings and status. Default settings for printing the result reports can also be configured.	9-5
Counter	This counts the number of pages printed or scanned.	3-11
User Property	Allows you to view information about logged in users and edit some of that information.	9-7
Cassette/MP Tray Settings	Select paper size and media type for Cassette 1 to 3 and multi purpose tray.	9-8
Common Settings	Configures overall machine operation.	9-9
Default Screen	Select the screen appearing right after start-up (default screen).	9-9
Sound	Set options for buzzer sound during the machine operations.	9-9
Original Settings	Configures settings for originals.	9-9
Paper Settings	Configures settings for paper.	9-10
Function Defaults	<p>Defaults are the values automatically set after the warm-up is completed or the Reset key is pressed.</p> <p>Set the defaults for available settings such as copying and sending. Setting the frequently-used values as defaults makes subsequent jobs easier.</p> <p> IMPORTANT: If you want to enable the changed defaults immediately, move to the function screen and press the Reset key.</p>	9-12
Paper Output	Select output tray respectively for copy jobs, print jobs from Custom Box, computers, and FAX RX data.	9-13
Preset Limit	Restrict the number of copies that can be made at one time.	9-13
Error Handling	Select whether to cancel or continue the job when error has occurred.	9-14
Color Toner Empty Action	Select whether printing is prohibited or the Print in Black and White setting is used for printing once the color toner runs out.	9-14
Measurement	Select inch or metric for the unit for paper dimensions.	9-14
Keyboard Layout	Change the layout of the touch panel keyboard used to enter characters.	9-15
USB Keyboard Type	Select the type of USB keyboard that you want to use.	9-15
Offset One Page Documents	Set whether one-page documents are sorted.	9-15
Copy	Configures settings for copying functions.	9-15
Send	Configures settings for sending functions.	9-16
Document Box	Configures settings related to the Job Box and Sub Address Box. For details on Job Box, refer to <i>Printing on page 5-1</i> and for details on Sub Address Box, refer to the <i>Operation Guide for FAX kit</i> .	—
FAX	Configures settings for fax functions. Refer to the <i>Operation Guide for FAX kit</i> .	—

Item	Description	Reference Page
Favorites/Application	Configure settings for Favorites/Application.	9-16
Internet	Set the proxy for connection to the Internet from an application.	9-17
Address Book/One Touch	Configures Address Book and One Touch Key settings. For details on Address Book, refer to <i>Registering Destinations in the Address Book on page 6-27</i> and for details on One Touch Key, refer to <i>Adding a Destination on One Touch Key on page 6-36</i> .	—
User Login/Job Accounting	Configures settings related to machine management. For details on User Login, refer to <i>User Login Administration on page 9-34</i> , and for details on Job Accounting, refer to <i>Job Accounting on page 9-59</i> .	—
Printer	Printing from computers, settings are generally made on the application software screen. However, the following settings are available for configuring the defaults to customize the machine.	9-17
System	Configures machine system settings.	9-19
Network	Configures network settings.	9-19
Interface Block Setting	This allows you to protect this machine by blocking the interface with external devices such as USB hosts or optional interfaces.	9-23
Security Level	The Security Level setting is primarily a menu option used by service personnel for maintenance work. There is no need for customers to use this menu.	—
Restart	Restart the CPU without turning the main power switch off. Use this to deal with any unstable operation by the machine. (Same as the computer restart.)	—
RAM Disk Setting	A RAM disk can be created and its size can be set.	9-23
Main Memory	Select the memory allocation scheme based on the application in which you are using the equipment.	9-24
Optional Function	You can use the optional applications installed on this machine.	11-5
Date/Timer	Configures settings related to the date and time.	9-24
Adjustment/Maintenance	Adjust printing quality and conduct machine maintenance.	9-26

Language

Item	Description
Language	Select the language displayed on the touch panel. Value: English, Deutsch, Français, Español, Italiano, Nederlands, Русский, Português

Report

Print reports to check the machine settings and status. Default settings for printing the result reports can also be configured.

Report Print

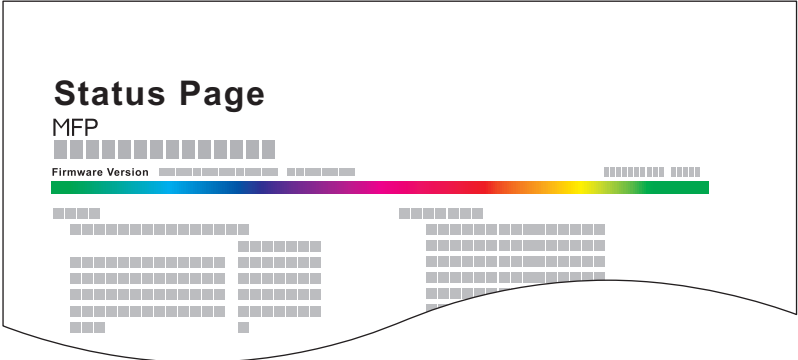
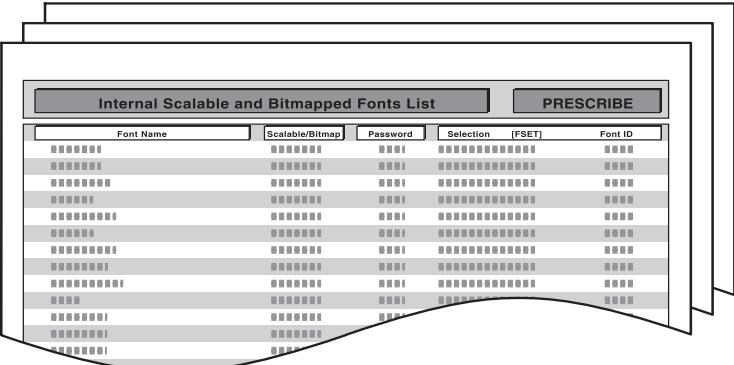
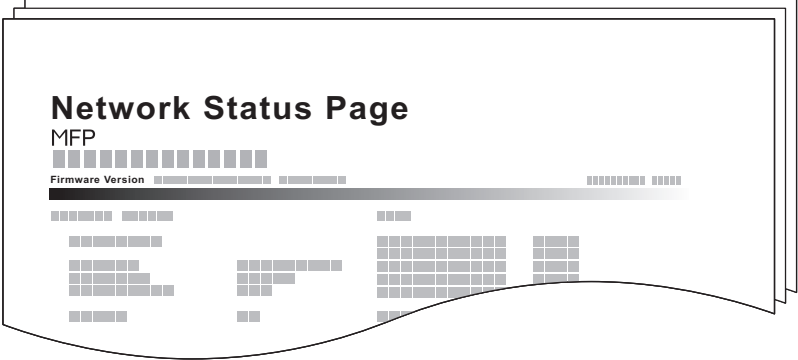
Item	Description
Status Page	<p>Prints the status page, allowing you to check the information including current settings, available memory space, and optional equipment installed.</p> 
Font List	<p>Prints the font list, allowing you to check the font samples installed in the machine.</p> 
Network Status	<p>Prints the network status, allowing you to check the information including network interface firmware version, network address and protocol.</p> 

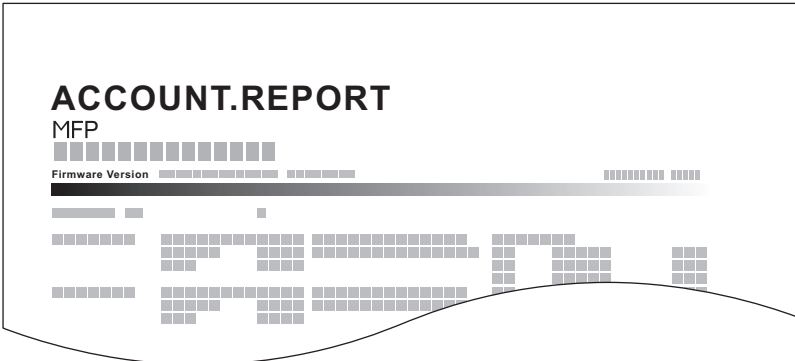
Item	Description
Service Status	Prints the service status. More detailed information is available than on the Status Page. Service personnel usually print the service status pages for maintenance purpose.
Accounting Report	<p>Prints the accounting report, allowing you to check the accounts that have been registered on the machine.</p> 

Result Report Settings

Item	Description
Send Result Report	Automatically print a report of transmission result when a transmission is complete.
E-mail/Folder	<p>Automatically print a report of transmission result when E-mail or SMB/FTP transmission is complete.</p> <p>Value: Off, On, Error Only</p>
Canceled before Sending	<p>Print a send result report if the job is canceled before being sent.</p> <p>Value: Off, On</p>
Job Finish Notice Setting	<p>Attaches sent images to job finish notices.</p> <p>Value: Do Not Attach Image, Attach Image</p>

Sending Log History

You can send the log history by e-mail. You can either send it manually as needed or have it sent automatically whenever a set number of jobs is reached.

 Refer to *Sending the Log History* on page 8-7.

User Property

Allows you to view information about logged in users and edit some of that information.





For details on User Login, refer to *User Login Administration* on page 9-34.

Item	Description
User Name	Changes the name shown on the user list. Up to 32 characters can be entered.
Login User Name	Displays the login user name that is entered at login.
Login Password	Changes the password that is entered at login. Up to 64 characters can be entered.
Access Level	Displays the user's access level.
Account Name	Displays the account to which the user belongs.
E-mail Address	Changes the user's e-mail address. Up to 128 characters can be entered.
Simple Login	When simple login is enabled, changes associated settings.
My Panel	Registers settings for individual users. Settings registered here can be applied simply by logging in. Network users are not displayed.
Group Name	When group authorization is enabled, displays the name shown in the group list.
Group ID	When group authorization is enabled, displays the ID shown in the group list.



Cassette/MP Tray Settings

Select paper size and media type for Cassette 1 to 3 and multi purpose tray.

Cassette1 (to 3)

Item	Description
Paper Size	<p>Set the paper size to load in Cassette 1 and optional paper feeders (Cassette 2 and 3).</p> <p>Value</p> <p>Auto: Automatically detect paper size. Select [Metric] or [Inch] for paper size. Metric: Select from A3, A4-R, A4, A5-R, B4, B5-R, B5, Folio or 216 × 340 mm. Inch: Select from Ledger, Letter-R, Letter, Legal, Statement-R or Oficio II. others: Select from 8K, 16K-R, or 16K.</p> <p> IMPORTANT: Specify the paper size as follows for the cassette that you want to use for fax reception.</p> <p>Inch models: Press [Auto] and then [Inch]. Metric models: Press [Auto] and then [Metric].</p>
Media Type	<p>Set the media type to load in Cassette 1 and optional paper feeders (Cassette 2 and 3).</p> <p>Value: Plain (105 g/m² or less), Rough, Vellum (59 g/m² or less), Recycled, Preprinted, Bond, Color, Prepunched, Letterhead, Thick (106 g/m² and more), High Quality, Custom 1-8</p> <p> NOTE: To print on preprinted or prepunched paper or on letterhead, refer to <i>Special Paper Action</i> on page 9-10.</p> <p>To change to a media type other than [Plain], refer to <i>Media Type Setting</i> on page 9-10. When the paper weight settings shown below are selected, the media indicated for each setting cannot be selected.</p> <p>Rough: Heavy 3 Bond: Heavy 3 Thick: Extra Heavy Custom 1 to 8: Heavy3 or Extra Heavy</p> <p>Refer to <i>Media Type Setting</i> on page 9-10 for selecting Custom 1- 8.</p>

Multi Purpose Tray

Item	Description
Paper Size	<p>Set the paper size for multi-purpose tray.</p> <p>Value</p> <p>Metric: Select from A3, A4-R, A4, A5-R, A6-R, B4, B5-R, B5, B6-R, Folio or 216 × 340 mm. Inch: Select from Ledger, Letter-R, Letter, Legal, Statement-R, Executive or Oficio II. others: Select from 8K, 16K-R, 16K, ISO B5, Envelope #10, Envelope #9, Envelope #6, Envelope Monarch, Envelope DL, Envelope C5, Envelope C4, Hagaki, Oufukuhagaki, Youkei 4, Youkei 2 or Custom.</p> <p>Size Entry: Enter a size not displayed in the standard sizes.</p> <p>Inch models – X: 5.83 to 17" (in 0.01" increments), Y: 3.86 to 11.69" (in 0.01" increments) Metric models – X: 148 to 432 mm (in 1 mm increments), Y: 98 to 297 mm (in 1 mm increments)</p> <p> NOTE: For instructions on how to specify the custom paper size, refer to <i>Custom Paper Size</i> on page 9-10.</p>
Media Type	<p>Set the media type for multi-purpose tray.</p> <p>Value: Plain (105 g/m² or less), Transparency, Rough, Vellum (59 g/m² or less), Labels, Recycled, Preprinted, Bond, Cardstock, Color, Prepunched, Letterhead, Envelope, Thick (106 g/m² and more), Coated, High Quality, Custom 1-8</p> <p> NOTE: To print on preprinted or prepunched paper or on letterhead, refer to <i>Special Paper Action</i> on page 9-10.</p> <p>Refer to <i>Media Type Setting</i> on page 9-10 for selecting Custom 1- 8.</p>

Common Settings

Configures overall machine operation.

Default Screen

Item	Description
Default Screen	Select the screen appearing right after start-up (default screen). Value: Copy, Send, FAX, Document Box, Favorites/Application, Status







Sound

Item	Description
Buzzer	Set options for buzzer sound during the machine operations.
Volume	Set the buzzer volume level. Value: 0 (Mute), 1 (Minimum) to 5 (Maximum)
Key Confirmation	Emit a sound when the operation panel and touch panel keys are pressed. Value: Off, On
Job Finish	Emit a sound when a print job is normally completed. Value: Off, On, FAX Reception Only  NOTE: [FAX Reception Only] is displayed when the optional fax is installed.
Ready	Emit a sound when the warm-up is completed. Value: Off, On
Warning	Emit a sound when errors occur. Value: Off, On
Key Confirmation (USB Keyboard)	Emit a sound when a key on the optional USB keyboard is pressed. Value: Off, On

Original Settings

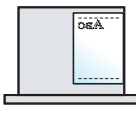
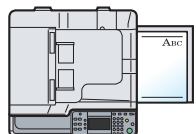
Item	Description
Custom Original Size	Set up frequently-used custom original size. To register a custom paper size, press [On] and enter the desired size. The custom size option is displayed on the screen to select original size. Value Custom: Off, On Size Entry Inch models – X: 2 to 17" (in 0.01" increments), Y: 2 to 11.69" (in 0.01" increments) Metric models – X: 50 to 432 mm (in 1 mm increments), Y: 50 to 297 mm (in 1 mm increments)
Original Auto Detect	Automatically detect originals of special or non-standard size.
A6/Hagaki	As A6 and Hagaki are similar in size, select either one of them for automatic detection. Value: A6, Hagaki
Folio	Select Folio for automatic detection. Value: Off, On
11 × 15"	Select the 11×15" size for automatic detection. Value: Off, On

Paper Settings

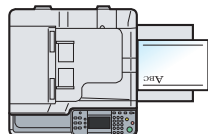
Item	Description
Custom Paper Size	<p>Set up frequently-used custom paper size.</p> <p>To register a custom paper size, press [On] and enter the desired size. The custom size option is displayed on the screen to select paper set in the multi purpose tray.</p> <p>Value</p> <p>Custom: Off, On</p> <p>Size Entry</p> <p>Inch models – X: 5.83 to 17" (in 0.01" increments), Y: 3.86 to 11.69" (in 0.01" increments)</p> <p>Metric models – X: 148 to 432 mm (in 1 mm increments), Y: 98 to 297 mm (in 1 mm increments)</p>
Media Type Setting	<p>Select weight for each media type.</p> <p>For Custom 1-8, settings for duplex printing and media type name can be changed.</p> <p>For details, refer to <i>Media Type Setting on page 9-11</i>.</p>
Default Paper Source	<p>Select the default paper source from Cassette 1-3 and multi purpose tray.</p> <p>Value: Cassette 1 to 3, Multi Purpose Tray</p>
Paper Selection	<p>Set the default paper selection.</p> <p>Value</p> <p>Auto: Automatically select the cassette containing paper in the same size as originals.</p> <p>Default Paper Source: Select paper source set by <i>Default Paper Source</i>.</p>
Media for Auto (Color)	<p>Select a default media type for auto paper selection when [Auto] is selected of Paper Selection. If Plain is selected, the paper source with plain paper loaded in the specific size is selected. Select [All Media Types] for the paper source with any kind of paper loaded in the specific size.</p> <p>Value: All Media Types, Plain, Transparency, Rough, Vellum, Labels, Recycled, Preprinted, Bond, Cardstock, Color, Prepunched, Letterhead, Envelope, Thick, Coated, High Quality, Custom 1 to 8</p>
Media for Auto (B&W)	
Special Paper Action	<p>When printing on Prepunched, Preprint, and Letterhead, punch-holes might not be aligned or the print direction might be upside-down depending on how originals are set and the combination of copying functions. In such a case, select [Adjust Print Direction] to adjust the print direction. When paper orientation is not important, select [Speed Priority].</p> <p>Example: copying on Letterhead</p> <div style="display: flex; justify-content: space-around; align-items: flex-end;"> <div style="text-align: center;">  <p>Original</p> </div> <div style="text-align: center;">  <p>Paper</p> </div> <div style="text-align: center;">  <p>Finished</p> </div> <div style="text-align: center;">  <p>Cassette</p> </div> <div style="text-align: center;">  <p>Multi Purpose Tray</p> </div> </div> <div style="display: flex; justify-content: space-around; align-items: flex-end; margin-top: 10px;"> <div style="text-align: center;">  <p>Original</p> </div> <div style="text-align: center;">  <p>Paper</p> </div> <div style="text-align: center;">  <p>Finished</p> </div> <div style="text-align: center;">  <p>Cassette</p> </div> <div style="text-align: center;">  <p>Multi Purpose Tray</p> </div> </div> <p>Value: Adjust Print Direction, Speed Priority</p>

Media Type Setting

Select the media type you wish to change.

Y: Available **N:** Not available

Paper Weight	Light	Normal 1	Normal 2	Normal 3	Heavy 1	Heavy 2	Heavy 3	Extra Heavy
Weight (g/m ²)	52 g/m ² to 59 g/m ²	60 g/m ² to 74 g/m ²	75 g/m ² to 90 g/m ²	91 g/m ² to 105 g/m ²	106 g/m ² to 128 g/m ²	129 g/m ² to 163 g/m ²	164 g/m ² to 256 g/m ²	Transparencies
Plain	Y	Y	Y (default)	Y	N	N	N	N
Transparency	N	N	N	N	Y*	Y*	Y*	Y* (default)
Rough	Y	Y	Y	Y (default)	Y*	Y*	Y*	N
Vellum	Y (default)	Y	Y	Y	N	N	N	N
Labels	Y*	Y*	Y*	Y*	Y* (default)	Y*	Y*	Y*
Recycled	Y	Y	Y (default)	Y	N	N	N	N
Preprinted	Y	Y	Y (default)	Y	N	N	N	N
Bond	Y	Y	Y	Y (default)	Y	Y	Y*	N
Cardstock	N	N	N	N	Y*	Y* (default)	Y*	Y*
Color	Y	Y	Y (default)	Y	N	N	N	N
Prepunched	Y	Y	Y (default)	Y	N	N	N	N
Letterhead	Y	Y	Y (default)	Y	N	N	N	N
Envelope	N	N	N	N	Y*	Y* (default)	Y*	Y*
Thick	N	N	N	N	Y	Y (default)	Y	Y*
Coated	Y*	Y*	Y*	Y*	Y* (default)	Y*	Y*	Y*
High Quality	Y	Y	Y (default)	Y	N	N	N	N
Custom 1-8	Y	Y	Y (default)	Y	Y	Y	Y*	Y*

* The media type cannot be selected for the cassettes.

For Custom 1-8, settings for duplex printing and media type name can be changed.

Item	Description
Custom 1-8	Duplex Select the setting for duplex. Value: Prohibit, Permit
	Name Change names for Custom 1-8. Names should be not more than 16 characters. Selecting media type at multi purpose tray, the name after change will be displayed.

Function Defaults

Item	Description
File Format	Select the default type of the files to be sent. Value: PDF, TIFF, JPEG, XPS
Original Orientation	Set the original orientation defaults. Value: Top Edge Top, Top Edge Left
Collate/Offset	Set the defaults for Collate/Offset. Value: Off, Collate Only, Offset Each Page, Offset Each Set
File Separation	Select the default file separation setting. Value: Off, Each Page
Scan Resolution	Select the default scanning resolution. Value: 600×600dpi, 400×400dpi Ultra Fine, 300×300dpi, 200×400dpi Super Fine, 200×200dpi Fine, 200×100dpi Normal
Color Selection (Copy)	Select the default copying color mode setting. Value: Auto Color, Full Color, Black & White
Color Select.(Send/Store)	Select the default color mode for scanning documents. Value: Auto (Color/Gray), Auto Color (Color/B & W), Full Color, Grayscale, Black & White
Original Image	Set the default original document type. Value: Text+Photo, Photo, Text, Graphic/Map, Text (for OCR), Printer Output
Background Density Adj.	Select the default value for background density adjustment. Value: Off, Auto, Manual (Darker 5)
EcoPrint	Select the EcoPrint default. Value: Off, On
Prevent Bleed-through	Set the default value for preventing bleed-through. Value: Off, On
Zoom	Select the enlarged/reduced default when paper size/sending size changed after the originals set. Value: 100%, Auto
Margin	Set the default margin. Value Left/Right: -18 to 18, Top/Bottom: -18 to 18 Left/Right: -0.75 to 0.75, Top/Bottom: -0.75 to 0.75
Continuous Scan	Set the continuous scan defaults. Value: Off, On
Auto Image Rotation	Select the default Auto Image Rotation setting. Value: Off, On
File Name Entry	Set an automatically entered name (default) for jobs. Additional information such as Date and Time and Job No. can also be set. Value File Name: Up to 32 characters can be entered. Additional Info: None, Date and Time, Job No., Job No. & Date and Time, Date and Time & Job No.

Item	Description
E-mail Subject/Body	Set the subject and body automatically entered (default subject and body) when sending the scanned originals by E-mail. Value Subject: Up to 60 characters can be entered. Body: Up to 500 characters can be entered.
FTP Encrypted TX	Set the default value for document encryption during transmission. Value: Off, On  NOTE: This setting is displayed when the secure protocol [SSL] setting is [On].
JPEG/TIFF Print	Select the image size (resolution) when printing JPEG or TIFF file. Value: Paper Size, Image Resolution, Print Resolution
XPS Fit to Page	Set the default value for the XPS fit to page function. Value: Off, On
Detail Settings	—
Image Quality	Set the default value for the image quality adjustment range when selecting the file format with which to send and store images. Value: 1 Low (High Comp.), 2, 3, 4, 5 High (Low Comp.)
PDF/A	Set the default value for PDF/A when selecting the file format with which to send and store images. Value: Off, PDF/A-1a, PDF/A-1b

* If you want to enable the changed defaults immediately, move to the function screen and press the **Reset** key.

Paper Output



Item	Description
Paper Output	Select output tray respectively for copy jobs, print jobs from Job Box, computers, and FAX RX data.* Value: Inner Tray, Finisher Tray, Job Separator Tray  NOTE: If the optional document finisher has been installed, [Inner Tray] will change to [Finisher Tray].

* If you want to enable the changed defaults immediately, move to the function screen and press the **Reset** key.

Preset Limit

Item	Description
Preset Limit	Restrict the number of copies that can be made at one time. Value: 1 to 999 copies.

Error Handling

Item	Description
Duplexing Error	Select what to do when duplex printing is not possible for the selected paper size and media type. Value 1-sided: Printed in 1-sided Display Error: Message to cancel printing is displayed.
Finishing Error	Select alternative actions when finishing (stapling or offsetting) is not available for the selected paper size or media type. Value Ignore: The setting is ignored and the job is printed. Display Error: Message to cancel printing is displayed.
No Staple Error	Select what to do when staples run out during printing. Value Ignore: Printing continues without stapling. Display Error: Message to cancel printing is displayed.  NOTE: This function requires the optional document finisher.
Stapling Limit Error	Select what to do when stapling capacity is exceeded during printing. Value Ignore: Printing continues without stapling. Display Error: Message to cancel printing is displayed.  NOTE: This function requires the optional document finisher.
Paper Mismatch Error	Select what to do when the selected paper size or type does not match paper size or type loaded in the specified paper source while printing from the computer by specifying the cassette or multi-purpose tray. Value Ignore: The setting is ignored and the job is printed. Display Error: Message to cancel printing is displayed.
Inserted Paper Mismatch	Select what to do when the paper size set for the paper source does not match the paper size that was actually loaded. Value Ignore: The setting is ignored and the job is printed. Display Error: Message to cancel printing is displayed.

Color Toner Empty Action

Item	Description
Color Toner Empty Action	Select whether printing is prohibited or the Print in Black and White setting is used for printing once the color toner runs out. Value : Stop printing, Print in Black & White

Measurement

Item	Description
Measurement	Select inch or metric for the unit for paper dimensions. Value : mm, inch

Keyboard Layout

Item	Description
Keyboard Layout	Change the layout of the touch panel keyboard used to enter characters. Value: QWERTY, QWERTZ, AZERTY

USB Keyboard Type

Item	Description
USB Keyboard Type	Select the type of USB keyboard that you want to use. Value: US-English, US-English with Euro, French, German

Offset One Page Documents

Item	Description
Offset One Page Documents	Set whether one-page documents are sorted. Value: Off, On  NOTE: This setting is displayed when an optional document finisher is installed.

Copy

Configures settings for copying functions.

Item	Description
Auto Paper Selection	If [Auto] is selected for Paper Selection, set the paper size selection method when the zoom changes.* Value Most Suitable Size: Select paper based on the current zoom and the size of the original. Same as Original Size: Select paper that matches the size of the original, regardless the zoom.
Auto % Priority	When a paper source of different size from the original is selected, select whether automatic zoom (reduce/zoom) is performed.* Value: Off, On
Reserve Next Priority	Once the scan of the original is complete, the basic screen will be displayed, and you can proceed to the next operation. Value: Off, On
Auto Image Rotation Action	Set whether the image is rotated when the orientation of the document to be printed is different from the orientation of the paper. Value: Unrotated Manual Copy: If a paper source or zoom ratio is specified, the image is not rotated. Apply All: Rotates all images. Follow Image Size: The image is rotated if the rotated image fits on the paper.  NOTE: This function is only enabled when <i>Auto Image Rotation on page 4-19</i> is set to [On].

* If you want to enable the changed defaults immediately, move to the function screen and press the **Reset** key.

Send

Configures settings for sending functions.

Item	Description
Dest. Check before Send	When performing sending jobs, display the confirmation screen of destinations after pressing the Start key. Value: Off, On
Entry Check for New Dest.	When adding new destination, display the entry check screen to check the entered destination. Value: Off, On
Send and Forward	Set whether to send the original to another destination and store it when sending images.
Forward	Set the rule to send the original. Multiple rules can be selected. Value Forward: Off, On Rule: FAX, E-mail, Folder(SMB), Folder(FTP)  NOTE: [FAX] is displayed when the optional FAX kit is installed.
Destination	Set the destination to use when storing originals. Select the destination using either of the following methods: <ul style="list-style-type: none"> • Address Book • Ext. Address Book • Address Entry (E-mail) • Address Entry (Folder)
Color TIFF Compression	Select the compression method for TIFF images handled on this machine. Value: TIFF V6, TTN2
Default Screen	Use this procedure to set the default screen displayed when you press the Send key. Value: Destination, Address Book, Ext. Address Book, One Touch

Favorites/Application

Configure settings for Favorites/Application.

Item	Description
Default Screen	Use this procedure to set the default screen displayed when you press the Favorites/ Application key. Value: Favorites, Application, Application 1 - 5 (applications being used)
Application	You can install, activate, deactivate, and delete applications. A list of installed applications is shown. You can view detailed information on the selected application by pressing [Detail].

Item		Description
Menu	Add	<p>You can install new applications.</p> <p>You can view detailed information on the selected application by pressing [Detail].</p> <p> NOTE: To install the applications, insert the USB memory containing the application to be installed into the USB Port. If <i>Removable Memory is recognized. Displaying files.</i> appears, press [No].</p> <p>To remove the USB memory, press [Remove Memory] and wait until the <i>Removable Memory can be safely removed</i> message appears. Then remove the USB memory.</p>
	Activate	<p>Activates the application selected on the list.</p> <p>[Official]: The application can be used without a time limit. Entry of the license key may be necessary.</p> <p>[Trial]: The application can be used on a trial basis for a limited period of time.</p>
	Deactivate	Deactivates the application selected on the list.
	Print Report	Prints information on the installed applications. The Application Name, ID (Application ID), Version, and other information can be checked.
	Delete	Deletes the application selected on the list.

Internet

Set the proxy for connection to the Internet from an application.

Item	Description
Proxy	Specify the proxy settings. <i>Value:</i> Off, On
Use Same Proxy	Set whether or not the same proxy server is used for all protocols. If the same proxy server is not used, select [Off]. <i>Value:</i> Off, On
HTTP Proxy Server	Set a proxy server (HTTP). <i>Value:</i> (Enter the proxy address and port number.)
HTTPS Proxy Server	Set a proxy server (HTTPS). This setup is available when [Use Same Proxy] is [Off]. <i>Value:</i> (Enter the proxy address and port number.)
No Proxy Domains	Set domains for which no proxy is used. <i>Value:</i> (Enter the domain name.)

Printer

Printing from computers, settings are generally made on the application software screen. However, the following settings are available for configuring the defaults to customize the machine.

Item	Description
Emulation	<p>Select the emulation for operating this machine by commands oriented to other types of printers.</p> <p><i>Value:</i> PCL6, KPDL, KPDL(Auto)</p>
KPDL Error Report	<p>When an error has occurred during printing in KPDL emulation mode, set whether or not the error report is output.</p> <p><i>Value:</i> Off, On</p>
Color Setting	<p>You can choose whether status reports are printed in color or black and white.</p> <p><i>Value:</i> Color, Black & White</p>

Item	Description
EcoPrint	EcoPrint conserves toner when printing. This is recommended for test copies where faded printing is not a problem. Value: Off, On
Override A4/Letter	Select whether to treat A4 size and Letter, which are similar in size, as the same size when printing. Value Off: A4 and Letter are not regarded as the same in size. On: A4 and Letter are regarded as the same in size. The machine will use whichever size is in the paper source.
Duplex	Select binding orientation for duplex mode. Value: 1-sided, 2-sided Bind LongEdge, 2-sided Bind ShortEdge
Copies	Set the default number of copies, from 1 to 999. Value: 1 to 999 copies
Orientation	Set the default orientation, [Portrait] or [Landscape]. Value: Portrait, Landscape
Wide A4	Turn this to on to increase the maximum number of characters that can be printed in a line for an A4 page (80 characters at 10 pitch) and Letter size page (80 characters at 10 pitch). This setting is only effective in PCL 6 emulation. Value: Off, On
Form Feed TimeOut	Receiving print data from the computer, the machine may sometimes wait if there is no information signaling that the last page does not have any more data to be printed. When the preset timeout passes, the machine automatically prints paper. The options are between 5 and 495 seconds. Value: 5 to 495 seconds
LF Action	Set the line feed action when the machine receives the line feed code (character code 0AH). Value: LF Only, LF and CR, Ignore LF
CR Action	Set the character return action when the machine receives the character return code (character code 0DH). Value: CR Only, LF and CR, Ignore CR
Job Name	Set whether the job name set in the printer driver is displayed. Value: Off, On
User Name	Set whether the user name set in the printer driver is displayed. Value: Off, On
Paper Feed Mode	While printing from the computer, select how to feed paper when the paper source and type are specified. Value Auto: Search the paper source that matches the selected paper size and type. Fixed: Print on paper loaded in the specified paper source.
Gloss Mode	Gloss Mode increases the effect of glossiness in printing by reducing the printing speed by half. Value: Off, On  IMPORTANT: Gloss Mode is not available when Labels and Transparency is selected as the paper type setting. (Refer to <i>Cassette/MP Tray Settings on page 9-8.</i>) Depending on the paper used, printing in gloss mode may cause wrinkle in paper. To reduce wrinkle, try using thicker paper.

System

Configures machine system settings.

Network

Configures network settings.

Host Name

Item	Description
Host Name	Check the host name of the machine.

TCP/IP

Item	Description
TCP/IP	Set up TCP/IP to connect to the Windows network.* Value: Off, On
IPv4 Settings	Set up TCP/IP (IPv4) to connect to the network. The IPv4 setting is available when selecting [On] for [TCP/IP].*
DHCP	Select whether or not to use the DHCP (IPv4) server. Value: Off, On
Bonjour	Select whether or not to use Bonjour. Value: Off, On
Auto-IP	Select whether or not to use Auto-IP. Value: Off, On
IP Address	Set the IP addresses. Value: ###.###.###.###
Subnet Mask	Set the IP subnet masks. Value: ###.###.###.###
Default Gateway	Set the IP gateway addresses. Value: ###.###.###.###

* After changing the setting, restart the system or turn the machine OFF and then ON.

Item	Description
IPv6 Settings	Set up TCP/IP (IPv6) to connect to the network. The IPv6 setting is available when selecting [On] for [TCP/IP].*
IPv6	Sets whether to use IPv6. Value: Off, On
Manual Setting	Manually specify the IP address, prefix length, and gateway address of TCP/IP (IPv6). The manual setting is available when selecting [On] for [IPv6]. Value IP Address (Manual): (numbers (128 bit in total) separated by colons) Prefix Length: 0 to 128 Default Gateway: ###.###.###.###  NOTE: [Default Gateway] is displayed when selecting [Off] for [RA (Stateless)].
RA (Stateless)	Select whether or not to use RA (Stateless). The RA (Stateless) settings are available when selecting [On] for [IPv6]. When selecting [On], [IP Address 1 (to 5)] appears under [IP Address (Stateless)/Prefix Length]. Value: Off, On
DHCP	Select whether or not to use the DHCP (IPv6) server. The DHCP (IPv6) Settings are available when selecting [On] for [IPv6]. Value: Off, On

* After changing the setting, restart the system or turn the machine OFF and then ON.

Item	Description
Protocol Detail	The table below lists the network related function settings. The network related functions are available when [TCP/IP] is [On].
NetBEUI	Selects whether or not to receive documents using NetBEUI.* Value: Off, On
LPD	Select whether or not to receive documents using LPD as the network protocol.* Value: Off, On
SMTP (E-mail TX)	Select whether or not to send e-mail using SMTP. Value: Off, On
POP3 (E-mail RX)	Select whether or not to receive e-mail using POP3. Value: Off, On
FTP Client (Transmission)	Select whether or not to send documents using FTP. When selecting [On], set the FTP Port Number. Use the FTP default port 21. Value: Off, On, Port 1 - 65535
FTP Server (Reception)	Select whether or not to receive documents using FTP.* Value: Off, On
SMB Client (Transmission)	Select whether or not to send documents using SMB. When selecting [On], set the SMB default Port Number. Use the SMB default port 139. For Windows Vista/7, use 445. Value: Off, On, Port 1 - 65535
LDAP	Select whether or not to use LDAP. Value: Off, On
SNMP	Select whether or not to communicate using SNMP.* Value: Off, On
SNMPv3	Select whether or not to communicate using SNMPv3.* Value: Off, On
HTTP	Select whether or not to communicate using HTTP.* Value: Off, On
HTTPS	Select whether or not to communicate using HTTPS. SSL must be set to [On] in <i>SSL on page 9-22</i> .* Value: Off, On
IPP	Select whether or not to communicate using IPP. When selecting [On], set the IPP default Port Number. Use the IPP default port 631.* Value: Off, On, Port 1 - 32767
IPP over SSL	Select whether or not to use IPP over SSL. When selecting [On], set the IPP over SSL default Port Number. Use the IPP over SSL default port 443. SSL must be set to [On] in <i>SSL on page 9-22</i> .* Value: Off, On, Port:1 - 32767
Raw Port	Select whether or not to receive documents using Raw Port.* Value: Off, On
ThinPrint	Select whether or not to use ThinPrint. Value: Off, On
ThinPrintOverSSL	Select whether or not to use ThinPrintOverSSL. SSL must be set to [On] in <i>SSL on page 9-22</i> . Value: Off, On

* After changing the setting, restart the system or turn the machine OFF and then ON.

WSD Scan

Item	Description
WSD Scan	Select whether or not to use WSD Scan.* Value: Off, On

* After changing the setting, restart the system or turn the machine OFF and then ON.

WSD Print

Item	Description
WSD Print	Select whether or not to use WSD Print.* Value: Off, On

* After changing the setting, restart the system or turn the machine OFF and then ON.

Enhanced WSD

Item	Description
Enhanced WSD	Set whether to use Kyocera's proprietary web services.* Selecting [Off] will disable the functionality of WIA, TWAIN and Network FAX drivers. If you want to disable KYOCERA Net Viewer functionality, Enhanced WSD, Enhanced WSD (SSL), SNMP and SNMPv3 (refer to <i>Protocol Detail on page 9-21</i>) must be set to [Off]. Value: Off, On

* After changing the setting, restart the system or turn the machine OFF and then ON.

Enhanced WSD (SSL)

Item	Description
Enhanced WSD (SSL)	Set whether to use Kyocera's proprietary web services over SSL.* Value: Off, On

* After changing the setting, restart the system or turn the machine OFF and then ON.

IPSec

Item	Description
IPSec	Make this setting when you use IPSec.* Value: Off, On

* After changing the setting, restart the system or turn the machine OFF and then ON.

Secure Protocol

Item	Description
SSL	Select whether or not to use SSL.* Value: Off, On
IPP Security	Select the IPP security level. This setup is available when SSL is [On].* Value: IPP/IPP over SSL, IPPoverSSL only
HTTP Security	Select the HTTP security level. This setup is available when SSL is [On].* Value: HTTP/HTTPS, HTTPS Only
LDAP Security (Ext. Address Book)	Select the type of encryption according to the type of security employed by the LDAP server. This setup is available when SSL is [On].*, **
LDAP Security (User Property)	Value: Off, SSL/TLS, STARTTLS

Item	Description
SMTP Security	Select the communication protocol according to the type of security employed by the SMTP server. This setup is available when SSL is [On]. Value: Off, SSL/TLS, STARTTLS
POP3 Security (User 1)	Select the communication protocol according to the type of security employed by the POP3 server. This setup is available when POP3 is [On]. Value: Off, SSL/TLS, STARTTLS
POP3 Security (User 2)	
POP3 Security (User 3)	

* After changing the setting, restart the system or turn the machine OFF and then ON.

** LDAP must be set to [On] in *Protocol Detail on page 9-21*.

LAN Interface

Item	Description
LAN Interface	Specify the settings for the LAN interface to be used.* Value: Auto, 10Base-Half, 10Base-Full, 100Base-Half, 100Base-Full, 1000BASE-T

* After changing the setting, restart the system or turn the machine OFF and then ON.

Interface Block Setting

This allows you to protect this machine by blocking the interface with external devices such as USB hosts or optional interfaces.

Item	Description
USB Host	This locks and protects the USB memory slot (A1) or USB port (A2) (USB host).* Value: Unblock, Block
USB Device	This locks and protects the USB interface connector (B1) (USB Device).* Value: Unblock, Block
USB Storage	This locks and protects the USB memory slot (A1).* Value: Unblock, Block
Optional Interface 1	This locks and protects the optional interface slots (OPT1 or OPT2).* Value: Unblock, Block
Optional Interface 2	

* After changing the setting, restart the system or turn the machine OFF and then ON.

RAM Disk Setting

Item	Description
RAM Disk Setting	A RAM disk can be created and its size can be set. Creating a RAM disk makes it possible to print from a Job Box.* Value RAM Disk Setting: Off, On RAM Disk Size: The setting range varies depending on the amount of memory installed and the main memory usage setting.

* After changing the setting, restart the system or turn the machine OFF and then ON.



Main Memory





Item	Description
Main Memory	Select the memory allocation scheme based on the application in which you are using the equipment.* Value: Printer Priority, Normal, Copy Priority

* After changing the setting, restart the system or turn the machine OFF and then ON.

Date/Timer

Configures settings related to the date and time.





Item	Description
Date/Time	Set the date and time for the location where you use the machine. If you perform Send as E-mail, the date and time set here will be displayed on the header. Value: Year (2000 to 2037), Month (1 to 12), Day (1 to 31), Hour (00 to 23), Minute (00 to 59), Second (00 to 59)
Date Format	Select the display format of year, month, and date. The year is displayed in Western notation. Value: Month/Day/Year, Day/Month/Year, Year/Month/Day
Time Zone	Set the time difference from GMT. Choose the nearest listed location from the list.
Auto Panel Reset	If no jobs are run for a certain period of time, automatically reset settings and return to the default setting. Select to use Auto Panel Reset or not. Value: Off, On  NOTE: The time allowed to elapse before the panel is reset is set with the <i>Panel Reset Timer</i> .
Panel Reset Timer	If you select [On] for Auto Panel Reset, set the amount of time to wait before Auto Panel Reset. Value: 5 to 495 seconds (every five seconds)  NOTE: If you select [Off] for [Auto Panel Reset], the time display does not appear.
Low Power Timer	Set amount of time before entering the Low Power mode. Value: 1 to 240 minutes (1 minute increments).
Auto Sleep	Set Auto Sleep to automatically enter Sleep Mode after a period of inactivity. Value: Off, On  NOTE: Refer to <i>Sleep and Auto Sleep on page 2-23</i> for Sleep. The time allowed to elapse until the auto sleep function is activated is set with the <i>Sleep Timer</i> .

Item	Description
<p>Sleep Level</p> <p>(Detailed settings)</p>	<p>Select the Sleep level.</p> <p>Set the Energy Saver mode to reduce power consumption even more than normal Sleep mode.</p> <p>Value: Quick Recovery, Energy Saver</p> <p> NOTE: If the optional Gigabit Ethernet Board is installed, Energy Saver cannot be specified.</p> <p>Set whether to use the Energy Saver mode for the following functions individually:</p> <ul style="list-style-type: none"> Network USB Cable Card Reader RAM Disk FAX Application <p>Value: Off, On</p> <p> NOTE: When the machine enters Energy Saver, the data stored in the RAM disk will be deleted. In addition, the machine does not wake from sleep mode when it receives print data from a PC connected by USB cable. Also, the ID card cannot be recognized.</p>
<p>Sleep Timer</p>	<p>Set amount of time before entering Sleep.</p> <p>Value: 1 to 240 minutes (1 minute increments)</p> <p> NOTE: If you select [Off] for [Auto Sleep], the time display does not appear.</p>
<p>Auto Error Clear</p>	<p>If an error occurs during processing, processing stops to wait for the next step to be taken by the user. In the Auto Error Clear mode, automatically clear the error after a set amount of time elapses. For details, refer to <i>Responding to Messages on page 10-14</i>.</p> <p>Value: Off, On</p>
<p>Error Clear Timer</p>	<p>If you select [On] for Auto Error Clear, set the amount of time to wait before automatically clearing errors.</p> <p>Value: 5 to 495 seconds (every five seconds)</p> <p> NOTE: If you select [Off] for [Auto Error Clear], the time display does not appear.</p>
<p>Interrupt Clear Timer</p>	<p>Set the period after which the machine reverts to Normal mode when it has been set to Interrupt Copy mode and then left unused.</p> <p>Value: 5 to 495 seconds (every five seconds)</p>

Adjustment/Maintenance

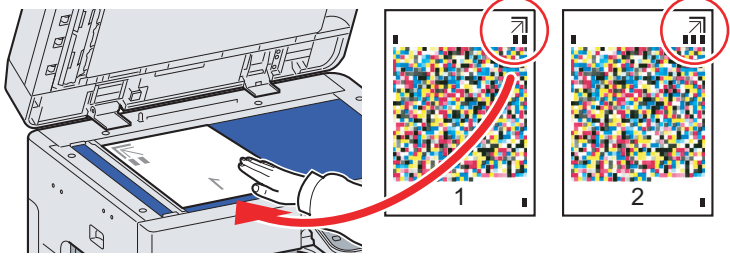
Adjust printing quality and conduct machine maintenance.

Item	Description
Density Adjustment	Adjust density.
Copy	Adjust copy density. Adjustment can be made in 7 levels. Value: -3 (Lighter), -2, -1, 0 (Normal), +1, +2, +3 (Darker)
Send/Box	Adjust scan density when sending or storing the data in Document Box. Adjustment can be made in 7 levels. Value: -3 (Lighter), -2, -1, 0 (Normal), +1, +2, +3 (Darker)
Background Density Adj.	Darkens or lightens overall background density adjustment.
Copy (Auto)	Darkens or lightens overall background density adjustment during copying. Adjustment can be made in 7 levels. Value: -3 (Lighter), -2, -1, 0 (Normal), +1, +2, +3 (Darker)
Send/Box (Auto)	Darkens or lightens overall background density when sending images or storing them in the Document Box. Adjustment can be made in 7 levels. Value: -3 (Lighter), -2, -1, 0 (Normal), +1, +2, +3 (Darker)
Toner Save Level (EcoPrint)	Set the toner-saving level when using EcoPrint.
Copy	Lowers or raises the toner-saving level during copying. Adjustment can be made in 5 levels.* Value: 1 to 5
Printer	Lowers or raises the toner-saving level during printing. Adjustment can be made in 5 levels. Value: 1 to 5
Auto Color Correction	This setting allows you to adjust the detection level used by the machine to determine whether the original is color or black and white during Auto Color Mode. Setting a lower value will result in more originals being identified as color, while a larger value will tend to increase the number of originals being identified as black and white. Value: 5 (B & W), 4, 3, 2, 1 (Color)
Correcting Black Line	Correct fine lines (streaks caused by contamination), which may appear on the image, when the document processor is used. Value Off: No correction performed. On (Low): Correction performed. The reproduction of fine lines on the original may become lighter than when using [Off]. On (High): Select this item if a streak remains after using [On (Low)]. The reproduction of fine lines on the original may become lighter than when using On (Low).
Display Brightness	Set the brightness of the touch panel. Value: 1 (Darker), 2, 3, 4 (Lighter)
Color Registration	When first installing the machine or moving it to a new location, color drift during printing may occur. Use this function to correct the color position of each of cyan, magenta and yellow to resolve color drift. For more information, refer to the <i>Color Registration Procedure</i> below.

Item	Description
<p>Tone Curve Adjustment</p>	<p>After prolonged use, or from the effects of surrounding temperature or humidity, the hue of printed color output may shift or color drift may occur. Use this function to correct color settings when the color of a finished copy does not match the original.</p> <p> NOTE: To perform tone curve adjustment, verify that either Letter or A4 paper is loaded into a cassette.</p> <p>Procedure</p>  <p>Press [Start] and print the first pattern. As shown in the illustration, place the printed side down on the platen.</p> <p>Press [Start]. The first pattern is read and adjustment begins.</p> <p>The second pattern is output. Confirm that a number "2" is printed on the pattern. Place the pattern on the platen in the same way as the first pattern.</p> <p>Press [Start]. The second pattern is read and adjustment begins.</p> <p>Turn the main power switch off and on. The adjustment will be completed after restarting the system.</p>
<p>Drum Refresh</p>	<p>Perform Drum Refresh when images show streaking with white lines. Takes about 120 seconds.</p> <p>Press [Start] to perform Drum Refresh.</p> <p> NOTE: Drum Refresh cannot be performed while printing. Execute Drum Refresh after the printing is done.</p>
<p>Calibration</p>	<p>Adjust color drift or hue of printed image in the most appropriate color.</p> <p>Press [Start] to perform Calibration.</p> <p>Press [OK] after Calibration is complete.</p> <p> NOTE: Perform Color Registration when the color drift is not adjusted even after performing Calibration, and perform Gray Adjust if the color hue is not improved.</p>
<p>Laser Scanner Cleaning</p>	<p>Remove white and color streaks from the image.</p> <p>Press [Start] to perform Laser Scanner Cleaning.</p> <p>Press [OK] after Laser Scanner Cleaning is complete.</p>
<p>DP Adjustment</p>	<p>Adjust scan action of the document processor. Place the adjustment original in the document processor.</p> <p>Press [Start] and adjustment begins.</p> <p> NOTE: This adjustment is for DP Leading edge and DP center adjust. Use this adjustment when the copy is skewed when using the Document Processor or when advised by a Service Technician.</p> <p>Call Service to obtain the adjustment original.</p>

* If you want to enable the changed defaults immediately, move to the function screen and press the **Reset** key.

Color Registration Procedure

Normal registration and detailed settings are available for Color Registration. Color drift can be largely corrected through normal registration. However, if it is not resolved or to perform more detailed settings, use the detailed settings.



NOTE

To perform color registration, verify that either Letter or A4 paper is loaded into a cassette.



IMPORTANT

Before performing color registration, be sure to perform Calibration (see page 9-27). If color drift remains, perform color registration. By performing color registration without performing Calibration, the color drift will be resolved once, however, it may cause the serious color drift later.

Normal Registration

1 Display the screen.

◆ System Menu / Counter

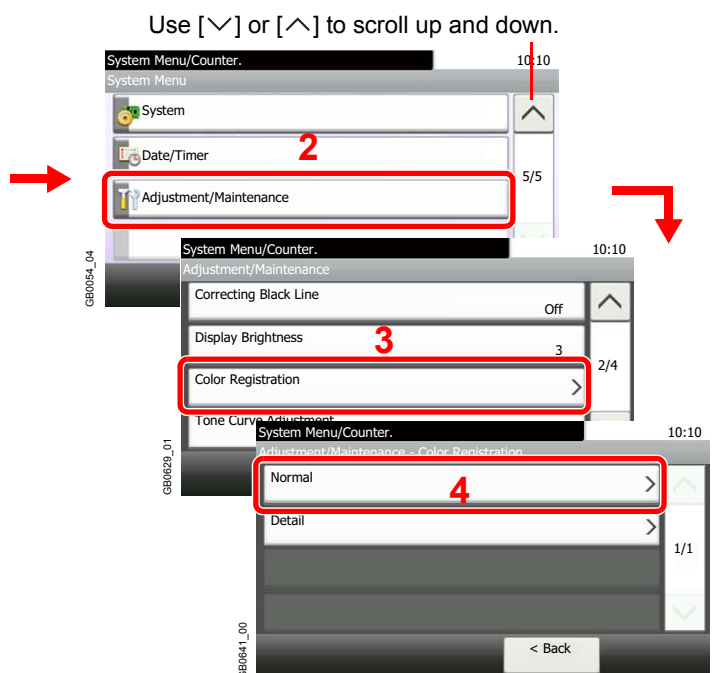
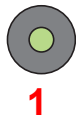

2 Print the chart.

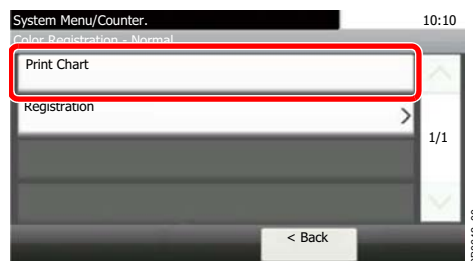

A chart is printed. On the chart, for each of M (magenta), C (cyan) and Y (yellow), 3 chart types are printed on one sheet: H-F (left), V (vertical), H-R (right).

Chart Example

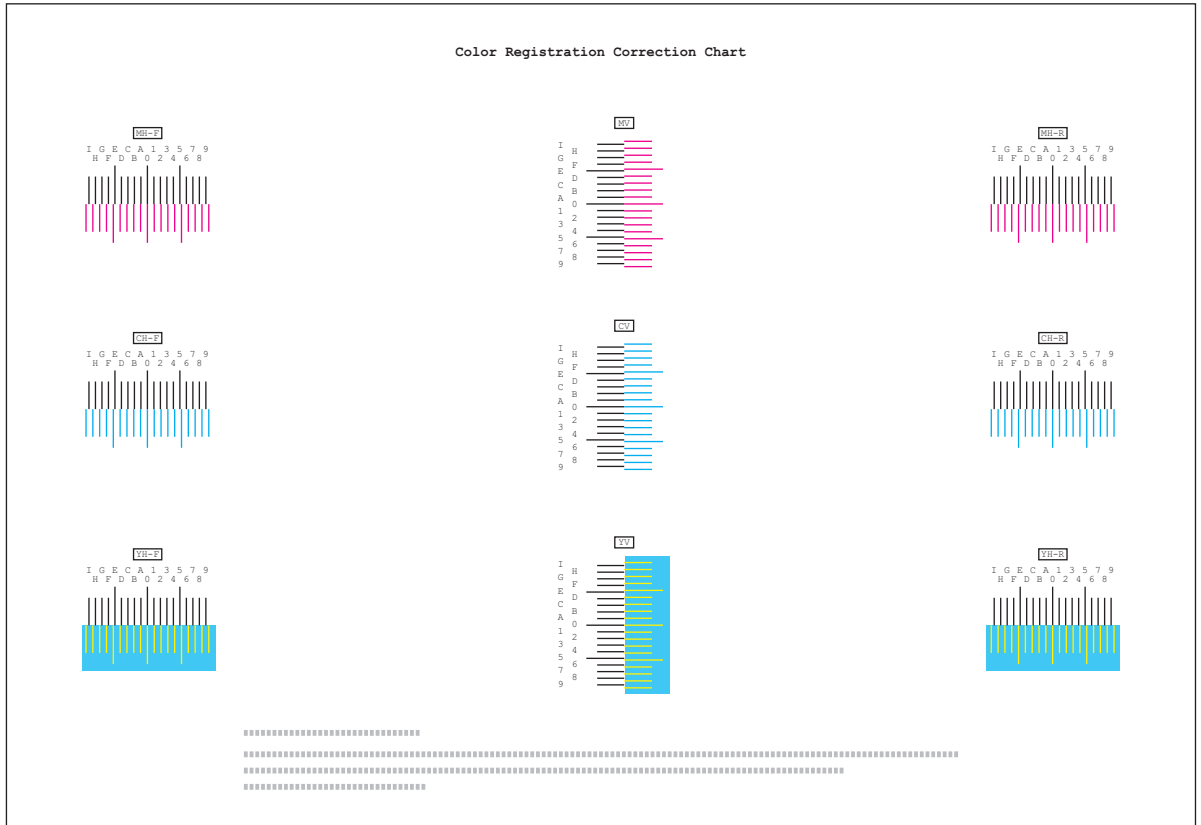

3 Enter the appropriate value.

- 1 Find the location on each chart where 2 lines most closely match. If this is the 0 position, registration for that color is not required. For the illustration, B is the appropriate value.

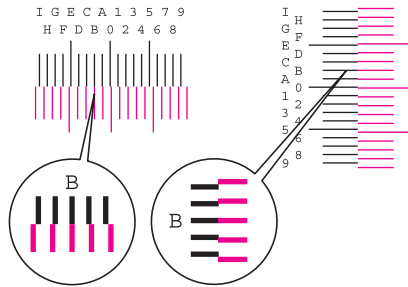

2

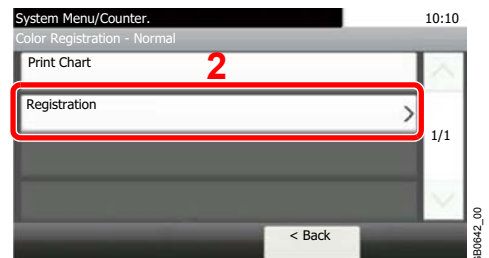
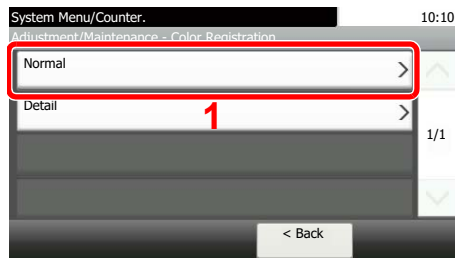

3 Select the chart to be corrected.

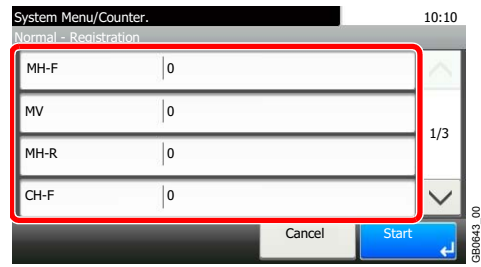

4 Press [+] or [-] to enter the values read from the chart.

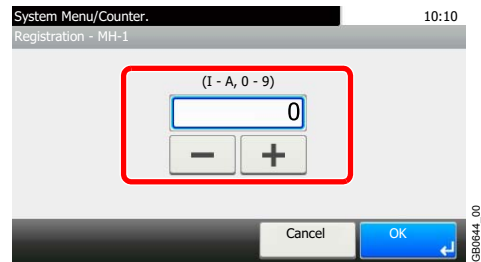

Press [+] to increase the value from 0 to 9. To decrease, press [-].

By pressing [-], the value changes from 0 to alphabetic letters, going from A to I. To move in the reverse direction, press [+].

You cannot use the numeric keys to enter these values.

5 Repeat steps **3** and **4** to enter the registration values for each chart.

6 Press [Start] after all values have been entered. Color registration begins.

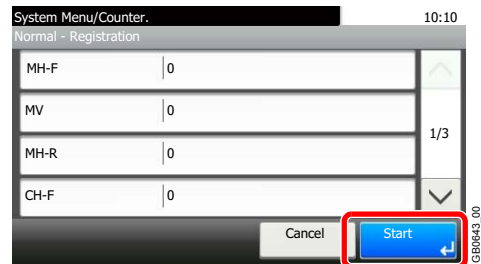

7 Press [OK] after color registration is complete.

Detailed Settings

1 Display the screen.

◆ System Menu / Counter

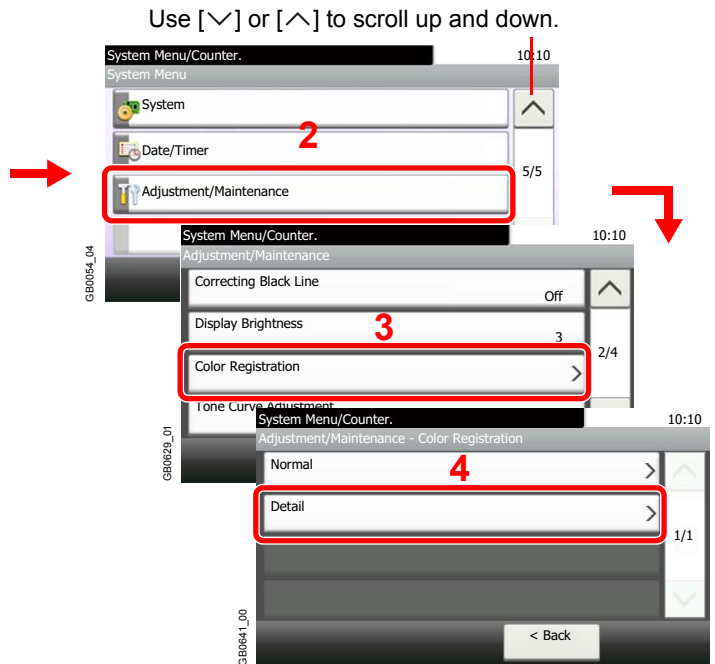
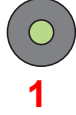

2 Print the chart.

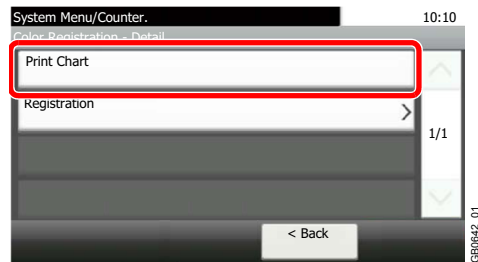

A chart is printed. On the chart, for each of M (magenta), C (cyan) and Y (yellow), charts for H-1 to 7 and V-1 to 5 are printed.

Chart Example

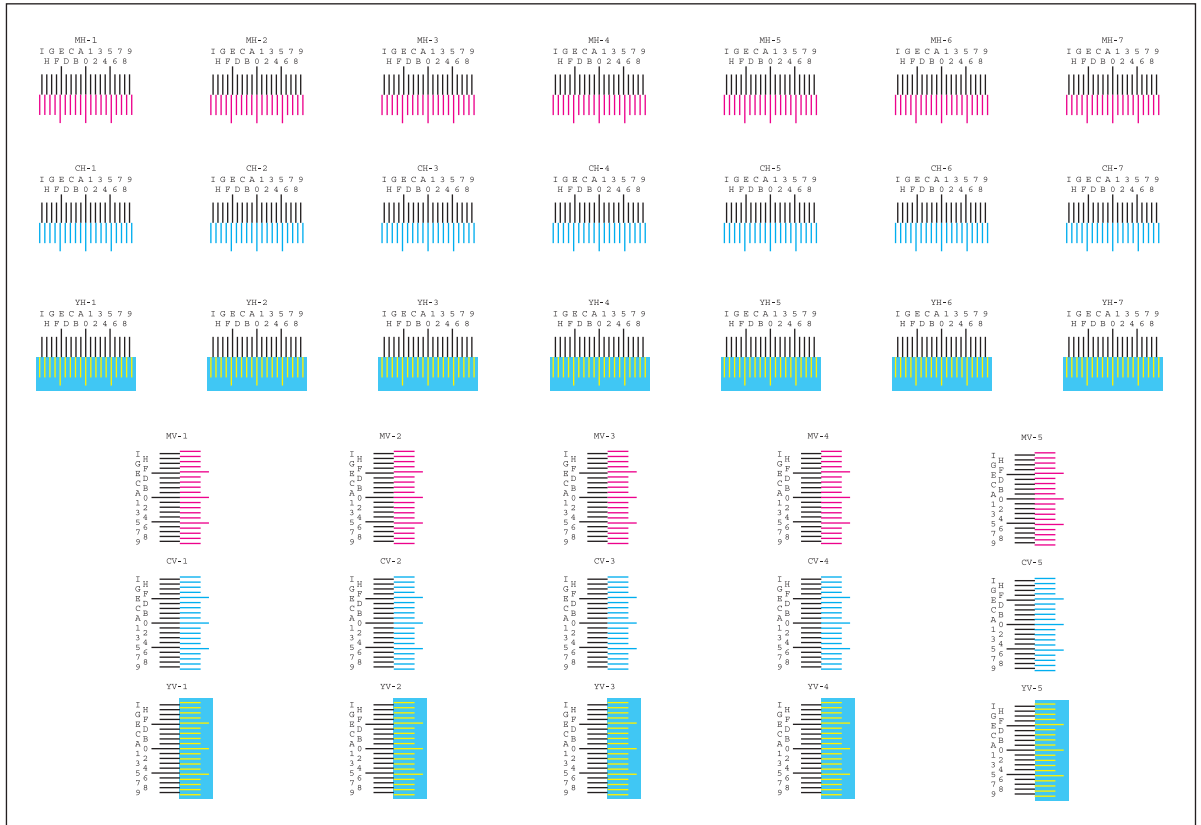

3 Enter the appropriate value.

- 1 Find the location on each chart where 2 lines most closely match. If this is the 0 position, registration for that color is not required. For the illustration, B is the appropriate value.

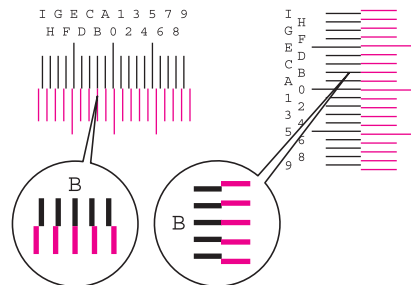

From charts V-1 to V-5, read only the values from V-3 (center).

2

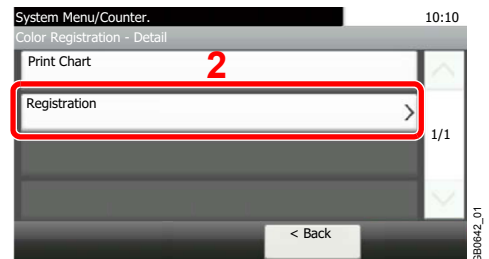
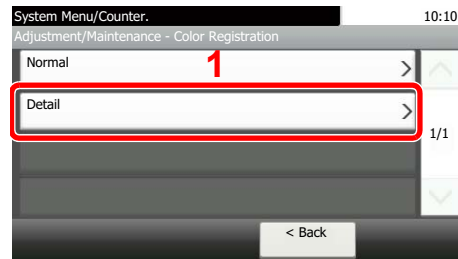

3 Select the chart to be corrected.

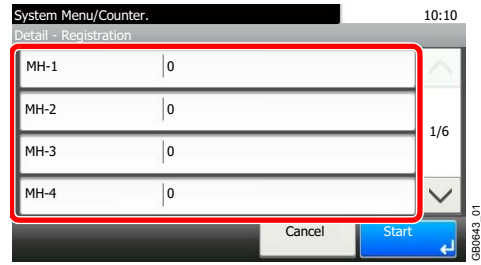

4 Press [+] or [-] to enter the values read from the chart.

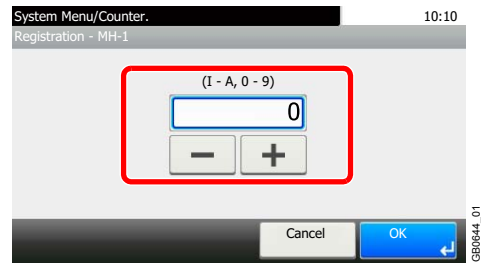

Press [+] to increase the value from 0 to 9. To decrease, press [-].

By pressing [-], the value changes from 0 to alphabetic letters, going from A to I. To move in the reverse direction, press [+].

You cannot use the numeric keys to enter these values.

5 Repeat steps **3** and **4** to enter the registration values for each chart.

6 Press [Start] after all values have been entered. Color registration begins.

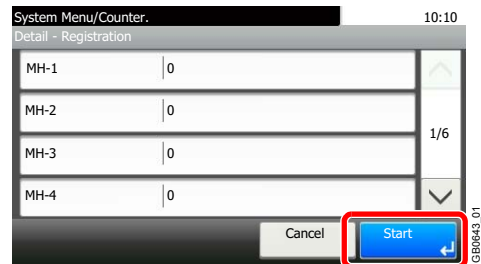

7 Press [OK] after color registration is complete.

User Login Administration

User login administration specifies how the user access is administered on this machine. Enter correct login user name and password for user authentication to login.

Access are in three levels - User, Administrator, and Machine Administrator. The security levels can be modified only by the machine administrator.

First User Login Administration

Follow these steps for the first user login administration. For details about the configuration method, refer to *User Login Settings* on page 9-35.

1 Enable user login administration.

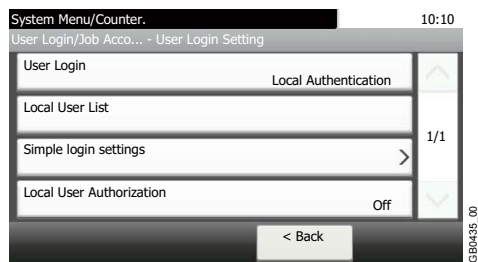

2 Add a user.



3 Log out.

Logout



4 The registered user logs in for operations.



User Login Settings

1 Display the screen.

◆ System Menu / Counter



1

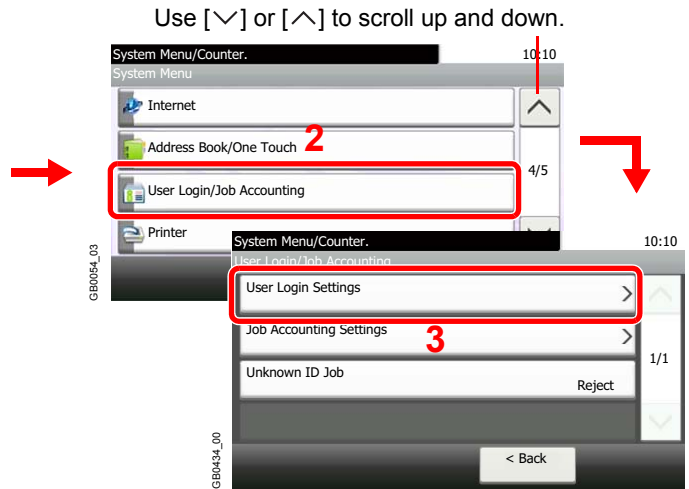

NOTE

You can only change the settings by logging in with administrator privileges. The factory default login user name and login password are set as shown below.

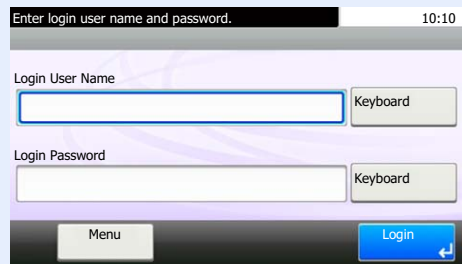

Model Name	Login User Name	Login Password
FS-C8520MFP	2000	2000
FS-C8525MFP	2500	2500

2 Configure the function.

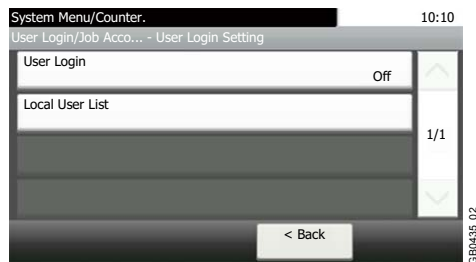

- Enabling/Disabling User Login Administration ▶ page 9-36
- Adding a User ▶ page 9-38
- Local User Authorization ▶ page 9-42
- Editing and Deleting Users ▶ page 9-44
- Simple Login ▶ page 9-47
- Group Authorization ▶ page 9-53
- Obtain Network User Property ▶ page 9-57

Enabling/Disabling User Login Administration

This enables user login administration. Select one of the following authentication methods:

Local Authentication	User authentication based on user properties on the local user list stored in the machine.
Network Authentication	User authentication based on Authentication Server. Use a user property stored in Authentication Server to access the network authentication login page.

1 Display the screen.

1 Referring to *User Login Settings* on page 9-35, display the screen.

2

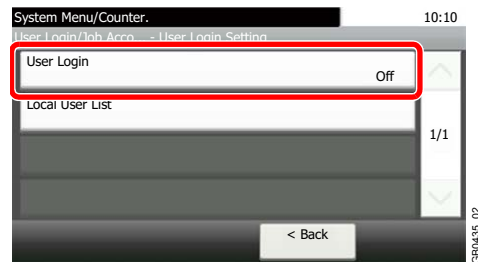

2 Select the authentication method.

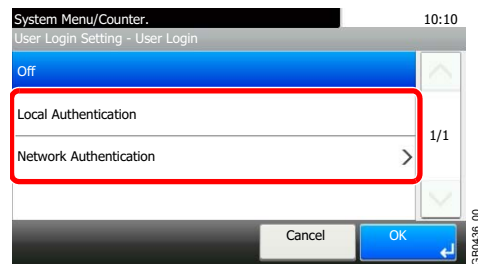

When selecting [Network Authentication]

Select the server type.

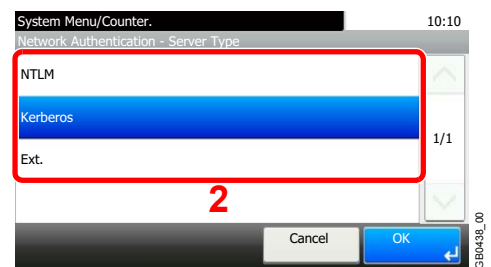
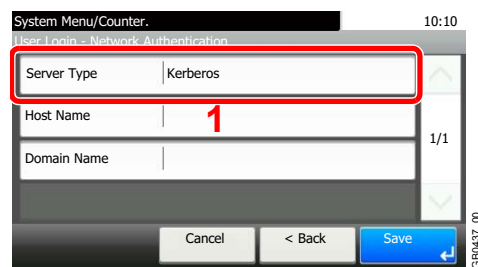

Enter the host name.

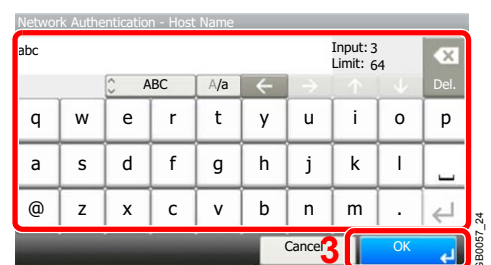
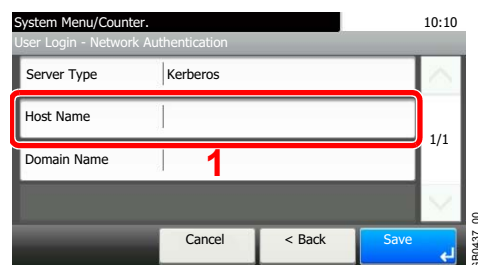

Up to 64 characters can be entered.

 Refer to *Character Entry Method* on page 11-7 for details on entering characters.

Enter a domain name.

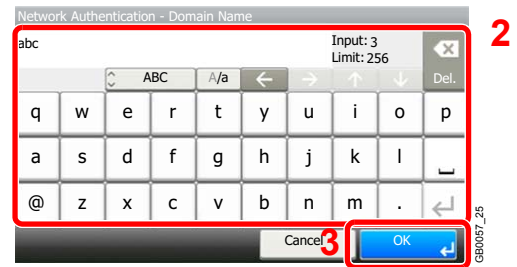
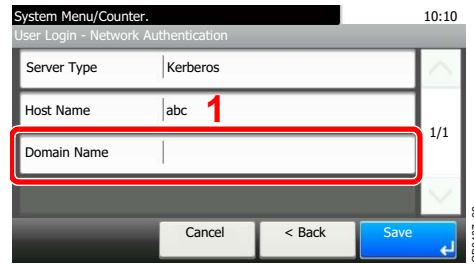

When selecting [NTLM] or [Kerberos] as the server type, enter a domain name of 256 characters or less.

Enter the port number.

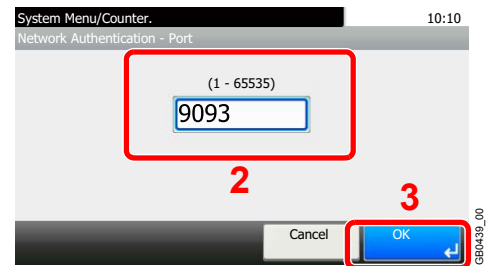
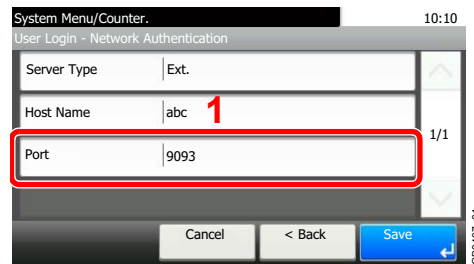

When selecting [Ext.] as the server type, enter the port number.

Press [Save].

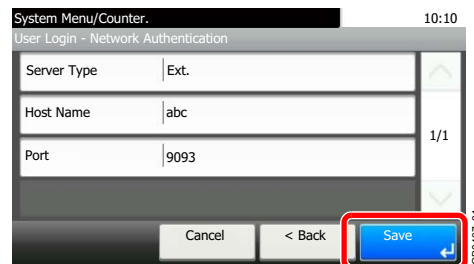

NOTE

If the login user name and password are rejected, check the following settings.

- Network Authentication setting of the machine
- User property of the Authentication Server
- Date and time setting of the machine and the Authentication Server

If you cannot login because of the setting of the machine, login with any administrator registered in the local user list and correct the settings. If the server type is [Kerberos], only domain names entered in uppercase will be recognized.

Adding a User

This adds a new user. You can add up to 100 users (including the default login user name).

The table below explains the user information to be registered.

User Name*	Enter the name displayed on the user list (up to 32 characters).
Login User Name*	Enter the login user name to login (up to 64 characters). The same login user name cannot be registered.
Login Password	Enter the password to login (up to 16 characters).
Account Name	Add an account where the user belongs. The user, who registered his/her account name, can login without entering the account ID. Refer to <i>Job Accounting on page 9-59</i> .
E-mail Address	The user can register his/her E-mail address (up to 128 characters). The registered address will be automatically selected for subsequent operations that need any E-mail function.
Access Level*	Select Administrator or User for user access privileges.
My Panel	Registers settings for individual users. Settings registered here can be applied simply by logging in.
Local Authorization	Restricts the use of the machine by user. Local user authorization must be enabled to use this function (see page 9-42). The following restriction items are available: Printer: Select whether or not to reject usage of print functions for the printer. Printer (Full Color): Select whether or not to reject usage of full-color print functions for the printer. Copy: Select whether or not to reject usage of copy functions. Copy (Full Color): Select whether or not to reject usage of full-color print functions for copies. Send: Select whether or not to reject usage of send functions other than faxing. FAX Transmission: Select whether or not to reject usage of the FAX transmissions. Storing in Box: Select whether or not to reject usage of storing in the document boxes. Storing in Memory: Select whether or not to reject usage of storing in the removable memory.

* Mandatory at user registration.



NOTE

By default, one of each default user with machine administrator rights and administrator privileges is already stored. Each user's properties are:

Machine Administrator

- User Name: DeviceAdmin
- Login User Name: FS-C8520MFP - 2000, FS-C8525MFP - 2500
- Login Password: FS-C8520MFP - 2000, FS-C8525MFP - 2500
- Access Level: Machine Administrator

Administrator

- User Name: Admin
- Login User Name: Admin
- Login Password: Admin
- Access Level: Administrator

* **Upper case and lower case letters are distinguished (case sensitive).**

It is recommended to periodically change the user name, login user name and login password regularly for your security.

1 Display the screen.

1 Referring to *User Login Settings* on page 9-35, display the screen.

2

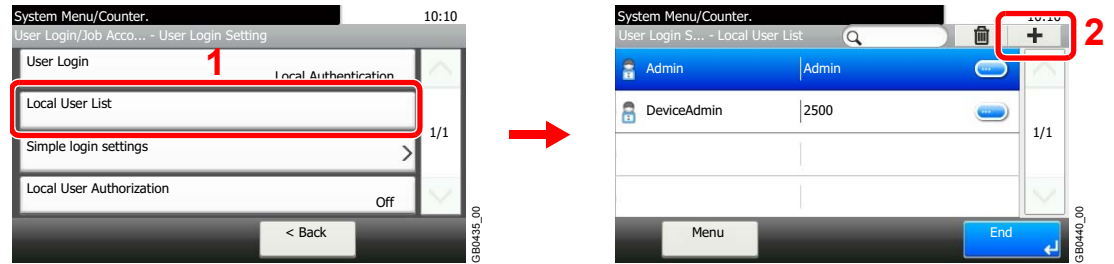

2 Enter the user information.

[User Name]

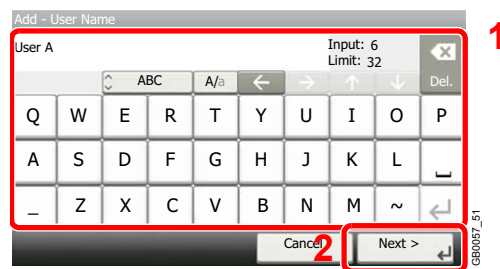

[Login User Name]

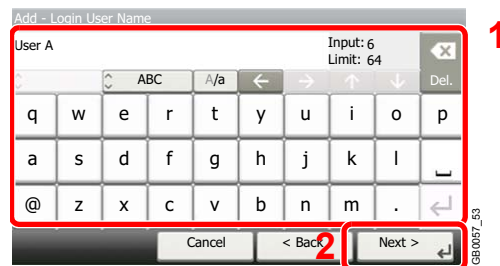

[Access Level]

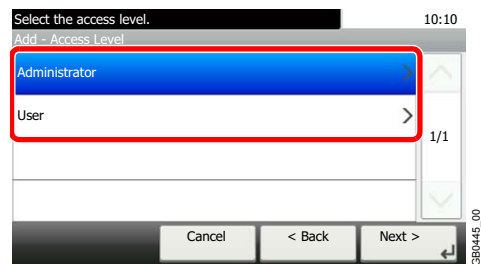

Select the user access privilege.

3 Check the settings.

Check the settings and change or add information as needed.

[User Name]

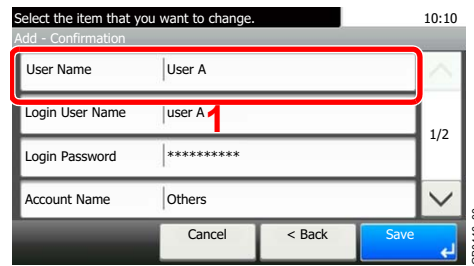

[Login User Name]

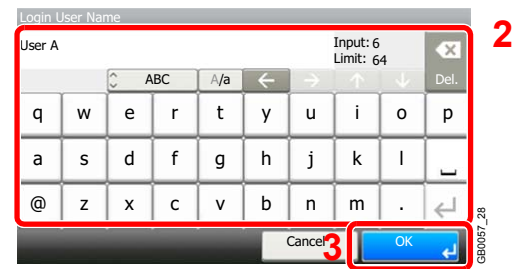
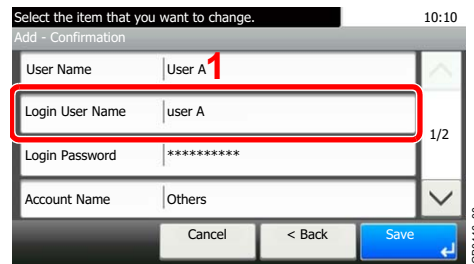

[Login Password]

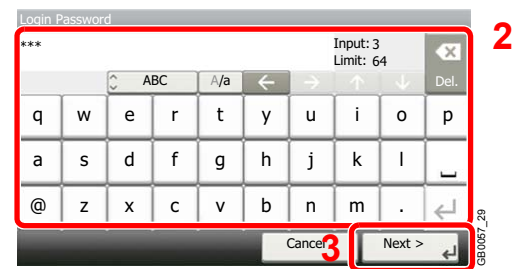
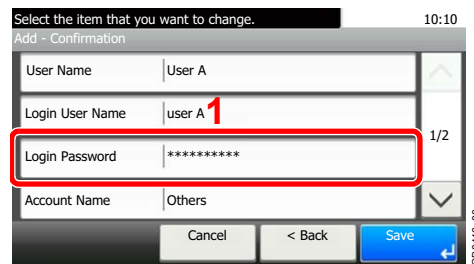

Enter the same login password twice for confirmation purposes.

[Accounting Name]

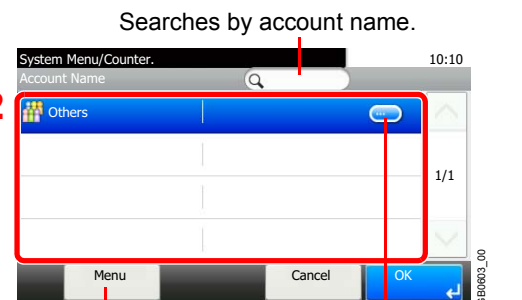
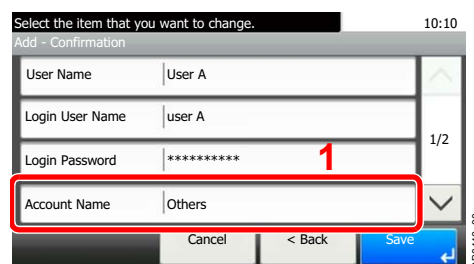

Allows you to search for an account name and sorts results.

Displays details for individual account names.

[E-mail Address]

[Access Level]

Select the user access privilege.

[My Panel]

 For details on My Panel, refer to *My Panel* on page 9-43.

[Local Authorization]

Use [∨] or [∧] to scroll up and down.

Change the limitations as needed.

4 Register the user.

Local User Authorization

Enables local user authorization. Job use can be prohibited for specific users. Set when adding a user (see page 9-38) or editing and deleting users (see page 9-44).

1 Display the screen.

1 Referring to *User Login Settings* on page 9-35, display the screen.

2 Select [Local Authentication] for the authentication method as explained in *Enabling/Disabling User Login Administration* on page 9-36.

3

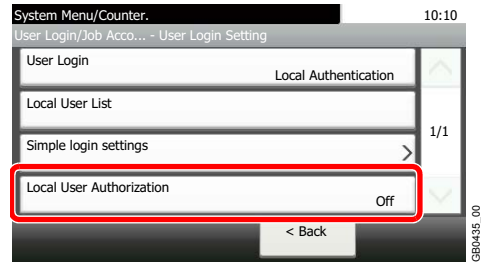

2 Select [On].

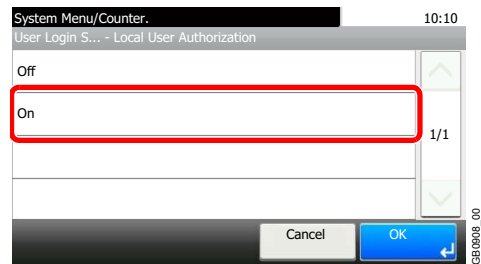

My Panel

Registers settings for individual users. Settings registered here can be applied simply by logging in. Set when *Adding a User* (see page 9-38) or *Editing and Deleting Users* (see page 9-44).

Environments in which shortcut can be configured

Language	Select the language displayed on the touch panel.
Default Screen	Set the screen appearing right after the user logs in (default screen).
Shortcut	Select either [Shared Shortcut] or [Private Shortcut].  NOTE: A shortcut must be registered ahead of time. Refer to <i>Registering Shortcuts</i> on page 3-22.

[Language]

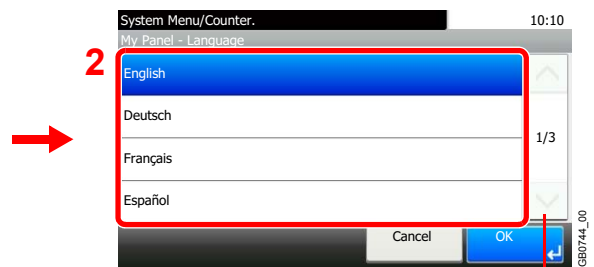
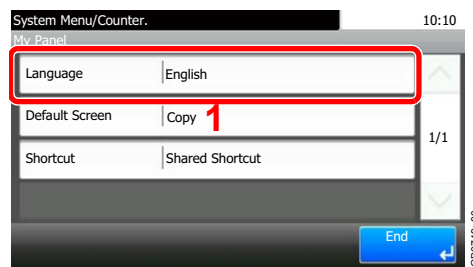

Use [∨] or [∧] to scroll up and down.

[Default Screen]

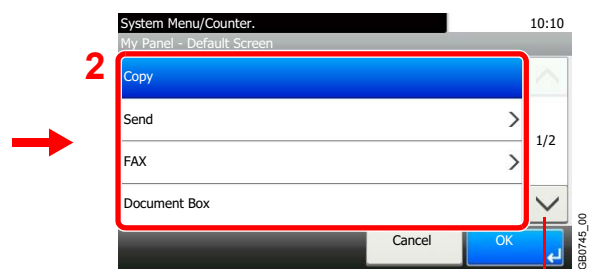
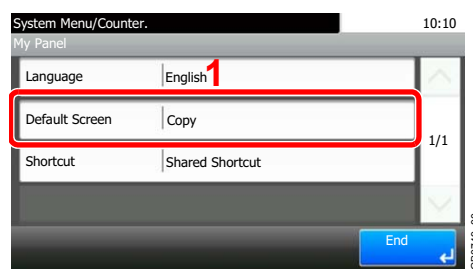

Use [∨] or [∧] to scroll up and down.

When [Send] or [FAX] has been selected, sets which screen to use as the default screen.

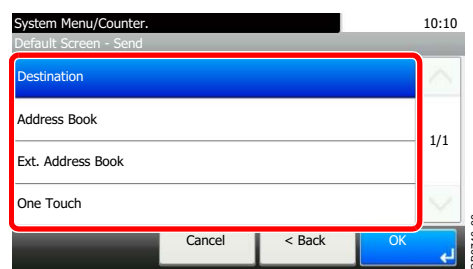

[Shortcut]

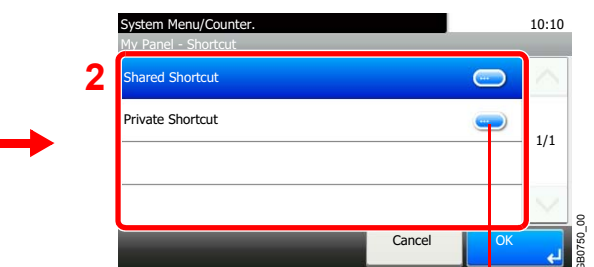
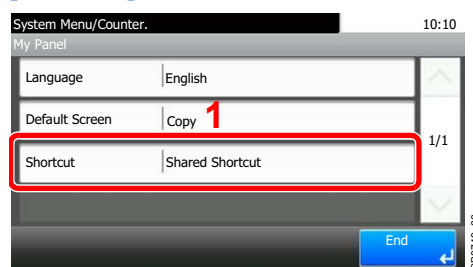

Displays details for individual shortcuts.

Editing and Deleting Users

User properties can be changed and users can be deleted.

1 Display the screen.

1 Referring to *User Login Settings* on page 9-35, display the screen.

2

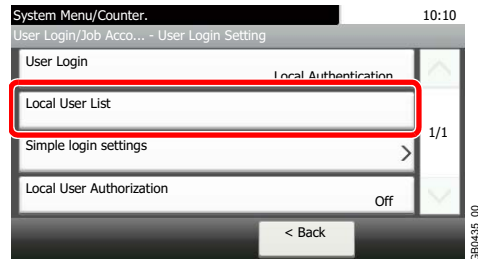

2 Edit or delete a user.

To edit a user

1 Press [...] for the user whose settings you wish to edit.

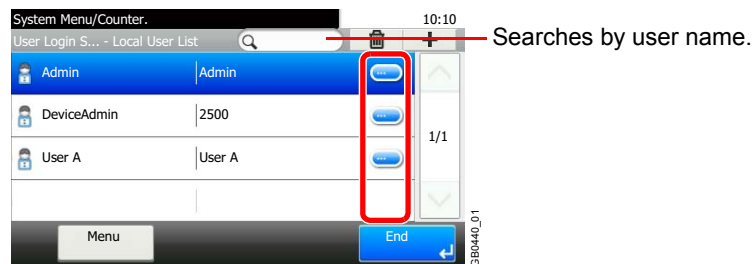

2 Edit the user.

 For more information about individual settings, refer to *Adding a User* on page 9-38.

[User Name]

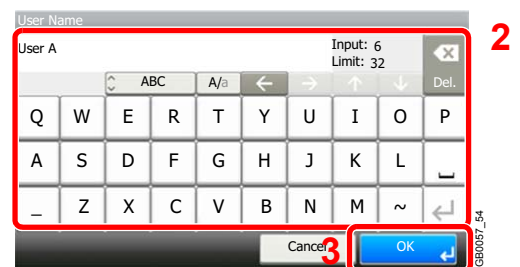
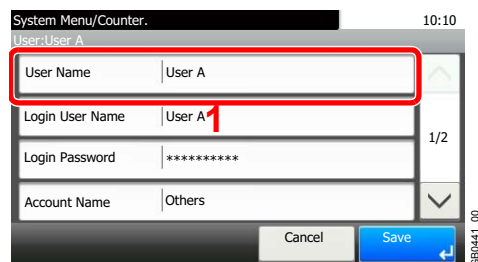

[Login User Name]

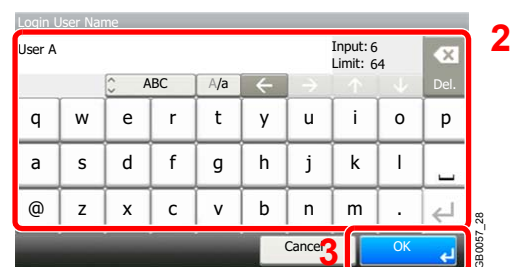
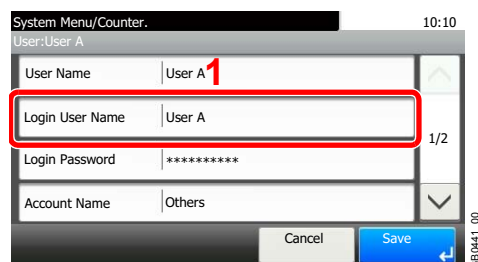

[Login Password]

System Menu/Counter. 10:10
User:User A

User Name	User A
Login User Name	User A
Login Password	*****
Account Name	Others

Cancel Save

Login Password

Input: 3
Limit: 64

q w e r t y u i o p
a s d f g h j k l
@ z x c v b n m .

Cancel Next >

Enter the same login password twice for confirmation purposes.

[Account Name]

System Menu/Counter. 10:10
User:User A

User Name	User A
Login User Name	User A
Login Password	*****
Account Name	Others

Cancel Save

Searches by account name.

System Menu/Counter. 10:10

Account Name

Others

Menu Cancel OK

Allows you to search for an account name and sorts results.

Displays details for individual account names.

[E-mail Address]

System Menu/Counter. 10:10
User:User A

E-mail Address	
Access Level	Administrator
My Panel	
Local Authorization	

Cancel Save

E-mail Address

abc@def.com

Input:11
Limit: 128

q w e r t y u i o p
a s d f g h j k l
@ z x c v b n m .

Cancel OK

[My Panel]

System Menu/Counter. 10:10
User:User A

E-mail Address	
Access Level	Administrator
My Panel	
Local Authorization	

Cancel Save

System Menu/Counter. 10:10

My Panel

Language	English
Default Screen	Copy
Shortcut	Shared Shortcut

End

 For details on My Panel, refer to *My Panel* on page 9-43.

[Local Authorization]

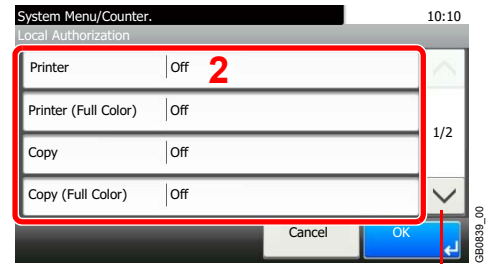
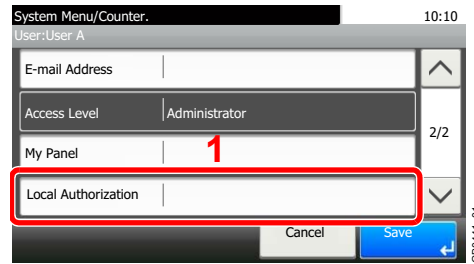

Use [∨] or [∧] to scroll up and down.

[Local Authorization] is displayed when selecting [On] for [Local User Authorization].

 Refer to *Local User Authorization* on page 9-42.

3 Register the user.

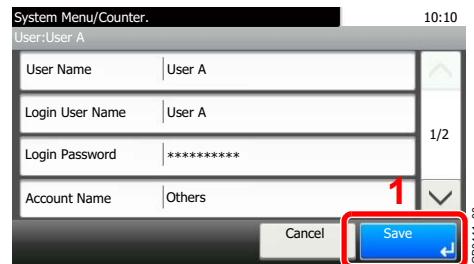

To delete

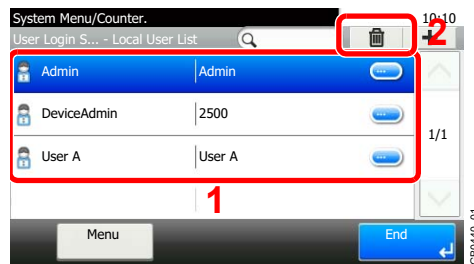

Select the user you wish to delete and press [(Delete)] (the trash can icon).



NOTE

Also, you can delete the user by selecting the user, press [Menu] and then [Delete].

Simple Login

The simple login function allows users to log in simply by selecting a user name. Users must be registered in advance to use this functionality.

 For details, refer to *Adding a User on page 9-38*.

Simple Login Settings

Enable simple login.

1 Display the screen.

- 1 Referring to *User Login Settings on page 9-35*, display the screen.
- 2 Select the authentication method as explained in *User Login Settings on page 9-35*.
- 3

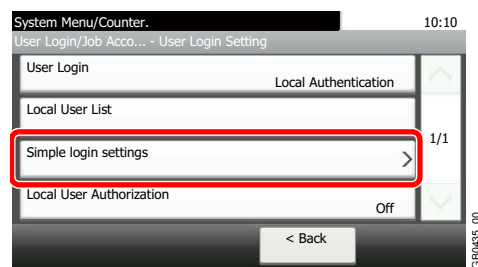

2 Enable simple login.

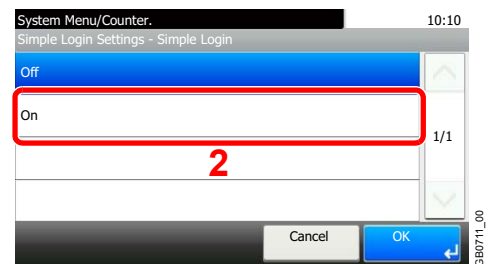
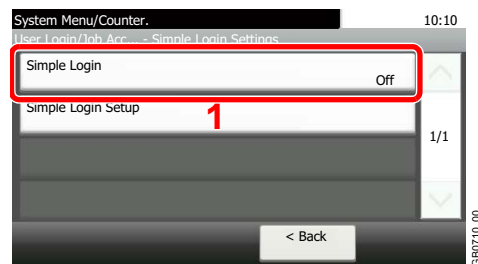

Register a User

Register users to use simple login. Up to 20 users can be registered.

The table below explains the user information to be registered.

Name	Set the user name to display on the Simple Login screen.
User	Select which registered users can use simple login.
Password Login	Set whether to require entry of a login password at login.
Icon	Select the icon to display on the Simple Login screen.

1 Display the screen.

- 1 Referring to *User Login Settings on page 9-35*, display the screen.

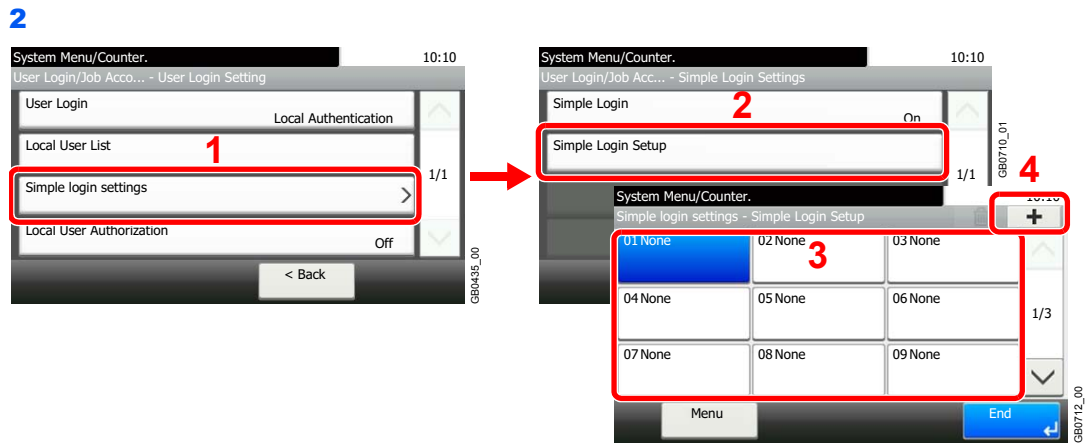

Select a key with no registered user, and press [+].

2 Enter the user information.

1 Select the type of user.

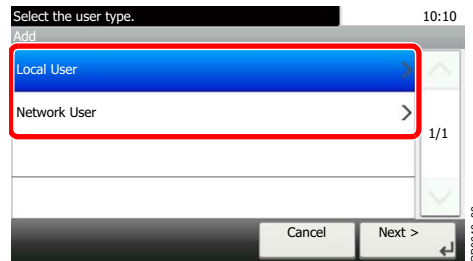

2 Select a user.

Local user

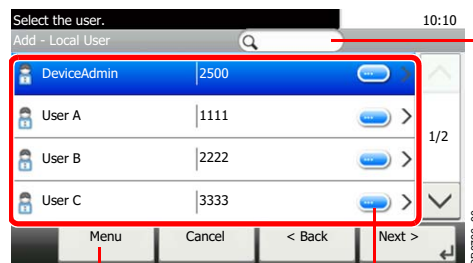

Searches by user name.

Allows you to search for a user and sorts results.

Displays details for individual users.

Network user

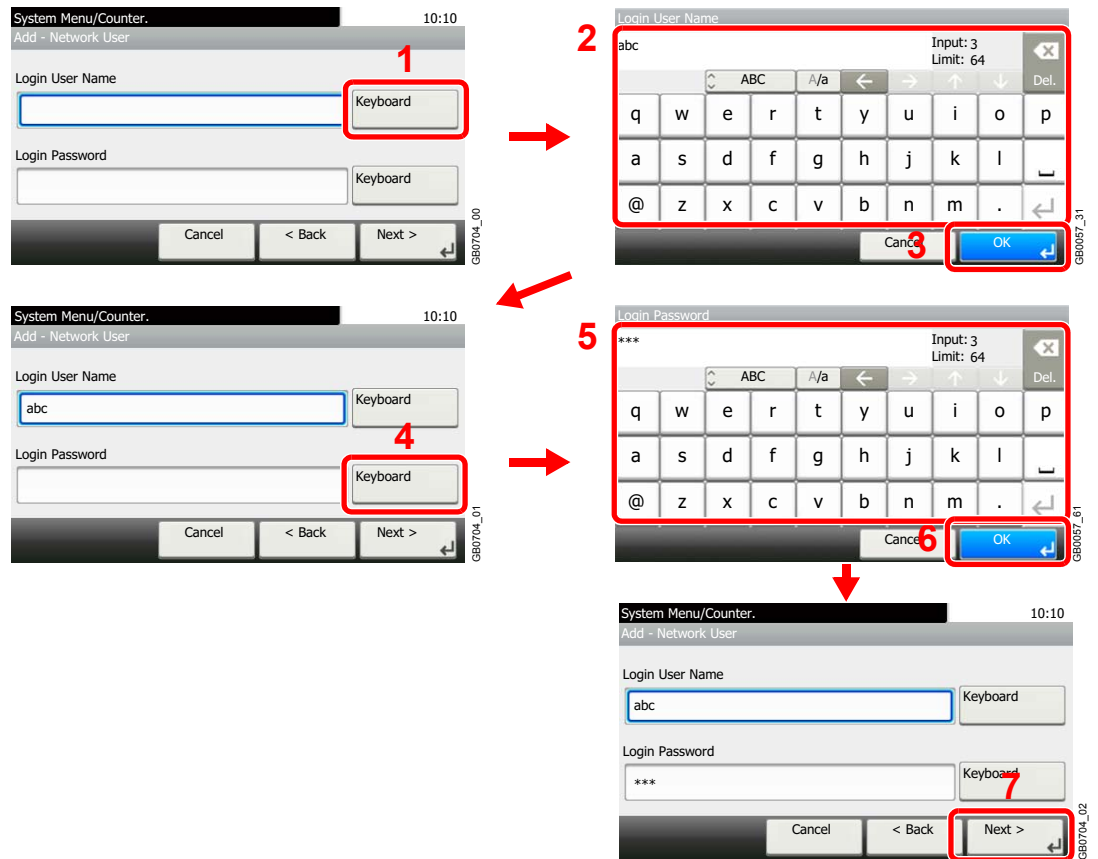

Enter the Login User Name and Login Password.

3 Enter the login user name to use with simple login.

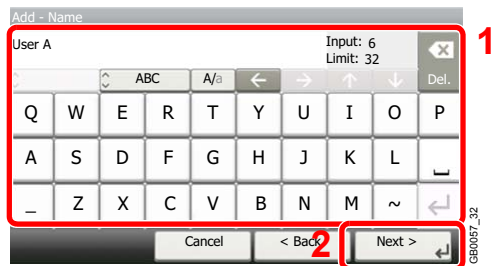

3 Check the settings.

Check the settings and change or add information as needed.

[Name]

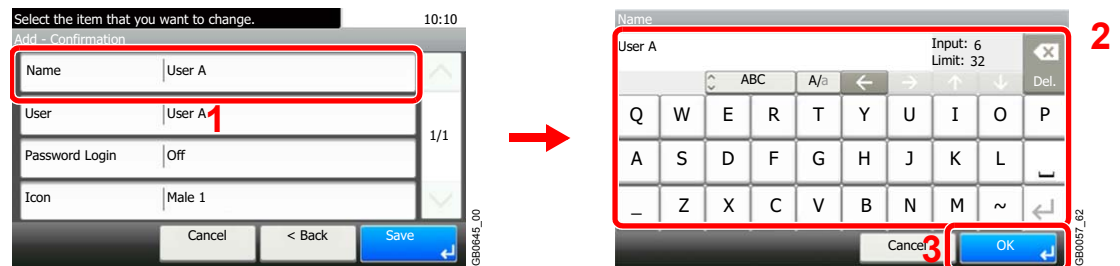

[User]

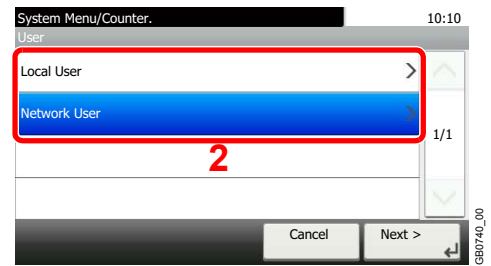
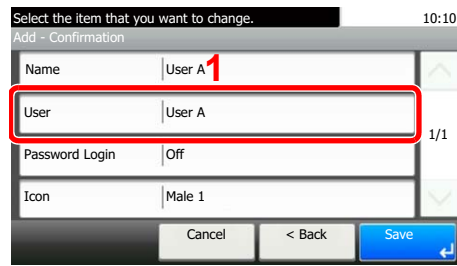

Select the user to use for simple logins from [Local User] or [Network User].

[Password Login]

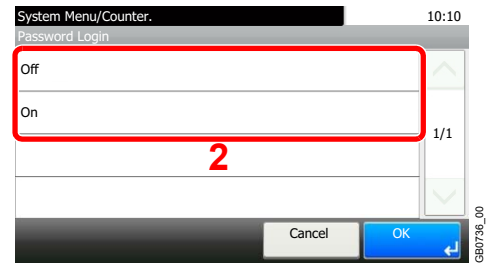
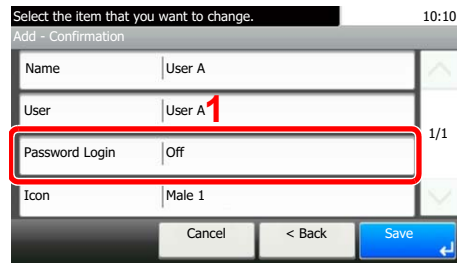

[Icon]

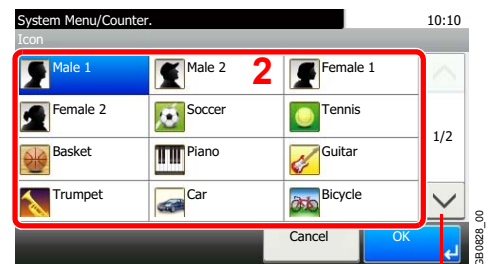
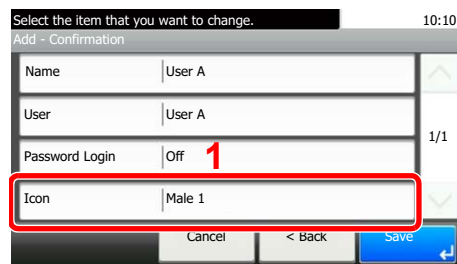

Use [∨] or [∧] to scroll up and down.

4 Register the user.

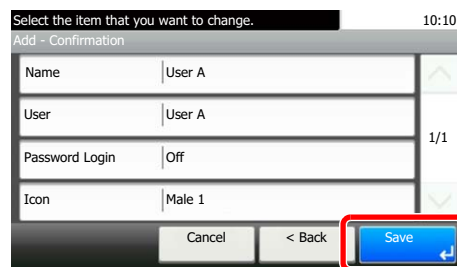

Editing and Deleting Users

User properties can be changed and users can be deleted.

1 Display the screen.

1 Referring to *User Login Settings* on page 9-35, display the screen.

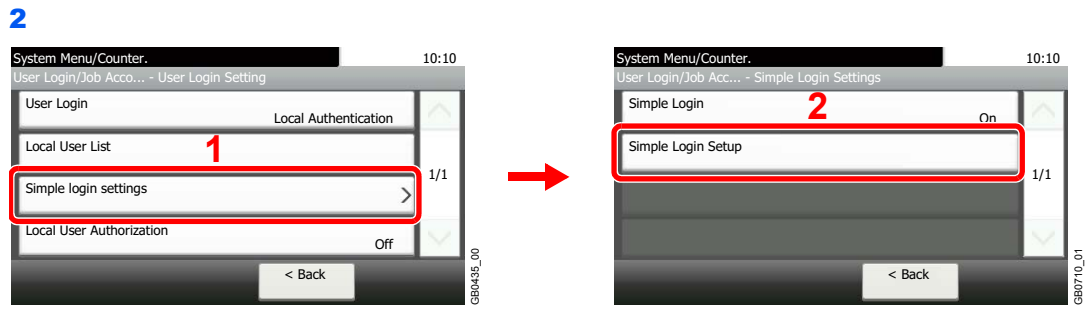

2 Edit or delete a user.

To edit a user

1 Select the user whose information you wish to edit and press [Menu] and then [Edit].

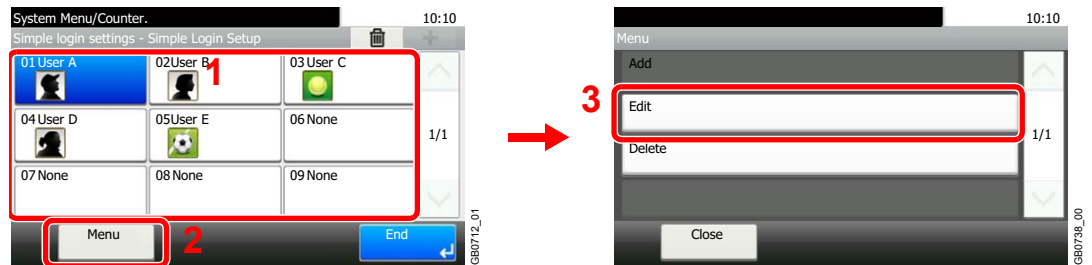

2 Edit the user.

[Name]

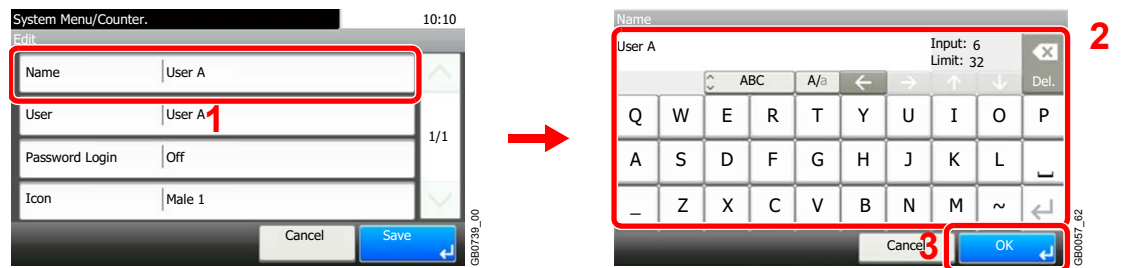

[User]

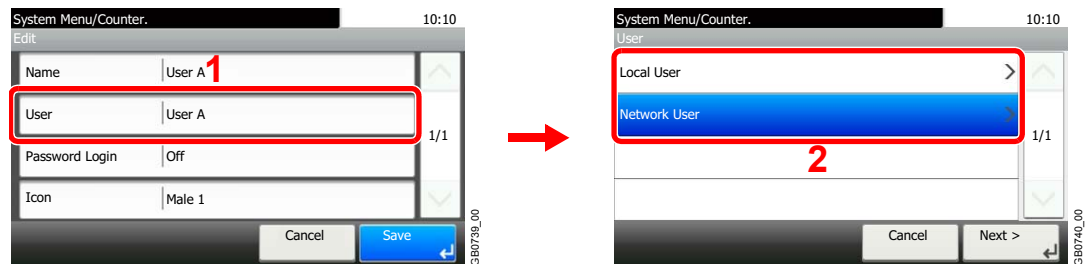

Select the user to use for simple logins from [Local User] or [Network User].

[Password Login]

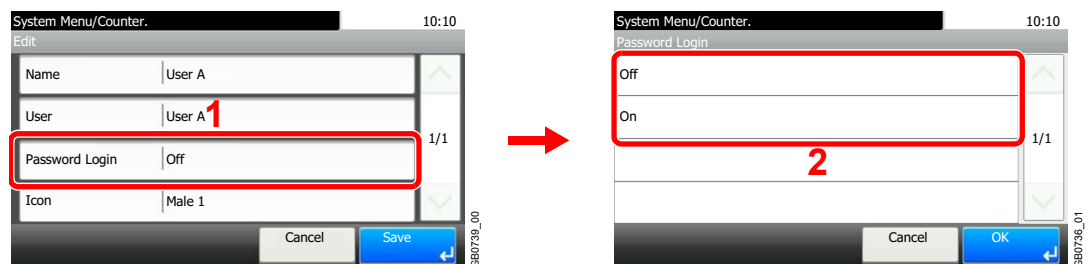

[Icon]

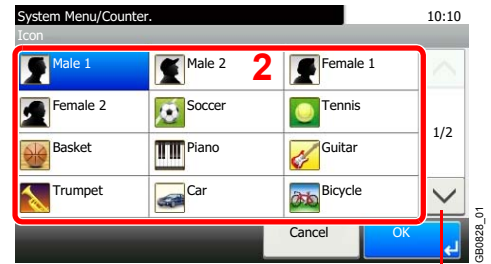
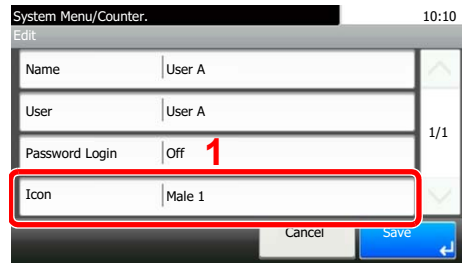

Use [∨] or [∧] to scroll up and down.

3 Register the user.

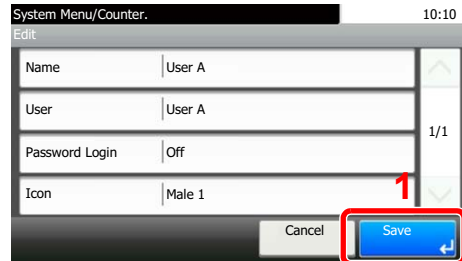

To delete

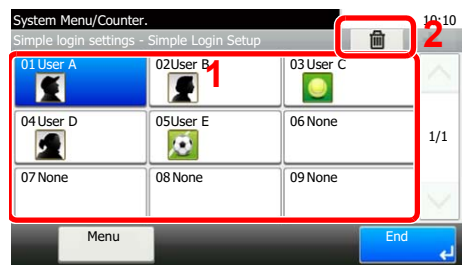

Select the user you wish to delete and press [(Delete)] (the trash can icon).



NOTE

You can also delete a user by selecting the name, pressing [Menu], and then pressing [Delete].

Group Authorization

Set restrictions of the machine usage by each individual group registered in the authentication server.

NOTE
To use the group authorization settings, [Network Authentication] must be selected for the authentication method and [NTLM] or [Kerberos] must be selected as the server type in *Enabling/Disabling User Login Administration on page 9-36*. Select [On] for LDAP in *Protocol Detail on page 9-21*.

Group Authorization Settings

Use the group authorization.

1 Display the screen.

1 Referring to *User Login Settings on page 9-35*, display the screen.

2

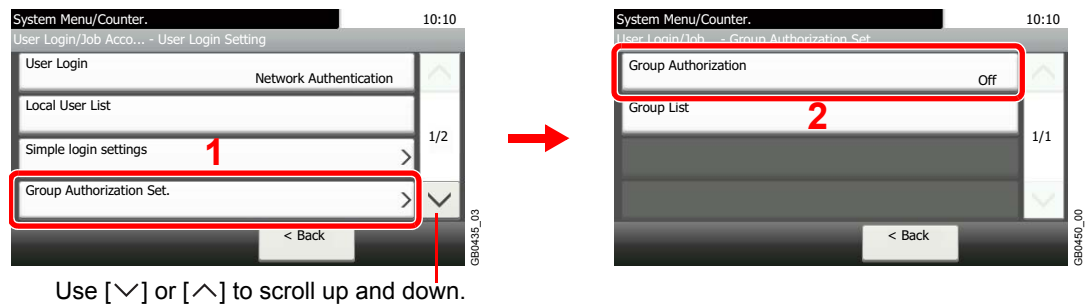

2 Select [On].

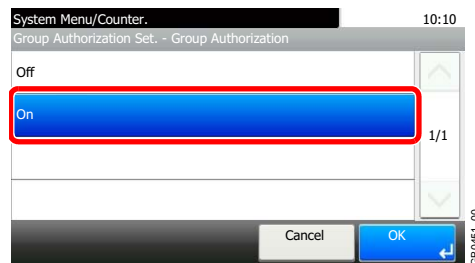

Add a Group

Register the groups that is restricted the machine usage. Up to 20 groups can be individually registered. Other users and groups belong to Others.

Group ID*	Enter the ID displayed on the group list (between 1 and 4294967295).
Group Name	Enter the name displayed on the group list (up to 32 characters).
Access Level	Select Administrator or User for group access privileges.
Printer	Select whether or not to reject usage of print functions for the printer.
Printer (Full Color)	Select whether or not to reject usage of full-color print functions for the printer.
Copy	Select whether or not to reject usage of copy functions.
Copy (Full Color)	Select whether or not to reject usage of full-color print functions for copies.
Send	Select whether or not to reject usage of the send functions.
FAX Transmission**	Select whether or not to reject usage of the FAX transmissions.

Storing in Box	Select whether or not to reject usage of storing in the document boxes.
Storing in Memory	Select whether or not to reject usage of storing in the removable memory.

* For Group ID, specify PrimaryGroupID assigned by ActiveDirectory of Windows. If you are using Windows Server 2008, check Attribute Editor tab of user properties. If you are using Windows Server 2000/2003, check ADSIEdit. ADSIEdit is a support tool included on the installation CD or DVD for Windows Server OS (under \SUPPORT\TOOLS).

** This item is displayed when the optional fax is installed.

1 Display the screen.

1 Referring to *User Login Settings* on page 9-35, display the screen.

2

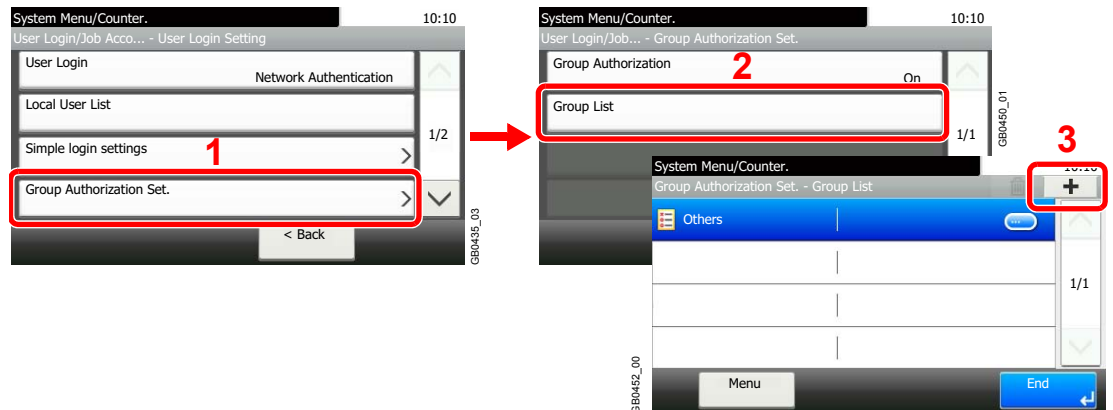

2 Enter the group information.

[Group ID]

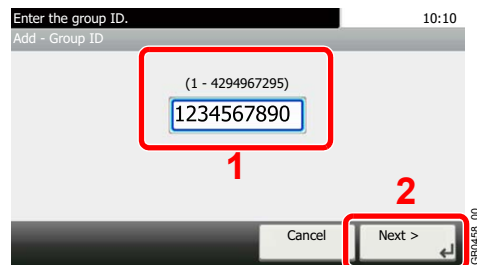

[Group Name]

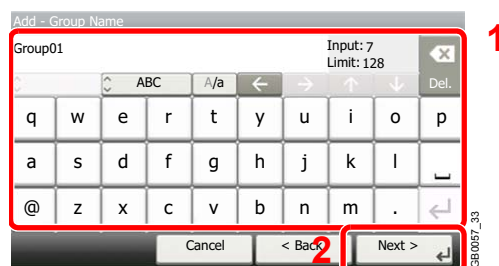

[Access Level]

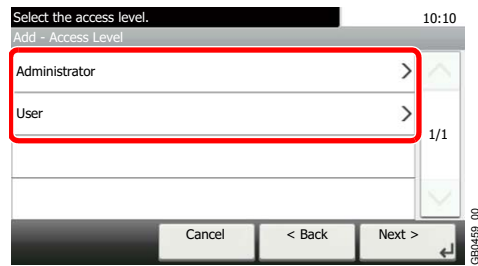

3 Check the settings.

Check the settings and change or add information as needed.

[Group ID]

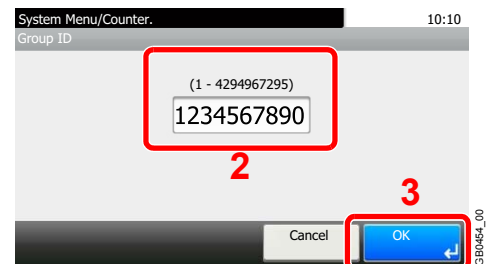
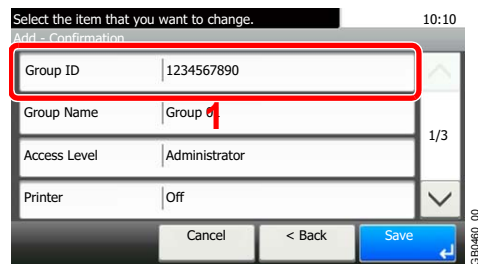

[Group Name]

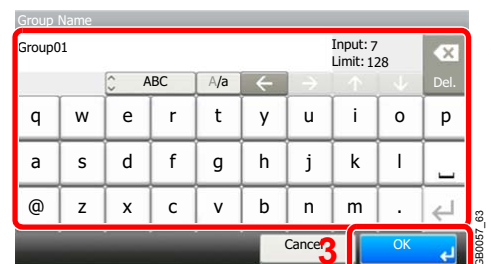
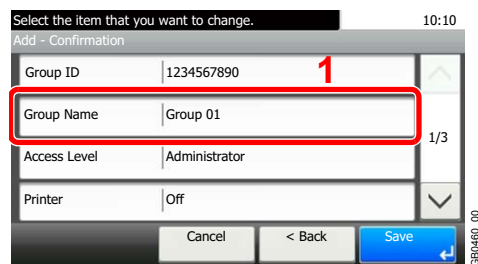

[Access Level]

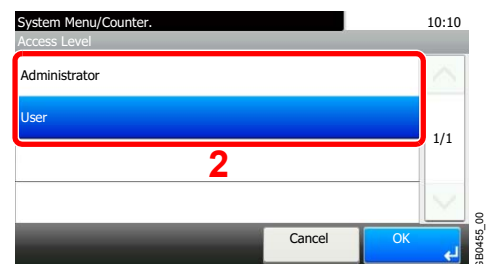
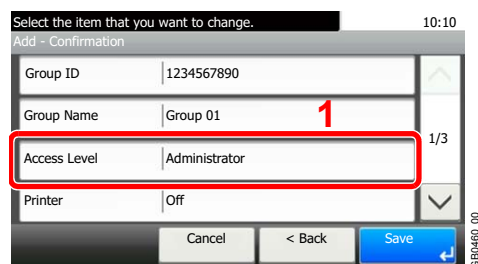

[Printer], [Printer (Full Color)], [Copy], [Copy (Full Color)], [Send], [FAX Transmission], [Storing in Box], [Storing in Memory]

Select the item that you want to change. 10:10
Add - Confirmation
Group ID | 1234567890
Group Name | Group 01
Access Level | Administrator
Printer | Off
Cancel < Back Save



System Menu/Counter. 10:10
Printer
Off
Reject Usage
Cancel OK

Select the item that you want to change. 10:10
Add - Confirmation
Printer (Full Color) | Off
Copy | Off
Copy (Full Color) | Off
Send | Off
Cancel < Back Save

Use [∨] or [∧] to scroll up and down.

Select the item that you want to change. 10:10
Add - Confirmation
FAX Transmission | Off
Storing in Box | Off
Storing in Memory | Off
Cancel < Back Save

Change the restrictions as needed.

4 Register the group.

Select the item that you want to change. 10:10
Add - Confirmation
Group ID | 1234567890
Group Name | Group 01
Access Level | Administrator
Printer | Off
Cancel < Back Save

Obtain Network User Property

Set the required information to obtain the network user property from the LDAP server.

NOTE

To obtain the network user property from the LDAP server, [Network Authentication] must be selected for the authentication method and [NTLM] or [Kerberos] must be selected as the server type in *Enabling/Disabling User Login Administration on page 9-36*.

Server Name*	Enter the LDAP server name or the IP address (up to 64 characters).
Port	Set the LDAP port number or use the default port 389.
Name 1**	Enter the LDAP Attribute to obtain the user name to be displayed from the LDAP server (up to 32 characters).
Name 2***	
E-mail Address****	Enter the LDAP Attribute to obtain the e-mail address from the LDAP server (up to 128 characters).
Search Timeout	Set the amount of time to wait before time-out in seconds (from 5 to 255 seconds).

- * If using Active Directory of Windows, the server name may be same as the server name entered in the network authentication.
- ** If using Active Directory of Windows, **displayName** of Attribute may be used as *Name 1*.
- *** Name 2 can be left out. When you assign **displayName** in *Name 1* and **department** in *Name 2*, and if the value of **displayName** is "Mike Smith" and the value of **department** is "Sales" in Active Directory of Windows, the user name appears as *Mike Smith Sales*.
- **** If using Active Directory of Windows, **mail** of Attribute may be used as E-mail Address.

1 Display the screen.

1 Referring to *User Login Settings on page 9-35*, display the screen.

2

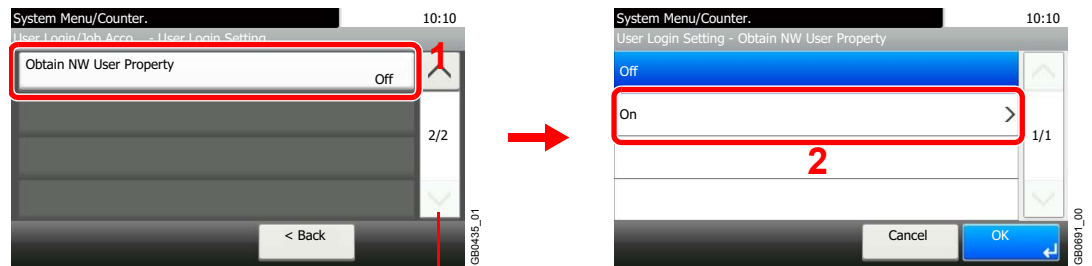

Use [∨] or [∧] to scroll up and down.

2 Configure the function.

[Server Name]

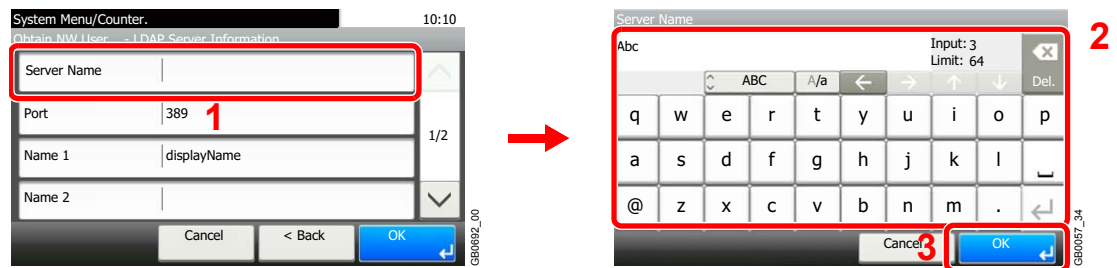

Up to 64 characters can be entered.

 Refer to *Character Entry Method on page 11-7* for details on entering characters.

[Port]

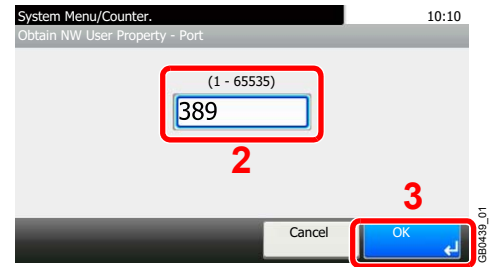
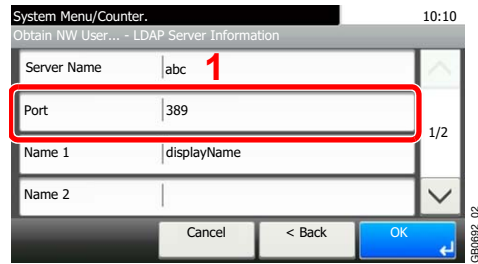

[Name 1] and [Name 2]

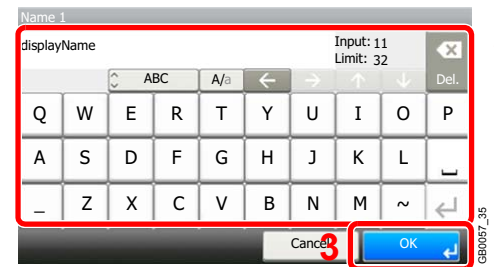

Up to 32 characters can be entered.

[E-mail Address]

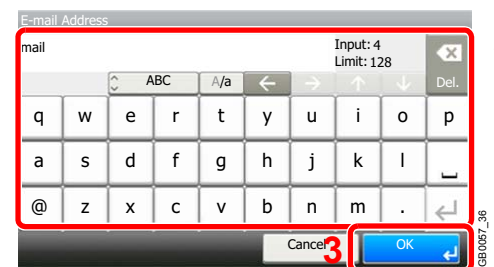
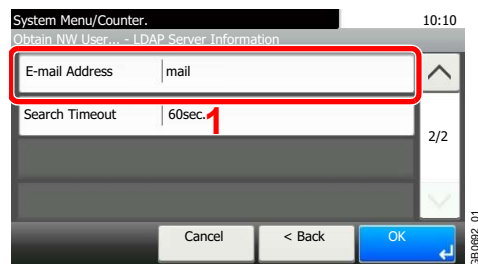

Up to 128 characters can be entered.

[Search Timeout]

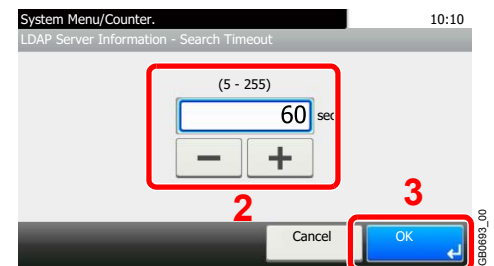
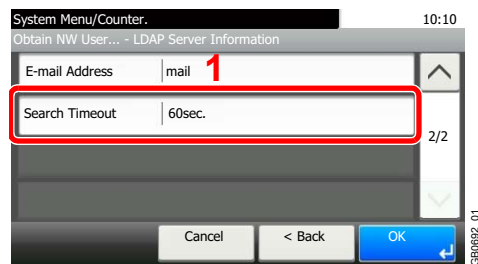

3 Press [OK].

Job Accounting

Job accounting Manages the copy/print count accumulated by individual accounts by assigning an ID to each account. Job accounting helps the following activities in business organizations.

- Manageability of up to 100 individual accounts.
- Availability for account IDs with as many as eight digits (between 0 and 99999999) for security.
- Integrated management of printing and scanning statistics through the use of an identical account ID.
- Tracking the print volume for each account and for all accounts combined.
- Restricting the print counter in one-page increments up to 9,999,999 copies.
- Resetting the print counter for each account or for all accounts combined.

First Job Accounting Setup

Follow these steps for the first job accounting setup. For details about the configuration method, refer to *Job Accounting Settings* on page 9-61.

1 Enable job accounting.

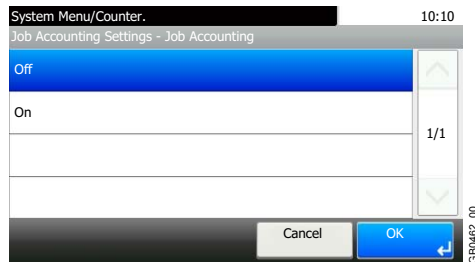

2 Add an account.

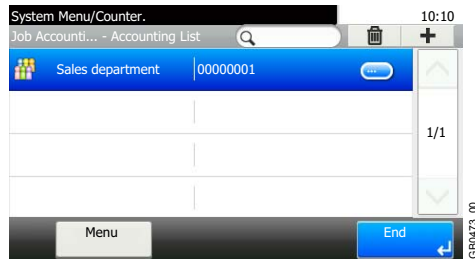

3 Log out.

Logout



4 Other users login for operations.

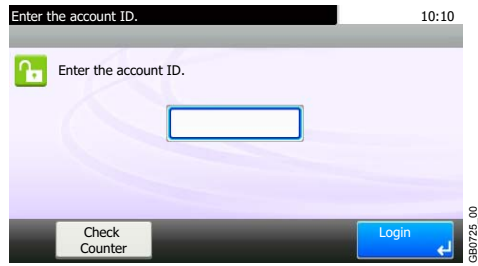

Job Accounting Settings

1 Display the screen.

◆ System Menu / Counter

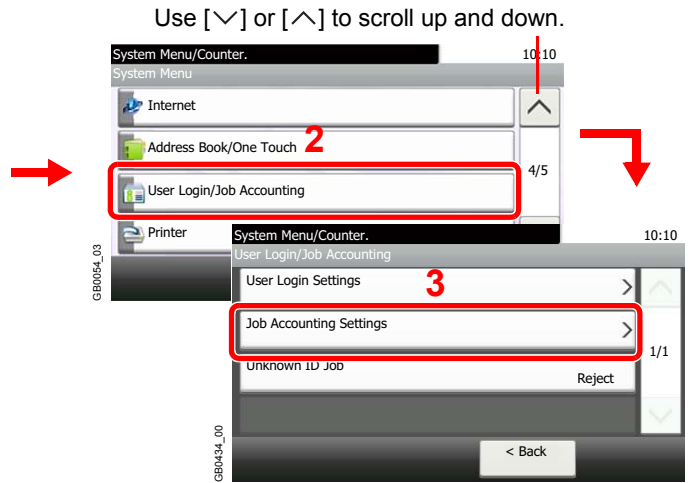
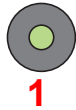

NOTE

You can only change the settings by logging in with administrator privileges. The factory default login user name and login password are set as shown below.

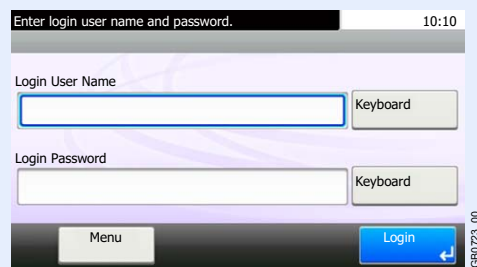

Model Name	Login User Name	Login Password
FS-C8520MFP	2000	2000
FS-C8525MFP	2500	2500

2 Configure the function.



- 🔍 Enabling/Disabling Job Accounting ▶ page 9-62
- 🔍 Login/Logout ▶ page 9-63
- 🔍 Adding an Account ▶ page 9-64
- 🔍 Editing and Deleting Accounts ▶ page 9-66
- 🔍 Restricting the Use of the Machine ▶ page 9-68
- 🔍 Counting the Number of Pages Printed ▶ page 9-70
- 🔍 Printing an Accounting Report ▶ page 9-72
- 🔍 Job Accounting Default Setting ▶ page 9-74
- 🔍 Unknown Login User Name Job ▶ page 9-76

Enabling/Disabling Job Accounting

Enable job accounting.

1 Display the screen.

1 Referring to *Job Accounting Settings on page 9-61*, display the screen.

2

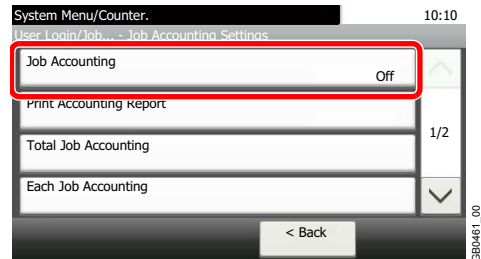

2 Enable job accounting.

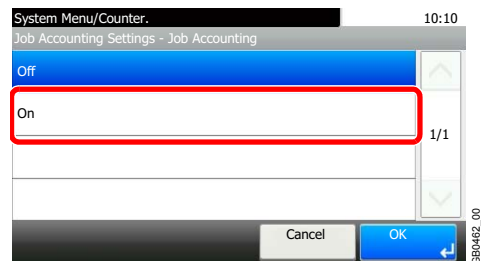

NOTE

When the display returns to the System Menu default screen, logout is automatically executed and the screen to enter the Account ID appears. To continue the operation, enter the Account ID.

Login/Logout

If job accounting is enabled, an account ID entry screen appears each time you use this machine.

Login

1 Enter the account ID.

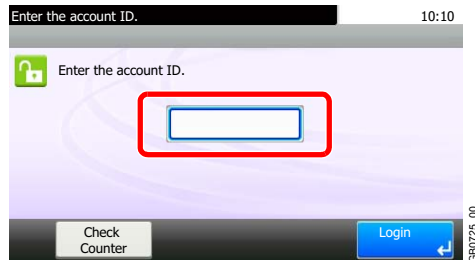

If this screen is displayed during operations, enter the account ID.



NOTE

If you entered a wrong character, press the **Clear** key and enter the account ID again.

If the entered account ID does not match the registered ID, a warning beep will sound and login will fail. Enter the correct account ID.

By pressing [Check Counter], you can refer to the number of pages printed and the number of pages scanned.

2 Log in.

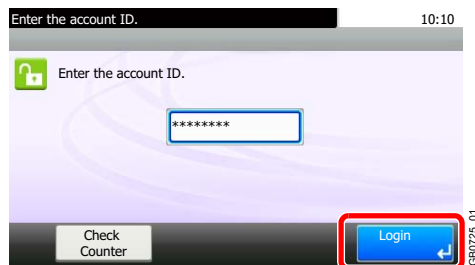

When the screen to enter the login user name and password appears

If user login administration is enabled, the screen to enter the login user name and password appears. Enter a login user name and password to login. (Refer to *Login/Logout on page 3-12.*) If the user has already registered the account information, the account ID entry would be skipped. (Refer to *Adding a User on page 9-38.*)

Logout

When the operations are complete, press the **Logout** key to return to the account ID entry screen.

Logout



Adding an Account

This section explains how to add a new account. The following entries are required.

Account Name	Enter the account name (up to 32 characters).
Account ID	Enter the account ID as many as eight digits (between 0 and 99999999).
Restriction	This Prohibits printing/scanning or restricts the number of sheets to load. Refer to <i>Restricting the Use of the Machine on page 9-68</i> .



NOTE

Any account ID that has already registered cannot be used. Enter any other account ID.

1 Display the screen.

1 Referring to *Job Accounting Settings on page 9-61*, display the screen.

2

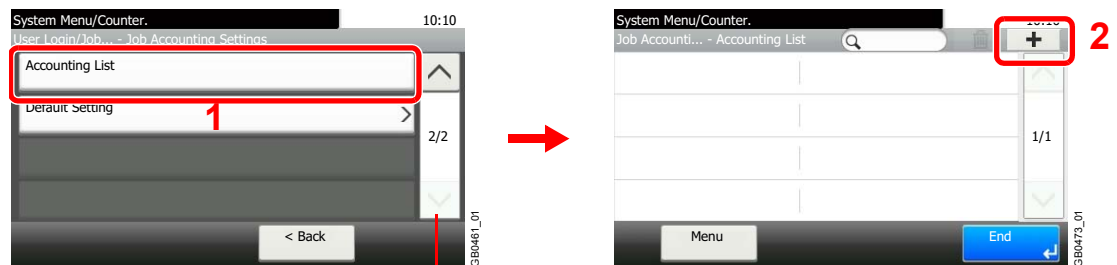

Use [∨] or [∧] to scroll up and down.

2 Enter the account information.

[Account Name]

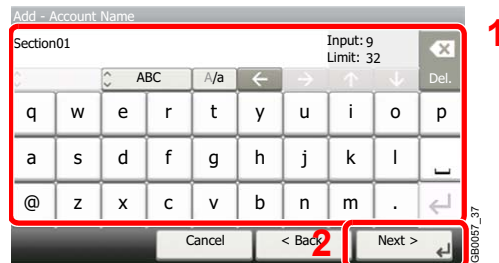

[Account ID]

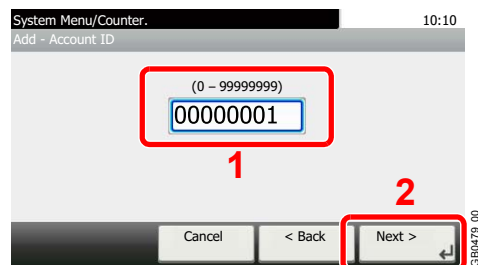

3 Check the settings.

Check the settings and change or add information as needed.

[Account Name]

Select the item that you want to change. 10:10
Add - Confirmation
Account Name Section 01
Account ID 00000001 1/2
Print (Total) Off
Print (Full Color) Off
Cancel < Back Save

Section01 Input: 9 Limit: 32
ABC A/a
q w e r t y u i o p
a s d f g h j k l
@ z x c v b n m .
Cancel OK

Refer to *Character Entry Method* on page 11-7 for details on entering characters.

[Account ID]

Select the item that you want to change. 10:10
Add - Confirmation
Account Name Section 01
Account ID 00000001 1/2
Print (Total) Off
Print (Full Color) Off
Cancel < Back Save

System Menu/Counter. 10:10
Account ID
(0 - 99999999)
00000001
Cancel OK

Restrictions

Select the item that you want to change. 10:10
Add - Confirmation
Account Name Section 01
Account ID 00000001 1/2
Print (Total) Off
Print (Full Color) Off
Cancel < Back Save

System Menu/Counter. 10:10
Print (Total)
Off
Counter Limit >
Reject Usage
Cancel OK

Select the item that you want to change. 10:10
Add - Confirmation
Scan (Others) Off
FAX Transmission Off 2/2
Cancel < Back Save

Use [v] or [^] to scroll up and down.

For details, refer to *Restricting the Use of the Machine* on page 9-68.

4 Register the account.

Select the item that you want to change. 10:10
Add - Confirmation
Account Name Section 01
Account ID 00000001 1/2
Print (Total) Off
Print (Full Color) Off
Cancel < Back Save

Editing and Deleting Accounts

This changes the registered account information or deletes the account.

1 Display the screen.

1 Referring to *Job Accounting Settings* on page 9-61, display the screen.

2

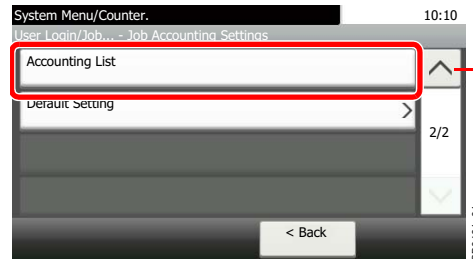

Use [∨] or [∧] to scroll up and down.

2 Edit or delete an account.

To edit an account

1 Press [...] for the account name you wish to edit.

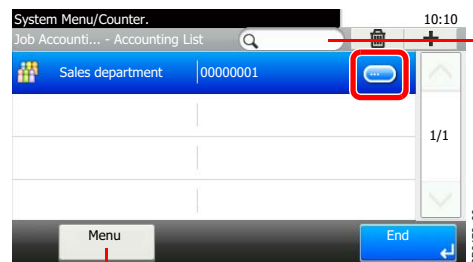

Searches by account name.

Allows you to search for an account name and sorts results.

You can specify an account name by account ID by pressing the **Quick No. Search** key.

2 Edit the account.

[Account Name]

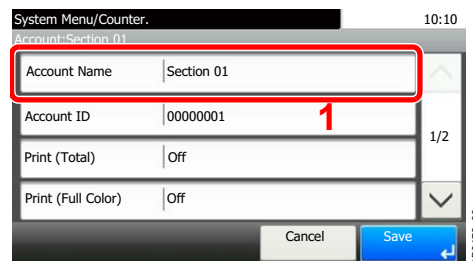

[Account ID]

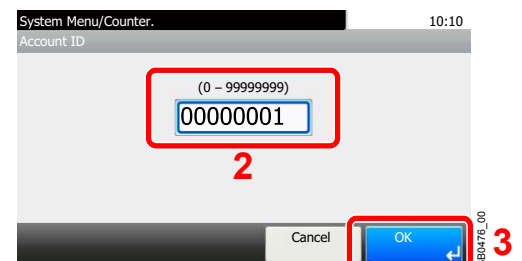
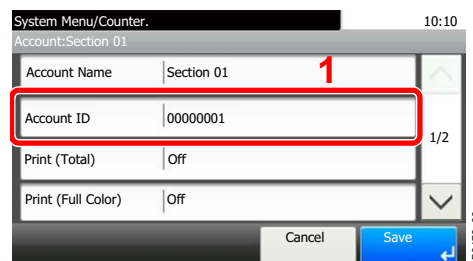

Restriction

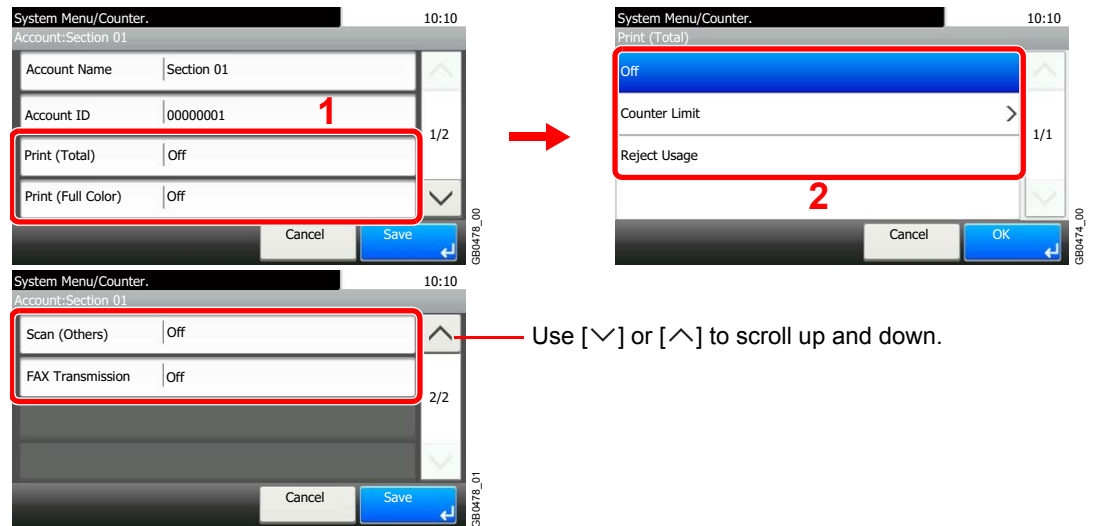

For details, refer to *Restricting the Use of the Machine* on page 9-68.

3 Register the account.

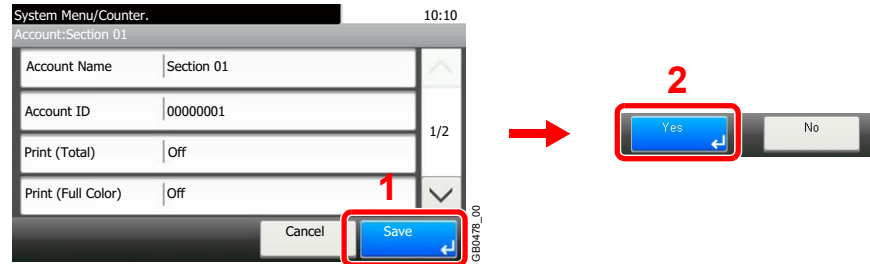

To delete



Select the account name you wish to delete and press [(Delete)] (the trash can icon).

Restricting the Use of the Machine

This section explains how to restrict the use of the machine by account or the number of pages available.

Set when *Adding an Account* (see page 9-64) or *Editing and Deleting Accounts* (see page 9-66).

The items that can be restricted differ depending on whether [Individual] or [Total] is selected for *Copier/Printer Count* on page 9-74.

Restriction Items

[Individual] selected for Copier/Printer Count

Copy (Total)	Limits the total number of pages used for full-color and black and white copying.
Copy (Full Color)	Limits the number of pages used for full-color copying.
Printer (Total)	Limits the total number of pages used for color and black and white printing.
Printer (Full Color)	Limits the number of pages used for color printing.
Scan (Others)	Limits the number of pages scanned (excludes copying).
FAX Transmission*	Limits the number of pages sent by fax.

* This item is displayed when the optional fax kit is installed.

[Total] selected for Copier/Printer Count

Print (Total)	Limits the total number of pages used for copying and printing.
Print (Full Color)	Limits the number of pages used for full-color printing.
Scan (Others)	Limits the number of pages scanned (excludes copying).
FAX Transmission*	Limits the number of pages sent by fax.

* Only displayed when the optional fax kit is installed.

Applying Restriction

Off	No restriction given.
Counter Limit	Restricts the print counter in one-page increments up to 9,999,999 pages.
Reject Usage	Restriction is applied.

 For details on the machine behaves when the counter has reached the limit of restriction, refer to *Apply Limit* on page 9-74.

1 Select the item to limit.

[Total] selected for Copier/Printer Count

Select the item that you want to change. 10:10
Add - Confirmation

Account Name	Section 01	1/2
Account ID	00000001	
Print (Total)	Off	
Print (Full Color)	Off	

Cancel < Back Save

GB0480_00

Use [∨] or [∧] to scroll up and down.

Select the item that you want to change. 10:10
Add - Confirmation

Scan (Others)	Off	2/2
FAX Transmission	Off	

Cancel < Back Save

GB0480_01

[Individual] selected for Copier/Printer Count

Select the item that you want to change. 10:10
Add - Confirmation

Account Name	Section 01	1/2
Account ID	00000001	
Copy (Total)	Off	
Copy (Full Color)	Off	

Cancel < Back Save

GB0480_02

Use [∨] or [∧] to scroll up and down.

Select the item that you want to change. 10:10
Add - Confirmation

Printer (Total)	Off	2/2
Printer (Full Color)	Off	
Scan (Others)	Off	
FAX Transmission	Off	

Cancel < Back Save

GB0480_03

2 Select a restriction method.

System Menu/Counter. 10:10
Print (Total)

Off		1/1
Counter Limit	>	
Reject Usage		

Cancel OK

GB0474_00

If [Counter Limit] is selected, press [+], [-] or numeric keys to select the number of pages, and press [OK].

Counting the Number of Pages Printed

This counts the number of pages printed. Counts are classified into Total Job Accounting and Each Job Accounting. A new count can also be started after resetting the count data which was stored for a certain period of time. Types of the counts are as follows.

Printed Pages	<p>Displays the number of pages copied and printed, and the total number of pages used. You can also use [by Paper Size], [by Duplex] and [by Combine] to check the number of pages used.</p> <ul style="list-style-type: none"> For copying, you can check the pages used for black and white and full-color copying as well as the total pages used. For printing, you can check the pages used for black and white and full-color printing as well as the total pages used. You can use [by Paper Size] to check the number of pages used in the paper size set in <i>Count by Paper Size on page 9-75</i> as well as the number of pages used in other paper sizes. You can use [by Duplex] to check the number of pages used in Duplex (1-sided) mode, Duplex (2-sided) mode and the total for both. You can use [by Combine] to check the number of pages used in Combine (None) mode, Combine (2 in 1) mode, Combine (4 in 1) mode and the total for all three.
Scanned Pages	Displays the number of pages scanned for copying, faxing* and other functions, as well as the total number of pages scanned.
FAX Transmission Pages*	Displays the number of pages faxed.
FAX Transmission Time*	Displays the total duration of fax transmissions.

* This item is displayed when the optional fax kit is installed.

1 Display the screen.

1 Referring to *Job Accounting Settings on page 9-61*, display the screen.

2

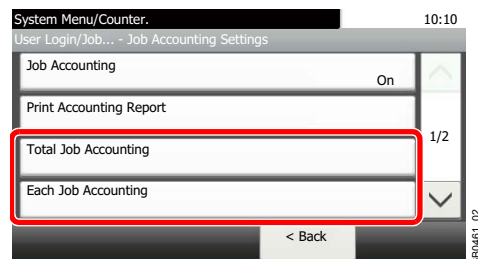

To count the number of pages for all account, select [Total Job Accounting]. To count the number of pages by account, select [Each Job Accounting].

Searches by account name.

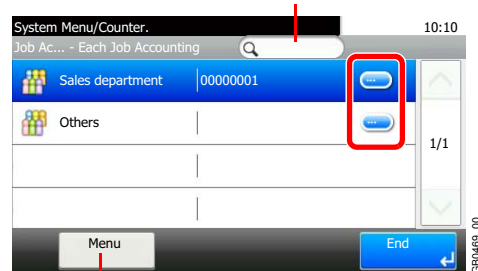

Allows you to search for an account name and sorts results.

To count the number of pages by account name, press [...] for the account name whose usage you wish to view.

2 View the number of pages.

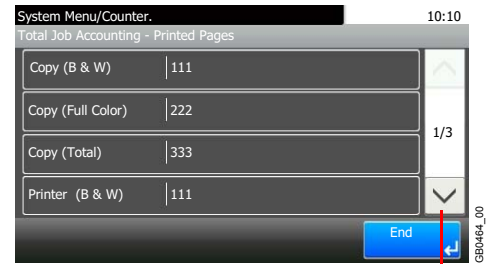
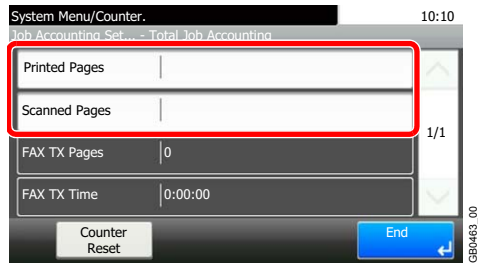

Use [∨] or [^] to scroll up and down.

To reset the counter

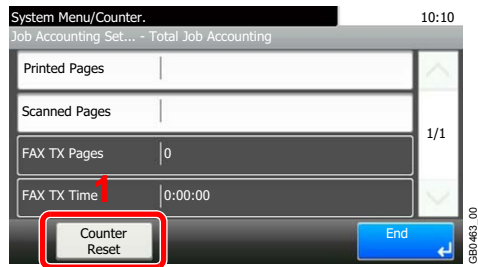

Printing an Accounting Report

Total pages counted at all relevant accounts can be printed as an accounting report. Reports have different formats depending on how the count of copiers and printers is administered.

Copier/Printer Count	Format	
When [Total] is selected for Copier/Printer Count	Print (Total)	Total number of pages used for copying and printing Total number of pages used for full-color copying and printing Total number of pages used for black-and-white copying and printing
When [Individual] is selected for Copier/Printer Count	Copy	Total number of pages used for copying Total number of pages used for full-color copying Total number of pages used for black-and-white copying
	Print	Total number of pages used for printing Total number of pages used for full-color printing Total number of pages used for black-and-white printing
Shared statistics	Scan	Total number of pages scanned
		Total number of pages scanned for copying
		Total number of pages faxed
		Total number of other pages scanned
	Fax	Total number of pages received
		Total number of pages sent
		Total duration of fax transmissions
	Other	Total number of duplex pages printed
		Total number of 1-sided pages printed
		Total number of combine (2 in 1) pages
Total number of combine (4 in 1) pages		
Total number of non-combine pages printed		

For count by paper size, page counts will be printed by paper size under "Paper Count".

1 Prepare paper.

Check that Letter or A4 paper is loaded in the cassette.

2 Display the screen.

Referring to *Job Accounting Settings on page 9-61*, display the screen.

3 Print reports.

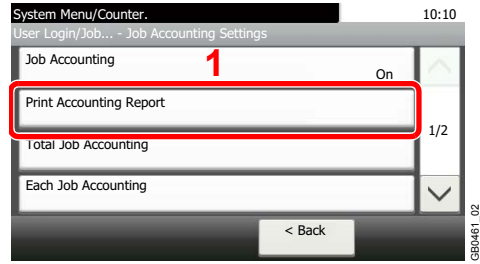

Job Accounting Default Setting

Sets default settings related to job accounting.

Display the screen.

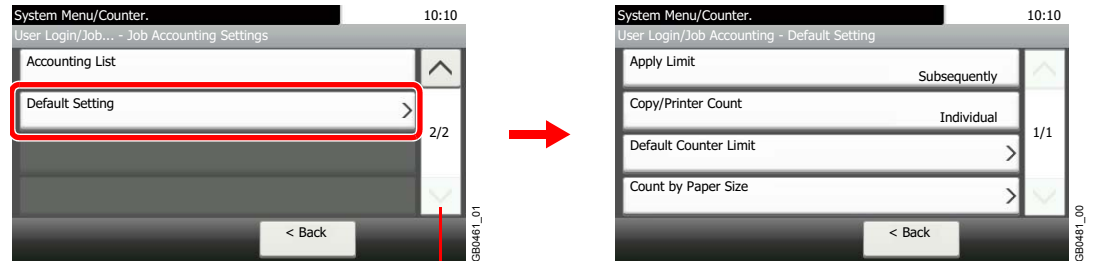

1 Referring to *Job Accounting Settings* on page 9-61, display the screen.

2



Use [∨] or [∧] to scroll up and down.

Setting Items

Item	Description
Apply Limit	<p>This specifies how the machine behaves when the counter has reached the limit of restriction.</p> <p>Value</p> <p>Immediately*: Job stops when the counter reaches its limit.</p> <p>Subsequently: Printing/scanning of the job continues but the subsequent job will be rejected.</p> <p>Alert Only: Job continues while displaying an alert message.</p>
Copier/Printer Count	<p>You can select how the copying and printing page counts are shown - either the total of both or each of copying and printing individually. The selection may influence restriction on the count and count method.</p> <p> Refer to <i>Restricting the Use of the Machine</i> on page 9-68, <i>Counting the Number of Pages Printed</i> on page 9-70 and <i>Printing an Accounting Report</i> on page 9-72 for details.</p> <p>Value: Total, Individual</p>
Default Counter Limit	<p>When you add a new account, you can change the default restrictions on the number of pages used.</p> <p> Refer to <i>Restricting the Use of the Machine</i> on page 9-68.</p> <p>Value: 1 to 9,999,999 in 1-sheet increments</p>

Item	Description
<p>Count by Paper Size</p>	<p>This counts the number of pages used for specific paper sizes (for example, count the number of pages printed using A4 paper).</p> <p>You can specify five paper sizes (1 to 5). The number of pages used for the paper sizes specified here can be referenced under [by Paper Size] when counting page use. This information can also be printed in accounting reports.</p> <p> Refer to <i>Counting the Number of Pages Printed on page 9-70</i> and <i>Printing an Accounting Report on page 9-72</i>.</p> <p>You can also count page use by specifying paper size and media type (for example, count the number of pages printed in color using A4 paper). If [All Media Types] is specified, the number of pages printed using the specified paper size is counted regardless of media type.</p> <p>Value</p> <p>Paper Size 1 to 5</p> <p>Paper size: A3, A4, A5, B4, B5, Folio, Ledger, Legal, Letter, Statement</p> <p>Media type: All Media Types, Plain, Transparency, Rough, Vellum, Labels, Recycled, Preprinted, Bond, Cardstock, Color, Prepunched, Letterhead, Envelope, Thick (106 g/m² and more), Coated, High Quality, Custom 1 to 8</p>

* The next job will be prohibited in sending or in storing in the box.

Unknown Login User Name Job

This specifies the behavior for handling the jobs sent with unknown login user names or User ID (i.e. unsent IDs). If the User Login is set to invalid and Job Accounting is set to valid, follow the procedure when the Account ID is unknown.

1 Display the screen.

◆ System Menu / Counter

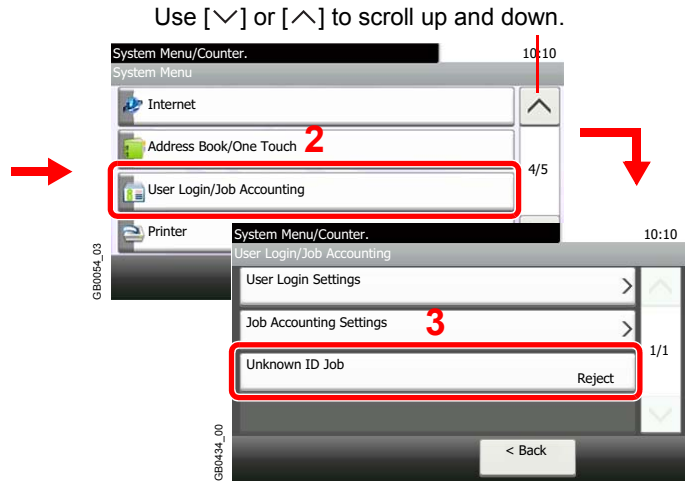
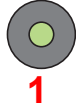

2 Select the function.

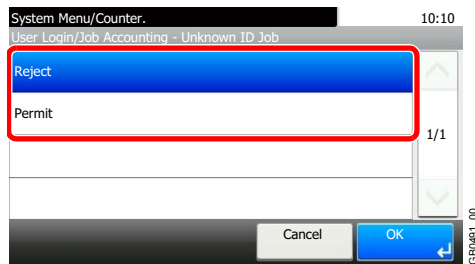

10 Troubleshooting

This chapter explains the following topics:

Toner Container Replacement	10-2
Waste Toner Box Replacement	10-4
Replacing Staples	10-5
Cleaning	10-6
Glass Platen	10-6
Document Processor	10-6
Solving Malfunctions	10-8
Responding to Messages	10-14
Clearing Paper Jams	10-26
Jam Location Indicators	10-26
Multi Purpose Tray	10-27
Inside the Right Cover 1	10-27
Cassette 1	10-28
Inside the Right Cover 3	10-28
Cassette 2 or 3	10-29
Optional Document Finisher	10-29
Optional Document Finisher Staple Jam	10-30
Bridge Unit	10-30
Document Processor	10-31

Toner Container Replacement

When the touch panel displays *Toner is empty.*, replace the toner.

CAUTION

Do not attempt to incinerate the toner container or the waste toner box. Dangerous sparks may cause burns.

NOTE

For the toner container, always use a genuine toner container. Using a toner container that is not genuine may cause image defects and product failure.

Return the exhausted toner container and waste toner box to your dealer or service representative. The collected toner container and waste toner box will be recycled or disposed in accordance with the relevant regulations.

Installation procedures of the toner container is same for every color. The procedures here represent the yellow toner container.

1 Remove the old toner container.

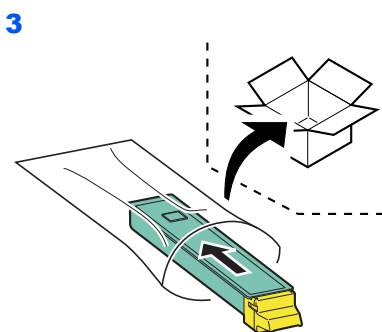
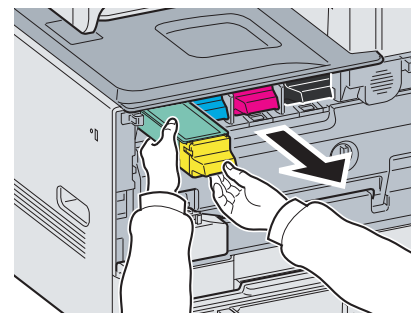
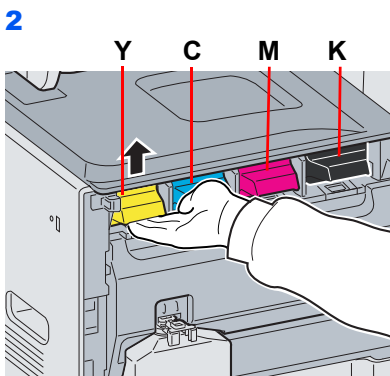
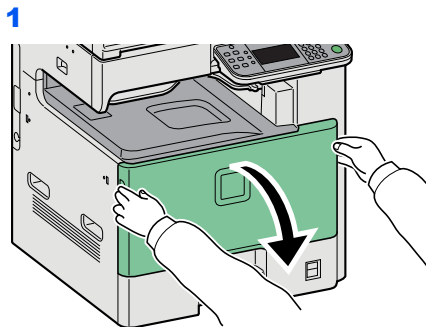

2 Prepare the new toner container.

1

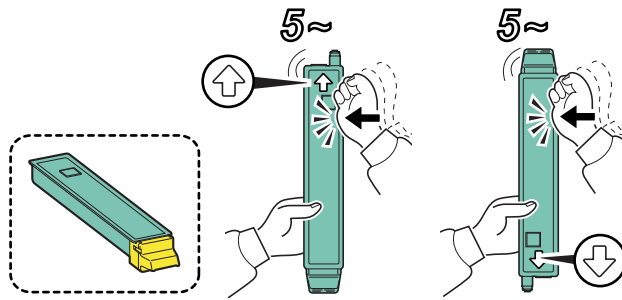

2

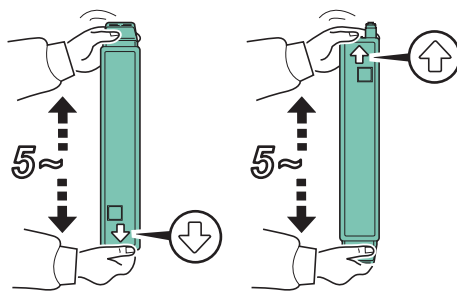

3

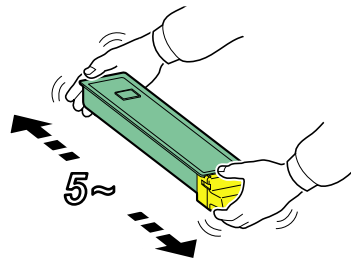

3 Install the new toner container.

1

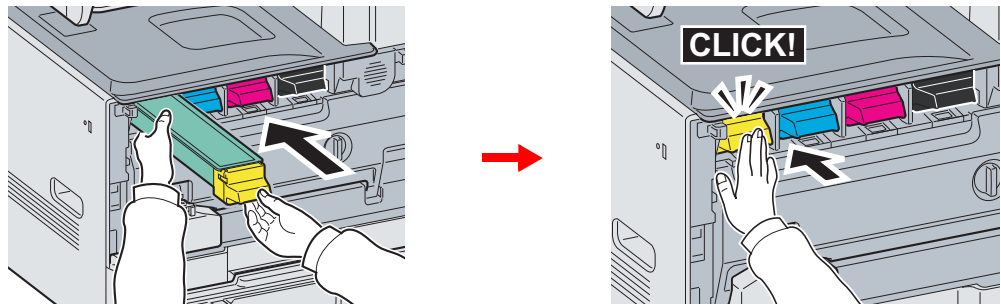

2

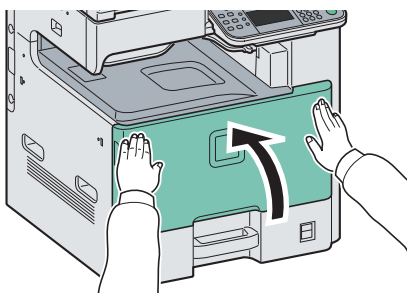

Waste Toner Box Replacement

When the touch panel displays *Check waste toner box.*, replace the waste toner box.

1 Remove the old waste toner box.

1

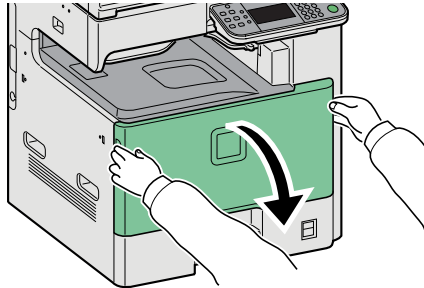

2

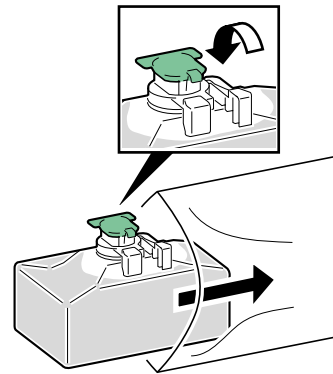
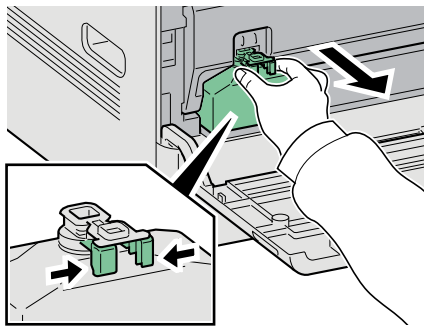

2 Install the new waste toner box.

1

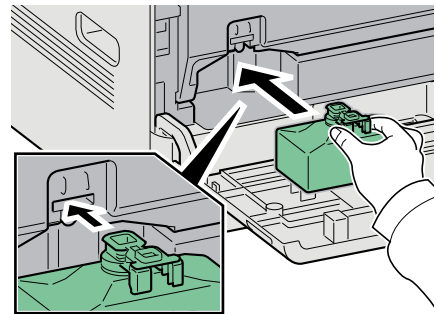
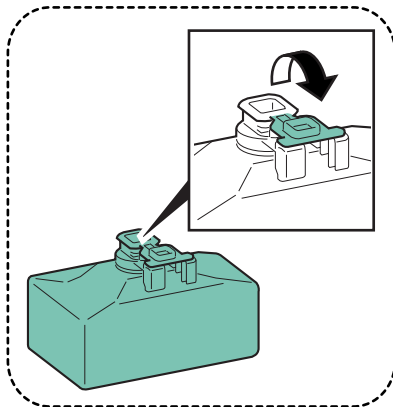

2

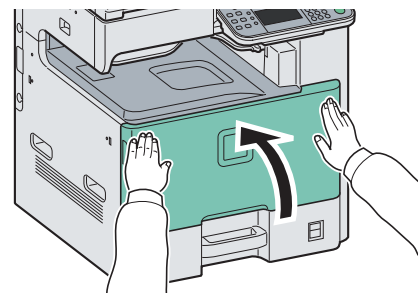
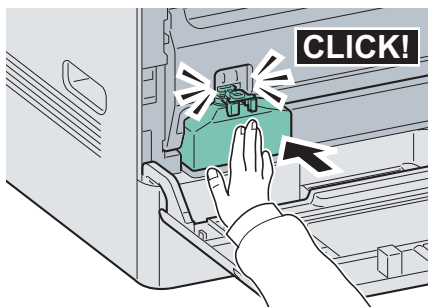

Replacing Staples

If a message displays indicating that staples have run out, the staple cartridge holder need to be replenished with staples.



NOTE

If the Staple Unit runs out of staples, contact your service representative or the place of purchase.

1 Remove the staple cartridge holder.

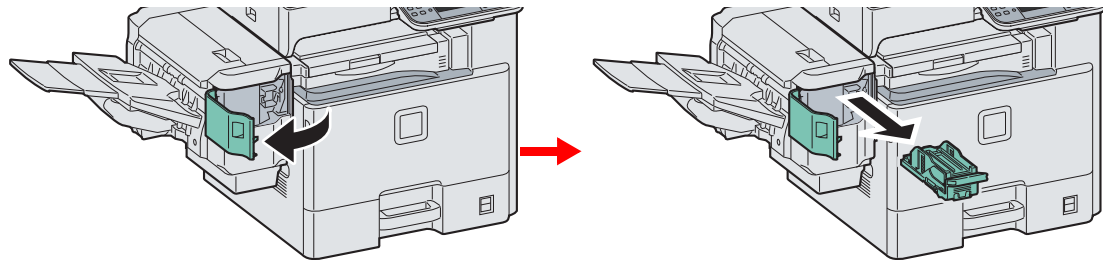

After the cartridge holder returned to the original position, open the staple cover and remove the cartridge holder.

2 Remove the empty staple cartridge.

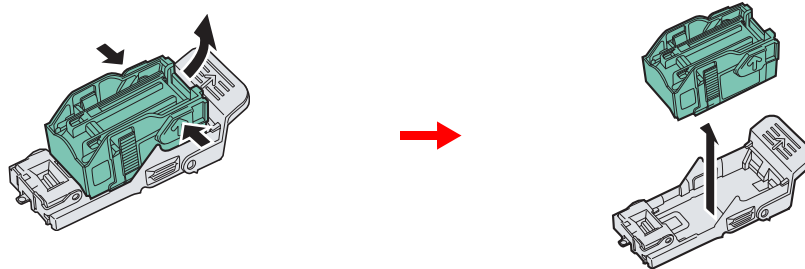

NOTE

The staple cartridge can only be removed when it contains no more staples.

3 Insert the new staple cartridge.

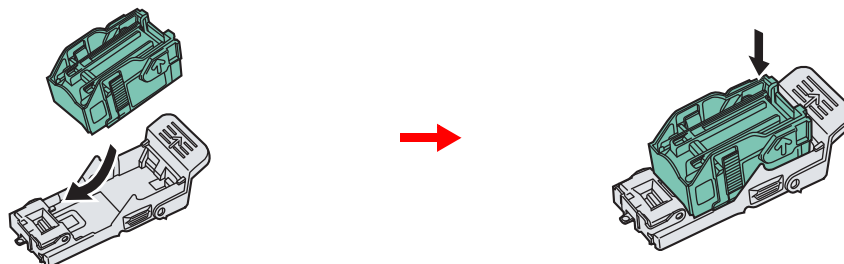

4 Re-install the staple cartridge holder.

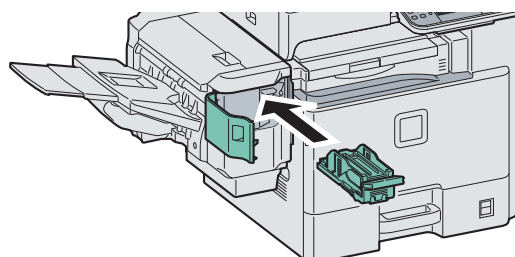

The staple cartridge holder will click into place when it has been inserted correctly.

Cleaning

Clean the machine regularly to ensure optimum output quality.

Caution

For safety, always unplug the power cord before cleaning the machine.

Glass Platen

Wipe the original holder, inside of the document processor, and the glass platen with a soft cloth dampened with alcohol or mild detergent.

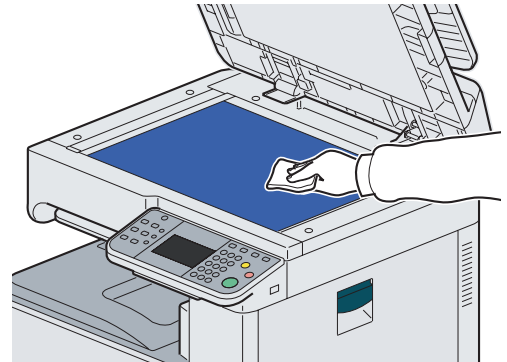
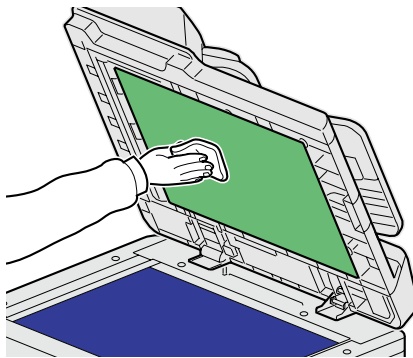

NOTE

Do not use organic solvents or other strong chemicals.

Document Processor

If black streaks or dirt appears in copies when using the document processor, clean the slit glass with the supplied cleaning cloth.



NOTE

Wipe the slit glasses with the dry accessory cloth. Do not use water, soap or solvents for cleaning.

1 Wipe the slit glass.

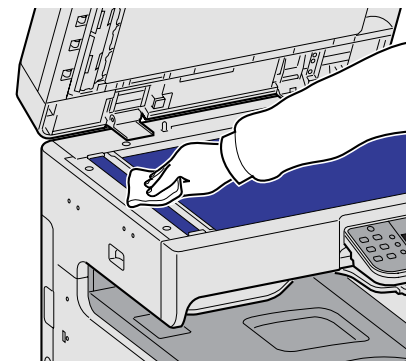
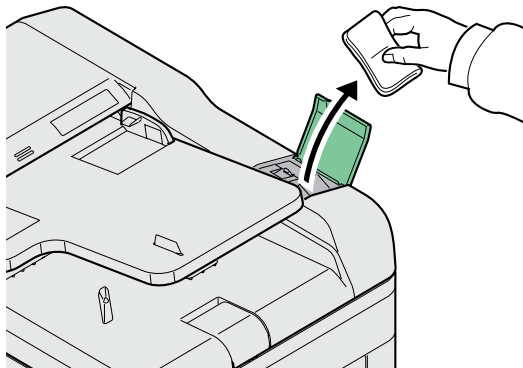



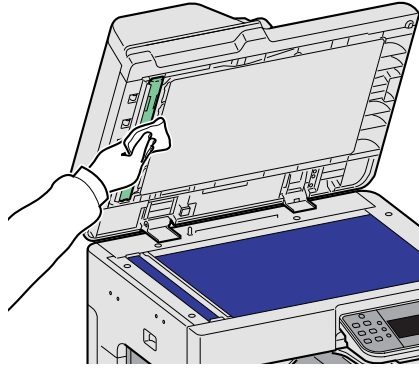

2 Wipe the white guide.



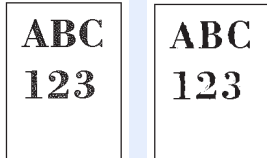
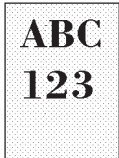

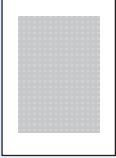



Solving Malfunctions

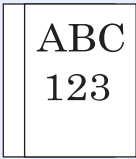
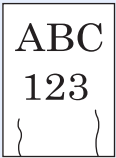

The table below provides general guidelines for problem solving. If a problem occurs with your machine, look into the checkpoints and perform procedures indicated on the following pages. If the problem persists, contact your Service Representative.

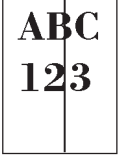
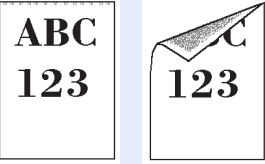
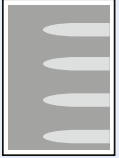
Symptom	Checkpoints	Corrective Actions	Reference Page
An application does not start.	Is the Auto Panel Reset time short?	Set the Auto Panel Reset time to 30 seconds or more.	9-24
The screen does not respond when the main power switch is turned on.	Is the machine plugged in?	Plug the power cord into an AC outlet.	2-11
Pressing the Start key does not produce printouts.	Is there a message on the screen?	Determine appropriate response to the message and respond accordingly.	10-14
	Is the machine in Sleep mode?	Press the Power key to recover the machine from Sleep mode.	2-23
Blank sheets are ejected. 	Are the originals loaded correctly?	When placing originals on the platen, place them face-down and align them with the original size indicator plates.	3-7
		When placing originals in the document processor, place them face-up.	3-9
	—	Check that the settings of the application software.	—
Printouts are totally too light. 	Is the paper damp?	Replace the paper with new paper.	3-2
		If you experience frequent problems, turn the cassette heater switch on.	2-4
	Have you changed the density?	Select appropriate density level.	3-51 9-26
	Is the toner distributed evenly within the toner container?	Shake the toner container from side to side about several times.	10-2
	Is there a message indicating the addition of toner?	Replace the toner container.	10-2
	Is EcoPrint mode enabled?	Disable EcoPrint mode.	4-15
	—	Press the System Menu/Counter key, [Adjustment/Maintenance], [Service Setting], [DEV-CLN], and then press [Start].	—
	—	Run [Laser Scanner Cleaning].	9-27
	—	Make sure the paper type setting is correct the paper being used.	9-8
Printouts are too dark even though the background of the scanned original is white. 	Have you changed the density?	Select appropriate density level.	3-51 9-26

Symptom	Checkpoints	Corrective Actions	Reference Page
The background density is obtrusive.	—	Run [Background Density Adjustment].	3-55 9-26
Copies have a moire pattern (dots grouped together in patterns and not aligned uniformly). 	Is the original a printed photograph?	Set the original image to [Photo].	3-53
Texts are not clearly printed. 	Did you choose appropriate image quality for the original?	Select appropriate image quality.	3-53
Black or color dots appear on the white background when white original is scanned. 	Is the original holder or the glass platen dirty?	Clean the original holder or the glass platen.	10-6
Printouts are fuzzy. 	Is the machine being used in conditions of very humid, or humidity or temperature rapidly changes?	Use in an environment that has suitable humidity.	1-3
		If you experience frequent problems, turn the cassette heater switch on.	2-4
Images are skewed. 	Are the originals placed correctly?	When placing originals on the platen, align them with the original size indicator plates.	3-7
		When placing originals in the document processor, align the original width guides securely before placing the originals.	3-8
	Is the paper loaded correctly?	Check the position of the paper width guides.	3-2
	—	Perform center line adjustment. For more information about how to do so, contact your service representative.	—

Symptom	Checkpoints	Corrective Actions	Reference Page
Paper often jams.	Is the paper loaded correctly?	Load the paper correctly.	3-2
	—	Turn the orientation 180 degrees around in which the paper is positioned.	1-16 3-3 3-7
	Is the paper of the supported type? Is it in good condition?	Remove the paper, turn it over, and reload it.	3-2
	Is the paper curled, folded or wrinkled?	Replace the paper with new paper.	3-2
	Are there any loose scraps or jammed paper in the machine?	Remove any jammed paper.	10-26
2 or more sheets are overlaps when ejected. (multi feed) 	—	Load the paper correctly.	3-2
Printouts are wrinkled. 	—	Turn the orientation 180 degrees around in which the paper is positioned.	3-2
	Is the paper damp?	Replace the paper with new paper. If you experience frequent problems, turn the cassette heater switch on.	3-2 2-4
Printouts are curled. 	—	Turn the orientation 180 degrees around in which the paper is positioned.	3-2
	Is the paper damp?	Replace the paper with new paper. If you experience frequent problems, turn the cassette heater switch on.	3-2 2-4
Cannot print.	Is the machine plugged in?	Plug the power cord into an AC outlet.	2-11
	Is the machine powered on?	Turn on the main power switch.	2-12
	Are the printer cable and network cable connected?	Connect the correct printer cable and network cable securely.	2-10
	Was the machine powered on before the printer cable was connected?	Power on the machine after connecting the printer cable.	2-10
	Is the print job paused?	Resume printing.	8-3
Cannot print with USB memory. USB memory not recognized.	Is the USB host blocked?	Select [Unblock] in the USB host settings.	9-23
	—	Check that the USB memory is securely plugged into the machine.	—
When displaying an image sent from the machine on the PC, an image size is shrunk vertically or horizontally.	Have you selected 200×100dpi Normal or 200×400dpi Super for the scan resolution?	Select a scan resolution other than 200×100dpi Normal or 200×400dpi Super when sending an image.	3-52

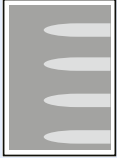
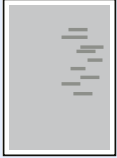
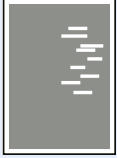
Symptom	Checkpoints	Corrective Actions	Reference Page
Printouts have vertical lines. 	Is the slit glass dirty?	Clean the slit glass.	10-6
	—	Run [Laser Scanner Cleaning].	9-27
Dirt on the top edge or back of the paper. 	Check the machine interior.	Open the right cover. If the machine interior is dirty with toner, clean it using soft, dry, lint-free cloth.	—
Part of the image is periodically faint or shows white lines. 	Have the developer unit and drum unit been loaded properly?	Load the developer unit and drum unit properly.	—
	—	Open and then close the right cover.	—
	—	Press the System Menu/Counter key, [Adjustment/Maintenance], [Service Setting], [MC] and decrease the adjustment value. Decrease the adjustment value 1 level at a time from the current value. If there is no improvement after the value is decreased by 1 level, decrease by 1 level again. If there is still no improvement, return the setting to the original value.	—
	—	Run [Drum Refresh].	9-27
	—	If you experience frequent problems, turn the cassette heater switch on.	2-4
Print on the back of the sheet is visible on the front. 	—	Set Prevent Bleed-through to [On].	3-56
Skewed-color printout. 	—	Run [Calibration].	9-27
	—	Run [Color Registration].	9-28
The previous image remains and lightly printed. 	—	Run [Drum Refresh].	9-27
	—	Press the System Menu/Counter key, [Adjustment/Maintenance], [Service Setting], [MC] and increase the adjustment value. Increase the adjustment value 1 level at a time from the current value. If there is no improvement after the value is increased by 1 level, increase by 1 level again. If there is still no improvement, return the setting to the original value.	—

Symptom	Checkpoints	Corrective Actions	Reference Page
Part of the image is periodically faint or blurred. 	—	Press the System Menu/Counter key, [Adjustment/Maintenance], [Service Setting], [MC] and decrease the adjustment value. Decrease the adjustment value 1 level at a time from the current value. If there is no improvement after the value is decreased by 1 level, decrease by 1 level again. If there is still no improvement, return the setting to the original value.	—
	—	Press the System Menu/Counter key, [Adjustment/Maintenance], [Service Setting], [DEV-CLN], and then press [Start].	—
Irregular horizontal lines appear in the image. 	—	Press the System Menu/Counter key, [Adjustment/Maintenance], [Service Setting], [MC] and decrease the adjustment value. Decrease the adjustment value 1 level at a time from the current value. If there is no improvement after the value is decreased by 1 level, decrease by 1 level again. If there is still no improvement, return the setting to the original value.	—
The altitude is 1500 m or higher and irregular horizontal white lines appear in the image. 	—	Press the System Menu/Counter key, [Adjustment/Maintenance], [Service Setting], [Altitude Adjustment] and change the adjustment value. Increase the adjustment value 1 level at a time from the current value. If there is no improvement after the value is increased by 1 level, increase by 1 level again.	—
The altitude is 1500 m or higher and dots appear in the image. 	—	Press the System Menu/Counter key, [Adjustment/Maintenance], [Service Setting], [Altitude Adjustment] and change the adjustment value. Increase the adjustment value 1 level at a time from the current value. If there is no improvement after the value is increased by 1 level, increase by 1 level again.	—
Colors appear different than you anticipated.	Did you choose appropriate image quality for the original?	Select appropriate image quality.	3-53
	Have you loaded color copy paper into the paper tray?	Load color copy paper into the paper tray.	—
	—	Run [Calibration].	9-27
	—	Run [Tone Curve Adjustment].	9-27
	—	When making copies Adjust the color balance.	4-17
—	When printing from a computer Adjust the color using the printer driver.	Printer Driver User Guide	

Symptom	Checkpoints	Corrective Actions	Reference Page
<i>Perform Tone Curve Adjustment.</i> is displayed.	Over long periods of use, the effects of the ambient temperature and humidity can cause color output hues to vary slightly.	Run [Tone Curve Adjustment].	9-27
The color toner is empty.	Do you want to continue printing in black and white?	If the black toner is remained, the machine continues printing in black and white by selecting [Print in Black and White] of Color Toner Empty Action.	9-14
The machine makes a clicking sound before starting to print or after printing.	—	The machine is adjusting itself. It is not a machine failure.	—
Cannot send via SMB.	Is the network cable connected?	Connect the correct network cable securely.	2-10
	Have the network settings for the equipment been configured properly?	Configure the TCP/IP settings properly.	9-19
	Have the folder sharing settings been configured properly?	Check sharing settings and access privileges under the folder properties.	6-7
	Has the SMB protocol been set to [On]?	Set the SMB protocol setting to [On].	2-25
	Has the [Host Name] been entered properly?*	Check the name of the computer to which data is being sent.	6-5
	Has the [Path] been entered properly?	Check the share name for the shared folder.	6-8
	Has the [Login User Name] been entered properly?*,**	Check the domain name and login user name.	6-21
	Has the same domain name been used for the [Host Name] and [Login User Name]?	Delete the domain name and backslash ("\") from the [Login User Name].	6-21
	Has the [Login Password] been entered properly?	Check the login password.	6-21
	Have exceptions for Windows Firewall been configured properly?	Configure exceptions for Windows Firewall properly.	6-10 6-13
	Do the time settings for the equipment, domain server, and data destination computer differ?	Set the equipment, domain server, and data destination computer to the same time.	—
Is the screen displaying <i>Send error.</i> ?	Refer to <i>Responding to Send Error.</i>	10-23	

* You can also enter a full computer name as the host name (for example, pc001.abcdnet.com).

** You can also enter login user names in the following formats:
 Domain_name/user_name (for example, abcdnet/james.smith)
 User_name@domain_name (for example, james.smith@abcdnet)

Responding to Messages

If the touch panel or the computer displays any of these messages, follow the corresponding procedure.

A

Message	Checkpoints	Corrective Actions	Reference Page
<i>Acceptable staple count exceeded.*</i>	Is the acceptable staple count exceeded? For details, refer to <i>Document Finisher (option)</i> on page 11-22.	Press [Continue] to print without stapling. Press [Cancel] to cancel the job.	—
<i>Activation error.</i>	—	Turn the main power switch off and on. If the error exists, contact administrator.	2-12
<i>Add the following paper in cassette #.</i>	Is the indicated cassette out of paper?	Load paper. Press [Paper Selection] to select the other paper source. Press [Continue] to print on the paper in the currently selected paper source.	3-3
<i>Add the following paper in the multi purpose tray.</i>	Is the paper of the selected size loaded in the multi purpose tray?	Load paper. Press [Paper Selection] to select the other paper source. Press [Continue] to print on the paper in the currently selected paper source.	3-5
	Does the paper size set for the paper source matches the paper size that was actually loaded?	Press [Continue] to continue printing. Press [Cancel] to cancel the job.	—
<i>Adjusting Scanner.</i>	—	The machine is under the adjustment to maintain its quality. Please wait.	—
<i>Adjusting...</i>	—	The machine is under the adjustment to maintain its quality. Please wait.	—



* When Auto Error Clear is set to [On], processing resumes automatically after a set amount of time elapses.

B

Message	Checkpoints	Corrective Actions	Reference Page
<i>Box limit exceeded.*</i>	Is [End] displayed on the touch panel?	Document box is full, and no further storage is available; Job is canceled. Press [End]. Try to perform the job again after printing or deleting data from the Document Box.	—

* When Auto Error Clear is set to [On], processing resumes automatically after a set amount of time elapses.

C

Message	Checkpoints	Corrective Actions	Reference Page
<i>Calibrating...</i>	—	The machine is under the adjustment to maintain its quality. Please wait.	—
<i>Cannot connect to Authentication Server.*</i>	—	Set machine time to match the server's time.	9-24
	—	Check the domain name.	9-34
	—	Check the host name.	9-34
	—	Check the connection status with the server.	—
<i>Cannot duplex print on the following paper.*</i>	Did you select a paper size/ media type that cannot be duplex printed?	Press [Paper Selection] to select the available paper. Press [Continue] to print without using Duplex function.	4-8
<i>Cannot offset the following paper.*</i>	Did you select a paper size/ media type that cannot be offset?	Press [Paper Selection] to select the available paper. Press [Continue] to print without using Offset function.	3-44
<i>Cannot print the specified number of copies.*</i>	—	Only one copy is available. Press [Continue] to continue printing. Press [Cancel] to cancel the job. The machine may reproduce the same originals by arranging the following settings: - Uncheck [RAM Disk] in the [Device Settings] tab of the printer's properties.  NOTE: If you unchecked the [RAM Disk], check the [RAM Disk] again after the printing is completed. If not, print speed may be reduced.	—
	Do you want to print the data stored in the USB memory?	Only one copy is available. Press [Continue] to continue printing. Press [Cancel] to cancel the job. The machine may reproduce the same originals by arranging the following settings: - Reduce the number of copies to be printed at once. Furthermore, the machine may reproduce the same originals by arranging the following settings: - Select [Copy Priority] of Main Memory in System Menu.  NOTE: Before changing the Main Memory setting, contact your administrator.	9-24
<i>Cannot process this job.*</i>	—	This job is canceled because it is restricted by User Authorization or Job Accounting. Press [End].	—

Message	Checkpoints	Corrective Actions	Reference Page
<i>Cannot staple at the specified position.</i>	Have you selected a position that cannot be stapled?	Press [Paper Selection] to select the available paper. Press [Continue] to print without using Staple function.	—
<i>Cannot staple the following paper.*</i>	Did you select a paper size/type that cannot be stapled?	Press [Paper Selection] to select the available paper. Press [Continue] to print without using Staple function.	—
<i>Cassette # failure.</i>	—	Contact your Service Representative. Press the System Menu/Counter key, [Adjustment/Maintenance], [Service Setting] and then [Enable Repaired Unit]. Press [Execute] to perform Enable Repaired Unit.	—
<i>Check the document processor.</i>	Is the document processor open?	Close the document processor.	—
<i>Check waste toner box.</i>	Is the waste toner box full?	Replace the waste toner box.	10-4
	—	The waste toner box is not installed correctly. Set it correctly.	10-4
<i>Cleaning the laser scanner...</i>	—	The machine is under the adjustment to maintain its quality. Please wait.	—

* When Auto Error Clear is set to [On], processing resumes automatically after a set amount of time elapses.

D

Message	Checkpoints	Corrective Actions	Reference Page
<i>Developer unit is not installed.</i> [C][M][Y][K]	—	Replace the developer unit (g) to our specified developer unit. See the leaflet supplied with the developer unit.	—
<i>Drum unit is not installed.</i> [C][M][Y][K]	—	Replace the drum unit (f) to our specified drum unit. See the leaflet supplied with the drum unit for details.	—

E

Message	Checkpoints	Corrective Actions	Reference Page
<i>Error occurred at cassette #.</i>	—	Remove the indicated cassette. Press [Next >] to follow the instructions.	—

F

Message	Checkpoints	Corrective Actions	Reference Page
<i>Failed to send the file information.</i>	Is the machine and the PC to which the scanned image is to be sent connected to the network?	Check the network and SMB settings. - The network cable is connected. - The hub is not operating properly. - The server is not operating properly. - Host name and IP address - Port number	2-8
	Is the account information (user ID, password) used to access the shared folder to which the scanned image is to be sent incorrect?	Check the following settings of the PC to which the scanned image is to be sent. - Host name - Path - Login user name  NOTE: If the sender is a domain user, specify the domain name. [Login User ID]@[Domain Name] Example: sa720XXXX@km - Login password - Folder share permissions of the recipient	—
<i>Failed to specify Job Accounting.*</i>	—	Failed to specify Job Accounting when processing the job externally. The job is canceled. Press [End].	—
<i>Failed to store job retention data.</i>	—	The job is canceled. Press [End]. Insufficient free space in the Job Box. Try to perform the job again after printing or deleting data from the Job Box.	—
<i>Finisher failure.</i>	—	Contact your Service Representative. Press the System Menu/Counter key, [Adjustment/Maintenance], [Service Setting] and then [Reset Disable Function Mode]. Press [Execute] to perform Reset Disable Function Mode.	—
<i>Finisher tray is full of paper.</i>	Is the acceptable storage capacity exceeded for the document finisher tray?	Remove paper from the document finisher tray.	—
<i>Fuser unit is not installed.</i>	—	Replace the fuser unit (h-1) to our specified fuser unit. See the leaflet supplied with the fuser unit for details.	—

* When Auto Error Clear is set to [On], processing resumes automatically after a set amount of time elapses.

I

Message	Checkpoints	Corrective Actions	Reference Page
<i>Incorrect account ID.*</i>	—	The account ID was incorrect when processing the job externally. The job is canceled. Press [End].	—
<i>Incorrect Login User Name or Password.*</i>	—	The login user name or password was incorrect when processing the job externally. The job is canceled. Press [End].	—
<i>Inner tray is full of paper.</i>	—	Remove paper from the inner tray. Printing then resumes.	—
<i>Intermediate transfer unit is not installed.</i>	—	Replace the intermediate transfer unit (r) to our specified intermediate transfer unit. See the leaflet supplied with intermediate transfer unit.	—
<i>Invalid configuration.</i>	Are the originals loaded correctly?	When placing originals on the platen, place them face-down and align them with the original size indicator plates. When placing originals in the optional document processor, place them face-up.	3-7

* When Auto Error Clear is set to [On], processing resumes automatically after a set amount of time elapses.

J

Message	Checkpoints	Corrective Actions	Reference Page
<i>Job Accounting restriction exceeded.*</i>	Is the acceptable printing count restricted by Job Accounting exceeded?	The printing count exceeded the acceptable count restricted by Job Accounting. Cannot print any more. This job is canceled. Press [End].	—
<i>Job separator tray is full of paper.</i>	Is the maximum capacity of the job separator tray exceeded?	Follow the instruction indicated on the machine and remove paper from the job separator tray.	—



* When Auto Error Clear is set to [On], processing resumes automatically after a set amount of time elapses.

K

Message	Checkpoints	Corrective Actions	Reference Page
<i>KPDL error.*</i>	—	PostScript error has occurred. The job is canceled. Press [End].	—

* When Auto Error Clear is set to [On], processing resumes automatically after a set amount of time elapses.

M

Message	Checkpoints	Corrective Actions	Reference Page
<i>Machine failure.</i>	Is the expansion memory replaced?	The memory is not installed correctly. Reinstall the memory.	11-3
	—	Internal error has occurred. Make a note of the error code displayed on the touch panel, and contact your Service Representative.	—
<i>Maximum number of scanned pages.</i>	Is the acceptable scanning count exceeded?	Only one copy of the scanned pages is available. Press [Continue] to print, send or store the scanned pages. Press [Cancel] to cancel printing, sending or storing.	—
<i>Memory is full.*</i>	—	The process cannot be performed due to insufficient memory. If only [End] is available, press [End]. The job will be canceled. The machine may reproduce the same originals by arranging the following settings: - Decrease [Image Quality] of [File Format]. Furthermore, the machine may reproduce the same originals by arranging the following settings: - Select [Normal] of Main Memory in System Menu.  NOTE: Before changing the Main Memory setting, contact your administrator.	3-52 9-24
	—	Unable to continue the job as the memory is used up. Press [Continue] to print the scanned pages. The print job cannot be processed completely. Press [Cancel] to cancel the job. The machine may reproduce the same originals by arranging the following settings: - Select [On] of RAM Disk Setting in System Menu, and then decrease the RAM disk size. - Select [Printer Priority] of Main Memory in System Menu.  NOTE: Before changing the RAM Disk Setting or Main Memory setting, contact your administrator.	9-23 9-24

* When Auto Error Clear is set to [On], processing resumes automatically after a set amount of time elapses.

P

Message	Checkpoints	Corrective Actions	Reference Page
<i>Paper is left.</i>	—	Remove paper from the document finisher.	—
<i>Paper jam.</i>	—	If a paper jam occurs, the machine will stop and the location of the jam will be indicated on the touch panel. Leave the machine on and follow the instruction to remove the jammed paper.	10-26
<i>Preparing to print.</i>	—	The machine is under the adjustment to maintain its quality. Please wait.	—
<i>Print overrun.</i>	—	Warning. Low printer memory. The job was paused. Press [Continue] to re-start the job.	—

R

Message	Checkpoints	Corrective Actions	Reference Page
<i>RAM disk error.*</i>	—	<p>An error has occurred on the RAM disk. Job is canceled. Press [End].</p> <p>The possible error codes and their descriptions are as follows.</p> <p>01: The amount of data that can be saved at once has been exceeded. Restart the system or turn the power OFF/ON. If the error still occurs, divide the file into smaller files.</p> <p>04: Insufficient space on the RAM disk. Increase the RAM disk size by changing RAM Disk Setting in System Menu.</p> <p> NOTE: The range of RAM disk size can be increased by selecting [Printer Priority] in Main Memory.</p>	9-23
<i>Removable memory error.*</i>	Is writing to a removable memory prohibited?	<p>An error occurred in the removable memory. The job stopped. Press [End].</p> <p>The possible error codes and their descriptions are as follows.</p> <p>01: Connect a removable memory that can be written to.</p>	—
	—	<p>An error occurred in the removable memory. The job stopped. Press [End].</p> <p>The possible error codes and their descriptions are as follows.</p> <p>01: The amount of data that can be saved at once has been exceeded. Restart the system or turn the power OFF/ON. If the error still occurs, the removable memory is not compatible with the machine. Use the removable memory formatted by this machine. If the removable memory cannot be formatted, it is damaged. Connect a compatible removable memory.</p>	7-3

Message	Checkpoints	Corrective Actions	Reference Page
<i>Removable Memory is full.*</i>	—	Job is canceled. Press [End]. Insufficient free space in the removable memory. Delete unnecessary files.	—
<i>Remove originals in the document processor.</i>	Are there any originals left in the document processor?	Remove originals from the document processor.	—
<i>Replace all originals and press [Continue].</i>	—	Remove originals from the document processor, put them back in their original order, and place them again. Press [Continue] to resume printing. Press [Cancel] to cancel the job.	—
<i>Replace MK.</i>	—	Replacement of the parts in the maintenance kit is necessary at every 200,000 pages of printing and requires professional servicing. Contact your Service Representative.	—

* When Auto Error Clear is set to [On], processing resumes automatically after a set amount of time elapses.

S

Message	Checkpoints	Corrective Actions	Reference Page
<i>Scanner memory is full.*</i>	—	Scanning cannot be performed due to insufficient memory of scanner. Only one copy of the scanned pages is available. Press [Continue] to print, send or store the scanned pages. Press [Cancel] to cancel the printing job. The machine may reproduce the same originals by arranging the following settings: -Reduce the number of originals to be scanned at once. Furthermore, the machine may reproduce the same originals by arranging the following settings: - Select [Copy Priority] of Main Memory in System Menu.  NOTE: Before changing the Main Memory setting, contact your administrator.	9-24
<i>Send error.*</i>	—	An error has occurred during transmission. The job is canceled. Press [End]. Refer to <i>Responding to Send Error</i> for the error code and corrective actions.	10-23
<i>Set cassette.</i>	Have the paper width guide and paper length guide been loaded properly?	Load the paper width guide and paper length guide properly so that there is no space between the guides and the paper.	3-3

Message	Checkpoints	Corrective Actions	Reference Page
<i>Staple is empty.*</i>	Has any of the document finisher run out of staples?	If the staples are depleted, the machine will stop and the location of staple depletion will be indicated on the touch panel. Leave the machine on and follow the instruction to replace the staple case. Press [Continue] to print without stapling. Press [Cancel] to cancel the job.	10-5
<i>Staple jam.</i>	—	If a staple jam occurs, the machine will stop and the location of the jam will be indicated on the touch panel. Leave the machine on and follow the instruction to remove the jammed staple.	10-30
<i>System error.</i>	—	System error has occurred. Follow the instructions on the touch panel.	—

* When Auto Error Clear is set to [On], processing resumes automatically after a set amount of time elapses.

T

Message	Checkpoints	Corrective Actions	Reference Page
<i>The cover is open.</i>	Is there any cover which is open?	Close the cover indicated on the touch panel.	—
<i>The manufacturer assumes no responsibility for damage caused by a non-genuine toner.</i>	Is the installed toner container our own brand?	We will not be liable for any damage caused by the use of third party supplies in this machine. If you want to continue, press [Next].	—
<i>The phone receiver is off the hook.</i>	—	Put down the receiver.	—
<i>The print system connected to the current port is not supported by the printer driver. Use a printer driver for this port that matches the print system.</i>	Is the printer driver for this product used?	Check the product name of the machine and reinstall the printer driver.	2-14
<i>The slit glass requires cleaning.</i>	—	Clean the slit glass using the cleaning cloth supplied with the document processor.	10-6
<i>This memory is not formatted.</i>	Is the removable memory formatted by this machine?	Perform [Format] on this machine.	8-11
<i>Toner is empty. [C][M][Y][K]</i>	—	Replace the toner container.  NOTE: If the color toner is empty but the black toner is remained, the machine continues printing in black and white by selecting [Print in Black and White] of Color Toner Empty Action.	10-2
<i>Toner is running out. [C][M][Y][K]</i>	—	It is almost time to replace the toner container. Obtain a new toner container.	—



U

Message	Checkpoints	Corrective Actions	Reference Page
<i>Unknown Toner Installed.</i>	Is the installed toner container our own brand?	We will not be liable for any damage caused by the use of third party supplies in this machine.	10-2
<i>Unknown Toner Installed. PC [C][M][Y][K]</i>	Does the installed toner container's regional specification match the machine's?	Install the specified container.	10-2

W

Message	Checkpoints	Corrective Actions	Reference Page
<i>Warning low memory.</i>	—	Cannot start the job. Try again later.	—

Responding to Send Error

Code	Error	Corrective Actions	Reference Page
1101	<i>Failed to send the e-mail.</i>	Check the host name of the SMTP server on the Command Center RX.	2-26
	<i>Failed to send via FTP.</i>	Check the host name of FTP.	6-23
	<i>Failed to send via SMB.</i>	Check the host name of SMB.	6-23
1102	<i>Failed to send via SMB.</i>	Check the SMB settings. <ul style="list-style-type: none"> • Login user name and login password  NOTE: If the sender is a domain user, specify the domain name. <ul style="list-style-type: none"> • Host name • Path 	6-24
	<i>Failed to send the e-mail.</i>	Check the followings on the Command Center RX. <ul style="list-style-type: none"> • SMTP login user name and login password • POP3 login user name and login password 	2-26
	<i>Failed to send via FTP.</i>	Check the FTP settings. <ul style="list-style-type: none"> • Login user name and login password  NOTE: If the sender is a domain user, specify the domain name. <ul style="list-style-type: none"> • Path • Folder share permissions of the recipient 	6-24
1103	<i>Failed to send via SMB.</i>	Check the SMB settings. <ul style="list-style-type: none"> • Login user name and login password  NOTE: If the sender is a domain user, specify the domain name. <ul style="list-style-type: none"> • Path • Folder share permissions of the recipient 	6-24
	<i>Failed to send via FTP.</i>	Check the FTP settings. <ul style="list-style-type: none"> • Path • Folder share permissions of the recipient 	6-24

Code	Error	Corrective Actions	Reference Page
1104	<i>Failed to send the e-mail.</i>	Check the e-mail address.  NOTE: If the address is rejected by the domain, you cannot send the e-mail.	6-20
1105	<i>Failed to send via SMB.</i>	Select [On] of the SMB settings on the Command Center RX.	2-26
	<i>Failed to send the e-mail.</i>	Select [On] of the SMTP settings on the Command Center RX.	
	<i>Failed to send via FTP.</i>	Select [On] of the FTP settings on the Command Center RX.	
1106	<i>Failed to send the e-mail.</i>	Check the sender address of SMTP on the Command Center RX.	2-26
1131	<i>Failed to send via FTP.</i>	Select [On] of the secure protocol settings on the Command Center RX.	2-26
1132	<i>Failed to send via FTP.</i>	Check the followings of the FTP server. <ul style="list-style-type: none"> • Is FTPS available? • Is the encryption available? 	2-26
2101	<i>Failed to send via SMB.</i>	Check the network and SMB settings. <ul style="list-style-type: none"> • The network cable is connected. • The hub is not operating properly. • The server is not operating properly. • Host name and IP address • Port number 	2-26
	<i>Failed to send via FTP.</i>	Check the network and FTP settings. <ul style="list-style-type: none"> • The network cable is connected. • The hub is not operating properly. • The server is not operating properly. • Host name and IP address • Port number 	
	<i>Failed to send the e-mail.</i>	Check the network and Command Center RX. <ul style="list-style-type: none"> • The network cable is connected. • The hub is not operating properly. • POP3 server name of the POP3 user • SMTP server name 	
2102 2103	<i>Failed to send via FTP.</i>	Check the followings of the FTP server. <ul style="list-style-type: none"> • Is FTP available? • The server is not operating properly. 	—
	<i>Failed to send the e-mail.</i>	Check the network. <ul style="list-style-type: none"> • The network cable is connected. • The hub is not operating properly. • The server is not operating properly. 	
2201 2202 2203 2231	<i>Failed to send the e-mail.</i> <i>Failed to send via FTP.</i> <i>Failed to send via SMB.</i> <i>Failed to send via FTP.</i>	Check the network. <ul style="list-style-type: none"> • The network cable is connected. • The hub is not operating properly. • The server is not operating properly. 	—
2204	<i>Failed to send the e-mail.</i>	Check the e-mail size limit of the SMTP settings on the Command Center RX.	2-26

Code	Error	Corrective Actions	Reference Page
3101	<i>Failed to send the e-mail.</i>	Check the authentication methods of both the sender and the recipient.	—
	<i>Failed to send via FTP.</i>	Check the network. <ul style="list-style-type: none"> • The network cable is connected. • The hub is not operating properly. • The server is not operating properly. 	—
3201	<i>Failed to send the e-mail.</i>	Check the SMTP user authentication method of the recipient.	—
0007 4201 4701 5101 5102 5103 5104 7101 7102 7103 720f	—	Turn the main power switch off and back on. If this error occurs several times, make a note of the displayed error code and contact your service representative.	2-12
9181	—	The scanned original exceeds the acceptable number of pages of 999. Send the excess pages separately.	—

Clearing Paper Jams

If a paper jam occurs, the touch panel will display Paper Jam. and the machine will stop. Refer to these procedures to remove the jammed paper.

How to read the screen

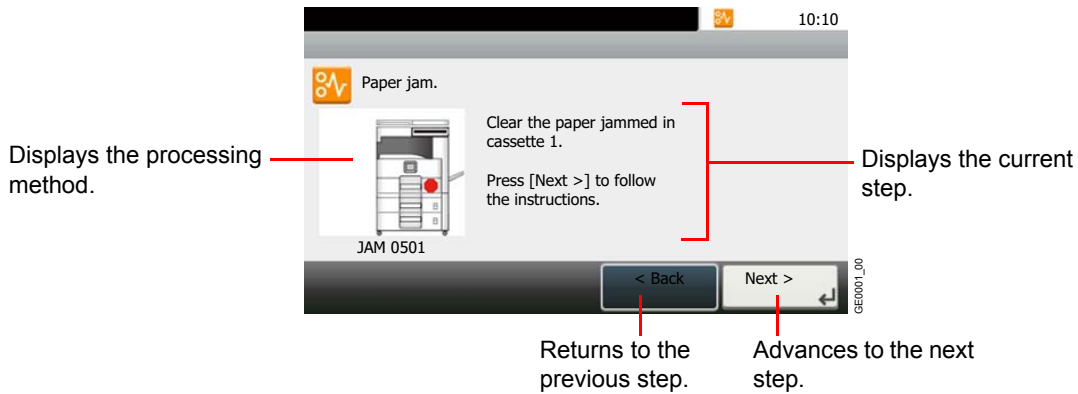

Jam Location Indicators

Detailed paper jam positions are as follows. Refer to the indicated page number to remove the paper jam.

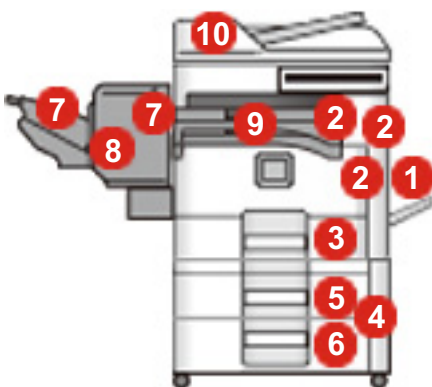

No.	Paper Jam Message	Reference Page
1	Clear the paper jammed in the multi purpose tray.	10-27
2	Clear the paper jammed in right cover 1.	10-27
3	Clear the paper jammed in cassette 1.	10-28
4	Clear the paper jammed in right cover 3.	10-28
5	Clear the paper jammed in cassette 2.	10-29
6	Clear the paper jammed in cassette 3.	
7	Clear the paper jammed in the finisher.	10-29
8	Clear the staple jammed in the finisher.	10-30
9	Clear the paper jammed in the bridge unit.	10-30
10	Clear the paper jammed in the document processor.	10-31

Precautions with Paper Jams

- Do not reuse jammed papers.
- If the paper tears during removal, be sure to remove any loose scraps of paper from inside the machine. Scraps of paper left in the machine could cause subsequent jamming.
- Discard paper that has jammed in the optional document finisher. A page affected by a paper jam will be printed again.

Caution

The fixing unit is extremely hot. Take sufficient care when working in this area, as there is a danger of getting burned.

Multi Purpose Tray

Follow the steps below to clear paper jams in the multi purpose tray.

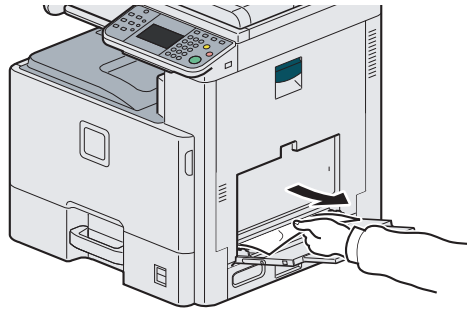

Inside the Right Cover 1

Follow the steps below to clear paper jams inside the right cover 1.

1

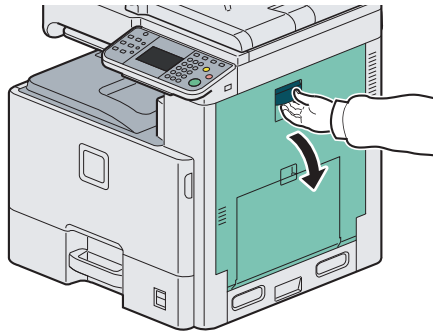

2

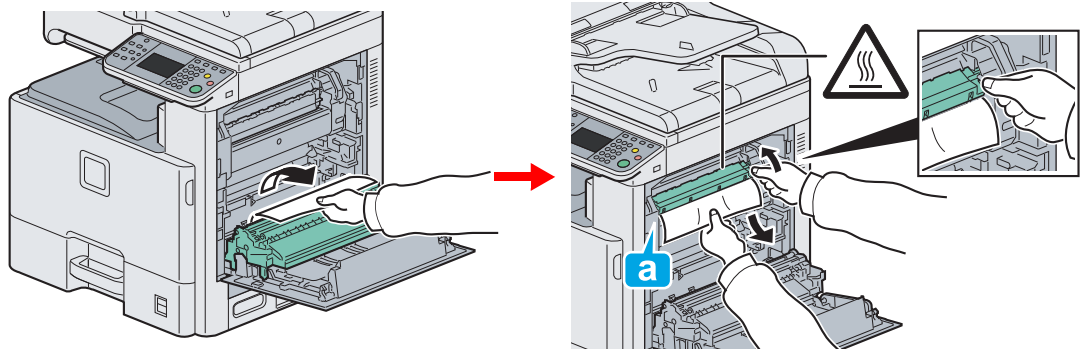

Caution

The fixing unit is extremely hot. Take sufficient care when working in this area, as there is a danger of getting burned.

3

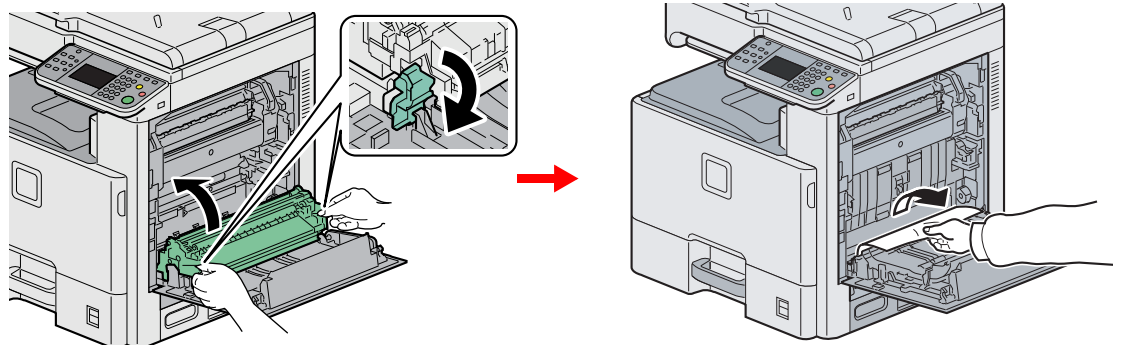

Cassette 1

Follow the steps below to clear paper jams in cassette 1.

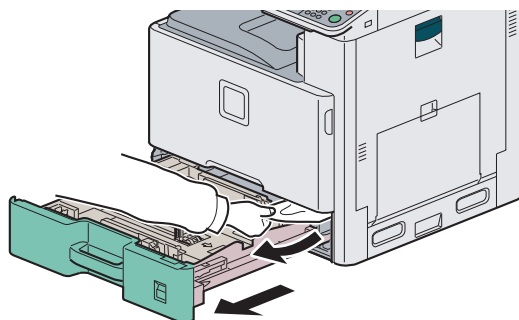

Inside the Right Cover 3

Follow the steps below to clear paper jams inside the right cover 3.

1

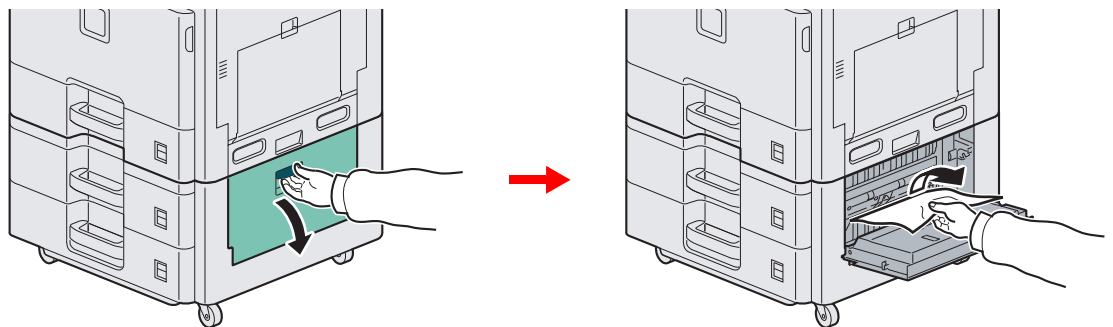

2

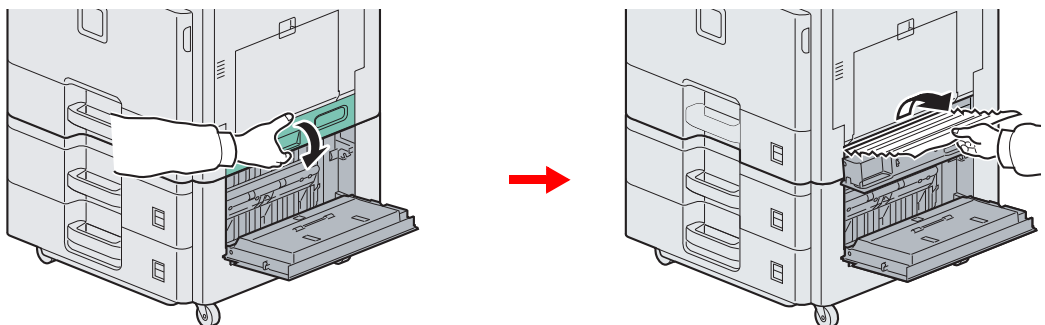

Cassette 2 or 3

Follow the steps below to clear paper jams in cassette 2 or 3.

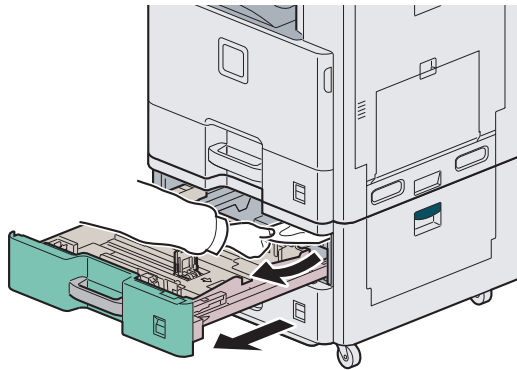

Optional Document Finisher

Follow the steps below to clear paper jams in the optional document finisher.

1

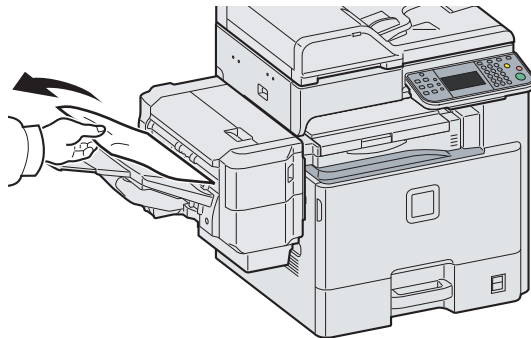

2

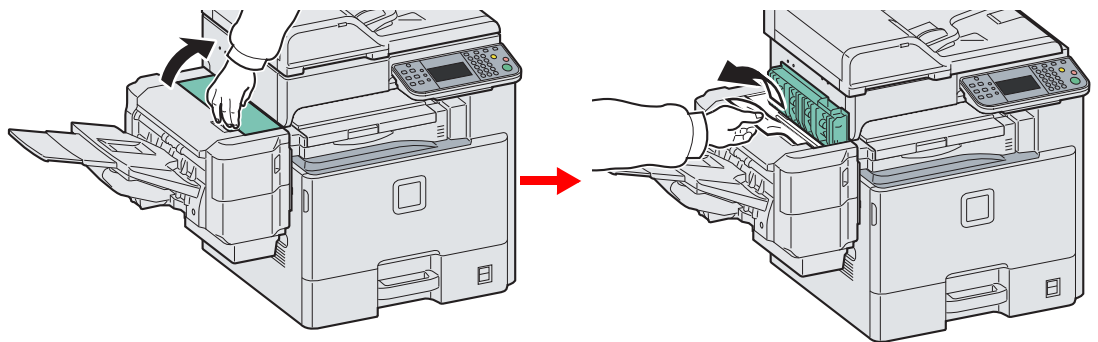

Optional Document Finisher Staple Jam

Follow the steps below to clear staple jams in the optional document finisher.

1

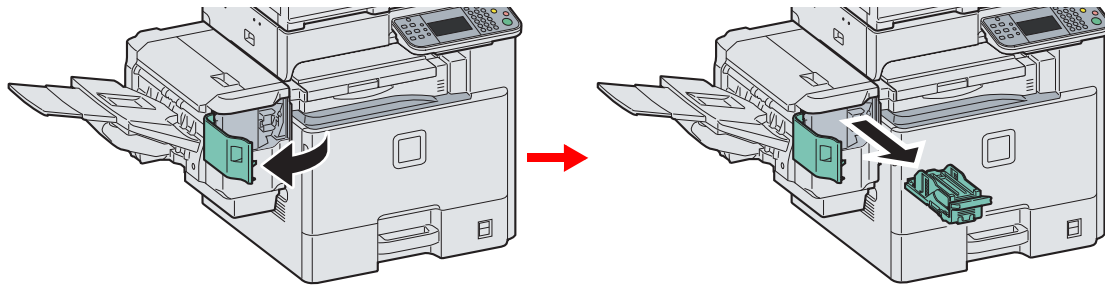

2

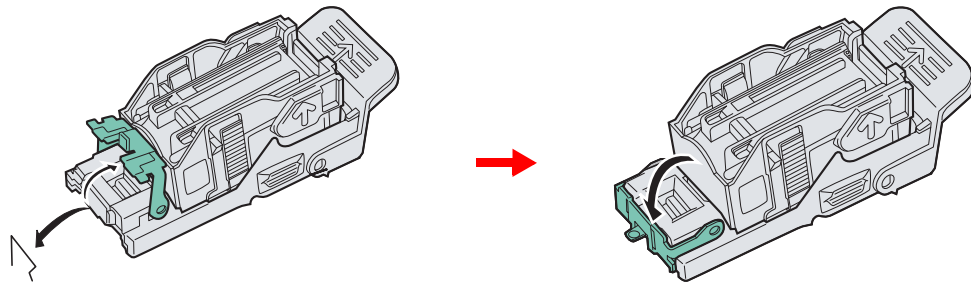

3

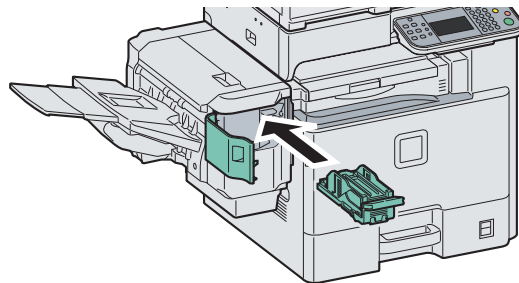

Bridge Unit

Follow the steps below to clear paper jams in the bridge unit.

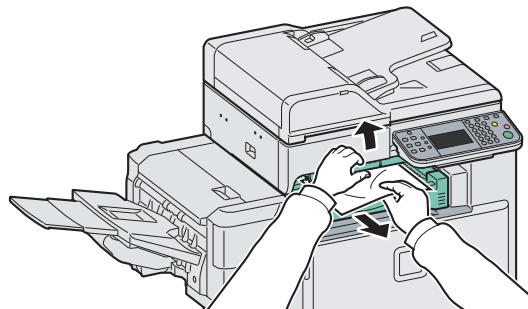

Document Processor

Follow the steps below to clear paper jams in the document processor.

1

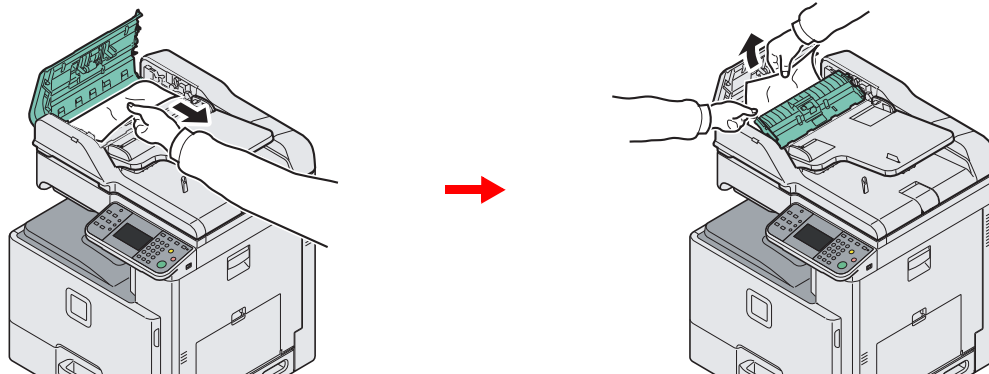

2

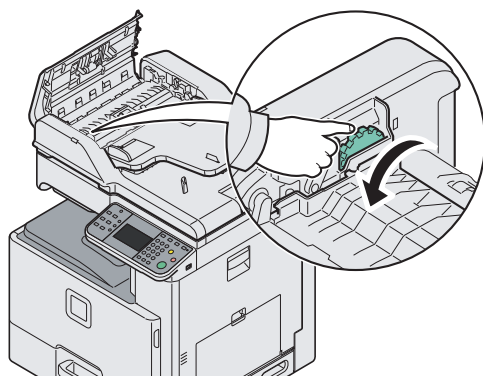

3

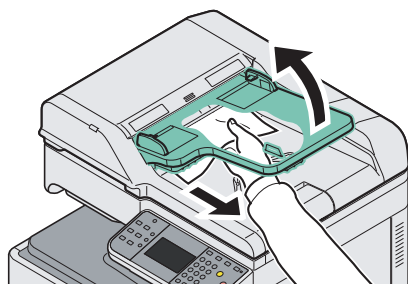

11 Appendix

This chapter explains the following topics:

Optional Equipment	11-2
Overview of Optional Equipment	11-2
PF-470 Paper Feeder (single cassette)	11-3
PF-471 Paper Feeder (double cassette)	11-3
DF-470 Document Finisher	11-3
FAX System (U) FAX Kit	11-3
Expansion Memory	11-3
Card Authentication Kit (B)	11-4
IB-50 Gigabit Ethernet Board	11-5
USB Keyboard	11-5
Optional Function	11-5
Character Entry Method	11-7
Paper	11-10
Basic Paper Specifications	11-11
Choosing the Appropriate Paper	11-11
Special Paper	11-14
Specifications	11-18
Common functions	11-18
Copy functions	11-19
Printer functions	11-20
Scanner	11-20
Document Processor	11-21
Paper Feeder (single cassette) (option)	11-21
Paper Feeder (double cassette) (option)	11-21
Document Finisher (option)	11-22
Environmental Specifications	11-22
Glossary	11-23

Optional Equipment

Overview of Optional Equipment

The following optional equipment is available for the machine.

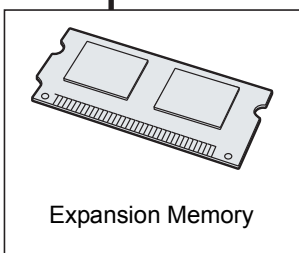
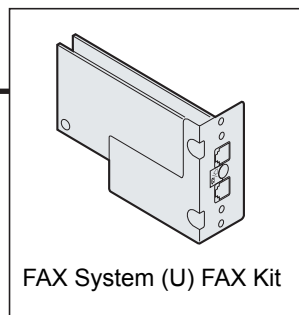
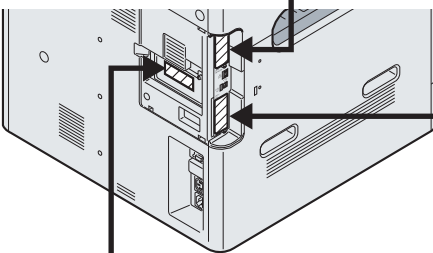
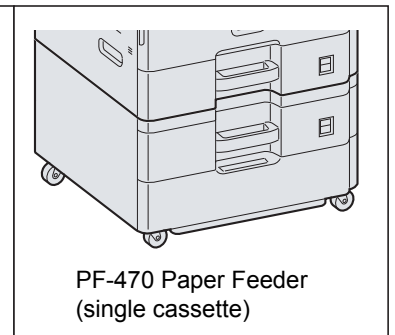
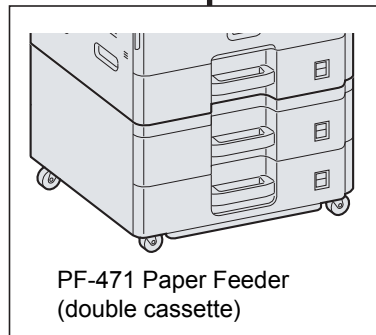
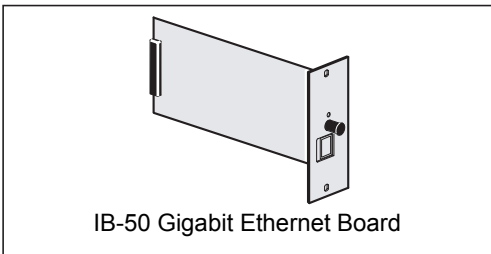
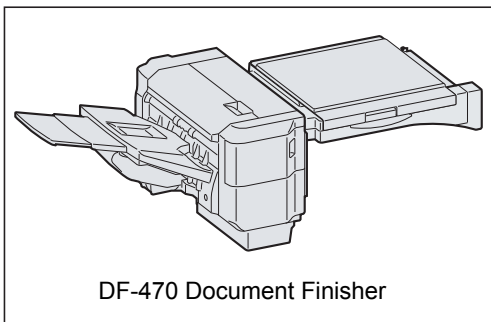
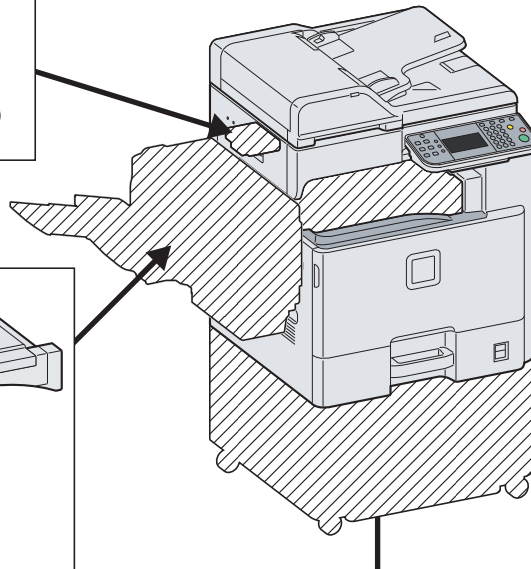
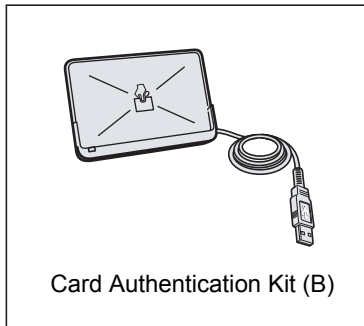

PF-470 Paper Feeder (single cassette)

An additional cassette identical to the machine's cassettes can be installed in the machine. Paper capacity and loading method are the same as Cassettes 1.

PF-471 Paper Feeder (double cassette)

Two additional cassettes identical to the machine's cassettes can be installed in the machine. Paper capacity and loading method are the same as Cassettes 1.

DF-470 Document Finisher

The document finisher holds a large quantity of finished copies. The finisher offers a convenient means of sorting. Sorted finished copies may also be stapled.

FAX System (U) FAX Kit

By installing the FAX kit, fax send/receive is enabled. Also, it is possible to use it as a network fax, by using it with a computer. For further details, refer to *Fax Kit Operation Guide*.

Expansion Memory

To expand the printer memory for more complex print jobs and faster print speed, you can plug in optional memory module (dual in line memory module) in the memory slot provided on the main controller board. You can select additional memory module from 1024 MB. The maximum memory size is 2048 MB.

Precautions for Handling the Memory Module

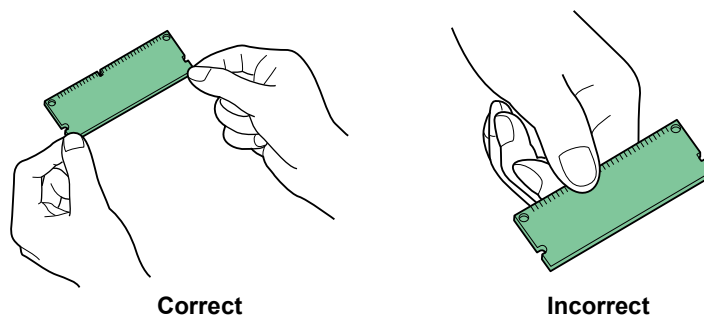

To protect electronic parts, discharge static electricity from your body by touching a water pipe (faucet) or other large metal object before handling the memory module. Or, wear an antistatic wrist strap, if possible, when you install the memory module.

Replacing the Memory Module

1 Power off.

Turn off the machine and disconnect the power cord and interface cable.

2 Remove the covers.

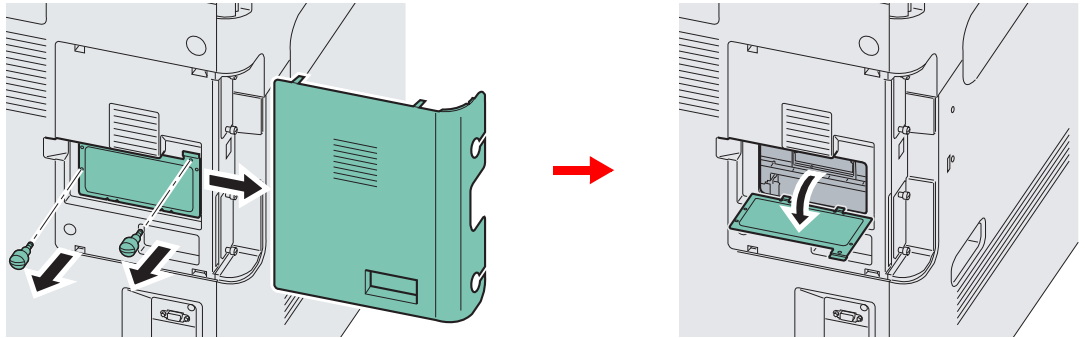

3 Replace the memory module.

- 1 Carefully push the two socket clamps straight up out of the socket, and remove the memory module.
- 2 Remove the memory module from its package.
- 3 With the memory connection terminal pointing toward the socket, align the cut-out part with the socket terminal and insert directly in at an angle.

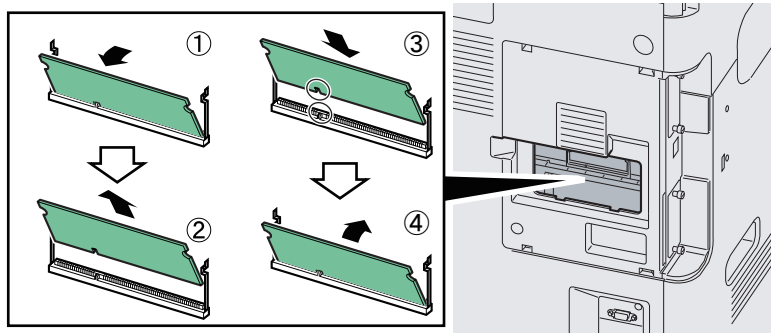

✓ IMPORTANT

Before inserting a memory module in the machine, make sure that the machine is switched off.

- 4 Carefully press the inserted memory down and into the machine.
- 5 Reinstall the covers.

Removing the Memory Module

To remove a memory module, remove the right cover and the memory slot cover from the machine. Then, carefully push out the two socket clamps. Ease the memory module out of the socket to remove.

Verifying the Expanded Memory

If not correctly installed, the error message "Machine failure" will appear. Re-install. To verify that the memory module is working properly, test it by printing a status page.



Refer to *Report* on page 9-5.

Card Authentication Kit (B)

User login administration can be performed using IC cards. To do so, it is necessary to register IC card information on the previously registered local user list. For more information about how to register this information, refer to the *IC Card Authentication Kit Operation Guide*.

IB-50 Gigabit Ethernet Board

The Gigabit Ethernet Board provides a high-speed connection for the Gigabit-per-second interface. Since the kit was designed to work with TCP/IP and NetBEUI protocols, in the same way as the main unit, it fulfills the network printing demands on Windows, Macintosh, and UNIX environments. This expansion kit is also compatible with ThinPrint.

USB Keyboard

A USB keyboard can be used to enter information into the text fields on the operation panel. Please contact your dealer or service representative for information on keyboards that are compatible with your MFP before you purchase one.

Optional Function

You can use the optional applications installed on this machine.

Overview of the Applications

The applications listed below are installed on this machine. You can use these applications for a limited period on a trial basis.

UG-33 (ThinPrint) (This application can only be activated in Europe.)

This application allows print data to be printed directly without a print driver.

NOTE
Restrictions such as the number of times the application can be used during the trial period differ depending on the application.

Starting Application Use

Use the procedure below to start using an application.

NOTE
If user login administration is disabled, the user authentication screen appears. Enter your login user name and password and then press [Login]. For this, you need to login with administrator privileges. The factory default login user name and login password are set as shown below.

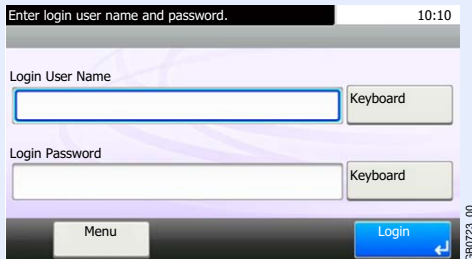

Model Name	Login User Name	Login Password
FS-C8520MFP	2000	2000
FS-C8525MFP	2500	2500

1 Display the screen.

* System Menu / Counter



1

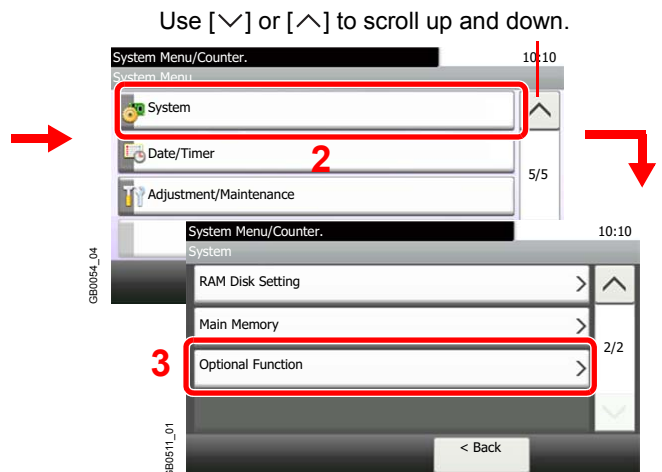

2 Start using an application.

- 1 Select the desired application and press [Activate].

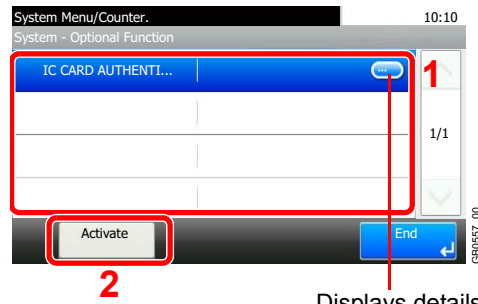

Displays details for individual applications.

- 2 Select [Official] and enter the license key using the numeric keys.

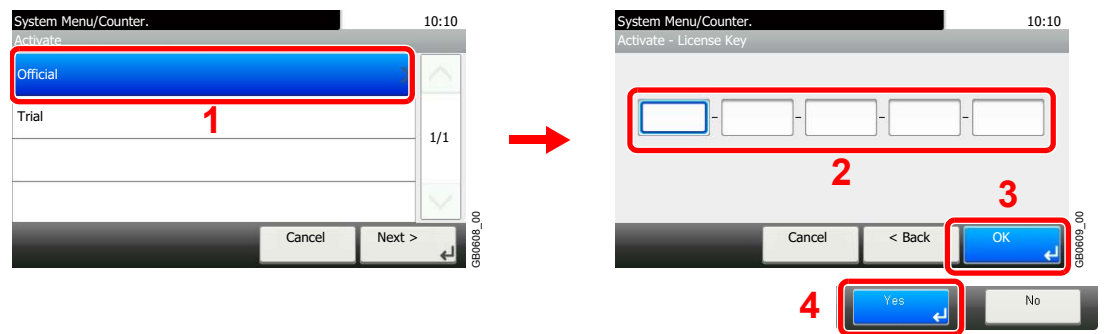

Some applications do not require you to enter a license key.

To use the application as a trial, select [Trial].



IMPORTANT

If you change the date/time while using the trial version of an application, you will no longer be able to use the application.

Character Entry Method

To enter characters for a name, use the on-display keyboard in the touch panel following the steps as explained below.

NOTE

QWERTY, QWERTZ and AZERTY are available as keyboard layouts the same as a PC keyboard. Press the **System Menu/Counter** key, [Common Settings] and then [Keyboard Layout] to choose desired layout. QWERTY layout is used here as an example. You may use another layout following the same steps.

Entry Screens

Lower-case Letter Entry Screen

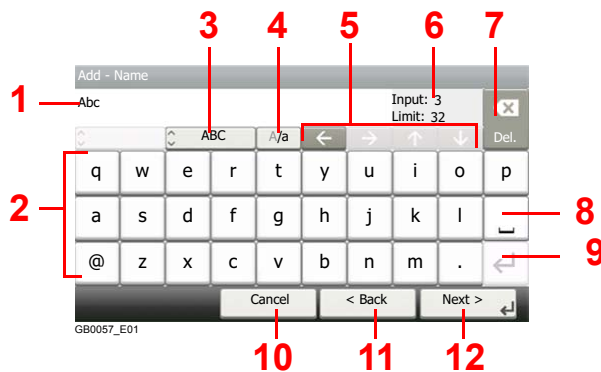

No.	Display/Key	Description
1	Display	Displays entered characters.
2	Keyboard	Press the character to enter.
3	[ABC] / [Symbol]	Select the characters that are entered. To enter symbols or numbers, select [Symbol].
4	[A/a]	Press to switch between upper case and lower case.
5	Cursor Key	Press to move the cursor on the display.
6	[Input] / [Limit] Display	Displays maximum number of characters and the number of characters entered.
7	Delete Key	Press to delete a character to the left of the cursor.
8	Space Key	Press to insert a space.
9	Enter Key	Press to enter a line break.
10	[Cancel]	Press to cancel entered characters and return to the screen before the entry was made.
11	[< Back]	Press to return to the previous screen.
12	[OK] / [Next >]	Press to save the entered characters and move to the next screen.

Upper-case Letter Entry Screen

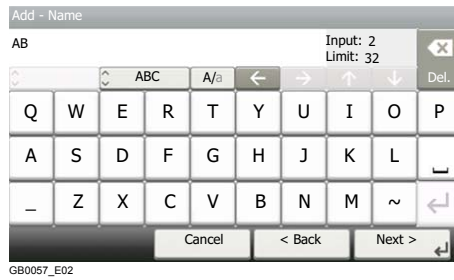

Number/Symbol Entry Screen

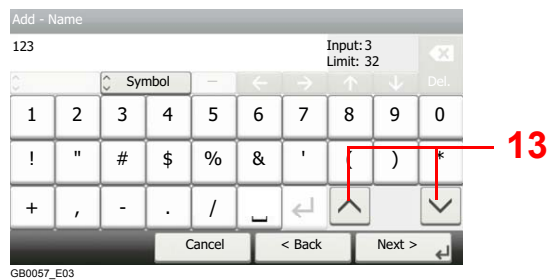

No.	Display/Key	Description
13	[▲]/[▼]	To enter a number or symbol not shown in the keyboard, press the cursor key and scroll the screen to view other numbers or symbols to enter.

Entering Characters

Follow the steps below to enter 'List A-1' for an example.

1 Enter 'List', (space).

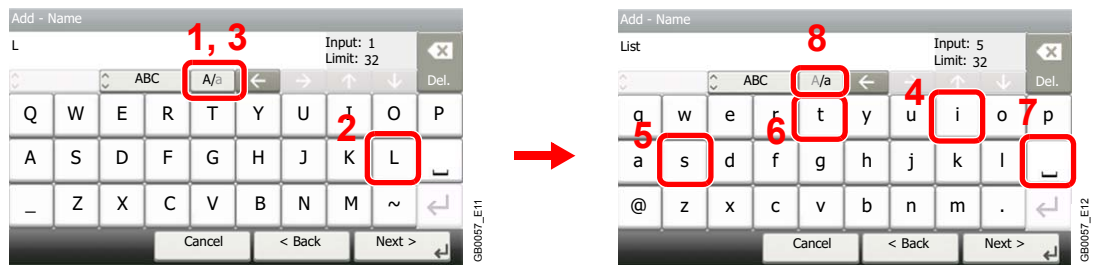

To shift from lower case to upper case letters, press [a/A]. To shift from upper case to lower case letters, press [A/a].

2 Enter 'A-1'.

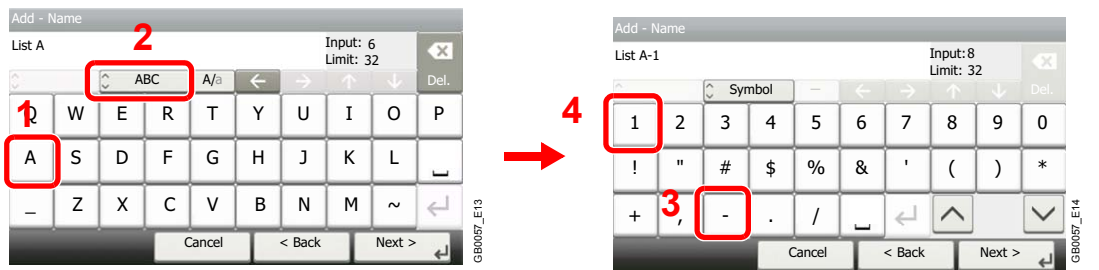

To enter numbers or symbols, press [ABC] to display [Symbol].

3 Register the characters you entered.

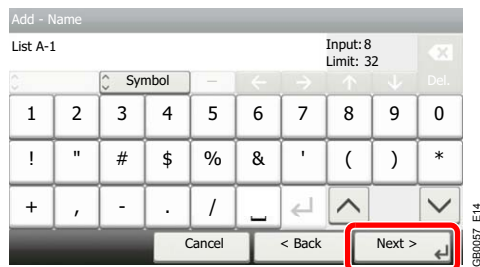

Press [Next>]. The entered characters are registered.

Paper

This section explains the paper that can be used in the paper source.

 For the media type that can be used in the paper source, refer to *Media Type Setting on page 9-11*.

Cassettes

Supported paper sizes	No. of sheets
Ledger, Letter-R, Letter, Legal, Statement-R, Oficio II, A3, A4-R, A4, A5-R, B4, B5-R, B5, Folio, 216 × 340 mm, 8K, 16K-R, 16K	500 (80 g/m ²)

Multi Purpose tray

Supported paper sizes	No. of sheets
Letter-R, Letter, Statement-R, Executive, A4-R, A4, A5-R, A6-R, B5-R, B5, B6-R, Folio, 16K-R, 16K (A4/Letter or smaller paper)	100 (80 g/m ²)
Ledger, Legal, Oficio II, A3, B4, 216 × 340 mm, 8K (Paper larger than A4/Letter)	25 (80 g/m ²)
Postcards (100 × 148 mm)	20
Envelope DL, Envelope C5, Envelope C4, Envelope #10 (Commercial #10), Envelope #9 (Commercial #9), Envelope #6 (Commercial #6 3/4), Monarch, ISO B5, Youkei 2, Youkei 4	5

Basic Paper Specifications

This machine is designed to print on standard copy paper as used in regular ('dry') copiers and page printers such as laser printers. It also supports a variety of other types of paper that conform to the specifications given in this appendix.

Be careful when choosing paper. Paper unsuitable for the machine may cause jams or may be wrinkled.

Supported Paper

Use standard copy paper for regular copiers or laser printers. The printing quality will be affected by the quality of paper. Poor quality paper may result in unsatisfactory output.

Basic Paper Specifications

The following table lists the specifications of paper that is supported with this machine. Refer to the subsequent sections for further details.

Criteria	Specifications
Weight	Cassettes: 52 to 256 g/m ²
	Multi purpose tray: 52 to 256 g/m ²
Thickness	0.086 to 0.230 mm
Dimensional accuracy	±0.7 mm
Squareness of corners	90°±0.2°
Moisture content	4 to 6%
Grain direction	Long grain (paper supply direction)
Pulp content	80% or more



NOTE

Some recycled paper does not meet requirements for use with this machine as listed in the Basic Paper Specifications shown below, such as moisture or pulp content. For this reason, we recommend purchasing a small amount of recycled paper as a sample for testing prior to use. Choose recycled paper that gives the best printing results and contains low levels of paper dust.

We are not responsible for the problems occurred from the use of paper that does not conform to our specifications.

Choosing the Appropriate Paper

This section describes guidelines for choosing paper.

Condition

Avoid using paper with bent corners or that is curled, dirty, or torn. Do not use paper that has a rough surface or paper fiber lint, or that is especially delicate. Use of paper in any of these conditions will not only deliver poor copies but may also cause jams and shorten the useful life of the machine. Choose paper with a smooth and even surface; however, avoid coated paper or paper with a treated surface as it may damage the drum or fusing unit.

Ingredient

Do not use paper such as paper that has been coated or surface-treated or paper that contains plastic or carbon. These paper may produce harmful fumes from the heat of printing and may damage the drum.

Be sure to use the standard paper that contains at least 80% pulp, i.e., not more than 20% of the total paper content consists of cotton or other fibers.

Supported Paper Sizes

Paper of the following sizes is supported by the machine.

Measurements in the table take into account a ± 0.7 mm dimensional accuracy for length and width. Corner angles must be $90^\circ \pm 0.2^\circ$.

Multi Purpose Tray	Cassette or Multi Purpose Tray
A6-R (105 × 148 mm)	A3 (297 × 420 mm)
B6-R (128 × 182 mm)	B4 (257 × 364 mm)
Hagaki (100×148mm)	A4 (297 × 210 mm)
Oufukuhagaki (148 × 200 mm)	A4-R (210 × 297 mm)
Executive (7 1/4 × 10 1/2")	B5 (257 × 182 mm)
Envelope DL (110 × 220 mm)	B5-R (182 × 257 mm)
Envelope C5 (162 × 229mm)	A5-R (148 × 210 mm)
Envelope C4 (229 × 324mm)	Folio (210 × 330 mm)
ISO B5 (176 × 250 mm)	Ledger
Envelope #10 (Commercial #10) (4 1/8 × 9 1/2")	Legal
Envelope #9 (Commercial #9) (3 7/8 × 8 7/8")	Letter
Envelope #6 (Commercial #6 3/4) (3 5/8 × 6 1/2")	Letter-R
Envelope Monarch (3 7/8 × 7 1/2")	Statement-R
Youkei 2 (114 × 162 mm)	Oficio II
Youkei 4 (105 × 235 mm)	216 × 340 mm
Size Entry (98 × 148 to 297 × 432 mm)	8K (273 × 394 mm)
	16K (273 × 197 mm)
	16K-R (197 × 273 mm)

Smoothness

The paper surface should be smooth, but it must be uncoated. With paper that is too smooth and slippery, several sheets may accidentally be supplied at once, causing jams.

Basis Weight

In countries that use the metric system, basis weight is the weight in grams of one sheet of paper one square meter in area. In the United States, basis weight is the weight in pounds of one ream (500 sheets) of paper cut to the standard size (or trade size) for a specific grade of paper. Paper that is too heavy or too light may be supplied incorrectly or cause paper jams, which may cause excessive wear of the machine. Mixed paper weight (i.e., thickness) may cause several sheets to be supplied at once accidentally and may also cause blurring or other printing problems if the toner fails to adhere correctly.

Thickness

Avoid using paper that is too thick or thin. Signs that paper may be thin include frequent problems with paper jams or with several sheets being supplied at once. Paper jams may also indicate that the paper is too thick. The proper thickness is between 0.086 and 0.230 mm.

Moisture Content

Paper moisture content is the ratio of moisture to dryness expressed as a percentage. Moisture affects how the paper is supplied, the electrostatic changeability of the paper, and how the toner adheres.

Paper moisture content varies depending on the relative humidity in the room. High relative humidity causes paper to become damp, making the edges expand so it appears wavy. Low relative humidity causes paper to lose moisture, making the edges tighten and weakening print contrast.

Wavy or tight edges may cause the paper to slip when it is supplied. Try to keep the moisture content between 4 to 6%.

To maintain the right level of moisture content, bear in mind the following considerations.

- Store paper in a cool, well-ventilated place.
- Store paper flat and unopened in the package. Once the package is opened, reseal it if the paper is not to be used for a while.
- Store paper sealed in the original package and box. Put a pallet under the carton to keep it raised above the floor. Especially during rainy seasons keep the paper a sufficient distance away from wooden or concrete floors.
- Before using paper that has been stored, keep it at the proper moisture level for at least 48 hours.
- Do not store paper where it is exposed to heat, sunlight, or dampness.

Other Paper Specifications

Porosity: The density of the paper fibers

Stiffness: Paper must be stiff enough or it may buckle in the machine, causing jams.

Curl: Most paper naturally tends to curl after the package is opened. When paper passes through the fixing unit, it curls upward slightly. To deliver flat printouts, load the paper so that the curl faces towards the bottom of the paper tray.

Static electricity: During printing, paper is electrostatically charged so that the toner adheres. Choose paper that can be discharged quickly so that copies do not cling together.

Whiteness: Paper whiteness affects print contrast. Use whiter paper for sharper, brighter copies.

Quality: Machine problems may occur if sheet sizes are not uniform or if corners are not square, edges are rough, sheets are uncut, or edges or corners are crushed. In order to prevent these problems, be especially careful when you cut the paper yourself.

Packaging: Choose paper that is properly packaged and stacked in boxes. Ideally, the packaging itself should have been treated with a coating to inhibit moisture.

Specially treated paper: We do not recommend printing onto the following types of paper, even if it conforms to the basic specifications. When you use these kinds of paper, purchase a small amount first as a sample to test.

- Glossy paper
- Watermarked paper
- Paper with an uneven surface
- Perforated paper

Special Paper

This section describes printing onto special paper and print media.

The following paper and media can be used.

- Transparencies
- Preprinted paper
- Bond paper
- Recycled paper
- Thin paper (from 52 g/m² to 64 g/m² or less)
- Letterhead
- Colored paper
- Prepunched paper
- Envelopes
- Cardstocks (Hagaki)
- Thick paper (from 106 g/m² to 256 g/m² or less)
- Labels
- Coated paper
- High-quality paper

When using these paper and media, choose that are designed specifically for copiers or page printers (such as laser printers). Use the multi purpose tray for transparencies, thick paper, envelopes, cardstocks, and labels.

Choosing Special Paper

Although special paper that meets the following requirements can be used with the machine, print quality will vary considerably due to differences in the construction and quality of special paper. Thus, special paper is more likely than regular paper to cause printing problems. Before purchasing special paper in volume, try testing a sample to ensure the print quality is satisfactory. General precautions when printing onto special paper are given below. Note that we are not responsible for any harm to the user or damage to the machine caused by moisture or specifications of special paper.

Select a cassette or multi purpose tray for special paper.

Transparencies

Transparencies must be able to withstand the heat of printing. Transparencies must meet the following conditions.

Heat resistance	Must withstand at least 190°C
Thickness	0.100 to 0.110 mm
Material	Polyester
Dimensional accuracy	±0.7 mm
Squareness of corners	90° ±0.2°

To avoid problems, use the multi purpose tray for transparencies and load transparencies with the long side facing the machine.

If transparencies jam frequently at output, try pulling the leading edge of sheets gently as they are ejected.

Label

Be sure to feed labels from the multi purpose tray.

For selecting labels, use extreme care so that the adhesive may not come in direct contact with any part of the machine and that the labels are not easily peeled from the carrier sheet. Adhesives that stick to the drum or rollers and peeled labels remaining in the machine may cause a failure.

When printing onto labels, you must be liable for the print quality and possible trouble.

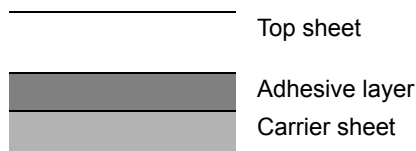

Labels consist of three layers as shown in the illustration. The adhesive layer contains materials that are easily affected by the force applied in the machine. The carrier sheet bears the top sheet until the label is used. This composition of labels may cause more problems.

The label surface must be covered completely with the top sheet. Gaps between labels may cause peeling of labels, resulting in a serious failure.

Some label paper has large margins on the top sheet. When using such paper, do not peel these margins from the carrier sheet before completing output.

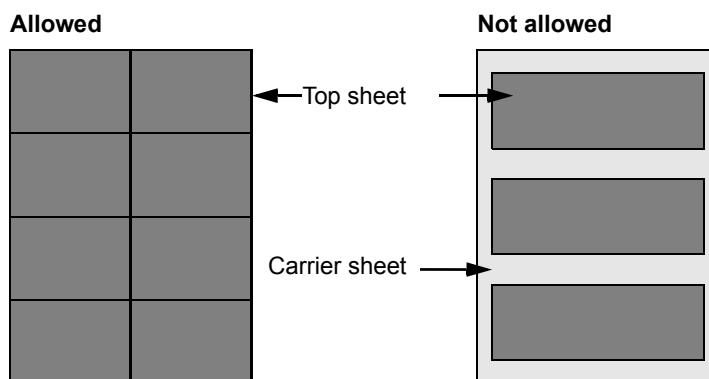

Use label paper that conforms to the following specifications.

Top sheet weight	44 to 74 g/m ²
Basis weight (overall paper weight)	104 to 151 g/m ²
Top sheet thickness	0.086 to 0.107 mm
Overall paper thickness	0.115 to 0.160 mm
Moisture content	4 to 6 % (composite)

Hagaki

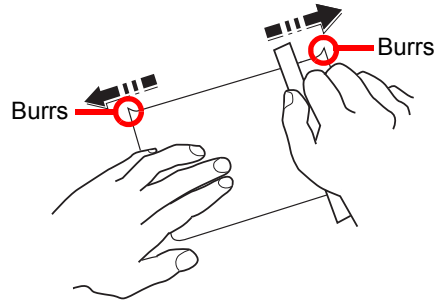

Before loading Hagaki into the multi purpose tray, fan them and align the edges. If the Hagaki paper is curled, straighten it before loading. Printing onto curled Hagaki may cause jams.

Use unfolded Oufukuhagaki (available at post offices). Some Hagaki may still have rough edges developed by a paper cutter on the back side. Remove any such rough edges by placing the Hagaki on a flat surface and rubbing the edges gently a few times with a ruler.

Envelopes

Use the multi purpose tray for envelopes.

Due to the structure of envelopes, printing evenly over the entire surface may not be possible in some cases. Thin envelopes in particular may be wrinkled by the machine in some cases as they pass through. Before purchasing envelopes in volume, try testing a sample to ensure the print quality.

Storing envelopes for a long period may cause them to become wrinkled. Thus, keep the package sealed until you are ready to use them.

Keep the following points in mind.

- Do not use envelopes with exposed adhesive. In addition, do not use the type of envelope in which the adhesive is exposed after the top layer is peeled off. Serious damage may be caused if the paper covering the adhesive comes off in the machine.
- Do not use envelopes with certain special features. For example, do not use envelopes with a grommet for winding a string to close the flap or envelopes with an open or film-covered window.
- If paper jams occur, load fewer envelopes at once.

Thick Paper

Before loading thick paper in the multi purpose tray, fan it and align the edges. Some thick paper may still have rough edges developed by a paper cutter on the back side. Remove any such rough edges just as with Hagaki by placing the paper on a flat surface and rubbing the edges gently a few times with a ruler. Printing onto paper with rough edges may cause jams



NOTE

If the paper is not supplied correctly even after it is smoothed, load the paper in the multi purpose tray with the leading edge raised a few millimeters.

Colored Paper

Colored paper must conform to the specifications listed on the page 11-11. In addition, the pigments in the paper must be able to withstand the heat of printing (up to 200°C or 392°F).

Preprinted Paper

Preprinted paper must conform to the specifications listed on the page 11-11. The colored ink must be able to withstand the heat of printing. It must be resistant to silicone oil as well. Do not use paper with a treated surface such as glossy paper used for calendars.

Recycled Paper

Recycled paper must conform to the specifications listed on the page 11-11; however, its whiteness may be considered separately.



NOTE

Before purchasing recycled paper in volume, try testing a sample to ensure that the print quality.

Coated Paper

Coated paper is created by treating the surface of the base paper with a coating that provides higher printing quality than plain paper. Coated paper is used for particularly high quality printing.

The surface of high-quality or medium-quality paper is coated with special agents that improve ink adhesion by making the paper surface smoother. These agents are used either to coat both sides of the paper or just one side. The coated side appears slightly glossy.



IMPORTANT

When printing on coated paper in very humid environments, ensure that the paper is kept dry as moisture may cause sheets to stick together when they are fed into the machine. If printing in very humid environments, set coated paper for one sheet each.

Specifications



IMPORTANT

Specifications are subject to change without notice.

Common functions

Item		Description	
		FS-C8520MFP	FS-C8525MFP
Type		Desktop	
Printing Method		Electrophotographic four color (CMYK) printing using tandem (4) drum system	
Image Write System		Semiconductor laser and electrophotography	
Paper Weight	Cassette	52 to 256 g/m ²	
	Multi Purpose Tray	52 to 256 g/m ²	
Media Type	Cassette	Plain, Rough, Vellum, Recycled, Preprinted, Bond, Color, Prepunched, Letterhead, Thick, High Quality, Custom 1 to 8 (Duplex: Same as Simplex)	
	Multi Purpose Tray	Plain, Transparency (OHP film), Rough, Vellum, Labels, Recycled, Preprinted, Bond, Cardstock, Color, Prepunched, Letterhead, Thick, Envelope, Coated, High Quality, Custom 1 to 8	
Paper Size	Cassette	Ledger, Letter-R, Letter, Legal, Statement-R, Oficio II, A3, A4-R, A4, A5-R, B4, B5-R, B5, Folio, 216 × 340 mm, 8K, 16K-R, 16K	
	Multi Purpose Tray	Maximum: Ledger/A3 Minimum: Statement-R/A6-R	
Paper Capacity	Cassette	500 sheets (80 g/m ²)	
	Multi Purpose Tray	100 sheets (80 g/m ² , Letter/A4 or less), 25 sheets (80 g/m ² , more than Letter/A4)	
Output Tray Capacity	Inner Tray	250 sheets (80 g/m ²)	
	Job Separator Tray	30 sheets (80 g/m ²)	
Main Memory	Standard	1.5 GB	
	Maximum	2 GB	
Interface	Standard	USB Interface Connector: 1 (USB Hi-Speed) USB memory slot: 2 (USB Hi-Speed) Network interface: 1 (10 BASE-T/100 BASE-TX/1000 BASE-T)	
	Option	eKUIO: 2	
Operating Environment	Temperature	10 to 32.5°C/50 to 90.5°F	
	Humidity	15 to 80 %	
	Altitude	2,500 m/8,202 ft maximum	
	Brightness	1,500 lux maximum	
Warm-up Time (22°C/71.6°F, 60%)	Power on	55 seconds or less	45 seconds or less
	Sleep	23 seconds or less	
Dimension (W × D × H)		23-1/4×23-1/4×29-7/16", 590×590×748 mm	

Item	Description	
	FS-C8520MFP	FS-C8525MFP
Weight (with toner container)	Approx. 176 lb/Approx. 80 kg	
Space Required (W × D)	34-7/16×23-1/4", 874×590 mm (Using multi purpose tray)	
Power Source	120 V Specification Model: 120 V (60 Hz, 12 A) 230 V Specification Model: 220 to 240V (50 Hz/ 60 Hz, 7.2 A)	
Options	Paper feeder (single cassette), Paper feeder (double cassette), Document finisher, FAX kit, Expansion memory, Card Authentication Kit, Gigabit Ethernet Board, USB keyboard	

Copy functions

Item	Description				
	FS-C8520MFP		FS-C8525MFP		
Max.Copy Speed	Full color	Black and White	Full color	Black and White	
	Letter/A4	20 sheets/min	20 sheets/min	25 sheets/min	25 sheets/min
	Letter-R/A4-R	14 sheets/min	14 sheets/min	17 sheets/min	17 sheets/min
	Ledger/A3	8 sheets/min	10 sheets/min	9 sheets/min	13 sheets/min
	Legal/B4	9 sheets/min	10 sheets/min	10 sheets/min	13 sheets/min
	B5	20 sheets/min	20 sheets/min	25 sheets/min	25 sheets/min
	B5-R	14 sheets/min	14 sheets/min	17 sheets/min	17 sheets/min
	A5-R	10 sheets/min	10 sheets/min	13 sheets/min	13 sheets/min
First Print Time (A4, feed from Cassette)	Full color: 13.6 seconds or less, Black and White: 11.7 seconds or less				
Zoom Level	Manual mode: 25 to 400%, 1% increments Auto mode: Preset Zoom				
Continuous Copying	1 to 999 sheets				
Resolution	600×600 dpi				
Supported Original Types	Sheet, Book, 3-dimensional objects (maximum original size: Ledger/A3)				
Original Feed System	Fixed				

Printer functions

Item	Description			
	FS-C8520MFP		FS-C8525MFP	
Printing Speed	Full color	Black and White	Full color	Black and White
	Letter/A4	20 sheets/min	20 sheets/min	25 sheets/min
	Letter-R/A4-R	14 sheets/min	14 sheets/min	17 sheets/min
	Ledger/A3	10 sheets/min	10 sheets/min	13 sheets/min
	Legal/B4	10 sheets/min	10 sheets/min	13 sheets/min
	B5	20 sheets/min	20 sheets/min	25 sheets/min
	B5-R	14 sheets/min	14 sheets/min	17 sheets/min
	A5-R	10 sheets/min	10 sheets/min	13 sheets/min
First Print Time (A4, feed from Cassette)	Full color: 14.0 seconds or less, Black and White: 11.0 seconds or less		Full color: 12.0 seconds or less, Black and White: 10.0 seconds or less	
Resolution	600×600 dpi			
Operating System	Windows XP, Windows Server 2003, Windows Vista, Windows 7, Windows Server 2008, Apple Macintosh OS X			
Page Description Language	PRESCRIBE			
Emulations	PCL6 (PCL5c, PCL-XL), KPDL3 (PostScript 3 compatible)			

Scanner

Item	Description	
System requirements	CPU: 600 Mhz or higher RAM: 128 MB or more	
Resolution	600 dpi, 400 dpi, 300 dpi, 200 dpi, 200×100 dpi, 200×400 dpi (Resolution in FAX mode included)	
File Format	TIFF (JPEG6.0, tn2), JPEG, XPS, PDF (1.4, /A)	
Scanning Speed*	(A4 landscape, 300 dpi, Image quality: Text/Photo original) 1-sided B/W 40 Images/min, Color 40 Images/min	
Network Protocol	TCP/IP	
Transmission System	PC transmission	SMB: Scan to SMB
		FTP: Scan to FTP, FTP over SSL
	E-mail transmission	SMTP: Scan to E-mail
	TWAIN scan**	
WIA scan***		

* When using the document processor (except TWAIN and WIA scanning)

** Available Operating System: Windows XP, Windows Server 2003, Windows Vista, Windows 7, Windows Server 2008

*** Available Operating System: Windows Vista, Windows 7, Windows Server 2008

Document Processor

Item	Description
Original Feed Method	Automatic feed
Supported Original Types	Sheet originals
Paper Size	Maximum: Ledger/A3, Minimum: Statement-R/A5-R
Paper Weight	45 to 160 g/m ² (duplex: 50 to 120 g/m ²)
Loading Capacity	50 sheets (50 to 80 g/m ²) maximum Mixed original sizes (auto selection): 30 sheets (50 to 80 g/m ²) maximum
Dimensions (W) × (D) × (H)	23-1/4×19-1/4×4-7/8" 590×489×123 mm
Weight	Approx. 15.4 lb or less/Approx. 7 kg or less

Paper Feeder (single cassette) (option)

Item	Description	
Paper Supply Method	Friction Feed (No. Sheets: 500, 80 g/m ² , 1 cassette)	
Paper Size	Ledger, Letter-R, Letter, Legal, Statement-R, Oficio II, A3, A4-R, A4, A5-R, B4, B5-R, B5, Folio, 216 × 340 mm, 8K, 16K-R, 16K	
Supported Paper	Paper weight	52 - 256 g/m ²
	Media types	Plain, Rough, Vellum, Recycled, Preprinted, Bond, Color, Prepunched, Letterhead, Thick, High Quality, Custom 1 to 8 (Duplex: Same as Simplex)
Dimensions (W) × (D) × (H)	23-1/4×23-3/16×13-7/8" 590×589×352 mm	
Weight	Approx. 46 lb/ Approx. 21 kg	

Paper Feeder (double cassette) (option)

Item	Description	
Paper Supply Method	Friction Feed (No. Sheets: 500, 80 g/m ² , 2 cassette)	
Paper Size	Ledger, Letter-R, Letter, Legal, Statement-R, Oficio II, A3, A4-R, A4, A5-R, B4, B5-R, B5, Folio, 216 × 340 mm, 8K, 16K-R, 16K	
Supported Paper	Paper weight	52 - 256 g/m ²
	Media types	Plain, Rough, Vellum, Recycled, Preprinted, Bond, Color, Prepunched, Letterhead, Thick, High Quality, Custom 1 to 8 (Duplex: Same as Simplex)
Dimensions (W) × (D) × (H)	23-1/4×23-3/16×13-7/8" 590×589×352 mm	
Weight	Approx. 46 lb/ Approx. 21 kg	

Document Finisher (option)

Item	Description
Number of Trays	1 tray
Paper Size (Non-stapling)	Ledger, Legal, Oficio II, A3, B4, Folio, 216 × 340 mm, 8K: 250 sheets Letter, Letter-R, Executive-R, Statement-R, A4, A4-R, B5, B5-R, A5-R, 16K: 500 sheets
Supported Paper Weight	45 to 256 g/m ² (Stapling: 90 g/m ² or less)
Maximum Sheets for Stapling	Ledger, Legal, Oficio II, A3, B4, 216 × 340 mm, 8K: 25 sheets Letter, Letter-R, A4, A4-R, B5, B5-R, 16K: 50 sheets (Paper weight 90 g/m ² or less)
Dimensions (W) × (D) × (H)	16-3/8×20-1/2×10-7/8" 416×521×275.5 mm
Weight	Approx. 26.4 lb/Approx. 12 kg

Environmental Specifications

Item	Description
Recovery time from Low Power Mode	10 seconds or less
Time to Low Power Mode	3 minutes
Recovery time from sleep	23 seconds or less
Time to sleep	FS-C8520MFP: 20 minutes FS-C8525MFP: 30 minutes
Duplexing	Standard



NOTE

Consult your dealer or service representative for recommended paper types.

EN ISO 7779

Der höchste Schalldruckpegel beträgt 70 dB (A) oder weniger gemäß EN ISO 7779.

EK1-ITB 2000

Das Gerät ist nicht für die Benutzung im unmittelbaren Gesichtsfeld am Bildschirmarbeitsplatz vorgesehen. Um störende Reflexionen am Bildschirmarbeitsplatz zu vermeiden, darf dieses Produkt nicht im unmittelbaren Gesichtsfeld platziert werden.

Glossary

Auto Form Feed Timeout

During data transmission, the machine may sometimes have to wait until receiving the next data. This is the auto form feed timeout. When the preset timeout passes, the machine automatically put paper out. However, no output is performed if the last page has no data to be printed.

Auto-IP

Auto-IP is a module that enables dynamic IPv4 addresses to be assigned to a device on startup. However, DHCP requires a DHCP server. Auto-IP is a server-less method of choosing an IP address. IP addresses between 169.254.0.0 to 169.254.255.255 are reserved for Auto-IP and assigned automatically.

Auto Paper Selection

A function to automatically select paper in the same size as original at printing

Auto Sleep

A mode designed for electrical power saving, activated when the machine is left unused or data transfer for a specific period. In Sleep mode, power consumption is kept to a minimum.

Bonjour

Bonjour, also known as zero-configuration networking, is a service that automatically detects computers, devices and services on an IP network. Bonjour, because an industry-standard IP protocol is used, allows devices to automatically recognize each other without an IP address being specified or DNS server being set. Bonjour also sends and receives network packets by UDP port 5353. If a firewall is enabled, the user must check that UDP port 5353 is left open so that Bonjour will run correctly. Some firewalls are set up so as to reject only certain Bonjour packets. If Bonjour does not run stably, check the firewall settings and ensure that Bonjour is registered on the exceptions list and that Bonjour packets are accepted. If you install Bonjour on Windows XP Service Pack 2 or later, the Windows firewall will be set up correctly for Bonjour.

Default Gateway

This indicates the device, such as a computer or router, that serves as the entrance/exit (gateway) for accessing computers outside the network that you are on. When no specific gateway is designated for a destination IP address, data is sent to the host designated as the Default Gateway.

DHCP (Dynamic Host Configuration Protocol)

Dynamic Host Configuration Protocol (DHCP) that automatically resolves IP addresses, subnet masks, and gateway addresses on a TCP/IP network. DHCP minimizes the load of network management employing a large number of client computers because it relieves individual clients including printers from the IP address being assigned.

DHCP (IPv6)

DHCP (IPv6) is the next-generation of the Internet's Dynamic Host Configuration Protocol and supports IPv6. It extends the BOOTP startup protocol that defines the protocols used for transferring configuration information to hosts on the network. DHCP (IPv6) permits the DHCP server to use its expanded functionality to send configuration parameters to an IPv6 node. Because the network addresses that can be used are allocated automatically, the IPv6 node management workload is reduced in systems where the administrator has to exercise close control over IP address allocation.

dpi (dots per inch)

A unit for resolution, representing the number of dots printed per inch (25.4 mm).

EcoPrint Mode

A printing mode that helps save toner. Copies made in this mode are thus lighter than normal.

Enhanced WSD

Kyocera's proprietary web services.

Emulation

The function to interpret and execute other printers' page description languages. The machine emulates operation of PCL6, KPDLL, and KPDLL (automatic).

FTP (File Transfer Protocol)

A protocol to transfer files on the TCP/IP network, whether the Internet or an intranet. Along with HTTP and SMTP/POP, FTP is now frequently used on the Internet.

Grayscale

A computer color expression. Displayed images of this sort are typically composed of shades of gray, varying from black at the weakest intensity to white at the strongest, without any other colors. Gray levels are displayed in numerical levels: that is, white and black only for 1 bit; 256 gray levels (including white and black) for 8 bits; and 65,536 gray levels for 16 bits.

Help

A ? (Help) key is provided on this machine's operation panel. If you are unsure of how to operate the machine, would like more information on its functions or are having problems getting the machine to work properly, press the ? (Help) key to view a detailed explanation on the touch panel.

IP Address

An Internet protocol address is a unique number that represents a specific computer or related device on the network. The format of an IP address is four sets of numbers separated by dots, e.g. 192.168.110.171. Each number should be between 0 and 255.

IPP

IPP (Internet Printing Protocol) is a standard that uses TCP/IP networks such as the Internet to enable print jobs to be sent between remote computers and printers. IPP is an extension of the HTTP protocol used to view websites and enables printing to be carried out via routers on printers in remote locations. It also supports the HTTP authentication mechanisms along with SSL server and client authentication as well as encryption.

KPDL (Kyocera Page Description Language)

Kyocera's PostScript page description language compatible with Adobe PostScript Level 3.

Multi Purpose (MP) Tray

The paper supply tray on the right side of the machine. Use this tray instead of the cassettes when printing onto envelopes, Hagaki, transparencies, or labels.

NetBEUI (NetBIOS Extended User Interface)

An interface, developed by IBM in 1985, as an update from NetBIOS. It enables more advanced functions on smaller networks than other protocols such as TCP/IP, etc. It is not suitable for larger networks due to lack of routing capabilities to choose the most appropriate routes. NetBEUI has been adopted by IBM for its OS/2 and Microsoft for its Windows as a standard protocol for file sharing and printing services.

PDF/A

This is "ISO 19005-1. Document management - Electronic document file format for long-term preservation - Part 1: Use of PDF (PDF/A)", and is a file format based on PDF 1.4. It has been standardized as ISO 19005-1, and is a specialization of PDF, which has been mainly used for printing, for long-term storage. A new part, ISO 19005-2 (PDF/A-2), is currently being prepared.

POP3 (Post Office Protocol 3)

A standard protocol to receive E-mail from the server in which the mail is stored on the Internet or an intranet.

PostScript

A page description language developed by Adobe Systems. It enables flexible font functions and highly-functional graphics, allowing higher quality printing. The first version called Level 1 was launched in 1985, followed by Level 2 that enabled color printing and two-byte languages (e.g. Japanese) in 1990. In 1996, Level 3 was released as an update for the Internet access and PDF format as well as gradual improvements in implementation technologies.

PPM (prints per minute)

This indicates the number of A4 size printouts made in one minute.

Printer Driver

The software to enable you to print data created on any application software. The printer driver for the machine is contained in the DVD enclosed in the package. Install the printer driver on the computer connected to the machine.

RA (Stateless)

The IPv6 router communicates (transmits) information such as the global address prefix using ICMPv6. This information is the Router Advertisement (RA). ICMPv6 stands for Internet Control Message Protocol, and is a IPv6 standard defined in the RFC 2463 "Internet Control Message Protocol (ICMPv6) for the Internet Protocol Version 6 (IPv6) Specification".

Send as E-mail

A function to send the image data stored in the machine as an E-mail attachment. E-mail addresses can be selected from the list or entered at each time.

SMTP (Simple Mail Transfer Protocol)

A protocol for E-mail transmission over the Internet or an intranet. It is used for transferring mail between mail servers as well as for sending mail from clients to their servers.

Status Page

The page lists machine conditions, such as the memory capacity, total number of prints and scans, and paper source settings.

Subnet Mask

The subnet mask is a way of augmenting the network address section of an IP address. A subnet mask represents all network address sections as 1 and all host address sections as 0. The number of bits in the prefix indicates the length of the network address. The term "prefix" refers to something added to the beginning and, in this context, indicates the first section of the IP address. When an IP address is written, the length of the network address is indicated by the prefix length after a forward slash (/). For example, "24" in the address "133.210.2.0/24". In this way, "133.210.2.0/24" denotes the IP address "133.210.2.0" with a 24-bit prefix (network section). This new network address section (originally part of the host address) made possible by the subnet mask is referred to as the subnet address. When you enter the subnet mask, be sure to set the *DHCP* setting to *Off*.

TCP/IP (Transmission Control Protocol/Internet Protocol)

TCP/IP is a suite of protocols designed to define the way computers and other devices communicate with each other over a network.

TCP/IP (IPv6)

TCP/IP (IPv6) is based on the current Internet protocol, TCP/IP (IPv4). IPv6 is the next-generation Internet protocol and expands the available address space, which resolves the problem of the lack of addresses under IPv4, while also introducing other improvements such as additional security functionality and the capacity to prioritize data transmission.

TWAIN (Technology Without Any Interested Name)

A technical specification for connecting scanners, digital cameras, and other image equipment to the computers. The TWAIN compatible devices enable you to process image data on any relevant application software. TWAIN is adopted on a large amount of graphic software (e.g. Adobe Photoshop) and OCR software.

USB (Universal Serial Bus)2.0

A USB interface standard for Hi-Speed USB 2.0. The maximum transfer rate is 480 Mbps. This machine is equipped with USB 2.0 for high-speed data transfer.

WIA (Windows Imaging Acquisition)

A function to import images supported after Windows Me/XP from digital cameras and other peripheral devices. This function replaces what TWAIN used to do; the feature is provided as a part of Windows functions and improves ease of operation, so that you import images directly to My Computer without using any application.

Index

Numerics

2-sided/Book Original 3-37

A

Address Book

- Adding a Contact 6-27
- Adding a Group 6-31
- Editing and Deleting 6-34

Adjustment/Maintenance

- Auto Color Correction 9-26
- Background Density Adj. 9-26
- Calibration 9-27
- Color Registration 9-26
- Correcting Black Line 9-26
- Density Adjustment 9-26
- Display Brightness 9-26
- DP Adjustment 9-27
- Drum Refresh 1 9-27
- Laser Scanner Cleaning 9-27
- Tone Curve Adjustment 9-27
- Toner Save Level (EcoPrint) 9-26

Applications 11-5

- Auto Form Feed Timeout 11-23
- Auto Image Rotation 4-19
- Auto-IP 11-23
 - Setup 9-19
- Auto Paper Selection 11-23
- Auto Sleep 2-23, 11-23

B

- Background Density Adjust 3-55
- Bonjour 11-23
 - Setup 9-19

C

- Cassette 2-2
 - Loading Paper 3-3
 - Paper Size and Media Type 9-8
- Character Entry Method 11-7
- Checking the Counter 3-11
- Cleaning
 - Document Processor 10-6
 - Glass Platen 10-6
- Cleaning Cloth 2-3
- Coated Paper 11-17
- Collate/Offset 3-44
- Color Balance 4-17
- Color Registration 9-26
- Color Selection 3-60
- Color Toner Empty Action 9-14
- Combine 4-12
 - 2 in 1 4-12
 - 4 in 1 4-12
 - Border Line 4-12
- Command Center RX 2-25

- Connecting
 - LAN Cable 2-10
 - Power Cable 2-11
 - USB Cable 2-11
- Connection Method 2-8
- Continuous Scan 3-40
- Conventions in This Guide 1-14
- Copying 4-1
- Copying Settings
 - Auto % Priority 9-15
 - Auto Paper Selection 9-15
 - Reserve Next Priority 9-15

D

- Date/Timer 2-24, 9-24
 - Auto Error Clear 9-25
 - Auto Panel Reset 9-24
 - Auto Sleep 9-24
 - Date/Time 9-24
 - Date Format 9-24
 - Error Clear Timer 9-25
 - Interrupt Clear Timer 9-25
 - Low Power Timer 9-24
 - Panel Reset Timer 9-24
 - Sleep Level 9-25
 - Sleep Timer 9-25
 - Time Zone 9-24
- Default
 - Auto Image Rotation 9-12
 - Background Density Adj. 9-12
 - Collate/Offset 9-12
 - Color Selection (Copy) 9-12
 - Color Selection (Send/Store) 9-12
 - Continuous Scan 9-12
 - EcoPrint 9-12
 - E-mail Subject/Body 9-13
 - File Format 9-12
 - File Name Entry 9-12
 - File Separation 9-12
 - FTP Encrypted TX 9-13
 - Image Quality 9-13
 - JPEG/TIFF Print 9-13
 - Margin 9-12
 - Original Image 9-12
 - Original Orientation 9-12
 - PDF/A Setting 9-13
 - Prevent Bleed-through 9-12
 - Scan Resolution 9-12
 - XPS Fit to Page 9-13
 - Zoom 9-12
- Default Gateway 11-23
 - Setup 9-19
- Default Screen 9-9
- Density 3-51

Destination 6-17
 Checking and Editing 6-25
 Choosing by One Touch Key 6-19
 Choosing from the Address Book 6-17
 Dest. Check before Send 9-16
 Entering a New E-mail Address 6-20
 Entry Check for New Dest. 9-16
 Multi Sending 6-26
 Specifying a New PC Folder 6-21
Device Status 8-11
 FAX 8-12
 Printer 8-12
 Removable Memory 8-12
 Scanner 8-11
DHCP 11-23
 Setup 9-19
DHCP (IPv6) 11-23
 Setup 9-20
Document Box
 Job Box 7-2
Document Processor 2-2
dpi 11-24
Duplex 4-8

E

EcoPrint 11-24
 Copy 4-15
 Printer 9-18
Emulation 11-24
 Selection 9-17
Encrypted PDF Password 7-12
Energy Saving Control Function 1-12
Enhanced WSD 9-22, 11-24
Environment 1-3
Error Handling 9-14
Expansion Memory 11-3

F

Favorites 3-14
 Editing and Deleting 3-18
 Registering 3-14
 Using 3-20
FAX Kit 11-3
File Format 3-58
File Name Entry 3-63
File Separation 6-42
First Print Time 11-19, 11-20
Front Cover 2-2
FTP 11-24
FTP Client (Transmission)
 Protocol Detail 9-21
FTP Encrypted TX 6-44
FTP Server (Reception)
 Protocol Detail 9-21

G

Glossary 11-23
GPL/LGPL 1-9
Grayscale 3-60, 11-24

H

Handles 2-2, 2-4
Help 11-24
Help Screen 3-28
Host Name 9-19
HTTP
 Protocol Detail 9-21
HTTPS
 Protocol Detail 9-21
HTTP Security 9-22
Hue Adjustment 4-16

I

Inner Tray 2-2
Interface Block 9-23
Interrupt Copy 4-20
IP Address 11-24
 Setup 9-19
IPP
 Protocol Detail 9-21
IPP over SSL
 Protocol Detail 9-21
IPP Security 9-22
IPSec
 Setup 9-22

J

Job
 Canceling 3-29
 Checking History 8-6
 Checking Status 8-2
 Details of the Status Screens 8-3
 Pause and Resumption 8-3
 Sending the Log History 8-7
Job Accounting 9-59
 Adding an Account 9-64
 Counting the Number of Pages Printed 9-70
 Default Setting 9-74
 Editing and Deleting 9-66
 Enabling/Disabling 9-62
 Login 9-63
 Logout 9-63
 Printing an Accounting Report 9-72
 Restricting the Use of the Machine 9-68
Job Box 5-7
 Automatic Delete Setting for Temporary Documents
 5-12
 Private Print 5-7
 Proof and Hold 5-9
Job Finish Notice 3-61
Job Separator Tray 2-2
JPEG/TIFF Print 7-13

K

Keyboard Layout 9-15
KPD L 11-24

L

Language 9-5

- LAN Interface [9-23](#)
- LDAP
 - Protocol Detail [9-21](#)
- LDAP Security [9-22](#)
- Legal Information [1-9](#)
- Legal Restriction on Copying [1-8](#)
- Legal Restriction on Scanning [1-8](#)
- Login [3-12](#), [9-63](#)
- Logout [3-13](#), [9-63](#)
- Low Power Mode [2-22](#)
- LPD
 - Protocol Detail [9-21](#)

M

- Machine Setup Wizard [2-24](#)
- Main Memory [9-24](#)
- Main Power Switch [2-4](#)
- Manual Setting (IPv6) [9-20](#)
- Margin [3-46](#)
- Measurement [9-14](#)
- Mixed Size Originals [3-35](#)
- Monotype Imaging License Agreement [1-11](#)
- Multi Purpose Tray [2-3](#), [11-25](#)
 - Loading Paper [3-5](#)
 - Paper Size and Media Type [9-8](#)
- Multi Sending [6-26](#)

N

- NetBEUI [11-25](#)
 - Protocol Detail [9-21](#)
- Network
 - Preparing [2-8](#)
 - Setup [2-24](#), [9-19](#)
- Network Cable
 - Connecting [2-10](#)
- Network Interface [2-4](#), [2-9](#)

O

- One Touch Key [6-36](#)
 - Adding a Destination [6-36](#)
 - Editing and Deleting [6-38](#)
- Open SSL License [1-10](#)
- Operation Panel [2-2](#), [2-6](#)
- Option
 - Card Authentication Kit [11-4](#)
 - Document Finisher [11-3](#)
 - Expansion Memory [11-3](#)
 - FAX Kit [11-3](#)
 - Gigabit Ethernet Board [11-5](#)
 - Overview [11-2](#)
 - Paper Feeder (double cassette) [11-3](#)
 - Paper Feeder (single cassette) [11-3](#)
- Optional Function [11-5](#)
- Option Interface [2-4](#)
- Original Image [3-53](#)
- Original Loaded Indicator [2-3](#)
- Original Orientation [3-34](#)

- Originals
 - Custom Original Size [9-9](#)
 - Loading Originals [3-7](#)
 - Original Auto Detect [9-9](#)
 - Original Size [3-32](#)
- Original Size [3-32](#)
- Original Size Indicator Plates [2-2](#)
- Original SSLeay License [1-10](#)
- Original Table [2-3](#)
- Original Width Guides [2-3](#)

P

- Paper
 - Appropriate Paper [11-11](#)
 - Before Loading [3-2](#)
 - Cassette [9-8](#)
 - Checking the Remaining Amount of Paper [8-13](#)
 - Custom Paper Size [9-10](#)
 - Default Paper Source [9-10](#)
 - Loading Envelopes [3-6](#)
 - Loading in the Cassettes [3-3](#)
 - Loading in the Multi Purpose Tray [3-5](#)
 - Media for Auto [9-10](#)
 - Media Type Setting [9-10](#)
 - Multi Purpose Tray [9-8](#)
 - Setup [9-10](#)
 - Size and Media [9-8](#)
 - Special Paper [11-14](#)
 - Special Paper Action [9-10](#)
 - Specifications [11-11](#)
- Paper Feeder (double cassette) [11-3](#)
- Paper Feeder (single cassette) [11-3](#)
- Paper Feed Mode [9-18](#)
- Paper Length Guide [2-3](#)
- Paper Output [3-43](#), [9-13](#)
- Paper Selection [3-42](#)
- Paper Width Guide [2-3](#)
- Part Names [2-2](#)
- PDF/A [11-25](#)
- Platen [2-2](#)
- POP3 [11-25](#)
- POP3 (E-mail RX)
 - Protocol Detail [9-21](#)
- PostScript [11-25](#)
- Power Cable
 - Connecting [2-11](#)
- Power Off [2-12](#)
- Power On [2-12](#)
- PPM [11-25](#)
- Precautions for Use [1-3](#)
- Preparing Cables [2-9](#)
- Prevent Bleed-through [3-56](#)
- Printer Driver [11-25](#)

- Printer Settings
 - Color Setting 9-17
 - Copies 9-18
 - CR Action 9-18
 - Duplex 9-18
 - EcoPrint 9-18
 - Emulation 9-17
 - Form Feed TimeOut 9-18
 - Gloss Mode 9-18
 - LF Action 9-18
 - Orientation 9-18
 - Override A4/Letter 9-18
 - Paper Feed Mode 9-18
 - Wide A4 9-18
 - Printing 5-1
 - Printing Speed 11-20
 - Priority Override 3-64
- Q**
- Quick Setup Wizard 3-26
- R**
- RA (Stateless) 11-25
 - Setup 9-20
 - Raw Port
 - Protocol Detail 9-21
 - Recycled Paper 11-17
 - Regarding Trade Names 1-9
 - Replacing Staples 10-5
 - Report Print 9-5
 - Accounting Report 9-6
 - Font List 9-5
 - Network Status 9-5
 - Service Status 9-6
 - Status Page 9-5
 - Resolution 11-19, 11-20
 - Restart 9-4
 - Result Report Settings 9-6
 - Right Cover 2-2
- S**
- Safety Conventions in This Guide 1-2
 - Saturation 4-18
 - Scan Resolution 3-52
 - Secure Protocol 9-22
 - Send as E-mail 6-2, 11-25
 - E-mail Subject/Body 6-43
 - Sending 6-1
 - Preparation for Sending a Document to a PC 6-5
 - Send as E-mail 6-2
 - Send to Folder (SMB/FTP) 6-2
 - Sending E-mail 2-26
 - Sending Size 6-40
 - Send Settings
 - Color TIFF Compression 9-16
 - Default Screen 9-16
 - Dest. Check before Send 9-16
 - Entry Check for New Dest. 9-16
 - Send and Forward 9-16
 - Sharpness 3-54
 - Shortcuts
 - Editing and Deleting 3-24
 - Registering 3-22
 - Using 3-25
 - Sleep 2-23
 - Slit Glass 2-2
 - SMB Client (Transmission)
 - Protocol Detail 9-21
 - SMTP 11-25
 - SMTP (E-mail TX)
 - Protocol Detail 9-21
 - SNMP
 - Protocol Detail 9-21
 - SNMPv3
 - Protocol Detail 9-21
 - Solving Malfunctions 10-8
 - Sound 9-9
 - Specifications
 - Copy 11-19
 - Document Finisher 11-22
 - Document Processor 11-21
 - Environmental Specifications 11-22
 - Machine 11-18
 - Paper Feeder (double cassette) 11-21
 - Paper Feeder (single cassette) 11-21
 - Printer 11-20
 - Scanner 11-20
 - Staple 3-49
 - Status 11-26
 - Status/Job Cancel 8-1
 - Status Page 11-26
 - Storing Size 7-15
 - Subnet Mask 11-26
 - Setup 9-19
 - Symbols 1-2
 - System Menu 9-2
- T**
- TCP/IP 11-26
 - TCP/IP (IPv4)
 - Setup 9-19
 - TCP/IP (IPv6) 11-26
 - ThinPrint
 - Protocol Detail 9-21
 - ThinPrintOverSSL
 - Protocol Detail 9-21
 - Tone Curve Adjustment 9-27
 - Toner Container 2-3
 - Checking the Remaining Amount of Toner 8-13
 - Replacement 10-2
 - Touch Panel 2-7
 - TWAIN 11-26
 - Setting TWAIN Driver 2-20
- U**
- Unknown Login User Name Job 9-76
 - USB 11-26
 - USB Cable
 - Connecting 2-11

USB Interface [2-4](#), [2-9](#)
USB Keyboard Type [9-15](#)
USB Memory
 Printing Documents [7-3](#)
 Removing [7-9](#)
 Saving Documents [7-6](#)
USB Memory Slot [2-2](#)
User Login Administration [9-34](#)
 Adding a User [9-38](#)
 Editing and Deleting [9-44](#)
 Enabling/Disabling [9-36](#)
 Group Authorization [9-53](#)
 Local User Authorization [9-42](#)
 My Panel [9-43](#)
 Obtain Network User Property [9-57](#)
 Simple Login [9-47](#)
User Property [9-7](#)

W

Waste Toner Box [2-3](#)
 Replacement [10-4](#)
WIA [11-26](#)
 Setting WIA Driver [2-21](#)
WSD Print
 Setup [9-22](#)
WSD Scan
 Setup [9-22](#)

X

XPS Fit to Page [7-14](#)

Z

Zoom
 Copy [4-5](#)
 Send/Store [3-57](#)



**QUALITY
CERTIFICATE**

This machine has passed
all quality controls and
final inspection.

KYOCERA Document Solutions America, Inc.**Headquarters**

225 Sand Road,
Fairfield, New Jersey 07004-0008, USA
Phone: +1-973-808-8444
Fax: +1-973-882-6000

Latin America

8240 NW 52nd Terrace Dawson Building, Suite 100
Miami, Florida 33166, USA
Phone: +1-305-421-6640
Fax: +1-305-421-6666

KYOCERA Document Solutions Canada, Ltd.

6120 Kestrel Rd., Mississauga, ON L5T 1S8,
Canada
Phone: +1-905-670-4425
Fax: +1-905-670-8116

**KYOCERA Document Solutions
Mexico, S.A. de C.V.**

Calle Arquimedes No. 130, 4 Piso, Colonia Polanco
Chapultepec, Delegacion Miguel Hidalgo,
Distrito Federal, C.P. 11560, México
Phone: +52-555-383-2741
Fax: +52-555-383-7804

KYOCERA Document Solutions Brazil, Ltd.

Av. Tambore, 1180 Mod. B-09 CEP 06460-000
Tambore-Barueri-SP, Brazil
Phone: +55-11-4195-8496
Fax: +55-11-4195-6167

**KYOCERA Document Solutions
Australia Pty. Ltd.**

Level 3, 6-10 Talavera Road North Ryde N.S.W, 2113,
Australia
Phone: +61-2-9888-9999
Fax: +61-2-9888-9588

**KYOCERA Document Solutions
New Zealand Ltd.**

1-3 Parkhead Place, Albany, Auckland 1330,
New Zealand
Phone: +64-9-415-4517
Fax: +64-9-415-4597

KYOCERA Document Solutions Asia Limited

16/F., Mita Centre, 552-566, Castle Peak Road
Tsuenwan, NT, Hong Kong
Phone: +852-2610-2181
Fax: +852-2610-2063

**KYOCERA Document Solutions
(Thailand) Corp., Ltd.**

335 Ratchadapisek Road, Bangsue, Bangkok 10800,
Thailand
Phone: +66-2-586-0333
Fax: +66-2-586-0278

**KYOCERA Document Solutions
Singapore Pte Ltd.**

12 Tai Seng Street #04-01A,
Luxasia Building, Singapore 534118
Phone: +65-6741-8733
Fax: +65-6748-3788

**KYOCERA Document Solutions
Hong Kong Limited**

16/F., Mita Centre, 552-566, Castle Peak Road
Tsuenwan, NT, Hong Kong
Phone: +852-2429-7422
Fax: +852-2423-2159

**KYOCERA Document Solutions
Taiwan Corporation**

6F., No.37, Sec. 3, Minquan E. Rd.,
Zhongshan Dist., Taipei 104, Taiwan R.O.C.
Phone: +886-2-2507-6709
Fax: +886-2-2507-8432

KYOCERA Document Solutions Korea Co., Ltd.

18F, Kangnam bldg, 1321-1,
Seocho-Dong, Seocho-Gu, Seoul, Korea
Phone: +822-6933-4050
Fax: +822-747-0084

**KYOCERA Document Solutions
India Private Limited**

First Floor, ORCHID CENTRE
Sector-53, Golf Course Road, Gurgaon 122 002, India
Phone: +91-0124-4671000
Fax: +91-0124-4671001

KYOCERA Document Solutions Europe B.V.

Bloemlaan 4, 2132 NP Hoofddorp,
The Netherlands
Phone: +31-20-654-0000
Fax: +31-20-653-1256

KYOCERA Document Solutions Nederland B.V.

Beechavenue 25, 1119 RA Schiphol-Rijk,
The Netherlands
Phone: +31-20-5877200
Fax: +31-20-5877260

KYOCERA Document Solutions (U.K.) Limited

8 Beacontree Plaza,
Gillette Way Reading, Berkshire RG2 0BS,
United Kingdom
Phone: +44-118-931-1500
Fax: +44-118-931-1108

KYOCERA Document Solutions Italia S.p.A.

Via Verdi, 89/91 20063 Cernusco s/N.(MI),
Italy
Phone: +39-02-921791
Fax: +39-02-92179-600

KYOCERA Document Solutions Belgium N.V.

Sint-Martinusweg 199-201 1930 Zaventem,
Belgium
Phone: +32-2-7209270
Fax: +32-2-7208748

KYOCERA Document Solutions France S.A.S.

Espace Technologique de St Aubin
Route de l'Orme 91195 Gif-sur-Yvette CEDEX,
France
Phone: +33-1-69852600
Fax: +33-1-69853409

KYOCERA Document Solutions Espana, S.A.

Edificio Kyocera, Avda. de Manacor No.2,
28290 Las Matas (Madrid), Spain
Phone: +34-91-6318392
Fax: +34-91-6318219

KYOCERA Document Solutions Finland Oy

Atomitie 5C, 00370 Helsinki,
Finland
Phone: +358-9-47805200
Fax: +358-9-47805390

**KYOCERA Document Solutions
Europe B.V., Amsterdam (NL) Zürich Branch**

Hohlstrasse 614, 8048 Zürich,
Switzerland
Phone: +41-44-9084949
Fax: +41-44-9084950

KYOCERA Document Solutions**Deutschland GmbH**

Otto-Hahn-Strasse 12, 40670 Meerbusch,
Germany
Phone: +49-2159-9180
Fax: +49-2159-918100

KYOCERA Document Solutions Austria GmbH

Eduard-Kittenberger-Gasse 95, 1230 Vienna,
Austria
Phone: +43-1-863380
Fax: +43-1-86338-400

KYOCERA Document Solutions Nordic AB

Esbogatan 16B 164 75 Kista, Sweden
Phone: +46-8-546-550-00
Fax: +46-8-546-550-10

KYOCERA Document Solutions Norge NUF

Postboks 150 Oppsal, 0619 Oslo,
Norway
Phone: +47-22-62-73-00
Fax: +47-22-62-72-00

KYOCERA Document Solutions Danmark A/S

Ejby Industrivej 60, DK-2600 Glostrup,
Denmark
Phone: +45-70223880
Fax: +45-45765850

KYOCERA Document Solutions Portugal Lda.

Rua do Centro Cultural, 41 (Alvalade) 1700-106 Lisboa,
Portugal
Phone: +351-21-843-6780
Fax: +351-21-849-3312

KYOCERA Document Solutions**South Africa (Pty) Ltd.**

49 Kyalami Boulevard,
Kyalami Business Park 1685 Midrand, South Africa
Phone: +27-11-540-2600
Fax: +27-11-466-3050

KYOCERA Document Solutions Russia LLC

Botanichesky pereulok 5, Moscow, 129090,
Russia
Phone: +7(495)741-0004
Fax: +7(495)741-0018

KYOCERA Document Solutions Middle East

Dubai Internet City, Bldg. 17,
Office 157 P.O. Box 500817, Dubai,
United Arab Emirates
Phone: +971-04-433-0412

KYOCERA Document Solutions Inc.

2-28, 1-chome, Tamatsukuri, Chuo-ku
Osaka 540-8585, Japan
Phone: +81-6-6764-3555
<http://www.kyoceradocumentsolutions.com>

