

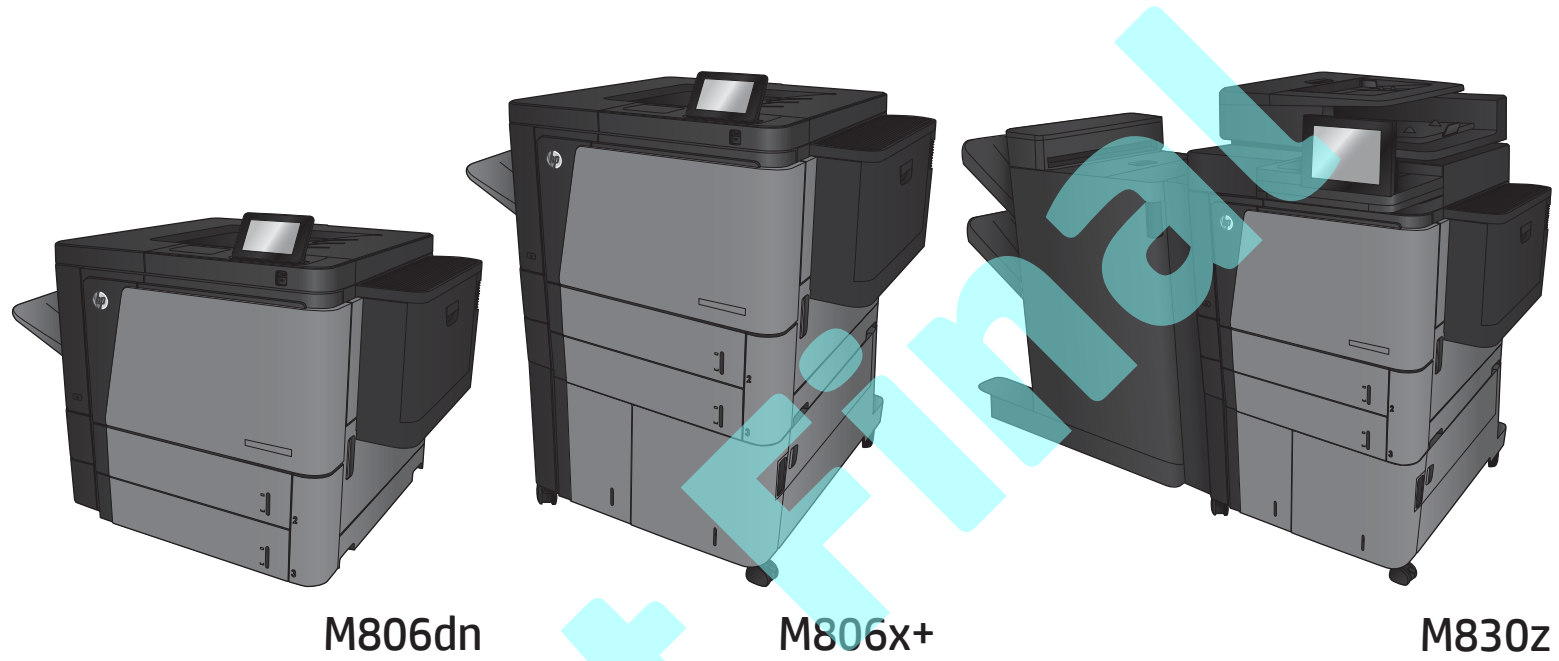

LASERJET ENTERPRISE M806 LASERJET ENTERPRISE FLOW MFP M830

Repair Manual





HP LaserJet Enterprise M806 and/or HP LaserJet Enterprise Flow MFP M830

Repair Manual

Not Final

Copyright and License

© 2013 Copyright Hewlett-Packard Development Company, L.P.

Reproduction, adaptation, or translation without prior written permission is prohibited, except as allowed under the copyright laws.

The information contained herein is subject to change without notice.

The only warranties for HP products and services are set forth in the express warranty statements accompanying such products and services. Nothing herein should be construed as constituting an additional warranty. HP shall not be liable for technical or editorial errors or omissions contained herein.

Part number: CZ244-90966

Edition 1, 11/2013

Trademark Credits

Microsoft®, Windows®, Windows® XP, and Windows Vista® are U.S. registered trademarks of Microsoft Corporation.

Not Final

Conventions used in this guide

 **TIP:** Tips provide helpful hints or shortcuts.

 **NOTE:** Notes provide important information to explain a concept or to complete a task.

 **CAUTION:** Cautions indicate procedures that you should follow to avoid losing data or damaging the product.

 **WARNING!** Warnings alert you to specific procedures that you should follow to avoid personal injury, catastrophic loss of data, or extensive damage to the product.

Not Final

Not Final

Table of contents

1 Removal and replacement	1
Removal and replacement strategy	2
Cautions during removal and replacement	2
Required tools	3
Types of screws	3
Service approach	3
Before performing service	4
After performing service	4
Parts removal order	4
Customer-self repair assemblies	5
Toner cartridge	5
Reinstall the toner cartridge	7
Transfer-roller assembly	8
.....	8
Duplexer	9
Fuser	10
Remove the fuser	10
Formatter	12
Remove the formatter	12
Reinstall the formatter	15
Hard-disk drive (HDD) or solid-state memory(SSM)	16
Identify the component type	16
Remove the HDD	17
Reinstall the HDD	18
Remove the SSM (M806 only)	19
Reinstall the SSM (M806 only)	21
Reinstall the product firmware	22
Memory DIMM	24
Remove the memory DIMM	24
Reinstall the memory DIMM	25
Fax PCA (M830 only)	26
Remove the fax PCA (M830 only)	26

Document feeder mylar strip (M830 only)	27
Install a replacement document feeder mylar strip (M830 only)	28
Document feeder white backing (M830 only)	30
Install a replacement document feeder white backing (M830 only)	31
Background selector (M830 only)	35
Reinstall the background selector (M830 only)	37
Control-panel assembly (M806 only)	38
Reinstall the control-panel assembly (M806 only)	43
Keyboard assembly (M830 only)	44
Remove the keyboard assembly (M830 only)	44
Reinstall the keyboard assembly (M830 only)	48
Control-panel assembly (M830 only)	52
Reinstall the control-panel assembly (M830 only)	55
Pickup, feed, and separation rollers and pads	57
Document-feeder roller (M830 only)	58
Remove the document-feeder roller (M830 only)	58
Reinstall the document-feeder roller (M830 only)	59
Document-feeder separation pad (M830 only)	60
Remove the document-feeder separation pad (M830 only)	60
Reinstall the document-feeder separation pad (M830 only)	62
Tray 1 rollers	65
Reinstall the Tray 1 rollers	67
Tray 2 and Tray 3 rollers	68
Reinstall the Tray 2 and Tray 3 rollers	69
High-capacity input (HCI) rollers	70
Reinstall the HCI rollers	71
Covers and doors	72
Location of major components	73
Scanner back cover (M830 only)	75
Scanner left cover (M830 only)	76
Remove the scanner left cover (M830 only)	76
Scanner right cover (M830 only)	78
Remove the scanner right cover (M830 only)	78
Scanner front cover (M830 only)	80
Remove the scanner front cover (M830 only)	80
Tray 1 (multipurpose tray)	84
Tray 2 and Tray 3	86
Face-up tray (output bin)	87
Hardware integration pocket (HIP) cover (M806 only)	88
Reinstall the HIP cover (M806 only)	90
Hardware integration pocket (HIP) cover (M830 only)	91

Reinstall the HIP cover (M830 only)	93
Control-panel base cover (M806 only)	94
Remove the control-panel base cover (M806 only)	94
Reinstall the control-panel base cover (M806 only)	96
Right top cover (M806 only)	98
Remove the right top cover (M806 only)	98
Reinstall the right top cover (M806 only)	100
Left top cover (M806 only)	102
Remove the left top cover (M806 only)	102
Reinstall the left top cover (M806 only)	103
Front door assembly	104
Reinstall the front door assembly	105
Front inner cover	106
Remove the front inner cover	106
Reinstall the front inner cover	108
Left rear cover	109
Reinstall the left rear cover	109
Rear cover	110
Reinstall the rear cover	111
Right rear cover	113
Remove the right rear cover	113
Left door assembly	116
Right door assembly	118
Remove the right door assembly	118
Reinstall the right door assembly	120
Left front cover	121
.....	121
Upper left cover (M806 only)	122
Remove the upper left cover (M806 only)	122
Reinstall the upper left cover (M806 only)	123
Upper left cover (M830 only)	124
Remove the upper left cover (M830 only)	124
Reinstall the upper left cover (M830 only)	125
Right lower front cover	126
Right lower cover	128
Remove the right lower cover	128
Main assemblies	130
Location of major components	132
Scanner control board (SCB) (M830 only)	135
Remove the SCB (M830 only)	135
Install a replacement SCB (M830 only)	140

Document feeder assembly (M830 only)	141
Remove the document feeder assembly (M830 only)	141
Reinstall the document feeder assembly (M830 only)	145
Scanner assembly (M830 only)	146
Remove the scanner assembly (M830 only)	146
Reinstall the scanner assembly (M830 only)	149
Cartridge-release lever	151
Remove the cartridge-release lever	151
Registration-jam-removal knob	154
Reinstall the registration-jam-removal knob	155
Power supply fan	157
Remove the power supply fan	157
Reinstall the power supply fan	158
Cartridge fan	160
Remove the cartridge fan	160
Reinstall the cartridge fan	163
Controller fan	164
Remove the controller fan	164
Reinstall the controller fan	166
Paper-pickup assembly	167
Remove the paper-pickup assembly	167
Registration assembly	171
Remove the registration assembly	171
Auto-close assembly	173
Remove the auto-close assembly	173
Reinstall the auto-close assembly	176
Low-voltage power supply (M806 only)	177
Remove the low-voltage power supply (M806 only)	177
Low-voltage power supply (M830 only)	179
Remove the low-voltage power supply (M830 only)	179
High-voltage power supply (M806 only)	182
Remove the high-voltage power supply (M806 only)	182
Reinstall the high-voltage power supply (M806 only)	183
High-voltage power supply (M830 only)	184
Remove the high-voltage power supply (M830 only)	184
Reinstall the high-voltage power supply (M830 only)	186
DC controller (M806 only)	187
Remove the DC controller (M806 only)	187
DC controller (M830 only)	190
Remove the DC controller (M830 only)	190
Cartridge contact assembly	193

Remove the cartridge contact assembly	193
Reinstall the cartridge contact assembly	194
Drum motor	195
Remove the drum motor	195
Drive assembly (M806 only)	196
Remove the drive assembly (M806 only)	196
Reinstall the drive assembly (M806 only)	198
Drive assembly (M830 only)	199
Remove the drive assembly (M830 only)	199
Reinstall the drive assembly (M830 only)	201
Transfer paper-feed assembly	202
Remove the transfer paper-feed assembly	202
Reinstall the transfer paper-feed assembly	203
Transfer-holder assembly	205
Remove the transfer-holder assembly	206
Reinstall the transfer-holder assembly	207
Cartridge-lifter assembly (M806 only)	208
Remove the cartridge-lifter assembly (M806 only)	208
Reinstall the cartridge-lifter assembly (M806 only)	214
Cartridge-lifter assembly (M830 only)	217
Remove the cartridge-lifter assembly (M830 only)	217
Reinstall the cartridge-lifter assembly (M830 only)	224
Driver PCA	228
Remove the driver PCA	228
Reinstall the driver PCA	229
Laser/scanner assembly	231
Remove the laser/scanner assembly	231
Face-down paper-delivery assembly (M806 only)	234
Remove the face-down paper-delivery assembly (M806 only)	234
Paper-delivery fan assembly (M830 only)	237
Remove the paper-delivery fan assembly (M830 only)	237
Reinstall the paper-delivery fan assembly (M830 only)	241
Fuser drive assembly	242
Remove the fuser drive assembly	243
Reinstall the fuser drive assembly	246
Power switch assembly	247
Remove the power switch assembly	247
Reinstall the power switch assembly	247
Interconnect PCA	248
Remove the interconnect PCA	248
Reinstall the interconnect PCA	250

Formatter cage	252
Remove the formatter cage	252
Reinstall the formatter cage	253
Fuser bias contact assembly	254
Remove the fuser bias contact assembly	255
Reinstall the fuser bias contact assembly	256
Cooling-unit assembly	258
Remove the cooling-unit assembly	258
Reinstall the cooling unit assembly	260
Tag assembly	261
Remove the tag assembly	261
Option-connector assembly	263
Remove the option-connector assembly	263
Reinstall the option-connector assembly	266
Input accessory	267
High capacity input feeder	268
Location of major components	268
HCI right tray	272
HCI left tray	273
HCI rear and right-rear corner covers	274
HCI right door assembly	276
Remove the HCI right door assembly	276
HCI left cover	277
Remove the HCI left cover	277
HCI center right cover	278
Remove the HCI center right cover	278
HCI lower right cover	280
Remove the HCI lower right cover	280
HCI right tray pickup motor	282
Remove the HCI right tray pickup motor	282
HCI right tray pickup drive	283
Remove the HCI right tray pickup drive	283
HCI left tray pickup motor	284
Remove the HCI left tray pickup motor	284
HCI left tray pickup drive	285
Remove the HCI left tray pickup drive	285
HCI merge drive assembly	286
Remove the HCI merge drive assembly	286
HCI right tray lifter drive assembly	287
Remove the HCI right tray lifter drive assembly	287
HCI left tray lifter drive assembly	288

Remove the HCI left tray lifter drive assembly	288
HCI right tray media-level sensor assembly	289
Remove the HCI right tray media-level sensor assembly	289
HCI left tray media-level sensor assembly	290
Remove the HCI left tray media-level sensor assembly	290
HCI right tray automatic close assembly	291
Remove the HCI right tray automatic close assembly	291
HCI left tray automatic close assembly	292
Remove the HCI left tray automatic close assembly	292
HCI right tray pickup assembly	293
Remove the HCI right tray pickup assembly	293
HCI left tray pickup assembly	295
Remove the HCI left tray pickup assembly	295
HCI merge assembly	297
Remove the HCI merge assembly	297
HCI controller PCA	299
Remove the HCI controller PCA	299
Finishing accessories	300
Identify the finishing accessories	301
Disconnect a finishing accessory from the product	303
Identifying finishing accessory covers and doors	305
Shared finishing accessory assemblies	307
Upper cover lock assembly	309
Right cover assembly	311
Pre-reverse cover assembly	312
Remove the pre-reverse cover assembly	312
Rear reverse cover assembly	314
Remove the rear reverse cover assembly	314
Upper reverse cover assembly	316
Remove the upper reverse cover assembly	316
Bin cable guide cover	317
Reinstall the bin cable guide cover	320
Open/closed stepped cover assembly	321
Upper stepped cover assembly	322
Lower stepped cover assembly	324
Remove the lower stepped cover assembly	324
Reinstall the lower stepped cover	327
Top door assembly	328
Front door	330
Remove the front door	330
Remove only the front door	331

Inner upper cover assembly	333
Inner upper cover assembly (remove)	334
Clutch assembly (front side)	336
Remove the clutch assembly (front side)	336
Sensor switch assembly	337
Remove the sensor switch assembly	337
Inner lower cover assembly	339
Inner lower cover assembly (remove)	341
Front foot cover assembly	344
Remove the front foot cover assembly	344
Lower lock release handle assembly	347
Remove the lower lock release handle cover assembly	347
Rear cover assembly	349
Remove the rear cover assembly	349
Remove only the rear cover	351
Main controller PCA assembly	353
Remove the main controller PCA assembly	353
Entrance upper guide assembly	368
Remove the entrance upper guide assembly	368
Rear foot cover assembly	371
Remove the rear foot cover assembly	371
Stack wall upper assembly and upper wall guide assembly	375
Remove the stack wall upper cover assembly	375
Upper crossmember assembly	378
Remove the upper crossmember assembly	378
Reinstall the upper crossmember assembly	386
Paper feed drive assembly	390
Remove the paper feed drive assembly	390
Pressure roller assembly	392
Remove the pressure roller assembly	392
Stack upper bin and lower bin assemblies	397
Remove the stack upper bin and lower bin assembly	397
Reinstall the stack upper bin and lower bin assemblies	400
Height wall assembly	401
Remove the height wall center assembly	401
Reinstall the height wall assembly	402
Paper face sensor and flag assembly	403
Remove the paper face sensor and flag assembly	403
Staple sub assembly	408
Remove the staple sub assembly	408
Staple connecting cable assembly	411

Remove the staple connecting cable assembly	411
Staple assembly	413
Remove the staple assembly	413
Paper detect holder assembly	417
Remove the paper detect holder assembly	417
Reinstall the paper detect holder assembly	418
Operation tray assembly	419
Remove the operation tray assembly	420
Reinstall the operation tray assembly	426
Swing guide assembly	430
Remove the swing guide assembly	431
Reinstall the swing guide assembly	437
Return roller assembly	441
Remove the return roller assembly	442
Clutch assembly (rear side)	443
Remove the clutch assembly (rear side)	443
Stack ejection motor assembly	446
Remove the stack ejection motor assembly	446
Press motor assembly	450
Remove the press motor assembly	450
Common driver PCA assembly	454
Remove the common controller PCA	454
Interface cable assembly	456
Remove the interface cable assembly	456
Reverse driver PCA assembly	458
Remove the reverse driver PCA assembly	458
Reverse assembly	459
Remove the reverse assembly	459
Paper pass assembly	462
Remove the paper pass assembly	462
Booklet maker accessory	466
Knob	467
Saddle output bin assembly	468
Reinstall the saddle output bin	469
Right cover assembly (BM PCA)	470
Remove the right cover assembly (BM PCA)	470
Booklet maker controller PCA	471
Remove the booklet maker controller PCA	471
Inner side plate assembly	472
Remove the inner side plate assembly	472
Before reinstalling the inner side plate assembly	476

Guide sensor assembly	479
Remove the guide sensor assembly	479
Guide motor assembly	481
Remove the guide motor assembly	481
Saddle motor assembly	483
Remove the saddle motor assembly (SS and BM)	483
Saddle feed motor assembly	485
Remove the saddle feed assembly	485
Folding-motor mount assembly	489
Remove the motor mount assembly	489
Reinstall the folding-motor mount assembly	493
Delivery switch mount assembly	494
Remove the delivery switch mount assembly	494
Saddle stapler assembly	497
Remove the saddle stapler assembly	497
Lower left guide assembly	499
Remove the lower left guide assembly	499
Saddle delivery inner cover, front assembly	501
Remove the saddle delivery inner cover, front assembly	501
Saddle delivery inner cover, rear assembly	503
Remove the saddle delivery inner cover, rear assembly	503
Saddle guide assembly	505
Remove the saddle guide assembly	506
Reinstall the saddle guide assembly	509
Saddle feed assembly	511
Remove the saddle feed assembly	511
Saddle assembly	514
Remove the saddle assembly	515
Reinstall the saddle assembly	523
Upper delivery guide assembly	524
Remove the upper delivery guide assembly	524
Saddle paper delivery assembly	526
Remove the saddle paper delivery assembly	526
Saddle rear end sensor assembly	531
Remove the saddle rear end sensor assembly	531
Stapler/stacker and stapler/stacker with hole punch accessories	537
Punch controller PCA assembly	538
Remove the punch controller PCA assembly	538
Dust collector assembly	539
Punch inner cover assembly	540
Remove the punch inner cover assembly	540

Punch top cover	541
Remove the punch top cover	541
Punch hole assembly	545
Remove the punch hole assembly	545
Reinstall the punch hole assembly	548
2 Parts and diagrams	551
Order parts by authorized service providers	552
Order parts, accessories, and supplies	552
Related documentation and software	552
Supplies part numbers	553
Customer self-repair parts	553
Service replacement parts	555
Accessories	556
How to use the parts lists and diagrams	556
Assembly locations	557
Base product (no optional trays or accessories)	557
Document feeder and scanner (M830)	560
High capacity input (HCI) feeder	561
Finishing accessories	562
Document feeder and scanner assemblies (M830)	564
Document feeder assemblies (M830)	566
Scanner assemblies (M830)	570
Covers	572
Internal assemblies	574
Internal assemblies (1 of 4)	574
Internal assemblies (2 of 4)	576
Internal assemblies (3 of 4)	578
Internal assemblies (4 of 4)	580
3500-sheet paper feeder (HCI)	582
3500-sheet paper feeder covers	582
3500-sheet paper deck components (1 of 2)	584
Stapler stacker/booklet maker	588
Stapler stacker covers	588
Booklet maker covers	590
Finisher main body (1 of 3)	592
Finisher main body (2 of 3)	594
Finisher main body (3 of 3)	596
Stapler/stacker finisher main body	598
Booklet maker finisher main body	600
Booklet maker saddle assembly	602

Alphabetical parts list 606
Numerical parts list 617

Index 629

Not Final

List of tables

Table 1-1	Covers and doors	73
Table 1-2	Main assemblies (1 of 2)	132
Table 1-3	Main assemblies (2 of 2)	133
Table 1-4	Printed circuit assemblies (PCAs)	134
Table 1-5	External covers and doors	268
Table 1-6	Main assemblies (1 of 2)	269
Table 1-7	Main assemblies (2 of 2)	270
Table 1-8	Printed circuit assembly (PCA)	271
Table 1-9	Finishing accessory covers and doors (1 of 2)	305
Table 1-10	Finishing accessory covers and doors (2 of 2)	306
Table 1-11	DIPSW settings	364
Table 1-12	Do not use these DIPSW settings	364
Table 2-1	Order parts, accessories, and supplies	552
Table 2-2	Related documentation and software	552
Table 2-3	Supplies part numbers	553
Table 2-4	Customer self-repair parts	553
Table 2-5	Service replacement parts	555
Table 2-6	M830 product integrated scanner assembly (ISA)	557
Table 2-7	Base product (no optional trays or accessories)	558
Table 2-8	Document feeder and scanner (M830)	560
Table 2-9	High capacity input (HCI) feeder covers	561
Table 2-10	Stapler/stacker and stapler/stacker with hole punch covers	562
Table 2-11	Booklet maker only covers	563
Table 2-12	Document feeder and scanner assemblies (M830)	565
Table 2-13	Document feeder assemblies (1 of 2; M830)	567
Table 2-14	Document feeder assemblies (2 of 2; M830)	569
Table 2-15	Scanner assemblies	571
Table 2-16	Covers	573
Table 2-17	Internal assemblies (1 of 4)	575
Table 2-18	Internal assemblies (2 of 4)	577
Table 2-19	Internal assemblies (3 of 4)	579
Table 2-20	Internal assemblies (4 of 4)	581

Table 2-21	3500-sheet paper feeder (1 of 3)	583
Table 2-22	3500-sheet paper feeder (1 of 2)	585
Table 2-23	3500-sheet paper feeder (2 of 2)	587
Table 2-24	Stapler stacker covers	589
Table 2-25	Booklet maker covers	591
Table 2-26	Finisher main body (1 of 3)	593
Table 2-27	Finisher main body (2 of 3)	595
Table 2-28	Finisher main body (3 of 3)	597
Table 2-29	Stapler/stacker finisher main body	599
Table 2-30	Booklet maker finisher main body	601
Table 2-31	Booklet maker saddle assembly	605
Table 2-32	Alphabetical parts list	606
Table 2-33	Numerical parts list	617

Not Final

List of figures

Figure 1-1	Screwdrivers	3
Figure 1-2	Remove the toner cartridge (1 of 3)	5
Figure 1-3	Remove the toner cartridge (2 of 3)	5
Figure 1-4	Remove the toner cartridge (3 of 3)	6
Figure 1-5	Reinstall the toner cartridge	7
Figure 1-6	Remove the transfer-roller assembly (1 of 2)	8
Figure 1-7	Remove the transfer-roller assembly (2 of 2)	8
Figure 1-8	Remove the duplexer (1 of 2)	9
Figure 1-9	Remove the duplexer (2 of 2)	9
Figure 1-10	Remove the fuser (1 of 3)	10
Figure 1-11	Remove the fuser (2 of 3)	10
Figure 1-12	Remove the fuser (3 of 3)	11
Figure 1-13	Remove the formatter (1 of 3)	12
Figure 1-14	Remove the formatter (2 of 3)	13
Figure 1-15	Remove the formatter (3 of 3)	13
Figure 1-16	Remove the HDD (1 of 2)	17
Figure 1-17	Remove the HDD (2 of 2)	17
Figure 1-18	Reinstall the HDD	18
Figure 1-19	Remove the SSM (M806; 1 of 3)	19
Figure 1-20	Remove the SSM (M806; 2 of 3)	19
Figure 1-21	Remove the SSM (M806; 3 of 3)	20
Figure 1-22	Reinstall the SSM (M806; 1 of 2)	21
Figure 1-23	Reinstall the SSM (M806; 2 of 2)	21
Figure 1-24	Remove the memory DIMM (1 of 2)	24
Figure 1-25	Remove the memory DIMM (2 of 2)	24
Figure 1-26	Reinstall the memory DIMM	25
Figure 1-27	Remove the fax PCA (M830; 1 of 2)	26
Figure 1-28	Remove the fax PCA (M830; 2 of 2)	26
Figure 1-29	Remove the document feeder mylar strip (M830; 1 of 3)	27
Figure 1-30	Remove the document feeder mylar strip (M830; 2 of 3)	27
Figure 1-31	Remove the document feeder mylar strip (M830; 3 of 3)	28
Figure 1-32	Install a replacement document feeder mylar strip (M830; 1 of 3)	28

Figure 1-33	Install a replacement document feeder mylar strip (M830; 2 of 3)	29
Figure 1-34	Install a replacement document feeder mylar strip (M830; 3 of 3)	29
Figure 1-35	Remove the document feeder white backing (M830; 1 of 3)	30
Figure 1-36	Remove the document feeder white backing (M830; 2 of 3)	30
Figure 1-37	Remove the document feeder white backing (M830; 3 of 3)	31
Figure 1-38	Install a replacement document feeder white backing (M830; 1 of 6)	31
Figure 1-39	Install a replacement document feeder white backing (M830; 2 of 6)	32
Figure 1-40	Install a replacement document feeder white backing (M830; 3 of 6)	32
Figure 1-41	Install a replacement document feeder white backing (M830; 4 of 6)	33
Figure 1-42	Install a replacement document feeder white backing (M830; 5 of 6)	33
Figure 1-43	Install a replacement document feeder white backing (M830; 6 of 6)	34
Figure 1-44	Remove the background selector (M830; 1 of 4)	35
Figure 1-45	Remove the background selector (M830; 2 of 4)	35
Figure 1-46	Remove the background selector (M830; 3 of 4)	36
Figure 1-47	Remove the background selector (M830; 4 of 4)	36
Figure 1-48	Reinstall the background selector (M830)	37
Figure 1-49	Remove the control-panel assembly (M806; 1 of 10)	38
Figure 1-50	Remove the control-panel assembly (M806; 2 of 10)	38
Figure 1-51	Remove the control-panel assembly (M806; 3 of 10)	39
Figure 1-52	Remove the control-panel assembly (M806; 4 of 10)	39
Figure 1-53	Remove the control-panel assembly (M806; 5 of 10)	40
Figure 1-54	Remove the control-panel assembly (M806; 6 of 10)	40
Figure 1-55	Remove the control-panel assembly (M806; 7 of 10)	41
Figure 1-56	Remove the control-panel assembly (M806; 8 of 10)	41
Figure 1-57	Remove the control-panel assembly (M806; 9 of 10)	42
Figure 1-58	Remove the control-panel assembly (M806; 10 of 10)	42
Figure 1-59	Reinstall the control panel (M806)	43
Figure 1-60	Remove the keyboard assembly (M830; 1 of 7)	44
Figure 1-61	Remove the keyboard assembly (M830; 2 of 7)	45
Figure 1-62	Remove the keyboard assembly (M830; 3 of 7)	45
Figure 1-63	Remove the keyboard assembly (M830; 4 of 7)	46
Figure 1-64	Remove the keyboard assembly (M830; 5 of 7)	46
Figure 1-65	Remove the keyboard assembly (M830; 6 of 7)	47
Figure 1-66	Remove the keyboard assembly (M830; 7 of 7)	47
Figure 1-67	Reinstall the keyboard assembly (M830; 1 of 7)	48
Figure 1-68	Reinstall the keyboard assembly (M830; 2 of 7)	48
Figure 1-69	Reinstall the keyboard assembly (M830; 3 of 7)	49
Figure 1-70	Reinstall the keyboard assembly (M830; 4 of 7)	49
Figure 1-71	Reinstall the keyboard assembly (M830; 5 of 7)	50
Figure 1-72	Reinstall the keyboard assembly (M830; 6 of 7)	50
Figure 1-73	Reinstall the keyboard assembly (M830; 7 of 7)	51

Figure 1-74	Remove the control-panel assembly (M830; 1 of 7)	52
Figure 1-75	Remove the control-panel assembly (M830; 2 of 7)	52
Figure 1-76	Remove the control-panel assembly (M830; 3 of 7)	53
Figure 1-77	Remove the control-panel assembly (M830; 4 of 7)	53
Figure 1-78	Remove the control-panel assembly (M830; 5 of 7)	54
Figure 1-79	Remove the control-panel assembly (M830; 6 of 7)	54
Figure 1-80	Remove the control-panel assembly (M830; 7 of 7)	55
Figure 1-81	Reinstall the control-panel assembly (M830; 1 of 3)	55
Figure 1-82	Reinstall the control-panel assembly (M830; 2 of 3)	56
Figure 1-83	Reinstall the control-panel assembly (M830; 3 of 3)	56
Figure 1-84	Remove the document-feeder roller (M830; 1 of 3)	58
Figure 1-85	Remove the document-feeder roller (M830; 2 of 3)	58
Figure 1-86	Remove the document-feeder roller (M830; 3 of 3)	59
Figure 1-87	Remove the document-feeder roller (M830)	59
Figure 1-88	Remove the document-feeder separation pad (M830; 1 of 4)	60
Figure 1-89	Remove the document-feeder separation pad (M830; 2 of 4)	60
Figure 1-90	Remove the document-feeder separation pad (M830; 3 of 4)	61
Figure 1-91	Remove the document-feeder separation pad (M830; 4 of 4)	61
Figure 1-92	Reinstall the document-feeder separation pad (M830; 1 of 5)	62
Figure 1-93	Reinstall the document-feeder separation pad (M830; 2 of 5)	62
Figure 1-94	Reinstall the document-feeder separation pad (M830; 3 of 5)	63
Figure 1-95	Reinstall the document-feeder separation pad (M830; 4 of 5)	63
Figure 1-96	Reinstall the document-feeder separation pad (M830; 5 of 5)	64
Figure 1-97	Remove the Tray 1 rollers (1 of 3)	65
Figure 1-98	Remove the Tray 1 rollers (2 of 3)	65
Figure 1-99	Remove the Tray 1 rollers (3 of 3)	66
Figure 1-100	Reinstall the Tray 1 rollers (1 of 2)	67
Figure 1-101	Reinstall the Tray 1 rollers (2 of 2)	67
Figure 1-102	Remove the Tray 2 and Tray 3 rollers (1 of 2)	68
Figure 1-103	Remove the Tray 2 and Tray 3 rollers (2 of 2)	68
Figure 1-104	Reinstall the Tray 2 and Tray 3 rollers	69
Figure 1-105	Remove the HCI rollers (1 of 2)	70
Figure 1-106	Remove the HCI rollers (2 of 2)	70
Figure 1-107	Reinstall the HCI rollers	71
Figure 1-108	Covers and doors	73
Figure 1-109	Remove the scanner back cover (M830; 1 of 2)	75
Figure 1-110	Remove the scanner back cover (M830; 2 of 2)	75
Figure 1-111	Remove the scanner left cover (M830; 1 of 3)	76
Figure 1-112	Remove the scanner left cover (M830; 2 of 3)	76
Figure 1-113	Remove the scanner left cover (M830; 3 of 3)	77
Figure 1-114	Remove the scanner right cover (M830; 1 of 4)	78

Figure 1-115	Remove the scanner right cover (M830; 2 of 4)	78
Figure 1-116	Remove the scanner right cover (M830; 3 of 4)	79
Figure 1-117	Remove the scanner right cover (M830; 4 of 4)	79
Figure 1-118	Remove the scanner front cover (M830; 1 of 7)	80
Figure 1-119	Remove the scanner front cover (M830; 2 of 7)	81
Figure 1-120	Remove the scanner front cover (M830; 3 of 7)	81
Figure 1-121	Remove the scanner front cover (M830; 4 of 7)	82
Figure 1-122	Remove the scanner front cover (M830; 5 of 7)	82
Figure 1-123	Remove the scanner front cover (M830; 6 of 7)	83
Figure 1-124	Remove the scanner front cover (M830; 7 of 7)	83
Figure 1-125	Remove Tray 1 (1 of 3)	84
Figure 1-126	Remove Tray 1 (2 of 3)	84
Figure 1-127	Remove Tray 1 (3 of 3)	85
Figure 1-128	Remove Tray 2 and Tray 3	86
Figure 1-129	Remove the face-up tray	87
Figure 1-130	Remove the HIP cover (M806; 1 of 3)	88
Figure 1-131	Remove the HIP cover (M806; 2 of 3)	88
Figure 1-132	Remove the HIP cover (M806; 3 of 3)	89
Figure 1-133	Reinstall the HIP cover (M806; 1 of 2)	90
Figure 1-134	Reinstall the HIP cover (M806; 2 of 2)	90
Figure 1-135	Remove the HIP cover (M830; 1 of 3)	91
Figure 1-136	Remove the HIP cover (M830; 2 of 3)	91
Figure 1-137	Remove the HIP cover (M830; 3 of 3)	92
Figure 1-138	Reinstall the HIP cover (M830; 1 of 2)	93
Figure 1-139	Reinstall the HIP cover (M830; 2 of 2)	93
Figure 1-140	Remove the control-panel base cover (M806; 1 of 3)	94
Figure 1-141	Remove the control-panel base cover (M806; 2 of 3)	94
Figure 1-142	Remove the control-panel base cover (M806; 3 of 3)	95
Figure 1-143	Reinstall the control-panel base cover (M806; 1 of 3)	96
Figure 1-144	Reinstall the control-panel base cover (M806; 2 of 3)	96
Figure 1-145	Reinstall the control-panel base cover (M806; 3 of 3)	97
Figure 1-146	Remove the right top cover (M806; 1 of 4)	98
Figure 1-147	Remove the right top cover (M806; 2 of 4)	99
Figure 1-148	Remove the right top cover (M806; 3 of 4)	99
Figure 1-149	Remove the right top cover (M806; 4 of 4)	100
Figure 1-150	Reinstall the right top cover (M806; 1 of 3)	100
Figure 1-151	Reinstall the right top cover (M806; 2 of 3)	101
Figure 1-152	Reinstall the right top cover (M806; 3 of 3)	101
Figure 1-153	Remove the left top cover (M806; 1 of 2)	102
Figure 1-154	Remove the left top cover (M806; 2 of 2)	103
Figure 1-155	Reinstall the left top cover (M806)	103

Figure 1-156	Remove the front door assembly (1 of 3)	104
Figure 1-157	Remove the front door assembly (2 of 3)	104
Figure 1-158	Remove the front door assembly (3 of 3)	105
Figure 1-159	Reinstall the front door assembly	105
Figure 1-160	Remove the front inner cover (1 of 3)	106
Figure 1-161	Remove the front inner cover (2 of 3)	107
Figure 1-162	Remove the front inner cover (3 of 3)	107
Figure 1-163	Remove the left rear cover.	109
Figure 1-164	Reinstall the left rear cover	109
Figure 1-165	Remove the rear cover (1 of 3)	110
Figure 1-166	Remove the rear cover (2 of 3)	110
Figure 1-167	Remove the rear cover (3 of 3)	111
Figure 1-168	Reinstall the rear cover (1 of 2)	111
Figure 1-169	Reinstall the rear cover (2 of 2)	112
Figure 1-170	Remove the right rear cover (1 of 5)	113
Figure 1-171	Remove the right rear cover (2 of 5)	113
Figure 1-172	Remove the right rear cover (3 of 5)	114
Figure 1-173	Remove the right rear cover (4 of 5)	114
Figure 1-174	Remove the right rear cover (5 of 5)	115
Figure 1-175	Remove the left door assembly (1 of 4)	116
Figure 1-176	Remove the left door assembly (2 of 4)	116
Figure 1-177	Remove the left door assembly (3 of 4)	117
Figure 1-178	Remove the left door assembly (4 of 4)	117
Figure 1-179	Remove the right door assembly (1 of 3)	118
Figure 1-180	Remove the right door assembly (2 of 3)	118
Figure 1-181	Remove the right door assembly (3 of 3)	119
Figure 1-182	Reinstall the right door assembly	120
Figure 1-183	Reinstall the right door assembly	120
Figure 1-184	Remove the left front cover (1 of 2)	121
Figure 1-185	Remove the left front cover (2 of 2)	121
Figure 1-186	Remove the upper left cover (M806 only; 1 of 2)	122
Figure 1-187	Remove the upper left cover (M806 only; 2 of 2)	123
Figure 1-188	Reinstall the upper left cover (M806 only)	123
Figure 1-189	Remove the upper left cover (M830 only; 1 of 2)	124
Figure 1-190	Remove the upper left cover (M830 only; 2 of 2)	124
Figure 1-191	Reinstall the upper left cover (M830 only)	125
Figure 1-192	Remove the right lower front cover (1 of 3)	126
Figure 1-193	Remove the right lower front cover (2 of 3)	126
Figure 1-194	Remove the right lower front cover (3 of 3)	127
Figure 1-195	Remove the right lower cover (1 of 2)	128
Figure 1-196	Remove the right lower cover (2 of 2)	129

Figure 1-197	Main assemblies (1 of 2)	132
Figure 1-198	Main assemblies (2 of 2)	133
Figure 1-199	Printed circuit assemblies (PCAs)	134
Figure 1-200	Remove the SCB (M830; 1 of 10)	135
Figure 1-201	Remove the SCB (M830; 2 of 10)	135
Figure 1-202	Remove the SCB (M830; 3 of 10)	136
Figure 1-203	Remove the SCB (M830; 4 of 10)	136
Figure 1-204	Remove the SCB (M830; 5 of 10)	137
Figure 1-205	Remove the SCB (M830; 6 of 10)	137
Figure 1-206	Remove the SCB (M830; 7 of 10)	138
Figure 1-207	Remove the SCB (M830; 8 of 10)	138
Figure 1-208	Remove the SCB (M830; 9 of 10)	139
Figure 1-209	Remove the SCB (M830; 10 of 10)	139
Figure 1-210	Install a replacement SCB (M830)	140
Figure 1-211	Remove the document feeder assembly (M830; 1 of 7)	141
Figure 1-212	Remove the document feeder assembly (M830; 2 of 7)	142
Figure 1-213	Remove the document feeder assembly (M830; 3 of 7)	142
Figure 1-214	Remove the document feeder assembly (M830; 4 of 7)	143
Figure 1-215	Remove the document feeder assembly (M830; 5 of 7)	143
Figure 1-216	Remove the document feeder assembly (M830; 6 of 7)	144
Figure 1-217	Remove the document feeder assembly (M830; 7 of 7)	144
Figure 1-218	Remove the scanner assembly (M830; 1 of 4)	146
Figure 1-219	Remove the scanner assembly (M830; 2 of 4)	147
Figure 1-220	Remove the scanner assembly (M830; 3 of 4)	147
Figure 1-221	Remove the scanner assembly (M830; 4 of 4)	148
Figure 1-222	Scanner assembly grommets (M830)	149
Figure 1-223	Scanner assembly clips (M830)	150
Figure 1-224	Remove the cartridge-release lever (1 of 4)	151
Figure 1-225	Remove the cartridge-release lever (2 of 4)	152
Figure 1-226	Remove the cartridge-release lever (3 of 4)	152
Figure 1-227	Remove the cartridge-release lever (4 of 4)	153
Figure 1-228	Remove the registration-jam-removal knob (1 of 3)	154
Figure 1-229	Remove the registration-jam-removal knob (2 of 3)	154
Figure 1-230	Remove the registration-jam-removal knob (3 of 3)	155
Figure 1-231	Reinstall the registration-jam-removal knob (1 of 3)	155
Figure 1-232	Reinstall the registration-jam-removal knob (2 of 3)	156
Figure 1-233	Reinstall the registration-jam-removal knob (3 of 3)	156
Figure 1-234	Remove the power supply fan (1 of 2)	157
Figure 1-235	Remove the power supply fan (2 of 2)	157
Figure 1-236	Reinstall the power supply fan (1 of 3)	158
Figure 1-237	Reinstall the power supply fan (2 of 3)	158

Figure 1-238	Reinstall the power supply fan (3 of 3)	159
Figure 1-239	Remove the cartridge fan (1 of 5)	160
Figure 1-240	Remove the cartridge fan (2 of 5)	161
Figure 1-241	Remove the cartridge fan (3 of 5)	161
Figure 1-242	Remove the cartridge fan (4 of 5)	162
Figure 1-243	Remove the cartridge fan (5 of 5)	162
Figure 1-244	Reinstall the cartridge fan	163
Figure 1-245	Remove the controller fan (1 of 3)	164
Figure 1-246	Remove the controller fan (2 of 3)	164
Figure 1-247	Remove the controller fan (3 of 3)	165
Figure 1-248	Reinstall the controller fan (1 of 2)	166
Figure 1-249	Reinstall the controller fan (2 of 2)	166
Figure 1-250	Remove the paper-pickup assembly (1 of 7)	167
Figure 1-251	Remove the paper-pickup assembly (2 of 7)	168
Figure 1-252	Remove the paper-pickup assembly (3 of 7)	168
Figure 1-253	Remove the paper-pickup assembly (4 of 7)	169
Figure 1-254	Remove the paper-pickup assembly (5 of 7)	169
Figure 1-255	Remove the paper-pickup assembly (6 of 7)	170
Figure 1-256	Remove the paper-pickup assembly (7 of 7)	170
Figure 1-257	Remove the registration assembly (1 of 3)	171
Figure 1-258	Remove the registration assembly (2 of 3)	172
Figure 1-259	Remove the registration assembly (3 of 3)	172
Figure 1-260	Remove the auto-close assembly (1 of 5)	173
Figure 1-261	Remove the auto-close assembly (2 of 5)	174
Figure 1-262	Remove the auto-close assembly (3 of 5)	174
Figure 1-263	Remove the auto-close assembly (4 of 5)	175
Figure 1-264	Remove the auto-close assembly (5 of 5)	175
Figure 1-265	Reinstall the auto-close assembly	176
Figure 1-266	Remove the low-voltage power supply (M806; 1 of 4)	177
Figure 1-267	Remove the low-voltage power supply (M806; 2 of 4)	177
Figure 1-268	Remove the low-voltage power supply (M806; 3 of 4)	178
Figure 1-269	Remove the low-voltage power supply (M806; 4 of 4)	178
Figure 1-270	Remove the low-voltage power supply (M830; 1 of 6)	179
Figure 1-271	Remove the low-voltage power supply (M830; 2 of 6)	179
Figure 1-272	Remove the low-voltage power supply (M830; 3 of 6)	180
Figure 1-273	Remove the low-voltage power supply (M830; 4 of 6)	180
Figure 1-274	Remove the low-voltage power supply (M830; 5 of 6)	181
Figure 1-275	Remove the low-voltage power supply (M830; 6 of 6)	181
Figure 1-276	Remove the high-voltage power supply (M806; 1 of 3)	182
Figure 1-277	Remove the high-voltage power supply (M806; 2 of 3)	182
Figure 1-278	Remove the high-voltage power supply (M806; 3 of 3)	183

Figure 1-279	Reinstall the high-voltage power supply (M806)	183
Figure 1-280	Remove the high-voltage power supply (M830; 1 of 4)	184
Figure 1-281	Remove the high-voltage power supply (M830; 2 of 4)	184
Figure 1-282	Remove the high-voltage power supply (M830; 3 of 4)	185
Figure 1-283	Remove the high-voltage power supply (M830; 4 of 4)	185
Figure 1-284	Reinstall the high-voltage power supply (M830; 1 of 2)	186
Figure 1-285	Reinstall the high-voltage power supply (M830; 2 of 2)	186
Figure 1-286	Remove the DC controller (M806; 1 of 4)	187
Figure 1-287	Remove the DC controller (M806; 2 of 4)	188
Figure 1-288	Remove the DC controller (M806; 3 of 4)	188
Figure 1-289	Remove the DC controller (M806; 4 of 4)	189
Figure 1-290	Remove the DC controller (M830; 1 of 5)	190
Figure 1-291	Remove the DC controller (M830; 2 of 5)	191
Figure 1-292	Remove the DC controller (M830; 3 of 5)	191
Figure 1-293	Remove the DC controller (M830; 4 of 5)	192
Figure 1-294	Remove the DC controller (M830; 5 of 5)	192
Figure 1-295	Remove the cartridge contact assembly (1 of 2)	193
Figure 1-296	Remove the cartridge contact assembly (2 of 2)	194
Figure 1-297	Reinstall the cartridge contact assembly	194
Figure 1-298	Remove the drum motor	195
Figure 1-299	Remove the drive assembly (M806; 1 of 3)	196
Figure 1-300	Remove the drive assembly (M806; 2 of 3)	197
Figure 1-301	Remove the drive assembly (M806; 3 of 3)	197
Figure 1-302	Reinstall the drive assembly (M806; 1 of 2)	198
Figure 1-303	Reinstall the drive assembly (M806; 2 of 2)	198
Figure 1-304	Remove the drive assembly (M830; 1 of 3)	199
Figure 1-305	Remove the drive assembly (M830; 2 of 3)	200
Figure 1-306	Remove the drive assembly (M830; 3 of 3)	200
Figure 1-307	Reinstall the drive assembly (M830; 1 of 2)	201
Figure 1-308	Reinstall the drive assembly (M830; 2 of 2)	201
Figure 1-309	Remove the transfer paper-feed assembly (1 of 2)	202
Figure 1-310	Remove the transfer paper-feed assembly (2 of 2)	203
Figure 1-311	Reinstall the transfer paper-feed assembly (1 of 2)	203
Figure 1-312	Reinstall the transfer paper-feed assembly (2 of 2)	204
Figure 1-313	Remove the transfer-holder assembly (1 of 3)	206
Figure 1-314	Remove the transfer-holder assembly (2 of 3)	206
Figure 1-315	Remove the transfer-holder assembly (3 of 3)	207
Figure 1-316	Reinstall the transfer-holder assembly	207
Figure 1-317	Remove the cartridge-lifter assembly (M806; 1 of 11)	208
Figure 1-318	Remove the cartridge-lifter assembly (M806; 2 of 11)	209
Figure 1-319	Remove the cartridge-lifter assembly (M806; 3 of 11)	209

Figure 1-320	Remove the cartridge-lifter assembly (M806; 4 of 11)	210
Figure 1-321	Remove the cartridge-lifter assembly (M806; 5 of 11)	210
Figure 1-322	Remove the cartridge-lifter assembly (M806; 6 of 11)	211
Figure 1-323	Remove the cartridge-lifter assembly (M806; 7 of 11)	211
Figure 1-324	Remove the cartridge-lifter assembly (M806; 8 of 11)	212
Figure 1-325	Remove the cartridge-lifter assembly (M806; 9 of 11)	212
Figure 1-326	Remove the cartridge-lifter assembly (M806; 10 of 11)	213
Figure 1-327	Remove the cartridge-lifter assembly (M806; 11 of 11)	213
Figure 1-328	Reinstall the cartridge-lifter assembly (M806; 1 of 6)	214
Figure 1-329	Reinstall the cartridge-lifter assembly (M806; 2 of 6)	214
Figure 1-330	Reinstall the cartridge-lifter assembly (M806; 3 of 6)	215
Figure 1-331	Reinstall the cartridge-lifter assembly (M806; 4 of 6)	215
Figure 1-332	Reinstall the cartridge-lifter assembly (M806; 5 of 6)	216
Figure 1-333	Reinstall the cartridge-lifter assembly (M806; 6 of 6)	216
Figure 1-334	Remove the cartridge-lifter assembly (M830; 1 of 14)	217
Figure 1-335	Remove the cartridge-lifter assembly (M830; 2 of 14)	218
Figure 1-336	Remove the cartridge-lifter assembly (M830; 3 of 14)	218
Figure 1-337	Remove the cartridge-lifter assembly (M830; 4 of 14)	219
Figure 1-338	Remove the cartridge-lifter assembly (M830; 5 of 14)	219
Figure 1-339	Remove the cartridge-lifter assembly (M830; 6 of 14)	220
Figure 1-340	Remove the cartridge-lifter assembly (M830; 7 of 14)	220
Figure 1-341	Remove the cartridge-lifter assembly (M830; 8 of 14)	221
Figure 1-342	Remove the cartridge-lifter assembly (M830; 9 of 14)	221
Figure 1-343	Remove the cartridge-lifter assembly (M830; 10 of 14)	222
Figure 1-344	Remove the cartridge-lifter assembly (M830; 11 of 14)	222
Figure 1-345	Remove the cartridge-lifter assembly (M830; 12 of 14)	223
Figure 1-346	Remove the cartridge-lifter assembly (M830; 13 of 14)	223
Figure 1-347	Remove the cartridge-lifter assembly (M830; 14 of 14)	224
Figure 1-348	Reinstall the cartridge-lifter assembly (M806; 1 of 6)	224
Figure 1-349	Reinstall the cartridge-lifter assembly (M806; 2 of 6)	225
Figure 1-350	Reinstall the cartridge-lifter assembly (M806; 3 of 6)	225
Figure 1-351	Reinstall the cartridge-lifter assembly (M806; 4 of 6)	226
Figure 1-352	Reinstall the cartridge-lifter assembly (M806; 5 of 6)	227
Figure 1-353	Reinstall the cartridge-lifter assembly (M806; 6 of 6)	227
Figure 1-354	Remove the driver PCA (1 of 2)	228
Figure 1-355	Remove the driver PCA (2 of 2)	229
Figure 1-356	Reinstall the driver PCA (1 of 2)	229
Figure 1-357	Reinstall the driver PCA (2 of 2)	230
Figure 1-358	Remove the laser/scanner assembly (1 of 4)	231
Figure 1-359	Remove the laser/scanner assembly (2 of 4)	232
Figure 1-360	Remove the laser/scanner assembly (3 of 4)	232

Figure 1-361	Remove the laser/scanner assembly (4 of 4)	233
Figure 1-362	Remove the face-down paper-delivery assembly (M806; 1 of 4)	234
Figure 1-363	Remove the face-down paper-delivery assembly (M806; 2 of 4)	235
Figure 1-364	Remove the face-down paper-delivery assembly (M806; 3 of 4)	235
Figure 1-365	Remove the face-down paper-delivery assembly (M806; 4 of 4)	236
Figure 1-366	Remove the paper-delivery fan assembly (M830; 1 of 7)	237
Figure 1-367	Remove the paper-delivery fan assembly (M830; 2 of 7)	238
Figure 1-368	Remove the paper-delivery fan assembly (M830; 3 of 7)	238
Figure 1-369	Remove the paper-delivery fan assembly (M830; 4 of 7)	239
Figure 1-370	Remove the paper-delivery fan assembly (M830; 5 of 7)	239
Figure 1-371	Remove the paper-delivery fan assembly (M830; 6 of 7)	240
Figure 1-372	Remove the paper-delivery fan assembly (M830; 7 of 7)	240
Figure 1-373	Reinstall the paper-delivery fan assembly (M830)	241
Figure 1-374	Remove the fuser drive assembly (1 of 5)	243
Figure 1-375	Remove the fuser drive assembly (2 of 5)	243
Figure 1-376	Remove the fuser drive assembly (3 of 5)	244
Figure 1-377	Remove the fuser drive assembly (4 of 5)	244
Figure 1-378	Remove the fuser drive assembly (5 of 5)	245
Figure 1-379	Reinstall the fuser drive assembly (1 of 2)	246
Figure 1-380	Reinstall the fuser drive assembly (2 of 2)	246
Figure 1-381	Remove the power switch assembly	247
Figure 1-382	Reinstall the power switch assembly	247
Figure 1-383	Remove the interconnect PCA (1 of 4)	248
Figure 1-384	Remove the interconnect PCA (2 of 4)	249
Figure 1-385	Remove the interconnect PCA (3 of 4)	249
Figure 1-386	Remove the interconnect PCA (4 of 4)	250
Figure 1-387	Reinstall the interconnect PCA	250
Figure 1-388	Reinstall the interconnect PCA	251
Figure 1-389	Remove the formatter cage	252
Figure 1-390	Reinstall the formatter cage	253
Figure 1-391	Remove the fuser bias contact assembly (1 of 3)	255
Figure 1-392	Remove the fuser bias contact assembly (2 of 3)	255
Figure 1-393	Remove the fuser bias contact assembly (3 of 3)	256
Figure 1-394	Reinstall the fuser bias contact assembly (1 of 2)	256
Figure 1-395	Reinstall the fuser bias contact assembly (2 of 2)	257
Figure 1-396	Remove the cooling-unit assembly (1 of 5)	258
Figure 1-397	Remove the cooling-unit assembly (2 of 5)	258
Figure 1-398	Remove the cooling-unit assembly (3 of 5)	259
Figure 1-399	Remove the cooling-unit assembly (4 of 5)	259
Figure 1-400	Remove the cooling-unit assembly (5 of 5)	260
Figure 1-401	Reinstall the cooling unit assembly	260

Figure 1-402	Remove the tag assembly (1 of 2)	261
Figure 1-403	Remove the tag assembly (2 of 2)	262
Figure 1-404	Remove the option-connector assembly (1 of 6)	263
Figure 1-405	Remove the option-connector assembly (2 of 6)	263
Figure 1-406	Remove the option-connector assembly (3 of 6)	264
Figure 1-407	Remove the option-connector assembly (4 of 6)	264
Figure 1-408	Remove the option-connector assembly (5 of 6)	265
Figure 1-409	Remove the option-connector assembly (6 of 6)	265
Figure 1-410	Reinstall the option connector assembly	266
Figure 1-411	External covers and doors	268
Figure 1-412	Main assemblies (1 of 2)	269
Figure 1-413	Main assemblies (2 of 2)	270
Figure 1-414	Printed circuit assembly (PCA)	271
Figure 1-415	Remove the HCI right tray	272
Figure 1-416	Remove the HCI left tray	273
Figure 1-417	Remove the HCI rear and right-rear corner covers (1 of 4)	274
Figure 1-418	Remove the HCI rear and right-rear corner covers (2 of 4)	274
Figure 1-419	Remove the HCI rear and right-rear corner covers (3 of 4)	275
Figure 1-420	Remove the HCI rear and right-rear corner covers (4 of 4)	275
Figure 1-421	Remove the HCI right door assembly (1 of 2)	276
Figure 1-422	Remove the HCI right door assembly (2 of 2)	276
Figure 1-423	Remove the HCI left cover (1 of 2)	277
Figure 1-424	Remove the HCI left cover (2 of 2)	277
Figure 1-425	Remove the HCI center right cover (1 of 4)	278
Figure 1-426	Remove the HCI center right cover (2 of 4)	278
Figure 1-427	Remove the HCI center right cover (3 of 4)	279
Figure 1-428	Remove the HCI center right cover (4 of 4)	279
Figure 1-429	Remove the HCI lower right cover (1 of 3)	280
Figure 1-430	Remove the HCI lower right cover (2 of 3)	280
Figure 1-431	Remove the HCI lower right cover (3 of 3)	281
Figure 1-432	Remove the HCI right tray pickup motor	282
Figure 1-433	Remove the HCI right tray pickup drive	283
Figure 1-434	Remove the HCI left tray pickup motor.	284
Figure 1-435	Remove the HCI left tray pickup drive (1 of 2)	285
Figure 1-436	Remove the HCI merge drive assembly (1 of 2)	286
Figure 1-437	Remove the HCI merge drive assembly (2 of 2)	286
Figure 1-438	Remove the HCI right tray lifter drive assembly	287
Figure 1-439	Remove the HCI left tray lifter drive assembly	288
Figure 1-440	Remove the HCI right tray media-level sensor assembly (1 of 2)	289
Figure 1-441	Remove the HCI right tray media-level sensor assembly (2 of 2)	289
Figure 1-442	Remove the HCI left tray media-level sensor assembly (1 of 2)	290

Figure 1-443	Remove the HCI left tray media-level sensor assembly (2 of 2)	290
Figure 1-444	Remove the HCI right tray automatic close assembly (1 of 2)	291
Figure 1-445	Remove the HCI right tray automatic close assembly (2 of 2)	291
Figure 1-446	Remove the HCI left tray automatic close assembly (1 of 2)	292
Figure 1-447	Remove the HCI left tray automatic close assembly (2 of 2)	292
Figure 1-448	Remove the HCI right tray pickup assembly (1 of 2)	293
Figure 1-449	Remove the HCI right tray pickup assembly (2 of 2)	294
Figure 1-450	Remove the HCI left tray pickup assembly (1 of 2)	295
Figure 1-451	Remove the HCI left tray pickup assembly (2 of 2)	296
Figure 1-452	Remove the HCI merge assembly (1 of 2)	297
Figure 1-453	Remove the HCI merge assembly (2 of 2)	298
Figure 1-454	Remove the HCI controller PCA	299
Figure 1-455	Identify the BM finishing accessory	301
Figure 1-456	Identify the SS finishing accessory	301
Figure 1-457	Identify the SSHP finishing accessory	302
Figure 1-458	Disconnect a finishing accessory from the product (1 of 4)	303
Figure 1-459	Disconnect a finishing accessory from the product (2 of 4)	303
Figure 1-460	Disconnect a finishing accessory from the product (3 of 4)	304
Figure 1-461	Disconnect a finishing accessory from the product (4 of 4)	304
Figure 1-462	Finishing accessory covers and doors (1 of 2)	305
Figure 1-463	Finishing accessory covers and doors (2 of 2)	306
Figure 1-464	Remove the upper cover lock assembly (1 of 3)	309
Figure 1-465	Remove the upper cover lock assembly (2 of 3)	309
Figure 1-466	Remove the upper cover lock assembly (3 of 3)	310
Figure 1-467	Remove the right cover assembly (1 of 2)	311
Figure 1-468	Remove the right cover assembly (2 of 2)	311
Figure 1-469	Remove the pre-reverse cover assembly (1 of 3)	312
Figure 1-470	Remove the pre-reverse cover assembly (2 of 3)	312
Figure 1-471	Remove the pre-reverse cover assembly (3 of 3)	313
Figure 1-472	Remove the rear reverse cover assembly (1 of 3)	314
Figure 1-473	Remove the rear reverse cover assembly (2 of 3)	314
Figure 1-474	Remove the rear reverse cover assembly (3 of 3)	315
Figure 1-475	Remove the upper reverse cover assembly (1 of 2)	316
Figure 1-476	Remove the upper reverse cover assembly (2 of 2)	316
Figure 1-477	Remove the bin cable guide cover (1 of 6)	317
Figure 1-478	Remove the bin cable guide cover (2 of 6)	317
Figure 1-479	Remove the bin cable guide cover (3 of 6)	318
Figure 1-480	Remove the bin cable guide cover (4 of 6)	318
Figure 1-481	Remove the bin cable guide cover (5 of 6)	319
Figure 1-482	Remove the bin cable guide cover (6 of 6)	319
Figure 1-483	Bin cable guide cover correctly installed	320

Figure 1-484	Bin cable guide cover incorrectly installed	320
Figure 1-485	Remove the open/close stepped cover assembly (1 of 2)	321
Figure 1-486	Remove the open/close stepped cover assembly (2 of 2)	321
Figure 1-487	Remove the upper stepped cover assembly (1 of 4)	322
Figure 1-488	Remove the upper stepped cover assembly (2 of 4)	322
Figure 1-489	Remove the upper stepped cover assembly (3 of 4)	323
Figure 1-490	Remove the upper stepped cover assembly (4 of 4)	323
Figure 1-491	Remove the lower stepped cover assembly (1 of 5)	324
Figure 1-492	Remove the lower stepped cover assembly (2 of 5)	325
Figure 1-493	Remove the lower stepped cover assembly (3 of 5)	325
Figure 1-494	Remove the lower stepped cover assembly (4 of 5)	326
Figure 1-495	Remove the lower stepped cover assembly (5 of 5)	326
Figure 1-496	Reinstall the lower stepped cover (1 of 2)	327
Figure 1-497	Reinstall the lower stepped cover (2 of 2)	327
Figure 1-498	Remove the top door assembly (1 of 3)	328
Figure 1-499	Remove the top door assembly (2 of 3)	328
Figure 1-500	Remove the top door assembly (3 of 3)	329
Figure 1-501	Remove the front door (1 of 2)	330
Figure 1-502	Remove the front door (2 of 2)	331
Figure 1-503	Remove only the front door (1 of 2)	331
Figure 1-504	Remove only the front door (2 of 2)	332
Figure 1-505	Move the inner upper cover out of the way (1 of 2)	333
Figure 1-506	Move the inner upper cover out of the way (2 of 2)	333
Figure 1-507	Remove the inner upper cover assembly (1 of 2)	334
Figure 1-508	Remove the inner upper cover assembly (2 of 2)	335
Figure 1-509	Remove the clutch assembly (front side; 1 of 2)	336
Figure 1-510	Remove the clutch assembly (front side; 2 of 2)	336
Figure 1-511	Remove the sensor switch assembly (1 of 4)	337
Figure 1-512	Remove the sensor switch assembly (2 of 4)	337
Figure 1-513	Remove the sensor switch assembly (3 of 4)	338
Figure 1-514	Remove the sensor switch assembly (4 of 4)	338
Figure 1-515	Move the inner lower cover out of the way (1 of 3)	339
Figure 1-516	Move the inner lower cover out of the way (2 of 3)	339
Figure 1-517	Move the inner lower cover out of the way (3 of 3)	340
Figure 1-518	Remove the inner lower cover assembly (1 of 5)	341
Figure 1-519	Remove the inner lower cover assembly (2 of 5)	342
Figure 1-520	Remove the inner lower cover assembly (3 of 5)	342
Figure 1-521	Remove the inner lower cover assembly (4 of 5)	343
Figure 1-522	Remove the inner lower cover assembly (5 of 5)	343
Figure 1-523	Remove the front foot cover assembly (1 of 5)	344
Figure 1-524	Remove the front foot cover assembly (2 of 5)	345

Figure 1-525	Remove the front foot cover assembly (3 of 5)	345
Figure 1-526	Remove the front foot cover assembly (4 of 5)	346
Figure 1-527	Remove the front foot cover assembly (5 of 5)	346
Figure 1-528	Remove the lower lock release handle assembly (1 of 3)	347
Figure 1-529	Remove the lower lock release handle assembly (2 of 3)	348
Figure 1-530	Remove the lower lock release handle assembly (3 of 3)	348
Figure 1-531	Remove the rear cover assembly (1 of 3)	349
Figure 1-532	Remove the rear cover assembly (2 of 3)	350
Figure 1-533	Remove the rear cover assembly (3 of 3)	350
Figure 1-534	Remove only the rear cover (1 of 3)	351
Figure 1-535	Remove only the rear cover (2 of 3)	351
Figure 1-536	Remove only the rear cover (3 of 3)	352
Figure 1-537	Remove the main controller PCA assembly (1 of 6)	353
Figure 1-538	Remove the main controller PCA assembly (2 of 6)	354
Figure 1-539	Remove the main controller PCA assembly (3 of 6)	354
Figure 1-540	Remove the main controller PCA assembly (4 of 6)	355
Figure 1-541	Remove the main controller PCA assembly (5 of 6)	355
Figure 1-542	Remove the main controller PCA assembly (6 of 6)	356
Figure 1-543	Install a replacement main controller PCA assembly	357
Figure 1-544	Main controller PCA switches	358
Figure 1-545	Booklet maker controller PCA switches (BM only)	359
Figure 1-546	DIPSW4 alignment settings	359
Figure 1-547	DIPSW4 staple position settings	360
Figure 1-548	DIPSW folding position settings	361
Figure 1-549	Mark the paper	362
Figure 1-550	Folding position adjustment (1 of 2)	362
Figure 1-551	Folding position adjustment (2 of 2)	363
Figure 1-552	Positive and negative width adjustment	364
Figure 1-553	Adjust the stitcher (1 of 6)	365
Figure 1-554	Adjust the stitcher (2 of 6)	365
Figure 1-555	Adjust the stitcher (3 of 6)	366
Figure 1-556	Adjust the stitcher (4 of 6)	366
Figure 1-557	Adjust the stitcher (5 of 6)	366
Figure 1-558	Adjust the stitcher (6 of 6)	367
Figure 1-559	Remove the entrance upper guide assembly (1 of 3)	368
Figure 1-560	Remove the entrance upper guide assembly (2 of 3)	369
Figure 1-561	Remove the entrance upper guide assembly (3 of 3)	370
Figure 1-562	Remove the rear foot cover assembly (1 of 7)	371
Figure 1-563	Remove the rear foot cover assembly (2 of 7)	372
Figure 1-564	Remove the rear foot cover assembly (3 of 7)	372
Figure 1-565	Remove the rear foot cover assembly (4 of 7)	373

Figure 1-566	Remove the rear foot cover assembly (5 of 7)	373
Figure 1-567	Remove the rear foot cover assembly (6 of 7)	374
Figure 1-568	Remove the rear foot cover assembly (7 of 7)	374
Figure 1-569	Remove the stack wall upper assembly and upper wall guide assembly (1 of 5)	375
Figure 1-570	Remove the stack wall upper assembly and upper wall guide assembly (2 of 5)	376
Figure 1-571	Remove the stack wall upper assembly and upper wall guide assembly (3 of 5)	376
Figure 1-572	Remove the stack wall upper assembly and upper wall guide assembly (4 of 5)	377
Figure 1-573	Remove the stack wall upper assembly and upper wall guide assembly (5 of 5)	377
Figure 1-574	Remove the upper crossmember assembly (1 of 13)	378
Figure 1-575	Remove the upper crossmember assembly (2 of 13)	379
Figure 1-576	Remove the upper crossmember assembly (3 of 13)	379
Figure 1-577	Remove the upper crossmember assembly (4 of 13)	380
Figure 1-578	Remove the upper crossmember assembly (5 of 13)	380
Figure 1-579	Remove the upper crossmember assembly (5 of 13)	381
Figure 1-580	Remove the upper crossmember assembly (7 of 13)	381
Figure 1-581	Remove the upper crossmember assembly (8 of 13)	382
Figure 1-582	Remove the upper crossmember assembly (9 of 13)	382
Figure 1-583	Remove the upper crossmember assembly (10 of 13)	383
Figure 1-584	Remove the upper crossmember assembly (11 of 13)	383
Figure 1-585	Remove the upper crossmember assembly (12 of 13)	384
Figure 1-586	Remove the upper crossmember assembly (13 of 13)	385
Figure 1-587	Reinstall the upper crossmember assembly (1 of 7)	386
Figure 1-588	Reinstall the upper crossmember assembly (2 of 7)	386
Figure 1-589	Reinstall the upper crossmember assembly (3 of 7)	387
Figure 1-590	Reinstall the upper crossmember assembly (4 of 7)	387
Figure 1-591	Reinstall the upper crossmember assembly (5 of 7)	388
Figure 1-592	Reinstall the upper crossmember assembly (6 of 7)	388
Figure 1-593	Reinstall the upper crossmember assembly (7 of 7)	389
Figure 1-594	Remove the paper feed drive assembly (1 of 2)	390
Figure 1-595	Remove the paper feed drive assembly (2 of 2)	391
Figure 1-596	Remove the pressure roller assembly (1 of 8)	392
Figure 1-597	Remove the pressure roller assembly (2 of 8)	393
Figure 1-598	Remove the pressure roller assembly (3 of 8)	393
Figure 1-599	Remove the pressure roller assembly (4 of 8)	394
Figure 1-600	Remove the pressure roller assembly (5 of 8)	394
Figure 1-601	Remove the pressure roller assembly (6 of 8)	395
Figure 1-602	Remove the pressure roller assembly (7 of 8)	395
Figure 1-603	Remove the pressure roller assembly (8 of 8)	396
Figure 1-604	Remove the stack upper bin and lower bin assemblies (1 of 5)	398
Figure 1-605	Remove the stack upper bin and lower bin assemblies (2 of 5)	398
Figure 1-606	Remove the stack upper bin and lower bin assemblies (3 of 5)	399

Figure 1-607	Remove the stack upper bin and lower bin assemblies (4 of 5)	399
Figure 1-608	Remove the stack upper bin and lower bin assemblies (5 of 5)	400
Figure 1-609	Reinstall the stack upper bin and lower bin assemblies	400
Figure 1-610	Remove the height wall assembly (1 of 2)	401
Figure 1-611	Remove the height wall assembly (2 of 2)	402
Figure 1-612	Reinstall the height wall assembly	402
Figure 1-613	Remove the paper face sensor and flag assembly (1 of 9)	403
Figure 1-614	Remove the paper face sensor and flag assembly (2 of 9)	404
Figure 1-615	Remove the paper face sensor and flag assembly (3 of 9)	404
Figure 1-616	Remove the paper face sensor and flag assembly (4 of 9)	405
Figure 1-617	Remove the paper face sensor and flag assembly (5 of 9)	405
Figure 1-618	Remove the paper face sensor and flag assembly (6 of 9)	406
Figure 1-619	Remove the paper face sensor and flag assembly (7 of 9)	406
Figure 1-620	Remove the paper face sensor and flag assembly (8 of 9)	407
Figure 1-621	Remove the paper face sensor and flag assembly (9 of 9)	407
Figure 1-622	Remove the staple sub assembly (1 of 6)	408
Figure 1-623	Remove the staple sub assembly (2 of 6)	408
Figure 1-624	Remove the staple sub assembly (3 of 6)	409
Figure 1-625	Remove the staple sub assembly (4 of 6)	409
Figure 1-626	Remove the staple sub assembly (5 of 6)	410
Figure 1-627	Remove the staple sub assembly (6 of 6)	410
Figure 1-628	Remove the staple connecting cable assembly (1 of 2)	411
Figure 1-629	Remove the staple connecting cable assembly (2 of 2)	412
Figure 1-630	Remove the staple assembly (1 of 7)	413
Figure 1-631	Remove the staple assembly (2 of 7)	414
Figure 1-632	Remove the staple assembly (3 of 7)	414
Figure 1-633	Remove the staple assembly (4 of 7)	415
Figure 1-634	Remove the staple assembly (5 of 7)	415
Figure 1-635	Remove the staple assembly (6 of 7)	416
Figure 1-636	Remove the staple assembly (7 of 7)	416
Figure 1-637	Remove the paper detect holder assembly	417
Figure 1-638	Reinstall the paper detect holder assembly	418
Figure 1-639	Identify the operation tray assembly	419
Figure 1-640	Remove the operation tray assembly (1 of 11)	420
Figure 1-641	Remove the operation tray assembly (2 of 11)	421
Figure 1-642	Remove the operation tray assembly (3 of 11)	422
Figure 1-643	Remove the operation tray assembly (4 of 11)	422
Figure 1-644	Remove the operation tray assembly (5 of 11)	423
Figure 1-645	Remove the operation tray assembly (6 of 11)	423
Figure 1-646	Remove the operation tray assembly (7 of 11)	424
Figure 1-647	Remove the operation tray assembly (8 of 11)	424

Figure 1-648	Remove the operation tray assembly (9 of 11)	425
Figure 1-649	Remove the operation tray assembly (10 of 11)	425
Figure 1-650	Remove the operation tray assembly (11 of 11)	426
Figure 1-651	Reinstall the operation tray assembly (1 of 5)	426
Figure 1-652	Reinstall the operation tray assembly (2 of 5)	427
Figure 1-653	Reinstall the operation tray assembly (3 of 5)	427
Figure 1-654	Reinstall the operation tray assembly (4 of 5)	428
Figure 1-655	Reinstall the operation tray assembly (5 of 5)	429
Figure 1-656	Identify the operation tray assembly	430
Figure 1-657	Remove the swing guide assembly (1 of 12)	431
Figure 1-658	Remove the swing guide assembly (2 of 12)	431
Figure 1-659	Remove the swing guide assembly (3 of 12)	432
Figure 1-660	Remove the swing guide assembly (4 of 12)	432
Figure 1-661	Remove the swing guide assembly (5 of 12)	433
Figure 1-662	Remove the swing guide assembly (6 of 12)	433
Figure 1-663	Remove the swing guide assembly (7 of 12)	434
Figure 1-664	Remove the swing guide assembly (8 of 12)	434
Figure 1-665	Remove the swing guide assembly (9 of 12)	435
Figure 1-666	Remove the swing guide assembly (10 of 12)	435
Figure 1-667	Remove the swing guide assembly (11 of 12)	436
Figure 1-668	Remove the swing guide assembly (12 of 12)	436
Figure 1-669	Reinstall the swing guide assembly (1 of 7)	437
Figure 1-670	Reinstall the swing guide assembly (2 of 7)	437
Figure 1-671	Reinstall the swing guide assembly (3 of 7)	438
Figure 1-672	Reinstall the swing guide assembly (4 of 7)	438
Figure 1-673	Reinstall the swing guide assembly (5 of 7)	439
Figure 1-674	Reinstall the swing guide assembly (6 of 7)	439
Figure 1-675	Reinstall the swing guide assembly (7 of 7)	440
Figure 1-676	Remove the return roller assembly (1 of 2)	442
Figure 1-677	Remove the return roller assembly (2 of 2)	442
Figure 1-678	Remove the clutch assembly (rear side; 1 of 6)	443
Figure 1-679	Remove the clutch assembly (rear side; 2 of 6)	443
Figure 1-680	Remove the clutch assembly (rear side; 3 of 6)	444
Figure 1-681	Remove the clutch assembly (rear side; 4 of 6)	444
Figure 1-682	Remove the clutch assembly (rear side; 5 of 6)	445
Figure 1-683	Remove the clutch assembly (rear side; 6 of 6)	445
Figure 1-684	Remove the stack ejection motor assembly (1 of 7)	446
Figure 1-685	Remove the stack ejection motor assembly (2 of 7)	446
Figure 1-686	Remove the stack ejection motor assembly (3 of 7)	447
Figure 1-687	Remove the stack ejection motor assembly (4 of 7)	447
Figure 1-688	Remove the stack ejection motor assembly (5 of 7)	448

Figure 1-689	Remove the stack ejection motor assembly (6 of 7)	448
Figure 1-690	Remove the stack ejection motor assembly (7 of 7)	449
Figure 1-691	Remove the press motor assembly (1 of 7)	450
Figure 1-692	Remove the press motor assembly (2 of 7)	450
Figure 1-693	Remove the press motor assembly (3 of 7)	451
Figure 1-694	Remove the press motor assembly (4 of 7)	451
Figure 1-695	Remove the press motor assembly (5 of 7)	452
Figure 1-696	Remove the press motor assembly (6 of 7)	452
Figure 1-697	Remove the press motor assembly (7 of 7)	453
Figure 1-698	Remove the common driver PCA assembly (1 of 2)	454
Figure 1-699	Remove the common driver PCA assembly (2 of 2)	455
Figure 1-700	Remove the interface cable assembly (1 of 3)	456
Figure 1-701	Remove the interface cable assembly (2 of 3)	456
Figure 1-702	Remove the interface cable assembly (3 of 3)	457
Figure 1-703	Remove the reverse driver PCA assembly	458
Figure 1-704	Remove the reverse assembly (BM and SS; 1 of 5)	459
Figure 1-705	Remove the reverse assembly (BM and SS; 2 of 5)	460
Figure 1-706	Remove the reverse assembly (BM and SS; 3 of 5)	460
Figure 1-707	Remove the reverse assembly (BM and SS; 4 of 5)	461
Figure 1-708	Remove the reverse assembly (BM and SS; 5 of 5)	461
Figure 1-709	Remove the paper pass assembly (1 of 7)	462
Figure 1-710	Remove the paper pass assembly (2 of 7)	463
Figure 1-711	Remove the paper pass assembly (3 of 7)	463
Figure 1-712	Remove the paper pass assembly (4 of 7)	464
Figure 1-713	Remove the paper pass assembly (5 of 7)	464
Figure 1-714	Remove the paper pass assembly (6 of 7)	465
Figure 1-715	Remove the paper pass assembly (7 of 7)	465
Figure 1-716	Remove the knob	467
Figure 1-717	Remove the saddle output bin assembly (1 of 2)	468
Figure 1-718	Remove the saddle output bin assembly (2 of 2)	468
Figure 1-719	Reinstall the saddle output bin assembly	469
Figure 1-720	Remove the right cover assembly (BM PCA; 1 of 2)	470
Figure 1-721	Remove the right cover assembly (BM PCA; 2 of 2)	470
Figure 1-722	Remove the booklet maker controller PCA	471
Figure 1-723	Remove the inner side plate assembly (1 of 8)	472
Figure 1-724	Remove the inner side plate assembly (2 of 8)	473
Figure 1-725	Remove the inner side plate assembly (3 of 8)	473
Figure 1-726	Remove the inner side plate assembly (4 of 8)	474
Figure 1-727	Remove the inner side plate assembly (5 of 8)	474
Figure 1-728	Remove the inner side plate assembly (6 of 8)	475
Figure 1-729	Remove the inner side plate assembly (7 of 8)	475

Figure 1-730	Remove the inner side plate assembly (8 of 8)	476
Figure 1-731	Inner plate assembly at the up position	476
Figure 1-732	Inner plate assembly at the middle position	477
Figure 1-733	Reinstall the inner side plate assembly (1 of 3)	477
Figure 1-734	Reinstall the inner side plate assembly (2 of 3)	478
Figure 1-735	Reinstall the inner side plate assembly (3 of 3)	478
Figure 1-736	Remove the guide sensor assembly (1 of 4)	479
Figure 1-737	Remove the guide sensor assembly (2 of 4)	479
Figure 1-738	Remove the guide sensor assembly (3 of 4)	480
Figure 1-739	Remove the guide sensor assembly (4 of 4)	480
Figure 1-740	Remove the guide motor assembly (1 of 3)	481
Figure 1-741	Remove the guide motor assembly (2 of 3)	482
Figure 1-742	Remove the guide motor assembly (3 of 3)	482
Figure 1-743	Remove the saddle motor assembly (1 of 3)	483
Figure 1-744	Remove the saddle motor assembly (2 of 3)	483
Figure 1-745	Remove the saddle motor assembly (3 of 3)	484
Figure 1-746	Remove the saddle feed motor assembly (1 of 6)	485
Figure 1-747	Remove the saddle feed motor assembly (2 of 6)	486
Figure 1-748	Remove the saddle feed motor assembly (3 of 6)	486
Figure 1-749	Remove the saddle feed motor assembly (4 of 6)	487
Figure 1-750	Remove the saddle feed motor assembly (5 of 6)	487
Figure 1-751	Remove the saddle feed motor assembly (6 of 6)	488
Figure 1-752	Remove the folding-motor mount assembly (1 of 6)	489
Figure 1-753	Remove the folding-motor mount assembly (2 of 6)	490
Figure 1-754	Remove the folding-motor mount assembly (3 of 6)	490
Figure 1-755	Remove the folding-motor mount assembly (4 of 6)	491
Figure 1-756	Remove the folding-motor mount assembly (5 of 6)	491
Figure 1-757	Remove the folding-motor mount assembly (6 of 6)	492
Figure 1-758	Reinstall the folding-motor mount assembly	493
Figure 1-759	Remove the delivery switch mount assembly (1 of 4)	494
Figure 1-760	Remove the delivery switch mount assembly (2 of 4)	495
Figure 1-761	Remove the delivery switch mount assembly (3 of 4)	495
Figure 1-762	Remove the delivery switch mount assembly (4 of 4)	496
Figure 1-763	Remove the saddle stapler assembly (1 of 3)	497
Figure 1-764	Remove the saddle stapler assembly (2 of 3)	498
Figure 1-765	Remove the saddle stapler assembly (3 of 3)	498
Figure 1-766	Remove the lower left guide assembly (1 of 3)	499
Figure 1-767	Remove the lower left guide assembly (2 of 3)	499
Figure 1-768	Remove the lower left guide assembly (3 of 3)	500
Figure 1-769	Remove the saddle delivery inner cover, front assembly (1 of 3)	501
Figure 1-770	Remove the saddle delivery inner cover, front assembly (2 of 3)	502

Figure 1-771	Remove the saddle delivery inner cover, front assembly (3 of 3)	502
Figure 1-772	Remove the saddle delivery inner cover, rear assembly (1 of 3)	503
Figure 1-773	Remove the saddle delivery inner cover, rear assembly (2 of 3)	504
Figure 1-774	Remove the saddle delivery inner cover, rear assembly (3 of 3)	504
Figure 1-775	Remove the saddle guide assembly (1 of 5)	506
Figure 1-776	Remove the saddle guide assembly (2 of 5)	506
Figure 1-777	Remove the saddle guide assembly (3 of 5)	507
Figure 1-778	Remove the saddle guide assembly (4 of 5)	507
Figure 1-779	Remove the saddle guide assembly (5 of 5)	508
Figure 1-780	Reinstall the saddle guide assembly (1 of 4)	509
Figure 1-781	Reinstall the saddle guide assembly (2 of 4)	509
Figure 1-782	Reinstall the saddle guide assembly (3 of 4)	510
Figure 1-783	Reinstall the saddle guide assembly (4 of 4)	510
Figure 1-784	Remove the saddle feed assembly (1 of 5)	511
Figure 1-785	Remove the saddle feed assembly (2 of 5)	512
Figure 1-786	Remove the saddle feed assembly (3 of 5)	512
Figure 1-787	Remove the saddle feed assembly (4 of 5)	513
Figure 1-788	Remove the saddle feed assembly (5 of 5)	513
Figure 1-789	Remove the saddle assembly (1 of 15)	515
Figure 1-790	Remove the saddle assembly (2 of 15)	515
Figure 1-791	Remove the saddle assembly (3 of 15)	516
Figure 1-792	Remove the saddle assembly (4 of 15)	516
Figure 1-793	Remove the saddle assembly (5 of 15)	517
Figure 1-794	Remove the saddle assembly (6 of 15)	517
Figure 1-795	Remove the saddle assembly (7 of 15)	518
Figure 1-796	Remove the saddle assembly (8 of 15)	518
Figure 1-797	Remove the saddle assembly (9 of 15)	519
Figure 1-798	Remove the saddle assembly (10 of 15)	519
Figure 1-799	Remove the saddle assembly (11 of 15)	520
Figure 1-800	Remove the saddle assembly (12 of 15)	520
Figure 1-801	Remove the saddle assembly (13 of 15)	521
Figure 1-802	Remove the saddle assembly (14 of 15)	521
Figure 1-803	Remove the saddle assembly (15 of 15)	522
Figure 1-804	Reinstall the saddle assembly	523
Figure 1-805	Remove the upper delivery guide assembly (1 of 3)	524
Figure 1-806	Remove the upper delivery guide assembly (2 of 3)	525
Figure 1-807	Remove the upper delivery guide assembly (3 of 3)	525
Figure 1-808	Remove the saddle paper delivery assembly (1 of 8)	526
Figure 1-809	Remove the saddle paper delivery assembly (2 of 8)	527
Figure 1-810	Remove the saddle paper delivery assembly (3 of 8)	527
Figure 1-811	Remove the saddle paper delivery assembly (4 of 8)	528

Figure 1-812	Remove the saddle paper delivery assembly (5 of 8)	528
Figure 1-813	Remove the saddle paper delivery assembly (6 of 8)	529
Figure 1-814	Remove the saddle paper delivery assembly (7 of 8)	529
Figure 1-815	Remove the saddle paper delivery assembly (8 of 8)	530
Figure 1-816	Remove the saddle rear end sensor assembly (1 of 10)	531
Figure 1-817	Remove the saddle rear end sensor assembly (2 of 10)	532
Figure 1-818	Remove the saddle rear end sensor assembly (3 of 10)	532
Figure 1-819	Remove the saddle rear end sensor assembly (4 of 10)	533
Figure 1-820	Remove the saddle rear end sensor assembly (5 of 10)	533
Figure 1-821	Remove the saddle rear end sensor assembly (6 of 10)	534
Figure 1-822	Remove the saddle rear end sensor assembly (7 of 10)	534
Figure 1-823	Remove the saddle rear end sensor assembly (8 of 10)	535
Figure 1-824	Remove the saddle rear end sensor assembly (9 of 10)	535
Figure 1-825	Remove the saddle rear end sensor assembly (10 of 10)	536
Figure 1-826	Remove the punch controller PCA assembly	538
Figure 1-827	Remove the dust collector assembly	539
Figure 1-828	Remove the punch inner cover assembly (1 of 2)	540
Figure 1-829	Remove the punch inner cover assembly (2 of 2)	540
Figure 1-830	Remove the punch top cover (1 of 6)	541
Figure 1-831	Remove the punch top cover (2 of 6)	542
Figure 1-832	Remove the punch top cover (3 of 6)	542
Figure 1-833	Remove the punch top cover (4 of 6)	543
Figure 1-834	Remove the punch top cover (5 of 6)	543
Figure 1-835	Remove the punch top cover (6 of 6)	544
Figure 1-836	Remove the punch hole assembly (1 of 5)	545
Figure 1-837	Remove the punch hole assembly (2 of 5)	546
Figure 1-838	Remove the punch hole assembly (3 of 5)	546
Figure 1-839	Remove the punch hole assembly (4 of 5)	547
Figure 1-840	Remove the punch hole assembly (5 of 5)	547
Figure 1-841	Adjust the punch hole location	548
Figure 1-842	Adjust the punch hole location	549
Figure 2-1	M830 product integrated scanner assembly (ISA)	557
Figure 2-2	Base product (no optional trays or accessories)	558
Figure 2-3	Document feeder and scanner (M830)	560
Figure 2-4	High capacity input (HCI) feeder covers	561
Figure 2-5	Stapler/stacker and stapler/stacker with hole punch covers	562
Figure 2-6	Booklet maker only covers	563
Figure 2-7	Document feeder and scanner assemblies (M830)	564
Figure 2-8	Document feeder assemblies (1 of 2; M830)	566
Figure 2-9	Document feeder assemblies (2 of 2; M830)	568
Figure 2-10	Scanner assemblies	570

Figure 2-11	Covers	572
Figure 2-12	Internal assemblies (1 of 4)	574
Figure 2-13	Internal assemblies (2 of 4)	576
Figure 2-14	Internal assemblies (3 of 4)	578
Figure 2-15	Internal assemblies (4 of 4)	580
Figure 2-16	3500-sheet paper feeder covers	582
Figure 2-17	3500-sheet paper feeder (1 of 2)	584
Figure 2-18	3500-sheet paper feeder (2 of 2)	586
Figure 2-19	Stapler stacker covers	588
Figure 2-20	Booklet maker covers	590
Figure 2-21	Finisher main body (1 of 3)	592
Figure 2-22	Finisher main body (2 of 3)	594
Figure 2-23	Finisher main body (3 of 3)	596
Figure 2-24	Stapler/stacker finisher main body	598
Figure 2-25	Booklet maker finisher main body	600
Figure 2-26	Booklet maker saddle assembly (1 of 3)	602
Figure 2-27	Booklet maker saddle assembly (2 of 3)	603
Figure 2-28	Booklet maker saddle assembly (3 of 3)	604

Not Final

1 Removal and replacement

- [Removal and replacement strategy](#)
- [Customer-self repair assemblies](#)
- [Pickup, feed, and separation rollers and pads](#)
- [Covers and doors](#)
- [Main assemblies](#)
- [Input accessory](#)
- [Finishing accessories](#)

Not Final

Removal and replacement strategy

Cautions during removal and replacement

This chapter describes the removal and replacement of field-replaceable units (FRUs) only.

Replacing FRUs is generally the reverse of removal. Notes are included to provide directions for difficult or critical replacement procedures.

HP does not support repairing individual subassemblies or troubleshooting to the PCA component level.

Never operate or service the product with the protective cover removed from the laser scanner assembly. The reflected beam, although invisible, can damage your eyes.

The sheet-metal parts can have sharp edges. Be careful when handling sheet-metal parts.



Some parts are sensitive to electrostatic discharge (ESD). Look for the ESD reminder when removing product parts. Always perform service work at an ESD-protected workstation or mat. If an ESD workstation or mat is not available, ground yourself by touching the sheet-metal chassis *before* touching an ESD-sensitive part.

Protect the ESD-sensitive parts by placing them in ESD pouches when they are out of the product.

CAUTION: Do not bend or fold the flat flexible cables (FFCs) during removal or installation.

 **NOTE:** To install a self-tapping screw, first turn it counterclockwise to align it with the existing thread pattern, and then carefully turn it clockwise to tighten. Do not overtighten. If a self-tapping screw-hole becomes stripped, repair the screw-hole or replace the affected assembly.

 **TIP:** For clarity, some figures in this chapter show assemblies removed that are not required to be removed to service the product (for example, the M830 scanner and document feeder assemblies). The procedures in this manual are correct for your product.

Required tools

- #2 Phillips screwdriver with a magnetic tip and a 152-mm (6-in) shaft length

 **NOTE:** For the best fit, use a JIS #2 Phillips screwdriver for the stapler/stacker.

- Small, flat-blade screwdriver
- Needle-nose pliers
- ESD strap (if one is available)
- Penlight



 **CAUTION:** Always use a Phillips screwdriver (callout 1). Do not use a Pozidriv screwdriver (callout 2) or any motorized screwdriver. These can damage screws or screw threads.

Figure 1-1 Screwdrivers

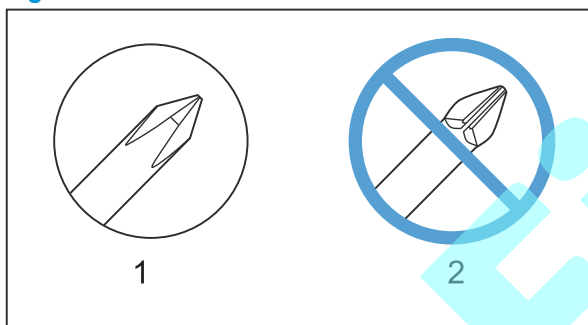

Types of screws

 **WARNING!** Make sure that assemblies are replaced with the correct screw type. Using the incorrect screw (for example, substituting a long screw for the correct shorter screw) can cause damage to the product or interfere with product operation. Do not intermix screws that are removed from one assembly with the screws that are removed from another assembly.

For a complete list of screw types and part numbers, see the Parts chapter in the product repair manual.

Service approach

The products described in this manual use a field repair strategy. Defective parts are diagnosed and replaced at the Field Replaceable Unit (FRU) assembly level. Repair normally begins by using the product internal diagnostics and the following two-step process:

1. Isolate the problem to the major system (for example, the network or server, or the product).
2. Troubleshoot the problem by using the procedures in the troubleshooting manual.

After you locate a faulty part, the product can usually be repaired at the assembly level by replacing FRUs. Some mechanical assemblies might need to be repaired at the subassembly level. Hewlett-Packard Company does not support replacement of components on the printed circuit assemblies.

The user replaces toner cartridges as they are depleted. Additional instructions about other user-replaceable parts are provided in this section.

The product tracks the amount of use on the customer-replaceable supplies by keeping a page count. The product prompts the user to replace certain items when a supply is depleted or a specific number of pages has been printed.

Swapping toner cartridges between products might cause a misrepresentation of supply life values and is not recommended.

Before performing service

⚠ WARNING! Turn the product off, wait 5 seconds, and then remove the power cord before attempting to service the product. *If this warning is not followed, severe injury and damage to the product can result.* The power must be on for certain functional checks during troubleshooting. However, the power supply should be disconnected during parts removal.

1. Remove all paper.
2. Place the product on an ESD mat (if available). If an ESD workstation or mat is not available, ground yourself by touching the sheet-metal chassis *before* touching an ESD-sensitive part.
3. Remove the toner cartridge.
4. Remove the trays.

After performing service

1. Reinstall the toner cartridge.
2. Reinstall the trays.
3. Return all paper to the trays.
4. Plug in the power cable and turn on the product.
5. Perform print-quality tests by printing from a host computer, the scanner glass, and the document feeder.

Parts removal order

If multiple components must be removed to gain access to an assembly, the first step of the removal procedure lists all of the components that must be removed to gain access to that assembly. Use these lists to determine which parts must be removed before removing other parts.

Customer-self repair assemblies

Toner cartridge

1. Open the front door.
2. Rotate the cartridge release lever down until it clicks into place.

Figure 1-2 Remove the toner cartridge (1 of 3)



3. Grasp the front handle (callout 1) with one hand, and then pull the print cartridge out of the product until the top handle (callout 2) is visible.

Figure 1-3 Remove the toner cartridge (2 of 3)

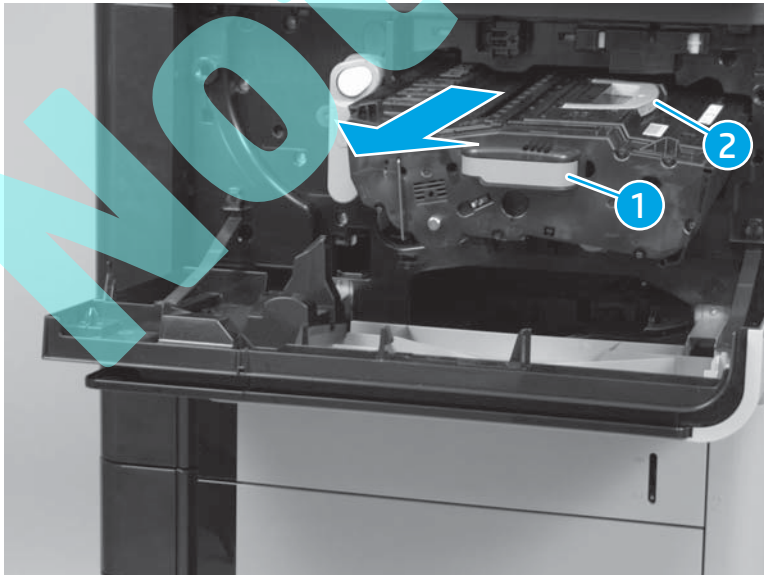

4. Grasp the top handle, and then continue pulling the print cartridge out of the product.

Figure 1-4 Remove the toner cartridge (3 of 3)

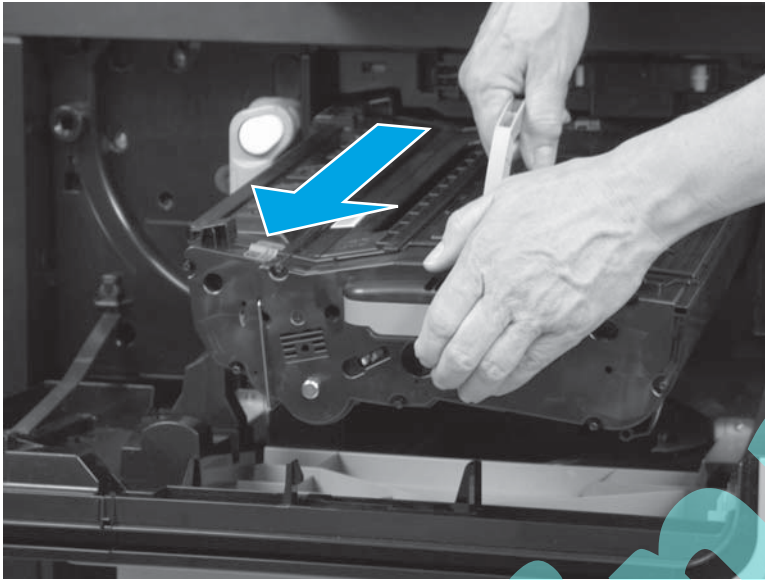

Not Final

Reinstall the toner cartridge

- Make sure that the transfer-roller assembly (see [Transfer-roller assembly on page 8](#)) is installed before installing the print cartridge.
- Align the print cartridge with its guides, and then insert it completely.
- Press and hold the white button on the cartridge release lever (callout 1), and then rotate the lever up until it locks into place (callout 2).

Figure 1-5 Reinstall the toner cartridge



Transfer-roller assembly

1. Open the front cover.
2. Rotate the cartridge release lever down until it clicks into place.

Figure 1-6 Remove the transfer-roller assembly (1 of 2)



3. Press the blue tab, and then slowly pull the transfer roller assembly toward the front of the product until it stops. Lift the assembly up to release the catch on the underside, and then remove the assembly.

 **Reinstallation tip** Make sure that the transfer roller is completely inserted and latched when it is reinstalled.

Figure 1-7 Remove the transfer-roller assembly (2 of 2)



Duplexer

1. If a finishing accessory is attached, release one handle, and then slide the finishing accessory away from the product.

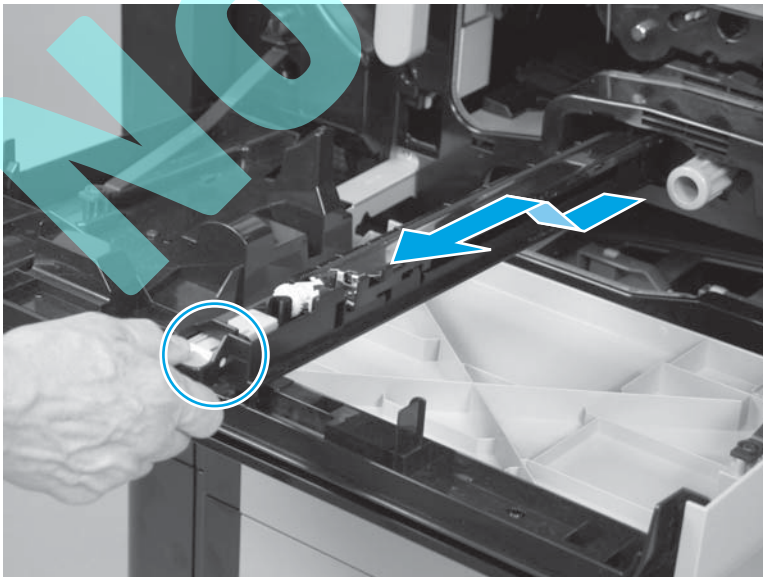
Figure 1-8 Remove the duplexer (1 of 2)

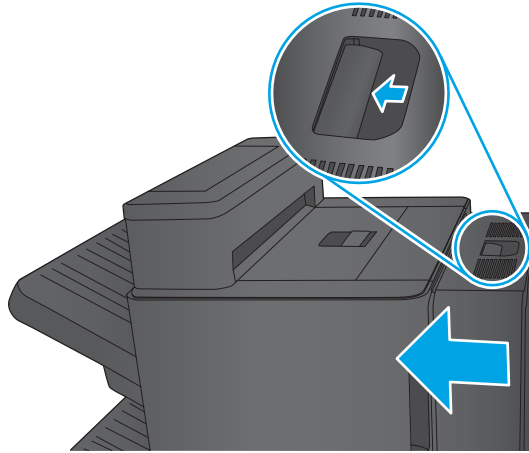

2. Open the left door, and then push down on the green tab to release the duplexer. Slide the duplexer towards the left door, and then lift it up and away from the product.

Figure 1-9 Remove the duplexer (2 of 2)

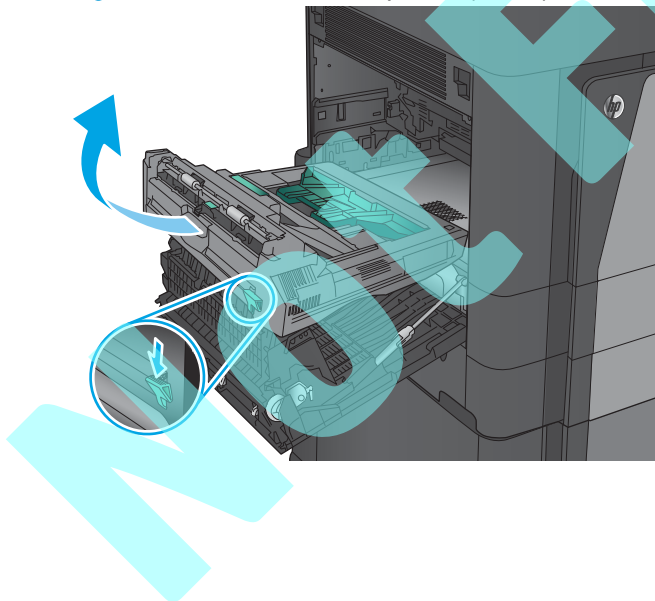

Fuser

Before proceeding, remove the following assemblies:

- Duplexer. See [Duplexer on page 9](#).

Remove the fuser

⚠ WARNING! The fuser might be hot.

1. If a finishing accessory is attached, release one handle, and then slide the finishing accessory away from the product.

Figure 1-10 Remove the fuser (1 of 3)

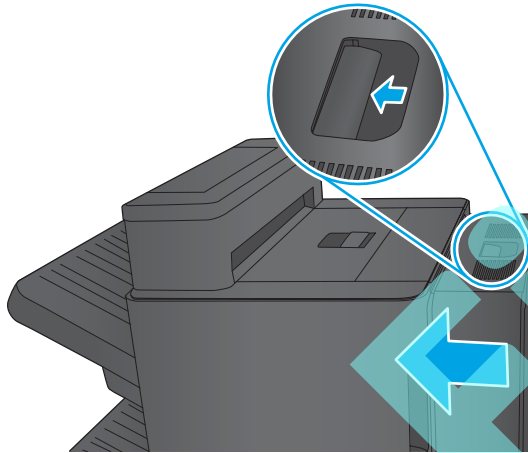

2. Open the left door, release two latches, and then slide the fuser toward the left door.

Figure 1-11 Remove the fuser (2 of 3)

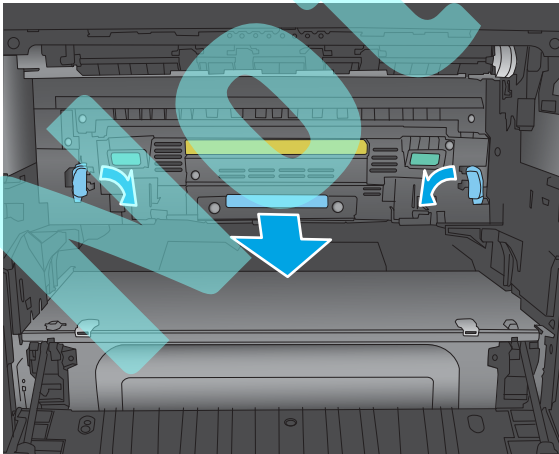

3. Grasp the fuser by the handle, and then lift it out of the product.

Figure 1-12 Remove the fuser (3 of 3)

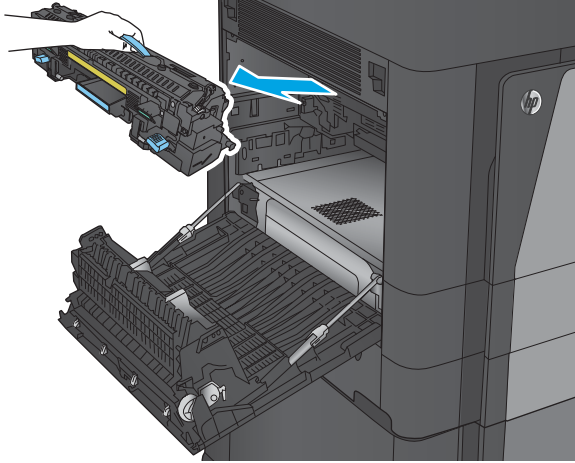

Not Final

Formatter

Remove the formatter

1. If a finishing accessory is attached, release one handle, and then slide the finishing accessory away from the product.

Figure 1-13 Remove the formatter (1 of 3)

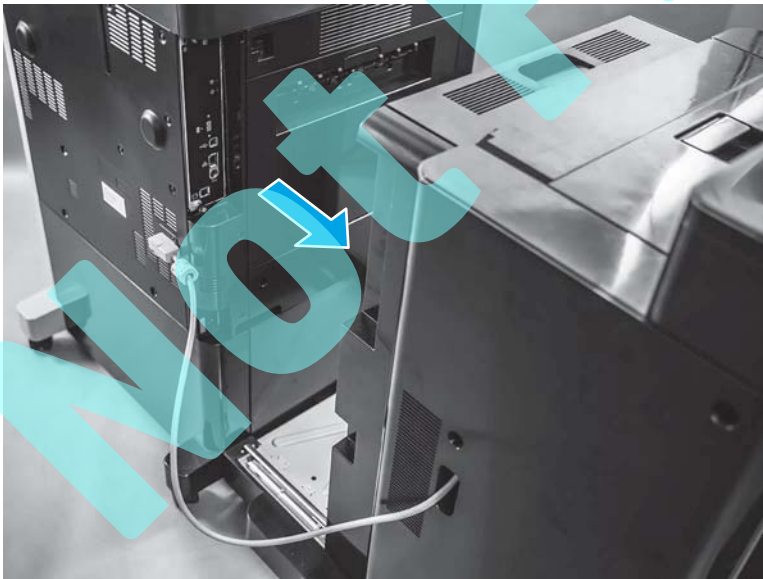
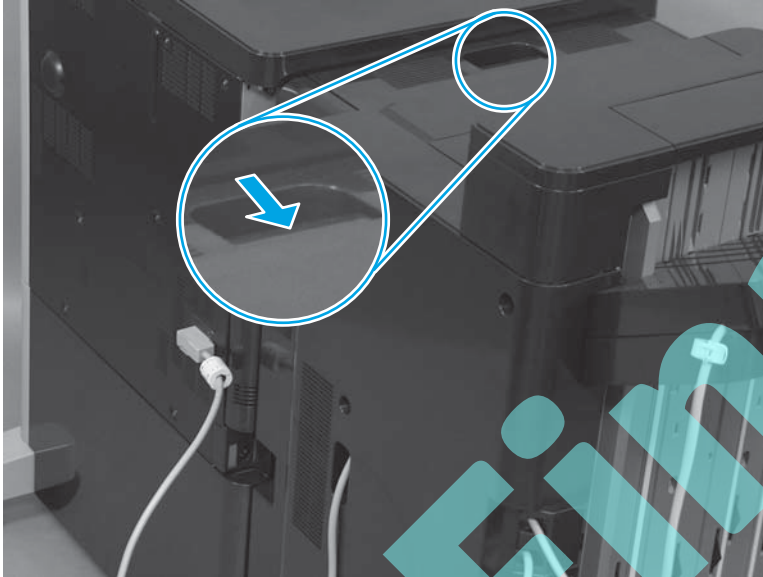

2. Loosen two screws.

Figure 1-14 Remove the formatter (2 of 3)

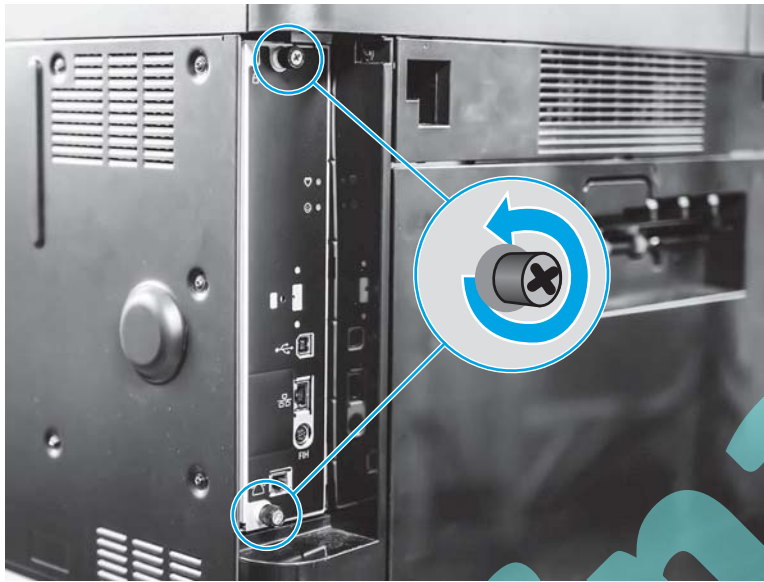

3. Grasp the screws, and then slide the formatter out of the product.

Figure 1-15 Remove the formatter (3 of 3)



4. Remove the following components from the existing formatter, and then reinstall them on the replacement formatter.

 **NOTE:** Not all of these components will be present on the existing formatter. Move those components that are currently installed.

- Hard-disk drive. See [Remove the HDD on page 17](#).
- Memory DIMM. See [Memory DIMM on page 24](#).

- Solid-state memory (M806 only). See [Remove the SSM \(M806 only\) on page 19](#).
- Fax PCA (M830 only). See [Fax PCA \(M830 only\) on page 26](#).

Not Final

Reinstall the formatter

Make sure the formatter is seated completely when reinstalling it. To verify that the formatter is correctly installed, use the power switch to turn on the product power, and then observe the following functions of the LEDs on the formatter.

- The heartbeat LED (callout 1) illuminates if the formatter is functioning correctly..
 - While the product is initializing, the heartbeat LED illuminates solid red for about one second, and then turns solid green for about twenty seconds.
 - After the initialization sequence is complete, the heartbeat LED blinks continuously if the printer is functioning correctly.
- The connectivity LED (callout 2) indicates that the formatter is completely seated. It illuminates green when the product power is turned on and stays green if the formatter is properly seated.

If the LEDs do not correctly function, see the LED diagnostics section in the product troubleshooting manual.

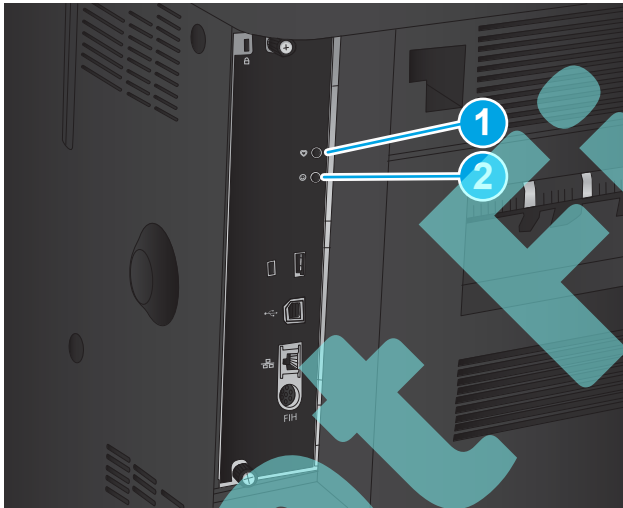

Hard-disk drive (HDD) or solid-state memory(SSM)

Before proceeding, remove the following assemblies:

- Formatter. See [Formatter on page 12](#).

Identify the component type

- Hard-disk drive (HDD). See [Remove the HDD on page 17](#).

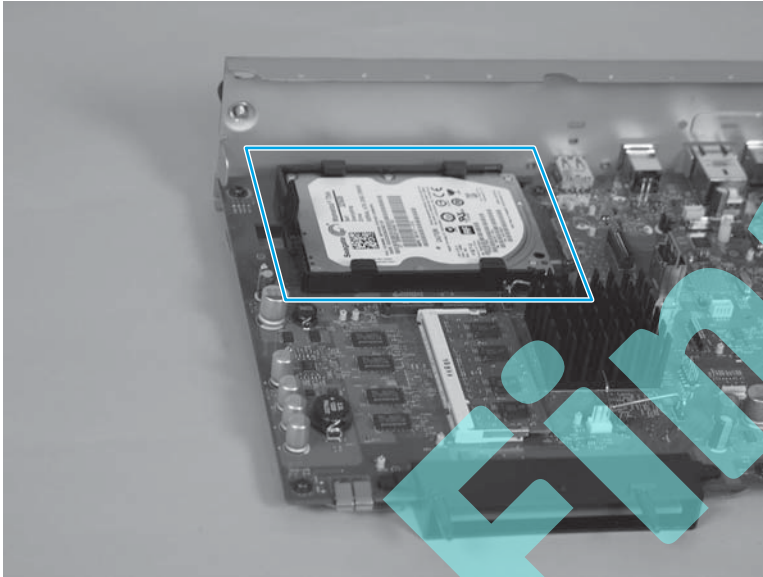

- Solid-state memory (SSM). See [Remove the SSM \(M806 only\) on page 19](#).

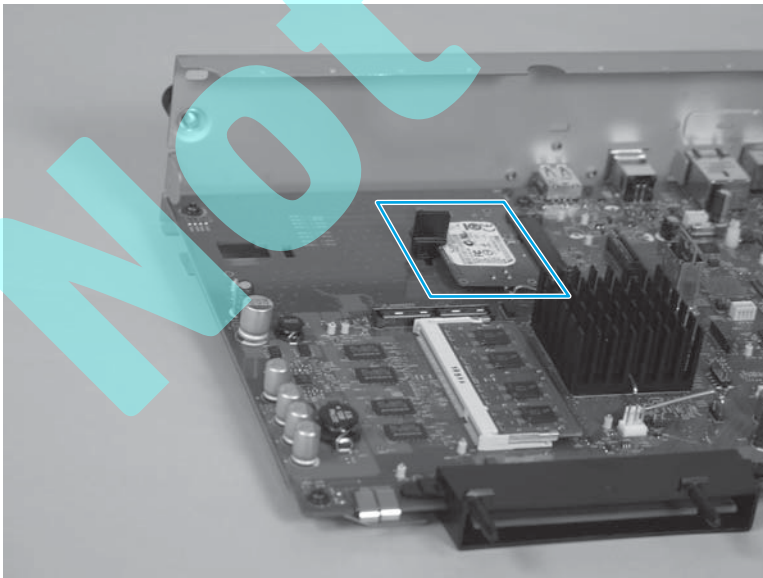

Remove the HDD

⚠ CAUTION:  ESD sensitive assembly.

1. Hold the locking lever on the black plastic HDD case in the release position.

⚠ CAUTION: The black plastic HDD case is fragile.

Figure 1-16 Remove the HDD (1 of 2)

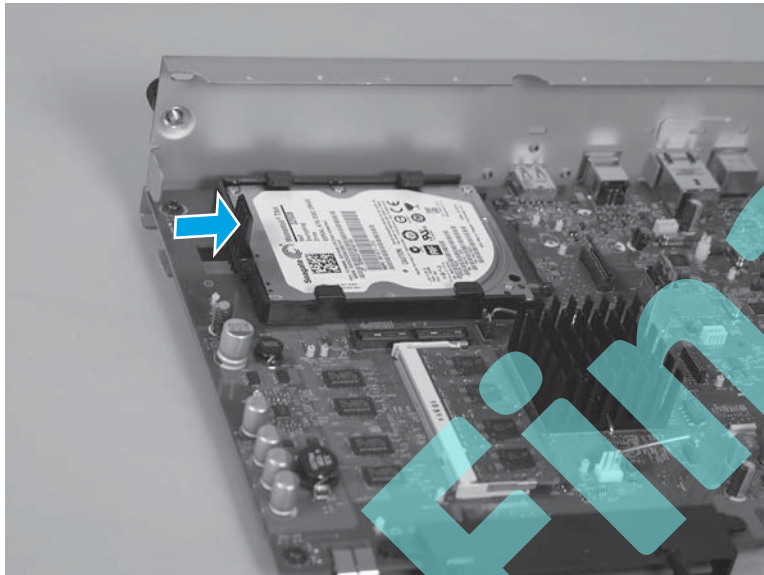

2. While holding the locking lever, slide the black plastic HDD case in the direction of the arrow to remove it.

Figure 1-17 Remove the HDD (2 of 2)

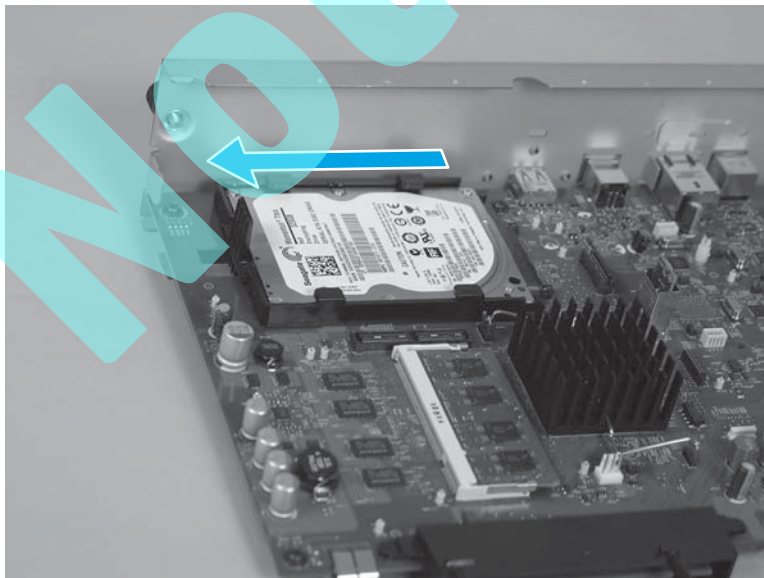

Reinstall the HDD

 **NOTE:** If you are installing a replacement drive, you must reinstall the product firmware. See [Reinstall the product firmware on page 22](#).

Make sure that the HDD is flat against the formatter (callout 1), and that the locking lever (callout 2) snaps into the locked position.

Figure 1-18 Reinstall the HDD

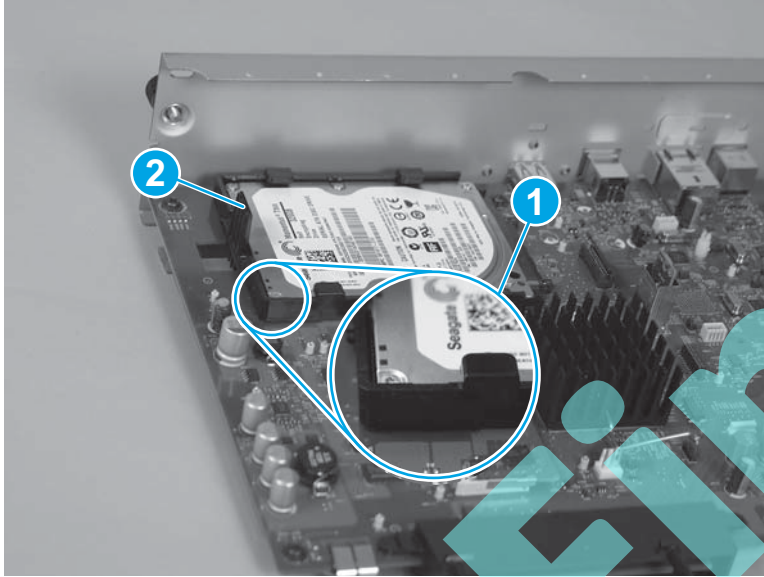

Remove the SSM (M806 only)

 **CAUTION:**  ESD sensitive assembly.

1. Rotate the retainer clip to release it.

Figure 1-19 Remove the SSM (M806; 1 of 3)

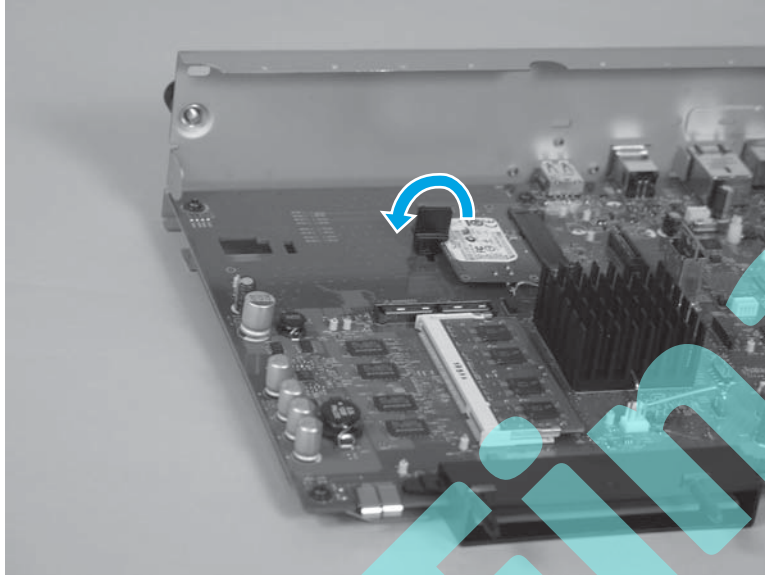

2. Lift the retainer clip up to remove it.

Figure 1-20 Remove the SSM (M806; 2 of 3)

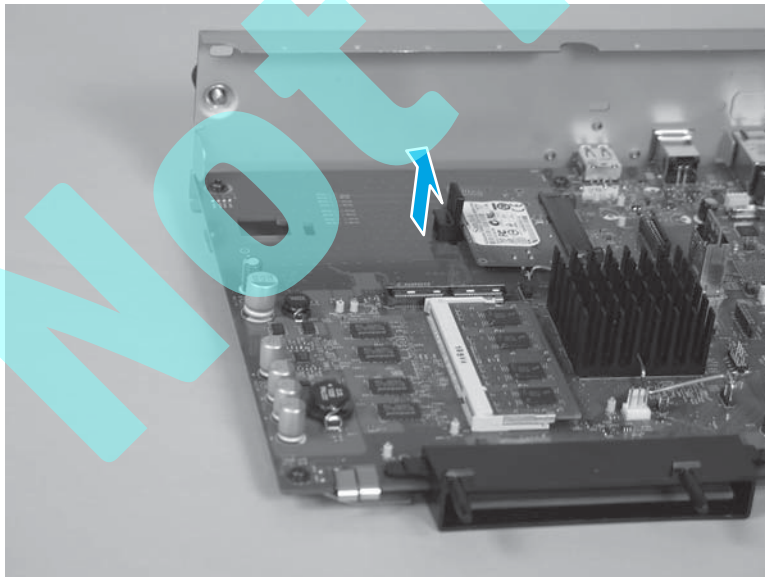

3. Slide the SSM away from the connector to remove it.

Figure 1-21 Remove the SSM (M806; 3 of 3)

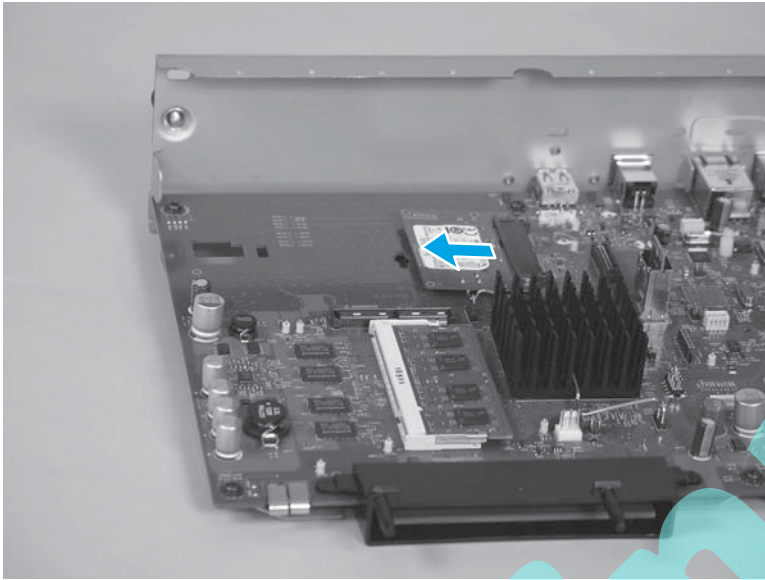

Not Final

Reinstall the SSM (M806 only)

 **NOTE:** If you are installing a replacement SSM, you must reinstall the product firmware. See [Reinstall the product firmware on page 22](#).

1. Make sure that the retainer clip (callout 1) is positioned correctly in the slot (callout 2).

Figure 1-22 Reinstall the SSM (M806; 1 of 2)

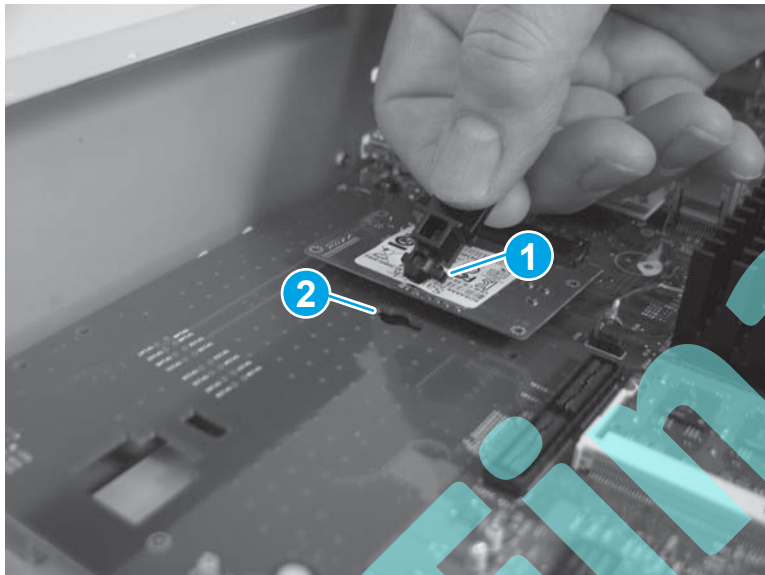

2. Rotate the retainer clip to secure the SSM.

Figure 1-23 Reinstall the SSM (M806; 2 of 2)

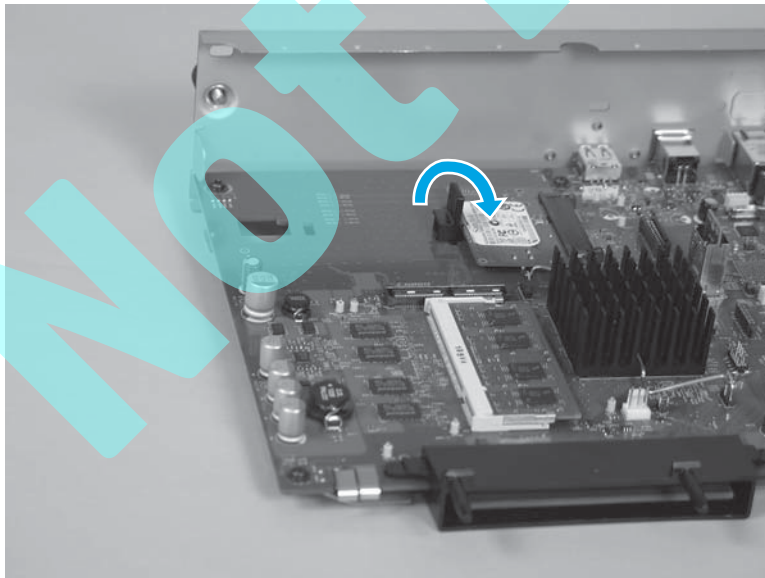

Reinstall the product firmware



NOTE: If you are installing a replacement HDD or SSM, use the procedure below to reinstall the product firmware on the replacement drive.

If you are removing the HDD or SSM so that it can be installed on a replacement formatter, you can skip this procedure.

1. Locate the product support website.
 - **In the US:**
 - Go to <http://www.hp.com/support/ljM806> or <http://www.hp.com/support/ljflowMFP830>.
 - **Outside the US:**
 - Go to <http://www.hp.com/support>.
 - Select your country/region.
 - Select **Product Support & Troubleshooting**
 - Enter the product name, and then select **Search**.
2. Select **Drivers, Software, and Firmware**, and then select **Cross operating system (BIOS, Firmware, Diagnostics, etc.)**.
3. Locate the firmware download, and then select **Download**.
4. Copy the firmware upgrade file to the root directory of a USB flash drive. The firmware upgrade file has a `.bd1` extension.
5. Insert the USB flash drive into the USB port on the product control panel.
6. The following message displays on the control panel: **Error: 99.09.63 Incorrect Disk**. Touch the **OK** button to continue.
7. Wait for the **Pre-Boot** menu to appear on the control-panel display, and then touch the down arrow ▼ button to scroll to **3 Administrator**. Touch the **OK** button to select it.
8. Touch the down arrow ▼ button to scroll to **6 Manage Disk**. Touch the **OK** button to select it.
9. Touch the down arrow ▼ button to scroll to **4 Clear Disk PWD**. Touch the **OK** button to select it.
10. The message **Proceed with Requested Action** displays. Touch the **OK** button to select it.
11. Touch the back ↵ button to return to the **Pre-Boot** menu home screen.
12. Touch the down arrow ▼ button to scroll to **3 Administrator**. Touch the **OK** button to select it.
13. Touch the down arrow ▼ button to scroll to **1 Download**. Touch the **OK** button to select it.
14. Touch the down arrow ▼ button to scroll to **3 USB Thumbdrive**. Touch the **OK** button to select it.
15. Touch the down arrow ▼ button to scroll to the firmware upgrade file that you downloaded in step 4. Touch the **OK** button to select it.



NOTE: If no `.bd1` files are listed, try saving the file to a different USB flash drive.

16. Wait while the file transfers. When the transfer is complete, the message **Complete** displays on the screen.
17. Turn the product off, remove the USB flash drive, and then turn the product on. Wait for several minutes while the product initializes.

Not Final

Memory DIMM

Before proceeding, remove the following assemblies:

- Formatter. See [Formatter on page 12](#).

Remove the memory DIMM

1. Release two clips.

Figure 1-24 Remove the memory DIMM (1 of 2)

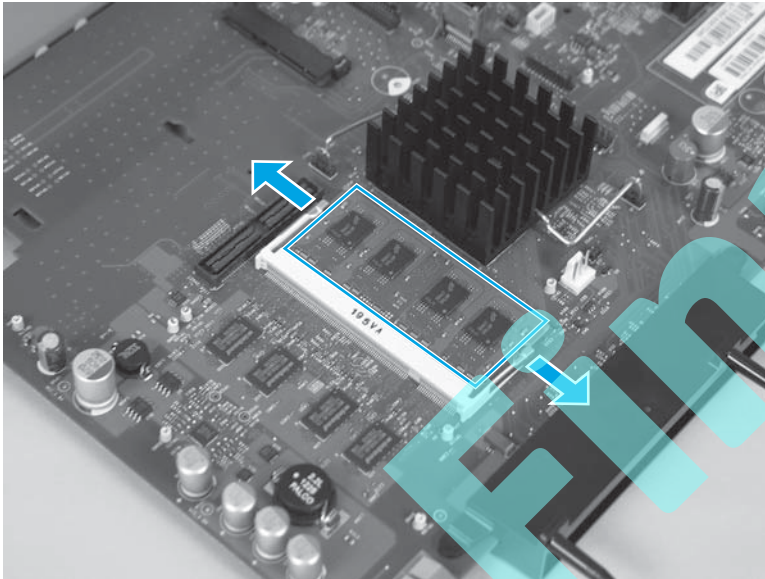

2. Rotate the DIMM upward (callout 1), and then remove it (callout 2).

Figure 1-25 Remove the memory DIMM (2 of 2)

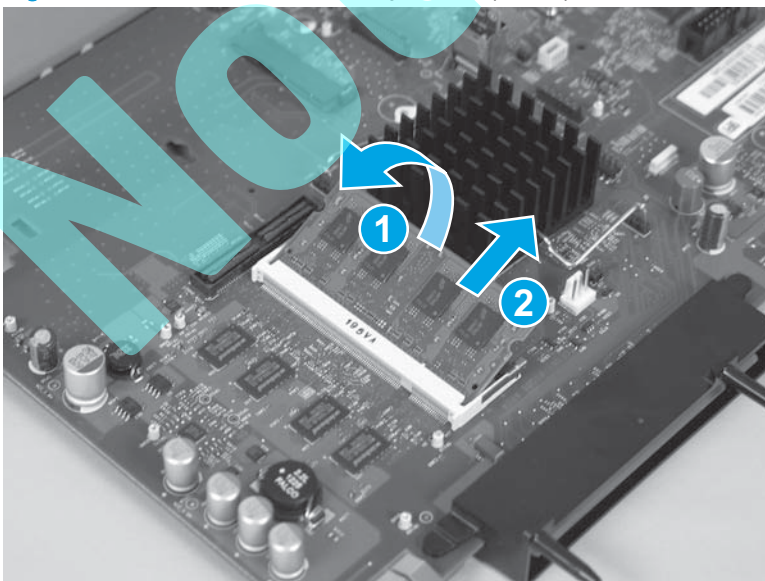

Reinstall the memory DIMM

Make sure that the memory DIMM snaps into the holder.

Figure 1-26 Reinstall the memory DIMM

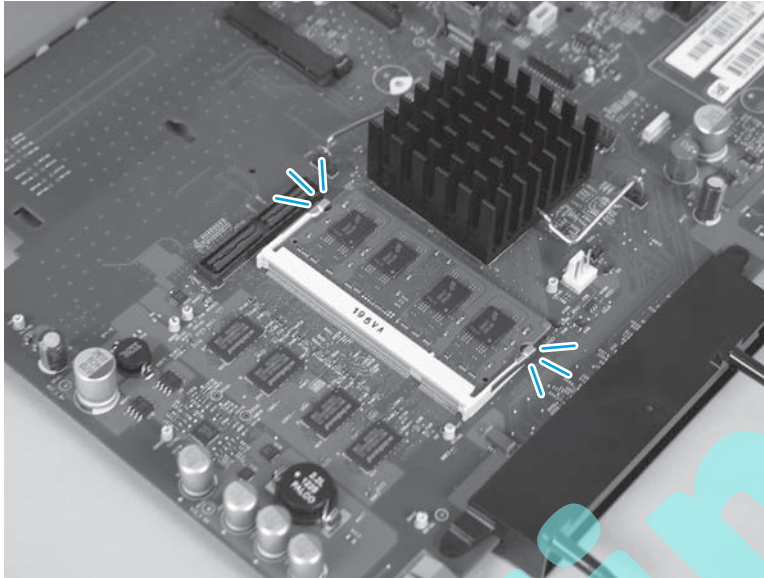

Not Final

Fax PCA (M830 only)

Before proceeding, remove the following assemblies:

- Formatter. See [Formatter on page 12](#).

Remove the fax PCA (M830 only)

1. Rotate the connector end of the fax PCA up and away from the formatter to release it.

Figure 1-27 Remove the fax PCA (M830; 1 of 2)

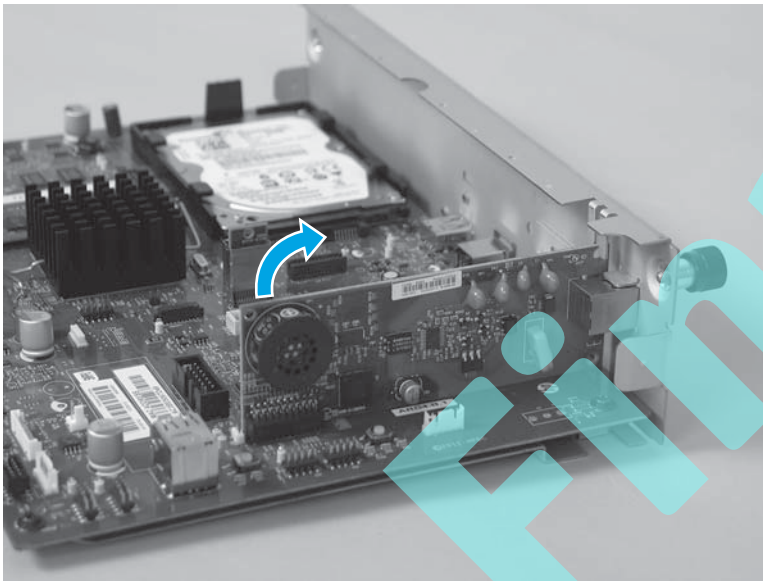

2. Carefully remove the fax PCA from the formatter bracket.

Figure 1-28 Remove the fax PCA (M830; 2 of 2)

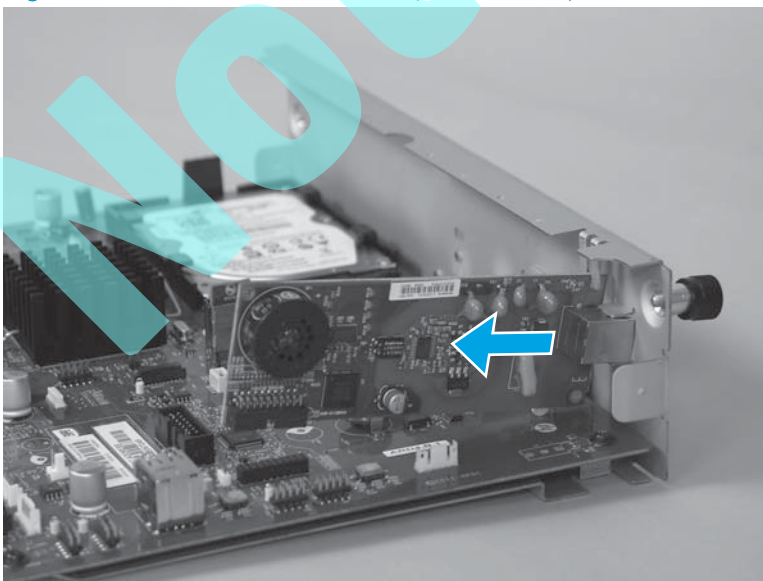

Document feeder mylar strip (M830 only)

1. Open the document feeder cover.

Figure 1-29 Remove the document feeder mylar strip (M830; 1 of 3)

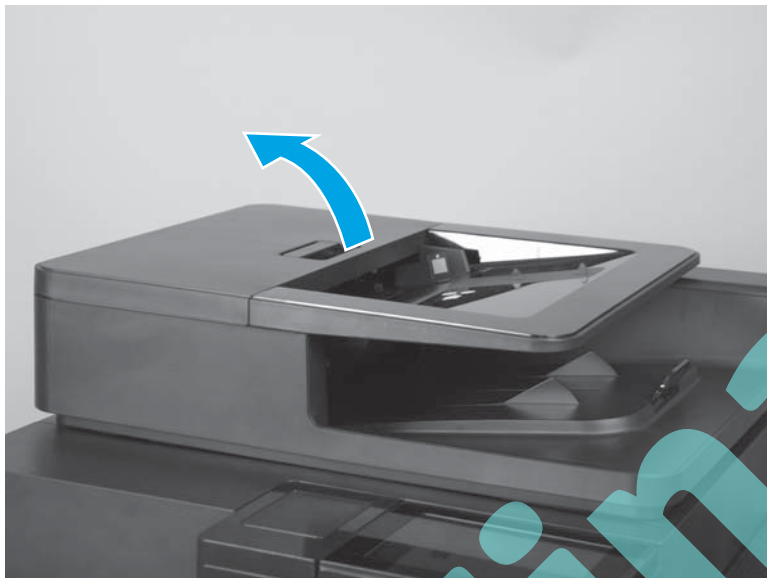

2. Locate the mylar strip.

Figure 1-30 Remove the document feeder mylar strip (M830; 2 of 3)

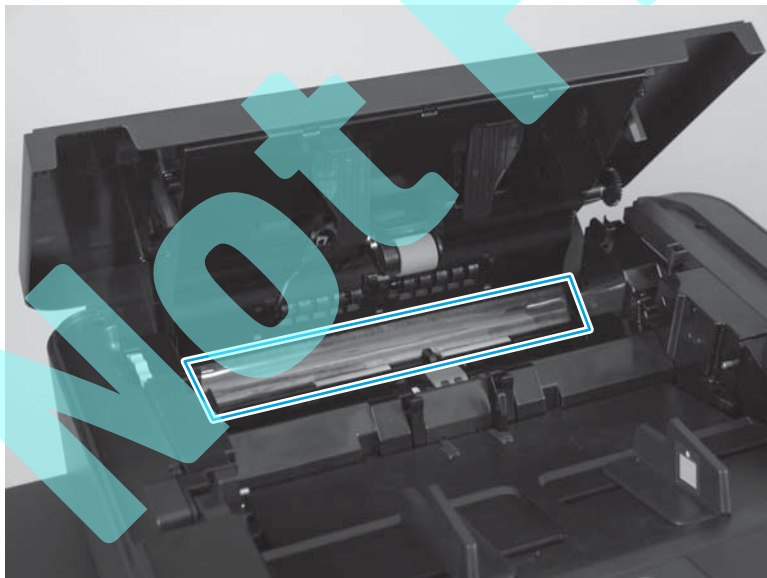

3. Carefully remove the mylar strip.

Figure 1-31 Remove the document feeder mylar strip (M830; 3 of 3)

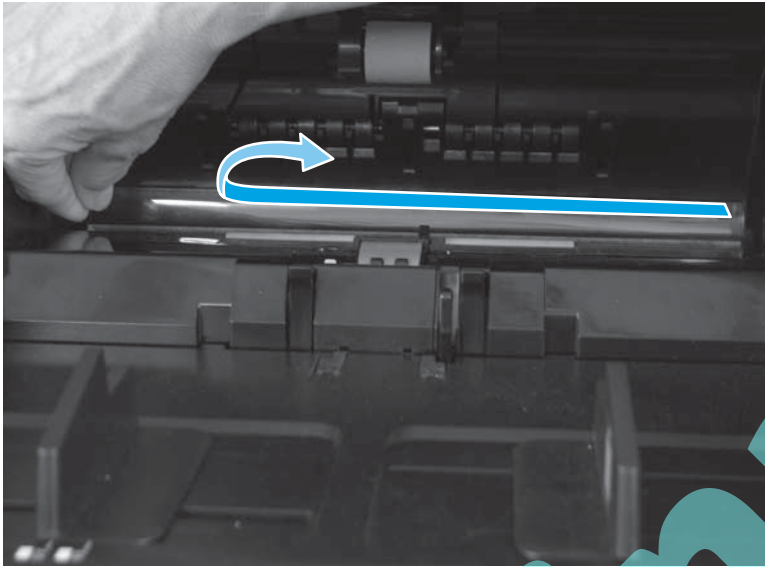

Install a replacement document feeder mylar strip (M830 only)

Use the following guidelines when you install the replacement mylar strip:

1. Skin oils on the mylar strip can cause paper pickup problems. Wash your hands before handling the replacement mylar strip.
2. When handling the replacement mylar strip, do not touch the adhesive portion of the strip.
3. Use your finger to remove any adhesive that remains after removing the mylar strip.

Figure 1-32 Install a replacement document feeder mylar strip (M830; 1 of 3)

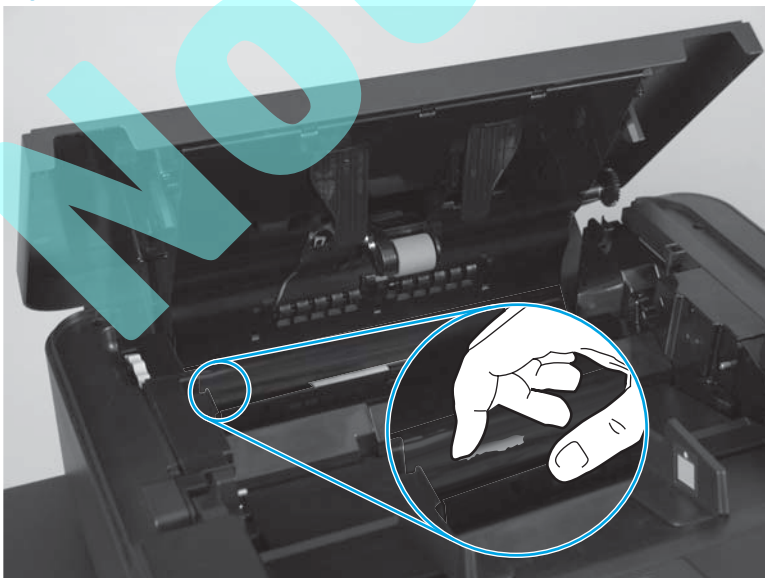

4. Position the replacement mylar strip as shown, with the rounded corners on the strip facing the document tray.

 **NOTE:** Make sure that the adhesive side of the guide is face down.

Figure 1-33 Install a replacement document feeder mylar strip (M830; 2 of 3)



5. Press down firmly on the strip to adhere it to the product.

Figure 1-34 Install a replacement document feeder mylar strip (M830; 3 of 3)

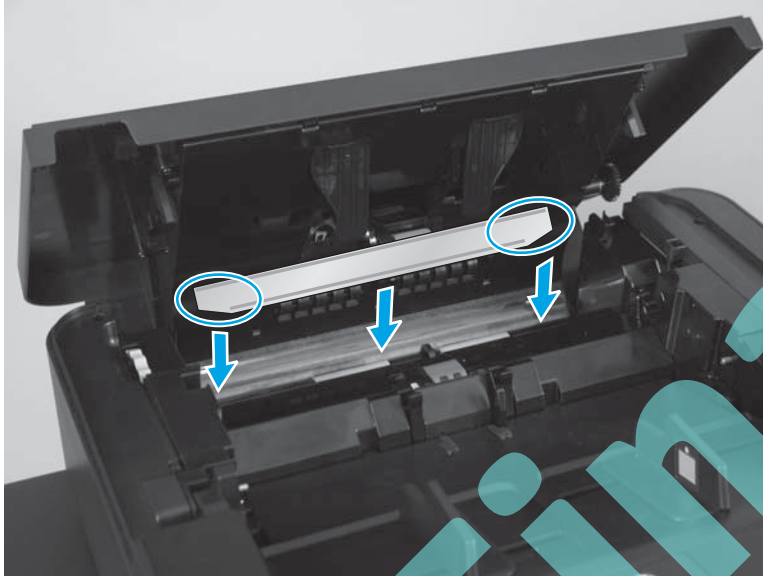
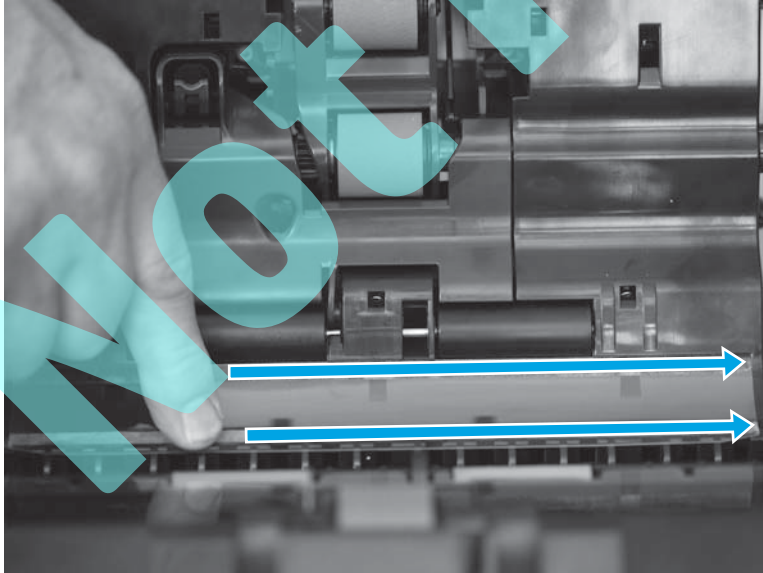

Document feeder white backing (M830 only)

1. Open the document feeder.

Figure 1-35 Remove the document feeder white backing (M830; 1 of 3)

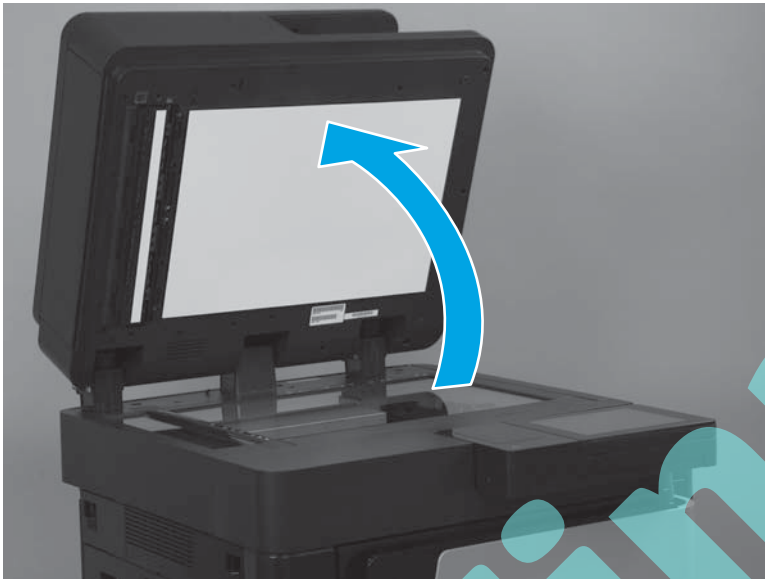

2. Carefully remove the white backing.

Figure 1-36 Remove the document feeder white backing (M830; 2 of 3)

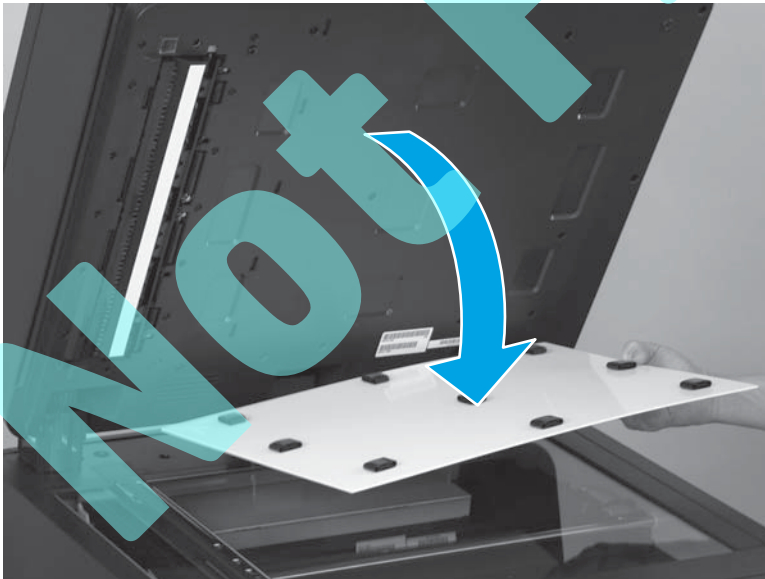

3. Remove any rubber stoppers that might still be attached to the document feeder.

Figure 1-37 Remove the document feeder white backing (M830; 3 of 3)



Install a replacement document feeder white backing (M830 only)

1. Position the replacement white backing on the scanner glass. Carefully remove the protective backing from the rubber stoppers.

⚠ CAUTION: Do not touch the exposed adhesive.

Figure 1-38 Install a replacement document feeder white backing (M830; 1 of 6)

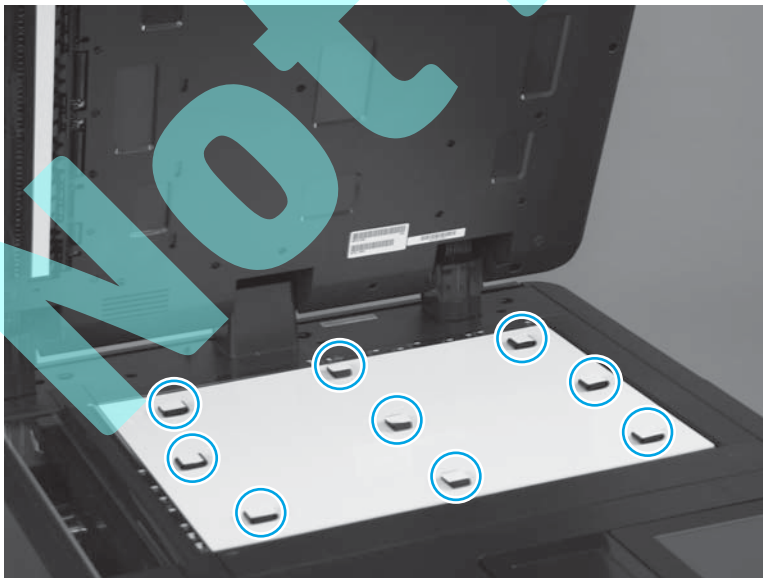

2. Make sure that the arrow on the replacement white backing is positioned in the upper-left corner of the scanner glass.

Figure 1-39 Install a replacement document feeder white backing (M830; 2 of 6)

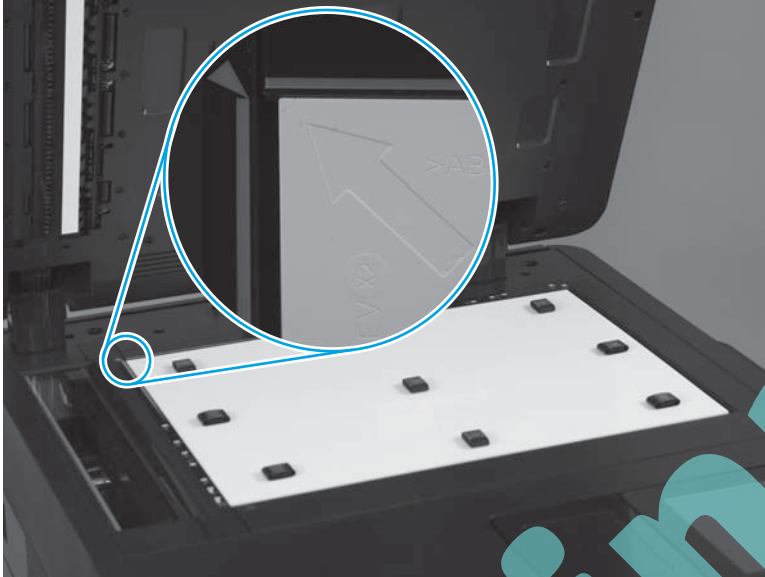

3. Completely close the document feeder.

Figure 1-40 Install a replacement document feeder white backing (M830; 3 of 6)



4. Firmly push down on the four corners of the document feeder to adhere the white backing to the document feeder.

Figure 1-41 Install a replacement document feeder white backing (M830; 4 of 6)



5. Carefully open the document feeder.

Figure 1-42 Install a replacement document feeder white backing (M830; 5 of 6)



6. Firmly press on the white backing over the areas shown below to make sure that the rubber stoppers are completely adhered to the document feeder.

Figure 1-43 Install a replacement document feeder white backing (M830; 6 of 6)

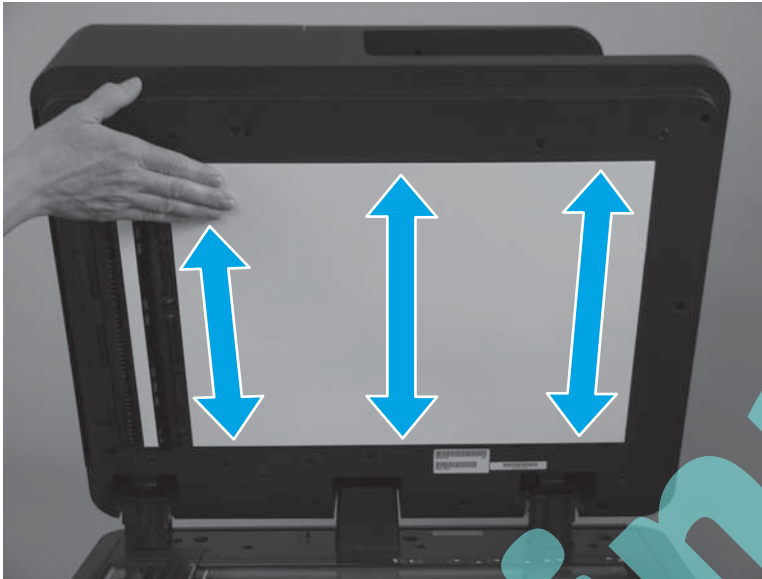

Background selector (M830 only)

1. Open the document-feeder door.

Figure 1-44 Remove the background selector (M830; 1 of 4)



2. Rotate the input tray up.

Figure 1-45 Remove the background selector (M830; 2 of 4)



3. Release two tabs.

Figure 1-46 Remove the background selector (M830; 3 of 4)

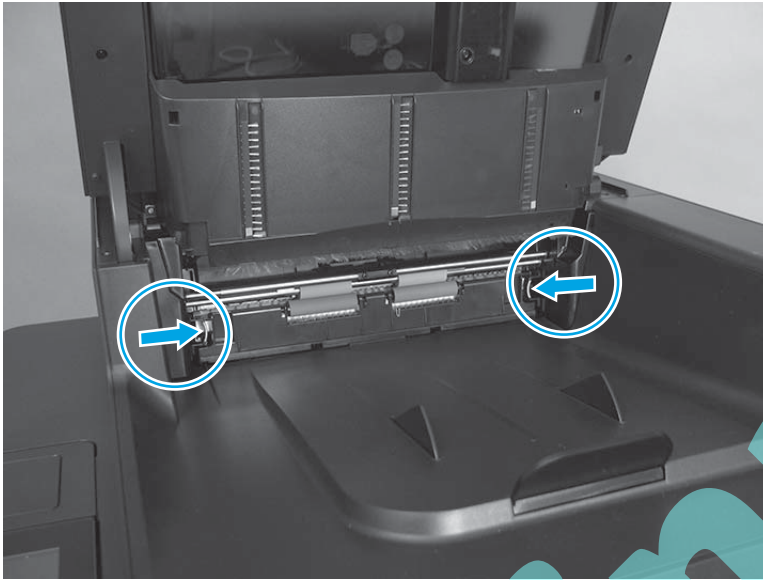

4. Slide the background selector away from the product to remove it.

Figure 1-47 Remove the background selector (M830; 4 of 4)

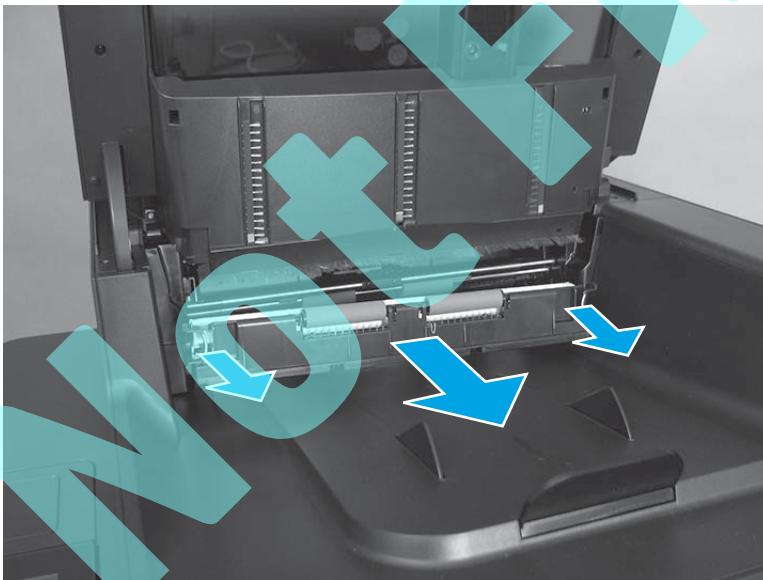

Reinstall the background selector (M830 only)

Push in on the background selector until the tabs snap into place.

 **NOTE:** If jams occur after the assembly is installed, make sure that the assembly is fully seated.

Figure 1-48 Reinstall the background selector (M830)

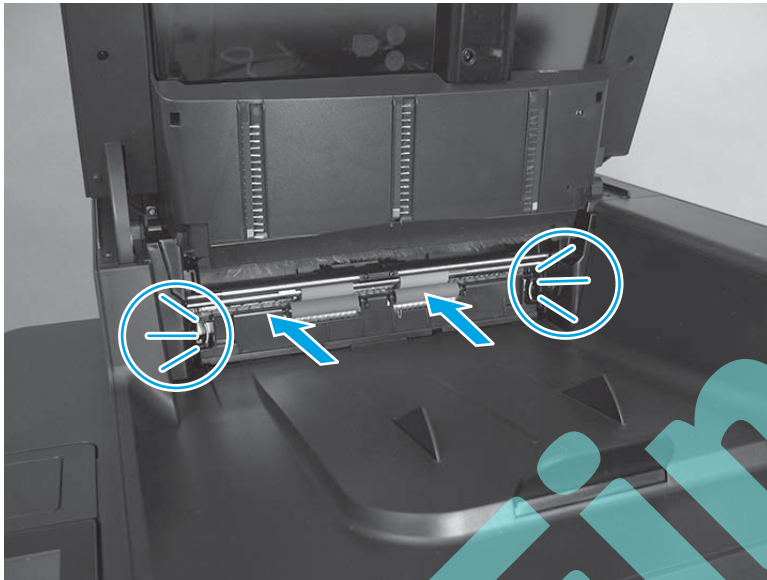

Control-panel assembly (M806 only)

1. Tilt the control panel up.

Figure 1-49 Remove the control-panel assembly (M806; 1 of 10)



2. Release one tab.

Figure 1-50 Remove the control-panel assembly (M806; 2 of 10)



3. Remove the cover.

Figure 1-51 Remove the control-panel assembly (M806; 3 of 10)



4. Rotate one blue locking latch to release it.

Figure 1-52 Remove the control-panel assembly (M806; 4 of 10)

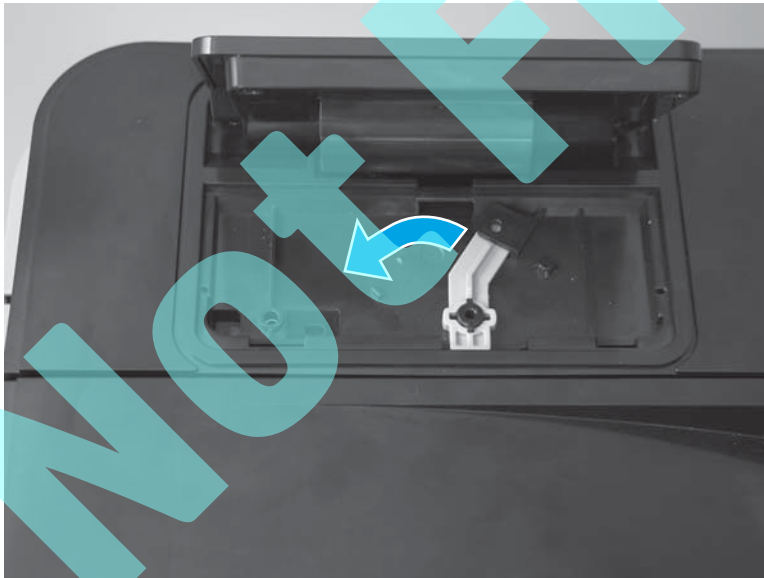

5. Rotate the back of the control panel up and away from the product.

Figure 1-53 Remove the control-panel assembly (M806; 5 of 10)



6. Lift the control-panel assembly up and off of the product.

CAUTION: The control panel is still attached to the product by the control-panel cables.

Figure 1-54 Remove the control-panel assembly (M806; 6 of 10)

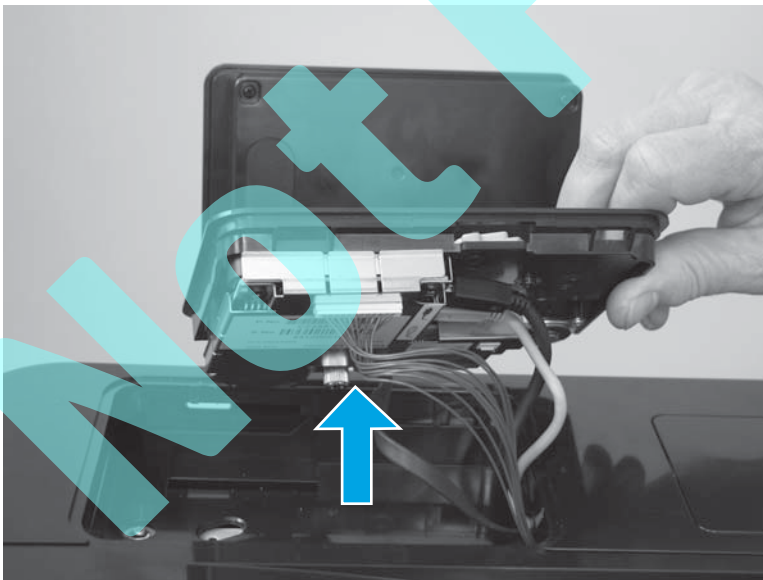

7. Tilt the control panel forward to gain access to the control-panel connectors.

Figure 1-55 Remove the control-panel assembly (M806; 7 of 10)



8. Remove one screw (callout 1), and then release one ground wire (callout 2).

Figure 1-56 Remove the control-panel assembly (M806; 8 of 10)

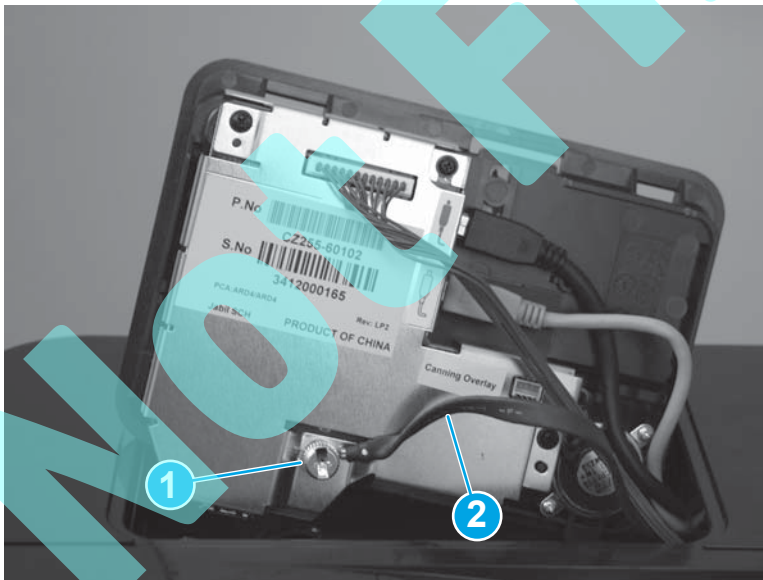

9. Disconnect two USB cables (callout 1), and then disconnect one connector (callout 2).

Figure 1-57 Remove the control-panel assembly (M806; 9 of 10)

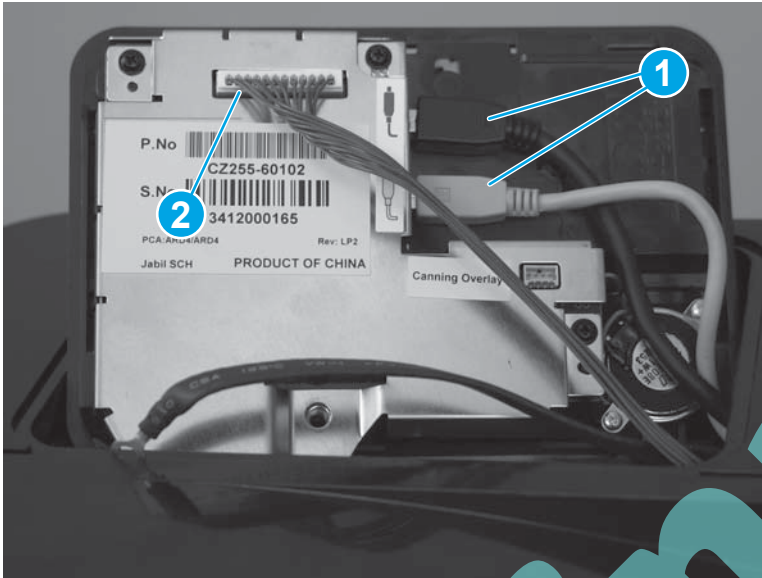

10. Lift the control-panel assembly up and away from the product to remove it.

Figure 1-58 Remove the control-panel assembly (M806; 10 of 10)

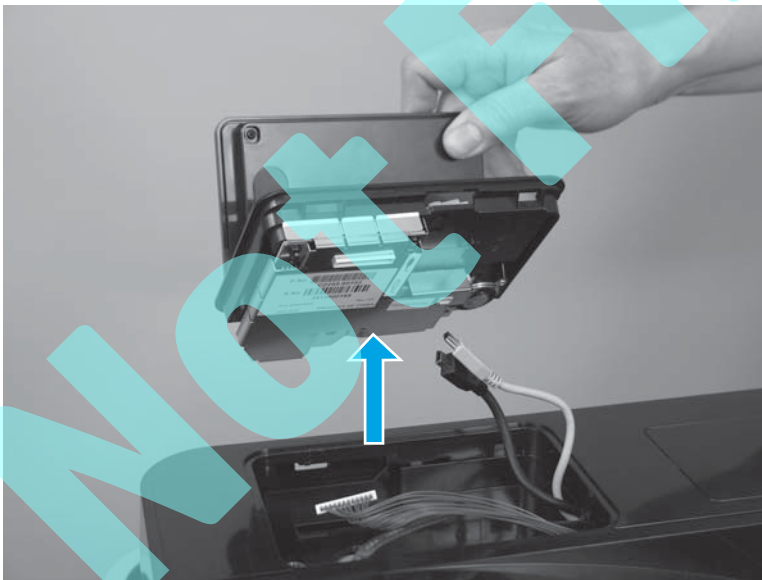

Reinstall the control-panel assembly (M806 only)

Make sure that the USB cables (callout 1) are connected to the correct connectors. See the label (callout 2) next to the connectors.

Figure 1-59 Reinstall the control panel (M806)

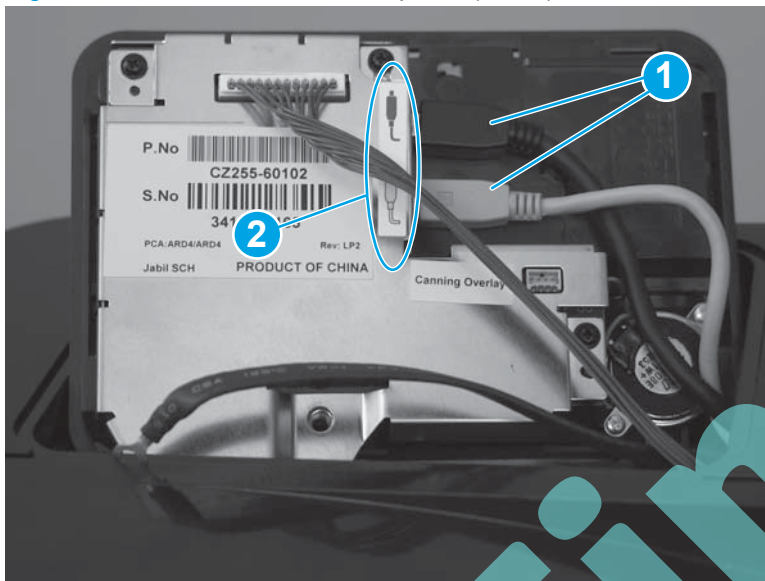

Keyboard assembly (M830 only)

Before proceeding, remove the following assemblies:

- Control Panel (M830 only). See [Control-panel assembly \(M830 only\) on page 52](#).

Remove the keyboard assembly (M830 only)

1. Place the control panel on a flat surface.

Figure 1-60 Remove the keyboard assembly (M830; 1 of 7)



2. Open the hinged latch to release the flat cable.

 **IMPORTANT:** This connector is a Zero Insertion Force (ZIF) connector that uses a hinged retainer to secure a flat cable. The hinged retainer must be opened to release the flat cable.

 **CAUTION:** Be careful. Do not dislodge the latch from the connector when opening it.

Figure 1-61 Remove the keyboard assembly (M830; 2 of 7)



3. Disconnect the flat cable.

Figure 1-62 Remove the keyboard assembly (M830; 3 of 7)

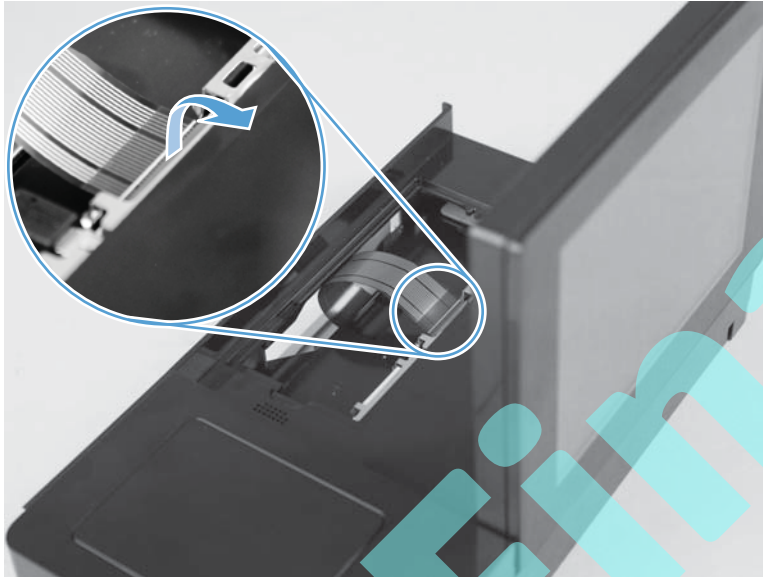

4. Tilt the screen down until it lays flat.

Figure 1-63 Remove the keyboard assembly (M830; 4 of 7)



5. Slide the keyboard tray all of the way out of the control panel until it stops.

Figure 1-64 Remove the keyboard assembly (M830; 5 of 7)

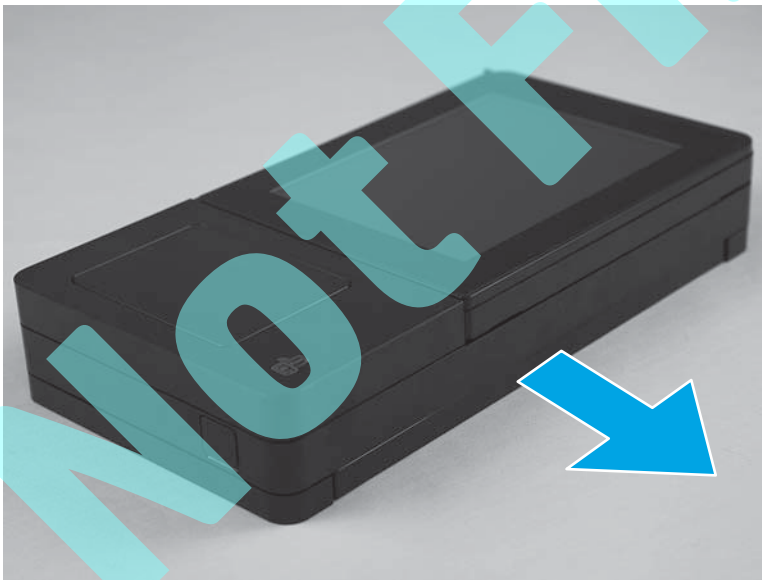

6. Turn the control panel face-down on the surface.

Figure 1-65 Remove the keyboard assembly (M830; 6 of 7)



7. Release and hold two tabs (callout 1) while sliding the keyboard tray away from the control panel (callout 2) to remove it.

Figure 1-66 Remove the keyboard assembly (M830; 7 of 7)

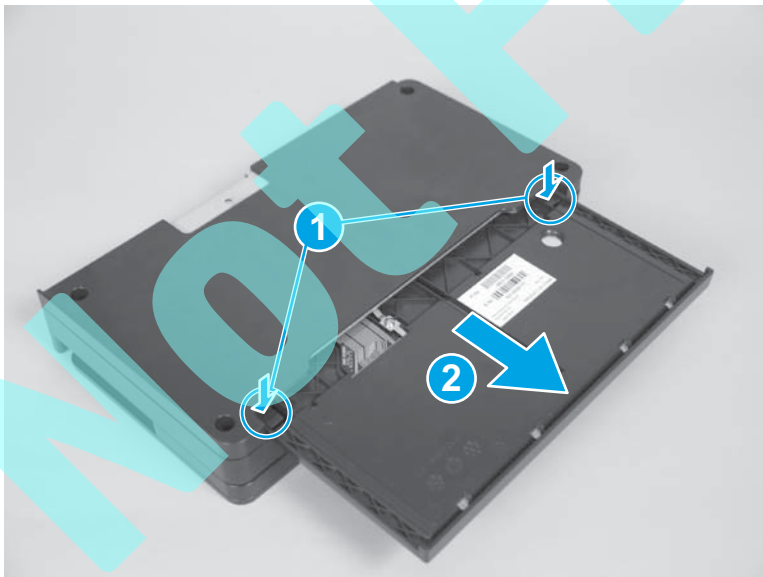

Reinstall the keyboard assembly (M830 only)

1. Turn the keyboard tray upside down, and then position the flat cable (callout 1) inside the tray cavity. Align the edges of the tray (callout 2) with the slots in the control panel (callout 3).

Figure 1-67 Reinstall the keyboard assembly (M830; 1 of 7)

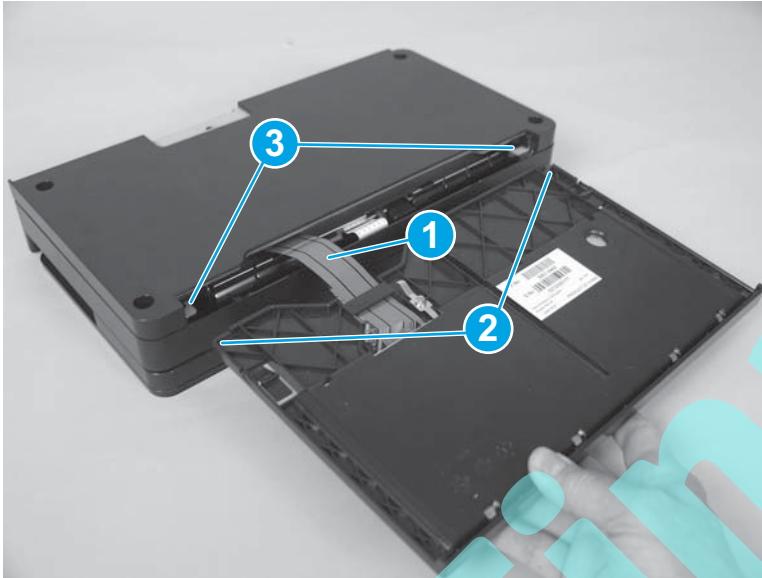

2. Slide the keyboard tray all the way into the control panel.

Figure 1-68 Reinstall the keyboard assembly (M830; 2 of 7)

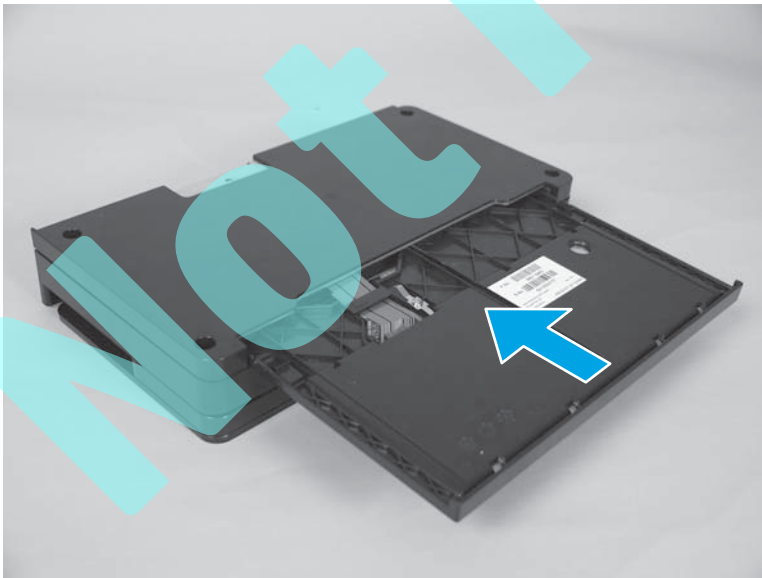

3. Turn the control panel face-up.

Figure 1-69 Reinstall the keyboard assembly (M830; 3 of 7)

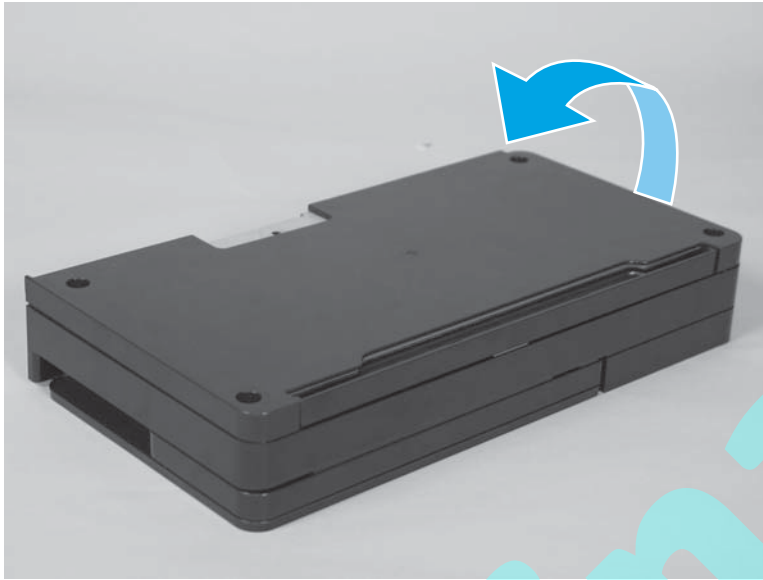

4. Tilt the screen up.

Figure 1-70 Reinstall the keyboard assembly (M830; 4 of 7)



5. Open the hinged latch, and then position the flat cable in the connector.

CAUTION: Be careful. Do not dislodge the latch from the connector when opening it.

Figure 1-71 Reinstall the keyboard assembly (M830; 5 of 7)

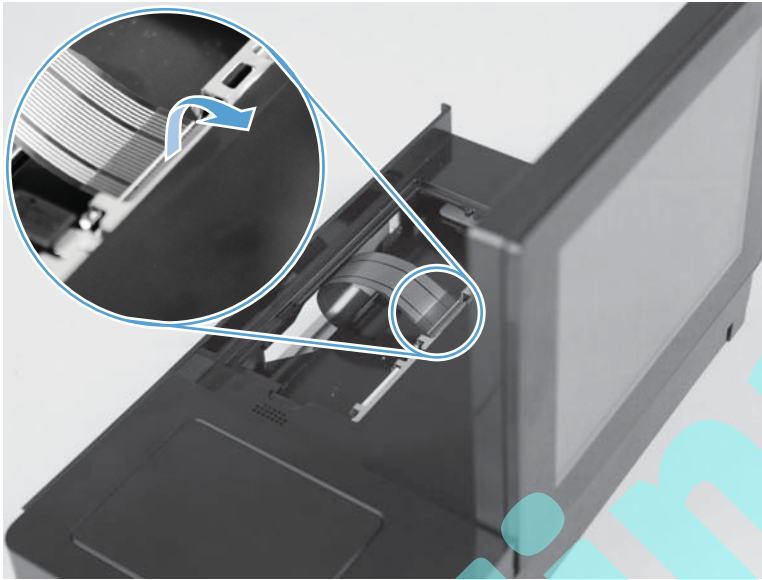

6. Use your finger to carefully close the latch to lock the flat cable into position.

IMPORTANT: IMPORTANT: This connector is a Zero Insertion Force (ZIF) connector that uses a hinged retainer to secure a flat cable. When the flat cable is reinstalled, fully insert the flat cable in the connector, and then close the hinged retainer to lock the flat cable into the connector and provide proper electrical contact. If the flat cable is not locked into the connector, no electrical contact will occur.

CAUTION: Be careful. Do not dislodge the latch from the connector when closing it.

Figure 1-72 Reinstall the keyboard assembly (M830; 6 of 7)

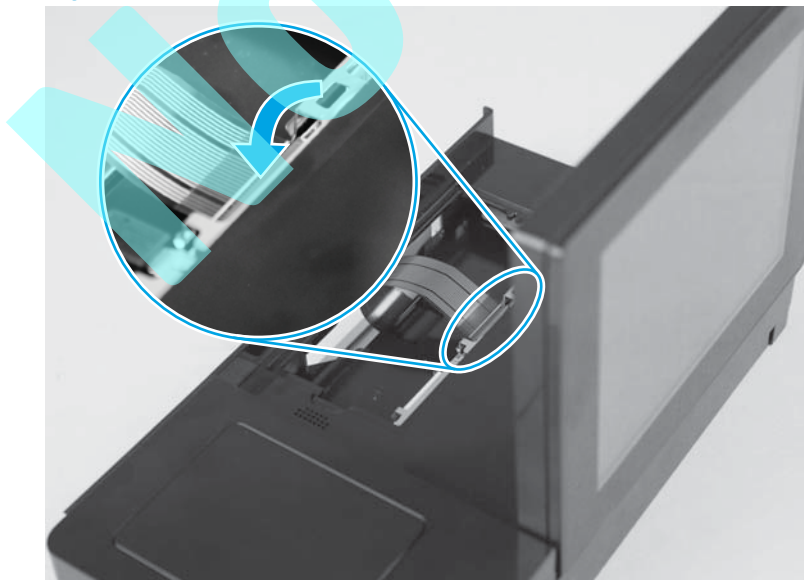

7. Slightly pull on the flat cable to verify that it is securely fastened in the connector.

⚠ CAUTION: Be careful. Do not use your full force to pull on the flat cable. A slight pull on the cable is sufficient to verify that it is securely fastened.

Figure 1-73 Reinstall the keyboard assembly (M830; 7 of 7)

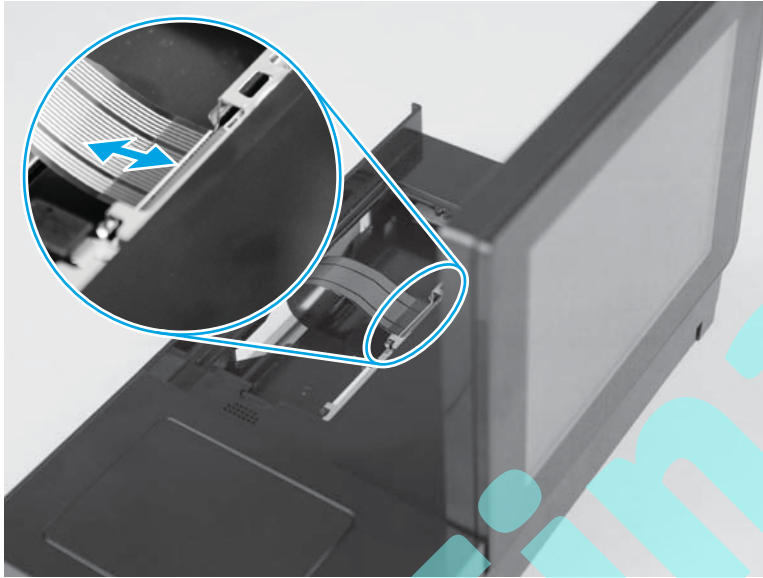

Not Final

Control-panel assembly (M830 only)

1. Tilt the control panel up.

Figure 1-74 Remove the control-panel assembly (M830; 1 of 7)



2. Release one tab, and then remove the cover.

Figure 1-75 Remove the control-panel assembly (M830; 2 of 7)



3. Slide the keyboard about halfway out of the product.

Figure 1-76 Remove the control-panel assembly (M830; 3 of 7)



4. Disconnect two connectors.

Figure 1-77 Remove the control-panel assembly (M830; 4 of 7)

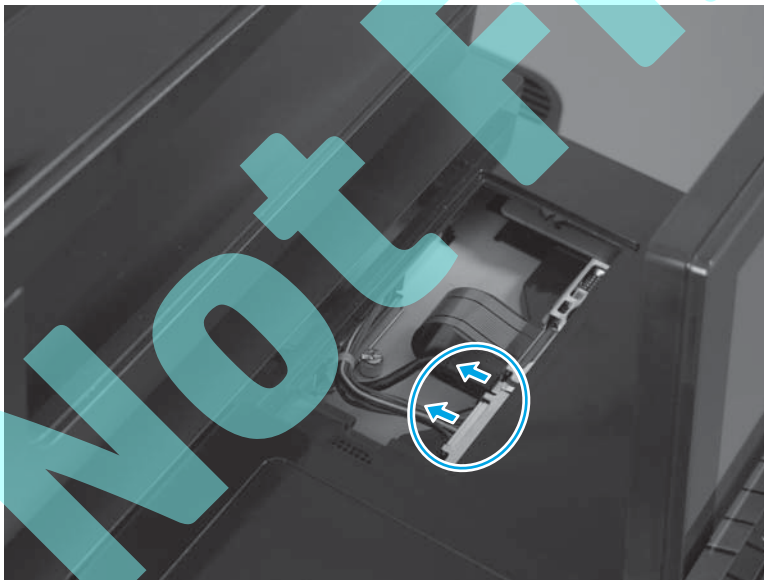

5. Remove one screw.

 **TIP:** Use the edge of a coin to loosen the screw.

Figure 1-78 Remove the control-panel assembly (M830; 5 of 7)



6. Slide the control panel toward the right door.

Figure 1-79 Remove the control-panel assembly (M830; 6 of 7)

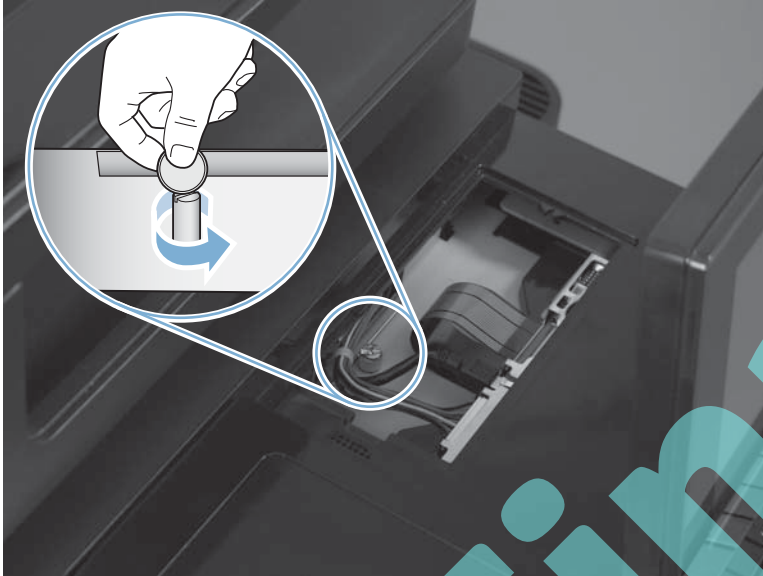

7. Slide the control panel towards the front of the product to remove it.

 **Reinstallation tip** If you are installing a replacement control-panel assembly, remove the keyboard assembly so that it can be installed on the replacement control-panel assembly. See [Keyboard assembly \(M830 only\) on page 44](#).

Figure 1-80 Remove the control-panel assembly (M830; 7 of 7)



Reinstall the control-panel assembly (M830 only)

1. Insert the cable and wire harness (callout 1) into the opening at the back of the control panel (callout 2).

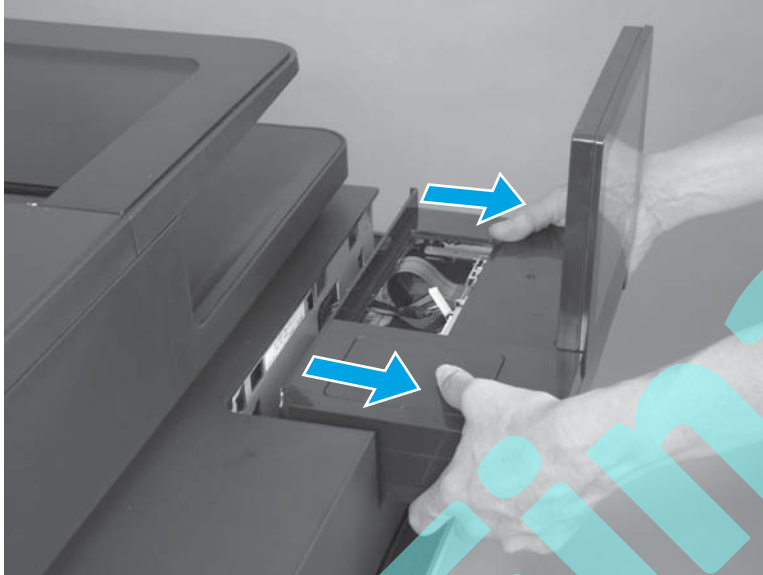
Figure 1-81 Reinstall the control-panel assembly (M830; 1 of 3)

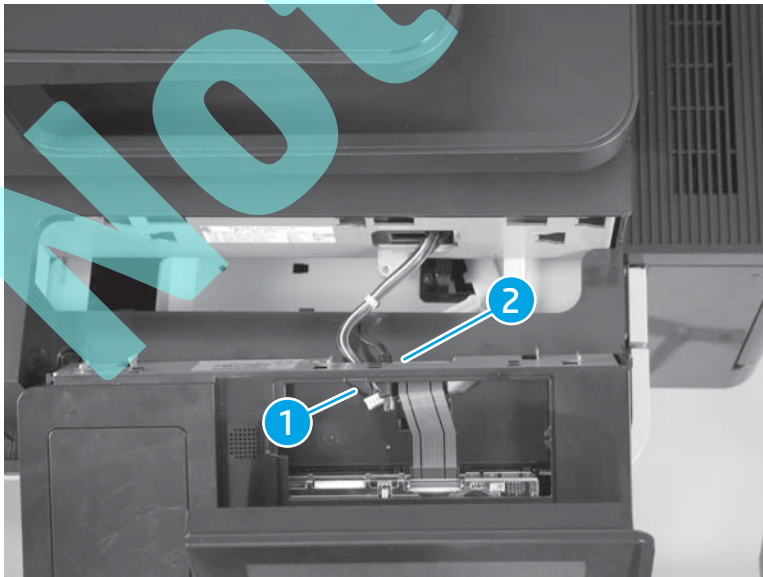

2. Insert the tabs on the control panel into the slots on the product.

Figure 1-82 Reinstall the control-panel assembly (M830; 2 of 3)

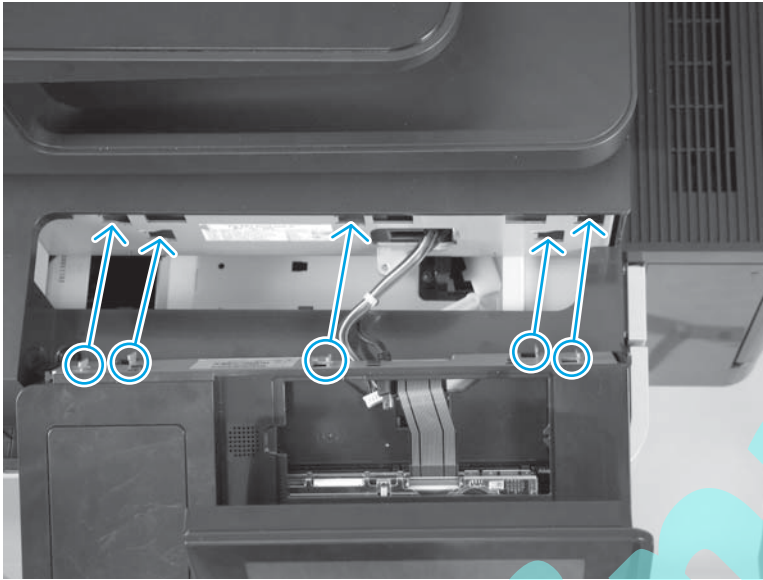

3. Slide the control panel toward the left door to secure it to the product.

Figure 1-83 Reinstall the control-panel assembly (M830; 3 of 3)

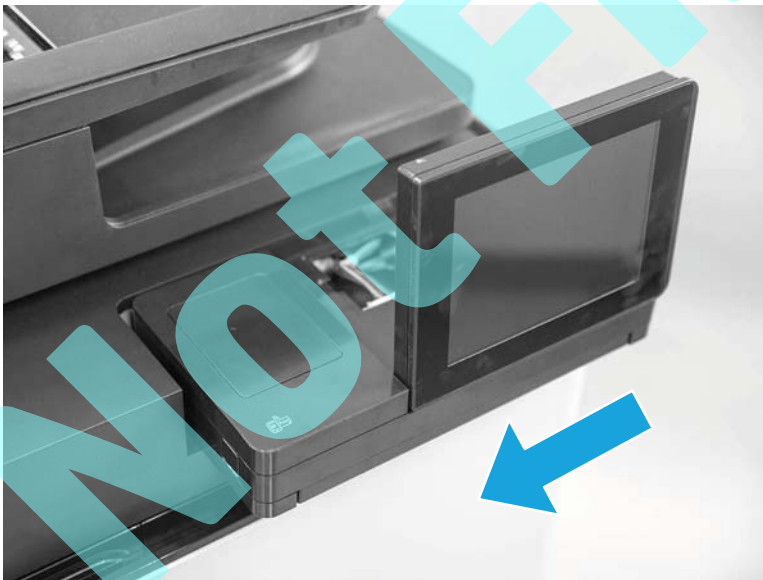

Pickup, feed, and separation rollers and pads

- [Document-feeder roller \(M830 only\)](#)
- [Document-feeder separation pad \(M830 only\)](#)
- [Tray 1 rollers](#)
- [Tray 2 and Tray 3 rollers](#)
- [High-capacity input \(HCI\) rollers](#)

Not Final

Document-feeder roller (M830 only)

Remove the document-feeder roller (M830 only)

⚠ CAUTION: If you are replacing the rollers, do not touch the surface of the replacement rollers. Skin oils deposited on the rollers might cause paper pickup problems.

1. Open the document-feeder door.

Figure 1-84 Remove the document-feeder roller (M830; 1 of 3)

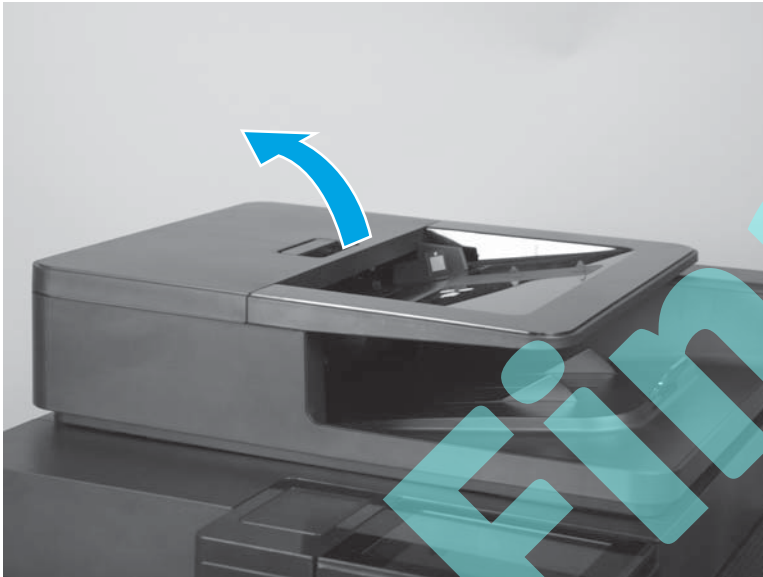

2. Release one tab, and then open the access door.

💡 Reinstallation tip When the roller is reinstalled, the access door must be fully closed. When you close the door, you should hear two audible clicks. If, after replacing the roller document feeder, a document feeder jam message appears on the control panel display, make sure that the access door is fully closed.

Figure 1-85 Remove the document-feeder roller (M830; 2 of 3)

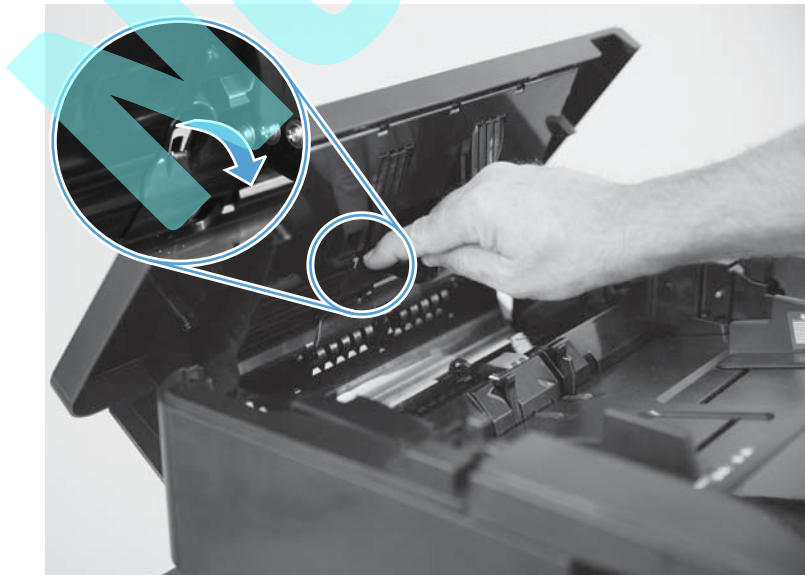

3. Slide the roller left, and then lift it up and out of the product.

Figure 1-86 Remove the document-feeder roller (M830; 3 of 3)

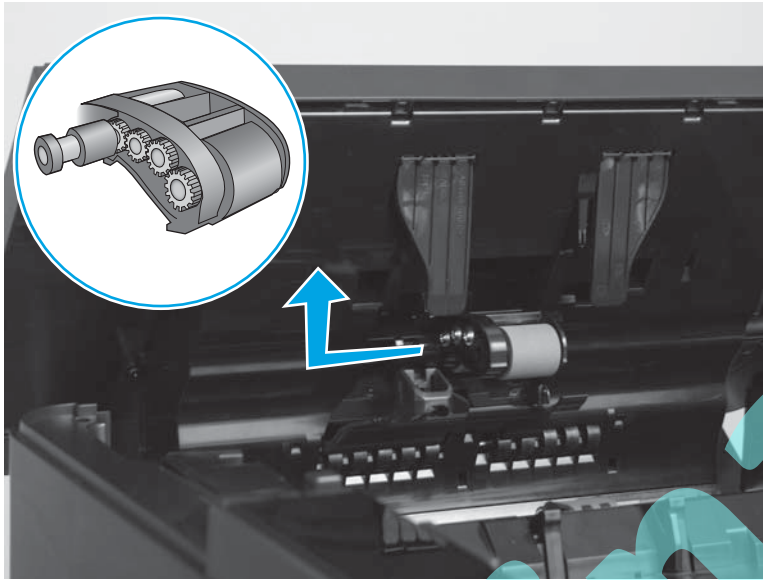

Reinstall the document-feeder roller (M830 only)

The roller assembly is keyed. When reinstalling the roller assembly, position the hex-shaped fitting on the shaft toward the rear of the product.

Figure 1-87 Remove the document-feeder roller (M830)

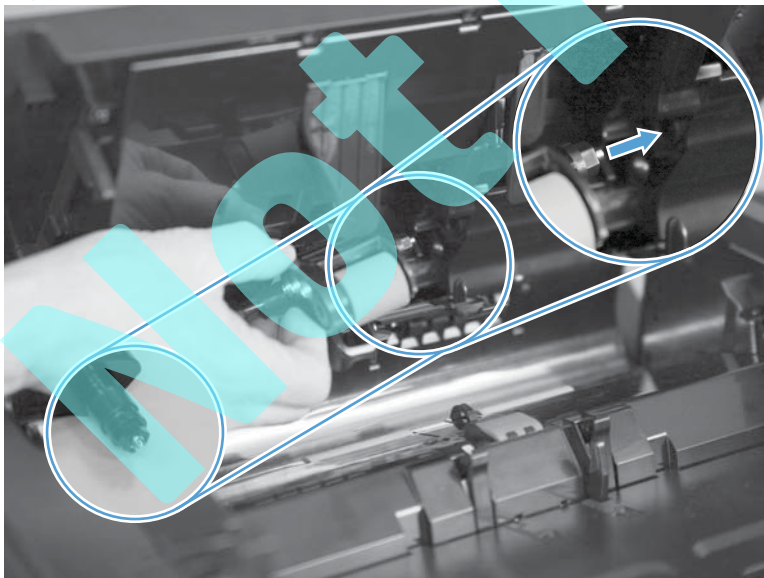

Document-feeder separation pad (M830 only)

Remove the document-feeder separation pad (M830 only)

⚠ CAUTION: If you are replacing the pad, do not touch the surface of the replacement pad. Skin oils deposited on the pad might cause paper pickup problems.

1. Open the document-feeder door.

Figure 1-88 Remove the document-feeder separation pad (M830; 1 of 4)



2. Release one tab.

Figure 1-89 Remove the document-feeder separation pad (M830; 2 of 4)



3. Hold the access door open to allow the separation pad to partially release and pop up.

 **NOTE:** The separation pad is spring-loaded and partially releases when the access door is opened.

Figure 1-90 Remove the document-feeder separation pad (M830; 3 of 4)



4. Lift the separation pad up and away from the product.

 **CAUTION:** If the spring becomes dislodged, securely reinstall it as shown below.

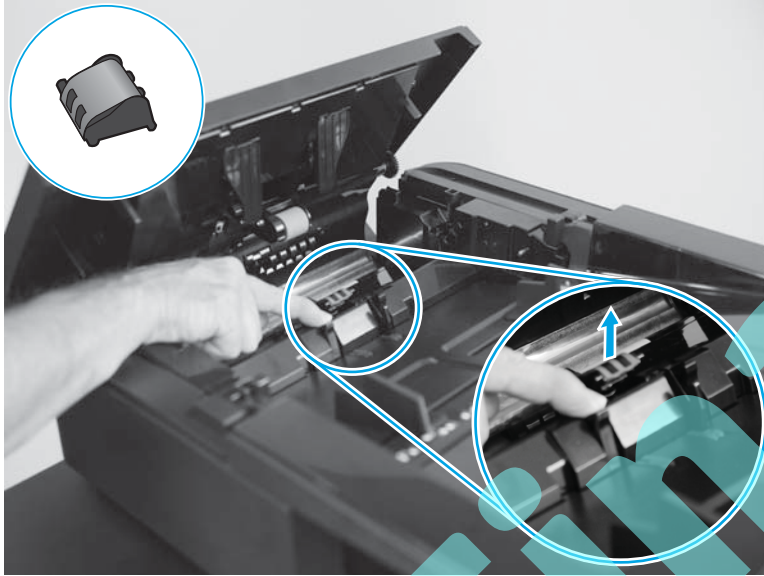
Figure 1-91 Remove the document-feeder separation pad (M830; 4 of 4)



Reinstall the document-feeder separation pad (M830 only)

1. Release and hold the separation pad access door open.

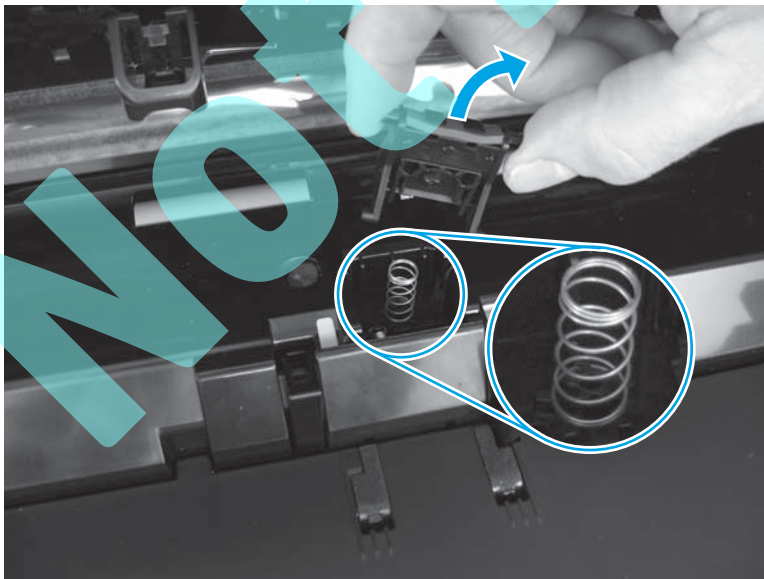
Figure 1-92 Reinstall the document-feeder separation pad (M830; 1 of 5)



2. Align the pins on the separation pad with the mounting slots.

Figure 1-93 Reinstall the document-feeder separation pad (M830; 2 of 5)



- Carefully press down on the separation pad to compress the spring.

Figure 1-94 Reinstall the document-feeder separation pad (M830; 3 of 5)



- Continue to press down on the separation pad, and then release the access door.

Figure 1-95 Reinstall the document-feeder separation pad (M830; 4 of 5)



5. Verify that the separation pad is correctly installed and that the access door is fully closed as shown below.

Figure 1-96 Reinstall the document-feeder separation pad (M830; 5 of 5)

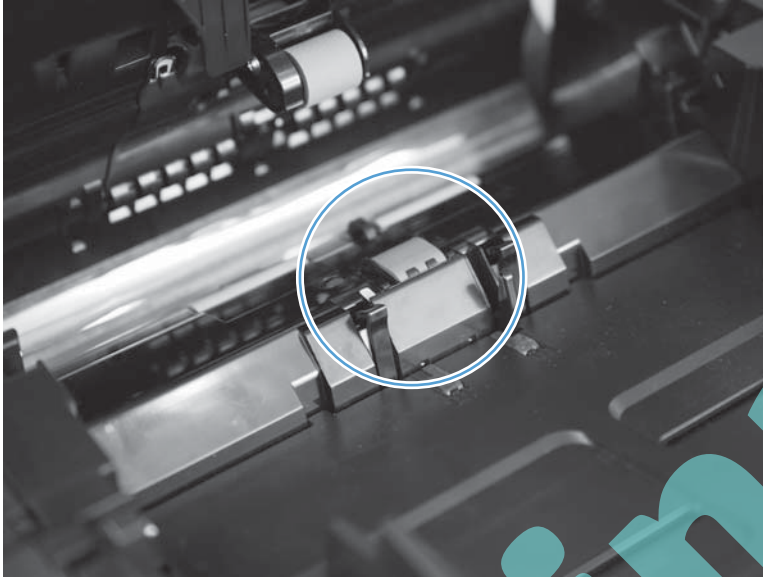

Not Final

Tray 1 rollers

⚠ CAUTION: If you are replacing the rollers, do not touch the surface of the replacement rollers. Skin oils deposited on the rollers might cause paper pickup problems.

1. Open Tray 1.

Figure 1-97 Remove the Tray 1 rollers (1 of 3)

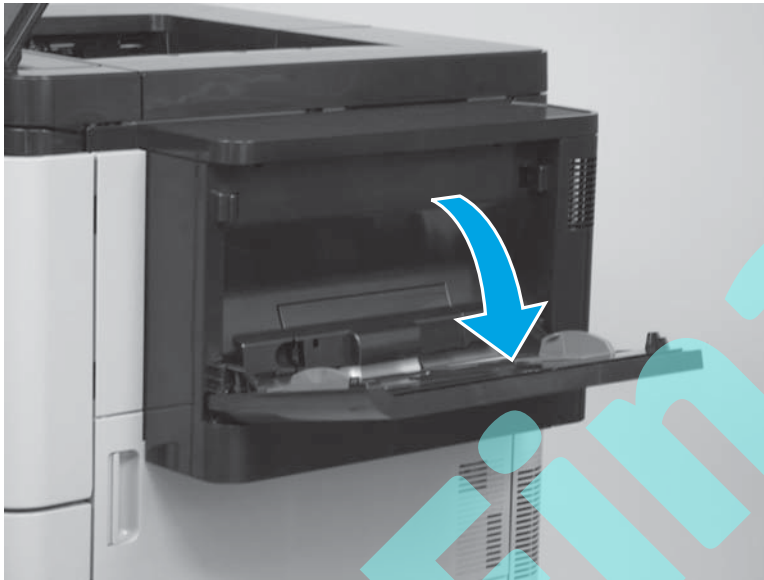

2. Release one tab (callout 1), and then remove the roller cover (callout 2).

Figure 1-98 Remove the Tray 1 rollers (2 of 3)

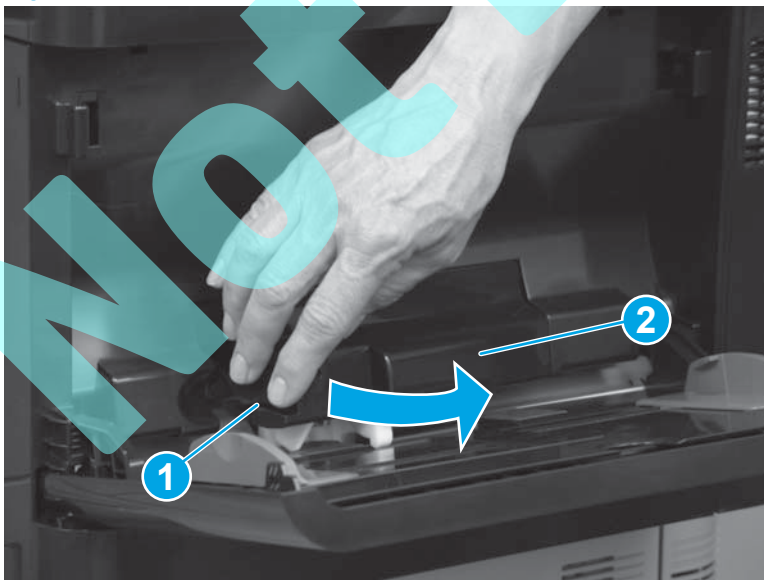

3. Pinch the tabs at the end of the rollers to release them, and then remove three rollers in the order shown below.

Figure 1-99 Remove the Tray 1 rollers (3 of 3)

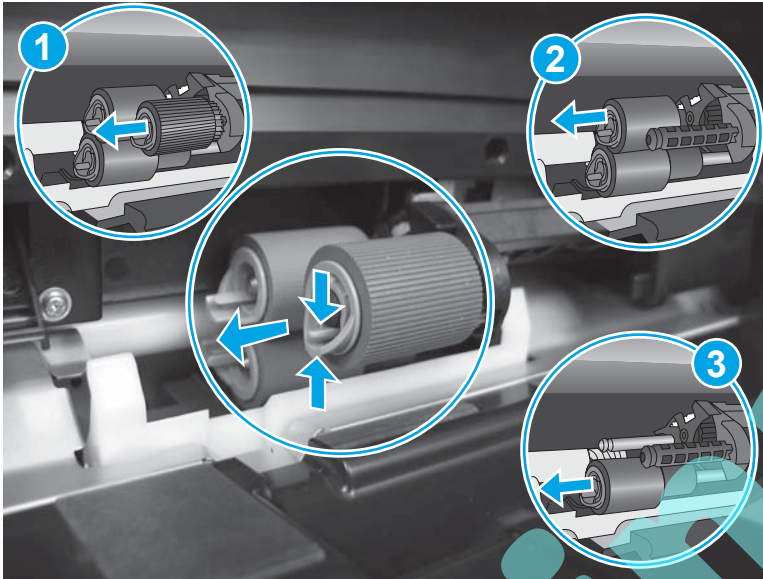

Reinstall the Tray 1 rollers

Reinstall the rollers in the order shown below. Make sure that the rollers snap into place.

Figure 1-100 Reinstall the Tray 1 rollers (1 of 2)

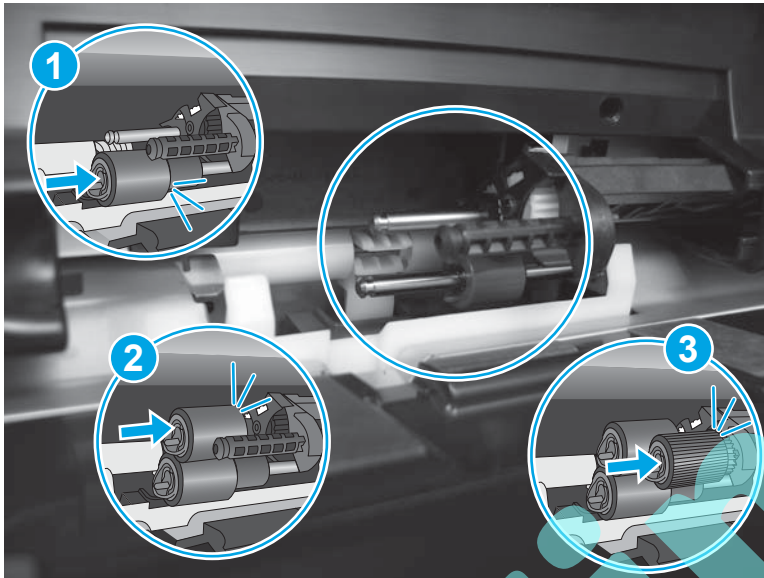

Insert the tab on the right side of the roller cover (callout 1) into the slot on the product (callout 2).

Figure 1-101 Reinstall the Tray 1 rollers (2 of 2)

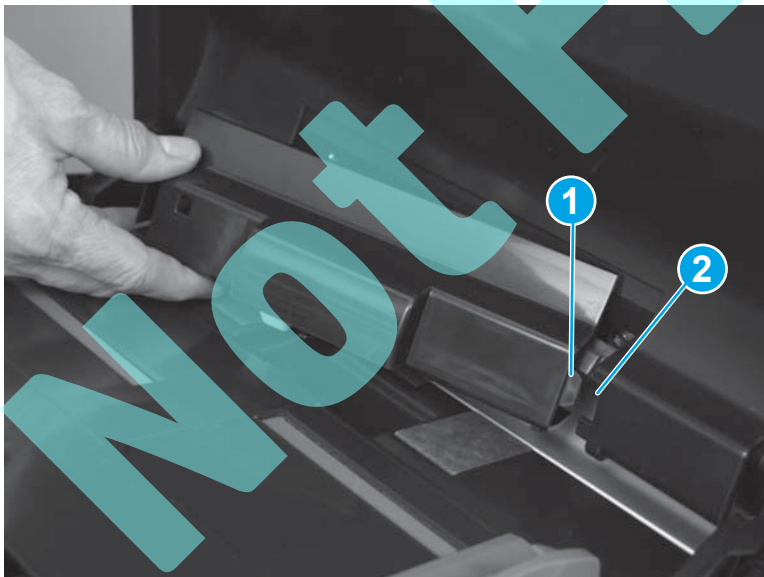

Tray 2 and Tray 3 rollers

CAUTION: If you are replacing the rollers, do not touch the surface of the replacement rollers. Skin oils deposited on the rollers might cause paper pickup problems.

1. Remove Tray 2 and Tray 3. See [Tray 2 and Tray 3 on page 86](#).
2. Locate the rollers inside the tray cavity.

Figure 1-102 Remove the Tray 2 and Tray 3 rollers (1 of 2)

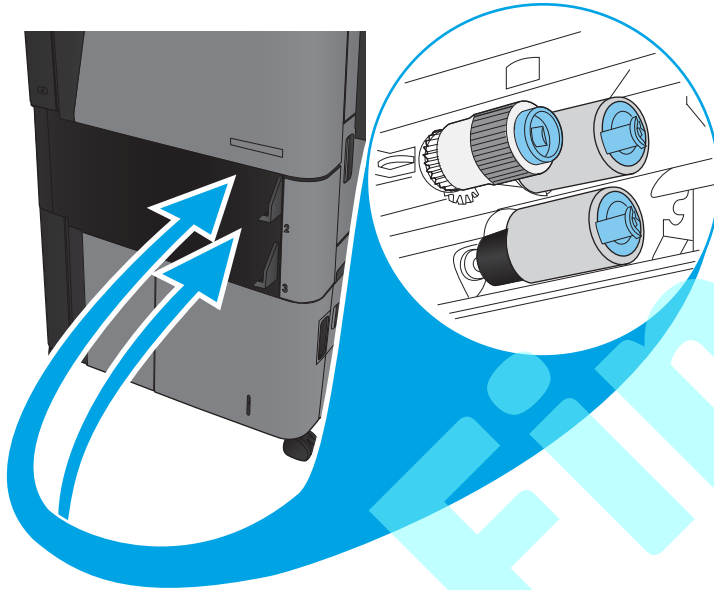

3. Pinch the tabs at the end of the rollers to release them, and then remove three rollers in the order shown below.

Figure 1-103 Remove the Tray 2 and Tray 3 rollers (2 of 2)

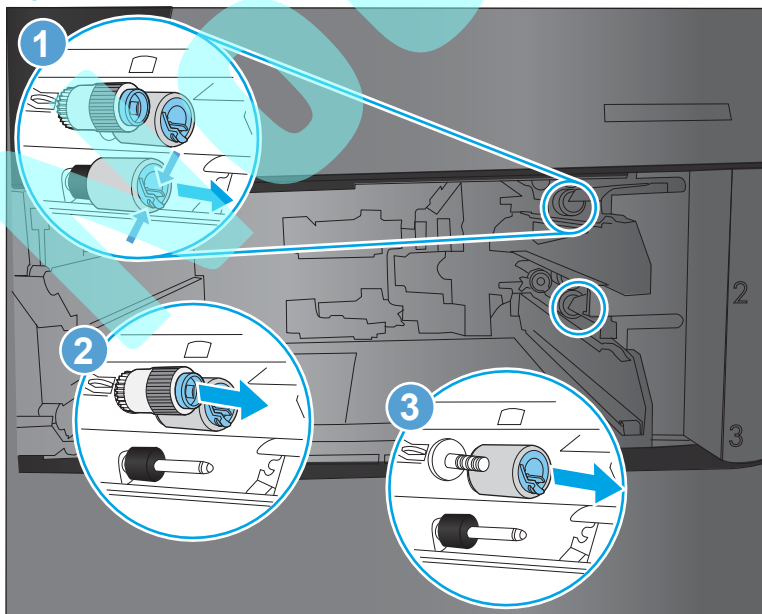

Reinstall the Tray 2 and Tray 3 rollers

Reinstall the rollers in the order shown below. Make sure that the rollers snap into place.

Figure 1-104 Reinstall the Tray 2 and Tray 3 rollers

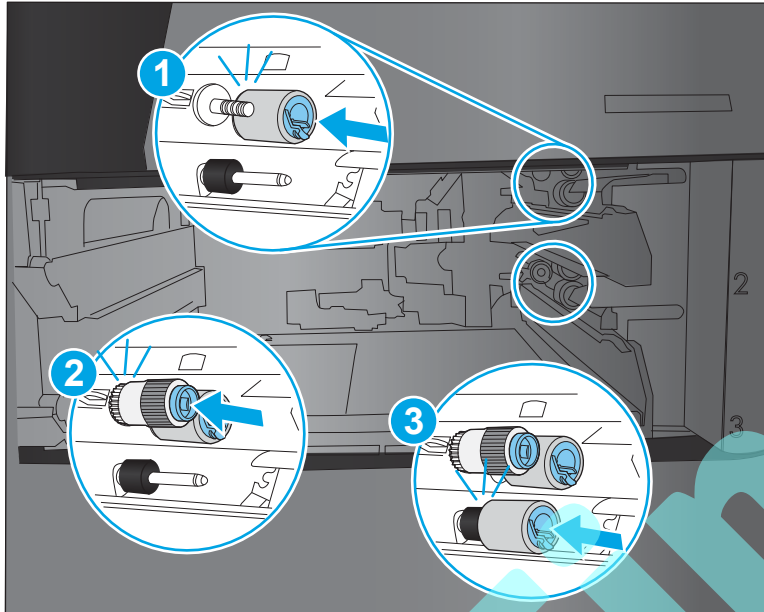

High-capacity input (HCI) rollers

⚠ CAUTION: If you are replacing the rollers, do not touch the surface of the replacement rollers. Skin oils deposited on the rollers might cause paper pickup problems.

1. Remove the HCI right tray and the HCI left tray. See [HCI right tray on page 272](#) and [HCI left tray on page 273](#).
2. Locate the rollers inside the tray cavity.

Figure 1-105 Remove the HCI rollers (1 of 2)

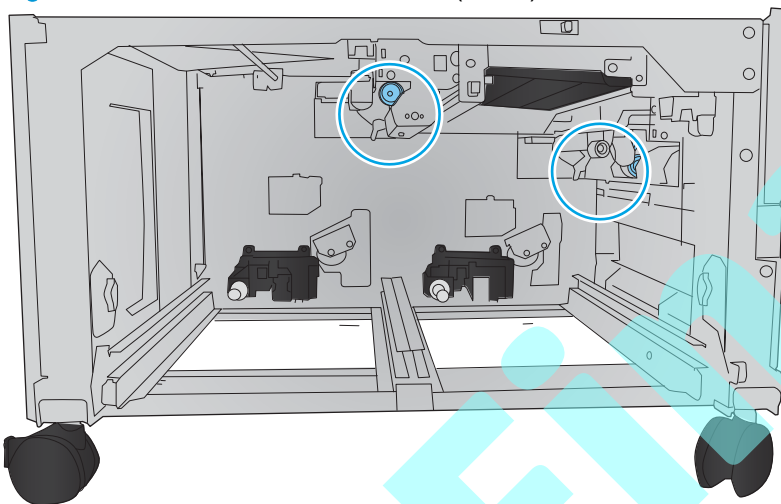

3. Pinch the tabs at the end of the rollers to release them, and then remove two rollers in the order shown below.

📝 NOTE: The uppermost roller is not replaced because it lasts the life of the product.

Figure 1-106 Remove the HCI rollers (2 of 2)

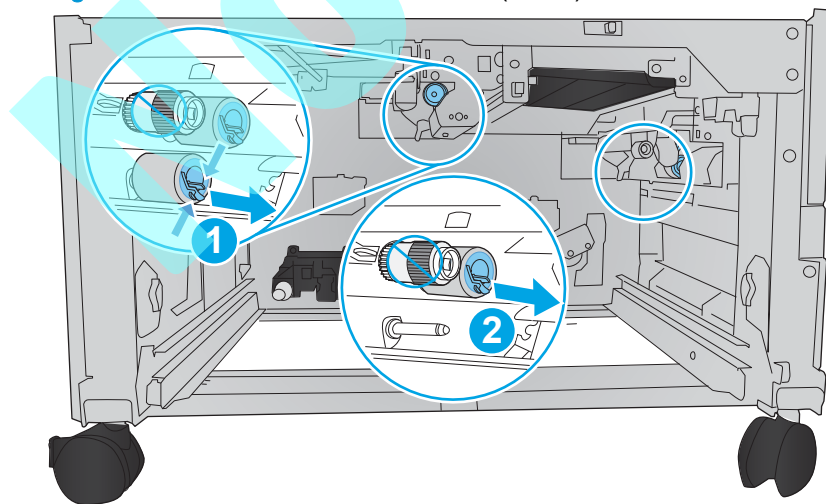

Reinstall the HCI rollers

Reinstall the rollers in the order shown below. Make sure that the rollers snap into place.

Figure 1-107 Reinstall the HCI rollers

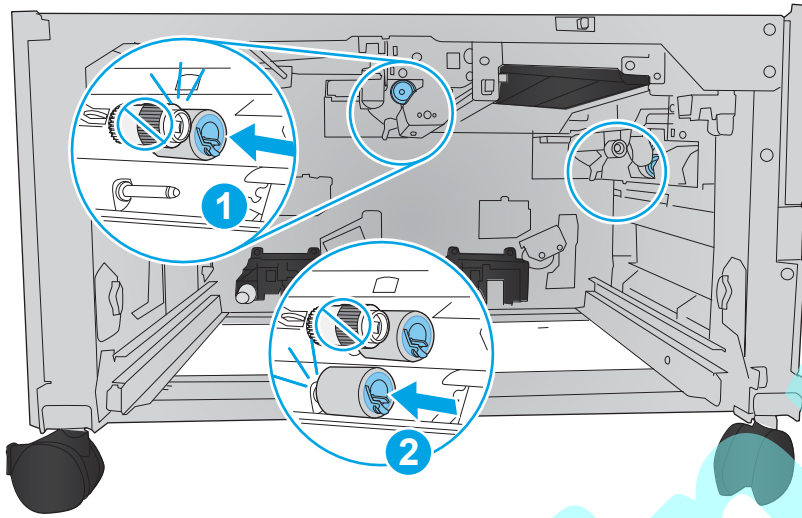

Not Final

Covers and doors

 **TIP:** For clarity, some figures in this chapter show assemblies removed that are not required to be removed to service the product (for example, the scanner and document feeder assemblies). The procedures in this manual are correct for your product.

- [Location of major components](#)
- [Scanner back cover \(M830 only\)](#)
- [Scanner left cover \(M830 only\)](#)
- [Scanner right cover \(M830 only\)](#)
- [Scanner front cover \(M830 only\)](#)
- [Tray 1 \(multipurpose tray\)](#)
- [Tray 2 and Tray 3](#)
- [Face-up tray \(output bin\)](#)
- [Hardware integration pocket \(HIP\) cover \(M806 only\)](#)
- [Hardware integration pocket \(HIP\) cover \(M830 only\)](#)
- [Control-panel base cover \(M806 only\)](#)
- [Right top cover \(M806 only\)](#)
- [Left top cover \(M806 only\)](#)
- [Front door assembly](#)
- [Front inner cover](#)
- [Left rear cover](#)
- [Rear cover](#)
- [Right rear cover](#)
- [Left door assembly](#)
- [Right door assembly](#)
- [Left front cover](#)
- [Upper left cover \(M806 only\)](#)
- [Upper left cover \(M830 only\)](#)
- [Right lower front cover](#)
- [Right lower cover](#)

Location of major components

Figure 1-108 Covers and doors

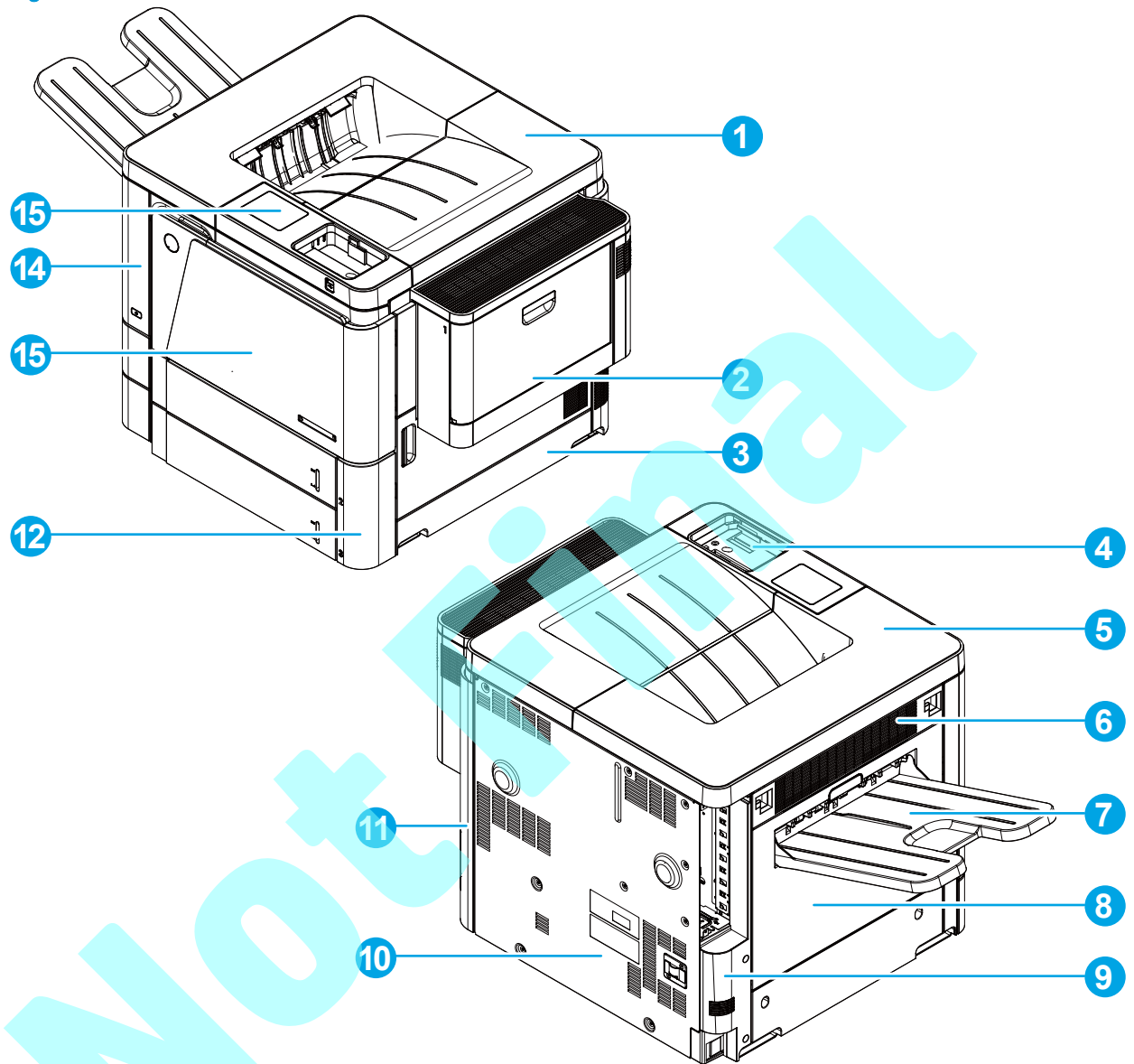

Table 1-1 Covers and doors

Item	Description	Item	Description
1	Right top cover (M806 only)	9	Left rear cover
2	Right door assembly	10	Rear cover
3	Lower right cover	11	Right rear cover
4	Control-panel base cover (M806 only)	12	Right lower front cover
5	Left top cover (M806 only)	13	Front door assembly
6	Upper left cover	14	Left front cover

Table 1-1 Covers and doors (continued)

Item	Description	Item	Description
7	Face-up tray (output bin)	15	Hardware integration pocket (HIP) cover (M806 only)
8	Left door assembly		

Not Final

Scanner back cover (M830 only)

1. Remove three screws.

Figure 1-109 Remove the scanner back cover (M830; 1 of 2)



2. Remove the cover.

Figure 1-110 Remove the scanner back cover (M830; 2 of 2)



Scanner left cover (M830 only)

Before proceeding, remove the following assemblies:

- Scanner back cover (M830 only). See [Scanner back cover \(M830 only\)](#) on page 75.

Remove the scanner left cover (M830 only)

1. Raise the document feeder to the open position.

Figure 1-111 Remove the scanner left cover (M830; 1 of 3)



2. Remove two screws.

Figure 1-112 Remove the scanner left cover (M830; 2 of 3)



3. Slide the cover towards the rear of the product to release it, and then remove the cover.

Figure 1-113 Remove the scanner left cover (M830; 3 of 3)

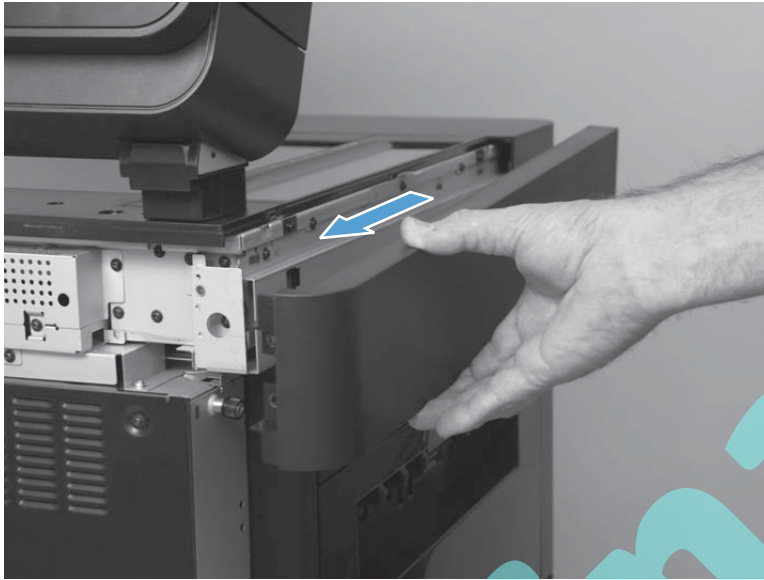

Not Final

Scanner right cover (M830 only)

Before proceeding, remove the following assemblies:

- Scanner back cover (M830 only). See [Scanner back cover \(M830 only\)](#) on page 75.

Remove the scanner right cover (M830 only)

1. Raise the document feeder to the open position.

Figure 1-114 Remove the scanner right cover (M830; 1 of 4)

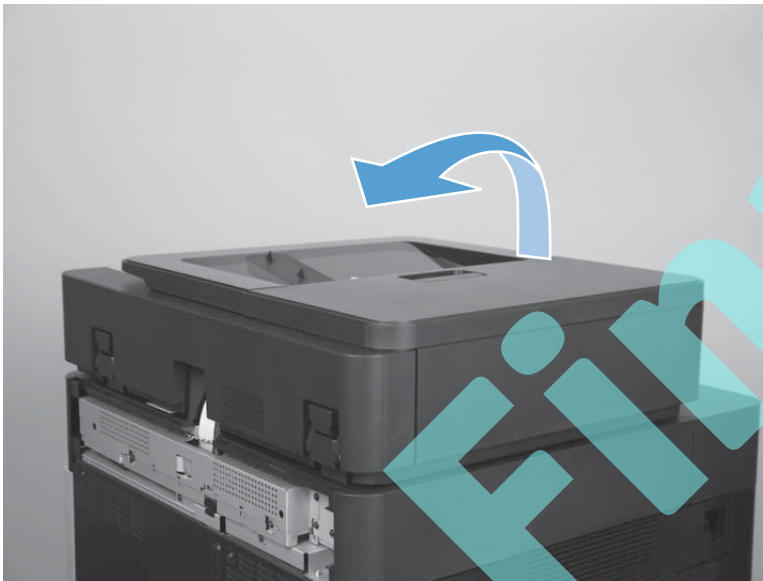

2. Remove two screws.

Figure 1-115 Remove the scanner right cover (M830; 2 of 4)



- Carefully flex the end of the cover to release one tab (callout 1), and then slightly slide the cover towards the rear of the product (callout 2) to release it.

 **TIP:** It might be easier to remove the product right rear cover and rear cover rather than flex the scanner right cover to release the tab.

Figure 1-116 Remove the scanner right cover (M830; 3 of 4)



- Slide the cover towards the rear of the product to remove it.

Figure 1-117 Remove the scanner right cover (M830; 4 of 4)

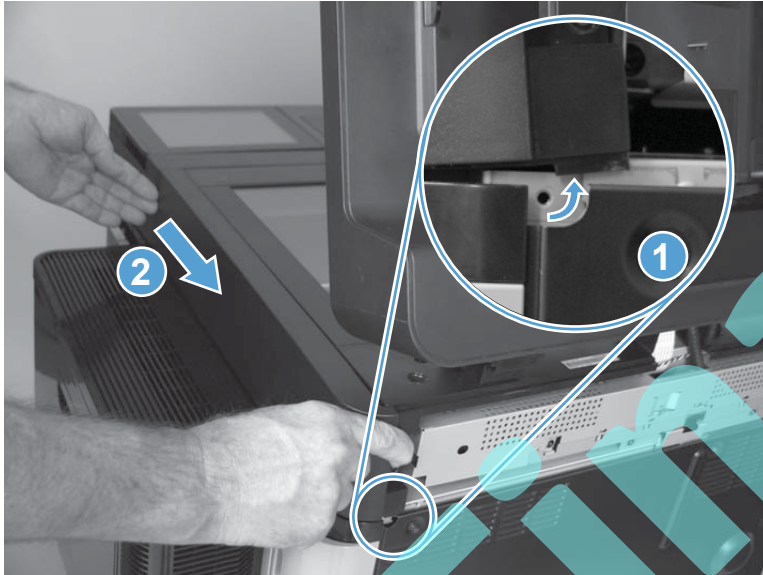
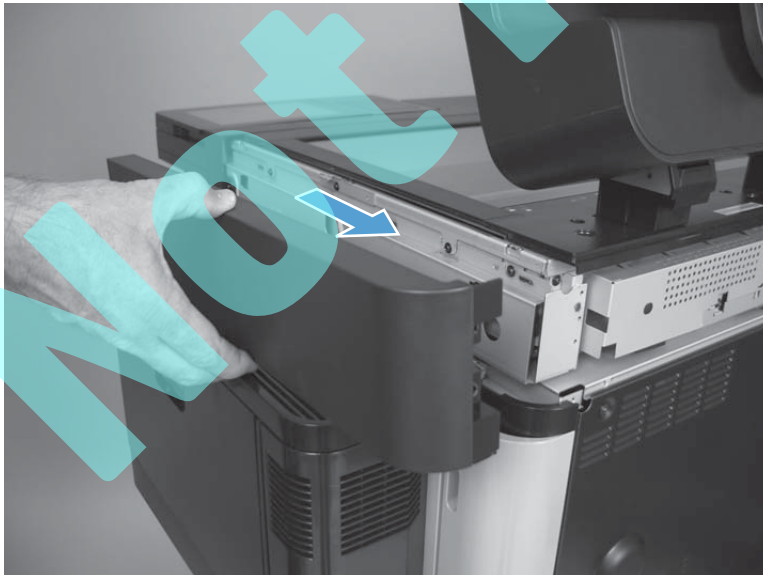

Scanner front cover (M830 only)

Before proceeding, remove the following assemblies:

- Hardware integration pocket (HIP) cover (M830 only). See [Hardware integration pocket \(HIP\) cover \(M830 only\) on page 91](#).
- Control panel assembly (M830 only). See [Control-panel assembly \(M830 only\) on page 52](#).
- Scanner back cover (M830 only). See [Scanner back cover \(M830 only\) on page 75](#).
- Scanner left cover (M830 only). See [Scanner left cover \(M830 only\) on page 76](#).
- Scanner right cover (M830 only). See [Scanner right cover \(M830 only\) on page 78](#).

Remove the scanner front cover (M830 only)

1. Raise the document feeder to the open position.

Figure 1-118 Remove the scanner front cover (M830; 1 of 7)

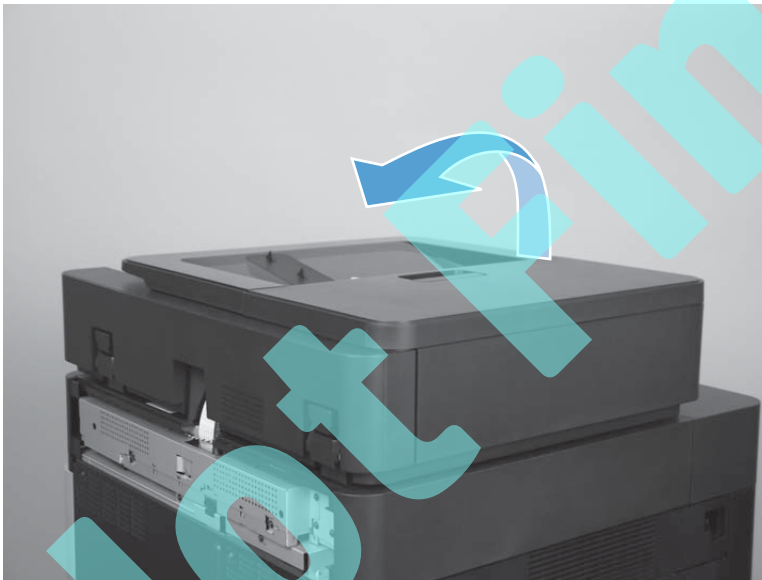

2. Remove two screws.

Figure 1-119 Remove the scanner front cover (M830; 2 of 7)



3. Remove one screw.

Figure 1-120 Remove the scanner front cover (M830; 3 of 7)

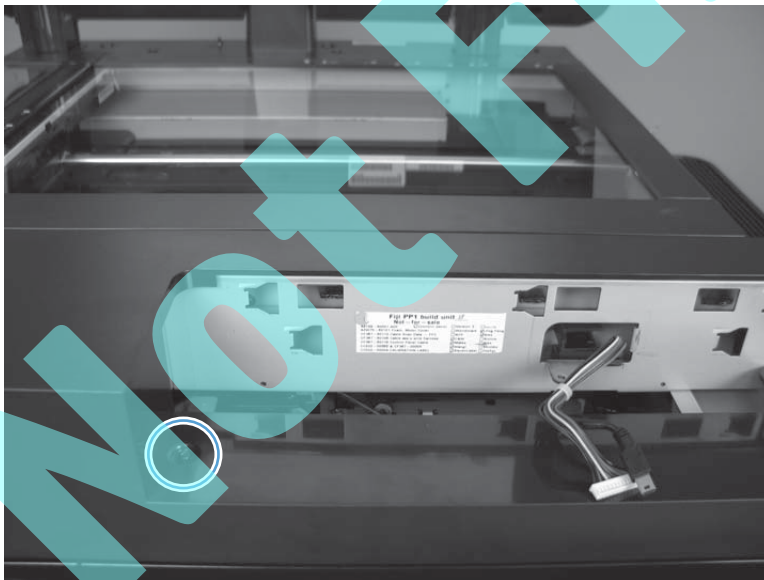

4. Remove two screws.

Figure 1-121 Remove the scanner front cover (M830; 4 of 7)



5. Carefully flex the edge of the cover away from the scanner to release one tab, and then slightly slide the cover toward the front of the product so that the tab stays released.

Figure 1-122 Remove the scanner front cover (M830; 5 of 7)

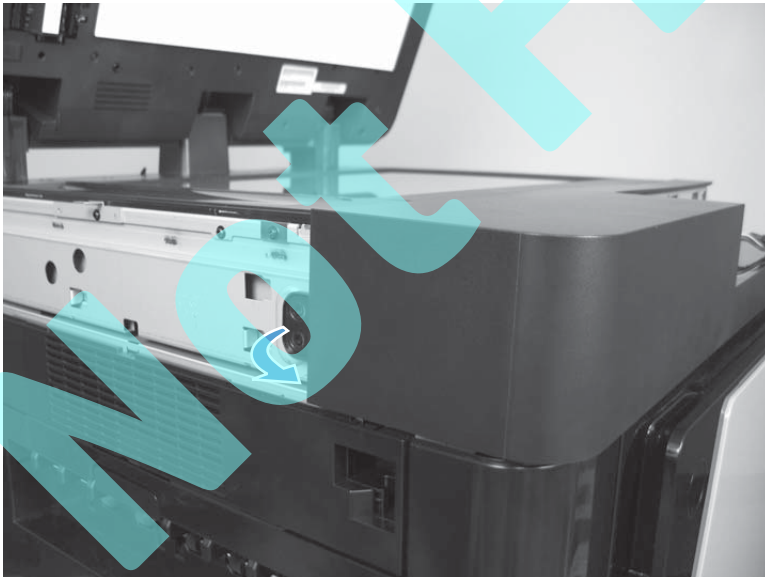

6. Carefully flex the edge of the cover away from the scanner to release one tab, and then slightly slide the cover toward the front of the product so that the tab stays released.

Figure 1-123 Remove the scanner front cover (M830; 6 of 7)



7. Slide the cover towards the front of the product to remove it.

Figure 1-124 Remove the scanner front cover (M830; 7 of 7)

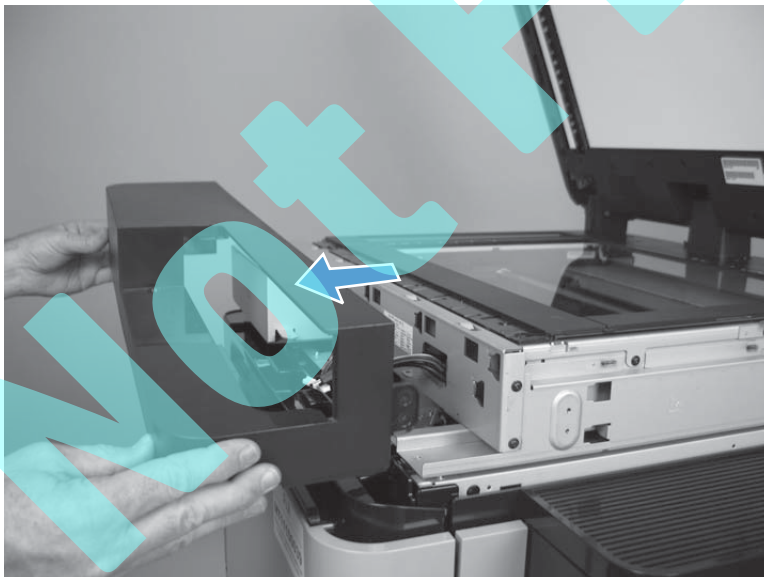

Tray 1 (multipurpose tray)

1. Open Tray 1 (callout 1), and then slide the tray extender out until it stops (callout 2).

Figure 1-125 Remove Tray 1 (1 of 3)

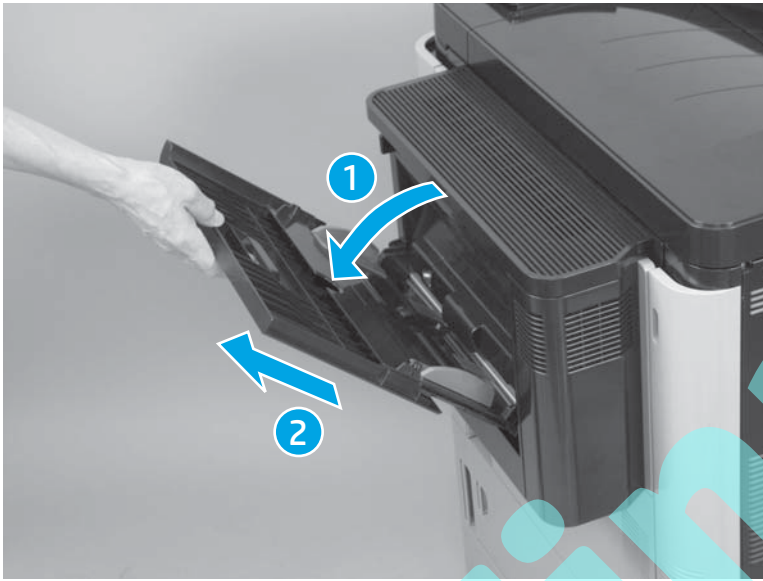

2. Open Tray 1 about halfway until the flat edge of the right hinge slot in the door is aligned with the flat edge of the right hinge pin on the product. Slowly rotate the right side of the tray up and off of the right hinge pin to release it.

Figure 1-126 Remove Tray 1 (2 of 3)

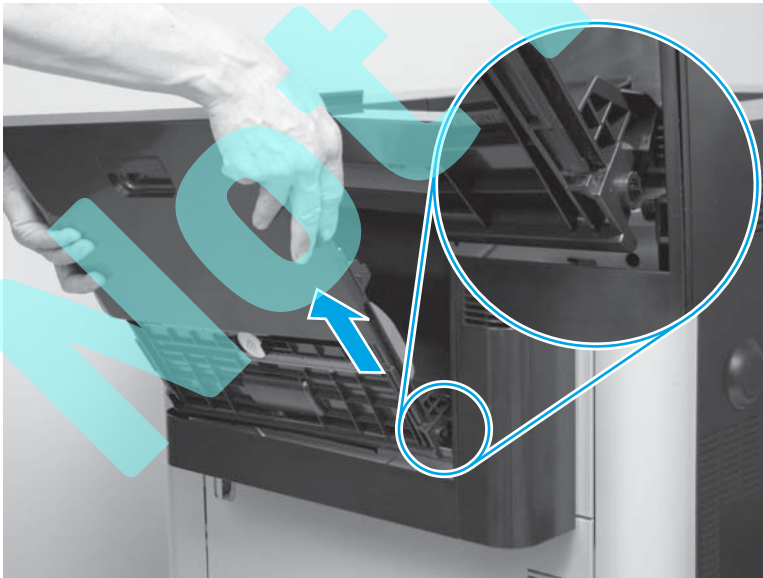

3. Slide the tray to the right to release it from the product.

Figure 1-127 Remove Tray 1 (3 of 3)



Not Final

Tray 2 and Tray 3

Slide the tray open until it stops, and then lift up on the front of the tray to release it. Remove the tray.

Figure 1-128 Remove Tray 2 and Tray 3

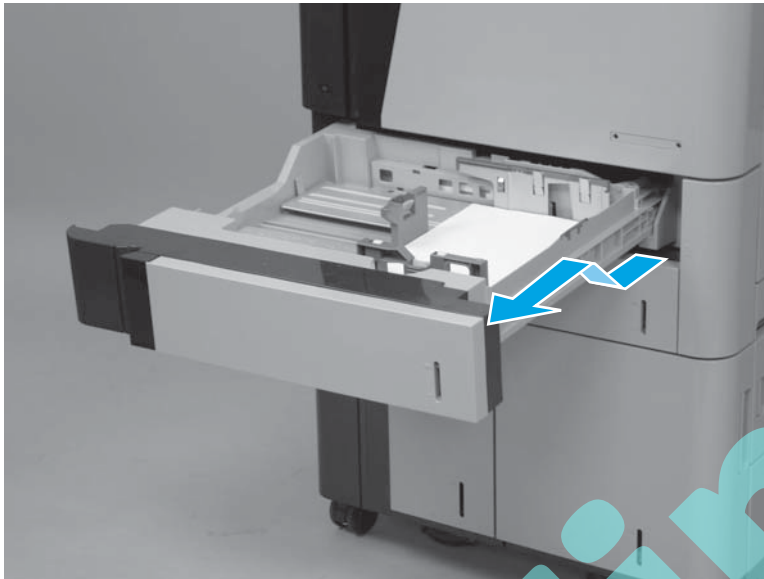

Not Final

Face-up tray (output bin)

Release two hinge tabs (callout 1), and then slide the tray away from the product (callout 2) to remove it

Figure 1-129 Remove the face-up tray

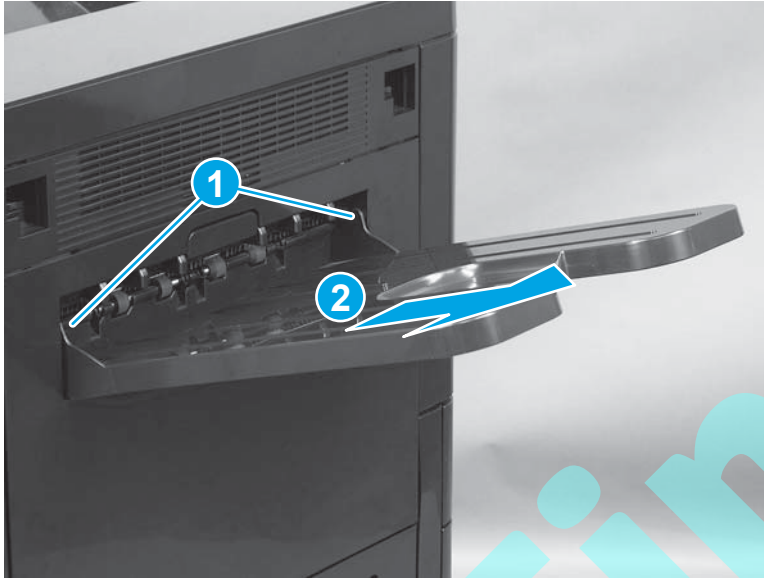

Hardware integration pocket (HIP) cover (M806 only)

1. Note the location of four tabs under the HIP cover.

Figure 1-130 Remove the HIP cover (M806; 1 of 3)



2. Release two tabs on the side of the HIP cover toward the back of the product.

Figure 1-131 Remove the HIP cover (M806; 2 of 3)



3. Lift the HIP cover up to remove it.

Figure 1-132 Remove the HIP cover (M806; 3 of 3)



Reinstall the HIP cover (M806 only)

1. Align the tabs (callout 1) on the cover with the slots in the product (callout 2).

Figure 1-133 Reinstall the HIP cover (M806; 1 of 2)

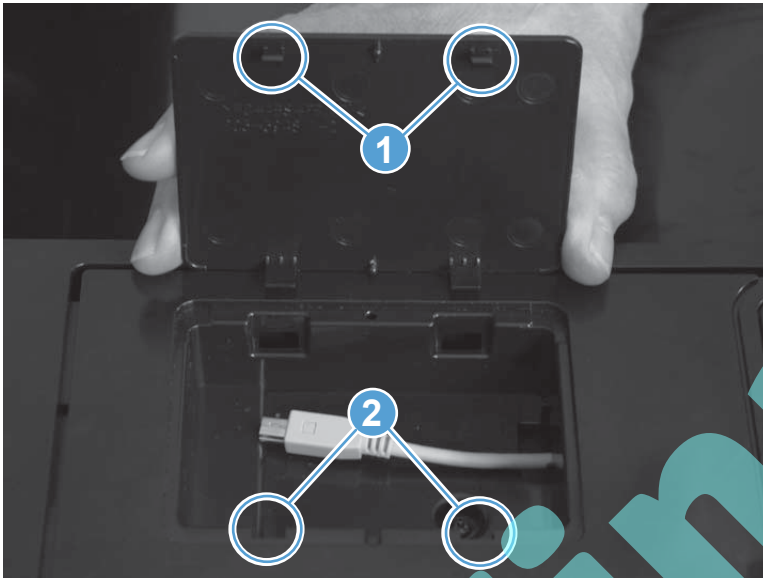

2. Lower the HIP cover into place.

Figure 1-134 Reinstall the HIP cover (M806; 2 of 2)

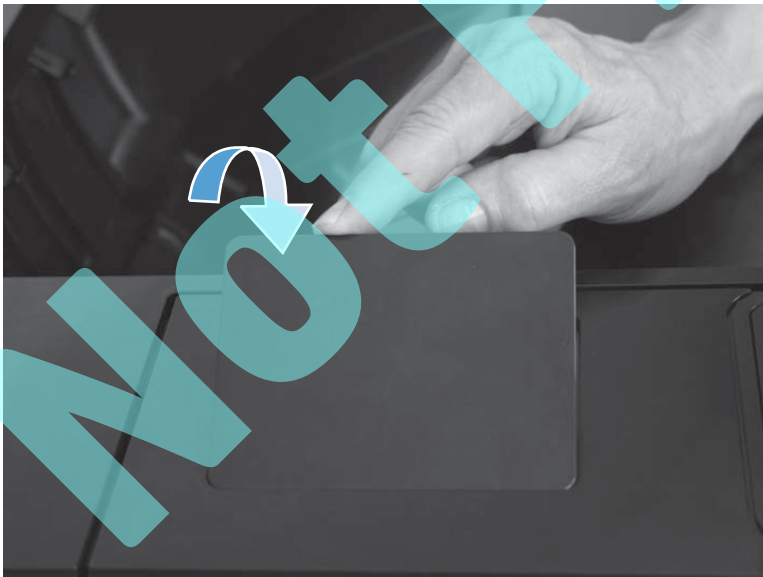

Hardware integration pocket (HIP) cover (M830 only)

1. Note the location of four tabs under the HIP cover.

Figure 1-135 Remove the HIP cover (M830; 1 of 3)



2. Release two tabs on the side of the HIP cover toward the control panel screen.

Figure 1-136 Remove the HIP cover (M830; 2 of 3)

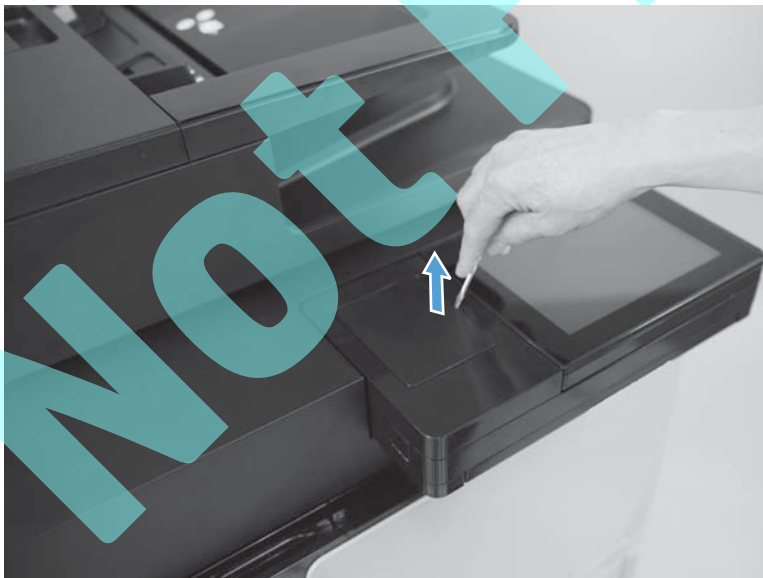

3. Remove the HIP cover.

Figure 1-137 Remove the HIP cover (M830; 3 of 3)



Not Final

Reinstall the HIP cover (M830 only)

1. Align the tabs (callout 1) on the cover with the slots in the product (callout 2).

Figure 1-138 Reinstall the HIP cover (M830; 1 of 2)

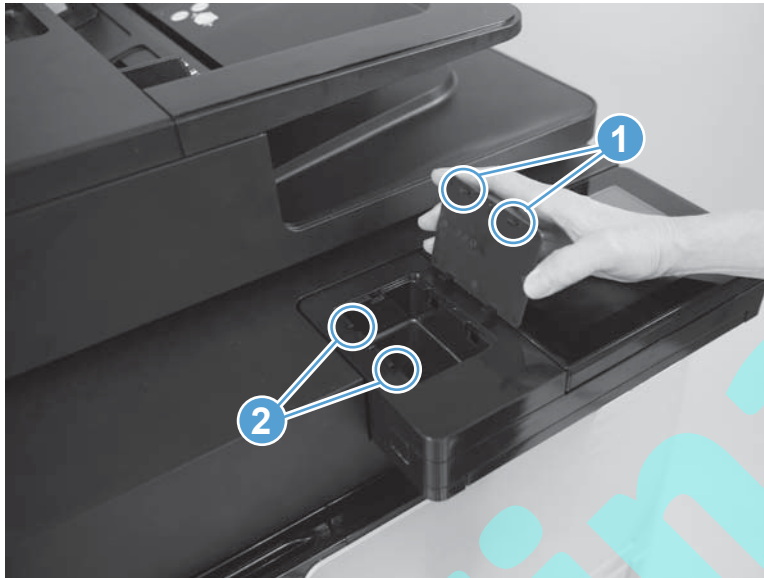

2. Lower the HIP cover into place.

Figure 1-139 Reinstall the HIP cover (M830; 2 of 2)



Control-panel base cover (M806 only)

Before proceeding, remove the following assemblies:

- Control panel (M806 only). See [Control-panel assembly \(M806 only\) on page 38](#).
- Hardware integration pocket (HIP) cover (M806 only). See [Hardware integration pocket \(HIP\) cover \(M806 only\) on page 88](#).

Remove the control-panel base cover (M806 only)

1. Open the right door. Remove one screw (callout 1), and then remove one screw (callout 2) inside the hardware integration pocket.

Figure 1-140 Remove the control-panel base cover (M806; 1 of 3)

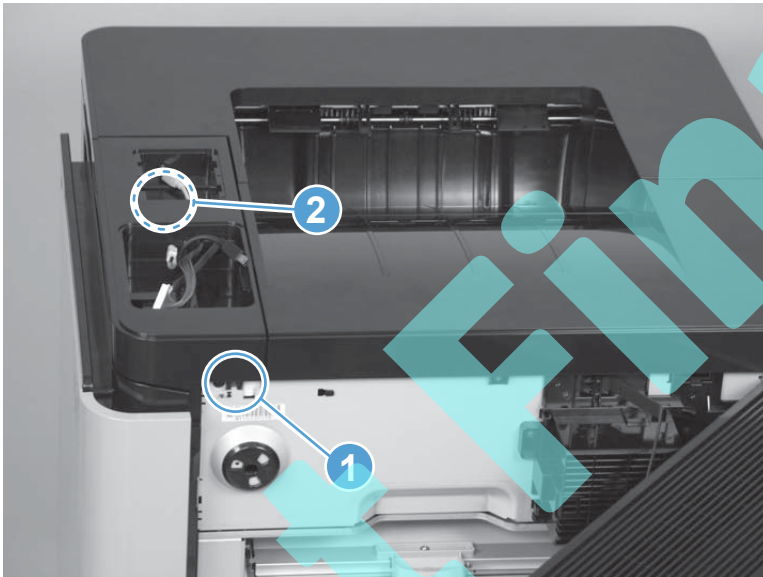

2. Slide the control-panel base cover toward the right door.

Figure 1-141 Remove the control-panel base cover (M806; 2 of 3)



3. Slightly lift the left side of the cover (callout 1), and then slide it toward the right door (callout 2) to remove it.

 **NOTE:** One USB cable under the cover is not captive when the cover is removed.

Figure 1-142 Remove the control-panel base cover (M806; 3 of 3)

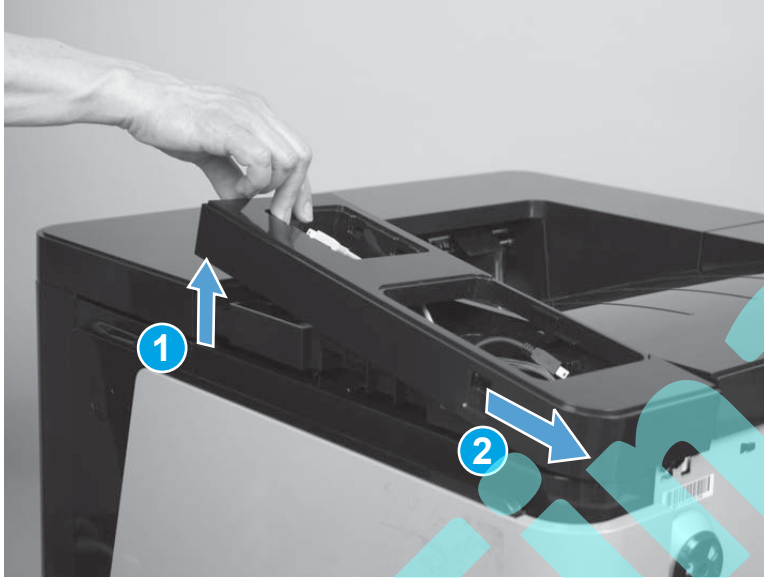

Reinstall the control-panel base cover (M806 only)

1. Position the USB cables, the ground wire, and the wire harness in the guides as shown below.

CAUTION: The wire harness and cables might be pinched between the product and the cover if they are not positioned correctly in the guides.

Figure 1-143 Reinstall the control-panel base cover (M806; 1 of 3)

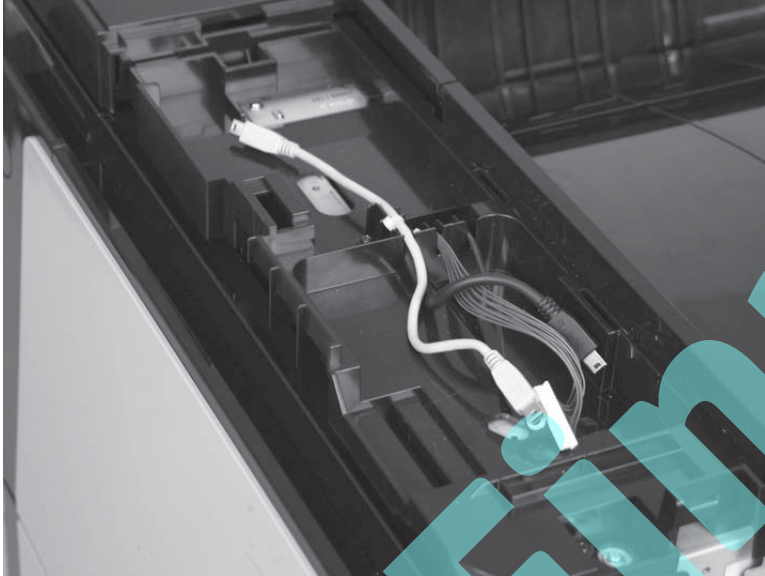

2. Insert the end of the USB cable through the opening in the cover.

Figure 1-144 Reinstall the control-panel base cover (M806; 2 of 3)



3. Open the right door. Position the tabs on the cover (callout 1) over the slots in the product (callout 2), and then slide the cover into place.

Figure 1-145 Reinstall the control-panel base cover (M806; 3 of 3)

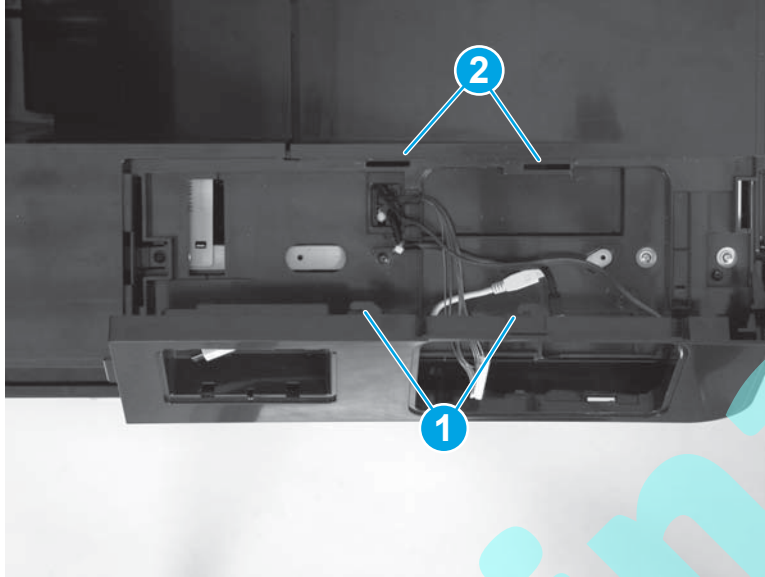

Right top cover (M806 only)

Before proceeding, remove the following assemblies:

- Control-panel assembly (M806 only). See [Control-panel assembly \(M806 only\) on page 38](#).
- Hardware integration pocket (HIP) cover (M806 only). See [Hardware integration pocket \(HIP\) cover \(M806 only\) on page 88](#).
- Control-panel base cover (M806 only). See [Control-panel base cover \(M806 only\) on page 94](#).

Remove the right top cover (M806 only)

1. Release the USB cables, the ground wire, and the wire harness from the guides.

 **NOTE:** One USB cable is not captive when it is released from the guides. Do not lose the cable.

Figure 1-146 Remove the right top cover (M806; 1 of 4)



2. Remove two screws.

Figure 1-147 Remove the right top cover (M806; 2 of 4)

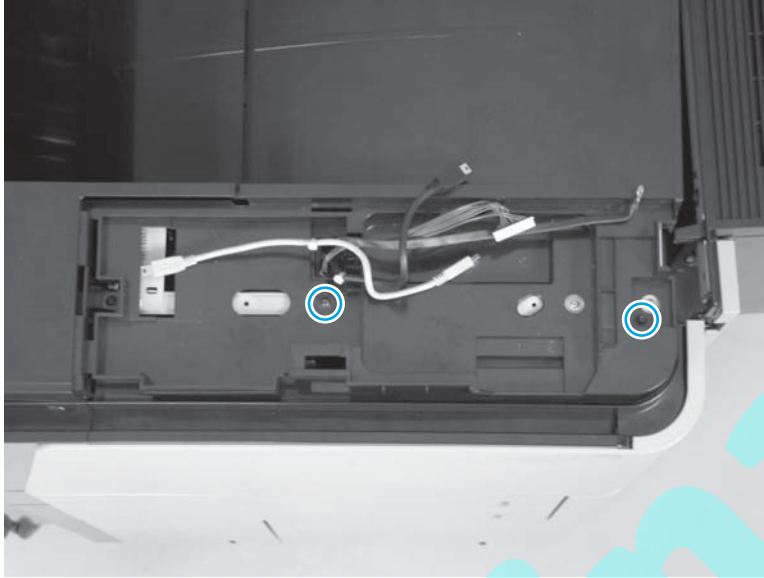

3. Open the right door, and then remove two screws.

Figure 1-148 Remove the right top cover (M806; 3 of 4)



4. Lift the right top cover up, and then pass the cables and wire harness through the opening in the cover. Remove the cover.

Figure 1-149 Remove the right top cover (M806; 4 of 4)

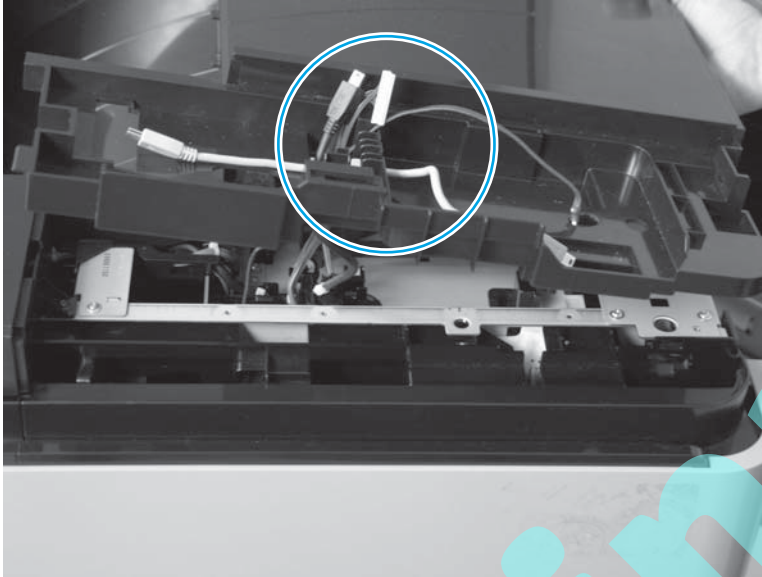

Reinstall the right top cover (M806 only)

1. Position the USB cable, the ground wire, and the wire harness (callout 1) in the guide on the product (callout 2).

⚠ CAUTION: The wire harness and cables might be pinched between the product and the cover if they are not positioned correctly in the guides.

Figure 1-150 Reinstall the right top cover (M806; 1 of 3)

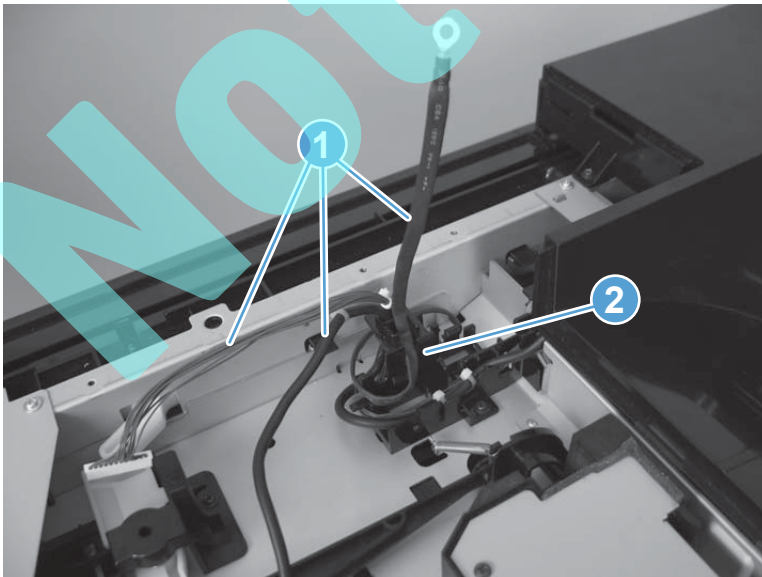

2. Insert the USB cable, the ground wire, and the wire harness through the opening in the right top cover.

Figure 1-151 Reinstall the right top cover (M806; 2 of 3)



3. Position the cables in the guides as shown below.

 **TIP:** Make sure that the light-colored USB cable is positioned as shown below.

Figure 1-152 Reinstall the right top cover (M806; 3 of 3)



Left top cover (M806 only)

Before proceeding, remove the following assemblies:

- Control-panel assembly (M806 only). See [Control-panel assembly \(M806 only\) on page 38](#).
- Hardware integration pocket (HIP) cover (M806 only). See [Hardware integration pocket \(HIP\) cover \(M806 only\) on page 88](#).
- Control-panel base cover (M806 only). See [Control-panel base cover \(M806 only\) on page 94](#).
- Right top cover (M806 only). See [Right top cover \(M806 only\) on page 98](#).

Remove the left top cover (M806 only)

1. Remove two screws.

Figure 1-153 Remove the left top cover (M806; 1 of 2)

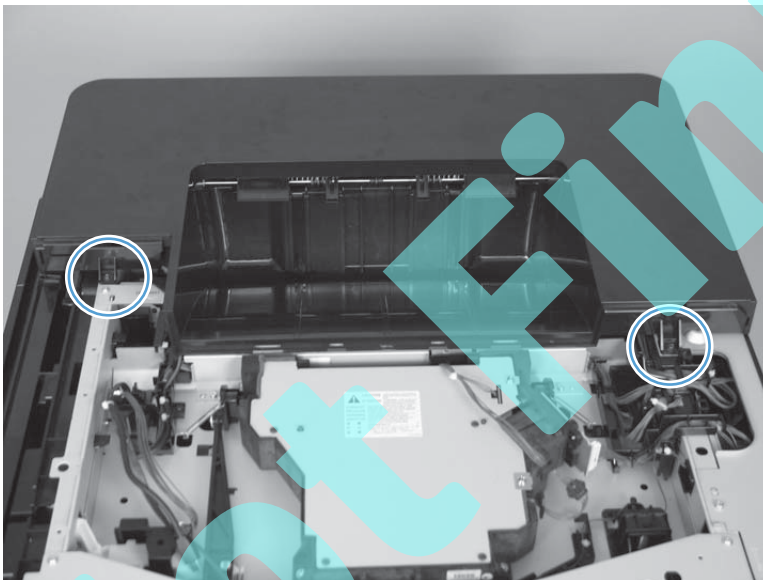

2. Slightly lift the side of the cover closest to the right door (callout 1), and then slide the cover towards the right door to remove it (callout 2).

Figure 1-154 Remove the left top cover (M806; 2 of 2)

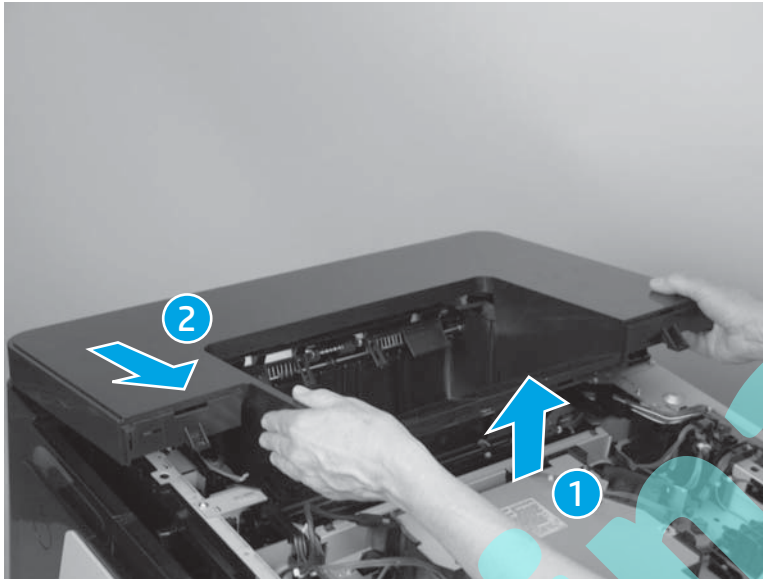

Reinstall the left top cover (M806 only)

Align the tabs (callout 1) with the slots in the sheet metal (callout 2) before sliding the cover into place.

Figure 1-155 Reinstall the left top cover (M806)



Front door assembly

1. Open the front door.
2. Remove two stoppers (callout 1).

Figure 1-156 Remove the front door assembly (1 of 3)



3. Release two tabs on each side of the clip, and then release the flexible door retainers.

Figure 1-157 Remove the front door assembly (2 of 3)

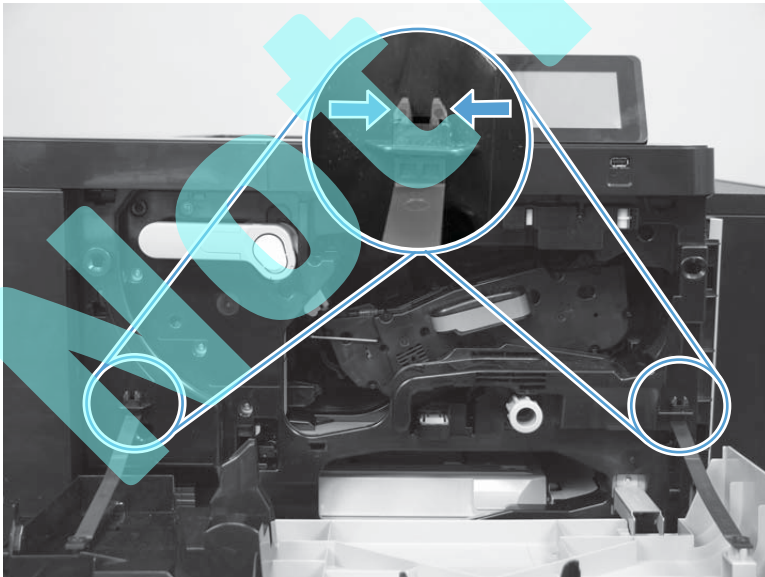

4. Rotate the door down as far as it will go (callout 1), and then slide the front-door assembly to the left to remove it from the product (callout 2).

Figure 1-158 Remove the front door assembly (3 of 3)

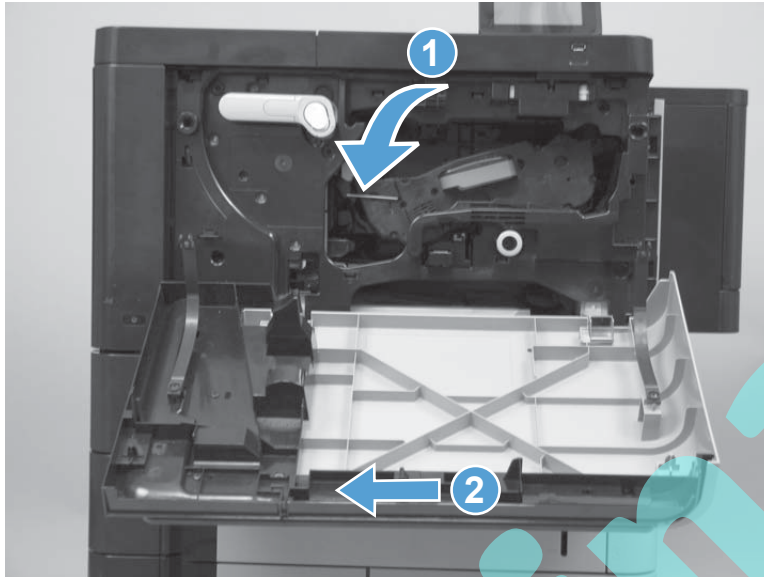

Reinstall the front door assembly

Make sure that the clips on the flexible door retainers are fully inserted into the holders on the product.

Figure 1-159 Reinstall the front door assembly



Front inner cover

Before proceeding, remove the following assemblies:

- Control-panel assembly (M806 only). See [Control-panel assembly \(M806 only\) on page 38](#).
- Hardware integration pocket (HIP) cover (M806 only). See [Hardware integration pocket \(HIP\) cover \(M806 only\) on page 88](#).
- Control-panel base cover (M806 only). See [Control-panel base cover \(M806 only\) on page 94](#).
- Right top cover (M806 only). See [Right top cover \(M806 only\) on page 98](#).
- Left top cover (M806 only). See [Left top cover \(M806 only\) on page 102](#).
- Left front cover. See [Left front cover on page 121](#).
- Front door assembly. See [Front door assembly on page 104](#).
- Cartridge-release lever. See [Cartridge-release lever on page 151](#).
- Registration-jam-removal knob. See [Registration-jam-removal knob on page 154](#).
- Tray 2 and Tray 3. See [Tray 2 and Tray 3 on page 86](#).
- Right lower front cover. See [Right lower front cover on page 126](#).

Remove the front inner cover

1. Remove two screws (callout 1), and then remove two brackets (callout 2).

Figure 1-160 Remove the front inner cover (1 of 3)

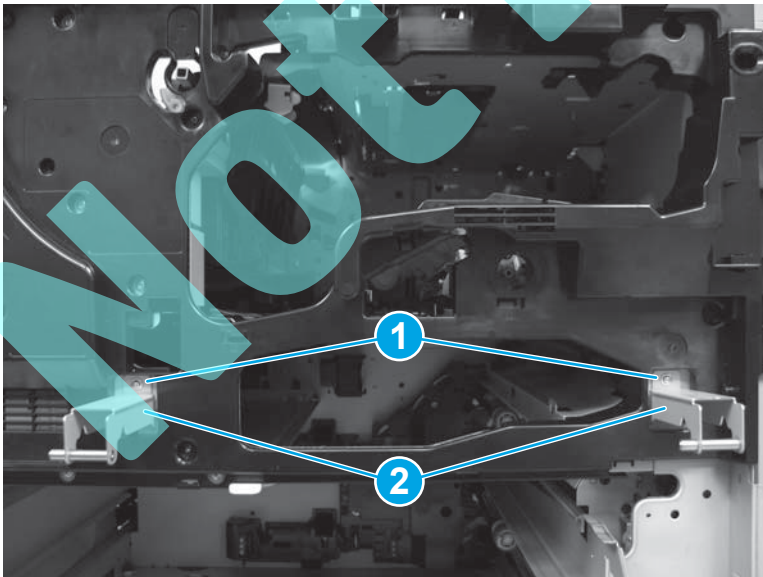

2. Remove six screws.

Figure 1-161 Remove the front inner cover (2 of 3)

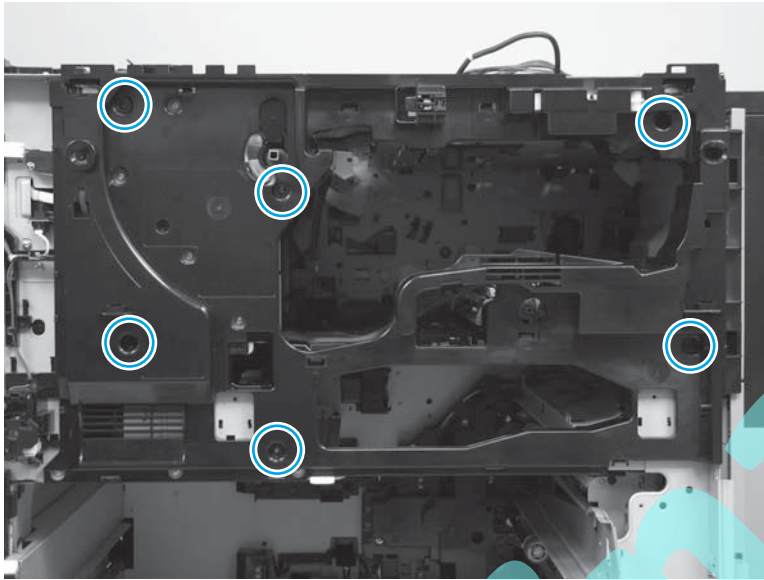

3. Release eight tabs, and then remove the front inner cover.

Figure 1-162 Remove the front inner cover (3 of 3)

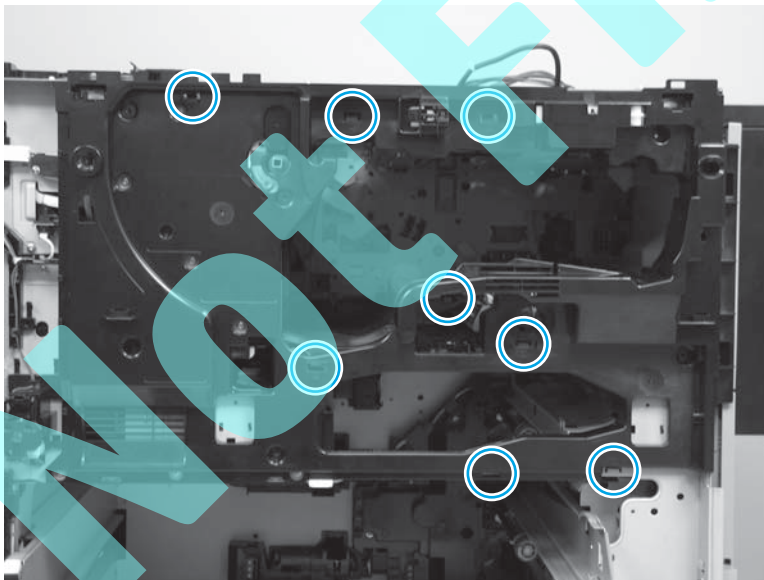

Reinstall the front inner cover

Ensure all eight tabs on the front inner cover are snapped into place, and then install the tabs on the brackets into the slots in the product.

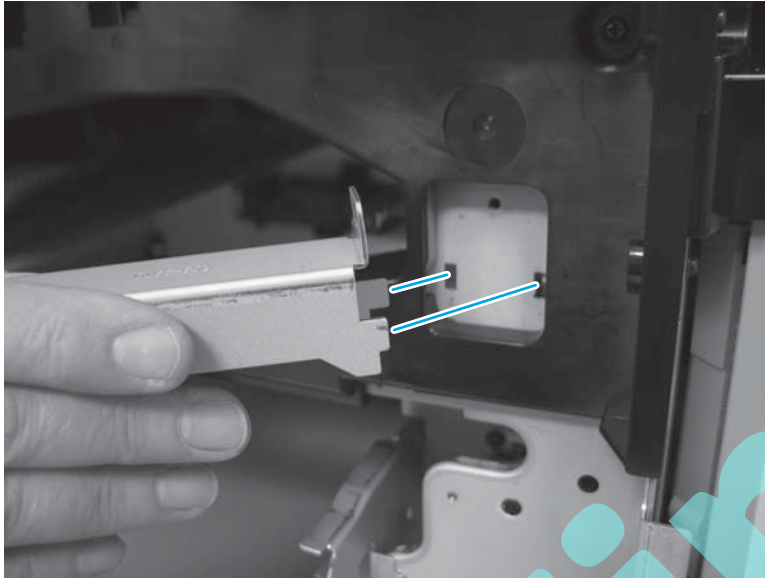

Not Final

Left rear cover

Open the left door assembly, remove three screws, and then remove the left rear cover.

Figure 1-163 Remove the left rear cover.

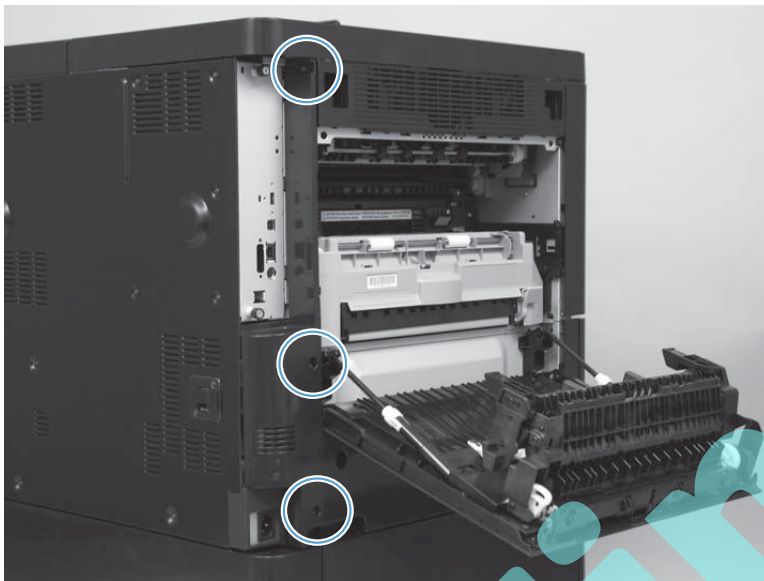

Reinstall the left rear cover

Align the tabs on the cover (callout 1) with the slots on the product (callout 2).

Figure 1-164 Reinstall the left rear cover

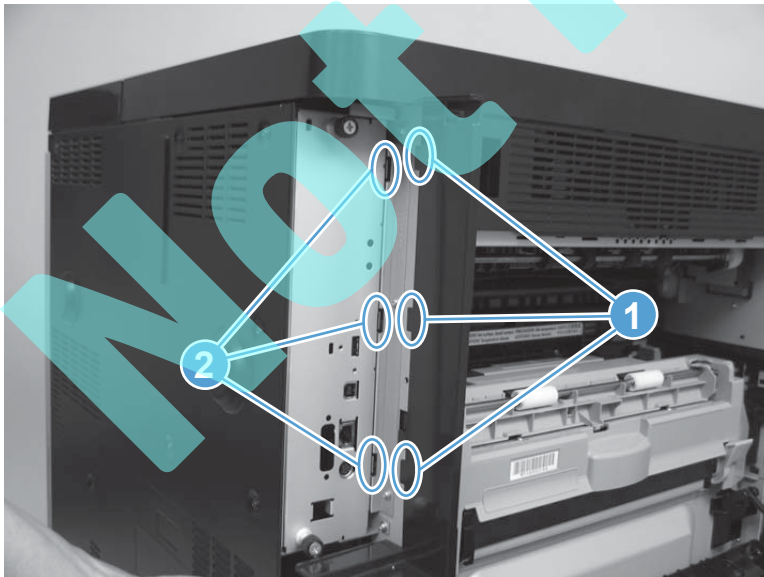

Rear cover

1. Remove one screw.

Figure 1-165 Remove the rear cover (1 of 3)



2. Remove nine screws.

Figure 1-166 Remove the rear cover (2 of 3)

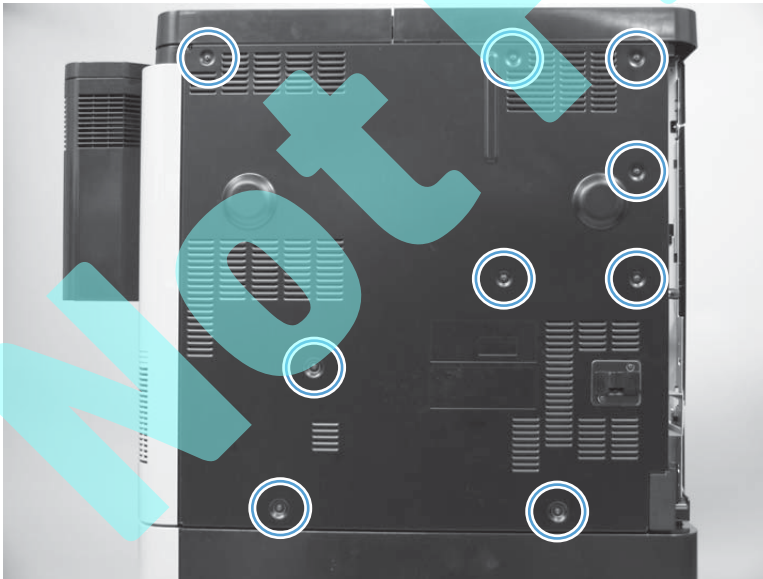

3. Slightly flex the lower portion of the left rear cover away from the product (callout 1) to release the rear cover, rotate the edge of the rear cover away from the product (callout 2), and then slide it away from the product to remove it (callout 3).

Figure 1-167 Remove the rear cover (3 of 3)

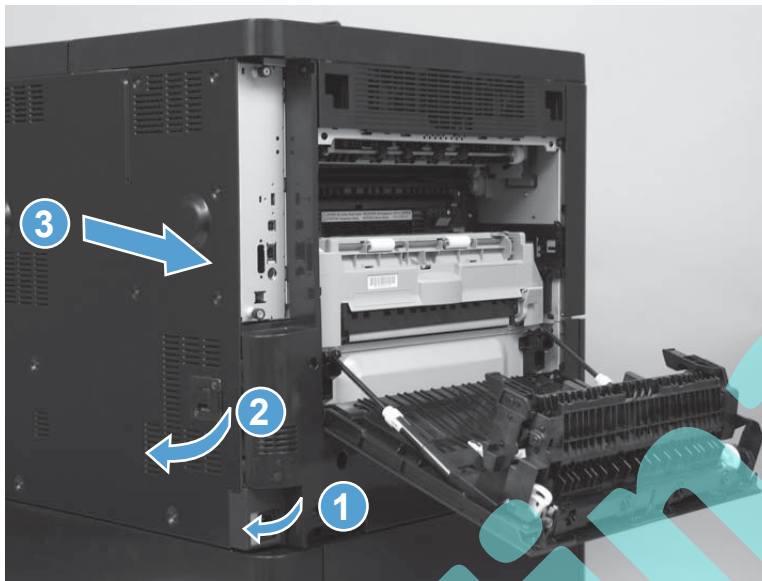

Reinstall the rear cover

1. Align the three tabs on the cover with the slots on the product, and then rotate the cover toward the product to reinstall it.

Figure 1-168 Reinstall the rear cover (1 of 2)



2. Slightly flex the lower portion of the left rear cover away from the product (callout 1) to install the edge of the rear cover (callout 2), and then reinstall 10 screws (nine for the rear cover, and one for the left rear cover).

Figure 1-169 Reinstall the rear cover (2 of 2)

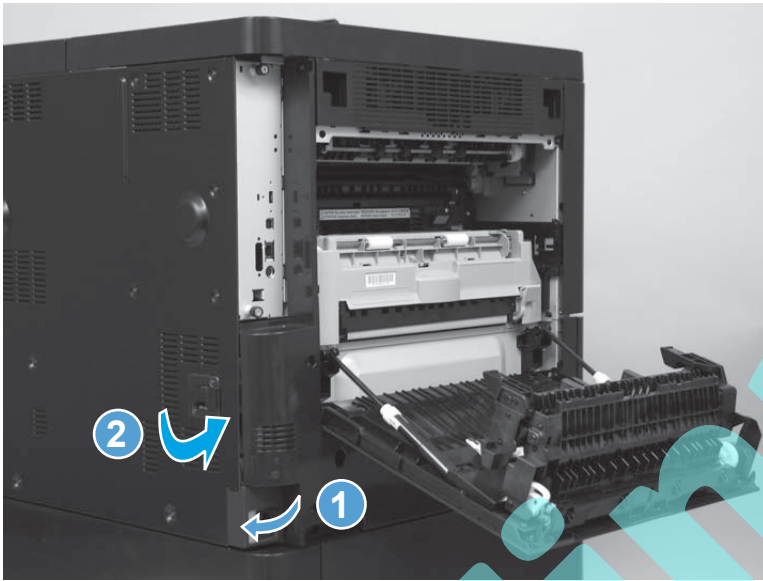

Right rear cover

Before proceeding, remove the following assemblies:

- Rear cover. See [Rear cover on page 110](#).

Remove the right rear cover

1. Remove one screw.

Figure 1-170 Remove the right rear cover (1 of 5)

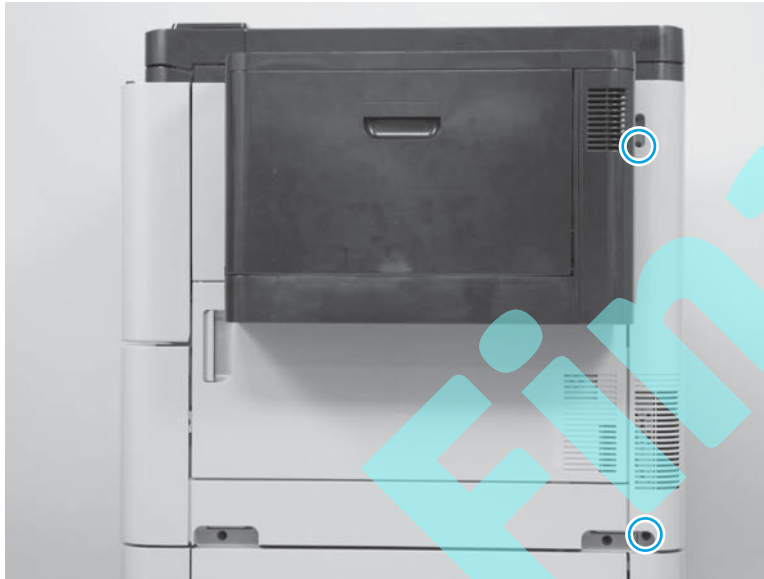

2. Release two tabs.

 **TIP:** Use a small, flat-blade screwdriver to release the top tab. Release the center tab by reaching inside the cover from the back of the product.

Figure 1-171 Remove the right rear cover (2 of 5)



3. Tilt the top of the cover away from the product.

 **TIP:** While tilting the top of the cover away from the product, you might need to slightly rotate the bottom of the cover to release it.

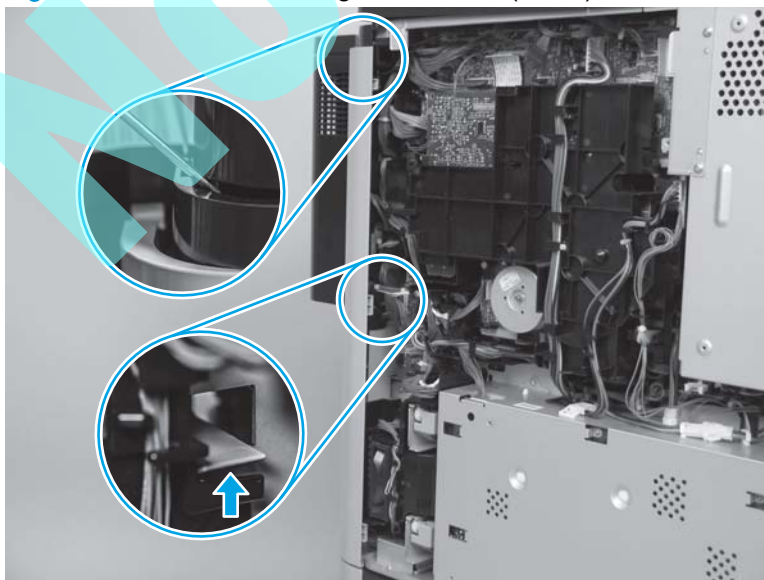
Figure 1-172 Remove the right rear cover (3 of 5)



4. Place a finger over the opening in the sheet metal for the center tab to prevent it from re-engaging while the cover is being removed.

 **NOTE:** The center tab is long and may break if it is allowed to re-engage while the cover is being pulled away from the product.

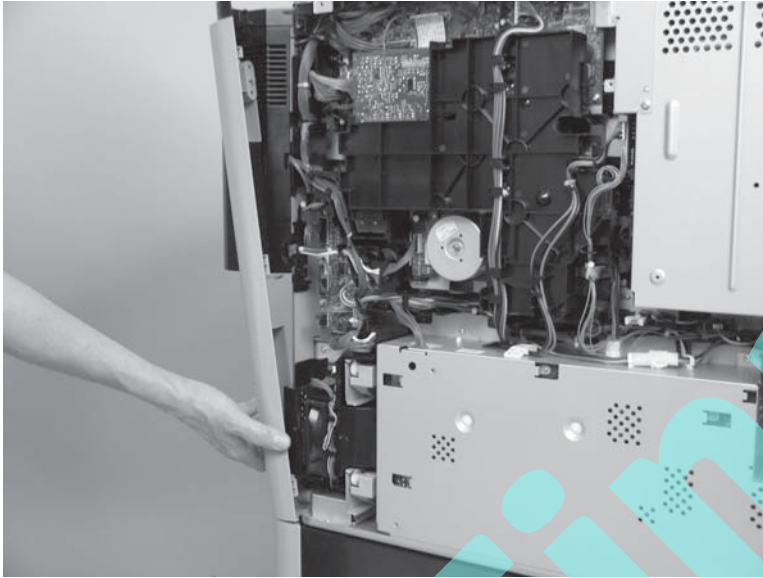
Figure 1-173 Remove the right rear cover (4 of 5)



5. Slide the bottom of the cover toward the back of the product to remove it.

 **Reinstallation tip** Slide the bottom of the right rear cover into place first, and then snap the tabs into place.

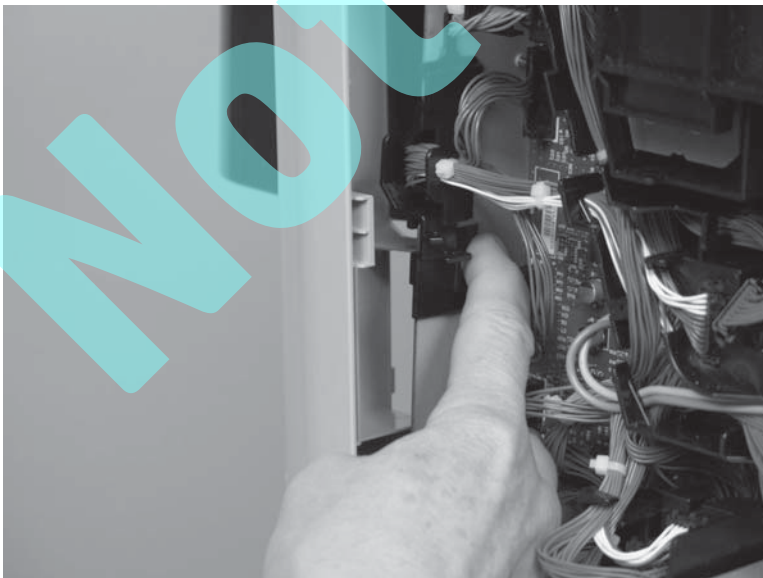
Figure 1-174 Remove the right rear cover (5 of 5)



Left door assembly

1. Open the left door assembly, and then locate the link arms on each side of the door.

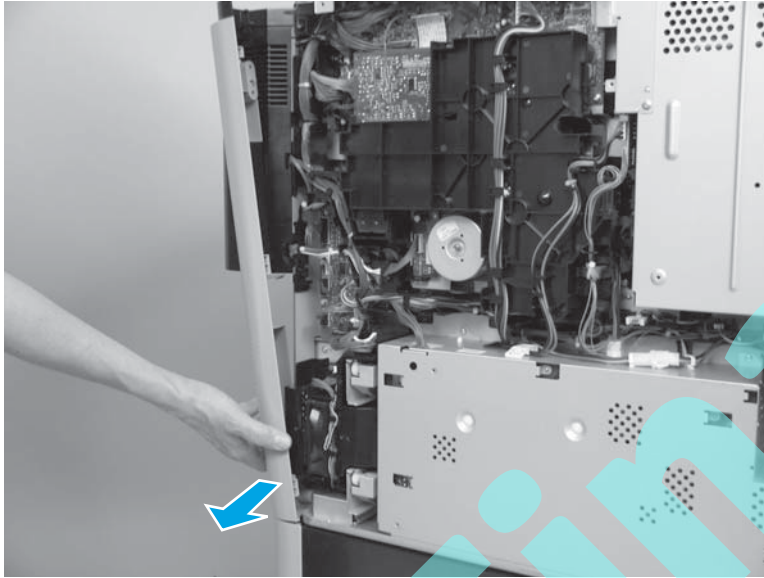
Figure 1-175 Remove the left door assembly (1 of 4).

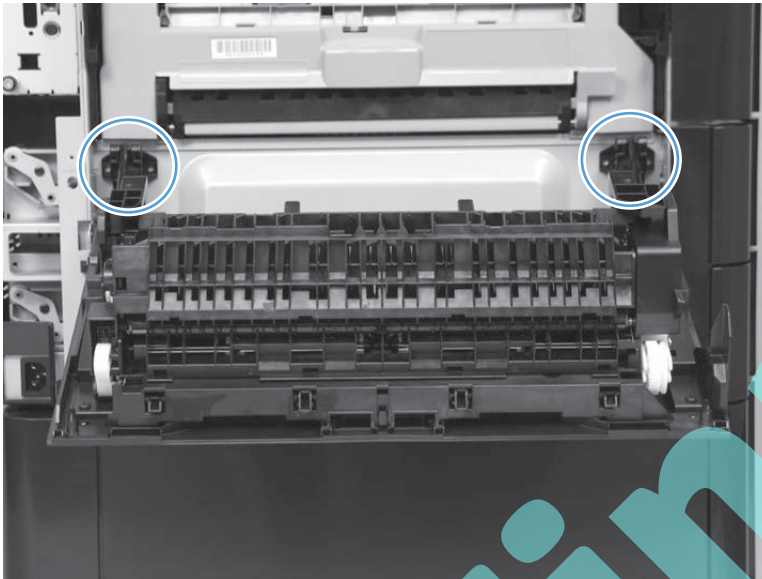

2. Push the end of the link arm toward the product, and then rotate it down to release the link arm from the product.

 **NOTE:** The link arm is spring-loaded and will retract into the left door assembly when it is released.

Figure 1-176 Remove the left door assembly (2 of 4).



3. Lift the door up until the flat edge of the right hinge slot in the door is aligned with the flat edge of the right hinge pin on the product. Slowly rotate the right side of the door up and off of the right hinge pin to release it.

Figure 1-177 Remove the left door assembly (3 of 4).

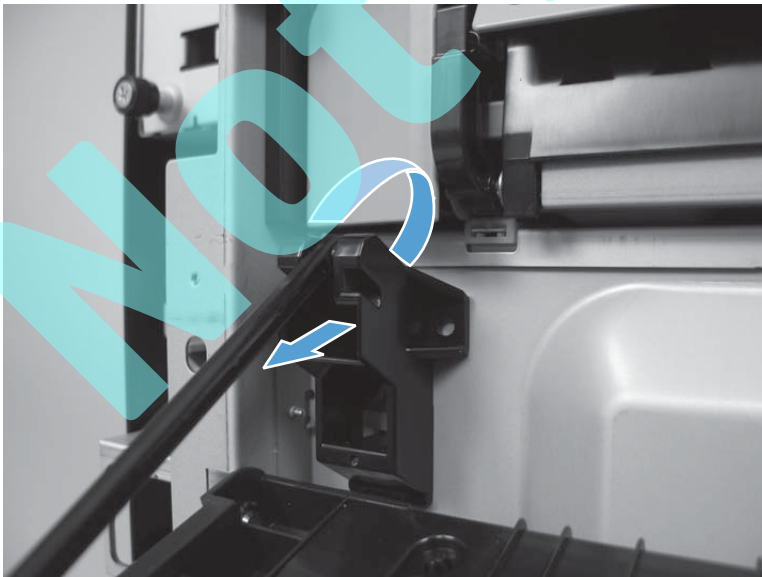
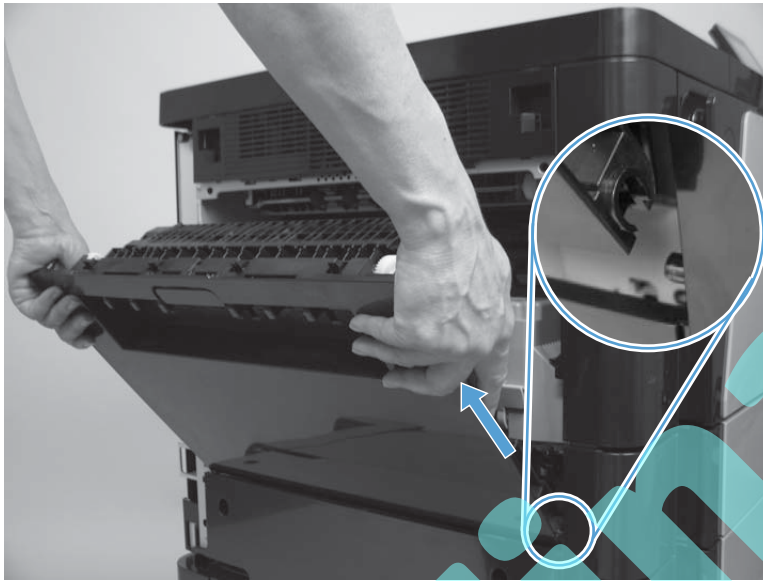

4. Slide the door to the right to release it from the left hinge pin, and then remove the door.

Figure 1-178 Remove the left door assembly (4 of 4).

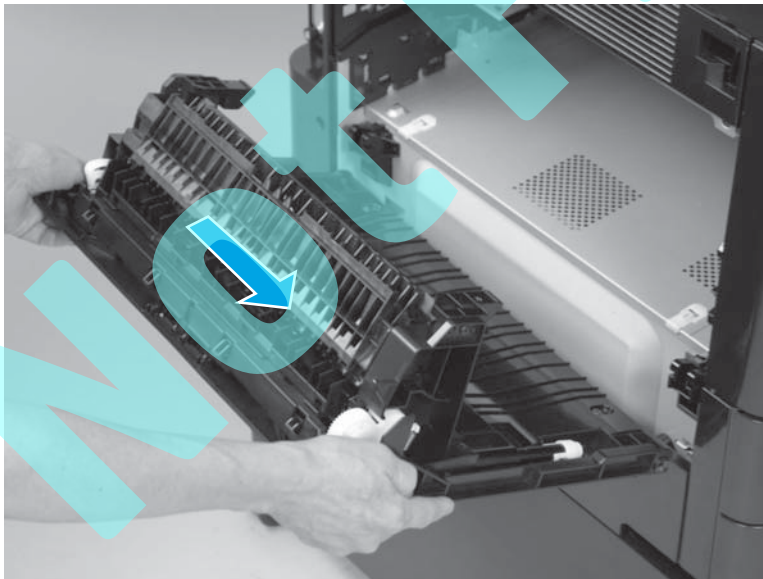

Right door assembly

Before proceeding, remove the following assemblies:

- Rear cover. See [Rear cover on page 110](#).
- Right rear cover. See [Right rear cover on page 113](#).

Remove the right door assembly

1. Disconnect one connector (callout 1), and then remove the wire harness from the guides (callout 2).

Figure 1-179 Remove the right door assembly (1 of 3).

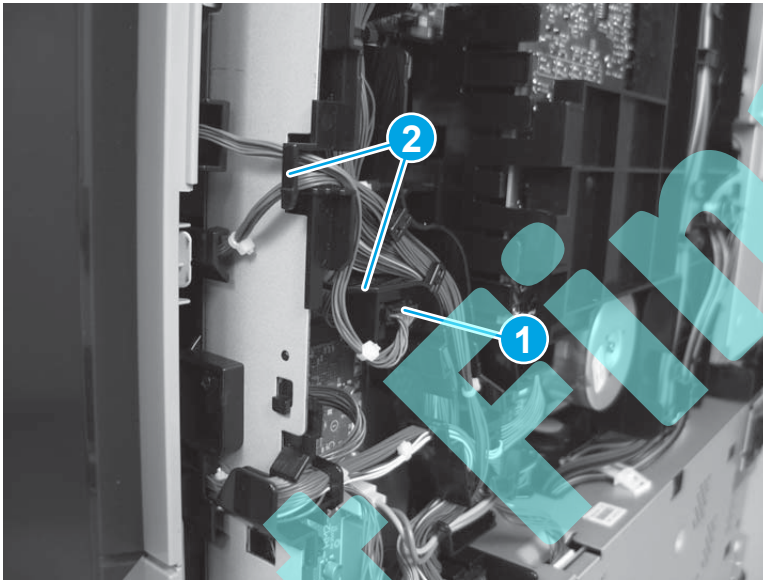

2. Release two tabs (callout 1), and then disconnect the clip (callout 2) on the flexible door retainer from the holder.

Figure 1-180 Remove the right door assembly (2 of 3).

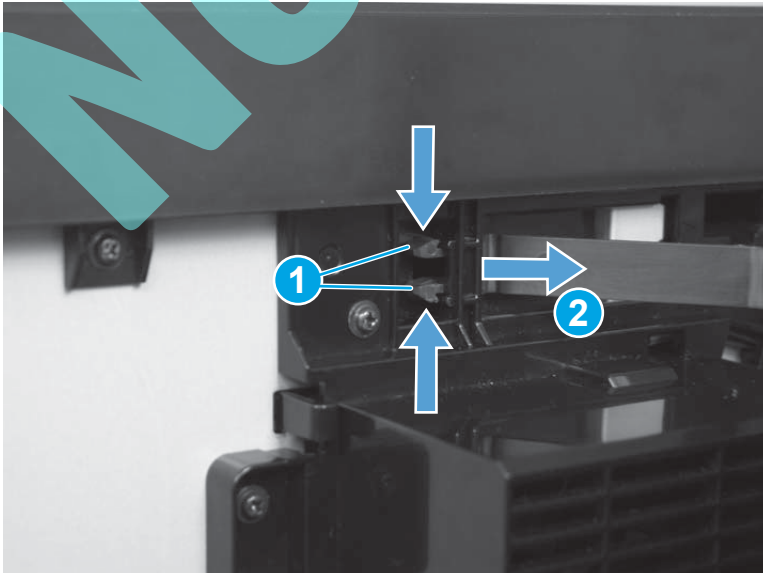

3. Open the right door assembly all the way, and then lift it up to remove it.

Figure 1-181 Remove the right door assembly (3 of 3).

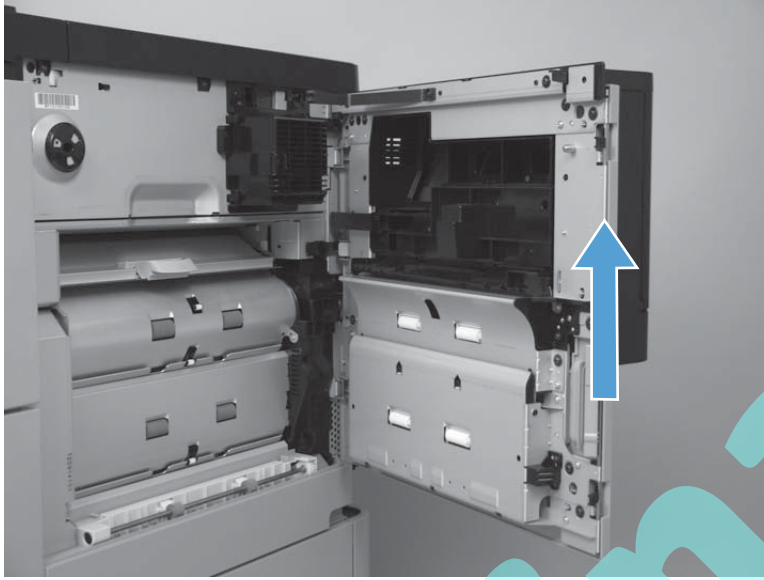

Reinstall the right door assembly

Align the hinge brackets on the door with the hinge pins on the product when reinstalling the door.

Figure 1-182 Reinstall the right door assembly

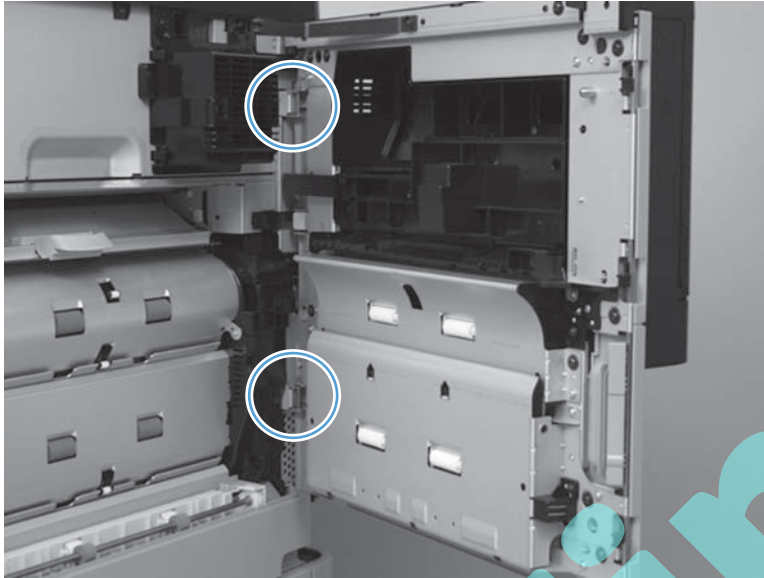

Make sure that the tabs on the flexible door retainer clip are fully inserted into the holder on the product.

Figure 1-183 Reinstall the right door assembly

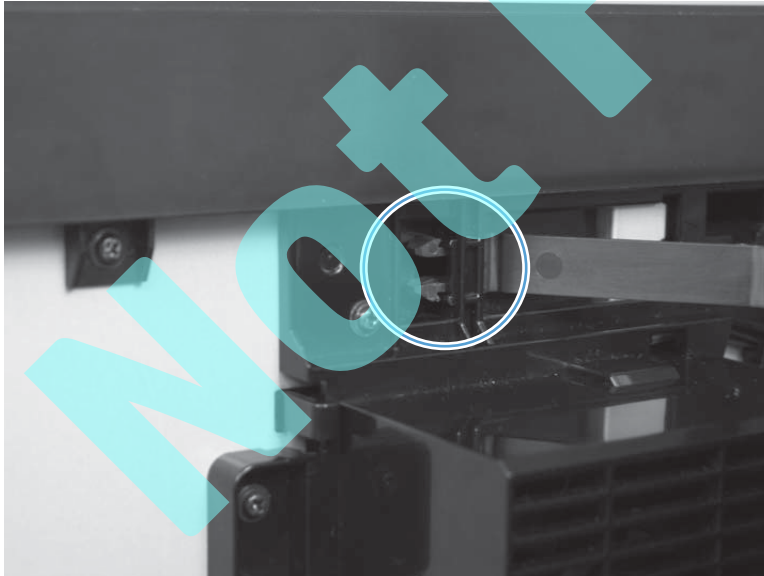

Left front cover

1. Open the front door, and then open the left door.
2. Remove one screw (callout 1), and then release two tabs (callout 2).

Figure 1-184 Remove the left front cover (1 of 2).

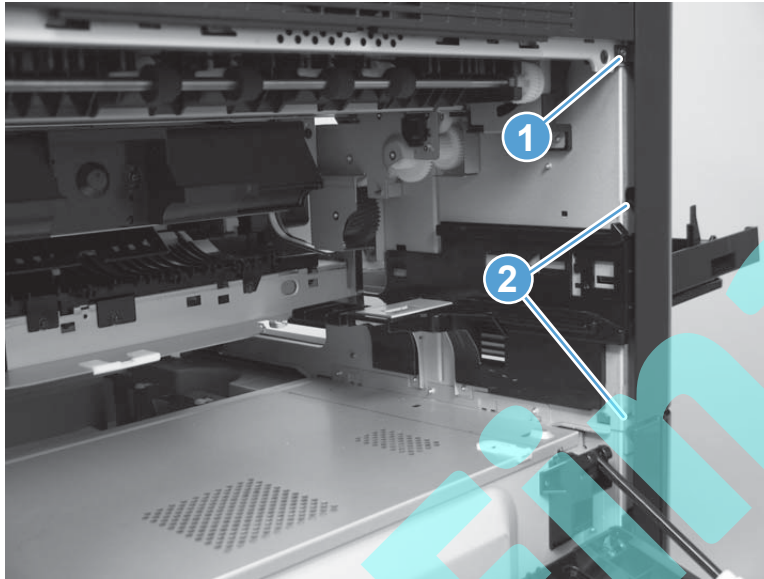

3. Release three tabs, and then remove the left front cover.

Figure 1-185 Remove the left front cover (2 of 2).



Upper left cover (M806 only)

Before proceeding, remove the following assemblies:

- Control-panel assembly (M806 only). See [Control-panel assembly \(M806 only\) on page 38](#).
- Hardware integration pocket (HIP) cover (M806 only). See [Hardware integration pocket \(HIP\) cover \(M806 only\) on page 88](#).
- Control-panel base cover (M806 only). See [Control-panel base cover \(M806 only\) on page 94](#).
- Right top cover (M806 only). See [Right top cover \(M806 only\) on page 98](#).
- Left top cover (M806 only). See [Left top cover \(M806 only\) on page 102](#).
- Left front cover. See [Left front cover on page 121](#).

Remove the upper left cover (M806 only)

1. Release three tabs using a small, flat-blade screwdriver.

Figure 1-186 Remove the upper left cover (M806 only; 1 of 2).

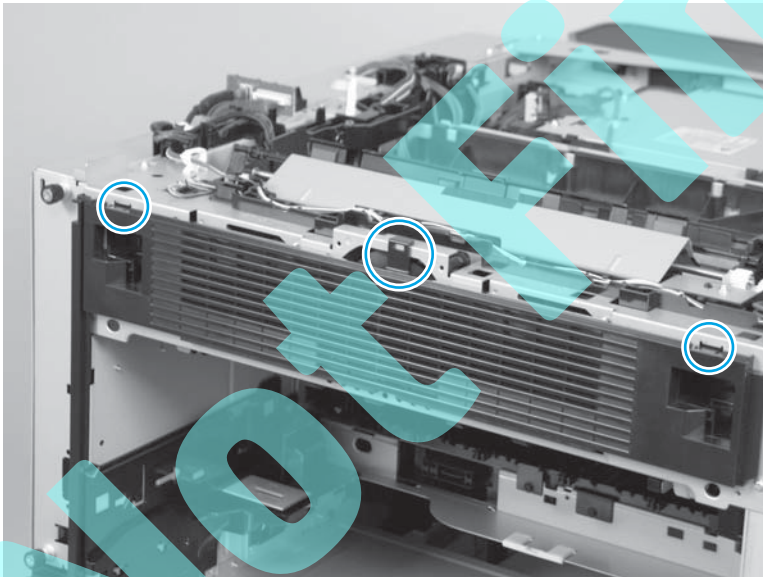

2. Rotate the top of the upper left cover away from the product, and then remove the cover.

Figure 1-187 Remove the upper left cover (M806 only; 2 of 2).

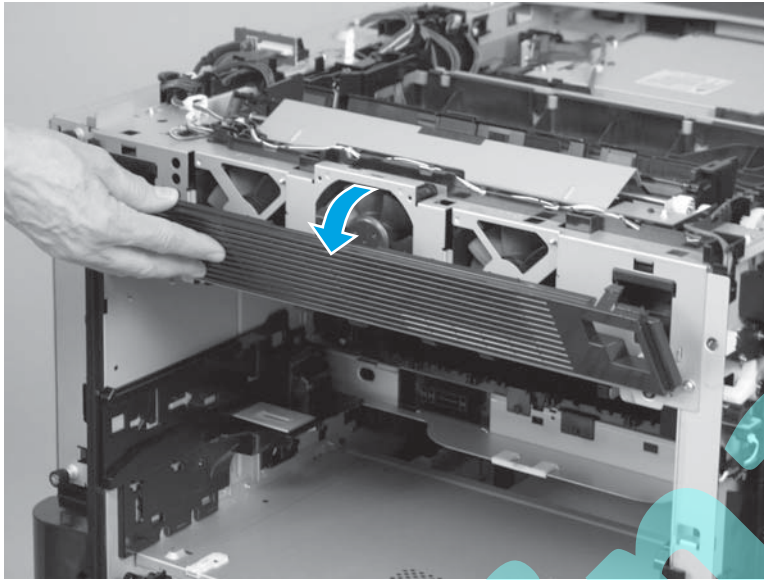

Reinstall the upper left cover (M806 only)

Align the tabs on the bottom of the cover with the slots in the product, and then rotate the top of the cover onto the product to install it.

Figure 1-188 Reinstall the upper left cover (M806 only)

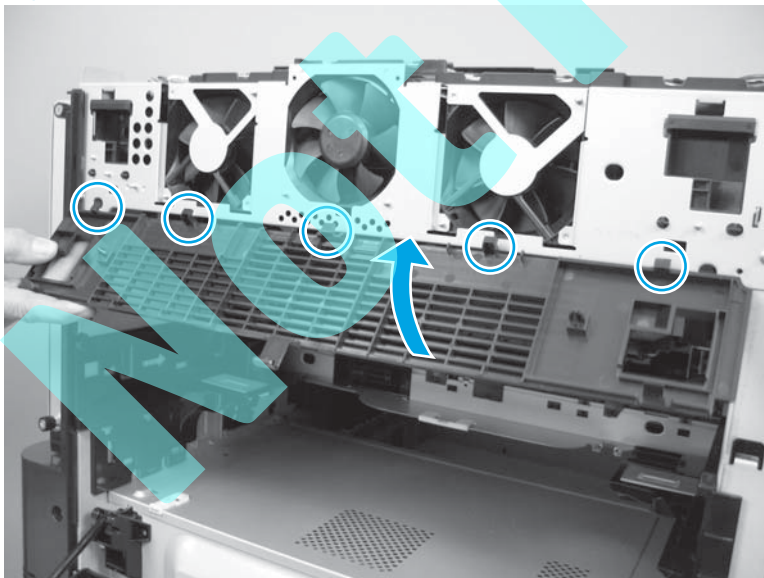

Upper left cover (M830 only)

Before proceeding, remove the following assemblies:

- Left front cover. See [Left front cover on page 121](#).

Remove the upper left cover (M830 only)

1. Open the left door.
2. Use a flat blade screwdriver to release three tabs.

Figure 1-189 Remove the upper left cover (M830 only; 1 of 2)

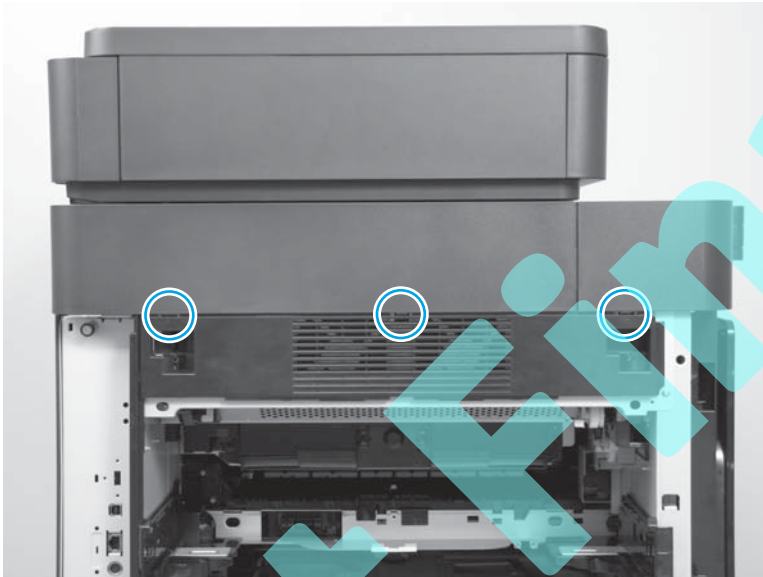

3. Rotate the top of the upper left cover away from the product, and then remove the cover.

Figure 1-190 Remove the upper left cover (M830 only; 2 of 2)

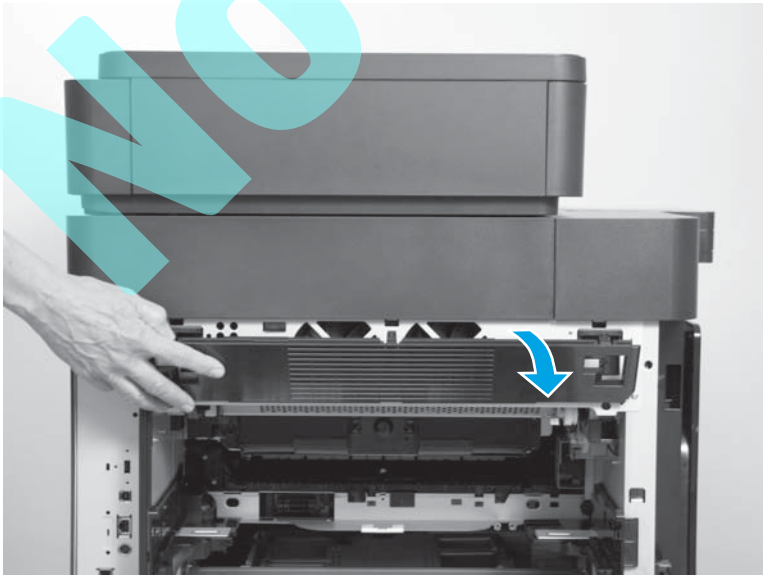

Reinstall the upper left cover (M830 only)

Align the tabs on the bottom of the cover with the slots in the product, and then rotate the top of the cover onto the product to install it.

Figure 1-191 Reinstall the upper left cover (M830 only)

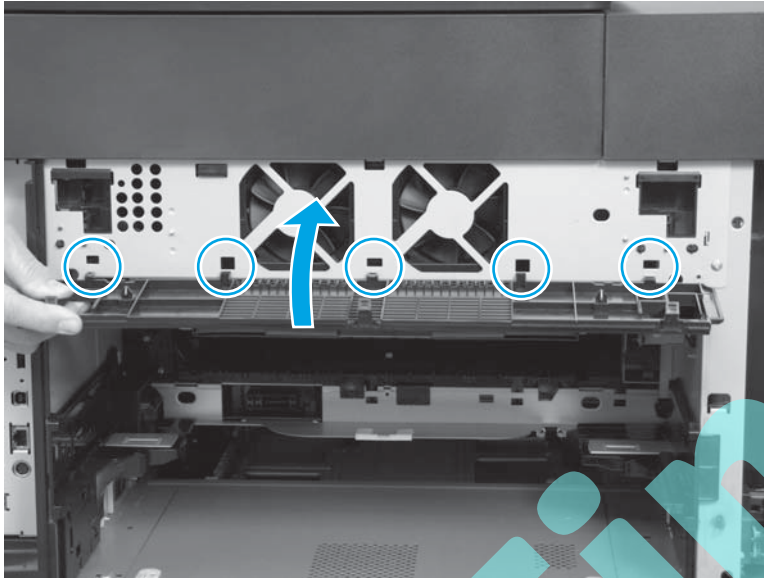

Not Final

Right lower front cover

1. Remove Tray 2 and Tray 3, and then remove two screws.

Figure 1-192 Remove the right lower front cover (1 of 3).



2. Release two tabs using a small, flat-blade screwdriver.

Figure 1-193 Remove the right lower front cover (2 of 3).



3. Remove the right lower front cover.

Figure 1-194 Remove the right lower front cover (3 of 3)

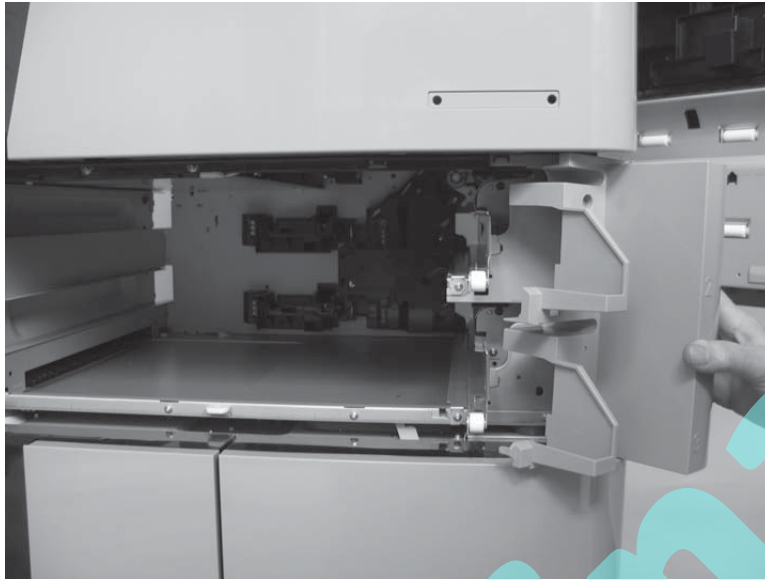

Not Final

Right lower cover

Before proceeding, remove the following assemblies:

- Rear cover. See [Rear cover on page 110](#).
- Right rear cover. See [Right rear cover on page 113](#).
- Right door assembly. See [Right door assembly on page 118](#).
- Right lower front cover. See [Right lower front cover on page 126](#).

Remove the right lower cover

1. Remove three screws.

Figure 1-195 Remove the right lower cover (1 of 2).

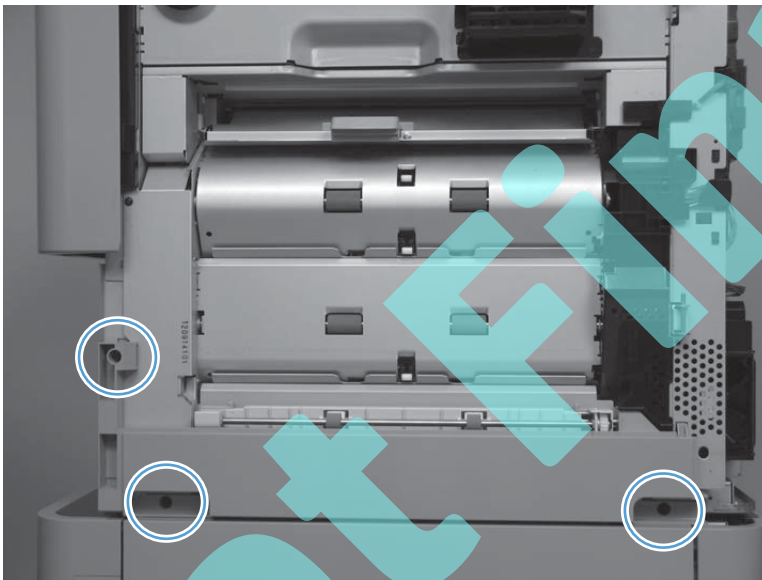

2. Rotate the bottom of the cover away from the product (callout 1). Gently pull down on the cover (callout 2) to release two tabs, and then remove the cover.

Figure 1-196 Remove the right lower cover (2 of 2).

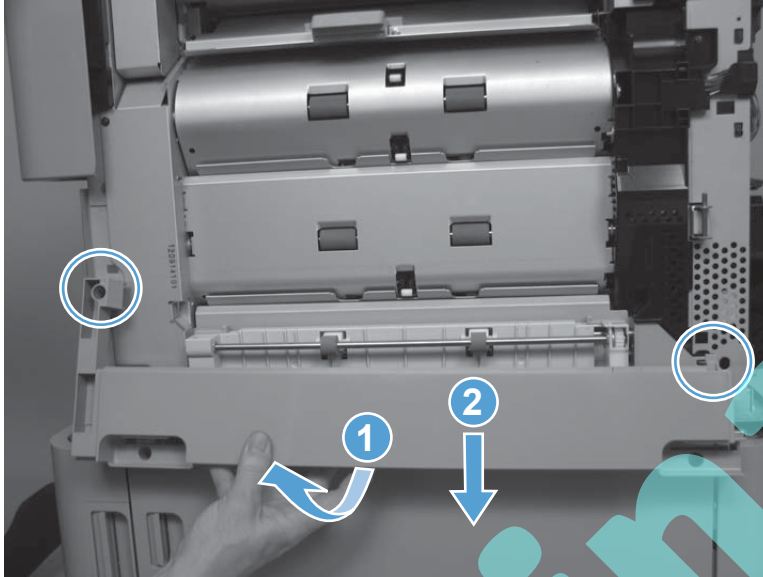

Main assemblies

 **TIP:** For clarity, some figures in this chapter show assemblies removed that are not required to be removed to service the product (for example, the scanner and document feeder assemblies). The procedures in this manual are correct for your product.

- [Location of major components](#)
- [Scanner control board \(SCB\) \(M830 only\)](#)
- [Document feeder assembly \(M830 only\)](#)
- [Scanner assembly \(M830 only\)](#)
- [Cartridge-release lever](#)
- [Registration-jam-removal knob](#)
- [Power supply fan](#)
- [Cartridge fan](#)
- [Controller fan](#)
- [Paper-pickup assembly](#)
- [Registration assembly](#)
- [Auto-close assembly](#)
- [Low-voltage power supply \(M806 only\)](#)
- [Low-voltage power supply \(M830 only\)](#)
- [High-voltage power supply \(M806 only\)](#)
- [High-voltage power supply \(M830 only\)](#)
- [DC controller \(M806 only\)](#)
- [DC controller \(M830 only\)](#)
- [Cartridge contact assembly](#)
- [Drum motor](#)
- [Drive assembly \(M806 only\)](#)
- [Drive assembly \(M830 only\)](#)
- [Transfer paper-feed assembly](#)
- [Transfer-holder assembly](#)
- [Cartridge-lifter assembly \(M806 only\)](#)
- [Cartridge-lifter assembly \(M830 only\)](#)
- [Driver PCA](#)
- [Laser/scanner assembly](#)

- [Face-down paper-delivery assembly \(M806 only\)](#)
- [Paper-delivery fan assembly \(M830 only\)](#)
- [Fuser drive assembly](#)
- [Power switch assembly](#)
- [Interconnect PCA](#)
- [Formatter cage](#)
- [Fuser bias contact assembly](#)
- [Cooling-unit assembly](#)
- [Tag assembly](#)
- [Option-connector assembly](#)

Not Final

Location of major components

Figure 1-197 Main assemblies (1 of 2)

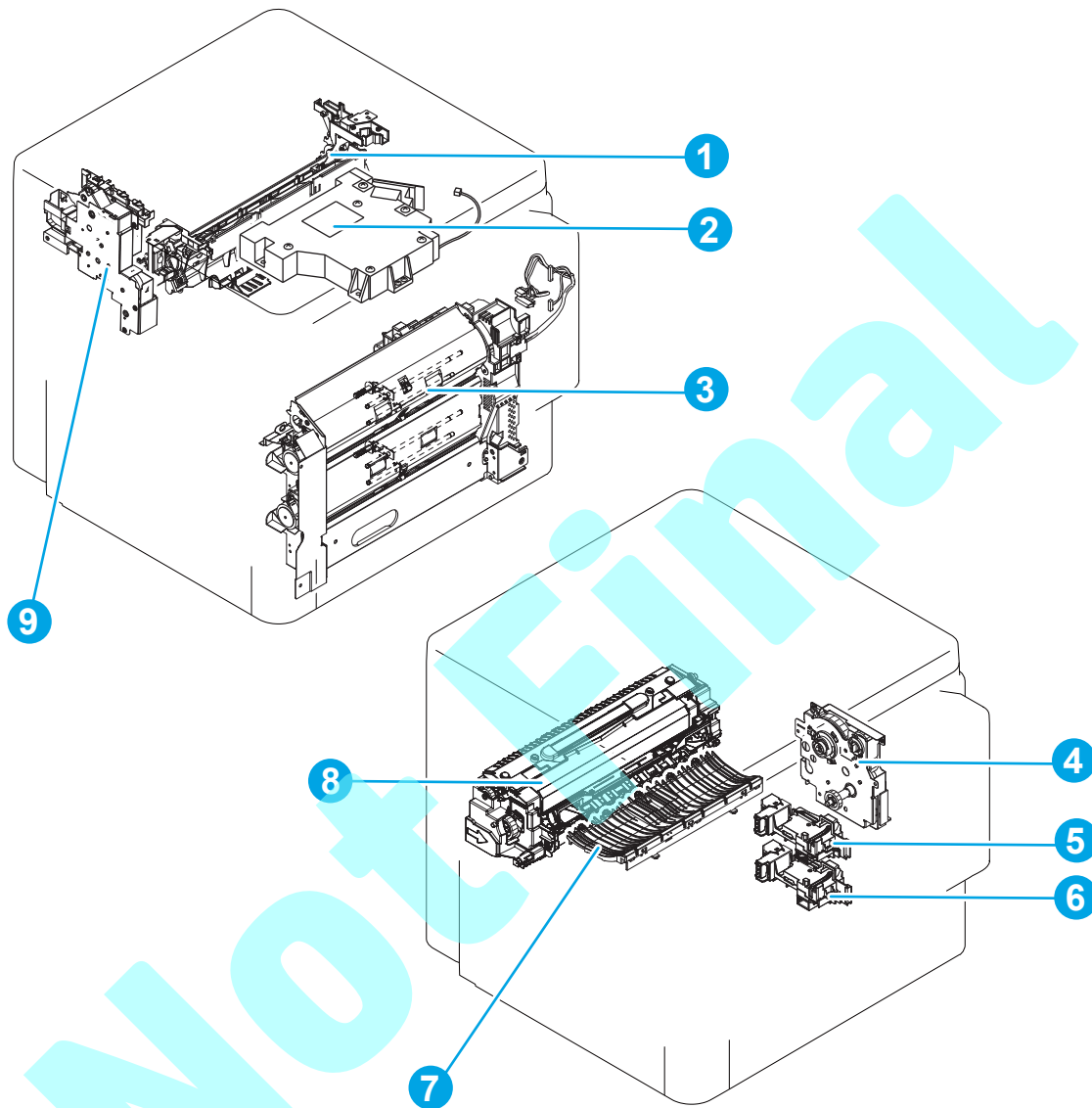

Table 1-2 Main assemblies (1 of 2)

Item	Description	Item	Description
1	Cartridge-lifter assembly	6	Lower auto-close assembly
2	Laser/scanner assembly	7	Transfer paper-feed assembly
3	Paper-pickup assembly	8	Fuser
4	Drive assembly	9	Fuser drive assembly
5	Upper auto-close assembly		

Figure 1-198 Main assemblies (2 of 2)

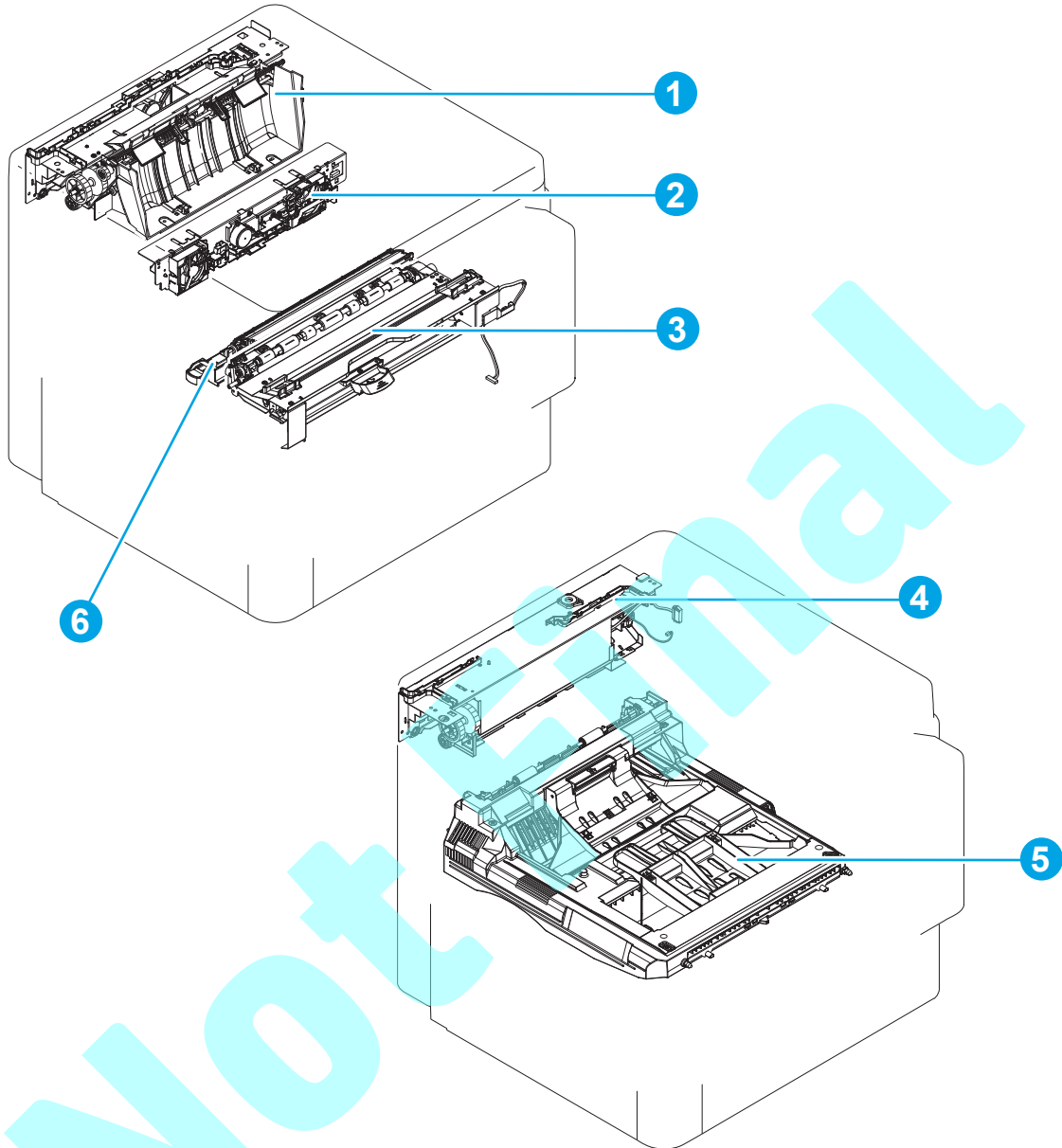

Table 1-3 Main assemblies (2 of 2)

Item	Description	Item	Description
1	Face-down paper-delivery assembly (M806 only)	4	Paper-delivery fan assembly (M830 only)
2	Cooling-unit assembly	5	Duplexer
3	Registration assembly	6	Transfer-roller assembly

Figure 1-199 Printed circuit assemblies (PCAs)

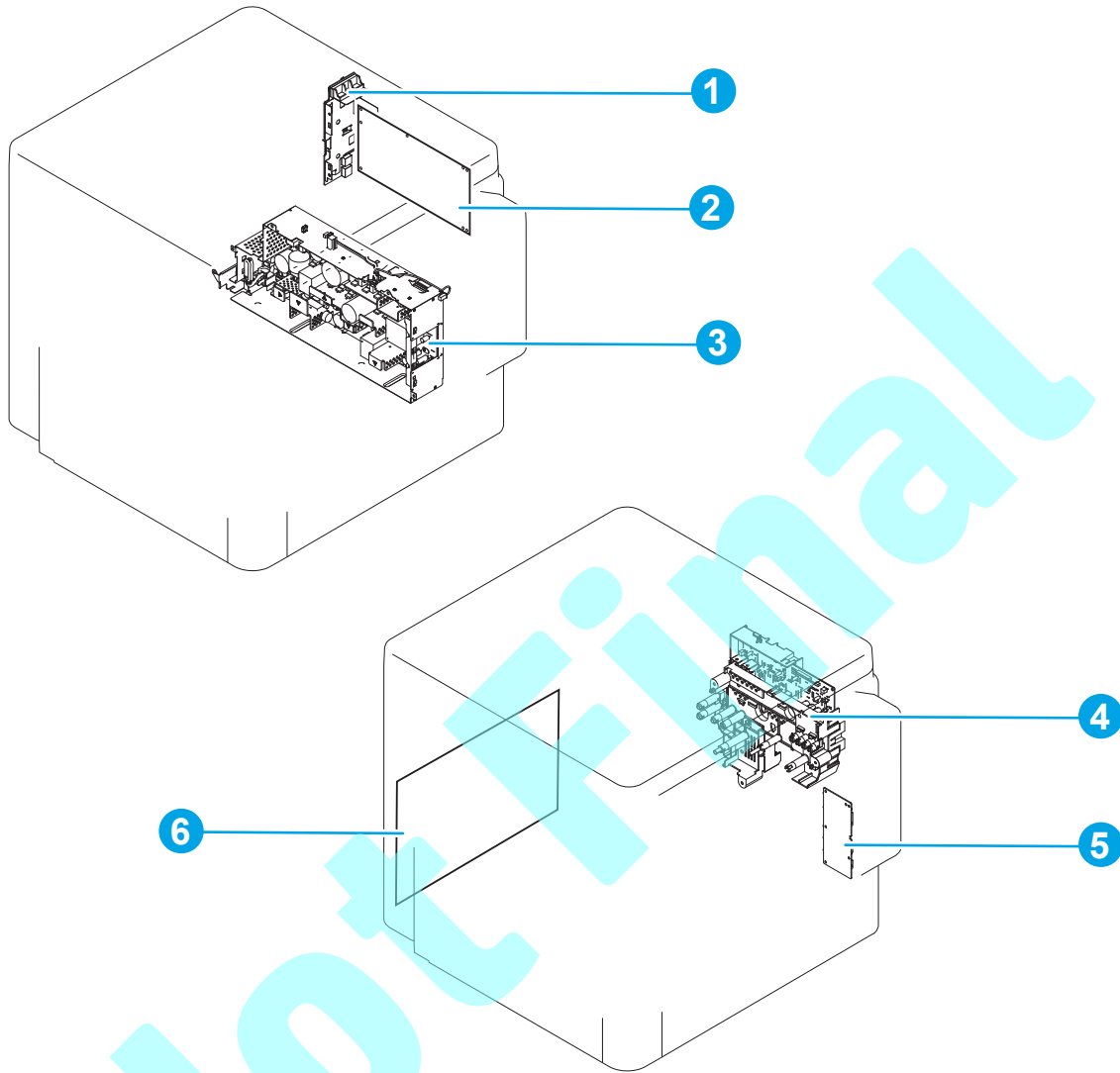

Table 1-4 Printed circuit assemblies (PCAs)

Item	Description	Item	Description
1	Interconnect PCA	4	High-voltage power supply
2	DC controller	5	Driver PCA
3	Low-voltage power supply		

Scanner control board (SCB) (M830 only)

Before proceeding, remove the following assemblies:

- Scanner back cover (M830 only). See [Scanner back cover \(M830 only\) on page 75](#).

Remove the SCB (M830 only)

1. Remove four screws.

Figure 1-200 Remove the SCB (M830; 1 of 10)

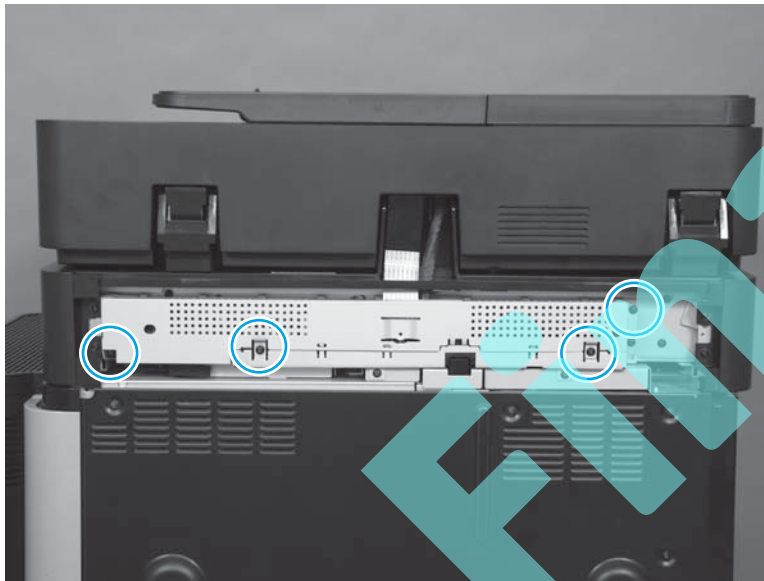

2. Remove the sheet-metal cover.

Figure 1-201 Remove the SCB (M830; 2 of 10)

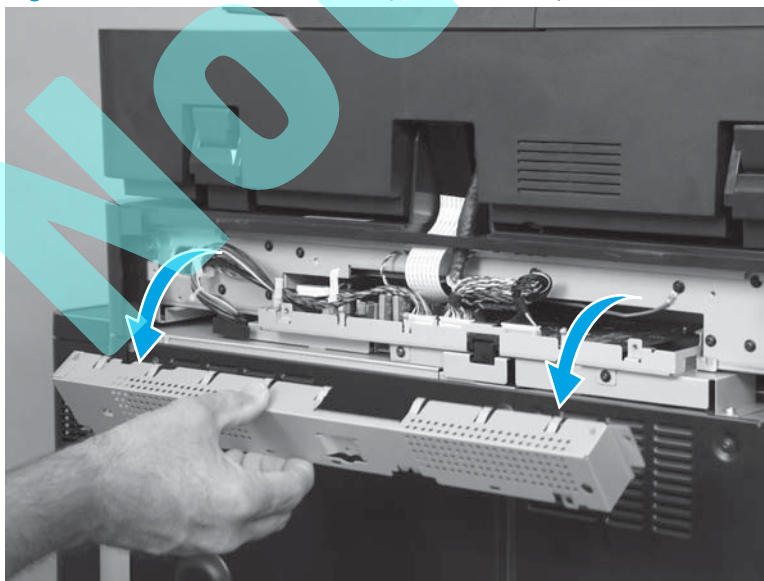

3. Disconnect three connectors (callout 1).

Figure 1-202 Remove the SCB (M830; 3 of 10)

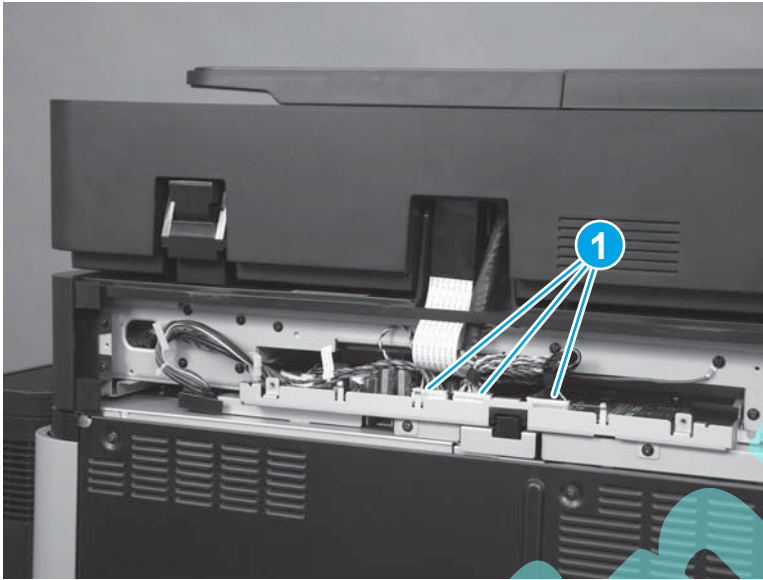

4. Disconnect one connector (callout 1), and then release the wire harnesses from the retainer (callout 2).

 **NOTE:** To make it easier to remove the SCB later in this procedure, make sure that you disconnect the connector (callout 1) at the product side of the wire harness, not at the SCB.

 **TIP:** Close the retainer (callout 2) to prevent the wire harnesses from being caught on it when the SCB is removed.

Figure 1-203 Remove the SCB (M830; 4 of 10)



5. Remove two screws.

Figure 1-204 Remove the SCB (M830; 5 of 10)

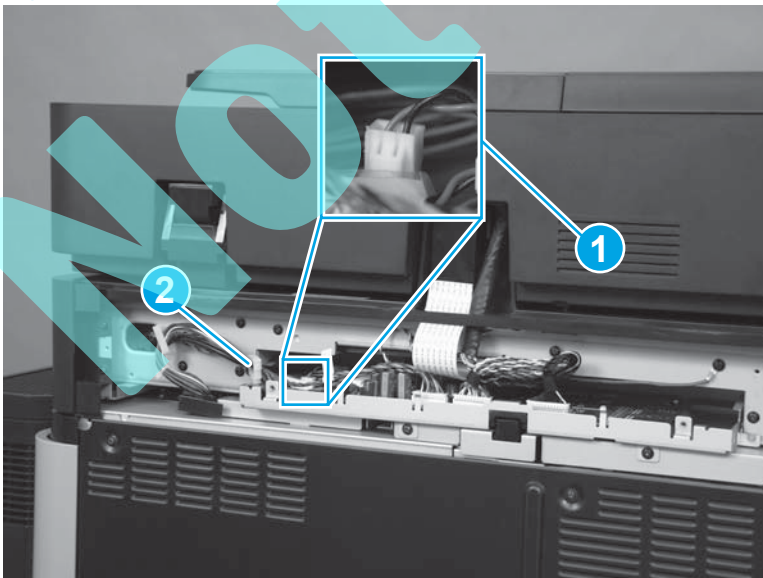
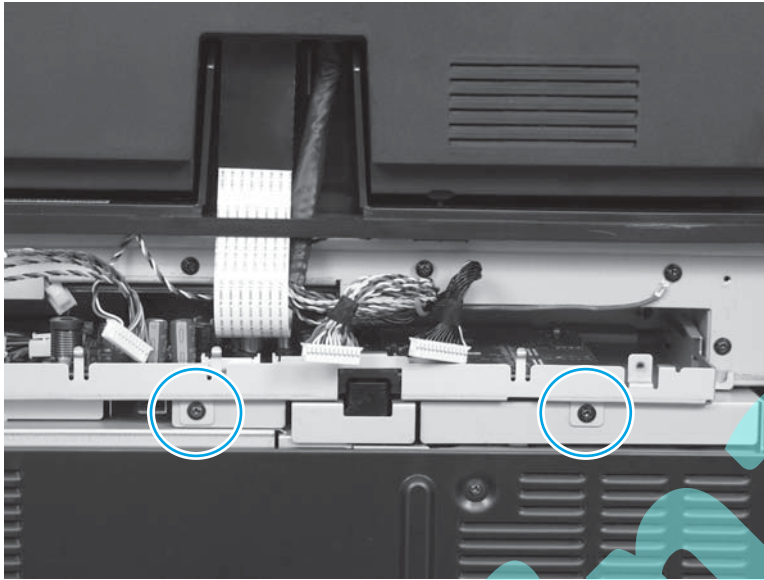

6. Slightly raise the front edge of the SCB to release one connector.

Figure 1-205 Remove the SCB (M830; 6 of 10)

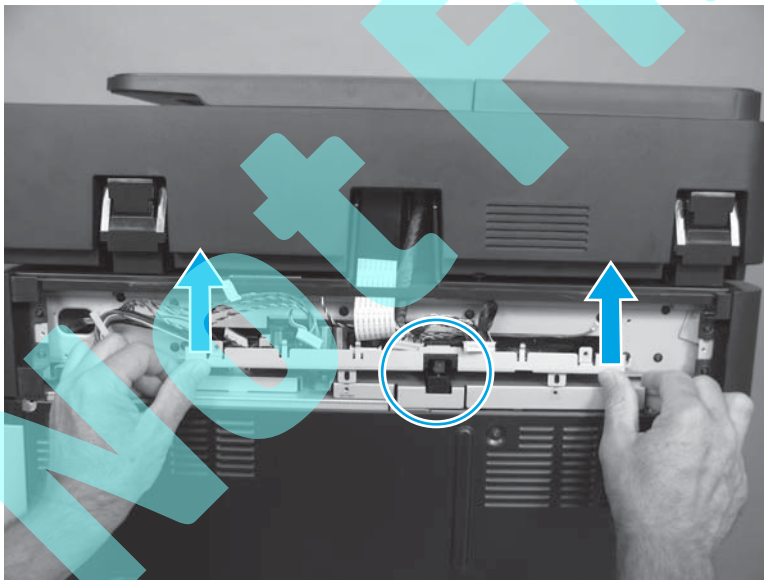

7. With the front edge of the SCB raised, carefully pull the SCB straight away from the product to release it, and then slide the assembly out of the product to access the remaining connectors.

It might take considerable force to release the SCB from the chassis.

CAUTION: The SCB is still attached to the scanner by two flat cables and two connectors. Do not attempt to completely remove the SCB.

Figure 1-206 Remove the SCB (M830; 7 of 10)

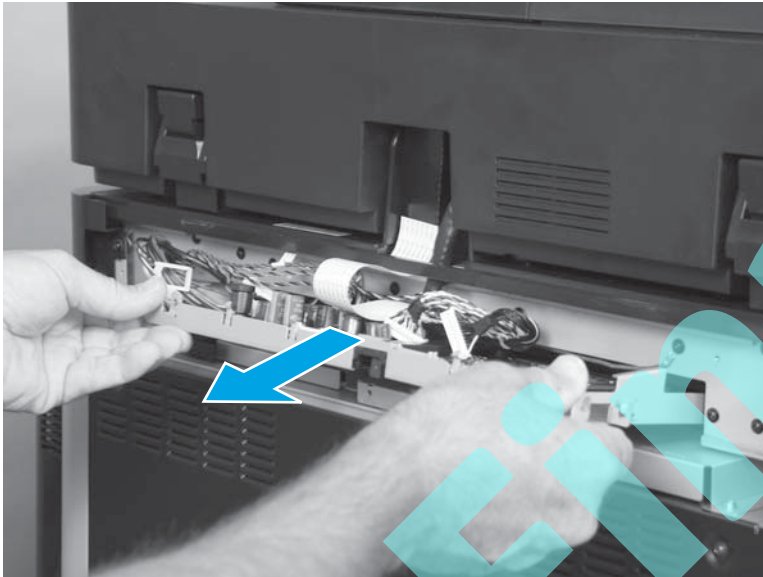

8. Disconnect two flat cables (callout 1), and the USB and wire harness connectors (callout 2).

Figure 1-207 Remove the SCB (M830; 8 of 10)

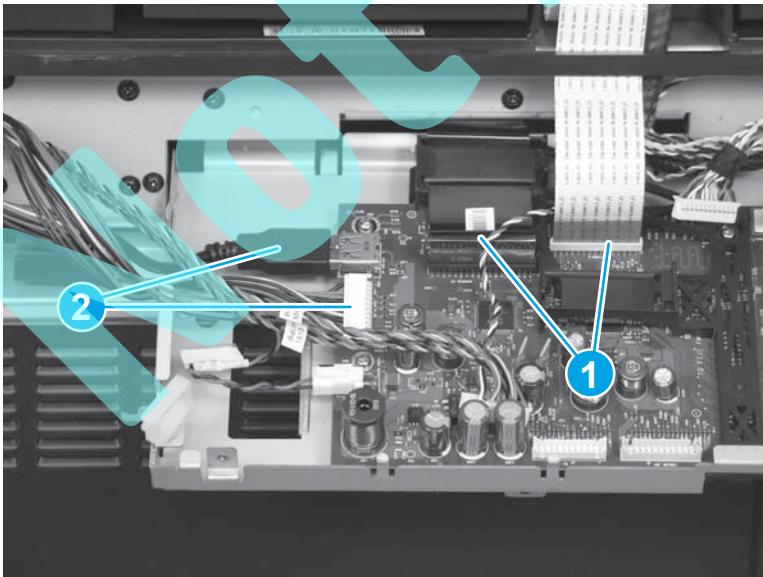

9. Release one tab (callout 1), rotate the right side of the ferrite up and away from the holder (callout 2), and then remove the ferrite from the holder.

 **Reinstallation tip** Before you reinstall the ferrite in the holder, connect the flat cable to the SCB.

Figure 1-208 Remove the SCB (M830; 9 of 10)

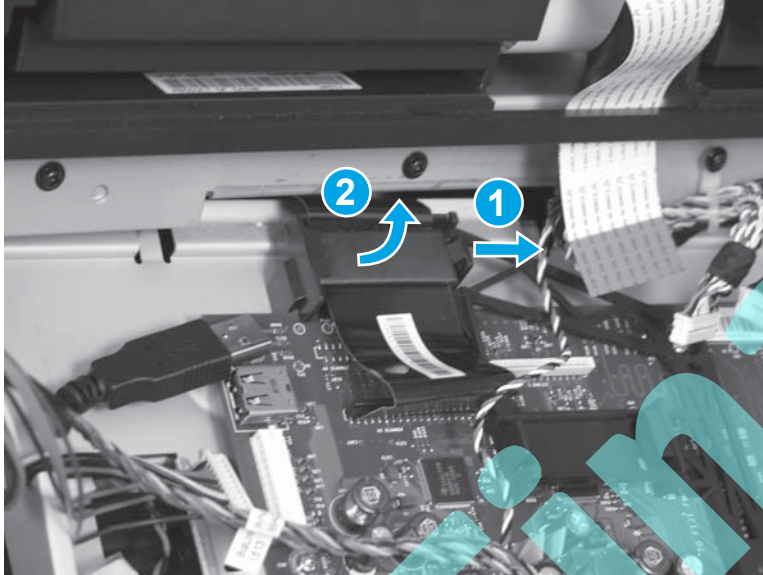

10. Carefully slide the SCB out of the chassis.

 **Reinstallation tip** Use care when you reinstall the SCB. Do not pinch or damage the flat cables or wire harnesses when the SCB is reinstalled.

Figure 1-209 Remove the SCB (M830; 10 of 10)



Install a replacement SCB (M830 only)

If you are installing a replacement SCB, remove one wire harness from the discarded SCB and install it on the replacement assembly.

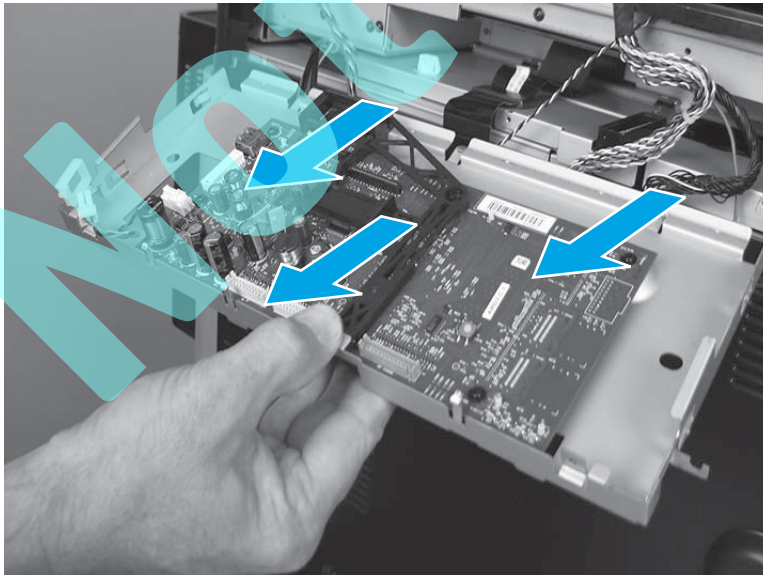
Figure 1-210 Install a replacement SCB (M830)

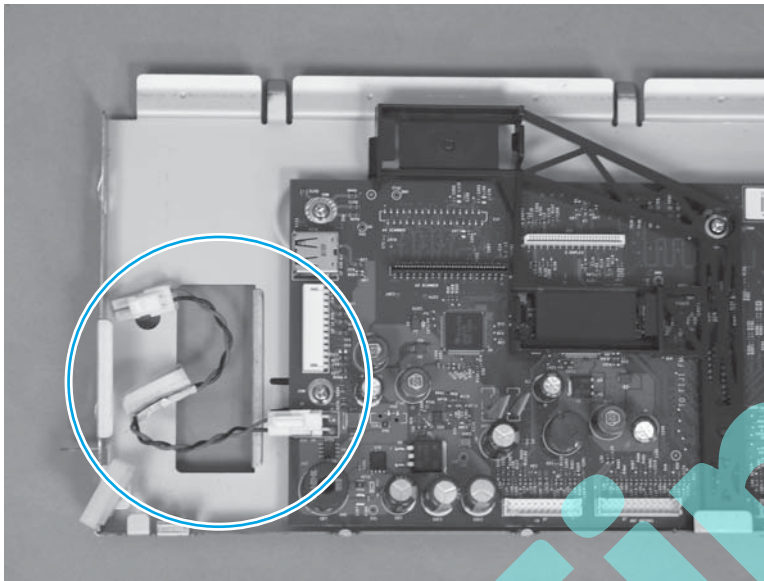

Document feeder assembly (M830 only)

Before proceeding, remove the following assemblies:

- Scanner back cover (M830 only). See [Scanner back cover \(M830 only\) on page 75](#).
- Scanner control board (SCB) (M830 only). See [Scanner control board \(SCB\) \(M830 only\) on page 135](#).

Remove the document feeder assembly (M830 only)

1. Remove two screws.

 **NOTE:** The screw (callout 1) that secures the wire retainer is longer than other screws used in the product. Make sure that you use this screw when the retainer is reinstalled.

 **Reinstallation tip** Make sure that you reattach the ground wire when you reinstall the second screw (callout 2).

Figure 1-211 Remove the document feeder assembly (M830; 1 of 7)



- Carefully thread the flat cable (callout 1) and the wire harness (callout 2) through the opening in the scanner cover.

Figure 1-212 Remove the document feeder assembly (M830; 2 of 7)

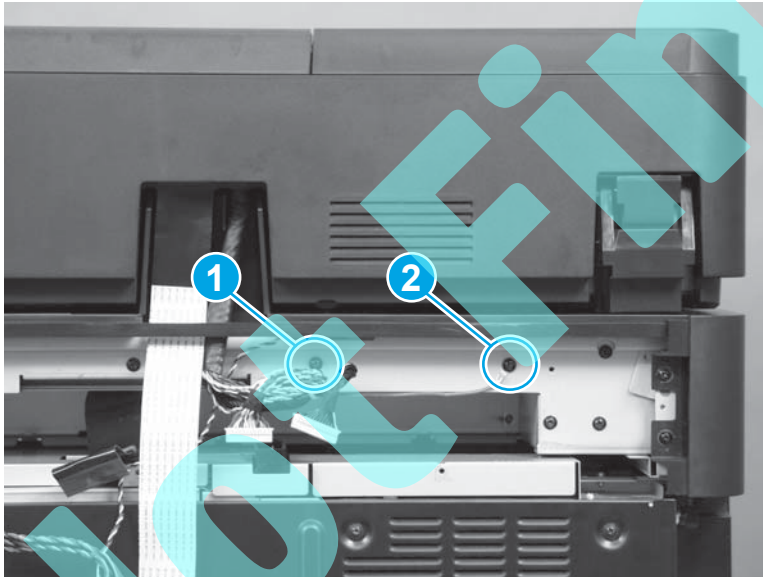
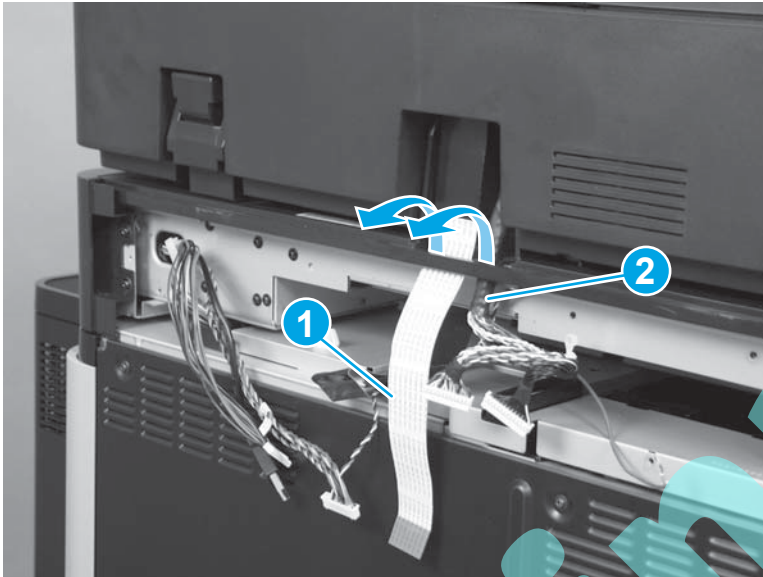

- Remove two screws.

 **NOTE:** These screws are longer than other screws used in the product. Make sure that you use these screws when the document feeder assembly is reinstalled.

Figure 1-213 Remove the document feeder assembly (M830; 3 of 7)



4. Open the document feeder.

Figure 1-214 Remove the document feeder assembly (M830; 4 of 7)

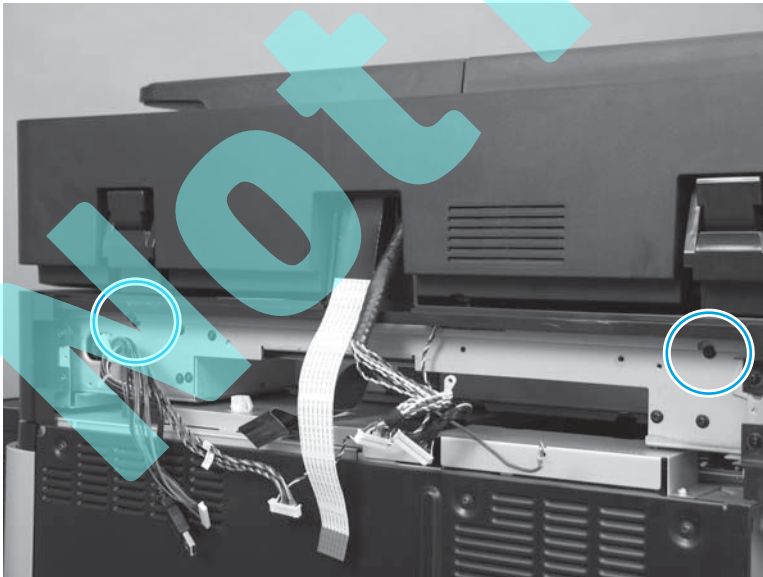
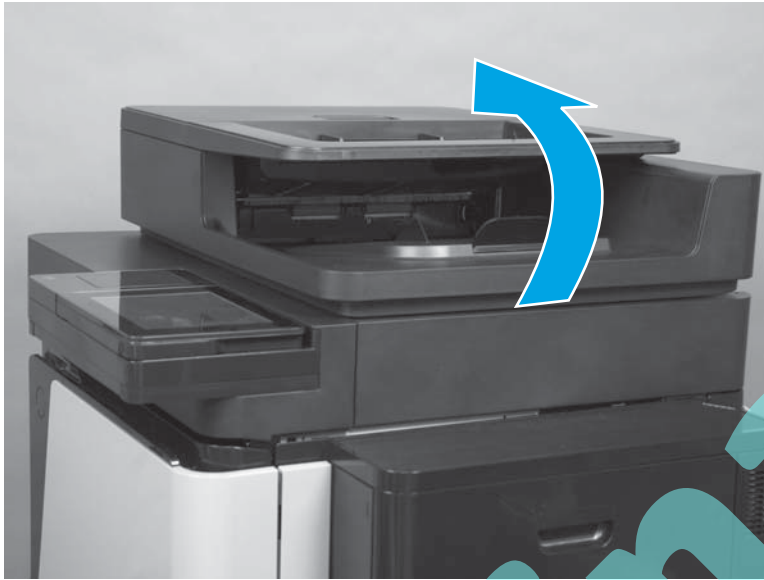

5. From behind the product, pull up on the assembly until it stops.

Figure 1-215 Remove the document feeder assembly (M830; 5 of 7)



- Carefully tilt the assembly back to release the hinge stops.

Figure 1-216 Remove the document feeder assembly (M830; 6 of 7)

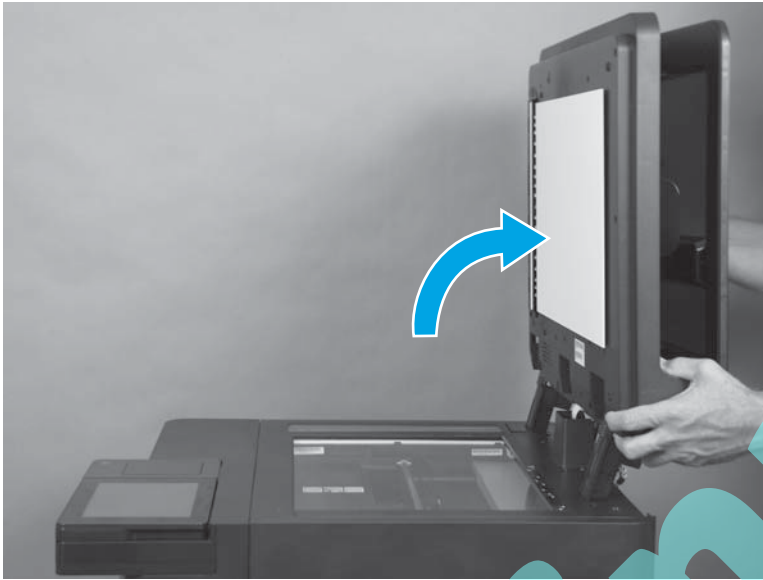

- Lift the assembly up and off of the product to remove it.

Figure 1-217 Remove the document feeder assembly (M830; 7 of 7)



Reinstall the document feeder assembly (M830 only)

 **NOTE:** If a replacement document feeder or scanner assembly is installed, you must install a replacement white backing on the document feeder. See [Document feeder white backing \(M830 only\) on page 30](#).

Installing a replacement document feeder assembly

If a replacement document feeder is installed, do the following:

1. From the Home screen on the control panel, scroll to and touch the [Device Maintenance](#) button.
2. Open the [Service](#) menu.
3. On the sign-in screen, select the [Service Access Code](#) option from the drop-down list.
4. Enter the following service access code for this product: 10083013.
5. Reset the following values:
 - [Document Feeder Kit Interval](#); set to zero
 - [ADF Count](#); set to zero

Not Final

Scanner assembly (M830 only)

CAUTION: The scanner assembly is heavy. HP recommends that two people lift the assembly off the product.

Before proceeding, remove the following assemblies:

- **Optional step:** Control panel assembly (M830 only). See [Control-panel assembly \(M830 only\) on page 52](#).

NOTE: If you are installing a replacement scanner assembly, remove the control panel assembly so that it can be installed on the replacement scanner assembly.

- Upper left cover (M830 only). See [Upper left cover \(M830 only\) on page 124](#).
- Scanner back cover (M830 only). See [Scanner back cover \(M830 only\) on page 75](#).
- Document feeder assembly (M830 only). See [Document feeder assembly \(M830 only\) on page 141](#).
- Scanner control board (M830 only). See [Scanner control board \(SCB\) \(M830 only\) on page 135](#).

Remove the scanner assembly (M830 only)

1. Use a small flat blade screwdriver to remove one clip.

Figure 1-218 Remove the scanner assembly (M830; 1 of 4)



2. Open the front door, use a small flat blade screwdriver to remove two clips, and then close the door.

Figure 1-219 Remove the scanner assembly (M830; 2 of 4)

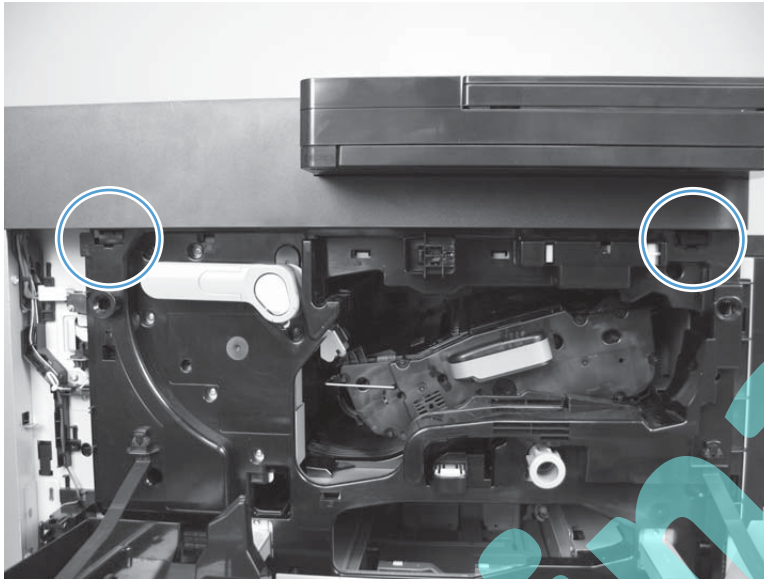

3. Open the right door, use a small flat blade screwdriver to remove one clip, and then close the door.

Figure 1-220 Remove the scanner assembly (M830; 3 of 4)

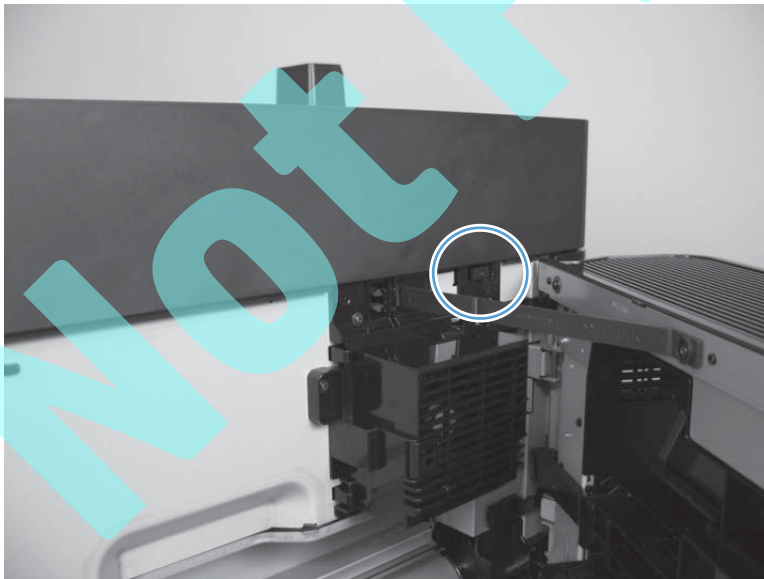

- Carefully lift the scanner assembly up and off of the product.

CAUTION: The scanner assembly is heavy. HP recommends that two people lift the assembly off the product.

IMPORTANT: The scanner assembly is installed on four grommets that can become dislodged when the assembly is removed. Do not lose the grommets when you remove the assembly.

Reinstallation tip If the grommets are not present on the product chassis when you remove the scanner assembly, check the locator pins on the bottom of the scanner assembly. The grommets can adhere to the pins and do not remain on the product chassis when the assembly is removed.

Figure 1-221 Remove the scanner assembly (M830; 4 of 4)

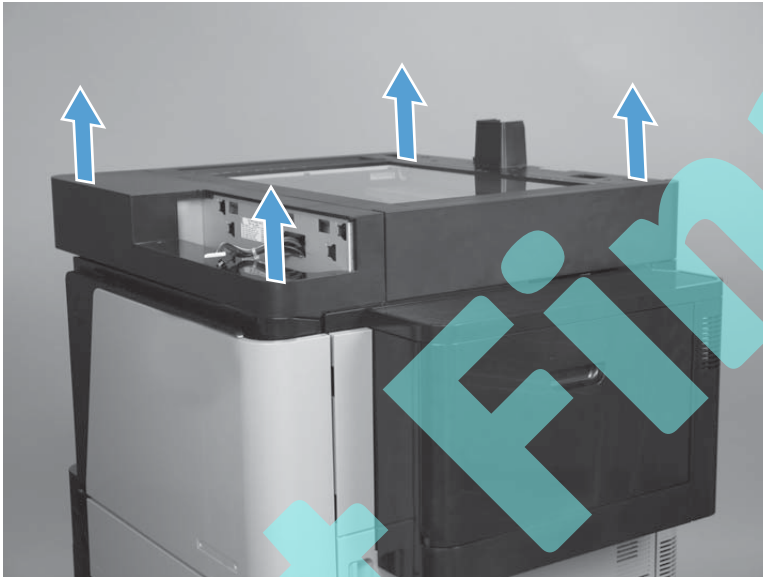

Reinstall the scanner assembly (M830 only)

 **NOTE:** If a replacement document feeder or scanner assembly is installed, you must install a replacement white backing on the document feeder. See [Document feeder white backing \(M830 only\) on page 30](#).

Reinstall the scanner assembly (M830)

1. Verify that the grounding grommet (callout 1), and the three rubber-insulator grommets (callout 2) are correctly installed before you place the scanner assembly on the product.

 **NOTE:** Replacement grommets (callout 3) are included in the replacement scanner kit. Do not place a replacement grommet on top of an existing grommet. Make sure that there is only one grommet in each position.

Figure 1-222 Scanner assembly grommets (M830)



2. Make sure that you install the four retainer clips when the scanner assembly is reinstalled.

 **NOTE:** Replacement retainer clips are included in the replacement scanner kit.

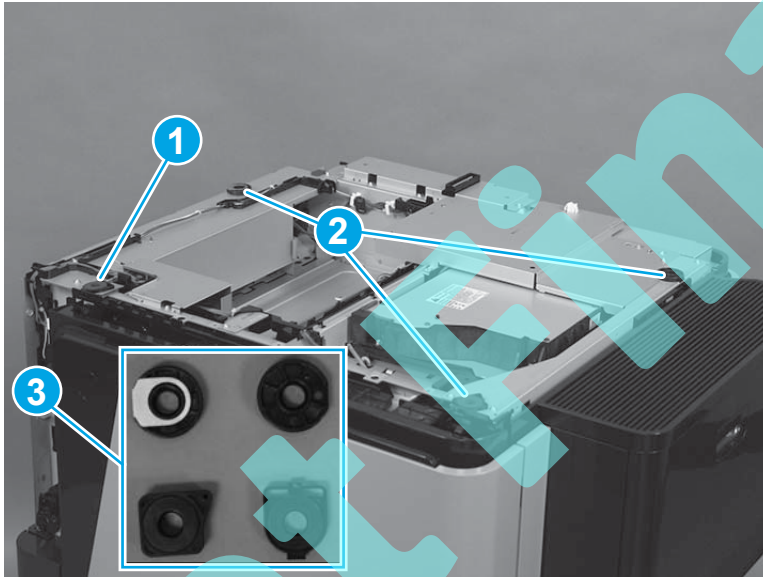
Figure 1-223 Scanner assembly clips (M830)



Installing a replacement scanner assembly (M830)

- ▲ Do the following:
 - a. From the Home screen on the control panel, scroll to and touch the [Device Maintenance](#) button.
 - b. Open the [Service](#) menu.
 - c. On the sign-in screen, select the [Service Access Code](#) option from the drop-down list.
 - d. Enter the following service access code for this product: 10083013.
 - e. Reset the following values:
 - [Flatbed Count](#); set to zero

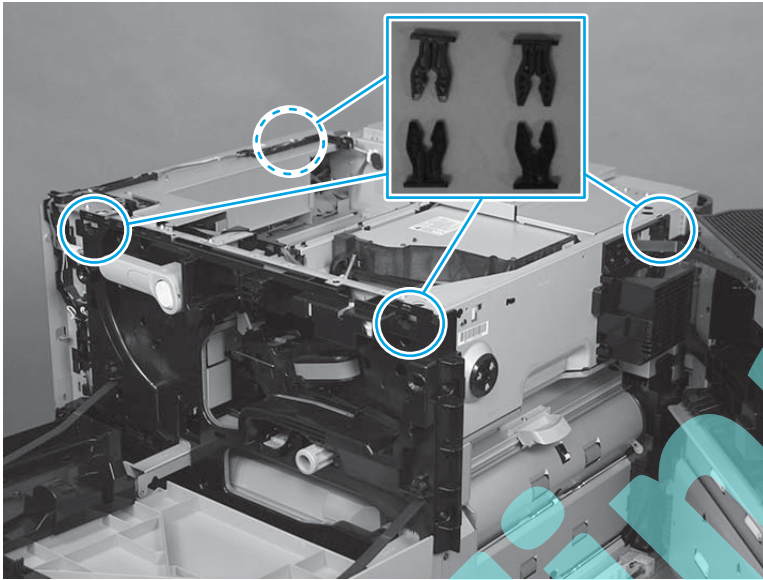
Cartridge-release lever

Before proceeding, remove the following assemblies:

- Control-panel assembly (M806 only). See [Control-panel assembly \(M806 only\) on page 38](#).
- Hardware integration pocket (HIP) cover (M806 only). See [Hardware integration pocket \(HIP\) cover \(M806 only\) on page 88](#).
- Control-panel base cover (M806 only). See [Control-panel base cover \(M806 only\) on page 94](#).
- Right top cover (M806 only). See [Right top cover \(M806 only\) on page 98](#).
- Left top cover (M806 only). See [Left top cover \(M806 only\) on page 102](#).

Remove the cartridge-release lever

1. Open the front door.

 **NOTE:** Remove the toner cartridge if it has not been removed prior to servicing the product. See [Toner cartridge on page 5](#).

2. Press and hold the white button on the cartridge-release lever (callout 1) and rotate it up to about the halfway position (callout 2).

Figure 1-224 Remove the cartridge-release lever (1 of 4)

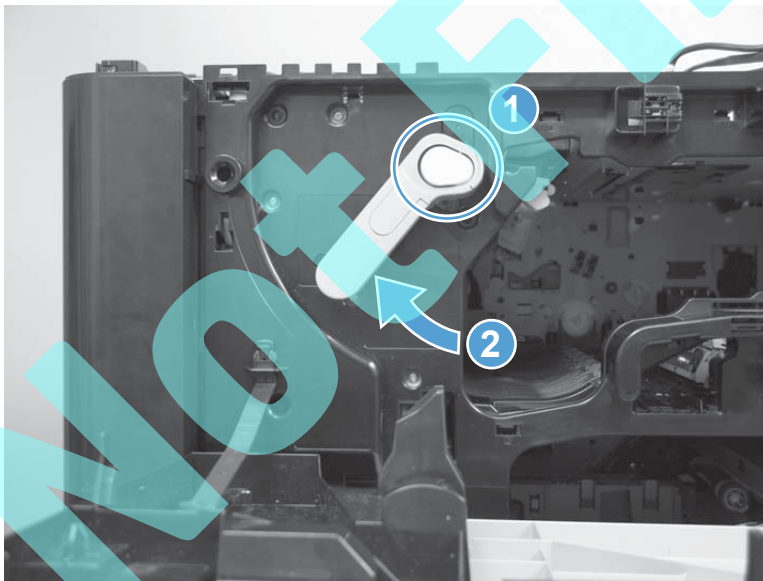

3. Remove two long screws from the cartridge-release lever shaft.

 **NOTE:** Look down at the top of the product to locate these screws.

Figure 1-225 Remove the cartridge-release lever (2 of 4).



4. Rotate the cartridge-release lever down to the vertical, unlocked position.

Figure 1-226 Remove the cartridge-release lever (3 of 4).

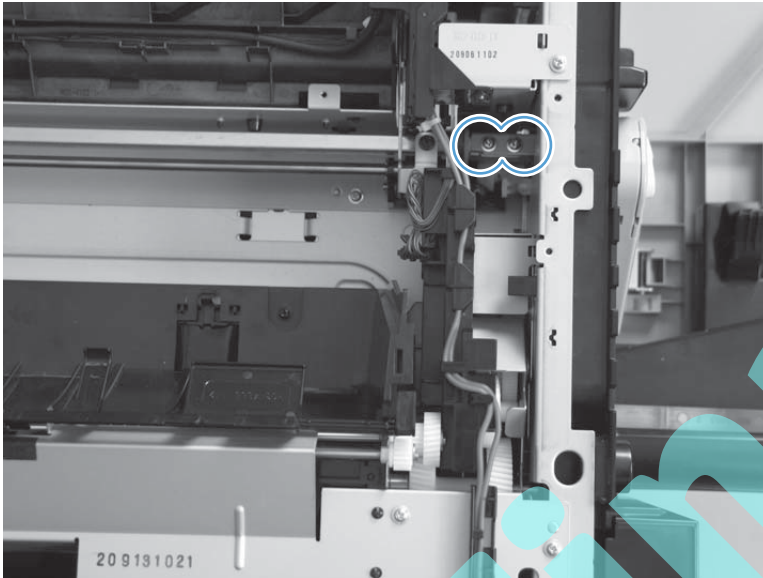
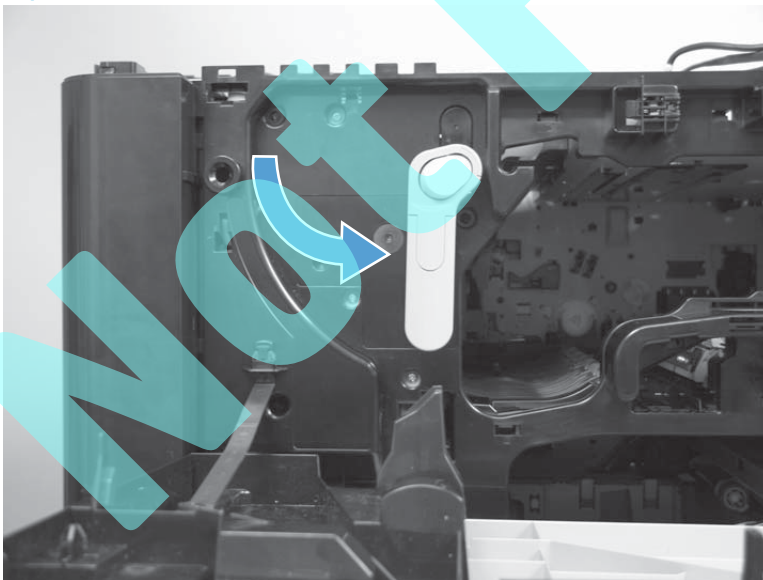

5. Slide the cartridge-release lever away from the front of the product to remove it.

Figure 1-227 Remove the cartridge-release lever (4 of 4).

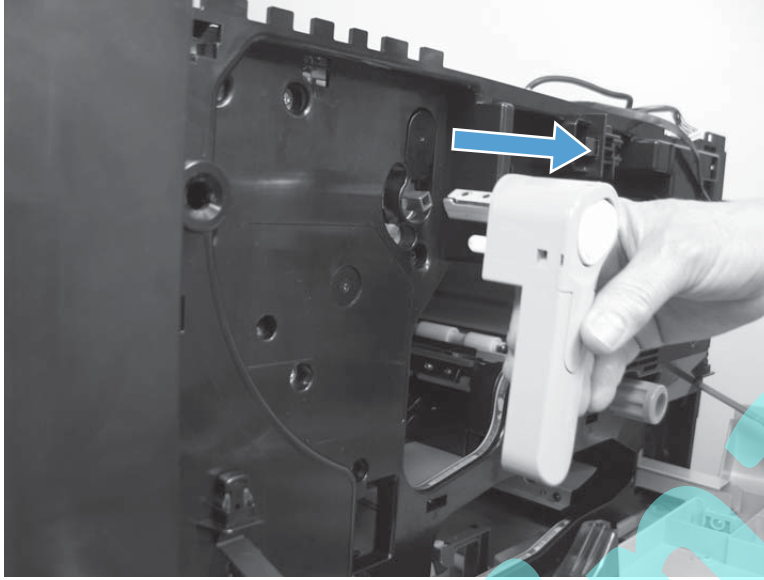

Not Final

Registration-jam-removal knob

1. Open the front door.

 **NOTE:** Remove the toner cartridge if it has not been removed prior to servicing the product. See [Toner cartridge on page 5](#).

2. Locate the screw inside the center of the registration-jam-removal knob.

Figure 1-228 Remove the registration-jam-removal knob (1 of 3)

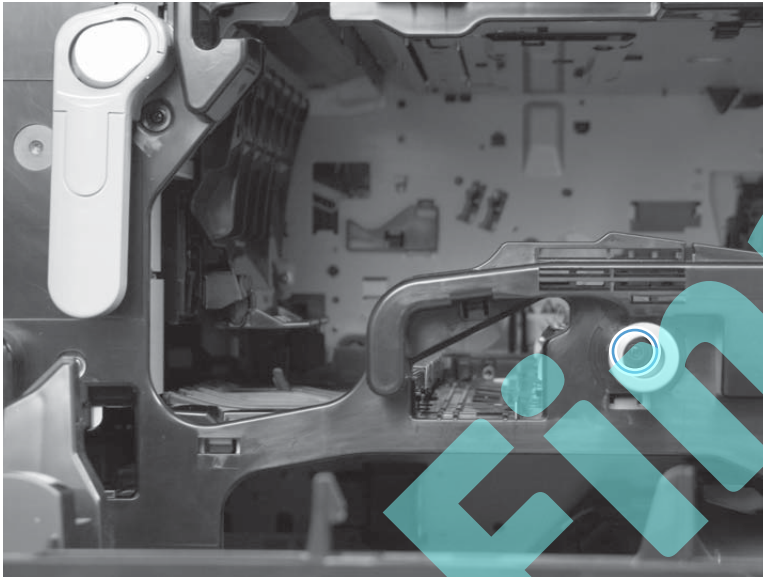

3. Use a pair of needle-nose pliers to grasp and hold the registration shaft assembly (callout 1) to prevent the shaft from turning, and then remove one screw inside the knob (callout 2).

 **TIP:** To locate the flat surfaces on the shaft, you might have to rotate the shaft by turning the registration-jam-removal knob.

Figure 1-229 Remove the registration-jam-removal knob (2 of 3)



4. Pull the knob away from the product to remove it.

 **NOTE:** One screw and one spring are not captive once the knob is removed.

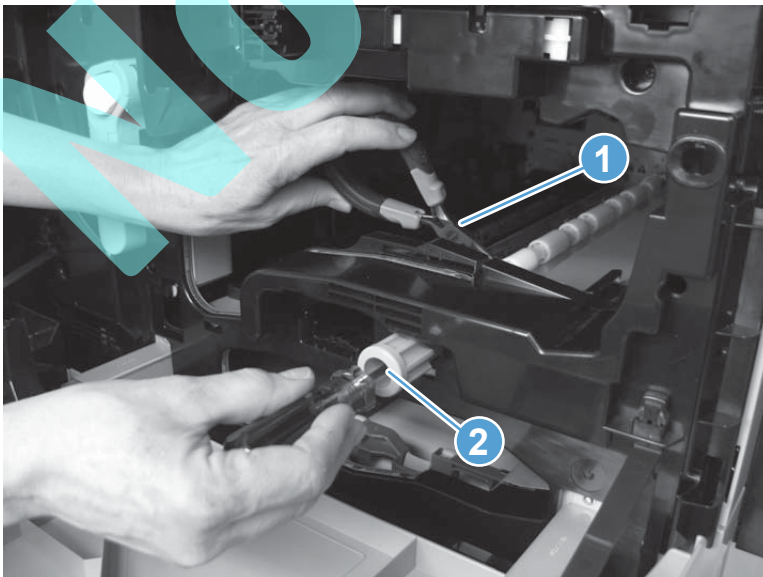
Figure 1-230 Remove the registration-jam-removal knob (3 of 3)



Reinstall the registration-jam-removal knob

1. Note the location of the shaft inside the product. The screw will be installed in the shaft.

Figure 1-231 Reinstall the registration-jam-removal knob (1 of 3)



2. Position the screw in the spring cap, and then hold the screw in place with a screwdriver. Insert the spring and the screw into the registration-jam-removal knob, and then align the end of the screw with the end of the shaft inside the product.

Figure 1-232 Reinstall the registration-jam-removal knob (2 of 3)

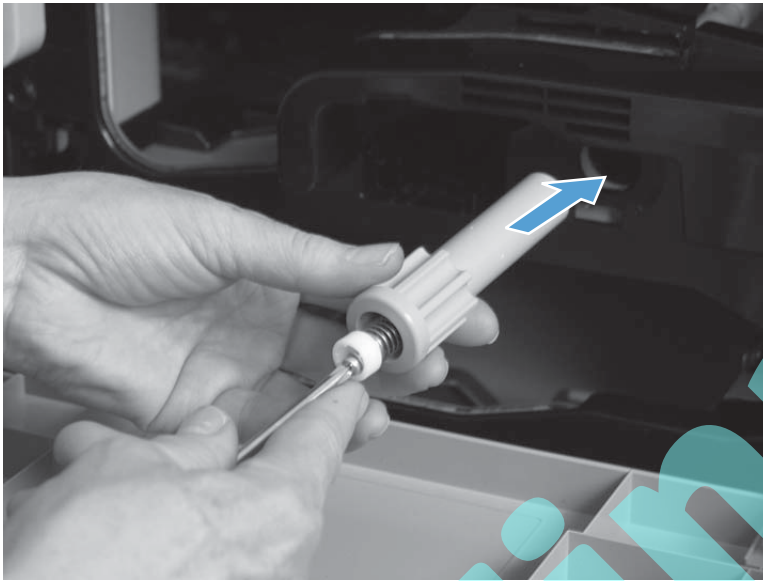

3. Use a pair of needle-nose pliers to grasp and hold the registration shaft assembly (callout 1) to prevent the shaft from turning, and then tighten the screw inside the knob (callout 2).

 **TIP:** To locate the flat surfaces on the shaft, you might have to rotate the shaft by turning the registration-jam-removal knob.

Figure 1-233 Reinstall the registration-jam-removal knob (3 of 3)



Power supply fan

Before proceeding, remove the following assemblies:

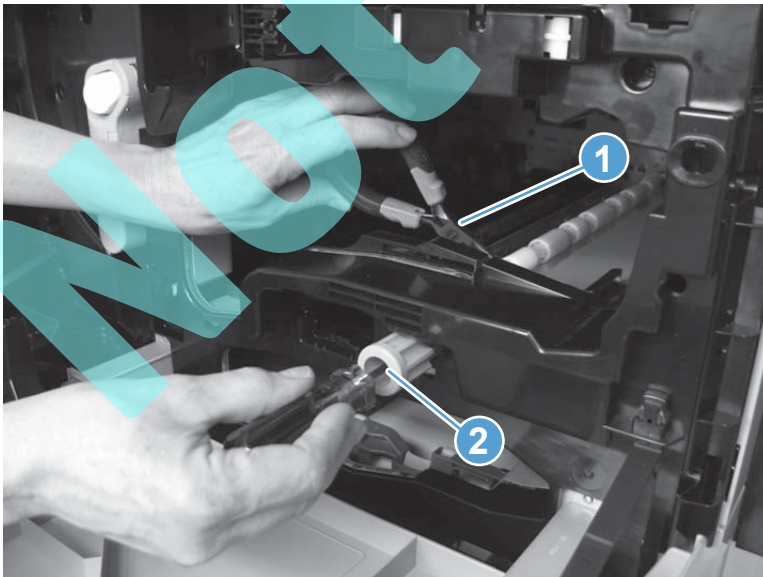
- Rear cover. See [Rear cover on page 110](#).

Remove the power supply fan

1. Disconnect one connector (callout 1), and then carefully release the wire harnesses from the guide (callout 2).

Figure 1-234 Remove the power supply fan (1 of 2)

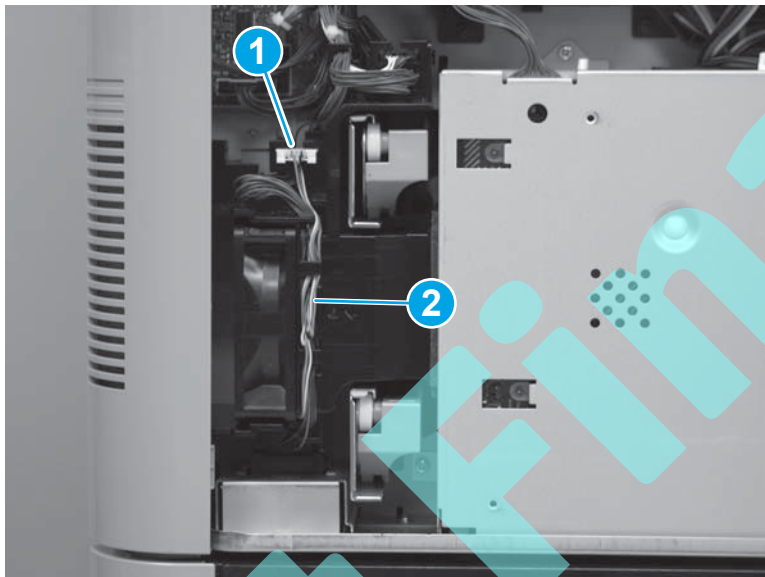

2. Firmly grasp the power supply fan, and then slide it out of the product.

Figure 1-235 Remove the power supply fan (2 of 2)

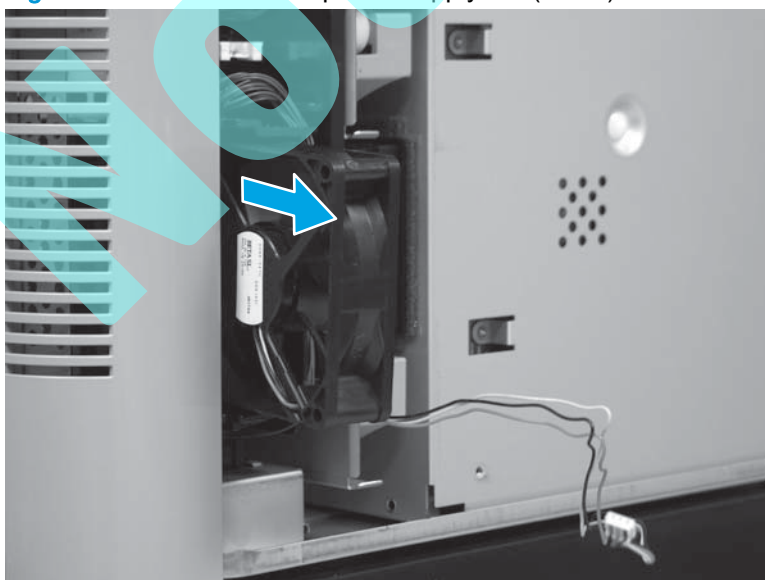

Reinstall the power supply fan

1. Make sure that the fan wires are routed correctly as shown below.

Figure 1-236 Reinstall the power supply fan (1 of 3)

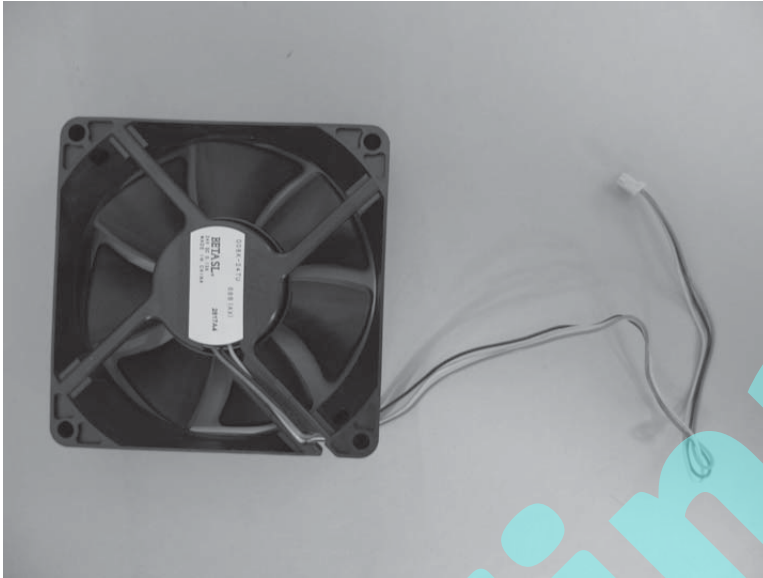

2. Make sure that the label on the fan (callout 1) and the wire harness (callout 2) are positioned as shown below when reinstalling the fan.

Figure 1-237 Reinstall the power supply fan (2 of 3)

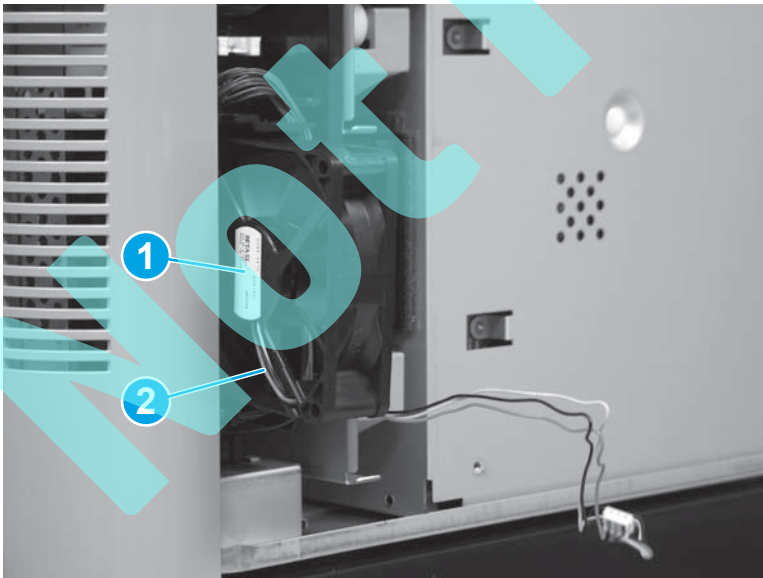

3. Make sure that the embossed arrow on the fan is visible and pointing the same direction as the embossed arrow on the exhaust duct.

Figure 1-238 Reinstall the power supply fan (3 of 3)

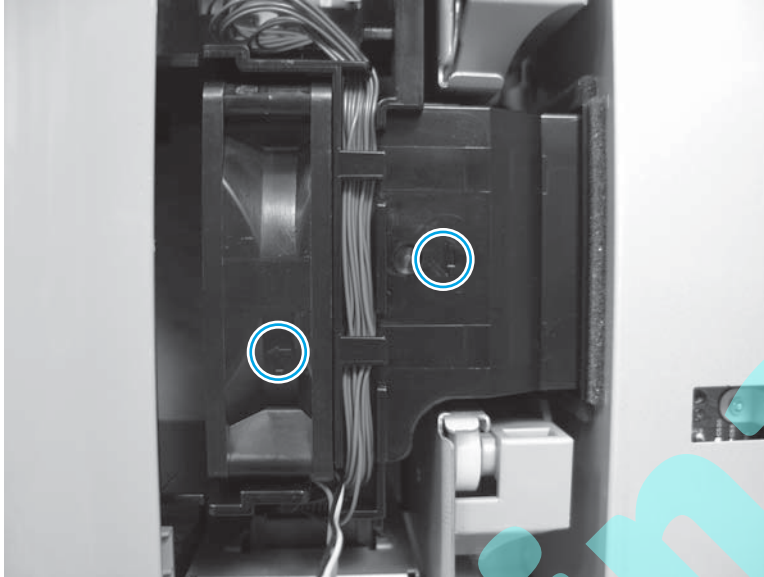

Cartridge fan

Before proceeding, remove the following assemblies:

- Control-panel assembly (M806 only). See [Control-panel assembly \(M806 only\) on page 38](#).
- Hardware integration pocket (HIP) cover (M806 only). See [Hardware integration pocket \(HIP\) cover \(M806 only\) on page 88](#).
- Control-panel base cover (M806 only). See [Control-panel base cover \(M806 only\) on page 94](#).
- Right top cover (M806 only). See [Right top cover \(M806 only\) on page 98](#).
- Rear cover. See [Rear cover on page 110](#).
- Right rear cover. See [Right rear cover on page 113](#).
- Right door assembly. See [Right door assembly on page 118](#).

Remove the cartridge fan

1. Disconnect one connector.

Figure 1-239 Remove the cartridge fan (1 of 5)



2. **M830 only:** Use a small flat blade screwdriver to remove one clip.

Figure 1-240 Remove the cartridge fan (2 of 5)

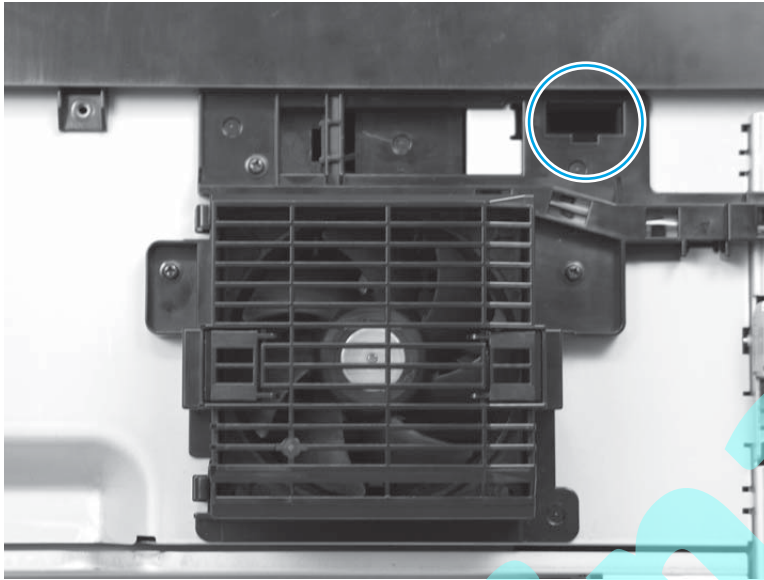

3. Remove three screws.

Figure 1-241 Remove the cartridge fan (3 of 5)



4. Release four tabs.

 **Reinstallation tip** Slide the tabs into the product before you snap the fan into place.

Figure 1-242 Remove the cartridge fan (4 of 5)



5. Rotate the fan upward, and then remove it.

Figure 1-243 Remove the cartridge fan (5 of 5)

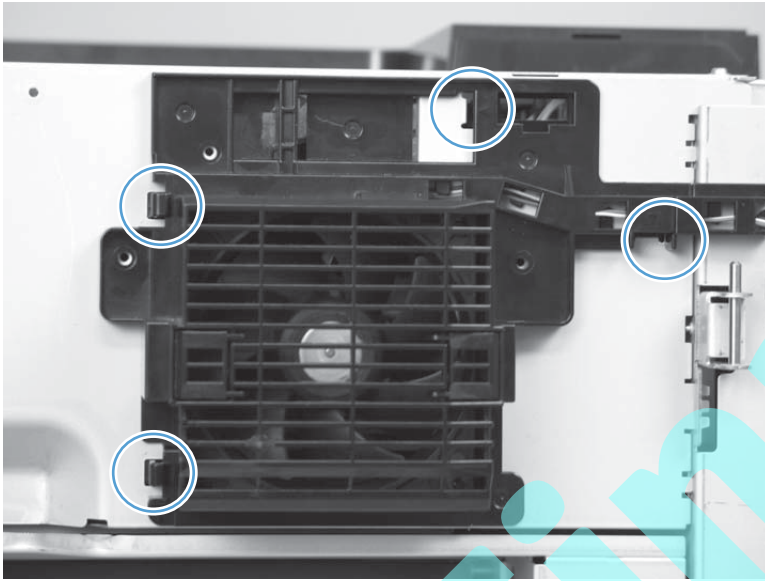
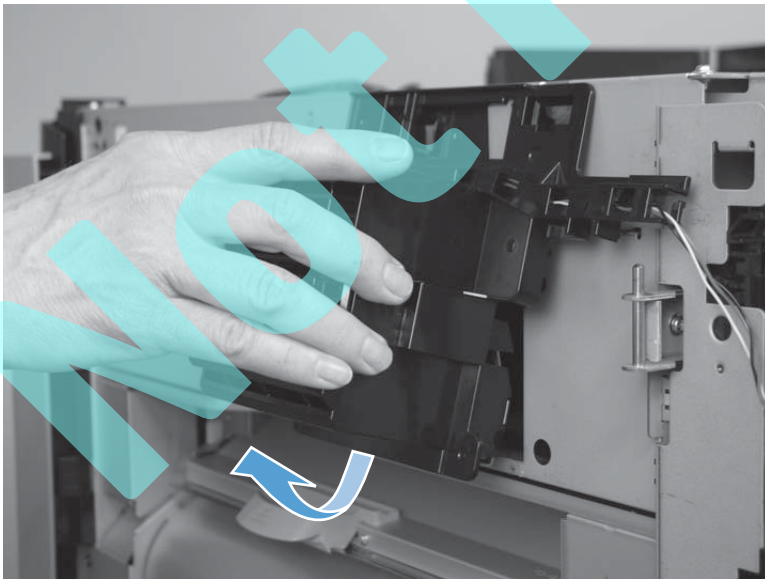

Reinstall the cartridge fan

If the sheet-metal fan cage becomes dislodged when the fan assembly is removed, position the cage on the fan as shown below before reinstalling the fan. Make sure that the holes on the fan cage are positioned over the locator pins on the fan assembly.

Figure 1-244 Reinstall the cartridge fan

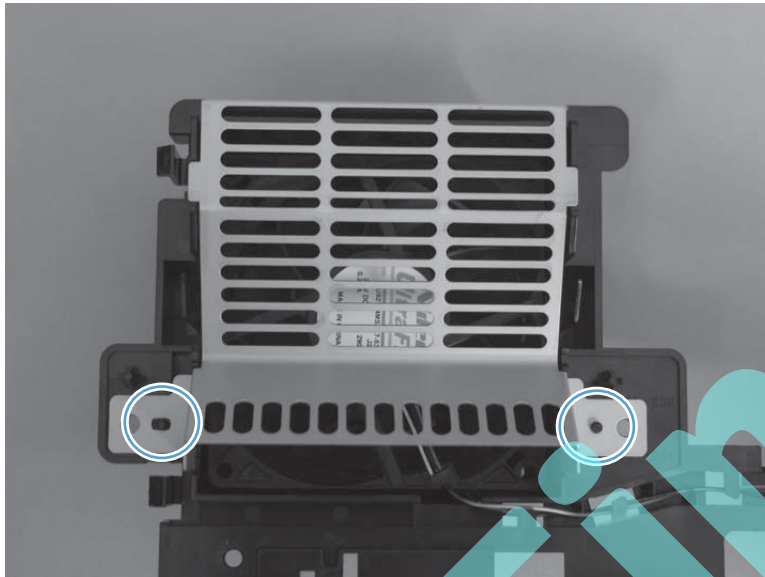

Controller fan

Before proceeding, remove the following assemblies:

- Rear cover. See [Rear cover on page 110](#).

Remove the controller fan

1. Locate the controller fan below the formatter.

Figure 1-245 Remove the controller fan (1 of 3)

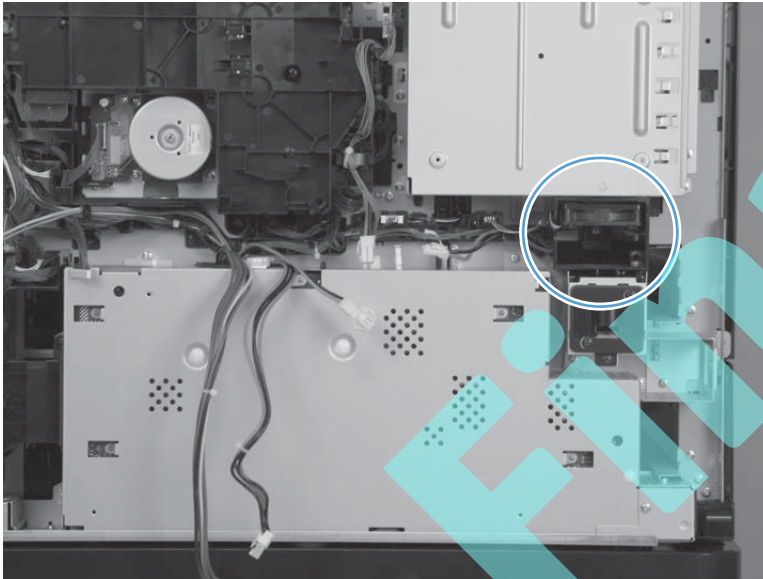

2. Disconnect one connector, and then carefully remove the wire harness from the guide.

Figure 1-246 Remove the controller fan (2 of 3)



3. Release two black tabs, and then slide the controller fan out of the product.

Figure 1-247 Remove the controller fan (3 of 3)

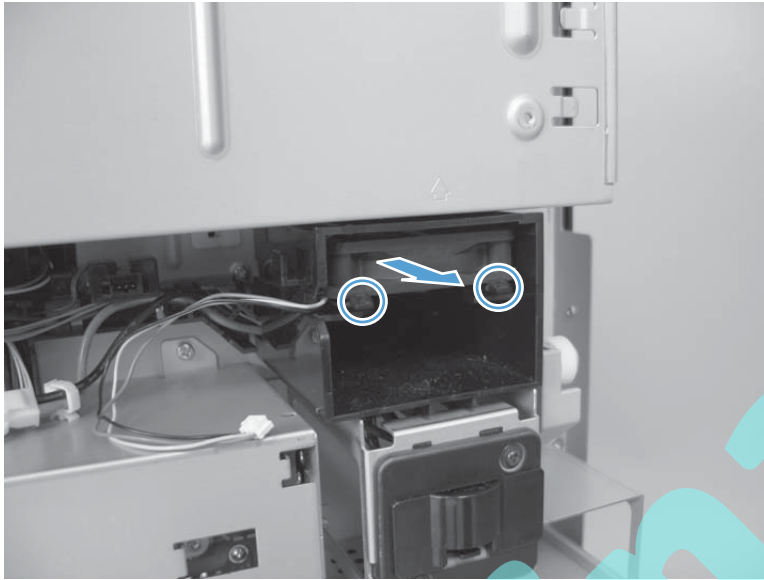

Not Final

Reinstall the controller fan

When reinstalling the fan, make sure that it is positioned as shown below.

Figure 1-248 Reinstall the controller fan (1 of 2)

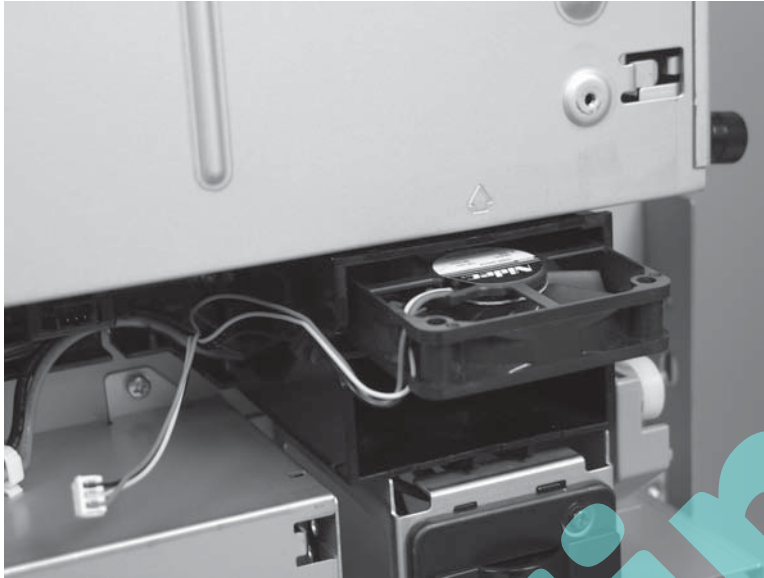

Make sure that the embossed arrows on the side of the fan facing the left door of the product are positioned as shown below.

Figure 1-249 Reinstall the controller fan (2 of 2)



Paper-pickup assembly

Before proceeding, remove the following assemblies:

- Tray 2 and Tray 3. See [Tray 2 and Tray 3 on page 86](#).
- Rear cover. See [Rear cover on page 110](#).
- Right rear cover. See [Right rear cover on page 113](#).
- Right door assembly. See [Right door assembly on page 118](#).
- Right lower front cover. See [Right lower front cover on page 126](#).
- Right lower cover. See [Right lower cover on page 128](#).

Remove the paper-pickup assembly

1. Remove four screws, two from each tray rail.

Figure 1-250 Remove the paper-pickup assembly (1 of 7)

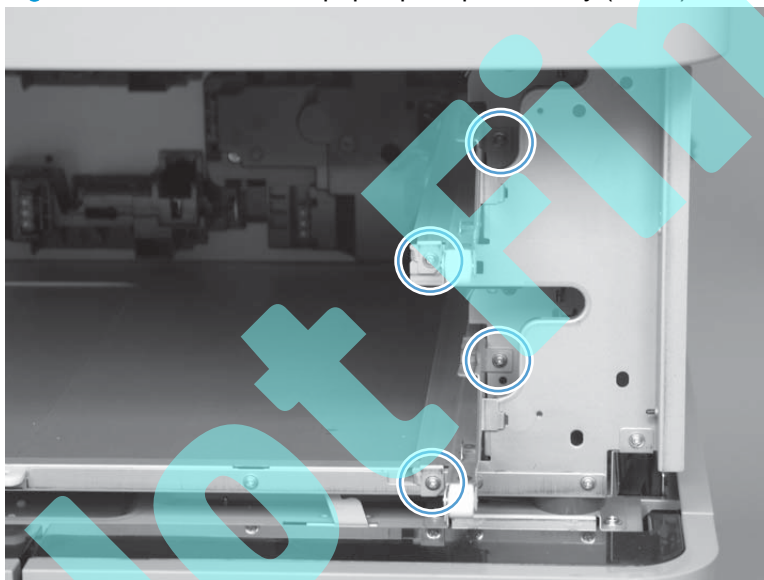

2. Remove the rails from the front of the product.

Figure 1-251 Remove the paper-pickup assembly (2 of 7)

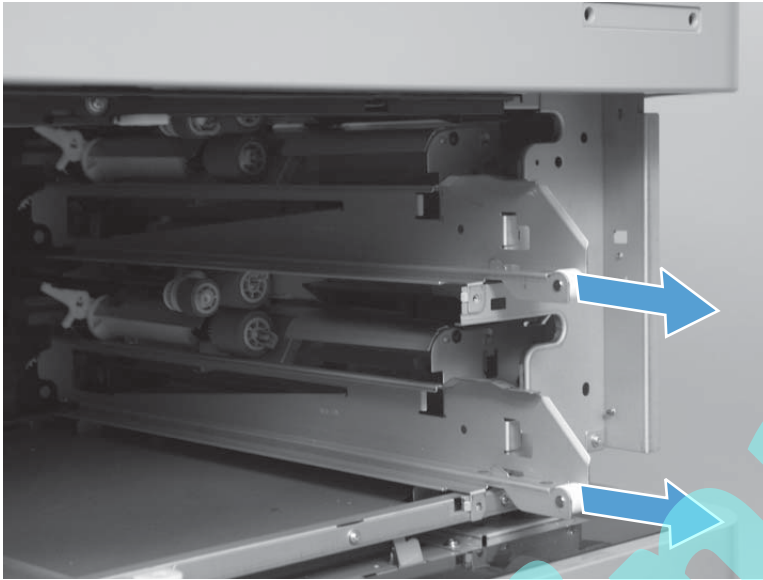

3. For products without a high-capacity input feeder installed, skip this step. Slide two levers toward the center (callout 1), and then lift up (callout 2) to remove the paper connecting unit.

Figure 1-252 Remove the paper-pickup assembly (3 of 7).

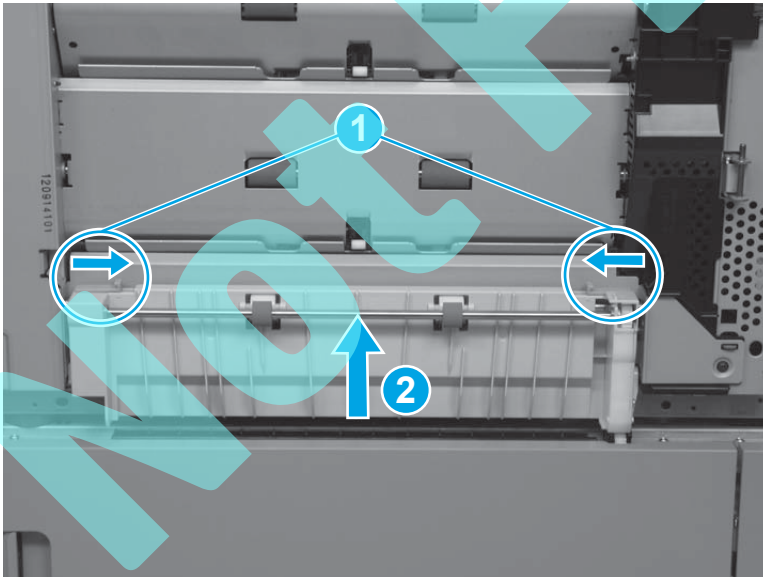

4. Disconnect four connectors (callout 1) located on the back of the product near the low-voltage power supply. Release the wire harnesses from the guides (callout 2).

Figure 1-253 Remove the paper-pickup assembly (4 of 7)

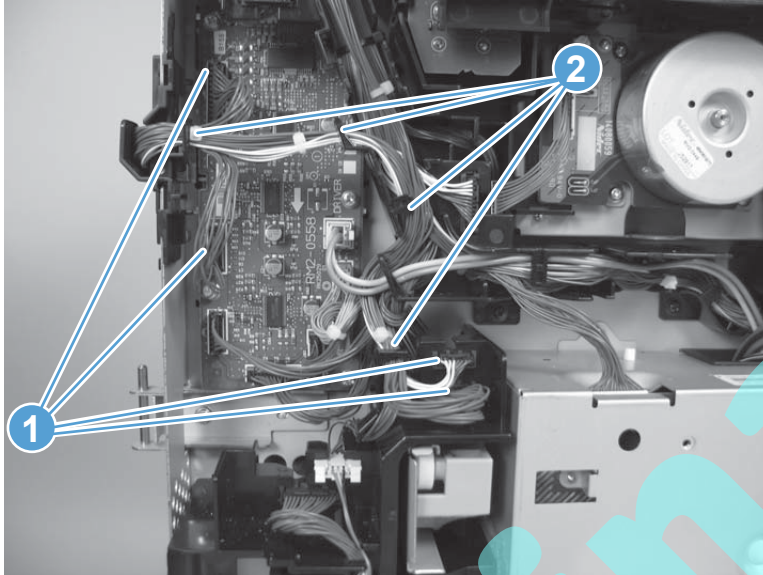

5. Push the registration handle down slightly (callout 1), and then lift it up and out (callout 2) to gain access to the paper-pickup assembly.

 **Reinstallation tip** Make sure that the registration handle is in the raised position when reinstalling the paper-pickup assembly.

Figure 1-254 Remove the paper-pickup assembly (5 of 7)



6. Open the front door, and then remove four screws.

Figure 1-255 Remove the paper-pickup assembly (6 of 7)

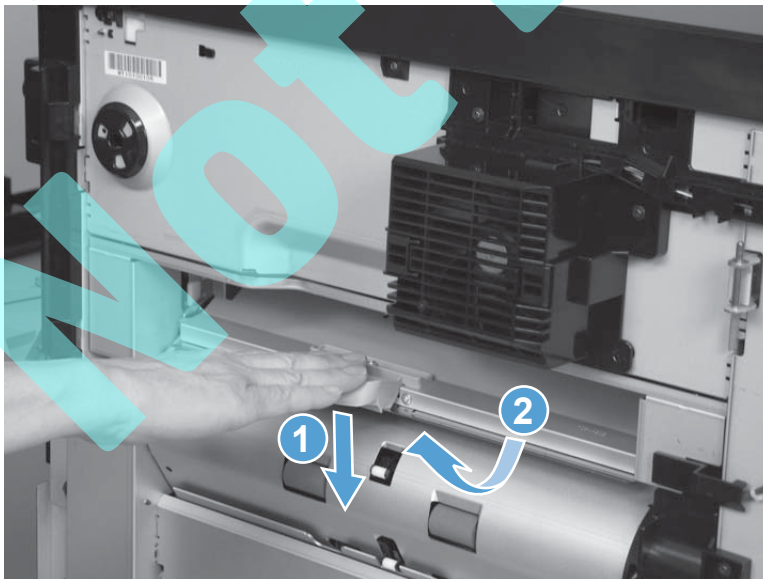

7. Grasp the handle, and then lift the paper-pickup assembly out of the product.

CAUTION: The paper-pickup assembly is heavy.

Reinstallation tip Make sure not to pinch any of the wire harnesses when reinstalling the paper-pickup assembly. All four wire harnesses are routed through the guide on the chassis.

Figure 1-256 Remove the paper-pickup assembly (7 of 7)

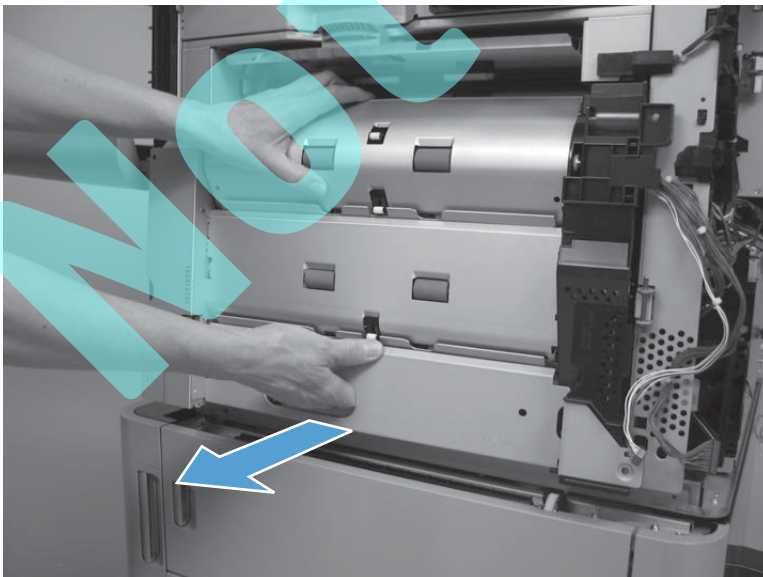

Registration assembly

Before proceeding, remove the following assemblies:

- Tray 2 and Tray 3. See [Tray 2 and Tray 3 on page 86](#).
- Transfer roller assembly. See [Transfer-roller assembly on page 8](#).
- Right lower cover. See [Right lower cover on page 128](#).
- Rear cover. See [Rear cover on page 110](#).
- Right rear cover. See [Right rear cover on page 113](#).
- Right door assembly. See [Right door assembly on page 118](#).
- Right lower front cover. See [Right lower front cover on page 126](#).
- Paper-pickup assembly. See [Paper-pickup assembly on page 167](#).
- Registration-jam-removal knob. See [Registration-jam-removal knob on page 154](#).

Remove the registration assembly

1. Disconnect one connector (callout 1) located on the back of the product near the low-voltage power supply. Remove the wire harness from the guides (callout 2)

Figure 1-257 Remove the registration assembly (1 of 3)

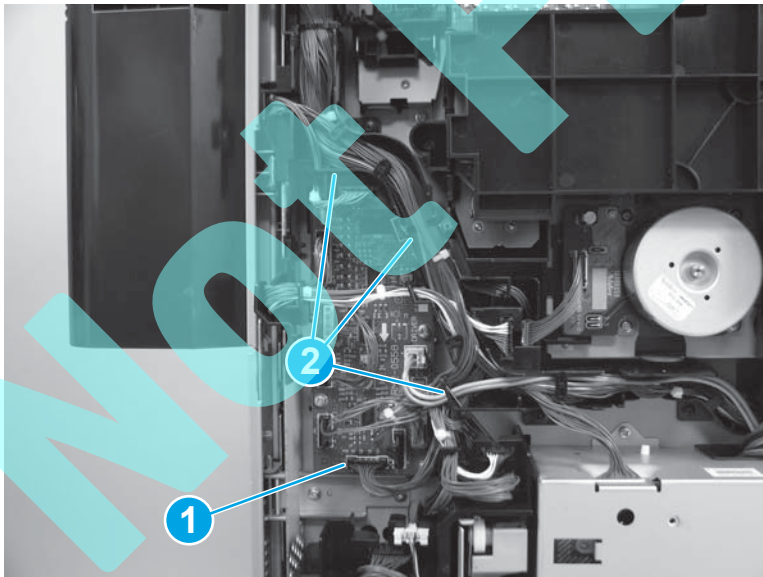

2. Remove two screws.

Figure 1-258 Remove the registration assembly (2 of 3)

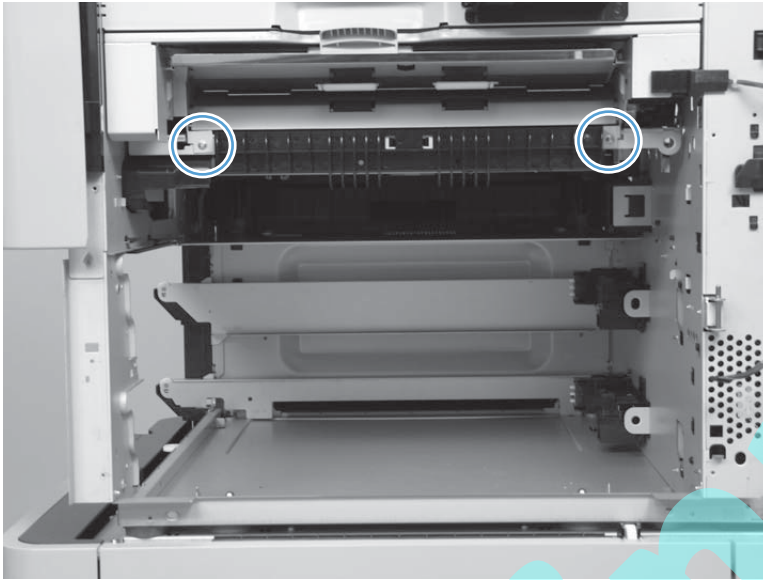

3. Slightly lift the registration assembly up, and then rotate it downward until you can remove it from the product.

Figure 1-259 Remove the registration assembly (3 of 3).

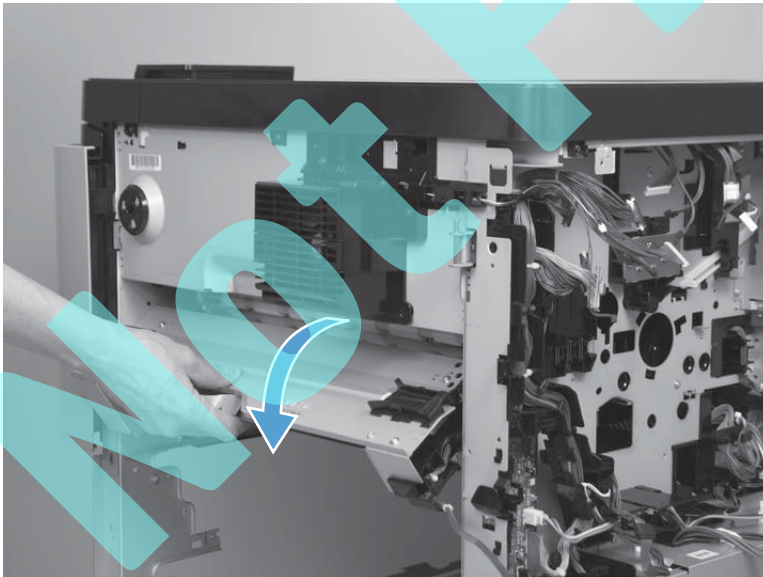

Auto-close assembly

 **NOTE:** This procedure is for removing the lower auto-close assembly. This same procedure can also be used to remove the upper auto-close assembly.

Before proceeding, remove the following assemblies:

- Tray 2 and Tray 3. See [Tray 2 and Tray 3 on page 86](#).

Remove the auto-close assembly

1. Release one tab (callout 1) by pushing up on the bottom of the plastic cover (callout 2).

 **NOTE:** The auto close assemblies are located at the back inside the Tray 2 and Tray 3 cavity.

Figure 1-260 Remove the auto-close assembly (1 of 5)

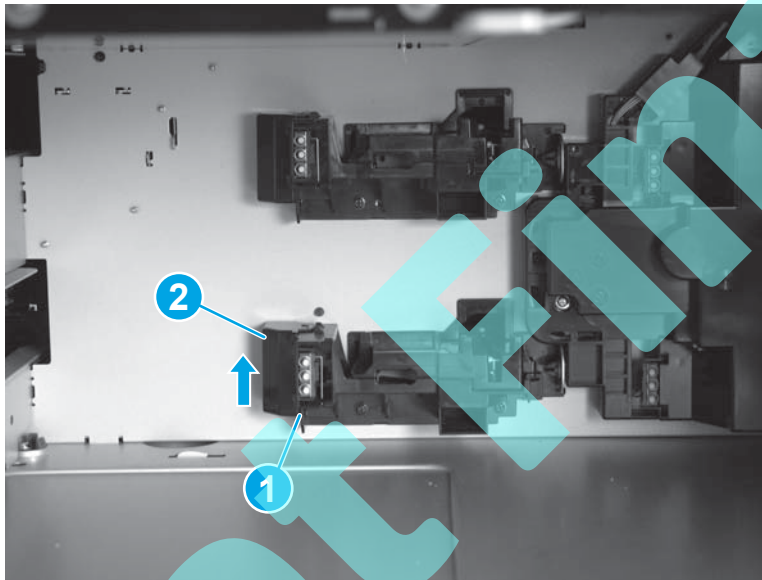

2. Remove the plastic cover.

Figure 1-261 Remove the auto-close assembly (2 of 5)

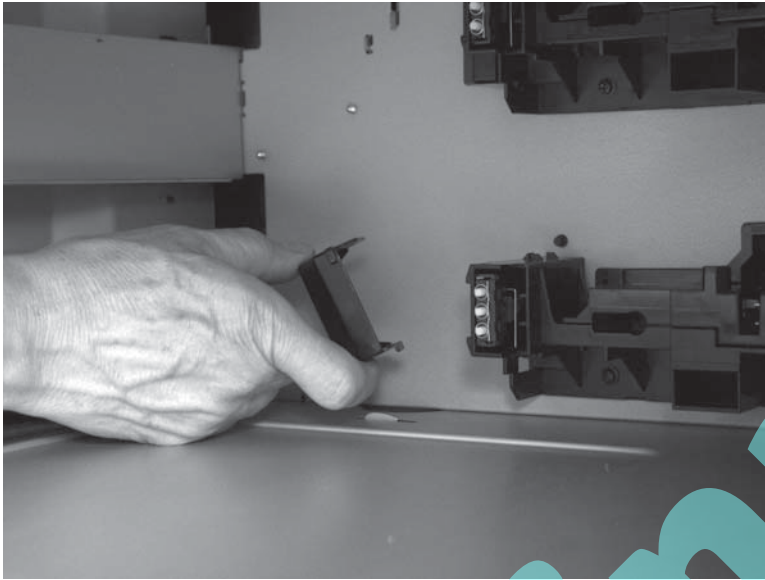

3. Remove two screws (callout 1), and then release one tab (callout 2).

 **NOTE:** Leave the connector connected at this time. It is easier to disconnect after the tab is released.

Figure 1-262 Remove the auto-close assembly (3 of 5)



4. Disconnect one connector.

Figure 1-263 Remove the auto-close assembly (4 of 5)

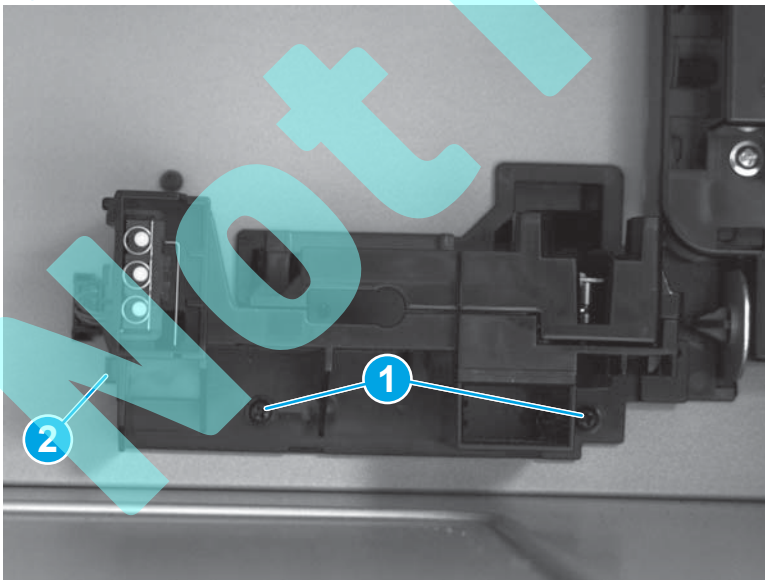
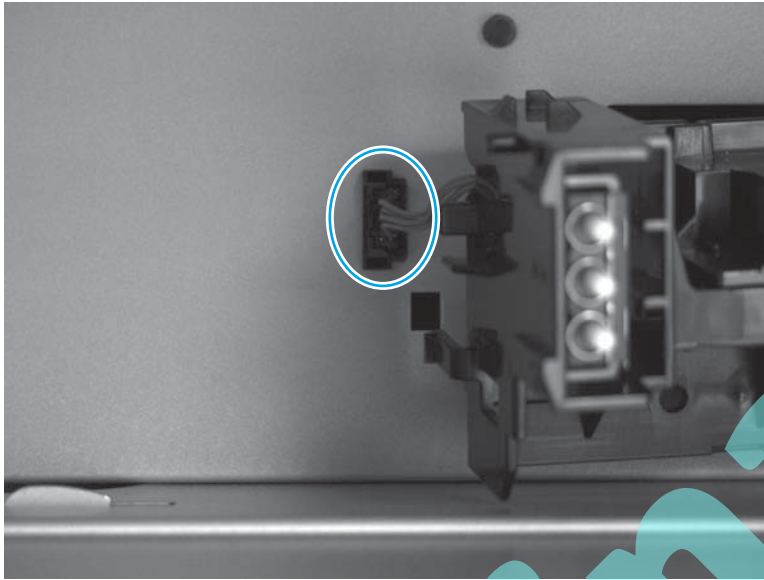

5. Rotate the left side of the assembly away from the product (callout 1), and then slide it toward the left door (callout 2) to remove it.

Figure 1-264 Remove the auto-close assembly (5 of 5)

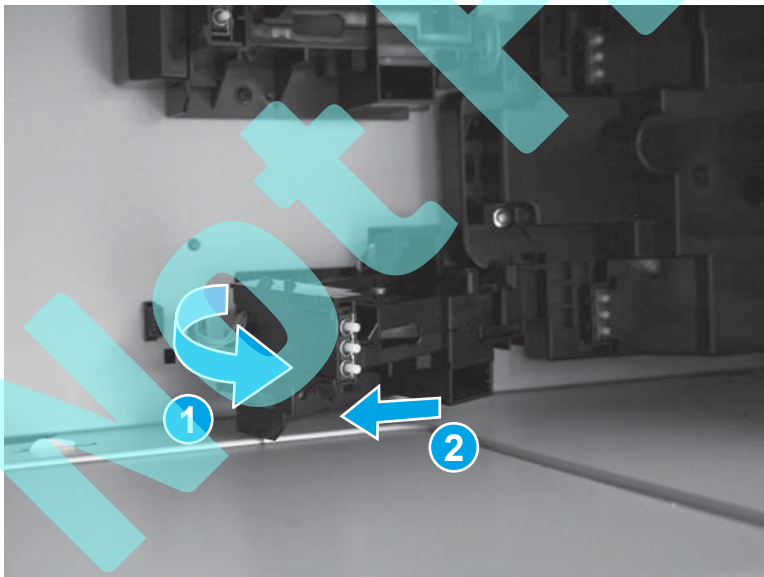

Reinstall the auto-close assembly

When reinstalling the cover, make sure that the tabs and slots on the cover (callout 1) are installed with the corresponding tabs and slots on the assembly (callout 2).

Figure 1-265 Reinstall the auto-close assembly

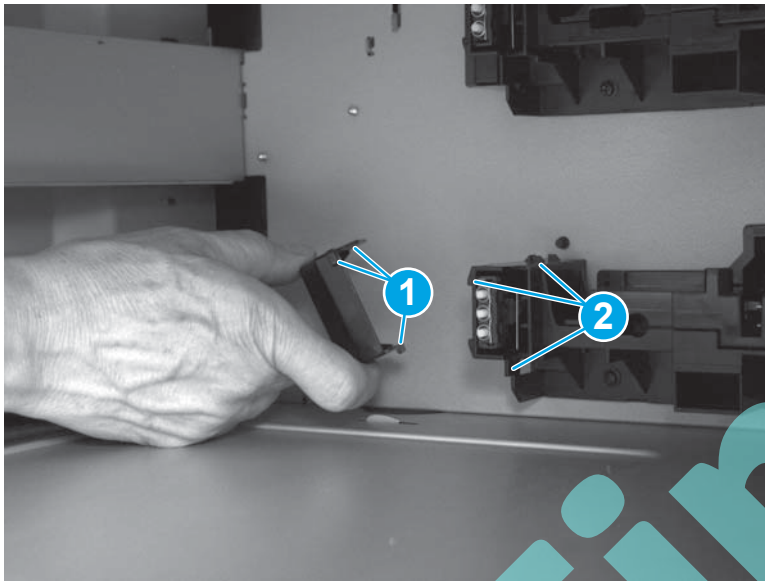

Low-voltage power supply (M806 only)

Before proceeding, remove the following assemblies:

- Rear cover. See [Rear cover on page 110](#).

Remove the low-voltage power supply (M806 only)

CAUTION:  ESD sensitive assembly.

1. Disconnect two connectors (callout 1), and then release the wire harness from the guides (callout 2).

Figure 1-266 Remove the low-voltage power supply (M806; 1 of 4)

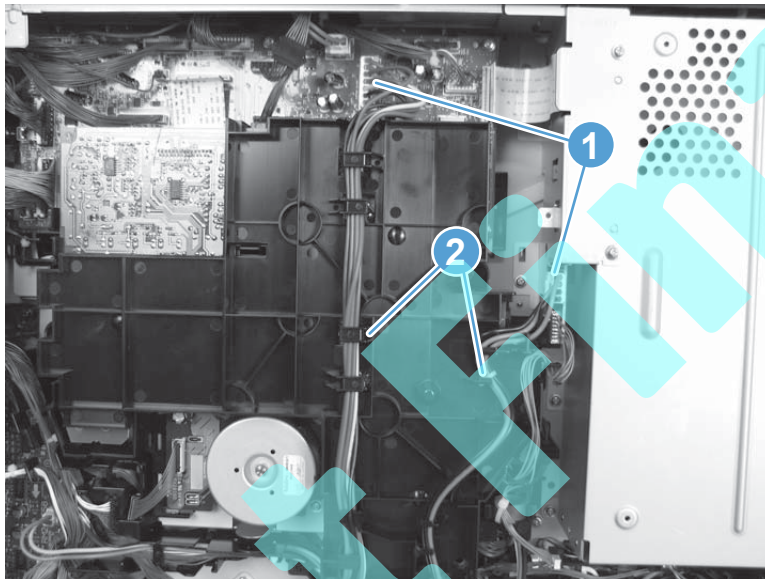

2. Disconnect three connectors.

Figure 1-267 Remove the low-voltage power supply (M806; 2 of 4)

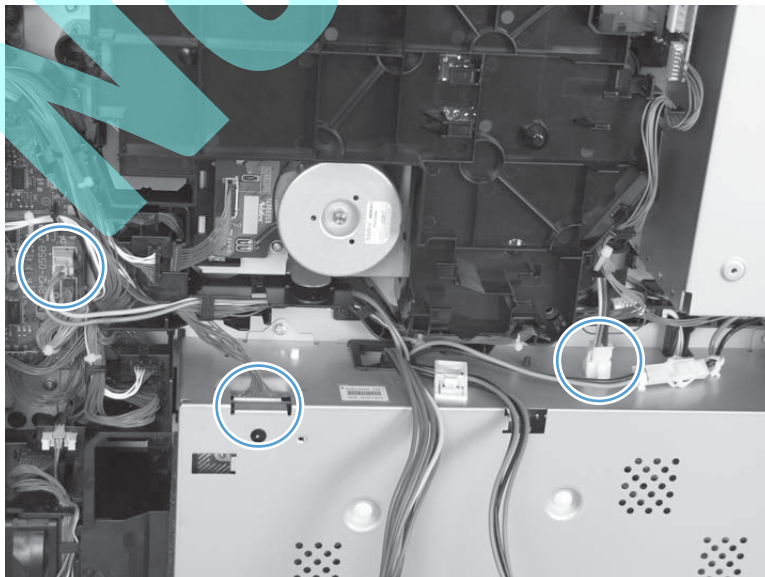

3. Release one wire harness from the retainers (callout 1). Disconnect one connector (callout 2) by pressing the tab on the side of the connector while pulling the connectors apart.

Figure 1-268 Remove the low-voltage power supply (M806; 3 of 4)

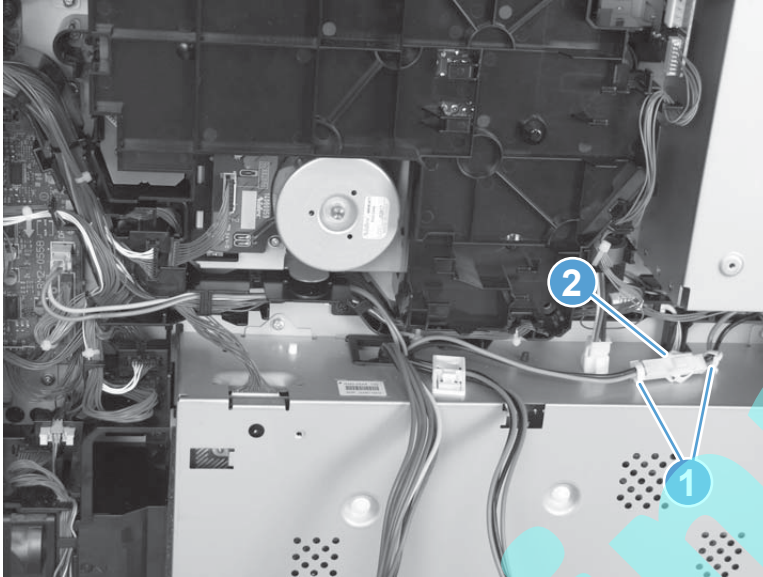

4. Remove five screws, and then lift up slightly to remove the low-voltage power supply.

Figure 1-269 Remove the low-voltage power supply (M806; 4 of 4)

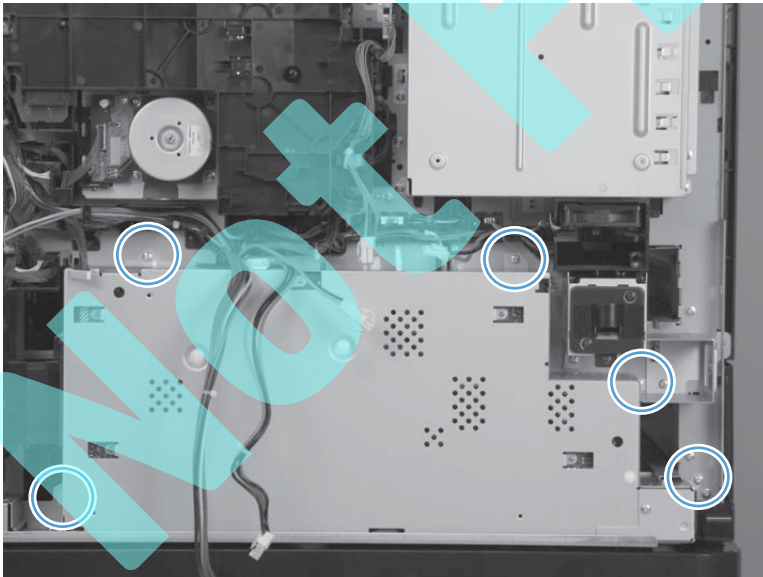

Low-voltage power supply (M830 only)

Before proceeding, remove the following assemblies:

- Rear cover. See [Rear cover on page 110](#).

Remove the low-voltage power supply (M830 only)

CAUTION:  ESD sensitive assembly.

1. Disconnect two connectors (callout 1), and then release the wire harness from the guides (callout 2).

Figure 1-270 Remove the low-voltage power supply (M830; 1 of 6)

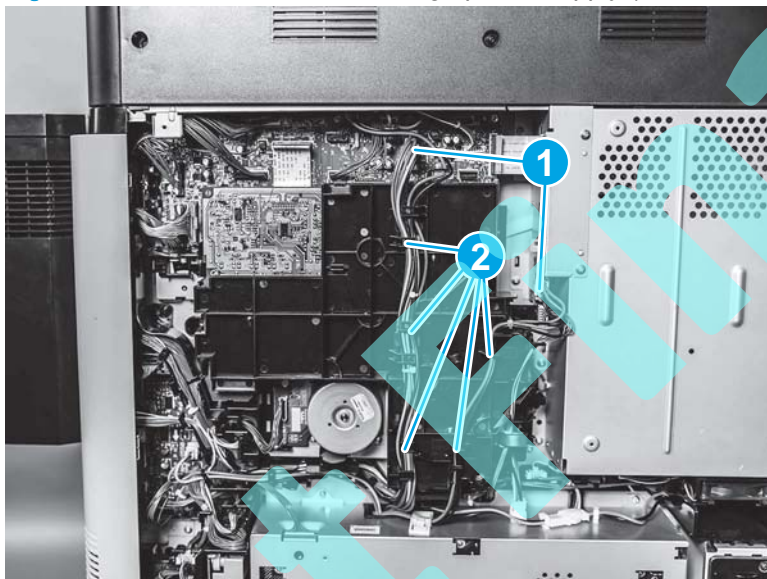

2. Disconnect three connectors.

Figure 1-271 Remove the low-voltage power supply (M830; 2 of 6)

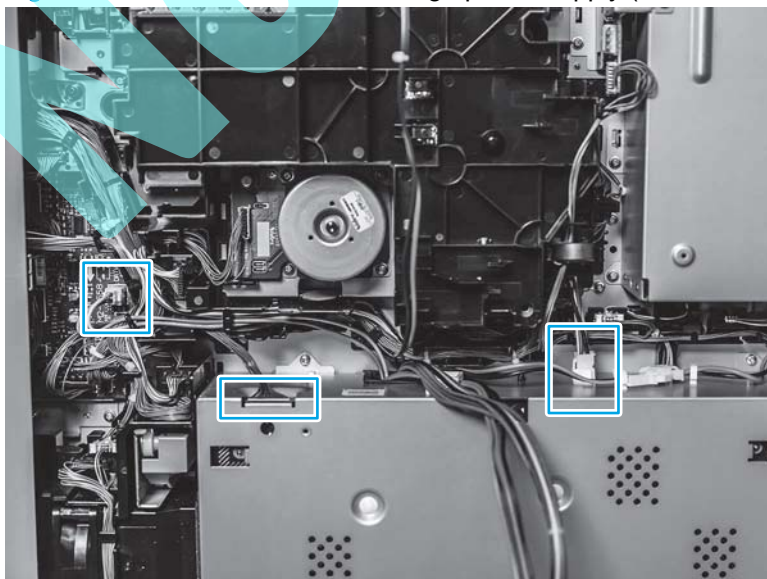

3. Release one wire harness from the retainers (callout 1). Disconnect one connector (callout 2) by pressing and holding the tab on the side of the connector while sliding it out of the socket.

Figure 1-272 Remove the low-voltage power supply (M830; 3 of 6)

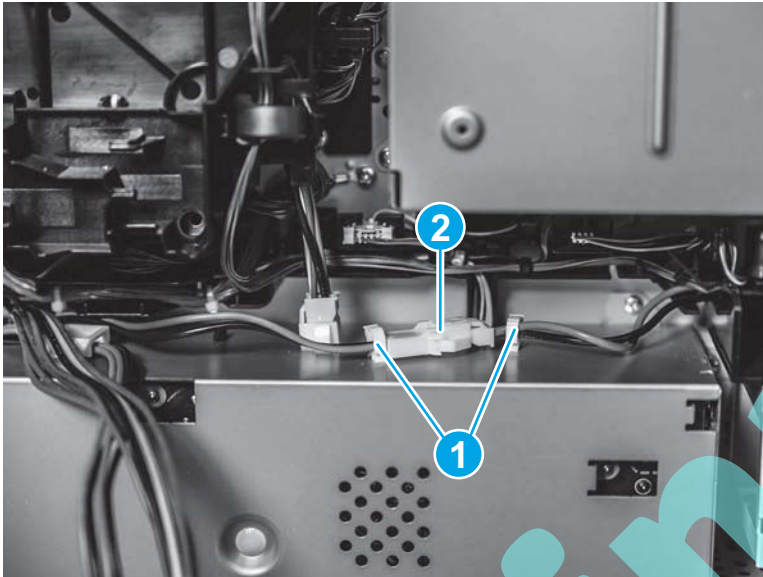

4. Remove five screws.

Figure 1-273 Remove the low-voltage power supply (M830; 4 of 6)

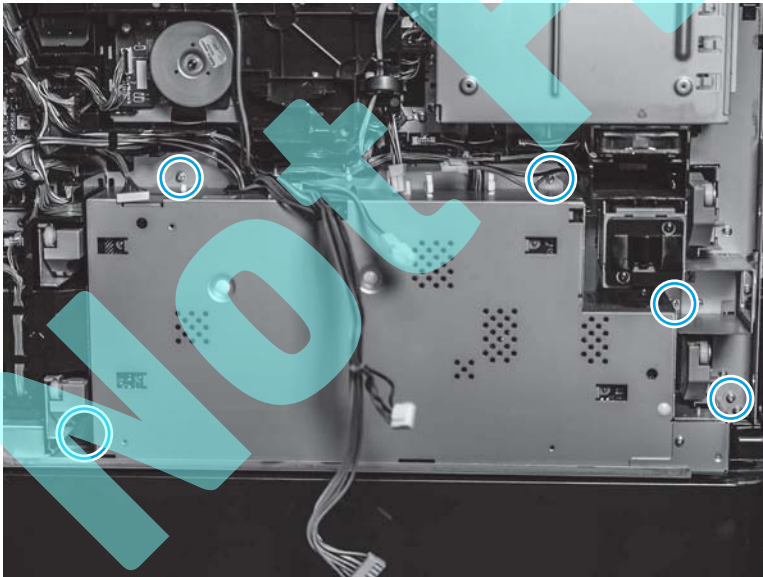

5. Lift up slightly, and then rotate the top of the low-voltage power supply away from the product until the back is facing up.

CAUTION: The low-voltage power supply is still connected to the product by one cable (callout 1).

Figure 1-274 Remove the low-voltage power supply (M830; 5 of 6)

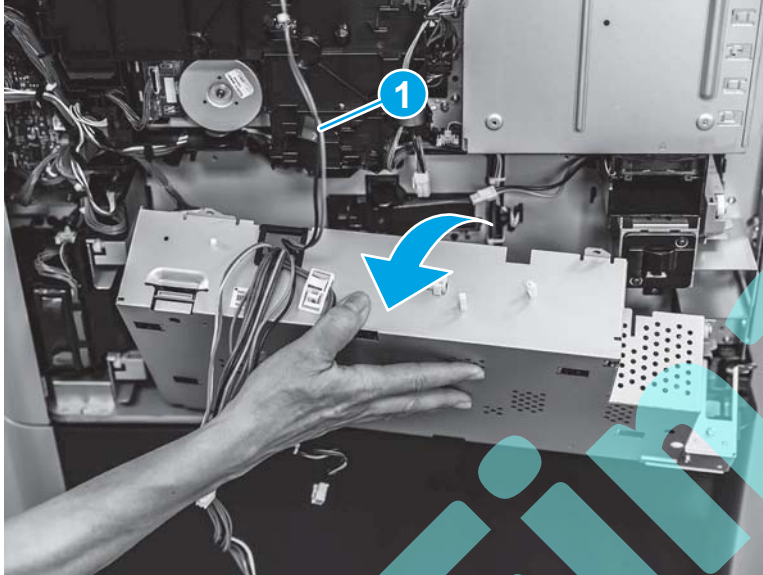

6. Disconnect one connector, and then remove the high-voltage power supply.

Figure 1-275 Remove the low-voltage power supply (M830; 6 of 6)

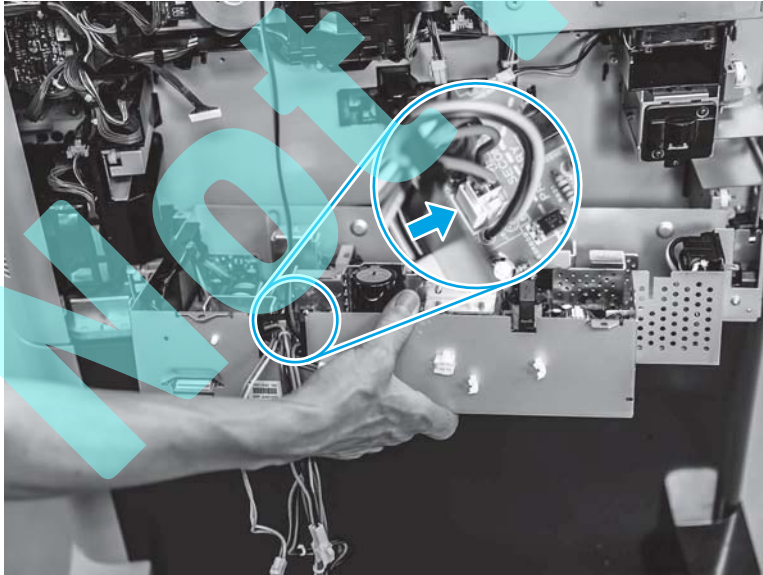

High-voltage power supply (M806 only)

Before proceeding, remove the following assemblies:

- Rear cover. See [Rear cover on page 110](#).

Remove the high-voltage power supply (M806 only)

CAUTION:  ESD sensitive assembly.

1. Disconnect four connectors (callout 1), and then release the wire harness from the guides (callout 2).

Figure 1-276 Remove the high-voltage power supply (M806; 1 of 3)

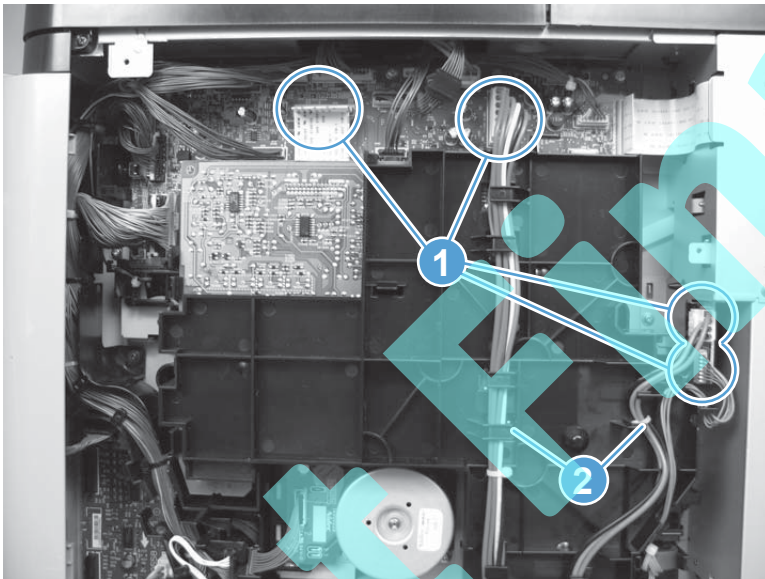

2. Release two tabs (callout 1), and then release one ferrite ring (callout 2).

Figure 1-277 Remove the high-voltage power supply (M806; 2 of 3)

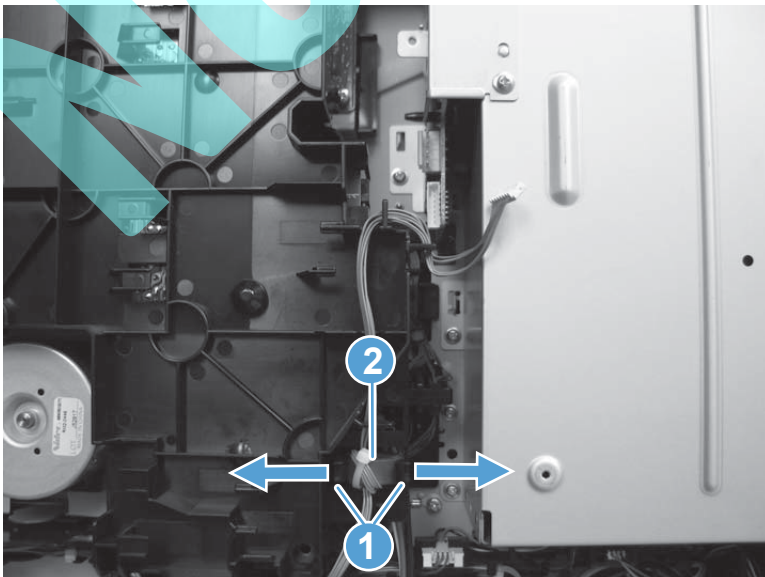

3. Remove three screws (callout 1), release one tab (callout 2), and then remove the high-voltage power supply.

Figure 1-278 Remove the high-voltage power supply (M806; 3 of 3)

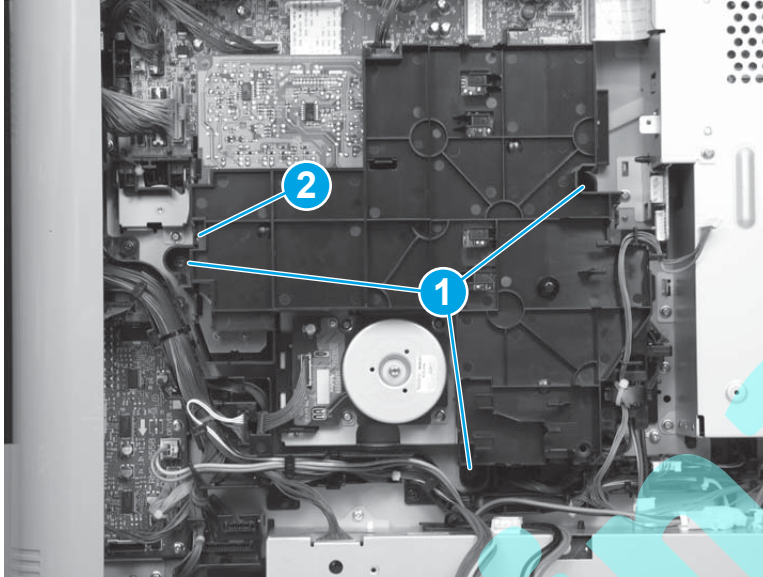

Reinstall the high-voltage power supply (M806 only)

Insert the spring contacts (callout 1) on the high-voltage power supply into the holes (callout 2) in the product.

Figure 1-279 Reinstall the high-voltage power supply (M806)

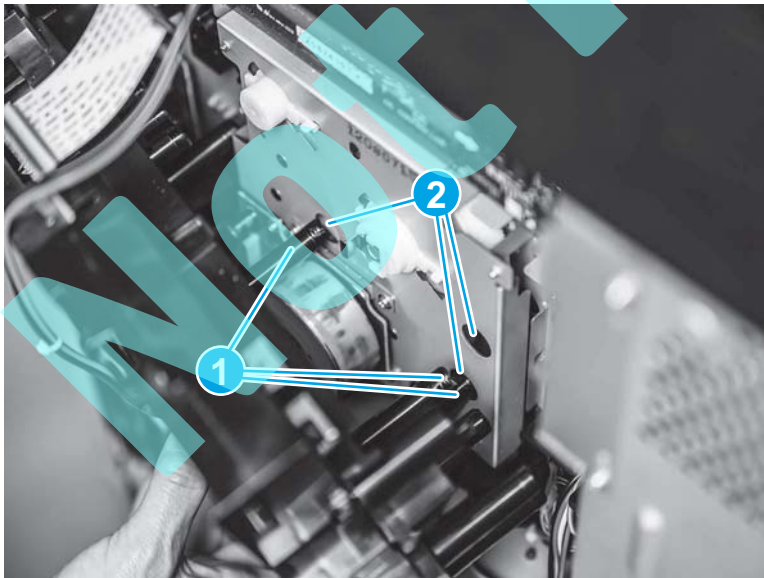

High-voltage power supply (M830 only)

Before proceeding, remove the following assemblies:

- Rear cover. See [Rear cover on page 110](#).

Remove the high-voltage power supply (M830 only)

CAUTION:  ESD sensitive assembly.

1. Disconnect four connectors (callout 1), and then release the wire harnesses from the guides (callout 2).

Figure 1-280 Remove the high-voltage power supply (M830; 1 of 4)

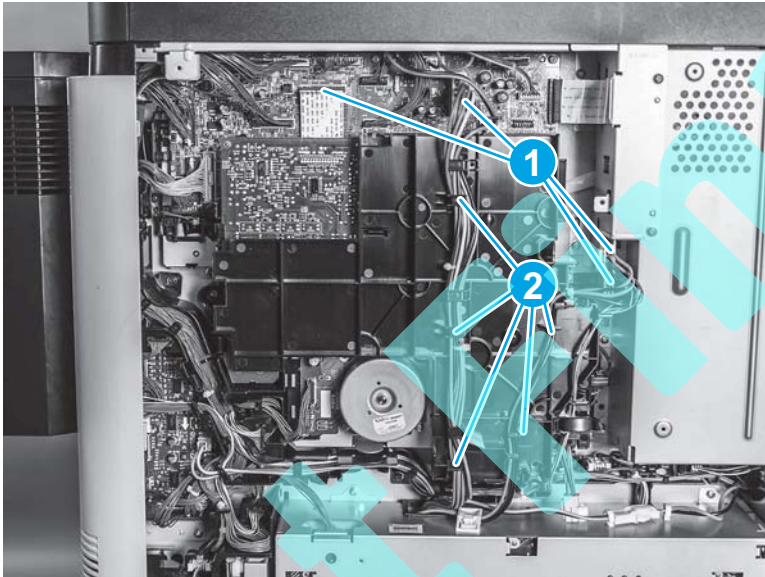

2. Release two tabs (callout 1), and then release one ferrite ring (callout 2).

Figure 1-281 Remove the high-voltage power supply (M830; 2 of 4)

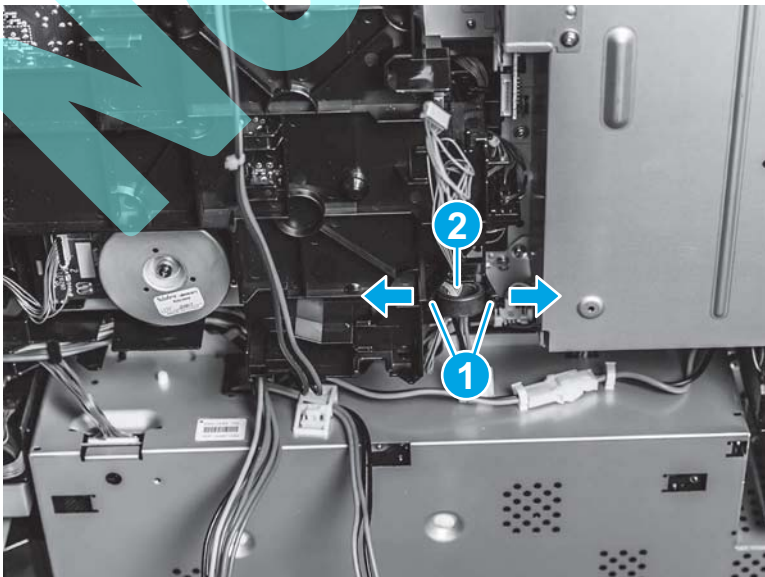

3. Remove three screws (callout 1), and then release one tab (callout 2).

 **NOTE:** One cable (callout 3) is not disconnected.

Figure 1-282 Remove the high-voltage power supply (M830; 3 of 4)



4. Hold one cable (callout 1) away from the product while removing the high-voltage power supply (callout 2). Make sure that the high-voltage power supply does not get caught on this cable.

Figure 1-283 Remove the high-voltage power supply (M830; 4 of 4)

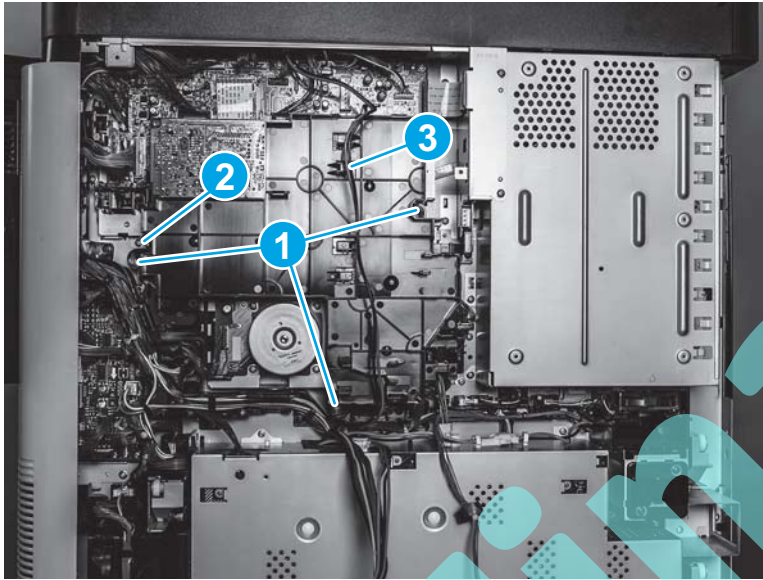
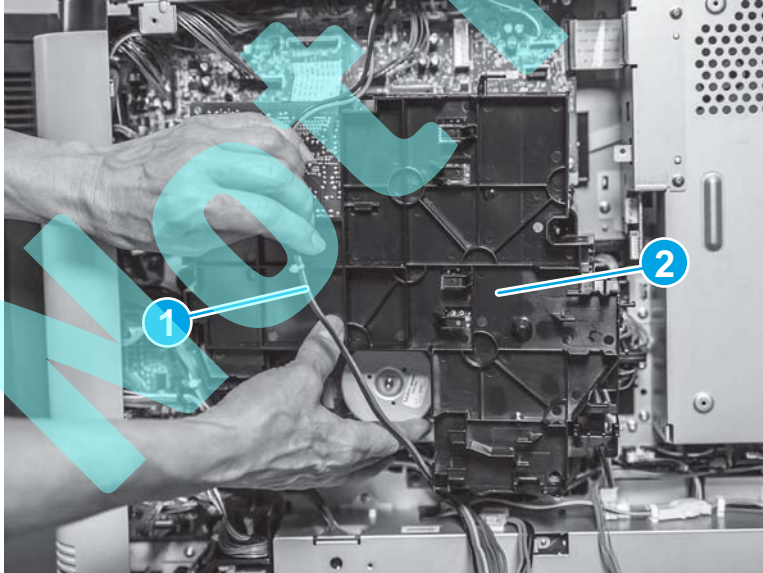

Reinstall the high-voltage power supply (M830 only)

1. Hold one cable away from the product, and then slide the high-voltage power supply between the cable and the product.

Figure 1-284 Reinstall the high-voltage power supply (M830; 1 of 2)



2. Insert the spring contacts (callout 1) on the high-voltage power supply into the holes (callout 2) in the product.

Figure 1-285 Reinstall the high-voltage power supply (M830; 2 of 2)

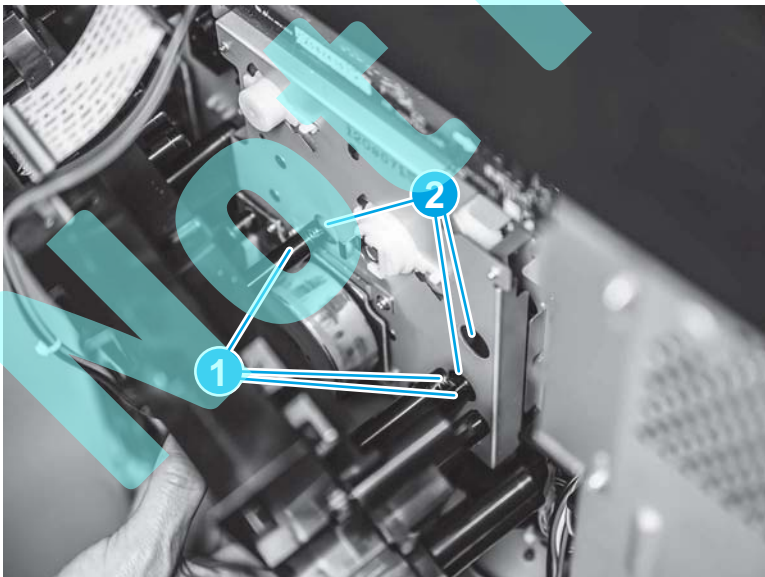

DC controller (M806 only)

Before proceeding, remove the following assemblies:

- Rear cover. See [Rear cover on page 110](#).
- High-voltage power supply (M806 only). See [High-voltage power supply \(M806 only\) on page 182](#).

Remove the DC controller (M806 only)

 **CAUTION:**  ESD sensitive assembly.

1. Disconnect all of the connectors (eighteen) on the DC controller.

 **NOTE:** The DC controller is located on the back of the printer behind the high-voltage power supply and above the drive assembly.

Figure 1-286 Remove the DC controller (M806; 1 of 4)



2. Remove four screws.

Figure 1-287 Remove the DC controller (M806; 2 of 4)

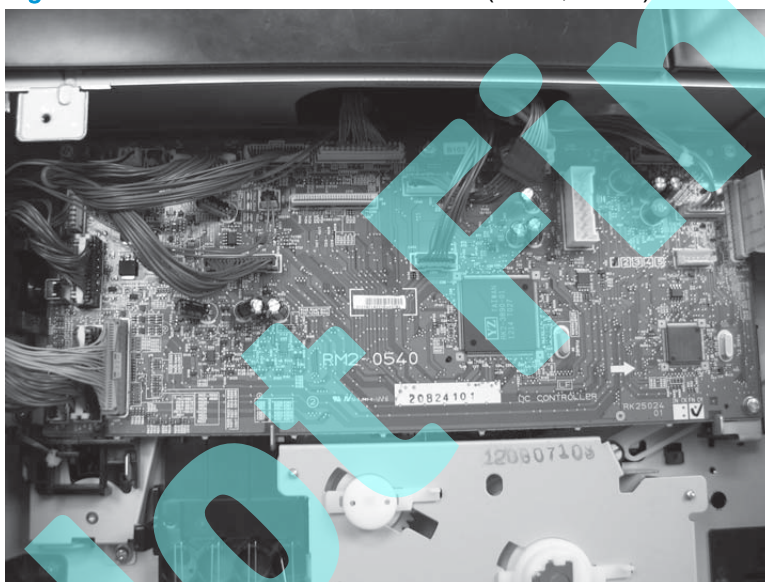
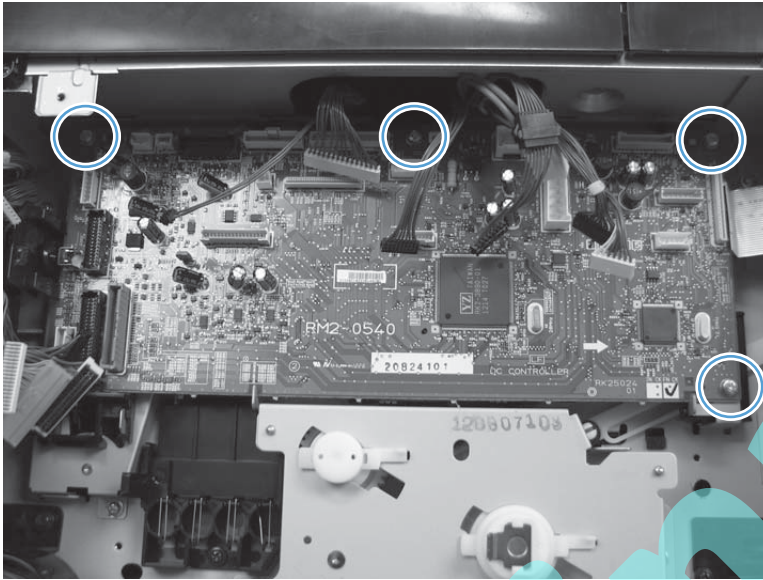

3. Release four tabs, and then rotate the top edge of the DC controller away from the product.

Figure 1-288 Remove the DC controller (M806; 3 of 4)

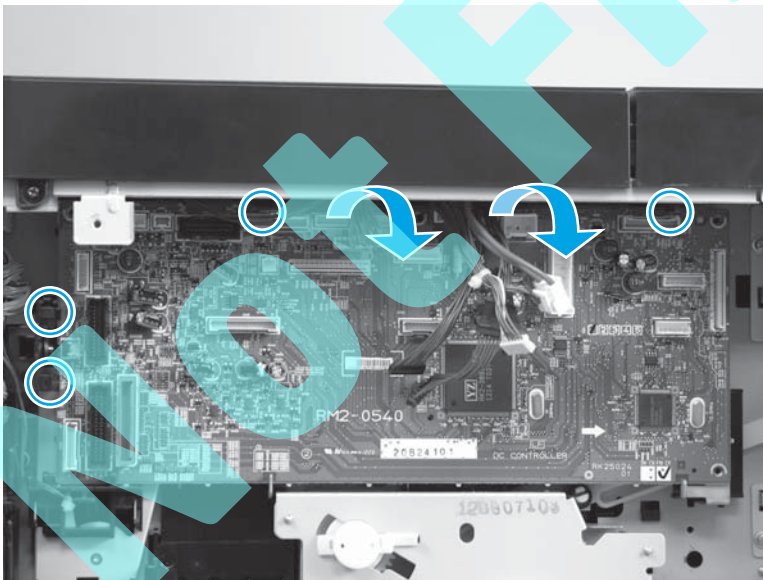

4. Lift the DC controller up to release it from three tabs, and then remove the DC controller.

 **Reinstallation tip** Insert the lower edge of the DC controller onto the three tabs. Align the screw holes on the DC controller with the screw holes on the product, and then push the DC Controller into place to engage the four tabs. Connect eighteen connectors.

Figure 1-289 Remove the DC controller (M806; 4 of 4)



DC controller (M830 only)

Before proceeding, remove the following assemblies:

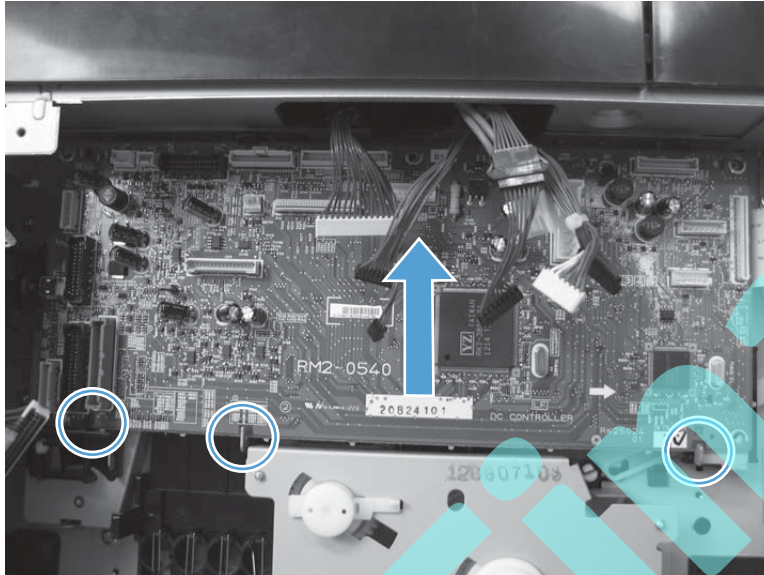
- Rear cover. See [Rear cover on page 110](#).
- High-voltage power supply (M830 only). See [High-voltage power supply \(M830 only\) on page 184](#).

Remove the DC controller (M830 only)

 **CAUTION:**  ESD sensitive assembly.

1. Disconnect all of the connectors (eighteen) on the DC controller. One cable (callout 1) is not disconnected.

 **NOTE:** The DC controller is located on the back of the printer behind the high-voltage power supply and above the drive assembly.

Figure 1-290 Remove the DC controller (M830; 1 of 5)



2. Remove four screws.

Figure 1-291 Remove the DC controller (M830; 2 of 5)

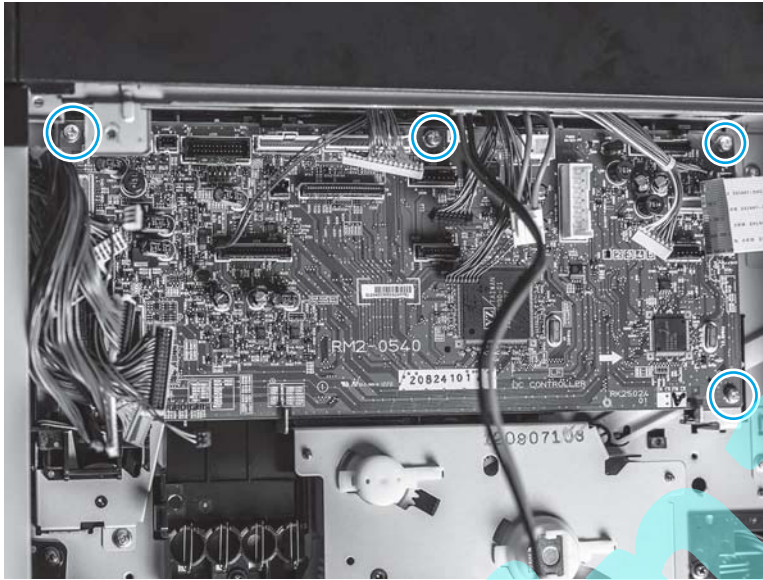

3. Release four tabs, and then rotate the top edge of the DC controller away from the product.

Figure 1-292 Remove the DC controller (M830; 3 of 5)

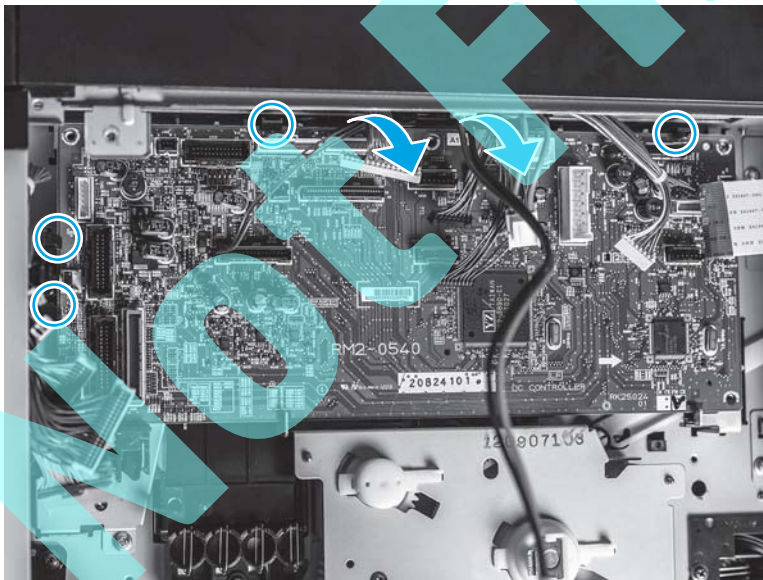

4. Lift the DC controller up to release it from three tabs.

 **Reinstallation tip** Insert the lower edge of the DC controller onto the three tabs. Align the screw holes on the DC controller with the screw holes on the product, and then push the DC Controller into place to engage the four tabs. Connect eighteen connectors.

Figure 1-293 Remove the DC controller (M830; 4 of 5)



5. Lower the DC controller, and then slide it under the cable (callout 1) to remove it.

Figure 1-294 Remove the DC controller (M830; 5 of 5)

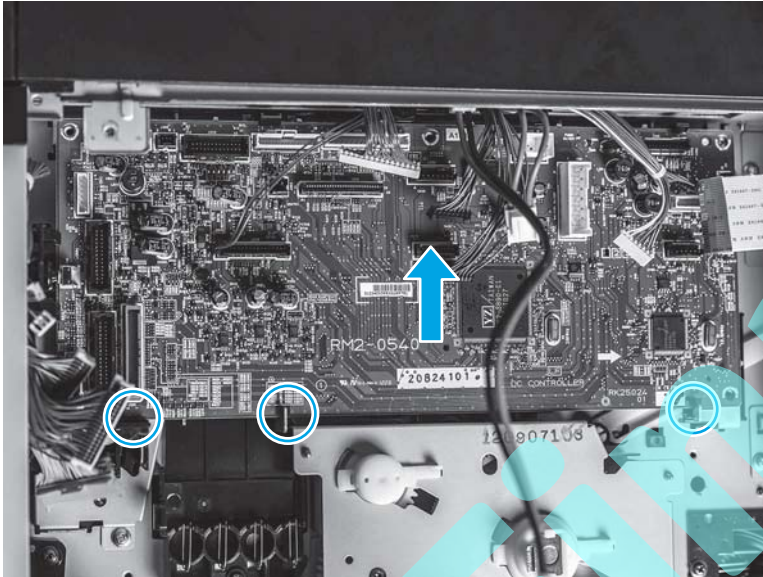
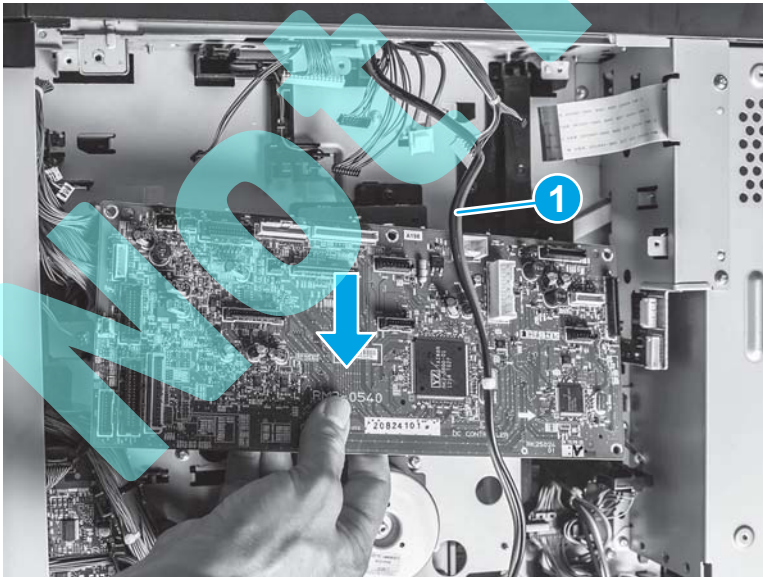

Cartridge contact assembly

Before proceeding, remove the following assemblies:

- Rear cover. See [Rear cover on page 110](#).
- High-voltage power supply (M806 only). See [High-voltage power supply \(M806 only\) on page 182](#).
- High-voltage power supply (M830 only). See [High-voltage power supply \(M830 only\) on page 184](#).
- DC Controller (M806 only). See [DC controller \(M806 only\) on page 187](#).
- DC Controller (M830 only). See [DC controller \(M830 only\) on page 190](#).

Remove the cartridge contact assembly

1. Remove one screw.

Figure 1-295 Remove the cartridge contact assembly (1 of 2)

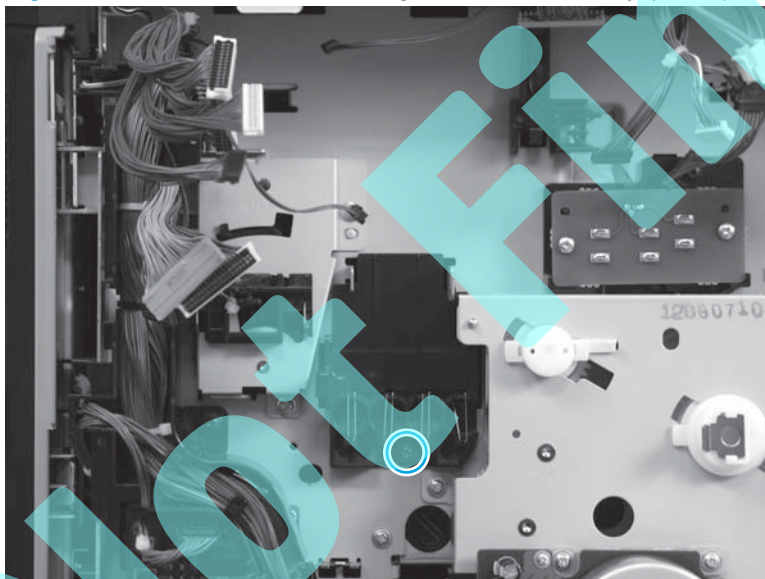

2. Remove the cartridge contact assembly (2 of 2)

Figure 1-296 Remove the cartridge contact assembly (2 of 2)

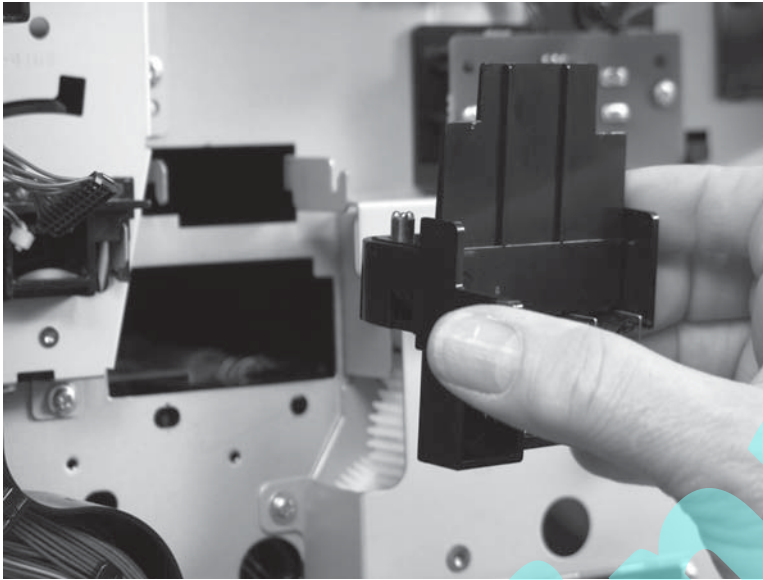

Reinstall the cartridge contact assembly

Rotate the right side of the assembly (callout 1) into the product first. Install the notch on the assembly (callout 2) under the hook (callout 3) on the product.

Figure 1-297 Reinstall the cartridge contact assembly

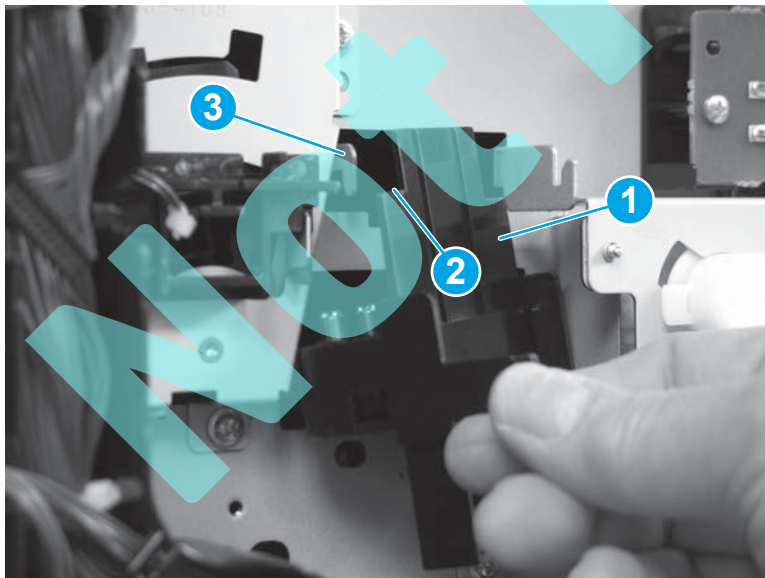

Drum motor

Before proceeding, remove the following assemblies:

- Rear cover. See [Rear cover on page 110](#).
- High-voltage power supply (M806 only). See [High-voltage power supply \(M806 only\) on page 182](#).
- High-voltage power supply (M830 only). See [High-voltage power supply \(M830 only\) on page 184](#).

Remove the drum motor

 **CAUTION:**  ESD sensitive assembly.

Disconnect one connector (callout 1), remove four screws (callout 2), and then remove the drum motor.

Figure 1-298 Remove the drum motor

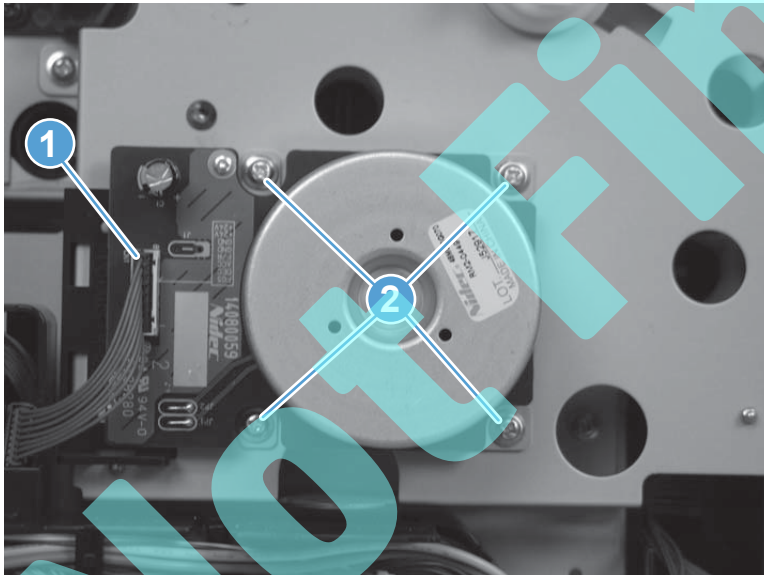

Drive assembly (M806 only)

Before proceeding, remove the following assemblies:

- Rear cover. See [Rear cover on page 110](#).
- High-voltage power supply (M806 only). See [High-voltage power supply \(M806 only\) on page 182](#).
- Drum motor. See [Drum motor on page 195](#).
- DC controller (M806 only). See [DC controller \(M806 only\) on page 187](#).

Remove the drive assembly (M806 only)

1. Open the front door.



NOTE: Remove the toner cartridge if it has not been removed prior to servicing the product. See [Toner cartridge on page 5](#).

2. Press and hold the white button on the cartridge-release lever (callout 1) and rotate it up to about the halfway position (callout 2).

Figure 1-299 Remove the drive assembly (M806; 1 of 3)



3. Pinch two tabs (callout 1) together with needle-nose pliers to release the activation lever (callout 2). Remove 3 screws (callout 3).

Figure 1-300 Remove the drive assembly (M806; 2 of 3)

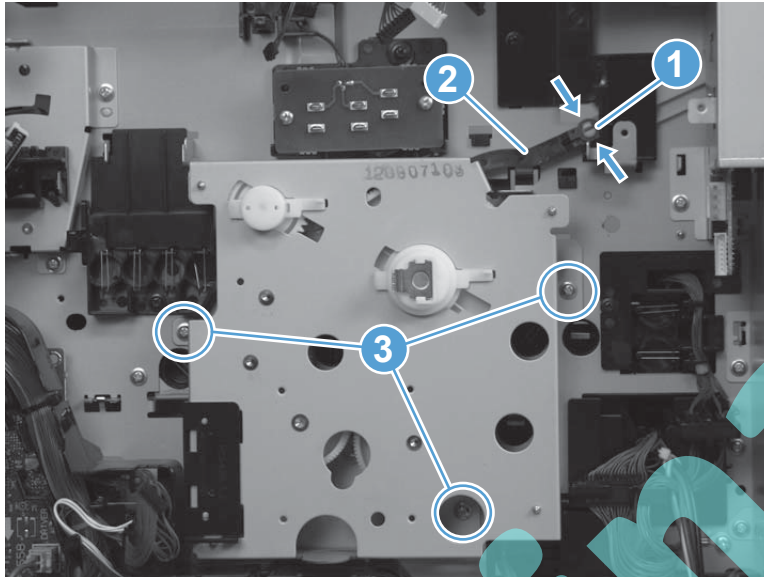

4. Rotate the drive assembly away from the product to remove it.

Figure 1-301 Remove the drive assembly (M806; 3 of 3)

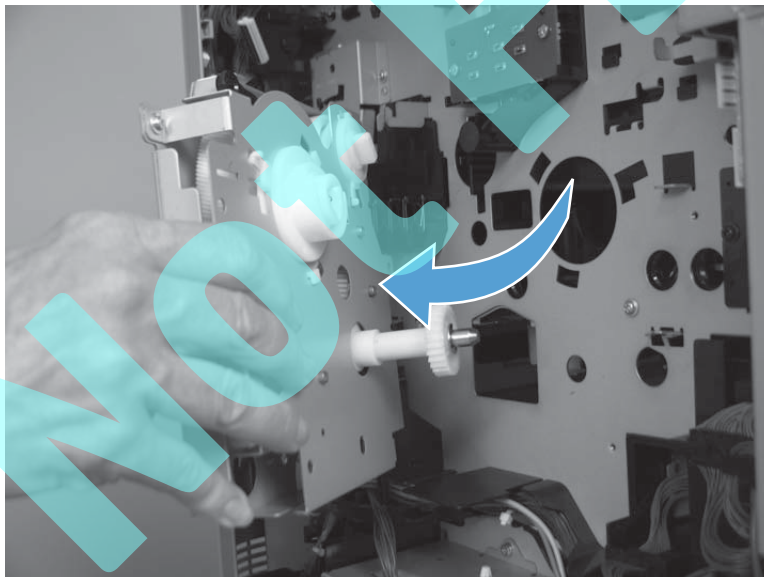

Reinstall the drive assembly (M806 only)

Align the gears on the drive assembly with the openings in the product.

Figure 1-302 Reinstall the drive assembly (M806; 1 of 2)

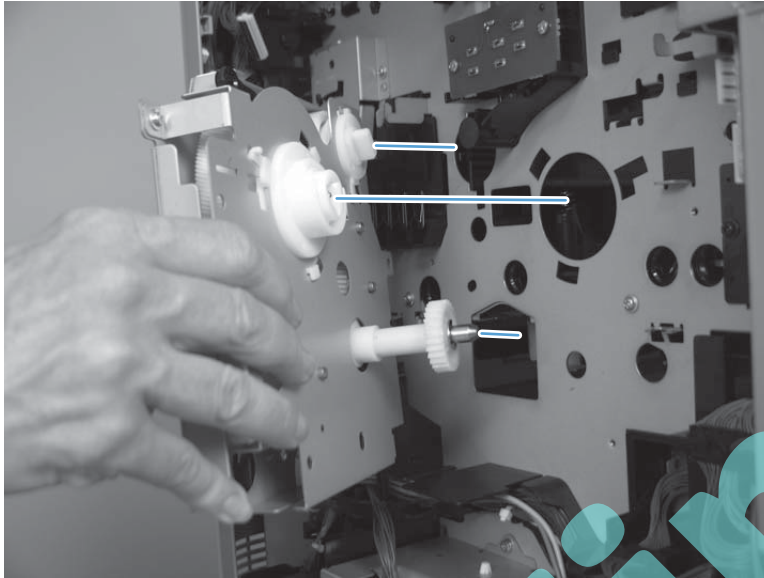

Make sure to reconnect the activation lever.

Figure 1-303 Reinstall the drive assembly (M806; 2 of 2)

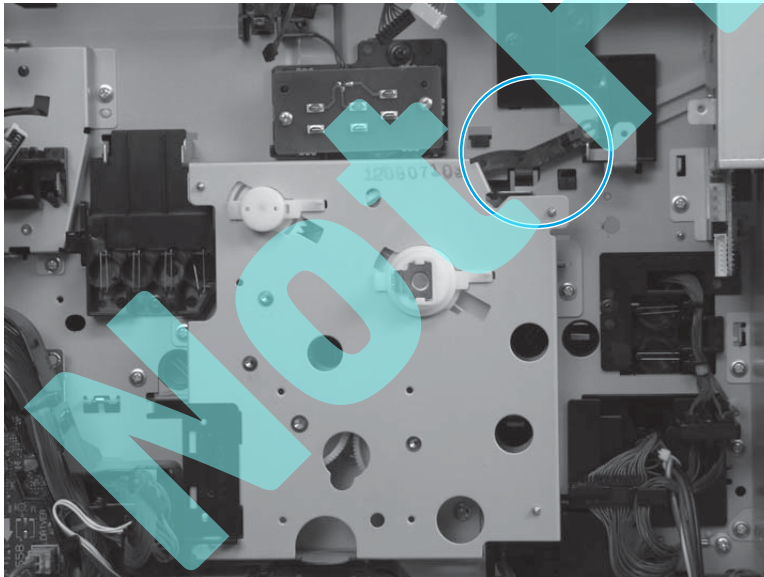

Drive assembly (M830 only)

Before proceeding, remove the following assemblies:

- Rear cover. See [Rear cover on page 110](#).
- High-voltage power supply (M830 only). See [High-voltage power supply \(M830 only\) on page 184](#).
- Drum motor. See [Drum motor on page 195](#).
- DC controller (M830 only). See [DC controller \(M830 only\) on page 190](#).

Remove the drive assembly (M830 only)

1. Open the front door.

 **NOTE:** Remove the toner cartridge if it has not been removed prior to servicing the product. See [Toner cartridge on page 5](#).

2. Press and hold the white button on the cartridge-release lever (callout 1) and rotate it up to about the halfway position (callout 2).

Figure 1-304 Remove the drive assembly (M830; 1 of 3)



3. Pinch two tabs (callout 1) together with needle-nose pliers to release the activation lever (callout 2). Remove 3 screws (callout 3).

Figure 1-305 Remove the drive assembly (M830; 2 of 3)

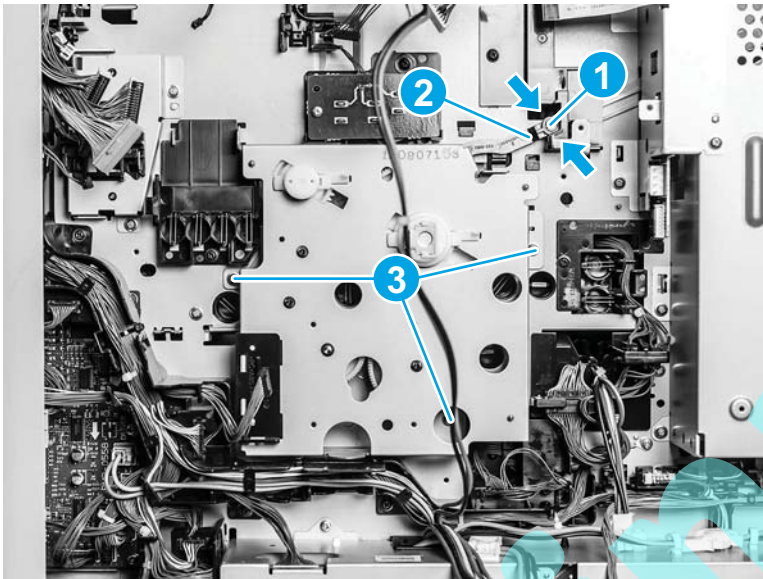

4. Rotate the drive assembly away from the product to remove it.

Figure 1-306 Remove the drive assembly (M830; 3 of 3)

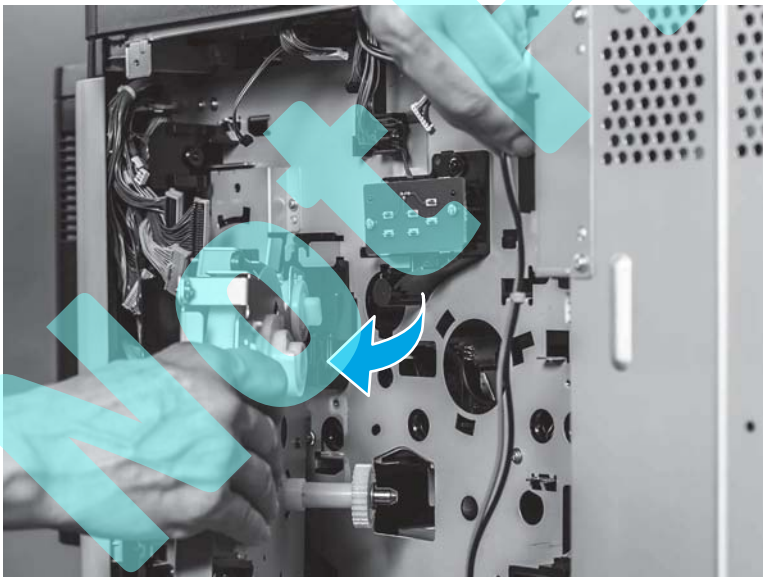

Reinstall the drive assembly (M830 only)

1. Hold the cable (callout 1) to one side. Align the gears on the drive assembly with the openings in the product.

Figure 1-307 Reinstall the drive assembly (M830; 1 of 2)

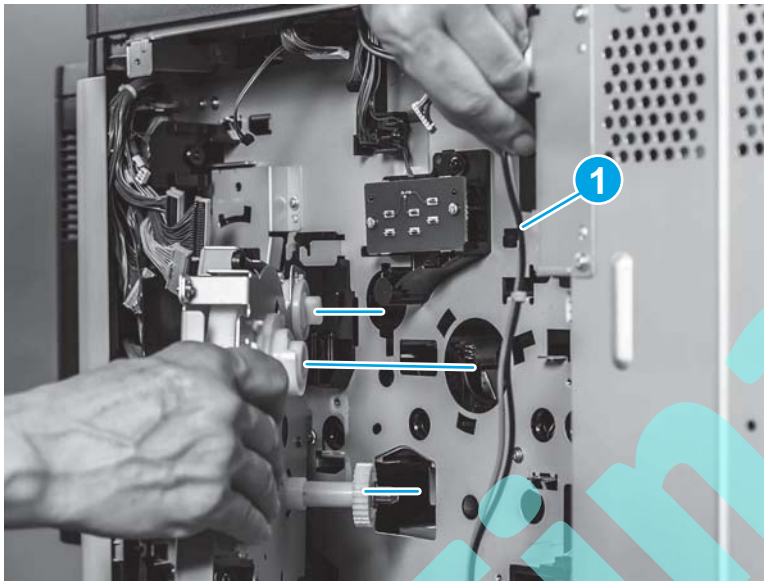

2. Make sure to reconnect the activation lever.

Figure 1-308 Reinstall the drive assembly (M830; 2 of 2)

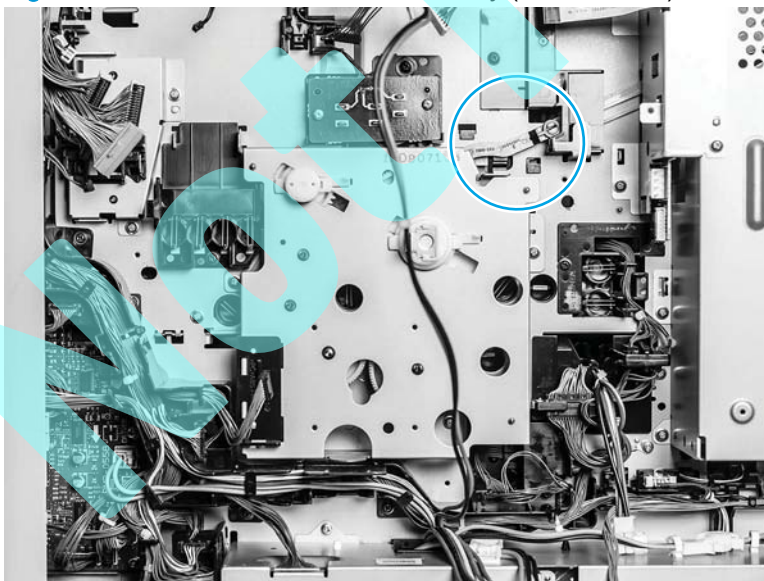

Transfer paper-feed assembly

Before proceeding, remove the following assemblies:

- Fuser. See [Fuser on page 10](#).
- Duplexer. See [Duplexer on page 9](#).

Remove the transfer paper-feed assembly

1. Open the left door.
2. Remove two screws (callout 1), and then release two tabs (callout 2).

Figure 1-309 Remove the transfer paper-feed assembly (1 of 2)

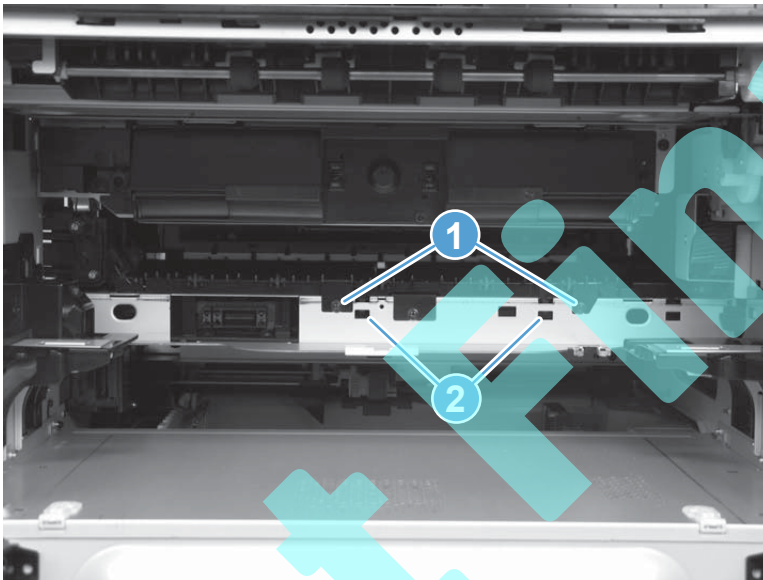

3. Slightly lift up the edge of the transfer paper-feed assembly (callout 1), and then lift and rotate it toward the left door (callout 2) to remove it.

Figure 1-310 Remove the transfer paper-feed assembly (2 of 2)

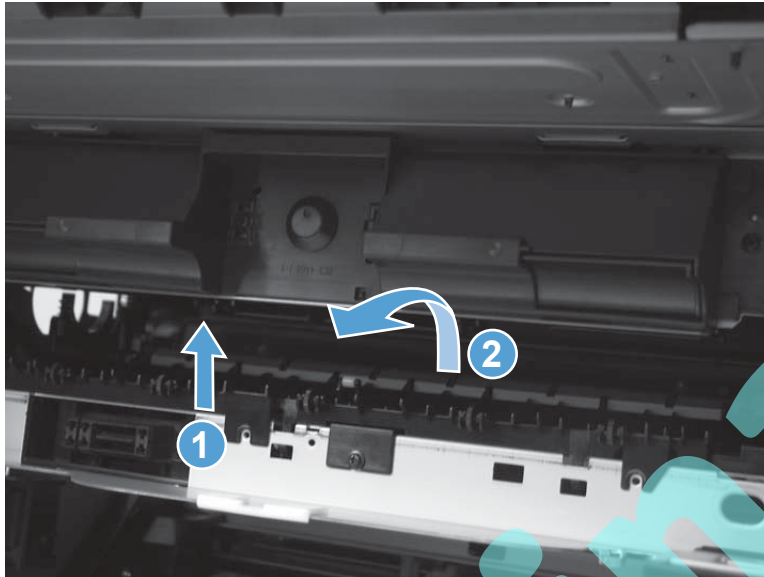

Reinstall the transfer paper-feed assembly

1. Position the tabs (callout 1) in the slots (callout 2) before sliding the transfer paper-feed assembly into the product.

Figure 1-311 Reinstall the transfer paper-feed assembly (1 of 2)

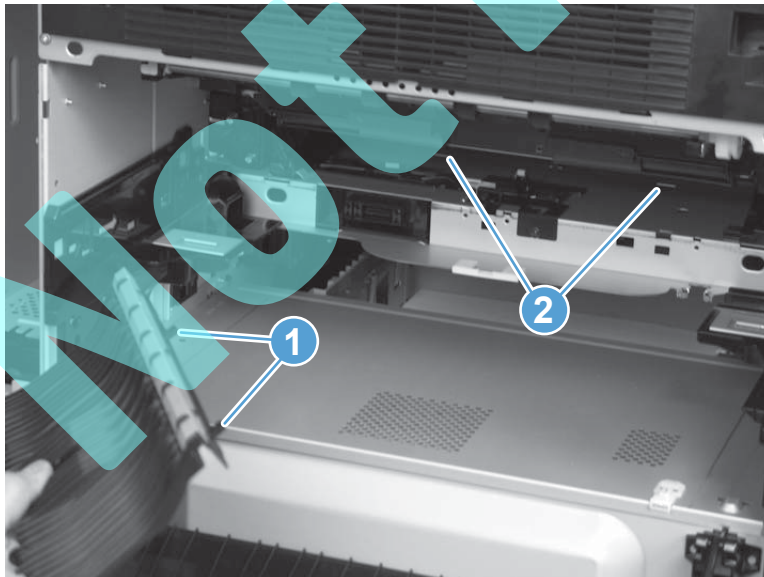

2. Hold the flag (callout 1) in the down position when reinstalling the transfer paper-feed assembly (callout 2).

Figure 1-312 Reinstall the transfer paper-feed assembly (2 of 2)

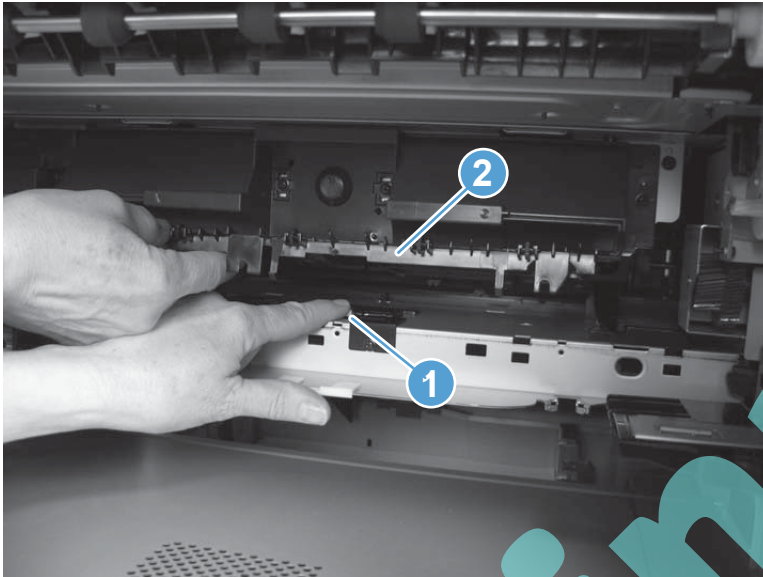

Transfer-holder assembly

Before proceeding, remove the following assemblies:

- Fuser. See [Fuser on page 10](#).
- Duplexer. See [Duplexer on page 9](#).
- Rear cover. See [Rear cover on page 110](#).
- Right rear cover. See [Right rear cover on page 113](#).
- Right door assembly. See [Right door assembly on page 118](#).
- Right lower front cover. See [Right lower front cover on page 126](#).
- Right lower cover. See [Right lower cover on page 128](#).
- Paper-pickup assembly. See [Paper-pickup assembly on page 167](#).
- Registration assembly. See [Registration assembly on page 171](#).
- Transfer paper-feed assembly. See [Transfer paper-feed assembly on page 202](#).
- Cooling unit assembly. See [Cooling-unit assembly on page 258](#).
- High-voltage power supply (M806 only). See [High-voltage power supply \(M806 only\) on page 182](#).
- High-voltage power supply (M830 only). See [High-voltage power supply \(M830 only\) on page 184](#).
- DC controller (M806 only). See [DC controller \(M806 only\) on page 187](#).
- DC controller (M830 only). See [DC controller \(M830 only\) on page 190](#).
- Drum motor. See [Drum motor on page 195](#).
- Drive assembly (M806 only). See [Drive assembly \(M806 only\) on page 196](#).
- Drive assembly (M830 only). See [Drive assembly \(M830 only\) on page 199](#).

Remove the transfer-holder assembly

1. Open the left door. Remove one screw (callout 1), and then release two tabs (callout 2).

 **TIP:** Use a Phillips-head screwdriver with a short shaft to remove this screw.

Figure 1-313 Remove the transfer-holder assembly (1 of 3)

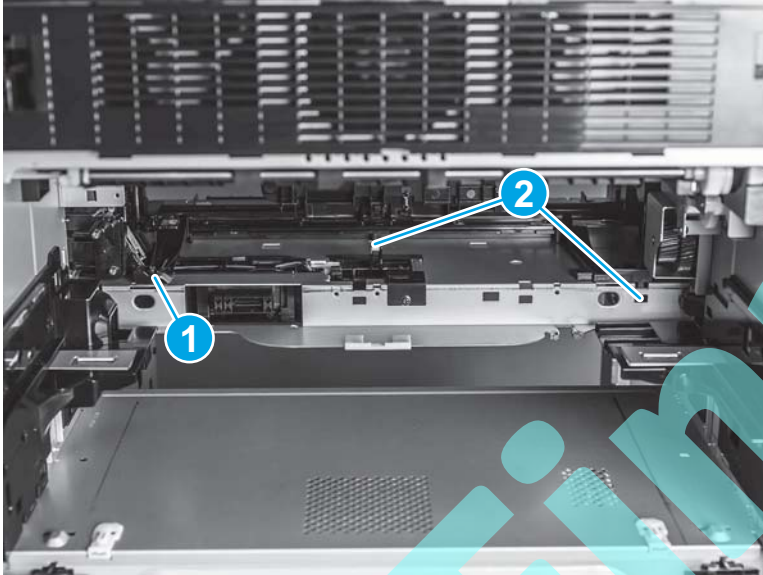

2. Lift up the front of the assembly (callout 1), slide the assembly slightly to the right to release it (callout 2), and then slide the assembly toward the left door (callout 3) to release three tabs.

Figure 1-314 Remove the transfer-holder assembly (2 of 3)



3. Lift the assembly up, and then slide it through the opening in the front of the product to remove it.

Figure 1-315 Remove the transfer-holder assembly (3 of 3)

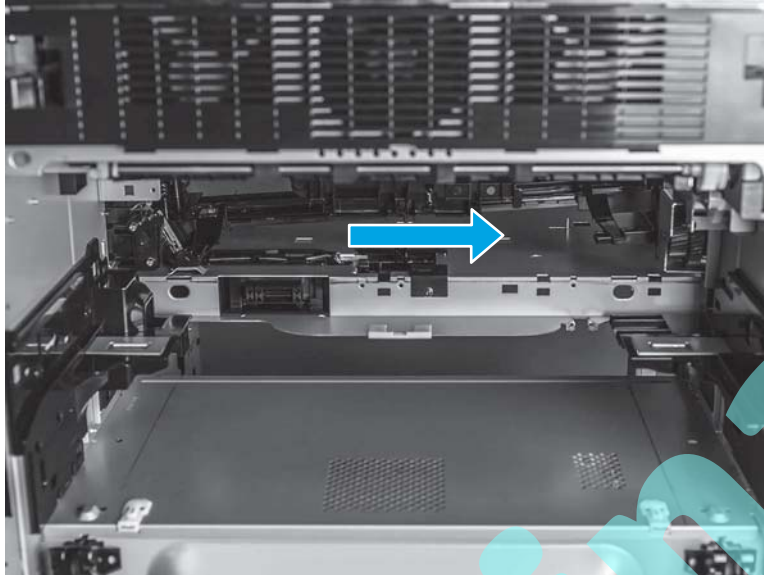

Reinstall the transfer-holder assembly

Position the locator pin (callout 1) in the slot in the product. Make sure that the three tabs (callout 2) are positioned in the slots (callout 3) in the product.

Figure 1-316 Reinstall the transfer-holder assembly

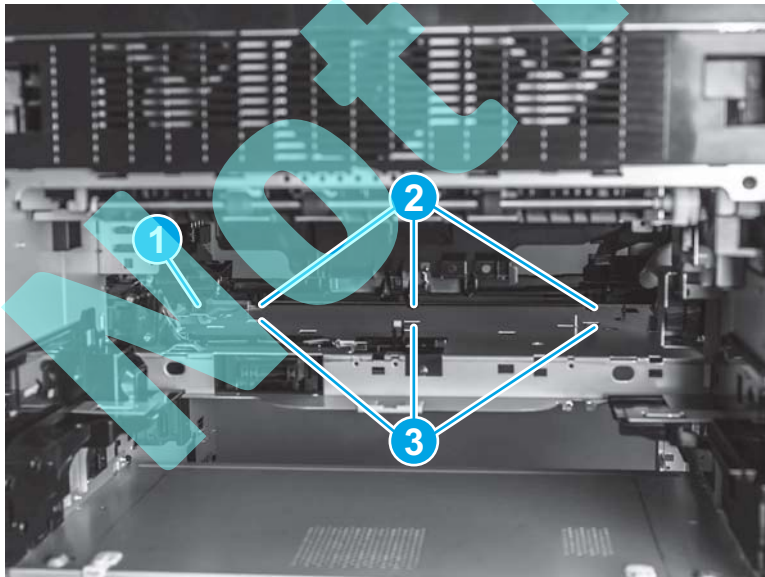

Cartridge-lifter assembly (M806 only)

Before proceeding, remove the following assemblies:

- Toner cartridge. See [Toner cartridge on page 5](#).
- Formatter. See [Formatter on page 12](#).
- Control-panel assembly (M806 only). See [Control-panel assembly \(M806 only\) on page 38](#).
- Hardware integration pocket (HIP) cover (M806 only). See [Hardware integration pocket \(HIP\) cover \(M806 only\) on page 88](#).
- Control-panel base cover (M806 only). See [Control-panel base cover \(M806 only\) on page 94](#).
- Right top cover (M806 only). See [Right top cover \(M806 only\) on page 98](#).
- Left top cover (M806 only). See [Left top cover \(M806 only\) on page 102](#).
- Cartridge-release lever. See [Cartridge-release lever on page 151](#).
- Rear cover. See [Rear cover on page 110](#).

Remove the cartridge-lifter assembly (M806 only)

1. Disconnect one connector on the front of the product.

Figure 1-317 Remove the cartridge-lifter assembly (M806; 1 of 11)

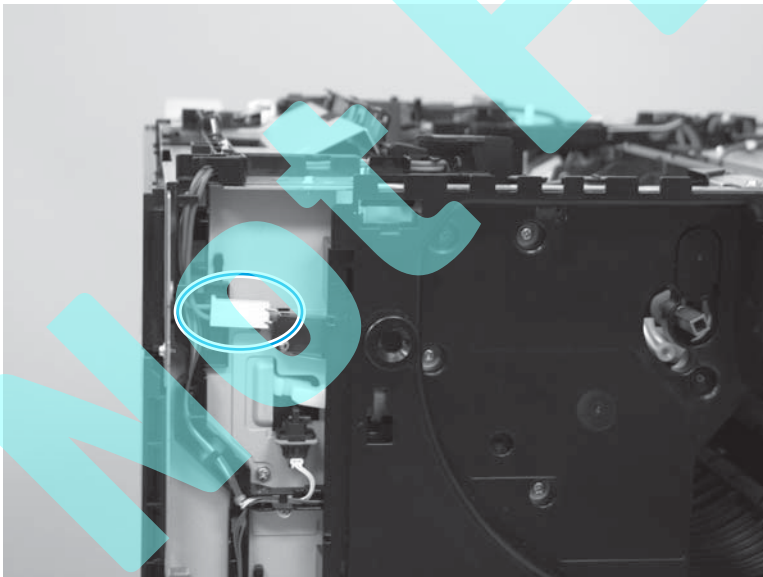

2. Disconnect three connectors on the top of the product.

Figure 1-318 Remove the cartridge-lifter assembly (M806; 2 of 11)

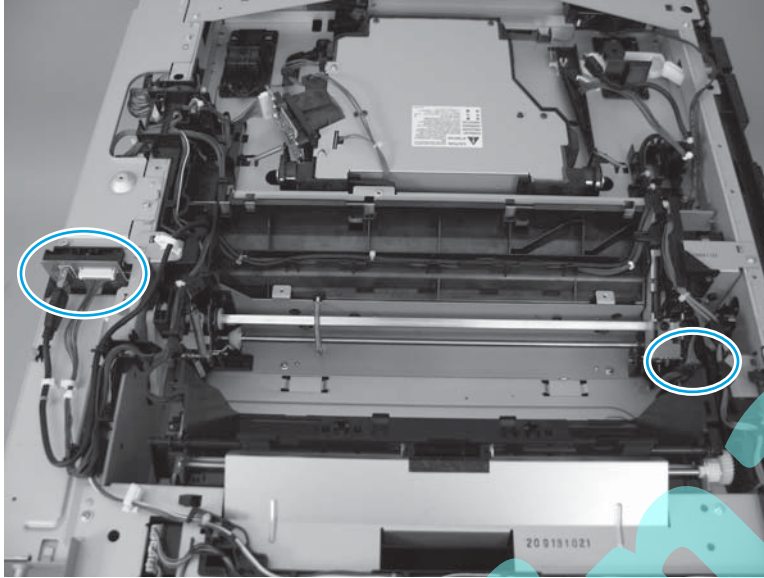

3. Disconnect two connectors on the back of the product.

Figure 1-319 Remove the cartridge-lifter assembly (M806; 3 of 11)

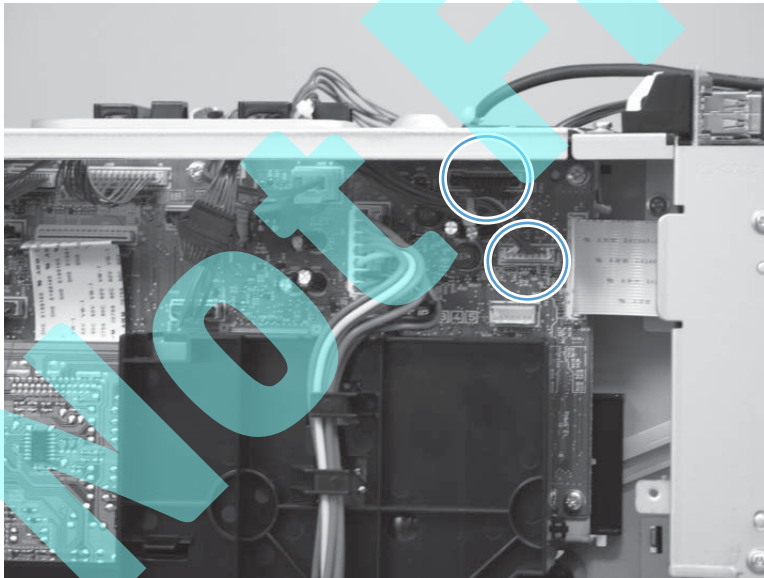

4. Remove the wire harnesses and cables from three retainers (callout 1), and then remove the wire harnesses and cables from the guides (callout 2).

Figure 1-320 Remove the cartridge-lifter assembly (M806; 4 of 11)

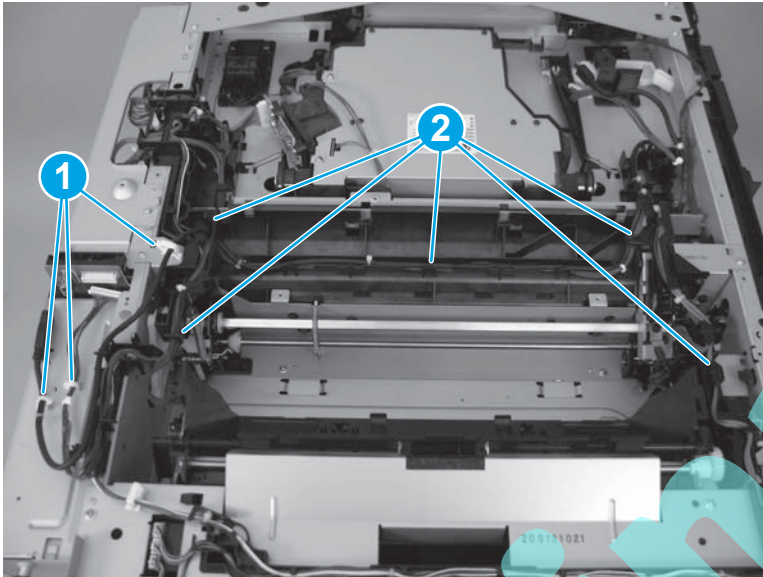

5. Use a small, flat-blade screwdriver to release two tabs on the small, black plastic cover on the front of the product.

Figure 1-321 Remove the cartridge-lifter assembly (M806; 5 of 11)

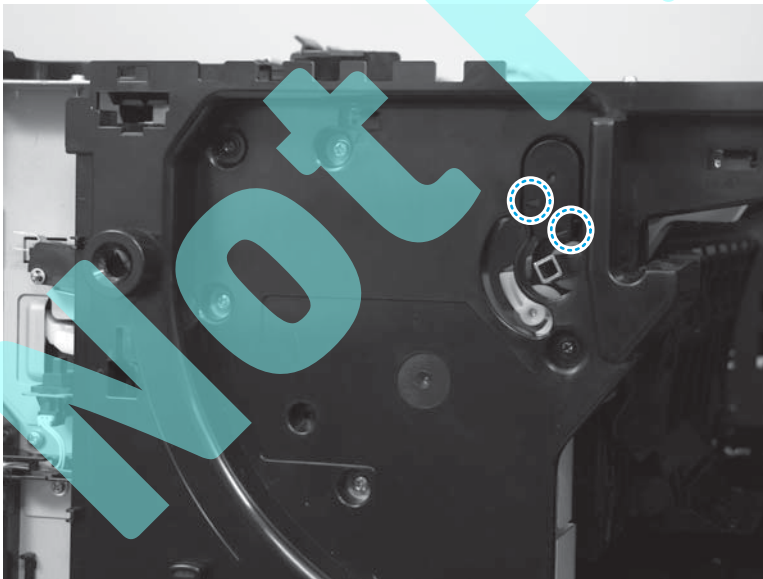

6. Remove the cover.

 **Reinstallation tip** Position the tab on the top of the cover in place on the product before snapping the two tabs into place.

Figure 1-322 Remove the cartridge-lifter assembly (M806; 6 of 11)



7. Remove four screws.

Figure 1-323 Remove the cartridge-lifter assembly (M806; 7 of 11)

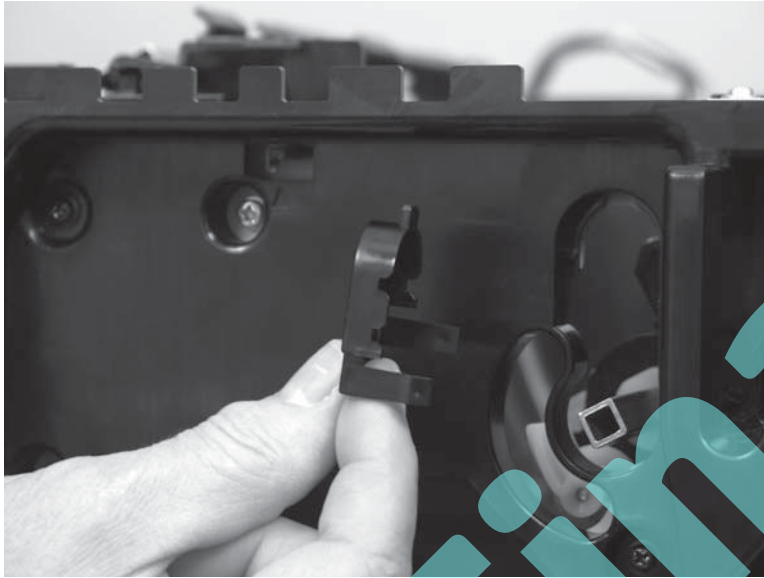
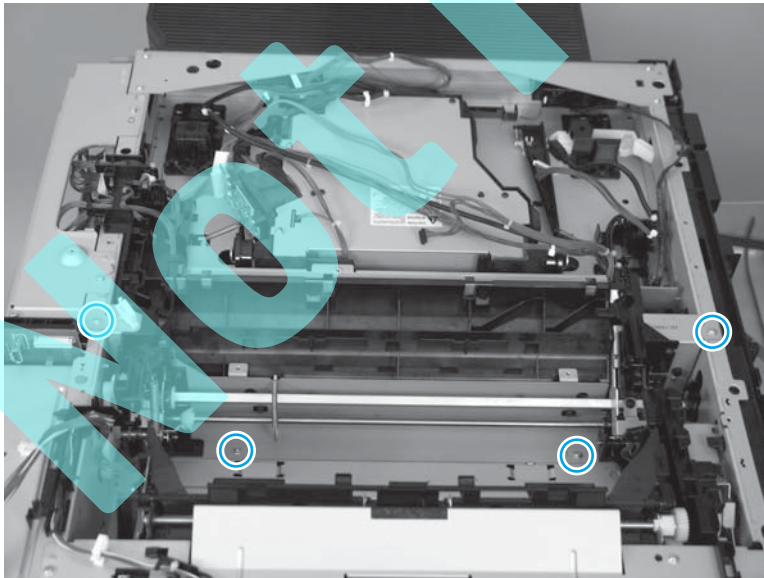

8. Note the location of one plastic arm inside the formatter case.

Figure 1-324 Remove the cartridge-lifter assembly (M806; 8 of 11)

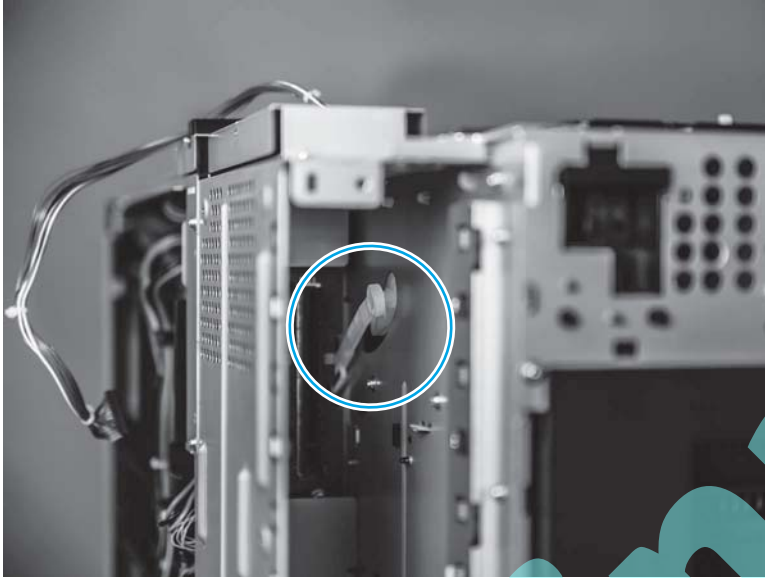

9. Release two tabs, and then disconnect the plastic arm.

Figure 1-325 Remove the cartridge-lifter assembly (M806; 9 of 11)



10. Lift the cartridge-lifter assembly up (callout 1), and then rotate it toward the right door (callout 2).

Figure 1-326 Remove the cartridge-lifter assembly (M806; 10 of 11)

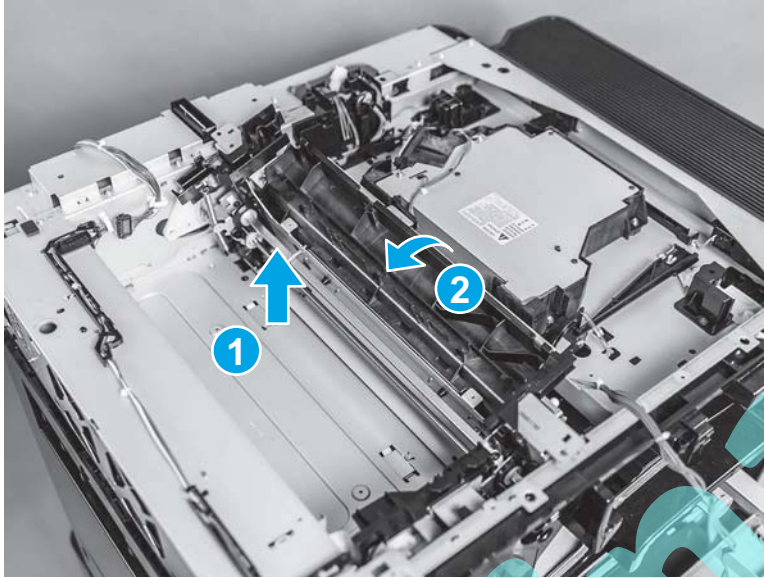

11. Slide the cartridge-lifter assembly toward the back of the product to remove it.

Figure 1-327 Remove the cartridge-lifter assembly (M806; 11 of 11)

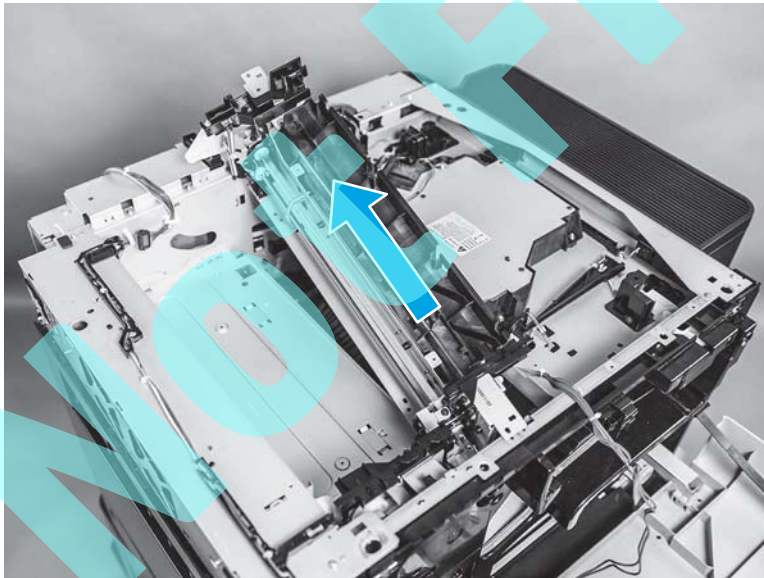

Reinstall the cartridge-lifter assembly (M806 only)

1. If the white, plastic fitting on the left end of the assembly becomes dislodged, make sure that it is repositioned correctly.

Figure 1-328 Reinstall the cartridge-lifter assembly (M806; 1 of 6)

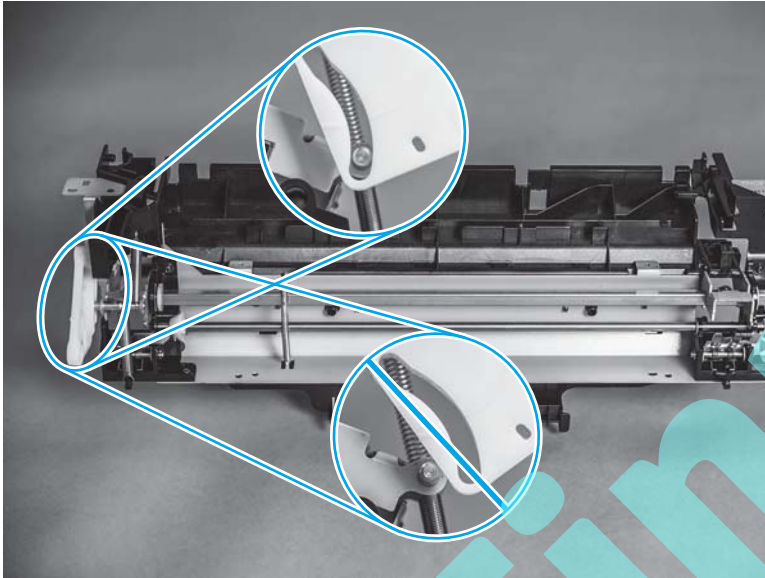

2. If the white, plastic fitting on the right end of the assembly becomes dislodged, make sure that it is repositioned correctly.

Figure 1-329 Reinstall the cartridge-lifter assembly (M806; 2 of 6)

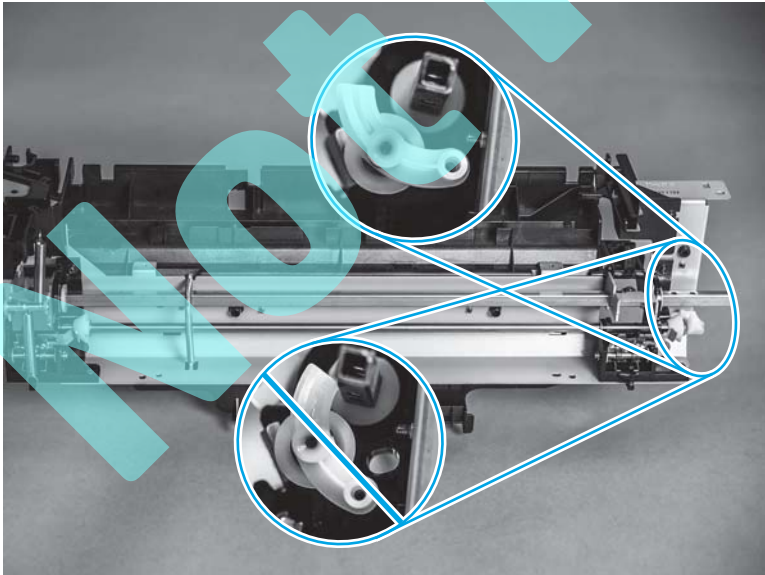

3. Make sure that the spring-loaded flap on the bottom of the assembly is positioned as shown below before reinstalling the cartridge-lifter assembly.

Figure 1-330 Reinstall the cartridge-lifter assembly (M806; 3 of 6)

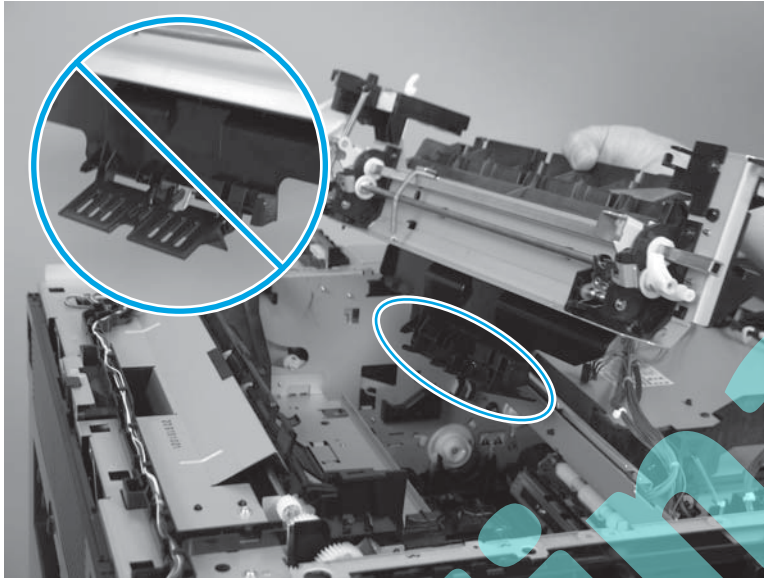

4. When the assembly is reinstalled, look inside the cartridge cavity to make sure that the spring-loaded flap is in the correct position.

Figure 1-331 Reinstall the cartridge-lifter assembly (M806; 4 of 6)

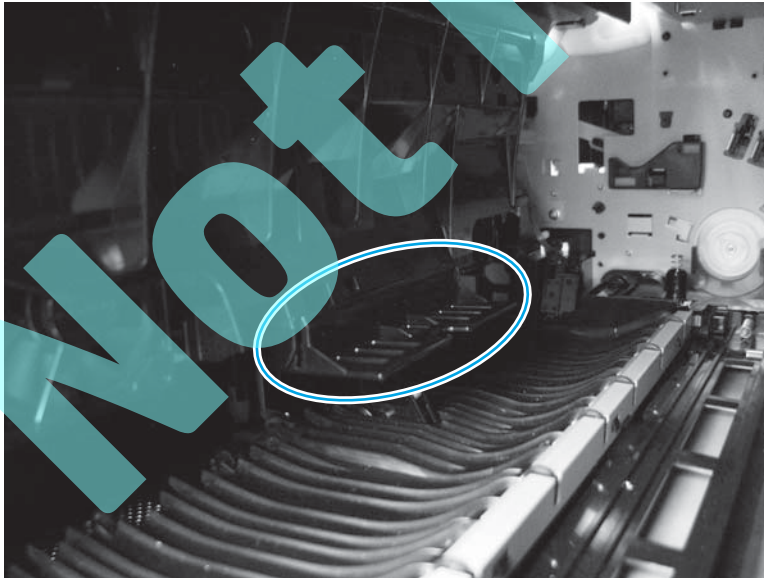

5. Make sure to reconnect the plastic arm by pressing the tabs into the white plastic fitting on the left side of the cartridge-lifter assembly.

Figure 1-332 Reinstall the cartridge-lifter assembly (M806; 5 of 6)

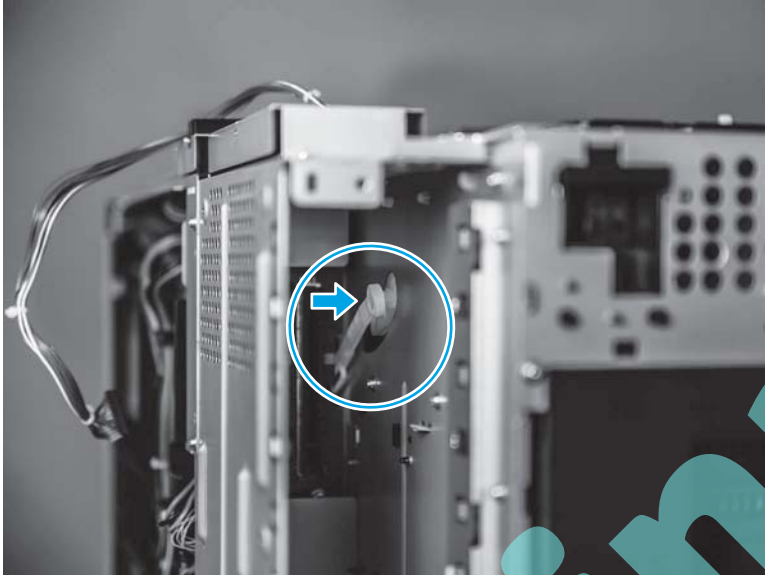

Figure 1-333 Reinstall the cartridge-lifter assembly (M806; 6 of 6)



Cartridge-lifter assembly (M830 only)

Before proceeding, remove the following assemblies:

- Toner cartridge. See [Toner cartridge on page 5](#).
- Formatter. See [Formatter on page 12](#).
- Left front cover (M830 only). See [Left front cover on page 121](#).
- Upper left cover (M830 only). See [Upper left cover \(M830 only\) on page 124](#).
- Scanner back cover (M830 only). See [Scanner back cover \(M830 only\) on page 75](#).
- Document feeder assembly (M830 only). See [Document feeder assembly \(M830 only\) on page 141](#).
- Scanner control board (SCB) (M830 only). See [Scanner control board \(SCB\) \(M830 only\) on page 135](#).
- Scanner assembly (M830 only). See [Scanner assembly \(M830 only\) on page 146](#).
- Cartridge-release lever. See [Cartridge-release lever on page 151](#).
- Rear cover. See [Rear cover on page 110](#).

Remove the cartridge-lifter assembly (M830 only)

1. Remove three screws.

 **NOTE:** Look down at the top of the product to locate these screws.

Figure 1-334 Remove the cartridge-lifter assembly (M830; 1 of 14)



2. Slightly lift the sheet metal plate, squeeze two tabs to release one connector, and then remove the sheet metal plate.

Figure 1-335 Remove the cartridge-lifter assembly (M830; 2 of 14)

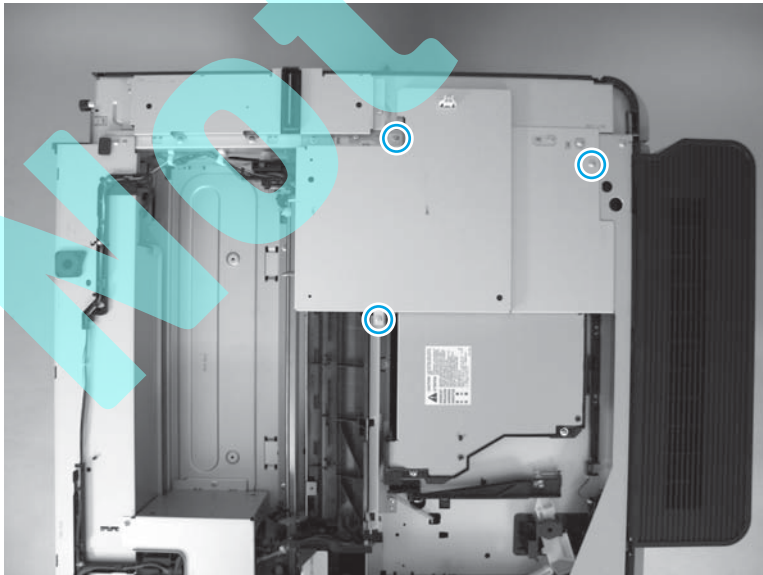
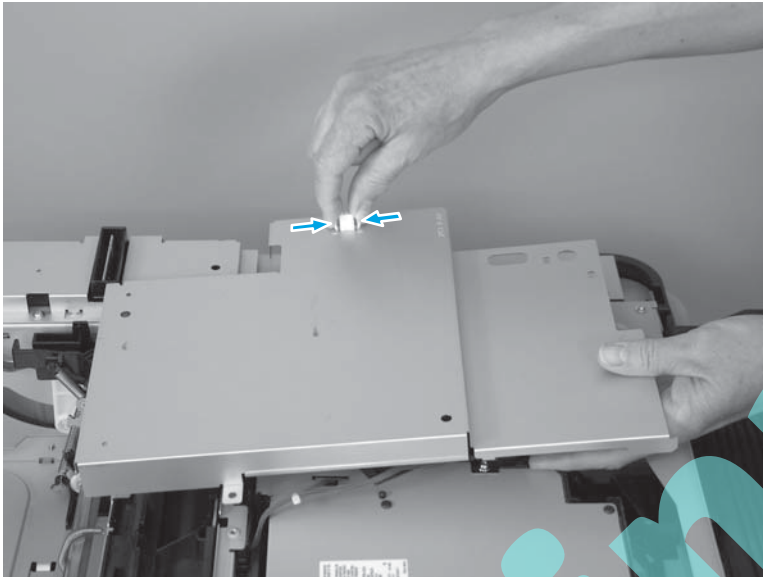

3. Remove three screws.



NOTE: Look down at the top of the product to locate these screws.

Figure 1-336 Remove the cartridge-lifter assembly (M830; 3 of 14)

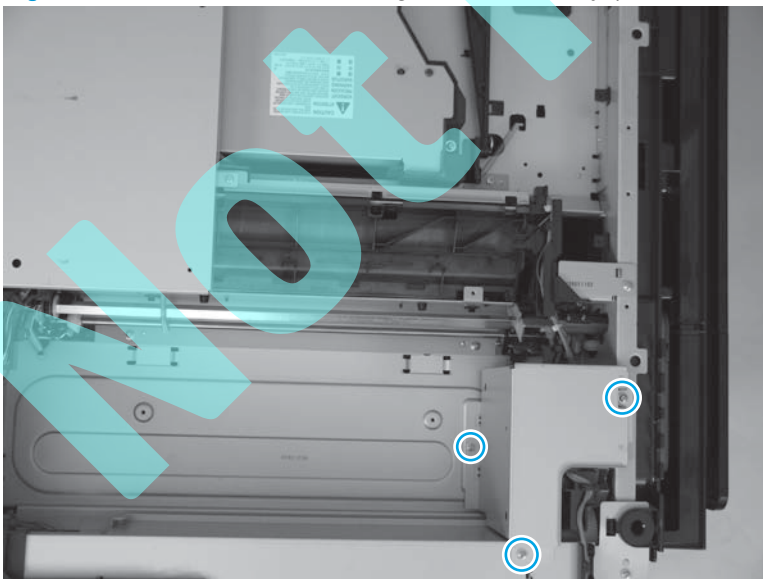

4. Remove the metal cover.

Figure 1-337 Remove the cartridge-lifter assembly (M830; 4 of 14)

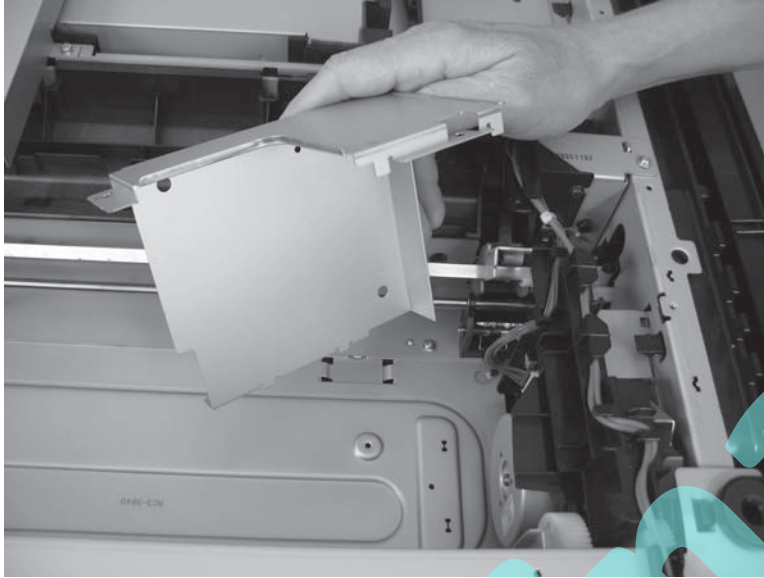

5. Disconnect one connector on the front of the product.

Figure 1-338 Remove the cartridge-lifter assembly (M830; 5 of 14)

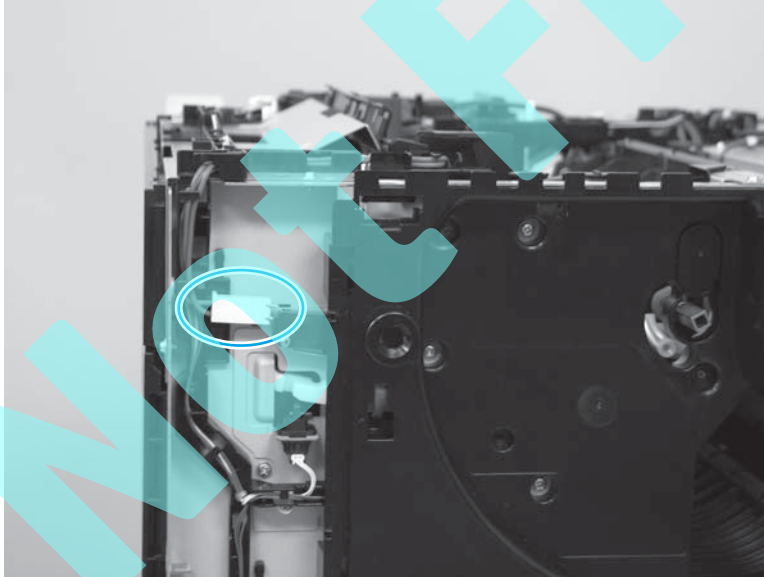

6. Disconnect one connector (callout 1), and then remove three screws (callout 2).

Figure 1-339 Remove the cartridge-lifter assembly (M830; 6 of 14)

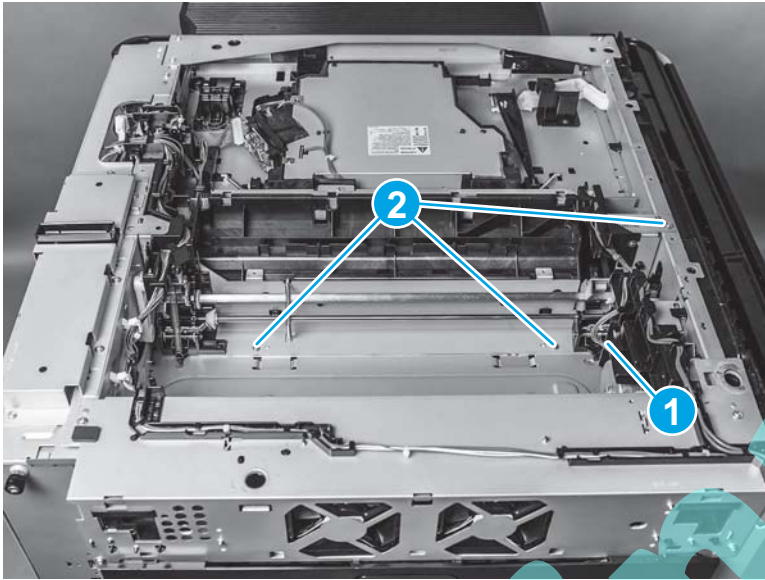

7. Disconnect two connectors on the back of the product.

Figure 1-340 Remove the cartridge-lifter assembly (M830; 7 of 14)



8. Remove the wire harnesses and cables from the guides.

Figure 1-341 Remove the cartridge-lifter assembly (M830; 8 of 14)

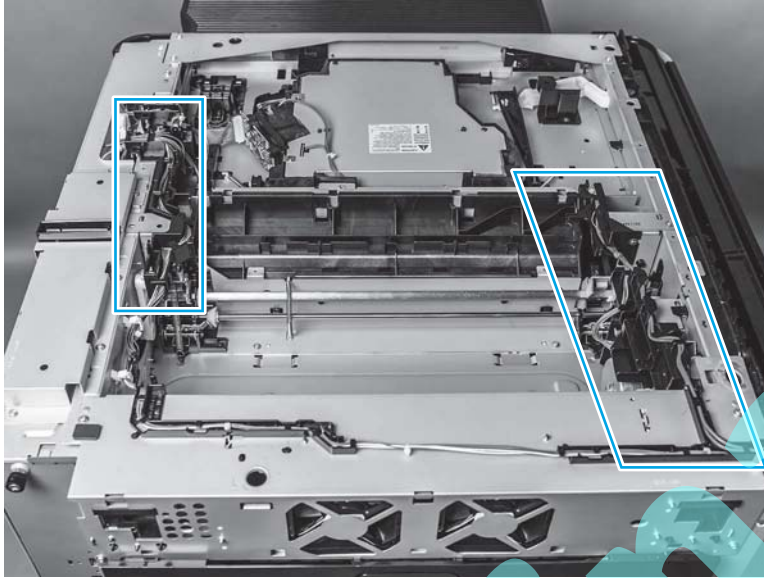

9. Use a small, flat-blade screwdriver to release two tabs on the small, black plastic cover on the front of the product.

Figure 1-342 Remove the cartridge-lifter assembly (M830; 9 of 14)

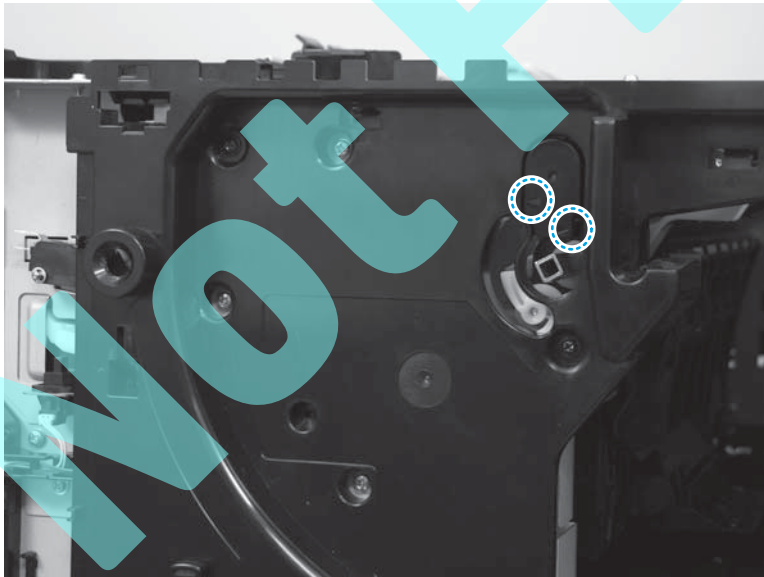

10. Remove the cover.

 **Reinstallation tip** Position the tab on the top of the cover in place on the product before snapping the two tabs into place.

Figure 1-343 Remove the cartridge-lifter assembly (M830; 10 of 14)



11. Note the location of one plastic arm inside the formatter case.

Figure 1-344 Remove the cartridge-lifter assembly (M830; 11 of 14)

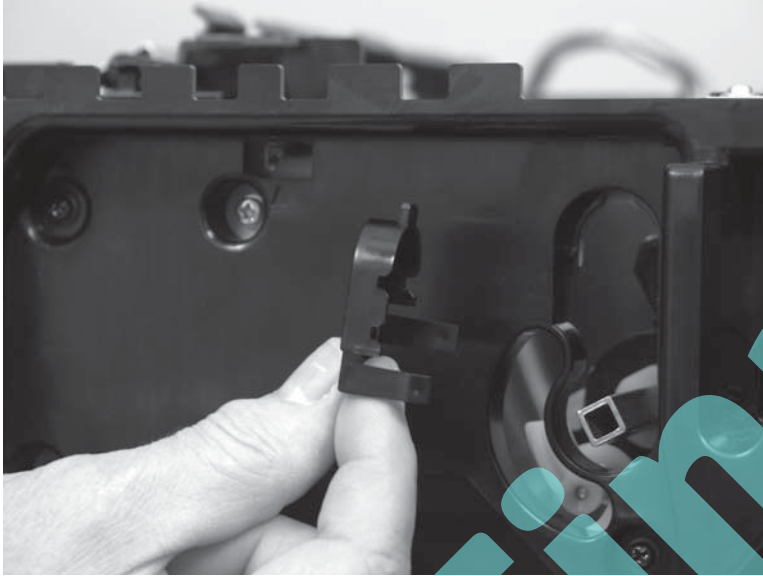

12. Release two tabs, and then disconnect the plastic arm.

Figure 1-345 Remove the cartridge-lifter assembly (M830; 12 of 14)



13. Lift the cartridge-lifter assembly up (callout 1), and then rotate it toward the right door (callout 2).

Figure 1-346 Remove the cartridge-lifter assembly (M830; 13 of 14)

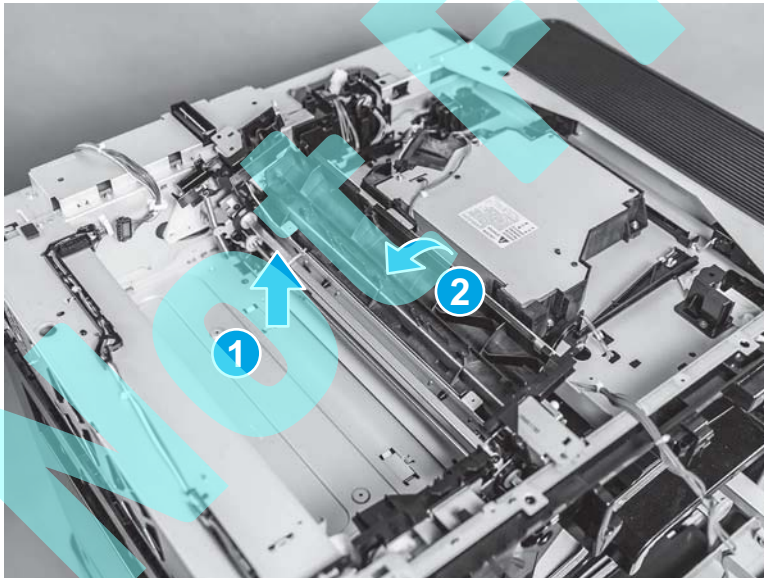

14. Slide the cartridge-lifter assembly toward the back of the product to remove it.

Figure 1-347 Remove the cartridge-lifter assembly (M830; 14 of 14)

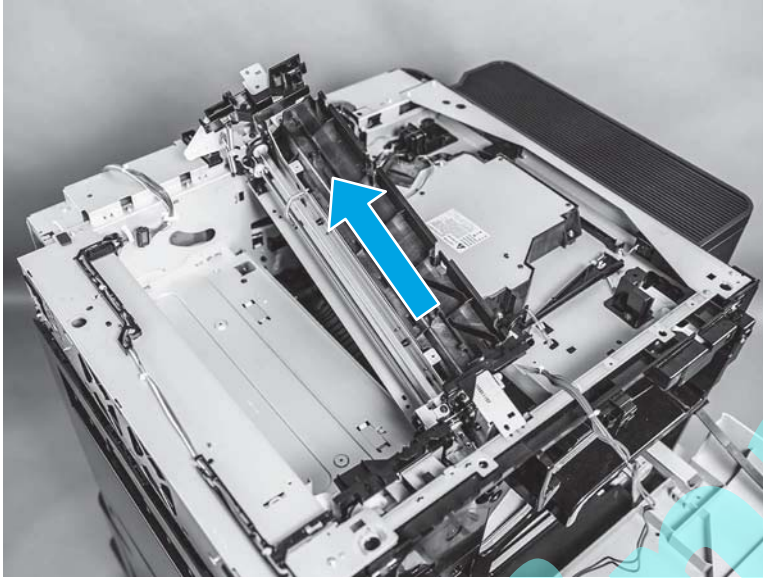

Reinstall the cartridge-lifter assembly (M830 only)

1. If the white, plastic fitting on the left end of the assembly becomes dislodged, make sure that it is repositioned correctly.

Figure 1-348 Reinstall the cartridge-lifter assembly (M806; 1 of 6)

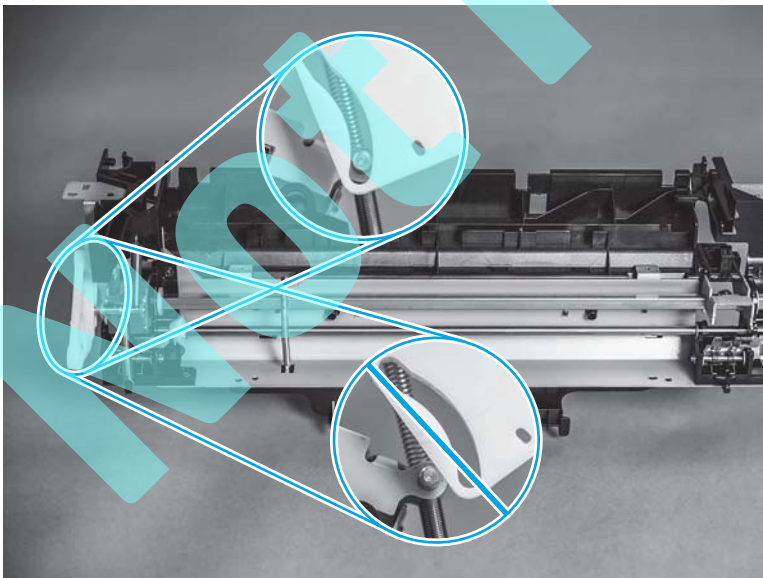

2. If the white, plastic fitting on the right end of the assembly becomes dislodged, make sure that it is repositioned correctly.

Figure 1-349 Reinstall the cartridge-lifter assembly (M806; 2 of 6)

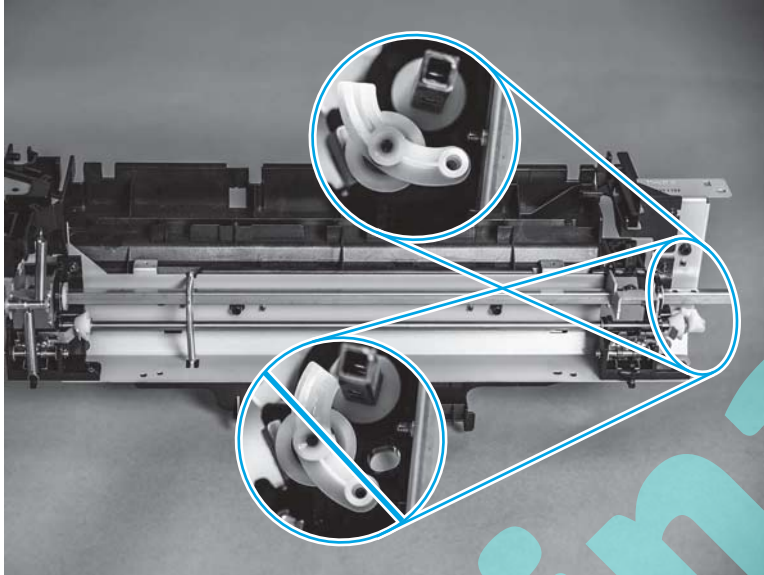

3. Make sure that the spring-loaded flap on the bottom of the assembly is positioned as shown below before reinstalling the cartridge-lifter assembly.

Figure 1-350 Reinstall the cartridge-lifter assembly (M806; 3 of 6)

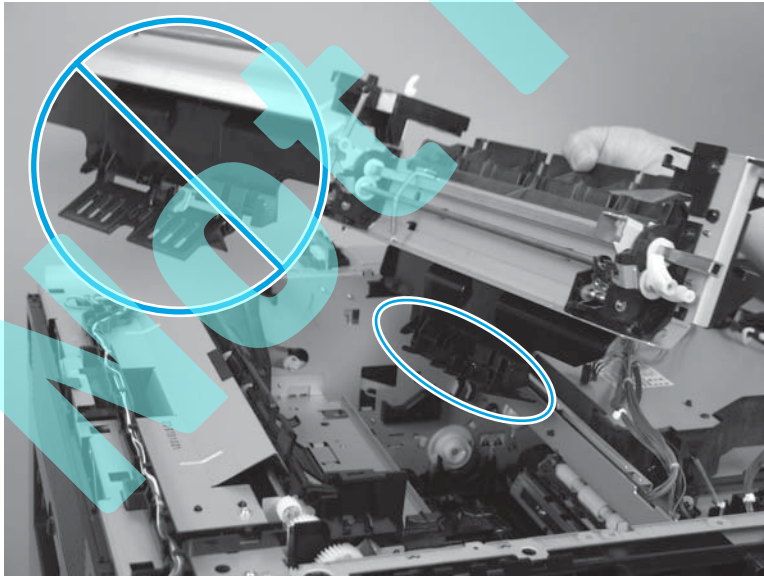

4. When the assembly is reinstalled, look inside the cartridge cavity to make sure that the spring-loaded flap is in the correct position.

Figure 1-351 Reinstall the cartridge-lifter assembly (M806; 4 of 6)

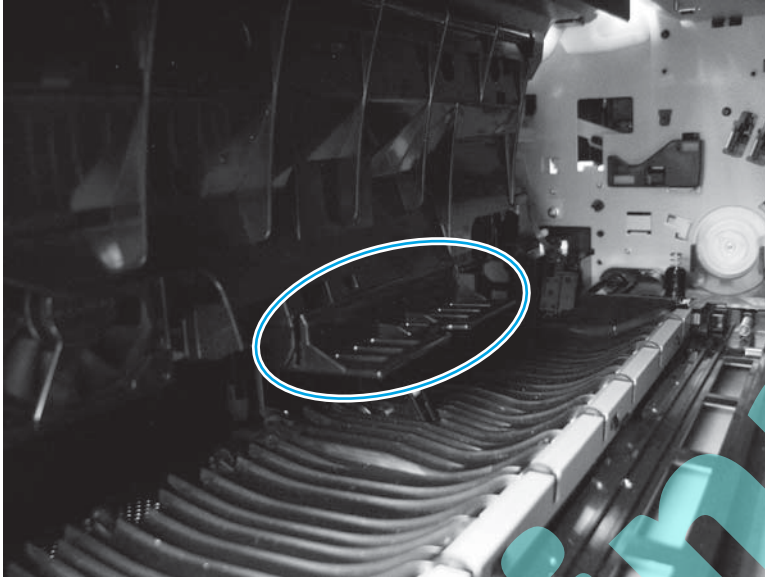

5. Make sure to reconnect the plastic arm by pressing the tabs into the white plastic fitting on the left side of the cartridge-lifter assembly.

Figure 1-352 Reinstall the cartridge-lifter assembly (M806; 5 of 6)

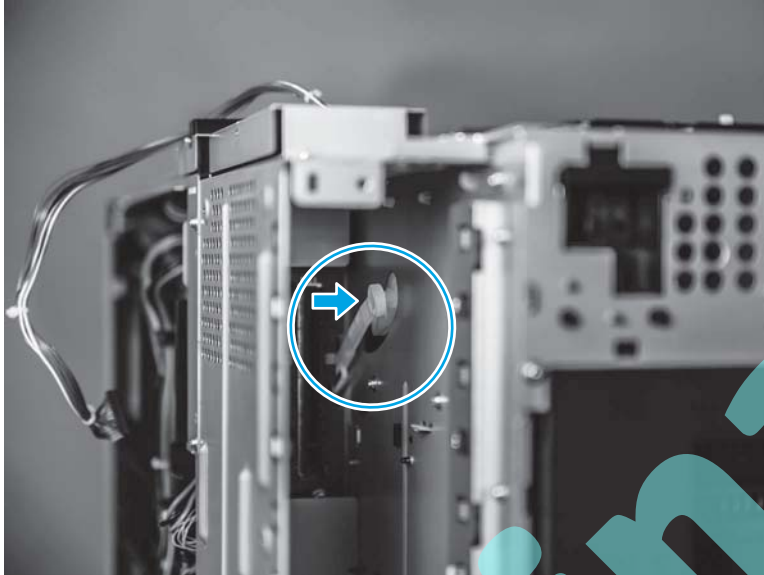

Figure 1-353 Reinstall the cartridge-lifter assembly (M806; 6 of 6)



Driver PCA

Before proceeding, remove the following assemblies:

- Rear cover. See [Rear cover on page 110](#).
- Right rear cover. See [Right rear cover on page 113](#).

Remove the driver PCA

 **CAUTION:**  ESD sensitive assembly.

1. Disconnect seven connectors (callout 1) on the driver PCA.

Figure 1-354 Remove the driver PCA (1 of 2)

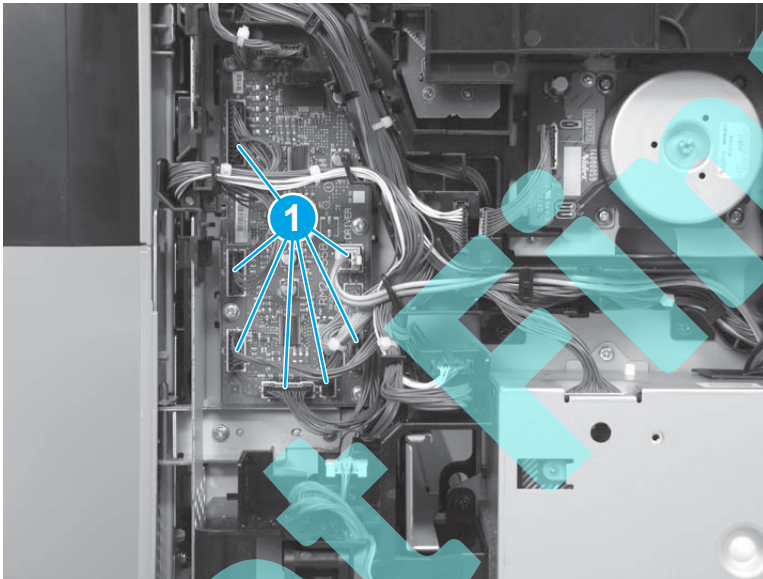

2. Remove four screws, and then remove the driver PCA.

Figure 1-355 Remove the driver PCA (2 of 2)

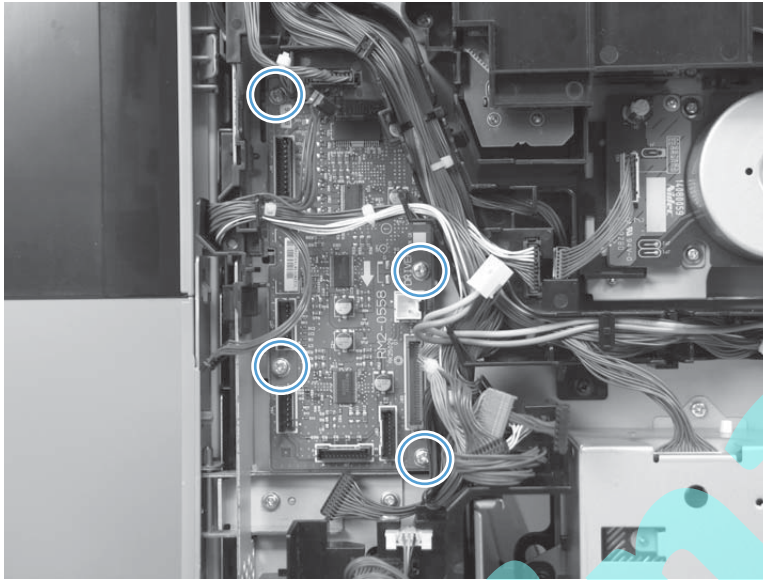

Reinstall the driver PCA

1. Position the hole in the driver PCA (callout 1) on the locator pin on the product (callout 2).

Figure 1-356 Reinstall the driver PCA (1 of 2)

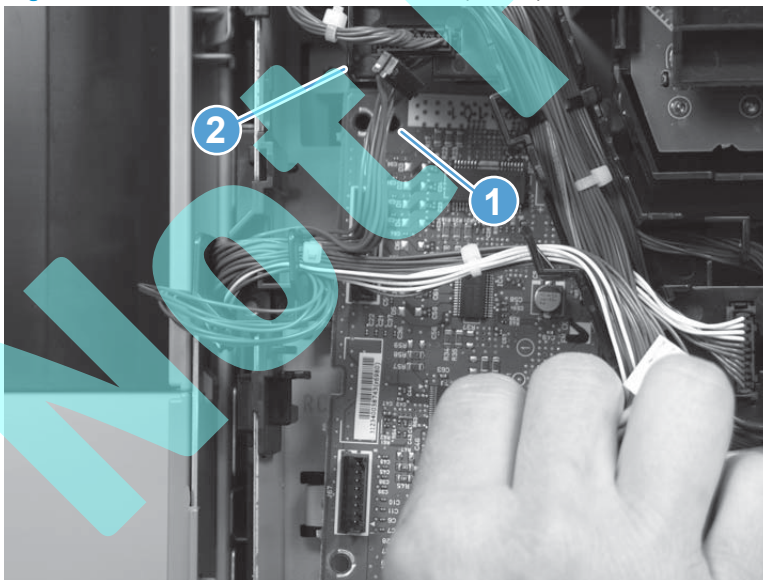

2. Position the notch in the driver PCA on the locator pin on the product.

Figure 1-357 Reinstall the driver PCA (2 of 2)

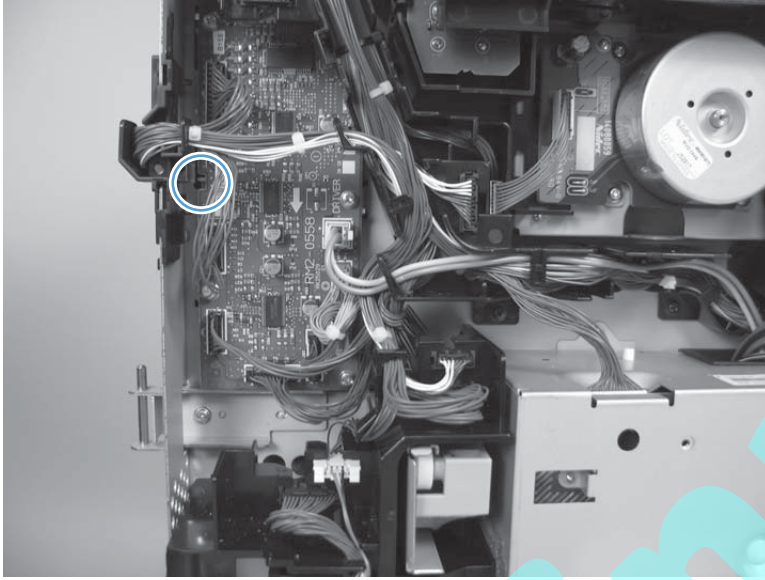

Laser/scanner assembly

Before proceeding, remove the following assemblies:

- Control-panel assembly (M806 only). See [Control-panel assembly \(M806 only\) on page 38](#).
- Hardware integration pocket (HIP) cover (M806 only). See [Hardware integration pocket \(HIP\) cover \(M806 only\) on page 88](#).
- Control-panel base cover (M806 only). See [Control-panel base cover \(M806 only\) on page 94](#).
- Right top cover (M806 only). See [Right top cover \(M806 only\) on page 98](#).
- Left front cover (M830 only). See [Left front cover on page 121](#).
- Upper left cover (M830 only). See [Upper left cover \(M830 only\) on page 124](#).
- Scanner back cover (M830 only). See [Scanner back cover \(M830 only\) on page 75](#).
- Document feeder assembly (M830 only). See [Document feeder assembly \(M830 only\) on page 141](#).
- Scanner control board (SCB) (M830 only). See [Scanner control board \(SCB\) \(M830 only\) on page 135](#).
- Scanner assembly (M830 only). See [Scanner assembly \(M830 only\) on page 146](#).

Remove the laser/scanner assembly

1. **M830 only:** Remove three screws.

Figure 1-358 Remove the laser/scanner assembly (1 of 4)



2. **M830 only:** Slightly lift the sheet metal plate, squeeze two tabs to release one connector, and then remove the sheet metal plate.

Figure 1-359 Remove the laser/scanner assembly (2 of 4)



3. Disconnect three connectors.

 **NOTE:** Look down at the top of the product to locate the laser/scanner assembly.

Figure 1-360 Remove the laser/scanner assembly (3 of 4)

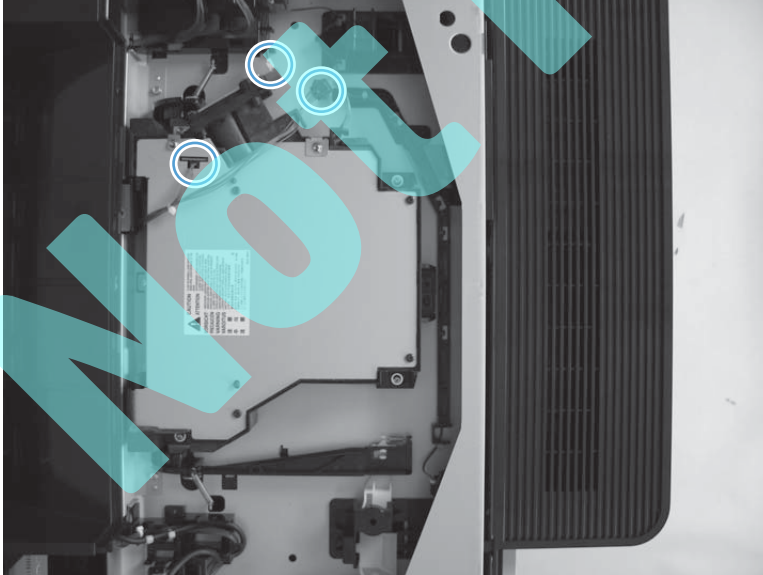

4. Remove four long screws, and then lift the laser/scanner assembly out of the product.

Figure 1-361 Remove the laser/scanner assembly (4 of 4)

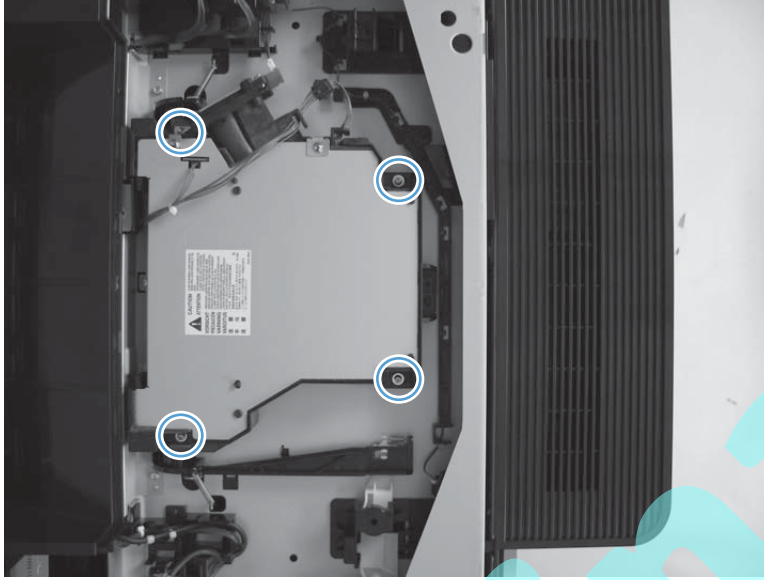

Not Final

Face-down paper-delivery assembly (M806 only)

Before proceeding, remove the following assemblies:

- Control-panel assembly (M806 only). See [Control-panel assembly \(M806 only\) on page 38](#).
- Hardware integration pocket (HIP) cover (M806 only). See [Hardware integration pocket \(HIP\) cover \(M806 only\) on page 88](#).
- Control-panel base cover (M806 only). See [Control-panel base cover \(M806 only\) on page 94](#).
- Right top cover (M806 only). See [Right top cover \(M806 only\) on page 98](#).
- Left top cover. See [Left top cover \(M806 only\) on page 102](#).
- Left front cover. See [Left front cover on page 121](#).
- Upper left cover (M806 only). See [Upper left cover \(M806 only\) on page 122](#).
- Left rear cover. See [Left rear cover on page 109](#).

Remove the face-down paper-delivery assembly (M806 only)

1. Disconnect one connector (callout 1), and then remove four screws (callout 2).

Figure 1-362 Remove the face-down paper-delivery assembly (M806; 1 of 4)

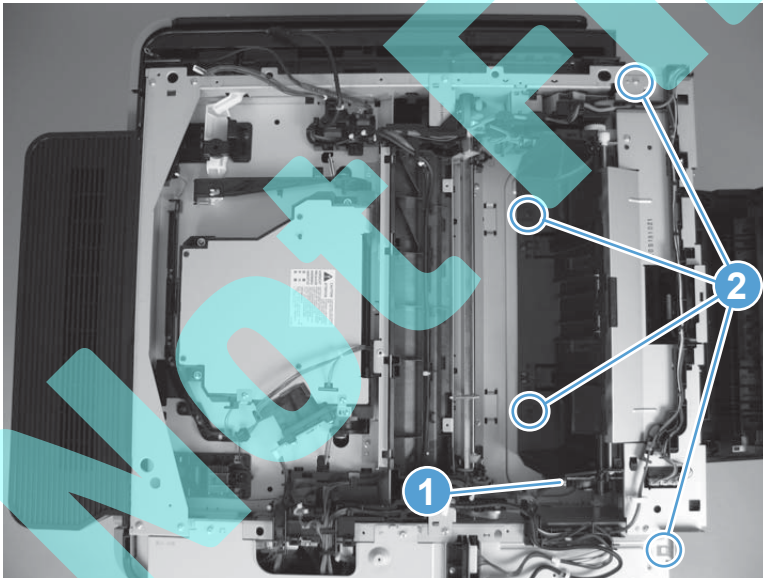

2. Remove two screws.

Figure 1-363 Remove the face-down paper-delivery assembly (M806; 2 of 4)

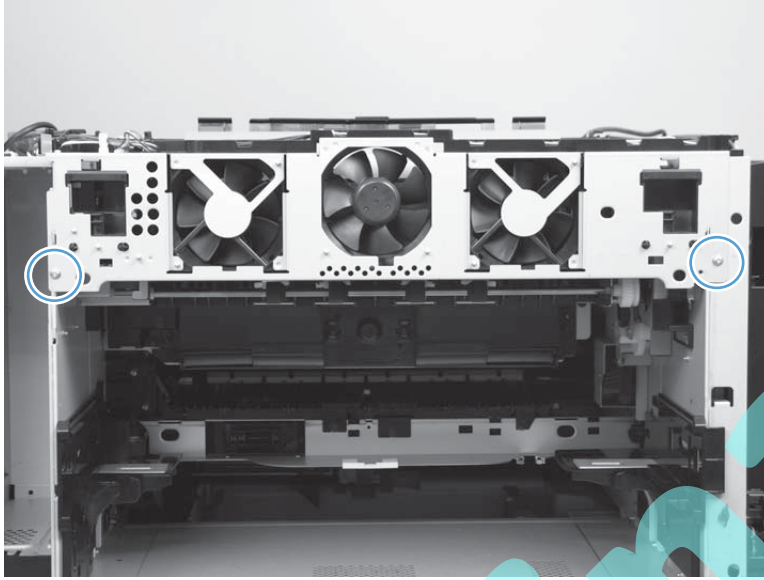

3. Carefully remove the wire harnesses from the guides.

Figure 1-364 Remove the face-down paper-delivery assembly (M806; 3 of 4)

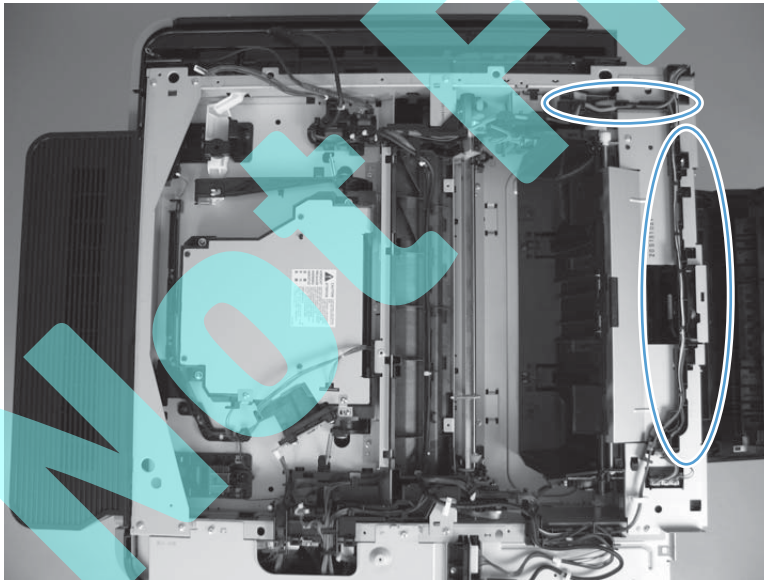

4. Lift the cables (callout 1) up, and then lift the face-down paper-delivery assembly (callout 2) up and out of the product.

 **NOTE:** Make sure that the assembly does not catch on the wire harnesses along the top of the assembly when you remove it from the product.

 **Reinstallation tip** Make sure that the wire harnesses are routed across the top of the assembly when you install it in the product.

Figure 1-365 Remove the face-down paper-delivery assembly (M806; 4 of 4)



Paper-delivery fan assembly (M830 only)

Before proceeding, remove the following assemblies:

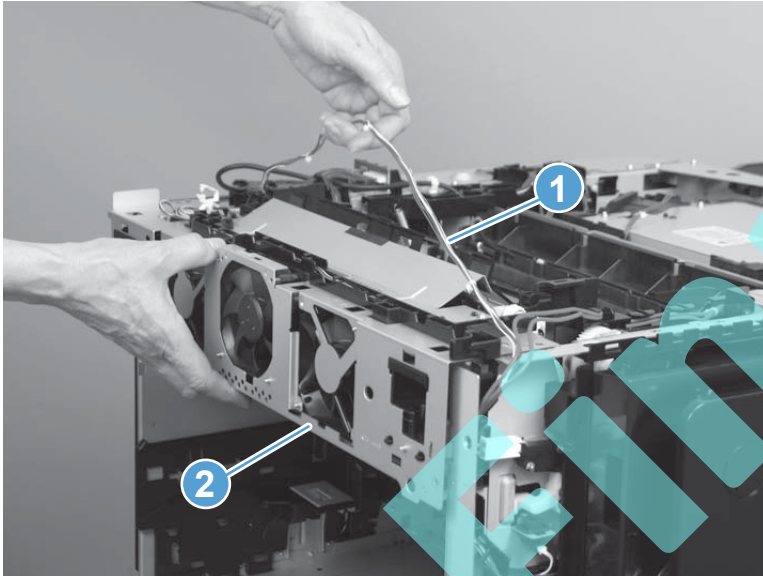
- Document feeder assembly (M830 only). See [Document feeder assembly \(M830 only\) on page 141](#).
- Scanner control board (SCB) (M830 only). See [Scanner control board \(SCB\) \(M830 only\) on page 135](#).
- Scanner assembly (M830 only). See [Scanner assembly \(M830 only\) on page 146](#).
- Left rear cover. See [Left rear cover on page 109](#).
- Left front cover. See [Left front cover on page 121](#).

Remove the paper-delivery fan assembly (M830 only)

1. Remove three screws.

 **NOTE:** Look down at the top of the product to locate these screws.

Figure 1-366 Remove the paper-delivery fan assembly (M830; 1 of 7)



2. Remove the metal cover.

Figure 1-367 Remove the paper-delivery fan assembly (M830; 2 of 7)

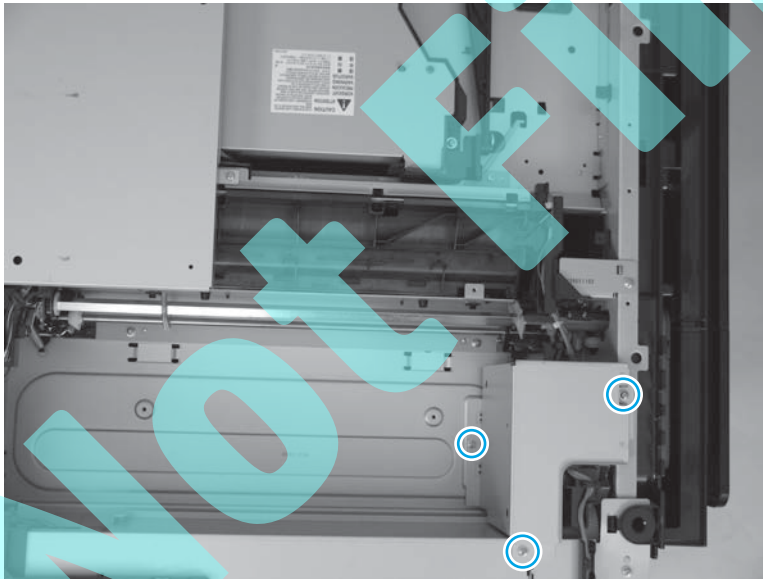
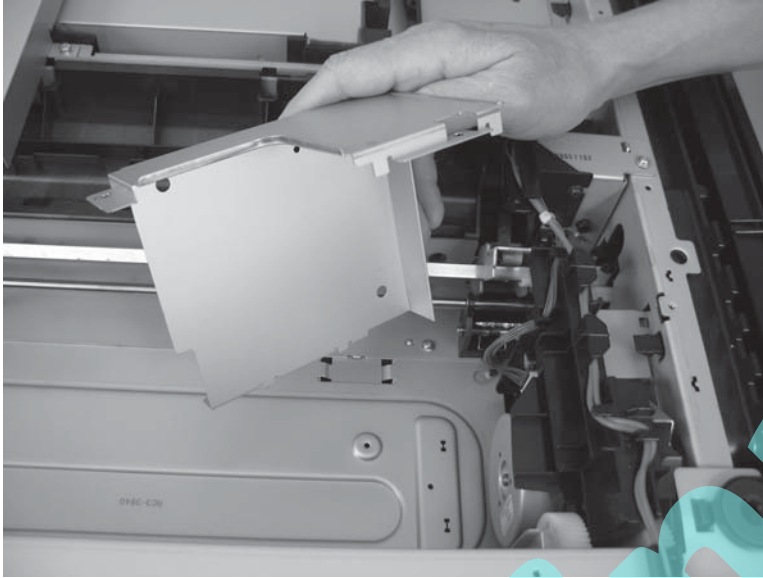

3. Disconnect one connector.

Figure 1-368 Remove the paper-delivery fan assembly (M830; 3 of 7)



4. Open the left door, and then remove four screws.

Figure 1-369 Remove the paper-delivery fan assembly (M830; 4 of 7)

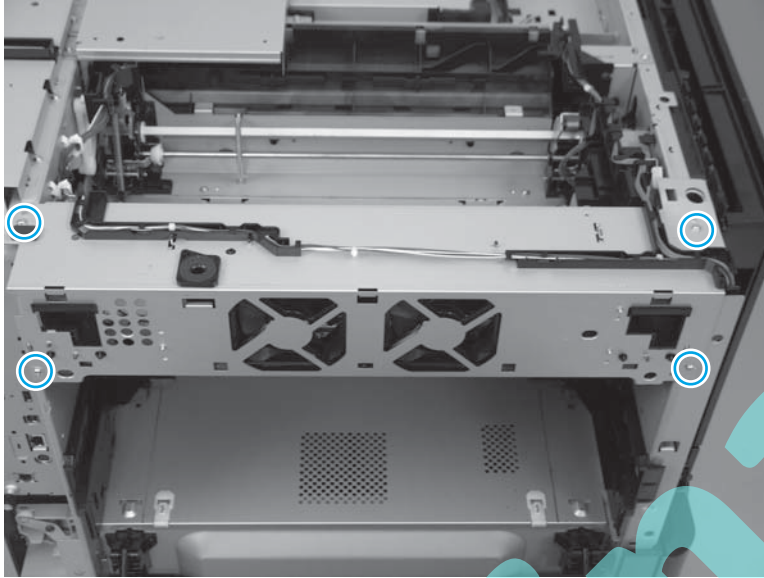

5. Carefully remove the wire harnesses from the guides on top of the assembly.

Figure 1-370 Remove the paper-delivery fan assembly (M830; 5 of 7)

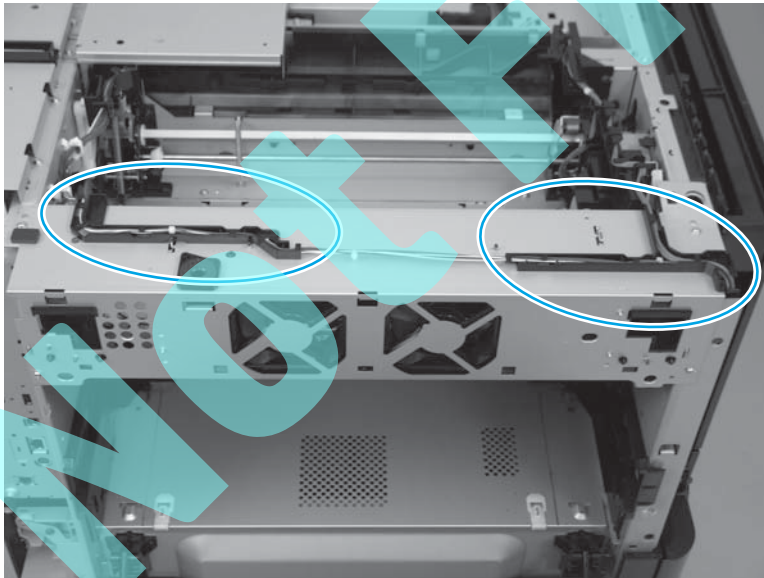

- Carefully remove the wire harnesses from the guide on the front of the product.

Figure 1-371 Remove the paper-delivery fan assembly (M830; 6 of 7)

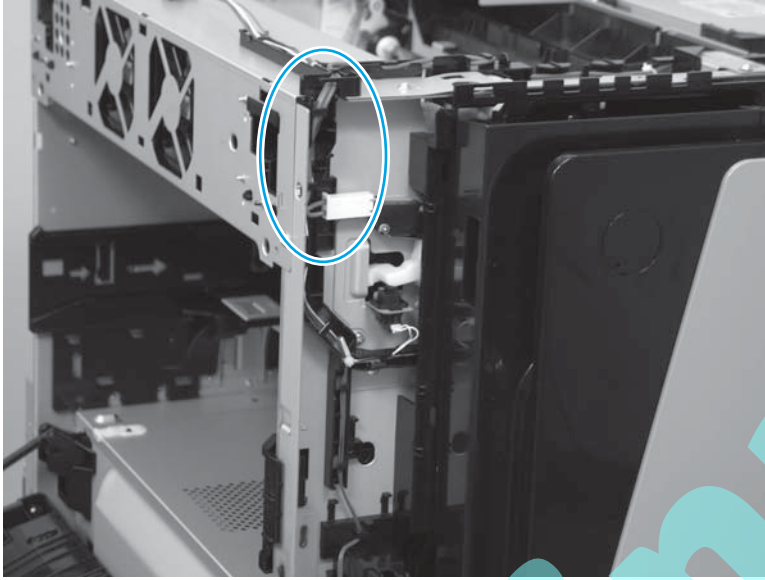

- Lift the cables (callout 1) up, and then lift the paper-delivery fan assembly (callout 2) up and out of the product.

 **Reinstallation tip** Make sure that the wire harnesses are routed across the top of the assembly when you install it in the product.

Figure 1-372 Remove the paper-delivery fan assembly (M830; 7 of 7)



Reinstall the paper-delivery fan assembly (M830 only)

When reinstalling the metal cover, make sure that the tabs (callout 1) on the cover are positioned in the slots on the product (callout 2).

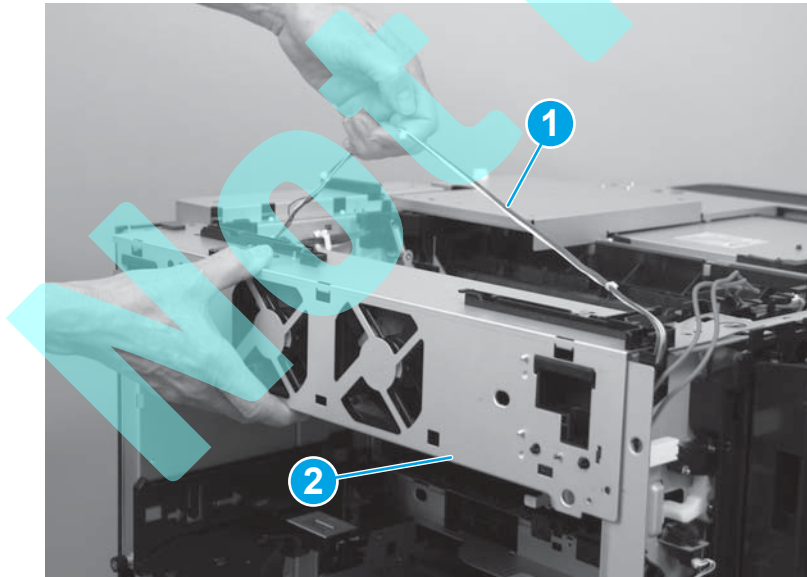
Figure 1-373 Reinstall the paper-delivery fan assembly (M830)

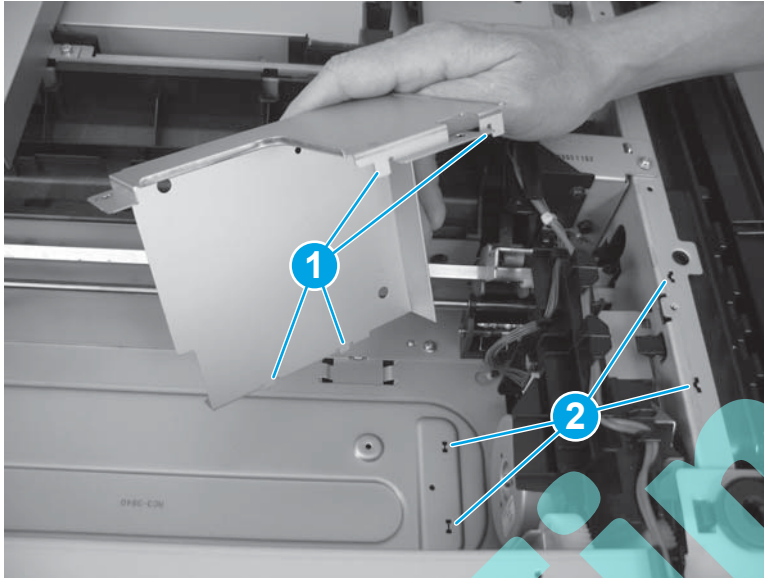

Fuser drive assembly

Before proceeding, remove the following assemblies:

- Control-panel assembly (M806 only). See [Control-panel assembly \(M806 only\) on page 38](#).
- Hardware integration pocket (HIP) cover (M806 only). See [Hardware integration pocket \(HIP\) cover \(M806 only\) on page 88](#).
- Control-panel base cover (M806 only). See [Control-panel base cover \(M806 only\) on page 94](#).
- Right top cover (M806 only). See [Right top cover \(M806 only\) on page 98](#).
- Left top cover. See [Left top cover \(M806 only\) on page 102](#).
- Left front cover. See [Left front cover on page 121](#).
- Upper left cover (M806 only). See [Upper left cover \(M806 only\) on page 122](#).
- Face-down paper-delivery assembly (M806 only). See [Face-down paper-delivery assembly \(M806 only\) on page 234](#).
- Document feeder assembly (M830 only). See [Document feeder assembly \(M830 only\) on page 141](#).
- Scanner control board (SCB) (M830 only). See [Scanner control board \(SCB\) \(M830 only\) on page 135](#).
- Scanner assembly (M830 only). See [Scanner assembly \(M830 only\) on page 146](#).
- Upper left cover (M830 only). See [Upper left cover \(M830 only\) on page 124](#).
- Paper-delivery fan assembly (M830 only). See [Paper-delivery fan assembly \(M830 only\) on page 237](#).

Remove the fuser drive assembly

1. Disconnect one connector (callout 1), and then remove the wire harness from the guide (callout 2).

Figure 1-374 Remove the fuser drive assembly (1 of 5)

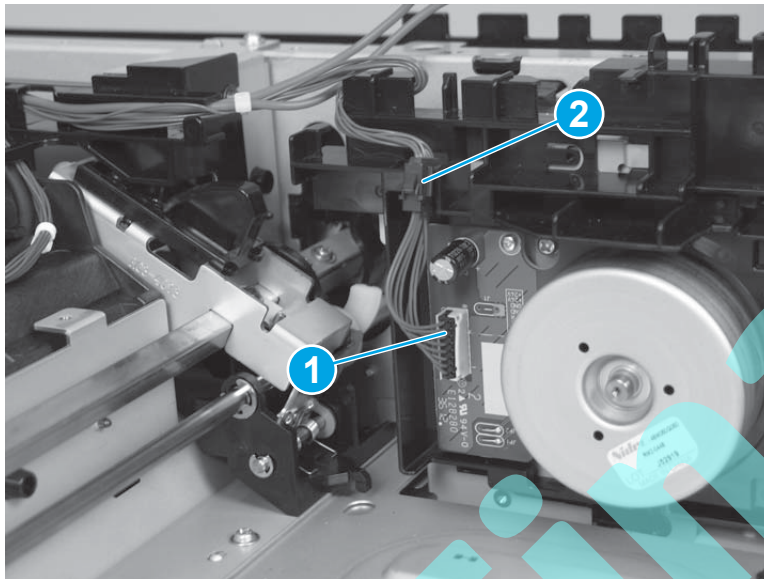

2. Remove five screws.

Figure 1-375 Remove the fuser drive assembly (2 of 5)

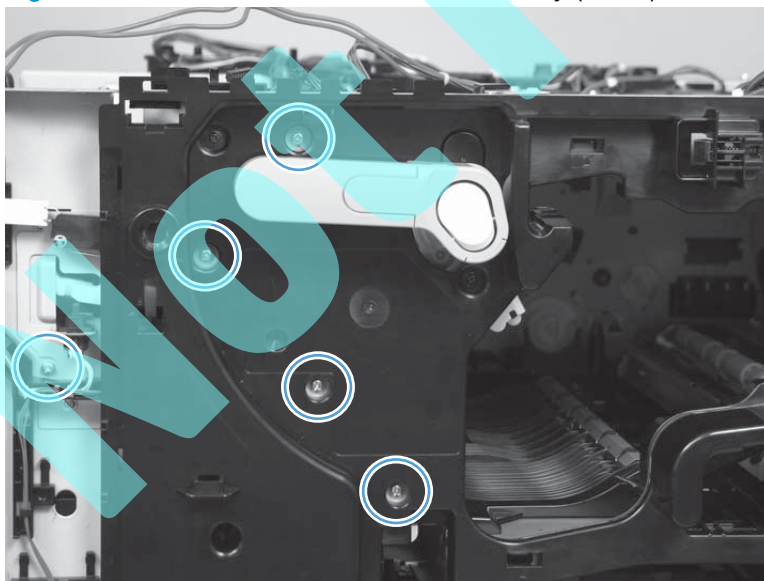

3. Remove one screw.

Figure 1-376 Remove the fuser drive assembly (3 of 5)

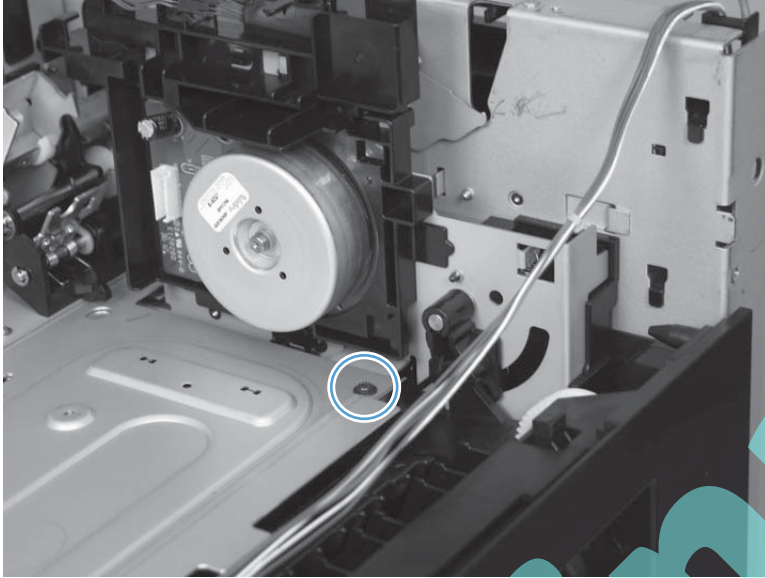

4. Lift up on the fuser drive assembly to release one locking tab.

Figure 1-377 Remove the fuser drive assembly (4 of 5)

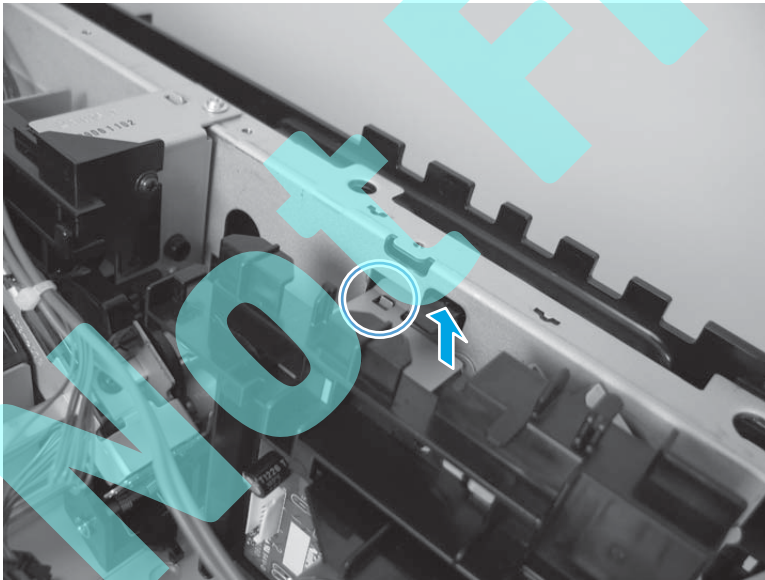

5. Slide the fuser drive assembly to the right (callout 1) and then lift it out of the product (callout 2).

Figure 1-378 Remove the fuser drive assembly (5 of 5)

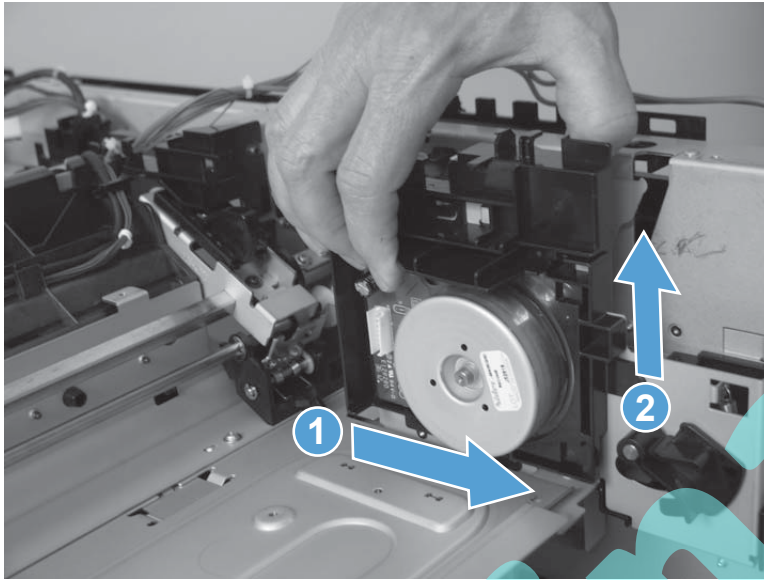

Not Final

Reinstall the fuser drive assembly

1. Make sure that the fuser drive assembly is positioned below the sheet metal shelf as shown below.

Figure 1-379 Reinstall the fuser drive assembly (1 of 2)



2. Position the fuser drive assembly on the locking tab.

Figure 1-380 Reinstall the fuser drive assembly (2 of 2)

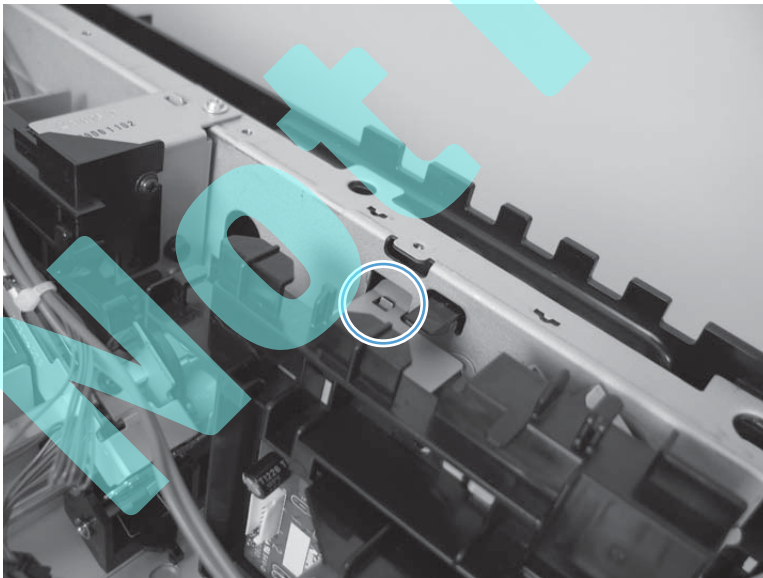

Power switch assembly

Before proceeding, remove the following assemblies:

- Left front cover

Remove the power switch assembly

- ▲ Release one tab (callout 1), and then remove the power switch assembly (callout 2).

Figure 1-381 Remove the power switch assembly)

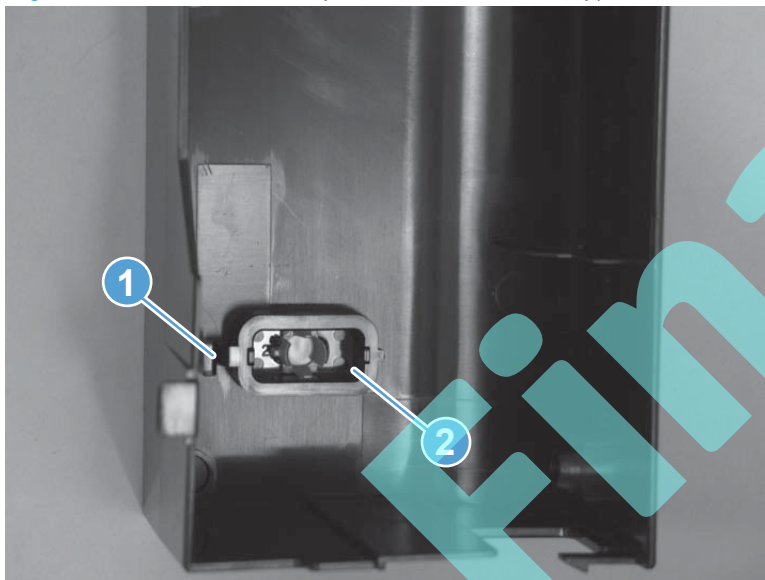

Reinstall the power switch assembly

Install the switch in the slot on the cover as shown below.

Figure 1-382 Reinstall the power switch assembly

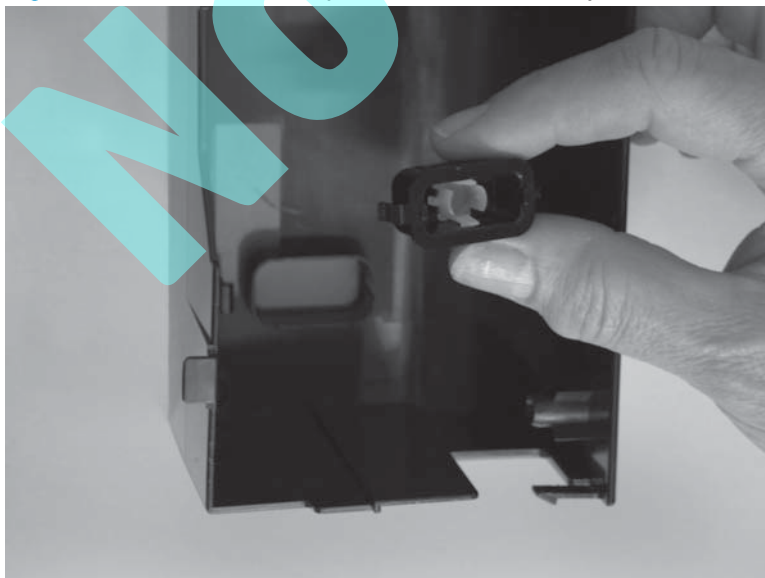

Interconnect PCA

Before proceeding, remove the following assemblies:

- Formatter. See [Formatter on page 12](#).
- Control-panel assembly (M806 only). See [Control-panel assembly \(M806 only\) on page 38](#).
- Hardware integration pocket (HIP) cover (M806 only). See [Hardware integration pocket \(HIP\) cover \(M806 only\) on page 88](#).
- Control-panel base cover (M806 only). See [Control-panel base cover \(M806 only\) on page 94](#).
- Right top cover (M806 only). See [Right top cover \(M806 only\) on page 98](#).
- Left top cover. See [Left top cover \(M806 only\) on page 102](#).
- Rear cover. See [Rear cover on page 110](#).
- Document feeder assembly (M830 only). See [Document feeder assembly \(M830 only\) on page 141](#).
- Scanner control board (SCB) (M830 only). See [Scanner control board \(SCB\) \(M830 only\) on page 135](#).
- Scanner assembly (M830 only). See [Scanner assembly \(M830 only\) on page 146](#).

Remove the interconnect PCA

1. **M830 only:** Remove four screws, and then remove the sheet metal plate.

Figure 1-383 Remove the interconnect PCA (1 of 4)

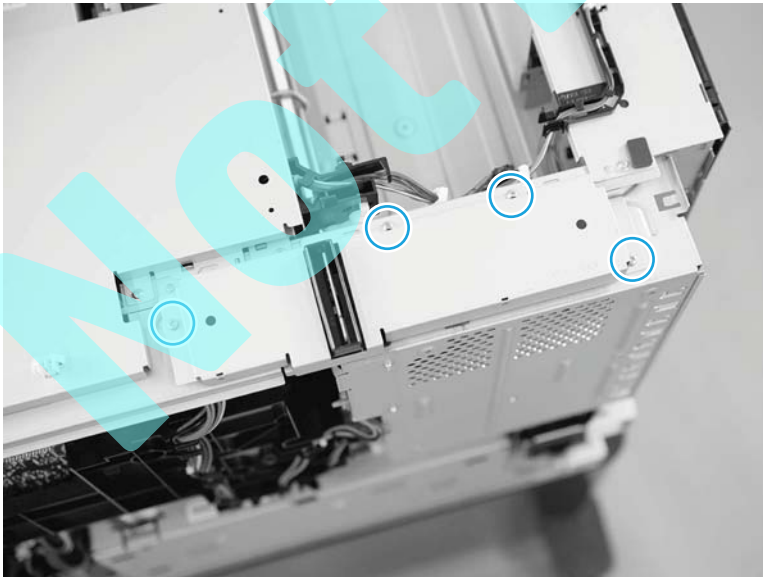

2. **M806 only:** Disconnect two connectors.

Figure 1-384 Remove the interconnect PCA (2 of 4)

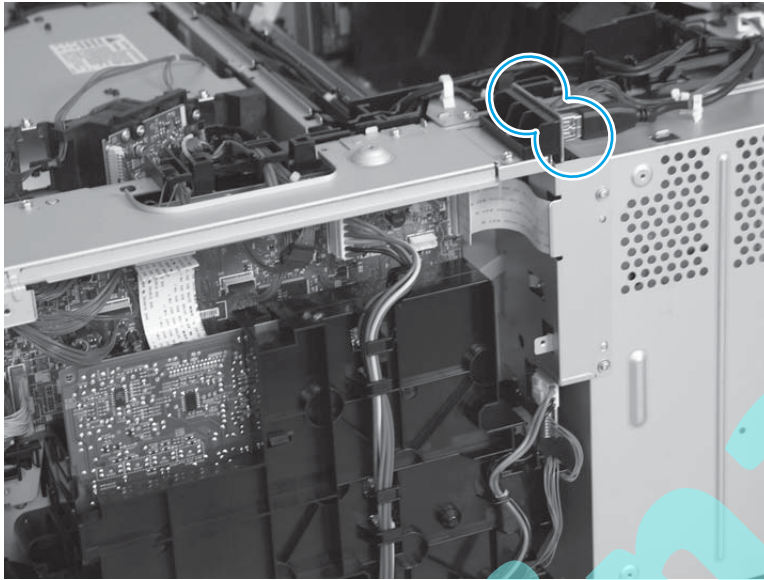

3. Disconnect three connectors.

Figure 1-385 Remove the interconnect PCA (3 of 4)

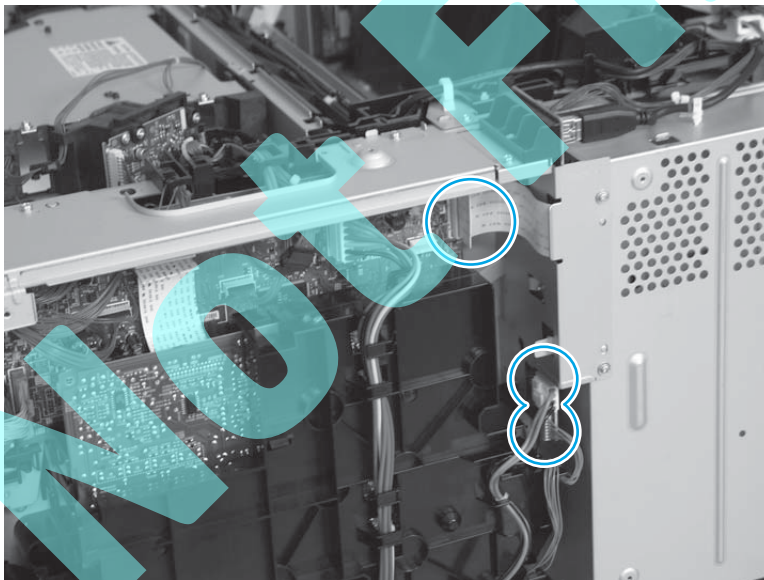

4. Remove five screws and then remove the interconnect PCA.

Figure 1-386 Remove the interconnect PCA (4 of 4)

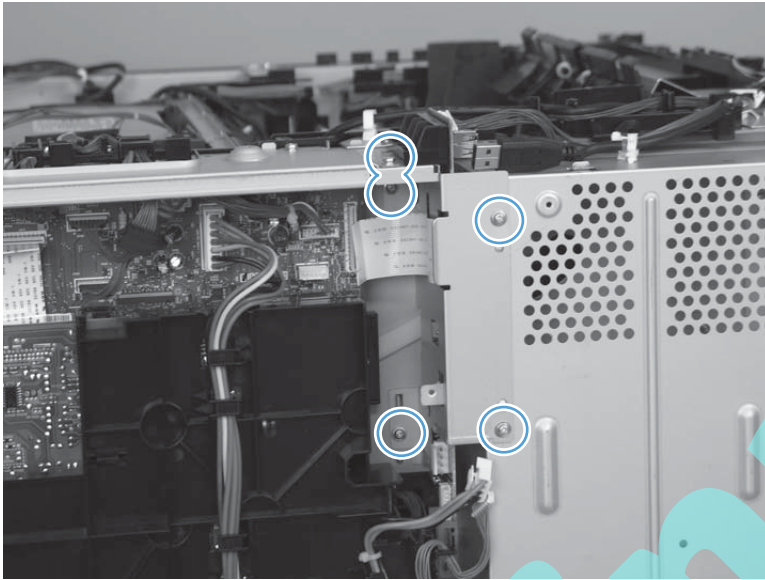

Reinstall the interconnect PCA

1. Position the slots (callout 1) on the interconnect PCA over the tabs (callout 2) on the product.

Figure 1-387 Reinstall the interconnect PCA

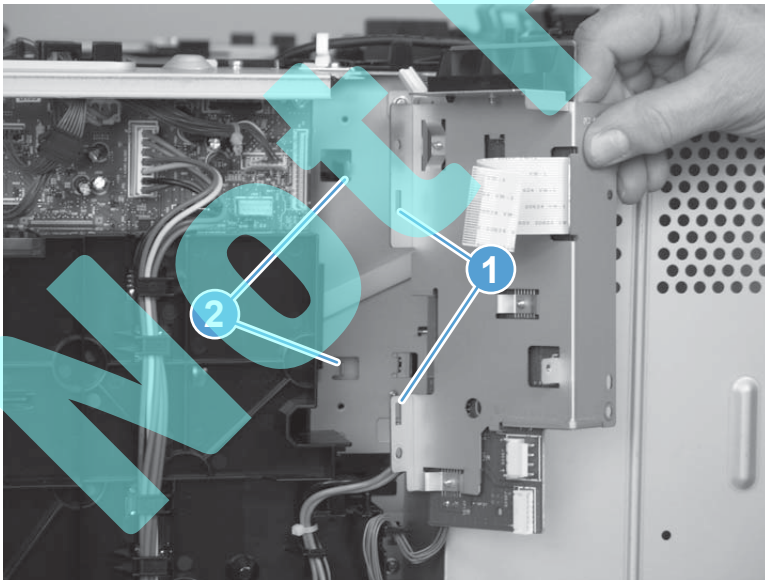

2. **M830 only:** Align the tabs (callout 1) on the sheet metal plate with the slots (callout 2) in the product.

Figure 1-388 Reinstall the interconnect PCA)

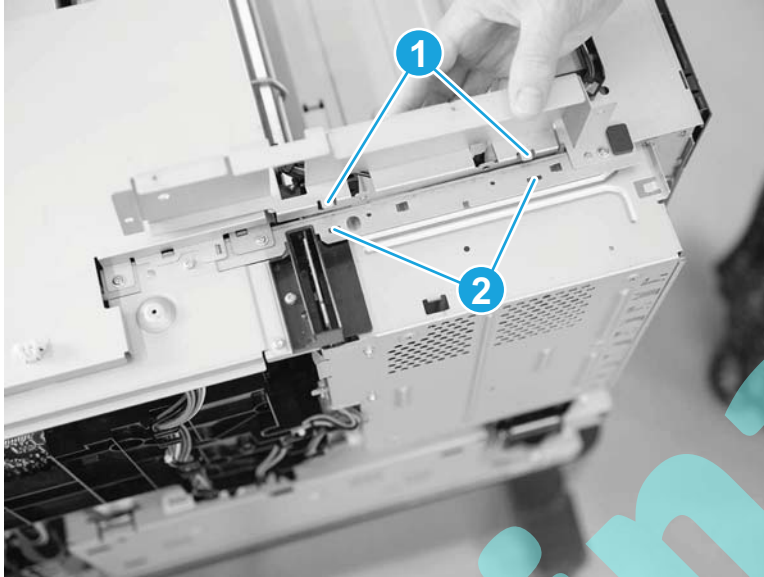

Not Final

Formatter cage

Before proceeding, remove the following assemblies:

- Formatter. See [Formatter on page 12](#).
- Control-panel assembly (M806 only). See [Control-panel assembly \(M806 only\) on page 38](#).
- Hardware integration pocket (HIP) cover (M806 only). See [Hardware integration pocket \(HIP\) cover \(M806 only\) on page 88](#).
- Control-panel base cover (M806 only). See [Control-panel base cover \(M806 only\) on page 94](#).
- Right top cover (M806 only). See [Right top cover \(M806 only\) on page 98](#).
- Left top cover. See [Left top cover \(M806 only\) on page 102](#).
- Left rear cover. See [Left rear cover on page 109](#).
- Rear cover. See [Rear cover on page 110](#).
- Interconnect PCA. See [Interconnect PCA on page 248](#).

Remove the formatter cage

Release two cables from retainers (callout 1), remove five screws (callout 2), and then remove the formatter cage.

Figure 1-389 Remove the formatter cage

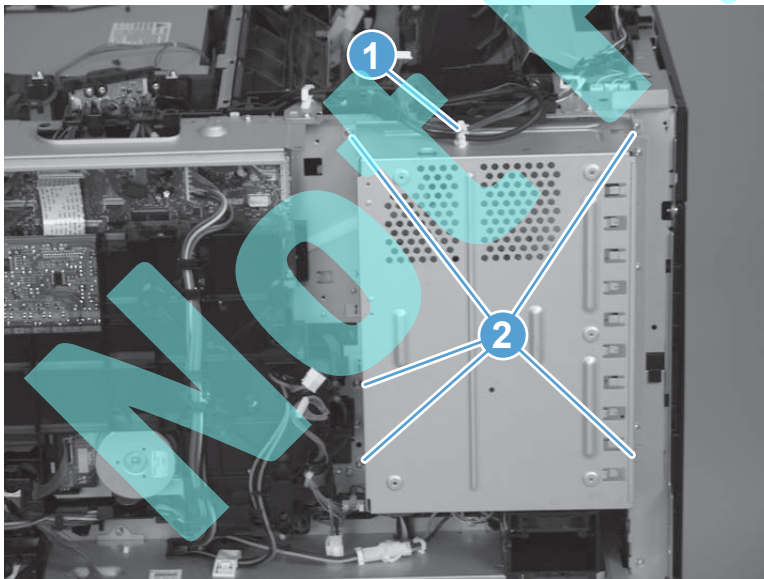

Reinstall the formatter cage

Position the slot (callout 1) on the formatter cage over the tab (callout 2) on the product.

Figure 1-390 Reinstall the formatter cage

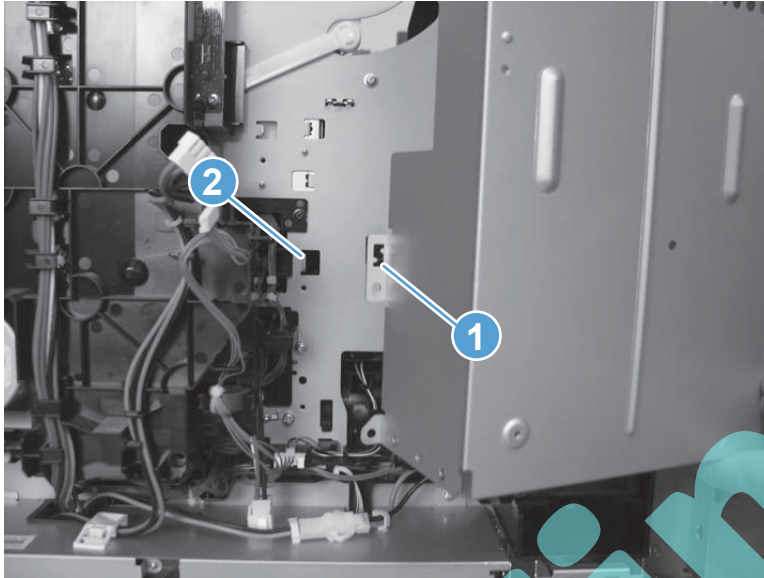

Not Final

Fuser bias contact assembly

Before proceeding, remove the following assemblies:

- Fuser. See [Fuser on page 10](#).
- Duplexer. See [Duplexer on page 9](#).
- Control-panel assembly (M806 only). See [Control-panel assembly \(M806 only\) on page 38](#).
- Hardware integration pocket (HIP) cover (M806 only). See [Hardware integration pocket \(HIP\) cover \(M806 only\) on page 88](#).
- Control-panel base cover (M806 only). See [Control-panel base cover \(M806 only\) on page 94](#).
- Right top cover (M806 only). See [Right top cover \(M806 only\) on page 98](#).
- Left top cover. (M806 only). See [Left top cover \(M806 only\) on page 102](#).
- Left front cover (M830 only). See [Left front cover on page 121](#).
- Upper left cover (M830 only). See [Upper left cover \(M830 only\) on page 124](#).
- Scanner back cover (M830 only). See [Scanner back cover \(M830 only\) on page 75](#).
- Document feeder assembly (M830 only). See [Document feeder assembly \(M830 only\) on page 141](#).
- Scanner control board (SCB) (M830 only). See [Scanner control board \(SCB\) \(M830 only\) on page 135](#).
- Scanner assembly (M830 only). See [Scanner assembly \(M830 only\) on page 146](#).
- Rear cover. See [Rear cover on page 110](#).
- Interconnect PCA. See [Interconnect PCA on page 248](#).
- High-voltage power supply (M806 only). See [High-voltage power supply \(M806 only\) on page 182](#).
- High-voltage power supply (M830 only). See [High-voltage power supply \(M830 only\) on page 184](#).

Remove the fuser bias contact assembly

1. Locate the fuser bias contact assembly.

Figure 1-391 Remove the fuser bias contact assembly (1 of 3)

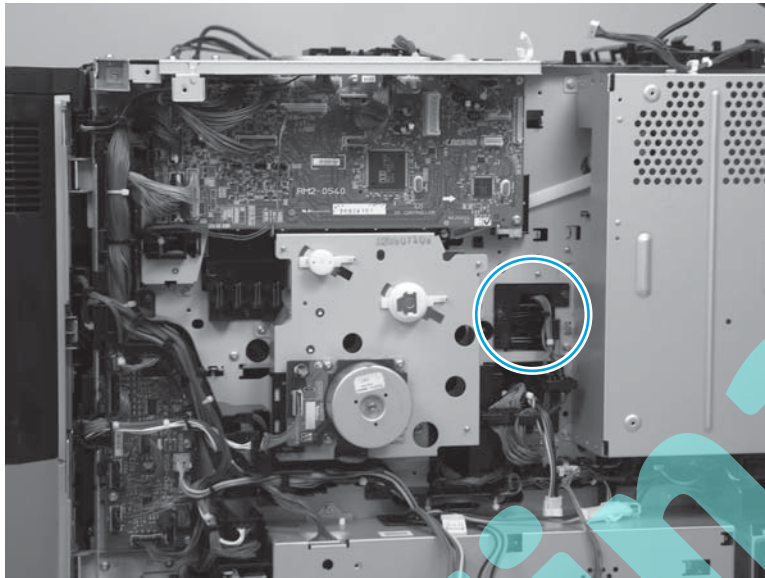

2. Disconnect three connectors.

Figure 1-392 Remove the fuser bias contact assembly (2 of 3)

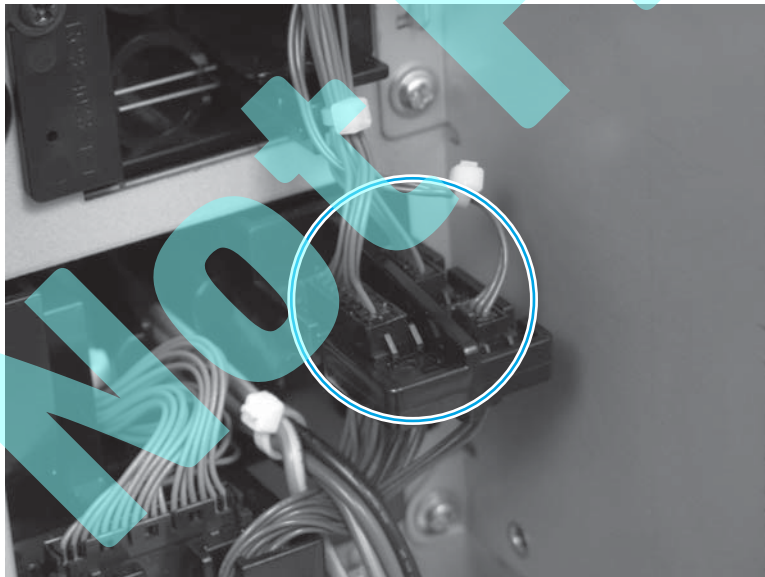

3. Remove two screws (callout 1), release the wire harnesses from the guide (callout 2), and then slide the fuser bias contact assembly toward the back of the product to remove it.

Figure 1-393 Remove the fuser bias contact assembly (3 of 3)

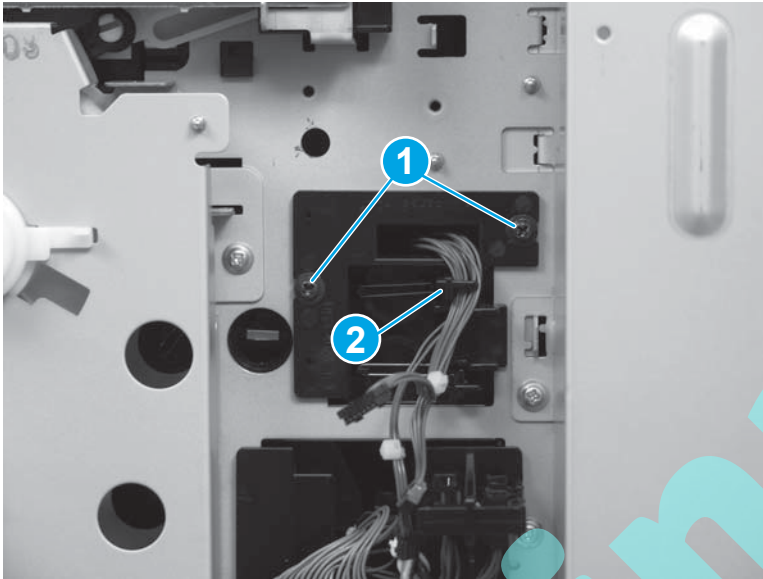

Reinstall the fuser bias contact assembly

1. Make sure that the wire harnesses are inserted through the opening in the fuser bias contact assembly.

Figure 1-394 Reinstall the fuser bias contact assembly (1 of 2)

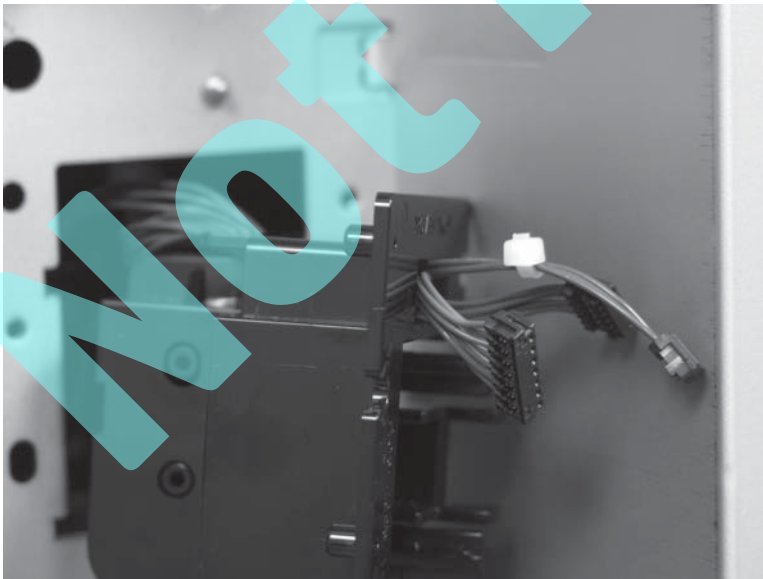

2. Make sure that the wire harnesses are routed inside the guide.

Figure 1-395 Reinstall the fuser bias contact assembly (2 of 2)



Not Final

Cooling-unit assembly

Before proceeding, remove the following assemblies:

- Duplexer. See [Duplexer on page 9](#).
- Fuser. See [Fuser on page 10](#).

Remove the cooling-unit assembly

1. Remove one screw (callout 1), and then release one tab (callout 2) on the cover.

Figure 1-396 Remove the cooling-unit assembly (1 of 5)

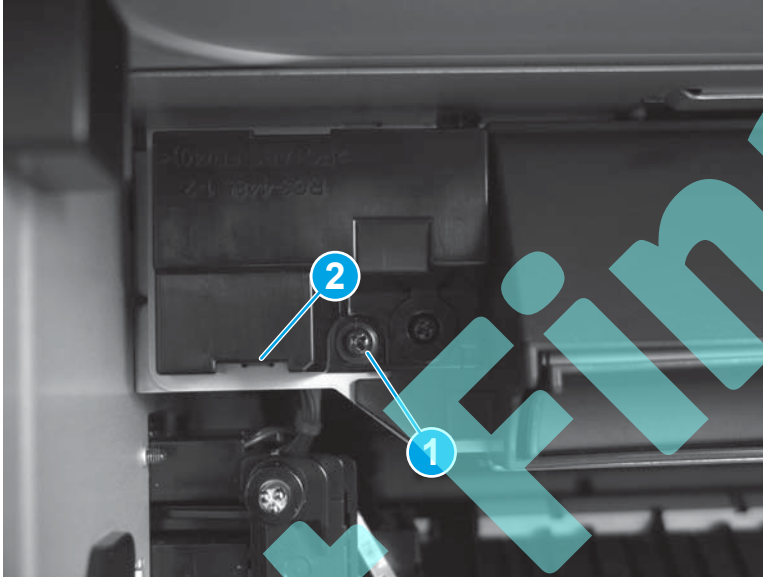

2. Rotate the top of the cover away from the product, and then remove it.

Figure 1-397 Remove the cooling-unit assembly (2 of 5)



3. Disconnect two connectors.

Figure 1-398 Remove the cooling-unit assembly (3 of 5)

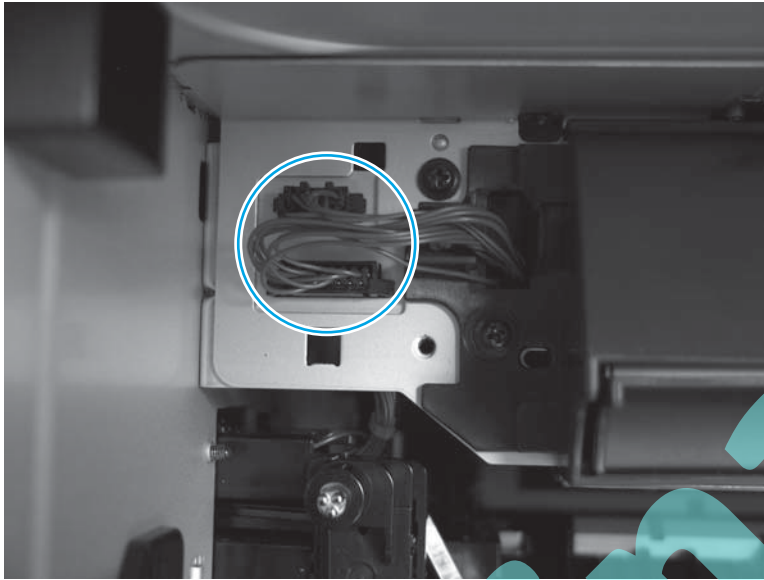

4. Remove two screws.

Figure 1-399 Remove the cooling-unit assembly (4 of 5)

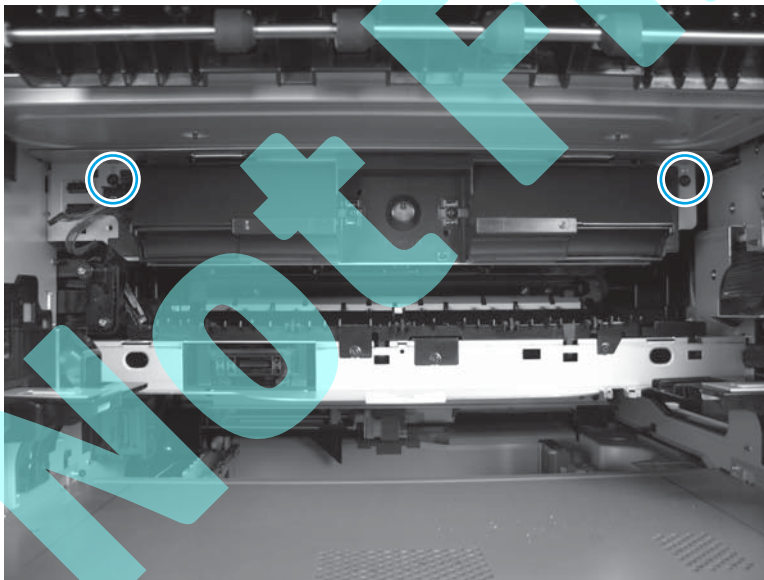

5. Slide the cooling-unit assembly out of the product to remove it.

Figure 1-400 Remove the cooling-unit assembly (5 of 5)

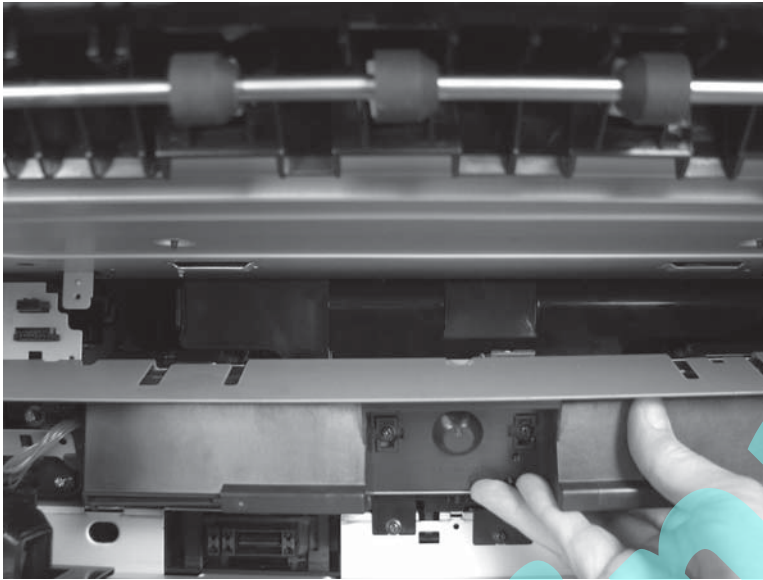

Reinstall the cooling unit assembly

Tilt the assembly to reinsert the metal tabs (callout 1) on top of the assembly into the sheet metal tabs (callout 2) on the product.

Figure 1-401 Reinstall the cooling unit assembly

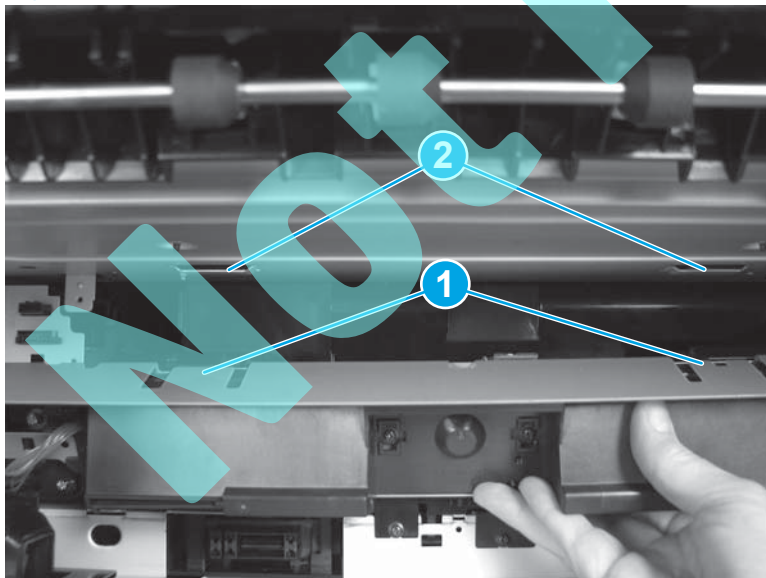

Tag assembly

Before proceeding, remove the following assemblies:

- Formatter. See [Formatter on page 12](#).
- Rear cover. See [Rear cover on page 110](#).
- High-voltage power supply (M806 only). See [High-voltage power supply \(M806 only\) on page 182](#).
- High-voltage power supply (M830 only). See [High-voltage power supply \(M830 only\) on page 184](#).
- DC controller (M806 only). See [DC controller \(M806 only\) on page 187](#).
- DC controller (M830 only). See [DC controller \(M830 only\) on page 190](#).

Remove the tag assembly

1. Remove three screws (callout 1).

 **NOTE:** Make sure that the wire harness (callout 2) is released from the guide (callout 3).

Figure 1-402 Remove the tag assembly (1 of 2)



2. Remove the tag assembly.

Figure 1-403 Remove the tag assembly (2 of 2)

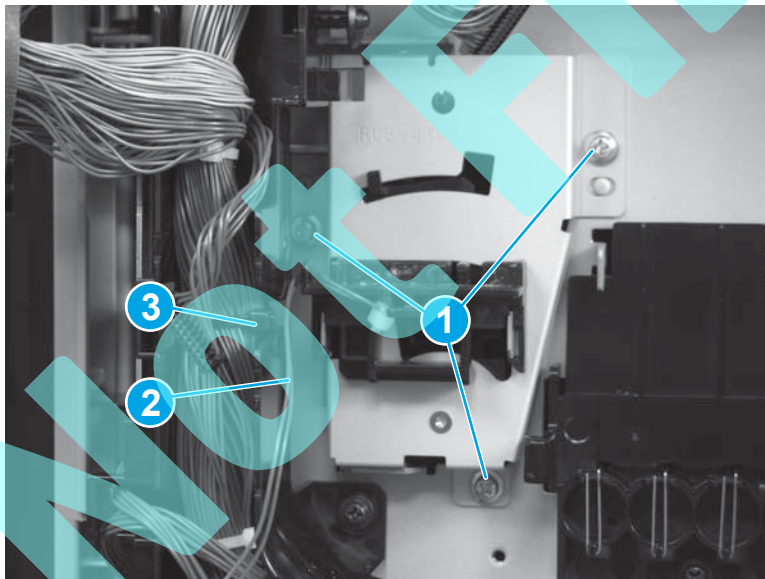
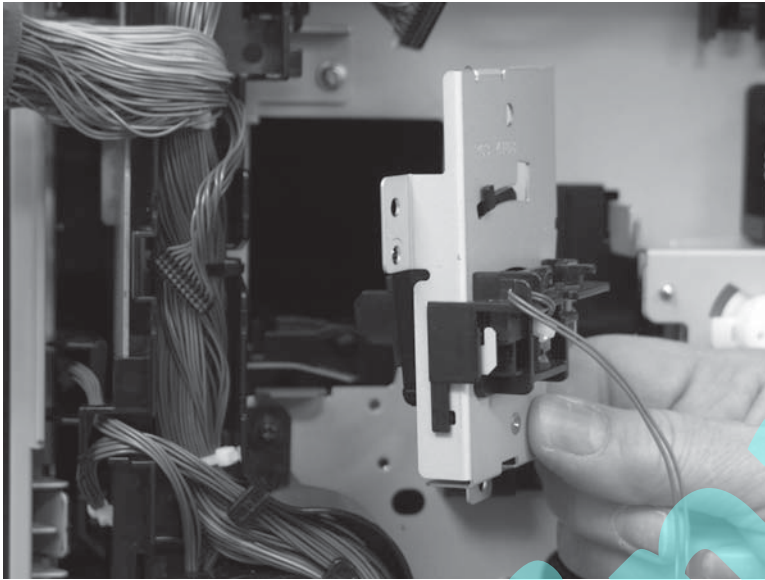

Not Final

Option-connector assembly

Before proceeding, remove the following assemblies:

- Rear cover. See [Rear cover on page 110](#).

Remove the option-connector assembly

1. Disconnect two connectors (callout 1), and then release the cables from the retainer clip (callout 2).

Figure 1-404 Remove the option-connector assembly (1 of 6)

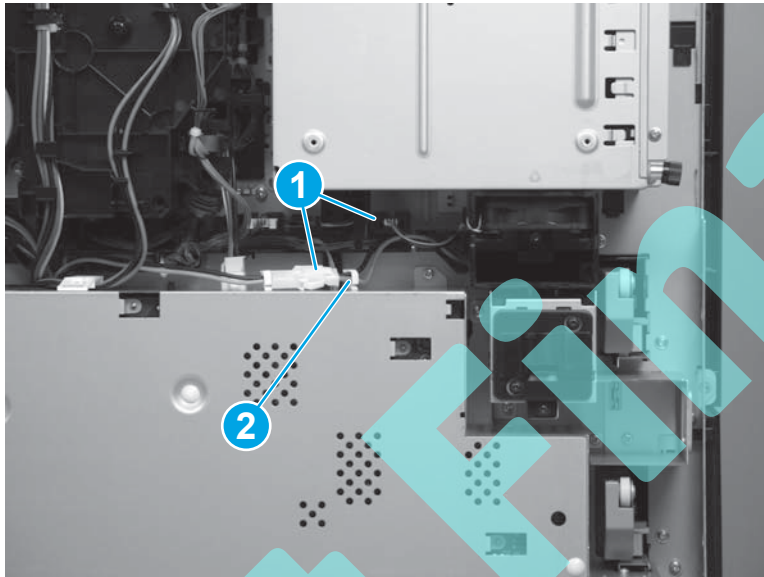

2. Remove four screws.

Figure 1-405 Remove the option-connector assembly (2 of 6)

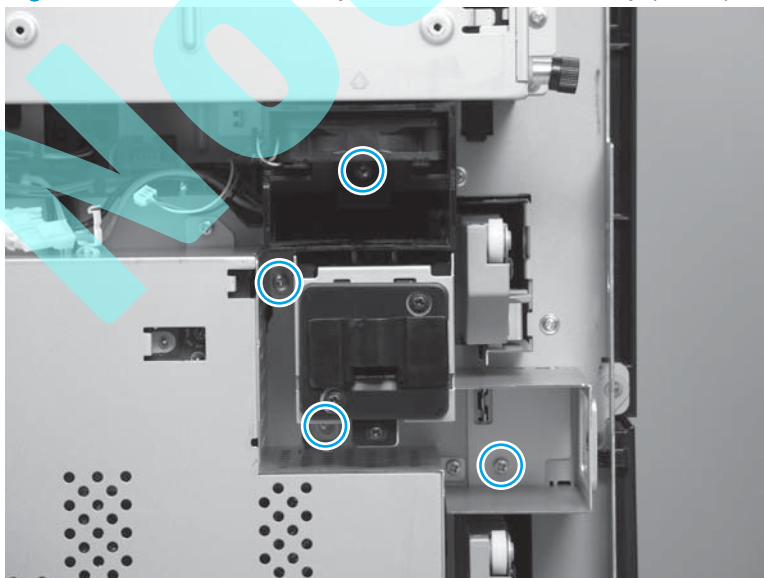

3. Remove the wire harness and cables (callout 1) from the guides (callout 2).

Figure 1-406 Remove the option-connector assembly (3 of 6)

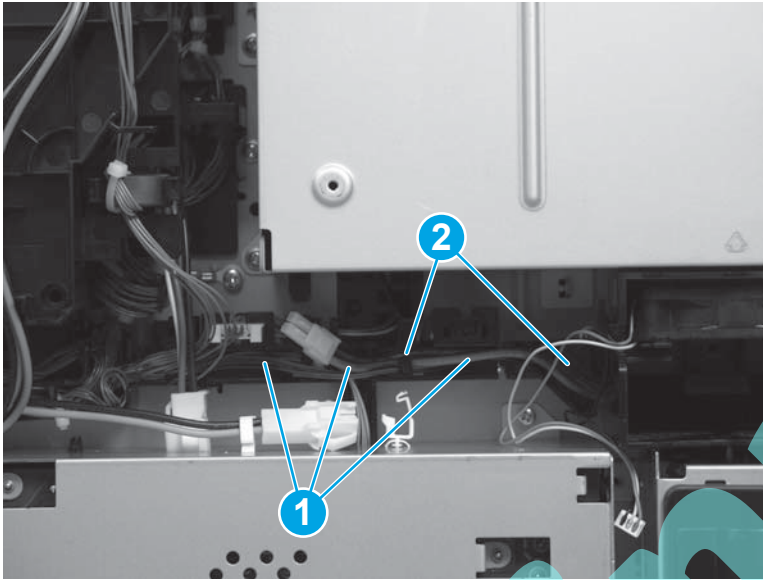

4. Lift the option-connector assembly away from the product.

CAUTION: The assembly is still connected to the product by one wire harness.

Figure 1-407 Remove the option-connector assembly (4 of 6)

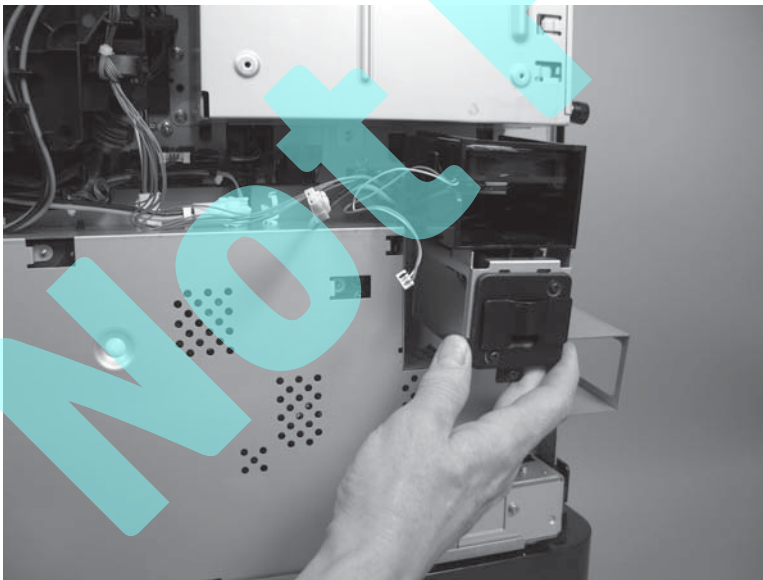

5. Disconnect one connector on the back side of the assembly.

Figure 1-408 Remove the option-connector assembly (5 of 6)

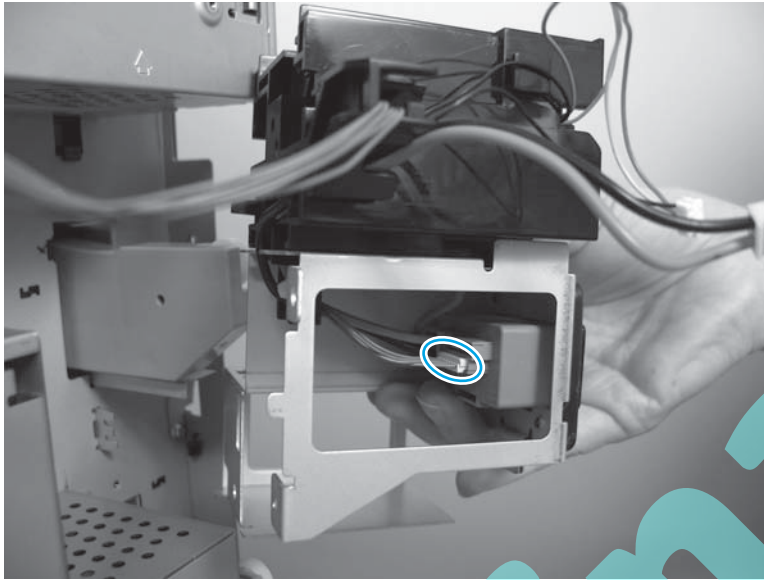

6. Remove the wire harness (callout 1) from the guides (callout 2), and then remove the option-connector assembly.

Figure 1-409 Remove the option-connector assembly (6 of 6)

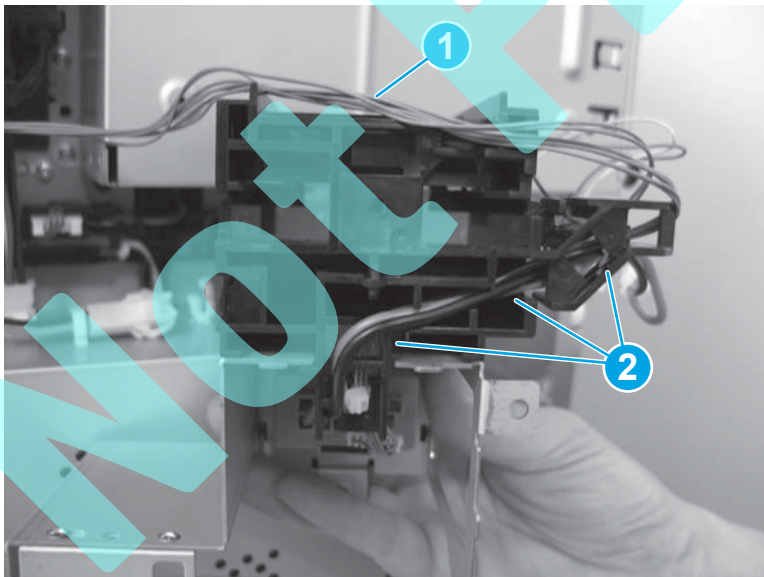

Reinstall the option-connector assembly

Make sure that the tabs on the assembly (callout 1) are positioned in the slots (callout 2) in the product.

Figure 1-410 Reinstall the option connector assembly

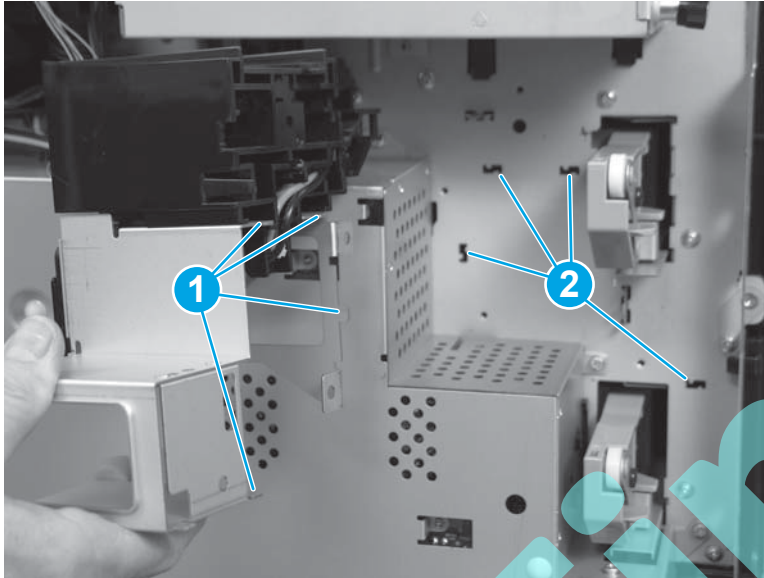

Input accessory

This section includes information about the following topics:

- [High capacity input feeder](#)

Not Final

High capacity input feeder

 **NOTE:** Some of the procedures in this section require the product to be removed from the input accessory.

Location of major components

Figure 1-411 External covers and doors

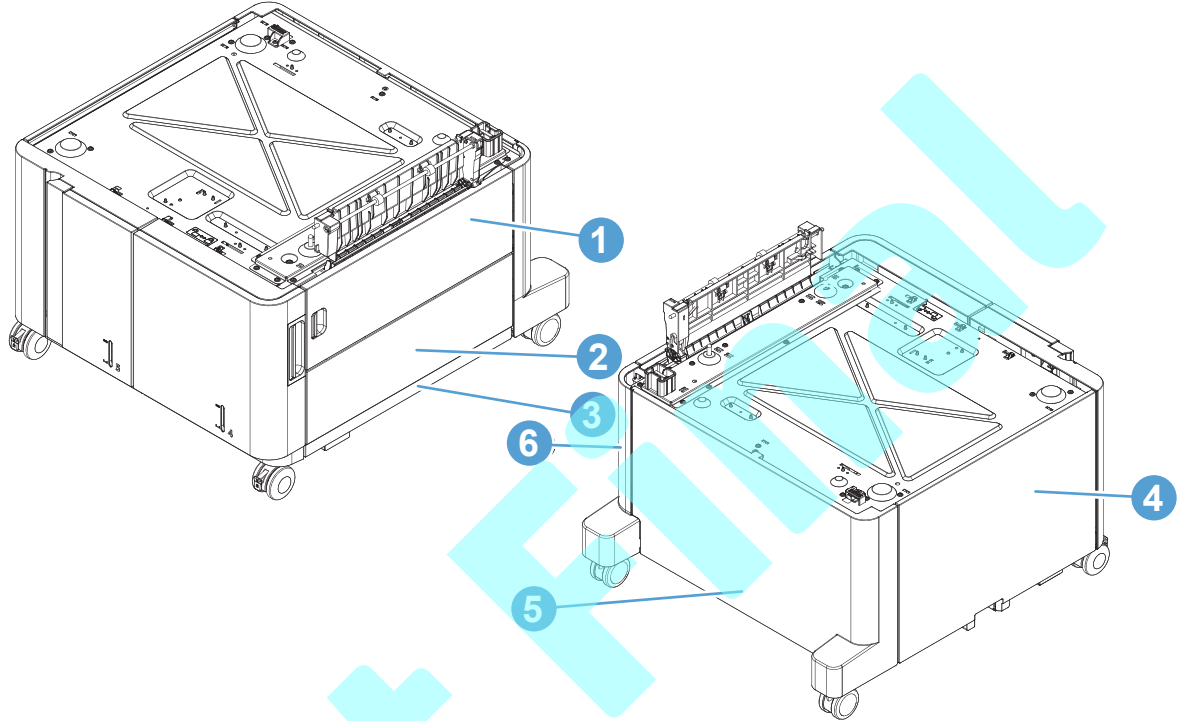

Table 1-5 External covers and doors

Item	Description	Item	Description
1	Right door assembly	4	Left cover
2	Center right cover	5	Rear cover
3	Lower right cover	6	Right-rear corner cover

Figure 1-412 Main assemblies (1 of 2)

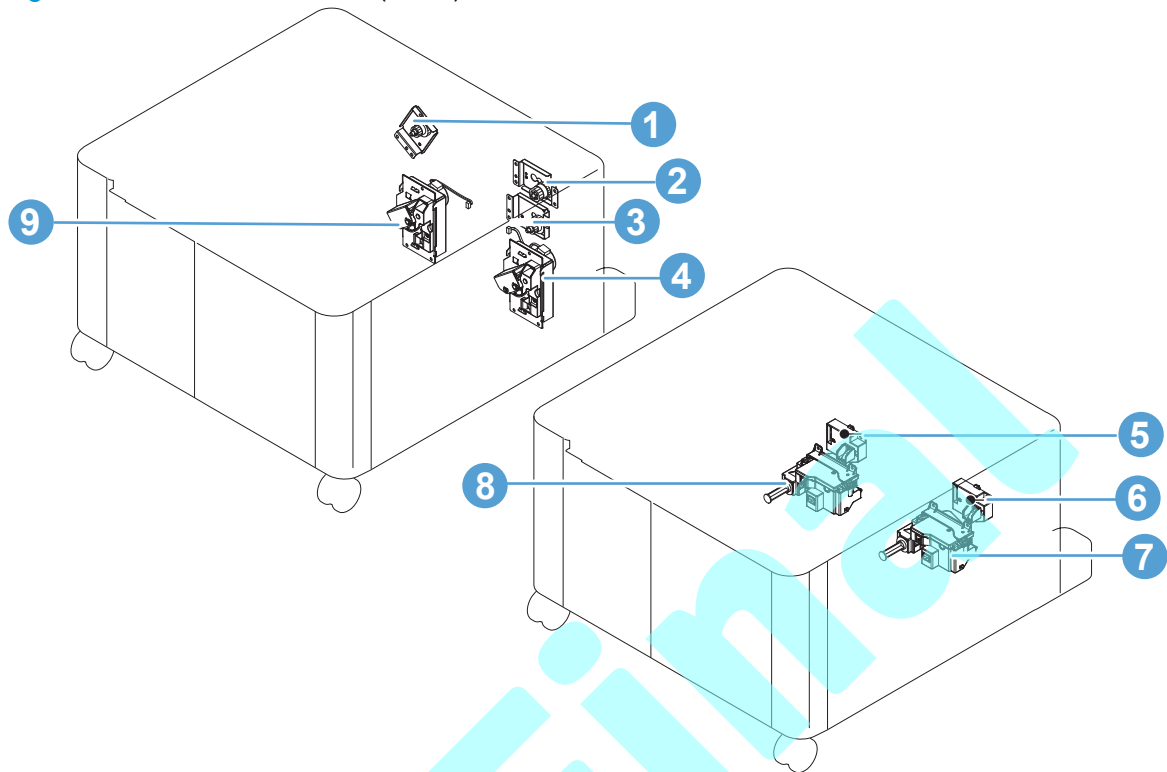

Table 1-6 Main assemblies (1 of 2)

Item	Description	Item	Description
1	Left tray pickup drive assembly	6	Right tray media-level sensor assembly
2	Merge drive assembly	7	Right tray automatic close assembly
3	Right tray pickup drive assembly	8	Left tray automatic close assembly
4	Right tray lifter drive assembly	9	Left tray lifter drive assembly
5	Left tray media-level sensor assembly		

Figure 1-413 Main assemblies (2 of 2)

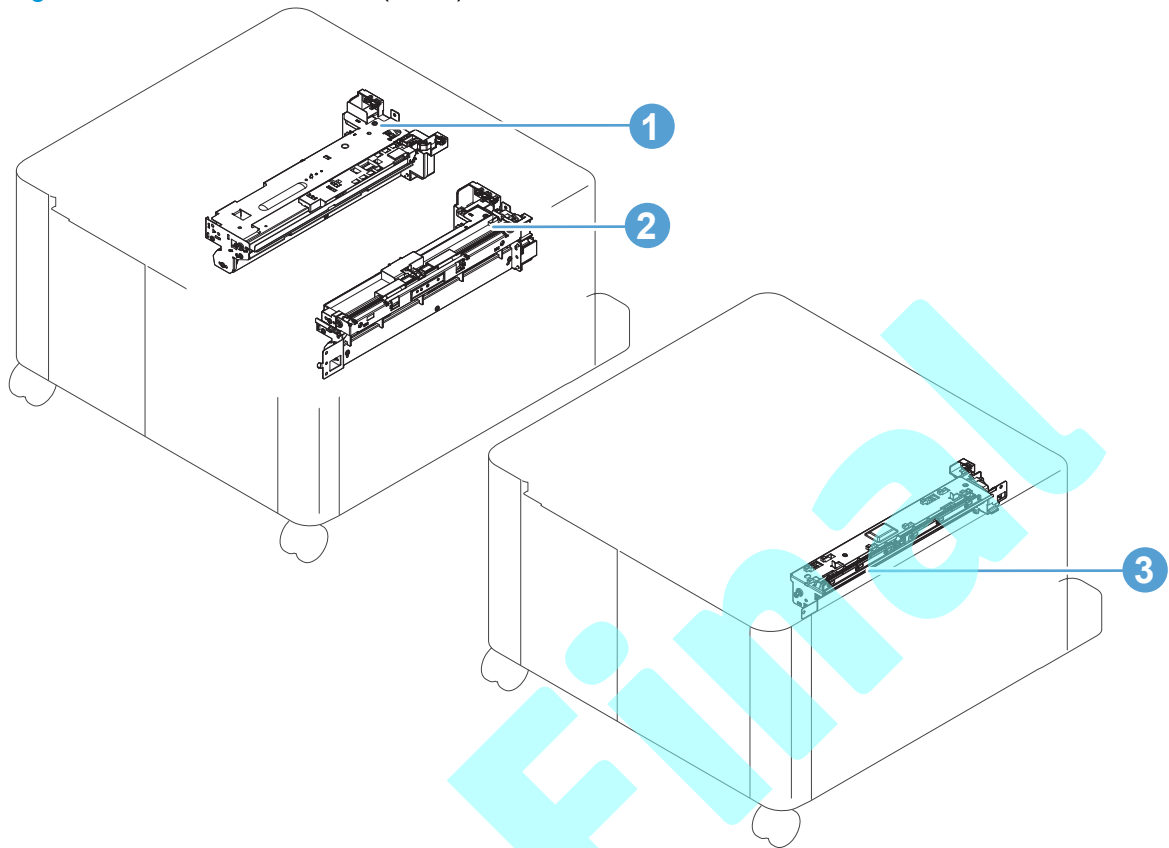

Table 1-7 Main assemblies (2 of 2)

Item	Description	Item	Description
1	Left tray pickup assembly	3	Merge assembly
2	Right tray pickup assembly		

Figure 1-414 Printed circuit assembly (PCA)

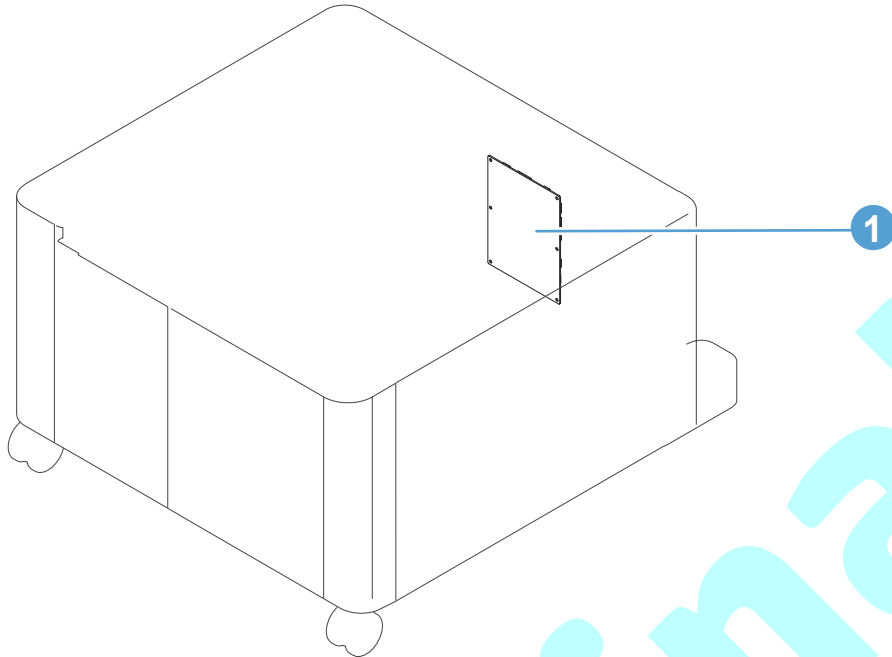

Table 1-8 Printed circuit assembly (PCA)

Item	Description	Item	Description
1	HCI controller PCA		

HCI right tray

1. Open the right tray.
2. Lower the tray release lever, and then remove the right tray.

 **NOTE:** When the tray is reinstalled, the release lever automatically returns to the locked position.

Figure 1-415 Remove the HCI right tray



HCI left tray

1. Open the left tray.
2. Lower the tray release lever, and then remove the left tray.

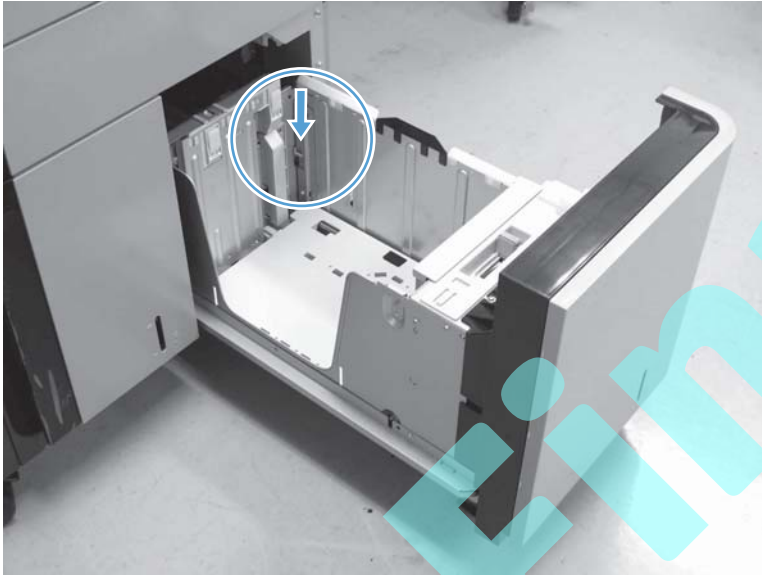
 **NOTE:** When the tray is reinstalled, the release lever automatically returns to the locked position.

Figure 1-416 Remove the HCI left tray



HCI rear and right-rear corner covers

1. Open the right door, and then remove one screw.

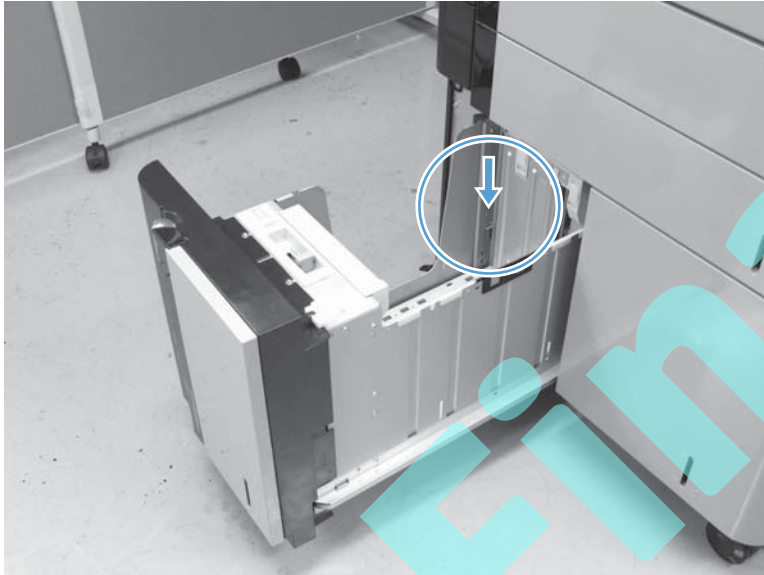
Figure 1-417 Remove the HCI rear and right-rear corner covers (1 of 4)

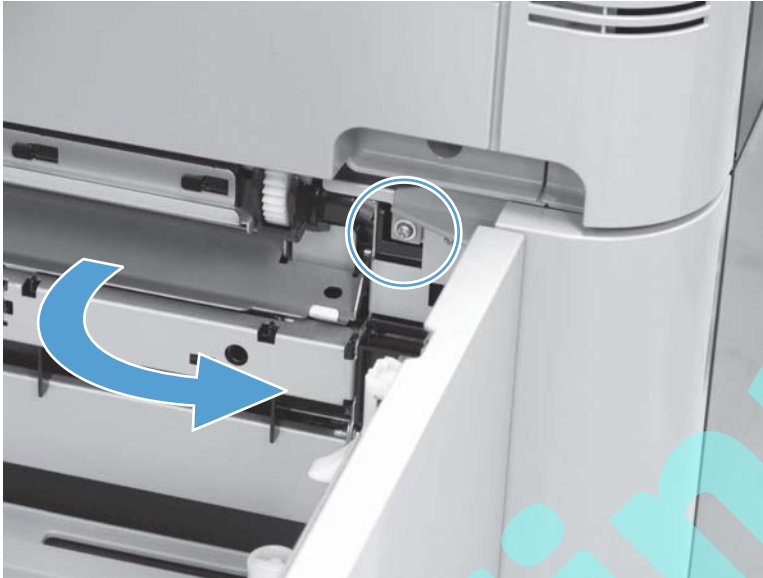

2. Release two tabs—located under the right-rear corner cover—and then slightly rotate the bottom of the right-rear cover away from the accessory.

Figure 1-418 Remove the HCI rear and right-rear corner covers (2 of 4)



3. Continue to rotate the right-rear corner cover away from the accessory (callout 1), and then slide the rear and right-rear corner covers toward the front of the accessory (callout 2) to release them.

Figure 1-419 Remove the HCI rear and right-rear corner covers (3 of 4)

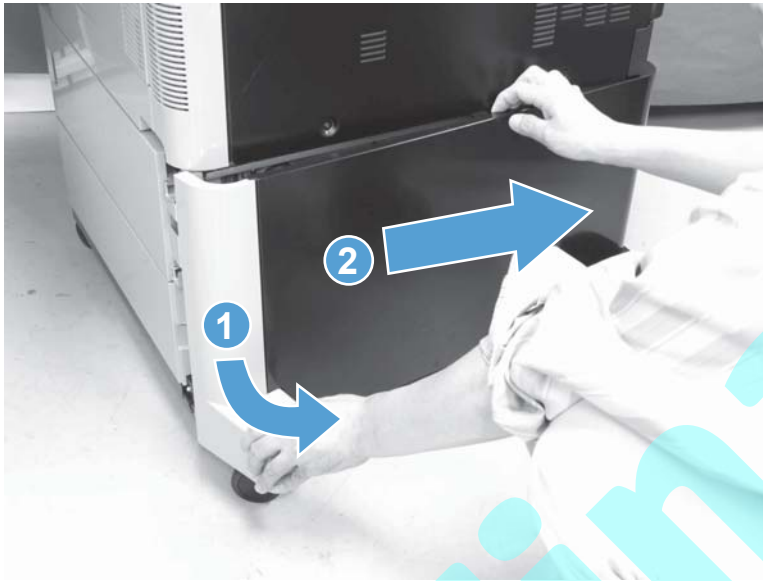

4. Continue to slide the rear and right-rear corner covers toward the front of the accessory to release on tab, and then remove the covers.

Figure 1-420 Remove the HCI rear and right-rear corner covers (4 of 4)



HCI right door assembly

Before proceeding, remove the following assemblies:

- HCI rear and right rear corner covers. See [HCI rear and right-rear corner covers on page 274](#).

Remove the HCI right door assembly

1. Open the right door (callout 1), and then pull up on the door retainer (callout 2) to release it.

Figure 1-421 Remove the HCI right door assembly (1 of 2)

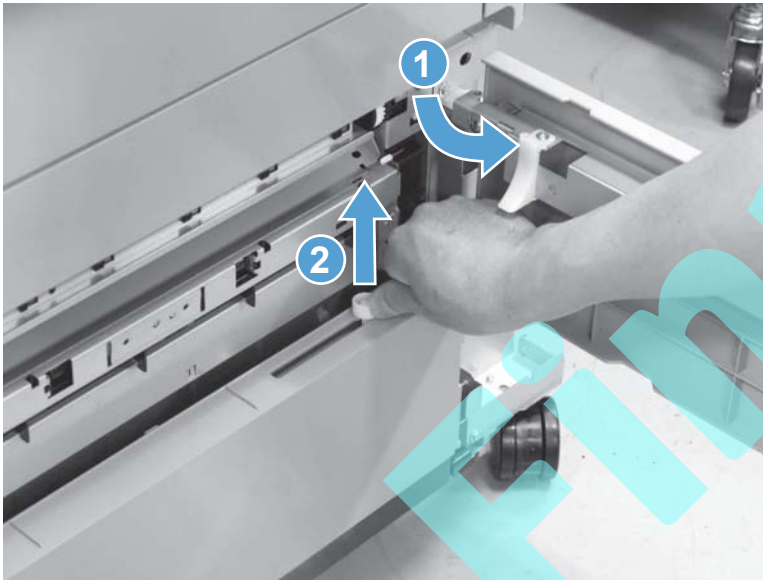

2. Lift the door straight up to remove it.

Figure 1-422 Remove the HCI right door assembly (2 of 2)

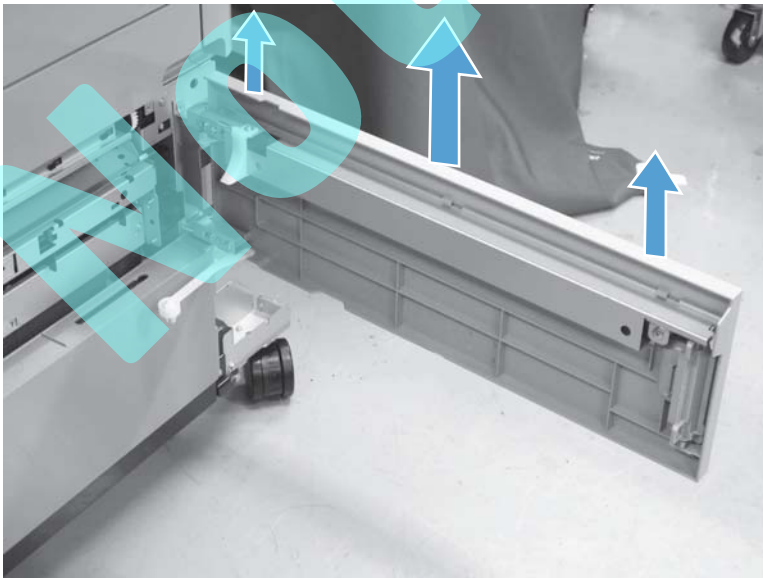

HCI left cover

Before proceeding, remove the following assemblies:

- HCI rear and right rear corner covers. See [HCI rear and right-rear corner covers on page 274](#).

Remove the HCI left cover

1. Remove one screw, and then slide the cover toward the rear of the accessory.

Figure 1-423 Remove the HCI left cover (1 of 2)

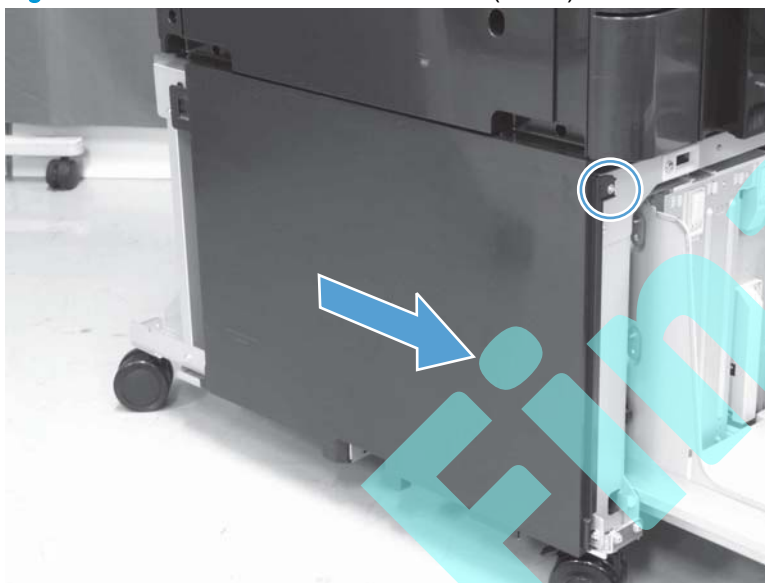

2. Release six tabs, and then remove the cover.

Figure 1-424 Remove the HCI left cover (2 of 2)

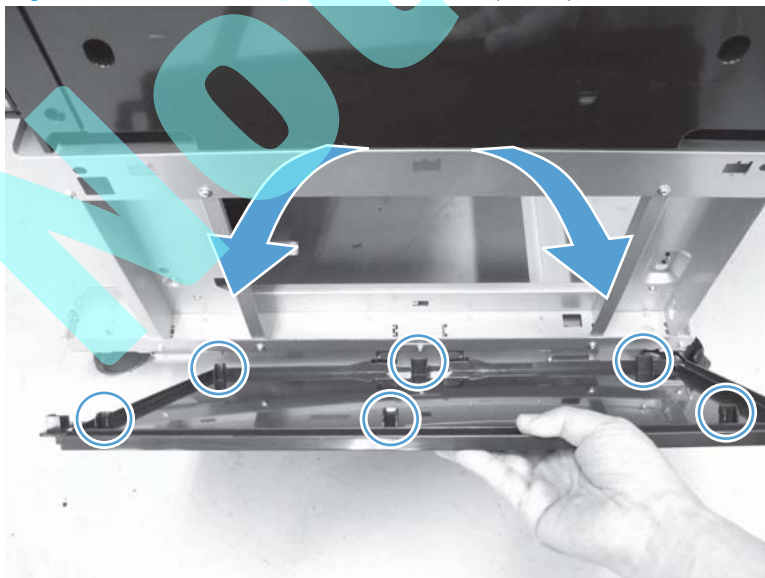

HCI center right cover

Before proceeding, remove the following assemblies:

- HCI rear and right rear corner covers. See [HCI rear and right-rear corner covers on page 274](#).
- HCI right door assembly. See [HCI right door assembly on page 276](#).

Remove the HCI center right cover

1. Remove two screws (callout 1), and then remove the lock holder (callout 2).

Figure 1-425 Remove the HCI center right cover (1 of 4)

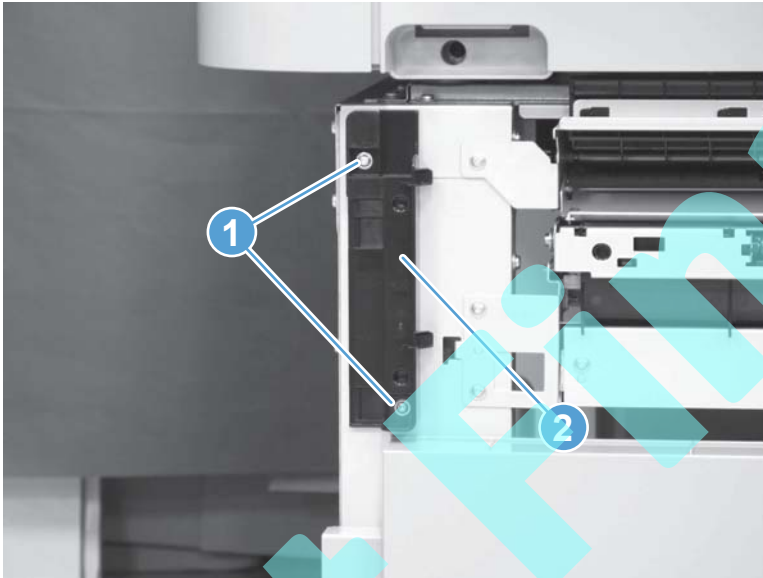

2. Remove three screws (callout 1), and then remove the hinge holder (callout 2).

Figure 1-426 Remove the HCI center right cover (2 of 4)

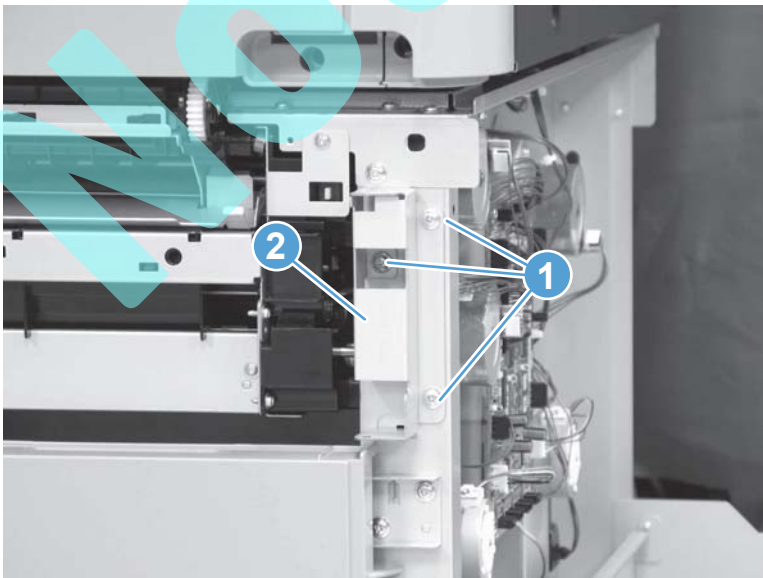

3. Remove one screw, and then slide the cover toward the right.

Figure 1-427 Remove the HCI center right cover (3 of 4)

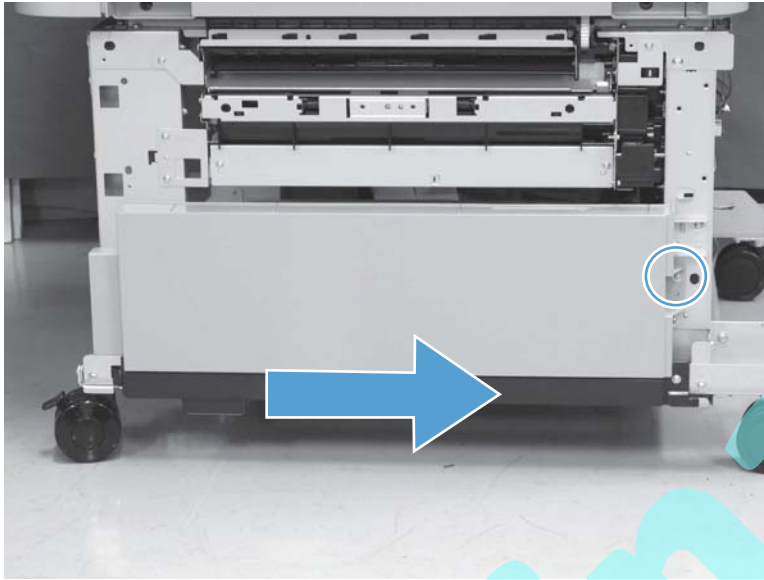

4. Release six tabs, and then remove the cover.

Figure 1-428 Remove the HCI center right cover (4 of 4)



HCI lower right cover

Before proceeding, remove the following assemblies:

- HCI rear and right rear corner covers. See [HCI rear and right-rear corner covers on page 274](#).
- HCI right door assembly. See [HCI right door assembly on page 276](#).
- HCI center right cover. See [HCI center right cover on page 278](#).

Remove the HCI lower right cover

1. Remove one screw.

Figure 1-429 Remove the HCI lower right cover (1 of 3)

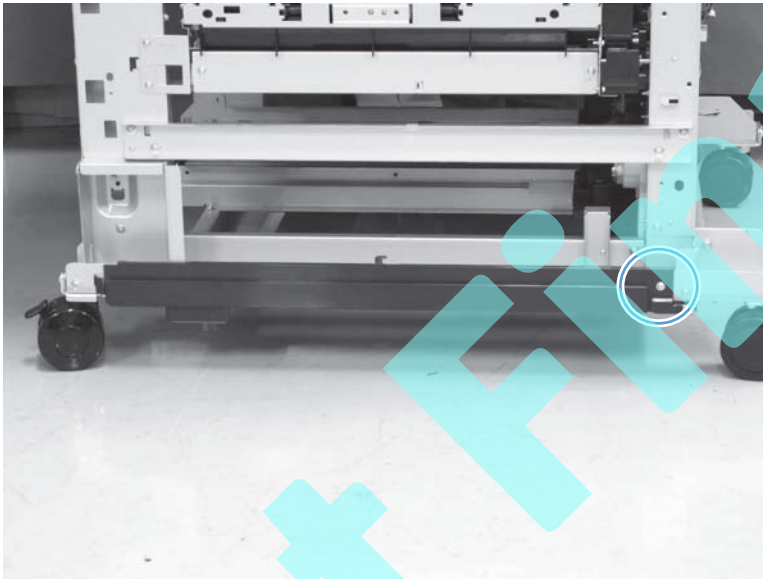

2. Release one tab.

Figure 1-430 Remove the HCI lower right cover (2 of 3)



3. Release one tab, and then remove the cover.

Figure 1-431 Remove the HCI lower right cover (3 of 3)



Not Final

HCI right tray pickup motor

Before proceeding, remove the following assemblies:

- HCI rear and right rear corner covers. See [HCI rear and right-rear corner covers on page 274](#).

Remove the HCI right tray pickup motor

- ▲ Disconnect one connector (callout 1), remove two screws (callout 2), and then remove the right tray pickup motor (callout 3).

Figure 1-432 Remove the HCI right tray pickup motor

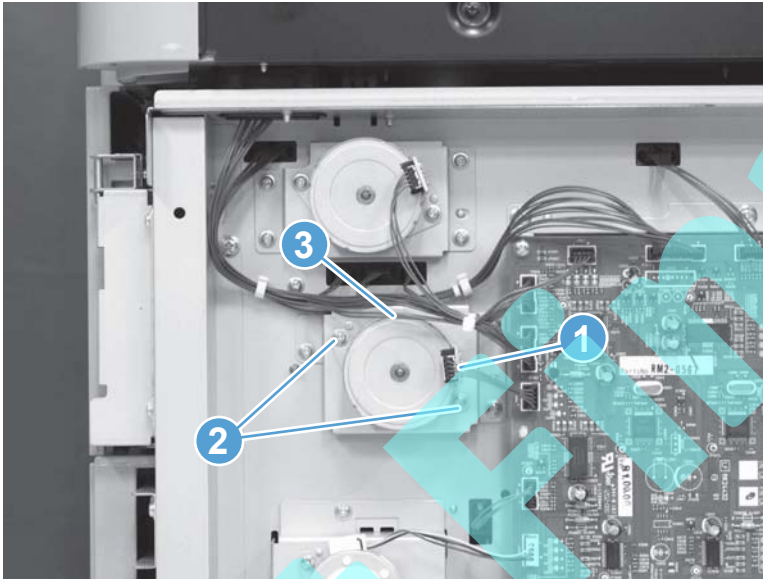

HCI right tray pickup drive

Before proceeding, remove the following assemblies:

- HCI rear and right rear corner covers. See [HCI rear and right-rear corner covers on page 274](#).

Remove the HCI right tray pickup drive

Disconnect one connector (callout 1), remove three screws (callout 2), and then remove the right tray pickup drive (callout 3).

 **NOTE:** If you are replacing the HCI right tray pickup drive, remove the HCI right tray pickup motor from the old part and move it to the replacement part. See [HCI right tray pickup motor on page 282](#).

Figure 1-433 Remove the HCI right tray pickup drive



HCI left tray pickup motor

Before proceeding, remove the following assemblies:

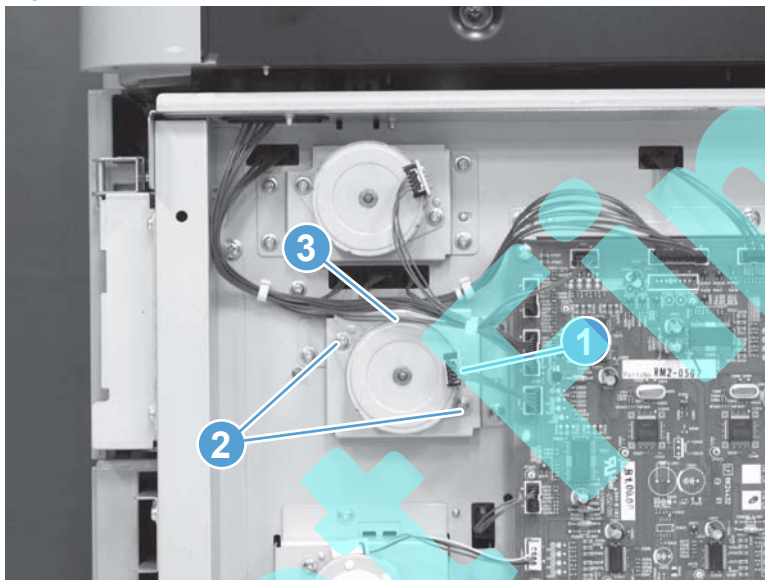
- HCI rear and right rear corner covers. See [HCI rear and right-rear corner covers on page 274](#).

Remove the HCI left tray pickup motor

Disconnect one connector (callout 1), remove two screws (callout 2), and then remove the left tray pickup motor (callout 3).

Figure 1-434 Remove the HCI left tray pickup motor.

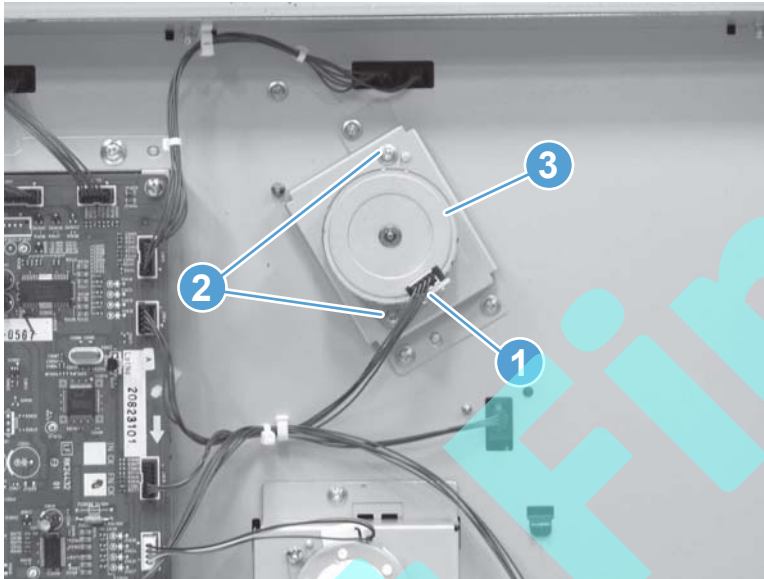

HCI left tray pickup drive

Before proceeding, remove the following assemblies:

- HCI rear and right rear corner covers. See [HCI rear and right-rear corner covers on page 274](#).

Remove the HCI left tray pickup drive

Disconnect one connector (callout 1), remove three screws (callout 2), and then remove the left tray pickup drive (callout 3).

 **NOTE:** If you are replacing the HCI left tray pickup drive, remove the HCI left tray pickup motor from the old part and move it to the replacement part. See [HCI left tray pickup motor on page 284](#).

Figure 1-435 Remove the HCI left tray pickup drive (1 of 2)



HCI merge drive assembly

Before proceeding, remove the following assemblies:

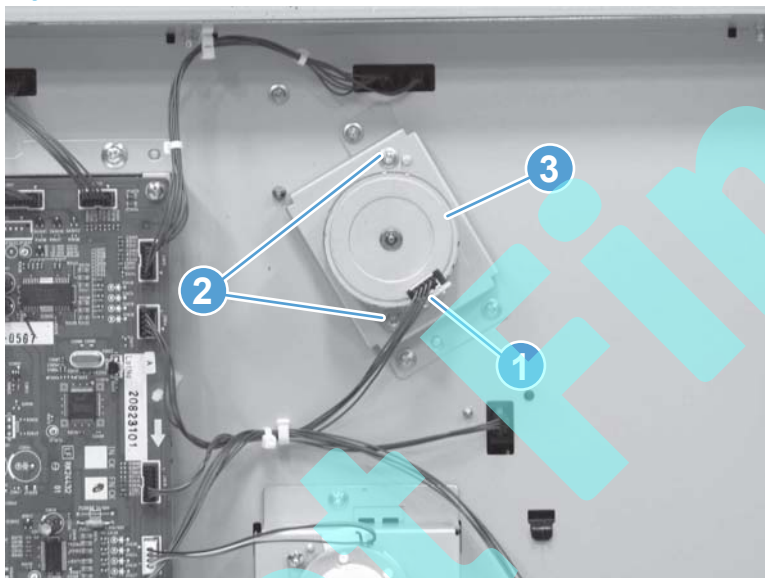
- HCI rear and right rear corner covers. See [HCI rear and right-rear corner covers on page 274](#).

Remove the HCI merge drive assembly

1. Disconnect one connector (callout 1), remove two screws (callout 2), and then remove the intermediate feed motor (callout 3).

Figure 1-436 Remove the HCI merge drive assembly (1 of 2)

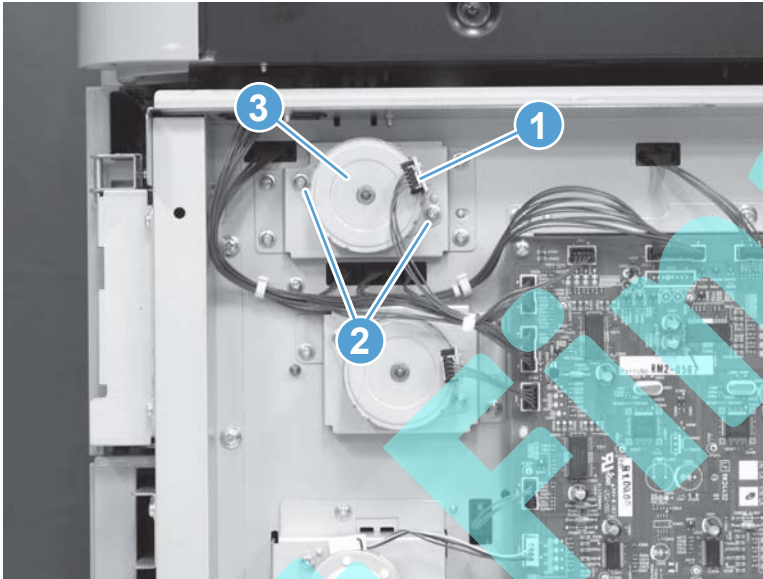

2. Remove four screws, and then remove the assembly.

Figure 1-437 Remove the HCI merge drive assembly (2 of 2)



HCI right tray lifter drive assembly

Before proceeding, remove the following assemblies:

- HCI rear and right rear corner covers. See [HCI rear and right-rear corner covers on page 274](#).

Remove the HCI right tray lifter drive assembly

1. Open the HCI right tray.
2. Disconnect one connector (callout 1), remove three screws (callout 2), and then lift the assembly up to remove it.

Figure 1-438 Remove the HCI right tray lifter drive assembly

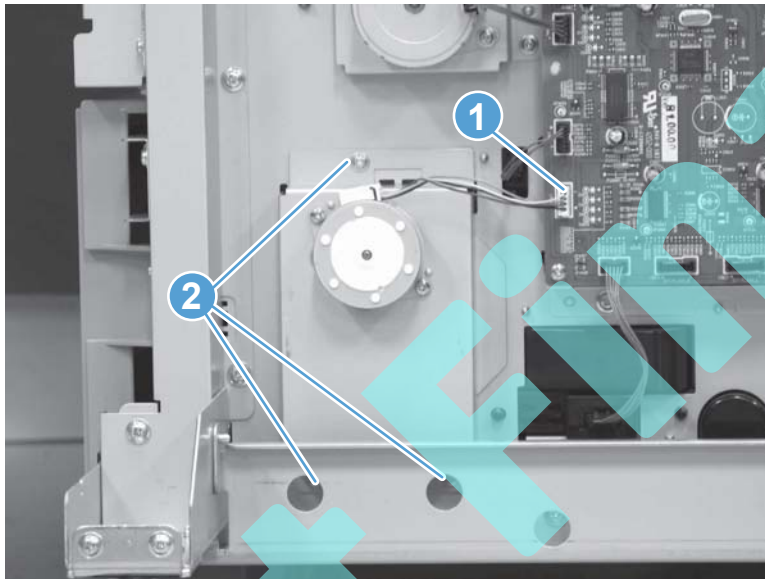

HCI left tray lifter drive assembly

Before proceeding, remove the following assemblies:

- HCI rear and right rear corner covers. See [HCI rear and right-rear corner covers on page 274](#).

Remove the HCI left tray lifter drive assembly

1. Open the HCI left tray.
2. Disconnect one connector (callout 1), remove three screws (callout 2), and then lift the assembly up to remove it

Figure 1-439 Remove the HCI left tray lifter drive assembly

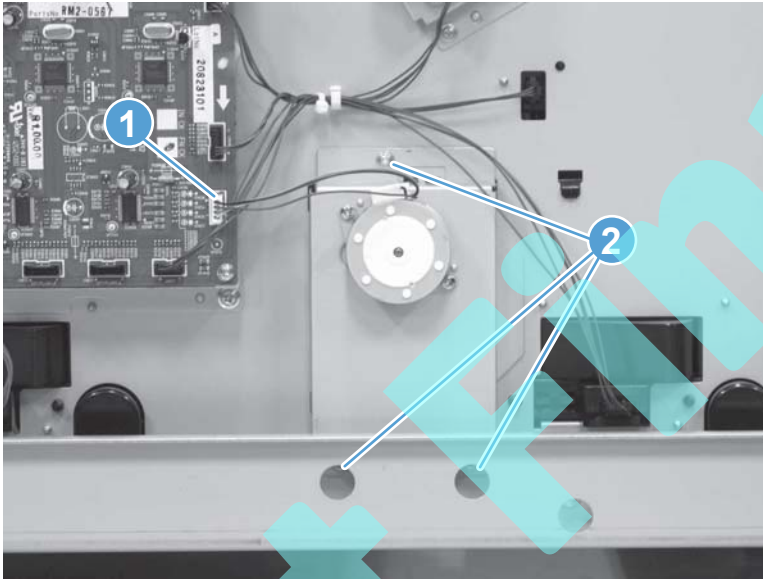

HCI right tray media-level sensor assembly

Before proceeding, remove the following assemblies:

- HCI right tray. See [HCI right tray on page 272](#).
- HCI rear and right rear corner covers. See [HCI rear and right-rear corner covers on page 274](#).

Remove the HCI right tray media-level sensor assembly

1. Disconnect one connector.

Figure 1-440 Remove the HCI right tray media-level sensor assembly (1 of 2)

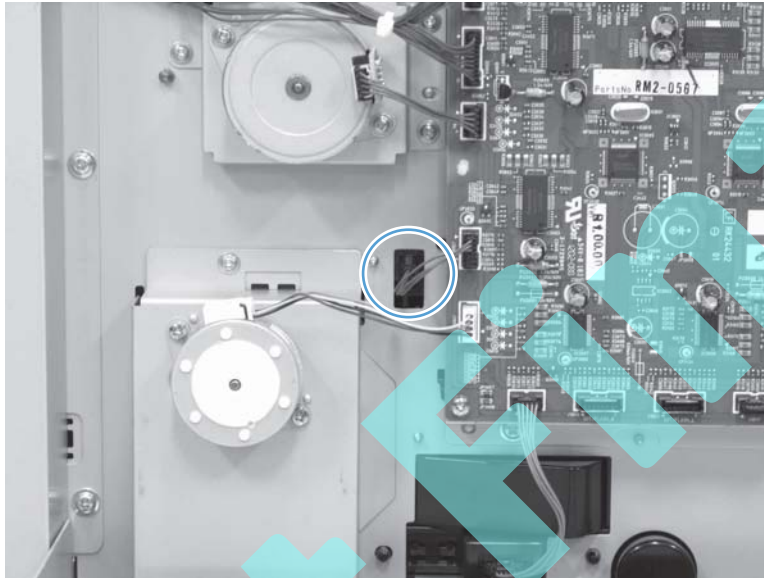

2. From inside the tray cavity, remove one screw, and then remove the assembly.

Figure 1-441 Remove the HCI right tray media-level sensor assembly (2 of 2)

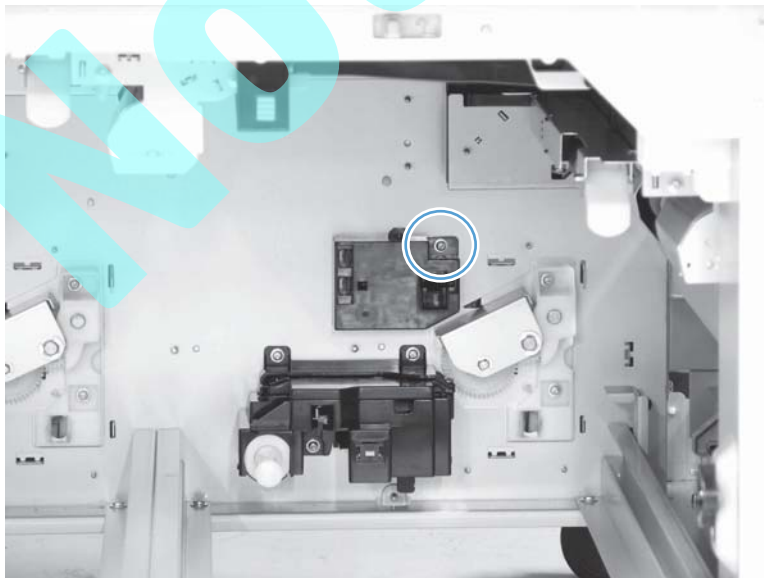

HCI left tray media-level sensor assembly

Before proceeding, remove the following assemblies:

- HCI left tray. See [HCI left tray on page 273](#).
- HCI rear and right rear corner covers. See [HCI rear and right-rear corner covers on page 274](#).

Remove the HCI left tray media-level sensor assembly

1. Disconnect one connector.

Figure 1-442 Remove the HCI left tray media-level sensor assembly (1 of 2)



2. From inside the tray cavity, remove one screw, and then remove the assembly.

Figure 1-443 Remove the HCI left tray media-level sensor assembly (2 of 2)



HCI right tray automatic close assembly

Before proceeding, remove the following assemblies:

- HCI right tray. See [HCI right tray on page 272](#).
- HCI rear and right rear corner covers. See [HCI rear and right-rear corner covers on page 274](#).

Remove the HCI right tray automatic close assembly

1. Disconnect one connector.

Figure 1-444 Remove the HCI right tray automatic close assembly (1 of 2)

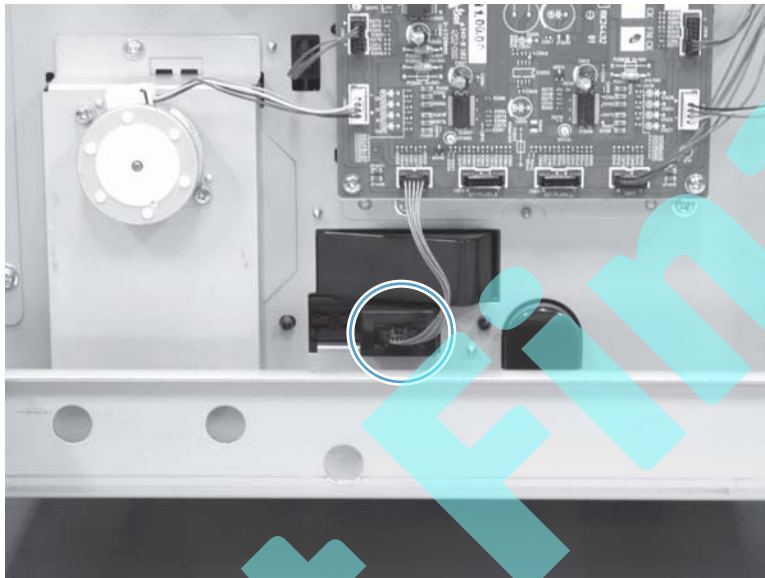

2. From inside the tray cavity, remove three screws, and then remove the assembly.

Figure 1-445 Remove the HCI right tray automatic close assembly (2 of 2)

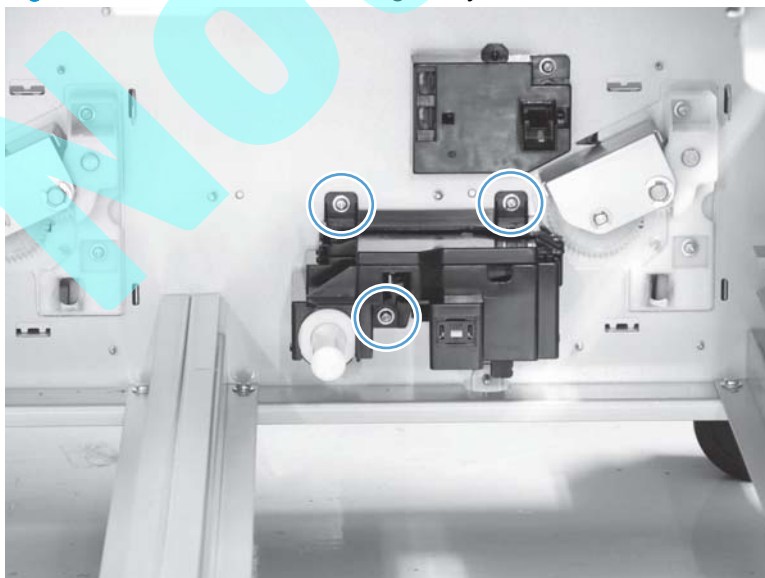

HCI left tray automatic close assembly

Before proceeding, remove the following assemblies:

- HCI left tray. See [HCI left tray on page 273](#).
- HCI rear and right rear corner covers. See [HCI rear and right-rear corner covers on page 274](#).

Remove the HCI left tray automatic close assembly

1. Disconnect one connector.

Figure 1-446 Remove the HCI left tray automatic close assembly (1 of 2)

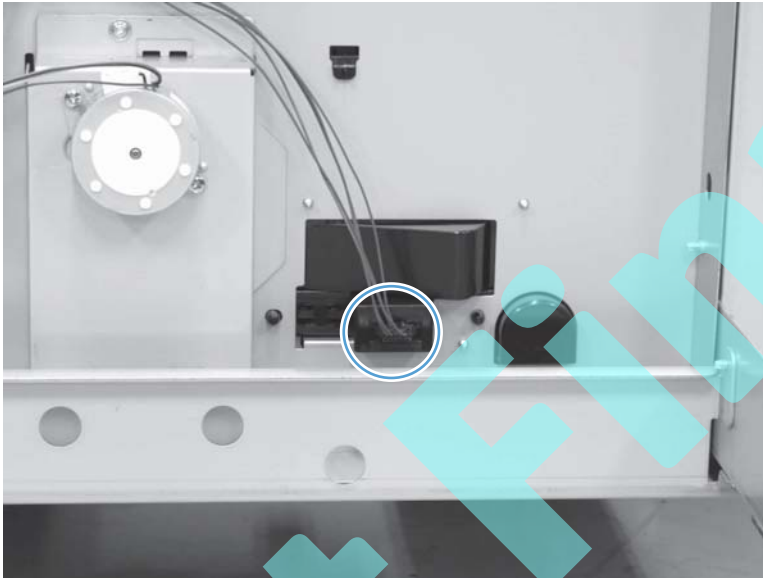

2. From inside the tray cavity, remove three screws, and then remove the assembly.

Figure 1-447 Remove the HCI left tray automatic close assembly (2 of 2)

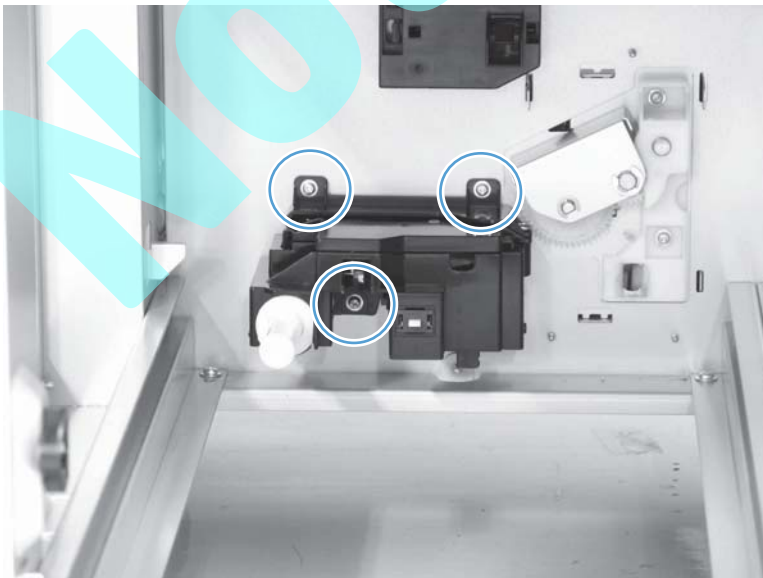

HCI right tray pickup assembly

Before proceeding, remove the following assemblies:

- HCI right tray. See [HCI right tray on page 272](#).
- HCI rear and right rear corner covers. See [HCI rear and right-rear corner covers on page 274](#).
- HCI right tray pickup drive. See [HCI right tray pickup drive on page 283](#).

Remove the HCI right tray pickup assembly

1. Disconnect three connectors (callout 1), and then remove one screw (callout 2).

Figure 1-448 Remove the HCI right tray pickup assembly (1 of 2)

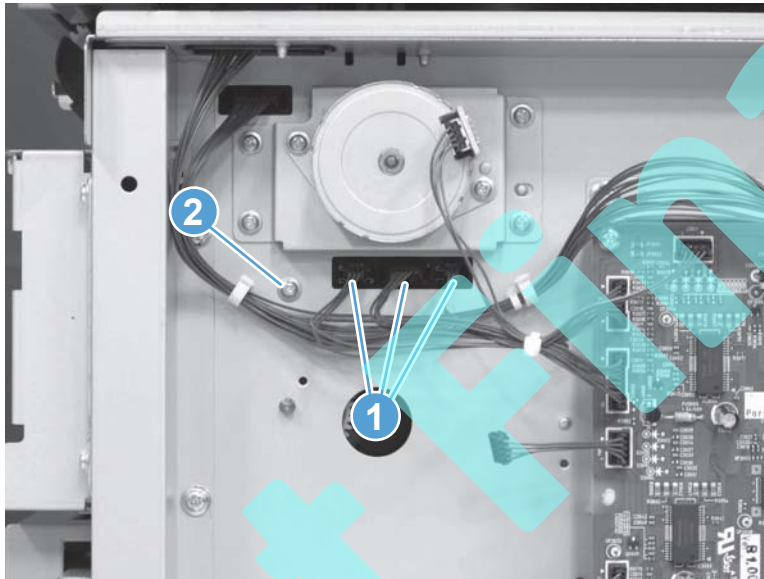

2. Remove two screws (callout 1), and then remove the assembly (callout 2).

 **TIP:** It might be easier to lift up on the merge assembly flap, and then remove (or replace) the pickup assembly from the right side of the HCI chassis (rather than from inside the tray cavity).

Figure 1-449 Remove the HCI right tray pickup assembly (2 of 2)



HCI left tray pickup assembly

Before proceeding, remove the following assemblies:

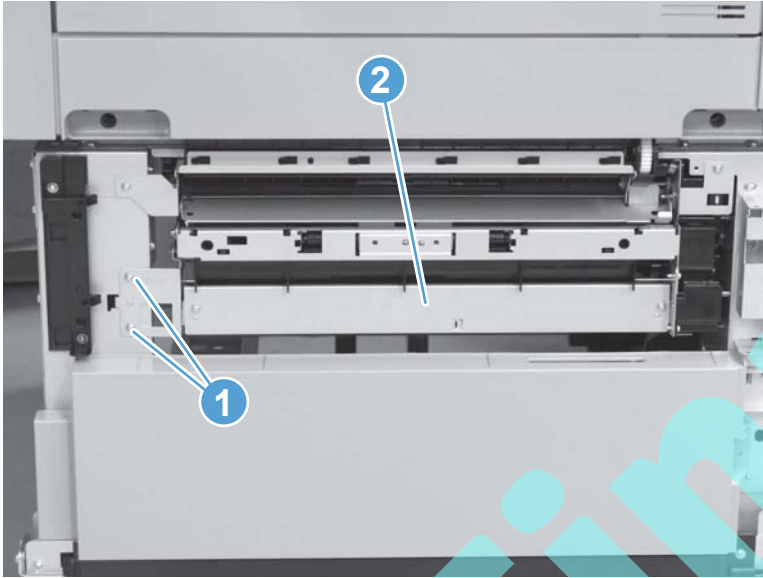
- HCI right tray. See [HCI right tray on page 272](#).
- HCI left tray. See [HCI left tray on page 273](#).
- HCI rear and right rear corner covers. See [HCI rear and right-rear corner covers on page 274](#).
- HCI left tray pickup drive. See [HCI left tray pickup drive on page 285](#).

Remove the HCI left tray pickup assembly

1. Disconnect three connectors (callout 1) and then remove one screw (callout 2).

Figure 1-450 Remove the HCI left tray pickup assembly (1 of 2)

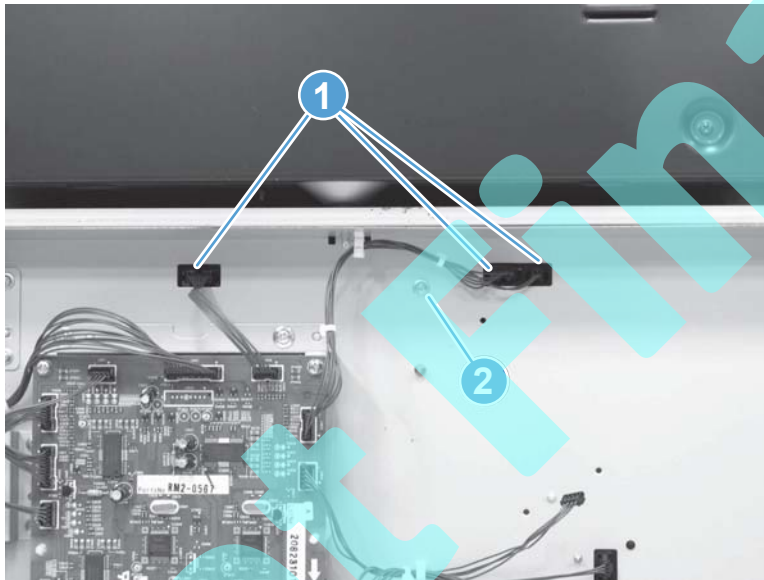

2. Inside the tray cavity, remove one screw (callout 1), and then remove the assembly (callout 2).

 **TIP:** Support the assembly when removing the screw (callout 1) so that it does not fall.

Figure 1-451 Remove the HCI left tray pickup assembly (2 of 2)

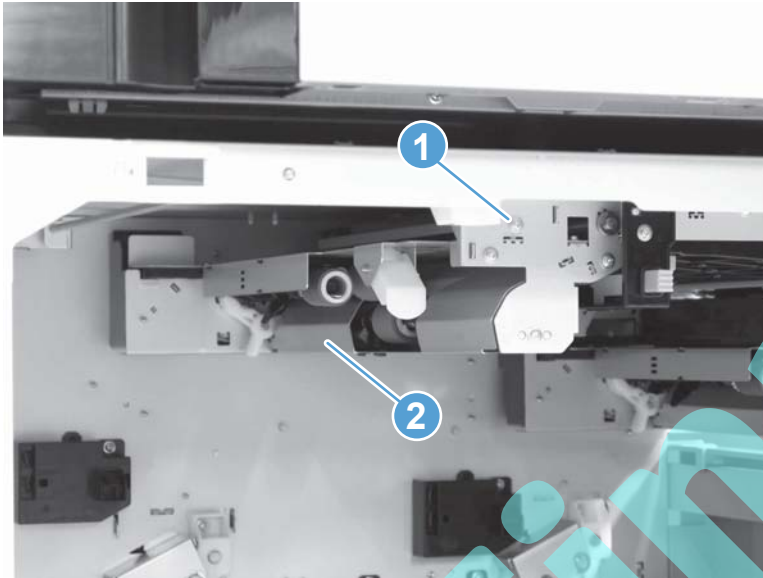

HCI merge assembly

Before proceeding, remove the following assemblies:

- HCI right tray. See [HCI right tray on page 272](#).
- HCI rear and right rear corner covers. See [HCI rear and right-rear corner covers on page 274](#).
- HCI right tray pickup drive. See [HCI right tray pickup drive on page 283](#).
- HCI right tray pickup assembly. See [HCI right tray pickup assembly on page 293](#).
- HCI merge drive assembly. See [HCI merge drive assembly on page 286](#).

Remove the HCI merge assembly

1. Disconnect one connector.

Figure 1-452 Remove the HCI merge assembly (1 of 2)



2. Remove two screws (callout 1), and then remove the assembly (callout 2).

Figure 1-453 Remove the HCI merge assembly (2 of 2)

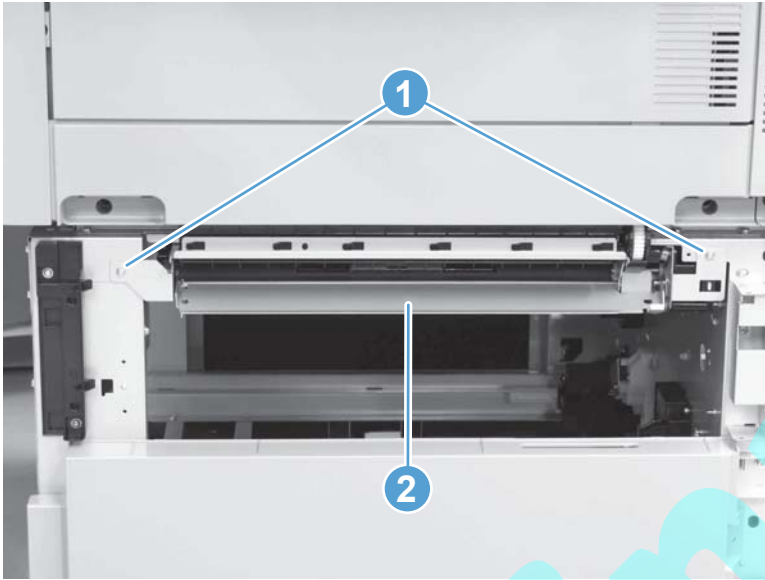

Not Final

HCI controller PCA

Before proceeding, remove the following assemblies:

- HCI rear and right rear corner covers. See [HCI rear and right-rear corner covers on page 274](#).

Remove the HCI controller PCA

Disconnect all of the connectors on the HCI controller PCA, remove four screws (callout 1), release two standoffs (callout 2), and then remove the PCA.

Figure 1-454 Remove the HCI controller PCA

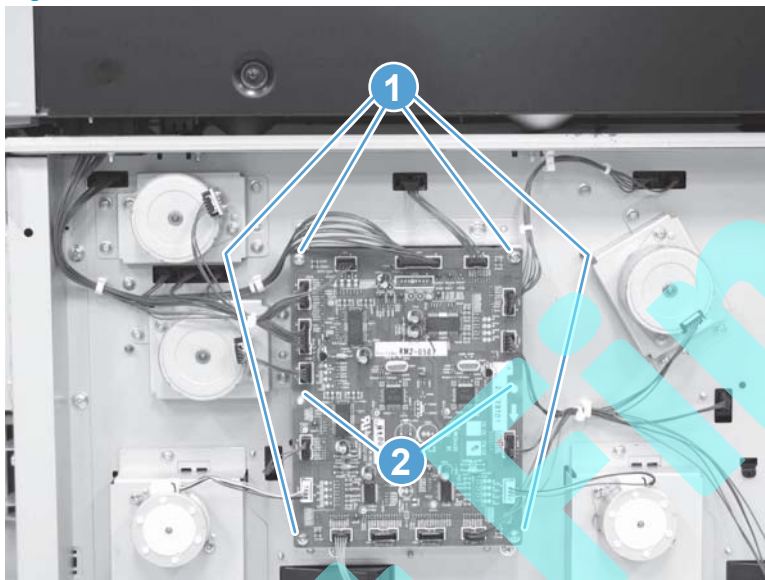

Finishing accessories

 **CAUTION:** Disconnect the finishing accessory from the product before servicing.

This section includes information about the following topics:

- [Identify the finishing accessories](#)
- [Disconnect a finishing accessory from the product](#)
- [Identifying finishing accessory covers and doors](#)
- [Shared finishing accessory assemblies](#)
- [Booklet maker accessory](#)
- [Stapler/stacker and stapler/stacker with hole punch accessories](#)

Not Final

Identify the finishing accessories

- Booklet maker (BM)

Includes booklet maker and stapler functions.

Figure 1-455 Identify the BM finishing accessory

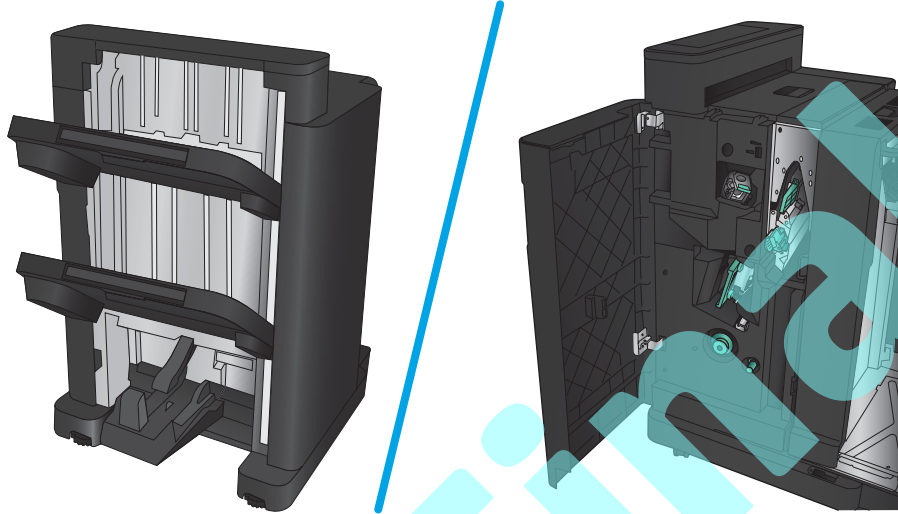

- Stapler/stacker (SS)

Includes stapler functions.

Figure 1-456 Identify the SS finishing accessory

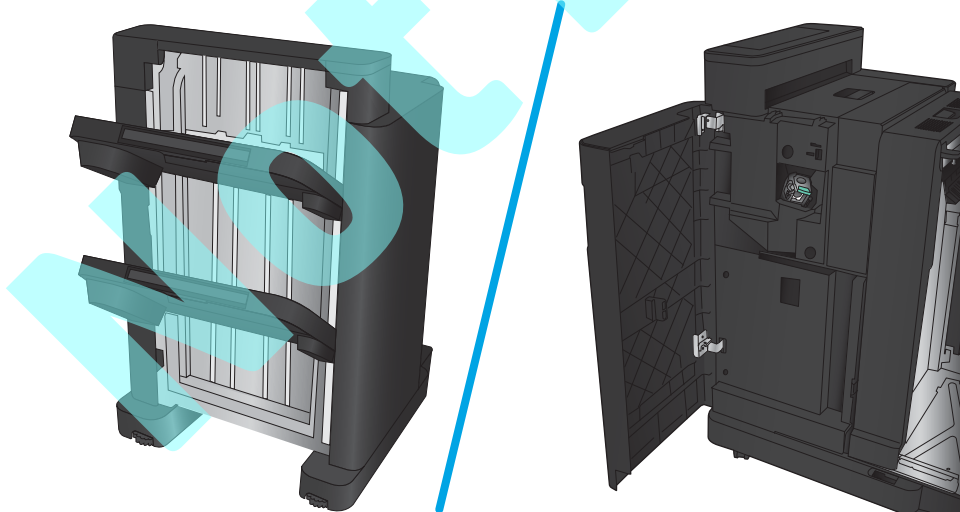

- Stapler/stacker with hole punch (SSHP)
Includes stapler and hole punch (2/3 or 2/4) functions.

Figure 1-457 Identify the SSHP finishing accessory

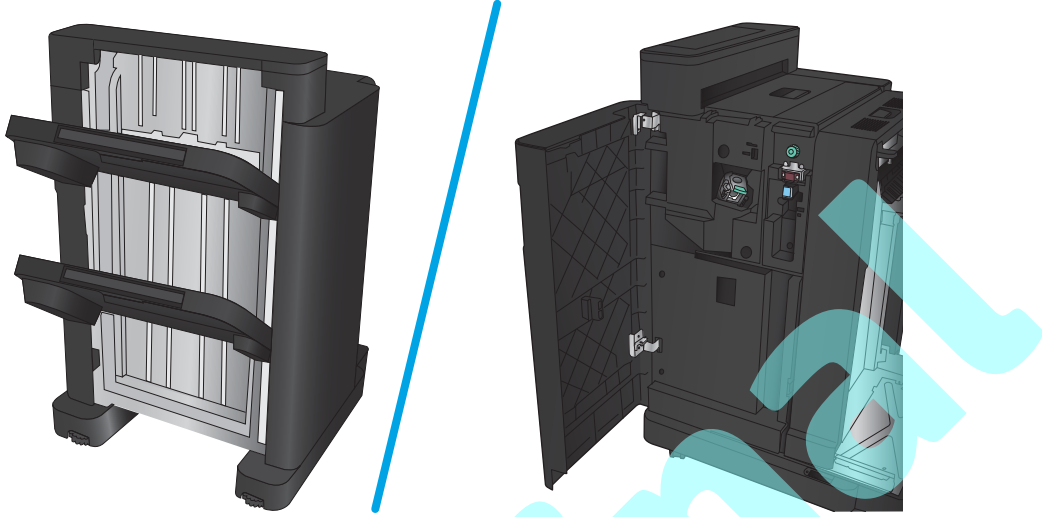

Disconnect a finishing accessory from the product

⚠ CAUTION: You must use the following procedure to disconnect a finishing accessory from the product. Incorrectly disconnecting a finishing accessory can damage the accessory.

1. Turn the product power off, and then disconnect the accessory interface cable from the product.

💡 TIP: Release one tab found on the bottom of the cable to release it.

Figure 1-458 Disconnect a finishing accessory from the product (1 of 4)

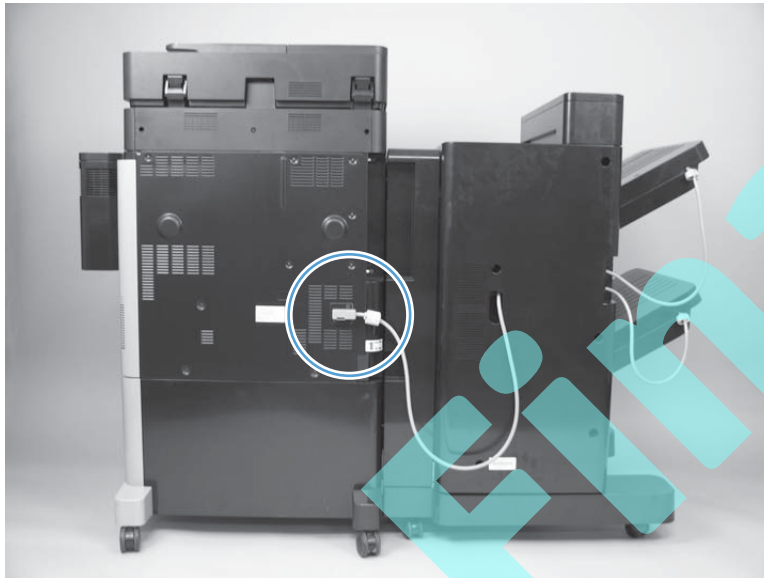

2. Open the accessory front door.

Figure 1-459 Disconnect a finishing accessory from the product (2 of 4)



3. Release and hold the lower-release latch, and then release and hold the upper release latch. Keep both of the latches in the release position.

Figure 1-460 Disconnect a finishing accessory from the product (3 of 4)

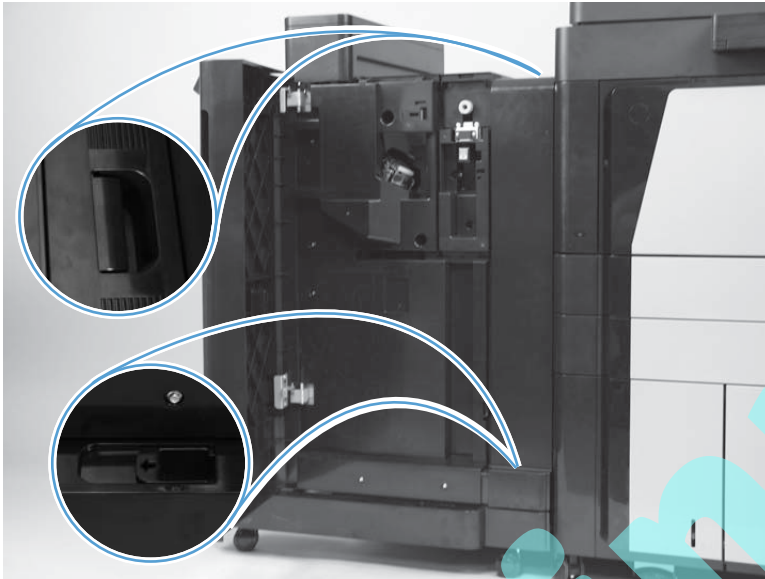

4. With the upper- and lower-release latches in the release position, carefully slide the accessory away from the product.

 **TIP:** It might be easier if two people slide the accessory away from the product.

Figure 1-461 Disconnect a finishing accessory from the product (4 of 4)

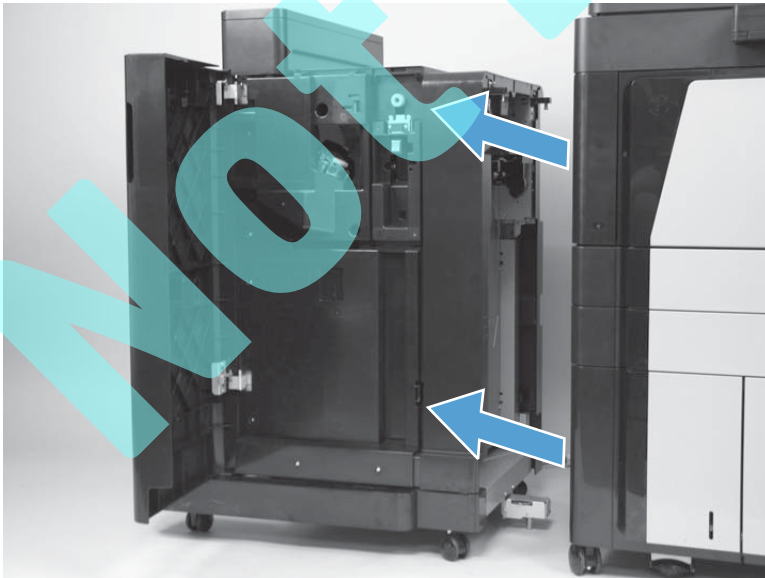

Identifying finishing accessory covers and doors

 **NOTE:** Unless otherwise noted, many of the covers, doors, and output bins are common to all of the finishing accessories.

Figure 1-462 Finishing accessory covers and doors (1 of 2)

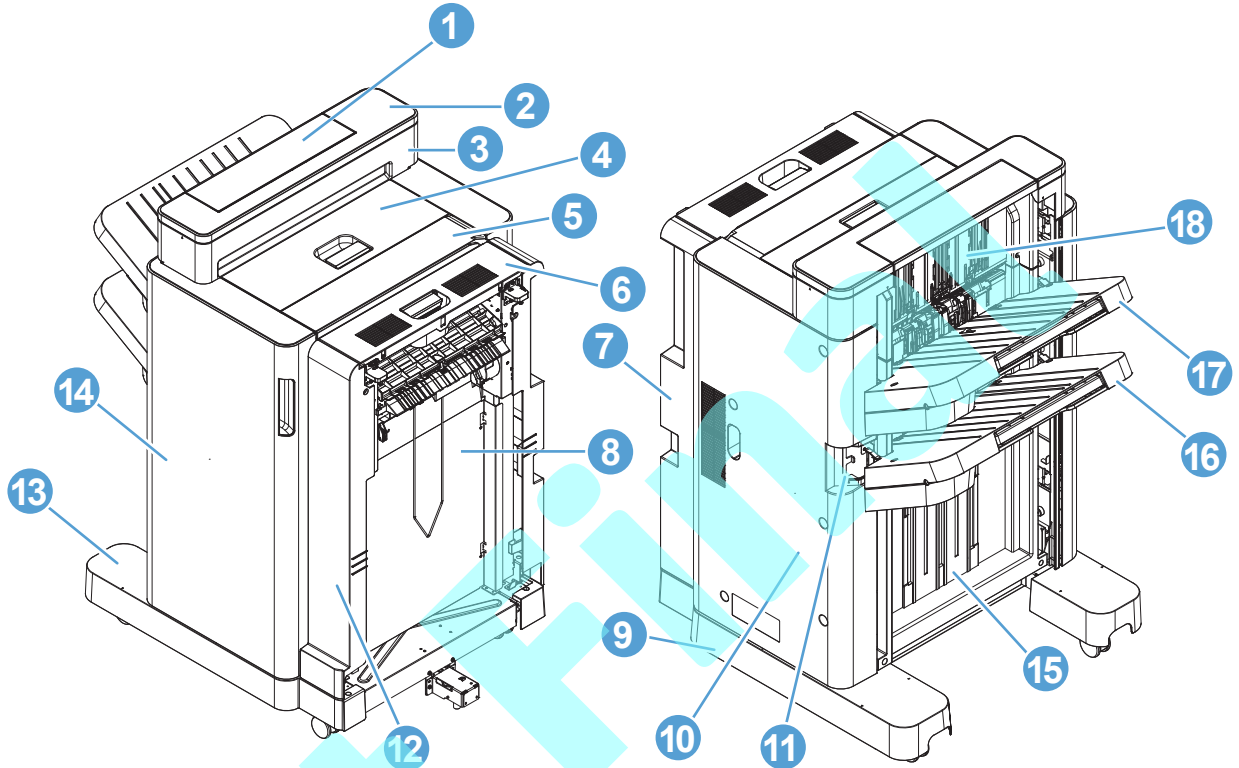

Table 1-9 Finishing accessory covers and doors (1 of 2)

Item	Description	Item	Description
1	Open/closed stepped cover assembly	10	Rear cover assembly
2	Upper stepped cover assembly	11	Bin cable guide cover
3	Lower stepped cover assembly	12	Pre-reverse cover assembly
4	Top cover assembly	13	Front foot cover assembly
5	Punch cover assembly	14	Front door
NOTE: Stapler/stacker with hole punch (SSHP) only.			
6	Upper reverse cover assembly	15	Height wall assembly
7	Rear reverse cover assembly	16	Lower bin assembly
8	Right cover assembly	17	Upper bin assembly
9	Rear foot cover assembly	18	Stack wall upper assembly and upper wall guide assemblies

Figure 1-463 Finishing accessory covers and doors (2 of 2)

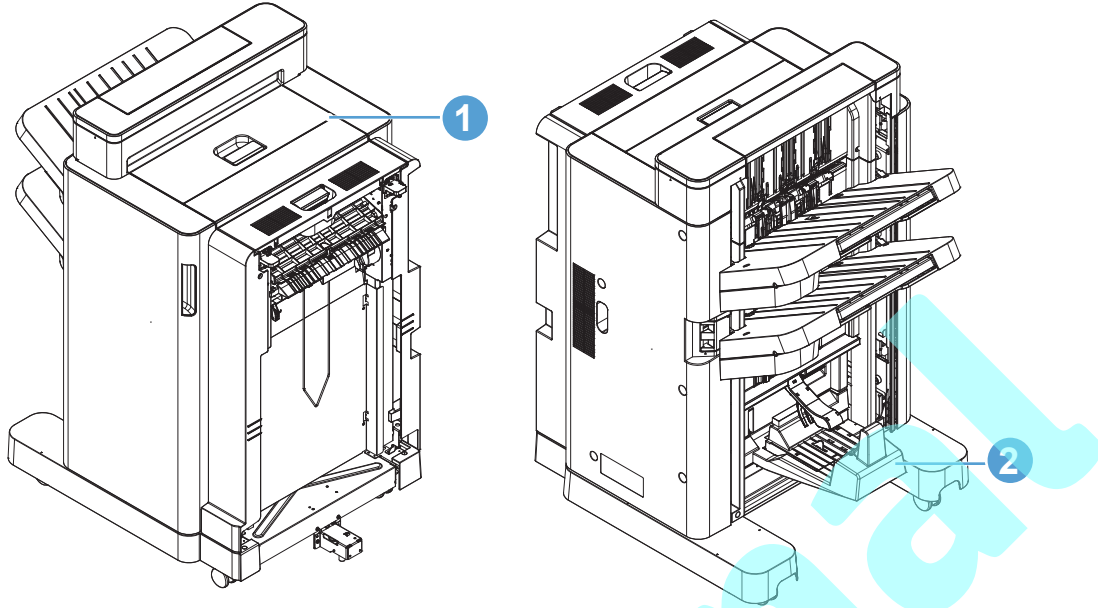

Table 1-10 Finishing accessory covers and doors (2 of 2)

Item	Description	Item	Description
1	Upper cover with extension assembly	2	Saddle output bin assembly
	NOTE: Booklet maker (BM) only.		NOTE: Booklet maker (BM) only.

Shared finishing accessory assemblies

The assemblies described in this section are found on each of the finishing accessories.

- [Upper cover lock assembly](#)
- [Right cover assembly](#)
- [Pre-reverse cover assembly](#)
- [Rear reverse cover assembly](#)
- [Upper reverse cover assembly](#)
- [Bin cable guide cover](#)
- [Open/closed stepped cover assembly](#)
- [Upper stepped cover assembly](#)
- [Lower stepped cover assembly](#)
- [Top door assembly](#)
- [Front door](#)
- [Inner upper cover assembly](#)
- [Clutch assembly \(front side\)](#)
- [Sensor switch assembly](#)
- [Inner lower cover assembly](#)
- [Front foot cover assembly](#)
- [Lower lock release handle assembly](#)
- [Rear cover assembly](#)
- [Main controller PCA assembly](#)
- [Entrance upper guide assembly](#)
- [Rear foot cover assembly](#)
- [Stack wall upper assembly and upper wall guide assembly](#)
- [Upper crossmember assembly](#)
- [Paper feed drive assembly](#)
- [Pressure roller assembly](#)
- [Stack upper bin and lower bin assemblies](#)
- [Height wall assembly](#)
- [Paper face sensor and flag assembly](#)
- [Staple sub assembly](#)

- [Staple connecting cable assembly](#)
- [Staple assembly](#)
- [Paper detect holder assembly](#)
- [Operation tray assembly](#)
- [Swing guide assembly](#)
- [Return roller assembly](#)
- [Clutch assembly \(rear side\)](#)
- [Stack ejection motor assembly](#)
- [Press motor assembly](#)
- [Common driver PCA assembly](#)
- [Interface cable assembly](#)
- [Reverse driver PCA assembly](#)
- [Reverse assembly](#)
- [Paper pass assembly](#)

Not Final

Upper cover lock assembly

1. Open the upper cover, and then carefully unsnap two spring loaded arms to release them from the latch shaft.

Figure 1-464 Remove the upper cover lock assembly (1 of 3)

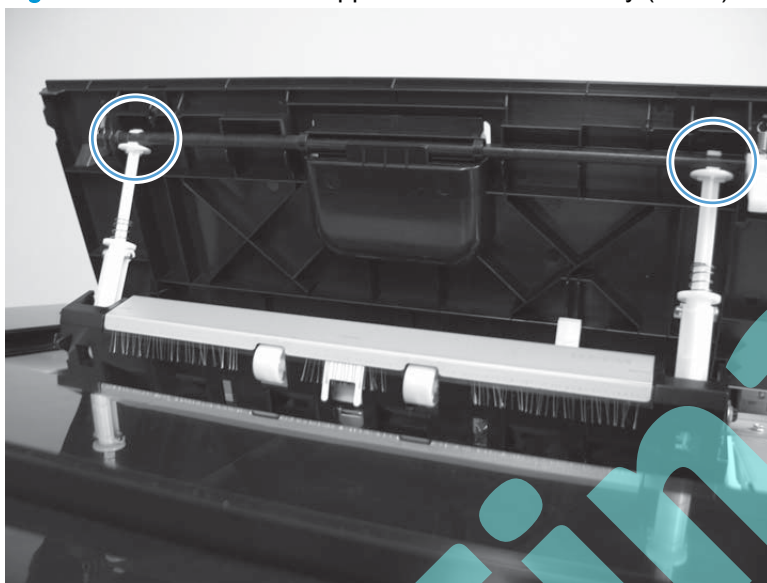

2. Move the upper cover out of the way, release one lever (callout 1) which holds the entrance upper guide assembly in the open position, and then lower the guide assembly (callout 2) into the accessory.

Figure 1-465 Remove the upper cover lock assembly (2 of 3)

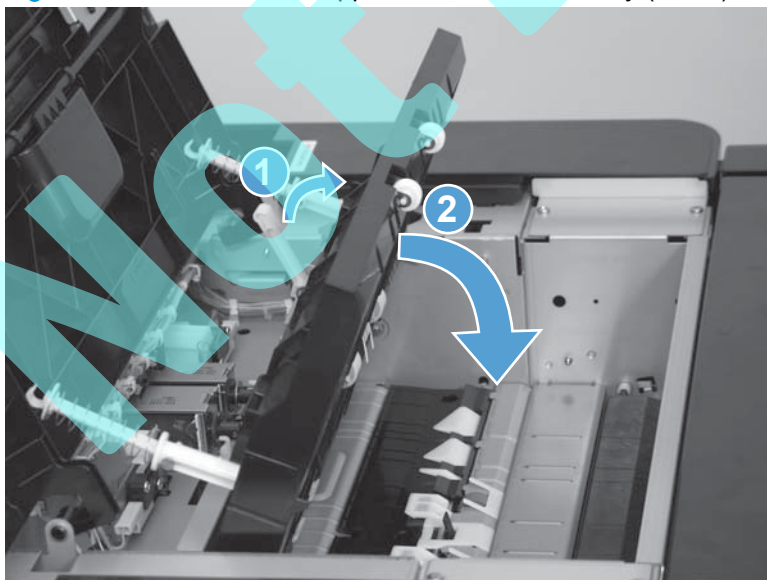

3. Remove one screw (callout 1), and then remove the upper cover lock assembly (callout 2).

Figure 1-466 Remove the upper cover lock assembly (3 of 3)

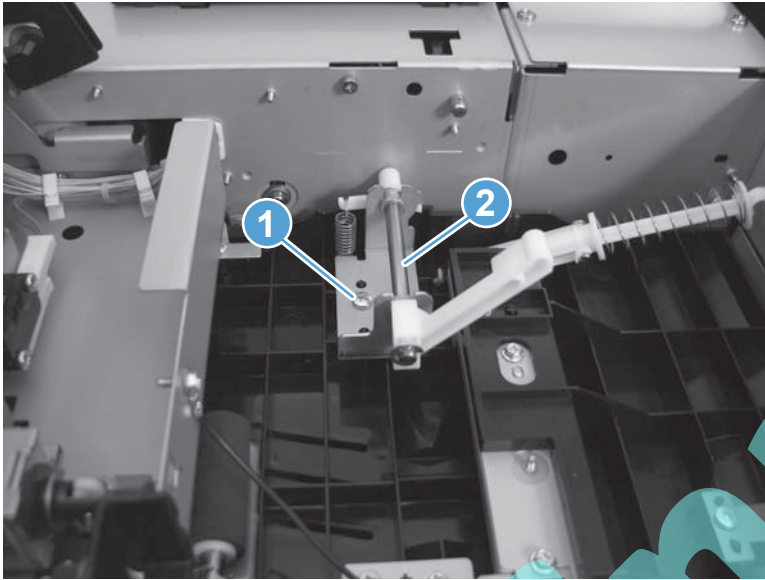

Right cover assembly

1. Remove four screws.

 **NOTE:** These screws have a larger head than other screws used in the accessory. Make sure that you use these screws when the assembly is reinstalled.

Figure 1-467 Remove the right cover assembly (1 of 2)



2. Lift the cover up to release it, and then remove the cover.

Figure 1-468 Remove the right cover assembly (2 of 2)

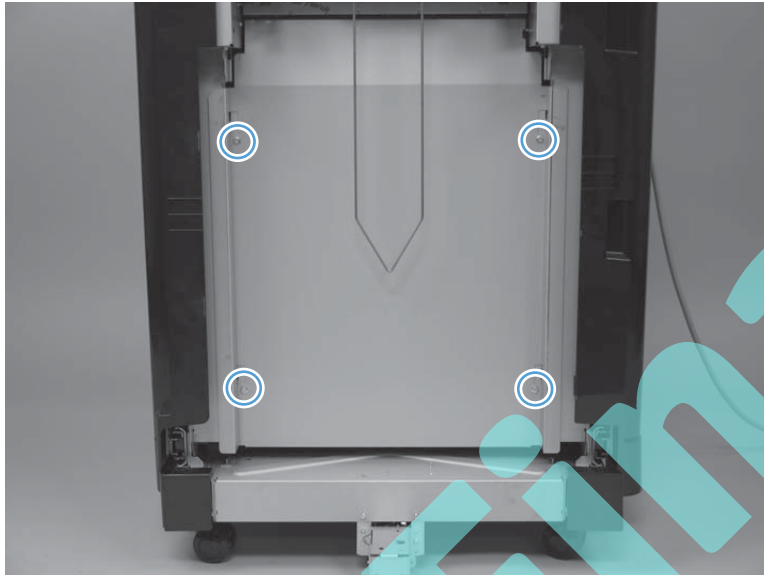
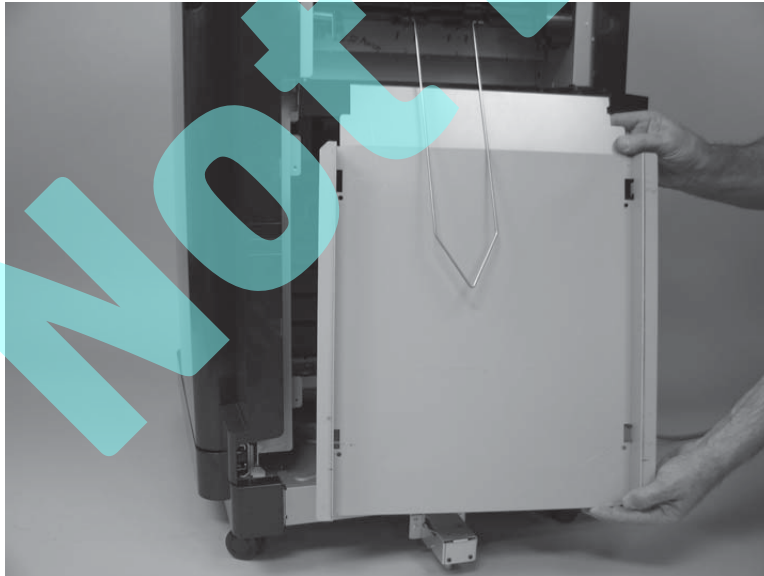

Pre-reverse cover assembly

Before proceeding, remove the following assemblies:

- Right cover assembly. See [Right cover assembly on page 311](#).

Remove the pre-reverse cover assembly

1. Remove one screw.

 **NOTE:** The cover is located on the product side of the accessory, to the right of the front door.

Figure 1-469 Remove the pre-reverse cover assembly (1 of 3)



2. Remove one screw.

Figure 1-470 Remove the pre-reverse cover assembly (2 of 3)

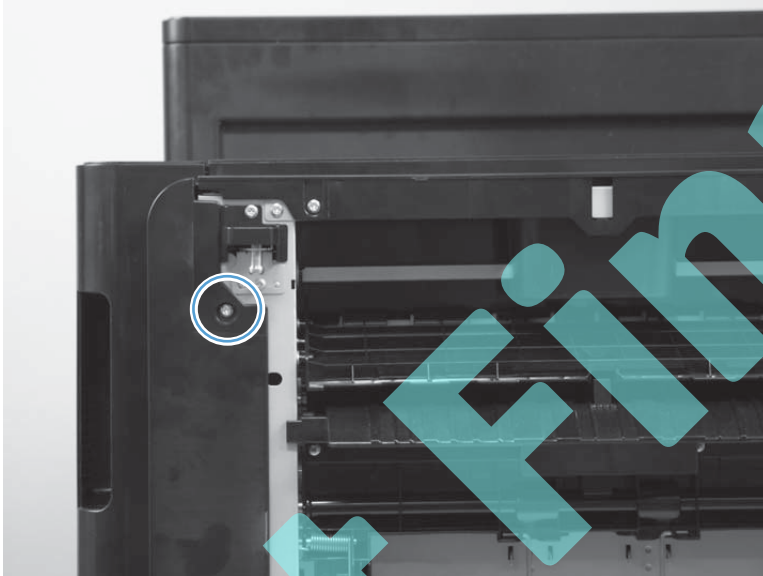

3. Lift up on the cover to release it, and then remove the cover.

Figure 1-471 Remove the pre-reverse cover assembly (3 of 3)

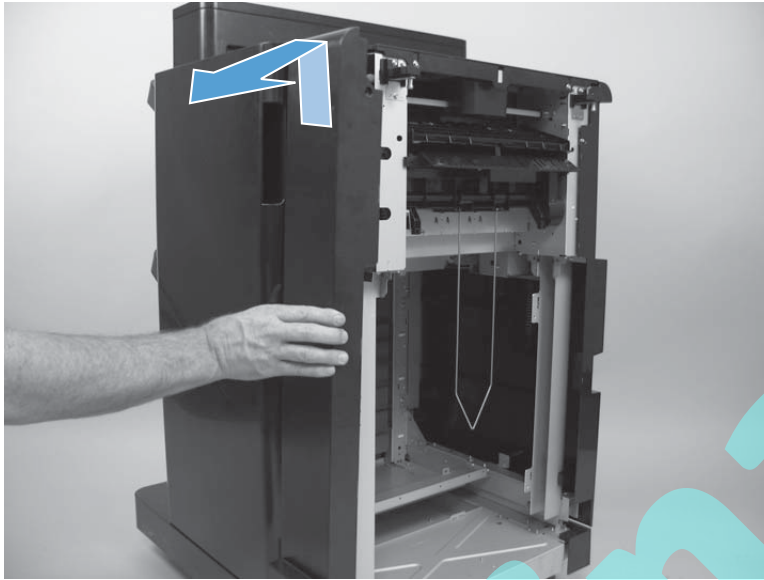

Not Final

Rear reverse cover assembly

Before proceeding, remove the following assemblies:

- Right cover assembly. See [Right cover assembly on page 311](#).

Remove the rear reverse cover assembly

1. Remove one screw.

 **NOTE:** The cover is located on the product side of the accessory, to the left of the rear cover.

Figure 1-472 Remove the rear reverse cover assembly (1 of 3)



2. Remove one screw.

Figure 1-473 Remove the rear reverse cover assembly (2 of 3)

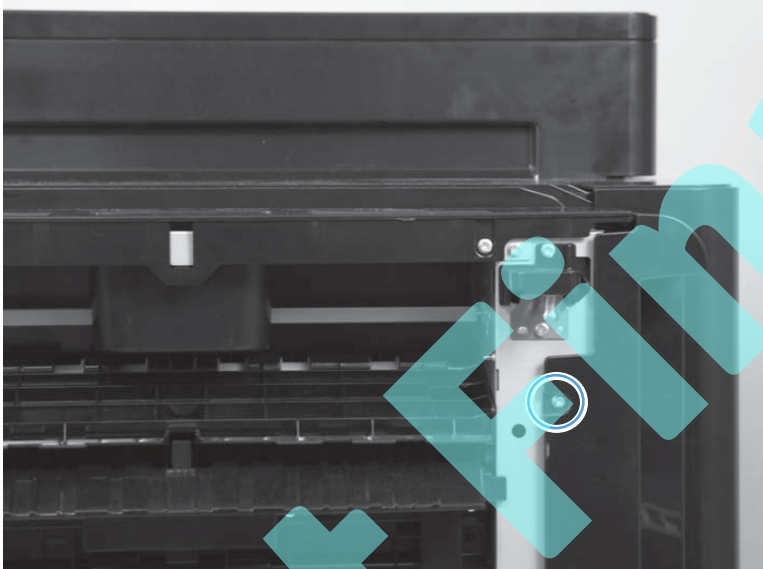

3. Lift up on the cover to release it, and then remove the cover.

Figure 1-474 Remove the rear reverse cover assembly (3 of 3)

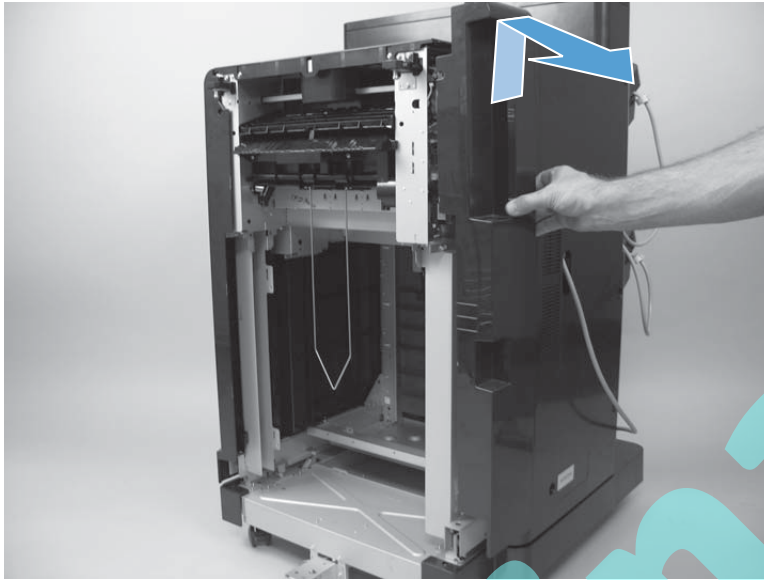

Not Final

Upper reverse cover assembly

Before proceeding, remove the following assemblies:

- Right cover assembly. See [Right cover assembly on page 311](#).
- Pre-reverse cover assembly. See [Pre-reverse cover assembly on page 312](#).
- Rear Reverse cover assembly. See [Rear reverse cover assembly on page 314](#).

Remove the upper reverse cover assembly

1. Remove two screws.

Figure 1-475 Remove the upper reverse cover assembly (1 of 2)

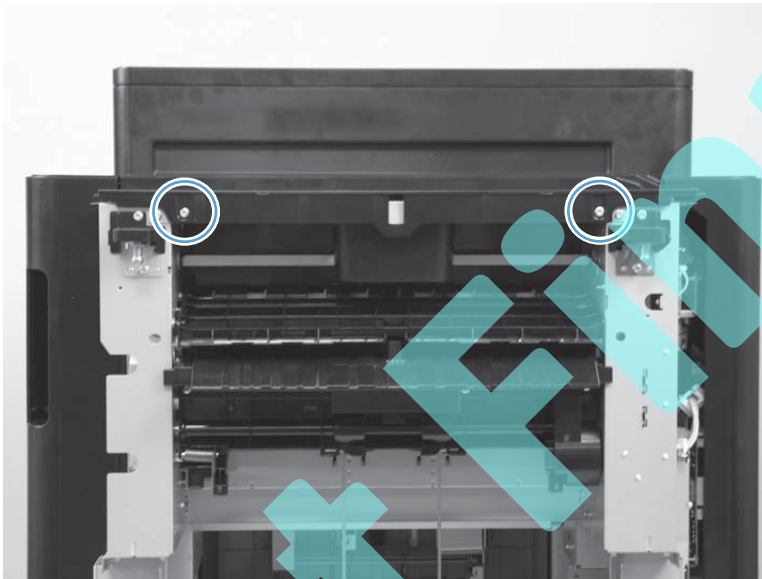

2. Lift the cover up, and then slide it away from the finishing accessory to remove it.

Figure 1-476 Remove the upper reverse cover assembly (2 of 2)

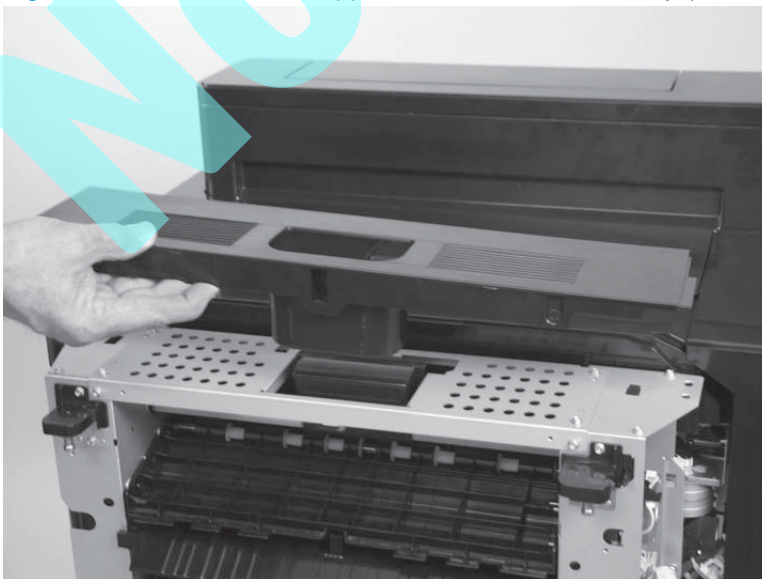

Bin cable guide cover

1. Use the figure below to locate the bin cable guide cover.

Figure 1-477 Remove the bin cable guide cover (1 of 6)

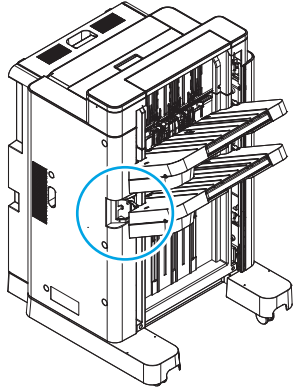

2. If the upper or lower stack bin prevents access to this cover, do the following:

 **TIP:** Push up on the bin to move it toward the top of the accessory. To move the bin down, use the following procedure to release the clutch.

- a. Support the bin.
- b. Release the bin clutch located on the underside of the bin, and then lower the bin to access the cover.

 **TIP:** Use a small flat blade screw driver to slide the raised portion of the clutch toward the spring to release the clutch.

Figure 1-478 Remove the bin cable guide cover (2 of 6)



3. Use your fingers to reach in behind the cover, and then rotate the end of the cover—near the stack bin cables—away from the accessory to release two tabs.

Figure 1-479 Remove the bin cable guide cover (3 of 6)

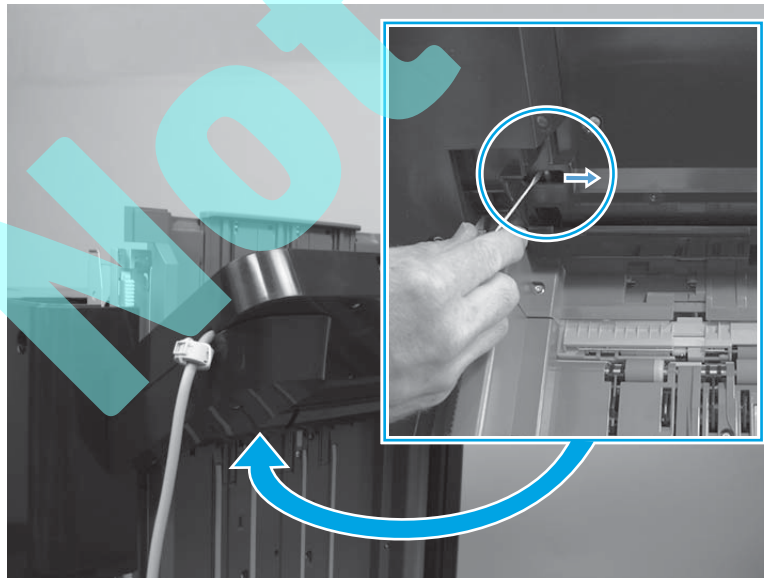

4. Slide the cover towards the stack bins to release it.

Figure 1-480 Remove the bin cable guide cover (4 of 6)

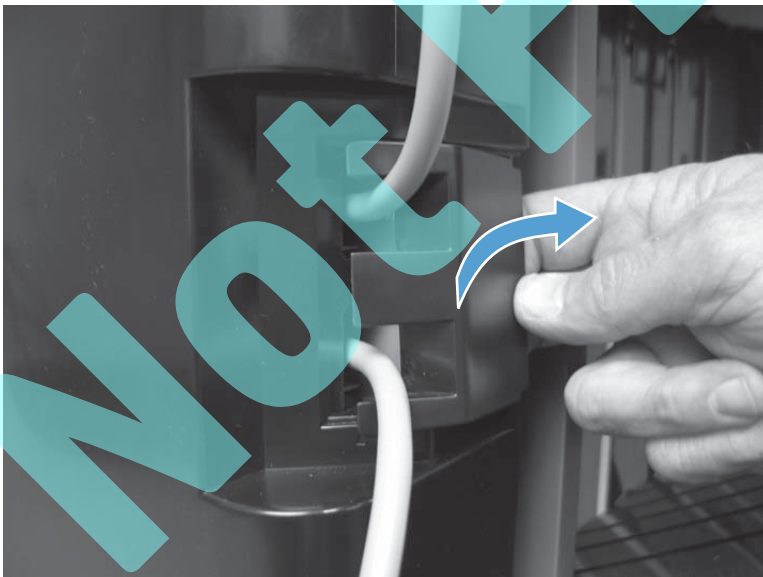

5. Remove the cover.

Figure 1-481 Remove the bin cable guide cover (5 of 6)



6. After the cover is removed, take note of the location of the two latching tabs (callout 1) and the two positioning tabs (callout 2).

When the bin cable guide cover is reinstalled, these tabs must be correctly positioned so that the cover is correctly installed and the bin cables will not bind on the cover when the bins move up and down.

Figure 1-482 Remove the bin cable guide cover (6 of 6)

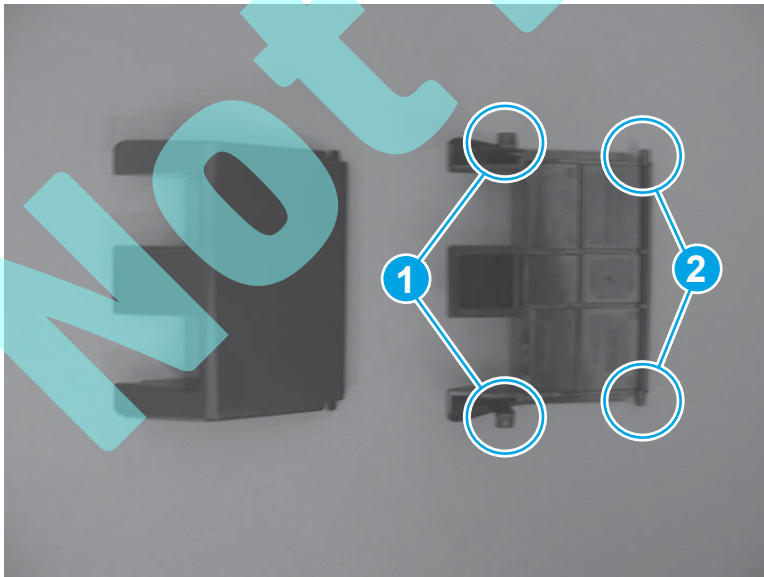

Reinstall the bin cable guide cover

If the cover is not correctly installed, the bin cable guide cover can bind on the cover which causes the upper and lower stack bins to not correctly function. If the bins cannot correctly function, a **66.60.32** error message appears on the control-panel display.

Make sure that the cover correctly fits flush up against the rear cover when it is correctly installed—there should not be a gap between the bin cable guide cover and the rear cover.

Figure 1-483 Bin cable guide cover correctly installed



Figure 1-484 Bin cable guide cover incorrectly installed



Open/closed stepped cover assembly

1. Open the cover.

Figure 1-485 Remove the open/close stepped cover assembly (1 of 2)

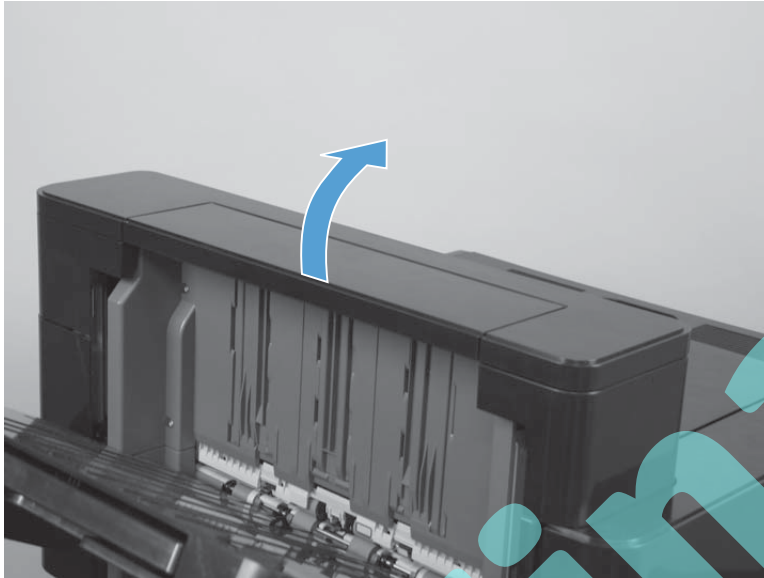

2. Carefully push in on the cover hinge (callout 1) to release the hinge pin, lift the rear edge of the cover out and up (callout 2), and then slide the cover to the right (callout 3). Unlatch the left hinge of cover by swinging it out and up to remove cover (callout 4).

Figure 1-486 Remove the open/close stepped cover assembly (2 of 2)

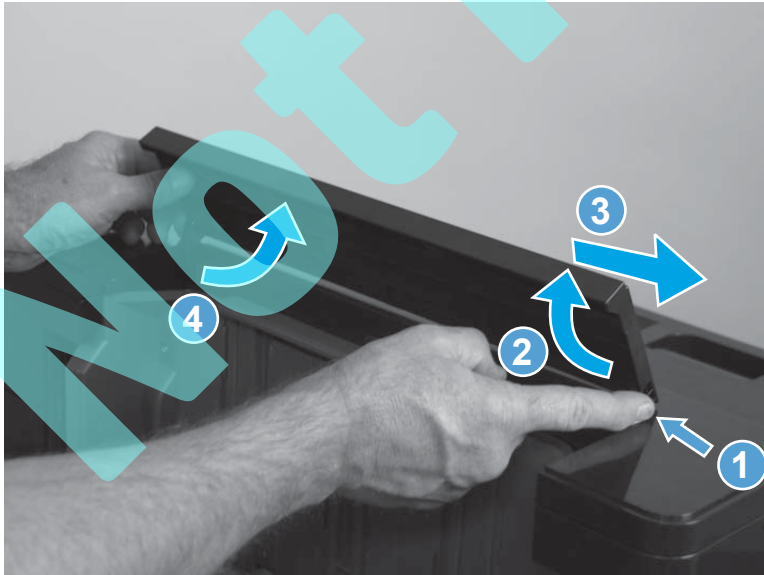

Upper stepped cover assembly

1. Release one tab (callout 1), and then use a small flat blade screw driver to release a second tab (callout 2).

 **TIP:** To locate the tabs, look for arrows embossed on the cover.

Figure 1-487 Remove the upper stepped cover assembly (1 of 4)



2. Use your finger to release one tab (callout 1), carefully pull up on the opposite corner of the cover (callout 2), and then push in on the cover to release a second tab (callout 3).

Figure 1-488 Remove the upper stepped cover assembly (2 of 4)

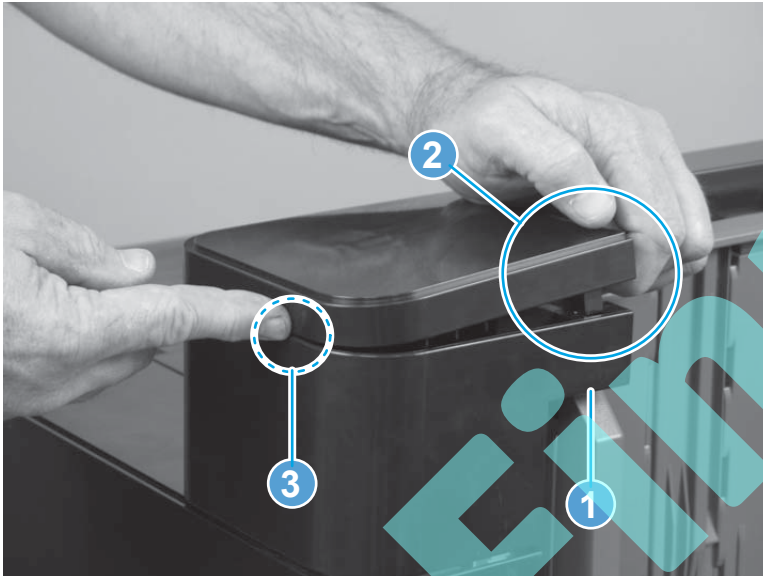
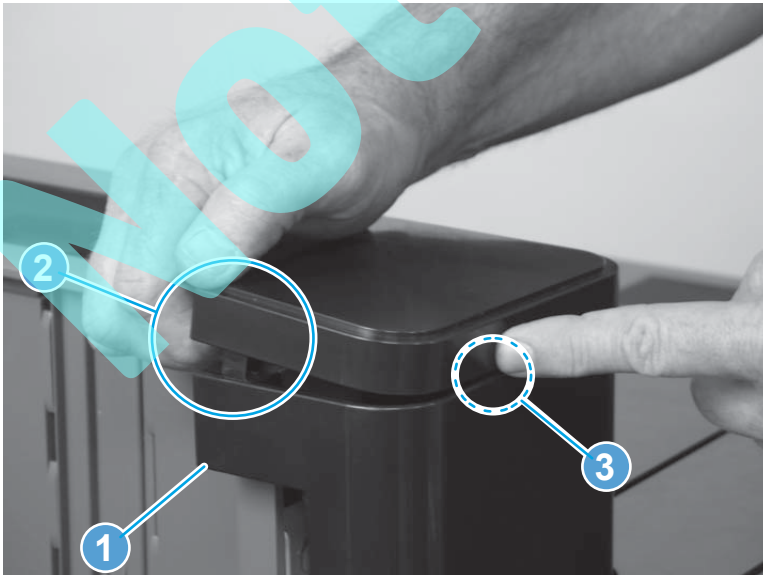

3. Rotate the edge of the cover nearest the stack bins (callout 1) up and away from the accessory.

 **TIP:** As you rotate the cover up, push in on the center of the cover (callout 2) to make it easier to remove.

Figure 1-489 Remove the upper stepped cover assembly (3 of 4)



4. Remove the cover.

Figure 1-490 Remove the upper stepped cover assembly (4 of 4)

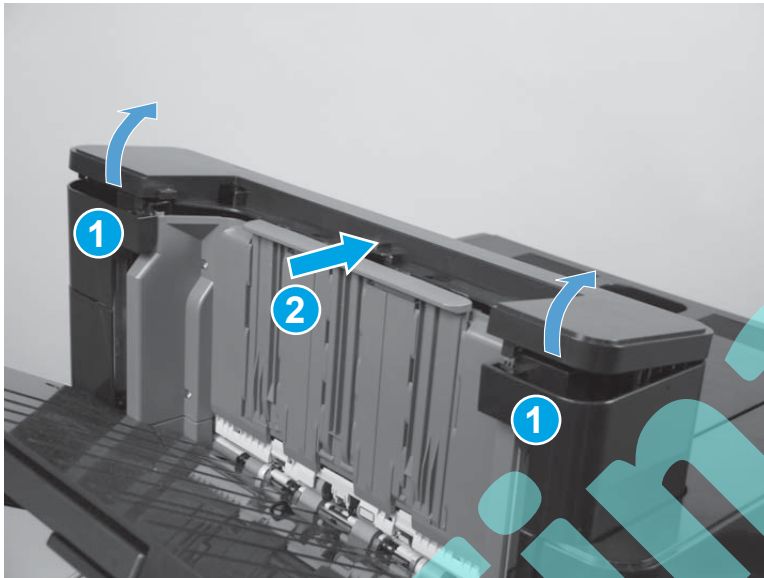
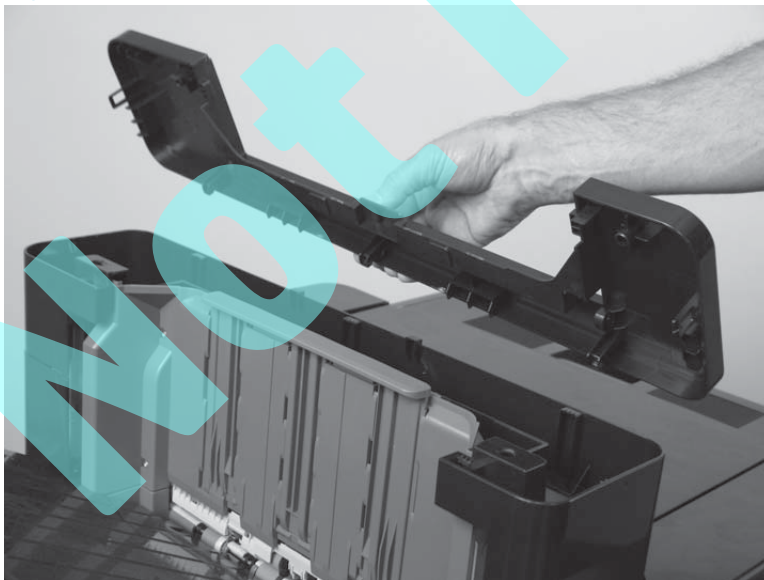

Lower stepped cover assembly

Before proceeding, remove the following assemblies:

- Open/closed stepped cover assembly. See [Open/closed stepped cover assembly on page 321](#).
- Upper stepped cover assembly. See [Upper stepped cover assembly on page 322](#).

Remove the lower stepped cover assembly

1. Remove two screws.

 **NOTE:** From the top of the accessory, look down into the lower stepped cover to locate these screws.

Figure 1-491 Remove the lower stepped cover assembly (1 of 5)



2. Remove one screw (callout 1) from the rear cover.

 **TIP:** Removing this screw is necessary to release the rear cover from the lower stepped cover when it is removed.

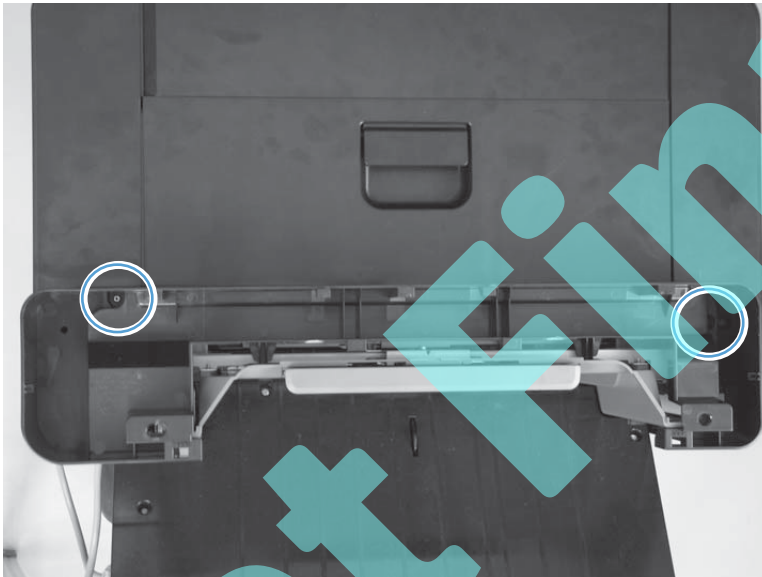
Figure 1-492 Remove the lower stepped cover assembly (2 of 5)



3. Carefully flex the corner of the rear cover away from the accessory (callout 1), and then slightly lift up and push in (callout 2) on the lower stepped cover to release one tab.

Figure 1-493 Remove the lower stepped cover assembly (3 of 5)

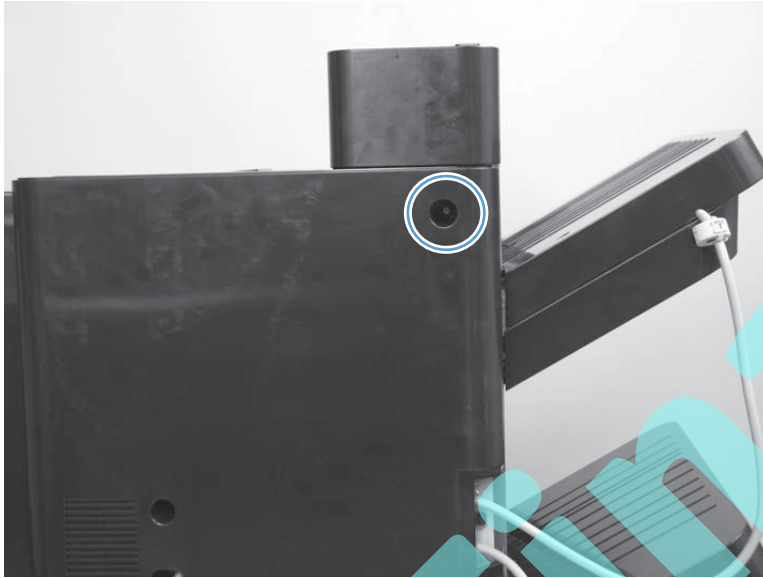
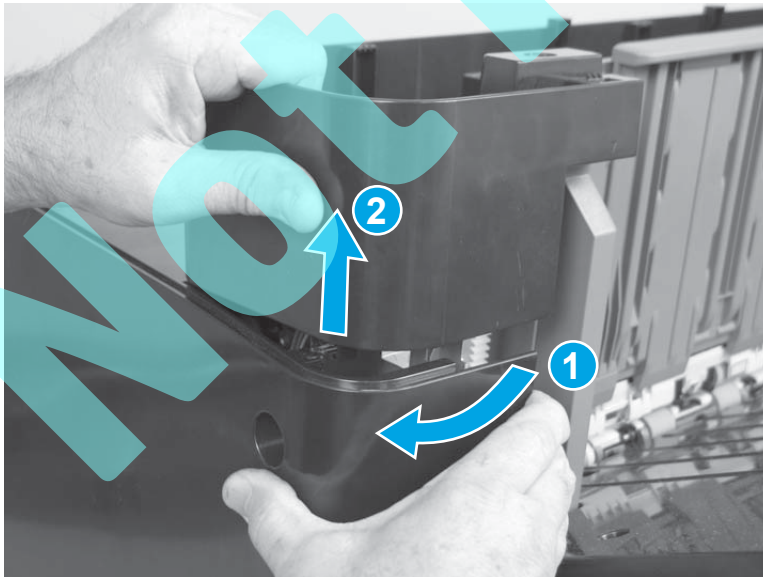

4. Rotate the edge of the cover nearest the stack bins up and away from the accessory.

Figure 1-494 Remove the lower stepped cover assembly (4 of 5)

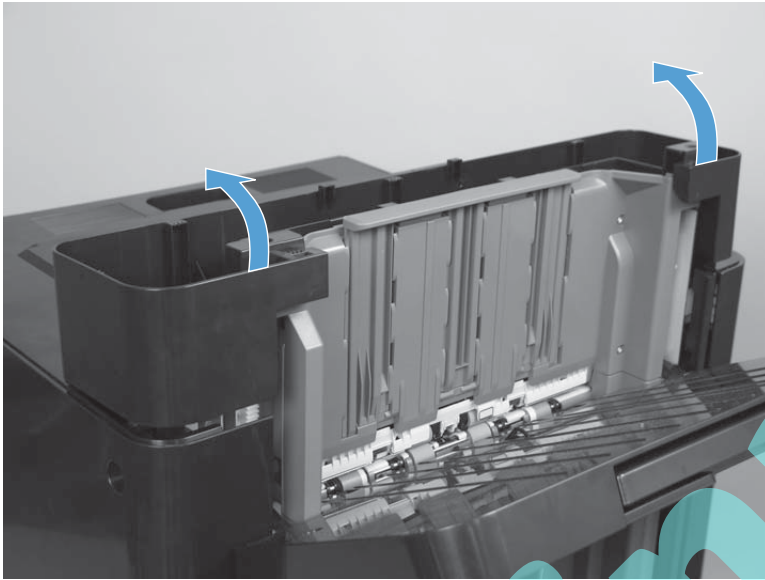

5. Remove the cover.

 **TIP:** Lifting and rotate cover as shown below so that the cover will slide out from under top door.

Figure 1-495 Remove the lower stepped cover assembly (5 of 5)



Reinstall the lower stepped cover

It is important verify that the lower stepped cover is correctly reinstalled by opening the top cover and making make sure that the slots in the cover are underneath the sheet-metal tabs on the chassis. See the figures below.

Figure 1-496 Reinstall the lower stepped cover (1 of 2)

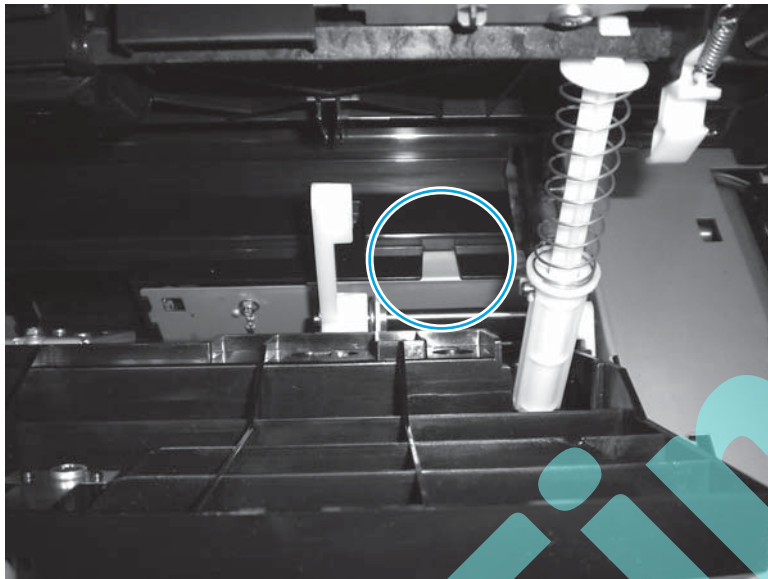



Figure 1-497 Reinstall the lower stepped cover (2 of 2)



Top door assembly

 **NOTE:** The following figures show the top door assembly on the stapler/stacker with hole punch (SSHP) finishing accessory. This removal procedure is valid for all of the finishing accessories.

The figures in this section show the stepped covers removed. You do not need to remove the stepped covers to remove the top door assembly.

1. Open the top door to the fully raised position.

 **TIP:** When fully opened, the top door locks in the open position.

Figure 1-498 Remove the top door assembly (1 of 3)



2. Carefully unsnap two spring loaded arms to release them from the latch shaft.

Figure 1-499 Remove the top door assembly (2 of 3)

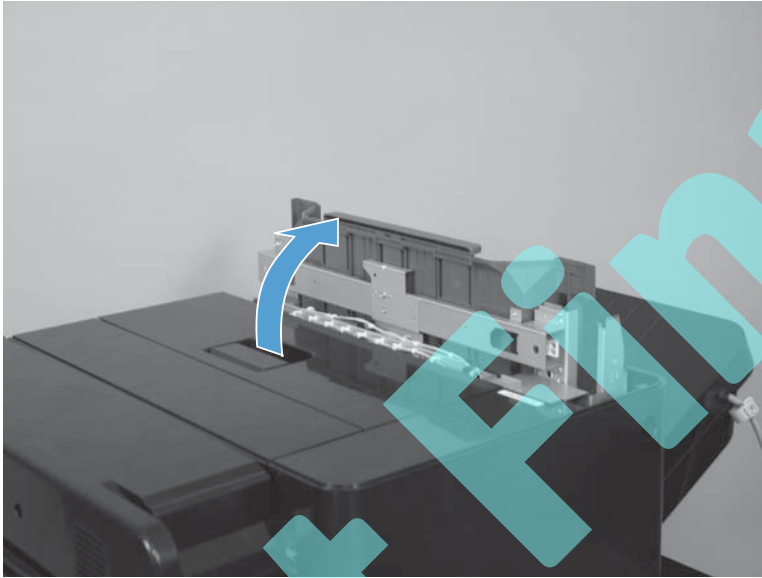
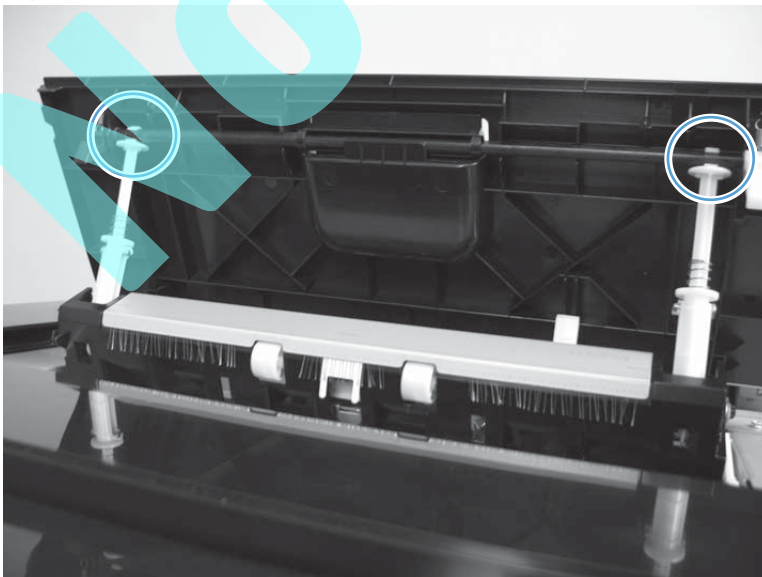

3. From the front of the finisher, slide the top door slightly towards the rear of the accessory until it stops (callout 1). Carefully press in on the front hinge to release the hinge from the bracket (callout 2), and then lift it out of the bracket (callout 3). Slide the top of the door towards the front of the accessory to release the rear hinge (callout 4) from the rear bracket to remove door.

Figure 1-500 Remove the top door assembly (3 of 3)

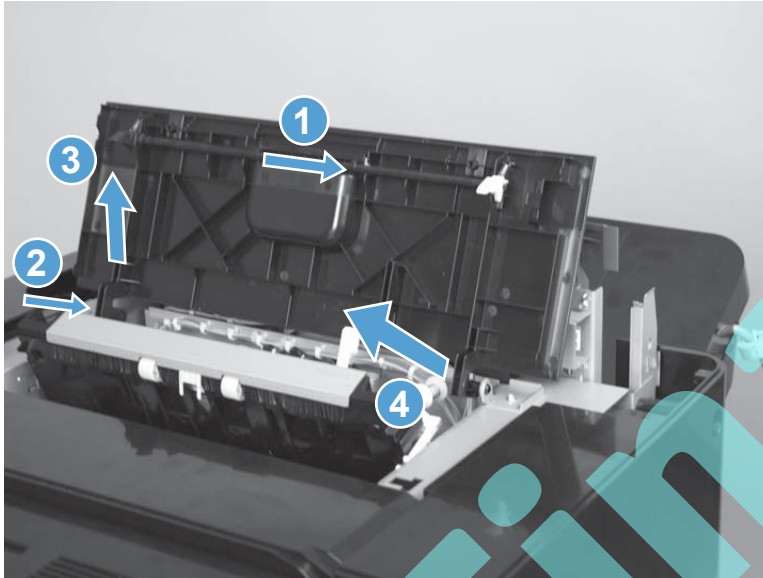

Front door

Before proceeding, remove the following assemblies:

 **TIP:** If the front door is being removed to replace it, use the following procedure. To remove the front door to gain access to other assemblies, see [Remove only the front door on page 331](#).

- Open/closed stepped cover assembly. See [Open/closed stepped cover assembly on page 321](#).
- Upper stepped cover assembly. See [Upper stepped cover assembly on page 322](#).
- Lower stepped cover assembly. See [Lower stepped cover assembly on page 324](#).

Remove the front door

1. Open the front door.

Figure 1-501 Remove the front door (1 of 2)

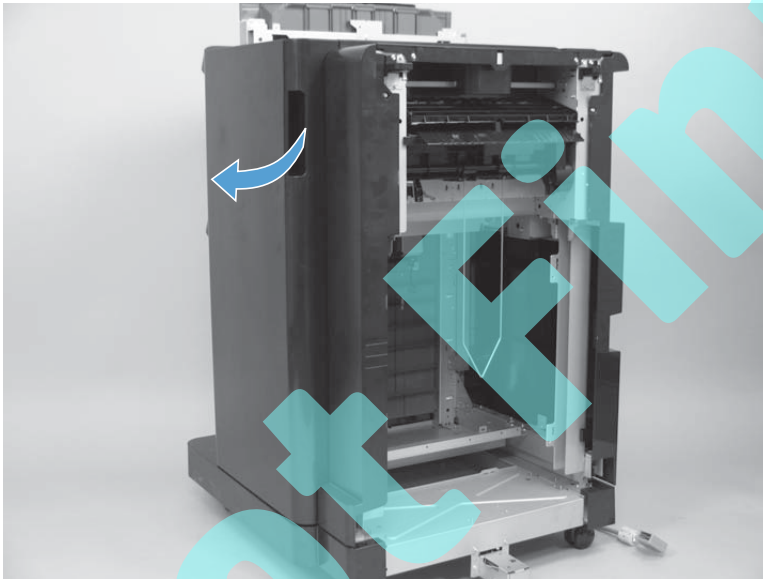

2. Lift the front cover up to release it from the hinge pins, and then remove the door.

Figure 1-502 Remove the front door (2 of 2)

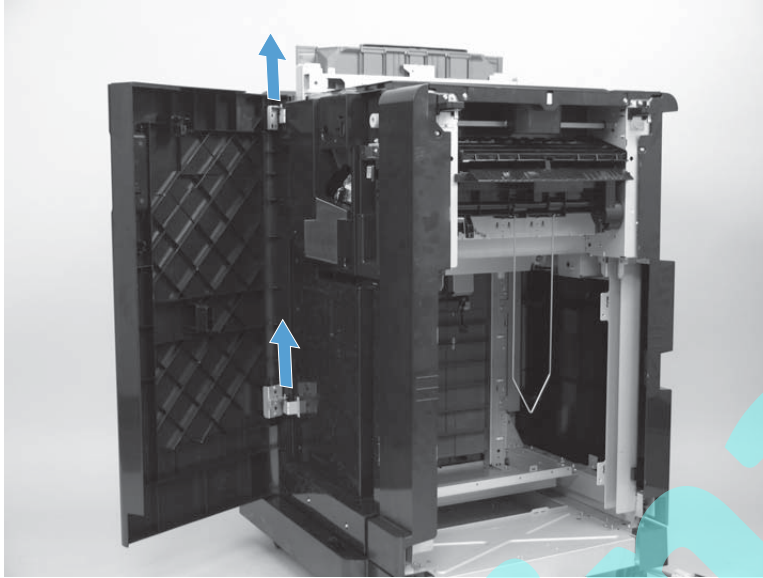

Remove only the front door

 **TIP:** To remove only the front door, use the following procedure.

1. Open the front door.
2. Support the door, and then remove one self tapping screw (callout 1) and the sheet-metal hinge (callout 2).

 **TIP:** To reinstall the self-tapping screw, first turn it counterclockwise (1/4 turn) to align it with the existing thread pattern, and then carefully turn it clockwise to tighten. Do not overtighten.

Figure 1-503 Remove only the front door (1 of 2)



3. With the door slightly angled away from the accessory so that it will not interfere with other accessory covers, lift the door up and off of the bottom hinge to remove it.

Figure 1-504 Remove only the front door (2 of 2)

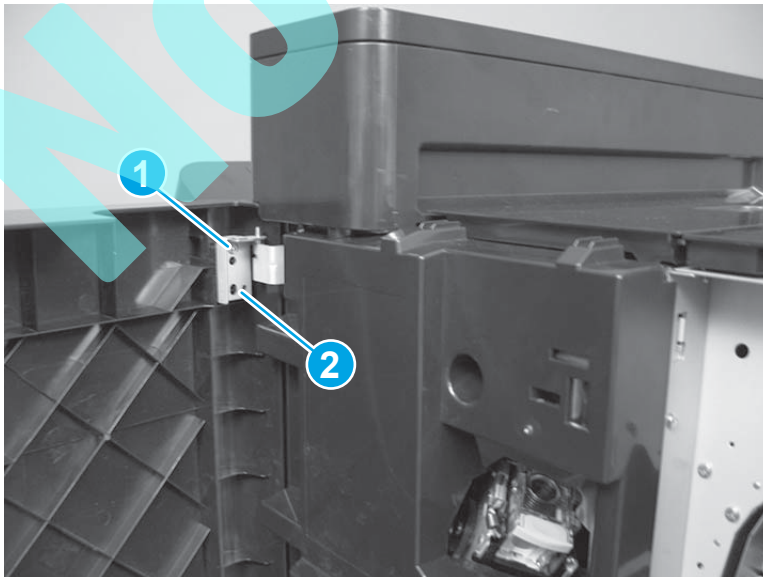
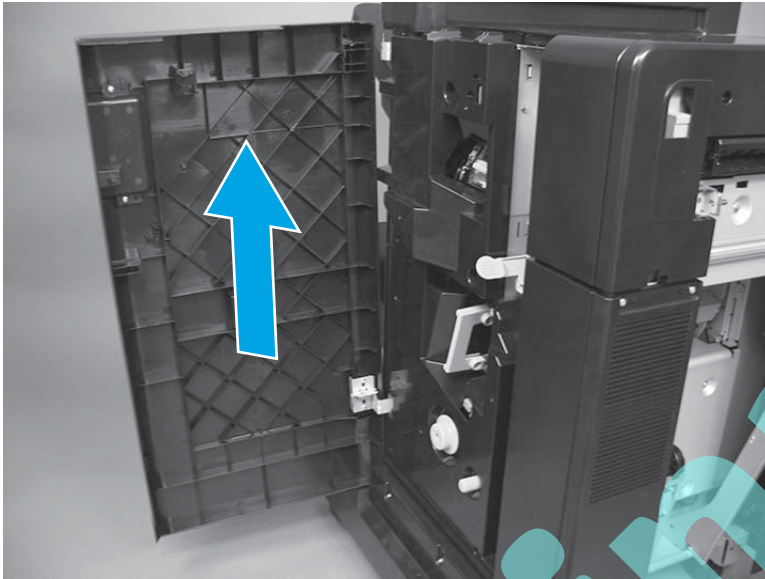

Inner upper cover assembly

 **TIP:** If the cover needs to be moved out of the way to gain access to assemblies immediately behind the cover, use the following procedure. If the cover needs to be removed to service other assemblies on the accessory, go to [Inner upper cover assembly \(remove\) on page 334](#).

1. Open the front door.
2. Remove four screws.

Figure 1-505 Move the inner upper cover out of the way (1 of 2)

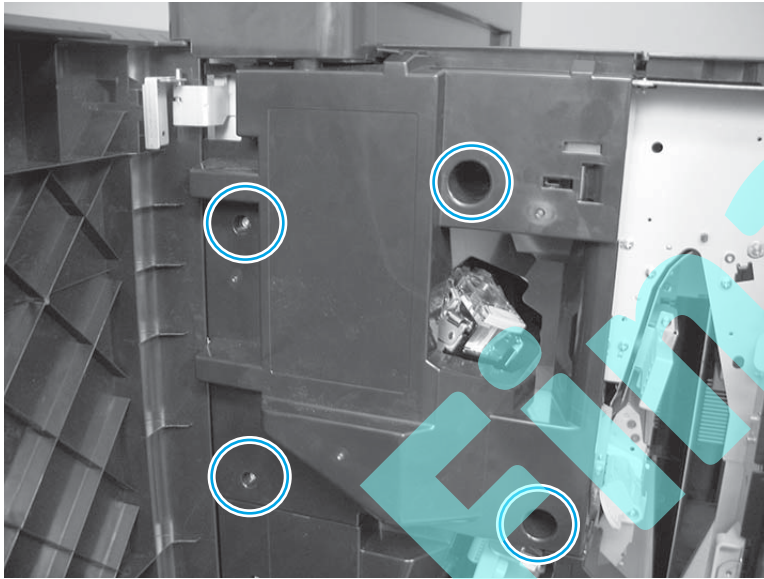

3. Rotate the cover towards the front door to move it out of the way.

 **CAUTION:** To prevent damage to the cover, make sure that it does not bind on the upper front door hinge when you move it out of the way.

Figure 1-506 Move the inner upper cover out of the way (2 of 2)



Inner upper cover assembly (remove)

Before proceeding, remove the following assemblies:

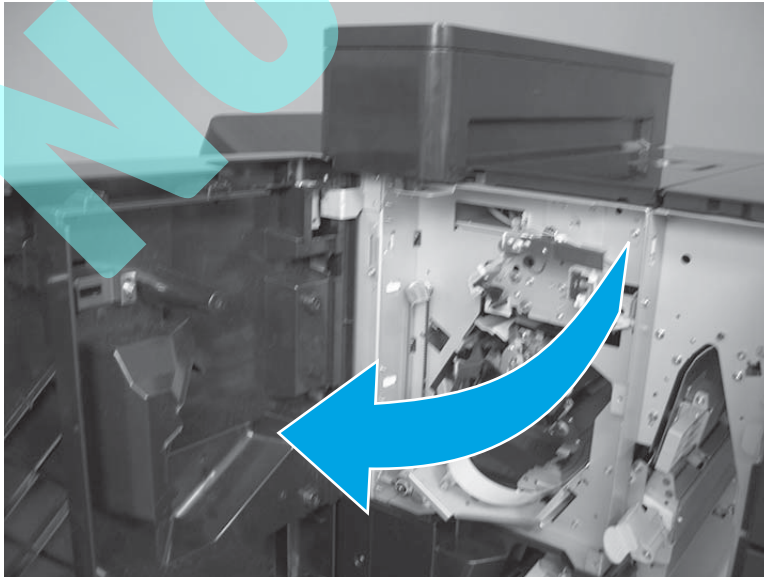
- Pre-reverse cover assembly. See [Pre-reverse cover assembly on page 312](#).
- Open/closed stepped cover assembly. See [Open/closed stepped cover assembly on page 321](#).
- Upper stepped cover assembly. See [Upper stepped cover assembly on page 322](#).
- Lower stepped cover assembly. See [Lower stepped cover assembly on page 324](#).
- Front door. See [Front door on page 330](#).

Remove the inner upper cover assembly

1. Remove four screws.

Figure 1-507 Remove the inner upper cover assembly (1 of 2)

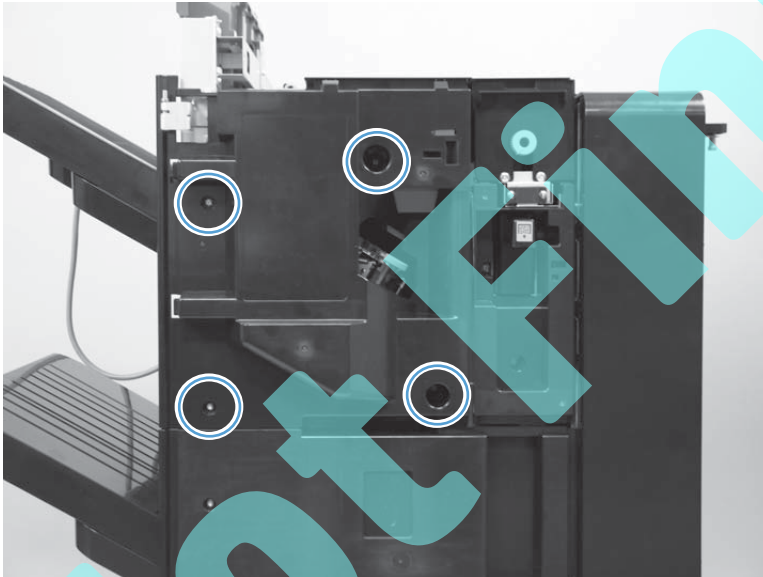

2. Remove the cover.

Figure 1-508 Remove the inner upper cover assembly (2 of 2)

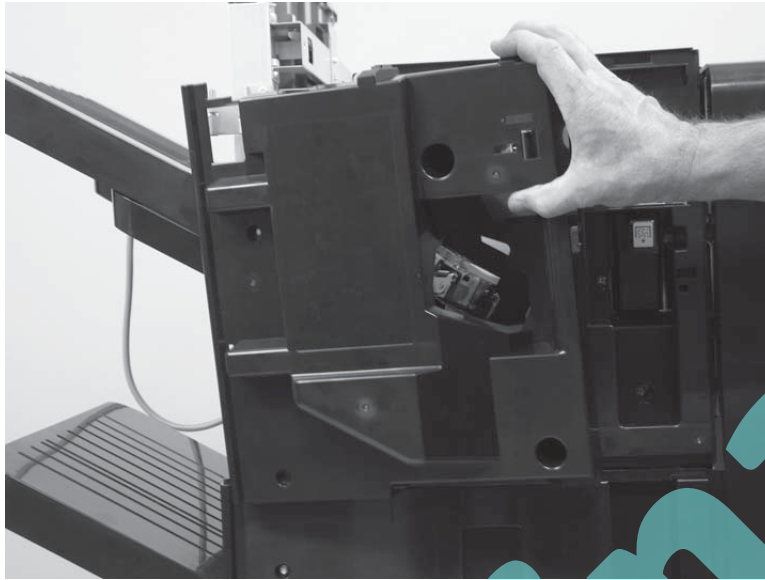

Not Final

Clutch assembly (front side)

Before proceeding, do the following:

- Move the inner upper cover out of the way. See [Inner upper cover assembly on page 333](#).

Remove the clutch assembly (front side)

1. Disconnect one connector (callout 1), and then release the wire harness from three retainers (callout 2).

Figure 1-509 Remove the clutch assembly (front side; 1 of 2)

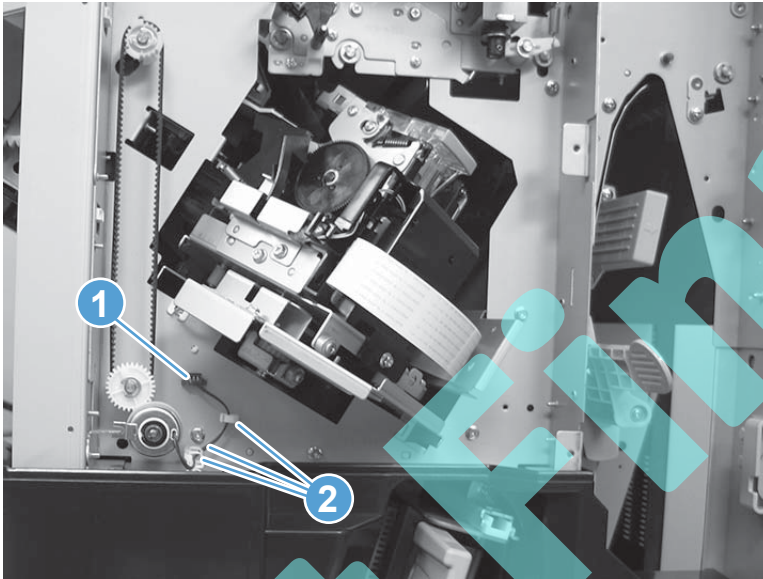

2. Remove one e-ring (callout 1), and then slide the clutch off of the shaft to remove it.

Figure 1-510 Remove the clutch assembly (front side; 2 of 2)

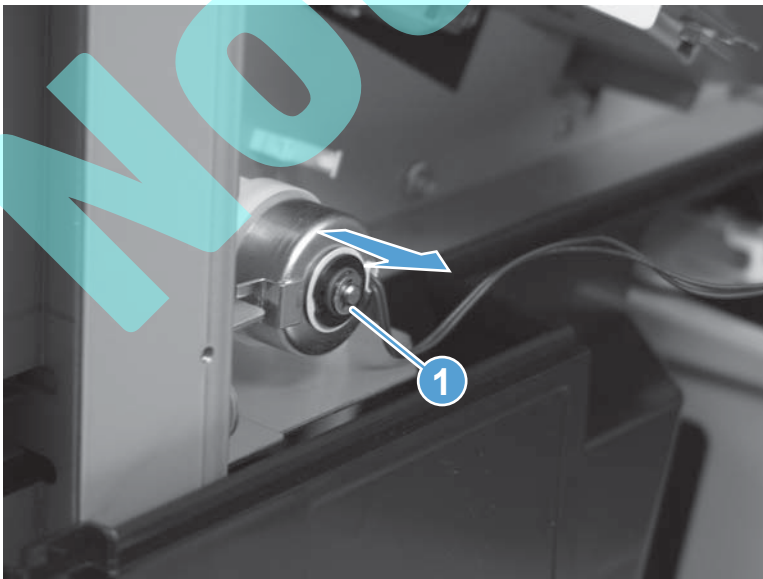

Sensor switch assembly

Before proceeding, do the following:

- Move the inner upper cover out of the way. See [Inner upper cover assembly on page 333](#).

Remove the sensor switch assembly

1. Disconnect one connector (callout 1), and then release the wire harnesses from three retainers (callout 2).

Figure 1-511 Remove the sensor switch assembly (1 of 4)

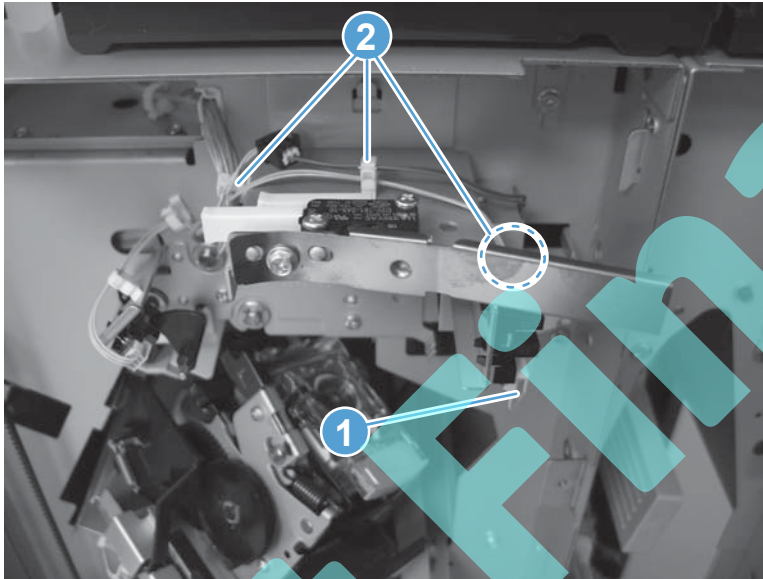

2. Use a small flat blade screwdriver to disconnect one connector (callout 1).

Figure 1-512 Remove the sensor switch assembly (2 of 4)

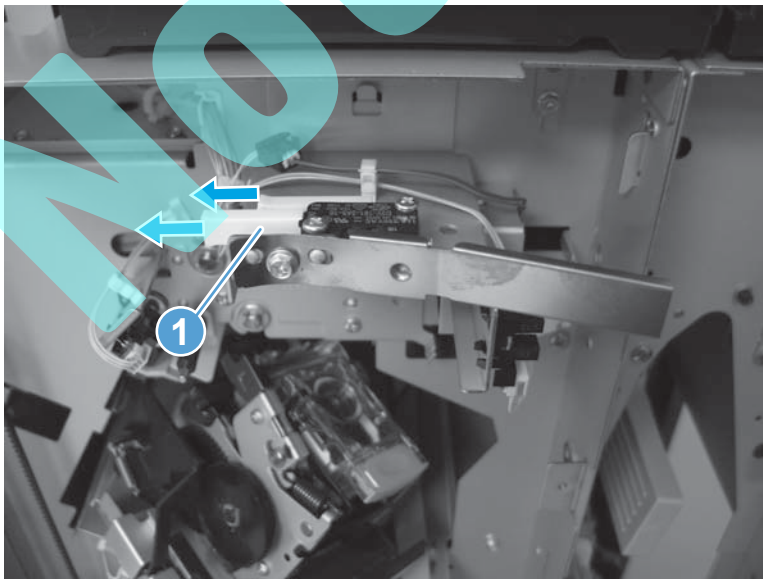

3. Remove one screw.

Figure 1-513 Remove the sensor switch assembly (3 of 4)

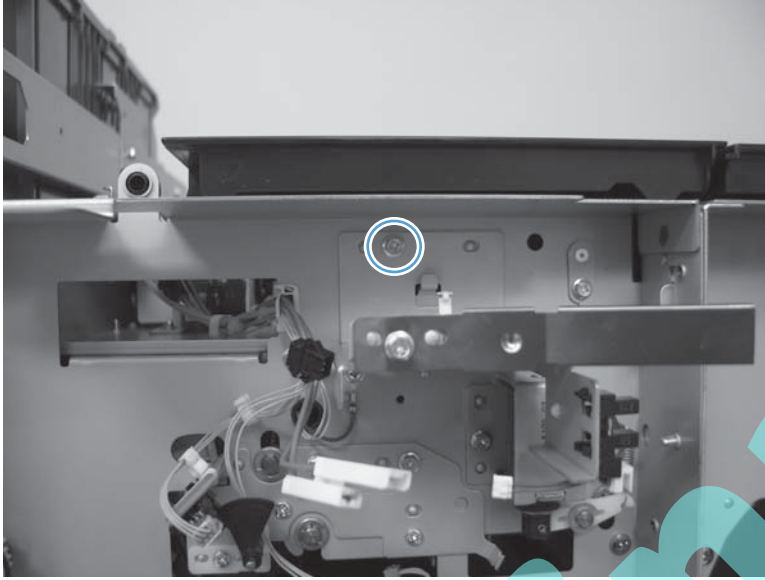

4. Remove the assembly.

Figure 1-514 Remove the sensor switch assembly (4 of 4)

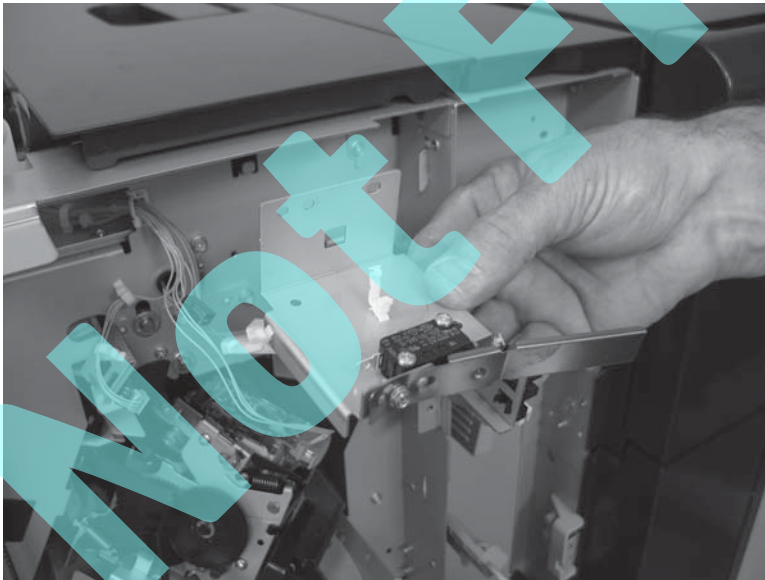

Inner lower cover assembly

 **TIP:** If the cover needs to be moved out of the way to gain access to assemblies immediately behind the cover, use the following procedure. If the cover needs to be removed to service other assemblies on the accessory, go to [Inner lower cover assembly \(remove\) on page 341](#).

1. Open the front door.
2. Move the inner upper cover out of the way. See [Inner upper cover assembly on page 333](#).
3. Remove six screws.

Figure 1-515 Move the inner lower cover out of the way (1 of 3)

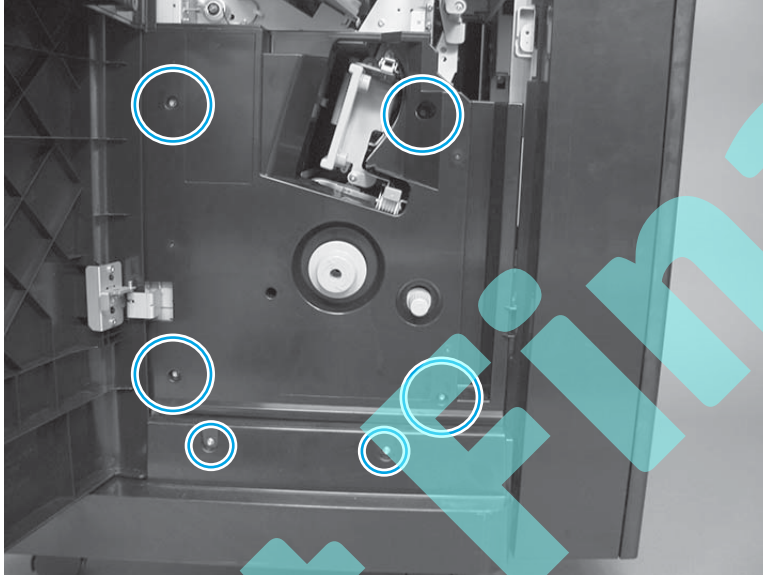

4. Remove one screw (callout 1), and then remove the green knob (callout 2).

Figure 1-516 Move the inner lower cover out of the way (2 of 3)

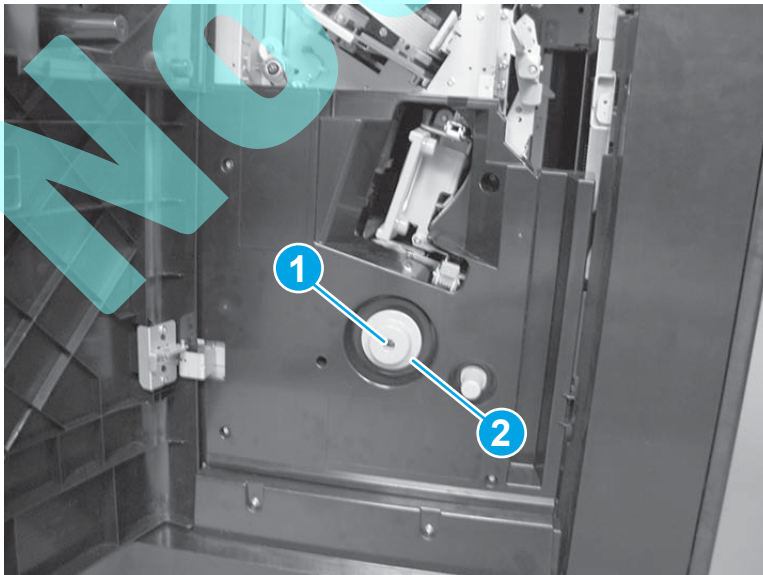

5. Slide the cover toward the front door so that it will not interfere with the inner upper cover, and then rotate the cover towards the front door to move it out of the way.

⚠ CAUTION: To prevent damage to the cover, make sure that it does not bind on the upper front door hinge when you move it out of the way.

Figure 1-517 Move the inner lower cover out of the way (3 of 3)

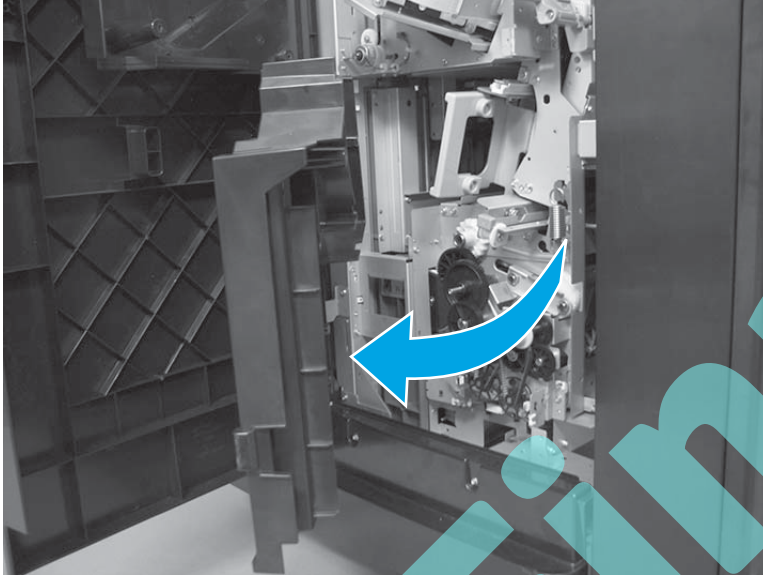

Inner lower cover assembly (remove)

Before proceeding, remove the following assemblies:

- Right cover assembly. See [Right cover assembly on page 311](#).
- Pre-reverse cover assembly. See [Pre-reverse cover assembly on page 312](#).
- Open/closed stepped cover assembly. See [Open/closed stepped cover assembly on page 321](#).
- Upper stepped cover assembly. See [Upper stepped cover assembly on page 322](#).
- Lower stepped cover assembly. See [Lower stepped cover assembly on page 324](#).
- Front door. See [Front door on page 330](#).
- Inner upper cover assembly. See [Inner upper cover assembly \(remove\) on page 334](#).

Remove the inner lower cover assembly

1. Do one of the following:
 - **Booklet maker (BM):** Remove six screws.

Figure 1-518 Remove the inner lower cover assembly (1 of 5)



- **Stapler/stacker (SS) and stapler/stacker with hole punch (SSHP):** Remove four screws.

Figure 1-519 Remove the inner lower cover assembly (2 of 5)

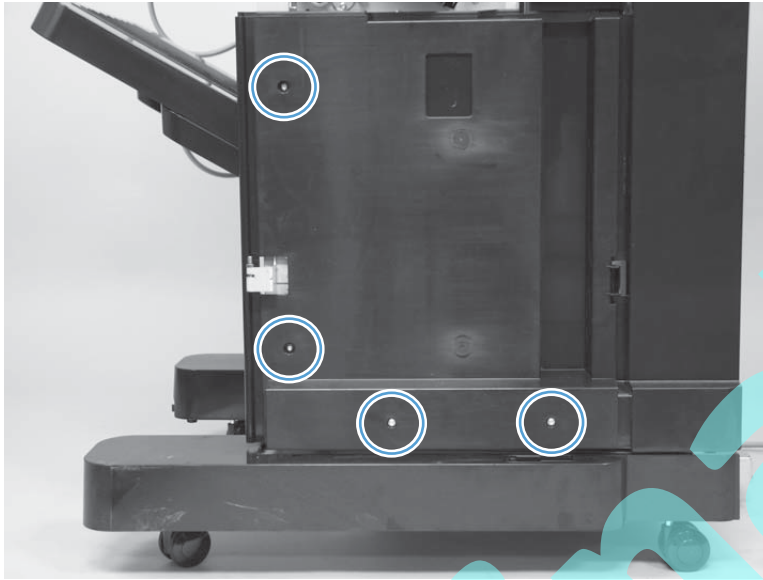

2. **Booklet maker (BM):** Remove one screw (callout 1), and then remove the green knob (callout 2).

Figure 1-520 Remove the inner lower cover assembly (3 of 5)

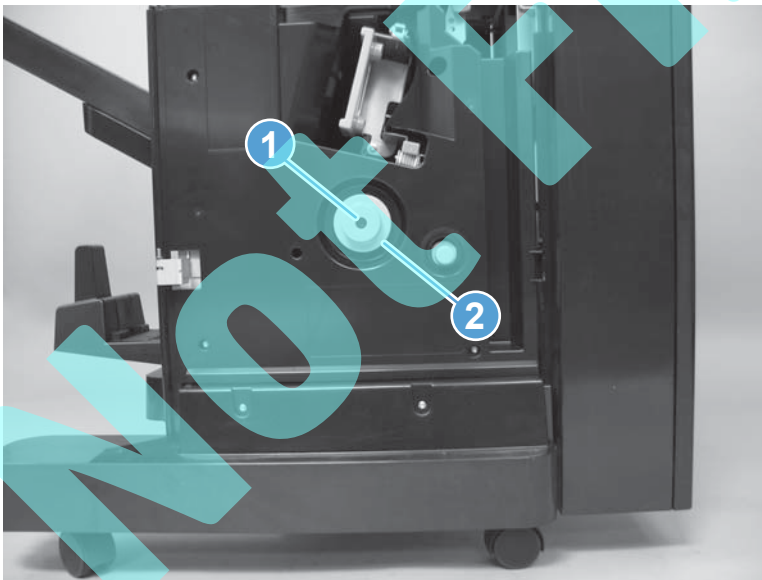

3. Rotate the bottom of the cover out and away from the accessory.

 **NOTE:** The figure below shows the SS and SSHP accessory cover. The procedure is the same for the BM accessory.

Figure 1-521 Remove the inner lower cover assembly (4 of 5)



4. Remove the cover.

 **NOTE:** The figure below shows the SS and SSHP accessory cover. The procedure is the same for the BM accessory.

Figure 1-522 Remove the inner lower cover assembly (5 of 5)



Front foot cover assembly

Before proceeding, remove the following assemblies:

- Right cover assembly. See [Right cover assembly on page 311](#).
- Pre-reverse cover assembly. See [Pre-reverse cover assembly on page 312](#).
- Front door. See [Remove only the front door on page 331](#).
- Inner upper cover assembly. See [Inner upper cover assembly \(remove\) on page 334](#).
- Inner lower cover assembly. See [Inner lower cover assembly on page 339](#).



NOTE: This cover only needs to be moved out of the way.

Remove the front foot cover assembly

1. Before proceeding, use the figure below to locate the three mounting tabs.

Figure 1-523 Remove the front foot cover assembly (1 of 5)

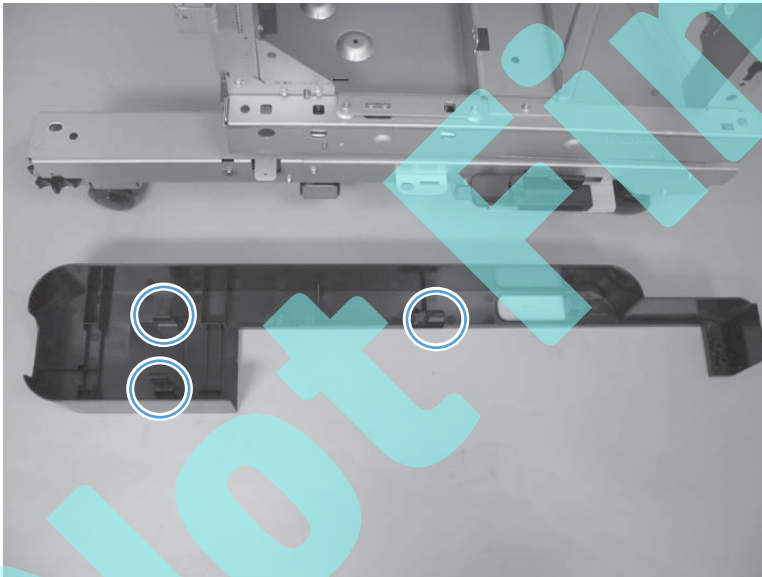

2. Remove two screws.

Figure 1-524 Remove the front foot cover assembly (2 of 5)

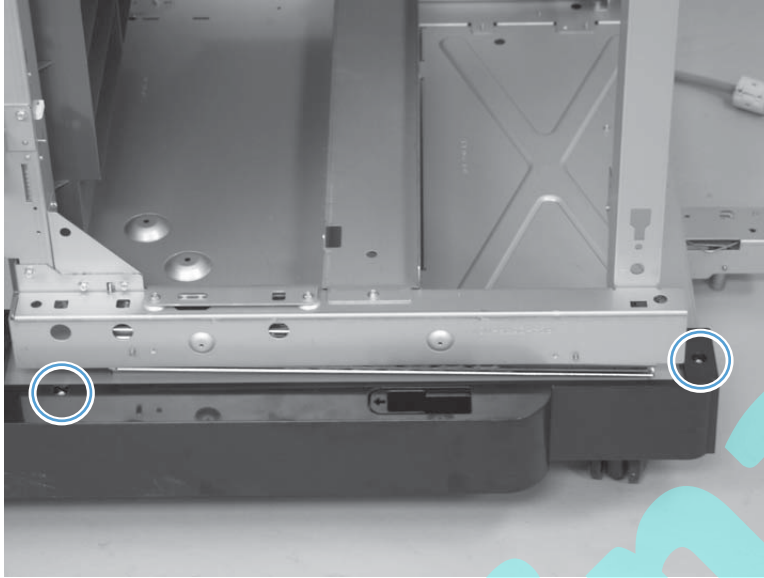

3. Use your fingers to reach up under the cover, release two tabs, and then slightly raise the cover.

 **TIP:** Look for the arrows embossed on the cover to locate the tabs.

Figure 1-525 Remove the front foot cover assembly (3 of 5)



4. Release one tab, and then slightly raise the cover.

 **TIP:** Look for the arrow embossed on the cover to locate the tab.

Figure 1-526 Remove the front foot cover assembly (4 of 5)



5. Rotate the cover away from the accessory to release it, and then remove the cover.

Figure 1-527 Remove the front foot cover assembly (5 of 5)

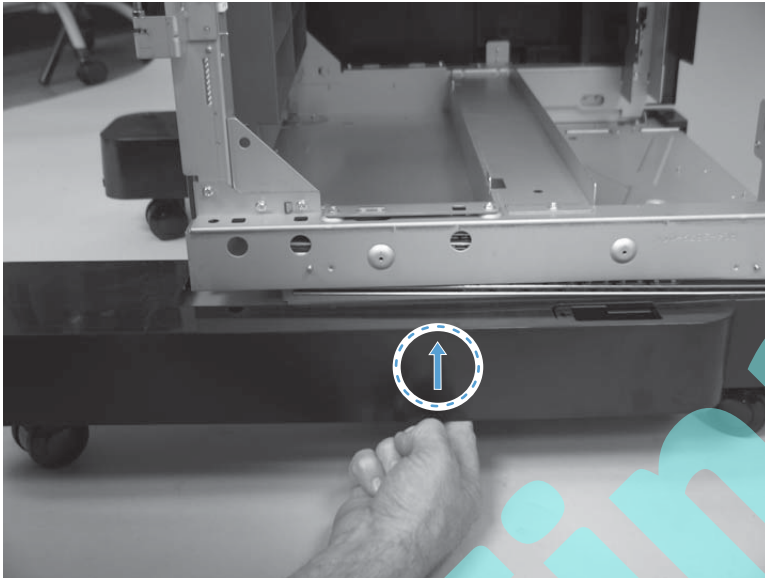
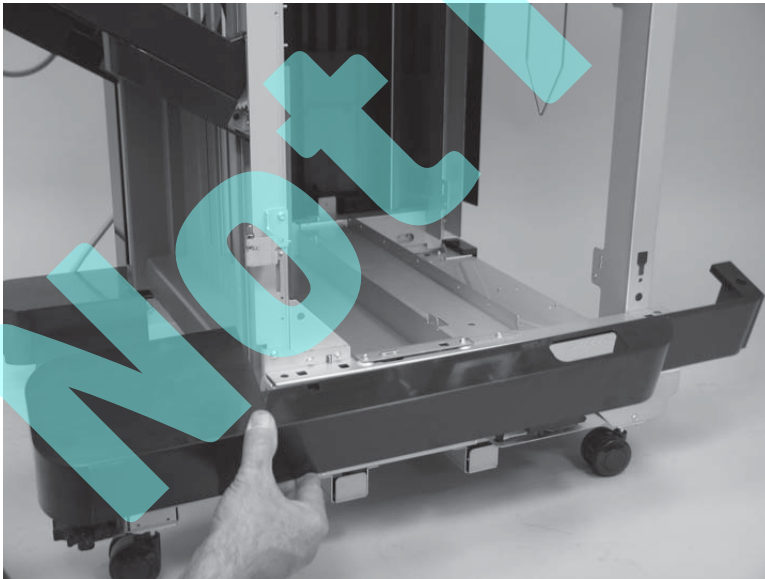

Lower lock release handle assembly

Before proceeding, remove the following assemblies:

- Right cover assembly. See [Right cover assembly on page 311](#).
- Pre-reverse cover assembly. See [Pre-reverse cover assembly on page 312](#).
- Front door. See [Remove only the front door on page 331](#).
- Inner upper cover assembly. See [Inner upper cover assembly on page 333](#).

 **NOTE:** This cover only needs to be moved out of the way.

- Inner lower cover assembly. See [Inner lower cover assembly on page 339](#).

 **NOTE:** This cover only needs to be moved out of the way.

- Front foot cover assembly. See [Front foot cover assembly on page 344](#).

Remove the lower lock release handle cover assembly

1. Slightly raise the handle to disengage the handle-to-lock slide pin underneath the handle.

Figure 1-528 Remove the lower lock release handle assembly (1 of 3)

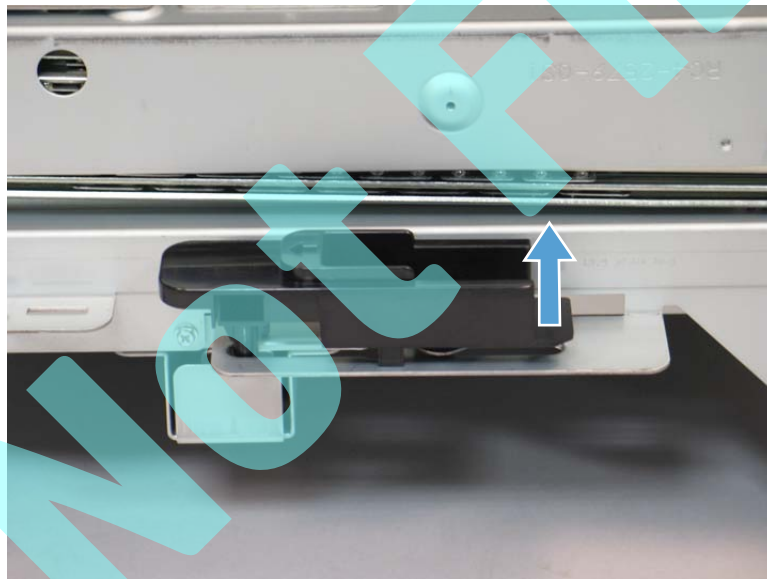

2. Slide the handle to the end of its travel.

Figure 1-529 Remove the lower lock release handle assembly (2 of 3)

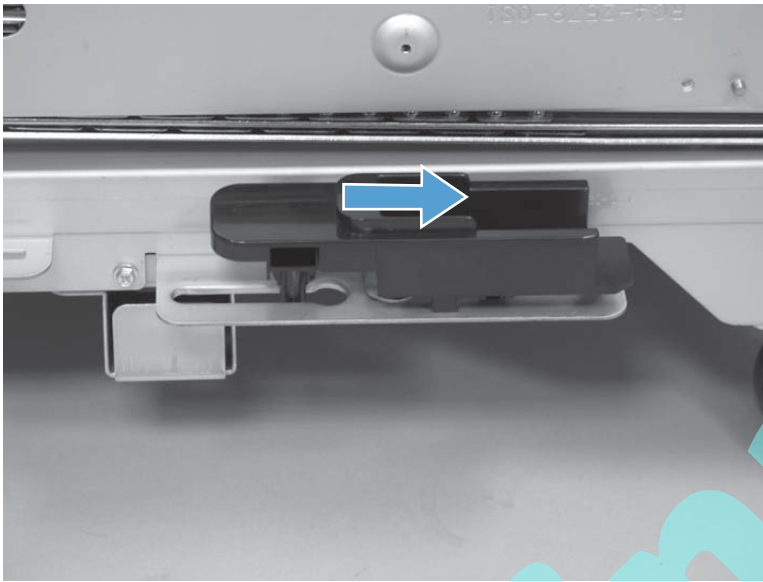

3. Rotate the end of the handle away from the finishing accessory chassis (callout 1) to release the keyed locking pin, and then lift up on the handle (callout 2) to remove it.

Figure 1-530 Remove the lower lock release handle assembly (3 of 3)

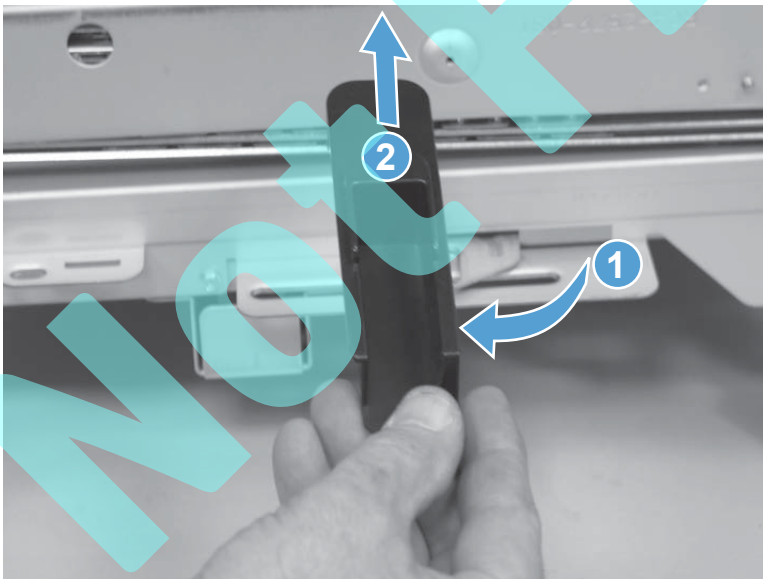

Rear cover assembly

Before proceeding, remove the following assemblies:

 **TIP:** If the rear cover is being removed to gain access to other assemblies, use the following procedure. If the cover is being moved to gain access to assemblies immediately behind the cover go to, see [Remove only the rear cover on page 351](#).

- Bin cable guide cover. See [Bin cable guide cover on page 317](#).
- Open/closed stepped cover assembly. See [Open/closed stepped cover assembly on page 321](#).
- Upper stepped cover assembly. See [Upper stepped cover assembly on page 322](#).
- Lower stepped cover assembly. See [Lower stepped cover assembly on page 324](#).

Remove the rear cover assembly

1. Open the top door to the fully raised position, and then remove one screw.

 **TIP:** When fully opened, the top door locks in the open position.

Figure 1-531 Remove the rear cover assembly (1 of 3)



2. Remove four screws.

 **NOTE:** A fifth screw (not shown) was removed when the lower stepped cover was removed.

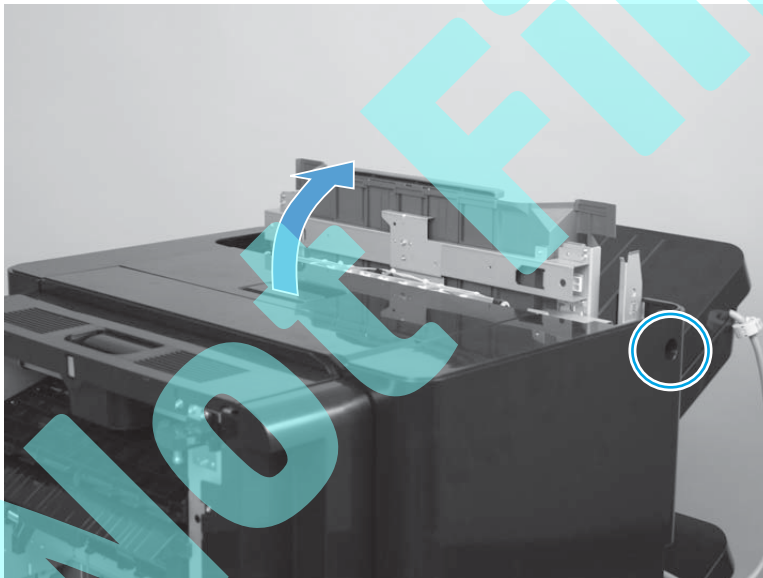
Figure 1-532 Remove the rear cover assembly (2 of 3)

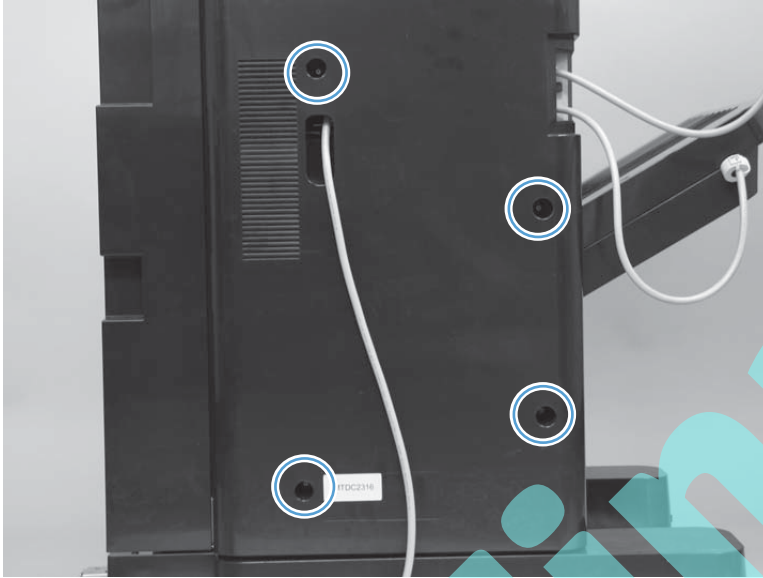

3. Lift up on the cover to release it (callout 1), and then remove the cover (callout 2).

 **NOTE:** As the cover is removed, carefully feed the interface cable through the hole provided in the cover.

Figure 1-533 Remove the rear cover assembly (3 of 3)

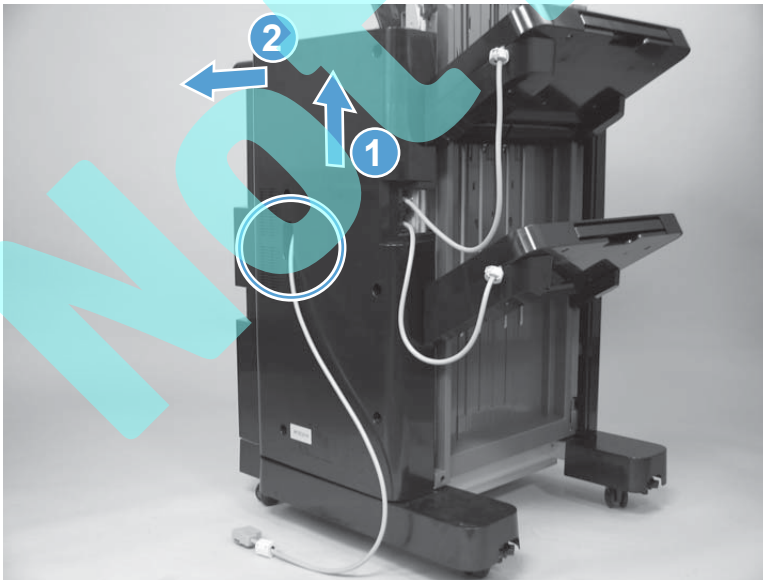

Remove only the rear cover

 **TIP:** To remove only the rear cover, use the following procedure.

1. Open the top door assembly, and then remove the bin cable guide cover. See [Bin cable guide cover on page 317](#).
2. Remove five screws.

Figure 1-534 Remove only the rear cover (1 of 3)

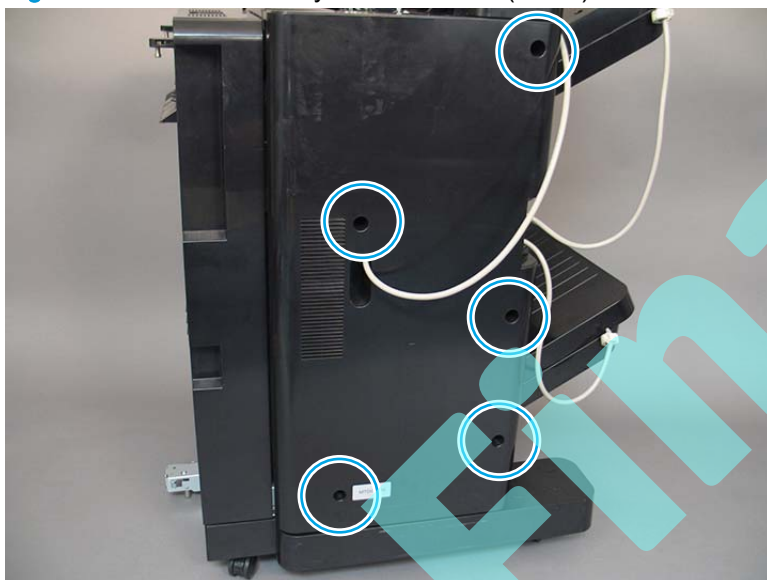

3. At the top of the accessory, lift up on the rear cover to release two tabs.

Figure 1-535 Remove only the rear cover (2 of 3)

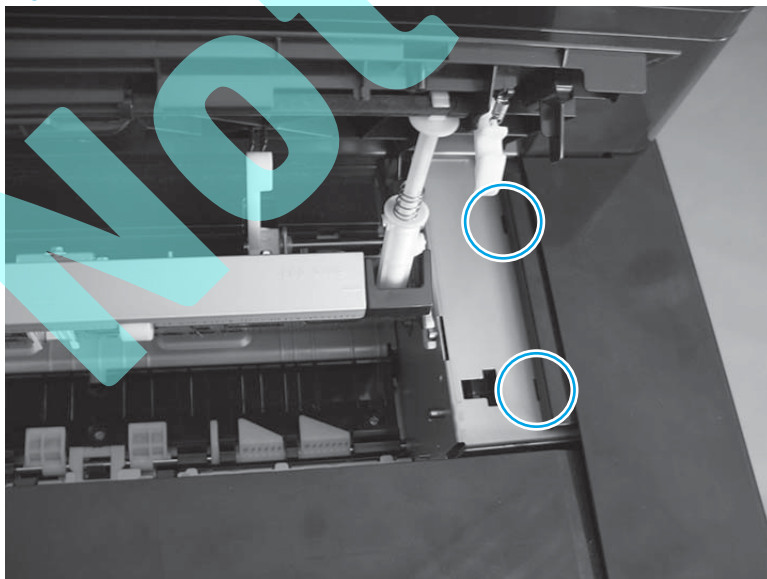

4. Remove the cover.

 **NOTE:** As the cover is removed, carefully feed the interface cable through the hole provided in the cover.

Figure 1-536 Remove only the rear cover (3 of 3)



Main controller PCA assembly

Before proceeding, remove the following assemblies:

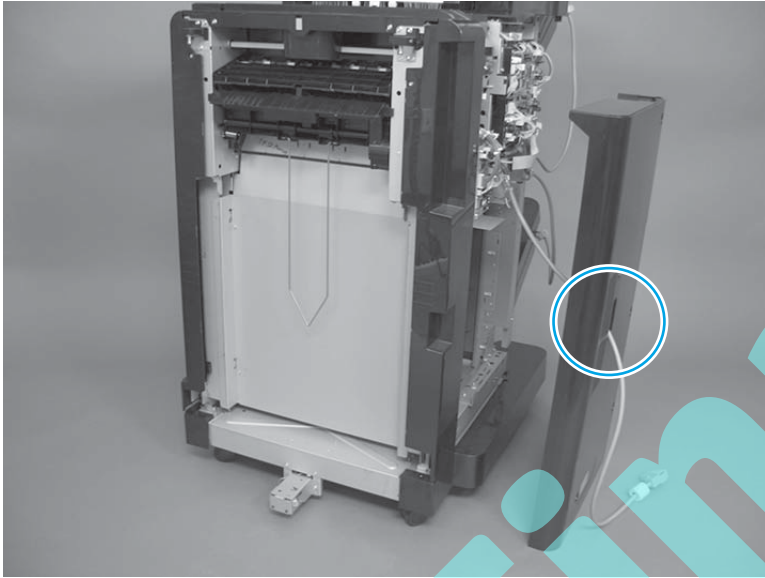
- Bin cable guide cover. See [Bin cable guide cover on page 317](#).
- Rear cover assembly. See [Remove only the rear cover on page 351](#).

Remove the main controller PCA assembly

CAUTION:  ESD sensitive assembly.

1. Disconnect 22 of the connectors, and then release the wire harnesses from the guides.

 **TIP:** Releasing the wire harnesses from the guides first might make it easier to disconnect some of the connectors on the PCA.

 **NOTE:** The following connectors are not used on the PCA:

- Booklet maker: J25, J27, J28, and J32
- Stapler/stacker with hole punch: J12, J15, J25, J27, J28, and J30
- Stapler/stacker: J9, J16, and J32

Figure 1-537 Remove the main controller PCA assembly (1 of 6)

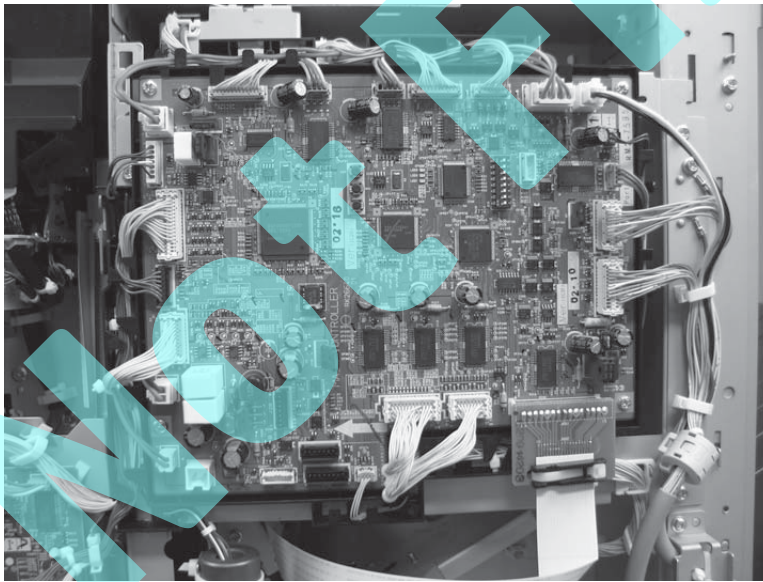

2. Remove two screws (callout 1) to release two ground wires, and then release the wire harnesses from four retainers (callout 2).

Figure 1-538 Remove the main controller PCA assembly (2 of 6)

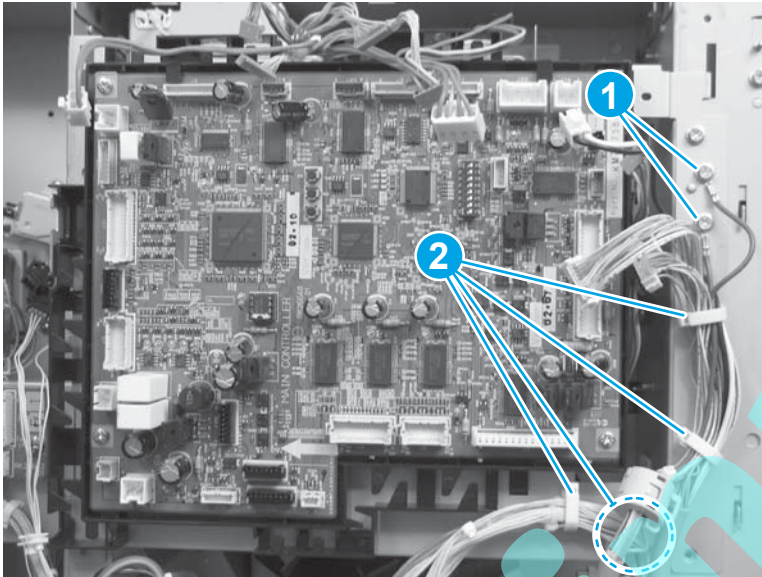

3. Release the wire harnesses from one retainer at the top of the sheet-metal PCA mounting bracket.

Figure 1-539 Remove the main controller PCA assembly (3 of 6)

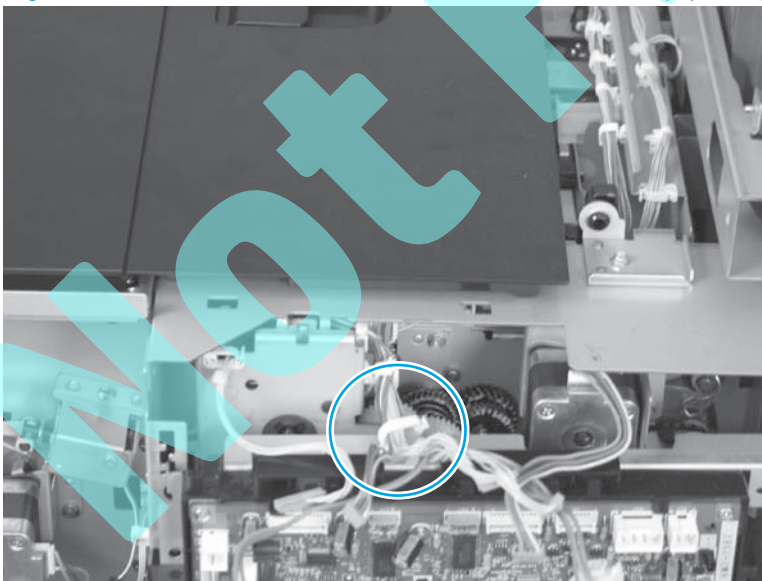

4. Remove four screws.

Figure 1-540 Remove the main controller PCA assembly (4 of 6)

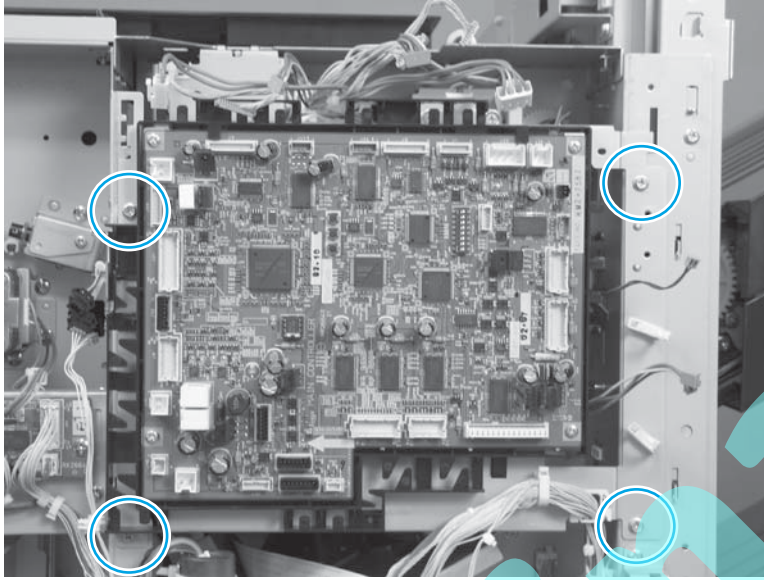

5. Lift up on the main controller PCA assembly to release it, and then remove the assembly.

Figure 1-541 Remove the main controller PCA assembly (5 of 6)

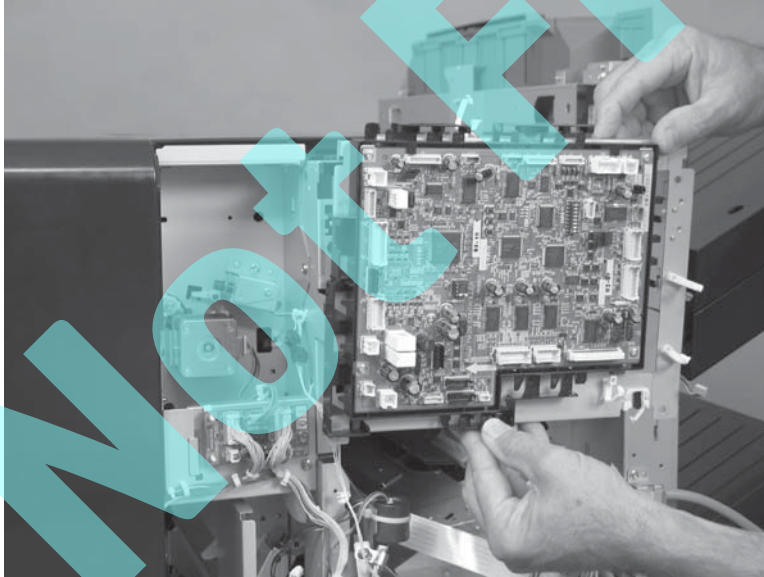

- Optional step:** Remove four screws, and then separate the main controller PCA from the sheet-metal mounting bracket.

Figure 1-542 Remove the main controller PCA assembly (6 of 6)

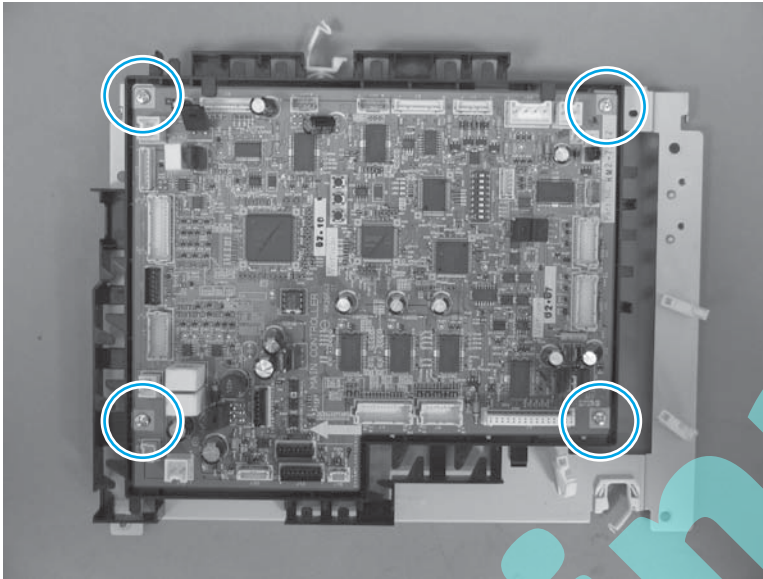

Not Final

Install a replacement main controller PCA assembly

The main controller PCA includes a removable memory device that contains important calibration information for the accessory. Carefully remove this device (pry it out of its socket, being careful to not bend or break the mounting pins), and then install it on the replacement PCA to retain the calibration information.

⚠ CAUTION: When you install the memory device, the notch on the device and the notch on the socket must be aligned. If the memory device is not correctly installed, the device polarity will be reversed which will damage the memory device.

Figure 1-543 Install a replacement main controller PCA assembly

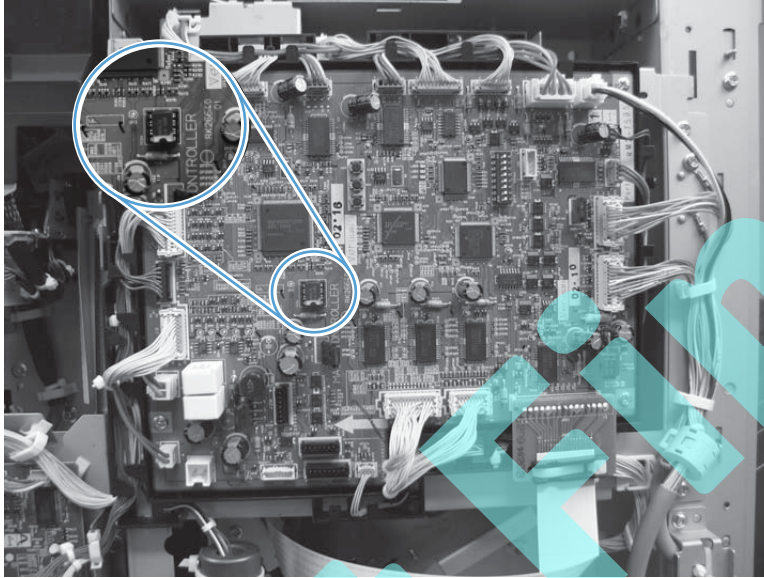

Adjustments

These adjustments are for the primary stapler unit for both the stapler stacker and booklet maker accessories. Test the finishing accessory functions after replacing the main controller PCA. If needed, use these procedures to make performance adjustments.

Access the main controller switches

- SW1, SW2, and SW3 (callout 1)
- DIPSW4 (callout 2)

 **NOTE:** DIPSW4 has eight electronic switches that can be configured in the ON or OFF position. The controller PCA is marked ON and OFF to show the current switch position.

Figure 1-544 Main controller PCA switches



Access the saddle controller switches (BM only)

- SW1 (callout 1)
- DIPSW (callout 2)

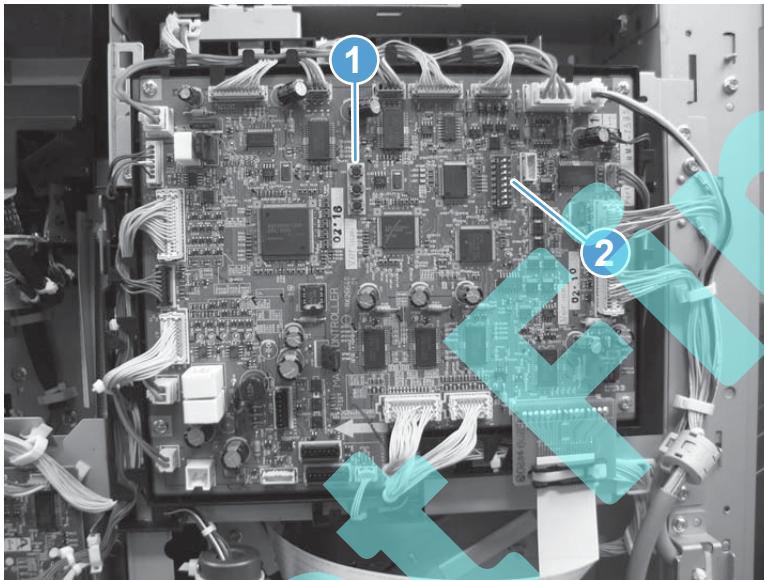
 **NOTE:** DIPSW has eight electronic switches that can be configured in the ON or OFF position. The controller PCA is marked ON and OFF to show the current switch position.

Figure 1-545 Booklet maker controller PCA switches (BM only)



Adjust the alignment position

Perform this adjustment if the alignment position must be changed.

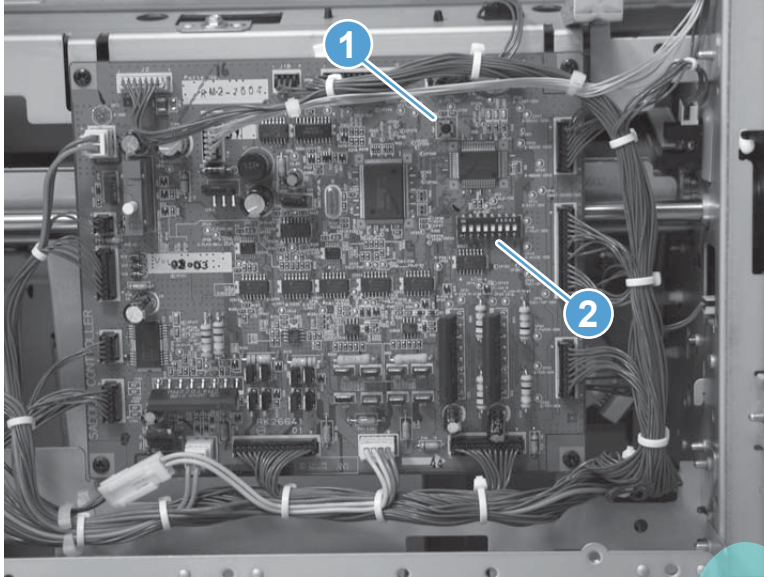
1. Turn the product power off, and then disconnect the interface cable from the product.
2. Access the main controller PCA, and then set DIPSW4 to one of the following:

Figure 1-546 DIPSW4 alignment settings

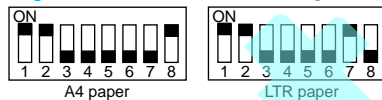

3. Connect the interface cable to the product, and then turn the product power on.
4. Press SW3 on the main controller PCA. When SW3 is pressed, the swing guide opens and the alignment plate moves to the prescribed position.
5. Place ten sheets of A4 or LTR paper between the alignment plates and align them squarely against the stopper.



NOTE: The object of this calibration is to adjust the plates so that they lightly and evenly touch the sides of the stacked paper.

6. Press SW1 or SW2 on the main controller PCA and adjust the alignment plate against the paper. The adjustment range is ± 4.2 mm (0.165 in).
 - Pressing SW1 moves the alignment plate 0.42 mm (0.016 in) forward
 - Pressing SW2 moves the alignment plate 0.42 mm (0.016 in) backward
7. When the adjustment is complete, remove the paper, and then press SW3 once to write the adjustment values to the memory device on the PCA.
8. Return all of the switches on DIPSW4 to the OFF position.
9. Turn the product power off, and then install the covers.

Adjust the staple position

Adjust the stapler position if the staple position must be changed. This adjustment sets the front and rear stitches with A4/A4R when the paper used for adjustment is AB type and with LTR/LTRR when the paper is INCH type.

1. Turn the product power off, and then disconnect the interface cable from the product.
2. Access the main controller PCA, and then set DIPSW4 according to paper/stitch position used for adjustment:

Figure 1-547 DIPSW4 staple position settings

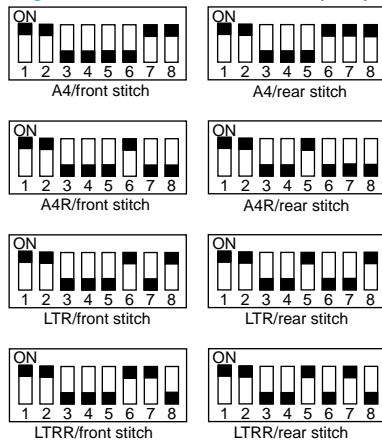

3. Connect the interface cable to the product, and then turn the product power on.
4. Press SW3 on the main controller PCA. When SW3 is pressed, the swing guide opens and the alignment plate moves to the prescribed position.
5. Place two sheets paper between the alignment plates and align them squarely against the stopper, and then push the rear edge of the paper against the rear alignment plate.

If the gap between the front alignment plate and front edge of the paper is 1 mm (0.039 in) or greater, adjust the plate alignment before continuing. See [Adjust the alignment position on page 359](#).
6. Press SW3 on the main controller PCA once to staple the paper. Remove the stapled paper and verify the staple position.
7. Press SW3 on the main controller PCA once.
8. If the staple position is correct, insert a sheet of paper between the aligning plates and align it against the stopper, push the far end edge of the paper to the rear aligning plate, press SW3 once (stapling action/store adjustment value), and then proceed to step 9.
9. If the staple position is incorrect, press SW1 or SW2 on the main controller PCA to adjust the staple position.
 - Pressing SW1 moves the alignment plate 0.49 mm (0.019 in) forward
 - Pressing SW2 moves the alignment plate 0.49 mm (0.019 in) backward
10. Repeat step 4 and step 5 until the staple is in the correct position.

11. Return all of the switches on DIPSW4 to the OFF position.
12. Turn the product power off, and then install the covers.

Adjust the folding position to the stitch position (booklet maker only)

Adjust the position of the booklet fold by changing the settings of bits six through eight of DIPSW on the booklet maker controller PCA to match the booklet stapling (stitching) position.

If the booklet maker controller PCA has been replaced, be sure to set the new DIPSW so that the settings will be the same as those on the old DIPSW.

Perform this adjustment if you must change the folding position. Set the DIPSW on the booklet maker controller PCA to match the stitching position (adjusting the distance over which the paper positioning plate is moved to the folding position from the stitching position).

1. Turn the product power off, and then disconnect the interface cable from the product.
2. Access the booklet maker controller PCA, and then set DIPSW. To establish a baseline for measurements, set bits 1 through 8 of DIPSW on the booklet maker controller PCA as follows:

 **NOTE:** Do not change bit 5.

Figure 1-548 DIPSW folding position settings



Do not change bit 5.

3. Do the following:
 - Open the front door and the paper-jam-access guide plate on the saddle guide assembly.
 - At the rear of the accessory, tape the actuator of the inlet-cover sensor (saddle guide assembly PI9) and inlet door switch (saddle guide assembly SW1) so that both sensor and switch remain activated. This simulates that the saddle guide is in the closed position throughout the adjustment procedure.

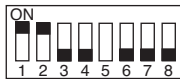
- Using two sheets of A3 or 11 x 17 paper, mark the top of the paper as shown below. This is a reference mark to show a specific end of the paper. The mark just needs to be somewhere at one end of the paper as shown below.

Figure 1-549 Mark the paper



- Close the saddle guide assembly and the front door of the accessory. Reconnect the interface cable from the booklet maker to the product. Turn the product power on, and wait until the product is in a Ready state.
- Press SW1 on the booklet maker controller PCA to activate the feed motor (M1). You will need to press and hold down SW1 for three seconds (or longer) if 11 x 17 paper is used.
- Open the front door of the accessory, and then open saddle guide assembly (callout 1). Insert the two sheets of marked paper into the paper path leading to the folding unit and past the booklet stapler unit. Push them in by hand until the front edge of the sheets push against the paper positioning plate.

Figure 1-550 Folding position adjustment (1 of 2)



8. Verify that the paper is properly located against the paper positioning plate by opening the booklet delivery door and looking at the paper positioning plate (callout 1).



 **NOTE:** It is important for the bottom of the sheets of paper to be squarely resting on the paper positioning plate for the adjustment to be accurate.

Figure 1-551 Folding position adjustment (2 of 2)



9. Close the saddle guide assembly.
10. Press SW1 on the booklet maker controller PCA. The saddle stitcher unit will "stitch" the sheets, and fold and deliver the stack automatically to the booklet output bin.
11. Measure the distance (L) between the stitching position and the folding position. Then perform a positive-width adjustment or a negative-width adjustment to suit the relationship between the stitching position and the folding position.

 **NOTE:** If the L adjustment is significantly larger than what the adjustment allows, the most common cause is that the paper was not fully inserted and resting squarely on the paper position plate.

- If the stitching position is above the folding position, perform a positive-width adjustment."
- If the stitching position is below the folding position, perform a negative-width adjustment."

Figure 1-552 Positive and negative width adjustment

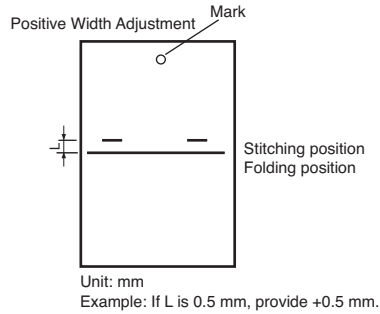
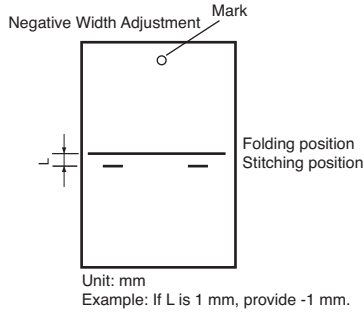

12. Refer to the following tables, and then change the settings of bits 6 through 8 on DIPSW.

Table 1-11 DIPSW settings

DIPSW Bit settings			Setting
			0.5 mm (0.019 in) units
Bit 6	Bit 7	Bit 8	
OFF	ON	ON	+3
OFF	ON	OFF	+2
OFF	OFF	ON	+1
OFF	OFF	OFF	0
ON	OFF	ON	-1
ON	ON	OFF	-2
ON	ON	ON	-3
ON	OFF	OFF	

Table 1-12 Do not use these DIPSW settings

DIPSW Bit settings		
Bit 6	Bit 7	Bit 8
ON	OFF	OFF

13. When adjustment has been completed and the stitch staples are within the fold line, set DIPSW bits 1 to 4 (only) to OFF.
14. Remove the tape from the actuator arm of switch SW1 and P19 on the rear frame of the accessory.

Adjust the stitcher unit

1. Open the front cover.
2. Pull out the stitcher mount unit to the front. Pull the stitcher towards you and then pull up.
3. Remove three screws (callout 1) and then remove the stitcher cover (callout 2).

Figure 1-553 Adjust the stitcher (1 of 6)

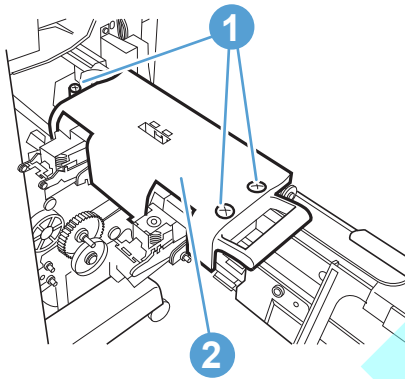

4. Remove the stitcher positioning tool (callout 1) from the back of the cover.

Figure 1-554 Adjust the stitcher (2 of 6)

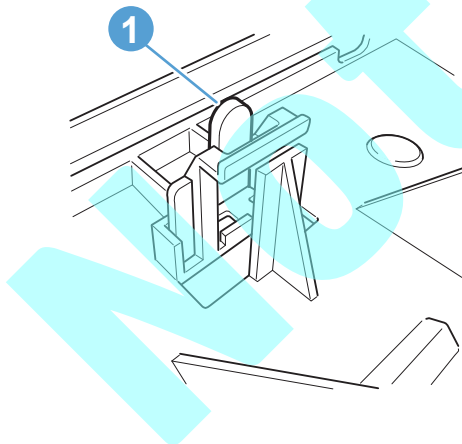

- To adjust the front stitcher, remove the front guide plate (callout 1) and center guide plate (callout 2). To adjust the rear stitcher, remove the center guide plate (callout 2) and the rear guide plate (callout 3).

 **TIP:** Remove one screw from each plate to remove the plates.

Figure 1-555 Adjust the stitcher (3 of 6)



- To adjust the front stitcher, loosen the two screws (callout 1) on the stitcher mount (callout 2). To adjust the rear stitcher, loosen the two screws (callout 3) on the stitcher mount.

Figure 1-556 Adjust the stitcher (4 of 6)

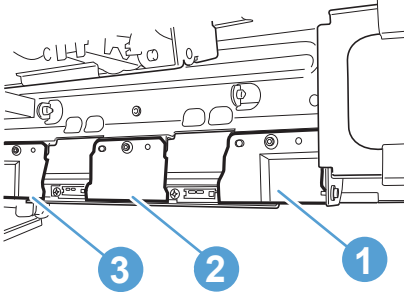
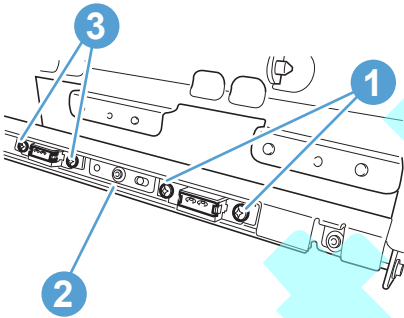

- Insert the tool (callout 1) into the staple slot of the stitcher (callout 2).

Figure 1-557 Adjust the stitcher (5 of 6)

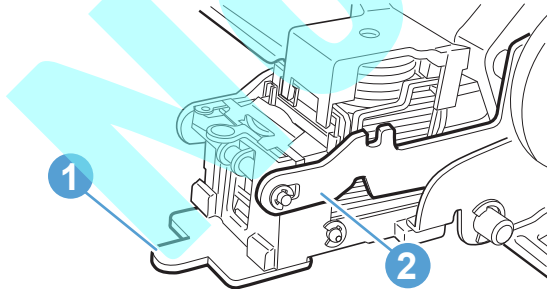

8. Tilt the stitcher, and turn the stitcher gear (callout 1) to match the recess of the tool (callout 2) and the mount (callout 3) and then tighten the screws on the stitcher mount.

Figure 1-558 Adjust the stitcher (6 of 6)

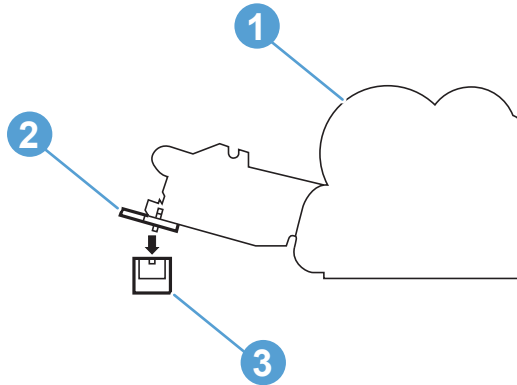

Not Final

Entrance upper guide assembly

Before proceeding, remove the following assemblies:

- Bin cable guide cover. See [Bin cable guide cover on page 317](#).
- Open/closed stepped cover assembly. See [Open/closed stepped cover assembly on page 321](#).
- Upper stepped cover assembly. See [Upper stepped cover assembly on page 322](#).
- Lower stepped cover assembly. See [Lower stepped cover assembly on page 324](#).
- Top door assembly. See [Top door assembly on page 328](#).
- Front door. See [Front door on page 330](#).
- Inner upper cover assembly. See [Inner upper cover assembly \(remove\) on page 334](#).

Remove the entrance upper guide assembly

1. On the upper front chassis, remove one screw (callout 1) to release the ground wire (callout 2), and then release the wire harness from three retainers (callout 3).

Figure 1-559 Remove the entrance upper guide assembly (1 of 3)

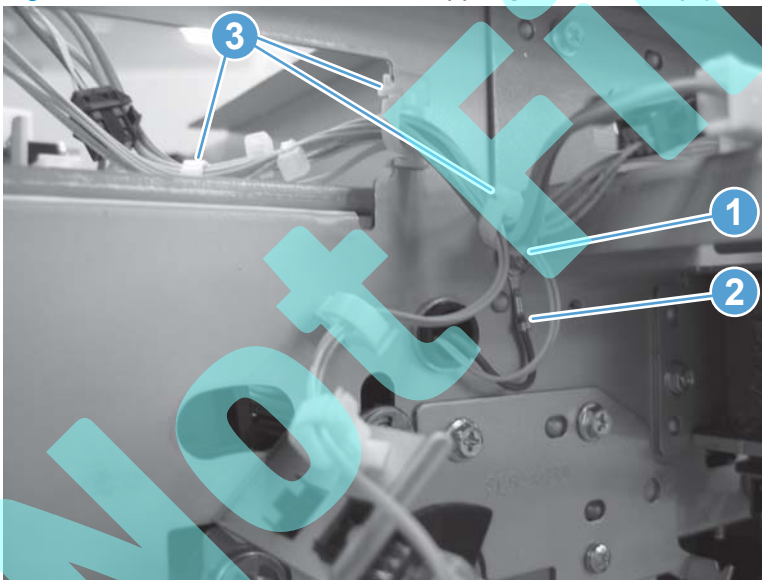

2. Disconnect one connector.

Figure 1-560 Remove the entrance upper guide assembly (2 of 3)

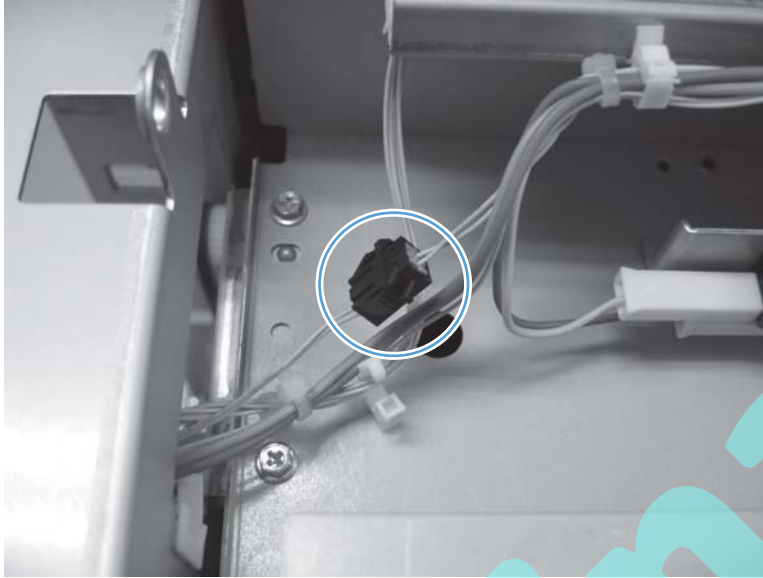

3. Do the following:
 - a. Remove one screw (callout 1), and then remove the door lock assembly (callout 2).
 - b. Remove one screw (callout 3) to release the remove the ground wire (callout 4).

 **TIP:** Use a small Phillips head screwdriver to remove this screw.

- c. Remove one screw (callout 5), and then remove the hinge pin (callout 6).
 - d. Lift the assembly up (callout 7), and then slide it to the right (carefully remove the wire harness through the access hole in the chassis) to remove it (callout 8).

 **NOTE:** The figure below shows the entrance guide assembly in the BM accessory. The assembly in the SSHP accessory is considerably smaller (about one half the size shown).

 **Reinstallation tip** Carefully guide the wire harness through the access hole in the chassis when you reinsert the entrance assembly.

Figure 1-561 Remove the entrance upper guide assembly (3 of 3)



Not Final

Rear foot cover assembly

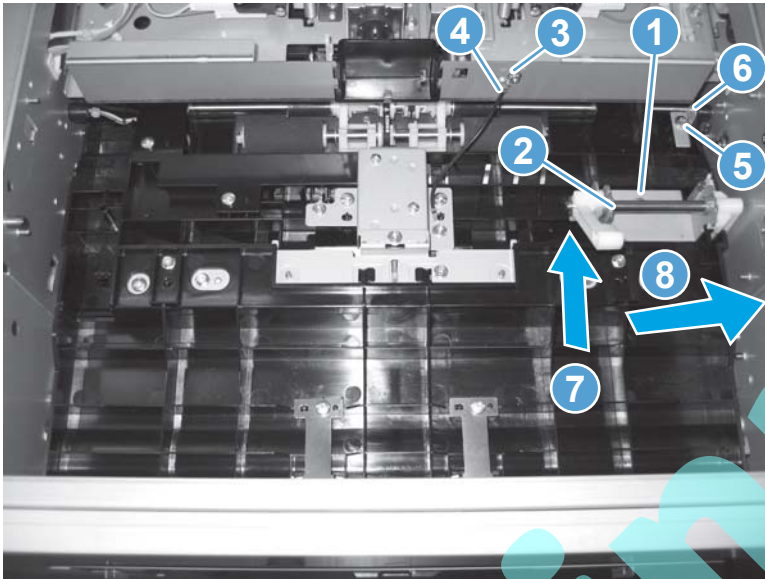
Before proceeding, remove the following assemblies:

- Rear reverse cover assembly. See [Rear reverse cover assembly on page 314](#).
- Bin cable guide cover. See [Bin cable guide cover on page 317](#).
- Open/closed stepped cover assembly. See [Open/closed stepped cover assembly on page 321](#).
- Upper stepped cover assembly. See [Upper stepped cover assembly on page 322](#).
- Lower stepped cover assembly. See [Lower stepped cover assembly on page 324](#).
- Rear cover assembly. See [Rear cover assembly on page 349](#).

Remove the rear foot cover assembly

1. Before proceeding, use the figure below to locate the three mounting tabs.

Figure 1-562 Remove the rear foot cover assembly (1 of 7)

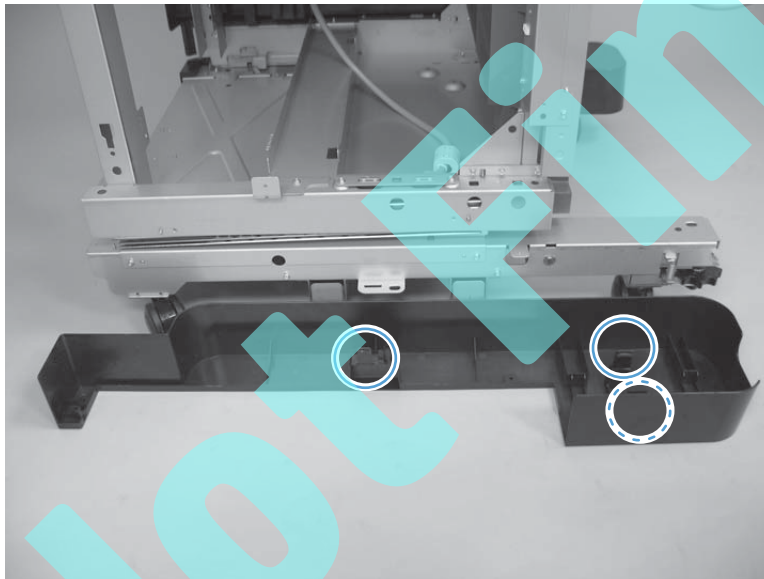

2. Remove two screws.

Figure 1-563 Remove the rear foot cover assembly (2 of 7)

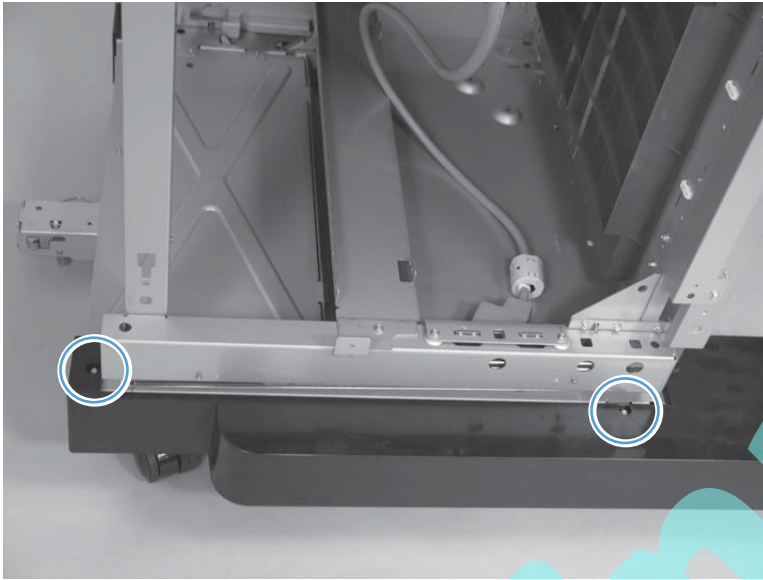

3. Use your fingers to reach up under the cover, release two tabs, and then slightly raise the cover.

 **TIP:** Look for the arrows embossed on the cover to locate the tabs.

Figure 1-564 Remove the rear foot cover assembly (3 of 7)



4. Release one tab, and slightly raise the cover.

 **TIP:** Look for the arrow embossed on the cover to locate the tab.

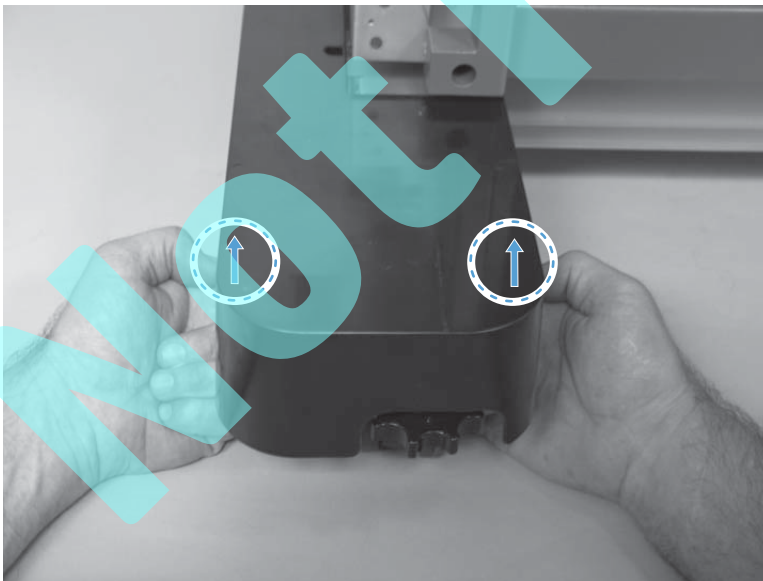
Figure 1-565 Remove the rear foot cover assembly (4 of 7)



5. Slightly flex the end of the cover (callout 1), and then slide the cover toward the stack bin end of the finishing accessory (callout 2).

Figure 1-566 Remove the rear foot cover assembly (5 of 7)

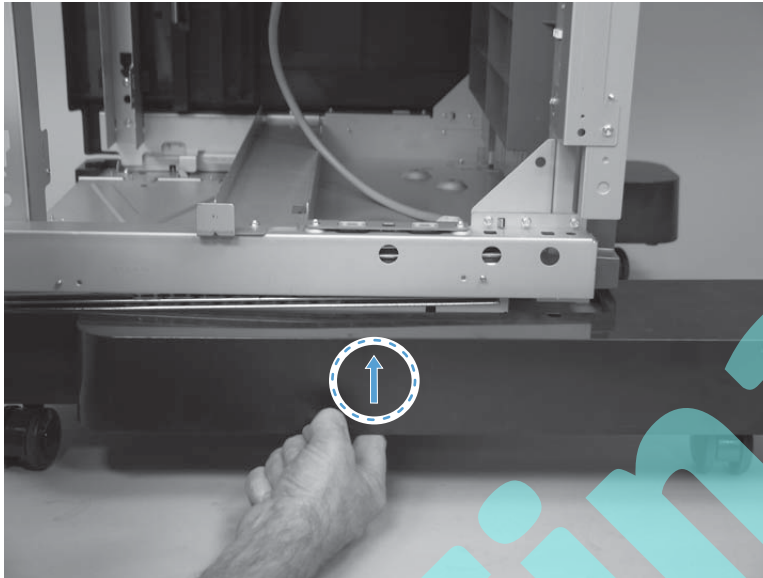
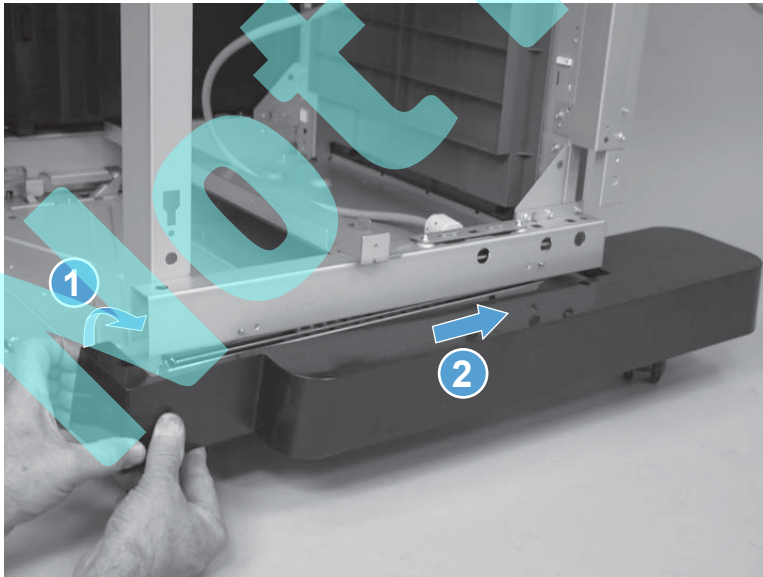

6. Continue to slide the cover toward the stack bin end of the finishing accessory until the front edge is past the height wall center assembly.

Figure 1-567 Remove the rear foot cover assembly (6 of 7)

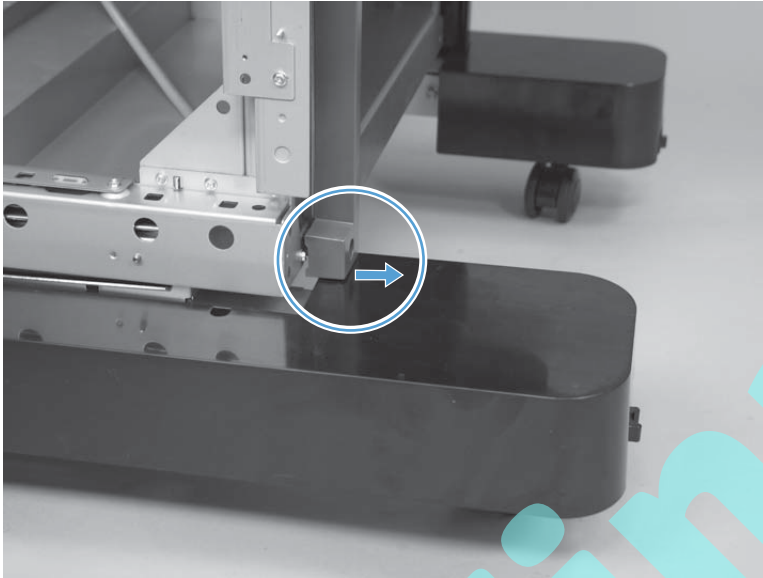

7. Remove the cover.

Figure 1-568 Remove the rear foot cover assembly (7 of 7)

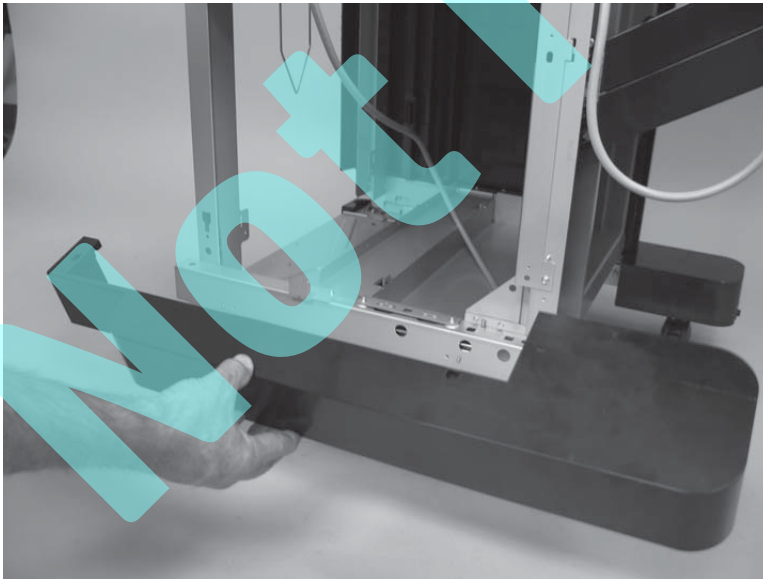

Stack wall upper assembly and upper wall guide assembly

Before proceeding, remove the following assemblies:

- Open/closed stepped cover assembly. See [Open/closed stepped cover assembly on page 321](#).
- Upper stepped cover assembly. See [Upper stepped cover assembly on page 322](#).
- Lower stepped cover assembly. See [Lower stepped cover assembly on page 324](#).

Remove the stack wall upper cover assembly

1. If the upper stack bin is in the raised position do the following:
 - a. Support the bin.
 - b. Use a small flat blade screwdriver to release the bin locking gear located on the underside of the bin near the drive assembly cover.

 **TIP:** Use a small flat blade screwdriver to release the bin locking gear located on the underside of the bin near the drive assembly cover.

 - c. Lower the bin to access the stack wall upper cover.

Figure 1-569 Remove the stack wall upper assembly and upper wall guide assembly (1 of 5)

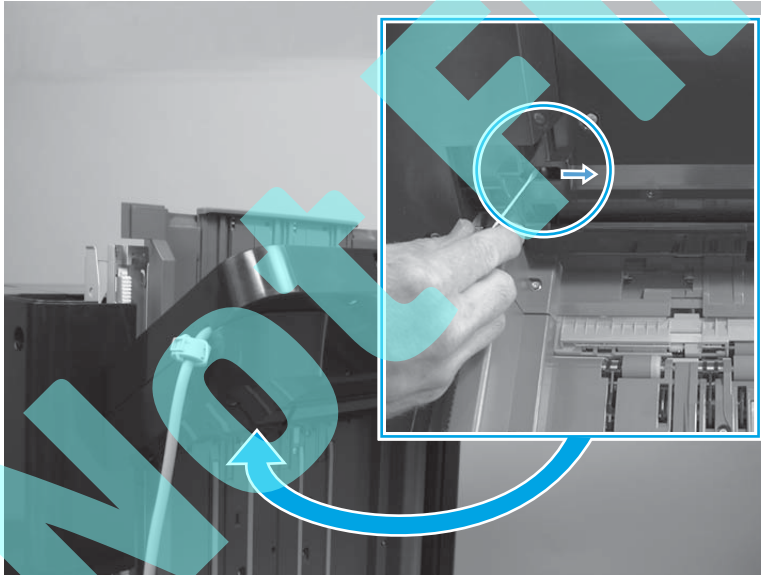

2. Remove four screws.

Figure 1-570 Remove the stack wall upper assembly and upper wall guide assembly (2 of 5)

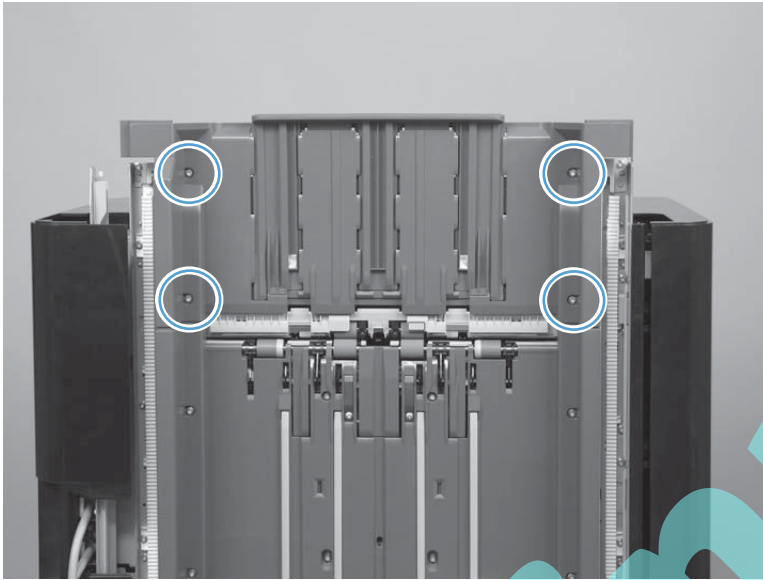

3. Raise the upper wall guide, and then remove one screw.

Figure 1-571 Remove the stack wall upper assembly and upper wall guide assembly (3 of 5)



4. Remove the cover.

Figure 1-572 Remove the stack wall upper assembly and upper wall guide assembly (4 of 5)

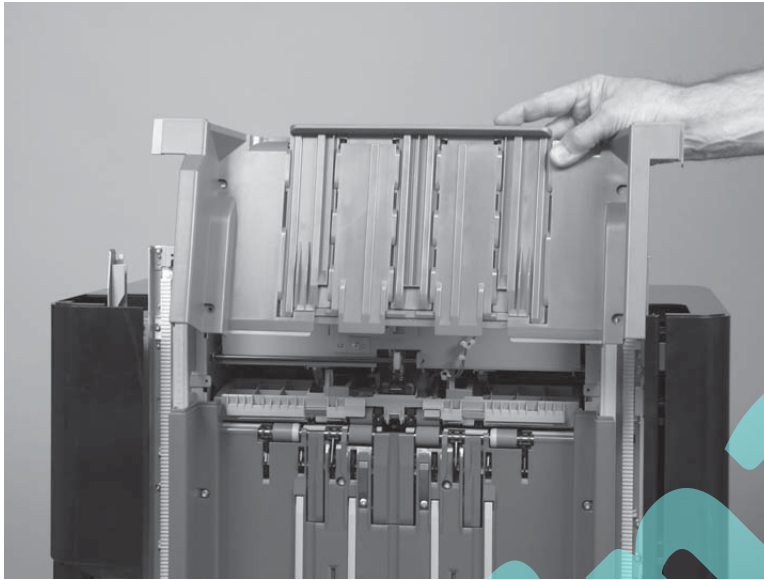

5. If necessary, separate the upper guide wall (callout 1) from the stack wall upper assembly (callout 2).

Figure 1-573 Remove the stack wall upper assembly and upper wall guide assembly (5 of 5)

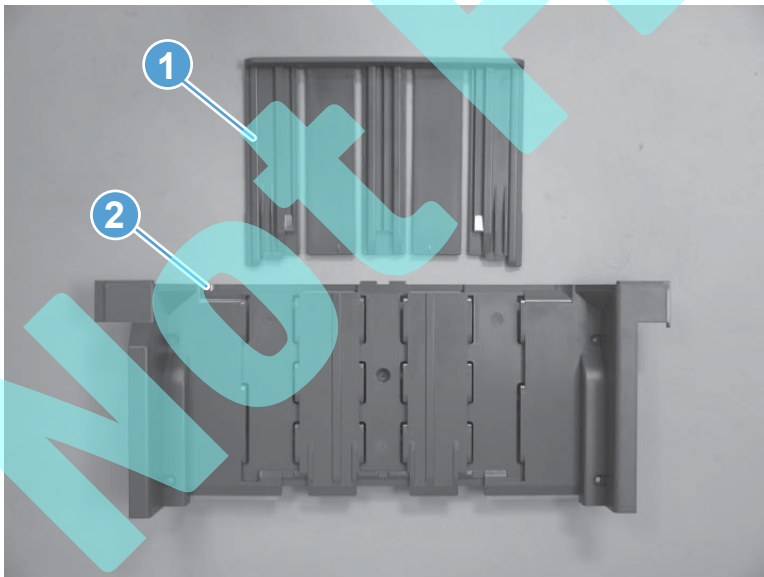

Upper crossmember assembly

Before proceeding, remove the following assemblies:

- Bin cable guide cover. See [Bin cable guide cover on page 317](#).
- Open/closed stepped cover assembly. See [Open/closed stepped cover assembly on page 321](#).
- Upper stepped cover assembly. See [Upper stepped cover assembly on page 322](#).
- Lower stepped cover assembly. See [Lower stepped cover assembly on page 324](#).
- Top cover assembly. See [Top door assembly on page 328](#).
- Front door. See [Front door on page 330](#).
- Inner upper cover assembly. See [Inner upper cover assembly \(remove\) on page 334](#).
- Rear cover assembly. See [Rear cover assembly on page 349](#).
- Stack wall upper cover assembly. See [Stack wall upper assembly and upper wall guide assembly on page 375](#).

Remove the upper crossmember assembly

1. At the top of the accessory, disconnect one connector (callout 1), and then release the wire harness from one retainer (callout 2).

 **TIP:** The connector is located near the two solenoids mounted at the middle of the crossmember assembly.

Figure 1-574 Remove the upper crossmember assembly (1 of 13)



2. Release the wire harness from two retainers, and move it out of the way.

Figure 1-575 Remove the upper crossmember assembly (2 of 13)

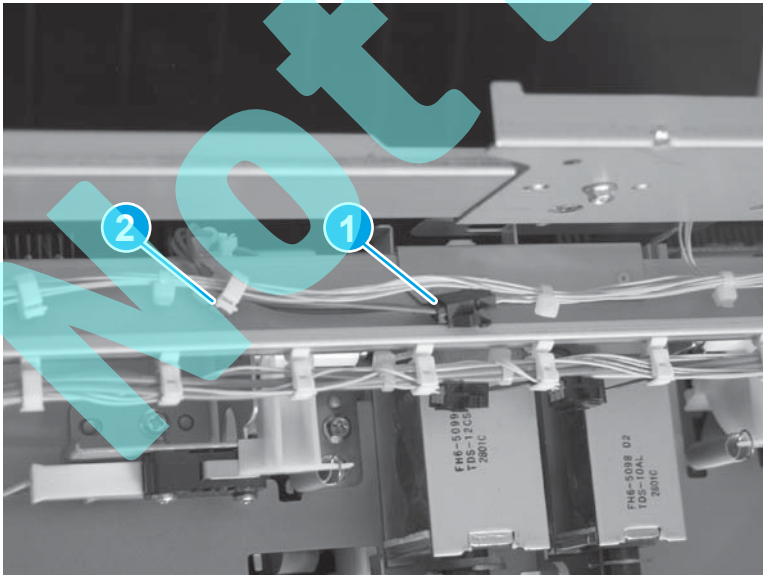
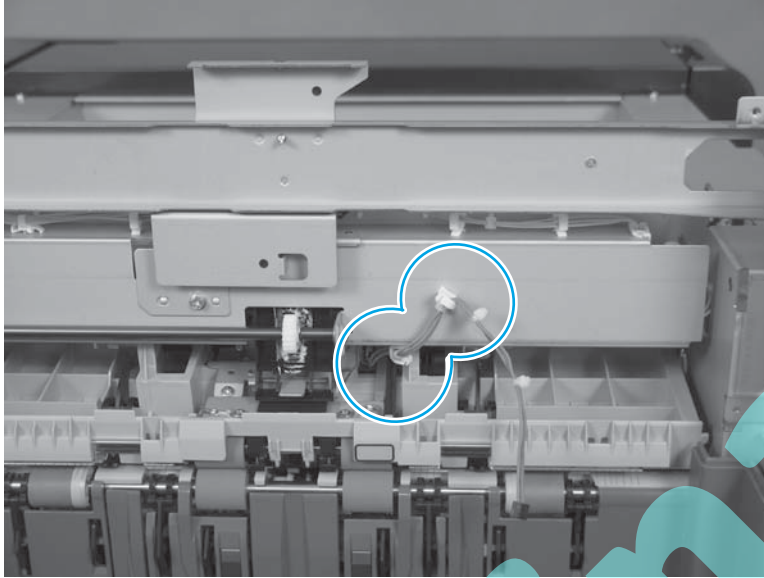

3. Remove one screw (callout 1), and then remove the sheet-metal bracket (callout 2).

Figure 1-576 Remove the upper crossmember assembly (3 of 13)

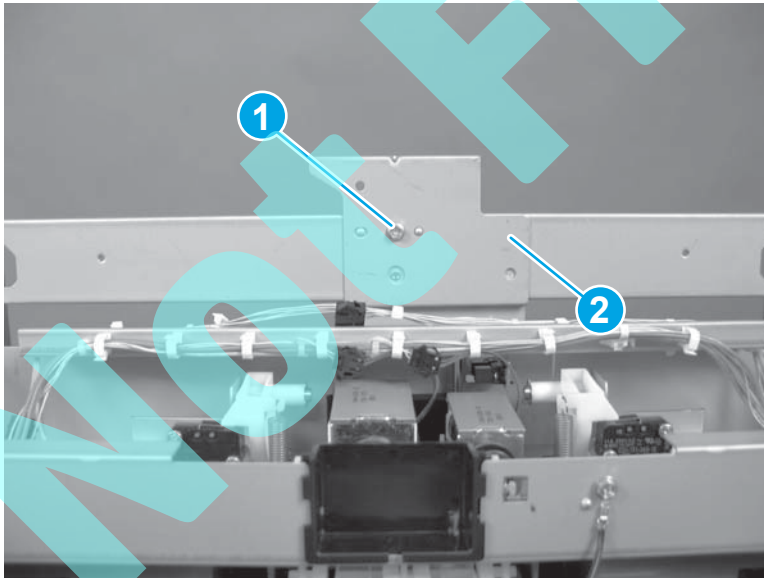

4. At the front of the accessory, disconnect four connectors (callout 1), and then remove the wire from the six wire retainers (callout 2).

 **TIP:** Use a small flat blade screwdriver to loosen, and then remove the large white-plastic connector on the front door detection switch.

Figure 1-577 Remove the upper crossmember assembly (4 of 13)



5. Release two tabs (callout 1), and then remove two wire tie retainers.

Figure 1-578 Remove the upper crossmember assembly (5 of 13)

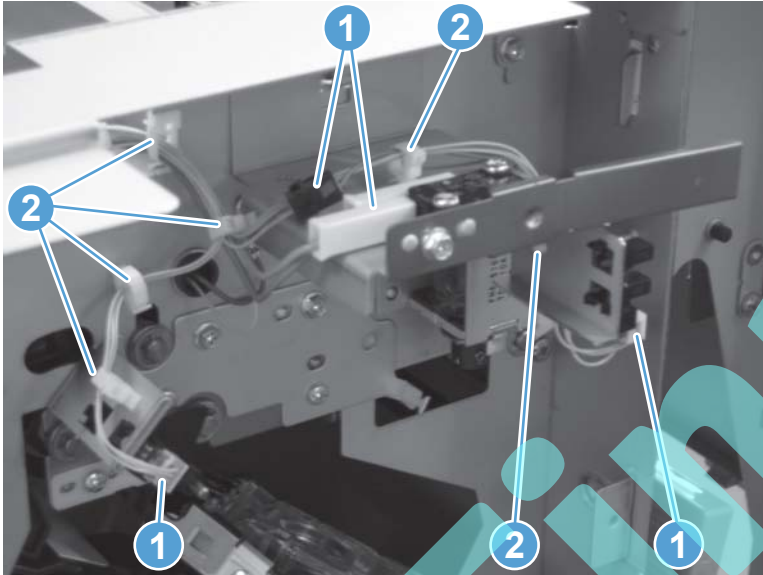
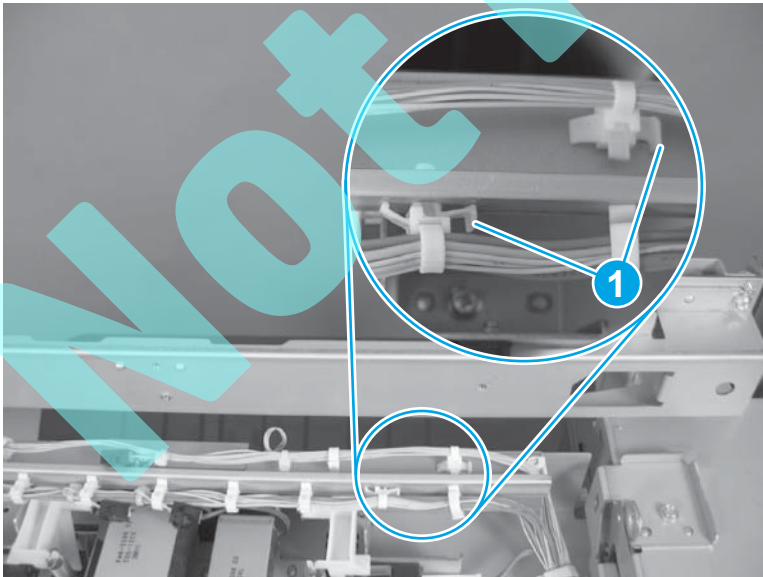

6. Remove one screw to release the ground wire.

Figure 1-579 Remove the upper crossmember assembly (5 of 13)

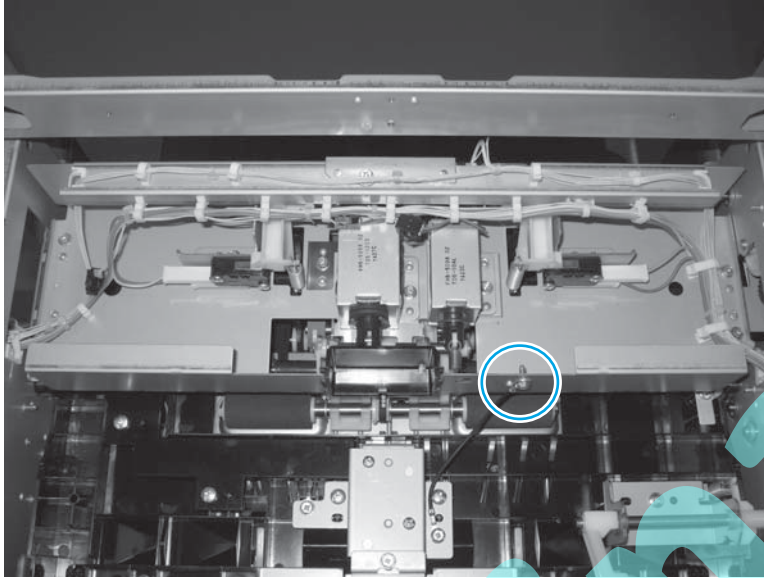

7. Remove one screw to release the ground wire.

 **TIP:** Use a small flat blade screwdriver to loosen, and then remove the two large white-plastic connectors.

Figure 1-580 Remove the upper crossmember assembly (7 of 13)



8. Release the wire harnesses from five retainers (callout 1) along the top of the assembly, and then release the wire harnesses from eleven retainers (callout 2) along the inside of the assembly.

 **TIP:** Move the wire harnesses out of the way.

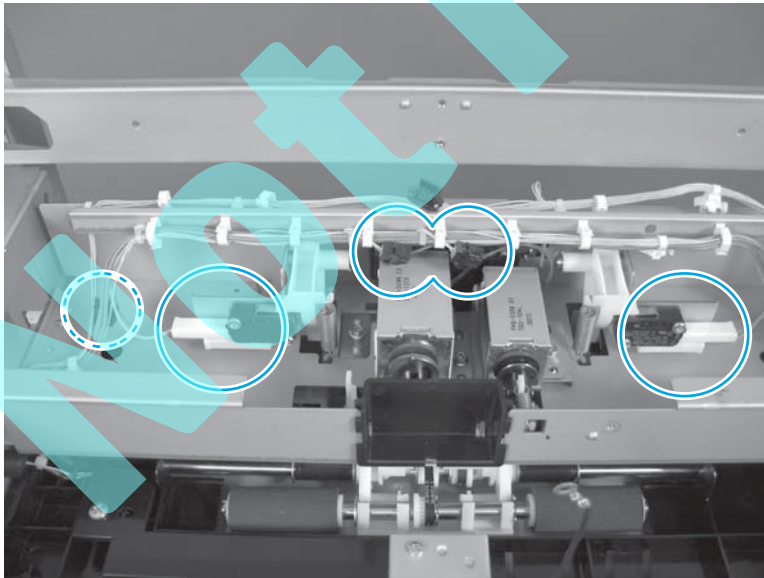
Figure 1-581 Remove the upper crossmember assembly (8 of 13)



9. Remove one screw (callout 1), and then remove the sheet-metal bracket (callout 2).

Figure 1-582 Remove the upper crossmember assembly (9 of 13)

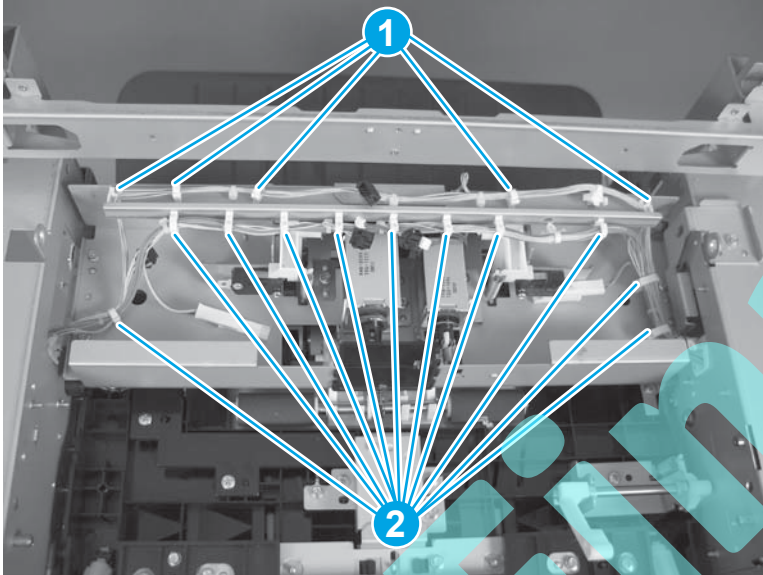
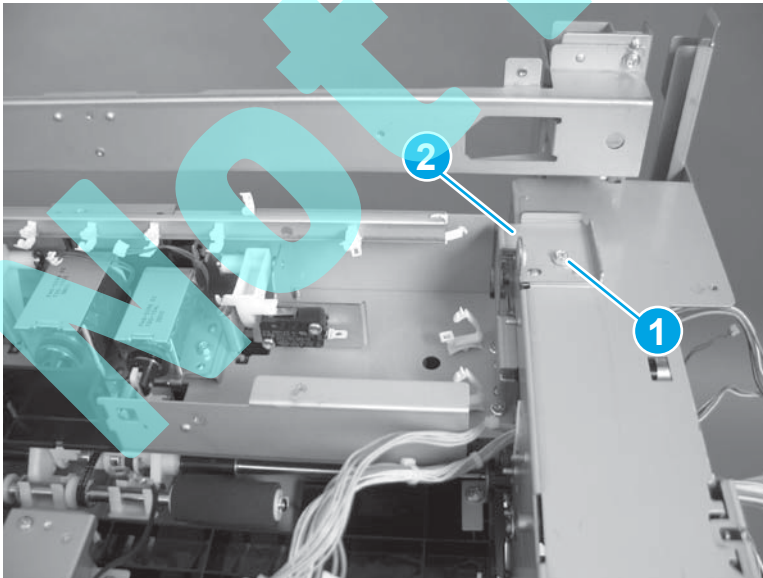

10. Remove four screws.

Figure 1-583 Remove the upper crossmember assembly (10 of 13)

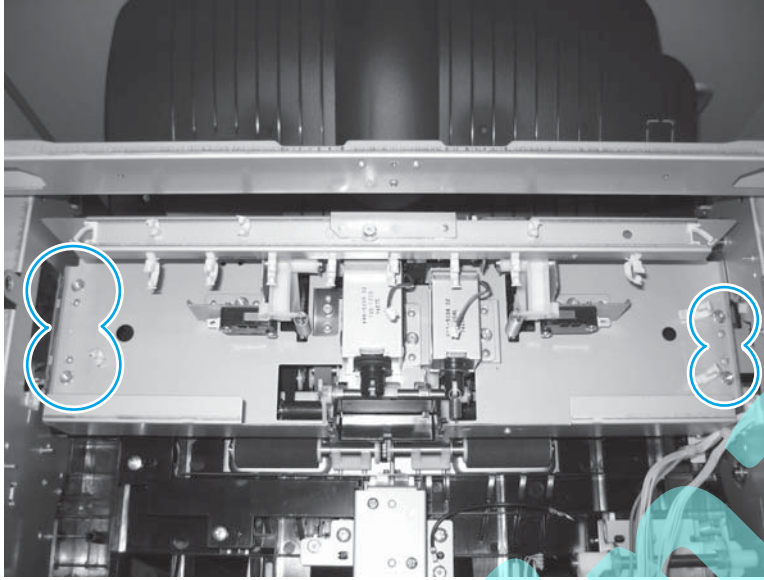

11. Remove one e-ring (callout 1), slide the gear shaft to the left (callout 2), remove one bushing (callout 3), and then move the gear shaft out of the way.

⚠ CAUTION: Do not lose the bushing (callout 3).

Figure 1-584 Remove the upper crossmember assembly (11 of 13)

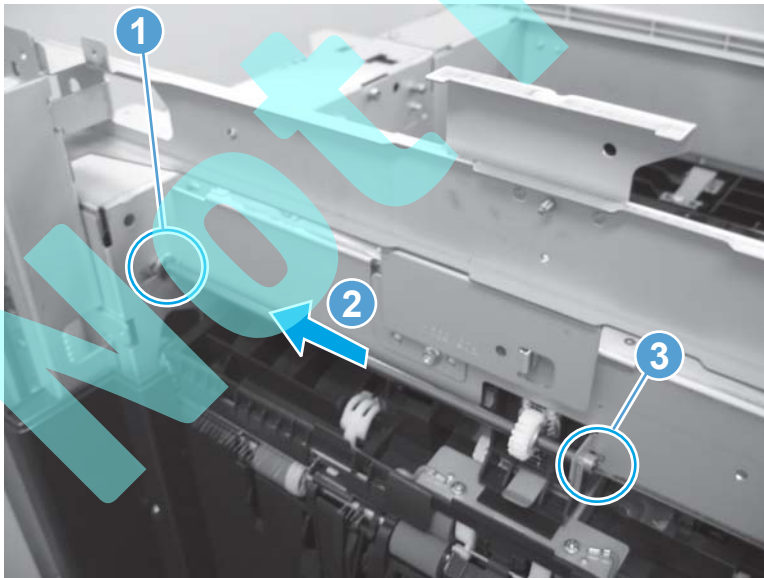

- Carefully rotate the edge of the upper crossmember assembly up (callout 1), support the swing guide assembly (callout 2), and then separate the black-plastic gear rack (callout 3) from the sheet metal tab (callout 4).

Figure 1-585 Remove the upper crossmember assembly (12 of 13)

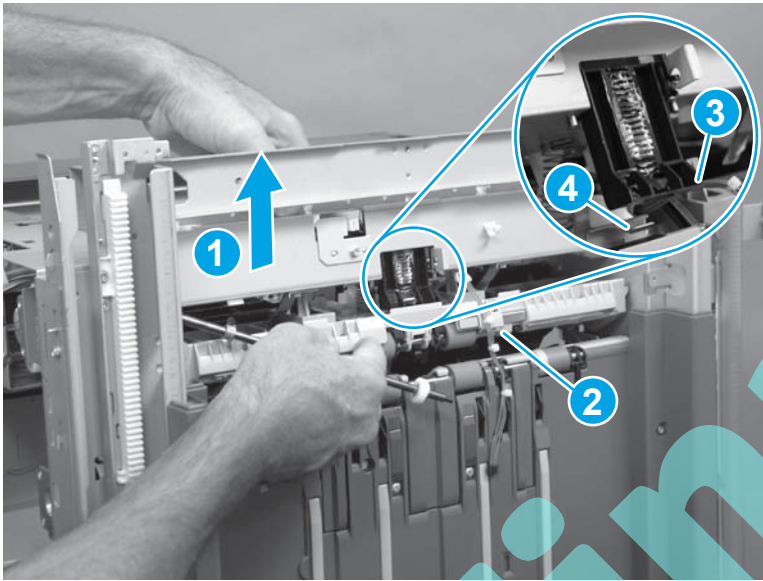

13. Remove the assembly.

⚠ CAUTION: The black plastic bracket (callout 1) along the front edge of the assembly, and the spring (callout 2) underneath the assembly are not captive. Do not lose these parts when removing or handling the assembly.

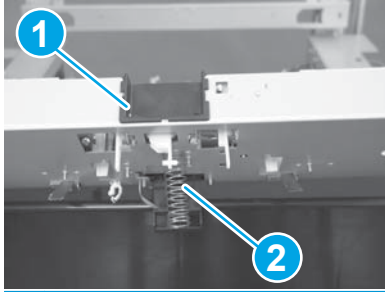
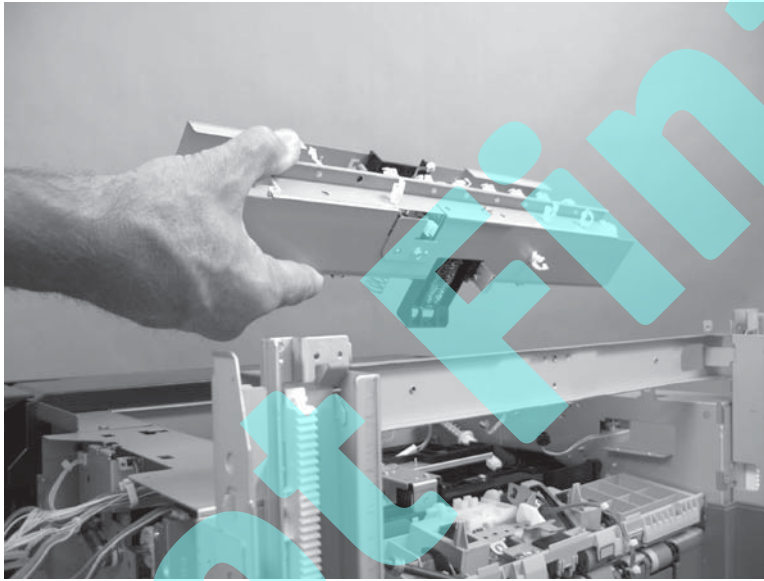

Figure 1-586 Remove the upper crossmember assembly (13 of 13)



Reinstall the upper crossmember assembly

1. When the assembly is positioned in the accessory, make sure that the spring underneath the assembly is seated on the pedestal on the swing guide.

Figure 1-587 Reinstall the upper crossmember assembly (1 of 7)

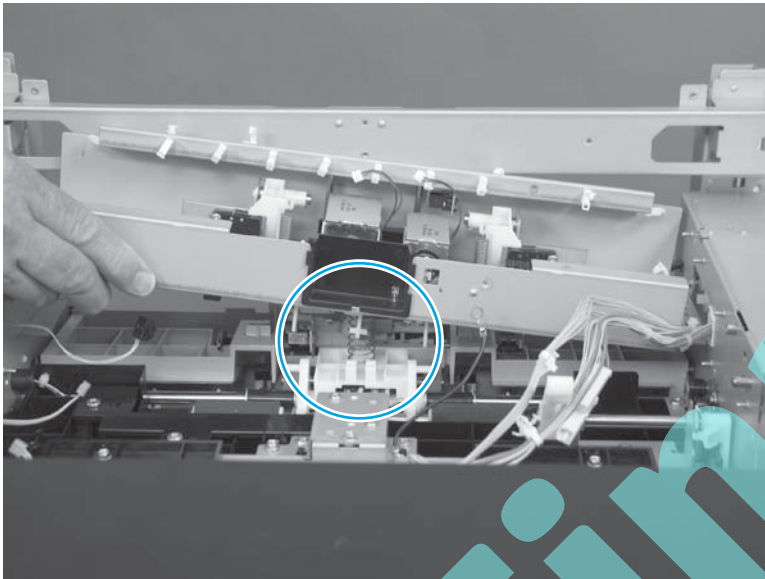

2. Verify that the two pivot arms are positioned in front of the pins (callout 1), and that the locking bar is seated in the cradle (callout 2).

 **Reinstallation tip** If after the upper crossmember assembly is removed and replaced the message **13.60.A1 Jam in Top Left Door** appears on the control panel display (or in the event log) after the product power is turned on, the two pivot arms or the locking bar might not have been properly installed.

Figure 1-588 Reinstall the upper crossmember assembly (2 of 7)



3. Install the mounting screws to secure the assembly to the chassis. Recheck the spring underneath the assembly. Verify that the spring is correctly positioned.

Figure 1-589 Reinstall the upper crossmember assembly (3 of 7)

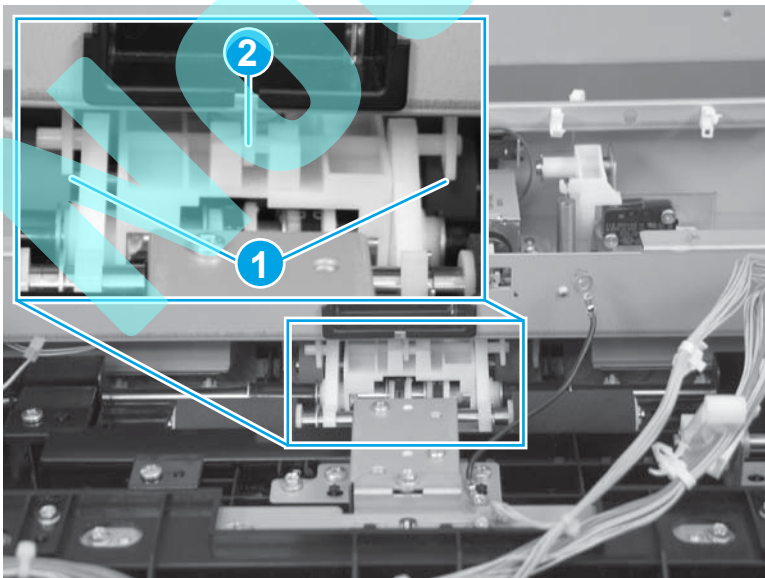
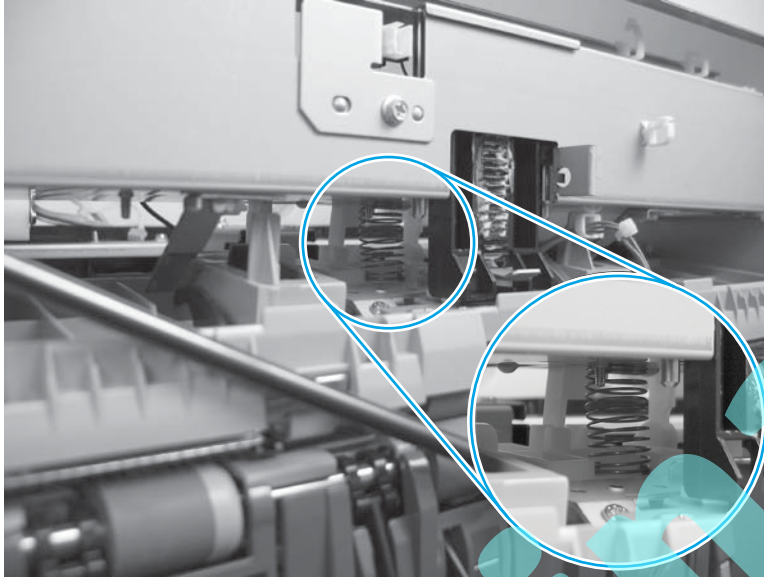

4. Recheck the locking bar underneath the assembly. Verify that it is correctly positioned in the cradle. If it is not correctly positioned, slightly lift up the upper crossmember assembly, and reposition the locking bar in the cradle.

 **TIP:** If necessary, slightly loosen, but do not remove, the assembly mounting screws to allow the assembly to be lifted up. Make sure that you retighten the mounting screws.

Figure 1-590 Reinstall the upper crossmember assembly (4 of 7)



5. To reinstall the gear shaft right-side bushing, align the keyed portion of the bushing with the slot in the chassis mounting tab.

Figure 1-591 Reinstall the upper crossmember assembly (5 of 7)

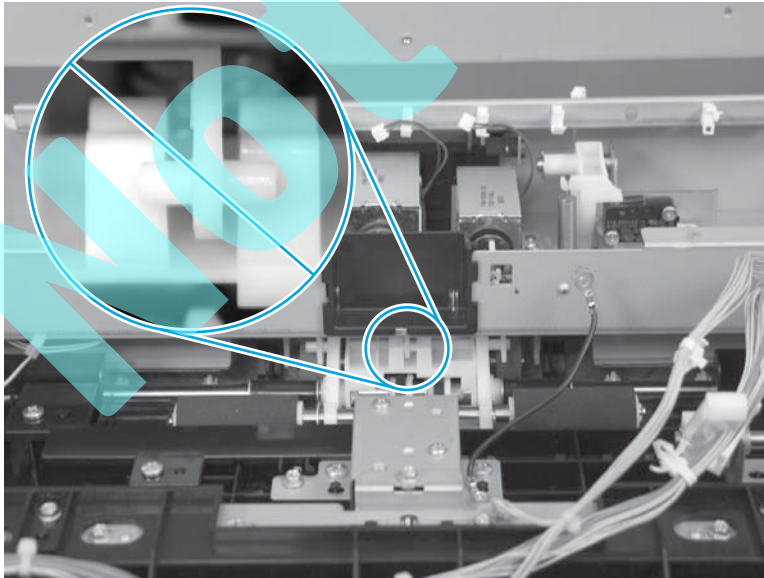
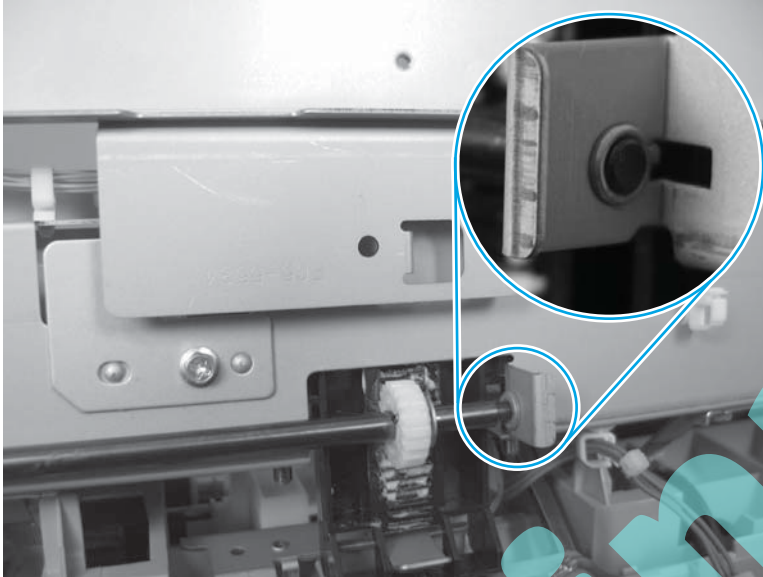

6. To reinstall the gear shaft left-side bushing, align the keyed portion of the bushing with the slot in the chassis (callout 1), and then install the e-ring (callout 2).

 **Reinstallation tip** If the e-ring slot on the gear shaft is **not** visible, make sure that the drive gear, clutch, and pin—on the drive gear side of the shaft—are correctly assembled. If necessary, see the following step to reassembly the gear-shaft-pin assembly.

Figure 1-592 Reinstall the upper crossmember assembly (6 of 7)



- Optional step:** Make sure that the clutch is correctly position on the gear—two tabs on the clutch engage two slots on the gear face—and that the pin is positioned in the slot on the end of the shaft.

Reinstall the gear shaft left-side bushing, and then install the e-ring (callout 2). See [Figure 1-592 Reinstall the upper crossmember assembly \(6 of 7\) on page 388](#).

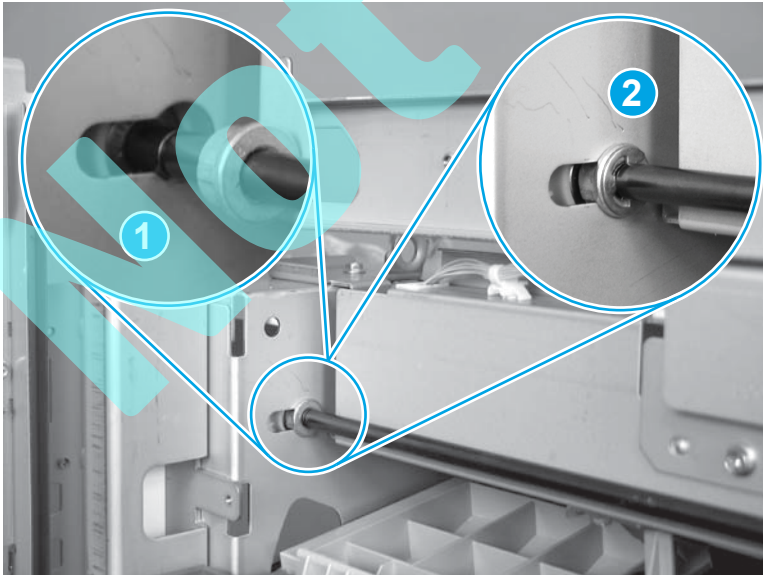
Figure 1-593 Reinstall the upper crossmember assembly (7 of 7)

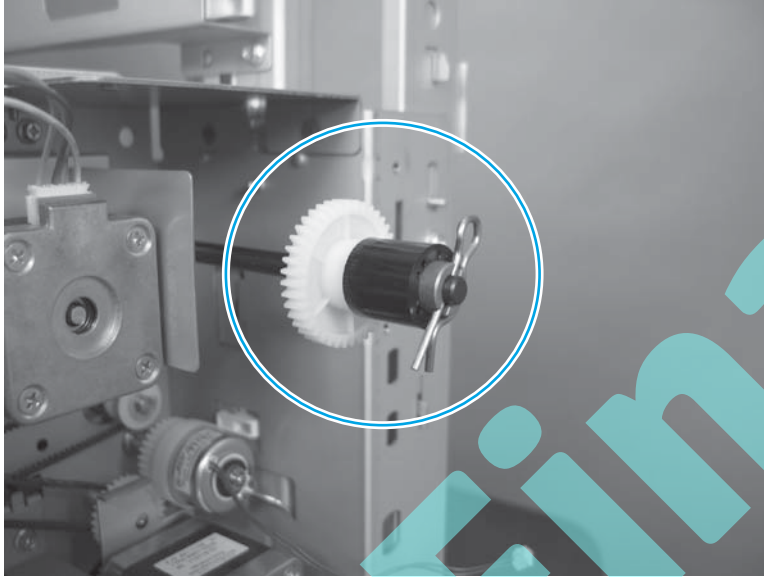

Paper feed drive assembly

Before proceeding, remove the following assemblies:

- Bin cable guide cover. See [Bin cable guide cover on page 317](#).
- Open/closed stepped cover assembly. See [Open/closed stepped cover assembly on page 321](#).
- Upper stepped cover assembly. See [Upper stepped cover assembly on page 322](#).
- Lower stepped cover assembly. See [Lower stepped cover assembly on page 324](#).
- Top cover assembly. See [Top door assembly on page 328](#).
- Front door. See [Front door on page 330](#).
- Inner upper cover assembly. See [Inner upper cover assembly \(remove\) on page 334](#).
- Rear cover assembly. See [Rear cover assembly on page 349](#).
- Main controller PCA assembly. See [Main controller PCA assembly on page 353](#).
- Stack wall upper cover assembly. See [Stack wall upper assembly and upper wall guide assembly on page 375](#).
- Upper crossmember assembly. See [Upper crossmember assembly on page 378](#).

Remove the paper feed drive assembly

1. Disconnect one connector (callout 1) and then release two retainers (callout 2).

Figure 1-594 Remove the paper feed drive assembly (1 of 2)

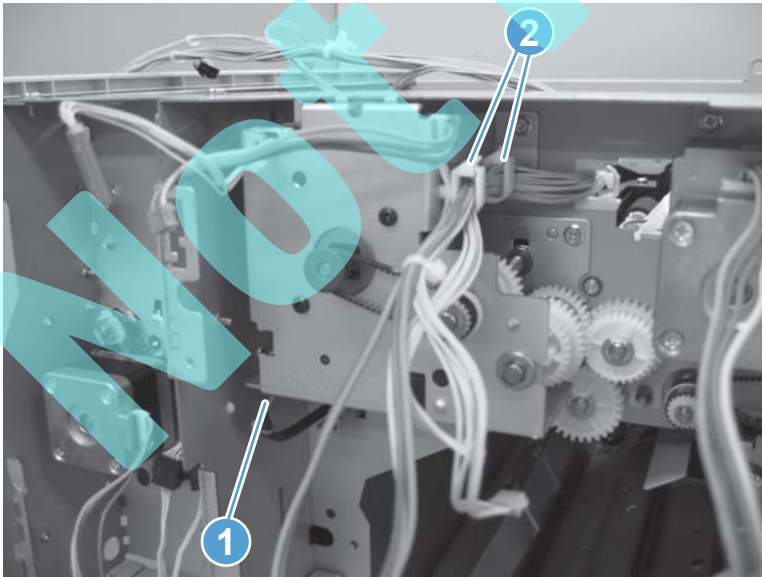

2. Remove three screws (callout 1), and then remove the paper feed drive assembly (callout 2).

 **NOTE:** As you remove the assembly, slip the drive belt located behind the assembly off of the drive gear. Do not lose the belt.

Figure 1-595 Remove the paper feed drive assembly (2 of 2)



Pressure roller assembly

Before proceeding, remove the following assemblies:

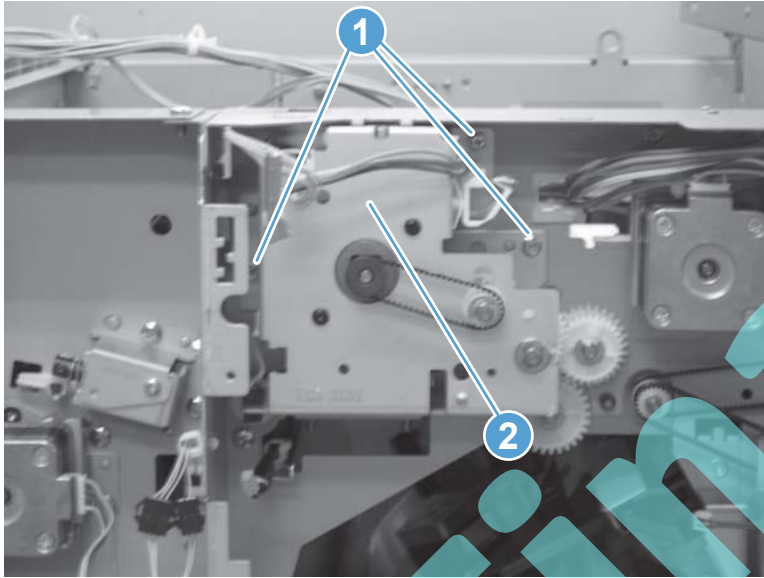
- Bin cable guide cover. See [Bin cable guide cover on page 317](#).
- Open/closed stepped cover assembly. See [Open/closed stepped cover assembly on page 321](#).
- Upper stepped cover assembly. See [Upper stepped cover assembly on page 322](#).
- Lower stepped cover assembly. See [Lower stepped cover assembly on page 324](#).
- Top cover assembly. See [Top door assembly on page 328](#).
- Front door. See [Front door on page 330](#).
- Inner upper cover assembly. See [Inner upper cover assembly \(remove\) on page 334](#).
- Rear cover assembly. See [Rear cover assembly on page 349](#).
- Main controller PCA assembly. See [Main controller PCA assembly on page 353](#).
- Stack wall upper cover assembly. See [Stack wall upper assembly and upper wall guide assembly on page 375](#).
- Upper crossmember assembly. See [Upper crossmember assembly on page 378](#).

Remove the pressure roller assembly

 **NOTE:** Some of the figures in this procedure show white plastic drive gears. The gears in the accessory are black plastic. However, this removal procedure is correct for this accessory.

1. Disconnect one connector (callout 1) and then release two retainers (callout 2).

Figure 1-596 Remove the pressure roller assembly (1 of 8)

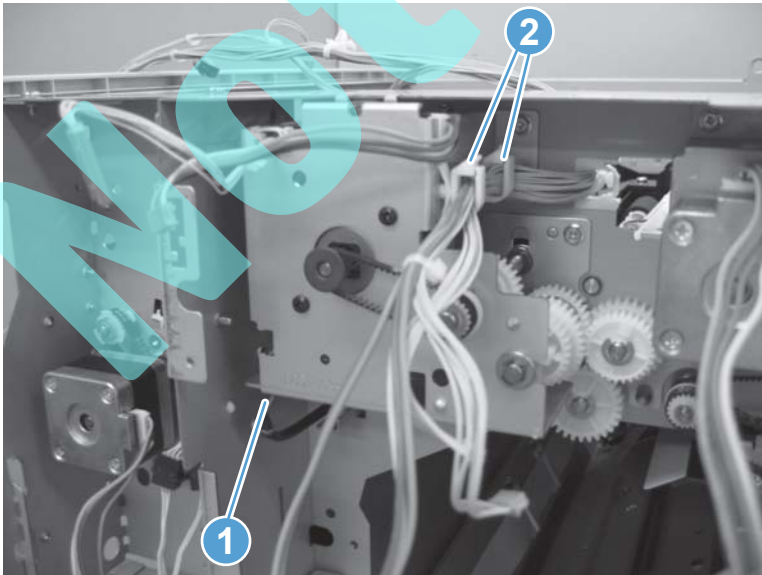

2. Remove three screws (callout 1), and then remove the paper feed motor assembly (callout 2).

 **NOTE:** As you remove the assembly, slip the drive belt located behind the assembly off of the drive gear. Do not lose the belt. Make sure that you connect the belt to the gear when the paper feed motor assembly is reinstalled.

Figure 1-597 Remove the pressure roller assembly (2 of 8)



3. Rotate the outer gear until the square box on the face of the gear is facing down. This horizontally aligns the locking pin behind the gear, and minimizes the possibility of the pin falling into the accessory when the gear is removed in the next step.

 **NOTE:** The outer gear is shown removed in the figure below.

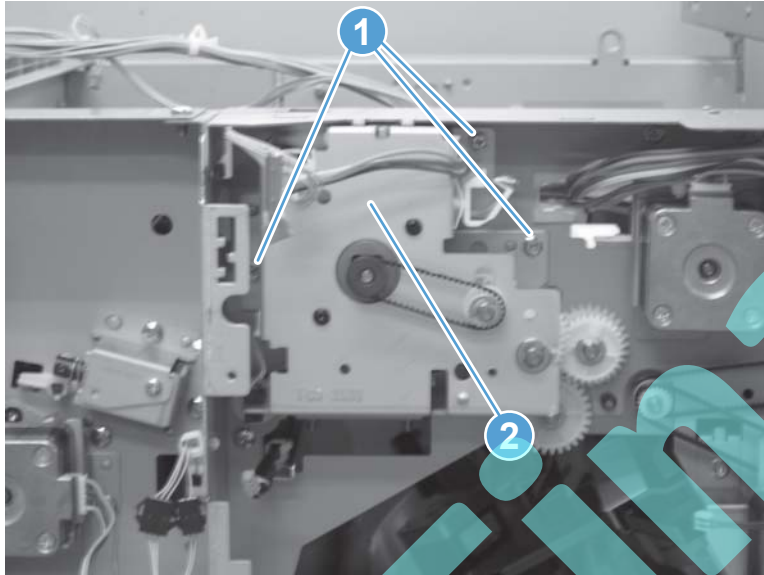
Figure 1-598 Remove the pressure roller assembly (3 of 8)

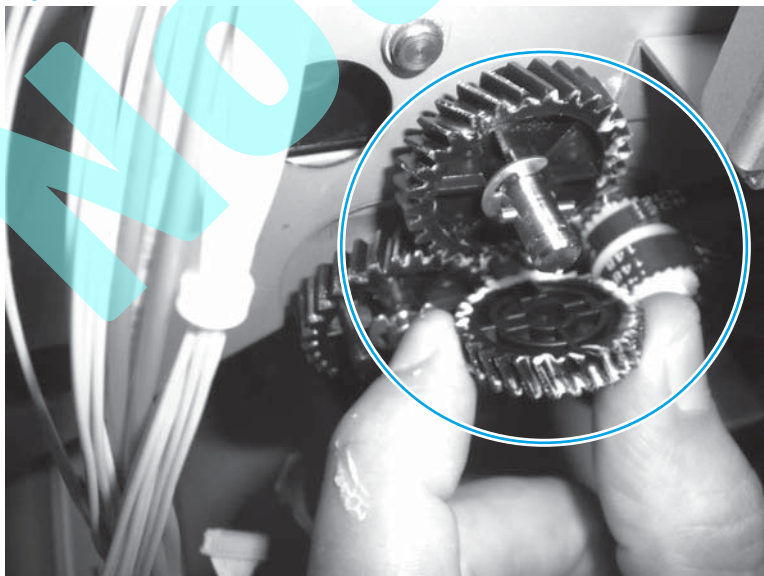

4. Remove one e-ring (callout 1), one gear (callout 2), and one pin (callout 3) behind the gear.



 **Reinstallation tip** Use the horizontal pin alignment described above to reinstall the pin.

Figure 1-599 Remove the pressure roller assembly (4 of 8)

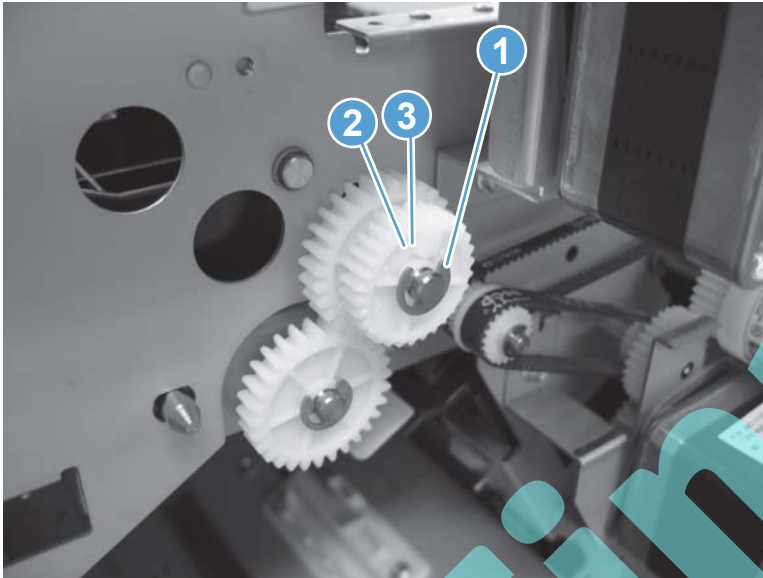

5. Remove one e-ring (callout 1), one gear (callout 2), and one pin (callout 3) behind the gear.

 **NOTE:** Before proceeding, rotate the inner gear until the visible hole in the shaft (callout 4) is horizontal to prevent the locking pin behind the gear from falling out of the shaft.

 **Reinstallation tip** Use the horizontal hole alignment described above to reinstall the pin.

Figure 1-600 Remove the pressure roller assembly (5 of 8)

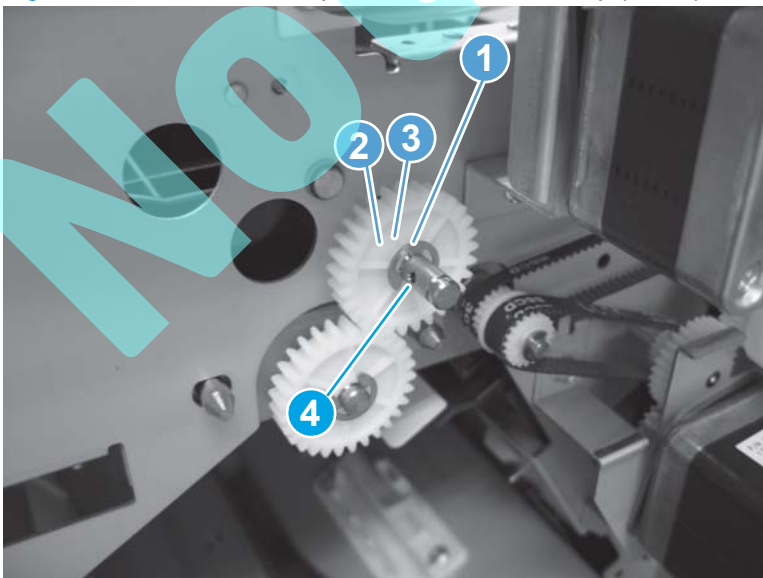

6. Remove the e-ring (callout 1) and then remove one bushing (callout 2).

Figure 1-601 Remove the pressure roller assembly (6 of 8)

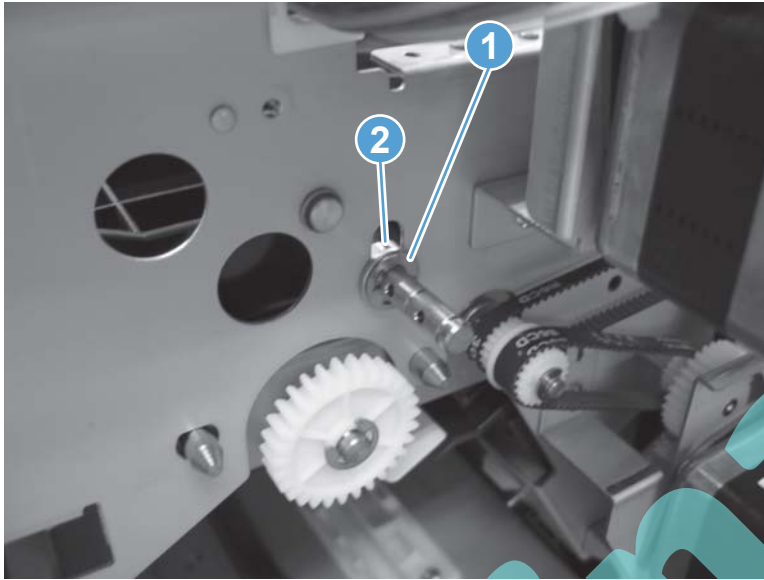

7. At the opposite side of the accessory, remove the e-ring (callout 1) and then remove one bushing (callout 2).

Figure 1-602 Remove the pressure roller assembly (7 of 8)

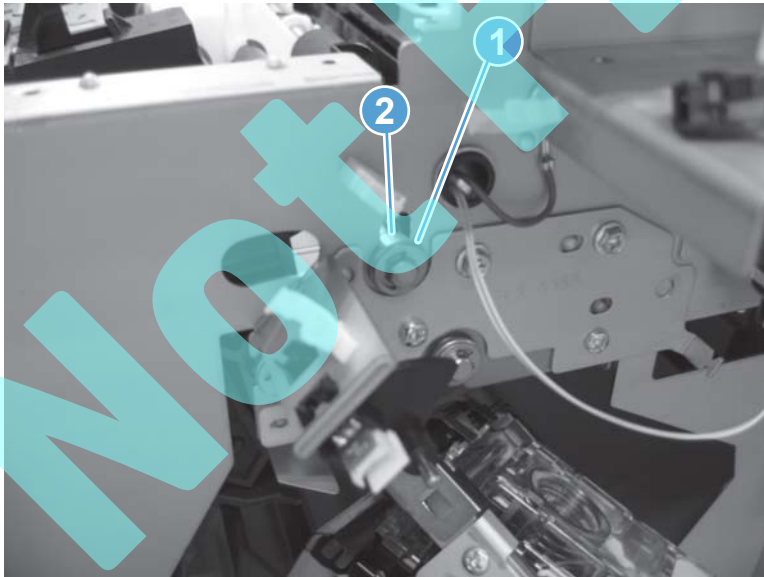

8. Grasp the plastic component (callout 1) in the middle of the assembly, lift it up to clear the metal bracket, and then slide the assembly to the rear to release the front of the shaft. Lift the pressure roller assembly out of the accessory to remove it.

 **Reinstallation tip** When the assembly is reinstalled, first position the rear of the shaft in the hole of the chassis.

Figure 1-603 Remove the pressure roller assembly (8 of 8)



Stack upper bin and lower bin assemblies

Before proceeding, remove the following assemblies:

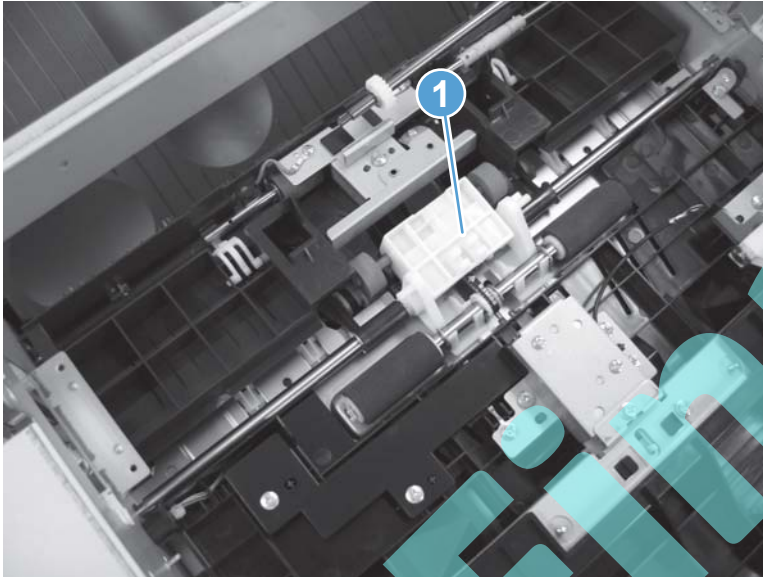
- Bin cable guide cover. See [Bin cable guide cover on page 317](#).
- Open/closed stepped cover assembly. See [Open/closed stepped cover assembly on page 321](#).
- Upper stepped cover assembly. See [Upper stepped cover assembly on page 322](#).
- Lower stepped cover assembly. See [Lower stepped cover assembly on page 324](#).
- Remove the following assemblies only if you need to remove the lower bin.
 - Front door. See [Front door on page 330](#).
 - Inner upper cover assembly. See [Inner upper cover assembly \(remove\) on page 334](#).
- Rear cover assembly. See [Rear cover assembly on page 349](#).
- Stack wall upper cover assembly. See [Stack wall upper assembly and upper wall guide assembly on page 375](#).

Remove the stack upper bin and lower bin assembly

 **NOTE:** The stack upper bin assembly and the stack lower bin assembly look identical, but are different. Do not reverse the locations of the bins when they are reinstalled.

The upper bin assembly has two connectors and a ground wire at the end of the cable. The lower bin assembly has only one connector and a ground wire at the end of the cable. Also, the lower bin assembly has a coil around the end of the cable.

1. Do the following:

Stack upper bin assembly: Remove one screw (callout 1), and then remove the upper sheet-metal cable retainer (callout 2).

Stack lower bin assembly: Remove one screw (callout 3), and then remove the lower sheet-metal cable retainer (callout 4).

Figure 1-604 Remove the stack upper bin and lower bin assemblies (1 of 5)

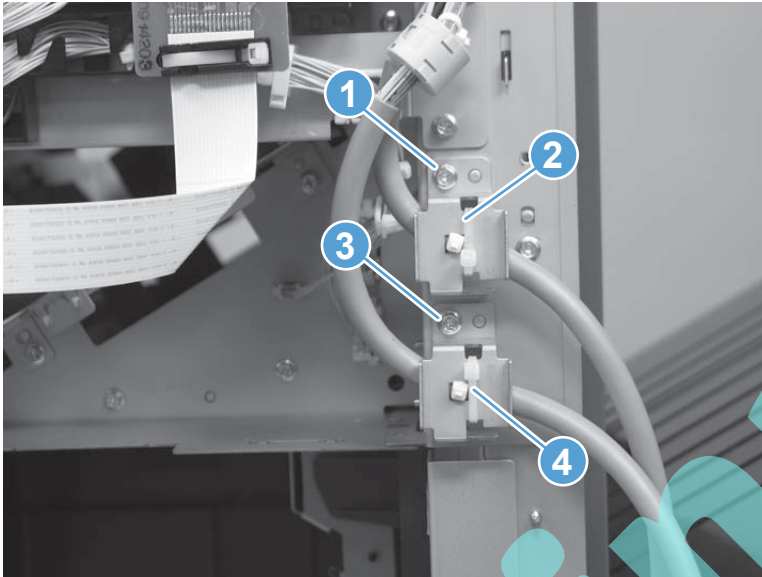

2. Release the wire harnesses from two retainers, and then do the following:

Stack upper bin assembly: Remove one ground screw (callout 1), and then disconnect two connectors (callout 2) on the controller PCA (J7 and J14).

Stack lower bin assembly: Remove one ground screw (callout 3), and then disconnect one connector (callout 4) on the controller PCA (J8).

Figure 1-605 Remove the stack upper bin and lower bin assemblies (2 of 5)

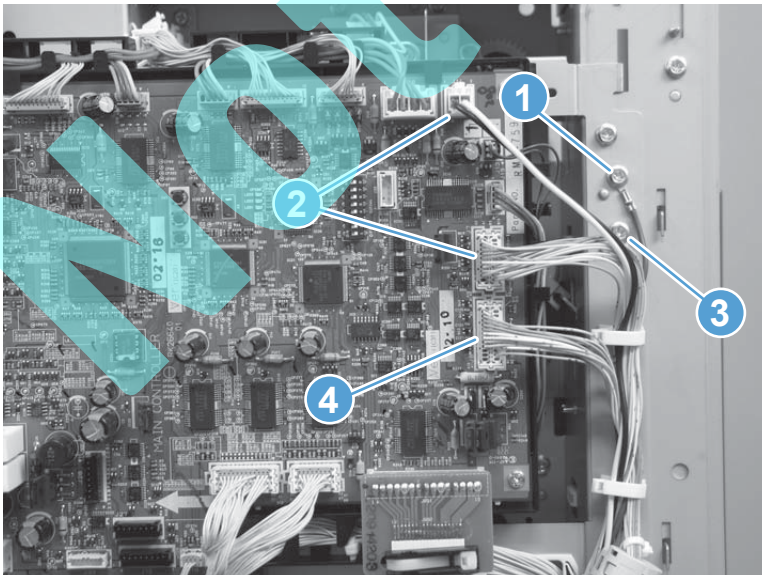

3. Remove two screws (callout 1), and the sheet-metal stop brackets (callout 2).

 **TIP:** The upper bin can be removed now.

Figure 1-606 Remove the stack upper bin and lower bin assemblies (3 of 5)



4. **Lower bin assembly only:** If you are removing the lower bin, remove one screw (callout 1), and then remove the sheet-metal stop bracket (callout 2).

Figure 1-607 Remove the stack upper bin and lower bin assemblies (4 of 5)

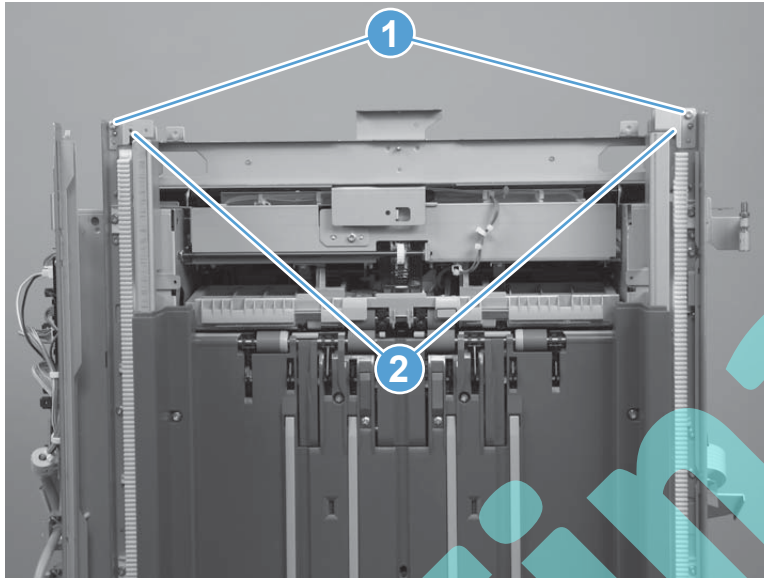
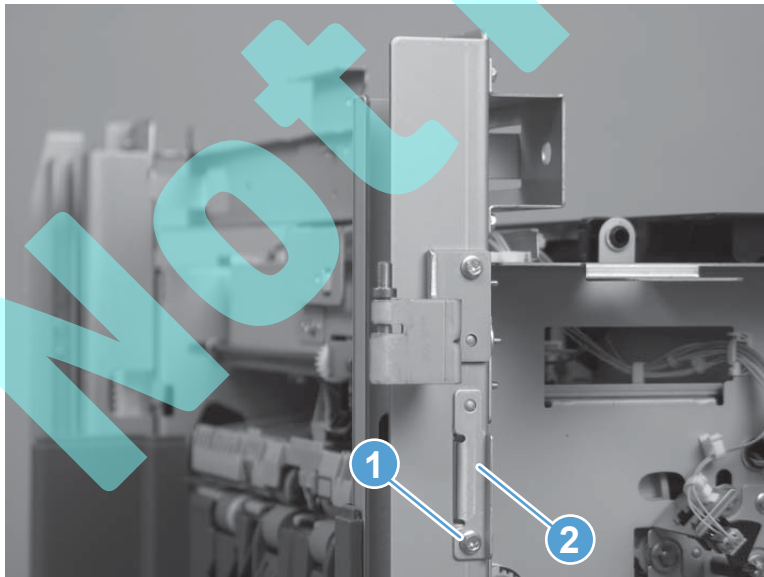

5. Carefully slide the bin up and off of the finishing accessory.

Figure 1-608 Remove the stack upper bin and lower bin assemblies (5 of 5)

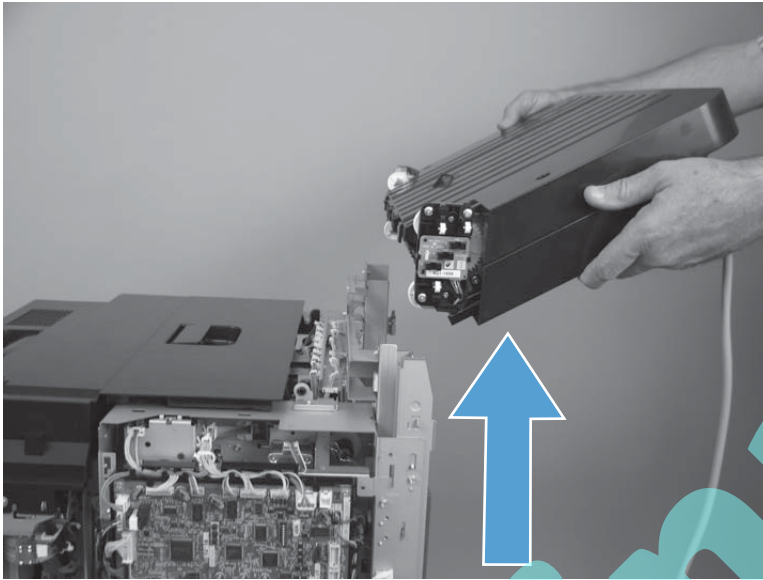

Reinstall the stack upper bin and lower bin assemblies

When the bins are reinstalled, use the following procedure to release the clutch and slide the bin down onto the accessory.

1. Support the bin.
2. Release the bin clutch located on the underside of the bin, and then lower the bin to access the cover.



 **TIP:** Use a small flat blade screw driver to slide the raised portion of the clutch toward the spring to release the clutch and lower the bin.

Figure 1-609 Reinstall the stack upper bin and lower bin assemblies

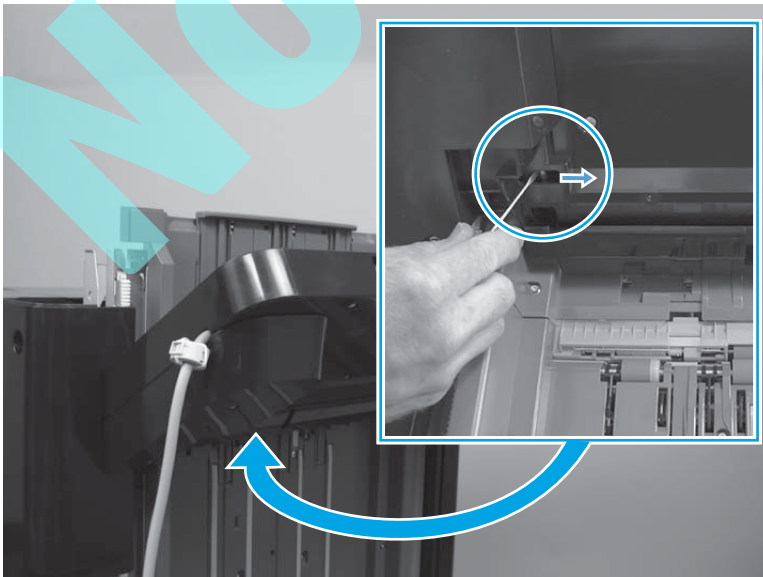

Height wall assembly

 **NOTE:** This assembly is described in the parts chapter as the following:

- Height wall lower assembly (stapler/stacker and stapler stacker with hole punch)
- Height wall center assembly (booklet maker)

Before proceeding, remove the following assemblies:

- Bin cable guide cover. See [Bin cable guide cover on page 317](#).
- Open/closed stepped cover assembly. See [Open/closed stepped cover assembly on page 321](#).
- Upper stepped cover assembly. See [Upper stepped cover assembly on page 322](#).
- Lower stepped cover assembly. See [Lower stepped cover assembly on page 324](#).
- Rear cover assembly. See [Rear cover assembly on page 349](#).
- Stack wall upper cover assembly. See [Stack wall upper assembly and upper wall guide assembly on page 375](#).
- Stack upper bin and lower bin assemblies. See [Stack upper bin and lower bin assemblies on page 397](#).

Remove the height wall center assembly

 **NOTE:** The following figures show the height wall assembly on the stapler/stacker with hole punch finishing accessory. This removal procedure is valid for all of the finishing accessories.

1. Remove ten screws.

Figure 1-610 Remove the height wall assembly (1 of 2)

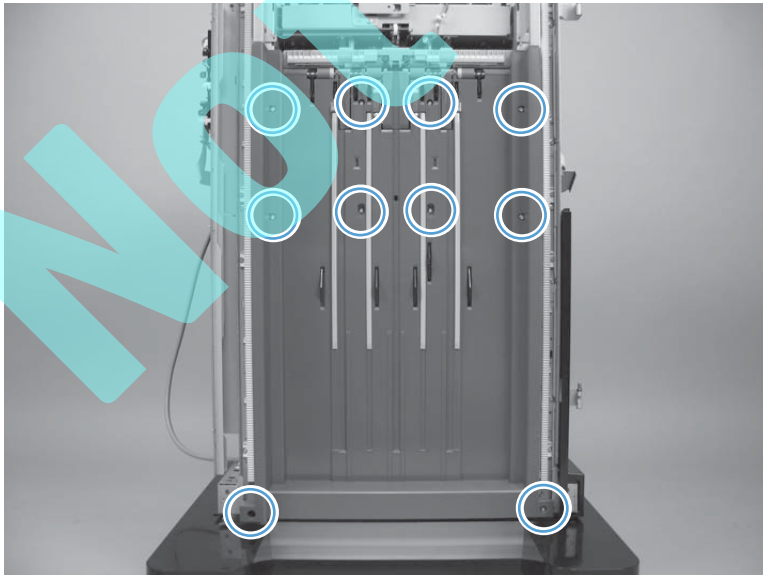

2. Remove the cover.

Figure 1-611 Remove the height wall assembly (2 of 2)

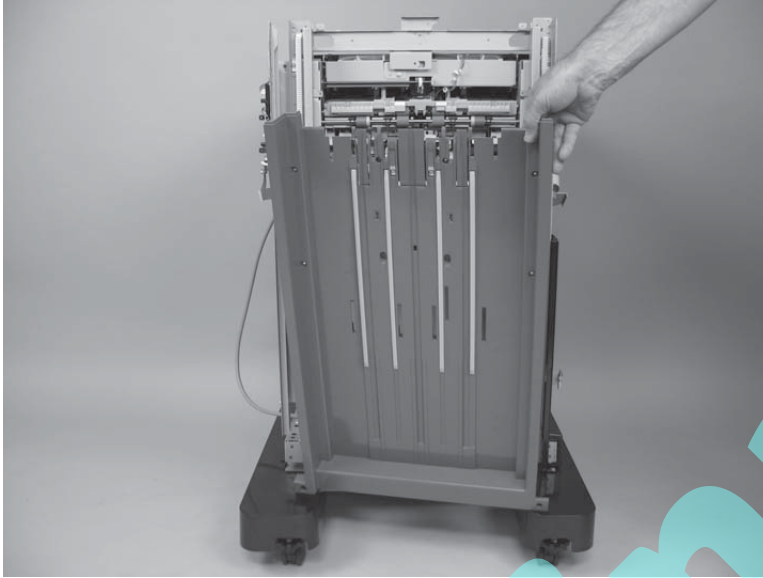

Reinstall the height wall assembly

Make sure that the black bracket is in the down position when the height wall assembly is reinstalled. If the bracket is in the up position when the assembly is reinstalled, the upper stack wall will not move up and down.

Figure 1-612 Reinstall the height wall assembly

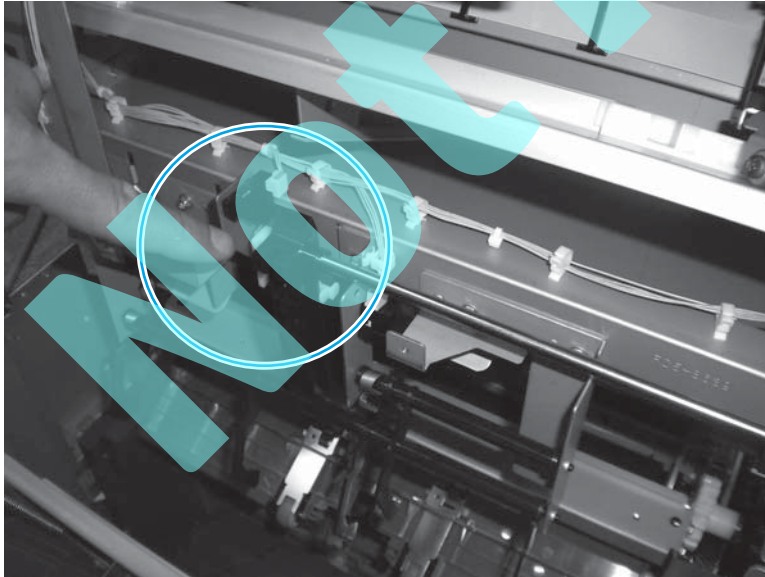

Paper face sensor and flag assembly

Before proceeding, remove the following assemblies:

- Bin cable guide cover. See [Bin cable guide cover on page 317](#).
- Open/closed stepped cover assembly. See [Open/closed stepped cover assembly on page 321](#).
- Upper stepped cover assembly. See [Upper stepped cover assembly on page 322](#).
- Lower stepped cover assembly. See [Lower stepped cover assembly on page 324](#).
- Rear cover assembly. See [Rear cover assembly on page 349](#).
- Stack wall upper cover assembly. See [Stack wall upper assembly and upper wall guide assembly on page 375](#).
- Stack upper bin and lower bin assemblies. See [Stack upper bin and lower bin assemblies on page 397](#).

Remove the paper face sensor and flag assembly

1. From the output side of the accessory, take note of how the spring on the left end of the flag is installed.

Figure 1-613 Remove the paper face sensor and flag assembly (1 of 9)

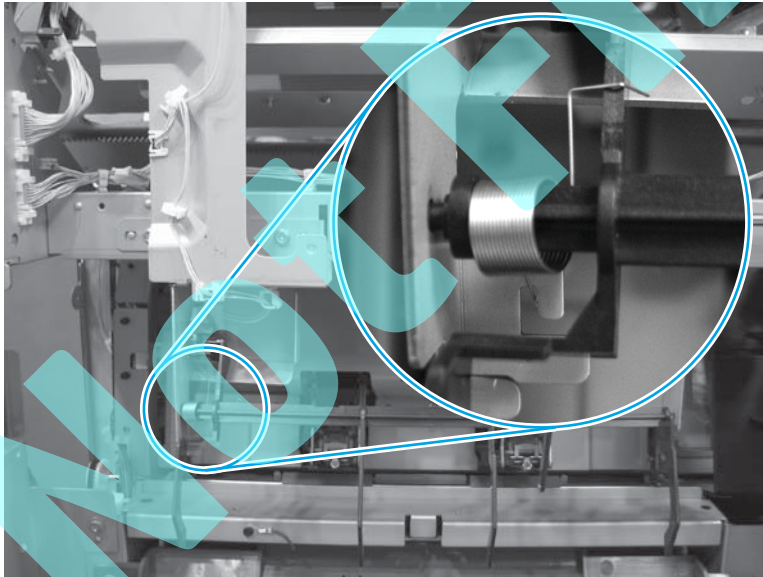

2. Disengage the bottom portion of the spring (callout 1) from the tab (callout 2) on the chassis.

 **NOTE:** The figure below shows the spring disengaged.

Figure 1-614 Remove the paper face sensor and flag assembly (2 of 9)



3. Carefully flex the middle of the flag shaft away from the accessory (callout 1), and then disengage the end of the shaft from the mounting hole in the chassis (callout 2).

Figure 1-615 Remove the paper face sensor and flag assembly (3 of 9)

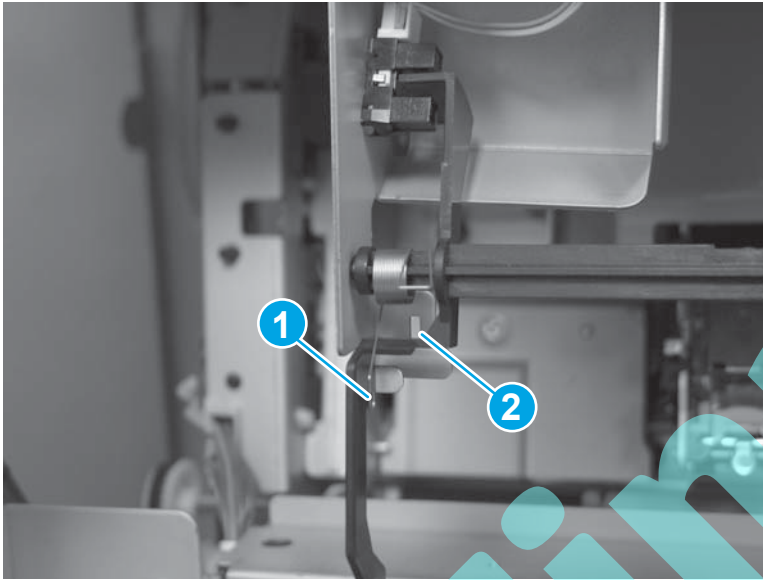
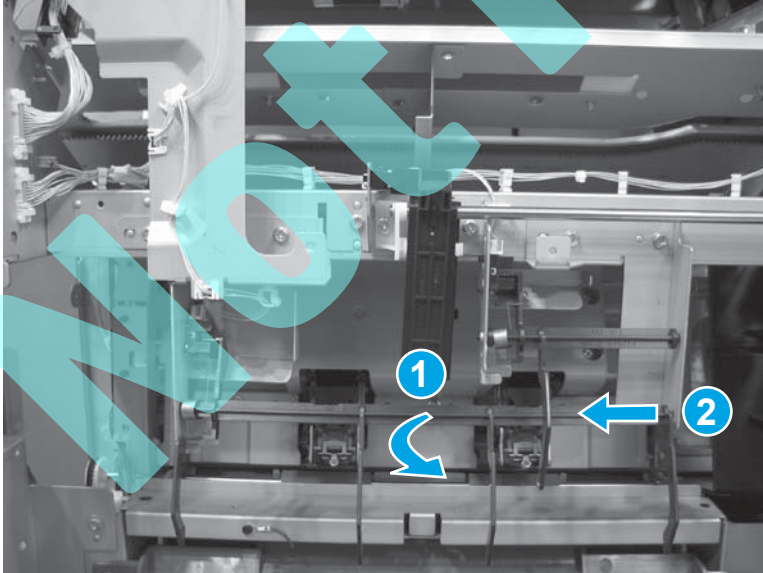

4. Remove the paper sensor flag.

Figure 1-616 Remove the paper face sensor and flag assembly (4 of 9)

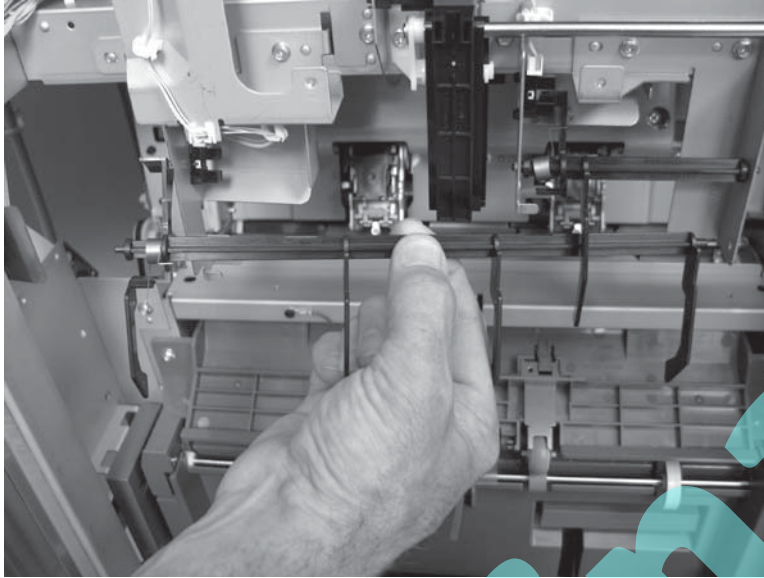

5. Release one tab, and then release the wire tie retainer.

Figure 1-617 Remove the paper face sensor and flag assembly (5 of 9)



6. Disconnect two connectors (callout 1), and then release the wire harnesses from five retainers (callout 2).

Figure 1-618 Remove the paper face sensor and flag assembly (6 of 9)

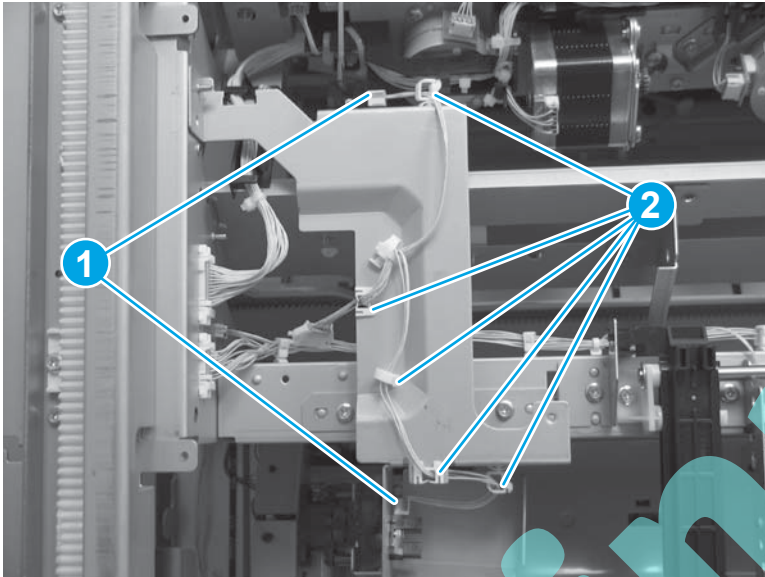

7. Remove two screws.

Figure 1-619 Remove the paper face sensor and flag assembly (7 of 9)

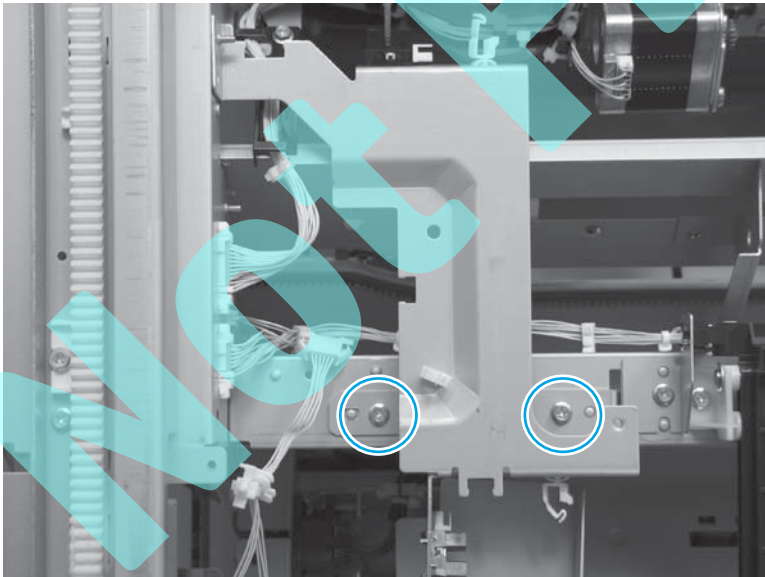

8. At the rear of the accessory, remove one screw.

Figure 1-620 Remove the paper face sensor and flag assembly (8 of 9)

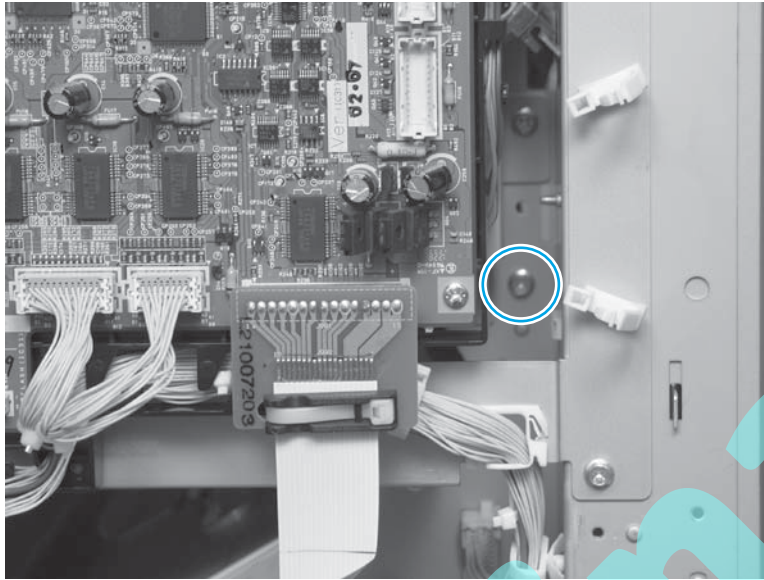

9. Remove the assembly.

Figure 1-621 Remove the paper face sensor and flag assembly (9 of 9)



Staple sub assembly

Before proceeding, do the following:

- Move the inner upper cover out of the way. See [Inner upper cover assembly on page 333](#).

Remove the staple sub assembly

1. Remove one screw (callout 1), and then remove the protective cover (callout 2)

Figure 1-622 Remove the staple sub assembly (1 of 6)

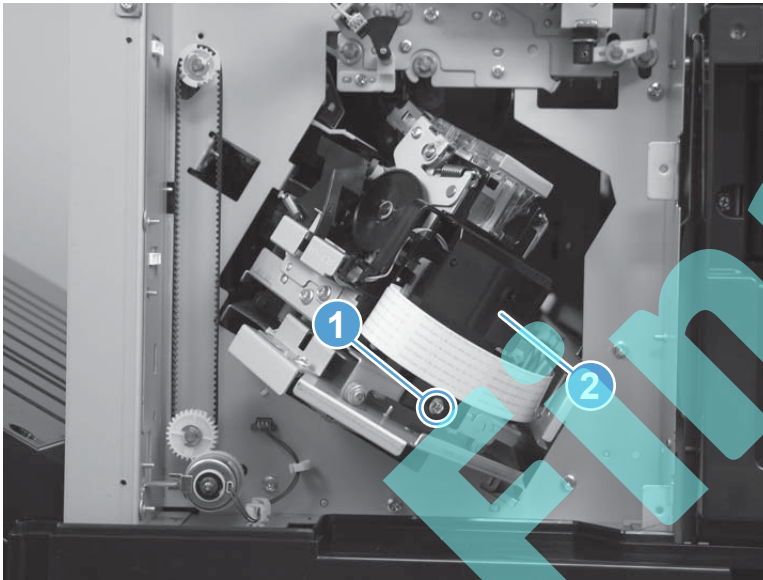

2. Disconnect two connectors (callout 1) on the PCA, and then disconnect one connector (callout 2) on the motor.

Figure 1-623 Remove the staple sub assembly (2 of 6)

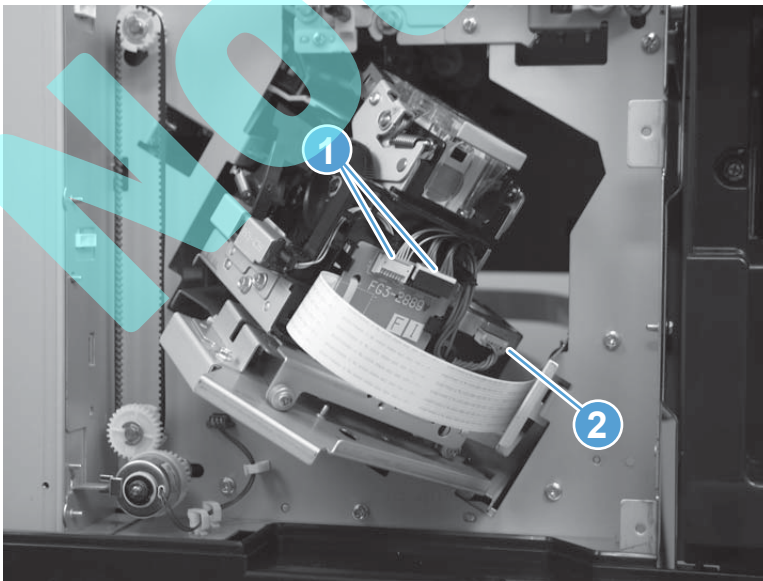

3. Release one tab (callout 1), and then remove the sub staple PCA (callout 2).

Figure 1-624 Remove the staple sub assembly (3 of 6)



4. Remove one screw.

Figure 1-625 Remove the staple sub assembly (4 of 6)



5. Slide the staple sub assembly away from the staple sub assembly motor to release the rear tabs of the assembly from the sheet-metal bracket.

 **Reinstallation tip** It is important that when you reinstall the staple sub assembly, make sure that the rear tabs of the assembly engage the slots in the sheet-metal bracket.

Figure 1-626 Remove the staple sub assembly (5 of 6)



6. Remove the staple sub assembly.

Figure 1-627 Remove the staple sub assembly (6 of 6)

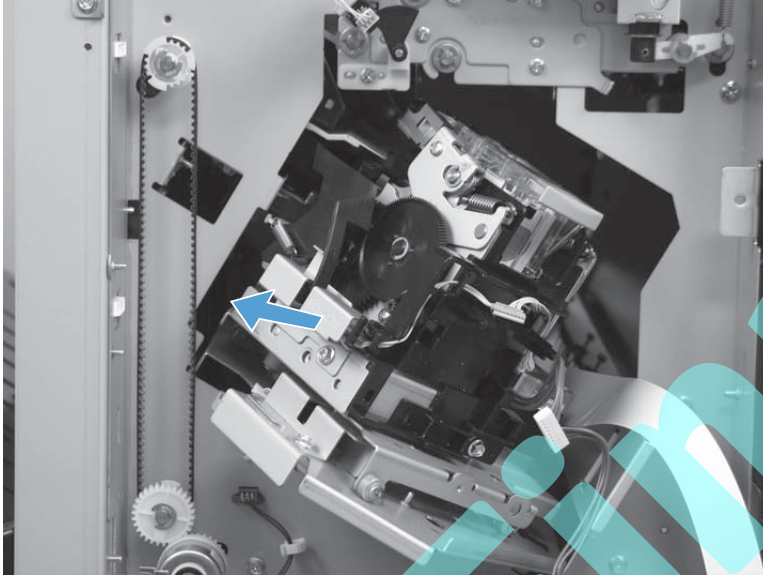
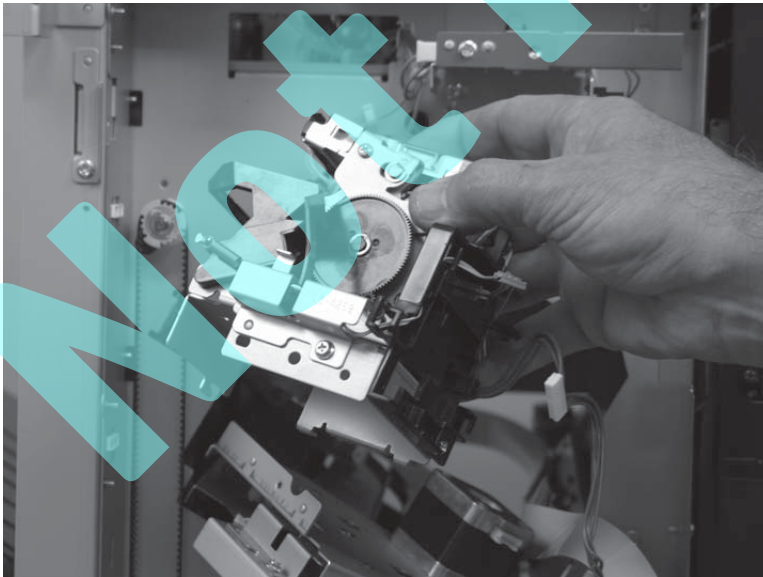

Staple connecting cable assembly

Before proceeding, remove the following assemblies:

- Bin cable guide cover. See [Bin cable guide cover on page 317](#).
- Inner upper cover assembly. See [Inner upper cover assembly on page 333](#).

 **NOTE:** This cover only needs to be moved out of the way.

- Rear cover assembly. See [Rear cover assembly on page 349](#).
- Staple sub assembly. See [Staple sub assembly on page 408](#).

Remove the staple connecting cable assembly

1. Disconnect one connector.

Figure 1-628 Remove the staple connecting cable assembly (1 of 2)

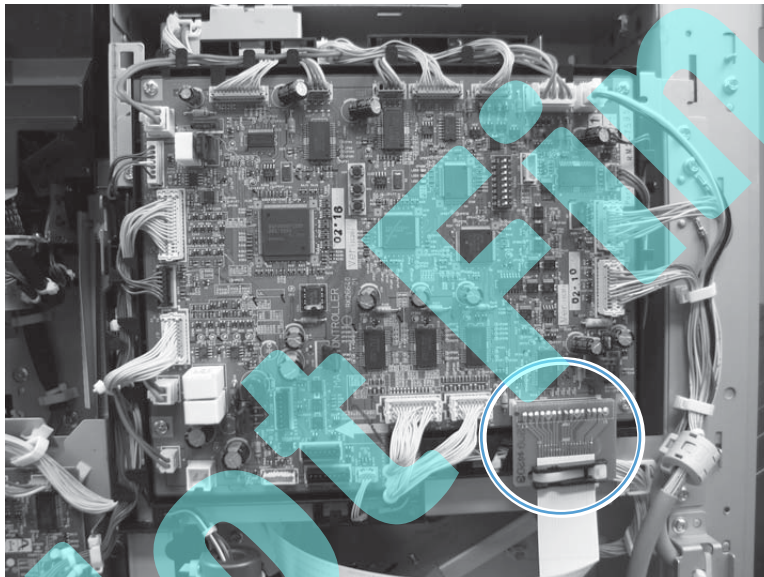

2. Release the cable from three retainers, and then remove the cable.

 **Reinstallation tip** When the cable is reinstalled, make sure that it is positioned correctly and will not be pulled tight at either end when the staple sub assembly moves along the staple assembly.

Align the black marks on the cable with the black marks on the chassis to place the cable in the correct position.

Figure 1-629 Remove the staple connecting cable assembly (2 of 2)

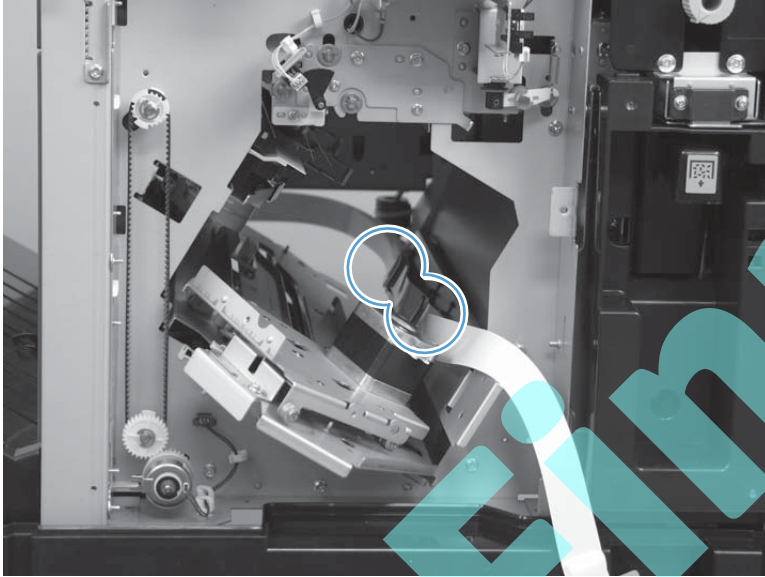

Staple assembly

Before proceeding, remove the following assemblies:

- Bin cable guide cover. See [Bin cable guide cover on page 317](#).
- Inner upper cover assembly. See [Inner upper cover assembly on page 333](#).

 **NOTE:** This cover only needs to be moved out of the way.

- Rear cover assembly. See [Rear cover assembly on page 349](#).
- Staple sub assembly. See [Staple sub assembly on page 408](#).

Remove the staple assembly

1. Remove two screws.

 **NOTE:** These screws are located under the controller PCA at the rear side of the accessory.

Figure 1-630 Remove the staple assembly (1 of 7)



- Carefully push the staple sub assembly base into the accessory.

Figure 1-631 Remove the staple assembly (2 of 7)

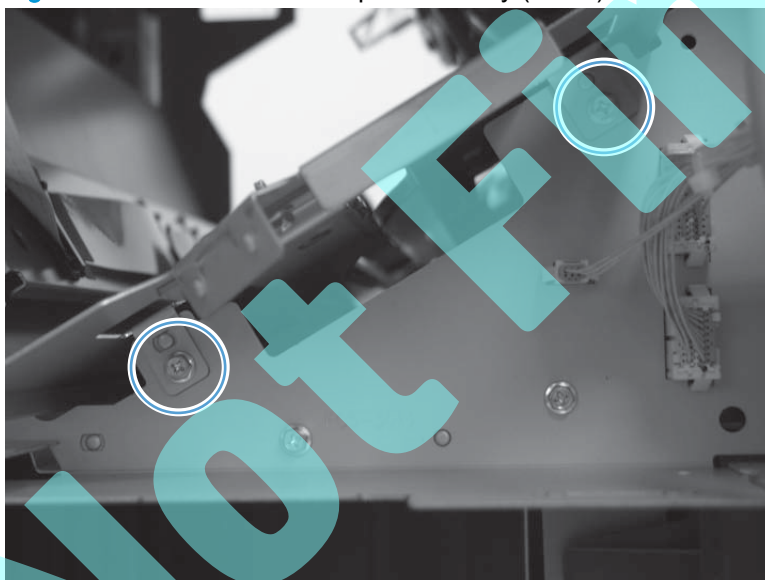
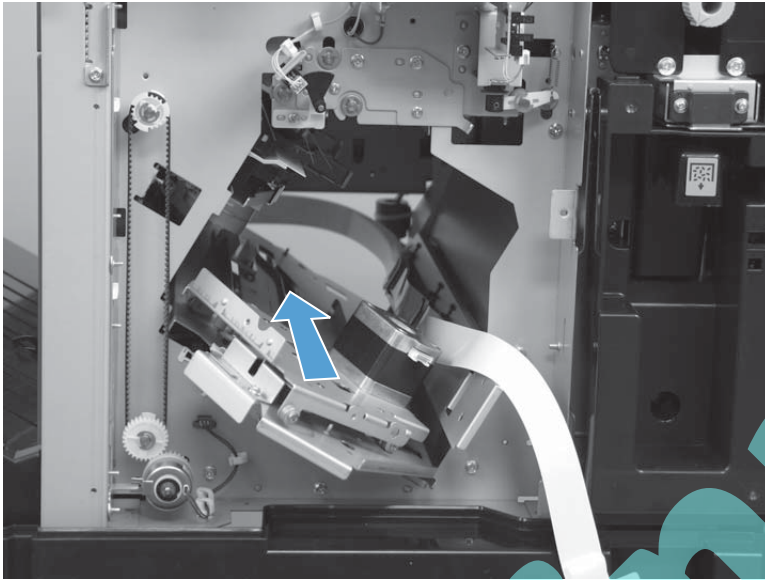

- Remove one screw (callout 1), and then remove the sheet-metal sensor cover (callout 2).

Figure 1-632 Remove the staple assembly (3 of 7)



4. Release one sensor (callout 1), and then release one wire retainer (callout 2).

To remove the sensor, use your finger to release the sensor tabs from the underside of the assembly.

 **TIP:** It is easier to release the entire retainer from the sheet-metal stapler assembly tray than trying to release the wire harness from the retainer.

Figure 1-633 Remove the staple assembly (4 of 7)



5. Carefully push the stapler assembly about one-half way into the accessory to release two tabs under the front edge of the assembly.

 **Reinstallation tip** Make sure that the two tabs are engaged in the slots in the chassis when the assembly is reinstalled.

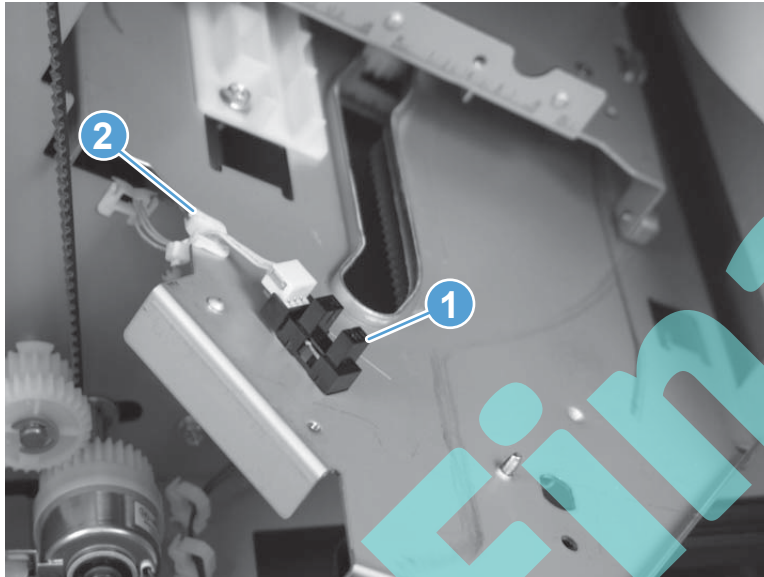
Figure 1-634 Remove the staple assembly (5 of 7)



6. Lift up the stapler assembly.

Figure 1-635 Remove the staple assembly (6 of 7)

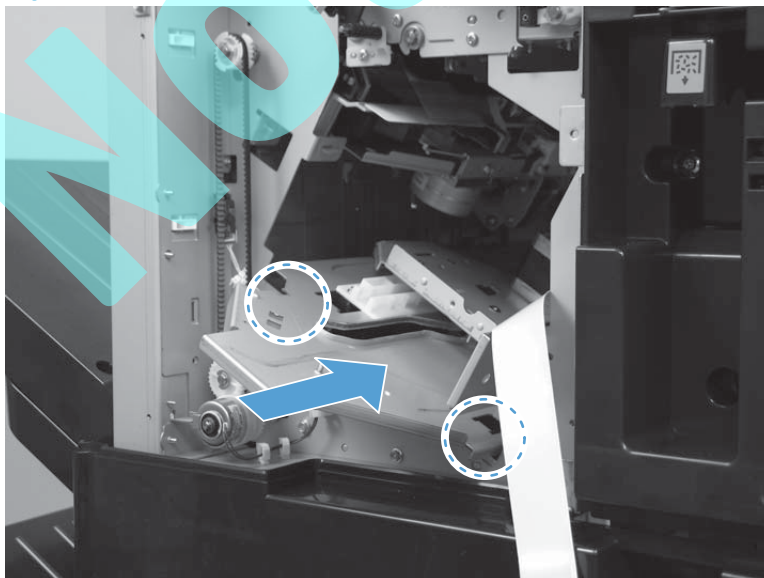

7. Carefully slide the stapler assembly out of the accessory.

 **TIP:** You might have to move the staple assembly up and down, and rotate it right and left, as you slide it out of the accessory to completely remove it.

Figure 1-636 Remove the staple assembly (7 of 7)



Paper detect holder assembly

Before proceeding, remove the following assemblies:

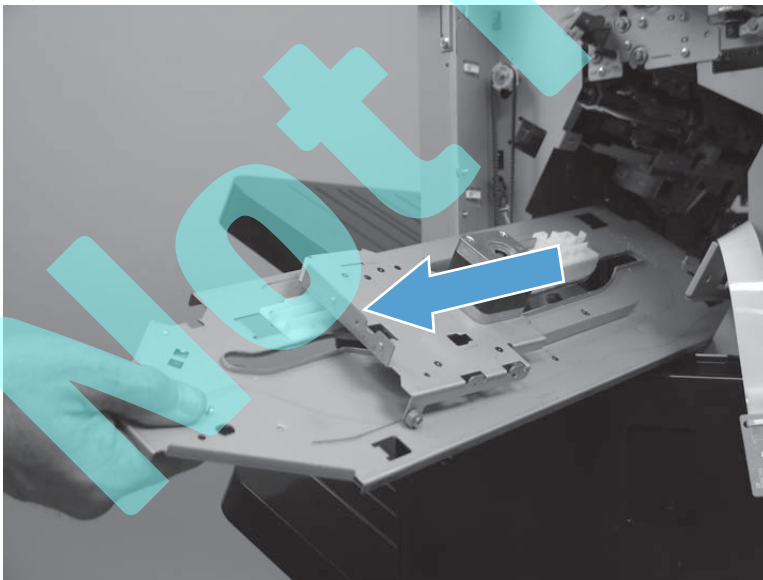
- Bin cable guide cover. See [Bin cable guide cover on page 317](#).
- Open/closed stepped cover assembly. See [Open/closed stepped cover assembly on page 321](#).
- Upper stepped cover assembly. See [Upper stepped cover assembly on page 322](#).
- Lower stepped cover assembly. See [Lower stepped cover assembly on page 324](#).
- Rear cover assembly. See [Rear cover assembly on page 349](#).
- Stack wall upper cover assembly. See [Stack wall upper assembly and upper wall guide assembly on page 375](#).
- Stack upper bin and lower bin assembly. See [Stack upper bin and lower bin assemblies on page 397](#).
- Height wall assembly. See [Height wall assembly on page 401](#).

Remove the paper detect holder assembly

The assembly is very fragile. Grip the assembly by the snap fasteners (callout 1) and not by the arm. To remove the paper detect assembly, start at one end, grip each snap fastener at the base and gently pull to remove one at a time.

Figure 1-637 Remove the paper detect holder assembly

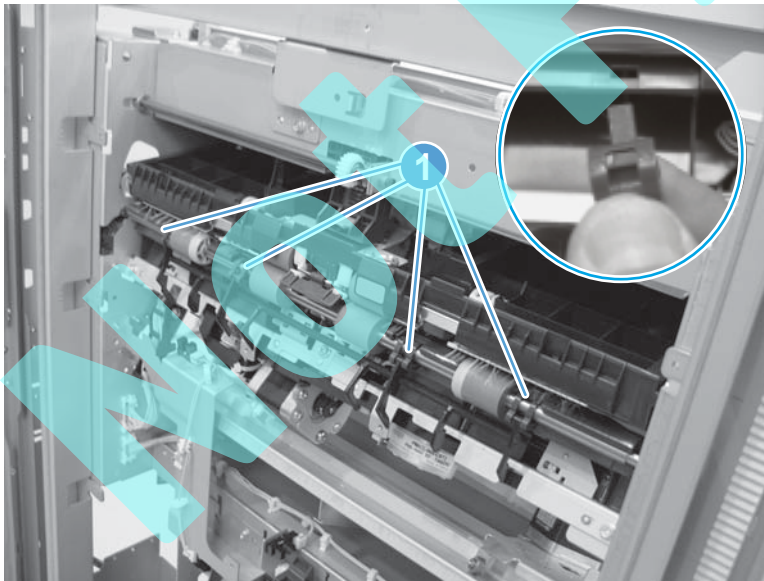

Reinstall the paper detect holder assembly

When reinstalling, the small tab (callout 1) on each snap fastener must be inserted into a hole (callout 2). The paper detect assembly (callout 3) will not work properly if the tabs are not installed correctly.

Figure 1-638 Reinstall the paper detect holder assembly

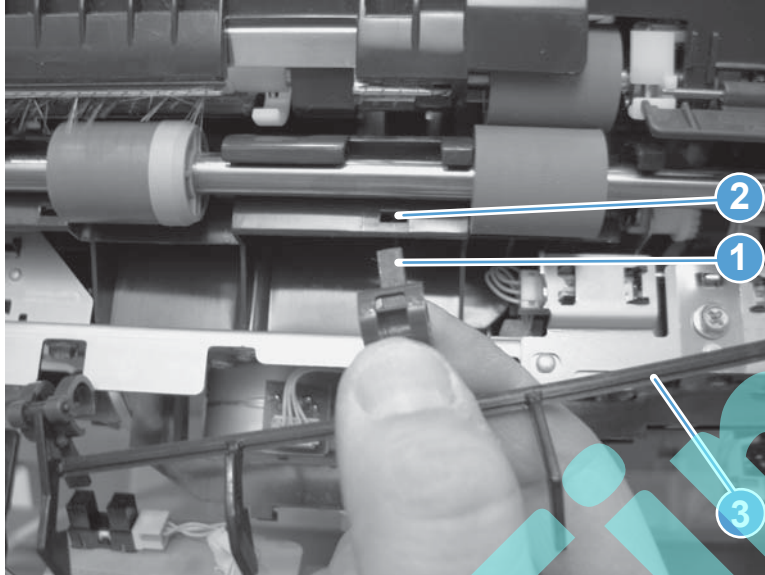

Operation tray assembly

Before proceeding, remove the following assemblies:

- Bin cable guide cover. See [Bin cable guide cover on page 317](#).
- Open/closed stepped cover assembly. See [Open/closed stepped cover assembly on page 321](#).
- Upper stepped cover assembly. See [Upper stepped cover assembly on page 322](#).
- Lower stepped cover assembly. See [Lower stepped cover assembly on page 324](#).
- Rear cover assembly. See [Rear cover assembly on page 349](#).
- Main controller PCA assembly. See [Main controller PCA assembly on page 353](#).
- Stack wall upper cover assembly. See [Stack wall upper assembly and upper wall guide assembly on page 375](#).
- Stack upper bin and lower bin assembly. See [Stack upper bin and lower bin assemblies on page 397](#).
- Height wall assembly. See [Height wall assembly on page 401](#).
- Paper detect holder assembly. See [Paper detect holder assembly on page 417](#).

The following figure shows the operation tray assembly. Use this figure to identify the assembly in the accessory.

Figure 1-639 Identify the operation tray assembly

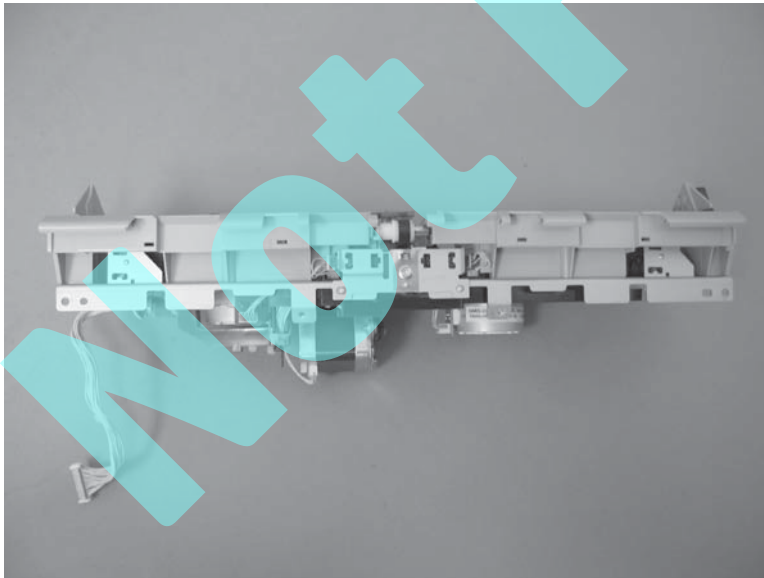

Remove the operation tray assembly

1. Remove one e-ring (callout 1).

Figure 1-640 Remove the operation tray assembly (1 of 11)

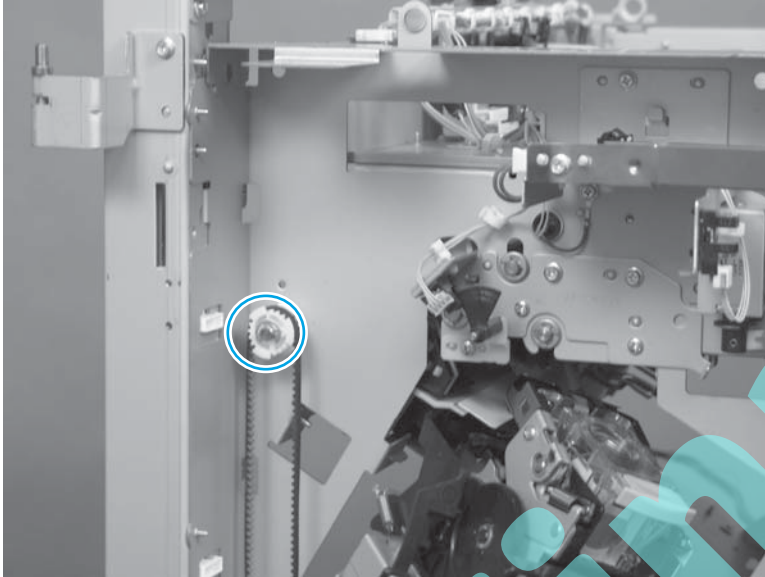

2. Carefully slide the gear and belt (callout 1) off of the shaft, and then remove the locking pin (callout 2). The locking pin behind the gear is not captive. Do not lose the pin when removing the gear and belt.

 **TIP:** Before removing the gear, rotate the gear until the lines on the gear face are vertical. This horizontally aligns the pin, and minimizes the possibility of it falling into the accessory when the gear is removed.

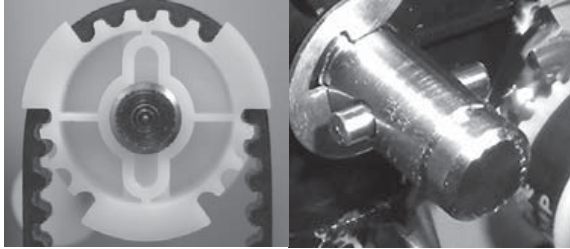
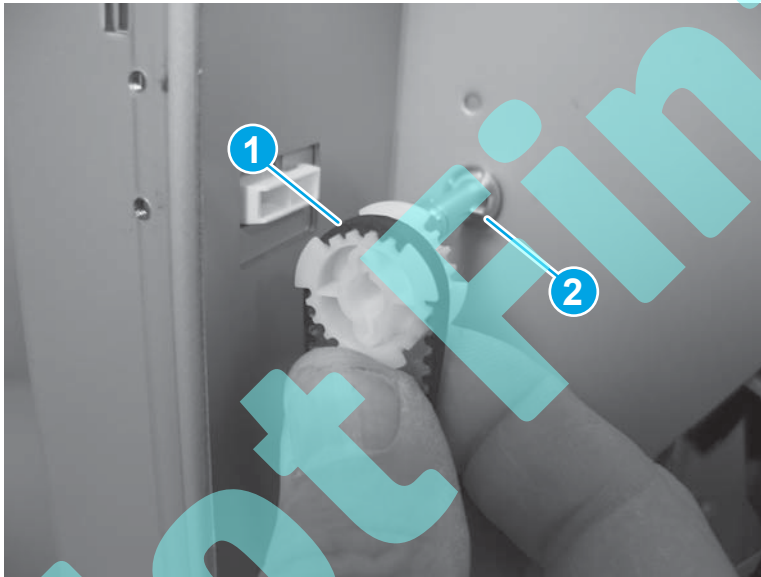

Figure 1-641 Remove the operation tray assembly (2 of 11)



3. Remove one e-ring.

Figure 1-642 Remove the operation tray assembly (3 of 11)



4. Remove one small flat washer and one bearing.

 **TIP:** It might be easier to remove the washer and bearing by using a small flat blade screwdriver.

Figure 1-643 Remove the operation tray assembly (4 of 11)



5. At the rear of the accessory, remove one e-ring (callout 1), and then slide the clutch (callout 2) off of the shaft to remove it.

Figure 1-644 Remove the operation tray assembly (5 of 11)

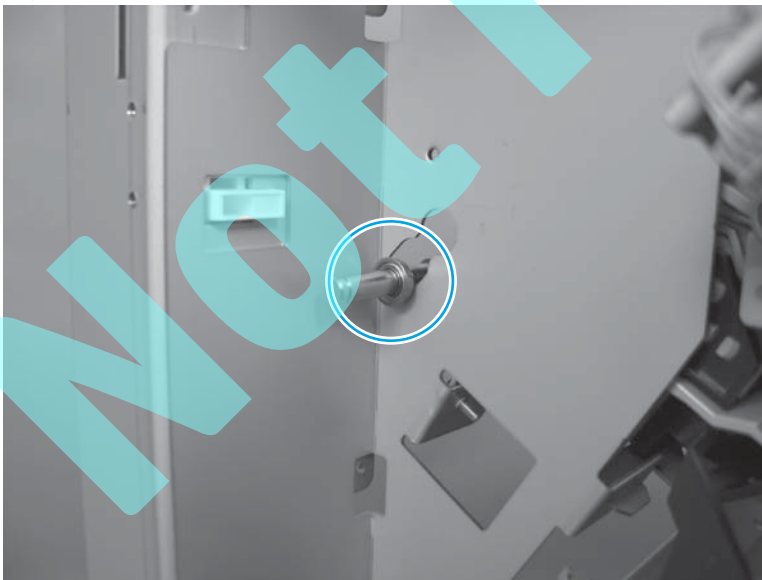
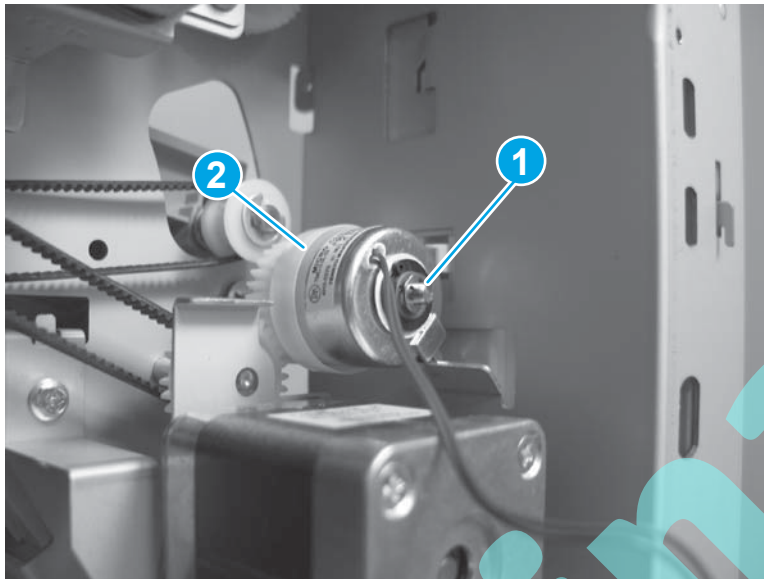

6. Slide the stack-delivery roller to the left (callout 1) to release the bearing (callout 2).

⚠ CAUTION: Avoid touching the rollers on the assembly. Skin oils can cause paper handling problems.

Figure 1-645 Remove the operation tray assembly (6 of 11)

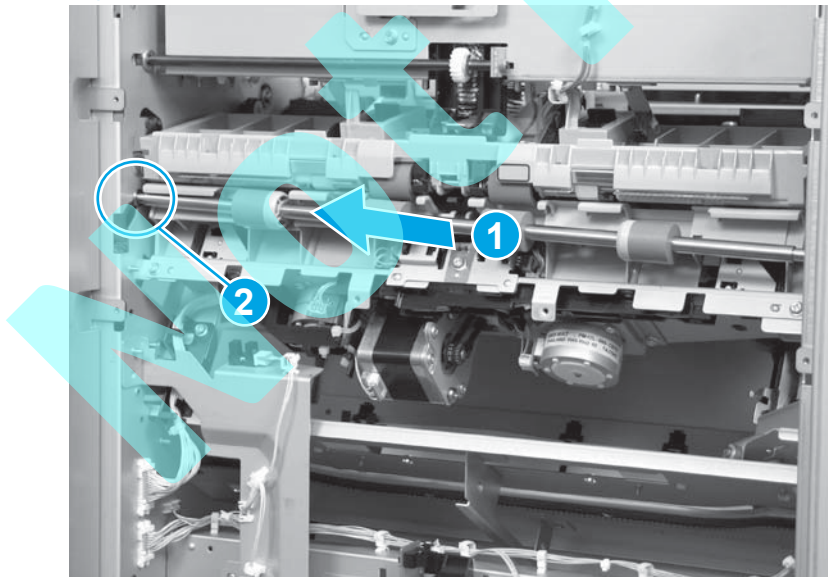

7. Carefully slide the bearing down the slot in the chassis.

Figure 1-646 Remove the operation tray assembly (7 of 11)

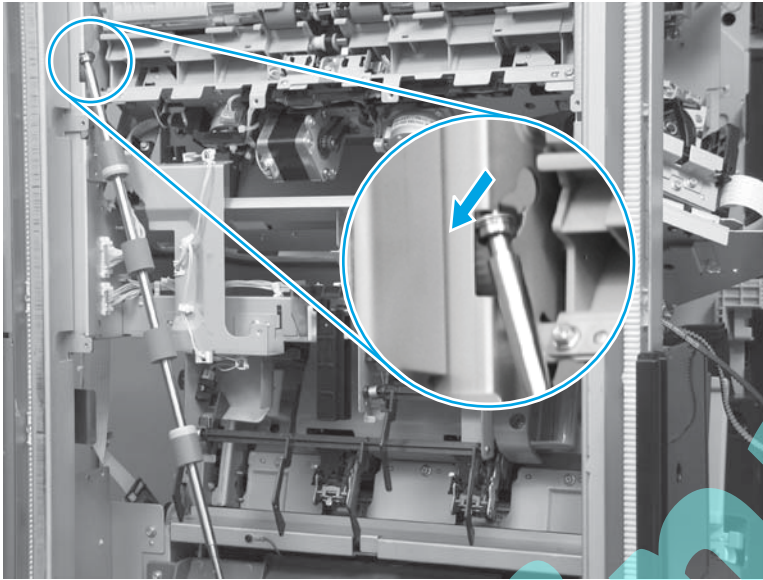

8. Remove the stack-delivery roller.

Figure 1-647 Remove the operation tray assembly (8 of 11)

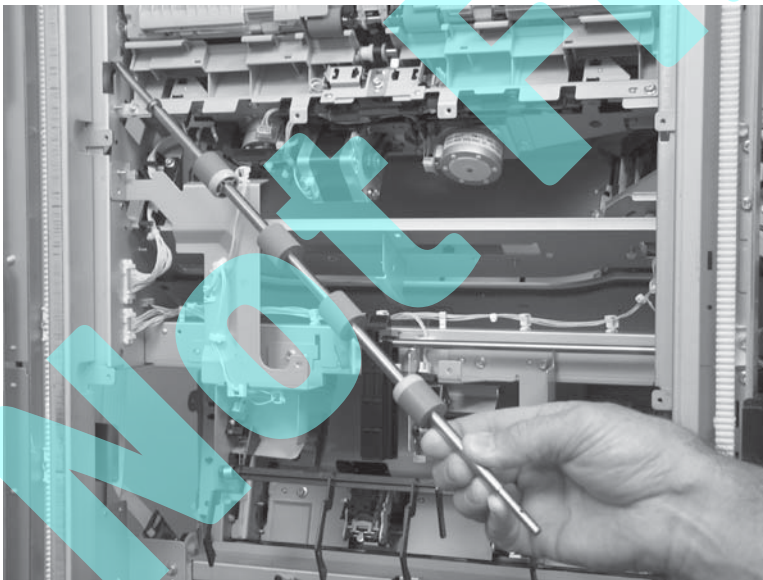

9. Disconnect one connector (callout 1), and then release the wire harness from the guide (callout 2).

Figure 1-648 Remove the operation tray assembly (9 of 11)

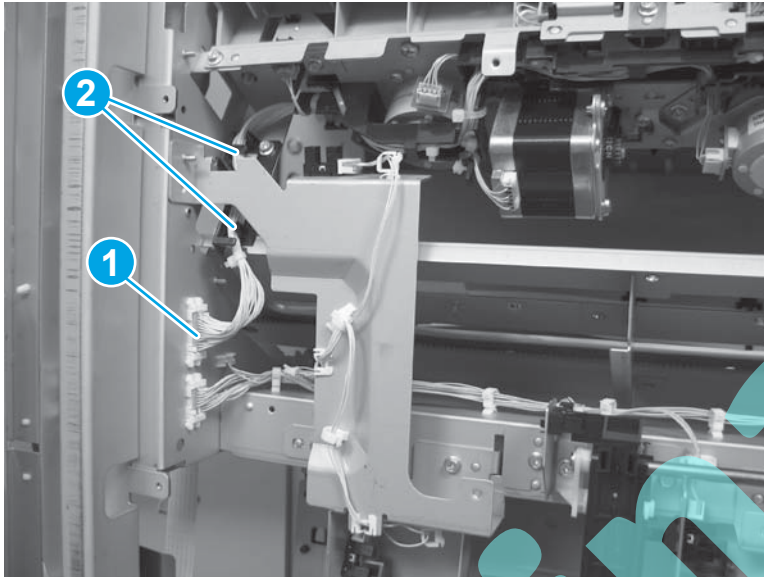

10. Remove two screws.

Figure 1-649 Remove the operation tray assembly (10 of 11)

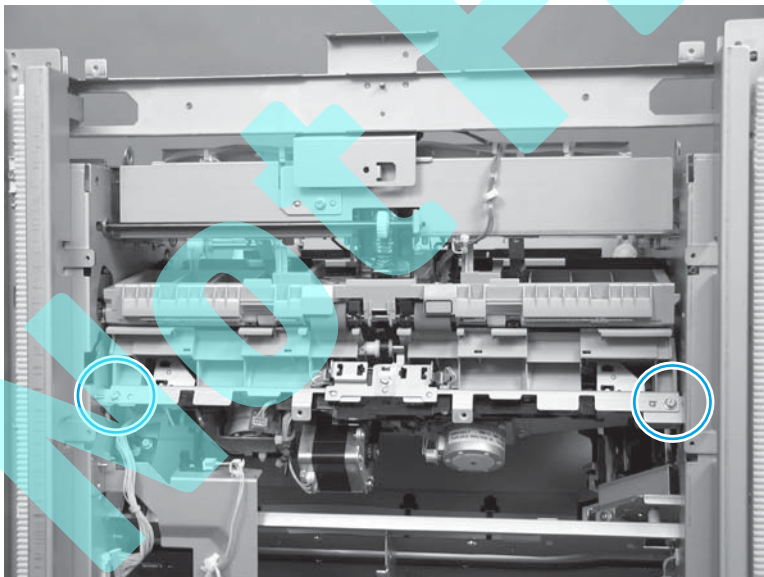

11. Raise the swing guide assembly, and then remove the operation tray assembly.

Figure 1-650 Remove the operation tray assembly (11 of 11)

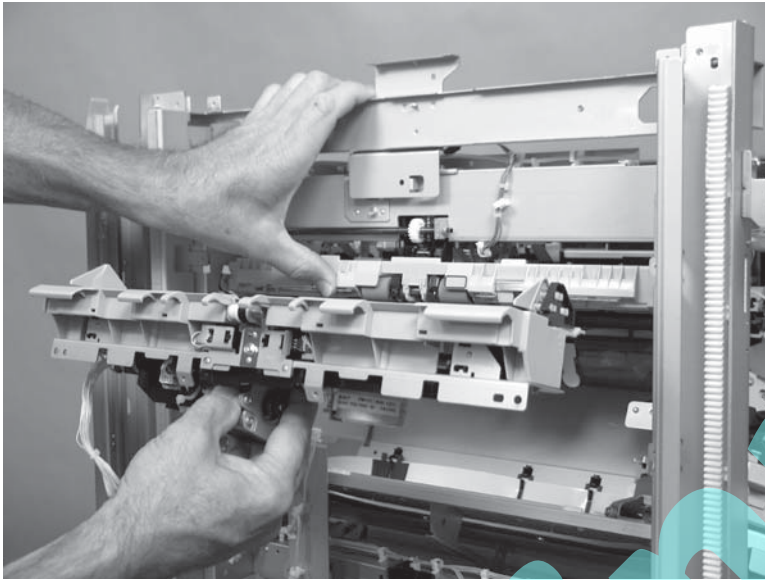

Reinstall the operation tray assembly

1. Before installing the operation-tray assembly, make sure that the staple assembly is out of the way.

Figure 1-651 Reinstall the operation tray assembly (1 of 5)

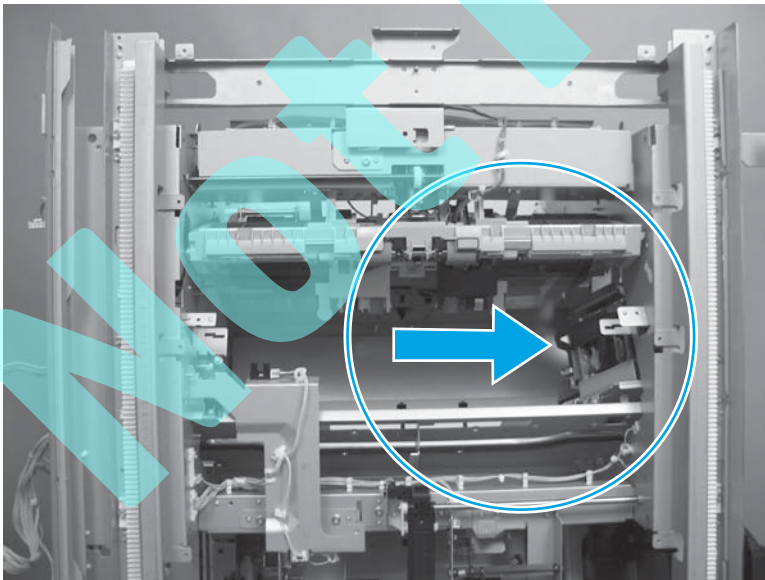

2. On the assembly, slide the joggers to the inside position.

Figure 1-652 Reinstall the operation tray assembly (2 of 5)

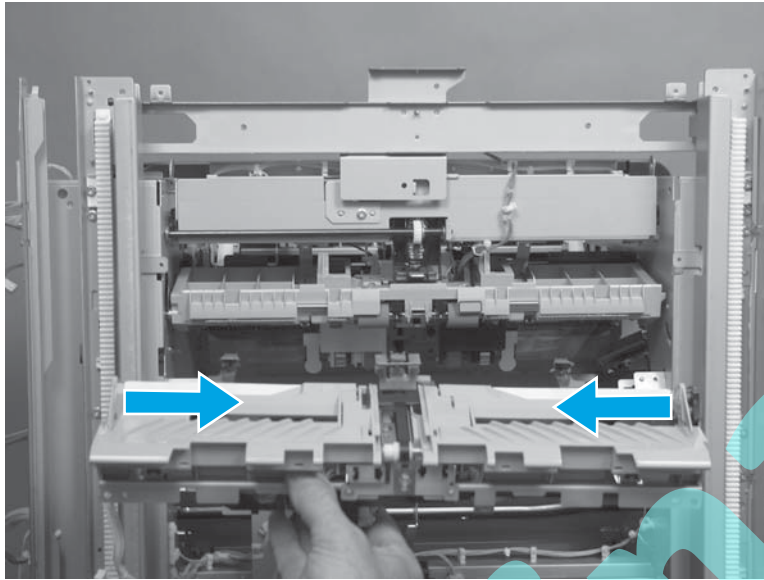

3. When the assembly is installed, do not damage the mylar sheets inside the accessory.

Locate the plastic pin on the back side of the gear. Install the gear goes with this pin facing the chassis. Then rotate the shaft so the hole is horizontal. Insert the metal locking pin, and then place the belt on the gear and slide the gear on the shaft so that it aligns with the locking pin in the slots on the gear.

Figure 1-653 Reinstall the operation tray assembly (3 of 5)

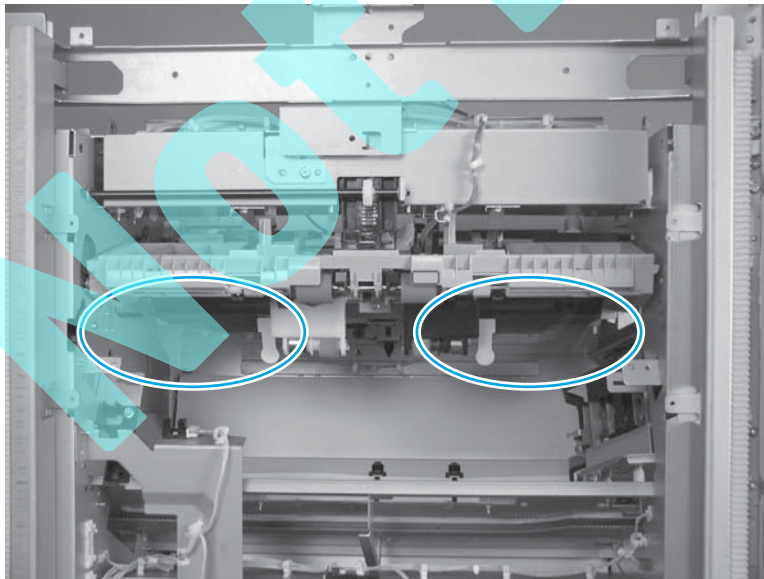

4. Before installing the drive gear, make sure that it will be positioned on the shaft with the white-plastic pin on the back of the gear facing the chassis.

Figure 1-654 Reinstall the operation tray assembly (4 of 5)

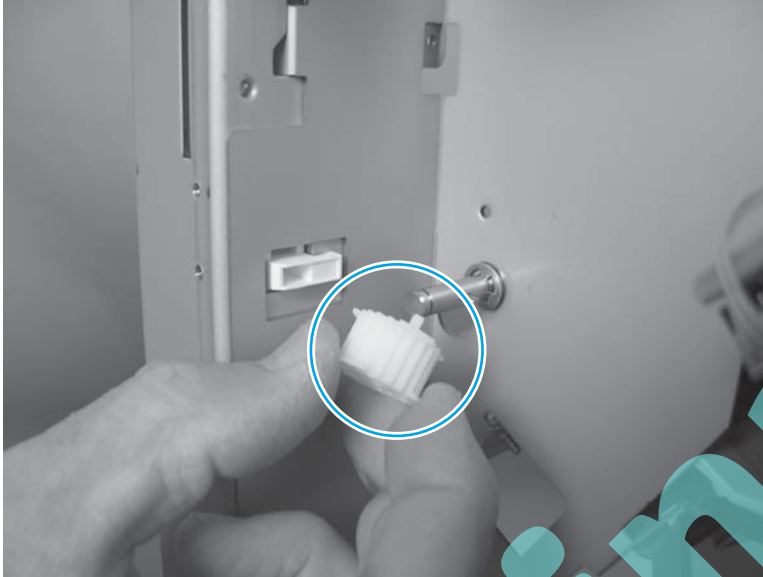

Not Final

5. Rotate the shaft so that the locking pin hole is horizontal, install the locking pin (callout 1), place the belt on the gear, and then slide the gear onto the shaft (callout 2).

 **TIP:** Rotate the gear until the lines on the gear face are vertical so that the slot on the back side of the gear for the locking pin is horizontally aligned.

When the gear is correctly installed on the shaft, the shaft should rotate when the gear is rotated—the gear should not freely rotate on the shaft.



Figure 1-655 Reinstall the operation tray assembly (5 of 5)

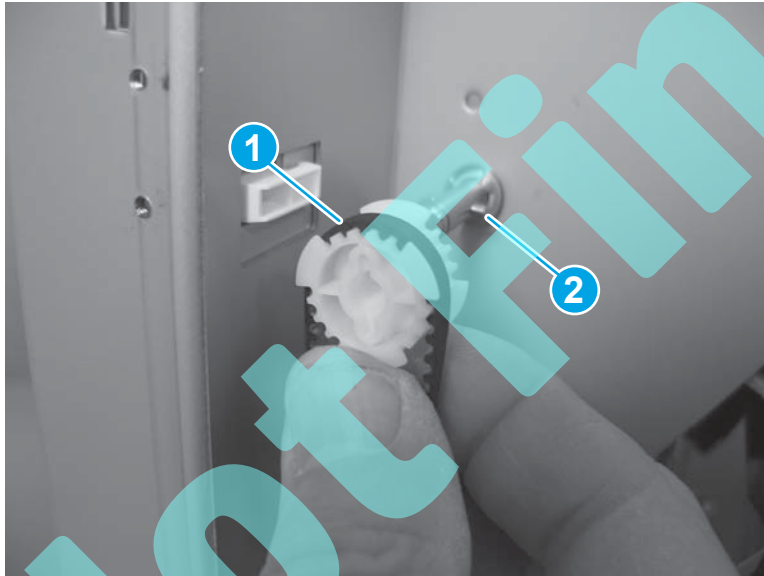

Swing guide assembly

Before proceeding, remove the following assemblies:

- Bin cable guide cover. See [Bin cable guide cover on page 317](#).
- Open/closed stepped cover assembly. See [Open/closed stepped cover assembly on page 321](#).
- Upper stepped cover assembly. See [Upper stepped cover assembly on page 322](#).
- Lower stepped cover assembly. See [Lower stepped cover assembly on page 324](#).
- Rear cover assembly. See [Rear cover assembly on page 349](#).
- Main controller PCA assembly. See [Main controller PCA assembly on page 353](#).
- Stack wall upper cover assembly. See [Stack wall upper assembly and upper wall guide assembly on page 375](#).
- Stack upper bin and lower bin assembly. See [Stack upper bin and lower bin assemblies on page 397](#).
- Stack upper bin and lower bin assembly. See [Stack upper bin and lower bin assemblies on page 397](#).
- Height wall assembly. See [Height wall assembly on page 401](#).
- Paper detect holder assembly. See [Paper detect holder assembly on page 417](#).
- Operation tray assembly. See [Operation tray assembly on page 419](#).

The following figure shows the swing guide assembly. Use this figure to identify the assembly in the accessory.

Figure 1-656 Identify the operation tray assembly

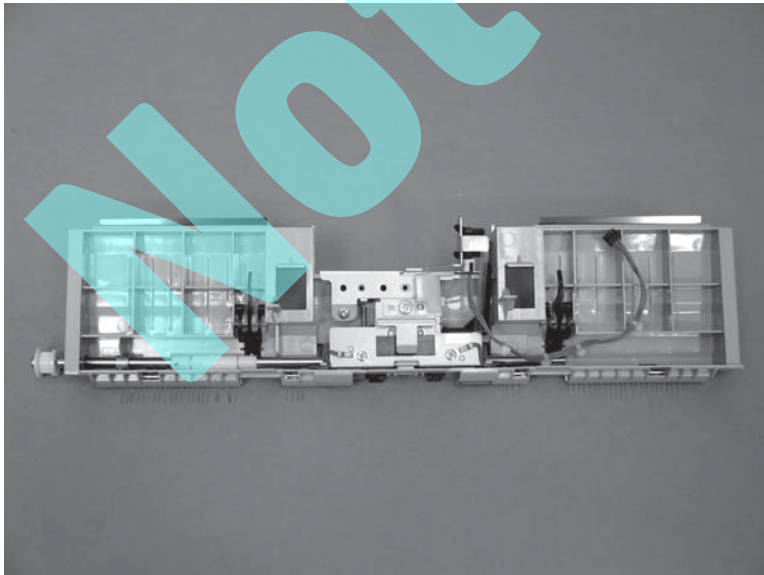

Remove the swing guide assembly

1. Look inside the accessory where the operation tray assembly was removed, and then locate and remove one e-ring.

 **NOTE:** This e-ring is located on the inside rear wall of the chassis.

Figure 1-657 Remove the swing guide assembly (1 of 12)



2. Slide the white-plastic bushing out of the holder.

Figure 1-658 Remove the swing guide assembly (2 of 12)

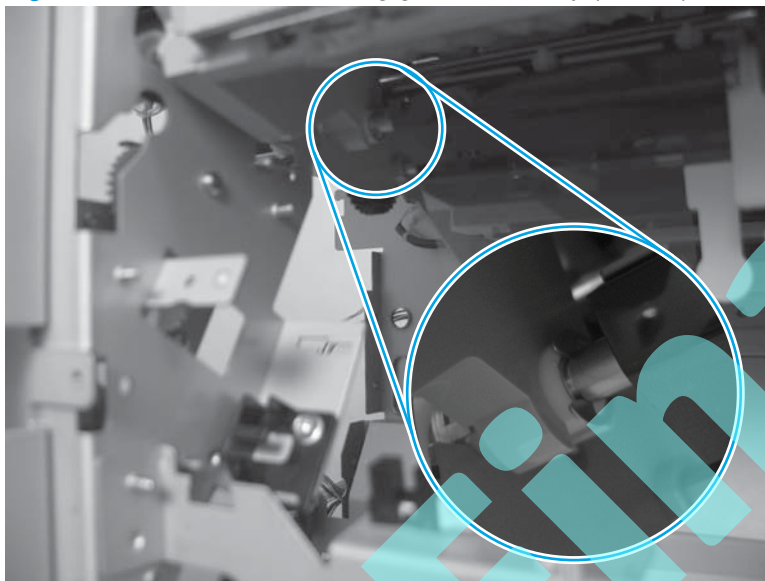
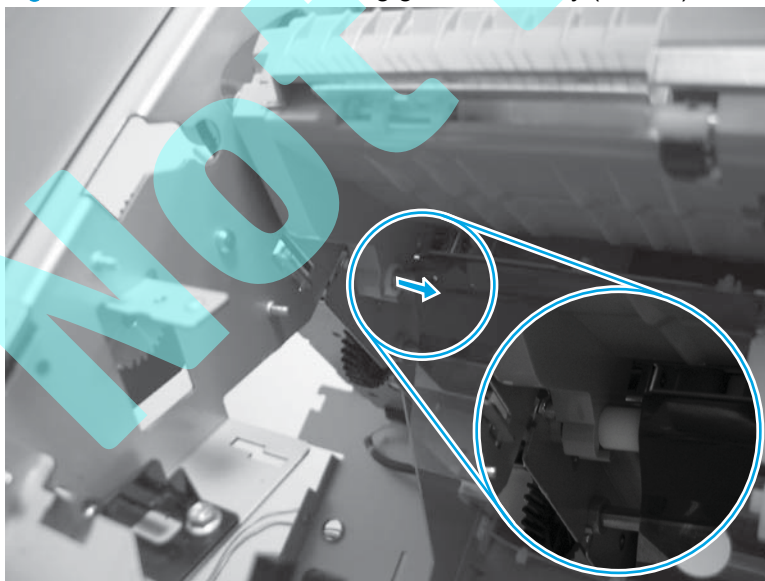

3. Release one belt (callout 1), and then move it out of the way.

Figure 1-659 Remove the swing guide assembly (3 of 12)

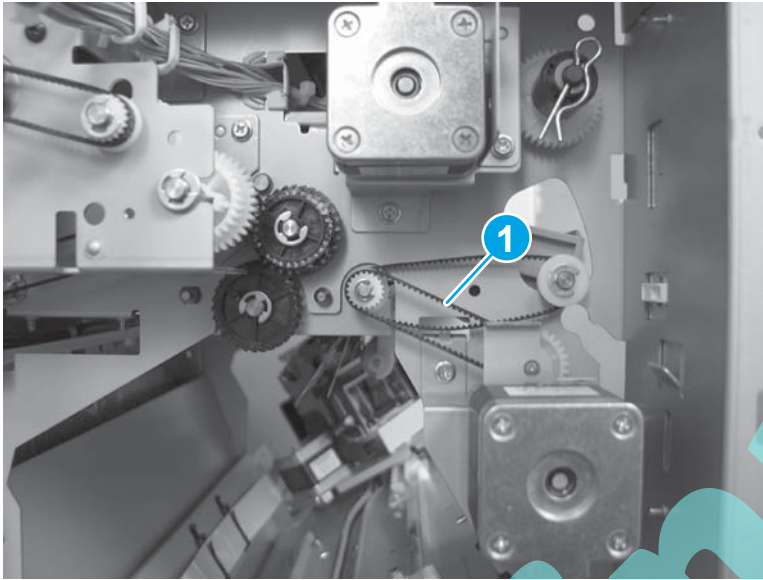

4. Remove one belt (callout 1).

Figure 1-660 Remove the swing guide assembly (4 of 12)

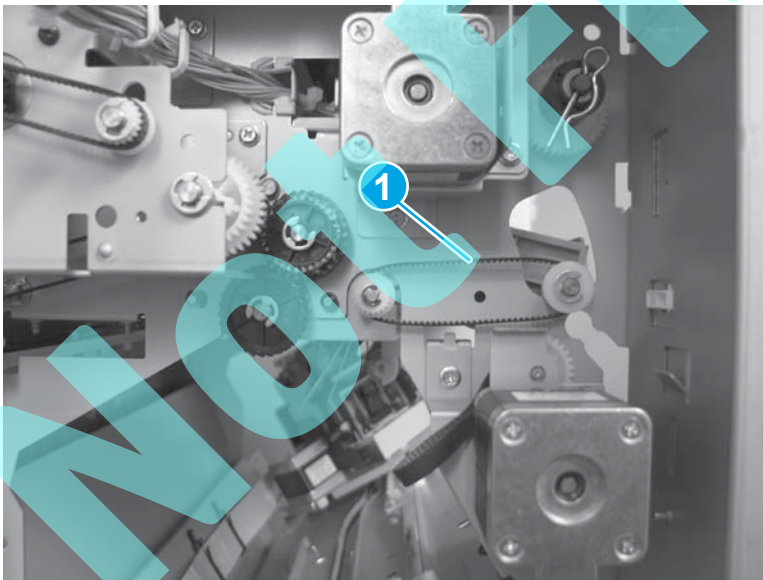

5. Look inside the accessory where the operation tray assembly was removed, and then locate and remove one e-ring. Slide the bushing out of the holder.

 **NOTE:** This e-ring and bushing are located on the inside front wall of the chassis.

Figure 1-661 Remove the swing guide assembly (5 of 12)

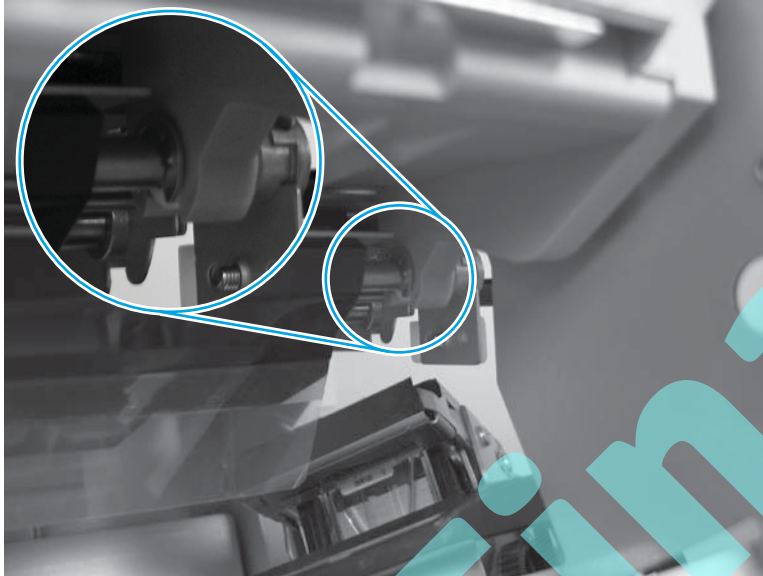

6. At the top of the accessory, disconnect one connector (callout 1), and then release the wire harness from one retainer (callout 2).

 **TIP:** Follow the wire harness to the swing guide assembly, and release two more retainers (not shown) on the front and bottom of the crossmember assembly.

Figure 1-662 Remove the swing guide assembly (6 of 12)



7. At the rear of the accessory, remove one retainer pin (callout 1), and then slide the clutch (callout 2) and gear (callout 3) off of the shaft to remove them.

Figure 1-663 Remove the swing guide assembly (7 of 12)

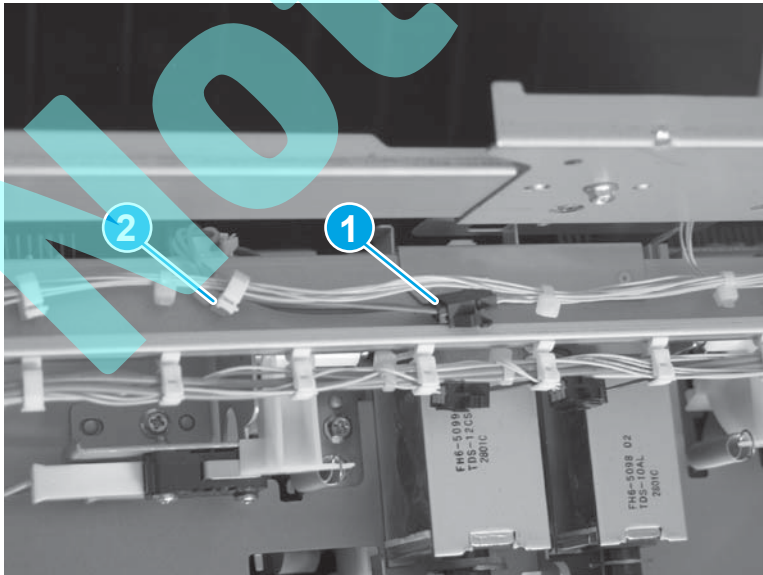
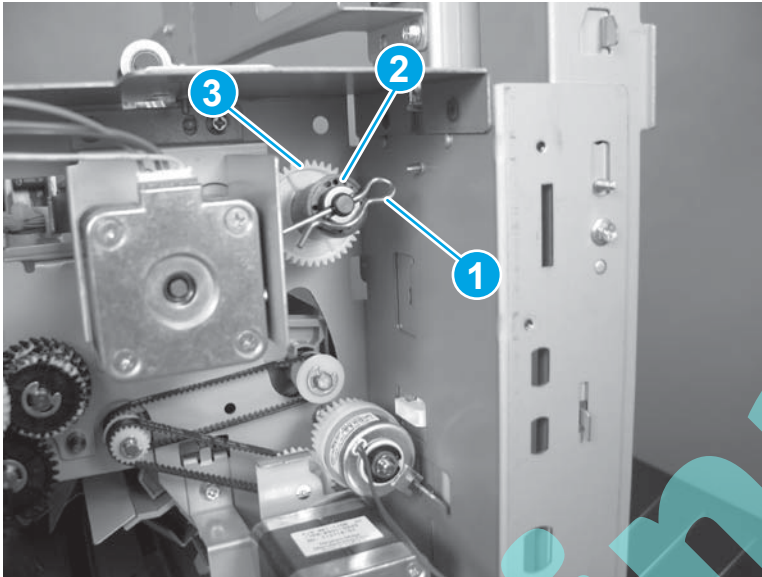

8. At the output side of the accessory, remove one e-ring (callout 1), slide the gear shaft to the left (callout 2), remove one bushing (callout 3).

CAUTION: Do not lose the bushing (callout 3).

Figure 1-664 Remove the swing guide assembly (8 of 12)

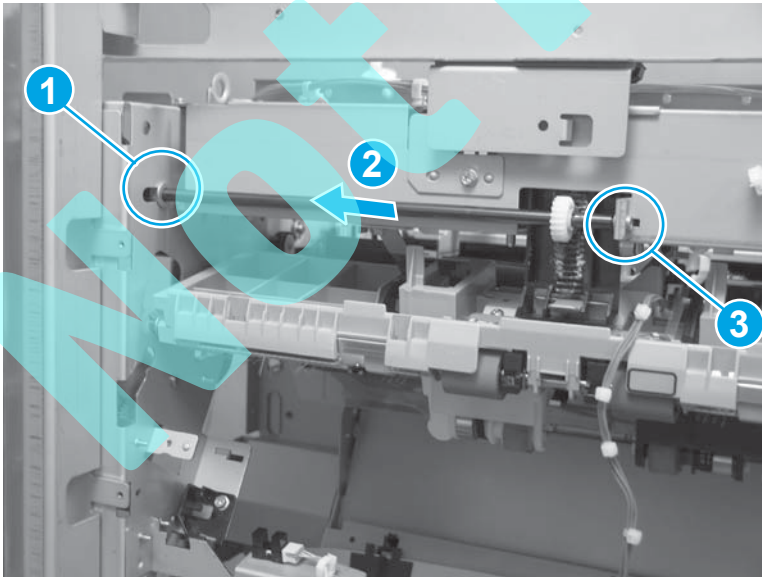

9. Remove the gear-shaft assembly.

Figure 1-665 Remove the swing guide assembly (9 of 12)

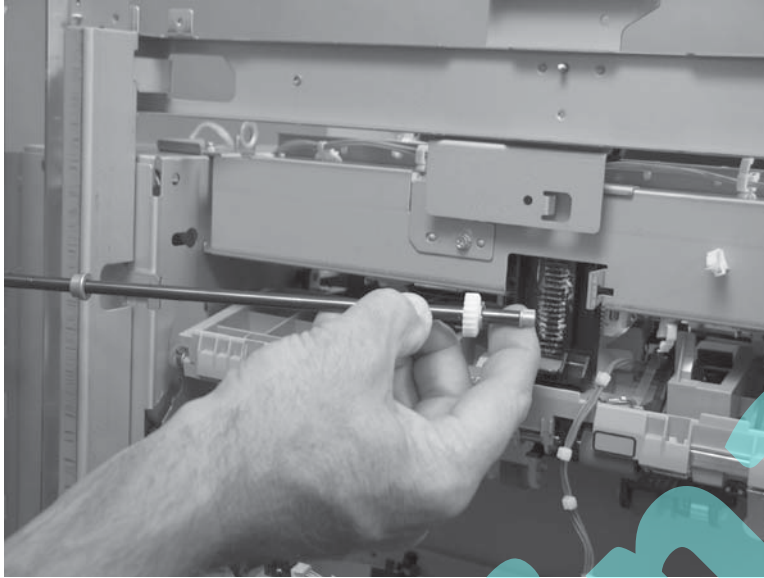

10. At the top of the accessory, loosen, but do not remove four screws on the upper crossmember assembly.

Figure 1-666 Remove the swing guide assembly (10 of 12)

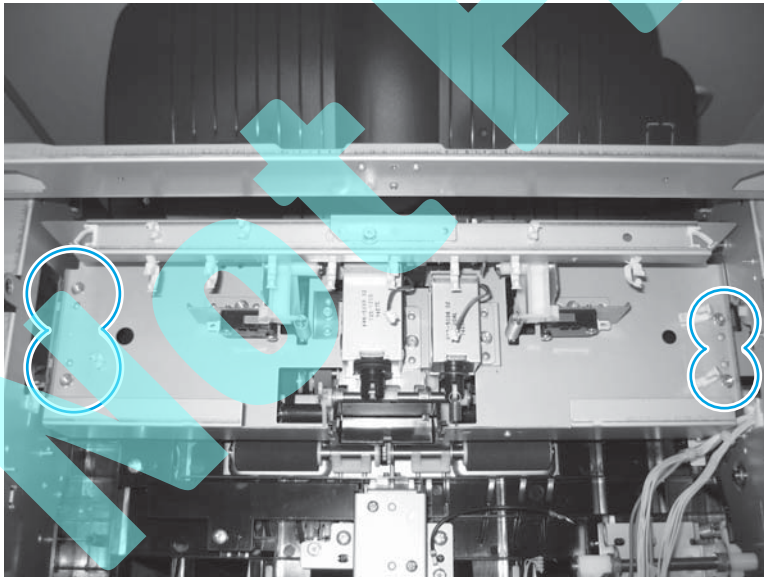

11. Carefully lift up on the edge of the upper crossmember assembly (callout 1), and then separate the black-plastic gear rack (callout 2) from the sheet metal tab (callout 3).

Figure 1-667 Remove the swing guide assembly (11 of 12)

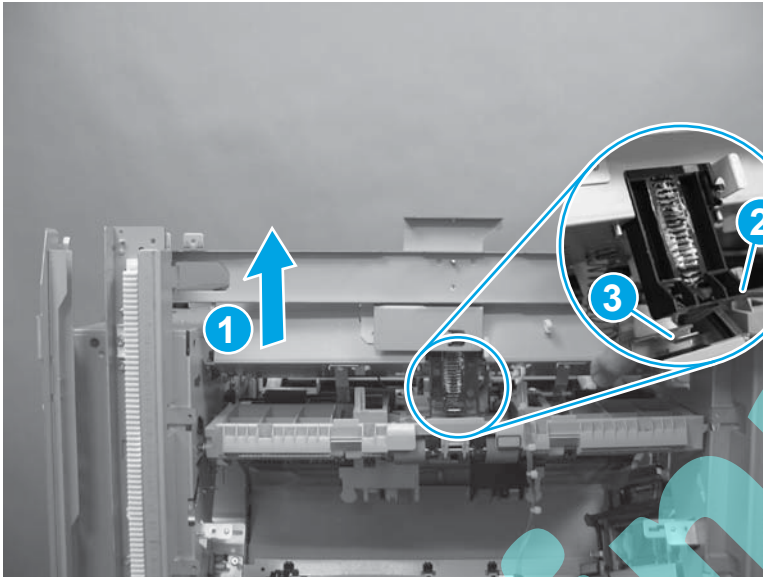

12. Carefully remove the swing guide assembly.

Figure 1-668 Remove the swing guide assembly (12 of 12)

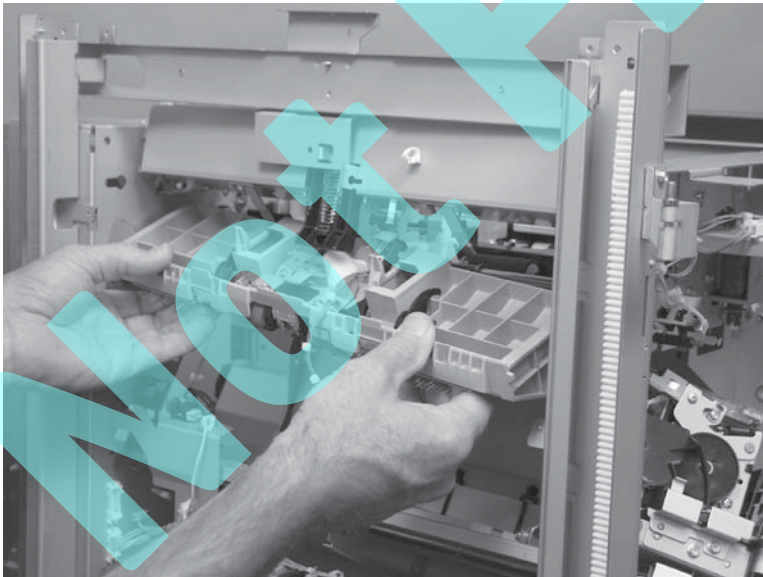

Reinstall the swing guide assembly

1. After the swing guide is reinstalled, verify that the two pivot arms on the upper crossmember are positioned in front of the pins (callout 1), and that the locking bar is seated in the cradle (callout 2).

 **NOTE:** Do not forget to retighten the four upper crossmember mounting screws.

 **Reinstallation tip** If after the swing guide assembly is removed and replaced the message **13.60.A1 Jam in Top Left Door** appears on the control panel display (or in the event log) after the product power is turned on, the two pivot arms or the locking bar might not have been properly installed.

Figure 1-669 Reinstall the swing guide assembly (1 of 7)



2. Verify that the spring underneath the upper crossmember assembly is correctly positioned.

Figure 1-670 Reinstall the swing guide assembly (2 of 7)

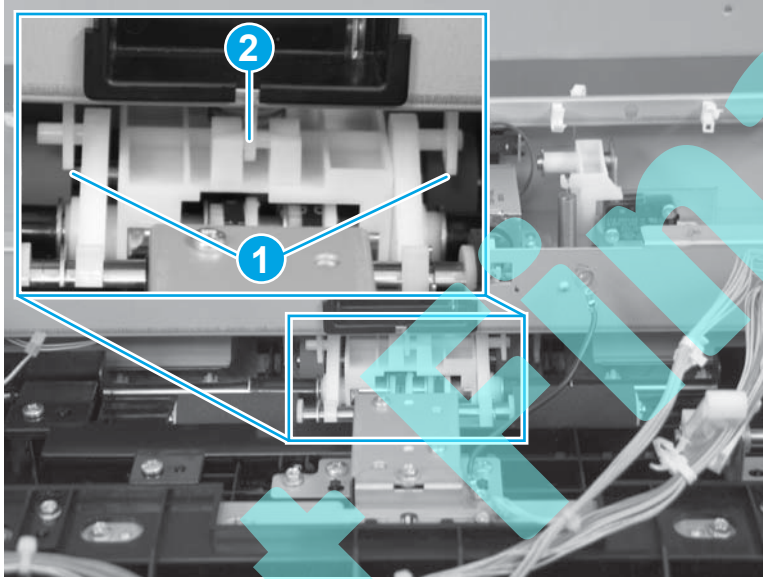
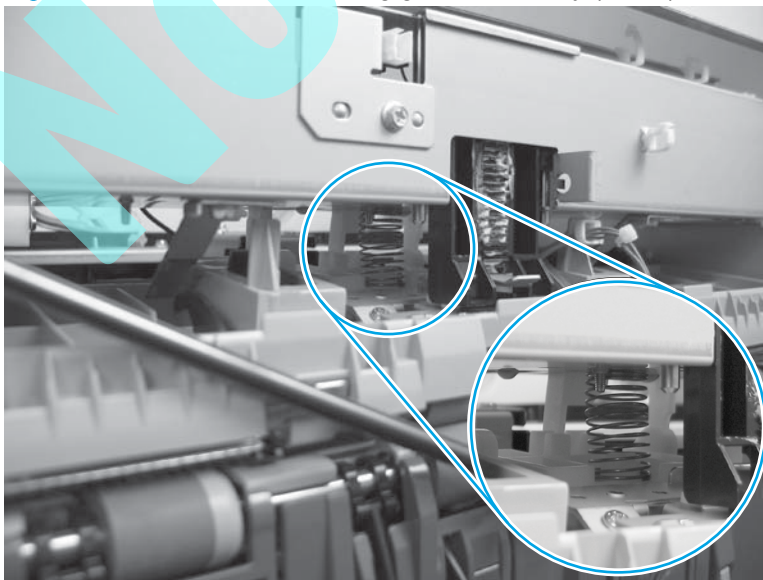

3. To reinstall the gear shaft right-side bushing, align the keyed portion of the bushing with the slot in the chassis mounting tab.

Figure 1-671 Reinstall the swing guide assembly (3 of 7)

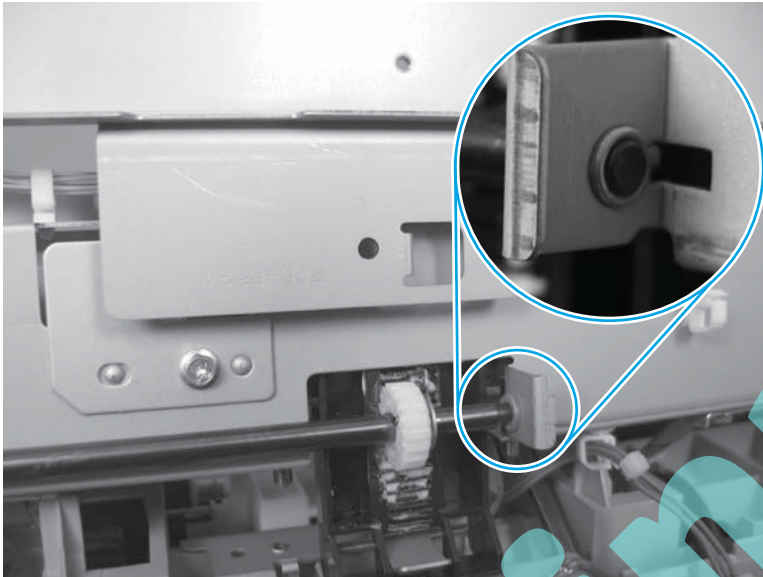

4. To reinstall the gear shaft left-side bushing, align the keyed portion of the bushing with the slot in the chassis (callout 1), and then install the e-ring (callout 2).

Figure 1-672 Reinstall the swing guide assembly (4 of 7)

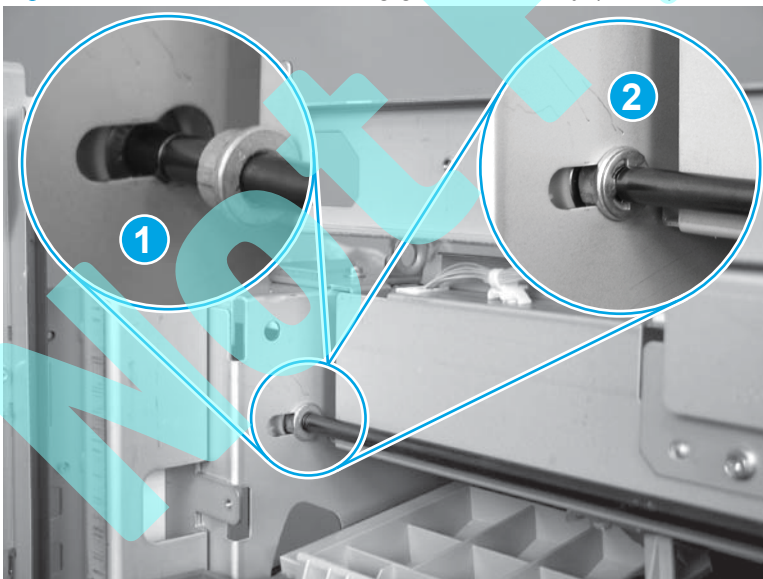

5. Make sure that the clutch is correctly position on the gear—two tabs on the clutch engage two slots on the gear face—and that the pin is positioned in the slot on the end of the shaft.

Figure 1-673 Reinstall the swing guide assembly (5 of 7)

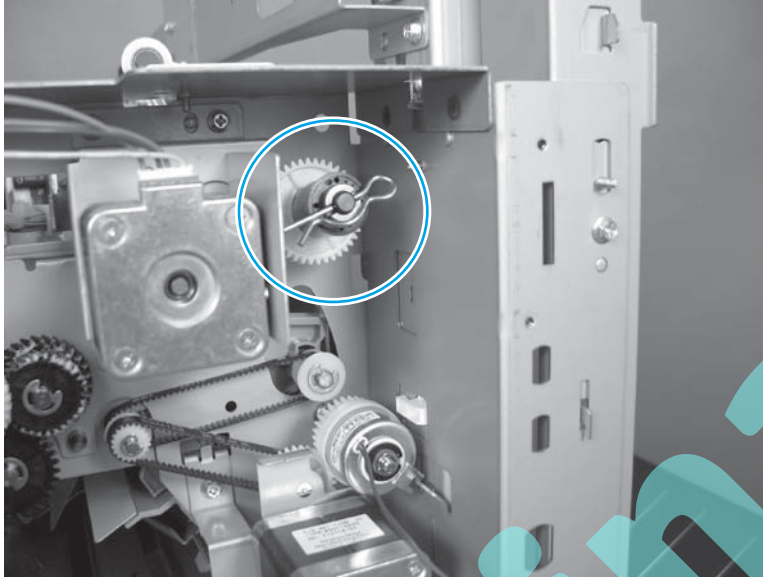

6. Recheck the locking bar underneath the upper crossmember assembly. Verify that it is correctly positioned in the cradle. If it is not correctly positioned, slightly lift up the upper crossmember assembly, and reposition the locking bar in the cradle.

TIP: If necessary, slightly loosen, but do not remove, the assembly mounting screws to allow the assembly to be lifted up. Make sure that you retighten the mounting screws.

Figure 1-674 Reinstall the swing guide assembly (6 of 7)

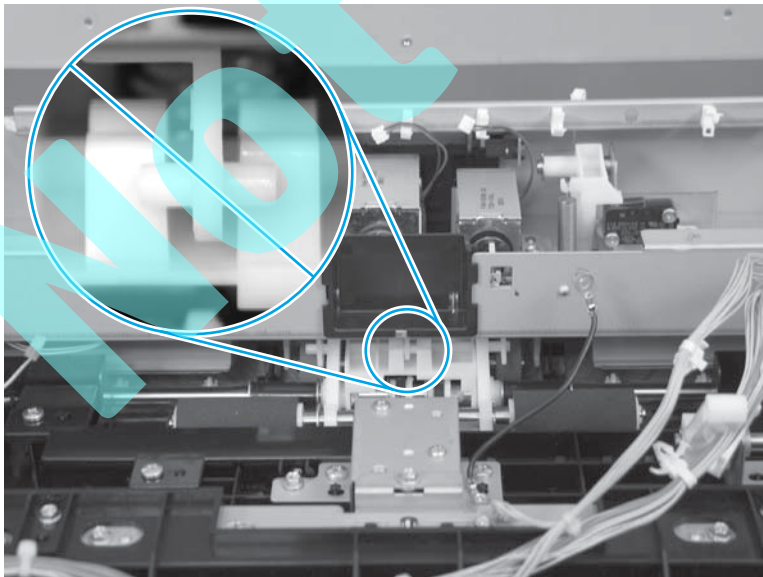

7. Make sure that the drive belts are correctly installed.

Figure 1-675 Reinstall the swing guide assembly (7 of 7)

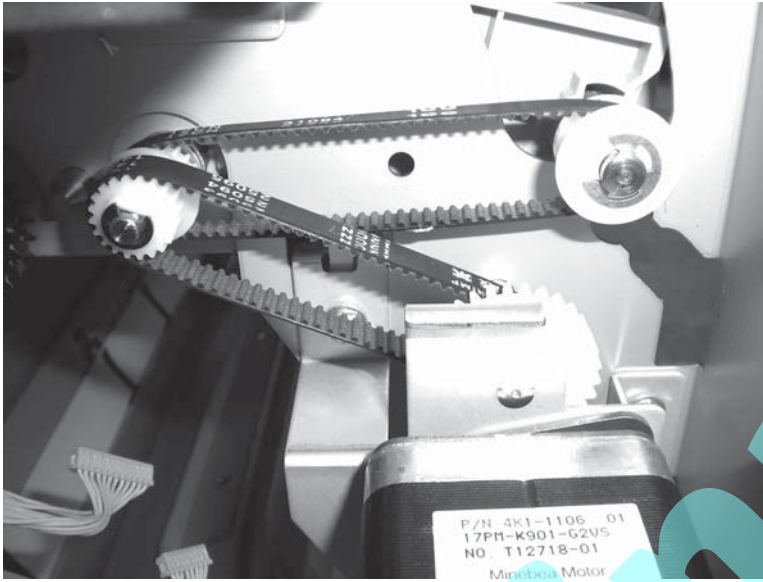

Return roller assembly

Before proceeding, remove the following assemblies:

- Bin cable guide cover. See [Bin cable guide cover on page 317](#).
- Open/closed stepped cover assembly. See [Open/closed stepped cover assembly on page 321](#).
- Upper stepped cover assembly. See [Upper stepped cover assembly on page 322](#).
- Lower stepped cover assembly. See [Lower stepped cover assembly on page 324](#).
- Rear cover assembly. See [Rear cover assembly on page 349](#).
- Main controller PCA assembly. See [Main controller PCA assembly on page 353](#).
- Stack wall upper cover assembly. See [Stack wall upper assembly and upper wall guide assembly on page 375](#).
- Stack upper bin and lower bin assembly. See [Stack upper bin and lower bin assemblies on page 397](#).
- Stack upper bin and lower bin assembly. See [Stack upper bin and lower bin assemblies on page 397](#).
- Height wall assembly. See [Height wall assembly on page 401](#).
- Paper detect holder assembly. See [Paper detect holder assembly on page 417](#).
- Operation tray assembly. See [Operation tray assembly on page 419](#).
- Swing guide assembly. See [Swing guide assembly on page 430](#).

Remove the return roller assembly

1. Disconnect one connector (callout 1), release two wire retainers (callout 2), and then remove two screws (callout 3).



 **TIP:** To make removing the return roller assembly easier, push the stapler assembly all of the way inside the accessory.

Figure 1-676 Remove the return roller assembly (1 of 2)

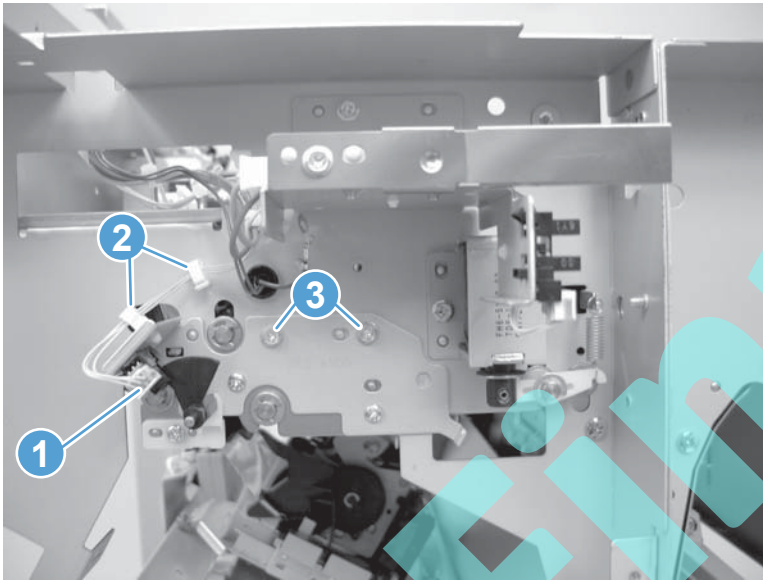

2. Remove the return roller assembly from the front side of the chassis.

 **NOTE:** When you remove the assembly, use both hands to support the return roller.

 **TIP:** Be careful not to damage the mylar sheet during removal or replacement.

Figure 1-677 Remove the return roller assembly (2 of 2)

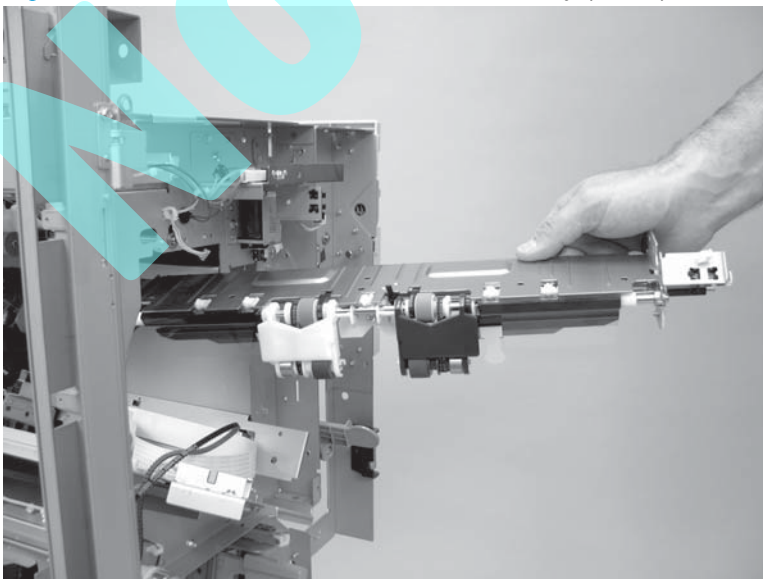

Clutch assembly (rear side)

Before proceeding, remove the following assemblies:

- Bin cable guide cover. See [Bin cable guide cover on page 317](#).
- Rear cover assembly. See [Remove only the rear cover on page 351](#).

Remove the clutch assembly (rear side)

1. Remove one screw (callout 1), and then remove the upper sheet-metal cable retainer (callout 2). Remove one screw (callout 3), and then remove the lower sheet-metal cable retainer (callout 4).

Figure 1-678 Remove the clutch assembly (rear side; 1 of 6)

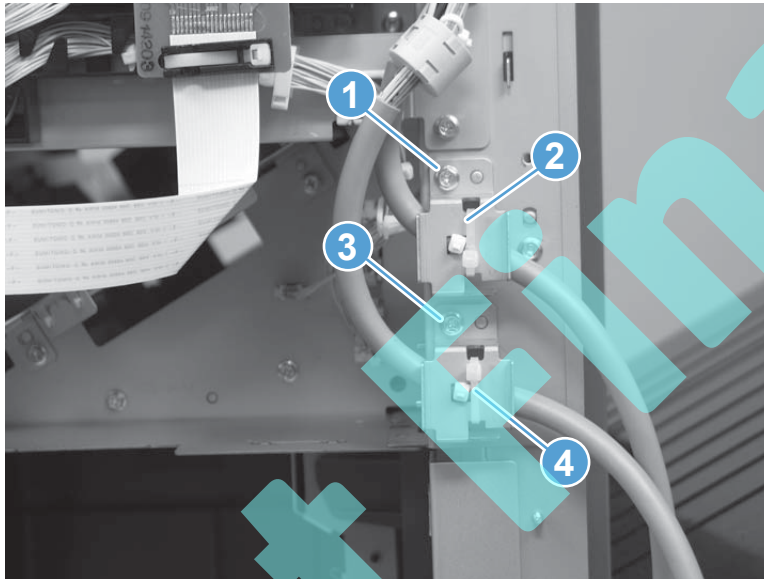

2. Disconnect eight connectors (callout 1), and then release the wire harnesses from the retainer and guide (callout 2).

Figure 1-679 Remove the clutch assembly (rear side; 2 of 6)

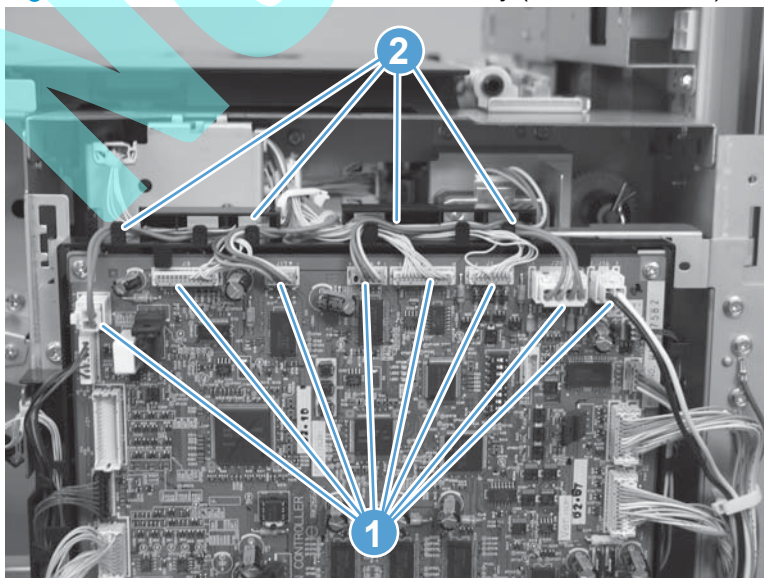

3. Disconnect two connectors (callout 1), and then release the wire harnesses from the retainers (callout 2).

Figure 1-680 Remove the clutch assembly (rear side; 3 of 6)

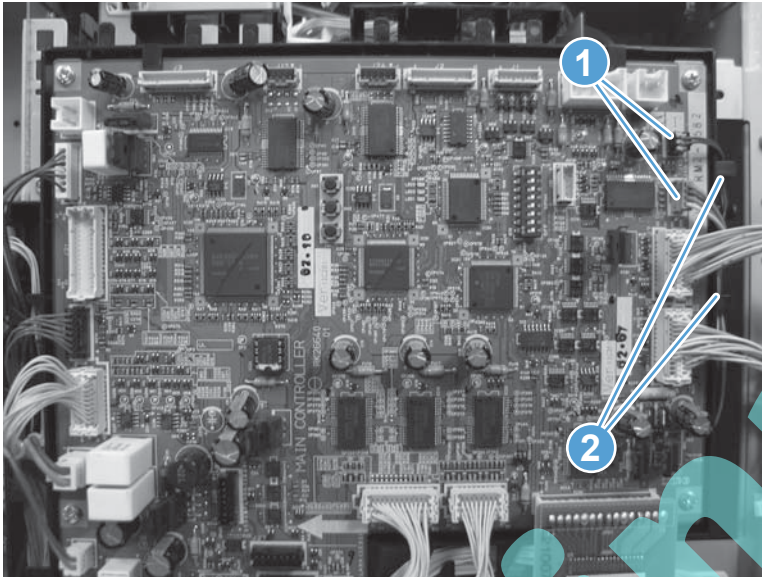

4. Remove four screws (callout 1), release the wire harnesses from one retainer (callout 2), and then slightly lift up on the controller PCA sheet-metal bracket (callout 3) to release it.

Figure 1-681 Remove the clutch assembly (rear side; 4 of 6)

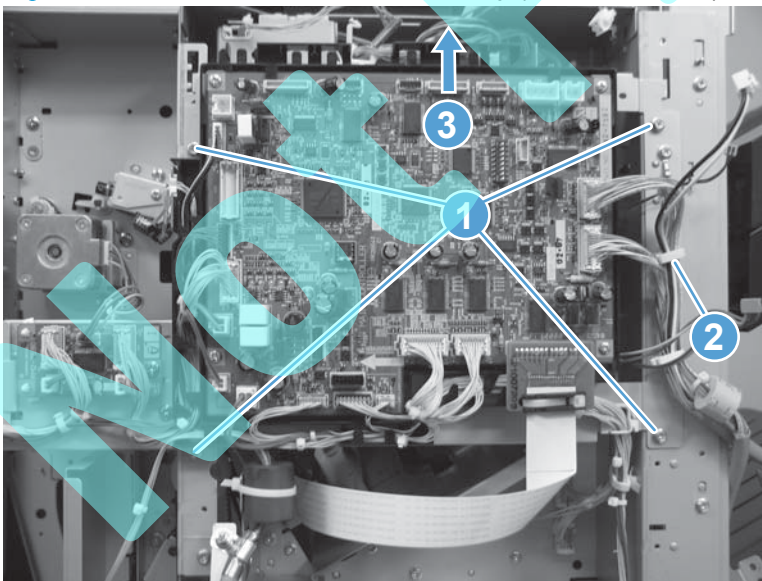

- Carefully rotate the top of the controller PCA away from the chassis, and then move it out of the way.

 **NOTE:** If needed, release additional wire harnesses from retainers to make it easier to rotate the PCA out of the way.

Figure 1-682 Remove the clutch assembly (rear side; 5 of 6)



- Remove one e-ring (callout 1), and then slide the clutch off of the shaft to remove it.

Figure 1-683 Remove the clutch assembly (rear side; 6 of 6)

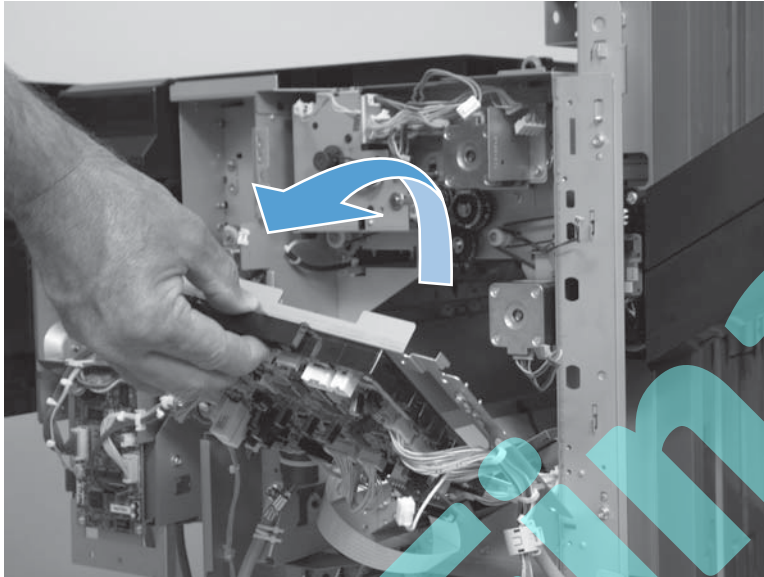
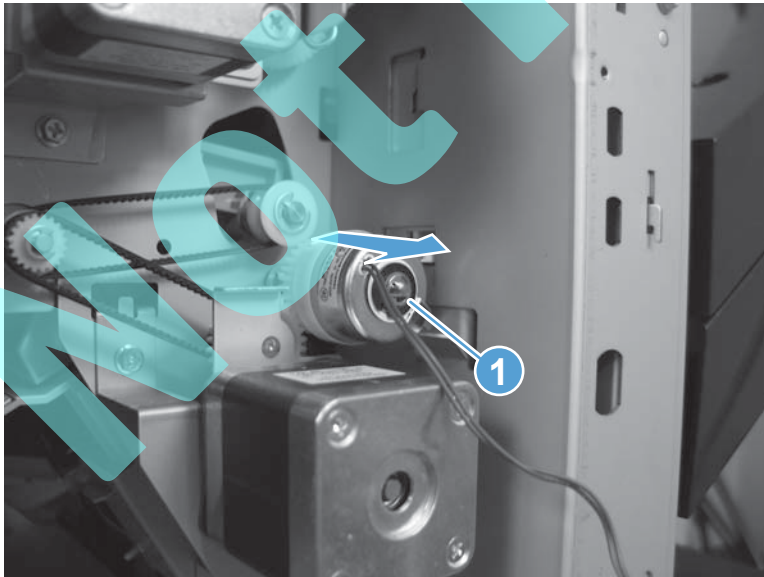

Stack ejection motor assembly

Before proceeding, remove the following assemblies:

- Bin cable guide cover. See [Bin cable guide cover on page 317](#).
- Rear cover assembly. See [Remove only the rear cover on page 351](#).

Remove the stack ejection motor assembly

1. Remove one screw (callout 1), and then remove the upper sheet-metal cable retainer (callout 2). Remove one screw (callout 3), and then remove the lower sheet-metal cable retainer (callout 4).

Figure 1-684 Remove the stack ejection motor assembly (1 of 7)

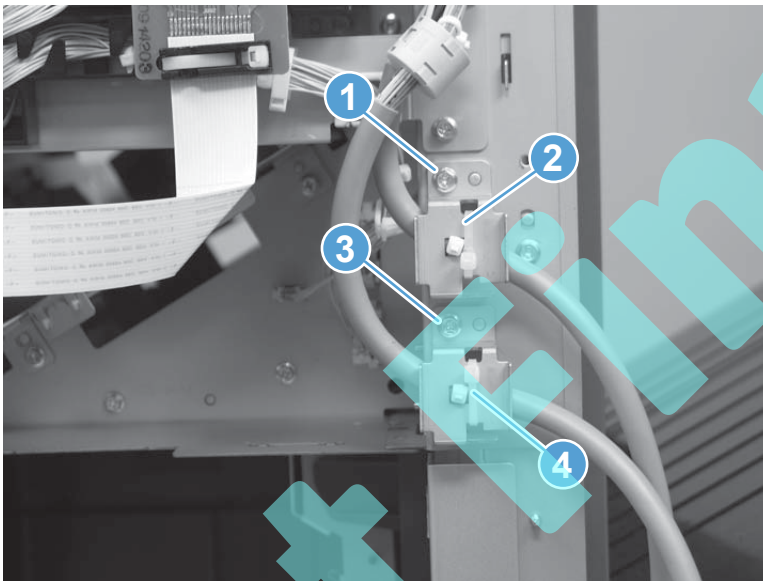

2. Disconnect eight connectors (callout 1), and then release the wire harnesses from the retainer and guide (callout 2).

Figure 1-685 Remove the stack ejection motor assembly (2 of 7)

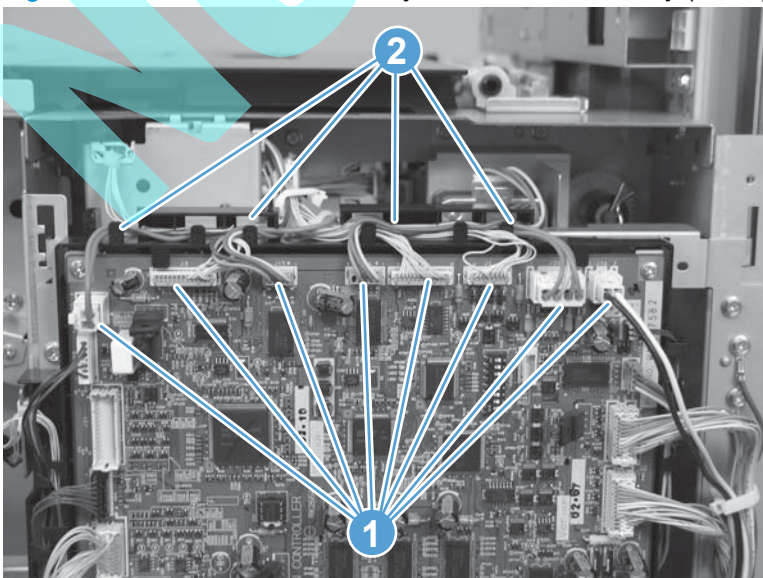

3. Disconnect two connectors (callout 1), and then release the wire harnesses from the retainers (callout 2).

Figure 1-686 Remove the stack ejection motor assembly (3 of 7)

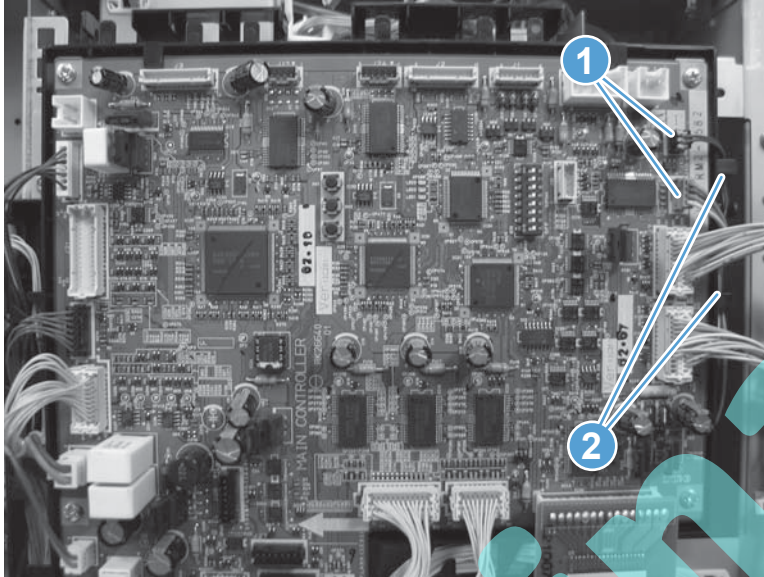

4. Remove four screws (callout 1), release the wire harnesses from one retainer (callout 2), and then slightly lift up on the controller PCA sheet-metal bracket (callout 3) to release it.

Figure 1-687 Remove the stack ejection motor assembly (4 of 7)

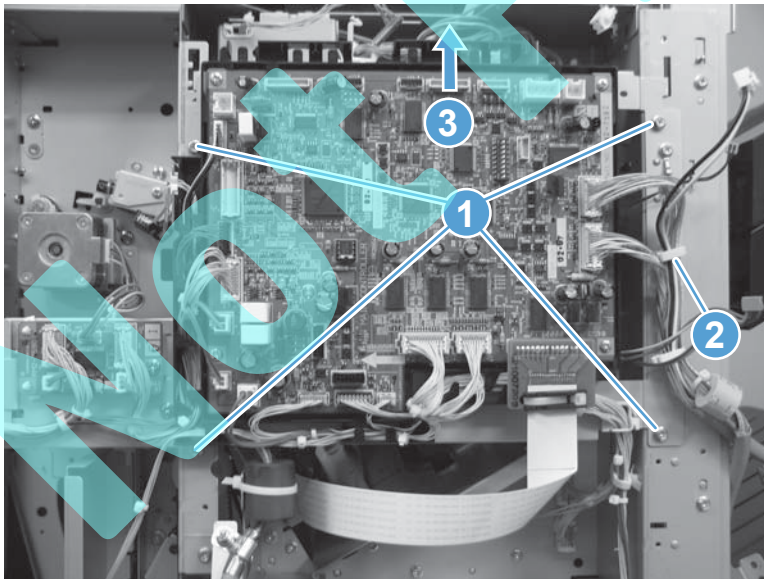

- Carefully rotate the top of the controller PCA away from the chassis, and then move it out of the way.

 **NOTE:** If needed, release additional wire harnesses from retainers to make it easier to rotate the PCA out of the way.

Figure 1-688 Remove the stack ejection motor assembly (5 of 7)



- Remove three screws.

Figure 1-689 Remove the stack ejection motor assembly (6 of 7)

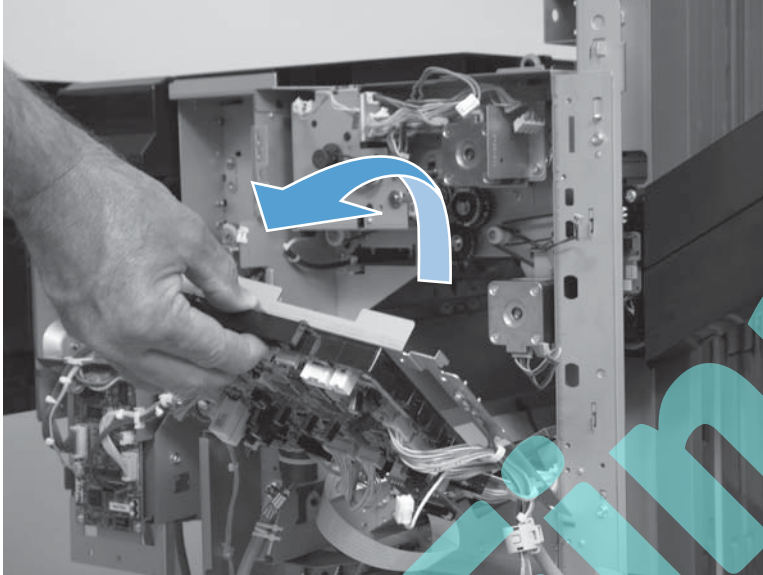
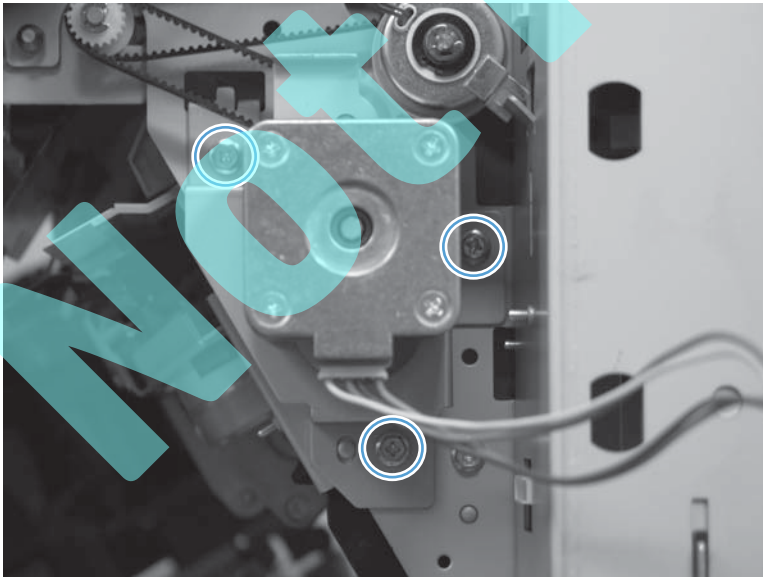

7. Remove the motor and drive belt.

⚠ CAUTION: The drive belt behind the motor is not captive. Do not lose the belt when the motor is removed.

💡 Reinstallation tip If you are installing a replacement motor, remove the wire harness (callout 1) and drive belt (callout 2) from the discarded motor, and then install them on the replacement motor.

Figure 1-690 Remove the stack ejection motor assembly (7 of 7)

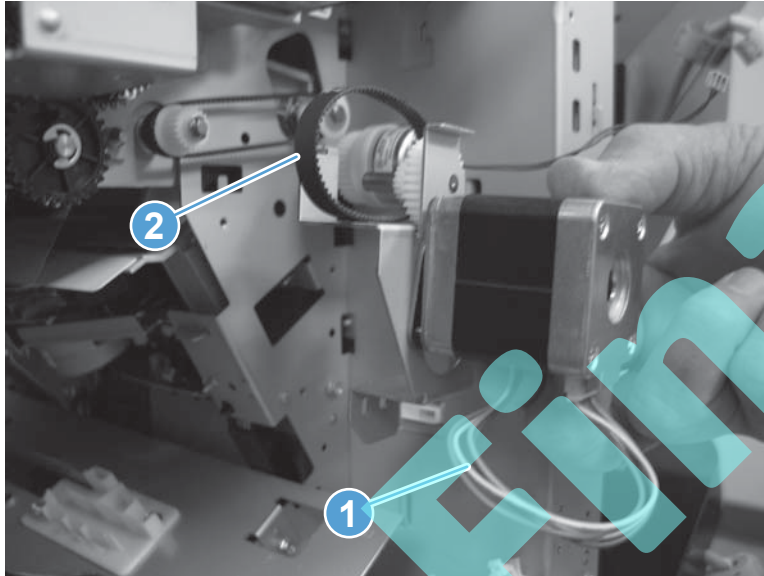

Press motor assembly

Before proceeding, remove the following assemblies:

- Bin cable guide cover. See [Bin cable guide cover on page 317](#).
- Rear cover assembly. See [Remove only the rear cover on page 351](#).

Remove the press motor assembly

1. Remove one screw (callout 1), and then remove the upper sheet-metal cable retainer (callout 2). Remove one screw (callout 3), and then remove the lower sheet-metal cable retainer (callout 4).

Figure 1-691 Remove the press motor assembly (1 of 7)

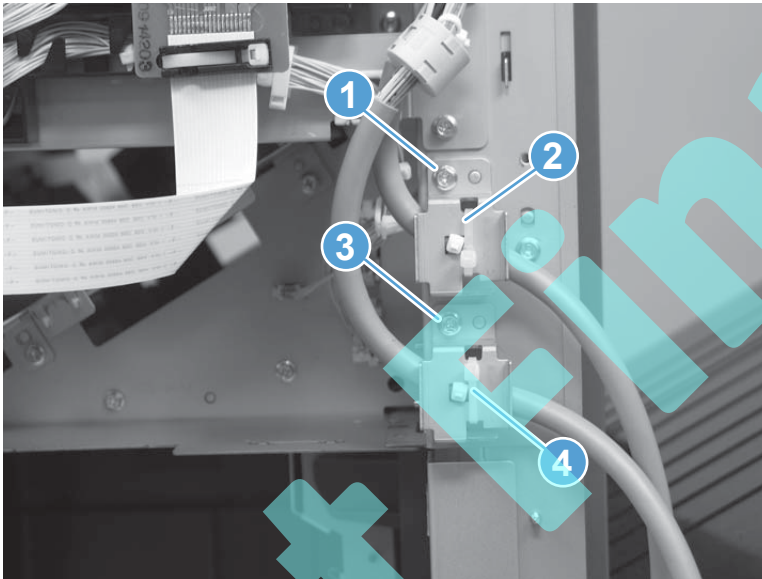

2. Disconnect eight connectors (callout 1), and then release the wire harnesses from the retainer and guide (callout 2).

Figure 1-692 Remove the press motor assembly (2 of 7)

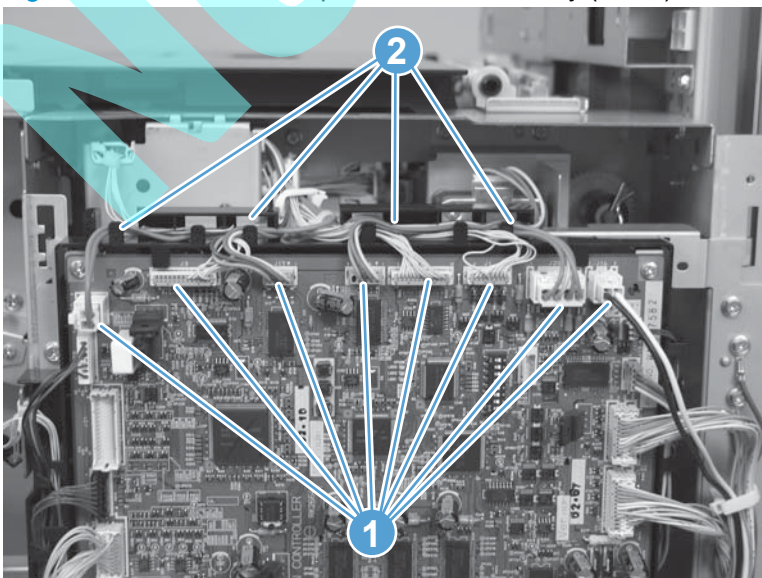

3. Disconnect two connectors (callout 1), and then release the wire harnesses from the retainers (callout 2).

Figure 1-693 Remove the press motor assembly (3 of 7)

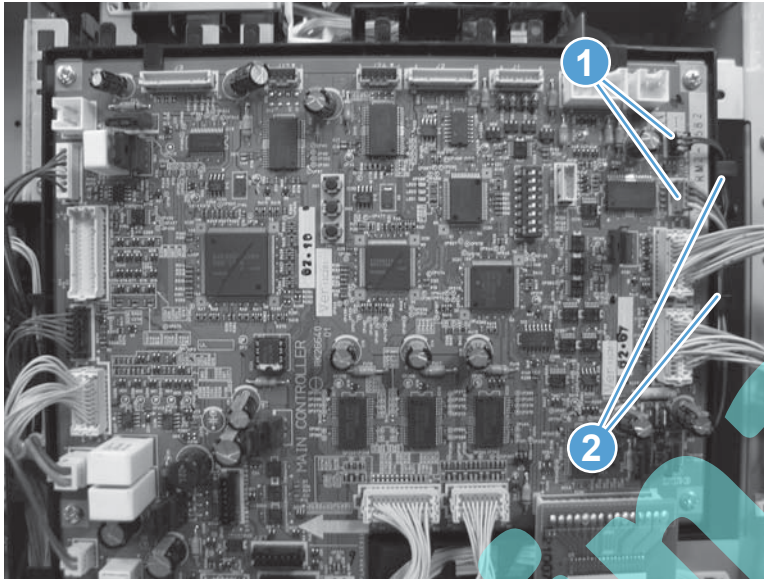

4. Remove four screws (callout 1), release the wire harnesses from one retainer (callout 2), and then slightly lift up on the controller PCA sheet-metal bracket (callout 3) to release it.

Figure 1-694 Remove the press motor assembly (4 of 7)

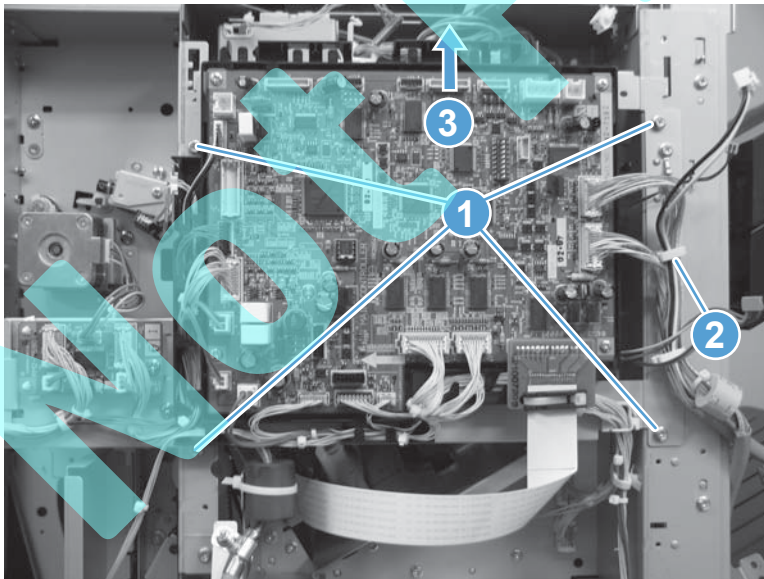

- Carefully rotate the top of the controller PCA away from the chassis, and then move it out of the way.

 **NOTE:** If needed, release additional wire harnesses from retainers to make it easier to rotate the PCA out of the way.

Figure 1-695 Remove the press motor assembly (5 of 7)



- Support the motor, and then remove three screws.

Figure 1-696 Remove the press motor assembly (6 of 7)

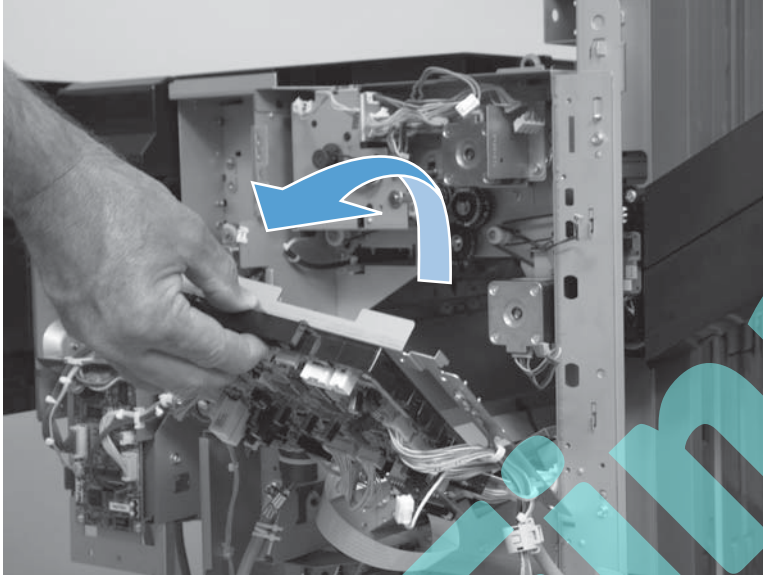
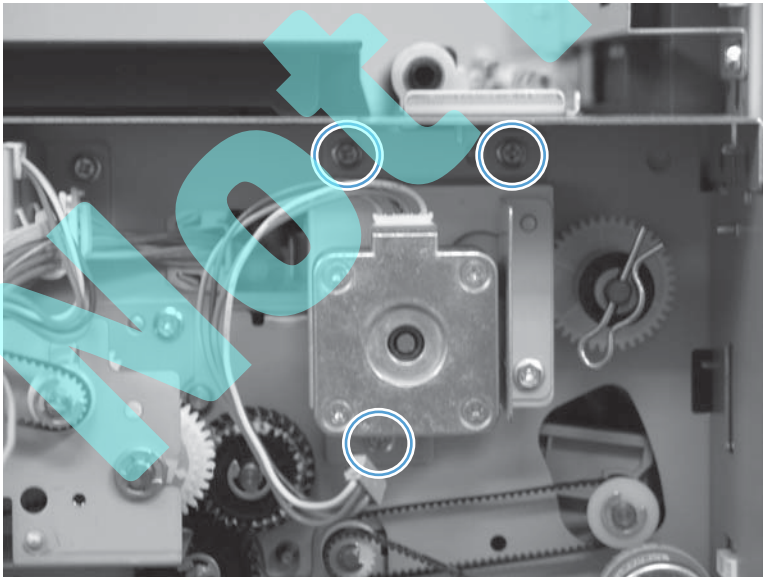

7. Remove the motor.



 **Reinstallation tip** If you are installing a replacement motor, remove the wire harness (callout 1) from the discarded motor, and then install it on the replacement motor.

Figure 1-697 Remove the press motor assembly (7 of 7)

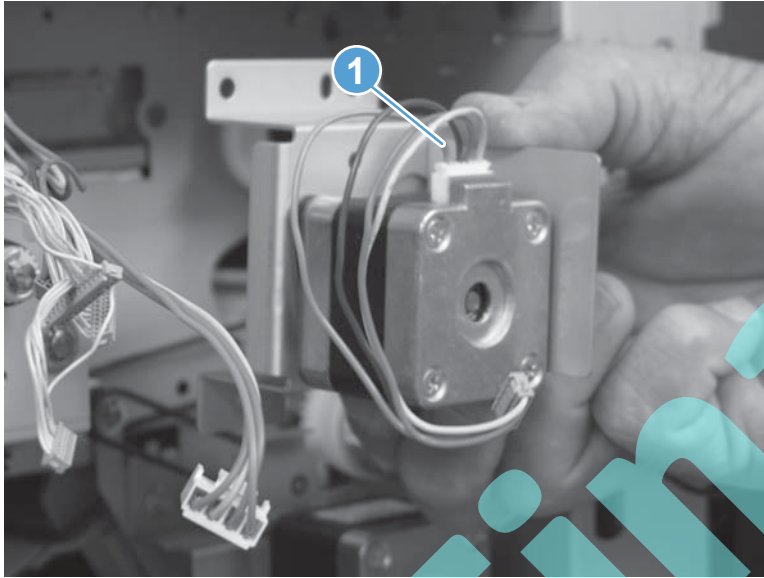

Not Final

Common driver PCA assembly

 **NOTE:** Only the booklet maker and stapler stacker accessories have a common driver PCA.

Before proceeding, remove the following assemblies:

- Bin cable guide cover. See [Bin cable guide cover on page 317](#).
- Rear cover assembly. See [Remove only the rear cover on page 351](#).

Remove the common controller PCA

 **CAUTION:**  ESD sensitive assembly.

 **NOTE:** The following connectors are not used on the PCA: J804, and J805.

1. Disconnect all of the connectors.

Figure 1-698 Remove the common driver PCA assembly (1 of 2)

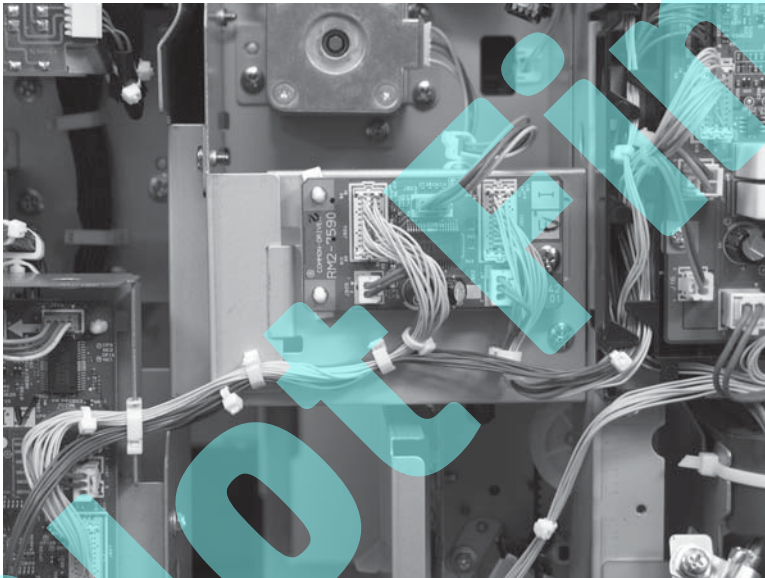

2. Remove one screw (callout 1), use a pair of needle-nose pliers to release two standoffs (callout 2), and then remove the PCA (callout 3).

Figure 1-699 Remove the common driver PCA assembly (2 of 2)

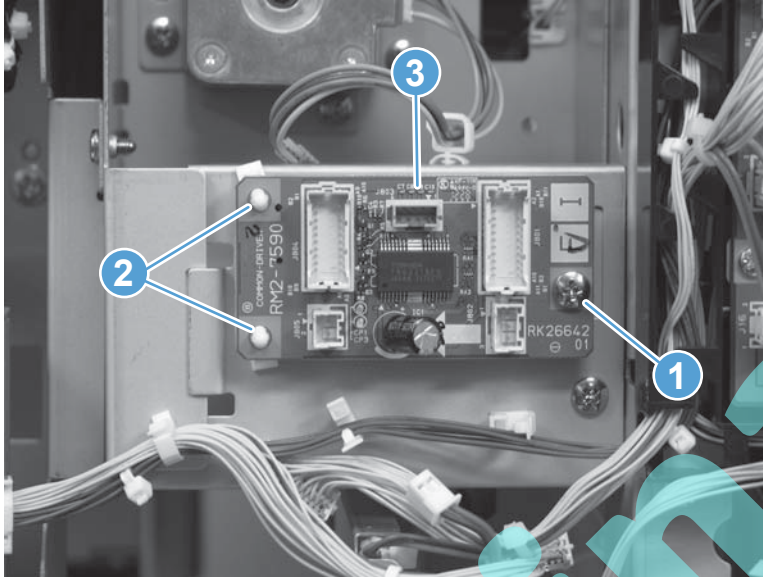

Interface cable assembly

Before proceeding, remove the following assemblies:

- Bin cable guide cover. See [Bin cable guide cover on page 317](#).
- Rear cover assembly. See [Remove only the rear cover on page 351](#).

Remove the interface cable assembly

1. Disconnect two connectors on the main controller PCA (J11 and J29; callout 1), and then release the wire harness from the retainer (callout 2).

Figure 1-700 Remove the interface cable assembly (1 of 3)

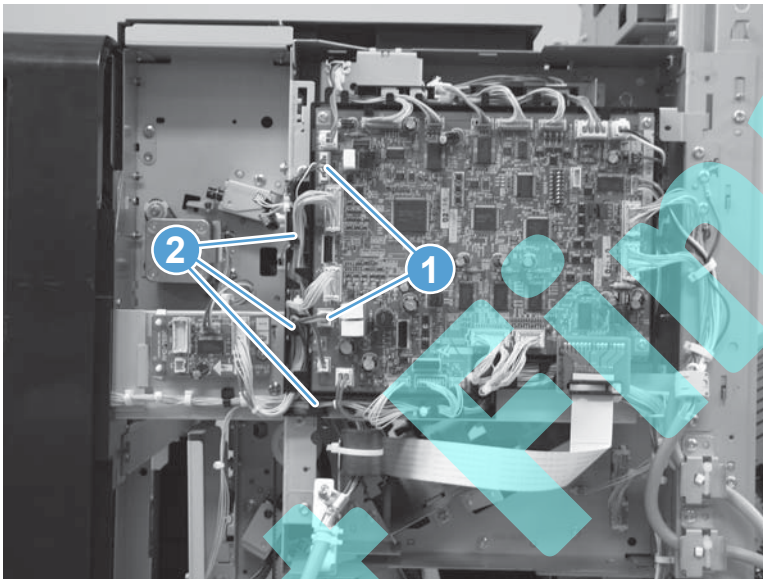

2. Remove two screws.

Figure 1-701 Remove the interface cable assembly (2 of 3)

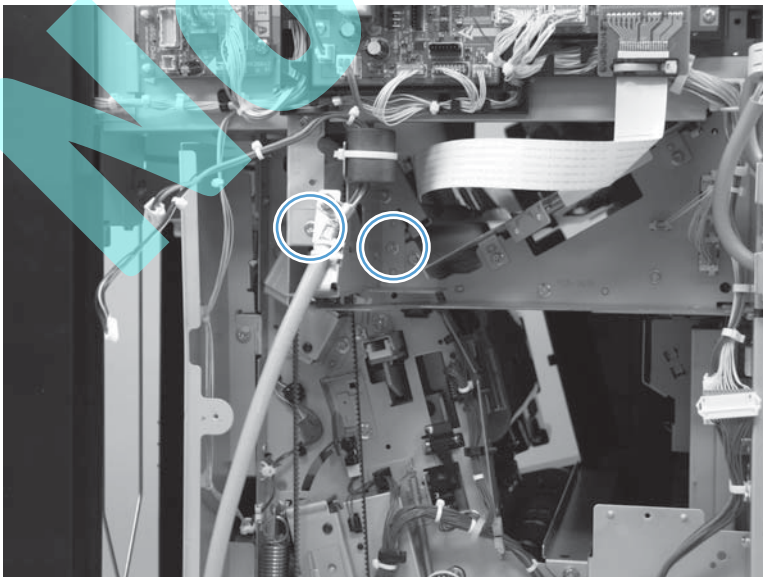

3. Remove the assembly.

Figure 1-702 Remove the interface cable assembly (3 of 3)

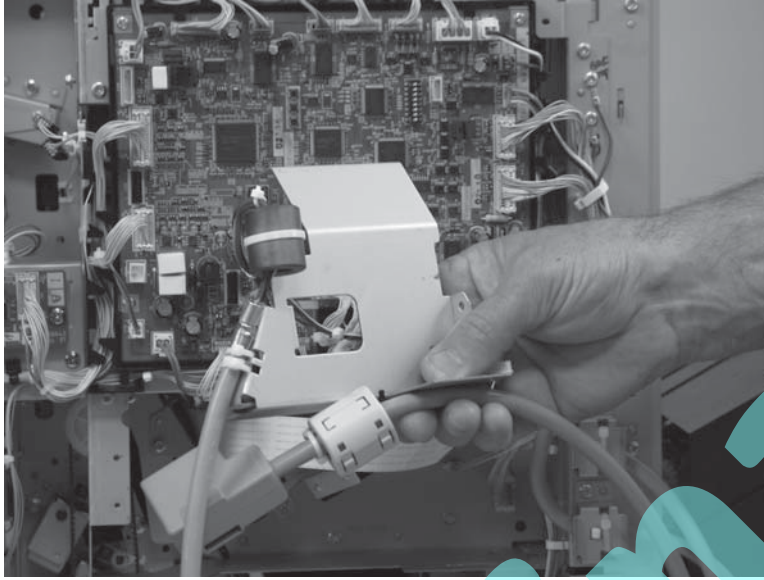

Reverse driver PCA assembly

Before proceeding, remove the following assemblies:

- Right cover assembly. See [Right cover assembly on page 311](#).
- Rear reverse cover assembly. See [Rear reverse cover assembly on page 314](#).
- Bin cable guide cover. See [Bin cable guide cover on page 317](#).
- Rear cover assembly. See [Remove only the rear cover on page 351](#).

Remove the reverse driver PCA assembly

CAUTION:  ESD sensitive assembly.

Disconnect the four connectors, remove two screws (callout 1) and release two standoffs (callout 2), and then remove the PCA.

TIP: It might be easier to release the retainers first, before disconnecting the top connector. Use needle-nose pliers to release the standoffs.

Figure 1-703 Remove the reverse driver PCA assembly

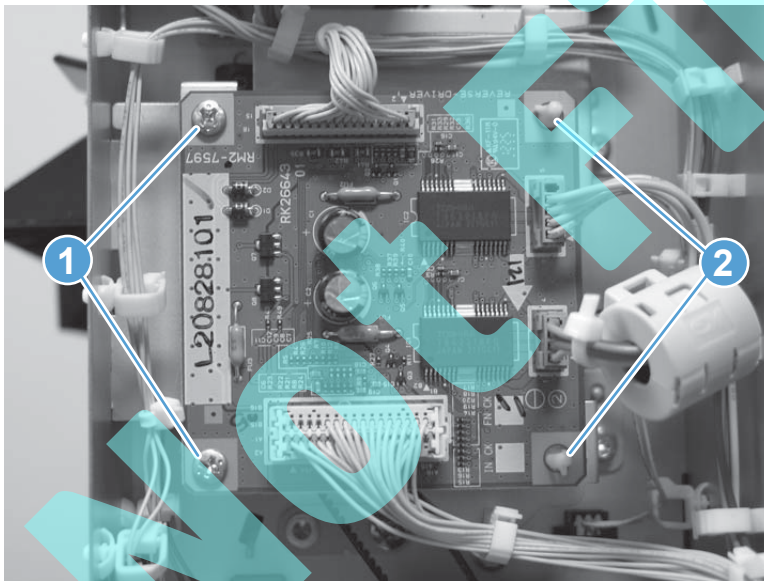

Reverse assembly

Before proceeding, remove the following assemblies:

- Right cover assembly. See [Right cover assembly on page 311](#).
- Pre-reverse cover assembly. See [Pre-reverse cover assembly on page 312](#).
- Rear reverse cover assembly. See [Rear reverse cover assembly on page 314](#).
- Upper reverse cover assembly. See [Upper reverse cover assembly on page 316](#).

Remove the reverse assembly

1. Release the wire harness from three retainers (callout 1), and then disconnect one connector (callout 2).

Figure 1-704 Remove the reverse assembly (BM and SS; 1 of 5)

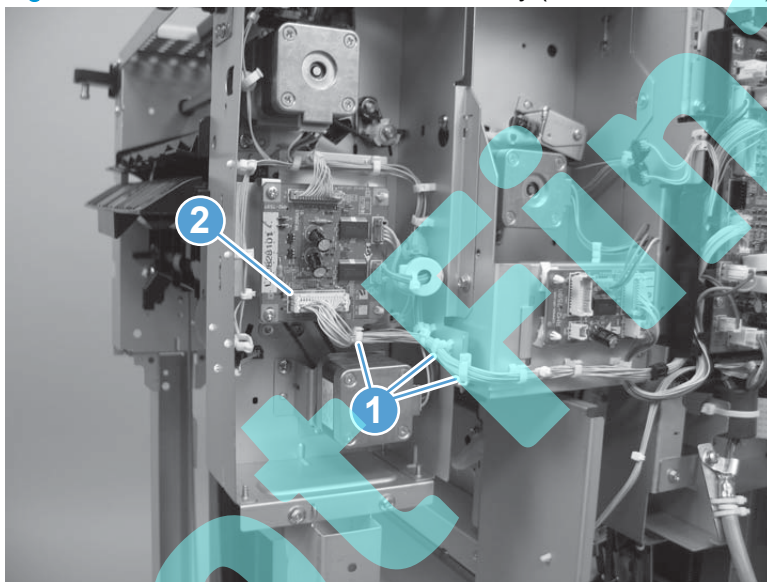

2. Remove the wire paper retaining guide (callout 1).

 **Reinstallation tip** If you are installing a replacement assembly, install the wire paper retaining guide wire paper retaining guide on the replacement reverse assembly.

Figure 1-705 Remove the reverse assembly (BM and SS; 2 of 5)



3. Remove four screws.

 **NOTE:** These screws have a larger head than other screws used in the accessory. Make sure that you use these screws when the assembly is reinstalled.

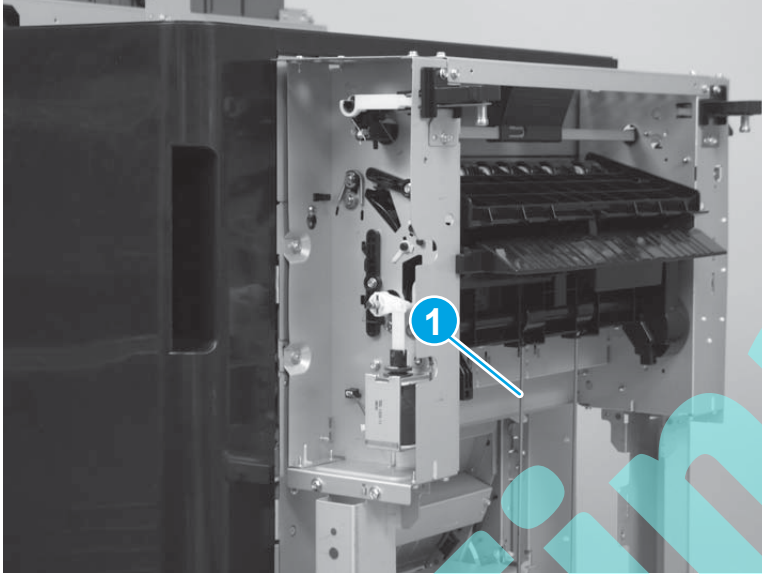
Figure 1-706 Remove the reverse assembly (BM and SS; 3 of 5)



4. Remove three screws.

 **NOTE:** These screws have a larger head than other screws used in the accessory. Make sure that you use these screws when the assembly is reinstalled.

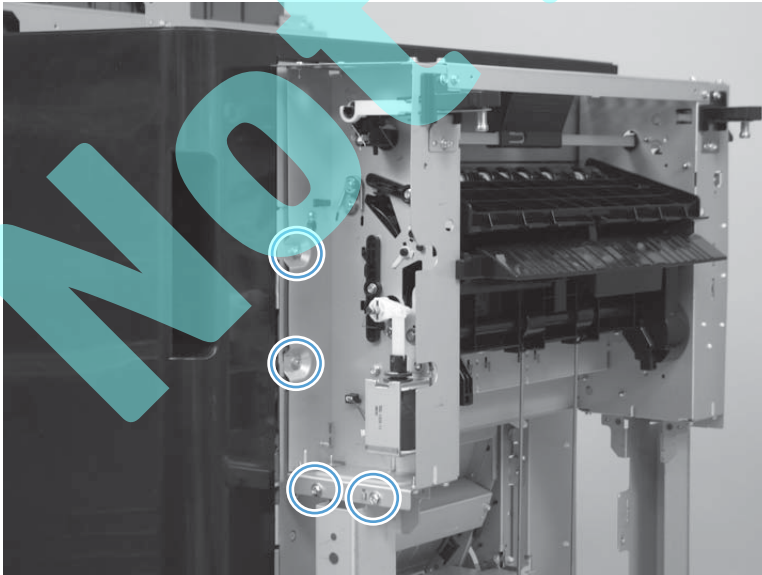
Figure 1-707 Remove the reverse assembly (BM and SS; 4 of 5)



5. Lift the assembly up to release it (callout 1), and then remove the assembly (callout 2).

Figure 1-708 Remove the reverse assembly (BM and SS; 5 of 5)

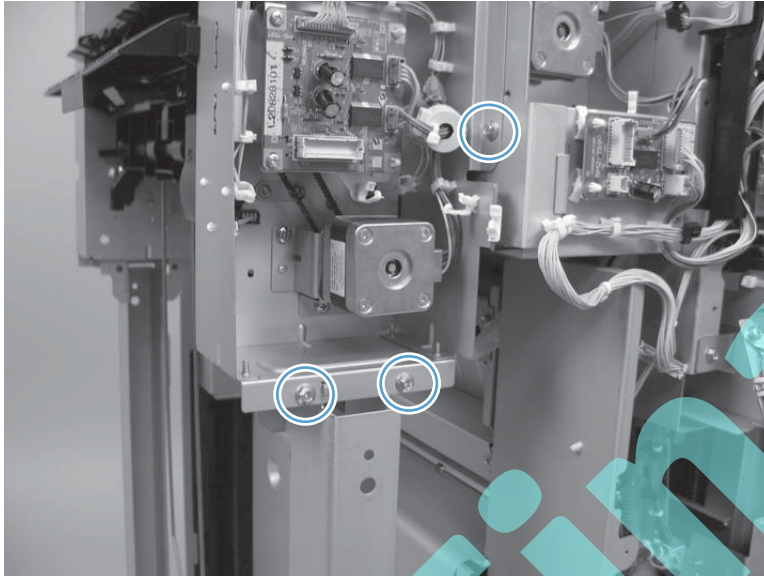
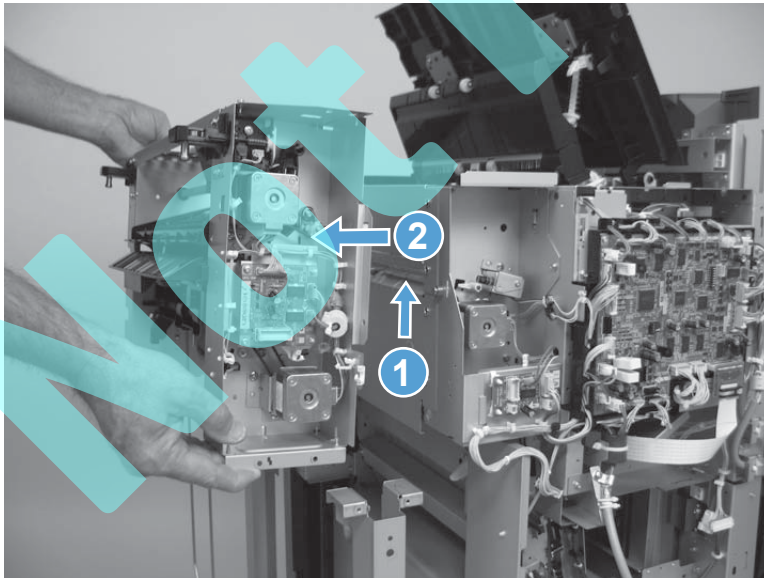

Paper pass assembly

 **NOTE:** This assembly is installed on the stapler/stacker (SS) and stapler/stacker with hole punch (SSHP) only.

Before proceeding, remove the following assemblies:

- Right cover assembly. See [Right cover assembly on page 311](#).
- Pre-reverse cover assembly. See [Pre-reverse cover assembly on page 312](#).
- Rear reverse cover assembly. See [Rear reverse cover assembly on page 314](#).
- Upper reverse cover assembly. See [Upper reverse cover assembly on page 316](#).
- Inner upper cover assembly. See [Inner upper cover assembly on page 333](#).

 **NOTE:** This cover only needs to be moved out of the way.

- Reverse assembly. See [Reverse assembly on page 459](#).

Remove the paper pass assembly

1. Disconnect two in-line connectors (callout 1), and then release the wire harnesses from one retainer (callout 2).

Figure 1-709 Remove the paper pass assembly (1 of 7)

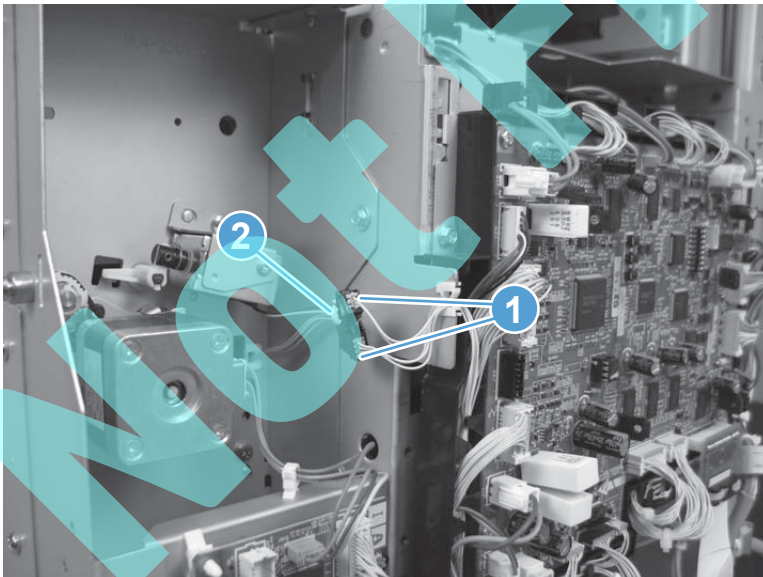

2. Release the wire harness from two retainers.

Figure 1-710 Remove the paper pass assembly (2 of 7)

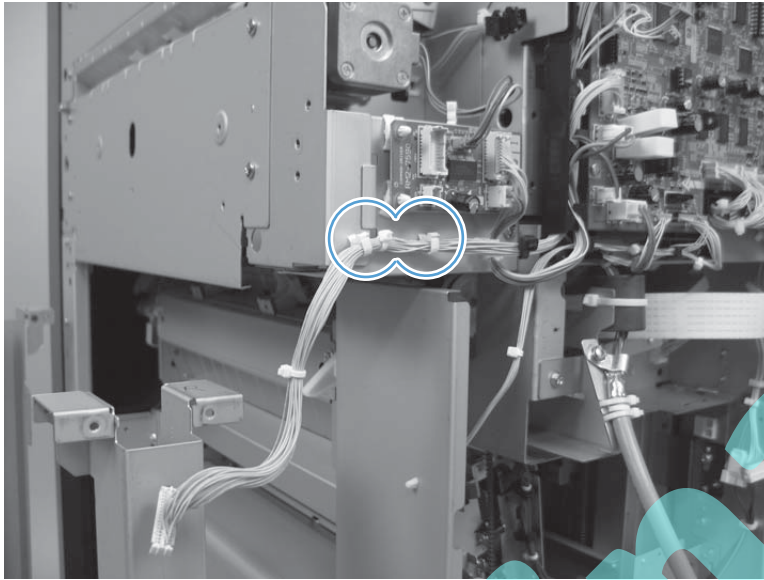

3. Disconnect two connectors (callout 1), and then release the wire harnesses from one retainer (callout 2).

Figure 1-711 Remove the paper pass assembly (3 of 7)

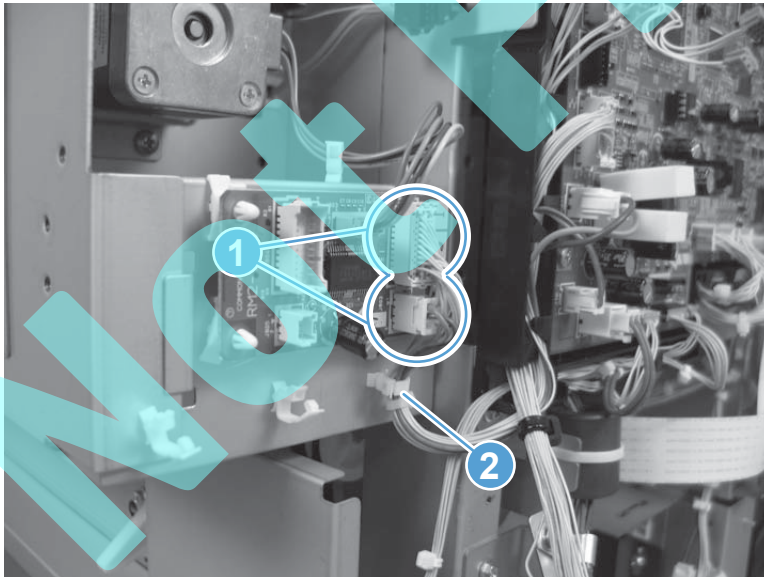

4. Remove two screws.

Figure 1-712 Remove the paper pass assembly (4 of 7)



5. Remove two screws.

Figure 1-713 Remove the paper pass assembly (5 of 7)

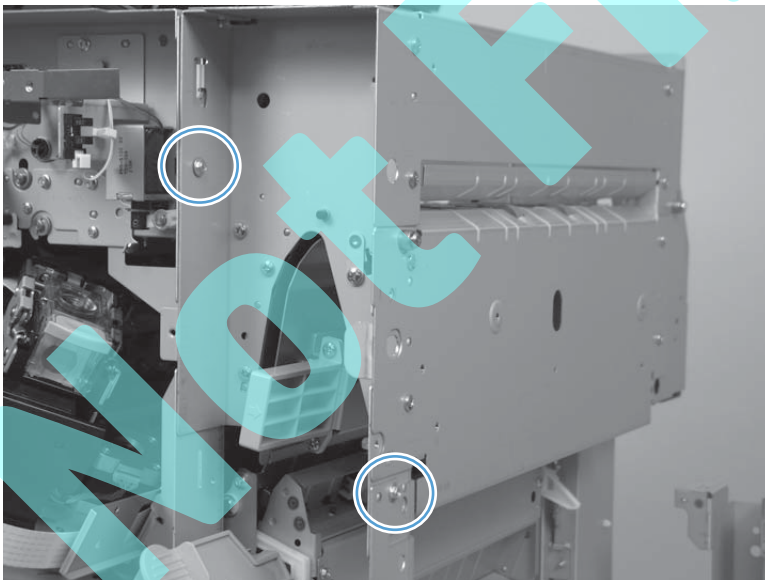

6. Remove two screws.

Figure 1-714 Remove the paper pass assembly (6 of 7)



7. Lift the assembly up to release it, and then remove the assembly.

Figure 1-715 Remove the paper pass assembly (7 of 7)

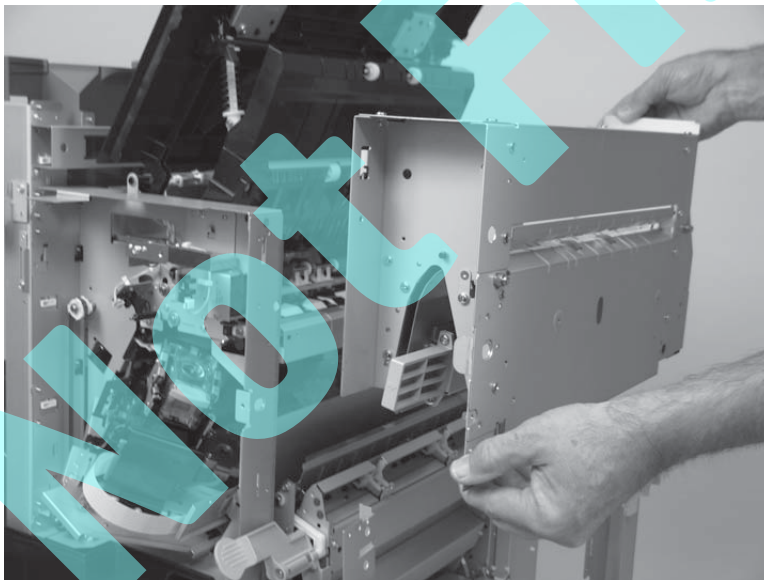

Booklet maker accessory

The assemblies described in this section are unique to the booklet-maker (BM) finishing accessory. For information about removing and replacing assemblies that are common to all of the finishing accessories, see [Shared finishing accessory assemblies on page 307](#).

- [Knob](#)
- [Saddle output bin assembly](#)
- [Right cover assembly \(BM PCA\)](#)
- [Booklet maker controller PCA](#)
- [Inner side plate assembly](#)
- [Guide sensor assembly](#)
- [Guide motor assembly](#)
- [Saddle motor assembly](#)
- [Saddle feed motor assembly](#)
- [Folding-motor mount assembly](#)
- [Delivery switch mount assembly](#)
- [Saddle stapler assembly](#)
- [Lower left guide assembly](#)
- [Saddle delivery inner cover, front assembly](#)
- [Saddle delivery inner cover, rear assembly](#)
- [Saddle guide assembly](#)
- [Saddle feed assembly](#)
- [Saddle assembly](#)
- [Upper delivery guide assembly](#)
- [Saddle paper delivery assembly](#)
- [Saddle rear end sensor assembly](#)

Knob

Remove one screw (callout 1), and then remove the green knob (callout 2).

Figure 1-716 Remove the knob

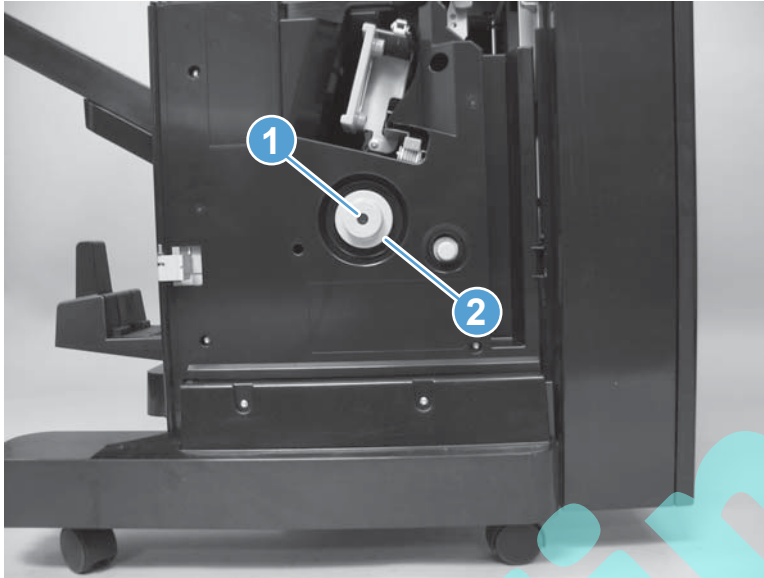

Not Final

Saddle output bin assembly

1. Carefully push in on the bin hinges to release the hinge pins, and then separate the bin from the finishing accessory.

⚠ CAUTION: The saddle output bin is still connected to the finishing accessory by a wire harness. Do not attempt to completely remove the bin.

💡 TIP: It might be easier to use a small flat blade screwdriver to push in on the bin hinges and release them.

Figure 1-717 Remove the saddle output bin assembly (1 of 2)

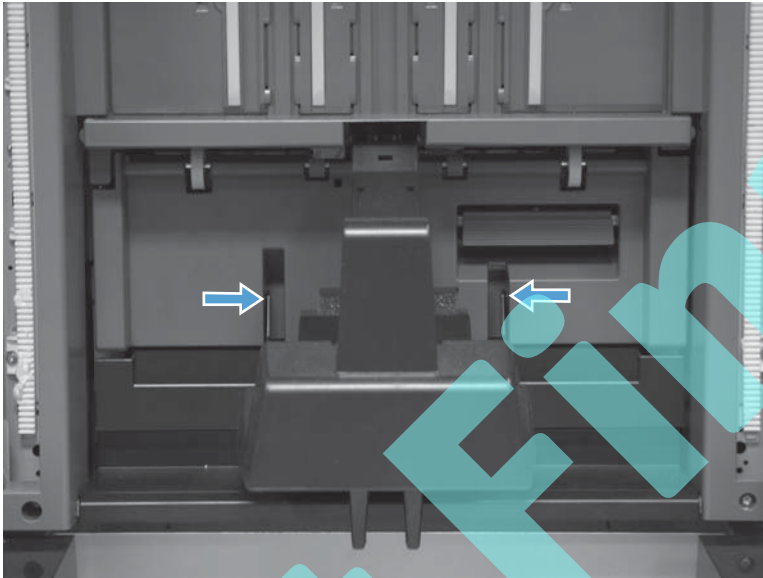

2. Disconnect one in-line connector, and then remove the bin.

💡 Reinstallation tip Make sure that this connector is reconnected before you reinstall the assembly.

Figure 1-718 Remove the saddle output bin assembly (2 of 2)



Reinstall the saddle output bin

The spring loaded arm above the saddle output bin assembly can be easily dislodged. Hold the arm out of the way when you position the assembly on the accessory. Make sure that the arm is intact when the assembly is installed.

Figure 1-719 Reinstall the saddle output bin assembly

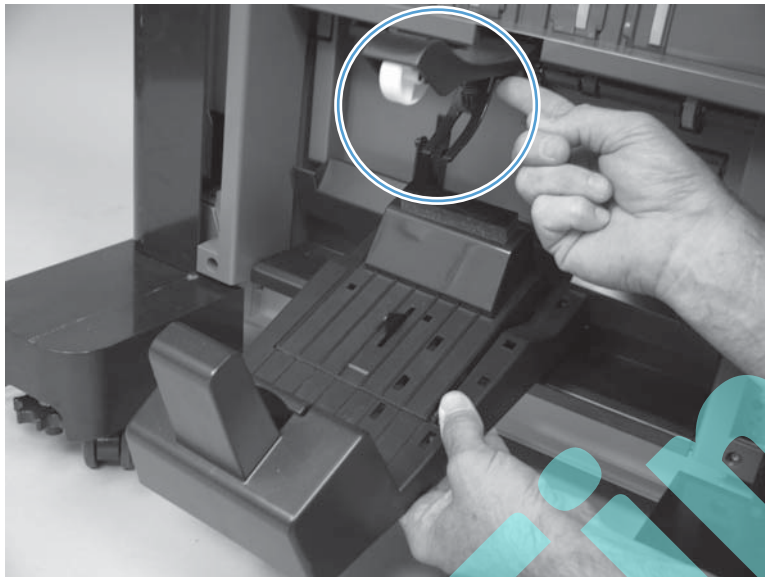

Right cover assembly (BM PCA)

Before proceeding, remove the following assemblies:

- Right cover. See [Right cover assembly on page 311](#).

Remove the right cover assembly (BM PCA)

1. Remove seven screws.

Figure 1-720 Remove the right cover assembly (BM PCA; 1 of 2)

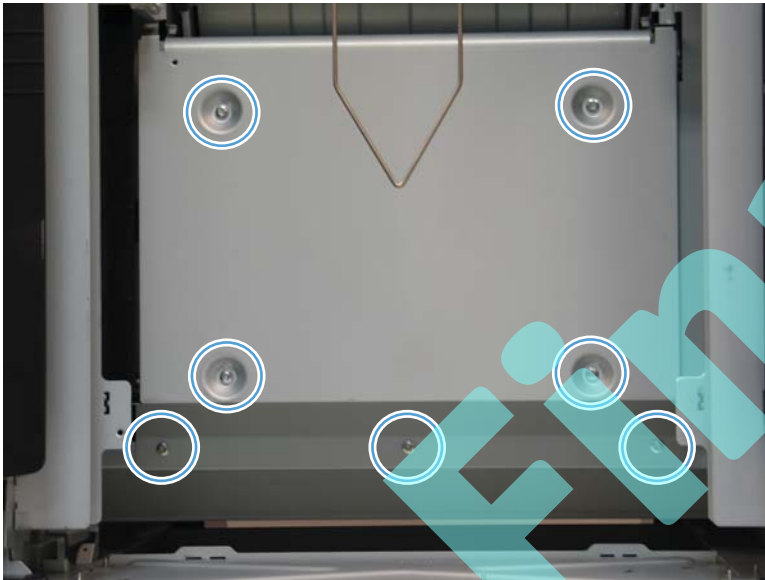

2. Remove the cover.

Figure 1-721 Remove the right cover assembly (BM PCA; 2 of 2)

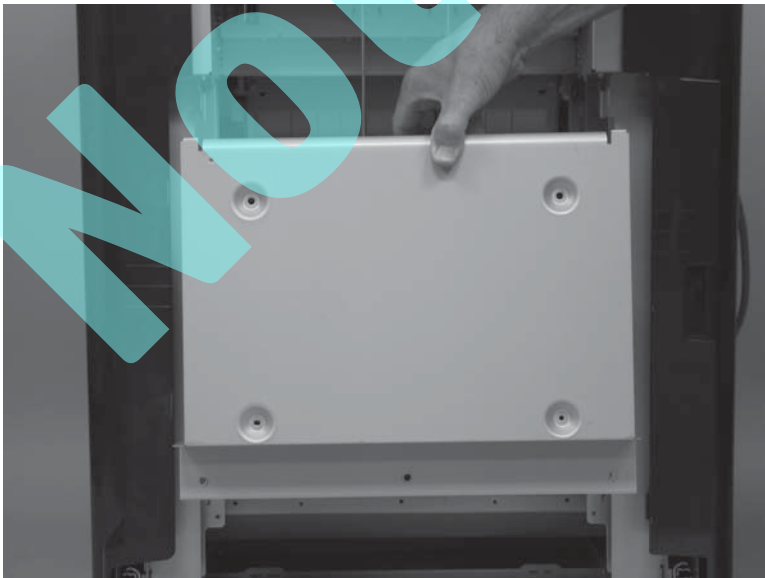

Booklet maker controller PCA

Before proceeding, remove the following assemblies:

- Right cover assembly. See [Right cover assembly on page 311](#).
- Right cover assembly (BM PCA). See [Right cover assembly \(BM PCA\) on page 470](#).

Remove the booklet maker controller PCA

CAUTION:  ESD sensitive assembly.

Remove all of the connectors, remove four screws, and then remove the PCA.

Figure 1-722 Remove the booklet maker controller PCA

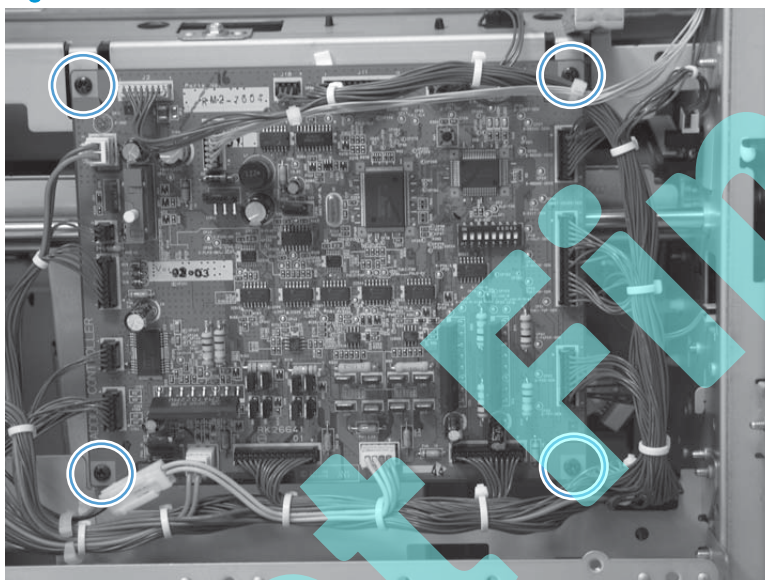

Inner side plate assembly

Before proceeding, remove the following assemblies:

- Right cover assembly. See [Right cover assembly on page 311](#).
- Right cover assembly (BM PCA). See [Right cover assembly \(BM PCA\) on page 470](#).
- Booklet maker controller PCA. See [Booklet maker controller PCA on page 471](#).

Remove the inner side plate assembly

 **TIP:** To make it easier to remove the inner side plate assembly, remove the wire paper retaining guide that hangs off of the accessory.

1. Disconnect three connectors, and then release the wire harnesses from two retainers.

Figure 1-723 Remove the inner side plate assembly (1 of 8)

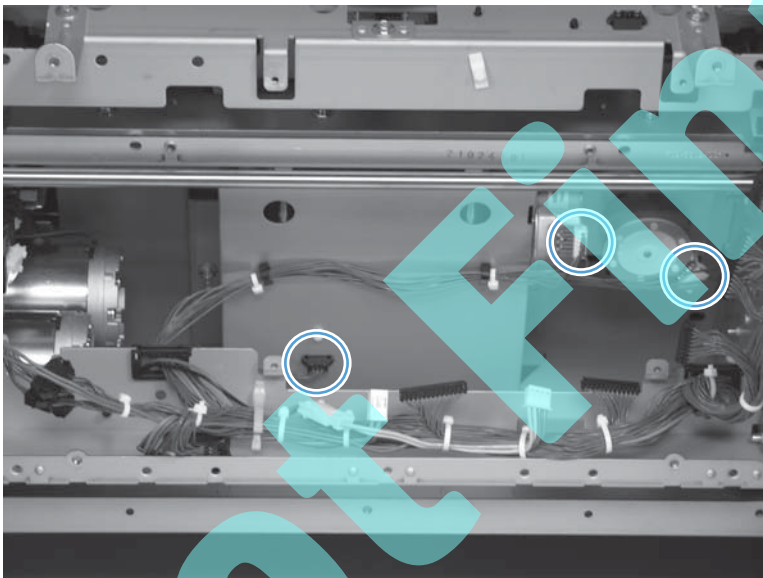

2. Remove two screws.

Figure 1-724 Remove the inner side plate assembly (2 of 8)

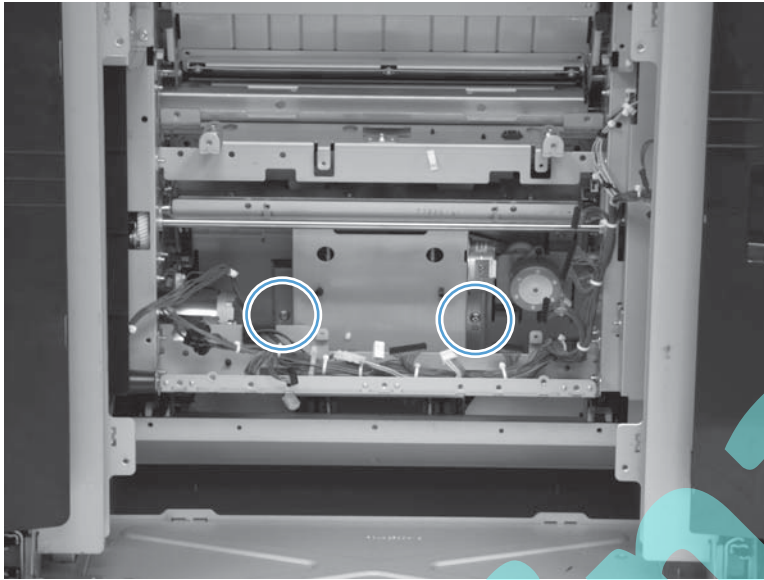

3. At the drive gear side of the accessory remove, two screws.

 **TIP:** Removing these screws loosens the tray under the assembly. When the tray is loose, it can be slightly moved out of the way which makes removing the inner side plate assembly easier.

Figure 1-725 Remove the inner side plate assembly (3 of 8)



4. Disconnect one connector (callout 1), and move the wire harness (callout 2) out of the way.

⚠ CAUTION: When you remove the assembly, do not allow the right end of the shaft on the assembly damage the sensor (callout 2).

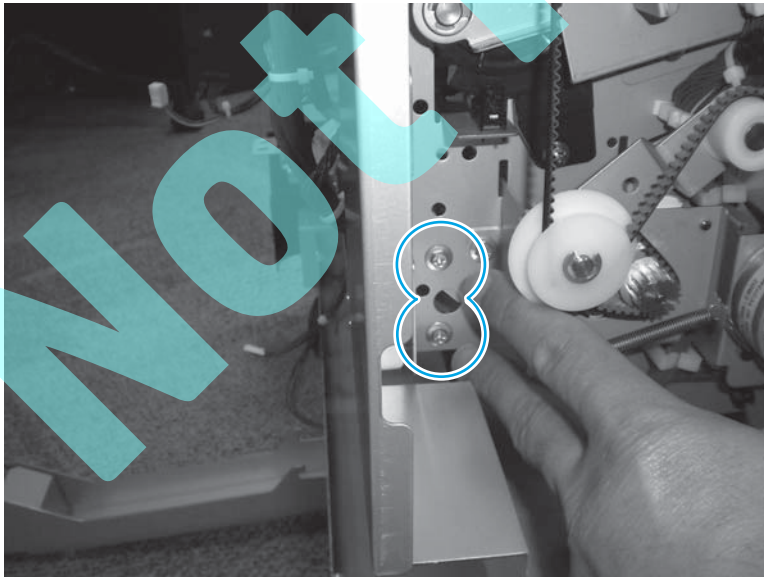
💡 Reinstallation tip Make sure that you reconnect the sensor connector (callout 1) when the assembly is reinstalled.

Figure 1-726 Remove the inner side plate assembly (4 of 8)

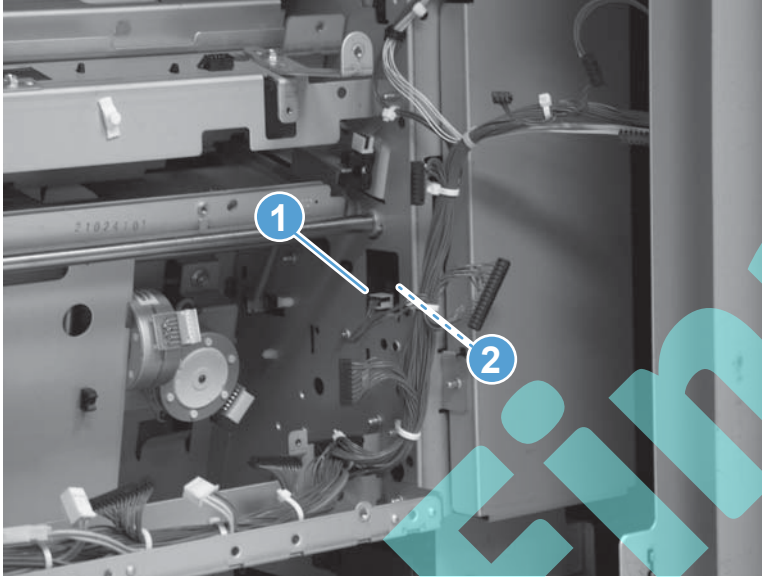

5. Slide the left end of the assembly shaft forward in the mounting hole provided in the chassis.

Figure 1-727 Remove the inner side plate assembly (5 of 8)

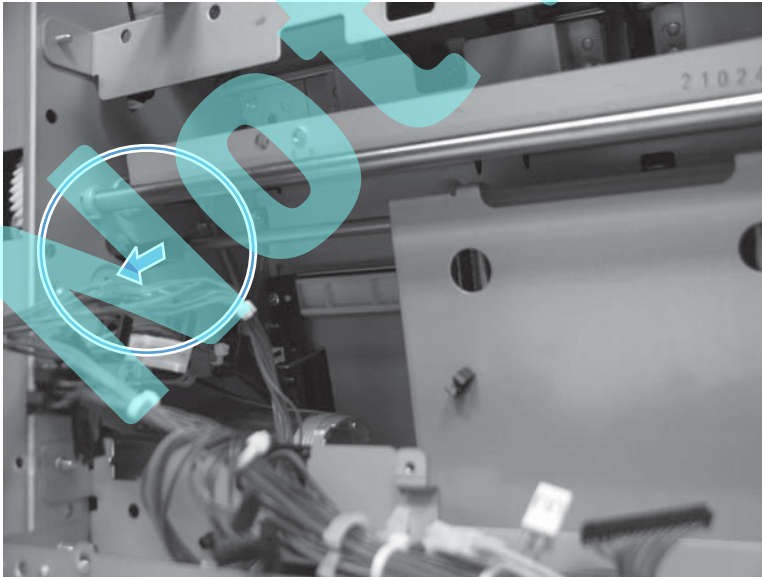

6. Slightly slide the assembly toward the left, and then rotate the right side of the shaft out of the hole in the chassis.

Figure 1-728 Remove the inner side plate assembly (6 of 8)

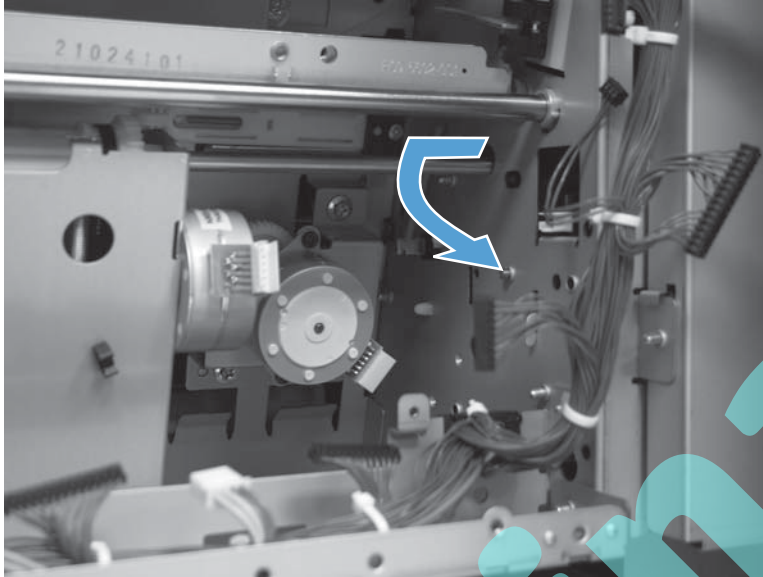

7. Continue to move the assembly toward the left until the right side of the shaft is past the chassis.

CAUTION: Do not damage the sensor (callout 1) with the end of the shaft (callout 2) when the shaft is rotated out of the chassis.

TIP: The assembly might feel stuck as you remove it. Continue to move the assembly left, and rotate the right end of the shaft out of the chassis. It might take some time to get the shaft out of the chassis.

Figure 1-729 Remove the inner side plate assembly (7 of 8)

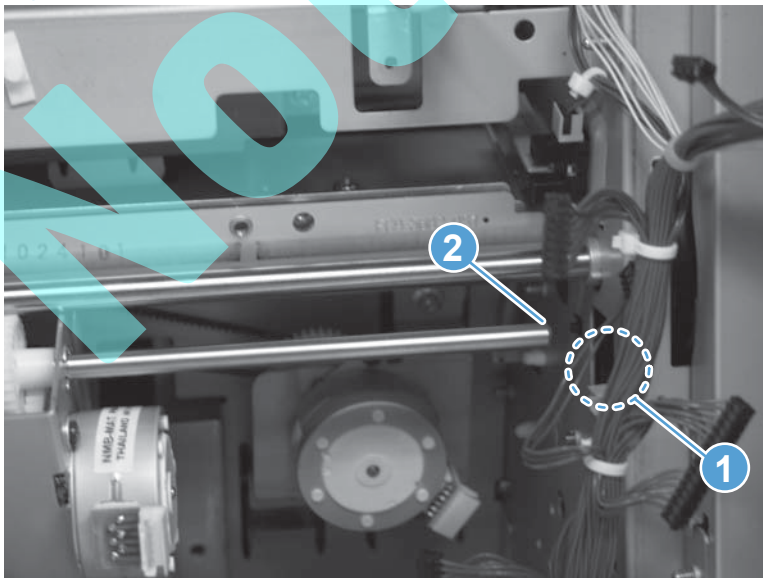

- Carefully remove the assembly.

Figure 1-730 Remove the inner side plate assembly (8 of 8)

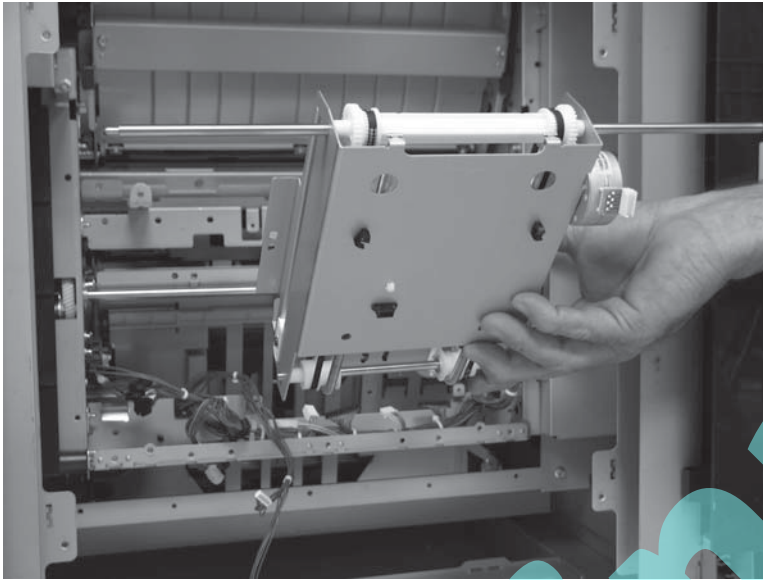

Before reinstalling the inner side plate assembly

To avoid damage to the assembly sensors, and to make reinstallation of the assembly easier, move the inner plate on the assembly to the middle of the inner plate assembly. After positioning the inner plate assembly, go to [Reinstall the inner side plate assembly on page 477](#).

Figure 1-731 Inner plate assembly at the up position

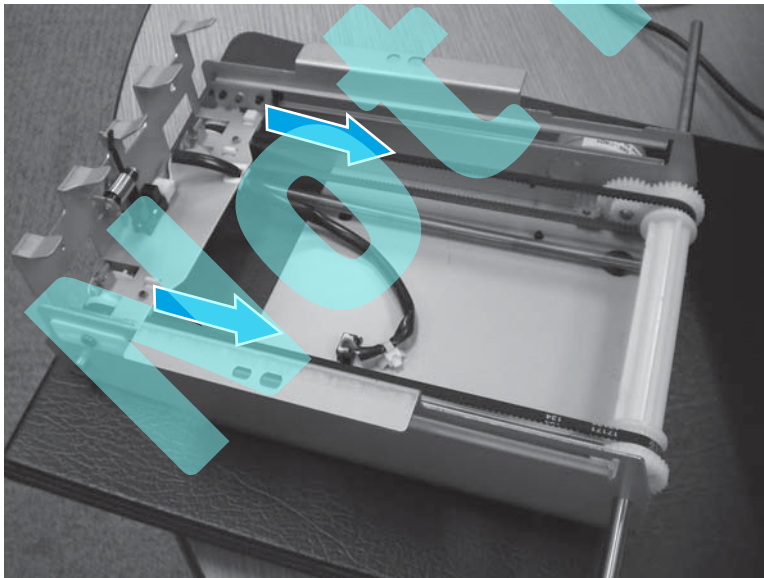
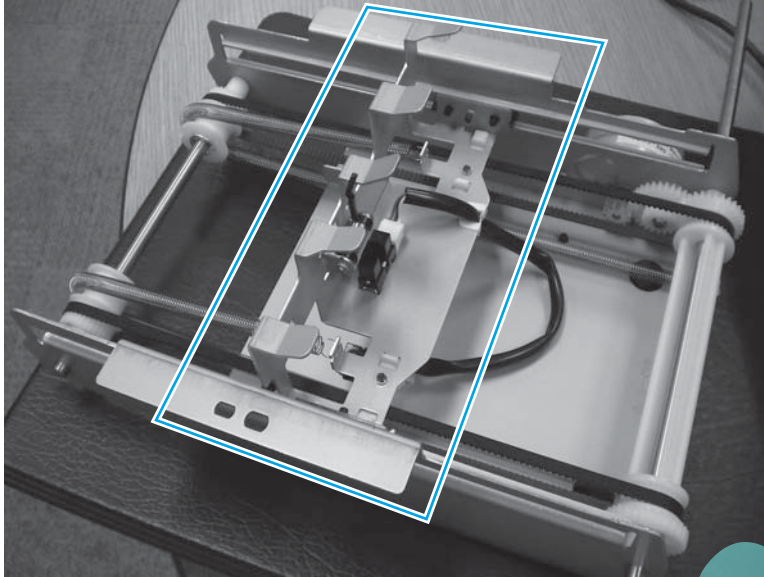

Figure 1-732 Inner plate assembly at the middle position



Reinstall the inner side plate assembly

1. Position the assembly in the chassis by aligning the sheet-metal fingers of the inner plate assembly (callout 1) with the slots (callout 2) in the saddle assembly.

Figure 1-733 Reinstall the inner side plate assembly (1 of 3)

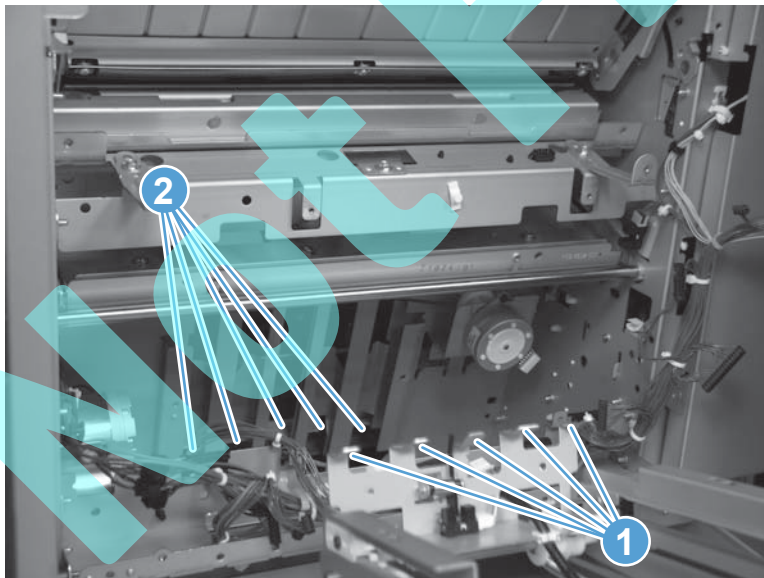

2. Slide the left end of the assembly shaft into the hole in the chassis.

Figure 1-734 Reinstall the inner side plate assembly (2 of 3)

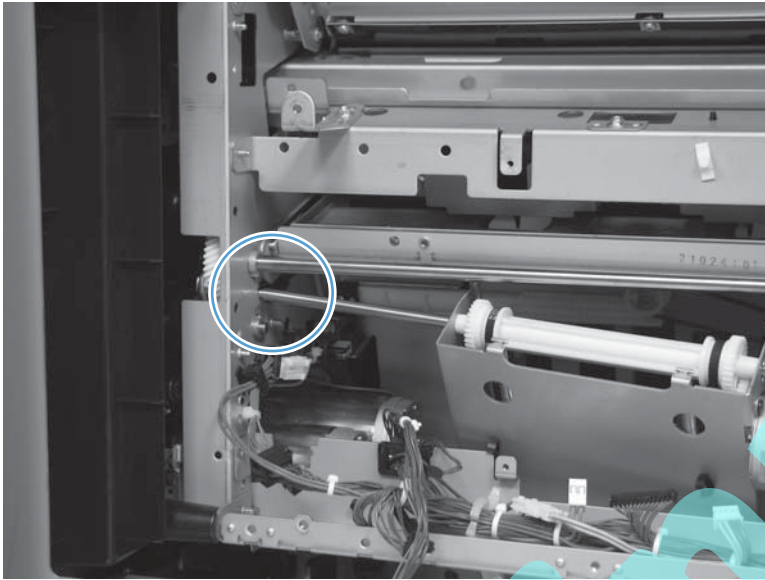

3. Push down on the assembly (callout 1) while rotating (callout 2) the right end of the shaft into the chassis.

CAUTION: Do not damage the sensor (callout 3) with the end of the shaft (callout 4) when the shaft is rotated into the chassis.

TIP: The assembly might feel stuck as you install it. Continue to move the assembly left, and rotate the right end of the shaft into the chassis. It might take some time to get the shaft into the chassis.

Figure 1-735 Reinstall the inner side plate assembly (3 of 3)

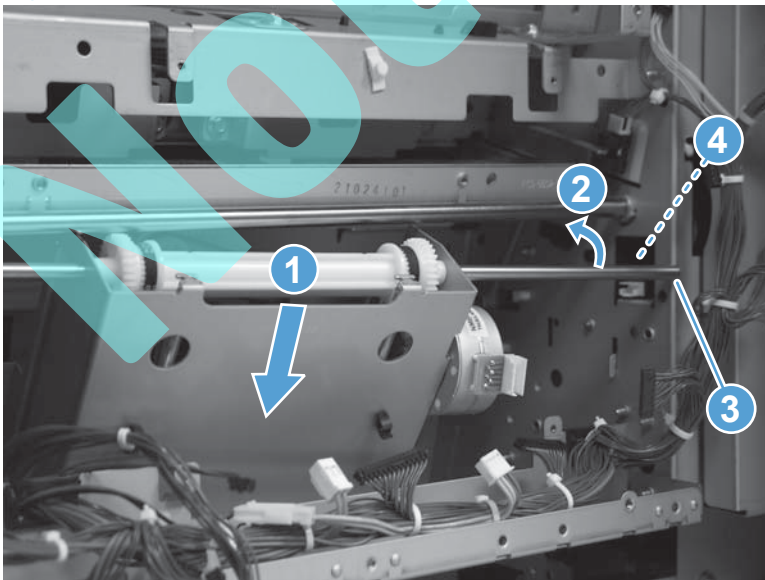

Guide sensor assembly

Before proceeding, remove the following assemblies:

- Bin cable guide cover. See [Bin cable guide cover on page 317](#).
- Rear cover assembly. See [Remove only the rear cover on page 351](#).

Remove the guide sensor assembly

 **NOTE:** This assembly is the folding roller home position sensor.

1. Disconnect one connector.

Figure 1-736 Remove the guide sensor assembly (1 of 4)

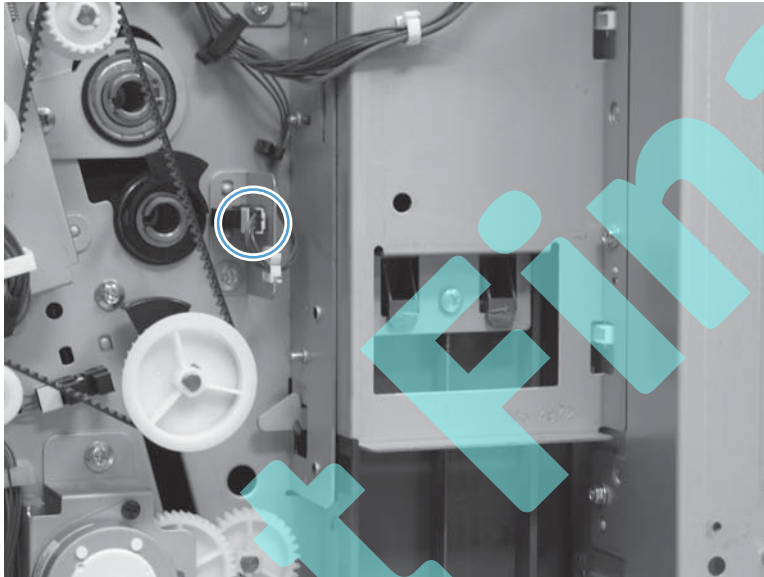

2. Release two tabs on the retainer, and then remove the retainer from the sheet-metal bracket.

Figure 1-737 Remove the guide sensor assembly (2 of 4)

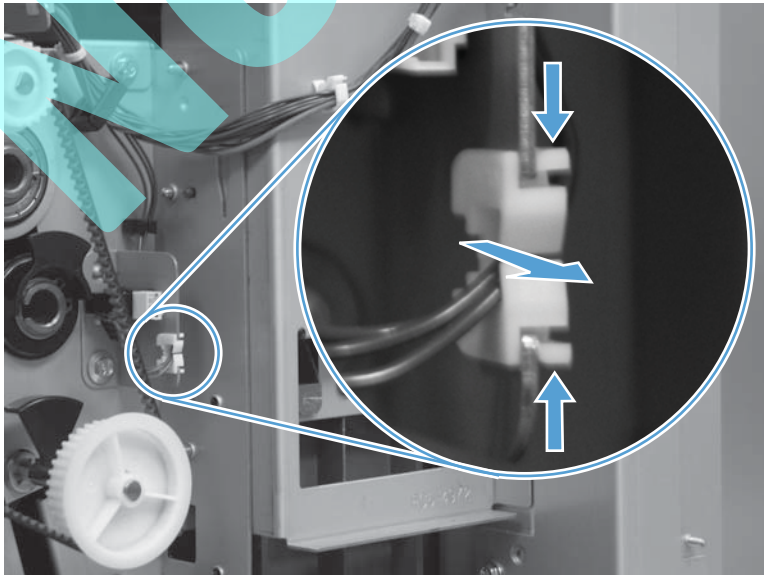

3. Remove one screw.

Figure 1-738 Remove the guide sensor assembly (3 of 4)

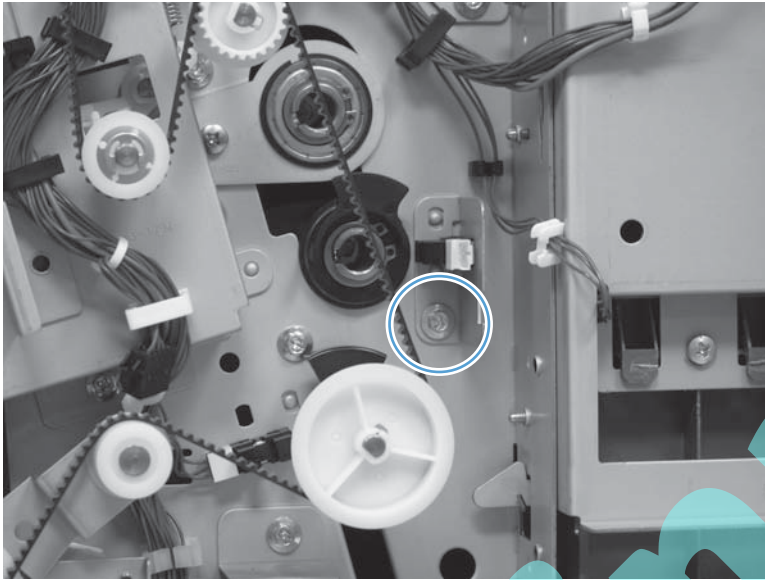

4. Remove the assembly.

Figure 1-739 Remove the guide sensor assembly (4 of 4)



Guide motor assembly

Before proceeding, remove the following assemblies:

- Bin cable guide cover. See [Bin cable guide cover on page 317](#).
- Rear cover assembly. See [Remove only the rear cover on page 351](#).

Remove the guide motor assembly

1. Disconnect one connector (callout 1), and then release the wire harness from one retainer (callout 2).

Figure 1-740 Remove the guide motor assembly (1 of 3)

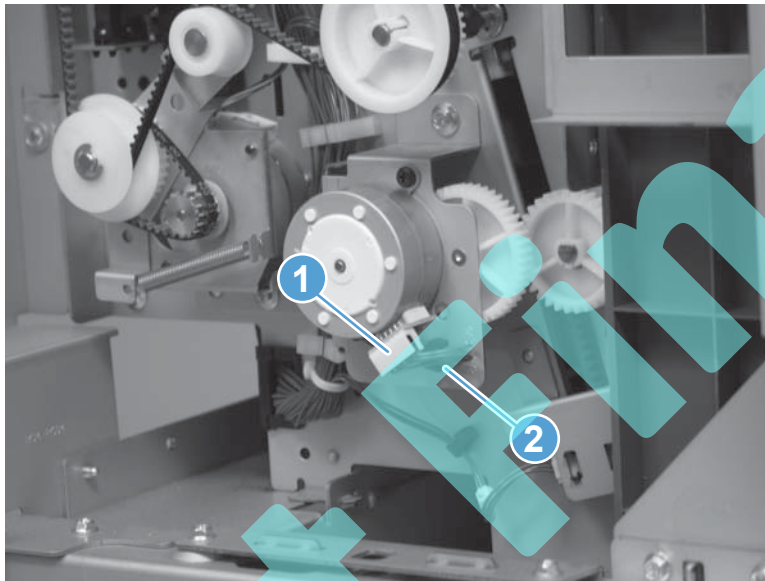

2. Remove two screws.

 **TIP:** One screw is hidden behind the wire harnesses along the left side of the sheet-metal mounting bracket. Use a small flat blade screwdriver to hold the wire harnesses out of the way to access this screw.

Figure 1-741 Remove the guide motor assembly (2 of 3)



3. Remove the assembly.

Figure 1-742 Remove the guide motor assembly (3 of 3)

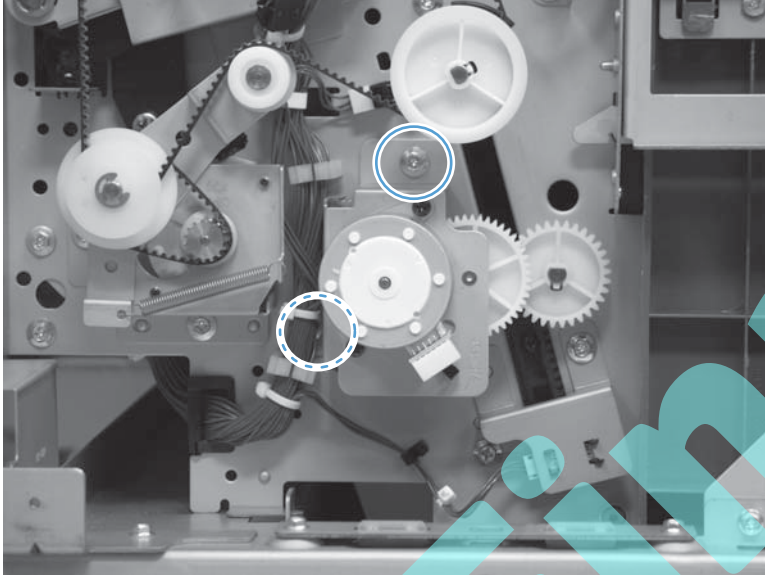
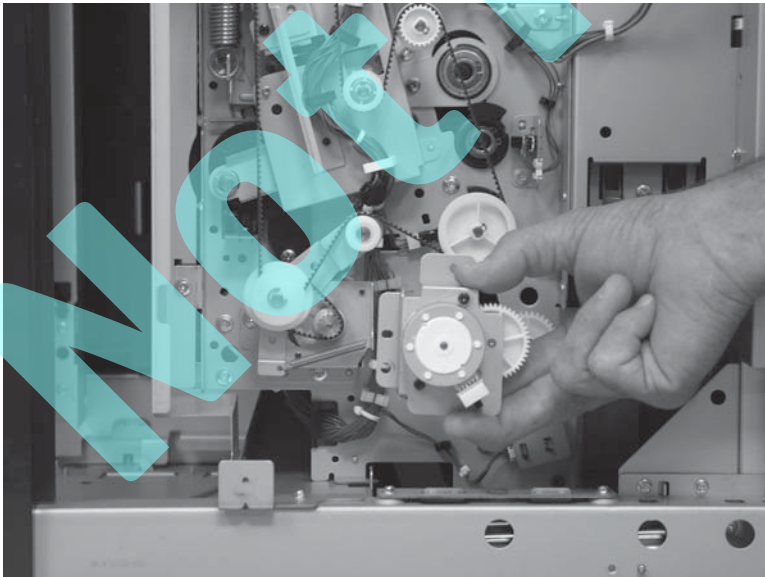

Saddle motor assembly

Before proceeding, remove the following assemblies:

- Bin cable guide cover. See [Bin cable guide cover on page 317](#).
- Rear cover assembly. See [Remove only the rear cover on page 351](#).

Remove the saddle motor assembly (SS and BM)

1. Disconnect one connector.

Figure 1-743 Remove the saddle motor assembly (1 of 3)

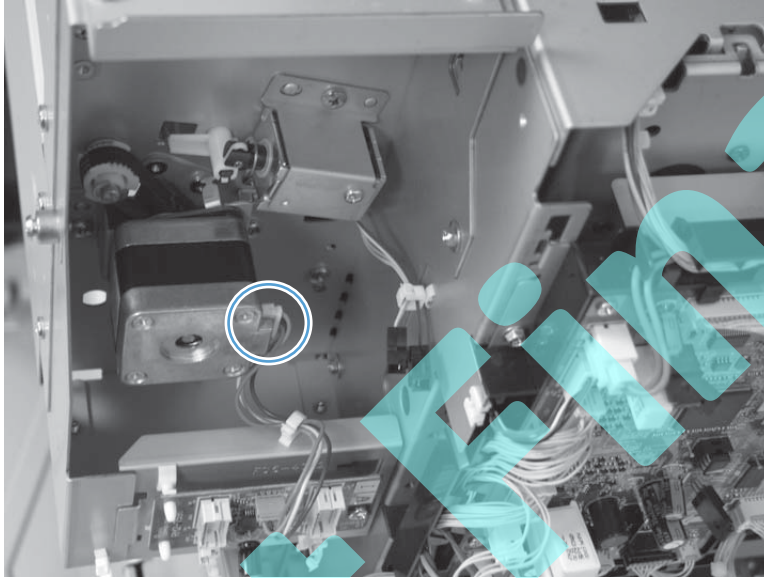

2. Remove three screws.

Figure 1-744 Remove the saddle motor assembly (2 of 3)

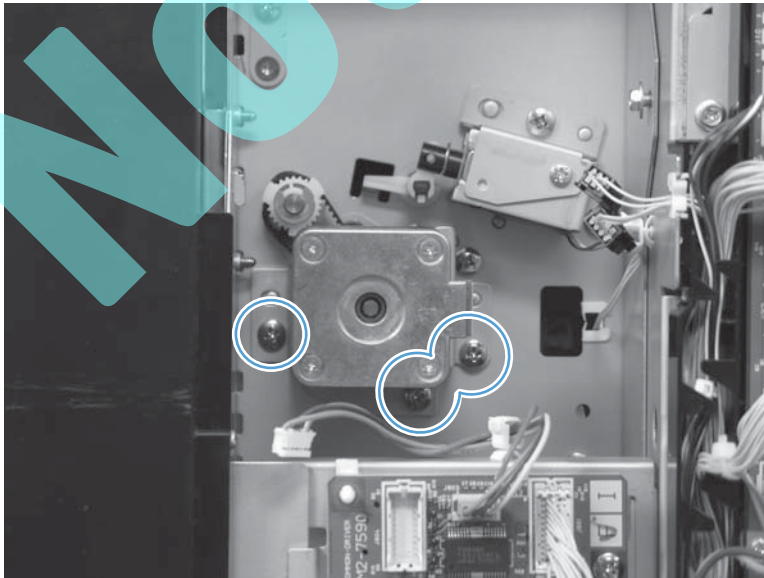

3. Remove the motor.

⚠ CAUTION: The drive belt behind the motor is not captive. Do not lose the belt when the motor is removed.

Figure 1-745 Remove the saddle motor assembly (3 of 3)

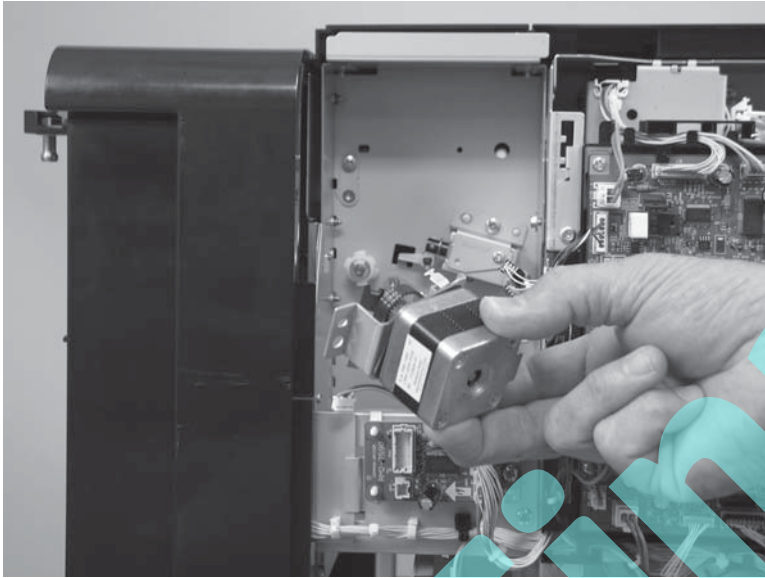

Saddle feed motor assembly

Before proceeding, remove the following assemblies:

- Bin cable guide cover. See [Bin cable guide cover on page 317](#).
- Rear cover assembly. See [Remove only the rear cover on page 351](#).

Remove the saddle feed assembly

1. Before beginning, take note of how the drive belt is routed over the gears and belt-tension arm. The belt will not be tensioned correctly if the belt is not routed properly when the assembly is reinstalled.

Figure 1-746 Remove the saddle feed motor assembly (1 of 6)

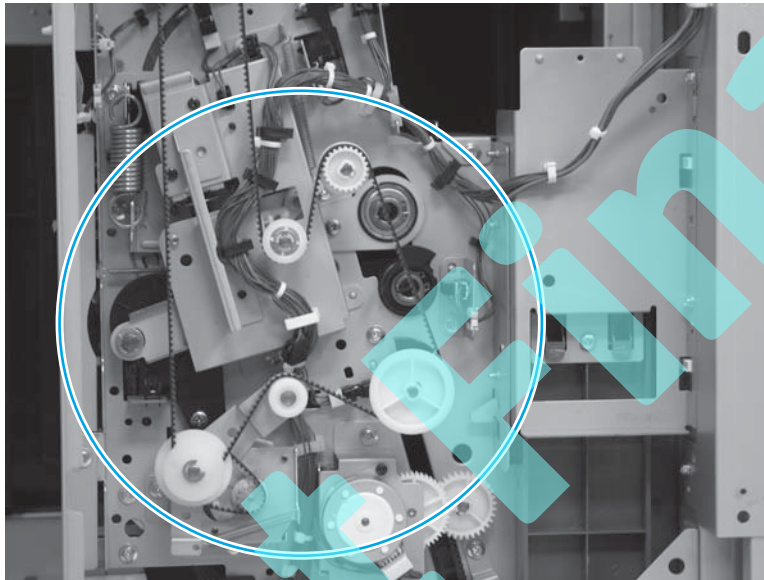

2. Push down on the belt tension arm (callout 1), and then remove the timing belt from the motor drive gear.



 **IMPORTANT:** Take note of how the belt is routed over the gears and belt-tension arm before you disengage the belt.

Figure 1-747 Remove the saddle feed motor assembly (2 of 6)

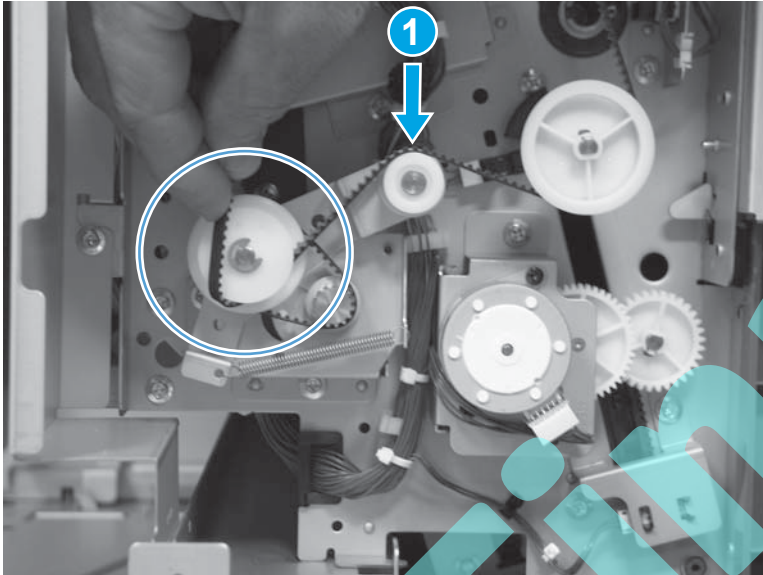

3. Remove one plastic wire cable tie.

 **CAUTION:** Do not damage the wire harnesses when this cable tie is removed.

Do not attempt to remove the connector at the motor end of the wire harness. This wire harness is soldered to the motor and cannot be removed.

Figure 1-748 Remove the saddle feed motor assembly (3 of 6)

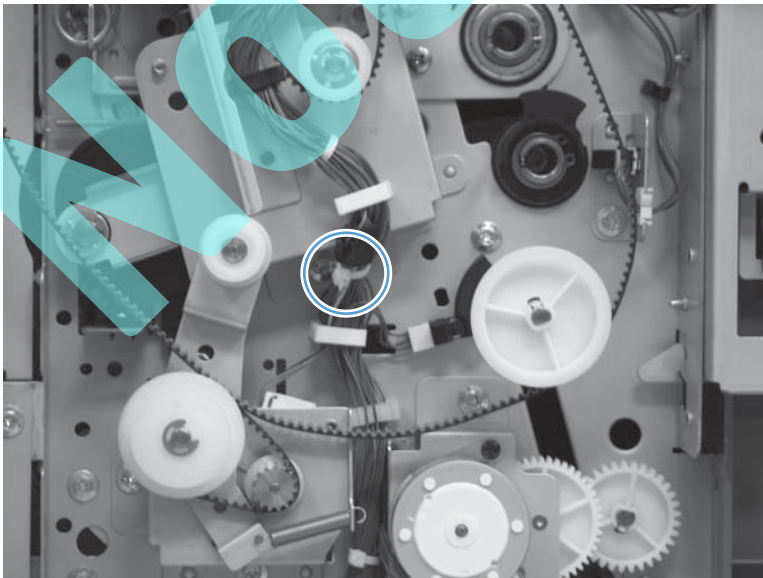

4. Disconnect one inline connector (callout 1), and then release the wire harness from one retainer (callout 2).

Figure 1-749 Remove the saddle feed motor assembly (4 of 6)

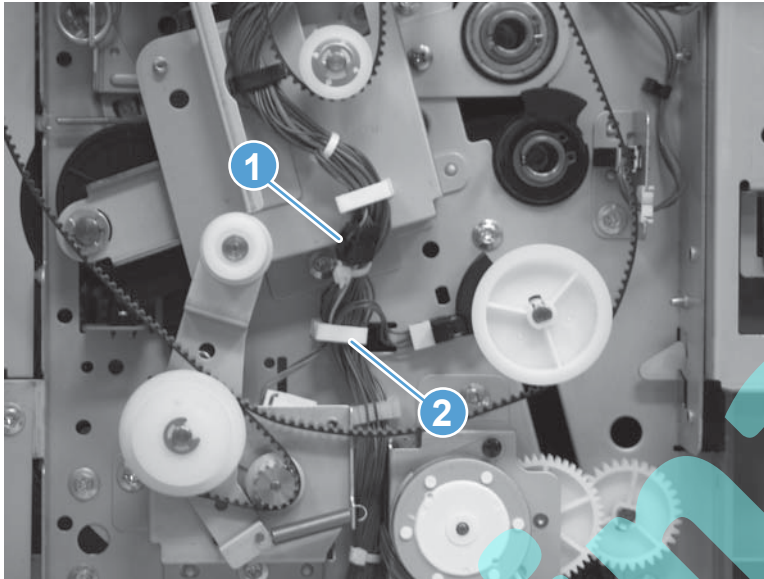

5. Remove two screws.

Figure 1-750 Remove the saddle feed motor assembly (5 of 6)

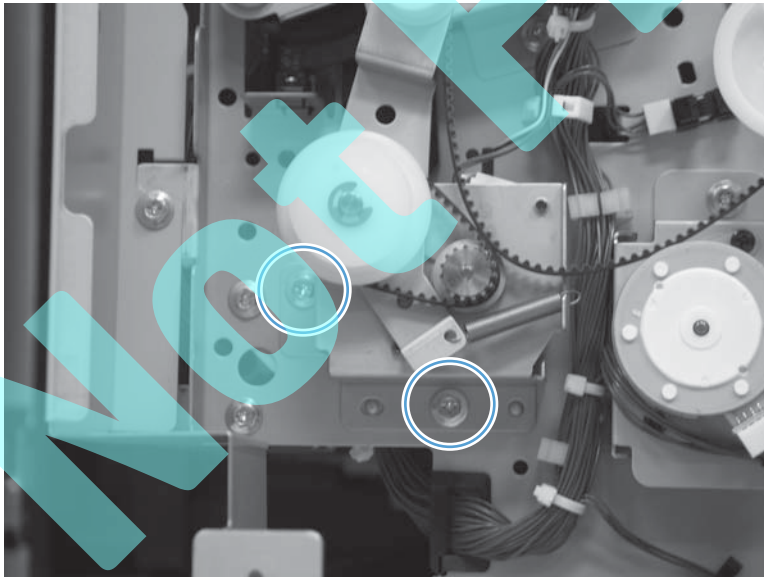

6. Remove the assembly.

Figure 1-751 Remove the saddle feed motor assembly (6 of 6)

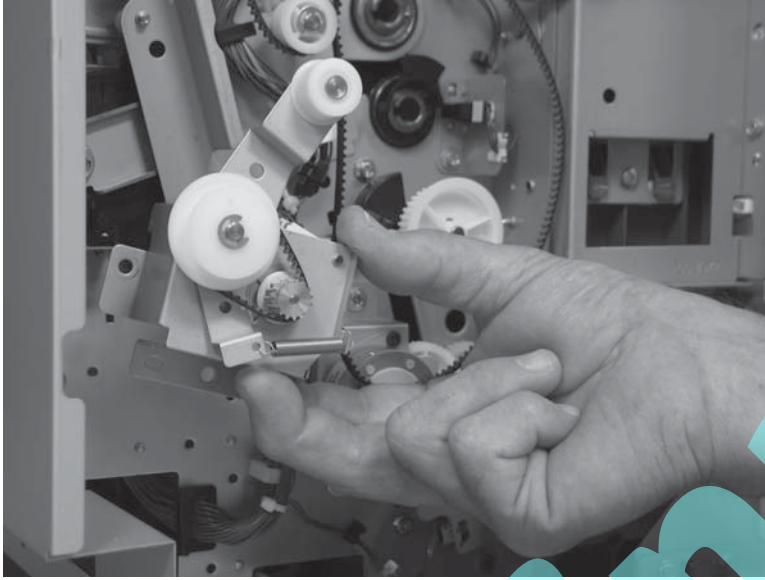

Not Final

Folding-motor mount assembly

Before proceeding, remove the following assemblies:

- Right cover assembly. See [Right cover assembly on page 311](#).
- Pre-reverse cover assembly. See [Pre-reverse cover assembly on page 312](#).
- Inner upper cover assembly. See [Inner upper cover assembly on page 333](#).

 **NOTE:** This cover only needs to be moved out of the way.

- Inner lower cover assembly. See [Inner lower cover assembly \(remove\) on page 341](#).

 **NOTE:** This cover only needs to be moved out of the way.

- Right cover assembly (BM PCA). See [Right cover assembly \(BM PCA\) on page 470](#).

Remove the motor mount assembly

1. Disconnect one connector (callout 1), release two tabs on one retainer (callout 2), remove the retainer from the sheet-metal bracket, and then release the wire harness from one retainer (callout 3).

Figure 1-752 Remove the folding-motor mount assembly (1 of 6)

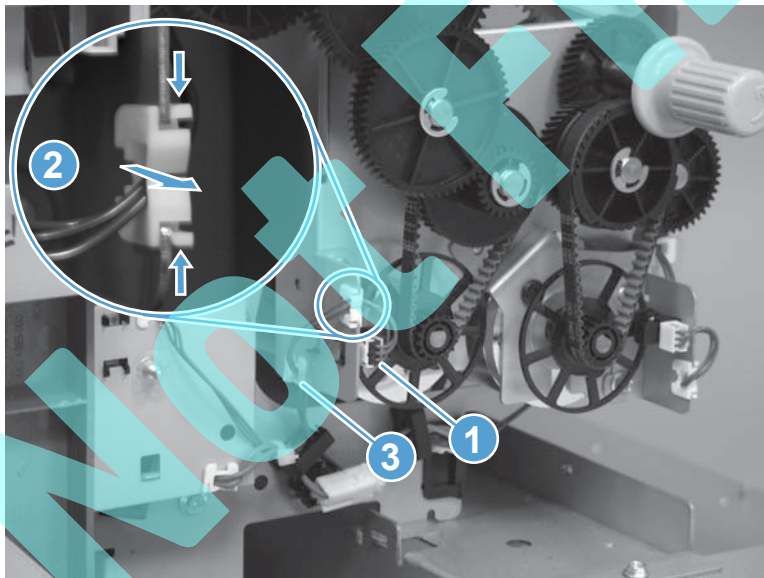

2. Disconnect one connector (callout 1), release two tabs (one each side) of three retainers (callout 2), and then remove the retainers from the sheet-metal bracket.

Figure 1-753 Remove the folding-motor mount assembly (2 of 6)

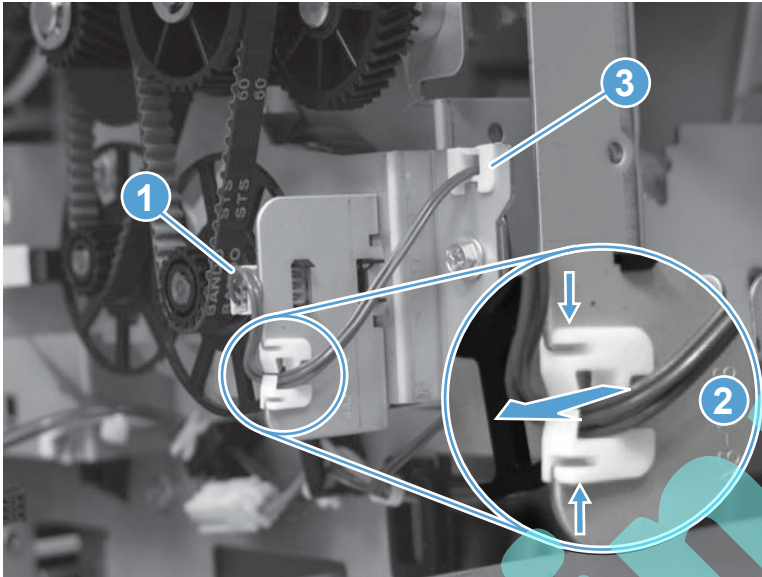

3. Disconnect one inline connector (callout 1), and then release the wire harness from two retainers (callout 2).

 **TIP:** One of the retainers is on the back side of the sheet-metal support bracket. Use a long-barrel flat blade screw driver to release a tab on the retainer to open it

When the assembly is reinstalled, you might have to disconnect connectors on the controller PCA, or release wire harnesses from other retainers in order to gain enough slack in the wire harnesses to close the retainer latch.

Figure 1-754 Remove the folding-motor mount assembly (3 of 6)

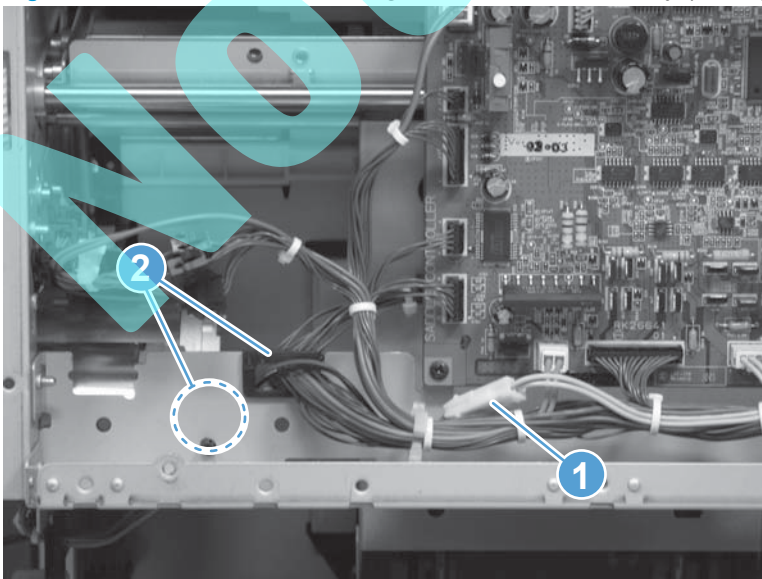

4. Disconnect one inline connector (callout 1), and then release the wire harness from one retainer (callout 2).

Figure 1-755 Remove the folding-motor mount assembly (4 of 6)



5. Remove three screws.

Figure 1-756 Remove the folding-motor mount assembly (5 of 6)

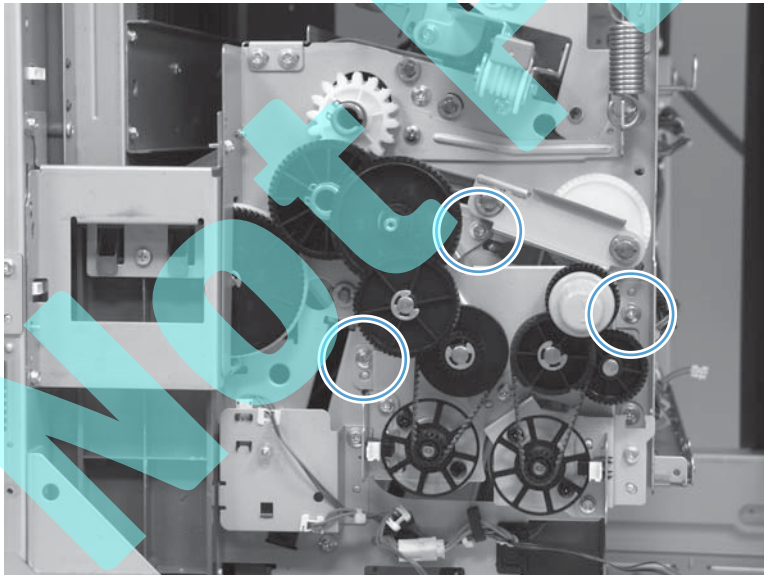

6. Remove the assembly.

⚠ CAUTION: There are two keyed bushings on the gear shafts that fit into holes on the chassis (see [Reinstall the folding-motor mount assembly on page 493](#)). The bushings are not captive. Do not lose them when the assembly is removed.

Figure 1-757 Remove the folding-motor mount assembly (6 of 6)

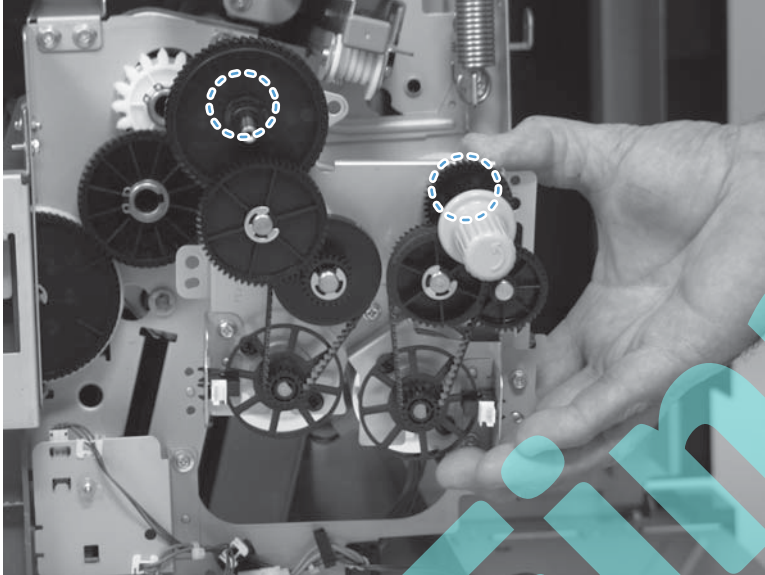

Reinstall the folding-motor mount assembly

Make sure that the two brass bushings (callout 1) are installed on the gear shafts, and that the keyed portion of the bushings are aligned with the associated large slots in the chassis mounting holes (callout 2). The sheet-metal mounting bracket must be tight up against the chassis before you install the mounting screws.

Figure 1-758 Reinstall the folding-motor mount assembly

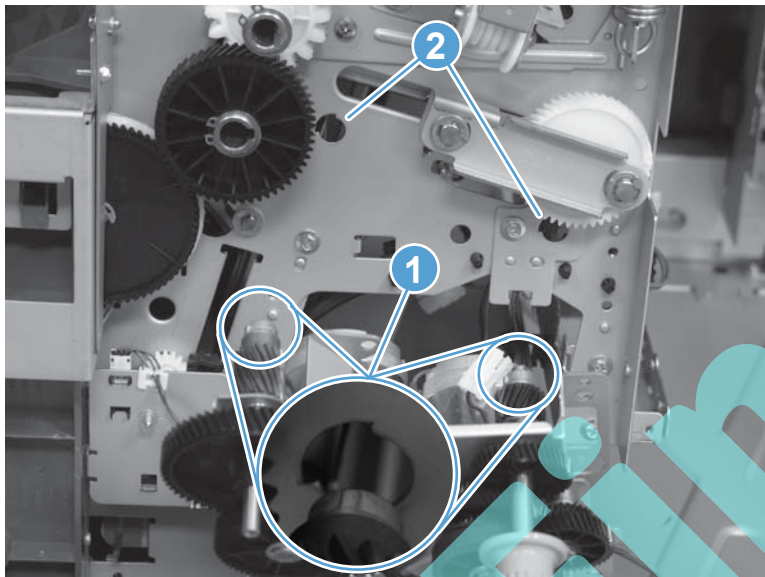

Delivery switch mount assembly

Before proceeding, remove the following assemblies:

- Right cover assembly. See [Right cover assembly on page 311](#).
- Inner upper cover assembly. See [Inner upper cover assembly on page 333](#).

 **NOTE:** This cover only needs to be moved out of the way.

- Inner lower cover assembly. See [Inner lower cover assembly \(remove\) on page 341](#).

 **NOTE:** This cover only needs to be moved out of the way.

Remove the delivery switch mount assembly

1. Open the lower booklet jam access door.

Figure 1-759 Remove the delivery switch mount assembly (1 of 4)

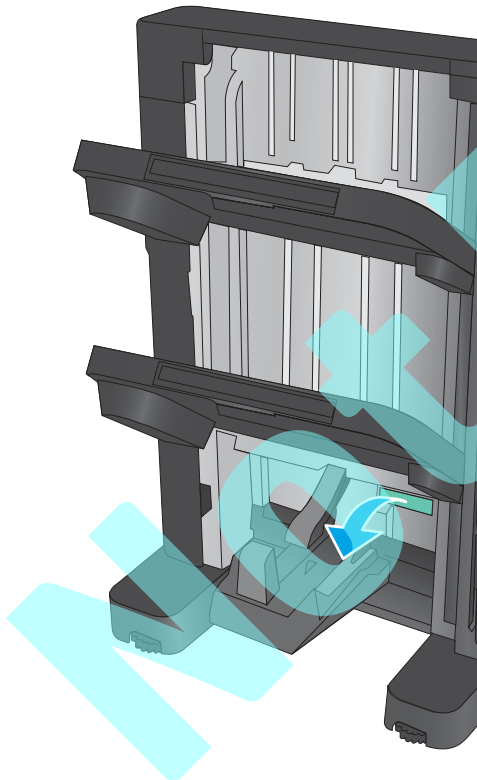

2. Release the wire harnesses from two retainers (callout 1), and then disconnect two inline connectors (callout 2).

 **TIP:** Releasing the wire harnesses from the retainers first, makes it easier to disconnect the connectors.

Figure 1-760 Remove the delivery switch mount assembly (2 of 4)



3. Remove one screw.

Figure 1-761 Remove the delivery switch mount assembly (3 of 4)

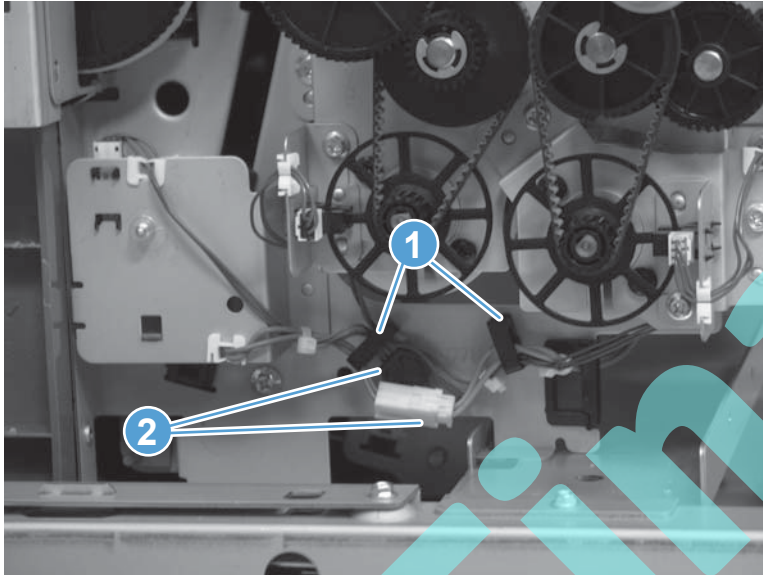
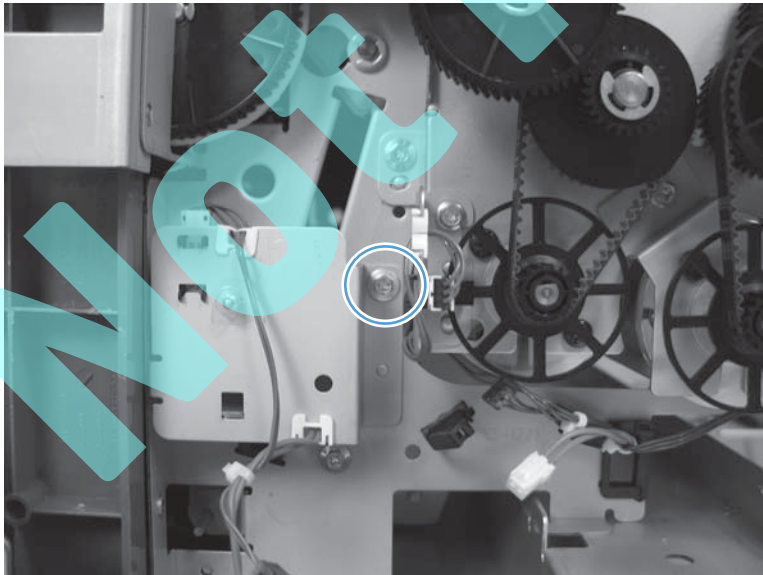

4. Remove the assembly.

Figure 1-762 Remove the delivery switch mount assembly (4 of 4)

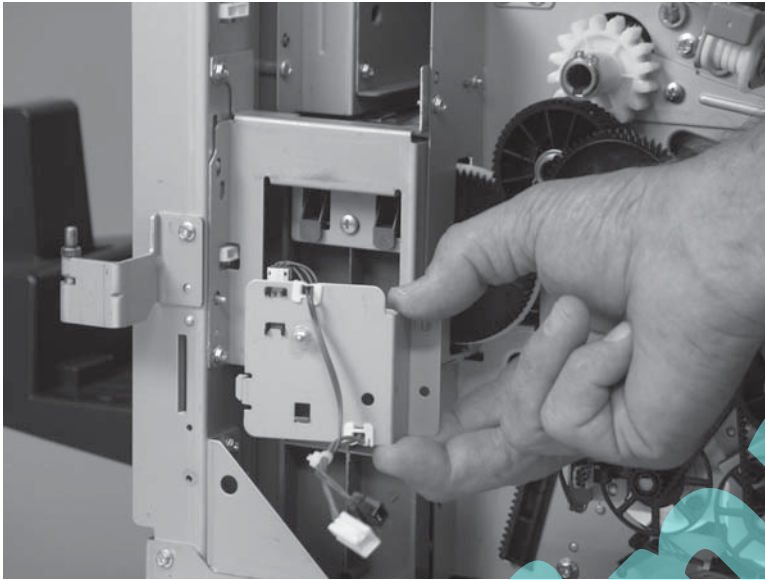

Saddle stapler assembly

Before proceeding, do the following:

- Move the inner upper cover out of the way. See [Inner upper cover assembly on page 333](#).
- Move the inner lower cover out of the way. See [Inner lower cover assembly \(remove\) on page 341](#).

Remove the saddle stapler assembly

1. Remove one e-ring.

Figure 1-763 Remove the saddle stapler assembly (1 of 3)

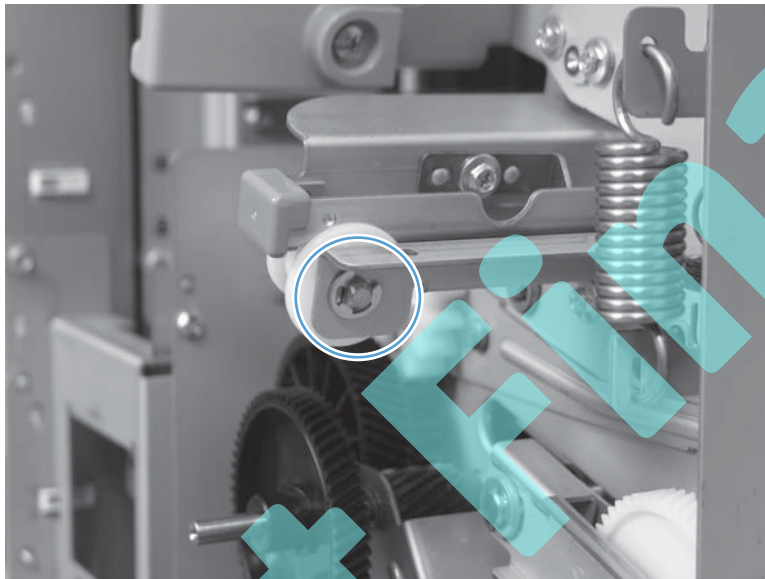

2. Remove one shaft (callout 1), and then remove the white plastic wheel (callout 2).

 **Reinstallation tip** The wheel is asymmetric. The small diameter end of the wheel should face towards the saddle stapler assembly when it is reinstalled.

Figure 1-764 Remove the saddle stapler assembly (2 of 3)



3. Pull the assembly straight out of the saddle assembly to remove it.

 **Reinstallation tip** If you are installing a replacement assembly, remove the staple cartridges from the discarded saddle stapler assembly, and then install them in the replacement assembly.

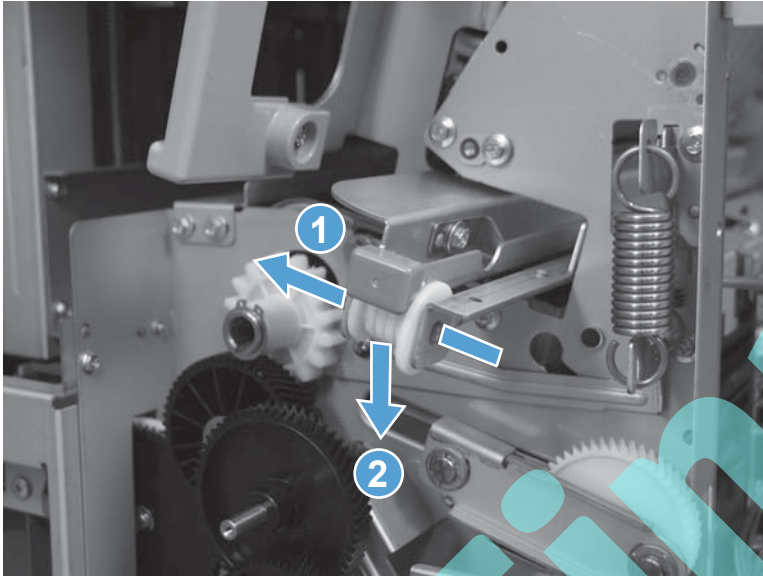
Figure 1-765 Remove the saddle stapler assembly (3 of 3)



Lower left guide assembly

Before proceeding, remove the following assemblies:

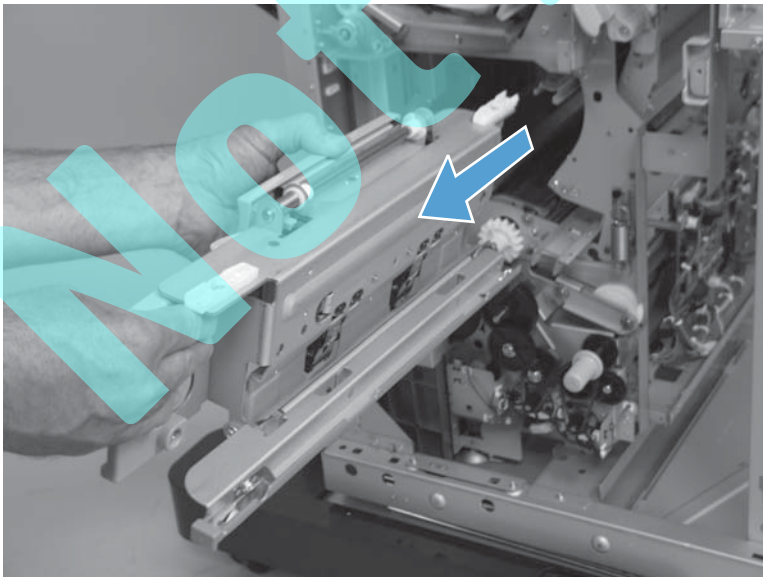
- **Booklet maker accessory only:** Saddle output bin assembly. See [Saddle output bin assembly on page 468](#).

Remove the lower left guide assembly

1. Remove one screw.

Figure 1-766 Remove the lower left guide assembly (1 of 3)

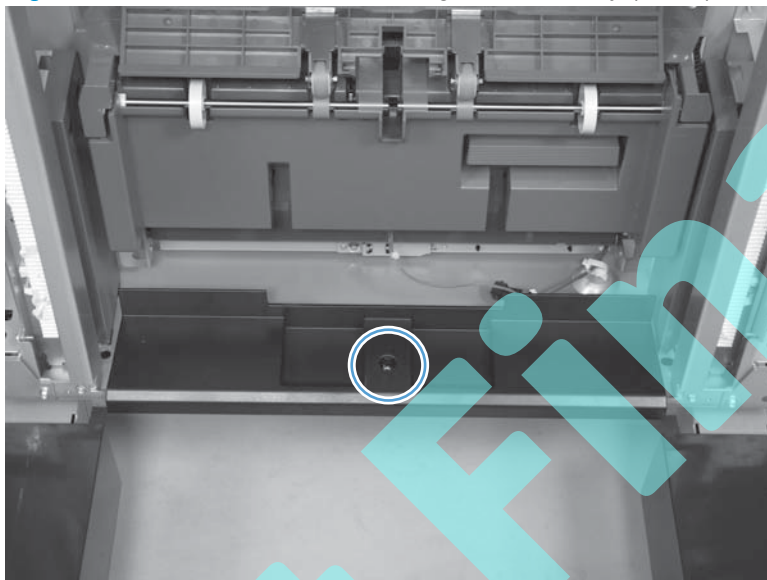

2. Release two tabs, and then remove the cover.

Figure 1-767 Remove the lower left guide assembly (2 of 3)

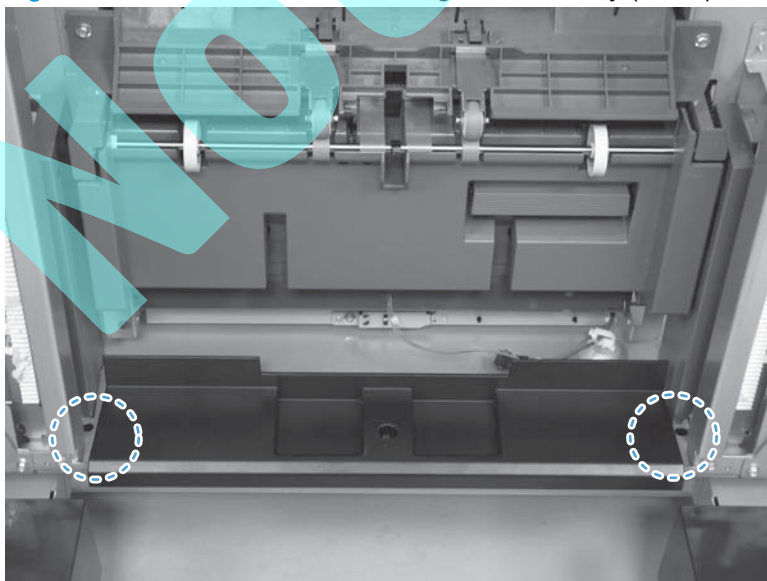

3. Remove the cover.

Figure 1-768 Remove the lower left guide assembly (3 of 3)

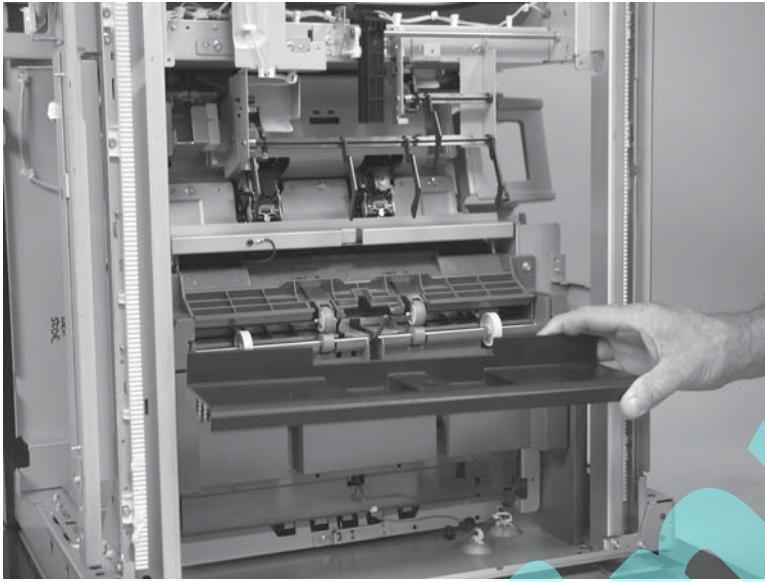

Saddle delivery inner cover, front assembly

Before proceeding, remove the following assemblies:

- Right cover assembly. See [Right cover assembly on page 311](#).
- Pre-reverse cover assembly. See [Pre-reverse cover assembly on page 312](#).
- Bin cable guide cover. See [Bin cable guide cover on page 317](#).
- Open/closed stepped cover assembly. See [Open/closed stepped cover assembly on page 321](#).
- Upper stepped cover assembly. See [Upper stepped cover assembly on page 322](#).
- Lower stepped cover assembly. See [Lower stepped cover assembly on page 324](#).
- Front door. See [Front door on page 330](#).
- Inner upper cover assembly. See [Inner upper cover assembly \(remove\) on page 334](#).
- Inner lower cover assembly. See [Inner lower cover assembly on page 339](#).

Remove the saddle delivery inner cover, front assembly

1. Remove one screw.

Figure 1-769 Remove the saddle delivery inner cover, front assembly (1 of 3)

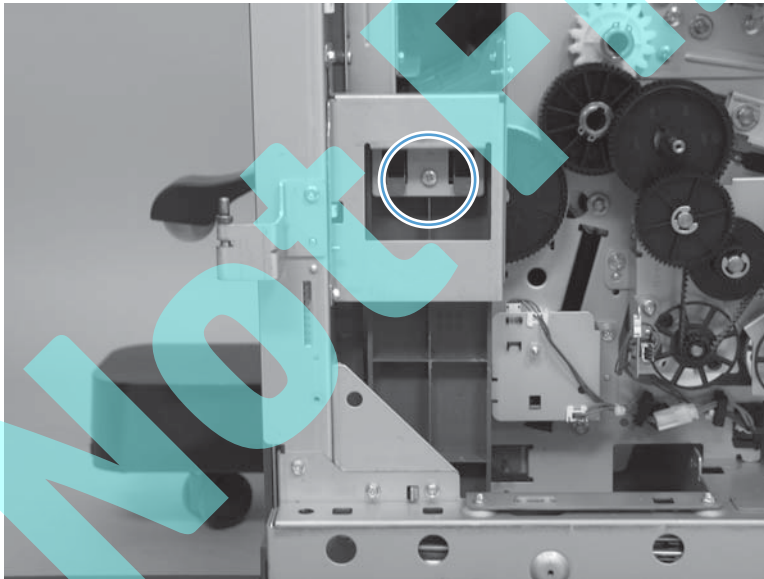

2. Slide the cover up to release two tabs.

Figure 1-770 Remove the saddle delivery inner cover, front assembly (2 of 3)

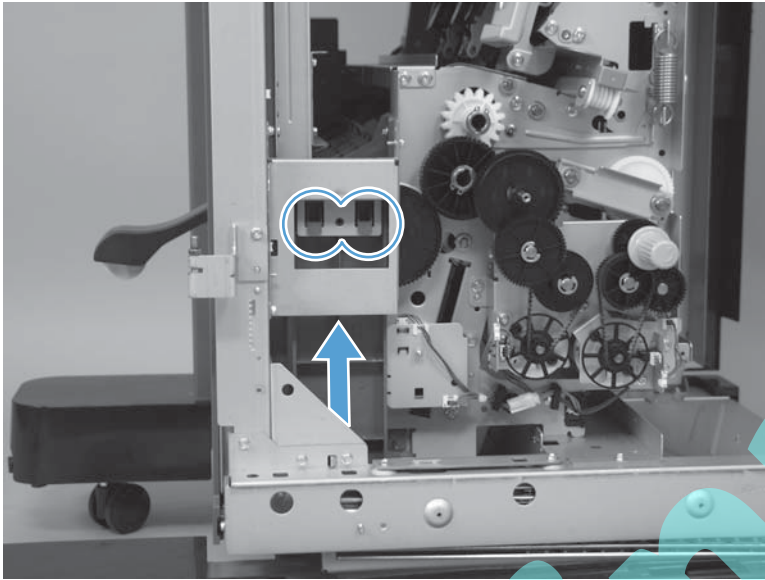

3. Remove the cover.

Figure 1-771 Remove the saddle delivery inner cover, front assembly (3 of 3)



Saddle delivery inner cover, rear assembly

Before proceeding, remove the following assemblies:

- Right cover assembly. See [Right cover assembly on page 311](#).
- Pre-reverse cove assembly. See [Pre-reverse cover assembly on page 312](#).
- Bin cable guide cover. See [Bin cable guide cover on page 317](#).
- Open/closed stepped cover assembly. See [Open/closed stepped cover assembly on page 321](#).
- Upper stepped cover assembly. See [Upper stepped cover assembly on page 322](#).
- Lower stepped cover assembly. See [Lower stepped cover assembly on page 324](#).
- Inner lower cover assembly. See [Inner lower cover assembly on page 339](#).
- Rear cover assembly. See [Rear cover assembly on page 349](#).
- Stack wall upper cover assembly. See [Stack wall upper assembly and upper wall guide assembly on page 375](#).
- Stack upper bin and lower bin assemblies. See [Stack upper bin and lower bin assemblies on page 397](#).
- Height wall center assembly. See [Height wall assembly on page 401](#).

Remove the saddle delivery inner cover, rear assembly

1. Remove one screw.

Figure 1-772 Remove the saddle delivery inner cover, rear assembly (1 of 3)

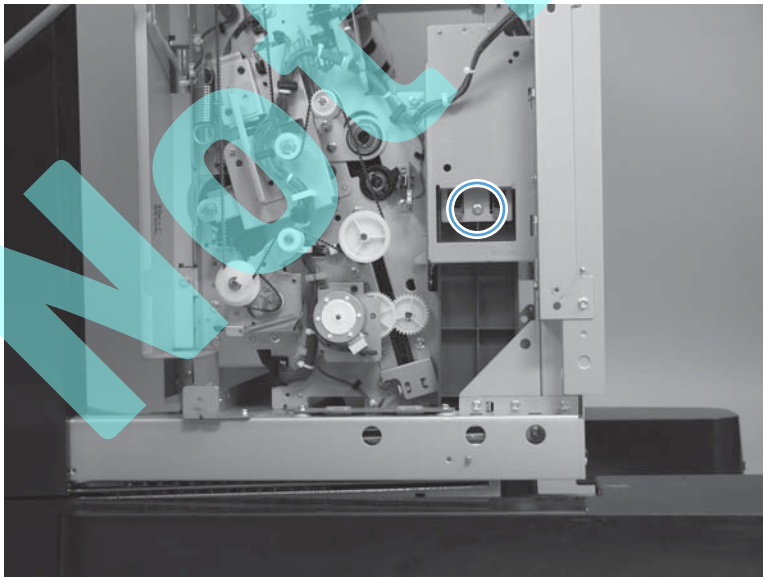

2. Slide the cover up to release two tabs.

Figure 1-773 Remove the saddle delivery inner cover, rear assembly (2 of 3)

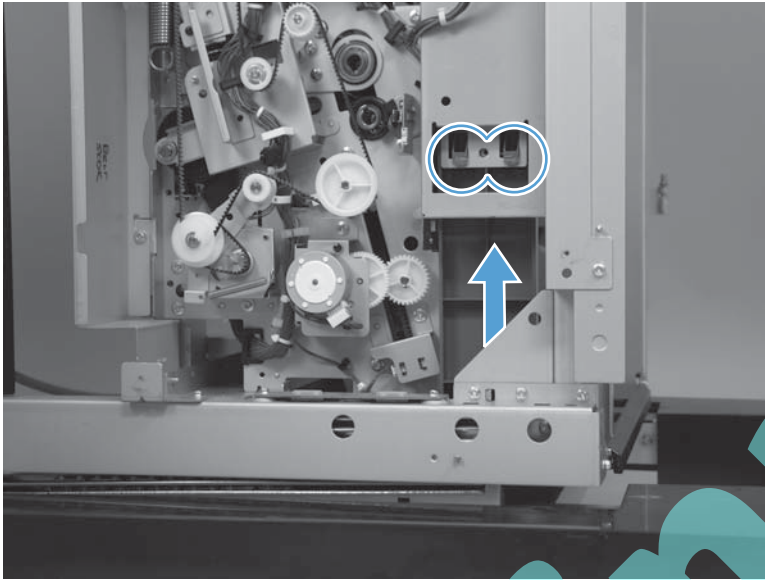

3. Remove the cover.

Figure 1-774 Remove the saddle delivery inner cover, rear assembly (3 of 3)

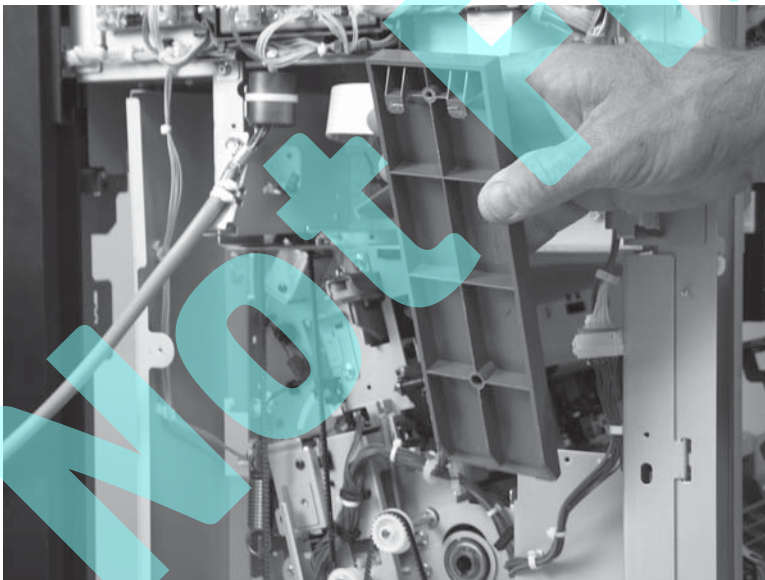

Saddle guide assembly

Before proceeding, remove the following assemblies:

- Right cover assembly. See [Right cover assembly on page 311](#).
- Right cover assembly (BM PCA). See [Right cover assembly \(BM PCA\) on page 470](#).



NOTE: Removing this cover is optional. It might make it easier to remove the saddle guide assembly if this cover removed first.

- Pre-reverse cover assembly. See [Pre-reverse cover assembly on page 312](#).
- Rear reverse cover assembly. See [Rear reverse cover assembly on page 314](#).
- Bin cable guide cover. See [Bin cable guide cover on page 317](#).
- Open/closed stepped cover assembly. See [Open/closed stepped cover assembly on page 321](#).
- Upper stepped cover assembly. See [Upper stepped cover assembly on page 322](#).
- Lower stepped cover assembly. See [Lower stepped cover assembly on page 324](#).
- Front door. See [Front door on page 330](#).
- Inner upper cover assembly. See [Inner upper cover assembly \(remove\) on page 334](#).
- Inner lower cover assembly. See [Inner lower cover assembly on page 339](#).
- Rear cover assembly. See [Rear cover assembly on page 349](#).
- Reverse assembly. See [Reverse assembly on page 459](#).
- Paper pass assembly. See [Paper pass assembly on page 462](#).

Remove the saddle guide assembly

1. Remove one screw (callout 1), and then remove the sheet-metal support bracket (callout 2).

Figure 1-775 Remove the saddle guide assembly (1 of 5)

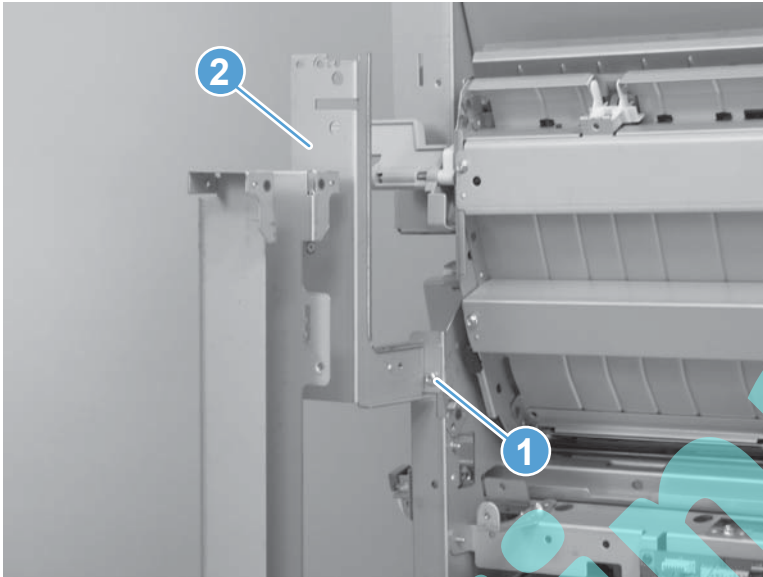

2. Release the lever, and then open the saddle guide.

Figure 1-776 Remove the saddle guide assembly (2 of 5)

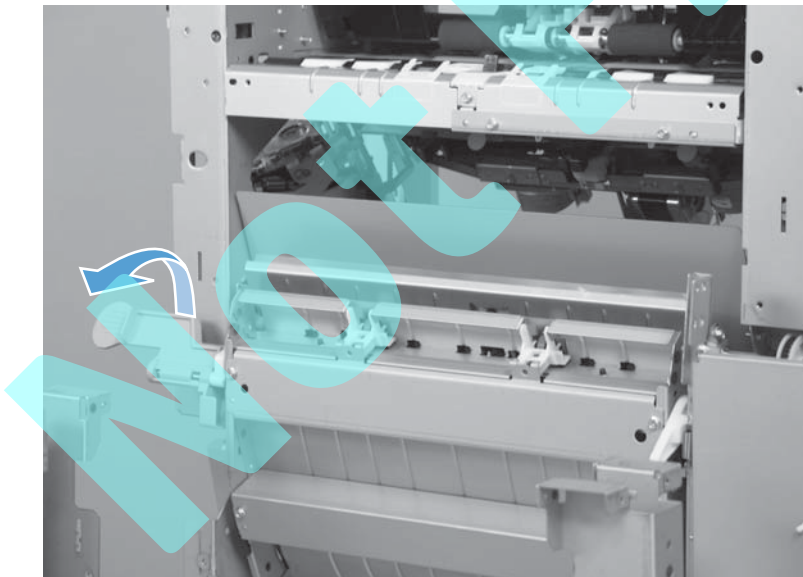

3. Remove one screw (callout 1), and then remove the hinge pin retainer (callout 2).

 **TIP:** Slightly move the saddle guide assembly back and forth to make removing the hinge pin retainer easier.

Figure 1-777 Remove the saddle guide assembly (3 of 5)



4. Slightly rotate the left side of the assembly away from the saddle assembly (callout 1), and then slide it to the left (callout 2).

 **NOTE:** There is a pin on the left side of the assembly that must clear the accessory chassis.

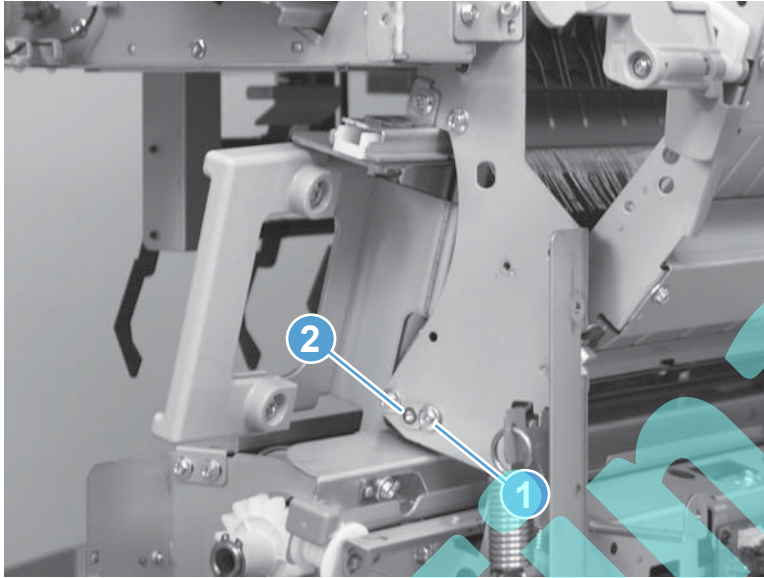
Figure 1-778 Remove the saddle guide assembly (4 of 5)



5. Remove the assembly.

Figure 1-779 Remove the saddle guide assembly (5 of 5)

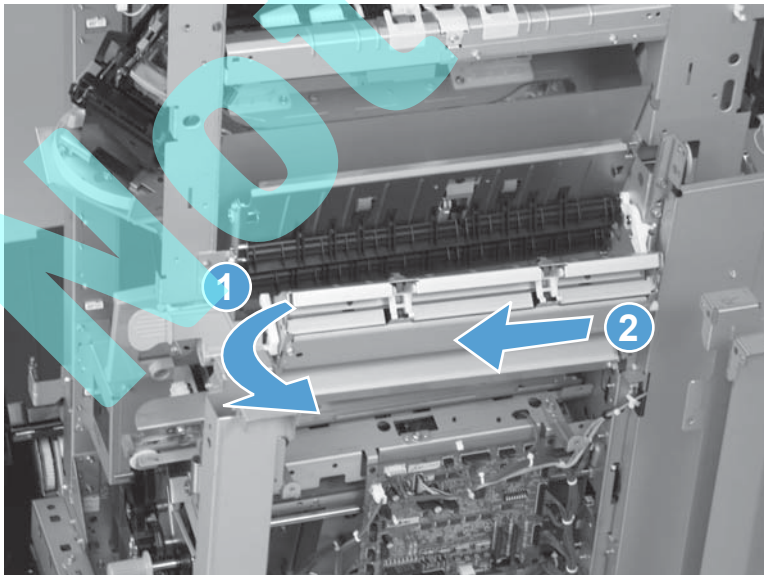
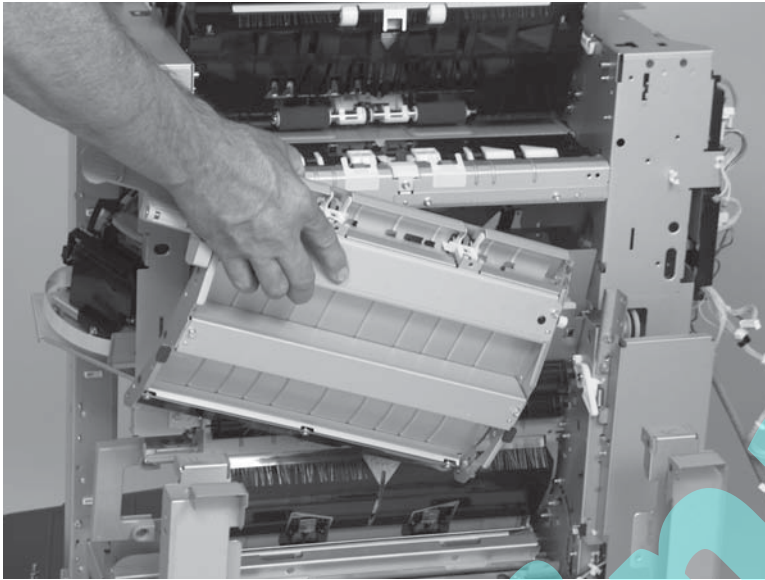

Not Final

Reinstall the saddle guide assembly

1. Slide the saddle stapler out of the accessory to avoid damage to the mylar strips on the saddle guide assembly when it is reinstalled.

Figure 1-780 Reinstall the saddle guide assembly (1 of 4)

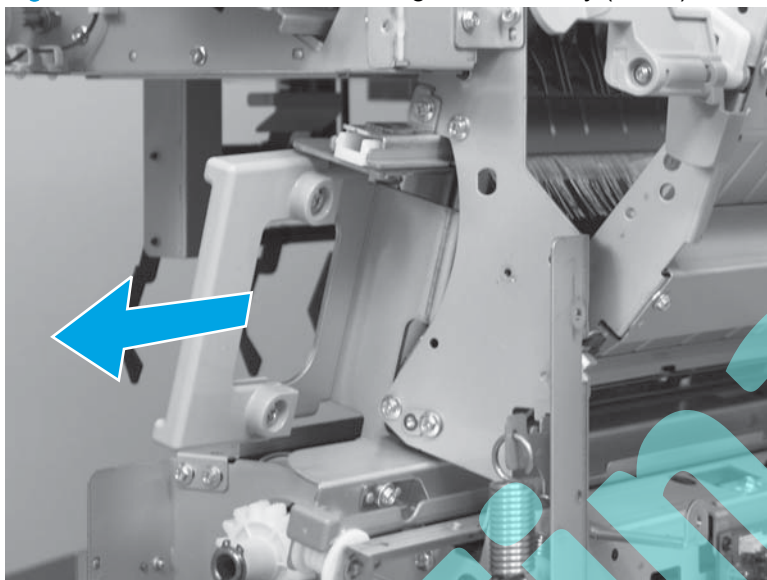

2. When you reinstall the assembly, do not damage the mylar strips (callout 1) on the assembly.

Figure 1-781 Reinstall the saddle guide assembly (2 of 4)



3. Make sure the shaft-end edge of the assembly, and the hinge-pin edge of the assembly, are behind the sheet-metal stoppers on the chassis.

Figure 1-782 Reinstall the saddle guide assembly (3 of 4)

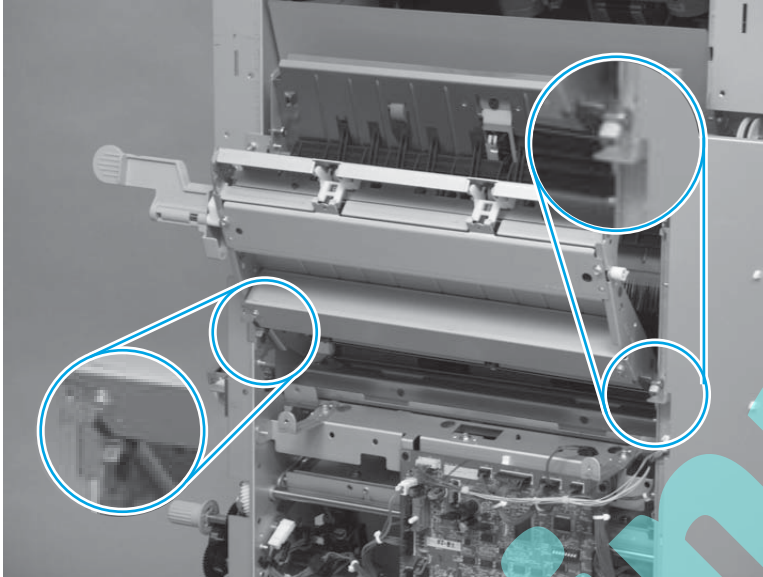

4. Install the hinge pin retainer (callout 1), and then install one screw (callout 2) to secure the assembly.

 **TIP:** Slightly move the saddle guide assembly back and forth to make installing the hinge pin retainer easier.

Figure 1-783 Reinstall the saddle guide assembly (4 of 4)



Saddle feed assembly

Before proceeding, remove the following assemblies:

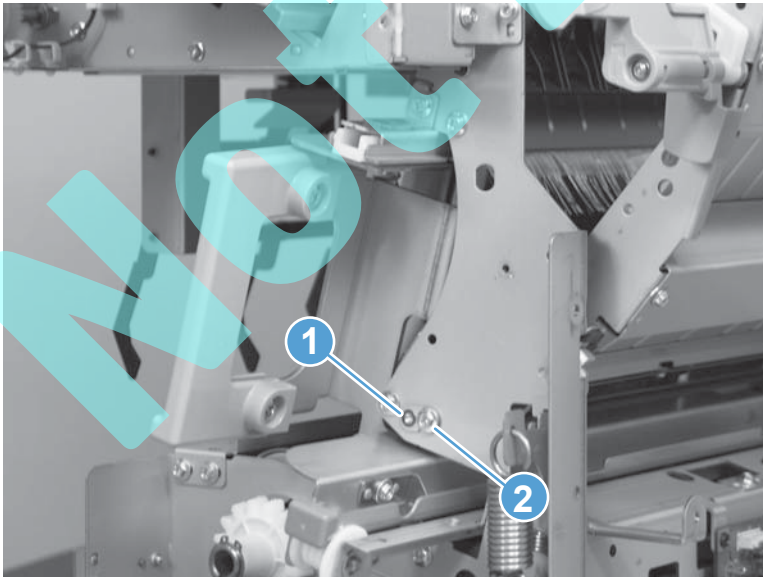
- Right cover assembly. See [Right cover assembly on page 311](#).
- Upper stepped cover assembly. See .
- Lower stepped cover assembly. See [Lower stepped cover assembly on page 324](#).
- Front door. See [Front door on page 330](#).
- Inner upper cover. See [Inner upper cover assembly \(remove\) on page 334](#).

Remove the saddle feed assembly

1. Disconnect four connectors (callout 1), and then release the wire harness from three retainers (callout 2).

 **TIP:** It might be easier to disconnect the connectors if you first release the wire harnesses from the retainers.

Figure 1-784 Remove the saddle feed assembly (1 of 5)



2. Disconnect two connectors (callout 1), and then release the wire harnesses from two retainers (callout 2).

 **TIP:** It might be easier to disconnect the connectors if you first release the wire harnesses from the retainers.

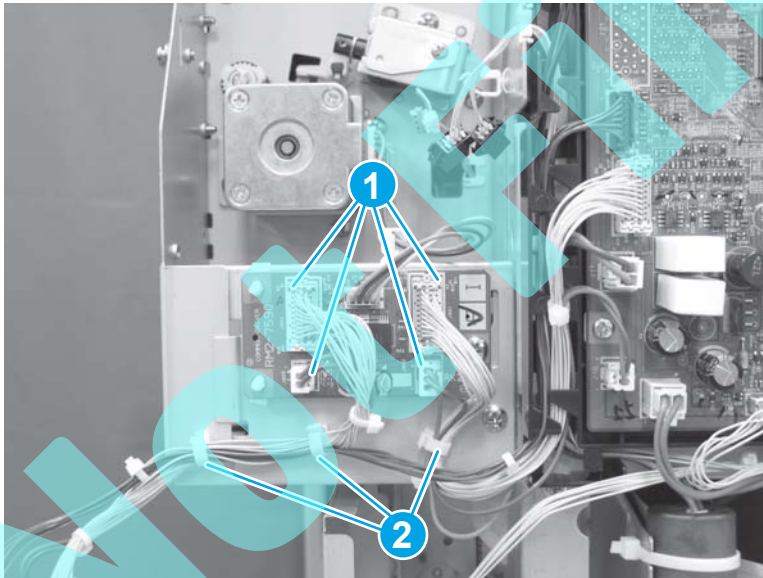
Figure 1-785 Remove the saddle feed assembly (2 of 5)



3. Remove two screws.

Figure 1-786 Remove the saddle feed assembly (3 of 5)

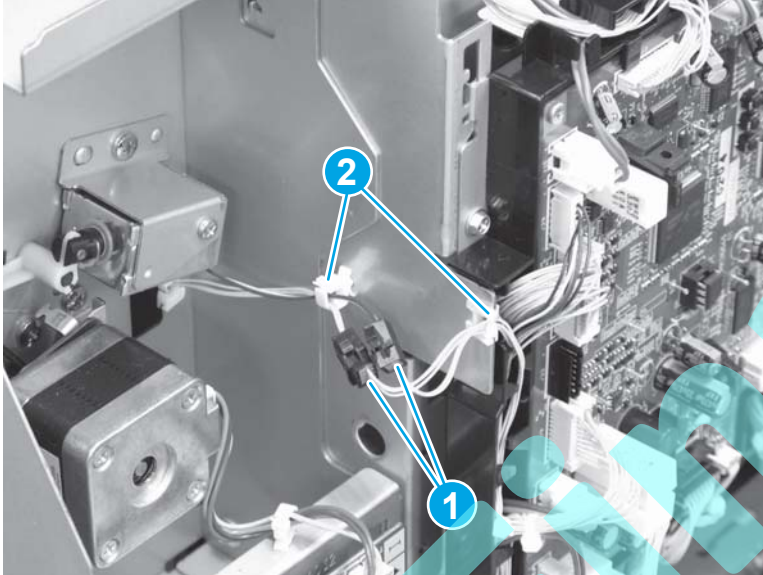
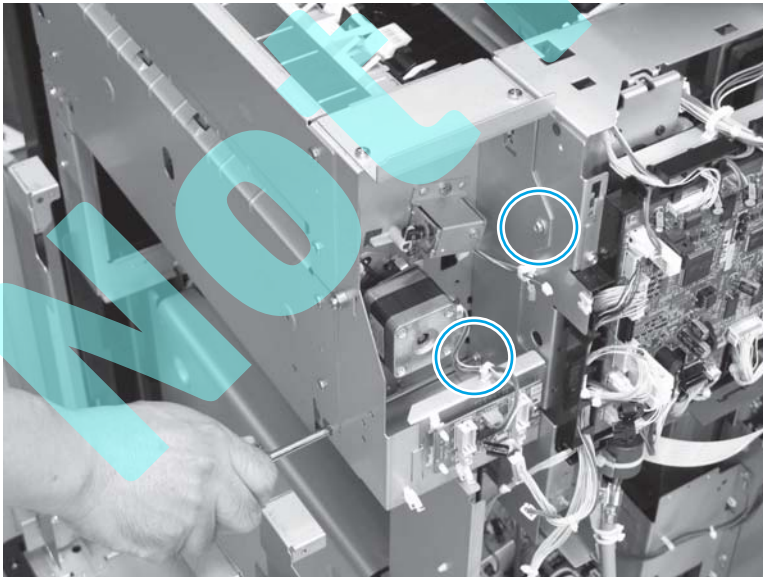

4. Remove two screws (callout 1), and then remove the sheet-metal bracket (callout 2).

Figure 1-787 Remove the saddle feed assembly (4 of 5)

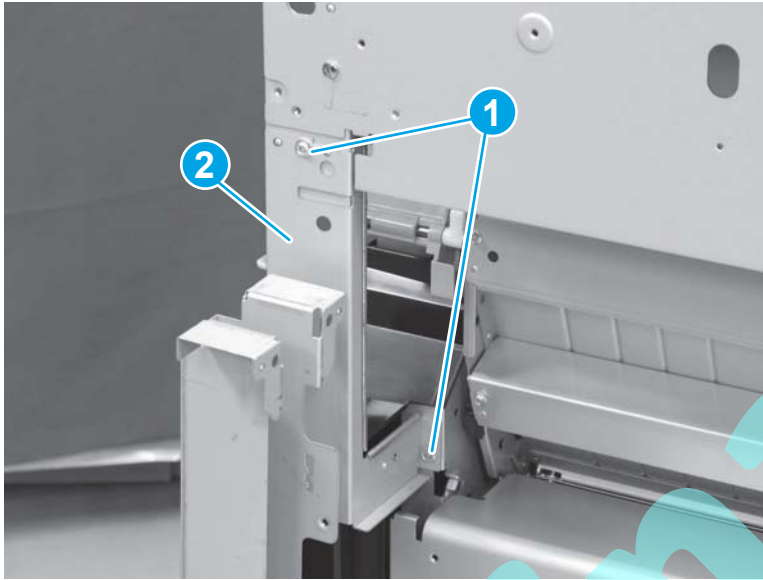

5. Remove one screw (callout 1), grasp the top of the saddle feed assembly (callout 2), and then lift it up to remove it.

Figure 1-788 Remove the saddle feed assembly (5 of 5)

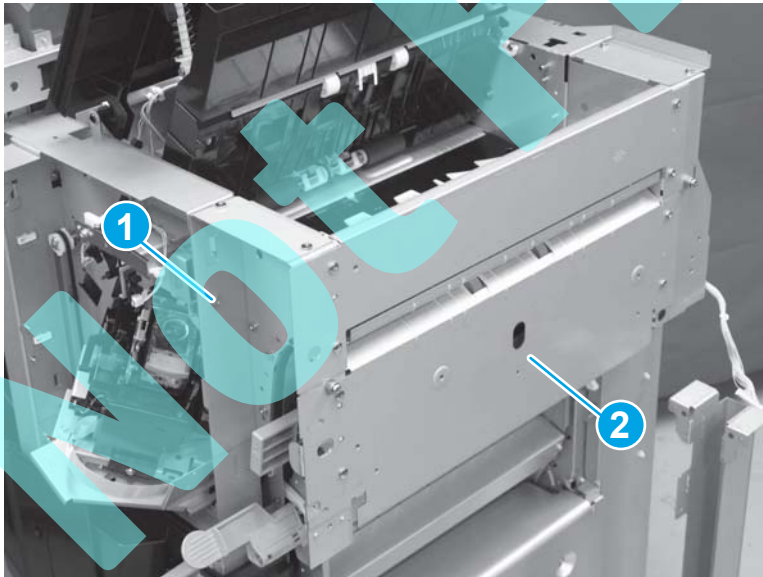

Saddle assembly



NOTE: The saddle assembly is not an orderable service part. This removal procedure is for reference only. HP does not recommend removing the saddle assembly at this time.

Before proceeding, remove the following assemblies:

- Right cover assembly. See [Right cover assembly on page 311](#).
- Pre-reverse cover assembly. See [Pre-reverse cover assembly on page 312](#).
- Rear reverse cover assembly. See [Rear reverse cover assembly on page 314](#).
- Bin cable guide cover. See [Bin cable guide cover on page 317](#).
- Open/closed stepped cover assembly. See [Open/closed stepped cover assembly on page 321](#).
- Upper stepped cover assembly. See [Upper stepped cover assembly on page 322](#).
- Lower stepped cover assembly. See [Lower stepped cover assembly on page 324](#).
- Front door. See [Front door on page 330](#).
- Inner upper cover assembly. See [Inner upper cover assembly \(remove\) on page 334](#).
- Inner lower cover assembly. See [Inner lower cover assembly on page 339](#).
- Rear cover assembly. See [Rear cover assembly on page 349](#).
- Reverse assembly. See [Reverse assembly on page 459](#).
- Saddle output bin assembly. See [Saddle output bin assembly on page 468](#).
- Paper pass assembly. See [Paper pass assembly on page 462](#).
- Right cover assembly (BM PCA). See [Right cover assembly \(BM PCA\) on page 470](#).
- Saddle delivery inner cover, front assembly. See [Saddle delivery inner cover, front assembly on page 501](#).

Remove the saddle assembly

1. Release the wire harnesses from the two retainers.

Figure 1-789 Remove the saddle assembly (1 of 15)



2. Disconnect two in-line connectors (callout 1), and then release the wire harness from one retainer (callout 2).

Figure 1-790 Remove the saddle assembly (2 of 15)

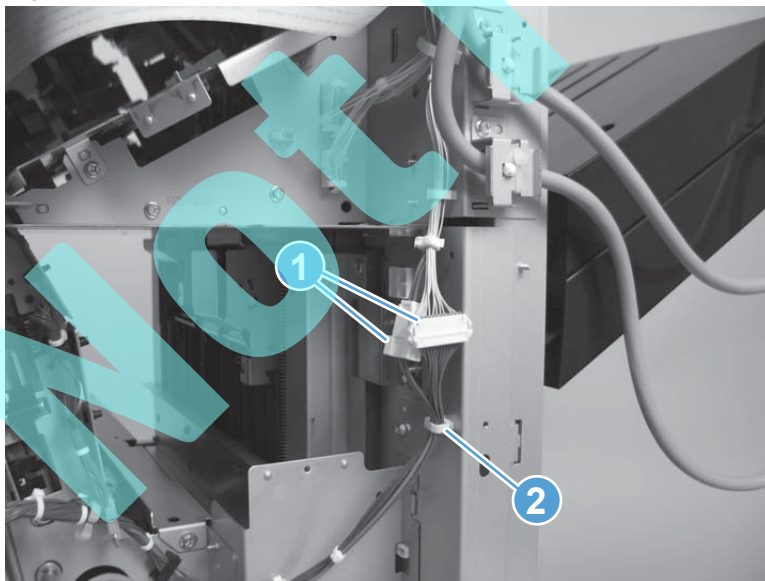

3. Disconnect one connector (callout 1) on the main controller PCA, and then release the wire harness from the guide (callout 2).

Figure 1-791 Remove the saddle assembly (3 of 15)

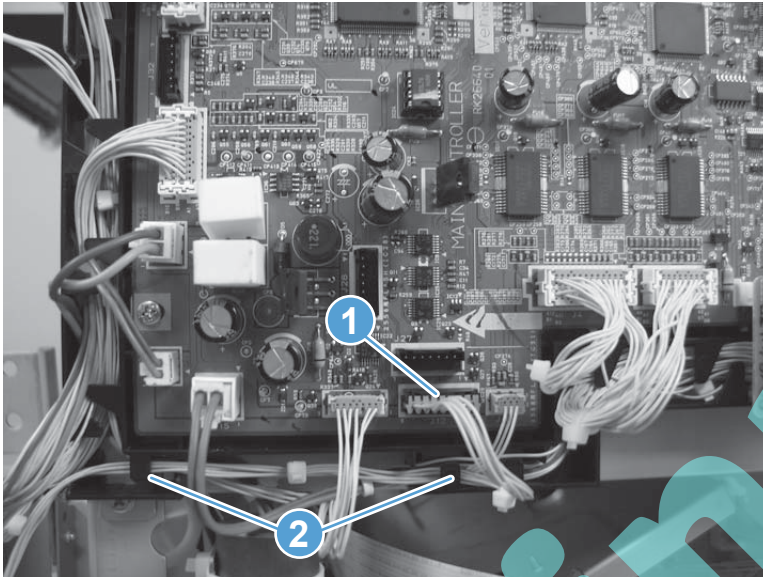

4. Release one tab (callout 1; one tab on each retainer) on two retainers to release them from the sheet-metal support bracket.

Figure 1-792 Remove the saddle assembly (4 of 15)



5. Remove one spring on the jam access locking arm. Set the spring aside.

⚠ CAUTION: The spring is not captive. Do not lose the spring when releasing it.

💡 Reinstallation tip Do not forget to reinstall this spring when the assembly is reinstalled, or a replacement assembly is installed.

Figure 1-793 Remove the saddle assembly (5 of 15)

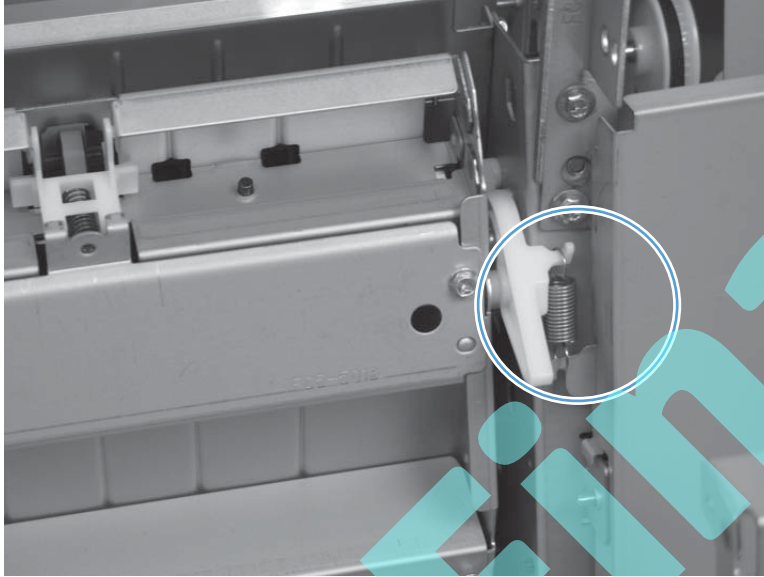

6. Remove one screw.

Figure 1-794 Remove the saddle assembly (6 of 15)

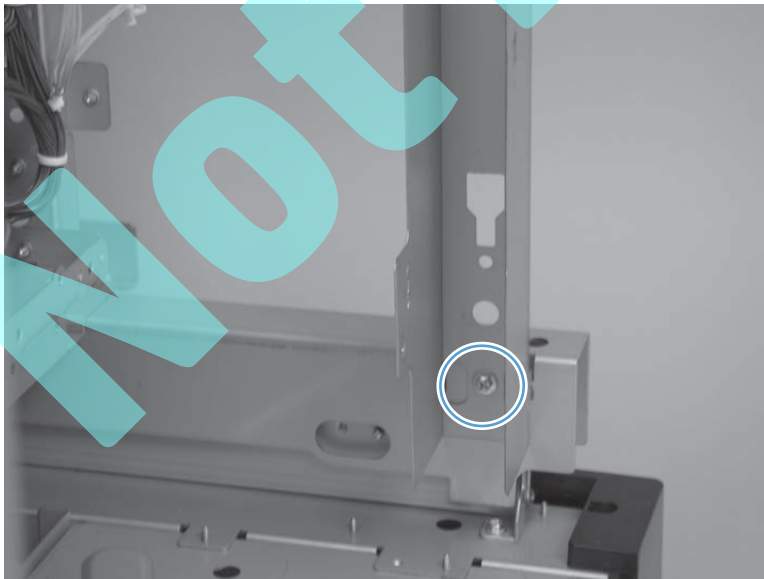

7. Remove the sheet-metal support post. Repeat the previous step and this step for the opposite post.

 **Reinstallation tip** When you reinstall the support posts, Make sure that the edges with the slotted tabs (callout 1) are positioned toward the saddle assembly. If the tabs are not correctly positioned, you will not be able to correctly install the accessory right cover.

Figure 1-795 Remove the saddle assembly (7 of 15)



8. Remove two screws.

Figure 1-796 Remove the saddle assembly (8 of 15)

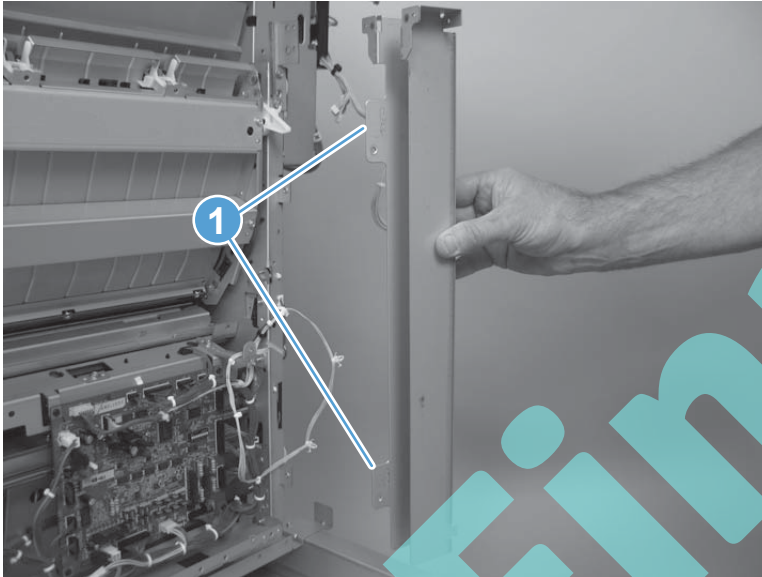
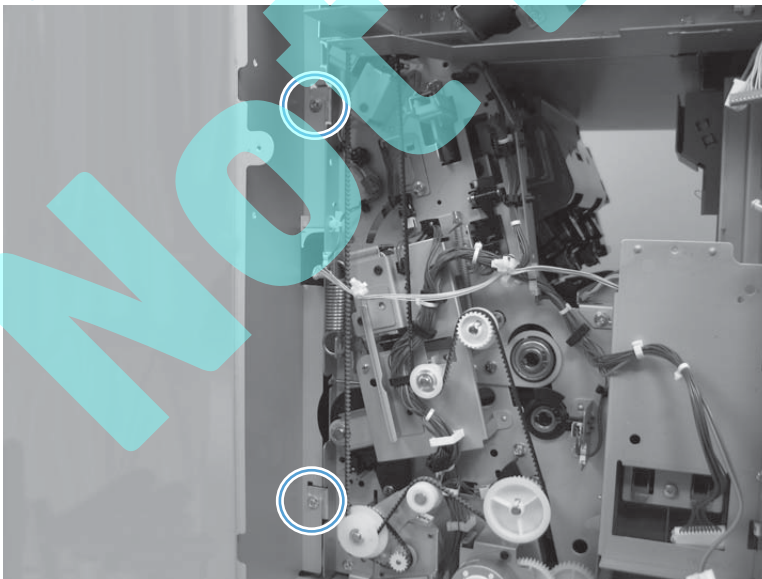

9. Remove one screws.

 **NOTE:** If you have not already removed the sheet-metal support post (callout 1), remove it now. See [Figure 1-794 Remove the saddle assembly \(6 of 15\) on page 517](#) and [Figure 1-795 Remove the saddle assembly \(7 of 15\) on page 518](#).

Figure 1-797 Remove the saddle assembly (9 of 15)



10. Remove the sheet metal bracket.

Figure 1-798 Remove the saddle assembly (10 of 15)

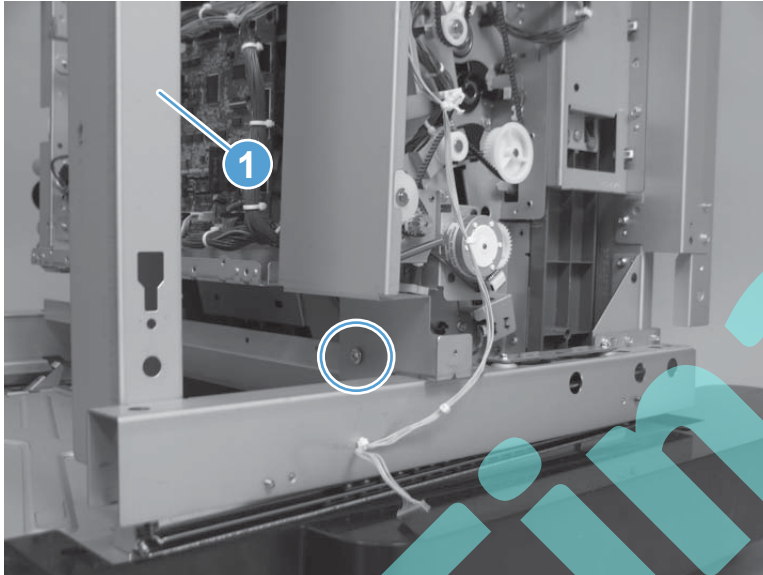
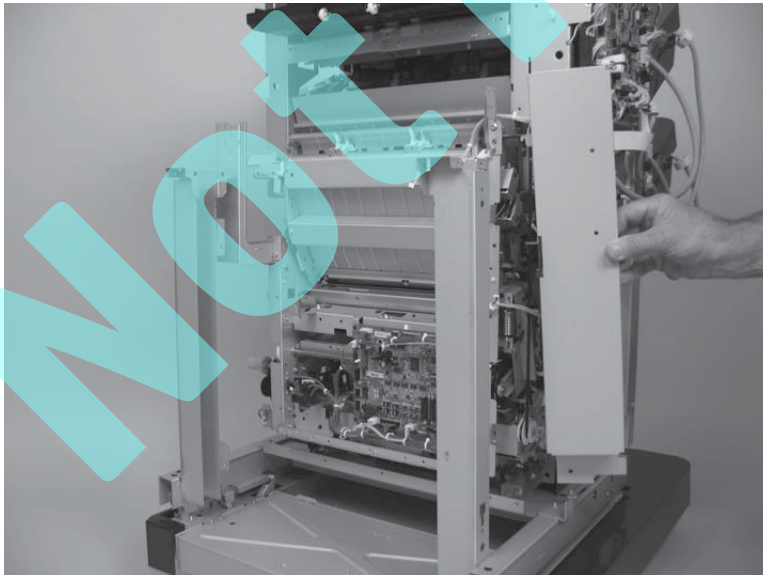

11. Remove two screws.

 **NOTE:** These two screws are located on the common controller PCA side of the accessory.

Figure 1-799 Remove the saddle assembly (11 of 15)



12. Open the jam access plate, and then remove two screws.

Figure 1-800 Remove the saddle assembly (12 of 15)

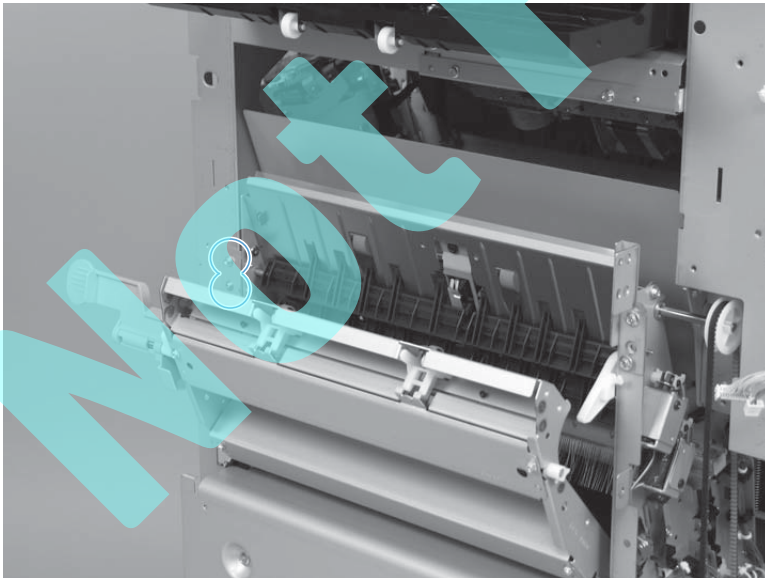

13. Remove one screw.

 **NOTE:** These two screws are located on the front side of the accessory.

Figure 1-801 Remove the saddle assembly (13 of 15)

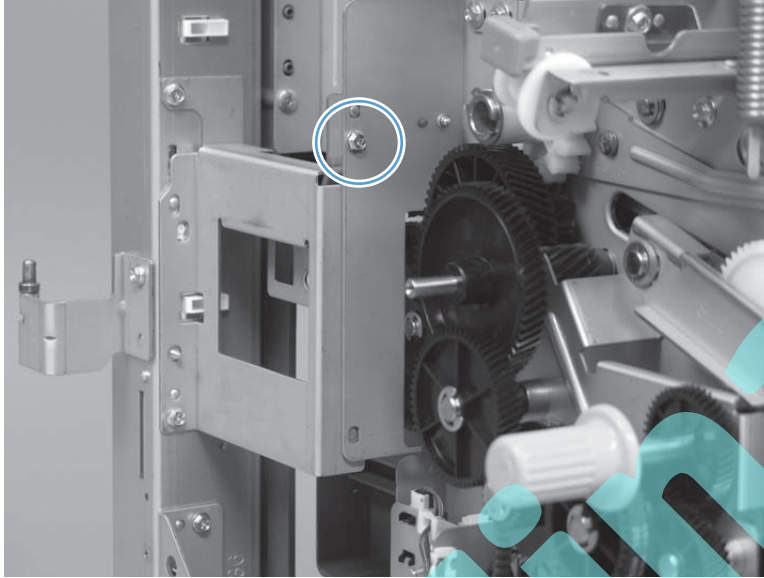

14. Slightly slide the saddle assembly away from the stack bin side of the accessory to release it.

Figure 1-802 Remove the saddle assembly (14 of 15)

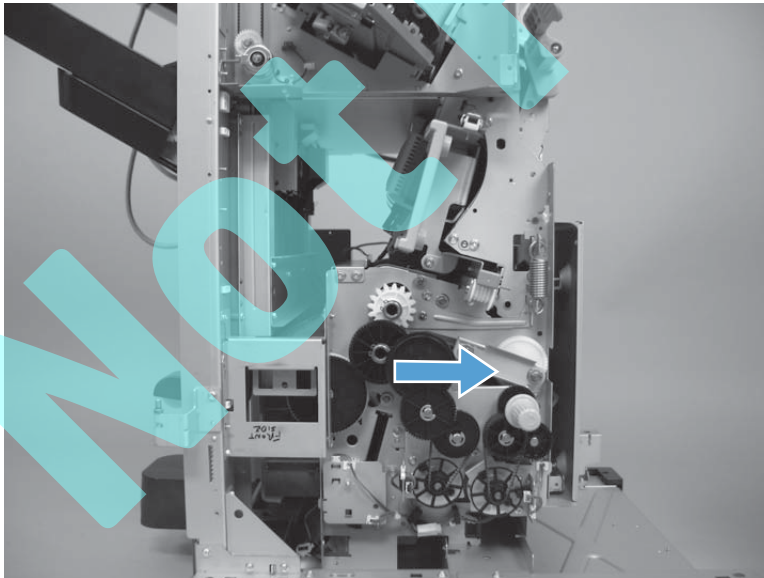

15. Carefully rotate the top of the assembly away from the accessory (callout 1), and then lift the assembly up and out of the accessory (callout 2).

⚠ CAUTION: The assembly is heavy.

📌 IMPORTANT: Do not grasp the assembly along the top edge (callout 3). Doing so can damage the mylar strip along the edge and cause paper jam problems when the assembly is reinstalled.

Figure 1-803 Remove the saddle assembly (15 of 15)

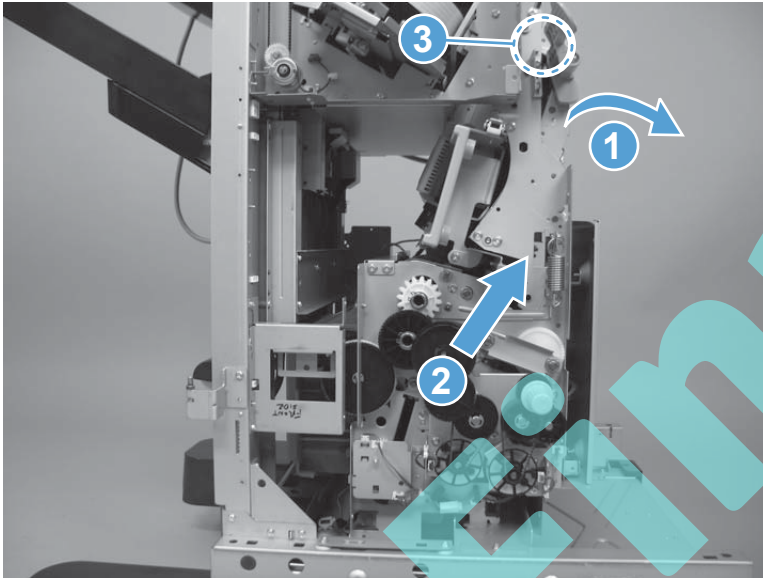

Reinstall the saddle assembly

Make sure that the two hooks on the bottom of the assembly (one shown) are correctly engaged with the chassis, and that the tabs on the rear saddle inner cover are in the slots in the chassis.

 **IMPORTANT:** Make sure that all of the assembly sheet-metal brackets that contact the accessory chassis are flush against the chassis to prevent paper jam problems after the assembly is reinstalled.

Make sure that the drive belts are correctly installed and have not been dislodged when handling the assembly.

Figure 1-804 Reinstall the saddle assembly

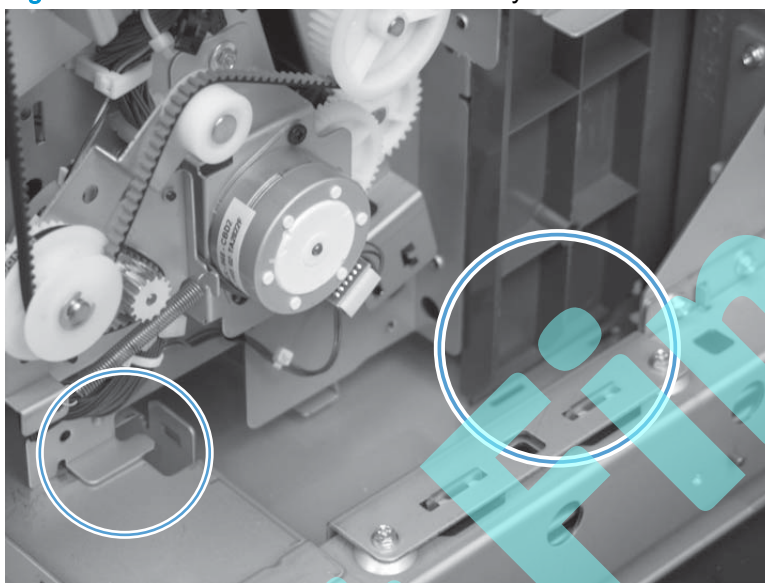

Upper delivery guide assembly

Before proceeding, remove the following assemblies:

- Right cover assembly. See [Right cover assembly on page 311](#).
- Pre-reverse cover assembly. See [Pre-reverse cover assembly on page 312](#).
- Rear reverse cover assembly. See [Rear reverse cover assembly on page 314](#).
- Bin cable guide cover. See [Bin cable guide cover on page 317](#).
- Open/closed stepped cover assembly. See [Open/closed stepped cover assembly on page 321](#).
- Upper stepped cover assembly. See [Upper stepped cover assembly on page 322](#).
- Lower stepped cover assembly. See [Lower stepped cover assembly on page 324](#).
- Front door. See [Front door on page 330](#).
- Inner upper cover assembly. See [Inner upper cover assembly \(remove\) on page 334](#).
- Inner lower cover assembly. See [Inner lower cover assembly on page 339](#).
- Rear cover assembly. See [Rear cover assembly on page 349](#).
- Reverse assembly. See [Reverse assembly on page 459](#).
- Paper pass assembly. See [Paper pass assembly on page 462](#).
- Saddle output bin assembly. See [Saddle output bin assembly on page 468](#).

Remove the upper delivery guide assembly

1. Open the saddle paper delivery assembly door.

Figure 1-805 Remove the upper delivery guide assembly (1 of 3)

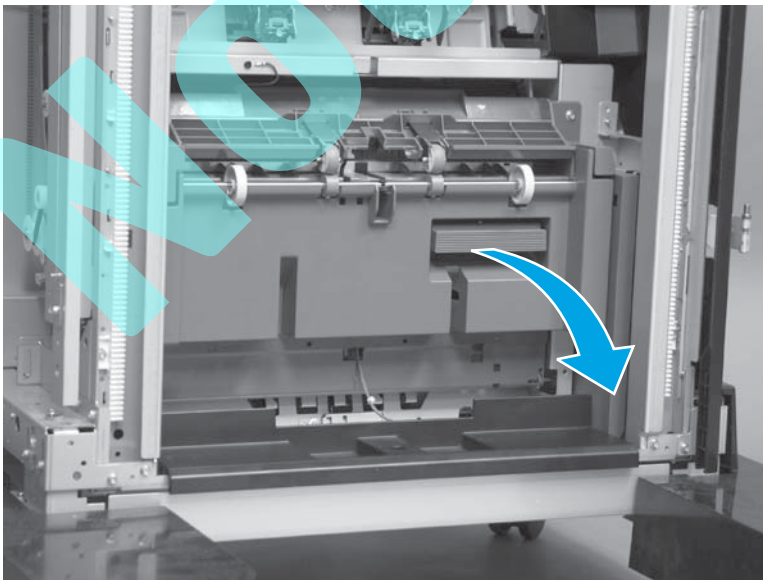

2. Remove four screws.

 **NOTE:** One screw is a ground wire connection. Make sure that you reconnect the ground wire when the assembly is reinstalled.

Figure 1-806 Remove the upper delivery guide assembly (2 of 3)



3. Remove the assembly.

Figure 1-807 Remove the upper delivery guide assembly (3 of 3)

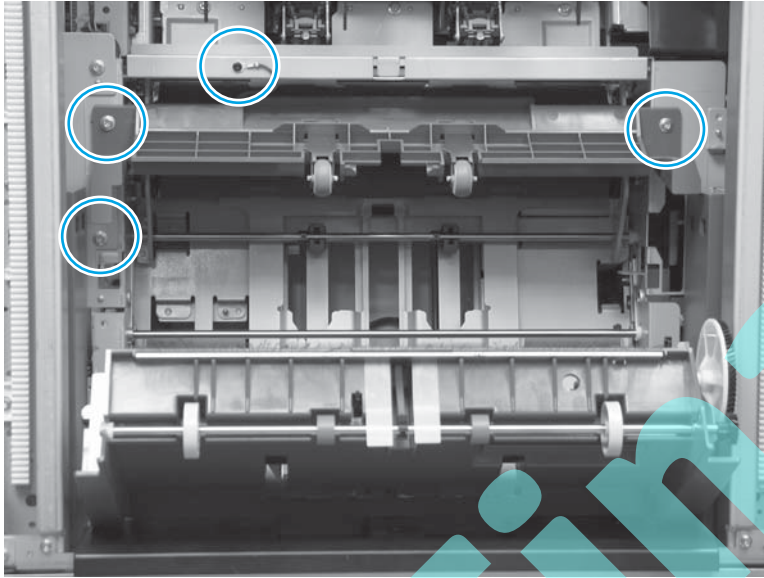
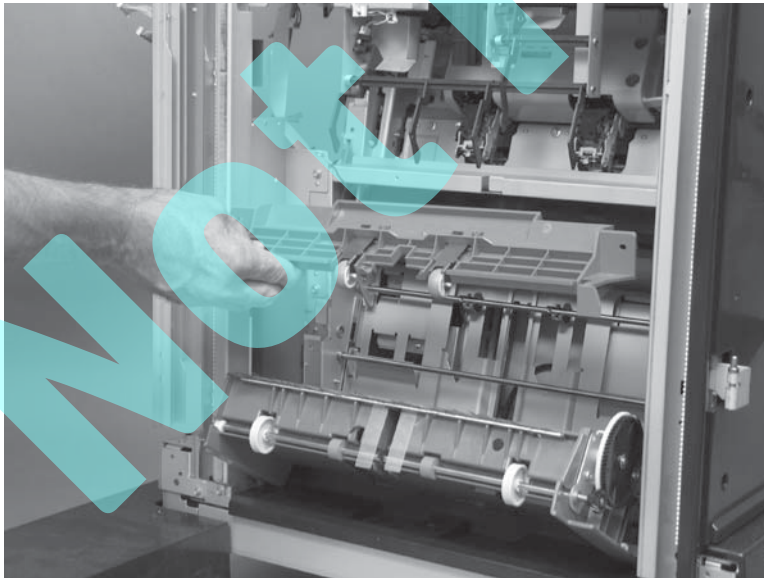

Saddle paper delivery assembly

Before proceeding, remove the following assemblies:

- Right cover assembly. See [Right cover assembly on page 311](#).
- Pre-reverse cover assembly. See [Pre-reverse cover assembly on page 312](#).
- Rear reverse cover assembly. See [Rear reverse cover assembly on page 314](#).
- Bin cable guide cover. See [Bin cable guide cover on page 317](#).
- Open/closed stepped cover assembly. See [Open/closed stepped cover assembly on page 321](#).
- Upper stepped cover assembly. See [Upper stepped cover assembly on page 322](#).
- Lower stepped cover assembly. See [Lower stepped cover assembly on page 324](#).
- Front door. See [Front door on page 330](#).
- Inner upper cover assembly. See [Inner upper cover assembly \(remove\) on page 334](#).
- Inner lower cover assembly. See [Inner lower cover assembly on page 339](#).
- Rear cover assembly. See [Rear cover assembly on page 349](#).
- Reverse assembly. See [Reverse assembly on page 459](#).
- Paper pass assembly. See [Paper pass assembly on page 462](#).
- Saddle output bin assembly. See [Saddle output bin assembly on page 468](#).

Remove the saddle paper delivery assembly

1. At the output side of the accessory, remove one screw.

Figure 1-808 Remove the saddle paper delivery assembly (1 of 8)



2. Release two tabs.

Figure 1-809 Remove the saddle paper delivery assembly (2 of 8)

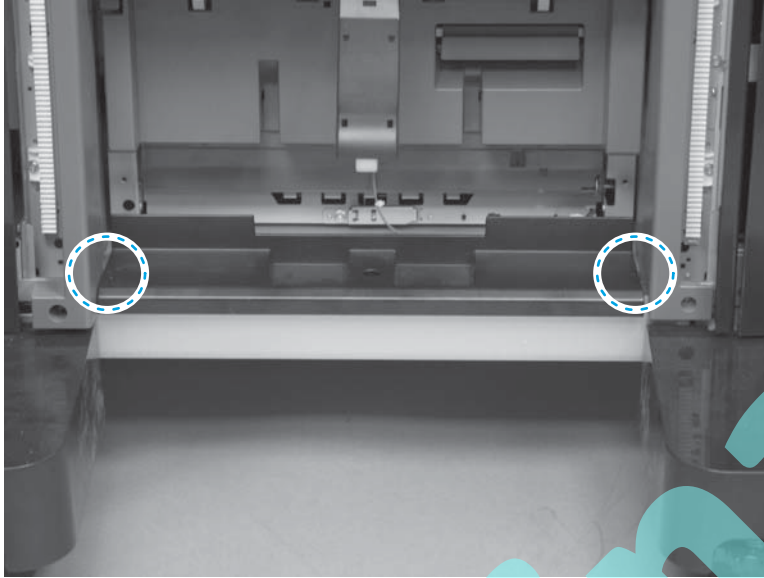

3. Remove the left lower guide.

Figure 1-810 Remove the saddle paper delivery assembly (3 of 8)

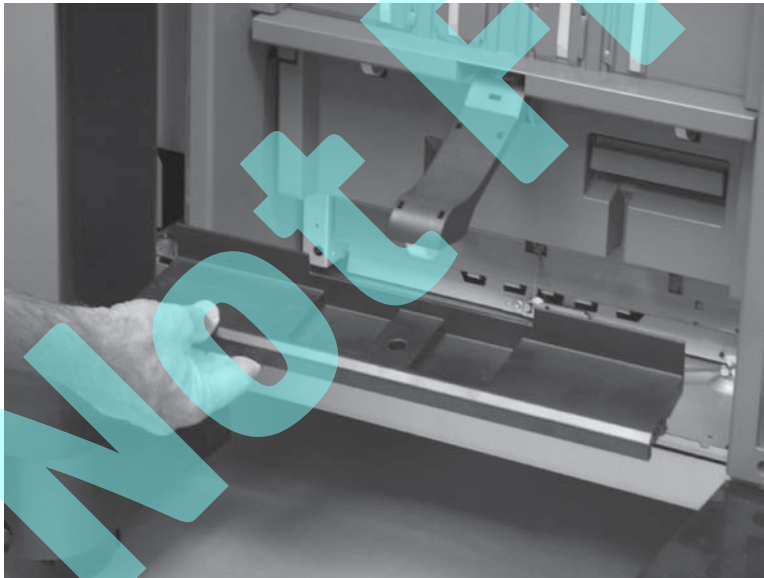

4. Disconnect one connector.

Figure 1-811 Remove the saddle paper delivery assembly (4 of 8)

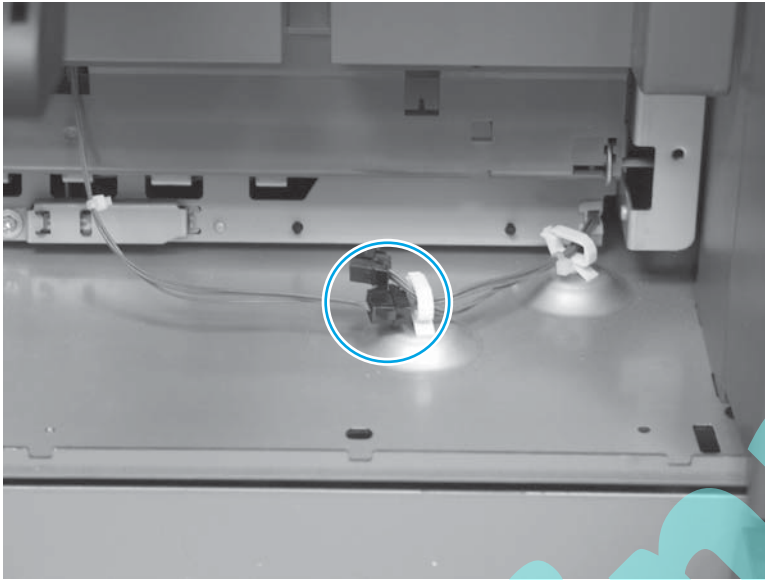

5. Open the upper delivery assembly door.

Figure 1-812 Remove the saddle paper delivery assembly (5 of 8)

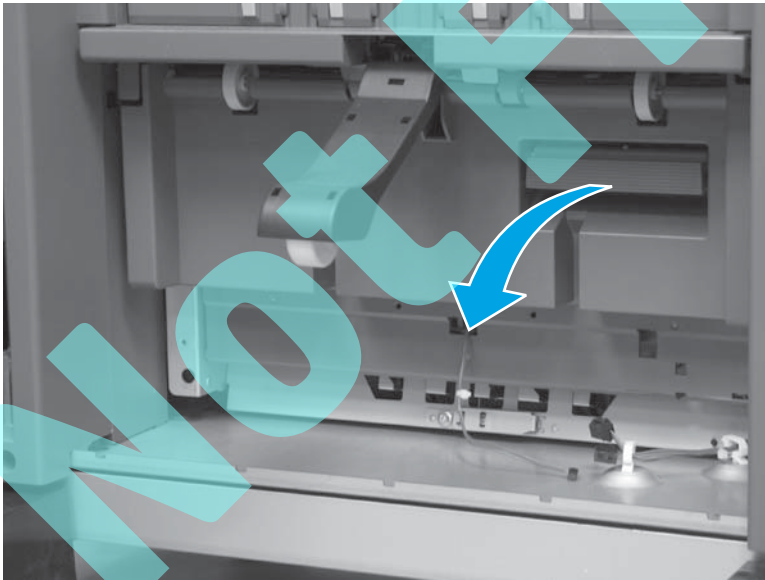

6. At the bottom lower-right corner of the upper delivery assembly door, locate and then rotate the locking pin to the upright position.

Figure 1-813 Remove the saddle paper delivery assembly (6 of 8)



7. Slide the locking pin to the left to remove it.

Figure 1-814 Remove the saddle paper delivery assembly (7 of 8)

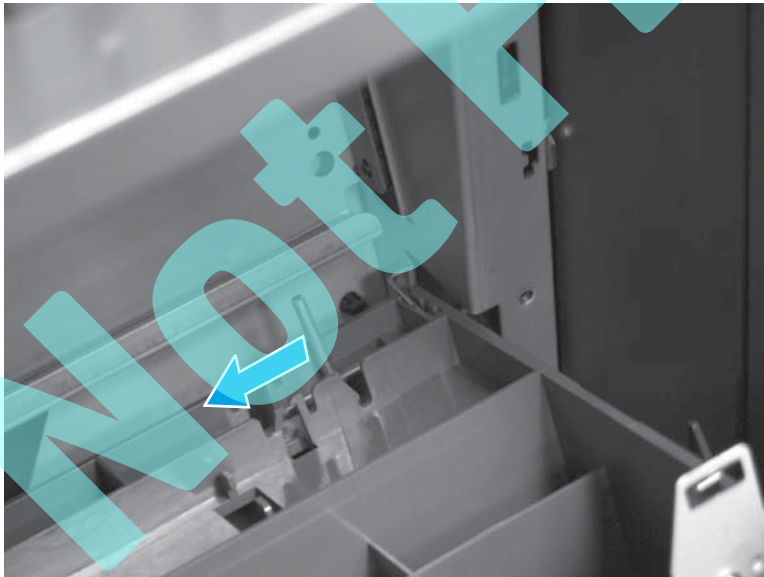

8. Remove the saddle paper delivery assembly.

Figure 1-815 Remove the saddle paper delivery assembly (8 of 8)

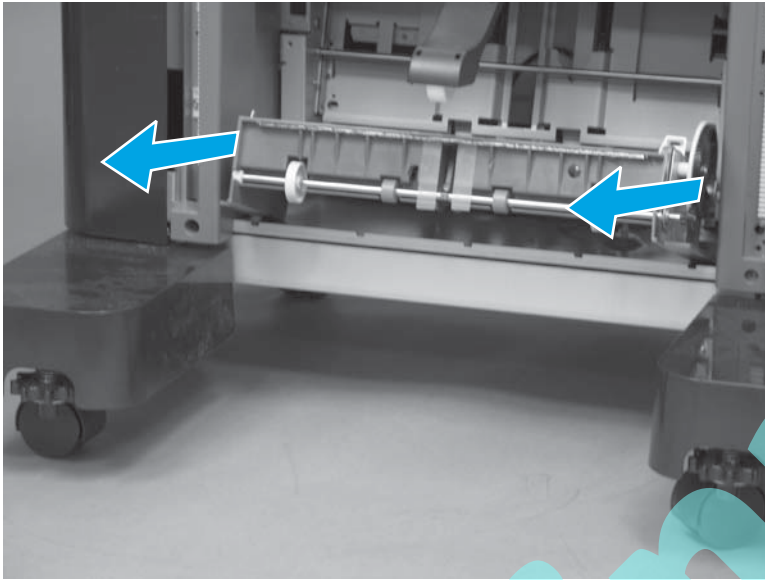

Not Final

Saddle rear end sensor assembly

Before proceeding, remove the following assemblies:

- Right cover assembly. See [Right cover assembly on page 311](#).
- Pre-reverse cover assembly. See [Pre-reverse cover assembly on page 312](#).
- Rear reverse cover assembly. See [Rear reverse cover assembly on page 314](#).
- Bin cable guide cover. See [Bin cable guide cover on page 317](#).
- Open/closed stepped cover assembly. See [Open/closed stepped cover assembly on page 321](#).
- Upper stepped cover assembly. See [Upper stepped cover assembly on page 322](#).
- Lower stepped cover assembly. See [Lower stepped cover assembly on page 324](#).
- Front door. See [Front door on page 330](#).
- Inner upper cover assembly. See [Inner upper cover assembly \(remove\) on page 334](#).
- Inner lower cover assembly. See [Inner lower cover assembly on page 339](#).
- Rear cover assembly. See [Rear cover assembly on page 349](#).
- Reverse assembly. See [Reverse assembly on page 459](#).
- Paper pass assembly. See [Paper pass assembly on page 462](#).
- Right cover assembly (BM PCA). See [Right cover assembly \(BM PCA\) on page 470](#).
- Saddle guide assembly. See [Saddle guide assembly on page 505](#).

Remove the saddle rear end sensor assembly

1. Remove one screw.

Figure 1-816 Remove the saddle rear end sensor assembly (1 of 10)

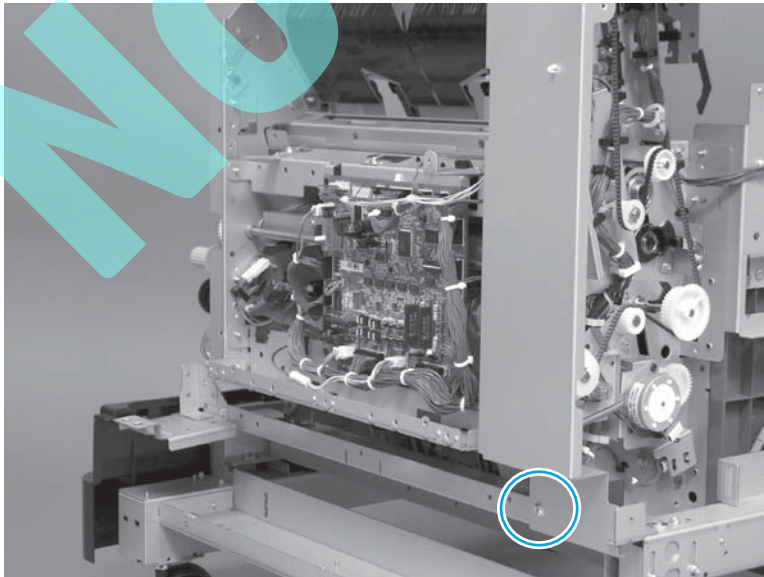

2. Remove two screws (callout 1), and then move the sheet-metal plate (callout 2) out of the way.

⚠ CAUTION: The sheet-metal plate (callout 2) is still attached to the accessory by a wire harness and two retainers. Do not attempt to completely remove the sheet-metal plate.

Figure 1-817 Remove the saddle rear end sensor assembly (2 of 10)

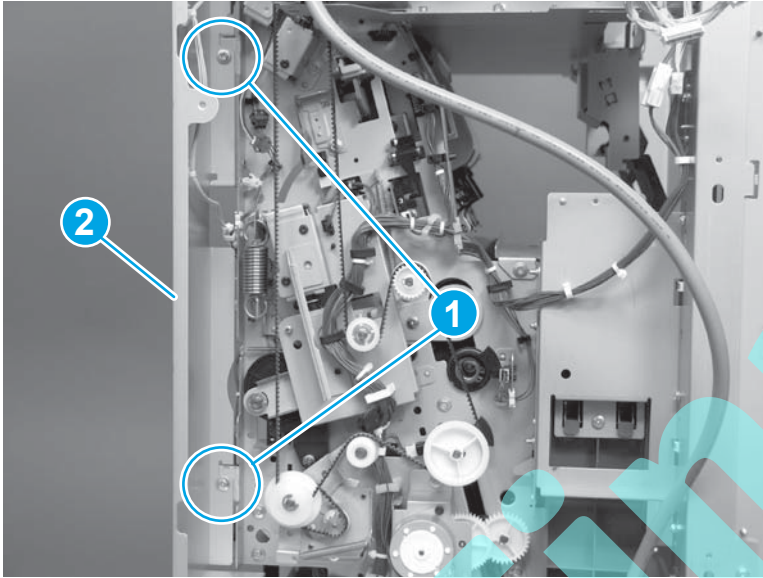

3. At the drive belt side of the accessory, remove one screw (callout 1), and then move the lower-deflector solenoid (callout 2) out of the way.

⚠ CAUTION: The solenoid (callout 2) is still attached to the accessory by one wire harness. Do not attempt to completely remove the solenoid.

📝 NOTE: The solenoid plunger (callout 3) slides out of the solenoid as it is removed.

Figure 1-818 Remove the saddle rear end sensor assembly (3 of 10)

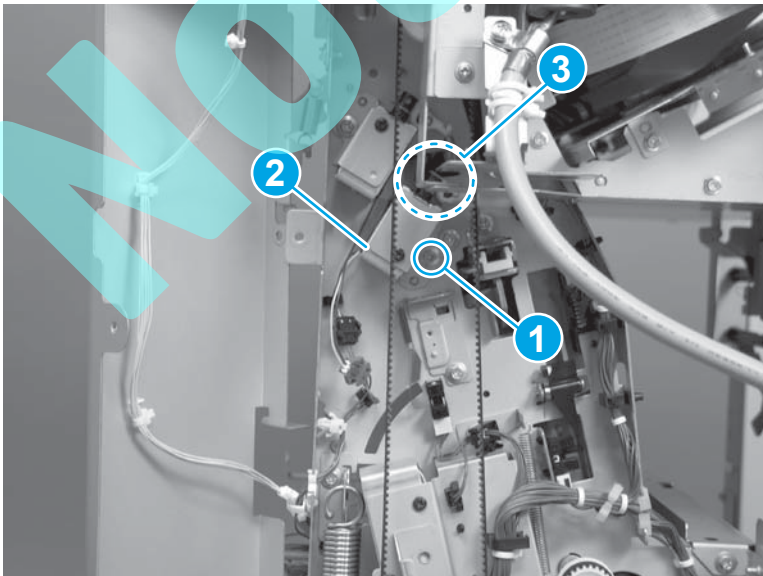

4. Remove one spring (callout 1), release one tab (callout 2) on the white-plastic retainer, and slide the retainer and lower-deflector solenoid plunger (callout 3) off of the deflector shaft.

Repeat the previous step and this step to remove the upper-deflector solenoid, spring, retainer, and plunger assemblies.

 **NOTE:** The upper-deflector solenoid is located above, and to the left of, the lower-deflector solenoid assembly.

Figure 1-819 Remove the saddle rear end sensor assembly (4 of 10)



5. At the output side of the accessory, carefully flex the middle of the lower-deflector (callout 1) to release the left end of the deflector shaft from the hole in the chassis (callout 2).

 **WARNING!** The deflector shafts (left end and right end of the deflector) are fragile. Do not break either of the deflector shafts when removing the deflector.

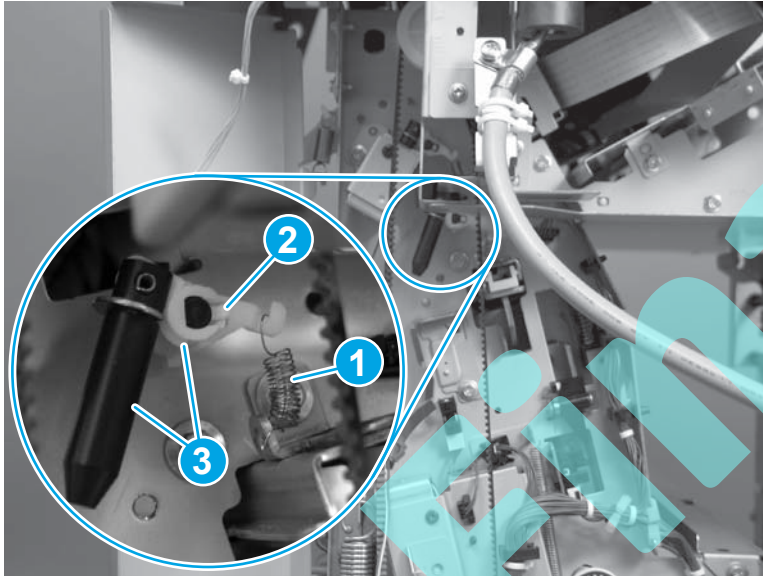
Figure 1-820 Remove the saddle rear end sensor assembly (5 of 10)



- Slide the deflector to the left to release the right end deflector shaft, and then remove the lower deflector.

Repeat the previous step and this step to remove the upper-deflector.

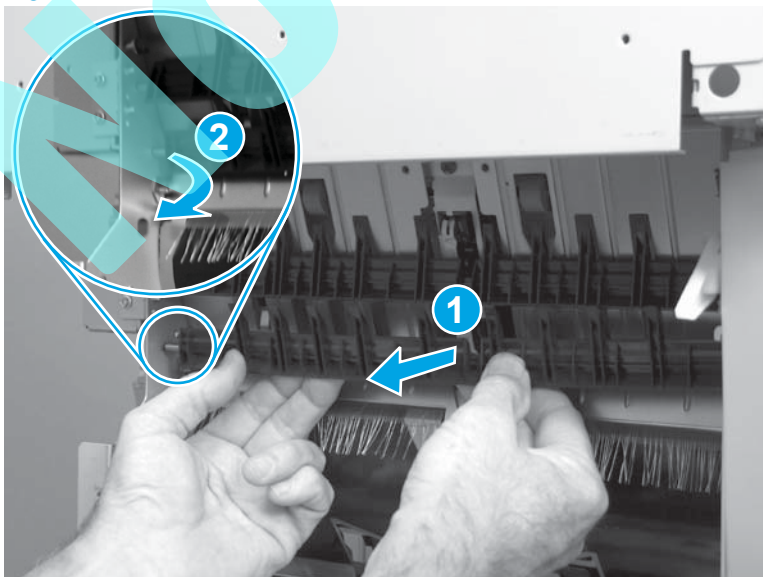
 **Reinstallation tip** The lower and upper deflector shafts are not identical. Make sure that you install the correct deflector when they are reinstalled.

Figure 1-821 Remove the saddle rear end sensor assembly (6 of 10)



- Remove one screw.

Figure 1-822 Remove the saddle rear end sensor assembly (7 of 10)

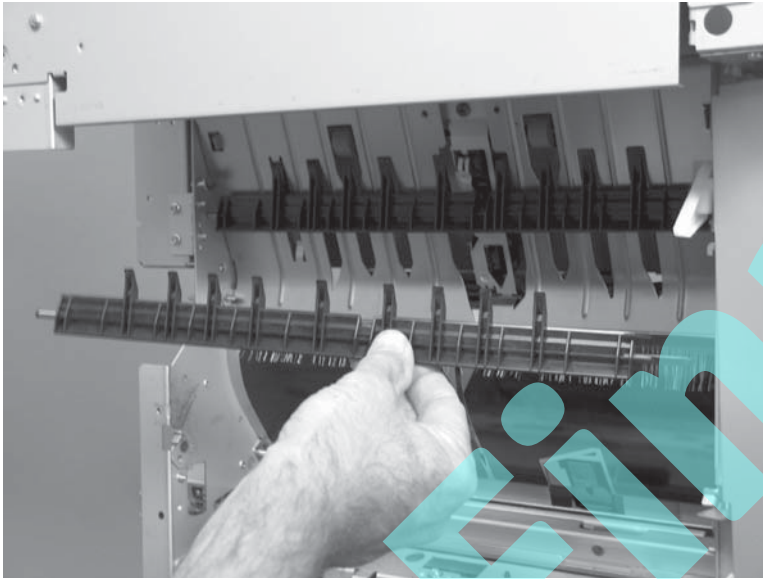

- Lift up on the sensor assembly to release it from the saddle assembly chassis.

CAUTION: The sensor assembly is still attached to the accessory by one wire harness. Do not attempt to completely remove the sensor assembly.

Figure 1-823 Remove the saddle rear end sensor assembly (8 of 10)

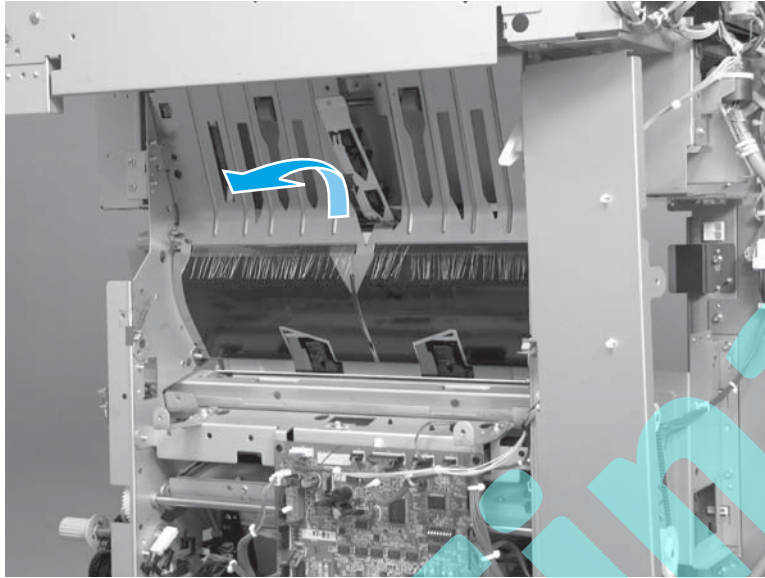

- Turn the assembly over, and then disconnect one connector.

Figure 1-824 Remove the saddle rear end sensor assembly (9 of 10)



10. Remove the saddle rear end sensor assembly.

Figure 1-825 Remove the saddle rear end sensor assembly (10 of 10)

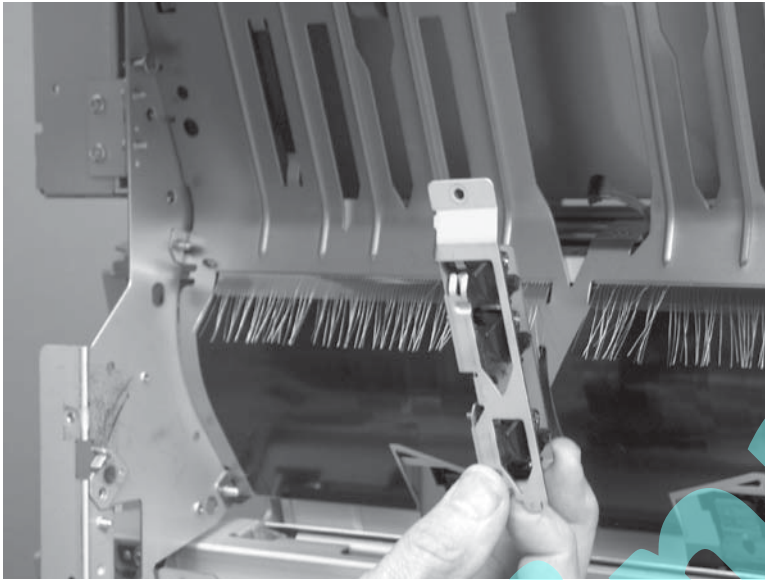

Stapler/stacker and stapler/stacker with hole punch accessories

The assemblies described in this section are unique to the stapler/stacker (SS) or stapler/stacker with hole punch (SSHP) finishing accessory. For information about removing and replacing assemblies that are common to all of the finishing accessories, see [Shared finishing accessory assemblies on page 307](#).

- [Punch controller PCA assembly](#)
- [Dust collector assembly](#)
- [Punch inner cover assembly](#)
- [Punch top cover](#)
- [Punch hole assembly](#)

Not Final

Punch controller PCA assembly

Before proceeding, remove the following assemblies:

- Bin cable guide cover. See [Bin cable guide cover on page 317](#).
- Rear cover assembly. See [Remove only the rear cover on page 351](#).

Remove the punch controller PCA assembly

CAUTION:  ESD sensitive assembly.

Disconnect the eight connectors, remove two screws (callout 1) and release two standoffs (callout 2), and then remove the PCA.

TIP: Releasing the wire harnesses from the retainers might make it easier to disconnect some of the connectors on the PCA.

Figure 1-826 Remove the punch controller PCA assembly

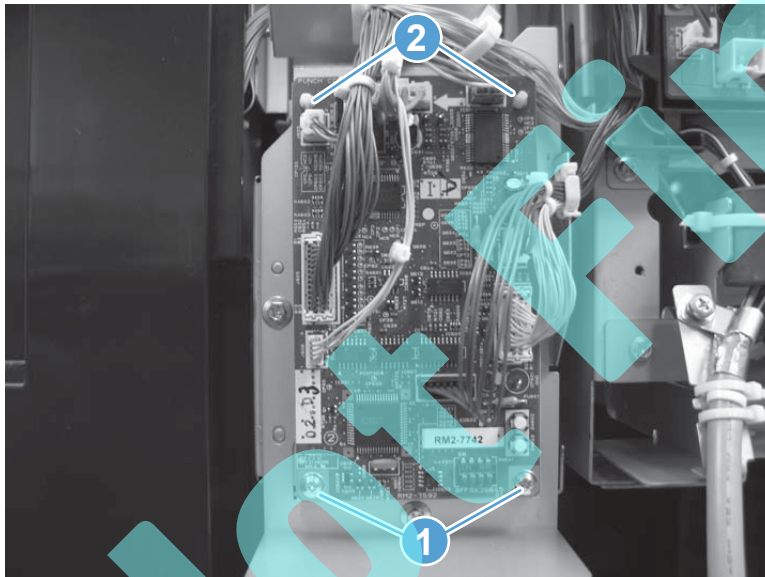

Dust collector assembly

Pull the dust collector straight out of the punch assembly to remove it.

Figure 1-827 Remove the dust collector assembly

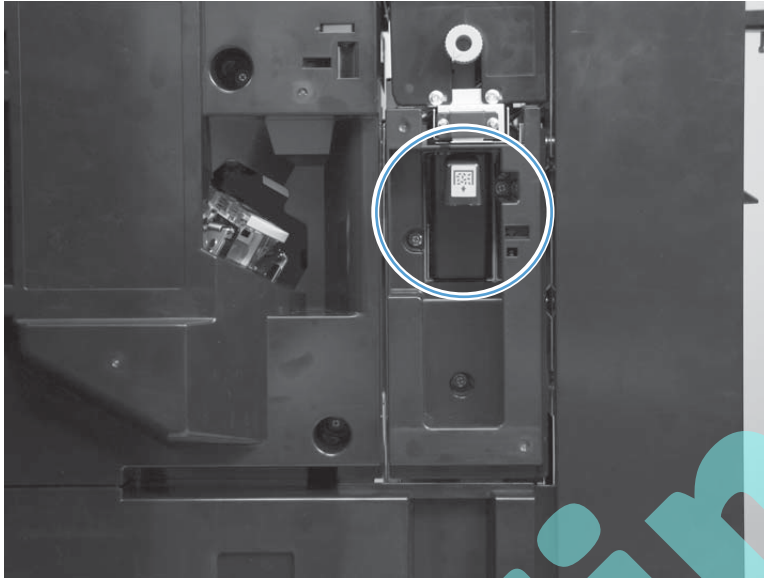

Not Final

Punch inner cover assembly

Before proceeding, remove the following assemblies:

- Dust collector assembly. See [Dust collector assembly on page 539](#).

Remove the punch inner cover assembly

1. Remove three screws.

 **NOTE:** These screws have a larger head than other screws used in the accessory. Make sure that you use these screws when the assembly is reinstalled.

Figure 1-828 Remove the punch inner cover assembly (1 of 2)



2. Remove the cover.

Figure 1-829 Remove the punch inner cover assembly (2 of 2)

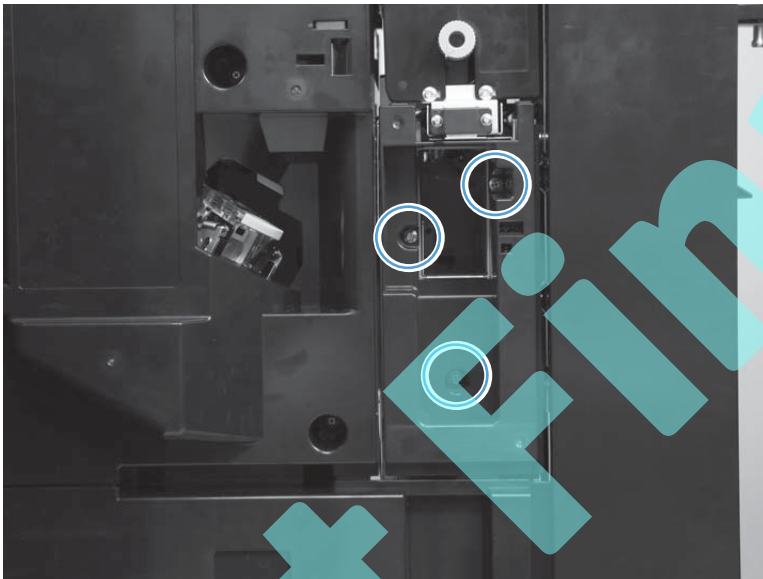
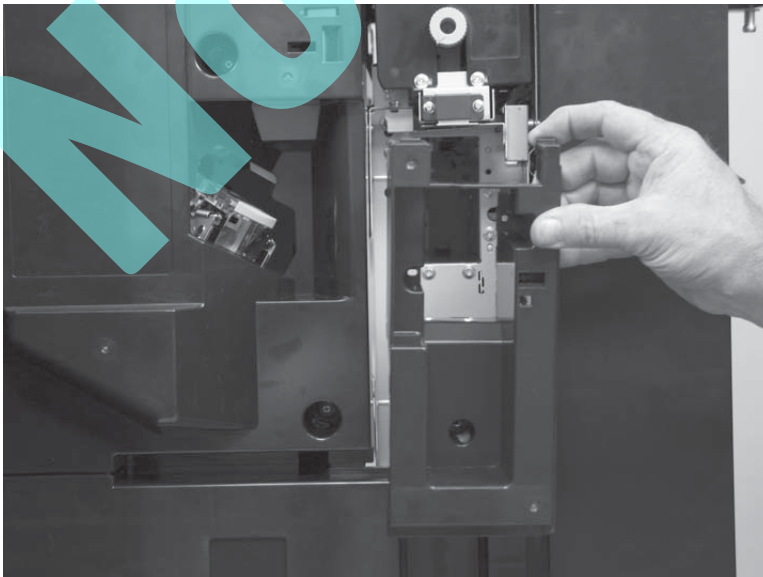

Punch top cover

Before proceeding, remove the following assemblies:

- Bin cable guide cover. See [Bin cable guide cover on page 317](#).
- Rear cover assembly. See [Remove only the rear cover on page 351](#).

Remove the punch top cover

1. Remove one screw.

 **NOTE:** This screw has a larger head than other screws used in the accessory. Make sure that you use this screw when the assembly is reinstalled.

Figure 1-830 Remove the punch top cover (1 of 6)



2. Open the front door.

Figure 1-831 Remove the punch top cover (2 of 6)

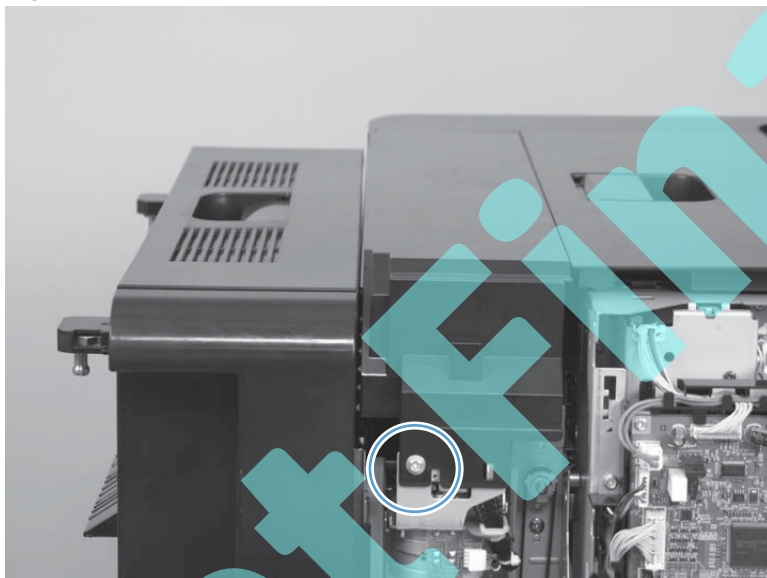
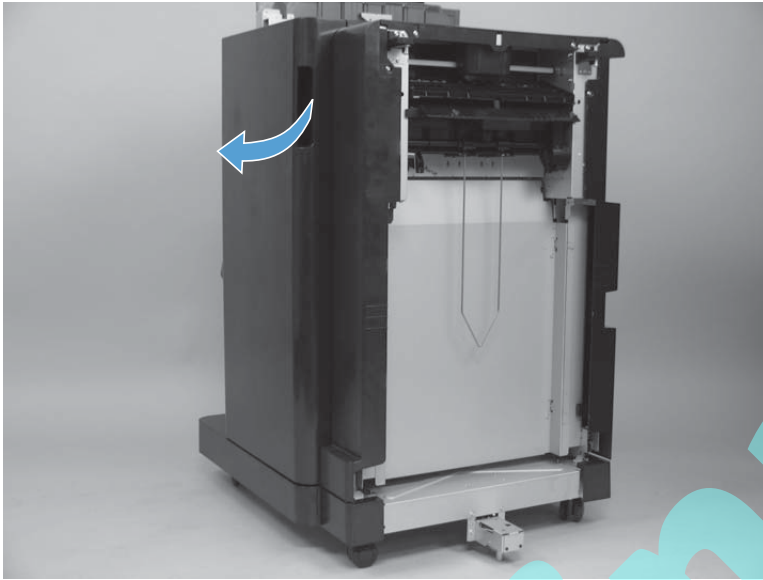

3. Remove two screws.

 **NOTE:** These screws have a larger head than other screws used in the accessory. Make sure that you use these screws when the assembly is reinstalled.

 **Reinstallation tip** The mounting holes for these two screws are slotted. Use these screws to adjust the position of the cover when it is reinstalled if it strikes the punch assembly or does not align correctly with the accessory covers.

Figure 1-832 Remove the punch top cover (3 of 6)



4. Slightly raise the front edge of the cover.

Figure 1-833 Remove the punch top cover (4 of 6)



5. Slide the cover towards the rear of the accessory to release it.

Figure 1-834 Remove the punch top cover (5 of 6)

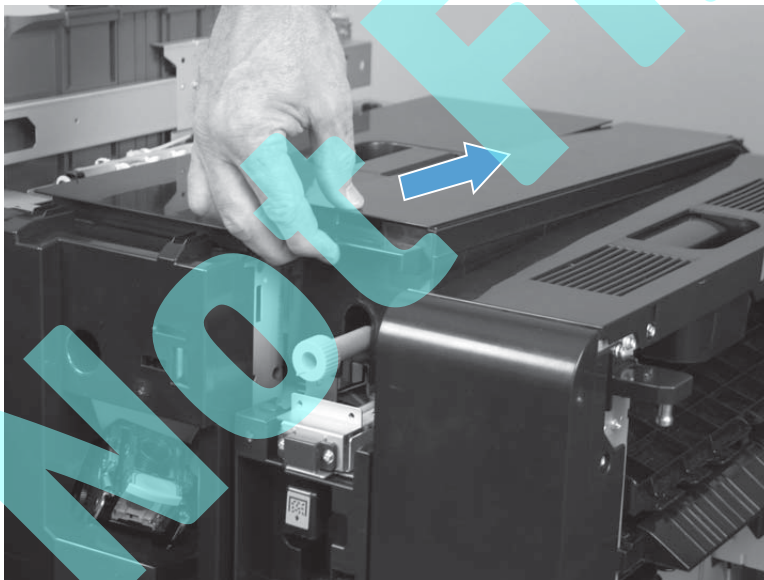

6. Rotate the cover up and off of the accessory to remove it.

Figure 1-835 Remove the punch top cover (6 of 6)

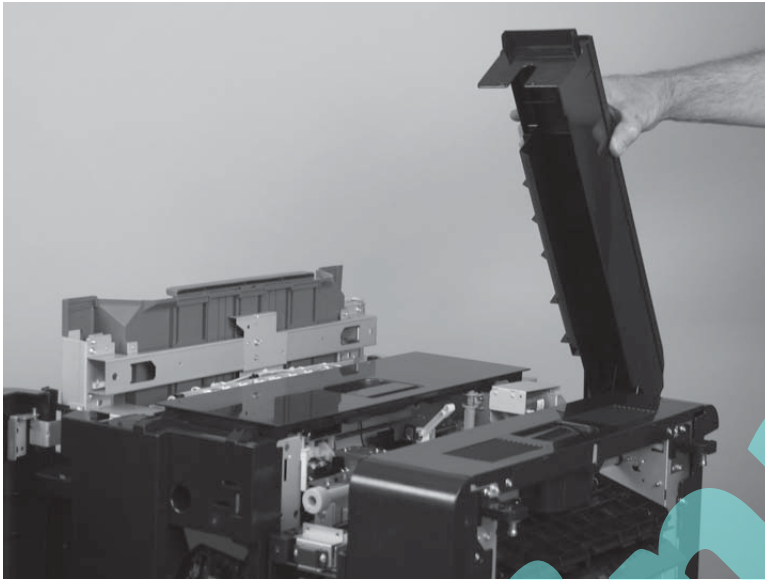

Not Final

Punch hole assembly

Before proceeding, remove the following assemblies:

- Right cover assembly. See [Right cover assembly on page 311](#).
- Pre-reverse cover assembly. See [Pre-reverse cover assembly on page 312](#).
- Rear reverse cover assembly. See [Rear reverse cover assembly on page 314](#).
- Upper reverse cover assembly. See [Upper reverse cover assembly on page 316](#).
- Bin cable guide cover. See [Bin cable guide cover on page 317](#).
- Open/closed stepped cover assembly. See [Open/closed stepped cover assembly on page 321](#).
- Upper stepped cover assembly. See [Upper stepped cover assembly on page 322](#).
- Lower stepped cover assembly. See [Lower stepped cover assembly on page 324](#).
- Rear cover assembly. See [Rear cover assembly on page 349](#).
- Reverse assembly. See [Reverse assembly on page 459](#).
- Dust collector assembly. See [Dust collector assembly on page 539](#).
- Punch inner cover assembly. See [Punch inner cover assembly on page 540](#).
- Punch top cover. See [Punch top cover on page 541](#).

Remove the punch hole assembly

1. Disconnect three connectors (callout 1) on the main controller PCA, and then release the wire harnesses from one retainer (callout 2).

Figure 1-836 Remove the punch hole assembly (1 of 5)

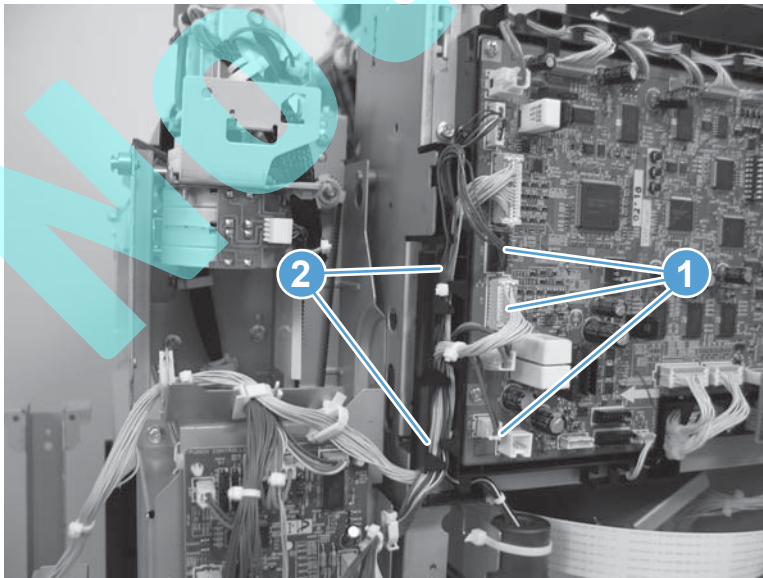

2. Release the wire harness from three retainers.

Figure 1-837 Remove the punch hole assembly (2 of 5)

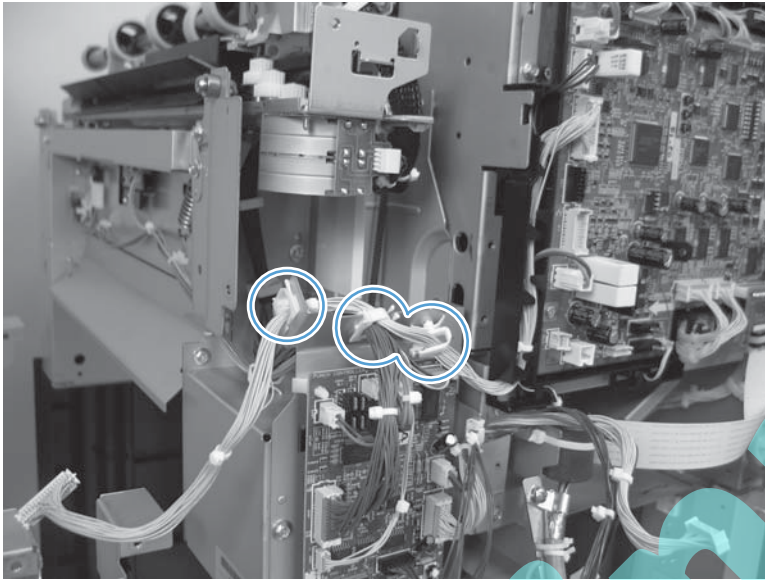

3. Remove one screw.

 **NOTE:** This screw has a larger head than other screws used in the accessory. Make sure that you use this screw when the assembly is reinstalled.

Figure 1-838 Remove the punch hole assembly (3 of 5)



4. Remove one screw.

 **NOTE:** This screw has a larger head than other screws used in the accessory. Make sure that you use this screw when the assembly is reinstalled.

Figure 1-839 Remove the punch hole assembly (4 of 5)

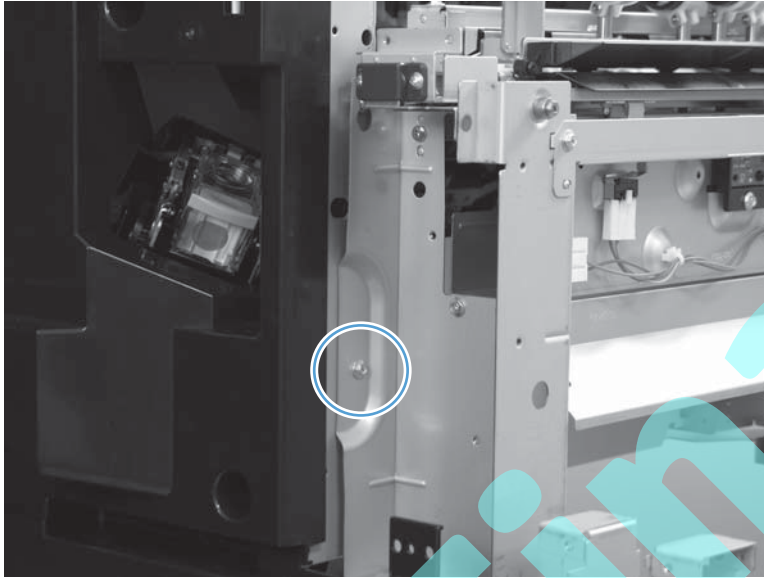

5. Lift the assembly up to release it, and then remove the assembly.

 **Reinstallation tip** If you are installing a replacement assembly, remove the punch controller PCA, and then install it on the replacement punch hole assembly. See [Punch controller PCA assembly on page 538](#).

Figure 1-840 Remove the punch hole assembly (5 of 5)



Reinstall the punch hole assembly

Punch adjustment is required when the punch holes are misaligned. If necessary, use the procedure below to adjust the position of punched holes after reinstalling, or replacing, the punch hole assembly.

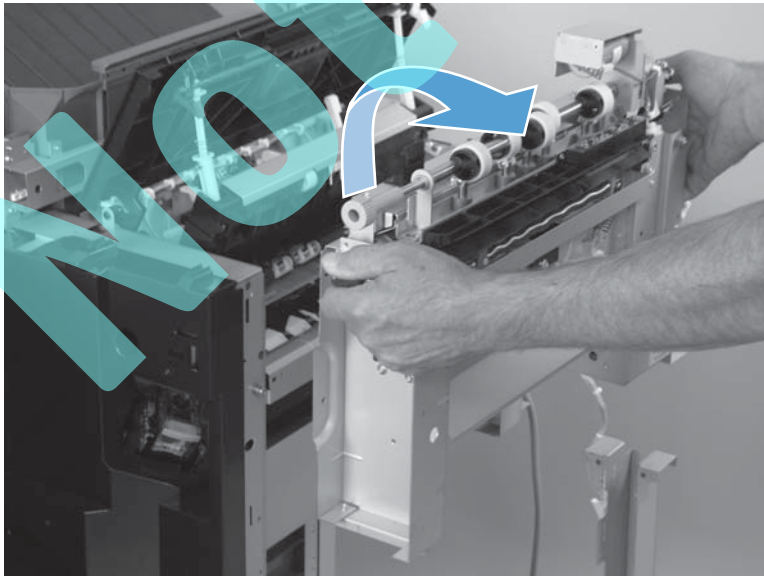
Adjust the punch hole location

Adjust the screw on the puncher assembly to correct the position of punch holes.

1. Identify in which direction the punched hole adjustment is required.

The figure below shows the punched hole misaligned to the left.

Figure 1-841 Adjust the punch hole location

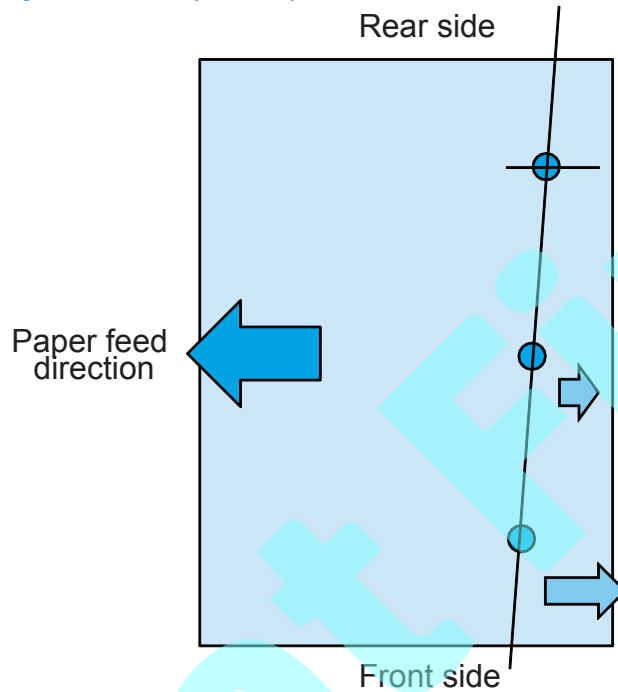

2. Loosen one screw, and then, move the punch assembly to the right.
Repeat this step for any other punch assemblies that require adjustment

Figure 1-842 Adjust the punch hole location

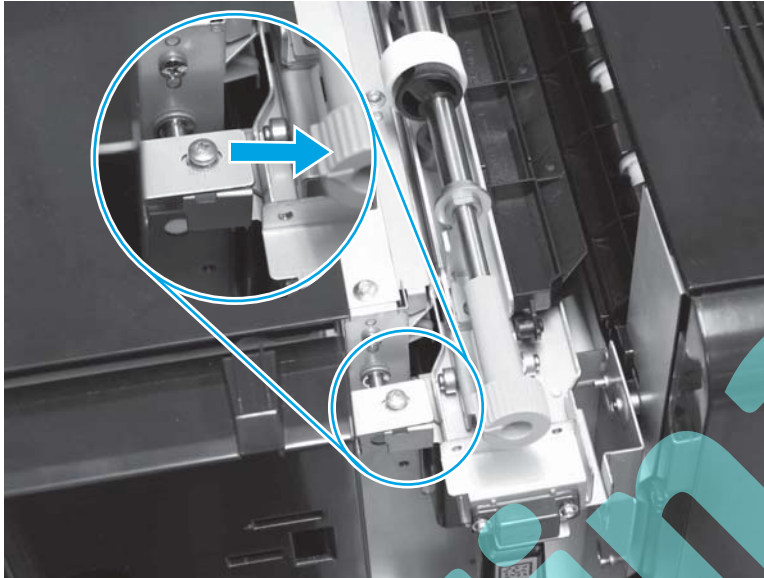

Not Final

Not Final

2 Parts and diagrams

- [Order parts by authorized service providers](#)
- [How to use the parts lists and diagrams](#)
- [Assembly locations](#)
- [Document feeder and scanner assemblies \(M830\)](#)
- [Document feeder assemblies \(M830\)](#)
- [Scanner assemblies \(M830\)](#)
- [Covers](#)
- [Internal assemblies](#)
- [3500-sheet paper feeder \(HCI\)](#)
- [Stapler stacker/booklet maker](#)
- [Alphabetical parts list](#)
- [Numerical parts list](#)

Order parts by authorized service providers

Order parts, accessories, and supplies

Table 2-1 Order parts, accessories, and supplies

Order supplies and paper	www.hp.com/go/suresupply
Order genuine HP parts or accessories	www.hp.com/buy/parts
Order through service or support providers	Contact an HP-authorized service or support provider.
Order using HP software	For information about using the HP software to order parts, accessories, and supplies, see the product user guide.

Related documentation and software

Table 2-2 Related documentation and software

Item	Description	Part number
<i>HP LaserJet Enterprise M806 User Guide</i>	Product user guide	CZ244-90904 (M806)
<i>HP LaserJet Enterprise Flow MFP M830 User Guide</i>		CF367-90904 (M830)
<i>HP LaserJet Enterprise M806/Flow MFP M830 Repair Manual</i>	English service manuals	CZ### ##### CZ### #####
<i>HP LaserJet Enterprise M806/Flow MFP M830 Troubleshooting Manual</i>		

Supplies part numbers

Table 2-3 Supplies part numbers

Item	Description	Part number
HP LaserJet toner cartridges	Black toner cartridge	CF325X (new)
		CF325-67901 (service)

Customer self-repair parts

The following customer self-repair parts are available for the product.

Each kit includes parts and installation instructions. The customer self repair (CSR) level indicates the expected difficulty the customer will experience when replacing this part:

- **A:** Easy
- **B:** Difficult

Table 2-4 Customer self-repair parts

Item	Description	CSR level	Part number
Hard disk drive replacement kit	• Hard Disk, 320GB	B	CF367-67913
	• Hard disk cradle		
FIPS 140 HDD for US Government Replacement Kit (M806)	• FIPS 140 HDD for U.S. Government	B	CZ244-67906
	• Hard disk cradle		
Solid state memory kit (M806)	• Solid state module, 8GB	B	CZ244-67905
	• SSM twist lock		
1GB DIMM replacement kit (M830)	IC DDR2-SDRAM 128MX64 200 SO-DIMM	B	CF367-67917
512MB DIMM Kit (M806)	512MB DIMM	B	CF306-67901
1GB DIMM Kit (M830)	1GB DIMM	B	CF367-67917
Formatter kit (M830)	• Formatter PCA assembly	B	CF367-67915
	• M3 Screws		
	• Formatter cage assembly		
	• Thumbscrew		
Formatter kit (M806)	• Formatter PCA assembly	B	CZ244-67901
	• M3 Screws		
	• Formatter cage assembly		
	• Thumbscrew		
Formatter kit (M806)	• Formatter PCA assembly	B	CZ244-67902 (China/India)
	• M3 Screws		
	• Formatter cage assembly		
	• Thumbscrew		

Table 2-4 Customer self-repair parts (continued)

Item	Description	CSR level	Part number
Fax-card replacement kit (M830)	<ul style="list-style-type: none"> Fax card PCA Fax cable 	A	CF367-67911
Fuser kit	<ul style="list-style-type: none"> Fuser Recycling instructions 		CF367-67905 (110V) CF367-67906 (220V)
Fuser maintenance kit	Fuser	A	C2H67-67901 (110V) C2H57-67901 (220V)
NOTE: Make sure that you use the correct part number for the rated voltage of the product.			
HCI kit	HCI		C3F79-67901
HCI right tray kit	Tray assembly, right	A	CZ244-67903
HCI left tray kit	Tray assembly, left	A	CZ244-67904
Stapler/stacker Kit	Stapler/stacker	A	CZ994-67901
Stapler/stacker 2/3 hole punch kit	Stapler/stacker 2/3 hole puncher		CZ995-67901
Stapler/stacker 2/4 hole punch kit	Stapler/stacker 2/4 hole puncher		CZ996-67901
Booklet maker kit	Booklet maker		CZ285-67901
Staple-cartridge refill kit	Staple cartridge refill	A	C8085-60541 C8091A
Tray 1 roller kit	<ul style="list-style-type: none"> Tray 1 pickup roller Tray 1 feed roller 	A	CF367-67904
Tray 2–X roller kit	<ul style="list-style-type: none"> Feed roller (engine) Pickup roller (engine) Feed roller (HCI) Pickup roller (HCI) 	A	CF367-67903
ADF roller maintenance kit (M830)	ADF roller	A	C1P70-67901
Black toner cartridge kit	Black toner cartridge	A	CF325-67901
2000-staple cartridge kit (booklet maker)	2000-staple cartridge	A	CF367-67914
USB wireless print server kit	Wireless print server	A	J8026-61001
NFC accessory kit	NFC accessory		J8029-61001
Transfer roller kit	Transfer roller	A	CF367-67907
White backing A/3 kit (M830)	White ADF Backing	A	5851-5864
ADF separation pad spring kit (M830)	Spring, compression	B	5851-5855

Table 2-4 Customer self-repair parts (continued)

Item	Description	CSR level	Part number
Backside background selector kit (M830)	Background selector for backside scan	A	5851-5861
Control-panel assembly kit (M806)	Control panel assembly	A	5851-5950
Control-panel assembly kit (without keyboard-M830)	Control panel assembly	A	5851-5952
US English keyboard kit (M830)		A	5851-5380
UK English keyboard kit (M830)		A	5851-5008
Keyboard overlay kit (M830)	Keyboard overlay	A	5851-6019 (FR, IT, RU, DE, ES: UK Kybd) 5851-6020 (FR-CN, ES-LA, ES: US Kybd) 5851-6021 (FR-SW, DE-SW, DA: UK Kybd) 5851-6022 (ZHTW, ZHCN) 5851-6023 (ES, PT) 5851-6024 (JA-KG, JA-KT)
Duplexing assembly kit	Duplexing assembly	A	CZ244-00028

Service replacement parts

Table 2-5 Service replacement parts

Item	Description	Part number
Front door assembly kit	<ul style="list-style-type: none"> Front door assembly HP logo jewel (35mm, round, polished) Product label/name plate 	CF367-67909
Toner vacuum service kit	<ul style="list-style-type: none"> Toner vacuum Instructions for use 	CC468-69002 (110V) CC468-69003 (220V)
ADF whole unit kit (M830)	<ul style="list-style-type: none"> ADF whole unit White backing A3 kit 	CF367-67920
Image scanner A3 whole unit kit (M830)	<ul style="list-style-type: none"> Image scanner A3 whole unit White backing A3 kit 	CF367-67919
Sanner control board kit (M830)	SCB assembly	CF367-60002

Table 2-5 Service replacement parts (continued)

Item	Description	Part number
A3 ADF mylar kit (M830)	Mylar	5851-5857
E-ring, pin, and bushing kit	<ul style="list-style-type: none"> • E-ring • E-ring for clutch • Washer • Pin • Bushing 	5851-6142

Accessories

Item	Description	Part number
HP LaserJet Stapler/Stacker	Stapler/stacker finishing accessory	CZ994A
HP LaserJet Stapler/Stacker with 2/3 hole punch	Stapler/stacker with hole punch finishing accessory for countries/regions that use imperial measurements	CZ995A
HP LaserJet Stapler/Stacker with 2/4 hole punch	Stapler/stacker with hole punch finishing accessory for countries/regions that use metric measurements	CZ996A
HP LaserJet Booklet Maker/Finisher	Booklet maker finishing accessory	CZ285A
HP Jetdirect ew2500 Wireless Print Server	USB wireless print server	J8026A
HP Jetdirect 2800w NFC & Wireless Direct Accessory	Wireless direct accessory for "touch" printing from mobile devices	J8029A

How to use the parts lists and diagrams

The figures in this chapter show the major subassemblies in the product and their component parts. A parts list table follows each exploded view assembly diagram. Each table lists the item number, the associated part number, and the description of each part. If a part is not listed in the table, then it is not a field replacement unit (FRU).

CAUTION: Be sure to order the correct part. When looking for part numbers for electrical components, pay careful attention to the voltage that is listed in the description column. Doing so will ensure that the part number selected is for the correct model.

NOTE: In this manual, the abbreviation "PCA" stands for "printed circuit-board assembly." Components described as a PCA might consist of a single circuit board or a circuit board plus other parts, such as cables and sensors.

Assembly locations

Base product (no optional trays or accessories)

Figure 2-1 M830 product integrated scanner assembly (ISA)

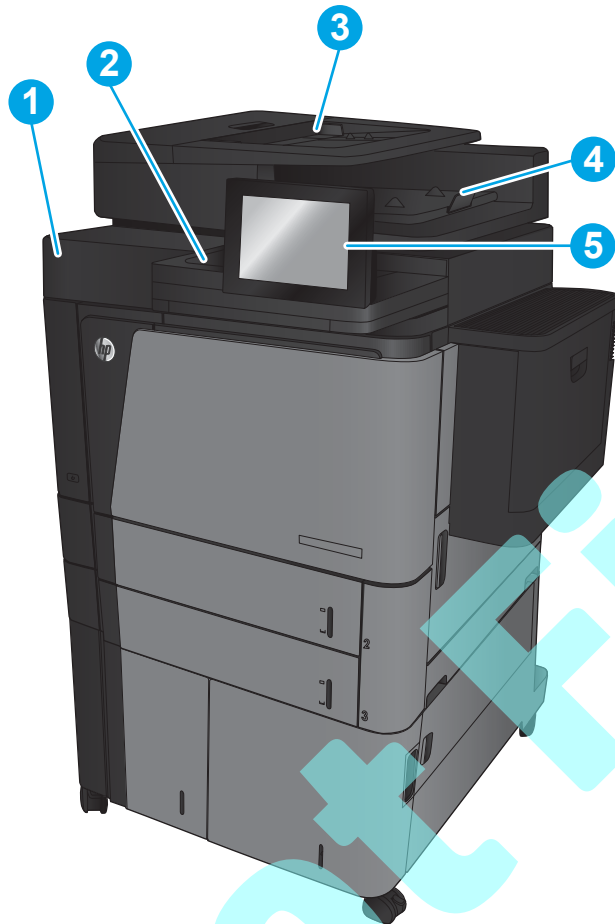

Table 2-6 M830 product integrated scanner assembly (ISA)

Item	Description	Item	Description
1	Scanner assembly	4	ADF output bin
2	Hardware Integration Pocket (HIP) cover	5	Control-panel assembly
3	Automatic document feeder (ADF)		

Figure 2-2 Base product (no optional trays or accessories)

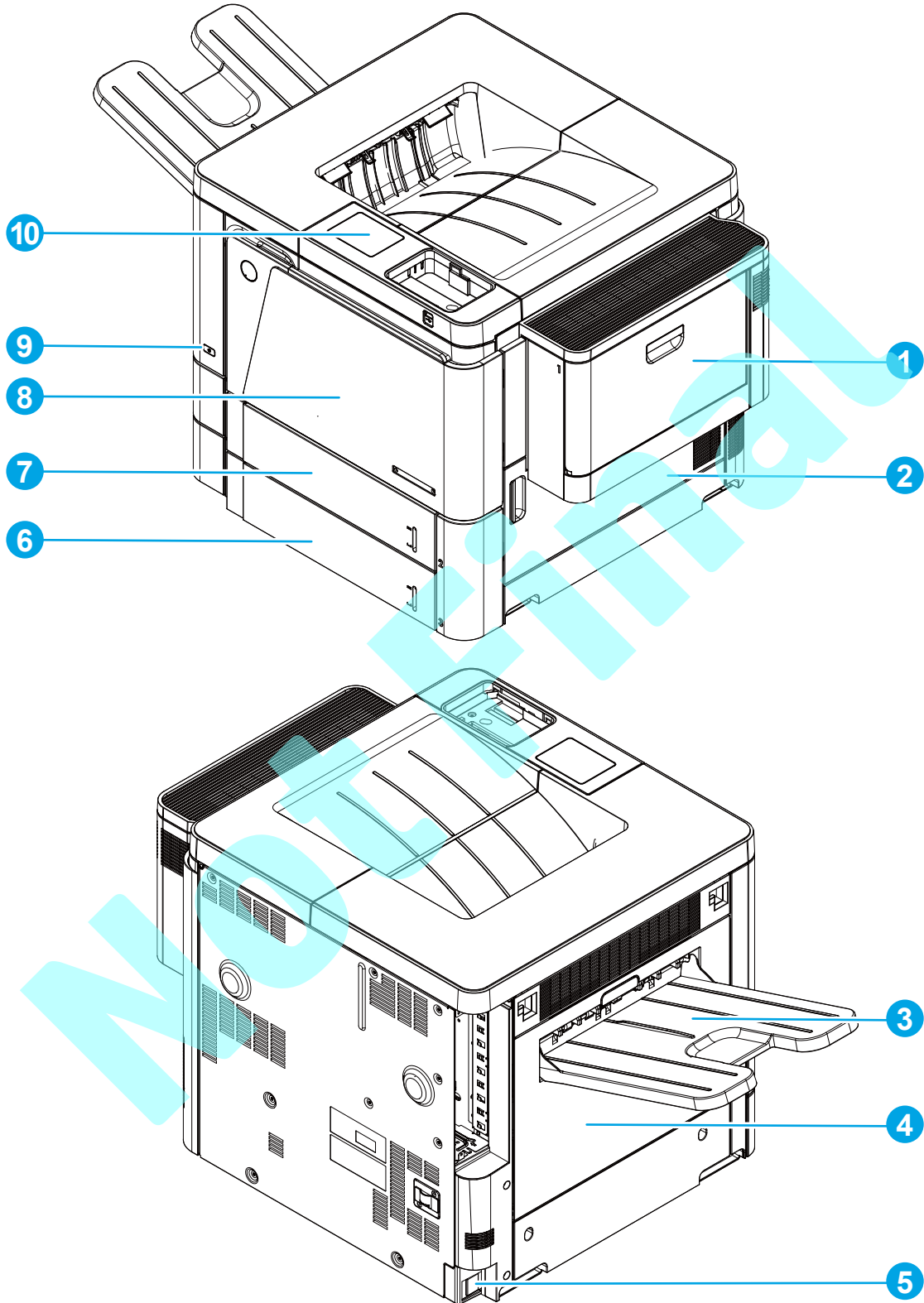

Table 2-7 Base product (no optional trays or accessories)

Item	Description	Item	Description
1	Multipurpose tray	6	Cassette 2

Table 2-7 Base product (no optional trays or accessories) (continued)

Item	Description	Item	Description
2	Right door	7	Cassette 1
3	Face-up tray	8	Front door
4	Left door	9	Power switch
5	Power receptacle	10	Hardware Integration Pocket (HIP) cover (M806 only)

NOTE: This cover is on the ISA for the M830 product.

Not Final

Document feeder and scanner (M830)

Figure 2-3 Document feeder and scanner (M830)

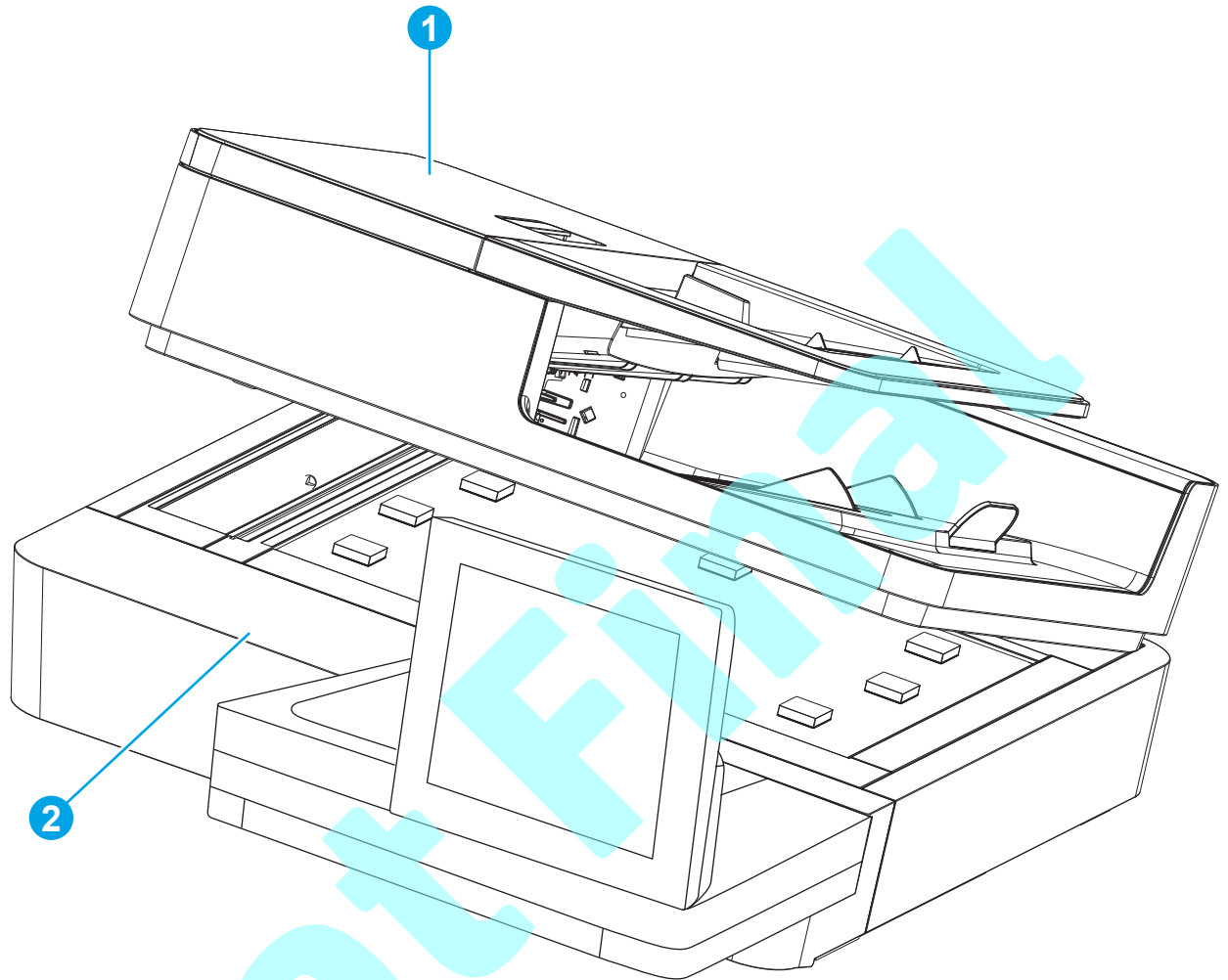

Table 2-8 Document feeder and scanner (M830)

Item	Description
1	Document feeder assembly
2	Scanner assembly

High capacity input (HCI) feeder

Figure 2-4 High capacity input (HCI) feeder covers

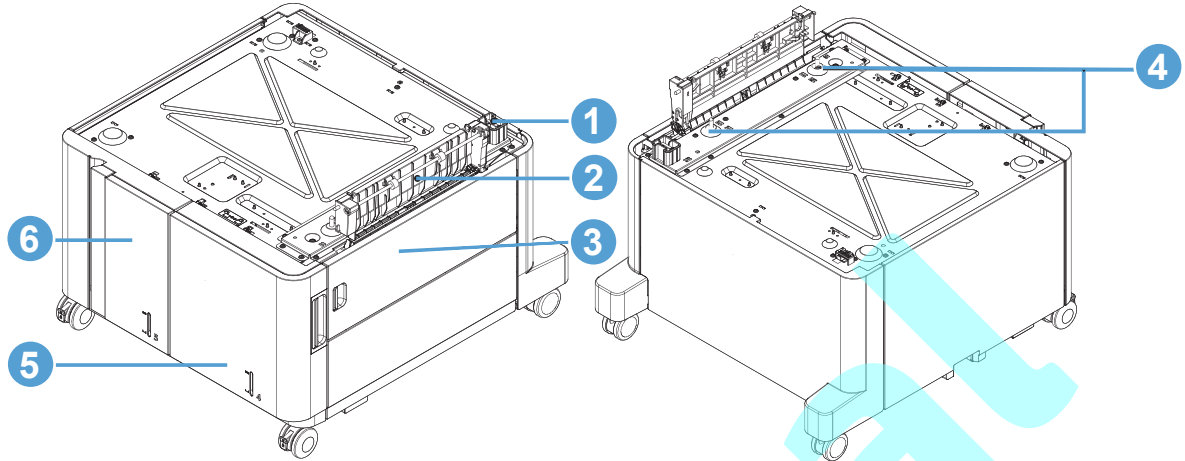

Table 2-9 High capacity input (HCI) feeder covers

Item	Description	Item	Description
1	Connector	4	Positioning pin
2	Paper path assembly	5	Right cassette
3	Right door	6	Left cassette

Finishing accessories

 **NOTE:** Unless otherwise noted, many of the covers, doors, and output bins are common to all of the finishing accessories.

Figure 2-5 Stapler/stacker and stapler/stacker with hole punch covers

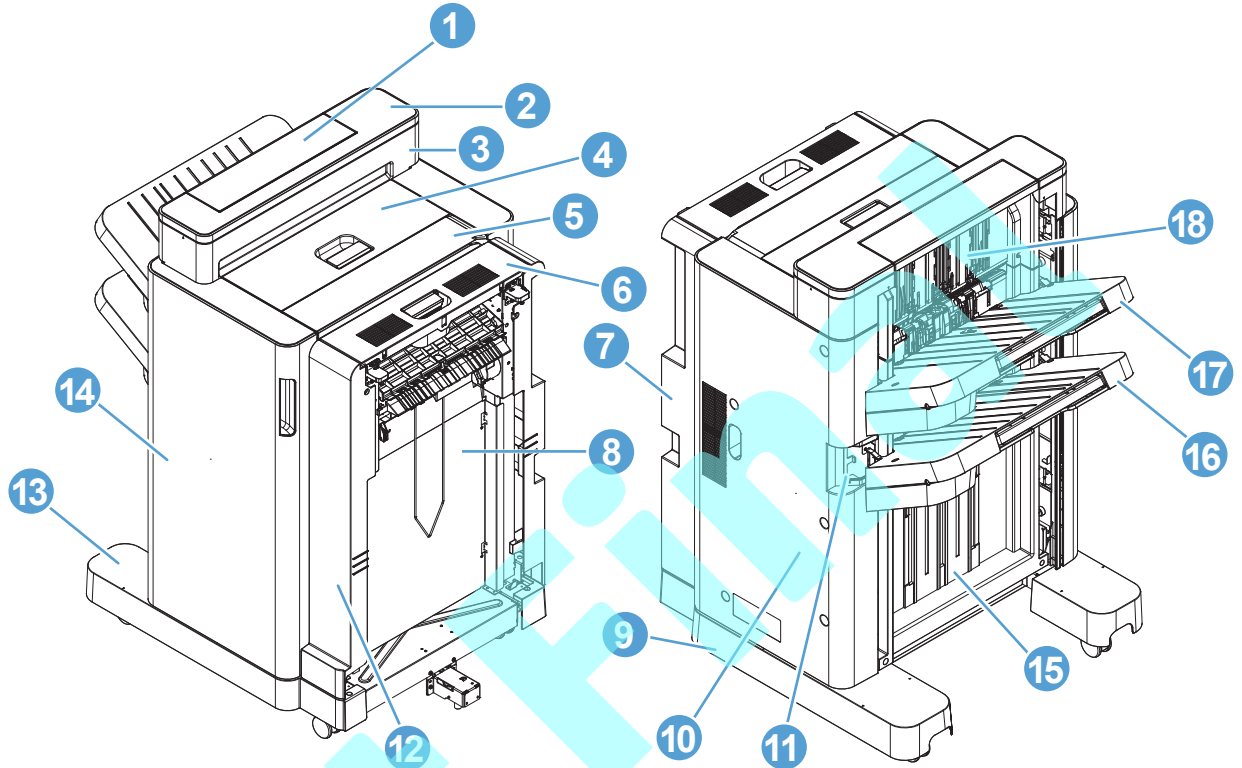

Table 2-10 Stapler/stacker and stapler/stacker with hole punch covers

Item	Description	Item	Description
1	Open/closed stepped cover	10	Rear cover
2	Upper stepped cover	11	Bin cable cover
3	Lower stepped cover	12	Pre-reverse cover
4	Upper (top) cover	13	Front foot cover
5	Punch cover	14	Front cover (door)
NOTE: Stapler/stacker with hole punch only.			
6	Upper reverse cover	15	Height wall assembly
7	Rear reverse cover	16	Lower bin assembly
8	Right cover	17	Upper bin assembly
9	Rear foot cover	18	Stack wall upper assembly and upper wall guide

Figure 2-6 Booklet maker only covers

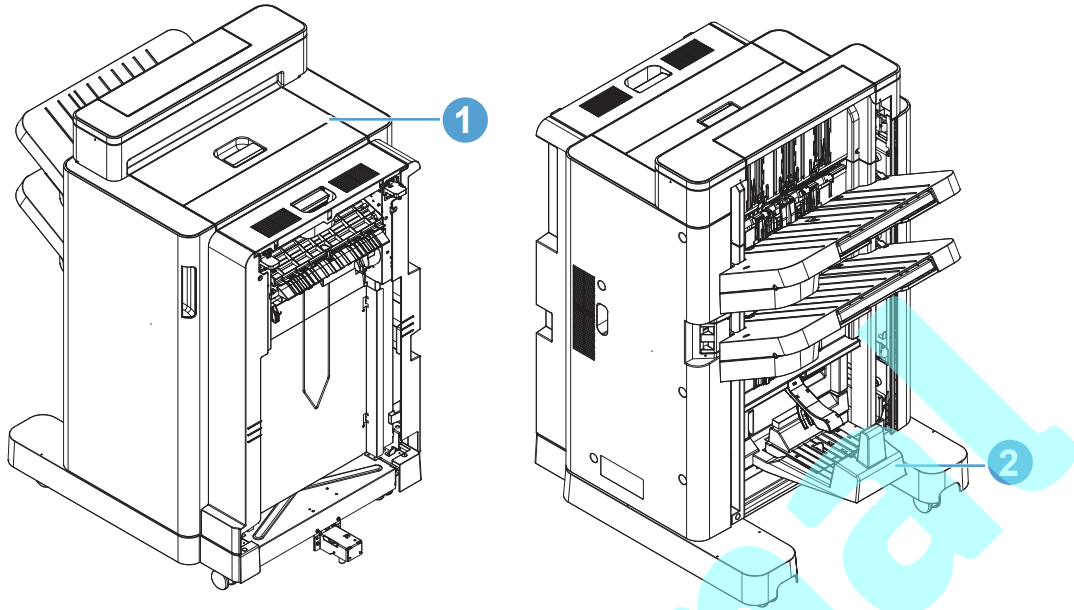

Table 2-11 Booklet maker only covers

Item	Description	Item	Description
1	Upper (top) cover with extension	2	Saddle bin assembly

Document feeder and scanner assemblies (M830)

Figure 2-7 Document feeder and scanner assemblies (M830)

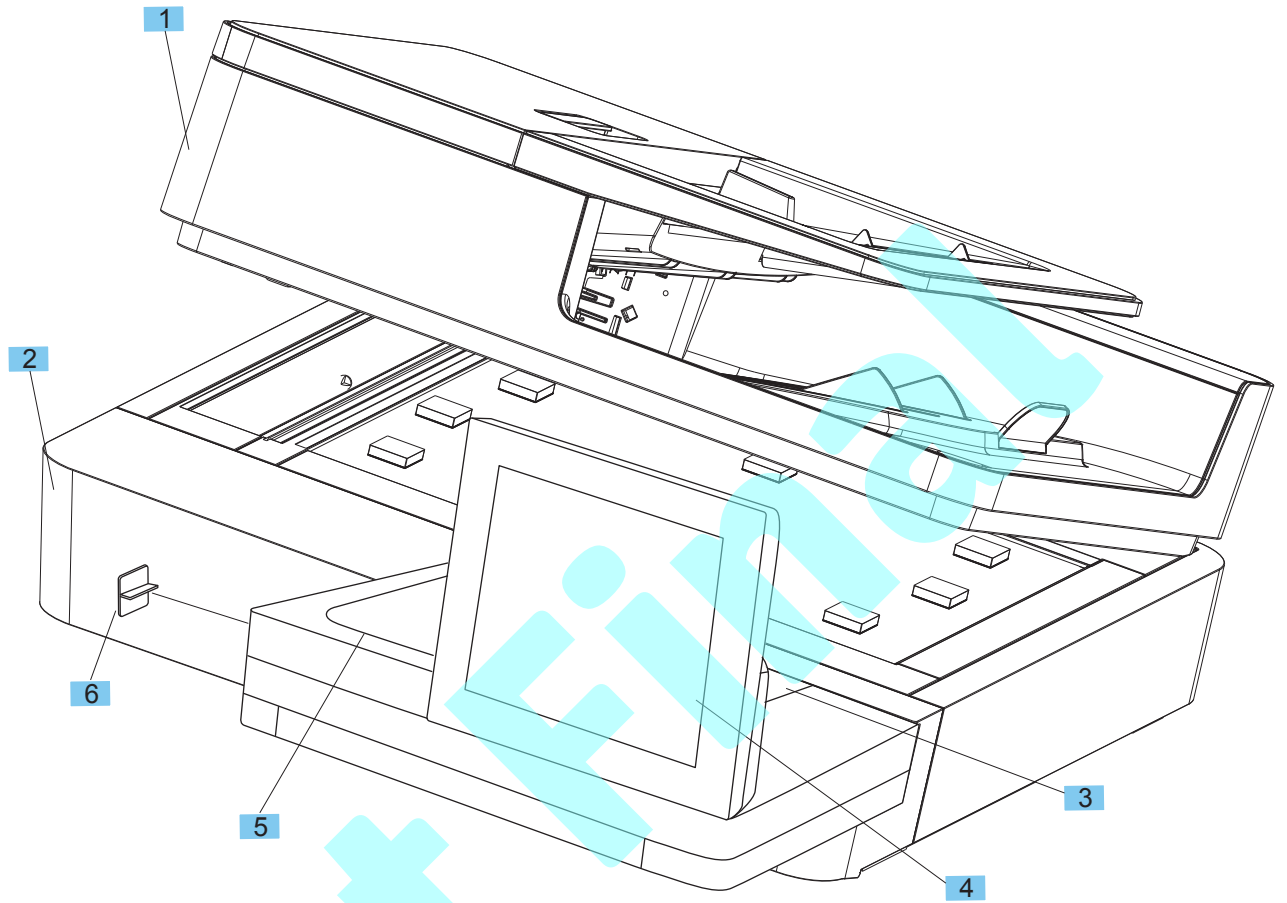

Table 2-12 Document feeder and scanner assemblies (M830)

Ref	Description	Part number	Qty
1	Kit, ADF whole unit, A3 (includes white backing kit) (M830)	CF367-67920	1
2	Kit, scanner whole unit (includes white backing kit) (M830)	CF367-67919	1
3	Cover, control panel access (M830)	5042-9118	1
4	Kit, control panel (without keyboard) (M830)	5851-5952	1
5	Cover, HIP (M830)	5851-5361	1
6	Cover, USB (M830)	5851-5360	1
Not shown	Kit, white backing, A3 (M830)	5851-5864	1
Not shown	Kit, ADF Mylar, A3 (M930)	5851-5857	1

Not Final

Document feeder assemblies (M830)

Figure 2-8 Document feeder assemblies (1 of 2; M830)

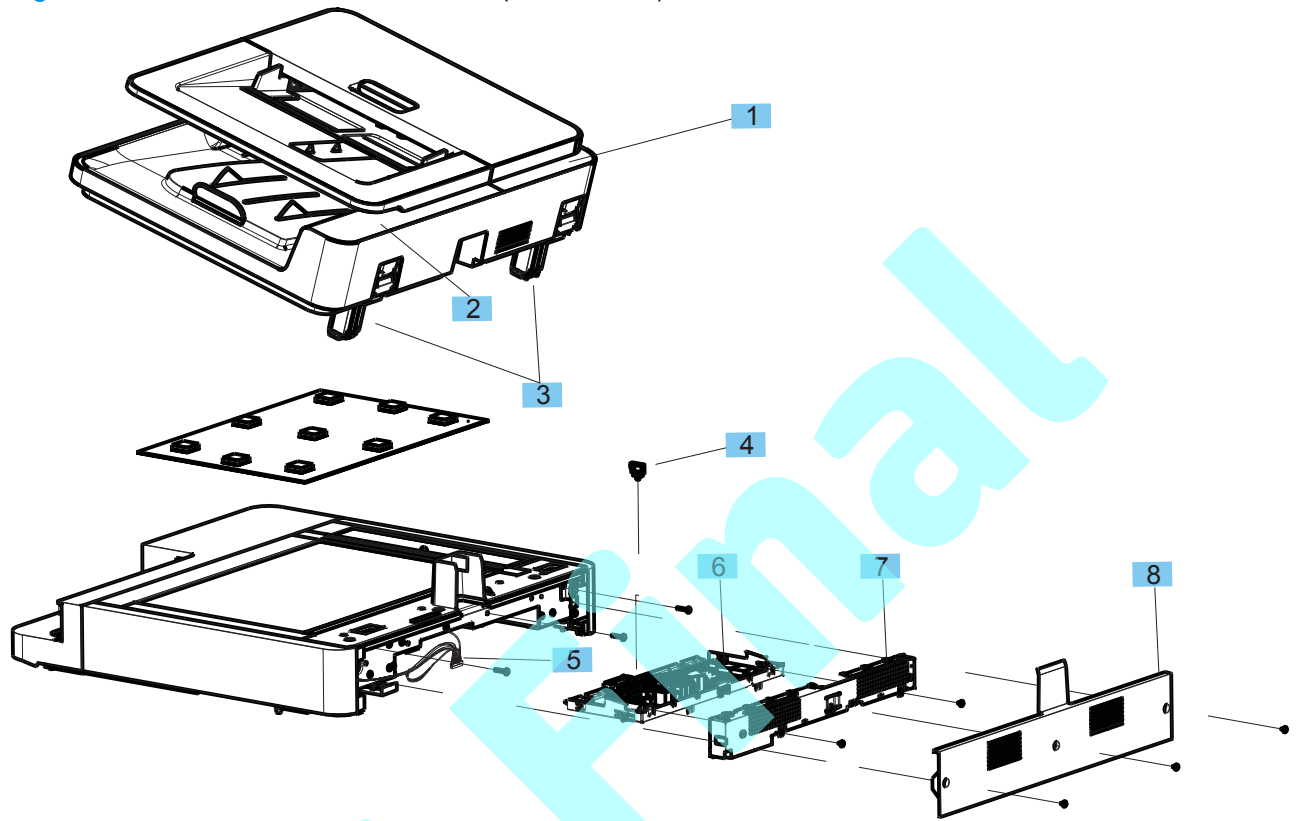

Table 2-13 Document feeder assemblies (1 of 2; M830)

Ref	Description	Part number	Qty
1	Cover, rear, left ADF (M830)	A8T68-40067	1
2	Cover, rear, right ADF (M830)	A8T68-40066	1
3	Assembly, ADF hinge (M830)	A8T68-60025	2
4	Clip, ISA cable (M830)	5851-4725	1
5	Cable, power, integrated scan assembly (M830)	CF367-60127	1
6	Scanner control board (SCB; M830)	CF367-60002	1
7	Cage, back, SCB cover (M830)	CF367-00018	1
8	Cover, back, scanner (M830)	CF368-60142	1
Not shown	Flag, paper presence (M830)	A8T68-40033	1
Not shown	Photosensor with connector (M830)	CC355-80014	1
Not shown	Stopper, load-front (M830)	A8T68-40034	1
Not shown	Stopper, load-rear (M830)	A8T68-40035	1
Not shown	Stopper, front (M830)	A8T68-40042	1
Not shown	Stopper, rear (M830)	A8T68-40042	1
Not shown	Lift plate assembly (M830)	A8T68-60006	1

Figure 2-9 Document feeder assemblies (2 of 2; M830)

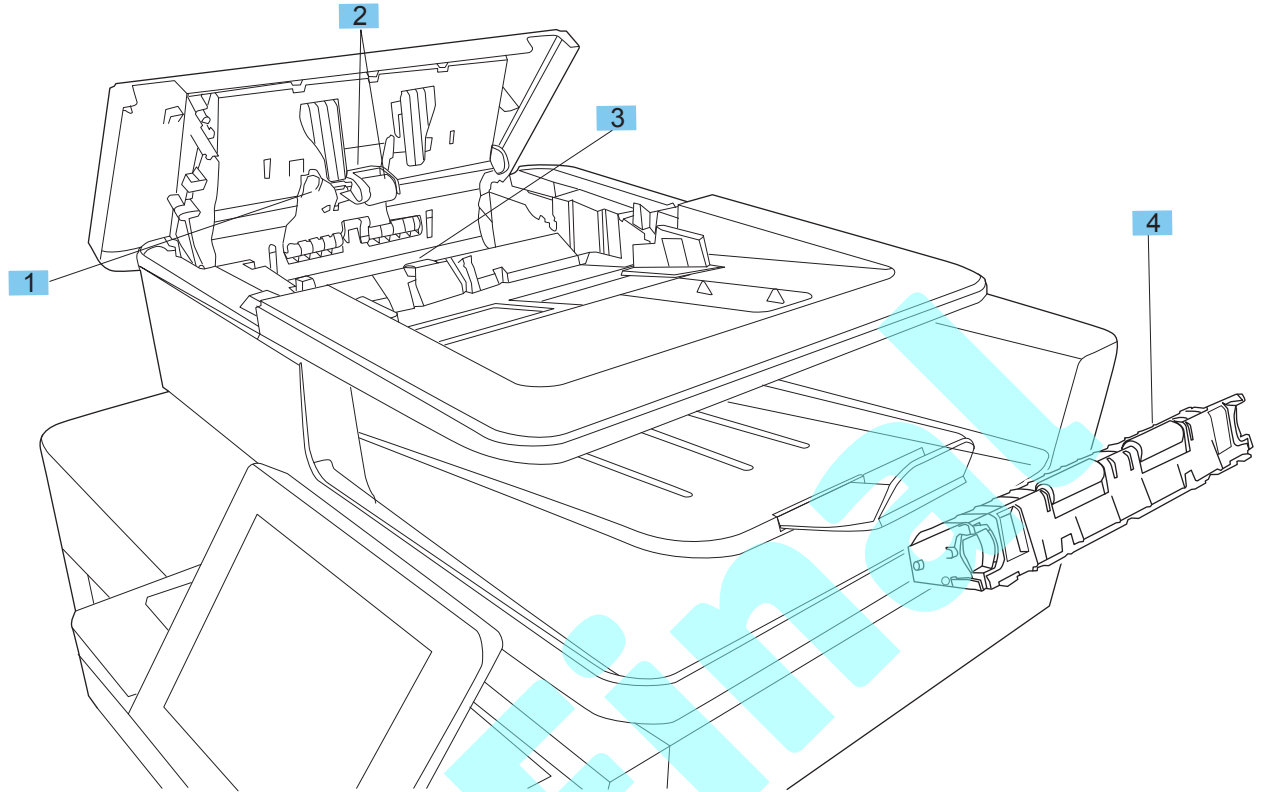

Table 2-14 Document feeder assemblies (2 of 2; M830)

Ref	Description	Part number	Qty
1	Cover, ADF roller (M830)	A8T68-40072	1
2	Kit, ADF roller (M830)	C1P70-67901	1
3	Background selector for backside scan (M830)	A8T68-60021	1
Not shown	Kit, ADF separation pad spring (M830)	5851-5855	1

Not Final

Scanner assemblies (M830)

Figure 2-10 Scanner assemblies

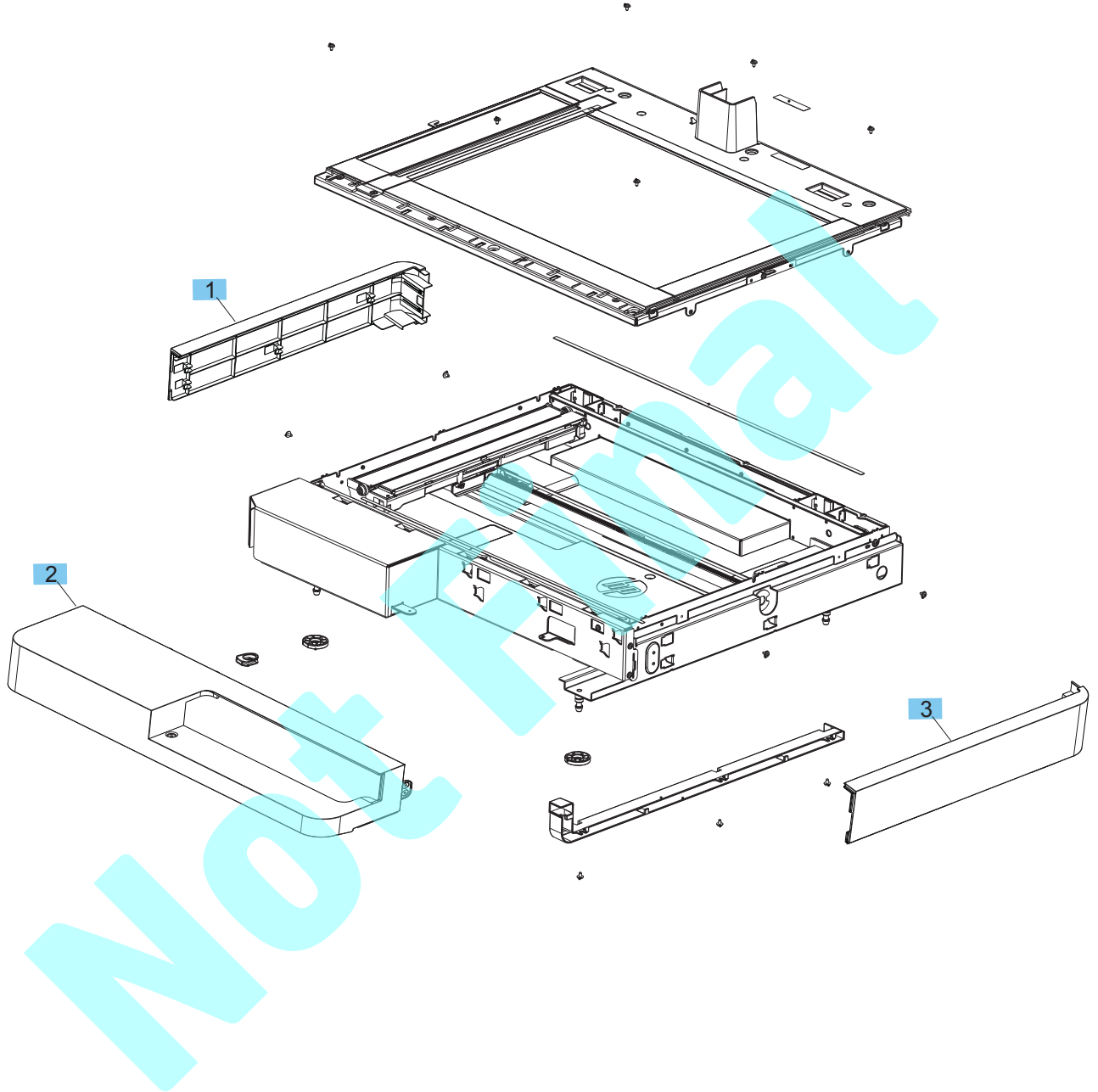

Table 2-15 Scanner assemblies

Ref	Description	Part number	Qty
1	Cover, left, scanner (M830)	CF367-40003	1
2	Cover, front, scanner (M830)	CF367-40002	1
3	Cover, right, scanner (M830)	CF367-40004	1

Not Final

Covers

Figure 2-11 Covers
M830

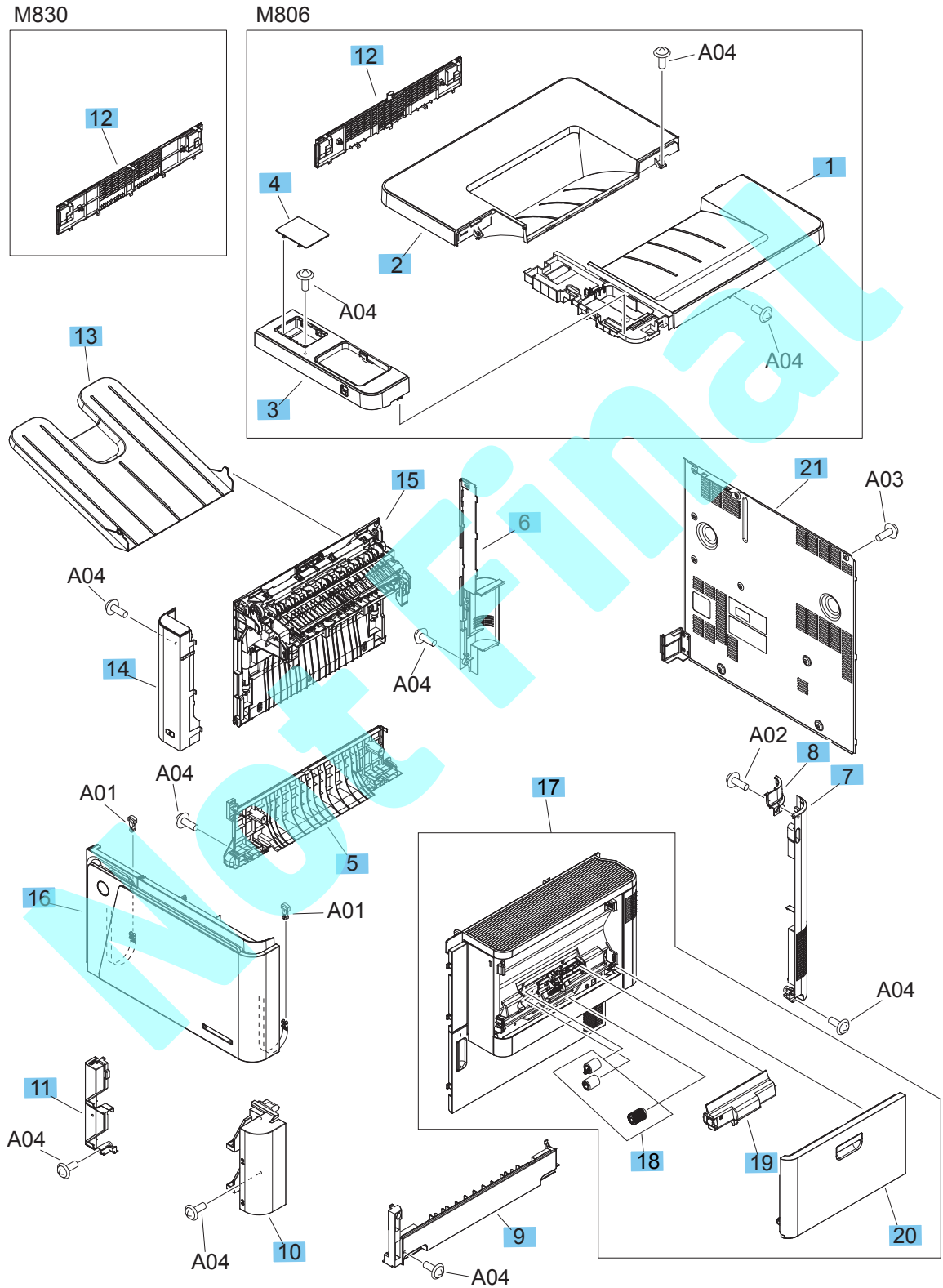

Table 2-16 Covers

Ref	Description	Part number	Qty
1	Cover, top right (M806)	RC3-3945-000CN	1
2	Cover, top left (M806)	RC3-3946-000CN	1
3	Cover, operation panel, top (M806)	RC3-3947-000CN	1
4	Cover, hip (M806)	RC3-3948-000CN	1
5	Cover, left lower	RC3-3949-000CN	1
6	Cover, corner, left rear	RC3-3952-000CN	1
7	Cover, right rear corner, lower	RC3-3954-000CN	1
8	Cover, right rear corner, upper	RC3-3955-000CN	1
9	Cover, right lower	RC3-3956-000CN	1
10	Cover, corner, right front	RC3-3957-000CN	2
11	Cover, corner, left front	RC3-3958-000CN	1
12	Cover, left upper (M806)	RC3-3979-000CN	1
12	Cover, left upper (M830)	RC3-4589-000CN	1
13	Tray, face-up	RC3-3985-000CN	1
14	Front left lower cover assembly	RM1-9722-000CN	1
15	Left door assembly	RM1-9736-000CN	1
16	Kit, front door assembly	CF367-67909	1
17	Right door assembly	RM1-9769-000CN	1
18	Kit, tray 2-X roller	CF367-67903	1
19	Roller cover assembly	RM1-9809-000CN	1
20	Multi-purpose tray (Tray 1) assembly	RM1-9774-000CN	1
21	Rear cover assembly	RM1-9787-000CN	1

Internal assemblies

Internal assemblies (1 of 4)

Figure 2-12 Internal assemblies (1 of 4)

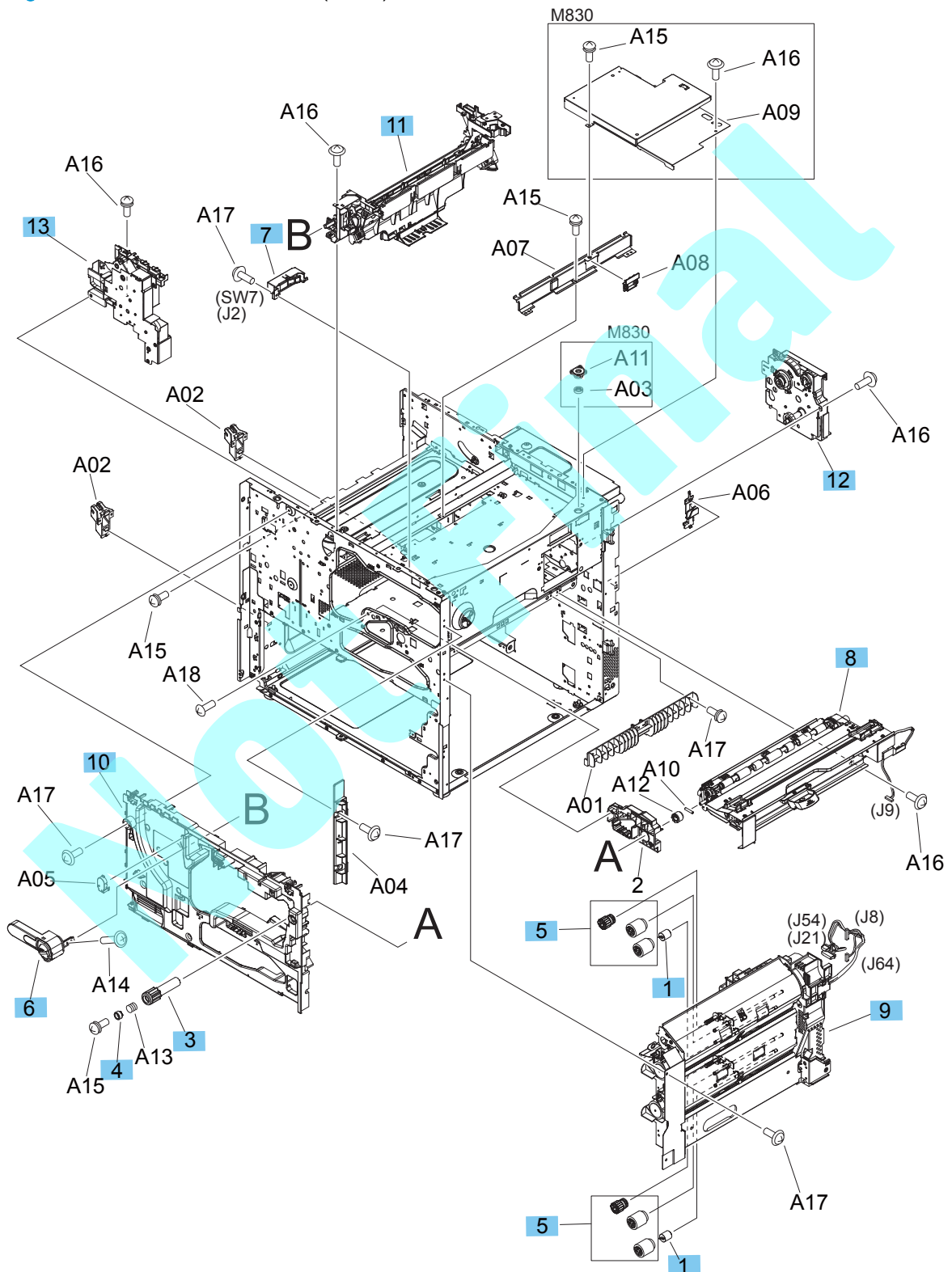

Table 2-17 Internal assemblies (1 of 4)

Ref	Description	Part number	Qty
1	Limiter, torque	RB2-5759-000CN	2
2	Guide, cartridge, front	RC3-3968-000CN	1
3	Dial, jam dispose	RC3-4269-000CN	1
4	Lid, jam dispose dial	RC4-2004-000CN	1
5	Kit, tray 2 roller	CF367-67903	4
6	Control lever assembly	RG5-5746-030CN	1
7	Right door switch assembly	RM1-9725-000CN	1
8	Registration assembly	RM1-9742-000CN	1
9	Paper pickup assembly	RM1-9745-000CN	1
10	Front inner cover assembly	RM1-9760-000CN	1
11	Cartridge lifter assembly	RM1-9775-000CN	1
12	Drum drive assembly	RM1-9784-000CN	1
13	Fusing drive assembly	RM1-9788-000CN	1

Not Final

Internal assemblies (2 of 4)

Figure 2-13 Internal assemblies (2 of 4)

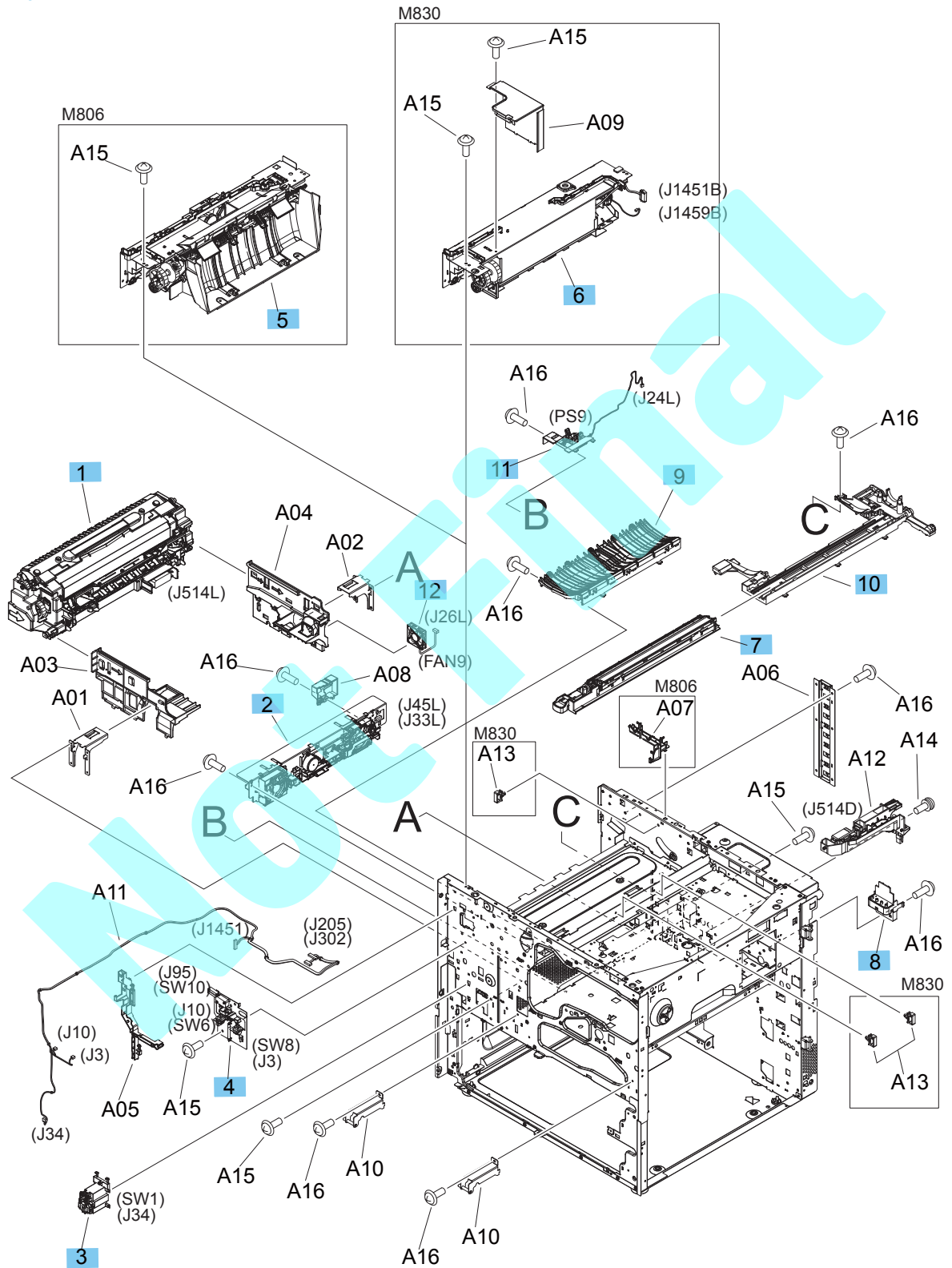

Table 2-18 Internal assemblies (2 of 4)

Ref	Description	Part number	Qty
1	Kit, fuser assembly, 110V	CF367-67905	1
1	Kit, fuser assembly, 220V	CF367-67906	1
2	Cooling unit assembly	RM1-9720-000CN	1
3	Power switch assembly	RM1-9723-000CN	1
4	Interlock assembly	RM1-9724-000CN	1
5	Face-down paper delivery assembly (M806)	RM1-9732-000CN	1
6	Paper delivery fan assembly (M830)	RM1-9734-000CN	1
7	Kit, transfer roller assembly	CF367-67907	1
8	Cartridge contact assembly	RM1-9758-000CN	1
9	Transfer paper feed assembly	RM1-9705-000CN	1
10	Transfer holder assembly	RM1-9706-000CN	1
11	Sensor unit, loop	RM1-9707-000CN	1
12	Fan	RK2-5004-000CN	1

Internal assemblies (3 of 4)

Figure 2-14 Internal assemblies (3 of 4)

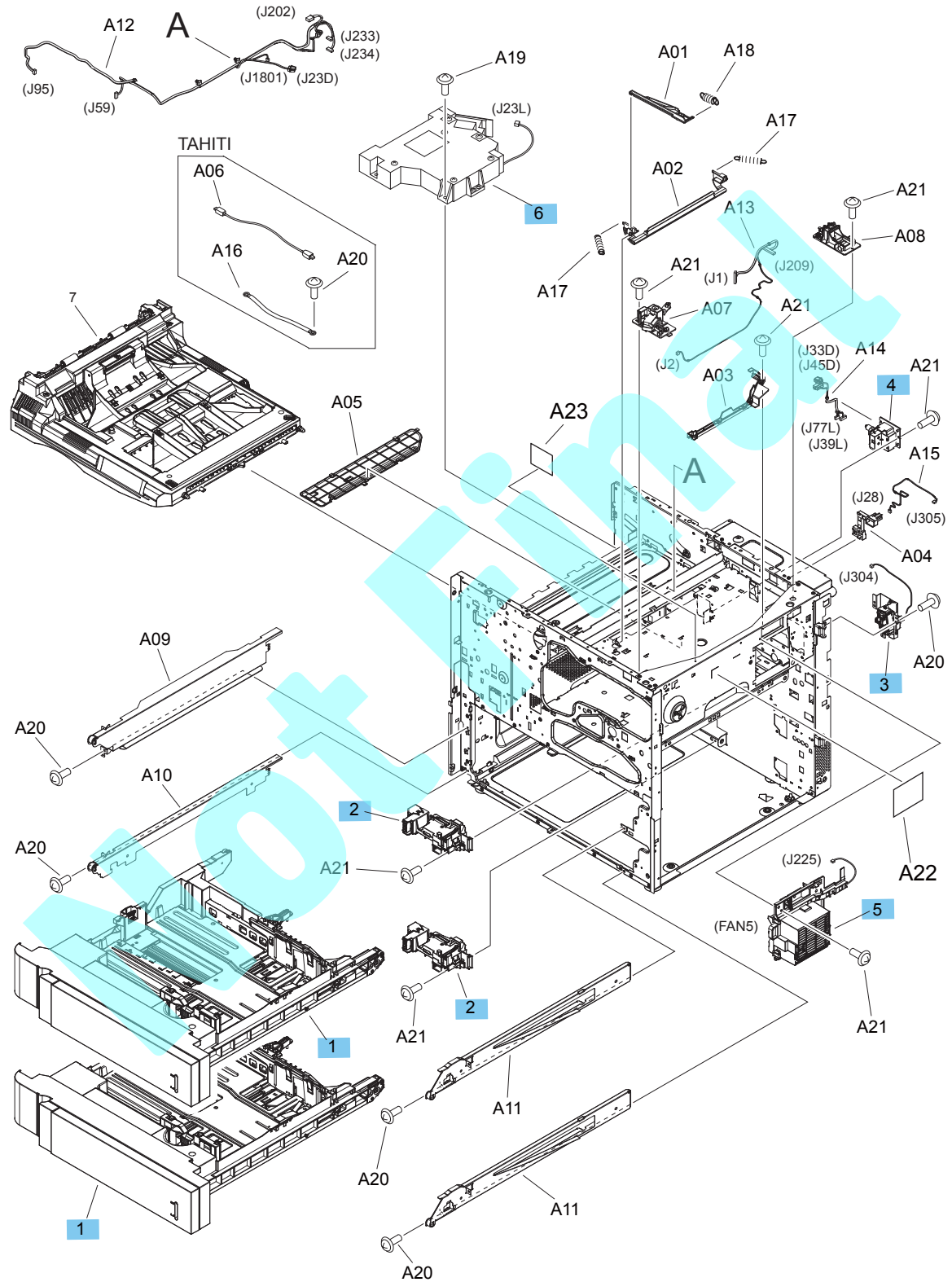

Table 2-19 Internal assemblies (3 of 4)

Ref	Description	Part number	Qty
1	Cassette assembly	RM1-9726-000CN	2
2	Auto close assembly	RM1-9757-000CN	2
3	Tag assembly	RM1-9759-000CN	1
4	Fixing bias contact assembly	RM1-9762-000CN	1
5	Cartridge fan assembly	RM1-9768-000CN	1
6	Laser scanner assembly	RM2-5207-000CN	1

Not Final

Internal assemblies (4 of 4)

Figure 2-15 Internal assemblies (4 of 4)

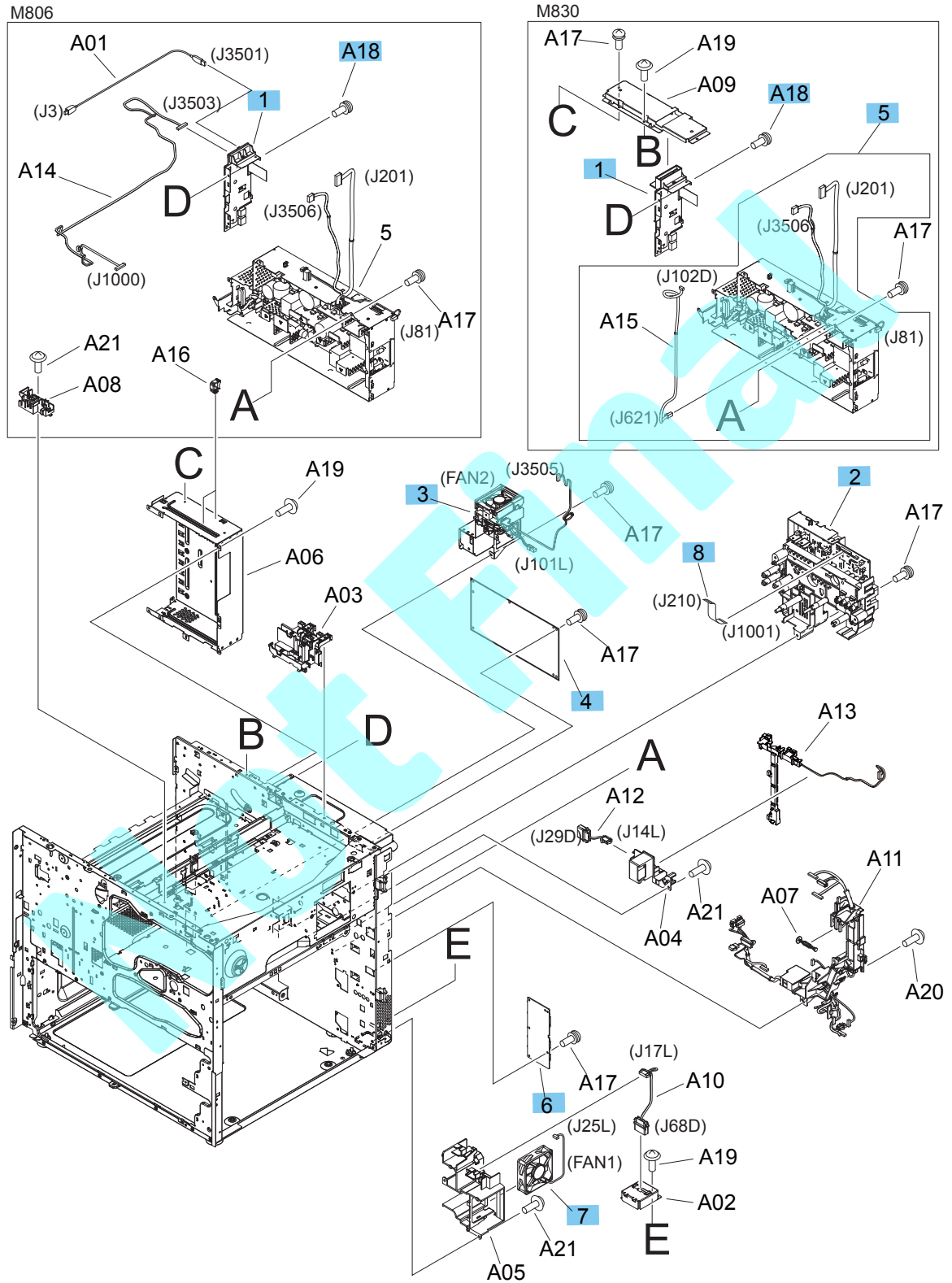

Table 2-20 Internal assemblies (4 of 4)

Ref	Description	Part number	Qty
1	ICB PCA assembly (M806)	RM1-9764-000CN	1
1	ICB PCA assembly (M830)	RM1-9765-000CN	1
2	High voltage power supply	RM1-9767-000CN	1
3	Option connector assembly	RM1-9778-000CN	1
4	DC controller PCA assembly	RM2-0540-000CN	1
5	Low-voltage power supply, 110-127V (M806)	RM2-0544-000CN	1
5	Low-voltage power supply, 220-240V (M806)	RM2-0545-000CN	1
5	Low-voltage power supply, 110-127V (M830)	RM2-0548-000CN	1
5	Low-voltage power supply, 220-240V (M830)	RM2-0549-000CN	1
6	Driver PCA assembly	RM2-0558-000CN	1
7	Fan	RK2-4997-000CN	1
8	Cable, flexible flat	RK2-5013-000CN	1
A18	Connector	VS17258-012CN	1

Not Final

3500-sheet paper feeder (HCI)

3500-sheet paper feeder covers

Figure 2-16 3500-sheet paper feeder covers

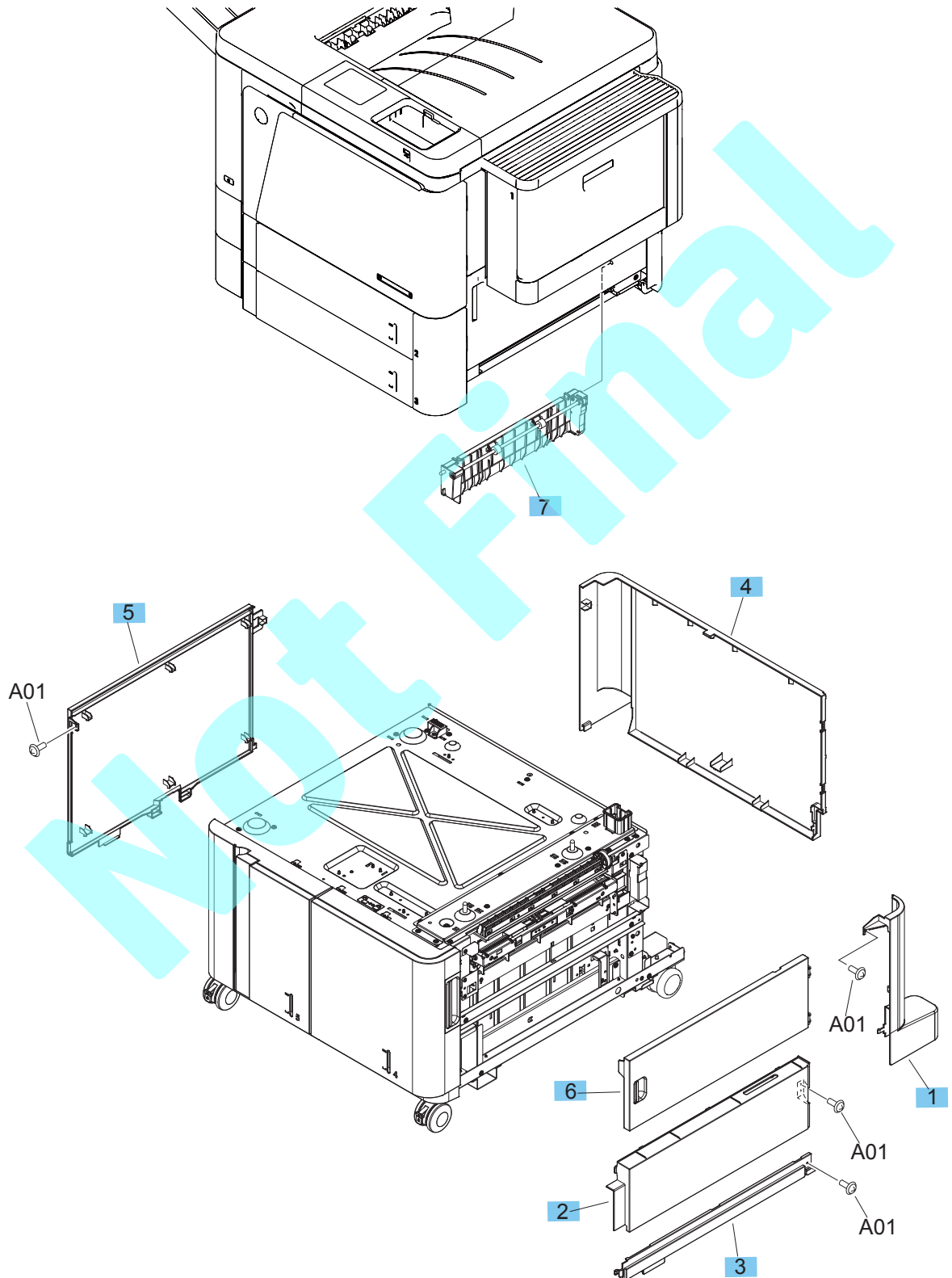

Table 2-21 3500-sheet paper feeder (1 of 3)

Ref	Description	Part number	Qty
1	Cover, corner, right rear	RC3-4715-000CN	1
2	Cover, right center	RC3-4716-000CN	1
3	Cover, right lower	RC3-4717-000CN	1
4	Cover, rear	RC3-4718-000CN	1
5	Cover, left	RC3-4719-000CN	1
6	Right door assembly	RM1-9577-000CN	1
7	Paper path connection assembly	RG5-6227-040CN	1

Not Final

3500-sheet paper deck components (1 of 2)

Figure 2-17 3500-sheet paper feeder (1 of 2)

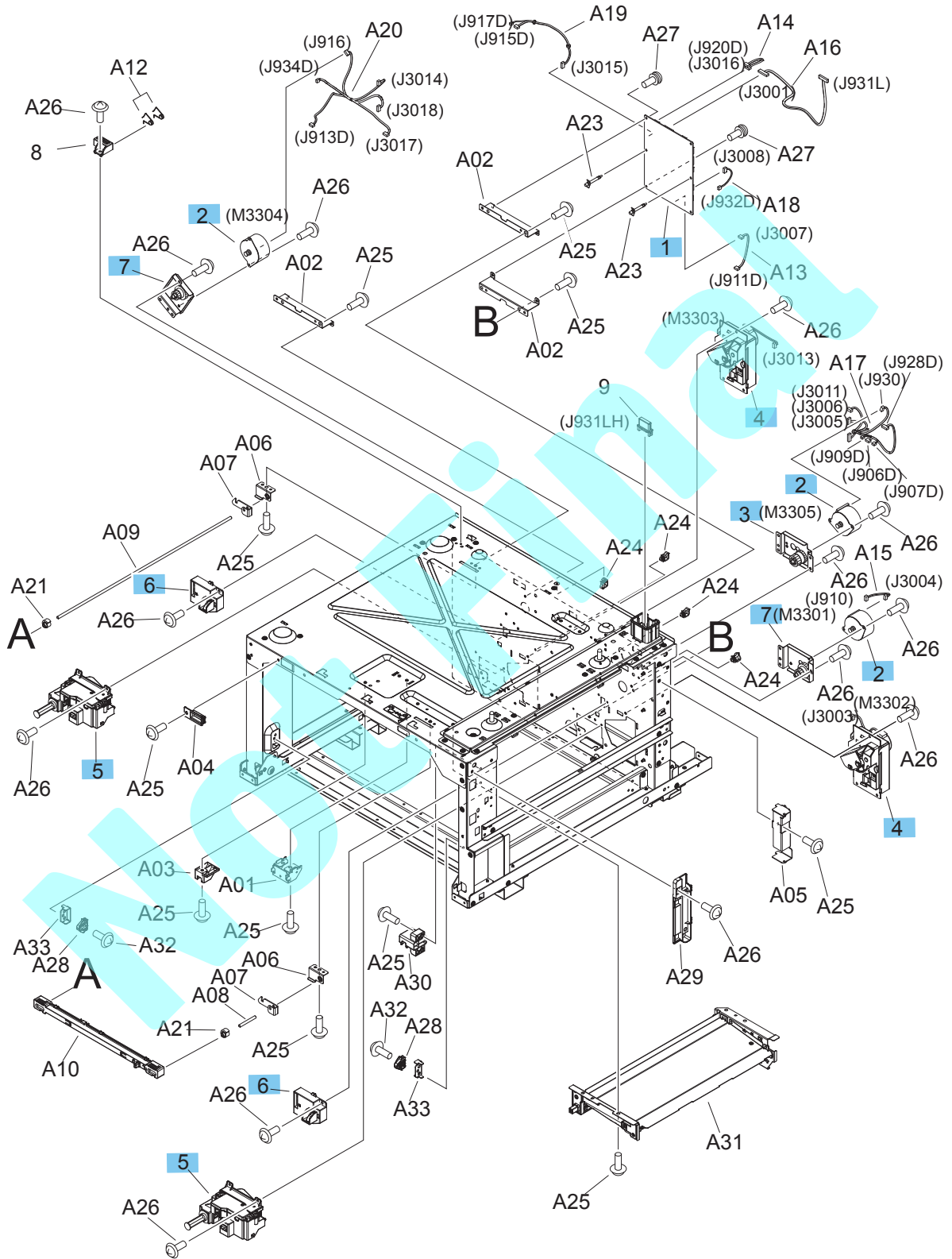

Table 2-22 3500-sheet paper feeder (1 of 2)

Ref	Description	Part number	Qty
1	Controller PCA assembly	RM2-0567-000CN	1
2	Motor, stepping, DC	RK2-1331-000CN	3
3	Crossing drive assembly	RM1-9582-000CN	1
4	Lifter drive assembly	RM1-8879-000CN	2
5	Auto close assembly	RM1-8880-000CN	2
6	Paper remnant detect assembly	RM1-9579-000CN	2
7	Paper pick-up drive assembly	RM1-9581-000CN	2

Not Final

Figure 2-18 3500-sheet paper feeder (2 of 2)

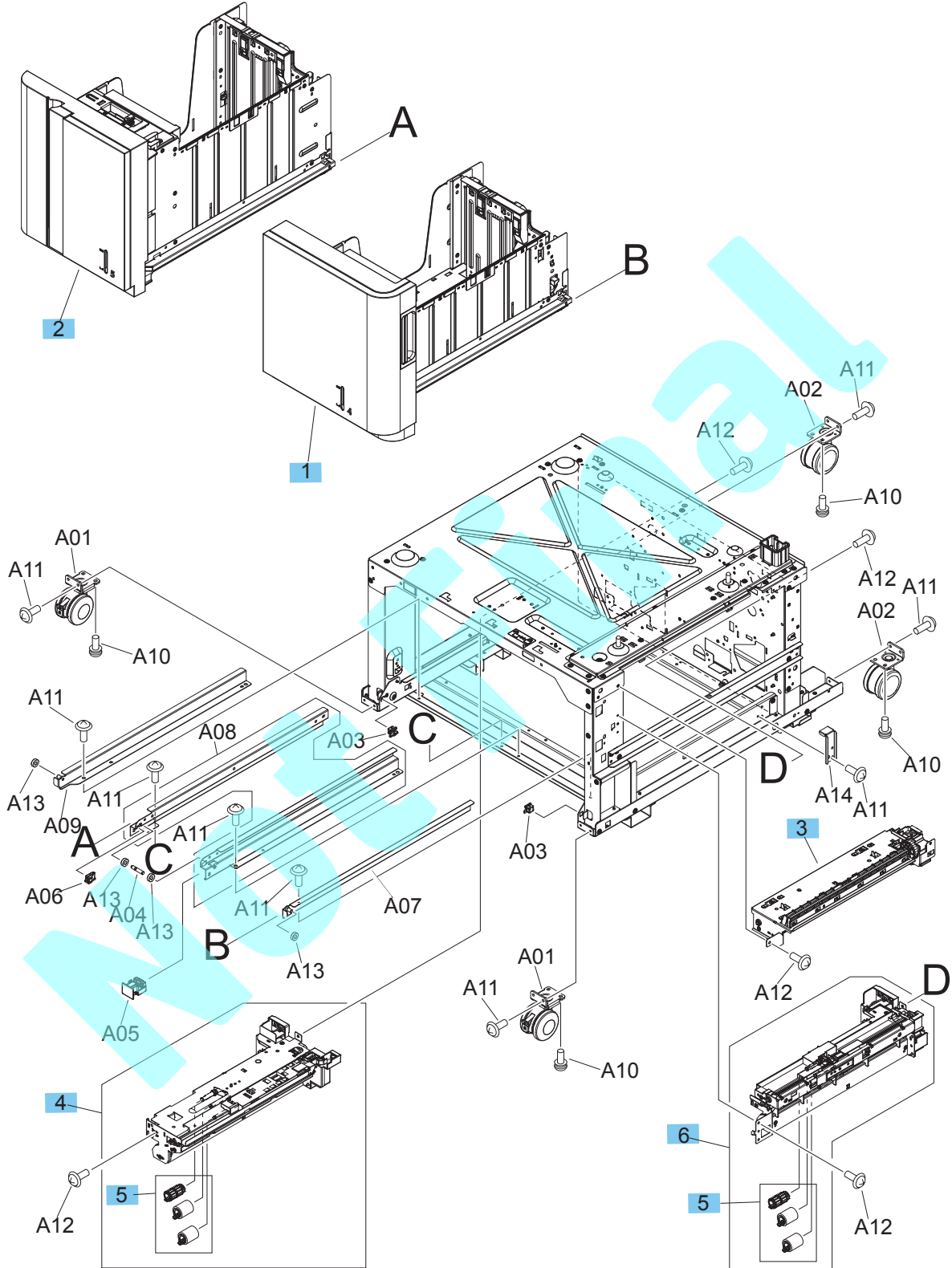

Table 2-23 3500-sheet paper feeder (2 of 2)

Ref	Description	Part number	Qty
1	Kit, HCI right tray	CZ244-67903	1
2	Kit, HCI left tray	CZ244-67904	1
3	Crossing paper feed assembly	RM1-9883-000CN	1
4	Paper pick-up assembly	RM2-0708-000CN	1
5	Kit, tray 2-x roller	CF367-67903	2
6	Paper pickup paper feed assembly	RM2-0709-000CN	1

Not Final

Stapler stacker/booklet maker

Stapler stacker covers

Figure 2-19 Stapler stacker covers

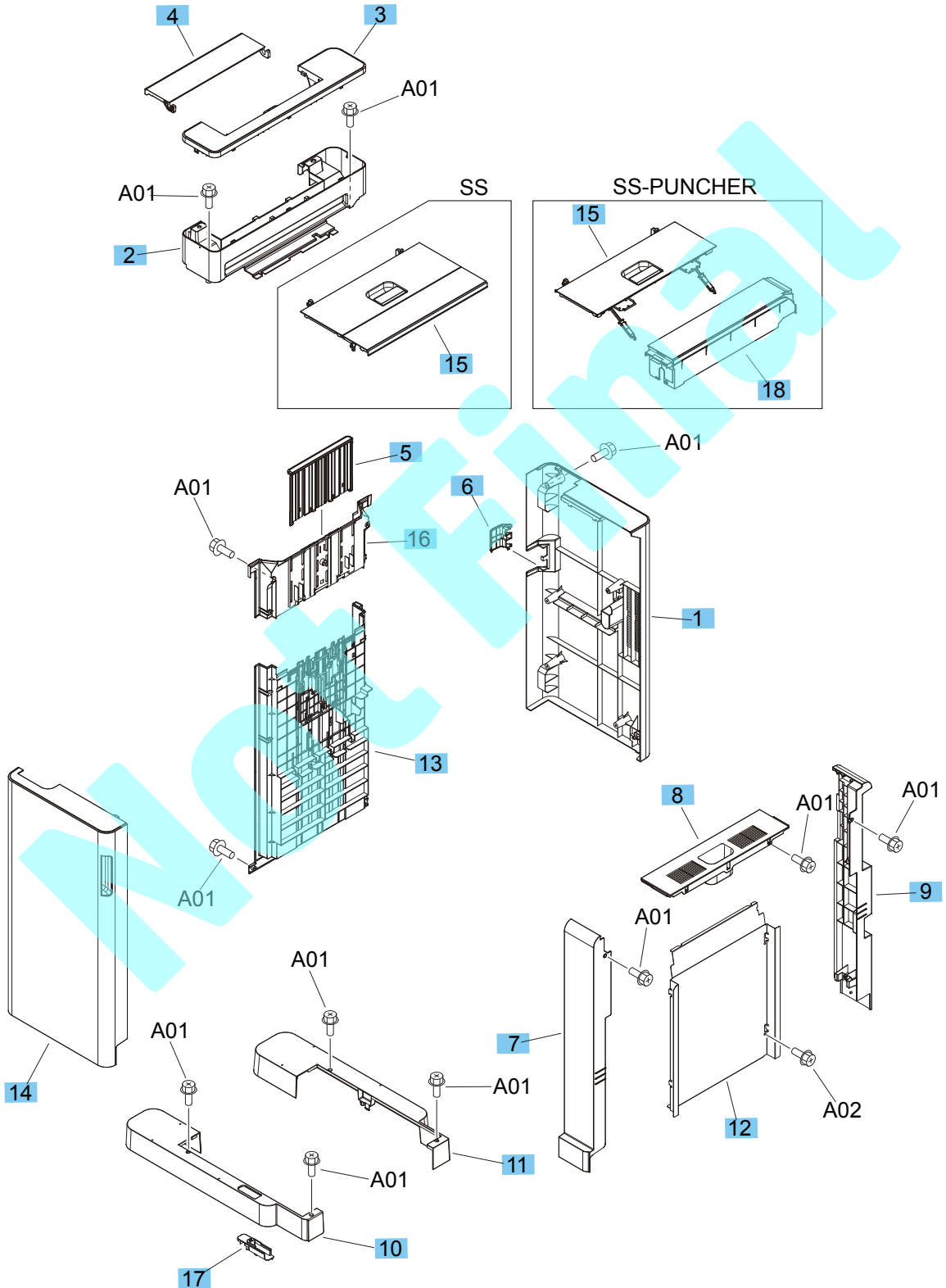

Table 2-24 Stapler stacker covers

Ref	Description	Part number	Qty
1	Cover, rear	RC4-2444-000CN	1
2	Cover, stepped, lower	RC4-2447-000CN	
3	Cover, stepped, upper	RC4-2448-000CN	1
4	Cover, open/close stepped	RC4-2449-000CN	1
5	Guide, wall, upper	RC4-2455-000CN	1
6	Cover, tray cable	RC4-2462-000CN	1
7	Cover, pre-reverse	RC4-2519-000CN	1
8	Cover, reverse, upper	RC4-2520-000CN	1
9	Cover, reverse, rear	RC4-2521-000CN	1
10	Cover, foot, front	RM2-6056-000CN	1
11	Cover, foot, rear	RM2-6057-000CN	1
12	Cover, right	RC4-2565-000CN	1
13	Height wall lower assembly	RM2-5853-000CN	1
14	Front cover assembly	RM2-5320-000CN	1
15	Upper cover assembly (stapler/stacker)	RM2-5322-000CN	1
15	Upper cover assembly (stapler/stacker, hole puncher)	RM2-5535-000CN	1
16	Stack wall upper assembly	RM2-5343-000CN	1
17	Handle, lock release	RC4-2584-000CN	1
18	Punch upper cover assembly (stapler/stacker, hole puncher)	RM2-5515-000CN	1

Booklet maker covers

Figure 2-20 Booklet maker covers

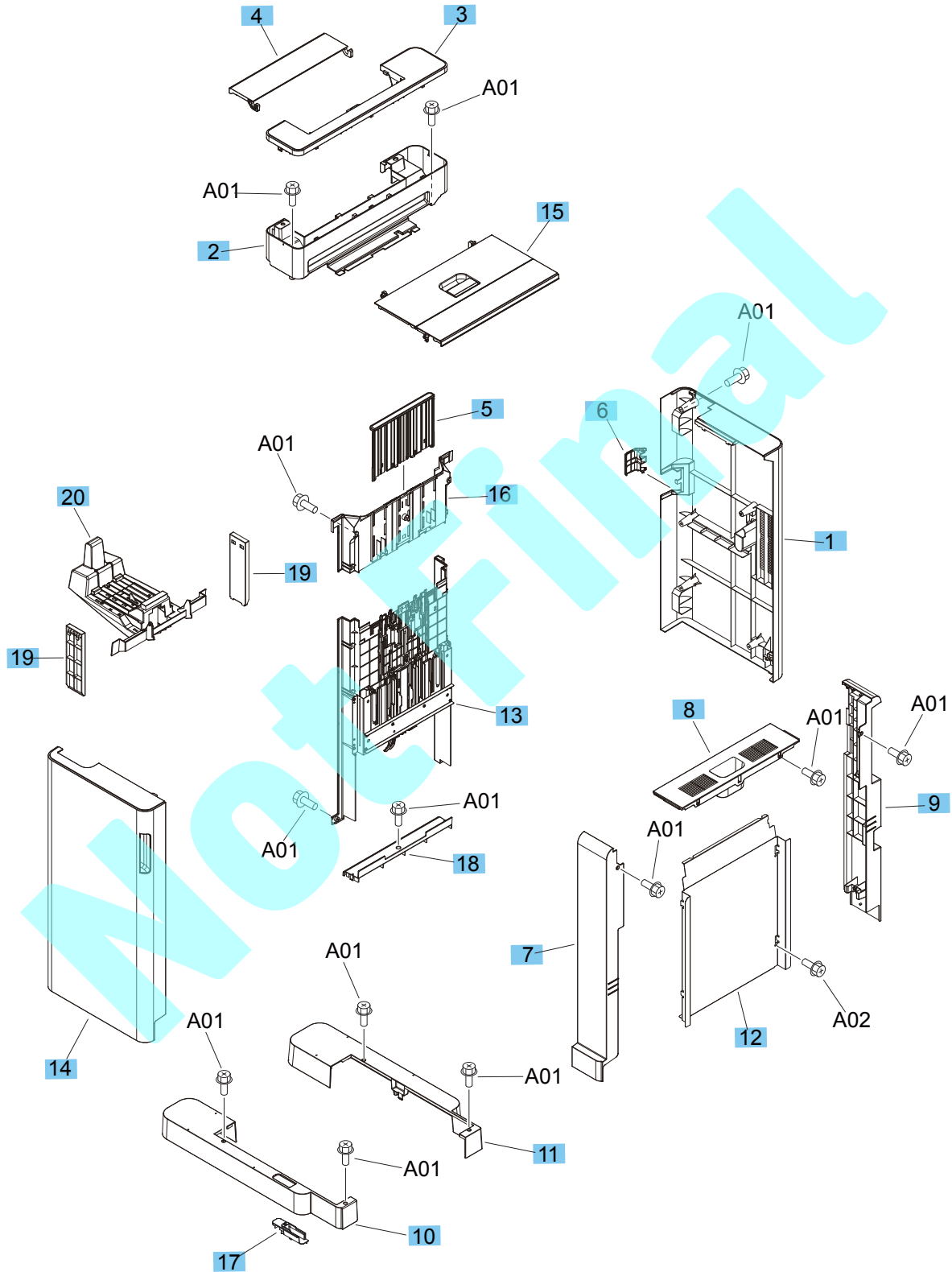

Table 2-25 Booklet maker covers

Ref	Description	Part number	Qty
1	Cover, rear	RC4-2444-000CN	1
2	Cover, stepped, lower	RC4-2447-000CN	1
3	Cover, stepped, upper	RC4-2448-000CN	1
4	Cover, open/close stepped	RC4-2449-000CN	1
5	Guide, wall, upper	RC4-2455-000CN	1
6	Cover, tray cable	RC4-2462-000CN	1
7	Cover, pre-reverse	RC4-2519-000CN	1
8	Cover, reverse, upper	RC4-2520-000CN	1
9	Cover, reverse, rear	RC4-2521-000CN	1
10	Cover, foot, front	RM2-6056-000CN	1
11	Cover, foot, rear	RM2-6057-000CN	1
12	Cover, right	RC4-2565-000CN	1
13	Height wall center assembly	RM2-5852-000CN	1
14	Front cover assembly	RM2-5320-000CN	1
15	Upper cover assembly	RM2-5322-000CN	1
16	Stack wall upper assembly	RM2-5343-000CN	1
17	Handle, lock release	RC4-2584-000CN	1
18	Guide, left lower	RC4-2467-000CN	1
19	Cover, saddle delivery inner	RC4-2471-000CN	2
20	Saddle tray assembly	RM2-5318-000	1

Finisher main body (1 of 3)

Figure 2-21 Finisher main body (1 of 3)

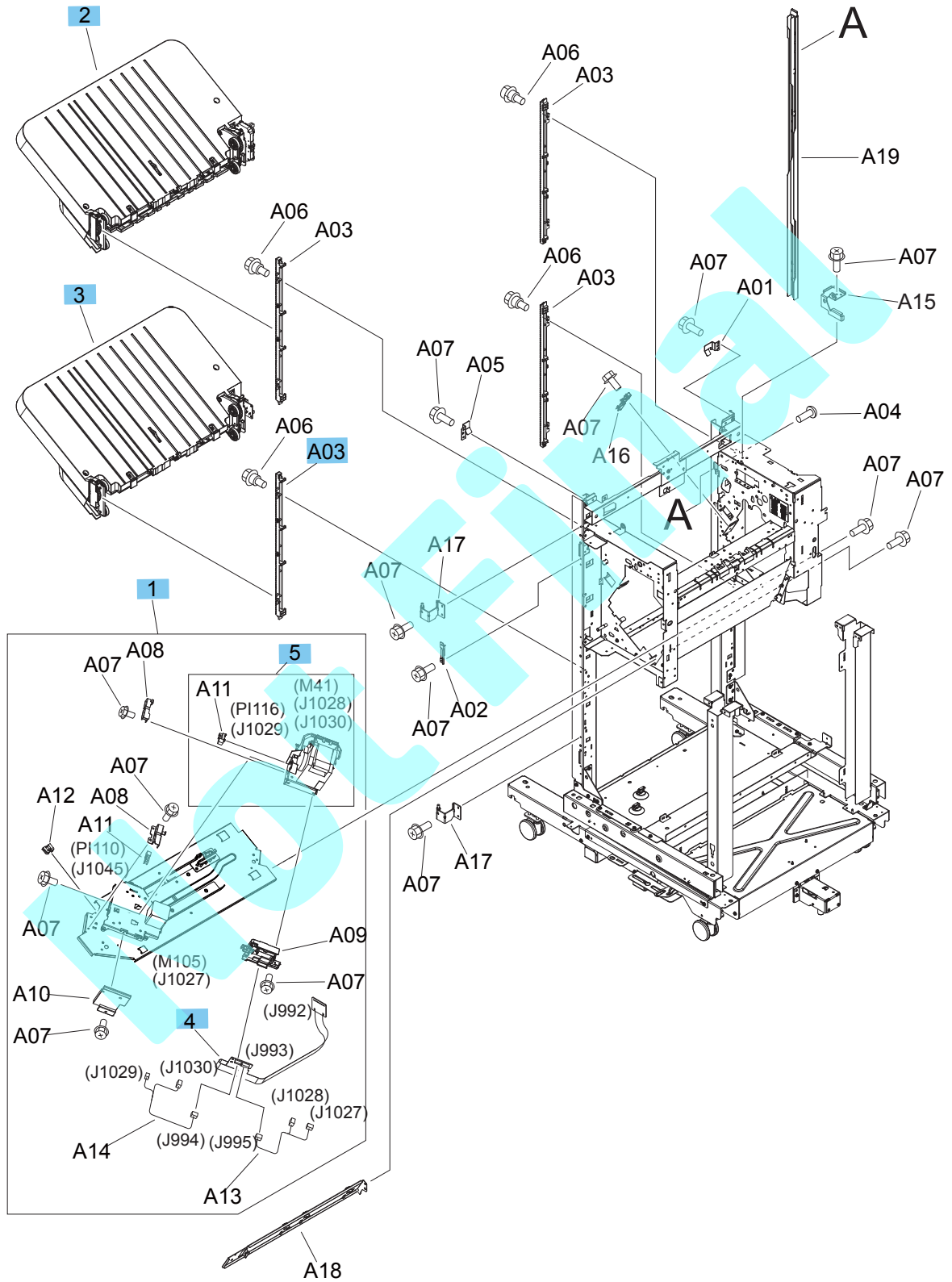

Table 2-26 Finisher main body (1 of 3)

Ref	Description	Part number	Qty
1	Staple assembly	4G3-0938-000CN	1
2	Stack upper tray assembly	RM2-5324-000CN	1
3	Stack lower tray assembly	RM2-5339-000CN	1
4	Cable, staple connecting	4G3-1777-000CN	1
5	Staple sub assembly	4G3-0939-000CN	1
A03	Rack, rail	FC5-5436-000CN	1

Not Final

Finisher main body (2 of 3)

Figure 2-22 Finisher main body (2 of 3)

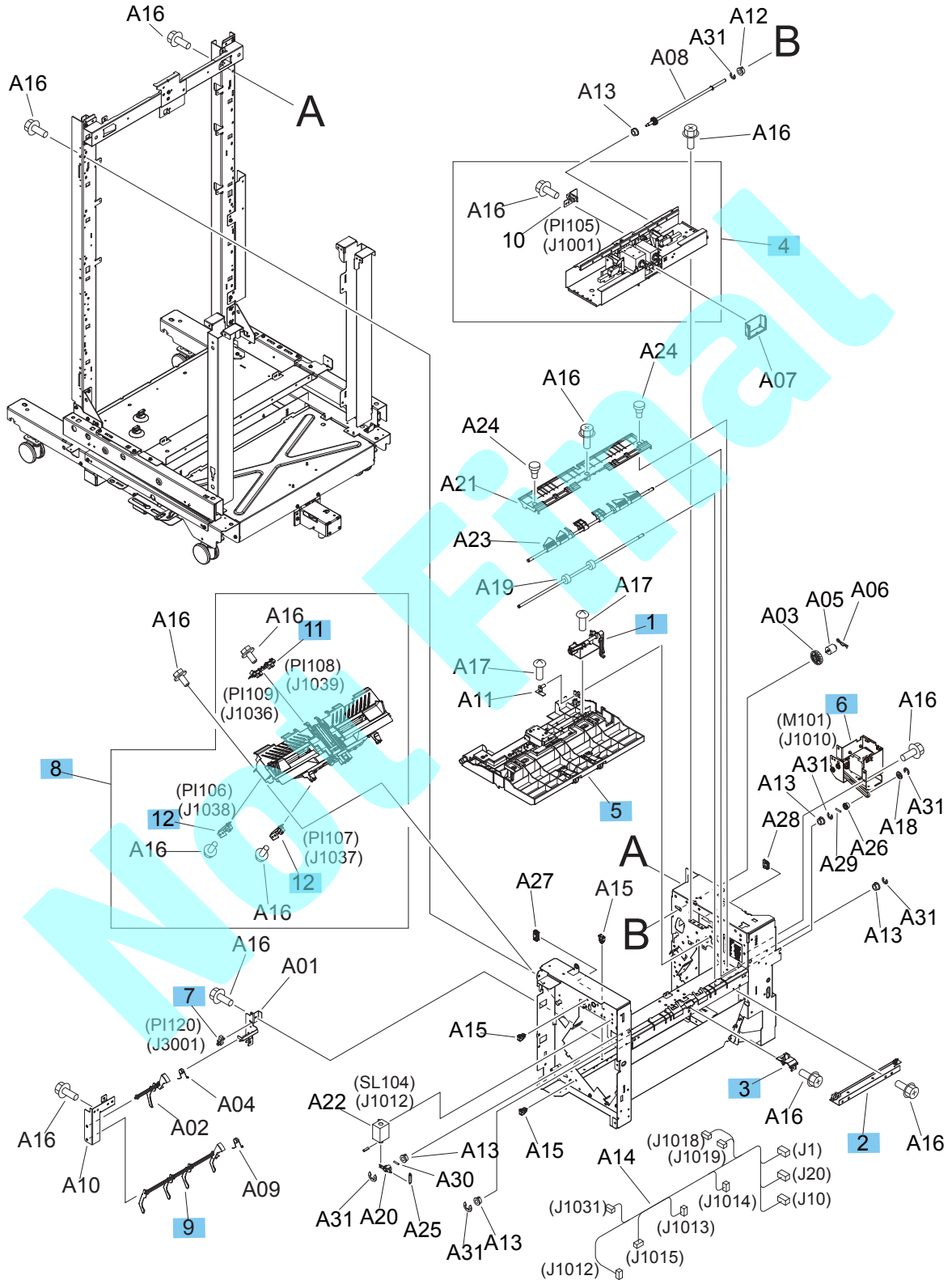

Table 2-27 Finisher main body (2 of 3)

Ref	Description	Part number	Qty
1	Upper cover lock assembly	4G3-0210-000CN	1
2	Entrance sensor bracket assembly	FM2-0717-000CN	1
3	Entrance sensor flag assembly	RM2-5849-000CN	1
4	Upper cross-member assembly	FM0-1882-000CN	1
5	Entrance upper guide assembly (booklet maker)	RM2-6024-000CN	1
5	Entrance upper guide assembly (stapler stacker)	FM0-1683-000CN	1
6	Paper feed motor assembly	FM0-1889-000CN	1
7	Photo interrupter tlp1242	WG8-5593-000CN	1
8	Operation tray assembly	RM2-5309-000CN	1
9	Flag, paper sensing sensor	FC5-5004-000CN	1
10	Swing H.P. sensor assembly	4G3-1564-000CN	1
11	Assist sensor assembly	FM2-1396-000CN	1
12	Adjust guide H.P. sensor assembly	FM2-1393-000CN	1

Table 2-28 Finisher main body (3 of 3)

Ref	Description	Part number	Qty
1	Stack ejection motor assembly	4G3-0769-000CN	1
2	Paper face sensor assembly	4G3-0934-000CN	1
3	Main controller PCB assembly	RM2-7595-000CN	1
4	Clutch, electromagnetic	4H3-0370-000CN	2
5	Return roller assembly	FM0-2403-000CN	1
6	Paper detect holder assembly, up	FM0-2429-000CN	1
7	Pressure roller assembly	FM2-0730-000CN	1
8	Shutter H.P. sensor assembly	FM2-1401-000CN	1
9	Press motor assembly	FM2-1409-000CN	1
10	Sensor/switch assembly	FM2-1417-000CN	1
11	Swing guide assembly	RM2-5307-000CN	1
12	Interface cable assembly	RM2-5539-000CN	1
A03	Bushing	FS5-1805-000CN	3
A04	Washer	FS5-6488-000CN	2
A08	Pulley, 20T	FU5-3086-000CN	2
A12	Pin, dowel	XD3-2200-102CN	3
A13	E-ring	XD9-0136-000CN	9
A17	Bearing, ball MF 106ZZS	XG9-0520-000CN	2

Stapler/stacker finisher main body

Figure 2-24 Stapler/stacker finisher main body
SS-PUNCHER

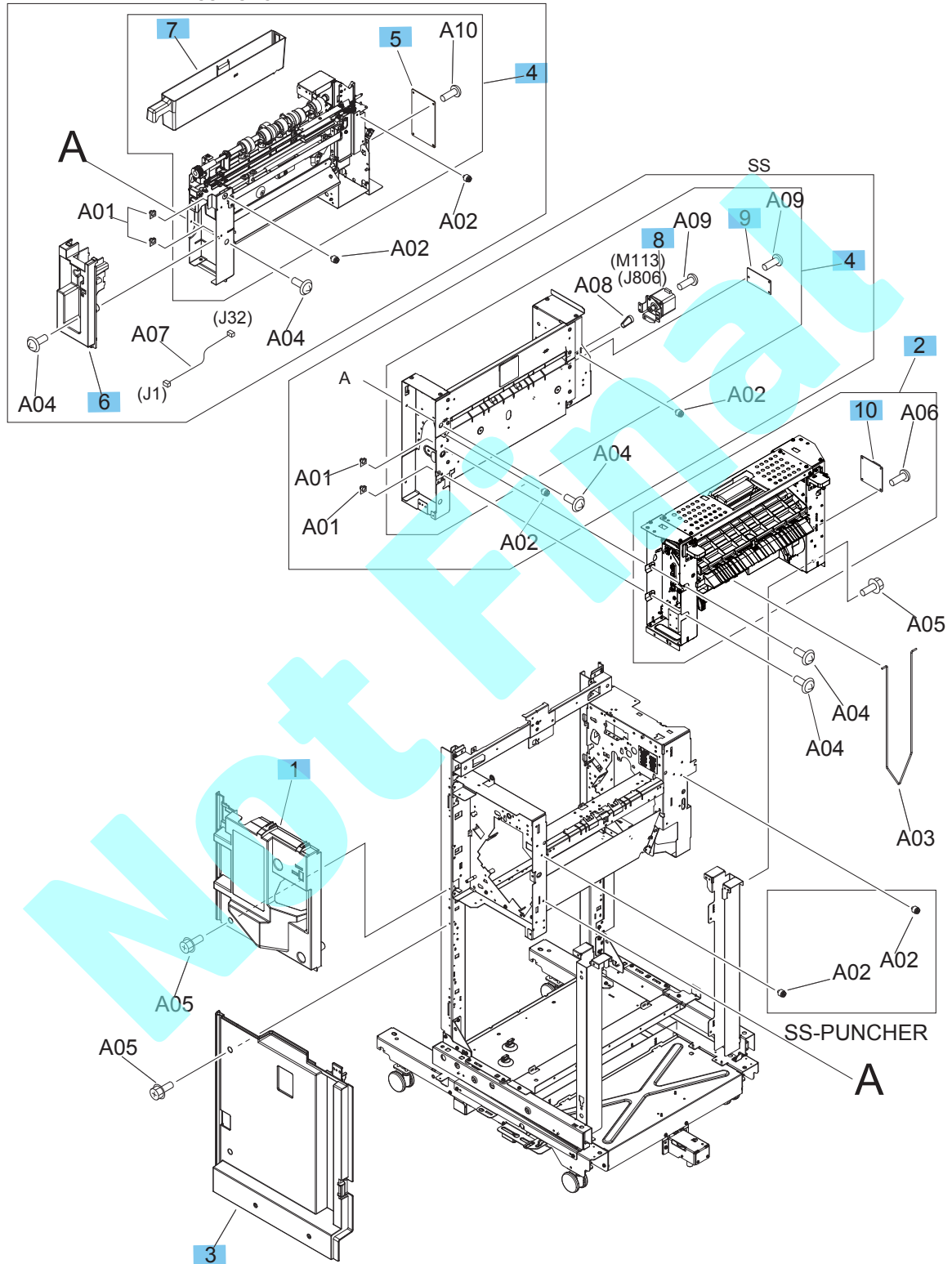

Table 2-29 Stapler/stacker finisher main body

Ref	Description	Part number	Qty
1	Inner cover upper assembly	RM2-5305-000CN	1
2	Reverse assembly	RM2-5490-000CN	1
3	Cover, inner, lower	RC4-2526-000CN	1
4	Paper pass assembly	RM2-5334-000CN	2
4	Punch hole assembly (stapler/stacker 2/3 hole punch)	RM2-5455-000CN	2
4	Punch hole assembly stapler/stacker 3/4 hole punch	RM2-5456-000CN	2
5	Punch controller PCB assembly	RM2-7742-000CN	1
6	Punch inner cover assembly (stapler/stacker, hole puncher)	RM2-5516-000CN	1
7	Box, dust (stapler/stacker, hole puncher)	RL2-1249-000CN	1
8	Saddle motor assembly (stapler/stacker)	FM2-0737-000CN	1
9	Driver PCA assembly (stapler/stacker)	RM2-7590-000CN	1
10	Reverse driver PCA assembly	RM2-7597-000CN	1

Not Final

Booklet maker finisher main body

Figure 2-25 Booklet maker finisher main body

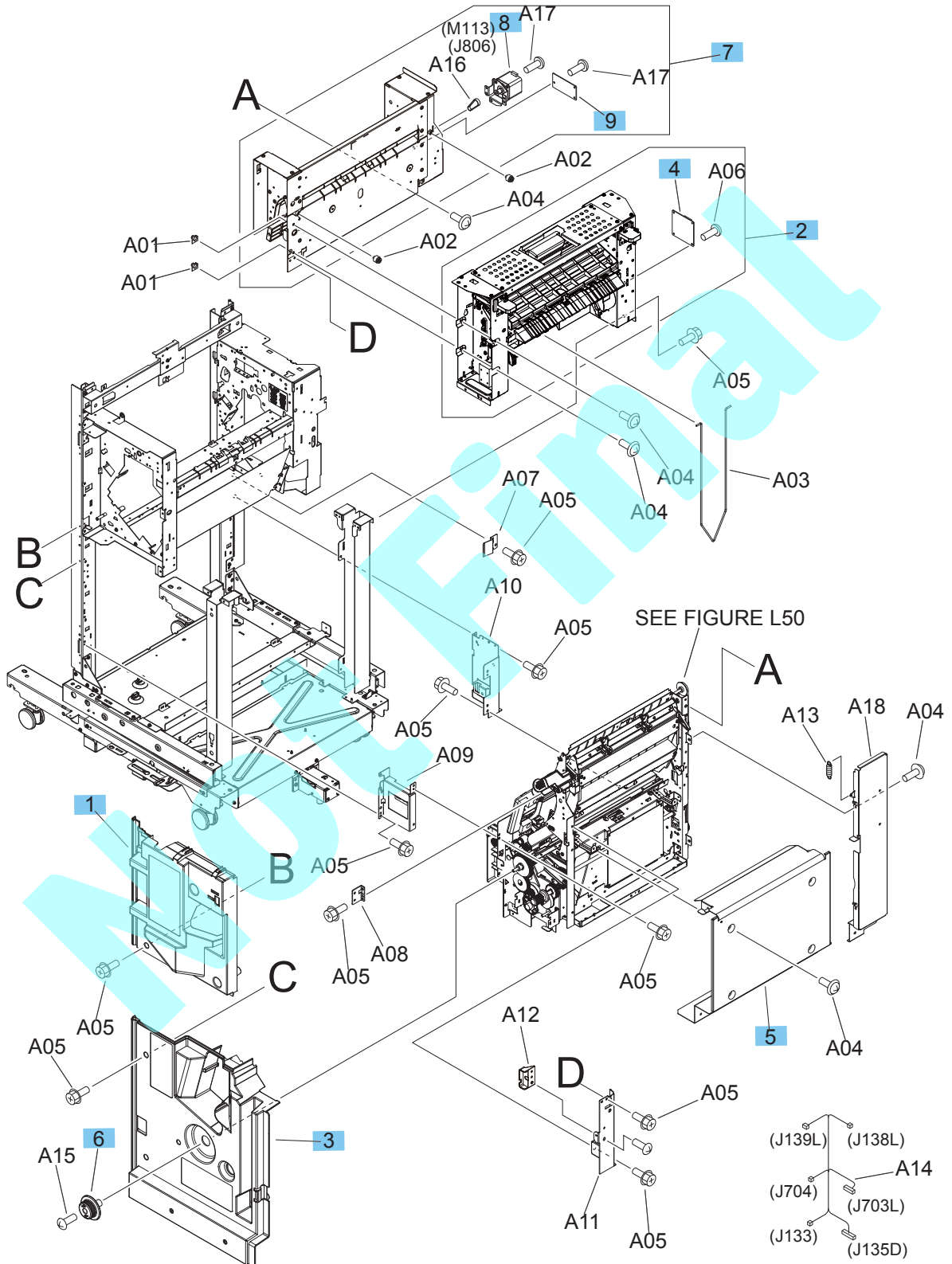

Table 2-30 Booklet maker finisher main body

Ref	Description	Part number	Qty
1	Inner cover upper assembly	RM2-5305-000	1
2	Reverse assembly	RM2-5490-000	1
3	Cover, inner, lower assembly	RM2-5479-000CN	1
4	Reverse driver PCA assembly	RM2-7597-000	2
5	Cover, right	FB3-7958-040CN	1
6	Knob	FB3-7881-000CN	1
7	Saddle paper feed assembly	RM2-5351-000CN	1
8	Saddle motor assembly	FM2-0737-000	1
9	Driver PCA assembly	RM2-7590-000	1

Not Final

Booklet maker saddle assembly

Figure 2-26 Booklet maker saddle assembly (1 of 3)

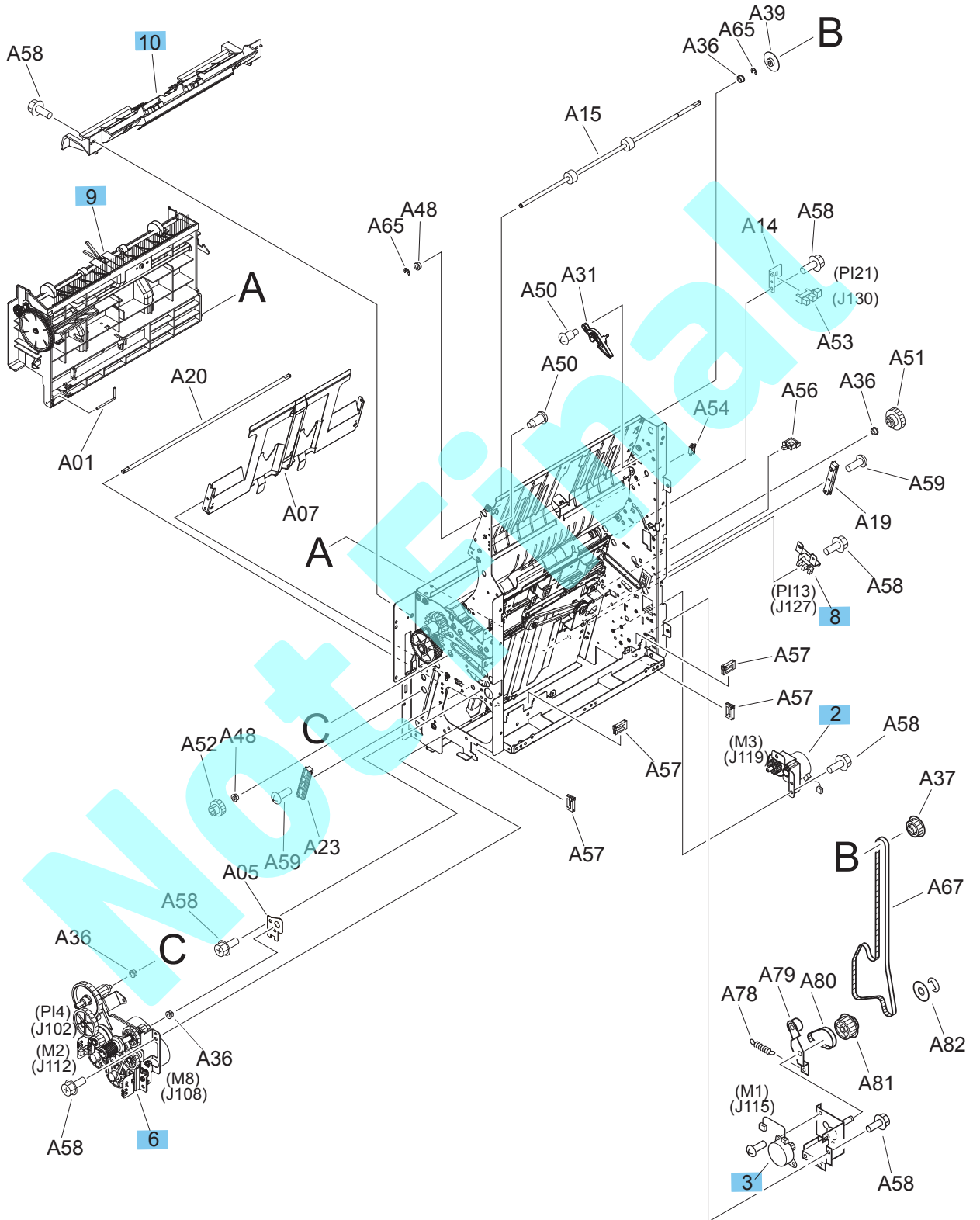

Figure 2-28 Booklet maker saddle assembly (3 of 3)

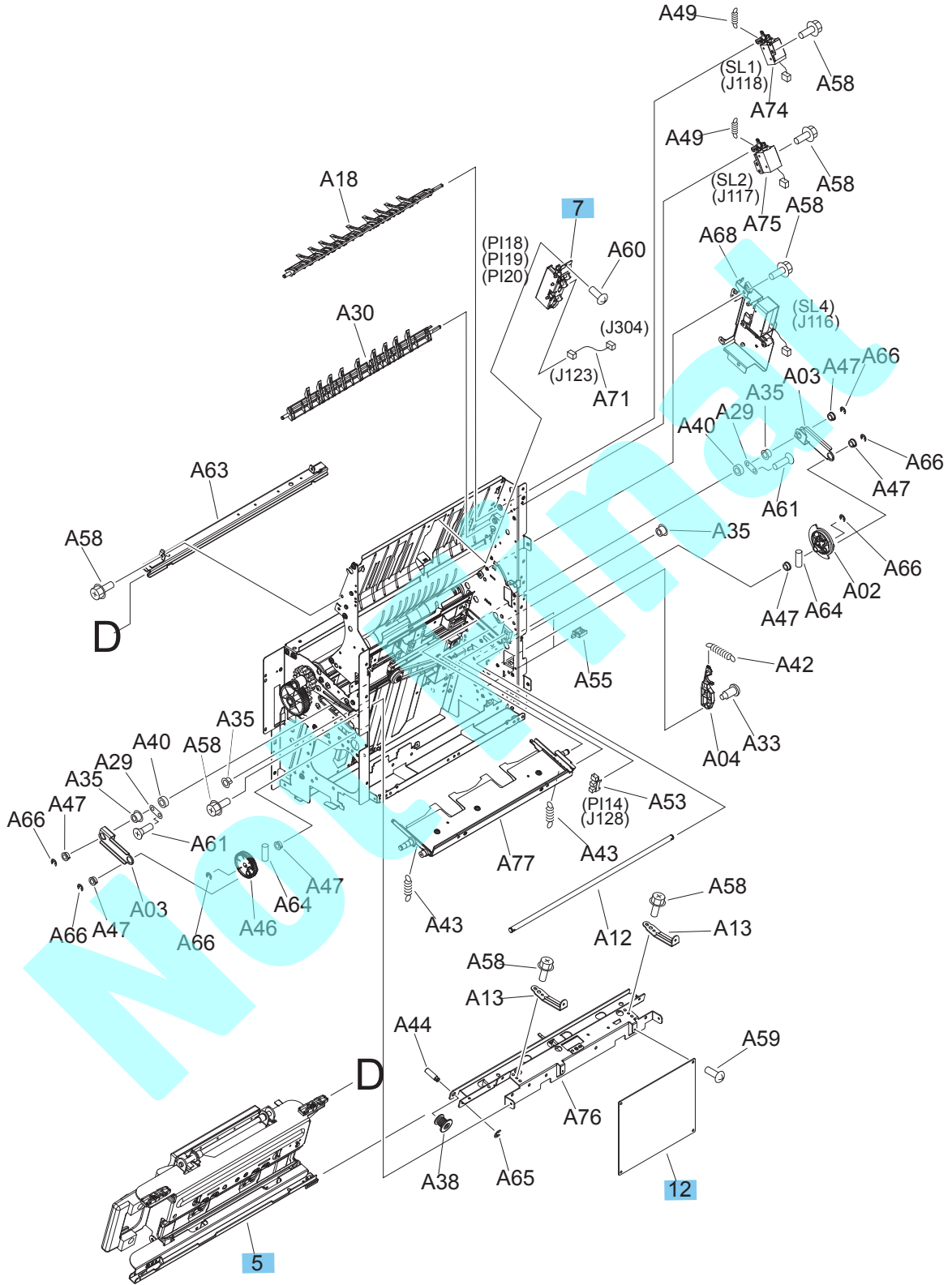

Table 2-31 Booklet maker saddle assembly

Ref	Description	Part number	Qty
1	Inner side plate assembly	4G3-0671-000CN	1
2	Guide motor assembly	4G3-0725-000CN	1
3	Saddle feed motor assembly	4H3-0369-000CN	1
4	Saddle guide assembly	4G3-1940-000CN	2
5	Saddle stapler assembly	4G3-2721-000CN	1
6	Motor mount assembly	FM0-1686-000CN	1
7	Rear end sensor assembly	FM2-0763-000CN	1
8	Guide sensor assembly	FM6-2283-000CN	1
9	Saddle paper delivery assembly	RM2-5332-000CN	1
10	Upper delivery guide assembly	RM2-5349-000CN	1
11	Delivery switch mount assembly	RM2-5633-000CN	1
12	Saddle controller PCA assembly	RM2-7604-000CN	1
Not shown	Assembly, E-ring saddle stapler	XD9-0136-000CN	1

Alphabetical parts list

Table 2-32 Alphabetical parts list

Description	Part number	Table and page
Adjust guide H.P. sensor assembly	FM2-1393-000CN	Finisher main body (2 of 3) on page 595
Assembly, ADF hinge (M830)	A8T68-60025	Document feeder assemblies (1 of 2; M830) on page 567
Assembly, E-ring saddle stapler	XD9-0136-000CN	Booklet maker saddle assembly on page 605
Assist sensor assembly	FM2-1396-000CN	Finisher main body (2 of 3) on page 595
Auto close assembly	RM1-9757-000CN	Internal assemblies (3 of 4) on page 579
Auto close assembly	RM1-8880-000CN	3500-sheet paper feeder (1 of 2) on page 585
Background selector for backside scan (M830)	A8T68-60021	Document feeder assemblies (2 of 2; M830) on page 569
Bearing, ball MF 106ZZS	XG9-0520-000CN	Finisher main body (3 of 3) on page 597
Box, dust (stapler/stacker, hole puncher)	RL2-1249-000CN	Stapler/stacker finisher main body on page 599
Bushing	FS5-1805-000CN	Finisher main body (3 of 3) on page 597
Cable, flexible flat	RK2-5013-000CN	Internal assemblies (4 of 4) on page 581
Cable, power, integrated scan assembly (M830)	CF367-60127	Document feeder assemblies (1 of 2; M830) on page 567
Cable, staple connecting	4G3-1777-000CN	Finisher main body (1 of 3) on page 593
Cage, back, SCB cover (M830)	CF367-00018	Document feeder assemblies (1 of 2; M830) on page 567
Cartridge contact assembly	RM1-9758-000CN	Internal assemblies (2 of 4) on page 577
Cartridge fan assembly	RM1-9768-000CN	Internal assemblies (3 of 4) on page 579
Cartridge lifter assembly	RM1-9775-000CN	Internal assemblies (1 of 4) on page 575
Cassette assembly	RM1-9726-000CN	Internal assemblies (3 of 4) on page 579
Clip, ISA cable (M830)	5851-4725	Document feeder assemblies (1 of 2; M830) on page 567
Clutch, electromagnetic	4H3-0370-000CN	Finisher main body (3 of 3) on page 597

Table 2-32 Alphabetical parts list (continued)

Description	Part number	Table and page
Connector	VS17258-012CN	Internal assemblies (4 of 4) on page 581
Control lever assembly	RG5-5746-030CN	Internal assemblies (1 of 4) on page 575
Controller PCA assembly	RM2-0567-000CN	3500-sheet paper feeder (1 of 2) on page 585
Cooling unit assembly	RM1-9720-000CN	Internal assemblies (2 of 4) on page 577
Cover, ADF roller (M830)	A8T68-40072	Document feeder assemblies (2 of 2; M830) on page 569
Cover, back, scanner (M830)	CF368-60142	Document feeder assemblies (1 of 2; M830) on page 567
Cover, control panel access (M830)	5042-9118	Document feeder and scanner assemblies (M830) on page 565
Cover, corner, left front	RC3-3958-000CN	Covers on page 573
Cover, corner, left rear	RC3-3952-000CN	Covers on page 573
Cover, corner, right front	RC3-3957-000CN	Covers on page 573
Cover, corner, right rear	RC3-4715-000CN	3500-sheet paper feeder (1 of 3) on page 583
Cover, foot, front	RM2-6056-000CN	Stapler stacker covers on page 589
Cover, foot, front	RM2-6056-000CN	Booklet maker covers on page 591
Cover, foot, rear	RM2-6057-000CN	Stapler stacker covers on page 589
Cover, foot, rear	RM2-6057-000CN	Booklet maker covers on page 591
Cover, front, scanner (M830)	CF367-40002	Scanner assemblies on page 571
Cover, hip (M806)	RC3-3948-000CN	Covers on page 573
Cover, HIP (M830)	5851-5361	Document feeder and scanner assemblies (M830) on page 565
Cover, inner, lower	RC4-2526-000CN	Stapler/stacker finisher main body on page 599
Cover, inner, lower assembly	RM2-5479-000CN	Booklet maker finisher main body on page 601
Cover, left	RC3-4719-000CN	3500-sheet paper feeder (1 of 3) on page 583
Cover, left lower	RC3-3949-000CN	Covers on page 573
Cover, left upper (M806)	RC3-3979-000CN	Covers on page 573

Table 2-32 Alphabetical parts list (continued)

Description	Part number	Table and page
Cover, left upper (M830)	RC3-4589-000CN	Covers on page 573
Cover, left, scanner (M830)	CF367-40003	Scanner assemblies on page 571
Cover, open/close stepped	RC4-2449-000CN	Stapler stacker covers on page 589
Cover, open/close stepped	RC4-2449-000CN	Booklet maker covers on page 591
Cover, operation panel, top (M806)	RC3-3947-000CN	Covers on page 573
Cover, pre-reverse	RC4-2519-000CN	Stapler stacker covers on page 589
Cover, pre-reverse	RC4-2519-000CN	Booklet maker covers on page 591
Cover, rear	RC3-4718-000CN	3500-sheet paper feeder (1 of 3) on page 583
Cover, rear	RC4-2444-000CN	Stapler stacker covers on page 589
Cover, rear	RC4-2444-000CN	Booklet maker covers on page 591
Cover, rear, left ADF (M830)	A8T68-40067	Document feeder assemblies (1 of 2; M830) on page 567
Cover, rear, right ADF (M830)	A8T68-40066	Document feeder assemblies (1 of 2; M830) on page 567
Cover, reverse, rear	RC4-2521-000CN	Stapler stacker covers on page 589
Cover, reverse, rear	RC4-2521-000CN	Booklet maker covers on page 591
Cover, reverse, upper	RC4-2520-000CN	Stapler stacker covers on page 589
Cover, reverse, upper	RC4-2520-000CN	Booklet maker covers on page 591
Cover, right	RC4-2565-000CN	Stapler stacker covers on page 589
Cover, right	RC4-2565-000CN	Booklet maker covers on page 591
Cover, right	FB3-7958-040CN	Booklet maker finisher main body on page 601
Cover, right center	RC3-4716-000CN	3500-sheet paper feeder (1 of 3) on page 583
Cover, right lower	RC3-3956-000CN	Covers on page 573
Cover, right lower	RC3-4717-000CN	3500-sheet paper feeder (1 of 3) on page 583
Cover, right, scanner (M830)	CF367-40004	Scanner assemblies on page 571

Table 2-32 Alphabetical parts list (continued)

Description	Part number	Table and page
Cover, saddle delivery inner	RC4-2471-000CN	Booklet maker covers on page 591
Cover, stepped, lower	RC4-2447-000CN	Stapler stacker covers on page 589
Cover, stepped, lower	RC4-2447-000CN	Booklet maker covers on page 591
Cover, stepped, upper	RC4-2448-000CN	Stapler stacker covers on page 589
Cover, stepped, upper	RC4-2448-000CN	Booklet maker covers on page 591
Cover, top left (M806)	RC3-3946-000CN	Covers on page 573
Cover, top right (M806)	RC3-3945-000CN	Covers on page 573
Cover, tray cable	RC4-2462-000CN	Stapler stacker covers on page 589
Cover, tray cable	RC4-2462-000CN	Booklet maker covers on page 591
Cover, USB (M830)	5851-5360	Document feeder and scanner assemblies (M830) on page 565
Cover, right rear corner, lower	RC3-3954-000CN	Covers on page 573
Cover, right rear corner, upper	RC3-3955-000CN	Covers on page 573
Crossing drive assembly	RM1-9582-000CN	3500-sheet paper feeder (1 of 2) on page 585
Crossing paper feed assembly	RM1-9883-000CN	3500-sheet paper feeder (2 of 2) on page 587
DC controller PCA assembly	RM2-0540-000CN	Internal assemblies (4 of 4) on page 581
Delivery switch mount assembly	RM2-5633-000CN	Booklet maker saddle assembly on page 605
Dial, jam dispose	RC3-4269-000CN	Internal assemblies (1 of 4) on page 575
Driver PCA assembly	RM2-0558-000CN	Internal assemblies (4 of 4) on page 581
Driver PCA assembly	RM2-7590-000	Booklet maker finisher main body on page 601
Driver PCA assembly (stapler/stacker)	RM2-7590-000CN	Stapler/stacker finisher main body on page 599
Drum drive assembly	RM1-9784-000CN	Internal assemblies (1 of 4) on page 575
E-ring	XD9-0136-000CN	Finisher main body (3 of 3) on page 597
Entrance sensor bracket assembly	FM2-0717-000CN	Finisher main body (2 of 3) on page 595

Table 2-32 Alphabetical parts list (continued)

Description	Part number	Table and page
Entrance sensor flag assembly	RM2-5849-000CN	Finisher main body (2 of 3) on page 595
Entrance upper guide assembly (booklet maker)	RM2-6024-000CN	Finisher main body (2 of 3) on page 595
Entrance upper guide assembly (stapler stacker)	FM0-1683-000CN	Finisher main body (2 of 3) on page 595
Face-down paper delivery assembly (M806)	RM1-9732-000CN	Internal assemblies (2 of 4) on page 577
Fan	RK2-5004-000CN	Internal assemblies (2 of 4) on page 577
Fan	RK2-4997-000CN	Internal assemblies (4 of 4) on page 581
Fixing bias contact assembly	RM1-9762-000CN	Internal assemblies (3 of 4) on page 579
Flag, paper presence (M830)	A8T68-40033	Document feeder assemblies (1 of 2; M830) on page 567
Flag, paper sensing sensor	FC5-5004-000CN	Finisher main body (2 of 3) on page 595
Front cover assembly	RM2-5320-000CN	Stapler stacker covers on page 589
Front cover assembly	RM2-5320-000CN	Booklet maker covers on page 591
Front inner cover assembly	RM1-9760-000CN	Internal assemblies (1 of 4) on page 575
Front left lower cover assembly	RM1-9722-000CN	Covers on page 573
Fusing drive assembly	RM1-9788-000CN	Internal assemblies (1 of 4) on page 575
Guide motor assembly	4G3-0725-000CN	Booklet maker saddle assembly on page 605
Guide sensor assembly	FM6-2283-000CN	Booklet maker saddle assembly on page 605
Guide, cartridge, front	RC3-3968-000CN	Internal assemblies (1 of 4) on page 575
Guide, left lower	RC4-2467-000CN	Booklet maker covers on page 591
Guide, wall, upper	RC4-2455-000CN	Stapler stacker covers on page 589
Guide, wall, upper	RC4-2455-000CN	Booklet maker covers on page 591
Handle, lock release	RC4-2584-000CN	Stapler stacker covers on page 589
Handle, lock release	RC4-2584-000CN	Booklet maker covers on page 591

Table 2-32 Alphabetical parts list (continued)

Description	Part number	Table and page
Height wall center assembly	RM2-5852-000CN	Booklet maker covers on page 591
Height wall lower assembly	RM2-5853-000CN	Stapler stacker covers on page 589
High voltage power supply	RM1-9767-000CN	Internal assemblies (4 of 4) on page 581
ICB PCA assembly (M806)	RM1-9764-000CN	Internal assemblies (4 of 4) on page 581
ICB PCA assembly (M830)	RM1-9765-000CN	Internal assemblies (4 of 4) on page 581
Inner cover upper assembly	RM2-5305-000CN	Stapler/stacker finisher main body on page 599
Inner cover upper assembly	RM2-5305-000	Booklet maker finisher main body on page 601
Inner side plate assembly	4G3-0671-000CN	Booklet maker saddle assembly on page 605
Interface cable assembly	RM2-5539-000CN	Finisher main body (3 of 3) on page 597
Interlock assembly	RM1-9724-000CN	Internal assemblies (2 of 4) on page 577
Kit, ADF Mylar, A3 (M930)	5851-5857	Document feeder and scanner assemblies (M830) on page 565
Kit, ADF roller (M830)	C1P70-67901	Document feeder assemblies (2 of 2; M830) on page 569
Kit, ADF separation pad spring (M830)	5851-5855	Document feeder assemblies (2 of 2; M830) on page 569
Kit, ADF whole unit, A3 (includes white backing kit) (M830)	CF367-67920	Document feeder and scanner assemblies (M830) on page 565
Kit, control panel (without keyboard) (M830)	5851-5952	Document feeder and scanner assemblies (M830) on page 565
Kit, front door assembly	CF367-67909	Covers on page 573
Kit, fuser assembly, 110V	CF367-67905	Internal assemblies (2 of 4) on page 577
Kit, fuser assembly, 220V	CF367-67906	Internal assemblies (2 of 4) on page 577
Kit, HCI left tray	CZ244-67904	3500-sheet paper feeder (2 of 2) on page 587
Kit, HCI right tray	CZ244-67903	3500-sheet paper feeder (2 of 2) on page 587

Table 2-32 Alphabetical parts list (continued)

Description	Part number	Table and page
Kit, scanner whole unit (includes white backing kit) (M830)	CF367-67919	Document feeder and scanner assemblies (M830) on page 565
Kit, transfer roller assembly	CF367-67907	Internal assemblies (2 of 4) on page 577
Kit, tray 2 roller	CF367-67903	Internal assemblies (1 of 4) on page 575
Kit, tray 2-X roller	CF367-67903	Covers on page 573
Kit, tray 2-x roller	CF367-67903	3500-sheet paper feeder (2 of 2) on page 587
Kit, white backing, A3 (M830)	5851-5864	Document feeder and scanner assemblies (M830) on page 565
Knob	FB3-7881-000CN	Booklet maker finisher main body on page 601
Laser scanner assembly	RM2-5207-000CN	Internal assemblies (3 of 4) on page 579
Left door assembly	RM1-9736-000CN	Covers on page 573
Lid, jam dispose dial	RC4-2004-000CN	Internal assemblies (1 of 4) on page 575
Lift plate assembly (M830)	A8T68-60006	Document feeder assemblies (1 of 2; M830) on page 567
Lifter drive assembly	RM1-8879-000CN	3500-sheet paper feeder (1 of 2) on page 585
Limiters, torque	RB2-5759-000CN	Internal assemblies (1 of 4) on page 575
Low-voltage power supply, 110-127V (M806)	RM2-0544-000CN	Internal assemblies (4 of 4) on page 581
Low-voltage power supply, 110-127V (M830)	RM2-0548-000CN	Internal assemblies (4 of 4) on page 581
Low-voltage power supply, 220-240V (M806)	RM2-0545-000CN	Internal assemblies (4 of 4) on page 581
Low-voltage power supply, 220-240V (M830)	RM2-0549-000CN	Internal assemblies (4 of 4) on page 581
Main controller PCB assembly	RM2-7595-000CN	Finisher main body (3 of 3) on page 597
Motor mount assembly	FM0-1686-000CN	Booklet maker saddle assembly on page 605
Motor, stepping, DC	RK2-1331-000CN	3500-sheet paper feeder (1 of 2) on page 585
Multi-purpose tray (Tray 1) assembly	RM1-9774-000CN	Covers on page 573
Operation tray assembly	RM2-5309-000CN	Finisher main body (2 of 3) on page 595

Table 2-32 Alphabetical parts list (continued)

Description	Part number	Table and page
Option connector assembly	RM1-9778-000CN	Internal assemblies (4 of 4) on page 581
Paper delivery fan assembly (M830)	RM1-9734-000CN	Internal assemblies (2 of 4) on page 577
Paper detect holder assembly, up	FM0-2429-000CN	Finisher main body (3 of 3) on page 597
Paper face sensor assembly	4G3-0934-000CN	Finisher main body (3 of 3) on page 597
Paper feed motor assembly	FM0-1889-000CN	Finisher main body (2 of 3) on page 595
Paper pass assembly	RM2-5334-000CN	Stapler/stacker finisher main body on page 599
Paper path connection assembly	RG5-6227-040CN	3500-sheet paper feeder (1 of 3) on page 583
Paper pick-up assembly	RM2-0708-000CN	3500-sheet paper feeder (2 of 2) on page 587
Paper pick-up drive assembly	RM1-9581-000CN	3500-sheet paper feeder (1 of 2) on page 585
Paper pickup assembly	RM1-9745-000CN	Internal assemblies (1 of 4) on page 575
Paper pickup paper feed assembly	RM2-0709-000CN	3500-sheet paper feeder (2 of 2) on page 587
Paper remnant detect assembly	RM1-9579-000CN	3500-sheet paper feeder (1 of 2) on page 585
Photo interrupter tlp1242	WG8-5593-000CN	Finisher main body (2 of 3) on page 595
Photosensor with connector (M830)	CC355-80014	Document feeder assemblies (1 of 2; M830) on page 567
Pin, dowel	XD3-2200-102CN	Finisher main body (3 of 3) on page 597
Power switch assembly	RM1-9723-000CN	Internal assemblies (2 of 4) on page 577
Press motor assembly	FM2-1409-000CN	Finisher main body (3 of 3) on page 597
Pressure roller assembly	FM2-0730-000CN	Finisher main body (3 of 3) on page 597
Pulley, 20T	FU5-3086-000CN	Finisher main body (3 of 3) on page 597
Punch controller PCB assembly	RM2-7742-000CN	Stapler/stacker finisher main body on page 599
Punch hole assembly (stapler/stacker 2/3 hole punch)	RM2-5455-000CN	Stapler/stacker finisher main body on page 599

Table 2-32 Alphabetical parts list (continued)

Description	Part number	Table and page
Punch hole assembly stapler/stacker 3/4 hole punch	RM2-5456-000CN	Stapler/stacker finisher main body on page 599
Punch inner cover assembly (stapler/stacker, hole puncher)	RM2-5516-000CN	Stapler/stacker finisher main body on page 599
Punch upper cover assembly (stapler/stacker, hole puncher)	RM2-5515-000CN	Stapler/stacker covers on page 589
Rack, rail	FC5-5436-000CN	Finisher main body (1 of 3) on page 593
Rear cover assembly	RM1-9787-000CN	Covers on page 573
Rear end sensor assembly	FM2-0763-000CN	Booklet maker saddle assembly on page 605
Registration assembly	RM1-9742-000CN	Internal assemblies (1 of 4) on page 575
Return roller assembly	FM0-2403-000CN	Finisher main body (3 of 3) on page 597
Reverse assembly	RM2-5490-000CN	Stapler/stacker finisher main body on page 599
Reverse assembly	RM2-5490-000	Booklet maker finisher main body on page 601
Reverse driver PCA assembly	RM2-7597-000CN	Stapler/stacker finisher main body on page 599
Reverse driver PCA assembly	RM2-7597-000	Booklet maker finisher main body on page 601
Right door assembly	RM1-9769-000CN	Covers on page 573
Right door assembly	RM1-9577-000CN	3500-sheet paper feeder (1 of 3) on page 583
Right door switch assembly	RM1-9725-000CN	Internal assemblies (1 of 4) on page 575
Roller cover assembly	RM1-9809-000CN	Covers on page 573
Saddle controller PCA assembly	RM2-7604-000CN	Booklet maker saddle assembly on page 605
Saddle feed motor assembly	4H3-0369-000CN	Booklet maker saddle assembly on page 605
Saddle guide assembly	4G3-1940-000CN	Booklet maker saddle assembly on page 605
Saddle motor assembly	FM2-0737-000	Booklet maker finisher main body on page 601
Saddle motor assembly (stapler/stacker)	FM2-0737-000CN	Stapler/stacker finisher main body on page 599
Saddle paper delivery assembly	RM2-5332-000CN	Booklet maker saddle assembly on page 605
Saddle paper feed assembly	RM2-5351-000CN	Booklet maker finisher main body on page 601

Table 2-32 Alphabetical parts list (continued)

Description	Part number	Table and page
Saddle stapler assembly	4G3-2721-000CN	Booklet maker saddle assembly on page 605
Saddle tray assembly	RM2-5318-000	Booklet maker covers on page 591
Scanner control board (SCB; M830)	CF367-60002	Document feeder assemblies (1 of 2; M830) on page 567
Sensor unit, loop	RM1-9707-000CN	Internal assemblies (2 of 4) on page 577
Sensor/switch assembly	FM2-1417-000CN	Finisher main body (3 of 3) on page 597
Shutter H.P. sensor assembly	FM2-1401-000CN	Finisher main body (3 of 3) on page 597
Stack ejection motor assembly	4G3-0769-000CN	Finisher main body (3 of 3) on page 597
Stack lower tray assembly	RM2-5339-000CN	Finisher main body (1 of 3) on page 593
Stack upper tray assembly	RM2-5324-000CN	Finisher main body (1 of 3) on page 593
Stack wall upper assembly	RM2-5343-000CN	Stapler stacker covers on page 589
Stack wall upper assembly	RM2-5343-000CN	Booklet maker covers on page 591
Staple assembly	4G3-0938-000CN	Finisher main body (1 of 3) on page 593
Staple sub assembly	4G3-0939-000CN	Finisher main body (1 of 3) on page 593
Stopper, front (M830)	A8T68-40042	Document feeder assemblies (1 of 2; M830) on page 567
Stopper, load-front (M830)	A8T68-40034	Document feeder assemblies (1 of 2; M830) on page 567
Stopper, load-rear (M830)	A8T68-40035	Document feeder assemblies (1 of 2; M830) on page 567
Stopper, rear (M830)	A8T68-40042	Document feeder assemblies (1 of 2; M830) on page 567
Swing guide assembly	RM2-5307-000CN	Finisher main body (3 of 3) on page 597
Swing H.P. sensor assembly	4G3-1564-000CN	Finisher main body (2 of 3) on page 595
Tag assembly	RM1-9759-000CN	Internal assemblies (3 of 4) on page 579
Transfer holder assembly	RM1-9706-000CN	Internal assemblies (2 of 4) on page 577

Table 2-32 Alphabetical parts list (continued)

Description	Part number	Table and page
Transfer paper feed assembly	RM1-9705-000CN	Internal assemblies (2 of 4) on page 577
Tray, face-up	RC3-3985-000CN	Covers on page 573
Upper cover assembly	RM2-5322-000CN	Booklet maker covers on page 591
Upper cover assembly (stapler/stacker)	RM2-5322-000CN	Stapler stacker covers on page 589
Upper cover assembly (stapler/stacker, hole puncher)	RM2-5535-000CN	Stapler stacker covers on page 589
Upper cover lock assembly	4G3-0210-000CN	Finisher main body (2 of 3) on page 595
Upper cross-member assembly	FM0-1882-000CN	Finisher main body (2 of 3) on page 595
Upper delivery guide assembly	RM2-5349-000CN	Booklet maker saddle assembly on page 605
Washer	FS5-6488-000CN	Finisher main body (3 of 3) on page 597

Numerical parts list

Table 2-33 Numerical parts list

Part number	Description	Table and page
4G3-0210-000CN	Upper cover lock assembly	Finisher main body (2 of 3) on page 595
4G3-0671-000CN	Inner side plate assembly	Booklet maker saddle assembly on page 605
4G3-0725-000CN	Guide motor assembly	Booklet maker saddle assembly on page 605
4G3-0769-000CN	Stack ejection motor assembly	Finisher main body (3 of 3) on page 597
4G3-0934-000CN	Paper face sensor assembly	Finisher main body (3 of 3) on page 597
4G3-0938-000CN	Staple assembly	Finisher main body (1 of 3) on page 593
4G3-0939-000CN	Staple sub assembly	Finisher main body (1 of 3) on page 593
4G3-1564-000CN	Swing H.P. sensor assembly	Finisher main body (2 of 3) on page 595
4G3-1777-000CN	Cable, staple connecting	Finisher main body (1 of 3) on page 593
4G3-1940-000CN	Saddle guide assembly	Booklet maker saddle assembly on page 605
4G3-2721-000CN	Saddle stapler assembly	Booklet maker saddle assembly on page 605
4H3-0369-000CN	Saddle feed motor assembly	Booklet maker saddle assembly on page 605
4H3-0370-000CN	Clutch, electromagnetic	Finisher main body (3 of 3) on page 597
5042-9118	Cover, control panel access (M830)	Document feeder and scanner assemblies (M830) on page 565
5851-4725	Clip, ISA cable (M830)	Document feeder assemblies (1 of 2; M830) on page 567
5851-5360	Cover, USB (M830)	Document feeder and scanner assemblies (M830) on page 565
5851-5361	Cover, HIP (M830)	Document feeder and scanner assemblies (M830) on page 565
5851-5855	Kit, ADF separation pad spring (M830)	Document feeder assemblies (2 of 2; M830) on page 569
5851-5857	Kit, ADF Mylar, A3 (M930)	Document feeder and scanner assemblies (M830) on page 565

Table 2-33 Numerical parts list (continued)

Part number	Description	Table and page
5851-5864	Kit, white backing, A3 (M830)	Document feeder and scanner assemblies (M830) on page 565
5851-5952	Kit, control panel (without keyboard) (M830)	Document feeder and scanner assemblies (M830) on page 565
A8T68-40033	Flag, paper presence (M830)	Document feeder assemblies (1 of 2; M830) on page 567
A8T68-40034	Stopper, load-front (M830)	Document feeder assemblies (1 of 2; M830) on page 567
A8T68-40035	Stopper, load-rear (M830)	Document feeder assemblies (1 of 2; M830) on page 567
A8T68-40042	Stopper, front (M830)	Document feeder assemblies (1 of 2; M830) on page 567
A8T68-40042	Stopper, rear (M830)	Document feeder assemblies (1 of 2; M830) on page 567
A8T68-40066	Cover, rear, right ADF (M830)	Document feeder assemblies (1 of 2; M830) on page 567
A8T68-40067	Cover, rear, left ADF (M830)	Document feeder assemblies (1 of 2; M830) on page 567
A8T68-40072	Cover, ADF roller (M830)	Document feeder assemblies (2 of 2; M830) on page 569
A8T68-60006	Lift plate assembly (M830)	Document feeder assemblies (1 of 2; M830) on page 567
A8T68-60021	Background selector for backside scan (M830)	Document feeder assemblies (2 of 2; M830) on page 569
A8T68-60025	Assembly, ADF hinge (M830)	Document feeder assemblies (1 of 2; M830) on page 567
C1P70-67901	Kit, ADF roller (M830)	Document feeder assemblies (2 of 2; M830) on page 569
CC355-80014	Photosensor with connector (M830)	Document feeder assemblies (1 of 2; M830) on page 567
CF367-00018	Cage, back, SCB cover (M830)	Document feeder assemblies (1 of 2; M830) on page 567
CF367-40002	Cover, front, scanner (M830)	Scanner assemblies on page 571
CF367-40003	Cover, left, scanner (M830)	Scanner assemblies on page 571
CF367-40004	Cover, right, scanner (M830)	Scanner assemblies on page 571
CF367-60002	Scanner control board (SCB; M830)	Document feeder assemblies (1 of 2; M830) on page 567
CF367-60127	Cable, power, integrated scan assembly (M830)	Document feeder assemblies (1 of 2; M830) on page 567

Table 2-33 Numerical parts list (continued)

Part number	Description	Table and page
CF367-67903	Kit, tray 2-X roller	Covers on page 573
CF367-67903	Kit, tray 2 roller	Internal assemblies (1 of 4) on page 575
CF367-67903	Kit, tray 2-x roller	3500-sheet paper feeder (2 of 2) on page 587
CF367-67905	Kit, fuser assembly, 110V	Internal assemblies (2 of 4) on page 577
CF367-67906	Kit, fuser assembly, 220V	Internal assemblies (2 of 4) on page 577
CF367-67907	Kit, transfer roller assembly	Internal assemblies (2 of 4) on page 577
CF367-67909	Kit, front door assembly	Covers on page 573
CF367-67919	Kit, scanner whole unit (includes white backing kit) (M830)	Document feeder and scanner assemblies (M830) on page 565
CF367-67920	Kit, ADF whole unit, A3 (includes white backing kit) (M830)	Document feeder and scanner assemblies (M830) on page 565
CF368-60142	Cover, back, scanner (M830)	Document feeder assemblies (1 of 2; M830) on page 567
CZ244-67903	Kit, HCI right tray	3500-sheet paper feeder (2 of 2) on page 587
CZ244-67904	Kit, HCI left tray	3500-sheet paper feeder (2 of 2) on page 587
FB3-7881-000CN	Knob	Booklet maker finisher main body on page 601
FB3-7958-040CN	Cover, right	Booklet maker finisher main body on page 601
FC5-5004-000CN	Flag, paper sensing sensor	Finisher main body (2 of 3) on page 595
FC5-5436-000CN	Rack, rail	Finisher main body (1 of 3) on page 593
FM0-1683-000CN	Entrance upper guide assembly (stapler stacker)	Finisher main body (2 of 3) on page 595
FM0-1686-000CN	Motor mount assembly	Booklet maker saddle assembly on page 605
FM0-1882-000CN	Upper cross-member assembly	Finisher main body (2 of 3) on page 595
FM0-1889-000CN	Paper feed motor assembly	Finisher main body (2 of 3) on page 595
FM0-2403-000CN	Return roller assembly	Finisher main body (3 of 3) on page 597

Table 2-33 Numerical parts list (continued)

Part number	Description	Table and page
FM0-2429-000CN	Paper detect holder assembly, up	Finisher main body (3 of 3) on page 597
FM2-0717-000CN	Entrance sensor bracket assembly	Finisher main body (2 of 3) on page 595
FM2-0730-000CN	Pressure roller assembly	Finisher main body (3 of 3) on page 597
FM2-0737-000	Saddle motor assembly	Booklet maker finisher main body on page 601
FM2-0737-000CN	Saddle motor assembly (stapler/stacker)	Stapler/stacker finisher main body on page 599
FM2-0763-000CN	Rear end sensor assembly	Booklet maker saddle assembly on page 605
FM2-1393-000CN	Adjust guide H.P. sensor assembly	Finisher main body (2 of 3) on page 595
FM2-1396-000CN	Assist sensor assembly	Finisher main body (2 of 3) on page 595
FM2-1401-000CN	Shutter H.P. sensor assembly	Finisher main body (3 of 3) on page 597
FM2-1409-000CN	Press motor assembly	Finisher main body (3 of 3) on page 597
FM2-1417-000CN	Sensor/switch assembly	Finisher main body (3 of 3) on page 597
FM6-2283-000CN	Guide sensor assembly	Booklet maker saddle assembly on page 605
FS5-1805-000CN	Bushing	Finisher main body (3 of 3) on page 597
FS5-6488-000CN	Washer	Finisher main body (3 of 3) on page 597
FU5-3086-000CN	Pulley, 20T	Finisher main body (3 of 3) on page 597
RB2-5759-000CN	Limiters, torque	Internal assemblies (1 of 4) on page 575
RC3-3945-000CN	Cover, top right (M806)	Covers on page 573
RC3-3946-000CN	Cover, top left (M806)	Covers on page 573
RC3-3947-000CN	Cover, operation panel, top (M806)	Covers on page 573
RC3-3948-000CN	Cover, hip (M806)	Covers on page 573
RC3-3949-000CN	Cover, left lower	Covers on page 573
RC3-3952-000CN	Cover, corner, left rear	Covers on page 573
RC3-3954-000CN	Cover, right rear corner, lower	Covers on page 573
RC3-3955-000CN	Cover, right rear corner, upper	Covers on page 573
RC3-3956-000CN	Cover, right lower	Covers on page 573

Table 2-33 Numerical parts list (continued)

Part number	Description	Table and page
RC3-3957-000CN	Cover, corner, right front	Covers on page 573
RC3-3958-000CN	Cover, corner, left front	Covers on page 573
RC3-3968-000CN	Guide, cartridge, front	Internal assemblies (1 of 4) on page 575
RC3-3979-000CN	Cover, left upper (M806)	Covers on page 573
RC3-3985-000CN	Tray, face-up	Covers on page 573
RC3-4269-000CN	Dial, jam dispose	Internal assemblies (1 of 4) on page 575
RC3-4589-000CN	Cover, left upper (M830)	Covers on page 573
RC3-4715-000CN	Cover, corner, right rear	3500-sheet paper feeder (1 of 3) on page 583
RC3-4716-000CN	Cover, right center	3500-sheet paper feeder (1 of 3) on page 583
RC3-4717-000CN	Cover, right lower	3500-sheet paper feeder (1 of 3) on page 583
RC3-4718-000CN	Cover, rear	3500-sheet paper feeder (1 of 3) on page 583
RC3-4719-000CN	Cover, left	3500-sheet paper feeder (1 of 3) on page 583
RC4-2004-000CN	Lid, jam dispose dial	Internal assemblies (1 of 4) on page 575
RC4-2444-000CN	Cover, rear	Stapler stacker covers on page 589
RC4-2444-000CN	Cover, rear	Booklet maker covers on page 591
RC4-2447-000CN	Cover, stepped, lower	Stapler stacker covers on page 589
RC4-2447-000CN	Cover, stepped, lower	Booklet maker covers on page 591
RC4-2448-000CN	Cover, stepped, upper	Stapler stacker covers on page 589
RC4-2448-000CN	Cover, stepped, upper	Booklet maker covers on page 591
RC4-2449-000CN	Cover, open/close stepped	Stapler stacker covers on page 589
RC4-2449-000CN	Cover, open/close stepped	Booklet maker covers on page 591
RC4-2455-000CN	Guide, wall, upper	Stapler stacker covers on page 589
RC4-2455-000CN	Guide, wall, upper	Booklet maker covers on page 591

Table 2-33 Numerical parts list (continued)

Part number	Description	Table and page
RC4-2462-000CN	Cover, tray cable	Stapler stacker covers on page 589
RC4-2462-000CN	Cover, tray cable	Booklet maker covers on page 591
RC4-2467-000CN	Guide, left lower	Booklet maker covers on page 591
RC4-2471-000CN	Cover, saddle delivery inner	Booklet maker covers on page 591
RC4-2519-000CN	Cover, pre-reverse	Stapler stacker covers on page 589
RC4-2519-000CN	Cover, pre-reverse	Booklet maker covers on page 591
RC4-2520-000CN	Cover, reverse, upper	Stapler stacker covers on page 589
RC4-2520-000CN	Cover, reverse, upper	Booklet maker covers on page 591
RC4-2521-000CN	Cover, reverse, rear	Stapler stacker covers on page 589
RC4-2521-000CN	Cover, reverse, rear	Booklet maker covers on page 591
RC4-2526-000CN	Cover, inner, lower	Stapler/stacker finisher main body on page 599
RC4-2565-000CN	Cover, right	Stapler stacker covers on page 589
RC4-2565-000CN	Cover, right	Booklet maker covers on page 591
RC4-2584-000CN	Handle, lock release	Stapler stacker covers on page 589
RC4-2584-000CN	Handle, lock release	Booklet maker covers on page 591
RG5-5746-030CN	Control lever assembly	Internal assemblies (1 of 4) on page 575
RG5-6227-040CN	Paper path connection assembly	3500-sheet paper feeder (1 of 3) on page 583
RK2-1331-000CN	Motor, stepping, DC	3500-sheet paper feeder (1 of 2) on page 585
RK2-4997-000CN	Fan	Internal assemblies (4 of 4) on page 581
RK2-5004-000CN	Fan	Internal assemblies (2 of 4) on page 577
RK2-5013-000CN	Cable, flexible flat	Internal assemblies (4 of 4) on page 581

Table 2-33 Numerical parts list (continued)

Part number	Description	Table and page
RL2-1249-000CN	Box, dust (stapler/stacker, hole puncher)	Stapler/stacker finisher main body on page 599
RM1-8879-000CN	Lifter drive assembly	3500-sheet paper feeder (1 of 2) on page 585
RM1-8880-000CN	Auto close assembly	3500-sheet paper feeder (1 of 2) on page 585
RM1-9577-000CN	Right door assembly	3500-sheet paper feeder (1 of 3) on page 583
RM1-9579-000CN	Paper remnant detect assembly	3500-sheet paper feeder (1 of 2) on page 585
RM1-9581-000CN	Paper pick-up drive assembly	3500-sheet paper feeder (1 of 2) on page 585
RM1-9582-000CN	Crossing drive assembly	3500-sheet paper feeder (1 of 2) on page 585
RM1-9705-000CN	Transfer paper feed assembly	Internal assemblies (2 of 4) on page 577
RM1-9706-000CN	Transfer holder assembly	Internal assemblies (2 of 4) on page 577
RM1-9707-000CN	Sensor unit, loop	Internal assemblies (2 of 4) on page 577
RM1-9720-000CN	Cooling unit assembly	Internal assemblies (2 of 4) on page 577
RM1-9722-000CN	Front left lower cover assembly	Covers on page 573
RM1-9723-000CN	Power switch assembly	Internal assemblies (2 of 4) on page 577
RM1-9724-000CN	Interlock assembly	Internal assemblies (2 of 4) on page 577
RM1-9725-000CN	Right door switch assembly	Internal assemblies (1 of 4) on page 575
RM1-9726-000CN	Cassette assembly	Internal assemblies (3 of 4) on page 579
RM1-9732-000CN	Face-down paper delivery assembly (M806)	Internal assemblies (2 of 4) on page 577
RM1-9734-000CN	Paper delivery fan assembly (M830)	Internal assemblies (2 of 4) on page 577
RM1-9736-000CN	Left door assembly	Covers on page 573
RM1-9742-000CN	Registration assembly	Internal assemblies (1 of 4) on page 575
RM1-9745-000CN	Paper pickup assembly	Internal assemblies (1 of 4) on page 575
RM1-9757-000CN	Auto close assembly	Internal assemblies (3 of 4) on page 579

Table 2-33 Numerical parts list (continued)

Part number	Description	Table and page
RM1-9758-000CN	Cartridge contact assembly	Internal assemblies (2 of 4) on page 577
RM1-9759-000CN	Tag assembly	Internal assemblies (3 of 4) on page 579
RM1-9760-000CN	Front inner cover assembly	Internal assemblies (1 of 4) on page 575
RM1-9762-000CN	Fixing bias contact assembly	Internal assemblies (3 of 4) on page 579
RM1-9764-000CN	ICB PCA assembly (M806)	Internal assemblies (4 of 4) on page 581
RM1-9765-000CN	ICB PCA assembly (M830)	Internal assemblies (4 of 4) on page 581
RM1-9767-000CN	High voltage power supply	Internal assemblies (4 of 4) on page 581
RM1-9768-000CN	Cartridge fan assembly	Internal assemblies (3 of 4) on page 579
RM1-9769-000CN	Right door assembly	Covers on page 573
RM1-9774-000CN	Multi-purpose tray (Tray 1) assembly	Covers on page 573
RM1-9775-000CN	Cartridge lifter assembly	Internal assemblies (1 of 4) on page 575
RM1-9778-000CN	Option connector assembly	Internal assemblies (4 of 4) on page 581
RM1-9784-000CN	Drum drive assembly	Internal assemblies (1 of 4) on page 575
RM1-9787-000CN	Rear cover assembly	Covers on page 573
RM1-9788-000CN	Fusing drive assembly	Internal assemblies (1 of 4) on page 575
RM1-9809-000CN	Roller cover assembly	Covers on page 573
RM1-9883-000CN	Crossing paper feed assembly	3500-sheet paper feeder (2 of 2) on page 587
RM2-0540-000CN	DC controller PCA assembly	Internal assemblies (4 of 4) on page 581
RM2-0544-000CN	Low-voltage power supply, 110-127V (M806)	Internal assemblies (4 of 4) on page 581
RM2-0545-000CN	Low-voltage power supply, 220-240V (M806)	Internal assemblies (4 of 4) on page 581
RM2-0548-000CN	Low-voltage power supply, 110-127V (M830)	Internal assemblies (4 of 4) on page 581
RM2-0549-000CN	Low-voltage power supply, 220-240V (M830)	Internal assemblies (4 of 4) on page 581
RM2-0558-000CN	Driver PCA assembly	Internal assemblies (4 of 4) on page 581

Table 2-33 Numerical parts list (continued)

Part number	Description	Table and page
RM2-0567-000CN	Controller PCA assembly	3500-sheet paper feeder (1 of 2) on page 585
RM2-0708-000CN	Paper pick-up assembly	3500-sheet paper feeder (2 of 2) on page 587
RM2-0709-000CN	Paper pickup paper feed assembly	3500-sheet paper feeder (2 of 2) on page 587
RM2-5207-000CN	Laser scanner assembly	Internal assemblies (3 of 4) on page 579
RM2-5305-000	Inner cover upper assembly	Booklet maker finisher main body on page 601
RM2-5305-000CN	Inner cover upper assembly	Stapler/stacker finisher main body on page 599
RM2-5307-000CN	Swing guide assembly	Finisher main body (3 of 3) on page 597
RM2-5309-000CN	Operation tray assembly	Finisher main body (2 of 3) on page 595
RM2-5318-000	Saddle tray assembly	Booklet maker covers on page 591
RM2-5320-000CN	Front cover assembly	Stapler stacker covers on page 589
RM2-5320-000CN	Front cover assembly	Booklet maker covers on page 591
RM2-5322-000CN	Upper cover assembly (stapler/stacker)	Stapler stacker covers on page 589
RM2-5322-000CN	Upper cover assembly	Booklet maker covers on page 591
RM2-5324-000CN	Stack upper tray assembly	Finisher main body (1 of 3) on page 593
RM2-5332-000CN	Saddle paper delivery assembly	Booklet maker saddle assembly on page 605
RM2-5334-000CN	Paper pass assembly	Stapler/stacker finisher main body on page 599
RM2-5339-000CN	Stack lower tray assembly	Finisher main body (1 of 3) on page 593
RM2-5343-000CN	Stack wall upper assembly	Stapler stacker covers on page 589
RM2-5343-000CN	Stack wall upper assembly	Booklet maker covers on page 591
RM2-5349-000CN	Upper delivery guide assembly	Booklet maker saddle assembly on page 605
RM2-5351-000CN	Saddle paper feed assembly	Booklet maker finisher main body on page 601

Table 2-33 Numerical parts list (continued)

Part number	Description	Table and page
RM2-5455-000CN	Punch hole assembly (stapler/stacker 2/3 hole punch)	Stapler/stacker finisher main body on page 599
RM2-5456-000CN	Punch hole assembly stapler/stacker 3/4 hole punch	Stapler/stacker finisher main body on page 599
RM2-5479-000CN	Cover, inner, lower assembly	Booklet maker finisher main body on page 601
RM2-5490-000	Reverse assembly	Booklet maker finisher main body on page 601
RM2-5490-000CN	Reverse assembly	Stapler/stacker finisher main body on page 599
RM2-5515-000CN	Punch upper cover assembly (stapler/stacker, hole puncher)	Stapler stacker covers on page 589
RM2-5516-000CN	Punch inner cover assembly (stapler/stacker, hole puncher)	Stapler/stacker finisher main body on page 599
RM2-5535-000CN	Upper cover assembly (stapler/stacker, hole puncher)	Stapler stacker covers on page 589
RM2-5539-000CN	Interface cable assembly	Finisher main body (3 of 3) on page 597
RM2-5633-000CN	Delivery switch mount assembly	Booklet maker saddle assembly on page 605
RM2-5849-000CN	Entrance sensor flag assembly	Finisher main body (2 of 3) on page 595
RM2-5852-000CN	Height wall center assembly	Booklet maker covers on page 591
RM2-5853-000CN	Height wall lower assembly	Stapler stacker covers on page 589
RM2-6024-000CN	Entrance upper guide assembly (booklet maker)	Finisher main body (2 of 3) on page 595
RM2-6056-000CN	Cover, foot, front	Stapler stacker covers on page 589
RM2-6056-000CN	Cover, foot, front	Booklet maker covers on page 591
RM2-6057-000CN	Cover, foot, rear	Stapler stacker covers on page 589
RM2-6057-000CN	Cover, foot, rear	Booklet maker covers on page 591
RM2-7590-000	Driver PCA assembly	Booklet maker finisher main body on page 601
RM2-7590-000CN	Driver PCA assembly (stapler/stacker)	Stapler/stacker finisher main body on page 599
RM2-7595-000CN	Main controller PCB assembly	Finisher main body (3 of 3) on page 597

Table 2-33 Numerical parts list (continued)

Part number	Description	Table and page
RM2-7597-000	Reverse driver PCA assembly	Booklet maker finisher main body on page 601
RM2-7597-000CN	Reverse driver PCA assembly	Stapler/stacker finisher main body on page 599
RM2-7604-000CN	Saddle controller PCA assembly	Booklet maker saddle assembly on page 605
RM2-7742-000CN	Punch controller PCB assembly	Stapler/stacker finisher main body on page 599
VS17258-012CN	Connector	Internal assemblies (4 of 4) on page 581
WG8-5593-000CN	Photo interrupter tlp1242	Finisher main body (2 of 3) on page 595
XD3-2200-102CN	Pin, dowel	Finisher main body (3 of 3) on page 597
XD9-0136-000CN	E-ring	Finisher main body (3 of 3) on page 597
XD9-0136-000CN	Assembly, E-ring saddle stapler	Booklet maker saddle assembly on page 605
XG9-0520-000CN	Bearing, ball MF 106ZZS	Finisher main body (3 of 3) on page 597

Not Final

Index

A

- accessories
 - ordering 552
 - part number 556
- after-service checklist 4
- auto-close assembly
 - removing and replacing 173

B

- background selector (M830 only)
 - removing and replacing 35
- before-service checklist 4
- bin cable cover
 - removing and replacing 317
- booklet maker
 - part number 556
- booklet maker accessory
 - removing and replacing procedures 466
- booklet maker controller PCA
 - removing and replacing 471

C

- cartridge
 - ordering 553
 - part number 553
- cartridge contact assembly
 - removing and replacing 193
- cartridge fan
 - removing and replacing 160
- cartridge-lifter assembly (M806 only)
 - removing and replacing 208
- cartridge-lifter assembly (M830 only)
 - removing and replacing 217
- cartridge-release lever
 - removing and replacing 151
- cautions iii

- center right cover, high capacity input (HCI) feeder
 - removing and replacing 278
 - clutch (front side)
 - removing and replacing 336
 - clutch (rear side)
 - removing and replacing 443
 - common driver PCA (booklet maker and stapler/stacker)
 - removing and replacing 454
 - control panel (M830 only)
 - removing and replacing 52
 - control panel assembly (M806 only)
 - removing and replacing 38
 - control-panel base cover
 - removing and replacing 94
 - controller fan
 - removing and replacing 164
 - controller PCA main
 - removing and replacing 353
 - controller PCA, high capacity input (HCI) feeder
 - removing and replacing 299
 - conventions, document iii
 - cooling-unit assembly
 - removing and replacing 258
 - covers
 - front door assembly,
 - removing 104
- ## D
- DC controller (M806 only)
 - removing and replacing 187
 - DC controller (M830 only)
 - removing and replacing 190
 - delivery switch mount assembly
 - removing and replacing 494
 - diagrams 551

DIMM

- removing and replacing 24
- document conventions iii
- document feeder assembly
 - removing and replacing 141
- document feeder mylar strips
 - removing and replacing 27
- document feeder white backing
 - removing and replacing 30
- document-feeder roller
 - removing and replacing 58
- document-feeder roller and separation pad
 - removing and replacing 60
- drive assembly (M806 only)
 - removing and replacing 196
- drive assembly (M830 only)
 - removing and replacing 199
- driver PCA
 - removing and replacing 228
- drum motor
 - removing and replacing 195
- duplexer
 - removing and replacing 9
- dust collector (stapler/stacker with hole punch)
 - removing and replacing 539

E

- electrostatic discharge (ESD) 2
- entrance upper guide assembly
 - removing and replacing 368
- ESD electrostatic discharge (ESD) 2

F

- face-down paper-delivery assembly
 - removing and replacing 234

- Face-up tray (output bin)
 - removing and replacing 87
- fax PCA
 - removing and replacing 26
- field-replaceable units (FRUs)
 - replacing 2
- finishing accessories
 - removing and replacing procedures 300
- finishing accessory covers and doors
 - Identifying 305
- folding-motor mount assembly
 - removing and replacing 489
- formatter
 - removing and replacing 12
- formatter cage
 - removing and replacing 252
- front door
 - removing and replacing 330
- front foot cover
 - removing and replacing 344
- front inner cover
 - removing and replacing 106
- FRUs (field-replaceable units)
 - replacing 2
- fuser
 - removing and replacing 10
- fuser bias contact assembly
 - removing and replacing 254
- fuser drive assembly
 - removing and replacing 242
- G**
- guide motor assembly
 - removing and replacing 481
- guide sensor assembly
 - removing and replacing 479
- H**
- hard disk drive (HDD)
 - removing and replacing 16
- hardware integration pocket (HIP) cover (M806 only)
 - removing and replacing 88
- hardware integration pocket (HIP) cover (M830 only)
 - removing and replacing 91
- height wall assembly
 - removing and replacing 401
- high capacity input (HCI) feeder
 - center right cover, removing and replacing 278
 - controller PCA, removing and replacing 299
 - left cover, removing and replacing 277
 - left tray automatic close assembly, removing and replacing 292
 - left tray lifter drive assembly, removing and replacing 288
 - left tray media-level sensor assembly, removing and replacing 290
 - left tray pickup assembly, removing and replacing 295
 - left tray pickup drive, removing and replacing 285
 - left tray pickup motor, removing and replacing 284
 - left tray, removing and replacing 273
 - lower right cover, removing and replacing 280
 - merge assembly, removing and replacing 297
 - merge drive assembly, removing and replacing 286
 - rear and right-rear corner covers, removing and replacing 274
 - removing and replacing 268
 - right door assembly, removing and replacing 276
 - right tray automatic close assembly, removing and replacing 291
 - right tray lifter drive assembly, removing and replacing 287
 - right tray media-level sensor assembly, removing and replacing 289
 - right tray pickup assembly, removing and replacing 293
 - right tray pickup drive, removing and replacing 283
 - right tray pickup motor, removing and replacing 282
 - right tray, removing and replacing 272
- high-capacity input rollers
 - removing and replacing 70
- high-voltage power supply (M806 only)
 - removing and replacing 182, 184
- I**
- inner lower cover
 - removing and replacing 339
- inner side plate assembly
 - removing and replacing 472
- inner upper cover
 - removing and replacing 333
- input accessory
 - accessory 267
 - installation 2
 - screws 2
 - See also* replacing parts
- interconnect PCA
 - removing and replacing 248
- interface cable
 - removing and replacing 456
- K**
- keyboard assembly(M830 only)
 - removing and replacing 44
- knob (booklet maker)
 - removing and replacing 467
- L**
- laser scanner
 - cautions for servicing 2
- laser/scanner assembly
 - removing and replacing 231
- left cover, high capacity input (HCI) feeder
 - removing and replacing 277
- left door assembly
 - removing and replacing 116
- left front cover
 - removing and replacing 121
- left rear cover
 - removing and replacing 109
- left top cover
 - removing and replacing 102

- left top cover (M806 only)
 - removing and replacing 102
 - left tray automatic close assembly, high capacity input (HCI) feeder
 - removing and replacing 292
 - left tray lifter drive assembly, high capacity input (HCI) feeder
 - removing and replacing 288
 - left tray media-level sensor assembly, high capacity input (HCI) feeder
 - removing and replacing 290
 - left tray pickup assembly, high capacity input (HCI) feeder
 - removing and replacing 295
 - left tray pickup drive, high capacity input (HCI) feeder
 - removing and replacing 285
 - left tray pickup motor, high capacity input (HCI) feeder
 - removing and replacing 284
 - left tray, high capacity input (HCI) feeder
 - removing and replacing 273
 - low-voltage power supply (M806 only)
 - removing and replacing 177
 - low-voltage power supply (M830 only)
 - removing and replacing 179
 - lower left guide
 - removing and replacing 499
 - Lower lock release handle cover
 - removing and replacing 347
 - lower right cover, high capacity input (HCI) feeder
 - removing and replacing 280
 - lower stepped cover
 - removing and replacing 324
- M**
- major components, finishing accessories 562
 - major components, high capacity input (HCI) 561
 - merge assembly, high capacity input (HCI) feeder
 - removing and replacing 297
 - merge drive assembly, high capacity input (HCI) feeder
 - removing and replacing 286
 - mylar strips
 - replace mylar 28
- N**
- notes iii
- O**
- open/closed stepped cover
 - removing and replacing 321
 - operation tray assembly
 - removing and replacing 419
 - option-connector assembly
 - removing and replacing 263
 - order parts by authorized service providers
 - order parts 552
 - ordering
 - product documents 552
 - supplies and accessories 552
 - toner cartridge 553
- P**
- paper detect holder assembly
 - removing and replacing 417
 - paper face sensor and flag assembly
 - removing and replacing 403
 - paper feed drive assembly
 - removing and replacing 390
 - paper pass assembly (stapler/stacker and booklet maker)
 - removing and replacing 462
 - paper-delivery fan assembly (M830 only)
 - removing and replacing 237
 - paper-pickup assembly
 - removing and replacing 167
 - part number
 - toner cartridge 553
 - part numbers
 - accessories 556
 - replacement parts 553
 - supplies 553
 - toner cartridges 553
 - parts 551
 - parts lists and diagrams
 - covers 572
 - internal assemblies (1 of 4) 574
 - internal assemblies (2 of 4) 576
 - using 556
 - pickup, feed, and separation
 - rollers and pads, remove 57
 - power supply fan
 - removing and replacing 157
 - power switch assembly
 - removing and replacing 247
 - pre-reverse cover
 - removing and replacing 312
 - press motor
 - removing and replacing 450
 - pressure roller assembly
 - removing and replacing 392
 - punch controller PCA
 - removing and replacing 538
 - punch hole assembly (stapler/stacker with hole punch)
 - removing and replacing 545
 - punch inner cover (stapler/stacker with hole punch)
 - removing and replacing 540
 - punch top cover
 - removing and replacing 541
- R**
- rear and right-rear corner covers, high capacity input (HCI) feeder
 - removing and replacing 274
 - rear cover
 - removing and replacing 110, 349
 - rear foot cover
 - removing and replacing 371
 - rear reverse cover
 - removing and replacing 314
 - registration assembly
 - removing and replacing 171
 - registration-jam-removal knob
 - removing and replacing 154
 - related documentation and software
 - order parts 552
 - removal order
 - removing order 4
 - removal strategy
 - removing and replacing 2

- remove the booklet maker controller PCA
 - booklet maker controller PCA, removing and replacing 471
- remove the clutch (front side)
 - clutch (front side), removing and replacing 336
- remove the clutch (rear side)
 - clutch (rear side), removing and replacing 443
- remove the common driver PCA (booklet maker and stapler/stacker)
 - controller driver PCA (booklet maker and stapler/stacker), removing and replacing 454
- remove the delivery switch mount assembly (booklet maker)
 - delivery switch mount assembly (booklet maker), removing and replacing 494
- remove the document feeder assembly (M830 only)
 - document feeder assembly (M830 only), removing and replacing 141
- remove the entrance upper guide assembly
 - entrance upper guide assembly, removing and replacing 368
- remove the folding-motor mount assembly
 - folding-motor mount assembly, removing and replacing 489
- remove the guide motor assembly (booklet maker)
 - guide motor assembly (booklet maker), removing and replacing 481
- remove the guide sensor assembly (booklet maker)
 - guide sensor assembly (booklet maker), removing and replacing 479
- remove the HCI center right cover
 - HCI center right cover, removing and replacing 278
- remove the HCI controller PCA
 - rear cover, removing and replacing 299
- remove the HCI left cover
 - left cover, removing and replacing 277
- remove the HCI left ray automatic close assembly
 - HCI left ray automatic close assembly, removing and replacing 292
- remove the HCI left tray lifter drive assembly
 - HCI left tray lifter drive assembly, removing and replacing 288
- remove the HCI left tray media-level sensor assembly
 - left tray media-level sensor assembly, removing and replacing 290
- remove the HCI left tray pickup assembly
 - HCI left tray pickup, removing and replacing 295
- remove the HCI lower right cover
 - rear cover, removing and replacing 280
- remove the HCI merge assembly
 - merge assembly, removing and replacing 297
- remove the HCI merge drive assembly
 - HCI merge drive assembly, removing and replacing 286
- remove the HCI right door assembly
 - right door assembly, removing and replacing 276
- remove the HCI right tray automatic close assembly
 - HCI right tray automatic close assembly, removing and replacing 291
- remove the HCI right tray lifter drive assembly
 - HCI right tray lifter drive assembly, removing and replacing 287
- remove the HCI right tray media-level sensor assembly
 - right tray media-level sensor assembly, removing and replacing 289
- Remove the HCI right tray pickup assembly
 - HCI right tray pickup assembly, removing and replacing 293
- remove the HCI right tray pickup drive
 - left tray pickup drive, removing and replacing 284, 285
 - right tray pickup drive, removing and replacing 282, 283
- remove the height wall assembly
 - height wall assembly, removing and replacing 401
- remove the inner side plate assembly (booklet maker)
 - inner side plate assembly (booklet maker), removing and replacing 472
- remove the interface cable
 - interface cable, removing and replacing 456
- remove the lower left guide
 - lower left guide, removing and replacing 499
- remove the lower stepped cover
 - stepped cover lower, removing and replacing 324
- remove the main controller PCA
 - controller PCA main, removing and replacing 353
- remove the operation tray assembly
 - operation tray assembly, removing and replacing 420
- remove the paper detect holder assembly
 - paper detect holder assembly, removing and replacing 417
- remove the paper face sensor and flag assembly
 - paper face sensor and flag assembly, removing and replacing 403

- remove the paper feed drive assembly
 - paper feed drive assembly, removing and replacing 390
- remove the paper pass assembly (stapler/stacker and booklet maker)
 - paper pass assembly (stapler/stacker and booklet maker), removing and replacing 462
- remove the press motor
 - press motor, removing and replacing 450
- remove the pressure roller assembly
 - pressure roller assembly, removing and replacing 392
- remove the punch controller PCA
 - controller PCA, removing and replacing 538
- remove the punch hole assembly (stapler/stacker with hole punch)
 - punch hole assembly (stapler/stacker with hole punch), removing and replacing 545
- remove the punch inner cover (stapler/stacker with hole punch)
 - punch inner cover (stapler/stacker with hole punch), removing and replacing 540
- remove the punch top cover
 - punch top cover, removing and replacing 541
- remove the rear cover
 - rear cover, removing and replacing 349
- remove the rear foot cover
 - rear foot cover, removing and replacing 371
- remove the return roller assembly
 - return roller assembly, removing and replacing 442
- remove the reverse assembly
 - reverse assembly, removing and replacing 459
- remove the reverse driver PCA
 - reverse driver PCA, removing and replacing 458
- remove the right cover (booklet maker PCA)
 - right cover (booklet maker PCA), removing and replacing 470
- remove the saddle assembly (booklet maker)
 - saddle assembly (booklet maker), removing and replacing 515
- remove the saddle delivery inner cover, front
 - saddle delivery inner cover front, removing and replacing 501
- remove the saddle delivery inner cover, rear
 - saddle delivery inner cover rear, removing and replacing 503
- remove the saddle feed assembly
 - saddle feed assembly, removing and replacing 511
- remove the saddle feed motor assembly (booklet maker)
 - saddle feed motor assembly (booklet maker), removing and replacing 485
- remove the saddle guide assembly (booklet maker)
 - saddle guide assembly (booklet maker), removing and replacing 506
- remove the saddle motor (stapler/stacker and booklet maker)
 - saddle motor (stapler/stacker and booklet maker), removing and replacing 483
- remove the saddle paper delivery assembly
 - saddle paper delivery assembly, removing and replacing 526
- remove the saddle rear end sensor assembly (booklet maker)
 - saddle rear end sensor assembly (booklet maker), removing and replacing 531
- remove the saddle stapler assembly (booklet maker)
 - saddle stapler assembly (booklet maker), removing and replacing 497
- remove the scanner assembly
 - scanner assembly, removing and replacing 146
- remove the scanner control board (SCB)
 - scanner control board (SCB), removing and replacing 135
- remove the scanner front cover
 - scanner front cover, removing and replacing 80
- remove the scanner left cover
 - scanner left cover, removing and replacing 76
- remove the scanner right cover
 - scanner right cover, removing and replacing 78
- remove the sensor switch assembly
 - sensor switch assembly, removing and replacing 337
- remove the stack ejection motor
 - stack ejection motor, removing and replacing 446
- remove the stack upper bin and lower bin
 - lower bin stack, removing and replacing 397
 - upper bin stack, removing and replacing 397
- remove the stack wall upper assembly and upper wall guide
 - stack wall upper assembly and upper wall guide, removing and replacing 375
- remove the staple assembly
 - staple assembly, removing and replacing 413
- remove the staple connecting cable
 - staple assembly, removing and replacing 411
- remove the staple sub assembly
 - staple sub assembly, removing and replacing 408

- remove the swing guide assembly
 - swing guide assembly, removing and replacing 431
 - remove the upper delivery guide assembly (booklet maker)
 - upper delivery guide assembly, removing and replacing 524
 - remove the uppercross member assembly
 - upper crossmember assembly, removing and replacing 378
 - removing parts
 - after-service checklist 4
 - before-service checklist 4
 - front door assembly 104
 - service approach 3
 - tools, required 3
 - repair approach 3
 - replace covers and doors
 - removing and replacing covers and doors 72
 - replacement parts
 - part numbers 553
 - replacing parts
 - about 2
 - after-service checklist 4
 - before-service checklist 4
 - screws 2
 - service approach 3
 - tools, required 3
 - return roller assembly
 - removing and replacing 441
 - reverse assembly
 - removing and replacing 459
 - reverse driver PCA
 - removing and replacing 458
 - right cover
 - removing and replacing 311
 - right cover (booklet maker PCA)
 - removing and replacing 470
 - right door assembly
 - removing and replacing 118
 - right door assembly, high capacity input (HCI) feeder
 - removing and replacing 276
 - right lower cover
 - removing and replacing 128
 - right lower front cover
 - removing and replacing 126
 - right rear cover
 - removing and replacing 113
 - right top cover
 - removing and replacing 98
 - right top cover (M806 only)
 - removing and replacing 98
 - right tray automatic close assembly, high capacity input (HCI) feeder
 - removing and replacing 291
 - right tray lifter drive assembly, high capacity input (HCI) feeder
 - removing and replacing 287
 - right tray media-level sensor assembly, high capacity input (HCI) feeder
 - removing and replacing 289
 - right tray pickup assembly, high capacity input (HCI) feeder
 - removing and replacing 293
 - right tray pickup drive, high capacity input (HCI) feeder
 - removing and replacing 283
 - right tray pickup motor, high capacity input (HCI) feeder
 - removing and replacing 282
 - right tray, high capacity input (HCI) feeder
 - removing and replacing 272
- S**
- saddle assembly (booklet maker)
 - removing and replacing 514
 - saddle delivery inner cover, front
 - removing and replacing 501
 - saddle delivery inner cover, rear
 - removing and replacing 503
 - saddle feed assembly
 - removing and replacing 511
 - saddle feed motor assembly
 - removing and replacing 485
 - saddle guide assembly
 - removing and replacing 505
 - saddle motor (stapler/stacker and booklet maker)
 - removing and replacing 483
 - saddle output bin assembly
 - removing and replacing procedures 468
 - saddle paper delivery assembly
 - removing and replacing 526
 - saddle rear end sensor assembly (booklet maker)
 - removing and replacing 531
 - saddle stapler assembly
 - removing and replacing 497
 - scanner assembly
 - removing and replacing 146
 - scanner back cover
 - removing and replacing 75
 - scanner control board (SCB)
 - removing and replacing 135
 - scanner front cover
 - removing and replacing 80
 - scanner left cover
 - removing and replacing 76
 - scanner right cover
 - removing and replacing 78
 - screwdrivers, required 3
 - screws
 - installing 2
 - types of 3
 - sensor switch assembly
 - removing and replacing 337
 - service approach 3
 - service replacement parts
 - order parts 555
 - shared finish accessory assemblies
 - removing and replacing procedures 307
 - solid state module (SSM)
 - removing and replacing 16
 - stack ejection motor
 - removing and replacing 446
 - stack upper bin and lower bin assemblies
 - removing and replacing 397
 - stack wall upper assembly and upper wall guide
 - removing and replacing 375
 - staple assembly
 - removing and replacing 413
 - staple connecting cable
 - removing and replacing 411
 - stapler sub assembly
 - removing and replacing 408
 - stapler/stacker
 - part number 556

stapler/stacker and stapler/stacker
with hole punch accessories
removing and replacing
procedures 537

static, precautions for 2

supplies
ordering 552
part numbers 553

supplies part numbers
order parts 553

swing guide assembly
removing and replacing 430

T

tag assembly
removing and replacing 261

tips iii

toner cartridge
ordering 553
part number 553
removing and replacing 5

toner cartridges
part numbers 553

tools, required 3

top door assembly
removing and replacing 328

transfer paper-feed assembly
removing and replacing 202

transfer-holder assembly
removing and replacing 205

transfer-roller assembly
removing and replacing 8

Tray 1 (multipurpose tray)
removing and replacing 84

Tray 1 rollers
removing and replacing 65

Tray 2 and Tray 3
removing and replacing 86

Tray 2 and Tray 3 rollers
removing and replacing 68

troubleshooting
service approach 3

U

upper cover lock assembly
removing and replacing 309

upper crossmember assembly
removing and replacing 378

upper delivery guide assembly
removing and replacing 524

upper left cover (M806 only)
removing and replacing 122

upper left cover (M830 only)
removing and replacing 124

upper reverse cover
removing and replacing 316

upper stepped cover
removing and replacing 322

W

warnings iii

white backing
removing and replacing 31,
37

Not Final



CZ244-90966

