

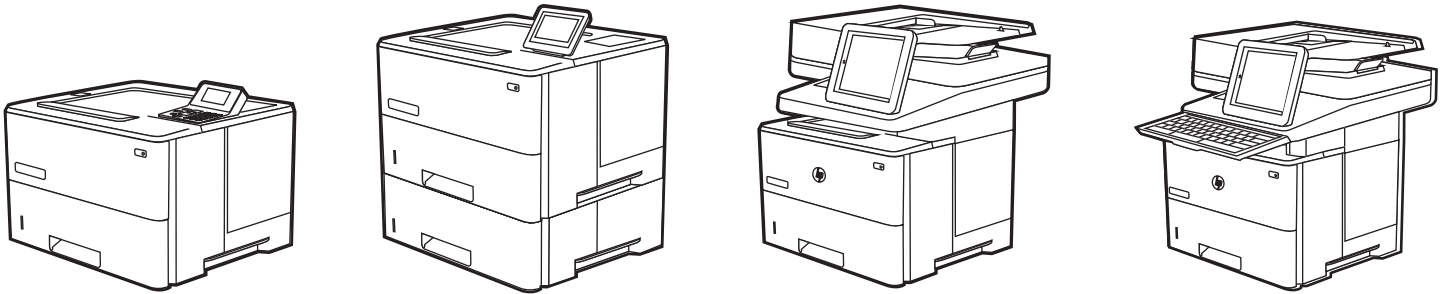

HP LaserJet Pro M501
HP LaserJet Enterprise M506, M507
HP LaserJet Enterprise MFP M527, M528
HP LaserJet Managed E50145, MFP E52645
HP LaserJet Managed E50045, MFP E52545

Service Manual: Troubleshooting



www.hp.com/videos/LaserJet
www.hp.com/support/ljM501
www.hp.com/support/ljM506
www.hp.com/support/ljM507
www.hp.com/support/ljM527mfp
www.hp.com/support/ljM528mfp

www.hp.com/support/ljE50045
www.hp.com/support/ljE50145
www.hp.com/support/ljE52545mfp
www.hp.com/support/ljE52645mfp



HP LaserJet Pro M501; HP LaserJet Enterprise M506, M507 and MFP M527, MFP M528; HP LaserJet Managed E50045 and MFP E52545; HP LaserJet Managed E50145 and MFP E52645 - Service Manual: Troubleshooting

SUMMARY

Learn about the printer theory of operation and how to solve printer problems. For printer part removal, replacement, and exploded parts diagrams, see the *Repair Manual*.

Copyright and License

© Copyright 2019 HP Development Company, L.P.

Reproduction, adaptation, or translation without prior written permission is prohibited, except as allowed under the copyright laws.

The information contained herein is subject to change without notice.

The only warranties for HP products and services are set forth in the express warranty statements accompanying such products and services. Nothing herein should be construed as constituting an additional warranty. HP shall not be liable for technical or editorial errors or omissions contained herein.

Edition 4, 3/2019

Revision history

View a list of document revisions.

The information contained herein is subject to change without notice. The only warranties for HP products and services are set forth in the express warranty statements accompanying such products and services. Nothing herein should be construed as constituting an additional warranty. HP shall not be liable for technical or editorial errors or omissions contained herein.

Table -1 Revision history

Revision number	Revision date	Revision notes
3	5/2019	<p>Added FutureSmart 4 steps to the following procedures:</p> <ul style="list-style-type: none"> • Use the solve problems checklist on page 75 • Print the Settings menu map on page 79 • Print current settings pages on page 81 • Print the event log on page 103 • HP Jetdirect LEDs on page 151 • Disable cartridge check (all except M501) on page 155 • Paper path test (all except M501) on page 157 • Paper path sensors test (all except M501) on page 159 • Manual sensor tests (all except M501) on page 161 • Tray/bin manual sensor test (all except M501) on page 164 • Print/stop test (all except M501) on page 167 • Individual component diagnostics (special-mode test; all except M501) on page 170 • Use the scanner tests on page 173 • Print a configuration page on page 196 • Print a fuser test page (all except M501) on page 204 • Control panel menus (all except M501) on page 219 • Check toner-cartridge status on page 298 • Print a cleaning page on page 298 • Step three: Set the individual tray alignment on page 300 • Print quality troubleshooting guide on page 310 • Change jam recovery (all except M501) on page 470 • Service menu (all except M501) on page 487 • Restore factory-set defaults (all except M501) on page 493 • Determine the installed revision of firmware (all except M501) on page 506 • USB flash drive (control panel menu) (all except M501) on page 511

Table -1 Revision history (continued)

Revision number	Revision date	Revision notes
3	5/2019	Added a procedure to access the touchscreen diagnostic mode for the M507x and E50145dn printers. <ul style="list-style-type: none">• Touchscreen diagnostic mode (M507x and E50145dn) on page 123
3	5/2019	Updated model list for control panel diagnostic keyboard test. <ul style="list-style-type: none">• Keyboard test (M527c/z, E52545c, M528c/z, E52645c only) on page 137
2	4/2016	LaserJet Pro M501 content added.
1	10/2015	HP LaserJet Enterprise M506/M527 Repair Manual initial release.

Table of contents

1 Theory of operations	1
Conventions used in this guide	1
HP service and support	1
Basic operation	3
Sequence of operation	4
Formatter-control system	6
Sleep mode (all except M501)	6
Sleep delay (M501)	7
Auto On / Auto Off mode (M501)	8
Printer job language (PJM)	8
Printer management language (PML)	8
Control panel	8
Easy-access USB port (all except M501)	9
Wireless (wireless models only)	9
Low end data model (LEDM) overview (M501)	9
Advanced control language (ACL) overview (M501)	9
Near field communication (NFC models only)	10
CPU	10
Input/output (I/O)	10
Memory	11
Firmware	11
Nonvolatile random access memory (NVRAM)	11
Random access memory (RAM)	11
HP Memory Enhancement technology (MEt)	11
Engine-control system	12
DC controller	13
Motors	14
Fans	15
Solenoids	15
Clutches	15
Switches	16
Photo interrupter sensors	16

Sensors	16
LEDs	16
Low-voltage power supply (LVPS)	18
Low-voltage power supply voltages description	20
Over-current/over-voltage protection	21
Sleep mode operation (all except M501)	21
Low-voltage power supply failure detection (all except M501)	22
Safety	22
Low-voltage power supply functions	22
High-voltage power supply	23
Fuser bias	23
High-voltage power supply circuits	23
Fuser control	25
Fuser circuits	25
Fuser control functions	26
Fuser heater protection	27
Fuser unit life detection (all except M501)	27
Fuser identification (all except M501)	27
Engine laser/scanner system	28
Laser/scanner failure detection	29
Safety	29
Image-formation process	30
Step 1: Primary charging	34
Step 2: Laser-beam exposure	34
Step 3: Development	35
Step 4: Transfer	35
Step 5: Separation	36
Step 6: Fusing	36
Step 7: Drum cleaning	37
Toner cartridge	38
Design	38
Memory chip	39
Dynamic security enabled printers in this guide	39
Dynamic security	40
Toner seal	40
Toner level and cartridge life detection	40
JetIntelligence	41
Authentication	41
Anti-theft	41
Paper handling system	42
Photo sensors and switches	44

Motors, clutches, and solenoids	45
Tray 1 (multipurpose) / Tray 2 (base printer)	47
Tray 1 paper pickup and feed	47
Tray 2 paper presence detection	48
Tray 2 lift operation	48
Tray 2 paper pickup	49
Tray 2 multiple feed prevention	49
Tray 2 presence detection	50
Tray 2 skew feed prevention	50
Feed speed control	51
Duplexing unit	53
Duplexing reverse and duplex feed control	53
Jam detection/prevention	53
Input accessories	56
Tray 3-5	57
Driver PCA	59
Electrical components	59
Paper pickup	60
Multiple feed prevention	60
Tray presence detection	60
Tray lift operation	60
Jam detection	61
Scanning and image capture system (M527/E52545/M528/E52645)	63
Document feeder system (M527/E52545/M528/E52645)	64
Document feed system	65
Sensors in the document feeder	65
Document feeder paper path	66
Document feeder simplex operation	67
Document feeder e-duplex operation	68
Deskew operation	68
Document feeder hinges	69
2 Solve problems	71
HP service and support	71
Solve problems checklist (M501)	73
Use the solve problems checklist (M501)	73
Print the menu map (M501)	74
Print the service page (includes the event log) (M501)	74
Solve problems checklist (all except M501)	75
Use the solve problems checklist	75
Print the Settings menu map	79

Print the settings menu map from a touchscreen control panel	79
Print the settings menu map from a LCD control panel	79
Print current settings pages	81
Print the current settings page from a touchscreen control panel	81
Print the current settings page from a LCD control panel	81
Pre-boot menu options	83
Open the Pre-boot menu from a touchscreen control panel	83
Open the Pre-boot menu from a LCD control panel	85
Cold reset using the Pre-boot menu from a touchscreen control panel	85
Cold reset using the Pre-boot menu from a LCD control panel	85
Remote Admin (all except M501)	93
Required software and network connection	94
Connect a remote connection	97
Disconnect a remote connection	101
Print the event log	103
Print the event log from the Administration menu (FutureSmart 3) or Support Tools menu (FutureSmart 4) from a touchscreen control panel	103
Print the event log from the Administration menu (FutureSmart 3) or Support Tools menu (FutureSmart 4) from a LCD control panel	103
Print the event log from the Service menu from a touchscreen control panel	104
Print the event log from the Service menu from a LCD control panel	104
Clear the event log from a touchscreen control panel	105
Clear the event log from a LCD control panel	105
Troubleshooting process	107
Determine the problem source	108
Pre-troubleshooting checklist	108
Troubleshooting flowchart	109
Power subsystem	112
Power-on checks	113
Power-on troubleshooting overview	114
Control panel checks (M501)	116
Control panel checks (all except M501)	118
Control panel diagnostics (M506x/M507x and M527/E52545/M528/E52645)	119
Touchscreen diagnostic mode (M506x, M527/E52545/M528/E52645)	119
Touchscreen diagnostic mode (M507x and E50145dn)	123
Control panel system diagnostics (M506x/M507x, M527/E52545/ M528/E52645)	125
Control panel diagnostic flowcharts (M506x/M507x, M527/E52545/ M528/E52645)	140
Tools for troubleshooting	145
Individual component diagnostics	146

LED diagnostics (M501)	147
Network port LEDs (M501)	147
M501 control panel LEDs	147
LED diagnostics (all except M501)	149
Understand lights on the formatter	149
Heartbeat LED	149
HP Jetdirect LEDs	151
Engine diagnostics	152
Engine test button	152
Defeating interlocks	153
Disable cartridge check (all except M501)	155
Paper path and sensor diagnostic tests (all except M501)	156
Paper path test (all except M501)	157
Paper path sensors test (all except M501)	159
Manual sensor tests (all except M501)	161
Tray/bin manual sensor test (all except M501)	164
Print/stop test (all except M501)	167
Access the print/stop test from a touchscreen control panel	167
Access the print/stop test from a LCD control panel	167
Common print stop test timing millisecond (ms) stops	168
Component tests (all except M501)	169
Individual component diagnostics (special-mode test; all except M501)	170
Scanner tests (M527/E52545/M528/E52645)	172
Scanner tests (M527/E52545/M528/E52645)	173
Diagrams	175
Diagrams: Block diagrams	176
Sensors and switches	176
Cross section diagrams	178
Diagrams: Printed circuit assembly (PCA) connector locations	181
Diagrams: External plug and port locations	185
Diagrams: Locations of major assemblies	189
Main assemblies (printer base)	189
Rollers and pads (printer base)	190
Motor and fans	190
Printed circuit assemblies (PCAs; printer base)	191
Diagrams: General timing chart	192
Diagrams: General circuit diagrams	192
Internal test and information pages	195
Print a configuration page	196
Print the configuration page from a LCD control panel (M501)	196

Print the configuration page from a LCD control panel (M506/E50045/ M507/E50145)	197
Print the configuration page from a touchscreen control panel (M527/ E52545/M528/E52645)	198
HP embedded Jetdirect page (all except M501)	199
Wireless page (all except M501)	200
Finding important information on the configuration pages	202
Print a fuser test page (all except M501)	204
Print a fuser test page from a touchscreen control panel	204
Print a fuser test page from a LCD control panel	204
Advanced configuration with HP Embedded Web Server (EWS) and HP Device Toolbox (Windows) (M501)	206
Open the HP Embedded Web Server (EWS) from the Start menu	206
Open the HP Embedded Web Server (EWS) from a Web browser	206
Control panel menus (M501)	209
Setup menu	210
HP Web Services menu (M501)	210
Reports menu (M501)	210
System Setup menu (M501)	211
Service menu (M501)	215
Network Setup menu (M501)	216
Quick Forms menu (M501)	217
Function specific menus (M501)	218
Apps (M501)	218
Jobs (M501)	218
Supplies Status (M501)	218
Control panel menus (all except M501)	219
Reports menu	219
Settings menu	222
General menu (all except M501)	222
Print menu (M506/E50045/M507/E50145) and Copy/Print menu (M527/E52545/M528/E52645)	228
Scan/Digital Send Settings menu (M527/E52545/M528/E52645)	249
Fax menu (M527/E52545/M528/E52645)	257
Manage Supplies menu	267
Networking menu	269
Support Tools menu	281
Maintenance menu (all except M501)	282
Troubleshooting menu	283
Error code and control panel message troubleshooting overview	289
Error codes	289

How to search for printer documentation	291
Resolve print-quality problems	295
Introduction	295
Resolving print quality problems	296
Print from a different software program	296
Check the paper-type setting for the print job	297
Check the paper type setting on the printer	297
Check the paper type setting (Windows)	297
Check the paper type setting (macOS)	297
Check toner-cartridge status	298
Step one: Print the Supplies Status Page	298
Step two: Check supplies status	298
Print a cleaning page	298
Visually inspect the toner cartridge or cartridges	299
Check paper and the printing environment	300
Step one: Use paper that meets HP specifications	300
Step two: Check the environment	300
Step three: Set the individual tray alignment	300
Try a different print driver	301
Troubleshoot image defects	301
Print quality troubleshooting guide	310
Image defects table	310
Product specific image defects	314
Repetitive image defect ruler	315
Use a ruler to measure between repetitive defects	316
Print-quality troubleshooting	320
Image defect events	321
Image defect (developmental) events	352
Other events	407
Clean the printer	424
Clean the paper path	424
Print a cleaning page	425
Print the cleaning page from a LCD control panel (M501)	425
Print the cleaning page from a LCD control panel (M506/E50045/M507/E50145)	425
Print the cleaning page from a touchscreen control panel (M527/E52545/M528/ E52645)	426
Enable and configure auto cleaning (M527/E52545/M528/E52645)	426
Check the scanner glass for dirt and smudges (M527/E52545/M528/E52645)	426
Clean the pickup rollers and separation pad in the document feeder (M527/E52545/M528/ E52645)	428
Clean the Tray 1 roller and separation pad	430

Step 1: Remove the roller	430
Step 2: Remove the separation pad assembly	431
Step 3: Clean the Tray 1 roller and separation pad	433
Step 4: Install the separation pad assembly	433
Step 5: Install the roller	435
Clean the Tray 2-X rollers	438
Step 1: Remove the tray	438
Step 2: Remove the roller assembly	439
Step 3: Clean the Tray 2-X rollers	440
Step 4: Install the roller assembly	441
Step 5: Install the tray	443
Solve paper handling problems	445
Printer feeds incorrect page size	445
Printer pulls from incorrect tray	445
Printer will not duplex or duplexes incorrectly	445
Paper does not feed from Tray 2-X	446
Output is curled or wrinkled	446
Printer does not pick up paper or misfeeds	448
The printer does not pick up paper	448
The printer picks up multiple sheets of paper	448
The document feeder jams, skews, or picks up multiple sheets of paper (M527/ E52545/M528/E52645)	449
Paper does not feed automatically	449
Clear paper jams	450
Paper path jam sensor locations	450
Auto-navigation for clearing jams	451
Experiencing frequent or recurring paper jams?	452
Clear paper jams in the document feeder	452
Clear paper jams in Tray 1	455
Clear paper jams in Tray 2 and the 550-sheet trays	458
Clear paper jams in the toner-cartridge area	461
Clear paper jams in the rear door and the fuser area	463
Clear paper jams in the output bin	464
Clear paper jams in the duplexer	465
Change jam recovery (all except M501)	470
Change jam recovery from a touchscreen control panel	470
Change jam recovery from a LCD control panel	470
Solve performance problems	472
Factors affecting print performance	472
Print speeds	473
The printer does not print or it prints slowly	475

The printer does not print	475
The printer prints slowly	475
Solve connectivity problems	477
Solve USB connection problems	477
Solve wired network problems	478
Introduction	478
Poor physical connection	478
The computer is using the incorrect IP address for the printer	478
The computer is unable to communicate with the printer	478
The printer is using incorrect link and duplex settings for the network	479
New software programs might be causing compatibility problems	479
The computer or workstation might be set up incorrectly	479
The printer is disabled, or other network settings are incorrect	479
Service mode functions (M501)	480
Service menu (M501)	480
Service menu settings	480
Restore the factory-set defaults	481
Restore the factory-set defaults from a LCD control panel (M501)	481
Secondary service menu (M501)	482
Open the secondary service menu (M501)	483
Open the secondary service menu from a LCD control panel (M501)	483
Secondary service menu structure (M501)	483
Printer resets (M501)	485
NVRAM initialization (M501)	485
Service mode functions (all except M501)	486
Service menu (all except M501)	487
Open the service menu from a touchscreen control panel	487
Open the service menu from a LCD control panel	487
Service menu items	488
Printer resets (all except M501)	492
Restore factory-set defaults (all except M501)	493
Restore factory-set defaults from a touchscreen control panel	493
Restore factory-set defaults from a LCD control panel	493
Restore the service ID (all except M501)	494
Restore the service ID	494
Convert the service ID to an actual date	494
Printer cold reset (all except M501)	495
Cold reset using the Pre-boot menu from a touchscreen control panel	495
Cold reset using the Pre-boot menu from a LCD control panel	495
Format Disk and Partial Clean functions (all except M501)	497
Active and repository firmware locations	497

Partial Clean	498
Execute a Partial Clean	499
Format Disk	500
Execute a Format Disk	501
Firmware upgrades (M501)	502
Determine the installed revision of firmware (M501)	502
Method one: Update the firmware using the control panel (M501)	503
Method two: Update the firmware using the Firmware Update Utility (M501)	503
Firmware upgrades (all except M501)	505
Determine the installed revision of firmware (all except M501)	506
Print the configuration page from a touchscreen control panel	506
Print the configuration page from a LCD control panel	506
Perform a firmware upgrade (all except M501)	508
HP Embedded Web Server (all except M501)	508
USB flash drive (Pre-boot menu) (all except M501)	509
USB flash drive firmware (Pre-boot menu) update from a touchscreen control panel	509
USB flash drive firmware (Pre-boot menu) update from a LCD control panel	510
USB flash drive (control panel menu) (all except M501)	511
USB flash drive firmware (control panel menu) update from a touchscreen control panel	511
USB flash drive firmware (control panel menu) update from a LCD control panel	511
Solve fax or email problems	512
Appendix A Printer specifications	515
Printer dimensions	516
HP LaserJet Pro M501 dimensions	516
HP LaserJet Enterprise M506/E50045/M507/E50145 dimensions	518
HP LaserJet Enterprise MFP M527/E52545/M528/E52645 dimensions	520
Printer space requirements	523
Power consumption, electrical specifications, and acoustic emissions	524
Operating-environment range	524
Certificate of Volatility	524
Index	535

1 Theory of operations

Learn about the printer theory of operations.

- [Conventions used in this guide](#)
- [HP service and support](#)
- [Basic operation](#)
- [Formatter-control system](#)
- [Engine-control system](#)
- [Engine laser/scanner system](#)
- [Paper handling system](#)
- [Input accessories](#)
- [Scanning and image capture system \(M527/E52545/M528/E52645\)](#)
- [Document feeder system \(M527/E52545/M528/E52645\)](#)

Conventions used in this guide

Learn about the conventions used in this publication.

 **TIP:** Tips provide helpful hints or shortcuts.

 **NOTE:** Notes provide important information to explain a concept or to complete a task.

 **CAUTION:** Cautions indicate procedures that you should follow to avoid losing data or damaging the product.

 **WARNING!** Warnings alert you to specific procedures that you should follow to avoid personal injury, catastrophic loss of data, or extensive damage to the product.

HP service and support

Learn about HP access to additional service and support information.

Additional service and support for channel partners

Channel partners go to partner.hp.com, and then use the steps below to access the HP Web-based Interactive Search Engine (WISE).

Access WISE for Channel partners

1. Select [Services & Support](#), and then select [Services Delivery](#).
2. Select [Technical Support](#), and then select [Technical Documentation](#).

Find information about the following topics

- Service manuals
- Service advisories
- Up-to-date control panel message (CPMD) troubleshooting
- Solutions for printer issues and emerging issues
- Remove and replace part instructions and videos
- Install and configure
- Printer specifications
- Warranty and regulatory information

Additional service and support for HP internal personnel

HP internal personnel, go to one of the following Web-based Interactive Search Engine (WISE) sites:

Americas (AMS)

- [WISE - English](#)
- [WISE - Spanish](#)
- [WISE - Portuguese](#)
- [WISE - French](#)

Asia Pacific / Japan (APJ)

- [WISE - English](#)
- [WISE - Japanese](#)
- [WISE - Korean](#)
- [WISE - Chinese \(simplified\)](#)
- [WISE - Chinese \(traditional\)](#)
- [WISE - Thai](#)

Europe / Middle East / Africa (EMEA)

- [WISE - English](#)

Basic operation

The printer routes all high-level processes through the formatter, which stores font information, processes the print image, and communicates with the host computer.

- [Sequence of operation](#)

The basic printer operation comprises the following systems:

- The engine-control system, which includes the high-voltage and low-voltage power supplies (HVPS and LVPS), fuser control circuits, and the DC controller printed circuit assembly (PCA)
- The laser/scanner system, which forms the latent image on the photosensitive drum
- The image-formation system, which transfers a toner image onto the paper
- The pickup, feed and delivery system, which uses a system of rollers and belts to transport the paper through the printer
- Accessory (optional paper feeder)

Figure 1-1 Relationship between the main printer systems

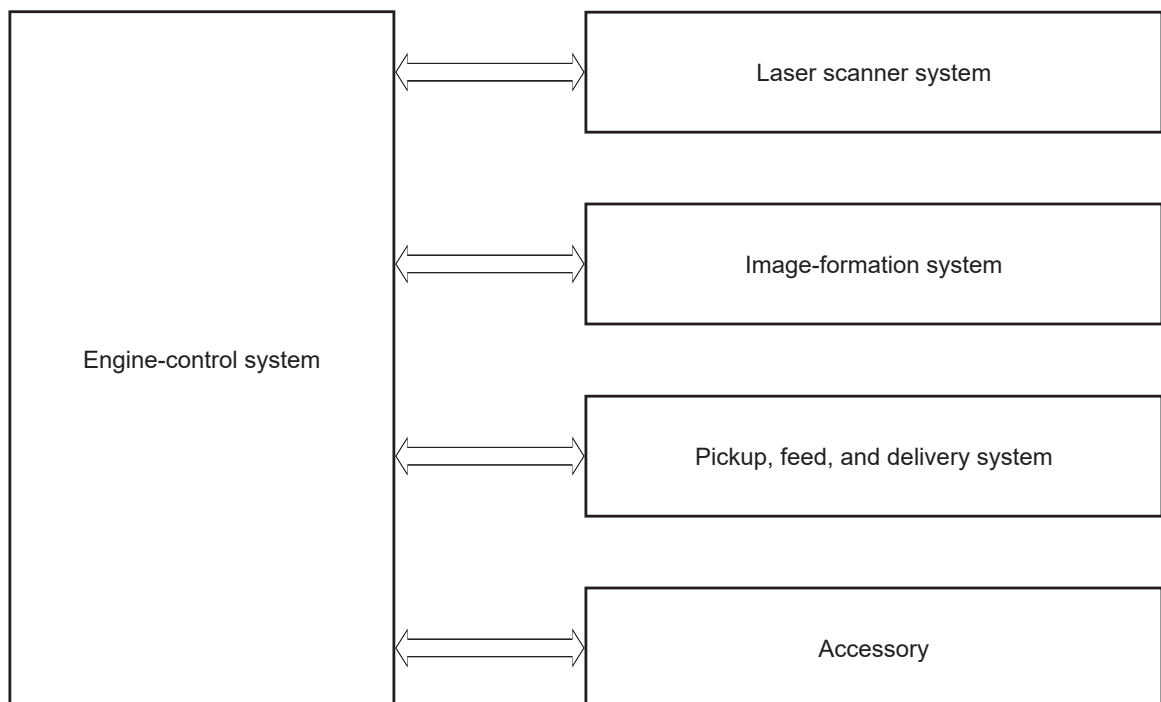
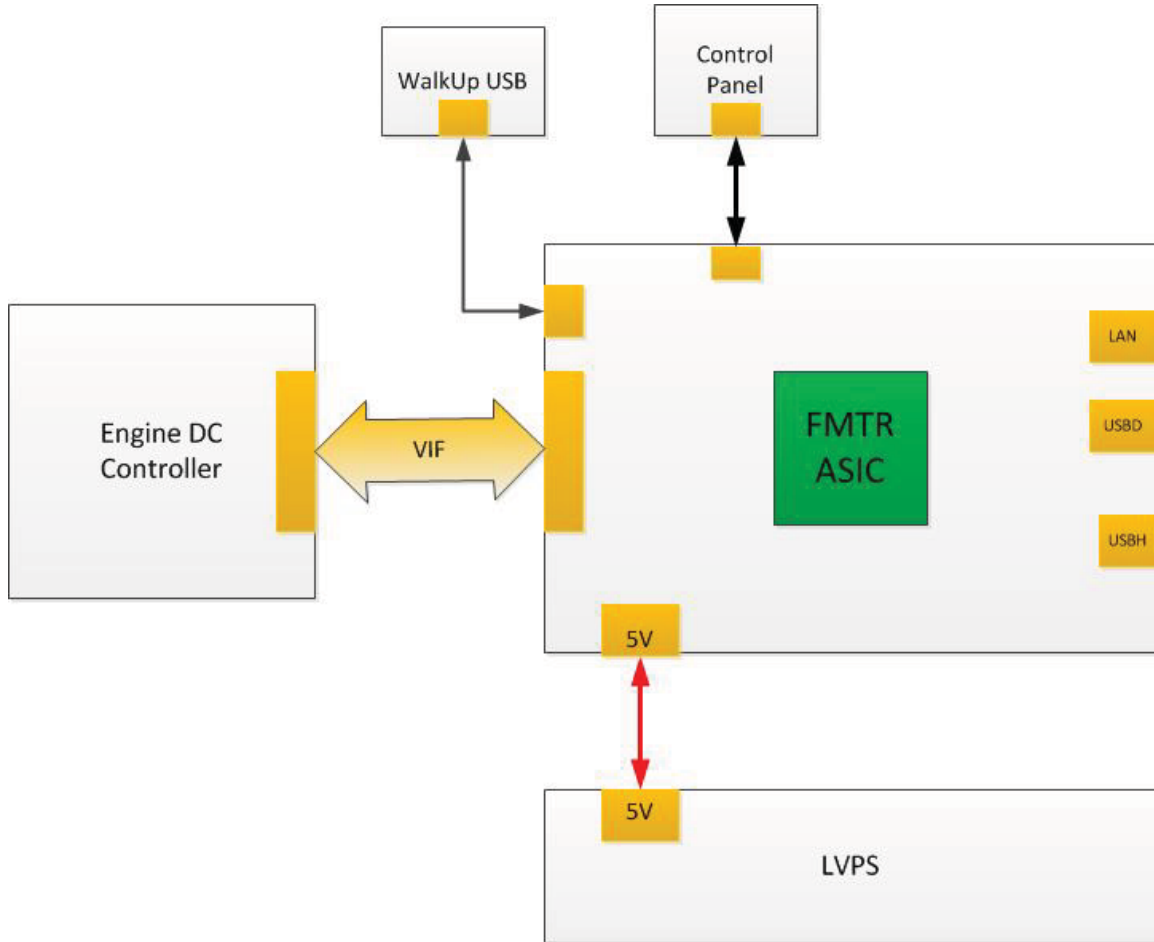

Figure 1-2 System block diagram



Sequence of operation

Review the following information about how the DC controller PCA controls the printer operating sequence.

Table 1-1 Sequence of operation

Period	Duration	Description
Waiting	From the time the power is turned on, the door is closed, or when the printer exits Sleep mode until the printer is ready for printing.	<ul style="list-style-type: none"> • Heats the fuser film in the fuser • Detects the toner cartridge • Rotates and stops each motor • Rotates and stops each fan • Cleans the transfer roller
Standby	From the end of the waiting sequence, the last rotation until the formatter receives a print command, or until the printer is turned off.	<ul style="list-style-type: none"> • Is in the Ready state • Enters Sleep mode if the formatter sends the sleep command • Rotates and stops each fan

Table 1-1 Sequence of operation (continued)

Period	Duration	Description
Initial rotation	From the time the formatter receives a print command until the paper enters the paper path.	<ul style="list-style-type: none">• Rotates each motor• Rotates each fan• Activates the high-voltage power supply (high-voltage bias)• Prepares the laser/scanner unit• Warms the fuser to the correct temperature
Printing	From the time the first sheet of paper enters the paper path until the last sheet has passed through the fuser.	<ul style="list-style-type: none">• Forms the image on the photosensitive drums• Transfers the toner to the paper• Fuses the toner image onto the paper
Last rotation	From the time the last sheet of paper exits the fuser until the motors stop rotating.	<ul style="list-style-type: none">• Stops each motor• Stops each fan• Stops the high-voltage power supply (high-voltage bias)• Stops the laser/scanner unit• Turns the fuser heater off• If another print command is received, the printer enters the initial rotation period when the last rotation is complete.

Formatter-control system

Review the following information about how the formatter operates.

- [Sleep mode \(all except M501\)](#)
- [Sleep delay \(M501\)](#)
- [Auto On / Auto Off mode \(M501\)](#)
- [Printer job language \(PJM\)](#)
- [Printer management language \(PML\)](#)
- [Control panel](#)
- [Easy-access USB port \(all except M501\)](#)
- [Wireless \(wireless models only\)](#)
- [Low end data model \(LED\) overview \(M501\)](#)
- [Advanced control language \(ACL\) overview \(M501\)](#)
- [Near field communication \(NFC models only\)](#)
- [CPU](#)
- [Input/output \(I/O\)](#)
- [Memory](#)

The formatter performs the following functions:

- Controls sleep mode
- Receives and processes print data from the various printer interfaces
- Monitors control panel functions and relaying printer status information through the control panel and the network or bi-directional interface
- Develops and coordinates data placement and timing with the DC controller PCA
- Stores font information
- Communicates with the host computer through the network or the bidirectional interface

The formatter receives a print job from the network or bidirectional interface and separates it into image information and instructions that control the printing process. The DC controller PCA synchronizes the image formation system with the paper input and output systems, and then signals the formatter to send the print image data.

Sleep mode (all except M501)

This feature conserves power after the printer has been idle for an adjustable period of time. When the printer is in Sleep mode, the printer retains all settings, downloaded fonts, and macros. The default setting is for Sleep mode to be enabled, and the printer enters Sleep mode after a 30-second idle time.

 **NOTE:** In the [General Settings](#) menu (a submenu of the [Administration](#) menu), this item is termed [Sleep Timer Settings](#).

The printer firmware uses a combination of timers and Sleep settings to control when the printer enters a different state, as well as what states the printer will enter. The available states are listed below, in descending order, from using the most power to using the least power:

- **Active:** The printer control panel is fully illuminated. The power button light is illuminated.
- **Shallow sleep:** The printer control panel is dim and the content is grayed out, but is still readable. The power button light is illuminated.
- **Sleep:** The printer control panel is off (blacked out). The power button light blinks once every three seconds.
- **Deep sleep:** The printer control panel is off (blacked out). The power button light blinks once every three seconds. The control panel and power button appearance is the same in this state as the sleep state. However, the printer is drawing less than 1 watt of power in the deep sleep state (as opposed to 6 watts of power in the sleep state).
- **Off:** This state is entered by pressing the power button or removing power from the printer. The power button light is not illuminated.

The printer exits Sleep mode and enters the warm-up cycle when any of the following events occur:

- The printer receives a print job, valid data, or a PML or PJP command.
- A control-panel button is pressed or the touchscreen is touched.
- A cover or door is opened.
- The engine-test switch is pressed.
- A paper tray, other than Tray 1, is opened.

 **NOTE:** If the printer is in the deep sleep state, opening a paper tray will not cause the printer to exit Sleep mode.

 **NOTE:** Printer error messages override the Sleep message. The printer enters Sleep mode at the appropriate time, but the error message continues to appear.

 **TIP:** When the printer is in Sleep mode, the sub-power supply is off and the low-voltage power supply is on.

Sleep delay (M501)

When the printer is in sleep delay mode, the control-panel backlight is turned off, but the printer retains all printer settings, downloaded fonts, and macros.

The default setting is a 5-minute idle time. This setting can be changed by using the control panel menus or the HP Embedded Web Server (EWS).

The printer exits sleep delay mode and enters the warm-up cycle when any of the following occurs:

- A print job, valid data, or a PML or PJP command is received at the serial port.
- The control panel is touched (button press or touchscreen touch depending on model).
- A tray is opened.

 **TIP:** Error messages override the sleep delay message. The printer enters sleep mode at the appropriate time, but the error message continues to appear.

Auto On / Auto Off mode (M501)

Use the following procedure to select the [Sleep/Auto Off](#) delay time.

1. On the printer control panel, press the **OK** button.
2. Open the following menus:
 - [System Setup](#)
 - [Energy Settings](#)
 - [Sleep/Auto Off After](#)
3. Use the arrow keys to select the time for the [Sleep/Auto Off](#) delay, and then press the **OK** button.

Printer job language (PJM)

PJM is an integral part of printer configuration, in addition to the standard printer command language (PCL) and PostScript (PS).

With standard cabling, the printer can use PJM to perform a variety of functions, such as these:

- **Two-way communication with the host computer through a network connection or a USB device port:** The printer can inform the host about the control-panel settings, and the control-panel settings can be changed from the host.
- **Dynamic I/O switching:** The printer uses this switching to be configured with a host on each I/O. The printer can receive data from more than one I/O simultaneously, until the I/O buffer is full. This can occur even when the printer is offline.
- **Context-sensitive switching:** The printer can automatically recognize the personality (PS or PCL) of each job and configure itself to serve that personality.
- **Isolation of print environment settings from one print job to the next:** For example, if a print job is sent to the printer in landscape mode, the subsequent print jobs print in landscape only if they are formatted for landscape printing.

Printer management language (PML)

PML allows remote configuration of the printer and status read-back from the printer through the I/O ports.

Control panel

Review the following information about the printer control panels.

The M501n and M501dn control panel is a 2-line backlit control panel display with numeric keypad and additional buttons for navigating control panel menus.

The M506n and M506dn control panel is a 4-line backlit control panel display with numeric keypad and additional buttons for navigating control panel menus. The M506x, M507x, and E50145dn control panel is a 10.9 cm (4.3 in) full-color SVGA with infrared touchscreen and adjustable viewing angle.

The M507n and M507dn control panel is a 6.9 cm (2.7 in) QVGA LCD color control panel with numeric keypad.

The control panel for all of the M527, M528, and E52645 models is a 20.3 cm (8 in) full-color SVGA with infrared touchscreen and adjustable viewing angle.

Easy-access USB port (all except M501)

All models feature easy-access USB printing, for quickly printing files without sending them from a computer.

The printer accepts standard USB flash drives in the USB port (usually found near the control panel). It supports the following types of files:

- .pdf
- .jpg
- .prn and .PRN
- .cht and .CHT
- .pxl
- .pcl and .PCL
- .ps and .PS
- .doc and .docx
- .ppt and .pptx

The USB port is disabled by default. Follow the instructions in the printer user guide to enable the USB port and print USB documents.

Wireless (wireless models only)

The M506x/M507x and M527z/M528z models contain a wireless card to enable wireless direct printing over an 802.11b/g/n wireless connection.



NOTE: This card does not enable the printer to connect to the network.

Low end data model (LEDm) overview (M501)

The low-end data model (LEDm) provides one consistent data representation method and defines the dynamic and capabilities tickets shared between clients and devices, as well as the access protocol, event, security, and discovery methods.

Advanced control language (ACL) overview (M501)

The advanced control language (ACL) is a language that supports printer control and firmware downloads in printers that support both PjL/PCL and host-based printing.

Each sequence of ACL commands must be preceded by a unified exit command (UEL) and an @PjL ENTER LANGUAGE=ACL command. The ACL sequence is always followed by a UEL. Any number of commands can be placed between the UELs. The only exception to these rules is the download command. If a firmware download is done, the download command must be the last command in the sequence. It will not be followed by a UEL.

The firmware searches for the UEL sequence when parsing commands. However, while downloading binary data such as host-based code or NVRAM data the firmware suspends UEL parsing. To handle hosts that “disappear” during binary sequences, the firmware times out all ACL command sessions. If a timeout occurs during a non-

download command sequence, it is treated as the receipt of a UEL. If a timeout occurs during firmware download, the printer resets.

Near field communication (NFC models only)

The M506x and M527z models support NFC capabilities.

NFC enables a connection between the printer and a mobile device, such as a smartphone or tablet, by touching the device to the NFC icon on the bottom of the control panel. Documents and images from the mobile device can then be printed through the wireless card on the printer.



NOTE: The customer can purchase a NFC accessory and add this functionality to other M506/M507/E50145 and M527/M528/E52645 models.

CPU

The formatter incorporates a 1.2 GHz processor.

Input/output (I/O)

The printer supports the following interfaces:

- Hi-Speed USB 2.0
- USB hosts
- 10/100/1000 Ethernet LAN connection with IPv4 and IPv6
- Fax PCA (fax models only)



NOTE: The M527/M528/E52645 printers include a fax phone line connection.

- Easy-access USB printing (no computer required; M506/M507/E50145 and M527/M528/E52645)
- HP near field communication (NFC) for printing from mobile devices (M506x and M527z models only)
- Wi-Fi Direct for printing from mobile devices (M506x/M507x and M527z/M528z models only)

Memory

The formatter incorporates different types of memory and storage to store the printer firmware as well as print-job data and user settings.

- [Firmware](#)
- [Nonvolatile random access memory \(NVRAM\)](#)
- [Random access memory \(RAM\)](#)
- [HP Memory Enhancement technology \(MEt\)](#)

 **NOTE:** M501 only: If the printer encounters a problem when managing available memory, a clearable warning message displays on the control panel.

Firmware

For the M501, Memory on the formatter stores the firmware. A remote firmware upgrade process is used to overwrite and upgrade the firmware.

For the M506n/M507n, M506dn/M507dn/E50145dn, M506x/M507x, and M527dn/M528dn/E52645dn models, the embedded Multi-Media Card (eMMC) on the formatter stores the firmware. For the M527c/M528c/E52645c, M527f/M528f, and M527z/M528z models, the high-performance hard disk (HDD) stores the firmware. A firmware upgrade process is used to overwrite and upgrade the firmware. The upgrade can use a network connection (remote upgrade) or be accomplished by using a USB flash drive.

Nonvolatile random access memory (NVRAM)

The printer uses NVRAM to store printer and user configuration settings.

The contents of NVRAM are retained when the printer is turned off or disconnected.

Random access memory (RAM)

The RAM on the formatter serves as a temporary storage area for printing and system operation.

HP Memory Enhancement technology (MEt)

MEt effectively doubles the amount of standard memory through a variety of font- and data-compression methods.

 **NOTE:** MEt is available only when printing in printer command language (PCL) mode. It is not functional when printing in PostScript (PS) mode.

Engine-control system

The engine-control system receives commands from the formatter and interacts with the other main systems to coordinate all printer functions.

- [DC controller](#)
- [Low-voltage power supply \(LVPS\)](#)
- [High-voltage power supply](#)
- [Fuser control](#)

Figure 1-3 Engine-control system

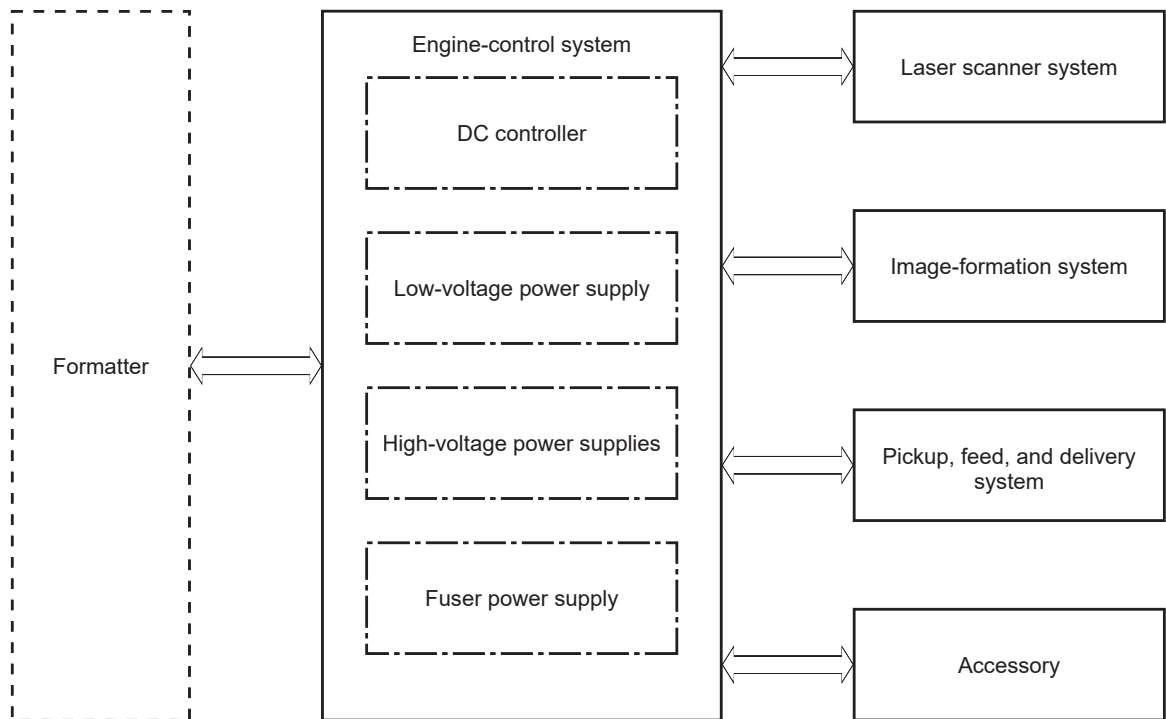

DC controller

The DC controller controls the operation of the printer and its components. The DC controller starts the printer operation when the printer power is turned on and the power supply sends DC voltage to the DC controller. After the printer enters the standby period, the DC controller sends out various signals to operate motors, solenoids, and other printer components based on the print command and image data that the host computer sends.

- [Motors](#)
- [Fans](#)
- [Solenoids](#)
- [Clutches](#)
- [Switches](#)
- [Photo interrupter sensors](#)
- [Sensors](#)
- [LEDs](#)

Figure 1-4 DC controller block diagram

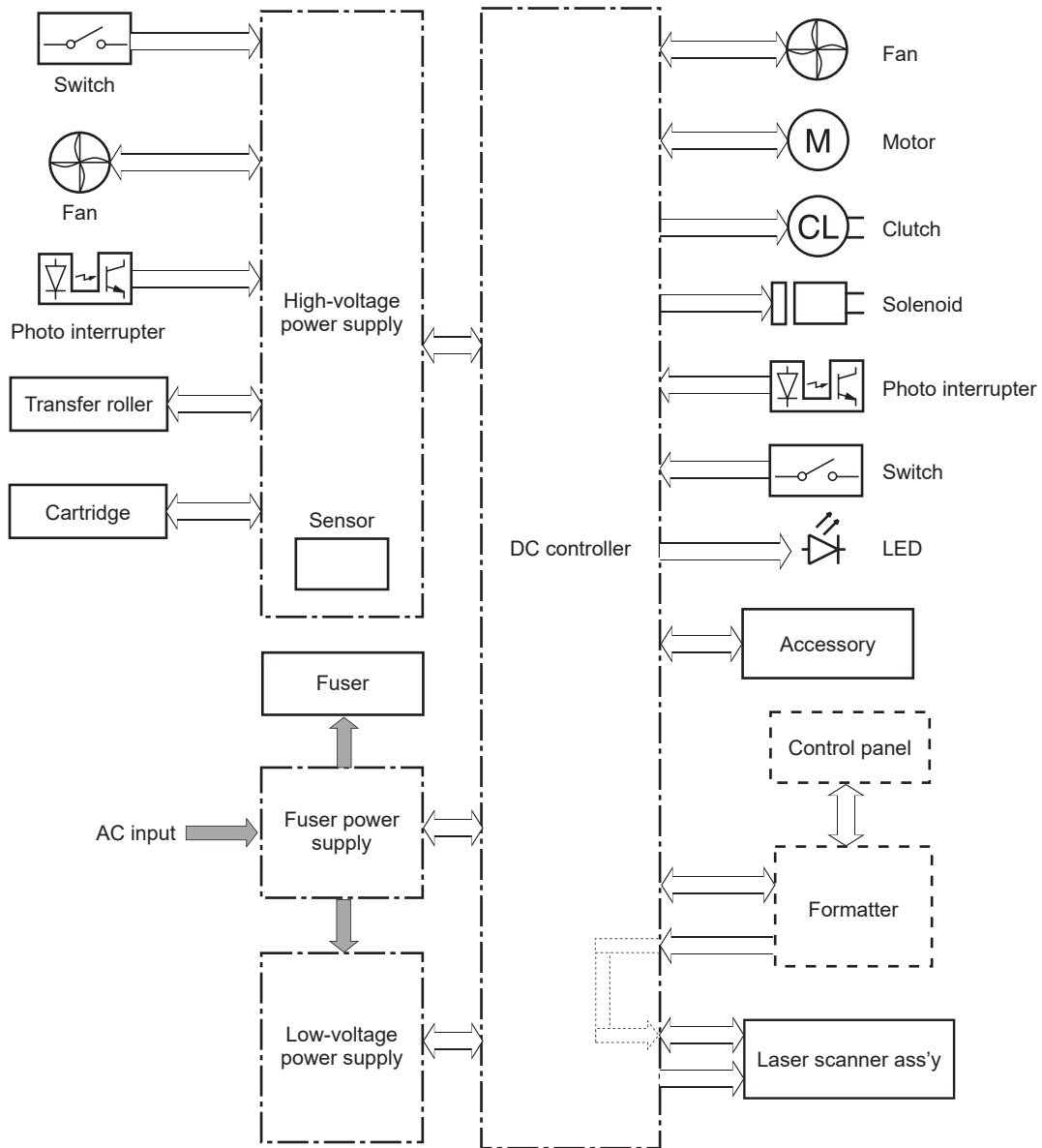

Motors

The printer has four motors. The motors drive the components in the paper-feed and image-formation systems.

The DC controller monitors the fuser motor and the scanner motor to determine if a motor has failed. It notifies the formatter when it encounters the following conditions:

- Startup failure: the motor does not reach a specified speed within a specified time from when the motor starts.
- Rotational failure: the rotational speed of the motor is not in the specified range for a specified time after the motor reaches a specified speed.

Table 1-2 Motors

Abbreviation	Name	Purpose	Failure detection
M1	Fuser motor	Drives the pressure roller and delivery roller; the pressurization and release of the pressure roller; and the engagement and disengagement of the primary and secondary transfer rollers	Yes
M2	Pickup motor	Drives the Tray 1 pickup roller, the Tray 2 pickup and feed rollers, the registration roller, and the feed roller	Yes
M3	Scanner motor	Drives the scanner mirror	Yes
M4	Lifter motor	Drives the Tray 2 lifter	Yes

Fans

The printer has two fans for preventing the temperature from rising in the printer and for cooling the printed pages.

The DC controller determines if there is a fan failure and notifies the formatter if a fan locks for a specified time from when the fan starts.

Table 1-3 Fans

Abbreviation	Name	Cooling area	Type	Speed
FM1	Main fan	Toner cartridge and laser scanner assembly	Intake	Full
FM2	Sub fan	Around the low-voltage power supply and formatter	Intake	Full/half

Solenoids

Solenoids are used in printer control.

Table 1-4 Solenoids

Component abbreviation	Component name
SL1	Tray 2 pickup solenoid
SL2	Tray 1 pickup solenoid
SL3	Duplex switchback solenoid (duplex models only)

Clutches

Clutches are used in printer control.

Table 1-5 Clutches

Component abbreviation	Component name
CL1	Duplex re-pickup clutch (duplex models only)

Switches

Switches are used in printer control.

Table 1-6 Switches

Component abbreviation	Component name
SW1	Power switch
SW2	Cartridge door switch
SW4	Tray 2 detection switch
SW5	Rear door switch
SW201	Test print switch

Photo interrupter sensors

Photo interrupter sensors are used in printer control.

Table 1-7 Photo interrupter sensors

Component abbreviation	Component name
PS1a	Media-width sensor
PS2b	Duplex feed sensor (duplex models only)
PS1	Tray 2 media out sensor
PS2	Top-of-page (TOP) sensor
PS3	Tray 1 media-out sensor
PS4	Output bin media-full sensor
PS11	Registration sensor
PS12	Media surface sensor
PS13	Fuser output sensor

Sensors

Sensors are used in printer control.

Table 1-8 Sensors

Component abbreviation	Component name
TH401	Environment sensor

LEDs

LEDs indicate if a printer system is correctly functioning.

Table 1-9 LEDs

Component abbreviation	Component name
LED1	Power supply LED

Low-voltage power supply (LVPS)

The low-voltage power-supply (LVPS) circuit converts the AC power from the wall receptacle into the DC voltage that the printer components use.

- [Low-voltage power supply voltages description](#)
- [Over-current/over-voltage protection](#)
- [Sleep mode operation \(all except M501\)](#)
- [Low-voltage power supply failure detection \(all except M501\)](#)
- [Safety](#)
- [Low-voltage power supply functions](#)

Figure 1-5 Low-voltage power-supply circuit (M501)

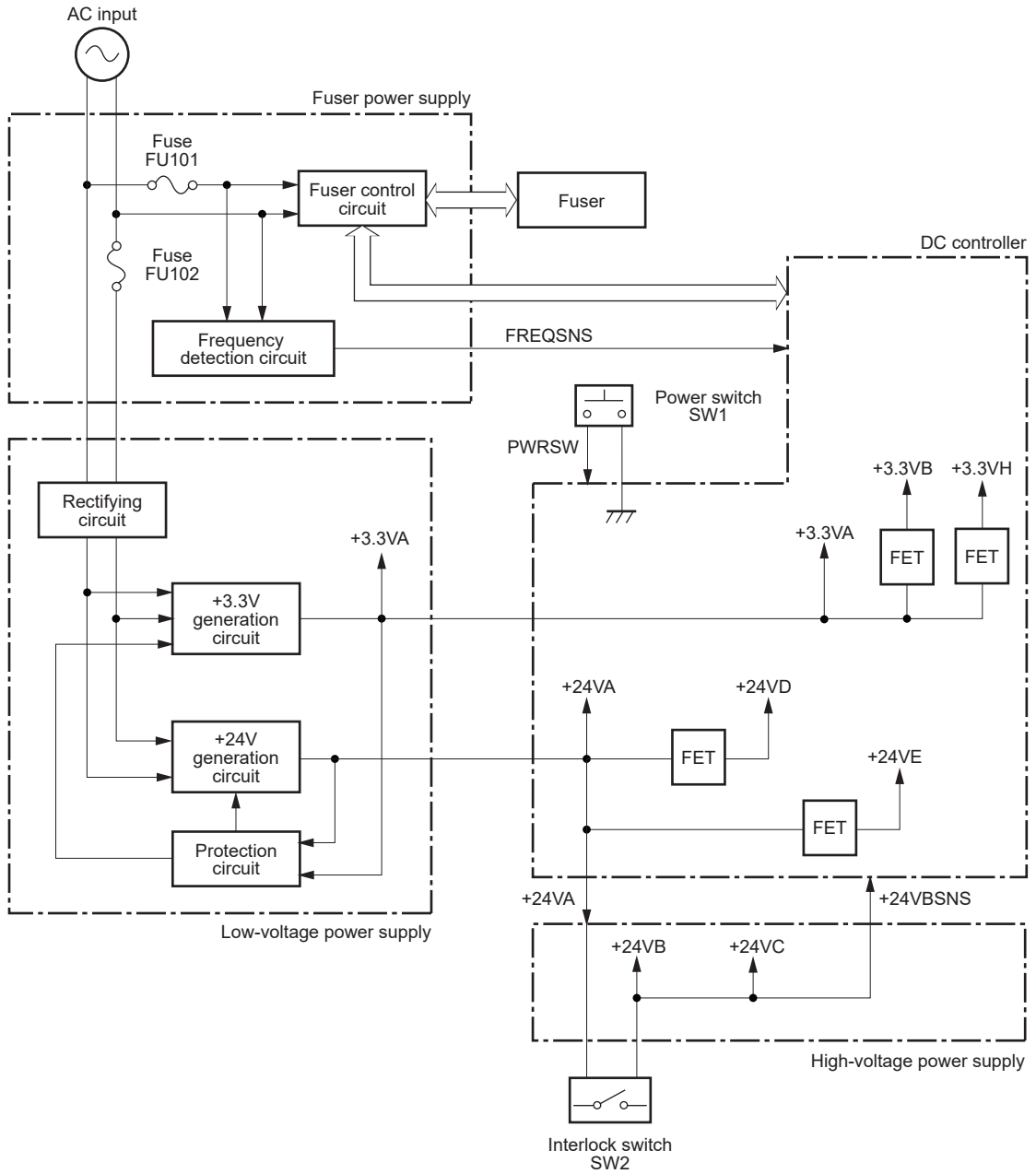
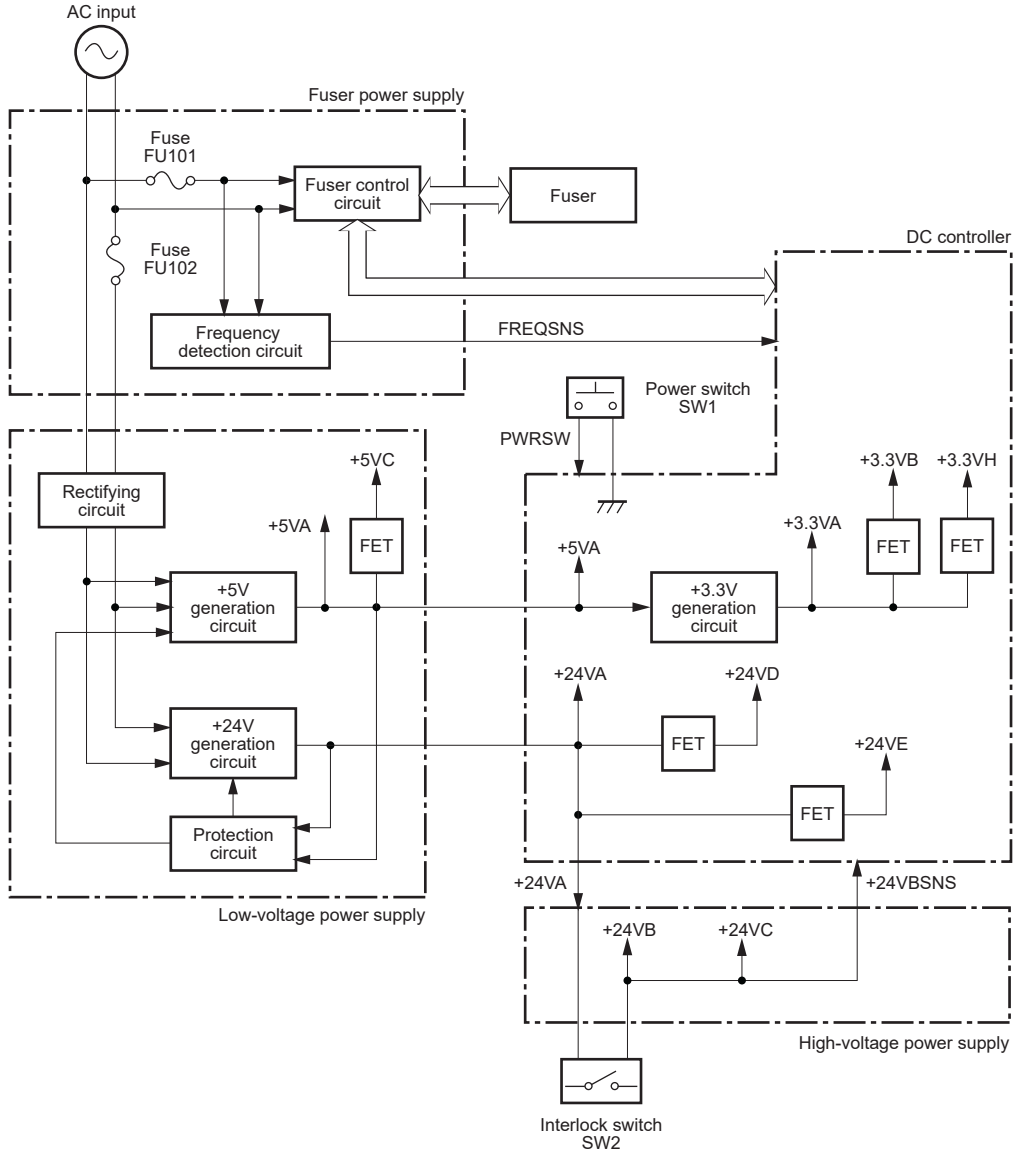

Figure 1-6 Low-voltage power-supply circuit (M506/E50045/M507/E50145, M527/E52545/M528/E52645)



Low-voltage power supply voltages description

The low-voltage power supply converts the AC power into two DC voltages, which it then subdivides, as described in the following table.

Table 1-10 Converted DC voltages

Main DC voltage	Sub-voltage	Behavior
+24 V	+24 VA	Constantly supplied Stopped during inactive OFF Becomes 4V during active OFF
+24 V	+24 VB	Stopped when cartridge door is opened. (SW2) Stopped during active OFF or inactive OFF

Table 1-10 Converted DC voltages (continued)

Main DC voltage	Sub-voltage	Behavior
+24 V	+24 VC	Stopped when cartridge door is opened. (SW2) Stopped during active OFF or inactive OFF
+24 V	+24 VD	Constantly supplied Stopped during active OFF or inactive OFF
+24 V	+24 VE (M527 only)	Constantly supplied Stopped during active OFF or inactive OFF
+5 V	+5 VA	Constantly supplied Becomes 3.4V during inactive OFF
+5 V	+5 VB	Constantly supplied Stopped during active OFF or inactive OFF
+5 V	+5 VC	Constantly supplied Stopped during inactive OFF
+3.3 V	+3.3 VA	Constantly supplied
+3.3 V	+3.3 VB	Constantly supplied Stopped during inactive OFF
+3.3 V	+3.3 VH	Constantly supplied Stopped during inactive OFF Supplied intermittently during inactive OFF

Over-current/over-voltage protection

The low-voltage power supply automatically stops supplying the DC voltage to the printer components whenever it detects excessive current or abnormal voltage. The low-voltage power supply has a protective circuit against over-current and over-voltage to prevent failures in the power supply circuit.

⚠ CAUTION: If DC voltage is not being supplied from the low-voltage power supply, the protective function might be running. In this case, turn the power switch off and unplug the power cord.

Do not turn the power switch on until the root cause is found and corrected.

If the protective function is active, the DC controller notifies the formatter of a low-voltage power supply failure. In addition, the low-voltage power supply has two fuses to protect against over-current. If over-current flows into the AC line, the fuse stops the AC power.

Sleep mode operation (all except M501)

Sleep mode conserves energy by stopping the power to several components when the printer is idle. If the DC controller detects voltage that is too high when the printer is in Sleep mode, it determines that the low-voltage power supply has failed, and it notifies the formatter.

Low-voltage power supply failure detection (all except M501)

The DC controller determines a low-voltage power supply failure and notifies the formatter when the low-voltage power supply does not supply +24 V.

Safety

Review the following information about the LVPS safety protection.

For personal safety, the printer interrupts +24VB and +24VC power when the cartridge door detection switch is turned off (see the "Converted DC voltages" table in the Troubleshooting Manual). This stops DC power supply to the following load:

- High-voltage power supply (HVPS)

The remote switch control circuit turns on or off the printer power so that the AC power flows even the power switch is turned off. Unplug the printer power cord before disassembling the printer.

Low-voltage power supply functions

The printer has the following low-voltage power supply functions:

Table 1-11 Low-voltage power supply functions

Function	Supported feature
Sleep mode	No
Power supply voltage detection	No
Automatic power OFF	No
Automatic power ON/OFF	No
Active OFF	Yes
Inactive OFF	Yes
Network mode	No
Power switch illumination	Yes
Low-voltage power supply failure detection	Yes
Power save mode	No
Fast boot mode	Yes

High-voltage power supply

The DC controller controls the high-voltage power supply (HVPS) to generate biases.

- [Fuser bias](#)
- [High-voltage power supply circuits](#)

The high-voltage power supply delivers the high-voltage biases to the following components used to transfer toner during the image-formation process:

- Primary charging roller (in the toner cartridges)
- Developing roller (in the toner cartridges)
- Transfer roller
- Pressure roller

Fuser bias

The printer uses instant-on fusing. The fuser bias is DC positive for improved print quality. The fuser bias circuit is located in the high-voltage power supply.

High-voltage power supply circuits

The high-voltage power supply contains the following separate circuits.

Figure 1-7 High-voltage power supply circuits

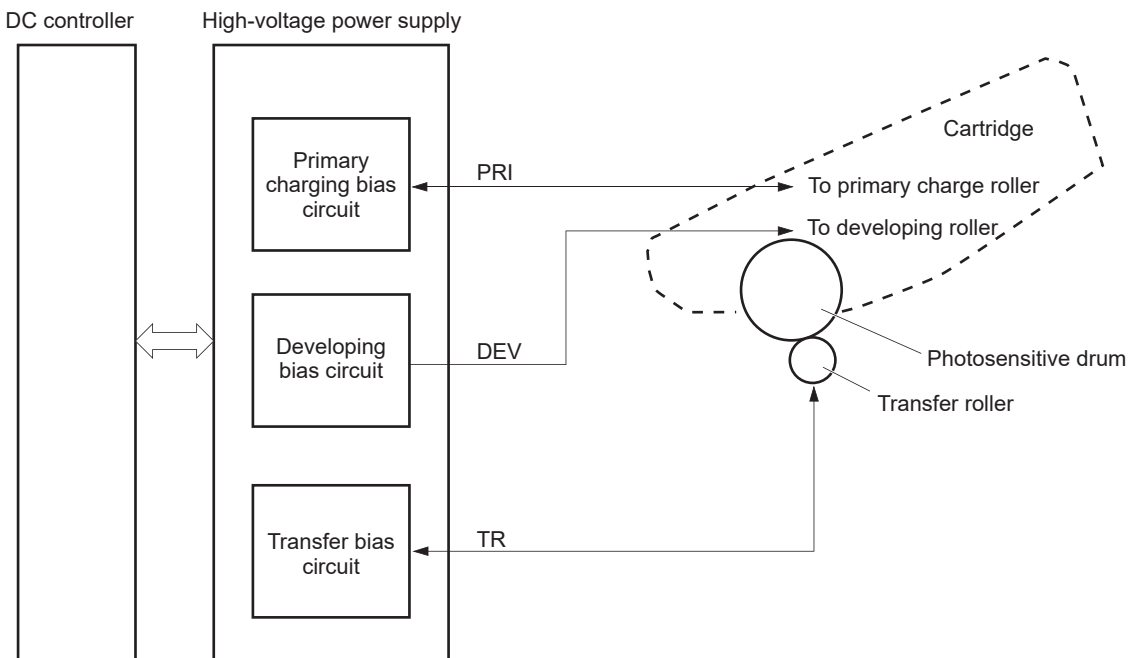

Table 1-12 High-voltage power supply circuits

Circuit	Description
Primary-charging-bias generation	The primary charging bias negatively charges the surface of the photosensitive drum to prepare for image formation.

Table 1-12 High-voltage power supply circuits (continued)

Circuit	Description
Developing-bias generation	The developing bias adheres toner to an electrostatic latent image formed on the photosensitive drum.
Transfer-bias generation	The primary transfer bias transfers the toner from the photosensitive drum onto the paper.

Fuser control

Learn about fuser control functions.

- [Fuser circuits](#)
- [Fuser control functions](#)
- [Fuser heater protection](#)
- [Fuser unit life detection \(all except M501\)](#)
- [Fuser identification \(all except M501\)](#)

The DC controller and components in the fuser perform the following functions related to fuser operation:

- Control fuser temperature
- Detect fuser failures
- Prevent excessive temperature rise
- Detect remaining life in the fuser
- Determine if the correct fuser is installed

Fuser circuits

The fuser heater control circuit and the fuser heater safety circuit control the fuser temperature according to commands from the DC controller.

Figure 1-8 Fuser components

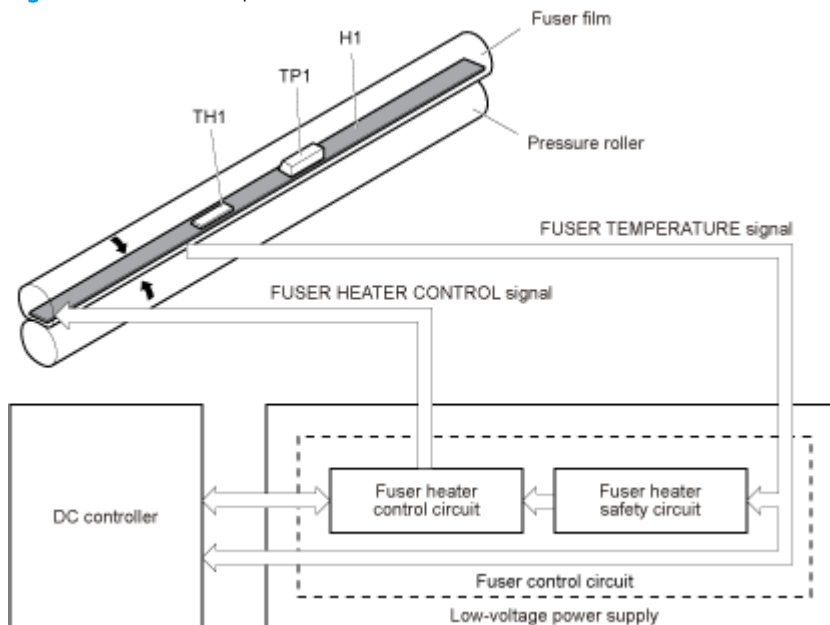

Table 1-13 Fuser components

Type of component	Abbreviation	Name	Function
Heaters	H1	Fuser main heater	Heats the center of the fuser sleeve

Table 1-13 Fuser components (continued)

Type of component	Abbreviation	Name	Function
Thermistors (Contact type)	TH1	Main thermistor	Detects the center temperature of the fuser heater
Thermal switch (Contact type)	TP1	Thermal switch	Prevents an abnormal temperature rise in the fuser heater

Fuser control functions

The diagram below describes the LVPS, DC controller, and fuser systems.

Figure 1-9 Fuser control

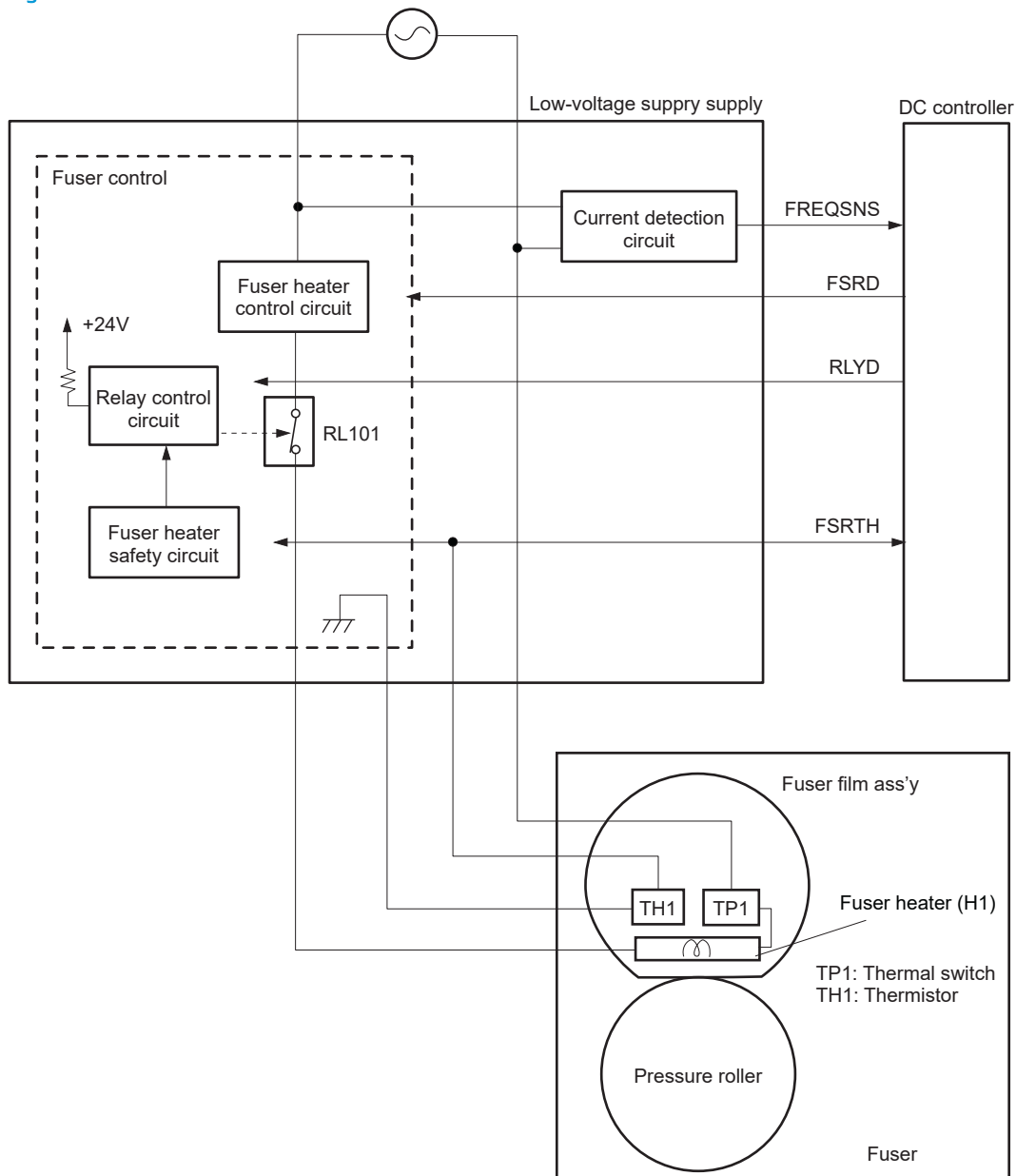

The printer has the following fuser control functions.

Table 1-14 Fuser control functions

Failure detection function	Supported feature
Fuser temperature control	Yes
Fuser failure detection	Yes
Frequency detection circuit failure detection	Yes
Fuser pressure release mechanism failure detection	No
Fuser type identification detection	Yes
Fuser presence detection	No
Fuser life detection	Yes
Relay failure detection	No
Fuser roller cleaning	Yes

Fuser heater protection

Fuser heater protection is a feature that detects excessive temperatures in the fuser and interrupts the power supply to the fuser heater.

The following three protective components prevent the fuser heater from excessive rising temperature:

- **DC controller:** When a thermistor or sub-thermistor detects a temperature above a certain threshold, the DC controller interrupts power to the specific heater.
- **Fuser-heater safety circuit:** The fuser heater safety circuit monitors the detected temperature of the sub thermistors.
- **Thermal switch:** If the temperature in the heaters is abnormally high, and the temperature in the thermostwitch exceeds a specified value, the contact to the thermostwitch breaks.

Fuser unit life detection (all except M501)

The fuser life is tracked by fuser rotations, and not by the number of pages printed. This is a more accurate tracking method since the fuser rotates for every print job.

There will be variations in fuser life depending on customer usage. Customers who are running one and two page intermittent jobs with long pauses between each job might reach the fuser low message sooner due to the fuser rotating more times per page than it would for larger print jobs.

Fuser identification (all except M501)

The printer detects the type and presence of the fuser. The DC controller notifies the formatter when it fails to detect the type or presence of the fuser.

 **NOTE:** This printer detects if a fuser of the correct voltage for the printer is installed. If a fuser of the incorrect voltage is installed, the DC controller notifies the formatter and an error message is displayed on the control panel.

Engine laser/scanner system

The laser/scanner system forms the latent electrostatic image on the photosensitive drums inside each of the toner cartridges.

- [Laser/scanner failure detection](#)
- [Safety](#)
- [Image-formation process](#)
- [Toner cartridge](#)

The DC controller receives instructions from the formatter regarding the image of the page to be printed. The DC controller signals the lasers to emit light, and the laser beams pass through lenses and onto the scanner mirror, which rotates at a constant speed. The mirror reflects the beam onto the photosensitive drum in the pattern required for the image, exposing the surface of the drum so it can receive toner.

The main components of the laser/scanner system, which are controlled by signals sent from the DC controller, are:

- Laser assembly
- Scanner motor assembly
- Beam detect (BD) sensor
- Scanner mirror

Figure 1-10 Laser/scanner system

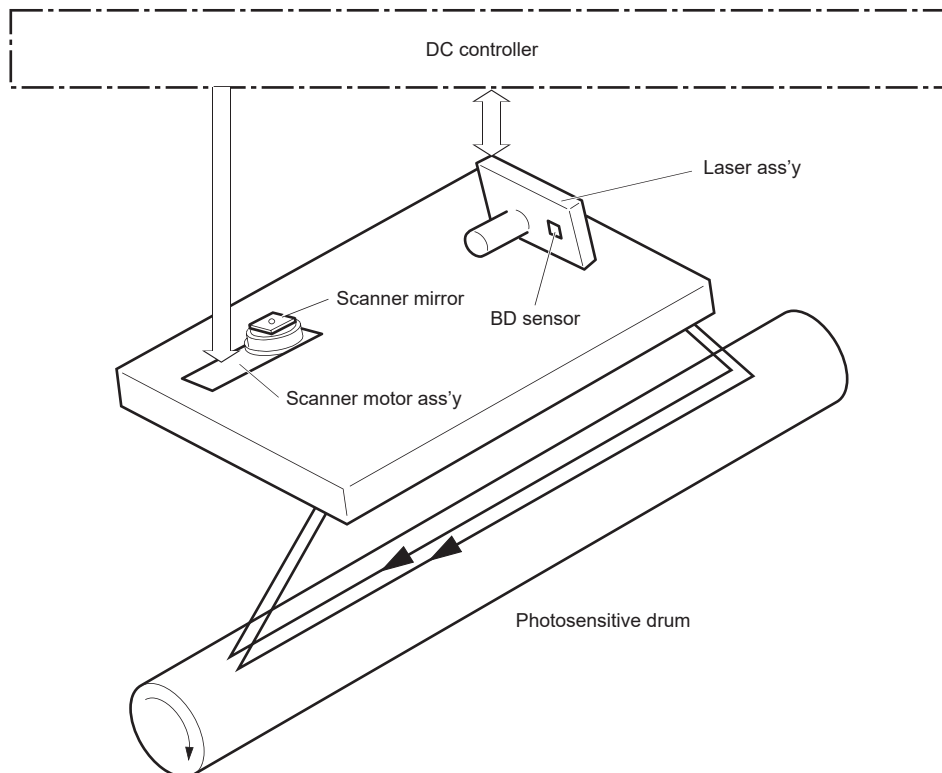

Laser/scanner failure detection

The DC controller determines an optical unit failure and notifies the formatter of the error status when any of the following occurs:

- **Beam detect (BD) failure detection:** The scan control board (SCB) does not detect the laser/scanner and/or the beam detect interval is outside a specified range during printing.
- **Laser/scanner motor startup failure:** The scanner motor does not reach a specified rotation frequency within a specified period of time from when the laser/scanner starts up.
- **Laser/scanner motor abnormal rotation:** The laser/scanner motor does not reach a specified rotational frequency within a specified period of time during a print operation.

Safety

The laser/scanner assembly has a mechanical laser shutter. For the safety of users and service technicians, the laser shutter interrupts the optical path of the laser/scanner assembly when the top door is opened (SW101).

Image-formation process

The image-formation system creates the printed image on the paper.

- [Step 1: Primary charging](#)
- [Step 2: Laser-beam exposure](#)
- [Step 3: Development](#)
- [Step 4: Transfer](#)
- [Step 5: Separation](#)
- [Step 6: Fusing](#)
- [Step 7: Drum cleaning](#)

The system consists of the following components:

- Toner cartridge
- Transfer roller
- Fuser
- Laser/scanner
- High-voltage power supply

The DC Controller controls the internal components of the image formation system (according to commands received from the formatter) to form the toner image on the photosensitive drum surface. The toner image is then transferred to the print media and fused.

Figure 1-11 Image-formation system

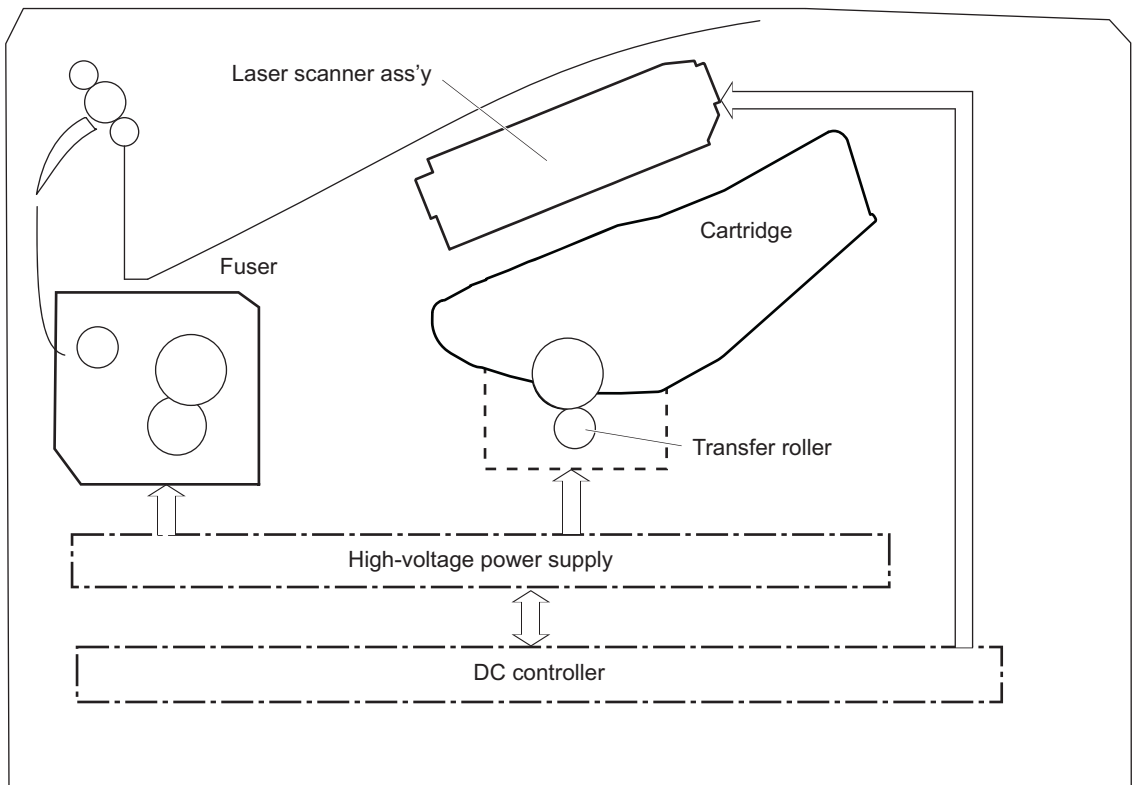

The fuser motor (M1) drives the following image formation components:

- Photosensitive drum
- Developing roller
- Primary charging roller (follows the photosensitive drum)
- Transfer roller (follows the photosensitive drum)
- Pressure roller
- Fuser film (follows the pressure roller)

 **NOTE:** The primary charging roller and developer roller are located in the toner cartridge.

Figure 1-12 Fuser motor

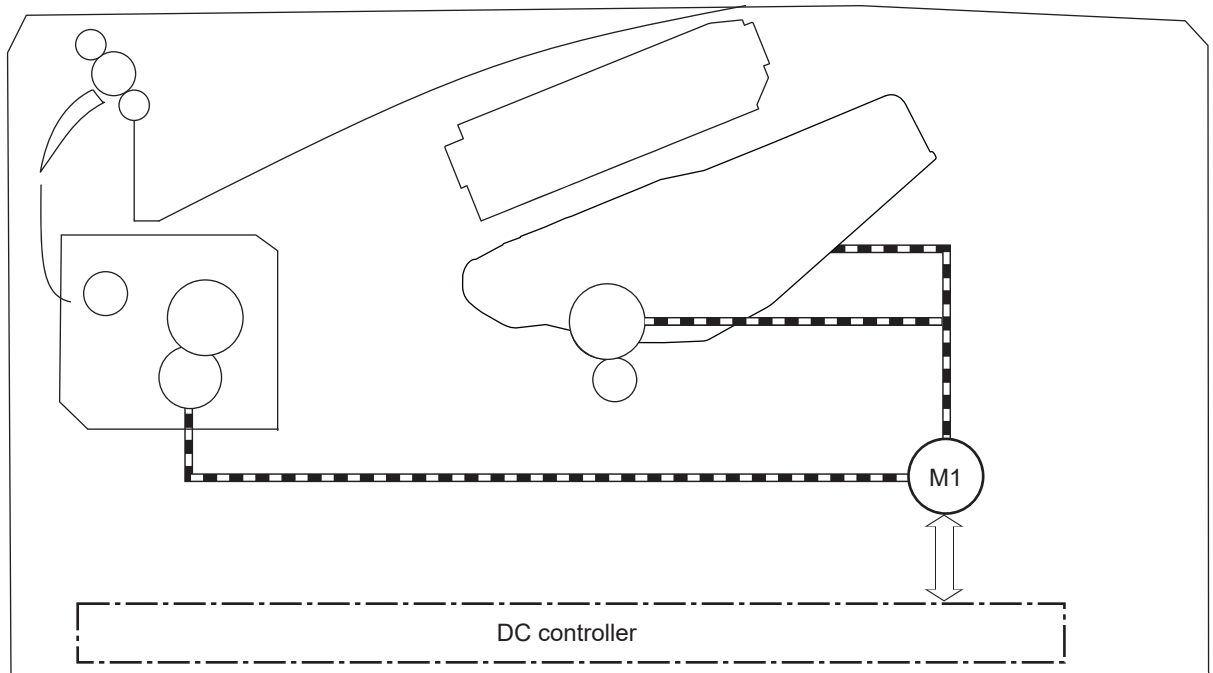

Abbreviation	Component
M1	Fuser motor

The following figure shows the location of the toner-level sensor.

Figure 1-13 Toner-level sensor

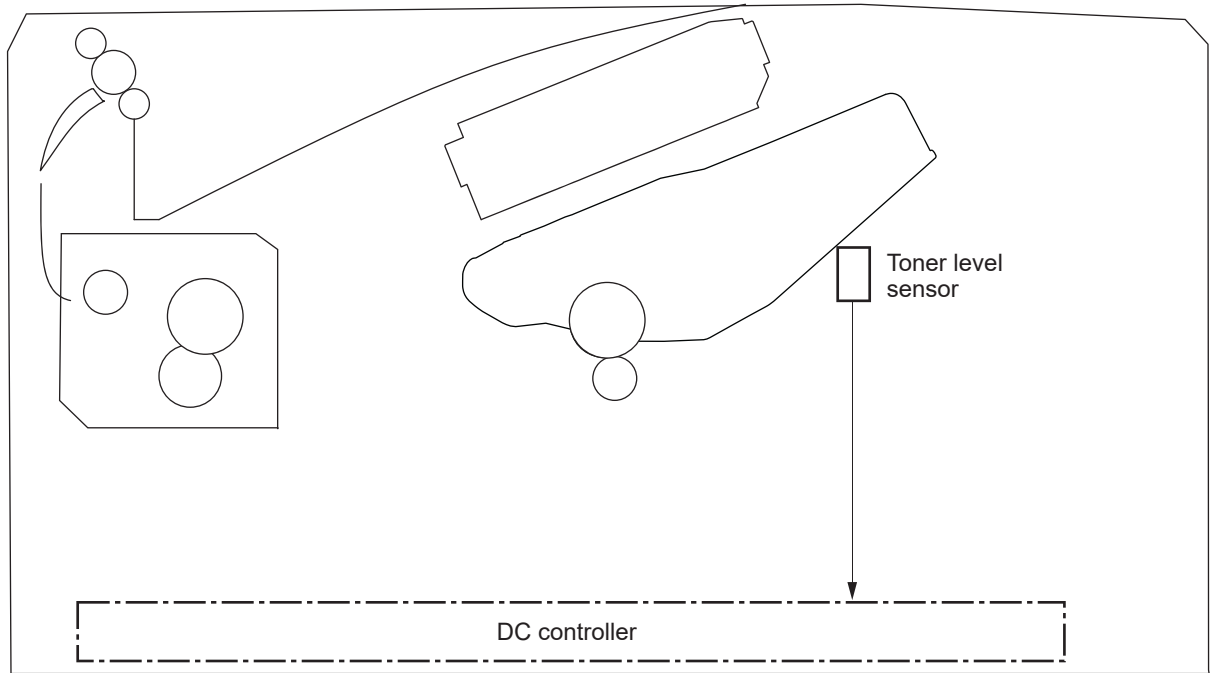

Abbreviation	Component
N/A	Toner-level sensor

The image-formation process consists of seven steps divided into five functional blocks.

Figure 1-14 Image-formation process

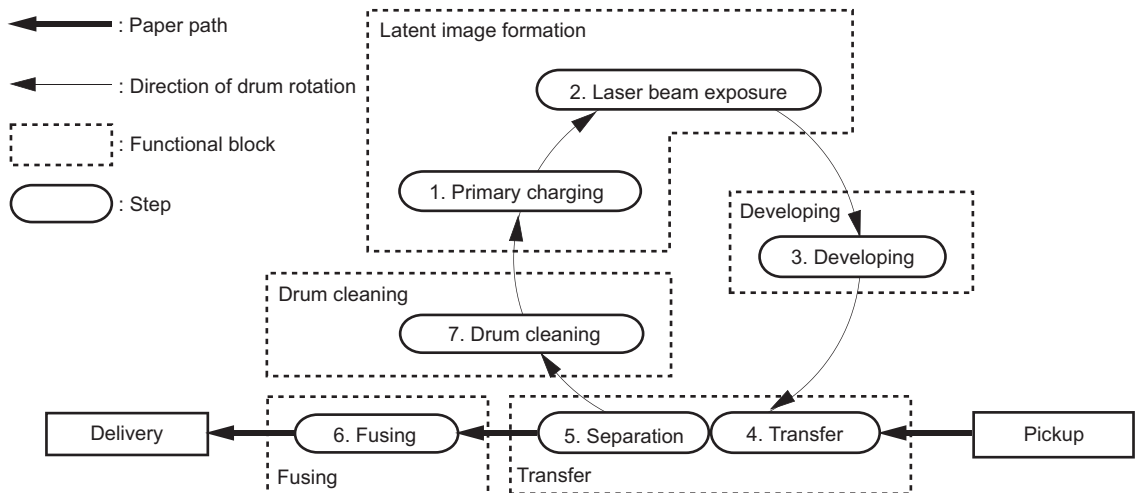

Table 1-15 Image-formation process

Functional block	Steps	Description
Latent image formation	1. Primary charging	An invisible latent image forms on the surface of the photosensitive drum.
	2. Laser-beam exposure	
Development	3. Developing	Toner adheres to the electrostatic latent image on the photosensitive drum.
Transfer	4. Transfer	The toner image transfers to the paper.
	5. Separation	
Fusing	6. Fusing	The toner fuses to the paper to make a permanent image.
Drum cleaning	7. Drum cleaning	Residual toner is removed from the drum.

Step 1: Primary charging

The primary charging roller contacts the photosensitive drum and charges the drum with negative potential.

Figure 1-15 Primary charging

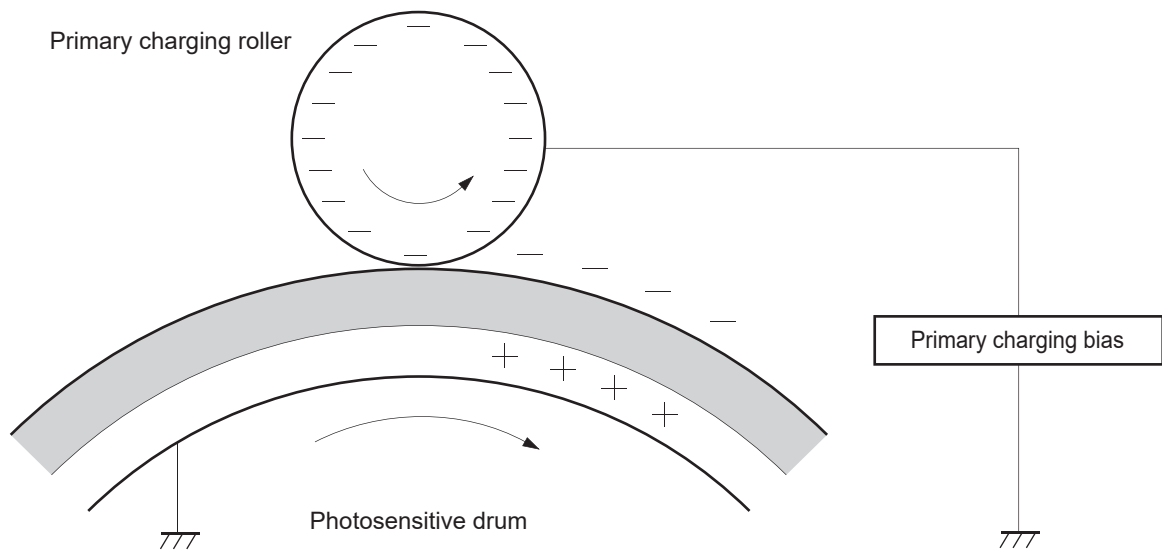

Step 2: Laser-beam exposure

The laser beam strikes the surface of the photosensitive drum in the areas where the image will form. The negative charge neutralizes in those areas, which are then ready to accept toner.

Figure 1-16 Laser-beam exposure

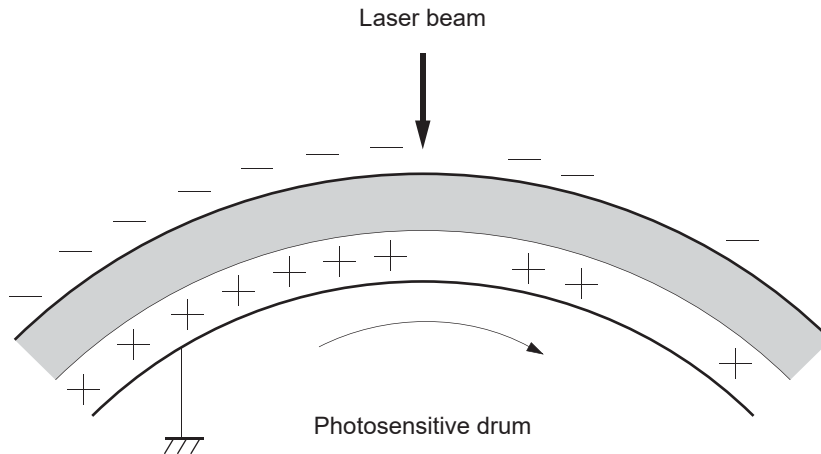

Step 3: Development

Toner acquires a negative charge as the developing cylinder contacts the developing blade. Because the negatively charged surface of the photosensitive drums have been neutralized where they have been struck by the laser beam, the toner adheres to those areas on the drums. The latent image becomes visible on the surface of each drum.

Figure 1-17 Development

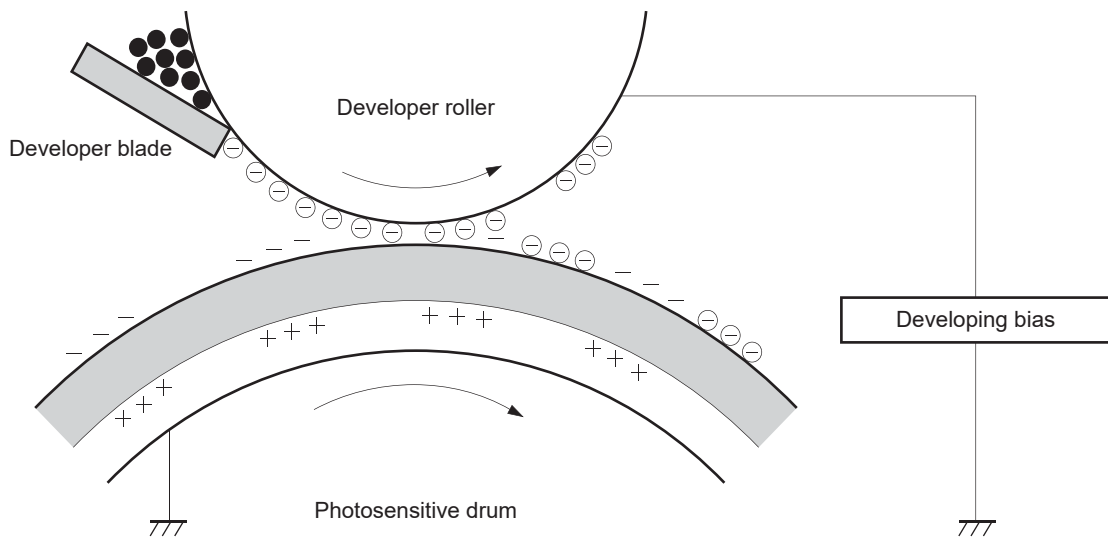

Step 4: Transfer

The toner image on the photosensitive drum transfers to the paper. Transfer bias applied to the transfer roller attracts the negatively charged toner to the paper.

Figure 1-18 Primary transfer

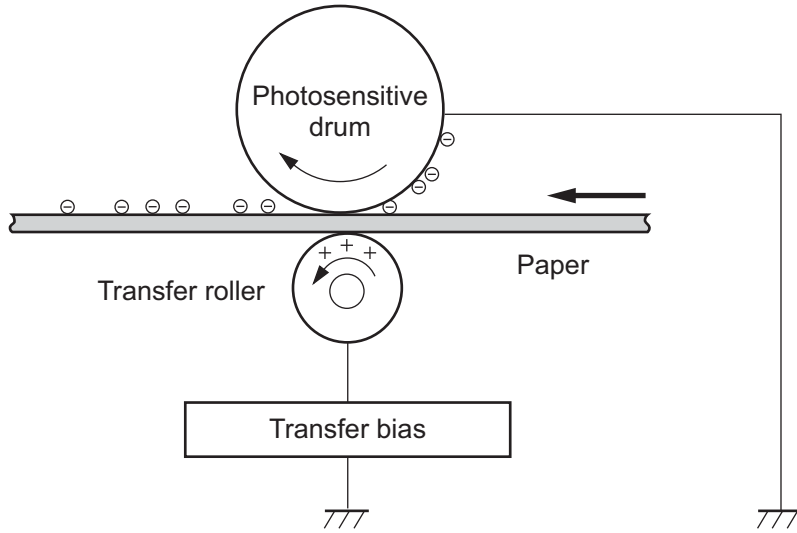

Step 5: Separation

The elasticity of the paper and the curvature of the photosensitive drum cause the paper to separate from the photosensitive drum. The static-charge eliminator removes excess charge from the paper to make sure that the toner fuses correctly.

Figure 1-19 Separation

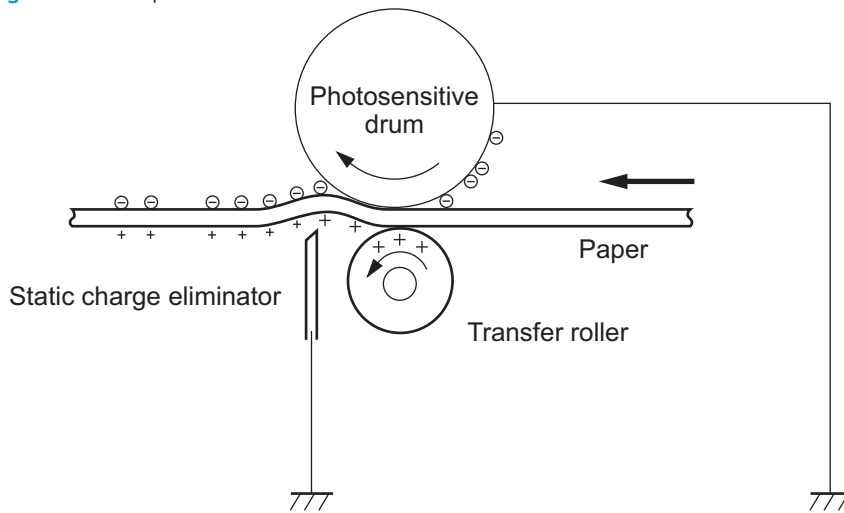

Step 6: Fusing

To create the permanent image, the paper passes through heated, pressurized rollers to melt the toner onto the page. Fusing bias is added to the pressure roller to improve the print quality.

Figure 1-20 Fusing

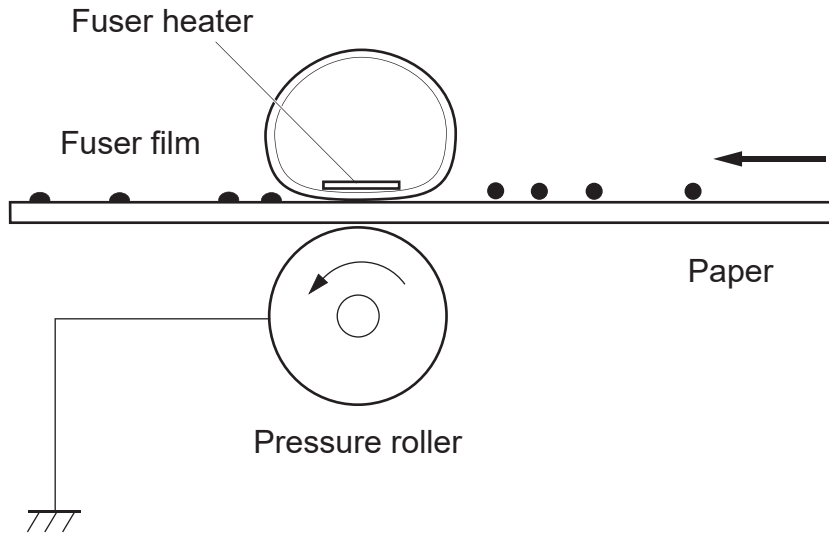

Step 7: Drum cleaning

The cleaning blade scrapes the residual toner off the surface of the photosensitive drum, and toner is deposited in the toner-collection portion of the cartridge.

Figure 1-21 ITB cleaning

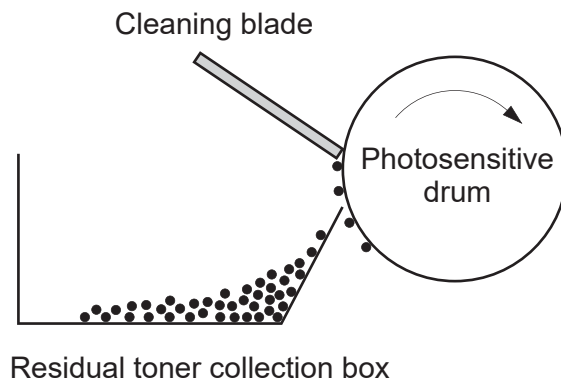

Toner cartridge

The printer has one toner cartridge.

- [Design](#)
- [Memory chip](#)
- [Dynamic security enabled printers in this guide](#)
- [Dynamic security](#)
- [Toner seal](#)
- [Toner level and cartridge life detection](#)
- [JetIntelligence](#)

Design

The toner cartridge is filled with toner and consists of the following components:

- Photosensitive drum
- Developer roller
- Primary-charging roller
- Memory chip

The DC controller rotates the drum motor to drive the photosensitive drum, developer roller, and the primary-charging roller.

Figure 1-22 Toner cartridge system

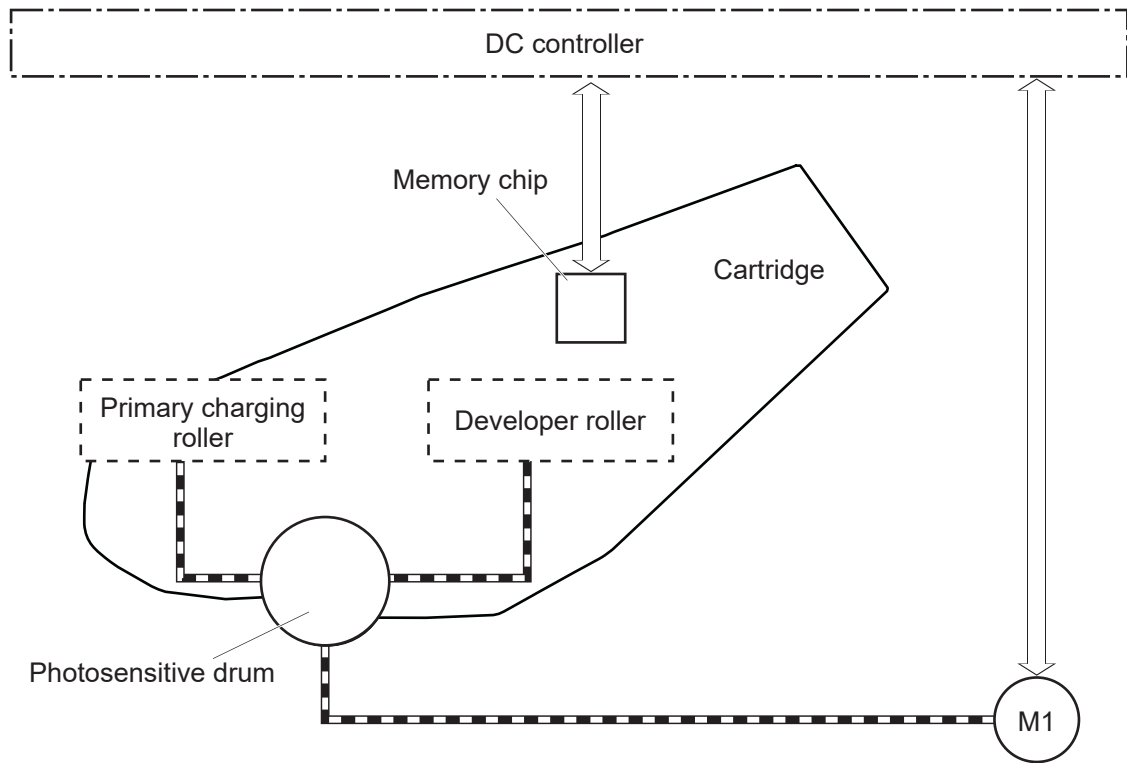

Function	Supported feature
Toner cartridge presence detection	Yes
Toner level detection	Yes
Toner cartridge life detection	Yes
Toner cartridge miss-installation detection	Not applicable (one cartridge)
Drum discharge	No
Transfer cleaning	Yes

Memory chip

The memory chip is non-volatile memory that stores information about the usage of the toner cartridge and helps protect the customer from counterfeit cartridges. This chip is also used to detect the presence of a cartridge within the printer. The printer reads and writes the data in the memory chip.

NOTE: The memory chip does not store any customer print, scan, copy, fax, or digital send information. The memory chip also supports the printer Jet Intelligence toner cartridge management functions.

Dynamic security enabled printers in this guide

The printers with dynamic security enabled that are discussed in this guide are the M507, E50145, M528, and E52645 printers.

Dynamic security

Learn about dynamic-security-enabled printers.

Certain HP printers use cartridges that have security chips or electronic circuitry. Cartridges using a non-HP chip or modified or non-HP circuitry* might not work. And, those that work today might not work in the future.

As is standard in the printing business, HP has a process for authenticating cartridges. HP continues to use security measures to protect the quality of our customer experience, maintain the integrity of our printing systems, and protect our intellectual property. These measures include authentication methods that change periodically and might prevent some third-party supplies from working now or in the future. HP printers and original HP cartridges deliver the best quality, security and reliability. When cartridges are cloned or counterfeited, the customer is exposed to quality and potential security risks, compromising the printing experience.

***Non-HP Chips and modified or non-HP electronic circuitry** are not produced or validated by HP. HP cannot guarantee that these chips or circuitry will work in your printer now or in the future. If you are using a non-original HP cartridge, please check with your supplier to ensure your cartridge has an original HP security chip or unmodified HP electronic circuitry.

Toner seal

The toner cartridge seal is opened automatically when the toner cartridge is installed into the printer.

Toner level and cartridge life detection

Review the following information about toner cartridge toner level and cartridge life detection.

Toner level detection: The DC controller detects the remaining toner in the cartridge by the optical detection method and then notifies the formatter of the remaining toner level.

Cartridge life detection: Cartridge life detection is measured in two ways.

1. Toner level:
 - For the first 75% of cartridge life, toner level is measure through pixel counting by the DC controller. Once the level reaches 25%, the toner level sensor utilizes electrical properties to determine the amount of toner remaining.
2. Rotations of internal components (OPC and developer):
 - The DC controller monitors these two life parameters and reports them to the formatter as percent life remaining. End of cartridge life is determined by the lower value of the two.

JetIntelligence

JetIntelligence supports two features for managing toner cartridges.

- [Authentication](#)
- [Anti-theft](#)

The authentication feature allows customers to specify the use of only genuine HP toner cartridges in the printer.

The anti-theft feature enables locking a cartridge to a specific printer or fleet of printers.

Authentication

The genuine HP authentication feature allows a customer to specify that only genuine HP supplies can be used in a printer.

If a non-HP or used supply is installed, the printer will not print. This feature is disabled by default, and can be enabled or disabled from the control panel or the Embedded Web Server (EWS).

If a genuine HP toner cartridge from another printer is moved to a printer with this feature enabled, the toner cartridge will authenticate and print, unless the toner cartridge has passed the low state. If the toner cartridge has passed the low state, an **Unauthorized Cartridge** message displays on the control panel.

If a non-HP toner cartridge is used in a printer with this feature enabled, the message **Unauthorized Cartridge** appears on the control-panel display.



NOTE: If a customer suspects they have a counterfeit cartridge, they should report it by going to www.hp.com/go/anticounterfeit and selecting **Report now**.

The printer still functions normally.

Anti-theft

The toner cartridge anti-theft feature allows a customer to configure the printer to automatically lock genuine HP toner cartridges to a specific printer or fleet of printers when they are installed.

A locked toner cartridge will only work in the specified printer or fleet of printers. This feature prevents toner cartridges from being stolen and used in another printer, or from being moved from an authorized printer to an unauthorized printer. This feature is disabled by default, and can be enabled or disabled from the control panel, the Embedded Web Server (EWS), or Web Jetadmin.

When the anti-theft feature is enabled, the toner cartridge in a printer will only work in the specified printer or fleet of printers. If a locked toner cartridge is moved to another printer, the cartridge will not print and the message **Protected Cartridge** appears on the control-panel display.



IMPORTANT: When a toner cartridge is locked to a specific printer or fleet of printers, it cannot be unlocked. This is a permanent operation.

Paper handling system

The DC controller controls the paper handling system according to commands from the formatter. The paper handling system uses a series of rollers to move the paper through the printer.

- [Photo sensors and switches](#)
- [Motors, clutches, and solenoids](#)
- [Tray 1 \(multipurpose\) / Tray 2 \(base printer\)](#)

The paper handling system consists of the following three functional blocks. The DC controller controls each block to pick up, feed and deliver the paper.

- **Pickup-and-feed-block:** Controls the movement of the paper from each pickup source to the fuser inlet
- **Fuser-and-delivery-block:** Controls the movement of the paper from the fuser to the delivery destination
- **Duplex block:** Controls the movement of the paper from the duplex switchback unit to the duplex re-pickup unit (duplex models only)

Figure 1-23 Paper handling system

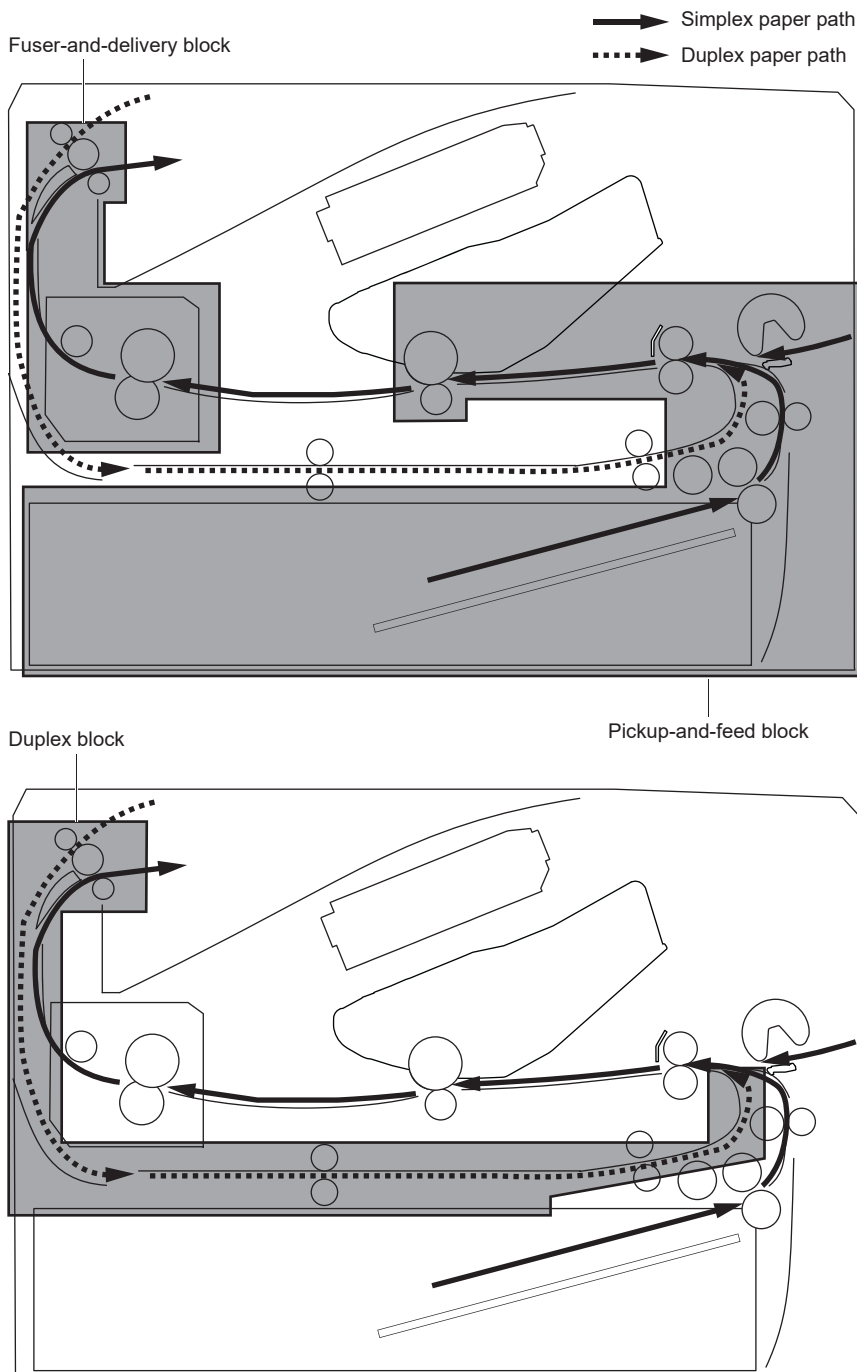

Function	Supported feature
Tray 2 media size detection	No
Tray 2 media presence detection	Yes
Tray 2 media level detection	No
Tray 2 lift-down control	No

Function	Supported feature
Tray 2 multiple-feed prevention mechanism	Yes
Tray 1 media presence detection	Yes
Tray 1 media width detection	No
Tray 1 last-media detection	No
Skew-feed prevention mechanism	Yes
Media detection	No
OHT detection	No
Image leading edge positioning	Yes
Media length detection	Yes
Media width detection	Yes
Pressure roller pressure release control	No
Output bin media-full detection	Yes
Automatic delivery	Yes
Duplex switchback control (duplex models only)	Yes
Duplex feed control (duplex models only)	Yes

Photo sensors and switches

The following figure shows the photo sensors and switches for the paper handling system.

Figure 1-24 Photo sensors and switches

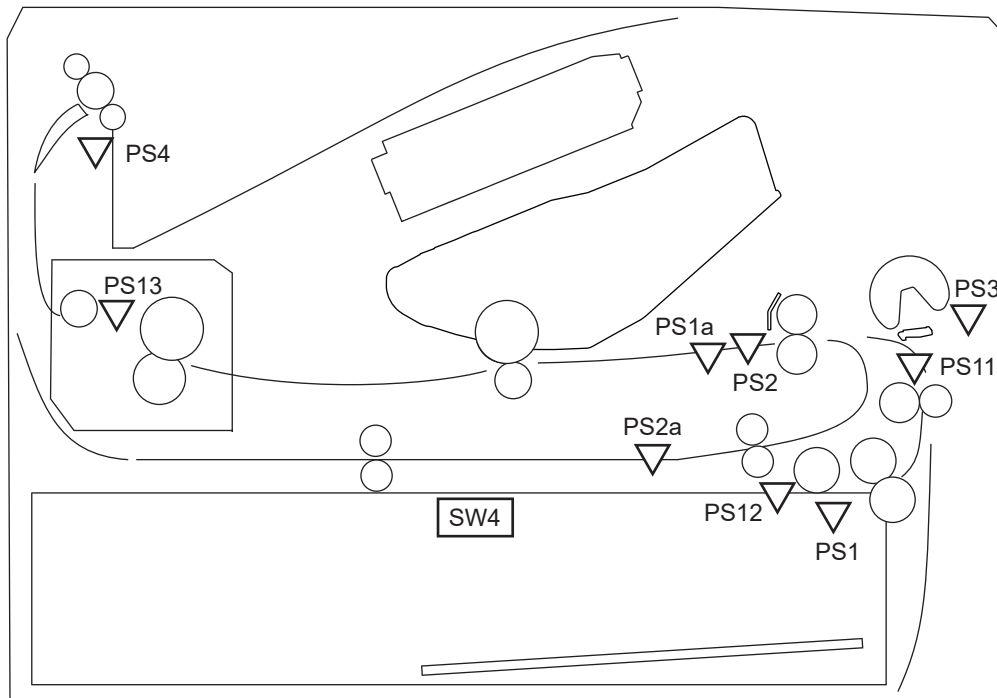

Table 1-16 Photo sensors and switches

Abbreviation	Component
PS1a	Media width sensor
PS2b	Duplex feed sensor (duplex models only)
PS1	Tray 2 media out sensor
PS2	TOP sensor
PS3	Tray 1 media out sensor
PS4	Output bin media-full sensor
PS11	Registration sensor
PS12	Media surface sensor
PS13	Fuser output sensor
SW4	Tray 2 detection switch

Motors, clutches, and solenoids

The following figure shows the motors, clutches, and solenoids for the paper handling system.

Figure 1-25 Motors, clutches, and solenoids

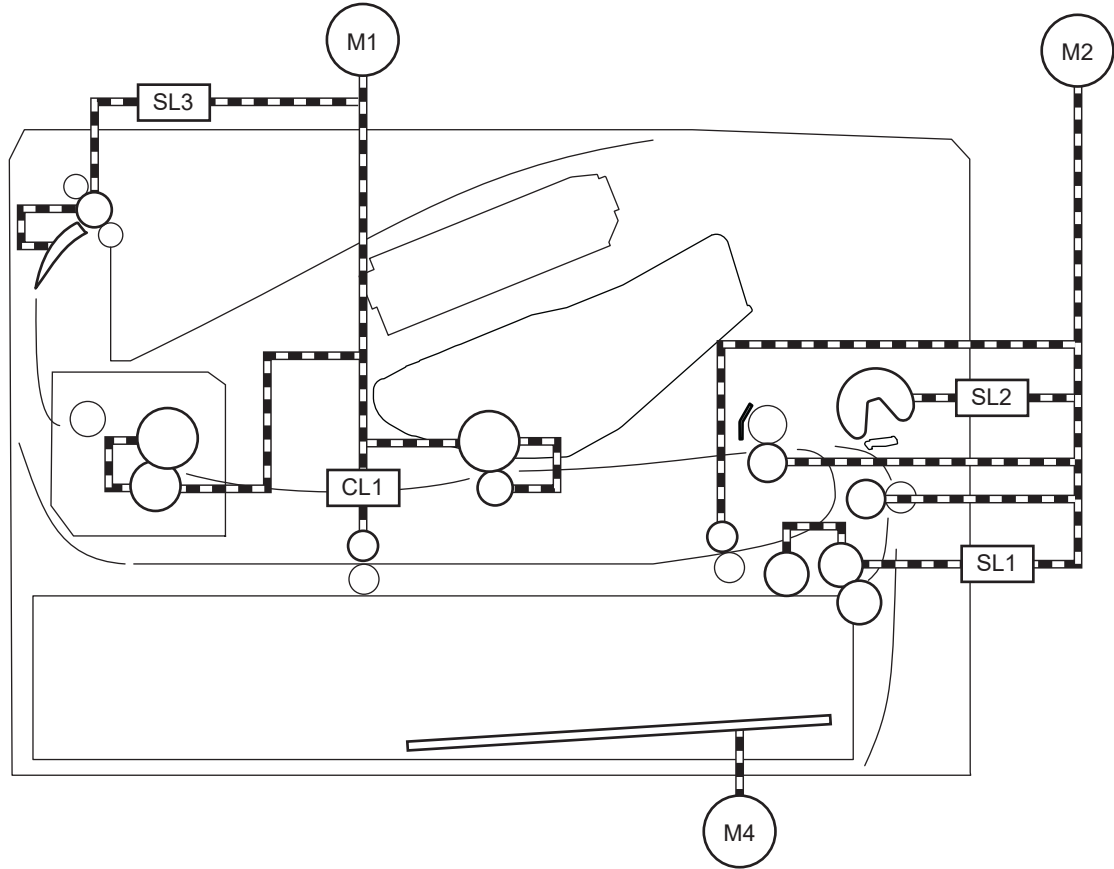

Abbreviation	Component
M1	Fuser motor
M2	Pickup motor
M4	Lifter motor
SL1	Tray 2 pickup solenoid
SL2	Tray 1 pickup solenoid
SL3	Duplex switchback solenoid (duplex models only)
CL1	Duplex re-pickup clutch (duplex models only)

Tray 1 (multipurpose) / Tray 2 (base printer)

Moving paper from Tray 1 and Tray 2 involves the interaction of multiple components within the printer. The following sections describe these processes.

- [Tray 1 paper pickup and feed](#)
- [Tray 2 paper presence detection](#)
- [Tray 2 lift operation](#)
- [Tray 2 paper pickup](#)
- [Tray 2 multiple feed prevention](#)
- [Tray 2 presence detection](#)
- [Tray 2 skew feed prevention](#)
- [Feed speed control](#)
- [Duplexing unit](#)
- [Jam detection/prevention](#)

Tray 1 paper pickup and feed

The printer picks up one sheet of paper from Tray 1.

Following are the sequence of steps for the Tray 1 pickup operation.

 **NOTE:** Tray 1 and Tray 2 are optimal for paper pickup when using special paper or media other than 20 lb plain paper. For Tray 1, the printer increases the number of attempts to pick up a page, which increases the reliability of successfully picking the page from the tray and decreases the possibility of a mis-pick jam.

HP recommends using Tray 1 or Tray 2 if the printer is experiencing excessive or reoccurring jams from trays other than Tray 1 and Tray 2, or for print jobs that require media other than 20 lb plain paper.

Always use Tray 1 when printing envelopes or labels.

1. The pickup motor reverses when a print command is received from the formatter.
2. When the DC controller turns on the Tray 1 pickup solenoid, the Tray 1 pickup roller rotates and the lifting plate lifts.
3. As the lifting plate rises, the paper is picked up.
4. The Tray 1 separation pad removes any multiply-fed sheets, and one sheet is fed into the printer.

The Tray 1 media-out sensor (SR8) detects whether paper is present in Tray 1.

Figure 1-26 Tray 1 pickup mechanism

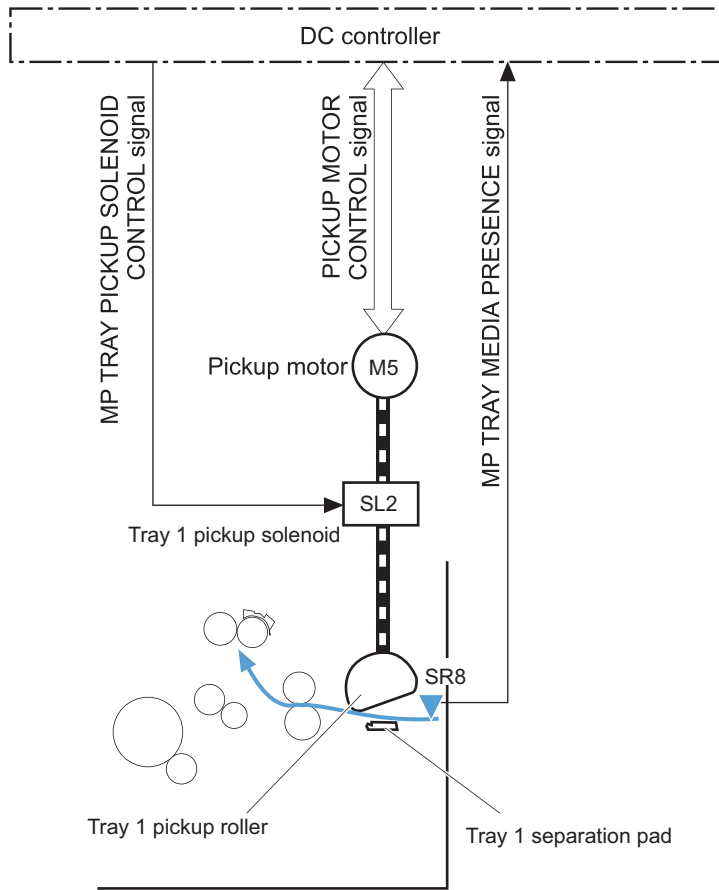

Tray 2 paper presence detection

The Tray 2 media-out sensor (SR12) detects the presence of paper in Tray 2.

The DC controller notifies the formatter when the Tray 2 media-out sensor detects that paper is absent.

Tray 2 lift operation

The printer keeps the paper stack surface at the correct pickup position. The Tray 2 lift-up operation is performed under the following conditions:

- The printer is turned on
- Tray 2 is installed
- The paper stack surface in Tray 2 lowers

The operational sequence of the Tray 2 lift-up is as follows:

1. The lifter motor (M4) rotates and the lifter moves up.
2. When the Tray 2 media stack surface sensor 2 detects the stack surface of media, the lifter motor stops.
3. The lifter motor rotates again to lift the lifter when the Tray 2 media stack surface sensor 1 detects the stack surface and then lowers during printing.

When a Tray 2 media stack surface sensors does not detect the stack surface within a specified time period after the lifter motor starts rotating, the DC controller determines a lifter motor failure and notifies the formatter.

Tray 2 paper pickup

Following are the sequence of steps for the Tray 2 pickup operation.

 **NOTE:** Tray 1 and Tray 2 are optimal for paper pickup when using special paper or media other than 20 lb plain paper. For Tray 1, the printer increases the number of attempts to pick up a page, which increases the reliability of successfully picking the page from the tray and decreases the possibility of a miss-pick jam.

HP recommends using Tray 1 or Tray 2 if the printer is experiencing excessive or reoccurring jams from trays other than Tray 1 and Tray 2, or for print jobs that require media other than 20 lb plain paper.

1. The printer is turned on or Tray 2 is inserted.
2. The tray lift-up operation raises the lifting plate so paper can be picked up.
3. The pickup motor rotates when a print command is received from the formatter.
4. The Tray 2 pickup roller and Tray 2 feed roller rotate.
5. The Tray 2 pickup solenoid turns on at a specified time.
6. The Tray 2 pickup cam rotates.
7. As the pickup arm lowers, the Tray 2 pickup roller touches the surface of the paper stack.
8. One sheet of paper feeds into the printer.

Tray 2 multiple feed prevention

The printer uses a separation roller method to prevent multiple sheets of print media from entering the paper path.

The separation roller overruns if just one sheet of paper is picked. If two or more sheets are picked, only the top sheet will be fed to registration and the multiply fed sheets will be held at the pickup location by the separation roller. This printer does not have an actively driven separation roller.

Figure 1-27 Tray 2 multiple feed prevention

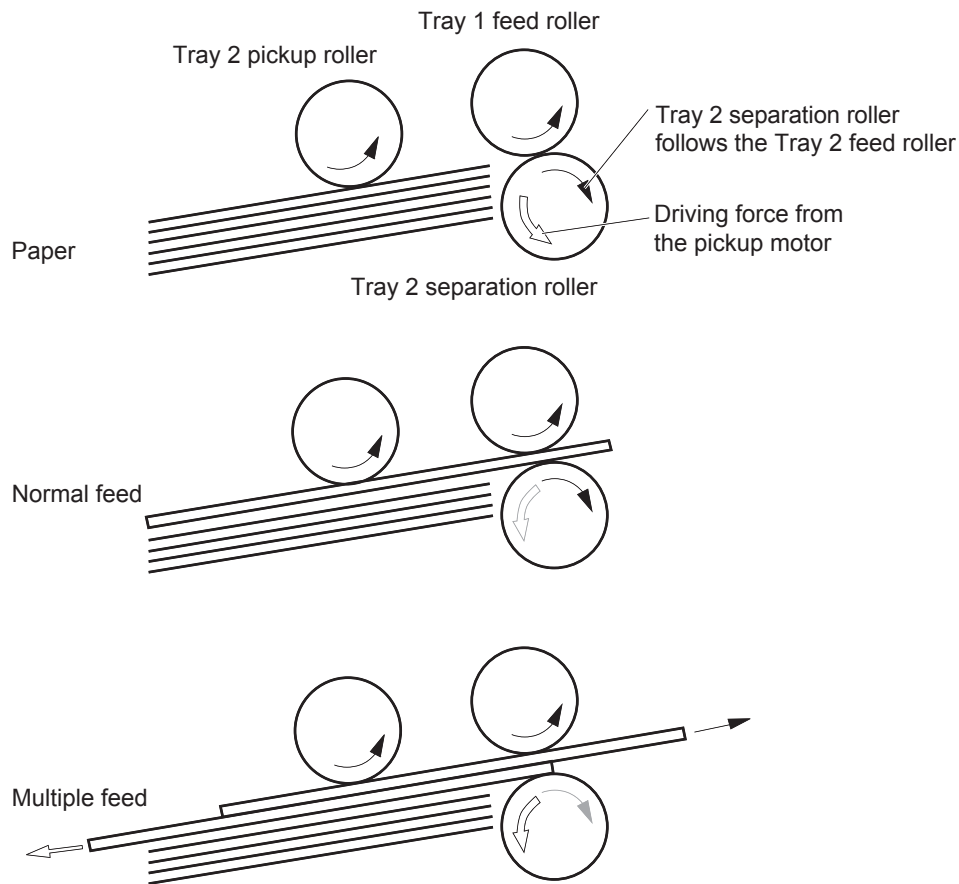

Tray 2 presence detection

The Tray 2 presence sensor is in the lifter drive unit.

The sensor detects the tray-presence sensor flag and determines whether Tray 2 is installed correctly.

Tray 2 skew feed prevention

The printer can straighten the paper without slowing the feed operation.

1. The leading edge of paper strikes the registration shutter, and the leading edge is aligned with the shutter.
2. As the feed rollers keep pushing the paper, the paper warps.
3. When the force is great enough, the registration shutter rotates, and the paper passes through straightened.

Figure 1-28 Skew-feed prevention

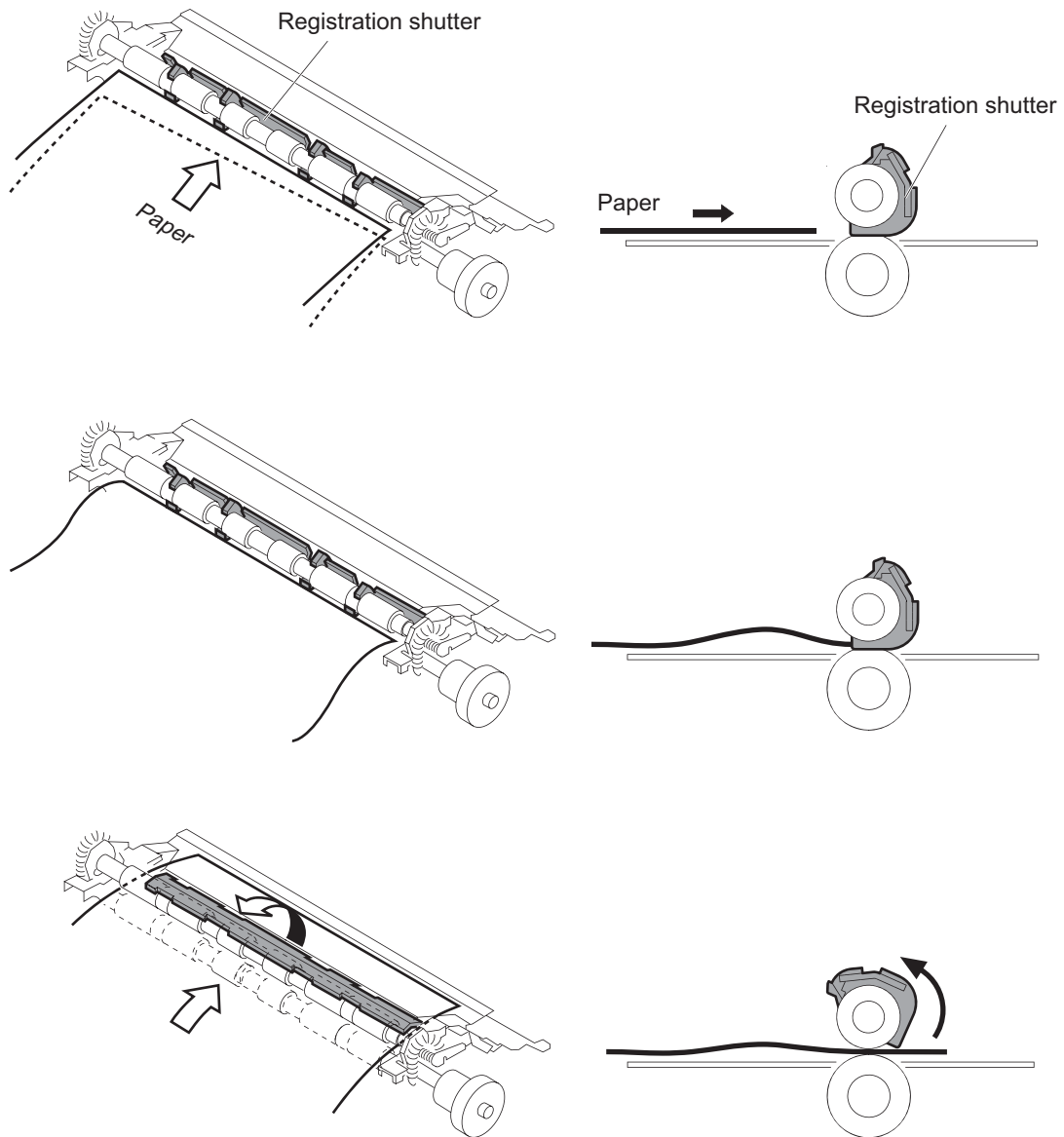

Feed speed control

The DC controller adjusts the feed speed to improve the print quality depending on the paper type.

The paper is fed at a specified speed according to the print mode designated by the formatter.

Feed speeds

- 1/1 speed = 210 mm/s
- Pro speed = 174 mm/s
- 1/2 speed = 105 mm/s
- 1/3 speed = 70 mm/s

Table 1-17 Print mode and feed speed

Print mode	Feed speed	Media sensor detection
Normal	1/1	Yes
Heavy media 1	Pro	No
Heavy media 2	1/2	Yes
Heavy media 3	1/3	Yes
Light media 1	1/1	Yes
Light media 2	1/1	Yes
Light media 3	1/3	Yes
Glossy media 1	1/3	Yes
Glossy media 2	1/3	Yes
Glossy media 3	1/3	Yes
Glossy film	1/3	Yes
Envelope 1	1/2	No
OHT	1/3	Yes
Label	1/2	No
Designated media 1	1/2	No
Designated media 2	1/3	No
Designated media 3	Pro	No

Duplexing unit

When duplexing, the fuser motor (M1) reverses the paper and feeds it through the paper path to print the second side.

- [Duplexing reverse and duplex feed control](#)

Duplexing reverse and duplex feed control

The duplex reverse control reverses the paper after the first side is printed and feeds it to the duplex re-pickup position to print the second side of the page.

1. At a specified time after the first side of a page is printed, the fuser motor rotates, and the duplex reverse solenoid is turned on.
2. The duplex flapper moves, and the paper feeds to the duplex reverse unit.
3. After a specified period of time, the fuser motor reverses, and the paper feeds to the duplex feed unit.
4. The fuser motor and the pickup motor move the paper to the duplex re-pickup position.
5. The fuser motor and the duplex feed clutch stop, and the paper feed operation pauses.
6. After a specified period of time, the fuser motor rotates, and the duplex feed clutch is turned on. The paper is then picked up again.

Jam detection/prevention

The printer uses the following sensors to detect the paper as it moves through the paper path and to report to the DC controller if the paper has jammed.

- Top of page (TOP) sensor (SR2)
- Media width sensor (SR1a)
- Fuser output sensor (SR13)
- Duplex feed sensor (SR2a)
- Registration sensor (SR11; M506/E50045/M507/E50145, M527/E52545/M528/E52645)
- Paper feeder feed sensor (SR432; M506/E50045/M507/E50145, M527/E52545/M528/E52645)

Figure 1-29 Jam detection sensors

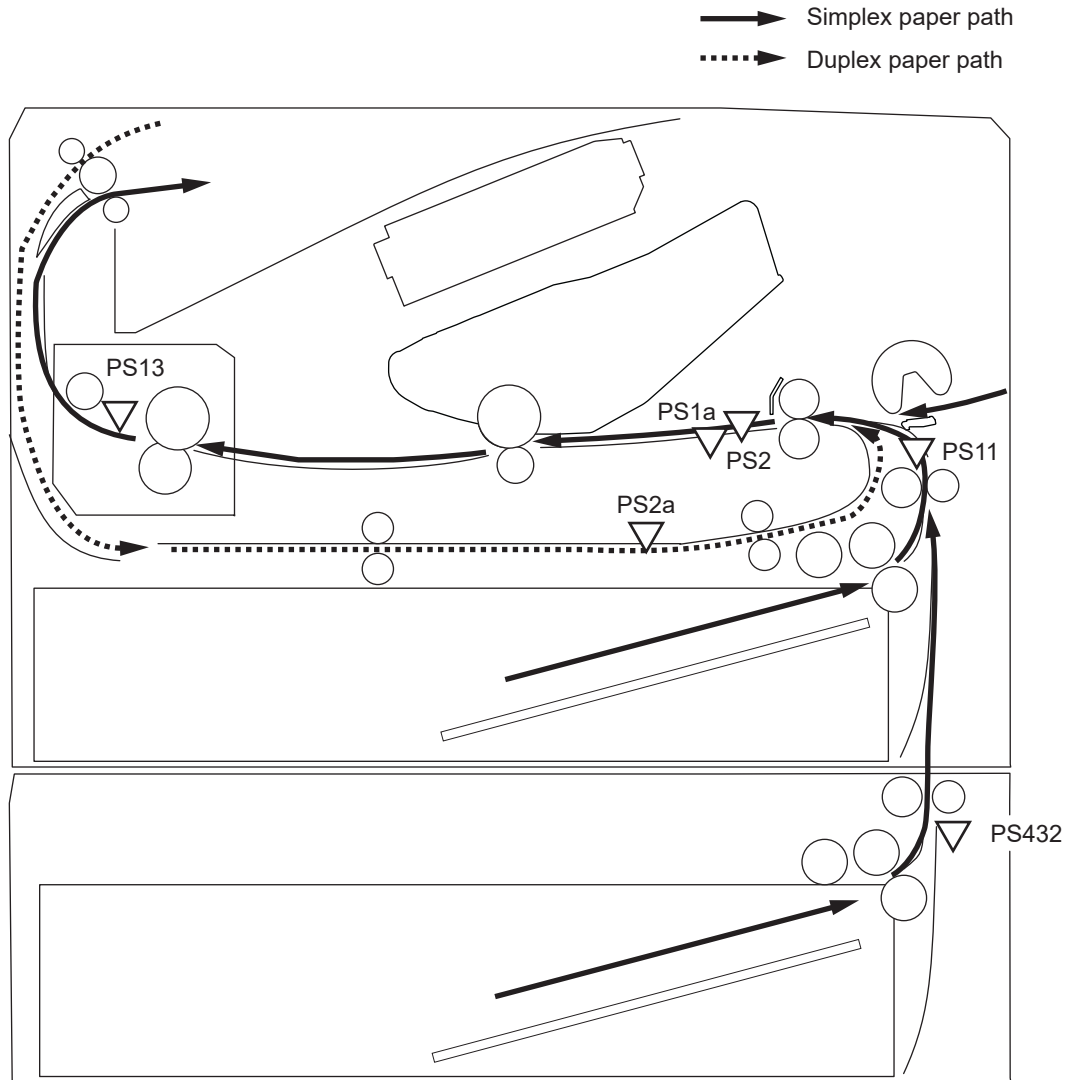

The printer determines that a jam has occurred if one of these sensors detects paper at an inappropriate time. The DC controller stops the print operation and notifies the formatter.

Table 1-18 Jams that the printer detects

Jam	Description
Media input delay jam 1	Media did not reach the registration sensor in time.
Media input delay jam 2	Media did not reach the source tray feed sensor in time.
Media input delay jam 3	Media did not reach the tray 3 feed sensor in time.
Duplex re-feed jam 1	Media did not reach the registration sensor in time.
Media input stay jam 1	Media remained at the registration sensor longer than legal-sized media should remain.
Fuser delivery delay jam 1	Media did not reach the fuser output sensor in time.
Fuser delivery stay jam 1	Media stayed at fuser output sensor longer than it should stay. Media is in duplex path.
Fuser delivery stay jam 2	Media stayed at fuser output sensor longer than it should stay. Media is in simplex path.

Table 1-18 Jams that the printer detects (continued)

Jam	Description
Wrap jam 1	Media is first detected at fuser output sensor and then disappeared from the sensor before it should have disappeared.
Door open jam	A door is open while paper is moving through the printer.
Residual Media in paper path jam 1	Media detected in the paper path.

Input accessories

Optional 550-sheet paper feeders are available for this printer.

- [Tray 3-5](#)

The M506/E50045/M507/E50145 and M527/E52545/M528/E52645 printers support up to three of these paper feeders at a time. The M501 printer supports one paper feeder.

Tray 3-5

The 550-sheet paper feeder is installed under the printer. It picks up paper and feeds it into the printer.

- [Driver PCA](#)
- [Electrical components](#)
- [Paper pickup](#)
- [Multiple feed prevention](#)
- [Tray presence detection](#)
- [Tray lift operation](#)
- [Jam detection](#)



NOTE: The M501 printer supports one paper feeder. The M506/E50045/M507/E50145 and M527/E52545/M528/E52645 printers support three paper feeders.

Figure 1-30 550-sheet paper feeder paper path

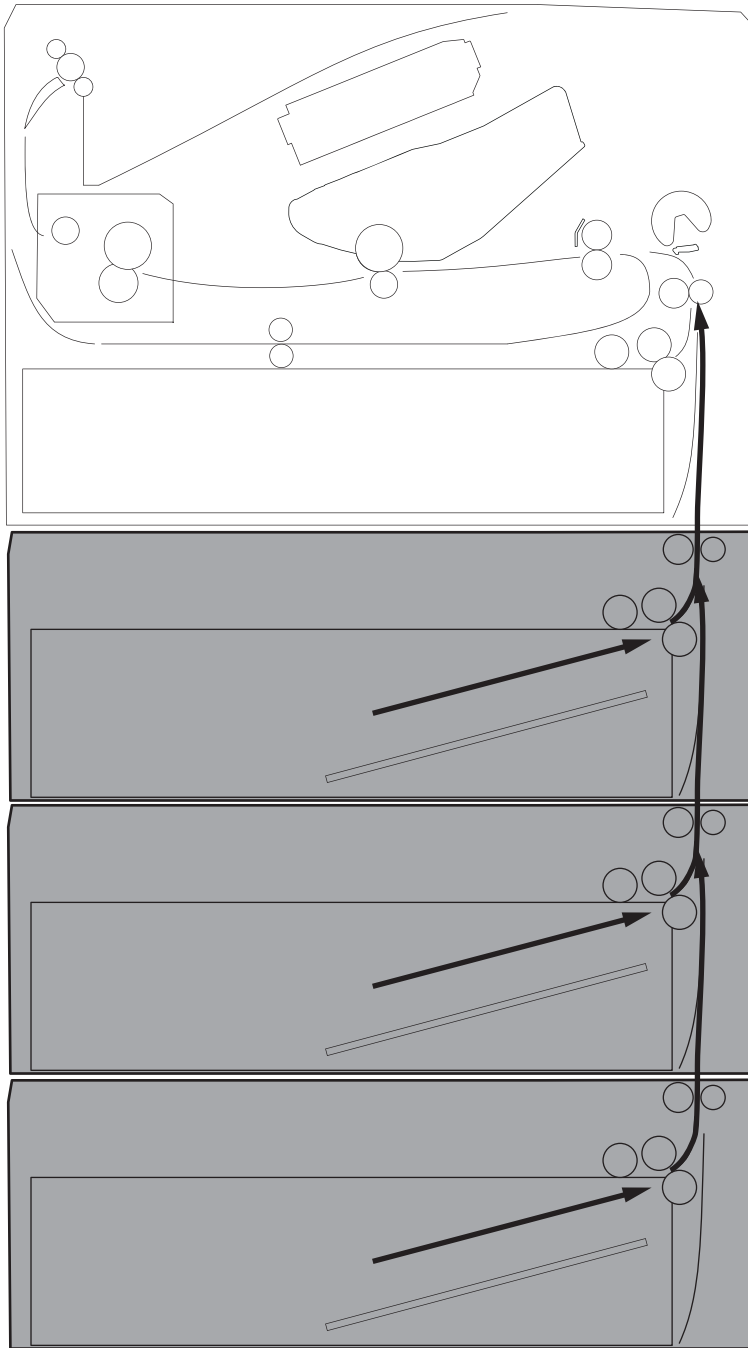

Function	Supported feature
Cassette lift-up control	Yes
Cassette presence detection	Yes
Cassette media size detection	No
Cassette media stack surface detection	Yes
Cassette media out detection	Yes

Function	Supported feature
Cassette media level detection	No
Multiple-feed prevention	Yes
Automatic delivery	Yes

Driver PCA

The paper feeder controller controls the operational sequence of the paper feeder.

Figure 1-31 Tray 3-5 driver PCA

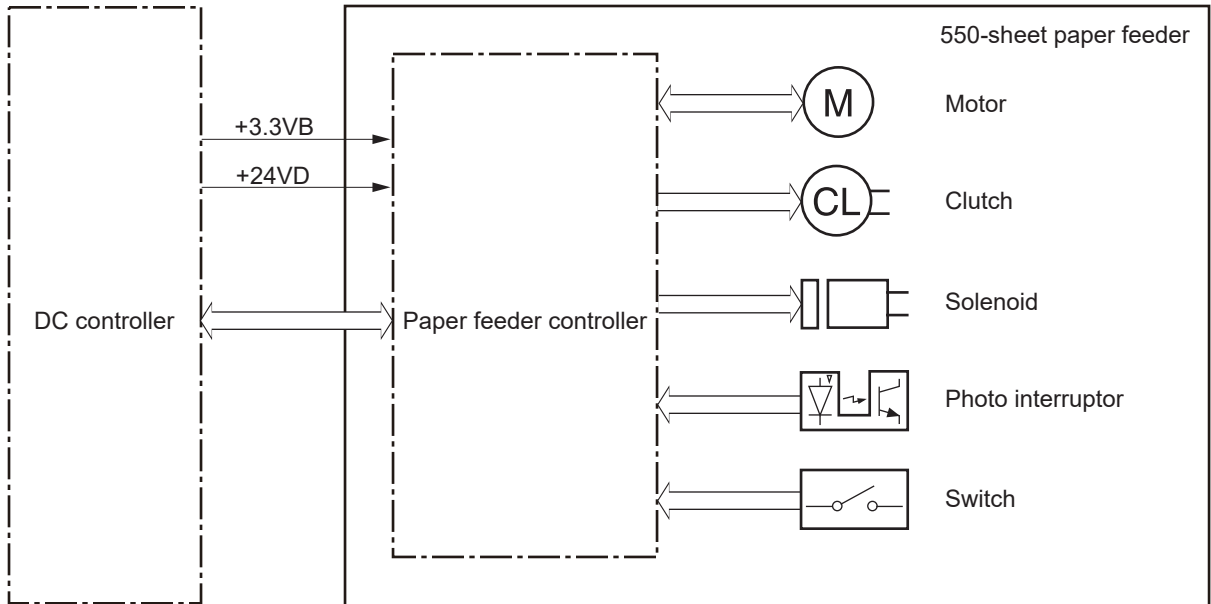

Electrical components

The 550-sheet paper feeder has one motor for lifting the tray and feeding paper.

Table 1-19 550-sheet paper feeder components

Component type	Abbreviation	Component name
Motor	M5	Optional tray lifter motor
Solenoid	SL4	Cassette pickup solenoid
Clutch	CL2	Feed clutch
Switch	SW3	Cassette detection switch
Photo interrupter	PS460	Media surface sensor
Photo interrupter	PS461	Cassette media out sensor
Photo interrupter	PS432	Feed sensor

Paper pickup

The paper feeder contains several motors, solenoids, sensors, and switches.

Figure 1-32 Paper pickup and feed components

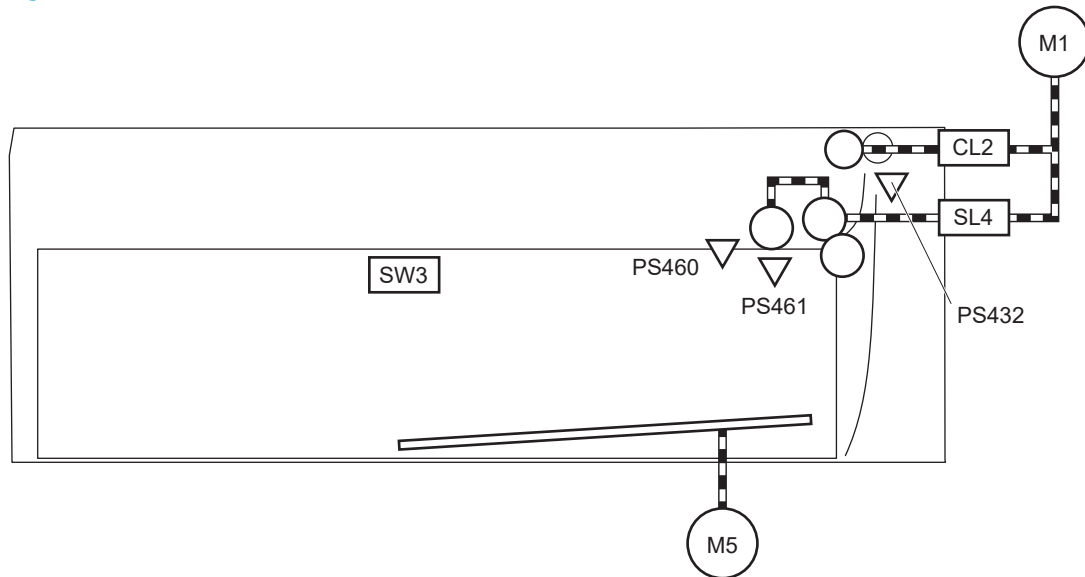

Table 1-20 Paper pickup and feed components

Component type	Abbreviation	Component name
Motors	M1	Fuser motor
Motors	M5	Lifter motor
Clutch	CL2	Feed clutch
Solenoid	SL4	Cassette pickup solenoid
Switches	SW3	Cassette detection switch
Sensors	PS460	Media surface sensor
Sensors	PS461	Cassette media out sensor
Sensors	PS432	Feed sensor

Multiple feed prevention

The Trays 3-5 multiple feed prevention for the paper feeder is operated in the same way as that of Tray 2.

Tray presence detection

The Trays 3-5 tray presence detection for the paper feeder is the same as that of Tray 2.

Tray lift operation

The 550-sheet paper feeder keeps the paper stack surface at the correct pickup position. The tray lift operation occurs under the following conditions:

- The printer is turned on
- The tray is inserted
- The paper stack surface of the tray lowers

The sequence occurs as follows:

1. The feeder tray-lifting motor rotates and the lifter moves up.
2. When the paper feeder media-stack-surface sensor detects the stack surface of the paper, the lifting motor stops.
3. The lifting motor rotates again to lift the lifter when the paper feeder media-stack-surface sensor detects the stack surface, and then lowers during printing.

If a tray media-stack-surface sensor does not detect a stack surface within a specified period after the lifting motor starts rotating, the paper feeder driver determines that the lifting motor has failed and notifies the formatter through the DC controller.

The paper feeder driver notifies the formatter if either of the paper feeder media-stack-surface sensors fails to detect the stack surface within a specified period from when a lift-up operation starts.

Jam detection

The 550-sheet paper feeder uses the paper feeder feed sensor (SR432) to detect the presence of paper and to check whether paper has jammed.

Figure 1-33 Jam detection (1x550-sheet paper feeder)

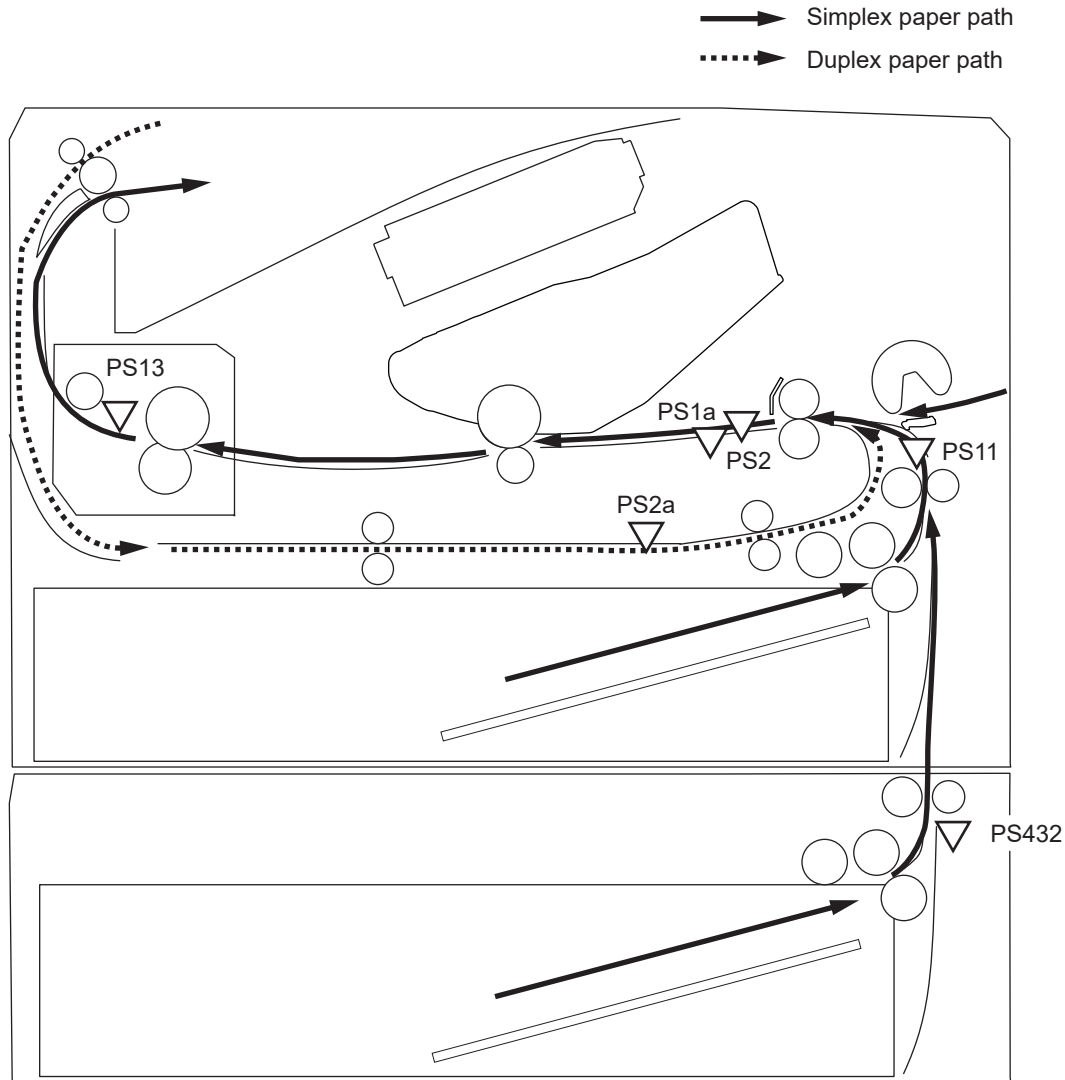

The 550-sheet paper feeder detects the following jams:

- **Media input delay jam 1 (550-sheet paper feeder):** Paper did not reach the registration sensor in time.
- **Media input delay jam 2 (550-sheet paper feeder):** Paper did not reach the source tray feed sensor in time.
- **Media input delay jam 3 (550-sheet paper feeder):** Paper did not reach the tray 3 feed sensor in time.
- **Pickup stationary jam (550-sheet paper feeder):** The feed sensor does not detect the trailing edge of paper within a specified time after the sensor detects the leading edge.
- **Residual paper jam (550-sheet paper feeder):** The feed sensor detects the presence of paper for a specified time during an automatic delivery operation.
- **Right door open jam (550-sheet paper feeder):** The right door open is detected during a paper feed operation.

Scanning and image capture system (M527/E52545/M528/E52645)

Figures in this section might look slightly different from your printer, but they are correct for the M527/E52545/M528/E52645 printers. All the information provided in this section is correct for these printers.



NOTE: This section is for the M527/E52545/M528/E52645 printers only.

The scanner is a carriage-type platen scanner which includes the frame, glass, scan module, and a scan control board (SCB). The scanner has a sensor to detect legal-sized media and a switch to indicate when the document feeder is opened.

The document feeder and control panel are attached to the scanner. If the scanner fails, it can be replaced as a whole unit. The scanner replacement part does not include the document feeder, control panel, or SCB.

Document feeder system (M527/E52545/M528/E52645)

Review the following information about the M527/E52545/M528/E52645 document feeder system.

- [Document feed system](#)



NOTE: This section is for the M527/E52545/M528/E52645 printers only.

Document feed system

This section describes the following:

- [Sensors in the document feeder](#)
- [Document feeder paper path](#)
- [Document feeder simplex operation](#)
- [Document feeder e-duplex operation](#)
- [Deskew operation](#)
- [Document feeder hinges](#)

The printer supports single-pass electronic duplexing (e-duplex) copy jobs. Two separate scan modules scan the front-side and back-side of an e-duplex copy job page in a single pass through the document feeder.

For the WF class, this ADF supports a smart background which auto-crops and adjusts the image extents.

Sensors in the document feeder

The document feeder contains the following sensors:

- **ADF paper present sensor:** Detects whether a document is present in the document feeder. If paper is present in the document feeder when copies are made, the printer scans the document using the document feeder. If no paper is present when copies are made, the printer scans the document using the scanner glass.
- **ADF Y (length) sensor:** Detects whether a legal-size original is present in the document feeder.
- **ADF jam cover sensor:** Detects whether the document feeder cover is open or closed.
- **ADF paper path deskew sensor:** Detects the top of the page as it enters the deskew rollers.
- **ADF paper path pick success sensor:** Detects a successful one page feed from the document feeder tray.



NOTE: This sensor uses ultrasonic sound to detect a multi-page paper feed.

- **Paper path sensor 1:** Detects the top of the page as it approaches the front-side scan module (document feeder glass).

Figure 1-34 Document feeder sensors

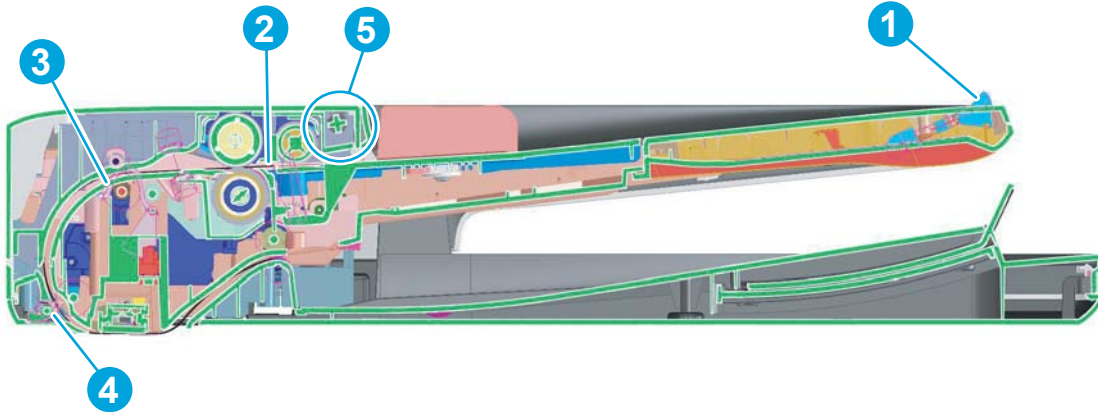

Item	Description
1	ADF Y (length) sensor
2	ADF paper present sensor
3	ADF deskew sensor
4	Paper path sensor 1
	NOTE: For an e-duplex copy job, this sensor is used to activate the front-side scan module (in the scanner base) and the front-side background selector (in the document feeder), if needed.
5	ADF jam cover sensor (open the jam access cover and insert a folded piece of paper to activate the flag)

Document feeder paper path

Review the following information about the document feeder paper path.

Figure 1-35 Document feeder paper path

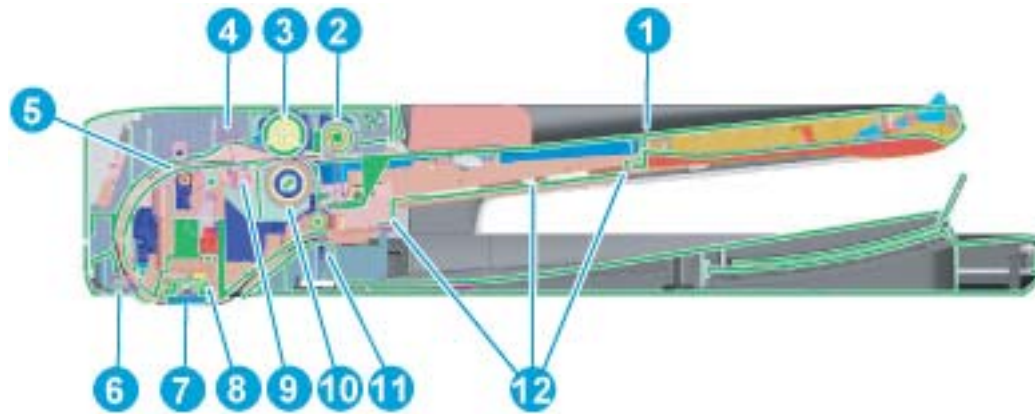

Item	Description	Item	Description
1	Input tray	7	Front-side scan module
			NOTE: This scan module (document feeder glass) is located in the scanner base.
2	Pre-pick roller	8	Back-side scan module

Item	Description	Item	Description
3	Pick roller	9	ADF pick success transmitter
4	ADF pick success receiver	10	Separator roller
5	Deskew drive roller	11	Exit drive roller
6	Prescan drive roller	12	Lift plate

Document feeder simplex operation

Following is the basic sequence of operation for a document feeder simplex job.

1. The ADF jam cover sensor detects when the cover door is in the closed position.
2. The ADF paper present sensor activates when paper is loaded onto the input tray.
3. The feed motor rotates to raise the lift plate and starts to pick the loaded paper.
4. The ADF multi-pick (ultrasonic) sensor activates when the leading edge of the media is driven past the sensor. The printer firmware registers a successful pick operation.
5. The ADF paper path deskew activates when the leading edge of the paper passes it. The printer firmware registers the leading edge of the paper position.
6. The leading edge of the paper drives into the nip point of the deskew drive roller and the deskew pinch rollers. This creates a buckle of paper by the nip point for pick-skew correction.
7. The deskew motor rotates the deskew drive roller to pull the paper into the prescan drive roller.
8. The pick motor stops turning and allows both the pick and feed roller to turn freely while the paper is pulled in by the deskew drive roller.
9. The feed motor rotates to drive the paper into the prescan front-side sensor. The firmware registers the leading edge position of the paper as the multi-pick sensor activates.
10. The feed motor continues to rotate and drive the leading edge of the paper through the preset distance from the multi-pick sensor to the front-side scan zone. The scanner begins the scanning and data retrieval process.
11. The ADF multi-pick (ultrasonic) sensor deactivates when the trailing edge of the paper passes the sensor. The firmware registers the trailing edge of the paper position.
12. The feed motor continues to rotate and drive the trailing edge of the paper through the preset distance from the ADF multi-pick (ultrasonic) sensor to the front-side scan zone. The scanner ends the scanning and data retrieval process.
13. The feed motor continues to rotate and ejects the trailing edge of the paper into the output bin.
14. One of the following occurs:
 - If the copy job is complete, the ADF paper present sensor deactivates. The feed motor reverses rotation to raise the pick roller.
 - If the copy job is not complete, the ADF paper present sensor is active. The printer firmware detects additional pages in the input tray and the process repeats.

Document feeder e-duplex operation

Following is the basic sequence of operation for a document feeder simplex job.



NOTE: For an e-duplex copy job, the background scan operation begins immediately after the simplex sequence of operation ends.

1. The feed motor continues to drive the paper until the leading edge activates the prescan back-side sensor. The printer firmware registers the position of the leading edge of the paper.
2. The feed motor continues to rotate to drive the leading edge of the paper through the preset distance from prescan back-side sensor to the back-side background selector scan zone. The back-side background scan module begins scanning and retrieval of the data.
3. The prescan back-side sensor deactivates when the trailing edge of the paper passes it. The printer firmware registers the trailing edge of the paper position.
4. The feed motor continues to rotate to drive the trailing edge of the paper edge past the back-side background selector scan zone.
5. The feed motor continues to rotate and ejects the trailing edge of the paper into the output bin.
6. One of the following occurs:
 - If the copy job is complete, the ADF paper present sensor deactivates. The feed motor reverses rotation to raise the pick roller.
 - If the copy job is not complete, the ADF paper present sensor is active. The printer firmware detects additional pages in the input tray and the process repeats.

Deskew operation

Sliding side guides on the input tray make sure that the paper stack is correctly aligned at the center of the input tray when paper is loaded in the tray. The correct position of the loaded paper is parallel with the direction of travel into the document feeder paper path.

The document feeder further reduces paper skew due to improper loading of paper in the input tray by buckling the paper to create a paper buffer.

The document feeder aligns the leading edge of the paper parallel with the deskew drive rollers before it is driven further into the document feeder paper path.



NOTE: If the page to be copied is smaller than the minimal sliding guide setting, do not use the document feeder for the copy job. Attempting to copy too small of a page using the document feeder can result in document feeder jams and/or damage to the original page. Instead, use the flatbed glass to copy the page.

Figure 1-36 Deskew operation



Document feeder hinges

Review the following information about the document feeder hinges.

The document feeder hinges allow positioning the assembly vertically above the scanner glass to accommodate the placement of books and other objects up to 25 mm (1.0 in) in height on the scanner glass. The document feeder still closes (the bottom of the ADF is kept parallel to the scanner glass) and allows the printer to operate.

The document feeder hinges provide height adjustment of 25 mm (1.0 in) when a maximum downward force of 4.5 kg (10 lb) is applied at the front edge of the assembly, with the fulcrum (such as the spine of a book) centered on the scanner glass and parallel to its long axis.

The document feeder will withstand a downward force of about 4.5 kg (10 lb) applied at the front edge center of the assembly—when the fulcrum (such as the spine of a book) is located anywhere on the scanner glass and parallel to its long axis—without breaking, deforming, detaching or experiencing performance degradation.

The document feeder hinges support the assembly in the open position and prevent the document feeder from suddenly closing in a damaging or loud manner.

The hinges can hold the document feeder static in all positions higher than 100 mm (3.93 in); measured at the front of the assembly. Less than 2.3 kg (5 lb) of force is required to open or close the document feeder.

The hinges allow the document feeder to open to an angle of between 60° and 80° from the horizontal position (this angle will not allow the printer to tip over).

Figure 1-37 Document feeder open (book mode)

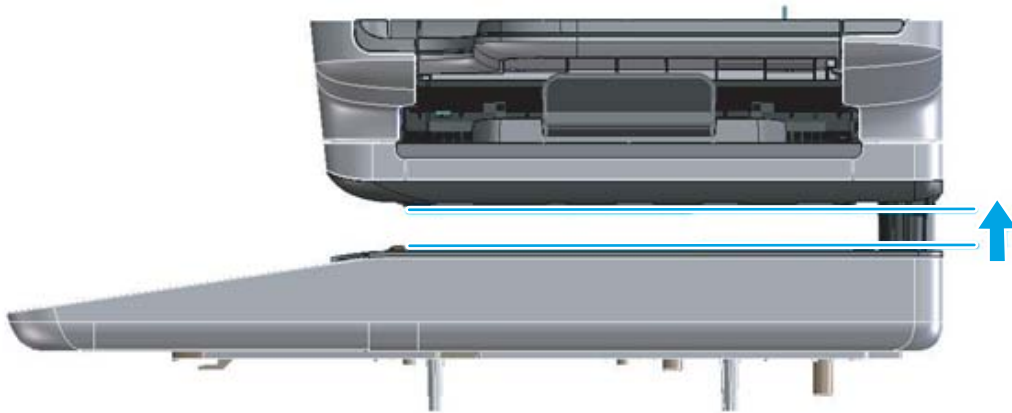

Figure 1-38 Document feeder open (60° to 80°)



2 Solve problems

Review the following information about solving printer problems.

- [HP service and support](#)
- [Solve problems checklist \(M501\)](#)
- [Solve problems checklist \(all except M501\)](#)
- [Troubleshooting process](#)
- [Tools for troubleshooting](#)
- [Resolve print-quality problems](#)
- [Print quality troubleshooting guide](#)
- [Clean the printer](#)
- [Solve paper handling problems](#)
- [Clear paper jams](#)
- [Solve performance problems](#)
- [Solve connectivity problems](#)
- [Service mode functions \(M501\)](#)
- [Service mode functions \(all except M501\)](#)
- [Firmware upgrades \(M501\)](#)
- [Firmware upgrades \(all except M501\)](#)
- [Solve fax or email problems](#)

HP service and support

Learn about HP access to additional service and support information.

Additional service and support for channel partners

Channel partners go to partner.hp.com, and then use the steps below to access the HP Web-based Interactive Search Engine (WISE).

Access WISE for Channel partners

1. Select [Services & Support](#), and then select [Services Delivery](#).
2. Select [Technical Support](#), and then select [Technical Documentation](#).

Find information about the following topics

- Service manuals
- Service advisories
- Up-to-date control panel message (CPMD) troubleshooting
- Solutions for printer issues and emerging issues
- Remove and replace part instructions and videos
- Install and configure
- Printer specifications
- Warranty and regulatory information

Additional service and support for HP internal personnel

HP internal personnel, go to one of the following Web-based Interactive Search Engine (WISE) sites:

Americas (AMS)

- [WISE - English](#)
- [WISE - Spanish](#)
- [WISE - Portuguese](#)
- [WISE - French](#)

Asia Pacific / Japan (APJ)

- [WISE - English](#)
- [WISE - Japanese](#)
- [WISE - Korean](#)
- [WISE - Chinese \(simplified\)](#)
- [WISE - Chinese \(traditional\)](#)
- [WISE - Thai](#)

Europe / Middle East / Africa (EMEA)

- [WISE - English](#)

Solve problems checklist (M501)

Review the following information about the solve problems checklist for the M501 model.

- [Use the solve problems checklist \(M501\)](#)
- [Print the menu map \(M501\)](#)
- [Print the service page \(includes the event log\) \(M501\)](#)

Use the solve problems checklist (M501)

If the printer is not correctly functioning, complete the steps (in the order given) in the following checklist. If the printer fails a checklist step, follow the corresponding troubleshooting suggestions for that step. If a checklist step resolves the problem, skip the remaining checklist items.

1. Make sure that the printer is set up correctly.
 - a. Press the power button to turn on the printer or to deactivate the Auto-Off mode.
 - b. Check the power-cable connections.
 - c. Make sure that the line voltage is correct for the printer power configuration. See the label that is on the printer for voltage requirements. If you are using a power strip and its voltage is not within specifications, plug the printer directly into the wall. If it is already plugged into the wall, try a different outlet.
2. Check the cable connections.
 - a. Check the cable connection between the printer and the computer. Make sure that the connection is secure.
 - b. Make sure that the cable itself is not faulty, by using a different cable if possible.
 - c. Check the network connection: Make sure that the network light is lit. The network light is next to the network port on the back of the printer.

If the printer remains unable to connect to the network, uninstall and then reinstall the printer. If the error persists, contact a network administrator.
3. Check to see if any messages appear on the control panel.
4. Make sure that the paper you are using meets specifications.
5. Make sure that the paper is loaded correctly in the input tray.
6. Make sure that the printer software is installed correctly.
7. Verify that you have installed the printer driver for this printer, and that you are selecting this printer from the list of available printers.
8. Print a configuration page.
 - a. On the printer control panel, press the **OK** button.
 - b. Open the **Reports** menu.
 - c. Select **Configuration Report**.
9. After printing the configuration page, check the following:

- a. If the page does not print, verify that the input tray contains paper and that the paper is properly loaded.
 - b. Make sure that each toner cartridge is installed correctly.
 - c. If the page jams in the printer, clear the jam.
 - d. If the print quality is unacceptable, complete the following steps:
 - Verify that the print settings are correct for the paper you are using.
 - Solve print-quality problems.
10. Print a small document from a different program that has printed in the past. If this solution works, then the problem is with the program you are using. If this solution does not work (the document does not print), complete these steps:
- a. Try printing the job from another computer that has the printer software installed.
 - b. Check the cable connection. Direct the printer to the correct port, or reinstall the software, selecting the connection type you are using.

Print the menu map (M501)

To more easily navigate individual settings, print a report of the complete printer menus.

1. On the printer control panel, press the **OK** button.
2. Open the **Reports** menu.
3. Select **Menu Structure**.

Print the service page (includes the event log) (M501)

Printing the service page provides a list of printer settings that might be helpful in the troubleshooting process, as well as the event log, which stores the last 10 error events that the printer experienced.

1. On the printer control panel, press the **OK** button.
2. Open the **Reports** menu.
3. Select the **Service Page** option to print the report.

The event log is located in the lower right-hand corner of the service page.

Solve problems checklist (all except M501)

Review the following information about the solve problems checklist for the M506/E50045/M507/E50145 and M527/E52545/M528/E52645 models.

- [Use the solve problems checklist](#)
- [Print the Settings menu map](#)
- [Print current settings pages](#)
- [Pre-boot menu options](#)
- [Print the event log](#)

Use the solve problems checklist

If the printer is not correctly functioning, complete the steps (in the order given) in the following checklist. If the printer fails a checklist step, follow the corresponding troubleshooting suggestions for that step. If a checklist step resolves the problem, skip the remaining checklist items.

1. If the control panel is blank or black, check the following before proceeding:
 - Check to make sure that the printer is not in Sleep mode (tap the touchscreen control panel or press a button on the LCD control panel).
 - Check the power cable.
 - Check that the power is turned on.
 - Make sure that the line voltage is correct for the printer power configuration. (See the label that is on the back of the printer for voltage requirements.) If a power strip is in use, and its voltage is not within specifications, connect the printer directly into the electrical outlet. If it is already connected into the outlet, try a different outlet.

If the control panel is not responding to touch (M506x/M507x, E50045/E50145, and M527/E52545/M528/E52645 models), or if it appears black or blank, try the following:

 **NOTE:** The following conditions indicate that the printer has frozen while in Sleep mode. Opening a door, tapping the control panel (touchscreen control panels), or pressing a control panel button (LCD control panels) causes the printer to wake up from Sleep mode.

- a. Turn the printer power off, and then on again.
- b. Verify that the control panel is correctly functioning by accessing the control panel diagnostics. See the Control-panel checks section in the printer *Troubleshooting Manual*.

 **TIP:** The LED on the formatter will blink if the control panel is not detected or the cables are not properly seated.

If the control panel does not respond to the diagnostic button, try the following:

- Try printing from a host computer. Does the printer print a test page?
- Is the printer HP Embedded Web Server (EWS) accessible?
- Turn the power off.



- Reseat the cable connections on the bottom of the control-panel assembly and the control panel connectors at the formatter.
 - Turn the printer power on, and then check for functionality of the control panel by tapping the touchscreen or pressing a button on the LCD control panel.
- c. Try upgrading the firmware. If the firmware upgrade fails to resolve the problem, and the printer still freezes while in Sleep mode, elevate the case after collecting the following info:
 - d. If the error persists, replace the control panel assembly.
2. The control panel should indicate a [Ready](#), [Paused](#), or [Sleep mode on](#) status. If an error message displays, resolve the error.
 - Try using the Power-on checks section in the printer *Troubleshooting Manual* to solve the problem.
 3. For network connection errors, check the cables.
 - a. Check the network cable connections between the printer and the computer or network port. Make sure that the connections are secure.

 **NOTE:** The network LEDs should be illuminated and flashing.

- b. Make sure that the cables are not faulty by trying different cables, if possible.
 - c. Check the network connection. Verify that the port is active.
4. Print a configuration page. If the printer is connected to a network, an HP Jetdirect page also prints.
 - a. For a printer with a touchscreen control panel, from the [Home](#) screen on the printer control panel, scroll to and touch the [Administration](#) button (FutureSmart 3), or touch the [Reports](#) button (FutureSmart 4).
 - b. Open the following menus:
 - [Reports](#) (FutureSmart 3)
 - [Configuration/Status Pages](#)
 - [Configuration Page](#)
 - c. Touch [Configuration Page](#) to select it.

 **TIP:** Multiple report pages can be selected, and then printed together.

 - d. Touch the [Print](#) button to print the pages.
 - a. For a LCD control panel, from the [Home](#) screen on the printer control panel, use the down arrow ▼ to scroll to [Administration](#), and then press the [OK](#) button (FutureSmart 3); or use the arrow keys to navigate to the [Reports](#), and then press the [OK](#) button (FutureSmart 4).
 - b. If necessary, use the down arrow ▼ button to scroll to [Reports](#), and then press the [OK](#) button (FutureSmart 3).
 - c. If necessary, use the down arrow ▼ button to scroll to [Configuration/Status Pages](#), and then press the [OK](#) button.

- d. Use the down arrow ▼ button to scroll to [Configuration page](#), and then press the [OK](#) button to select it.
 - e. Use the up arrow ▲ button to scroll to [Print](#), and then press the [OK](#) button to print the pages.
-
-  **TIP:** Multiple report pages can be selected, and then printed together.
-
- If the pages do not print, check that at least one tray contains paper.
-
-  **TIP:** Make sure that the selected paper size and type meet HP specifications. Also open the **Trays** menu on the printer control panel and verify that the tray is configured correctly for the paper type and size.
-
- If the page jams in the printer, follow the instructions on the control panel to clear the jam.
 - If the page does not print correctly, the problem is with the printer hardware.
 - If the page prints correctly, the printer hardware is working. The problem is with the host computer, with the print driver, or with the program.
5. Print a supplies status page and then check that the maintenance items below are not at their end-of-life.

 **TIP:** If a maintenance item needs to be replaced, order the part number provided below.

- a. For a printer with a touchscreen control panel, from the Home screen on the printer control panel, scroll to and touch the [Administration](#) button (FutureSmart 3), or touch the [Reports](#) button (FutureSmart 4).
- b. Open the following menus:
 - [Reports](#) (FutureSmart 3)
 - [Configuration/Status Pages](#)
 - [Supplies Status Page](#)
- c. Touch the [Print](#) button to print the page, and then check the maintenance items (listed below in this step).

 **TIP:** Multiple report pages can be selected, and then printed together.

- a. For printers with LCD control panels, from the [Home](#) screen on the printer control panel, use the down arrow ▼ button to scroll to [Administration](#), and then press the [OK](#) button (FutureSmart 3); or use the arrow keys to navigate to the [Reports](#), and then press the [OK](#) button (FutureSmart 4).
- b. If necessary, use the down arrow ▼ button to scroll to [Reports](#), and then press the [OK](#) button (FutureSmart 3).
- c. If necessary, use the down arrow ▼ button to scroll to [Configuration/Status Pages](#), and then press the [OK](#) button.
- d. Use the down arrow ▼ button to scroll to [Supplies Status Page](#), and then press the [OK](#) button to select it.
- e. Use the up arrow ▲ button to scroll to [Print](#), and then press the [OK](#) button to print the page, and then check the maintenance items (listed below in this step).

 **TIP:** Multiple report pages can be selected, and then printed together.

HP long-life consumables and maintenance kit life specifications are estimations. Actual individual life/yield during normal use varies depending on usage, environment, media, and other factors. Estimated life is not an implied guarantee or warrantable.

- Fixing assembly (fuser); estimated life: 150,000 pages
 - RM2-5679-000 (110V)
(M501/M506/E50045/M527/E52545)
 - RM2-2585-000CN (110V)
(M507/E50145/M528/E52645)
 - RM2-5692-000 (220V)
(M501/M506/E50045/M527/E52545)
 - RM2-2586-000CN (220V)
(M507/E50145/M528/E52645)
 - Document feeder maintenance kit; estimated life: 150,000 pages
 - B5L52-67903
6. Verify that the correct print driver for this printer is installed. Check the program to make sure that the print driver for this printer is used. The print driver is on the CD that came with the printer, or can be downloaded from this Web site: <http://www.hp.com/support/ljM501> or <http://www.hp.com/support/ljM506> or <http://www.hp.com/support/ljE50045> or <http://www.hp.com/support/ljM507> or <http://www.hp.com/support/ljE50145> or <http://www.hp.com/support/ljM527mfp> or <http://www.hp.com/support/ljE52545mfp> or <http://www.hp.com/support/ljM528mfp> or <http://www.hp.com/support/E52645mfp>.
 7. Print a short document from a different program that has worked in the past. If this solution works, the problem is with the program. If this solution does not work (the document does not print), complete these steps:
 - a. Try printing the job from another computer that has the printer software installed.
 - b. If the printer is connected to the network, connect the printer directly to a host computer with a USB cable. Redirect the printer to the correct port, or reinstall the software (make sure to select the new connection type).

Print the Settings menu map

To more easily navigate individual settings, print a report of the complete [Settings](#) menu (FutureSmart 4), or the complete [Administration](#) menu (FutureSmart 3).

- [Print the settings menu map from a touchscreen control panel](#)
- [Print the settings menu map from a LCD control panel](#)

Print the settings menu map from a touchscreen control panel

Use the following procedure to print the menu map from a touchscreen control panel.

1. From the [Home](#) screen on the printer control panel, scroll to and touch the [Administration](#) button (FutureSmart 3), or touch the [Reports](#) button (FutureSmart 4).
2. Open the following menus:
 - [Reports](#) (FutureSmart 3)
 - [Configuration/Status Pages](#)
3. Select the [Administration Menu Map](#) option (FutureSmart 3) or the [Settings Menu Map](#) option (FutureSmart 4).
4. Touch the [Print](#) button to print the report.

 **TIP:** Multiple report pages can be selected, and then printed together.

Print the settings menu map from a LCD control panel

Use the following procedure to print the menu map from a LCD control panel.

FutureSmart 3

1. From the [Home](#) screen on the printer control panel, use the down arrow ▼ button to scroll to [Administration](#), and then press the [OK](#) button.
2. Open the following menus:
 - [Reports](#)
 - [Configuration/Status Pages](#)
3. Use the down arrow ▼ button to scroll to [Administration Menu Map](#), and then press the [OK](#) button to select it.
4. Use the up arrow ▲ button to scroll to [Print](#), and then press the [OK](#) button to print the pages.

 **TIP:** Multiple report pages can be selected, and then printed together.

FutureSmart 4

1. From the [Home](#) screen on the printer control panel, use the arrow keys to navigate to [Reports](#), and then select [OK](#).
2. Select [Configuration/Status Pages](#).

3. Select [Settings Menu Map](#), and then select [OK](#).
4. Use the down arrow ▼ to scroll down to [Cancel](#), and then use the right arrow ► to highlight the print icon . Select [OK](#) to print the pages.

 **TIP:** Multiple report pages can be selected, and then printed together.

Print current settings pages

Printing the current settings page provides a map of the user configurable settings that might be helpful in the troubleshooting process.

- [Print the current settings page from a touchscreen control panel](#)
- [Print the current settings page from a LCD control panel](#)

Print the current settings page from a touchscreen control panel

Use the following procedure to print the current settings page from a touchscreen control panel.

1. From the [Home](#) screen on the printer control panel, scroll to and touch the [Administration](#) button (FutureSmart 3), or touch the [Reports](#) button (FutureSmart 4).
2. Open the following menus:
 - [Reports](#) (FutureSmart 3)
 - [Configuration/Status Pages](#)
3. Select the [Current Settings Page](#) option.
4. Touch the [Print](#) button to print the report.

 **TIP:** Multiple report pages can be selected, and then printed together.

Print the current settings page from a LCD control panel

Use the following procedure to print the current settings page from a LCD control panel.

FutureSmart 3

1. From the [Home](#) screen on the printer control panel, use the down arrow ▼ button to scroll to [Administration](#), and then press the [OK](#) button.
2. Open the following menus:
 - [Reports](#)
 - [Configuration/Status Pages](#)
3. Use the down arrow ▼ button to scroll to [Current Settings Page](#), and then press the [OK](#) button to select it.
4. Use the up arrow ▲ button to scroll to [Print](#), and then press the [OK](#) button to print the pages.

 **TIP:** Multiple report pages can be selected, and then printed together.

FutureSmart 4

1. From the [Home](#) screen on the printer control panel, use the arrow keys to navigate to [Reports](#), and then select [OK](#).
2. Select [Configuration/Status Pages](#).

3. Select [Current Settings Page](#), and then select [OK](#).
4. Use the down arrow ▼ to scroll down to [Cancel](#), and then use the right arrow ► to highlight the print icon . Select [OK](#) to print the pages.

 **TIP:** Multiple report pages can be selected, and then printed together.

Pre-boot menu options

The [Pre-boot](#) menus are available prior to the printer initializing.

- [Open the Pre-boot menu from a touchscreen control panel](#)
- [Open the Pre-boot menu from a LCD control panel](#)
- [Cold reset using the Pre-boot menu from a touchscreen control panel](#)
- [Cold reset using the Pre-boot menu from a LCD control panel](#)
- [Remote Admin \(all except M501\)](#)

⚠ CAUTION: The [Format Disk](#) option (printers with a hard-disk drive only) performs a disk initialization for the entire disk. The operating system, firmware files, and third party files (among other files) will be completely lost. HP does not recommend this action.

💡 TIP: The [Pre-boot](#) menu can be remotely accessed by using a telnet network protocol to establish an administration connection to the printer. See the Remote Admin (all except M501) topic in the *Troubleshooting Manual*.

Open the Pre-boot menu from a touchscreen control panel

Use the following procedure to open the [Pre-boot](#) menu from a touchscreen control panel.

1. Touch the middle of the control-panel display when you see the [1/8](#) under the logo.



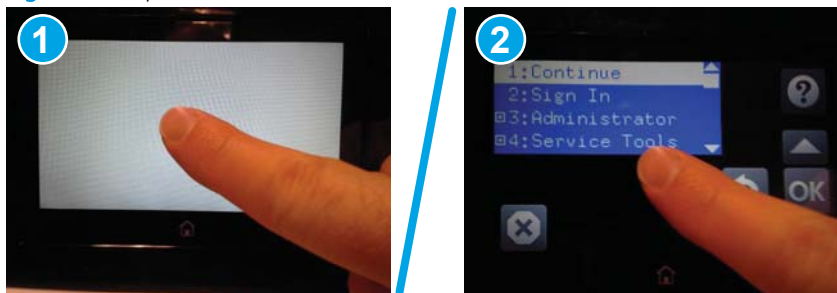



Figure 2-1 Open the [Pre-boot](#) menu

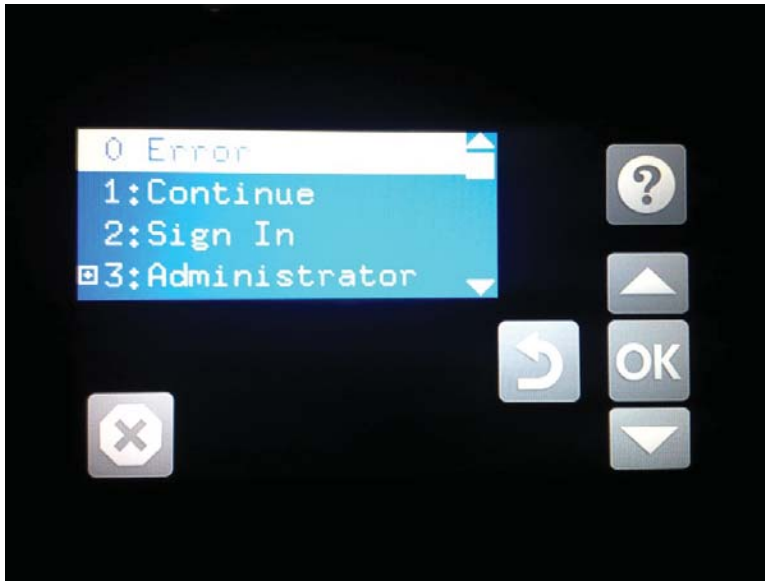

- On the **Pre-boot** menu screen, use the following buttons to navigate the tests.

Figure 2-2 Pre-boot menu



Button	Description
	Use this button to see more information about a selected item.
	Use this button to scroll up through menu items.
	Use this button to select a highlighted menu item.
	Use this button to scroll down through menu items.
	Use this button to go back to the previous menu.
	Not used.
	Use this button to exit a diagnostic test.

3. Use the arrow buttons on the touchscreen to navigate the **Pre-boot** menu.
4. Touch the **OK** button to select a menu item.

Open the Pre-boot menu from a LCD control panel

Use the following procedure to open the **Pre-boot** menu from a LCD control panel.

1. Press the **Cancel**  button when you see the **1/8** under the logo.
2. Use the arrow buttons on the control panel to navigate the **Pre-boot** menu.
3. Press the **OK** button to select a menu item.

Cold reset using the Pre-boot menu from a touchscreen control panel

Use the following procedure to perform a cold reset using the **Pre-boot** menu from a touchscreen control panel.

CAUTION: This procedure resets all printer configurations and settings to factory defaults (customer configurations and settings are lost).

1. Touch the middle of the control-panel display when you see the **1/8** under the logo.

Figure 2-3 Open the **Pre-boot** menu

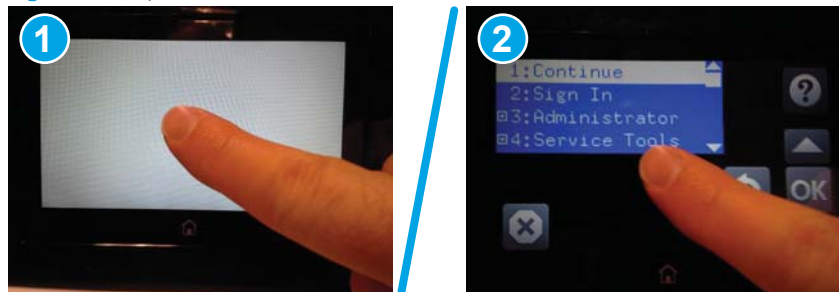

2. Use the down arrow ▼ button to highlight the **+3:Administrator** item, and then touch the **OK** button.
3. Use the down arrow ▼ button to highlight the **+8:Startup Options** item, and then touch the **OK** button.
4. Use the down arrow ▼ button to highlight the **2 Cold Reset** item, and then touch the **OK** button to select it.
5. Touch the Home button to return to the main **Pre-boot** menu and highlight the **1:Continue** item, and then touch the **OK** button.

NOTE: The printer will initialize.

Cold reset using the Pre-boot menu from a LCD control panel

Use the following procedure to perform a cold reset using the **Pre-boot** menu from a LCD control panel.

CAUTION: This procedure resets all printer configurations and settings to factory defaults (customer configurations and settings are lost).

1. Press the **Cancel**  button when you see the **1/8** under the logo.
2. Use the down arrow ▼ button to highlight the **+3:Administrator** item, and then press the **OK** button.

3. Use the down arrow ▼ button to highlight the +8:Startup Options item, and then press the OK button.
4. Use the down arrow ▼ button to highlight the 2 Cold Reset item, and then press the OK button to select it.
5. Touch the Home button to return to the main Pre-boot menu and highlight the 1:Continue item, and then touch the OK button.

 **NOTE:** The printer will initialize.

 **NOTE:** Some of the pre-boot options in the following tables are not supported by the current version of the printer firmware and are included for information only. Future versions of firmware will support these options.

Table 2-1 Pre-boot menu options (1 of 7)

Menu option	First level	Second level	Third level	Description
Continue				<p>Selecting the Continue item exits the Pre-boot menu and continues the normal boot process.</p> <p>If a selection is not made in the initial menu within 30 seconds, the printer returns to a normal boot (the same as selecting Continue).</p> <p>If the user navigates to another menu, the timeout does not apply.</p>
Sign In				Enter the administrator PIN or service PIN if one is required to open the Pre-boot menu.
Administrator				<p>This item navigates to the Administrator submenus.</p> <p>If authentication is required (and the user is not already signed in) the Sign In prompt displays. The user is required to sign in.</p>
Administrator	Download	Network USB USB Thumbdrive		This item initiates a Pre-boot firmware download process. A USB Thumbdrive option will work on all FutureSmart printers. USB or Network connections are not currently supported.
Administrator	Format Disk			<p>This item reinitializes the disk and cleans all disk partitions.</p> <p>CAUTION: Selecting the Format Disk item removes all data. A delete confirmation prompt is not provided.</p> <p>The system is not bootable after this action and a 99.09.67 error displays on the control panel. A firmware download must be performed to return the system to a bootable state.</p>
Administrator	Partial Clean			<p>This item reinitializes the disk (removing all data except the firmware repository where the master firmware bundle is downloaded and saved).</p> <p>CAUTION: Selecting the Partial Clean item removes all data except the firmware repository. A delete confirmation prompt is not provided.</p> <p>CAUTION: This procedure resets all printer configurations and settings to factory defaults (customer configurations and settings are lost).</p> <p>This allows a user to reformat the disk by removing the firmware image from the active directory without having to download new firmware code (printer remains bootable).</p>

Table 2-1 Pre-boot menu options (1 of 7) (continued)

Menu option	First level	Second level	Third level	Description
Administrator	Change Password			Select this item to set or change the administrator password.
Administrator	Clear Password			Select the Clear Password item to remove a password from the Administrator menu. Before the password is actually cleared, a message will be shown asking to confirm that the password should be cleared. Press the OK button to confirm the action. When the confirmation prompt displays, press the OK button to clear the password.

Table 2-2 Pre-boot menu options (2 of 7)

Menu option	First level	Second level	Third level	Description
Administrator (continued)	Manage Disk	Clear disk		Select the Clear disk item to enable using an external device for job storage. Job storage is normally enabled only for the Boot device. This will be grayed out unless the 99.09.68 error is displayed.
Administrator	Manage Disk	Lock Disk		Select the Lock Disk item to lock (mate) a new secure disk to this printer. The secure disk already locked to this printer will remain accessible to this printer. Use this function to have more than one encrypted disk accessible by the printer when using them interchangeably. The data stored on the secure disk locked to this printer always remains accessible to this printer.
Administrator	Manage Disk	Leave Unlocked		Select the Leave Unlocked item to use a new secure disk in an unlocked mode for a single service event. The secure disk that is already locked to this printer will remain accessible to this printer and uses the old disk's encryption password with the new disk. The secure disk that is already locked to this printer remains accessible to this printer.
Administrator	Manage Disk	Clear Disk Pwd		Select the Clear Disk Pwd item to continue using the non-secure disk and clear the password associated with the yet-to-be installed secure disk. CAUTION: Data on the missing secure disk will be permanently inaccessible.
Administrator	Manage Disk	Retain Password		Select the Retain Password item to use the non-secure disk for this session only, and then search for the missing secure disk in future sessions.
Administrator	Manage Disk	Boot Device	Secure Erase	Select the Secure Erase item to erase all of the data on the disk and unlock it if required. This might take a long time. NOTE: The system will be unusable until the system files are reinstalled. The ATA secure-erase command is a one-pass overwrite, which erases the entire disk including firmware. The disk remains an encrypted disk.

Table 2-2 Pre-boot menu options (2 of 7) (continued)

Menu option	First level	Second level	Third level	Description
Administrator	Manage Disk	Boot Device	Erase/Unlock	Select the Erase/Unlock item to cryptographically erase all data on the disk and unlock the disk to allow a user to gain access to it from any printer. NOTE: The system will be unusable until the system files are reinstalled. It erases the encryption key. The encryption key is erased, so the disk becomes a non-encrypted disk.
Administrator	Manage Disk	Boot Device	Get Status	This item provides disk status information if any is available.

Table 2-3 Pre-boot menu options (3 of 7)

Menu option	First level	Second level	Third level	Description
Administrator (continued)	Manage Disk (continued)	Internal Device		Select the Internal Device item to erase the internal device or get a status about the internal device.
Administrator	Manage Disk	Internal Device	Secure Erase	Select the Secure Erase item to erase all of the data on the disk and unlock it if required. This might take a long time. NOTE: The system will be unusable until the system files are reinstalled. The ATA secure-erase command erases the entire disk, including firmware. The disk remains an encrypted disk.
Administrator	Manage Disk	Internal Device	Erase/Unlock	Select the Erase/Unlock item to cryptographically erase all of the data on disk and unlock the disk to allow the user to gain access to it from any printer. NOTE: The system will be unusable until the system files are reinstalled. The HP High Performance Secure Hard Disk is erased.
Administrator	Manage Disk	Internal Device	Get Status	This item provides disk status information if any is available.
Administrator	Manage Disk	External Device		Select the External Device item to erase the external device or get status about the external device.
Administrator	Manage Disk	External Device	Secure Erase	Select the Secure Erase item to erase all of the data on the disk and unlock it if required. This might take a long time. NOTE: The system will be unusable until the system files are reinstalled. The ATA secure-erase command erases the entire disk, including firmware. The disk remains an encrypted disk.
Administrator	Manage Disk	External Device	Erase/Unlock	Select the Erase/Unlock item to cryptographically erase all of the data on disk and unlock the disk to allow a user to gain access to it from any printer. NOTE: The system will be unusable until the system files are reinstalled. The encryption key is erased, so the disk becomes a non-encrypted disk.
Administrator	Manage Disk	External Device	Get Status	This item provides disk status information if any is available.

Table 2-4 Pre-boot menu options (4 of 7)

Menu option	First level	Second level	Third level	Description
Administrator (continued)	Configure LAN NOTE: This configuration is only active when the Pre-boot menu is open.	IP Mode [DHCP]		The network can be configured to obtain the network settings from a DHCP server or as static. Use this item for automatic IP address acquisition from the DHCP server.
Administrator	Configure LAN NOTE: This configuration is only active when the Pre-boot menu is open.	IP Mode [STATIC]		Use this item to manually assign the network addresses.
Administrator	Configure LAN NOTE: This configuration is only active when the Pre-boot menu is open.	IP Mode [STATIC]	IP Address	Use this item to manually enter the IP addresses.
Administrator	Configure LAN NOTE: This configuration is only active when the Pre-boot menu is open.	IP Mode [STATIC]	Subnet Mask	Use this item to manually enter the subnet mask.
Administrator	Configure LAN NOTE: This configuration is only active when the Pre-boot menu is open.	IP Mode [STATIC]	Default Gateway	Use this item to manually enter the default gateway.
Administrator	Configure LAN NOTE: This configuration is only active when the Pre-boot menu is open.	IP Mode [STATIC]	Save	Select the Save item to save the manual settings.

Table 2-5 Pre-boot menu options (5 of 7)

Menu option	First level	Second level	Third level	Description
Administrator (continued)	Startup Options			Select the Startup Options item to specify options that can be set for the next time the printer is turned on and initializes to the Ready state.
Administrator	Startup Options	Show Revision		Not currently functional: Select the Show Revision item to allow the printer to initialize and show the firmware version when the printer reaches the Ready state. Once the printer power is turned on the next time, the Show Revision item is unchecked so that the firmware revision is not shown.

Table 2-5 Pre-boot menu options (5 of 7) (continued)

Menu option	First level	Second level	Third level	Description
Administrator	Startup Options	Cold Reset		Select the Cold Reset item to clear the IP address and all customer settings. (This item also returns all settings to factory defaults.) NOTE: Items in the Service menu are not reset.
Administrator	Startup Options	Skip Disk Load		Select the Skip Disk Load item to disable installed third-party applications.
Administrator	Startup Options	Skip Cal		Select the Skip Cal item to skip the printer calibration for the very next power-initialization cycle only.
Administrator	Startup Options	Lock Service		CAUTION: Select the Lock Service item to lock the Service menu access (both in the Pre-boot menu and the Device Maintenance menu). Service personnel must have the administrator remove the Lock Service setting before they can open the Service menu.
Administrator	Startup Options	Skip FSCK		Select the Skip FSCK item to disable Chkdisk/ScanVolume during startup.
Administrator	Startup Options	First Power		Not currently functional: This item allows the printer to initialize as if it is the first time it has been turned on. For example, the user is prompted to configure first-time settings like date/time, language, and other settings. Select this item so that it is enabled for the next time the printer power is turned on. When the printer power is turned on the next time, this item is unchecked so that the pre-configured settings are used during configuration, and the first-time setting prompt is not used.
Administrator	Startup Options	Embedded Jetdirect Off		Select the Embedded Jetdirect Off item to disable the embedded HP Jetdirect. By default this item is unchecked so that HP Jetdirect is always enabled.
Administrator	Startup Options	WiFi Accessory		Select the WiFi Accessory item to enable the wireless accessory.

Table 2-6 Pre-boot menu options (6 of 7)

Menu option	First level	Second level	Third level	Description
Administrator (continued)	Diagnostics			Diagnostic items are useful to diagnose hardware components and their interface connections. Use these items to troubleshoot specific hardware components, and the interface between them and other components.
Administrator	Diagnostics	Memory	Do Not Run	Use the Do Not Run item to exclude the Memory diagnostic when executing multiple diagnostics.
Administrator	Diagnostics		Short	Use the Short item to select a brief memory test. NOTE: This test requires about four minutes to execute.

Table 2-6 Pre-boot menu options (6 of 7) (continued)

Menu option	First level	Second level	Third level	Description
Administrator	Diagnostics		Long	Use the Long item to select an extended memory test. NOTE: This test requires about twenty minutes to execute.
Administrator	Diagnostics	Disk	Do Not Run	Use the Do Not Run item to exclude the Disk diagnostic when executing multiple diagnostics.
Administrator	Diagnostics		Short	Use the Short item to select a brief firmware self-test. NOTE: This test requires about two or three minutes to execute.
Administrator	Diagnostics		Long	Use the Long item to select an extended firmware self-test. NOTE: This test requires about sixty minutes to execute.
Administrator	Diagnostics		Optimized	Use the Optimized item to select a test that checks the active sectors on the disk. NOTE: This test requires about thirty minutes to execute.
Administrator	Diagnostics		Raw	Use the Raw item to select a test that checks every sector on the disk. NOTE: This test requires about fifty minutes to execute.
Administrator	Diagnostics		Smart	Use the Smart item to select a very brief test that checks the drive self-monitoring analysis and reporting technology (SMART) status—the drive detects and reports reliability indicators to help anticipate disk failures (SMART status).
Administrator	Diagnostics	CPB		Use the CPB item to verify the integrity of the copy processor board (CPB) and the formatter PCA connections.
Administrator	Diagnostics	Interconnect		Use the Interconnect item to verify the integrity of the interconnect PCA (ICB) and its connections.
Administrator	Diagnostics	Run Selected		Select the Run Selected item to execute a selected test. NOTE: If more than one test is selected, they are executed in sequence.

Table 2-7 Pre-boot menu options (7 of 7)

Menu option	First level	Second level	Third level	Description
Administrator (continued)	Remote Admin	Start Telnet		The Remote Admin item allows a service technician to access to the printer Pre-boot menu remotely, and to navigate the menu selections from a remote location. IMPORTANT: A Remote Admin connection must be initiated by a person that is physically present at the printer. This person will also need to provide a randomly generated PIN to the remote service technician. NOTE: For more information about using the Remote Admin function, see "Remote Admin (M506/M507/E50145, M527/M528/E52645)" in the Troubleshooting Manual.
Administrator	Remote Admin	Stop Telnet		

Table 2-7 Pre-boot menu options (7 of 7) (continued)

Menu option	First level	Second level	Third level	Description
Administrator	Remote Admin	Refresh IP		
Administrator	System Triage	Copy Logs		<p>If the device will not boot to the Ready state, or the diagnostic log feature found in the Troubleshooting menu is not accessible, then use the System Triage item to copy the diagnostic logs to a USB flash drive at the next printer start up.</p> <p>The files can then be sent to HP to help diagnose the problem.</p>
Administrator	Change Svc PWD			Use this item to change the Service menu personal identification number (PIN).
Administrator	Reset Svc PWD			If the Service menu personal identification number (PIN) has been changed. Use this item to reset it to the original PIN.
Service Tools	Reset Password			Use this item to reset the Pre-boot administrator password.
Service Tools	Subsystems			For manufacturing use only. Do not change these values.
Developer Tools	Netexec			

Remote Admin (all except M501)

This section describes the following Remote Admin items.

- [Required software and network connection](#)
- [Connect a remote connection](#)
- [Disconnect a remote connection](#)

The Remote Admin feature allows remote access the printer [Pre-boot](#) menu (BIOS environment). The printer functions as a telnet server which uses the telnet networking protocol to transmit text data. Any computer (with telnet installed and enabled) can function as the telnet client to remotely display and interact with the [Pre-boot](#) menu.



IMPORTANT: While the Remote Admin function allows remote access the [Pre-boot](#) menu, for security reasons the Remote Admin connection must be initiated by a person that is physically present at the printer.

Required software and network connection

Before using the Remote Admin feature, make sure that the telnet network protocol is installed and enabled on the remote telnet client computer.

- [Enable the Windows telnet client](#)
- [Network connection](#)

 **NOTE:** This section describes enabling and configuring the telnet feature for computers using a Windows® operating system.

HP recommends that the telnet client computer be a Windows-based system; however, there are other operating systems that support the telnet network protocol. For information about enabling and configuring the telnet network protocol for other operating systems, see the owner's manual for that operating system.

Enable the Windows telnet client

All computers using the Windows operating system have the telnet client installed, however, the telnet client function might not be enabled by default.

 **NOTE:** The figures and menus in this section are for the Windows 7 Enterprise® operating system. Screens and menu selections might vary slightly for other operating systems.

1. Use the **Start** menu to open the **Control Panel**, and then click the **Programs** item to select it.

Figure 2-4 Open the Control Panel

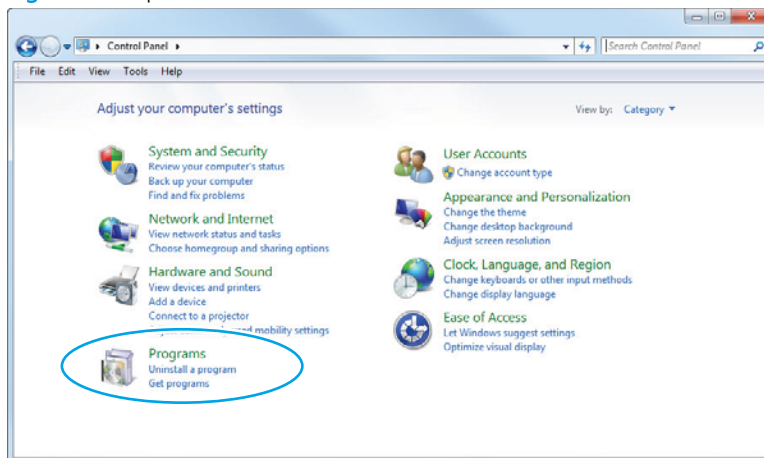

2. Click the **Turn Windows features on or off** item to select it.

Figure 2-5 Turn Windows features on or off

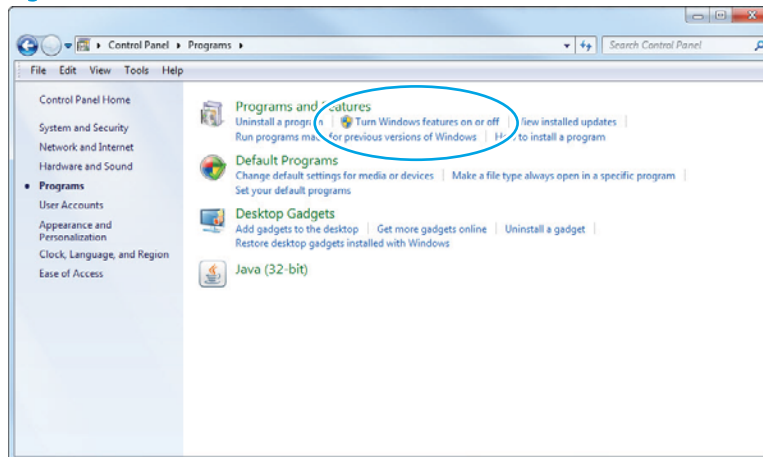

3. In the **Windows Features** box, scroll down to **Telnet Client**. If the check box is not checked, click the box to select it, and then click the **OK** button.

TIP: If the check box is already checked then the telnet client function is already enabled. Click the **Cancel** button.

Figure 2-6 Enable the telnet client feature

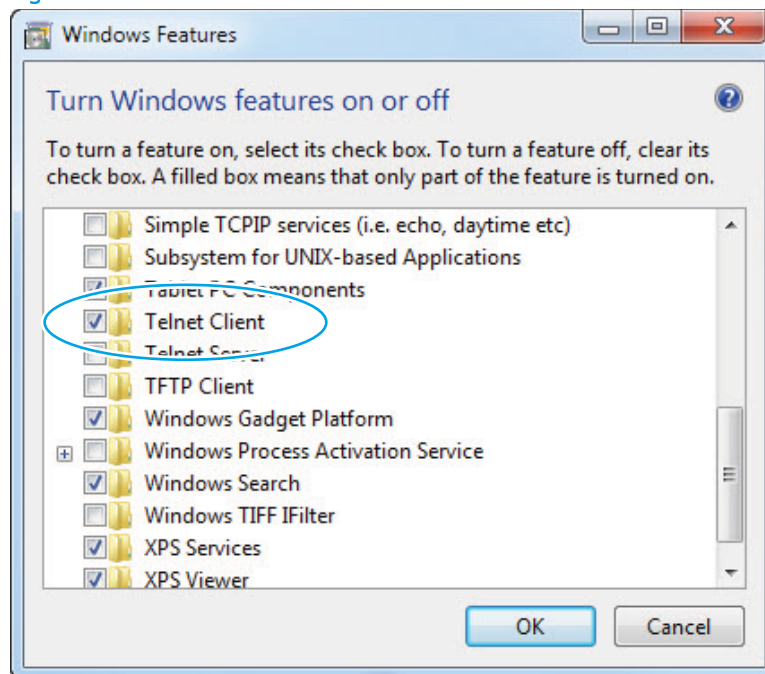

Network connection

The remote telnet client computer must have direct network access to the printer for the Remote Admin function to operate. This means that the telnet client computer must be on the same network as the printer.

The Remote Admin function cannot be accessed through a network firewall or other remote access network security programs.

If a private network is not accessible, ask the network administrator to set up a virtual private network (VPN) connection to the network.

Connect a remote connection

Use the following procedures to connect a remote connection.

- [Start the telnet server function at the printer](#)
- [Start the telnet client function at the remote computer](#)

Start the telnet server function at the printer

For security reasons the Remote Admin feature must be initiated by a person that is physically present at the printer. The following steps must be performed by a person that is physically present at the printer.

 **NOTE:** This person might need to sign in with an administrator or service password depending on how the printer is configured.

1. Turn the printer on.
2. The HP logo displays on the printer control panel. When a [1/8](#) with an underscore displays, touch the middle of the screen to open the [Pre-boot](#) menu.
3. Use the arrow buttons on the touchscreen to scroll down and highlight the [+3:Administrator](#) item, and then touch the [OK](#) button to select it.

Figure 2-7 Select the [+3:Administrator](#) item

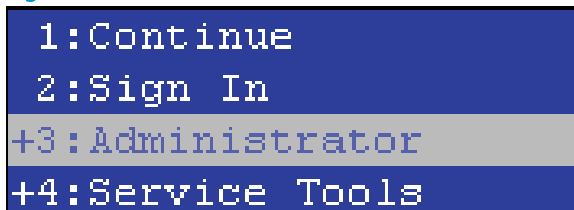

4. Use the arrow buttons on the touchscreen to scroll down and highlight the [+A:Remote Admin](#) item, and then touch the [OK](#) button to select it.

Figure 2-8 Select the [+A:Remote Admin](#) item

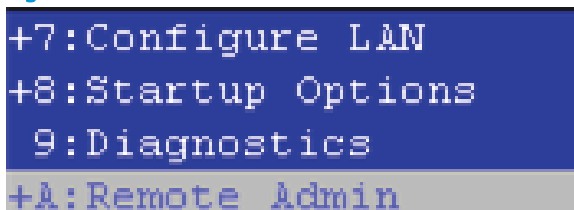

5. Use the arrow buttons on the touchscreen to scroll down and highlight the [1:Start Telnet](#) item, and then touch the [OK](#) button to select it.

Figure 2-9 Select the [1:Start Telnet](#) item

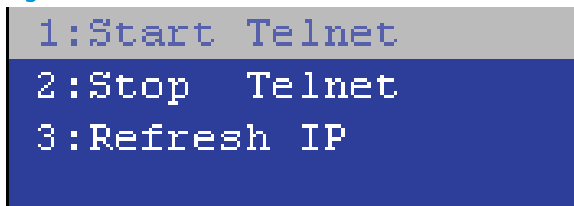

6. Do one of the following

- If a connecting message displays briefly, go to [7](#).

Figure 2-10 Telnet connecting message

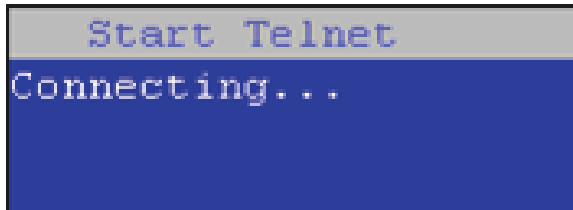

- If an error message displays, use the steps below to identify the problem.

Figure 2-11 Telnet error message

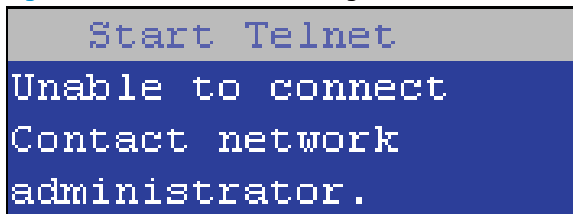

1. The printer network cable is not correctly connected.
 2. The BIOS LAN settings are incorrect.
 - The printer should be configured to use a static IP address, but is configured to use DHCP instead.
 - The printer is configured to use a static IP address, but the IP address is incorrect.
 3. The printer is correctly configured to use DHCP, but the DHCP server is not turned on or is malfunctioning.
7. When the printer telnet server function is initialized, the following screen appears. Use the information on this screen to connect the remote telnet client computer to the printer.

 **NOTE:** The printer is now ready to receive remote telnet client commands.

- **IP:** The static or dynamically allocated IP address for the printer.
- **Port:** The standard telnet port (23).
- **Pin:** A randomly generated 4-digit personal identification number (PIN).

Figure 2-12 Telnet server function initialized

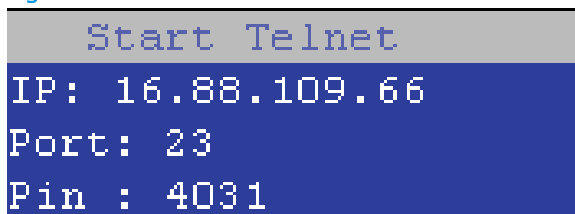

Start the telnet client function at the remote computer

The following steps establish a Remote Admin connection from a remote computer to the printer.

1. From the **Start** menu click **Run** to open a dialog box, type `cmd` in the **Open** field, and then click the **OK** button to open a Windows command window.

Figure 2-13 Open a command window

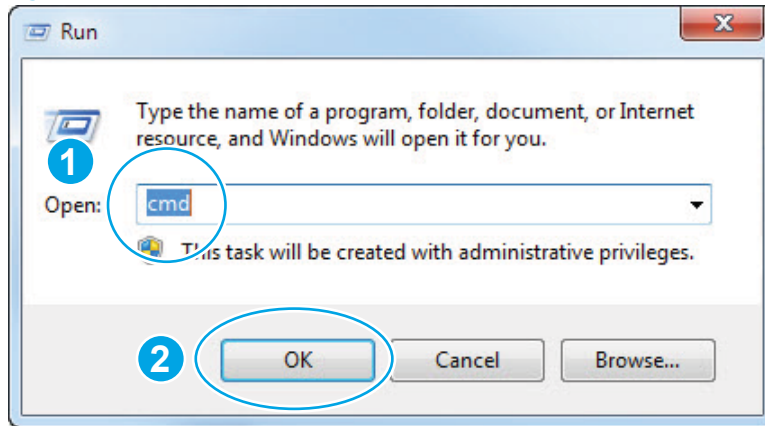

2. From any displayed directory, type `telnet` at the prompt, and then press the **Enter** key.

Figure 2-14 Start a telnet session

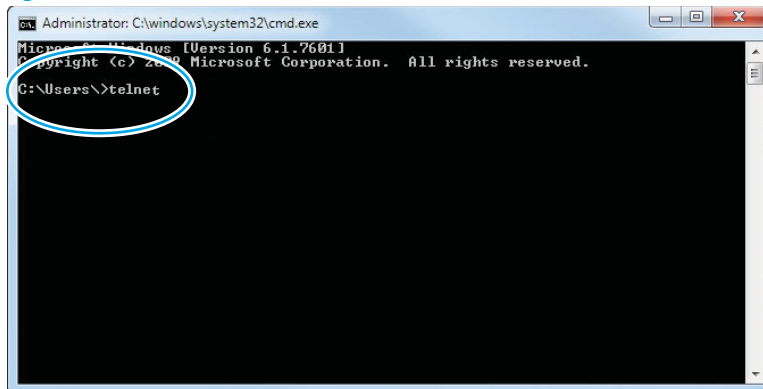

3. Type `<IP ADDRESS>` at the telnet prompt, and then press the **Enter** key.

 **NOTE:** For `<IP ADDRESS>`, substitute the IP address that was displayed in step 7 in "Start the telnet server function at the printer" in the *Troubleshooting Manual*.

 **TIP:** If the telnet connection fails to establish a connection, the printer is probably behind a firewall or on a different network than the remote telnet client computer. See "Network connection" in the *Troubleshooting Manual*.

Figure 2-15 Establish a telnet connection



4. Type the PIN that was displayed in step 7 in "Start the telnet server function at the printer" in the *Troubleshooting Manual* at the prompt, and then press the **Enter** key.

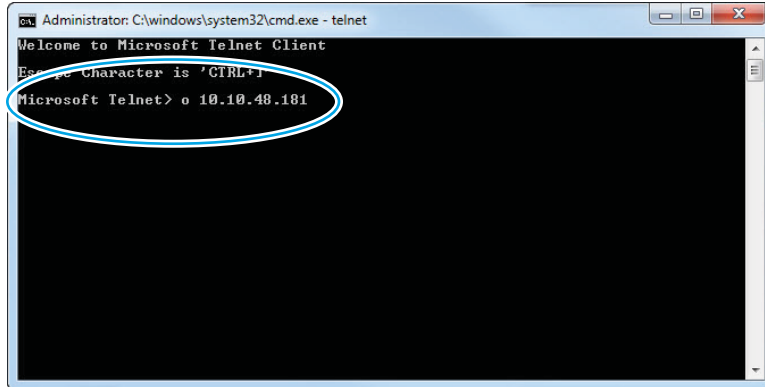

 **IMPORTANT:** Make sure to type the PIN correctly. After five incorrect PIN entries, the printer terminates the Remote Admin connection. The Remote Admin feature must be re-initiated at the printer. See "Start the telnet server function at the printer" in the *Troubleshooting Manual*.

Figure 2-16 Enter the PIN

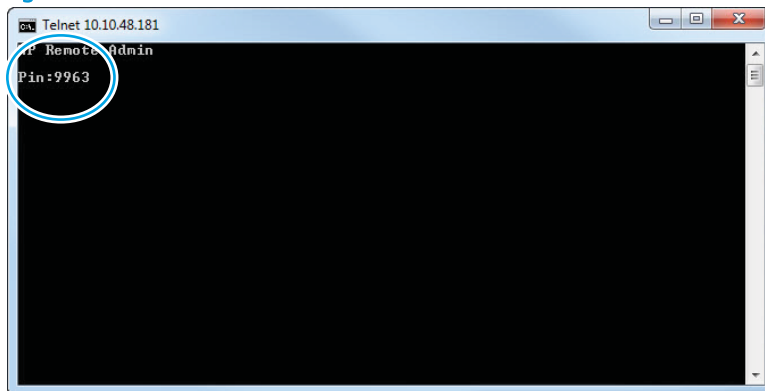

5. The following screen displays when the correct PIN is entered and the Remote Admin connection is successful. For information about the Pre-boot menu and options, see "Pre-boot menu options" in the *Troubleshooting Manual*.

 **NOTE:** Because a Remote Admin connection is an unsecure telnet network protocol connection, the following Pre-boot menu items are disabled for the remote telnet client computer.

- The **+3:Administrator** menu **4:Change Password** item.
 - The **+3:Administrator** menu **5:Clear Password** item.
 - The **+3:Administrator** menu **6:Disk Manage** item.
-

Figure 2-17 Remote Admin window

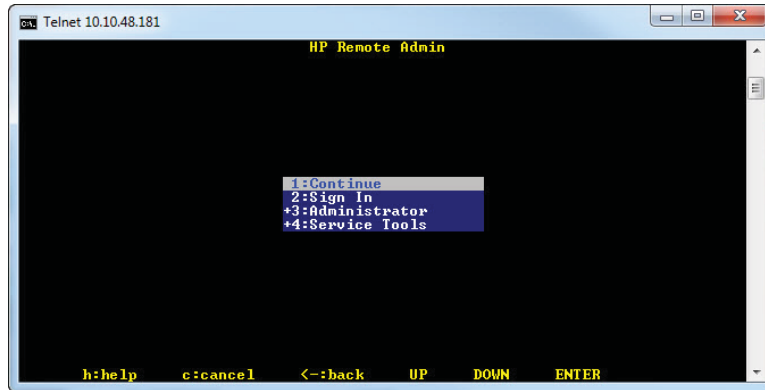

Disconnect a remote connection

The Remote Admin connection can be terminated from the printer control panel or the remote telnet client computer.

 **NOTE:** The following procedure describes terminating a Remote Admin connection from the remote telnet client computer.

1. From the Pre-boot main menu, use the arrow buttons on the keyboard to scroll down to the **+3:Administrator** item, and then press the **Enter** key.

Figure 2-18 Access the administrator menu

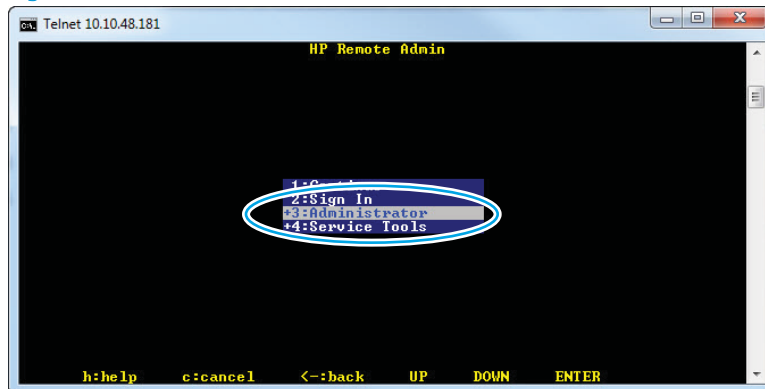

2. Use the arrow buttons on the keyboard to scroll down to the **+A:Remote Admin** item, and then press the **Enter** key.

Figure 2-19 Access the remote admin menu

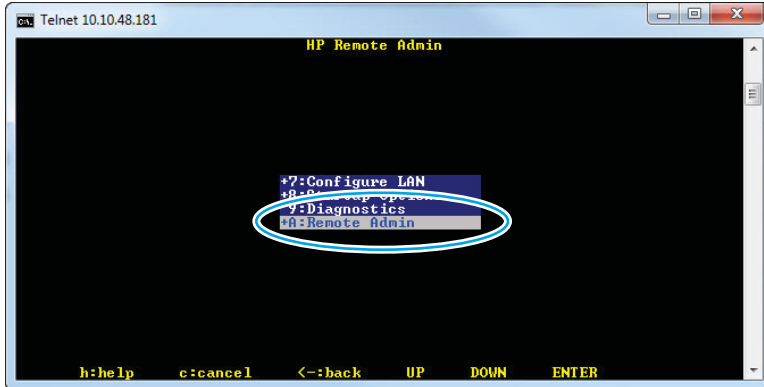

3. Use the arrow buttons on the keyboard to scroll down to the **2:Stop Telnet** item, and then press the **Enter** key. The Remote Admin connection between the printer and the remote telnet client computer terminates.

 **IMPORTANT:** The printer remains in the Pre-boot menu. Have the person that is physically present at the printer do the following:

- Touch the **Home** button to return to the main Pre-boot menu and highlight the **1:Continue** item, and then touch the **OK** button. The printer will continue to initialize.

Figure 2-20 Terminate the telnet connection

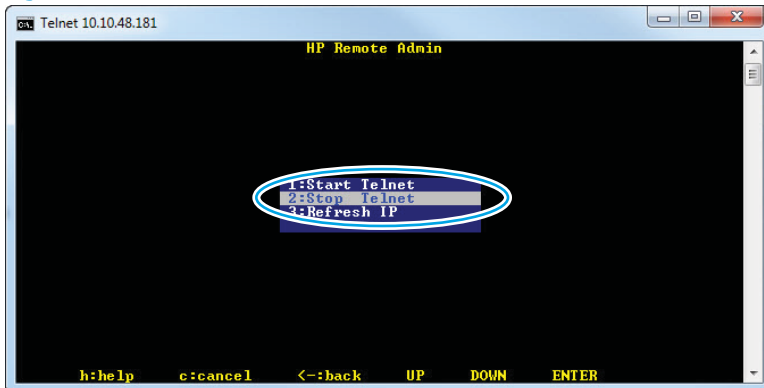

Print the event log

Printing the event log might be helpful in the troubleshooting process.

- [Print the event log from the Administration menu \(FutureSmart 3\) or Support Tools menu \(FutureSmart 4\) from a touchscreen control panel](#)
- [Print the event log from the Administration menu \(FutureSmart 3\) or Support Tools menu \(FutureSmart 4\) from a LCD control panel](#)
- [Print the event log from the Service menu from a touchscreen control panel](#)
- [Print the event log from the Service menu from a LCD control panel](#)
- [Clear the event log from a touchscreen control panel](#)
- [Clear the event log from a LCD control panel](#)

For more information, see the interpret control-panel messages and event log entries topics in the printer *Troubleshooting Manual*.

Print the event log from the Administration menu (FutureSmart 3) or Support Tools menu (FutureSmart 4) from a touchscreen control panel

Use the following procedure to print the event log from the [Administration](#) menu from a touchscreen control panel.

1. From the [Home](#) screen on the printer control panel, scroll to and touch the [Administration](#) button (FutureSmart 3), or touch the [Support Tools](#) button (FutureSmart 4).
2. Open the following menus:
 - [Troubleshooting](#)
 - [Event Log](#)
3. The event log displays on the screen. To print it, touch the [Print](#) button.

Print the event log from the Administration menu (FutureSmart 3) or Support Tools menu (FutureSmart 4) from a LCD control panel

Use the following procedure to print the event log from the [Administration](#) menu (FutureSmart 3) or the [Support Tools](#) menu (FutureSmart 4) from a LCD control panel.

FutureSmart 3

1. From the [Home](#) screen on the printer control panel, use the down arrow ▼ button to scroll to [Administration](#), and then press the [OK](#) button.
2. Use the down arrow ▼ button to scroll to [Troubleshooting](#), and then press the [OK](#) button.
3. If necessary, use the down arrow ▼ button to scroll to [Print Event Log](#), and then press the [OK](#) button to print the page.

FutureSmart 4

1. From the [Home](#) screen on the printer control panel, use the arrow keys to navigate to [Support Tools](#), and then select [OK](#).
2. Select [Troubleshooting](#), and then select [OK](#).
3. Select [Event Log](#).
4. Use the down arrow ▼ to scroll down to [Cancel](#), and then use the right arrow ► to highlight the print icon . Select [OK](#) to print the pages.

 **TIP:** Multiple report pages can be selected, and then printed together.

Print the event log from the Service menu from a touchscreen control panel

Use the following procedure to print the event log from the [Service](#) menu from a touchscreen control panel.

1. From the [Home](#) screen on the printer control panel, scroll to and touch the [Device Maintenance](#) button (FutureSmart 3), or touch the [Support Tools](#) button (FutureSmart 4).
2. Open the [Service](#) menu.
3. On the sign-in screen, select the [Service Access Code](#) option from the drop-down list.
4. Enter the following service access code for the printer:
 - 10050615 (M506/E50045/M507/E50145)
 - 11052715 (M527/E52545/M528/E52645)
5. Touch the [Print Event Log](#) item.

Print the event log from the Service menu from a LCD control panel

Use the following procedure to print the event log from the [Service](#) menu from a LCD control panel.

FutureSmart 3

1. From the [Home](#) screen on the printer control panel, use the down arrow ▼ button to scroll to [Device Maintenance](#), and then press the [OK](#) button.
2. Use the down arrow ▼ button to scroll to [Service](#), and then press the [OK](#) button.
3. On the sign-in screen, use the down arrow ▼ button to scroll to [Service Access Code](#) option and then press the [OK](#) button.
4. Enter the following service access code for the printer:
 - 10050615 (M506/E50045/M507/E50145)
 - 11052715 (M527/E52545/M528/E52645)
5. If necessary, use the down arrow ▼ button to scroll to [Print Event Log](#), and then press the [OK](#) button to print the page.

FutureSmart 4

1. From the [Home](#) screen on the printer control panel, use the arrow keys to navigate to [Support Tools](#), and then select [OK](#).
2. Select [Service](#), and then select [OK](#).
3. On the sign-in screen, select Service Access Code from the drop-down list.
4. Enter the following service access code for the printer:
 - 10050615 (M506/E50045/M507/E50145)
 - 11052715 (M527/E52545/M528/E52645)
5. Select [Event Log](#).
6. Use the down arrow ▼ to scroll down to [Cancel](#), and then use the right arrow ► to highlight the print icon . Select [OK](#) to print the pages.

Clear the event log from a touchscreen control panel

Use the following procedure to clear the event log from a touchscreen control panel.

1. From the [Home](#) screen on the printer control panel, scroll to and touch the [Device Maintenance](#) button (FutureSmart 3), or touch the [Support Tools](#) button (FutureSmart 4).
2. Open the [Service](#) menu.
3. On the sign-in screen, select the [Service Access Code](#) option from the drop-down list.
4. Enter the following service access code for the printer:
 - 10050615 (M506/E50045/M507/E50145)
 - 11052715 (M527/E52545/M528/E52645)
5. Select the [Clear Event Log](#) item, and then touch the [OK](#) button.

Clear the event log from a LCD control panel

Use the following procedure to clear the event log from a LCD control panel.

FutureSmart 3

1. From the [Home](#) screen on the printer control panel, use the down arrow ▼ button to scroll to [Device Maintenance](#), and then press the [OK](#) button.
2. Use the down arrow ▼ button to scroll to [Service](#), and then press the [OK](#) button.
3. On the sign-in screen, use the down arrow ▼ button to scroll to [Service Access Code](#) option and then press the [OK](#) button.
4. Enter the following service access code for the printer:
 - 10050615 (M506/E50045/M507/E50145)
 - 11052715 (M527/E52545/M528/E52645)
5. If necessary, use the down arrow ▼ button to scroll to [Clear Event Log](#), and then press the [OK](#) button.

FutureSmart 4

1. From the [Home](#) screen on the printer control panel, use the arrow keys to navigate to [Support Tools](#), and then select [OK](#).
2. Select [Service](#), and then select [OK](#).
3. On the sign-in screen, select Service Access Code from the drop-down list.
4. Enter the following service access code for the printer:
 - 10050615 (M506/E50045/M507/E50145)
 - 11052715 (M527/E52545/M528/E52645)
5. Select [Event Log](#).
6. Use the down arrow ▼ to scroll down to [Cancel](#), and then use the right arrow ► to highlight the trash can icon . Select [OK](#) to clear the event log.

Troubleshooting process

Review the following information about the troubleshooting process.

- [Determine the problem source](#)
- [Power subsystem](#)
- [Control panel checks \(M501\)](#)
- [Control panel checks \(all except M501\)](#)

Determine the problem source

When the printer malfunctions or encounters an unexpected situation, the printer control panel alerts the user to the situation.

- [Pre-troubleshooting checklist](#)
- [Troubleshooting flowchart](#)

This section contains a pre-troubleshooting checklist and a troubleshooting flow chart to filter out many possible causes of the problem.

- Use the pre-troubleshooting check list to gather information about the problem from the customer.
- Use the troubleshooting flowchart to pinpoint the root cause of hardware malfunctions. The flowchart guides you to the section of this chapter that contains steps for correcting the malfunction.

Before beginning any troubleshooting procedure, check the following issues:

- Are supply items within their rated life?
- Does the configuration page reveal any configuration errors?



NOTE: The customer is responsible for checking supplies and for using supplies that are in good condition.

Pre-troubleshooting checklist

The following table includes basic questions to ask the customer to quickly help define the problem(s).

Table 2-8 Pre-troubleshooting checklist

General topic	Questions
Environment	<ul style="list-style-type: none">• Is the printer installed on a solid, level surface (+/- 1°)?• Is the power-supply voltage within ± 10 volts of the specified power source?• Is the power-supply plug inserted in the printer and the wall outlet (not a surge protector)?• Is the operating environment within the specified parameters?• Is the printer exposed to ammonia gas, such as that produced by diazo copiers or office cleaning materials? NOTE: Diazo copiers produce ammonia gas as part of the copying processes. Ammonia gas (from cleaning supplies or a diazo copier) can have an adverse effect on some printer components (for example, the toner cartridge or cartridges OPC).• Is the printer exposed to direct sunlight?• Is the printer exposed to an air conditioning or heating vent that can cause temperature fluctuations?
Media	<ul style="list-style-type: none">• Does the customer use only supported media?• Is the media in good condition (no curls, folds, or distortion)?• Is the media stored correctly and within environmental limits?

Table 2-8 Pre-troubleshooting checklist (continued)

General topic	Questions
Input trays	<ul style="list-style-type: none"> • Is the amount of media in the tray within specifications? • Is the media correctly placed in the tray? • Are the paper guides aligned with the stack (no gaps in the stack or excessive pressure causing the stack to bow)? • Is the tray (or trays) correctly installed in the printer?
Toner cartridge	<ul style="list-style-type: none"> • Is the toner cartridge (or cartridges) installed correctly?
Transfer unit and fuser	<ul style="list-style-type: none"> • Are the transfer unit and fuser installed correctly? <p>NOTE: For printers with an intermediate transfer belt (ITB), is the ITB installed correctly and fully seated. If a replacement ITB was installed, was all of the packing materials removed?</p>
Covers	<ul style="list-style-type: none"> • Is the toner cartridge door closed?
Condensation	<ul style="list-style-type: none"> • Does condensation occur following a temperature change (particularly in winter following cold storage)? If so, wipe affected parts dry or leave the printer on for 10 to 20 minutes. • Was a toner cartridge (or cartridges) opened soon after being moved from a cold to a warm room? If so, allow the toner cartridge (or cartridges) to sit at room temperature for 1 to 2 hours.
Miscellaneous	<ul style="list-style-type: none"> • Check for and remove any non-HP components (toner cartridges, memory modules, and EIO cards) from the printer. • Remove the printer from the network and ensure that the failure is associated with the printer before beginning troubleshooting. • For any color print-quality issues (color printers only), calibrate the printer, and then print a diagnostics page to verify print quality.

Troubleshooting flowchart

This flowchart highlights the general processes to follow to quickly isolate and solve printer hardware problems.

Each row depicts a major troubleshooting step. Follow a “yes” answer to a question to proceed to the next major step. A “no” answer indicates that more testing is needed. Go to the appropriate section in this chapter, and follow the instructions there. After completing the instructions, go to the next major step in this troubleshooting flowchart.

Table 2-9 Troubleshooting flowchart

Step	Question	Action
1 Power on	Is the printer on and does a readable message display?	Follow the power-on troubleshooting checks. See "Power subsystem" in the <i>Troubleshooting Manual</i> . After the control panel display is functional, see step 2.
	Yes ↓ No →	

Table 2-9 Troubleshooting flowchart (continued)

Step	Question	Action
2 Control panel messages	Does the message Ready display on the control panel?	
	Yes ↓ No →	After the errors have been corrected, go to step 3.
3 Event log	Open the Troubleshooting menu and print an event log to see the history of errors with this printer. Does the event log print?	
	Yes ↓ No →	<p>If the event log does not print, check for error messages.</p> <p>If paper jams inside the printer, see the jams section of the printer service manual.</p> <p>If error messages display on the control panel when trying to print an event log, see the control panel message section of the printer troubleshooting service manual.</p> <p>After successfully printing and evaluating the event log, see step 4.</p>
4 Information pages	Open the Reports menu and print the configuration pages to verify that all the accessories are installed. Are all the accessories installed?	
	Yes ↓ No →	<p>If accessories that are installed are not listed on the configuration page, remove the accessory and reinstall it.</p> <p>After evaluating the configuration pages, see step 5.</p>
5 Print quality	Does the print quality meet the customer's requirements?	
	Yes ↓ No →	<p>Compare the images with the sample defects in the image defect tables. See the images defects table in the printer repair service manual.</p> <p>After the print quality is acceptable, see step 6.</p>

Table 2-9 Troubleshooting flowchart (continued)

Step	Question	Action
6 Interface	Can the customer print successfully from the host computer?	Verify that all I/O cables are connected correctly and that a valid IP address is listed on the HP Jetdirect configuration page. If error messages display on the control panel when trying to print an event log, see the control-panel message section of the printer troubleshooting service manual. When the customer can print from the host computer, this is the end of the troubleshooting process.
	Yes. This is the end of the troubleshooting process.	
	No →	

Power subsystem

Review the following information about the power subsystem.

- [Power-on checks](#)

Power-on checks

The basic printer functions should start up when the printer is connected into an electrical outlet and the power switch is pushed to the *on* position. If the printer does not start, use the information in this section to isolate and solve the problem.

- [Power-on troubleshooting overview](#)

If the control panel display remains blank, random patterns display, or asterisks remain on the control panel display, perform power-on checks to find the cause of the problem.



NOTE: For touchscreen control panel models, also try the control panel checks in the printer troubleshooting manual.

Power-on troubleshooting overview

During normal operation, cooling fans begins to spin briefly after the printer power is turned on. Place a hand over the vents in the right- and left-side covers. Lean close to the printer to hear the fans operating. If the fan are operating, the dc side of the power supply is functioning.

- [Troubleshooting power on problems](#)
- [Troubleshooting a blank control panel](#)

If the fans are operating correctly, the next troubleshooting step is to isolate print engine, formatter, and control panel problems. Perform an engine test. If the formatter is damaged, it might interfere with the engine test. If the engine-test page does not print, try removing the formatter, and then performing the engine test again. If the engine test is then successful, the problem is almost certainly with the formatter, the control panel, or the cable that connects them.

 **NOTE:** Depressing, and holding down, the test-page switch causes the printer to continually print test pages. Releasing the switch stops the test page continuous printing.

Troubleshooting power on problems

Use the following procedure to troubleshoot power on problems.

1. Verify that power is available to the printer. If the printer is plugged into a surge protector or uninterruptible power supply (UPS), remove it, and then plug the printer directly into a known operating wall receptacle (make sure that the wall receptacle provides the correct voltage and current for the printer).

Unplug any other devices on the same circuit that the printer is using.

2. Try another known operating wall receptacle and a different power cord.
3. Listen for startup noises (for example, fans or motors) and look for illuminated lights on the control panel and formatter LEDs.

 **NOTE:** Operational fans, motors, and control-panel lights indicate the following:

- AC power is present at the printer.
 - The power supply is providing either or both 24 Vdc and 5 Vdc voltages.
 - The DC controller microprocessor is functioning.
-

4. Check the following:
 - a. Turn the printer on, and then listen for startup noises. If normal startup noises are heard, go to step c below.
 - b. If normal startup noises are not heard, turn the printer off, and then remove any installed accessories (for example, envelope feeders, paper feeders, or output accessories).

Turn the printer on, and then listen for startup noises. If normal startup noises are heard, the problem might be with one of the accessories.
 - c. Turn the printer off and then remove the power connector from the formatter. Turn the printer on, and then use a small pointed object (like a paper clip) to depress the test-page switch located on the rear side of the printer (near the formatter).

 **NOTE:** The test page can only use Tray 2 as the paper source, so make sure that paper is loaded in Tray 2.



- d. If the engine test page prints, the print engine is operating normally. Replace the formatter.

 **NOTE:** M506/E50045/M507/E50145 (all) and M527dn/E52545dn/M528dn/E52645dn models only: If the engine test page does not print, turn the printer off, remove the embedded MultiMedia Card (eMMC), and then try the engine test again. If the page prints, the problem might be the eMMC.

- e. If after replacing the formatter normal startup noises are still not heard, replace the DC controller.

 **NOTE:** If the error persists after replacing these assemblies, escalate the problem to the Global Business Unit (GBU).

Troubleshooting a blank control panel

A blank control panel display can be caused by one or more of the following:

1. Verify that power is available to the printer. If the printer is plugged into a surge protector or uninterruptible power supply (UPS), remove it, and then plug the printer directly into a known operating wall receptacle (make sure that the wall receptacle provides the correct voltage and current for the printer).
2. Make sure that the power switch is in the *on* position.
3. Make sure that the fans run briefly, which indicates that the power supply is operational.
4. Make sure that the control-panel display wire harness is connected.
5. Make sure that the formatter connectors are fully seated. Make sure the power switch is in the on position, and then verify that the heartbeat LED is blinking and that the connectivity LED is illuminated.
6. Remove any external solutions, and then try to turn the printer on again.
7. If the control panel display is blank, but the cooling fans run briefly after the printer power is turned on, try printing an engine-test page to determine whether the problem is with the control panel display, formatter, or other printer assemblies.

- a. Remove the formatter.
- b. Use a small pointed object to depress the test-page switch located on the rear of the printer.

 **NOTE:** The test page can only use Tray 2 as the paper source, so make sure that paper is loaded in Tray 2.







- c. If the engine test page prints, the print engine is operating normally (a failed engine test print page does not necessarily indicate that the print engine or DC controller is defective).
 - d. Use the control panel diagnostics to test the control panel. See the control panel checks section in the printer troubleshooting manual. If the error persists, proceed to [8](#).
8. If the print engine appears to be correctly operating (the engine test page successfully printed) and the control panel is still blank, replace the power supply.
 9. If after replacing the power supply normal startup noises and lights are still not present, replace the DC controller.

 **NOTE:** If the error persists after replacing these assemblies, escalate the problem to the Global Business Unit (GBU).

Control panel checks (M501)

The printer includes diagnostic tests for the control panel. This mode allows for troubleshooting issues with the LEDs (2-line control panels), display, and the buttons.

1. Open the secondary service menu.
 - a. From the printer control panel, press the setup  button to open the main menu.
 - b. Press and the down arrow  button, and then quickly press the Cancel  button.
 - c. Press the setup  button. The message **2ndary Service** appears on the control-panel display.
 - d. Press the **OK** button to open the **2ndary Service** menu.



NOTE: Use the arrow buttons to scroll through the **2ndary Service** menu.

2. Select one of the following tests:

- **LED test:** Test the LED lights on 2-line control panels. The touchscreen control panels do not have any LEDs.
- **Display Test:** Test the control panel display.
- **Button Test:** Test the control panel buttons.

Control panel checks (all except M501)

Review the following information about control panel checks.

- [Control panel diagnostics \(M506x/M507x and M527/E52545/M528/E52645\)](#)



NOTE: The printer includes a diagnostic test mode for the touchscreen control panels. Diagnostic tests are not available for the LCD control panel.

Control panel diagnostics (M506x/M507x and M527/E52545/M528/E52645)

Review the following information about the control panel diagnostics.

- [Touchscreen diagnostic mode \(M506x, M527/E52545/M528/E52645\)](#)
- [Touchscreen diagnostic mode \(M507x and E50145dn\)](#)
- [Control panel system diagnostics \(M506x/M507x, M527/E52545/M528/E52645\)](#)
- [Control panel diagnostic flowcharts \(M506x/M507x, M527/E52545/M528/E52645\)](#)

Touchscreen diagnostic mode (M506x, M527/E52545/M528/E52645)

Use the diagnostics in this section to test the control panel hardware and embedded firmware.

These tests are useful for checking control panel functionality independent of the printer control panel system diagnostics. To test the control panel using the system diagnostics, see "Control panel system diagnostics (M506x/M507x, M527/E52545/M528/E52645)" in the *Troubleshooting Manual*.

1. **M506x only:** Locate the diagnostic-tests access button on the back of the control panel.

Figure 2-21 Diagnostic-tests access button (M506x)



2. **M506x only:** Press the diagnostics-access button. Repeatedly pressing the button cycles through the available diagnostics.

 **NOTE:** A pen, pencil, or other small blunt object is needed to press the button.

 **TIP:** When pressed, the button illuminates green.

Figure 2-22 Press the diagnostics-access button (M506x)



3. **M527/E52545/M528/E52645 only:** Locate the diagnostic-tests access button on the back of the control panel.

Figure 2-23 Diagnostic-tests access button (M527/E52545/M528/E52645)



4. **M527/E52545/M528/E52645 only:** Press the diagnostics-access button. Repeatedly pressing the button cycles through the available diagnostics.

Figure 2-24 Press the diagnostics-access button (M527/E52545/M528/E52645)



5. A yellow screen appears (after the first press of the button) indicating that the control panel firmware is version A (a magenta screen indicates version B firmware).

 **NOTE:** If a different color appears on the screen, contact your global business unit (GBU) to determine the firmware version.

 **TIP:** After 4 seconds of inactivity, the diagnostic mode times out and is exited.

Figure 2-25 Control panel version A yellow screen



6. Touch the screen to cycle the screen through the following:
 - A red screen.

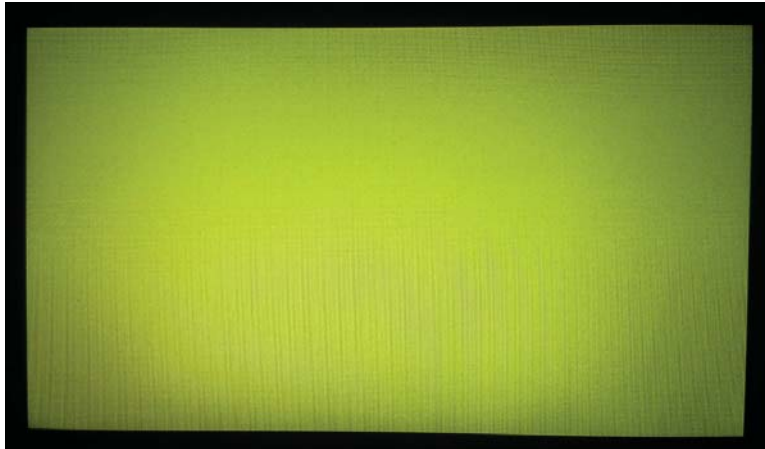
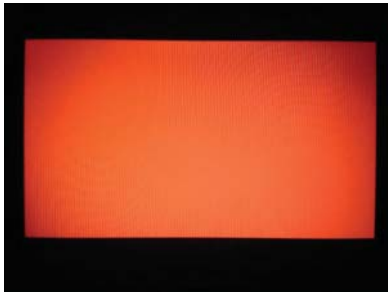

- A green screen.

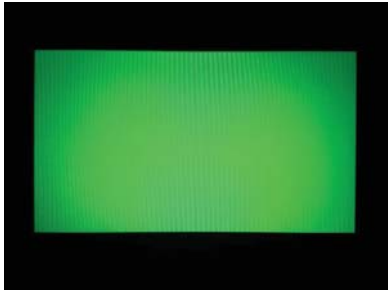

- A blue screen.



- Five brightness levels of a white screen.

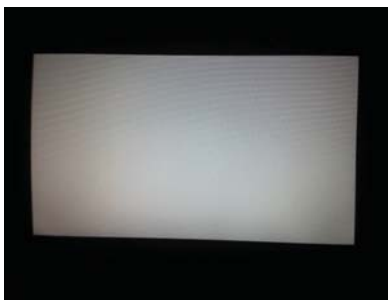

- A final black screen.

 **TIP:** When the final black screen displays, press the Home button to cycle through the diagnostic screens and test its functionality.



7. Pressing the diagnostic-tests button with the black screen displayed exits the diagnostic mode.

Figure 2-26 Exit the diagnostic mode

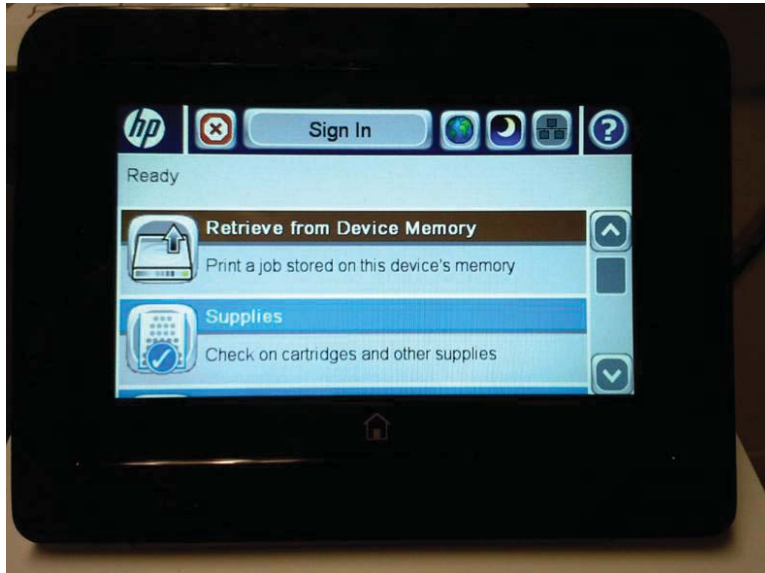

Touchscreen diagnostic mode (M507x and E50145dn)

Use the diagnostics in this section to test the control panel hardware and embedded firmware.

These tests are useful for checking control panel functionality independent of the printer control panel system diagnostics. To test the control panel using the system diagnostics, see "Control panel system diagnostics (M506x/M507x, M527/M528/E52645)" in the Troubleshooting Manual.

1. **M507x and E50145dn only:** Locate the diagnostic-tests access button on the back of the control panel.

Figure 2-27 Diagnostic-tests access button (M507x and E50145dn)



2. Press the diagnostics-access button to enter the diagnostic mode.

 **NOTE:** A pen, pencil, or other small blunt object is needed to press the button.

 **TIP:** When pressed, the button illuminates green.

Figure 2-28 Press the diagnostics-access button (M507x and E50145dn)



Repeatedly pressing the button cycles through different brightness levels on the touchscreen control panel.

3. To exit the diagnostic mode, wait approximately five seconds. The diagnostic mode automatically ends, and the touchscreen control panel returns to normal mode.

Control panel system diagnostics (M506x/M507x, M527/E52545/M528/E52645)

Use the diagnostics in this section to test the control panel hardware and display using the printer firmware system diagnostics.

- [Open the control panel system diagnostic tests](#)
- [Screen test](#)
- [Touch test](#)
- [SoftKey test](#)
- [Backlight test](#)
- [Sound test](#)
- [Keyboard test \(M527c/z, E52545c, M528c/z, E52645c only\)](#)
- [Version](#)

Open the control panel system diagnostic tests

Use the following procedure to open the control panel system diagnostics tests from a touchscreen control panel.

1. Turn the printer power off, and then on again.
2. Touch the middle of the control panel display when you see the 1/8 under the logo.



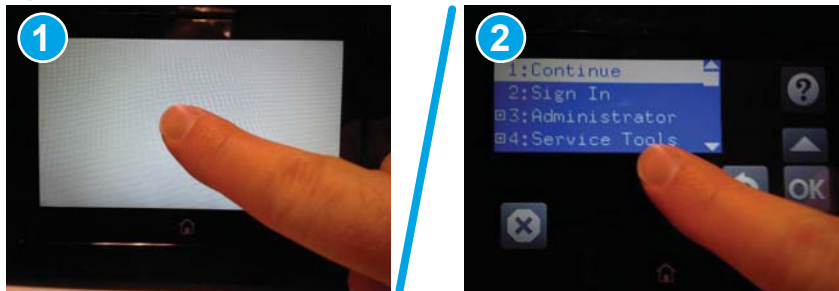



Figure 2-29 Open the Pre-boot menu



- On the **Pre-boot** menu screen, use the following buttons to navigate the tests.

Figure 2-30 Pre-boot menu



Button	Description
	Use this button to see more information about a selected item.
	Use this button to scroll up through menu items.
	Use this button to select a highlighted menu item.
	Use this button to scroll down through menu items.
	Use this button to go back to the previous menu.
	Not used.
	Use this button to exit a diagnostic test.

4. Use the **down arrow** ▼ button to scroll to **+3 Administration**, and then press the **OK** button to select it.

Figure 2-31 Access the administration menu

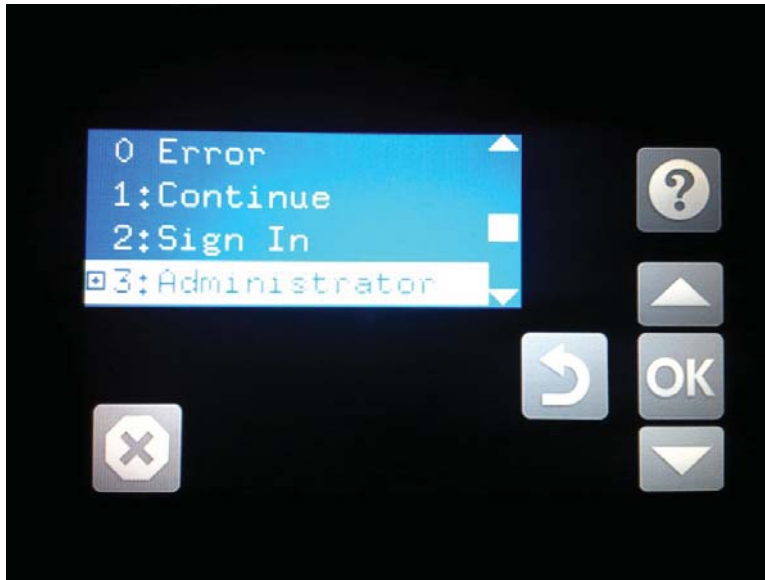

5. Use the **down arrow** ▼ button to scroll to **+E CP Diagnostics**, and then press the **OK** button to select it.

 **NOTE:** An administrator password might be required to continue.

Figure 2-32 Access the diagnostics menu



Screen test

Use the following procedure to perform a screen test.

1. Open the control panel system diagnostic tests. See "Open the control panel systems diagnostic tests" in the Troubleshooting Manual.

2. With 1 Screen Test highlighted, press the OK button to select it.

Figure 2-33 Open the screen test

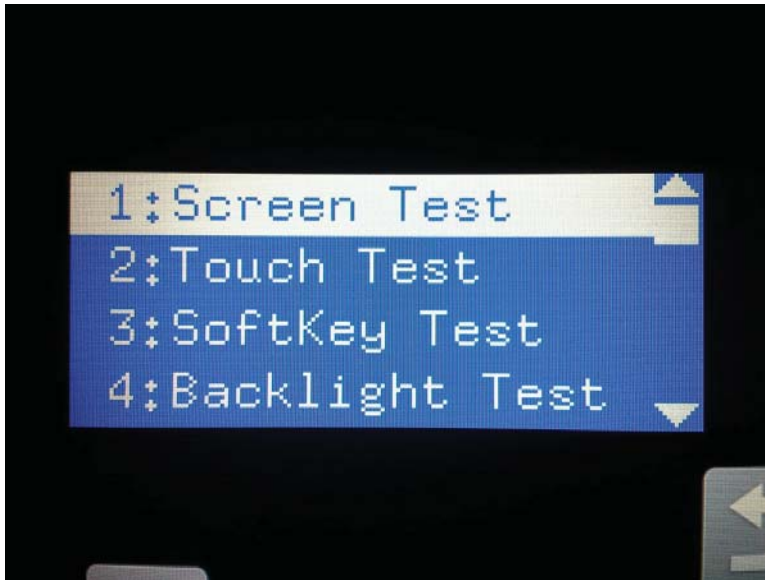

The blue vertical gradient screen appears.

Figure 2-34 Blue vertical gradient screen

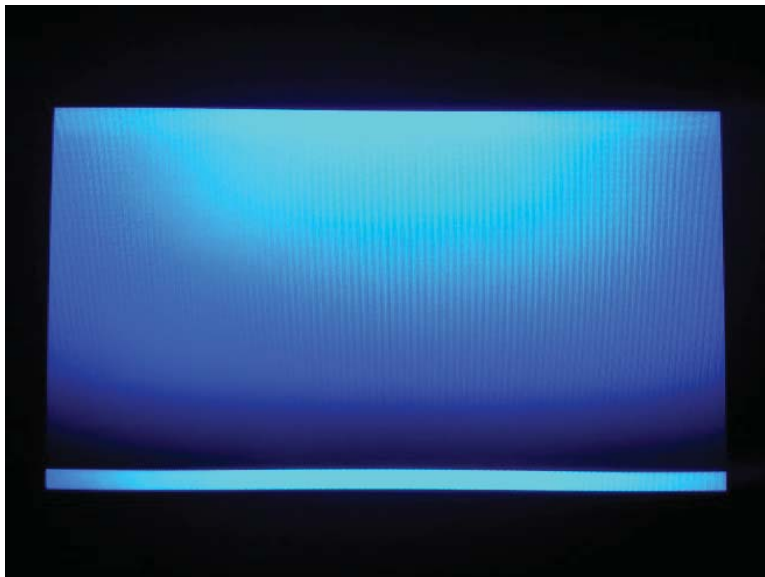

3. Touch the touchscreen to scroll through the remaining touchscreen test screens.

 **NOTE:** Touch the Home button to exit the test.

Table 2-10 Touchscreen test screens







Screen	Description
	Green vertical gradient
	Red vertical gradient
	Blue horizontal gradient
	Green horizontal gradient
	Red horizontal gradient
	Blue with black horizontal interlaced

Table 2-10 Touchscreen test screens (continued)

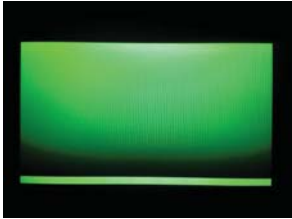
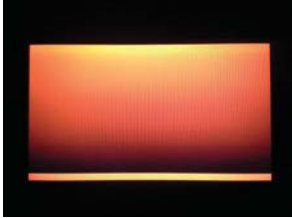
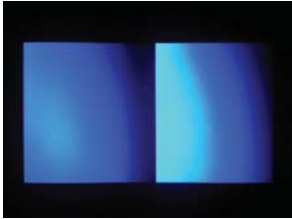
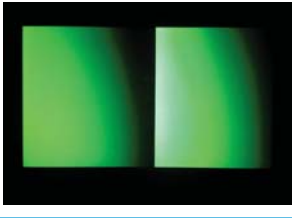
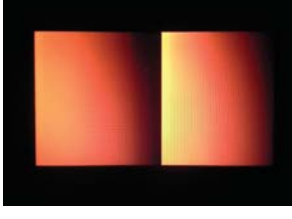
Screen	Description
	Green with black horizontal interlaced
	Red with black horizontal interlaced
	Blue with black vertical interlaced
	Green with black vertical interlaced
	Red with black vertical interlaced
	Black with white center

Table 2-10 Touchscreen test screens (continued)

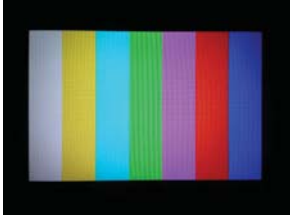
Screen	Description
	White with black center
	Checkerboard
	Multicolor stripes
	Blue green grid meshing

Touch test

Use the following procedure to perform a touch test.

1. Open the control panel system diagnostic tests. See "Open the control panel systems diagnostic tests" in the Troubleshooting Manual..

2. Use the [down arrow ▼](#) button to scroll to [2 Touch Test](#), and then press the [OK](#) button to select it.

[Figure 2-35](#) Open the touch test

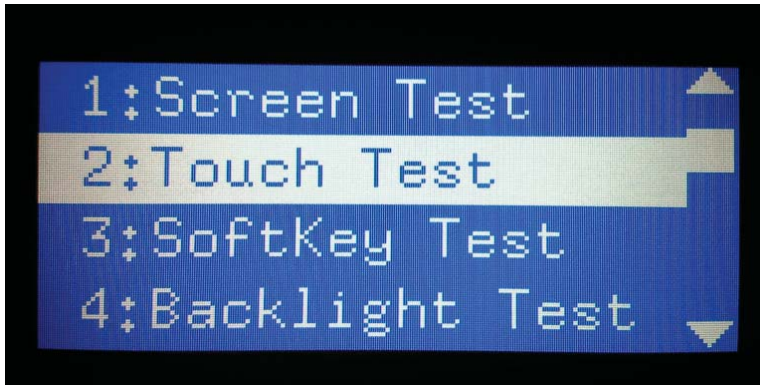

3. Use your finger to touch the white grid on the display.

Figure 2-36 Touch the white grid

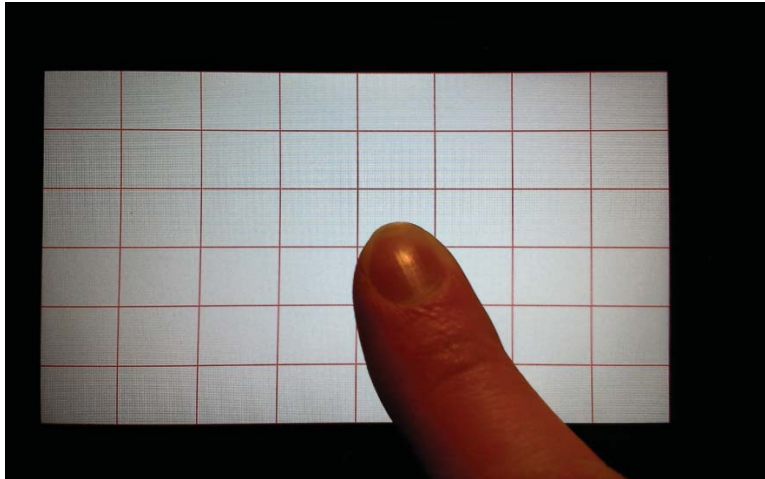

A mark appears on the grid where it was touched.

 **NOTE:** Touch the Home button to exit the test.

Figure 2-37 Verify the mark



SoftKey test

Use the following procedure to perform a SoftKey test.

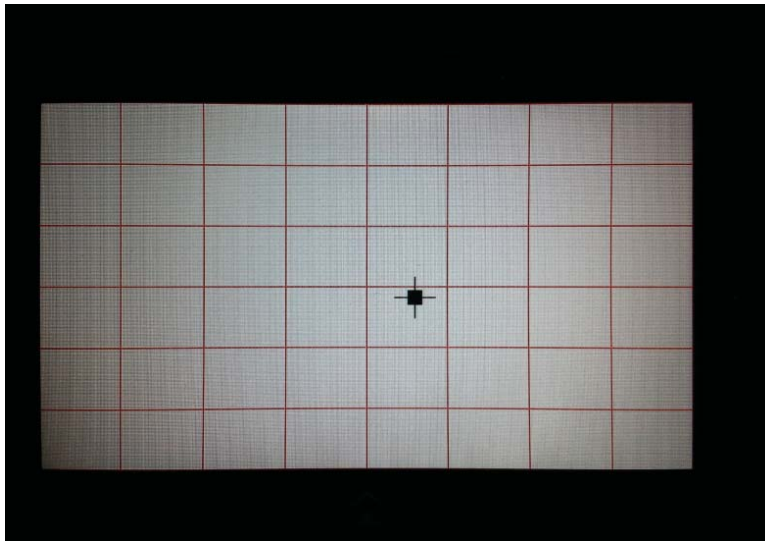
1. Open the control panel system diagnostic tests. See "Open the control panel systems diagnostic tests" in the Troubleshooting Manual.

2. Use the **down arrow ▼** button to scroll to **3 SoftKey Test**, and then press the **OK** button to select it.

Figure 2-38 Open the softkey test

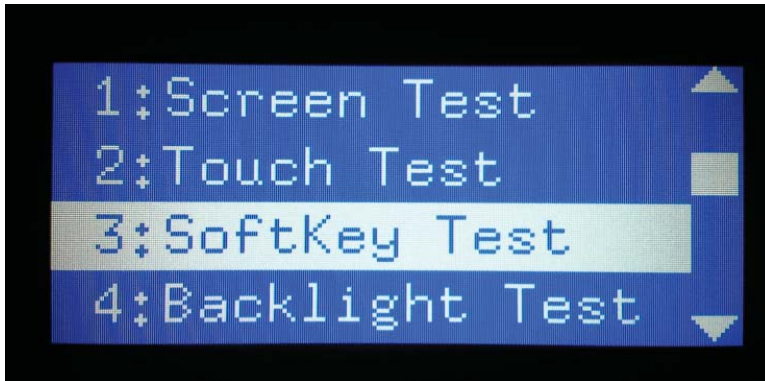

3. When prompted, touch the Home button.

Figure 2-39 Touch the Home button

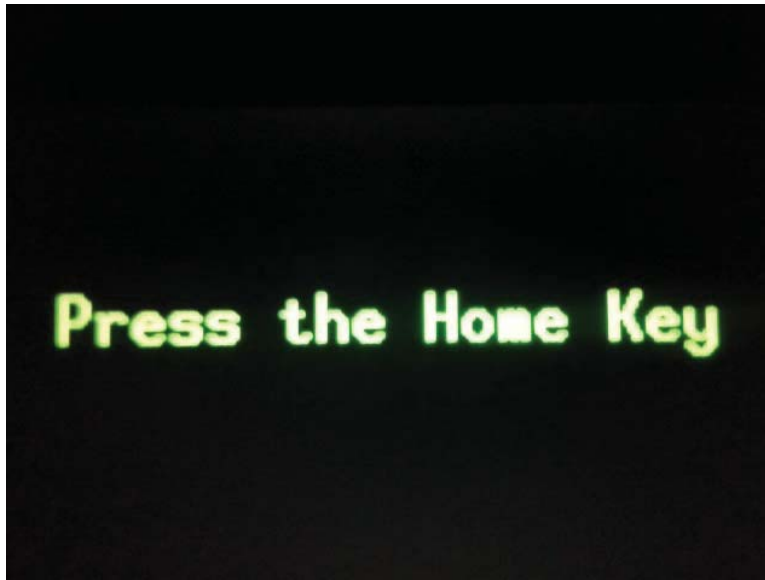

If the test is successful, the following screen appears on the display.

 **NOTE:** Touch the screen to exit the test.

Figure 2-40 Successful test



Backlight test

Use the following procedure to perform a backlight test.

1. Open the control panel system diagnostic tests. See "Open the control panel systems diagnostic tests" in the Troubleshooting Manual.

2. Use the **down arrow ▼** button to scroll to **4 Backlight Test**, and then press the **OK** button to select it.
After selecting the **4 Backlight Test**, the screen automatically dims, and then returns to full brightness.

 **NOTE:** Touch any key to exit the test.

Figure 2-41 Open the backlight test



Sound test

Use the following procedure to perform a sound test.

1. Open the control panel system diagnostic tests. See "Open the control panel systems diagnostic tests" in the Troubleshooting Manual.

2. Use the [down arrow ▼](#) button to scroll to [5 Sound Test](#), and then press the [OK](#) button to select it.

After selecting the [5 Sound Test](#), the printer emits a series of audible tones.



 **NOTE:** Touch any key to exit the test.

Figure 2-42 Open the sound test



Keyboard test (M527c/z, E52545c, M528c/z, E52645c only)

Use the following procedure to perform a keyboard test on M527c/z, E52545c, M528c/z, and E52645c printers only.

 **IMPORTANT:** The control panel system diagnostic tests include a [6 Keyboard Test](#) item. This test is **not** valid for the M506x, M507x, M527dn/f, E52545dn, M528dn/f, or E52645dn printers even though this option is present in the control panel system diagnostic tests menu.

If the [6 Keyboard Test](#) is opened on the M506x, M507x, M527dn/f, E52545dn, M528dn/f, or E52645dn printers, the printer power must be turned off to exit the test.

HP does not recommend turning the printer power off during the control panel system diagnostic tests.

1. Open the control panel system diagnostic tests. See the control panel system diagnostics test section in the Troubleshooting Manual.

2. Use the [down arrow ▼](#) button to scroll to [6 Keyboard Test](#), and then press the [OK](#) button to select it.

Figure 2-43 Do not open the keyboard test except for M527c/z, E52545c, M528c/z, or E52645c printers

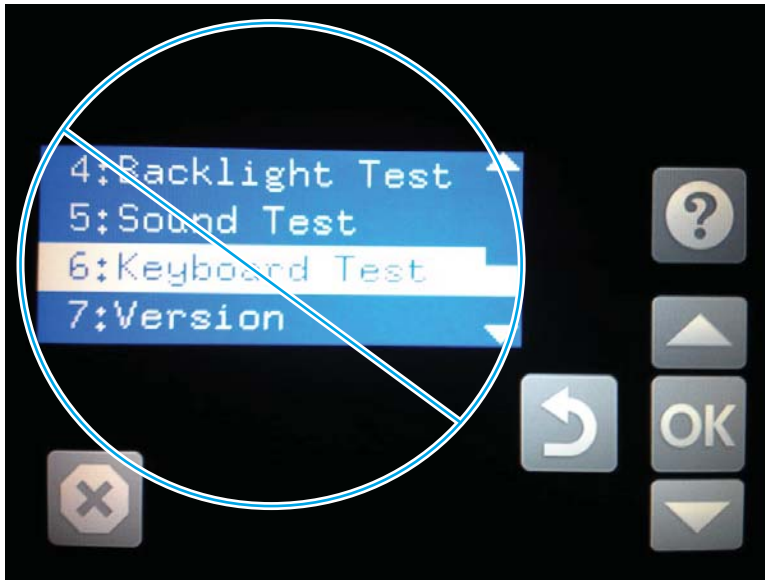

3. When prompted, touch the [H](#) key on the keyboard or the Home button to exit the test.

Version

Use the following procedure to view the control panel version information.

1. Open the control panel system diagnostic tests. See "Open the control panel systems diagnostic tests" in the *Troubleshooting Manual*.
2. Use the [down arrow ▼](#) button to scroll to [7 Version](#), and then press the [OK](#) button to select it.

 **NOTE:** Touch any key to exit the test.

 **NOTE:** The following types of information are for the control panel only, not the printer.

- Panel ID
- Hardware (version)
- Firmware (version)
- KB Hw (version)
- KB Firm (version)
- LCD Vendor
- Touch Controller Version

Figure 2-44 Open the version information

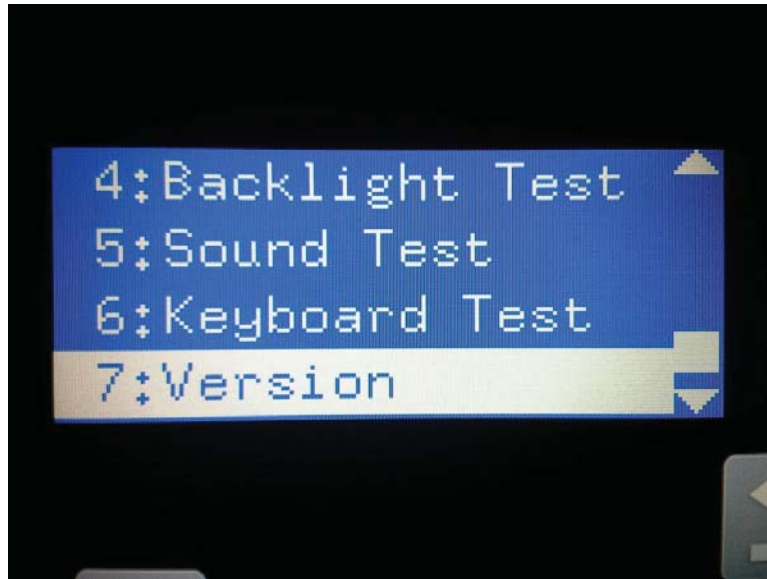

Control panel diagnostic flowcharts (M506x/M507x, M527/E52545/M528/E52645)

Use the flowcharts in this section to troubleshoot the following control panel problems.

- [Touchscreen black, white, or dim \(no image\)](#)
- [Touchscreen has an unresponsive zone](#)
- [No control panel sound](#)
- [Home button is unresponsive](#)
- [Hardware integration pocket \(HIP\) is not functioning \(control panel functional\)](#)

Touchscreen black, white, or dim (no image)

To open the diagnostic function, press the button on the back of the control panel.

Figure 2-45 Touchscreen blank, white, or dim (no image)

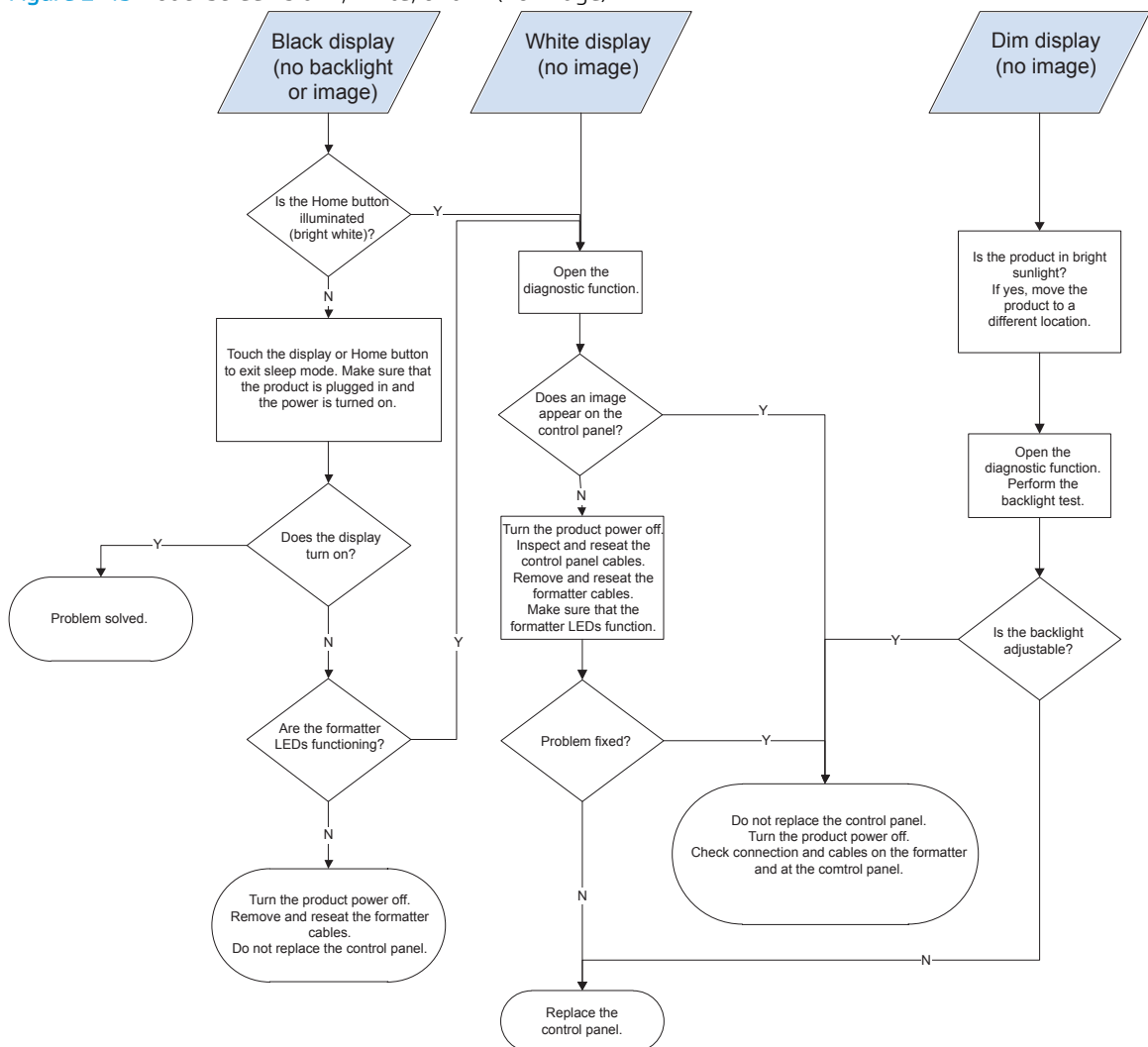

Touchscreen has an unresponsive zone

To open the diagnostic function, press the button on the back of the control panel.

Figure 2-46 Touchscreen has an unresponsive zone

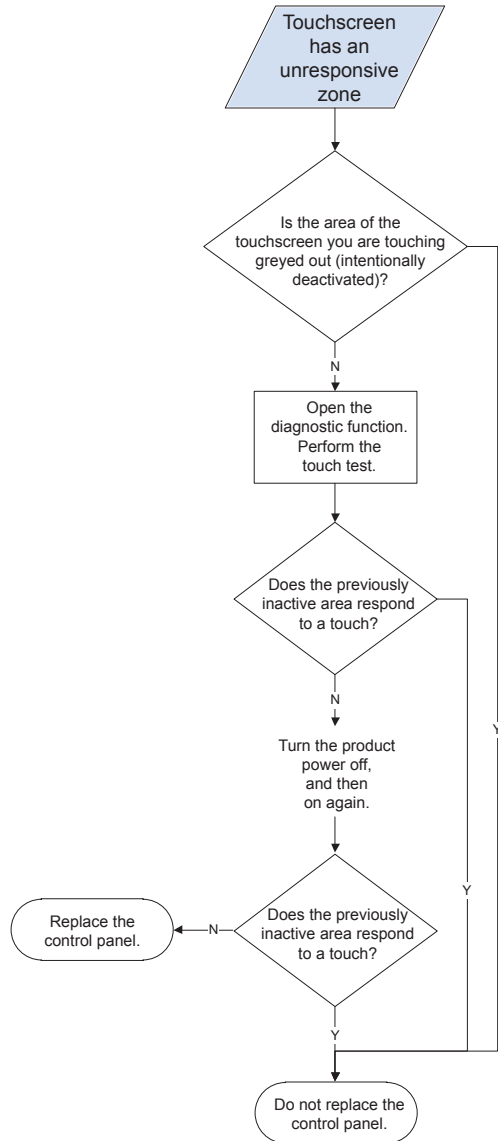

No control panel sound

To open the diagnostic function, press the button on the back of the control panel.

Figure 2-47 No control panel sound

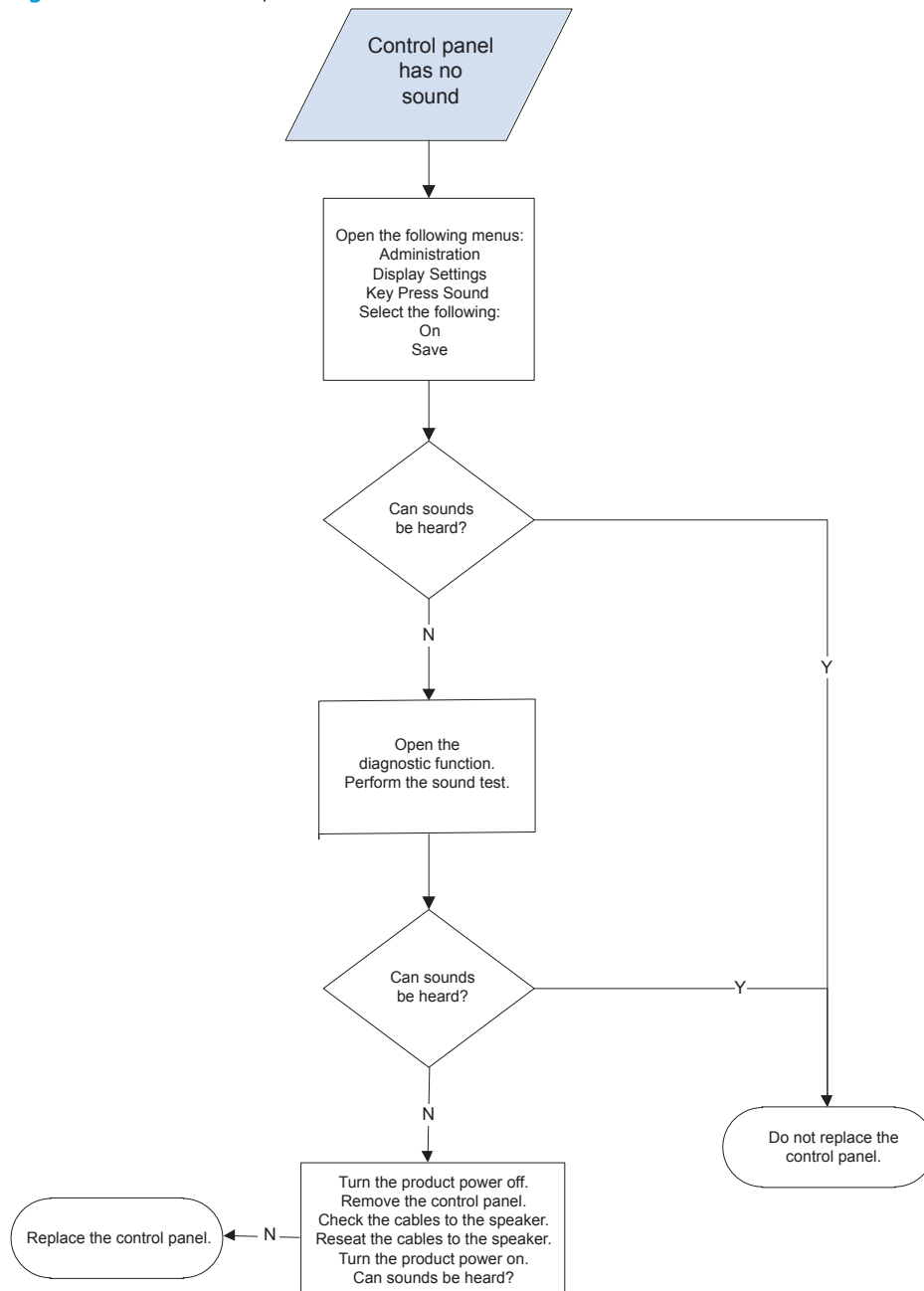

Home button is unresponsive

To open the diagnostic function, press the button on the back of the control panel.

Figure 2-48 Home button is unresponsive

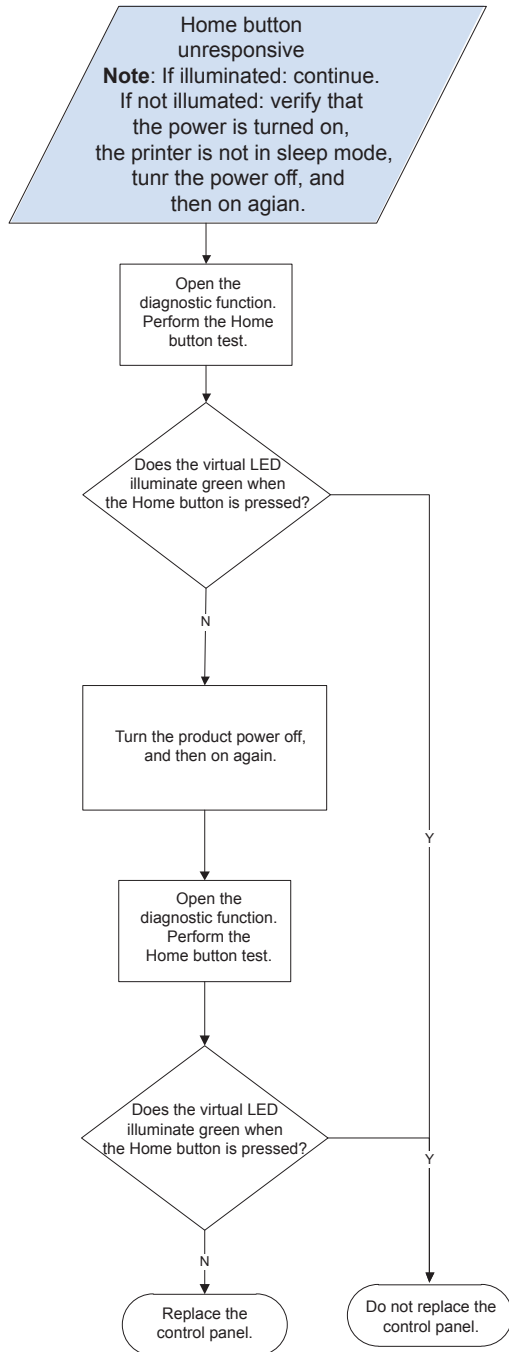

Hardware integration pocket (HIP) is not functioning (control panel functional)

Review the following information when the HIP is not functioning, but the control panel is functional.

Figure 2-49 Hardware integration pocket (HIP) is not functioning (control panel functional)

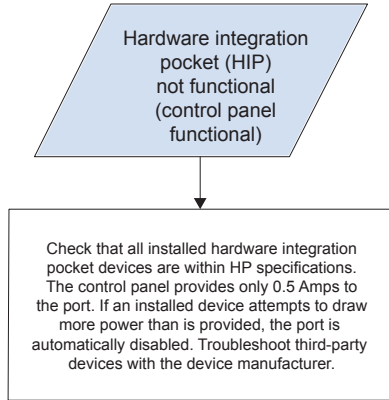

Tools for troubleshooting

This section describes tools that can help to solve printer problems.

- [Individual component diagnostics](#)
- [Diagrams](#)
- [Internal test and information pages](#)
- [Control panel menus \(M501\)](#)
- [Control panel menus \(all except M501\)](#)
- [Error code and control panel message troubleshooting overview](#)

Individual component diagnostics

Review the following information about individual component diagnostics.

- [LED diagnostics \(M501\)](#)
- [LED diagnostics \(all except M501\)](#)
- [Engine diagnostics](#)
- [Paper path and sensor diagnostic tests \(all except M501\)](#)
- [Print/stop test \(all except M501\)](#)
- [Component tests \(all except M501\)](#)
- [Scanner tests \(M527/E52545/M528/E52645\)](#)

LED diagnostics (M501)

LED, engine, and individual diagnostics can identify and troubleshoot printer problems.

- [Network port LEDs \(M501\)](#)
- [M501 control panel LEDs](#)

Network port LEDs (M501)

The formatter has two network port LEDs. When the printer is connected to a properly working network through a network cable, the amber LED indicates network activity, and the green LED indicates the link status.

Figure 2-50 Formatter network port LEDs

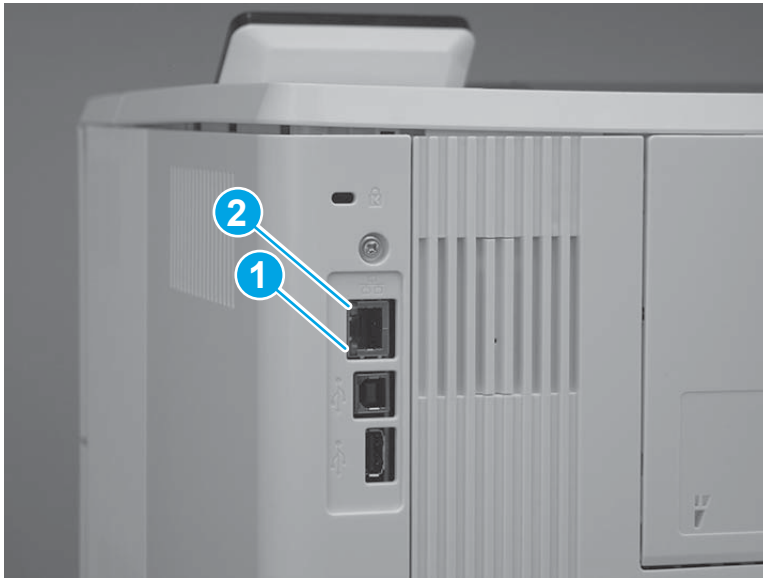

1	Link status LED (green)
2	Network activity LED (amber)

A blinking amber LED indicates network traffic. If the green LED is off, a link has failed. For link failures, check all of the network cable connections. In addition, you can try to manually configure the network card link speed setting by using the printer control panel.

1. On the printer control panel, press the **OK** button.
2. Open the following menus:
 - [Network Setup](#)
 - [Link Speed](#)
3. Select the appropriate link speed.

M501 control panel LEDs

The state of the Ready light and Attention light on the printer signal the printer status. The following table outlines the possible control panel light states.

Printer state	Ready light state	Attention light state
Initializing	Blinking	Blinking
Ready	On	Off
Receiving data/processing job or cancelling job	Blinking	Off
Error message	Off	Blinking
Fatal error (49 or 79 error) ¹	On	On

¹ The printer restarts after one of these errors occurs.

LED diagnostics (all except M501)

LED, engine, and individual diagnostics can identify and troubleshoot printer problems.

- [Understand lights on the formatter](#)
- [Heartbeat LED](#)
- [HP Jetdirect LEDs](#)

Understand lights on the formatter

Three LEDs on the formatter indicate that the printer is functioning correctly.

Figure 2-51 Formatter LED lights

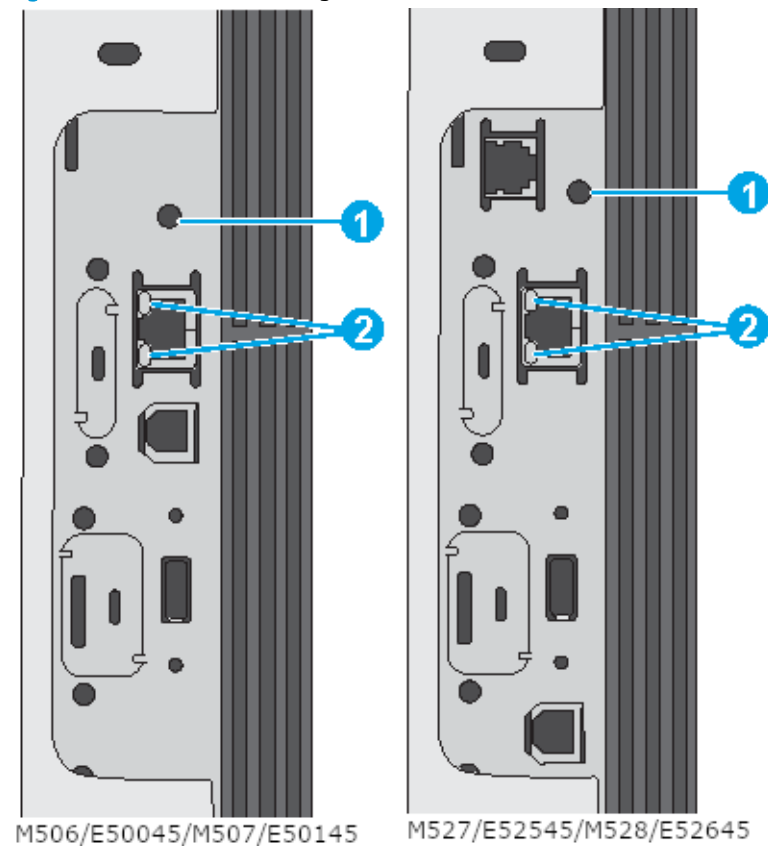

M506/E50045/M507/E50145

M527/E52545/M528/E52645

1	Heartbeat LED
2	HP Jetdirect LEDs

Heartbeat LED

The heartbeat LED indicates that the formatter is functioning correctly.

While the printer is initializing after it is turned on, the LED blinks rapidly, and then turns off. When the printer has finished the initialization sequence, the heartbeat LED pulses on and off.

The following list describes the heartbeat LED operation while the printer is executing the firmware boot process.



NOTE: When the initialization process completes, the heartbeat LED should be illuminated solid green.

If after initialization, the heartbeat LED is not solid green, see [Table 2-11 Heartbeat LED, printer operational \(all except M501\) on page 150](#).

- Green
 - Blinking: The printer is correctly functioning.
 - Solid: The FW has not yet booted.
- Amber
 - Blinking: The control panel is not detected.
 - Solid: The FFC between the formatter and DC controller is not connected or is damaged.
- Red
 - Solid: Valid SPI code; there is a problem releasing ASIC and running the BIOS
 - Solid: BIOS initiates PROSAC to change the LED from red to green.
 - Solid: PROSAC is not running (No ROM or SPI code).
 - Blinking: Valid SPI code not found.
- Off: No 5V or 3.3V PROSAC power.

The following table describes the heartbeat LED operation when the printer completes the firmware boot process and is in the **Ready** state.

Table 2-11 Heartbeat LED, printer operational (all except M501)

LED color	Description
Green	<ul style="list-style-type: none"> ● Normal operation <ul style="list-style-type: none"> – Formatter is operating normally – Firmware is operating normally – Control panel is connected
Yellow	<ul style="list-style-type: none"> ● Formatter cannot connect to the control panel <ul style="list-style-type: none"> – Check control panel connections – Verify control panel functionality
Red	<ul style="list-style-type: none"> ● Formatter error or failure <ul style="list-style-type: none"> – Serial peripheral interface (SPI) flash memory boot error – Power on self-test (formatter) failed – Diagnostic (formatter) failed
Off	<p>TIP: The heartbeat LED is off if the power cable is disconnected, the printer power switch is in the off position, or the printer is in Sleep Mode.</p> <ul style="list-style-type: none"> ● Firmware or system freeze

Table 2-11 Heartbeat LED, printer operational (all except M501) (continued)

LED color	Description
	<ul style="list-style-type: none">– Check control panel for an error message– Control panel failure
	<p>NOTE: This condition is not usually caused by a formatter failure. Turn the power off, and then on again. If the error persists, perform a firmware upgrade.</p>

HP Jetdirect LEDs

The embedded HP Jetdirect print server has two LEDs. The yellow LED indicates network activity, and the green LED indicates the link status. A blinking yellow LED indicates network traffic. If the green LED is off, a link has failed.

For link failures, check all the network cable connections. In addition, try to manually configure the link settings on the embedded print server by using the printer control-panel menus.

1. From the [Home](#) screen on the printer control panel, scroll to and touch the [Administration](#) button (FutureSmart 3), or scroll to and touch the [Settings](#) button (FutureSmart 4).
2. Open the following menus:
 - [Network Settings](#) (FutureSmart 3) or [Networking](#) (FutureSmart 4).
 - [Embedded Jetdirect Menu](#)
 - [Link Speed](#)
3. Select the appropriate link speed, and then touch the [OK](#) button.

Engine diagnostics

The printer contains extensive internal engine diagnostics that help in troubleshooting print quality, paper path, noise, assembly, and timing issues.

- [Engine test button](#)
- [Defeating interlocks](#)
- [Disable cartridge check \(all except M501\)](#)

Engine test button

To verify that the printer engine is functioning, print an engine test page.

Use a small pointed object to depress the test-page switch located on the rear side of the printer. The test page should have a series of lines that are parallel to the short end of the page. The test page can use only Tray 2 as the paper source, so make sure that paper is loaded in Tray 2.

 **NOTE:** Depressing and holding down the test-page switch causes the printer to continually print test pages. Releasing the switch stops the test page continuous printing.

Figure 2-52 Engine test button



Defeating interlocks

Different tests can be used to isolate different types of issues. For assembly or noise isolation, run the diagnostic test when the toner cartridge door or rear door is open.

- [Defeat the rear door interlock](#)
- [Defeat the toner cartridge door interlock](#)

Defeating the door interlocks allows observation of the paper pick operation (and view the page enter registration).

⚠ WARNING! Be careful when performing printer diagnostics to avoid risk of injury. Only trained service personnel should open and run the diagnostics with a door open. Never touch any of the power supplies when the printer is turned on.

Defeat the rear door interlock

Use the following procedure to defeat the rear door interlock.

1. Open the rear door.
2. Insert a folded piece of paper into the slot.

💡 TIP: Fold a stiff piece of paper, for example a business card or index card, into two 10 mm (.375 in) strips, and insert the strips into the slot for the cartridge door logic switches.

Figure 2-53 Defeat the rear door interlock



Defeat the toner cartridge door interlock

Use the following procedure to defeat the toner cartridge door interlock.

1. Open the toner cartridge door.

2. Insert a folded piece of paper into the slot.

 **TIP:** Fold a stiff piece of paper, for example a business card or index card, into two 10 mm (.375 in) strips, and insert the strips into the slot for the cartridge door logic switches.

Figure 2-54 Defeat the toner cartridge door interlock



Disable cartridge check (all except M501)

Use this diagnostic test to print internal pages or send an external job to the printer when the toner cartridge is removed or exchanged. Supply errors are ignored while the printer is in this mode.

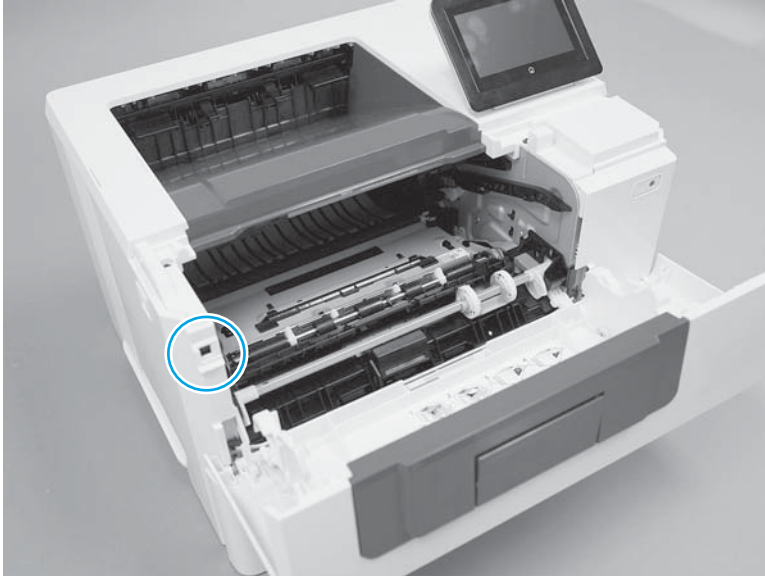
- [Disable cartridge check from a touchscreen control panel](#)
- [Disable cartridge check from a LCD control panel](#)

When the printer is in this mode, access the troubleshooting menus and print internal pages (the print quality pages will be the most useful). This test can be used to isolate problems, such as noise, and to isolate print-quality problems that are related to the toner cartridge.



NOTE: Do not remove or exchange the toner cartridge until after beginning the disable cartridge check diagnostic.

Disable cartridge check from a touchscreen control panel

Use the following procedure to disable cartridge check from a touchscreen control panel.

1. From the [Home](#) screen on the printer control panel, scroll to and touch the [Administration](#) button (FutureSmart 3), or scroll to and touch the [Support Tools](#) button (FutureSmart 4).
2. Open the following menus:
 - [Troubleshooting](#)
 - [Diagnostic Tests](#)
 - [Disable Cartridge Check](#)

Disable cartridge check from a LCD control panel

Use the following procedure to disable cartridge check from a LCD control panel.

FutureSmart 3

1. From the [Home](#) screen on the printer control panel, use the down arrow ▼ button to scroll to [Administration](#), and then press the [OK](#) button.
2. Use the down arrow ▼ button to scroll to [Troubleshooting](#), and then press the [OK](#) button.
3. Use the down arrow ▼ button to scroll to [Diagnostics](#), and then press the [OK](#) button.
4. Use the down arrow ▼ button to scroll to [Disable Cartridge Check](#), and then press the [OK](#) button to select it.

FutureSmart 4

1. From the [Home](#) screen on the printer control panel, use the arrow keys to navigate to [Support Tools](#), and then press the [OK](#) button.
2. Use the down arrow ▼ button to scroll to [Troubleshooting](#), and then press the [OK](#) button.
3. Use the down arrow ▼ button to scroll to [Diagnostic Tests](#), and then press the [OK](#) button.
4. Select [Continue](#) to enter *Maintenance Mode*.
5. Use the down arrow ▼ button to scroll to [Disable Cartridge Check](#), and then press the [OK](#) button to select it.

Paper path and sensor diagnostic tests (all except M501)

Review the following information about the paper path and sensor diagnostics test for the M506/M507/E50145 and M527/M528/E52645 printers.

- [Paper path test \(all except M501\)](#)
- [Paper path sensors test \(all except M501\)](#)
- [Manual sensor tests \(all except M501\)](#)
- [Tray/bin manual sensor test \(all except M501\)](#)

Paper path test (all except M501)

This diagnostic test generates one or more test pages. Use these pages to isolate the cause of jams.

- [Access the paper path test from a touchscreen control panel](#)
- [Access the paper path test from a LCD control panel](#)

To isolate a problem, specify which input tray to use, specify whether to use the duplex path (duplex models only), and specify the number of copies to print. Multiple copies can be printed to help isolate intermittent problems. The following options become available after beginning the diagnostic feature:

- **Print Test Page:** Run the paper-path test from the default settings: Tray 2, no duplex, and one copy. To specify other settings, scroll down the menu, and select the setting, and then scroll back up and select [Print Test Page](#) to start the test.
- **Source Tray:** Select Tray 1, Tray 2, or the optional tray.
- **Test Duplex Path:** Enable or disable two-sided printing from designated optional tray (depending on how many optional accessories are installed).
- **Number of Copies:** Set the numbers of copies to be printed; the choices are 1, 10, 50, 100, or 500.

Access the paper path test from a touchscreen control panel

Use the following procedure to access the paper path test from a touchscreen control panel.

1. From the [Home](#) screen on the printer control panel, scroll to and touch the [Administration](#) button (FutureSmart 3), or scroll to and touch the [Support Tools](#) button (FutureSmart 4).
2. Open the following menus:
 - [Troubleshooting](#)
 - [Diagnostic Tests](#)
 - [Paper Path Test](#)
3. Select the paper path test options for the test.

Access the paper path test from a LCD control panel

Use the following procedure to access the paper path test from a LCD control panel.

FutureSmart 3

1. From the [Home](#) screen on the printer control panel, use the down arrow ▼ button to scroll to [Administration](#), and then press the [OK](#) button.
2. Use the down arrow ▼ button to scroll to [Troubleshooting](#), and then press the [OK](#) button.
3. Use the down arrow ▼ button to scroll to [Diagnostic Tests](#), and then press the [OK](#) button.
4. Use the down arrow ▼ button to scroll to [Paper Path Test](#), and then press the [OK](#) button.

FutureSmart 4

1. From the [Home](#) screen on the printer control panel, use the arrow keys to navigate to [Support Tools](#), and then press the [OK](#) button.
2. Use the down arrow ▼ button to scroll to [Troubleshooting](#), and then press the [OK](#) button.

3. Use the down arrow ▼ button to scroll to [Diagnostic Tests](#), and then press the [OK](#) button.
4. Select [Continue](#) to enter *Maintenance Mode*.
5. Use the down arrow ▼ button to scroll to [Paper Path Test](#), and then press the [OK](#) button.

Paper path sensors test (all except M501)

This test displays the status of each paper path sensor and allows viewing of sensor status while printing internal pages.

- [Access the paper path sensors test from a touchscreen control panel](#)
- [Access the paper path sensors test from a LCD control panel](#)

Access the paper path sensors test from a touchscreen control panel

Use the following procedure to access the paper path sensors test from a touchscreen control panel.

1. From the [Home](#) screen on the printer control panel, scroll to and touch the [Administration](#) button (FutureSmart 3), or scroll to and touch the [Support Tools](#) button (FutureSmart 4).
2. Open the following menus:
 - [Troubleshooting](#)
 - [Diagnostic Tests](#)
 - [Paper Path Sensors](#)
3. Touch [Start](#) to run the test.

Access the paper path sensors test from a LCD control panel

Use the following procedure to access the paper path sensors test from a LCD control panel.

FutureSmart 3

1. From the [Home](#) screen on the printer control panel, use the down arrow ▼ button to scroll to [Administration](#), and then press the [OK](#) button.
2. Use the down arrow ▼ button to scroll to [Troubleshooting](#), and then press the [OK](#) button.
3. Use the down arrow ▼ button to scroll to [Diagnostic Tests](#), and then press the [OK](#) button.
4. Use the down arrow ▼ button to scroll to [Paper Path Sensors](#), and then press the [OK](#) button.

FutureSmart 4

1. From the [Home](#) screen on the printer control panel, use the arrow keys to navigate to [Support Tools](#), and then press the [OK](#) button.
2. Use the down arrow ▼ button to scroll to [Troubleshooting](#), and then press the [OK](#) button.
3. Use the down arrow ▼ button to scroll to [Diagnostic Tests](#), and then press the [OK](#) button.
4. Select [Continue](#) to enter *Maintenance Mode*.
5. Use the down arrow ▼ button to scroll to [Paper Path Sensors](#), and then press the [OK](#) button.



NOTE: The menu list of sensors and switches for the [Paper path sensors test](#), [Manual Sensor Test](#), and the [Tray/Bin Manual Sensor Test](#) varies depending on which optional accessories are installed.

The tables in this section describe the sensor tests available with an optional 1x550-sheet paper feeder installed.

For trays other than Tray 1 or Tray 2, the tray number associated with a sensor or switch depends on the number of accessories installed.

Table 2-12 Paper path sensors diagnostic tests (all except M501)

Sensor name	Sensor/Switch number	Replacement part number	Descriptions
Tray 3 feed sensor ¹	PS8008	F2A68-67909	Optional paper feeder
Prefeed sensor	PS102	NA	Not replaceable ²
Top-of-Page (TOP) sensor	PS215	NA	Not replaceable ²
Paper width 3 sensor	NA	NA	Not replaceable ²
Paper width 2 sensor	NA	NA	Not replaceable ²
Paper width 1 sensor	NA	NA	Not replaceable ²
Fuser output sensor	PS2	RM2-5679-000CN (110 V) RM2-5692-000CN (220 V) (M501/M506/E50045/M527/E52545)	Fuser
Fuser output sensor	PS2	RM2-2585-000CN (110 V) RM2-2586-000CN (220 V) (M507/E50145/M528/E52645)	Fuser
Duplexer refeed sensor	PS502	NA	Not replaceable ²
NOTE: Duplex models only.			
Output bin full sensor	PS4	NA	Not replaceable ²

¹ Only appears if optional accessories are installed.

² Require whole unit replacement.

Manual sensor tests (all except M501)

The table in this section lists the sensors and switches available in the [Manual Sensor Test](#).

- [Access the manual sensor test from a touchscreen control panel](#)
- [Access the manual sensor test from a LCD control panel](#)

Access the manual sensor test from a touchscreen control panel

The [Manual Sensor Test](#) screen shows the sensor number, sensor name (M506x/M507x and M527/E52545/M528/E52645 only), sensor state (active or inactive), and the number of times the sensor has been toggled (activated).

1. From the [Home](#) screen on the printer control panel, scroll to and touch the [Administration](#) button (FutureSmart 3), or scroll to and touch the [Support Tools](#) button (FutureSmart 4).
2. Open the following menus:
 - [Troubleshooting](#)
 - [Diagnostic Tests](#)
 - [Manual Sensor Test](#)
3. Activate the desired sensor, and then check the control panel display to verify the sensor state (active or inactive).



NOTE: Only the M506x/M507x and M527/E52545/M528/E52645 control panel displays the [State](#) and [Toggle](#) descriptor.

- The [State](#) virtual LED next to the sensor number and sensor name (M506x/M507x and M527/E52545/M528/E52645 only) illuminates green when the sensor is active.
- The [Toggle](#) virtual LED next to the sensor number and sensor name (M506x/M507x and M527/E52545/M528/E52645 only) illuminates green after the sensor is activated and increments by one each time the sensor is interrupted (activated or deactivated).

For example, opening the front door increments the [SW501 Cartridge doorToggled](#) item count two times—once when the door is opened, and once when the door is closed.

Access the manual sensor test from a LCD control panel

Use the following procedure to access the manual sensor test from a LCD control panel.

FutureSmart 3

1. From the [Home](#) screen on the printer control panel, use the down arrow ▼ button to scroll to [Administration](#), and then press the [OK](#) button.
2. Use the down arrow ▼ button to scroll to [Troubleshooting](#), and then press the [OK](#) button.
3. Use the down arrow ▼ button to scroll to [Diagnostic Tests](#), and then press the [OK](#) button.
4. Use the down arrow ▼ button to scroll to [Manual Sensor Test](#), and then press the [OK](#) button.
5. Activate the desired sensor, and then check the control panel display to verify the sensor state (active or inactive).

 **TIP:** Press the return arrow ↵ button to reset the sensor or press the Cancel  button to exit the test.

 **NOTE:** Only the M506x/M507x and M527/E52545/M528/E52645 control panel displays the **State** and **Toggle** descriptor.

- The **State** virtual LED next to the sensor number and sensor name (M506x/M507x and M527/E52545/M528/E52645 only) illuminates green when the sensor is active.
- The **Toggle** virtual LED next to the sensor number and sensor name (M506x/M507x and M527/E52545/M528/E52645 only) illuminates green after the sensor is activated and increments by one each time the sensor is interrupted (activated or deactivated).

For example, opening the cartridge door increments the **SW501 Front door opening/closing Toggled** item count two times—once when the door is opened, and once when the door is closed.

FutureSmart 4

1. From the **Home** screen on the printer control panel, use the arrow keys to navigate to **Support Tools**, and then press the **OK** button.
2. Use the down arrow ▼ button to scroll to **Troubleshooting**, and then press the **OK** button.
3. Use the down arrow ▼ button to scroll to **Diagnostic Tests**, and then press the **OK** button.
4. Select **Continue** to enter *Maintenance Mode*.
5. Use the down arrow ▼ button to scroll to **Manual Sensor Test**, and then press the **OK** button.
6. Activate the desired sensor, and then check the control panel display to verify the sensor state (active or inactive).

Press the return arrow ↵ button to reset the sensor or press the Cancel  button to exit the test.

 **NOTE:** Only the M506x/M507x and M527/E52545/M528/E52645 control panel displays the **State** and **Toggle** descriptor.

- The **State** virtual LED next to the sensor number and sensor name illuminates green when the sensor is active.
- The **Toggle** virtual LED next to the sensor number and sensor name illuminates green after the sensor is activated and increments by one each time the sensor is interrupted (activated or deactivated).

For example, opening the front door increments the **SW3 Front door opening/closing Toggled** item count two times—once when the door is opened, and once when the door is closed.

 **NOTE:** The following table describes the sensor tests available with an optional 1x550-sheet paper feeder installed.

For trays other than Tray 1 or Tray 2, the tray number associated with a sensor or switch depends on the number and type of accessories installed.

Table 2-13 Manual sensor diagnostic tests (all except M501)

Sensor or switch	Replacement Part number	Description
SW501 Cartridge door sensor	RK2-0534-000CN	Microswitch (SW2)

Table 2-13 Manual sensor diagnostic tests (all except M501) (continued)

Sensor or switch	Replacement Part number	Description
PS8008 Tray 3 feed sensor ¹	F2A68-67909	550-sheet paper feeder
PS102 Prefeed sensor	NA	Not replaceable ²
PS215 Top-of-Page (TOP) sensor	NA	Not replaceable ²
Paper width 3 sensor	NA	Not replaceable ²
Paper width 2 sensor	NA	Not replaceable ²
Paper width 1 sensor	NA	Not replaceable ²
PS2 Fuser output sensor	RM2-5679-000CN (110 V) RM2-5692-000CN (220 V) (M501/M506/E50045/M527/E52545)	Fuser
PS2 Fuser output sensor	RM2-2585-000CN (110 V) RM2-2586-000CN (220 V) (M507/E50145/M528/E52645)	Fuser
PS502 Duplexer refeed sensor	NA	Not replaceable ²
NOTE: Duplex models only.		
PS4 Output bin full sensor	NA	Not replaceable ²

¹ Only appears if optional accessories are installed.

² Requires whole unit replacement.

Tray/bin manual sensor test (all except M501)

The table in this section lists the sensors and switches available in the [Tray/Bin Manual Sensor Test](#).

- [Access the tray/bin manual sensor test from a touchscreen control panel](#)
- [Access the tray/bin manual sensor test from a LCD control panel](#)

Access the tray/bin manual sensor test from a touchscreen control panel

The [Tray/Bin Manual Sensor Test](#) screen shows the sensor number, sensor name (M506x/M507x and M527/E52545/M528/E52645 only), sensor state (active or inactive), and the number of times the sensor has been toggled (activated).

1. From the [Home](#) screen on the printer control panel, scroll to and touch the [Administration](#) button (FutureSmart 3), or scroll to and touch the [Support Tools](#) button (FutureSmart 4).
2. Open the following menus:
 - [Troubleshooting](#)
 - [Diagnostic Tests](#)
 - [Tray/Bin Manual Sensor Test](#)
3. Activate the desired sensor, and then check the control panel display to verify the sensor state (active or inactive).



NOTE: Only the M506x/M507x and M527/E52545/M528/E52645 control panel displays the [State](#) and [Toggle](#) descriptor.

- The [State](#) virtual LED next to the sensor number and sensor name (M506x/M507x and M527/E52545/M528/E52645 only) illuminates green when the sensor is active.
- The [Toggle](#) virtual LED next to the sensor number and sensor name illuminates green after the sensor is activated and increments by one each time the sensor is interrupted (activated or deactivated).



For example, raising, and then releasing, the output bin full flag increments the [PS4 Output bin full Toggled](#) item count two times—once when the flag is raise, and once when it is released.

Access the tray/bin manual sensor test from a LCD control panel

Use the following procedure to access the tray/bin manual sensor test from a LCD control panel.

FutureSmart 3

1. From the [Home](#) screen on the printer control panel, use the down arrow ▼ button to scroll to [Administration](#), and then press the [OK](#) button.
2. Use the down arrow ▼ button to scroll to [Troubleshooting](#), and then press the [OK](#) button.
3. Use the down arrow ▼ button to scroll to [Diagnostic Tests](#), and then press the [OK](#) button.
4. Use the down arrow ▼ button to scroll to [Tray/Bin manual Sensor Test](#), and then press the [OK](#) button.
5. Activate the desired sensor, and then check the control panel display to verify the sensor state (active or inactive).

 **TIP:** Press the return arrow ↵ button to reset the sensor or press the Cancel  button to exit the test.

 **NOTE:** Only the M506x/M507x and M527/E52545/M528/E52645 control panel displays the [State](#) and [Toggle](#) descriptor.

- The [State](#) virtual LED next to the sensor number and sensor name (M506x/M507x and M527/E52545/M528/E52645 only) illuminates green when the sensor is active.
- The [Toggle](#) virtual LED next to the sensor number and sensor name (M506x/M507x and M527/E52545/M528/E52645 only) illuminates green after the sensor is activated and increments by one each time the sensor is interrupted (activated or deactivated).

For example, raising, and then releasing, the output bin full flag increments the [PS4 Output bin full Toggled](#) item count two times—once when the flag is raise, and once when it is released.

FutureSmart 4

1. From the [Home](#) screen on the printer control panel, use the arrow keys to navigate to [Support Tools](#), and then press the [OK](#) button.
2. Use the down arrow ▼ button to scroll to [Troubleshooting](#), and then press the [OK](#) button.
3. Use the down arrow ▼ button to scroll to [Diagnostic Tests](#), and then press the [OK](#) button.
4. Select [Continue](#) to enter *Maintenance Mode*.
5. Use the down arrow ▼ button to scroll to [Tray/Bin manual Sensor Test](#), and then press the [OK](#) button.
6. Activate the desired sensor, and then check the control panel display to verify the sensor state (active or inactive).

Press the return arrow ↵ button to reset the sensor or press the Cancel  button to exit the test.

 **NOTE:** Only the M506x/M507x and M527/E52545/M528/E52645 control panel displays the [State](#) and [Toggle](#) descriptor.

- The [State](#) virtual LED next to the sensor number and sensor name illuminates green when the sensor is active.
- The [Toggle](#) virtual LED next to the sensor number and sensor name illuminates green after the sensor is activated and increments by one each time the sensor is interrupted (activated or deactivated).

For example, opening the front door increments the [SW3 Front door opening/closing Toggled](#) item count two times—once when the door is opened, and once when the door is closed.

 **NOTE:** The following table describes the sensor tests available with an optional 1x550-sheet paper feeder installed.

For trays other than Tray 1 or Tray 2, the tray number associated with a sensor or switch depends on the number and type of accessories installed.

Table 2-14 Tray/bin manual sensors (all except M501)

Sensor or switch name	Replacement part number	Descriptions
PS205 Tray 1 paper sensor	F2A68-67914	Cartridge door assembly

Table 2-14 Tray/bin manual sensors (all except M501) (continued)

Sensor or switch name	Replacement part number	Descriptions
PS3 Tray 2 paper sensor	NA	Not replaceable ¹
PS451 Tray 3 paper sensor ²	F2A68-67909	Optional paper feeder
PS8008 Tray 3 paper feed sensor ²	F2A68-67909	Optional paper feeder
PS1603 Tray 3 feed sensor ²	F2G68-67901	Optional paper feeder
PS4 Output bin full sensor	NA	Not replaceable ¹

¹ Requires whole unit replacement.

² Only appears if optional accessories are installed.

Print/stop test (all except M501)

Use this diagnostic test to isolate the cause of problems such as image-formation defects and jams within the engine.

- [Access the print/stop test from a touchscreen control panel](#)
- [Access the print/stop test from a LCD control panel](#)
- [Common print stop test timing millisecond \(ms\) stops](#)

During this test, stop the paper anywhere along the printer paper path. The test can be programmed to stop printing internal pages or an external print job when the paper reaches a certain position. The test can also be programmed to stop from 0 to 60,000 ms. If the timer is set to a value that is greater than the job-print time, the printer can recover in one of two ways.

- After the print job is completed press **OK** button to return to the **Troubleshooting** menu before the timer times out.
- After the timer times out, touch the **Stop** button. Activate the door switch to restart the engine and return it to a normal state.

Access the print/stop test from a touchscreen control panel

Use the following procedure to access the print/stop test from a touchscreen control panel.

1. From the **Home** screen on the printer control panel, scroll to and touch the **Administration** button (FutureSmart 3), or scroll to and touch the **Support Tools** button (FutureSmart 4).
2. Open the following menus:
 - **Troubleshooting**
 - **Diagnostic Tests**
 - **Print/Stop Test**
3. Enter a range, and then touch the **OK** button.

Access the print/stop test from a LCD control panel

Use the following procedure to access the print/stop test from a LCD control panel.

FutureSmart 3

1. From the **Home** screen on the printer control panel, use the down arrow ▼ button to scroll to **Administration**, and then press the **OK** button.
2. Use the down arrow ▼ button to scroll to **Troubleshooting**, and then press the **OK** button.
3. Use the down arrow ▼ button to scroll to **Diagnostic Test**, and then press the **OK** button.
4. Use the down arrow ▼ button to scroll to **Print/Stop Test**, and then press the **OK** button.

FutureSmart 4

1. From the **Home** screen on the printer control panel, use the arrow keys to navigate to **Support Tools**, and then press the **OK** button.
2. Use the down arrow ▼ button to scroll to **Troubleshooting**, and then press the **OK** button.

3. Use the down arrow ▼ button to scroll to [Diagnostic Tests](#), and then press the [OK](#) button.
4. Select [Continue](#) to enter *Maintenance Mode*.
5. Use the down arrow ▼ button to scroll to [Print/Stop Test](#), and then press the [OK](#) button.

Common print stop test timing millisecond (ms) stops

Review the following information about common print stop test timing stops.

- **600 ms:** The page has passed the registration area and the leading edge is just short of entering the fuser. The image can be seen on the paper but has not fused. If the defect is visible then the cause might be the drum, transfer roller, or a roller prior to, or in, the registration area.
- **1200 ms:** The leading edge is about 18mm (0.71 in) into the top output bin. The image has gone through the fuser. If the defect was not visible prior to the fuser, and is visible after the fuser, then the fuser is the likely cause of the print quality defect. Inspect the fuser for damage, debris, or labels stuck to the fuser. Replace the fuser. Discuss media specifications and proper care of the fuser with the customer.

Component tests (all except M501)

Use the procedure below to test various printer mechanical and electromechanical assemblies.

- [Individual component diagnostics \(special-mode test; all except M501\)](#)

Individual component diagnostics (special-mode test; all except M501)

This test activates individual parts independently to isolate problems.

- [Access the individual component diagnostics from a touchscreen control panel](#)
- [Access the individual component diagnostics from a LCD control panel](#)



NOTE: The following table describes the sensor tests available with an optional 1x550-sheet paper feeder installed.

For trays other than Tray 1 or Tray 2, the tray number associated with a sensor or switch depends on the number and type of accessories installed.

Each component test can be performed once or repeatedly. If the [Repeat](#) option is enabled from the drop-down menu, the test cycles the component on and off. This process continues for two minutes, and then the test terminates.



NOTE: The cartridge door interlocks must be defeated to run the component tests. A control panel display prompt appears to indicate removing the toner cartridge, during certain tests.

Access the individual component diagnostics from a touchscreen control panel

Use the following procedure to access the individual component diagnostics from a touchscreen control panel.

1. From the [Home](#) screen on the printer control panel, scroll to and touch the [Administration](#) button (FutureSmart 3), or scroll to and touch the [Support Tools](#) button (FutureSmart 4).
2. Open the following menus:
 - [Troubleshooting](#)
 - [Diagnostic Tests](#)
 - [Component Test](#)
3. Select the component test options for the test.

Access the individual component diagnostics from a LCD control panel

Use the following procedure to access the individual component diagnostics from a LCD control panel.

FutureSmart 3

1. From the [Home](#) screen on the printer control panel, use the down arrow ▼ button to scroll to [Administration](#), and then press the [OK](#) button.
2. Use the down arrow ▼ button to scroll to [Troubleshooting](#), and then press the [OK](#) button.
3. Use the down arrow ▼ button to scroll to [Diagnostic Test](#), and then press the [OK](#) button.
4. Use the down arrow ▼ button to scroll to [Component Test](#), and then press the [OK](#) button.

FutureSmart 4

1. From the [Home](#) screen on the printer control panel, use the arrow keys to navigate to [Support Tools](#), and then press the [OK](#) button.
2. Use the down arrow ▼ button to scroll to [Troubleshooting](#), and then press the [OK](#) button.

3. Use the down arrow ▼ button to scroll to [Diagnostic Tests](#), and then press the [OK](#) button.
4. Select [Continue](#) to enter *Maintenance Mode*.
5. Use the down arrow ▼ button to scroll to [Component Test](#), and then press the [OK](#) button.
6. Select the component and desired options.
7. Select [Start](#) to start the test.
8. Select [Stop](#) to stop the test.



NOTE: The following table describes the sensor tests available with an optional 1x550-sheet paper feeder installed.

For trays other than Tray 1 or Tray 2, the tray number associated with a sensor or switch depends on the number and type of accessories installed.

Table 2-15 Component test details (all except M501)

Component test	Item tested	Comments
Fuser motor	M1	Activates the specified motor.
Pickup motor	M2	Activates the specified motor.
Tray 1 Pickup Solenoid	SL2	Activates the specified solenoid.
Tray 2 Pickup Solenoid	SL1	Activates the specified solenoid.
Tray 3 Pickup Solenoid ¹		Activates the specified solenoid.
Duplex switchback solenoid	SL3	Activates the specified solenoid.
NOTE: Duplex models only.		
Optional Clutch Drive		Activates the specified clutch/drive.
Repick Clutch	CL1	Activates the specified clutch.
NOTE: Duplex models only.		
Laser Scanner Motor	M3	Activates the specified motor.
Repeat	NA	Choose Off to execute the test once. Choose On to execute the test continuously.

¹ Only appears if an optional 550-sheet paper feeder accessory is installed.

Scanner tests (M527/E52545/M528/E52645)

Use these diagnostic tests to manually test the document feeder and scanner sensors.

- [Scanner tests \(M527/E52545/M528/E52645\)](#)

Scanner tests (M527/E52545/M528/E52645)

This section lists the sensors available in the [Scanner Tests](#).

- [Document feeder and image scanner sensor replacement parts](#)
- [Use the scanner tests](#)

Document feeder and image scanner sensor replacement parts

If a document feeder or image scanner sensor fails, replace the following assemblies.

- Document feeder sensors
 - Document feeder whole unit kit Enterprise printers; 5851-6568



NOTE: Includes the white backing kit.

- Document feeder whole unit kit Work Flow printers; 5851-6569



NOTE: Includes the white backing kit.

- Scanner sub assembly (SSA) kit; F2A76-67909



NOTE: Includes the white backing kit.

Use the scanner tests

The [Scanner Tests](#) screen shows the sensor name, sensor state (active or inactive), and the number of times the sensor has been toggled (activated).

1. From the [Home](#) screen on the printer control panel, scroll to and touch the [Administration](#) button (FutureSmart 3), or scroll to and touch the [Support Tools](#) button (FutureSmart 4).
2. Open the following menus:
 - [Troubleshooting](#)
 - [Diagnostic Tests](#)
 - [Scanner Tests](#)
 - [Sensors](#)
3. Touch the sensor name on the [Scanner Tests](#) screen to display a sensor location graphic on the control panel display.
4. Activate the desired sensor, and then check the control panel display to verify the sensor state (active or inactive).
 - The [State](#) virtual LED next to the sensor number and sensor name illuminates green when the sensor is active.
 - The [Toggle](#) virtual LED next to the sensor number and sensor name illuminates green after the sensor is activated and increments by one each time the sensor is interrupted (activated or deactivated).

For example, opening the flatbed cover increments the [Flatbed cover Toggle](#) item count two times—once when the door is opened, and once when the door is closed.

Scanner tests sensors

- ADF paper present
- ADF Y (length)
- ADF jam cover
- ADF paper path deskew
- ADF paper path pick success
- Paper path sensor 1 (unreachable)
- Paper path sensor 2 (unreachable)
- Flatbed Y (length)
- Flatbed cover

Diagrams

Use the diagrams in this section to identify printer components.

- [Diagrams: Block diagrams](#)
- [Diagrams: External plug and port locations](#)
- [Diagrams: Locations of major assemblies](#)
- [Diagrams: General timing chart](#)
- [Diagrams: General circuit diagrams](#)

Diagrams: Block diagrams

Use the diagrams in this section to identify printer sensors, switches, and assemblies.

- [Sensors and switches](#)
- [Cross section diagrams](#)
- [Diagrams: Printed circuit assembly \(PCA\) connector locations](#)

Sensors and switches

Review the following information about the sensors and switches.

Figure 2-55 Printer base, sensors and switches block diagram

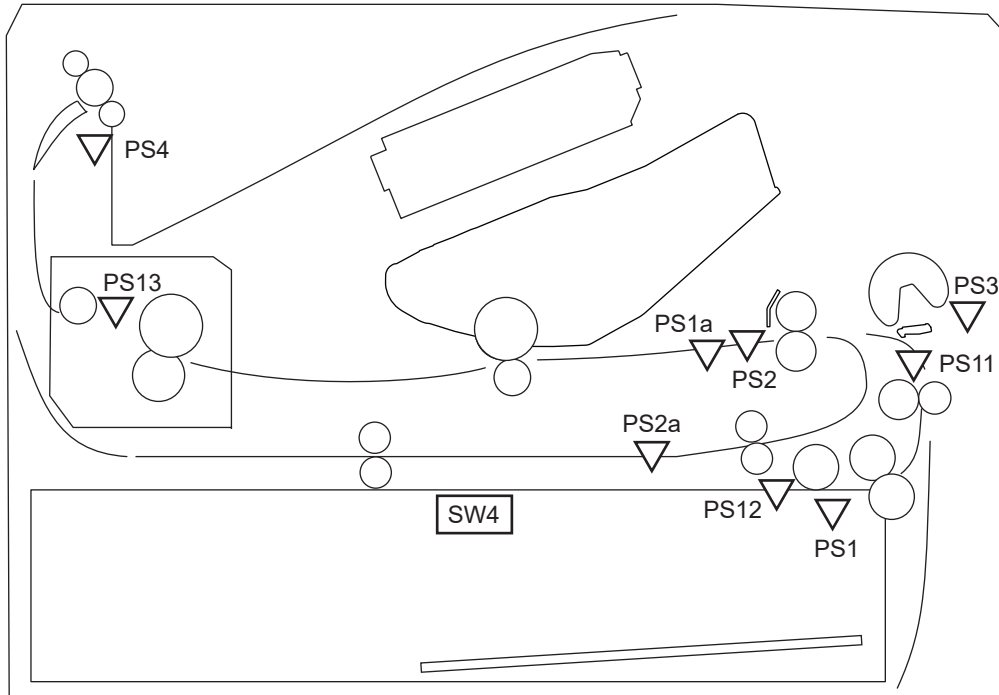

Sensor	Description	Sensor	Description
SR1a	Media width sensor	SR4	Output bin media-full sensor
SR2b	Duplex feed sensor ¹	SR11	Registration sensor
SR1	Cassette media out sensor	SR12	Prefeed sensor
SR2	Top-of-Page (TOP) sensor	SR13	Fuser output sensor
SR3	Tray 1 (multipurpose tray) media out and registration sensor	SW4	Cassette detection switch

¹ Duplex models only.

Figure 2-56 1x550-sheet paper feeder, sensors and switches block diagram

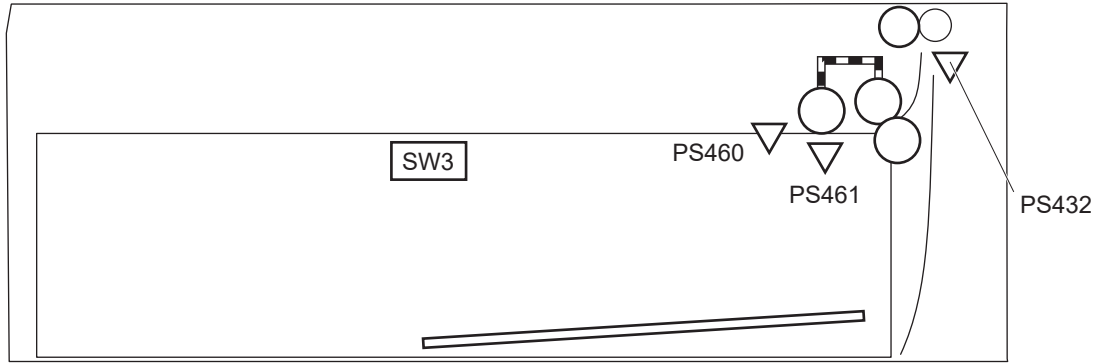

Sensor	Description
PS460	Media surface sensor
PS461	Cassette media out sensor
PS432	Feed sensor
SW3	Cassette detection switch

Figure 2-57 Printer base, motors, clutches, and solenoids block diagram

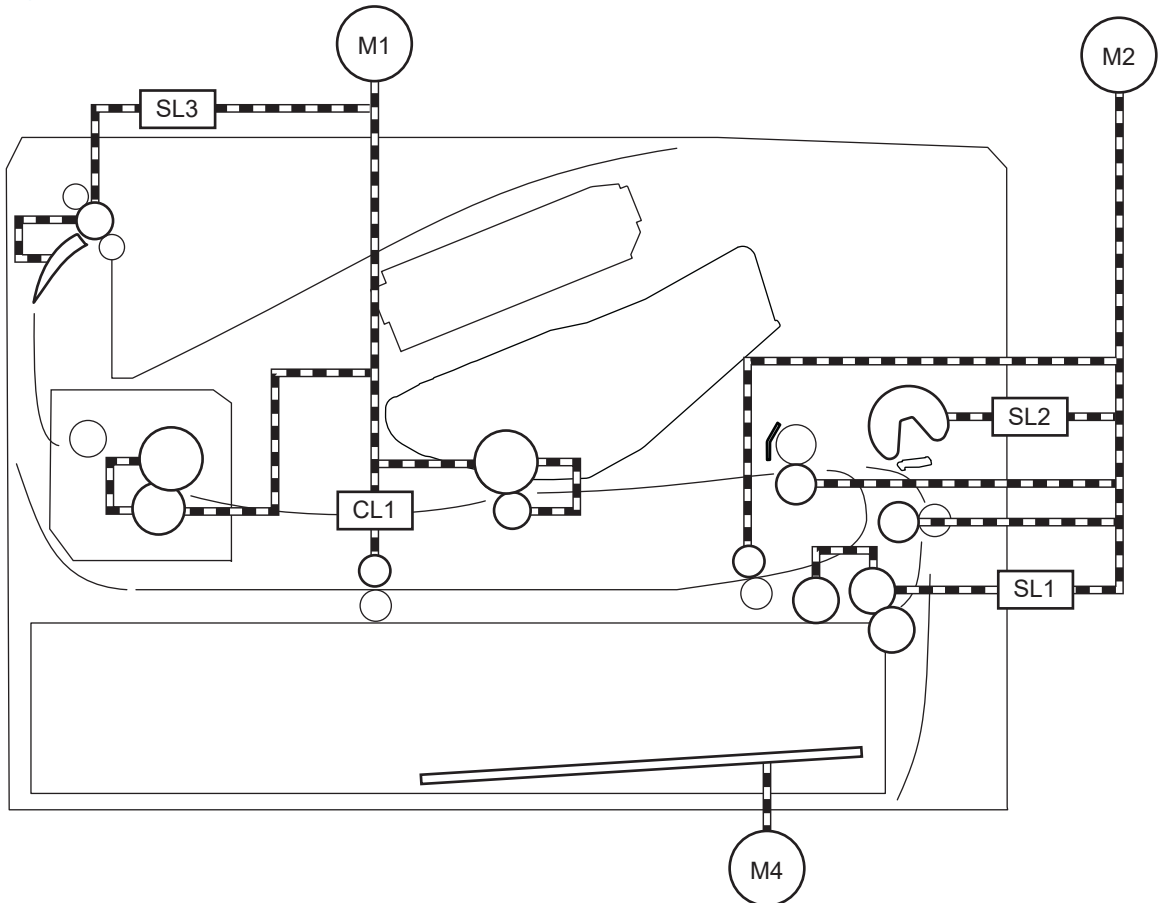

Item	Description
M1	Fuser motor
M2	Pickup motor
M4	Lifter motor
SL1	Cassette pickup solenoid
SL2	Tray 1 (MP) pickup solenoid
SL3	Duplex switchback solenoid ¹
CL1	Duplex re-pickup clutch ¹

¹ Duplex models only.

Figure 2-58 1x550-sheet paper feeder, motors, clutches, and solenoids block diagram

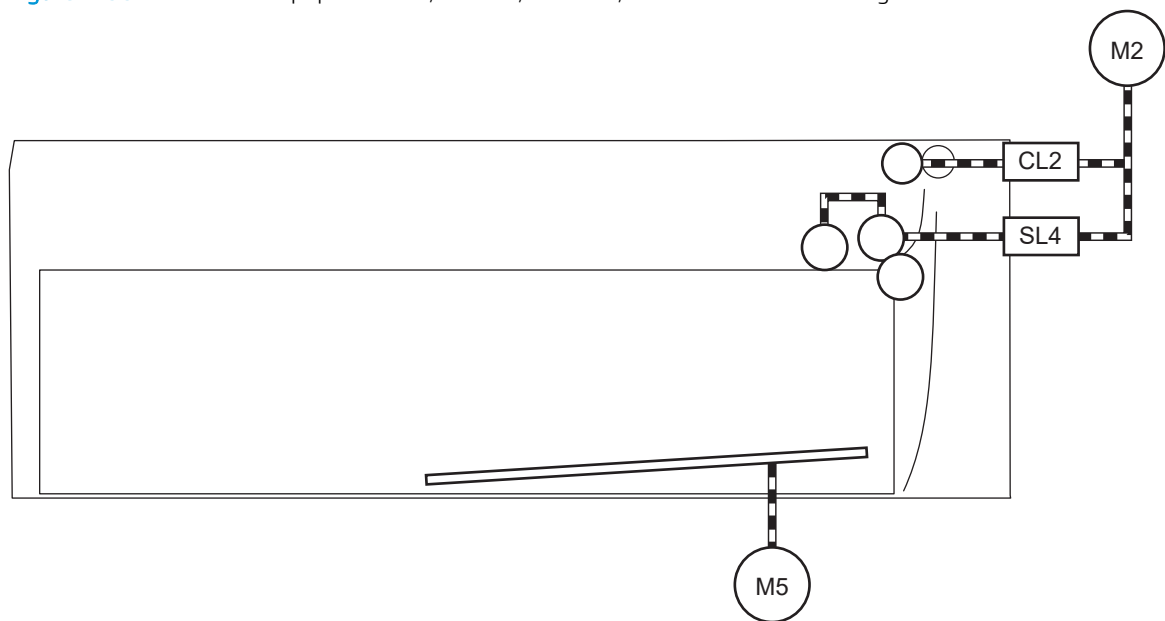

M2	Fuser motor (located in the printer)
M5	Lifter motor
CL2	Feed clutch
SL4	Cassette pickup solenoid

Cross section diagrams

Review the following information about the cross section diagrams.

Figure 2-59 Printer base, cross section diagram

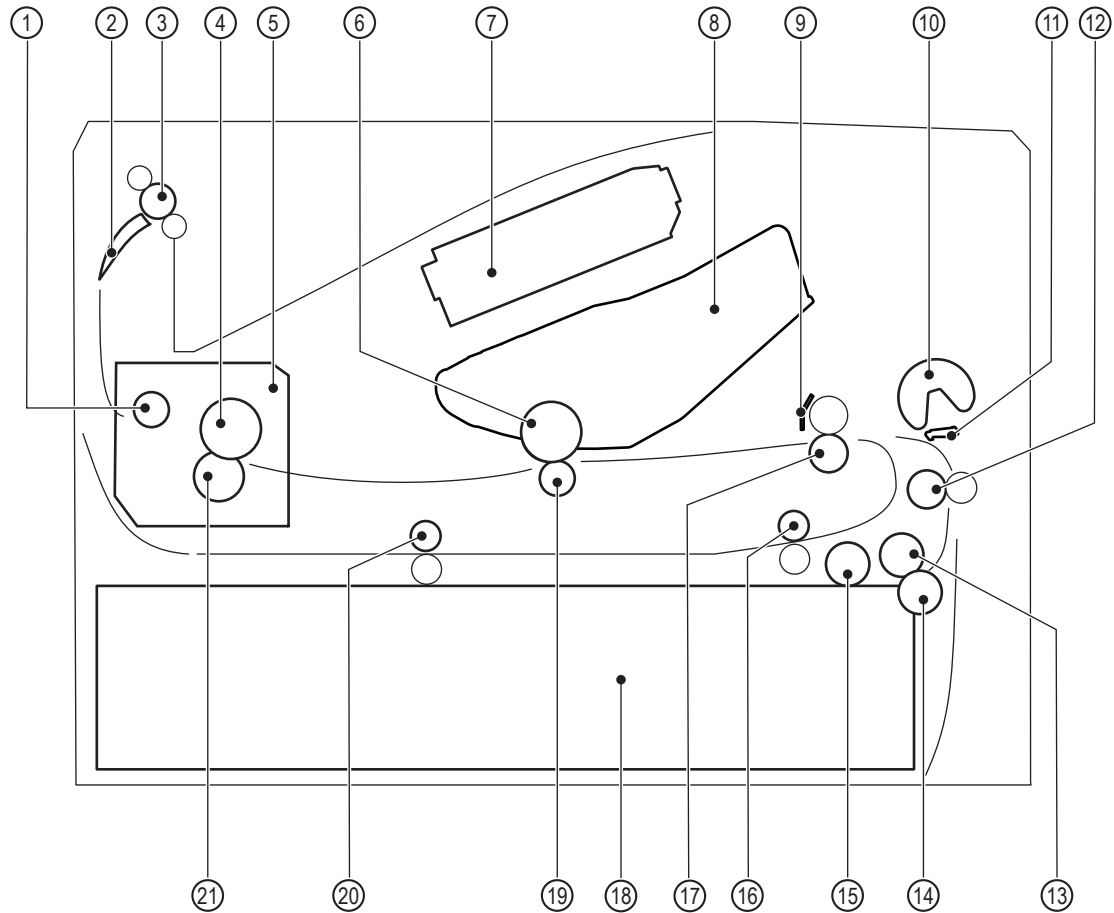

Item	Description	Item	Description
1	Fuser output roller	12	Feed roller
2	Duplex flapper ¹	13	Tray 2 feed roller
3	Output roller	14	Tray 2 separation roller
4	Fuser film	15	Tray 2 pickup roller
5	Fuser	16	Duplex re-pickup roller ¹
6	Photosensitive drum	17	Registration roller
7	Laser/scanner assembly	18	Cassette
8	Toner cartridge	19	Transfer roller
9	Registration shutter	20	Duplex feed roller ¹
10	Tray 1 (MP) tray pickup roller	21	Pressure roller
11	Tray 1 (MP) tray separation pad		

¹ Duplex models only.

Figure 2-60 1x550-sheet paper feeder, cross section diagram

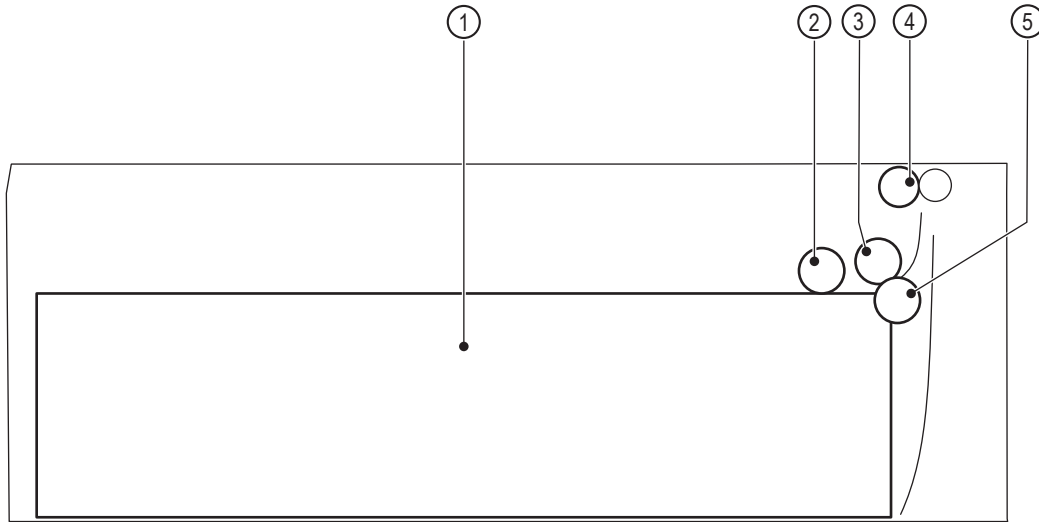

Item	Description
1	Cassette
2	Cassette pickup roller
3	Cassette feed roller
4	Feed roller
5	Cassette separation roller

Diagrams: Printed circuit assembly (PCA) connector locations

Use the diagrams in this section to identify printer PCA connector locations.

- [DC controller connections](#)
- [Formatter PCA \(M501\)](#)
- [Formatter PCA \(M506/E50045/M507/E50145\)](#)
- [Formatter PCA \(M527/E52545/M528/E52645\)](#)
- [1x550-sheet paper feeder controller PCA connections](#)

DC controller connections

Each of the connections on the DC controller PCA is indicated in the following figure.

Figure 2-61 DC controller PCA connectors

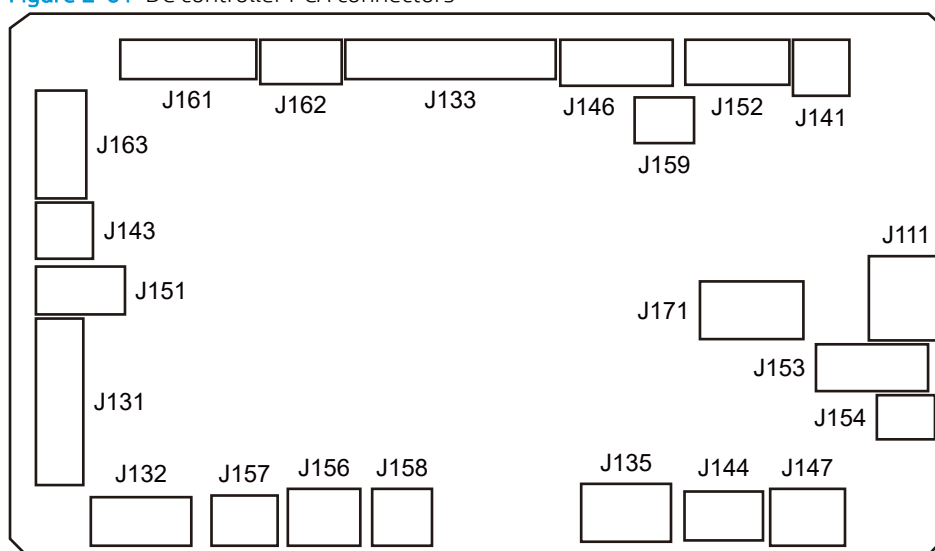

Item	Description	Item	Description
J111	Not used	J152	Output bin media-full sensor (PS4) Fuser output sensor (PS13) Thermistor (YH401)
J131	Low-voltage power supply (LVPS) Power LED	J153	Paper feeder
J132	Fuser power supply (FPS)	J154	Duplex re-pickup clutch (CL1) ¹
J133	High-voltage power supply (HVPS)	J156	Media surface sensor (PS12)
J135	Low-voltage power supply (LVPS)	J157	Registration sensor (PS11)
J141	Duplex switchback solenoid (SL3) ¹	J158	Cassette detection switch (SW4)
J143	Tray 1 (MP) tray pickup solenoid (SL2)	J159	Rear door switch (SW5)
J144	Lifter motor Cassette pickup solenoid (SL1)	J161	Laser/scanner assembly

Item	Description	Item	Description
J146	Fuser motor (M1)	J162	Laser/scanner motor
J147	Sub fan (FM2)	J163	Formatter
J151	Media width sensor (PS1a) Duplex feed sensor (PS2b) ¹ Top-of-Page (TOP) sensor (PS2)	J171	Pickup motor (M2)

¹ Duplex models only.

Formatter PCA (M501)

Review the following information about the formatter PCA for the M501 printer.

Figure 2-62 Formatter PCA M501

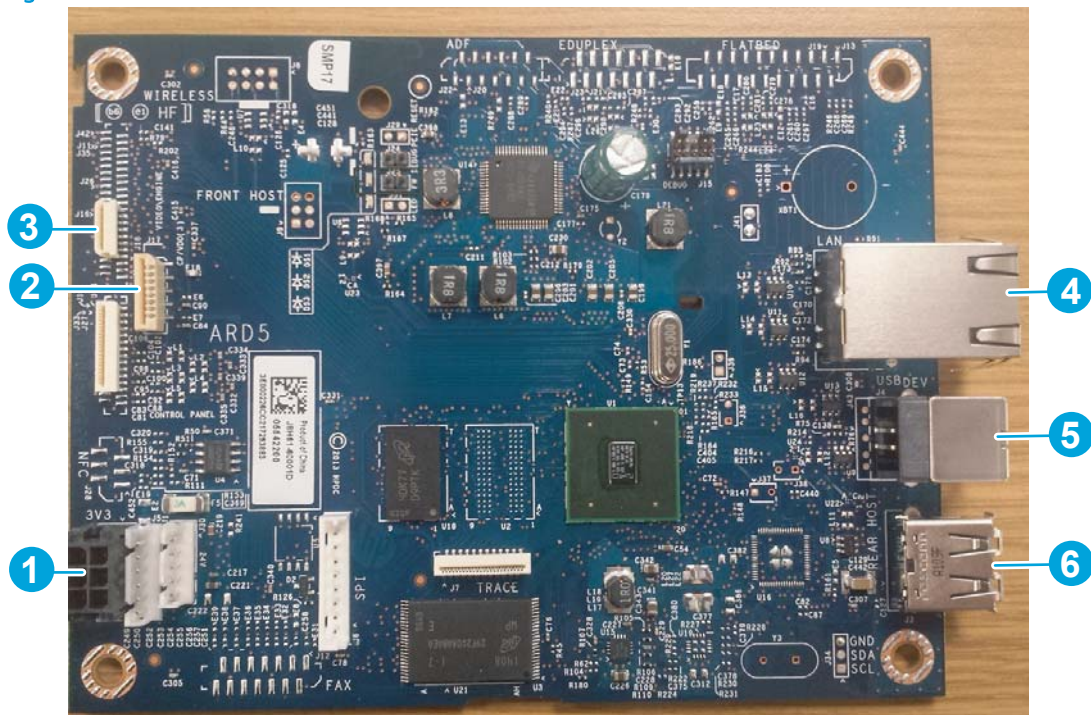

Item	Description	Item	Description
1	Control panel	4	Local area network (LAN)
2	Engine	5	USB device
3	Power supply	6	USB host

Formatter PCA (M506/E50045/M507/E50145)

Review the following information about the formatter PCA for the M506/E50045/M507/E50145 printers.

Figure 2-63 Formatter PCA (M506/E50045/M507/E50145)

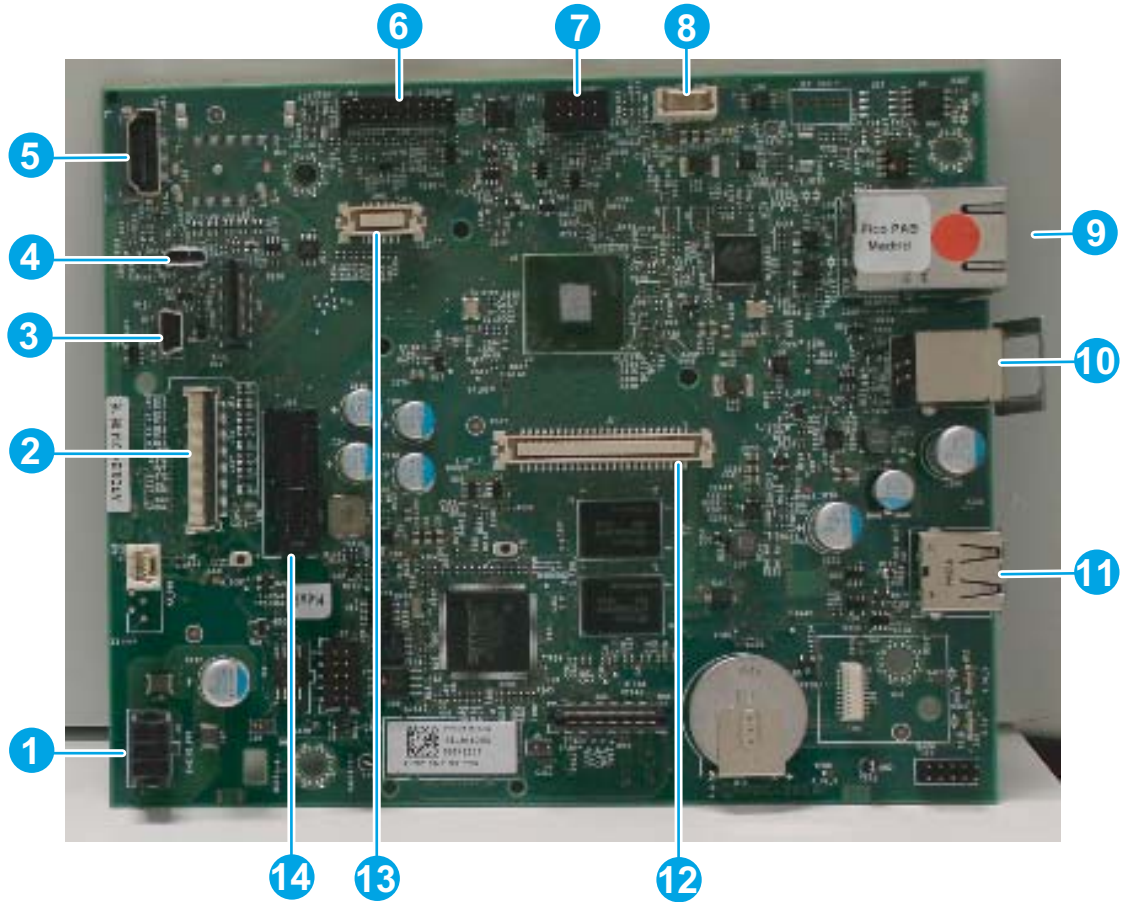

Item	Description	Item	Description
1	Power	8	IOD
2	Engine I/F	9	Local area network (LAN)
3	Hardware integration pocket (HIP)	10	USB device
4	Easy-access USB	11	USB host
5	Control panel HDMI	12	Dual in-line memory module (DIMM)
6	Control panel sideband	13	embedded MultiMedia Card (eMMC)
7	Wireless	14	Hard-disk drive (HDD) riser

Formatter PCA (M527/E52545/M528/E52645)

Review the following information about the formatter PCA for the M527/E52545/M528/E52645 printers.

Figure 2-64 Formatter PCA M527/E52545/M528/E52645

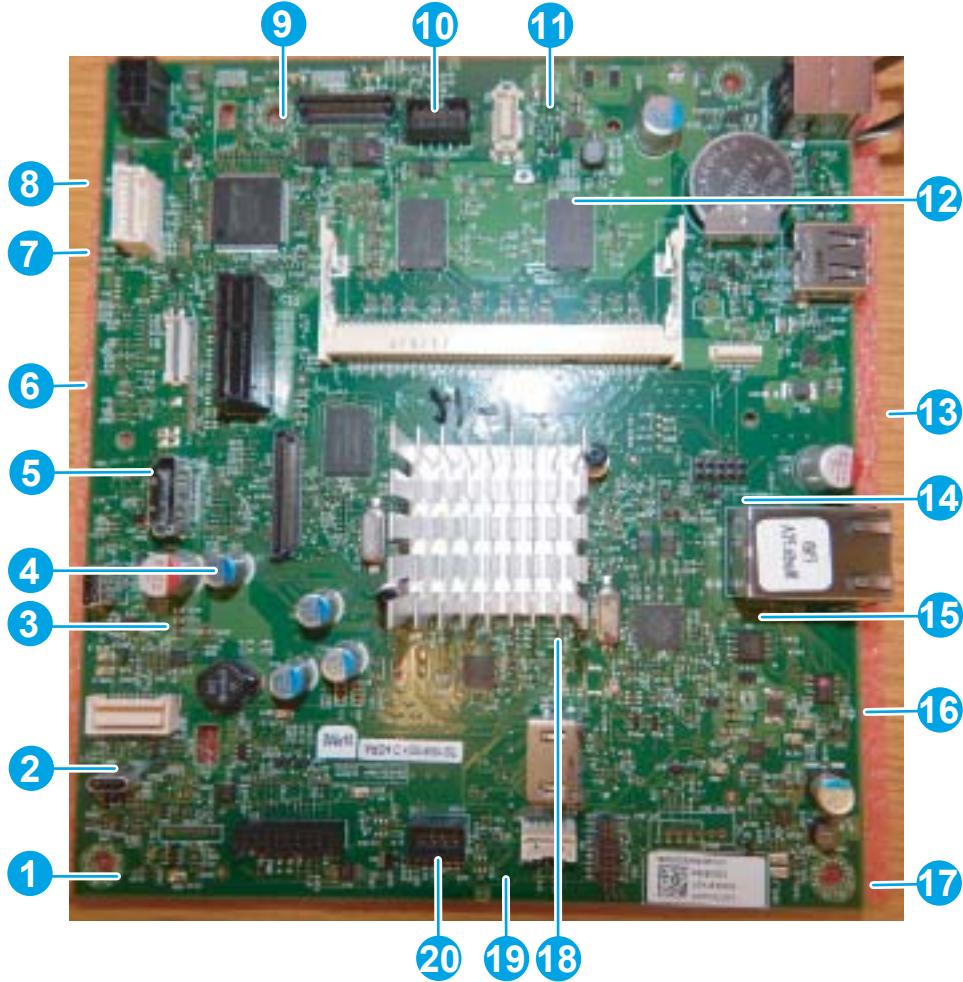

Item	Description	Item	Description
1	Power	11	NVRAM
2	Accessible architecture	12	Control panel HDMI
3	Engine and video control	13	Local area network (LAN)
4	Hard-disk drive (HDD) riser	14	BASH
5	Scanner HDMI	15	Auxiliary
6	Hardware integration pocket (HIP)	16	USB host
7	Fax	17	USB device
8	Easy-access USB	18	Dual in-line memory module (DIMM)
9	Control panel sideband	19	embedded MultiMedia Card (eMMC)
			NOTE: Only the M527dn/E52545dn/M528dn/E52645dn uses the eMMC.
10	Wireless	20	Debug port

1x550-sheet paper feeder controller PCA connections

Each of the connections on the 1x550-sheet paper feeder controller PCA is indicated in the following figure.

Figure 2-65 1x550-sheet paper feeder controller PCA connectors

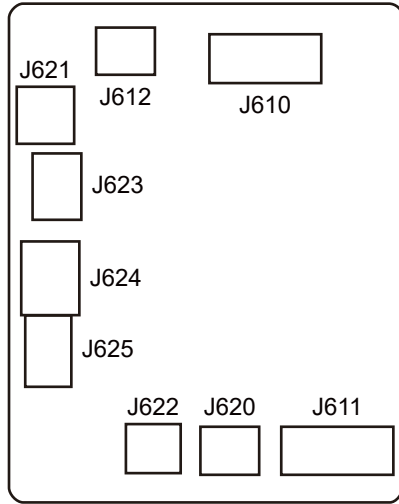

Item	Description	Item	Description
J610	Printer	J622	Lifter motor (M5)
J611	Paper feeder	J623	Media surface sensor (PS460)
J612	Cassette detection switch (SW3)	J624	Feed sensor (PS432)
J620	Lifter motor (M5)	J625	Cassette media out sensor (PS461)
J621	Cassette pickup solenoid (SL4)		

Diagrams: External plug and port locations

Use the following figure to locate and identify the printer external port locations.

Figure 2-66 External plug and port locations (M501)

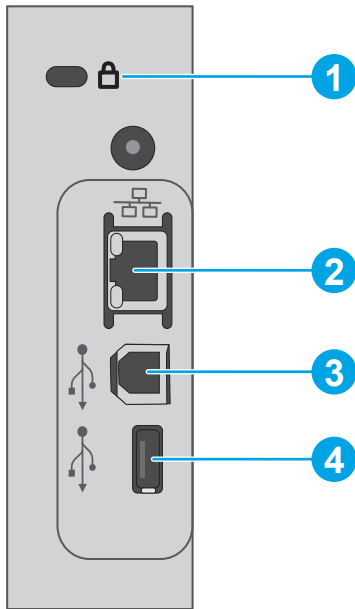

Item	Description
1	Slot for a cable-type security lock
2	Local area network (LAN) Ethernet (RJ-45) network port
3	Hi-Speed USB 2.0 printing port
4	USB port for job storage feature (requires a 16 GB or larger USB flash drive)

Figure 2-67 External plug and port locations (M506/E50045/M507/E50145)

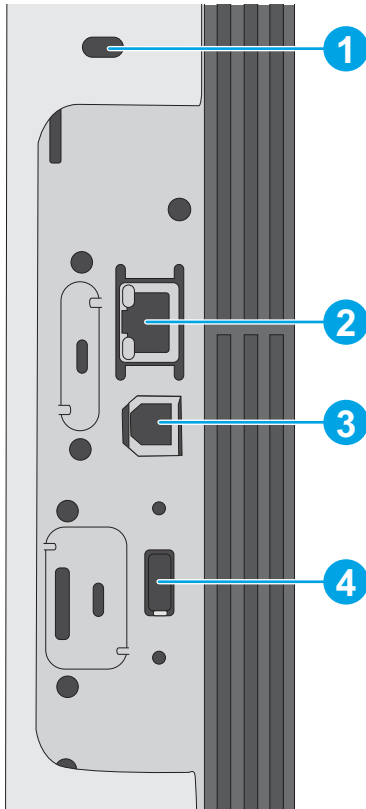

Item	Description
1	Slot for a cable-type security lock
2	Local area network (LAN) Ethernet (RJ-45) network port
3	Hi-Speed USB 2.0 printing port
4	USB port for connecting external USB devices (this port might be covered)

NOTE: For easy-access USB printing, use the USB port on the top cover.

Figure 2-68 External plug and port locations (M527/E52545/M528/E52645)

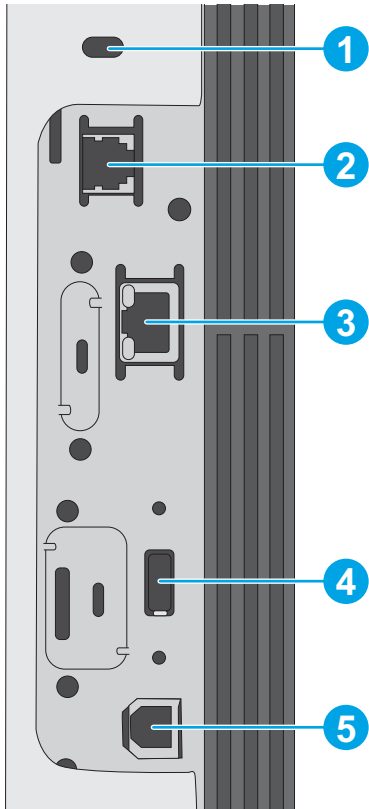

Item	Description
1	Slot for a cable-type security lock
2	Fax port (f and z models only)
3	Local area network (LAN) Ethernet (RJ-45) network port
4	USB port for connecting external USB devices (this port might be covered)
	NOTE: For easy-access USB printing, use the USB port on the top cover.
5	Hi-Speed USB 2.0 printing port

Diagrams: Locations of major assemblies

Use the figures in this section to identify and locate major components and assemblies in the printer.

- [Main assemblies \(printer base\)](#)
- [Rollers and pads \(printer base\)](#)
- [Motor and fans](#)
- [Printed circuit assemblies \(PCAs; printer base\)](#)

Main assemblies (printer base)

Review the following information about the main assemblies (printer base).

Figure 2-69 Main assemblies

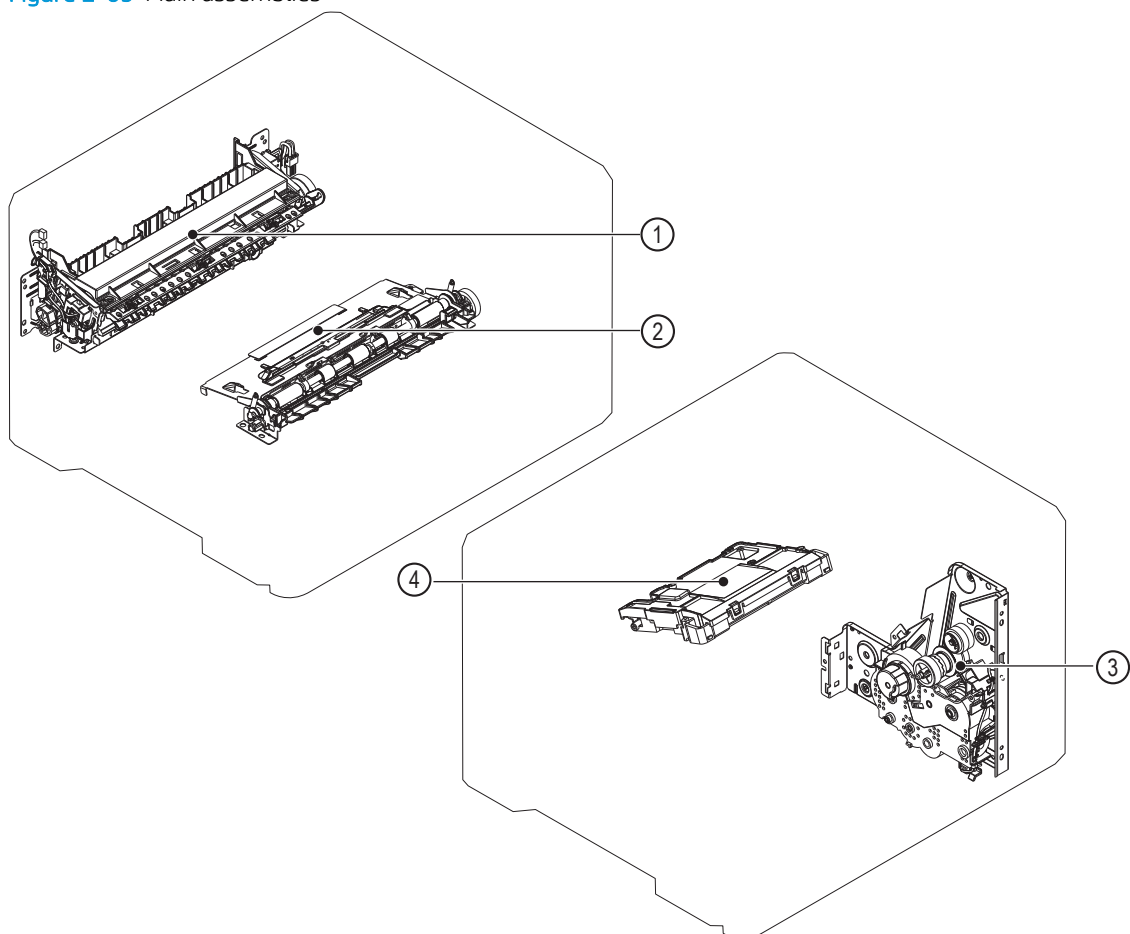

Item	Description
1	Fuser
2	Registration assembly
3	Feed drive assembly
4	Laser/scanner assembly

Rollers and pads (printer base)

Review the following information about the rollers and pads (printer base).

Figure 2-70 Rollers and pads (printer base)

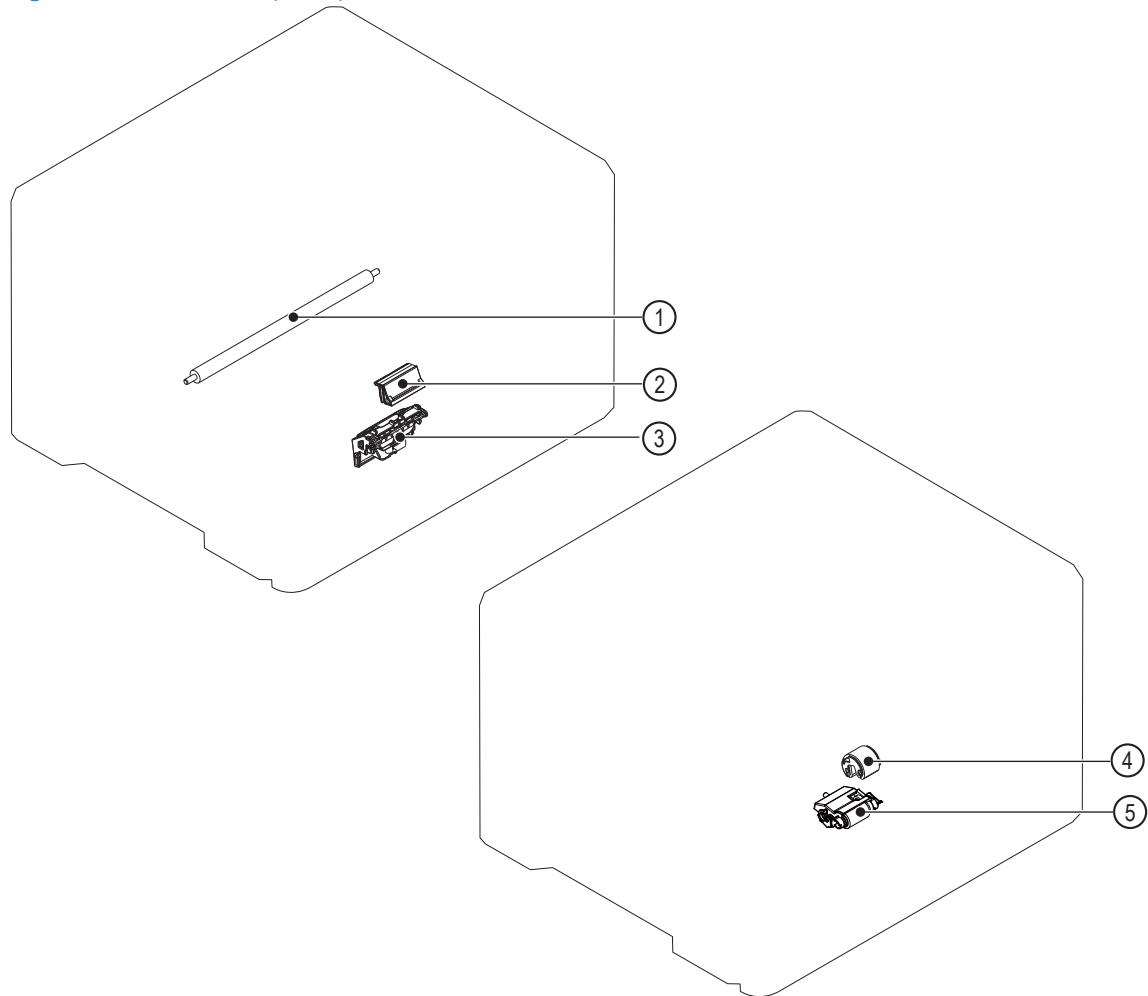

Item	Description
1	Transfer roller
2	Tray 1 separation pad assembly
3	Tray 2 separation roller assembly
4	Tray 1 pickup roller
5	Tray 2 pickup roller assembly

Motor and fans

Review the following information about the motor and fans.

Figure 2-71 Motor and fans

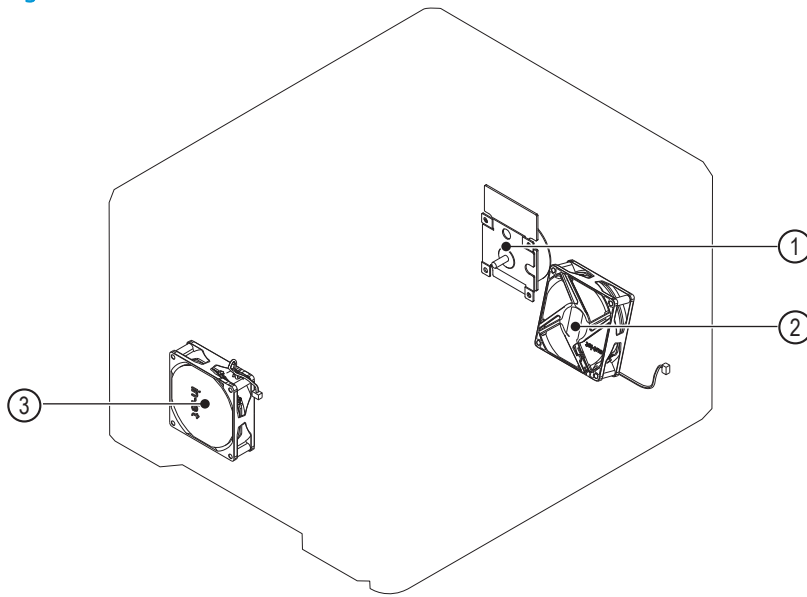

Item	Description
1	Fuser motor (M1)
2	Main fan (FM1)
3	Sub fan (FM2)

Printed circuit assemblies (PCAs; printer base)

Review the following information about the PCAs (printer base).

Figure 2-72 PCAs (printer base)

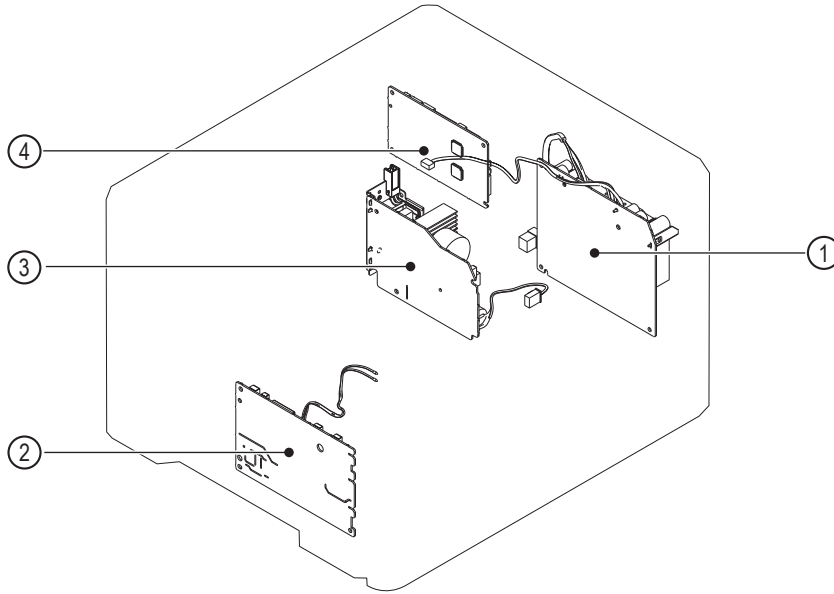

Item	Description
1	Low-voltage power supply (LVPS)
2	High-voltage power supply (HVPS)
3	Fuser power supply (FPS)
4	DC controller PCA

Diagrams: General timing chart

Review the following information about the general timing chart.

Figure 2-73 General timing chart



Diagrams: General circuit diagrams

Review the following information about the general circuit diagrams.

Figure 2-74 General circuit diagram for the printer base (1 of 2)

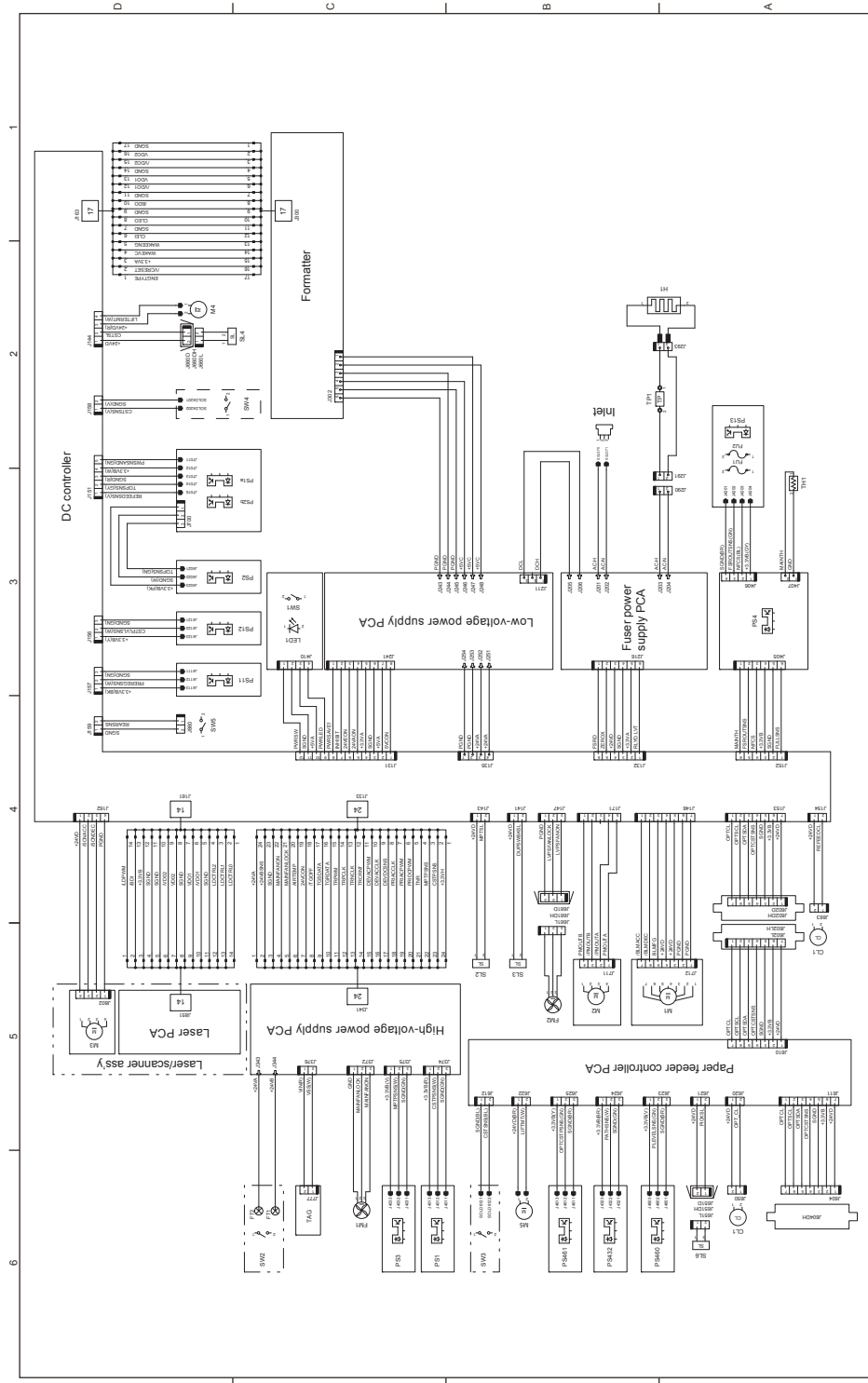
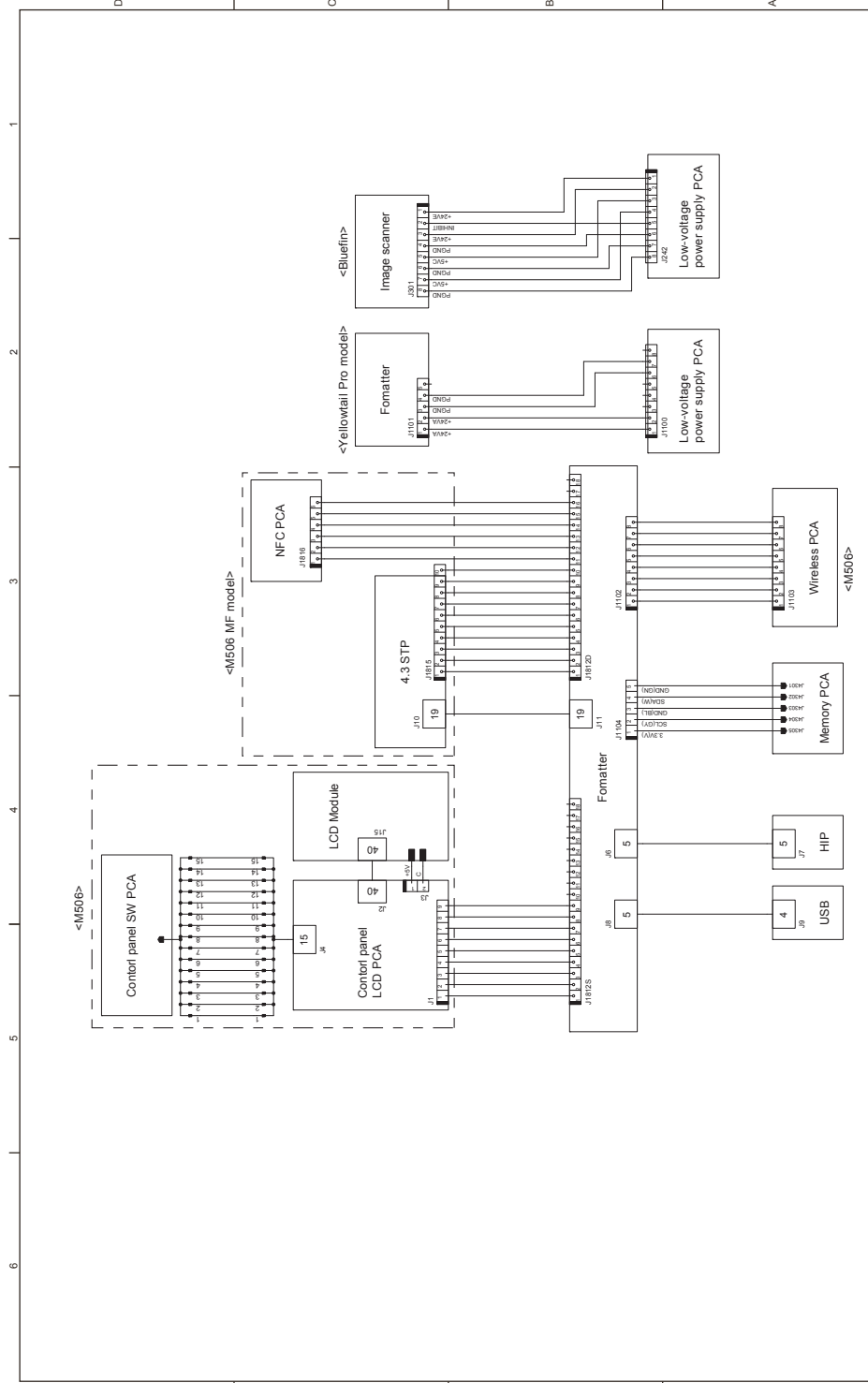

Figure 2-75 General circuit diagram for the printer base (2 of 2)



Internal test and information pages

Review the following information about the internal test and information pages.

- [Print a configuration page](#)
- [Print a fuser test page \(all except M501\)](#)
- [Advanced configuration with HP Embedded Web Server \(EWS\) and HP Device Toolbox \(Windows\) \(M501\)](#)

Print a configuration page

Use the following procedures to print a configuration page.

- [Print the configuration page from a LCD control panel \(M501\)](#)
- [Print the configuration page from a LCD control panel \(M506/E50045/M507/E50145\)](#)
- [Print the configuration page from a touchscreen control panel \(M527/E52545/M528/E52645\)](#)
- [HP embedded Jetdirect page \(all except M501\)](#)
- [Wireless page \(all except M501\)](#)
- [Finding important information on the configuration pages](#)



NOTE: Depending on the model, up to three pages print when printing a configuration page. In addition to the main configuration page, the HP embedded Jetdirect configuration and the wireless pages print.

Print the configuration page from a LCD control panel (M501)

Use the following procedure to print the configuration page from a LCD control panel on an M501 printer.

1. On the printer control panel, press the **OK** button.
2. Open the **Reports** menu.
3. Select **Configuration Report**.

Figure 2-76 Configuration report (M501)

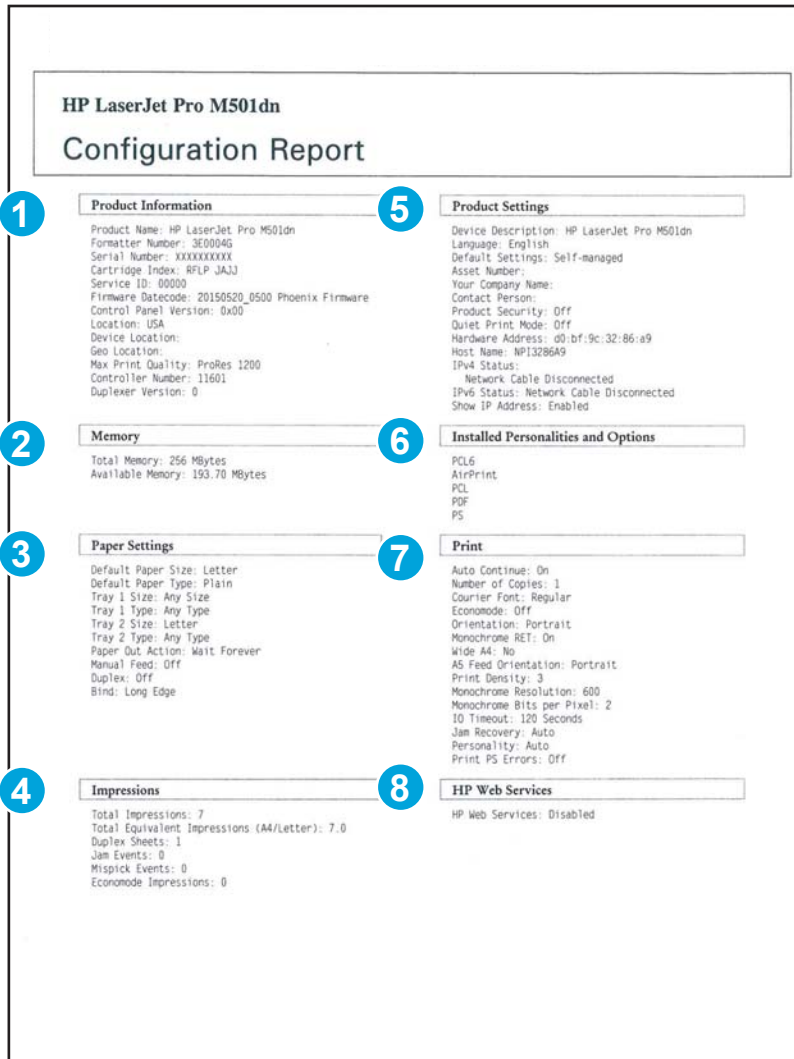

Item	Description	Item	Description
1	Product information	5	Product settings
2	Memory	6	Installed personalities and options
3	Paper settings	7	Print
4	Impressions	8	HP Web services

Print the configuration page from a LCD control panel (M506/E50045/M507/E50145)

Use the following procedure to print the configuration page from a LCD control panel on an M506/E50045/M507/E50145 printer.

FutureSmart 3

1. From the [Home](#) screen on the printer control panel, use the down arrow ▼ button to scroll to [Administration](#), and then press the [OK](#) button.
2. Open the following menus:

- [Reports](#)
 - [Configuration/Status Pages](#)
3. Use the down arrow ▼ button to scroll to [Configuration Page](#), and then press the [OK](#) button to select it.
 4. Use the up arrow ▲ button to scroll to [Print](#), and then press the [OK](#) button to print the pages.

FutureSmart 4

1. From the [Home](#) screen on the printer control panel, use the arrow keys to navigate to [Reports](#), and then press the [OK](#) button.
2. Use the down arrow ▼ button to scroll to [Configuration/Status Pages](#), and then press the [OK](#) button.
3. Use the down arrow ▼ button to scroll to [Configuration Page](#), and then press the [OK](#) button.
4. Use the down arrow ▼ to scroll down to [Cancel](#), and then use the right arrow ► to highlight the print icon . Select [OK](#) to print the pages.

Print the configuration page from a touchscreen control panel (M527/E52545/M528/E52645)

Use the following procedure to print the configuration page from a touchscreen control panel on an M527/E52545/M528/E52645 printer.

1. From the [Home](#) screen on the printer control panel, scroll to and touch the [Administration](#) button (FutureSmart 3), or scroll to and touch the [Reports](#) button (FutureSmart 4).
2. Open the following menus:
 - [Reports](#) (FutureSmart 3)
 - [Configuration/Status Pages](#)
3. Touch [Configuration Page](#) to select it.
4. Touch the [Print](#) button to print the pages.

Figure 2-77 Configuration page (all except M501)

Configuration Page
HP LaserJet M506
Page 1

1 Device Information

Product Name: HP LaserJet M605
 Device Name: HP LaserJet M605
 Model Number: CAXXAA
 DC Controller Version: 1.102
 Device Serial Number: XXXXXXXXXX
 Formatter Number: XXXXXXXXXX
 Firmware Bundle Version: Beta
 Firmware Revision: 235/930_482546
 Firmware Datecode: 20140617
 HP FutureSmart Level: HP FutureSmart 3
 NFC revision: Not Installed
 Service ID: 00000
 Maintenance Kit Interval: 225000
 Pages Since Last Maintenance: 0
 PS wait Time-out: 300 seconds
 Engine Cycles*: 7
 *Not weighted for billing

2 Installed Personalities and Options

PCL: 20010402
 PCLXL: 20010402
 POSTSCRIPT: 20010402
 PDF: 20130901
 AirPrint: 2040201
 Internal Disk: Hard Disk: Enabled
 Serial Number: DE160322
 Model: Toshiba 09G400
 Capacity: 3776 MB
 Hard Disk Encryption Status: Disk cannot be encrypted
 HP Printer Trusted Platform Module: Enabled
 Firmware: 01.02.149.32
 Ek Thumbprint:
 C4E91A00436783210A0F476F98139EFC54E036A9
 SRK Thumbprint:
 F8091A00436783210A0F476F98139EFC54E084F9
 Embedded HP JetDirect J.BA3: NP1245593
 Wireless HP JetDirect J8032E: 0.0.0.0

3 HP Web Services

HP Web Services: Disabled
 ePrint: Disabled

4 Memory

Total RAM: 512 MB

5 Event Log

Number of Entries in Use: 17
 Three Most Recent Entries:

Number	Cycles	Event
17	7	10:99:40
16	7	33:02:02
15	7	33:02:02

6 Security

Hard Disk Encryption Status:
 Internal Disk: Disk cannot be encrypted
 Job Data Encryption Status: Encrypted (AES-128)
 Job Data Persistence: [[[violatle]]]
 File Erase Mode: Non-Secure Fast Erase (No overwrite)
 Control Panel Password: Disabled
 Support Key: 805F-7995-UEXG
 Host USB plug and play: Enabled
 Device USB: Enabled

7 Paper Trays and Options

Default Paper Size: Letter
 Tray 1 Size: Any Size
 Tray 1 Type: Any Type
 Tray 2 Size: Letter
 Tray 2 Type: Plain
 1: Output Bin 1, 500 Sheets, Standard bin (correct order)
 2: Output Bin 2, 100 Sheets, Rear bin (straightest path)

April 27, 2000 6:56:00 PM

English (United States)

Item	Description	Item	Description
1	Device information	5	Event log
2	Installed personalities and options	6	Security
3	HP Web services	7	Paper trays and options
4	Memory		

HP embedded Jetdirect page (all except M501)

The second configuration page is the HP embedded Jetdirect page, which contains the following information:
 Always make sure the status line under the general information line indicates "HP embedded Jetdirect page."

Figure 2-78 HP embedded Jetdirect page (all except M501)

Embedded Jetdirect Page
HP LaserJet M506
Page 1

<p>1 ----- General Information ----- Status: I/O Card Initializing Model Number: J8032E Hardware Address: 6CC217245593 Firmware Version: JD124500215 Port Config: Unknown Auto Negotiation: On Manufacturing ID: 5107510700****-M Build Date: 06/16/2014 06:00:50 WS Registration: Not Registered ePrint: Not Applicable Email: Not Applicable</p>	<p>4 ----- TCP/IP ----- IPv4: Enabled IPv6: Enabled Host Name: NP1245593 IPv4 Domain Name: Not Specified IPv6 Domain Name: Not Specified Primary DNS Server: Not Specified Secondary DNS Server: Not Specified DNS(IPv6): Not Specified Not Specified WINS Server: Not Specified TCP Idle Timeout: 90 sec</p>	
<p>2 ----- Security Settings ----- IPsec: Disabled Secure Web: HTTPS Required Cert Expires: 2005-01-17 02:14 UTC SNMP Versions: 1:2 SNMP Set Only Name: Not Specified SNMP Get Only Name: Not Specified/Default Access List: Not Specified Admin Password: Not Specified Announcement Agent: Success FIPS: Disabled</p>	<p>5 ----- IPv4 ----- Status: Initializing IP Address: 0.0.0.0 Subnet Mask: 0.0.0.0 Default Gateway: 0.0.0.0 Config By: Not Configured BOOTP/DHCP Server: 0.0.0.0 TFTP Server: 0.0.0.0 Bonjour Service Name: Not Specified</p>	
<p>3 ----- Network Statistics ----- Total Packets Received: 0 Unicast Packets Received: 0 Bad Packets Received: 0 Framing Errors Received: 0 Total Packets Transmitted: 0 Unsendable Packets: 0 Transmit Collisions: 0 Transmit Late Collisions: 0 Last Make: 000005F0000000000000000000000000 00000000000000000000000000000000 00000000000000000000000000000002</p>	<p>6 ----- IPv6 ----- Status: Ready Link-Local: Not Configured Stateless: Not Configured DHCPv6: Not Configured Manual: Not Configured</p>	

Apr/27/2009 6:56:00 PM
English (United States)

Item	Description
1	General Information indicates the printer status, model number, hardware firmware version, port select, port configuration, auto negotiation, manufacturing identification, and manufactured date.
4	Security Settings information
3	Network Statistics indicates the total packets received, unicast packets received, bad packets received, framing errors received, total packets transmitted, unsendable packets, transmit collisions, and transmit late collisions.
4	TCP/IP information, including the IP address
5	IPv4 information
6	IPv6 information

Wireless page (all except M501)

The third configuration page is the wireless page, which contains the following information:

NOTE: Wireless models only.

Always make sure the status line under the general information line indicates "I/O Card Ready."

Figure 2-79 Wireless page (all except M501)

The screenshot shows the 'Wireless' page for an HP LaserJet M506 printer. The page is titled 'Wireless' and 'HP LaserJet M506' with 'Page 1' in the top right corner. The content is organized into several sections, each highlighted with a numbered callout:

- 1** General Information: Status: I/O Card Ready; Model Number: J8032E; Hardware Address: 6CC21245593; Firmware Version: JD124500215; Network Connection Type: Wireless Direct; Data Rate Detected: Unknown; Link Config: 802.11; Manufacturing ID: 5107510700****4; Build Date: 06/16/2014 06:00:50.
- 2** Wireless Direct: Status: Disabled.
- 3** Connected Clients: MAC Address: IP Address.
- 4** Security Settings: IPsec: Disabled; Secure Web: HTTPS Required; Cert Expires: 2005-01-17 02:14 UTC; SNMP Versions: 1, 2; SNMP Set Only Name: Not Specified; SNMP Get Only Name: Not Specified/Default; Access List: Not Specified; Admin Password: Not Specified; Announcement Agent: Success; FIPS: Disabled.
- 5** Network Statistics: Total Packets Received: 0; Unicast Packets Received: 0; Bad Packets Received: 0; Framing Errors Received: 0.
- 6** TCP/IP: IPv4: Enabled; IPv6: Enabled; Host Name: NP1245593; TCP Idle Timeout: 90 sec.
- 7** IPv4: Status: Initializing; Bonjour Service Name: Not Specified.
- 8** IPv6: Status: Ready; Link-Local: Not Configured.

At the bottom left, it says 'Apr 27/2000 8:56:00 PM' and at the bottom right, it says 'English (United States)'.

Item	Description
1	General Information indicates the printer status, model number, hardware firmware version, port select, port configuration, auto negotiation, manufacturing identification, and manufactured date.
2	Wireless Direct indicates the wireless function status.
3	Connected Clients indicates the MAC or IP address of connected clients.
4	Security Settings information
5	Network Statistics indicates the total packets received, unicast packets received, bad packets received, framing errors received, total packets transmitted, unsendable packets, transmit collisions, and transmit late collisions.
6	TCP/IP information, including the IP address.
7	IPv4 information.
8	IPv6 information.

Finding important information on the configuration pages

Certain information, such as the firmware date codes, the IP address, and the email gateways, is especially helpful while servicing the printer. This information is on the various configuration pages.

Table 2-16 Important information on the configuration pages

Type of information	Specific information	Configuration page
<p>Firmware date codes</p> <p>When performing a remote firmware upgrade procedure, all of these firmware components are upgraded.</p>	<p>DC controller (all except M501)</p> <p>NOTE: For the M501 printer, the DC controller version is listed as the controller number under product information on the configuration page.</p>	<p>Look on the main configuration page, under "Device Information."</p>
<p>Firmware date codes</p> <p>When performing a remote firmware upgrade procedure, all of these firmware components are upgraded.</p>	<p>Firmware datecode</p> <p>NOTE: For the M501 printer, open the main menus, select the Service menu, and then select Firmware Datecode.</p>	<p>Look on the main configuration page, under "Product Information" (M501) or "Device Information" (all except M501).</p>
<p>Firmware date codes</p> <p>When performing a remote firmware upgrade procedure, all of these firmware components are upgraded.</p>	<p>HP embedded Jetdirect firmware version (all except M501)</p>	<p>Look on the HP embedded Jetdirect page, under "General Information."</p>
<p>Accessories and internal storage</p> <p>All optional devices that are installed on the printer should be listed on the main configuration page.</p> <p>In addition, separate pages print for the optional paper handling devices and the fax accessory (all except M501). These pages list more-detailed information for those devices.</p>	<p>Embedded HP Jetdirect (all except M501)</p>	<p>Look on the main configuration page, under "Installed Personalities and Options." Shows model and ID.</p>
<p>Accessories and internal storage</p> <p>All optional devices that are installed on the printer should be listed on the main configuration page.</p> <p>In addition, separate pages print for the optional paper handling devices and the fax accessory (all except M501). These pages list more-detailed information for those devices.</p>	<p>Total RAM</p>	<p>Look on the main configuration page, under "Memory."</p>
<p>Additional 550-sheet feeders</p>	<p>Additional 550-sheet feeders</p>	<p>Look on the main configuration page, under "Paper Trays and Options" (all except M501).</p>
<p>Engine cycles and event logs</p> <p>Total page counts and maintenance kit counts are important for ongoing printer maintenance.</p> <p>The configuration page lists only the three most recent errors. To see a list of the 50 most recent errors, print an event log from the Diagnostics menu.</p>	<p>Engine cycles</p>	<p>Look on the main configuration page, under "Impressions" (M501) or "Device Information" (all except M501).</p>

Table 2-16 Important information on the configuration pages (continued)

Type of information	Specific information	Configuration page
Event-log information (all except M501)	Event-log information	Look on the main configuration page, under "Event Log."
Error report information (M501)	Error-log information	Open the 2ndary Service menu, select Service Reports , and then select Error Report . Press the OK button to print the report. NOTE: This report can also be printed using the HP Embedded Web Server (EWS).

Print a fuser test page (all except M501)

Use the fuser test page to evaluate problems with fuser print quality.

- [Print a fuser test page from a touchscreen control panel](#)
- [Print a fuser test page from a LCD control panel](#)

Print a fuser test page from a touchscreen control panel

Use the following procedure to print a fuser test page from a touchscreen control panel.

1. From the [Home](#) screen on the printer control panel, scroll to and touch the [Administration](#) button (FutureSmart 3), or scroll to and touch the [Support Tools](#) button (FutureSmart 4).
2. Open the following menus:
 - [Troubleshooting](#)
 - [Print Quality Pages](#)
 - [Fuser Test Page](#)
3. Touch the [Print](#) button.

Print a fuser test page from a LCD control panel

Use the following procedure to print a fuser test page from a LCD control panel.

FutureSmart 3

1. From the [Home](#) screen on the printer control panel, use the down arrow ▼ button to scroll to [Administration](#), and then press the [OK](#) button.
2. Use the down arrow ▼ button to scroll to [Troubleshooting](#), and then press the [OK](#) button.
3. If necessary, use the down arrow ▼ button to scroll to [Print Quality Pages](#), and then press the [OK](#) button to start the calibration process.
4. If necessary, use the down arrow ▼ button to scroll to [Fuser Test Page](#), and then press the [OK](#) button to print the page.

FutureSmart 4

1. From the [Home](#) screen on the printer control panel, use the arrow keys to navigate to [Support Tools](#), and then select [OK](#).
2. Navigate to [Maintenance](#), and then select [OK](#).
3. Navigate to [Troubleshooting](#), and then select [OK](#).
4. Use the down arrow ▼ button to scroll to [Print Quality Pages](#), and then press the [OK](#) button.
5. Use the down arrow ▼ button to scroll to [Fuser Test Page](#), and then press the [OK](#) button.
6. Use the down arrow ▼ to scroll down to [Cancel](#), and then use the right arrow ► to highlight the print icon . Select [OK](#) to print the pages.

Figure 2-80 Fuser test page (all except M501)



Advanced configuration with HP Embedded Web Server (EWS) and HP Device Toolbox (Windows) (M501)

Use the HP Embedded Web Server to manage printing functions from your computer instead of the printer control panel.

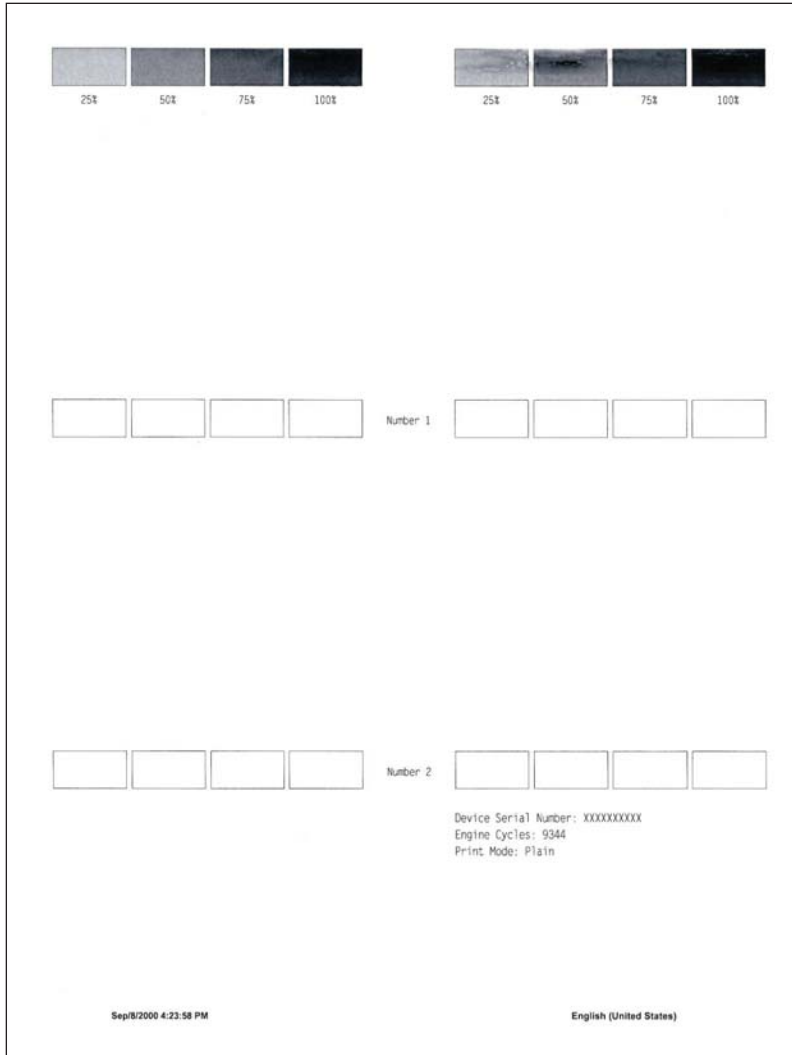
- [Open the HP Embedded Web Server \(EWS\) from the Start menu](#)
- [Open the HP Embedded Web Server \(EWS\) from a Web browser](#)
- View printer status information
- Determine the remaining life for all supplies and order new ones
- View and change tray configurations (paper types and sizes)
- View and print internal pages
- View and change network configuration

The HP Embedded Web Server works when the printer is connected to an IP-based network. The HP Embedded Web Server does not support IPX-based printer connections. You do not have to have Internet access to open and use the HP Embedded Web Server.

When the printer is connected to the network, the HP Embedded Web Server is automatically available.

 **NOTE:** HP Device Toolbox is available only if you performed a full installation when you installed the printer. Depending on how the printer is connected, some features might not be available.

 **NOTE:** The HP Embedded Web Server is not accessible beyond the network firewall.

Open the HP Embedded Web Server (EWS) from the Start menu





Use the following procedure to open the HP Embedded Web Server (EWS) from the Start menu.

1. Click the **Start** button, and then click the **Programs** item.
2. Click your HP printer group, and then click the **HP Device Toolbox** item.

Open the HP Embedded Web Server (EWS) from a Web browser

Use the following procedure to open the HP Embedded Web Server (EWS) from a Web browser.

1. **2-line control panels:** On the printer control panel, press the **OK** button. Open the **Network Setup** menu, and then select **Show IP Address** to display the IP address or host name.

Touchscreen control panels: From the Home screen on the printer control panel, touch the Connection Information  /  button, and then touch the **Network Connected**  button or the **Network Wi-Fi ON**  button to display the IP address or host name.

- Open a Web browser, and in the address line, type the IP address or host name exactly as it displays on the printer control panel. Press the **Enter** key on the computer keyboard. The EWS opens.

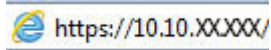

 **NOTE:** If the Web browser displays a **There is a problem with this website's security certificate** message when attempting to open the EWS, click **Continue to this website (not recommended)**.

Choosing **Continue to this website (not recommended)** will not harm the computer while navigating within the EWS for the HP printer.

Tab or section	Description
Home tab Provides printer, status, and configuration information.	<ul style="list-style-type: none"> • Device Status: Shows the printer status and shows the approximate percent life remaining of HP supplies. • Supplies Status: Shows the approximate percent life remaining of HP supplies. Actual supply life remaining can vary. Consider having a replacement supply available to install when print quality is no longer acceptable. The supply does not need to be replaced unless the print quality is no longer acceptable. • Device Configuration: Shows the information found on the printer configuration page. • Network Summary: Shows the information found on the printer network configuration page. • Reports: Print the configuration and supplies status pages that the printer generates. • Event Log: Shows a list of all printer events and errors.
System tab Provides the ability to configure the printer from your computer.	<ul style="list-style-type: none"> • Device Information: Provides basic printer and company information. • Paper Setup: Change the default paper-handling settings for the printer. • Print Quality: Change the default print-quality settings for the printer. • EcoSMART Console: Change the default times for entering Sleep mode or Auto Power Down mode. Configure which events cause the printer to wake. • Paper Types: Configure print modes that correspond to the paper types that the printer accepts. • System Setup: Change the system defaults for the printer. • Service: Perform the cleaning procedure on the printer. • Save and Restore: Save the current settings for the printer to a file on the computer. Use this file to load the same settings onto another printer or to restore these settings to this printer at a later time. • Administration: Set or change the printer password. Enable or disable printer features. <p>NOTE: The System tab can be password-protected. If this printer is on a network, always consult with the administrator before changing settings on this tab.</p>
Print tab Provides the ability to change default print settings from your computer.	<ul style="list-style-type: none"> • Printing: Change the default print settings, such as number of copies and paper orientation. These are the same options that are available on the control panel. • PCL5c: View and change the PCL5c settings. • PostScript: Turn off or on the Print PS Errors feature.

Tab or section	Description
Fax tab (Fax models only)	<ul style="list-style-type: none"> ● Receive Options: Configure how the printer handles incoming faxes. ● Phone Book: Add or delete entries in the fax phone book. ● Junk Fax List: Set fax numbers to block from sending faxes to the printer. ● Fax Activity Log: Review recent fax activity for the printer.
Scan tab (MFP models only)	Configure the Scan to Network Folder and Scan to E-mail features. <ul style="list-style-type: none"> ● Network Folder Setup: Configure folders on the network to which the printer can save a scanned file. ● Scan to E-mail Setup: Begin the process to set up the Scan to E-mail feature. ● Outgoing E-mail Profiles: Set an email address that will appear as the “from” address for all emails sent from the printer. Configure the SMTP Server information. ● E-mail Address Book: Add or delete entries in the email address book. ● E-mail Options: Configure a default subject line and body text. Configure default scan settings for emails.
Networking tab (Network-connected printers only) Provides the ability to change network settings from your computer.	Network administrators can use this tab to control network-related settings for the printer when it is connected to an IP-based network. It also allows the network administrator to set up Wireless Direct functionality. This tab does not appear if the printer is directly connected to a computer.
HP Web Services tab	Use this tab to set up and use various Web tools with the printer.

Control panel menus (M501)

Review the following information about the control panel menus.

- [Setup menu](#)
- [Function specific menus \(M501\)](#)

Setup menu

To open this menu, either press the **OK** button (2-line control panels) or touch the **Setup**  button (touchscreen control panels). The following sub menus are available:

- [HP Web Services menu \(M501\)](#)
- [Reports menu \(M501\)](#)
- [System Setup menu \(M501\)](#)
- [Service menu \(M501\)](#)
- [Network Setup menu \(M501\)](#)
- [Quick Forms menu \(M501\)](#)

HP Web Services menu (M501)

Review the following information about the HP Web Services menu for the M501 printer.

Table 2-17 HP Web Services menu (M501)

Menu item	Description
Enable Web Services	Use Enable Web Services to set up Web Services on the printer. NOTE: You must be connected to a network to enable HP Web Services.
Proxy Settings	The Proxy Settings sub-menu includes the following: <ul style="list-style-type: none">• Proxy Server• Proxy Port• Username• Password

Reports menu (M501)

Review the following information about the Reports menu for the M501 printer.

Table 2-18 Reports menu (M501)

Menu item	Description
Demo Page	Prints a page that demonstrates print quality.
Menu Structure	Prints a control-panel menu layout map.
Configuration Report	Prints a list of the printer settings.

Table 2-18 Reports menu (M501) (continued)

Menu item	Description
Supplies Status	Prints the toner cartridge status. Includes the following information: <ul style="list-style-type: none"> • Approximate pages remaining • Supply level • Serial number • Number of pages printed • First install date • Last used date
Network Summary	Displays status for: <ul style="list-style-type: none"> • Network hardware configuration • Enabled features • TCP/IP and SNMP information • Network statistics
Usage Page	Displays the number of pages printed by the printer. (Specific items reported are model dependent.)
PCL Font List	Prints a list of all installed PCL 5 fonts.
PS Font List	Prints a list of all installed PS fonts.
PCL6 Font List	Prints a list of all installed PCL 6 fonts.
Service Page	Prints the service page. The service page includes information about supported paper types, and other settings that are not included on the configuration page. It also includes the event log.
Print Quality Page	Prints a page that helps solve problems with print quality.
Default Info Page	Prints a page that shows the default settings for the LaserJet Update feature.

System Setup menu (M501)

In the following table, items that have an asterisk (*) indicate the factory default setting.

Table 2-19 System Setup menu (M501)

Menu item	Sub-menu item	Sub-menu item	Description
Language	(List of available control-panel display languages.)		Sets the language in which the control panel displays messages and printer reports.
Paper Setup	Default Paper Size	Letter	Sets the size for printing internal reports or any print job that does not specify a size. NOTE: The default setting is determined by the choice of location during the initial printer setup.
		A4	
		Legal	
	Default Paper Type	Lists available paper types.	Sets the type for printing internal reports or any print job that does not specify a type.

Table 2-19 System Setup menu (M501) (continued)

Menu item	Sub-menu item	Sub-menu item	Description
	Tray 1	Paper Type Paper Size	Configures the size and type for the tray.
	Tray 2	Paper Type Paper Size	Configures the size and type for the tray.
	Tray 3	Paper Type Paper Size	Configures the size and type for the tray.
	Paper Out Action	Wait forever* Cancel Override	<p>Determines how the printer reacts when a print job requires a paper size or type that is unavailable or when the tray is empty.</p> <ul style="list-style-type: none"> • Wait forever: The printer waits until you load the correct paper. • Override: Print on a different size paper after a specified delay. • Cancel: Automatically cancel the print job after a specified delay. • If you select either the Override or Cancel item, the control panel prompts you for the number of seconds to delay.
Print Quality	Adjust Alignment	Print Test Page	<p>Shifts the margin alignment to center the image on the page from top to bottom, and left to right. You can also align the image that is printed on the front with the image that is printed on the back. Allows for one-sided and two-sided printing alignment.</p> <p>Print Test Page: Prints a test page that shows the current registration settings.</p>
Print Quality (continued)	Adjust Alignment (continued)	Adjust Tray 1	<ul style="list-style-type: none"> • X1 Shift: Registration of the image on the paper from side to side, as the paper lies in the tray. For duplex models, this side is the second side (back) of the paper. • X2 Shift: Registration of the image on the paper from side to side, as the paper lies in the tray, for the first side (front) of a duplexed page. This item appears only on duplex models. <p>NOTE: Set X1 Shift first.</p> <ul style="list-style-type: none"> • Y Shift: Registration of the image on the paper from top to bottom as the paper lies in the tray.
		Adjust Tray 2	<ul style="list-style-type: none"> • X1 Shift: Registration of the image on the paper from side to side, as the paper lies in the tray. For duplex models, this side is the second side (back) of the paper. • X2 Shift: Registration of the image on the paper from side to side, as the paper lies in the tray, for the first side (front) of a duplexed page. This item appears only on duplex models. <p>NOTE: Set X1 Shift first.</p> <ul style="list-style-type: none"> • Y Shift: Registration of the image on the paper from top to bottom as the paper lies in the tray.

Table 2-19 System Setup menu (M501) (continued)

Menu item	Sub-menu item	Sub-menu item	Description
Energy Settings	Sleep/Auto Off After	5 minutes*	Specifies the amount of idle time before the printer enters sleep mode.
		1 Minute	
		1 Hour	
		30 Minutes	
		15 Minutes	
	Shut Down After	Never	Set the amount of elapsed time before the printer turns itself off.
		30 Minutes	
		1 Hour	
		2 Hours	
		4 Hours	
		8 Hours	
	Delay Shut Down	No Delay	Select whether or not the printer delays shutting down after the user presses the power button. No Delay: The printer shuts down immediately. When Ports Are Active: The printer waits until there is no I/O port activity before shutting down.
When Ports Are Active			
Supply Settings	Black Cartridge	Very Low Setting	Stop: The printer stops printing until you replace the print cartridge. Prompt*: The printer stops printing and prompts you to replace the print cartridge. You can acknowledge the prompt and continue printing. Continue: The printer alerts you that the print cartridge is very low, but it continues printing.
		Low Threshold	Enter a percentage for the low threshold setting.
	Store Usage Data		Select where to store the printer's usage data, either on the supplies or not on the supplies.
	Cartridge Policy	Off Authorized HP	Use the Cartridge Policy feature to allow only genuine HP cartridges to be used with this printer. When someone attempts to install a cartridge that is not a genuine HP cartridge, the printer control panel displays a message informing that the cartridge is unauthorized, and it displays information explaining how to proceed.

Table 2-19 System Setup menu (M501) (continued)

Menu item	Sub-menu item	Sub-menu item	Description
	Cartridge Protection	Protect Cartridges	<p>Use the Cartridge Protection feature to permanently associate toner cartridges with a specific printer so they cannot be used in other printers. When someone attempts to transfer a protected cartridge from the original printer into another printer, that printer will not print. The printer control panel displays a message informing that the cartridge is protected, and it displays information explaining how to proceed.</p> <p>After selecting Protect Cartridges, when the printer prompts to confirm, select Continue to enable the feature.</p> <p>NOTE: After enabling cartridge protection for the printer, all subsequent toner cartridges installed in the printer are automatically and <i>permanently</i> protected. To avoid protecting a new cartridge, disable the feature before installing the new cartridge. To disable the feature, select Cancel rather than Continue in this step.</p>
Administration	Product Security	On	Set the printer-security feature. If you select the On setting, you must set a password.
		Off	
	Manage Stored Jobs	Quick Copy	<p>The number of copies sent are printed immediately, and then that number of copies is printed anytime the stored job is retrieved.</p> <ul style="list-style-type: none"> • Job type: temporary • Job deleted after printing: no • PIN protection: no
		Proof and Hold	<p>The first copy is printed immediately. Additional copies are printed by using the printer control panel.</p> <p>For example, ten copies are sent to the printer. One copy prints immediately. Nine copies are printed anytime the stored job is retrieved. The job is deleted after all copies are printed.</p> <ul style="list-style-type: none"> • Job type: temporary • Job deleted after printing: yes • PIN protection: no
Personal Job		<p>The job is stored in the printer memory until it is printed, and then the job is automatically deleted.</p> <ul style="list-style-type: none"> • Job type: temporary • Job deleted after printing: yes • PIN protection: yes (optional) 	
	Stored Job	<p>The job is stored in the printer memory until it is printed, and then the job is manually deleted, or deleted after a predetermined retention time period.</p> <ul style="list-style-type: none"> • Job type: standard • Job deleted after printing: no • PIN protection: yes (optional) 	

Table 2-19 System Setup menu (M501) (continued)

Menu item	Sub-menu item	Sub-menu item	Description
Inactivity Timer			Set the amount of time that passes before a given menu or item will close due to printer inactivity.
Courier Font	Regular*		Set Courier font values.
	Dark		

Service menu (M501)

In the following table, items that have an asterisk (*) indicate the factory default setting.

Table 2-20 Service menu (M501)

Menu item	Sub-menu item	Sub-menu item	Description
Cleaning Page			Cleans the printer when specks or other marks appear on printed output. The cleaning process removes dust and excess toner from the paper path. When selected, the printer prompts you to load plain Letter or A4 paper in Tray 1. Touch the OK button to begin the cleaning process. Wait until the process completes. Discard the page that prints.
USB Speed	High*		Sets the USB speed for the USB connection to the computer. For the printer to actually operate at high speed, it must have high speed enabled and be connected to an EHCI host controller that is also operating at high speed. This menu item does not reflect the current operating speed of the printer.
	Full		
Less Paper Curl	On		When printed pages are consistently curled, this option sets the printer to a mode that reduces curl.
	Off*		
Archive Print	On		When printing pages that will be stored for a long time, this option sets the printer to a mode that reduces toner smearing and dusting.
	Off*		
Firmware Datecode			Displays the current firmware datecode.
Restore Defaults			Sets all settings to the factory default values.
Signature Check	Cancel if Invalid*		Validates HP firmware downloads.
	Prompt if Invalid		
LaserJet Update	Check for Updates Now	Install Now	Check for printer firmware updates.
		Remind Me Later	
		Skip this Update	

Table 2–20 Service menu (M501) (continued)

Menu item	Sub-menu item	Sub-menu item	Description
	Manage Updates	Allow Downgrade	Manage how the printer handles firmware updates.
		Check Automatically	
		Prompt Before Install	
		Allow Updates	
SMTP Comm. Report			The <i>SMTP Communication Report</i> contains the SMTP communication to and from the printer from the last Scan to E-mail job.

Network Setup menu (M501)

In the following table, items that have an asterisk (*) indicate the factory default setting.

Table 2–21 Network Setup menu (M501)

Menu item	Sub-menu item	Description	
Google Cloud Print	Print Claim Sheet	Press OK to send printer capabilities and model number to Google and print a sheet of registration instructions from Google.	
	Proxy Settings	Proxy Server	Enter proxy information.
		Proxy Port	
		Username	
		Password	
IPv4 Config Method	DHCP	The printer automatically configures all the TCP/IP settings via DHCP, BootP or AutoIP. <i>Manual:</i> You can manually configure the IP address, subnet mask, and default gateway. The control panel prompts you to specify values for each address section. As each address is completed, the printer prompts for address confirmation before moving to the next one. After all three addresses are set, the network reinitializes.	
	BOOTP		
	Auto IP		
	Manual		
Auto Crossover	On	This item is used when you are connecting the printer directly to a personal computer using an Ethernet cable (you might have to set this to <i>On</i> or <i>Off</i> depending on the computer being used).	
	Off		
Network Services	IPv4	Enable or disable the IPv4 and IPv6 protocols. By default, each protocol is enabled.	
	IPv6		
Link Speed	Automatic*	Sets the link speed manually if needed.	
	10T Full	After setting the link speed, the printer automatically restarts.	
	10T Half		
	100TX Full		
	100TX Half		
	1000T Full		

Table 2-21 Network Setup menu (M501) (continued)

Menu item	Sub-menu item	Description
Security	Product Security	Enable printer security. If turned on, the printer prompts you to set a password. After it is set, the password will be needed to change printer settings.
	HTTPS Enforcement	An encrypted communication and secure identification of a network web server. Only enabled if the printer is password protected.
	Firewall	Enable, disable, or reset the printer firewall.
	Access Control List	Enable, disable, or reset the network access control list.
	Reset All Security	Reset the security settings to the factory-set default values.
Restore Defaults		Resets all network configurations to their factory defaults.

Quick Forms menu (M501)

Review the following information about the Quick Forms menu for the M501 printer.

Table 2-22 Quick Forms menu

Menu item	Sub-menu item	Description
Notebook Paper	Narrow Rule	Prints pages that have preprinted lines.
	Wide Rule	
	Child Rule	
Graph Paper	1/8 inch	Prints pages that have preprinted graph lines.
	5 mm	
Checklist	1-Column	Prints pages that have preprinted lines with check boxes.
	2-Column	
Music Paper	Portrait	Prints pages that have preprinted lines for writing music.
	Landscape	

Function specific menus (M501)

Review the following information about the function specific menus for the M501 printer.

- [Apps \(M501\)](#)
- [Jobs \(M501\)](#)
- [Supplies Status \(M501\)](#)

Apps (M501)

Use the [Apps](#) menu to install HP Web Services applications.

Jobs (M501)

Use the [Jobs](#) menu to manage stored jobs. Requires a USB 2.0 storage device with at least 16 GB free space to be installed in the rear host USB port.

Supplies Status (M501)

Use the [Supplies Status](#) menu to print a supplies status page. Press [Report](#).

Control panel menus (all except M501)

Review the following information about the control panel menus.

- [Reports menu](#)
- [Settings menu](#)
- [Support Tools menu](#)

Reports menu

Review the following information about the [Reports](#) menu.

To display: At the printer control panel, select the [Reports](#) menu.

 **NOTE:** For the M506x/M507x and M527/E52545/M528/E52645 models, use the [Print](#) button to print the report.

For all other models, use the up arrow ▲ button or down arrow ▼ button to highlight the report, and then press the [OK](#) button. Then use the up arrow ▲ button to highlight [Print](#), and then press the [OK](#) button to print the report.

In the following table, asterisks (*) indicate the factory default setting.

Table 2-23 Reports menu

First level	Second level	Values	Description
Configuration/Status Pages	Settings Menu Map	Cancel	Shows a map of the entire control panel system and the selected values for each setting.
		View	
		Print	
Configuration/Status Pages	Current Settings Page	Cancel	Shows a summary of the current settings for the printer. This might be helpful if you plan to make changes and need a record of the present configuration.
		View	
		Print	
Configuration/Status Pages	Configuration Page	Cancel	Shows the printer settings and installed accessories.
		View	
		Print	
Configuration/Status Pages	How to Connect Page	Cancel	Shows the network information typically needed to connect the printer to a network.
		View	
		Print	

Table 2-23 Reports menu (continued)

First level	Second level	Values	Description
Configuration/Status Pages	Supplies Status Page	Cancel View Print	Shows the approximate remaining life for the supplies; reports statistics on total number of pages and jobs processed, serial number, page counts, and maintenance information. HP provides approximations of the remaining life for the supplies as a customer convenience. The actual remaining supply levels might be different than the approximations provided.
Configuration/Status Pages	Usage Page	Cancel View Print	Shows a count of all paper sizes that have passed through the printer; lists whether they were simplex or duplex, and reports the page count.
Configuration/Status Pages	File Directory Page	Cancel View Print	Shows the file name and folder name for files that are stored in the printer memory.
Configuration/Status Pages	Web Services Status Page	Cancel View Print	Shows the detected Web Services for the printer.
Fax Reports Fax models only	Fax Activity Log	Cancel View Print	Contains a list of the faxes that have been sent from or received by this printer.
Fax Reports Fax models only	Billing Codes Report	Cancel View Print	Provides a list of billing codes that have been used for outgoing faxes. This report shows how many sent faxes were billed to each code.
Fax Reports Fax models only	Blocked Fax List	Cancel View Print	A list of phone numbers that are blocked from sending faxes to this printer.
Fax Reports Fax models only	Speed Dial List	Cancel View Print	Shows the speed dials that have been set up for this printer.
Fax Reports Fax models only	Fax Call Report	Cancel View Print	A detailed report of the last fax operation, either sent or received.

Table 2-23 Reports menu (continued)

First level	Second level	Values	Description
Other Pages	PCL Font List	Cancel Print	Prints the available PCL fonts.
Other Pages	PS Font List	Cancel Print	Prints the available PS fonts.

Settings menu

You can perform basic printer setup by using the [Settings](#) menu. Use the HP Embedded Web Server for more advanced printer setup. To open the HP Embedded Web Server, enter the printer IP address or host name in the address bar of a Web browser.

- [General menu \(all except M501\)](#)
- [Print menu \(M506/E50045/M507/E50145\) and Copy/Print menu \(M527/E52545/M528/E52645\)](#)
- [Scan/Digital Send Settings menu \(M527/E52545/M528/E52645\)](#)
- [Fax menu \(M527/E52545/M528/E52645\)](#)
- [Manage Supplies menu](#)
- [Networking menu](#)



NOTE: Where applicable, the M527/E52545/M528/E52645 printer displays a [View](#) button.

General menu (all except M501)

Review the following information about the [Settings](#) menu.

To display: At the printer control panel, select the [Settings](#) menu, and then select the [General](#) menu.

In the following table, asterisks (*) indicate the factory default setting.

Table 2-24 [General](#) menu (M506/E50045/M507/E50145, M527/E52545/M528/E52645)

First level	Second level	Third level	Fourth level	Values	Description
Date/Time Settings	Date/Time Format	Date Format		DD/MMM/YYYY MMM/DD/YYYY YYYY/MMM/DD	Use the Date/Time Settings menu to specify the date and time and to configure date/time settings.
Date/Time Settings	Date/Time Format	Time Format		12 hour (AM/PM) 24 hours	Select the format that the printer uses to show the date and time, for example 12-hour format or 24-hour format.
Date/Time Settings	Date/Time	Time Zone			Select the time zone from a list.
Date/Time Settings	Date/Time	Date			Select the date from a pop-up calendar.
Date/Time Settings	Date/Time	Time			Select the time from a pop-up keypad.
Date/Time Settings	Date/Time	Adjust for Daylight Savings		Checkbox	If you are in an area that uses daylight savings time, select the Adjust for Daylight Savings box.

Table 2-24 General menu (M506/E50045/M507/E50145, M527/E52545/M528/E52645) (continued)

First level	Second level	Third level	Fourth level	Values	Description
Energy Settings M527/E52545/M528/ E52645 printer	Sleep Schedule	A list of scheduled events displays.		+ (Add) Edit Delete	Use to configure the printer to automatically wake up or go to sleep at specific times on specific days. Using this feature saves energy. NOTE: You must configure the date and time settings before you can use this feature.
Energy Settings M527/E52545/M528/ E52645 printer	Sleep Schedule	A list of scheduled events displays.	Event Type	Wake Sleep	Select whether to add or edit a Wake event or a Sleep event, and then select the time and the days for the wake or sleep event.
Energy Settings M527/E52545/M528/ E52645 printer	Sleep Schedule	A list of scheduled events displays.	Event Time		
Energy Settings M527/E52545/M528/ E52645 printer	Sleep Schedule	A list of scheduled events displays.	Event Days	Select days of the week from a list.	
Energy Settings M527/E52545/M528/ E52645 printer	Sleep Timer Settings	Sleep Mode/Auto Off After		Range: 1 to 120 minutes Default = 60 minutes	Set the number of minutes after which the printer enters Sleep or Auto Off mode. Use the arrow buttons on the control panel to increase or decrease the number of minutes.
Energy Settings M527/E52545/M528/ E52645 printer	Wake/Auto On to These Events			All Events* Network port Power button only	
Energy Settings M506/E50045/M507/ E50145 printer	Sleep Timer Settings	Sleep/Auto Off Timer		Enabled* Disabled	Enable or disable the printer sleep or auto off function.
Energy Settings M506/E50045/M507/ E50145 printer	Sleep Timer Settings	Sleep Mode/Auto Off After		Range: 1 to 120 minutes Default = 60 minutes	Set the number of minutes after which the printer enters Sleep or Auto Off mode. Use the arrow buttons on the control panel to increase or decrease the number of minutes.

Table 2-24 General menu (M506/E50045/M507/E50145, M527/E52545/M528/E52645) (continued)

First level	Second level	Third level	Fourth level	Values	Description
Display Settings	Display Brightness	A sliding bar displays with the indicator set in the middle. Use the arrow keys to select the desired brightness and then select <i>Done</i> .			Use to specify the intensity of the LCD control panel display.
Display Settings	System Sound			On* Off	Use to enable or disable sounds on the printer.
Display Settings	Language Settings	Language		Select from a list of languages that the printer supports.	Use to select a different language for control panel messages and specify the default keyboard layout. When you select a new language, the keyboard layout automatically changes to match the factory default for the selected language.
Display Settings		Keyboard Layout		Each language has a default keyboard layout. To change it, select from a list of layouts.	Select the default keyboard layout that matches the language you want to use.
Display Settings	Information Screen			Show connection information* Hide connection information	Use this menu item to display or hide connection information on the Home screen.
Display Settings	Inactivity Timeout			Range: 10-300 seconds Default = 60 seconds	Specifies the amount of time that elapses between any activity on the control panel and when the printer resets to the default settings. When the timeout expires, the control panel display returns to the Home menu, and any user signed in to the printer is signed out.

Table 2-24 General menu (M506/E50045/M507/E50145, M527/E52545/M528/E52645) (continued)

First level	Second level	Third level	Fourth level	Values	Description
Display Settings	Clearable Warnings			<p>Display during job*</p> <p>Display until cleared</p>	Use this feature to set the period that a clearable warning displays on the control panel. If the On setting is selected, clearable warnings appear until the Clearable Warnings button is pressed. If the Job setting is selected, clearable warnings stay on the display during the job that generated the warning and disappear from the display when the next job starts.
Display Settings	Continuable Events			<p>Auto-continue (10 seconds)*</p> <p>Touch OK to continue</p>	Use this option to configure the printer behavior when the printer encounters certain errors. If the Auto-continue (10 seconds) option is selected, the job will continue after 10 seconds. If the Touch OK to continue option is selected, the job will stop and require the user to touch the OK button before continuing.
Enable Device USB				<p>Enabled</p> <p>Disabled*</p>	Enables the printer to open a file from a USB drive.
Quiet Mode				<p>Off*</p> <p>On</p> <p>Automatic transition</p> <p>Range: 10-300 pages</p> <p>Default = 10 pages</p>	<p>Quiet Mode slows the printer down to reduce the noise the printer makes when printing.</p> <p>Automatic transition allows you to set a predetermined job size of 10 to 999 pages, and print jobs will print in Quiet Mode for all print jobs up to the predetermined page size.</p>

Table 2-24 General menu (M506/E50045/M507/E50145, M527/E52545/M528/E52645) (continued)

First level	Second level	Third level	Fourth level	Values	Description
Jam Recovery				Automatic* Off On	<p>This printer provides a jam recovery feature that reprints jammed pages. Select one of the following options:</p> <p>Automatic: The printer attempts to reprint jammed pages when sufficient memory is available. This is the default setting.</p> <p>Off: The printer does not attempt to reprint jammed pages. Because no memory is used to store the most recent pages, performance is optimal.</p> <p>NOTE: When using this option, if the printer runs out of paper and the job is being printed on both sides, some pages can be lost.</p> <p>On: The printer always reprints jammed pages. Additional memory is allocated to store the last few pages printed. This might cause overall performance to suffer.</p>
Auto Recovery				Enabled Disabled*	<p>If Auto Recovery is enabled and an unrecoverable error occurs in the device firmware, the device automatically turns off and turns back on to recover from the error.</p>

Table 2-24 General menu (M506/E50045/M507/E50145, M527/E52545/M528/E52645) (continued)

First level	Second level	Third level	Fourth level	Values	Description
Enable Auto Send				Disabled* Enabled	<p>Browse to the HP Embedded Web Server AutoSend configuration page for advanced set up and the HP online Privacy Statement Information.</p> <p>Use the Enable Auto Send menu to enable or disable the AutoSend feature. The AutoSend feature enables your product to periodically send product configuration information including serial number, event logs, page usage counts and supplies status information to HP web addresses (URLs), or email addresses. Information sent to HP is used to improve products and services, and to monitor the product if you have a relationship with HP that provides you services such as proactive cartridge replacement, pay-per-page contracts, support agreements, or usage tracking.</p>

Table 2-24 General menu (M506/E50045/M507/E50145, M527/E52545/M528/E52645) (continued)

First level	Second level	Third level	Fourth level	Values	Description
Hold Off Print Job				Enabled* Disabled	Enable this feature if you want to prevent print jobs from starting while a user is initiating a copy job from the control panel. Held print jobs start printing after the copy job is finished, provided that no other copy job is in the print queue.
Reset Factory Settings				Address Book (M527/E52545/M528/E52645 only) Copy (M527/E52545/M528/E52645 only) Digital Send (M527/E52545/M528/E52645 only) E-mail (M527/E52545/M528/E52645 only) Fax (M527/E52545/M528/E52645 only) General (M527/E52545/M528/E52645 only) Print (M527/E52545/M528/E52645 only) Security (M527/E52545/M528/E52645 only) Cancel (M506/E50045/M507/E50145 only) Reset (M506/E50045/M507/E50145 only)	Use to restore all printer settings to their factory defaults.

Print menu (M506/E50045/M507/E50145) and Copy/Print menu (M527/E52545/M528/E52645)

Review the following information about the [Print](#) menu for the M506/E50045/M507/E50145) and the [Copy/Print](#) menu for the M527/E52545/M528/E52645 printers.

To display: At the printer control panel, select the [Settings](#) menu, and then select the [Print](#) menu (M506/E50045/M507/E50145) or the [Copy/Print](#) menu (M527/E52545/M528/E52645).

In the following table, asterisks (*) indicate the factory default setting.

Table 2-25 Print menu (M506/E50045/M507/E50145) or Copy/Print menu (M527/E52545/M528/E52645)

First level	Second level	Third level	Fourth Level	Values	Description
Copy Settings M527/E52545/M528/ E52645 only	Image preview			Make optional Require preview Disable preview	Use this menu to configure how Copy behaves.
Copy Settings M527/E52545/M528/ E52645 only	Copies			1-9999 Default = 1	Configure the default options for copy jobs. If the user does not specify the job options when creating the job, the default options are used.
Copy Settings M527/E52545/M528/ E52645 only	Sides	Original Sides		1-sided 2-sided Flip pages up	Use to indicate whether the original document is printed on one or both sides. For example, select Original Sides 1-sided and Output Sides 2-sided when the original is printed on one side, but you want to make two-sided copies. Select Flip pages up to print the pages with long edge of the in the landscape orientation.
Copy Settings M527/E52545/M528/ E52645 only	Sides	Output Sides		1-sided 2-sided Flip pages up	Use to indicate whether the copies should be printed on one or both sides. For example, select Original Sides 1-sided and Output Sides 2-sided when the original is printed on one side, but you want to make two-sided copies. Select Flip pages up to print the pages with long edge of the in the landscape orientation.
Copy Settings M527/E52545/M528/ E52645 only	Watermark	Watermark Type		None* Text	Use to set a text watermark.
Copy Settings M527/E52545/M528/ E52645 only	Watermark	Watermark Text		Draft Confidential Secret Top Secret Urgent	Select a predefined text watermark.

Table 2-25 Print menu (M506/E50045/M507/E50145) or Copy/Print menu (M527/E52545/M528/E52645) (continued)

First level	Second level	Third level	Fourth Level	Values	Description	
Copy Settings M527/E52545/M528/ E52645 only	Watermark	Text Font		Letter Gothic*	Select the font of the text watermark.	
				Antique Olive		
				New Century Schoolbook Roman		
				Garamond Antiqua		
Copy Settings M527/E52545/M528/ E52645 only	Watermark	Text Size		30 point	Select the font point size of the text watermark.	
				40 point*		
				60 point		
Copy Settings M527/E52545/M528/ E52645 only	Watermark	Darkness		1 - (Lighter)	Select the darkness of the text watermark.	
				2		
				3*		
				4		
				5 - (Darker)		
Copy Settings M527/E52545/M528/ E52645 only	Stamps	Stamp Content		User-defined value	Use to set a stamp in any or all the following locations in the document:	
				None*		
				IP address		
				User name		<ul style="list-style-type: none"> • Top Left
				Product information		<ul style="list-style-type: none"> • Top Center
				Page number		<ul style="list-style-type: none"> • Top Right
				Date and time		<ul style="list-style-type: none"> • Bottom Left • Bottom Center • Bottom Right
Copy Settings M527/E52545/M528/ E52645 only	Stamps	Text Font		Letter Gothic*	Select the font of the stamp.	
				Antique Olive		
				New Century Schoolbook Roman		
				Garamond Antiqua		
Copy Settings M527/E52545/M528/ E52645 only	Stamps	Text Size		8 point	Select the font point size of the stamp.	
				12 point*		
				20 point		
Copy Settings M527/E52545/M528/ E52645 only	Stamps	White background		Disabled*	Select the check box to enable a white background for the stamp.	
				Enabled		

Table 2-25 Print menu (M506/E50045/M507/E50145) or Copy/Print menu (M527/E52545/M528/E52645) (continued)

First level	Second level	Third level	Fourth Level	Values	Description
Copy Settings M527/E52545/M528/ E52645 only	Scan Mode			Standard document*	Use to indicate the type of original document to be scanned.
				Prompt for additional pages	Select Prompt for additional pages to copy or scan an original document that has more pages than the document feeder can accommodate at one time, or to scan originals of different sizes that cannot be scanned together, and then combine these separate scan jobs into a single job.
				Book 2-sided ID	
Copy Settings M527/E52545/M528/ E52645 only	Reduce/Enlarge			Automatic*	Scale the size of the document up or down.
				Include margins	To reduce the image, select a scaling percentage that is less than 100. To enlarge the image, select a scaling percentage that is greater than 100.
				Manual Default=100	When Include margins is enabled, the printer reduces the image slightly to fit the entire scanned image within the printable area on the page.

Table 2-25 Print menu (M506/E50045/M507/E50145) or Copy/Print menu (M527/E52545/M528/E52645) (continued)

First level	Second level	Third level	Fourth Level	Values	Description
Copy Settings	Original Size			Automatically detect*	Specify the size of the original document.
M527/E52545/M528/ E52645 only				Letter (8.5x11)	
				Mixed Letter/Legal	
				Legal (8.5x14)	
				Executive (7.25x10.5)	
				Statement (5.5x8.5)	
				Oficio (8.5x13)	
				4x6	
				5x7	
				5x8	
				A4 (210x297 mm)	
				A5 (148x210 mm)	
				A6 (105x148 mm)	
				RA4 (215x305 mm)	
				B5 (182x257 mm)	
				B6 (128x182 mm)	
				10x15cm	
				16K (195x270 mm)	
			16K (184x260 mm)		
			16K (197x273 mm)		
			DPostcard JIS (148x200 mm)		
			Oficio (216x340 mm)		

Table 2-25 Print menu (M506/E50045/M507/E50145) or Copy/Print menu (M527/E52545/M528/E52645) (continued)

First level	Second level	Third level	Fourth Level	Values	Description
Copy Settings	Paper Selection		Paper Size	Match original size*	Select the size of paper to use when printing or making copies.
M527/E52545/M528/E52645 only				Letter (8.5x11)	
				Legal (8.5x14)	
				Executive (7.25x10.5)	
				Statement (5.5x8.5)	
				Oficio (8.5x13)	
				3x5	
				4x6	
				5x7	
				5x8	
				A4 (210x297 mm)	
				A5 (148x210 mm)	
				A6 (105x148 mm)	
				RA4 (215x305 mm)	
				B5 (182x257 mm)	
				B6 (128x182 mm)	
				10x15cm	
				16K (195x270 mm)	
				16K (184x260 mm)	
				16K (197x273 mm)	
				Postcard JIS (100x148 mm)	
				DPostcard JIS (148x200 mm)	
				Envelope #9	
				Envelope #10	
				Envelope Monarch	
				Envelope #10	
				Envelope B5	
				Envelope C5	
				Envelope C6	
				Envelope DL	
				Custom	
				Oficio (216x340 mm)	

Table 2-25 Print menu (M506/E50045/M507/E50145) or Copy/Print menu (M527/E52545/M528/E52645) (continued)

First level	Second level	Third level	Fourth Level	Values	Description
Copy Settings M527/E52545/M528/ E52645 only	Paper Selection		Paper Type	Any Type	Select the type of paper to use when printing or making copies.
				Plain*	
				Light 60-74g	
				Intermediate 85-95g	
				Mid-Weight 96-110g	
				Heavy 111-130g	
				Extra Heavy 131-175g	
				Cardstock 176-220g	
				Mono Transparency	
				Labels	
				Letterhead	
				Envelope	
				Preprinted	
				Prepunched	
				Colored	
Bond					
Recycled					
Rough					
HP EcoFFICIENT					
Light Bond					
Copy Settings M527/E52545/M528/ E52645 only	Paper Selection		Paper Tray	Automatically detect*	Select which tray to use when printing or making copies.
				Manually Feed	
				Tray 1	
				Tray 2	
Copy Settings M527/E52545/M528/ E52645 only	Booklet	Booklet Format		Enabled	Select to have Booklet Format off or on.
				Disabled*	
Copy Settings M527/E52545/M528/ E52645 only	Booklet	Booklet Format	Borders on each page	Enabled	Select to have borders printed on the page.
				Disabled*	
Copy Settings M527/E52545/M528/ E52645 only	Content Orientation			Portrait*	Specify the way the content of the original document is placed on the page.
				Landscape	

Table 2-25 Print menu (M506/E50045/M507/E50145) or Copy/Print menu (M527/E52545/M528/E52645) (continued)

First level	Second level	Third level	Fourth Level	Values	Description
Copy Settings M527/E52545/M528/ E52645 only	Pages per Sheet			One*	Select how many pages to print on one sheet.
				Two	
				Four	
Copy Settings M527/E52545/M528/ E52645 only	Page Order			Right, then down	Select to print the pages in rows or columns.
				Down, then right	
Copy Settings M527/E52545/M528/ E52645 only	Add page borders			Enabled	Select the Add page borders checkbox to add borders to the pages.
				Disabled*	
Copy Settings M527/E52545/M528/ E52645 only	Image Adjustment	Darkness		1 - (Lighter)	Adjust to increase or decrease the amount of white and black in the colors.
				2	
				3	
				4	
				5*	
				6	
				7	
				8	
				9 - (Darker)	
Copy Settings M527/E52545/M528/ E52645 only	Image Adjustment	Contrast		1 - (Less)	Adjust to increase or decrease the difference between the lightest and darkest color on the page.
				2	
				3	
				4	
				5*	
				6	
				7	
				8	
				9 - (More)	

Table 2-25 Print menu (M506/E50045/M507/E50145) or Copy/Print menu (M527/E52545/M528/E52645) (continued)

First level	Second level	Third level	Fourth Level	Values	Description
Copy Settings M527/E52545/M528/ E52645 only	Image Adjustment	Background Cleanup		1 - (Normal)	Adjust if you are having trouble copying a faint image.
				2	
				3*	
				4	
				5*	
				6	
				7	
				8	
				9 - (Cleaner)	
Copy Settings M527/E52545/M528/ E52645 only	Image Adjustment	Sharpness		1 - (Less)	Adjust to sharpen or soften the image.
				2	
				3*	
				4	
				5 - (More)	
Copy Settings M527/E52545/M528/ E52645 only	Optimize Text/Picture		Text	Select to optimize for the output of a particular type of content.	
			Mixed*		
			Printed picture		
			Photograph		
Copy Settings M527/E52545/M528/ E52645 only	Edge-to-Edge		Normal (recommended)	When the Edge-to-Edge feature is enabled, the product minimizes margins and prints as close to the edge of the paper as possible.	
			Edge-to-Edge output		
Copy Settings M527/E52545/M528/ E52645 only	Erase Edges	Use inches		Enabled*	Use the Erase Edges feature to remove blemishes, such as dark borders or staple marks, by cleaning the edges of the scanned image.
				Disabled	
					Disabling Use inches changes the measurements to millimeters.

Table 2-25 Print menu (M506/E50045/M507/E50145) or Copy/Print menu (M527/E52545/M528/E52645) (continued)

First level	Second level	Third level	Fourth Level	Values	Description
Copy Settings M527/E52545/M528/ E52645 only	Erase Edges	Front Side		Specify a different width for each edge Apply same width to all edges* All edges value Default = 0.00	Sets the width of the edge to clean.
Copy Settings M527/E52545/M528/ E52645 only	Erase Edges	Back Side		Specify a different width for each edge Apply same width to all edges Mirror front side*	Sets the width of the edge to clean.
Copy Settings M527/E52545/M528/ E52645 only	Collate			Collate on* Collate off	When Collate on is selected, each set of copied pages are assembled in the same order as the original document.
Copy Settings M527/E52545/M528/ E52645 only	Multi-feed Detection			Disabled Enabled*	Use this feature to detect when multiple pages are fed simultaneously into the ADF (automatic document feeder) or sheet-feed scanner.
Copy Settings M527/E52545/M528/ E52645 only				Enable Print from USB Drive	Enabled Disabled*
Manage Stored Jobs	Job Sort Order			Job Name* Date*	This option allows you list the jobs either alphabetically or chronologically.
Manage Stored Jobs	Retain Temporary Jobs			Do not retain Personal jobs only All temporary jobs	Sets which temporary jobs will be retained in the event of a printer reboot.

Table 2-25 Print menu (M506/E50045/M507/E50145) or Copy/Print menu (M527/E52545/M528/E52645) (continued)

First level	Second level	Third level	Fourth Level	Values	Description
Manage Stored Jobs	Temporary Job Storage Limit			1-300 Default = 32	Configure global settings for jobs that are stored in the printer memory. The Temporary Job Storage Limit feature specifies the number of temporary jobs that can be stored on the printer. The maximum allowed value is 300.
Manage Stored Jobs	Temporary Job Storage Retention			Off 30 minutes 1 hour 4 hours 1 day 1 week 4 weeks 3 days	Configure global settings for temporary jobs that are stored in the printer memory. The Temporary Stored Job Retention feature specifies the amount of time temporary jobs can be stored on the printer.
Manage Stored Jobs	Standard Stored Job Retention			Off 30 minutes 1 hour 4 hours 1 day 1 week 4 weeks 3 days	Configure global settings for jobs that are stored in the printer memory. The Standard Stored Job Retention feature specifies the amount of time jobs can be stored on the printer.
Default Print Options	Number of Copies			Range: 1-32000 Default = 1	Sets the default number of copies for a copy job. This default applies when the Copy function or the Quick Copy function is initiated from the printer Home screen.
Default Print Options	Paper Selection	Paper size Paper type Paper tray		Select from a list of sizes that the printer supports.	Configures the default paper size, type and tray used for print jobs.

Table 2-25 Print menu (M506/E50045/M507/E50145) or Copy/Print menu (M527/E52545/M528/E52645) (continued)

First level	Second level	Third level	Fourth Level	Values	Description
Default Print Options	Default Custom Paper Size	X Dimension		Range: 3.00-8.50 inches Default = 8.5 inches	Configures the default paper size that is used when the user selects Custom as the paper size for a print job.
Default Print Options	Default Custom Paper Size	Y Dimension		Range: 5.00-14.00 inches Default = 14 inches	Configures the default paper size that is used when the user selects Custom as the paper size for a print job.
Default Print Options	Default Custom Paper Size	Use Inches		Enabled* Disabled	
Default Print Options	Output Sides			1-sided* 2-sided	Use to indicate whether the original document is printed on one or both sides.
Default Print Options	Edge-to-Edge			Normal (recommended)* Edge-to-Edge output	Use to avoid shadows that can appear along the edges of copies when the original document is printed close to the edges.
Default Print Options	Resolution			FastRes 1200* ProRes 1200	Use to select the level of desired print quality.
Default Print Options	Resolution	Economode		Enabled Disabled*	Text is printed using less toner. This setting is useful when you are printing drafts. You can turn on this option independently of other print quality settings.
PCL and Postscript Settings	Courier Font			Regular* Dark	Select which version of the Courier font you want to use. The factory default setting is Regular , which uses an average stroke width. The Dark setting can be used if a heavier Courier font is needed.
PCL and Postscript Settings	Wide A4			Enabled Disabled*	Changes the printable area of A4-size paper. If you enable this option, eighty 10-pitch characters can be printed on a single line of A4 paper.

Table 2-25 Print menu (M506/E50045/M507/E50145) or Copy/Print menu (M527/E52545/M528/E52645) (continued)

First level	Second level	Third level	Fourth Level	Values	Description
PCL and Postscript Settings	Print PS Errors			Enabled	Use this feature to select whether a PostScript (PS) error page is printed when the printer encounters a PS error.
				Disabled*	
PCL and Postscript Settings	Print PDF Errors			Enabled	Selects whether a PDF error page is printed when the printer encounters a PDF error.
				Disabled*	
PCL and Postscript Settings	Personality			Automatic*	Configures the default print language or personality for the printer. Normally you should not change the printer language. If you change the setting to a specific printer language, the printer does not automatically switch from one language to another unless specific software commands are sent to it.
				PCL	
				PS	
				PDF	
PCL and Postscript Settings	PCL	Font Settings	Font Source	Internal	Selects the font source for the user-soft default font. The list of available options varies depending on the installed printer options.
				Disk resident*	
PCL and Postscript Settings	PCL	Font Settings	Font Number	Range: 0-110	Specifies the font number for the user-soft default font using the source that is specified in the Font Source menu. The printer assigns a number to each font and lists it on the PCL font list. The font number displays in the Font # column of the printout.
				Default = 0	
PCL and Postscript Settings	PCL	Font Settings	Font Pitch	Range: 0.44-99.99	If the Font Source option and the Font Number setting indicate a contour font, then use this feature to select a default pitch (for a fixed-spaced font).
				Default = 10	

Table 2-25 Print menu (M506/E50045/M507/E50145) or Copy/Print menu (M527/E52545/M528/E52645) (continued)

First level	Second level	Third level	Fourth Level	Values	Description
PCL and Postscript Settings	PCL	PCL Settings	Form Length	Range: 5-128 lines Default = 60	Controls the PCL print-command options. PCL is a set of printer commands that HP developed to provide access to printer features. Use the Form Length feature to select the user soft -default vertical form length.
PCL and Postscript Settings	PCL	PCL Settings	Orientation	Portrait* Landscape	Select the orientation that is most often used for copy or scan originals. Select the Portrait option if the short edge is at the top or select the Landscape option if the long edge is at the top.
PCL and Postscript Settings	PCL	PCL Settings	Symbol Set	Select from a list of symbol sets.	Select any one of several available symbol sets from the control panel. A symbol set is a unique grouping of all the characters in a font. The factory default value for this option is PC-8. Either PC-8 or PC-850 are recommended for line-draw characters.
PCL and Postscript Settings	PCL	PCL Settings	Append CR to LF	Enabled Disabled*	When enabled, this option appends a carriage return to each line feed encountered in backwards-compatible PCL jobs.
PCL and Postscript Settings	PCL	PCL Settings	Suppress Blank Pages	Enabled Disabled*	This option is for users who are generating their own PCL, which could include extra form feeds that would cause blank pages to be printed. When the On option is selected, form feeds are ignored if the page is blank.

Table 2-25 Print menu (M506/E50045/M507/E50145) or Copy/Print menu (M527/E52545/M528/E52645) (continued)

First level	Second level	Third level	Fourth Level	Values	Description
PCL and Postscript Settings	PCL	PCL Settings	Media Source Mapping	Standard* Classic	Use to select and maintain input trays by number when you are not using the printer driver, or when the software program has no option for tray selection. The following options are available: Standard: Tray numbering is based on newer HP LaserJet models. Classic: Tray numbering is based on HP LaserJet 4 and older models.
Print Quality	General	Toner Density		A sliding bar appears with the indicator set in the middle between Less and More.	Lighten or darken the print on the page by changing the toner density setting.
Print Quality	General	REt		Disabled Enabled*	Use this setting to enable or disable Resolution Enhancement technology (REt), which produces smoother angles, curves, and edges.
Print Quality	Image Registration	Tray	Tray 1 Tray 2 Tray 3 Tray 4 Tray 5 Depends upon the number of trays installed		Specify tray to be adjusted

Table 2-25 Print menu (M506/E50045/M507/E50145) or Copy/Print menu (M527/E52545/M528/E52645) (continued)

First level	Second level	Third level	Fourth Level	Values	Description
Print Quality	Image Registration	Front-side Horizontal Shift		-5.00 mm to 5.00 mm	Shift the margin alignment to center the image on the page from top to bottom and from left to right. You can also align the image on the front with the image printed on the back.
		Front-side Vertical Shift			The direction that is perpendicular to the way the paper passes through the printer is referred to as X. This is also known as the scan direction. X1 is the scan direction for a single-sided page or for the second side of a two-sided page. X2 is the scan direction for the first side of a two-sided page.
		Back-side Horizontal Shift			The direction that the paper feeds through the printer is referred to as Y. Y1 is the feed direction for a single-sided page or for the second side of a two-sided page. Y2 is the feed direction for the first side of a two-sided page.
		Back-side Vertical Shift			Use the Adjust Tray <X> menu to adjust the registration settings for each tray. Before adjusting these values, print a registration test page. It provides alignment guides in the X and Y directions so you can determine which adjustments are necessary. You can adjust values for X1 Shift, X2 Shift, Y1 Shift, and Y2 Shift.
Print Quality	Image Registration	Print Test Page			Use the Print Test Page option to print a page to test the image registration. It provides alignment guides in the X and Y directions so you can determine which adjustments are necessary.

Table 2-25 Print menu (M506/E50045/M507/E50145) or Copy/Print menu (M527/E52545/M528/E52645) (continued)

First level	Second level	Third level	Fourth Level	Values	Description
Print Quality	Auto Sense Behavior	Tray 1		Sense every page Sense first page Sense transparency only	
Print Quality	Auto Sense Behavior	All Other Trays		Sense first page Sense transparency only	
Print Quality	Adjust Paper types	Select from a list of paper types that the printer supports. The available options are the same for each paper type.	Print mode	Select from a list of paper types Reset Paper Types	Changing the Print mode setting is usually the first first thing to try to resolve print-quality problems. Problems can include toner not sticking well to the page, a faint image of the page repeated on the same or following page, incorrect gloss level, and so on.
Print Quality	Adjust Paper types	Select from a list of paper types that the printer supports. The available options are the same for each paper type.	Resistance mode	Normal* Up 1 Up 2	Use this setting to correct print quality problems in low-humidity environments and highly resistive paper. Use the Up options to solve print quality problems that are related to faded images or scattered toner on certain paper types. The Up options raise the secondary transfer bias.
Print Quality	Adjust Paper types	Select from a list of paper types that the printer supports. The available options are the same for each paper type.	Paper curl mode	Normal* Reduced	Use this setting to reduce paper curl in print jobs.
Print Quality	Optimize	Line Detail		Normal* Off Alternate	Use this setting if you have scattered lines in printed pages.
Print Quality	Optimize	Moisture Control		Normal* Alternate	

Table 2-25 Print menu (M506/E50045/M507/E50145) or Copy/Print menu (M527/E52545/M528/E52645) (continued)

First level	Second level	Third level	Fourth Level	Values	Description
Print Quality	Optimize	Envelope control		Normal	
				Reduced Temp	
Print Quality	Optimize	Tray 1		Normal	
				Alternate	
Print Quality	Optimize	Background		Normal	
				Alternate	
Print Quality	Optimize	Uniformity Control		Normal	
				Alternate 1	
				Alternate 2	
Print Quality	Optimize	Cac03		Off	
				On	
Print Quality	Optimize	Best Normal		Off	
				On	
Print Quality	Optimize	Tracking Control		Off	
				On	
Print Quality	Optimize	Registration		Normal	
				Alternate	
Print Quality	Optimize	Transfer Control		Normal	
				Alternate 1	
Print Quality	Optimize	Moisture Control		Normal	
				Alternate	
Print Quality	Optimize	Reset Optimize		Reset	
Print Quality	Edge Control			Off	
				Light	
				Normal*	
				Maximum	

Table 2-25 Print menu (M506/E50045/M507/E50145) or Copy/Print menu (M527/E52545/M528/E52645) (continued)

First level	Second level	Third level	Fourth Level	Values	Description
Manage Trays	Use Requested Tray			<p>Exclusively*</p> <p>When available</p>	<p>Controls how the printer handles jobs that have specified a specific input tray. Two options are available:</p> <p>Exclusively: The printer never selects a different tray when the user has indicated that a specific tray should be used, even if that tray is empty.</p> <p>When available: The printer pulls from another tray if the specified tray is empty, even though the specific tray was indicated for the job.</p>
Manage Trays	Manually Feed Prompt			<p>Always prompt*</p> <p>Prompt on mismatch</p>	<p>Indicate whether a prompt should appear when the type or size for a job does not match the specified tray and the printer pulls from the multipurpose tray instead. Two options are available:</p> <p>Always: A prompt always displays before using the multipurpose tray.</p> <p>Prompt on mismatch: A prompt displays only if the size or type do not match or the tray is empty.</p>

Table 2-25 Print menu (M506/E50045/M507/E50145) or Copy/Print menu (M527/E52545/M528/E52645) (continued)

First level	Second level	Third level	Fourth Level	Values	Description
Manage Trays	Size/Type Prompt			<p>Display*</p> <p>Do not display</p>	<p>Controls whether the tray configuration message displays whenever a tray is closed. Two options are available:</p> <p>Display: Shows the tray configuration message when a tray is closed. The user is able to configure the tray settings directly from this message.</p> <p>Do not display: Prevents the tray configuration message from automatically appearing.</p>
Manage Trays	Use Another Tray			<p>Allow*</p> <p>Do not allow</p>	<p>Use to turn on or off the control panel prompt to select another tray when the specified tray is empty. Two options are available:</p> <p>Allow: When this option is selected the user is prompted to either add paper to the selected tray or to choose a different tray. This is the factory default.</p> <p>Do not allow: When this option is selected, the user is not given the option of selecting a different tray. The printer prompts the user to add paper to the tray that was initially selected.</p>

Table 2-25 Print menu (M506/E50045/M507/E50145) or Copy/Print menu (M527/E52545/M528/E52645) (continued)

First level	Second level	Third level	Fourth Level	Values	Description
Manage Trays	Alternative Letterhead Mode			Off* On	Use to load letterhead or preprinted paper into the tray the same way for all print jobs, whether you are printing to one side of the sheet or to both sides of the sheet. When this option is selected, load the paper as you would for printing on both sides. See the user documentation that came with the printer for instructions about loading letterhead for printing on both sides. When this option is selected, the printer speed slows to the speed required for printing on both sides.

Table 2-25 Print menu (M506/E50045/M507/E50145) or Copy/Print menu (M527/E52545/M528/E52645) (continued)

First level	Second level	Third level	Fourth Level	Values	Description
Manage Trays	Duplex Blank Pages			Automatic* Always	Controls how the printer handles two-sided jobs (duplexing). Two options are available: Automatic: Choose this option to skip printing blank sides during a two-sided print job. The printer can print jobs faster when blank sides are skipped. Always: Choose this option to print all sides of a two-sided job, even if one side is blank. This might be preferable for certain jobs that use paper types such as letterhead or prepunched paper.
Manage Trays	Override A4/Letter			Yes* No	Prints on letter-size paper when an A4 job is sent but no A4-size paper is loaded in the printer (or to print on A4 paper when a letter-size job is sent but no letter-size paper is loaded). This option will also override A3 with ledger-size paper and ledger with A3-size paper.

Scan/Digital Send Settings menu (M527/E52545/M528/E52645)

Review the following information about the [Scan/Digital Send Settings](#) menu for M527/E52545/M528/E52645 printers.

To display: At the printer control panel, select the [Settings](#) menu, and then select the [Scan/Digital Send Settings](#) menu.

In the following table, asterisks (*) indicate the factory default setting.

Table 2-26 Scan/Digital Send Settings menu (M527/E52545/M528/E52645)

First level	Second level	Third level	Fourth level	Values	Description
Scan to Email Settings	E-mail Setup	E-mail Setup Wizard			Use to configure settings that apply to sending documents through email or saving documents to a folder on the network or on a USB multi-drive.
Scan to Network Folder Settings	NOTE: Email Settings only				The E-mail Setup Wizard feature configures the printer to send scanned images as email attachments. To open the printer HP Embedded Web Server and set up the email notification server, enter the printer IP address into a Web browser.
Scan to USB Drive Settings					
NOTE: The same options are available for each of these features, except where noted.					
	Default Job Options	Image Preview		Make optional* Require preview Disable preview	<p>Defines the default job options for each function. If you do not specify the job options when creating the job, the default options are used. For complete setup, go to the HP Embedded Web Server by typing the IP address of the printer into a Web browser.</p> <p>Use the Image Preview feature to scan a document and display a preview before completing the job. Select whether this feature is available on the printer.</p> <p>Make optional: The feature is optional, depending on the user who is signed in.</p> <p>Require preview Previews are required for all users.</p> <p>Disable preview: Previews are disabled for all users.</p>

Table 2-26 Scan/Digital Send Settings menu (M527/E52545/M528/E52645) (continued)

First level	Second level	Third level	Fourth level	Values	Description
		Default File Name		[Untitled]*	The printer is shipped with a factory default file name of [Untitled] for any scanned files that are sent or saved. Use this feature to specify a different default file name. If you are saving a file to a network folder or USB storage device and a file with the default file name already exists, a number is appended to the file name, for example, [Untitled]001.
		Document File Type		Select from a list of file types.	<p>PDF provides the best overall image and text quality.</p> <p>JPEG is a good choice for most graphics. Most computers have a browser that can view .JPEG files. This file type produces one file per page.</p> <p>TIFF is a standard file format that many graphics programs support. This file type produces one file per page.</p> <p>MTIFF: stands for multi-page TIFF. This file type saves multiple scanned pages in a single file.</p> <p>XPS (XML Paper Specification) creates an XAML file that preserves the original formatting of the document and supports color graphics and embedded fonts.</p> <p>PDF/A (Archivable): provides archivable text and image quality.</p> <p>NOTE: OCR file types are not supported on this printer unless attached to DSS.</p>

Table 2-26 Scan/Digital Send Settings menu (M527/E52545/M528/E52645) (continued)

First level	Second level	Third level	Fourth level	Values	Description
		Optimize Text/Picture		Mixed* Text Printed picture Photograph	<p>Use to optimize the output for a particular type of content. You can optimize the output for text, printed pictures, or a mixture.</p> <p>Mixed: Use to optimize the setting for text and for pictures.</p> <p>Text: Use to optimize the text portion of the copy when text and/or pictures are on the original.</p> <p>Printed picture: Use for line drawings and preprinted images, such as magazine clippings or pages from books.</p> <p>Photograph: Best suited for making copies of printed pictures.</p>
		Quality and File Size		High (large file) Medium* Low (small file)	<p>Use to select the quality for the output. Higher-quality images require a larger file size than lower-quality images. Larger files take more time to send, and some recipients might have trouble receiving larger files.</p>
		Original Sides		1-sided 2-sided	<p>Use to describe the layout for each side of the original document. First select whether the original document is printed on one side or both sides. Then touch the Orientation setting to indicate whether the original has portrait or landscape orientation. If it is printed on both sides, also select the 2-sided format that matches the original document.</p>

Table 2-26 Scan/Digital Send Settings menu (M527/E52545/M528/E52645) (continued)

First level	Second level	Third level	Fourth level	Values	Description
			Orientation	Automatically detect Portrait* Landscape	For some features to work correctly, you must specify the way the content of the original document is placed on the page. Portrait orientation means the short edge of the page is along the top. Landscape orientation means the long edge of the page is along the top. In the Orientation area, select whether the original document has a portrait or landscape orientation.
		Resolution		600 dpi 400 dpi 300 dpi 200 dpi 150 dpi* 75 dpi	Sets the resolution for sent documents. Higher resolution images have more dots per inch (dpi), so they show more detail. Lower resolution images have fewer dots per inch and show less detail, but the file size is smaller. Some file types, for example a file that will be processed with OCR, require a specific resolution. When these file types are selected, the Resolution setting might automatically change to a valid value.
		Content Orientation	Orientation	Auto Detect Portrait* Landscape	For some features to work correctly, you must specify the way the content of the original document is placed on the page. Portrait orientation means the short edge of the page is along the top. Landscape orientation means the long edge of the page is along the top. In the Orientation area, select whether the original document has a portrait or landscape orientation.

Table 2-26 Scan/Digital Send Settings menu (M527/E52545/M528/E52645) (continued)

First level	Second level	Third level	Fourth level	Values	Description
		Color/Black		Automatically detect color or black*	Use to enable or disable color scanning.
				Automatically detect color or gray	Automatically detect color or black: When pages without color are detected, the printer creates an image of the page in 1-bit black if other settings allow. If the other settings don't allow (File Type, for example), the image is in grayscale.
				Color	
				Black	
				Black/Gray	
					Automatically detect color or gray: When pages without color are detected, the printer creates an image of the page in grayscale. Select this option for the best image quality for non-color pages.
					Color: Scans documents in color.
					Black/Gray: Scans documents in grayscale.
					Black: Scans documents in black and white with a compressed file size.
		Original Size		Select from a list of supported sizes.	Use to describe the page size of the original document.
		Notification		Do not notify*	Configure to receive notification about the status of a sent document.
				Notify when job completes	
				Notify only if job fails	Do not notify: Turns off this feature.
					Notify when job completes: Select to receive notification for this job only.

Table 2-26 Scan/Digital Send Settings menu (M527/E52545/M528/E52645) (continued)

First level	Second level	Third level	Fourth level	Values	Description
				Print	<p>Notify only if job fails: Select to receive notification only if the job is not sent successfully.</p> <p>Print: Select to print the notification at this printer.</p>
				E-mail	
			Include Thumbnail		<p>NOTE: When sending an analog fax, select Include Thumbnail to receive a thumbnail image of the first page of the fax in your notification.</p>
			Notification E-mail address		<p>E-mail: Select to receive the notification in an email. Touch the text box following Email Address, and then type the email address for the notification.</p>
		Image Adjustment	Darkness		<p>Use to improve the overall quality of the copy.</p> <p>Adjust the Darkness setting to increase or decrease the amount of white and black in the colors.</p>
			Contrast		<p>Adjust the Contrast setting to increase or decrease the difference between the lightest and darkest color on the page.</p>
			Background Cleanup		<p>Adjust the Background Cleanup setting if you are having trouble copying a faint image.</p>
			Sharpness		<p>Adjust the Sharpness setting to clarify or soften the image. For example, increasing the sharpness could make text appear crisper, but decreasing it could make photographs appear smoother.</p>
			Automatic Tone		

Table 2-26 Scan/Digital Send Settings menu (M527/E52545/M528/E52645) (continued)

First level	Second level	Third level	Fourth level	Values	Description
			Default		Select this to make the selected Image Adjustment setting the default value.
		Cropping Options		Do not crop* Crop to content Crop to paper	Use this menu item to automatically crop the scan for digital sending. Use the Crop to content option to scan the smallest possible area that has detectable content.
		Erase Edges		Use Inches Back side erase Front side erase	Use this menu item to remove blemishes, such as dark borders or staple marks, by cleaning the specified edges of the scanned image. In each of the text boxes enter the measurements, in millimeters or inches, for how much of the top edge, bottom edge, left edge, and right edge to clean.
		Multi-feed Detection		On* Off	This setting stops the scanning process if it detects multiple-page feeds through the document feeder.
		Blank Page Suppression		Disabled* Enabled	Use to prevent blank pages in the original document from being included in the output document.

Table 2-26 Scan/Digital Send Settings menu (M527/E52545/M528/E52645) (continued)

First level	Second level	Third level	Fourth level	Values	Description
Digital Send Service Setup	Allow Usage of Digital Sending Software (DSS) Server			Enabled* Disabled	Configure how the printer interacts with the HP Digital Sending Software (DSS) server. HP DSS handles digital sending tasks, such as faxing, emailing, and sending scanned documents to a network folder or USB storage device. Use the Allow Usage of Digital Sending Software (DSS) Server option to configure the printer to use HP DSS.
	Allow Transfer to New Digital Sending Software (DSS) Server			Enabled* Disabled	Use the Allow Transfer to New Digital Sending Software (DSS) Server option to specify whether DSS management of a printer is transferable to a different DSS.

Fax menu (M527/E52545/M528/E52645)

Review the following information about the [Fax](#) menu for the M527/E52545/M528/E52645 printers.

To display: At the printer control panel, select the [Settings](#) menu, and then select the [Fax](#) menu.

In the following table, asterisks (*) indicate the factory default setting.

Table 2-27 Fax menu (M527/E52545/M528/E52645)

First level	Second level	Third level	Fourth level	Values	Description
Internal Fax Modem Setup					Configure settings for sending faxes from the printer. Use the Internal Fax Modem Setup feature to set up options for faxing. NOTE: To set up LAN fax or Internet fax, use the HP Embedded Web Server. To open the HP Embedded Web Server, type the printer network address into a Web browser. To configure the fax features, select the Fax tab.

Table 2-27 Fax menu (M527/E52545/M528/E52645) (continued)

First level	Second level	Third level	Fourth level	Values	Description
Fax Send Settings	Fax Send Setup	Fax Dialing Settings	Fax Dial Volume	Off Low* High	These settings control how the fax modem dials the outgoing fax number when faxes are sent.
Fax Send Settings	Fax Send Setup	Fax Dialing Settings	Dialing Mode	Tone* Pulse	
Fax Send Settings	Fax Send Setup	Fax Dialing Settings	Redial Interval	1 – 5 Minutes Default = 5 minutes	
Fax Send Settings	Fax Send Setup	Fax Dialing Settings	Fax Send Speed	Fast* Medium Slow	
Fax Send Settings	Fax Send Setup	Fax Dialing Settings	Dialing Prefix		
Fax Send Settings	Fax Send Setup	Fax Dialing Settings	Detect Dial Tone		
Fax Send Settings	Fax Send Setup	Fax Dialing Settings	Redial on Error	Range: 0 – 9 Default = 2	
Fax Send Settings	Fax Send Setup	Fax Dialing Settings	Redial on No Answer	Range: 0 – 2 Default = 0	
Fax Send Settings	Fax Send Setup	Fax Dialing Settings	Redial on Busy	Range: 0 – 9 Default = 3	
Fax Send Settings	Fax Send Setup	General Fax Send Settings	Fax Number Confirmation	Enabled Disabled*	If this feature is enabled, you must enter the fax number twice.
Fax Send Settings	Fax Send Setup	General Fax Send Settings	PC Fax Send	Enabled* Disabled	Enables users who have the correct driver installed to send faxes through the printer from their computers.
Fax Send Settings	Fax Send Setup	General Fax Send Settings	JBIG Compression	Enabled* Disabled	The JBIG compression reduces fax-transmission time, which can result in lower phone charges. However, using JBIG compression sometimes causes compatibility problems with older fax machines. If this occurs, turn off the JBIG compression.

Table 2-27 Fax menu (M527/E52545/M528/E52645) (continued)

First level	Second level	Third level	Fourth level	Values	Description
Fax Send Settings	Fax Send Setup	General Fax Send Settings	Error Correction Mode	Enabled* Disabled	When error-correction mode is enabled and an error occurs during fax transmission, the printer sends or receives the error portion again.
Fax Send Settings	Fax Send Setup	General Fax Send Settings	Fax Header	Prepend* Overlay	Use to prepend or overlay the fax header page.
Fax Send Settings	Fax Send Setup	Billing Codes	Enable Billing Codes	Off On*	<p>When billing codes are enabled, a prompt displays that asks the user to enter the billing code for an outgoing fax. This prompt does not appear if the Allow users to edit billing codes check box is not checked.</p> <p>You can also use the billing codes report in the Reports menu to view the list of the billing codes that have been used for faxes that have been sent from the printer. The list is grouped by billing code and also shows fax details. This feature can be used for billing or usage tracking.</p>
Fax Send Settings	Fax Send Setup	Billing Codes	Default Billing Code		Specify a default billing code for faxing. If you specify a default billing code, this code displays in the Billing Code field when the user sends an outgoing fax. If this field is blank, no default billing code is provided for the user.
Fax Send Settings	Fax Send Setup	Billing Codes	Minimum Length	Range: 1 – 16 Default = 1	Specify the required length of the billing code. Billing codes can be between 1 and 16 characters long.
Fax Send Settings	Fax Send Setup	Billing Codes	Allow users to edit billing codes	Off On*	

Table 2-27 Fax menu (M527/E52545/M528/E52645) (continued)

First level	Second level	Third level	Fourth level	Values	Description
Fax Send Settings	Default Job Options	Image Preview		Make optional* Require preview Disable preview	<p>Use the Image Preview feature to scan a document and display a preview before completing the job. Select whether this feature is available on the printer.</p> <p>Make optional: The feature is optional, depending on the user who is signed in.</p> <p>Require preview Previews are required for all users.</p> <p>Disable preview: Previews are disabled for all users.</p>
Fax Send Settings	Default Job Options	Resolution		Standard (100 x 200dpi)* Fine (200 x 200dpi) Superfine (300 x 300dpi)	<p>Select the resolution for outgoing faxes. If you increase the resolution, faxes might be clearer but they could transmit more slowly. Some file types, for example a file that will be processed with OCR, require a specific resolution. When these file types are selected, the Resolution setting might be automatically changed to a valid value.</p>

Table 2-27 Fax menu (M527/E52545/M528/E52645) (continued)

First level	Second level	Third level	Fourth level	Values	Description
Fax Send Settings	Default Job Options	Original Sides		1-sided* 2-sided Pages flip up	Use to describe the layout for each side of the original document. First select whether the original document is printed on one side or both sides. Then touch the Orientation setting to indicate whether the original has portrait or landscape orientation. If it is printed on both sides, also select the 2-sided format that matches the original document. If the Pages flip up option is selected, the back side of the page is printed upside-down. This option is for print jobs that are bound along the top edge.
Fax Send Settings	Default Job Options	Original Sides	Orientation	Portrait* Landscape	For some features to work correctly, you must specify the way the content of the original document is placed on the page. Portrait : This setting means the short edge of the page is along the top. Landscape : This setting means the long edge of the page is along the top.
Fax Send Settings	Default Job Options	Notification		Do not notify* Notify when job completes Notify only if job fails	Use to receive notification about the status of a sent document. Do not notify : Turns off this feature. Notify when job completes : Select to receive notification for this job only. Notify only if job fails : Select to receive notification only if the job is not sent successfully.

Table 2-27 Fax menu (M527/E52545/M528/E52645) (continued)

First level	Second level	Third level	Fourth level	Values	Description
Fax Send Settings	Default Job Options	Notification		Print E-mail	<p>Print: Select to print the notification at this printer.</p> <p>E-mail: Select to receive the notification in an email. Touch the text box following Email Address, and then enter the email address for the notification.</p>
Fax Send Settings	Default Job Options	Notification	Include Thumbnail		When sending an analog fax, select Include Thumbnail to receive a thumbnail image of the first page of the fax in your notification.
Fax Send Settings	Default Job Options	Notification	Notification E-mail address		Provide the email address that will receive notifications.
Fax Send Settings	Default Job Options	Content Orientation	Orientation	Portrait* Landscape	<p>For some features to work correctly, you must specify the way the content of the original document is placed on the page.</p> <p>Portrait: This setting means the short edge of the page is along the top.</p> <p>Landscape: This setting means the long edge of the page is along the top.</p>
Fax Send Settings	Default Job Options	Original Size		Select from a list of sizes that the printer supports.	Use to describe the page size of the original document.
Fax Send Settings	Default Job Options	Image Adjustment	Darkness		<p>Use to improve the overall quality of the copy.</p> <p>Adjust the Darkness setting to increase or decrease the amount of white and black in the colors.</p>
Fax Send Settings	Default Job Options	Image Adjustment	Contrast		Adjust the Contrast setting to increase or decrease the difference between the lightest and darkest color on the page.

Table 2-27 Fax menu (M527/E52545/M528/E52645) (continued)

First level	Second level	Third level	Fourth level	Values	Description
Fax Send Settings	Default Job Options	Image Adjustment	Background Cleanup		Adjust the Background Cleanup setting if you are having trouble copying a faint image.
Fax Send Settings	Default Job Options	Image Adjustment	Sharpness		Adjust the Sharpness setting to clarify or soften the image. For example, increasing the sharpness could make text appear crisper, but decreasing it could make photographs appear smoother.
Fax Send Settings	Default Job Options	Image Adjustment	Automatic Tone		The printer automatically adjusts the Darkness , Contrast , and Background Cleanup settings to the most appropriate for the scanned document.
Fax Send Settings	Default Job Options	Optimize Text/Picture	Manually adjust*	Optimize For Text Printed picture Photograph	<p>Optimizes the output for a particular type of content. You can optimize the output for text, printed pictures, or a mixture.</p> <p>Manually adjust: Use to manually optimize the setting for text or for pictures.</p> <p>Text: Use to optimize the text portion of the copy where text and/or pictures are on the original.</p> <p>Printed picture: Use for line drawings and preprinted images, such as magazine clippings or pages from books.</p> <p>Photograph: Best suited for making copies of printed pictures.</p>
Fax Send Settings	Default Job Options	Multi-feed Detection		Disabled Enabled*	This setting stops the scanning process if it detects multiple-page feeds through the document feeder.

Table 2-27 Fax menu (M527/E52545/M528/E52645) (continued)

First level	Second level	Third level	Fourth level	Values	Description
Fax Send Settings	Default Job Options	Blank Page Suppression		Disabled* Enabled	Prevents blank pages in the original document from being included in the output document.
Fax Receive Settings	Fax Receive Setup	Ringer Volume		Off Low* High	Use to configure settings for receiving faxes.
Fax Receive Settings	Fax Receive Setup	Rings To Answer		Range: 1–6 Default = 1	
Fax Receive Settings	Fax Receive Setup	Fax Send Speed		Fast* Medium Slow	
Fax Receive Settings	Fax Receive Setup	Ring Interval		Range: 220–600 ms Default = 600 ms	
Fax Receive Settings	Fax Receive Setup	Ring Frequency		Range: 1–200 Default = 68hz	
Fax Receive Settings	Fax Printing Schedule			Always store faxes Always print faxes* Use schedule	If you have concerns about the security of private faxes, use this feature to store faxes rather than having them automatically print. Select Incoming Fax Options, and then you can choose to always store faxes, always print them, or you can set up a schedule for each day of the week.
Fax Receive Settings	Fax Printing Schedule	Schedule	Add Edit Delete	Print incoming faxes Store incoming faxes Time Event Days	If you are using a fax printing schedule, use this menu to configure when to print faxes.

Table 2-27 Fax menu (M527/E52545/M528/E52645) (continued)

First level	Second level	Third level	Fourth level	Values	Description
Fax Receive Settings	Blocked Fax Numbers	Fax Number to Block			<p>The blocked fax list can contain up to 30 numbers. When the printer receives a call from one of the blocked fax numbers, it deletes the incoming fax. It also logs the blocked fax in the activity log along with job-accounting information.</p> <p>Add blocked numbers: Enter a fax number into the Fax Number to Block field, and then touch the arrow button to add a new number to the blocked fax list.</p> <p>To remove blocked numbers: Select a number and touch the Delete button to delete it from the blocked fax list.</p> <p>To clear all blocked numbers: Touch the Delete All button to clear all of the numbers from the blocked fax list.</p> <p>You can also use the Blocked Fax List report in the Information menu to view the list of the fax numbers that have been blocked on this printer.</p>
Fax Receive Settings	Default Job Options	Notification		<p>Do not notify*</p> <p>Notify when job completes</p> <p>Notify only if job fails</p>	<p>Configure to receive notification about the status of a sent document.</p> <p>Do not notify: Turns off this feature.</p> <p>Notify when job completes: Select to receive notification for this job only.</p> <p>Notify only if job fails: Select to receive notification only if the job is not sent successfully.</p>

Table 2-27 Fax menu (M527/E52545/M528/E52645) (continued)

First level	Second level	Third level	Fourth level	Values	Description
Fax Receive Settings	Default Job Options			Print E-mail*	E-mail: Select to receive the notification in an email. Touch the text box following Email Address , and then enter the email address for the notification.
Fax Receive Settings	Default Job Options		Include Thumbnail		NOTE: When sending an analog fax, select Include Thumbnail to receive a thumbnail image of the first page of the fax in your notification.
Fax Receive Settings	Default Job Options		Notification E-mail address		
Fax Receive Settings	Default Job Options	Stamp Received Faxes		Enabled Disabled*	Use this option to add the date, time, sender's phone number, and page number to each page of the faxes that this printer receives.
Fax Receive Settings	Default Job Options	Fit to Page		Enabled* Disabled	Use to shrink faxes that are larger than Letter-size or A4-size so that they can fit onto a Letter-size or A4-size page. If this feature set to Disabled , faxes larger than Letter or A4 will flow across multiple pages.
Fax Receive Settings	Default Job Options	Paper Selection		Automatic* Select from a list of the trays.	
Fax Receive Settings	Default Job Options	Output sides		1-sided* 2-sided Pages flip up	Use to describe the layout for each side of the original document. First select whether the original document is printed on one side or both sides. Then touch the Orientation setting to indicate whether the original has portrait or landscape orientation. If it is printed on both sides, also select the 2-sided format that matches the original document.

Table 2-27 Fax menu (M527/E52545/M528/E52645) (continued)

First level	Second level	Third level	Fourth level	Values	Description
Fax Forwarding	Enable Fax Forwarding			Disabled* Enabled	Use to forward received faxes to another fax machine.
Fax Forwarding	Type of Fax Job to Forward			All faxes Sent faxes Received faxes	
Fax Forwarding	Fax Forwarding Number				Enter the fax forwarding number.
Clear Fax Activity Log				Cancel Clear	Clears all events from the Fax Activity Log list.

Manage Supplies menu

Review the following information about the [Manage Supplies](#) menu.

To display: At the printer control panel, select the [Settings](#) menu, and then select the [Manage Supplies](#) menu.

In the following table, asterisks (*) indicate the factory default setting.

Table 2-28 Manage Supplies menu

First level	Second level	Third level	Fourth level	Values	Description
Low Warning Thresholds	Black Cartridge			1-100% Default = 4%	Set the estimated percentage at which the printer notifies you when a toner cartridge is very low.
Low Warning Thresholds	Document Feeder Kit			1-100% Default = 10%	Set the estimated percentage at which the printer notifies you when the document feeder kit is very low.
Low Warning Thresholds	Maintenance Kit			1-100% Default = 10%	Set the estimated percentage at which the printer notifies you when the maintenance kit is very low.
Low Warning Threshold Message				On* Off	Displays a message on the control panel when a cartridge is very low.

Table 2-28 Manage Supplies menu (continued)

First level	Second level	Third level	Fourth level	Values	Description
Low Behavior				Continue* Stop	Use one of these options to specify the action for the device to take when a supply reaches a low condition. Stop: Stops the current print job. Continue: Completes the current print job.
Very Low Behavior	Black Cartridge			Stop Continue* Prompt to continue	Use one or more of these options to specify the action for the device to take when a supply reaches a very low condition. Stop: Stops the current print job. Continue: Completes the current print job. Prompt to continue: Allows the user to decide whether or not to finish printing.
Very Low Behavior	Document Feeder Kit M527/E52545/M528/ E52645 only			Stop Continue Prompt to continue*	Use one or more of these options to specify the action for the device to take when a supply reaches a very low condition. Stop: Stops the current print job. Continue: Completes the current print job. Prompt to continue: Allows the user to decide whether or not to finish printing.

Table 2-28 Manage Supplies menu (continued)

First level	Second level	Third level	Fourth level	Values	Description
Very Low Behavior	Maintenance Kit M506/E50045/M507/ E50145 only			Stop	Use one or more of these options to specify the action for the device to take when a supply reaches a very low condition. Stop: Stops the current print job. Continue: Completes the current print job. Prompt to continue: Allows the user to decide whether or not to finish printing.
				Continue	
				Prompt to continue*	
Store Usage Data				On supplies*	Store Usage Data provides a way to suppress the toner cartridges from storing most of the information gathered exclusively for the purpose of understanding the usage of the printer. Select the On supplies setting to store the data on the toner cartridge memory chip. Select the Not on supplies setting to suppress the information from being stored on the memory chip.
				Not on supplies	
Cartridge Protection				Off*	Select to permanently protect cartridges so that they can be used only in this product or fleet of products.
				Protect cartridges	
Cartridge Policy				Off*	Set Authorized HP to allow only genuine HP cartridges to be used in this printer.
				Authorized HP	
Reset Supplies	Document Feeder Kit (M527/E52545/M528/ E52645 only) Maintenance Kit (M506/E50045/M507/ E50145 only)			Reset	Select this option if you have installed a new document feeder kit (M527/E52545/M528/E52645) or maintenance kit (M506/E50045/M507/E50145).
				Cancel	

Networking menu

Review the following information about the [Networking](#) menu.

To display: At the printer control panel, select the [Settings](#) menu, and then select the [Networking](#) menu.

In the following table, asterisks (*) indicate the factory default setting.

Table 2-29 Networking menu

First level	Second level	Third level	Fourth level	Values	Description
Ethernet	Information	Print Security Report		Yes No*	<p>Yes: Prints a page that contains the current security settings on the HP Jetdirect print server.</p> <p>No: A security settings page is not printed.</p>
Ethernet	TCP/IP	Host Name		Use the arrow buttons to edit the host name. NPIXXXXXX*	<p>An alphanumeric string, up to 32 characters, used to identify the printer. This name is listed on the HP Jetdirect configuration page. The default host name is NPIxxxxxx, where xxxxxx is the last six digits of the LAN hardware (MAC) address.</p>

Table 2-29 Networking menu (continued)

First level	Second level	Third level	Fourth level	Values	Description
Ethernet	TCP/IP	IPv4 Settings	Config Method	Bootp DHCP* Auto IP Manual	<p>Specifies the method that TCP/IPv4 parameters will be configured on the HP Jetdirect print server.</p> <p>Bootp (Bootstrap Protocol): Use for automatic configuration from a BootP server.</p> <p>DHCP (Dynamic Host Configuration Protocol): Use for automatic configuration from a DHCPv4 server. If selected and a DHCP lease exists, the DHCP Release menu and the DHCP Renew menu are available to set DHCP lease options.</p> <p>Auto IP: Use for automatic link-local IPv4 addressing. An address in the form 169.254.x.x is assigned automatically.</p> <p>If you set this option to the Manual setting, use the Manual Settings menu to configure TCP/IPv4 parameters.</p>

Table 2-29 Networking menu (continued)

First level	Second level	Third level	Fourth level	Values	Description
Ethernet	TCP/IP	IPV4 Settings	Default IP	Auto IP* Legacy	Specify the IP address to default to when the print server is unable to obtain an IP address from the network during a forced TCP/IP reconfiguration (for example, when manually configured to use BootP or DHCP). NOTE: This feature assigns a static IP address that might interfere with a managed network. Auto IP: A link-local IP address 169.254.x.x is set. Legacy: The address 192.0.0.192 is set, consistent with older HP Jetdirect printers.
Ethernet	TCP/IP	IPV4 Settings	DHCP Release	Yes No*	
Ethernet	TCP/IP	IPV4 Settings	DHCP Renew	Yes No*	
Ethernet	TCP/IP	IPV4 Settings	Primary DNS	Range: 0-255 Default = xxx.xxx.xx.xx	Specify the IP address (n.n.n.n) of a Primary Domain Name System (DNS) Server.
Ethernet	TCP/IP	IPV4 Settings	Secondary DNS	Range: 0-255 Default = 0.0.0.0	Specify the IP address (n.n.n.n) of a Secondary DNS Server.
Ethernet	TCP/IP	IPV6 Settings	Enable	Off On*	Use this item to enable or disable IPv6 operation on the print server. Off: IPv6 is disabled. On: IPv6 is enabled.
Ethernet	TCP/IP	IPV6 Settings	Address	Manual Settings Enable Address	Use this item to enable and manually configure a TCP/IPv6 address.

Table 2-29 Networking menu (continued)

First level	Second level	Third level	Fourth level	Values	Description
Ethernet	TCP/IP	IPv6 Settings	DHCPv6 Policy	Router Specified Router Unavailable* Always	<p>Router Specified: The stateful auto-configuration method to be used by the print server is determined by a router. The router specifies whether the print server obtains its address, its configuration information, or both from a DHCPv6 server.</p> <p>Router Unavailable: If a router is not available, the print server should attempt to obtain its stateful configuration from a DHCPv6 server.</p> <p>Always: Whether a router is available, the print server always attempts to obtain its stateful configuration from a DHCPv6 server.</p>
Ethernet	TCP/IP	IPv6 Settings	Primary DNS	Range: 0-255 Default = xxx.xxx.xx.xx	Specify the IP address (n.n.n.n) of a Primary Domain Name System (DNS) Server.
Ethernet	TCP/IP	IPv6 Settings	Secondary DNS	Range: 0-255 Default = 0.0.0.0	Specify the IP address (n.n.n.n) of a Secondary DNS Server.
Ethernet	TCP/IP	Proxy Server		Select from a provided list.	<p>Specifies the proxy server to be used by embedded applications in the printer. A proxy server is typically used by network clients for Internet access. It caches Web pages, and provides a degree of Internet security for those clients.</p> <p>To specify a proxy server, enter its IPv4 address or fully-qualified domain name. The name can be up to 255 octets.</p> <p>For some networks, you might need to contact your Internet Service Provider (ISP) for the proxy server address.</p>

Table 2-29 Networking menu (continued)

First level	Second level	Third level	Fourth level	Values	Description
Ethernet	TCP/IP	Proxy Port		Range: 1-65535 Default = 00080	Enter the port number used by the proxy server for client support. The port number identifies the port reserved for proxy activity on your network, and can be a value from 0 to 65535.
Ethernet	TCP/IP	Idle Timeout		Range: 1-3600 Default = 0270	The time period, in seconds, after which an idle TCP print data connection is closed (default is 270 seconds, 0 disables the timeout).
Wi-Fi Direct	Status			On* Off	
Wi-Fi Direct	Wi-Fi Direct Name			DIRECT-xx-HP [printer model]* xx represents two unique characters to help identify the printer.	Displays the Wi-Fi Direct printer name.

Table 2-29 Networking menu (continued)

First level	Second level	Third level	Fourth level	Values	Description
Wi-Fi Direct	Channel			1	Displays the available channels.
				2*	
				3	
				4	
				5	
				6	
				7	
				8	
				9	
				10	
				11	
				36	
				40	
				44	
				48	
				149	
		153			
		157			
		161			
		165			
Wi-Fi Direct	Connection Method			Automatic*	<p>Automatic: A mobile device can automatically connect to the printer and print a document.</p> <p>Manual: You must acknowledge the connection by touching the printer display when prompted or by entering a PIN code, provided by the printer, into the mobile device.</p>
				Manual	
Wi-Fi Direct	Wi-Fi Direct Password			12345678*	Displays the Wi-Fi Direct password for the printer.

Table 2-29 Networking menu (continued)

First level	Second level	Third level	Fourth level	Values	Description
Wireless	Information	Print Security Report		Yes No*	Yes: Prints a page that contains the current security settings on the HP Jetdirect print server. No: A security settings page is not printed.
Wireless	Wireless Station	Status			
Wireless	Wireless Station	SSID			
Wireless	Wireless Station	Authentication			
Wireless	Wireless Station	Reset 802.11			
Wireless	Wireless Station	Wi-Fi Protected Setup			
Wireless	TCP/IP	Host Name		NPIXXXXXX* Edit the host name as needed.	An alphanumeric string, up to 32 characters, used to identify the printer. This name is listed on the HP Jetdirect configuration page. The default host name is NPIxxxxxx, where xxxxxx is the last six digits of the LAN hardware (MAC) address.

Table 2-29 Networking menu (continued)

First level	Second level	Third level	Fourth level	Values	Description
Wireless	TCP/IP	IPv4 Settings	Config Method	Bootp DHCP* Auto IP Manual	<p>Specifies the method that TCP/IPv4 parameters will be configured on the HP Jetdirect print server.</p> <p>Bootp (Bootstrap Protocol): Use for automatic configuration from a BootP server.</p> <p>DHCP (Dynamic Host Configuration Protocol): Use for automatic configuration from a DHCPv4 server. If selected and a DHCP lease exists, the DHCP Release menu and the DHCP Renew menu are available to set DHCP lease options.</p> <p>Auto IP: Use for automatic link-local IPv4 addressing. An address in the form 169.254.x.x is assigned automatically.</p> <p>If you set this option to the Manual setting, use the Manual Settings menu to configure TCP/IPv4 parameters.</p>

Table 2-29 Networking menu (continued)

First level	Second level	Third level	Fourth level	Values	Description
Wireless	TCP/IP	IPV4 Settings	Default IP	Auto IP* Legacy	Specify the IP address to default to when the print server is unable to obtain an IP address from the network during a forced TCP/IP reconfiguration (for example, when manually configured to use BootP or DHCP). NOTE: This feature assigns a static IP address that might interfere with a managed network. Auto IP: A link-local IP address 169.254.x.x is set. Legacy: The address 192.0.0.192 is set, consistent with older HP Jetdirect printers.
Wireless	TCP/IP	IPV4 Settings	DHCP Release	Yes No*	
Wireless	TCP/IP	IPV4 Settings	DHCP Renew	Yes No*	
Wireless	TCP/IP	IPV4 Settings	Primary DNS	Range: 0-255 Default = xxx.xxx.xx.xx	Specify the IP address (n.n.n.n) of a Primary Domain Name System (DNS) Server.
Wireless	TCP/IP	IPV4 Settings	Secondary DNS	Range: 0-255 Default = 0.0.0.0	Specify the IP address (n.n.n.n) of a Secondary DNS Server.
Wireless	TCP/IP	IPV6 Settings	Enable	Off On*	Use this item to enable or disable IPv6 operation on the print server. Off: IPv6 is disabled. On: IPv6 is enabled.
Wireless	TCP/IP	IPV6 Settings	Address	Manual Settings Enable Address	Use this item to enable and manually configure a TCP/IPv6 address.

Table 2-29 Networking menu (continued)

First level	Second level	Third level	Fourth level	Values	Description
Wireless	TCP/IP	IPv6 Settings	DHCPv6 Policy	Router Specified Router Unavailable* Always	<p>Router Specified: The stateful auto-configuration method to be used by the print server is determined by a router. The router specifies whether the print server obtains its address, its configuration information, or both from a DHCPv6 server.</p> <p>Router Unavailable: If a router is not available, the print server should attempt to obtain its stateful configuration from a DHCPv6 server.</p> <p>Always: Whether a router is available, the print server always attempts to obtain its stateful configuration from a DHCPv6 server.</p>
Wireless	TCP/IP	IPv6 Settings	Primary DNS	Range: 0-255 Default = xxx.xxx.xx.xx	Specify the IP address (n.n.n.n) of a Primary Domain Name System (DNS) Server.
Wireless	TCP/IP	IPv6 Settings	Secondary DNS	Range: 0-255 Default = 0.0.0.0	Specify the IP address (n.n.n.n) of a Secondary DNS Server.
Wireless	TCP/IP	Proxy Server		Select from a provided list.	<p>Specifies the proxy server to be used by embedded applications in the printer. A proxy server is typically used by network clients for Internet access. It caches Web pages, and provides a degree of Internet security for those clients.</p> <p>To specify a proxy server, enter its IPv4 address or fully-qualified domain name. The name can be up to 255 octets.</p> <p>For some networks, you might need to contact your Internet Service Provider (ISP) for the proxy server address.</p>

Table 2-29 Networking menu (continued)

First level	Second level	Third level	Fourth level	Values	Description
Wireless	TCP/IP	Proxy Port		Range: 1-65535 Default = 80	Enter the port number used by the proxy server for client support. The port number identifies the port reserved for proxy activity on your network, and can be a value from 0 to 65535.
Wireless	TCP/IP	Idle Timeout		Range: 1-3600 Default = 270	The time period, in seconds, after which an idle TCP print data connection is closed (default is 270 seconds, 0 disables the timeout).
Wireless	Security	Secure Web		HTTPS Required* HTTPS Optional	
Wireless	Security	IPSEC		Keep Disable*	
Wireless	Security	802.1X		Reset Keep*	
Wireless	Security	Announcement Agent		Enable* Disable	
Wireless	Security	Reset Security		Yes No*	
I/O Timeout				Range: 5 – 300 sec Default = 10	Use to set the I/O timeout period in seconds. I/O timeout refers to the elapsed time before a print job fails. If the stream of data that the printer receives for a print job gets interrupted, this setting indicates how long the printer will wait before it reports that the job has failed.

Support Tools menu

The menus under the [Support Tools](#) menu contain the options for maintaining the printer and troubleshooting printer problems. Learn about these menus and settings.

- [Maintenance menu \(all except M501\)](#)
- [Troubleshooting menu](#)

Maintenance menu (all except M501)

Review the following information about the [Maintenance](#) menu for the M506/E50045/M507/E50145 and M527/E52545/M528/E52645 printers.

- [Backup/Restore menu \(all except M501\)](#)
- [Calibration/Cleaning menu \(all except M501\)](#)
- [USB Firmware Upgrade menu \(all except M501\)](#)
- [Service menu \(all except M501\)](#)

Backup/Restore menu (all except M501)

Review the following information about the [Backup/Restore](#) menu for the M506/E50045/M507/E50145 and M527/E52545/M528/E52645 printers.

To display: At the printer control panel, select the [Support Tools](#) menu, select the [Maintenance](#) menu, and then select the [Backup/Restore](#) menu.

In the following table, asterisks (*) indicate the factory default setting.

Table 2-30 [Backup/Restore](#) menu (all except M501)

First level	Second level	Third level	Values	Description
Back up Data	Enable Scheduled Backups	Backup Time	Enter a time	
		Days Between Backups	Enter the number of days	
	Back up Now			
	Export Last Backup			
Restore Data			Insert a USB drive that contains the backup file.	

Calibration/Cleaning menu (all except M501)

Review the following information about the [Calibration/Cleaning](#) menu for the M506/E50045/M507/E50145 and M527/E52545/M528/E52645 printers.

To display: At the printer control panel, select the [Support Tools](#) menu, select the [Maintenance](#) menu, and then select the [Calibration/Cleaning](#) menu.

In the following table, asterisks (*) indicate the factory default setting.

Table 2-31 Calibration/Cleaning menu (all except M501)

First level	Values	Description
Cleaning Page	Automatic Cleaning Interval	Use this menu to configure the settings for the product to automatically print a cleaning page.
	Off*	
	1000 pages	Select Off to disable automatic cleaning.
	2000 pages	
	5000 pages	
	10000 pages	Select a cleaning interval to set the number of pages to be printed before an automatic cleaning page is printed.
	20000 pages	
		Touch Print to manually print a cleaning page.
		NOTE: Cleaning pages print on the default paper size configured for the printer.
Calibrate Scanner	Done	Touch Start to calibrate the device scanner. Messages on the control panel display will lead you through the calibration process.
(M527/E52545/M528/E52645 only)	Start	
Clean Document Feeder Rollers	Set cleaning reminder interval	Configure cleaning settings for the document feeder rollers.
(M527/E52545/M528/E52645 only)	Range: 0 – 100%	
	Default = 10%	
	Done	
	Clean Now	

USB Firmware Upgrade menu (all except M501)

Review the following information about the [USB Firmware Upgrade](#) menu for the M506/E50045/M507/E50145 and M527/E52545/M528/E52645 printers.

To display: At the printer control panel, select the [Support Tools](#) menu, select the [Maintenance](#) menu, and then select the [USB Firmware Upgrade](#) menu.

Insert a USB storage device with a firmware upgrade bundle into the USB port, and follow the on-screen instructions.

Service menu (all except M501)

Review the following information about the [Service](#) menu for the M506/E50045/M507/E50145 and M527/E52545/M528/E52645 printers.

To display: At the printer control panel, select the [Support Tools](#) menu, and then select the [Service](#) menu.

The [Service](#) menu is locked and requires a PIN for access. This menu is intended for use by authorized service personnel. See the Service mode function section in the printer troubleshooting manual.

Troubleshooting menu

Review the following information about the [Troubleshooting](#) menu.

To display: At the printer control panel, select the [Support Tools](#) menu, and then select the [Troubleshooting](#) menu.

In the following table, asterisks (*) indicate the factory default setting.

Table 2-32 Troubleshooting menu



First level	Second level	Third level	Fourth level	Values	Description
Reports	Configuration/Status Pages		Settings Menu Map		Select the desired report and then select the print icon  to print the page.
			Current Settings Page		
			Configuration Page		
			Supplies Status Page		
			Usage Page		
			Paper Path Page		
			File Directory Page		
			Web Services Status Page		
			PCL Font List		
			PS Font List		
			Event Log		
			Warning Log Page		
			T.30 Protocol Trace		
	PQ Troubleshooting Pages				
	Paper Path Test				
Reports	Fax Reports		Fax Activity Log		Select the desired report and then select the print icon  to print the page.
			Billing Codes Report		
			Blocked Fax List		
			Fax Call Report		
Reports	Other Pages		PCL Font List		Select the desired report and then select the print icon  to print the page.
			PS Font List		

Table 2-32 Troubleshooting menu (continued)

First level	Second level	Third level	Fourth level	Values	Description
Fax Tools	Fax T.30 Trace Report			Never automatically print*	Use to print or configure the fax T.30 trace report. T.30 is the standard that specifies handshaking, protocols, and error correction between fax machines.
				Print after every fax	
				Print only after fax send jobs	
				Print only after received faxes	
				Print only after fax send errors	
				Print only after fax receive errors	
Fax Tools (Fax models only)	Fax V.34			Enable*	Use to disable V.34 modulations if several fax failures have occurred or if phone line conditions require it.
				Disable	
Fax Tools (Fax models only)	JBIG Compression			On	
				Off*	
Fax Tools (Fax models only)	Fax Speaker Mode			Normal*	Used by a technician to evaluate and diagnose fax issues by listening to the sounds of fax modulations
				Diagnostic	
Fax Tools (Fax models only)	Fax Service Log			Print	The standard fax log includes basic information such as the time and whether the fax was successful. The detailed fax log shows the intermediate results of the redial process not shown in the standard fax log.
Print Quality Pages	PQ Troubleshooting Pages			Print	Use to print pages that help you resolve problems with print quality.

Table 2-32 Troubleshooting menu (continued)

First level	Second level	Third level	Fourth level	Values	Description
Event Log					Prints the 50 most recent events in the Event Log. For each event, the printed log shows the error number, page count, error code, and description or personality.
Paper Path Page				Print	Shows how many pages were printed from each tray.
Diagnostic Tests	Disable Cartridge Check			Continue	Use this diagnostic test to print internal pages or send an external job to the printer when the toner cartridge is removed or exchanged. Supply errors are ignored while the printer is in this mode.
Diagnostic Tests	Paper Path Test	Source Tray		Select from a list of the available trays.	Generates a test page for testing paper handling features. You can define the path that is used for the test in order to test specific paper paths
Diagnostic Tests	Paper Path Test	Number of Copies		Range: 1–500 Default = 1	Sets the default number of copies for a copy job. This default applies when the Copy or Quick Copy function is initiated from the printer Home screen. The factory default setting is 1.
Diagnostic Tests	Paper Path Test	Test Duplex Path (Duplex models only)		Enable Disable*	Prints on both sides of the paper.
Diagnostic Tests	Print/Stop Test				Specify the length of time in milliseconds (0–60,000).
Diagnostic Tests	Paper Path Sensor Test			Select from a list of the printer sensors.	Initiates a test of the paper path sensors.

Table 2-32 Troubleshooting menu (continued)

First level	Second level	Third level	Fourth level	Values	Description
Diagnostic Tests	Manual Sensor Test			Select from a list of available components Reset	Test the printer sensors and switches for correct operation. Each sensor is displayed on the control-panel screen, along with its status. Manually trip each sensor and watch for it to change on the screen. Press the Stop button to abort the test.
Diagnostic Tests	Tray/Bin Manual Sensor Test			Select from a list of available components Reset	Test the printer sensors and switches for correct operation. Each sensor is displayed on the control-panel screen, along with its status. Manually trip each sensor and watch for it to change on the screen. Press the Stop button to abort the test.
Diagnostic Tests	Component Test			Select from a list of available components.	Use to exercise individual parts independently to isolate noise, leaking, or other issues. To start the test, select one of the components. The test will run the number of times specified by the Repeat option. You might be prompted to remove parts from the printer during the test. Press the Stop button to abort the test.
Diagnostic Tests	Continuous Scan (M527/E52545/ M528/E52645 only)				2-sided
Diagnostic Tests	Scanner Tests (M527/E52545/ M528/E52645 only)				Sensors
Generate Debug Data					Start

Table 2-32 Troubleshooting menu (continued)

First level	Second level	Third level	Fourth level	Values	Description
Retrieve Diagnostic Data				Create device data file	Create files that contain information about the printer that can help identify the cause of problems.
				Create zipped debug information file	
				Include crash dump files	
				Clean up debug information	
				Send to E-mail	
				Export to USB	
Retrieve Fax Diagnostic Data				Create device data file	Create files that contain information about the printer that can help identify the cause of problems.
				Create zipped debug information file	
				Include crash dump files	
				Clean up debug information	
				Send to E-mail	
				Export to USB	

Error code and control panel message troubleshooting overview

Error codes and control-panel messages display on the printer control panel to indicate the current printer status or situations that might require action.

- [Error codes](#)
- [How to search for printer documentation](#)

Error codes

Error codes indicate the current printer status or situations that might require action.

Error codes are numerical, or alphanumerical, and have a set structure with six characters (example: 13.WX.YZ).

- The first two characters are numeric and represent the system component that is causing the error. For example, in error code 10.22.15, **10 = Supplies** for HP LaserJets.
- The remaining four characters (WX, Y, and Z values) further define the error.

HP LaserJet and HP PageWide Enterprise error codes are documented in the control panel message document (CPMD) for each printer

The CPMD is a comprehensive list of error codes, diagnostic and troubleshooting steps to clear or resolve the error, and other helpful information such as service mode pins and part numbers.

The CPMD is continually updated and republished with the latest information for the following error codes.

Table 2-33 Error codes: The first two characters

Error code	System component	System error description
10.WX.YZ	Supplies (LaserJet)	Supply error or supply memory error
11.WX.YZ	Real-time clock	Internal error with the clock on the formatter.
13.WX.YZ	Jam (LaserJet)	Paper jam or open door jam error.
15.WX.YZ	Jam (PageWide)	Paper jam or open door jam error.
17.WX.YZ	Supplies (PageWide)	Supply error or supply memory error.
20.WX.YZ	Printer memory	Insufficient memory or buffering error.
21.WX.YZ	Page	Page complexity causing a decompression error when trying to process job.
30.WX.YZ	Scanner	Flatbed scanner error occurring inside the unit.
31.WX.YZ	Document feeder	Document feeder, scanner, or jam error.
32.WX.YZ	Backup, restore, or reset	Backup, restore, or reset notification or error.
33.WX.YZ	Security	Backup, Disk, EFI BIOS, Firmware integrity (SureStart), or error.
40.WX.YZ	Input/Output (I/O)	Partition manager, secure erase, or USB accessory error.

Table 2-33 Error codes: The first two characters (continued)

Error code	System component	System error description
41.WX.YZ	Fuser, Laser scanner, or Paper path	Miscellaneous error including general and misprint or mismatch errors typically involving (but not limited to) the fuser, the laser scanner, or the paper path.
42.WX.YZ	Firmware	Firmware failure involving the Event Log, Shell, System Manager, or other component.
44.WX.YZ	Firmware	Firmware failure involving a digital sending component.
45.WX.YZ	OXPd/Web Kit (PageWide)	Informational notifications involving the OXPd Web Kit (communications log).
46.WX.YZ	Engine (LaserJet)	Engine communication error.
47.WX.YZ	Firmware	Job parser or printer calibration error.
48.WX.YZ	Firmware	PJA job accounting, job management, or job pipeline error.
49.WX.YZ	Firmware	Firmware communication error.
50.WX.YZ	Fuser (LaserJet)	Fuser error.
51.WX.YZ	Laser scanner (LaserJet)	Laser scanner beam error.
52.WX.YZ	Laser scanner (LaserJet)	Laser scanner startup error.
54.WX.YZ	Sensor	Sensor error (not jam related).
55.WX.YZ	DC controller (LaserJet)	DC controller communication error.
56.WX.YZ	Paper handling (LaserJet)	Paper input/output or accessory error.
57.WX.YZ	Fan	Fan error.
58.WX.YZ	Sensor	Engine sensor failure.
59.WX.YZ	Motor (LaserJet)	Motor error.
60.WX.YZ	Tray motor error (LaserJet)	Tray lifting or pick up error.
61.WX.YZ	Engine (PageWide and LaserJet)	Print engine error with the 8-bit data package.
62.WX.YZ	System (LaserJet) Print bar (PageWide)	LaserJet internal system error. PageWide print system error.
63.WX.YZ	Engine (LaserJet)	General engine error (electrical, communication, etc.).
65.WX.YZ	Connector	Output accessory connection error.
66.WX.YZ	Output accessory	Output accessory error.
67.WX.YZ	Input accessory	Input accessory connection error.
69.WX.YZ	Duplexer	Duplexer error.
70.WX.YZ	DC controller (LaserJet)	DC controller firmware error.
80.WX.YZ	Managed device	Embedded Jetdirect error.

Table 2-33 Error codes: The first two characters (continued)

Error code	System component	System error description
81.WX.YZ	Near Field Communication (NFC)	Wireless, Bluetooth or internal EIO error.
82.WX.YZ	Memory (hard disk, EMMC, etc.)	Disk hardware error.
90.WX.YZ	Internal diagnostics	Internal test of systems (i.e. disk, CPB, display) or interconnection error.
98.WX.YZ	Hard disk	Hard disk partition error.
99.WX.YZ	Firmware installer	Remote Firmware Upgrade (RFU), firmware install (engine or accessory), or disk error

How to search for printer documentation

Find printer documentation using the internal HP portals.

The CPMD, error codes, and other support documentation for each printer is found on the internal HP portals [GCSN](#) and [WISE](#) (formerly SAW). GCSN is available to HP channel partners and WISE is available to call agents, service technicians, and other HP internal users. The level of detail available will depend on your access credentials.

How to search WISE for printer documentation

These instructions are for HP internal use by call agents, service technicians, and other internal users. [View a video of how to find support content in WISE.](#)

To view a list of control panel message documents per printer in WISE, enter document ID **c05048451**, to locate CPMD list.

Go to WISE and enter this document ID **c05791539** for written instructions.

How to search GCSN for printer documentation

These instructions are for internal use by HP Channel Partners. [View a video of how find support content in GCSN](#), or follow the steps below.

1. On the Home screen in GCSN, open **Technical information** using one of the following two methods:
 - Type **TINF** in the **Speedcode** field found in the upper right corner and press **Enter**, or
 - On the Home page, click **Technical information** in the left pane.

Figure 2-81 GCSN home page

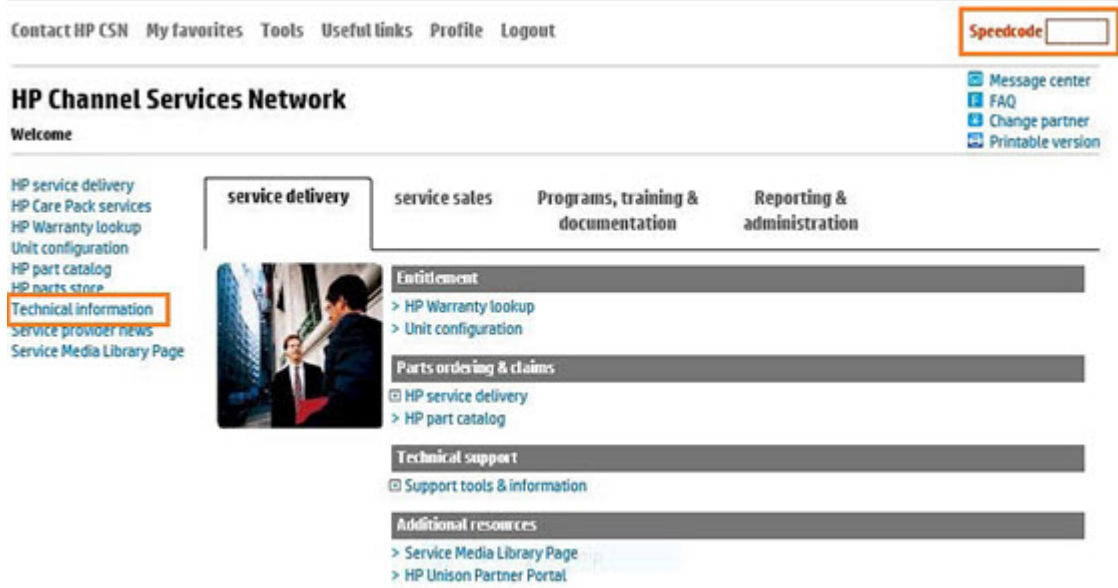

2. Under **Product Search**, select the **Type**, **Category**, **Family**, and **Series** that match your product model (leave the **Model** field as blank or the default).

 **NOTE:** Make sure to login to GCSN using your service-qualified credentials to access the most comprehensive content list available. To find out how to become service-qualified, contact your HP representative.

Figure 2-82 Sample product search criteria (GCSN)

Product Search [Add Favorites](#)

Type
Printers and Multifunction

Category
Multifunction and All-in-One

Family
HP LaserJet MFP and All-in-One Products

Series
HP Color LaserJet Enterprise MFP M682 series

Model
Select a Model

- Click **Add Favorites** and then click **Add** to add the printer to your Favorites list and allow you to bypass the **Product Search** fields next time for that particular model (optional).

Figure 2-83 Add favorites (GCSN)

- Clear all of the high-level check boxes.

Figure 2-84 Clear search criteria (GCSN)

- Select the check boxes for the document types for which you want to search.

 **NOTE:** Select only the high-level **Manuals and Guides** search option if you are not sure in which type of manual or guide the content might be listed.

Figure 2-85 Select search criteria (GCSN)

- Select **Submit**.
- If needed, click **Back To selection Criteria** and narrow your search (the maximum allowed search result is 100 documents).



NOTE: Do not select the **Top Issue** option unless you only want to view top issues for that model. All other available content is filtered out.

Table 2-34 Information type selections

Technical information type	Select this checkbox
Control panel message document (CPMD)	CPMD-Map
List of all CPMDs per product	Support Information
Installation Guide or Hardware Install Guide	Maintenance/Service Guide or Install Guide
Service cost document	Install Guide or Service Guide/Manual
Service guide or Service manual	Service Guide/Manual
Self-solve or troubleshooting document	Support Information
User manual or User guide	User Guide
Warranty and Legal Guide	Warranty Statement

Resolve print-quality problems

Use the information below to troubleshoot print-quality problems, including issues with image quality and color quality.

- [Introduction](#)
- [Resolving print quality problems](#)

Introduction

Use the information below to troubleshoot print-quality problems, including issues with image quality.

The troubleshooting steps can help resolve the following defects:

- Blank pages
- Black pages
- Curled paper
- Dark or light bands
- Dark or light streaks
- Fuzzy print
- Gray background or dark print
- Light print
- Loose toner
- Missing toner
- Scattered dots of toner
- Skewed images
- Smears
- Streaks

Resolving print quality problems

To resolve print-quality issues, try these steps in the order presented.

- [Print from a different software program](#)
- [Check the paper-type setting for the print job](#)
- [Check toner-cartridge status](#)
- [Print a cleaning page](#)
- [Visually inspect the toner cartridge or cartridges](#)
- [Check paper and the printing environment](#)
- [Try a different print driver](#)
- [Troubleshoot image defects](#)

To troubleshoot specific image defects, see [Troubleshoot Image Defects](#).

Print from a different software program

Try printing from a different software program.

If the page prints correctly, the problem is with the software program from which you were printing.

Check the paper-type setting for the print job

Check the paper type setting when printing from a software program and the printed pages have smears, fuzzy or dark print, curled paper, scattered dots of toner, loose toner, or small areas of missing toner.

- [Check the paper type setting on the printer](#)
- [Check the paper type setting \(Windows\)](#)
- [Check the paper type setting \(macOS\)](#)

Check the paper type setting on the printer

Check the paper type setting on the printer control panel, and change the setting as needed.

1. Open the tray.
2. Verify that the tray is loaded with the correct type of paper.
3. Close the tray.
4. Follow the control panel instructions to confirm or modify the paper type settings for the tray.

Check the paper type setting (Windows)

Check the paper type setting for Windows, and change the setting as needed.

1. From the software program, select the **Print** option.
2. Select the printer, and then click the **Properties** or **Preferences** button.
3. Click the **Paper/Quality** tab.
4. From the **Paper Type** drop-down list, click the **More...** option.
5. Expand the list of **Type is:** options.
6. Expand the category of paper types that best describes your paper.
7. Select the option for the type of paper you are using, and click the **OK** button.
8. Click the **OK** button to close the **Document Properties** dialog box. In the **Print** dialog box, click the **OK** button to print the job.

Check the paper type setting (macOS)

Check the paper type setting for macOS, and change the setting as needed.

1. Click the **File** menu, and then click the **Print** option.
2. In the **Printer** menu, select the printer.
3. Click **Show Details** or **Copies & Pages**.
4. Open the menus drop-down list, and then click the **Paper/Quality** menu.
5. Select a type from the **Media Type** drop-down list.
6. Click the **Print** button.

Check toner-cartridge status

Follow these steps to check the estimated life remaining in the toner cartridges and if applicable, the status of other replaceable maintenance parts.

- [Step one: Print the Supplies Status Page](#)
- [Step two: Check supplies status](#)

Step one: Print the Supplies Status Page

The supplies status page indicates the cartridge status.

1. From the Home screen on the printer control panel, select the [Reports](#) menu.
2. Select the [Configuration/Status Pages](#) menu.
3. Select [Supplies Status Page](#), and then select [Print](#) to print the page.

Step two: Check supplies status

Check the supplies status report as follows.

1. Look at the supplies status report to check the percent of life remaining for the toner cartridges and, if applicable, the status of other replaceable maintenance parts.

Print quality problems can occur when using a toner cartridge that is at its estimated end of life. The supplies status page indicates when a supply level is very low. After an HP supply has reached the very low threshold, HP's premium protection warranty on that supply has ended.

The toner cartridge does not need to be replaced now unless the print quality is no longer acceptable. Consider having a replacement available to install when print quality is no longer acceptable.

If you determine that you need to replace a toner cartridge or other replaceable maintenance parts, the supplies status page lists the genuine HP part numbers.

2. Check to see if you are using a genuine HP cartridge.

A genuine HP toner cartridge has the word "HP" on it, or has the HP logo on it. For more information on identifying HP cartridges go to www.hp.com/go/learnaboutsupplies.

Print a cleaning page

During the printing process paper, toner, and dust particles can accumulate inside the printer and can cause print-quality issues such as toner specks or spatter, smears, streaks, lines, or repeating marks.

Follow these steps to clean the printer paper path:

1. From the Home screen on the printer control panel, select the [Support Tools](#) menu.
2. Select the following menus:

- a. [Maintenance](#)
 - b. [Calibration/Cleaning](#)
 - c. [Cleaning Page](#)
3. Select [Print](#) to print the page.

A **Cleaning...** message displays on the printer control panel. The cleaning process takes a few minutes to complete. Do not turn the printer off until the cleaning process has finished. When it is finished, discard the printed page.

Visually inspect the toner cartridge or cartridges

Follow these steps to inspect each toner cartridge:

1. Remove the toner cartridge from the printer, and verify that the sealing tape has been removed.
2. Check the memory chip for damage.
3. Examine the surface of the green imaging drum.

 **CAUTION:** Do not touch the imaging drum. Fingerprints on the imaging drum can cause print-quality problems.

4. If you see any scratches, fingerprints, or other damage on the imaging drum, replace the toner cartridge.
5. Reinstall the toner cartridge and print a few pages to see if the problem has resolved.

Check paper and the printing environment

Use the following information to check the paper selection and the printing environment.

- [Step one: Use paper that meets HP specifications](#)
- [Step two: Check the environment](#)
- [Step three: Set the individual tray alignment](#)

Step one: Use paper that meets HP specifications

Some print-quality problems arise from using paper that does not meet HP specifications.

- Always use a paper type and weight that this printer supports.
- Use paper that is of good quality and free of cuts, nicks, tears, spots, loose particles, dust, wrinkles, voids, staples, and curled or bent edges.
- Use paper that has not been previously printed on.
- Use paper that does not contain metallic material, such as glitter.
- Use paper that is designed for use in laser printers. Do not use paper that is designed only for use in Inkjet printers.
- Use paper that is not too rough. Using smoother paper generally results in better print quality.

Step two: Check the environment

The environment can directly affect print quality and is a common cause of print-quality or paper-feeding issues. Try the following solutions:

- Move the printer away from drafty locations, such as open windows or doors, or air-conditioning vents.
- Make sure the printer is not exposed to temperatures or humidity outside of printer specifications.
- Do not place the printer in a confined space, such as a cabinet.
- Place the printer on a sturdy, level surface.
- Remove anything that is blocking the vents on the printer. The printer requires good air flow on all sides, including the top.
- Protect the printer from airborne debris, dust, steam, grease, or other elements that can leave residue inside the printer.

Step three: Set the individual tray alignment

Follow these steps when text or images are not centered or aligned correctly on the printed page when printing from specific trays.

1. From the Home screen on the printer control panel, select the [Settings](#) menu.
2. Select the following menus:

- a. [Copy/Print](#) or [Print](#)
 - b. [Print Quality](#)
 - c. [Image Registration](#)
3. Select [Tray](#), and then select the tray to adjust.
 4. Select [Print Test Page](#), and then follow the instructions on the printed pages.
 5. Select [Print Test Page](#) again to verify the results, and then make further adjustments if necessary.
 6. Select [Done](#) to save the new settings.

Try a different print driver

Try a different print driver when printing from a software program and the printed pages have unexpected lines in graphics, missing text, missing graphics, incorrect formatting, or substituted fonts.

Download any of the following drivers from the HP Web site: <http://www.hp.com/support/ljM501> or <http://www.hp.com/support/ljM506> or <http://www.hp.com/support/ljE50045> or <http://www.hp.com/support/ljM507> or <http://www.hp.com/support/ljE50145> or <http://www.hp.com/support/ljM527mfp> or <http://www.hp.com/support/ljE52545mfp> or <http://www.hp.com/support/ljM528mfp> or <http://www.hp.com/support/E52645mfp>.

Table 2-35 Print drivers

Driver	Description
HP PCL.6 driver	If available, this printer-specific print driver supports older operating systems like Windows XP and Windows Vista. For a list of supported operating systems, go to www.hp.com/go/support .
HP PCL 6 driver	This printer-specific print driver supports Windows 7 and newer operating systems that support version 3 drivers. For a list of supported operating systems, go to www.hp.com/go/support .
HP PCL-6 driver	This product-specific print driver supports Windows 8 and newer operating systems that support version 4 drivers. For a list of supported operating systems, go to www.hp.com/go/support .
HP UPD PS driver	<ul style="list-style-type: none"> • Recommended for printing with Adobe software programs or with other highly graphics-intensive software programs • Provides support for printing from Postscript emulation needs, or for Postscript flash font support
HP UPD PCL 6	<ul style="list-style-type: none"> • Recommended for printing in all Windows environments • Provides the overall best speed, print quality, and printer feature support for most users • Developed to align with Windows Graphic Device Interface (GDI) for best speed in Windows environments • Might not be fully compatible with third-party and custom software programs that are based on PCL 5

Troubleshoot image defects

Review examples of image defects and steps to resolve these defects.

Table 2-36 Image defects table quick reference

Sample	Description	Possible solutions
Table 2-43 Light print on page 307 	Table 2-41 Gray background or dark print on page 306 	Table 2-39 Blank page — No print on page 304 
Table 2-38 Black page on page 304 	Table 2-37 Banding defects on page 303 	Table 2-45 Streak defects on page 309 
Table 2-40 Fixing/fuser defects on page 305 	Table 2-42 Image placement defects on page 306 	Table 2-44 Output defects on page 308 

Image defects, no matter the cause, can often be resolved using the same steps. Use the following steps as a starting point for solving image defect issues.

1. Reprint the document. Print quality defects can be intermittent in nature or can go away completely with continued printing.
2. Check the condition of the cartridge or cartridges. If a cartridge is in a **Very Low** state (it has passed the rated life), replace the cartridge.
3. Make sure that the driver and tray print mode settings match the media that is loaded in the tray. Try using a different ream of media or a different tray. Try using a different print mode.
4. Make sure that the printer is within the supported operating temperature/humidity range.
5. Make sure that the paper type, size, and weight are supported by the printer. See support.hp.com for a list of the supported paper sizes and types for the printer.

 **NOTE:** The term “fusing” refers to the part of the printing process where toner is affixed to paper.

The following examples depict letter-size paper that has passed through the printer short edge first.

Table 2-37 Banding defects

Sample	Description	Possible solutions
	<p>Dark or light lines which repeat down the length of the page, and are wide-pitch and/or impulse bands. They might be sharp or soft in nature. The defect displays only in areas of fill, not in text or sections with no printed content.</p>	<ol style="list-style-type: none"> 1. Reprint the document. 2. Try printing from another tray. 3. Replace the cartridge. 4. Use a different paper type. 5. Enterprise models only: From the Home screen on the printer control panel, go to the Adjust Paper Types menu, and then choose a print mode that is designed for a slightly heavier media than what you are using. This slows the print speed and might improve the print quality. 6. If the issue persists, go to support.hp.com.

Table 2-38 Black page

Sample	Description	Possible solutions
	The entire printed page is black.	<ol style="list-style-type: none">1. Visually inspect the cartridge to check for damage.2. Make sure that the cartridge is installed correctly.3. Replace the cartridge.4. If the issue persists, go to support.hp.com.

Table 2-39 Blank page — No print

Sample	Description	Possible solutions
	The page is completely blank and contains no printed content.	<ol style="list-style-type: none">1. Make sure that the cartridges are genuine HP cartridges.2. Make sure that the cartridge is installed correctly.3. Print with a different cartridge.4. Check the paper type in the paper tray and adjust the printer settings to match. If necessary, select a lighter paper type.5. If the issue persists, go to support.hp.com.

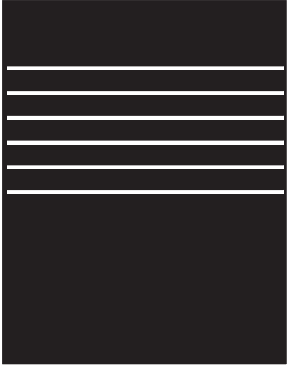
Table 2-40 Fixing/fuser defects

Sample	Description	Possible solutions
	<p>Slight shadows or offsets of the image are repeated down the page. The repeated image might fade with each recurrence.</p>	<ol style="list-style-type: none"> 1. Reprint the document. 2. Check the paper type in the paper tray and adjust the printer settings to match. If necessary, select a lighter paper type. 3. If the issue persists, go to support.hp.com.
	<p>Toner rubs off along either edge of the page. This defect is more common at the edges of high-coverage jobs, and on light media types, but can occur anywhere on the page.</p>	<ol style="list-style-type: none"> 1. Reprint the document. 2. Check the paper type in the paper tray and adjust the printer settings to match. If necessary, select a heavier paper type. 3. Enterprise models only: From the printer control panel, go to the Edge-to-Edge menu and then select Normal. Reprint the document. 4. Enterprise models only: From the printer control panel, select Auto Include Margins and then reprint the document. 5. If the issue persists, go to support.hp.com.

Table 2-41 Gray background or dark print

Sample	Description	Possible solutions
	<p>The image or text is darker than expected and/or the background is gray.</p>	<ol style="list-style-type: none"> 1. Make sure that the paper in the trays has not already been run through the printer. 2. Use a different paper type. 3. Reprint the document. 4. Mono models only: From the Home screen on the printer control panel, go to the Adjust Toner Density menu, and then adjust the toner density to a lower level. 5. Make sure that the printer is within the supported operating temperature and humidity range. 6. Replace the cartridge. 7. If the issue persists, go to support.hp.com.

Table 2-42 Image placement defects

Sample	Description	Possible solutions
	<p>The image is not centered, or is skewed on the page. The defect occurs when the paper is not positioned properly as it is pulled from the tray and moves through the paper path.</p>	<ol style="list-style-type: none"> 1. Reprint the document. 2. Remove the paper and then reload the tray. Make sure that all the paper edges are even on all sides. 3. Make sure that the top of the paper stack is below the tray-full indicator. Do not overfill the tray. 4. Make sure that the paper guides are adjusted to the correct size for the paper. Do not adjust the paper guides tightly against the paper stack. Adjust them to the indentations or markings in the tray. 5. If the issue persists, go to support.hp.com.

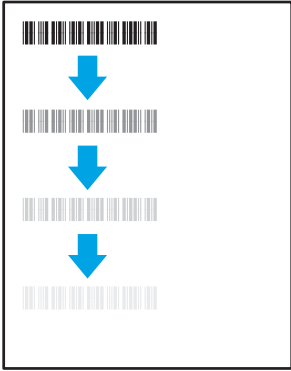
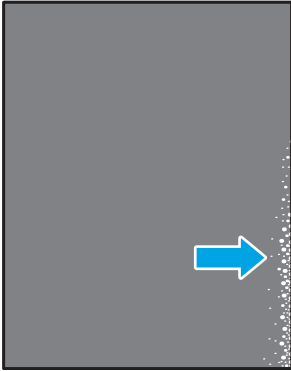
Table 2-43 Light print

Sample	Description	Possible solutions
	The printed content is light or faded on the entire page.	<ol style="list-style-type: none">1. Reprint the document.2. Remove the cartridge, and then shake it to redistribute the toner.3. Mono models only: Make sure that the EconoMode setting is disabled, both at the printer control panel and in the print driver.4. Make sure that the cartridge is installed correctly.5. Print a Supplies Status Page and check the life and usage of the cartridge.6. Replace the cartridge.7. If the issue persists, go to support.hp.com.

Table 2-44 Output defects



Sample	Description	Possible solutions
	<p>Printed pages have curled edges. The curled edge can be along the short or long side of the paper. Two types of curl are possible:</p> <ul style="list-style-type: none"> • Positive curl: The paper curls toward the printed side. The defect occurs in dry environments or when printing high-coverage pages. • Negative curl: The paper curls away from the printed side. The defect occurs in high-humidity environments or when printing low-coverage pages. 	<ol style="list-style-type: none"> 1. Reprint the document. 2. Positive curl: From the printer control panel, select a heavier paper type. The heavier paper type creates a higher temperature for printing. Negative curl: From the printer control panel, select a lighter paper type. The lighter paper type creates a lower temperature for printing. Try storing the paper in a dry environment prior to use, or use freshly opened paper.
	<p>The paper does not stack well in the output tray. The stack might be uneven, skewed, or the pages might be pushed out of the tray and onto the floor. Any of the following conditions can cause this defect:</p> <ul style="list-style-type: none"> • Extreme paper curl • The paper in the tray is wrinkled or deformed • The paper is a non-standard paper type, such as envelopes • The output tray is too full 	<ol style="list-style-type: none"> 1. Reprint the document. 2. Extend the output bin extension. 3. If the defect is caused by extreme paper curl, refer to the troubleshooting steps for "Output curl." 4. Use a different paper type. 5. Use freshly opened paper. 6. Remove the paper from the output tray before the tray gets too full. 7. If the issue persists, go to support.hp.com.

Table 2-45 Streak defects

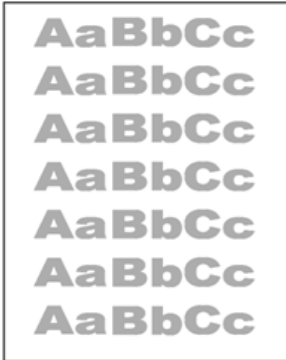
Sample	Description	Possible solutions
	<p>Light vertical streaks that usually span the length of the page. The defect displays only in areas of fill, not in text or sections with no printed content.</p>	<ol style="list-style-type: none"> 1. Reprint the document. 2. Remove the cartridge, and then shake it to redistribute the toner. 3. If the issue persists, go to support.hp.com. <p>NOTE: Both light and dark vertical streaks can occur when the printing environment is outside the specified range for temperature or humidity. Refer to your printer's environmental specifications for allowable temperature and humidity levels.</p>
	<p>Dark vertical lines which occur down the length of the page. The defect might occur anywhere on the page, in areas of fill or in sections with no printed content.</p>	<ol style="list-style-type: none"> 1. Reprint the document. 2. Remove the cartridge, and then shake it to redistribute the toner. 3. Print a cleaning page. 4. Check the toner level in the cartridge. 5. If the issue persists, go to support.hp.com.

Print quality troubleshooting guide

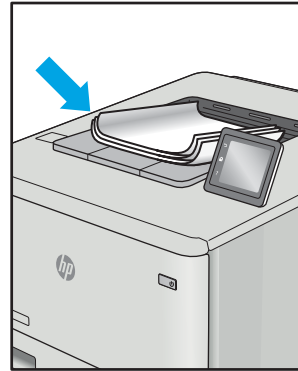
Review the following information about print quality troubleshooting.

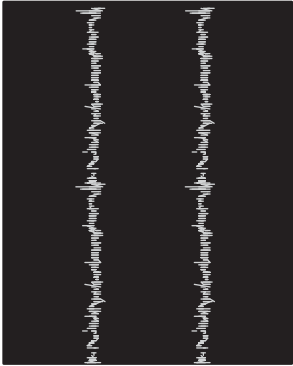
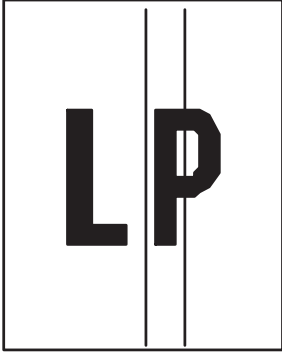
- [Image defects table](#)
- [Product specific image defects](#)

Image defects table

Image defects, no matter what their cause, can often be resolved using the same steps. Use the following steps as a starting point for solving image defect issues.

1. Reprint the document. Print quality defects can be intermittent in nature or can go away completely with continued printing.
2. Check the condition of your cartridge(s). If it is in a **Very Low** state (it has passed the rated life), replace your cartridge(s).
3. Check that the driver/tray print mode settings match the media that is loaded in a given tray. Try using a different ream of media or a different tray. Try using a different print mode.
4. Verify that your printer is in within its supported operating temperature/humidity range.
5. Verify the paper type, size and weight are supported by the printer. See the printer support page at www.hp.com/support for a list of the supported paper sizes and types for your printer.

 **NOTE:** The term “fusing” refers to the part of the printing process where toner is affixed to paper.

The following examples depict letter-size paper that has passed through the printer short-edge first.

Table 2-46 Image defect examples

Description	Sample	Possible solutions
Banding		
Repetitive wide-pitch banding and impulse bands: Dark or light lines which repeat down the length of the page. They might be sharp or soft in nature. The defect displays only in areas of fill, not in text or sections with no printed content.		<ol style="list-style-type: none">1. Reprint the document.2. Try printing from another tray.3. Replace the cartridge.4. Use a different paper type.5. Enterprise models only: From the Home screen on the printer control panel, go to the Adjust Paper Types menu, and then choose a print mode that is designed for a slightly heavier media than what you are using. This slows the print speed and might improve the print quality.6. If the problem persists, go to www.hp.com/support.
Streaks		

Table 2-46 Image defect examples (continued)

Description	Sample	Possible solutions
<p>Light vertical streaks: Light streaks that usually span the length of the page. The defect displays only in areas of fill, not in text or sections with no printed content.</p>		<ol style="list-style-type: none"> 1. Reprint the document. 2. Remove the cartridge, and then shake it to redistribute the toner. 3. If the problem persists, go to www.hp.com/support. <p>Both light and dark vertical streaks can occur when the printing environment is outside the specified range for temperature or humidity. Refer to your printer's environmental specifications for allowable temperature and humidity levels.</p>
<p>Dark vertical streaks and ITB cleaning streaks (color models only): Dark lines which occur down the length of the page. The defect might occur anywhere on the page, in areas of fill or in sections with no printed content.</p>		<ol style="list-style-type: none"> 1. Reprint the document. 2. Remove the cartridge, and then shake it to redistribute the toner. 3. Print a cleaning page. 4. Check the toner level in the toner cartridge(s). 5. If the problem persists, go to www.hp.com/support.
<p>Fixing/fuser</p>		
<p>Hot fuser offset (shadow): Slight shadows, or offsets, of the image repeated down the page. The repeated image might fade with each recurrence.</p>		<ol style="list-style-type: none"> 1. Reprint the document. 2. Check the paper type in the paper tray and adjust the printer settings to match. If necessary, select a lighter paper type. 3. If the problem persists, go to www.hp.com/support.

Table 2-46 Image defect examples (continued)



Description	Sample	Possible solutions
<p>Poor fusing: Toner rubs off along either edge of page. This defect is more common at the edges of high-coverage jobs and on light media types but can occur anywhere on the page.</p>		<ol style="list-style-type: none"> 1. Reprint the document. 2. Check the paper type in the paper tray and adjust the printer settings to match. If necessary, select a heavier paper type. 3. Enterprise models only: From the printer control panel, go to the Edge-to-Edge menu and then select Normal. Reprint the document. 4. Enterprise models only: From the printer control panel, select Auto Include Margins and then reprint the document. 5. If the problem persists, go to www.hp.com/support.
<p>Image placement</p>		
<p>Margins and skew</p>		<ol style="list-style-type: none"> 1. Reprint the document. 2. Remove the paper and then reload the tray. Make sure that all the paper edges are even on all sides. 3. Make sure that the top of the paper stack is below the tray full indicator. Do not overfill the tray. 4. Make sure that the paper guides are adjusted to the correct size for the paper. Do not adjust the paper guides tightly against the paper stack. Adjust them to the indentations or markings in the tray. 5. If the problem persists, go to www.hp.com/support.
<p>Color plane registrations</p>		
<p>Color plane registrations (color models only)</p>		<ol style="list-style-type: none"> 1. Reprint the document. 2. From the printer control panel, calibrate the printer. 3. If a cartridge has reached a Very Low state or the printed output is severely faded, replace the cartridge. 4. From the printer control panel use the Restore Calibration feature to reset the printer's calibration settings to the factory defaults. 5. If the problem persists, go to www.hp.com/support.
<p>Output</p>		

Table 2-46 Image defect examples (continued)

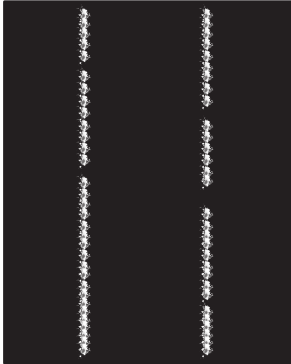
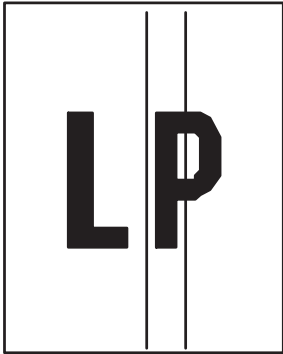
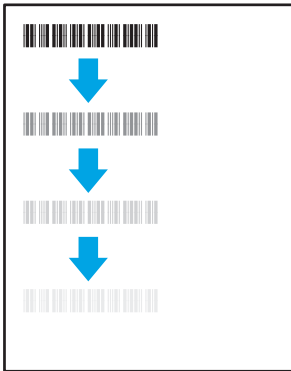
Description	Sample	Possible solutions
<p>Output curl</p> <p>Printed paper has curled edges. The curled edge can be along the short or long side of the paper. Two types of curl are possible:</p> <ul style="list-style-type: none"> • Positive curl: The paper curls toward the printed side. The defect occurs in dry environments or when printing high coverage pages. • Negative curl: The paper curls away from the printed side. The defect occurs in high-humidity environments or when printing low coverage pages. 		<ol style="list-style-type: none"> 1. Reprint the document. 2. Positive curl: From the printer control panel, select a heavier paper type. The heavier paper type creates a higher temperature for printing. Negative curl: From the printer control panel, select a lighter paper type. The lighter paper type creates a lower temperature for printing. Try storing the paper in a dry environment prior or use freshly opened paper. 3. Print in duplex mode. 4. If the problem persists, go to www.hp.com/support.
<p>Output stacking</p> <p>The paper does not stack well in the output tray. The stack might be uneven, skewed, or the pages might be pushed out of the tray and onto the floor. Any of the following conditions can cause this defect:</p> <ul style="list-style-type: none"> • Extreme paper curl • The paper in the tray is wrinkled or deformed • The paper is a non-standard paper type, such as envelopes • The output tray is too full 		<ol style="list-style-type: none"> 1. Reprint the document. 2. Flip out the output bin extension. 3. If the defect is caused by extreme paper curl, complete the troubleshooting steps for Output curl. 4. Use a different paper type. 5. Use freshly opened paper. 6. Remove the paper from the output tray before the tray gets too full. 7. If the problem persists, go to www.hp.com/support.

Product specific image defects

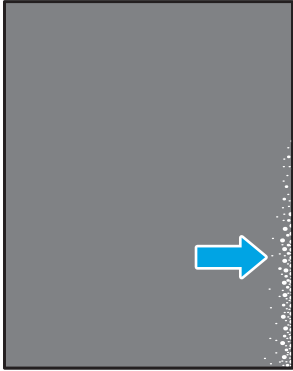
Review the following information about product specific image defects.

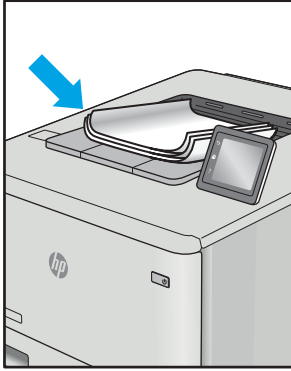
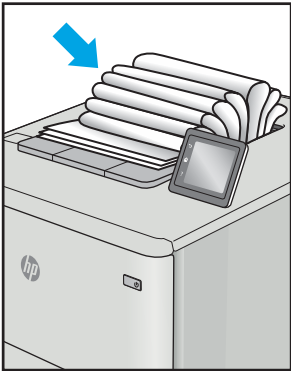
- [Repetitive image defect ruler](#)
- [Print-quality troubleshooting](#)

Repetitive image defect ruler

Review the following information about a repetitive image defect ruler.

- [Use a ruler to measure between repetitive defects](#)

When troubleshooting the source of some print image defects, one solution is to identify if it is a repetitive defect (does the print quality defect appear multiple times on the printed page?). If this is the case, use a ruler to measure occurrences of repetitive image defects to help solve image-quality problems. For more information, see [Use a ruler to measure between repetitive defects on page 316](#).

Use a ruler to measure occurrences of repetitive image defects to help solve image-quality problems. Place the ruler next to the first occurrence of the defect on the page. Find the distance between identical defects and use the table below to identify the component that is causing the defect.

 **IMPORTANT:** Do not use solvents or oils to clean rollers. Instead, rub the roller with a lint-free cloth. If dirt is difficult to remove, rub the roller with a lint-free cloth that has been dampened with water.

 **NOTE:** Defects on the tray pickup rollers or the Tray 1 pickup roller do not cause a repetitive defect. Defects on these rollers cause a defect to appear only on the leading edge of the image.

 **TIP:** To make a printer specific repetitive defect ruler, use a metric ruler to transfer the measurements in [Table 2-47 Repetitive defects on page 315](#) to a transparency or the edge of a piece of paper—clearly label each ruler mark with the associated defective assembly.

Table 2-47 Repetitive defects

Assembly	Distance between defects
Developer roller (toner cartridge) ¹	27.8 mm (1.09 in)
Charge roller (toner cartridge) ¹	28.3 mm (1.11 in)
Face down roller	36.9 mm (1.45 in)
Transfer roller	39 mm (1.53 in)
Duplex feed roller	40.3 mm (1.58 in)
Registration roller	43.3 mm (1.70 in)
Middle feed roller (cassette)	
Middle feed roller (optional input feeder)	
Switchback roller	43.4 mm (1.70 in)
Feed roller cassette)	47.4 mm (1.87 in)
Feed roller (optional input feeder)	
Pick roller (cassette)	49.7 mm (1.95 in)
Pickup roller (optional input feeder)	
Pressure roller ² (fuser)	63.5 mm (2.50 in)
Photosensitive drum ¹ (OPC drum; toner cartridge)	75.4 mm (2.96 in)
Fuser sleeve ² (fuser)	

Table 2-47 Repetitive defects (continued)

Assembly	Distance between defects
Pick roller (Tray 1)	78.7 mm (3.09 in)

¹ The primary charging roller and photosensitive drum cannot be cleaned because they are internal assemblies in the toner cartridge. If one of these assemblies is causing the defect, replace the toner cartridge.

² The primary fuser sleeve unit or pressure roller cannot be cleaned because they are internal assemblies in the fuser. If one of these assemblies is causing the defect, replace the fuser.

Use a ruler to measure between repetitive defects

The figures in this section show color repetitive defect pages. However, the process for measuring repetitive defects is valid for mono pages.

1. Identify a repetitive defect on the page.

 **TIP:** Print a cleaning page to see if that resolves the defect.

 **NOTE:** These are examples only, other types of repetitive defects might appear on a page.

- Lines (callout 1)
- Smudges (callout 2)
- Dots or spots (callout 3)

Figure 2-86 Examples of repetitive defects

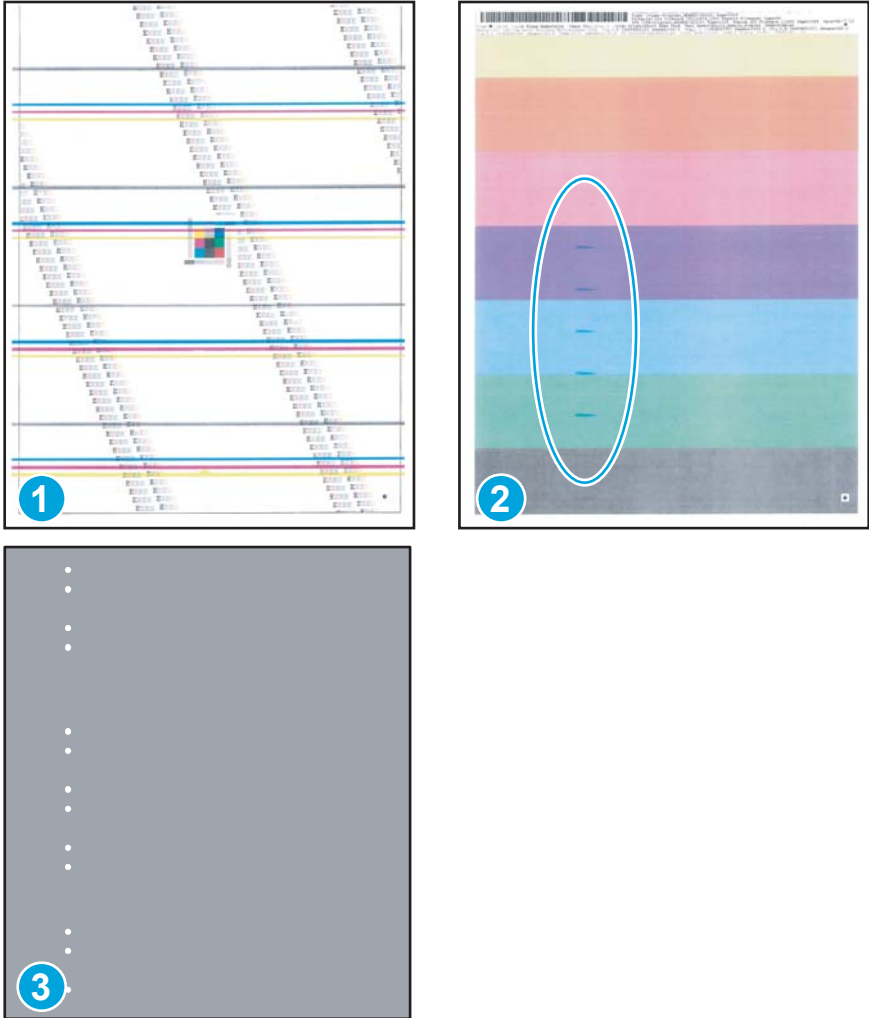

2. Position a metric ruler on the page with the “zero” ruler mark at one occurrence of the defect (callout 1).

Figure 2-87 Place the ruler on the page

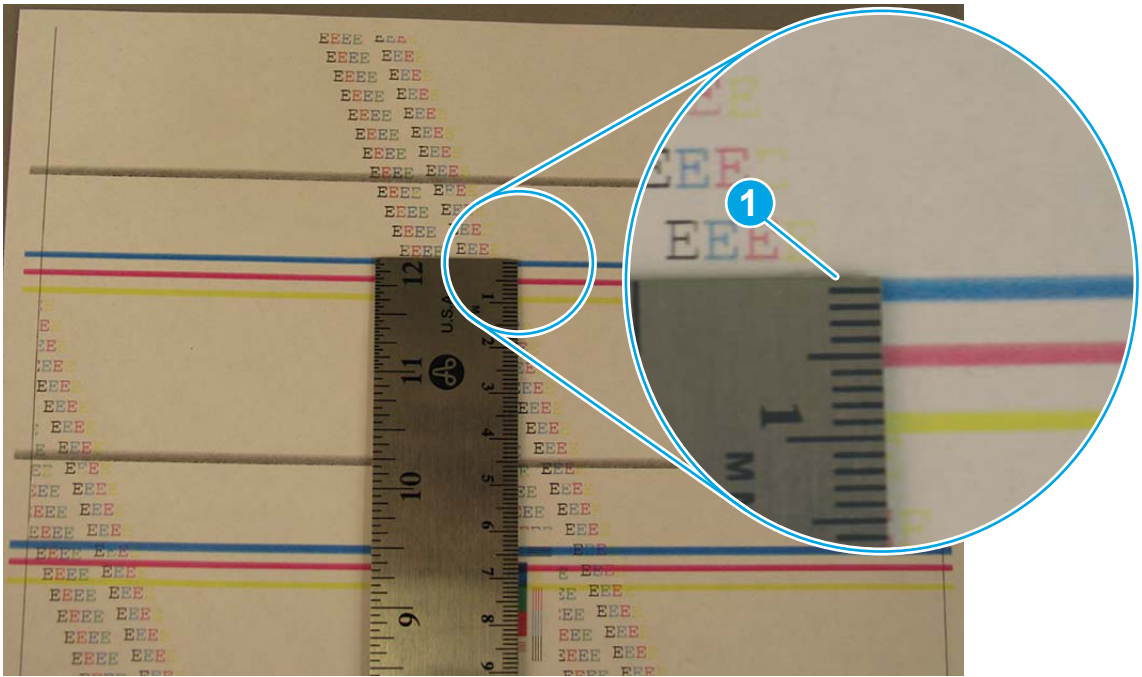

3. Locate the next occurrence of the defect (callout 1).

Figure 2-88 Locate the next repetitive defect

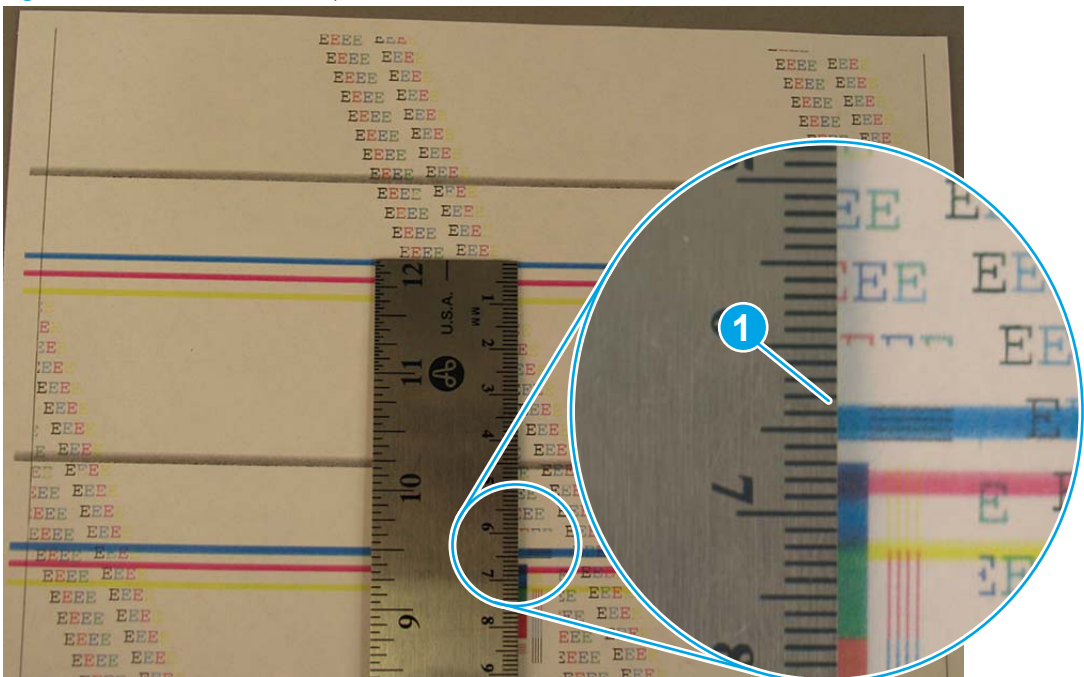

4. Measure the distance (in millimeters) between the two occurrences (callout 1), and then use the Repetitive defects table to determine the defective assembly.

 **TIP:** Always measure from and to the same point on the defects. For example, if the ruler is “zeroed” at the top edge of a defect, measure to the top edge of the next occurrence of that defect.

Figure 2-89 Determine the defective assembly



Print-quality troubleshooting

Review the following information about print-quality troubleshooting.

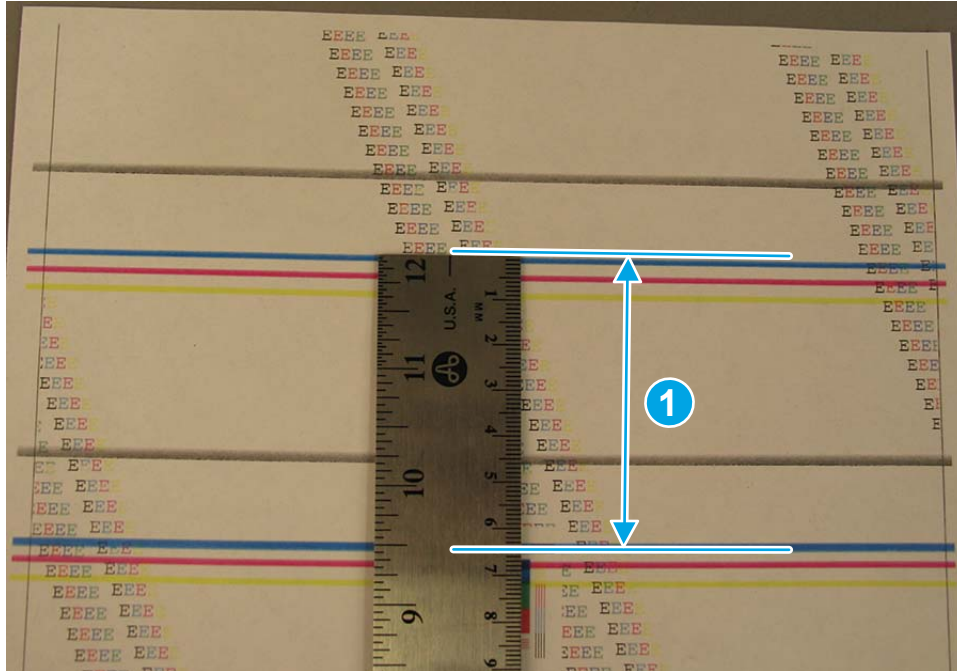
- [Image defect events](#)
- [Image defect \(developmental\) events](#)
- [Other events](#)



NOTE: The image defects described in this section are printer-specific image defects.

Image defect events

Review the following information about image defect events.

- [Graininess](#)
- [Streaks](#)
- [Banding](#)

 **NOTE:** The image defects described in this section are defects that occurred during development and that could not be fully eliminated. Customers might observe these defects.

Graininess

Review the following information about graininess image defect events.

- [Graininess/fixing mottle](#)

Graininess/fixing mottle

Review the following information about the graininess/fixing mottle image defect event.

- [Description of the defect](#)
- [Conditions that can cause the defect](#)
- [Solutions for the defect](#)
- [Parts related to the defect](#)

Figure 2-90 Graininess/fixing mottle



Description of the defect

This defect is large areas of fill that appear blotchy, grainy, non-uniform, or mottled (marked with spots or smears of color).

The graininess/fixing mottle defect is caused by how the toner (dot) is pressed or melted and the severity of the defect depends on the paper roughness. This leads to the density variance or uneven gloss. Graininess/fixing mottle is caused by inconsistently melted toner.

Conditions that can cause the defect

The defect appears in large areas of fill and is more severe in low temperature and humidity environments.

Solutions for the defect

Use the following steps to solve the defect.

- **M501:** From the printer control panel, change the print mode from plain to intermediate (this slows the print speed).

1. Open the following menus:

- Setup
- System Setup
- Paper Setup
- Tray <X>



NOTE: Select the tray you want to configure.

- Paper Type

2. Select [Intermediate 85–95g](#).

- **M506/E50045 and M527/E52545:** From the printer control panel, change the print mode from plain to intermediate (this slows the print speed).

1. Open the following menus:

- Trays
- Tray
- Modify

2. Select [Intermediate 85–95g](#).

- **M507/E50145 and M528/E52645:** From the printer control panel, change the print mode from plain to intermediate (this slows the print speed).

1. Open the following menus:

- Trays
- Tray <X>



NOTE: Select the tray you want to configure.

- Type

2. Select [Intermediate 85–95g](#).

- Try using a smoother paper.

Parts related to the defect

The following item(s) might need to be repaired or replaced to prevent this defect from occurring.

- Media
- Toner cartridge
- Fuser

Streaks

Review the following information about streak image defect events.

- [Vertical streaks - high temperature/humidity](#)

Conditions that can cause the defect

This defect primarily occurs in high temperature and high humidity environments.

Solutions for the defect

Use the following steps to solve the defect.

- Resend the print job.
- If the defect does not improve within two to three print jobs, remove the toner cartridge and gently rock it back and forth from side to side (this distributes the toner evenly in the toner cartridge).
- If the toner cartridge has reached the **Very Low** state, replace it.
- If the defect persists, replace the toner cartridge.

Parts related to the defect

The following item(s) might need to be repaired or replaced to prevent this defect from occurring.

- Toner cartridge

Banding

Review the following information about banding image defect events.

- [Dark streaks \(early in toner cartridge life\)](#)
- [Fine-pitch banding](#)
- [Wide-pitch banding 27.8 mm1.09 in](#)
- [AC banding 4.6 mm0.18 in](#)
- [OPC sharp bands at 75mm2.95 in pitch \(version 1\)](#)
- [OPC sharp bands at 75 mm2.95 in pitch \(version 2\)](#)
- [Impulse band 49-50 mm1.92-1.96 in from the leading edge](#)
- [Impulse band 75-82 mm2.95-3.22 in from the trailing edge](#)
- [Impulse band 102 mm4.01 in from the trailing edge](#)

Dark streaks (early in toner cartridge life)

Review the following information about the dark streaks early in toner cartridge life image defect event.

- [Description of the defect](#)
- [Conditions that can cause the defect](#)
- [Solutions for the defect](#)
- [Parts related to the defect](#)

Figure 2-92 Dark streaks (early in toner cartridge life)



Description of the defect

Smearred dark streaks come and go down the page, and are more common at the right and left edges of the page.

This issue is caused by grease from toner cartridge stirring system contaminating the supply hopper which then causes the toner to cluster and results in dark streaks on the page. Countermeasures include optimizing grease: amount, position, and stickiness. This defect appears in areas of fill, not in text.

Conditions that can cause the defect

This defect occurs when using a new toner cartridge and usually decreases over toner cartridge life.

Solutions for the defect

Use the following steps to solve the defect.

- Resend the print job.
- If the defect does not improve within two to three print jobs, remove the toner cartridge and gently rock it back and forth from side to side (this distributes the toner evenly in the toner cartridge).
- If the defect persists, replace the toner cartridge.

Parts related to the defect

The following item(s) might need to be repaired or replaced to prevent this defect from occurring.

- Toner cartridge

Fine-pitch banding

Review the following information about the fine-pitch banding image defect event.

- [Description of the defect](#)
- [Conditions that can cause the defect](#)
- [Solutions for the defect](#)
- [Parts related to the defect](#)

Figure 2-93 Fine-pitch banding

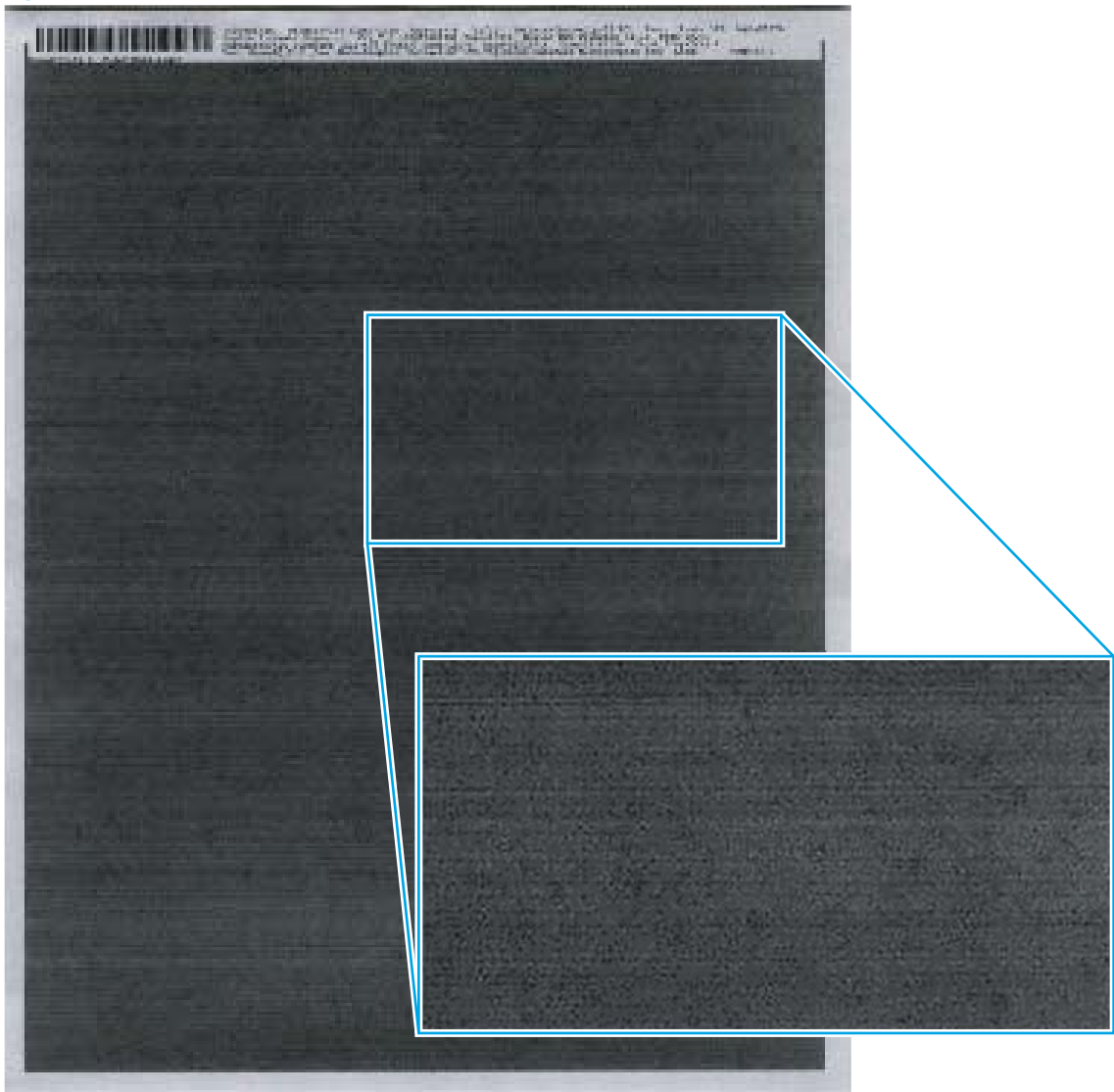

Description of the defect

This defect appears as alternating light and dark (evenly spaced) repetitive horizontal lines.

The 0.93 mm (0.03 in) fine-pitch banding is caused by the main drive motor gear tooth engagement. This defect appears in areas of fill, not in text.

Conditions that can cause the defect

The alignment of the motor gear and drum drive gear is the important factor for this banding and specifically the accuracy of the motor installed surface and accuracy of the bearing shaft position at the both sides of the drum drive gear shaft.

Solutions for the defect

Use the following steps to solve the defect.

- Try using a smoother paper.
- **M501:** From the printer control panel, change the print mode from plain to intermediate (this slows the print speed).

1. Open the following menus:

- Setup
- System Setup
- Paper Setup
- Tray <X>



NOTE: Select the tray you want to configure.

- Paper Type

2. Select **Intermediate 85–95g**.

- **M506/E50045 and M527/E52545:** From the printer control panel, change the print mode from plain to intermediate (this slows the print speed).

1. Open the following menus:

- Trays
- Tray
- Modify
- Next

2. Select **Intermediate 85–95g**.

- **M507/E50145 and M528/E52645:** From the printer control panel, change the print mode from plain to intermediate (this slows the print speed).

1. Open the following menus:

- Trays
- Tray <X>



NOTE: Select the tray you want to configure.

- Type

2. Select **Intermediate 85–95g**.

Parts related to the defect

The following item(s) might need to be repaired or replaced to prevent this defect from occurring.

- Toner cartridge
- Printer engine (whole unit replacement)

Wide-pitch banding 27.8 mm (1.09 in)

Review the following information about the wide-pitch banding (27.8 mm (1.09 in)) image defect event.

- [Description of the defect](#)
- [Conditions that can cause the defect](#)
- [Solutions for the defect](#)
- [Parts related to the defect](#)

Figure 2-94 Wide-pitch banding

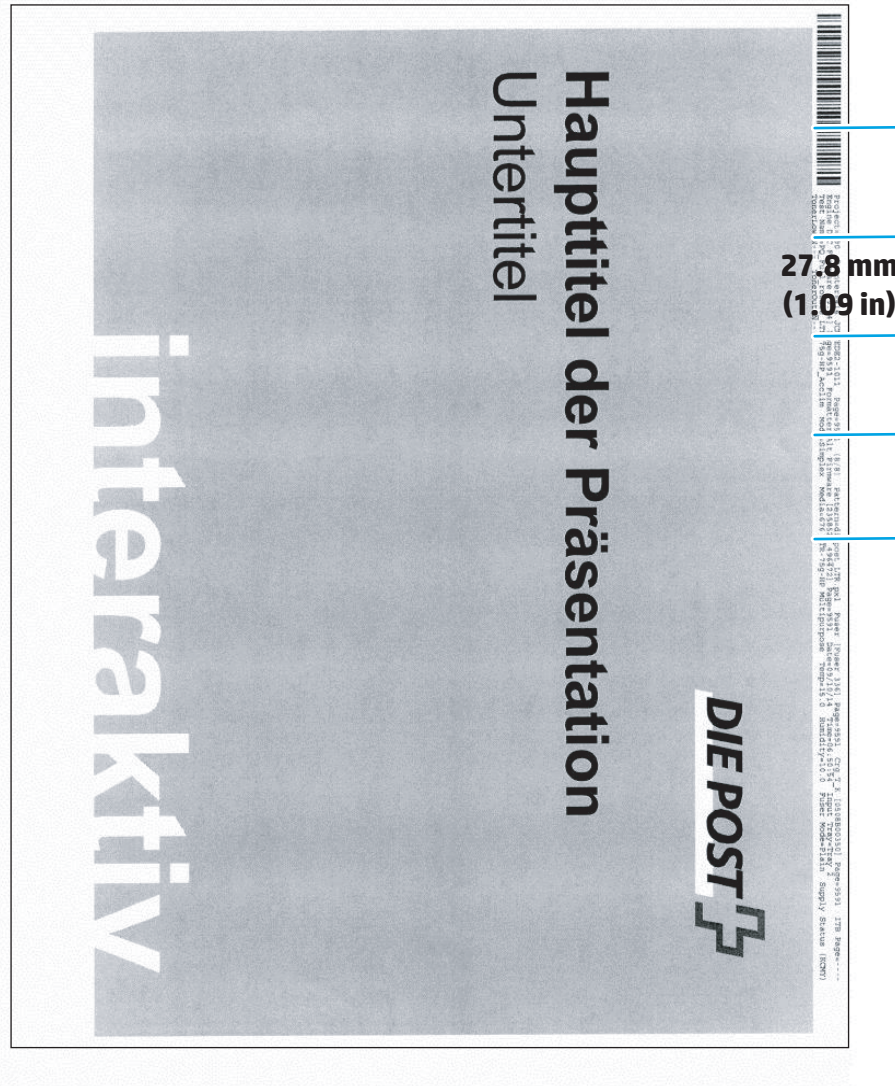

Description of the defect

This defect appears as soft, gradual bands can be seen over a constant density area.

It appears as slight gradients which repeat at approximately a 27.8 mm (1.09 in) pitch. This defect appears in areas of fill, not in text.

Conditions that can cause the defect

This defect is a density variation which appears on the PQ due to the gap variation between the OPC and the developer sleeve. This gap varies due to the accuracy of the OPC, developer sleeve, and the spacer placed between the OPC and the developer sleeve.

Solutions for the defect

Use the following steps to solve the defect.

- Resend the print job.
- If the defect persists, replace the toner cartridge.

Parts related to the defect

The following item(s) might need to be repaired or replaced to prevent this defect from occurring.

- Toner cartridge

AC banding 4.6 mm (0.18 in)

Review the following information about the AC banding (4.6 mm (0.18 in)) image defect event.

- [Description of the defect](#)
- [Conditions that can cause the defect](#)
- [Solutions for the defect](#)
- [Parts related to the defect](#)

Figure 2-95 AC banding

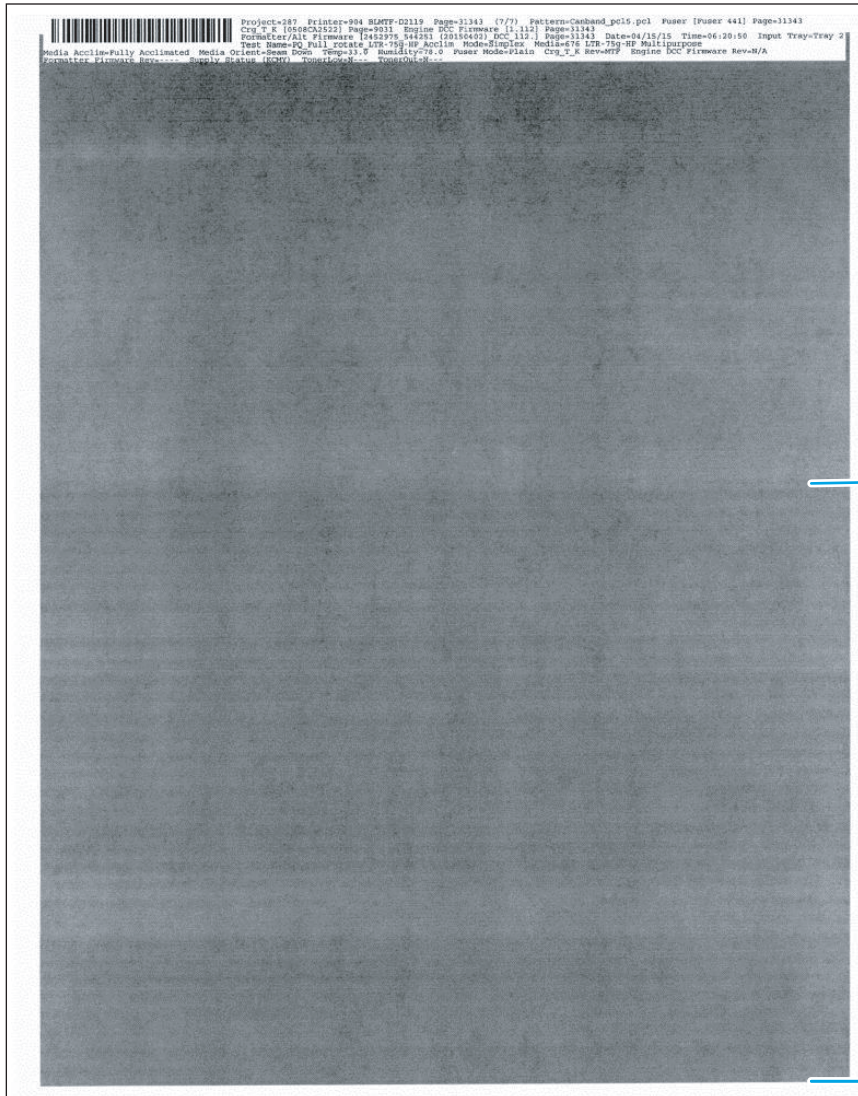

Description of the defect

This defect appears as alternating light and dark bands that repeat at 4.6 mm (0.18 in) pitch might be visible starting midway down the page in high-temperature and high-humidity environments.

This defect is caused by the transfer current getting pulled into the fusing area through the paper from the fuser heater voltage supply. The transfer banding occurs at the power supply voltage frequency. A capacitor was added to the transfer front guide to improve the level as a countermeasure during development.

Conditions that can cause the defect

This defect usually occurs when printing in **Plain** print mode in high-humidity environments on fully acclimated (low resistivity) paper, which makes the transfer current flow to the fusing area more easily.

The defect occurs more often with 220V units, which have higher impressed voltage to the fuser heater. This defect appears in areas of fill, not in text.

Solutions for the defect

Use the following steps to solve the defect.

- Try printing the job on a newly opened supply of paper.
- Cool the printer environment, and then resend the print job.
- **M501:** From the printer control panel, change the print mode from plain to intermediate (this slows the print speed).
 1. Open the following menus:
 - [Setup](#)
 - [System Setup](#)
 - [Paper Setup](#)
 - [Tray <X>](#)
 -  **NOTE:** Select the tray you want to configure.
 - [Paper Type](#)
- 2. Select [Intermediate 85–95g](#).
- **M506/E50045 and M527/E52545:** From the printer control panel, change the print mode from plain to intermediate (this slows the print speed).
 1. Open the following menus:
 - [Trays](#)
 - [Tray](#)
 - [Modify](#)
 - [Next](#)
 2. Select [Intermediate 85–95g](#).
- **M507/E50145 and M528/E52645:** From the printer control panel, change the print mode from plain to intermediate (this slows the print speed).
 1. Open the following menus:

- Trays
- Tray <X>



NOTE: Select the tray you want to configure.

- Type

2. Select **Intermediate 85–95g**.

Parts related to the defect

The following item(s) might need to be repaired or replaced to prevent this defect from occurring.

- Media
- Fuser

OPC sharp bands at 75mm (2.95 in) pitch (version 1)

Review the following information about the OPC sharp bands at 75mm (2.95 in) pitch (version 1) image defect event.

- [Description of the defect](#)
- [Conditions that can cause the defect](#)
- [Solutions for the defect](#)
- [Parts related to the defect](#)

Figure 2-96 OPC sharp bands (version 1)

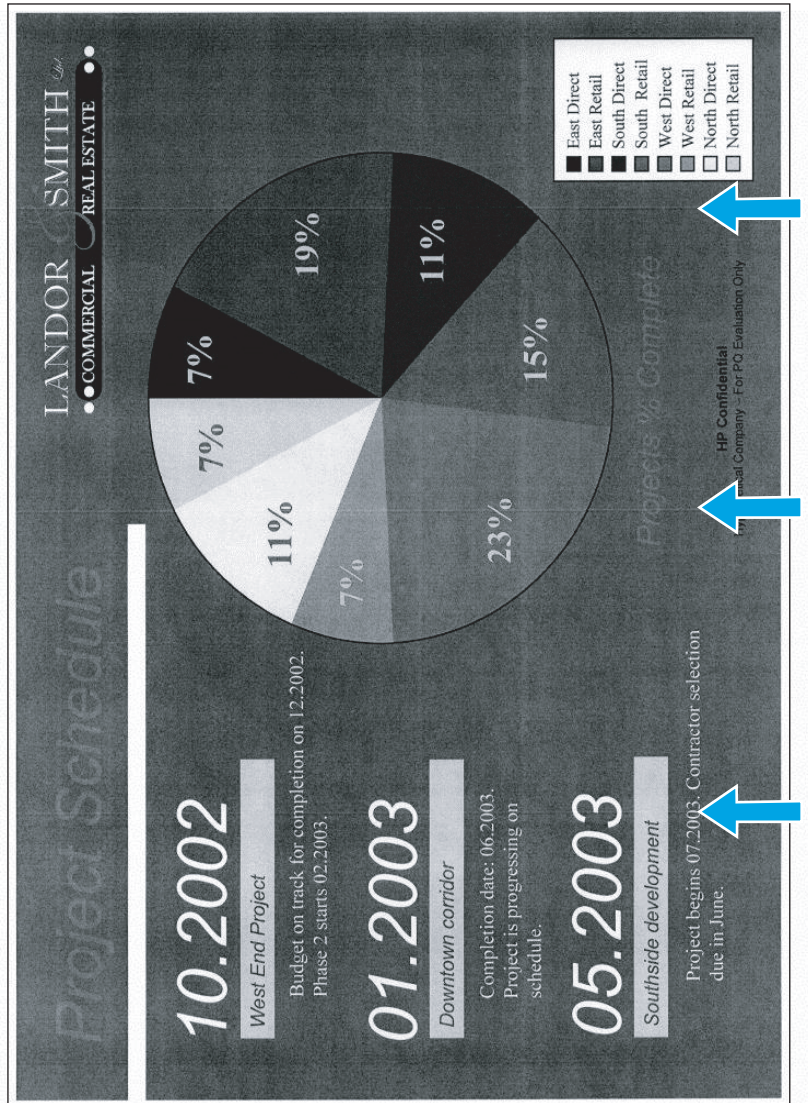

Description of the defect

This defect appears as sharp bands which repeat at a 75mm (2.95 in) pitch down the page as a light/dark line.

Waste products (for example, toner or paper) accumulate at the contact position between the C-blade and the OPC. When the OPC stops, the waste material can form a light attachment to the OPC. When the OPC begins to

turn again, the material removal can affect the OPC charge for several rotations. This defect appears in areas of fill, not in text.



NOTE: This defect is also called C-blade blur and is common to many color and mono products. This defect looks similar to OPC sharp bands version 2, but appears to be light/dark.

Conditions that can cause the defect

This defect might occur any time the toner cartridge is idle for long periods of time.

Solutions for the defect

Use the following steps to solve the defect.

- Resend the print job. The defect should fade with subsequent printed pages.
- If the defect persists, replace the toner cartridge

Parts related to the defect

The following item(s) might need to be repaired or replaced to prevent this defect from occurring.

- Toner cartridge

OPC sharp bands at 75 mm (2.95 in) pitch (version 2)

Review the following information about the OPC sharp bands at 75mm (2.95 in) pitch (version 2) image defect event.

- [Description of the defect](#)
- [Conditions that can cause the defect](#)
- [Solutions for the defect](#)
- [Parts related to the defect](#)

Figure 2-97 OPC sharp bands (version 2)

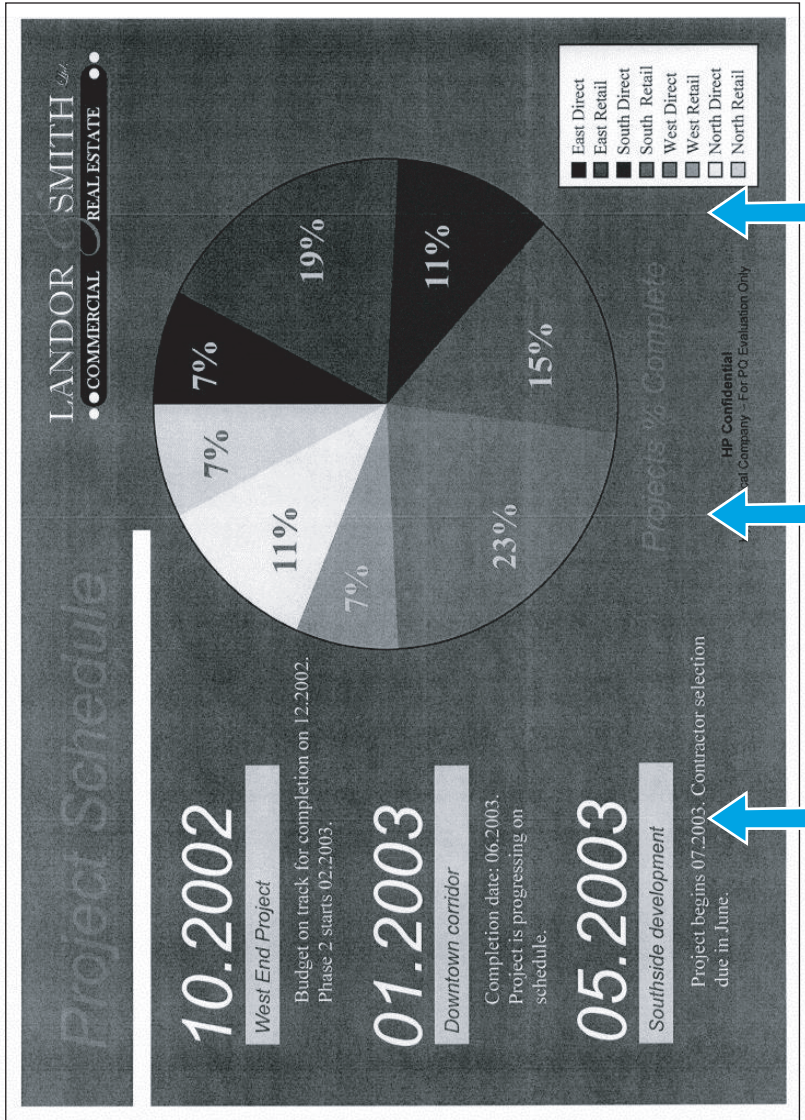

Description of the defect

This defect appears as sharp bands which repeat at a 75 mm (2.95 in) pitch down the page as a dark line.

The OPC drum is rubbed by the cleaning blade or charge roller due to vibration or impact. The rubbing effects the OPC charge but the defect fades with usage and time. This defect appears in areas of fill, not in text.



NOTE: This defect looks similar to OPC sharp bands version 1, but appears to be dark.

Conditions that can cause the defect

This defect can occur at the beginning of toner cartridge use, or if the cartridge is subject to vibration (for example, transportation).

Solutions for the defect

Use the following steps to solve the defect.

- Resend the print job. The defect should fade with subsequent printed pages.
- If the defect persists, replace the toner cartridge

Parts related to the defect

The following item(s) might need to be repaired or replaced to prevent this defect from occurring.

- Toner cartridge

Impulse band 49-50 mm (1.92-1.96 in) from the leading edge

Review the following information about the impulse band 49-50 mm (1.92-1.96 in) from the leading edge image defect event.

- [Description of the defect](#)
- [Conditions that can cause the defect](#)
- [Solutions for the defect](#)
- [Parts related to the defect](#)

Figure 2-98 Impulse band (leading edge)

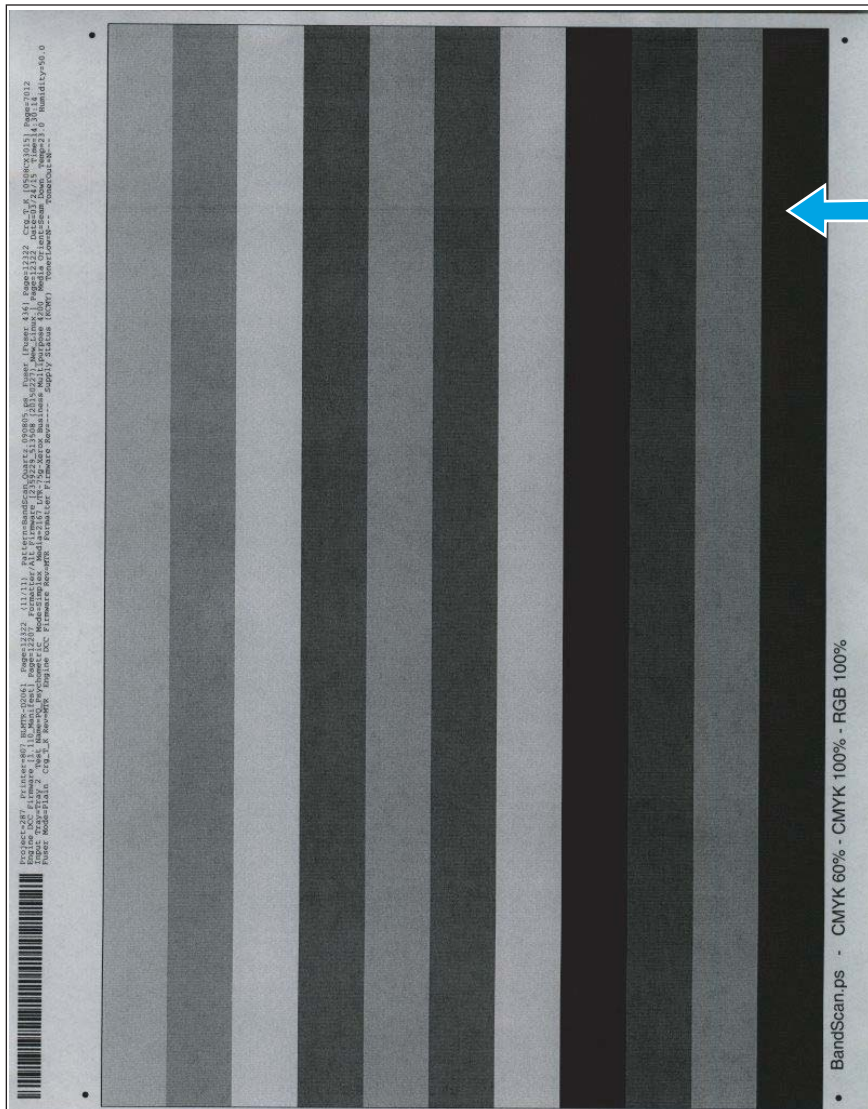

Description of the defect

This defect appears as a dark and usually sharp band and occurs 49-50 mm (1.92-1.96 in) from the leading edge of the page.

This impulse band is caused by the trailing edge of the previous page touching the OPC as it leaves the transfer area, which causes a memory charge disturbance. This defect appears in areas of fill, not in text.

Conditions that can cause the defect

This defect only occurs during continuous printing, on the second and subsequent pages of a job.

Solutions for the defect

Use the following steps to solve the defect.

- Resend the print job. Impulse bands can be variable.
- **M501:** If the defect appears during continuous printing, from the printer control panel enable the [Less Paper Curl](#) print mode.

 **NOTE:** This mode adds a rotation of the OPC drum to the inter-page gap timing that conditions the drum and minimizes the defect.

1. Open the following menus:
 - [Setup](#)
 - [Service](#)
 - [Less Paper Curl](#)
 2. Select [On](#).
- **M506/E50045 and M527/E52545:** From the printer control panel, change the print mode to [Paper Curl Mode](#).

 **NOTE:** This mode adds a rotation of the OPC drum to the inter-page gap timing that conditions the drum and minimizes the defect.

1. Open the following menus:
 - [Administration](#)
 - [General Settings](#)
 - [Print Quality](#)
 - [Adjust Paper Types](#)
 2. Select [Paper Curl Mode](#).
- **M507/E50145 and M528/E52645:** change the print mode to [Paper Curl Mode](#).

 **NOTE:** This mode adds a rotation of the OPC drum to the inter-page gap timing that conditions the drum and minimizes the defect.

1. Open the following menus:
 - [Settings](#)
 - [Copy/Print](#)

- [Print Quality](#)
 - [Adjust Paper Types](#)
2. Select the appropriate paper type for the paper used.
 3. Select [Paper Curl Mode](#).

Parts related to the defect

The following item(s) might need to be repaired or replaced to prevent this defect from occurring.

- Media
- Toner cartridge

Impulse band 75-82 mm (2.95-3.22 in) from the trailing edge

Review the following information about the impulse band 75-82 mm (2.95-3.22 in) from the trailing edge image defect event.

- [Description of the defect](#)
- [Conditions that can cause the defect](#)
- [Solutions for the defect](#)
- [Parts related to the defect](#)

Figure 2-99 Impulse band (trailing edge)

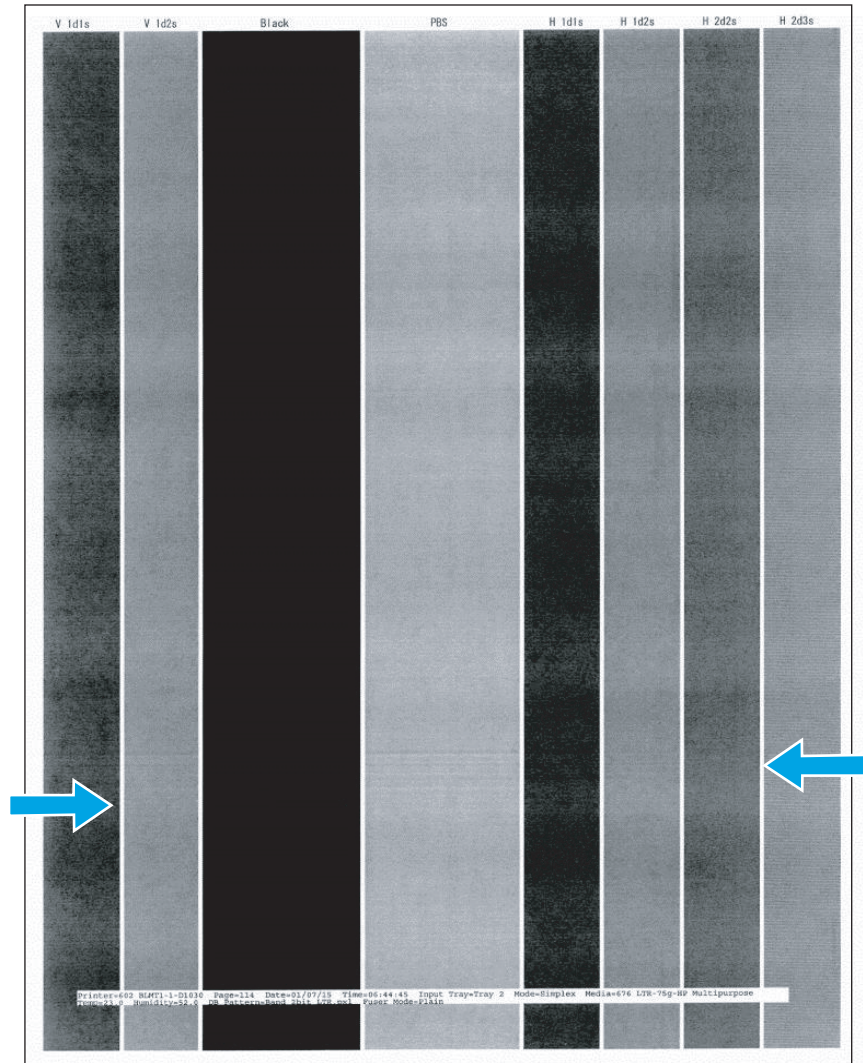

Description of the defect

This defect appears as a dark band and occurs 75-82 mm (2.95-3.22 in) from the trailing edge of the page.



This impulse band is a development blur which occurs when the paper trailing edge goes through the registration roller. This defect appears in areas of fill, not in text.

Conditions that can cause the defect

During the print job, the transfer top guide might be vibrating.

Solutions for the defect

Use the following steps to solve the defect.

- Resend the print job. Impulse bands can be variable.
- **M501:** From the printer control panel, change the print mode from plain to intermediate (this slows the print speed).
 1. Open the following menus:
 - Setup
 - System Setup
 - Paper Setup
 - Tray <X>
 -  **NOTE:** Select the tray you want to configure.
 - Paper Type
- 2. Select [Intermediate 85–95g](#).
- **M506/E50045 and M527/E52545:** From the printer control panel, change the print mode from plain to intermediate (this slows the print speed).
 1. Open the following menus:
 - Trays
 - Tray
 - Modify
 - Next
 2. Select [Intermediate 85–95g](#).
- **M507/E50145 and M528/E52645:** From the printer control panel, change the print mode from plain to intermediate (this slows the print speed).
 1. Open the following menus:
 - Trays
 - Tray <X>
 -  **NOTE:** Select the tray you want to configure.
 - Type
- 2. Select [Intermediate 85–95g](#).

Parts related to the defect

The following item(s) might need to be repaired or replaced to prevent this defect from occurring.

- Media
- Registration assembly

Impulse band 102 mm (4.01 in) from the trailing edge

Review the following information about the impulse band 102 mm (4.01 in) from the trailing edge image defect event.

- [Description of the defect](#)
- [Conditions that can cause the defect](#)
- [Solutions for the defect](#)
- [Parts related to the defect](#)

Figure 2-100 Impulse band (trailing edge)

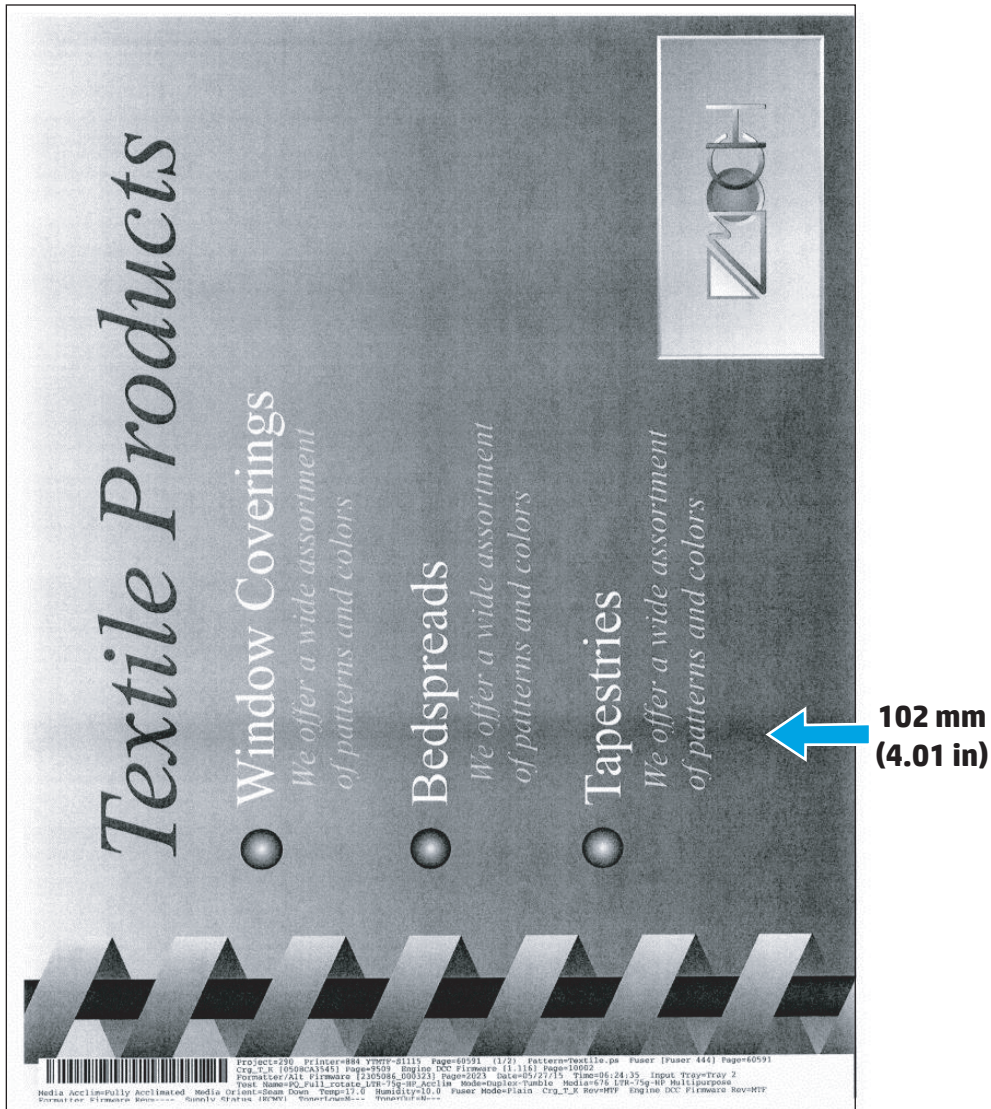

Description of the defect

This defect appears as a soft dark band and occurs 102 mm (4.01 in) from the trailing edge of the page.

The cause of this defect is poor sliding performance of the transfer bearing (TR bearing) and transfer roller shaft.

Conditions that can cause the defect

This defect is more likely to occur in low temperature/low humidity environments and at cold start conditions.

Solutions for the defect

Use the following steps to solve the defect.

- Resend the print job. Impulse bands can be variable.
- Try using a different media type.
- **M501:** From the printer control panel, change the print mode from plain to intermediate (this slows the print speed).

1. Open the following menus:

- Setup
- System Setup
- Paper Setup
- Tray <X>



NOTE: Select the tray you want to configure.

- Paper Type

2. Select **Intermediate 85–95g**.

- **M506/E50045 and M527/E52545:** From the printer control panel, change the print mode from plain to intermediate (this slows the print speed).

1. Open the following menus:

- Trays
- Tray
- Modify
- Next

2. Select **Intermediate 85–95g**.

- **M507/E50145 and M528/E52645:** From the printer control panel, change the print mode from plain to intermediate (this slows the print speed).

1. Open the following menus:

- Trays
- Tray <X>



NOTE: Select the tray you want to configure.

- Type

2. Select **Intermediate 85–95g**.

Parts related to the defect

The following item(s) might need to be repaired or replaced to prevent this defect from occurring.

- Media
- Transfer roller

Image defect (developmental) events

Review the following information about image defect (developmental) events.

- [Cleaning defect events](#)
- [Part/assembly defect events](#)
- [Transfer bias defect events](#)
- [Toner leak defect events](#)
- [Paper path impulse defect events](#)
- [Fuser/fixing defect events](#)
- [Miscellaneous defect events](#)



NOTE: The image defects described in this section are defects that occurred during printer development, and HP implemented a solution to eliminate them. Customers should not observe these defects. These defects are included for the unlikely event that they reoccur.

Cleaning defect events

Review the following information about cleaning image defect (developmental) events.

- [Rain-toner attached to the OPC](#)
- [Developer defect repeats at 27.8 mm1.09 in pitch](#)
- [Random missing toner](#)

Rain-toner attached to the OPC

Review the following information about the rain-toner attached to the OPC cleaning defect event.

- [Description of the defect](#)
- [Conditions that can cause the defect](#)
- [Solutions for the defect](#)
- [Parts related to the defect](#)



NOTE: This defect occurred at some point during printer development. HP has implemented a solution to the problem. This defect is included in the image defects section for the unlikely event that it reoccurs.

Figure 2-101 Rain-toner attached to the OPC

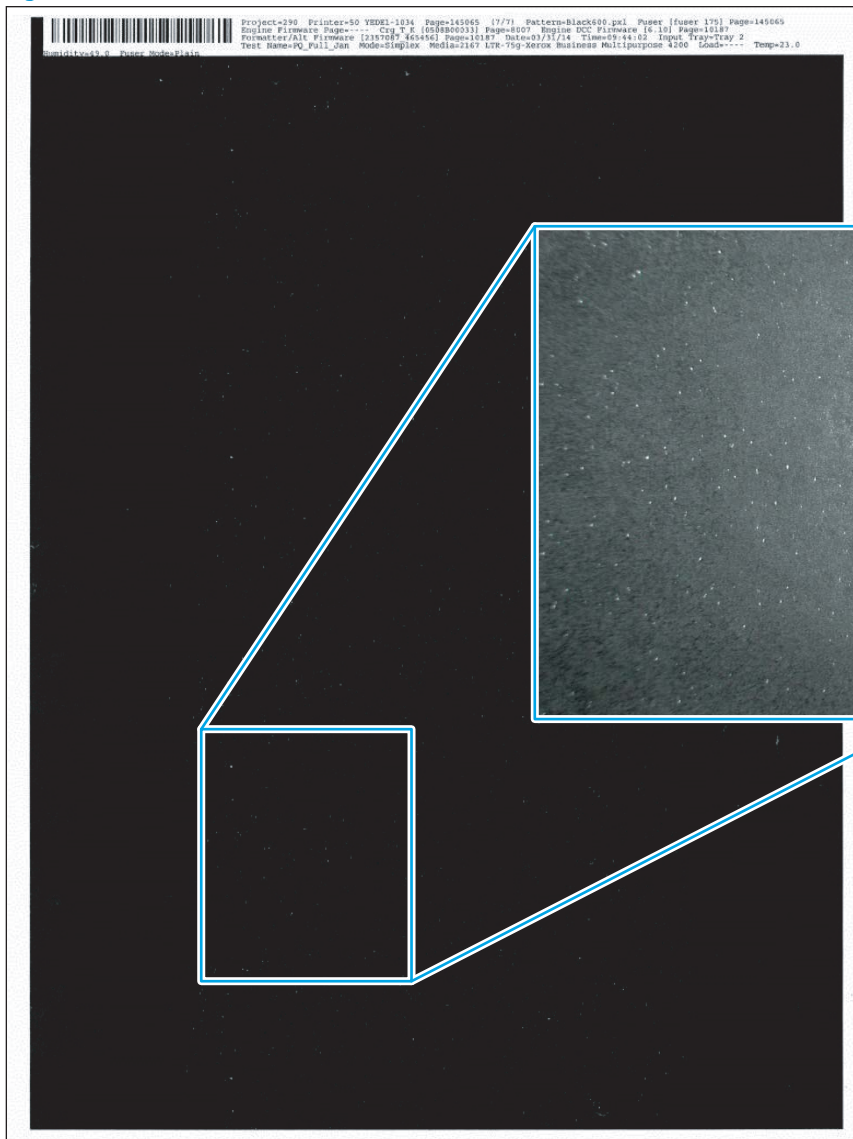

Description of the defect

This defect appears as very small white voids which appear in solid black areas. This issue occurs when toner attached to the OPC cannot be removed by the cleaning blade. This defect appears in areas of solid fill, not in text.

Conditions that can cause the defect

This defect is likely to occur in the later stages of toner cartridge life.

Solutions for the defect

Use the following step to solve the defect.

- Verify that the toner is within the expected life. If not, replace the toner cartridge.

Parts related to the defect

The following item(s) might need to be repaired or replaced to prevent this defect from occurring.

- Toner cartridge

Developer defect repeats at 27.8 mm (1.09 in) pitch

Review the following information about the developer defect repeats at 27.8 mm (1.09 in) pitch cleaning defect event.

- [Description of the defect](#)
- [Conditions that can cause the defect](#)
- [Solutions for the defect](#)
- [Parts related to the defect](#)

 **NOTE:** This defect occurred at some point during printer development. HP has implemented a solution to the problem. This defect is included in the image defects section for the unlikely event that it reoccurs.

Figure 2-102 Developer defect

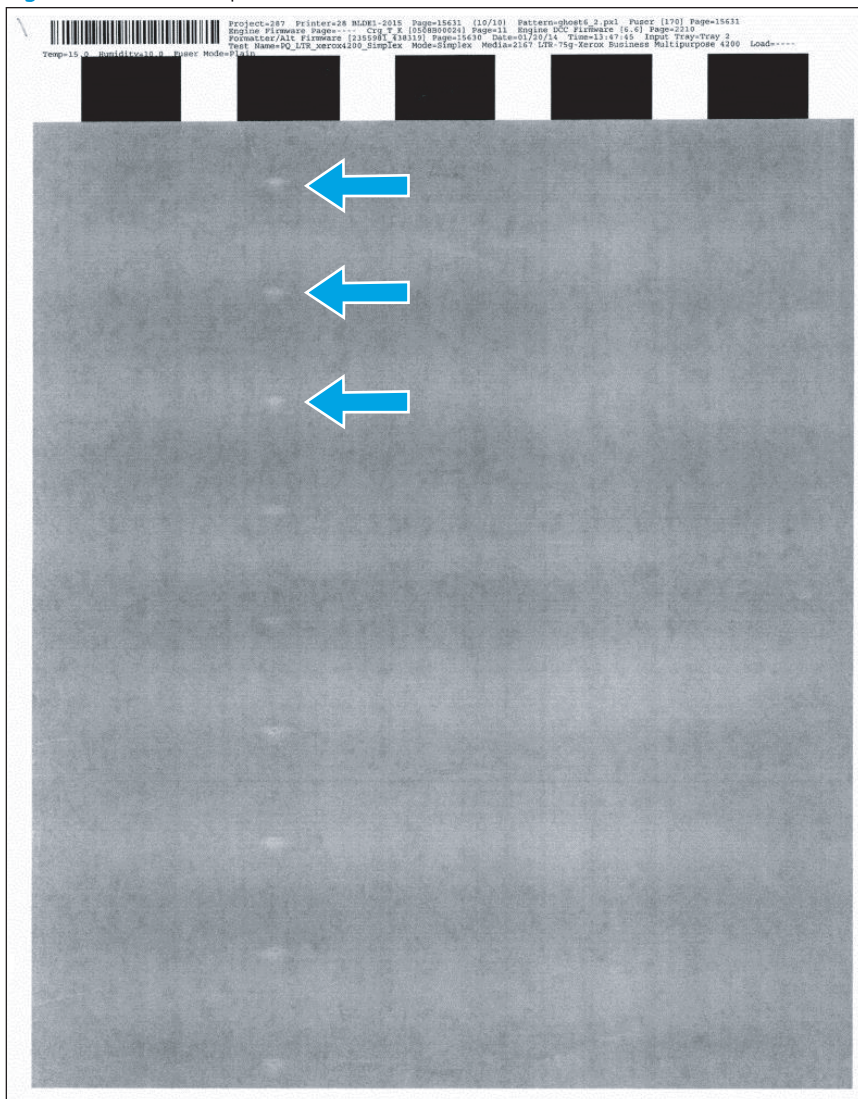

Description of the defect

This defect appears as a soft white spot which repeats at 27.8 mm (1.09 in) (developer roller) pitch. This defect appears in areas of solid fill, not in text.

Conditions that can cause the defect

This defect is caused by a cartridge cleaning performance issue caused by contamination.

Solutions for the defect

Use the following steps to solve the defect.

- Resend the print job (the defect should fade with subsequent printed pages).
- If the defect persists, replace the toner cartridge.

Parts related to the defect

The following item(s) might need to be repaired or replaced to prevent this defect from occurring.

- Toner cartridge

Random missing toner

Review the following information about the random missing toner cleaning defect event.

- [Description of the defect](#)
- [Conditions that can cause the defect](#)
- [Solutions for the defect](#)
- [Parts related to the defect](#)



NOTE: This defect occurred at some point during printer development. HP has implemented a solution to the problem. This defect is included in the image defects section for the unlikely event that it reoccurs.

Figure 2-103 Random missing toner

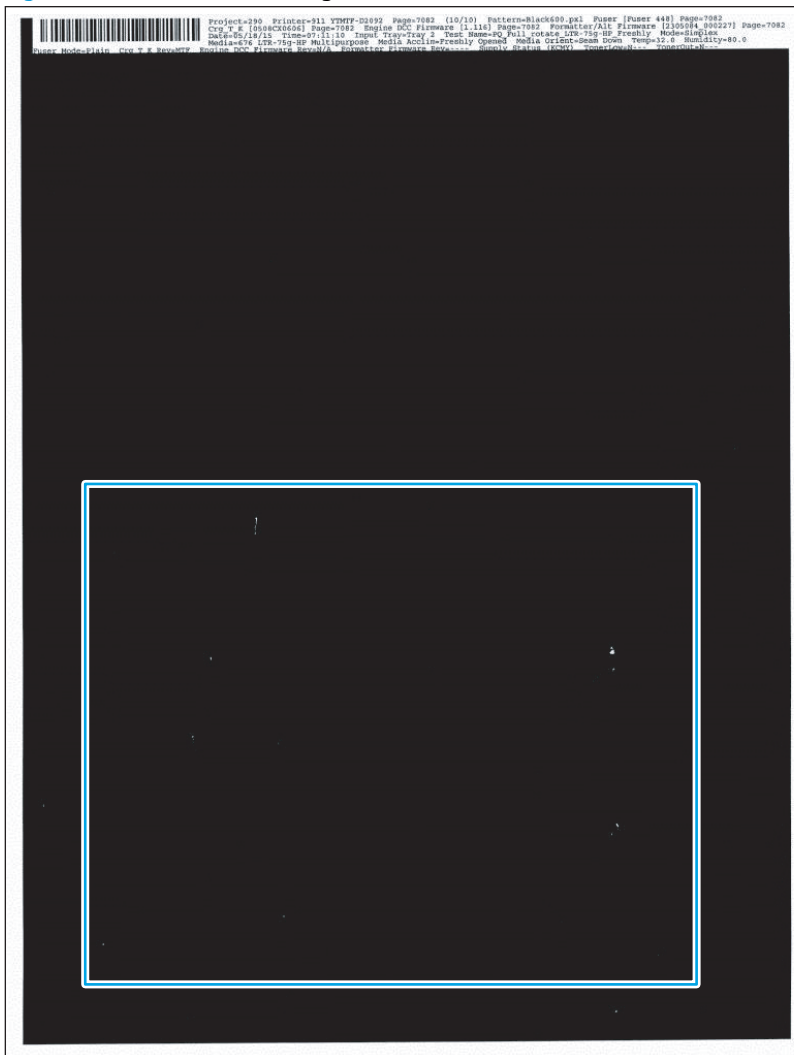

Description of the defect

This defect appears as white spots which appear in solid black areas (sometimes with a tail). This defect appears in areas of solid fill, not in text.

Conditions that can cause the defect

This defect is caused by contaminants attaching to the OPC. If the contaminant is large, the size of missing toner will be large.

Solutions for the defect

Use the following steps to solve the defect.

- Resend the print job. This defect is highly variable.

Parts related to the defect

The following item(s) might need to be repaired or replaced to prevent this defect from occurring.

- Toner cartridge

Part/assembly defect events

Review the following information about part/assembly image defect (developmental) events.

- [OPC gear slip](#)
- [OPC wide-pitch banding](#)

OPC gear slip

Review the following information about the OPC gear slip part/assembly defect event.

- [Description of the defect](#)
- [Conditions that can cause the defect](#)
- [Solutions for the defect](#)
- [Parts related to the defect](#)

 **NOTE:** This defect occurred at some point during printer development. HP has implemented a solution to the problem. This defect is included in the image defects section for the unlikely event that it reoccurs.

Figure 2-104 OPC gear slip

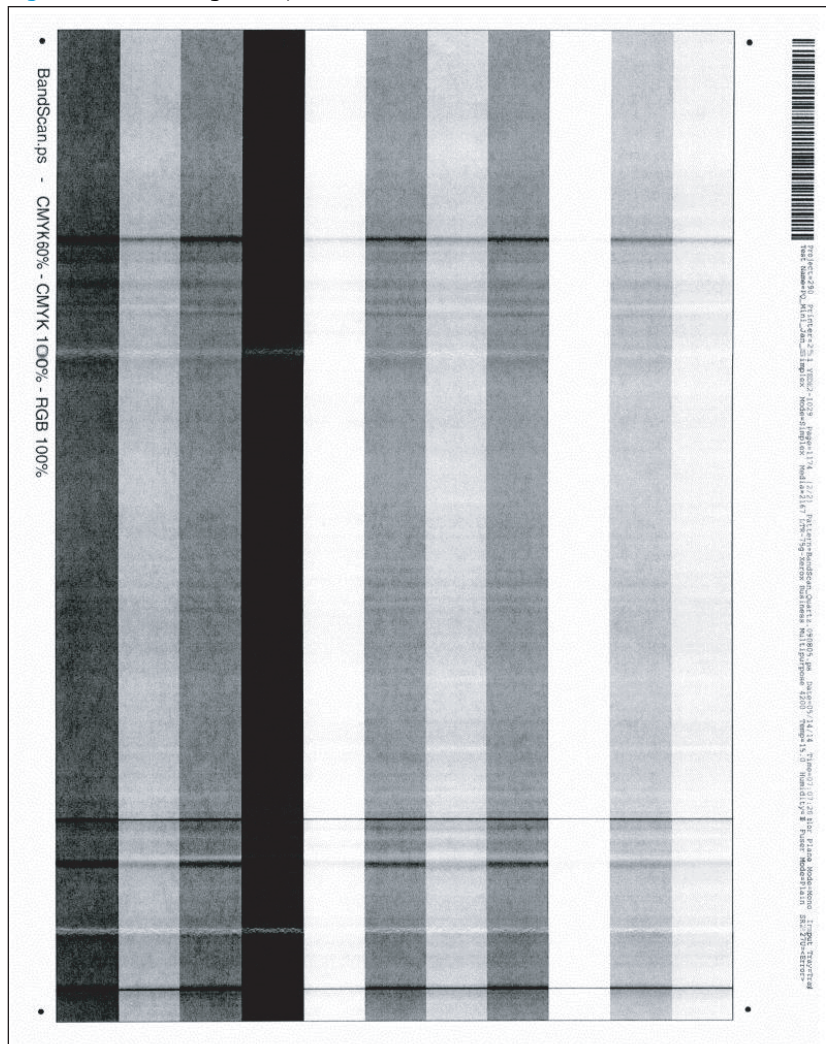

Description of the defect

This defect appears as severe banding. This defect is caused by OPC gear slip (a failed connection between the OPC gear and the drum).

Conditions that can cause the defect

This defect is not dependent on environmental conditions.

Solutions for the defect

Use the following steps to solve the defect.

- Resend the print job.
- If the defect persists, replace the toner cartridge.

Parts related to the defect

The following item(s) might need to be repaired or replaced to prevent this defect from occurring.

- Toner cartridge

OPC wide-pitch banding

Review the following information about the OPC wide-pitch banding part/assembly defect event.

- [Description of the defect](#)
- [Conditions that can cause the defect](#)
- [Solutions for the defect](#)
- [Parts related to the defect](#)

 **NOTE:** This defect occurred at some point during printer development. HP has implemented a solution to the problem. This defect is included in the image defects section for the unlikely event that it reoccurs.

Figure 2-105 OPC wide-pitch banding

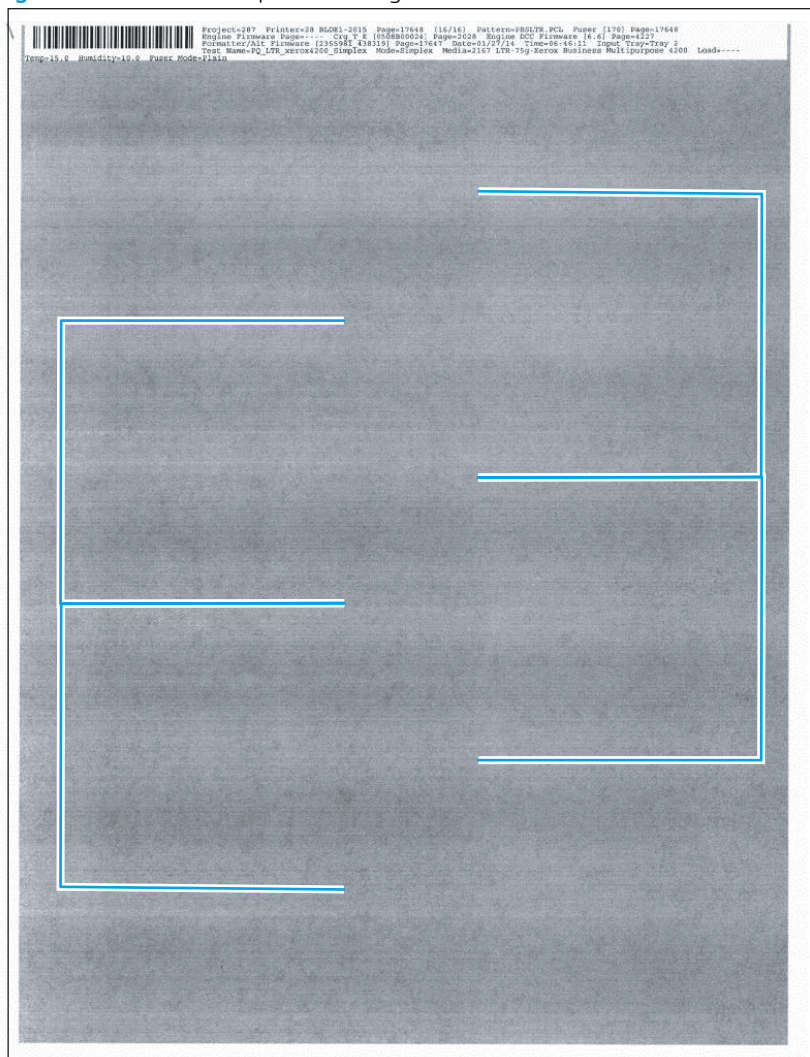

Description of the defect

This defect appears as overlapping sets of wide-pitch bands (repeating at 75 mm (2.95 in)).

Conditions that can cause the defect

This defect is caused by OPC deformation during the assembly process.

Solutions for the defect

Use the following steps to solve the defect.

- Resend the print job (the defect should fade with subsequent printed pages).
- If the defect persists, replace the toner cartridge.

Parts related to the defect

The following item(s) might need to be repaired or replaced to prevent this defect from occurring.

- Toner cartridge

Transfer bias defect events

Review the following information about the transfer bias image defect (developmental) events.

- [Leading edge - mid-page toner scatter](#)
- [Density change at 75 mm2.95 in from the leading edge](#)
- [Transfer issue - random voids](#)

Leading edge - mid-page toner scatter

Review the following information about the leading edge - mid-page toner scatter transfer bias defect event.

- [Description of the defect](#)
- [Conditions that can cause the defect](#)
- [Solutions for the defect](#)
- [Parts related to the defect](#)



NOTE: This defect occurred at some point during printer development. HP has implemented a solution to the problem. This defect is included in the image defects section for the unlikely event that it reoccurs.

Figure 2-106 Leading edge - mid-page toner scatter

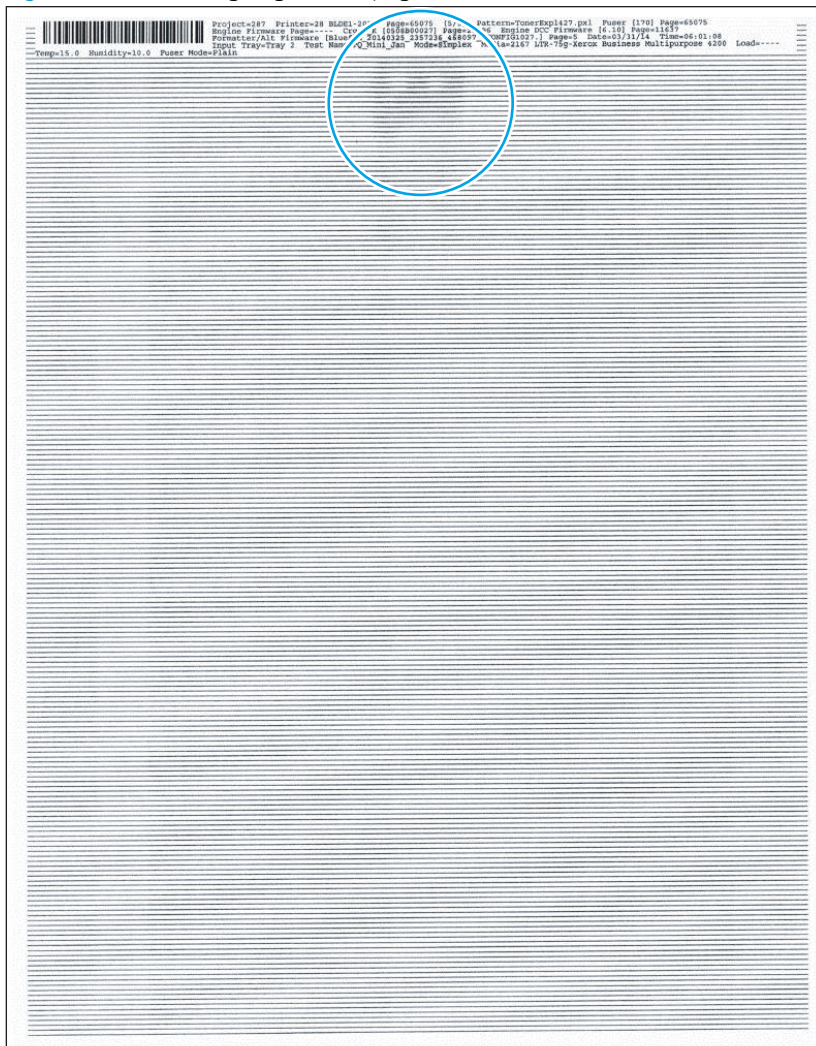

Description of the defect

This defect appears as a non-uniform or smear that might appear in the middle of the page at the top of a page. This occurs when the toner scatters at transfer in the area where the media rubs the pick roller and the middle roller. This defect is more likely to occur when media with high resistivity is used. The static charge eliminator (metal brush) on the transfer guide keeps this defect from occurring.

Conditions that can cause the defect

This defect might occur in low temperature/low humidity environments and in cold start conditions.

Solutions for the defect

Use the following steps to solve the defect.

- Resend the print job (the defect should fade with subsequent printed pages as the printer warms up).
- Try using a different media type.

Parts related to the defect

The following item(s) might need to be repaired or replaced to prevent this defect from occurring.

- Media
- Printer engine (whole unit replacement)

Description of the defect

This defect appears as a light image in the first 75 mm (2.95 in) of the page. This defect is created by a charge ghost due to the lack of charge current.

Conditions that can cause the defect

This defect happens when there is high print coverage across the longitudinal direction and charging is not able to reach the target potential due to the lack of current that charges OPC in the area and the density becomes high at the next OPC rotation. This shows up in areas of fill, not in text.

Solutions for the defect

Use the following steps to solve the defect.

- Resend the print job.

Parts related to the defect

The following item(s) might need to be repaired or replaced to prevent this defect from occurring.

- No parts are related to this defect.

Transfer issue - random voids

Review the following information about the transfer issue - random voids transfer bias defect event.

- [Description of the defect](#)
- [Conditions that can cause the defect](#)
- [Solutions for the defect](#)
- [Parts related to the defect](#)

 **NOTE:** This defect occurred at some point during printer development. HP has implemented a solution to the problem. This defect is included in the image defects section for the unlikely event that it reoccurs.

Figure 2-108 Transfer issue - random voids

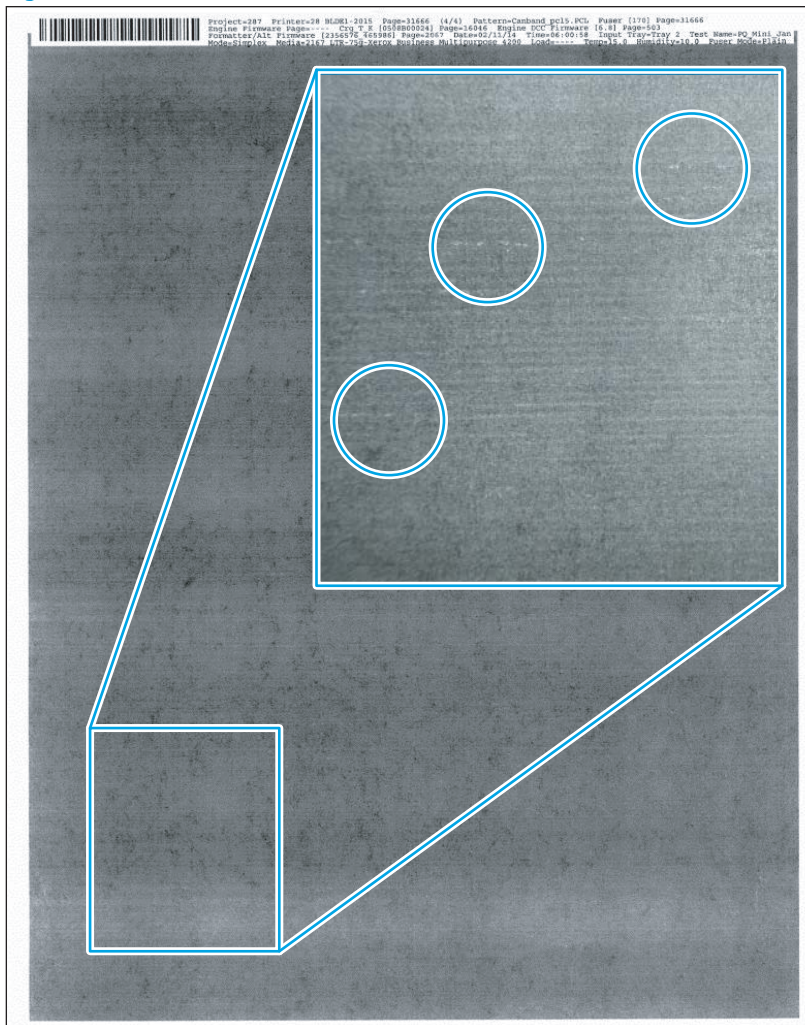

Description of the defect

This defect appears as very small sections of missing toner in random locations on the page. The transfer bias was too strong and caused the missing toner.

Conditions that can cause the defect

This defect is not dependent on environmental conditions.

Solutions for the defect

Use the following steps to solve the defect.

- **All except M501:** If the defect is persistent, reprint your document with a lower transfer bias setting.
 1. Open the following menus:
 - [Administration](#)
 - [General Settings](#)
 - [Print Quality](#)
 - [Adjust Paper Types](#)
 2. Select [Resistance Mode](#).
- **M507/E50145 and M528/E52645:** If the defect is persistent, reprint your document with a lower transfer bias setting.
 1. Open the following menus:
 - [Settings](#)
 - [Copy/Print](#)
 - [Print Quality](#)
 - [Adjust Paper Types](#)
 2. Select the appropriate paper type for the paper used.
 3. Select [Resistance Mode](#).

Parts related to the defect

The following item(s) might need to be repaired or replaced to prevent this defect from occurring.

- No parts are related to this defect.

Toner leak defect events

Review the following information about the toner leak image defect (developmental) events.

- [Right to left fade and banding](#)
- [Cartridge fine pitch \(1.5 mm/0.05 in\) banding](#)
- [382 mm/15.03 in + IPG repeating defect](#)

Right to left fade and banding

Review the following information about the right to left fade and banding toner leak defect event.

- [Description of the defect](#)
- [Conditions that can cause the defect](#)
- [Solutions for the defect](#)
- [Parts related to the defect](#)



NOTE: This defect occurred at some point during printer development. HP has implemented a solution to the problem. This defect is included in the image defects section for the unlikely event that it reoccurs.

Figure 2-109 Right to left fade and banding

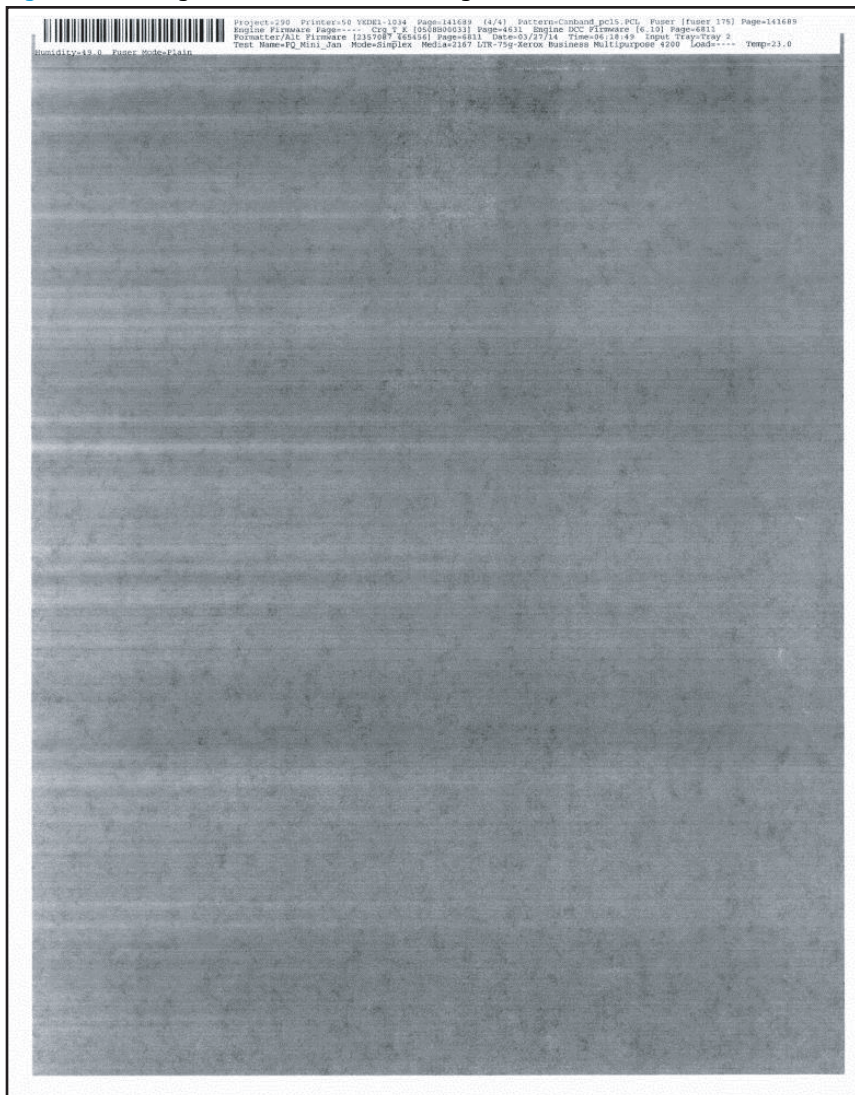

Description of the defect

This defect appears as fading and banding at an edge and occurs when the cartridge seals leak allowing toner into the gap between the OPC drum and the SD roller/sleeve. This appears in areas of fill, not in text

Conditions that can cause the defect

This defect is likely to occur in the later stages of toner cartridge life.

Solutions for the defect

Use the following steps to solve the defect.

- Resend the print job.
- Verify that the toner is within the expected life, if not replace the toner cartridge.
- If the defect persists, replace the toner cartridge.

Parts related to the defect

The following item(s) might need to be repaired or replaced to prevent this defect from occurring.

- Toner cartridge

Cartridge fine pitch (1.5 mm (0.05 in)) banding

Review the following information about the cartridge fine pitch (1.5 mm (0.05 in)) banding toner leak defect event.

- [Description of the defect](#)
- [Conditions that can cause the defect](#)
- [Solutions for the defect](#)
- [Parts related to the defect](#)

 **NOTE:** This defect occurred at some point during printer development. HP has implemented a solution to the problem. This defect is included in the image defects section for the unlikely event that it reoccurs.

Figure 2-110 Cartridge fine pitch banding

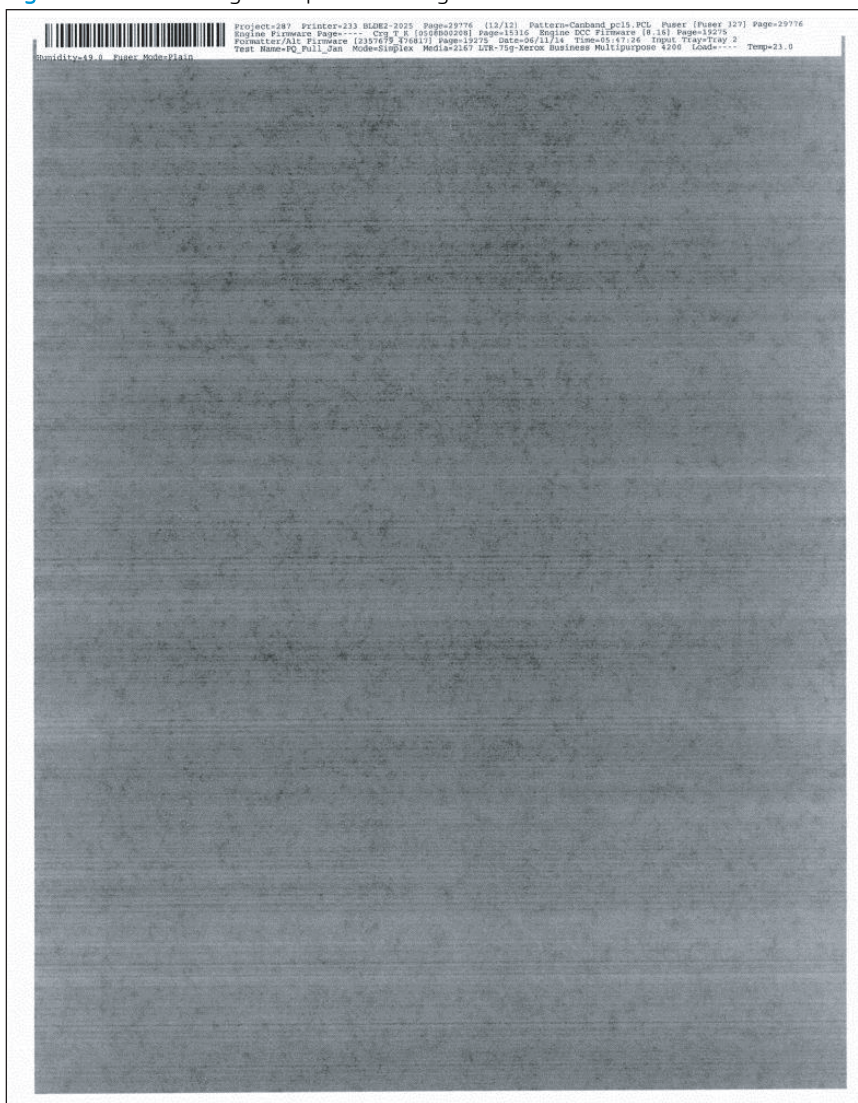

Description of the defect

This defect appears as alternating light and dark, evenly spaced, repetitive horizontal lines at a 1.5 mm (0.05 in) pitch. This defect is caused by toner leaking in the drive gear area of the toner cartridge. This appears in areas of fill, not in text.

Conditions that can cause the defect

This defect is likely to occur in the later stages of toner cartridge life.

Solutions for the defect

Use the following steps to solve the defect.

- Resend the print job.
- Verify that the toner is within the expected life, if not replace the toner cartridge.
- If the defect persists, replace the toner cartridge.

Parts related to the defect

The following item(s) might need to be repaired or replaced to prevent this defect from occurring.

- Toner cartridge

382 mm (15.03 in) + IPG repeating defect

Review the following information about the 382 mm (15.03 in) + IPG repeating toner leak defect event.

- [Description of the defect](#)
- [Conditions that can cause the defect](#)
- [Solutions for the defect](#)
- [Parts related to the defect](#)



NOTE: This defect occurred at some point during printer development. HP has implemented a solution to the problem. This defect is included in the image defects section for the unlikely event that it reoccurs.

Figure 2-111 IPG repeating defect

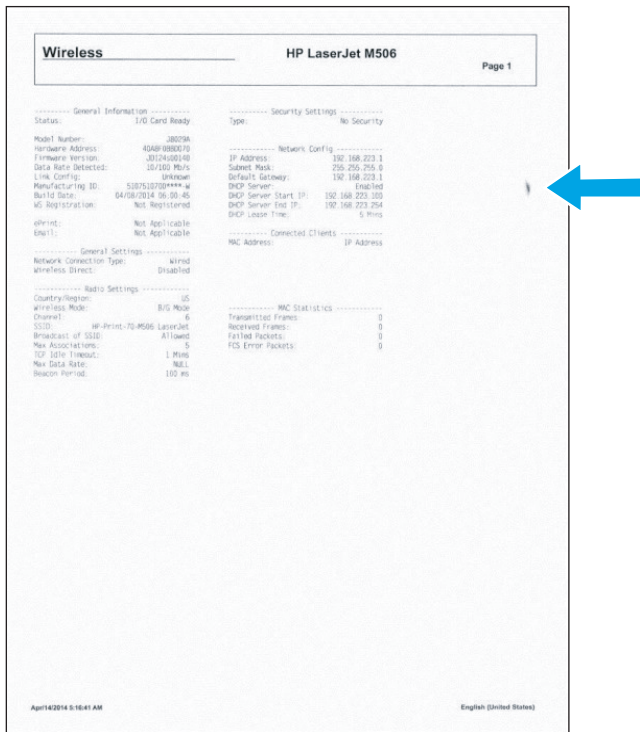
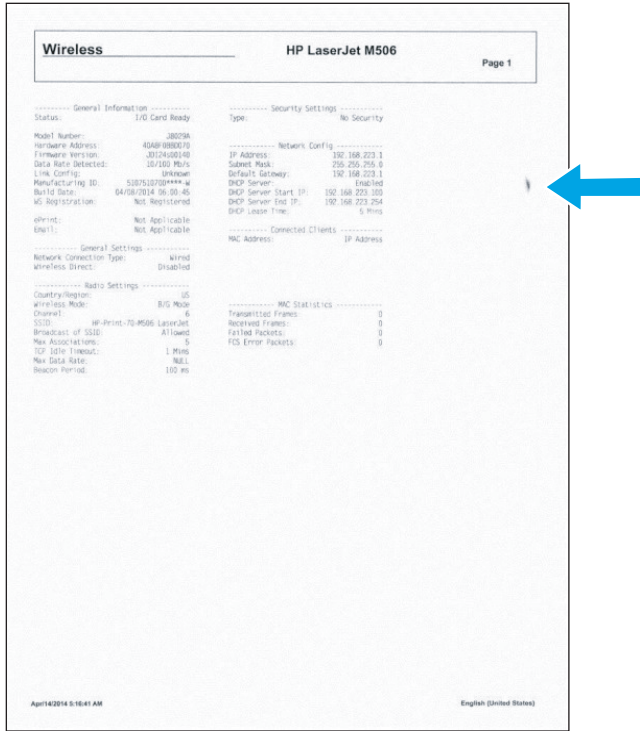

Description of the defect

This defect appears as a dark crescent moon shape defect and it appears in non-print areas of the page. The defect occurs when the toner is thrown outside the toner cartridge at the stirring pitch due to the waviness of the blow out seal. The waviness creates a gap between sleeve and blow out seal. The cause of the blow out seal waviness is that the edge of blow out seal contacts with the edge of the sleeve/drum spacer.

Conditions that can cause the defect

This defect is not dependent on environmental conditions.

Solutions for the defect

Use the following steps to solve the defect.

- Resend the print job.
- If the defect does not improve within two to three print jobs, remove the toner cartridge and gently rock it back and forth from side to side (this distributes the toner evenly in the toner cartridge).
- If the defect persists, replace the toner cartridge.

Parts related to the defect

The following item(s) might need to be repaired or replaced to prevent this defect from occurring.

- Toner cartridge

Paper path impulse defect events

Review the following information about paper path impulse image defect (developmental) events.

- [Impulse band 15 mm0.59 in from the leading edge](#)
- [Toner in the leading edge margin \(fuser slap\)](#)
- [6-7 mm0.23-0.27 in wide-pitch banding](#)

Impulse band 15 mm (0.59 in) from the leading edge

Review the following information about the impulse band 15 mm (0.59 in) from the leading edge paper path impulse defect event.

- [Description of the defect](#)
- [Conditions that can cause the defect](#)
- [Solutions for the defect](#)
- [Parts related to the defect](#)



NOTE: This defect occurred at some point during printer development. HP has implemented a solution to the problem. This defect is included in the image defects section for the unlikely event that it reoccurs.

Figure 2-112 Impulse band leading edge

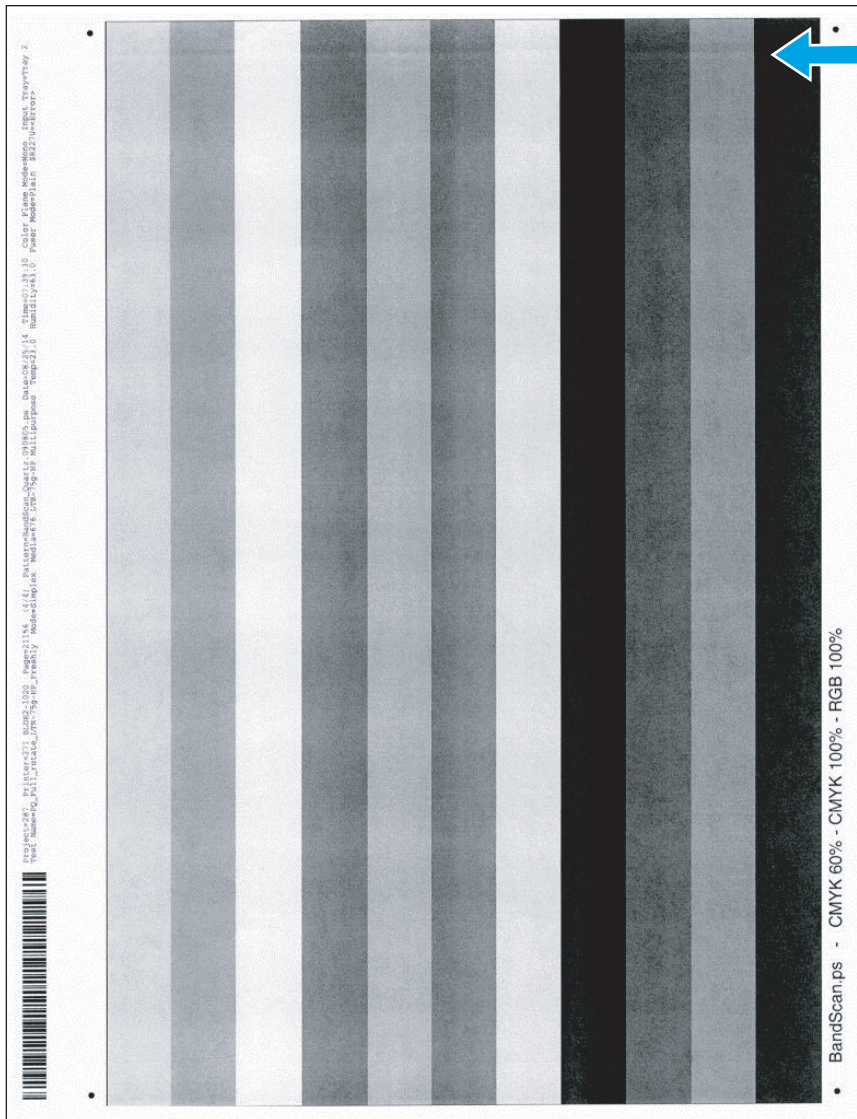

Description of the defect

This defect appears as a dark and usually sharp band occurs 15 mm (0.59 in) from the leading edge of the page. This band shows up in areas of fill, not in text.

Conditions that can cause the defect

The defect occurs when the paper leading edge goes into the transfer area.

Solutions for the defect

Use the following steps to solve the defect.

- Resend the print job. Impulse bands can be variable.
- **M501:** From the printer control panel, change the print mode from plain to intermediate (this slows the print speed).
 1. Open the following menus:
 - Setup
 - System Setup
 - Paper Setup
 - Tray <X>

 **NOTE:** Select the tray you want to configure.

 - Paper Type
- 2. Select **Intermediate 85–95g**.
- Try using a different media type.
- **M506/E50045 and M527/E52545:** From the printer control panel, change the print mode from plain to intermediate (this slows the print speed).
 1. Open the following menus:
 - Trays
 - Tray
 - Modify
 - Next
 2. Select **Intermediate 85–95g**.
- **M507/E50145 and M528/E52645:** From the printer control panel, change the print mode from plain to intermediate (this slows the print speed).
 1. Open the following menus:

- Trays
- Tray <X>



NOTE: Select the tray you want to configure.

- Type

2. Select [Intermediate 85–95g](#).

Parts related to the defect

The following item(s) might need to be repaired or replaced to prevent this defect from occurring.

- Media
- Registration assembly

Toner in the leading edge margin (fuser slap)

Review the following information about the toner in the leading edge margin (fuser slap) paper path impulse defect event.

- [Description of the defect](#)
- [Conditions that can cause the defect](#)
- [Solutions for the defect](#)
- [Parts related to the defect](#)

 **NOTE:** This defect occurred at some point during printer development. HP has implemented a solution to the problem. This defect is included in the image defects section for the unlikely event that it reoccurs.

Figure 2-113 Toner in the leading edge margin (fuser slap)

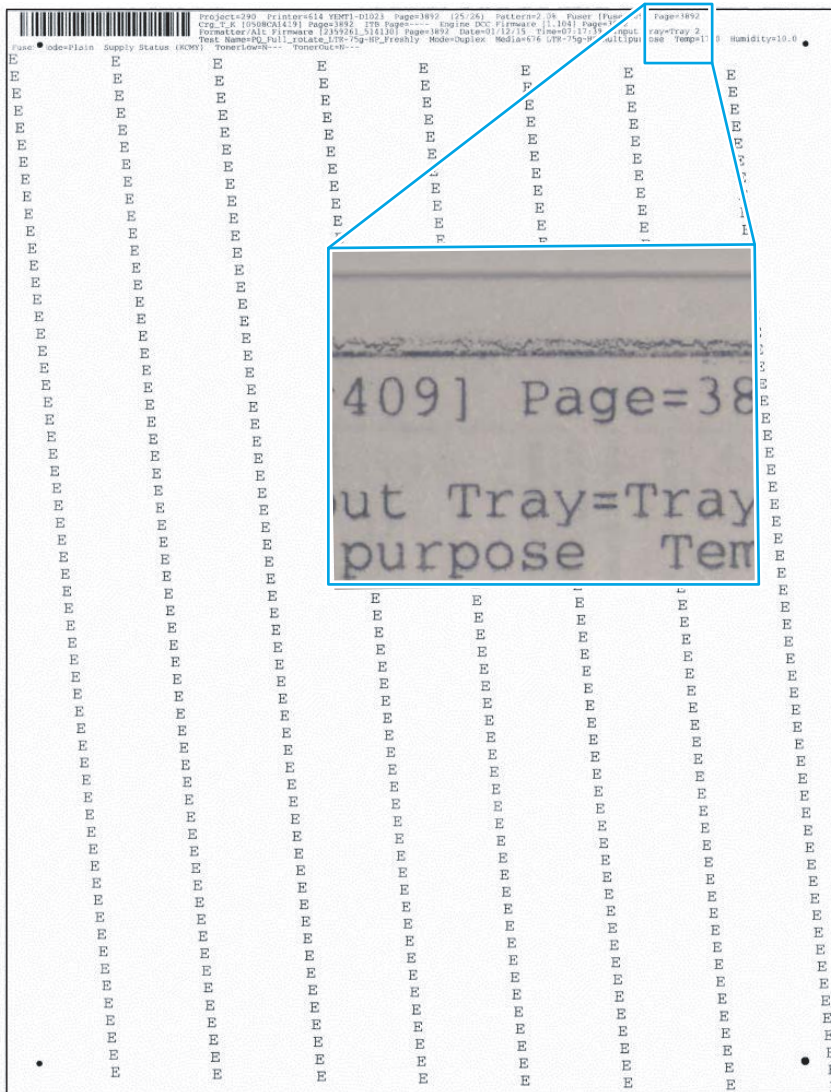

Description of the defect

This defect appears as scattered toner which occurs at the leading edge of the page. This defect occurs when the page enters the fuser and the page touches the fuser film which rubs the image on the page.

Conditions that can cause the defect

This defect is not dependent on environmental conditions, but is more likely to occur on pages with small top margins or when using curled media.

Solutions for the defect

Use the following steps to solve the defect.

- Resend the print job. This defect can be variable.
- Try using a different media type.
- **M501**: From the printer control panel, increase the leading edge margin.

Before beginning, use the [Print Test Page](#) option to print a registration test page. This page provides alignment guides in the X and Y directions.

1. Open the following menus:

- [Setup](#)
- [System Setup](#)
- [Print Quality](#)
- [Adjust Alignment](#)
- [Adjust Tray <X>](#)



NOTE: Select the tray you want to configure.

2. Adjust the [Y Shift](#) setting.



NOTE: Adjust the “Y” value in .25 mm increments.

- **M506/E50045 and M527/E52545**: From the printer control panel, increase the leading edge margin.

Before beginning, use the [Print Test Page](#) option to print a registration test page. This page provides alignment guides in the X and Y directions.

1. Open the following menus:

- [Administration](#)
- [General Settings](#)
- [Print Quality](#)
- [Image Registration](#)
- [Adjust Tray <X>](#)

 **NOTE:** Select the tray you want to configure.

2. Adjust the [Y1 Shift](#) (simplex pages) and/or [Y2 Shift](#) (duplex pages) settings.

 **NOTE:** Adjust the “Y” values in .25 mm increments.

- **M507/E50145 and M528/E52645:** From the printer control panel, increase the leading edge margin.

Before beginning, use the [Print Test Page](#) option to print a registration test page.

1. Open the following menus:
 - [Settings](#)
 - [Copy/Print](#)
 - [Print Quality](#)
 - [Image Registration](#)
2. Select the tray you want to configure.
3. Adjust the Front-side Vertical Shift (simplex pages) and/or Back-side Vertical Shift (duplex pages). Adjust the Vertical Shift values in .25 mm increments.

Parts related to the defect

The following item(s) might need to be repaired or replaced to prevent this defect from occurring.

- Media
- Fuser

6-7 mm (0.23-0.27 in) wide-pitch banding

Review the following information about the 6-7 mm (0.23-0.27 in) wide-pitch banding paper path impulse defect event.

- [Description of the defect](#)
- [Conditions that can cause the defect](#)
- [Solutions for the defect](#)
- [Parts related to the defect](#)

 **NOTE:** This defect occurred at some point during printer development. HP has implemented a solution to the problem. This defect is included in the image defects section for the unlikely event that it reoccurs.

Figure 2-114 Wide-pitch banding

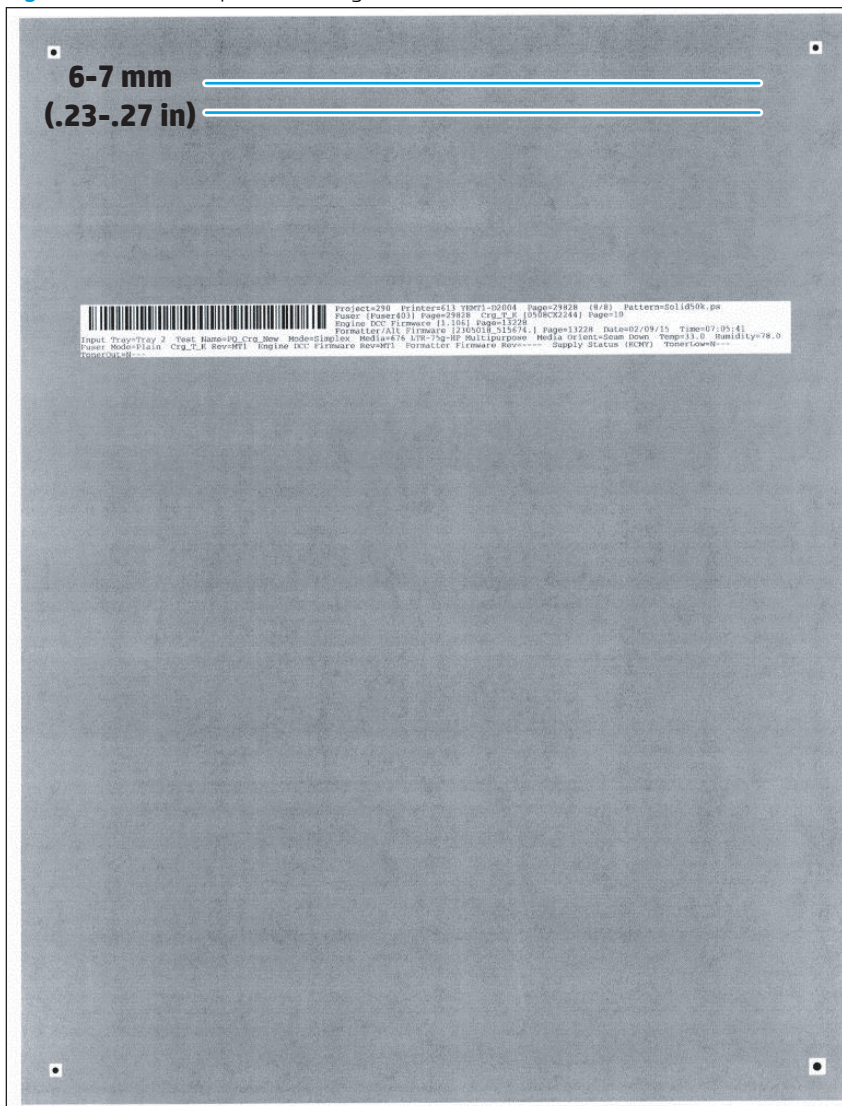

Description of the defect

This defect appears as soft bands that repeat at 6-7 mm (0.23-0.27 in).

This banding occurs when the transfer top guide vibrates, which is conveyed to the page as well as the page at the transfer area, causing the uneven density. The left and right edges of the back side of transfer top guide contact with the positioning guide at the transfer frame by the spring at the right edge of the pivot shaft. Since the spring is used only at the right edge, the left side of the alignment feature receives smaller pressing force. When the pressing force is small, the sheet metal vibrates easily. This band shows up in areas of fill, not in text.

Conditions that can cause the defect

During the print job, the transfer top guide might be vibrating.

Solutions for the defect

Use the following steps to solve the defect.

- Try using a different media type.
 - **M501:** From the printer control panel, change the print mode from plain to intermediate (this slows the print speed).
 1. Open the following menus:
 - Setup
 - System Setup
 - Paper Setup
 - Tray <X>

 **NOTE:** Select the tray you want to configure.

 - Paper Type
 - 2. Select **Intermediate 85–95g**.
- **M506/E50045 and M527/E52545:** From the printer control panel, change the print mode from plain to intermediate (this slows the print speed).
 1. Open the following menus:
 - Trays
 - Tray
 - Modify
 - Next
 2. Select **Intermediate 85–95g**.
- **M507/E50145 and M528/E52645:** From the printer control panel, change the print mode from plain to intermediate (this slows the print speed).
 1. Open the following menus:

- Trays
- Tray <X>



NOTE: Select the tray you want to configure.

- Type

2. Select [Intermediate 85–95g](#).

Parts related to the defect

The following item(s) might need to be repaired or replaced to prevent this defect from occurring.

- Media
- Transfer assembly

Fuser/fixing defect events

Review the following information about the fuser/fixing image defect (developmental) events.

- [Fuser blisters](#)
- [Hot fuser offset](#)
- [Poor edge fixing - within the image assurance area](#)
- [Poor edge fixing - outside the image assurance area](#)

Fuser blisters

Review the following information about the fuser blisters fuser/fixing defect event.

- [Description of the defect](#)
- [Conditions that can cause the defect](#)
- [Solutions for the defect](#)
- [Parts related to the defect](#)



NOTE: This defect occurred at some point during printer development. HP has implemented a solution to the problem. This defect is included in the image defects section for the unlikely event that it reoccurs.

Figure 2-115 Fuser blisters

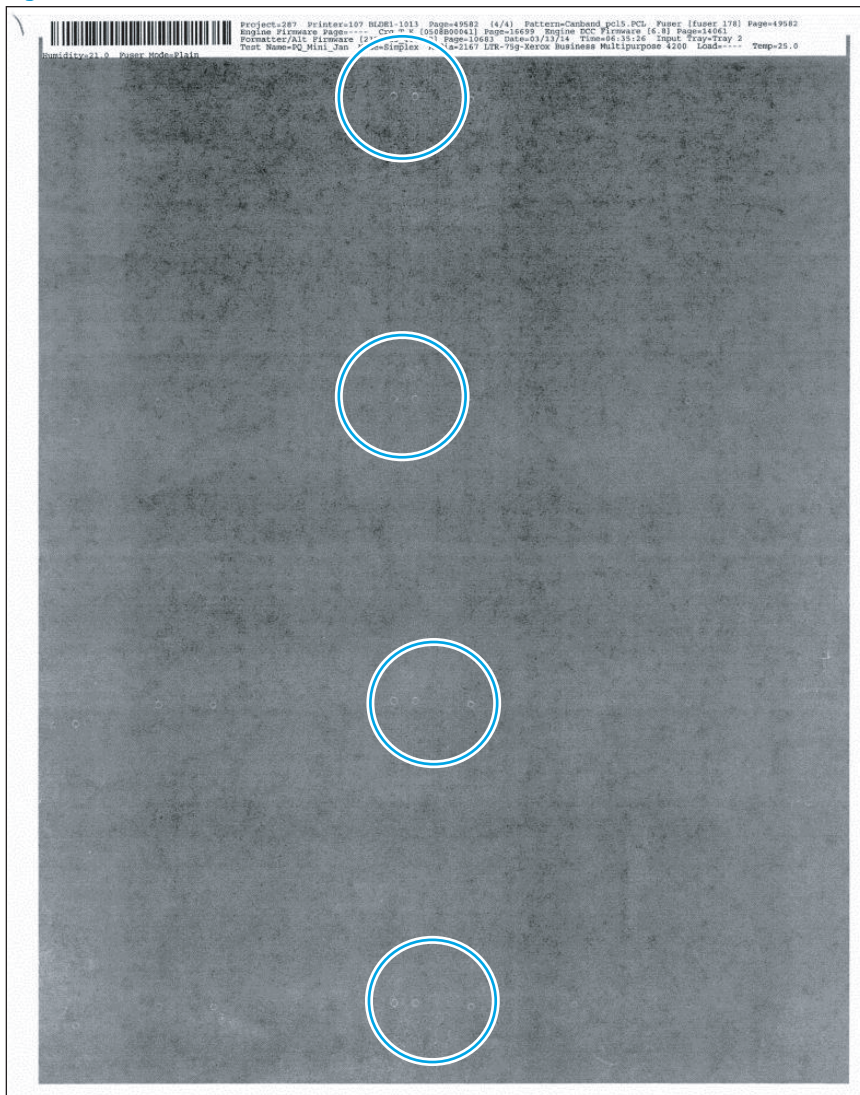

Description of the defect

This defect appears as repeating print defects visible in the image at the fuser pitch of 75.4 mm (2.96 in). These defects were caused by contamination between the films on the fuser.

Figure 2-116 Contaminated fuser film

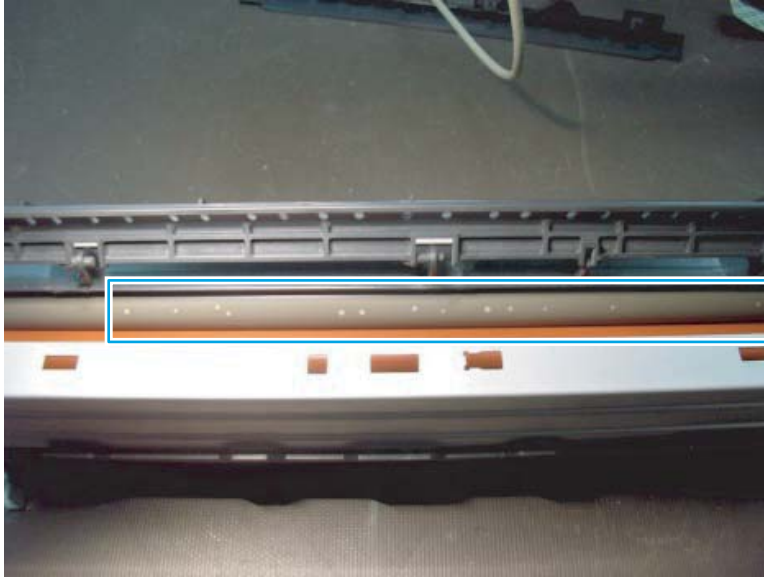

Conditions that can cause the defect

A defect similar in appearance could occur if a page with sharp objects (for example, staples) is put through the printer.

Solutions for the defect

Use the following steps to solve the defect.

- Resend the print job.
- If the defect persists, replace the fuser.

Parts related to the defect

The following item(s) might need to be repaired or replaced to prevent this defect from occurring.

- Fuser

Hot fuser offset

Review the following information about the hot fuser offset fuser/fixing defect event.

- [Description of the defect](#)
- [Conditions that can cause the defect](#)
- [Solutions for the defect](#)
- [Parts related to the defect](#)

 **NOTE:** This defect occurred at some point during printer development. HP has implemented a solution to the problem. This defect is included in the image defects section for the unlikely event that it reoccurs.

Figure 2-117 Hot fuser offset

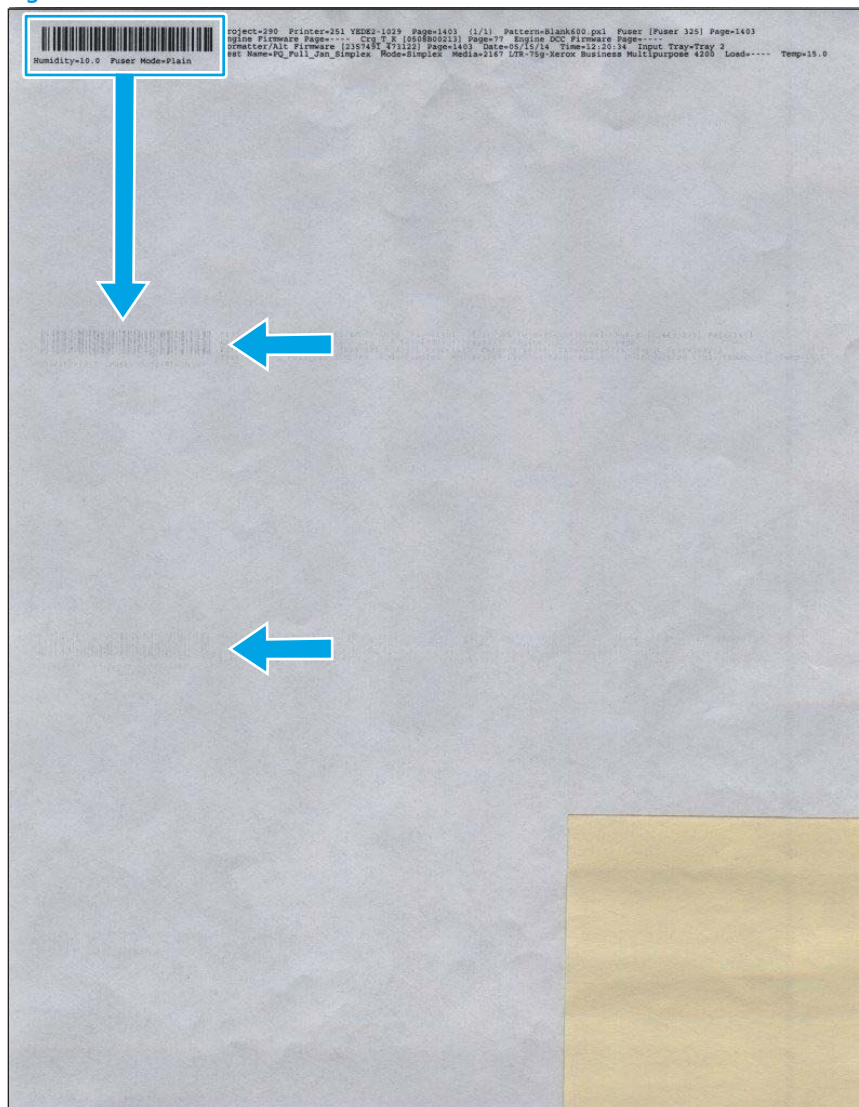

Description of the defect

This defect appears as slight offset of the image that repeats down the page spaced approximately 75.0 mm (2.95 in) apart. This defect occurred when the fuser thermistor detection temperature did not follow the target temperature.

Conditions that can cause the defect

This defect is likely to occur in the later stages of fuser life.

Solutions for the defect

Use the following steps to solve the defect.

- Resend the print job and use a lighter fuser mode.
- If the defect persists, replace the fuser.

Parts related to the defect

The following item(s) might need to be repaired or replaced to prevent this defect from occurring.

- Fuser

Poor edge fixing - within the image assurance area

Review the following information about the poor edge fixing - within the image assurance area fuser/fixing defect event.

- [Description of the defect](#)
- [Conditions that can cause the defect](#)
- [Solutions for the defect](#)
- [Parts related to the defect](#)

 **NOTE:** This defect occurred at some point during printer development. HP has implemented a solution to the problem. This defect is included in the image defects section for the unlikely event that it reoccurs.

Figure 2-118 Poor edge fixing - within the image assurance area

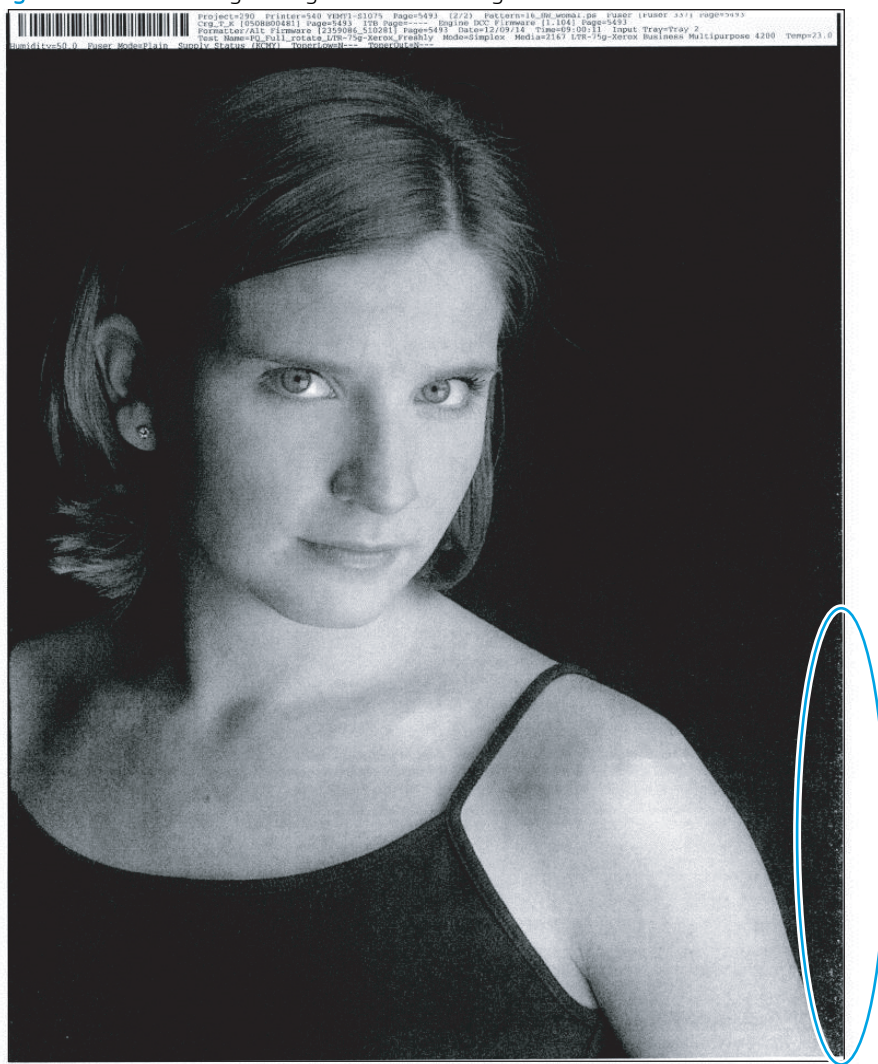

Description of the defect

This defect appears as missing toner inside the 6 mm (0.23 in) image assurance area. Toner rubs off the page. The fuser temperature is too cold.



NOTE: The image assurance area is 5 mm (0.19 in) from the top and bottom edge of the page and 5 mm (0.19 in) from the edge on each side of the page.

Conditions that can cause the defect

This defect is not dependent on environmental conditions, but is more common at the edges of high-coverage print jobs.

Solutions for the defect

Use the following steps to solve the defect.

- **M501:** From the printer control panel, change the print mode from plain to intermediate (this slows the print speed).

1. Open the following menus:

- Setup
- System Setup
- Paper Setup
- Tray <X>



NOTE: Select the tray you want to configure.

- Paper Type

2. Select **Intermediate 85–95g**.

- **M506/M507/E50145 and M527/M528/E52645:** Confirm that the correct print mode is selected for the media being used. Use a print mode for a heavier media type.

- **M506/E50045 and M527/E52545:** From the printer control panel, change the print mode from plain to intermediate (this slows the print speed).

1. Open the following menus:

- Trays
- Tray
- Modify
- Next

2. Select **Intermediate 85–95g**.

- **M507/E50145 and M528/E52645:** From the printer control panel, change the print mode from plain to intermediate (this slows the print speed).

1. Open the following menus:

- Trays
- Tray <X>



NOTE: Select the tray you want to configure.

- Type

2. Select [Intermediate 85–95g](#).

Parts related to the defect

The following item(s) might need to be repaired or replaced to prevent this defect from occurring.

- Fuser

Poor edge fixing - outside the image assurance area

Review the following information about the poor edge fixing - outside the image assurance area fuser/fixing defect event.

- [Description of the defect](#)
- [Conditions that can cause the defect](#)
- [Solutions for the defect](#)
- [Parts related to the defect](#)

 **NOTE:** This defect occurred at some point during printer development. HP has implemented a solution to the problem. This defect is included in the image defects section for the unlikely event that it reoccurs.

Figure 2-119 Poor edge fixing - outside the image assurance area

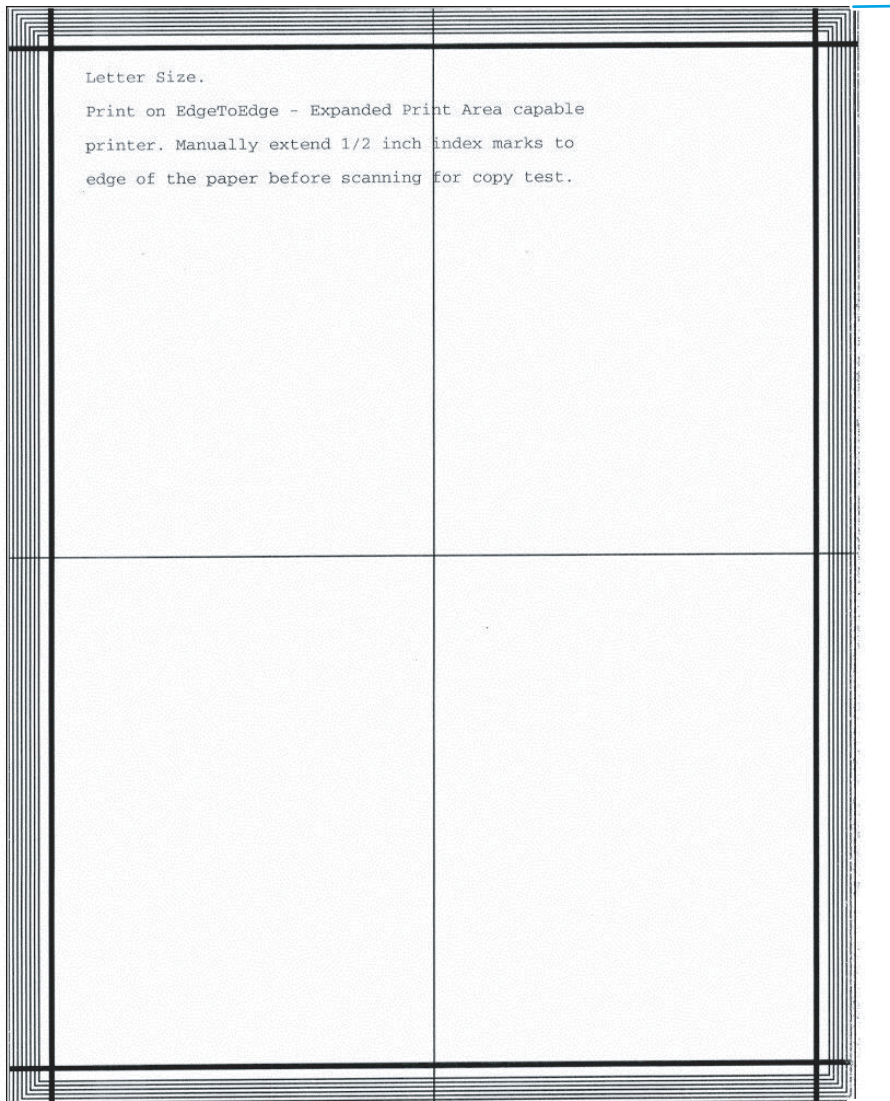

Description of the defect

This defect appears as missing toner outside the 6 mm (0.23 in) image assurance area. Toner rubs off the page. Poor edge fixing might occur when the printer is using [Edge to Edge](#) print mode and the image extends past the 5 mm (0.19 in) image assurance area.



NOTE: The image assurance area is 5 mm (0.19 in) from the top and bottom edge of the page and 5 mm (0.19 in) from the edge on each side of the page.

Conditions that can cause the defect

This defect is not dependent on environmental conditions, but is more common at the edges of high-coverage print jobs.

Solutions for the defect

Use the following steps to solve the defect.

- **M506/E50045 and M527/E52545:** Resend the print job with [Edge to Edge](#) mode set to [Normal](#). From the printer control panel, change the print mode from plain to intermediate (this slows the print speed).
 1. Open the following menus:
 - [Administration](#)
 - [Default print options](#)
 - [Edge to Edge](#)
 2. Select [Normal](#).
- **M507/E50145 and M528/E52645:** Resend the print job with [Edge to Edge](#) mode set to [Normal](#).
 1. Open the following menus:
 - Settings
 - Copy/Print
 - Default Print Options
 - Edge-to-Edge
 2. Select [Normal](#).
- **M501:** Resend the print job with increased side margins. From the printer control panel, adjust the page margins.

Before beginning, use the [Print Test Page](#) option to print a registration test page. This page provides alignment guides in the X and Y directions.

1. Open the following menus:
 - [Setup](#)
 - [System Setup](#)
 - [Print Quality](#)

- [Adjust Alignment](#)
- [Adjust Tray <X>](#)

 **NOTE:** Select the tray you want to configure.

2. Adjust the [X1 Shift](#) and [X2 Shift](#) settings.

 **NOTE:** Adjust the “X” values in .25 mm increments.

- **M506/E50045 and M527/E52545:** Resend the print job with increased side margins. From the printer control panel, adjust the page margins.

Before beginning, use the [Print Test Page](#) option to print a registration test page. This page provides alignment guides in the horizontal and vertical directions.

1. Open the following menus:

- [Administration](#)
- [General Settings](#)
- [Print Quality](#)
- [Image Registration](#)
- [Adjust Tray <X>](#)

 **NOTE:** Select the tray you want to configure.

2. Adjust the [X1 Shift](#) (simplex pages) and/or [X2 Shift](#) (duplex pages).

 **NOTE:** Adjust the “X” values in .25 mm increments.

- **M507/E50145 and M528/E52645:** Resend the print job with increased side margins. From the printer control panel, adjust the page margins.

Before beginning, use the [Print Test Page](#) option to print a registration test page. This page provides alignment guides in the horizontal and vertical directions.

1. Open the following menus:

- [Settings](#)
- [Copy/Print](#)
- [Print Quality](#)
- [Image Registration](#)

2. Select the tray you want to configure.

3. Adjust the Front-side Horizontal Shift (simplex pages) and/or Back-side Horizontal Shift (duplex pages). Adjust the Horizontal Shift values in .25 mm increments.

- **M501:** From the printer control panel, change the print mode from plain to intermediate (this slows the print speed).

1. Open the following menus:

- Setup
- System Setup
- Paper Setup
- Tray <X>

 **NOTE:** Select the tray you want to configure.

- Paper Type
2. Select [Intermediate 85–95g](#)
- **M506/E50045 and M527/E52545:** From the printer control panel, change the print mode from plain to intermediate (this slows the print speed).
 1. Open the following menus:
 - Trays
 - Tray
 - Modify
 - Next
 2. Select [Intermediate 85–95g](#).
 - **M507/E50145 and M528/E52645:** From the printer control panel, change the print mode from plain to intermediate (this slows the print speed).
 1. Open the following menus:
 - Trays
 - Tray <X>

 **NOTE:** Select the tray you want to configure.

- Type
2. Select [Intermediate 85–95g](#).

Parts related to the defect

The following item(s) might need to be repaired or replaced to prevent this defect from occurring.

- Fuser

Miscellaneous defect events

Review the following information about miscellaneous image defect (developmental) events.

- [Uneven density - across the page](#)
- [Water drop \(condensation\)](#)

Uneven density - across the page

Review the following information about the uneven density - across the page image defect (developmental) event.

- [Description of the defect](#)
- [Conditions that can cause the defect](#)
- [Solutions for the defect](#)
- [Parts related to the defect](#)

 **NOTE:** This defect occurred at some point during printer development. HP has implemented a solution to the problem. This defect is included in the image defects section for the unlikely event that it reoccurs.

Figure 2-120 Uneven Density - across the page

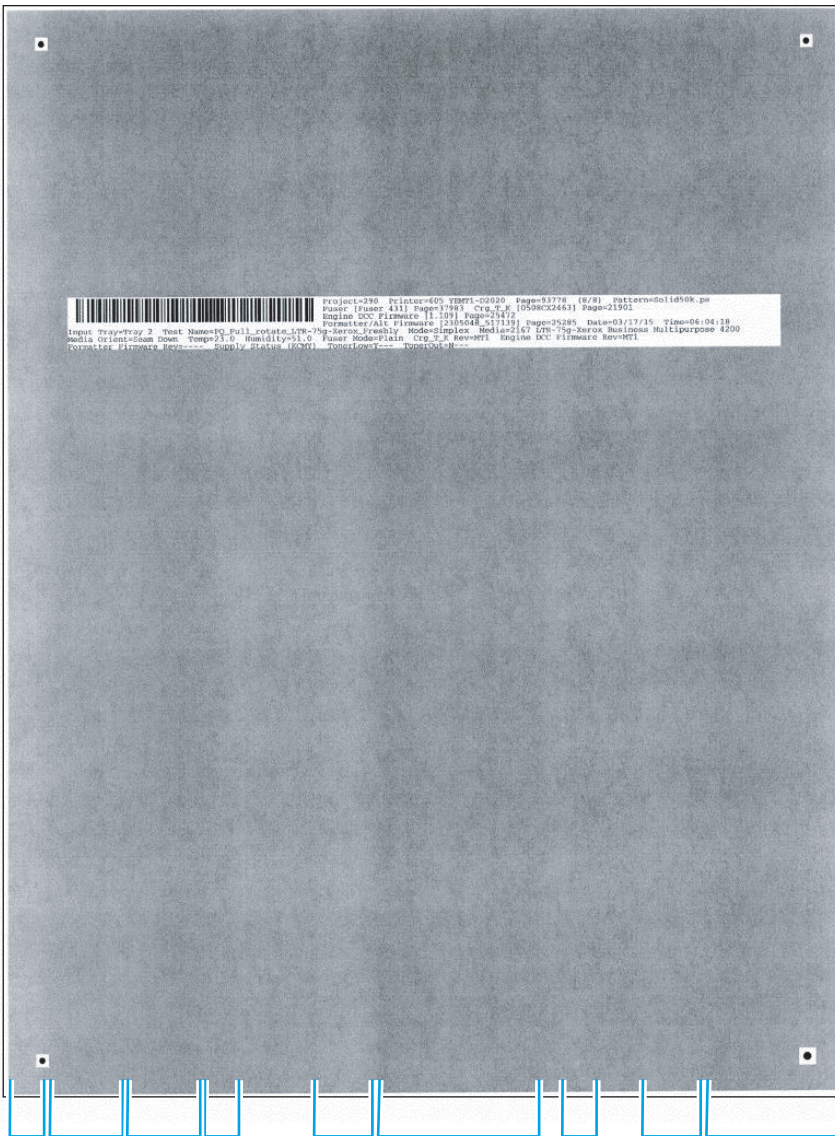

Description of the defect

This defect appears as areas of varying (light/dark) density across the page. This is caused by variation in the position of the stirring system at initial cartridge assembly resulting in toner material attached to the D-blade. Uneven attachment of toner component to D-blade is caused by uneven toner coating on the sleeve during initial sequence. This banding shows up in areas of fill, not in text.

Conditions that can cause the defect

This defect is likely to occur in the later stages of toner cartridge life.

Solutions for the defect

Use the following steps to solve the defect.

- Resend the print job.
- If the defect does not improve within two to three print jobs, remove the toner cartridge and gently rock it back and forth from side to side (this distributes the toner evenly in the toner cartridge).
- If the defect persists, replace the toner cartridge.

Parts related to the defect

The following item(s) might need to be repaired or replaced to prevent this defect from occurring.

- Toner cartridge

Water drop (condensation)

Review the following information about the water drop (condensation) image defect (developmental) event.

- [Description of the defect](#)
- [Conditions that can cause the defect](#)
- [Solutions for the defect](#)
- [Parts related to the defect](#)

 **NOTE:** This defect occurred at some point during printer development. HP has implemented a solution to the problem. This defect is included in the image defects section for the unlikely event that it reoccurs.

Figure 2-121 Water drop (condensation)

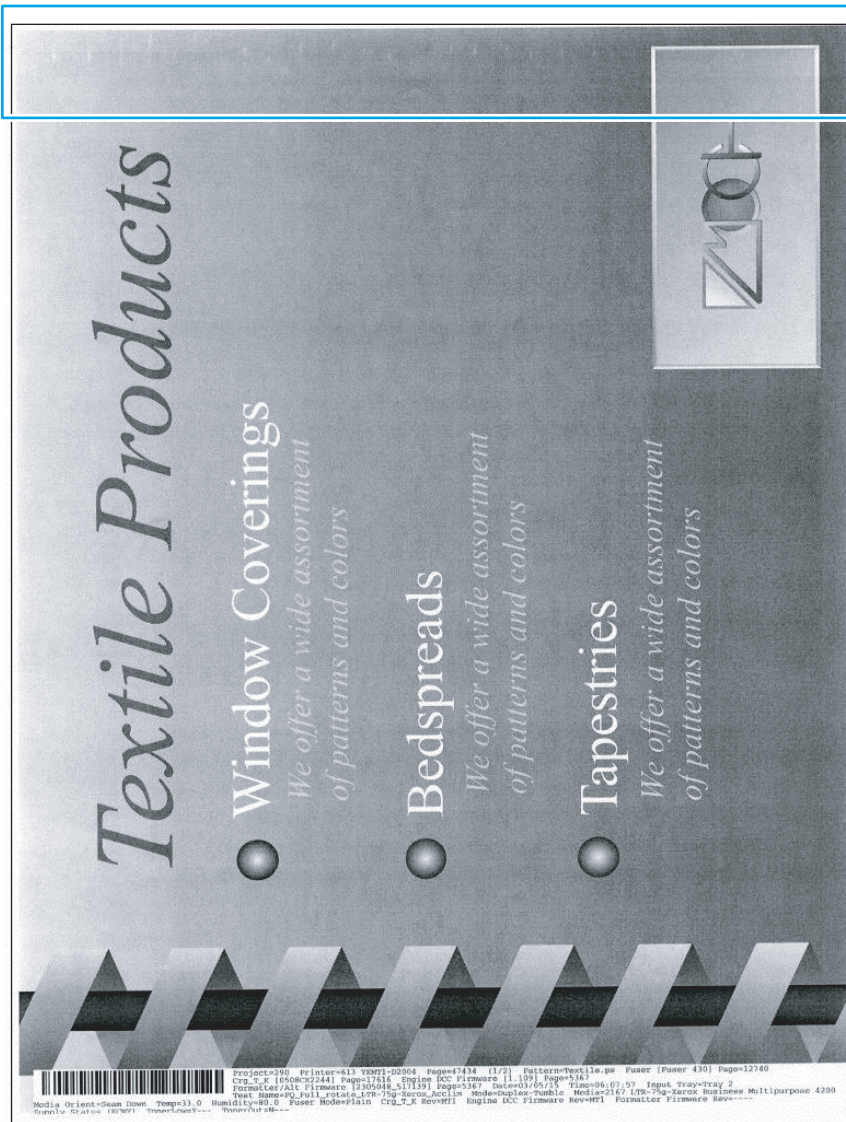

Description of the defect

This defect appears as short, soft, light streaks at the top of a page. Condensation collects on the fuser exit guide ribs and transfers to the trailing (unprinted side) of the first pass page of a duplex job. When the duplexed page is printed, the condensation affects the transfer of the toner and causes the defect.

Conditions that can cause the defect

This defect might occur in low temperature high humidity environments and in cold start conditions.

Solutions for the defect

Use the following steps to solve the defect.

- Resend the print job. This defect can be variable.
- **M506/E50045 and M527/E52545:** If the defect does not improve within two to three print jobs, change the print mode [Moisture Control](#) from [Normal](#) to [Alternate](#).
 1. Open the following menus:
 - [Administration](#)
 - [General Settings](#)
 - [Print Quality](#)
 - [Optimize](#)
 - [Moisture Control](#)
 2. Select [Alternate](#).
- **M507/E50145 and M528/E52645:** If the defect does not improve within two to three print jobs, change the print mode [Moisture Control](#) from [Normal](#) to [Alternate](#).
 1. Open the following menus:
 - [Settings](#)
 - [Copy/Print](#)
 - [Print Quality](#)
 - [Optimize](#)
 - [Moisture Control](#)
 2. Select [Alternate](#).

Parts related to the defect

The following item(s) might need to be repaired or replaced to prevent this defect from occurring.

- Media
- Fuser

Other events

Review the following information about other print-quality events.

- [Fuser contamination](#)
- [Image placement - margins and skew](#)
- [Output curl](#)
- [Sticky output](#)
- [Output stacking](#)
- [Paper handling - misprints](#)
- [Paper handling - multifeeds](#)
- [Paper handling - jams](#)



NOTE: The examples in this section describe other printer events that can occur. Customers might observe these problems.

Fuser contamination

Review the following information about the fuser contamination event.

- [Description of the defect](#)
- [Conditions that can cause the defect](#)
- [Solutions for the defect](#)
- [Parts related to the defect](#)

Figure 2-122 Fuser contamination

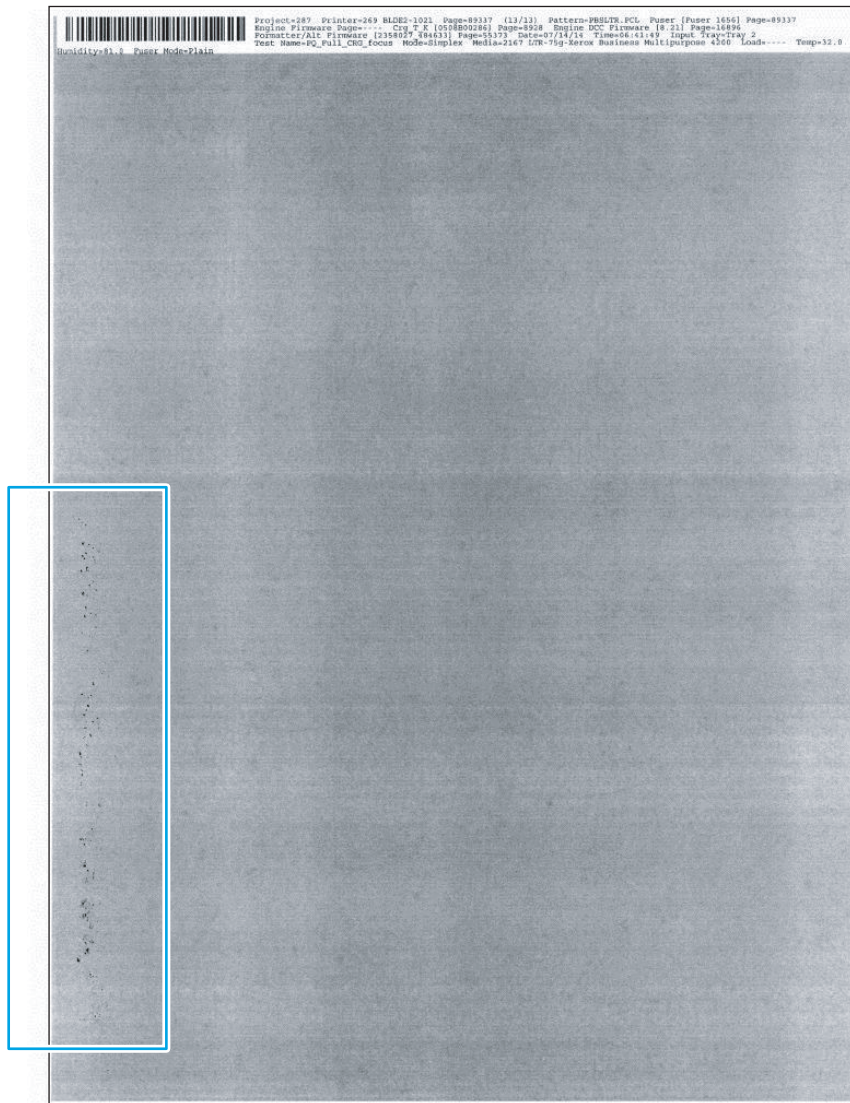

Description of the defect

This defect appears as dark globs of toner observed on the front or back of the page. Toner builds up on the fuser sleeve and pressure roller and comes off on subsequent pages. This defect can be either repeating at 75 mm (2.95 in) or does not repeat.

Conditions that can cause the defect

This defect might occur in the following conditions:

- Inappropriate media type print mode is selected (fuser too cold)
- Fuser jams were observed on the previous jobs
- Narrow media was printed for extended periods of time

Solutions for the defect

Use the following steps to solve the defect.

- **M501:** From the printer control panel, process a cleaning page to remove the contamination in the fuser.

 **NOTE:** If a repeating defect does not disappear after processing multiple cleaning pages, a permanent defect might be present on the fuser sleeve.

– Open the following menus:

- [Setup](#)
- [Service](#)
- [Cleaning Page](#)

 **NOTE:** Touch the **OK** button to begin the cleaning process. Wait until the process completes. Discard the page that prints.

- **M506/E50045 and M527/E52545:** From the printer control panel, process a cleaning page to remove the contamination in the fuser.

 **NOTE:** If a repeating defect does not disappear after processing multiple cleaning pages, a permanent defect might be present on the fuser sleeve.

1. Open the following menus:

- [Device Maintenance](#)
- [Calibration/Cleaning](#)
- [Cleaning Page](#)

2. Select **Print**.

 **NOTE:** The process takes up to 1.5 minutes.

- **M507/E50145 and M528/E52645:** From the printer control panel, process a cleaning page to remove the contamination in the fuser.

 **NOTE:** If a repeating defect does not disappear after processing multiple cleaning pages, a permanent defect might be present on the fuser sleeve.

1. Open the following menus:

- [Support Tools](#)
- [Maintenance](#)

- [Calibration/Cleaning](#)
 - [Cleaning Page](#)
2. Select [Print](#).

 **NOTE:** The process takes up to 1.5 minutes.

Parts related to the defect

The following item(s) might need to be repaired or replaced to prevent this defect from occurring.

- Fuser

Image placement - margins and skew

Review the following information about the image placement - margins and skew event.

- [Description of the defect](#)
- [Conditions that can cause the defect](#)
- [Solutions for the defect](#)
- [Parts related to the defect](#)

Figure 2-123 Image placement - margins and skew

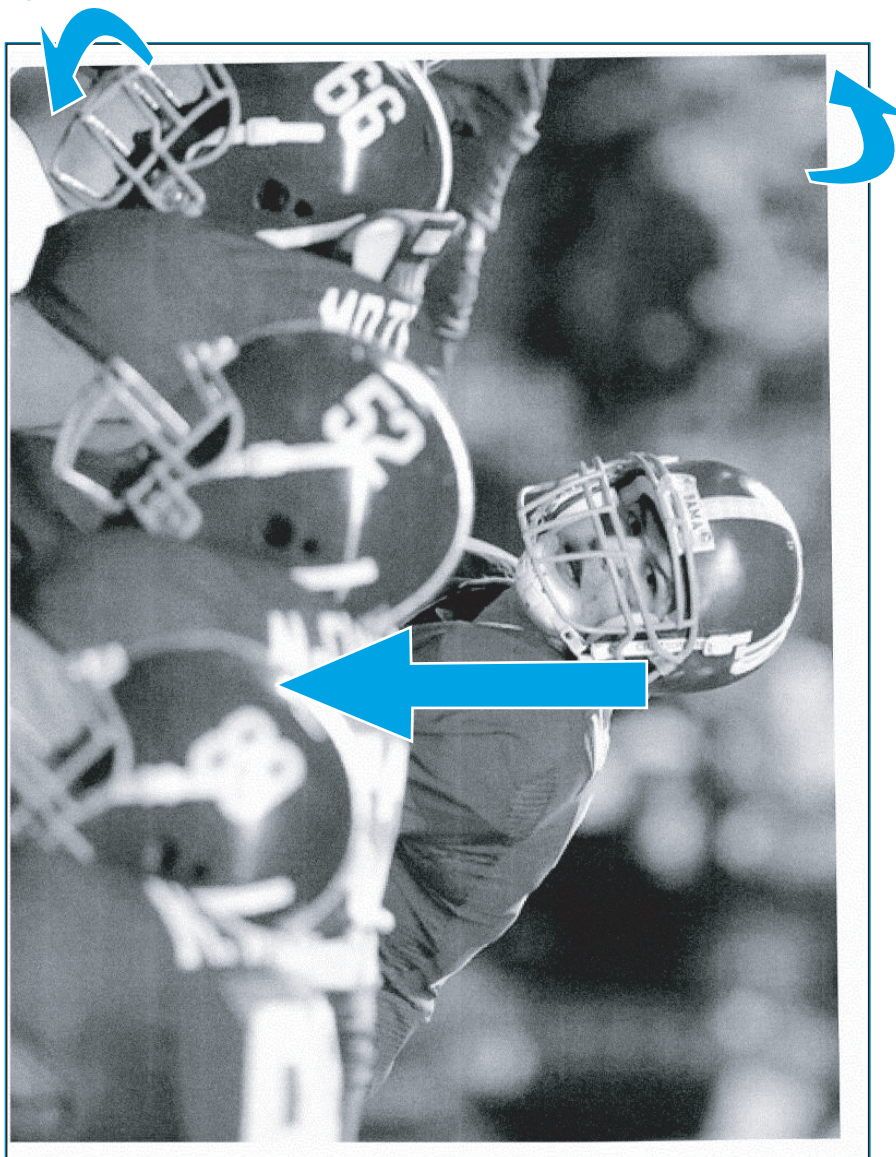

Description of the defect

This defect appears as image that is not centered or skewed on the page. The media is not positioned properly as it is pulled from the tray and goes through the paper path.

Conditions that can cause the defect

This defect might occur if the IPA is off in any environment and from any tray.

Solutions for the defect

Use the following steps to solve the defect.

- Before loading paper in the tray, hold the stack of paper, and then tap the bottom edge on a flat surface so that the stack is even on all sides.
- Make sure that the paper guides are adjusted to the correct size for the selected paper and do not overfill the tray. Verify that the top of the stack is below the tray full indicator.
- Do not adjust the paper guides tightly against the paper stack. Adjust them to the indentations or markings in the tray.
- **M501:** Before beginning, use the [Print Test Page](#) option to print a registration test page. This page provides alignment guides in the X and Y directions.

1. Open the following menus:

- [Setup](#)
- [System Setup](#)
- [Print Quality](#)
- [Adjust Alignment](#)
- [Adjust Tray <X>](#)

 **NOTE:** Select the tray you want to configure.

2.  **NOTE:** Adjust the “X” and “Y” values in .25 mm increments.

- [X1 Shift](#)

 **NOTE:** Registration of the image on the paper from side to side, as the paper lies in the tray. For duplex models, this side is the second side (back) of the paper.

- [X2 Shift](#)

 **NOTE:** Registration of the image on the paper from side to side, as the paper lies in the tray, for the first side (front) of a duplexed page. This item appears only on duplex models.

- [Y Shift](#)

 **NOTE:** Registration of the image on the paper from top to bottom as the paper lies in the tray.

- **M506/E50045 and M527/E52545:** For image placement defects do the following. Resend the print job. If the error persists, change the image placement settings for the tray that the defect occurs. From the printer control panel, process a cleaning page to remove the contamination in the fuser.

Before beginning, use the [Print Test Page](#) option to print a registration test page. This page provides alignment guides in the X and Y directions.

1. Open the following menus:

- [Administration](#)
- [General Settings](#)
- [Print Quality](#)
- [Registration](#)
- [Adjust Tray <X>](#)

 **NOTE:** Select the tray you want to configure.

2.  **NOTE:** Adjust the “X” and “Y” values in .25 mm increments.

- [X1](#) (horizontal; simplex)
 - [X2](#) (vertical; simplex)
 - [Y1](#) (horizontal; duplex)
 - [Y2](#) (vertical; duplex)
-

- **M507/E50145 and M528/E52645:** For image placement defects do the following. Resend the print job. If the error persists, change the image placement settings for the tray that the defect occurs. From the printer control panel, process a cleaning page to remove the contamination in the fuser.

Before beginning, use the [Print Test Page](#) option to print a registration test page. This page provides alignment guides in the X and Y directions.

1. Open the following menus:
 - [Settings](#)
 - [Copy/Print](#)
 - [Print Quality](#)
 - [Image Registration](#)
2. Select the tray you want to configure.
3. Adjust the appropriate margin settings. Front-side settings are for simplex pages, and back-side settings are for duplex pages. Adjust the Vertical and Horizontal Shift values in .25 mm increments.

Parts related to the defect

The following item(s) might need to be repaired or replaced to prevent this defect from occurring.

- Media
- Tray guides
- Registration assembly
- Feed rollers

Output curl

Review the following information about the output curl event.

- [Description of the defect](#)
- [Conditions that can cause the defect](#)
- [Solutions for the defect](#)
- [Parts related to the defect](#)

Figure 2-124 Output curl



Description of the defect

This defect appears as printed pages are curled. Two types of curl are possible:

- Positive curl: paper curls toward the printed side
- Negative curl: paper curls away from printed side

This defect is caused by uneven drying conditions for the two sides of the paper and fuser location close to the paper output.

Conditions that can cause the defect

Positive curl occurs in dry environments or when printing high coverage pages.

Negative curl occurs in high humidity environments when printing low coverage pages.

Solutions for the defect

Use the following steps to solve the defect.

General curl defect solutions

- Resend the print job. Use the duplex option in the printer driver.
- Do not adjust the paper guides tightly against the paper stack. Adjust them to the indentations or markings in the tray.
- **M501:** From the printer control panel, enable the [Paper Curl](#) print mode option.
 1. Open the following menus:
 - [Setup](#)
 - [Service](#)
 - [Less Paper Curl](#)
 2. Select [On](#).
- **M506/E50045 and M527/E52545:** From the printer control panel, change the print mode [Paper Curl](#) from [Normal](#) to [Reduced](#).
 1. Open the following menus:
 - [Administration](#)
 - [General Settings](#)
 - [Print Quality](#)
 - [Optimize](#)
 - [Paper Curl](#)
 2. Select [Reduced](#).
- **M507/E50145 and M528/E52645:** From the printer control panel, change the print mode [Paper Curl](#) from [Normal](#) to [Reduced](#).
 1. Open the following menus:
 - [Settings](#)
 - [Copy/Print](#)
 - [Print Quality](#)
 - [Adjust Paper Types](#)
 2. Select the appropriate paper type for the paper used.

3. Select [Paper Curl Mode](#).
4. Select [Reduced](#).

Specific curl defect solutions

- Positive curl: Use a higher temperature media type (heavier weight) mode which will increase the negative curl tendency reducing the positive curl. Also, more fusing could be selected in the extended print modes for the selected paper type.
- Negative curl: Use a lower temperature media type (lighter weight) mode or select a reduced paper curl or lower fusing temperature setting in extended print modes. If possible, try storing media in a dry environment prior to printing or use freshly opened paper (non-acclimated).

Parts related to the defect

The following item(s) might need to be repaired or replaced to prevent this defect from occurring.

- Media
- Fuser

Sticky output

Review the following information about the sticky output event.

- [Description of the defect](#)
- [Conditions that can cause the defect](#)
- [Solutions for the defect](#)
- [Parts related to the defect](#)

Figure 2-125 Sticky output

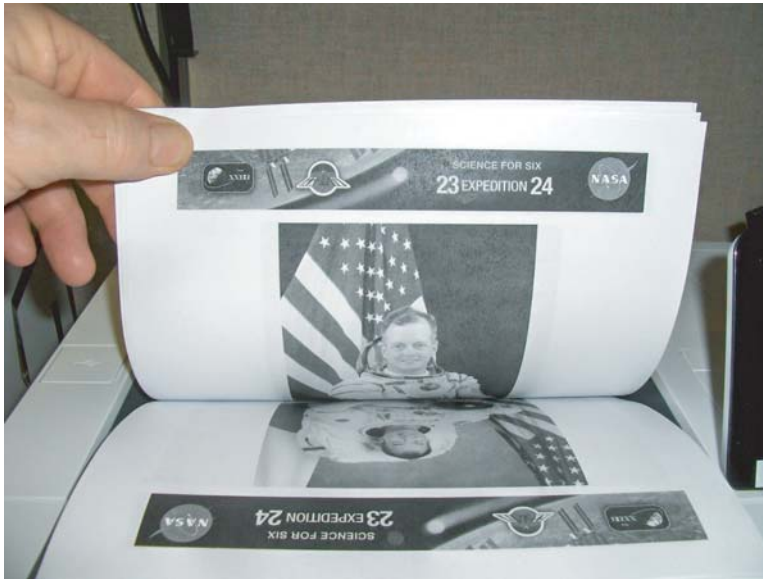

Description of the defect

This defect appears as output pages that stick together when printing heavy coverage images in duplex mode. When printing large jobs the output stack retains enough heat that the toner on the top page does not cool sufficiently and can be tacky in heavy coverage areas. When the next page is output if there is heavy coverage that lands on the top page in the stack, the toner-to-toner contact might stick.

Conditions that can cause the defect

This defect might occur in the following conditions:

- Large jobs greater than 25 pages (50 Images)
- Plain fuser mode
- Back-to-back images with heavy (greater than 80% density) coverage
- More severe on smooth heavy media

Solutions for the defect

Use the following steps to solve the defect.

- Confirm that the correct print mode is selected for the paper being used.
- Flex the output stack before separating pages.

- Print smaller jobs and remove the output before sending the next job.
- Use the Intermediate Fuser mode which slows the printing and allows more time for cooling.
- Try printing in Quiet mode which lowers the fuser temperature and slows the output.

M501: From the printer control panel, enable the [Quiet Print Mode](#) option.

1. Open the following menus:
 - [Setup](#)
 - [System Setup](#)
 - [Quiet Print Mode](#)
2. Select [On](#).

Parts related to the defect

The following item(s) might need to be repaired or replaced to prevent this defect from occurring.

- Media
- Fuser

Output stacking

Review the following information about the output stacking event.

- [Description of the defect](#)
- [Conditions that can cause the defect](#)
- [Solutions for the defect](#)
- [Parts related to the defect](#)

Figure 2-126 Output stacking



Description of the defect

This defect appears as output pages that do not stack properly in the output bin. The stack may be uneven or skewed or pages could be pushed out of the tray and onto the floor.

Conditions that can cause the defect

Poor stacking can occur when there is significant paper curl present, if the paper being used is wrinkled or deformed, if using non-standard media types such as envelopes, or if the output bin gets too full. Causes for this

defect vary depending on the type of media being used. If paper curl is present, the cause can be attributed to uneven drying of the media in the fuser.

Solutions for the defect

Use the following steps to solve the defect.

- Use the output bin extension.
- If applicable, use the solutions in "Output curl" in the *Troubleshooting Manual*.
- Use different paper that meets HP specifications for this printer.
- Use freshly opened paper (non-acclimated).
- Remove paper from the output tray before the stack becomes too large.

Parts related to the defect

The following item(s) might need to be repaired or replaced to prevent this defect from occurring.

- Media
- Fuser

Paper handling - misprints

Review the following information about the paper handling - misprints event.

- [Description of the defect](#)
- [Conditions that can cause the defect](#)
- [Solutions for the defect](#)
- [Parts related to the defect](#)

Description of the defect

This defect appears as media in the paper path that does not behave as the printer user expects. The control panel displays a **41.XX.XX** error. A sensor is triggered at an unexpected timing and displays an error message.

Conditions that can cause the defect

Misprints occur in any environment.

Solutions for the defect

Use the following steps to solve the defect.

- Make sure that the size of the paper loaded in a specified tray matches the control panel setting.
- Make sure that the paper guides in the tray are adjusted correctly for the size of paper and the rear door is fully closed.
- Make sure that the input tray and output bin are not overfilled.
- Try using a new supply of paper or a different type of paper.

Parts related to the defect

The following item(s) might need to be repaired or replaced to prevent this defect from occurring.

- Media
- Tray guides
- Registration assembly
- Feed rollers

Paper handling - multifeeds

Review the following information about the paper handling - multifeeds event.

- [Description of the defect](#)
- [Conditions that can cause the defect](#)
- [Solutions for the defect](#)
- [Parts related to the defect](#)

Description of the defect

This defect appears as one (or many) pages feed through the paper path together. Sheets of paper stick together (physically or statically) and the separation pressure from the pick roller is unable to separate the sheets.

Conditions that can cause the defect

The multifeed defect can occur in any environment, but occurs more frequently in HH and NN (as opposed to LL), on glossy media (as opposed to plain media) and with freshly opened (as opposed to fully acclimated) paper.

Solutions for the defect

Use the following steps to solve the defect.

- Make sure that the input tray is not overfilled.
- Make sure that the paper guides in the tray are adjusted correctly for the size of paper.
- Remove the stack of paper from the tray, flex it, rotate it 180 degrees and then flip it over. Insert the media in a new orientation.
- Load a smaller stack of media in the input tray.
- Fan the media.
- Try a new supply of paper or a different type of paper.

Parts related to the defect

The following item(s) might need to be repaired or replaced to prevent this defect from occurring.

- Media
- Tray guides
- Registration assembly
- Feed rollers

Paper handling - jams

Review the following information about the paper handling - jams event.

- [Description of the defect](#)
- [Conditions that can cause the defect](#)
- [Solutions for the defect](#)
- [Parts related to the defect](#)

Description of the defect

This defect appears as media stuck in the paper path. The control panel displays a **13.XX.XX** error. Media does not enter, pass through, or exit the paper path correctly.

Conditions that can cause the defect

Jams occur in any environment.

Solutions for the defect

Use the following steps to solve the defect.

- Clear the jam (input tray, rear door, bottom duplex tray, or output bin).
- Make sure that the paper guides in the tray are adjusted correctly for the size of paper and the rear door is fully closed.
- Make sure that the input tray and output bin are not overfilled.
- Load a smaller stack of media in the input tray.
- Try a new supply of paper or a different type of paper.

Parts related to the defect

The following item(s) might need to be repaired or replaced to prevent this defect from occurring.

- Media
- Tray guides
- Registration assembly
- Feed rollers

Clean the printer

Review the following information about cleaning the printer.

- [Clean the paper path](#)
- [Print a cleaning page](#)
- [Enable and configure auto cleaning \(M527/E52545/M528/E52645\)](#)
- [Check the scanner glass for dirt and smudges \(M527/E52545/M528/E52645\)](#)
- [Clean the pickup rollers and separation pad in the document feeder \(M527/E52545/M528/E52645\)](#)
- [Clean the Tray 1 roller and separation pad](#)
- [Clean the Tray 2-X rollers](#)



NOTE: To clean the printer exterior, use a soft, water-moistened cloth.

Clean the paper path

Over time, particles of toner and paper accumulate inside the printer. This can cause print-quality problems during printing. Cleaning the paper path eliminates or reduces these problems.

Clean the paper path and toner-cartridge areas every time that the toner cartridge is changed or whenever print-quality problems occur. As much as possible, keep the printer free from dust and debris.

Print a cleaning page

Use the following procedures to print a cleaning page.

- [Print the cleaning page from a LCD control panel \(M501\)](#)
- [Print the cleaning page from a LCD control panel \(M506/E50045/M507/E50145\)](#)
- [Print the cleaning page from a touchscreen control panel \(M527/E52545/M528/E52645\)](#)

Print the cleaning page from a LCD control panel (M501)

Use the following procedure to print the cleaning page from a LCD control panel on an M501 printer.

1. From the printer control panel, press the **OK** button.
2. Open the **Service** menu.
3. Use the arrow keys to select the **Cleaning mode** option, and then press the **OK** button.

The printer prints the first side and then prompts you to remove the page from the output bin and reload it in Tray 1, keeping the same orientation. Wait until the process is complete. Discard the page that prints.

Print the cleaning page from a LCD control panel (M506/E50045/M507/E50145)

Use the following procedure to print the cleaning page from a LCD control panel on an M506/E50045/M507/E50145 printer.

FutureSmart 3

1. From the **Home** screen on the printer control panel, use the down arrow ▼ button to scroll to **Device Maintenance**, and then press the **OK** button.
2. Use the down arrow ▼ button to scroll to **Calibration/Cleaning**, and then press the **OK** button.
3. If necessary, use the down arrow ▼ button to scroll to **Cleaning**, and then press the **OK** button to print the page.
4. Follow the instruction on the printed cleaning page to finish the cleaning page process.

FutureSmart 4

1. From the **Home** screen on the printer control panel, use the arrow keys to navigate to **Support Tools**, and then press the **OK** button.
2. Use the down arrow ▼ button to scroll to **Maintenance**, and then press the **OK** button.
3. Use the down arrow ▼ button to scroll to **Calibration/Cleaning**, and then press the **OK** button.
4. Select **Continue** to enter *Maintenance Mode*.
5. Use the down arrow ▼ button to scroll to **Cleaning page**, and then press the **OK** button to print the page.
6. Follow the instruction on the printed cleaning page to finish the cleaning page process.
7. A **Cleaning...** message displays on the printer control panel. The cleaning process takes a few minutes to complete. Do not turn the printer off until the cleaning process has finished. When it is finished, discard the printed page.

Print the cleaning page from a touchscreen control panel (M527/E52545/M528/E52645)

Use the following procedure to print the cleaning page from a touchscreen control panel (M527/E52545/M528/E52645).

1. From the [Home](#) screen on the printer control panel, scroll to and touch the [Device Maintenance](#) button (FutureSmart 3), or scroll to and touch the [Support Tools](#) button (FutureSmart 4).
2. Open the following menus:
 - [Maintenance](#) (FutureSmart 4)
 - [Calibration/Cleaning](#)
3. Touch [Cleaning Page](#), and then press the [OK](#) button (FutureSmart 3) or the [Print](#) button (FutureSmart 4) to print the page.
4. The cleaning process can take several minutes. When it is finished, discard the printed page.

Enable and configure auto cleaning (M527/E52545/M528/E52645)

Use the procedure in this section to enable and configure the automatic cleaning function from a touchscreen control panel.

1. From the [Home](#) screen on the printer control panel, scroll to and touch the [Device Maintenance](#) button (FutureSmart 3), or scroll to and touch the [Support Tools](#) button (FutureSmart 4).
2. Open the following menus:
 - [Maintenance](#) (FutureSmart 4)
 - [Calibration/Cleaning](#)
 - [Auto Cleaning](#) (FutureSmart 3) or [Cleaning Page](#) (FutureSmart 4).
3. **FutureSmart 3:** Select the [Enable](#) item, and then touch the [Save](#) button.
4. **FutureSmart 4:** Under [Automatic Cleaning Interval](#), select the desired page interval when the printer should automatically print a cleaning page, and then touch the [Done](#) button.

Check the scanner glass for dirt and smudges (M527/E52545/M528/E52645)

Over time, specks of debris might collect on the scanner glass and white plastic backing, which can affect performance.

Use the following procedure to clean the scanner if the printed pages have streaks, unwanted lines, black dots, poor print quality, or unclear text.

1. Press the power button to turn the printer off, and then disconnect the power cable from the electrical outlet.



2. Open the scanner lid.

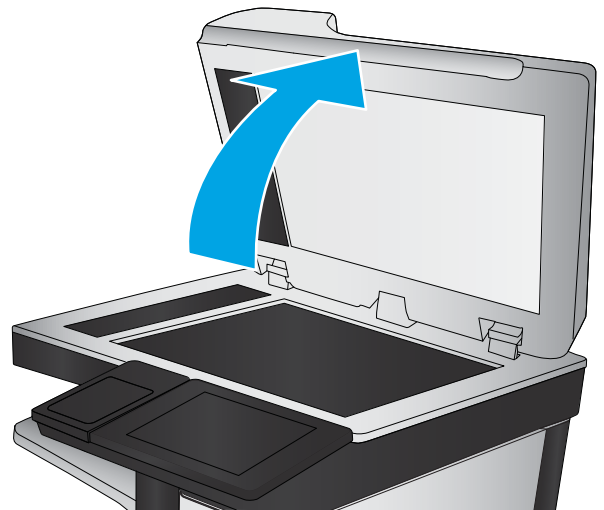

3. Clean the scanner glass, the document feeder strips, and the white plastic backing with a soft cloth or sponge that has been moistened with nonabrasive glass cleaner.

CAUTION: Do not use abrasives, acetone, benzene, ammonia, ethyl alcohol, or carbon tetrachloride on any part of the printer; these can damage the printer. Do not place liquids directly on the glass or platen. They might seep and damage the printer.

NOTE: If you are having trouble with streaks on copies when you are using the document feeder, be sure to clean the small strip of glass on the left side of the scanner.

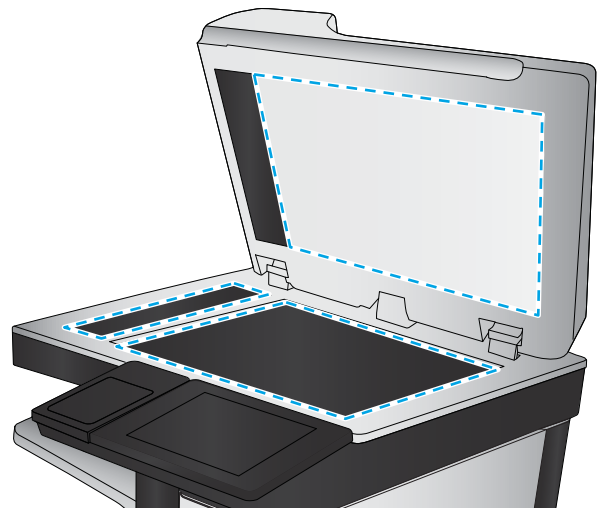

4. Dry the glass and white plastic parts with a chamois or a cellulose sponge to prevent spotting.
5. Connect the power cable to an outlet, and then press the power button to turn the printer on.

Clean the pickup rollers and separation pad in the document feeder (M527/E52545/ M528/E52645)

Use the following procedure to clean the pickup rollers and separation pad in the document feeder for the M527/
E52545/M528/E52645 printer.

1. Lift the document-feeder latch.

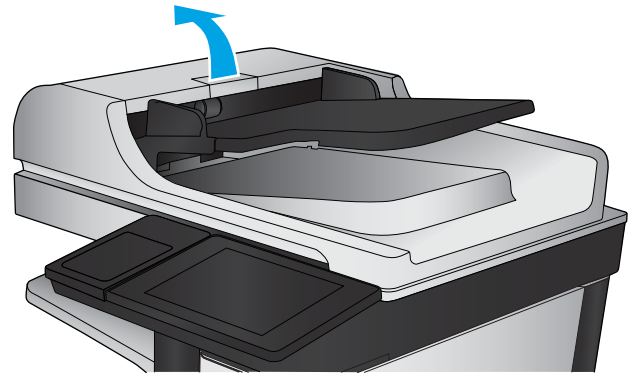

2. Open the document-feeder cover.

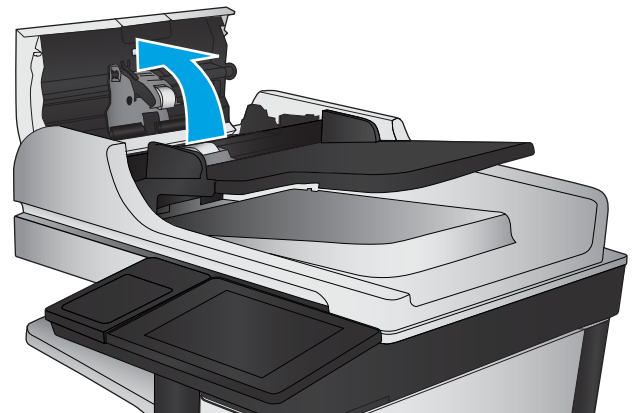

3. Remove any visible lint or dust from each of the feed rollers and the separation pad using compressed air or a clean lint-free cloth moistened with warm water.

NOTE: Lift up the roller assembly to access and clean the second roller.

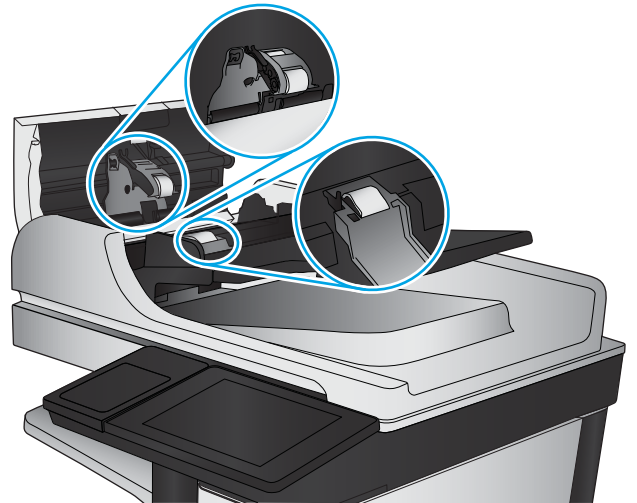

4. Close the document-feeder cover.

If the error persists, install a document feeder maintenance kit (B5L52-67903).

Clean the Tray 1 roller and separation pad

Use the following procedure to clean the Tray 1 roller and separation pad.

- [Step 1: Remove the roller](#)
- [Step 2: Remove the separation pad assembly](#)
- [Step 3: Clean the Tray 1 roller and separation pad](#)
- [Step 4: Install the separation pad assembly](#)
- [Step 5: Install the roller](#)

 **NOTE:** The figures in this section show the M506x. However, the procedure is correct for all M506/E50045/M507/E50145 models and the M501 and M527/E52545/M528/E52645 printers.

Step 1: Remove the roller

Use the following procedure to remove the roller.

1. Open the toner-cartridge door.

Figure 2-127 Open the toner-cartridge door



2. Release two tabs between the roller collar and roller (callout 1), and then rotate the top of the roller out and away from the printer (callout 2).

 **TIP:** Pushing down on the top of the roller might make it easier to release the tabs.

Figure 2-128 Release two tabs



3. Remove the roller.

Figure 2-129 Remove the roller

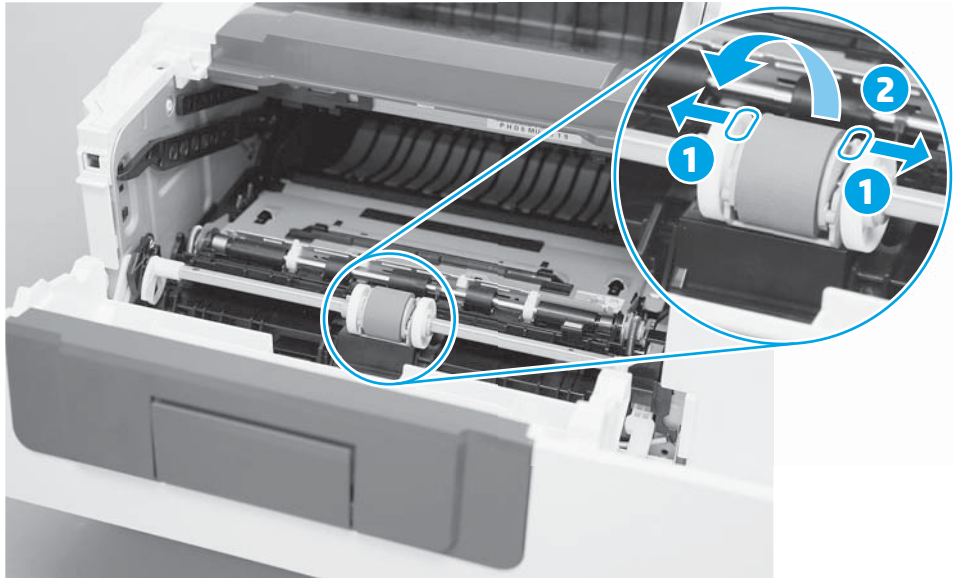
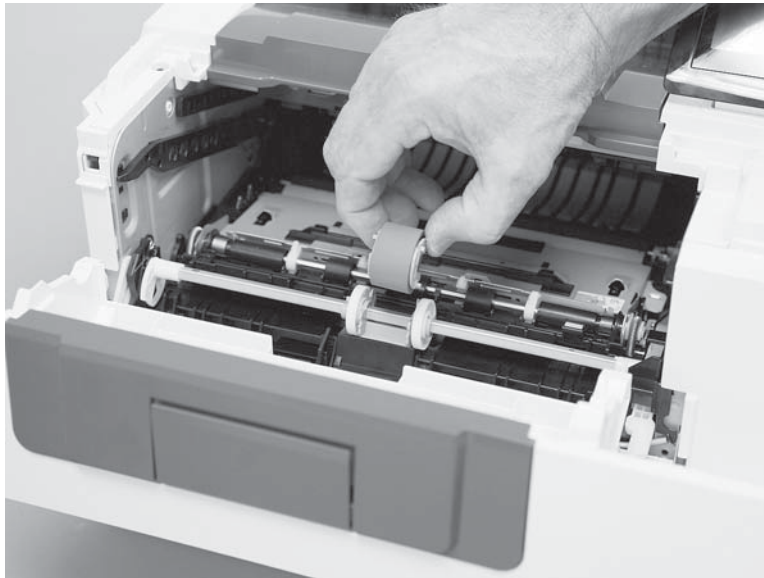

Step 2: Remove the separation pad assembly

Use the following procedure to remove the separation pad assembly.

1. Open the toner-cartridge door.

Figure 2-130 Open the toner-cartridge door



2. Release two tabs between the roller collar and roller (callout 1), and then rotate the top of the roller out and away from the printer (callout 2).

 **TIP:** Pushing down on the top of the roller might make it easier to release the tabs.

Figure 2-131 Release two tabs



3. Remove the roller.

Figure 2-132 Remove the roller

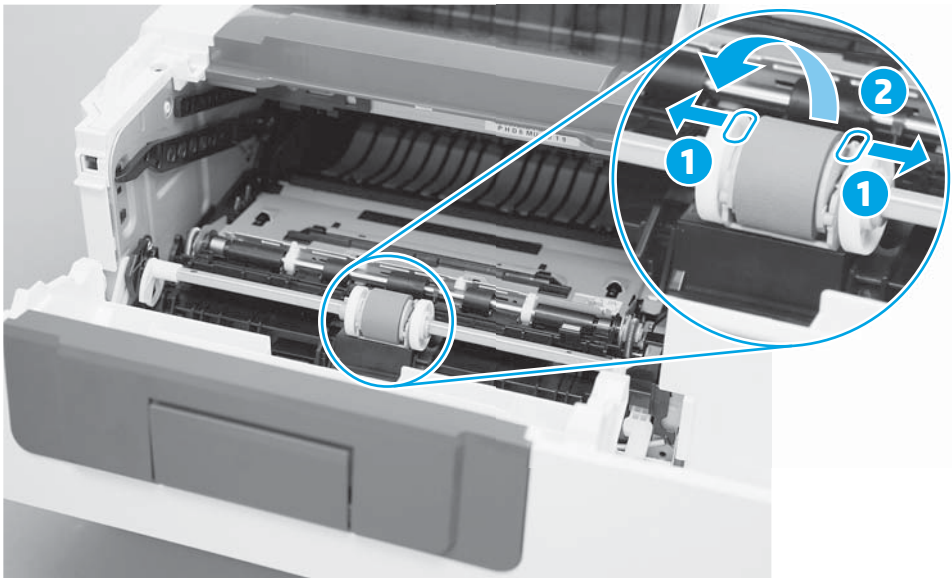
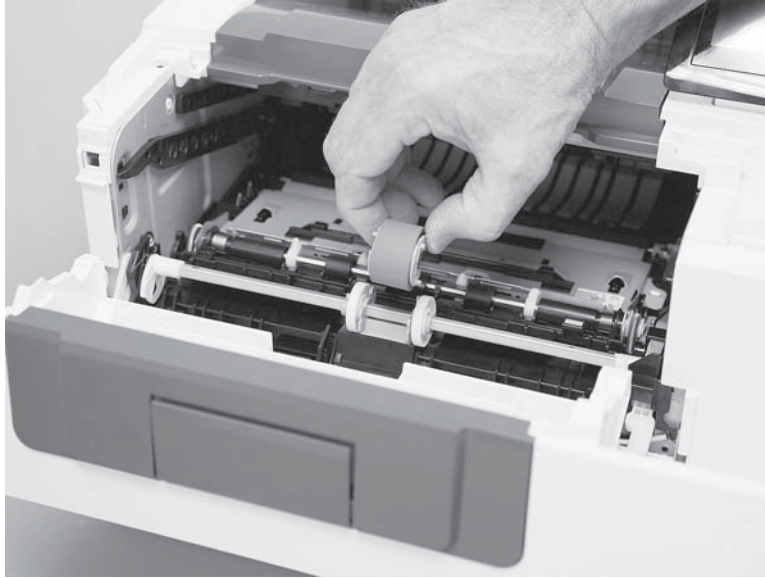

Step 3: Clean the Tray 1 roller and separation pad

Use the following procedure to clean the Tray 1 roller and separation pad.

- ▲ Use a damp, lint-free cloth to gently clean the rollers.

⚠ CAUTION: When handling the roller and pad, avoid touching the spongy surfaces. Skin oils and fingerprints on a roller surface can cause print-quality problems.

Figure 2-133 Clean the rollers and pad

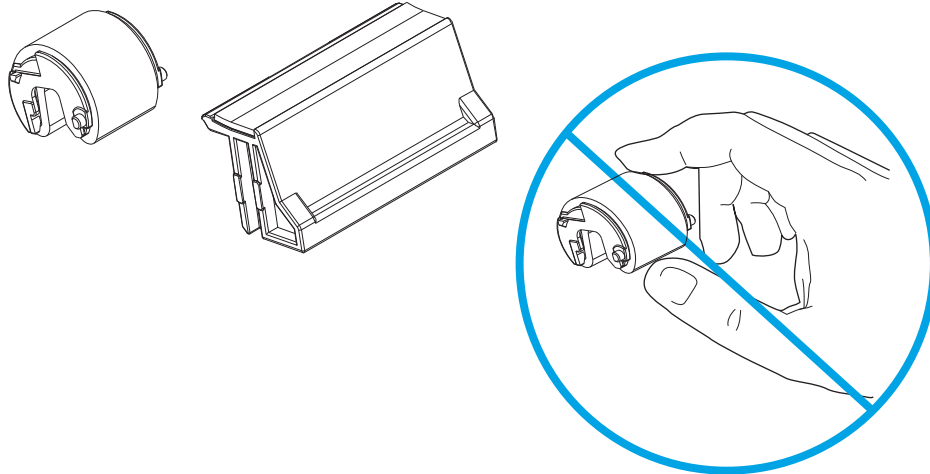

Step 4: Install the separation pad assembly

Use the following procedure to install the separation pad assembly.

⚠ CAUTION: Do not touch the black rubber portion of the pad assembly. Skin oils on the pad can cause paper handling problems. HP recommends washing your hands before handling the assembly.

1. Install the spring (callout 1) from the discarded separation pad assembly (or use the one supplied in this kit) on to the replacement assembly (callout 2).

Figure 2-134 Install the spring

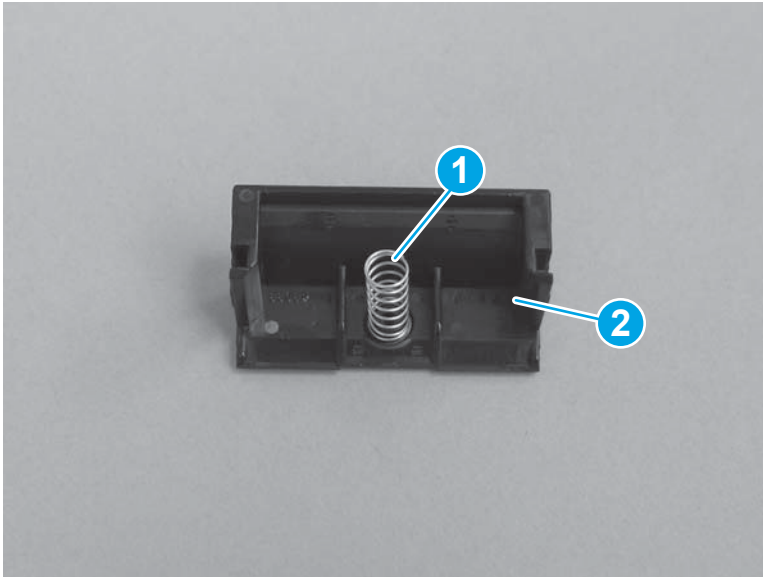

2. Align the slots in the assembly (callout 1) with the rails on the holder (callout 2).

Figure 2-135 Align the assembly with the holder

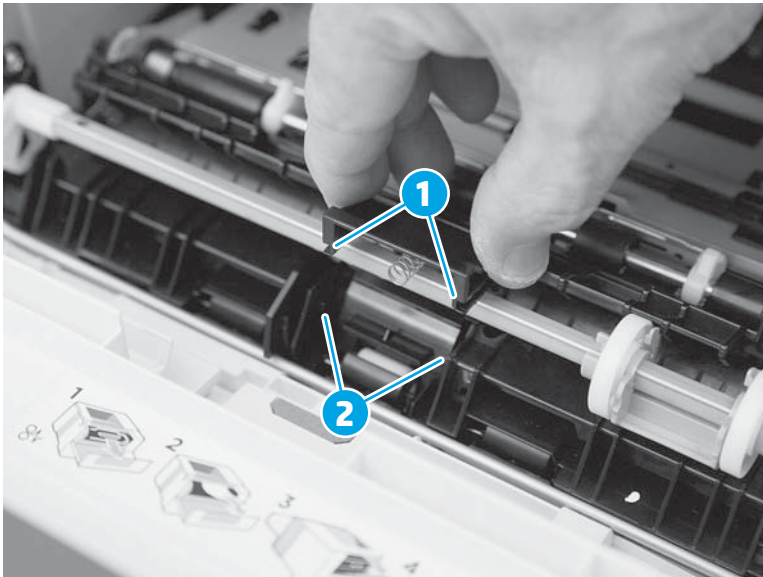

3. Install the pad assembly into the holder.

 **Reinstallation tip:** The separation pad should freely move up and down on the spring when correctly installed. If the pad does not freely move, remove it, check the spring, and then reinstall it.

Figure 2-136 Install the pad assembly



4. Slide the roller carriage back to the center of the shaft (the locking tab snaps into place).

 **NOTE:** Slightly depress the separation pad so that the roller carriage can slide over it.

Figure 2-137 Slide the roller carriage to the left



Step 5: Install the roller

Use the following procedure to install the roller.

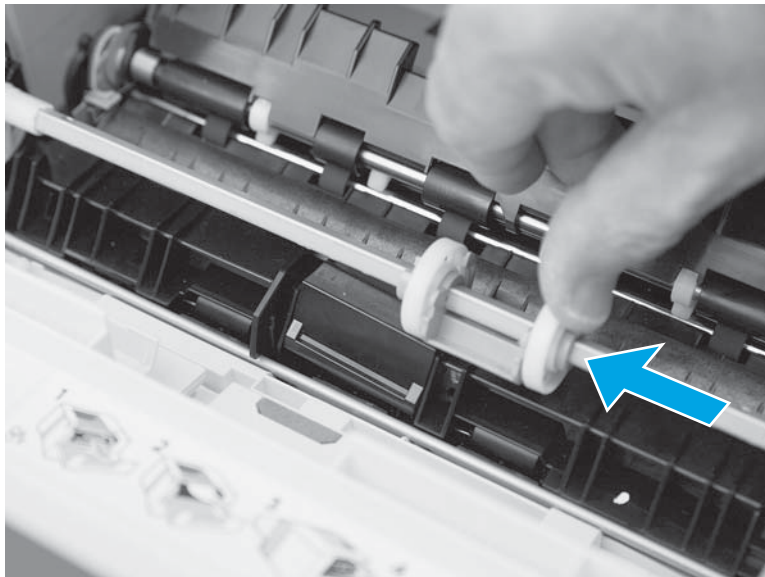
⚠ CAUTION: Do not touch the gray spongy portion of the replacement roller. Skin oils on the roller can cause paper handling problems. HP recommends washing your hands before handling the assembly.

1. Place the pins on the under-side of the pickup roller in the slots on the holder, and then rotate the top of the roller up and toward the printer.

📝 NOTE: In this step, you start with the roller upside down, and then rotate it up and into its final installed position.

Figure 2-138 Install the roller

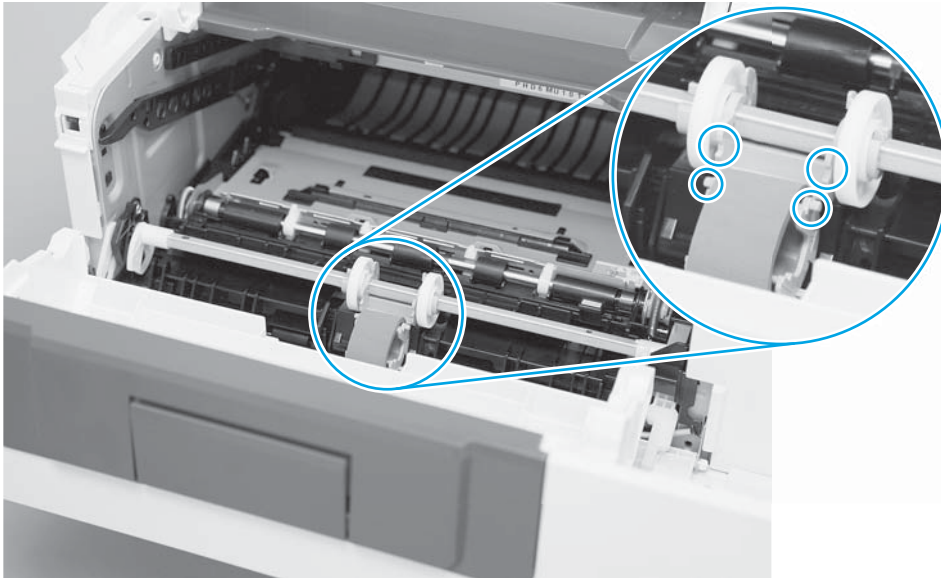

2. Continue to rotate the top of the roller toward the printer until two tabs snap into place.

Figure 2-139 Engage two tabs

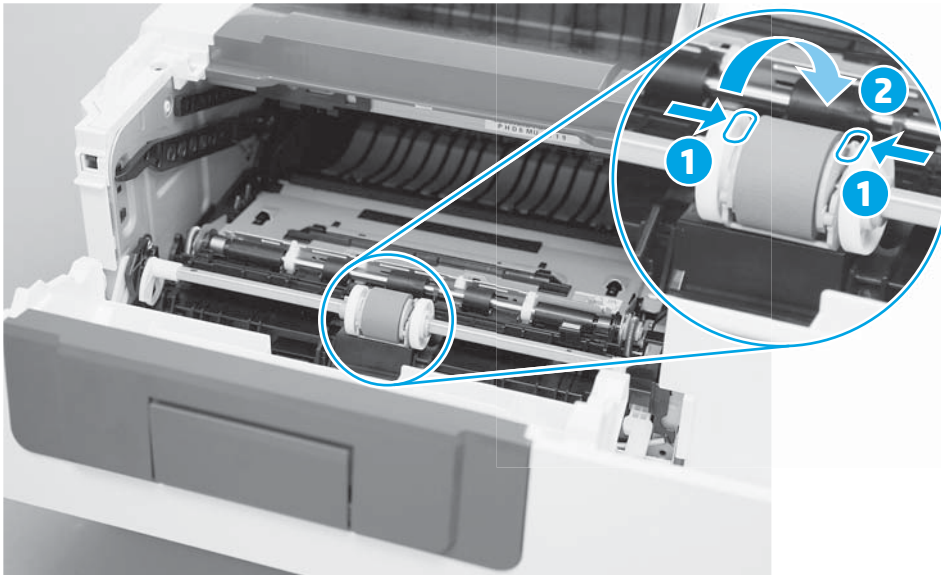

3. Close the toner-cartridge door.

 **NOTE:** If the toner cartridge was removed, do not forget to reinstall it.

Figure 2-140 Close the toner-cartridge door



Clean the Tray 2-X rollers

Use the following procedures to clean the Tray 2-X rollers.

- [Step 1: Remove the tray](#)
- [Step 2: Remove the roller assembly](#)
- [Step 3: Clean the Tray 2-X rollers](#)
- [Step 4: Install the roller assembly](#)
- [Step 5: Install the tray](#)

 **NOTE:** The figures in this section show the M506x and M527. However, the procedure is correct for all M506/E50045/M507/E50145 models, and the M501 and the M527/E52545/M528/E52645 printers.

Step 1: Remove the tray

Use the following procedure to remove the tray.

1. Pull the tray straight out of the printer until it stops.

Figure 2-141 Pull the tray out until it stops



2. Lift the front of the tray, and then pull it out of the printer to remove it.

Figure 2-142 Release and remove the tray



Step 2: Remove the roller assembly

Use the following procedure to remove the roller assembly.

⚠ CAUTION: When handling the roller assembly, do not touch the gray spongy portion of the rollers. Skin oils on the rollers can cause paper handling problems. HP recommends washing your hands before handling the assembly.

📝 NOTE: The figures in this section show the M506 and M527 Tray 2. However, the procedure is correct for replacing the Tray 2 pickup and feed roller and separation roller assemblies in the M501, as well as the optional Tray 3, Tray 4, and Tray 5 accessories.

1. Look up into the tray cavity to locate the roller assembly.

Figure 2-143 Locate the roller assembly



2. Grasp the white tab on the roller holder (callout 1), and then slide the roller assembly to the left to compress the spring loaded shaft (callout 2).

Figure 2-144 Compress the spring-loaded shaft

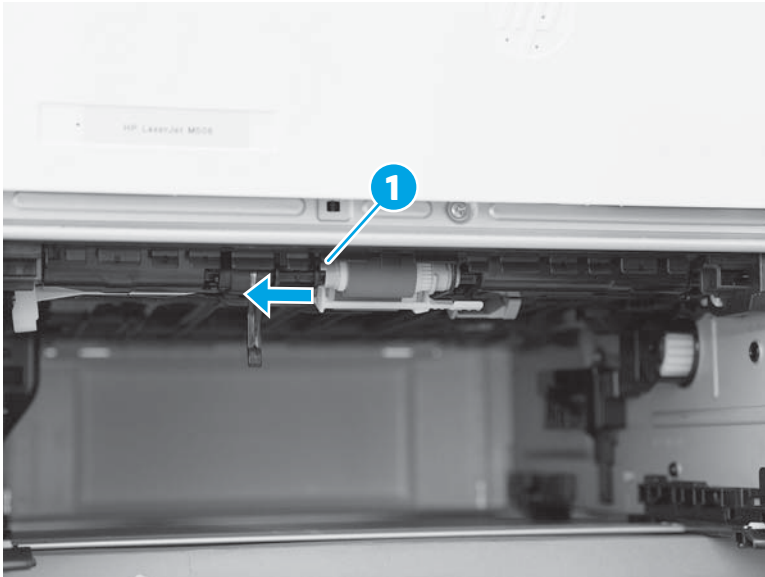

3. With the spring loaded shaft depressed, rotate the right side of the roller assembly down and towards you to release it.

Figure 2-145 Remove the roller assembly



Step 3: Clean the Tray 2-X rollers

Use the following procedure to clean the Tray 2-X rollers.

- ▲ Use a damp, lint-free cloth to gently clean the rollers.

⚠ CAUTION: When handling the rollers, avoid touching the spongy surfaces. Skin oils and fingerprints on a roller surface can cause print-quality problems.

Figure 2-146 Clean the rollers

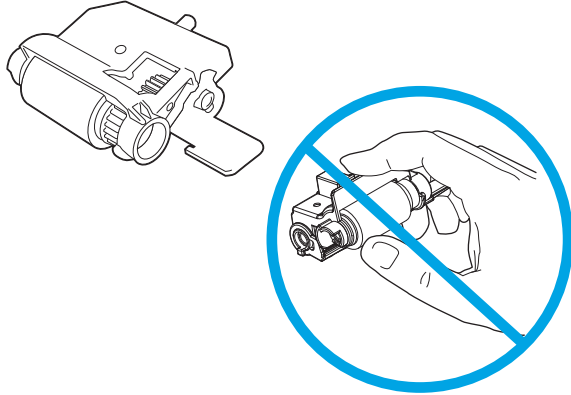

Step 4: Install the roller assembly

Use the following procedure to install the roller assembly.

CAUTION: When handling the roller assembly, do not touch the gray spongy portion of the rollers. Skin oils on the rollers can cause paper handling problems. HP recommends washing your hands before handling the assembly.

NOTE: The figures in this section show the M506 and M527 Tray 2. However, the procedure is correct for replacing the Tray 2 pickup and feed roller and separation roller assemblies in the M501, as well as the optional Tray 3, Tray 4, and Tray 5 accessories.

1. When the assembly is installed, the actuator pin (callout 1) on the roller assembly must be installed in the slot (callout 2) in the actuator arm.

Figure 2-147 Check the pin on the assembly

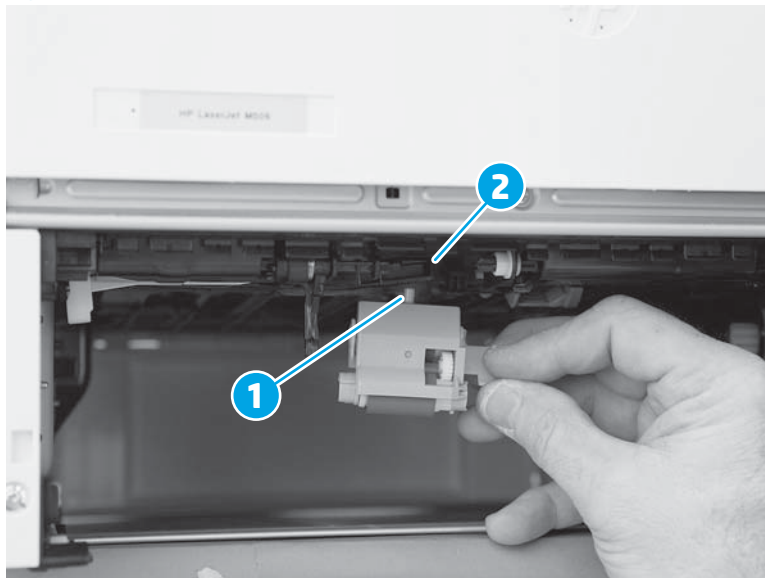

2. Position the left end of the assembly on the spring loaded shaft and push it left to compress the shaft (callout 1), keep the roller holder parallel to the underside of the printer, and then rotate the right end up and into the printer (callout 2).

Figure 2-148 Install the roller assembly



3. Slowly release the depressed spring loaded shaft to allow the right end of the roller assembly to engage with the right-side drive shaft.

Make sure that the right side of the assembly is fully engaged with the right-side drive shaft.

Figure 2-149 Decompress the spring-loaded shaft

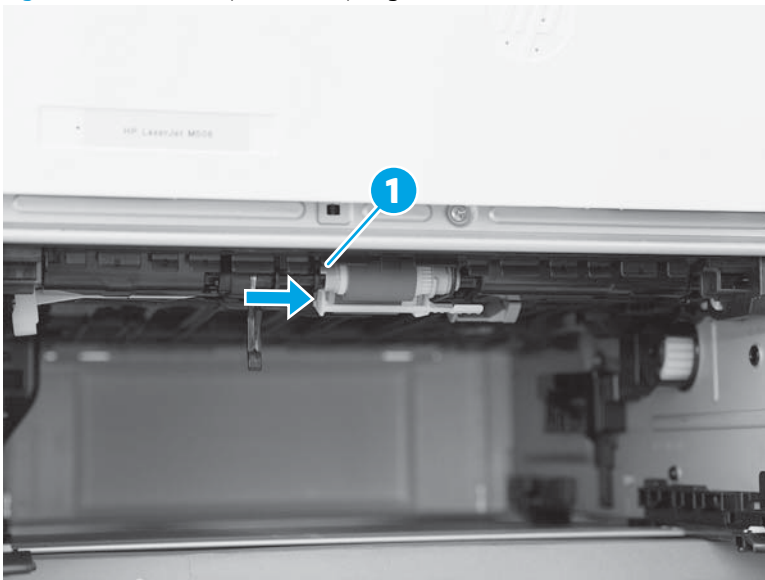

4. To check the installation, repeatedly push up and release, the tray actuator (callout 1) and observe the roller assembly. If the assembly is correctly installed, it moves up and down (callout 2).

 **NOTE:** If the assembly does not properly move, remove it and then reinstall it, making sure that the pin on the assembly is installed in the slot in the actuator arm. See [Figure 2-147 Check the pin on the assembly on page 441](#).

Figure 2-150 Check the installation



Step 5: Install the tray

Use the following procedure to install the tray.

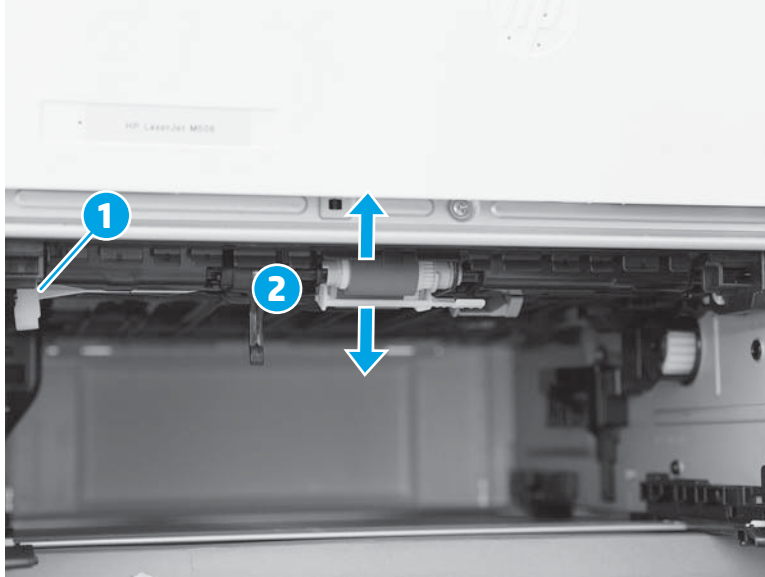
1. With the tray at a slight angle, align the sides of the tray with the rails in the accessory, and then partially slide the tray into the printer.

Figure 2-151 Install the tray

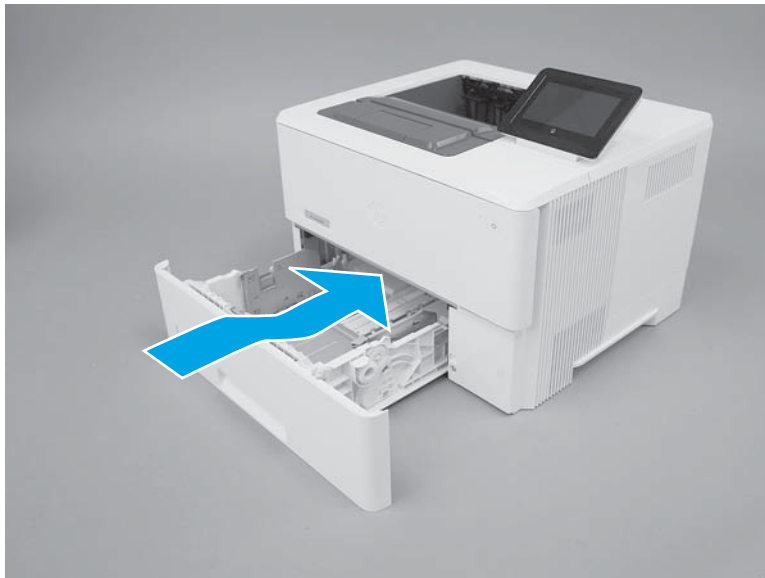

2. Push the tray straight into the accessory to close it.

Figure 2-152 Close the tray



Solve paper handling problems

Review the following information to solve paper handling problems.

- [Printer feeds incorrect page size](#)
- [Printer pulls from incorrect tray](#)
- [Printer will not duplex or duplexes incorrectly](#)
- [Paper does not feed from Tray 2-X](#)
- [Output is curled or wrinkled](#)
- [Printer does not pick up paper or misfeeds](#)

Printer feeds incorrect page size

Review the following information when the printer feeds an incorrect page size.

Table 2-48 Printer feeds incorrect page size

Cause	Solution
The correct size paper is not loaded in the tray.	Load the correct size paper in the tray.
The correct size paper is not selected in the software program or printer driver.	Confirm that the settings in the software program and printer driver are correct, because the software program settings override the printer driver and control panel settings, and the printer driver settings override the control panel settings.
The correct size paper for the tray is not selected in the printer control panel.	From the control panel, select the correct size paper for the tray.
The paper size is not configured correctly for the tray.	Print a configuration page to determine the paper size for which the tray is configured.
The guides in the tray are not against the paper.	Verify that the paper guides are touching the paper.

Printer pulls from incorrect tray

Review the following information when the printer pulls from an incorrect tray.

Table 2-49 Printer pulls from incorrect tray

Cause	Solution
A driver for a different printer is in use.	Use a driver for this printer.
The specified tray is empty.	Load paper in the specified tray.
The paper size is not configured correctly for the input tray.	Print a configuration page or use the control panel to determine the paper size for which the tray is configured.
The guides in the tray are not against the paper.	Verify that the guides are touching the paper.

Printer will not duplex or duplexes incorrectly

Review the following information when the printer will not duplex or duplexes incorrectly.

Table 2-50 Printer will not duplex (print 2-sided jobs) or duplexes incorrectly

Cause	Solution
The duplex job is trying to use unsupported paper.	Verify that the paper is supported for duplex printing.
The printer driver is not set up for duplex printing.	Set up the printer driver to enable duplex printing.
The first page is printing on the back of preprinted forms or letterhead.	Load preprinted forms and letterhead in Tray 1 with the letterhead or printed side down, with the top of the page leading into the printer. For Tray 2-X, load the paper printed side up with the top of the page toward the right of the printer.
The printer model does not support automatic 2-sided printing.	The printer model does not support automatic 2-sided printing.

Paper does not feed from Tray 2-X

Review the following information when the paper does not feed from Tray 2-X.

Table 2-51 Paper does not feed from Tray 2-X

Cause	Solution
The correct size paper is not loaded.	Load the correct size paper.
The input tray is empty.	Load paper in the input tray.
The correct paper type for the input tray is not selected in the printer control panel.	From the printer control panel, select the correct paper type for the input tray. Trays configured for a paper type with a specific weight range will not match a print job that specifies an exact weight, even if the specified weight is within the weight range.
Paper from a previous jam has not been completely removed.	Open the printer and remove any paper in the paper path. Closely inspect the fuser area for jams.
None of the optional trays appear as input tray options.	The optional trays only display as available if they are installed. Verify that any optional trays are correctly installed. Verify that the printer driver has been configured to recognize the optional trays.
An optional tray is incorrectly installed.	Print a configuration page to confirm that the optional tray is installed. If not, verify that the tray is correctly attached to the printer.
The paper size is not configured correctly for the input tray.	Print a configuration page or use the control panel to determine the paper size for which the tray is configured.
The guides in the tray are not against the paper.	Verify that the guides are touching the paper.

Output is curled or wrinkled

Review the following information when the output is curled or wrinkled.

Table 2-52 Output is curled or wrinkled

Cause	Solution
Paper does not meet the specifications for this printer.	Use only paper that meets the HP paper specifications for this printer.

Table 2-52 Output is curled or wrinkled (continued)

Cause	Solution
The correct paper type for the input tray is not selected in the printer control panel.	From the printer control panel, select the correct paper type for the input tray. Trays configured for a paper type with a specific weight range will not match a print job that specifies an exact weight, even if the specified weight is within the weight range.
Paper is damaged or in poor condition.	Remove paper from the input tray and load paper that is in good condition.
The printer is operating in an excessively humid environment.	Verify that the printing environment is within humidity specifications.
The print job consist of large, solid-filled areas.	Large, solid-filled areas can cause excessive curl. Try using a different pattern.
Paper used was not stored correctly and might have absorbed moisture.	Remove paper and replace it with paper from a fresh, unopened package.
Paper has poorly cut edges.	Remove paper, flex it, rotate it 180 degrees or turn it over, and then reload it into the input tray. Do not fan paper. If the problem persists, replace the paper.
The specific paper type was not configured for the tray or selected in the software.	Configure the software for the paper (see the software documentation). Configure the tray for the paper.
The paper has previously been used for a print job.	Do not re-use paper.

Printer does not pick up paper or misfeeds

Use the following procedures if the printer will not pick up paper or misfeeds paper.

- [The printer does not pick up paper](#)
- [The printer picks up multiple sheets of paper](#)
- [The document feeder jams, skews, or picks up multiple sheets of paper \(M527/E52545/M528/E52645\)](#)
- [Paper does not feed automatically](#)

The printer does not pick up paper

If the printer does not pick up paper from the tray, try these solutions.



NOTE: Tray 1 and Tray 2 are optimal for paper pickup when using special paper or media other than 20lb plain paper. For Tray 1 and Tray 2 the printer increases the number of attempts to pick up a page, which increases the reliability of successfully picking the page from the tray and decreases the possibility of a mispick jam.

HP recommends using Tray 1 or Tray 2 if the printer is experiencing excessive or reoccurring jams from trays other than Tray 1 and Tray 2, or for print jobs that require media other than 20lb plain paper.

1. Open the printer and remove any jammed sheets of paper.
2. Load the tray with the correct size of paper for the job.
3. Make sure the paper size and type are set correctly on the printer control panel.
4. Make sure the paper guides in the tray are adjusted correctly for the size of paper. Adjust the guides to the appropriate indentation in the tray.
5. Check the printer control panel to see if the printer is waiting for an acknowledgment to the feed the paper manually prompt. Load paper, and continue.
6. The rollers above the tray might be contaminated. Clean the rollers with a lint-free cloth dampened with warm water.

The printer picks up multiple sheets of paper

If the printer picks up multiple sheets of paper from the tray, try these solutions.

1. Remove the stack of paper from the tray and flex it, rotate it 180 degrees, and flip it over. *Do not fan the paper.* Return the stack of paper to the tray.
2. Use only paper that meets HP specifications for this printer.
3. Use paper that is not wrinkled, folded, or damaged. If necessary, use paper from a different package.
4. Make sure the tray is not overfilled. If it is, remove the entire stack of paper from the tray, straighten the stack, and then return some of the paper to the tray.
5. Make sure the paper guides in the tray are adjusted correctly for the size of paper. Adjust the guides to the appropriate indentation in the tray.
6. Make sure the printing environment is within recommended specifications.

The document feeder jams, skews, or picks up multiple sheets of paper (M527/E52545/M528/E52645)

Review the following information when the document feeder jams, skews, or picks up multiple sheets of paper.

- Check to see if there are areas on the page that might have had staples removed. This can cause jams and/or mispicks.
- The original might have something on it, such as staples or self-adhesive notes that must be removed.
- Check that all rollers are in place and correctly installed.
- Make sure that the top document-feeder cover is closed.
- The pages might not be placed correctly. Straighten the pages and adjust the paper guides to center the stack.
- The paper guides must be touching the sides of the paper stack to work correctly. Make sure that the paper stack is straight and the guides are against the paper stack.
- The document feeder input tray or output bin might contain more than the maximum number of pages. Make sure the paper stack fits below the guides in the input tray, and remove pages from the output bin.
- Verify that there are no pieces of paper, staples, paper clips, or other debris in the paper path.
- Clean the document-feeder rollers and the separation pad. Use compressed air or a clean, lint-free cloth moistened with warm water. If misfeeds still occur, replace the rollers.

Paper does not feed automatically

Review the following information when the paper does not feed automatically.

Table 2-53 Paper does not feed automatically

Cause	Solution
Manual feed is selected in the software program.	Load Tray 1 with paper, or, if the paper is loaded, press the OK button.
The correct size paper is not loaded.	Load the correct size paper.
The input tray is empty.	Load paper into the input tray.
Paper from a previous jam has not been completely removed.	Open the printer and remove any paper in the paper path.
The paper size is not configured correctly for the input tray.	Print a configuration page or use the control panel to determine the paper size for which the tray is configured.
The guides in the tray are not against the paper.	Verify that the rear and width paper guides are touching the paper.

Clear paper jams

Use the following information and procedures to clear paper jams.

- [Paper path jam sensor locations](#)
- [Auto-navigation for clearing jams](#)
- [Experiencing frequent or recurring paper jams?](#)
- [Clear paper jams in the document feeder](#)
- [Clear paper jams in Tray 1](#)
- [Clear paper jams in Tray 2 and the 550-sheet trays](#)
- [Clear paper jams in the toner-cartridge area](#)
- [Clear paper jams in the rear door and the fuser area](#)
- [Clear paper jams in the output bin](#)
- [Clear paper jams in the duplexer](#)
- [Change jam recovery \(all except M501\)](#)

Paper path jam sensor locations

Use the figures below to identify the locations of sensors where reoccurring jams are found.

Figure 2-153 Jam sensors

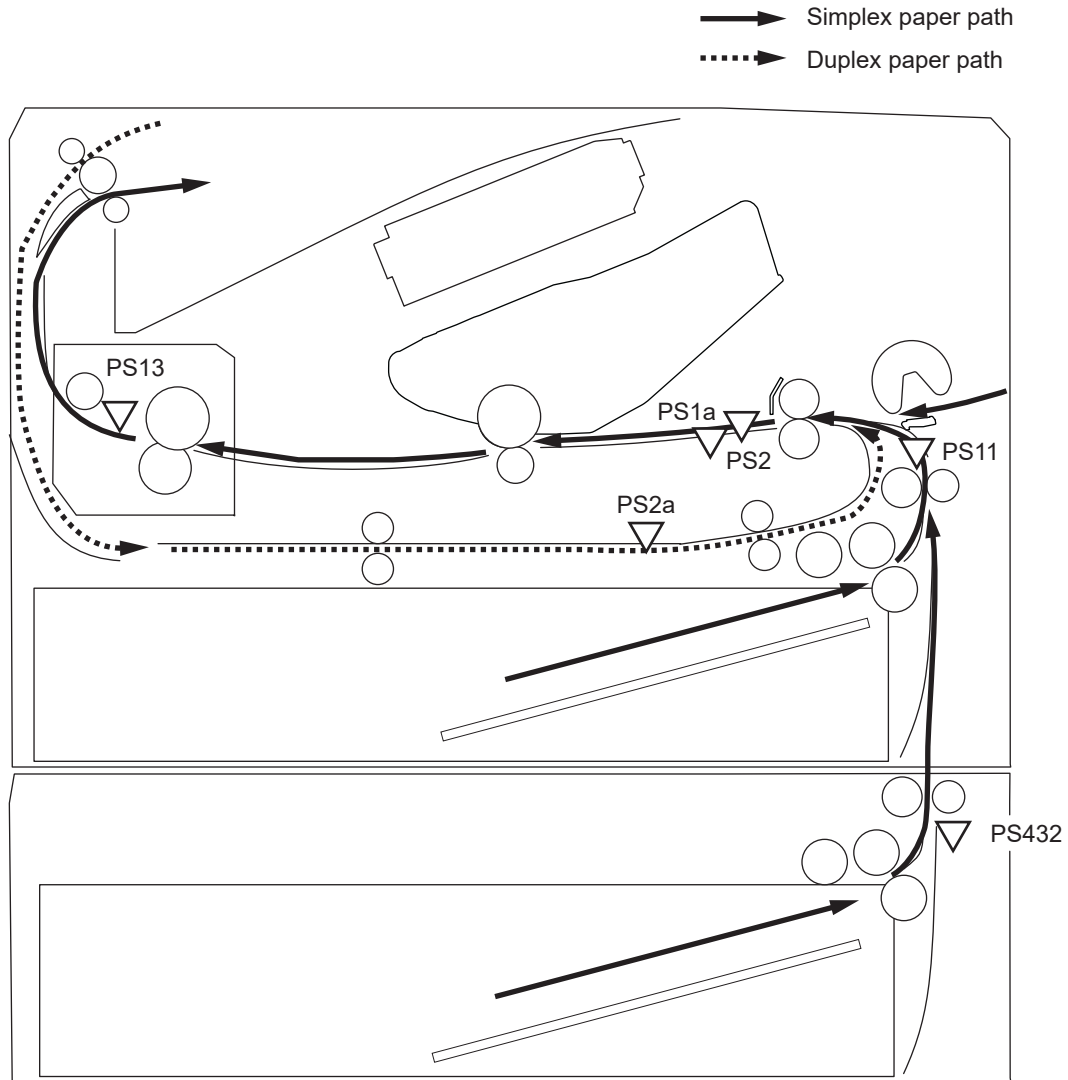

Table 2-54 Jam sensors

Sensor	Description	Sensor	Description
SR2	TOP sensor	SR2a	Duplex feed sensor ¹
SR1a	Media-width sensor	SR11	Registration sensor
SR13	Fuser output sensor	SR432	Paper feeder feed sensor ²

¹ Duplex models only.

² 550-sheet paper feeder accessory.

Auto-navigation for clearing jams

The auto-navigation feature assists you in clearing jams by providing step-by-step instructions on the control panel. When you complete a step, the product displays instructions for the next step until you have completed all steps in the procedure.

Experiencing frequent or recurring paper jams?

To reduce the number of paper jams, try these solutions.

1. Use only paper that meets HP specifications for this product.
2. Use paper that is not wrinkled, folded, or damaged. If necessary, use paper from a different package.
3. Use paper that has not previously been printed or copied on.
4. Make sure the tray is not overfilled. If it is, remove the entire stack of paper from the tray, straighten the stack, and then return some of the paper to the tray.
5. Make sure the paper guides in the tray are adjusted correctly for the size of paper. Adjust the guides so they are touching the paper stack without bending it.
6. Make sure that the tray is fully inserted in the product.
7. If you are printing on heavy, embossed, or perforated paper, use the manual feed feature and feed sheets one at a time.
8. Open the [Trays](#) menu on the product control panel. Verify that the tray is configured correctly for the paper type and size.
9. Make sure the printing environment is within recommended specifications.

Clear paper jams in the document feeder

The following information describes how to clear paper jams in the document feeder.

When a jam occurs, the control panel displays an animation that assists in clearing the jam.

1. Lift the latch to release the document-feeder cover.

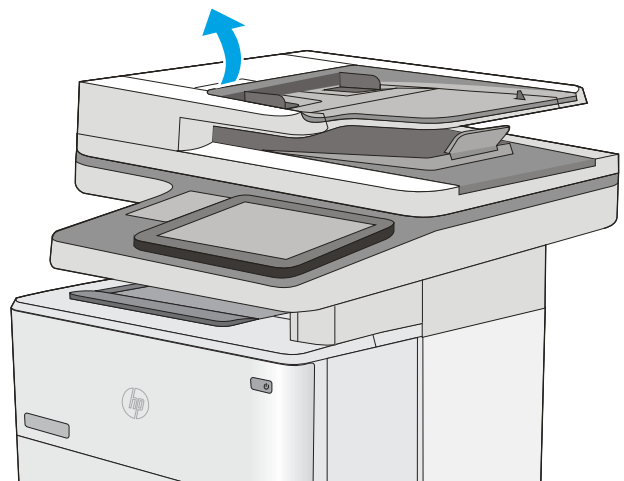

2. Open the document-feeder cover.

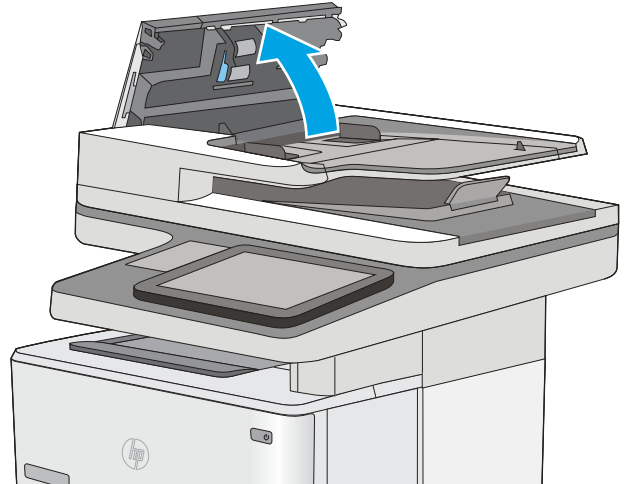

3. Remove any jammed paper.



4. Lift the document-feeder input tray.

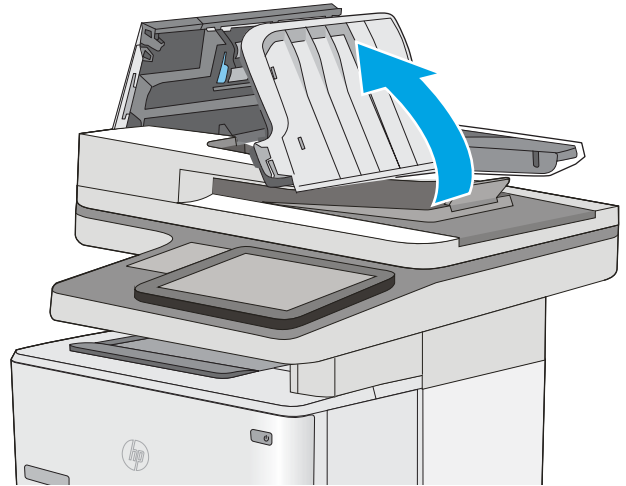

5. Remove any jammed paper.

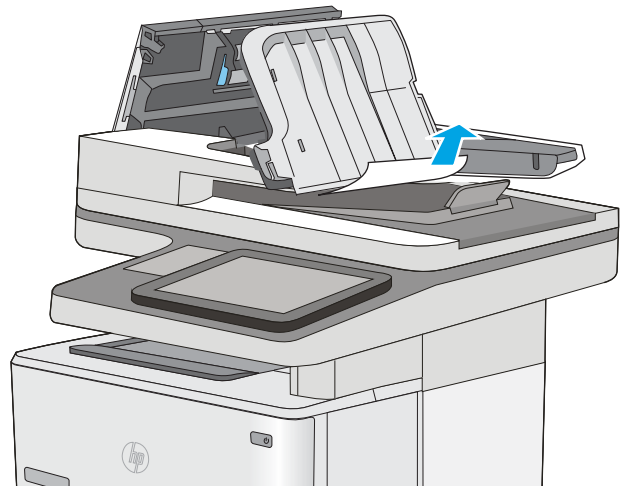

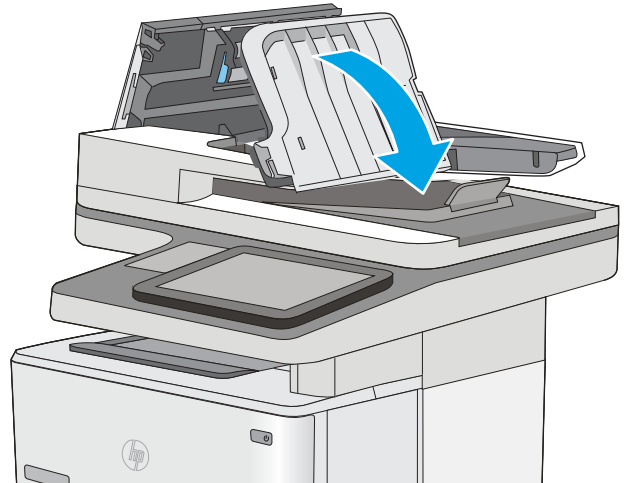

6. Lower the document-feeder input tray.

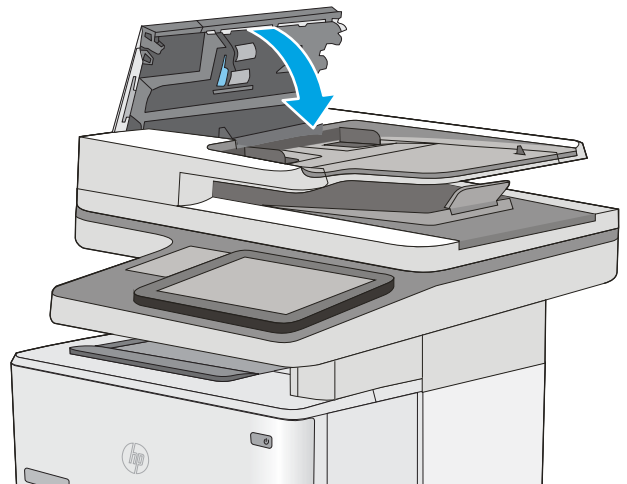

7. Close the document-feeder cover.

NOTE: Verify that the latch on the top of the document-feeder cover is completely closed.



 **NOTE:** To avoid jams, make sure the guides in the document-feeder input tray are adjusted against the document, without bending the document. To copy narrow documents, use the flatbed scanner. Remove all staples and paper clips from original documents.

 **NOTE:** Original documents that are printed on heavy, glossy paper can jam more frequently than originals that are printed on plain paper.

Clear paper jams in Tray 1

Use the following procedure to clear paper jams in Tray 1.

When a jam occurs, the control panel displays an animation that assists in clearing the jam.

1. If most of the sheet of paper is visible in the tray, slowly pull the jammed paper out of the printer. Make sure that the entire sheet is removed. If it tears, continue with the following steps to find the remnants.

If most of the sheet of paper has been pulled inside the printer, continue with the following steps.

2. Press the top-cover-release button on the left side of the printer.

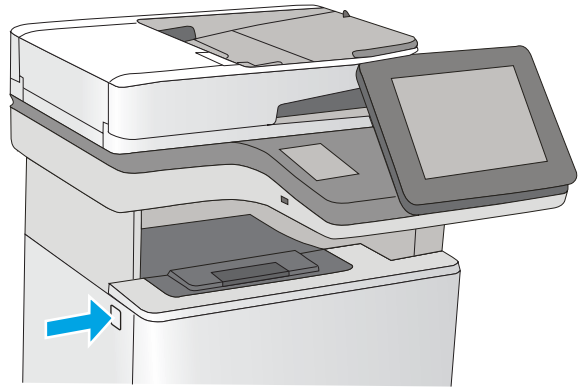
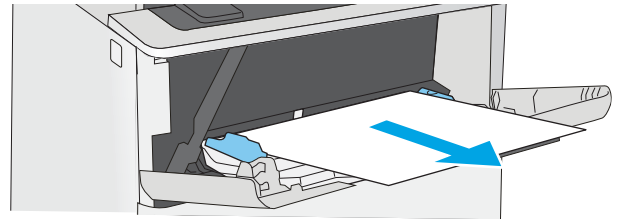

3. Open the front door.

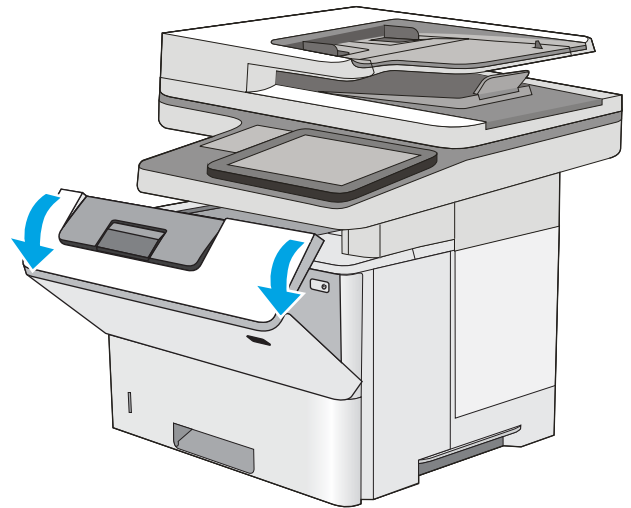

4. Remove the toner cartridge.

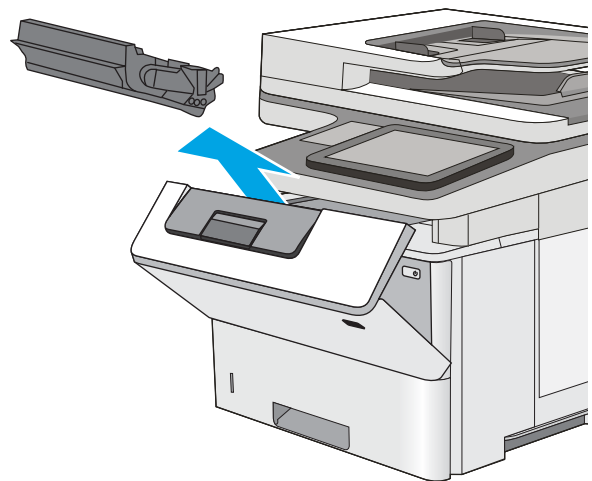

5. Lift the jam-access cover and slowly remove any jammed paper. Be careful not to tear the paper.

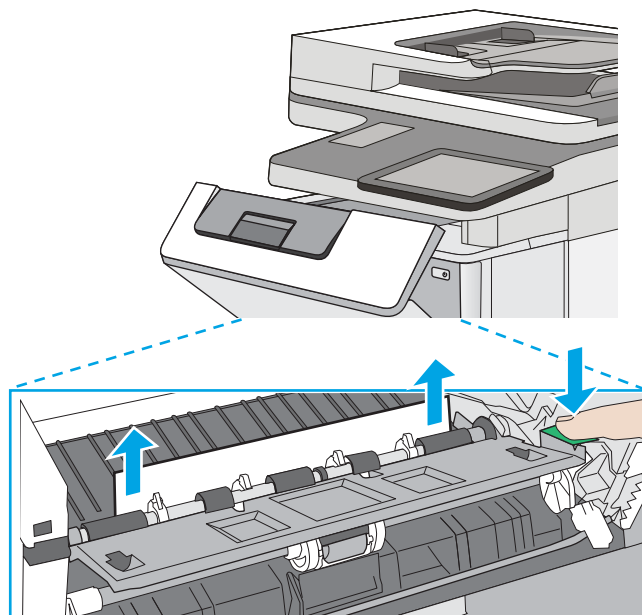

6. Reinsert the toner cartridge.

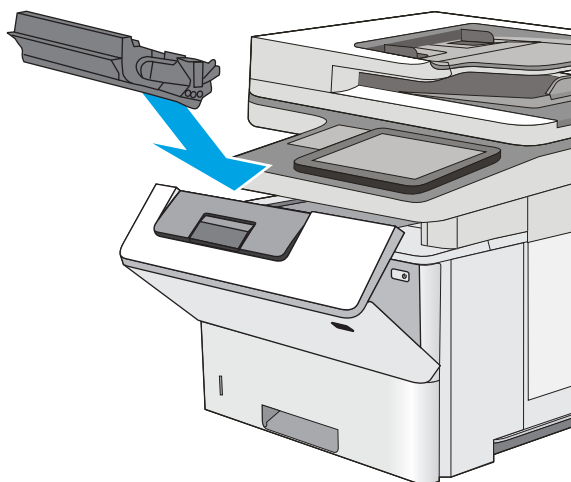

7. Close the front door.

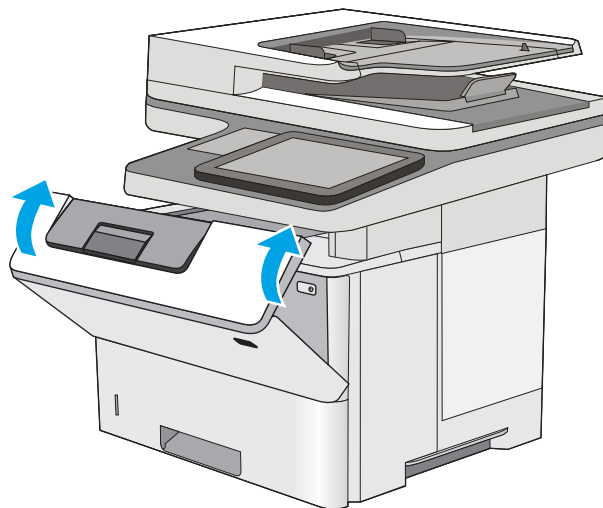

Clear paper jams in Tray 2 and the 550-sheet trays

Use the following procedure to check for paper in all possible jam locations related to Tray 2 and the 550-sheet trays.

When a jam occurs, the control panel displays an animation that assists in clearing the jam.

1. Remove the tray from the printer.

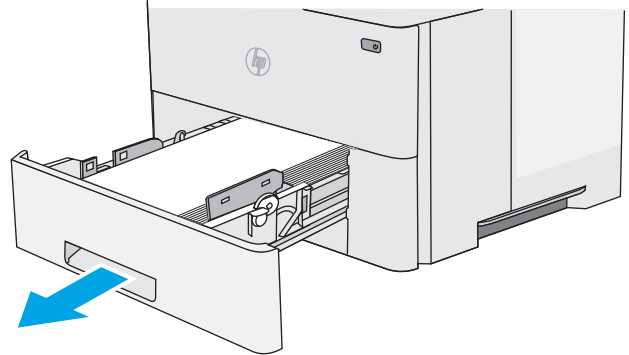

2. Remove the paper from the tray, and discard any damaged paper.

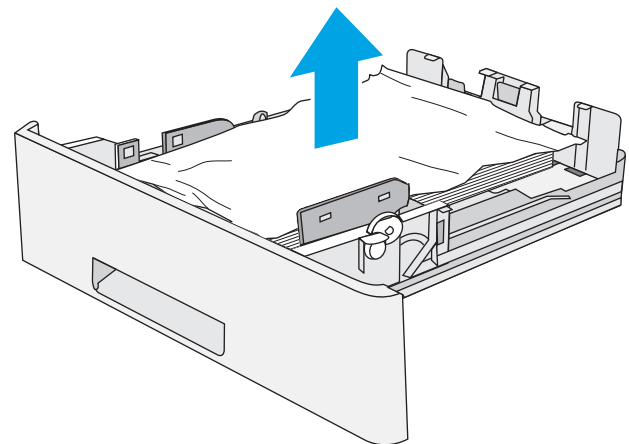

3. Verify that the rear paper guide is adjusted to the indentation for the correct paper size. If necessary, pinch the release and move the rear paper guide to the correct position. It should click into place.

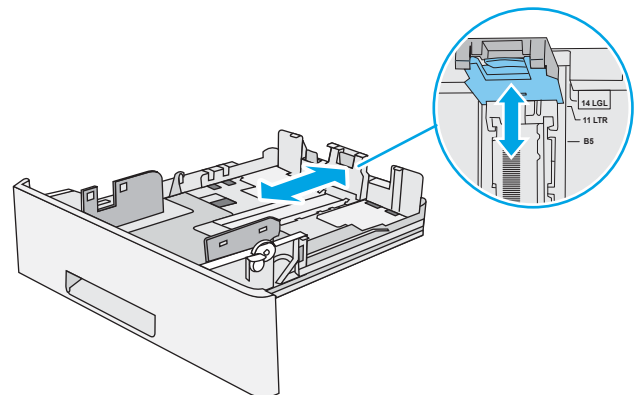

4. Load the paper into the tray. Make sure that the stack is flat at all four corners and that the top of the stack is below the maximum-height indicators.

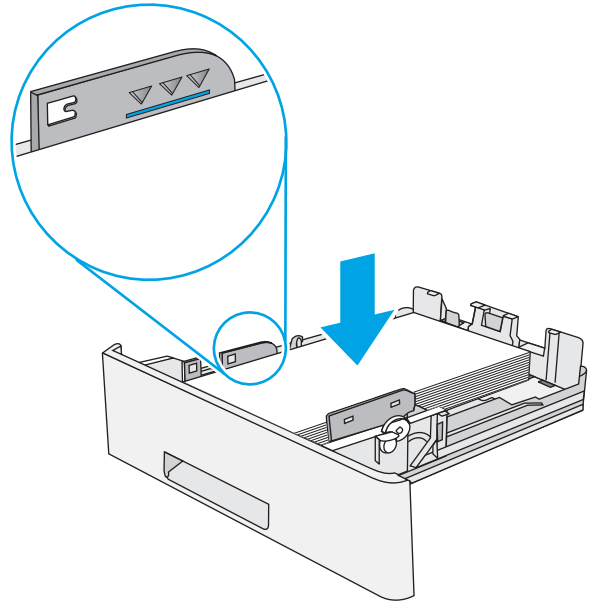

5. Reinsert and close the tray.

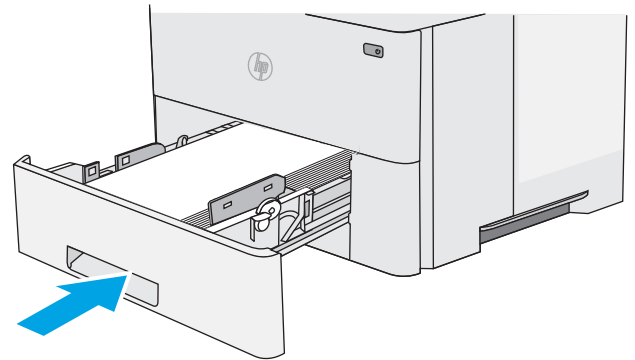

6. Press the top-cover-release button on the left side of the printer.

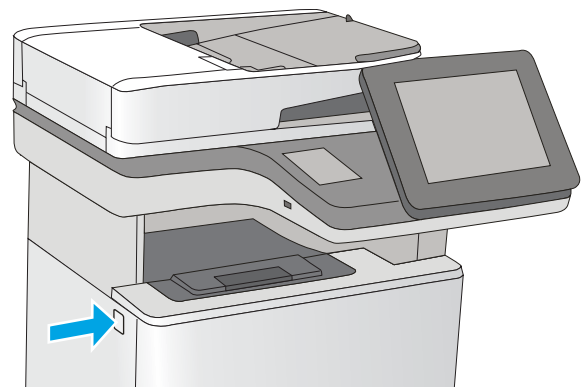

7. Open the front door.

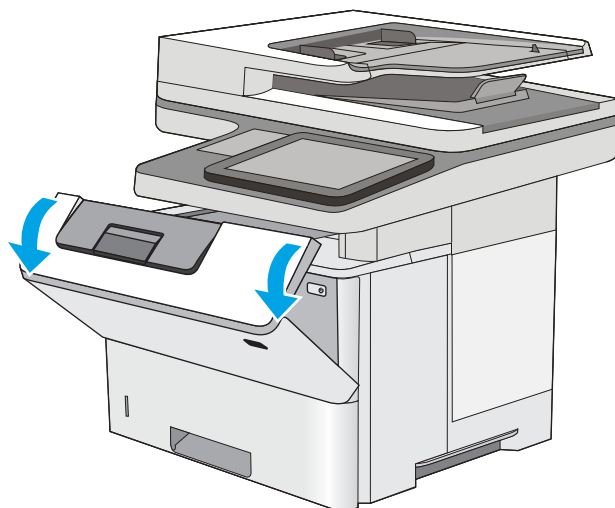

8. Remove the toner cartridge.

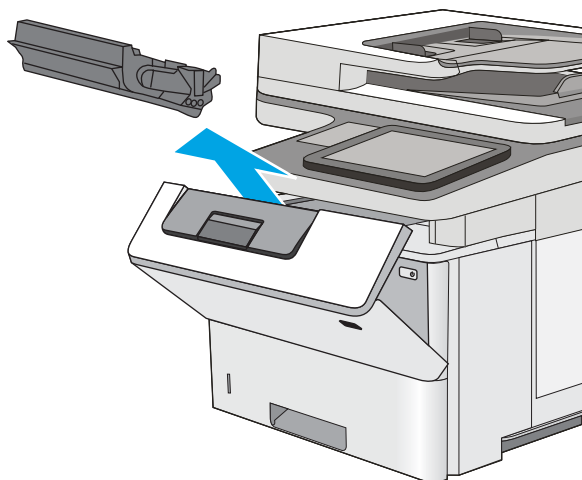

9. Lift the jam-access cover and slowly remove any jammed paper. Be careful not to tear the paper.

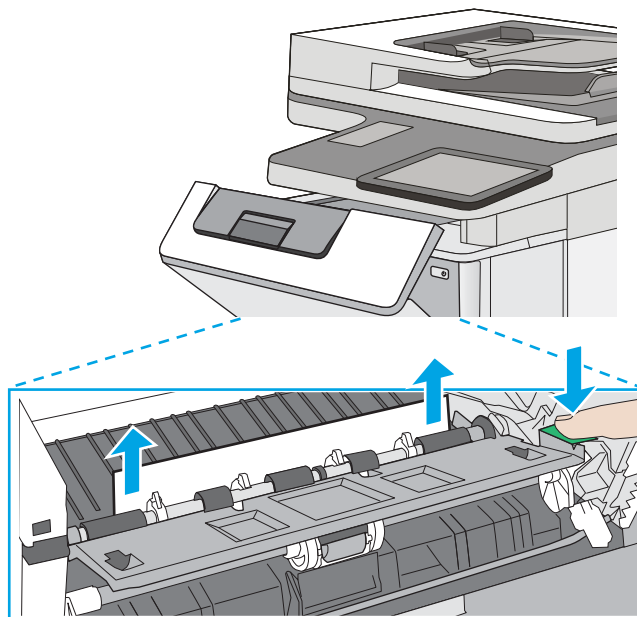

10. Reinsert the toner cartridge.

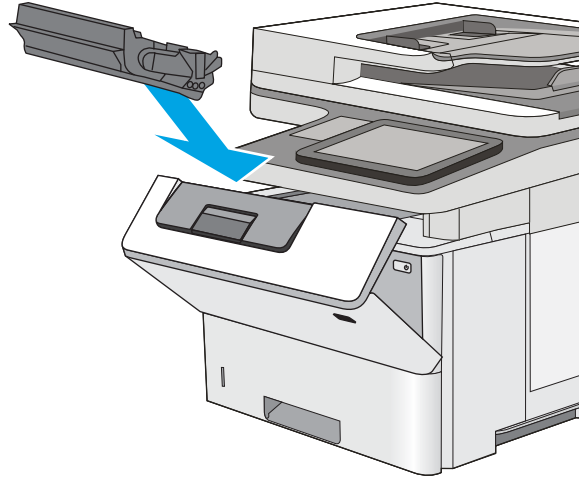

11. Close the front door.

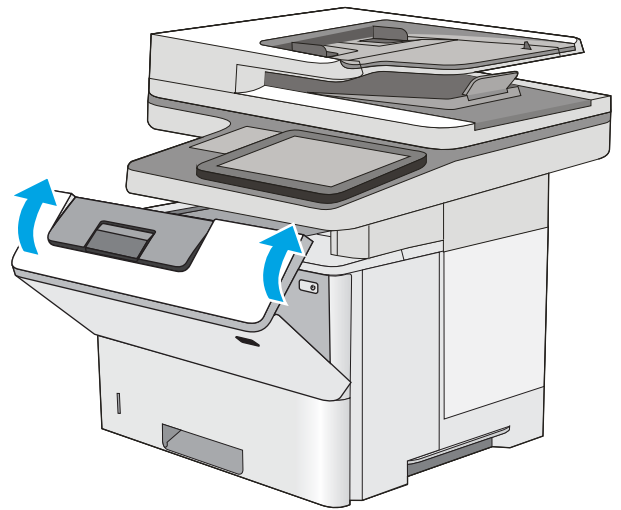

Clear paper jams in the toner-cartridge area

Use the following procedure to check for paper in all possible jam locations in the toner-cartridge area.

When a jam occurs, the control panel displays an animation that assists in clearing the jam.

1. Press the top-cover-release button on the left side of the printer.

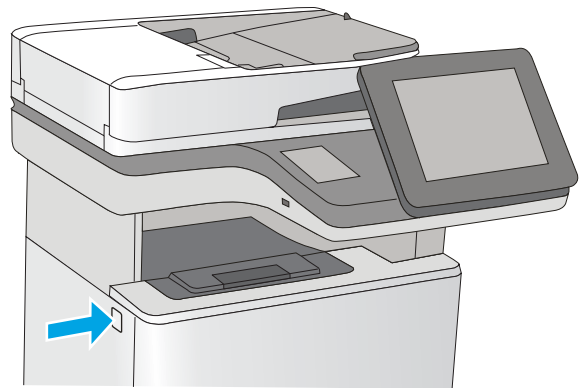

2. Open the front door.

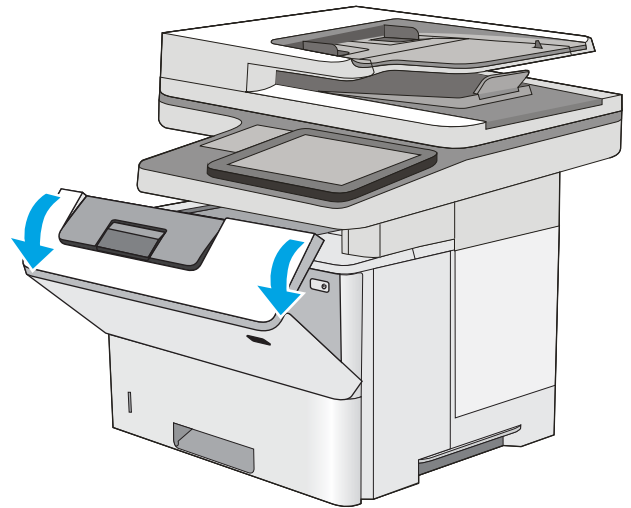

3. Remove the toner cartridge.

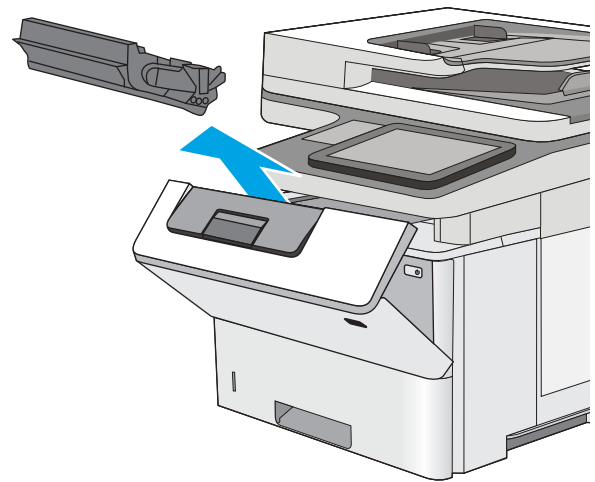

4. Lift the jam-access cover and slowly remove any jammed paper. Be careful not to tear the paper.

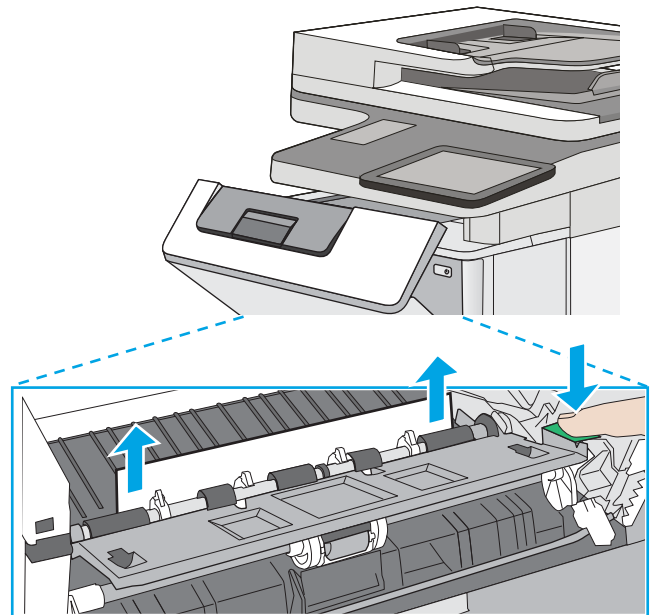

5. Reinsert the toner cartridge.

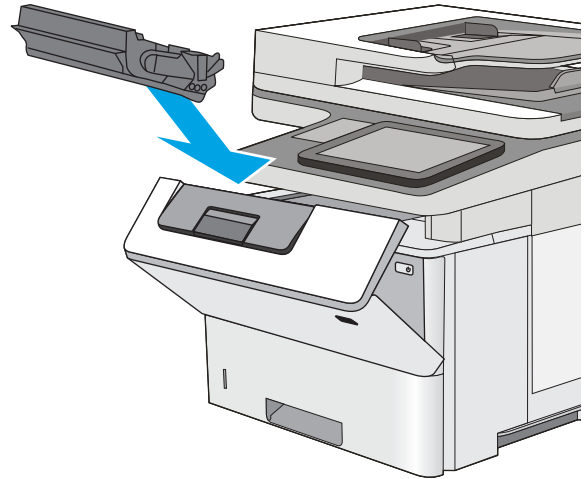

6. Close the front door.

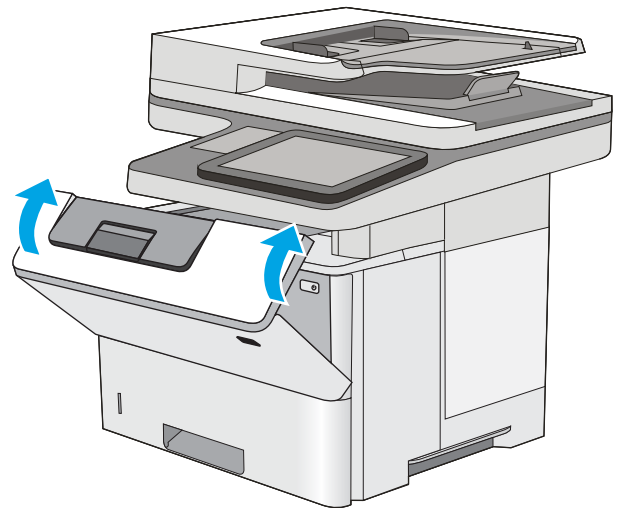

Clear paper jams in the rear door and the fuser area

Use the following procedure to clear paper jams in the rear door and fuser area.

When a jam occurs, the control panel displays an animation that assists in clearing the jam.

 **NOTE:** The fuser is hot while the printer is in use. Wait for the fuser to cool before clearing jams.

1. Open the rear door.

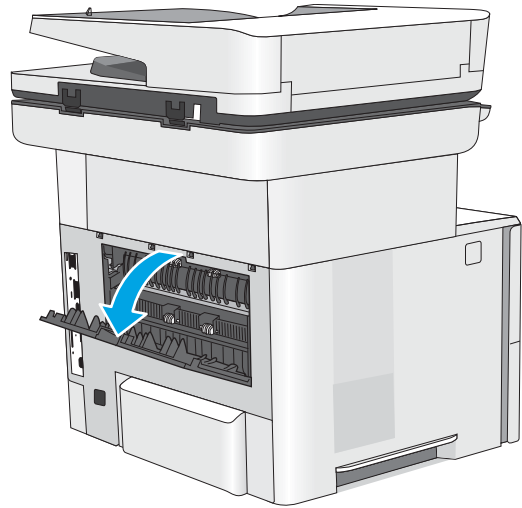

2. Remove any jammed paper.

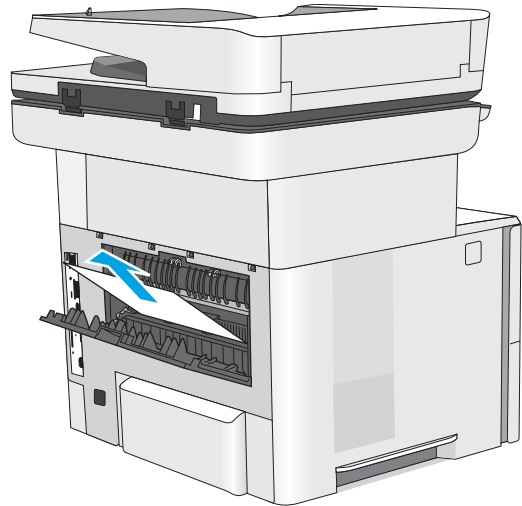

3. Close the rear door

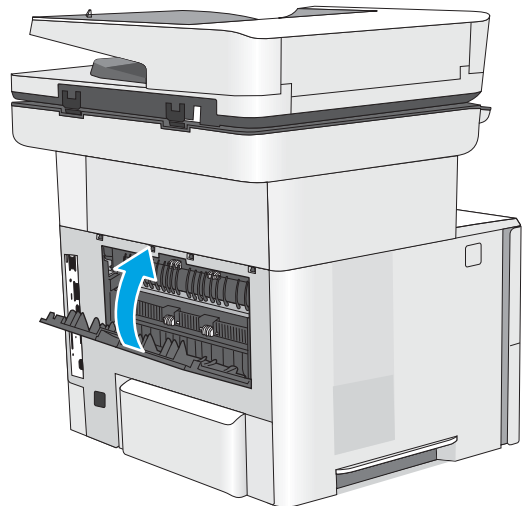

Clear paper jams in the output bin

Use the following procedure to check for paper in all possible jam locations in the output bin.

When a jam occurs, the control panel displays an animation that assists in clearing the jam.

1. If paper is visible in the output bin, grasp the leading edge and remove it.

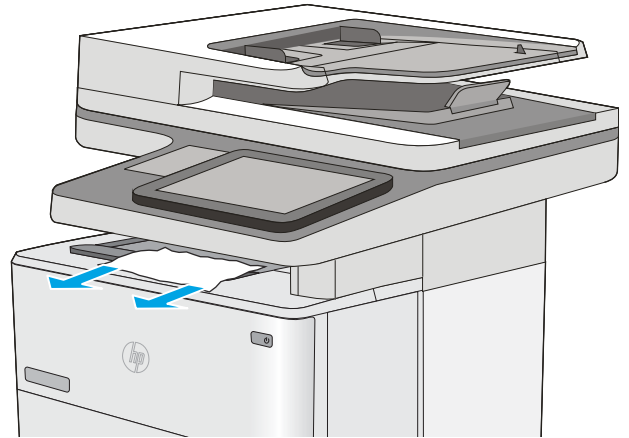

Clear paper jams in the duplexer

Use the following procedure to check for paper in all possible jam locations in the automatic duplexer.

When a jam occurs, the control panel displays an animation that assists in clearing the jam.

1. Remove Tray 2 from the printer.

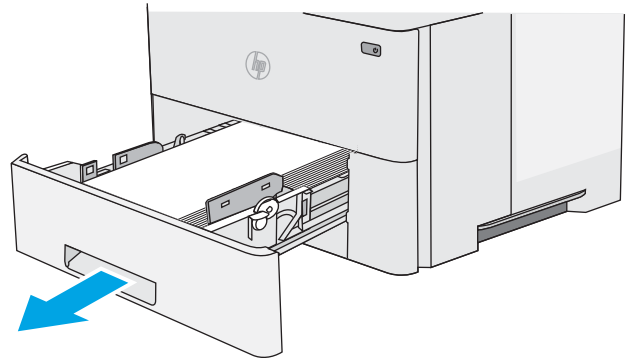

2. Pull forward on the green tab inside the tray area to release the duplex pan.

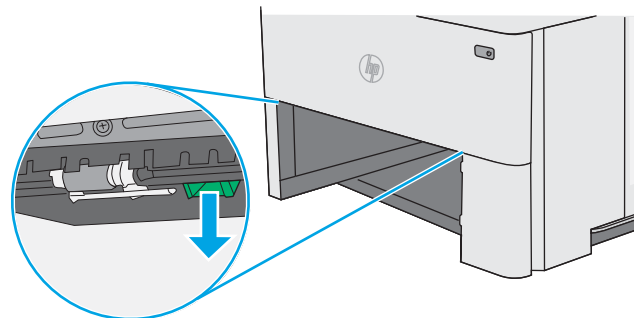

3. Remove any jammed paper.

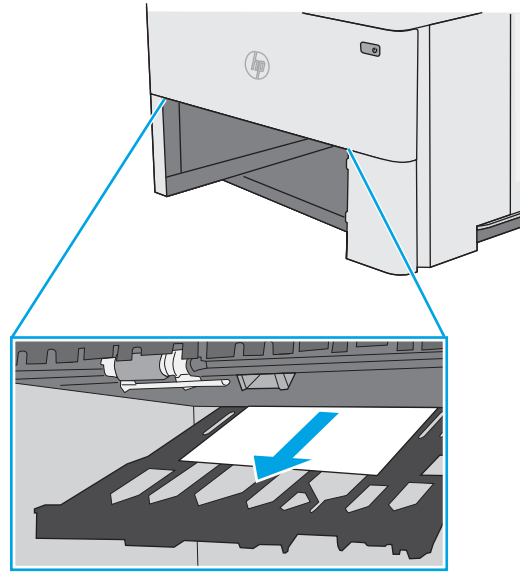

4. Close the duplex pan.

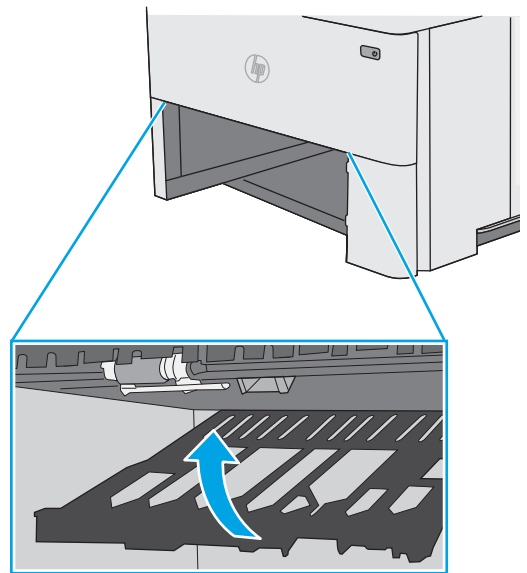

5. Reinsert and close the tray.

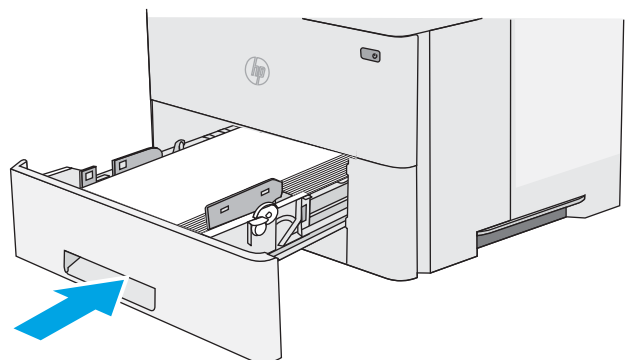

6. Open the rear door.

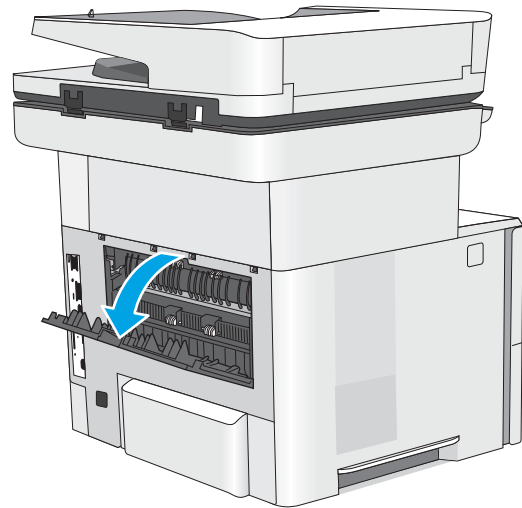

7. Remove any jammed paper.

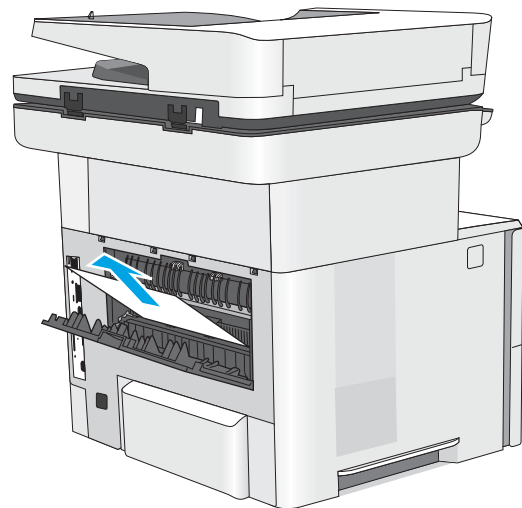

8. Close the rear door

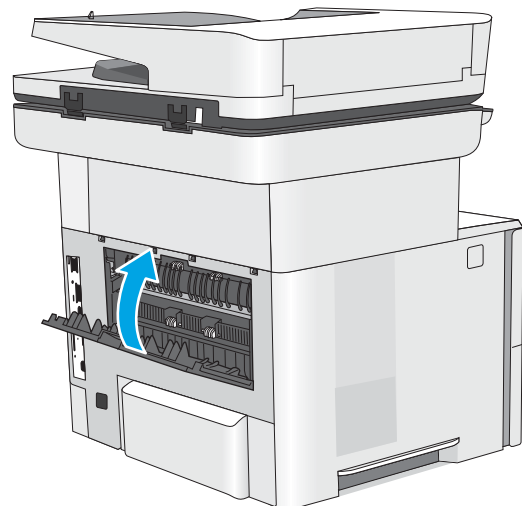

9. Press the top-cover-release button on the left side of the printer.

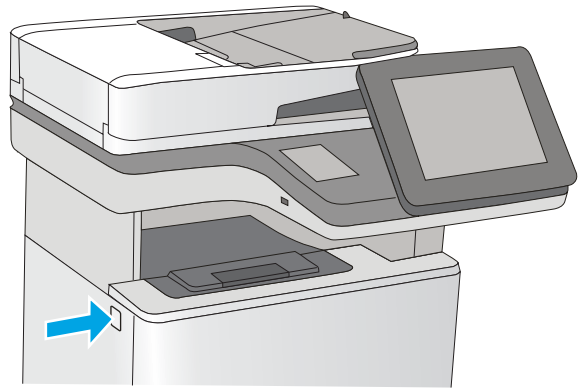

10. Open the front door.

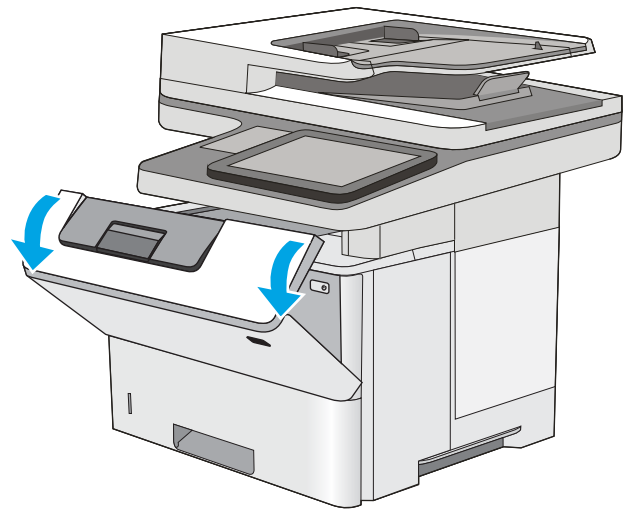

11. Remove the toner cartridge.

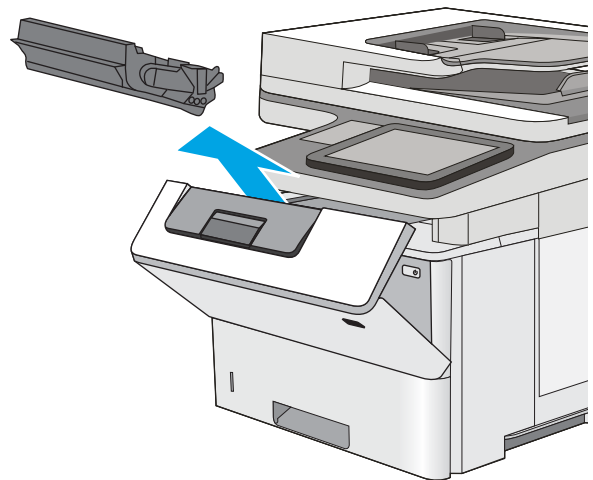

12. Lift the jam-access cover and slowly remove any jammed paper. Be careful not to tear the paper.

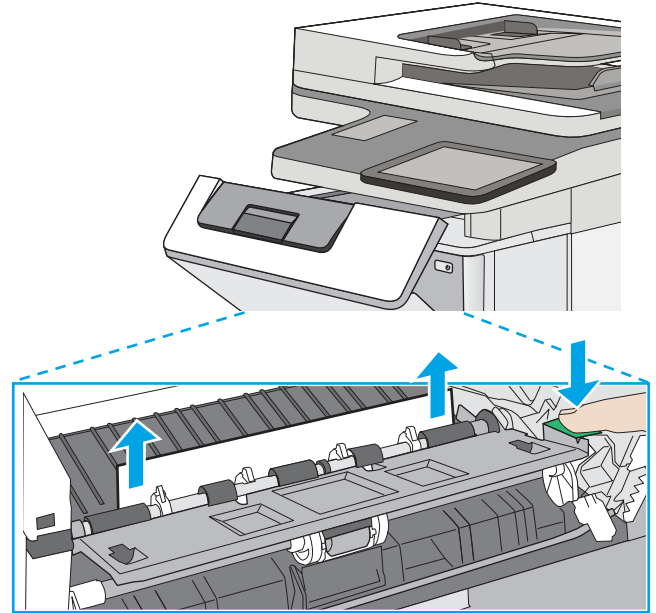

13. Reinsert the toner cartridge.

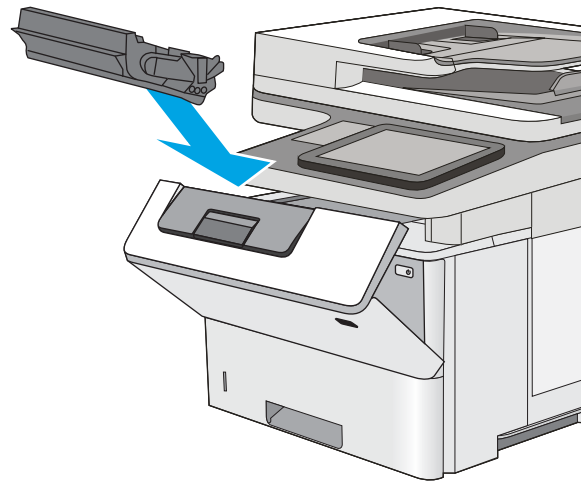

14. Close the front door.

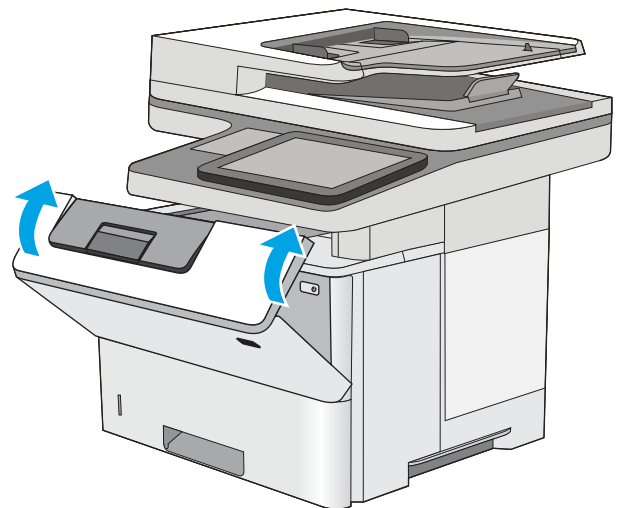

Change jam recovery (all except M501)

This printer provides a jam recovery feature that reprints jammed pages.

- [Change jam recovery from a touchscreen control panel](#)
- [Change jam recovery from a LCD control panel](#)

Change jam recovery from a touchscreen control panel

Use the following procedure to change jam recovery from a touchscreen control panel.

1. From the Home screen on the printer control panel, scroll to and touch the [Administration](#) button (FutureSmart 3), or scroll to and touch the [Settings](#) button (FutureSmart 4).
2. Open the [General Settings](#) menu (FutureSmart 3) or the [Settings](#) menu (FutureSmart 4), and then open the [Jam Recovery](#) menu.
3. Select one of the following options:
 - [Automatic](#) — The printer attempts to reprint jammed pages when sufficient memory is available. This is the default setting.
 - [Off](#) — The printer does not attempt to reprint jammed pages. Because no memory is used to store the most recent pages, performance is optimal.



NOTE: Some pages can be lost if the printer runs out of paper while printing a duplex job with Jam Recovery set to [Off](#).

- [On](#) — The printer always reprints jammed pages. Additional memory is allocated to store the last few pages printed.

Change jam recovery from a LCD control panel

Use the following procedure to change jam recovery from a LCD control panel.

FutureSmart 3

1. From the [Home](#) screen on the printer control panel, use the down arrow ▼ button to scroll to [Administration](#), and then press the [OK](#) button.
2. Use the down arrow ▼ button to scroll to [General Settings](#), and then press the [OK](#) button.
3. Use the down arrow ▼ button to scroll to [Jam Recovery](#), and then press the [OK](#) button.
4. Use the down arrow ▼ button to scroll to an option, and then press the [OK](#) button to select it.
 - [Automatic](#) — The printer attempts to reprint jammed pages when sufficient memory is available. This is the default setting.
 - [Off](#) — The printer does not attempt to reprint jammed pages. Because no memory is used to store the most recent pages, performance is optimal.



NOTE: Some pages can be lost if the printer runs out of paper while printing a duplex job with Jam Recovery set to [Off](#).

- [On](#) — The printer always reprints jammed pages. Additional memory is allocated to store the last few pages printed.

FutureSmart 4

1. From the [Home](#) screen on the printer control panel, use the arrow keys to navigate to [Settings](#), and then press the [OK](#) button.
 2. Use the down arrow ▼ button to scroll to [General](#), and then press the [OK](#) button.
 3. Use the down arrow ▼ button to scroll to [Jam Recovery](#), and then press the [OK](#) button.
 4. Use the down arrow ▼ button to scroll to an option, and then press the [OK](#) button to select it.
 - [Auto](#) — The printer attempts to reprint jammed pages when sufficient memory is available. This is the default setting.
 - [Off](#) — The printer does not attempt to reprint jammed pages. Because no memory is used to store the most recent pages, performance is optimal.
-
-  **NOTE:** Some pages can be lost if the printer runs out of paper while printing a duplex job with Jam Recovery set to [Off](#).
-
- [On](#) — The printer always reprints jammed pages. Additional memory is allocated to store the last few pages printed.

Solve performance problems

Review the following information and procedures to solve performance problems.

- [Factors affecting print performance](#)
- [Print speeds](#)
- [The printer does not print or it prints slowly](#)



NOTE: Tray 1 and Tray 2 are optimal for paper pickup when using special paper or media other than 20lb plain paper. For Tray 1 and Tray 2 the printer increases the number of attempts to pick up a page, which increases the reliability of successfully picking the page from the tray and decreases the possibility of a mis-pick jam.

HP recommends using Tray 1 or Tray 2 if the printer is experiencing excessive or reoccurring jams from trays other than Tray 1 and Tray 2, or for print jobs that require media other than 20lb plain paper.

Factors affecting print performance

Review the following information about factors affecting print performance.

Table 2-55 Solve performance problems

Problem	Cause	Solution
Pages print but are totally blank.	The document might contain blank pages.	Check the original document to see if content is present on all of the pages.
Pages print but are totally blank.	The printer might be malfunctioning.	To check the printer, print a Configuration page.
Pages print but are totally blank.	Make sure that the printer is not feeding multiple pages (especially if very thin paper is used).	Make sure that the paper meets HP specifications for this printer. For a complete list of specific HP-brand paper that this printer supports, go to http://www.hp.com/support/ljM501 or http://www.hp.com/support/ljM506 or http://www.hp.com/support/ljE50045 or http://www.hp.com/support/ljM507 or http://www.hp.com/support/ljE50145 or http://www.hp.com/support/ljM527mfp or http://www.hp.com/support/ljE52545mfp or http://www.hp.com/support/ljM528mfp or http://www.hp.com/support/E52645mfp .
Pages print very slowly. NOTE: Some software programs process print jobs slowly.	Heavier paper types can slow the print job.	Print on a different type of paper.
Pages print very slowly. NOTE: Some software programs process print jobs slowly.	Complex pages can print slowly.	Proper fusing might require a slower print speed to ensure the best print quality.
Pages print very slowly. NOTE: Some software programs process print jobs slowly.	Large batches, narrow paper, and special paper such as gloss, transparency, cardstock, and HP Tough Paper can slow the print job.	Print in smaller batches, on a different type of paper, or on a different size of paper.
Pages did not print.	The printer might not be pulling paper correctly.	Make sure paper is loaded in the tray correctly.

Table 2-55 Solve performance problems (continued)

Problem	Cause	Solution
Pages did not print.	The paper is jamming in the printer.	Clear the jam.
Pages did not print.	The USB cable might be defective or incorrectly connected.	<ul style="list-style-type: none">• Disconnect the USB cable at both ends and reconnect it.• Try printing a job that has printed in the past.• Try using a different USB cable.
Pages did not print.	Other devices are running on the host computer.	The printer might not share a USB port. If an external hard drive or network switchbox is connected to the same port as the printer, the other device might be interfering with the printer. To connect and use the printer, disconnect the other device or use two USB ports on the host computer.
Pages did not print.	The print job might not have arrived at the printer.	Check the printer status queue. Also, the Printing message should appear on the control panel display.

Print speeds

Print speed is the number of pages that print in one minute. Print speed depends on different engine-process speeds or operational pauses between printed pages during normal printer operation. Factors that determine the print speed of the printer include the following:

- **Page formatting time**

The printer must pause for each page to be formatted before it prints. Complex pages take more time to format, resulting in reduced print speed. However, most jobs print at full engine speed.
- **Media size**

Legal-size media reduces print speed because it is longer than the standard Letter- or A4-size media. A reduce print speed is used when printing on narrow media to prevent the edges of the fuser from overheating.
- **Media mode**

Some media types require a reduced print speed to achieve maximum print quality on that media. For example, glossy, heavy, and specialty media (for example, envelopes or photos) require a reduced print speed. To maximize the print speed for special media types, make sure that the correct media type in the print driver is selected.
- **Printer temperature**

To prevent printer damage, print speed is reduced if the printer reaches a specific internal temperature (thermal slow down). The starting temperature of the printer, ambient environment temperature, and the print job size effect the number of pages that can be printed before the printer reduces the print speed. Thermal slow down reduces print speed by printing four pages and then pausing for an amount of time before printing continues.
- **Other print speed reduction factors**

Other factors (especially during large print jobs) that can cause reduced print speeds include:

- Density control sequence; occurs every 150 pages and takes about 120 seconds

The printer does not print or it prints slowly

Use the following procedures when the printer does not print or it prints slowly.

- [The printer does not print](#)
- [The printer prints slowly](#)

The printer does not print

If the printer does not print at all, try the following solutions.

1. Make sure the printer is turned on and that the control panel indicates it is ready.
 - If the control panel does not indicate the printer is ready, turn the printer off and then on again.
 - If the control panel indicates the printer is ready, try sending the job again.
2. If the control panel indicates the printer has an error, resolve the error and then try sending the job again.
3. Make sure the cables are all connected correctly. If the printer is connected to a network, check the following items:
 - Check the bottom LED next to the network connection on the printer. If the network is active, the light is green.
 - Make sure that a network cable and not a phone cord is used to connect to the network.
 - Make sure the network router, hub, or switch is turned on and that it is working correctly.
4. Install the HP software for the printer. Using generic printer drivers can cause delays clearing jobs from the print queue.
5. From the list of printers on your computer, right-click the name of this product, click **Properties**, and open the **Ports** tab.
 - If a network cable is used to connect to the network, make sure the printer name listed on the **Ports** tab matches the one on the printer configuration page.
 - If a USB cable is used, and the printer is connected to a wireless network, make sure the box is checked next to **Virtual printer port for USB**.
6. If a personal firewall system on the computer is used, it might be blocking communication with the printer. Try temporarily disabling the firewall to see if it is the source of the problem.
7. If the host computer or the printer is connected to a wireless network, low signal quality or interference might be delaying print jobs.

The printer prints slowly

If the printer prints, but it seems slow, try the following solutions.

1. Make sure the computer meets the minimum specifications for this printer. For a list of specifications, go to this Web site: <http://www.hp.com/support/ljM501> or <http://www.hp.com/support/ljM506> or <http://www.hp.com/support/ljE50045> or <http://www.hp.com/support/ljM507> or <http://www.hp.com/>

support/ljE50145 or <http://www.hp.com/support/ljM527mfp> or <http://www.hp.com/support/ljE52545mfp>
or <http://www.hp.com/support/ljM528mfp> or <http://www.hp.com/support/E52645mfp>.

2. When the printer is configured to print on some paper types, such as heavy paper, the printer prints more slowly so it can correctly fuse the toner to the paper. If the paper type setting is not correct for the type of paper you are using, change the setting to the correct paper type.
3. If the host computer or the printer is connected to a wireless network, low signal quality or interference might be delaying print jobs.

Solve connectivity problems

Review the following information and procedures to solve connectivity problems.

- [Solve USB connection problems](#)
- [Solve wired network problems](#)

Solve USB connection problems

If you have connected the product directly to a computer, check the cable.

- Verify that the cable is connected to the computer and to the product.
- Verify that the cable is not longer than 2 m (6.65 ft). Try using a shorter cable.
- Verify that the cable is working correctly by connecting it to another product. Replace the cable if necessary.

Solve wired network problems

Review the following information and procedures to solve wired network problems.

- [Introduction](#)
- [Poor physical connection](#)
- [The computer is using the incorrect IP address for the printer](#)
- [The computer is unable to communicate with the printer](#)
- [The printer is using incorrect link and duplex settings for the network](#)
- [New software programs might be causing compatibility problems](#)
- [The computer or workstation might be set up incorrectly](#)
- [The printer is disabled, or other network settings are incorrect](#)

Introduction

Check the following items to verify that the printer is communicating with the network. Before beginning, print a configuration page from the printer control panel and locate the printer IP address that is listed on this page.

Poor physical connection

Use the following procedure when the printer has a poor physical connection.

1. Verify that the printer is attached to the correct network port using a cable of the correct length.
2. Verify that cable connections are secure.
3. Look at the network port connection on the back of the printer, and verify that the amber activity light and the green link-status light are lit.
4. If the problem continues, try a different cable or port on the hub.

The computer is using the incorrect IP address for the printer

Use the following procedure when the computer is using the incorrect IP address for the printer.

1. Open the printer properties and click the **Ports** tab. Verify that the current IP address for the printer is selected. The printer IP address is listed on the printer configuration page.
2. If you installed the printer using the HP standard TCP/IP port, select the box labeled **Always print to this printer, even if its IP address changes**.
3. If you installed the printer using a Microsoft standard TCP/IP port, use the hostname instead of the IP address.
4. If the IP address is correct, delete the printer and then add it again.

The computer is unable to communicate with the printer

Use the following procedure when the computer is unable to communicate with the printer.

1. Test network communication by pinging the network.

- a. Open a command-line prompt on your computer.
 - For Windows, click **Start**, click **Run**, type `cmd`, and then press [Enter](#).
 - For OS X, go to **Applications**, then **Utilities**, and open **Terminal**.
 - b. Type `ping` followed by the IP address for your printer.
 - c. If the window displays round-trip times, the network is working.
2. If the ping command failed, verify that the network hubs are on, and then verify that the network settings, the printer, and the computer are all configured for the same network.

The printer is using incorrect link and duplex settings for the network

HP recommends leaving these settings in automatic mode (the default setting). If you change these settings, you must also change them for your network.

New software programs might be causing compatibility problems

Verify that any new software programs are correctly installed and that they use the correct print driver.

The computer or workstation might be set up incorrectly

Use the following procedure when the computer or workstation might be set up incorrectly.

1. Check the network drivers, print drivers, and the network redirection settings.
2. Verify that the operating system is configured correctly.

The printer is disabled, or other network settings are incorrect

Use the following procedure when the printer is disabled, or other network settings are incorrect.

1. Review the configuration page to check the status of the network protocol. Enable it if necessary.
2. Reconfigure the network settings if necessary.

Service mode functions (M501)

Review the following information about service mode functions on an M501 printer.

- [Service menu \(M501\)](#)
- [Service menu settings](#)
- [Restore the factory-set defaults](#)
- [Secondary service menu \(M501\)](#)
- [Printer resets \(M501\)](#)

Service menu (M501)

Use the control panel [Service](#) menu to troubleshoot printer problems.

Service menu settings

The [Service](#) menu is used to adjust print settings, restore factory default settings, and clean the print paper path.

The following [Service](#) menu items are available:

- [Cleaning Page](#)—used to remove dust and toner from the print paper path.
- [USB Speed](#)—used to set the USB speed to high or full.
- [Less Paper Curl](#)—used to put the printer into a mode that reduces paper curl.
- [Archive Print](#)—used to put the printer into a mode that produces output less susceptible to toner smearing and dusting for preservation and archival.
- [Firmware Date](#)—used to display the product's firmware date code.
- [Restore Defaults](#)—used to reset all customer-accessible menu settings back to the factory default settings (except language) via the control panel or software.



NOTE: This [Service](#) menu item does not reset factory-settable settings, including formatter number, page counts, factory paper settings, language, and so on.

- [Signature Check](#)—used to configure how the printer proceeds when a firmware upgrade file does not have a valid signature.
- [LaserJet Update](#)—used to manually update the firmware or to set up automatic firmware updates.

Restore the factory-set defaults

Use the following procedure to restore the factory-set defaults.

- [Restore the factory-set defaults from a LCD control panel \(M501\)](#)

Restore the factory-set defaults from a LCD control panel (M501)

Use the following procedure to restore the factory-set defaults from a LCD control panel on an M501 printer.

1. On the printer control panel, press the **OK** button to open the menus.
2. Open the following menus:
 - [Service](#)
 - [Restore Defaults](#)

The printer automatically restarts.

Secondary service menu (M501)

Use the secondary service menu to print service-related reports and to run special tests. Customers do not have access to this menu.

- [Open the secondary service menu \(M501\)](#)
- [Secondary service menu structure \(M501\)](#)





Open the secondary service menu (M501)

Use the following procedure to open the secondary service menu on an M501 printer.

- [Open the secondary service menu from a LCD control panel \(M501\)](#)

Open the secondary service menu from a LCD control panel (M501)

Use the following procedure to open the secondary service menu from a LCD control panel on an M501 printer.

1. Make sure the printer is in the Ready state.
2. From the printer control panel, press the setup  button to open the main menu.
3. Press and the down arrow  button, and then quickly press the Cancel  button.
4. Press the setup  button. The message **2ndary Service** appears on the control panel display.
5. Press the **OK** button to open the **2ndary Service** menu.



NOTE: Use the arrow buttons to scroll though the **2ndary Service** menu.

Secondary service menu structure (M501)

Review the following information about the secondary service menu structure on an M501 printer.

Table 2-56 Secondary Service menu (M501)

Menu item	Sub-menu item	Description
Service Reports	Cont-Self Test	Print a continuous configuration page.
Service Reports	Error Report	Print an error report.
Service Reports	Extended key map	10-key pad values for job storage.
Speed		Use this item to toggle between high and low.
Default settings		Taylor system defaults (IT managed or self-managed).
Location	A list of available locations appears	This item sets certain printer parameters that are dependent on the location, such as the default paper size and the symbol set. Scroll to the appropriate location and select Yes to set the location. The printer automatically restarts after you change the location.
Line Frequency		This item allows the refresh rate of the touchscreen control panel to be changed between 50 and 60 Hz.
LED Test		This item allows the testing of the different LED Displays
Display Test		Use this test to verify that the LEDs and characters on the control-panel display function correctly. At the beginning of the test, each of the LEDs is turned on one-at-time. Press the OK button to continue to the next LED. After the LED test is complete, the character test begins by testing the pixels on each line. Then, each of the 255 characters is displayed in groups of 16. Press the OK button to continue to the next group of 16 characters. You can cancel the test at any time by pressing the Cancel  button.
Button Test		Use this test to verify that the control-panel buttons function correctly. The display prompts you to press each button.

Table 2-56 Secondary Service menu (M501) (continued)

Menu item	Sub-menu item	Description
CP FW Version		This item shows the current date code of the firmware.
NAND Reset		This item allows the NAND to be reset.
Permanent Config		Allow or prevent the action to be performed.

Printer resets (M501)

Review the following information about printer resets on an M501 printer.

- [NVRAM initialization \(M501\)](#)

NVRAM initialization (M501)

Use the following procedure to perform an NVRAM initialization on an M501 printer.

⚠ CAUTION: All HP Jetdirect settings are also reset. Be sure to print a configuration page before performing an NVRAM initialization. Make note of the IP address that is listed on the Jetdirect configuration page. You need to restore the IP address after performing an NVRAM initialization.

An NVRAM initialization erases all data stored in the unprotected NVRAM sections. Performing an NVRAM initialization resets the following settings and information:

- All menu settings are reset to factory default values.
- All localization settings, including language and country/region, are reset.

After performing an NVRAM initialization, reconfigure any computers that print to this printer so that the computers can recognize the printer.

1. Turn the printer off.
2. Simultaneously press and hold the up arrow ▲ button and the Cancel ✕ button. Keep these buttons depressed as you turn the printer on.
3. When the [Permanent Storage Init.](#) message appears on the display, release the buttons.
4. When the printer has finished the NVRAM initialization, it returns to the Ready state.

Service mode functions (all except M501)

Review the following information about service mode functions.

- [Service menu \(all except M501\)](#)
- [Printer resets \(all except M501\)](#)
- [Format Disk and Partial Clean functions \(all except M501\)](#)

Service menu (all except M501)

The [Service](#) menu is PIN-protected for added security. Only authorized service people have access to the [Service](#) menu. When selecting [Service](#) from the list of menus, the printer prompts the user to enter an eight-digit personal identification number (PIN).

- [Open the service menu from a touchscreen control panel](#)
- [Open the service menu from a LCD control panel](#)
- [Service menu items](#)



NOTE: The printer automatically exits the [Service](#) menu after about one minute if no items are selected or changed.

Open the service menu from a touchscreen control panel

Use the following procedure to open the service menu from a touchscreen control panel.

1. From the Home screen on the printer control panel, scroll to and touch the [Device Maintenance](#) button (FutureSmart 3), or scroll to and touch the [Support Tools](#) button (FutureSmart 4).
2. Open the [Service](#) menu.
3. On the sign-in screen, select [Service Access Code](#) from the drop-down list.
4. Enter the following service access code for the printer:
 - 10050615 (M506/E50045/M507/E50145)
 - 11052715 (M527/E52545/M528/E52645)

Open the service menu from a LCD control panel

Use the following procedure to open the service menu from a LCD control panel.

FutureSmart 3

1. From the [Home](#) screen on the printer control panel, use the down arrow ▼ button to scroll to [Device Maintenance](#), and then press the [OK](#) button.
2. Use the down arrow ▼ button to scroll to [Service](#), and then press the [OK](#) button to select it.
3. Use the down arrow ▼ button to scroll to [Service Access Code](#), and then press the [OK](#) button to select it.
4. Enter the following service access code for the printer:



NOTE: After entering the PIN, press the [OK](#) button.

- 10050615 (M506/E50045/M507/E50145)
- 11052715 (M527/E52545/M528/E52645)

FutureSmart 4

1. From the [Home](#) screen on the printer control panel, use the arrow keys to navigate to [Support Tools](#), and then select [OK](#).
2. Navigate to [Maintenance](#), and then select [OK](#).

3. Navigate to [Service](#), and then select [OK](#).
4. Enter the following service access code for the printer:

 **NOTE:** After entering the PIN, select [Sign In](#).

- 10050615 (M506/E50045/M507/E50145)
- 11052715 (M527/E52545/M528/E52645)

Service menu items

The following menu items appear in the [Service](#) menu.

Table 2-57 Service menu (all except M501)

First level	Second level	Value	Description
Event Log	Print		Print or view the event log.
Clear Event Log	Clear		Use this item to clear the printer event log.
Cycle Counts	Total Engine Cycles		Set the page count that was stored in NVRAM prior to installing a new formatter.
Cycle Counts	Refurbish Cycle Count		Use this item to record the page count when the printer was refurbished.
Cycle Counts	Document (M527/E52545/M528/E52645 only)		Total number of pages since the document feeder kit was replaced.
Cycle Counts	Document Feeder Kit Interval (M527/E52545/M528/E52645 only)		Use this item to set the interval that causes the printer to prompt the customer to replace document feeder maintenance kit.
Cycle Counts	Clean Rollers Count (M527/E52545/M528/E52645 only)		Total number of pages since the document feeder rollers were cleaned.
Cycle Counts	Clean Rollers Interval (M527/E52545/M528/E52645 only)		Use this item to set the interval that causes the printer to prompt the customer to clean the document feeder rollers and separation pad.
Cycle Counts	ADF Count (M527/E52545/M528/E52645 only)		Set the total pages fed through the document feeder.
Cycle Counts	Flatbed Count (M527/E52545/M528/E52645 only)		Set the total pages scanned from the flatbed.
Cycle Counts	ADF Simplex Count (M527/E52545/M528/E52645 only)		Set the total single-sided pages fed through the document feeder.
Cycle Counts	ADF Duplex Count (M527/E52545/M528/E52645 only)		Set the total two-sided pages fed through the document feeder.

Table 2-57 Service menu (all except M501) (continued)

First level	Second level	Value	Description
Cycle Counts	Copy Scan Count (M527/E52545/M528/E52645 only)		Set the total copy pages that have been scanned.
Cycle Counts	Send Scan Count (M527/E52545/M528/E52645 only)		Set the number of scanned pages sent to email.
Cycle Counts	Fax Scan Count NOTE: M527/E52545/M528/E52645 fax models only.		Set the number of scanned pages that have been faxed.
Cycle Counts	Copy Pages Count (M527/E52545/M528/E52645 only)		Set the number of scanned pages that have been printed.
Scanner Settings (M527/E52545/M528/E52645 only)	ADF Settings	Leading edge front	Set the calibration values. WARNING! Do not change these values unless instructed to do so.
		Leading edge back	
		Trailing edge front	
		Trailing edge back	
		Left side front	
		Left side back	
Scanner Settings (M527/E52545/M528/E52645 only)	Glass Settings	Leading edge glass	
		Left Side Glass	
Serial Number			Set the serial number.
Service ID			Use this item to show the date that the printer was first used on the control panel. This eliminates the need for users to keep paper receipts for proof of warranty.
Cold Reset Paper			When you perform a cold reset, the paper size that is stored in NVRAM is reset to the default factory setting. If you replace a formatter board in a country/region that uses A4 as the standard paper size, use this menu to reset the default paper size to A4. LETTER and A4 are the only available values.
Low Alerts		Enable Disable	Turn on (or off) low alerts (for supplies).
Reset Low Alerts		<ul style="list-style-type: none"> ● Reset to level 1 ● Reset to level 2 ● Reset to level 3 ● Set to non-HP managed mode 	

Table 2-57 Service menu (all except M501) (continued)

First level	Second level	Value	Description
PTT Test Mode NOTE: M527/E52545/M528/E52645 fax models only.			Test the internal modem for the analog fax accessory.
PTT Test Mode NOTE: M527/E52545/M528/E52645 fax models only.	Hook Operations	Off Hook On Hook	
PTT Test Mode NOTE: M527/E52545/M528/E52645 fax models only.	Generate Random Data	Select a value from the list.	
PTT Test Mode NOTE: M527/E52545/M528/E52645 fax models only.	Generate DTMF Tone Burst	Select a value from the list.	
PTT Test Mode NOTE: M527/E52545/M528/E52645 fax models only.	Generate DTMF Continuous Tone	Select a value from the list.	
PTT Test Mode NOTE: M527/E52545/M528/E52645 fax models only.	Generate Pulse Burst	Select a value from the list.	
PTT Test Mode NOTE: M527/E52545/M528/E52645 fax models only.	Generate Tone Dial Number	Enter dial number.	
PTT Test Mode NOTE: M527/E52545/M528/E52645 fax models only.	Generate Pulse Dial Number	Enter dial number.	
PTT Test Mode NOTE: M527/E52545/M528/E52645 fax models only.	Generate Single Modem Tone	Range: 1100–2100 Hz Default = 2100 Hz	
PTT Test Mode NOTE: M527/E52545/M528/E52645 fax models only.	Line Measurements		
PTT Test Mode NOTE: M527/E52545/M528/E52645 fax models only.	Fax Transmit Signal Loss		
Test Support	Continuous Scan (M527/E52545/M528/E52645 only)	2-sided Save to Disk	
Test Support	Continuous Copy (M527/E52545/M528/E52645 only)	2-sided Save to Disk	

Table 2-57 Service menu (all except M501) (continued)

First level	Second level	Value	Description
Test Support	Raw Scan (M527/E52545/M528/E52645 only)	2-sided Mechanical Calibration	
Test Support	Continuous Print from USB		
Test Support	Automatic Calibrations (M527/E52545/M528/E52645 only)	Disabled Enabled*	
Test Support	Runtime Configuration (M527/E52545/M528/E52645 only)	Standard StandardEIC Workflow WorkflowEIC Reconfigure	

Printer resets (all except M501)

Review the following information and procedures about printer resets.

- [Restore factory-set defaults \(all except M501\)](#)
- [Restore the service ID \(all except M501\)](#)
- [Printer cold reset \(all except M501\)](#)

Restore factory-set defaults (all except M501)

Use the following procedures to restore the factory-set defaults.

- [Restore factory-set defaults from a touchscreen control panel](#)
- [Restore factory-set defaults from a LCD control panel](#)



NOTE: The printer restarts automatically after the reset operation completes.

Restore factory-set defaults from a touchscreen control panel

Use the following procedure to restore factory-set defaults from a touchscreen control panel.

1. From the Home screen on the printer control panel, scroll to and touch the [Administration](#) button (FutureSmart 3), or scroll to and touch the [Settings](#) button (FutureSmart 4).
2. Open the following menus:
 - [General Settings](#) (FutureSmart 3) or [General](#) (FutureSmart 4).
 - [Restore Factory Settings](#) (FutureSmart 3) or [Reset Factory Settings](#) (FutureSmart 4).
3. A verification message advises that completing the reset function might result in loss of data. Touch the [Reset](#) button to complete the process.

Restore factory-set defaults from a LCD control panel

Use the following procedure to restore factory-set defaults from a LCD control panel.

FutureSmart 3

1. From the [Home](#) screen on the printer control panel, use the down arrow ▼ button to scroll to [Administration](#), and then press the [OK](#) button.
2. Use the down arrow ▼ button to scroll to [General Settings](#), and then press the [OK](#) button to select it.
3. Use the down arrow ▼ button to scroll to [Restore Factory Settings](#), and then press the [OK](#) button to select it.
4. Use the down arrow ▼ button to scroll to [Restore](#), and then press the [OK](#) button to select it.
5. A verification message advises that completing the reset function might result in loss of data. Touch the [Reset](#) button to complete the process.

FutureSmart 4

1. From the [Home](#) screen on the printer control panel, use the arrow keys to navigate to [Settings](#), and then select [OK](#).
2. Use the down arrow ▼ button to scroll to [General](#), and then press the [OK](#) button.
3. Use the down arrow ▼ button to scroll to [Reset Factory Settings](#), and then press the [OK](#) button to select it.
4. A verification message advises that completing the reset function might result in loss of data. Touch the [Reset](#) button to complete the process.

Restore the service ID (all except M501)

Use the following procedure to restore the service ID.

- [Restore the service ID](#)
- [Convert the service ID to an actual date](#)

Restore the service ID

When replacing the formatter, the date is lost. Use this menu item to reset the date to the original date that the printer was first used. The date format is YYDDD. Use the following formula to calculate the dates:

1. To calculate YY, subtract 1990 from the calendar year. For instance, if the printer was first used in 2002, calculate YY as follows: $2002 - 1990 = 12$. $YY = 12$.
2. Subtract 1 from 10 (October is the tenth month of the year): $10 - 1 = 9$.
 - Multiply 9 by 30: $9 \times 30 = 270$ or add 17 to 270: $270 + 17 = 287$. Thus, $DDD = 287$.

Convert the service ID to an actual date

Use the printer Service ID number to determine whether the printer is still under warranty. Use the following formula to convert the Service ID into the installation date as follows:

1. Add 1990 to YY to get the actual year that the printer was installed.
2. Divide DDD by 30. If there is a remainder, add 1 to the result. This is the month.
3. The remainder from the calculation in step 2 is the date.

Using the Service ID 12287 as an example, the date conversion is as follows:

1. $12 + 1990 = 2002$, so the year is 2002.
2. 287 divided by $30 = 9$ with a remainder of 17. Because there is a remainder, add 1 to 9 to get 10, which represents October.
3. The remainder in step 2 is 17, so that is the date.

The complete date is 17-October-2002.



NOTE: A six-day grace period is built into the date system.

Printer cold reset (all except M501)

Use the following procedures to perform a printer cold reset.

- [Cold reset using the Pre-boot menu from a touchscreen control panel](#)
- [Cold reset using the Pre-boot menu from a LCD control panel](#)

Cold reset using the Pre-boot menu from a touchscreen control panel

Use the following procedure to perform a cold reset using the Pre-boot menu from a touchscreen control panel.

⚠ CAUTION: This procedure resets all printer configurations and settings to factory defaults (customer configurations and settings are lost).

1. Touch the middle of the control panel display when you see the 1/8 under the logo.

Figure 2-154 Open the Pre-boot menu



2. Use the down arrow ▼ button to highlight the +3:Administrator item, and then touch the OK button.
3. Use the down arrow ▼ button to highlight the +8:Startup Options item, and then touch the OK button.
4. Use the down arrow ▼ button to highlight the 2 Cold Reset item, and then touch the OK button to select it.
5. Touch the Home button to return to the main Pre-boot menu and highlight the 1:Continue item, and then touch the OK button.

📝 NOTE: The printer will initialize.

Cold reset using the Pre-boot menu from a LCD control panel

Use the following procedure to perform a cold reset using the Pre-boot menu from a LCD control panel.

⚠ CAUTION: This procedure resets all printer configurations and settings to factory defaults (customer configurations and settings are lost).

1. Press the Cancel  button when you see the 1/8 under the logo.
2. Use the down arrow ▼ button to highlight the +3:Administrator item, and then press the OK button.
3. Use the down arrow ▼ button to highlight the +8:Startup Options item, and then press the OK button.
4. Use the down arrow ▼ button to highlight the 2 Cold Reset item, and then press the OK button to select it.
5. Touch the Home button to return to the main Pre-boot menu and highlight the 1:Continue item, and then touch the OK button.

 **NOTE:** The printer will initialize.

Format Disk and Partial Clean functions (all except M501)

Review the following information about the [Format Disk](#) and [Partial Clean](#) functions.

- [Active and repository firmware locations](#)
- [Partial Clean](#)
- [Format Disk](#)



NOTE: Only for printers with an optional hard-disk drive (HDD) installed).

Active and repository firmware locations

The firmware bundle consists of multiple parts. The main components are the Windows CE Operating System and the printer/peripheral firmware files.

There are two locations/partitions on the hard drive where the firmware components are stored:

- The Active, where the operating system and firmware currently are executing.
- The Repository, the recovery location.

If the Active location is damaged, or a [Partial Clean](#) was performed, the printer automatically copies over the OS and firmware files from the Repository location and the printer recovers.

If both the Active and Repository locations are damaged, or a [Format Disk](#) was performed, then both locations are gone and the error message **99.09.67** displays on the control-panel display. The user must upload the firmware to the printer in order for it to function again.



CAUTION: The [Format Disk](#) option performs a disk initialization for the entire disk. The operating system, firmware files, and third party files (among other files) will be completely lost. HP does not recommend this action.

Partial Clean

The [Partial Clean](#) option erases all partitions and data on the disk drive, except for the firmware repository where a backup copy of the firmware file is stored. This allows the disk drive to be reformatted without having to download a firmware upgrade file to return the printer to a bootable state.

- [Execute a Partial Clean](#)

Characteristics of a Partial Clean

- Customer-defined settings, third-party solutions, firmware files, and the operating system are deleted.
- Rebooting the printer restores the firmware files from the Repository location, but does not restore any customer-defined settings.
- For previous HP printers, a Hard Disk Initialization is similar to executing the [Partial Clean](#) function for this printer.

 **CAUTION:** HP recommends backing-up printer configuration data before executing a [Partial Clean](#) to retain customer-defined settings (if needed). See the [Backup/Restore](#) item in the [Device Maintenance](#) menu.

Reasons for performing Partial Clean

- The printer continually boots up in an error state.



NOTE: Try clearing the error prior to executing a [Partial Clean](#).

- The printer will not respond to commands from the control panel.
- Executing the [Partial Clean](#) function is helpful for troubleshooting hard disk problems.
- To reset the printer by deleting all solutions and customer-defined settings.
- The printer default settings are not properly working.

Execute a Partial Clean

Use the following procedures to execute a [Partial Clean](#) on the printer.

- [Execute a Partial Clean from a touchscreen control panel](#)
- [Execute a Partial Clean from a LCD control panel](#)

Execute a Partial Clean from a touchscreen control panel

Use the following procedure to execute a [Partial Clean](#) from a touchscreen control panel.

⚠ CAUTION: This procedure resets all printer configurations and settings to factory defaults (customer configurations and settings are lost).

1. Touch the middle of the control-panel display when you see the 1/8 under the logo.

Figure 2-155 Open the Pre-boot menu



2. Use the down arrow ▼ button to highlight the **+3:Administrator** item, and then touch the **OK** button.
3. Use the down arrow ▼ button to highlight **Partial Clean** and then touch the **OK** button.
4. Touch the **OK** button again.
5. Touch the Home button to highlight **Continue**, and then touch the **OK** button.

📝 NOTE: The printer initializes.

Execute a Partial Clean from a LCD control panel

Use the following procedure to execute a [Partial Clean](#) from a LCD control panel.

⚠ CAUTION: This procedure resets all printer configurations and settings to factory defaults (customer configurations and settings are lost).

1. Press the **Cancel**  button when you see the 1/8 under the logo.
2. Use the down arrow ▼ button to highlight the **+3:Administrator** item, and then press the **OK** button.
3. Use the down arrow ▼ button to highlight **Partial Clean** and then press the **OK** button.
4. Press the **OK** button again.
5. Press the Home button to highlight **Continue**, and then press the **OK** button.

📝 NOTE: The printer initializes.

Format Disk

The [Format Disk](#) option erases the entire disk drive.

- [Execute a Format Disk](#)

 **CAUTION:** After executing a [Format Disk](#) option, the printer is *not* bootable.

Characteristics of a Format Disk

- Customer-defined settings, third-party solutions, firmware files, and the operating system are deleted.

 **NOTE:** Rebooting the printer *does not* restore the firmware files.

- Rebooting the printer restores the firmware files from the Repository location, but does not restore any customer-defined settings.
- After executing the [Format Disk](#) function, the message **99.09.67** displays on the control panel.
- After executing the [Format Disk](#) function, the printer firmware must be reloaded.

 **CAUTION:** HP recommends not using the [Format Disk](#) option unless an error occurs and the solution in the printer service manual recommends this solution. After executing the [Format Disk](#) function, the printer is unusable.

HP recommends backing-up printer configuration data before executing a [Format Disk](#) to retain customer-defined settings (if needed). See the [Backup/Restore](#) item in the [Device Maintenance](#) menu.

Reasons for performing Format Disk

- The printer continually boots up in an error state.

 **NOTE:** Try clearing the error prior to executing a [Format Disk](#).

- The printer will not respond to commands from the control panel.
- Executing the [Format Disk](#) function is helpful for troubleshooting hard disk problems.
- To reset the printer by deleting all solutions and customer-defined settings.

Execute a Format Disk

Use the following procedures to execute a [Format Disk](#) on the printer.

- [Execute a Format Disk from a touchscreen control panel](#)
- [Execute a Format Disk from a LCD control panel](#)

Execute a Format Disk from a touchscreen control panel

Use the following procedure to execute a [Format Disk](#) from a touchscreen control panel.

CAUTION: This procedure resets all printer configurations and settings to factory defaults (customer configurations and settings are lost).

1. Touch the middle of the control-panel display when you see the [1/8](#) under the logo.

Figure 2-156 Open the Pre-boot menu



2. Use the down arrow ▼ button to highlight the [+3:Administrator](#) item, and then touch the [OK](#) button.
3. Use the down arrow ▼ button to highlight [Format Disk](#), and then touch the [OK](#) button.
4. Touch the [OK](#) button again.

NOTE: When the [Format Disk](#) operation is complete, reload the printer firmware.

Execute a Format Disk from a LCD control panel

Use the following procedure to execute a [Format Disk](#) from a LCD control panel.

CAUTION: This procedure resets all printer configurations and settings to factory defaults (customer configurations and settings are lost).

1. Press the [Cancel](#)  button when you see the [1/8](#) under the logo.
2. Use the down arrow ▼ button to highlight the [+3:Administrator](#) item, and then press the [OK](#) button.
3. Use the down arrow ▼ button to highlight [Format Disk](#), and then press the [OK](#) button.
4. Press the [OK](#) button again.

NOTE: When the [Format Disk](#) operation is complete, reload the printer firmware.

Firmware upgrades (M501)

HP offers periodic printer updates, new Web Services apps, and new features to existing Web Services apps. Follow these steps to update the firmware for a single printer. When you update the firmware, Web Service apps will update automatically.

- [Determine the installed revision of firmware \(M501\)](#)
- [Method one: Update the firmware using the control panel \(M501\)](#)
- [Method two: Update the firmware using the Firmware Update Utility \(M501\)](#)

There are two supported methods to perform a firmware update on this printer. Use only one of the following methods to update the printer firmware.

Determine the installed revision of firmware (M501)

Use the following procedure to determine the installed revision of firmware on an M501 printer.

 **NOTE:** Print a configuration page to determine the installed revision of firmware.

1. On the printer control panel, press the **OK** button.
2. Open the **Reports** menu.
3. Select **Configuration Report**.

Figure 2-157 Configuration page firmware date code location (M501)

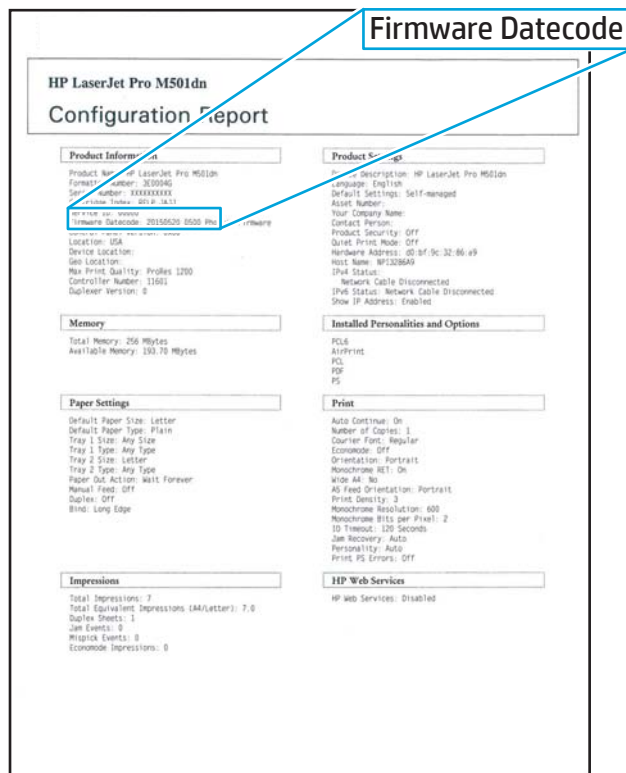

Method one: Update the firmware using the control panel (M501)

Use these steps to load the firmware from the control panel (for network-connected printers only), and/or set the printer to automatically load future firmware updates. For USB-connected printers, use method two.

1. Make sure the printer is connected to a wired (Ethernet) or wireless network with an active Internet connection.

 **NOTE:** The printer must be connected to the internet to update the firmware via a network connection.

2. From the Home screen on the printer control panel, open the [Setup](#) menu.
 - For standard control panels, press the left or right arrow button.
3. Scroll to and open the [Service](#) menu, and then open the [LaserJet Update](#) menu.

 **NOTE:** If the [LaserJet Update](#) option is not listed, use method two.

4. Check for updates.
 - For standard control panels, select **Check for Update**.

 **NOTE:** The printer automatically checks for an update, and if a newer version is detected, the update process automatically starts.

5. Set the printer to automatically update the firmware when updates become available.

From the Home screen on the printer control panel, open the [Setup](#) menu.

- For standard control panels, press the left or right arrow button.

Scroll to and open the [Service](#) menu, open the [LaserJet Update](#) menu, and then select the [Manage Updates](#) menu.

Set the printer to automatically update the firmware.

- For standard control panels, set the **Allow Updates** option to **YES**, and then set the **Automatic Check** option to **ON**.

Method two: Update the firmware using the Firmware Update Utility (M501)

Use these steps to manually download and install the Firmware Update Utility from HP.com.

 **NOTE:** This method is the only firmware update option available for printers connected to the computer via a USB cable. It also works for printers connected to a network.

1. Go to www.hp.com/go/support, click the **Drivers & Software** link, type the printer name in the search field, press the **ENTER** button, and then select the printer from the list of search results.
2. Select the operating system.
3. Under the **Firmware** section, locate the **Firmware Update Utility**.
4. Click **Download**, click **Run**, and then click **Run** again.
5. When the utility launches, select the printer from the drop-down list, and then click **Send Firmware**.



NOTE: To print a configuration page to verify the installed firmware version before or after the update process, click **Print Config**.

6. Follow the on-screen instructions to complete the installation, and then click the **Exit** button to close the utility.

Firmware upgrades (all except M501)

Review the following information about downloading firmware upgrades.

- [Determine the installed revision of firmware \(all except M501\)](#)
- [Perform a firmware upgrade \(all except M501\)](#)

To download the most recent firmware upgrade for the printer, go to:

- In the US, go to <http://www.hp.com/support/ljM501> or <http://www.hp.com/support/ljM506> or <http://www.hp.com/support/ljE50045> or <http://www.hp.com/support/ljM507> or <http://www.hp.com/support/ljE50145> or <http://www.hp.com/support/ljM527mfp> or <http://www.hp.com/support/ljE52545mfp> or <http://www.hp.com/support/ljM528mfp> or <http://www.hp.com/support/E52645mfp>.

- a. Select **Get drivers, Software, and Firmware**, and then select the appropriate product by name.



NOTE: More than one printer model might be listed. Make sure to select the correct model so that the upgraded firmware supports all of the printer functions.

- b. Select the driver language and operating system.
 - c. Locate the firmware download, and then select **Download**.
- Outside the U.S., go to www.hp.com/support.
 - a. Select your country/region.
 - b. Select **Drivers & Downloads**.
 - c. Enter the product name in the **Find my product** dialogue box, and then select **Go**.



TIP: Click on the **How do I find my product name/number?** link to see a short video on identifying the printer name and number.

- d. Select the appropriate product by name.



NOTE: More than one printer model might be listed. Make sure to select the correct model so that the upgraded firmware supports all of the printer functions.

- e. Select the driver language and operating system.
- f. Locate the firmware download, and then select **Download**.

Determine the installed revision of firmware (all except M501)

Use the following procedures to determine the installed revision of firmware.

- [Print the configuration page from a touchscreen control panel](#)
- [Print the configuration page from a LCD control panel](#)



NOTE: Print a configuration page to determine the installed revision of firmware.

Print the configuration page from a touchscreen control panel

Use the following procedure to print the configuration page from a touchscreen control panel.

1. From the [Home](#) screen on the printer control panel, scroll to and touch the [Administration](#) button (FutureSmart 3), or scroll to and touch the [Reports](#) button (FutureSmart 4).
2. Open the following menus:
 - [Reports](#) (FutureSmart 3)
 - [Configuration/Status Pages](#)
3. Touch [Configuration Page](#) to select it.
4. Touch the [Print](#) button to print the pages.

Print the configuration page from a LCD control panel

Use the following procedure to print the configuration page from a LCD control panel.

FutureSmart 3

1. From the [Home](#) screen on the printer control panel, use the down arrow ▼ button to scroll to [Administration](#), and then press the [OK](#) button.
2. Open the following menus:
 - [Reports](#)
 - [Configuration/Status Pages](#)
3. Use the down arrow ▼ button to scroll to [Configuration Page](#), and then press the [OK](#) button to select it.
4. Use the up arrow ▲ button to scroll to [Print](#), and then press the [OK](#) button to print the pages.

FutureSmart 4

1. From the [Home](#) screen on the printer control panel, use the arrow keys to navigate to [Reports](#), and then press the [OK](#) button.
2. Use the down arrow ▼ button to scroll to [Configuration/Status Pages](#), and then press the [OK](#) button.
3. Use the down arrow ▼ button to scroll to [Configuration Page](#), and then press the [OK](#) button.
4. Use the down arrow ▼ to scroll down to [Cancel](#), and then use the right arrow ► to highlight the print icon . Select [OK](#) to print the pages.

Figure 2-158 Configuration page firmware version (all except M501)

Configuration Page
HP LaserJet M506
Page 1

Device Information

Product Name: HP LaserJet M506
 Device Name: LaserJet M506
 Model Number: C8000A
 DC Controller Version: 1.100
 Serial Number: XXXXXXXX
 Meter Number: XXXXXXXX

Firmware Revision: 2267930.482546

HP FutureSmart Level: HP FutureSmart 3
 MIC revision: Not Installed
 Service ID: 0000
 Maintenance Kit Interval: 225000
 Pages Since Last Maintenance: 0
 PS Wait Time-out: 300 seconds
 Engine Cycles*: 3
 *Not weighted for billing

Installed Personalities and Options

PCI: 20010402
 PCLE: 20010402
 POSTSCRIPT: 20010402
 PDF: 2010901
 AirPrint: 204001
 Internal Disk: Hard Disk: Enabled
 Serial Number: 0830302
 Model: TOSHIBA S96400
 Capacity: 375 MB
 Hard Disk Encryption Status: Disk cannot be encrypted
 HP Printer Trusted Platform Module: Enabled
 Firmware: 01.00.149.00
 iK ThruPrint:
 C4E31A24C491E3110A9F476F98139C154C036A9
 SN: ThruPrint:
 F0C9A264C603210A6F476F98139C154C036A9
 Encodes HP JetDirect 1.8A: HP124993
 Wireless HP JetDirect 2830CE: 0.0.0.0

HP Web Services

HP Web Services: Disabled
 ePrint: Disabled

Memory

Installed RAM: 512 MB

Event Log

Number of Entries in Log: 17
 Three Most Recent Entries:

Number	Cycles	Event
16	1	10:09:40
15	7	33:02:20
15	7	33:02:22

Security

Hard Disk Encryption Status:
 Internal Disk: Disk cannot be encrypted
 Job Data Encryption Status: Encrypted (AES-128)
 Job Data Persistence: [Event 1413]
 File Erase Mode: Non-Secure Fast Erase (No overwrites)
 Control Panel Password: Disabled
 Support Key: NOSP-TPMS-SEAS
 Host USB plug and play: Enabled
 Device USB: Enabled

Paper Trays and Options

Default Paper Size: Letter
 Tray 1 Size: Any Size
 Tray 1 Type: Any Type
 Tray 2 Size: Letter
 Tray 2 Type: Plain
 1. Output Bin 1: 500 Sheets, Standard bin (connect order)
 2. Output Bin 2: 200 Sheets, Rear bin (straight path)

Apr27/2008 8:36:00 PM
English (United States)

Perform a firmware upgrade (all except M501)

The firmware bundle is a .bdl file. This file requires an interactive upgrade method. The traditional FTP, LPR, or Port 9100 methods of upgrading are not available.

- [HP Embedded Web Server \(all except M501\)](#)
- [USB flash drive \(Pre-boot menu\) \(all except M501\)](#)
- [USB flash drive \(control panel menu\) \(all except M501\)](#)

Use one of the following methods to upgrade the firmware for this printer.

HP Embedded Web Server (all except M501)

Use the following procedure to perform a firmware upgrade using the HP Embedded Web Server.

 **NOTE:** The printer should be at the **Ready** state.

The firmware update might take 10 minutes or longer based on the input/output (I/O) transfer rates and the time it takes for the printer to reinitialize.

1. Open an Internet browser window.
2. Enter the printer IP address in the URL line.
3. Select the **Firmware Upgrade** link from the **General** tab or from the **Troubleshooting** tab.
4. Browse to the location that the firmware upgrade file was downloaded to, and then select the firmware file. The file has a .bdl file extension. Select the **Install** button to perform the upgrade.

 **NOTE:** Do not close the browser window OR interrupt communication until the HP Embedded Web Server (EWS) displays the confirmation page.

5. After the printer reinitializes, print a configuration page and verify that the latest firmware version has been installed.

USB flash drive (Pre-boot menu) (all except M501)

Use the following procedures to perform a firmware upgrade using a USB flash drive and the Pre-boot menu.

- [USB flash drive firmware \(Pre-boot menu\) update from a touchscreen control panel](#)
- [USB flash drive firmware \(Pre-boot menu\) update from a LCD control panel](#)

 **IMPORTANT:** Only use this method of performing a firmware upgrade if the printer cannot initialize to the **Ready** state.

USB flash drive firmware (Pre-boot menu) update from a touchscreen control panel

Use the following procedure to perform a USB flash drive firmware (Pre-boot menu) update from a touchscreen control panel.

1. Copy the .bdl file to a portable USB flash drive.
2. Touch the middle of the control panel display when you see the 1/8 under the logo.

Figure 2-159 Open the Pre-boot menu

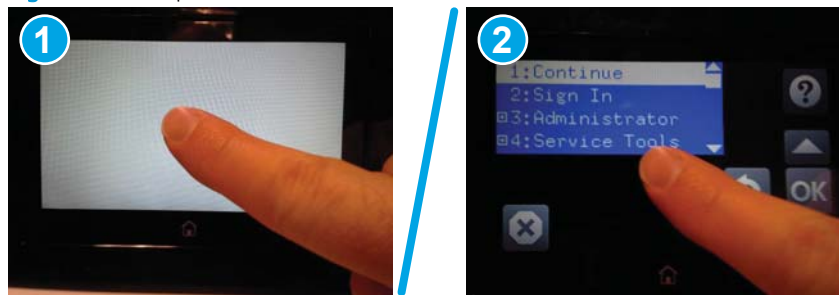

3. Touch the down arrow ▼ button to highlight **+3 Administrator**, and then touch the **OK** button.
4. If necessary, touch the down arrow ▼ button to highlight **+1 Download**, and then touch the **OK** button.
5. Insert the USB flash drive with the .bdl file on it into the USB port on the printer.

 **NOTE:** If the error message **No USB Thumbdrive Files Found** displays on the control panel display, try using a different portable storage device.

6. Touch the down arrow ▼ button to highlight **USB Thumbdrive**, and then touch the **OK** button.
7. Touch the down arrow ▼ button to highlight the .bdl file, and then touch the **OK** button.

 **NOTE:** The upgrade process can take 10 minutes or longer to complete.

 **TIP:** If there is more than one .bdl file on the storage device, make sure to select the correct file for this printer.

8. When the message **Complete** displays on the control panel display, touch the down arrow ▼ button several times until the message **Continue** displays.
9. Touch the **OK** button to begin the upgrade. When the upgrade is complete, the printer will initialize to the **Ready** state.
10. When the upgrade process is complete, print a configuration page and verify that the upgrade firmware version was installed.

USB flash drive firmware (Pre-boot menu) update from a LCD control panel

Use the following procedure to perform a USB flash drive firmware (Pre-boot menu) update from a LCD control panel.

1. Press the **Cancel**  button when you see the 1/8 under the logo.
2. Press the down arrow ▼ button to highlight **+3 Administrator**, and then press the **OK** button.
3. If necessary, press the down arrow ▼ button to highlight **+1 Download**, and then press the **OK** button.
4. Insert the USB flash drive with the .bdl file on it into the USB port on the printer.

 **NOTE:** If the error message **No USB Thumbdrive Files Found** displays on the control panel display, try using a different portable storage device.

5. Press the down arrow ▼ button to highlight **USB Thumbdrive**, and then press the **OK** button.
6. Press the down arrow ▼ button to highlight the .bdl file, and then press the **OK** button.

 **NOTE:** The upgrade process can take 10 minutes or longer to complete.

 **TIP:** If there is more than one .bdl file on the storage device, make sure to select the correct file for this printer.

7. When the message **Complete** displays on the control panel display, turn the printer power off, and then on again.
8. When the upgrade process is complete, print a configuration page and verify that the upgrade firmware version was installed.

USB flash drive (control panel menu) (all except M501)

Use the following procedures to perform a firmware upgrade using a USB flash drive and the control panel menu.

- [USB flash drive firmware \(control panel menu\) update from a touchscreen control panel](#)
- [USB flash drive firmware \(control panel menu\) update from a LCD control panel](#)

 **NOTE:** USB flash drives that are not using a FAT32 format, or do not have a CD formatted partition, might not be recognized by the printer. If the printer does not recognize a USB flash drive, try using a different USB flash drive.

 **TIP:** The USB port on the printer must be enabled. If it is disabled, use the [Enable Retrieve from USB](#) item in the [General Settings](#) menu to enable it.

USB flash drive firmware (control panel menu) update from a touchscreen control panel

Use the following procedure to perform a USB flash drive firmware (control panel menu) update from a touchscreen control panel.

1. Copy the .bdl file to a portable USB flash drive.
2. Turn the printer on, and then wait until it reaches the **Ready** state.
3. From the [Home](#) screen on the printer control panel, scroll to and touch the [Device Maintenance](#) button (FutureSmart 3), or scroll to and touch the [Support Tools](#) button (FutureSmart 4).
4. Open the [Maintenance](#) menu (FutureSmart 4).
5. Touch the [USB Firmware Upgrade](#) button.
6. Insert the USB flash drive with the .bdl file on it into the USB port on the printer.
7. Touch the .bdl file, and then touch the [Upgrade](#) button.

 **TIP:** If there is more than one .bdl file on the storage device, make sure to select the correct file for this printer.

8. Select one of the following options:

- [Upgrade](#)

 **NOTE:** The upgrade process can take 10 minutes or longer to complete.

- [Re-install](#)
- [Downgrade](#)

9. When the upgrade is complete, the printer will initialize to the **Ready** state. Print a configuration page and verify that the upgrade firmware version was installed.

USB flash drive firmware (control panel menu) update from a LCD control panel

Use the following procedure to perform a USB flash drive firmware (control panel menu) update from a LCD control panel.

FutureSmart 3

1. From the [Home](#) screen on the printer control panel, use the down arrow ▼ button to scroll to [Device Maintenance](#), and then press the [OK](#) button.
2. Open the following menus:
 - [USB Firmware Upgrade](#)
3. Insert the USB flash drive with the .bdl file on it into the USB port on the printer.
4. If necessary, use the down arrow ▼ button to scroll to the appropriate .bdl file, and then press the [OK](#) button to select.
5. Use the down arrow ▼ button to scroll to [Upgrade](#), and then press the [OK](#) button to start the firmware upgrade.



NOTE: If the firmware in the .bdl file on the portable USB storage device matches the installed firmware on the printer, [Upgrade](#) is replaced by [Re-Install](#).

FutureSmart 4

1. From the [Home](#) screen on the printer control panel, use the arrow keys to navigate to [Support Tools](#), and then select [OK](#).
2. Navigate to [Maintenance](#), and then select [OK](#).
3. Navigate to [USB Firmware Upgrade](#), and then select [OK](#).
4. Insert the USB flash drive with the .bdl file on it into the USB port on the printer.
5. If necessary, use the down arrow ▼ button to scroll to the appropriate .bdl file, and then press the [OK](#) button to select.

Solve fax or email problems

Fax or email troubleshooting information is not provided in this service manual. The most current information is available in WISE or HP Channel Services Network (CSN). Search using model number then use "fax troubleshooting" as the search term.

HP service personnel, go to one of the following Web-based Interactive Search Engines (WISE) sites:

- **AMS**
 - <https://support.hp.com/wise/home/ams-en>
 - <https://support.hp.com/wise/home/ams-es>
 - <https://support.hp.com/wise/home/ams-pt>
- **APJ**
 - <https://support.hp.com/wise/home/apj-en>
 - <https://support.hp.com/wise/home/apj-ja>
 - <https://support.hp.com/wise/home/apj-ko>

- <https://support.hp.com/wise/home/apj-zh-Hans>
- <https://support.hp.com/wise/home/apj-zh-Hant>
- EMEA
 - <https://support.hp.com/wise/home/emea-en>

Channel partners, go to HP Channel Services Network (CSN) at <http://www.hp.com/partners/csn>.

A Printer specifications

Review the following specifications for the printers.

- [Printer dimensions](#)
- [Printer space requirements](#)
- [Power consumption, electrical specifications, and acoustic emissions](#)
- [Operating-environment range](#)
- [Certificate of Volatility](#)

Printer dimensions

Review the dimensions for the printers.

- [HP LaserJet Pro M501 dimensions](#)
- [HP LaserJet Enterprise M506/E50045/M507/E50145 dimensions](#)
- [HP LaserJet Enterprise MFP M527/E52545/M528/E52645 dimensions](#)

HP LaserJet Pro M501 dimensions

Review the following dimensions for the M501 printer.

 **NOTE:** An optional 550-sheet paper feeder is available for this printer. The M501 printer supports one paper feeder.

Figure A-1 Dimensions for the base printer

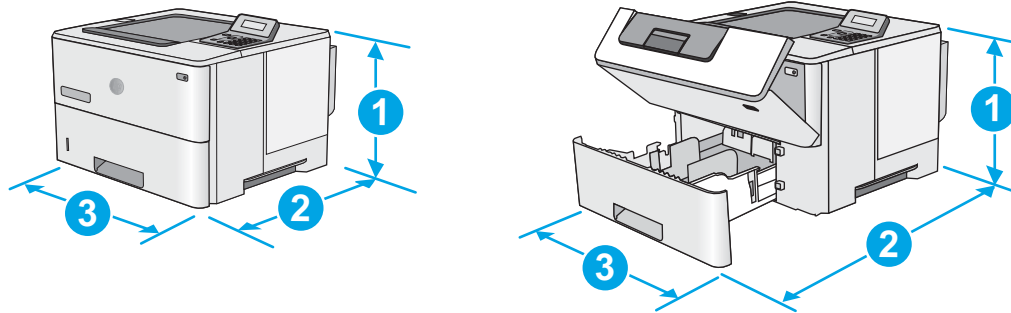

Table A-1 Dimensions for the base printer

Measurement	Printer fully closed	Printer fully opened
1. Height	289 mm (11.4 in)	289 mm (11.4 in)
2. Depth	Tray 2 dust cover closed: 376 mm (14.8 in)	569 mm (22.4 in)
	Tray 2 dust cover open: 444 mm (17.5 in)	
3. Width	410 mm (16.1 in)	410 mm (16.1 in)
Weight	11.6 kg (25.6 lb)	

Figure A-2 Dimensions for the printer with the 1 x 550-sheet paper feeder

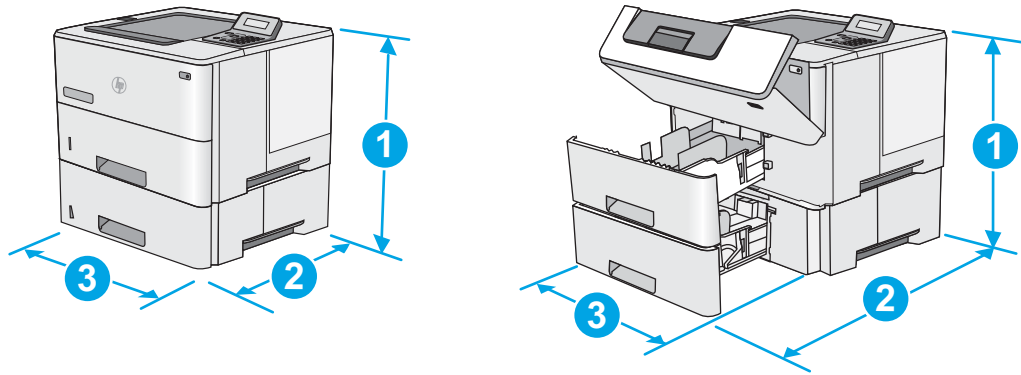

Table A-2 Dimensions for the printer with the 1 x 550-sheet paper feeder

Measurement	Printer and accessories fully closed	Printer and accessories fully opened ¹
1. Height	419 mm (16.5 in)	419 mm (16.5 in)
2. Depth	Tray 2 dust cover closed: 376 mm (14.8 in)	569 mm (22.4 in)
	Tray 2 dust cover open: 444 mm (17.5 in)	
3. Width	410 mm (16.1 in)	410 mm (16.1 in)
Weight	15.4 kg (34 lb)	

¹ These values are subject to change. For current information, go to <http://www.hp.com/support/ijM501> or <http://www.hp.com/support/ijM506> or <http://www.hp.com/support/ijE50045> or <http://www.hp.com/support/ijM507> or <http://www.hp.com/support/ijE50145> or <http://www.hp.com/support/ijM527mfp> or <http://www.hp.com/support/ijE52545mfp> or <http://www.hp.com/support/ijM528mfp> or <http://www.hp.com/support/E52645mfp>.

Figure A-3 Dimensions for the 1 x 550-sheet paper feeder

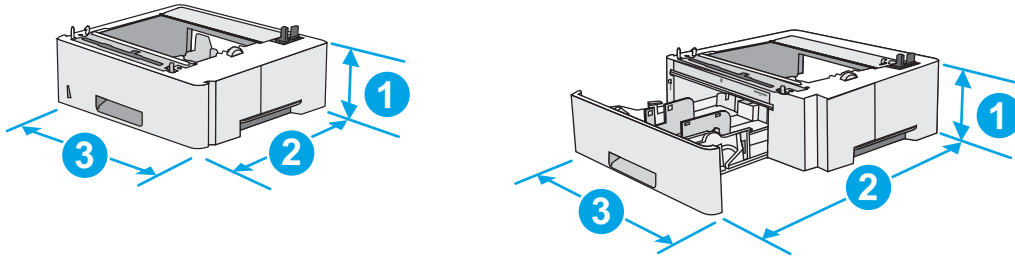

Table A-3 Dimensions for the 1 x 550-sheet paper feeder

Measurement	Value
1. Height	130 mm (5.1 in)
2. Depth	Tray closed: 376 mm (14.8 in)
	Tray opened: 569 mm (22.4 in)
3. Width	410 mm (16.1 in)
Weight	3.8 kg (8.4 lb)

HP LaserJet Enterprise M506/E50045/M507/E50145 dimensions

Review the following dimensions for the M506/E50045/M507/E50145 printer.

NOTE: An optional 550-sheet paper feeder is available for this printer. The M506/M507/E50145 printer supports up to three of these paper feeders at a time.

Figure A-4 M506/M507 dimensions for the n and dn models; E50045/E50145 dimensions for the dn model

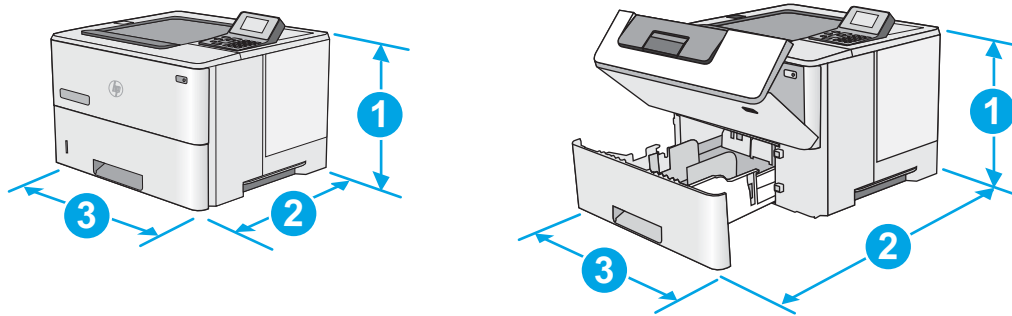

Table A-4 M506/M507 dimensions for the n and dn models; E50045/E50145 dimensions for the dn model

Measurement	Printer fully closed	Printer fully opened
1. Height	296 mm (11.7 in)	296 mm (11.7 in)
2. Depth	Tray 2 dust cover closed: 376 mm (14.8 in)	569 mm (22.4 in)
	Tray 2 dust cover open: 444 mm (17.5 in)	
3. Width	410 mm (16.1 in)	410 mm (16.1 in)
Weight	12 kg (26.5 lb)	

Figure A-5 M506/M507 dimensions for the x model

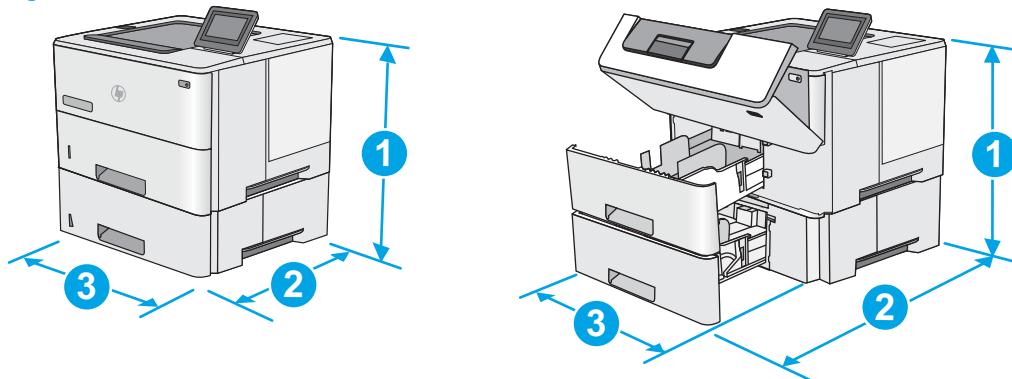

Table A-5 M506/M507 dimensions for the x model

Measurement	Printer fully closed	Printer fully opened
1. Height	415 mm (16.3 in)	487 mm (19.2 in)
2. Depth	Tray 2 dust cover closed: 376 mm (14.8 in)	569 mm (22.4 in)
	Tray 2 dust cover open: 444 mm (17.5 in)	
3. Width	410 mm (16.1 in)	410 mm (16.1 in)
Weight	13.4 kg (29.5 lb)	

Figure A-6 Dimensions for the 1 x 550-sheet paper feeder

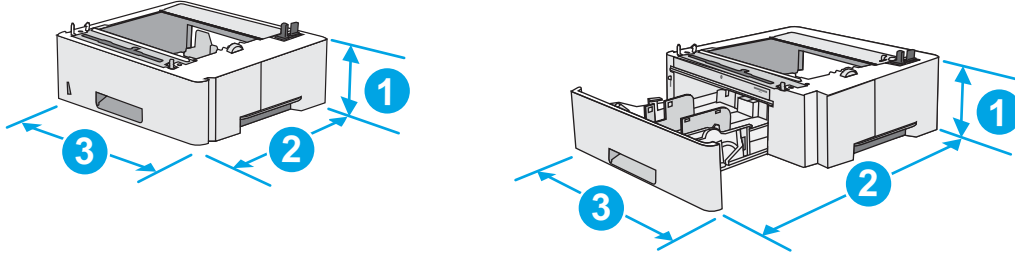

Table A-6 Dimensions for the 1 x 550-sheet paper feeder

Measurement	Value
1. Height	130 mm (5.1 in)
2. Depth	Tray closed: 376 mm (14.8 in) Tray opened: 569 mm (22.4 in)
3. Width	410 mm (16.1 in)
Weight	1.4 kg (3 lb)

Figure A-7 Dimensions for the cabinet/stand

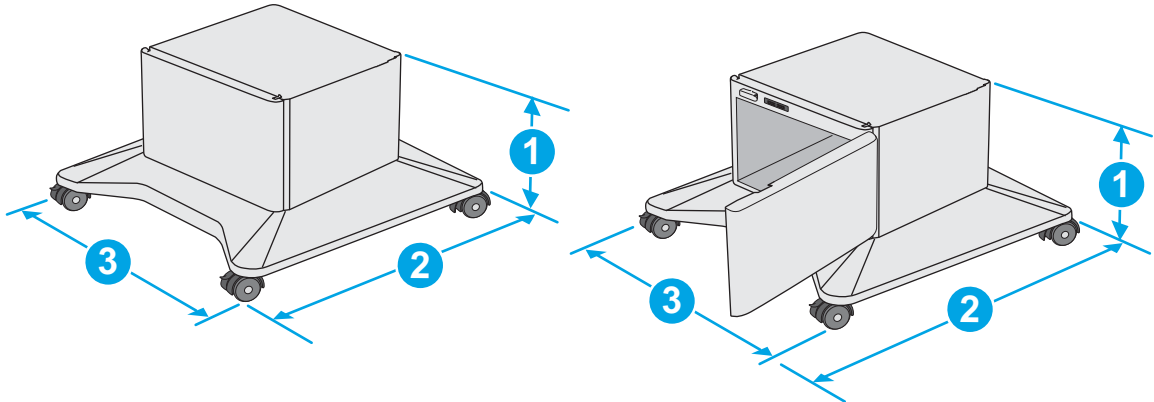

Table A-7 Dimensions for the cabinet/stand

Measurement	Value
1. Height	381 mm (15.0 in)
2. Depth	Door closed: 632 mm (24.9 in) Door opened and rear castors rotated: 865 mm (34.0 in)
3. Width	Door closed: 600 mm (23.6 in) Door opened and rear castors rotated: 630 mm (24.8 in)
Weight	9.0 kg (20 lb)

Figure A-8 M506/E50045/M507/E50145 dimensions for the printer with three 1 x 550-sheet paper feeders and the cabinet/stand

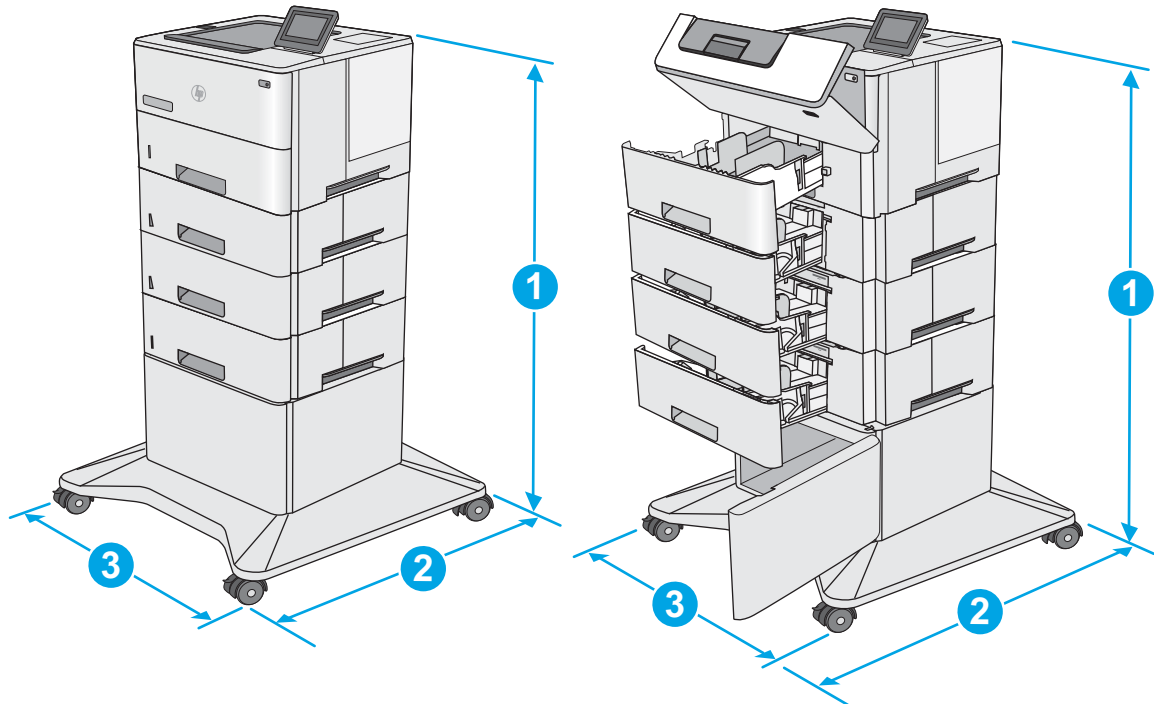

Table A-8 M506/E50045/M507/E50145 dimensions for the printer with three 1 x 550-sheet paper feeders and the cabinet/stand

Measurement	Printer and accessories fully closed	Printer and accessories fully opened ¹
1. Height	1067 mm (42.0 in)	1067 mm (42.0 in)
2. Depth	632 mm (24.9 in)	865 mm (34.0 in)
3. Width	600 mm (23.6 in)	630 mm (24.8 in)
Weight	25.2 kg (55.5 lb)	

¹ Do not extend more than one paper tray at a time.

HP LaserJet Enterprise MFP M527/E52545/M528/E52645 dimensions

Review the following dimensions for the M527/E52545/M528/E52645 printer.

 **NOTE:** An optional 550-sheet paper feeder is available for this printer. The M527/E52545/M528/E52645 printer supports up to three of these paper feeders at a time.

Figure A-9 M527/M528 dimensions for the dn, f, c, and z models; E52545/E52645 dimensions for the dn and c models

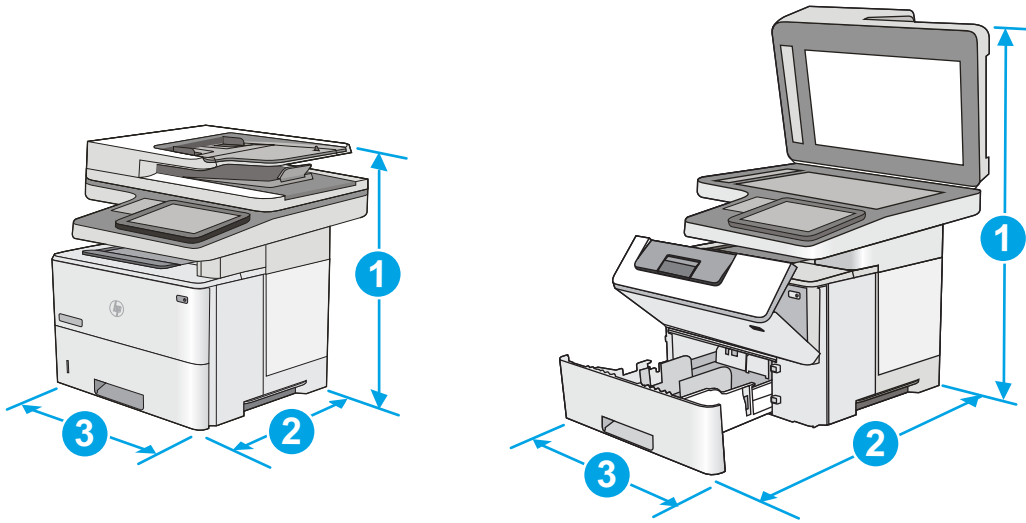

Table A-9 M527/M528 dimensions for the dn, f, c, and z models; E52545/E52645 dimensions for the dn and c models

Measurement	Printer fully closed	Printer fully opened
1. Height	497 mm (19.6 in)	750 mm (29.5 in)
2. Depth	Tray 2 dust cover closed: 496 mm (19.5 in)	674 mm (26.5 in)
	Tray 2 dust cover open: 559 mm (22.0 in)	
3. Width	482 mm (19.0 in)	482 mm (19.0 in)
Weight	23 kg (50.8 lb)	

Figure A-10 Dimensions for the 1 x 550-sheet paper feeder

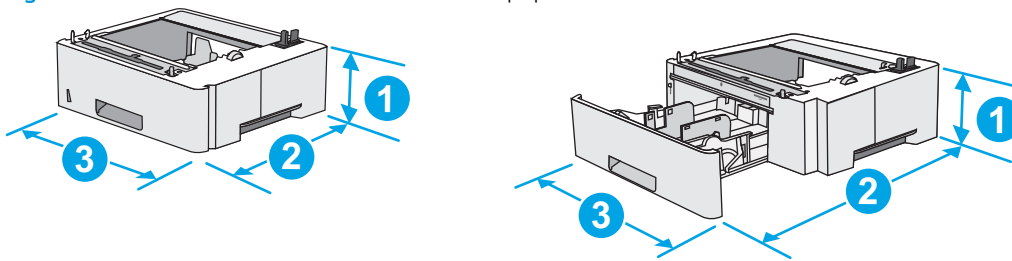

Table A-10 Dimensions for the 1 x 550-sheet paper feeder

Measurement	Value
1. Height	130 mm (5.1 in)
2. Depth	Tray closed: 376 mm (14.8 in)
	Tray opened: 569 mm (22.4 in)
3. Width	410 mm (16.1 in)
Weight	1.4 kg (3 lb)

Figure A-11 Dimensions for the cabinet/stand

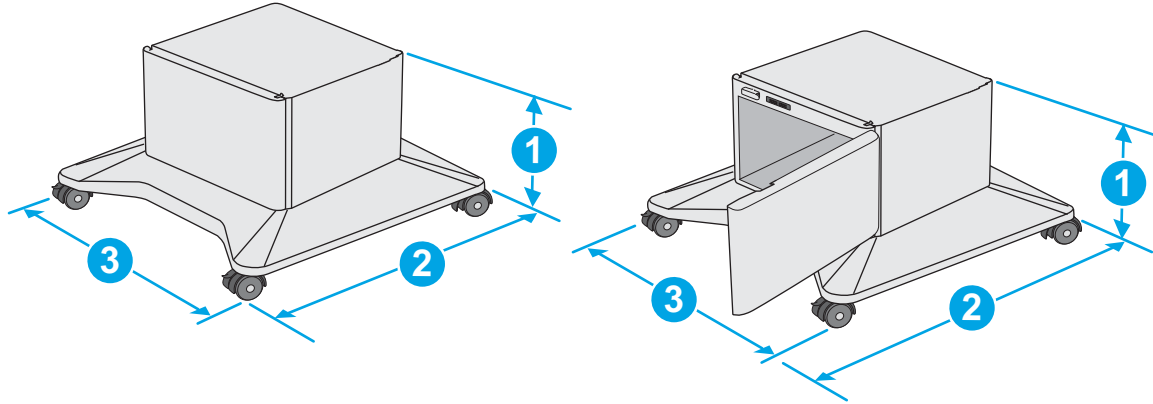

Table A-11 Dimensions for the cabinet/stand

Measurement	Value
1. Height	381 mm (15.0 in)
2. Depth	Door closed: 632 mm (24.9 in)
	Door opened and rear castors rotated: 865 mm (34.0 in)
3. Width	Door closed: 600 mm (23.6 in)
	Door opened and rear castors rotated: 630 mm (24.8 in)
Weight	9.0 kg (20 lb)

Figure A-12 M527/E52545/M528/E52645 dimensions for the printer with three 1 x 550-sheet paper feeders and the cabinet/stand

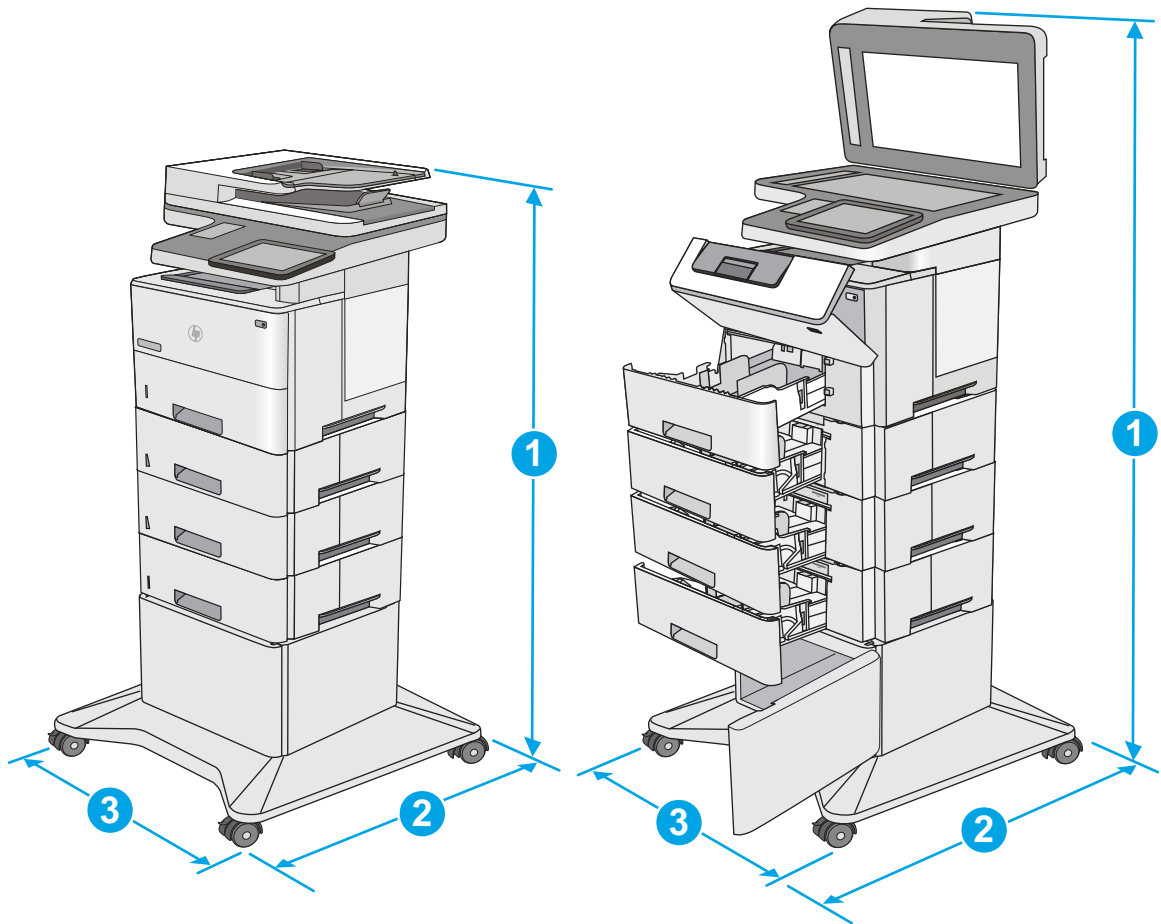

Table A-12 M527/E52545/M528/E52645 dimensions for the printer with three 1 x 550-sheet paper feeders and the cabinet/stand

Measurement	Printer and accessories fully closed	Printer and accessories fully opened ¹
1. Height	1268 mm (49.9 in)	1521 mm (59.9 in)
2. Depth	632 mm (24.9 in)	865 mm (34.0 in)
3. Width	600 mm (23.6 in)	630 mm (24.8 in)
Weight	36.2 kg (79.8 lb)	

¹ Do not extend more than one paper tray at a time.

Printer space requirements

HP recommends that the following distances be added to the printer dimensions provided in this chapter to make sure there is sufficient space to open doors and covers, and to provide proper ventilation.

See "HP LaserJet Enterprise M506/M507/E50145 dimensions" or "HP LaserJet Enterprise MFP M527/M528/E52645 dimensions" in the Troubleshooting Manual.

- From the left-side or right-side of the printer to an obstruction, add:

- 430 mm (17 in)
- From the front-side of the printer to an obstruction, add:
 - 610 mm (24 in)
- From the back-side of the printer to an obstruction, add:
 - 460 mm (18 in)

Power consumption, electrical specifications, and acoustic emissions

Review the following information about power consumption, electrical specifications, and acoustic emissions.

See <http://www.hp.com/support/ljM501> or <http://www.hp.com/support/ljM506> or <http://www.hp.com/support/ljE50045> or <http://www.hp.com/support/ljM507> or <http://www.hp.com/support/ljE50145> or <http://www.hp.com/support/ljM527mfp> or <http://www.hp.com/support/ljE52545mfp> or <http://www.hp.com/support/ljM528mfp> or <http://www.hp.com/support/E52645mfp> for current information.

⚠ CAUTION: Power requirements are based on the country/region where the printer is sold. Do not convert operating voltages. This will damage the printer and void the printer warranty.

Operating-environment range

Review the operating-environment range.

Table A-13 Operating-environment specifications¹

Environment	Recommended	Allowed
Temperature	17° to 25°C (62.6° to 77°F)	15° to 30°C (59° to 86°F)
Relative humidity	30% to 70% relative humidity (RH)	10% to 80% RH

¹ These values are subject to change. For current information, go to <http://www.hp.com/support/ljM501> or <http://www.hp.com/support/ljM506> or <http://www.hp.com/support/ljE50045> or <http://www.hp.com/support/ljM507> or <http://www.hp.com/support/ljE50145> or <http://www.hp.com/support/ljM527mfp> or <http://www.hp.com/support/ljE52545mfp> or <http://www.hp.com/support/ljM528mfp> or <http://www.hp.com/support/E52645mfp>.

Certificate of Volatility

Review the certificates of volatility for the printers.

Figure A-13 Certificate of Volatility (1 of 2; M501)

Hewlett-Packard Certificate of Volatility				
Model: HP LaserJet Pro M501		Part Number: J8H60A=M501n J8H61A=M501dn		Address: HP Development Company 11311 Chinden Blvd Boise, ID 83714
Volatile Memory				
Does the device contain volatile memory (Memory whose contents are lost when power is removed)? <input checked="" type="checkbox"/> Yes <input type="checkbox"/> No If Yes please describe the type, size, function, and steps to clear the memory below				
Type (SRAM, DRAM, etc):	Size: 256MB	User Modifiable: <input type="checkbox"/> Yes <input checked="" type="checkbox"/> No	Function: Used for temporary storage during the processing of jobs and for applications running on the OS.	Steps to clear memory: When the printer is powered OFF, the memory is erased.
Type (SRAM, DRAM, etc):	Size: 256MB	User Modifiable: <input type="checkbox"/> Yes <input checked="" type="checkbox"/> No	Function: Used for temporary storage during the processing of jobs and for applications running on the OS.	Steps to clear memory: When the printer is powered OFF, the memory is erased.
Type (SRAM, DRAM, etc):	Size:	User Modifiable: <input type="checkbox"/> Yes <input type="checkbox"/> No	Function:	Steps to clear memory:
Non-Volatile Memory				
Does the device contain non-volatile memory (Memory whose contents are retained when power is removed)? <input checked="" type="checkbox"/> Yes <input type="checkbox"/> No If Yes please describe the type, size, function, and steps to clear the memory below				
Type (Flash, EEPROM, etc):	Size: 2GB	User Modifiable: <input type="checkbox"/> Yes <input checked="" type="checkbox"/> No	Function: Device Firmware	Steps to clear memory:
Type (Flash, EEPROM, etc):	Size:	User Modifiable: <input type="checkbox"/> Yes <input type="checkbox"/> No	Function:	Steps to clear memory:
Type (Flash, EEPROM, etc):	Size:	User Modifiable: <input type="checkbox"/> Yes <input type="checkbox"/> No	Function:	Steps to clear memory:
Mass Storage				
Does the device contain mass storage memory (Hard Disk Drive, Tape Backup)? <input type="checkbox"/> Yes <input checked="" type="checkbox"/> No If Yes please describe the type, size, function, and steps to clear the memory below				
Type (HDD, Tape, etc):	Size:	User Modifiable: <input type="checkbox"/> Yes <input type="checkbox"/> No	Function:	Steps to clear memory:
Type (HDD, Tape, etc):	Size:	User Modifiable: <input type="checkbox"/> Yes <input type="checkbox"/> No	Function:	Steps to clear memory:
USB				
Does the item accept USB input and if so, for what purpose (i.e Print Jobs, device firmware updates, scan upload)? <input type="checkbox"/> Yes <input checked="" type="checkbox"/> No If Yes please describe below				
The front USB host can accept print jobs, scan uploads, photos and can be used to upload printer firmware.				
Can any data other than scan upload be sent to the USB device)? <input checked="" type="checkbox"/> Yes <input type="checkbox"/> No If Yes please describe below				
Rear USB host when configured will accept stored jobs, encrypted files stored and deleted by user.				

Figure A-14 Certificate of Volatility (2 of 2; M501)

RF/RFID	
Does the item use RF or RFID for receive or transmit of any data including remote diagnostics. (e.g. Cellular phone, Bluetooth) <input type="checkbox"/> Yes <input type="checkbox"/> No If Yes please describe below	
Purpose: Wireless Information string	
Frequency:	Bandwidth:
Modulation:	Effective Radiate Power (ERP):
Specifications:	

Other Transmission Capabilities	
Does the device employ any other methods of non-wired access to transmit or receive any data whatsoever (e.g. anything other than standard hard wired TCP/IP, direct USB, or parallel connections)? <input type="checkbox"/> Yes <input checked="" type="checkbox"/> No If Yes please describe below:	
Purpose:	
Frequency:	Bandwidth:
Modulation:	Effective Radiate Power (ERP):
Specifications:	

Other Capabilities	
Does the device employ any other method of communications such as a Modem to transmit or receive any data whatsoever? <input type="checkbox"/> Yes <input checked="" type="checkbox"/> No If Yes please describe below:	
Purpose:	
Specifications:	

Figure A-15 Certificate of Volatility (1 of 2; M506)

HP Certificate of Volatility				
Model: LaserJet Enterprise M506	Part Number: M506n = F2A68A M506dn = F2A69A M506x = F2A70A	Address: HP Development Company 11311 Chinden Blvd Boise, ID 83714		

Volatile Memory				
Does the device contain volatile memory (Memory whose contents are lost when power is removed)? <input checked="" type="checkbox"/> Yes <input type="checkbox"/> No If Yes please describe the type, size, function, and steps to clear the memory below				
Type (SRAM, DRAM, etc): DRAM	Size: 512MB	User Modifiable: <input type="checkbox"/> Yes <input checked="" type="checkbox"/> No	Function: Operation system and print buffer	Steps to clear memory: There are no steps to clear this data.
Type (SRAM, DRAM, etc):	Size:	User Modifiable: <input type="checkbox"/> Yes <input type="checkbox"/> No	Function:	Steps to clear memory:
Type (SRAM, DRAM, etc):	Size:	User Modifiable: <input type="checkbox"/> Yes <input type="checkbox"/> No	Function:	Steps to clear memory:

Non-Volatile Memory				
Does the device contain non-volatile memory (Memory whose contents are retained when power is removed)? <input checked="" type="checkbox"/> Yes <input type="checkbox"/> No If Yes please describe the type, size, function, and steps to clear the memory below				
Type (Flash, EEPROM, etc): EEPROM	Size: 32KB	User Modifiable: <input type="checkbox"/> Yes <input checked="" type="checkbox"/> No	Function: Store customer setting data for backup/restore	Steps to clear memory: There are no steps to clear this data.
Type (Flash, EEPROM, etc): SPI	Size: 4MB	User Modifiable: <input type="checkbox"/> Yes <input checked="" type="checkbox"/> No	Function: BIOS	Steps to clear memory: There are no steps to clear this data.
Type (Flash, EEPROM, etc): None	Size:	User Modifiable: <input type="checkbox"/> Yes <input type="checkbox"/> No	Function:	Steps to clear memory:

Mass Storage				
Does the device contain mass storage memory (Hard Disk Drive, Tape Backup)? <input checked="" type="checkbox"/> Yes <input type="checkbox"/> No If Yes please describe the type, size, function, and steps to clear the memory below				
Type (HDD, Tape, etc): eMMC	Size: 4GB	User Modifiable: <input checked="" type="checkbox"/> Yes <input type="checkbox"/> No	Function: OS and user data	Steps to clear memory: Firmware update
Type (HDD, Tape, etc): HDD	Size: 320GB	User Modifiable: <input checked="" type="checkbox"/> Yes <input type="checkbox"/> No	Function: OS and user data	Steps to clear memory: Firmware update

USB	
Does the item accept USB input and if so, for what purpose (i.e Print Jobs, device firmware updates, scan upload)? <input checked="" type="checkbox"/> Yes <input type="checkbox"/> No If Yes please describe below	
Walk-up USB print	
Can any data other than scan upload be sent to the USB device)? <input type="checkbox"/> Yes <input checked="" type="checkbox"/> No If Yes please describe below	

Figure A-16 Certificate of Volatility (2 of 2; M506)

RF/RFID			
Does the item use RF or RFID for receive or transmit of any data including remote diagnostics. (e.g. Cellular phone, Bluetooth) <input type="checkbox"/> Yes <input checked="" type="checkbox"/> No If Yes please describe below			
Purpose			
Frequency:)		Bandwidth:	
Modulation:		Effective Radiate Power (ERP):	
Specifications:			
Other Transmission Capabilities			
Does the device employ any other methods of non-wired access to transmit or receive any data whatsoever (e.g. anything other than standard hard wired TCP/IP, direct USB, or parallel connections)? <input checked="" type="checkbox"/> Yes <input type="checkbox"/> No If Yes please describe below:			
Purpose: Wireless direct print.			
Frequency: 2.4Ghz		Bandwidth:	
Modulation:		Effective Radiate Power (ERP):	
Specifications: 802.11 b/g/n			
Other Capabilities			
Does the device employ any other method of communications such as a Modem to transmit or receive any data whatsoever? <input checked="" type="checkbox"/> Yes <input type="checkbox"/> No If Yes please describe below:			
Purpose: NFC; to support tap to print only			
Specifications: NFC Tag Type 4 ISO 14443B			
Author Information			
Name:	Title: Security Technical Marketing Engineer	Email:	Business Unit: IPG
			Date Prepared: 06/29/15

Figure A-17 Certificate of Volatility (1 of 2; M527)

HP Certificate of Volatility				
Model: LaserJet Enterprise M527		Part Number: M527dn = F2A76A M527f = F2A77A M527z = F2A78A		Address: HP Development Company 11311 Chinden Blvd Boise, ID 83714
Volatile Memory				
Does the device contain volatile memory (Memory whose contents are lost when power is removed)? <input checked="" type="checkbox"/> Yes <input type="checkbox"/> No If Yes please describe the type, size, function, and steps to clear the memory below				
Type (SRAM, DRAM, etc): DRAM	Size: 1792MB	User Modifiable: <input type="checkbox"/> Yes <input checked="" type="checkbox"/> No	Function: Operation system and print buffer	Steps to clear memory: There are no steps to clear this data.
Type (SRAM, DRAM, etc):	Size:	User Modifiable: <input type="checkbox"/> Yes <input type="checkbox"/> No	Function:	Steps to clear memory:
Type (SRAM, DRAM, etc):	Size:	User Modifiable: <input type="checkbox"/> Yes <input type="checkbox"/> No	Function:	Steps to clear memory:
Non-Volatile Memory				
Does the device contain non-volatile memory (Memory whose contents are retained when power is removed)? <input checked="" type="checkbox"/> Yes <input type="checkbox"/> No If Yes please describe the type, size, function, and steps to clear the memory below				
Type (Flash, EEPROM, etc): EEPROM	Size: 32KB	User Modifiable: <input type="checkbox"/> Yes <input checked="" type="checkbox"/> No	Function: Store customer setting data for backup/restore	Steps to clear memory: There are no steps to clear this data.
Type (Flash, EEPROM, etc): SPI	Size: 4MB	User Modifiable: <input type="checkbox"/> Yes <input checked="" type="checkbox"/> No	Function: BIOS	Steps to clear memory: There are no steps to clear this data.
Type (Flash, EEPROM, etc): None	Size:	User Modifiable: <input type="checkbox"/> Yes <input type="checkbox"/> No	Function:	Steps to clear memory:
Mass Storage				
Does the device contain mass storage memory (Hard Disk Drive, Tape Backup)? <input checked="" type="checkbox"/> Yes <input type="checkbox"/> No If Yes please describe the type, size, function, and steps to clear the memory below				
Type (HDD, Tape, etc): eMMC	Size: 16GB	User Modifiable: <input checked="" type="checkbox"/> Yes <input type="checkbox"/> No	Function: OS and user data	Steps to clear memory: Firmware update
Type (HDD, Tape, etc): HDD	Size: 320GB	User Modifiable: <input checked="" type="checkbox"/> Yes <input type="checkbox"/> No	Function: OS and user data	Steps to clear memory: Firmware update
USB				
Does the item accept USB input and if so, for what purpose (i.e Print Jobs, device firmware updates, scan upload)? <input checked="" type="checkbox"/> Yes <input type="checkbox"/> No If Yes please describe below				
Walk-up USB print				
Can any data other than scan upload be sent to the USB device)? <input type="checkbox"/> Yes <input checked="" type="checkbox"/> No If Yes please describe below				

Figure A-18 Certificate of Volatility (2 of 2; M527)

RF/RFID			
Does the item use RF or RFID for receive or transmit of any data including remote diagnostics. (e.g. Cellular phone, Bluetooth) <input type="checkbox"/> Yes <input checked="" type="checkbox"/> No If Yes please describe below			
Purpose			
Frequency:)		Bandwidth:	
Modulation:		Effective Radiate Power (ERP):	
Specifications:			
Other Transmission Capabilities			
Does the device employ any other methods of non-wired access to transmit or receive any data whatsoever (e.g. anything other than standard hard wired TCP/IP, direct USB, or parallel connections)? <input checked="" type="checkbox"/> Yes <input type="checkbox"/> No If Yes please describe below:			
Purpose: Wireless direct print.			
Frequency: 2.4Ghz		Bandwidth:	
Modulation:		Effective Radiate Power (ERP):	
Specifications: 802.11 b/g/n			
Other Capabilities			
Does the device employ any other method of communications such as a Modem to transmit or receive any data whatsoever? <input checked="" type="checkbox"/> Yes <input type="checkbox"/> No If Yes please describe below:			
Purpose: NFC; to support tap to print only			
Specifications: NFC Tag Type 4 ISO 14443B			
Author Information			
Name:	Title: Security Technical Marketing Engineer	Email:	Business Unit: IPG
			Date Prepared: 06/29/15

Figure A-19 Certificate of Volatility (1 of 2; M507/E50145)

Hewlett-Packard Certificate of Volatility					
Model: HP LaserJet Enterprise M507 series HP LaserJet Managed Enterprise E50145 series		Part Number: Enterprise 1PV86A=M507n 1PV87A=M507dn 1PV88A=M507x 1PV89A=M507dng		Managed 1PU51A=E50145dn	Address: Hewlett Packard Company 11311 Chinden Blvd Boise, ID 83714
Volatile Memory					
Does the device contain volatile memory (Memory whose contents are lost when power is removed)? <input checked="" type="checkbox"/> Yes <input type="checkbox"/> No If Yes please describe the type, size, function, and steps to clear the memory below					
Type (SRAM, DRAM, etc): DDR3 - DRAM	Size: 1GB	User Modifiable: <input type="checkbox"/> Yes <input checked="" type="checkbox"/> No	Function: Operation system and print/scan buffer	Steps to clear memory: When the printer is powered off the memory is erased.	
Type (SRAM, DRAM, etc):	Size:	User Modifiable: <input type="checkbox"/> Yes <input type="checkbox"/> No	Function:	Steps to clear memory:	
Type (SRAM, DRAM, etc):	Size:	User Modifiable: <input type="checkbox"/> Yes <input type="checkbox"/> No	Function:	Steps to clear memory:	
Non-Volatile Memory					
Does the device contain non-volatile memory (Memory whose contents are retained when power is removed)? <input checked="" type="checkbox"/> Yes <input type="checkbox"/> No If Yes please describe the type, size, function, and steps to clear the memory below					
Type (Flash, EEPROM, etc): IOD EEPROM	Size: 32KB	User Modifiable: <input type="checkbox"/> Yes <input checked="" type="checkbox"/> No	Function: Store customer setting data for backup/restore	Steps to clear memory: There are no steps to clear this data.	
Type (Flash, EEPROM, etc): SPI Flash	Size: 4MB	User Modifiable: <input checked="" type="checkbox"/> Yes <input type="checkbox"/> No	Function: Contains the boot code and factory product configuration data required for the device to function. User modifications are limited to downloading digitally signed HP firmware images.	Steps to clear memory: There are no steps to clear this data	
Type (Flash, EEPROM, etc):	Size:	User Modifiable: <input type="checkbox"/> Yes <input type="checkbox"/> No	Function:	Steps to clear memory:	
Mass Storage					
Does the device contain mass storage memory (Hard Disk Drive, Tape Backup)? <input checked="" type="checkbox"/> Yes <input type="checkbox"/> No If Yes please describe the type, size, function, and steps to clear the memory below					
Type (HDD, Tape, etc): HDD	Size: 320GB	User Modifiable: <input checked="" type="checkbox"/> Yes <input type="checkbox"/> No	Function: OS and user data	Steps to clear memory: Firmware update	
Type (HDD, Tape, etc): EMMC	Size: 8GB	User Modifiable: <input checked="" type="checkbox"/> Yes <input type="checkbox"/> No	Function: OS and user data	Steps to clear memory: Firmware update	

Figure A-20 Certificate of Volatility (2 of 2; M507/E50145)

USB	
Does the item accept USB input and if so, for what purpose (i.e Print Jobs, device firmware updates, scan upload)? <input checked="" type="checkbox"/> Yes <input type="checkbox"/> No If Yes please describe below	
Print jobs, HP digitally signed firmware upgrades, 3rd party application loading. USB ports can be disabled.	
Can any data other than scan upload be sent to the USB device? <input checked="" type="checkbox"/> Yes <input type="checkbox"/> No If Yes please describe below	
Diagnostic service logs can be uploaded. Print files can be printed via a USB thumb drive.	

RF/RFID	
Does the item use RF or RFID for receive or transmit of any data including remote diagnostics. (e.g. Cellular phone, Bluetooth) <input type="checkbox"/> Yes <input checked="" type="checkbox"/> No If Yes please describe below	
Purpose:	
Frequency:	Bandwidth:
Modulation:	Effective Radiate Power (ERP):
Specifications:	

Other Transmission Capabilities	
Does the device employ any other methods of non-wired access to transmit or receive any data whatsoever (e.g. anything other than standard hard wired TCP/IP, direct USB, or parallel connections)? <input checked="" type="checkbox"/> Yes <input type="checkbox"/> No If Yes please describe below:	
Purpose: WiFi Direct Print	
Frequency: 2.4 GHz, 5 GHz	Bandwidth: 2401 - 2495 MHz; depending on selected channel in 2.4GHz band. 5180 - 5825 MHz; depending on selected channel in 5GHz band.
Modulation:	Effective Radiate Power (ERP):
Specifications: 802.11 b/g/n	

Other Transmission Capabilities	
Does the device employ any other methods of non-wired access to transmit or receive any data whatsoever (e.g. anything other than standard hard wired TCP/IP, direct USB, or parallel connections)? <input checked="" type="checkbox"/> Yes <input type="checkbox"/> No If Yes please describe below:	
Purpose: Device Beaconsing, Secure Print Apps	
Frequency: 2.4 GHz	Bandwidth: 2400-2483.5 MHz; depending on selected channel.
Modulation:	Effective Radiate Power (ERP):
Specifications: BTLE4.0 compliant	

Other Capabilities	
Does the device employ any other method of communications such as a Modem to transmit or receive any data whatsoever? <input type="checkbox"/> Yes <input checked="" type="checkbox"/> No If Yes please describe below:	
Purpose:	
Specifications:	

Figure A-21 Certificate of Volatility (1 of 2; M528/E52645)

Hewlett-Packard Certificate of Volatility					
Model: HP LaserJet Enterprise M528 series HP LaserJet Managed Enterprise E52645 series		Part Number: Enterprise 1PV64A=M528dn 1PV65A=M528f 1PV66A=M528c 1PV67A=M528z		Managed 1PS54A=E52645dn 1PS55A=E52645c	Address: Hewlett Packard Company 11311 Chinden Blvd Boise, ID 83714
Volatile Memory					
Does the device contain volatile memory (Memory whose contents are lost when power is removed)? <input checked="" type="checkbox"/> Yes <input type="checkbox"/> No If Yes please describe the type, size, function, and steps to clear the memory below					
Type (SRAM, DRAM, etc): DDR3 - DRAM	Size: 1GB	User Modifiable: <input type="checkbox"/> Yes <input checked="" type="checkbox"/> No	Function: Operation system and print/scan buffer	Steps to clear memory: When the printer is powered off the memory is erased.	
Type (SRAM, DRAM, etc):	Size:	User Modifiable: <input type="checkbox"/> Yes <input type="checkbox"/> No	Function:	Steps to clear memory:	
Type (SRAM, DRAM, etc):	Size:	User Modifiable: <input type="checkbox"/> Yes <input type="checkbox"/> No	Function:	Steps to clear memory:	
Non-Volatile Memory					
Does the device contain non-volatile memory (Memory whose contents are retained when power is removed)? <input checked="" type="checkbox"/> Yes <input type="checkbox"/> No If Yes please describe the type, size, function, and steps to clear the memory below					
Type (Flash, EEPROM, etc): IOD EEPROM	Size: 32KB	User Modifiable: <input type="checkbox"/> Yes <input checked="" type="checkbox"/> No	Function: Store customer setting data for backup/restore	Steps to clear memory: There are no steps to clear this data.	
Type (Flash, EEPROM, etc): SPI Flash	Size: 4MB	User Modifiable: <input checked="" type="checkbox"/> Yes <input type="checkbox"/> No	Function: Contains the boot code and factory product configuration data required for the device to function. User modifications are limited to downloading digitally signed HP firmware images.	Steps to clear memory: There are no steps to clear this data	
Type (Flash, EEPROM, etc):	Size:	User Modifiable: <input type="checkbox"/> Yes <input type="checkbox"/> No	Function:	Steps to clear memory:	
Mass Storage					
Does the device contain mass storage memory (Hard Disk Drive, Tape Backup)? <input checked="" type="checkbox"/> Yes <input type="checkbox"/> No If Yes please describe the type, size, function, and steps to clear the memory below					
Type (HDD, Tape, etc): HDD	Size: 320GB	User Modifiable: <input checked="" type="checkbox"/> Yes <input type="checkbox"/> No	Function: OS and user data	Steps to clear memory: Firmware update	
Type (HDD, Tape, etc): EMMC	Size: 8GB	User Modifiable: <input checked="" type="checkbox"/> Yes <input type="checkbox"/> No	Function: OS and user data	Steps to clear memory: Firmware update	

Figure A-22 Certificate of Volatility (2 of 2; M528/E52645)

USB	
Does the item accept USB input and if so, for what purpose (i.e Print Jobs, device firmware updates, scan upload)? <input checked="" type="checkbox"/> Yes <input type="checkbox"/> No If Yes please describe below	
Print jobs, HP digitally signed firmware upgrades, 3rd party application loading. USB ports can be disabled.	
Can any data other than scan upload be sent to the USB device)? <input checked="" type="checkbox"/> Yes <input type="checkbox"/> No If Yes please describe below	
Diagnostic service logs can be uploaded. Print files can be printed via a USB thumb drive.	
RF/RIFID	
Does the item use RF or RFID for receive or transmit of any data including remote diagnostics. (e.g. Cellular phone, Bluetooth) <input type="checkbox"/> Yes <input checked="" type="checkbox"/> No If Yes please describe below	
Purpose:	
Frequency:	Bandwidth:
Modulation:	Effective Radiate Power (ERP):
Specifications:	
Other Transmission Capabilities	
Does the device employ any other methods of non-wired access to transmit or receive any data whatsoever (e.g. anything other than standard hard wired TCP/IP, direct USB, or parallel connections)? <input checked="" type="checkbox"/> Yes <input type="checkbox"/> No If Yes please describe below:	
Purpose: WiFi Direct Print	
Frequency: 2.4 GHz, 5 GHz	Bandwidth: 2401 - 2495 MHz; depending on selected channel in 2.4GHz band. 5180 - 5825 MHz; depending on selected channel in 5GHz band.
Modulation:	Effective Radiate Power (ERP):
Specifications: 802.11 b/g/n	
Other Transmission Capabilities	
Does the device employ any other methods of non-wired access to transmit or receive any data whatsoever (e.g. anything other than standard hard wired TCP/IP, direct USB, or parallel connections)? <input checked="" type="checkbox"/> Yes <input type="checkbox"/> No If Yes please describe below:	
Purpose: Device Beaconsing, Secure Print Apps	
Frequency: 2.4 GHz	Bandwidth: 2400-2483.5 MHz; depending on selected channel.
Modulation:	Effective Radiate Power (ERP):
Specifications: BTLE4.0 compliant	
Other Capabilities	
Does the device employ any other method of communications such as a Modem to transmit or receive any data whatsoever? <input type="checkbox"/> Yes <input checked="" type="checkbox"/> No If Yes please describe below:	
Purpose:	
Specifications:	

Index

Symbols/Numerics

- 1x550-sheet paper feeder controller
PCA
 - connections, diagrams 145, 185
- 2ndary service menu (M501) 480, 482
- 550-sheet paper feeder
 - paper path 57
- 550-sheet tray
 - clearing jams 458

A

- accessories installed, information 145, 196, 202
- acoustic specifications 515, 524
- anti-theft feature
 - JetIntelligence 41
 - toner cartridge 41
- authentication
 - JetIntelligence 41
 - toner cartridge 41
- auto on / auto off mode
 - M501 8
- auto on / auto off mode (M501)
 - setup and operation 8
- automatic document feeder
 - scanning and image capture (M527/E52545/M528/E52645 only) 64

B

- backup error
 - 32.WX.YZ error 145
 - reset error 145
 - restore error 145
- basic printer operation 3
- bias generation
 - high-voltage power supply 23

- blank pages
 - troubleshooting 472
- block diagram
 - cross section 145, 178
 - external plug and port locations 145, 185
 - printed circuit assembly (PCA)
 - connector locations 145, 181
 - sensors and switches 145, 176
- browser requirements
 - HP Embedded Web Server 145, 206

C

- cables
 - USB, troubleshooting 472
- calibrate
 - colors 295
- Calibrate/Cleaning menu (M506/E50045/M507/E50145, M527/E52545/M528/E52645), control panel 282
- Calibrate/Cleaning menu (M506/M507/E50145, M527/M528/E52645), control panel 145
- cartridge
 - dynamic security 40
 - life detection 39
 - memory chip 39
 - presence detection 39
 - toner level detection 39
- cassette presence detection
 - trays 3-5 60
- caution 1
- certificate of volatility 515, 524
- Channel partners
 - WISE 1, 71
- checklist
 - problems 75
- checklist (M501)
 - problems 73
- checklists
 - pre-troubleshooting 107, 108
- circuit diagrams 145, 192
- clean the paper path
 - cleaning page printing 424, 425
- cleaning
 - glass (M527/M528/E52645) 424
 - mode (M501) 480
 - paper path 295, 296, 424
 - printer 424
 - rollers document feeder (M527/M528/E52645) 424
 - tray 1 rollers and separation pad 424, 430
 - tray 2-X rollers 424, 438
- cleaning page 145, 282
- clutches
 - DC controller 15
 - image-formation system 45
- cold reset 486, 487
- color options
 - changing, Windows 295
- color theme
 - changing, Windows 295
- colors
 - calibrate 295
- component test (M506/E50045/M507/E50145, M527/E52545/M528/E52645)
 - special mode test 170
- component test (M506/M507, M527/M528)
 - special mode test 146
- component test (M506/M507/E50145, M527/M528/E52645)
 - special mode test 145

- components
 - DC controller 13
 - engine-control system 12
 - fuser 25
 - paper feeder 60
 - paper handling 42
 - toner cartridge 38
- components (M506/M507, M527/ M528)
 - diagnostic tests 146
- components (M506/M507/E50145, M527/M528/E52645)
 - diagnostic tests 145, 169
- configuration pages
 - information 145, 196, 202
 - printing 145, 196
- connections
 - 1x550-sheet paper feeder controller PCA 145, 185
 - DC controller 145, 181
- connector error
 - 65.WX.YZ error 145
- control functions
 - fuser 26
- control panel 8
 - button test 480, 482, 483
 - connections diagram 145, 181
 - CPMD 145
 - display test 480, 482, 483
 - LED test 480, 482, 483
 - menus 145, 210
- control panel diagnostic flowcharts (M506x and M527) 107
- control panel diagnostic flowcharts (M506x/M507x, M527/E52545/ M528/E52645) 118, 140
- control panel menus 219
- control panel message document WISE, search 289
- control-panel menus (M501) 145, 209
- control-panel menus (M506/M507/ E50145, M527/M528/E52645) 145
- conventions used 1
- cooling
 - areas and fans 15
- counts 486, 487
 - copy scan 486, 487
 - document feeder 486, 487
- document feeder duplex 486, 487
- document feeder roller clean 486, 487
- document feeder roller interval 486, 487
- document feeder simplex 486, 487
- engine cycles 486, 487
- fax scan 486, 487
- flatbed cycle 486, 487
- page, reset 486, 487
- refurbish cycle 486, 487
- reset after replacing formatter 486, 487
- send scan 486, 487
- See also* pages counts; pages counts
- CPMD
 - error codes 289
- CPMP
 - WISE 291
- CPU 10
- cross section
 - block diagram 145, 178
- current settings pages 81
- D**
- date
 - codes for firmware 145, 196, 202
 - product first used 486, 487
- DC controller
 - clutches 15
 - components 13
 - connections, diagrams 145, 181
 - fans 15
 - motors 14
 - sensors 16
 - solenoids 15
 - switches 16
- DC controller communication error 55.WX.YZ error 145
- DC controller firmware error 70.WX.YZ error 145
- DC motors 14
- decoding
 - message 145
- default settings, restoring
 - NVRAM initialization (M501) 480, 485
- defaults
 - restoring 480, 481
 - restoring (M501) 480
- defeating
 - interlocks 145, 146, 153
- determine problem source 107, 108
- determine the installed revision of firmware (M501) 502
- determine the installed revision of firmware (M506/E50045/M507/ E50145, M527/E52545/M528/ E52645) 505, 506
- development process 35
- diagnostics
 - engine 145, 146, 152
 - networks 145
- diagnostics (M506/M507, M527/ M528)
 - component 146
 - LED 146
- diagnostics (M506/M507/E50145, M527/M528/E52645)
 - component 145, 169
 - LED 145, 149
- diagrams
 - block 145, 175
 - circuit 145, 192
 - DC controller connections 145, 181
 - formatter connectors (M501) 145, 182
 - formatter connectors (M506) 145
 - formatter connectors (M506/ E50045/M507/E50145) 182
 - formatter connectors (M527/ E52545/M528/E52645) 183
 - formatter connectors (M527/ M528/E52645) 145
 - main assemblies (printer base) 145, 189
 - motor and fans 145, 189, 190
 - printed circuit assemblies (PCAs; printer base) 145, 189, 191
 - rollers and pads (printer base) 145, 189, 190
 - timing 145, 192

- digital sending error (firmware)
 - 44.WX.YZ error 145
- dimensions, printer M501 515, 516
- dimensions, printer M506/E50045/M507/E50145 518
- dimensions, printer M506/M507 515, 516
- dimensions, printer M527/E52545/M528/E52645 520
- dimensions, printer M527/M528 515, 516
- document feeder
 - automatic document feeder (M527/E52545/M528/E52645 only) 64
 - jams 452
 - paper-feeding problems (M527/E52545/M528/E52645) 449
 - paper-feeding problems (M527/M528) 448
- document feeder count
 - document feeder pages 486, 487
- document feeder error
 - 31.WX.YZ error 145
- document feeder kit interval 486, 487
- document feeder rollers (M527/M528/E52645)
 - cleaning 424
- documentation, printer error codes and messages
 - WISE 291
- drum cleaning 37
- duplex printing accessory
 - connections diagram 145, 181
- duplexer
 - clearing jams 465
- duplexer error
 - 69.WX.YZ error 145
- duplexing unit
 - motors 14
- dynamic security
 - toner cartridge 40
- dynamic security enabled printers 39

E

- EconoMode setting 295, 296
- electrical specifications 515, 524

- email problems
 - get help from WISE 512
- Embedded Jetdirect error
 - 80.WX.YZ error 145
- Embedded Web Server (EWS)
 - features 145, 206
- embedded web server (M506/E50045/M507/E50145, M527/E52545/M528/E52645) 505, 508
- engine
 - diagnostics 145, 146, 152
 - test page 145, 146, 152
- engine error (LaserJet)
 - 46.WX.YZ error 145
 - 63.WX.YZ error 145
- engine error (PageWide)
 - 61.WX.YZ error 145
- engine power supply
 - connections diagram 145, 181
- engine-control system
 - components 12
- envelope feeder
 - connections diagram 145, 181
- error
 - fault 145
- error codes 289
 - CPMD 289
- error log (M501)
 - information 145, 196
- event log 103
 - clear 486, 487
 - clear using LCD control panel 103, 105
 - clear using touchscreen control panel 103, 105
 - error codes 289
 - information 202
- event log (M506/M507, M527/M528)
 - information 196
- event log (M506/M507/E50145, M527/M528/E52645)
 - information 145
- event log error (firmware)
 - 42.WX.YZ error 145
- exhaust fans 15
- Explorer, versions supported
 - HP Embedded Web Server 145, 206
- external plug and port locations
 - block diagram 145, 185

F

- factory defaults, restoring
 - NVRAM initialization (M501) 480, 485
- failure detection
 - laser/scanner 29
 - motors 14
- failure detection (low-voltage power supply) 22
- fan error
 - 58.WX.YZ error 145
- fans
 - connections diagram 145, 181
 - DC controller 15
 - exhaust 15
 - intake 15
- fax problems
 - get help from WISE 512
- firmware
 - date codes 145, 196, 202
- firmware communication error
 - 49.WX.YZ error 145
- firmware install error
 - 99.WX.YZ error 145
 - hard disk error 145
 - remote firmware upgrade error 145
- firmware version 480, 482, 483
- firmware, downloading new (M506/E50045/M507/E50145, M527/E52545/M528/E52645) 505
- firmware, downloading new M501) 502
- flatbed
 - scanning and image capture (M527/E52545/M528/E52645 only) 63
- flowcharts
 - troubleshooting 107, 108, 109
- formatter
 - connections diagram 145, 181
 - resets after replacing 486, 487
- formatter connectors (M501)
 - diagrams 145, 182
- formatter connectors (M506)
 - diagrams 145
- formatter connectors (M506/E50045/M507/E50145)
 - diagrams 182

- formatter connectors (M527/E52545/
M528/E52645)
 - diagrams 183
- formatter connectors (M527/M528/
E52645)
 - diagrams 145
- formatter control system 6
- formatter lights 145, 146, 147, 149
- fuser 25
 - clearing jams 463
 - components 25
 - connections diagram 145, 181
 - control functions 26
 - control-circuit function 25
 - identification 27
 - life detection 27
 - temperature protection 27
 - See also* fusing and delivery unit
- fuser error
 - 41.WX.YZ error 145
 - laser scanner error 145
 - paper path error 145
- fuser error (LaserJet)
 - 50.WX.YZ error 145
- fuser test page
 - print 145, 204
- fuser test page (M506/M507/E50145,
M527/M528/E52645)
 - print 145
- fusing process 36

- G**
- glass (M527/M528/E52645),
 - cleaning 424
- guide, print-quality troubleshooting
310

- H**
- hard disk partition error
 - 98.WX.YZ error 145
- hardware integration pocket (HIP) is
not functioning 107, 118, 140, 143
- heartbeat LED 145, 146, 149
- heaters
 - fuser 25
- high-voltage power supply (HVPS)
 - bias generation 23
 - circuits 23
 - operations 23
- home button is unresponsive 107,
118, 140, 142
- HP Device Toolbox, using (M501)
145, 206
- HP embedded Jetdirect page 199
- HP embedded Jetdirect page (M506/
M507, M527/M528) 196
- HP embedded Jetdirect page (M506/
M507/E50145, M527/M528/
E52645) 145
- HP Embedded Web Server (EWS)
 - features 145, 206
- HP EWS, using (M501) 145, 206
- HP internal users
 - WISE 1, 71
- HP Jetdirect print server
 - configuration page 145, 196,
199
 - lights 145, 146, 147, 149
 - NVRAM initialization (M501) 480,
485
- HVPS (high-voltage power supply)
 - bias generation 23
 - circuits 23
 - operations 23

- I**
- I/O interfaces 10
- image capture system
 - scanning (M527/E52545/M528/
E52645 only) 63
- image defects, product specific 310,
314
- image defects, repetitive ruler 310,
314, 315
- image quality
 - check toner cartridge status 296
 - check toner-cartridge status 295,
298
 - tray 1 rollers and separation pad,
clean 424, 430
 - tray 2-X rollers, clean 424, 438
- image quality issues
 - examples and solutions 310
- image-formation process
 - development process 35
 - drum cleaning 37
 - fusing process 36
 - laser-beam exposure 34
 - primary charging 34
 - primary transfer process 35
 - separation process 36
- image-formation system
 - clutches 45
 - motors 45
 - solenoids 45
- image-information process 30
- individual component diagnostics
145, 146
- initial rotation period 4
- initialization
 - NVRAM (M501) 480, 485
- input accessory error
 - 67.WX.YZ error 145
- input/output error
 - 40.WX.YZ error 145
- input/output interfaces 10
- installation
 - date calculation 486, 487
 - verify for optional accessories
145, 196
- intake fans 15
- interlocks
 - defeating 145, 146, 153
- internal diagnostics error
 - 90.WX.YZ error 145
 - video display error 145
- Internet Explorer, versions supported
 - HP Embedded Web Server 145,
206
- IPv4 information 145, 196, 199, 200
- IPv6 information 145, 196, 199, 200

- J**
- jam error (LaserJet)
 - 13.WX.YZ error 145
- jam error (PageWide)
 - 13.WX.YZ error 145
- jams
 - 550-sheet trays 458
 - auto-navigation 451
 - causes of 452
 - detection in trays 3-5 61
 - document feeder 452
 - duplexer 465
 - fuser 463
 - output bin 464
 - rear door 463
 - recovery 470
 - sensor locations 450

- sensors 450
- toner cartridge area 461
- Tray 1 455
- Tray 2 458
- jams (M506/E50045/M507/E50145, M527/E52545/M528/E52645)
 - diagnostic test for 157
- jams (M506/M507, M527/M528)
 - diagnostic test for 146
- jams (M506/M507/E50145, M527/M528/E52645)
 - diagnostic test for 145
- Jetdirect print server
 - lights 145, 146, 147, 149
 - NVRAM initialization (M501) 480, 485
- JetIntelligence
 - anti-theft feature 41
 - authentication 41
 - toner cartridge 41
- job accounting error (firmware)
 - 48.WX.YZ error 145
- job management error (firmware) 145
- job pipeline error (firmware) 145
- job parser error (firmware)
 - 47.WX.YZ error 145
 - printer calibration error 145

K

- keyboard 8

L

- laser scanner error (LaserJet)
 - 51.WX.YZ error 145
 - 52.WX.YZ error 145
- laser-beam exposure 34
- laser/scanner
 - failure detection 29
 - operations 28
 - safety 29
- laser/scanner assembly
 - connections diagram 145, 181
- last rotation period 4
- latent image formation 30
- LEDs (M501)
 - formatter lights 145, 146, 147
- LEDs (M506/M507, M527/M528). *See* lights

- LEDs (M506/M507/E50145, M527/M528/E52645). *See* lights
- LEDs, troubleshooting (M501) 145, 146, 147
- lights
 - formatter 145, 146, 147, 149
 - (M501)
 - formatter 145, 146, 147
 - (M506/M507, M527/M528)
 - troubleshooting with 146
 - (M506/M507/E50145, M527/M528/E52645)
 - troubleshooting with 145, 149
- link speed settings 145
- location
 - setting 480, 482, 483
- low-voltage power supply (LVPS)
 - converted DC voltages 20
 - failure detection 22
 - operations 22
 - protection for components 21
 - stops and interruptions 20
- LVPS (low-voltage power supply)
 - converted DC voltages 20
 - failure detection 22
 - operations 22
 - protection for components 21
 - stops and interruptions 20

M

- M501
 - auto on / auto off mode 8
 - main assemblies (printer base)
 - block diagram 145, 189
 - memory
 - NVRAM initialization (M501) 480, 485
 - toner cartridge 39
 - Memory Enhancement technology (MEt) 11
 - memory error
 - 82.WX.YZ error 145
 - EMMC error 145
 - hard disk error 145
 - menu
 - Administration menu (M506/M507/E50145, M527/M528/E52645) 145
 - Backup/Restore menu (M506/E50045/M507/E50145, M527/E52545/M528/E52645) 282
 - Backup/Restore menu (M506/M507/E50145, M527/M528/E52645) 145
 - Calibrate/Cleaning menu (M506/E50045/M507/E50145, M527/E52545/M528/E52645) 282
 - Calibrate/Cleaning menu (M506/M507/E50145, M527/M528/E52645) 145
 - control panel, access 145, 210
 - Copy Settings menu (M527/M528/E52645) 145
 - Copy/Print (M527/E52545/M528/E52645) 228
 - Display Settings menu (M506/M507/E50145, M527/M528/E52645) 145
 - Fax menu (M527/E52545/M528/E52645) 257
 - Fax Settings menu (M527/M528/E52645) 145
 - General menu 222
 - General Settings menu (M506/M507/E50145, M527/M528/E52645) 145
 - HP Web Services (M501) 145, 210
 - Manage Supplies menu 267
 - Manage Supplies menu (M506/M507/E50145, M527/M528/E52645) 145
 - Manage Trays menu (M506/M507/E50145, M527/M528/E52645) 145
 - Network Settings menu (M506/M507/E50145, M527/M528/E52645) 145
 - Network Setup (M501) 145, 216
 - Networking 269
 - Print (M506/E50045/M507/E50145) 228
 - Print Options menu (M506/M507/E50145, M527/M528/E52645) 145
 - Print Settings menu (M506/M507/E50145, M527/M528/E52645) 145

- Quick Forms (M501) 145, 217
 - Reports (M501) 145, 210
 - Reports menu 219
 - Reports menu (M506/M507/
E50145, M527/M528/E52645)
145
 - Scan/Digital Send Settings menu
(M527/E52545/M528/
E52645) 249
 - Scan/Digital Send Settings menu
(M527/M528/E52645) 145
 - Service (M501) 145, 215
 - Service menu (M506/E50045/
M507/E50145, M527/E52545/
M528/E52645) 282, 283
 - Service menu (M506/M507/
E50145, M527/M528/E52645)
145
 - Settings menu 222
 - Support Tools menu 281
 - System Setup (M501) 145, 211
 - troubleshooting menu 283
 - troubleshooting menu (M506/
M507/E50145, M527/M528/
E52645) 145
 - USB Firmware Upgrade menu
(M506/E50045/M507/E50145,
M527/E52545/M528/E52645)
282, 283
 - USB Firmware Upgrade menu
(M506/M507/E50145, M527/
M528/E52645) 145
 - menu map 79
 - menu map (M501) 74
 - menus, control panel
 - Calibrate/Cleaning (M506/E50045/
M507/E50145, M527/E52545/
M528/E52645) 282
 - Calibrate/Cleaning (M506/M507/
E50145, M527/M528/E52645)
145
 - motor and fans
 - block diagram 145, 189, 190
 - motor control
 - trays 3-5 59
 - motor error (LaserJet)
 - 59.WX.YZ error 145
 - motors
 - connections diagram 145, 181
 - DC controller 14
 - failure detection 14
 - image-formation system 45
 - paper feeder 60
 - stepping 14
 - movement of paper through printer.
See paper handling
 - multiple feed prevention
 - trays 3-5 60
- N**
- Near Field Communication error
 - 81.WX.YZ error 145
 - Bluetooth error 145
 - external I/O card error 145
 - internal EIO error 145
 - wireless error 145
 - Netscape Navigator, versions
supported
 - HP Embedded Web Server 145,
206
 - network
 - configuring (M501) 145, 216
 - Network Setup menu (M501) 145,
216
 - networks
 - diagnostics 145
 - HP embedded Jetdirect
configuration page 145, 196,
199
 - link speed settings 145
 - wireless page 145, 196, 200
 - no control panel sound 107, 118,
140, 141
 - note 1
 - NVRAM initialization (M501) 480,
485
- O**
- operation
 - Sleep delay (M501) 7
 - Sleep mode (M506/M507/E50145,
M527/M528/E52645) 6
 - operation sequence 4
 - operations
 - laser/scanner 28
 - toner cartridge memory 39
 - output accessory error
 - 66.WX.YZ error 145
 - output bin
 - clearing jams 464
 - over-current protection 21
 - over-voltage protection 21
 - OXPd/Web kit error
 - 45.WX.YZ error 145
- P**
- page error
 - 21.WX.YZ error 145
 - pages
 - blank 472
 - not printing 472
 - printing slowly 472
 - pages count 486, 487
 - reset 486, 487
 - See also counts; counts
 - paper
 - default size reset 486, 487
 - jam detection 61
 - jams 452
 - selecting 295, 296, 300
 - paper (M506/M507, M527/M528)
 - stop in path for testing 146
 - paper (M506/M507/E50145, M527/
M528/E52645)
 - stop in path for testing 145, 167
 - paper feeder
 - electrical components 60
 - paper handling
 - components 42
 - overview 42
 - solve problems 445
 - paper handling error (LaserJet)
 - 56.WX.YZ error 145
 - paper jams
 - document feeder 452
 - paper movement
 - operation 42
 - paper path
 - 550-sheet paper feeder 57
 - printer 42
 - paper path (M506/E50045/M507/
E50145, M527/E52545/M528/
E52645)
 - diagnostic test 157
 - test, sensors 159
 - paper path (M506/M507, M527/M528)
 - diagnostic test 146
 - stop movement for testing 146

paper path (M506/M507/E50145, M527/M528/E52645)
 diagnostic test 145
 stop movement for testing 145, 167

paper-path (M506/M507, M527/M528)
 test, sensors 146

paper-path (M506/M507/E50145, M527/M528/E52645)
 test, sensors 145

password
 Service menu PIN 486, 487

periods of the operation sequence 4

PJL (printer job language) 8

PML (printer management language) 8

power
 consumption 515, 524

power subsystem 107, 112

power supply 18
 connections diagram 145, 181
 troubleshooting 107, 112, 113
See also low-voltage power supply;
 high-voltage power supply

power-on troubleshooting overview
 107, 112, 113, 114

power-save mode. *See* sleep settings

powersave (M501) 480

pre-boot menu options 83

pre-troubleshooting checklist 107, 108

primary charging process 34

print bar error (PageWide)
 62.WX.YZ error 145

print quality
 test pages 145, 195

print stop test
 timing stops 168

Print Test Page 145, 222

print-quality troubleshooting 145, 310, 314, 320
 AC banding 310, 314, 320, 321, 328, 336
 cartridge fine pitch banding 310, 314, 320, 352, 372, 375
 dark streaks (early in toner cartridge life) 310, 314, 320, 321, 328, 329
 density change 310, 314, 320, 352, 365, 368
 developer defect 310, 314, 320, 352, 353, 356
 fine-pitch banding 310, 314, 320, 321, 328, 331
 fuser blisters 310, 314, 320, 352, 390, 391
 fuser contamination 310, 314, 320, 407, 408
 graininess/fixing mottle 310, 314, 320, 321, 322, 323
 hot fuser offset 310, 314, 320, 352, 390, 393
 image placement - margins and skew 310, 314, 320, 407, 411
 impulse band (leading edge) 310, 314, 320, 321, 328, 343, 352, 380, 381
 impulse band (trailing edge) 310, 314, 320, 321, 328, 346, 349
 IPG repeating defect 310, 314, 320, 352, 372, 377
 leading edge - mid-page toner scatter 310, 314, 320, 352, 365, 366
 OPC gear slip 310, 314, 320, 352, 360, 361
 OPC sharp bands (version 1) 310, 314, 320, 321, 328, 339
 OPC sharp bands (version 2) 310, 314, 320, 321, 328, 341
 OPC wide-pitch banding 310, 314, 320, 352, 360, 363
 output curl 310, 314, 320, 407, 414
 output stacking 310, 314, 320, 407, 419
 paper handling - jams 310, 314, 320, 407, 423
 paper handling - misprints 310, 314, 320, 407, 421
 paper handling - multifeeds 310, 314, 320, 407, 422
 poor edge fixing - outside the image assurance area 310, 314, 320, 352, 390, 398
 poor edge fixing - within the image assurance area 310, 314, 320, 352, 390, 395
 rain-toner attached to the OPC 310, 314, 320, 352, 353, 354
 random missing toner 310, 314, 320, 352, 353, 358
 right to left fade and banding 310, 314, 320, 352, 372, 373
 sticky output 310, 314, 320, 407, 417
 toner in the leading edge margin (fuser slap) 310, 314, 320, 352, 380, 384
 transfer issue - random voids 310, 314, 320, 352, 365, 370
 uneven Density - across the page 310, 314, 320, 352, 402, 403
 vertical streaks - high temperature/humidity 310, 314, 320, 321, 325, 326
 water drop (condensation) 310, 314, 320, 352, 402, 405
 wide-pitch banding 310, 314, 320, 321, 328, 334, 352, 380, 387

printed circuit assemblies (PCAs; printer base)
 block diagram 145, 189, 191

printed circuit assembly (PCA)
 connector locations
 block diagram 145, 181

printer cold reset (M506/E50045/M507/E50145, M527/E52545/M528/E52645) 486, 492, 495

printer dimensions
 M506/M507, M527/M528,
 accessories 515, 516

printer job language (PJL) 8

printer management language (PML) 8

printer memory error
 20.WX.YZ error 145

printer resets (M506/E50045/M507/E50145, M527/E52545/M528/E52645) 486, 492

printer space requirements 515, 523

printing
 period in operation sequence 4
 stop for testing 145, 146, 167
 troubleshooting 472

problem-solving
 networks 145

Process Cleaning Page 145, 282

- Q**
Quick Forms menu (M501) 145, 217
- R**
real-time clock error
 11.WX.YZ error 145
rear door
 clearing jams 463
repetitive image defect ruler 310, 314, 315
reports
 configuration page 145, 210
 default info page 145, 210
 demo page 145, 210
 error 480, 482, 483
 menu map 145, 210
 network summary 145, 210
 PCL 6 font list 145, 210
 PCL font list 145, 210
 print quality page 145, 210
 PS font list 145, 210
 service 480, 482, 483
 service page 145, 210
 supplies status page 145, 210
 usage page 145, 210
resets
 NVRAM initialization (M501) 480, 485
restore factory settings (M506/E50045/M507/E50145, M527/E52545/M528/E52645) 486, 492, 493
restore the service ID (M506/E50045/M507/E50145, M527/E52545/M528/E52645) 486, 492, 494
restoring
 defaults (M501) 480
 factory defaults 480, 481
restoring default settings
 NVRAM initialization (M501) 480, 485
revision history iii
rollers and pads (printer base)
 block diagram 145, 189, 190
- S**
safety
 laser/scanner 29
scanner (M527/E52545/M528/E52645)
 tests 172
scanner (M527/M528)
 tests 146
scanner (M527/M528/E52645)
 glass cleaning 424
 tests 145
scanner error
 30.WX.YZ error 145
scanner settings 486, 487
scanner tests 173
scanning
 image capture (M527/E52545/M528/E52645 only) 63
secondary service menu (M501) 480, 482
security error
 33.WX.YZ error 145
security settings information 145, 196, 199, 200
sensor error
 54.WX.YZ error 145
 58.WX.YZ error 145
sensors
 block diagram 145, 176
 connections diagram 145, 181
 DC controller 16
 image-formation system 30
 paper feeder 60
 paper handling 44
 scanner tests 173
sensors (M506/E50045/M507/E50145, M527/E52545/M528/E52645)
 diagnostic tests 159
 tests, manual sensor 161
 tests, manual tray/bin 164
sensors (M506/M507, M527/M528)
 diagnostic tests 146
 tests, diagnostic sensor and paper path 146
 tests, manual sensor 146
 tests, manual tray/bin 146
sensors (M506/M507/E50145, M527/M528/E52645)
 diagnostic tests 145
 tests, diagnostic sensor and paper path 145, 156
 tests, manual sensor 145
 tests, manual tray/bin 145
separation process 36
serial number 486, 487
service and support
 WISE 1, 71
Service ID
 convert to date 486, 487
 restore 486, 487
service menu 480
 secondary (M501) 480, 482
Service menu (M501) 145, 215
Service menu options (M506/E50045/M507/E50145, M527/E52545/M528/E52645) 486, 487
service menu settings
 cleaning mode (M501) 480
 powersave (M501) 480
 restoring defaults (M501) 480
service menu settings (M501) 480
service mode functions (M501) 480
service mode functions (M506/E50045/M507/E50145, M527/E52545/M528/E52645) 486
service page (M501) 74
settings
 restore factory (M506/E50045/M507/E50145, M527/E52545/M528/E52645) 486, 492, 493
sleep delay (M501)
 operation 7
sleep mode (M506/M507/E50145, M527/M528/E52645)
 operation 6
sleep settings
 voltage too high during 21
sleep settings (M501) 7
sleep settings (M506/M507/E50145, M527/M528/E52645) 6
solenoids
 DC controller 15
 image-formation system 45
solve connectivity problems 477
solve performance problems 472
 factors affecting print performance 472
 print speeds 473
printer does not print 475
printer prints slowly 475

- solve problems 71
 - output is curled or wrinkled 446
 - paper does not feed
 - automatically 448, 449
 - paper does not feed from Tray 2-X 446
 - paper handling 445
 - printer does not pick up paper 448
 - printer does not pick up paper or misfeeds 448
 - printer feeds incorrect page size 445
 - printer picks up multiple sheets of paper 448
 - printer pulls from incorrect tray 445
 - printer will not duplex or duplexes incorrectly 445
- solving
 - direct-connect problems 477
- space requirements, printer 515, 523
- specifications
 - electrical and acoustic 515, 524
 - space requirements 515, 523
- standby period 4
- stepping motors 14
- stop printing for test (M506/M507, M527/M528) 146
- stop printing for test (M506/M507/E50145, M527/M528/E52645) 145, 167
- sub-voltage
 - low-voltage power supply circuit 20
- supplies error (LaserJet)
 - 10.WX.YZ error 145
- supplies error (PageWide)
 - 17.WX.YZ error 145
- switches
 - block diagram 145, 176
 - connections diagram 145, 181
 - DC controller 16
 - paper feeder 60
 - paper handling 44
- system error (LaserJet)
 - 62.WX.YZ error 145
- system requirements
 - HP Embedded Web Server 145, 206
 - System Setup menu (M501) 145, 211
- T**
- TCP/IP information 145, 196, 199, 200
- temperature
 - fuser heater protection 27
- test pages
 - fuser 145, 204
- test pages (M506/M507/E50145, M527/M528/E52645)
 - fuser 145
- tests
 - component tests list and descriptions 145, 146, 170
 - engine 145, 146, 152
 - networks 145
 - scanner (M527/E52545/M528/E52645) 172
 - scanner (M527/M528) 146
 - scanner (M527/M528/E52645) 145
 - tests (M506/E50045/M507/E50145, M527/E52545/M528/E52645)
 - disable cartridge check 155
 - manual sensor tests 161
 - paper path 157
 - paper path sensors 159
 - tray/bin manual sensor 164
 - tests (M506/M507, M527/M528)
 - disable cartridge check 146
 - manual sensor tests 146
 - paper path 146
 - paper path and sensor diagnostic 146
 - paper-path sensors 146
 - tray/bin manual sensor 146
 - tests (M506/M507/E50145, M527/M528/E52645)
 - disable cartridge check 145
 - manual sensor tests 145
 - paper path 145
 - paper path and sensor diagnostic 145, 156
 - paper-path sensors 145
 - tray/bin manual sensor 145
- tests (M527/E52545/M528/E52645)
 - scanner tests 172
- tests (M527/M528)
 - scanner tests 146
- tests (M527/M528/E52645)
 - scanner tests 145
- theory of operations 1
- thermistors
 - fuser 25
- thermoswitches
 - fuser 25
- timing chart 145, 192
- timing stops
 - print stop test 168
- tip 1
- toner
 - image formation, use during 30
- toner cartridge
 - anti-theft feature 41
 - authentication 41
 - dynamic security 40
 - JetIntelligence 41
 - life detection 39
 - memory chip 39
 - presence detection 39
 - toner level detection 39
- toner cartridge (M506/E50045/M507/E50145, M527/E52545/M528/E52645)
 - diagnostic test 155
- toner cartridge (M506/M507, M527/M528)
 - diagnostic test 146
- toner cartridge (M506/M507/E50145, M527/M528/E52645)
 - diagnostic test 145
- toner cartridge area
 - clearing jams 461
- toner cartridges 38
 - components 38
 - error conditions 38
 - operations 38
- touchscreen blank, white, or dim (no image) 107, 118, 140
- touchscreen control panel 8
- touchscreen has an unresponsive zone 107, 118, 140
- transfer processes 35
- tray
 - lift operation 60

- Tray 1
 - clearing jams 455
 - tray 1 rollers and separation pad
 - cleaning 424, 430
 - Tray 2
 - clearing jams 458
 - tray 2-X rollers
 - cleaning 424, 438
 - tray motor error (LaserJet)
 - 60.WX.YZ error 145
 - tray selection - use requested tray 145
 - trays 3-5
 - cassette lift operation 60
 - jam detection 61
 - motor control 59
 - multiple feed prevention 60
 - tray presence detection 60
 - troubleshooting 71
 - blank pages 472
 - check toner cartridge status 296
 - check toner-cartridge status 295, 298
 - checklist 75, 107, 108
 - clean the paper path 424, 425
 - configuration pages for 145, 196
 - control panel checks 118
 - direct-connect problems 477
 - flowchart 107, 108, 109
 - jams 450, 452
 - network problems 477, 478
 - NVRAM initialization (M501) 480, 485
 - pages not printing 472
 - pages printing slowly 472
 - power 107, 112, 113
 - process 107
 - USB cables 472
 - wired network 477, 478
 - troubleshooting (M501)
 - checklist 73
 - control panel checks 107
 - LED diagnostics 145, 146, 147
 - troubleshooting (M506/M507, M527/M528)
 - lights, using 146
 - troubleshooting (M506/M507/E50145, M527/M528/E52645)
 - lights, using 145, 149
 - troubleshooting (M506/M527)
 - control panel checks 107
- U**
- understand lights on the formatter
 - formatter lights 149
 - understand lights on the formatter (M506/M507, M527/M528)
 - formatter lights 146
 - understand lights on the formatter (M506/M507/E50145, M527/M528/E52645)
 - formatter lights 145
 - understand the lights on the formatter
 - heartbeat LED 149
 - HP Jetdirect LEDs 149
 - understand the lights on the formatter (M506/M507, M527/M528)
 - heartbeat LED 146
 - HP Jetdirect LEDs 146
 - understand the lights on the formatter (M506/M507/E50145, M527/M528/E52645)
 - heartbeat LED 145
 - HP Jetdirect LEDs 145
 - upgrade firmware (M506/E50045/M507/E50145, M527/E52545/M528/E52645) 505, 508
 - upgrades, downloading product firmware (M506/E50045/M507/E50145, M527/E52545/M528/E52645) 505
 - upgrades, downloading product firmware (M501) 502
 - USB flash drive
 - firmware upgrade, control panel (M506/E50045/M507/E50145, M527/E52545/M528/E52645) 505, 508, 511
 - firmware upgrade, pre-boot menu (M506/E50045/M507/E50145, M527/E52545/M528/E52645) 505, 508, 509
 - USB port
 - troubleshooting 472
 - Use Requested Tray 145
- W**
- waiting period 4
 - warning 1
 - warranty date information 486, 487
 - Web browser requirements
 - HP Embedded Web Server 145, 206
 - Web-based Interactive Search Engine (WISE)
 - HP internal users and Channel partners 1, 71
 - weight, printer M501 515, 516
 - weight, printer M506/E50045/M507/E50145 518
 - weight, printer M506/M507 515, 516
 - weight, printer M527/E52545/M528/E52645 520
 - weight, printer M527/M528 515, 516
 - wireless
 - configuration page 145, 196, 200
 - wireless page 200
 - wireless page (M506/M507, M527/M528) 196
 - wireless page (M506/M507/E50145, M527/M528/E52645) 145
 - WISE
 - CPMD 291
 - email problems 512
 - fax problems 512
 - HP internal users and Channel partners 1, 71
 - Wise
 - control panel message document 289