

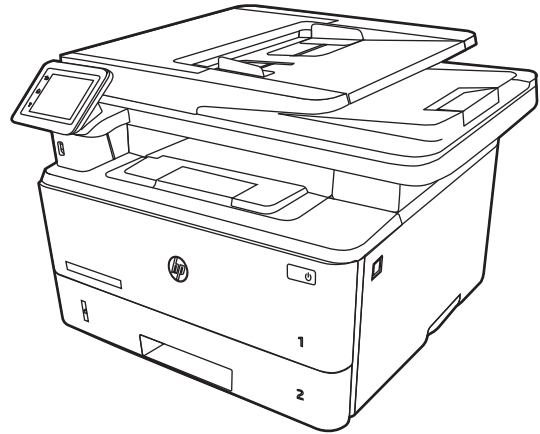

HP LaserJet Pro M304, M305, M404, M405

HP LaserJet Pro MFP M329, M428, M429

Service Manual: Repair

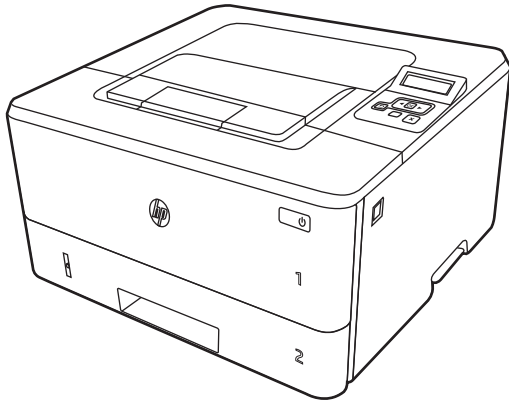

www.hp.com/videos/LaserJet
www.hp.com/support/ljM304
www.hp.com/support/ljM404

www.hp.com/support/ljM329MFP
www.hp.com/support/ljM428MFP
www.hp.com/support/ljM429MFP



LaserJet Pro M304, M305, M404, M405 and
LaserJet Pro MFP M329, M428, M429

Repair Manual

Copyright and License

© Copyright 2019 HP Development Company, L.P.

Reproduction, adaptation, or translation without prior written permission is prohibited, except as allowed under the copyright laws.

The information contained herein is subject to change without notice.

The only warranties for HP products and services are set forth in the express warranty statements accompanying such products and services. Nothing herein should be construed as constituting an additional warranty. HP shall not be liable for technical or editorial errors or omissions contained herein.

Edition 2, 4/2019

Conventions used in this guide

 **TIP:** Helpful hints or shortcuts.

Reinstallation tip: Reinstallation helpful hints, shortcuts, or considerations.

 **NOTE:** Information that explains a concept or how to complete a task.

 **IMPORTANT:** Information that help the user to avoid potential printer error conditions.

 **CAUTION:** Procedures that the user must follow to avoid losing data or damaging the printer.

 **WARNING!** Procedures that the user must follow to avoid personal injury, catastrophic loss of data, or extensive damage to the printer.

HP service and support

Learn about HP access to additional service and support information.

Additional service and support for channel partners

Channel partners, go to partner.hp.com, and then use the steps below to access the HP Web-based Interactive Search Engine (WISE).

Access WISE for Channel partners

1. Select **Services & Support**, and then select **Services Delivery**.
2. Select **Technical Support**, and then select **Technical Documentation**.

Find information about the following topics

- Service manuals
- Service advisories
- Up-to-date control panel message (CPMD) troubleshooting
- Install and configure
- Printer specifications
- Solutions for printer issues and emerging issues
- Remove and replace part instructions and videos
- Warranty and regulatory information

Additional service and support for HP internal personnel

HP internal personnel, go to one of the following Web-based Interactive Search Engine (WISE) sites:

Americas (AMS)

- <https://support.hp.com/wise/home/ams-en> WISE - English
- <https://support.hp.com/wise/home/ams-es> WISE - Spanish
- <https://support.hp.com/wise/home/ams-pt> WISE - Portuguese
- <https://support.hp.com/wise/home/ams-fr> WISE - French

Asia Pacific / Japan (APJ)

- <https://support.hp.com/wise/home/apj-en> WISE - English
- <https://support.hp.com/wise/home/apj-ja> WISE - Japanese
- <https://support.hp.com/wise/home/apj-ko> WISE - Korean
- <https://support.hp.com/wise/home/apj-zh-Hans> WISE - Chinese (simplified)

- [https://support.hp.com/wise/home/apj-zh-HantWISE - Chinese \(traditional\)](https://support.hp.com/wise/home/apj-zh-HantWISE - Chinese (traditional))
- <https://support.hp.com/wise/home/apj-thWISE - Thai>

Europe / Middle East / Africa (EMEA)

- <https://support.hp.com/wise/home/emea-enWISE - English>

Revision history

The information contained herein is subject to change without notice. The only warranties for HP products and services are set forth in the express warranty statements accompanying such products and services. Nothing herein should be construed as constituting an additional warranty. HP shall not be liable for technical or editorial errors or omissions contained herein.

Table -1 Revision history

Revision number	Revision date	Revision notes
1	8/2019	HP LaserJet Pro M304, M305, M404, M405 HP LaserJet Pro MFP M329, M428, M429 Repair manual initial release

Table of contents

1 Removal and replacement	1
HP service and support	2
Additional service and support for channel partners	2
Additional service and support for HP internal personnel	2
Removal and replacement strategy	4
Introduction	4
Considerations during removal and replacement	4
Electrostatic discharge	5
Required tools	5
Fasteners used in this printer	6
Service approach	7
Before performing service	7
Repair Mode	7
When using toner cartridges multiple times	7
After performing service	8
Post-service test	8
Print-quality test	8
Copy quality test (MFP only)	9
Fax-quality test (fax models)	9
Other tests	9
Removal and replacement procedures	10
Customer self-repair (CSR) A parts and assemblies	10
Removal and replacement: RL2-0656-000CN multipurpose tray roller	11
Introduction	11
Step 1: Remove the roller	11
Step 2: Unpack the replacement assembly	13
Step 3: Install the roller	14
Removal and replacement: RM2-5392-010CN 250-sheet paper input tray	16
Introduction	16
Step 1: Remove Tray 2	16
Step 2: Unpack the replacement assembly	17
Step 3: Install Tray 2	17

Removal and replacement: RM2-5413-000CN optional Tray 3 cassette	19
Introduction	19
Step 1: Remove optional Tray 3	19
Step 2: Unpack the replacement assembly	20
Step 3: Install optional Tray 3	21
Removal and replacement: RM2-5397-000CN Tray 2 separation roller assembly	23
Introduction	23
Step 1: Remove Tray 2	23
Step 2: Remove the separation pad roller assembly (Tray 2)	24
Step 3: Unpack the replacement assembly	25
Step 4: Install the separation pad roller assembly (Tray 2)	25
Step 5: Install Tray 2	26
Removal and replacement: RM2-5745-000CN optional Tray 3 separation roller assembly	28
Introduction	28
Step 1: Remove Tray 3	28
Step 2: Remove the separation roller assembly (optional Tray 3)	29
Step 3: Unpack the replacement assembly	30
Step 4: Install the separation roller assembly (optional Tray 3)	31
Step 5: Install Tray 3	32
Removal and replacement: RM2-5741-000CN optional Tray 3 paper pickup roller assembly	34
Introduction	34
Step 1: Remove optional Tray 3	34
Step 2: Remove the paper pickup roller assembly (optional Tray 3)	35
Step 3: Unpack the replacement assembly	37
Step 4: Install the paper pickup roller assembly (optional Tray 3)	38
Step 5: Install optional Tray 3	39
Removal and replacement: RM2-5452-000CN Tray 2 paper pickup roller assembly	41
Introduction	41
Step 1: Remove Tray 2	41
Step 2: Remove the pickup roller assembly (Tray 2)	42
Step 3: Unpack the replacement assembly	44
Step 4: Install the pickup roller assembly (Tray 2)	45
Step 5: Install Tray 2	46
Removal and replacement: External panels, covers, and doors	48
Removal and replacement: Damper sheets	49
Introduction	49
Step 1: Remove the damper sheets	49
Step 2: Unpack the replacement assembly	50
Removal and replacement: Rear USB cover	49

Introduction	51
Step 1: Remove the rear USB cover	51
Step 2: Unpack the replacement assembly	52
Removal and replacement: Support shaft	54
Introduction	54
Step 1: Remove the support shaft	54
Step 2: Unpack the replacement assembly	55
Removal and replacement: Cartridge door assembly	57
Introduction	57
Step 1: Remove the cartridge door assembly	57
Step 2: Unpack the replacement assembly	61
Removal and replacement: Pressure-release link	62
Introduction	62
Step 1: Remove the cartridge door assembly	62
Step 2: Remove the pressure-release link	66
Step 3: Unpack the replacement assembly	67
Removal and replacement: Left cover	68
Introduction	68
Step 1: Remove the rear USB cover	68
Step 2: Remove the network cover	69
Step 3: Remove Tray 2	70
Step 4: Remove the cartridge door assembly	70
Step 5: Remove the left cover	74
Step 6: Unpack the replacement assembly	75
Removal and replacement: Right cover	77
Introduction	77
Step 1: Remove Tray 2	77
Step 2: Remove the cartridge door assembly	78
Step 3: Remove the right cover	81
Step 4: Unpack the replacement assembly	82
Removal and replacement: Rear door assembly	84
Introduction	84
Step 1: Remove Tray 2	85
Step 2: Remove the cartridge door assembly	85
Step 3: Remove the left cover	88
Step 4: Remove the right cover	90
Step 5: Remove the rear door assembly	91
Step 6: Unpack the replacement assembly	92
Removal and replacement: Cassette rear cover	93
Introduction	93
Step 1: Remove Tray 2	94

Step 2: Remove the cartridge door assembly	94
Step 3: Remove the left cover	97
Step 4: Remove the right cover	99
Step 5: Remove the rear door assembly	100
Step 6: Remove the cassette rear cover	101
Step 7: Unpack the replacement assembly	102
Removal and replacement: Top cover (M329/M428/M429)	103
Introduction	103
Step 1: Remove Tray 2	104
Step 2: Remove the cartridge door assembly	104
Step 3: Remove the left cover	107
Step 4: Remove the right cover	109
Step 5: Remove the integrated scanner assembly (M329/M428/M429)	110
Step 6: Remove the control panel (M329/M428/M429)	114
Step 7: Remove the top cover (M329/M428/M429)	118
Step 8: Unpack the replacement assembly	120
Removal and replacement: Cable guide (M329/M428/M429)	121
Introduction	121
Step 1: Remove Tray 2	122
Step 2: Remove the cartridge door assembly	122
Step 3: Remove the left cover	126
Step 4: Remove the right cover	127
Step 5: Remove the control panel (M329/M428/M429)	128
Step 6: Remove the integrated scanner assembly (M329/M428/M429)	132
Step 7: Remove the top cover (M329/M428/M429)	137
Step 8: Remove the cable guide (M329/M428/M429)	139
Step 9: Unpack the replacement assembly	140
Removal and replacement: Top cover (M304/M305/M404/M405)	142
Introduction	142
Step 1: Remove Tray 2	142
Step 2: Remove the cartridge door assembly	143
Step 3: Remove the left cover	146
Step 4: Remove the right cover	148
Step 5: Remove the top cover (M304/M305/M404/M405)	149
Step 7: Unpack the replacement assembly	150
Removal and replacement: 2-line LCD operator and indication covers (M304/M305/ M404/M405)	151
Introduction	151
Step 1: Remove Tray 2	152
Step 2: Remove the cartridge door assembly	152
Step 3: Remove the left cover	155

Step 4: Remove the right cover	157
Step 5: Remove the top cover (M304/M305/M404/M405)	158
Step 6: Remove the 2-line LCD operator and indication covers (M304/ M305/M404/M405)	159
Step 7: Unpack the replacement assembly	160
Removal and replacement: Paper delivery tray (output bin)	162
Introduction	162
Step 1: Remove Tray 2	163
Step 2: Remove the cartridge door assembly	163
Step 3: Remove the left cover	167
Step 4: Remove the right cover	168
Step 5: Remove the integrated scanner assembly (M329/M428/M429)	169
Step 6: Remove the control panel (M329/M428/M429)	174
Step 7: Remove the top cover (M329/M428/M429)	178
Step 8: Remove the top cover (M304/M305/M404/M405)	180
Step 9: Remove the paper delivery tray (output bin)	181
Step 10: Unpack the replacement assembly	182
Removal and replacement: Integrated scanner assembly (M329/M428/M429)	183
Introduction	183
Step 1: Remove Tray 2	184
Step 2: Remove the cartridge door assembly	184
Step 3: Remove the left cover	187
Step 4: Remove the ISA (M329/M428/M429)	189
Step 5: Unpack the replacement assembly	194
Removal and replacement: ISA lift assembly and slider pin (M329/M428/M429)	195
Introduction	195
Step 1: Remove the slider pin (M329/M428/M429)	196
Step 2: Remove the ISA lift assembly (M329/M428/M429)	196
Step 3: Unpack the replacement assembly	198
Removal and replacement: Internal parts and assemblies	200
Removal and replacement: Fuser	201
Introduction	201
Step 1: Remove Tray 2	202
Step 2: Remove the cartridge door assembly	202
Step 3: Remove the left cover	206
Step 4: Remove the right cover	207
Step 5: Remove the rear door assembly	208
Step 6: Remove the fuser	209
Step 7: Unpack the replacement assembly	212
Removal and replacement: Registration assembly	214
Introduction	214

Step 1: Remove Tray 2	215
Step 2: Remove the cartridge door assembly	215
Step 3: Remove the left cover	219
Step 4: Remove the right cover	220
Step 5: Remove the rear door assembly	221
Step 6: Remove the integrated scanner assembly (M329/M428/M429)	222
Step 7: Remove the control panel (M329/M428/M429)	227
Step 8: Remove the top cover (M329/M428/M429)	231
Step 9: Remove the top cover (M304/M305/M404/M405)	233
Step 10: Remove the paper delivery tray (output bin)	234
Step 11: Remove the fuser	235
Step 12: Remove the registration assembly	238
Step 13: Unpack the replacement assembly	241
Removal and replacement: Main motor (M1)	243
Introduction	243
Step 1: Remove Tray 2	243
Step 2: Remove the cartridge door assembly	244
Step 3: Remove the right cover	247
Step 4: Remove the main motor (M1)	248
Step 5: Unpack the replacement assembly	249
Removal and replacement: Power switch printed circuit assembly	250
Introduction	250
Step 1: Remove Tray 2	250
Step 2: Remove the cartridge door assembly	251
Step 3: Remove the right cover	254
Step 4: Remove the power switch PCA	255
Step 5: Unpack the replacement assembly	257
Removal and replacement: Fax PCA (M329/M428/M429)	259
Introduction	259
Step 1: Remove Tray 2	260
Step 2: Remove the cartridge door assembly	260
Step 3: Remove the left cover	264
Step 4: Remove the fax PCA (Fax models only)	265
Step 5: Unpack the replacement assembly	266
Removal and replacement: Mute USB PCA (M329/M428/M429)	268
Introduction	268
Step 1: Remove Tray 2	268
Step 2: Remove the cartridge door assembly	269
Step 3: Remove the left cover	272
Step 4: Remove the Mute USB PCA (M329/M428/M429)	274
Step 5: Unpack the replacement assembly	275

Removal and replacement: Wireless PCA	277
Introduction	277
Step 1: Remove Tray 2	278
Step 2: Remove the cartridge door assembly	278
Step 3: Remove the left cover	281
Step 4: Remove the wireless PCA	283
Step 5: Unpack the replacement assembly	284
Removal and replacement: Formatter PCA	285
Introduction	285
Step 1: Remove Tray 2	287
Step 2: Remove the cartridge door assembly	288
Step 3: Remove the left cover	291
Step 4: Remove the wireless PCA	293
Step 5: Remove the formatter PCA	294
Step 6: Unpack the replacement assembly	295
Removal and replacement: Fan (FM1)	296
Introduction	296
Step 1: Remove Tray 2	296
Step 2: Remove the cartridge door assembly	297
Step 3: Remove the left cover	300
Step 4: Remove the fan (FM1)	302
Step 5: Unpack the replacement assembly	303
Removal and replacement: Fan holder (FM1)	305
Introduction	305
Step 1: Remove Tray 2	305
Step 2: Remove the cartridge door assembly	306
Step 3: Remove the left cover	309
Step 4: Remove the fan (FM1)	311
Step 5: Remove the fan holder (FM1)	312
Step 6: Unpack the replacement assembly	315
Removal and replacement: Laser scanner assembly	316
Introduction	316
Step 1: Remove Tray 2	317
Step 2: Remove the cartridge door assembly	317
Step 3: Remove the left cover	321
Step 4: Remove the right cover	322
Step 5: Remove the integrated scanner assembly (M329/M428/M429)	323
Step 6: Remove the control panel (M329/M428/M429)	328
Step 7: Remove the top cover (M329/M428/M429)	332
Step 8: Remove the top cover (M304/M305/M404/M405)	334
Step 9: Remove the paper delivery tray (output bin)	335

Step 10: Remove the laser scanner assembly	336
Step 11: Unpack the replacement assembly	337
Removal and replacement: Sheet-metal formatter bracket and formatter PCA	338
Step 1: Remove Tray 2	338
Step 2: Remove the cartridge door assembly	338
Step 3: Remove the left cover	342
Step 4: Remove the right cover	343
Step 5: Remove the integrated scanner assembly (M329/M428/M429)	344
Step 6: Remove the control panel (M329/M428/M429)	349
Step 7: Remove the top cover (M329/M428/M429)	353
Step 8: Remove the top cover (M304/M305/M404/M405)	355
Step 9: Remove the sheet-metal formatter bracket and formatter PCA	356
Removal and replacement: Control panel FFC, (M304/M305/M404/M405)	361
Introduction	361
Step 1: Remove Tray 2	362
Step 2: Remove the cartridge door assembly	362
Step 3: Remove the left cover	365
Step 4: Remove the right cover	367
Step 5: Remove the top cover (M304/M305/M404/M405)	368
Step 6: Remove the paper delivery tray (output bin)	369
Step 7: Remove the control panel FFC	370
Step 8: Unpack the replacement assembly	371
Removal and replacement: Formatter FFC	372
Introduction	372
Step 1: Remove Tray 2	373
Step 2: Remove the cartridge door assembly	373
Step 3: Remove the left cover	377
Step 4: Remove the right cover	378
Step 5: Remove the integrated scanner assembly (M329/M428/M429)	379
Step 6: Remove the control panel (M329/M428/M429)	384
Step 7: Remove the top cover (M329/M428/M429)	388
Step 8: Remove the top cover (M304/M305/M404/M405)	390
Step 9: Remove the sheet-metal formatter bracket and formatter PCA	391
Step 10: Remove the formatter FFC	396
Step 11: Unpack the replacement assembly	396
Removal and replacement: DC controller	398
Introduction	398
Step 1: Remove Tray 2	399
Step 2: Remove the cartridge door assembly	399
Step 3: Remove the left cover	403
Step 4: Remove the right cover	404

Step 5: Remove the rear door assembly	405
Step 6: Remove the integrated scanner assembly (M329/M428/M429)	406
Step 7: Remove the control panel (M329/M428/M429)	411
Step 8: Remove the top cover (M329/M428/M429)	415
Step 9: Remove the top cover (M304/M305/M404/M405)	417
Step 10: Remove the paper delivery tray (output bin)	418
Step 11: Remove the sheet-metal formatter bracket and formatter PCA ...	419
Step 12: Remove the DC controller	423
Step 13: Unpack the replacement assembly	425
Removal and replacement: Tag-cable assembly (toner-cartridge memory)	426
Introduction	426
Step 1: Remove Tray 2	427
Step 2: Remove the cartridge door assembly	427
Step 3: Remove the left cover	431
Step 4: Remove the right cover	432
Step 5: Remove the integrated scanner assembly (M329/M428/M429)	433
Step 6: Remove the control panel (M329/M428/M429)	438
Step 7: Remove the top cover (M329/M428/M429)	442
Step 8: Remove the top cover (M304/M305/M404/M405)	444
Step 9: Remove the paper delivery tray (output bin)	445
Step 10: Remove the sheet-metal formatter bracket and formatter PCA ...	446
Step 11: Remove the tag-cable assembly (toner-cartridge memory)	450
Step 12: Unpack the replacement assembly	451
Removal and replacement: Connecting PCA	453
Introduction	453
Step 1: Remove Tray 2	454
Step 2: Remove the cartridge door assembly	454
Step 3: Remove the left cover	458
Step 4: Remove the right cover	459
Step 5: Remove the integrated scanner assembly (M329/M428/M429)	460
Step 6: Remove the control panel (M329/M428/M429)	465
Step 7: Remove the top cover (M329/M428/M429)	469
Step 8: Remove the top cover (M304/M305/M404/M405)	471
Step 9: Remove the paper delivery tray (output bin)	472
Step 10: Remove the sheet-metal formatter bracket and formatter PCA ...	473
Step 11: Remove the connecting PCA	477
Step 12: Unpack the replacement assembly	478
Removal and replacement: Laser scanner FFC	480
Introduction	480
Step 1: Remove Tray 2	481
Step 2: Remove the cartridge door assembly	481

Step 3: Remove the left cover	485
Step 4: Remove the right cover	486
Step 5: Remove the integrated scanner assembly (M329/M428/M429)	487
Step 6: Remove the control panel (M329/M428/M429)	492
Step 7: Remove the top cover (M329/M428/M429)	496
Step 8: Remove the top cover (M304/M305/M404/M405)	498
Step 9: Remove the paper delivery tray (output bin)	499
Step 10: Remove the sheet-metal formatter bracket and formatter PCA ...	500
Step 11: Remove the tag-cable assembly	504
Step 12: Remove the laser scanner FFC	505
Step 13: Unpack the replacement assembly	508
Removal and replacement: High-voltage power supply	509
Introduction	509
Step 1: Remove Tray 2	510
Step 2: Remove the cartridge door assembly	510
Step 3: Remove the left cover	514
Step 4: Remove the right cover	515
Step 5: Remove the integrated scanner assembly (M329/M428/M429)	516
Step 6: Remove the control panel (M329/M428/M429)	521
Step 7: Remove the top cover (M329/M428/M429)	525
Step 8: Remove the top cover (M304/M305/M404/M405)	527
Step 9: Remove the paper delivery tray (output bin)	528
Step 10: Remove the sheet-metal formatter bracket and formatter PCA ...	529
Step 11: Remove the HVPS	533
Step 12: Unpack the replacement assembly	535
Removal and replacement: Low-voltage power supply	537
Introduction	537
Step 1: Remove Tray 2	538
Step 2: Remove the cartridge door assembly	538
Step 3: Remove the left cover	542
Step 4: Remove the right cover	543
Step 5: Remove the integrated scanner assembly (M329/M428/M429)	544
Step 6: Remove the control panel (M329/M428/M429)	549
Step 7: Remove the top cover (M329/M428/M429)	553
Step 8: Remove the top cover (M304/M305/M404/M405)	555
Step 9: Remove the paper delivery tray (output bin)	556
Step 10: Remove the fan (FM1)	557
Step 11: Remove the sheet-metal formatter bracket and formatter PCA ...	558
Step 12: Remove the LVPS	563
Step 13: Unpack the replacement assembly	566
Removal and replacement: Control-panel assembly (M304/M305/M404/M405)	568

Introduction	568
Step 1: Remove Tray 2	569
Step 2: Remove the cartridge door assembly	569
Step 3: Remove the left cover	572
Step 4: Remove the right cover	574
Step 5: Remove the top cover (M304/M305/M404/M405)	368
Step 6: Remove the paper delivery tray (output bin)	335
Step 7: Remove the control-panel assembly (M304/M305/M404/M405) ...	577
Step 8: Unpack the replacement assembly	577
Removal and replacement: Control panel (M329/M428/M429) and control panel sub assemblies	579
Introduction	579
Step 1: Remove the control panel mount cover M329/M428/M429)	580
Step 2: Remove the control panel (M329/M428/M429)	582
Step 3: Remove the control panel mount base (M329/M428/M429)	586
Step 4: Remove the control panel mount chassis assembly (M329/ M448/M429)	587
Step 5: Remove Tray 2	588
Step 6: Remove the cartridge door assembly	589
Step 7: Remove the left cover	592
Step 8: Remove the control panel 22-pin FFC (M329/M428/M429)	594
Step 9: Unpack the replacement assembly	596
Removal and replacement: Trays	598
Removal and replacement: Tray 2	598
Removal and replacement: RM2-5392-010CN 250-sheet paper input tray	599
Removal and replacement: RM2-5452-000CN Tray 2 paper pickup roller assembly	601
Removal and replacement: RM2-5397-000CN Tray 2 separation roller assembly	605
Removal and replacement: RM2-5375-000CN Tray 2 sensor assembly	68
Removal and replacement: Accessories	622
550-sheet paper feeder	622
Removal and replacement: D9P29-67018 optional 550-sheet paper feeder	623
Removal and replacement: RM2-5413-000CN optional Tray 3 cassette	628
Removal and replacement: RM2-5741-000CN optional Tray 3 paper pickup roller assembly	632
Removal and replacement: RM2-5745-000CN optional Tray 3 separation roller assembly	639

2 Parts and diagrams	645
HP service and support	646
Additional service and support for channel partners	646
Additional service and support for HP internal personnel	646
Order parts, accessories, and supplies	648
Ordering	648
Orderable parts	648
Whole unit replacement (WUR)	648
Supplies	650
Accessories	651
Customer self-repair parts	651
Related documentation and software	651
Assembly locations	653
HP LaserJet Pro M304/M305/M404/M405	653
HP LaserJet Pro MFP M329/M4284/M429	655
How to use the parts lists and diagrams	657
Document feeder and image scanner	658
Main assemblies	658
Covers, printer base	660
Covers (M304/M305/M404/M405)	660
Covers (M329/M428/M429)	662
Internal components, printer base	664
Internal components, printer base (1 of 3)	664
Internal components, printer base (2 of 3)	666
Internal components, printer base (3 of 3)	668
550-sheet paper feeder	672
Covers, 550-sheet paper feeder	672
Main body, 550-sheet paper feeder	674
Alphabetical parts list	676
Numerical parts list	684
Index	693

List of tables

Table 2-1	HP LaserJet Pro M304/M305/M404/M405	648
Table 2-2	HP LaserJet Pro MFP M329/M428/M429	649
Table 2-3	Supplies	650
Table 2-4	Accessories	651
Table 2-5	Printer front view (SFP)	653
Table 2-6	Printer rear view (SFP)	654
Table 2-7	Printer front view (MFP)	655
Table 2-8	Printer rear view (MFP)	656
Table 2-9	Main assembly (document feeder and image scanner)	659
Table 2-10	Covers (M304/M305/M404/M405)	661
Table 2-11	Covers (M329/M428/M429)	663
Table 2-12	Internal components, printer base (1 of 3)	665
Table 2-13	Internal components, printer base (2 of 3)	667
Table 2-14	Internal components, printer base (3 of 3)	669
Table 2-15	Covers, 550-sheet paper feeder	673
Table 2-16	Main body, 550-sheet paper feeder	675

List of figures

Figure 1-1	Screwdrivers	6
Figure 1-2	Open the toner-cartridge door	12
Figure 1-3	Release two tabs	12
Figure 1-4	Remove the roller	13
Figure 1-5	Recycle and unpack	13
Figure 1-6	Install the roller	14
Figure 1-7	Engage two tabs	14
Figure 1-8	Close the toner-cartridge door	15
Figure 1-9	Remove the tray	17
Figure 1-10	Recycle and unpack	17
Figure 1-11	Install the tray	18
Figure 1-12	Pull the tray out of the printer	20
Figure 1-13	Release and remove the tray	20
Figure 1-14	Recycle and unpack	21
Figure 1-15	Install the tray	21
Figure 1-16	Close the tray	22
Figure 1-17	Remove the tray	24
Figure 1-18	Release the assembly	24
Figure 1-19	Remove the assembly	25
Figure 1-20	Recycle and unpack	25
Figure 1-21	Install the assembly	26
Figure 1-22	Release the assembly	26
Figure 1-23	Install the tray	27
Figure 1-24	Pull the tray out of the printer	29
Figure 1-25	Release and remove the tray	29
Figure 1-26	Release the assembly	30
Figure 1-27	Remove the assembly	30
Figure 1-28	Recycle and unpack	31
Figure 1-29	Install the assembly	31
Figure 1-30	Release the assembly	32
Figure 1-31	Install the tray	32
Figure 1-32	Close the tray	33

Figure 1-33	Pull the tray out of the printer	35
Figure 1-34	Release and remove the tray	35
Figure 1-35	Turn the accessory over	36
Figure 1-36	Release the assembly	36
Figure 1-37	Rotate the assembly up	37
Figure 1-38	Remove the assembly	37
Figure 1-39	Recycle and unpack	38
Figure 1-40	Install the roller assembly	38
Figure 1-41	Release the assembly	39
Figure 1-42	Check the installation	39
Figure 1-43	Install the tray	40
Figure 1-44	Close the tray	40
Figure 1-45	Remove the tray	42
Figure 1-46	Tilt the printer backward	42
Figure 1-47	Place the printer bottom-side face forward	43
Figure 1-48	Release one tab	43
Figure 1-49	Remove the roller holder	44
Figure 1-50	Recycle and unpack	44
Figure 1-51	Install the roller holder	45
Figure 1-52	Check the tab	45
Figure 1-53	Rotate the printer forward	46
Figure 1-54	Place the printer in the operational position	46
Figure 1-55	Install the tray	47
Figure 1-56	Remove the damper sheets	50
Figure 1-57	Pull the cover straight off	52
Figure 1-58	Remove the cover	52
Figure 1-59	Release the support shaft	55
Figure 1-60	Remove the support shaft	55
Figure 1-61	Release the support shaft	58
Figure 1-62	Remove the support shaft	58
Figure 1-63	Remove the guide	59
Figure 1-64	Release the pressure-release link	59
Figure 1-65	Release the door	60
Figure 1-66	Release the left-side retainer arm	60
Figure 1-67	Remove the door	61
Figure 1-68	Release the support shaft	63
Figure 1-69	Remove the support shaft	63
Figure 1-70	Remove the guide	64
Figure 1-71	Release the pressure-release link	64
Figure 1-72	Release the door	65
Figure 1-73	Release the left-side retainer arm	65

Figure 1-74	Remove the door	66
Figure 1-75	Release the pressure-release link	66
Figure 1-76	Remove the pressure-release link	67
Figure 1-77	Pull the cover straight off	69
Figure 1-78	Remove the cover	69
Figure 1-79	Pull the cover straight off	70
Figure 1-80	Remove the tray	70
Figure 1-81	Release the support shaft	71
Figure 1-82	Remove the support shaft	71
Figure 1-83	Remove the guide	72
Figure 1-84	Release the pressure-release link	72
Figure 1-85	Release the door	73
Figure 1-86	Release the left-side retainer arm	73
Figure 1-87	Remove the door	74
Figure 1-88	Remove one screw	74
Figure 1-89	Release two bosses and three tabs	75
Figure 1-90	Remove the cover	75
Figure 1-91	Remove the tray	78
Figure 1-92	Release the support shaft	78
Figure 1-93	Remove the support shaft	79
Figure 1-94	Remove the guide	79
Figure 1-95	Release the pressure-release link	80
Figure 1-96	Release the door	80
Figure 1-97	Release the left-side retainer arm	81
Figure 1-98	Remove the door	81
Figure 1-99	Release two bosses and three tabs	82
Figure 1-100	Remove the cover	82
Figure 1-101	Remove the tray	85
Figure 1-102	Release the support shaft	85
Figure 1-103	Remove the support shaft	86
Figure 1-104	Remove the guide	86
Figure 1-105	Release the pressure-release link	87
Figure 1-106	Release the door	87
Figure 1-107	Release the left-side retainer arm	88
Figure 1-108	Remove the door	88
Figure 1-109	Remove one screw	89
Figure 1-110	Release two bosses and three tabs	89
Figure 1-111	Remove the cover	90
Figure 1-112	Release two bosses and three tabs	90
Figure 1-113	Remove the cover	90
Figure 1-114	Duplex models, lower the duplex feed assembly	91

Figure 1-115	Remove two screws	91
Figure 1-116	Remove the tray	94
Figure 1-117	Release the support shaft	94
Figure 1-118	Remove the support shaft	95
Figure 1-119	Remove the guide	95
Figure 1-120	Release the pressure-release link	96
Figure 1-121	Release the door	96
Figure 1-122	Release the left-side retainer arm	97
Figure 1-123	Remove the door	97
Figure 1-124	Remove one screw	98
Figure 1-125	Release two bosses and three tabs	98
Figure 1-126	Remove the cover	99
Figure 1-127	Release two bosses and three tabs	99
Figure 1-128	Remove the cover	99
Figure 1-129	Duplex models, lower the duplex feed assembly	100
Figure 1-130	Remove two screws	100
Figure 1-131	Locate the hinge retainer	101
Figure 1-132	Release the retainer and the hinge pin	101
Figure 1-133	Remove the cover	102
Figure 1-134	Remove the tray	104
Figure 1-135	Release the support shaft	104
Figure 1-136	Remove the support shaft	105
Figure 1-137	Remove the guide	105
Figure 1-138	Release the pressure-release link	106
Figure 1-139	Release the door	106
Figure 1-140	Release the left-side retainer arm	107
Figure 1-141	Remove the door	107
Figure 1-142	Remove one screw	108
Figure 1-143	Release two bosses and three tabs	108
Figure 1-144	Remove the cover	109
Figure 1-145	Release two bosses and three tabs	109
Figure 1-146	Remove the cover	109
Figure 1-147	Raise the ISA	110
Figure 1-148	Remove the ISA FFC cover	110
Figure 1-149	Disconnect three FFCs	111
Figure 1-150	Remove one screw	111
Figure 1-151	Pass the wire through the opening	112
Figure 1-152	Release one tab and rotate the slider pin	112
Figure 1-153	Remove the slider pin	113
Figure 1-154	Rotate the ISA towards the rear of the printer	113
Figure 1-155	Release the ISA	114

Figure 1-156	Remove the ISA	114
Figure 1-157	Disconnect one connector	115
Figure 1-158	Remove one screw	115
Figure 1-159	Release two tabs	116
Figure 1-160	Remove the cover	116
Figure 1-161	Remove one screw	117
Figure 1-162	Remove two screws	117
Figure 1-163	Lift up the control-panel assembly	118
Figure 1-164	Remove the control-panel assembly	118
Figure 1-165	Remove the USB cable	119
Figure 1-166	Remove the support arm	119
Figure 1-167	Remove the cover	120
Figure 1-168	Remove the tray	122
Figure 1-169	Release the support shaft	123
Figure 1-170	Remove the support shaft	123
Figure 1-171	Remove the guide	124
Figure 1-172	Release the pressure-release link	124
Figure 1-173	Release the door	125
Figure 1-174	Release the left-side retainer arm	125
Figure 1-175	Remove the door	126
Figure 1-176	Remove one screw	126
Figure 1-177	Release two bosses and three tabs	127
Figure 1-178	Remove the cover	127
Figure 1-179	Release two bosses and three tabs	128
Figure 1-180	Remove the cover	128
Figure 1-181	Disconnect one connector	129
Figure 1-182	Remove one screw	129
Figure 1-183	Release two tabs	130
Figure 1-184	Remove the cover	130
Figure 1-185	Remove one screw	131
Figure 1-186	Remove two screws	131
Figure 1-187	Lift up the control-panel assembly	132
Figure 1-188	Remove the control-panel assembly	132
Figure 1-189	Raise the ISA	133
Figure 1-190	Remove the ISA FFC cover	133
Figure 1-191	Disconnect three FFCs	134
Figure 1-192	Remove one screw	134
Figure 1-193	Pass the wire through the opening	135
Figure 1-194	Release one tab and rotate the slider pin	135
Figure 1-195	Remove the slider pin	136
Figure 1-196	Rotate the ISA towards the rear of the printer	136

Figure 1-197	Release the ISA	137
Figure 1-198	Remove the ISA	137
Figure 1-199	Remove the USB cable	138
Figure 1-200	Remove the support arm	138
Figure 1-201	Remove the cover	139
Figure 1-202	Release one tab	139
Figure 1-203	Release the guide	140
Figure 1-204	Remove the guide	140
Figure 1-205	Remove the tray	143
Figure 1-206	Release the support shaft	143
Figure 1-207	Remove the support shaft	144
Figure 1-208	Remove the guide	144
Figure 1-209	Release the pressure-release link	145
Figure 1-210	Release the door	145
Figure 1-211	Release the left-side retainer arm	146
Figure 1-212	Remove the door	146
Figure 1-213	Remove one screw	147
Figure 1-214	Release two bosses and three tabs	147
Figure 1-215	Remove the cover	148
Figure 1-216	Release two bosses and three tabs	148
Figure 1-217	Remove the cover	148
Figure 1-218	Remove one screw	149
Figure 1-219	Release one boss and one tab	149
Figure 1-220	Remove the cover	150
Figure 1-221	Remove the tray	152
Figure 1-222	Release the support shaft	152
Figure 1-223	Remove the support shaft	153
Figure 1-224	Remove the guide	153
Figure 1-225	Release the pressure-release link	154
Figure 1-226	Release the door	154
Figure 1-227	Release the left-side retainer arm	155
Figure 1-228	Remove the door	155
Figure 1-229	Remove one screw	156
Figure 1-230	Release two bosses and three tabs	156
Figure 1-231	Remove the cover	157
Figure 1-232	Release two bosses and three tabs	157
Figure 1-233	Remove the cover	157
Figure 1-234	Remove one screw	158
Figure 1-235	Release one boss and one tab	158
Figure 1-236	Remove the cover	159
Figure 1-237	Rotate the top edge of the operator cover	159

Figure 1-238	Remove the cover	160
Figure 1-239	Remove the cover	160
Figure 1-240	Remove the tray	163
Figure 1-241	Release the support shaft	164
Figure 1-242	Remove the support shaft	164
Figure 1-243	Remove the guide	165
Figure 1-244	Release the pressure-release link	165
Figure 1-245	Release the door	166
Figure 1-246	Release the left-side retainer arm	166
Figure 1-247	Remove the door	167
Figure 1-248	Remove one screw	167
Figure 1-249	Release two bosses and three tabs	168
Figure 1-250	Remove the cover	168
Figure 1-251	Release two bosses and three tabs	169
Figure 1-252	Remove the cover	169
Figure 1-253	Raise the ISA	170
Figure 1-254	Remove the ISA FFC cover	170
Figure 1-255	Disconnect three FFCs	171
Figure 1-256	Remove one screw	171
Figure 1-257	Pass the wire through the opening	172
Figure 1-258	Release one tab and rotate the slider pin	172
Figure 1-259	Remove the slider pin	173
Figure 1-260	Rotate the ISA towards the rear of the printer	173
Figure 1-261	Release the ISA	174
Figure 1-262	Remove the ISA	174
Figure 1-263	Disconnect one connector	175
Figure 1-264	Remove one screw	175
Figure 1-265	Release two tabs	176
Figure 1-266	Remove the cover	176
Figure 1-267	Remove one screw	177
Figure 1-268	Remove two screws	177
Figure 1-269	Lift up the control-panel assembly	178
Figure 1-270	Remove the control-panel assembly	178
Figure 1-271	Remove the USB cable	179
Figure 1-272	Remove the support arm	179
Figure 1-273	Remove the cover	180
Figure 1-274	Remove one screw	180
Figure 1-275	Release one boss and one tab	181
Figure 1-276	Remove the cover	181
Figure 1-277	Release two tabs	182
Figure 1-278	Remove the tray	184

Figure 1-279	Release the support shaft	184
Figure 1-280	Remove the support shaft	185
Figure 1-281	Remove the guide	185
Figure 1-282	Release the pressure-release link	186
Figure 1-283	Release the door	186
Figure 1-284	Release the left-side retainer arm	187
Figure 1-285	Remove the door	187
Figure 1-286	Remove one screw	188
Figure 1-287	Release two bosses and three tabs	188
Figure 1-288	Remove the cover	189
Figure 1-289	Raise the ISA	189
Figure 1-290	Remove the ISA FFC cover	190
Figure 1-291	Disconnect three FFCs	190
Figure 1-292	Remove one screw	191
Figure 1-293	Pass the wire through the opening	191
Figure 1-294	Release one tab and rotate the slider pin	192
Figure 1-295	Remove the slider pin	192
Figure 1-296	Rotate the ISA towards the rear of the printer	193
Figure 1-297	Release the ISA	193
Figure 1-298	Remove the ISA	194
Figure 1-299	Release one tab and rotate the slider pin	196
Figure 1-300	Remove the slider pin	196
Figure 1-301	Lower the support arm	197
Figure 1-302	Before proceeding take note	197
Figure 1-303	Remove one screw	198
Figure 1-304	Remove the support arm	198
Figure 1-305	Remove the tray	202
Figure 1-306	Release the support shaft	203
Figure 1-307	Remove the support shaft	203
Figure 1-308	Remove the guide	204
Figure 1-309	Release the pressure-release link	204
Figure 1-310	Release the door	205
Figure 1-311	Release the left-side retainer arm	205
Figure 1-312	Remove the door	206
Figure 1-313	Remove one screw	206
Figure 1-314	Release two bosses and three tabs	207
Figure 1-315	Remove the cover	207
Figure 1-316	Release two bosses and three tabs	208
Figure 1-317	Remove the cover	208
Figure 1-318	Duplex models, lower the duplex feed assembly	209
Figure 1-319	Remove two screws	209

Figure 1-320	Disconnect one connector	210
Figure 1-321	Remove the cover	210
Figure 1-322	Disconnect two connectors	211
Figure 1-323	Remove four screws	211
Figure 1-324	Release the pressure-release arm	212
Figure 1-325	Remove the fuser	212
Figure 1-326	Remove the tray	215
Figure 1-327	Release the support shaft	216
Figure 1-328	Remove the support shaft	216
Figure 1-329	Remove the guide	217
Figure 1-330	Release the pressure-release link	217
Figure 1-331	Release the door	218
Figure 1-332	Release the left-side retainer arm	218
Figure 1-333	Remove the door	219
Figure 1-334	Remove one screw	219
Figure 1-335	Release two bosses and three tabs	220
Figure 1-336	Remove the cover	220
Figure 1-337	Release two bosses and three tabs	221
Figure 1-338	Remove the cover	221
Figure 1-339	Duplex models, lower the duplex feed assembly	222
Figure 1-340	Remove two screws	222
Figure 1-341	Raise the ISA	223
Figure 1-342	Remove the ISA FFC cover	223
Figure 1-343	Disconnect three FFCs	224
Figure 1-344	Remove one screw	224
Figure 1-345	Pass the wire through the opening	225
Figure 1-346	Release one tab and rotate the slider pin	225
Figure 1-347	Remove the slider pin	226
Figure 1-348	Rotate the ISA towards the rear of the printer	226
Figure 1-349	Release the ISA	227
Figure 1-350	Remove the ISA	227
Figure 1-351	Disconnect one connector	228
Figure 1-352	Remove one screw	228
Figure 1-353	Release two tabs	229
Figure 1-354	Remove the cover	229
Figure 1-355	Remove one screw	230
Figure 1-356	Remove two screws	230
Figure 1-357	Lift up the control-panel assembly	231
Figure 1-358	Remove the control-panel assembly	231
Figure 1-359	Remove the USB cable	232
Figure 1-360	Remove the support arm	232

Figure 1-361	Remove the cover	233
Figure 1-362	Remove one screw	233
Figure 1-363	Release one boss and one tab	234
Figure 1-364	Remove the cover	234
Figure 1-365	Release two tabs	235
Figure 1-366	Disconnect one connector	235
Figure 1-367	Remove the cover	236
Figure 1-368	Disconnect two connectors	236
Figure 1-369	Remove four screws	237
Figure 1-370	Release the pressure-release arm	237
Figure 1-371	Remove the fuser	238
Figure 1-372	Place the printer bottom-side face forward	238
Figure 1-373	Remove one screw and the guide	239
Figure 1-374	Move the link arm out of the way	239
Figure 1-375	Remove two screws	240
Figure 1-376	Move the pressure-release arm out of the way	240
Figure 1-377	Release the assembly	241
Figure 1-378	Remove the assembly	241
Figure 1-379	Remove the tray	244
Figure 1-380	Release the support shaft	244
Figure 1-381	Remove the support shaft	245
Figure 1-382	Remove the guide	245
Figure 1-383	Release the pressure-release link	246
Figure 1-384	Release the door	246
Figure 1-385	Release the left-side retainer arm	247
Figure 1-386	Remove the door	247
Figure 1-387	Release two bosses and three tabs	248
Figure 1-388	Remove the cover	248
Figure 1-389	Remove the motor	249
Figure 1-390	Remove the tray	251
Figure 1-391	Release the support shaft	251
Figure 1-392	Remove the support shaft	252
Figure 1-393	Remove the guide	252
Figure 1-394	Release the pressure-release link	253
Figure 1-395	Release the door	253
Figure 1-396	Release the left-side retainer arm	254
Figure 1-397	Remove the door	254
Figure 1-398	Release two bosses and three tabs	255
Figure 1-399	Remove the cover	255
Figure 1-400	Release one tab	256
Figure 1-401	Remove the switch lever	256

Figure 1-402	Disconnect one connector	257
Figure 1-403	Release one tab and remove the PCA	257
Figure 1-404	Remove the tray	260
Figure 1-405	Release the support shaft	261
Figure 1-406	Remove the support shaft	261
Figure 1-407	Remove the guide	262
Figure 1-408	Release the pressure-release link	262
Figure 1-409	Release the door	263
Figure 1-410	Release the left-side retainer arm	263
Figure 1-411	Remove the door	264
Figure 1-412	Remove one screw	264
Figure 1-413	Release two bosses and three tabs	265
Figure 1-414	Remove the cover	265
Figure 1-415	Remove three screws	266
Figure 1-416	Disconnect one connector and remove the PCA	266
Figure 1-417	Remove the tray	269
Figure 1-418	Release the support shaft	269
Figure 1-419	Remove the support shaft	270
Figure 1-420	Remove the guide	270
Figure 1-421	Release the pressure-release link	271
Figure 1-422	Release the door	271
Figure 1-423	Release the left-side retainer arm	272
Figure 1-424	Remove the door	272
Figure 1-425	Remove one screw	273
Figure 1-426	Release two bosses and three tabs	273
Figure 1-427	Remove the cover	274
Figure 1-428	Disconnect one connector	274
Figure 1-429	Remove one screw	275
Figure 1-430	Remove the mute USB PCA	275
Figure 1-431	Remove the tray	278
Figure 1-432	Release the support shaft	278
Figure 1-433	Remove the support shaft	279
Figure 1-434	Remove the guide	279
Figure 1-435	Release the pressure-release link	280
Figure 1-436	Release the door	280
Figure 1-437	Release the left-side retainer arm	281
Figure 1-438	Remove the door	281
Figure 1-439	Remove one screw	282
Figure 1-440	Release two bosses and three tabs	282
Figure 1-441	Remove the cover	283
Figure 1-442	Release one or two tabs	283

Figure 1-443	Remove the wireless PCA	284
Figure 1-444	Remove the tray	288
Figure 1-445	Release the support shaft	288
Figure 1-446	Remove the support shaft	289
Figure 1-447	Remove the guide	289
Figure 1-448	Release the pressure-release link	290
Figure 1-449	Release the door	290
Figure 1-450	Release the left-side retainer arm	291
Figure 1-451	Remove the door	291
Figure 1-452	Remove one screw	292
Figure 1-453	Release two bosses and three tabs	292
Figure 1-454	Remove the cover	293
Figure 1-455	Release one or two tabs	293
Figure 1-456	Remove the wireless PCA	294
Figure 1-457	Disconnect all of the connectors and FFCs	294
Figure 1-458	Remove the formatter PCA	295
Figure 1-459	Remove the tray	297
Figure 1-460	Release the support shaft	297
Figure 1-461	Remove the support shaft	298
Figure 1-462	Remove the guide	298
Figure 1-463	Release the pressure-release link	299
Figure 1-464	Release the door	299
Figure 1-465	Release the left-side retainer arm	300
Figure 1-466	Remove the door	300
Figure 1-467	Remove one screw	301
Figure 1-468	Release two bosses and three tabs	301
Figure 1-469	Remove the cover	302
Figure 1-470	Disconnect one connector	302
Figure 1-471	Release two tabs	303
Figure 1-472	Remove the fan	303
Figure 1-473	Remove the tray	306
Figure 1-474	Release the support shaft	306
Figure 1-475	Remove the support shaft	307
Figure 1-476	Remove the guide	307
Figure 1-477	Release the pressure-release link	308
Figure 1-478	Release the door	308
Figure 1-479	Release the left-side retainer arm	309
Figure 1-480	Remove the door	309
Figure 1-481	Remove one screw	310
Figure 1-482	Release two bosses and three tabs	310
Figure 1-483	Remove the cover	311

Figure 1-484	Disconnect one connector	311
Figure 1-485	Release two tabs	312
Figure 1-486	Remove the fan	312
Figure 1-487	Release the wire harness (SFP shown)	313
Figure 1-488	Remove one screw	313
Figure 1-489	Release one tab	314
Figure 1-490	Release one tab	314
Figure 1-491	Remove the holder	315
Figure 1-492	Remove the tray	317
Figure 1-493	Release the support shaft	318
Figure 1-494	Remove the support shaft	318
Figure 1-495	Remove the guide	319
Figure 1-496	Release the pressure-release link	319
Figure 1-497	Release the door	320
Figure 1-498	Release the left-side retainer arm	320
Figure 1-499	Remove the door	321
Figure 1-500	Remove one screw	321
Figure 1-501	Release two bosses and three tabs	322
Figure 1-502	Remove the cover	322
Figure 1-503	Release two bosses and three tabs	323
Figure 1-504	Remove the cover	323
Figure 1-505	Raise the ISA	324
Figure 1-506	Remove the ISA FFC cover	324
Figure 1-507	Disconnect three FFCs	325
Figure 1-508	Remove one screw	325
Figure 1-509	Pass the wire through the opening	326
Figure 1-510	Release one tab and rotate the slider pin	326
Figure 1-511	Remove the slider pin	327
Figure 1-512	Rotate the ISA towards the rear of the printer	327
Figure 1-513	Release the ISA	328
Figure 1-514	Remove the ISA	328
Figure 1-515	Disconnect one connector	329
Figure 1-516	Remove one screw	329
Figure 1-517	Release two tabs	330
Figure 1-518	Remove the cover	330
Figure 1-519	Remove one screw	331
Figure 1-520	Remove two screws	331
Figure 1-521	Lift up the control-panel assembly	332
Figure 1-522	Remove the control-panel assembly	332
Figure 1-523	Remove the USB cable	333
Figure 1-524	Remove the support arm	333

Figure 1-525	Remove the cover	334
Figure 1-526	Remove one screw	334
Figure 1-527	Release one boss and one tab	335
Figure 1-528	Remove the cover	335
Figure 1-529	Release two tabs	336
Figure 1-530	Disconnect one FFC and one connector	336
Figure 1-531	Remove the laser scanner	337
Figure 1-532	Remove the tray	338
Figure 1-533	Release the support shaft	339
Figure 1-534	Remove the support shaft	339
Figure 1-535	Remove the guide	340
Figure 1-536	Release the pressure-release link	340
Figure 1-537	Release the door	341
Figure 1-538	Release the left-side retainer arm	341
Figure 1-539	Remove the door	342
Figure 1-540	Remove one screw	342
Figure 1-541	Release two bosses and three tabs	343
Figure 1-542	Remove the cover	343
Figure 1-543	Release two bosses and three tabs	344
Figure 1-544	Remove the cover	344
Figure 1-545	Raise the ISA	345
Figure 1-546	Remove the ISA FFC cover	345
Figure 1-547	Disconnect three FFCs	346
Figure 1-548	Remove one screw	346
Figure 1-549	Pass the wire through the opening	347
Figure 1-550	Release one tab and rotate the slider pin	347
Figure 1-551	Remove the slider pin	348
Figure 1-552	Rotate the ISA towards the rear of the printer	348
Figure 1-553	Release the ISA	349
Figure 1-554	Remove the ISA	349
Figure 1-555	Disconnect one connector	350
Figure 1-556	Remove one screw	350
Figure 1-557	Release two tabs	351
Figure 1-558	Remove the cover	351
Figure 1-559	Remove one screw	352
Figure 1-560	Remove two screws	352
Figure 1-561	Lift up the control-panel assembly	353
Figure 1-562	Remove the control-panel assembly	353
Figure 1-563	Remove the USB cable	354
Figure 1-564	Remove the support arm	354
Figure 1-565	Remove the cover	355

Figure 1-566	Remove one screw	355
Figure 1-567	Release one boss and one tab	356
Figure 1-568	Remove the cover	356
Figure 1-569	Remove the wireless PCA	357
Figure 1-570	Disconnect the connectors	357
Figure 1-571	Remove the fax PCA	358
Figure 1-572	Remove the FFC guide	358
Figure 1-573	Remove the guide	359
Figure 1-574	Remove two screws	359
Figure 1-575	Remove one screw	360
Figure 1-576	Remove two screws	360
Figure 1-577	Remove the bracket	360
Figure 1-578	Remove the tray	362
Figure 1-579	Release the support shaft	362
Figure 1-580	Remove the support shaft	363
Figure 1-581	Remove the guide	363
Figure 1-582	Release the pressure-release link	364
Figure 1-583	Release the door	364
Figure 1-584	Release the left-side retainer arm	365
Figure 1-585	Remove the door	365
Figure 1-586	Remove one screw	366
Figure 1-587	Release two bosses and three tabs	366
Figure 1-588	Remove the cover	367
Figure 1-589	Release two bosses and three tabs	367
Figure 1-590	Remove the cover	367
Figure 1-591	Remove one screw	368
Figure 1-592	Release one boss and one tab	368
Figure 1-593	Remove the cover	369
Figure 1-594	Release two tabs	369
Figure 1-595	Disconnect the FFC	370
Figure 1-596	Release the FFC from the guide	370
Figure 1-597	Disconnect and remove the FFC	371
Figure 1-598	Remove the tray	373
Figure 1-599	Release the support shaft	374
Figure 1-600	Remove the support shaft	374
Figure 1-601	Remove the guide	375
Figure 1-602	Release the pressure-release link	375
Figure 1-603	Release the door	376
Figure 1-604	Release the left-side retainer arm	376
Figure 1-605	Remove the door	377
Figure 1-606	Remove one screw	377

Figure 1-607	Release two bosses and three tabs	378
Figure 1-608	Remove the cover	378
Figure 1-609	Release two bosses and three tabs	379
Figure 1-610	Remove the cover	379
Figure 1-611	Raise the ISA	380
Figure 1-612	Remove the ISA FFC cover	380
Figure 1-613	Disconnect three FFCs	381
Figure 1-614	Remove one screw	381
Figure 1-615	Pass the wire through the opening	382
Figure 1-616	Release one tab and rotate the slider pin	382
Figure 1-617	Remove the slider pin	383
Figure 1-618	Rotate the ISA towards the rear of the printer	383
Figure 1-619	Release the ISA	384
Figure 1-620	Remove the ISA	384
Figure 1-621	Disconnect one connector	385
Figure 1-622	Remove one screw	385
Figure 1-623	Release two tabs	386
Figure 1-624	Remove the cover	386
Figure 1-625	Remove one screw	387
Figure 1-626	Remove two screws	387
Figure 1-627	Lift up the control-panel assembly	388
Figure 1-628	Remove the control-panel assembly	388
Figure 1-629	Remove the USB cable	389
Figure 1-630	Remove the support arm	389
Figure 1-631	Remove the cover	390
Figure 1-632	Remove one screw	390
Figure 1-633	Release one boss and one tab	391
Figure 1-634	Remove the cover	391
Figure 1-635	Remove the wireless PCA	392
Figure 1-636	Disconnect the connectors	392
Figure 1-637	Remove the fax PCA	393
Figure 1-638	Remove the FFC guide	393
Figure 1-639	Remove the guide	394
Figure 1-640	Remove two screws	394
Figure 1-641	Remove one screw	395
Figure 1-642	Remove two screws	395
Figure 1-643	Remove the bracket	395
Figure 1-644	Release the FFC	396
Figure 1-645	Disconnect the FFC	396
Figure 1-646	Remove the tray	399
Figure 1-647	Release the support shaft	400

Figure 1-648	Remove the support shaft	400
Figure 1-649	Remove the guide	401
Figure 1-650	Release the pressure-release link	401
Figure 1-651	Release the door	402
Figure 1-652	Release the left-side retainer arm	402
Figure 1-653	Remove the door	403
Figure 1-654	Remove one screw	403
Figure 1-655	Release two bosses and three tabs	404
Figure 1-656	Remove the cover	404
Figure 1-657	Release two bosses and three tabs	405
Figure 1-658	Remove the cover	405
Figure 1-659	Duplex models, lower the duplex feed assembly	406
Figure 1-660	Remove two screws	406
Figure 1-661	Raise the ISA	407
Figure 1-662	Remove the ISA FFC cover	407
Figure 1-663	Disconnect three FFCs	408
Figure 1-664	Remove one screw	408
Figure 1-665	Pass the wire through the opening	409
Figure 1-666	Release one tab and rotate the slider pin	409
Figure 1-667	Remove the slider pin	410
Figure 1-668	Rotate the ISA towards the rear of the printer	410
Figure 1-669	Release the ISA	411
Figure 1-670	Remove the ISA	411
Figure 1-671	Disconnect one connector	412
Figure 1-672	Remove one screw	412
Figure 1-673	Release two tabs	413
Figure 1-674	Remove the cover	413
Figure 1-675	Remove one screw	414
Figure 1-676	Remove two screws	414
Figure 1-677	Lift up the control-panel assembly	415
Figure 1-678	Remove the control-panel assembly	415
Figure 1-679	Remove the USB cable	416
Figure 1-680	Remove the support arm	416
Figure 1-681	Remove the cover	417
Figure 1-682	Remove one screw	417
Figure 1-683	Release one boss and one tab	418
Figure 1-684	Remove the cover	418
Figure 1-685	Release two tabs	419
Figure 1-686	Remove the wireless PCA	419
Figure 1-687	Disconnect the connectors	420
Figure 1-688	Remove the fax PCA	420

Figure 1-689	Remove the FFC guide	421
Figure 1-690	Remove the guide	421
Figure 1-691	Remove two screws	422
Figure 1-692	Remove one screw	422
Figure 1-693	Remove two screws	422
Figure 1-694	Remove the bracket	423
Figure 1-695	Disconnect three FFCs and six connectors	423
Figure 1-696	Remove two screws	424
Figure 1-697	Remove the DC controller	424
Figure 1-698	Disconnect one the FFC	425
Figure 1-699	Remove the tray	427
Figure 1-700	Release the support shaft	428
Figure 1-701	Remove the support shaft	428
Figure 1-702	Remove the guide	429
Figure 1-703	Release the pressure-release link	429
Figure 1-704	Release the door	430
Figure 1-705	Release the left-side retainer arm	430
Figure 1-706	Remove the door	431
Figure 1-707	Remove one screw	431
Figure 1-708	Release two bosses and three tabs	432
Figure 1-709	Remove the cover	432
Figure 1-710	Release two bosses and three tabs	433
Figure 1-711	Remove the cover	433
Figure 1-712	Raise the ISA	434
Figure 1-713	Remove the ISA FFC cover	434
Figure 1-714	Disconnect three FFCs	435
Figure 1-715	Remove one screw	435
Figure 1-716	Pass the wire through the opening	436
Figure 1-717	Release one tab and rotate the slider pin	436
Figure 1-718	Remove the slider pin	437
Figure 1-719	Rotate the ISA towards the rear of the printer	437
Figure 1-720	Release the ISA	438
Figure 1-721	Remove the ISA	438
Figure 1-722	Disconnect one connector	439
Figure 1-723	Remove one screw	439
Figure 1-724	Release two tabs	440
Figure 1-725	Remove the cover	440
Figure 1-726	Remove one screw	441
Figure 1-727	Remove two screws	441
Figure 1-728	Lift up the control-panel assembly	442
Figure 1-729	Remove the control-panel assembly	442

Figure 1-730	Remove the USB cable	443
Figure 1-731	Remove the support arm	443
Figure 1-732	Remove the cover	444
Figure 1-733	Remove one screw	444
Figure 1-734	Release one boss and one tab	445
Figure 1-735	Remove the cover	445
Figure 1-736	Release two tabs	446
Figure 1-737	Remove the wireless PCA	446
Figure 1-738	Disconnect the connectors	447
Figure 1-739	Remove the fax PCA	447
Figure 1-740	Remove the FFC guide	448
Figure 1-741	Remove the guide	448
Figure 1-742	Remove two screws	449
Figure 1-743	Remove one screw	449
Figure 1-744	Remove two screws	449
Figure 1-745	Remove the bracket	450
Figure 1-746	Disconnect one connector	450
Figure 1-747	Remove one screw	451
Figure 1-748	Remove the tag-cable assembly	451
Figure 1-749	Remove the tray	454
Figure 1-750	Release the support shaft	455
Figure 1-751	Remove the support shaft	455
Figure 1-752	Remove the guide	456
Figure 1-753	Release the pressure-release link	456
Figure 1-754	Release the door	457
Figure 1-755	Release the left-side retainer arm	457
Figure 1-756	Remove the door	458
Figure 1-757	Remove one screw	458
Figure 1-758	Release two bosses and three tabs	459
Figure 1-759	Remove the cover	459
Figure 1-760	Release two bosses and three tabs	460
Figure 1-761	Remove the cover	460
Figure 1-762	Raise the ISA	461
Figure 1-763	Remove the ISA FFC cover	461
Figure 1-764	Disconnect three FFCs	462
Figure 1-765	Remove one screw	462
Figure 1-766	Pass the wire through the opening	463
Figure 1-767	Release one tab and rotate the slider pin	463
Figure 1-768	Remove the slider pin	464
Figure 1-769	Rotate the ISA towards the rear of the printer	464
Figure 1-770	Release the ISA	465

Figure 1-771	Remove the ISA	465
Figure 1-772	Disconnect one connector	466
Figure 1-773	Remove one screw	466
Figure 1-774	Release two tabs	467
Figure 1-775	Remove the cover	467
Figure 1-776	Remove one screw	468
Figure 1-777	Remove two screws	468
Figure 1-778	Lift up the control-panel assembly	469
Figure 1-779	Remove the control-panel assembly	469
Figure 1-780	Remove the USB cable	470
Figure 1-781	Remove the support arm	470
Figure 1-782	Remove the cover	471
Figure 1-783	Remove one screw	471
Figure 1-784	Release one boss and one tab	472
Figure 1-785	Remove the cover	472
Figure 1-786	Release two tabs	473
Figure 1-787	Remove the wireless PCA	473
Figure 1-788	Disconnect the connectors	474
Figure 1-789	Remove the fax PCA	474
Figure 1-790	Remove the FFC guide	475
Figure 1-791	Remove the guide	475
Figure 1-792	Remove two screws	476
Figure 1-793	Remove one screw	476
Figure 1-794	Remove two screws	476
Figure 1-795	Remove the bracket	477
Figure 1-796	Disconnect nine connectors	477
Figure 1-797	Remove one screw	478
Figure 1-798	Remove the connecting PCA	478
Figure 1-799	Remove the tray	481
Figure 1-800	Release the support shaft	482
Figure 1-801	Remove the support shaft	482
Figure 1-802	Remove the guide	483
Figure 1-803	Release the pressure-release link	483
Figure 1-804	Release the door	484
Figure 1-805	Release the left-side retainer arm	484
Figure 1-806	Remove the door	485
Figure 1-807	Remove one screw	485
Figure 1-808	Release two bosses and three tabs	486
Figure 1-809	Remove the cover	486
Figure 1-810	Release two bosses and three tabs	487
Figure 1-811	Remove the cover	487

Figure 1-812	Raise the ISA	488
Figure 1-813	Remove the ISA FFC cover	488
Figure 1-814	Disconnect three FFCs	489
Figure 1-815	Remove one screw	489
Figure 1-816	Pass the wire through the opening	490
Figure 1-817	Release one tab and rotate the slider pin	490
Figure 1-818	Remove the slider pin	491
Figure 1-819	Rotate the ISA towards the rear of the printer	491
Figure 1-820	Release the ISA	492
Figure 1-821	Remove the ISA	492
Figure 1-822	Disconnect one connector	493
Figure 1-823	Remove one screw	493
Figure 1-824	Release two tabs	494
Figure 1-825	Remove the cover	494
Figure 1-826	Remove one screw	495
Figure 1-827	Remove two screws	495
Figure 1-828	Lift up the control-panel assembly	496
Figure 1-829	Remove the control-panel assembly	496
Figure 1-830	Remove the USB cable	497
Figure 1-831	Remove the support arm	497
Figure 1-832	Remove the cover	498
Figure 1-833	Remove one screw	498
Figure 1-834	Release one boss and one tab	499
Figure 1-835	Remove the cover	499
Figure 1-836	Release two tabs	500
Figure 1-837	Remove the wireless PCA	500
Figure 1-838	Disconnect the connectors	501
Figure 1-839	Remove the fax PCA	501
Figure 1-840	Remove the FFC guide	502
Figure 1-841	Remove the guide	502
Figure 1-842	Remove two screws	503
Figure 1-843	Remove one screw	503
Figure 1-844	Remove two screws	503
Figure 1-845	Remove the bracket	504
Figure 1-846	Disconnect one connector	504
Figure 1-847	Remove one screw	505
Figure 1-848	Remove the tag-cable assembly	505
Figure 1-849	Disconnect one FFC	506
Figure 1-850	Remove one screw and the sheet-metal plate	506
Figure 1-851	Disconnect one FFC	507
Figure 1-852	Release the ferrite	507

Figure 1-853	Remove the FFC	508
Figure 1-854	Remove the tray	510
Figure 1-855	Release the support shaft	511
Figure 1-856	Remove the support shaft	511
Figure 1-857	Remove the guide	512
Figure 1-858	Release the pressure-release link	512
Figure 1-859	Release the door	513
Figure 1-860	Release the left-side retainer arm	513
Figure 1-861	Remove the door	514
Figure 1-862	Remove one screw	514
Figure 1-863	Release two bosses and three tabs	515
Figure 1-864	Remove the cover	515
Figure 1-865	Release two bosses and three tabs	516
Figure 1-866	Remove the cover	516
Figure 1-867	Raise the ISA	517
Figure 1-868	Remove the ISA FFC cover	517
Figure 1-869	Disconnect three FFCs	518
Figure 1-870	Remove one screw	518
Figure 1-871	Pass the wire through the opening	519
Figure 1-872	Release one tab and rotate the slider pin	519
Figure 1-873	Remove the slider pin	520
Figure 1-874	Rotate the ISA towards the rear of the printer	520
Figure 1-875	Release the ISA	521
Figure 1-876	Remove the ISA	521
Figure 1-877	Disconnect one connector	522
Figure 1-878	Remove one screw	522
Figure 1-879	Release two tabs	523
Figure 1-880	Remove the cover	523
Figure 1-881	Remove one screw	524
Figure 1-882	Remove two screws	524
Figure 1-883	Lift up the control-panel assembly	525
Figure 1-884	Remove the control-panel assembly	525
Figure 1-885	Remove the USB cable	526
Figure 1-886	Remove the support arm	526
Figure 1-887	Remove the cover	527
Figure 1-888	Remove one screw	527
Figure 1-889	Release one boss and one tab	528
Figure 1-890	Remove the cover	528
Figure 1-891	Release two tabs	529
Figure 1-892	Remove the wireless PCA	529
Figure 1-893	Disconnect the connectors	530

Figure 1-894	Remove the fax PCA	530
Figure 1-895	Remove the FFC guide	531
Figure 1-896	Remove the guide	531
Figure 1-897	Remove two screws	532
Figure 1-898	Remove one screw	532
Figure 1-899	Remove two screws	532
Figure 1-900	Remove the bracket	533
Figure 1-901	Disconnect one FFC	533
Figure 1-902	Disconnect one connector	534
Figure 1-903	Remove two screws	534
Figure 1-904	Release one tab	535
Figure 1-905	Remove the HVPS	535
Figure 1-906	Remove the tray	538
Figure 1-907	Release the support shaft	539
Figure 1-908	Remove the support shaft	539
Figure 1-909	Remove the guide	540
Figure 1-910	Release the pressure-release link	540
Figure 1-911	Release the door	541
Figure 1-912	Release the left-side retainer arm	541
Figure 1-913	Remove the door	542
Figure 1-914	Remove one screw	542
Figure 1-915	Release two bosses and three tabs	543
Figure 1-916	Remove the cover	543
Figure 1-917	Release two bosses and three tabs	544
Figure 1-918	Remove the cover	544
Figure 1-919	Raise the ISA	545
Figure 1-920	Remove the ISA FFC cover	545
Figure 1-921	Disconnect three FFCs	546
Figure 1-922	Remove one screw	546
Figure 1-923	Pass the wire through the opening	547
Figure 1-924	Release one tab and rotate the slider pin	547
Figure 1-925	Remove the slider pin	548
Figure 1-926	Rotate the ISA towards the rear of the printer	548
Figure 1-927	Release the ISA	549
Figure 1-928	Remove the ISA	549
Figure 1-929	Disconnect one connector	550
Figure 1-930	Remove one screw	550
Figure 1-931	Release two tabs	551
Figure 1-932	Remove the cover	551
Figure 1-933	Remove one screw	552
Figure 1-934	Remove two screws	552

Figure 1-935	Lift up the control-panel assembly	553
Figure 1-936	Remove the control-panel assembly	553
Figure 1-937	Remove the USB cable	554
Figure 1-938	Remove the support arm	554
Figure 1-939	Remove the cover	555
Figure 1-940	Remove one screw	555
Figure 1-941	Release one boss and one tab	556
Figure 1-942	Remove the cover	556
Figure 1-943	Release two tabs	557
Figure 1-944	Disconnect one connector	557
Figure 1-945	Release two tabs	558
Figure 1-946	Remove the fan	558
Figure 1-947	Remove the wireless PCA	559
Figure 1-948	Disconnect the connectors	559
Figure 1-949	Remove the fax PCA	560
Figure 1-950	Remove the FFC guide	560
Figure 1-951	Remove the guide	561
Figure 1-952	Remove two screws	561
Figure 1-953	Remove one screw	562
Figure 1-954	Remove two screws	562
Figure 1-955	Remove the bracket	562
Figure 1-956	Disconnect two connectors	563
Figure 1-957	Remove one screw	563
Figure 1-958	Release one tab	564
Figure 1-959	Release one tab	564
Figure 1-960	Remove the holder	565
Figure 1-961	Remove two screws	565
Figure 1-962	Remove three screws	566
Figure 1-963	Remove the LVPS	566
Figure 1-964	Remove the tray	569
Figure 1-965	Release the support shaft	569
Figure 1-966	Remove the support shaft	570
Figure 1-967	Remove the guide	570
Figure 1-968	Release the pressure-release link	571
Figure 1-969	Release the door	571
Figure 1-970	Release the left-side retainer arm	572
Figure 1-971	Remove the door	572
Figure 1-972	Remove one screw	573
Figure 1-973	Release two bosses and three tabs	573
Figure 1-974	Remove the cover	574
Figure 1-975	Release two bosses and three tabs	574

Figure 1-976	Remove the cover	574
Figure 1-977	Remove one screw	575
Figure 1-978	Release one boss and one tab	575
Figure 1-979	Remove the cover	576
Figure 1-980	Release two tabs	576
Figure 1-981	Disconnect one FFC	577
Figure 1-982	Remove one screw and the control panel	577
Figure 1-983	Open the ISA	580
Figure 1-984	Remove one screw	581
Figure 1-985	Release two tabs	581
Figure 1-986	Remove the cover	582
Figure 1-987	Disconnect one connector	582
Figure 1-988	Remove one screw	583
Figure 1-989	Release two tabs	583
Figure 1-990	Remove the cover	584
Figure 1-991	Remove one screw	584
Figure 1-992	Remove two screws	585
Figure 1-993	Lift up the control-panel assembly	585
Figure 1-994	Remove the control-panel assembly	586
Figure 1-995	Remove two screws	586
Figure 1-996	Remove the FFC	587
Figure 1-997	Release the control panel mount base	587
Figure 1-998	Release the mount chassis assembly	588
Figure 1-999	Remove the mount chassis assembly	588
Figure 1-1000	Remove the tray	589
Figure 1-1001	Release the support shaft	589
Figure 1-1002	Remove the support shaft	590
Figure 1-1003	Remove the guide	590
Figure 1-1004	Release the pressure-release link	591
Figure 1-1005	Release the door	591
Figure 1-1006	Release the left-side retainer arm	592
Figure 1-1007	Remove the door	592
Figure 1-1008	Remove one screw	593
Figure 1-1009	Release two bosses and three tabs	593
Figure 1-1010	Remove the cover	594
Figure 1-1011	Remove the ISA FFC cover	594
Figure 1-1012	Disconnect one FFC	595
Figure 1-1013	Release the control-panel FFC cover	595
Figure 1-1014	Remove the cover and FFC	596
Figure 1-1015	Remove the FFC	596
Figure 1-1016	Remove the tray	600

Figure 1-1017	Remove the tray	602
Figure 1-1018	Tilt the printer backward	602
Figure 1-1019	Place the printer bottom-side face forward	603
Figure 1-1020	Release one tab	603
Figure 1-1021	Remove the roller holder	604
Figure 1-1022	Remove the tray	606
Figure 1-1023	Release the assembly	606
Figure 1-1024	Remove the assembly	607
Figure 1-1025	Remove the tray	609
Figure 1-1026	Release the support shaft	609
Figure 1-1027	Remove the support shaft	610
Figure 1-1028	Remove the guide	610
Figure 1-1029	Release the pressure-release link	611
Figure 1-1030	Release the door	611
Figure 1-1031	Release the left-side retainer arm	612
Figure 1-1032	Remove the door	612
Figure 1-1033	Remove one screw	613
Figure 1-1034	Release two bosses and three tabs	613
Figure 1-1035	Remove the cover	614
Figure 1-1036	Release two bosses and three tabs	614
Figure 1-1037	Remove the cover	614
Figure 1-1038	Rotate the Tray 1 pickup roller shaft	615
Figure 1-1039	Slide the roller and holder out of the way	615
Figure 1-1040	Remove the Tray 1 separation pad	616
Figure 1-1041	Remove the front stay	616
Figure 1-1042	Remove the springs (1 of 2)	617
Figure 1-1043	Remove the springs (2 of 2)	617
Figure 1-1044	Remove two screw and release two bosses	618
Figure 1-1045	Separate the Tray 1 pickup assembly from the printer	618
Figure 1-1046	Remove the pickup guide	619
Figure 1-1047	Remove the guide and sensor lever assembly	619
Figure 1-1048	Remove the sensor lever	620
Figure 1-1049	Remove the printer	624
Figure 1-1050	Recycle and unpack	624
Figure 1-1051	Remove shipping tape	625
Figure 1-1052	Install the printer	625
Figure 1-1053	Remove Tray 3	626
Figure 1-1054	Adjust the paper guides	626
Figure 1-1055	Load paper	627
Figure 1-1056	Install	627
Figure 1-1057	Pull the tray out of the printer	629

Figure 1-1058	Release and remove the tray	629
Figure 1-1059	Recycle and unpack	630
Figure 1-1060	Install the tray	630
Figure 1-1061	Close the tray	631
Figure 1-1062	Pull the tray out of the printer	633
Figure 1-1063	Release and remove the tray	633
Figure 1-1064	Turn the accessory over	634
Figure 1-1065	Release the assembly	634
Figure 1-1066	Rotate the assembly up	635
Figure 1-1067	Remove the assembly	635
Figure 1-1068	Recycle and unpack	636
Figure 1-1069	Install the roller assembly	38
Figure 1-1070	Release the assembly	637
Figure 1-1071	Check the installation	637
Figure 1-1072	Install the tray	638
Figure 1-1073	Close the tray	638
Figure 1-1074	Pull the tray out of the printer	640
Figure 1-1075	Release and remove the tray	640
Figure 1-1076	Release the assembly	641
Figure 1-1077	Remove the assembly	641
Figure 1-1078	Recycle and unpack	642
Figure 1-1079	Install the assembly	642
Figure 1-1080	Release the assembly	643
Figure 1-1081	Install the tray	643
Figure 1-1082	Close the tray	644
Figure 2-1	Printer front view (SFP)	653
Figure 2-2	Printer rear view (SFP)	654
Figure 2-3	Printer front view (MFP)	655
Figure 2-4	Printer rear view (MFP)	656
Figure 2-5	Main assembly (document feeder and image scanner)	658
Figure 2-6	Covers (M304/M305/M404/M405)	660
Figure 2-7	Covers (M329/M428/M429)	662
Figure 2-8	Internal components, printer base (1 of 3)	664
Figure 2-9	Internal components, printer base (2 of 3)	666
Figure 2-10	Internal components, printer base (3 of 3)	668
Figure 2-11	Covers, 550-sheet paper feeder	672
Figure 2-12	Main body, 550-sheet paper feeder	674

1 Removal and replacement

- [HP service and support](#)
- [Removal and replacement strategy](#)
- [Service approach](#)
- [Removal and replacement procedures](#)

HP service and support

Learn about HP access to additional service and support information.

Additional service and support for channel partners

Channel partners, go to partner.hp.com, and then use the steps below to access the HP Web-based Interactive Search Engine (WISE).

Access WISE for Channel partners

1. Select **Services & Support**, and then select **Services Delivery**.
2. Select **Technical Support**, and then select **Technical Documentation**.

Find information about the following topics

- Service manuals
- Service advisories
- Up-to-date control panel message (CPMD) troubleshooting
- Install and configure
- Printer specifications
- Solutions for printer issues and emerging issues
- Remove and replace part instructions and videos
- Warranty and regulatory information

Additional service and support for HP internal personnel

HP internal personnel, go to one of the following Web-based Interactive Search Engine (WISE) sites:

Americas (AMS)

- <https://support.hp.com/wise/home/ams-enWISE> - English
- <https://support.hp.com/wise/home/ams-esWISE> - Spanish
- <https://support.hp.com/wise/home/ams-ptWISE> - Portuguese
- <https://support.hp.com/wise/home/ams-frWISE> - French

Asia Pacific / Japan (APJ)

- <https://support.hp.com/wise/home/apj-enWISE> - English
- <https://support.hp.com/wise/home/apj-jaWISE> - Japanese
- <https://support.hp.com/wise/home/apj-koWISE> - Korean
- <https://support.hp.com/wise/home/apj-zh-HansWISE> - Chinese (simplified)

- [https://support.hp.com/wise/home/apj-zh-HantWISE - Chinese \(traditional\)](https://support.hp.com/wise/home/apj-zh-HantWISE - Chinese (traditional))
- <https://support.hp.com/wise/home/apj-thWISE - Thai>

Europe / Middle East / Africa (EMEA)

- <https://support.hp.com/wise/home/emea-enWISE - English>

Removal and replacement strategy

Introduction

The printer uses a field repair strategy. Defective parts are diagnosed and replaced at the Field Replaceable Unit (FRU) assembly level. Repair normally begins by using the printer internal diagnostics and the following two-step process:

1. Isolate the problem to the major system (for example, the network, server, or printer).
2. Identify the cause of failures according to the printer troubleshooting service manual and follow the disassembly procedures to replace the defective parts or the consumable parts.

After locating a faulty part, the printer can usually be repaired at the assembly level by replacing FRUs. Some mechanical assemblies might need to be repaired at the subassembly level. HP does not support replacement of components on the printed circuit assemblies.

The user replaces toner cartridges as they are depleted. Additional instructions about other user-replaceable parts are provided in this section.

The printer tracks the amount of use on the customer-replaceable supplies by keeping a page count. The printer prompts the user to replace certain items when a supply is depleted or a specific number of pages has been printed.

Swapping toner cartridges between products might cause a misrepresentation of supply life values and is not recommended.

Considerations during removal and replacement

This chapter describes the removal and replacement of FRUs only.

Replacing FRUs is generally the reverse of removal. Notes are included to provide directions for difficult or critical replacement procedures.

HP does not support repairing individual subassemblies or troubleshooting to the printed-circuit assembly (PCA) component level.

 **WARNING!** Never operate or service the printer with the protective cover removed from the laser scanner assembly. The reflected beam, although invisible, can cause damage to the eyes.

The sheet-metal parts can have sharp edges. Be careful when handling sheet-metal parts.

Before attempting to remove or replace parts, turn the printer off and remove the power cable. Never operate the printer with the parts removed from the printer.

Turn the printer off, wait 5 seconds, and then remove the power cord before attempting to service the printer. *If this warning is not followed*, severe injury can result as well as damage to the printer. The power must be on for certain functional checks during troubleshooting. However, the power cord must be disconnected during parts removal. AC voltage is still present inside the printer when the power switch is in the off position. The power cord must be *disconnected* before servicing the printer.

 **CAUTION:** Incorrectly routed or loose wire harnesses might interfere with other internal components or assemblies and be damaged, pinched, or frayed. Make sure that wire harnesses are correctly routed and retained when installing assemblies.

Do not bend or fold the flat flexible cables (FFCs) during removal or installation. Do not straighten pre-folds in the FFCs.

Do not expose the toner cartridge, or cartridges, to strong light even for a short time.

 **IMPORTANT:** When an assembly is removed that includes a rating plate or tag (or a printer code label), make sure to transfer the plate or tag (or code label) to the replacement assembly.

Do not replace the formatter and DC controller simultaneously during a single printer servicing. Doing so might cause the printer to become unstable or inoperable.

During removal, replacement, or transportation of the printer, remove the cassettes.

Incorrectly routed or loose wire harnesses can interfere with other internal components and can become damaged or broken.

 **NOTE:** During assembly removal and replacement, or if the printer is moved, remove the toner cartridge.

Toner is a non-poisonous substance composed of plastic and a small number of colored components. If toner gets on the skin or clothing, wipe it off with dry tissue paper and wash in cold water. Hot water sets toner and it might be difficult, or impossible, to remove. Toner easily breaks down vinyl materials, so avoid letting toner contact vinyl.



Reassembling procedures are generally the reverse of removal unless otherwise specified. Occasionally, notes and tips are included to provide directions for difficult or critical replacement procedures.

Note the length, diameter, color, type, and location of each screw. Be sure to return each screw to its original location during reassembly.

To install a self-tapping screw, first turn it counterclockwise to align it with the existing thread pattern, and then carefully turn it clockwise to tighten. Do not overtighten. If a self-tapping screw hole becomes stripped, repair the screw-hole or replace the affected assembly.

 **TIP:** Some figures might show assemblies removed or installed that have not yet been removed or installed at that specific step. However, the procedures are correct for this printer and the target assembly. Always thoroughly read the instructions that accompany each figure.

Electrostatic discharge

 **CAUTION:**  Some parts are sensitive to electrostatic discharge (ESD). Look for the ESD reminder when removing printer parts. Always perform service work at an ESD-protected workstation or mat. If an ESD workstation or mat is not available, touch the sheet-metal chassis to provide a static ground *before* touching an ESD-sensitive assembly.

Protect the ESD-sensitive assemblies by placing them in ESD pouches when they are out of the printer.

Required tools

- #2 Phillips screwdriver with a magnetic tip and a 152 mm (6 in) shaft length
- Small, flat-blade screwdriver
- Socket screwdriver 5.5 mm (.216 in) shaft length

- Needle-nose pliers
- ESD strap (if one is available)
- Penlight

⚠ CAUTION: Always use a Phillips screwdriver (callout 1). Do not use a Pozidriv screwdriver (callout 2) or any motorized screwdriver. These can damage screws or screw threads.

Figure 1-1 Screwdrivers

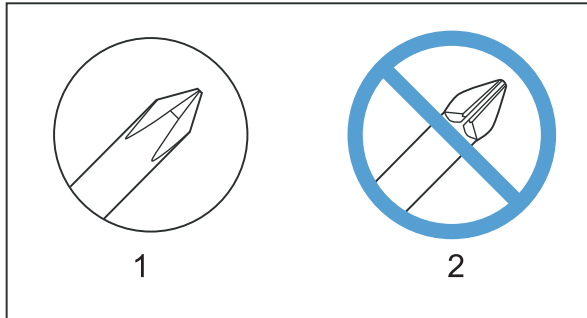

Fasteners used in this printer

⚠ WARNING! Make sure that assemblies are replaced with the correct screw type. Using the incorrect screw (for example, substituting a long screw for the correct shorter screw) can cause damage to the printer or interfere with printer operation. Do not intermix screws that are removed from one assembly with the screws that are removed from another assembly.

📝 NOTE: To install a self-tapping screw, first turn it counterclockwise to align it with the existing thread pattern, and then carefully turn it clockwise to tighten. Do not overtighten. If a self-tapping screw hole becomes stripped, repair the screw hole or replace the affected assembly.

Always take note of the length, diameter, color, type, and location of each removed screw. Make sure that screws are installed in the original location they were removed from during reinstallation.

For a complete list of screw types and part numbers, see the Parts chapter.

Service approach

Before performing service

- Remove all paper from the product.
- Turn off the power using the power switch.
- Unplug the power cable and interface cable or cables.
- Place the product on an ESD workstation or mat, or use an ESD strap (if one is available). If an ESD workstation, mat, or strap is not available, ground yourself by touching the sheet-metal chassis *before* touching an ESD-sensitive part.
- Remove the toner cartridge.
- Remove the Tray 2 cassette.

Repair Mode

When using toner cartridges multiple times

 **IMPORTANT:** This topic describes how to use toner cartridges in multiple devices for testing or verifying repairs.

This applies to the following HP printers:

- HP LaserJet Pro M404-M405 series
- HP LaserJet Pro MFP M428-M429 series

There are a limited number of times a toner cartridge (or a set of cartridges) can be installed in different printers. For example, if a set of cartridges is repeatedly used to test printers that have been repaired, it is recommended that the printer is first put into **Repair Mode** before installing the test cartridges into the printer. Failing to use **Repair Mode** will cause the test cartridges to be disabled after use in several printers. If the toner cartridge is disabled a supplies error message **10.0X.11** appears on the control-panel display, and the toner cartridge will not be functional.

 **NOTE:** **Repair Mode** remains enabled for up to 75 printed pages or until the printer powered is turned off.

Supplies error messages

- **10.00.11:** Black cartridge problem > Bad data from supply
- **10.01.11:** Cyan cartridge problem > Bad data from supply
- **10.02.11:** Magenta cartridge problem > Bad data from supply
- **10.03.11:** Yellow cartridge problem > Bad data from supply

To enter **Repair Mode**, perform the following steps for the type of control panel being used:

For 2-line control panels

1. While in a Ready state, press the **OK** button to enter the **Main Menu**.
2. Press the **OK** button to enter the **Setup Menu**.

3. Use the left ◀ or the right ▶ buttons to navigate to [Printer Maintenance](#) menu, and then press [OK](#) button.
4. From the [Printer Maintenance](#) menu, use the left ◀ or the right ▶ to navigate to the [Restore](#) menu, and then press the [OK](#) button.
5. From the [Restore](#) menu, use the left ◀ or the right ▶ to navigate to the [Repair Mode](#), and then press the [OK](#) button.
6. Follow the on-screen instructions by pressing the [OK](#) button, and then immediately install one or more test cartridges.

For touch screen control panels

1. From the touch screen pull down the dashboard and select the [Setup](#) icon to enter the [Setup](#)  menu.
2. From the [Setup](#) menu, scroll to and then select [Printer Maintenance](#) menu.
3. From the [Printer Maintenance](#) menu, select [Restore](#) .
4. From the [Restore](#) menu, select [Repair Mode](#).
5. A dialog will appear, follow the instructions in the dialog to [Start the Repair Mode](#) touch [OK](#), and then immediately install one or more test cartridges into the printer.



NOTE: If the [Repair Mode](#) is not present in the [Restore](#) menu, then the firmware must be updated to acquire this functionality. The [Repair Mode](#) setting was not present in the original first release of firmware with these products. The print cartridges do not need to be installed to perform a firmware update.

After performing service

1. Reinstall the toner cartridge or toner cartridges.
2. Reinstall the trays.
3. Return all paper to the trays.
4. Plug in the power cable and turn on the printer.
5. Perform print-quality tests by printing from a host computer.

Post-service test

Perform the following test to verify that the repair or replacement was successful.

Print-quality test

1. Verify that you have completed the necessary reassembly steps.
2. Make sure that the tray contains clean, unmarked paper.
3. Attach the power cord and interface cable or interface cables, and then turn on the product.
4. Verify that the expected startup sounds occur.
5. Print a configuration page, and then verify that the expected printing sounds occur.
6. Print a demo page, and then verify that the print quality is as expected.

7. Send a print job from the host computer, and then verify that the output meets expectations.
8. Clean the outside of the product with a damp cloth.

Copy quality test (MFP only)

1. Verify that you have completed the necessary reassembly steps.
2. Make sure that the input tray contains clean, unmarked paper.
3. Attach the power cord and interface cable or interface cables, and then turn on the product.
4. Verify that the expected startup sounds occur.
5. Copy a configuration page (or other page), and then verify that the expected printing sounds occur.



NOTE: Use the document feeder and the flatbed glass to make copies.

6. Verify that the copy output meets expectations.

Fax-quality test (fax models)

1. Verify that you have completed the necessary reassembly steps.
2. Make sure that the tray contains clean, unmarked paper.
3. Attach the power cord and interface cable or interface cables, and then turn on the product.
4. Verify that the expected startup sounds occur.
5. Print a configuration page, and then verify that the expected printing sounds occur.
6. Place the configuration page in the document feeder.
7. Type a valid fax number, and send the fax job.
8. Verify that the send quality and the receive quality meet expectations.

Other tests

Operate the printer in a manner that exercises the specific part or parts that have been repaired or replaced.

Removal and replacement procedures

Customer self-repair (CSR) A parts and assemblies

The CSR level indicates the expected difficulty the customer will experience when removing and replacing an assembly. The CSR A assemblies in this section are easy for the customer to remove and replace.

- [Removal and replacement: RL2-0656-000CN multipurpose tray roller](#)
- [Removal and replacement: RM2-5392-010CN 250-sheet paper input tray](#)
- [Removal and replacement: RM2-5413-000CN optional Tray 3 cassette](#)
- [Removal and replacement: RM2-5397-000CN Tray 2 separation roller assembly](#)
- [Removal and replacement: RM2-5745-000CN optional Tray 3 separation roller assembly](#)
- [Removal and replacement: RM2-5741-000CN optional Tray 3 paper pickup roller assembly](#)
- [Removal and replacement: RM2-5452-000CN Tray 2 paper pickup roller assembly](#)

Removal and replacement: RL2-0656-000CN multipurpose tray roller

- [Introduction](#)
- [Step 1: Remove the roller](#)
- [Step 2: Unpack the replacement assembly](#)
- [Step 3: Install the roller](#)

Introduction

This document provides the procedures to remove and replace the Multipurpose (MP) tray (Tray 1) roller.

Before performing service

Turn the printer power off

- Disconnect the power cable.

 **WARNING!** To avoid damage to the printer, turn the printer off, wait 30 seconds, and then remove the power cable before attempting to service the printer.

Use the table below to identify the correct part number for your printer. To order the part, go to www.hp.com/buy/parts.

MP tray (Tray 1) roller part number	
RL2-0656-000CN	Roller, MP tray (Tray 1)

Required tools

- No special tools are required to remove this part.

After performing service

Turn the printer power on

- Connect the power cable.
- Use the power switch to turn the power on.

Post service test

Make sure that the printer initializes to a **Ready** state.

Print a page from Tray 1 to make sure that the printer is functioning correctly.

Step 1: Remove the roller

The M329/M428/M429 printer is shown in this procedure. However, the instructions are valid for the M304/M305/M404/M405 printers.

1. Press the door-release button, and then open the toner-cartridge door.

Figure 1-2 Open the toner-cartridge door



2. Release two tabs between the roller collar and roller, and then rotate the top of the roller out and away from the printer.

 **TIP:** Pushing down on the top of the roller might make it easier to release the tabs.

Figure 1-3 Release two tabs



3. Remove the roller.

Figure 1-4 Remove the roller

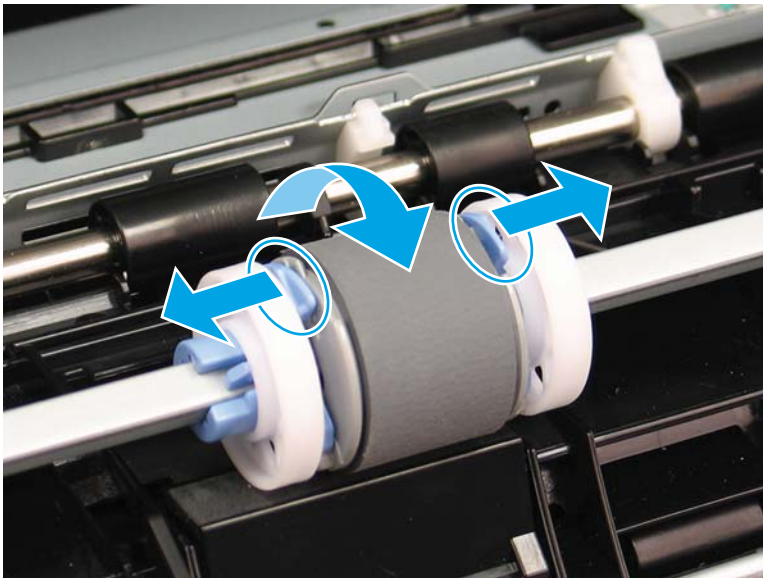
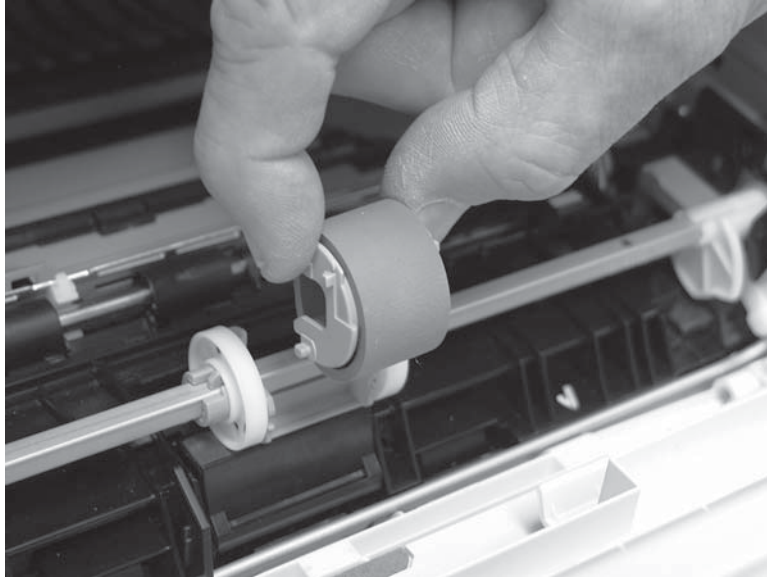

Step 2: Unpack the replacement assembly

Unpack the replacement part from the packaging.

<http://www8.hp.com/us/en/hp-information/environment/product-recycling.html>

CAUTION: Do not touch the gray spongy portion of the replacement roller. Skin oils on the roller can cause paper handling problems.

NOTE: HP recommends responsible disposal of the defective part.

Figure 1-5 Recycle and unpack

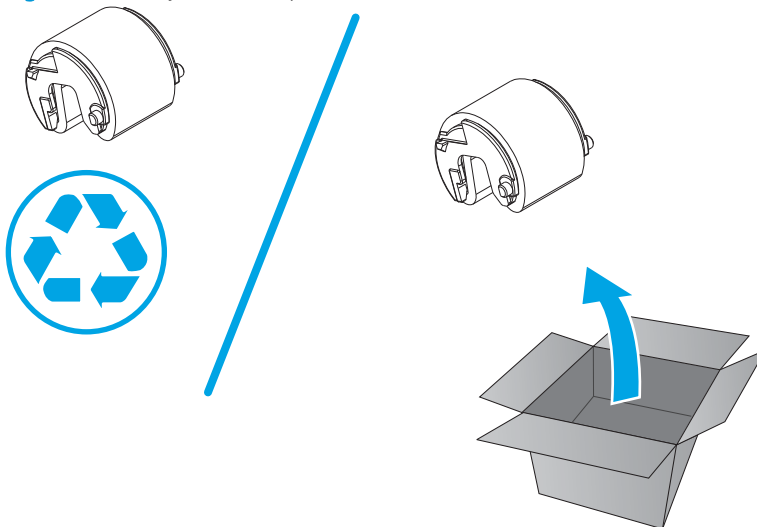

Step 3: Install the roller

⚠ CAUTION: Do not touch the gray spongy portion of the replacement roller. Skin oils on the roller can cause paper handling problems.

The M329/M428/M429 printer is shown in this procedure. However, the instructions are valid for the M304/M305/M404/M405 printers.

1. Position the replacement pickup roller with the pins in the provided slots on the holder, and then rotate the top of the roller up and toward the printer.

Figure 1-6 Install the roller

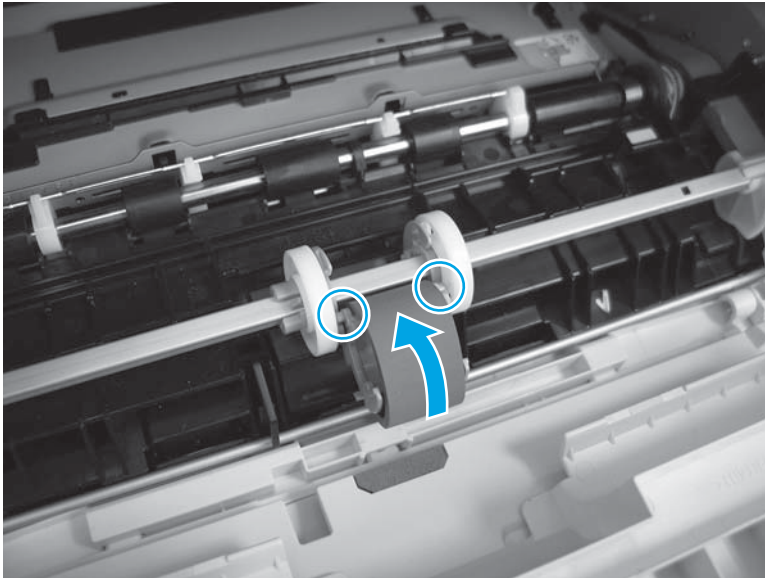

2. Continue to rotate the top of the roller toward the printer (callout 1), until two tabs (callout 2) snap into place.

Figure 1-7 Engage two tabs

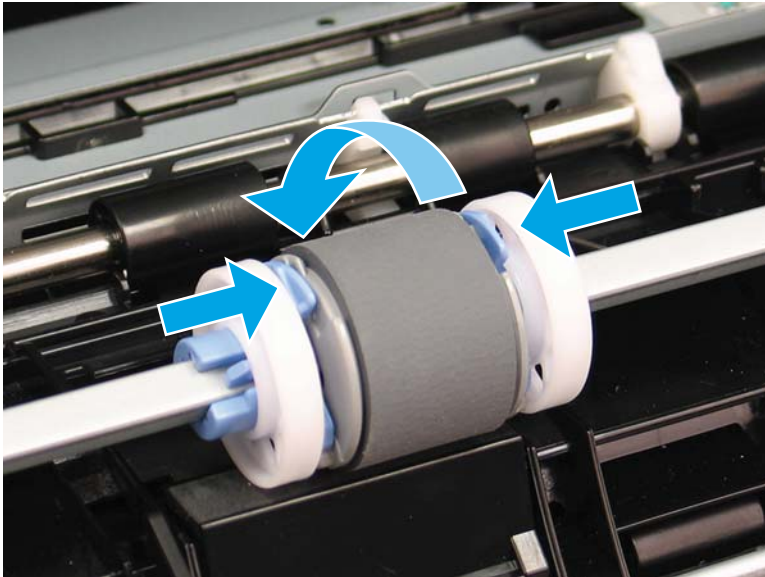

3. Close the toner-cartridge door.

Figure 1-8 Close the toner-cartridge door



Removal and replacement: RM2-5392-010CN 250-sheet paper input tray

- [Introduction](#)
- [Step 1: Remove Tray 2](#)
- [Step 2: Unpack the replacement assembly](#)
- [Step 3: Install Tray 2](#)

Introduction

This document provides the procedures to remove and replace Tray 2.

Before performing service

Turn the printer power off

- Disconnect the power cable.

 **WARNING!** To avoid damage to the printer, turn the printer off, wait 30 seconds, and then remove the power cable before attempting to service the printer.

Use the table below to identify the correct part number for your printer. To order the part, go to www.hp.com/buy/parts.

Tray 2 part number	
RM2-5392-010CN	Cassette (Tray 2) assembly

Required tools

- No special tools are required to remove this part.

After performing service

Turn the printer power on

- Connect the power cable.
- Use the power switch to turn the power on.

Post service test

Make sure that the printer initializes to a **Ready** state.

Print a configuration page (from Tray 2) to make sure that the printer is functioning correctly.

Step 1: Remove Tray 2

- ▲ Pull the tray straight out of the printer to remove it.

Figure 1-9 Remove the tray



Step 2: Unpack the replacement assembly

Unpack the replacement part from the packaging.

<http://www8.hp.com/us/en/hp-information/environment/product-recycling.html>

 **NOTE:** HP recommends responsible disposal of the defective part.

Figure 1-10 Recycle and unpack

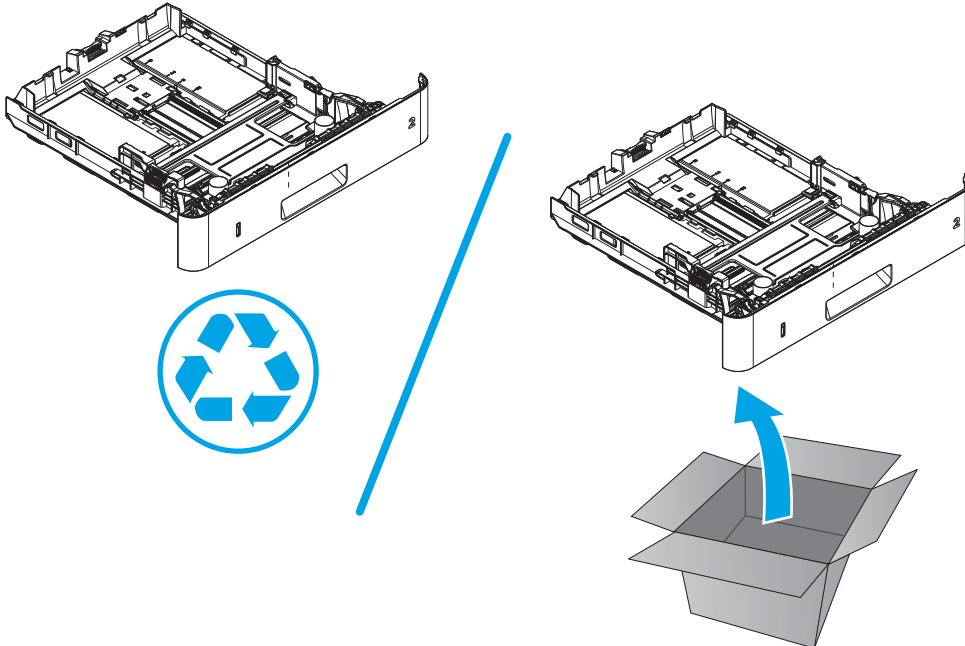

Step 3: Install Tray 2

- ▲ Slide the tray straight into the printer to install it.

Figure 1-11 Install the tray



Removal and replacement: RM2-5413-000CN optional Tray 3 cassette

- [Introduction](#)
- [Step 1: Remove optional Tray 3](#)
- [Step 2: Unpack the replacement assembly](#)
- [Step 3: Install optional Tray 3](#)

Introduction

This document provides the procedures to remove and replace the optional Tray 3 cassette.

Before performing service

Turn the printer power off

- Disconnect the power cable.

 **WARNING!** To avoid damage to the printer, turn the printer off, wait 30 seconds, and then remove the power cable before attempting to service the printer.

Use the table below to identify the correct part number for your printer. To order the part, go to www.hp.com/buy/parts.

Tray 3 part number	
RM2-5413-000CN	550-sheet paper feeder cassette (optional Tray 3)

Required tools

- No special tools are required to remove this part.

After performing service

Turn the printer power on

- Connect the power cable.
- Use the power switch to turn the power on.

Post service test

Make sure that the printer initializes to a **Ready** state.

Print a page from Tray 3 to make sure that the paper feeder is functioning correctly.

Step 1: Remove optional Tray 3

1. Pull the tray straight out of the printer until it stops.

Figure 1-12 Pull the tray out of the printer

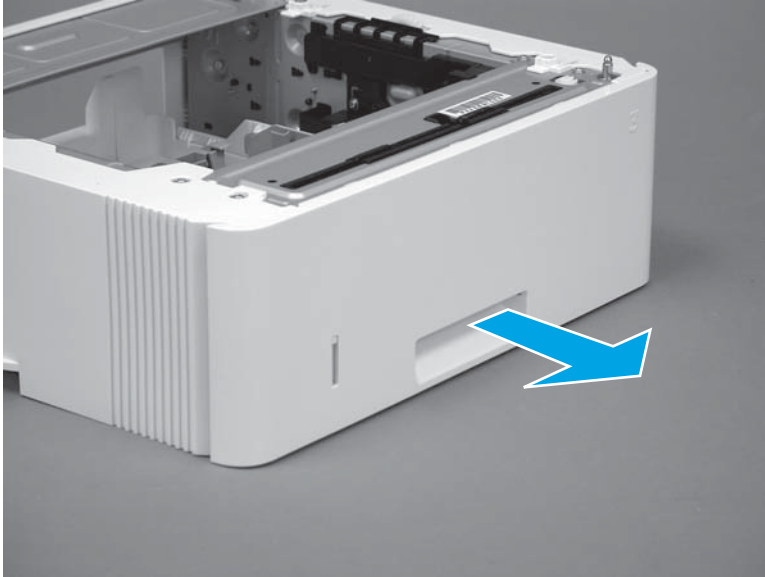

2. Slightly lift up on the front of the tray to release it, and then continue to pull the tray out of the accessory to remove it.

Figure 1-13 Release and remove the tray

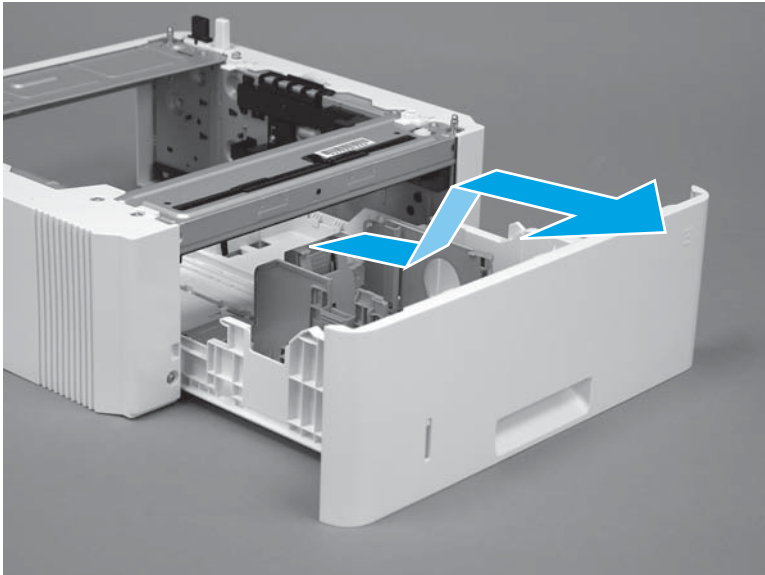

Step 2: Unpack the replacement assembly

Unpack the replacement part from the packaging.

<http://www8.hp.com/us/en/hp-information/environment/product-recycling.html>



NOTE: HP recommends responsible disposal of the defective part.

Figure 1-14 Recycle and unpack

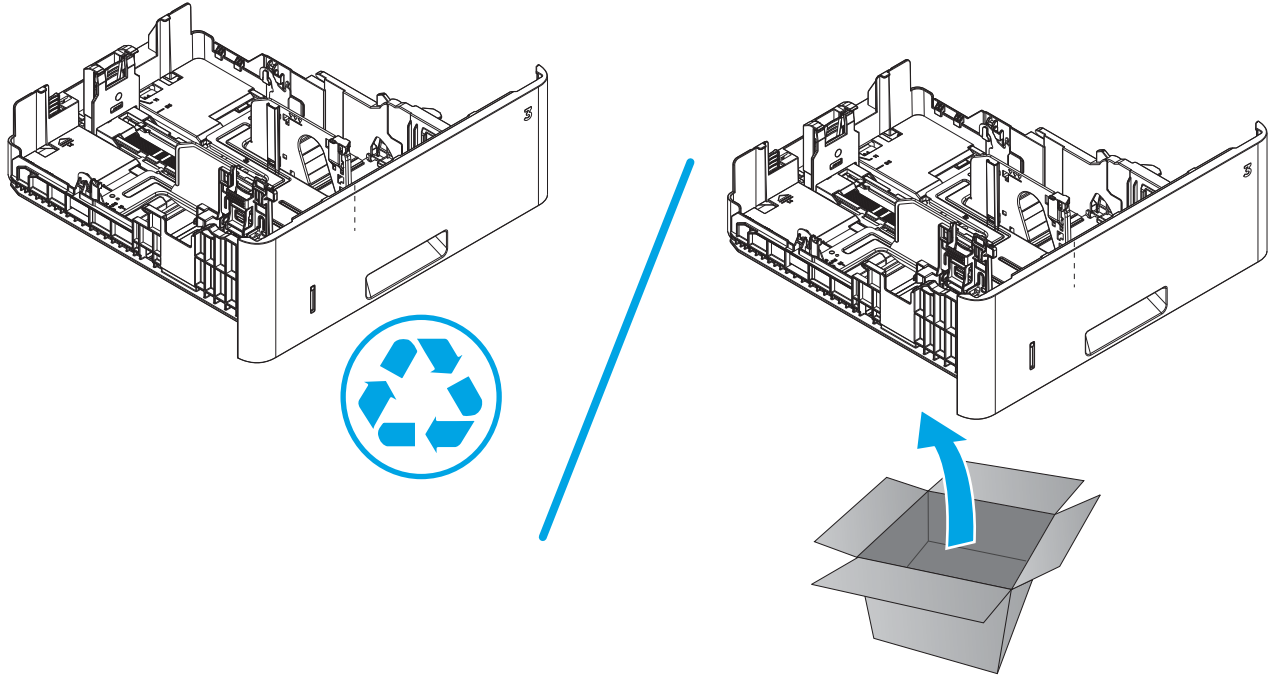

Step 3: Install optional Tray 3

1. With the tray at a slight angle, align the sides of the tray with the rails in the accessory, and then partially slide the tray into the accessory.

Figure 1-15 Install the tray

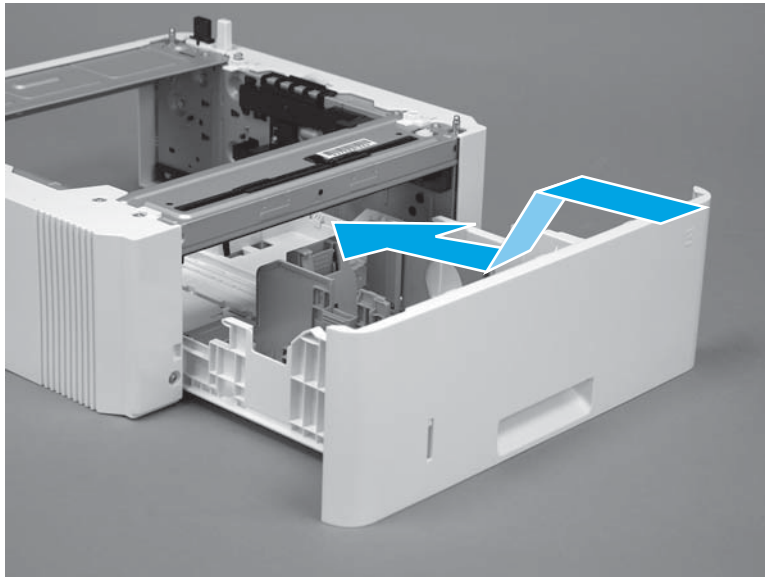

2. Push the tray straight into the accessory to close it.

Figure 1-16 Close the tray

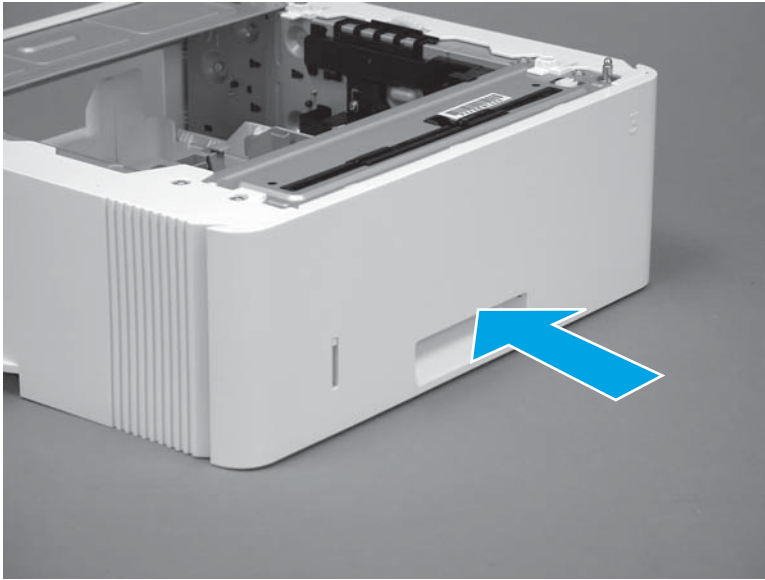

Removal and replacement: RM2-5397-000CN Tray 2 separation roller assembly

- [Introduction](#)
- [Step 1: Remove Tray 2](#)
- [Step 2: Remove the separation pad roller assembly \(Tray 2\)](#)
- [Step 3: Unpack the replacement assembly](#)
- [Step 4: Install the separation pad roller assembly \(Tray 2\)](#)
- [Step 5: Install Tray 2](#)

Introduction

This document provides the procedures to remove and replace the separation roller assembly (Tray 2).

Before performing service

Turn the printer power off

- Disconnect the power cable.

 **WARNING!** To avoid damage to the printer, turn the printer off, wait 30 seconds, and then remove the power cable before attempting to service the printer.

Use the table below to identify the correct part number for your printer. To order the part, go to www.hp.com/buy/parts.

Separation roller assembly (Tray 2) part number	
RM2-5397-000CN	Separation roller assembly (Tray 2)

Required tools

- No special tools are required to install this kit.

After performing service

Turn the printer power on

- Connect the power cable.
- Use the power switch to turn the power on.

Post service test

Make sure that the printer initializes to a **Ready** state.

Print a configuration page to make sure that the printer is functioning correctly.

Step 1: Remove Tray 2

- ▲ Pull the tray straight out of the printer to remove it.

Figure 1-17 Remove the tray



Step 2: Remove the separation pad roller assembly (Tray 2)

1. Press the locking lever (callout 1), and then pull the separation roller assembly straight up to release it.

Figure 1-18 Release the assembly

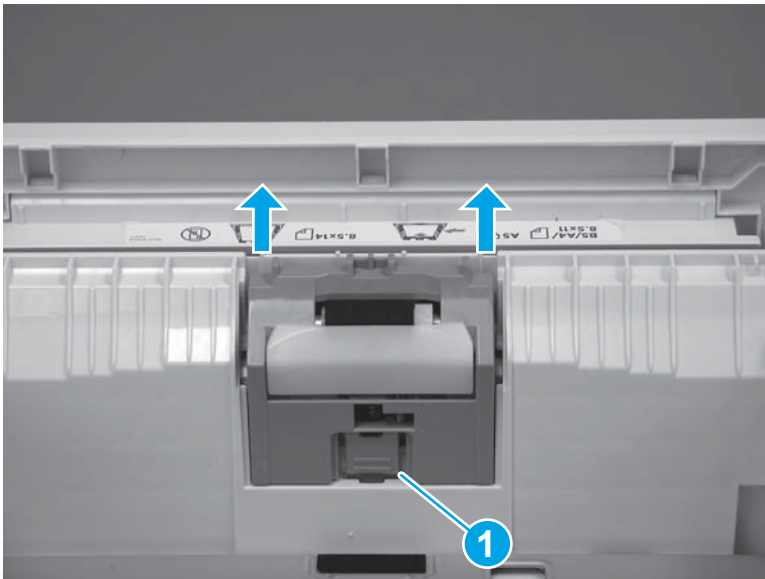

2. Remove the assembly.

Figure 1-19 Remove the assembly

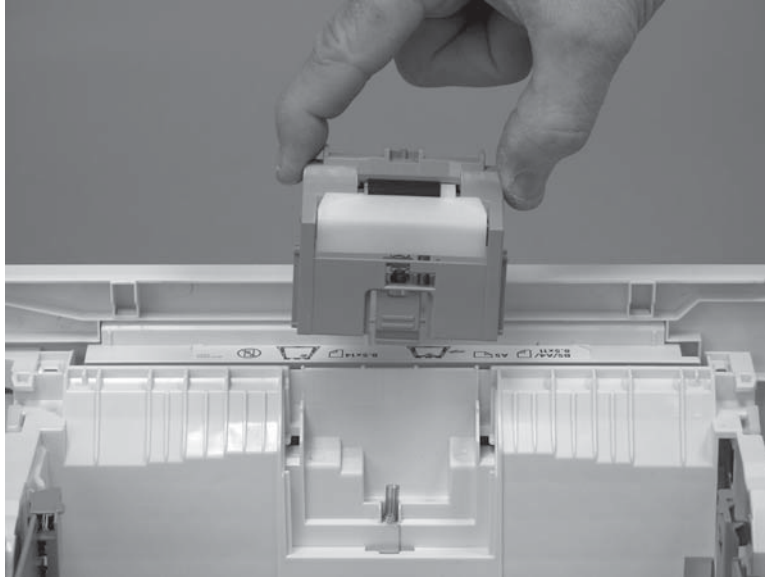

Step 3: Unpack the replacement assembly

Unpack the replacement part from the packaging.

<http://www8.hp.com/us/en/hp-information/environment/product-recycling.html>

 **NOTE:** HP recommends responsible disposal of the defective part.

Figure 1-20 Recycle and unpack

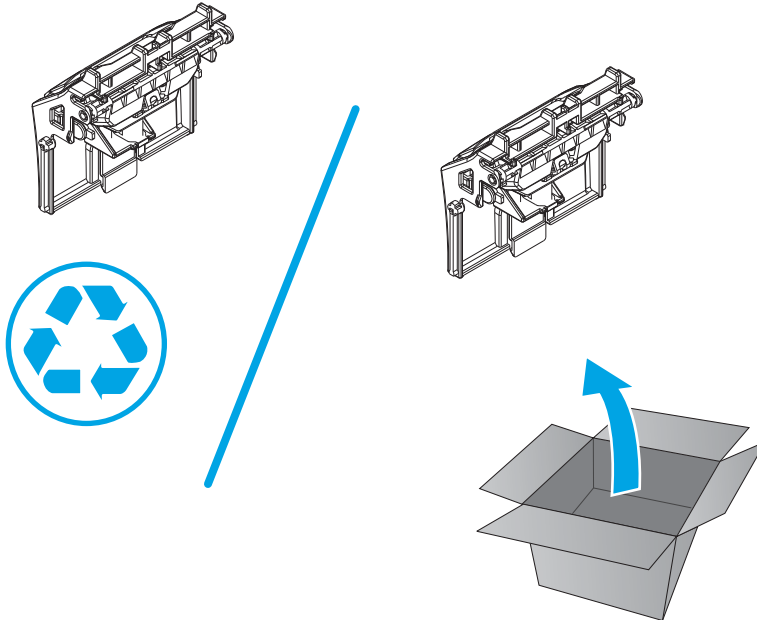

Step 4: Install the separation pad roller assembly (Tray 2)

1. Install the assembly in the slots in the cassette.

Figure 1-21 Install the assembly

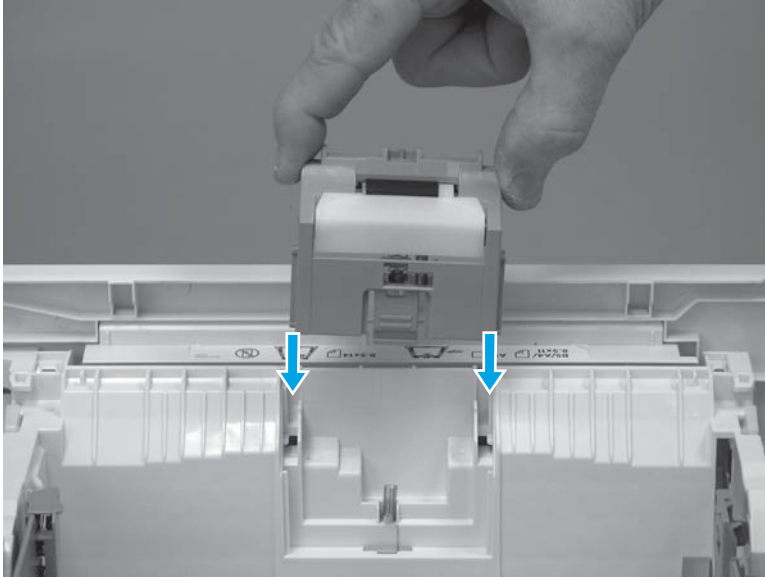

2. Push the separation roller assembly straight down until it snaps into place.

Figure 1-22 Release the assembly

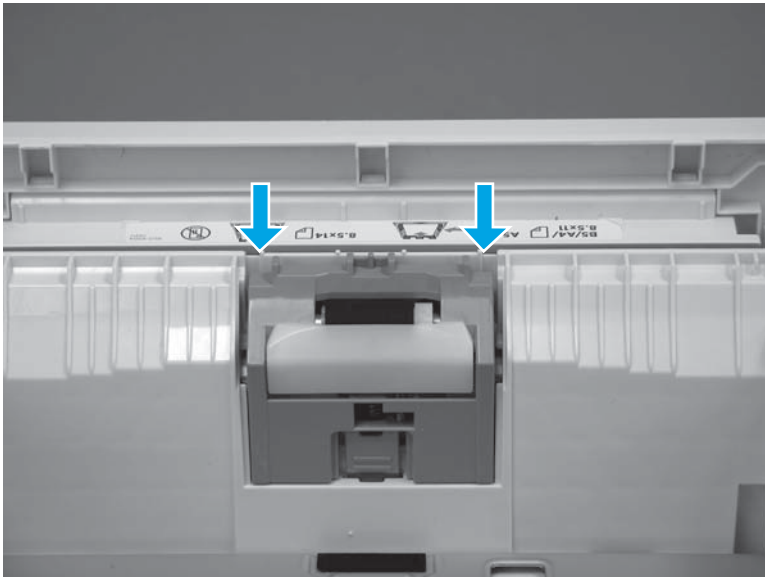

Step 5: Install Tray 2

- ▲ Slide the tray straight into the printer to install it.

Figure 1-23 Install the tray



Removal and replacement: RM2-5745-000CN optional Tray 3 separation roller assembly

- [Introduction](#)
- [Step 1: Remove Tray 3](#)
- [Step 2: Remove the separation roller assembly \(optional Tray 3\)](#)
- [Step 3: Unpack the replacement assembly](#)
- [Step 4: Install the separation roller assembly \(optional Tray 3\)](#)
- [Step 5: Install Tray 3](#)

Introduction

This document provides the procedures to remove and replace the separation roller assembly (500-sheet feeder).

Before performing service

Turn the printer power off

- Disconnect the power cable.

 **WARNING!** To avoid damage to the printer, turn the printer off, wait 30 seconds, and then remove the power cable before attempting to service the printer.

Use the table below to identify the correct part number for your printer. To order the part, go to www.hp.com/buy/parts.

Separation roller assembly (550-sheet feeder) part number	
---	--

RM2-5745-000CN	Separation roller assembly (550-sheet feeder)
----------------	---

Required tools

- No special tools are required to install this kit.

After performing service

Turn the printer power on

- Connect the power cable.
- Use the power switch to turn the power on.

Post service test

Make sure that the printer initializes to a **Ready** state.

Print a page from the accessory to make sure that the accessory is functioning correctly.

Step 1: Remove Tray 3

1. Pull the tray straight out of the printer until it stops.

Figure 1-24 Pull the tray out of the printer

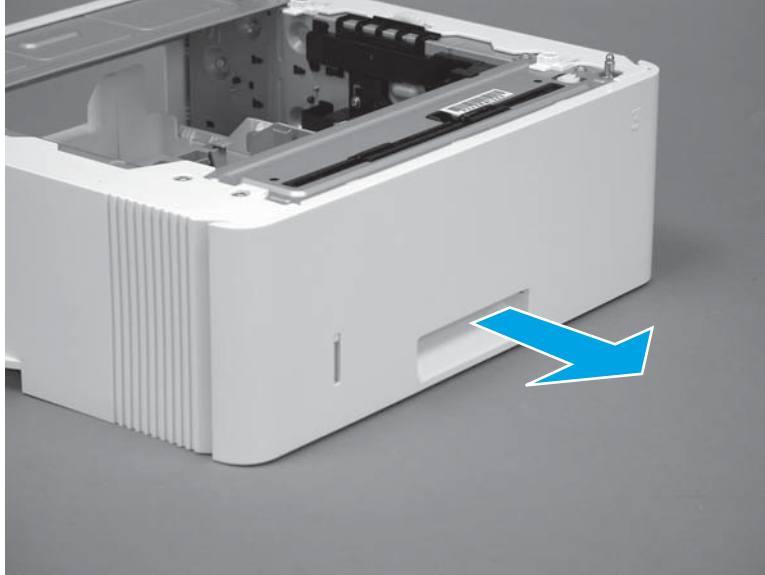

2. Slightly lift up on the front of the tray to release it, and then continue to pull the tray out of the accessory to remove it.

Figure 1-25 Release and remove the tray

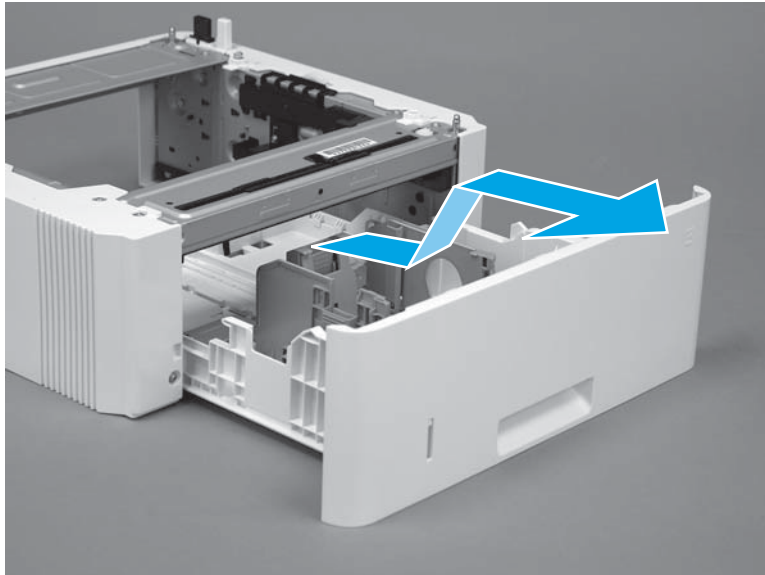

Step 2: Remove the separation roller assembly (optional Tray 3)

1. Press the locking lever (callout 1), and then pull the separation roller assembly straight up to release it.

Figure 1-26 Release the assembly

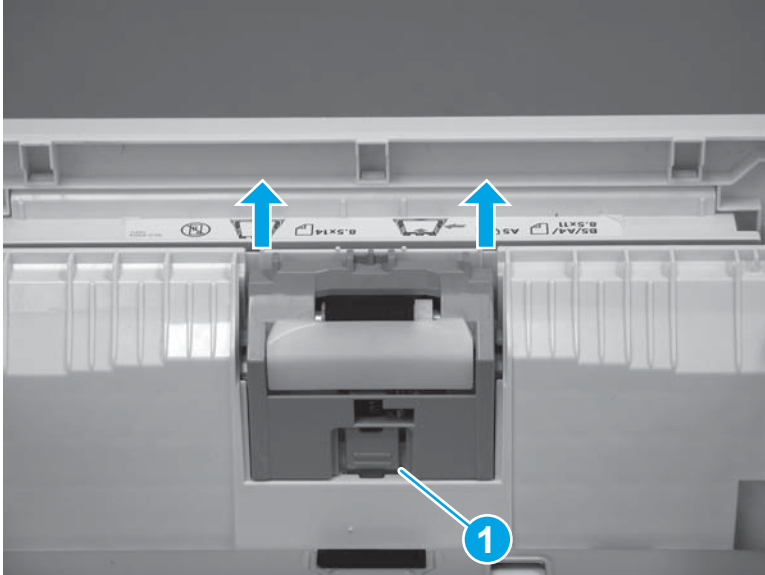

2. Remove the assembly.

Figure 1-27 Remove the assembly

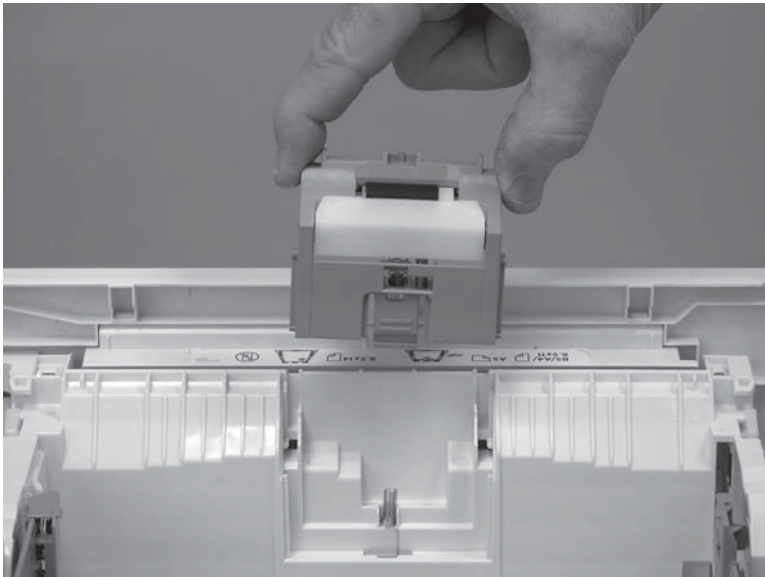

Step 3: Unpack the replacement assembly

Unpack the replacement part from the packaging.

<http://www8.hp.com/us/en/hp-information/environment/product-recycling.html>



NOTE: HP recommends responsible disposal of the defective part.

Figure 1-28 Recycle and unpack

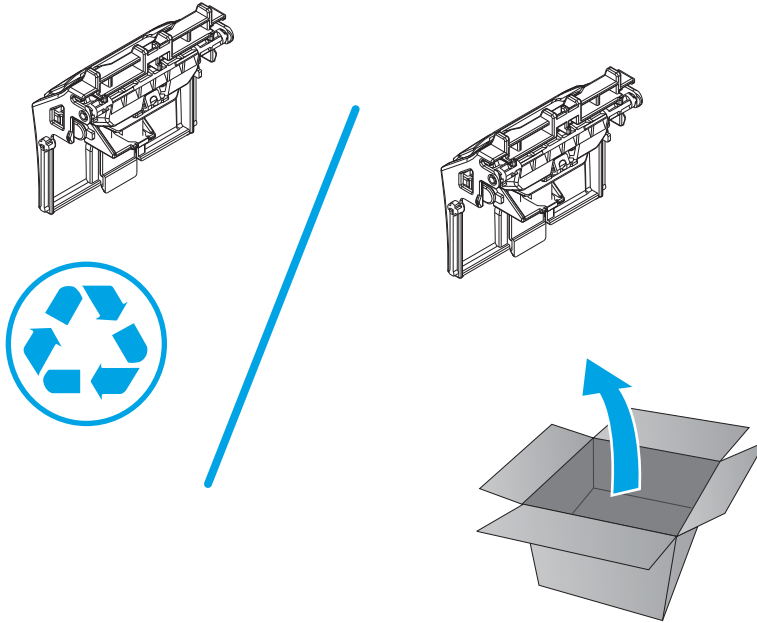

Step 4: Install the separation roller assembly (optional Tray 3)

1. Install the assembly in the slots in the cassette.

Figure 1-29 Install the assembly

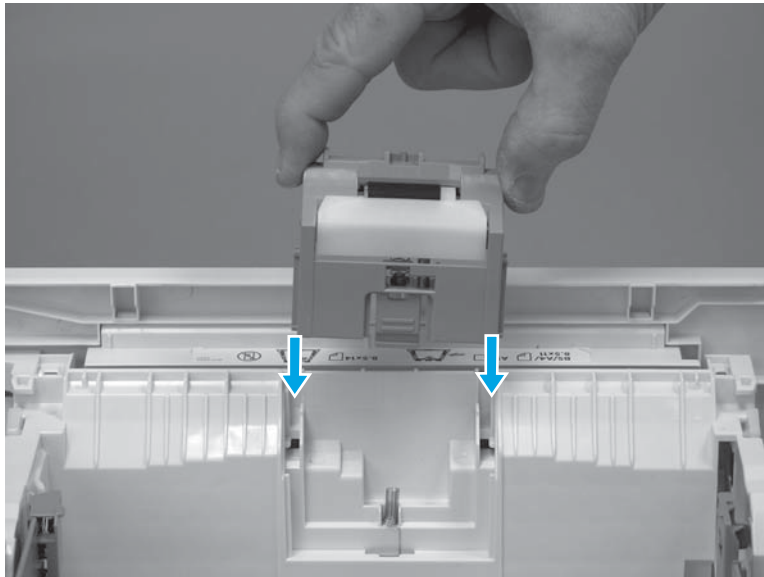

2. Push the separation roller assembly straight down until it snaps into place.

Figure 1-30 Release the assembly

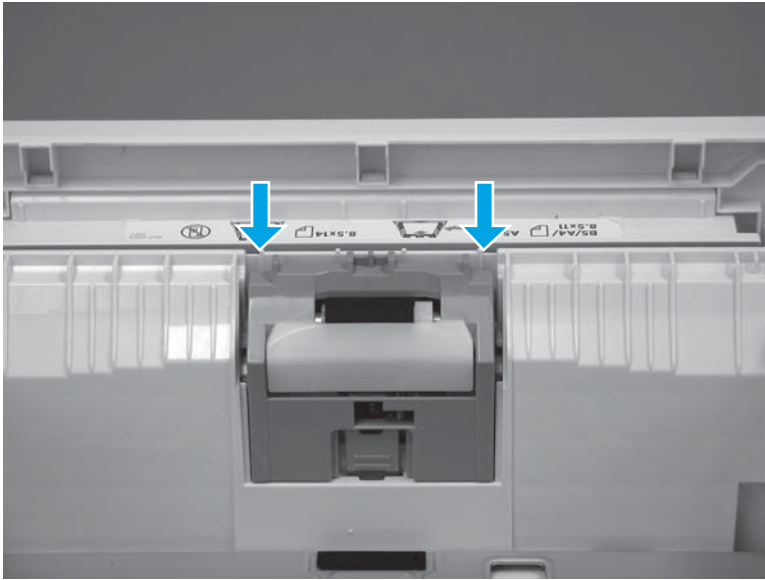

Step 5: Install Tray 3

1. With the tray at a slight angle, align the sides of the tray with the rails in the accessory, and then partially slide the tray into the accessory.

Figure 1-31 Install the tray

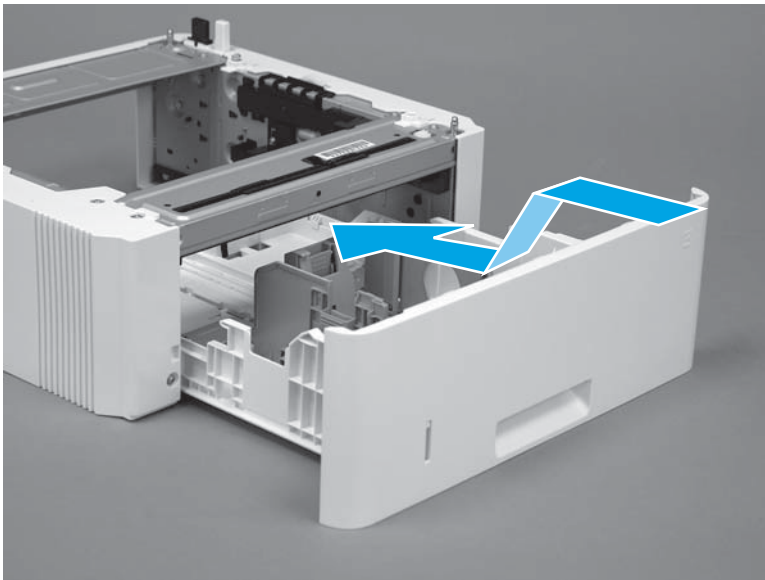

2. Push the tray straight into the accessory to close it.

Figure 1-32 Close the tray

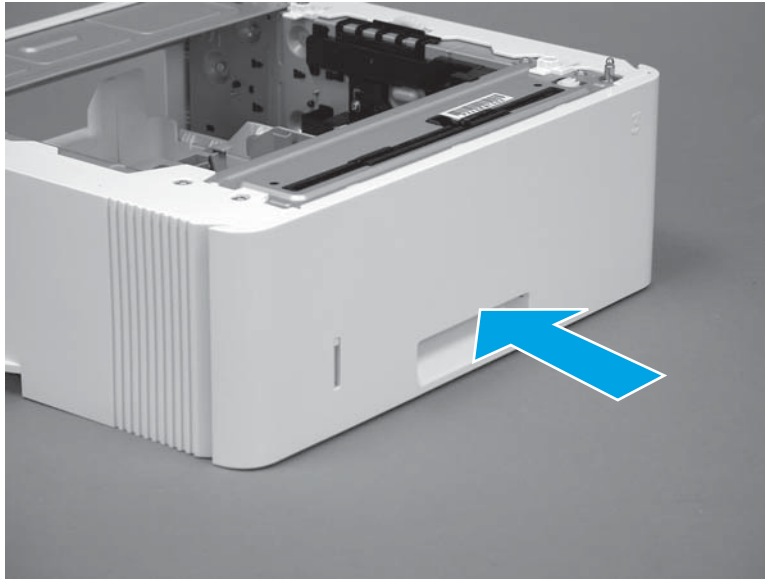

Removal and replacement: RM2-5741-000CN optional Tray 3 paper pickup roller assembly

- [Introduction](#)
- [Step 1: Remove optional Tray 3](#)
- [Step 2: Remove the paper pickup roller assembly \(optional Tray 3\)](#)
- [Step 3: Unpack the replacement assembly](#)
- [Step 4: Install the paper pickup roller assembly \(optional Tray 3\)](#)
- [Step 5: Install optional Tray 3](#)

Introduction

This document provides the procedures to remove and replace the paper pickup roller assembly (Tray 3).

Before performing service

Turn the printer power off

- Disconnect the power cable.

 **WARNING!** To avoid damage to the printer, turn the printer off, wait 30 seconds, and then remove the power cable before attempting to service the printer.

Use the table below to identify the correct part number for your printer. To order the part, go to www.hp.com/buy/parts.

Paper pickup roller assembly (Tray 3) part number	
RM2-5741-000N	Paper pickup roller assembly (Tray 3)

Required tools

- No special tools are required to remove this part.

After performing service

Turn the printer power on

- Connect the power cable.
- Use the power switch to turn the power on.

Post service test

Make sure that the printer initializes to a **Ready** state.

Print a page from the accessory to make sure that the printer is functioning correctly.

Step 1: Remove optional Tray 3

1. Pull the tray straight out of the printer until it stops.

Figure 1-33 Pull the tray out of the printer

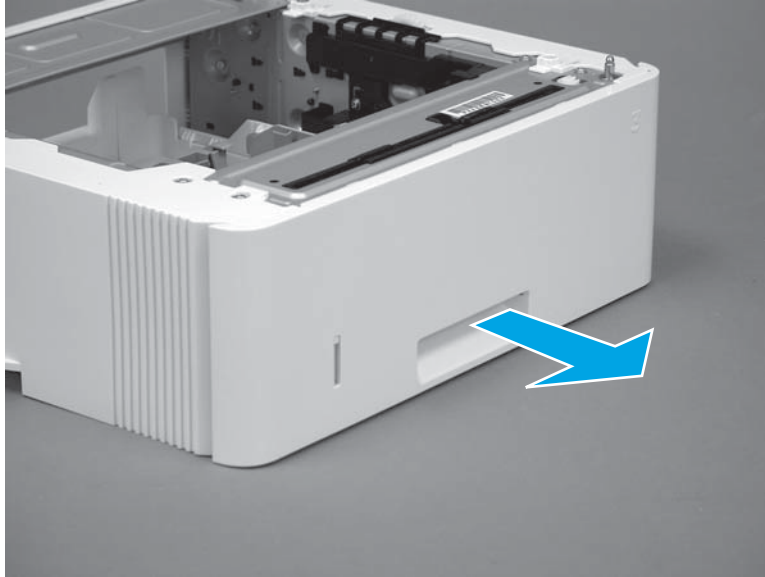

2. Slightly lift up on the front of the tray to release it, and then continue to pull the tray out of the accessory to remove it.

Figure 1-34 Release and remove the tray

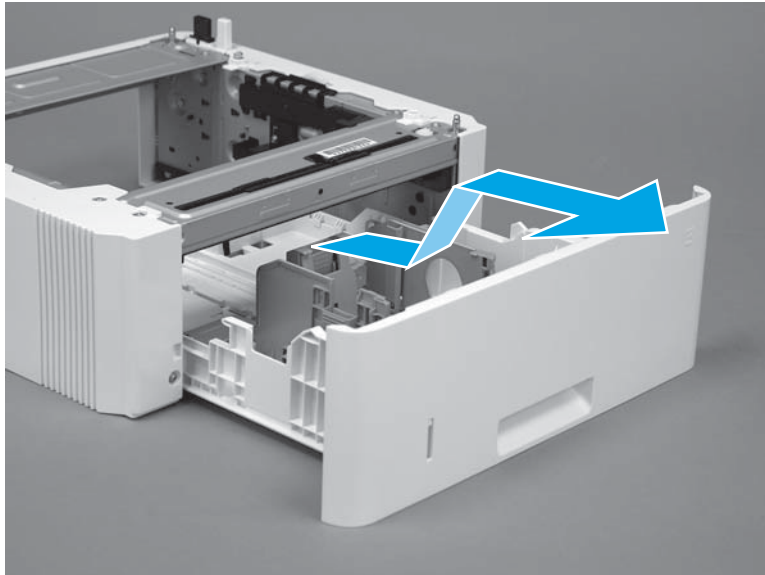

Step 2: Remove the paper pickup roller assembly (optional Tray 3)

CAUTION: When handling the roller holder, do not touch the gray spongy portion of the rollers. Skin oils on the rollers can cause paper handling problems.

1. Carefully turn the accessory over to expose the roller assembly.

Figure 1-35 Turn the accessory over

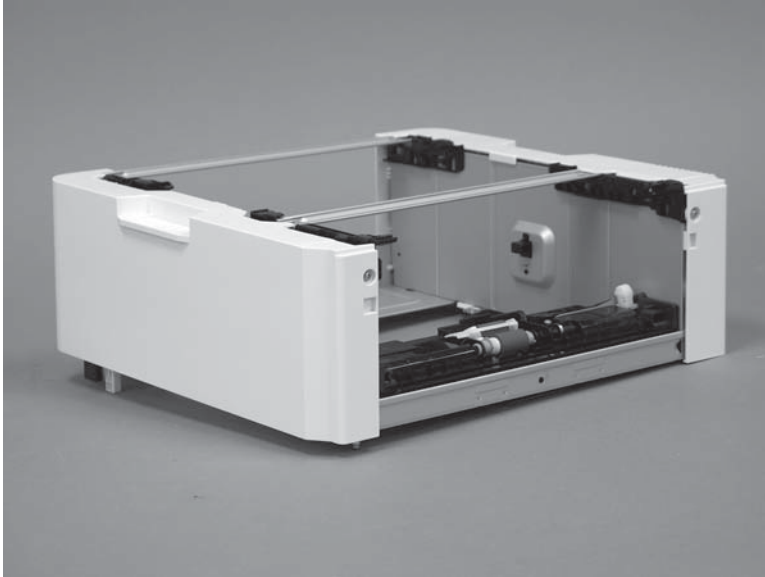

2. Slide the roller holder to the right to compress the spring-loaded shaft and release the assembly.

Figure 1-36 Release the assembly

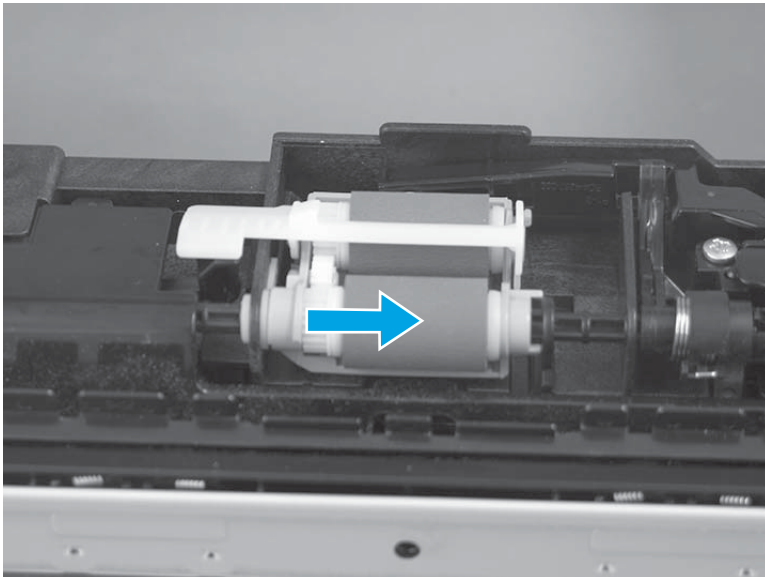

3. Rotate the end of the assembly up and away from the accessory.

Figure 1-37 Rotate the assembly up

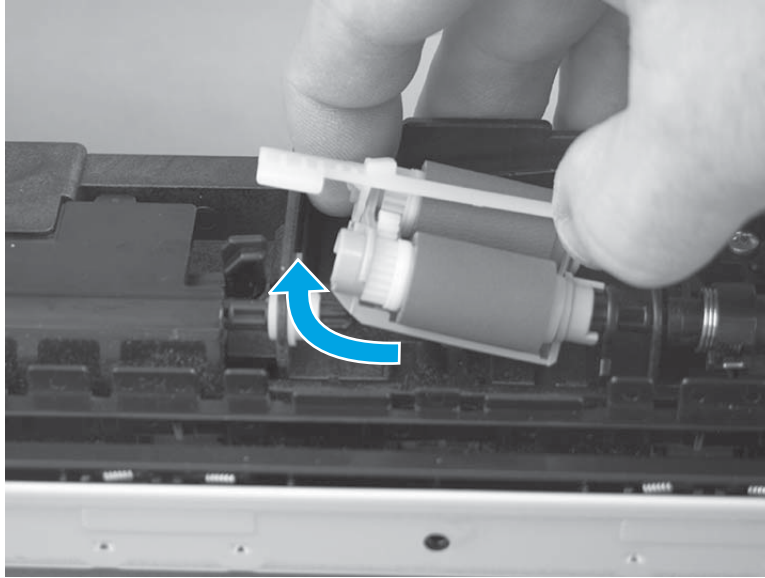

4. Remove the roller assembly.

Figure 1-38 Remove the assembly

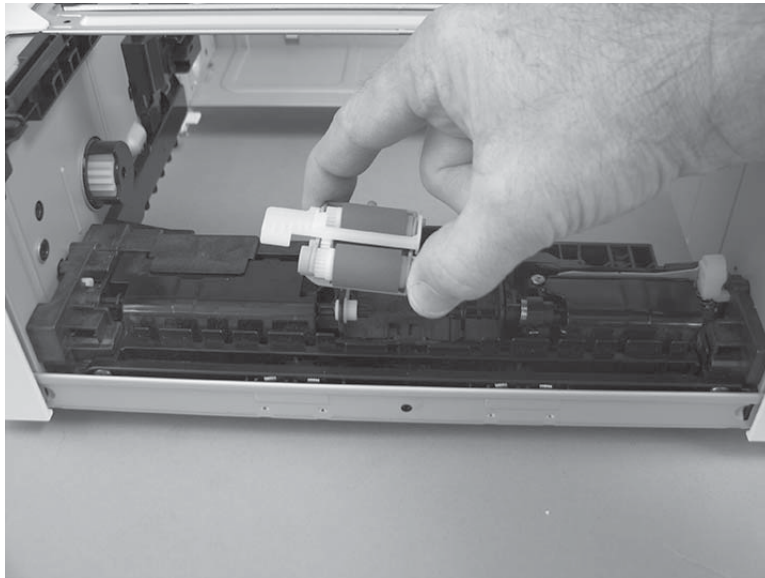

Step 3: Unpack the replacement assembly

Unpack the replacement part from the packaging.

<http://www8.hp.com/us/en/hp-information/environment/product-recycling.html>

CAUTION: When handling the roller holder, do not touch the gray spongy portion of the rollers. Skin oils on the rollers can cause paper handling problems.

NOTE: HP recommends responsible disposal of the defective part.

Figure 1-39 Recycle and unpack

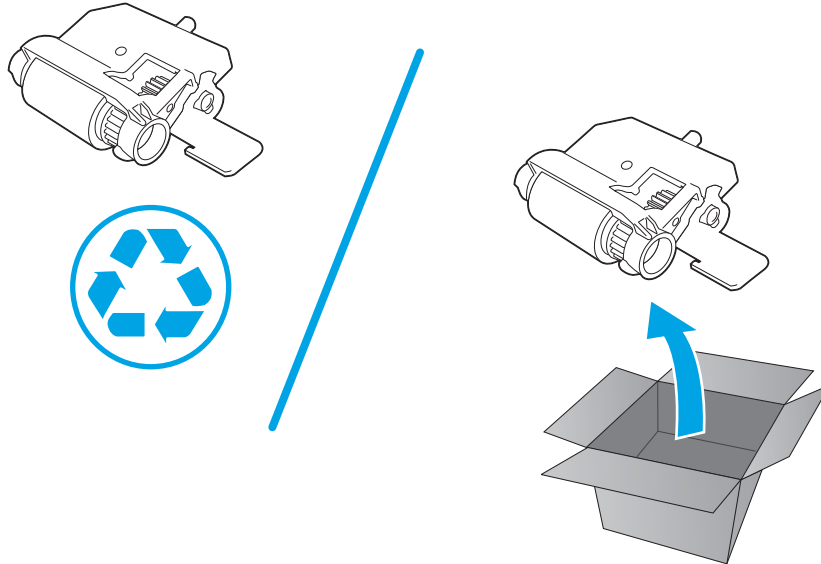

Step 4: Install the paper pickup roller assembly (optional Tray 3)

CAUTION: When handling the roller holder, do not touch the gray spongy portion of the rollers. Skin oils on the rollers can cause paper handling problems.

1. Install the right end of the assembly on the spring-loaded shaft (callout 1), and then slide it to the right to compress the shaft (callout 2).

IMPORTANT: Make sure that the pin on the back of the holder (callout 3) is inserted in the slot (callout 4) in the lever arm. If the pin is not correctly installed, the accessory will not pick paper.

Figure 1-40 Install the roller assembly

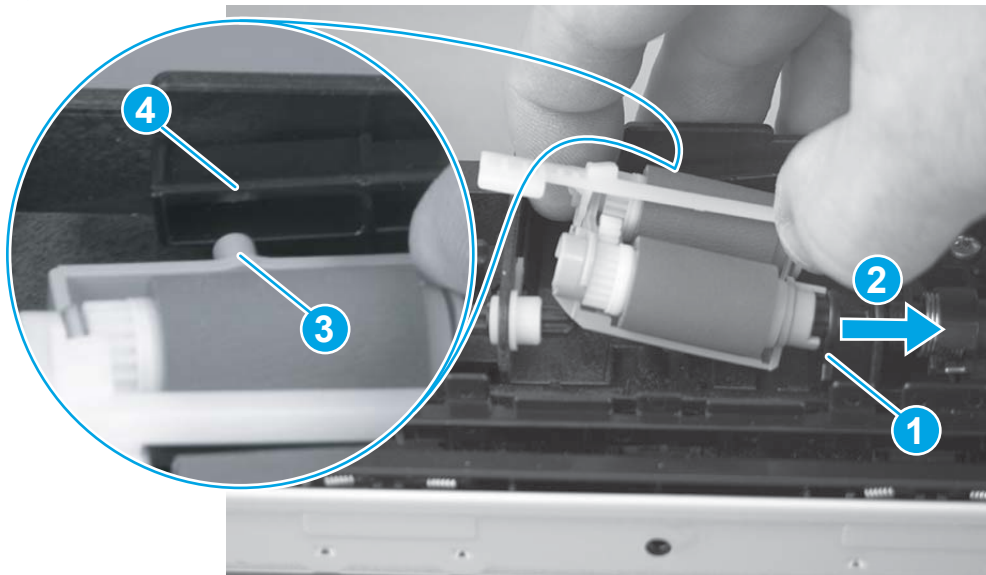

2. Rotate the left end of the assembly down and into place (callout 1), and then slide the assembly to the left (callout 2) to engage the drive end of the assembly with the drive shaft (callout 3).

Figure 1-41 Release the assembly

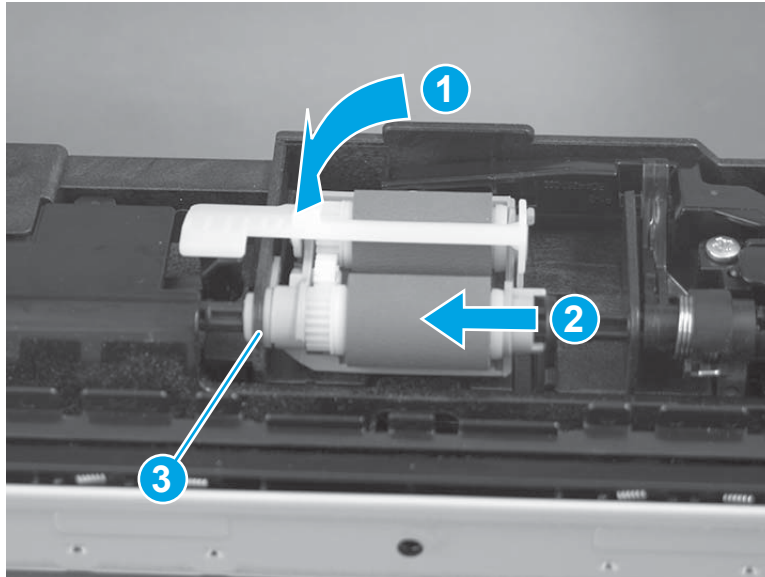

3. Push down and then release the tray-roller actuator (callout 1) and observe the roller assembly. It should move up and down (callout 2) in response to the actuator.

 **NOTE:** If it does not, remove the roller assembly and reinstall it making sure that the pin on the back of the assembly is in the lever arm. See [Figure 1-40 Install the roller assembly on page 38](#).

Figure 1-42 Check the installation



Step 5: Install optional Tray 3

1. With the tray at a slight angle, align the sides of the tray with the rails in the accessory, and then partially slide the tray into the accessory.

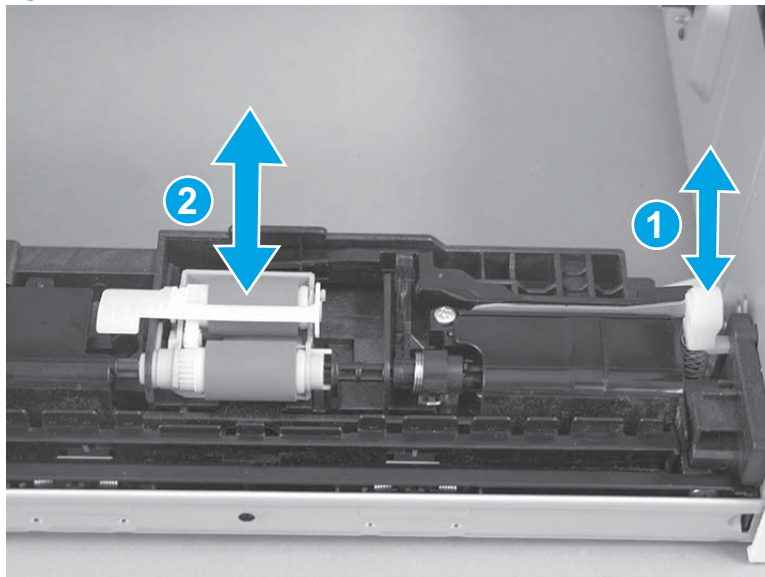
Figure 1-43 Install the tray

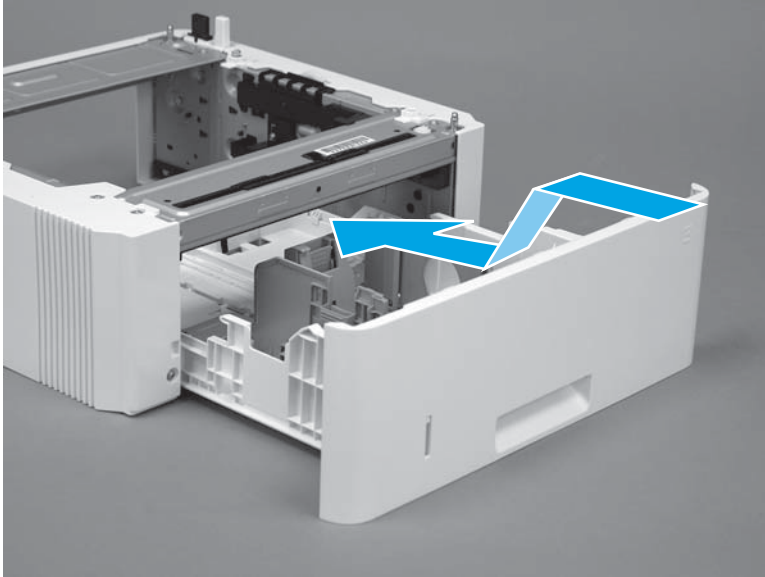

2. Push the tray straight into the accessory to close it.

Figure 1-44 Close the tray

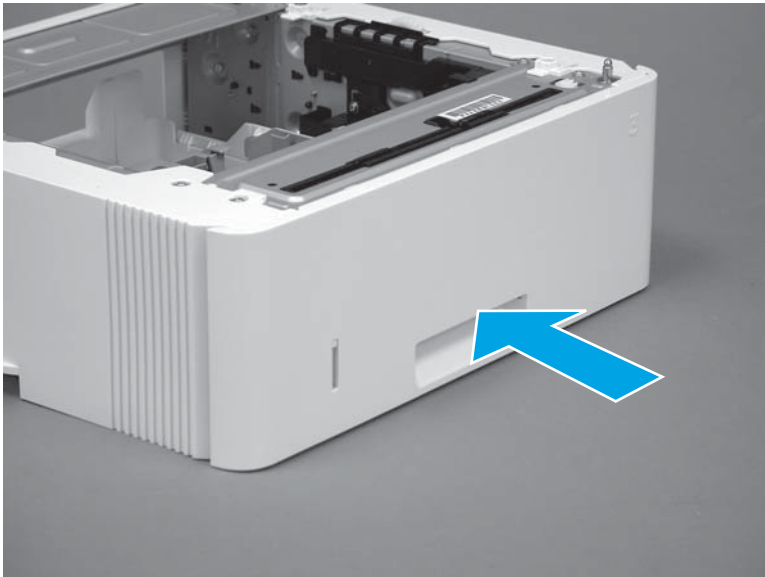

Removal and replacement: RM2-5452-000CN Tray 2 paper pickup roller assembly

- [Introduction](#)
- [Step 1: Remove Tray 2](#)
- [Step 2: Remove the pickup roller assembly \(Tray 2\)](#)
- [Step 3: Unpack the replacement assembly](#)
- [Step 4: Install the pickup roller assembly \(Tray 2\)](#)
- [Step 5: Install Tray 2](#)

Introduction

This document provides the procedures to remove and replace the paper pickup roller assembly (Tray 2).

Before performing service

Turn the printer power off

- Disconnect the power cable.

 **WARNING!** To avoid damage to the printer, turn the printer off, wait 30 seconds, and then remove the power cable before attempting to service the printer.

Use the table below to identify the correct part number for your printer. To order the part, go to www.hp.com/buy/parts.

Paper pickup roller assembly (Tray 2) part number	
RM2-5452-000CN	Paper pickup roller assembly (Tray 2)

Required tools

- No special tools are required to remove this part.

After performing service

Turn the printer power on

- Connect the power cable.
- Use the power switch to turn the power on.

Post service test

Make sure that the printer initializes to a **Ready** state.

Print a page from Tray 2 to make sure that the printer is functioning correctly.

Step 1: Remove Tray 2

- ▲ Pull the tray straight out of the printer to remove it.

Figure 1-45 Remove the tray



Step 2: Remove the pickup roller assembly (Tray 2)

CAUTION: When handling the roller holder, do not touch the gray spongy portion of the rollers. Skin oils on the rollers can cause paper handling problems.

NOTE: The M304/M305/M404/M405 printer is shown in this procedure. However, the instructions are valid for the M329/M428/M429 printers.

1. Carefully rotate the printer backward.

CAUTION: To avoid damage to the rear cassette cover, keep it in the closed position.

Figure 1-46 Tilt the printer backward

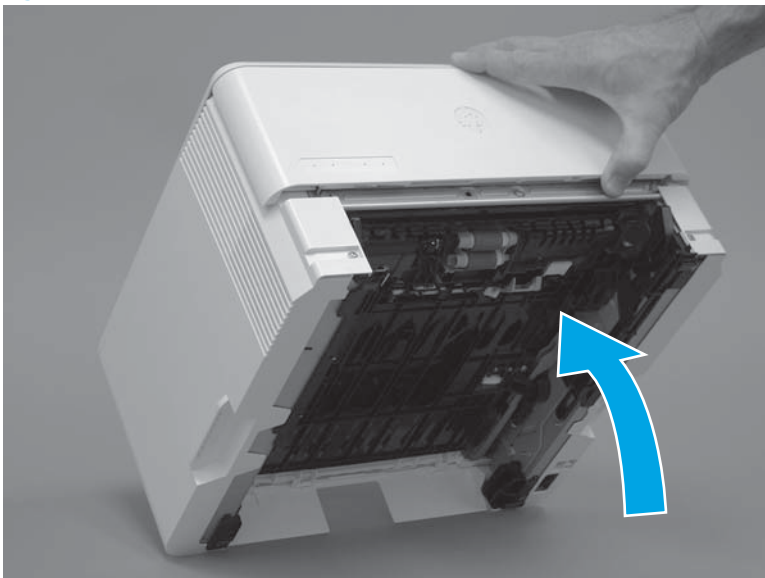

2. Continue rotate the printer backward until it rests on the rear cover, bottom-side face forward.

CAUTION: M329/M428/M429: The integrated scanner assembly (ISA) is not captive, and can unexpectedly open when the printer is tilted back.

Figure 1-47 Place the printer bottom-side face forward

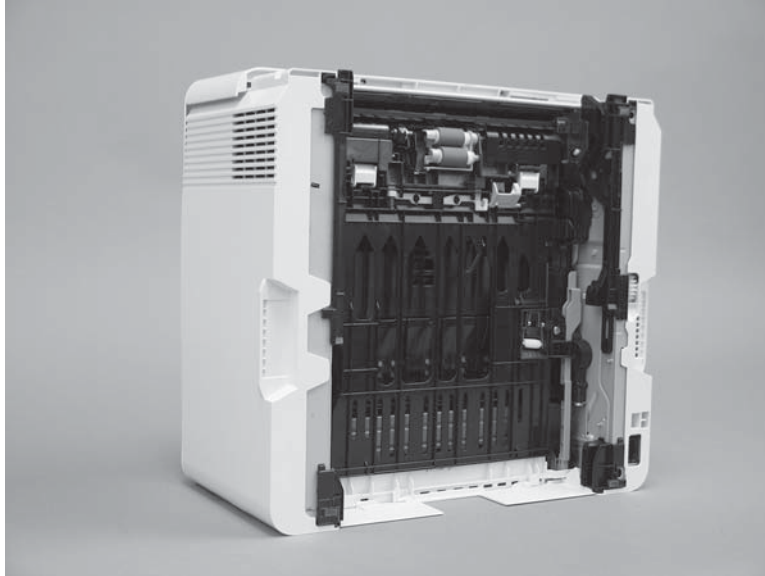

3. Release one tab (callout 1), and then slide the roller holder toward the left side of the printer to release it.

Figure 1-48 Release one tab

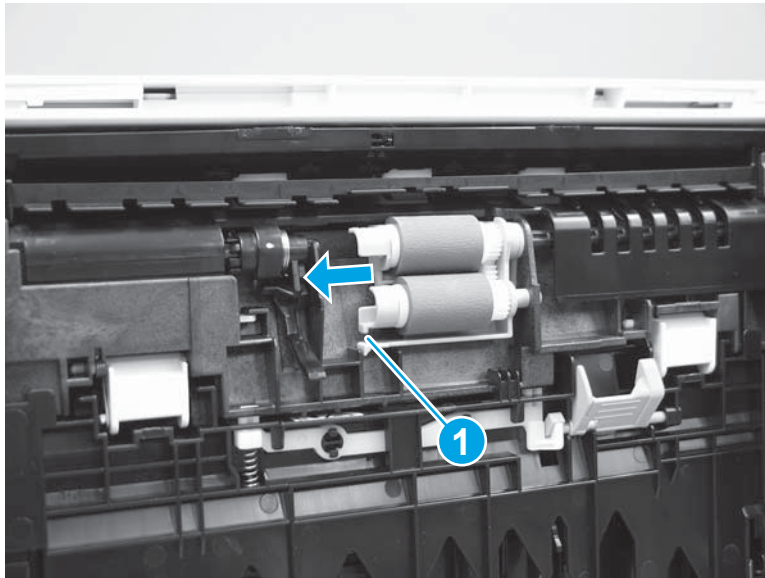

4. Remove the roller holder.

Figure 1-49 Remove the roller holder

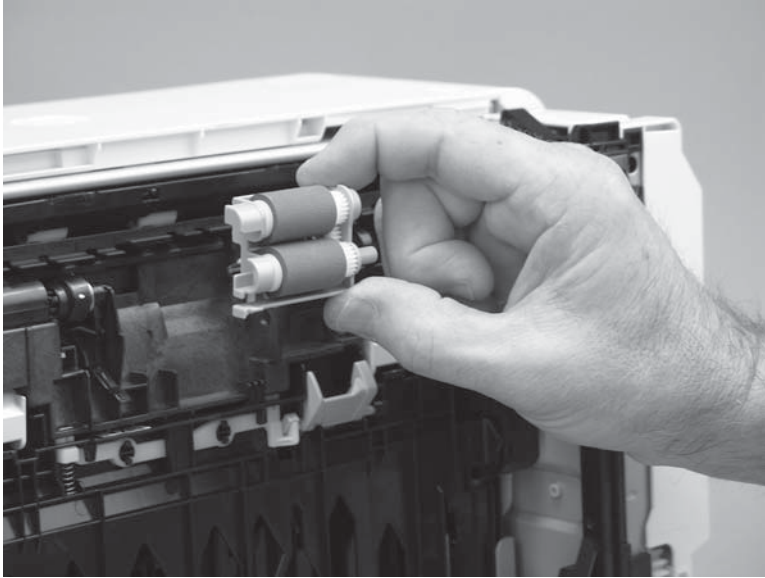

Step 3: Unpack the replacement assembly

Unpack the replacement part from the packaging.

<http://www8.hp.com/us/en/hp-information/environment/product-recycling.html>

CAUTION: When handling the roller holder, do not touch the gray spongy portion of the rollers. Skin oils on the rollers can cause paper handling problems.

NOTE: HP recommends responsible disposal of the defective part.

Figure 1-50 Recycle and unpack

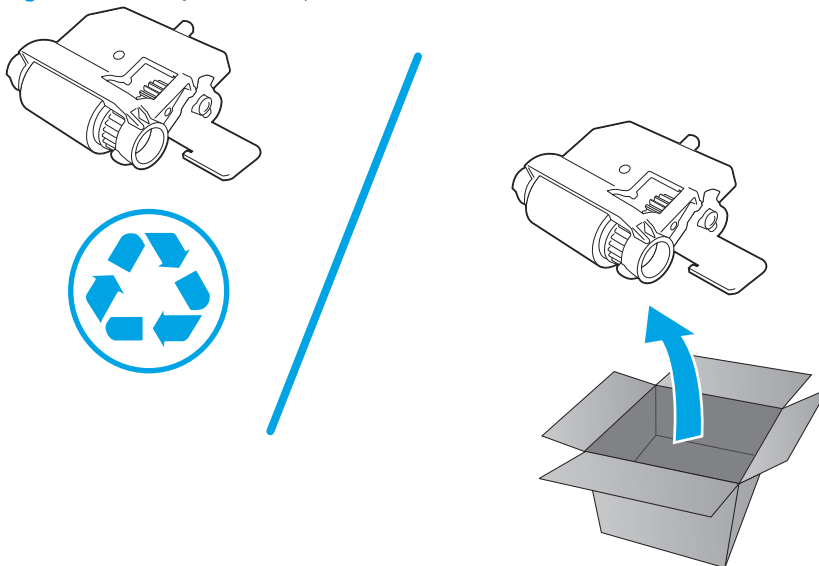

Step 4: Install the pickup roller assembly (Tray 2)

CAUTION: When handling the roller holder, do not touch the gray spongy portion of the rollers. Skin oils on the rollers can cause paper handling problems.

NOTE: The M304/M305/M404/M405 printer is shown in this procedure. However, the instructions are valid for the M329/M428/M429 printers.

1. Position the roller holder assembly in the printer as shown, and then slide it toward the right side of the printer.

Figure 1-51 Install the roller holder

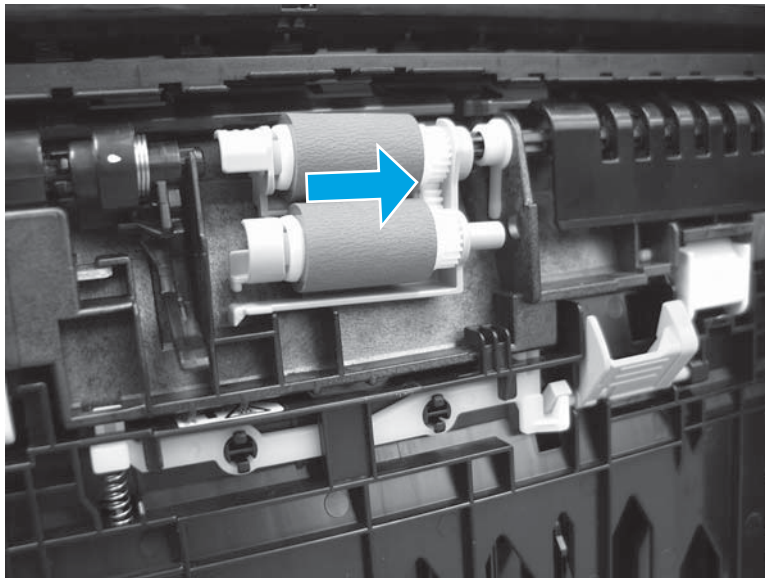

2. Make sure that the tab snaps into place.

Figure 1-52 Check the tab

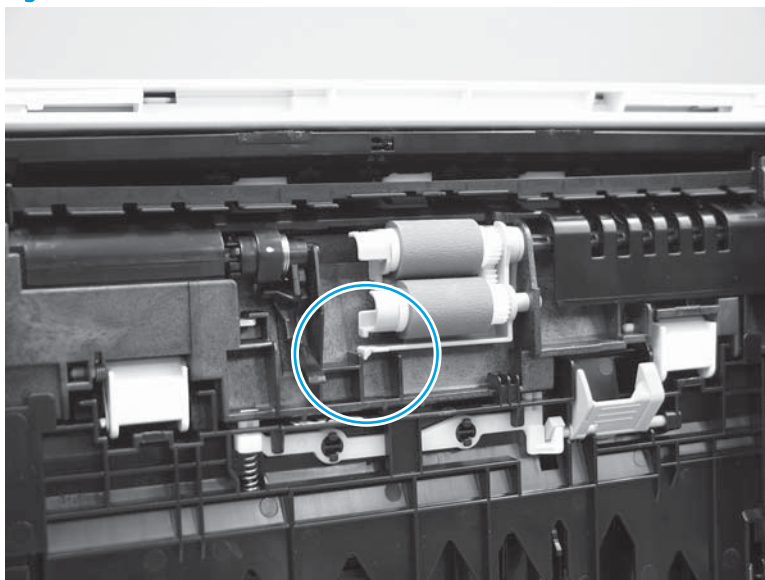

- Carefully rotate the printer forward.

Figure 1-53 Rotate the printer forward

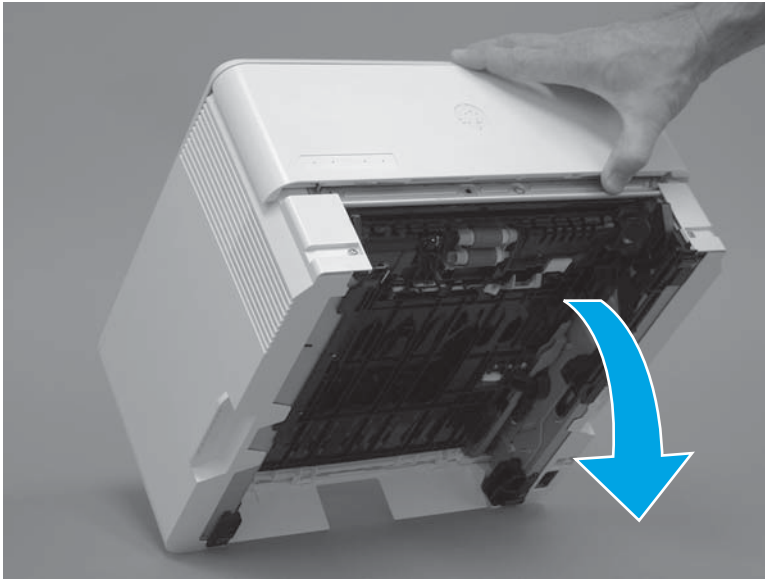

- Continue rotate the printer forward until it rests in the operational position.

Figure 1-54 Place the printer in the operational position



Step 5: Install Tray 2

- ▲ Slide the tray straight into the printer to install it.

Figure 1-55 Install the tray



Removal and replacement: External panels, covers, and doors

- [Removal and replacement: Damper sheets](#)
- [Removal and replacement: Rear USB cover](#)
- [Removal and replacement: Support shaft](#)
- [Removal and replacement: Cartridge door assembly](#)
- [Removal and replacement: Pressure-release link](#)
- [Removal and replacement: Left cover](#)
- [Removal and replacement: Right cover](#)
- [Removal and replacement: Rear door assembly](#)
- [Removal and replacement: Cassette rear cover](#)
- [Removal and replacement: Top cover \(M329/M428/M429\)](#)
- [Removal and replacement: Cable guide \(M329/M428/M429\)](#)
- [Removal and replacement: Top cover \(M304/M305/M404/M405\)](#)
- [Removal and replacement: 2-line LCD operator and indication covers \(M304/M305/M404/M405\)](#)
- [Removal and replacement: Paper delivery tray \(output bin\)](#)
- [Removal and replacement: Integrated scanner assembly \(M329/M428/M429\)](#)
- [Removal and replacement: ISA lift assembly and slider pin \(M329/M428/M429\)](#)

Removal and replacement: Damper sheets

- [Introduction](#)
- [Step 1: Remove the damper sheets](#)
- [Step 2: Unpack the replacement assembly](#)

Introduction

This document provides the procedures to remove and replace the damper sheets.

Before performing service

Turn the printer power off

- Disconnect the power cable.

 **WARNING!** To avoid damage to the printer, turn the printer off, wait 30 seconds, and then remove the power cord before attempting to service the printer.

Use the table below to identify the correct part number for your printer. To order the part, go to www.hp.com/buy/parts.

Damper sheets part number	
RC2-6075-000CN	Sheets, damper (2)

Required tools

- No special tools are needed to remove or install this assembly.

After performing service

Turn the printer power on

- Connect the power cable.
- Use the power switch to turn the power on.

Post service test

No post service test are available for this assembly.

Step 1: Remove the damper sheets

- ▲ Remove the damper sheets from the rear cover.

 **Reinstallation tip:** Make sure that all of the residual adhesive is removed from the rear cover damper sheet area. Residual adhesive can cause the replacement sheets to not adhere properly to the door.

Figure 1-56 Remove the damper sheets



Step 2: Unpack the replacement assembly

1. Dispose of the defective part.

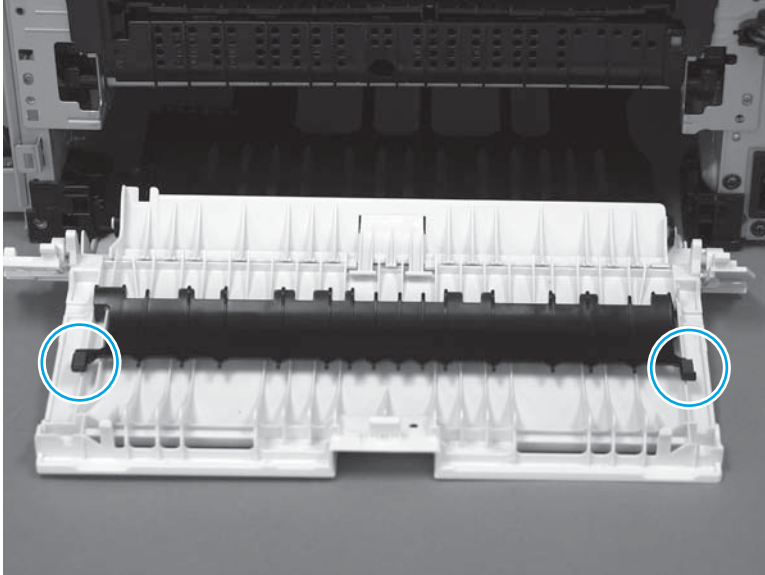

NOTE: HP recommends responsible disposal of the defective part.

<http://www8.hp.com/us/en/hp-information/environment/product-recycling.html>

2. Unpack the replacement part from the packaging.



CAUTION:  Some parts are sensitive to electrostatic discharge (ESD). Always perform service work at an ESD-protected workstation or mat. If an ESD workstation or mat is not available, touch the sheet-metal chassis to provide a static ground before touching an ESD-sensitive assembly. Protect the ESD-sensitive assemblies by placing them in ESD pouches when they are out of the printer.

If the replacement part is a roller or pad, avoid touching the spongy part of it. Skin oils on the roller or pad can cause paper pickup and/or print-quality problems. HP recommends using disposable gloves when handling rollers or pads or washing your hands before touching rollers or pads.



IMPORTANT: Make sure that all of the shipping materials (for example shipping tape) are removed from the replacement part prior to installation.

3. To install an assembly, reverse the removal steps.



NOTE: When applicable, special installation instructions are provided for an assembly at the end of the removal procedure. Always completely read the removal instructions and follow all special installation instructions.

Removal and replacement: Rear USB cover

- [Introduction](#)
- [Step 1: Remove the rear USB cover](#)
- [Step 2: Unpack the replacement assembly](#)

Introduction

This document provides the procedures to remove and replace the rear USB cover.

Before performing service

Turn the printer power off

- Disconnect the power cable.

 **WARNING!** To avoid damage to the printer, turn the printer off, wait 30 seconds, and then remove the power cable before attempting to service the printer.

Use the table below to identify the correct part number for your printer. To order the part, go to www.hp.com/buy/parts.

Rear USB cover part number	
RC4-3298-000CN	Rear USB cover, small (M304/M305/M404/M405)
RC4-3299-000CN	Rear USB cover, small (M329/M428/M429)

Required tools

- No special tools are needed to remove or install this assembly.

After performing service

Turn the printer power on

- Connect the power cable.
- Use the power switch to turn the power on.

Post service test

No post service test are available for this assembly.

Step 1: Remove the rear USB cover

1. Use a finger to release two tabs (callout 1), and then pull the cover straight off of the printer.

Figure 1-57 Pull the cover straight off

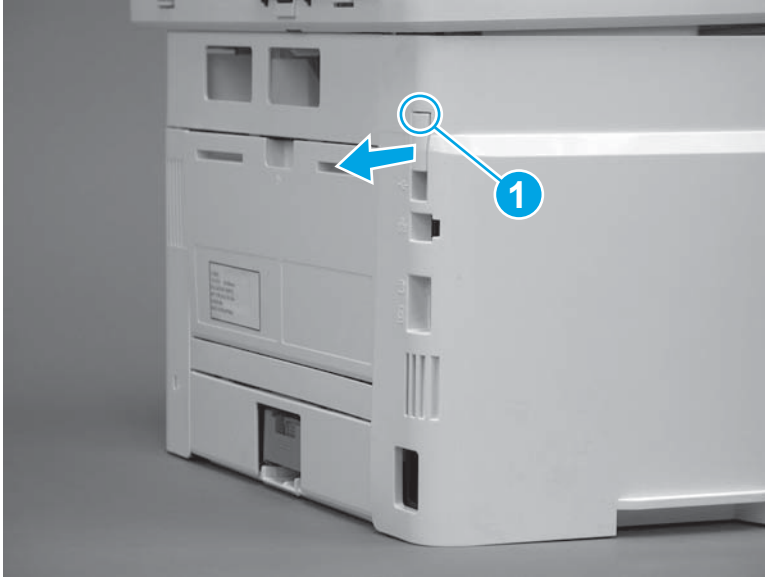

2. Remove the cover.

 **NOTE:** For network models, also remove the network port cover (not shown; RC4-2907-000CN).

Figure 1-58 Remove the cover





Step 2: Unpack the replacement assembly

1. Dispose of the defective part.

 **NOTE:** HP recommends responsible disposal of the defective part.

<http://www8.hp.com/us/en/hp-information/environment/product-recycling.html>

2. Unpack the replacement part from the packaging.

 **CAUTION:**  Some parts are sensitive to electrostatic discharge (ESD). Always perform service work at an ESD-protected workstation or mat. If an ESD workstation or mat is not available, touch the sheet-metal chassis to provide a static ground before touching an ESD-sensitive assembly. Protect the ESD-sensitive assemblies by placing them in ESD pouches when they are out of the printer.

If the replacement part is a roller or pad, avoid touching the spongy part of it. Skin oils on the roller or pad can cause paper pickup and/or print-quality problems. HP recommends using disposable gloves when handling rollers or pads or washing your hands before touching rollers or pads.

 **IMPORTANT:** Make sure that all of the shipping materials (for example shipping tape) are removed from the replacement part prior to installation.

3. To install an assembly, reverse the removal steps.

 **NOTE:** When applicable, special installation instructions are provided for an assembly at the end of the removal procedure. Always completely read the removal instructions and follow all special installation instructions.

Removal and replacement: Support shaft

- [Introduction](#)
- [Step 1: Remove the support shaft](#)
- [Step 2: Unpack the replacement assembly](#)

Introduction

This document provides the procedures to remove and replace the toner-cartridge door support shaft.

Before performing service

Turn the printer power off

- Disconnect the power cable.

 **WARNING!** To avoid damage to the printer, turn the printer off, wait 30 seconds, and then remove the power cord before attempting to service the printer.

Use the table below to identify the correct part number for your printer. To order the part, go to www.hp.com/buy/parts.

Support shaft part number	
RC4-3002-000CN	Shaft, support

Required tools

- Optional: Small flat-blade screwdriver.

After performing service

Turn the printer power on

- Connect the power cable.
- Use the power switch to turn the power on.

Post service test

Make sure that toner toner-cartridge door correctly opens and closes.

Step 1: Remove the support shaft

1. Release the support shaft (callout 1), and then slide it toward the center of the door (callout 2).

 **TIP:** It might be easier to release the support shaft by using a small flat-blade screwdriver.

Reinstallation tip: Make sure that the support shaft is fully installed and correctly orientated so that it will not interfere with the door opening and closing.

Figure 1-59 Release the support shaft

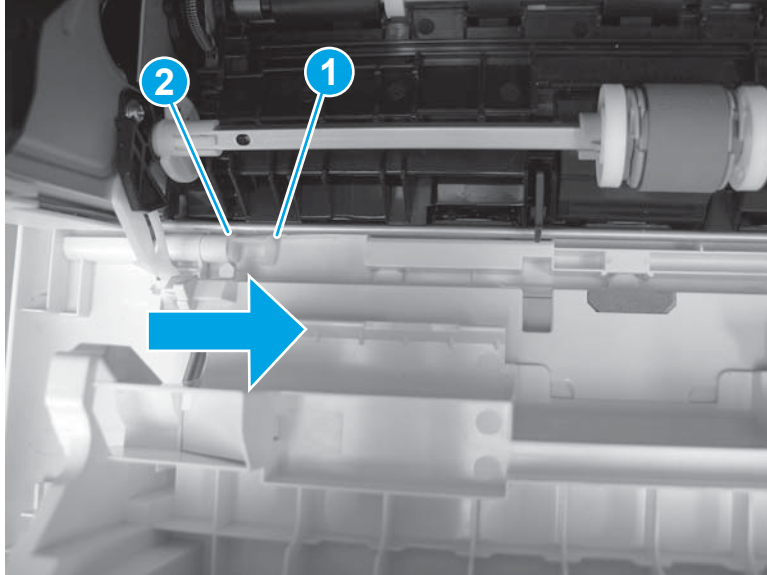

2. Remove the support shaft.

Figure 1-60 Remove the support shaft

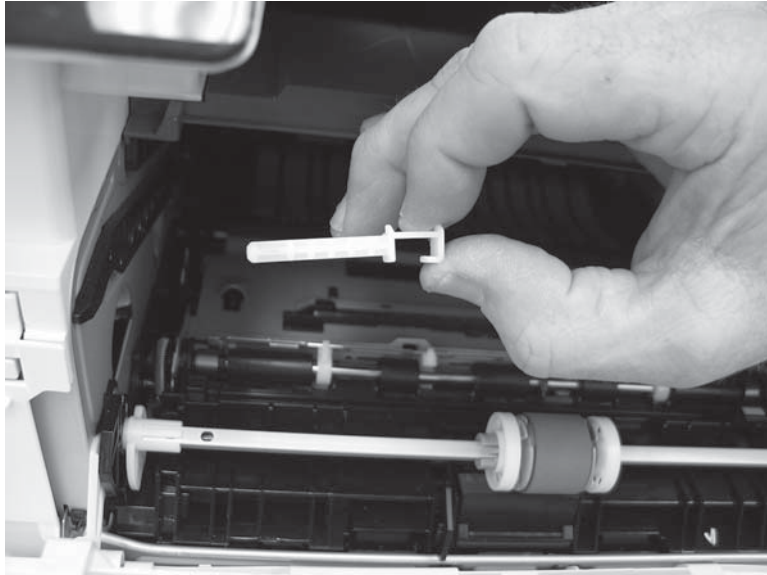



Step 2: Unpack the replacement assembly

1. Dispose of the defective part.

 **NOTE:** HP recommends responsible disposal of the defective part.

<http://www8.hp.com/us/en/hp-information/environment/product-recycling.html>

2. Unpack the replacement part from the packaging.

 **CAUTION:**  Some parts are sensitive to electrostatic discharge (ESD). Always perform service work at an ESD-protected workstation or mat. If an ESD workstation or mat is not available, touch the sheet-metal chassis to provide a static ground before touching an ESD-sensitive assembly. Protect the ESD-sensitive assemblies by placing them in ESD pouches when they are out of the printer.

If the replacement part is a roller or pad, avoid touching the spongy part of it. Skin oils on the roller or pad can cause paper pickup and/or print-quality problems. HP recommends using disposable gloves when handling rollers or pads or washing your hands before touching rollers or pads.

 **IMPORTANT:** Make sure that all of the shipping materials (for example shipping tape) are removed from the replacement part prior to installation.

3. To install an assembly, reverse the removal steps.

 **NOTE:** When applicable, special installation instructions are provided for an assembly at the end of the removal procedure. Always completely read the removal instructions and follow all special installation instructions.

Removal and replacement: Cartridge door assembly

- [Introduction](#)
- [Step 1: Remove the cartridge door assembly](#)
- [Step 2: Unpack the replacement assembly](#)

Introduction

This document provides the procedures to remove and replace the cartridge door assembly.

Before performing service

Turn the printer power off

- Disconnect the power cable.

 **WARNING!** To avoid damage to the printer, turn the printer off, wait 30 seconds, and then remove the power cable before attempting to service the printer.

Use the table below to identify the correct part number for your printer. To order the part, go to www.hp.com/buy/parts.

Cartridge door assembly part number	
RM2-2562-000CN	Cartridge door assembly (M304/M305/M404/M405 models)
RM2-2567-000CN	Cartridge door assembly (M329/M428/M429 models)

Required tools

- Small flat-blade screwdriver.

After performing service

Turn the printer power on

- Connect the power cable.
- Use the power switch to turn the power on.

Post service test

Make sure that the cartridge door assembly correctly opens and closes.

Step 1: Remove the cartridge door assembly

 **NOTE:** If the toner cartridge was not removed prior to servicing the printer, remove it now.

1. Release the support shaft (callout 1), and then slide it toward the center of the door (callout 2).

 **TIP:** It might be easier to release the support shaft by using a small flat-blade screwdriver.

Figure 1-61 Release the support shaft

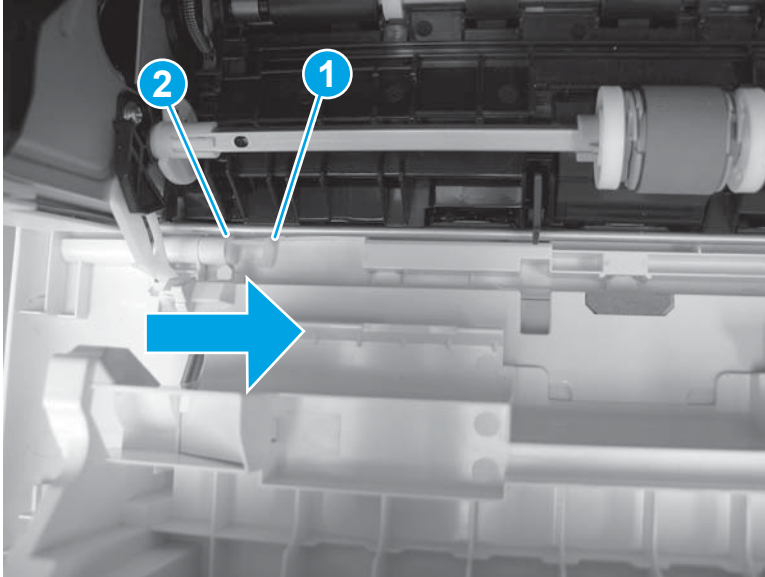

2. Remove the support shaft.

Figure 1-62 Remove the support shaft

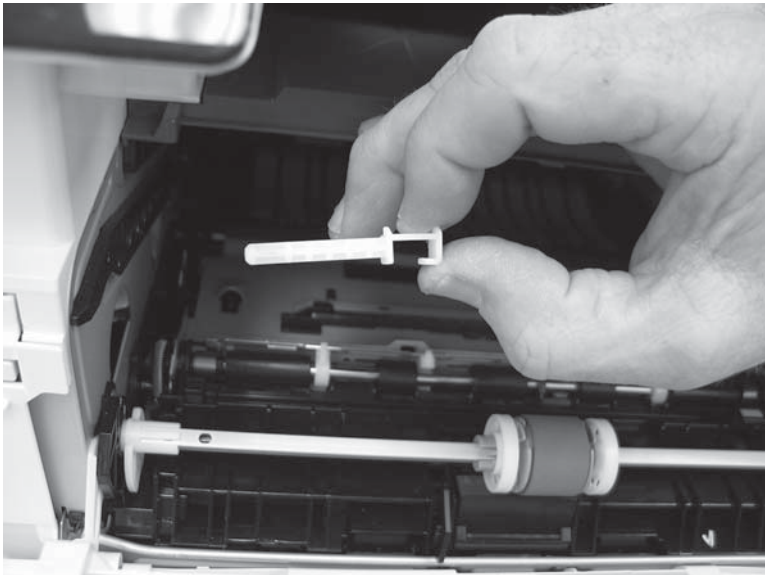

3. Release one tab (callout 1), and then slide the guide out of the printer (callout 2).

CAUTION: Be careful, the tab (callout 1) can be easily broken.

Figure 1-63 Remove the guide

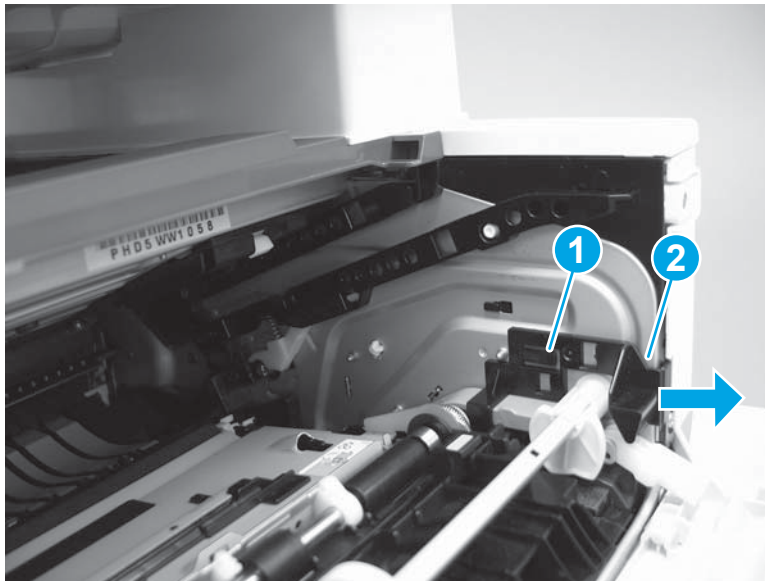

4. Use a small flat-blade screwdriver to gently pry the white-plastic door arm (callout 1) off of the gray-plastic pressure-release link (callout 2) to release the door arm.

Figure 1-64 Release the pressure-release link

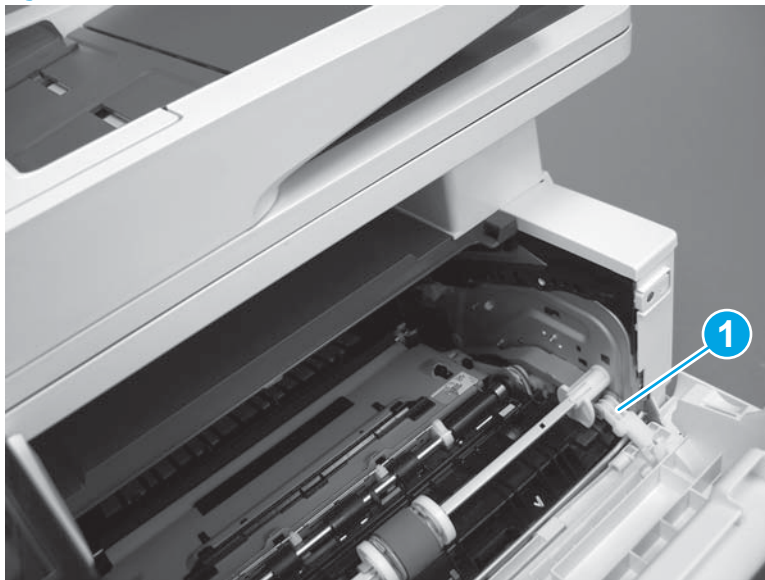

5. With the door in the partially closed position, slightly raise the left end (callout 1; raise it over the sheet-metal hinge boss), and then slide the door to the left (callout 2) to release the right hinge (callout 3).

⚠ CAUTION: The door is still attached to the printer by the left-side retainer arm. Do not attempt to completely remove the door.

💡 Reinstallation tip: When reinstalling the door, there are two right-side hinge pins (not shown in callout 3). Keep a finger pressed on the left-side retainer arm so that it does not disengage from the door.

Figure 1-65 Release the door

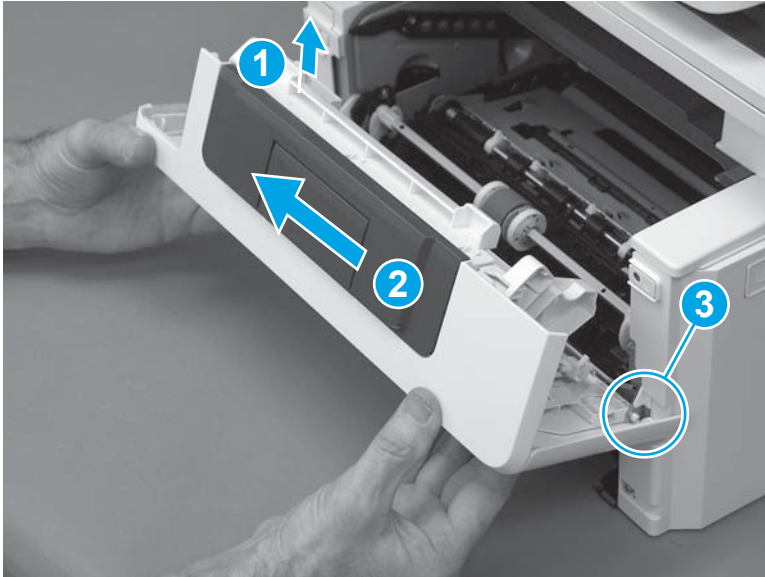

6. Rotate the door away from the printer until the keyed pin on the left-side retainer arm can disengage from the door.

Figure 1-66 Release the left-side retainer arm

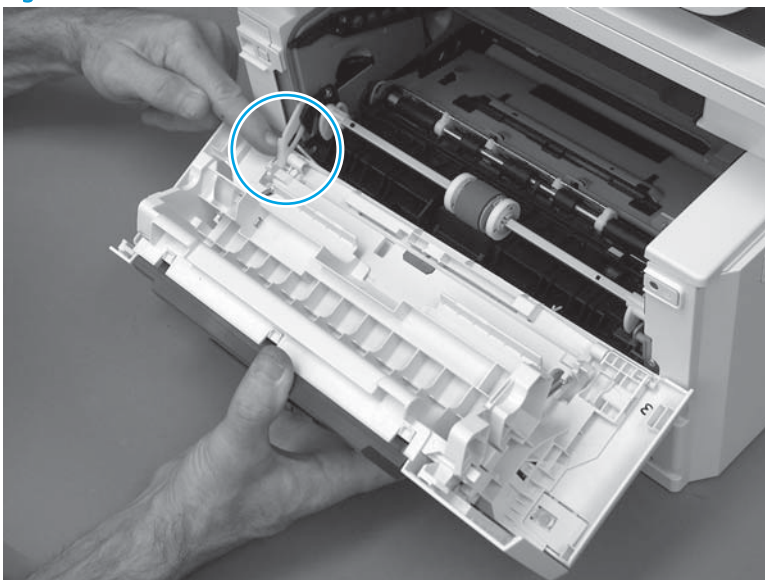

7. Remove the door.

Figure 1-67 Remove the door

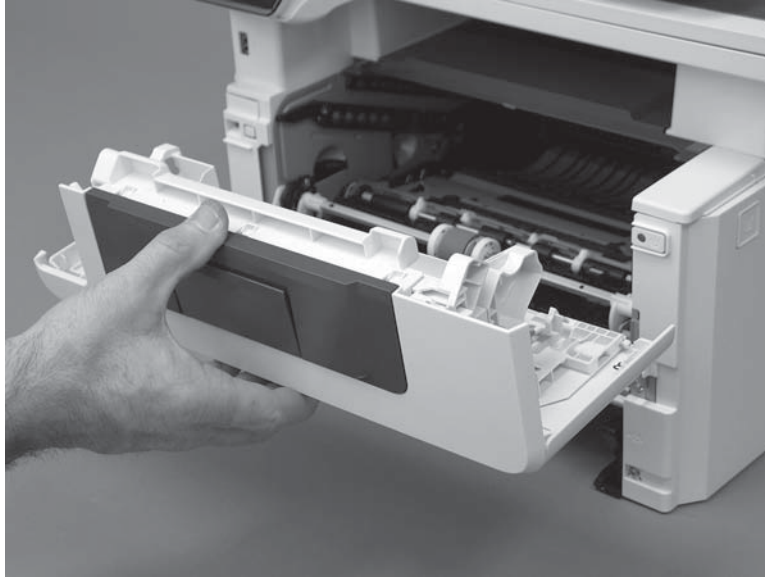



Step 2: Unpack the replacement assembly

1. Dispose of the defective part.

 **NOTE:** HP recommends responsible disposal of the defective part.

<http://www8.hp.com/us/en/hp-information/environment/product-recycling.html>

2. Unpack the replacement part from the packaging.

 **CAUTION:**  Some parts are sensitive to electrostatic discharge (ESD). Always perform service work at an ESD-protected workstation or mat. If an ESD workstation or mat is not available, touch the sheet-metal chassis to provide a static ground before touching an ESD-sensitive assembly. Protect the ESD-sensitive assemblies by placing them in ESD pouches when they are out of the printer.

If the replacement part is a roller or pad, avoid touching the spongy part of it. Skin oils on the roller or pad can cause paper pickup and/or print-quality problems. HP recommends using disposable gloves when handling rollers or pads or washing your hands before touching rollers or pads.

 **IMPORTANT:** Make sure that all of the shipping materials (for example shipping tape) are removed from the replacement part prior to installation.

3. To install an assembly, reverse the removal steps.

 **NOTE:** When applicable, special installation instructions are provided for an assembly at the end of the removal procedure. Always completely read the removal instructions and follow all special installation instructions.

Removal and replacement: Pressure-release link

- [Introduction](#)
- [Step 1: Remove the cartridge door assembly](#)
- [Step 2: Remove the pressure-release link](#)
- [Step 3: Unpack the replacement assembly](#)

Introduction

This document provides the procedures to remove and replace the pressure-release link arm.

Before performing service

Turn the printer power off

- Disconnect the power cable.

 **WARNING!** To avoid damage to the printer, turn the printer off, wait 30 seconds, and then remove the power cable before attempting to service the printer.

Use the table below to identify the correct part number for your printer. To order the part, go to www.hp.com/buy/parts.

Pressure-release link part number	
RC4-4479-000CN	Link, pressure-release link

Required tools

- Small flat-blade screwdriver.

After performing service

Turn the printer power on

- Connect the power cable.
- Use the power switch to turn the power on.

Post service test

Make sure that the toner-cartridge door correctly opens and closes.

Step 1: Remove the cartridge door assembly

 **NOTE:** If the toner cartridge was not removed prior to servicing the printer, remove it now.

1. Release the support shaft (callout 1), and then slide it toward the center of the door (callout 2).

 **TIP:** It might be easier to release the support shaft by using a small flat-blade screwdriver.

Figure 1-68 Release the support shaft

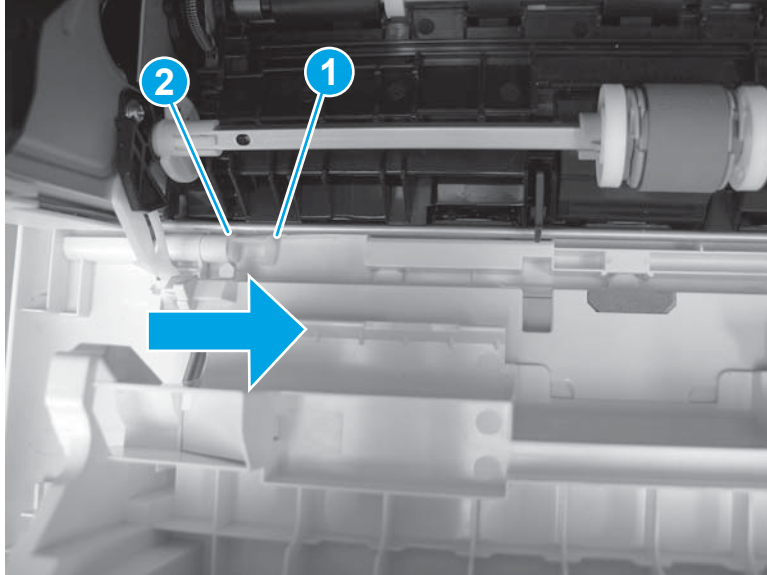

2. Remove the support shaft.

Figure 1-69 Remove the support shaft

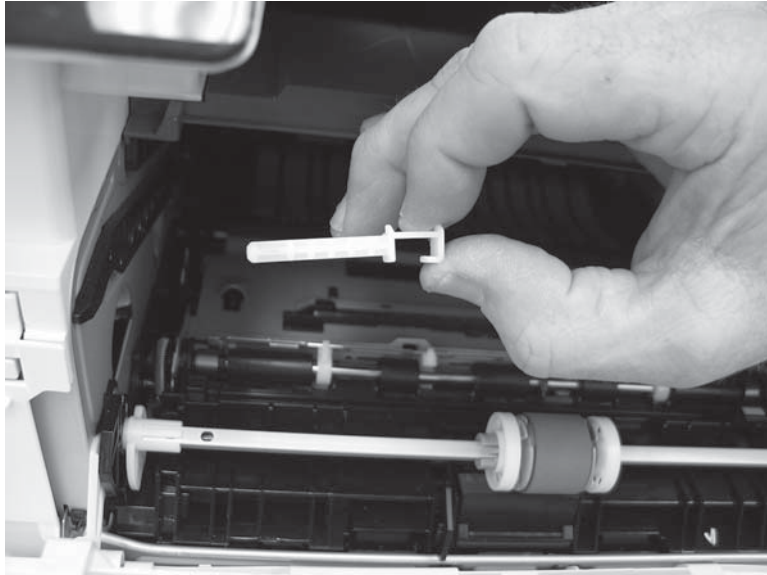

3. Release one tab (callout 1), and then slide the guide out of the printer (callout 2).

⚠ CAUTION: Be careful, the tab (callout 1) can be easily broken.

Figure 1-70 Remove the guide

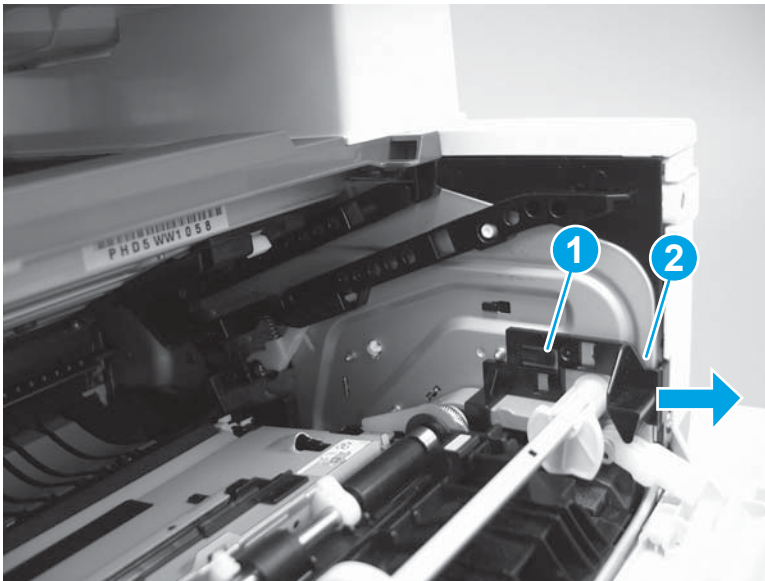

4. Use a small flat-blade screwdriver to gently pry the white-plastic door arm (callout 1) off of the gray-plastic pressure-release link (callout 2) to release the door arm.

Figure 1-71 Release the pressure-release link

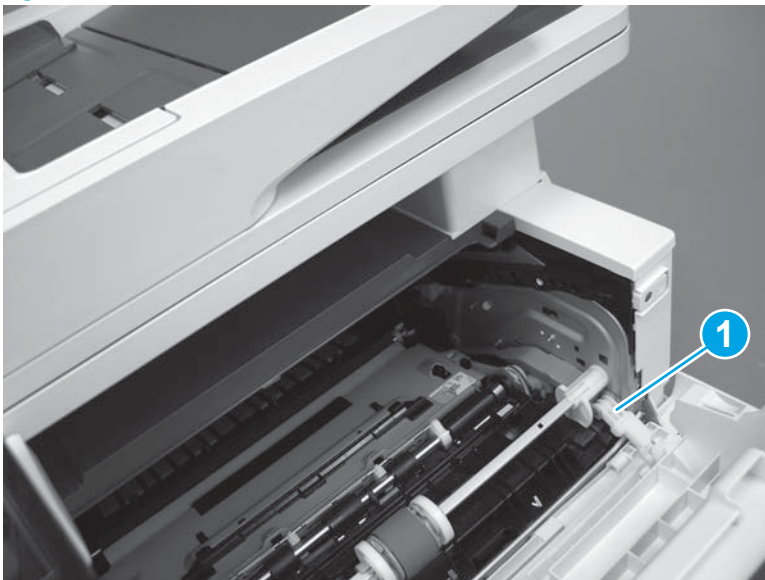

5. With the door in the partially closed position, slightly raise the left end (callout 1; raise it over the sheet-metal hinge boss), and then slide the door to the left (callout 2) to release the right hinge (callout 3).

⚠ CAUTION: The door is still attached to the printer by the left-side retainer arm. Do not attempt to completely remove the door.

💡 Reinstallation tip: When reinstalling the door, there are two right-side hinge pins (not shown in callout 3). Keep a finger pressed on the left-side retainer arm so that it does not disengage from the door.

Figure 1-72 Release the door

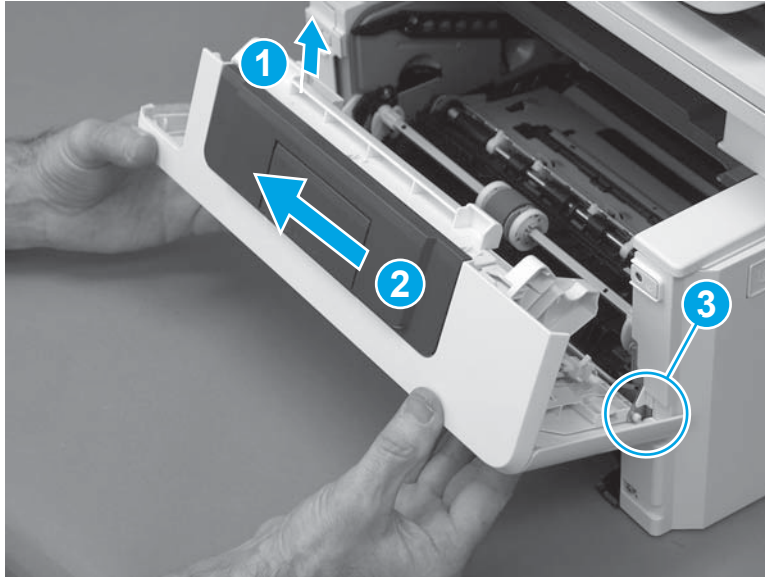

6. Rotate the door away from the printer until the keyed pin on the left-side retainer arm can disengage from the door.

Figure 1-73 Release the left-side retainer arm

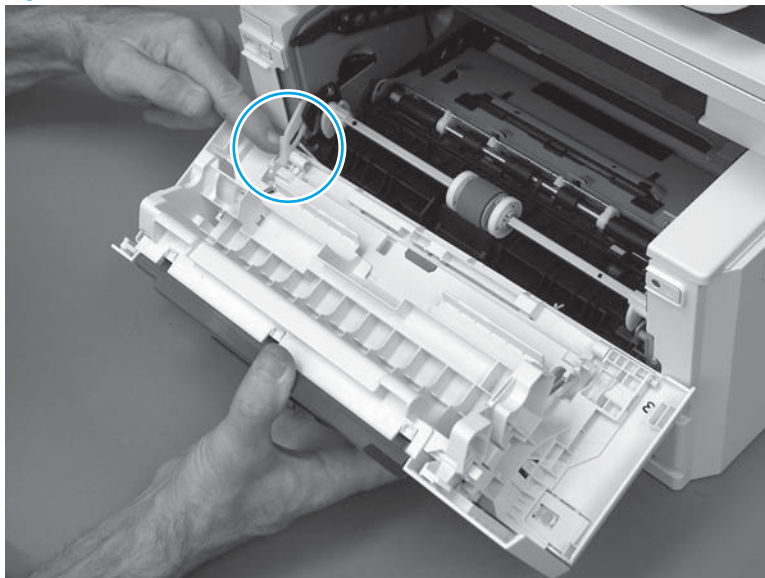

7. Remove the door.

Figure 1-74 Remove the door

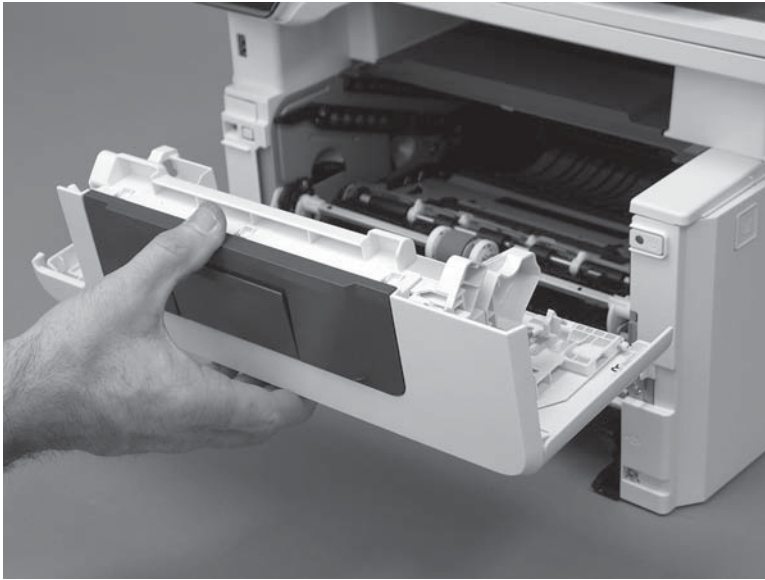

Step 2: Remove the pressure-release link

1. Rotate the pressure-release link until the keyed portion of the pin aligns with the slot in the holder.

Figure 1-75 Release the pressure-release link

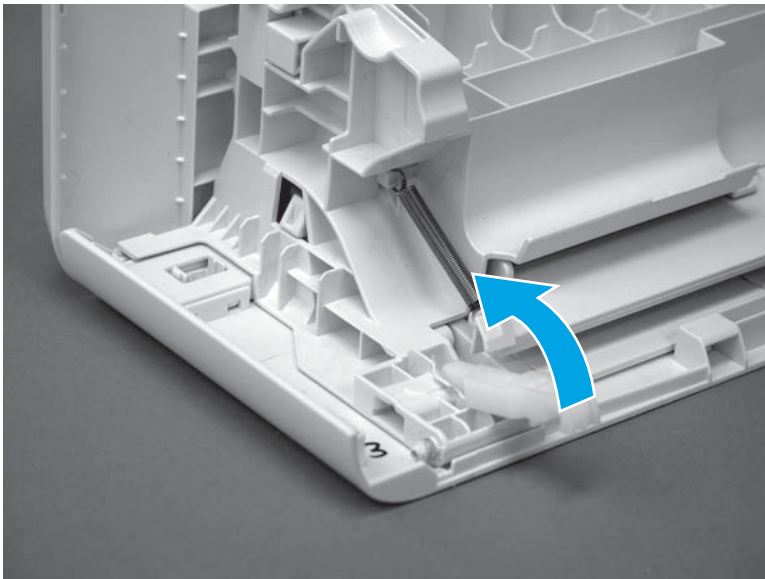

2. Remove the pressure-release link.

Figure 1-76 Remove the pressure-release link

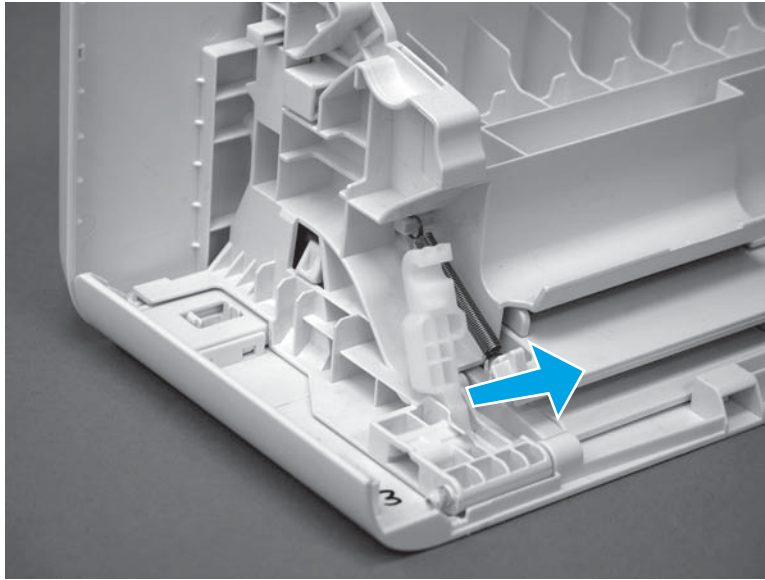



Step 3: Unpack the replacement assembly

1. Dispose of the defective part.

 **NOTE:** HP recommends responsible disposal of the defective part.

<http://www8.hp.com/us/en/hp-information/environment/product-recycling.html>

2. Unpack the replacement part from the packaging.

 **CAUTION:**  Some parts are sensitive to electrostatic discharge (ESD). Always perform service work at an ESD-protected workstation or mat. If an ESD workstation or mat is not available, touch the sheet-metal chassis to provide a static ground before touching an ESD-sensitive assembly. Protect the ESD-sensitive assemblies by placing them in ESD pouches when they are out of the printer.

If the replacement part is a roller or pad, avoid touching the spongy part of it. Skin oils on the roller or pad can cause paper pickup and/or print-quality problems. HP recommends using disposable gloves when handling rollers or pads or washing your hands before touching rollers or pads.

 **IMPORTANT:** Make sure that all of the shipping materials (for example shipping tape) are removed from the replacement part prior to installation.

3. To install an assembly, reverse the removal steps.

 **NOTE:** When applicable, special installation instructions are provided for an assembly at the end of the removal procedure. Always completely read the removal instructions and follow all special installation instructions.

Removal and replacement: Left cover

- [Introduction](#)
- [Step 1: Remove the rear USB cover](#)
- [Step 2: Remove the network cover](#)
- [Step 3: Remove Tray 2](#)
- [Step 4: Remove the cartridge door assembly](#)
- [Step 5: Remove the left cover](#)
- [Step 6: Unpack the replacement assembly](#)

Introduction

This document provides the procedures to remove and replace the left cover.

Before performing service

Turn the printer power off

- Disconnect the power cable.

 **WARNING!** To avoid damage to the printer, turn the printer off, wait 30 seconds, and then remove the power cable before attempting to service the printer.

Use the table below to identify the correct part number for your printer. To order the part, go to www.hp.com/buy/parts.

Left cover part number	
RL2-3251-000CN	Left cover (M304/M305/M404/M405 models)
RM2-2579-000CN	Left cover (M329/M428/M429 models)

Required tools

- #2 Phillips screwdriver with a magnetic tip.

After performing service

Turn the printer power on

- Connect the power cable.
- Use the power switch to turn the power on.

Post service test

Make sure that the printer initializes to a **Ready** state.

Step 1: Remove the rear USB cover

1. Use a finger to release two tabs (callout 1), and then pull the cover straight off of the printer.

Figure 1-77 Pull the cover straight off

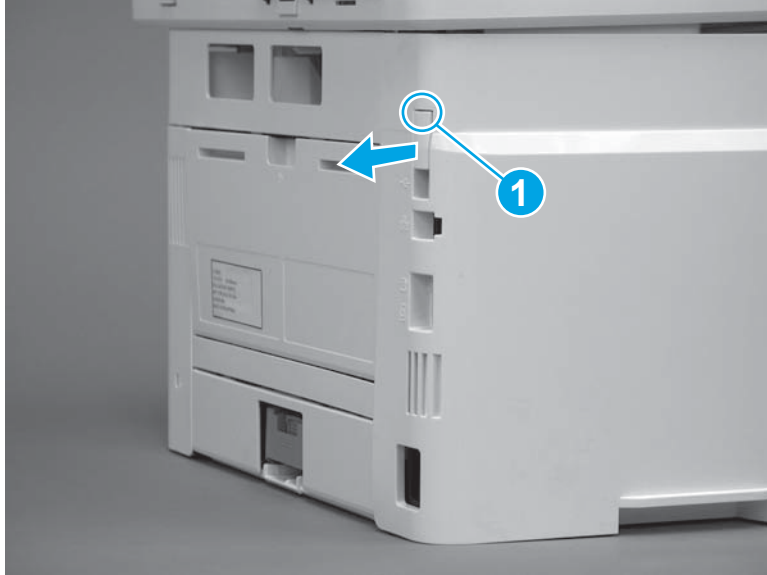

2. Remove the cover.

 **NOTE:** For network models, also remove the network port cover (not shown; RC4-2907-000CN).

Figure 1-78 Remove the cover



Step 2: Remove the network cover

M428dw/fdn/fdw/dw, M305dn, M404n/dn/dw, M405n/dn/dw printers only.

- ▲ Grasp the network cover, and then pull the cover straight off of the printer.

Figure 1-79 Pull the cover straight off

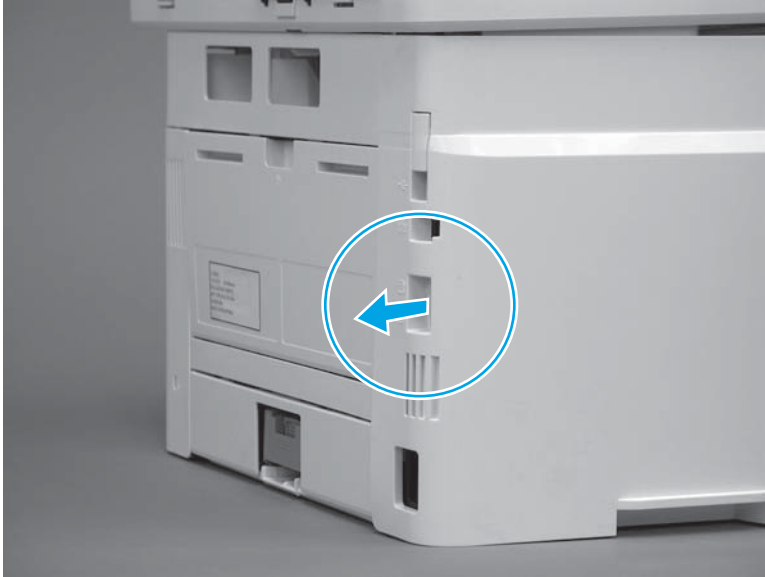

Step 3: Remove Tray 2

- ▲ Pull the tray straight out of the printer to remove it.

Figure 1-80 Remove the tray



Step 4: Remove the cartridge door assembly

 **NOTE:** If the toner cartridge was not removed prior to servicing the printer, remove it now.

1. Release the support shaft (callout 1), and then slide it toward the center of the door (callout 2).

 **TIP:** It might be easier to release the support shaft by using a small flat-blade screwdriver.

Figure 1-81 Release the support shaft

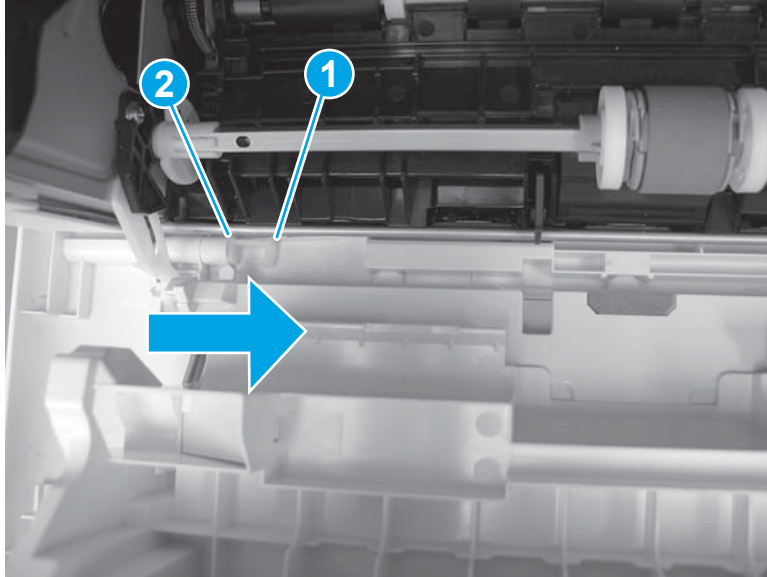

2. Remove the support shaft.

Figure 1-82 Remove the support shaft

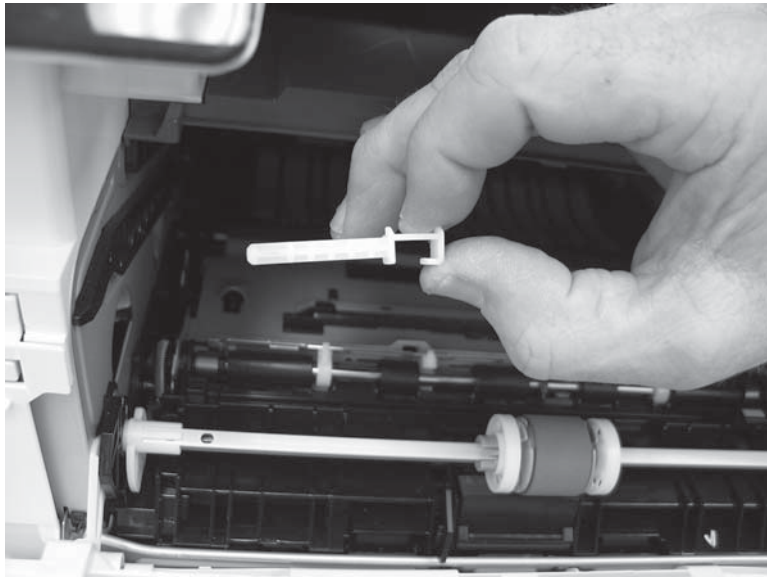

3. Release one tab (callout 1), and then slide the guide out of the printer (callout 2).

⚠ CAUTION: Be careful, the tab (callout 1) can be easily broken.

Figure 1-83 Remove the guide

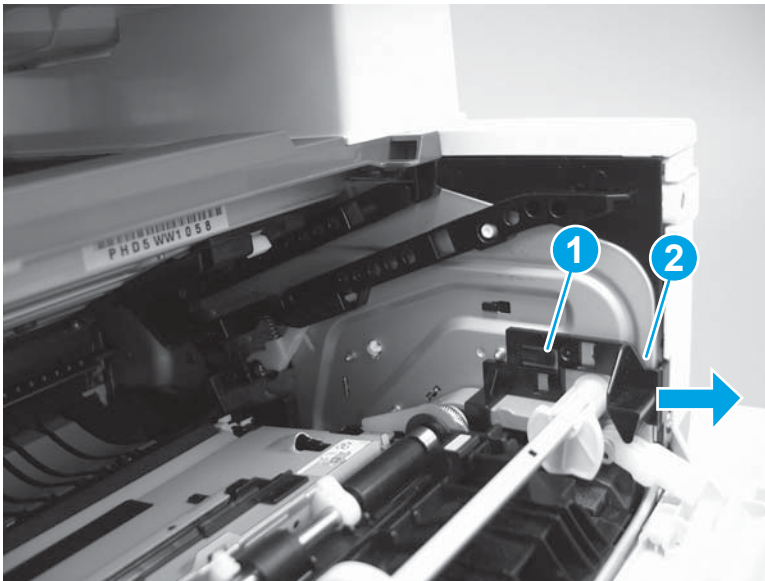

4. Use a small flat-blade screwdriver to gently pry the white-plastic door arm (callout 1) off of the gray-plastic pressure-release link (callout 2) to release the door arm.

Figure 1-84 Release the pressure-release link

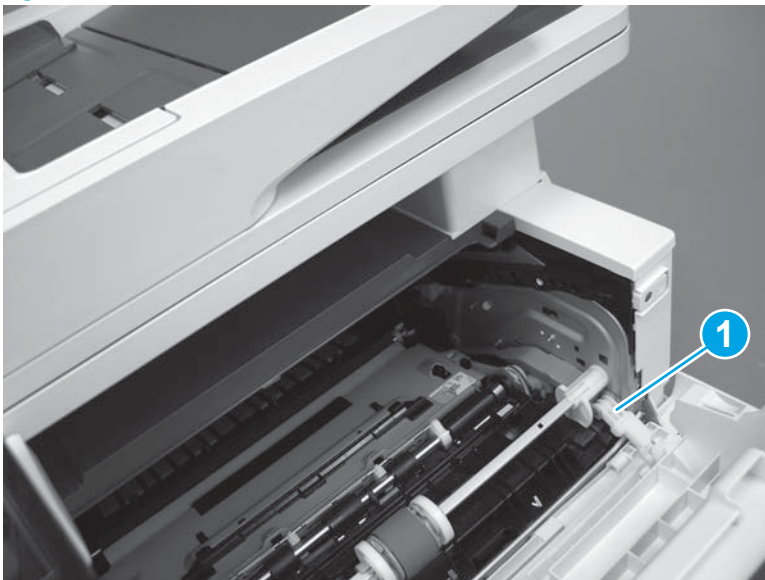

5. With the door in the partially closed position, slightly raise the left end (callout 1; raise it over the sheet-metal hinge boss), and then slide the door to the left (callout 2) to release the right hinge (callout 3).

⚠ CAUTION: The door is still attached to the printer by the left-side retainer arm. Do not attempt to completely remove the door.

💡 Reinstallation tip: When reinstalling the door, there are two right-side hinge pins (not shown in callout 3). Keep a finger pressed on the left-side retainer arm so that it does not disengage from the door.

Figure 1-85 Release the door

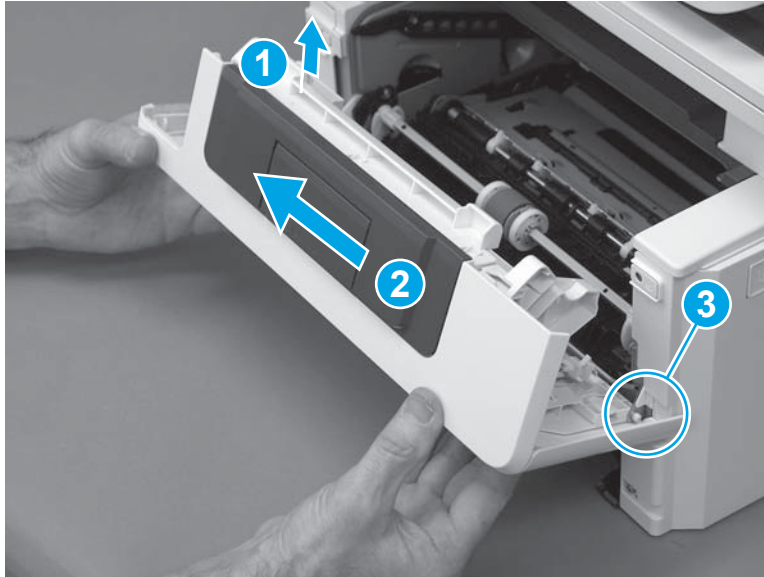

6. Rotate the door away from the printer until the keyed pin on the left-side retainer arm can disengage from the door.

Figure 1-86 Release the left-side retainer arm

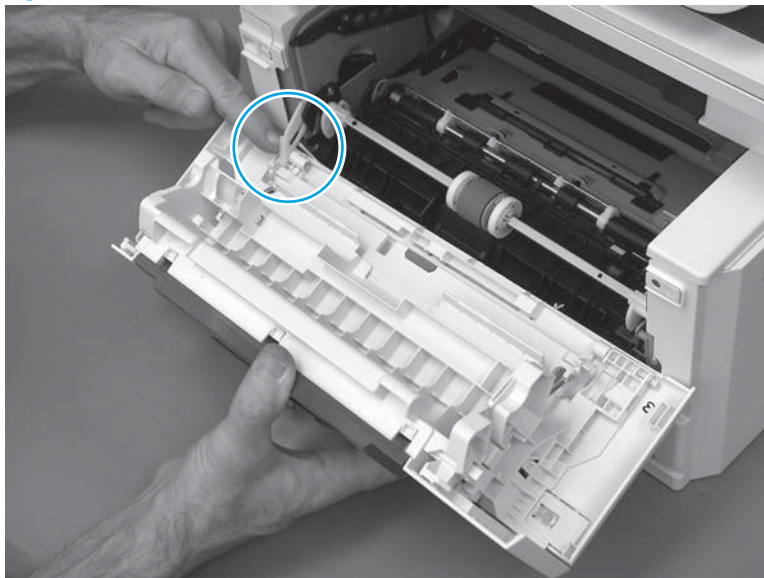

7. Remove the door.

Figure 1-87 Remove the door

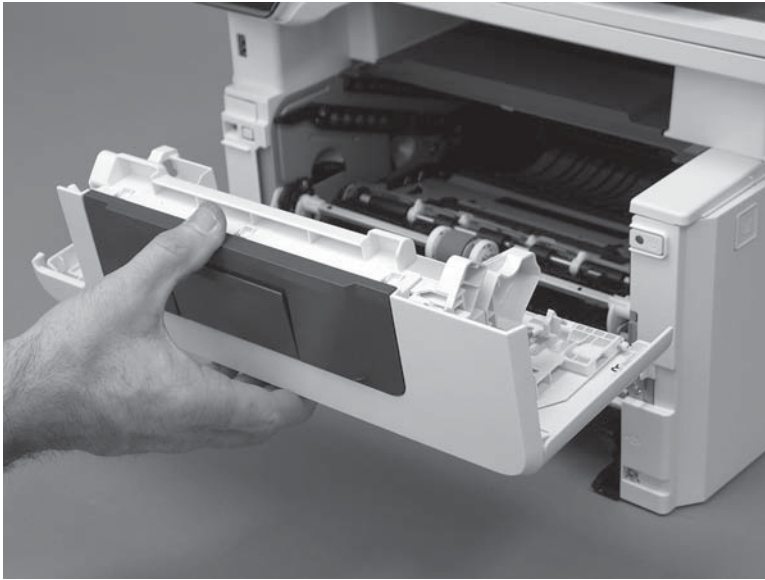

Step 5: Remove the left cover

1. Remove one screw (callout 1).

Figure 1-88 Remove one screw

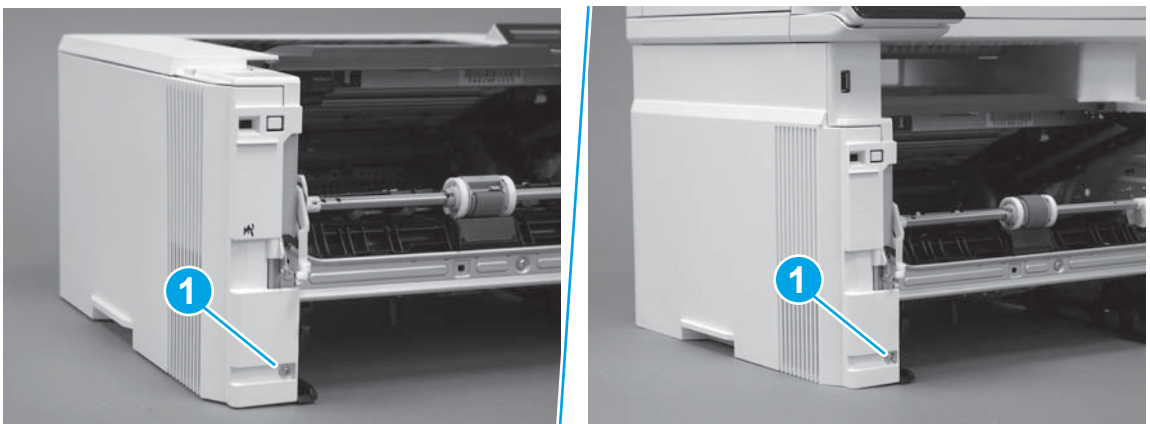

2. Open the rear door, release two bosses (callout 1), and then release three tabs (callout 2).

Figure 1-89 Release two bosses and three tabs

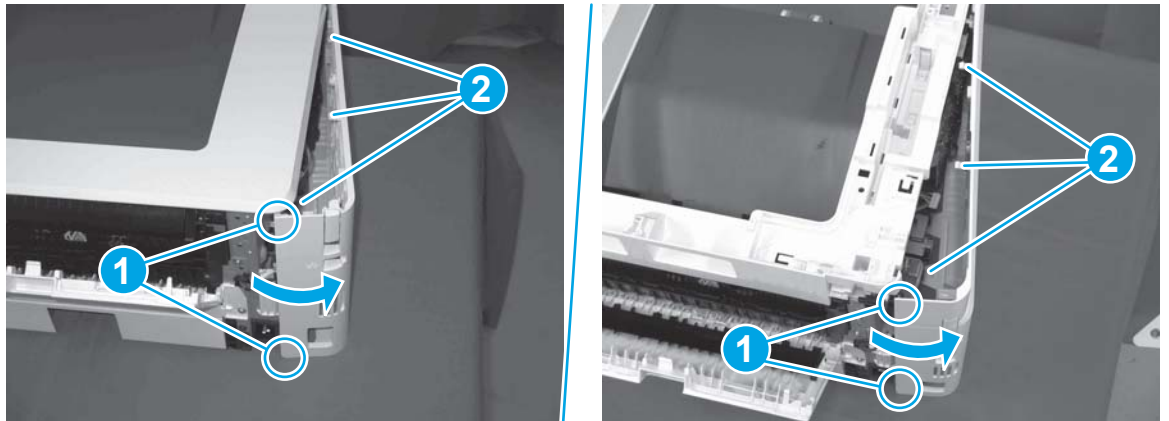

3. At the front of the printer, do one of the following:
 - **M304/M305/M404/M405:** Release two bosses (callout 1), and then remove the cover (callout 2).
 - **M329/M428/M429:** Release one tab (callout 3), two bosses (callout 4), and then remove the cover (callout 5).

⚠ CAUTION: Be careful when releasing the upper bosses on the M329/M428/M429 cover. One portion of the cover (callout 6) is fragile and is easily broken.

Figure 1-90 Remove the cover

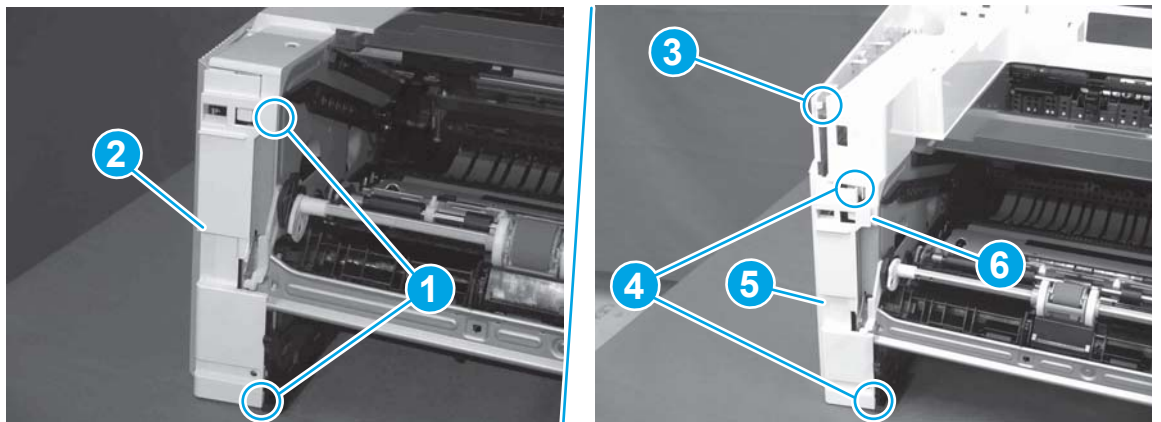



Step 6: Unpack the replacement assembly

1. Dispose of the defective part.

 **NOTE:** HP recommends responsible disposal of the defective part.

<http://www8.hp.com/us/en/hp-information/environment/product-recycling.html>

2. Unpack the replacement part from the packaging.

 **CAUTION:**  Some parts are sensitive to electrostatic discharge (ESD). Always perform service work at an ESD-protected workstation or mat. If an ESD workstation or mat is not available, touch the sheet-metal chassis to provide a static ground before touching an ESD-sensitive assembly. Protect the ESD-sensitive assemblies by placing them in ESD pouches when they are out of the printer.

If the replacement part is a roller or pad, avoid touching the spongy part of it. Skin oils on the roller or pad can cause paper pickup and/or print-quality problems. HP recommends using disposable gloves when handling rollers or pads or washing your hands before touching rollers or pads.

 **IMPORTANT:** Make sure that all of the shipping materials (for example shipping tape) are removed from the replacement part prior to installation.

3. To install an assembly, reverse the removal steps.

 **NOTE:** When applicable, special installation instructions are provided for an assembly at the end of the removal procedure. Always completely read the removal instructions and follow all special installation instructions.

Removal and replacement: Right cover

- [Introduction](#)
- [Step 1: Remove Tray 2](#)
- [Step 2: Remove the cartridge door assembly](#)
- [Step 3: Remove the right cover](#)
- [Step 4: Unpack the replacement assembly](#)

Introduction

This document provides the procedures to remove and replace the right cover.

Before performing service

Turn the printer power off

- Disconnect the power cable.

 **WARNING!** To avoid damage to the printer, turn the printer off, wait 30 seconds, and then remove the power cable before attempting to service the printer.

Use the table below to identify the correct part number for your printer. To order the part, go to www.hp.com/buy/parts.

Right cover part number	
RM2-5434-000CN	Right cover

Required tools

- #2 Phillips screwdriver with a magnetic tip.

After performing service

Turn the printer power on

- Connect the power cable.
- Use the power switch to turn the power on.

Post service test

Make sure that the printer initializes to a **Ready** state.

Step 1: Remove Tray 2

- ▲ Pull the tray straight out of the printer to remove it.

Figure 1-91 Remove the tray



Step 2: Remove the cartridge door assembly

 **NOTE:** If the toner cartridge was not removed prior to servicing the printer, remove it now.

1. Release the support shaft (callout 1), and then slide it toward the center of the door (callout 2).

 **TIP:** It might be easier to release the support shaft by using a small flat-blade screwdriver.

Figure 1-92 Release the support shaft

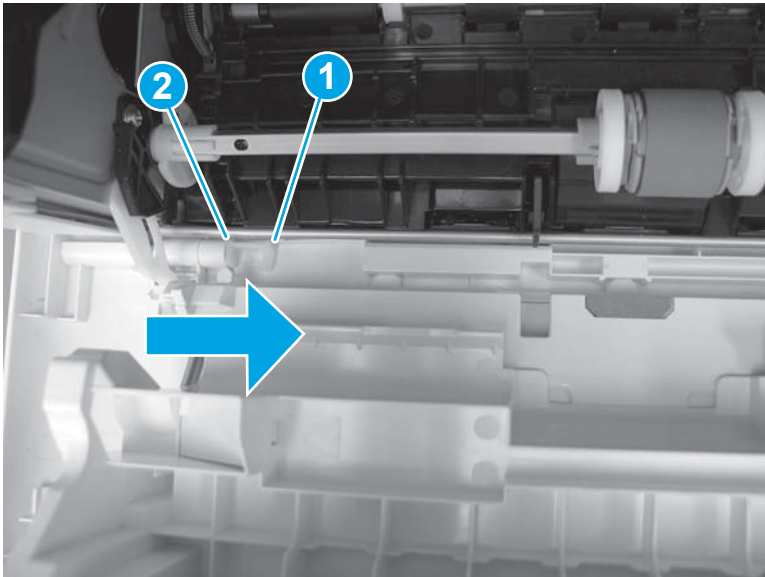

2. Remove the support shaft.

Figure 1-93 Remove the support shaft

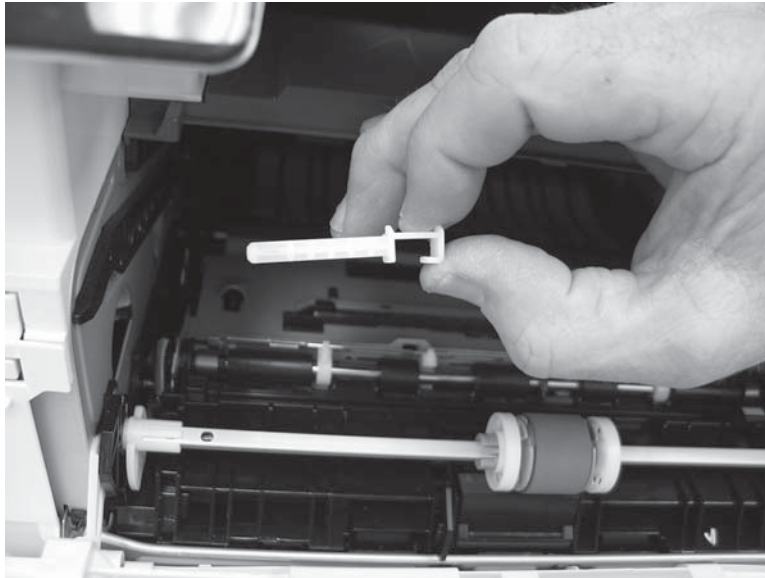

3. Release one tab (callout 1), and then slide the guide out of the printer (callout 2).

⚠ CAUTION: Be careful, the tab (callout 1) can be easily broken.

Figure 1-94 Remove the guide

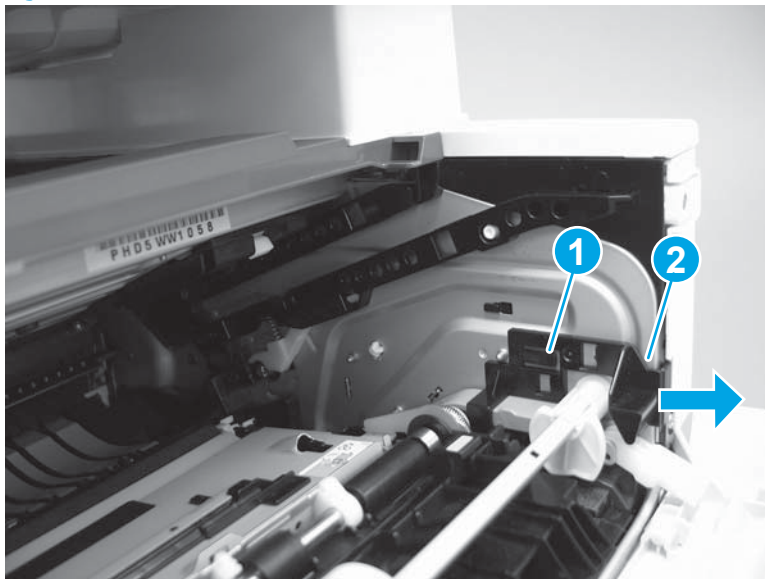

4. Use a small flat-blade screwdriver to gently pry the white-plastic door arm (callout 1) off of the gray-plastic pressure-release link (callout 2) to release the door arm.

Figure 1-95 Release the pressure-release link

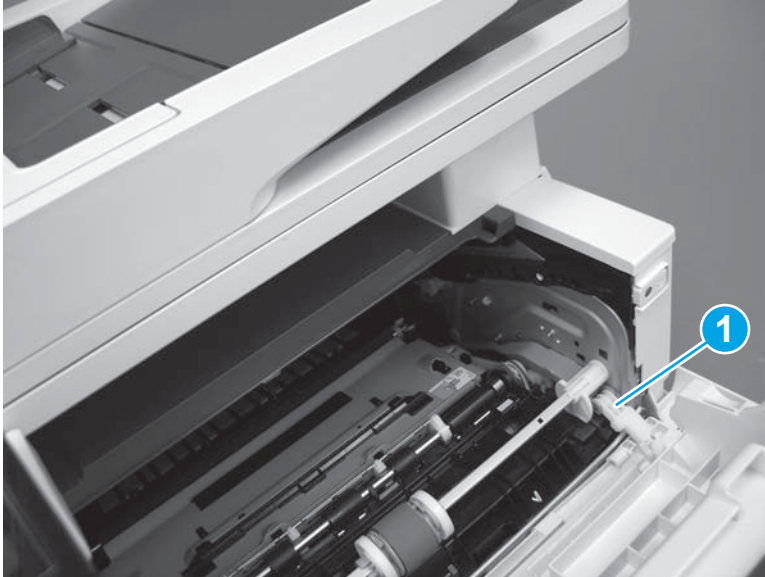

5. With the door in the partially closed position, slightly raise the left end (callout 1; raise it over the sheet-metal hinge boss), and then slide the door to the left (callout 2) to release the right hinge (callout 3).

⚠ CAUTION: The door is still attached to the printer by the left-side retainer arm. Do not attempt to completely remove the door.

💡 Reinstallation tip: When reinstalling the door, there are two right-side hinge pins (not shown in callout 3). Keep a finger pressed on the left-side retainer arm so that it does not disengage from the door.

Figure 1-96 Release the door

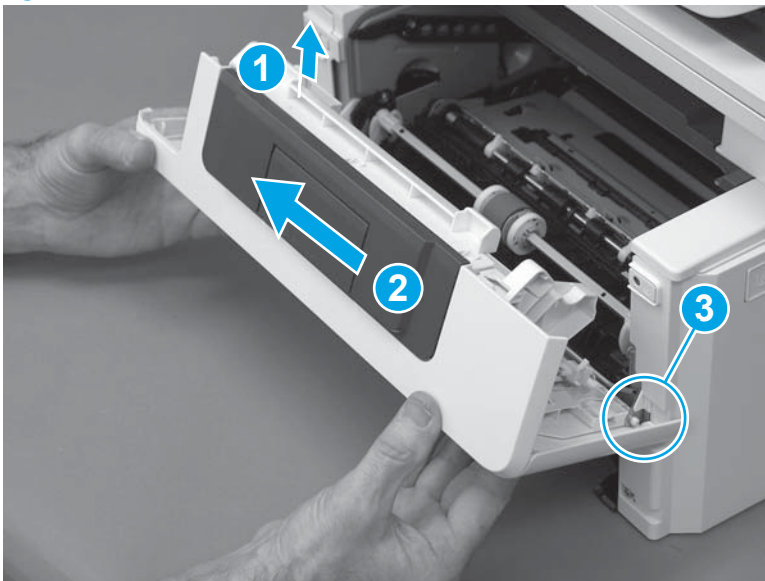

6. Rotate the door away from the printer until the keyed pin on the left-side retainer arm can disengage from the door.

Figure 1-97 Release the left-side retainer arm

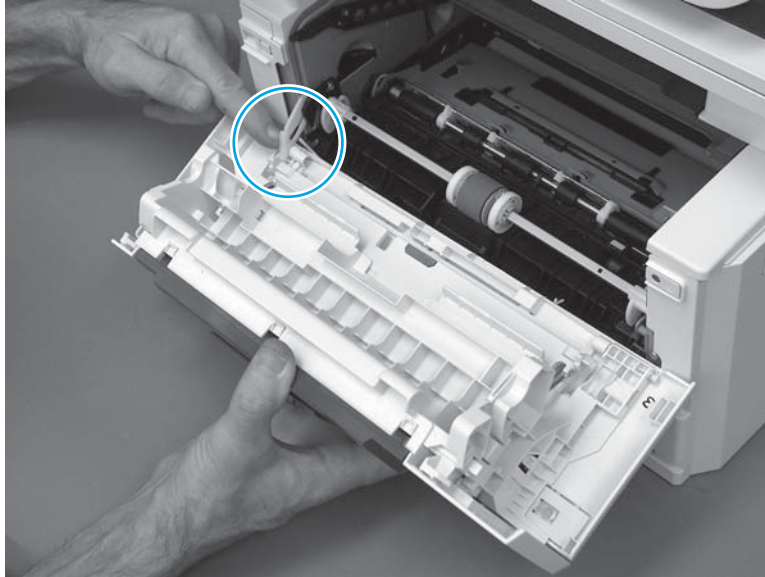

7. Remove the door.

Figure 1-98 Remove the door

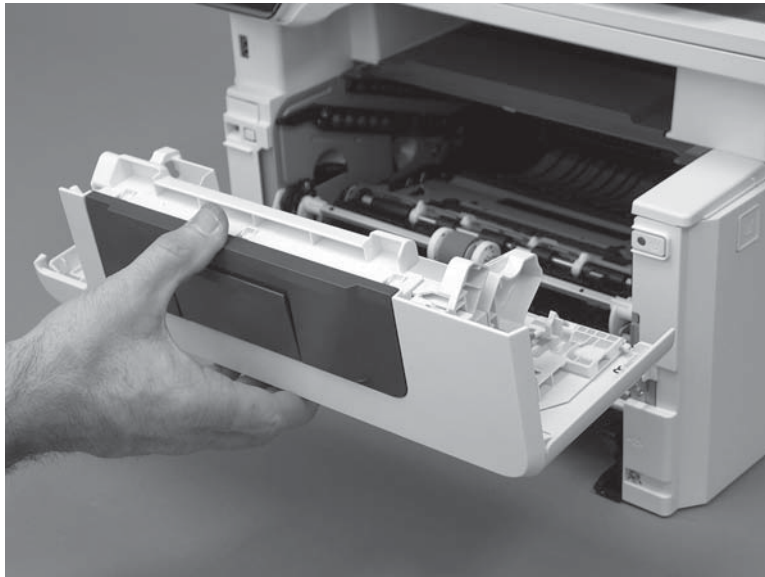

Step 3: Remove the right cover

1. At the front of the printer, release two bosses (callout 1), and then release three tabs (callout 2).

 **Reinstallation tip:** Remove, and then reinstall the cover if the switch or button does not correctly function.

Figure 1-99 Release two bosses and three tabs

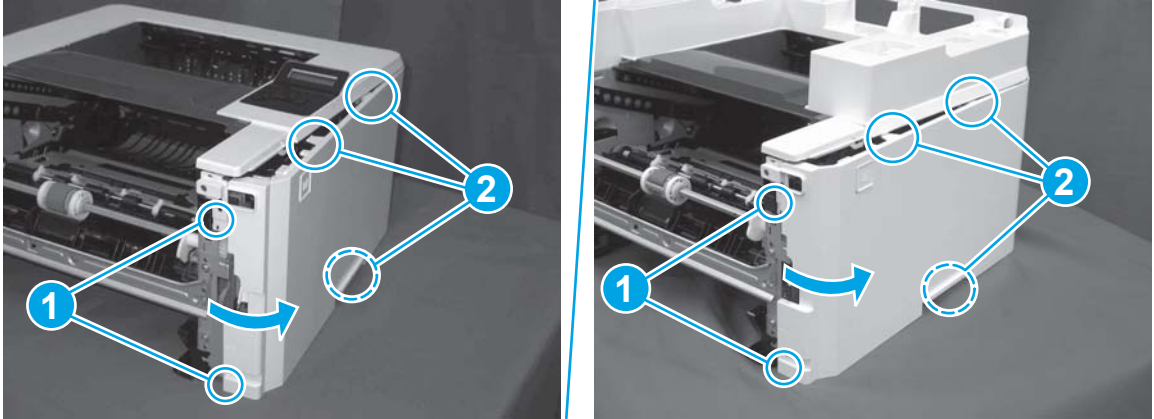

2. Open the rear door, release two bosses (callout 1), and then remove the cover (callout 2).

Figure 1-100 Remove the cover

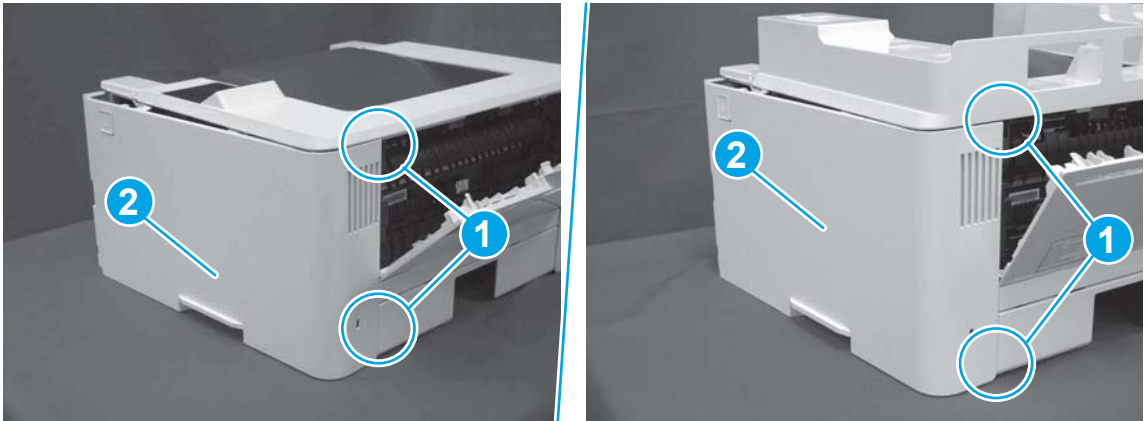



Step 4: Unpack the replacement assembly

1. Dispose of the defective part.

 **NOTE:** HP recommends responsible disposal of the defective part.

<http://www8.hp.com/us/en/hp-information/environment/product-recycling.html>

2. Unpack the replacement part from the packaging.

 **CAUTION:**  Some parts are sensitive to electrostatic discharge (ESD). Always perform service work at an ESD-protected workstation or mat. If an ESD workstation or mat is not available, touch the sheet-metal chassis to provide a static ground before touching an ESD-sensitive assembly. Protect the ESD-sensitive assemblies by placing them in ESD pouches when they are out of the printer.

If the replacement part is a roller or pad, avoid touching the spongy part of it. Skin oils on the roller or pad can cause paper pickup and/or print-quality problems. HP recommends using disposable gloves when handling rollers or pads or washing your hands before touching rollers or pads.

 **IMPORTANT:** Make sure that all of the shipping materials (for example shipping tape) are removed from the replacement part prior to installation.

3. To install an assembly, reverse the removal steps.

 **NOTE:** When applicable, special installation instructions are provided for an assembly at the end of the removal procedure. Always completely read the removal instructions and follow all special installation instructions.

Removal and replacement: Rear door assembly



NOTE: Only duplex models have a duplex tray assembly installed.

- [Introduction](#)
- [Step 1: Remove Tray 2](#)
- [Step 2: Remove the cartridge door assembly](#)
- [Step 3: Remove the left cover](#)
- [Step 4: Remove the right cover](#)
- [Step 5: Remove the rear door assembly](#)
- [Step 6: Unpack the replacement assembly](#)

Introduction

This document provides the procedures to remove and replace the rear door assembly.

Before performing service

Turn the printer power off

- Disconnect the power cable.



WARNING! To avoid damage to the printer, turn the printer off, wait 30 seconds, and then remove the power cable before attempting to service the printer.

Use the table below to identify the correct part number for your printer. To order the part, go to www.hp.com/buy/parts.

Rear door assembly part number	
RM2-5430-000CN	Rear door assembly (simplex)
RM2-5405-000CN	Rear door assembly (duplex)

Required tools

- #2 Phillips screwdriver with a magnetic tip.

After performing service

Turn the printer power on

- Connect the power cable.
- Use the power switch to turn the power on.

Post service test

Make sure that the printer initializes to a **Ready** state.

Print a configuration page to make sure that the printer is functioning correctly.

Step 1: Remove Tray 2

- ▲ Pull the tray straight out of the printer to remove it.

Figure 1-101 Remove the tray



Step 2: Remove the cartridge door assembly

 **NOTE:** If the toner cartridge was not removed prior to servicing the printer, remove it now.

1. Release the support shaft (callout 1), and then slide it toward the center of the door (callout 2).

 **TIP:** It might be easier to release the support shaft by using a small flat-blade screwdriver.

Figure 1-102 Release the support shaft

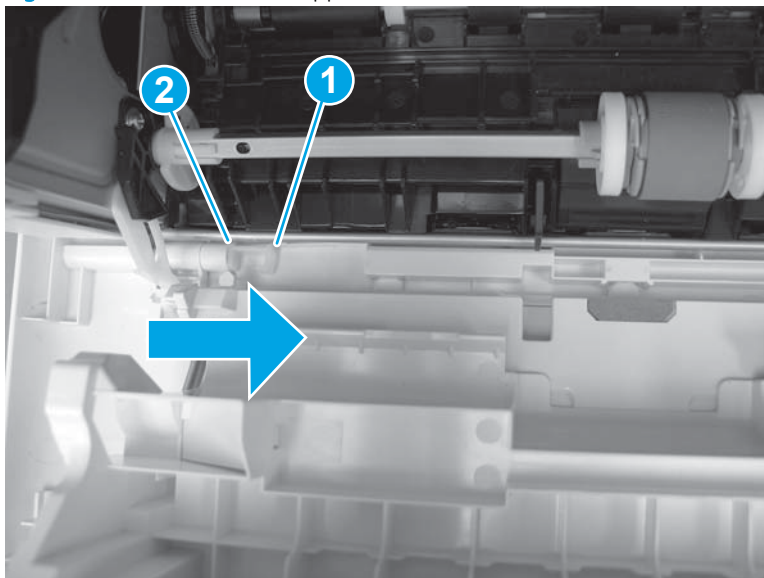

2. Remove the support shaft.

Figure 1-103 Remove the support shaft

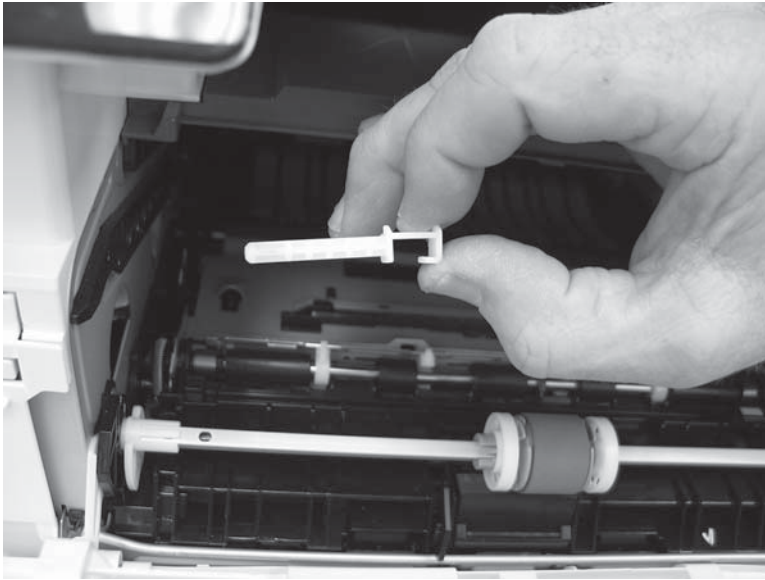

3. Release one tab (callout 1), and then slide the guide out of the printer (callout 2).

⚠ CAUTION: Be careful, the tab (callout 1) can be easily broken.

Figure 1-104 Remove the guide

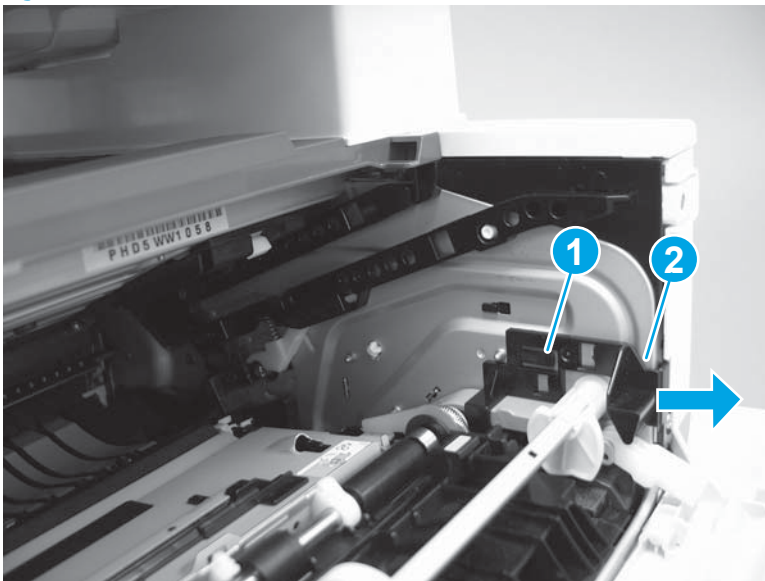

4. Use a small flat-blade screwdriver to gently pry the white-plastic door arm (callout 1) off of the gray-plastic pressure-release link (callout 2) to release the door arm.

Figure 1-105 Release the pressure-release link

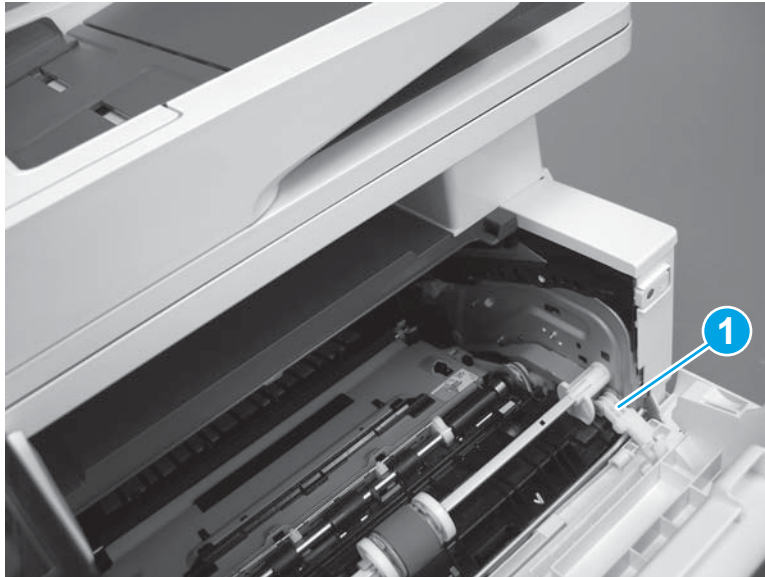

5. With the door in the partially closed position, slightly raise the left end (callout 1; raise it over the sheet-metal hinge boss), and then slide the door to the left (callout 2) to release the right hinge (callout 3).

⚠ CAUTION: The door is still attached to the printer by the left-side retainer arm. Do not attempt to completely remove the door.

💡 Reinstallation tip: When reinstalling the door, there are two right-side hinge pins (not shown in callout 3). Keep a finger pressed on the left-side retainer arm so that it does not disengage from the door.

Figure 1-106 Release the door

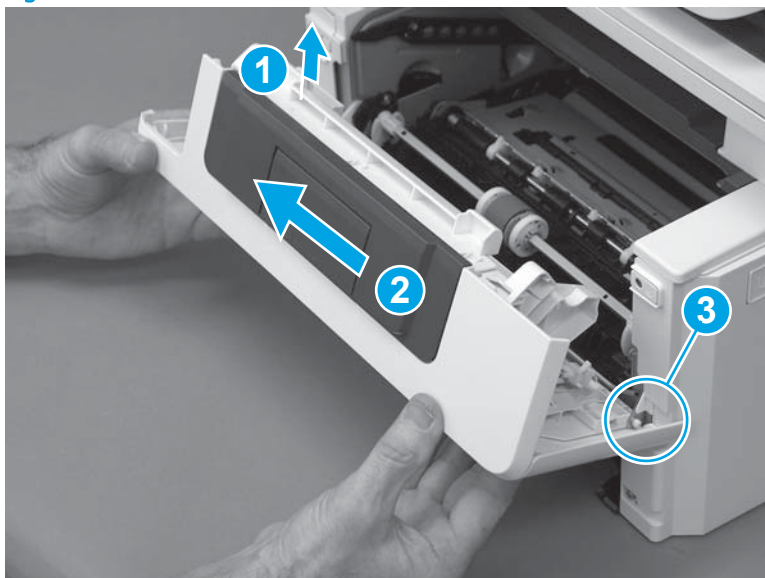

6. Rotate the door away from the printer until the keyed pin on the left-side retainer arm can disengage from the door.

Figure 1-107 Release the left-side retainer arm

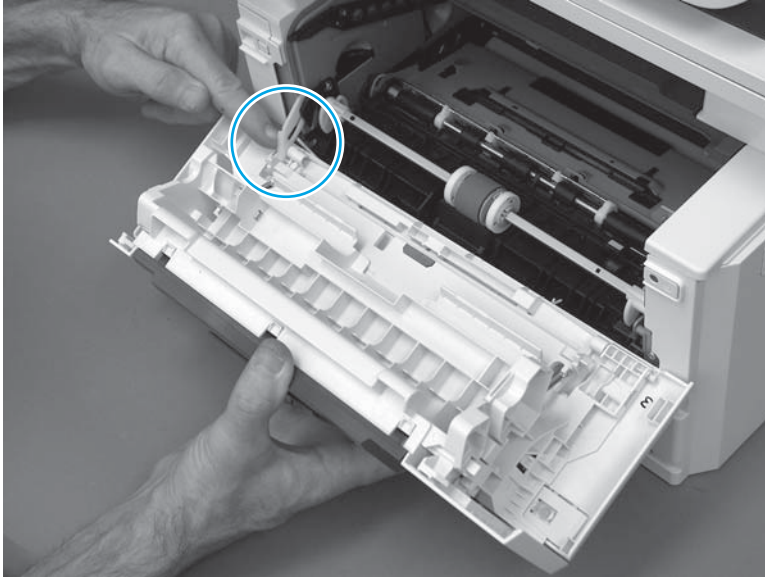

7. Remove the door.

Figure 1-108 Remove the door

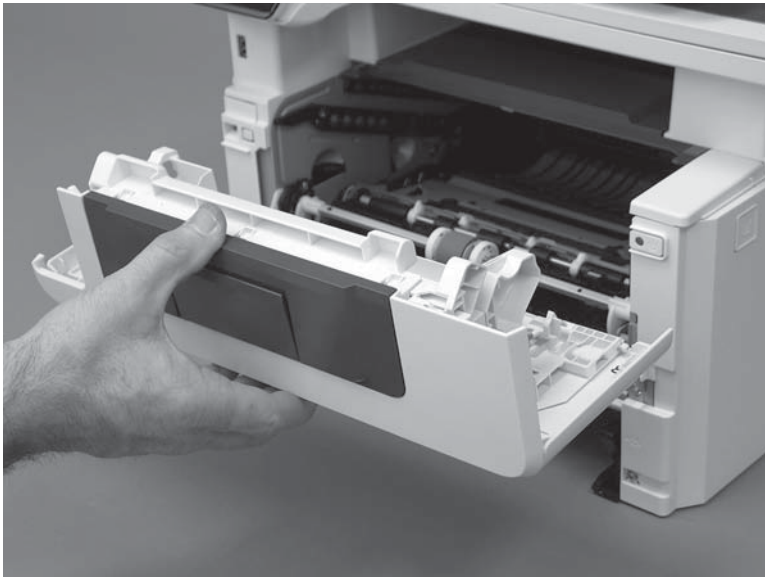

Step 3: Remove the left cover

1. Remove one screw (callout 1).

Figure 1-109 Remove one screw

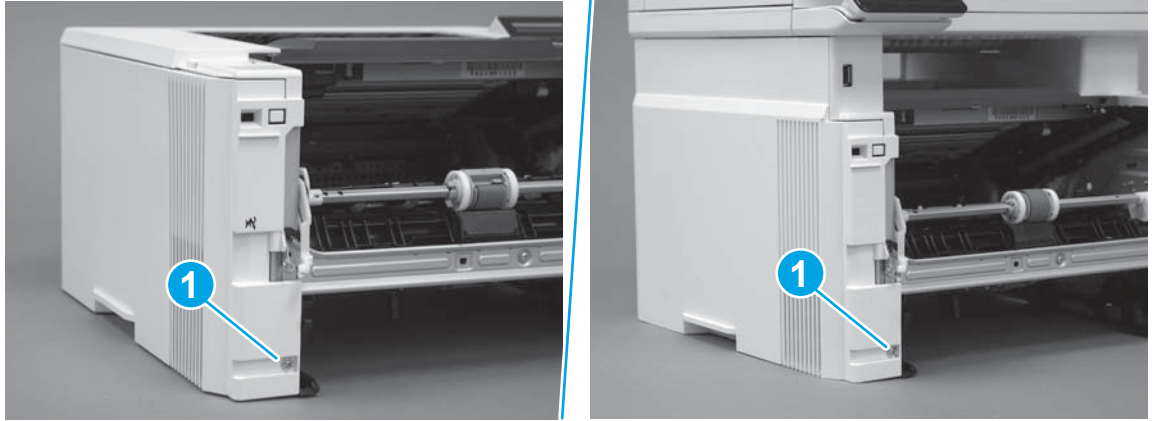

2. Open the rear door, release two bosses (callout 1), and then release three tabs (callout 2).

Figure 1-110 Release two bosses and three tabs

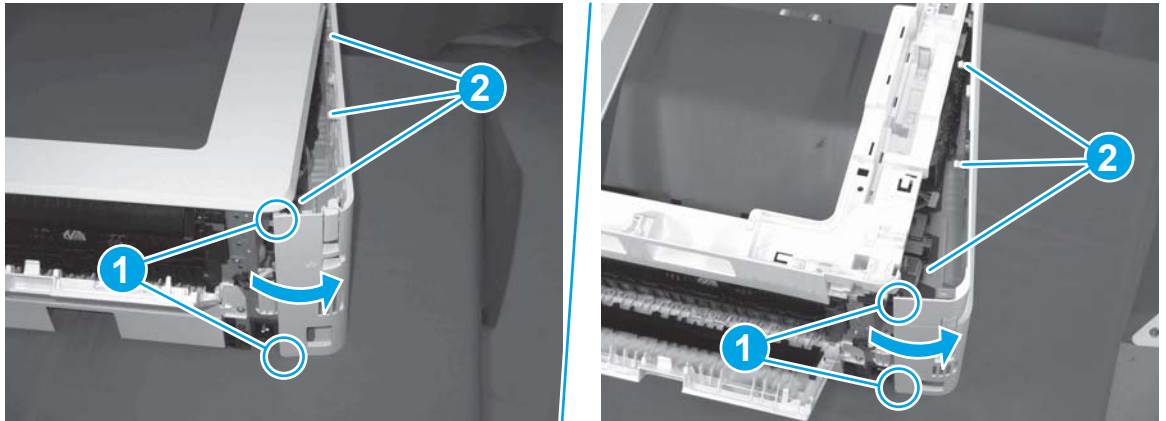

3. At the front of the printer, do one of the following:
 - **M304/M305/M404/M405:** Release two bosses (callout 1), and then remove the cover (callout 2).
 - **M329/M428/M429:** Release one tab (callout 3), two bosses (callout 4), and then remove the cover (callout 5).

⚠ CAUTION: Be careful when releasing the upper bosses on the M329/M428/M429 cover. One portion of the cover (callout 6) is fragile and is easily broken.

Figure 1-111 Remove the cover

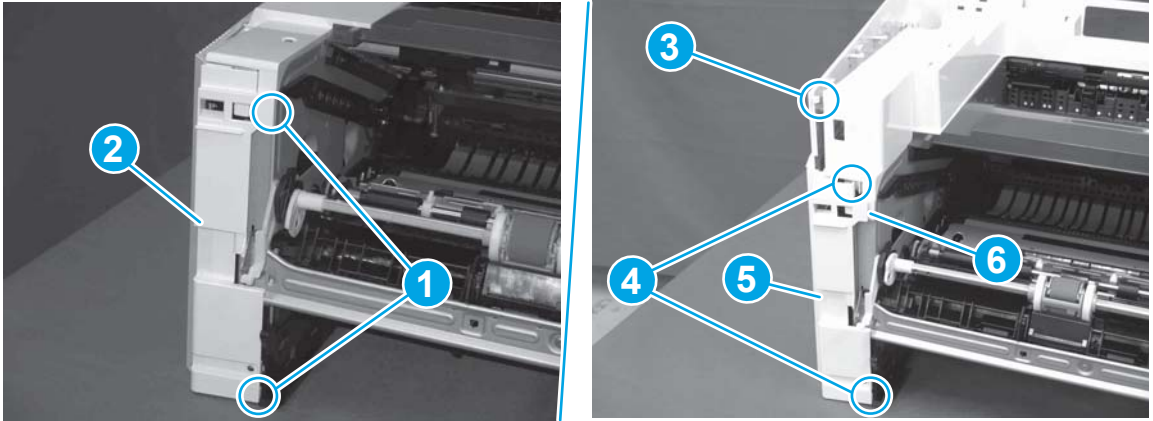

Step 4: Remove the right cover

1. At the front of the printer, release two bosses (callout 1), and then release three tabs (callout 2).

 **Reinstallation tip:** Remove, and then reinstall the cover if the switch or button does not correctly function.

Figure 1-112 Release two bosses and three tabs

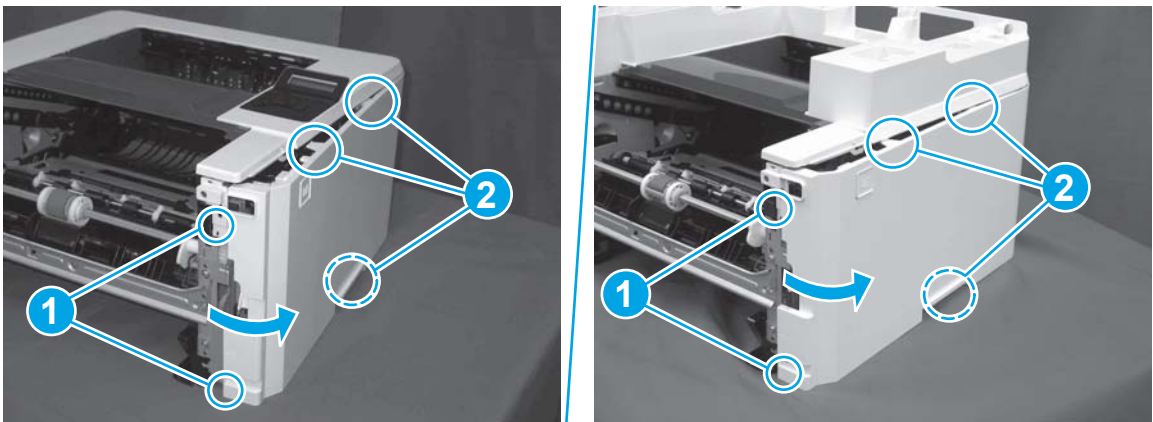

2. Open the rear door, release two bosses (callout 1), and then remove the cover (callout 2).

Figure 1-113 Remove the cover

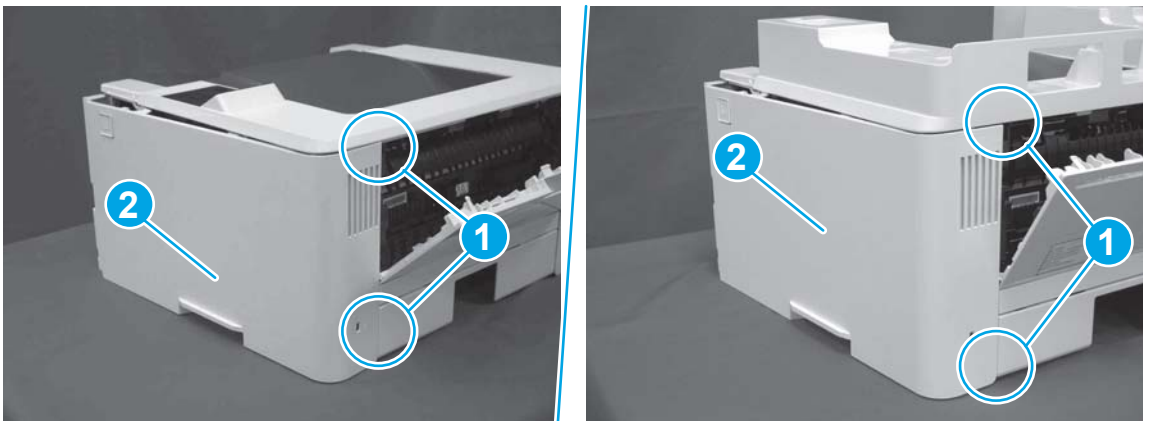

Step 5: Remove the rear door assembly

1. **Duplex models only:** Inside the Tray 2 cavity, press the green jam access lever (callout 1), and then lower the duplex feed assembly (callout 2).

 **Reinstallation tip:** **Duplex models only:** Reach in from the front of the Tray 2 cavity and raise the feed assembly to the up and locked position so that the rear cover will fit flat against the chassis.

Figure 1-114 Duplex models, lower the duplex feed assembly



2. At the rear of the printer, remove two screws (callout 1), and then remove the rear door assembly (callout 2).

 **Reinstallation tip:** **Duplex models only:** Slide the duplex tray into the Tray 2 cavity.

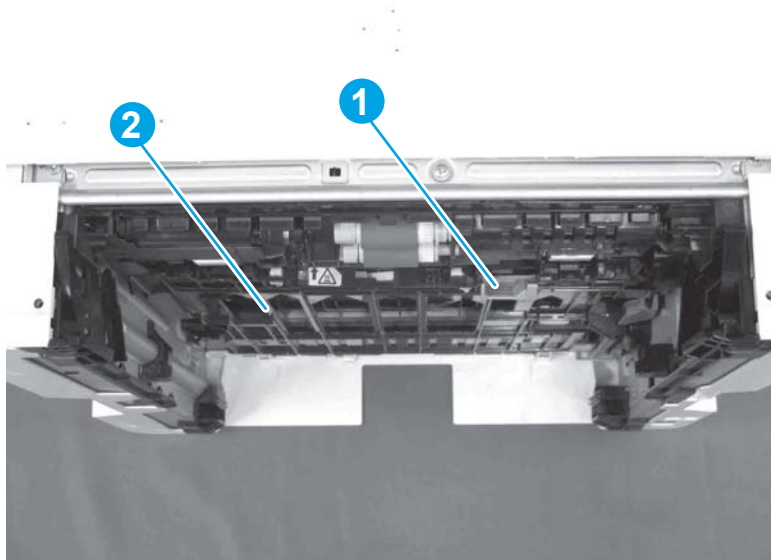
Figure 1-115 Remove two screws



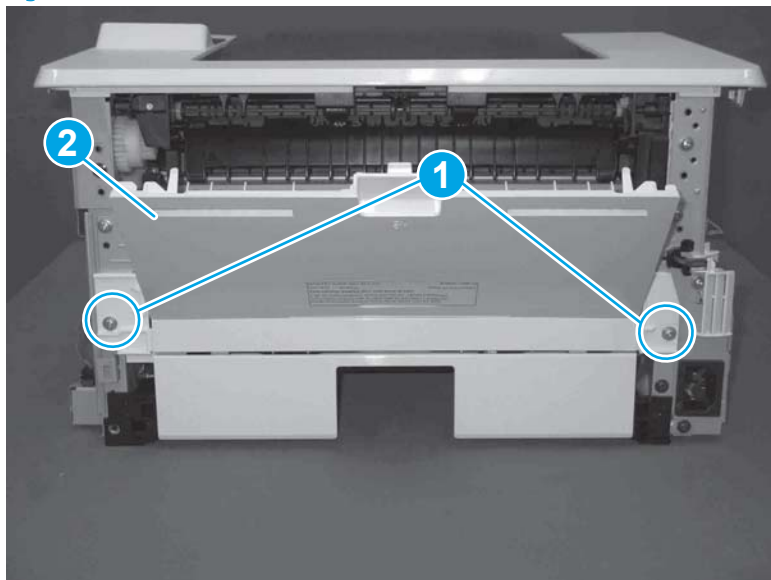

Step 6: Unpack the replacement assembly

1. Dispose of the defective part.

 **NOTE:** HP recommends responsible disposal of the defective part.

<http://www8.hp.com/us/en/hp-information/environment/product-recycling.html>

2. Unpack the replacement part from the packaging.

 **CAUTION:**  Some parts are sensitive to electrostatic discharge (ESD). Always perform service work at an ESD-protected workstation or mat. If an ESD workstation or mat is not available, touch the sheet-metal chassis to provide a static ground before touching an ESD-sensitive assembly. Protect the ESD-sensitive assemblies by placing them in ESD pouches when they are out of the printer.

If the replacement part is a roller or pad, avoid touching the spongy part of it. Skin oils on the roller or pad can cause paper pickup and/or print-quality problems. HP recommends using disposable gloves when handling rollers or pads or washing your hands before touching rollers or pads.

 **IMPORTANT:** Make sure that all of the shipping materials (for example shipping tape) are removed from the replacement part prior to installation.

3. To install an assembly, reverse the removal steps.

 **NOTE:** When applicable, special installation instructions are provided for an assembly at the end of the removal procedure. Always completely read the removal instructions and follow all special installation instructions.

Removal and replacement: Cassette rear cover

- [Introduction](#)
- [Step 1: Remove Tray 2](#)
- [Step 2: Remove the cartridge door assembly](#)
- [Step 3: Remove the left cover](#)
- [Step 4: Remove the right cover](#)
- [Step 5: Remove the rear door assembly](#)
- [Step 6: Remove the cassette rear cover](#)
- [Step 7: Unpack the replacement assembly](#)

Introduction

This document provides the procedures to remove and replace the cassette rear cover.

Before performing service

Turn the printer power off

- Disconnect the power cable.

 **WARNING!** To avoid damage to the printer, turn the printer off, wait 30 seconds, and then remove the power cable before attempting to service the printer.

Use the table below to identify the correct part number for your printer. To order the part, go to www.hp.com/buy/parts.

Cassette rear cover part number	
RC4-3082-000CN	Cassette rear cover

Required tools

- #2 Phillips screwdriver with a magnetic tip.

After performing service

Turn the printer power on

- Connect the power cable.
- Use the power switch to turn the power on.

Post service test

Make sure that the printer initializes to a **Ready** state.

Print a configuration page to make sure that the printer is functioning correctly.

Step 1: Remove Tray 2

- ▲ Pull the tray straight out of the printer to remove it.

Figure 1-116 Remove the tray



Step 2: Remove the cartridge door assembly

 **NOTE:** If the toner cartridge was not removed prior to servicing the printer, remove it now.

1. Release the support shaft (callout 1), and then slide it toward the center of the door (callout 2).

 **TIP:** It might be easier to release the support shaft by using a small flat-blade screwdriver.

Figure 1-117 Release the support shaft

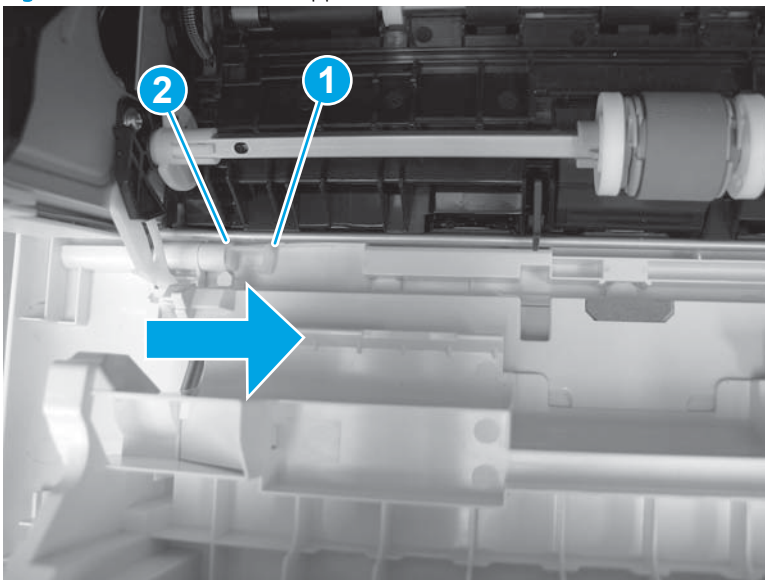

2. Remove the support shaft.

Figure 1-118 Remove the support shaft

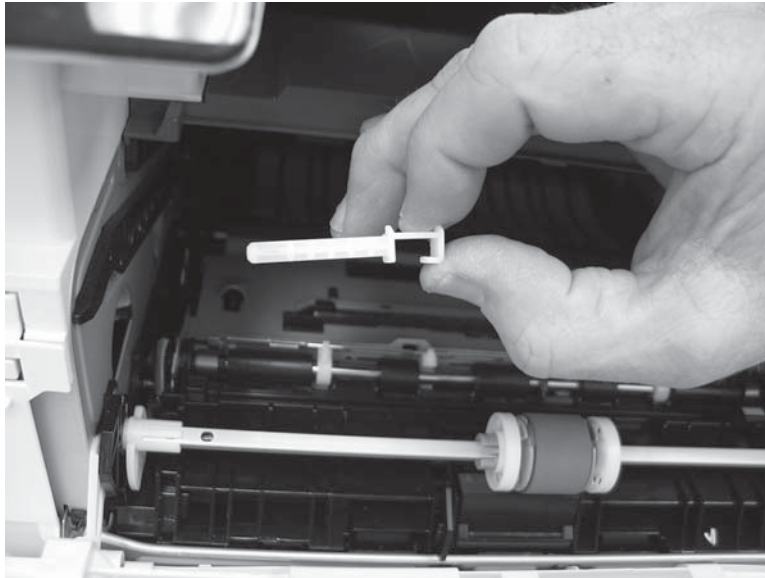

3. Release one tab (callout 1), and then slide the guide out of the printer (callout 2).

⚠ CAUTION: Be careful, the tab (callout 1) can be easily broken.

Figure 1-119 Remove the guide

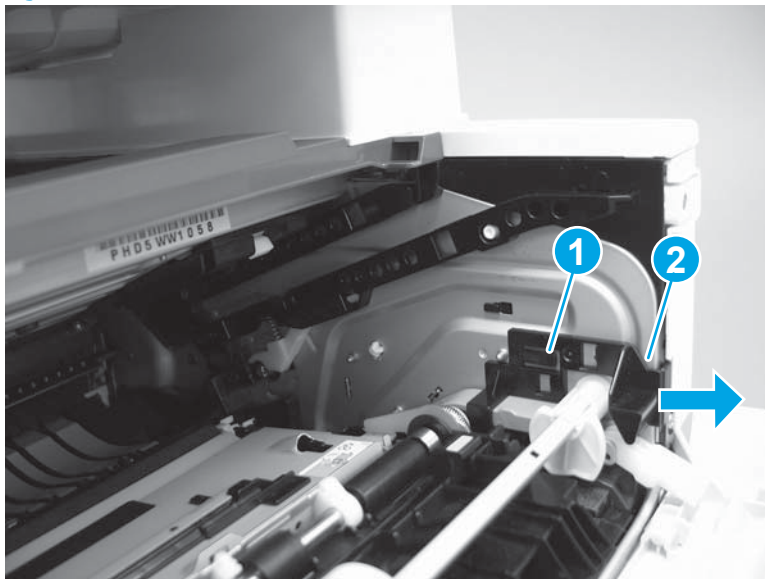

4. Use a small flat-blade screwdriver to gently pry the white-plastic door arm (callout 1) off of the gray-plastic pressure-release link (callout 2) to release the door arm.

Figure 1-120 Release the pressure-release link

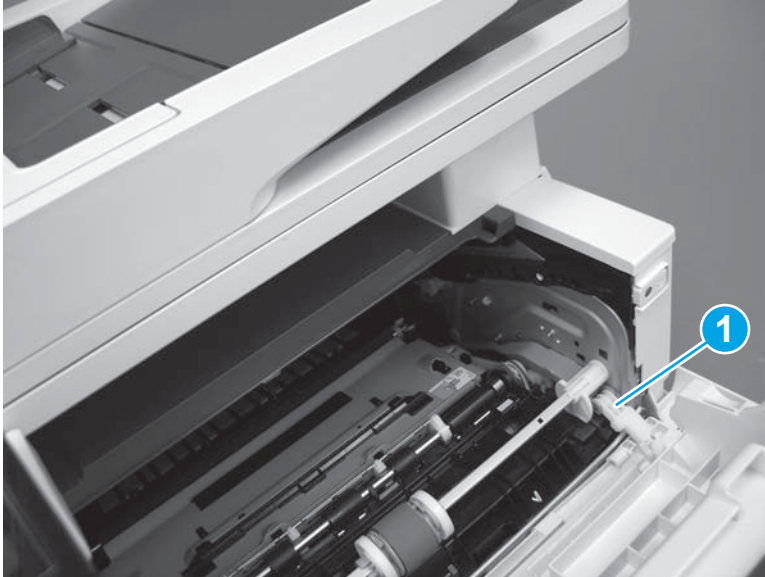

5. With the door in the partially closed position, slightly raise the left end (callout 1; raise it over the sheet-metal hinge boss), and then slide the door to the left (callout 2) to release the right hinge (callout 3).

⚠ CAUTION: The door is still attached to the printer by the left-side retainer arm. Do not attempt to completely remove the door.

💡 Reinstallation tip: When reinstalling the door, there are two right-side hinge pins (not shown in callout 3). Keep a finger pressed on the left-side retainer arm so that it does not disengage from the door.

Figure 1-121 Release the door

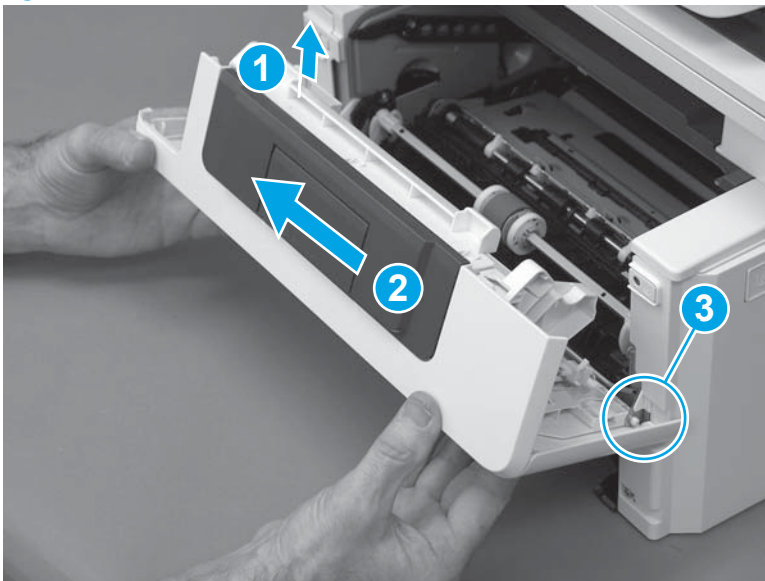

6. Rotate the door away from the printer until the keyed pin on the left-side retainer arm can disengage from the door.

Figure 1-122 Release the left-side retainer arm

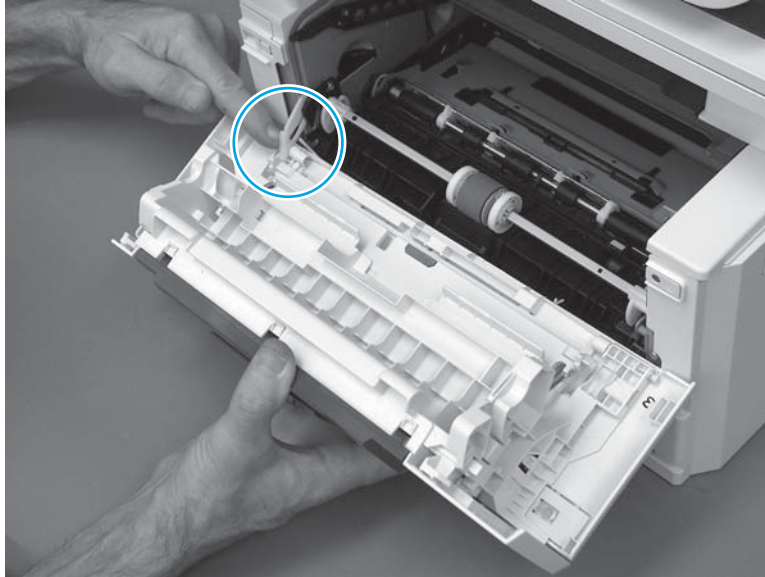

7. Remove the door.

Figure 1-123 Remove the door

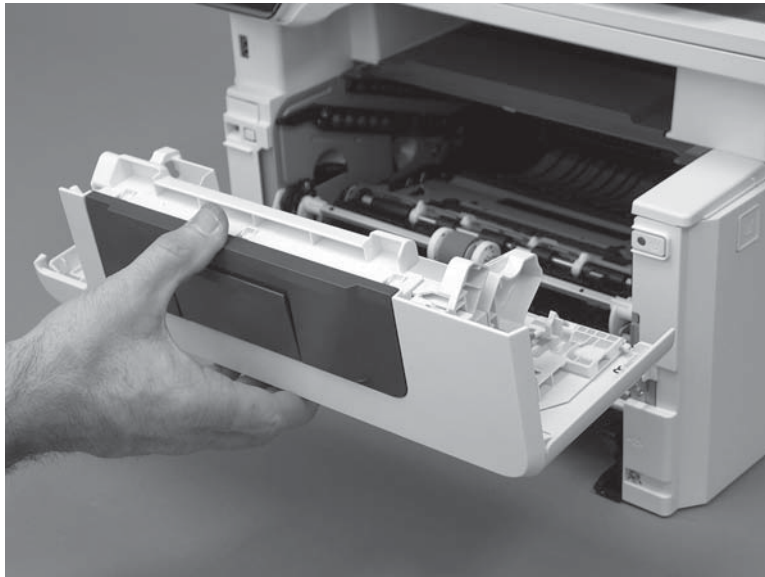

Step 3: Remove the left cover

1. Remove one screw (callout 1).

Figure 1-124 Remove one screw

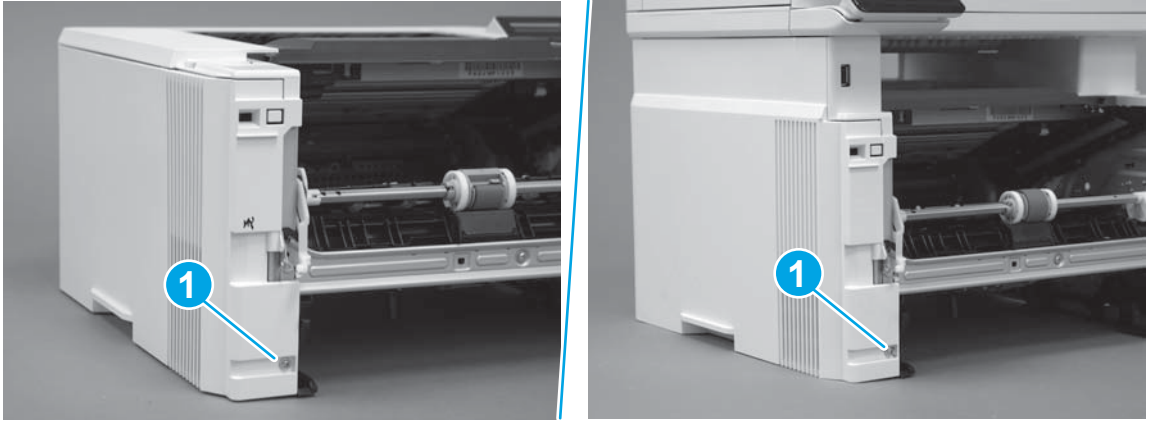

2. Open the rear door, release two bosses (callout 1), and then release three tabs (callout 2).

Figure 1-125 Release two bosses and three tabs

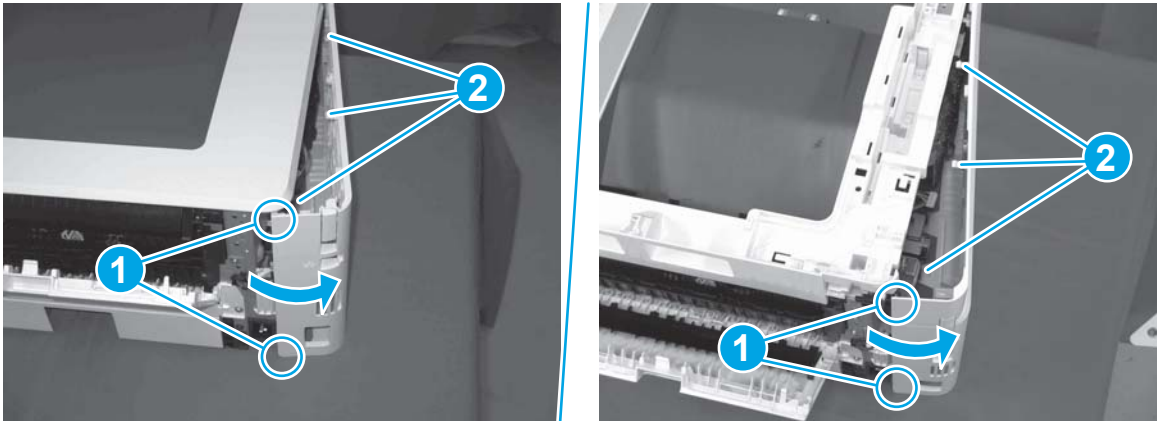

3. At the front of the printer, do one of the following:
 - **M304/M305/M404/M405:** Release two bosses (callout 1), and then remove the cover (callout 2).
 - **M329/M428/M429:** Release one tab (callout 3), two bosses (callout 4), and then remove the cover (callout 5).

CAUTION: Be careful when releasing the upper bosses on the M329/M428/M429 cover. One portion of the cover (callout 6) is fragile and is easily broken.

Figure 1-126 Remove the cover

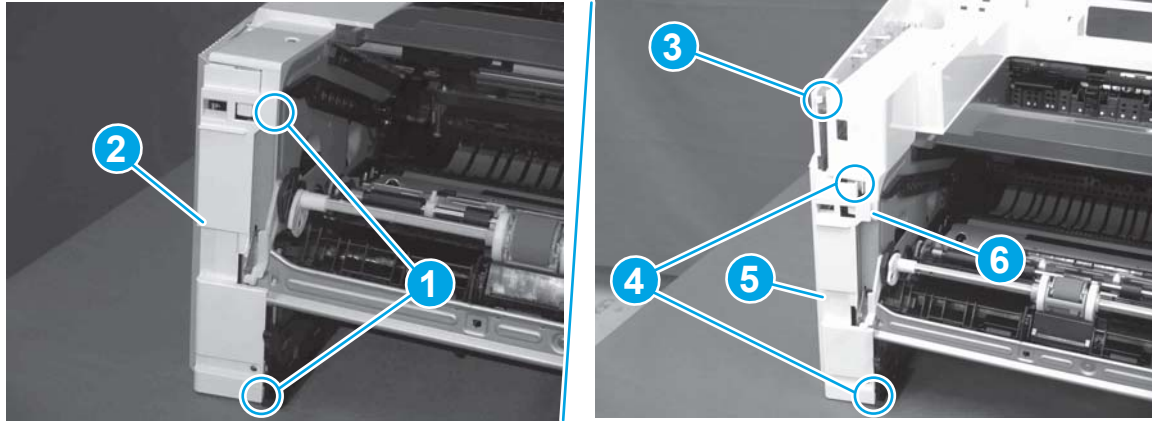

Step 4: Remove the right cover

1. At the front of the printer, release two bosses (callout 1), and then release three tabs (callout 2).

 **Reinstallation tip:** Remove, and then reinstall the cover if the switch or button does not correctly function.

Figure 1-127 Release two bosses and three tabs

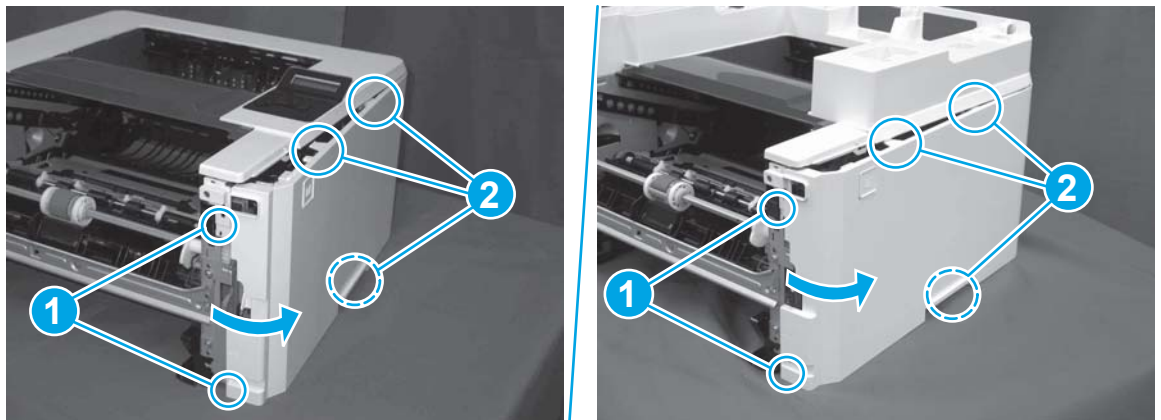

2. Open the rear door, release two bosses (callout 1), and then remove the cover (callout 2).

Figure 1-128 Remove the cover

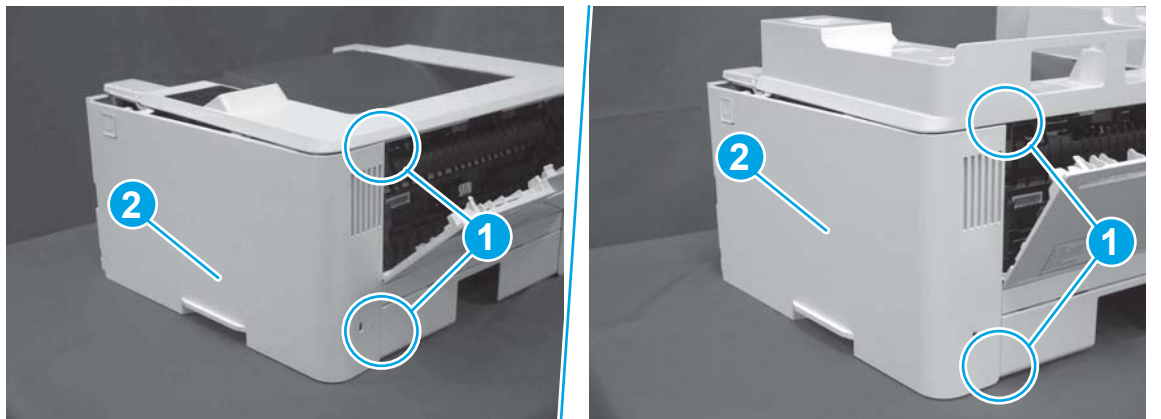

Step 5: Remove the rear door assembly

1. **Duplex models only:** Inside the Tray 2 cavity, press the green jam access lever (callout 1), and then lower the duplex feed assembly (callout 2).

 **Reinstallation tip:** **Duplex models only:** Reach in from the front of the Tray 2 cavity and raise the feed assembly to the up and locked position so that the rear cover will fit flat against the chassis.

Figure 1-129 Duplex models, lower the duplex feed assembly



2. At the rear of the printer, remove two screws (callout 1), and then remove the rear door assembly (callout 2).

 **Reinstallation tip:** **Duplex models only:** Slide the duplex tray into the Tray 2 cavity.

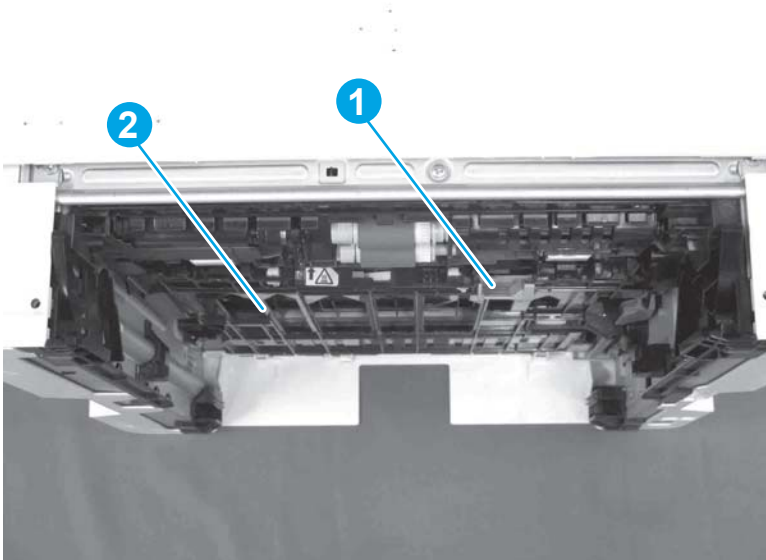
Figure 1-130 Remove two screws



Step 6: Remove the cassette rear cover

The figures in this procedure show a duplex rear cover assembly. However, the procedure is valid for a simple rear cover.

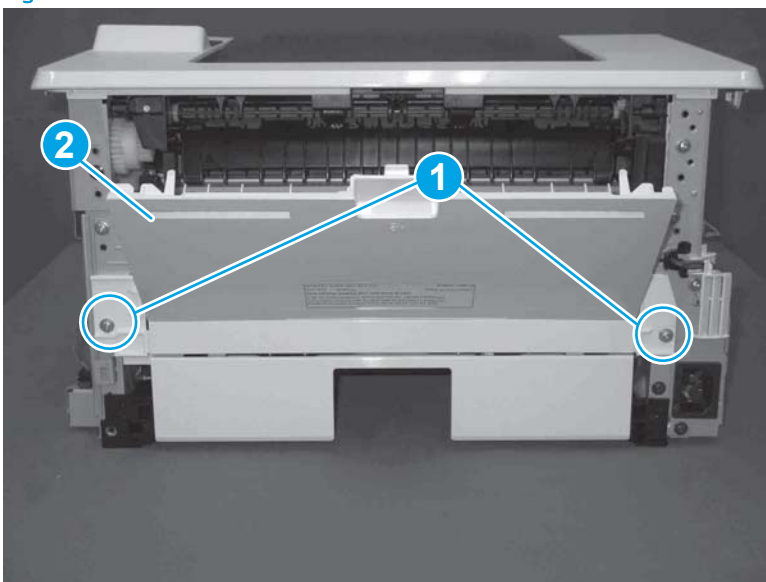
1. Locate the left-side hinge retainer (callout 1).

Figure 1-131 Locate the hinge retainer

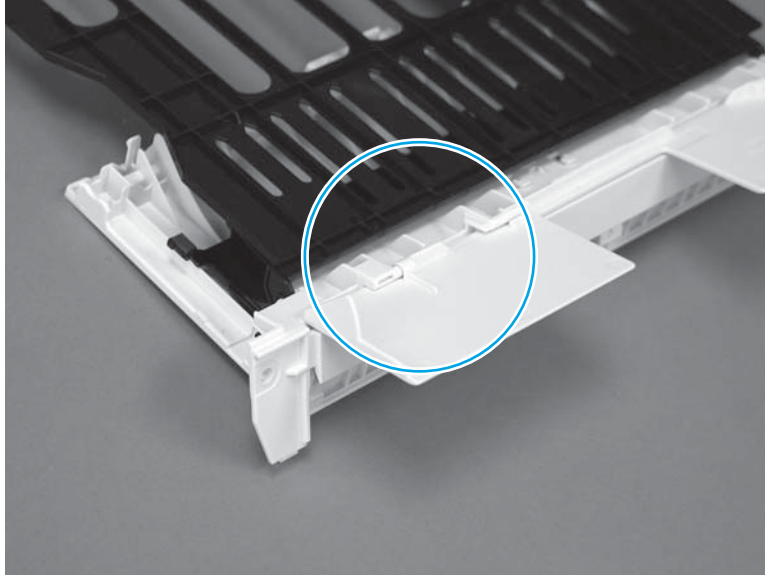

2. Carefully flex the cover to release the retainer (callout 1), and the left-side hinge pin (callout 2).

 **Reinstallation tip:** When the cover is correctly installed, it moves freely on the hinge pins.

Figure 1-132 Release the retainer and the hinge pin



3. Remove the cover.

Figure 1-133 Remove the cover

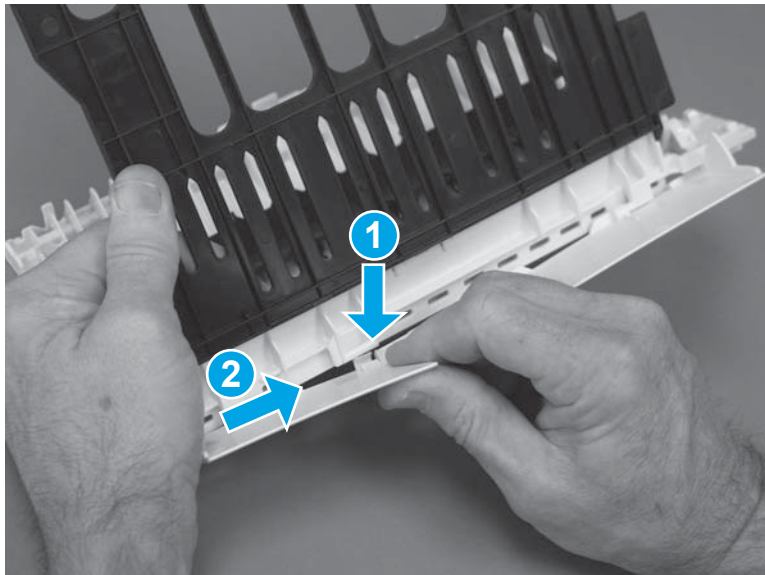
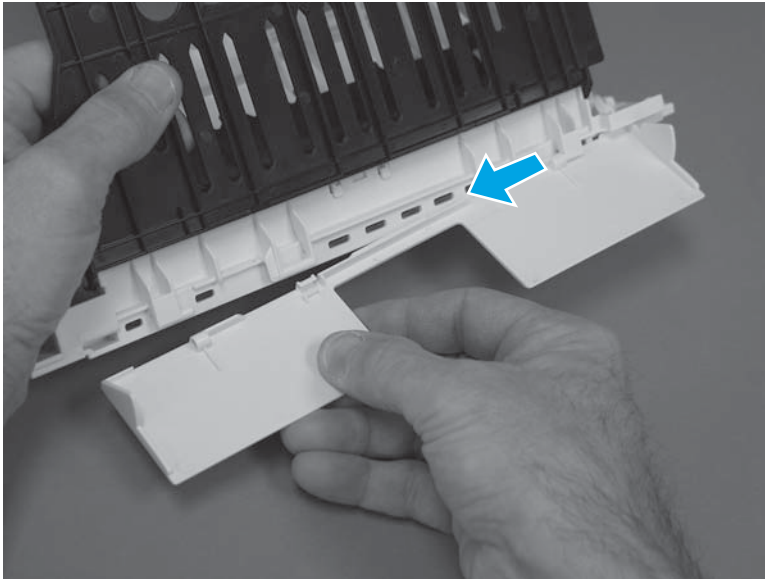



Step 7: Unpack the replacement assembly

1. Dispose of the defective part.

 **NOTE:** HP recommends responsible disposal of the defective part.

<http://www8.hp.com/us/en/hp-information/environment/product-recycling.html>

2. Unpack the replacement part from the packaging.

 **CAUTION:**  Some parts are sensitive to electrostatic discharge (ESD). Always perform service work at an ESD-protected workstation or mat. If an ESD workstation or mat is not available, touch the sheet-metal chassis to provide a static ground before touching an ESD-sensitive assembly. Protect the ESD-sensitive assemblies by placing them in ESD pouches when they are out of the printer.

If the replacement part is a roller or pad, avoid touching the spongy part of it. Skin oils on the roller or pad can cause paper pickup and/or print-quality problems. HP recommends using disposable gloves when handling rollers or pads or washing your hands before touching rollers or pads.

 **IMPORTANT:** Make sure that all of the shipping materials (for example shipping tape) are removed from the replacement part prior to installation.

3. To install an assembly, reverse the removal steps.

 **NOTE:** When applicable, special installation instructions are provided for an assembly at the end of the removal procedure. Always completely read the removal instructions and follow all special installation instructions.

Removal and replacement: Top cover (M329/M428/M429)

- [Introduction](#)
- [Step 1: Remove Tray 2](#)
- [Step 2: Remove the cartridge door assembly](#)
- [Step 3: Remove the left cover](#)
- [Step 4: Remove the right cover](#)
- [Step 5: Remove the integrated scanner assembly \(M329/M428/M429\)](#)
- [Step 6: Remove the control panel \(M329/M428/M429\)](#)
- [Step 7: Remove the top cover \(M329/M428/M429\)](#)
- [Step 8: Unpack the replacement assembly](#)

Introduction

This document provides the procedures to remove and replace the top cover (M329/M428/M429).

Before performing service

Turn the printer power off

- Disconnect the power cable.

 **WARNING!** To avoid damage to the printer, turn the printer off, wait 30 seconds, and then remove the power cable before attempting to service the printer.

Use the table below to identify the correct part number for your printer. To order the part, go to www.hp.com/buy/parts.

Top cover (M329/M428/M429) part number	
RC4-3207-000CN	Top cover (M329/M428/M429)

Required tools

- #2 Phillips screwdriver with a magnetic tip.
- Small flat-blade screw driver

After performing service

Turn the printer power on

- Connect the power cable.
- Use the power switch to turn the power on.

Post service test

Make sure that the printer initializes to a **Ready** state.

Print a configuration page to make sure that the printer is functioning correctly.

Step 1: Remove Tray 2

- ▲ Pull the tray straight out of the printer to remove it.

Figure 1-134 Remove the tray



Step 2: Remove the cartridge door assembly

 **NOTE:** If the toner cartridge was not removed prior to servicing the printer, remove it now.

1. Release the support shaft (callout 1), and then slide it toward the center of the door (callout 2).

 **TIP:** It might be easier to release the support shaft by using a small flat-blade screwdriver.

Figure 1-135 Release the support shaft

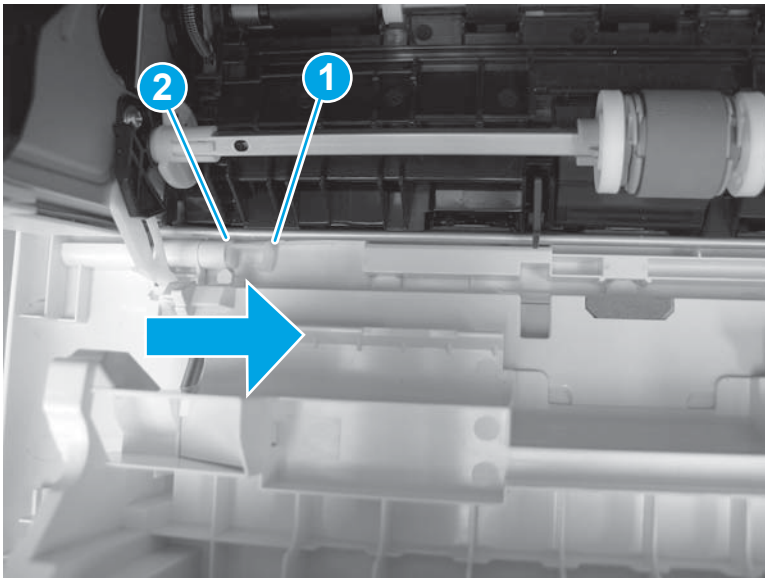

2. Remove the support shaft.

Figure 1-136 Remove the support shaft

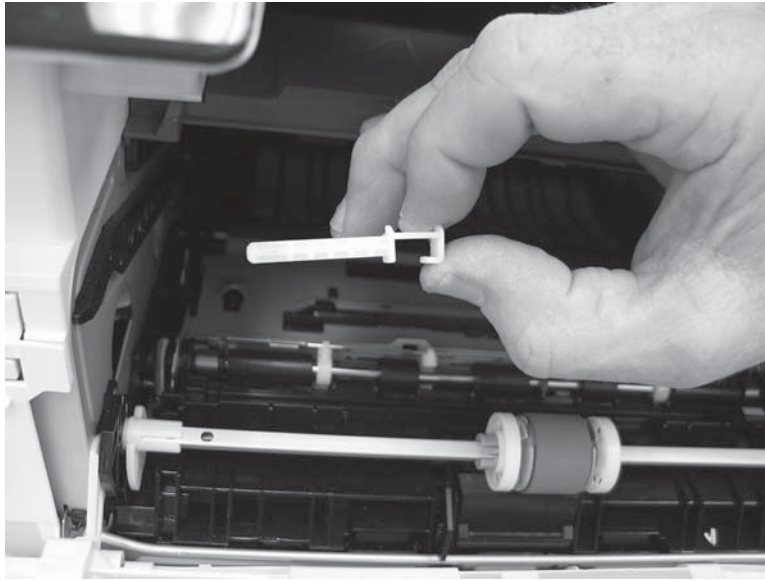

3. Release one tab (callout 1), and then slide the guide out of the printer (callout 2).

⚠ CAUTION: Be careful, the tab (callout 1) can be easily broken.

Figure 1-137 Remove the guide

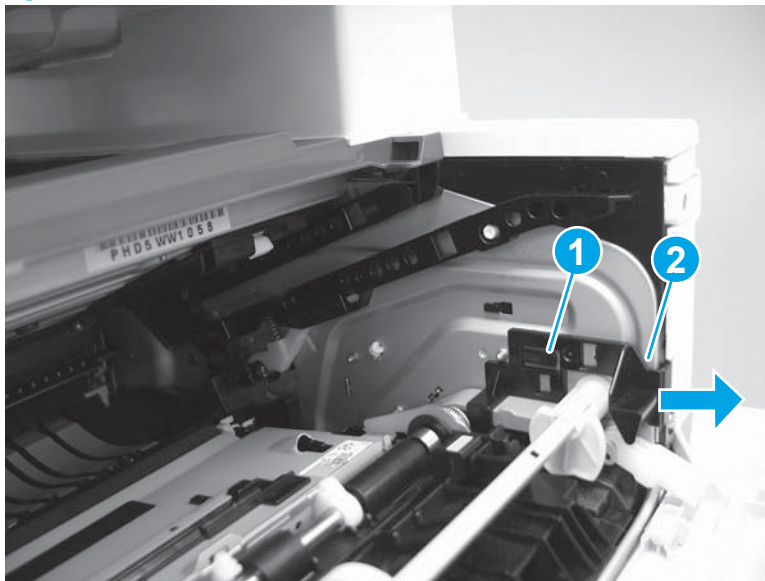

4. Use a small flat-blade screwdriver to gently pry the white-plastic door arm (callout 1) off of the gray-plastic pressure-release link (callout 2) to release the door arm.

Figure 1-138 Release the pressure-release link

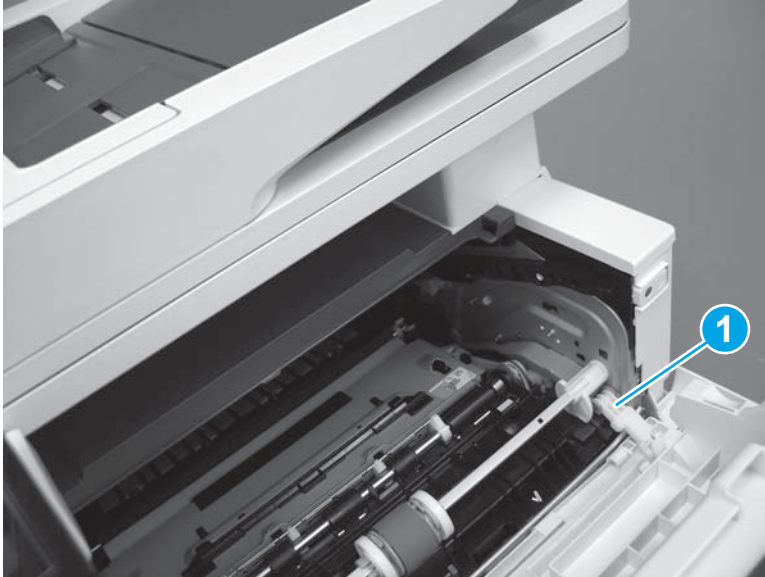

5. With the door in the partially closed position, slightly raise the left end (callout 1; raise it over the sheet-metal hinge boss), and then slide the door to the left (callout 2) to release the right hinge (callout 3).

CAUTION: The door is still attached to the printer by the left-side retainer arm. Do not attempt to completely remove the door.

Reinstallation tip: When reinstalling the door, there are two right-side hinge pins (not shown in callout 3). Keep a finger pressed on the left-side retainer arm so that it does not disengage from the door.

Figure 1-139 Release the door

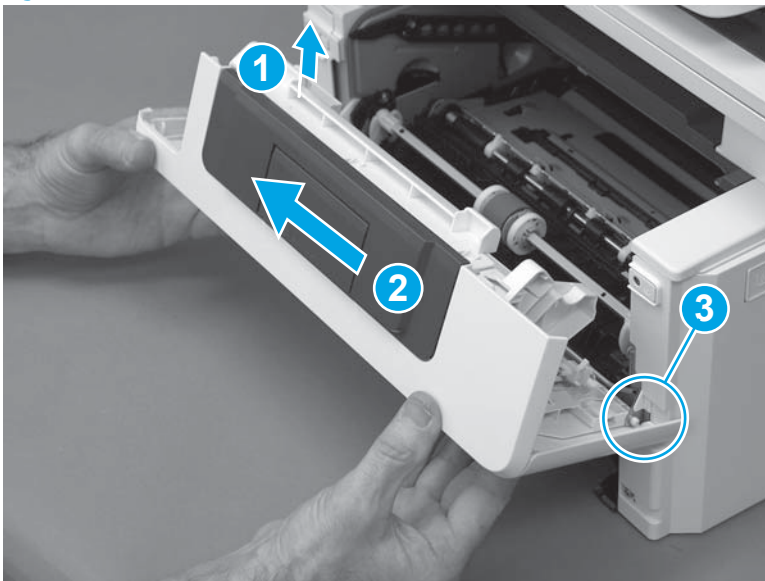

6. Rotate the door away from the printer until the keyed pin on the left-side retainer arm can disengage from the door.

Figure 1-140 Release the left-side retainer arm

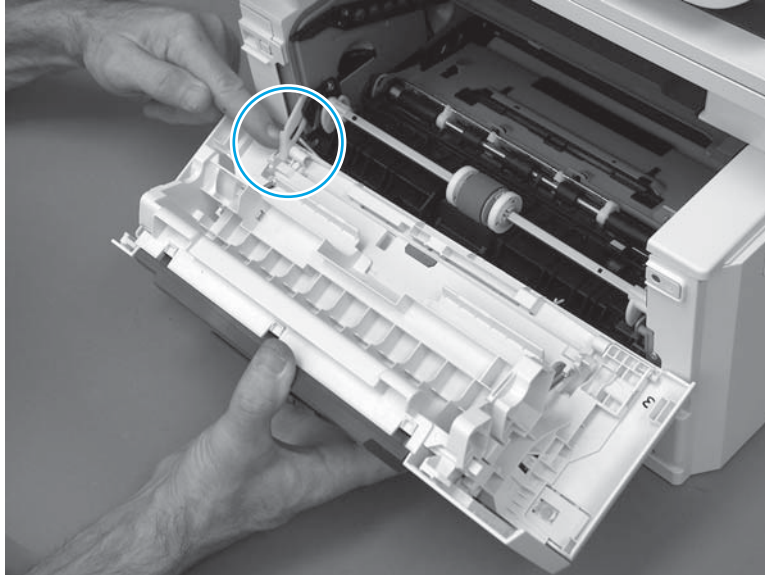

7. Remove the door.

Figure 1-141 Remove the door

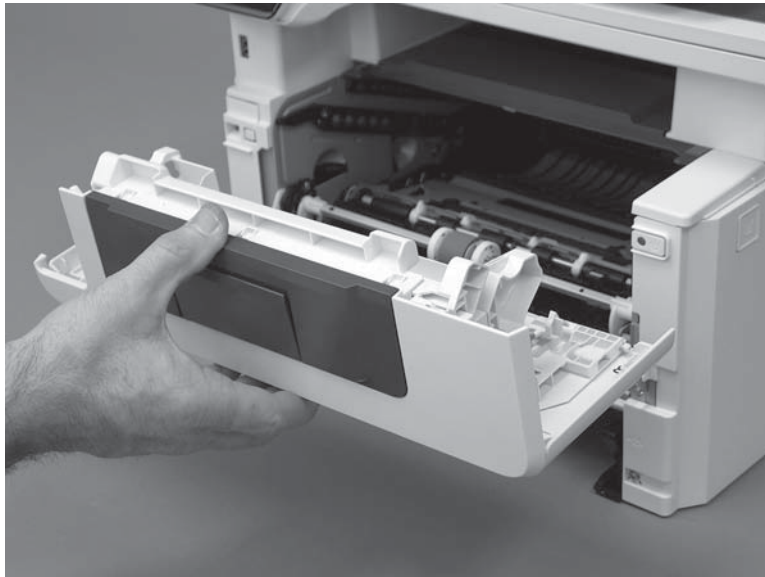

Step 3: Remove the left cover

1. Remove one screw (callout 1).

Figure 1-142 Remove one screw

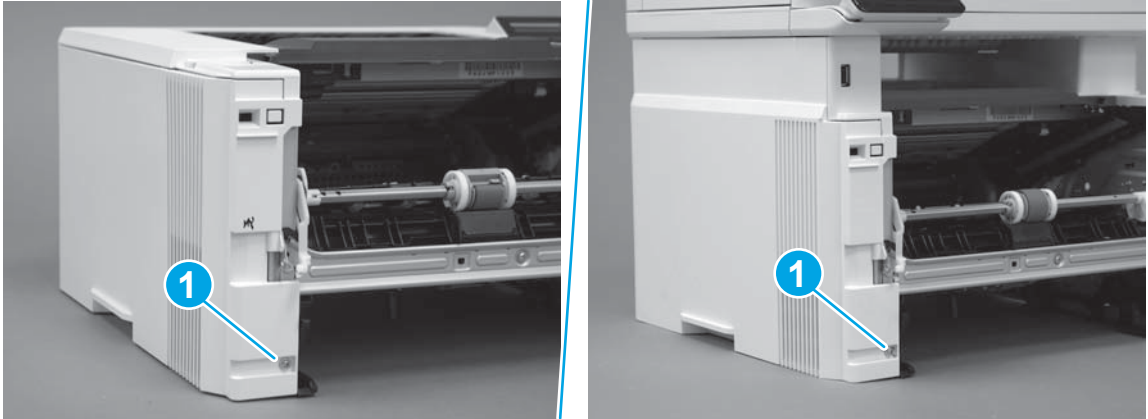

2. Open the rear door, release two bosses (callout 1), and then release three tabs (callout 2).

Figure 1-143 Release two bosses and three tabs

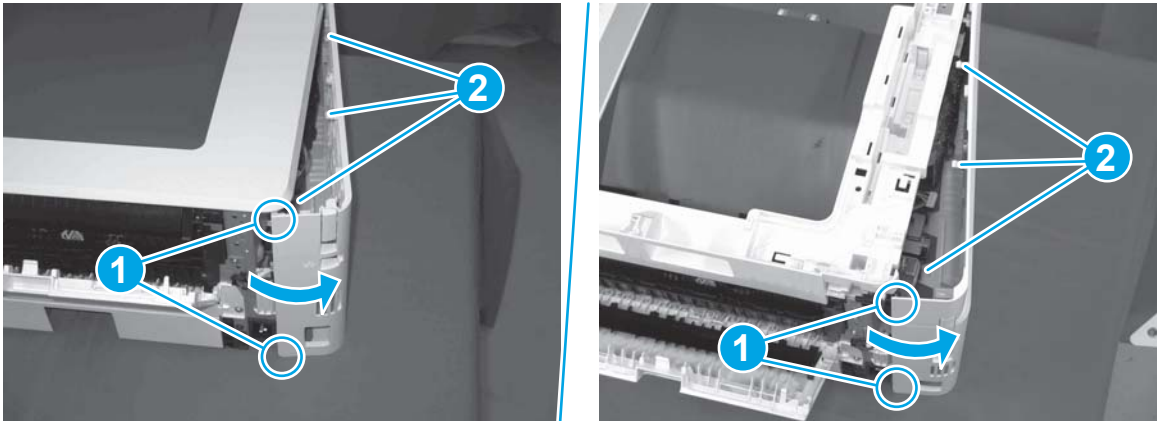

3. At the front of the printer, do one of the following:
 - **M304/M305/M404/M405:** Release two bosses (callout 1), and then remove the cover (callout 2).
 - **M329/M428/M429:** Release one tab (callout 3), two bosses (callout 4), and then remove the cover (callout 5).

CAUTION: Be careful when releasing the upper bosses on the M329/M428/M429 cover. One portion of the cover (callout 6) is fragile and is easily broken.

Figure 1-144 Remove the cover

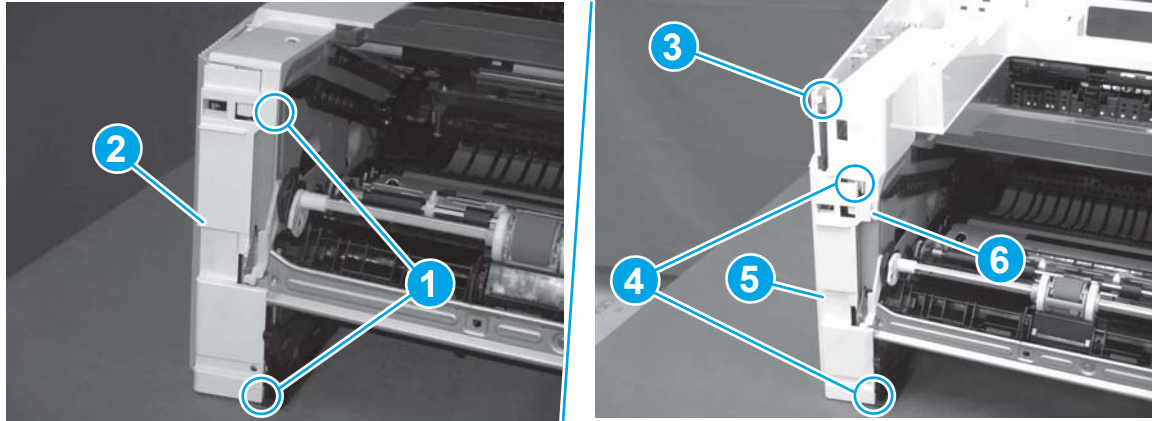

Step 4: Remove the right cover

1. At the front of the printer, release two bosses (callout 1), and then release three tabs (callout 2).

 **Reinstallation tip:** Remove, and then reinstall the cover if the switch or button does not correctly function.

Figure 1-145 Release two bosses and three tabs

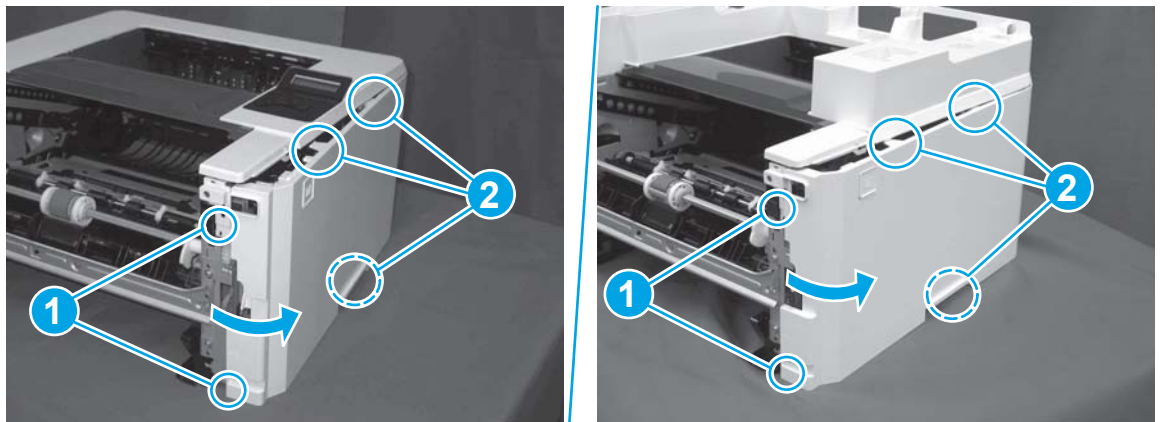

2. Open the rear door, release two bosses (callout 1), and then remove the cover (callout 2).

Figure 1-146 Remove the cover

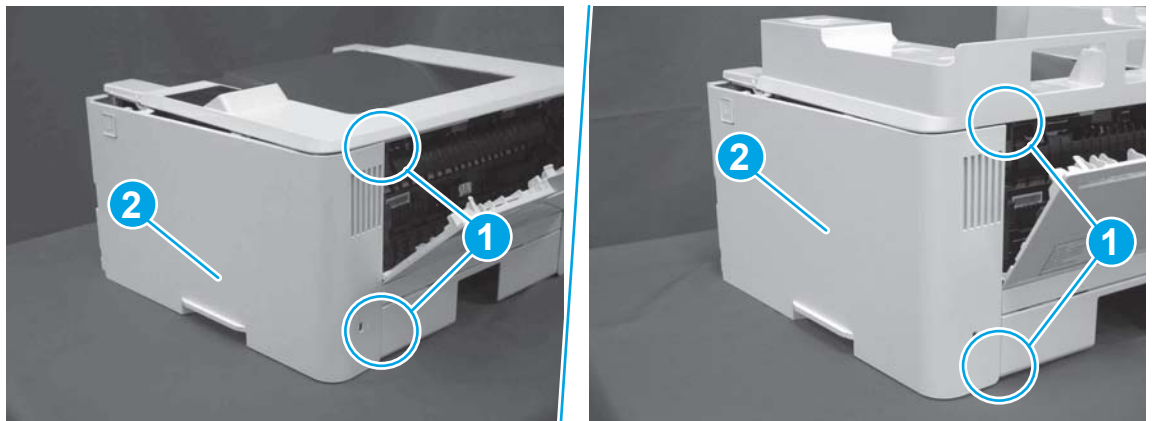

Step 5: Remove the integrated scanner assembly (M329/M428/M429)

 **NOTE:** M329/M428/M429 models only. The integrated scanner assembly (ISA) includes the sub-scanner assembly (SSA) and the automatic document feeder (ADF).

1. Raise the ISA.

Figure 1-147 Raise the ISA

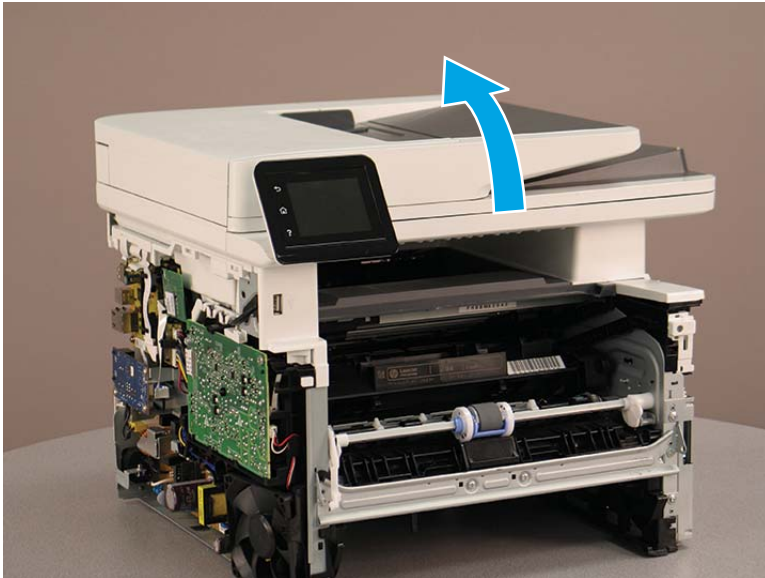

2. Release the ISA flat-flexible cable (FFC) cover (callout 1), and then remove it (callout 2).

Figure 1-148 Remove the ISA FFC cover

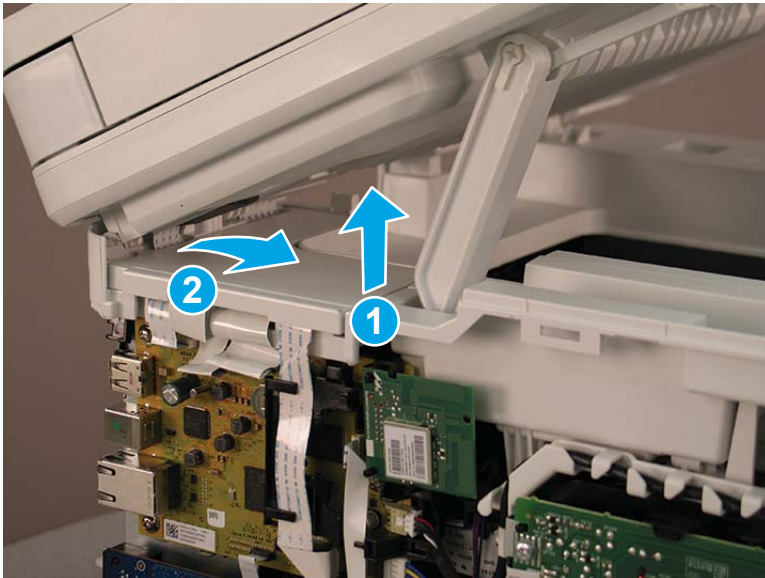

3. Disconnect three FFCs (callout 1), and then remove the ferrite (callout 2) from the holder.

CAUTION: The ferrite is not captive on the FFC. Do not lose the ferrite while handling the ISA.

Figure 1-149 Disconnect three FFCs

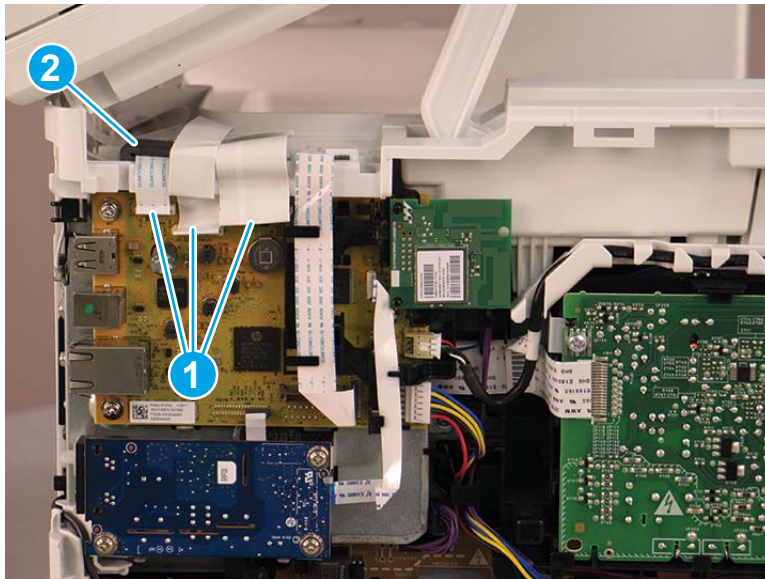

4. Remove one screw (callout 1).

Figure 1-150 Remove one screw

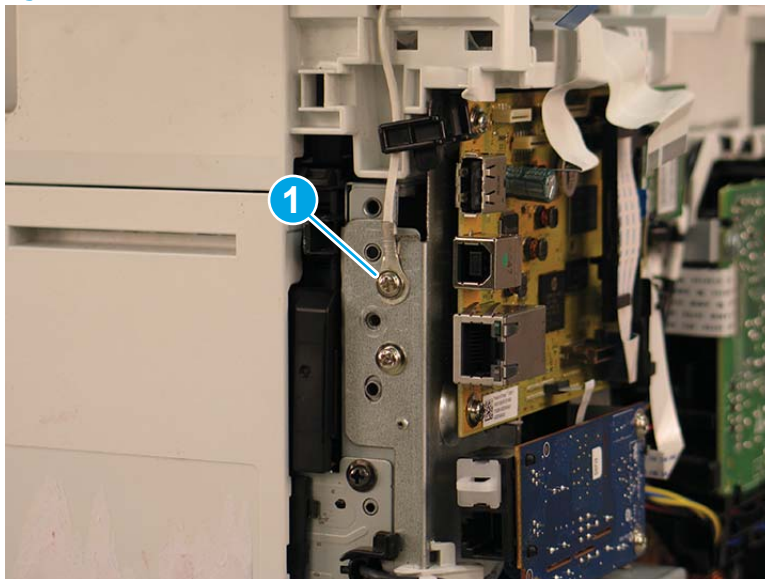

5. Pass the ground wire through the opening in the top cover.

Figure 1-151 Pass the wire through the opening

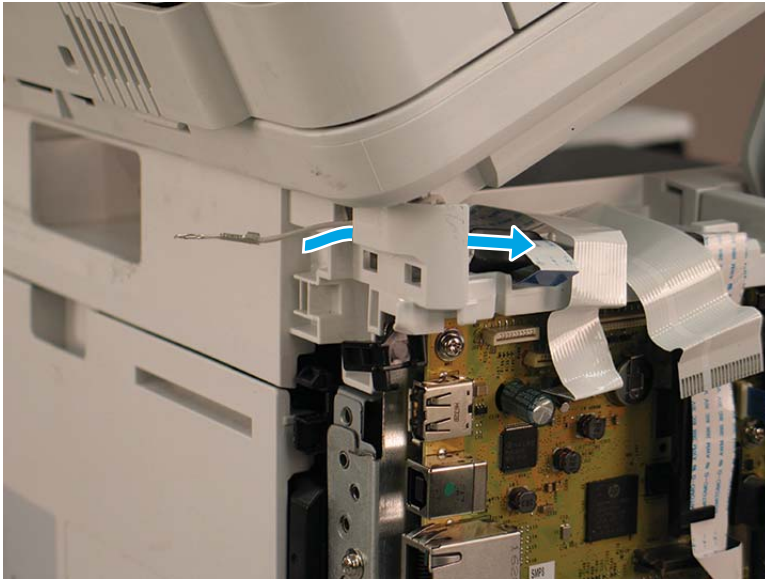

6. Release one tab (callout 1), and then rotate the ISA slider pin (callout 2) towards the front of the printer to release it.

Figure 1-152 Release one tab and rotate the slider pin

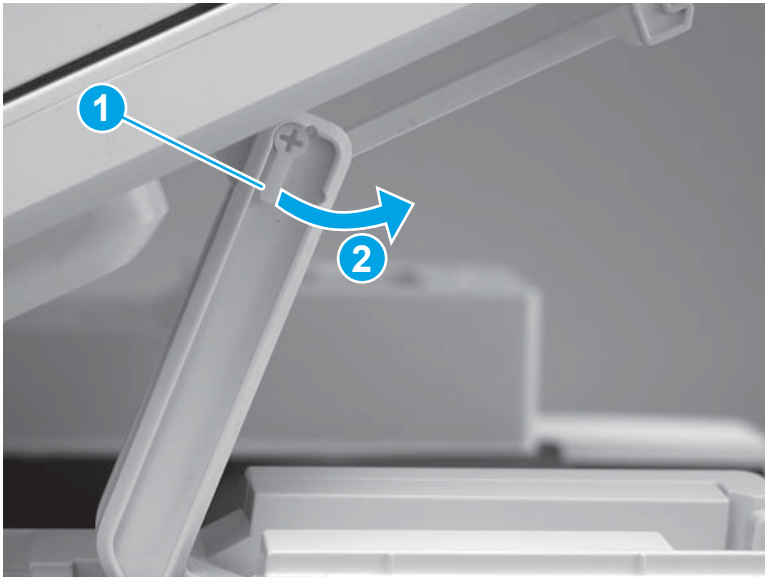

7. Remove the slider pin.

 **Reinstallation tip:** Align the keyed portion of the locking pin with the slot and hole in the support arm.

Figure 1-153 Remove the slider pin



8. Rotate the ISA towards the rear of the printer until it stops.

Figure 1-154 Rotate the ISA towards the rear of the printer

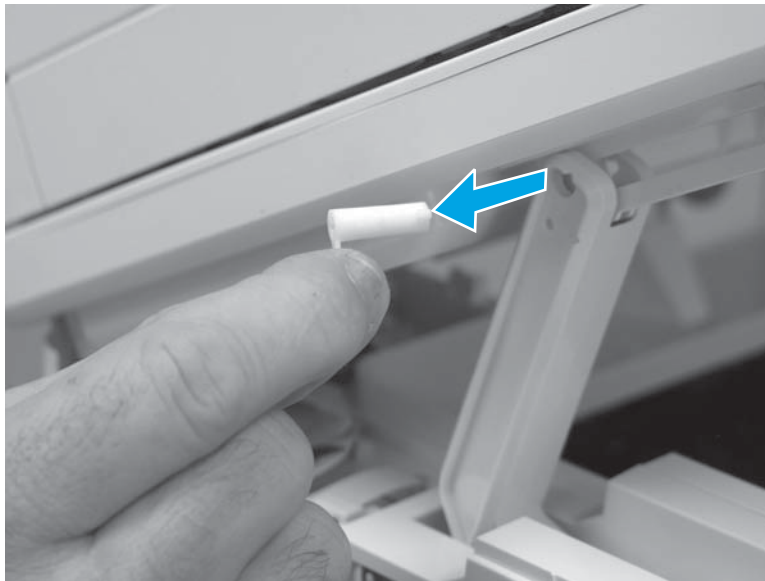
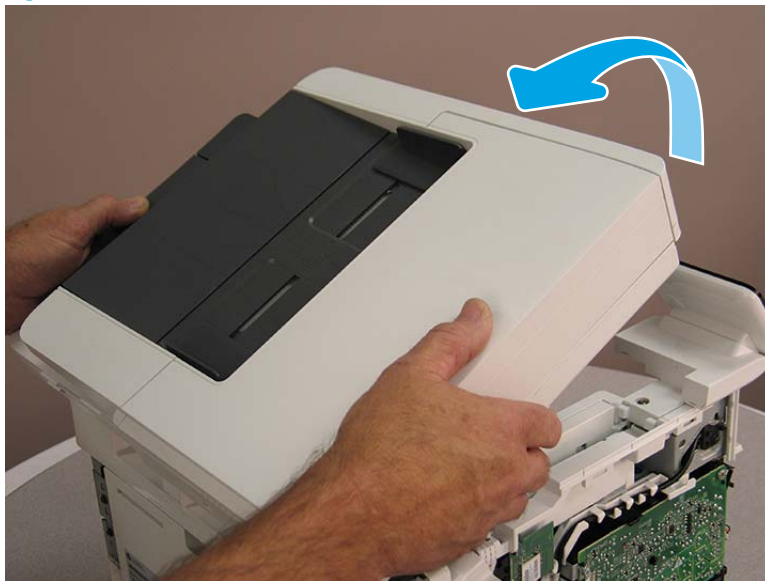

9. Slide the ISA as shown to release it.

Figure 1-155 Release the ISA

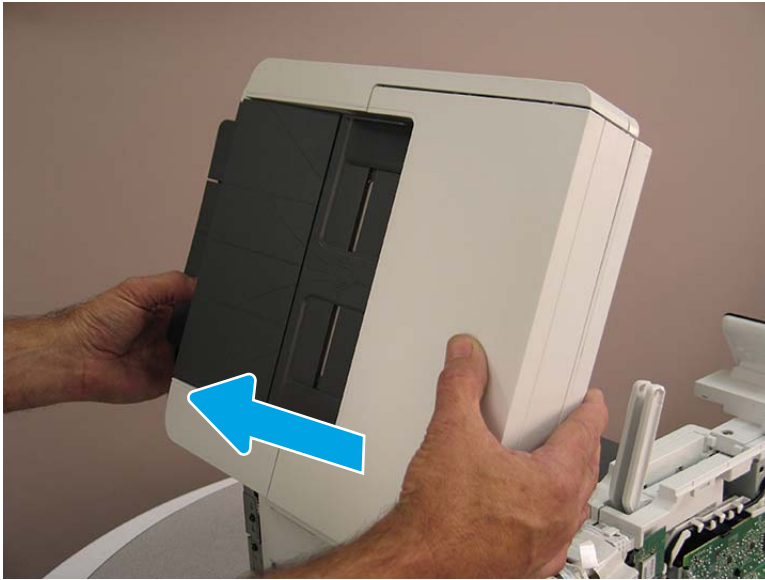

10. Remove the ISA.

Figure 1-156 Remove the ISA

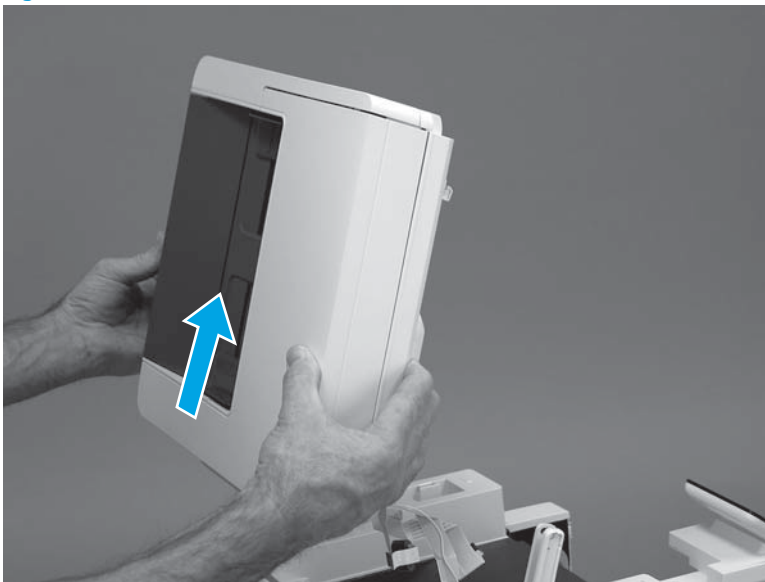

Step 6: Remove the control panel (M329/M428/M429)

1. Disconnect one FFC (callout 1), and then release the FFC from the guide (callout 2).

Figure 1-157 Disconnect one connector

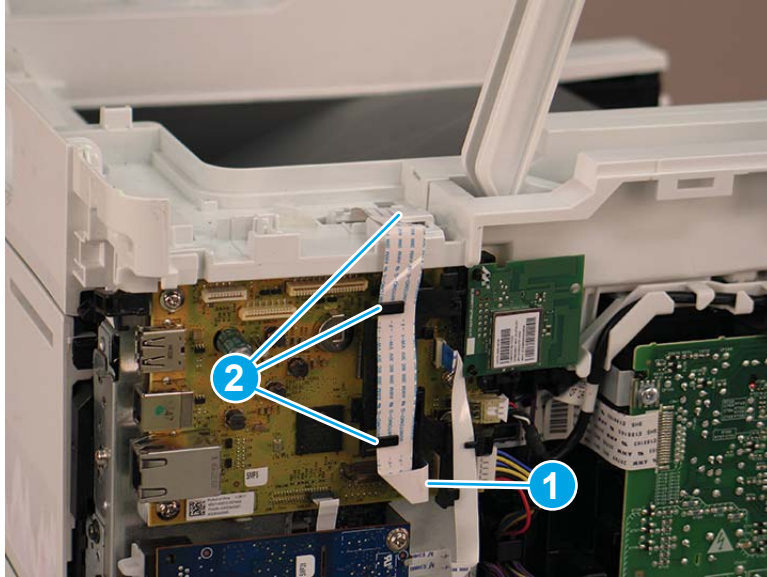

2. Remove one screw (callout 1).

Figure 1-158 Remove one screw

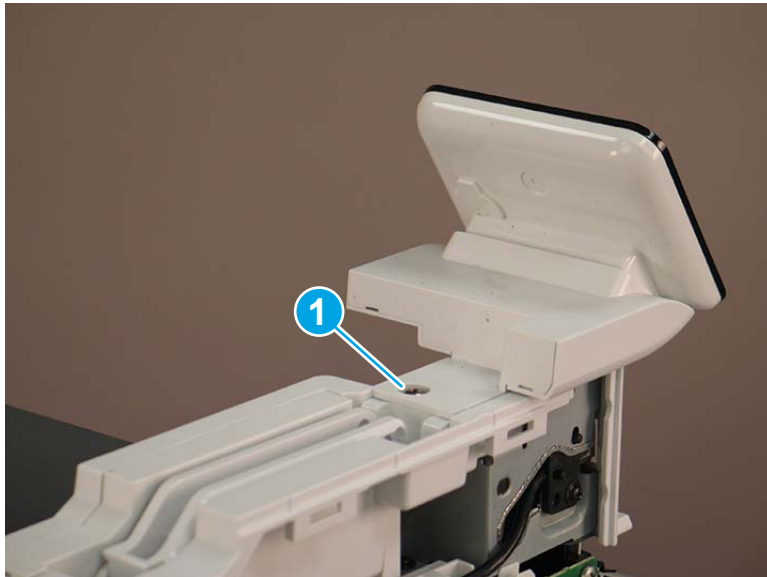

3. Use a small flat-blade screwdriver to release two tabs (callout 1) on the control-panel cable cover.

Figure 1-159 Release two tabs

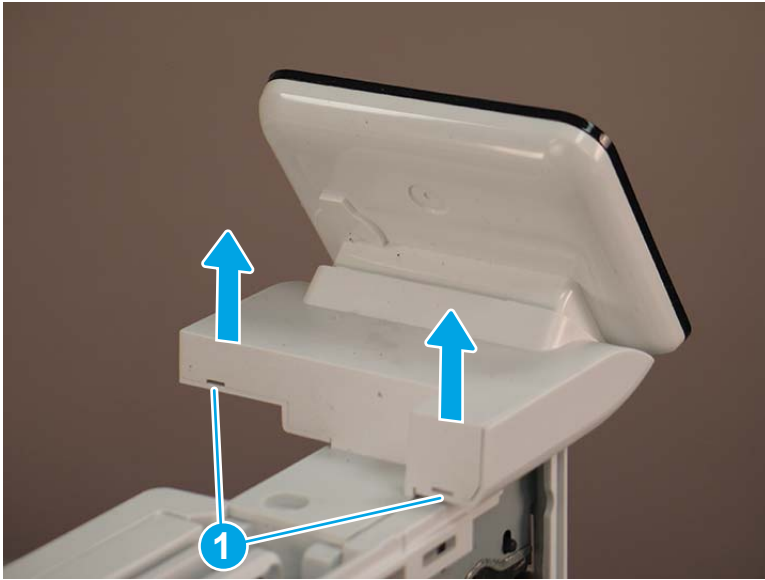

4. Remove the control-panel cable cover.

Figure 1-160 Remove the cover



5. Remove one grounding screw (callout 1), and then move the ground cable (callout 2) out of the way.

Figure 1-161 Remove one screw

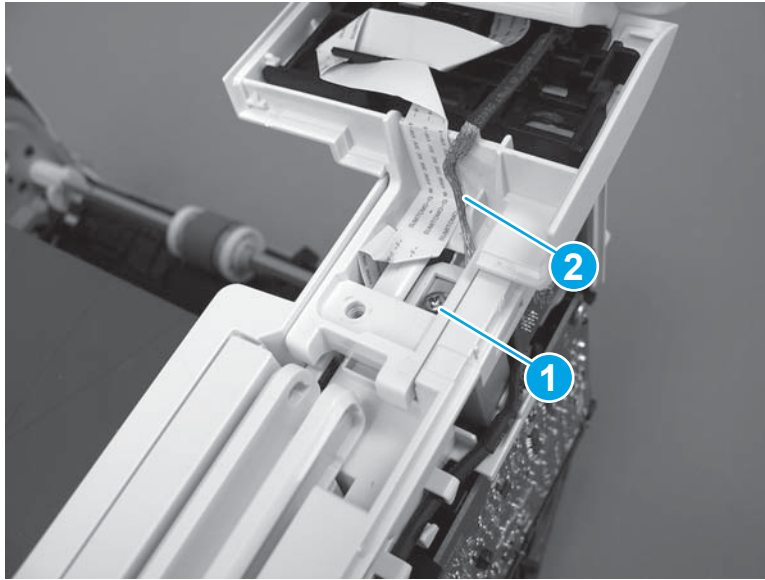

6. Move the FFC out of the way, and then remove two screws (callout 1).

Figure 1-162 Remove two screws



7. Slightly lift up the control-panel assembly to separate it from the top cover.

⚠ CAUTION: The control panel assembly is still connected to the printer by the FFC. Do not attempt to completely remove the assembly.

Figure 1-163 Lift up the control-panel assembly



8. Lift up the control-panel FFC cover to remove the control-panel assembly.

Figure 1-164 Remove the control-panel assembly

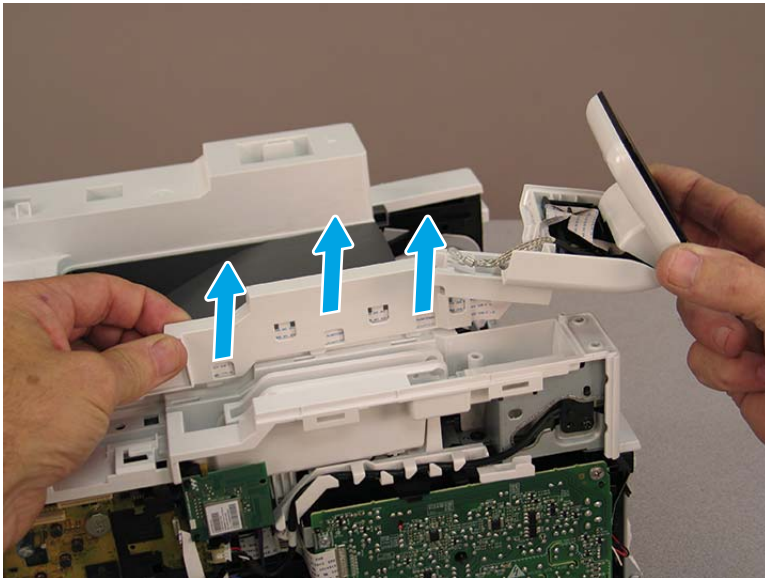

Step 7: Remove the top cover (M329/M428/M429)

1. Release the USB cable (callout 1) from the cable guide.

Figure 1-165 Remove the USB cable

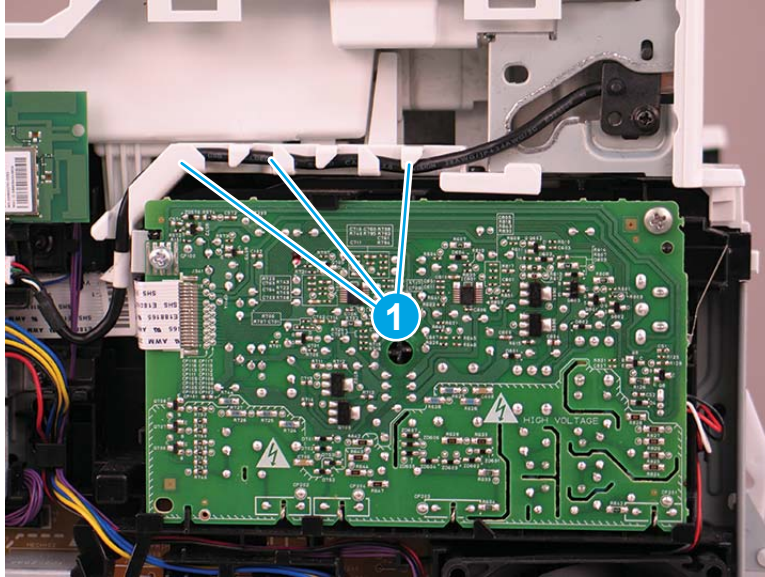

2. Remove one screw (callout 1), and then remove the support arm (callout 2).

⚠ CAUTION: The support arm is spring loaded and can unexpectedly spring into the open position. To avoid injury, do not place a finger in the screw well when the support arm is in the closed position.

Figure 1-166 Remove the support arm

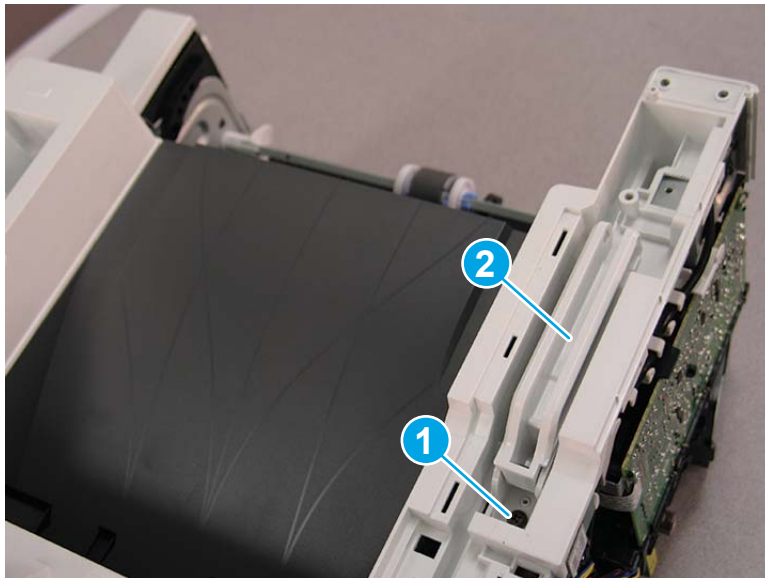

3. Remove five screws (callout 1), release four bosses (callout 2), and then remove the top cover (callout 3).

Figure 1-167 Remove the cover

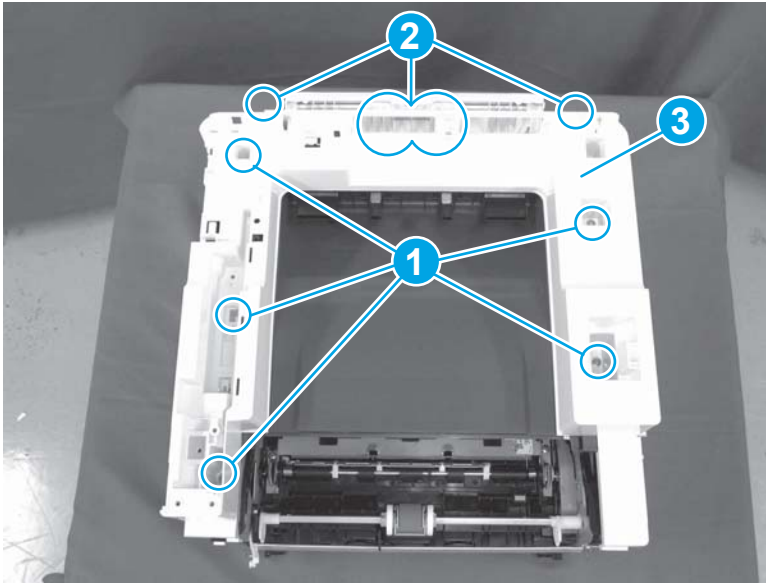



Step 8: Unpack the replacement assembly

1. Dispose of the defective part.

 **NOTE:** HP recommends responsible disposal of the defective part.

<http://www8.hp.com/us/en/hp-information/environment/product-recycling.html>

2. Unpack the replacement part from the packaging.

 **CAUTION:**  Some parts are sensitive to electrostatic discharge (ESD). Always perform service work at an ESD-protected workstation or mat. If an ESD workstation or mat is not available, touch the sheet-metal chassis to provide a static ground before touching an ESD-sensitive assembly. Protect the ESD-sensitive assemblies by placing them in ESD pouches when they are out of the printer.

If the replacement part is a roller or pad, avoid touching the spongy part of it. Skin oils on the roller or pad can cause paper pickup and/or print-quality problems. HP recommends using disposable gloves when handling rollers or pads or washing your hands before touching rollers or pads.

 **IMPORTANT:** Make sure that all of the shipping materials (for example shipping tape) are removed from the replacement part prior to installation.

3. To install an assembly, reverse the removal steps.

 **NOTE:** When applicable, special installation instructions are provided for an assembly at the end of the removal procedure. Always completely read the removal instructions and follow all special installation instructions.

Removal and replacement: Cable guide (M329/M428/M429)

- [Introduction](#)
- [Step 1: Remove Tray 2](#)
- [Step 2: Remove the cartridge door assembly](#)
- [Step 3: Remove the left cover](#)
- [Step 4: Remove the right cover](#)
- [Step 5: Remove the control panel \(M329/M428/M429\)](#)
- [Step 6: Remove the integrated scanner assembly \(M329/M428/M429\)](#)
- [Step 7: Remove the top cover \(M329/M428/M429\)](#)
- [Step 8: Remove the cable guide \(M329/M428/M429\)](#)
- [Step 9: Unpack the replacement assembly](#)

Introduction

This document provides the procedures to remove and replace the cable guide (M329/M428/M429).

Before performing service

Turn the printer power off

- Disconnect the power cable.

 **WARNING!** To avoid damage to the printer, turn the printer off, wait 30 seconds, and then remove the power cable before attempting to service the printer.

Use the table below to identify the correct part number for your printer. To order the part, go to www.hp.com/buy/parts.

Cable guide (M329/M428/M429) part number	
RC4-3217-000CN	Cable guide (M329/M428/M429)

Required tools

- #2 Phillips screwdriver with a magnetic tip.
- Small flat-blade screw driver

After performing service

Turn the printer power on

- Connect the power cable.
- Use the power switch to turn the power on.

Post service test

Make sure that the printer initializes to a **Ready** state.

Print a configuration page to make sure that the printer is functioning correctly.

Step 1: Remove Tray 2

- ▲ Pull the tray straight out of the printer to remove it.

Figure 1-168 Remove the tray



Step 2: Remove the cartridge door assembly

 **NOTE:** If the toner cartridge was not removed prior to servicing the printer, remove it now.

1. Release the support shaft (callout 1), and then slide it toward the center of the door (callout 2).

 **TIP:** It might be easier to release the support shaft by using a small flat-blade screwdriver.

Figure 1-169 Release the support shaft

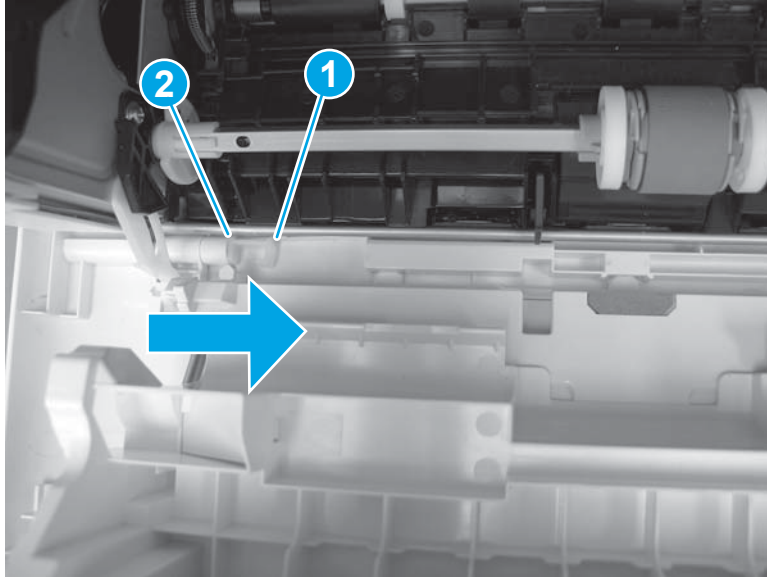

2. Remove the support shaft.

Figure 1-170 Remove the support shaft

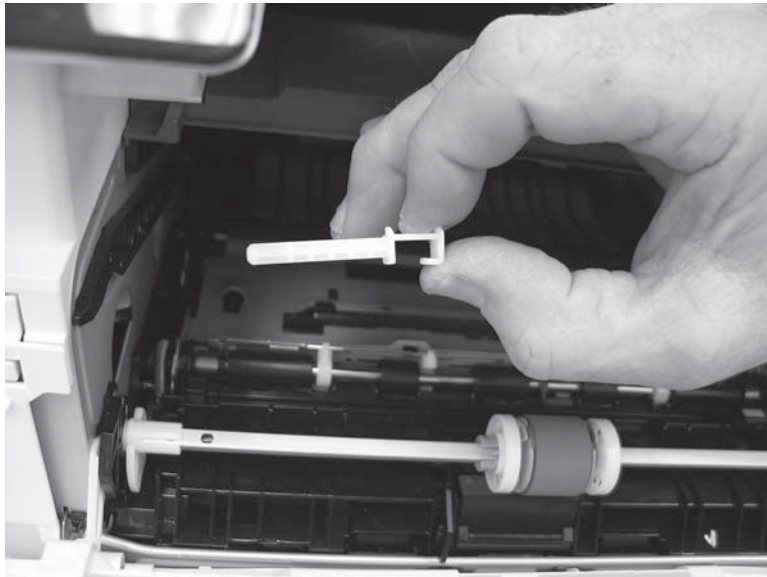

3. Release one tab (callout 1), and then slide the guide out of the printer (callout 2).

⚠ CAUTION: Be careful, the tab (callout 1) can be easily broken.

Figure 1-171 Remove the guide

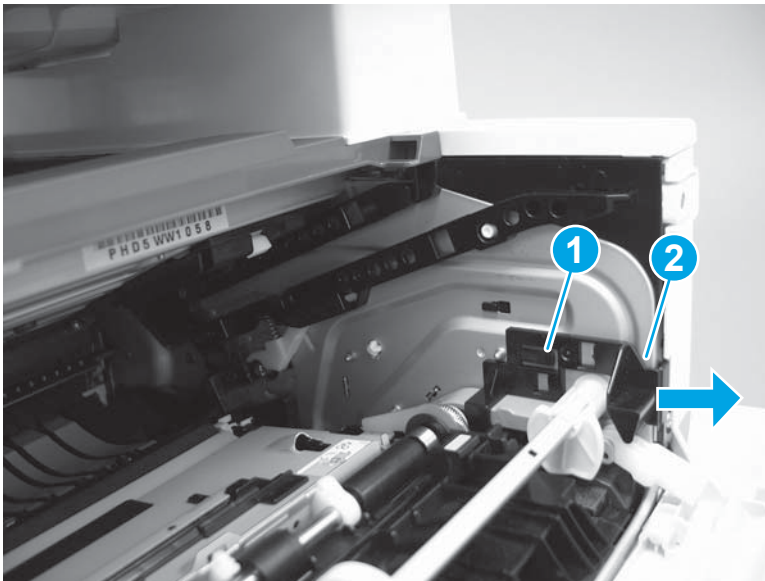

4. Use a small flat-blade screwdriver to gently pry the white-plastic door arm (callout 1) off of the gray-plastic pressure-release link (callout 2) to release the door arm.

Figure 1-172 Release the pressure-release link

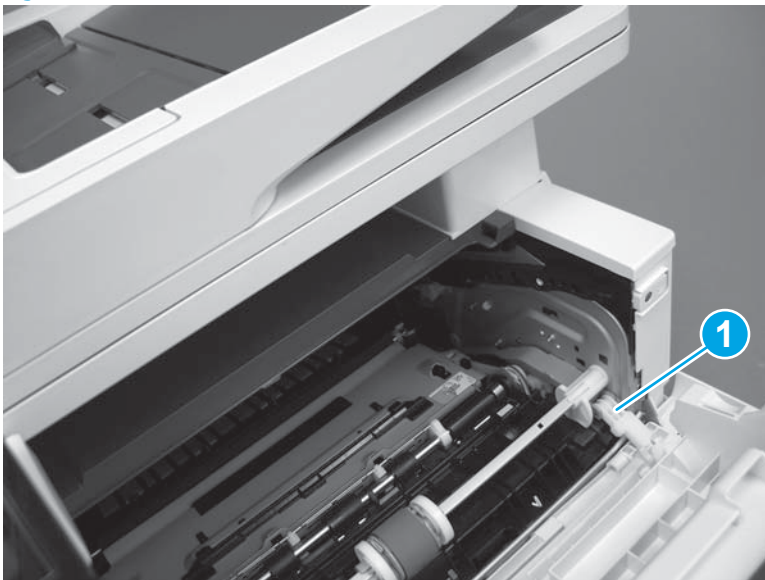

5. With the door in the partially closed position, slightly raise the left end (callout 1; raise it over the sheet-metal hinge boss), and then slide the door to the left (callout 2) to release the right hinge (callout 3).

⚠ CAUTION: The door is still attached to the printer by the left-side retainer arm. Do not attempt to completely remove the door.

💡 Reinstallation tip: When reinstalling the door, there are two right-side hinge pins (not shown in callout 3). Keep a finger pressed on the left-side retainer arm so that it does not disengage from the door.

Figure 1-173 Release the door

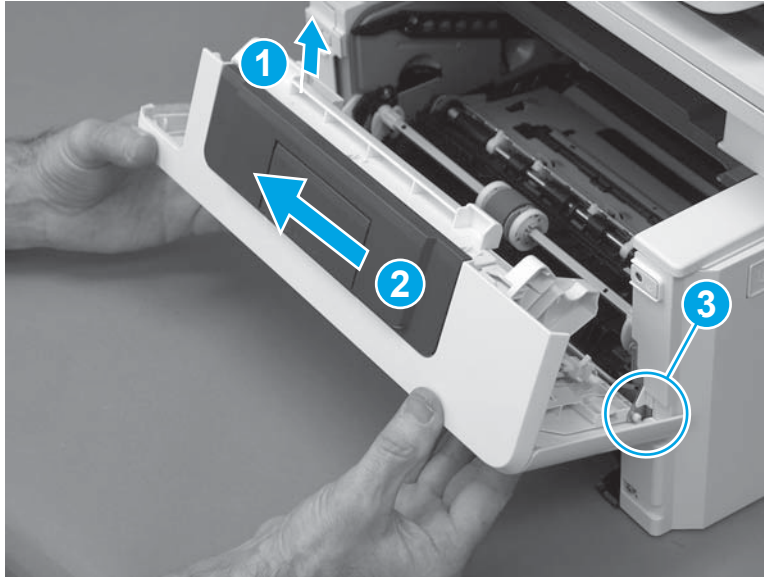

6. Rotate the door away from the printer until the keyed pin on the left-side retainer arm can disengage from the door.

Figure 1-174 Release the left-side retainer arm

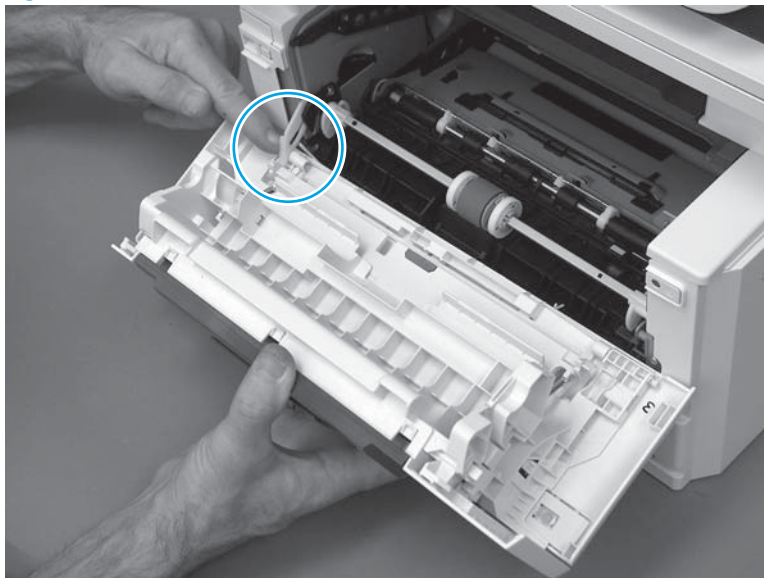

7. Remove the door.

Figure 1-175 Remove the door

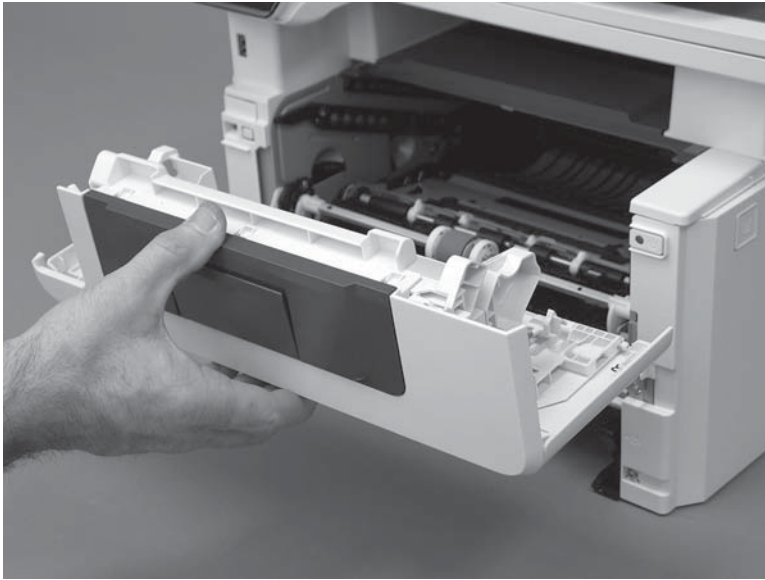

Step 3: Remove the left cover

1. Remove one screw (callout 1).

Figure 1-176 Remove one screw

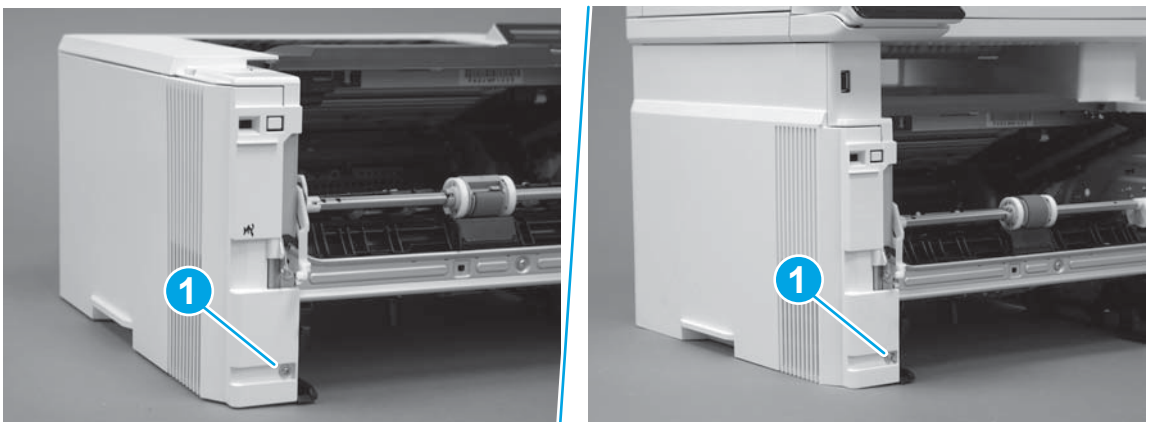

2. Open the rear door, release two bosses (callout 1), and then release three tabs (callout 2).

Figure 1-177 Release two bosses and three tabs

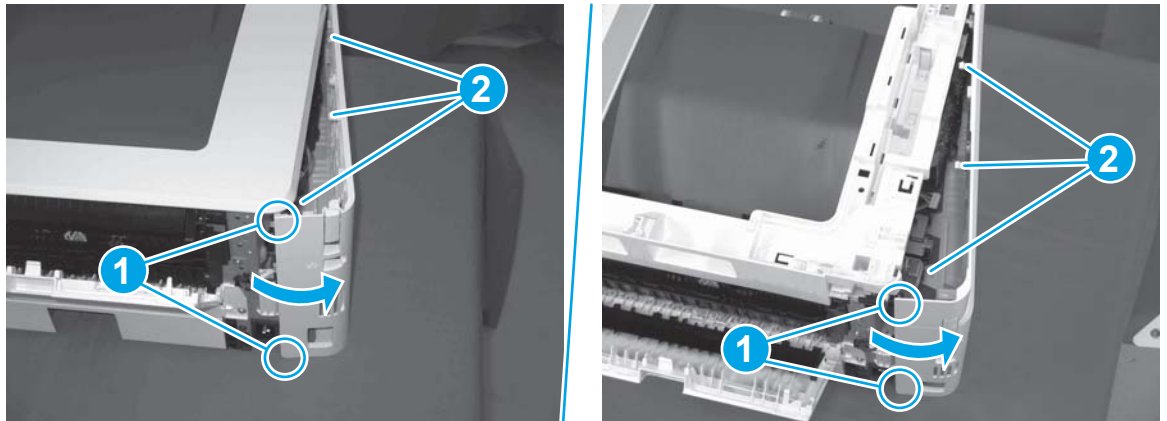

3. At the front of the printer, do one of the following:
 - **M304/M305/M404/M405:** Release two bosses (callout 1), and then remove the cover (callout 2).
 - **M329/M428/M429:** Release one tab (callout 3), two bosses (callout 4), and then remove the cover (callout 5).

⚠ CAUTION: Be careful when releasing the upper bosses on the M329/M428/M429 cover. One portion of the cover (callout 6) is fragile and is easily broken.

Figure 1-178 Remove the cover

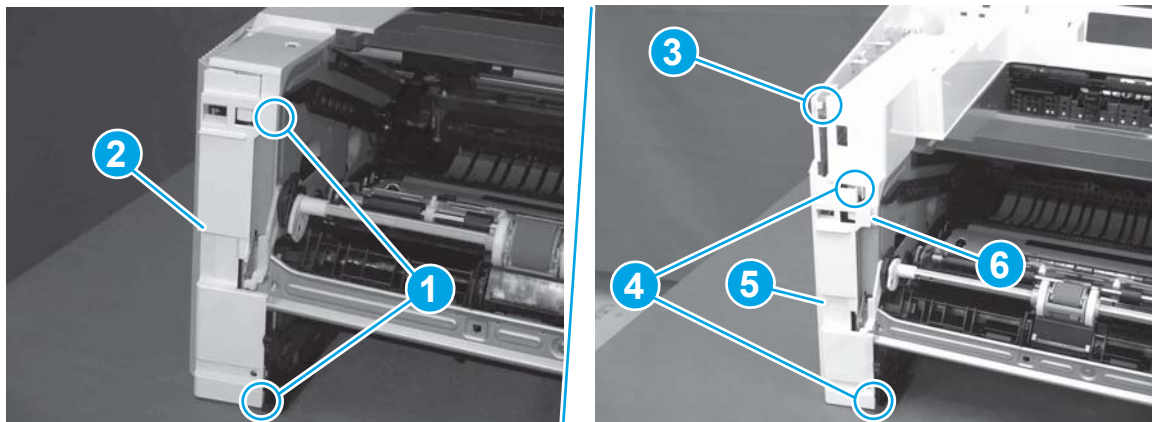

Step 4: Remove the right cover

1. At the front of the printer, release two bosses (callout 1), and then release three tabs (callout 2).

💡 Reinstallation tip: Remove, and then reinstall the cover if the switch or button does not correctly function.

Figure 1-179 Release two bosses and three tabs

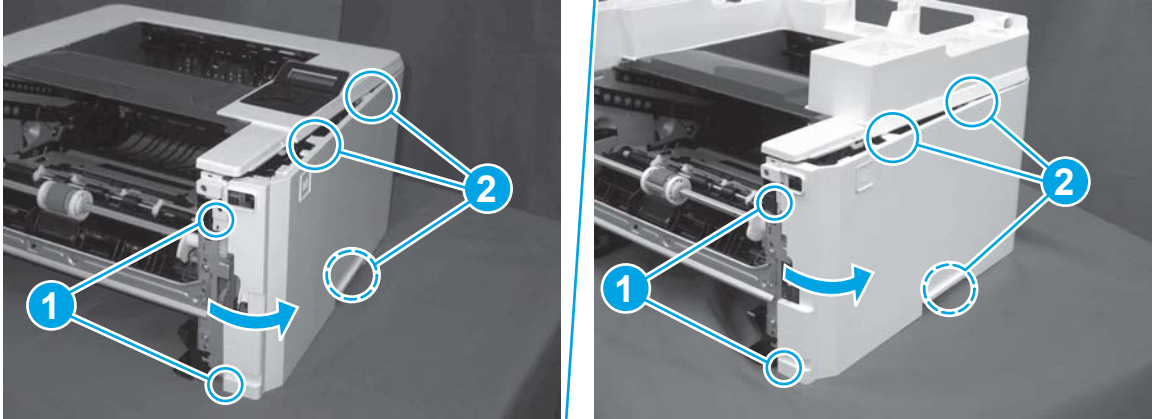

2. Open the rear door, release two bosses (callout 1), and then remove the cover (callout 2).

Figure 1-180 Remove the cover

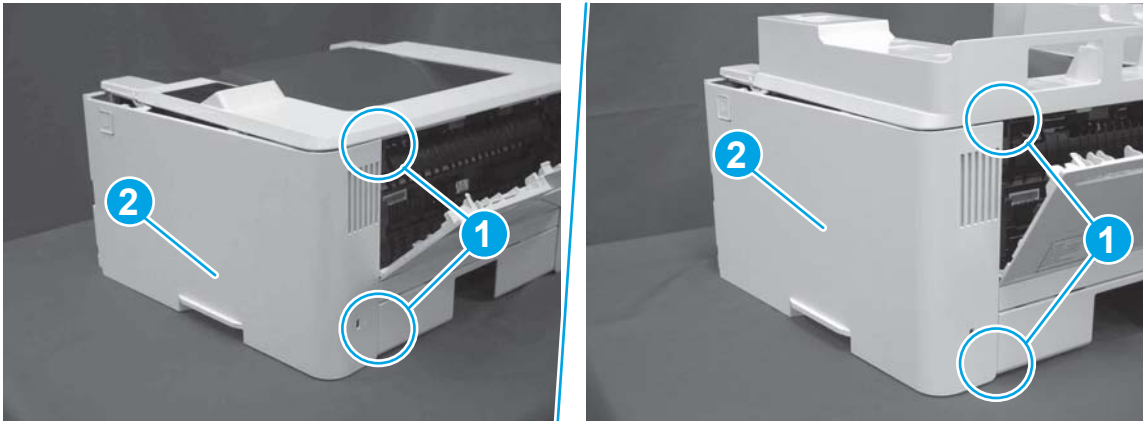

Step 5: Remove the control panel (M329/M428/M429)

1. Disconnect one FFC (callout 1), and then release the FFC from the guide (callout 2).

Figure 1-181 Disconnect one connector

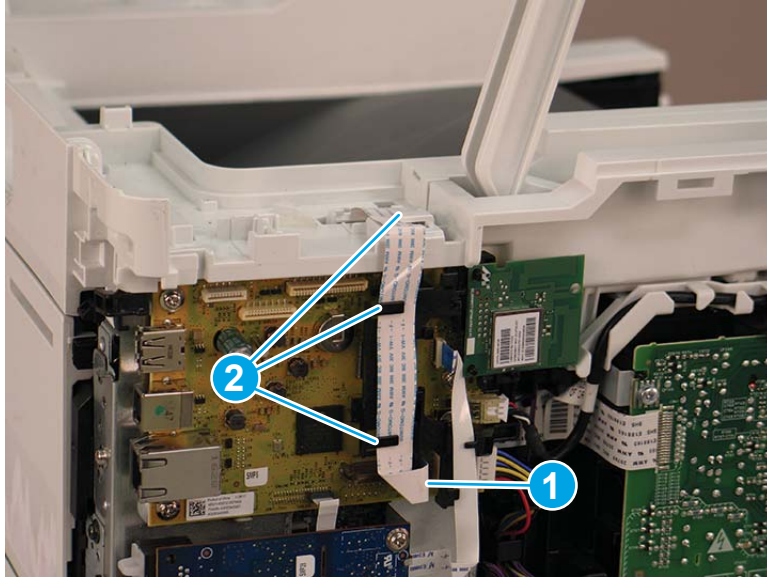

2. Remove one screw (callout 1).

Figure 1-182 Remove one screw

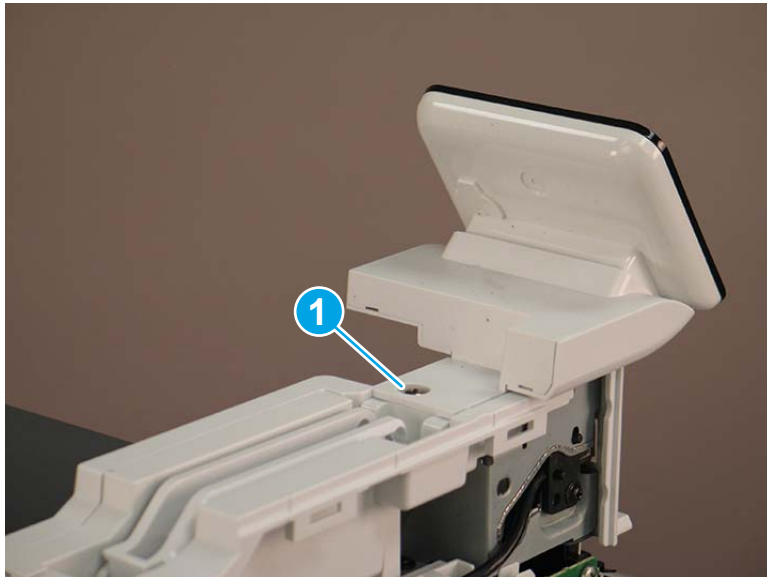

3. Use a small flat-blade screwdriver to release two tabs (callout 1) on the control-panel cable cover.

Figure 1-183 Release two tabs

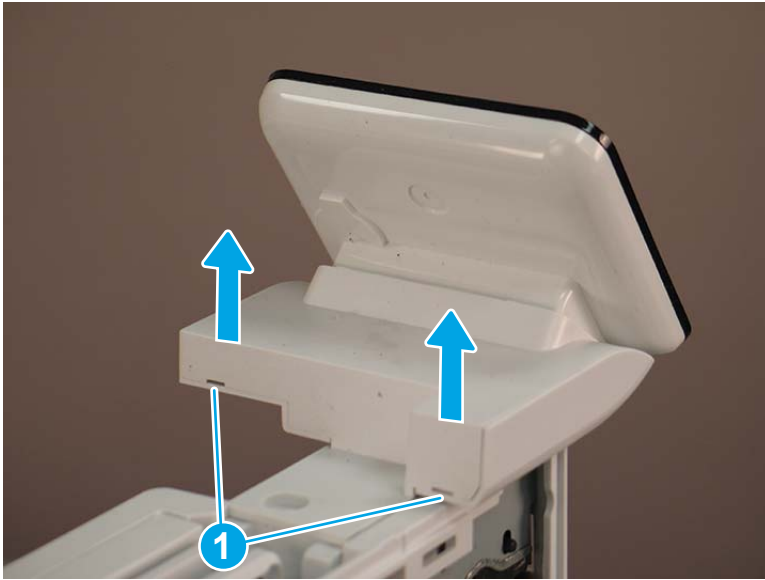

4. Remove the control-panel cable cover.

Figure 1-184 Remove the cover



5. Remove one grounding screw (callout 1), and then move the ground cable (callout 2) out of the way.

Figure 1-185 Remove one screw

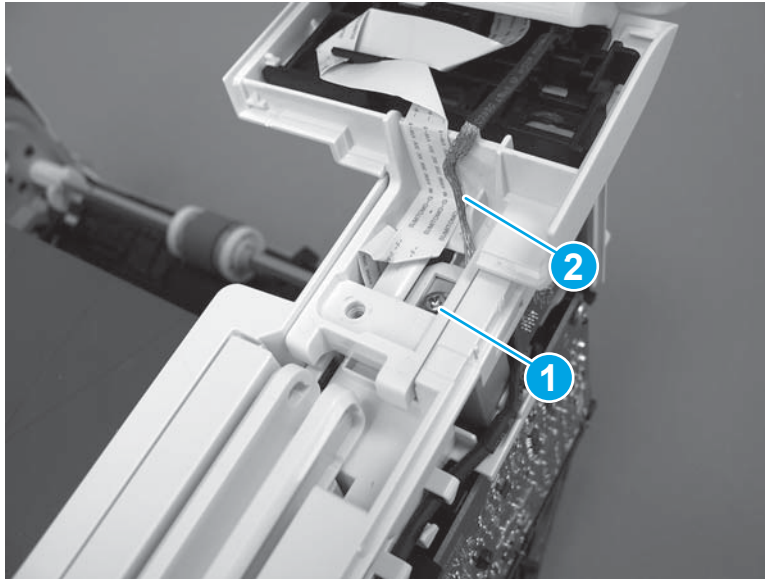

6. Move the FFC out of the way, and then remove two screws (callout 1).

Figure 1-186 Remove two screws



7. Slightly lift up the control-panel assembly to separate it from the top cover.

⚠ CAUTION: The control panel assembly is still connected to the printer by the FFC. Do not attempt to completely remove the assembly.

Figure 1-187 Lift up the control-panel assembly



8. Lift up the control-panel FFC cover to remove the control-panel assembly.

Figure 1-188 Remove the control-panel assembly

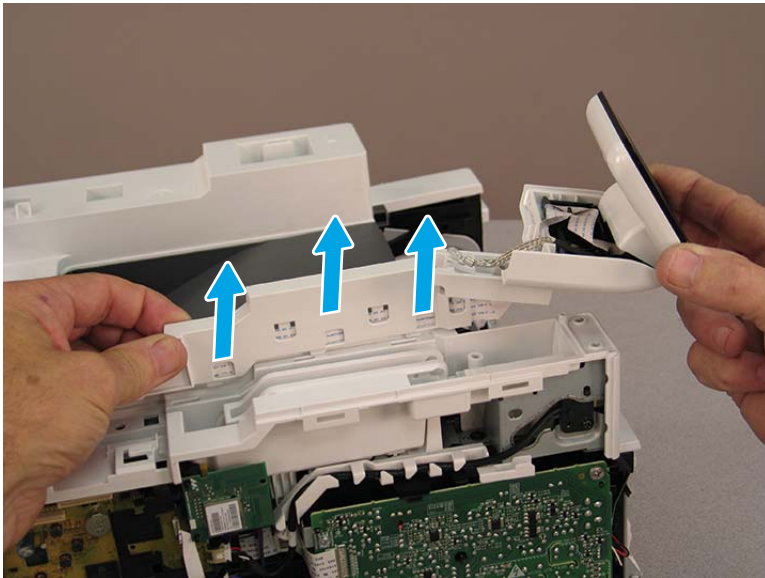

Step 6: Remove the integrated scanner assembly (M329/M428/M429)

📝 NOTE: M329/M428/M429 models only. The integrated scanner assembly (ISA) includes the sub-scanner assembly (SSA) and the automatic document feeder (ADF).

1. Raise the ISA.

Figure 1-189 Raise the ISA

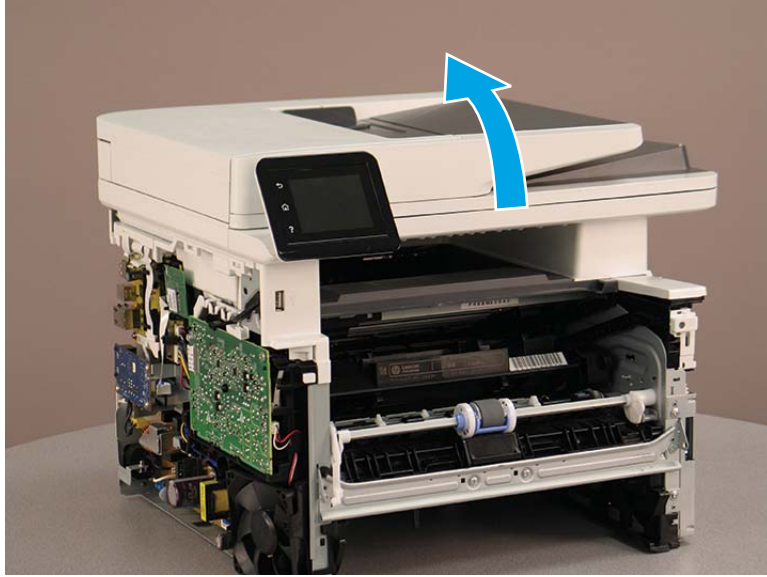

2. Release the ISA flat-flexible cable (FFC) cover (callout 1), and then remove it (callout 2).

Figure 1-190 Remove the ISA FFC cover

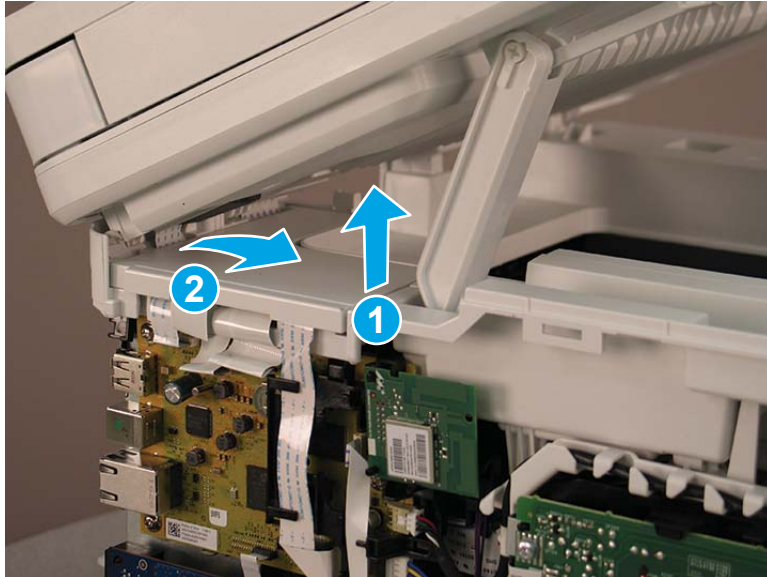

3. Disconnect three FFCs (callout 1), and then remove the ferrite (callout 2) from the holder.

⚠ CAUTION: The ferrite is not captive on the FFC. Do not lose the ferrite while handling the ISA.

Figure 1-191 Disconnect three FFCs

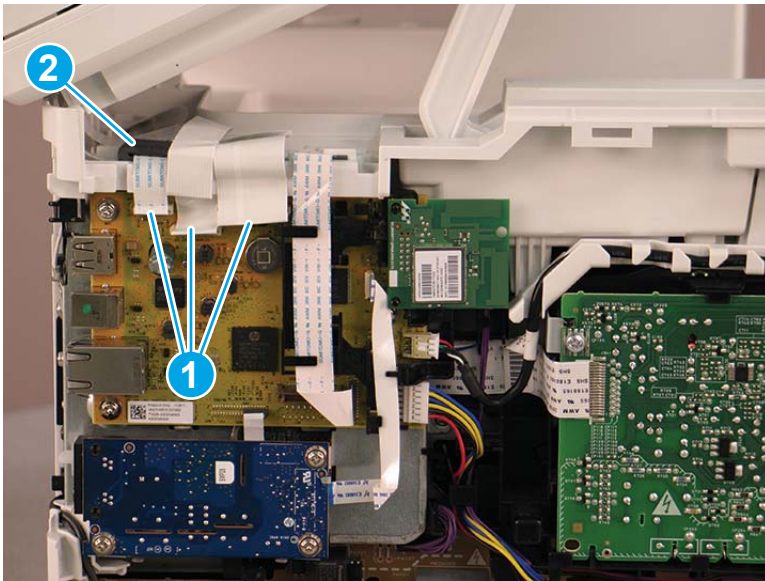

4. Remove one screw (callout 1).

Figure 1-192 Remove one screw

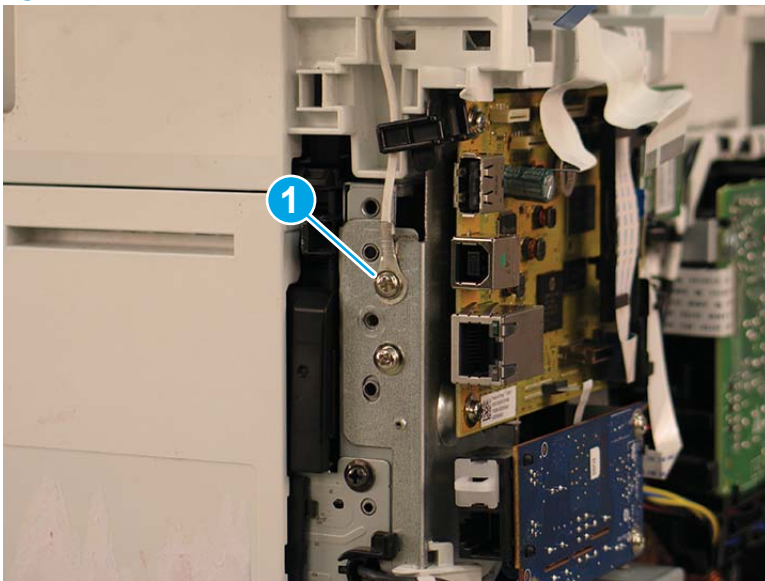

5. Pass the ground wire through the opening in the top cover.

Figure 1-193 Pass the wire through the opening

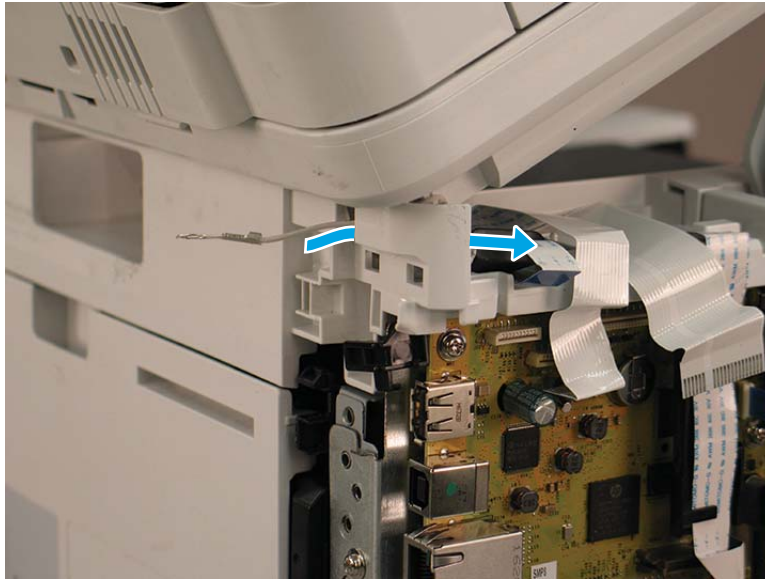

6. Release one tab (callout 1), and then rotate the ISA slider pin (callout 2) towards the front of the printer to release it.

Figure 1-194 Release one tab and rotate the slider pin

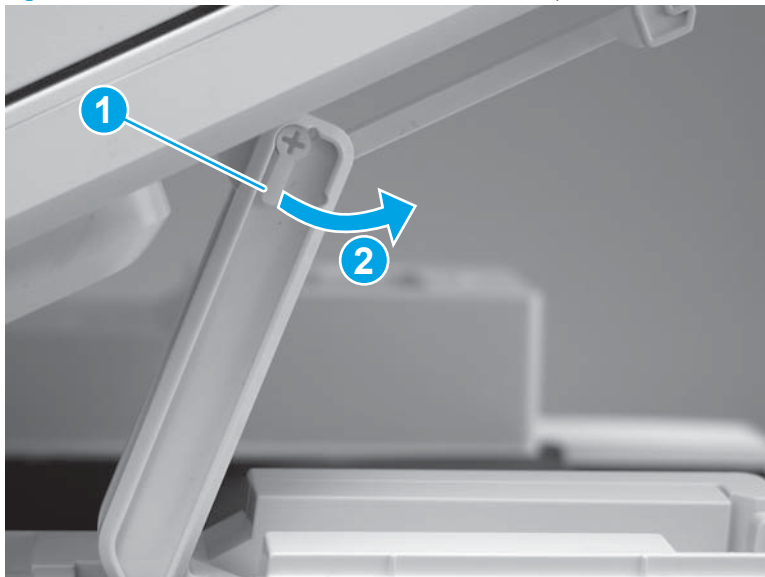

7. Remove the slider pin.

 **Reinstallation tip:** Align the keyed portion of the locking pin with the slot and hole in the support arm.

Figure 1-195 Remove the slider pin

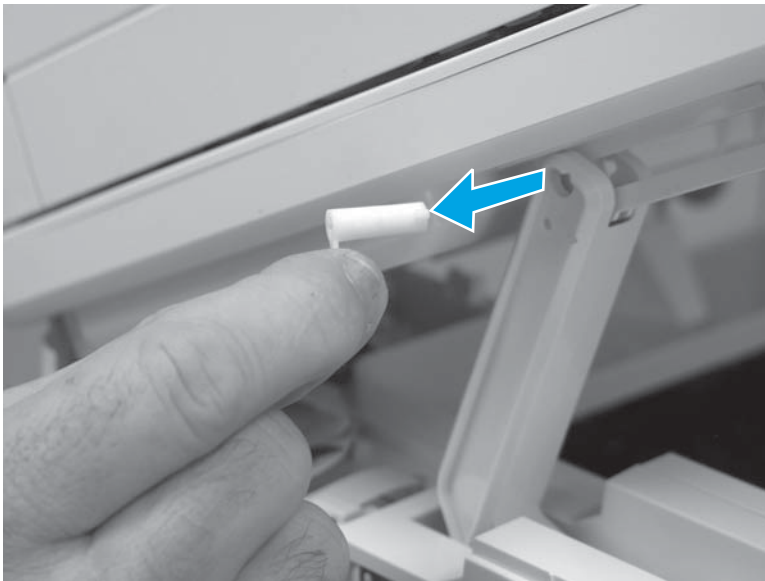

8. Rotate the ISA towards the rear of the printer until it stops.

Figure 1-196 Rotate the ISA towards the rear of the printer

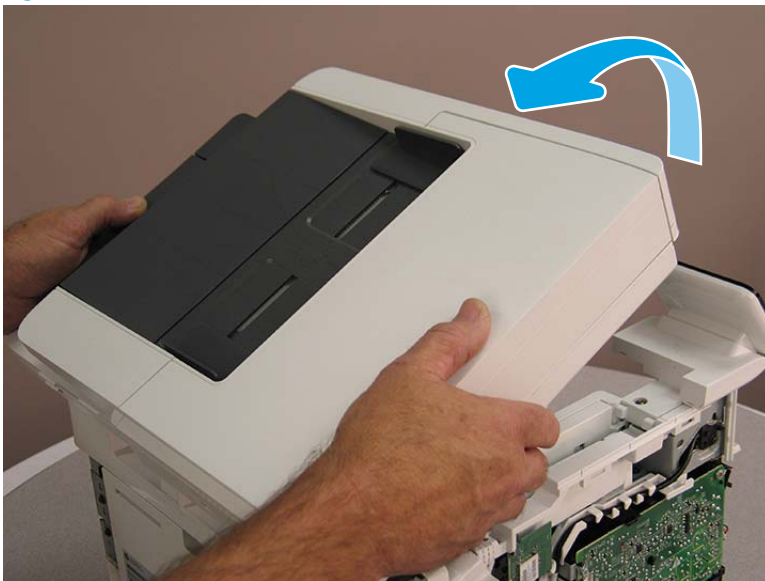

9. Slide the ISA as shown to release it.

Figure 1-197 Release the ISA

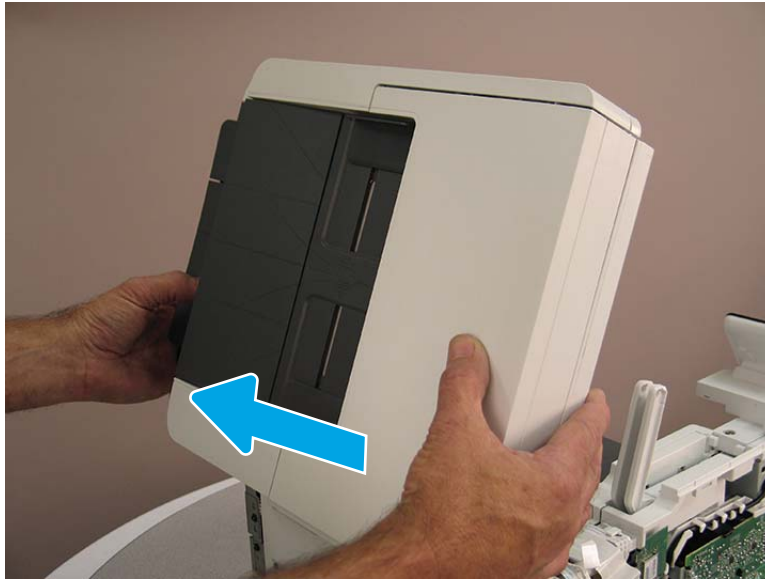

10. Remove the ISA.

Figure 1-198 Remove the ISA

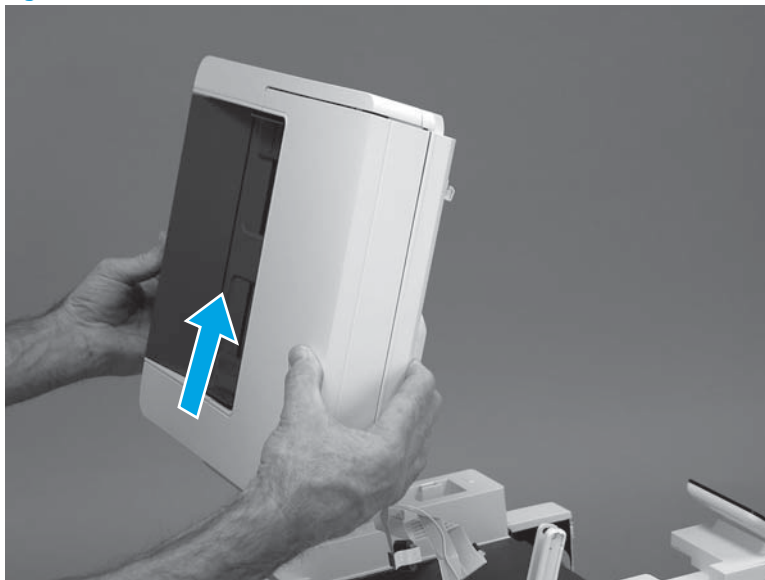

Step 7: Remove the top cover (M329/M428/M429)

1. Release the USB cable (callout 1) from the cable guide.

Figure 1-199 Remove the USB cable

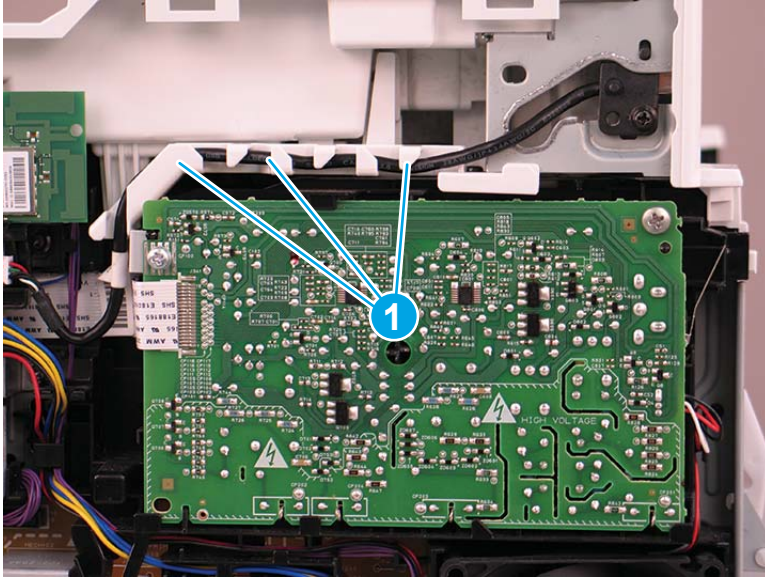

2. Remove one screw (callout 1), and then remove the support arm (callout 2).

⚠ CAUTION: The support arm is spring loaded and can unexpectedly spring into the open position. To avoid injury, do not place a finger in the screw well when the support arm is in the closed position.

Figure 1-200 Remove the support arm

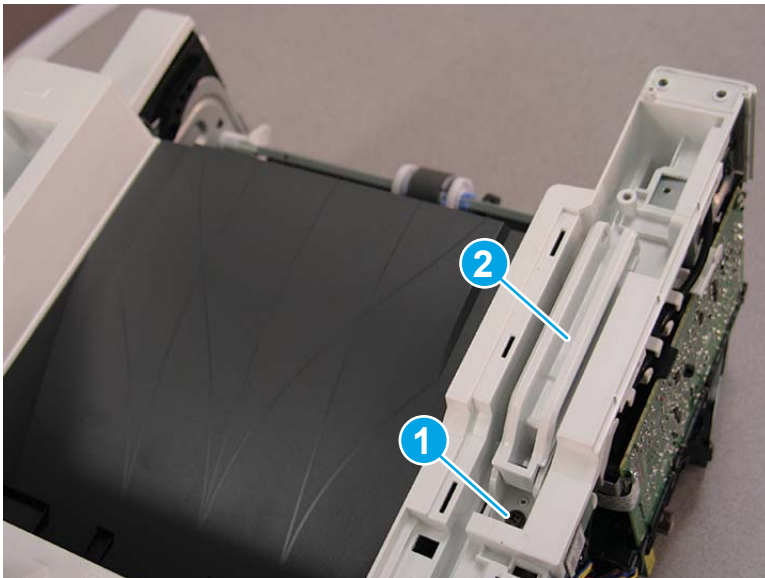

3. Remove five screws (callout 1), release four bosses (callout 2), and then remove the top cover (callout 3).

Figure 1-201 Remove the cover

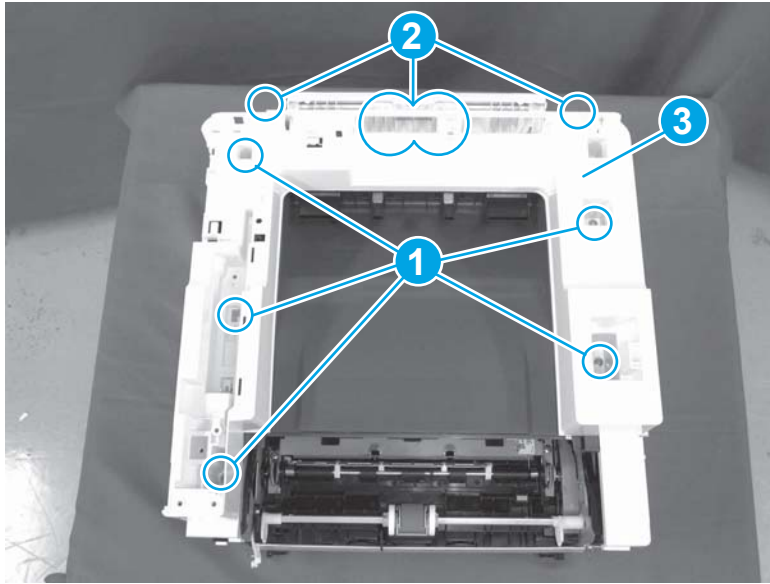

Step 8: Remove the cable guide (M329/M428/M429)

1. Turn the top cover over, and then release one tab (callout 1).

Figure 1-202 Release one tab

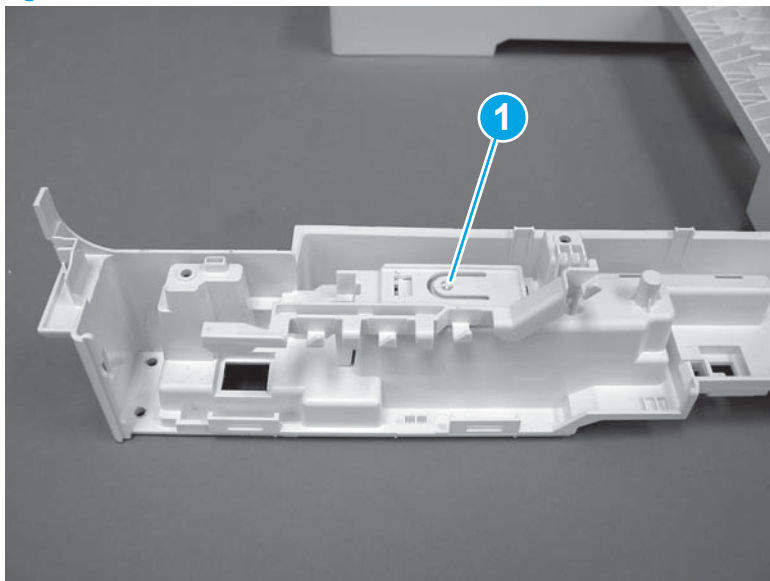

2. Slide the guide as shown to release it.

Figure 1-203 Release the guide

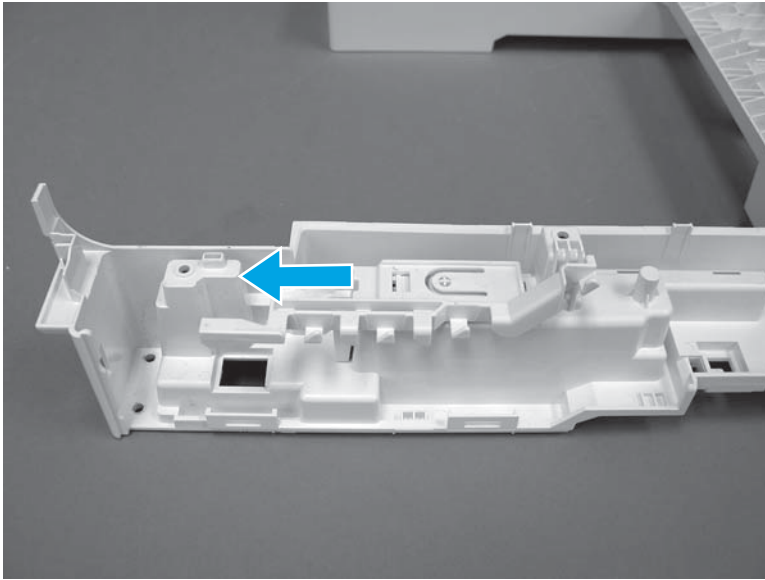

3. Remove the guide.

Figure 1-204 Remove the guide

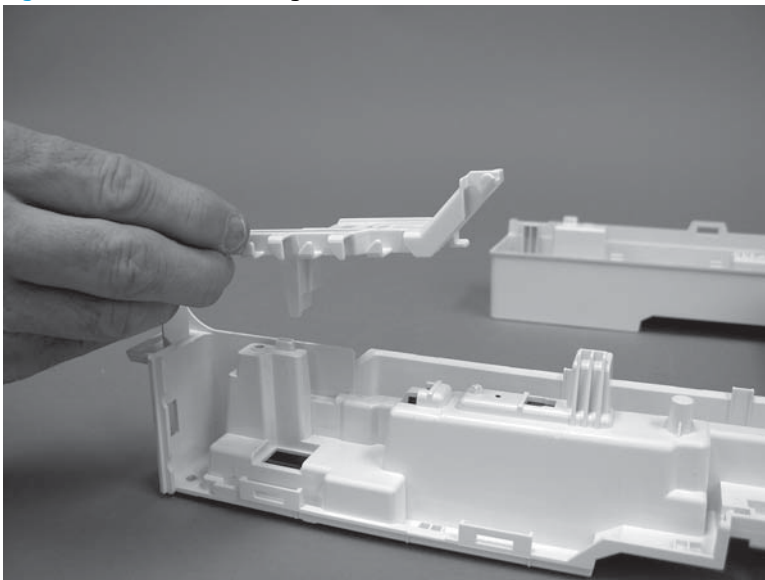



Step 9: Unpack the replacement assembly

1. Dispose of the defective part.

 **NOTE:** HP recommends responsible disposal of the defective part.

<http://www8.hp.com/us/en/hp-information/environment/product-recycling.html>

2. Unpack the replacement part from the packaging.

 **CAUTION:**  Some parts are sensitive to electrostatic discharge (ESD). Always perform service work at an ESD-protected workstation or mat. If an ESD workstation or mat is not available, touch the sheet-metal chassis to provide a static ground before touching an ESD-sensitive assembly. Protect the ESD-sensitive assemblies by placing them in ESD pouches when they are out of the printer.

If the replacement part is a roller or pad, avoid touching the spongy part of it. Skin oils on the roller or pad can cause paper pickup and/or print-quality problems. HP recommends using disposable gloves when handling rollers or pads or washing your hands before touching rollers or pads.

 **IMPORTANT:** Make sure that all of the shipping materials (for example shipping tape) are removed from the replacement part prior to installation.

3. To install an assembly, reverse the removal steps.

 **NOTE:** When applicable, special installation instructions are provided for an assembly at the end of the removal procedure. Always completely read the removal instructions and follow all special installation instructions.

Removal and replacement: Top cover (M304/M305/M404/M405)

- [Introduction](#)
- [Step 1: Remove Tray 2](#)
- [Step 2: Remove the cartridge door assembly](#)
- [Step 3: Remove the left cover](#)
- [Step 4: Remove the right cover](#)
- [Step 5: Remove the top cover \(M304/M305/M404/M405\)](#)
- [Step 7: Unpack the replacement assembly](#)

Introduction

This document provides the procedures to remove and replace the top cover (M304/M305/M404/M405).

Before performing service

Turn the printer power off

- Disconnect the power cable.

 **WARNING!** To avoid damage to the printer, turn the printer off, wait 30 seconds, and then remove the power cable before attempting to service the printer.

Use the table below to identify the correct part number for your printer. To order the part, go to www.hp.com/buy/parts.

Top cover (M304/M305/M404/M405) part number

RC4-2956-000CN

Top cover (M304/M305/M404/M405)

Required tools

- #2 Phillips screwdriver with a magnetic tip.

After performing service

Turn the printer power on

- Connect the power cable.
- Use the power switch to turn the power on.

Post service test

Make sure that the printer initializes to a **Ready** state.

Print a configuration page to make sure that the printer is functioning correctly.

Step 1: Remove Tray 2

- ▲ Pull the tray straight out of the printer to remove it.

Figure 1-205 Remove the tray



Step 2: Remove the cartridge door assembly

 **NOTE:** If the toner cartridge was not removed prior to servicing the printer, remove it now.

1. Release the support shaft (callout 1), and then slide it toward the center of the door (callout 2).

 **TIP:** It might be easier to release the support shaft by using a small flat-blade screwdriver.

Figure 1-206 Release the support shaft

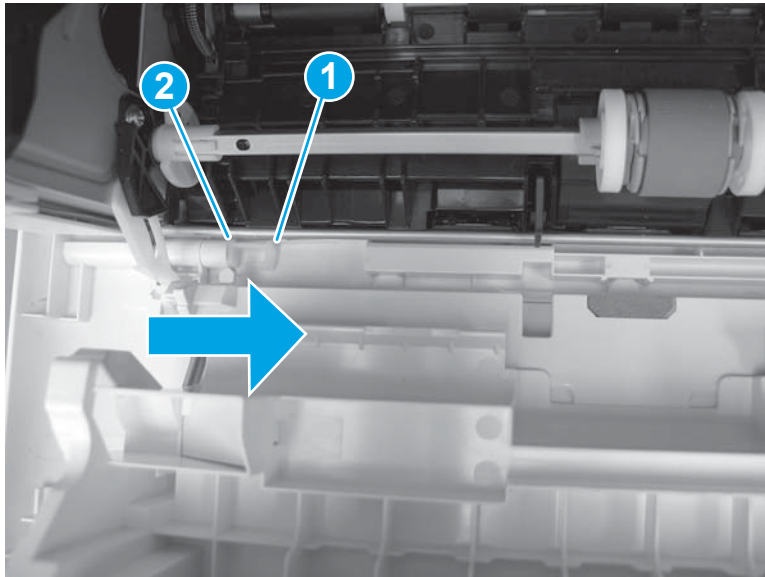

2. Remove the support shaft.

Figure 1-207 Remove the support shaft

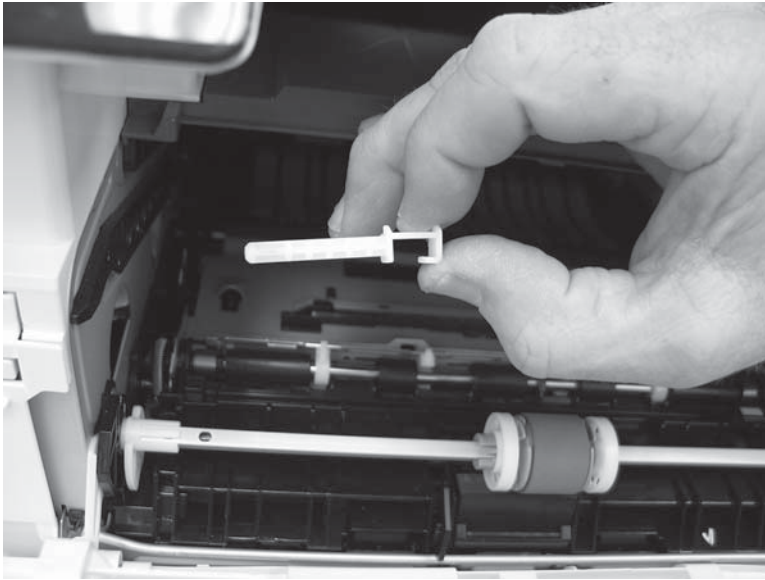

3. Release one tab (callout 1), and then slide the guide out of the printer (callout 2).

⚠ CAUTION: Be careful, the tab (callout 1) can be easily broken.

Figure 1-208 Remove the guide

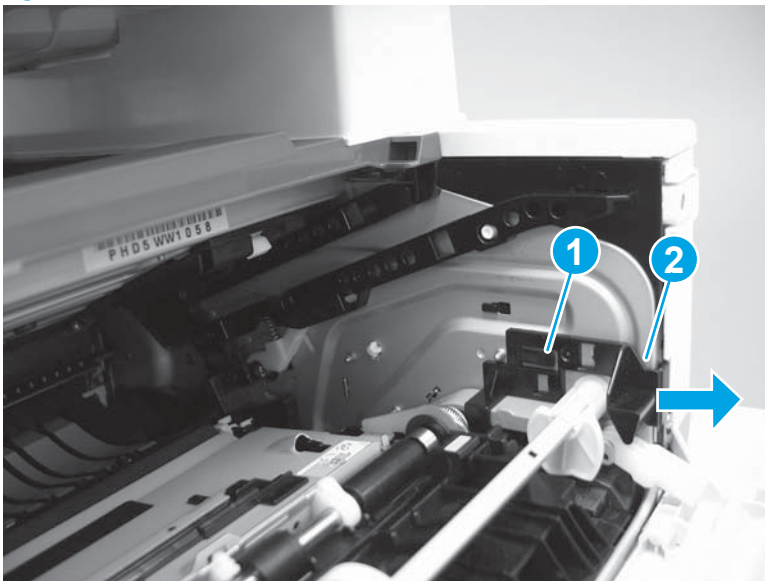

4. Use a small flat-blade screwdriver to gently pry the white-plastic door arm (callout 1) off of the gray-plastic pressure-release link (callout 2) to release the door arm.

Figure 1-209 Release the pressure-release link

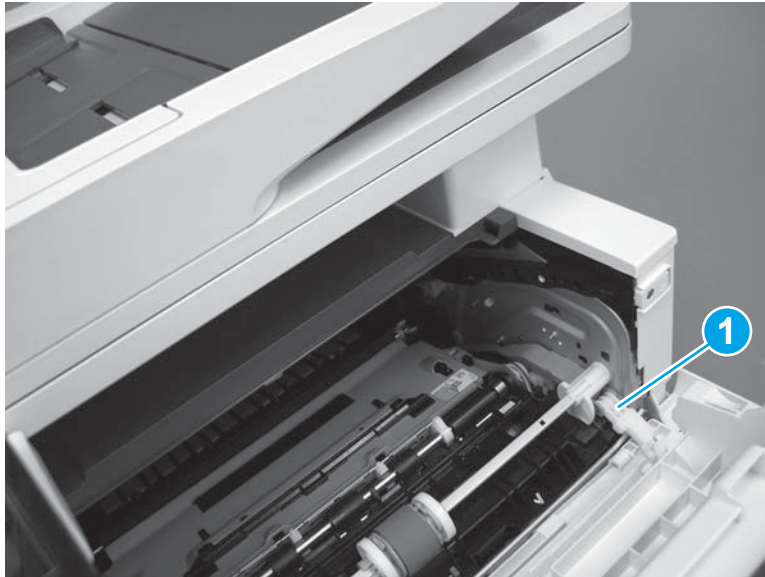

5. With the door in the partially closed position, slightly raise the left end (callout 1; raise it over the sheet-metal hinge boss), and then slide the door to the left (callout 2) to release the right hinge (callout 3).

⚠ CAUTION: The door is still attached to the printer by the left-side retainer arm. Do not attempt to completely remove the door.

💡 Reinstallation tip: When reinstalling the door, there are two right-side hinge pins (not shown in callout 3). Keep a finger pressed on the left-side retainer arm so that it does not disengage from the door.

Figure 1-210 Release the door

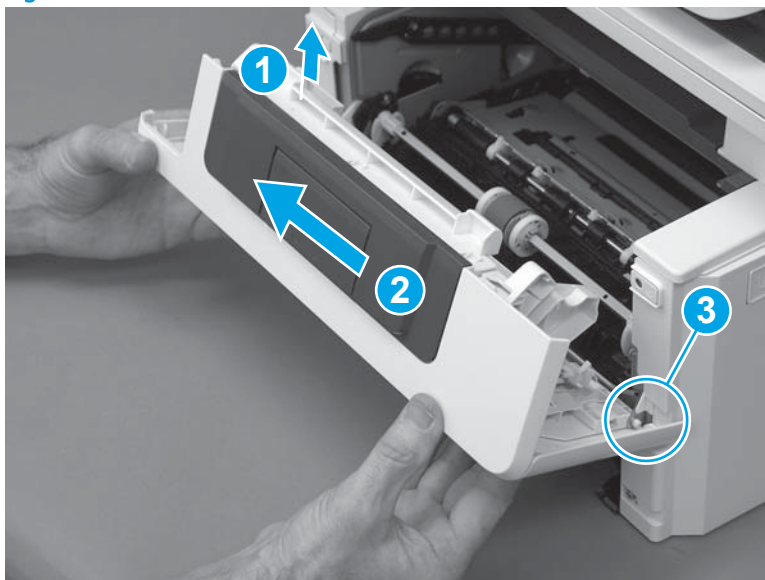

6. Rotate the door away from the printer until the keyed pin on the left-side retainer arm can disengage from the door.

Figure 1-211 Release the left-side retainer arm

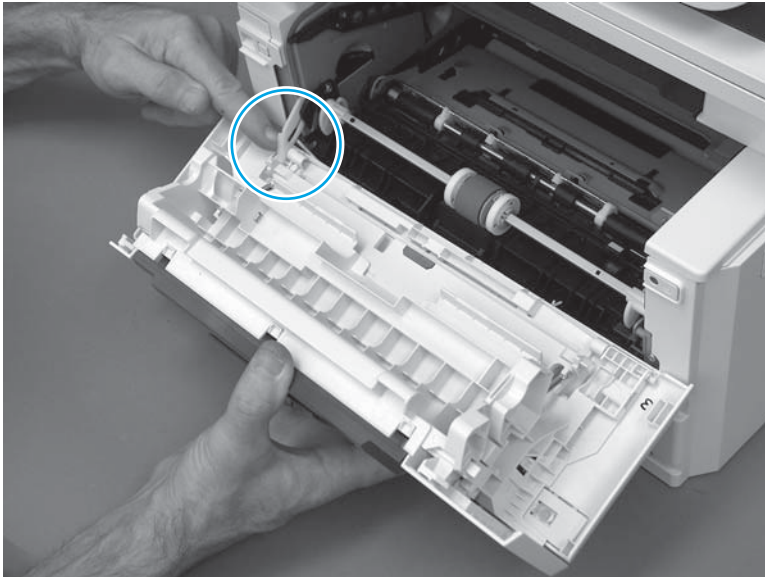

7. Remove the door.

Figure 1-212 Remove the door

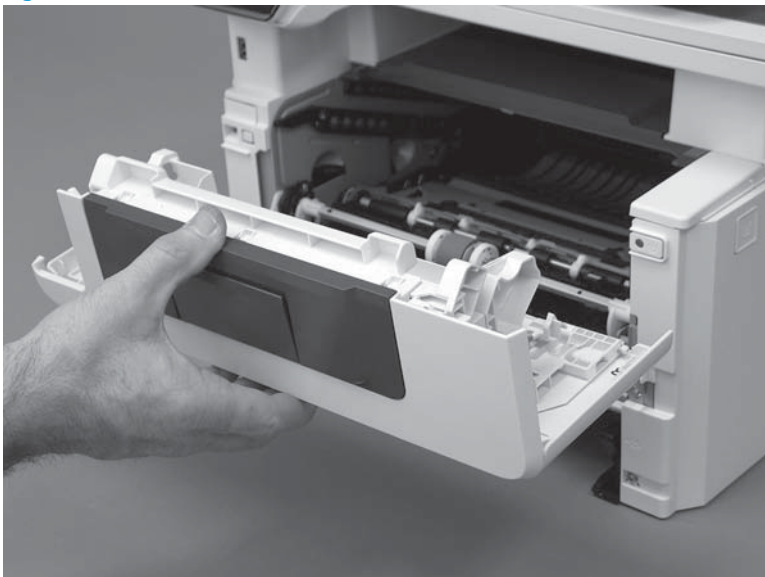

Step 3: Remove the left cover

1. Remove one screw (callout 1).

Figure 1-213 Remove one screw

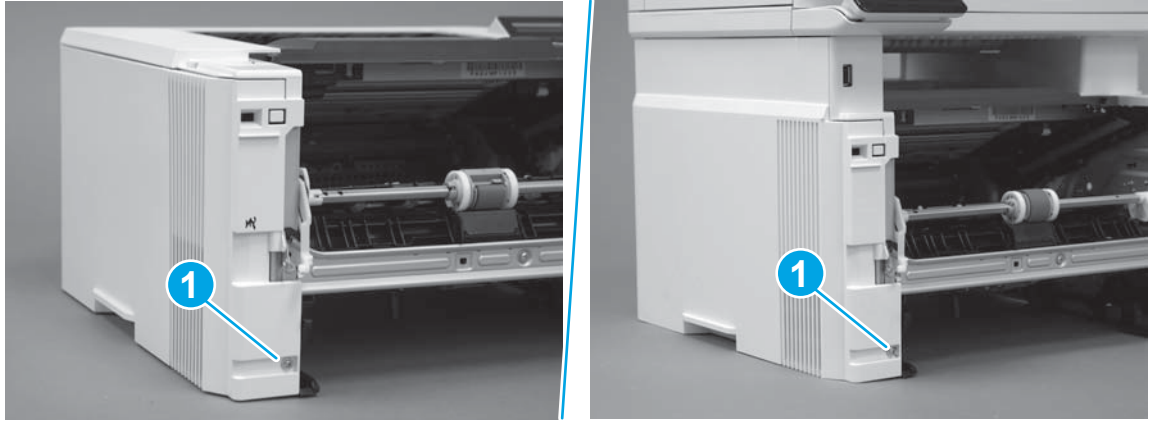

2. Open the rear door, release two bosses (callout 1), and then release three tabs (callout 2).

Figure 1-214 Release two bosses and three tabs

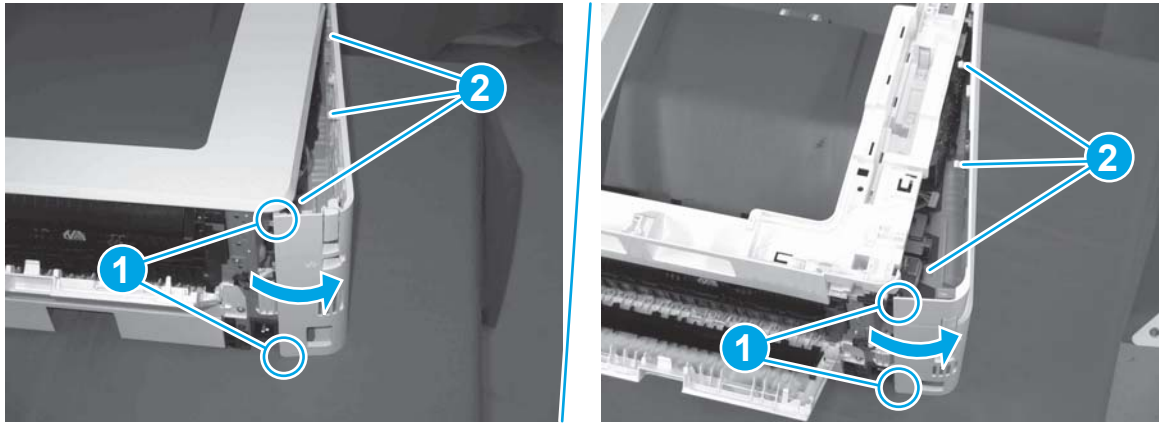

3. At the front of the printer, do one of the following:
 - **M304/M305/M404/M405:** Release two bosses (callout 1), and then remove the cover (callout 2).
 - **M329/M428/M429:** Release one tab (callout 3), two bosses (callout 4), and then remove the cover (callout 5).

⚠ CAUTION: Be careful when releasing the upper bosses on the M329/M428/M429 cover. One portion of the cover (callout 6) is fragile and is easily broken.

Figure 1-215 Remove the cover

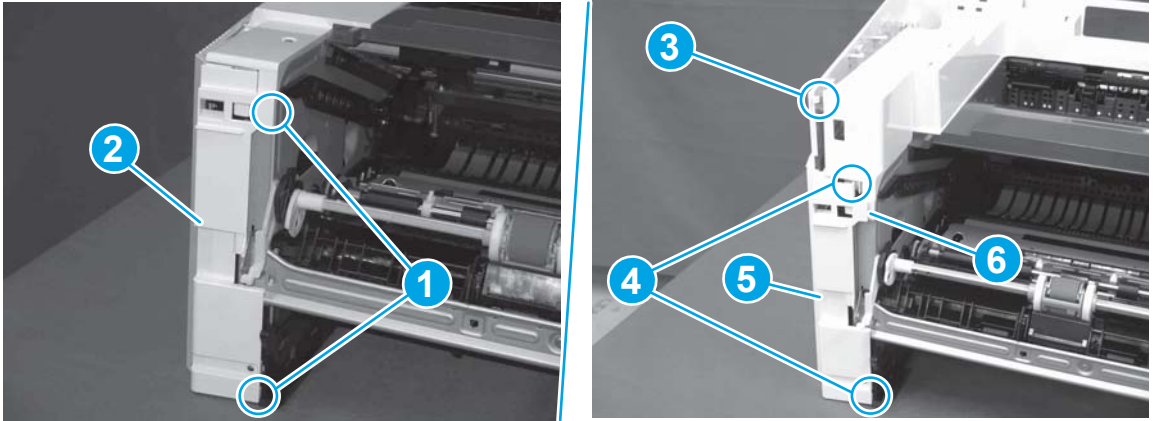

Step 4: Remove the right cover

1. At the front of the printer, release two bosses (callout 1), and then release three tabs (callout 2).

 **Reinstallation tip:** Remove, and then reinstall the cover if the switch or button does not correctly function.

Figure 1-216 Release two bosses and three tabs

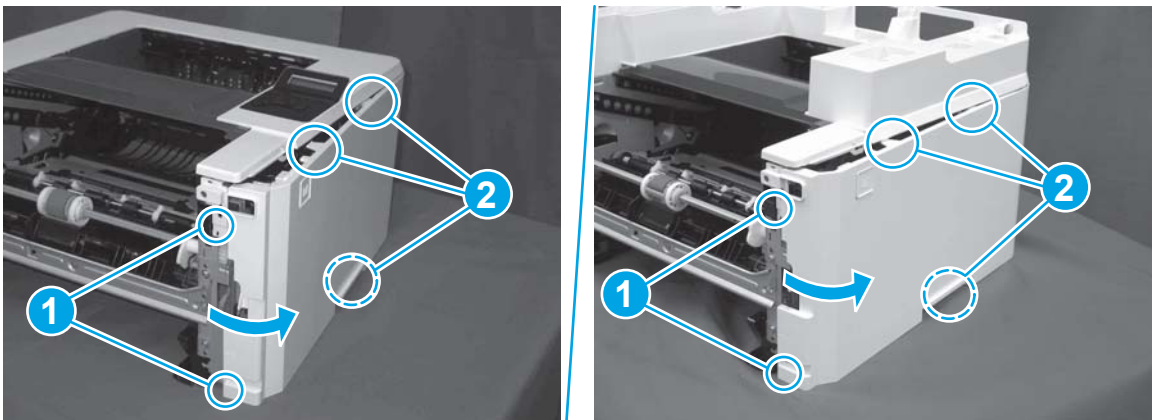

2. Open the rear door, release two bosses (callout 1), and then remove the cover (callout 2).

Figure 1-217 Remove the cover

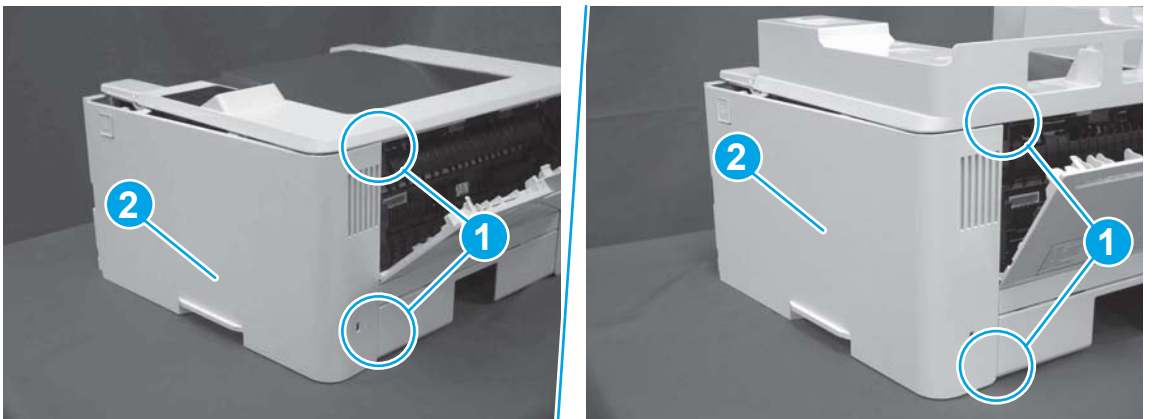

Step 5: Remove the top cover (M304/M305/M404/M405)

1. Remove one screw (callout 1).

Figure 1-218 Remove one screw



2. At the right side of the printer, release the one boss (callout 1), and then release one tab (callout 2).

Figure 1-219 Release one boss and one tab

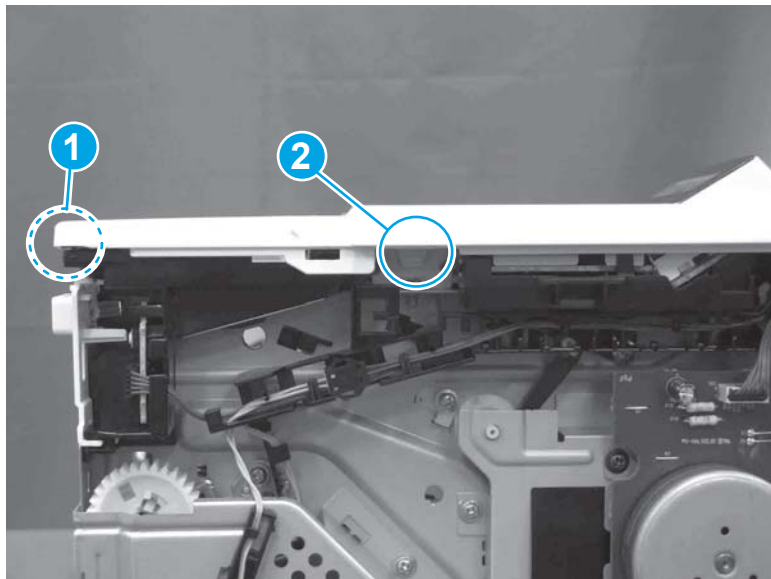

3. Release four tabs (callout 1), release four bosses (callout 2), and then remove the top cover (callout 3).

 **TIP:** Open the rear door to make releasing the bosses (callout 3) easier.

Figure 1-220 Remove the cover



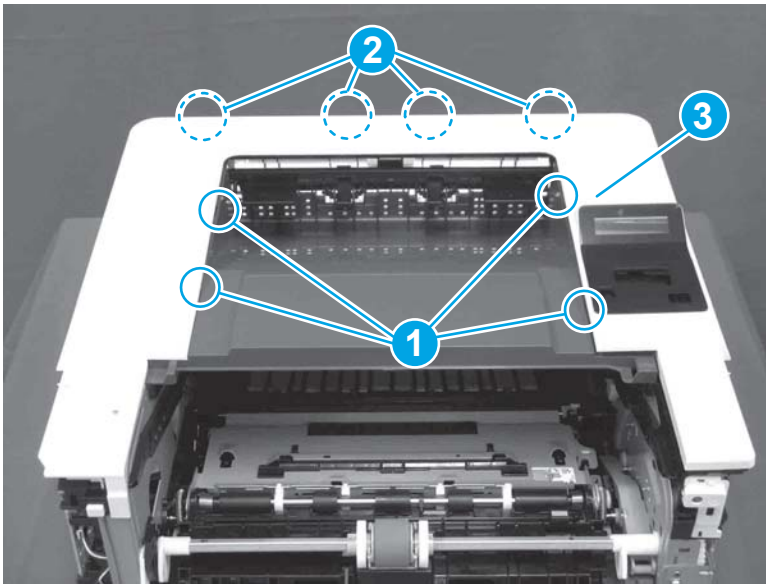

Step 7: Unpack the replacement assembly

1. Dispose of the defective part.

 **NOTE:** HP recommends responsible disposal of the defective part.

<http://www8.hp.com/us/en/hp-information/environment/product-recycling.html>

2. Unpack the replacement part from the packaging.

 **CAUTION:**  Some parts are sensitive to electrostatic discharge (ESD). Always perform service work at an ESD-protected workstation or mat. If an ESD workstation or mat is not available, touch the sheet-metal chassis to provide a static ground before touching an ESD-sensitive assembly. Protect the ESD-sensitive assemblies by placing them in ESD pouches when they are out of the printer.

If the replacement part is a roller or pad, avoid touching the spongy part of it. Skin oils on the roller or pad can cause paper pickup and/or print-quality problems. HP recommends using disposable gloves when handling rollers or pads or washing your hands before touching rollers or pads.

 **IMPORTANT:** Make sure that all of the shipping materials (for example shipping tape) are removed from the replacement part prior to installation.

3. To install an assembly, reverse the removal steps.

 **NOTE:** When applicable, special installation instructions are provided for an assembly at the end of the removal procedure. Always completely read the removal instructions and follow all special installation instructions.

Removal and replacement: 2-line LCD operator and indication covers (M304/M305/M404/M405)

- [Introduction](#)
- [Step 1: Remove Tray 2](#)
- [Step 2: Remove the cartridge door assembly](#)
- [Step 3: Remove the left cover](#)
- [Step 4: Remove the right cover](#)
- [Step 5: Remove the top cover \(M304/M305/M404/M405\)](#)
- [Step 6: Remove the 2-line LCD operator and indication covers \(M304/M305/M404/M405\)](#)
- [Step 7: Unpack the replacement assembly](#)

Introduction

This document provides the procedures to remove and replace the 2-line LCD operator and indication covers.

Before performing service

Turn the printer power off

- Disconnect the power cable.

 **WARNING!** To avoid damage to the printer, turn the printer off, wait 30 seconds, and then remove the power cable before attempting to service the printer.

Use the table below to identify the correct part number for your printer. To order the part, go to www.hp.com/buy/parts.

2-line LCD operator and indication covers (M304/M305/M404/M405) part number	
RC4-3312-000CN	2-line LCD operator cover (M304/M305/M404/M405; non-wireless models)
RC4-3322-000CN	2-line LCD operator cover (M404dw/M405dw; wireless model)
RL2-0675-000CN	2-line LCD indication cover (M304/M305/M404/M405)

Required tools

- #2 Phillips screwdriver with a magnetic tip.

After performing service

Turn the printer power on

- Connect the power cable.
- Use the power switch to turn the power on.

Post service test

Make sure that the printer initializes to a **Ready** state.

Print a configuration page to make sure that the printer is functioning correctly.

Step 1: Remove Tray 2

- ▲ Pull the tray straight out of the printer to remove it.

Figure 1-221 Remove the tray



Step 2: Remove the cartridge door assembly

 **NOTE:** If the toner cartridge was not removed prior to servicing the printer, remove it now.

1. Release the support shaft (callout 1), and then slide it toward the center of the door (callout 2).

 **TIP:** It might be easier to release the support shaft by using a small flat-blade screwdriver.

Figure 1-222 Release the support shaft

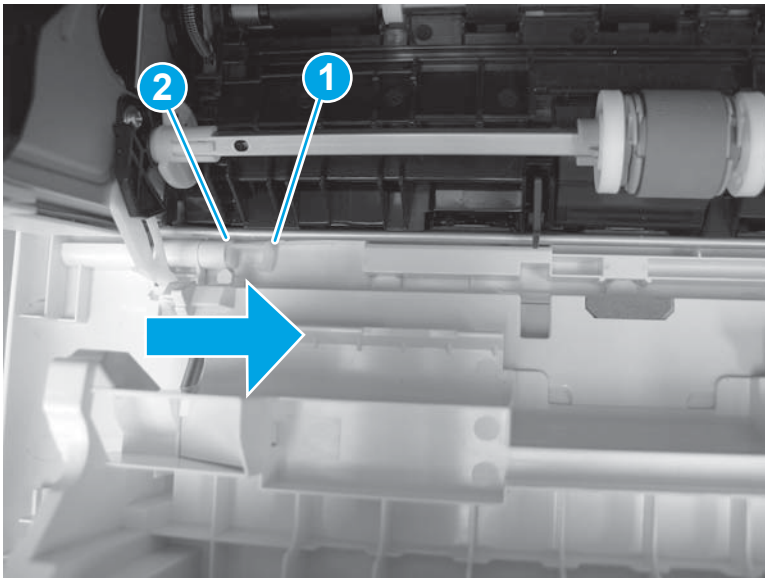

2. Remove the support shaft.

Figure 1-223 Remove the support shaft

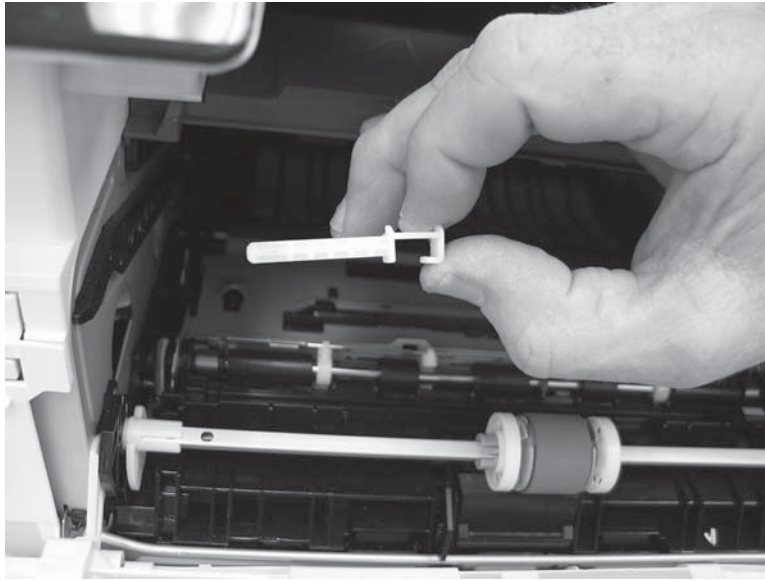

3. Release one tab (callout 1), and then slide the guide out of the printer (callout 2).

⚠ CAUTION: Be careful, the tab (callout 1) can be easily broken.

Figure 1-224 Remove the guide

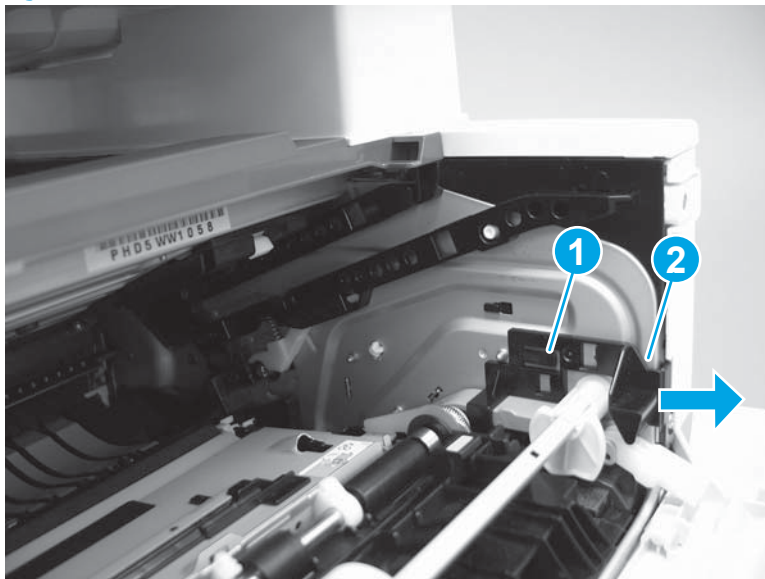

4. Use a small flat-blade screwdriver to gently pry the white-plastic door arm (callout 1) off of the gray-plastic pressure-release link (callout 2) to release the door arm.

Figure 1-225 Release the pressure-release link

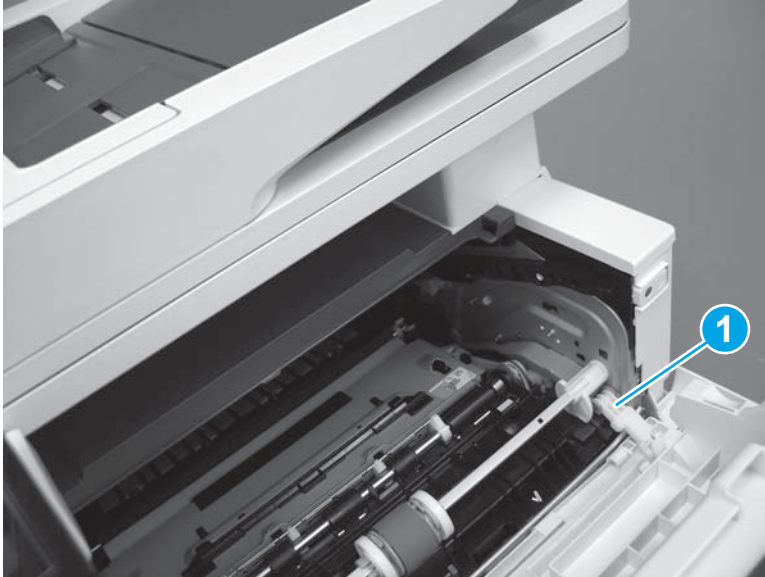

5. With the door in the partially closed position, slightly raise the left end (callout 1; raise it over the sheet-metal hinge boss), and then slide the door to the left (callout 2) to release the right hinge (callout 3).

⚠ CAUTION: The door is still attached to the printer by the left-side retainer arm. Do not attempt to completely remove the door.

💡 Reinstallation tip: When reinstalling the door, there are two right-side hinge pins (not shown in callout 3). Keep a finger pressed on the left-side retainer arm so that it does not disengage from the door.

Figure 1-226 Release the door

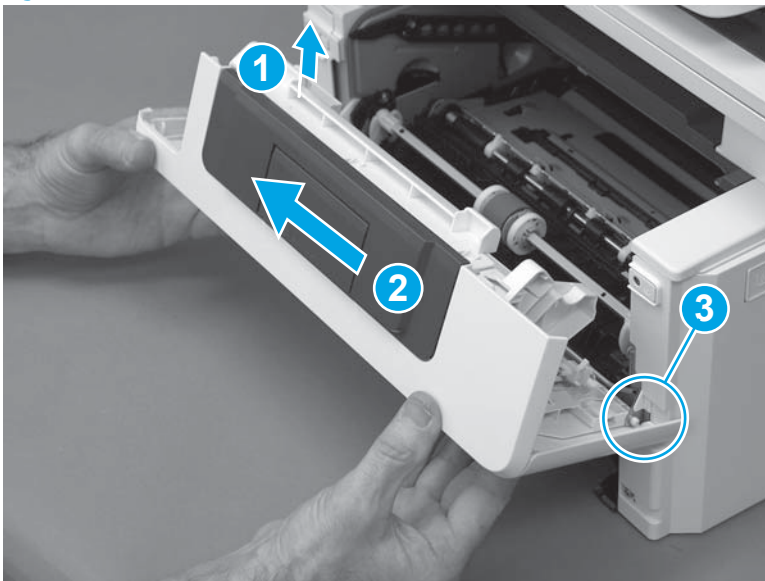

6. Rotate the door away from the printer until the keyed pin on the left-side retainer arm can disengage from the door.

Figure 1-227 Release the left-side retainer arm

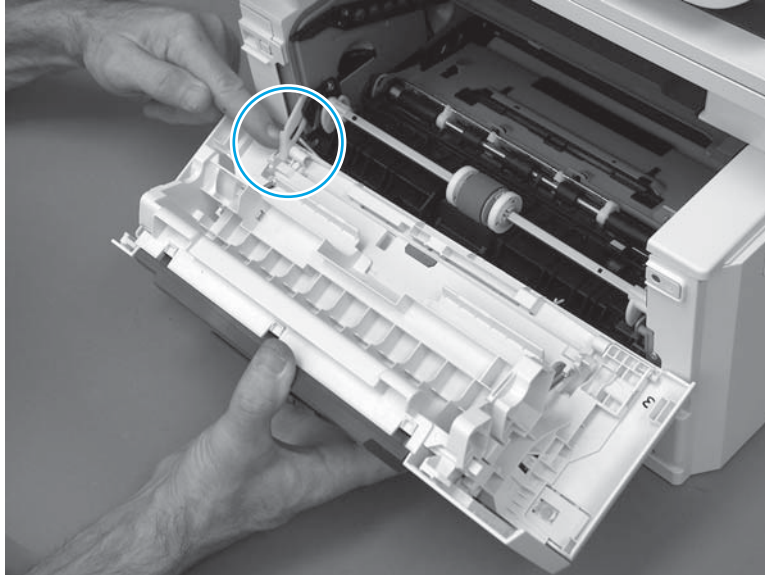

7. Remove the door.

Figure 1-228 Remove the door

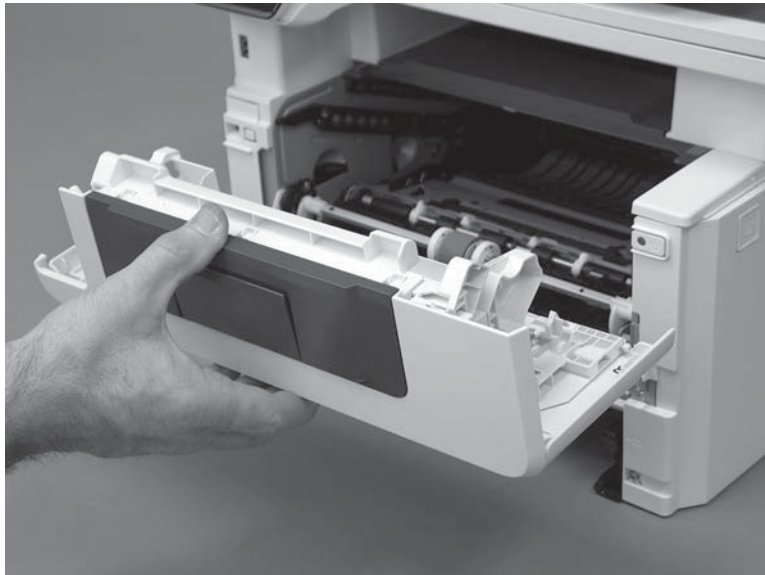

Step 3: Remove the left cover

1. Remove one screw (callout 1).

Figure 1-229 Remove one screw

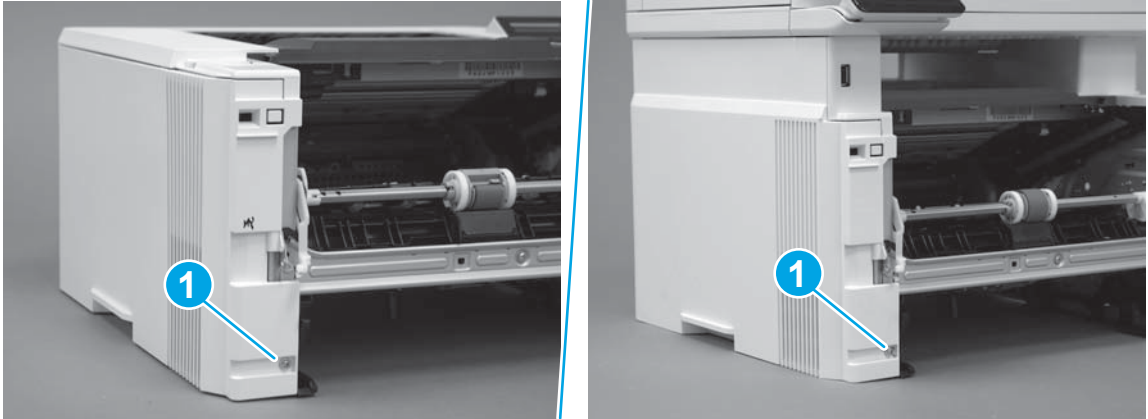

2. Open the rear door, release two bosses (callout 1), and then release three tabs (callout 2).

Figure 1-230 Release two bosses and three tabs

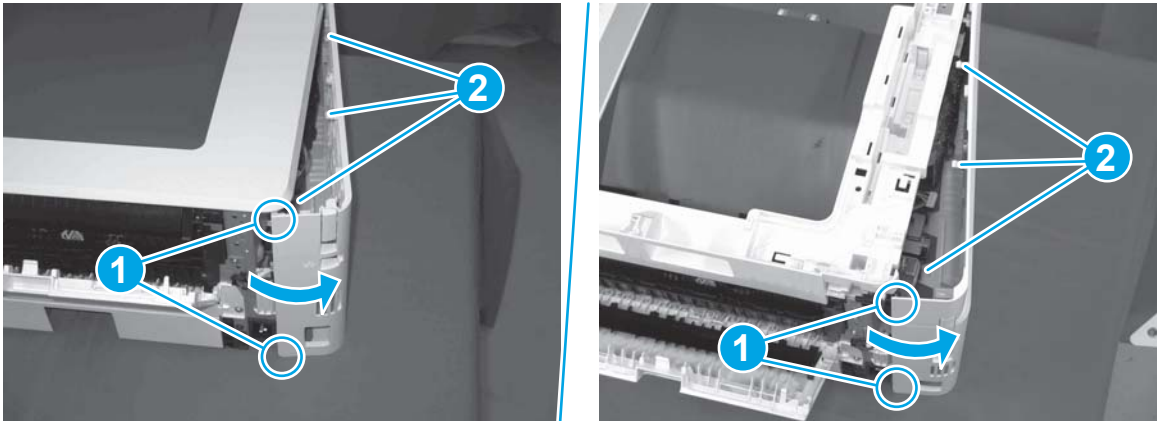

3. At the front of the printer, do one of the following:
 - **M304/M305/M404/M405:** Release two bosses (callout 1), and then remove the cover (callout 2).
 - **M329/M428/M429:** Release one tab (callout 3), two bosses (callout 4), and then remove the cover (callout 5).

CAUTION: Be careful when releasing the upper bosses on the M329/M428/M429 cover. One portion of the cover (callout 6) is fragile and is easily broken.

Figure 1-231 Remove the cover

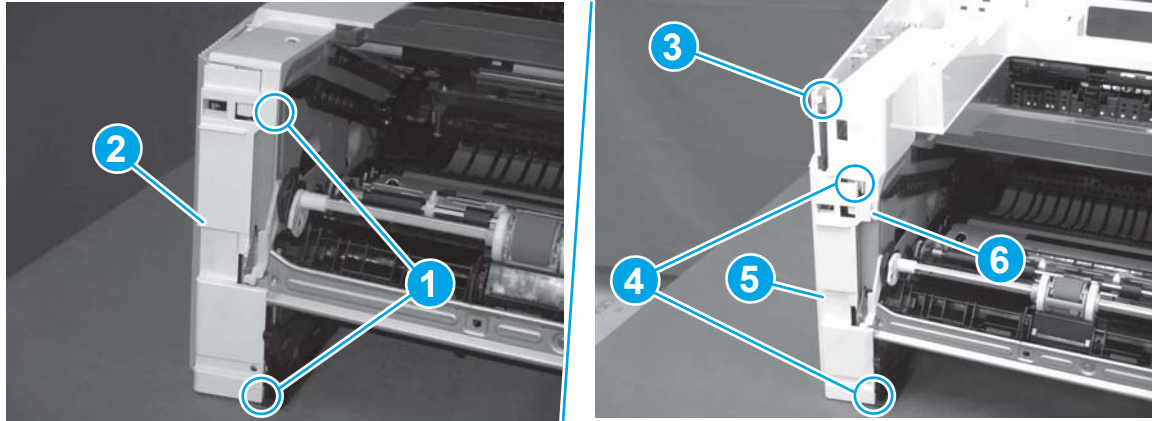

Step 4: Remove the right cover

1. At the front of the printer, release two bosses (callout 1), and then release three tabs (callout 2).

 **Reinstallation tip:** Remove, and then reinstall the cover if the switch or button does not correctly function.

Figure 1-232 Release two bosses and three tabs

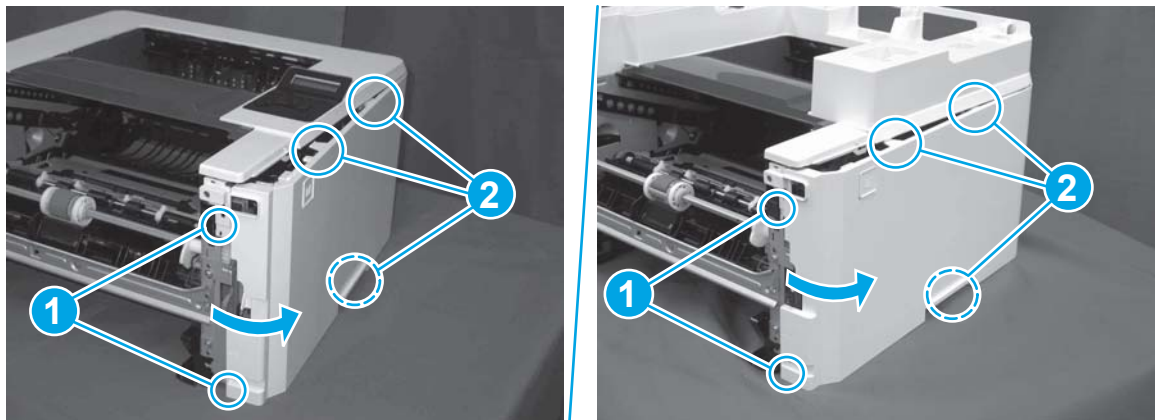

2. Open the rear door, release two bosses (callout 1), and then remove the cover (callout 2).

Figure 1-233 Remove the cover

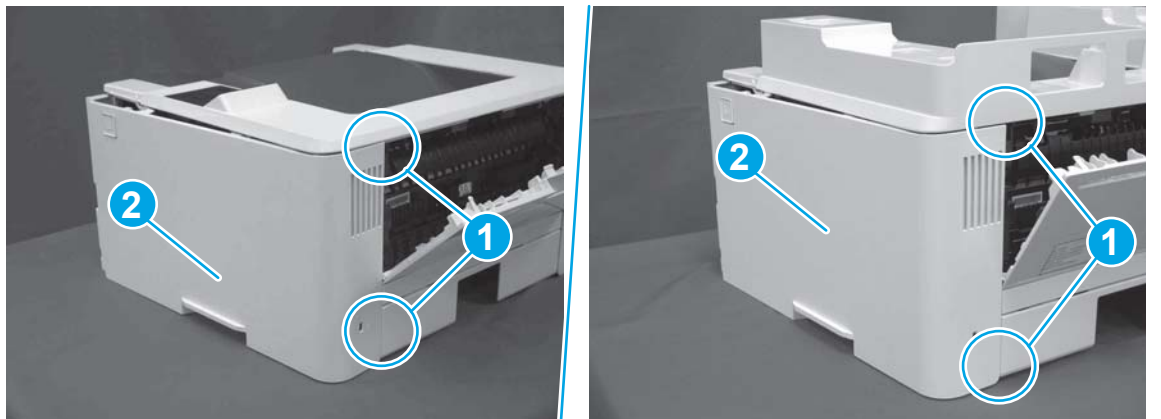

Step 5: Remove the top cover (M304/M305/M404/M405)

1. Remove one screw (callout 1).

Figure 1-234 Remove one screw



2. At the right side of the printer, release the one boss (callout 1), and then release one tab (callout 2).

Figure 1-235 Release one boss and one tab

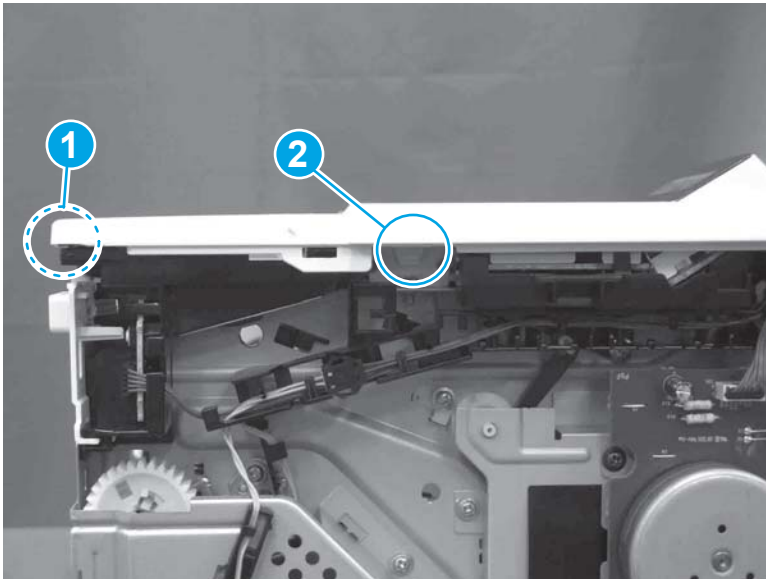

3. Release four tabs (callout 1), release four bosses (callout 2), and then remove the top cover (callout 3).

 **TIP:** Open the rear door to make releasing the bosses (callout 3) easier.

Figure 1-236 Remove the cover



Step 6: Remove the 2-line LCD operator and indication covers (M304/M305/M404/M405)

1. Rotate the top edge of the operator cover away from the printer to release it.

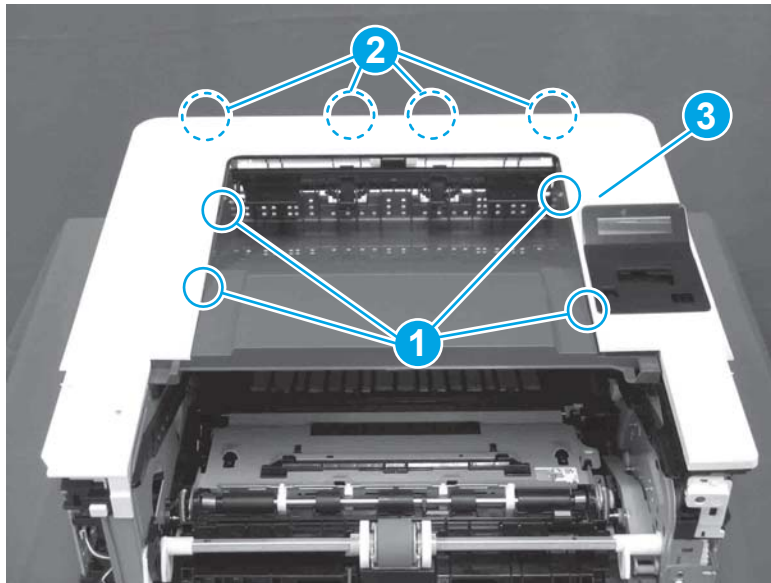
 **Reinstallation tip:** Use two-sided tape to secure the upper edge of the operator cover to the top cover.

Figure 1-237 Rotate the top edge of the operator cover



2. Remove the operator cover.

Figure 1-238 Remove the cover

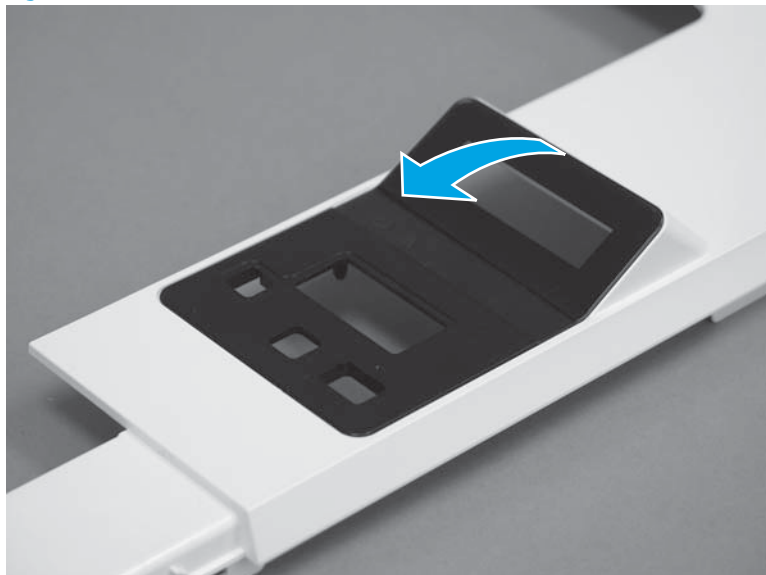

3. Turn the top cover over, release two tabs (callout 1), and then remove the indication cover.

Figure 1-239 Remove the cover

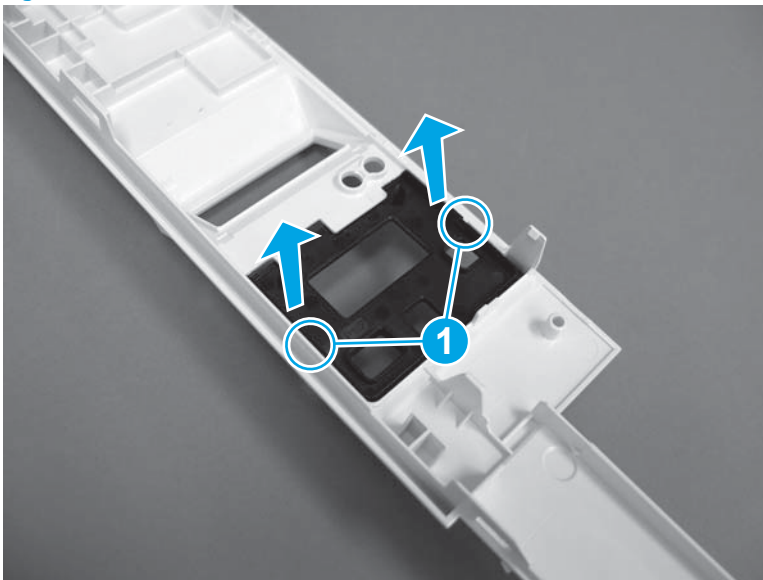



Step 7: Unpack the replacement assembly

1. Dispose of the defective part.

 **NOTE:** HP recommends responsible disposal of the defective part.

<http://www8.hp.com/us/en/hp-information/environment/product-recycling.html>

2. Unpack the replacement part from the packaging.

 **CAUTION:**  Some parts are sensitive to electrostatic discharge (ESD). Always perform service work at an ESD-protected workstation or mat. If an ESD workstation or mat is not available, touch the sheet-metal chassis to provide a static ground before touching an ESD-sensitive assembly. Protect the ESD-sensitive assemblies by placing them in ESD pouches when they are out of the printer.

If the replacement part is a roller or pad, avoid touching the spongy part of it. Skin oils on the roller or pad can cause paper pickup and/or print-quality problems. HP recommends using disposable gloves when handling rollers or pads or washing your hands before touching rollers or pads.

 **IMPORTANT:** Make sure that all of the shipping materials (for example shipping tape) are removed from the replacement part prior to installation.

3. To install an assembly, reverse the removal steps.

 **NOTE:** When applicable, special installation instructions are provided for an assembly at the end of the removal procedure. Always completely read the removal instructions and follow all special installation instructions.

Removal and replacement: Paper delivery tray (output bin)

- [Introduction](#)
- [Step 1: Remove Tray 2](#)
- [Step 2: Remove the cartridge door assembly](#)
- [Step 3: Remove the left cover](#)
- [Step 4: Remove the right cover](#)
- [Step 5: Remove the integrated scanner assembly \(M329/M428/M429\)](#)
- [Step 6: Remove the control panel \(M329/M428/M429\)](#)
- [Step 7: Remove the top cover \(M329/M428/M429\)](#)
- [Step 8: Remove the top cover \(M304/M305/M404/M405\)](#)
- [Step 9: Remove the paper delivery tray \(output bin\)](#)
- [Step 10: Unpack the replacement assembly](#)

Introduction

This document provides the procedures to remove and replace the paper delivery tray (output bin).

Before performing service

Turn the printer power off

- Disconnect the power cable.

 **WARNING!** To avoid damage to the printer, turn the printer off, wait 30 seconds, and then remove the power cable before attempting to service the printer.

Use the table below to identify the correct part number for your printer. To order the part, go to www.hp.com/buy/parts.

Paper delivery tray (output bin) part number	
RC4-3231-000CN	Paper delivery tray (output bin; non-wireless models)
RM2-2581-000CN	Paper delivery tray (output bin; wireless models)

Required tools

- #2 Phillips screwdriver with a magnetic tip.
- Small flat-blade screwdriver (M329/M428/M429 required; M304/M305/M404/M405 optional)

After performing service

Turn the printer power on

- Connect the power cable.
- Use the power switch to turn the power on.

Post service test

Make sure that the printer initializes to a **Ready** state.

Print a configuration page to make sure that the printer is functioning correctly.

Step 1: Remove Tray 2

- ▲ Pull the tray straight out of the printer to remove it.

Figure 1-240 Remove the tray



Step 2: Remove the cartridge door assembly

 **NOTE:** If the toner cartridge was not removed prior to servicing the printer, remove it now.

1. Release the support shaft (callout 1), and then slide it toward the center of the door (callout 2).

 **TIP:** It might be easier to release the support shaft by using a small flat-blade screwdriver.

Figure 1-241 Release the support shaft

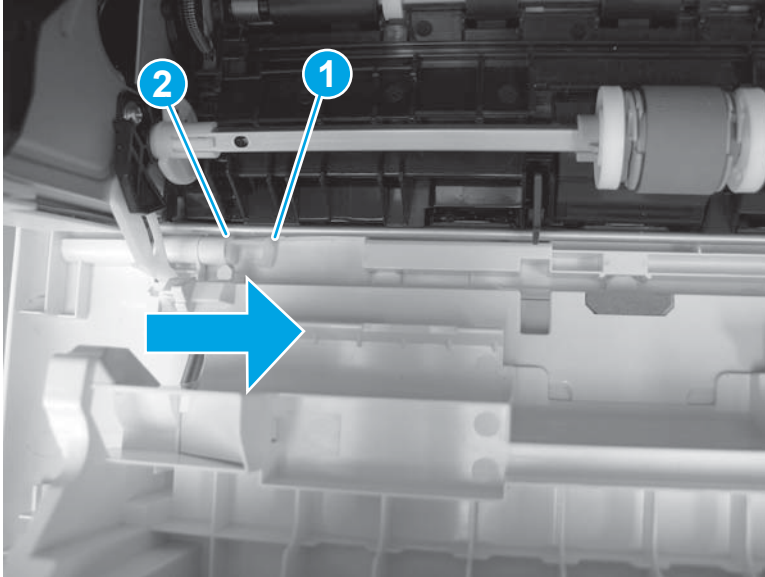

2. Remove the support shaft.

Figure 1-242 Remove the support shaft

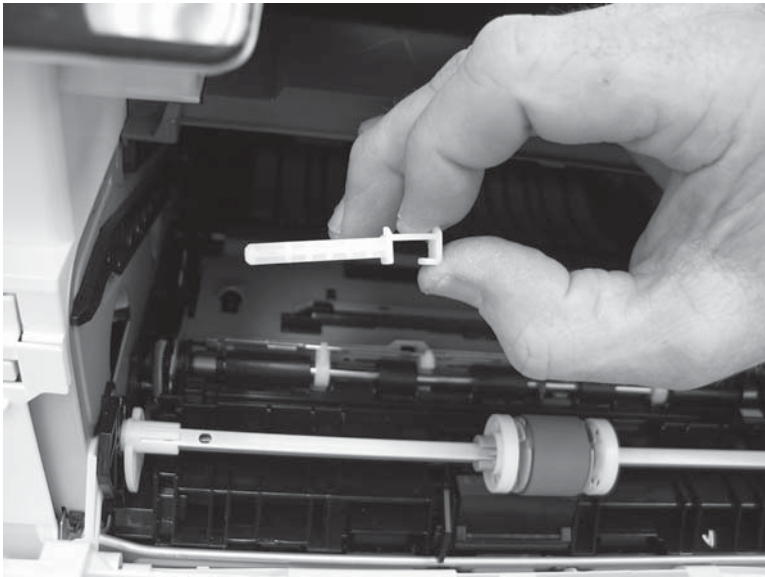

3. Release one tab (callout 1), and then slide the guide out of the printer (callout 2).

CAUTION: Be careful, the tab (callout 1) can be easily broken.

Figure 1-243 Remove the guide

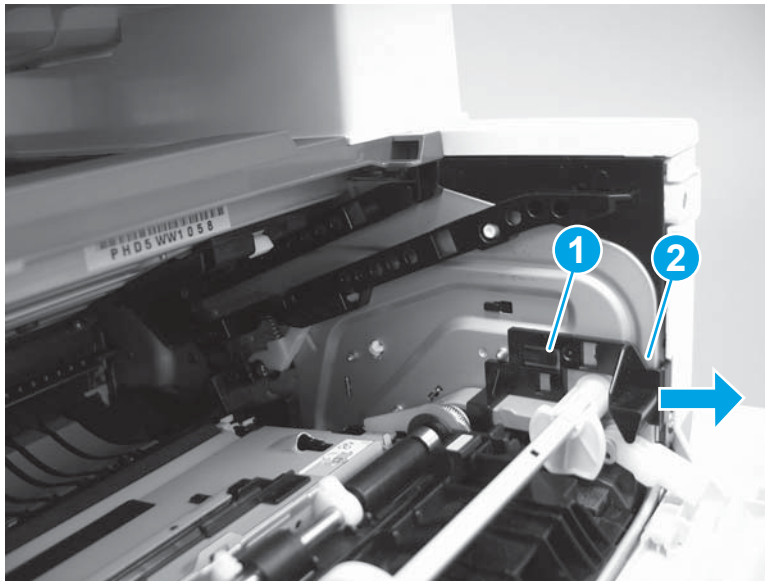

4. Use a small flat-blade screwdriver to gently pry the white-plastic door arm (callout 1) off of the gray-plastic pressure-release link (callout 2) to release the door arm.

Figure 1-244 Release the pressure-release link

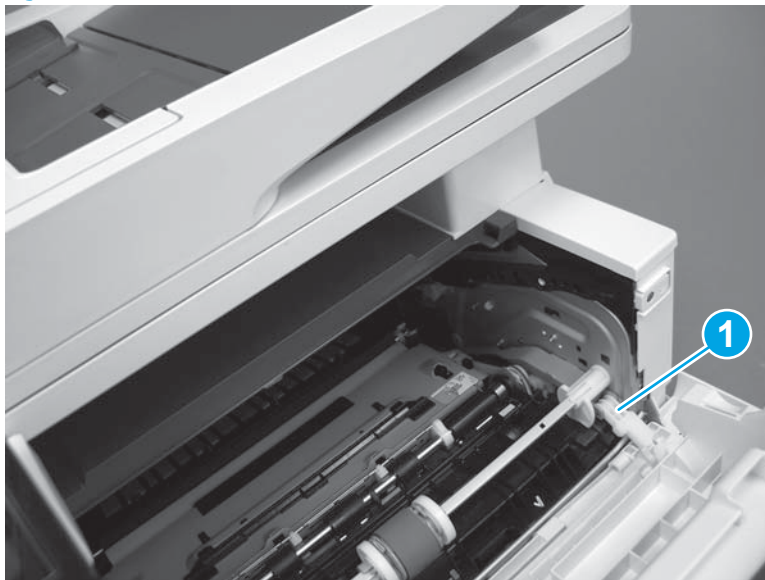

5. With the door in the partially closed position, slightly raise the left end (callout 1; raise it over the sheet-metal hinge boss), and then slide the door to the left (callout 2) to release the right hinge (callout 3).

⚠ CAUTION: The door is still attached to the printer by the left-side retainer arm. Do not attempt to completely remove the door.

💡 Reinstallation tip: When reinstalling the door, there are two right-side hinge pins (not shown in callout 3). Keep a finger pressed on the left-side retainer arm so that it does not disengage from the door.

Figure 1-245 Release the door

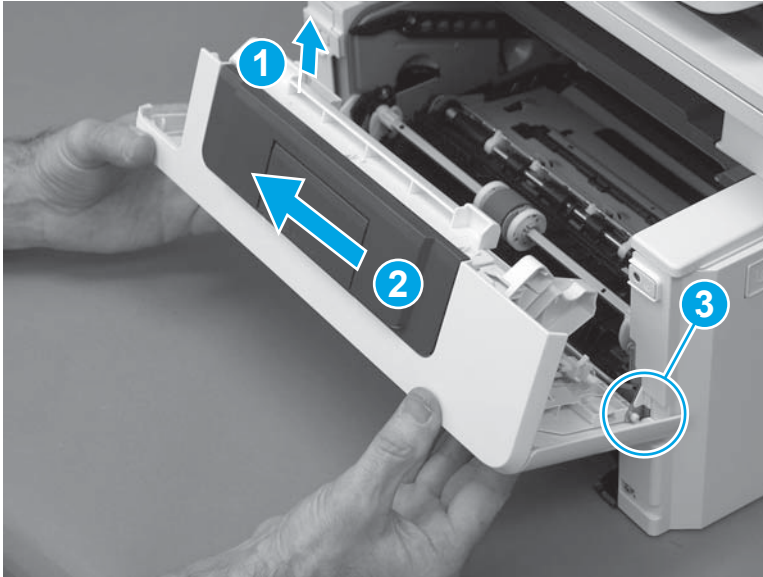

6. Rotate the door away from the printer until the keyed pin on the left-side retainer arm can disengage from the door.

Figure 1-246 Release the left-side retainer arm

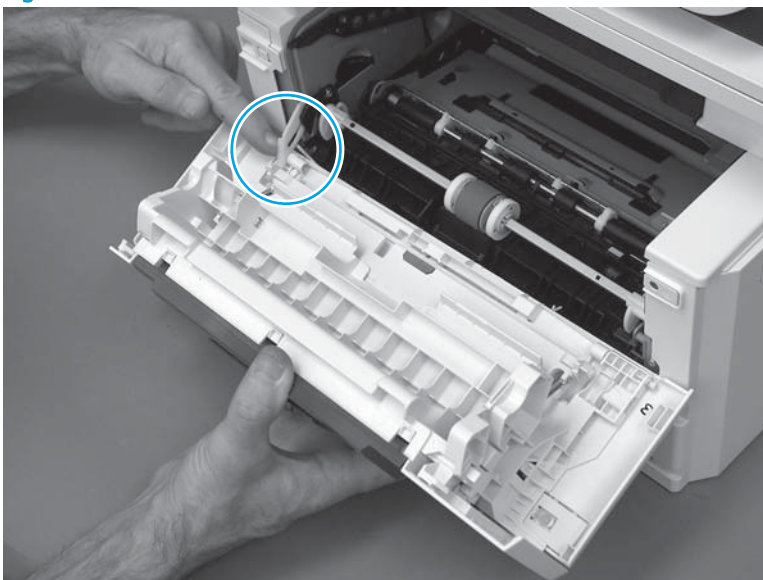

7. Remove the door.

Figure 1-247 Remove the door

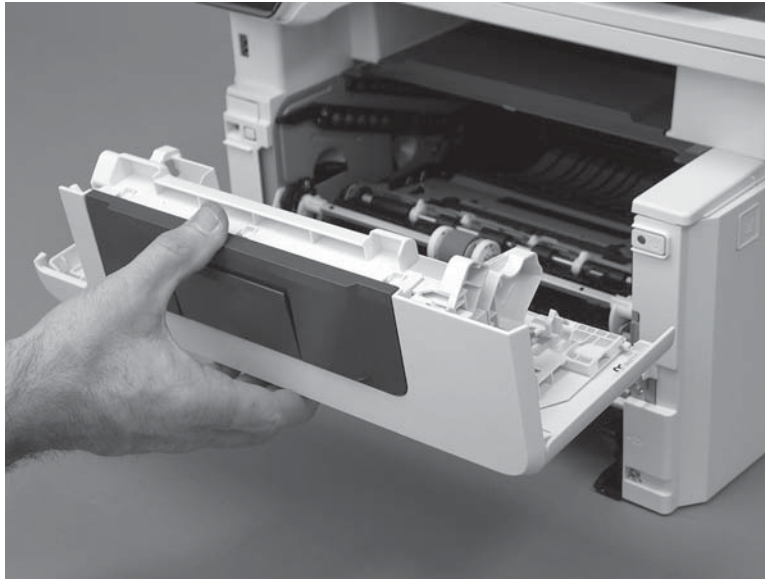

Step 3: Remove the left cover

1. Remove one screw (callout 1).

Figure 1-248 Remove one screw

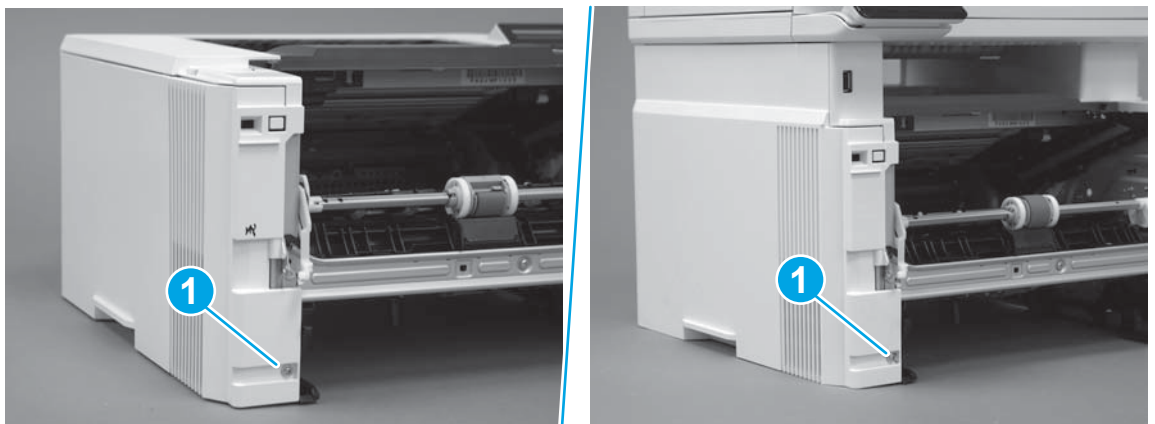

2. Open the rear door, release two bosses (callout 1), and then release three tabs (callout 2).

Figure 1-249 Release two bosses and three tabs

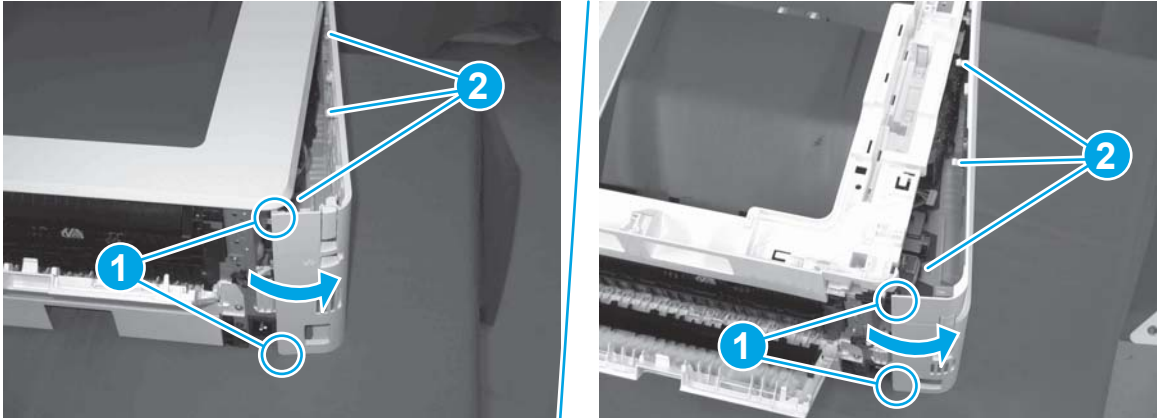

3. At the front of the printer, do one of the following:
 - **M304/M305/M404/M405:** Release two bosses (callout 1), and then remove the cover (callout 2).
 - **M329/M428/M429:** Release one tab (callout 3), two bosses (callout 4), and then remove the cover (callout 5).

CAUTION: Be careful when releasing the upper bosses on the M329/M428/M429 cover. One portion of the cover (callout 6) is fragile and is easily broken.

Figure 1-250 Remove the cover

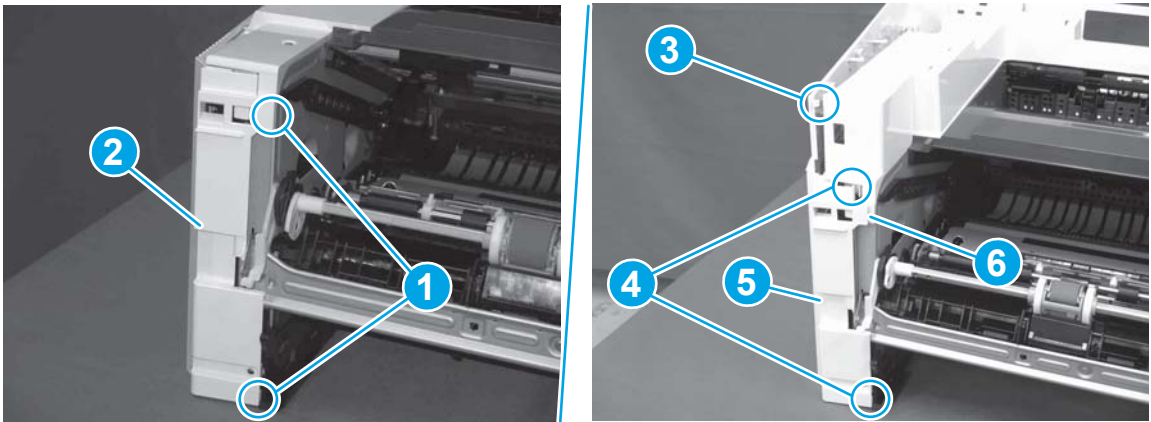

Step 4: Remove the right cover

1. At the front of the printer, release two bosses (callout 1), and then release three tabs (callout 2).

Reinstallation tip: Remove, and then reinstall the cover if the switch or button does not correctly function.

Figure 1-251 Release two bosses and three tabs

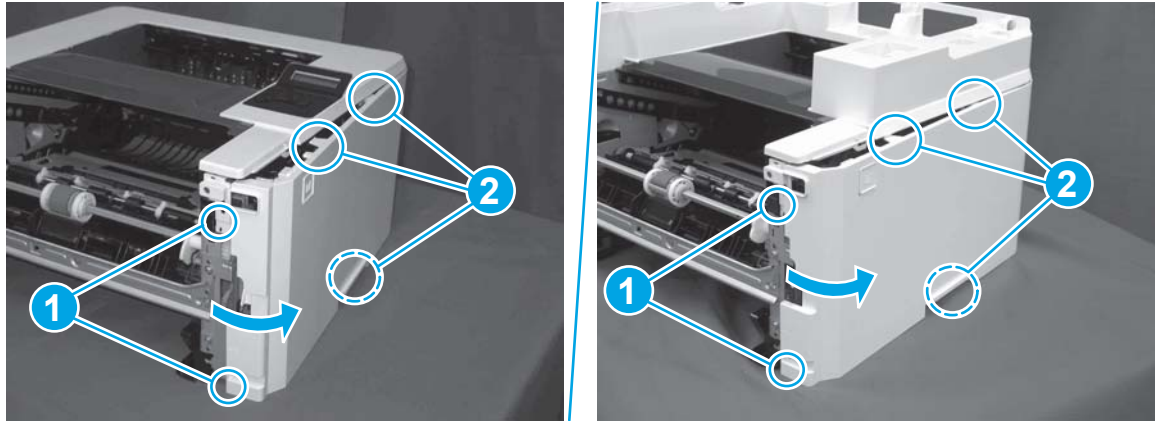

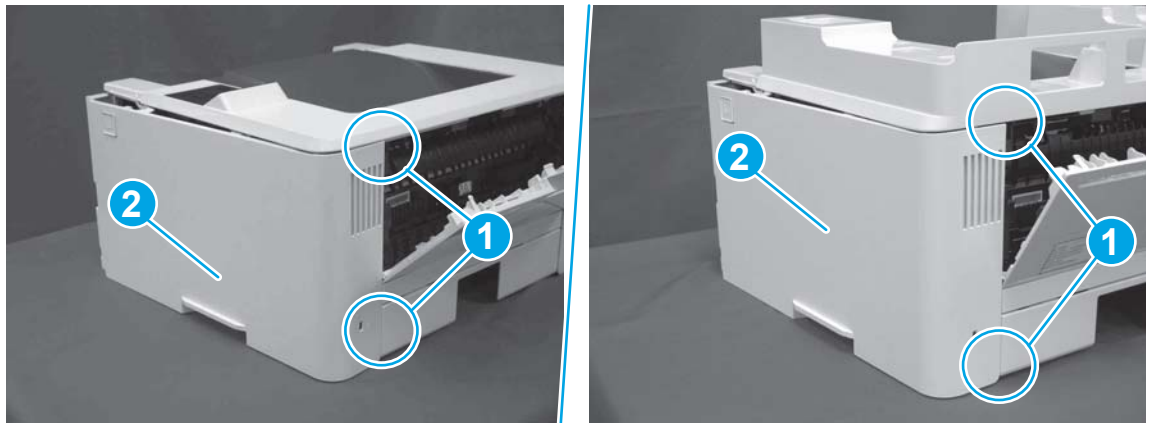

2. Open the rear door, release two bosses (callout 1), and then remove the cover (callout 2).

Figure 1-252 Remove the cover



Step 5: Remove the integrated scanner assembly (M329/M428/M429)

 **NOTE:** The step is for the M329/M428/M429 printer. For the M304/M305/M404/M405, skip this step and go to [Step 8: Remove the top cover \(M304/M305/M404/M405\) on page 180.](#)

 **NOTE:** M329/M428/M429 models only. The integrated scanner assembly (ISA) includes the sub-scanner assembly (SSA) and the automatic document feeder (ADF).

1. Raise the ISA.

Figure 1-253 Raise the ISA

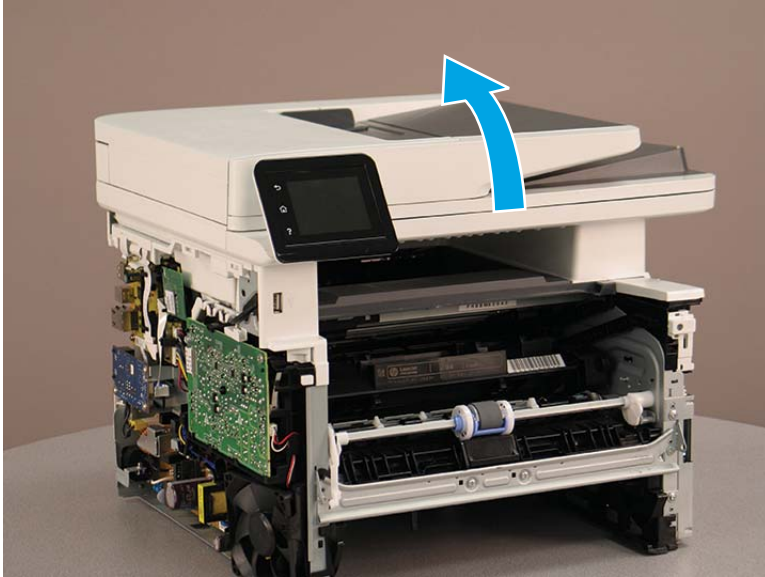

2. Release the ISA flat-flexible cable (FFC) cover (callout 1), and then remove it (callout 2).

Figure 1-254 Remove the ISA FFC cover

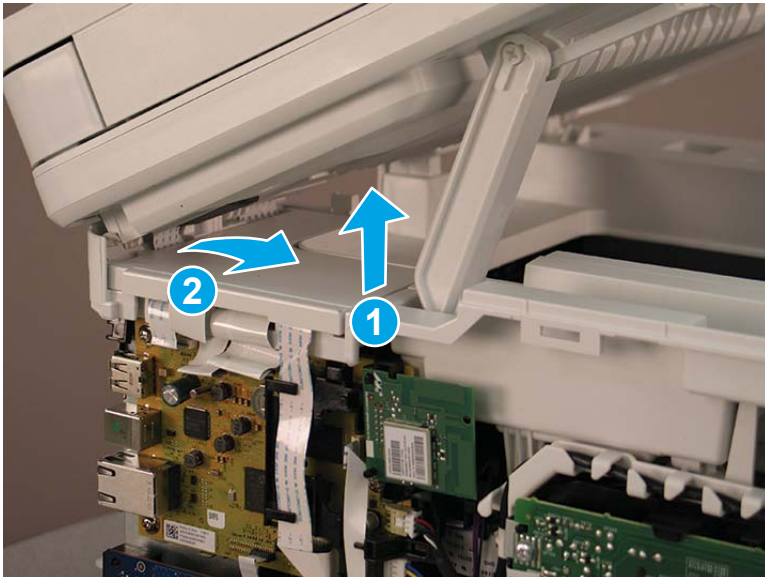

3. Disconnect three FFCs (callout 1), and then remove the ferrite (callout 2) from the holder.

CAUTION: The ferrite is not captive on the FFC. Do not lose the ferrite while handling the ISA.

Figure 1-255 Disconnect three FFCs

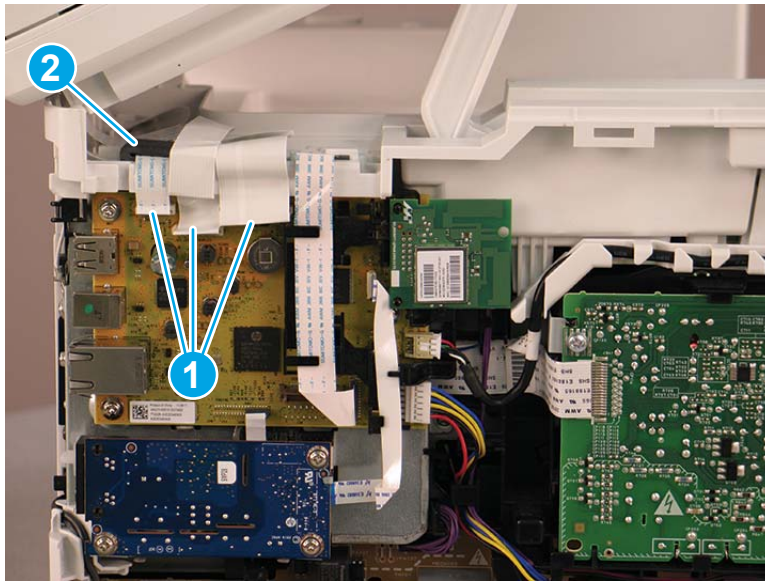

4. Remove one screw (callout 1).

Figure 1-256 Remove one screw

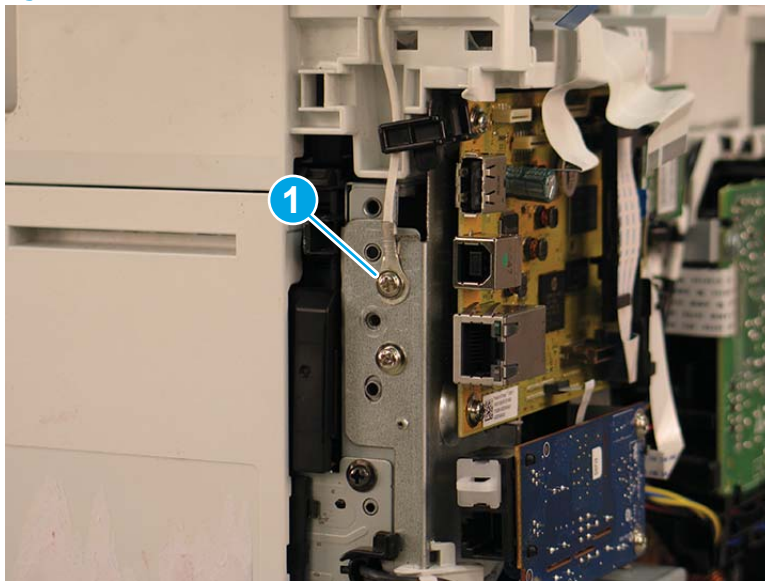

5. Pass the ground wire through the opening in the top cover.

Figure 1-257 Pass the wire through the opening

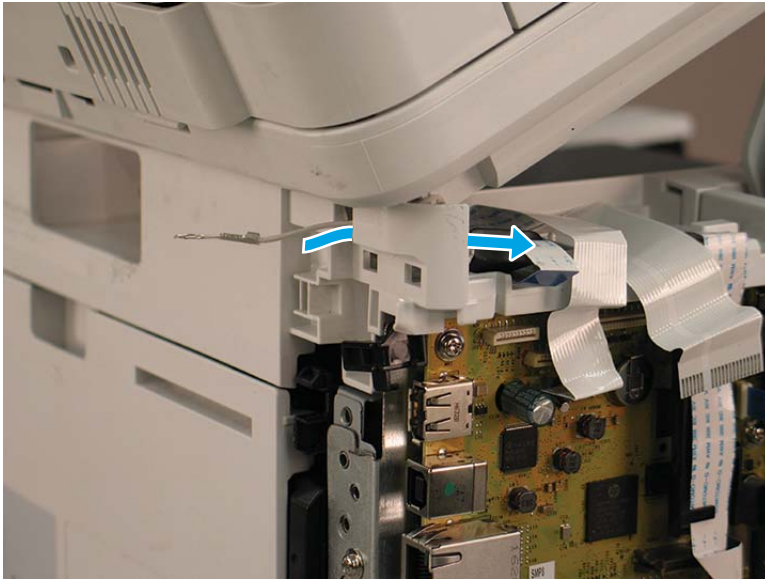

6. Release one tab (callout 1), and then rotate the ISA slider pin (callout 2) towards the front of the printer to release it.

Figure 1-258 Release one tab and rotate the slider pin

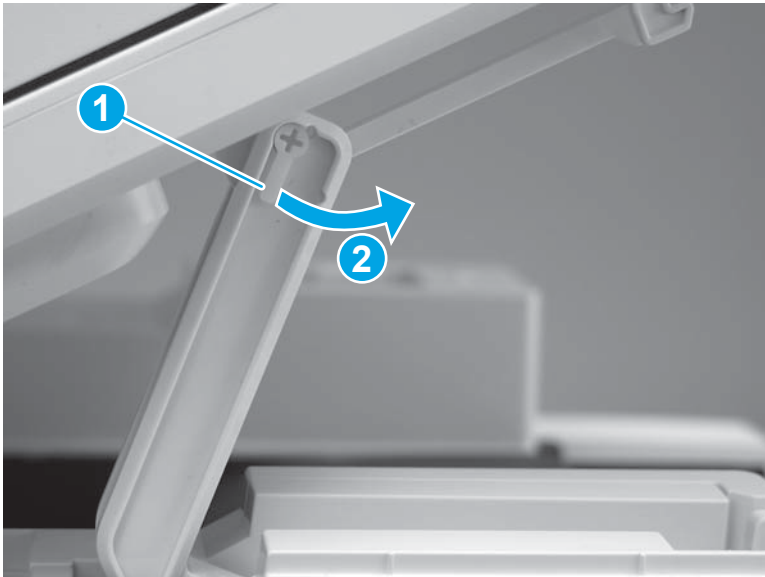

7. Remove the slider pin.

 **Reinstallation tip:** Align the keyed portion of the locking pin with the slot and hole in the support arm.

Figure 1-259 Remove the slider pin



8. Rotate the ISA towards the rear of the printer until it stops.

Figure 1-260 Rotate the ISA towards the rear of the printer

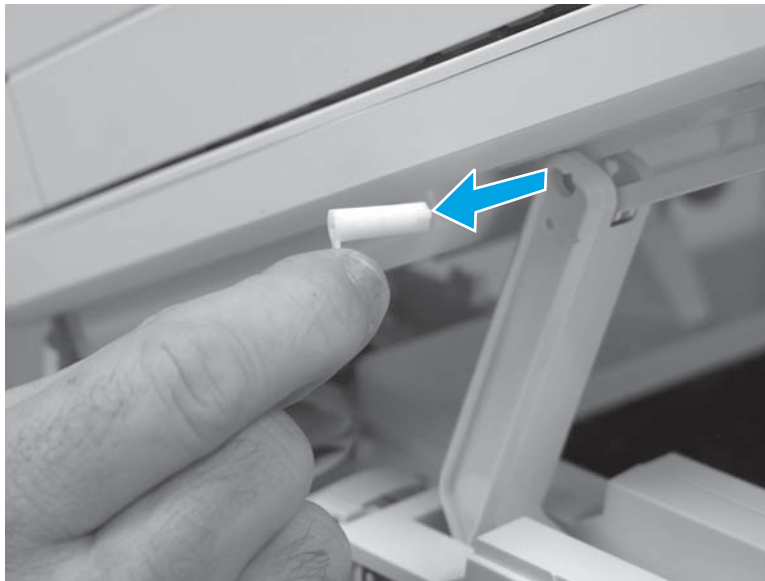
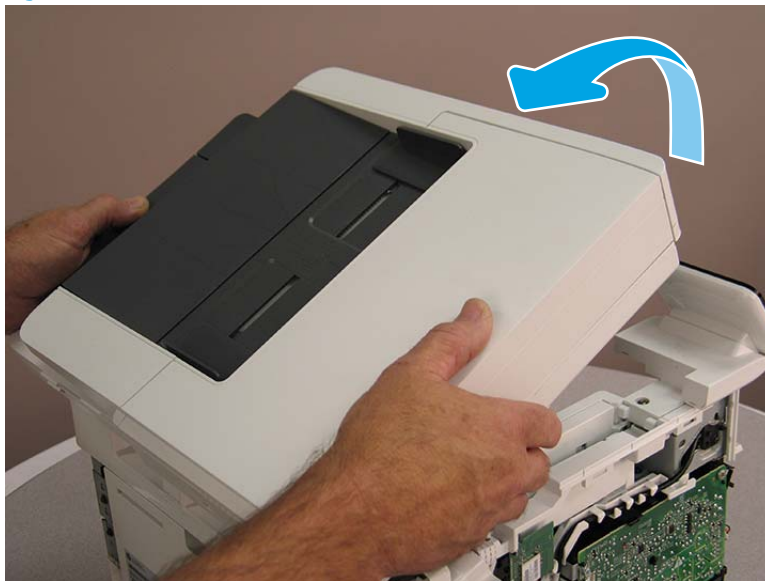

- Slide the ISA as shown to release it.

Figure 1-261 Release the ISA

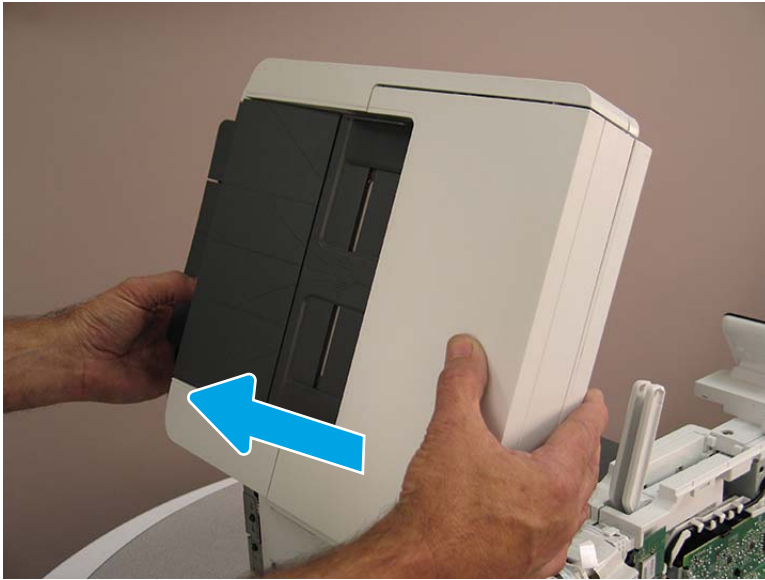

- Remove the ISA.

Figure 1-262 Remove the ISA

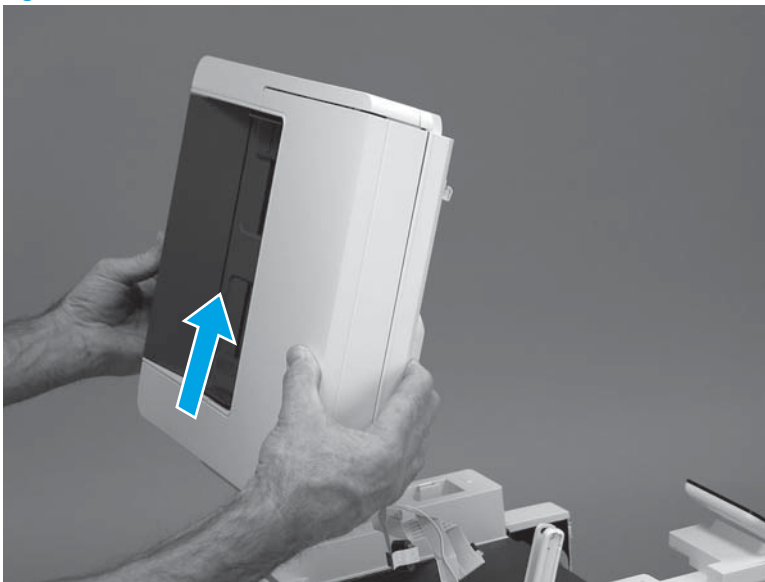

Step 6: Remove the control panel (M329/M428/M429)

 **NOTE:** The step is for the M329/M428/M429 printer. For the M304/M305/M404/M405, skip this step and go to [Step 8: Remove the top cover \(M304/M305/M404/M405\) on page 180.](#)

- Disconnect one FFC (callout 1), and then release the FFC from the guide (callout 2).

Figure 1-263 Disconnect one connector

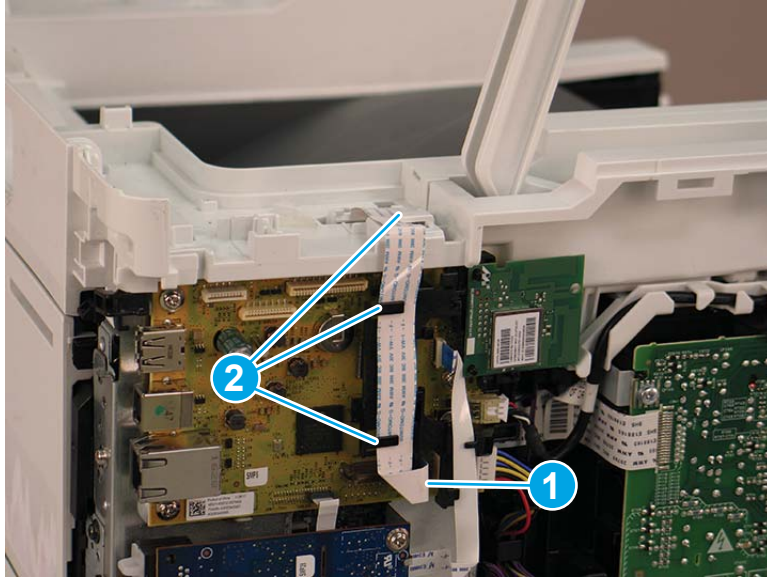

2. Remove one screw (callout 1).

Figure 1-264 Remove one screw

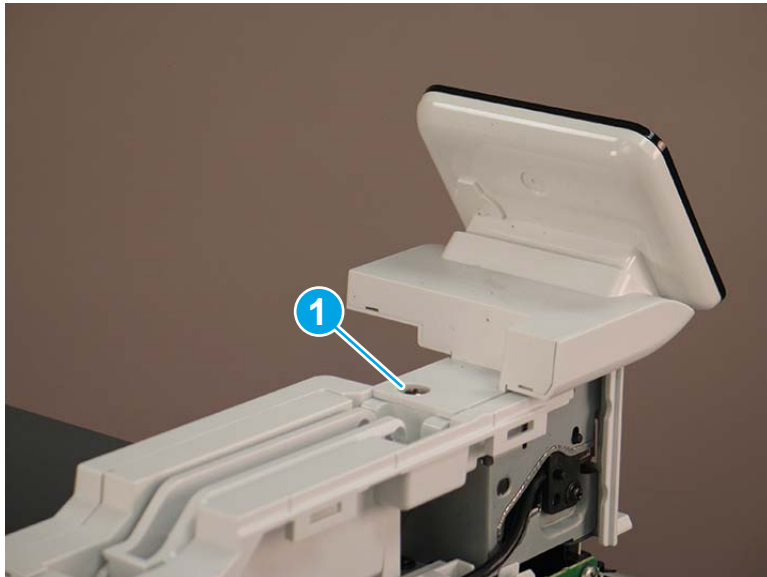

3. Use a small flat-blade screwdriver to release two tabs (callout 1) on the control-panel cable cover.

Figure 1-265 Release two tabs

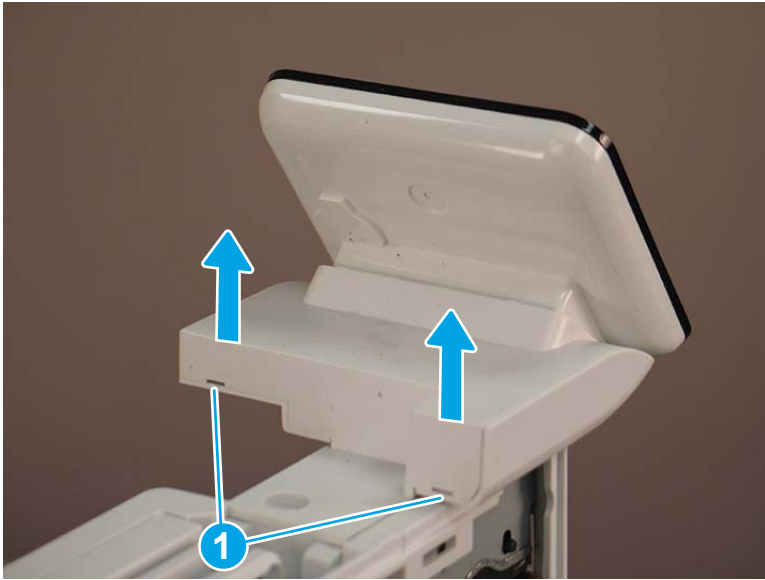

4. Remove the control-panel cable cover.

Figure 1-266 Remove the cover



5. Remove one grounding screw (callout 1), and then move the ground cable (callout 2) out of the way.

Figure 1-267 Remove one screw

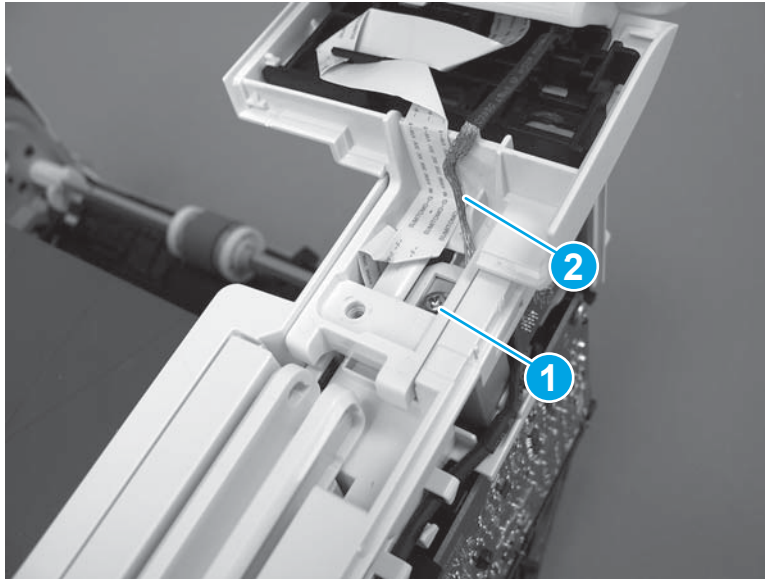

6. Move the FFC out of the way, and then remove two screws (callout 1).

Figure 1-268 Remove two screws

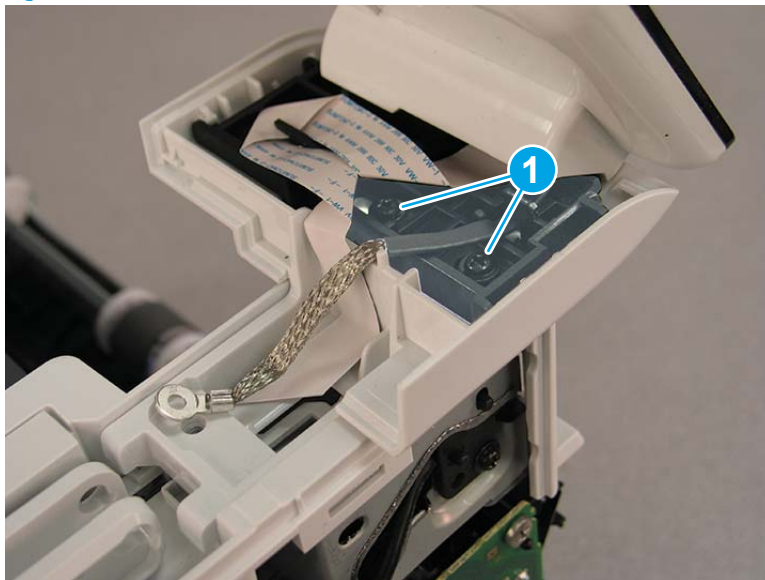

7. Slightly lift up the control-panel assembly to separate it from the top cover.

⚠ CAUTION: The control panel assembly is still connected to the printer by the FFC. Do not attempt to completely remove the assembly.

Figure 1-269 Lift up the control-panel assembly



8. Lift up the control-panel FFC cover to remove the control-panel assembly.

Figure 1-270 Remove the control-panel assembly

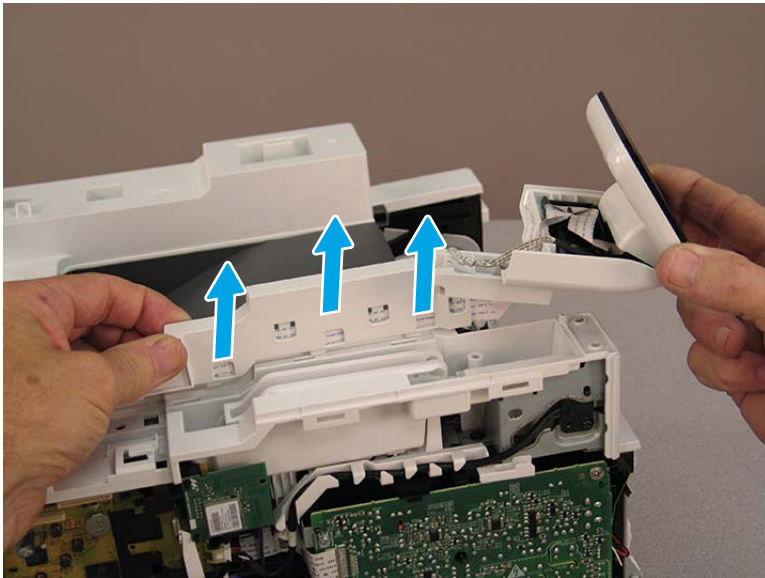

Step 7: Remove the top cover (M329/M428/M429)

📝 NOTE: The step is for the M329/M428/M429 printer. For the M304/M305/M404/M405, skip this step and go to [Step 8: Remove the top cover \(M304/M305/M404/M405\) on page 180.](#)

1. Release the USB cable (callout 1) from the cable guide.

Figure 1-271 Remove the USB cable

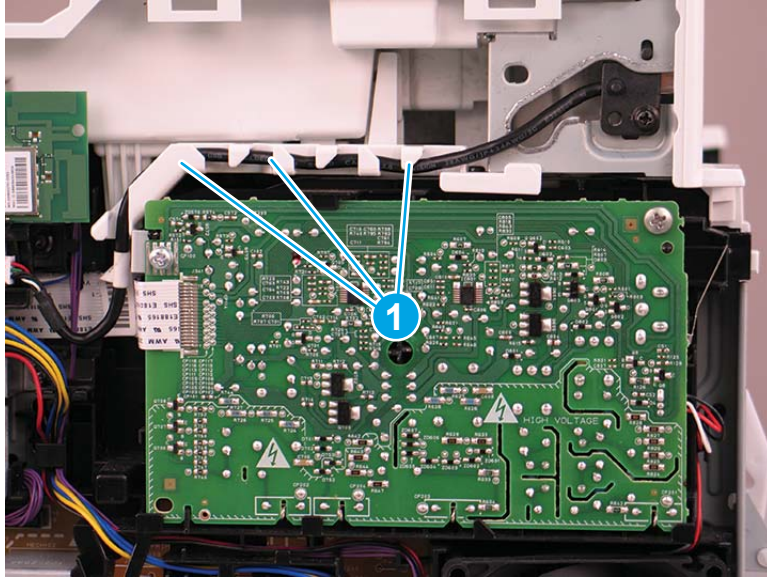

2. Remove one screw (callout 1), and then remove the support arm (callout 2).

⚠ CAUTION: The support arm is spring loaded and can unexpectedly spring into the open position. To avoid injury, do not place a finger in the screw well when the support arm is in the closed position.

Figure 1-272 Remove the support arm

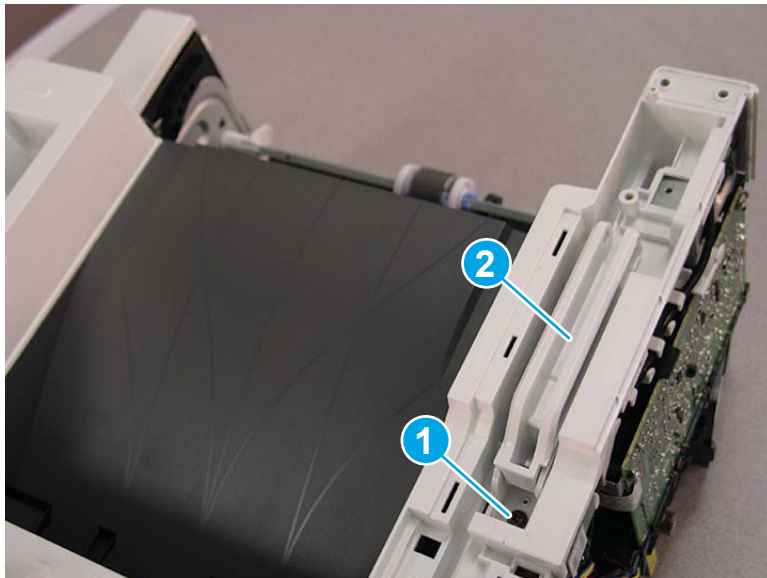

3. Remove five screws (callout 1), release four bosses (callout 2), and then remove the top cover (callout 3).

Figure 1-273 Remove the cover

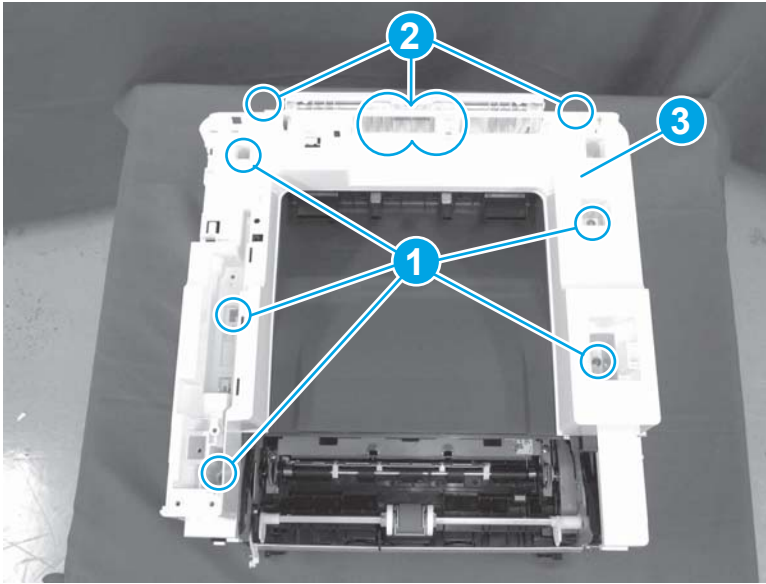

Step 8: Remove the top cover (M304/M305/M404/M405)

 **NOTE:** The step is for the M304/M305/M404/M405 printer. For the M329/M428/M429, skip this step and go to [Step 9: Remove the paper delivery tray \(output bin\) on page 181.](#)

1. Remove one screw (callout 1).

Figure 1-274 Remove one screw



2. At the right side of the printer, release the one boss (callout 1), and then release one tab (callout 2).

Figure 1-275 Release one boss and one tab

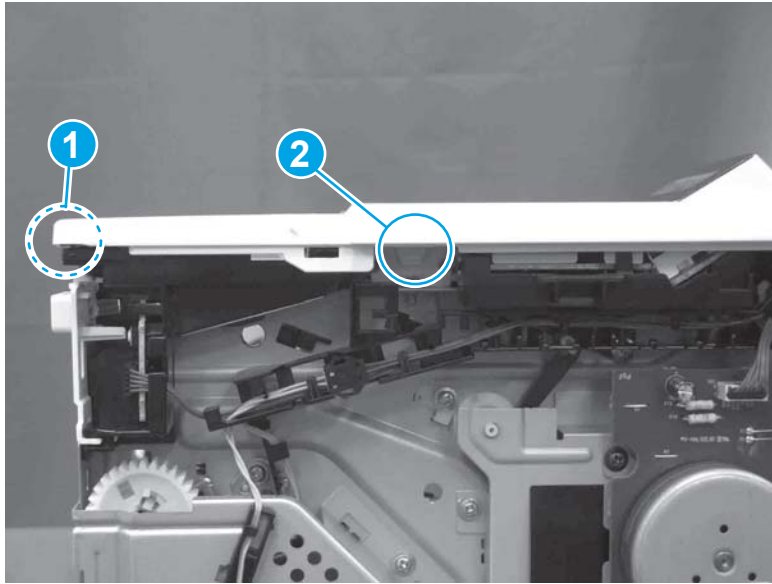

3. Release four tabs (callout 1), release four bosses (callout 2), and then remove the top cover (callout 3).



 **TIP:** Open the rear door to make releasing the bosses (callout 3) easier.

Figure 1-276 Remove the cover

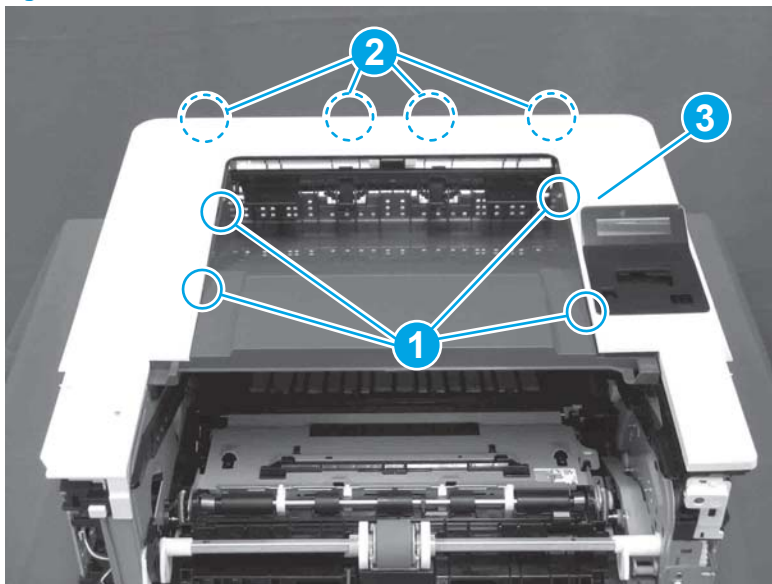

Step 9: Remove the paper delivery tray (output bin)

 **NOTE:** This procedure shows the M304/M305/M404/M405 model, however, the paper delivery tray (output bin) removal is similar for the M329/M428/M429 printer.

- ▲ Release two bosses (callout 1), release two tabs (callout 2), and then remove the paper delivery tray (output bin; callout 3).

Figure 1-277 Release two tabs

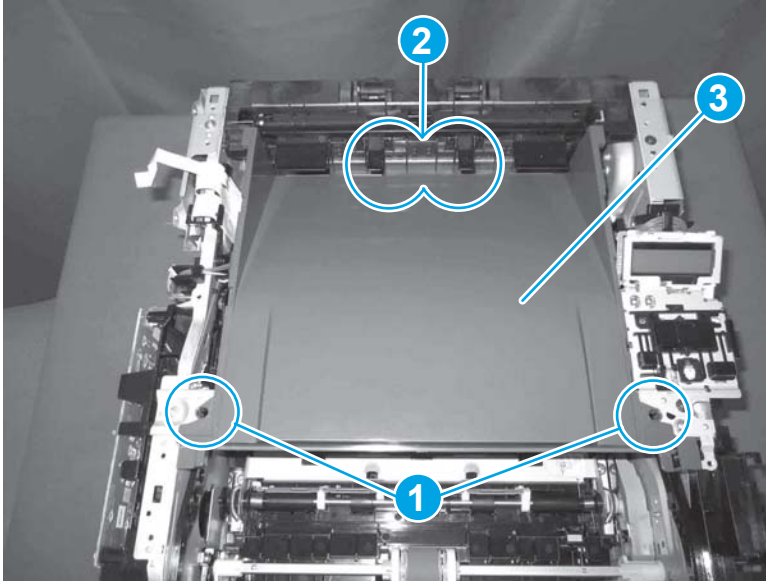



Step 10: Unpack the replacement assembly

1. Dispose of the defective part.

 **NOTE:** HP recommends responsible disposal of the defective part.

<http://www8.hp.com/us/en/hp-information/environment/product-recycling.html>

2. Unpack the replacement part from the packaging.

 **CAUTION:**  Some parts are sensitive to electrostatic discharge (ESD). Always perform service work at an ESD-protected workstation or mat. If an ESD workstation or mat is not available, touch the sheet-metal chassis to provide a static ground before touching an ESD-sensitive assembly. Protect the ESD-sensitive assemblies by placing them in ESD pouches when they are out of the printer.

If the replacement part is a roller or pad, avoid touching the spongy part of it. Skin oils on the roller or pad can cause paper pickup and/or print-quality problems. HP recommends using disposable gloves when handling rollers or pads or washing your hands before touching rollers or pads.

 **IMPORTANT:** Make sure that all of the shipping materials (for example shipping tape) are removed from the replacement part prior to installation.

3. To install an assembly, reverse the removal steps.

 **NOTE:** When applicable, special installation instructions are provided for an assembly at the end of the removal procedure. Always completely read the removal instructions and follow all special installation instructions.

Removal and replacement: Integrated scanner assembly (M329/M428/M429)

 **NOTE:** M329/M428/M429 models only. The integrated scanner assembly (ISA) includes the sub-scanner assembly (SSA) and the automatic document feeder (ADF).

- [Introduction](#)
- [Step 1: Remove Tray 2](#)
- [Step 2: Remove the cartridge door assembly](#)
- [Step 3: Remove the left cover](#)
- [Step 4: Remove the ISA \(M329/M428/M429\)](#)
- [Step 5: Unpack the replacement assembly](#)

Introduction

This document provides the procedures to remove and replace the ISA.

Before performing service

Turn the printer power off

- Disconnect the power cable.

 **WARNING!** To avoid damage to the printer, turn the printer off, wait 30 seconds, and then remove the power cable before attempting to service the printer.

Use the table below to identify the correct part number for your printer. To order the part, go to www.hp.com/buy/parts.

ISA part number ¹	
W1A73-60109	Assembly scanner/ADF Pilderiver plus duplex
W1A73-60108	Assembly scanner/ADF Pilderiver plus simplex

¹ The ISA includes the SSA and the ADF.

Required tools

- #2 Phillips screwdriver with a magnetic tip.

After performing service

Turn the printer power on

- Connect the power cable.
- Use the power switch to turn the power on.

Post service test

Make sure that the printer initializes to a **Ready** state.

Print a configuration page, and then make a copy using the document feeder to make sure that it is properly functioning.

Step 1: Remove Tray 2

- ▲ Pull the tray straight out of the printer to remove it.

Figure 1-278 Remove the tray



Step 2: Remove the cartridge door assembly

 **NOTE:** If the toner cartridge was not removed prior to servicing the printer, remove it now.

1. Release the support shaft (callout 1), and then slide it toward the center of the door (callout 2).

 **TIP:** It might be easier to release the support shaft by using a small flat-blade screwdriver.

Figure 1-279 Release the support shaft

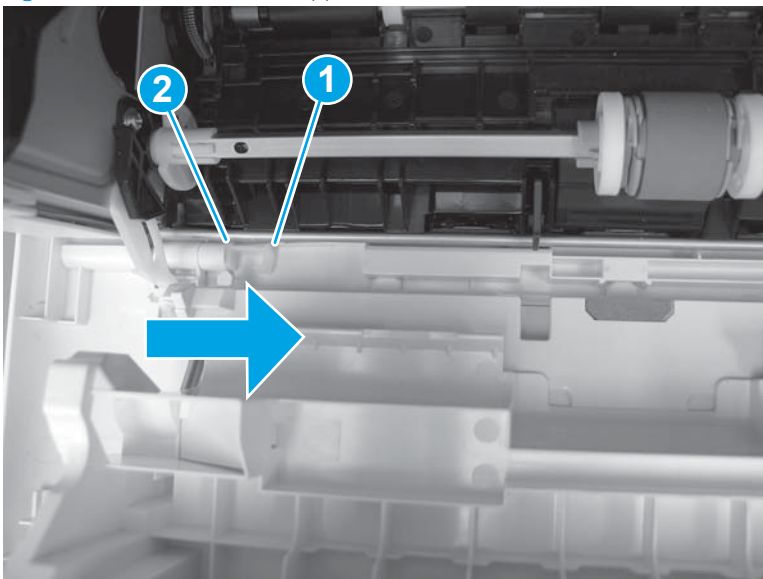

2. Remove the support shaft.

Figure 1-280 Remove the support shaft

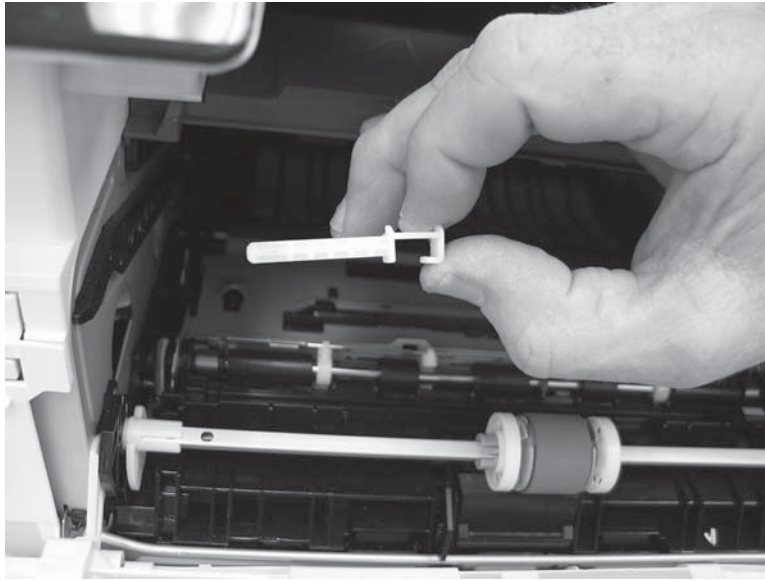

3. Release one tab (callout 1), and then slide the guide out of the printer (callout 2).

⚠ CAUTION: Be careful, the tab (callout 1) can be easily broken.

Figure 1-281 Remove the guide

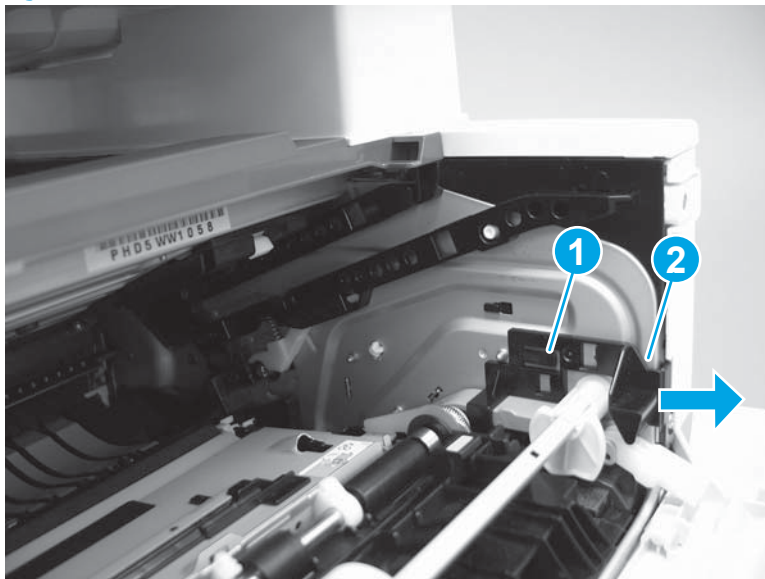

4. Use a small flat-blade screwdriver to gently pry the white-plastic door arm (callout 1) off of the gray-plastic pressure-release link (callout 2) to release the door arm.

Figure 1-282 Release the pressure-release link

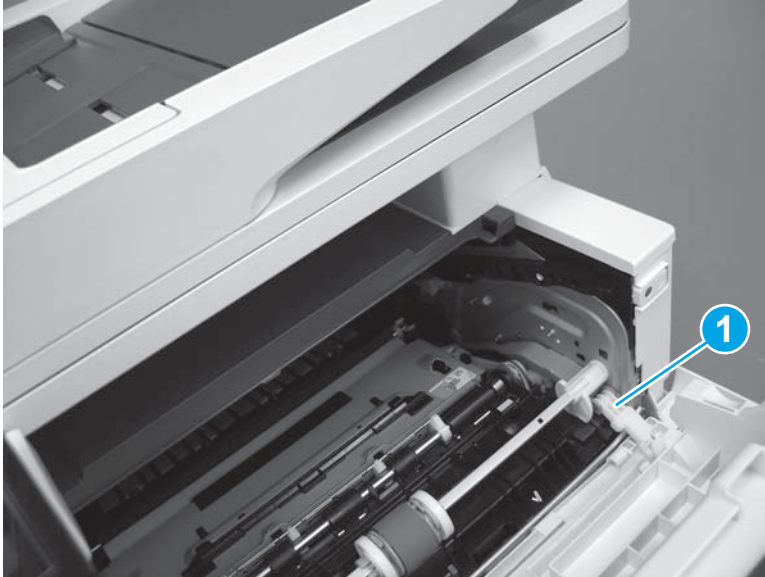

5. With the door in the partially closed position, slightly raise the left end (callout 1; raise it over the sheet-metal hinge boss), and then slide the door to the left (callout 2) to release the right hinge (callout 3).

CAUTION: The door is still attached to the printer by the left-side retainer arm. Do not attempt to completely remove the door.

Reinstallation tip: When reinstalling the door, there are two right-side hinge pins (not shown in callout 3). Keep a finger pressed on the left-side retainer arm so that it does not disengage from the door.

Figure 1-283 Release the door

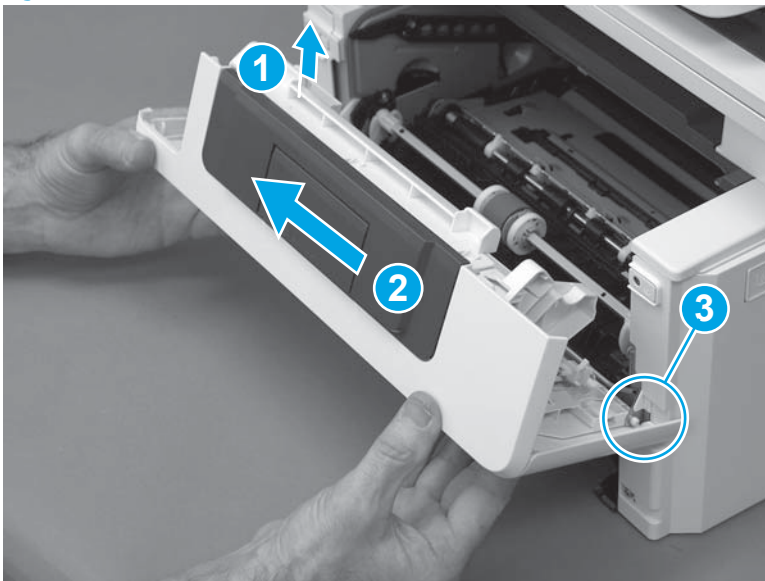

6. Rotate the door away from the printer until the keyed pin on the left-side retainer arm can disengage from the door.

Figure 1-284 Release the left-side retainer arm

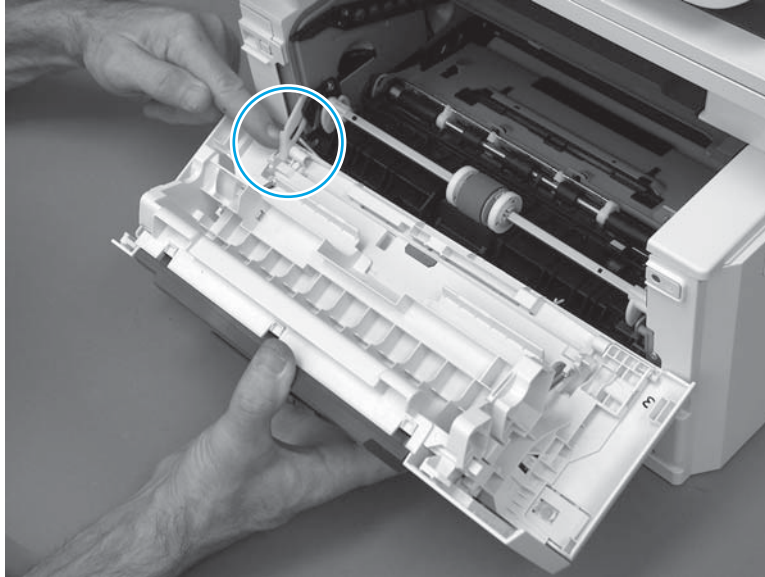

7. Remove the door.

Figure 1-285 Remove the door

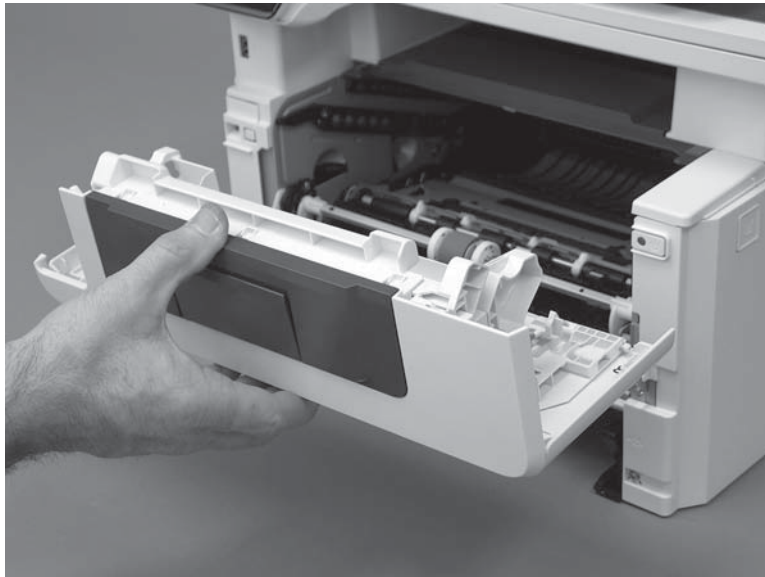

Step 3: Remove the left cover

1. Remove one screw (callout 1).

Figure 1-286 Remove one screw

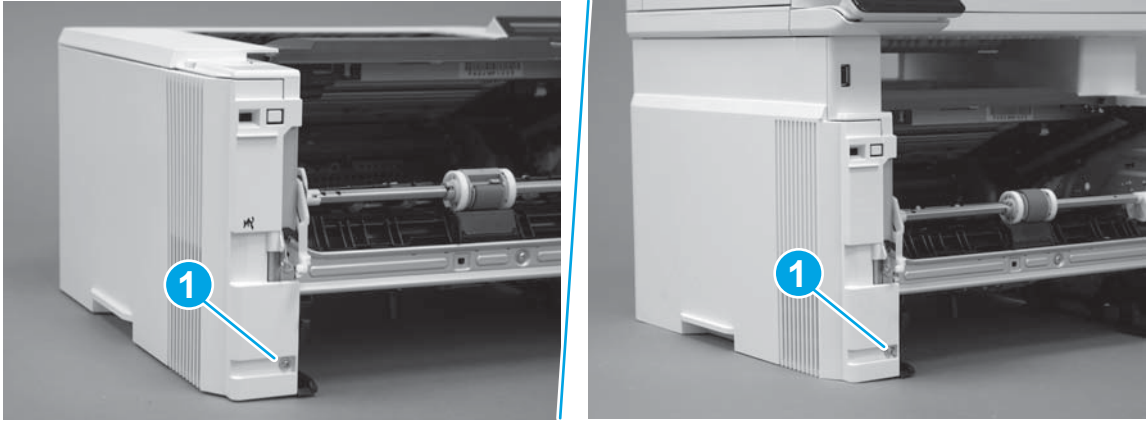

2. Open the rear door, release two bosses (callout 1), and then release three tabs (callout 2).

Figure 1-287 Release two bosses and three tabs

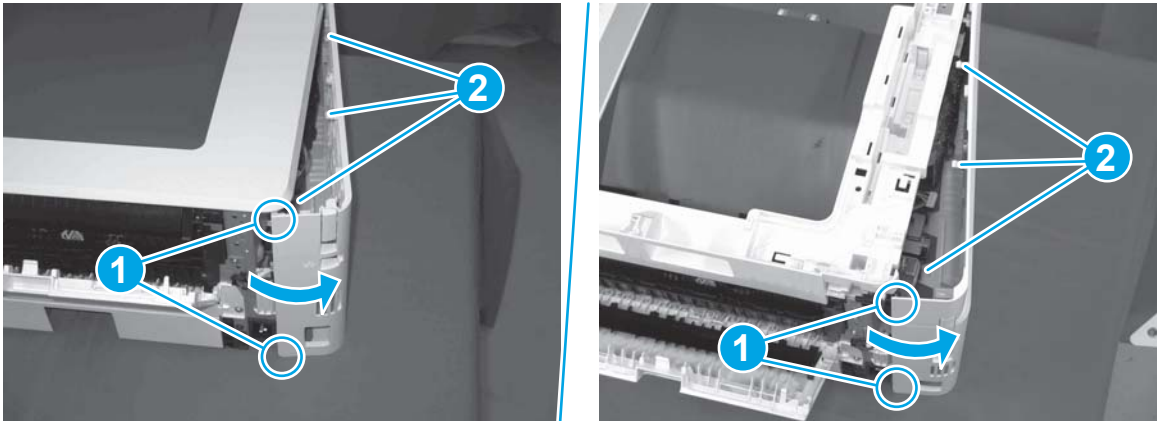

3. At the front of the printer, do one of the following:
 - **M304/M305/M404/M405:** Release two bosses (callout 1), and then remove the cover (callout 2).
 - **M329/M428/M429:** Release one tab (callout 3), two bosses (callout 4), and then remove the cover (callout 5).

CAUTION: Be careful when releasing the upper bosses on the M329/M428/M429 cover. One portion of the cover (callout 6) is fragile and is easily broken.

Figure 1-288 Remove the cover

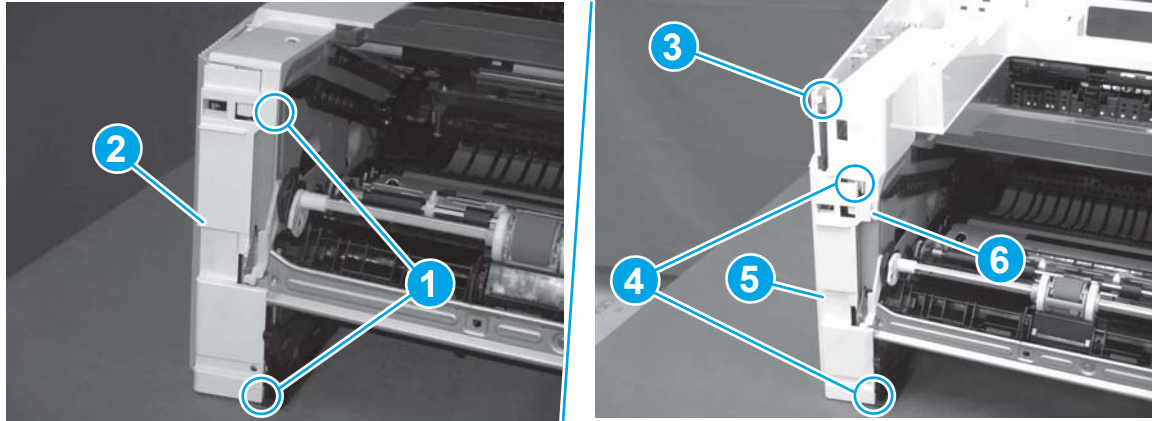

Step 4: Remove the ISA (M329/M428/M429)

 **NOTE:** M329/M428/M429 models only. The integrated scanner assembly (ISA) includes the sub-scanner assembly (SSA) and the automatic document feeder (ADF).

1. Raise the ISA.

Figure 1-289 Raise the ISA

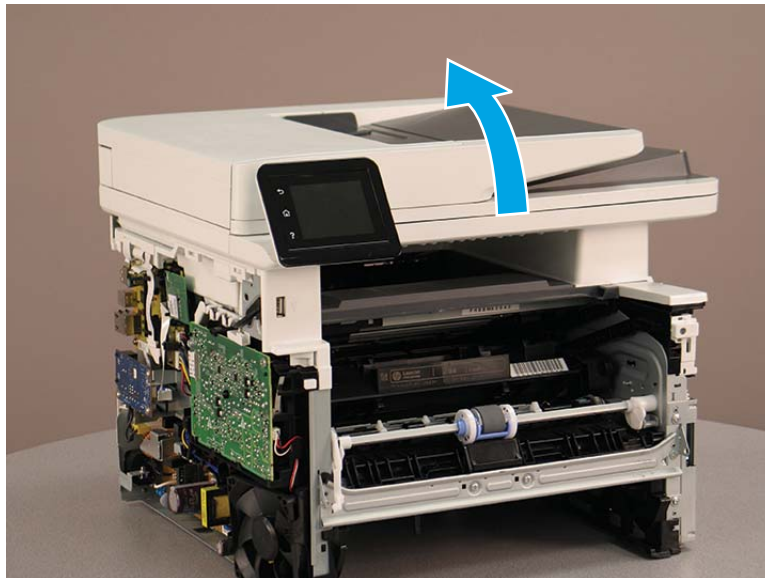

2. Release the ISA flat-flexible cable (FFC) cover (callout 1), and then remove it (callout 2).

Figure 1-290 Remove the ISA FFC cover

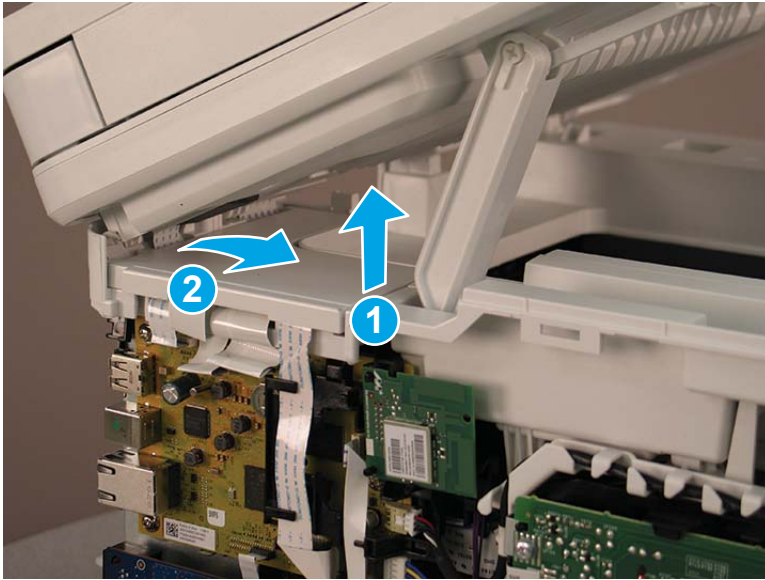

3. Disconnect three FFCs (callout 1), and then remove the ferrite (callout 2) from the holder.

CAUTION: The ferrite is not captive on the FFC. Do not lose the ferrite while handling the ISA.

Figure 1-291 Disconnect three FFCs

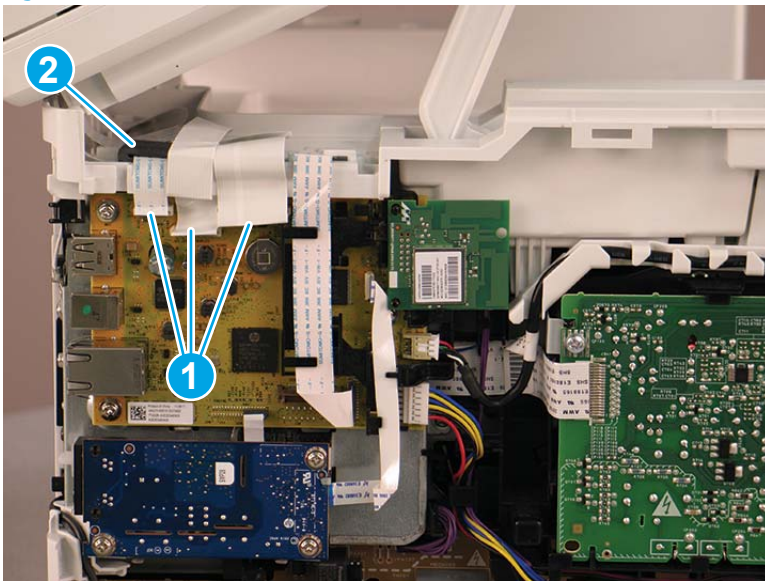

4. Remove one screw (callout 1).

Figure 1-292 Remove one screw

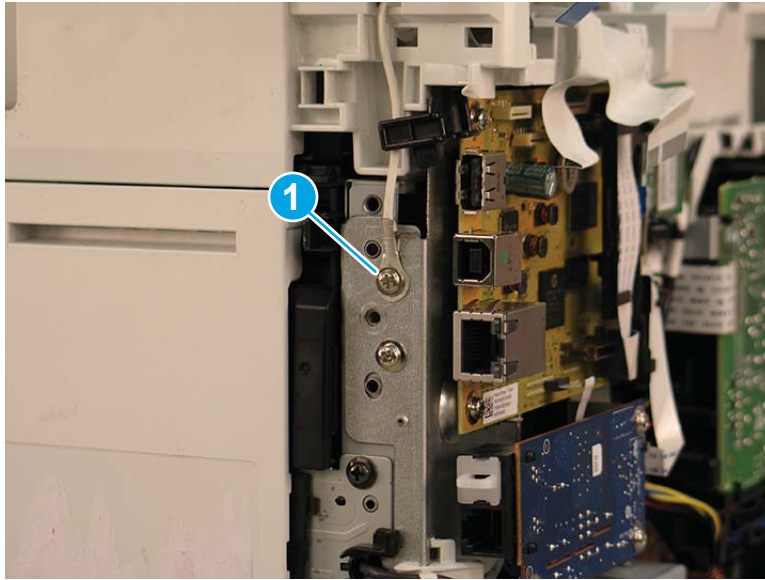

5. Pass the ground wire through the opening in the top cover.

Figure 1-293 Pass the wire through the opening

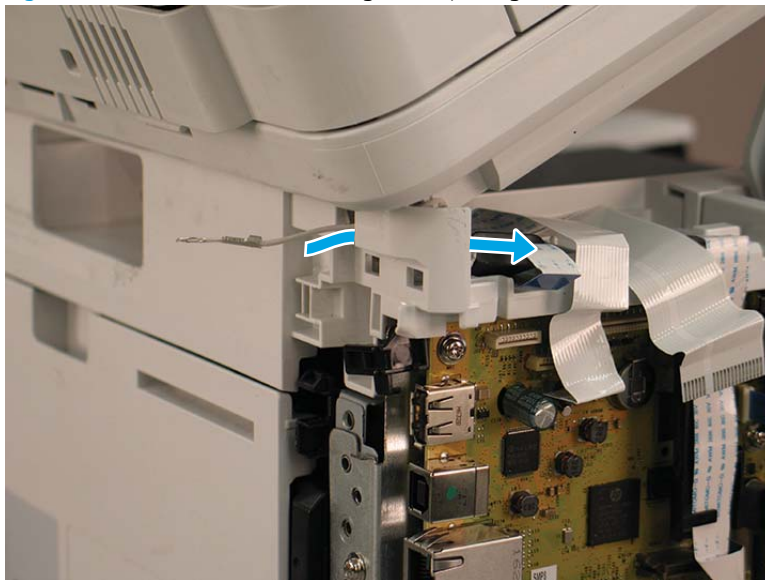

6. Release one tab (callout 1), and then rotate the ISA slider pin (callout 2) towards the front of the printer to release it.

Figure 1-294 Release one tab and rotate the slider pin

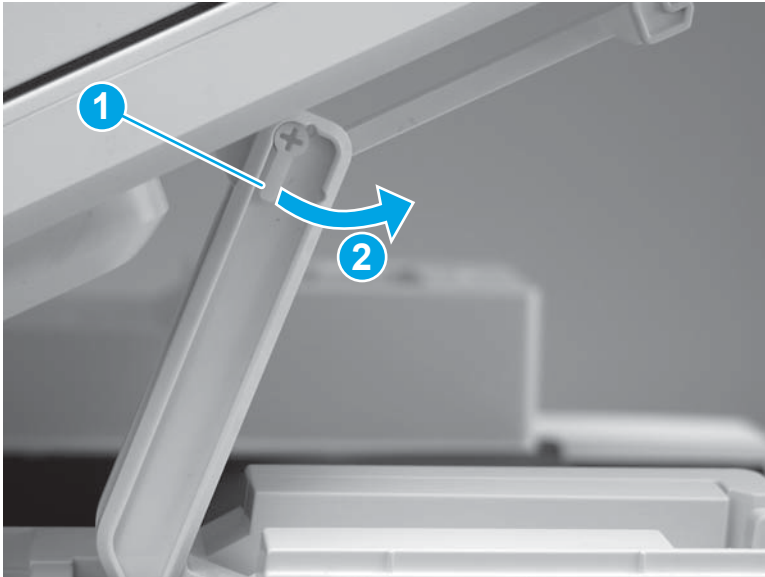

7. Remove the slider pin.

 **Reinstallation tip:** Align the keyed portion of the locking pin with the slot and hole in the support arm.

Figure 1-295 Remove the slider pin



8. Rotate the ISA towards the rear of the printer until it stops.

Figure 1-296 Rotate the ISA towards the rear of the printer

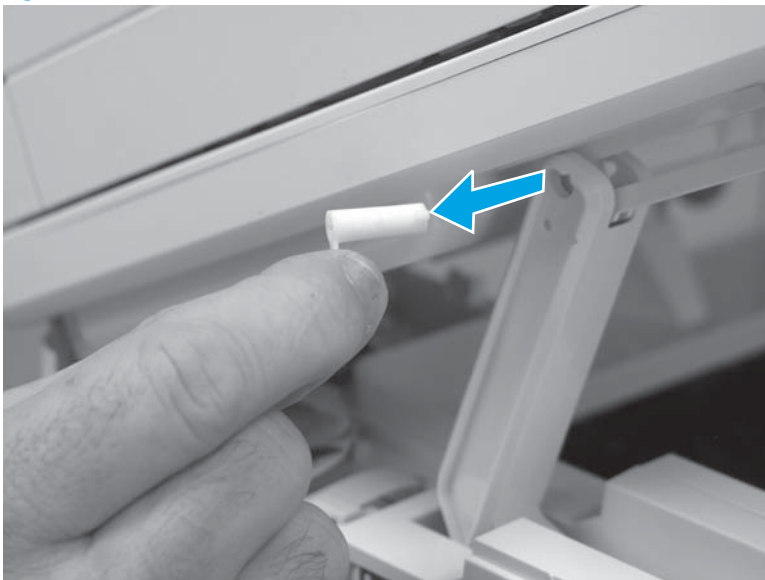
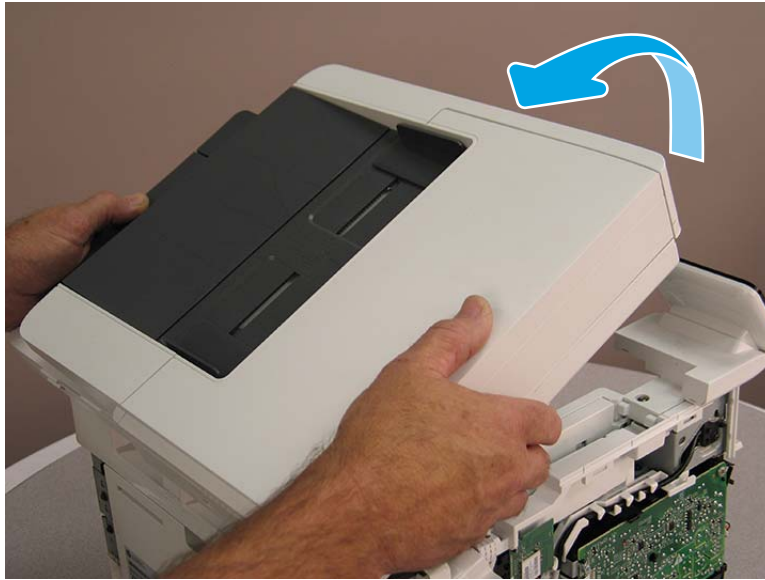

9. Slide the ISA as shown to release it.

Figure 1-297 Release the ISA

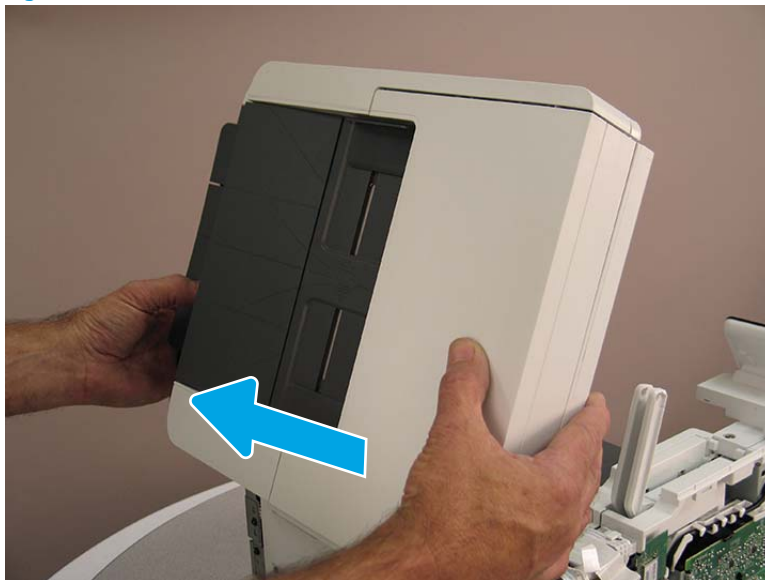

10. Remove the ISA.

Figure 1-298 Remove the ISA

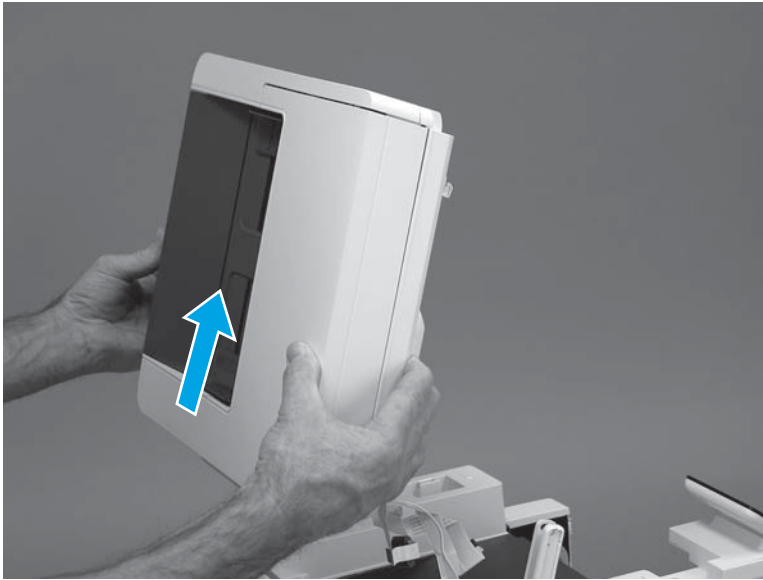



Step 5: Unpack the replacement assembly

1. Dispose of the defective part.

 **NOTE:** HP recommends responsible disposal of the defective part.

<http://www8.hp.com/us/en/hp-information/environment/product-recycling.html>

2. Unpack the replacement part from the packaging.

 **CAUTION:**  Some parts are sensitive to electrostatic discharge (ESD). Always perform service work at an ESD-protected workstation or mat. If an ESD workstation or mat is not available, touch the sheet-metal chassis to provide a static ground before touching an ESD-sensitive assembly. Protect the ESD-sensitive assemblies by placing them in ESD pouches when they are out of the printer.

If the replacement part is a roller or pad, avoid touching the spongy part of it. Skin oils on the roller or pad can cause paper pickup and/or print-quality problems. HP recommends using disposable gloves when handling rollers or pads or washing your hands before touching rollers or pads.

 **IMPORTANT:** Make sure that all of the shipping materials (for example shipping tape) are removed from the replacement part prior to installation.

3. To install an assembly, reverse the removal steps.

 **NOTE:** When applicable, special installation instructions are provided for an assembly at the end of the removal procedure. Always completely read the removal instructions and follow all special installation instructions.

Removal and replacement: ISA lift assembly and slider pin (M329/M428/M429)

 **NOTE:** M329/M428/M429 models only.

- [Introduction](#)
- [Step 1: Remove the slider pin \(M329/M428/M429\)](#)
- [Step 2: Remove the ISA lift assembly \(M329/M428/M429\)](#)
- [Step 3: Unpack the replacement assembly](#)

Introduction

This document provides the procedures to remove and replace the integrated scanner assembly (ISA) support arm.

Before performing service

Turn the printer power off

- Disconnect the power cable.

 **WARNING!** To avoid damage to the printer, turn the printer off, wait 30 seconds, and then remove the power cable before attempting to service the printer.

Use the table below to identify the correct part number for your printer. To order the part, go to www.hp.com/buy/parts.

ISA lift assembly and slider pin	
B3Q10-60128	ISA lift assembly
B3Q10-40041	Slider pin, ISA lift assembly

Required tools

- #2 Phillips screwdriver with a magnetic tip.

After performing service

Turn the printer power on

- Connect the power cable.
- Use the power switch to turn the power on.

Post service test

Make sure that the printer initializes to a **Ready** state.

Print a configuration page, and then make a copy using the document feeder to make sure that it is properly functioning.

Step 1: Remove the slider pin (M329/M428/M429)

1. Open the ISA, release one tab (callout 1), and then rotate the ISA slider pin (callout 2) towards the front of the printer to release it.

Figure 1-299 Release one tab and rotate the slider pin

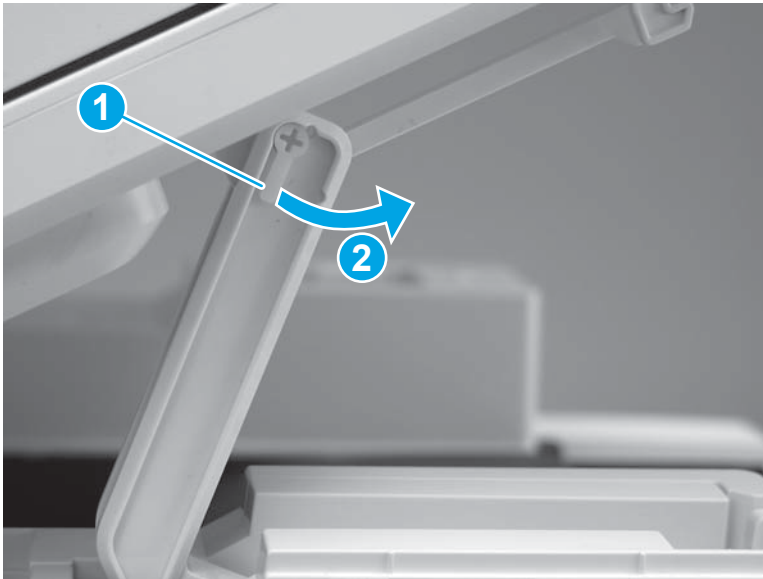

2. Remove the slider pin.

 **Reinstallation tip:** Align the keyed portion of the slider pin with the slot and hole in the lift assembly.

Figure 1-300 Remove the slider pin

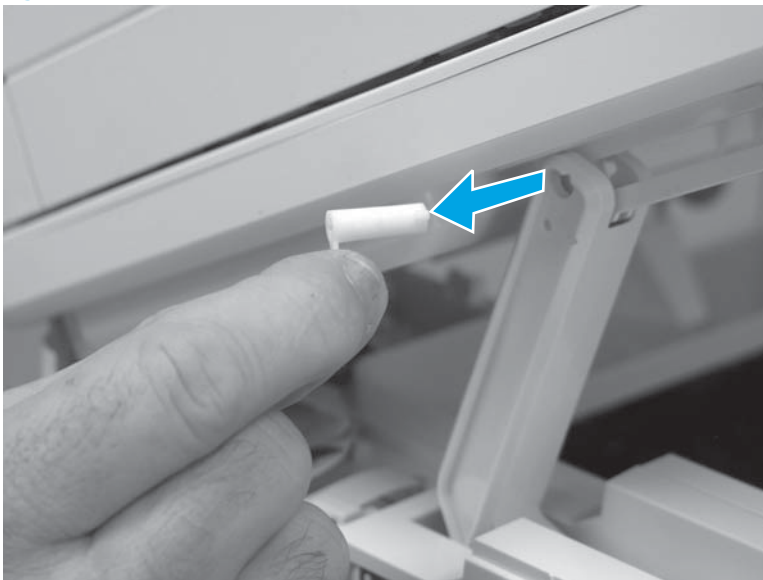

Step 2: Remove the ISA lift assembly (M329/M428/M429)

1. Move the ISA out of the way, and then lower the support arm to the closed position.

 **CAUTION:** The ISA hinges are not captive in the top cover mounting bosses. Do not allow the ISA to slip off of the top cover.

 **Reinstallation tip:** If the replacement lift assembly is in the closed position, place it in the open position.

Figure 1-301 Lower the support arm



2. Before proceeding take note of the following.

 **CAUTION:** The support arm is spring loaded and can unexpectedly spring into the open position. To avoid injury, do not place a finger in the screw well when the support arm is in the closed position.

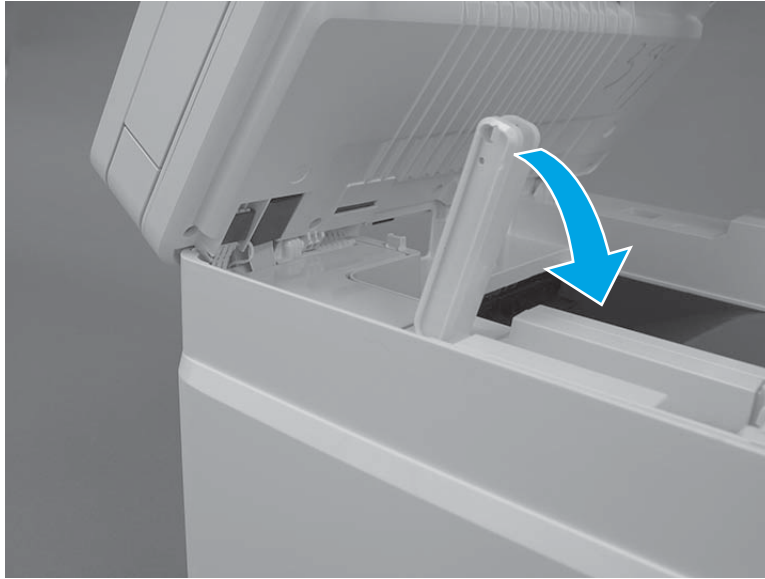
Figure 1-302 Before proceeding take note



3. Remove one screw (callout 1).

Figure 1-303 Remove one screw

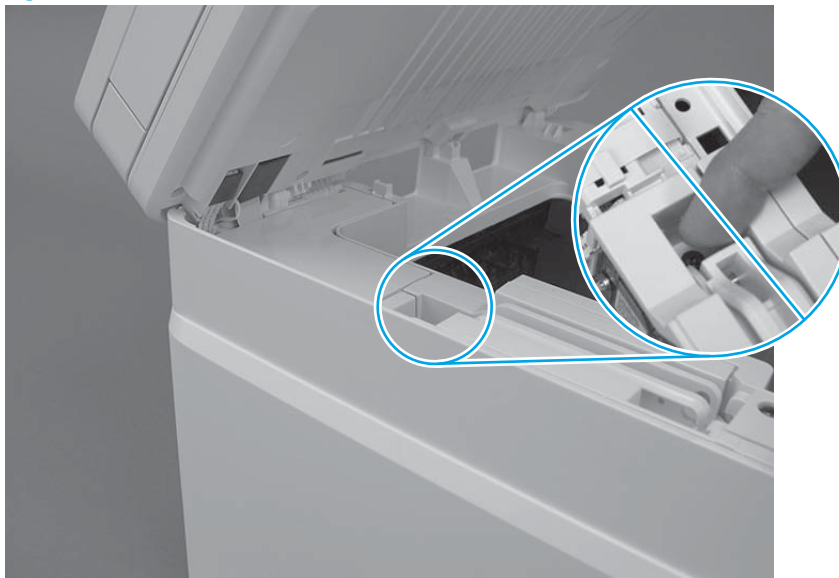

4. Remove the support arm.

Figure 1-304 Remove the support arm





Step 3: Unpack the replacement assembly

1. Dispose of the defective part.

 **NOTE:** HP recommends responsible disposal of the defective part.

<http://www8.hp.com/us/en/hp-information/environment/product-recycling.html>

2. Unpack the replacement part from the packaging.

 **CAUTION:**  Some parts are sensitive to electrostatic discharge (ESD). Always perform service work at an ESD-protected workstation or mat. If an ESD workstation or mat is not available, touch the sheet-metal chassis to provide a static ground before touching an ESD-sensitive assembly. Protect the ESD-sensitive assemblies by placing them in ESD pouches when they are out of the printer.

If the replacement part is a roller or pad, avoid touching the spongy part of it. Skin oils on the roller or pad can cause paper pickup and/or print-quality problems. HP recommends using disposable gloves when handling rollers or pads or washing your hands before touching rollers or pads.

 **IMPORTANT:** Make sure that all of the shipping materials (for example shipping tape) are removed from the replacement part prior to installation.

3. To install an assembly, reverse the removal steps.

 **NOTE:** When applicable, special installation instructions are provided for an assembly at the end of the removal procedure. Always completely read the removal instructions and follow all special installation instructions.

Removal and replacement: Internal parts and assemblies

- [Removal and replacement: Fuser](#)
- [Removal and replacement: Registration assembly](#)
- [Removal and replacement: Main motor \(M1\)](#)
- [Removal and replacement: Power switch printed circuit assembly](#)
- [Removal and replacement: Fax PCA \(M329/M428/M429\)](#)
- [Removal and replacement: Mute USB PCA \(M329/M428/M429\)](#)
- [Removal and replacement: Wireless PCA](#)
- [Removal and replacement: Formatter PCA](#)
- [Removal and replacement: Fan \(FM1\)](#)
- [Removal and replacement: Fan holder \(FM1\)](#)
- [Removal and replacement: Laser scanner assembly](#)
- [Removal and replacement: Sheet-metal formatter bracket and formatter PCA](#)
- [Removal and replacement: Control panel FFC, \(M304/M305/M404/M405\)](#)
- [Removal and replacement: Formatter FFC](#)
- [Removal and replacement: DC controller](#)
- [Removal and replacement: Tag-cable assembly \(toner-cartridge memory\)](#)
- [Removal and replacement: Connecting PCA](#)
- [Removal and replacement: Laser scanner FFC](#)
- [Removal and replacement: High-voltage power supply](#)
- [Removal and replacement: Low-voltage power supply](#)
- [Removal and replacement: Control-panel assembly \(M304/M305/M404/M405\)](#)
- [Removal and replacement: Control panel \(M329/M428/M429\) and control panel sub assemblies](#)

Removal and replacement: Fuser

- [Introduction](#)
- [Step 1: Remove Tray 2](#)
- [Step 2: Remove the cartridge door assembly](#)
- [Step 3: Remove the left cover](#)
- [Step 4: Remove the right cover](#)
- [Step 5: Remove the rear door assembly](#)
- [Step 6: Remove the fuser](#)
- [Step 7: Unpack the replacement assembly](#)

Introduction

This document provides the procedures to remove and replace the fuser.

Before performing service

Turn the printer power off

- Disconnect the power cable.

⚠ WARNING! To avoid damage to the printer, turn the printer off, wait 30 seconds, and then remove the power cable before attempting to service the printer.

Make sure the correct voltage fuser is installed in the printer.

⚠ CAUTION: The fuser is hot. Wait at least 30 minutes after turning the printer off before removing the fuser.

Use the table below to identify the correct part number for your printer. To order the part, go to www.hp.com/buy/parts.

Fuser part number	
RM2-2554-000CN	Fuser (110V/127V)
RM2-2555-000CN	Fuser (220V/240V)

Required tools

- #2 Phillips screwdriver with a magnetic tip.

After performing service

Turn the printer power on

- Connect the power cable.
- Use the power switch to turn the power on.

Post service test

Make sure that the printer initializes to a **Ready** state.

Print a configuration page to make sure that the printer is functioning correctly.

Step 1: Remove Tray 2

- ▲ Pull the tray straight out of the printer to remove it.

Figure 1-305 Remove the tray



Step 2: Remove the cartridge door assembly

 **NOTE:** If the toner cartridge was not removed prior to servicing the printer, remove it now.

1. Release the support shaft (callout 1), and then slide it toward the center of the door (callout 2).

 **TIP:** It might be easier to release the support shaft by using a small flat-blade screwdriver.

Figure 1-306 Release the support shaft

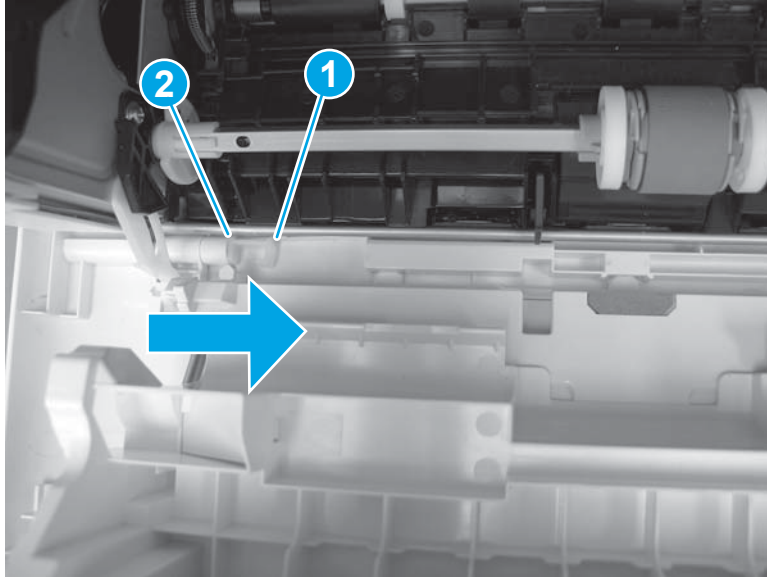

2. Remove the support shaft.

Figure 1-307 Remove the support shaft

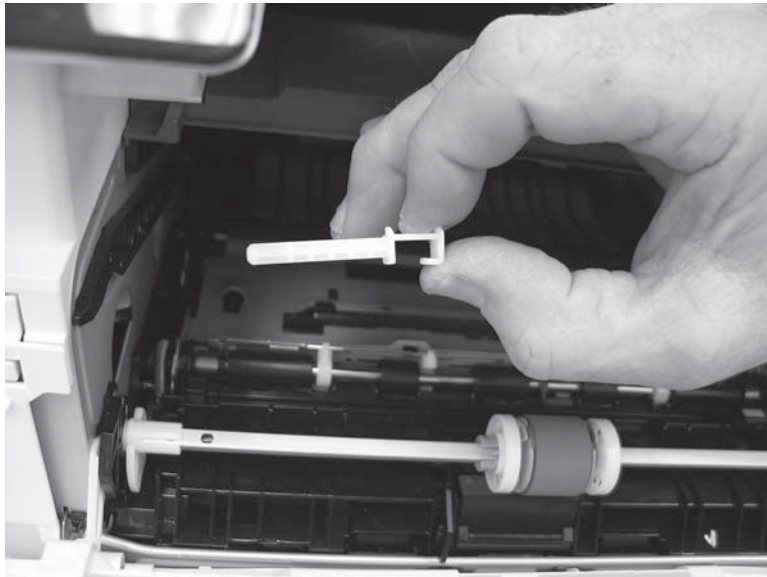

3. Release one tab (callout 1), and then slide the guide out of the printer (callout 2).

⚠ CAUTION: Be careful, the tab (callout 1) can be easily broken.

Figure 1-308 Remove the guide

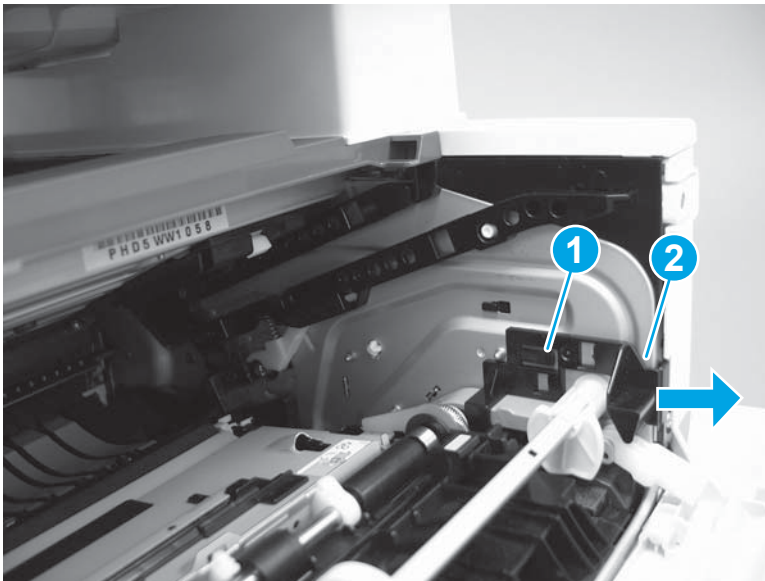

4. Use a small flat-blade screwdriver to gently pry the white-plastic door arm (callout 1) off of the gray-plastic pressure-release link (callout 2) to release the door arm.

Figure 1-309 Release the pressure-release link

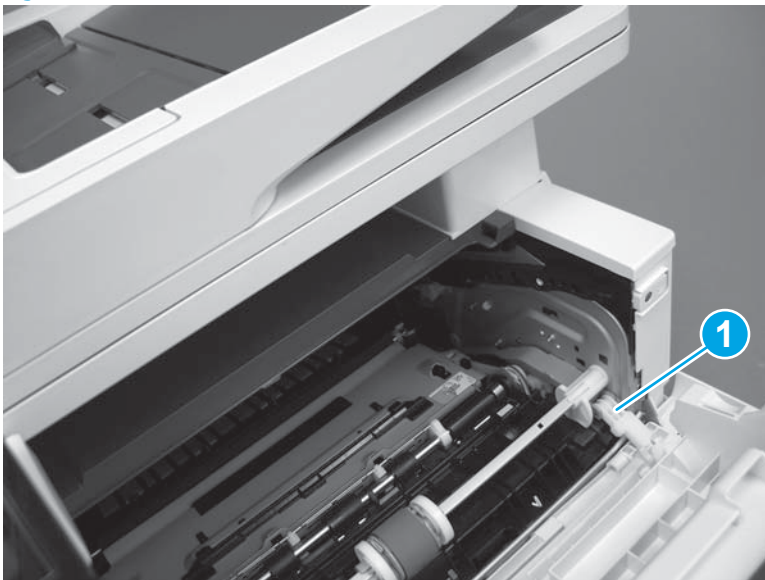

5. With the door in the partially closed position, slightly raise the left end (callout 1; raise it over the sheet-metal hinge boss), and then slide the door to the left (callout 2) to release the right hinge (callout 3).

⚠ CAUTION: The door is still attached to the printer by the left-side retainer arm. Do not attempt to completely remove the door.

💡 Reinstallation tip: When reinstalling the door, there are two right-side hinge pins (not shown in callout 3). Keep a finger pressed on the left-side retainer arm so that it does not disengage from the door.

Figure 1-310 Release the door

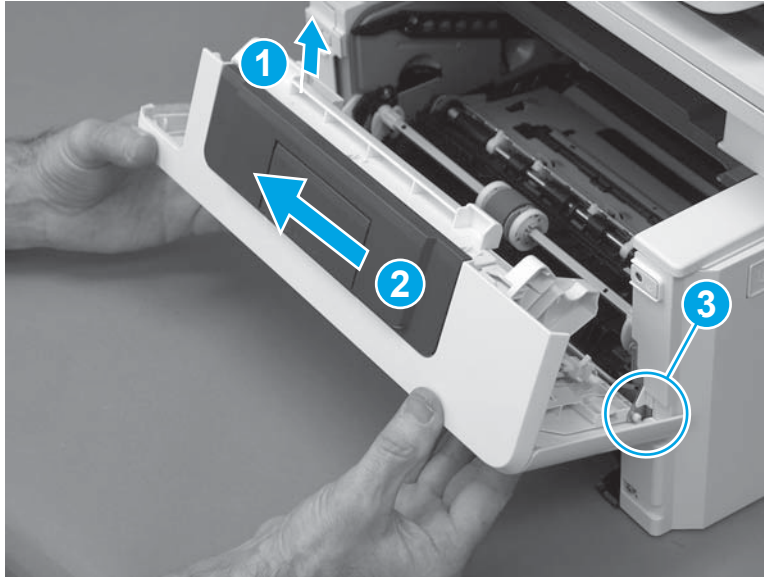

6. Rotate the door away from the printer until the keyed pin on the left-side retainer arm can disengage from the door.

Figure 1-311 Release the left-side retainer arm

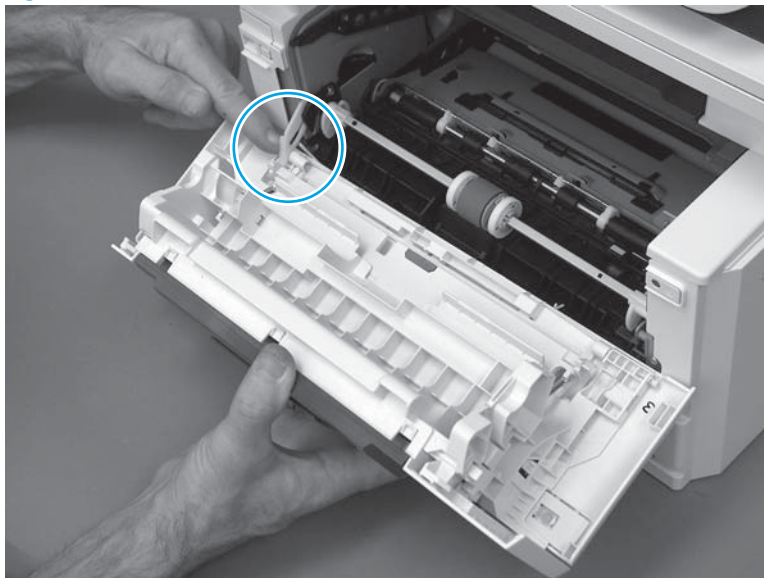

7. Remove the door.

Figure 1-312 Remove the door

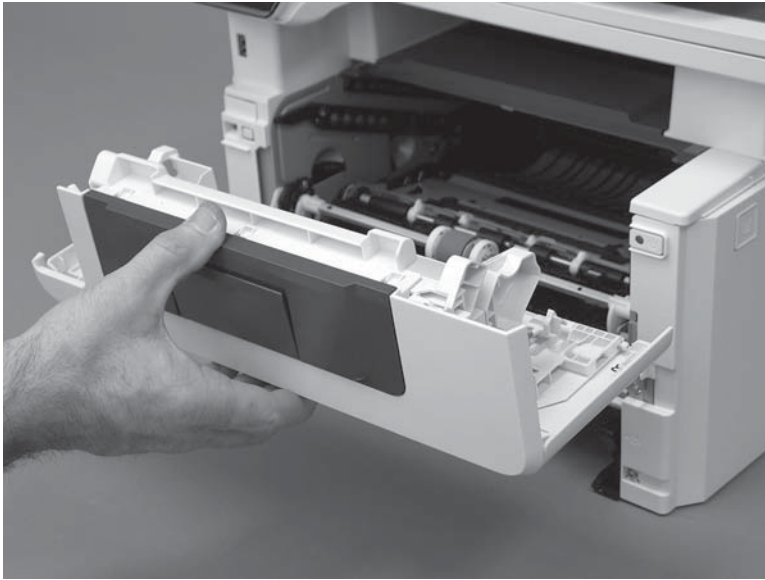

Step 3: Remove the left cover

1. Remove one screw (callout 1).

Figure 1-313 Remove one screw

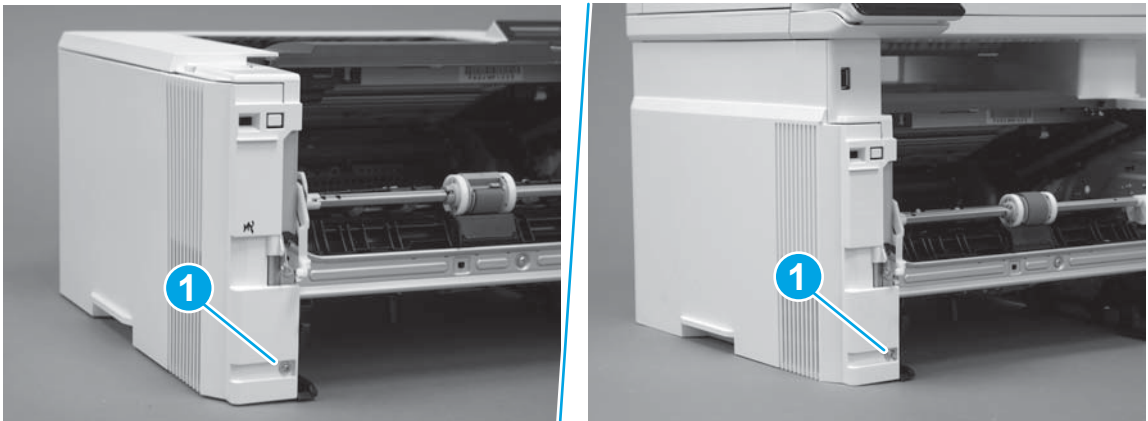

2. Open the rear door, release two bosses (callout 1), and then release three tabs (callout 2).

Figure 1-314 Release two bosses and three tabs

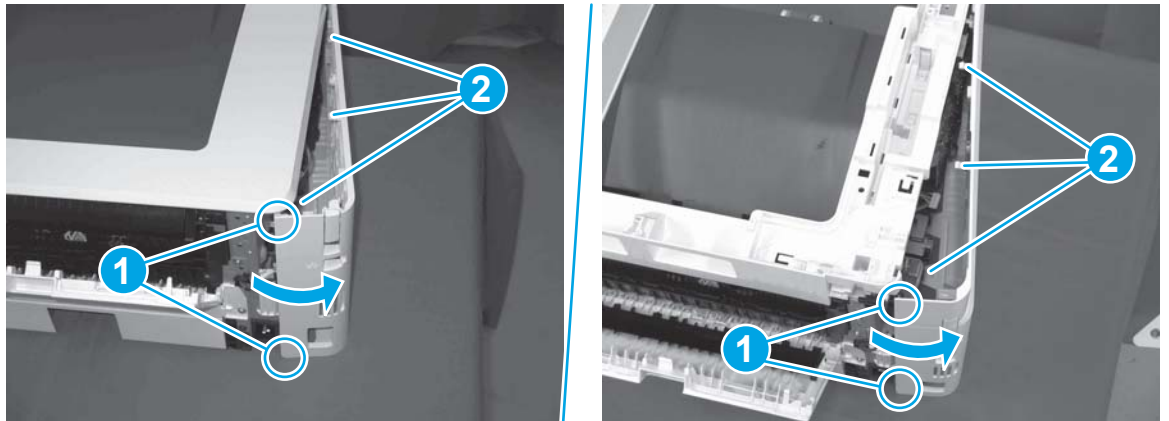

3. At the front of the printer, do one of the following:
 - **M304/M305/M404/M405:** Release two bosses (callout 1), and then remove the cover (callout 2).
 - **M329/M428/M429:** Release one tab (callout 3), two bosses (callout 4), and then remove the cover (callout 5).

⚠ CAUTION: Be careful when releasing the upper bosses on the M329/M428/M429 cover. One portion of the cover (callout 6) is fragile and is easily broken.

Figure 1-315 Remove the cover

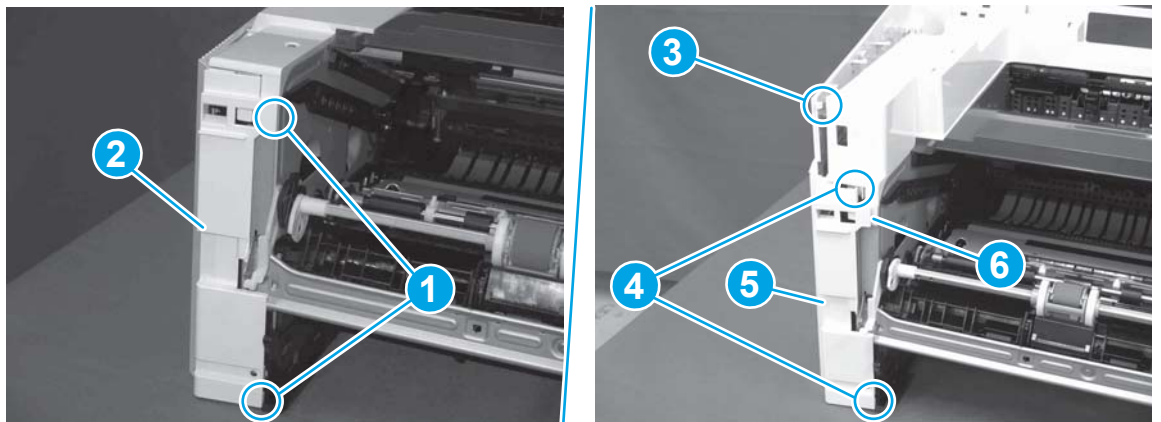

Step 4: Remove the right cover

1. At the front of the printer, release two bosses (callout 1), and then release three tabs (callout 2).

💡 Reinstallation tip: Remove, and then reinstall the cover if the switch or button does not correctly function.

Figure 1-316 Release two bosses and three tabs

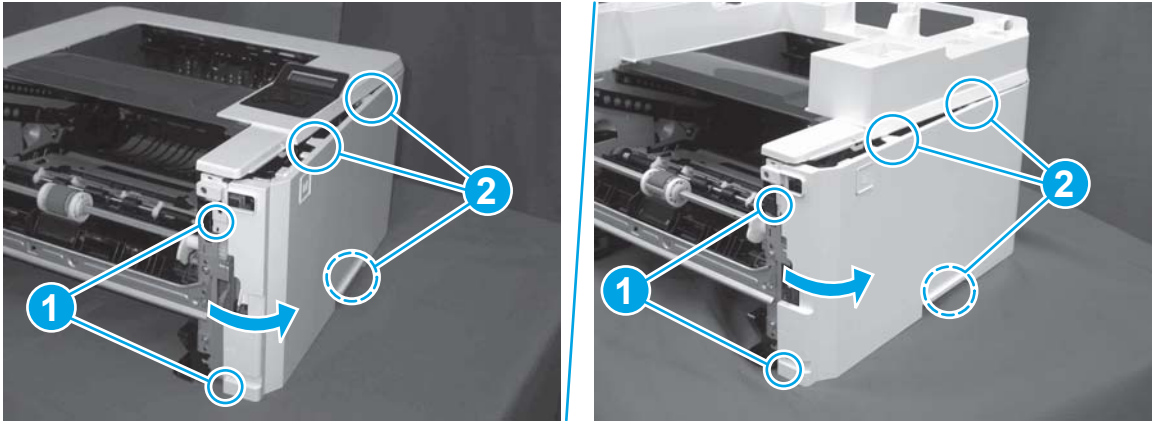

2. Open the rear door, release two bosses (callout 1), and then remove the cover (callout 2).

Figure 1-317 Remove the cover

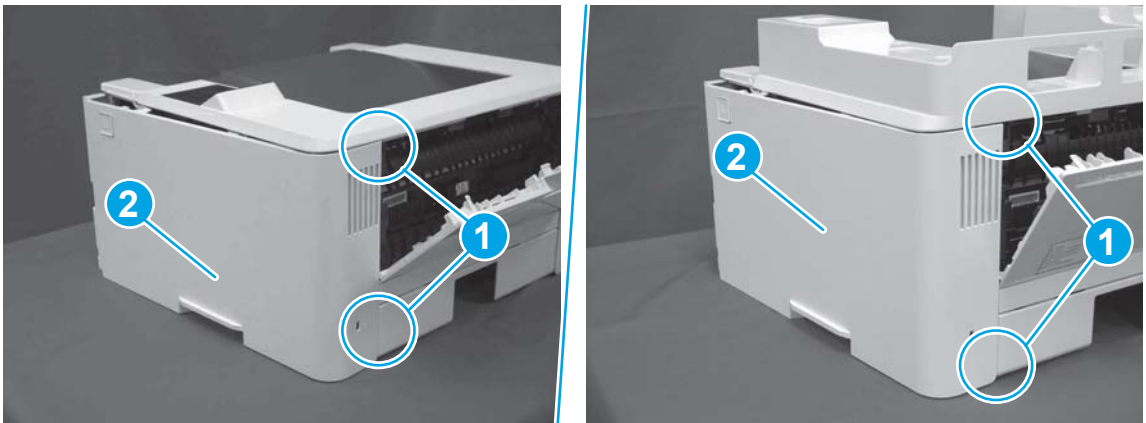

Step 5: Remove the rear door assembly

1. **Duplex models only:** Inside the Tray 2 cavity, press the green jam access lever (callout 1), and then lower the duplex feed assembly (callout 2).

Figure 1-318 Duplex models, lower the duplex feed assembly

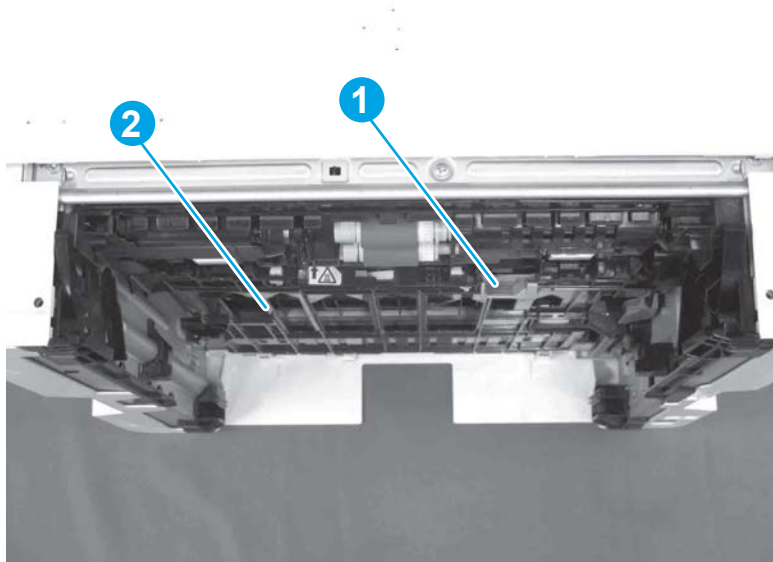

2. At the rear of the printer, remove two screws (callout 1), and then remove the rear door assembly (callout 2).

Figure 1-319 Remove two screws

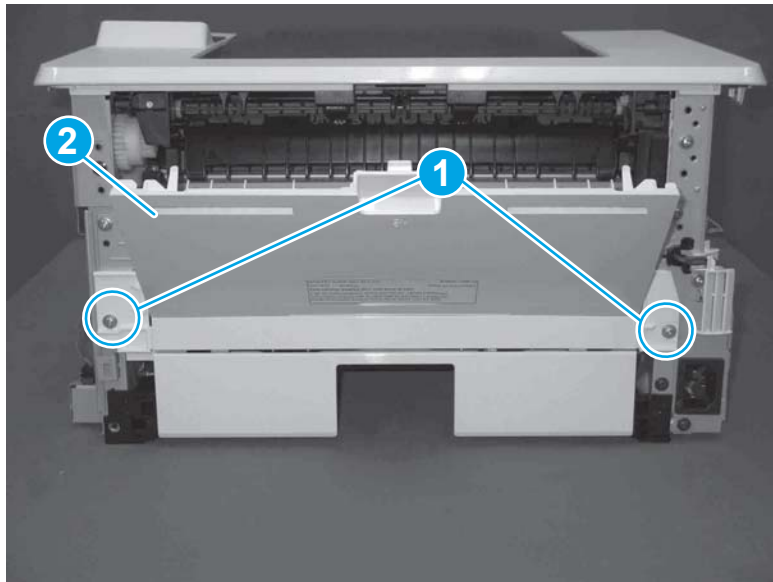

Step 6: Remove the fuser

1. Disconnect one connector (callout 1), and then release the wire harness from the guide (callout 2).

Figure 1-320 Disconnect one connector

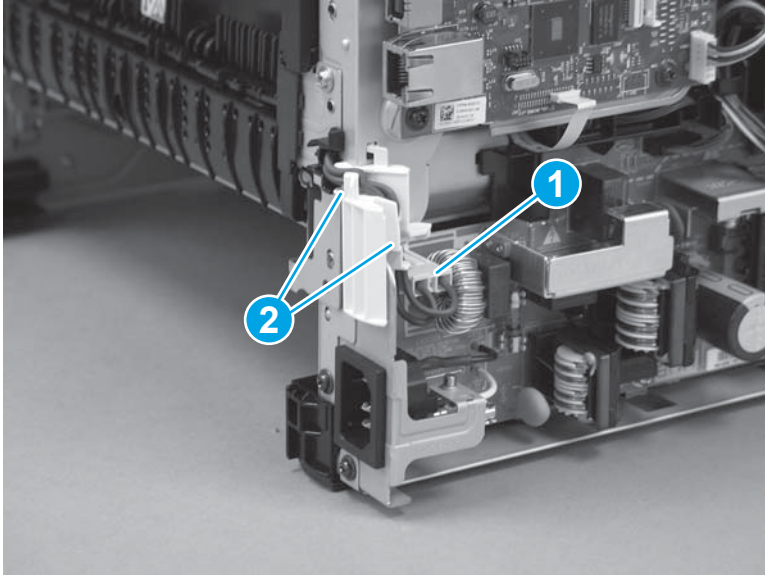

2. Pull the upper connector cover (callout 1) straight off of the printer to remove it.

Figure 1-321 Remove the cover

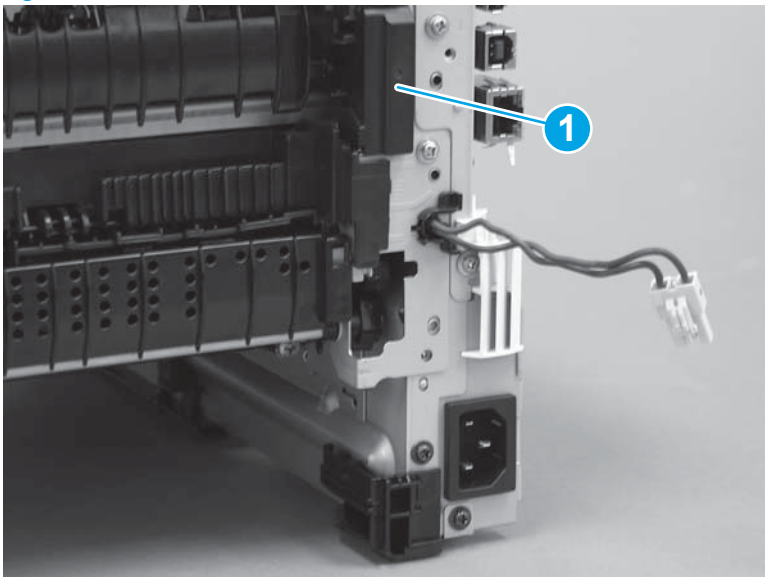

3. Disconnect two connectors (callout 1).

Figure 1-322 Disconnect two connectors

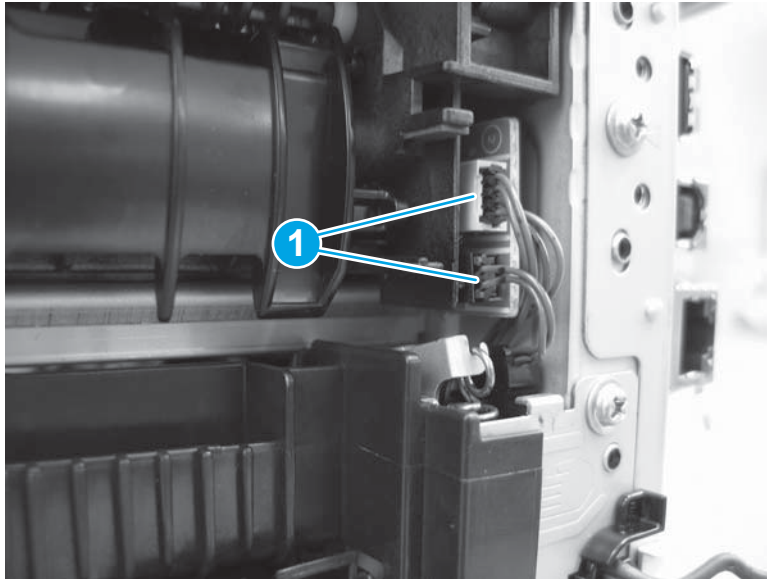

4. Remove four screws (callout 1).

Figure 1-323 Remove four screws

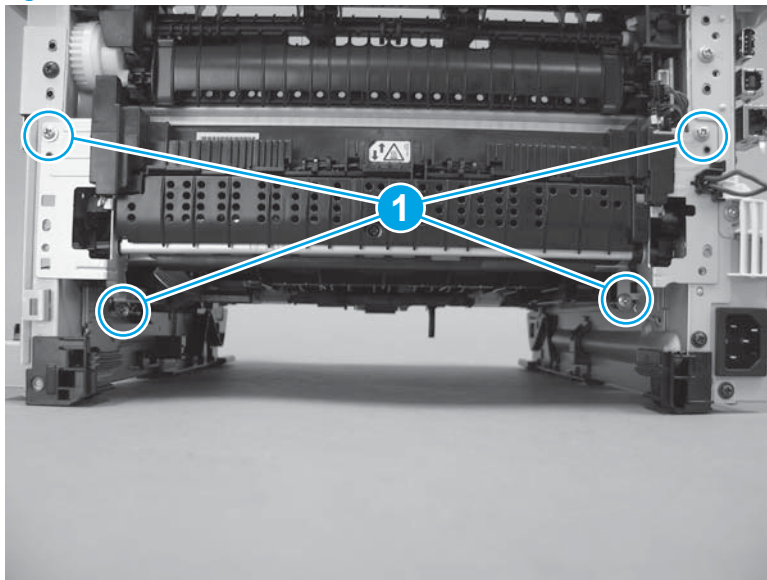

5. Pull the pressure-release link arm (callout 1) to release it from the fuser.

 **Reinstallation tip:** Make sure that the pressure-release arm is correctly connected to the fuser (callout 2).

Figure 1-324 Release the pressure-release arm

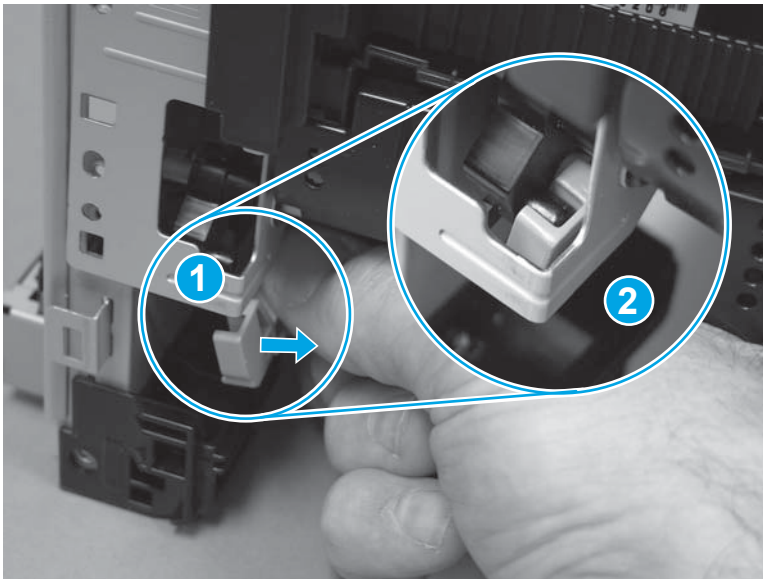

6. Slide the fuser straight out of the printer.

Figure 1-325 Remove the fuser

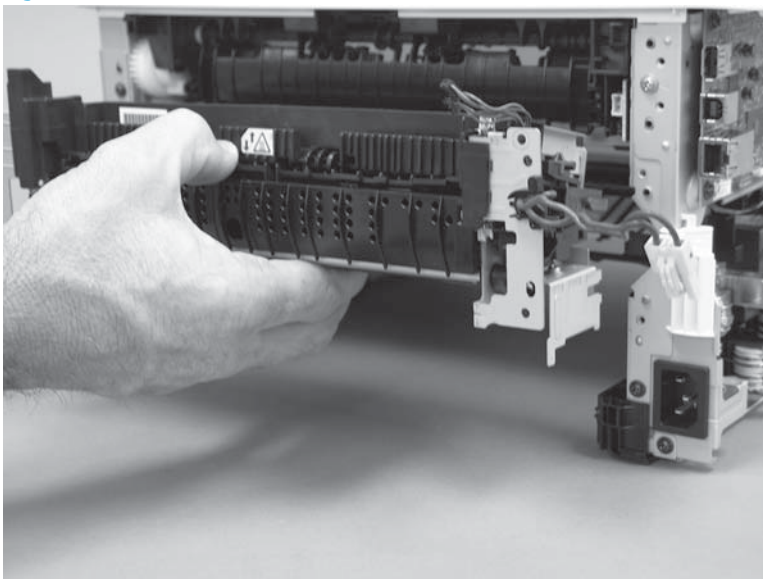



Step 7: Unpack the replacement assembly

1. Dispose of the defective part.

 **NOTE:** HP recommends responsible disposal of the defective part.

<http://www8.hp.com/us/en/hp-information/environment/product-recycling.html>

2. Unpack the replacement part from the packaging.

 **CAUTION:**  Some parts are sensitive to electrostatic discharge (ESD). Always perform service work at an ESD-protected workstation or mat. If an ESD workstation or mat is not available, touch the sheet-metal chassis to provide a static ground before touching an ESD-sensitive assembly. Protect the ESD-sensitive assemblies by placing them in ESD pouches when they are out of the printer.

If the replacement part is a roller or pad, avoid touching the spongy part of it. Skin oils on the roller or pad can cause paper pickup and/or print-quality problems. HP recommends using disposable gloves when handling rollers or pads or washing your hands before touching rollers or pads.

 **IMPORTANT:** Make sure that all of the shipping materials (for example shipping tape) are removed from the replacement part prior to installation.

3. To install an assembly, reverse the removal steps.

 **NOTE:** When applicable, special installation instructions are provided for an assembly at the end of the removal procedure. Always completely read the removal instructions and follow all special installation instructions.

Removal and replacement: Registration assembly

- [Introduction](#)
- [Step 1: Remove Tray 2](#)
- [Step 2: Remove the cartridge door assembly](#)
- [Step 3: Remove the left cover](#)
- [Step 4: Remove the right cover](#)
- [Step 5: Remove the rear door assembly](#)
- [Step 6: Remove the integrated scanner assembly \(M329/M428/M429\)](#)
- [Step 7: Remove the control panel \(M329/M428/M429\)](#)
- [Step 8: Remove the top cover \(M329/M428/M429\)](#)
- [Step 9: Remove the top cover \(M304/M305/M404/M405\)](#)
- [Step 10: Remove the paper delivery tray \(output bin\)](#)
- [Step 11: Remove the fuser](#)
- [Step 12: Remove the registration assembly](#)
- [Step 13: Unpack the replacement assembly](#)

Introduction

This document provides the procedures to remove and replace the registration assembly.

Before performing service

Turn the printer power off

- Disconnect the power cable.

⚠ WARNING! To avoid damage to the printer, turn the printer off, wait 30 seconds, and then remove the power cable before attempting to service the printer.

Make sure the correct voltage fuser is installed in the printer.

⚠ CAUTION: The fuser is hot. Wait at least 30 minutes after turning the printer off before removing the fuser.

Use the table below to identify the correct part number for your printer. To order the part, go to www.hp.com/buy/parts.

Registration assembly part number

RM2-2577-000CN

Registration assembly

Required tools

- #2 Phillips screwdriver with a magnetic tip.

After performing service

Turn the printer power on

- Connect the power cable.
- Use the power switch to turn the power on.

Post service test

Make sure that the printer initializes to a **Ready** state.

Print a configuration page to make sure that the printer is functioning correctly.

Step 1: Remove Tray 2

- ▲ Pull the tray straight out of the printer to remove it.

Figure 1-326 Remove the tray



Step 2: Remove the cartridge door assembly

 **NOTE:** If the toner cartridge was not removed prior to servicing the printer, remove it now.

1. Release the support shaft (callout 1), and then slide it toward the center of the door (callout 2).

 **TIP:** It might be easier to release the support shaft by using a small flat-blade screwdriver.

Figure 1-327 Release the support shaft

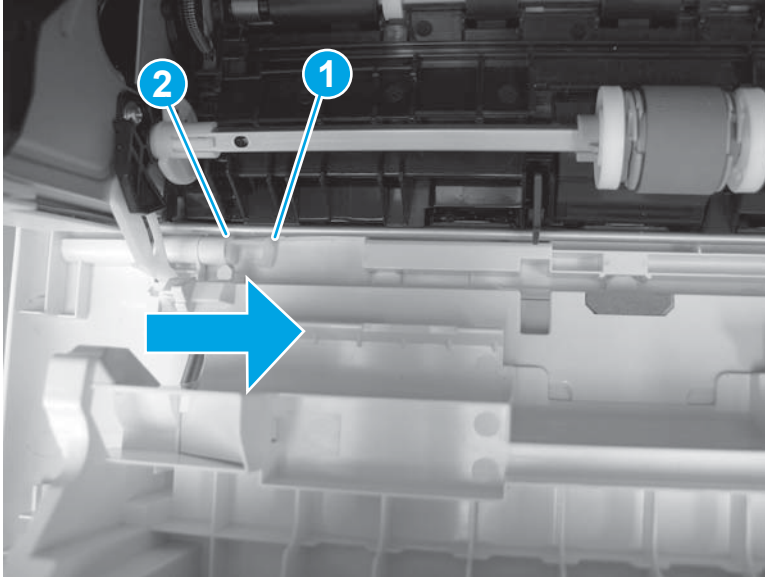

2. Remove the support shaft.

Figure 1-328 Remove the support shaft

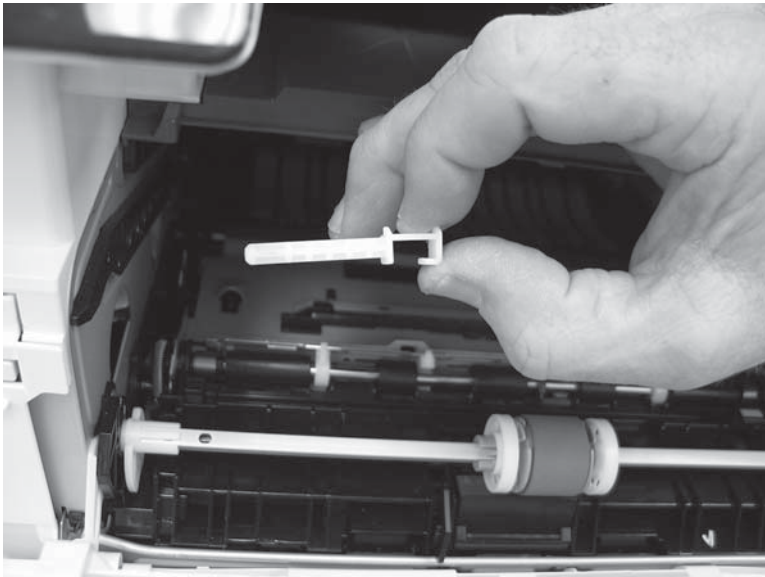

3. Release one tab (callout 1), and then slide the guide out of the printer (callout 2).

CAUTION: Be careful, the tab (callout 1) can be easily broken.

Figure 1-329 Remove the guide

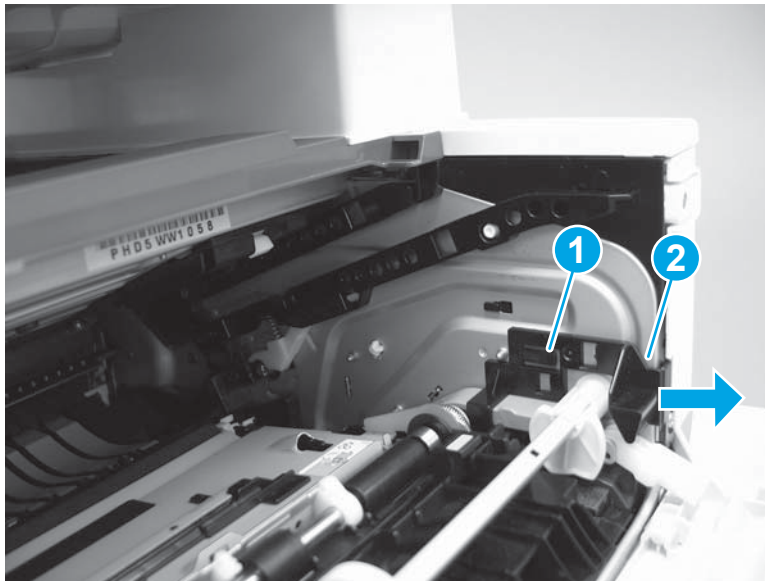

4. Use a small flat-blade screwdriver to gently pry the white-plastic door arm (callout 1) off of the gray-plastic pressure-release link (callout 2) to release the door arm.

Figure 1-330 Release the pressure-release link

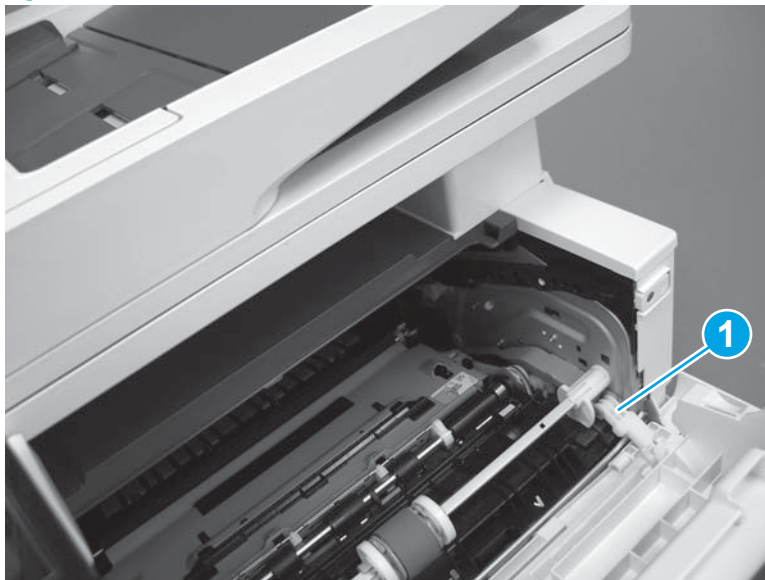

5. With the door in the partially closed position, slightly raise the left end (callout 1; raise it over the sheet-metal hinge boss), and then slide the door to the left (callout 2) to release the right hinge (callout 3).

⚠ CAUTION: The door is still attached to the printer by the left-side retainer arm. Do not attempt to completely remove the door.

💡 Reinstallation tip: When reinstalling the door, there are two right-side hinge pins (not shown in callout 3). Keep a finger pressed on the left-side retainer arm so that it does not disengage from the door.

Figure 1-331 Release the door

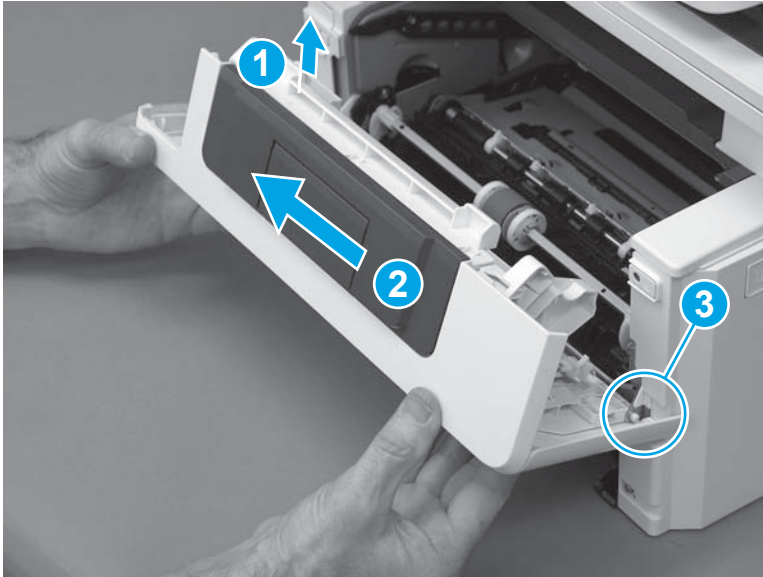

6. Rotate the door away from the printer until the keyed pin on the left-side retainer arm can disengage from the door.

Figure 1-332 Release the left-side retainer arm

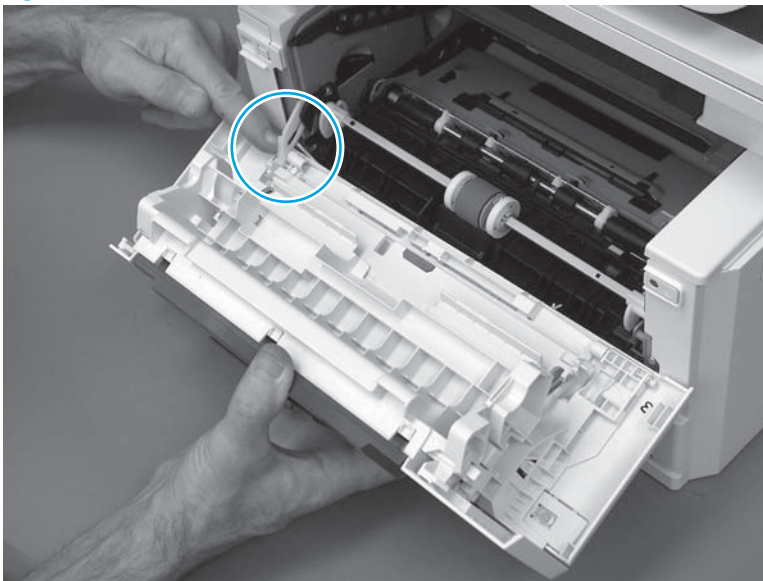

7. Remove the door.

Figure 1-333 Remove the door

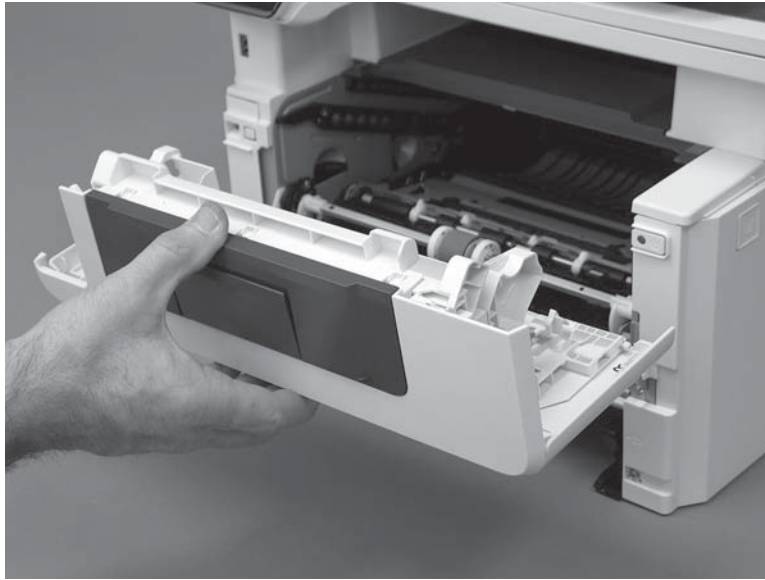

Step 3: Remove the left cover

1. Remove one screw (callout 1).

Figure 1-334 Remove one screw

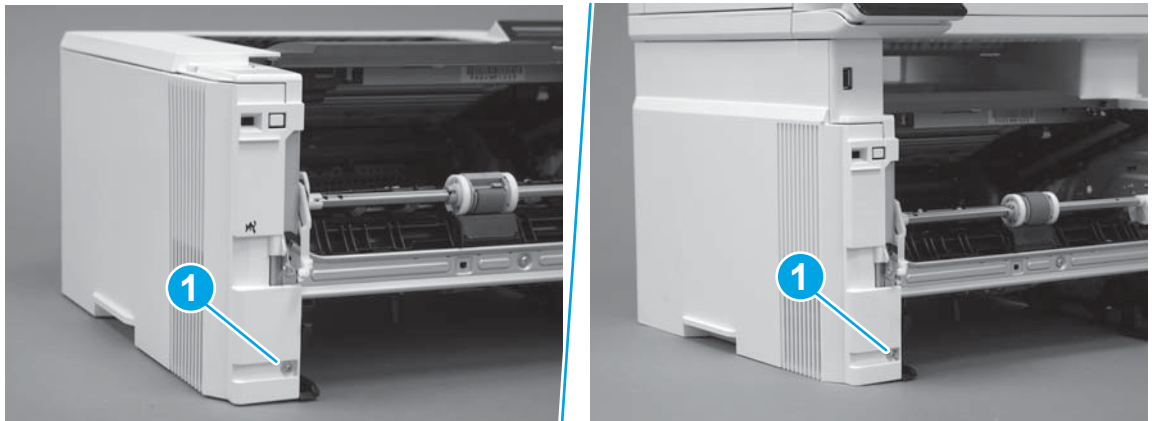

2. Open the rear door, release two bosses (callout 1), and then release three tabs (callout 2).

Figure 1-335 Release two bosses and three tabs

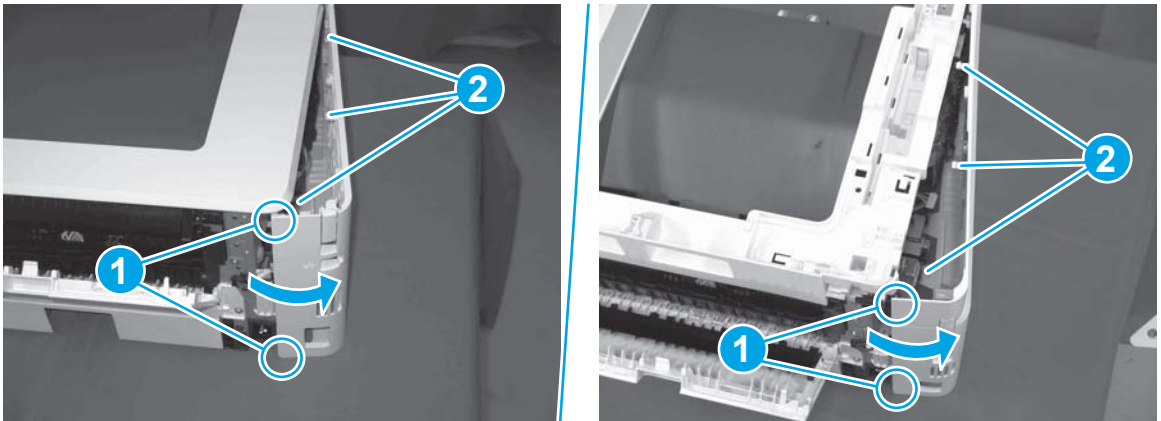

3. At the front of the printer, do one of the following:
 - **M304/M305/M404/M405:** Release two bosses (callout 1), and then remove the cover (callout 2).
 - **M329/M428/M429:** Release one tab (callout 3), two bosses (callout 4), and then remove the cover (callout 5).

CAUTION: Be careful when releasing the upper bosses on the M329/M428/M429 cover. One portion of the cover (callout 6) is fragile and is easily broken.

Figure 1-336 Remove the cover

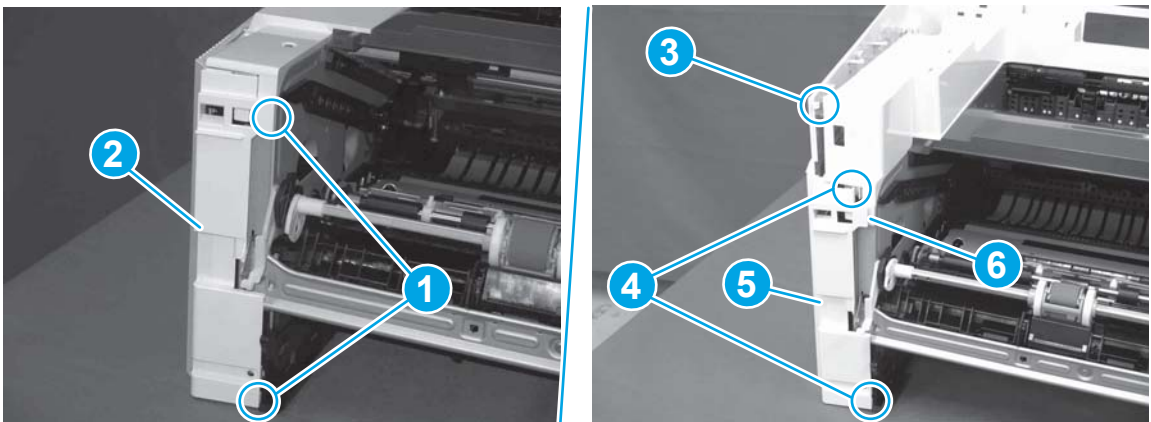

Step 4: Remove the right cover

1. At the front of the printer, release two bosses (callout 1), and then release three tabs (callout 2).

Reinstallation tip: Remove, and then reinstall the cover if the switch or button does not correctly function.

Figure 1-337 Release two bosses and three tabs

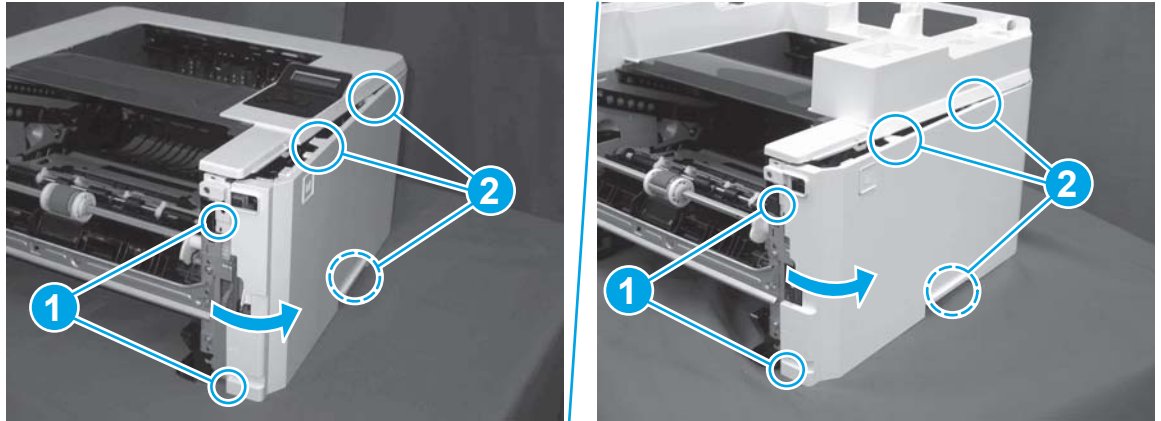

2. Open the rear door, release two bosses (callout 1), and then remove the cover (callout 2).

Figure 1-338 Remove the cover

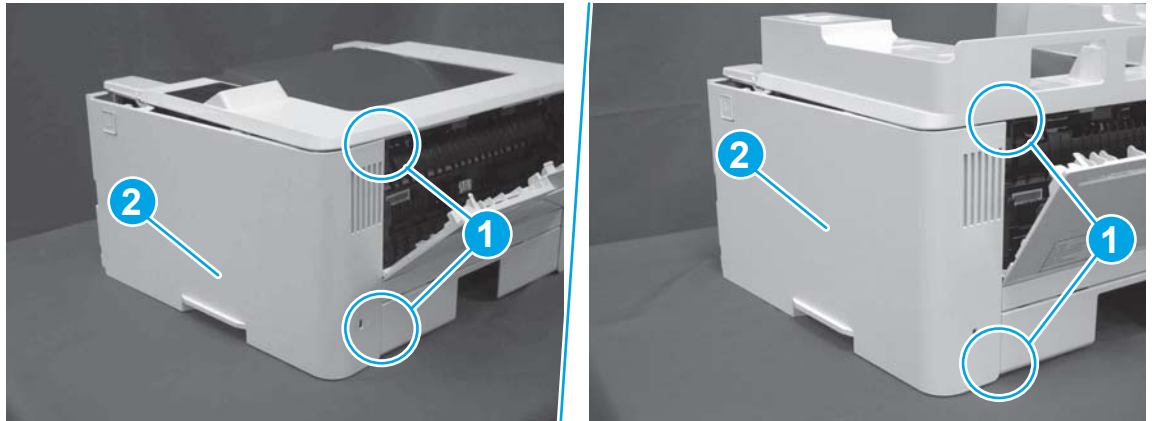

Step 5: Remove the rear door assembly

1. **Duplex models only:** Inside the Tray 2 cavity, press the green jam access lever (callout 1), and then lower the duplex feed assembly (callout 2).

Figure 1-339 Duplex models, lower the duplex feed assembly

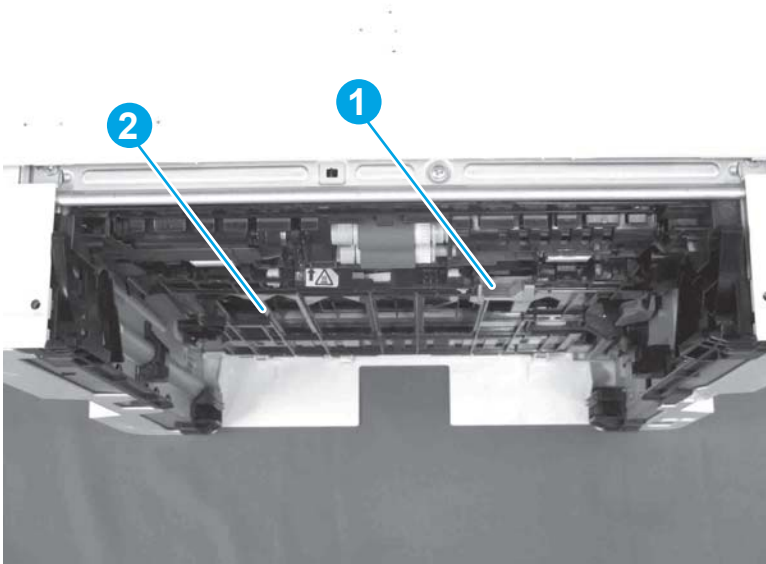

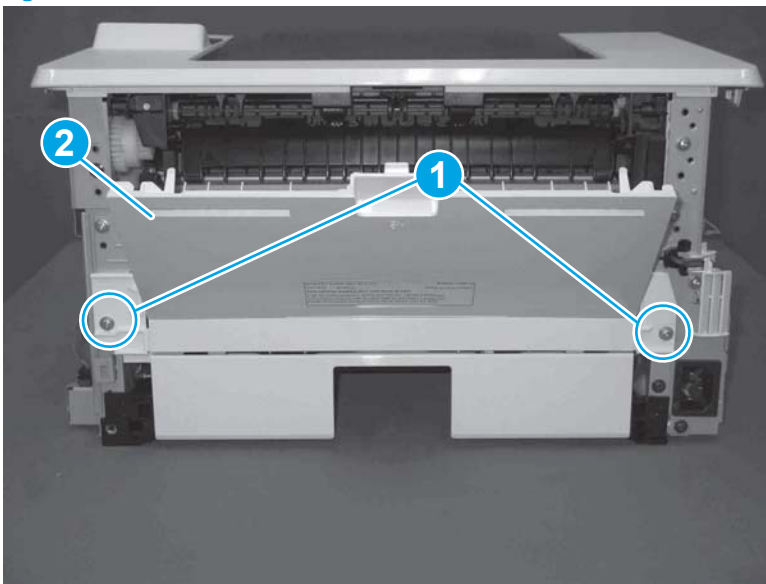

2. At the rear of the printer, remove two screws (callout 1), and then remove the rear door assembly (callout 2).

Figure 1-340 Remove two screws



Step 6: Remove the integrated scanner assembly (M329/M428/M429)

 **NOTE:** The step is for the M329/M428/M429 printer. For the M304/M305/M404/M405, skip this step and go to [Step 9: Remove the top cover \(M304/M305/M404/M405\) on page 233](#).

 **NOTE:** M329/M428/M429 models only. The integrated scanner assembly (ISA) includes the sub-scanner assembly (SSA) and the automatic document feeder (ADF).

1. Raise the ISA.

Figure 1-341 Raise the ISA

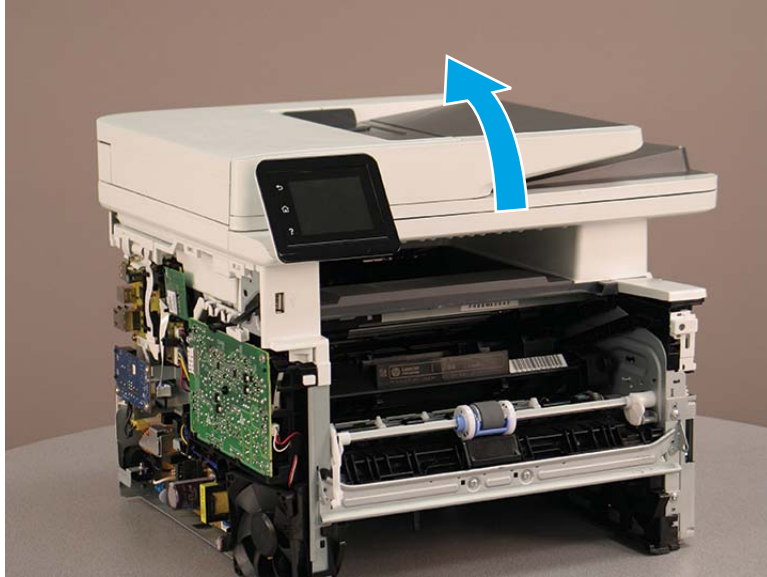

2. Release the ISA flat-flexible cable (FFC) cover (callout 1), and then remove it (callout 2).

Figure 1-342 Remove the ISA FFC cover

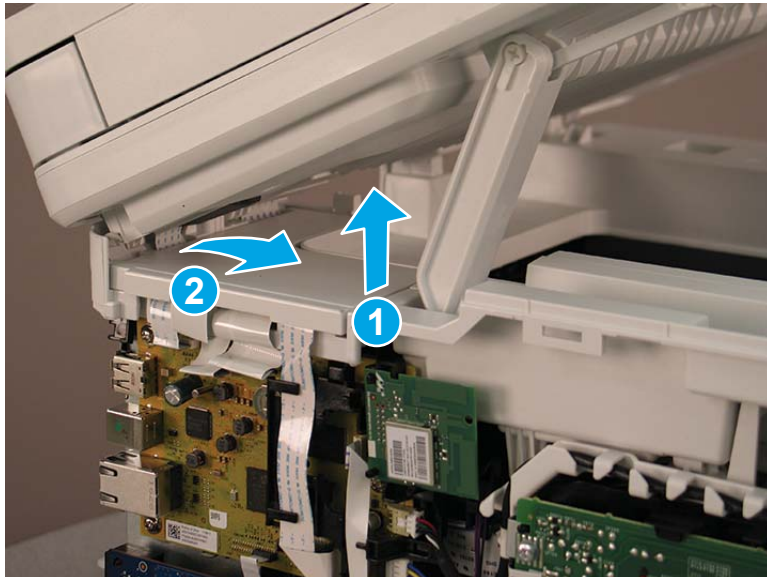

3. Disconnect three FFCs (callout 1), and then remove the ferrite (callout 2) from the holder.

⚠ CAUTION: The ferrite is not captive on the FFC. Do not lose the ferrite while handling the ISA.

Figure 1-343 Disconnect three FFCs

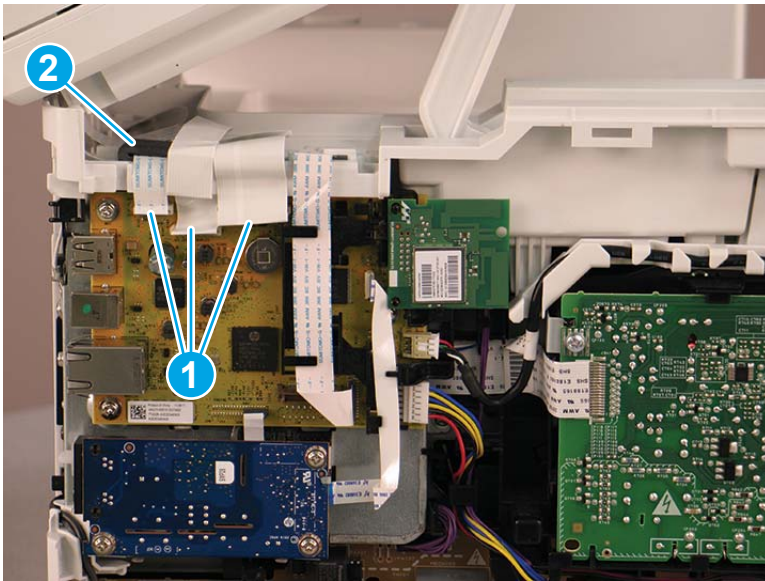

4. Remove one screw (callout 1).

Figure 1-344 Remove one screw

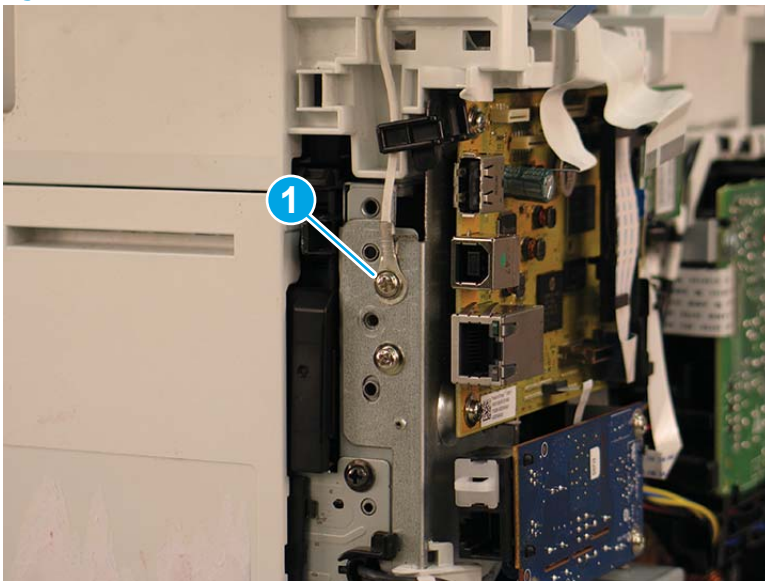

5. Pass the ground wire through the opening in the top cover.

Figure 1-345 Pass the wire through the opening



6. Release one tab (callout 1), and then rotate the ISA slider pin (callout 2) towards the front of the printer to release it.

Figure 1-346 Release one tab and rotate the slider pin

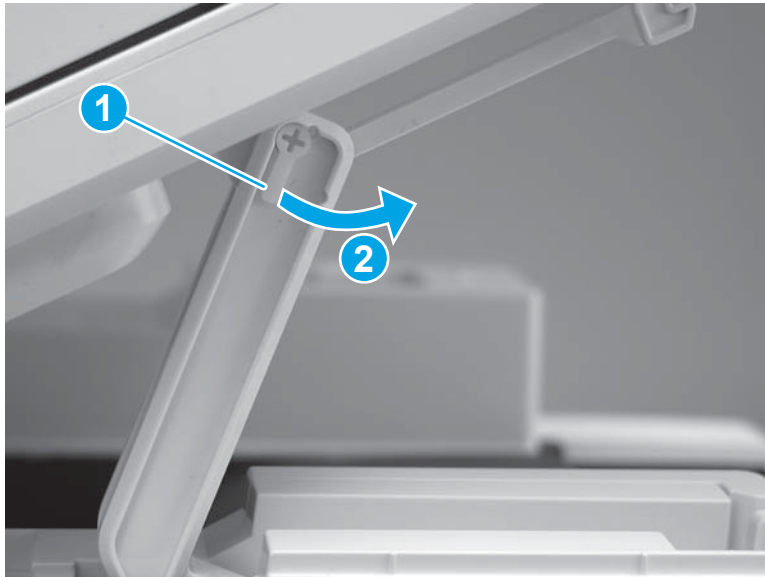

7. Remove the slider pin.

 **Reinstallation tip:** Align the keyed portion of the locking pin with the slot and hole in the support arm.

Figure 1-347 Remove the slider pin

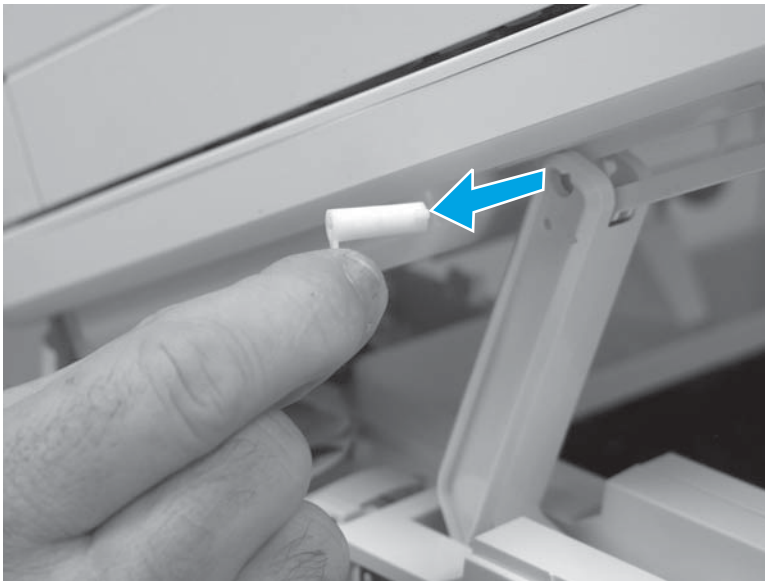

8. Rotate the ISA towards the rear of the printer until it stops.

Figure 1-348 Rotate the ISA towards the rear of the printer

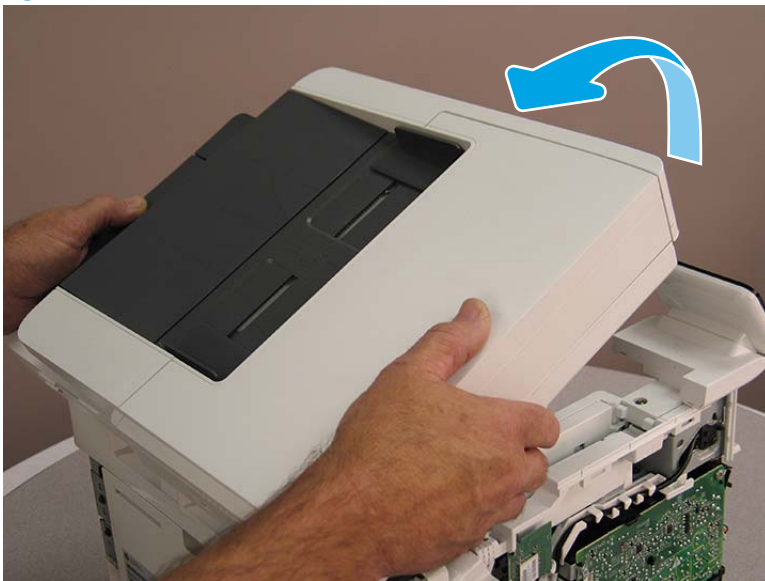

- Slide the ISA as shown to release it.

Figure 1-349 Release the ISA

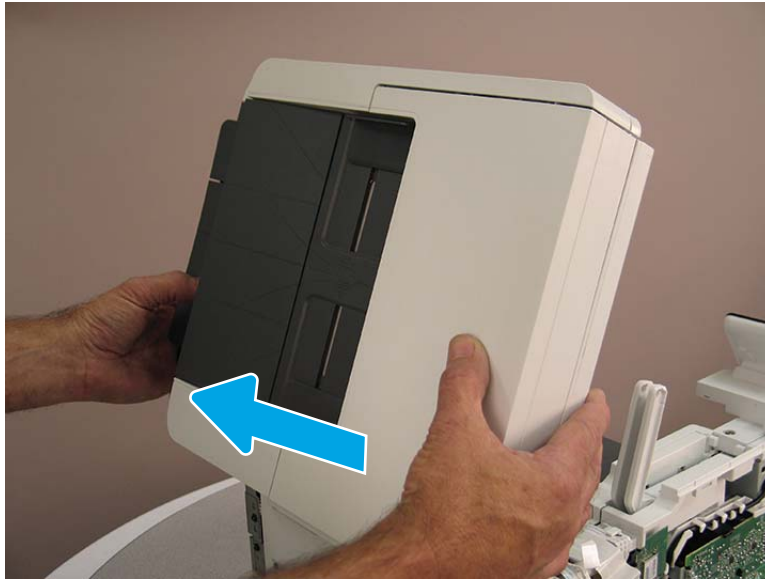

- Remove the ISA.

Figure 1-350 Remove the ISA

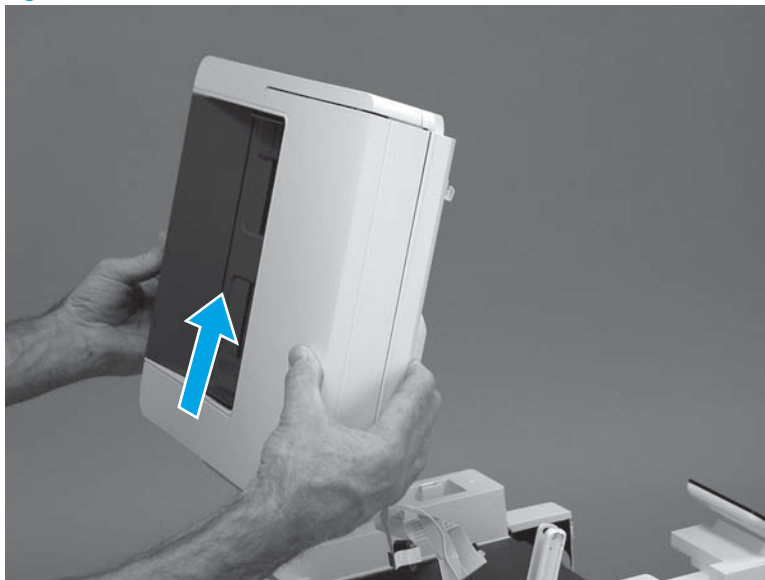

Step 7: Remove the control panel (M329/M428/M429)

 **NOTE:** The step is for the M329/M428/M429 printer. For the M304/M305/M404/M405, skip this step and go to [Step 9: Remove the top cover \(M304/M305/M404/M405\) on page 233](#).

- Disconnect one FFC (callout 1), and then release the FFC from the guide (callout 2).

Figure 1-351 Disconnect one connector

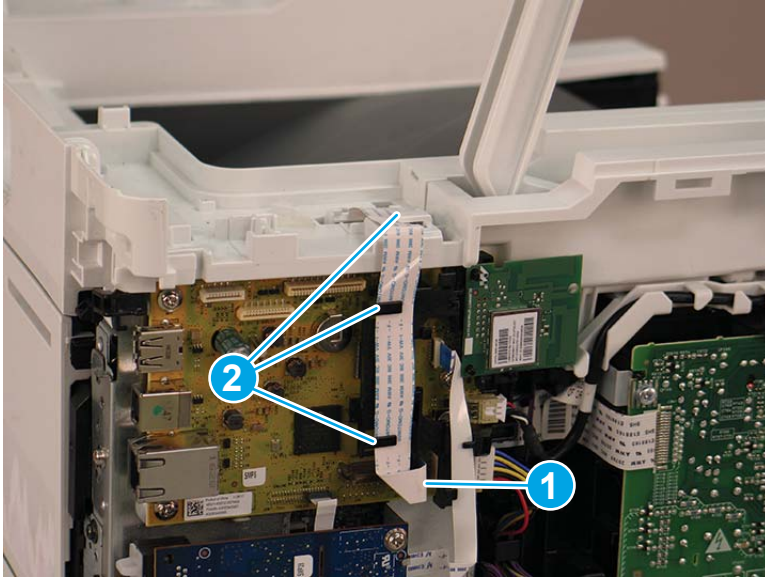

2. Remove one screw (callout 1).

Figure 1-352 Remove one screw

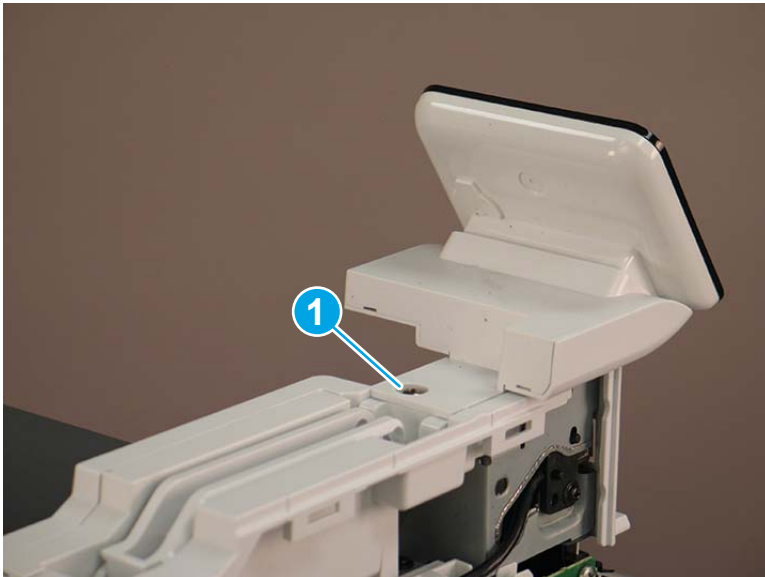

3. Use a small flat-blade screwdriver to release two tabs (callout 1) on the control-panel cable cover.

Figure 1-353 Release two tabs

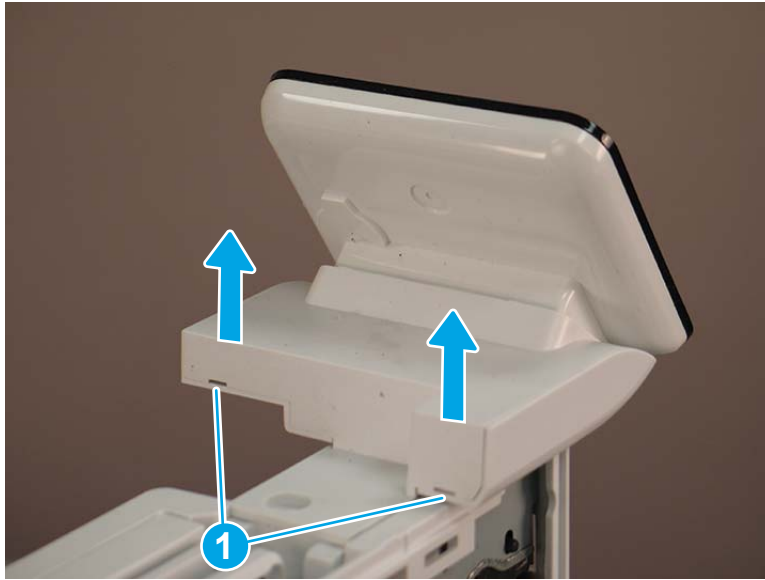

4. Remove the control-panel cable cover.

Figure 1-354 Remove the cover



5. Remove one grounding screw (callout 1), and then move the ground cable (callout 2) out of the way.

Figure 1-355 Remove one screw

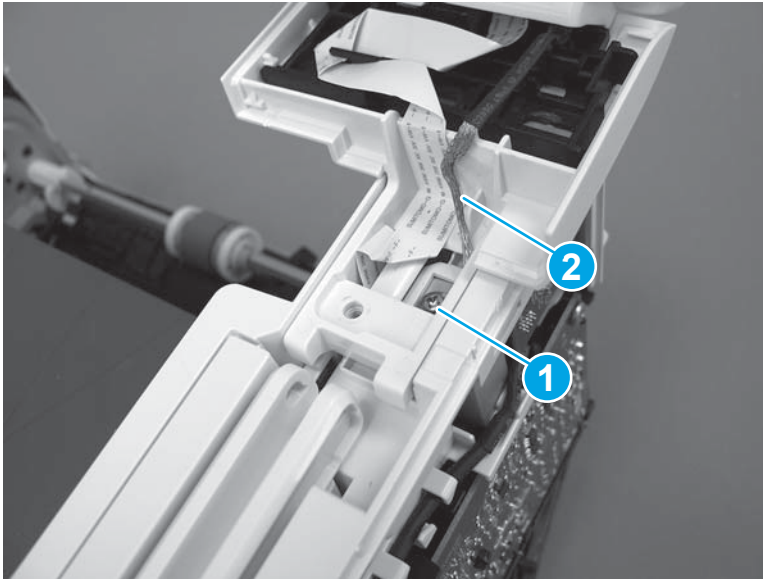

6. Move the FFC out of the way, and then remove two screws (callout 1).

Figure 1-356 Remove two screws



7. Slightly lift up the control-panel assembly to separate it from the top cover.

CAUTION: The control panel assembly is still connected to the printer by the FFC. Do not attempt to completely remove the assembly.

Figure 1-357 Lift up the control-panel assembly



8. Lift up the control-panel FFC cover to remove the control-panel assembly.

Figure 1-358 Remove the control-panel assembly

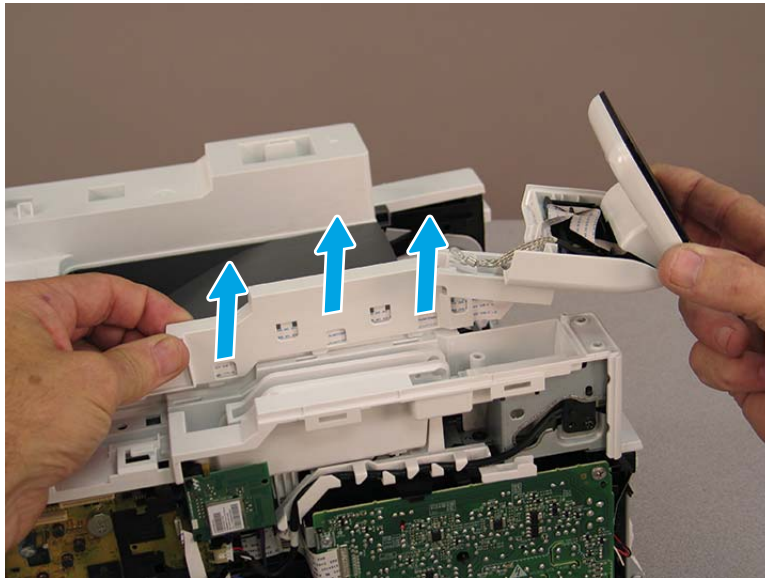

Step 8: Remove the top cover (M329/M428/M429)

NOTE: The step is for the M329/M428/M429 printer. For the M304/M305/M404/M405, skip this step and go to [Step 9: Remove the top cover \(M304/M305/M404/M405\) on page 233](#).

1. Release the USB cable (callout 1) from the cable guide.

Figure 1-359 Remove the USB cable

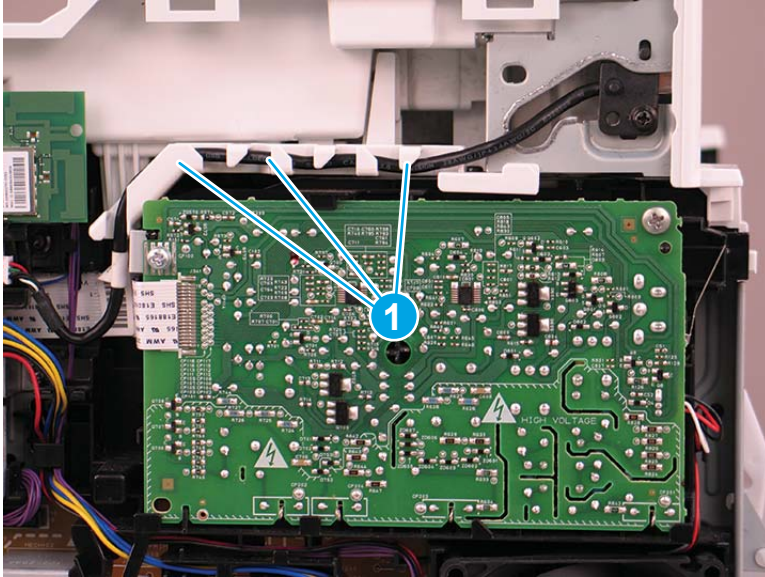

2. Remove one screw (callout 1), and then remove the support arm (callout 2).

⚠ CAUTION: The support arm is spring loaded and can unexpectedly spring into the open position. To avoid injury, do not place a finger in the screw well when the support arm is in the closed position.

Figure 1-360 Remove the support arm

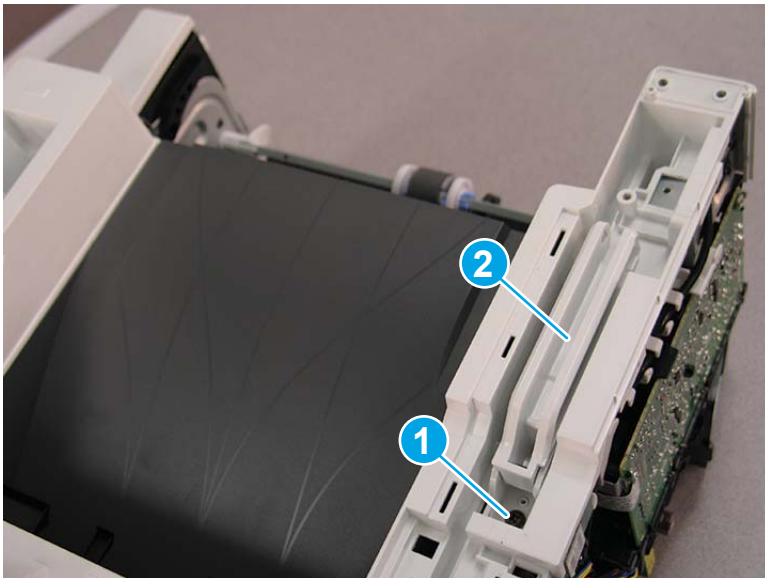

3. Remove five screws (callout 1), release four bosses (callout 2), and then remove the top cover (callout 3).

Figure 1-361 Remove the cover

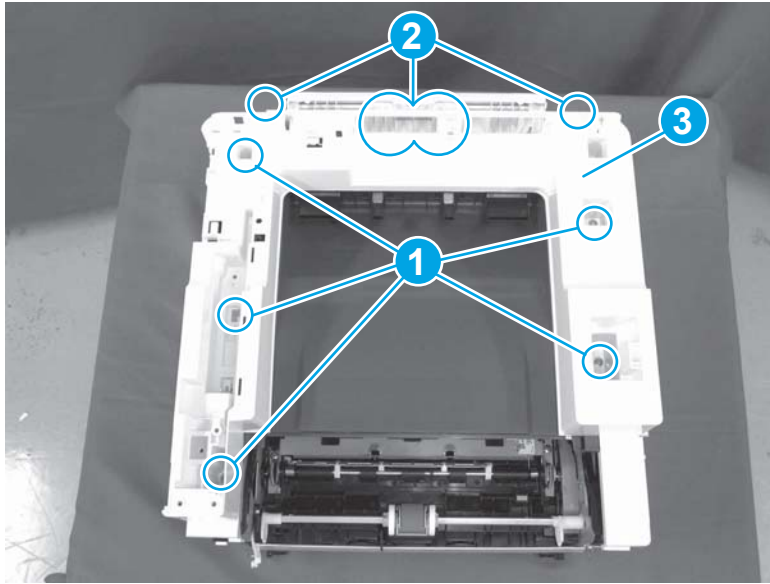

Step 9: Remove the top cover (M304/M305/M404/M405)

 **NOTE:** The step is for the M304/M305/M404/M405 printer. For the M329/M428/M429, skip this step and go to [Step 10: Remove the paper delivery tray \(output bin\) on page 234.](#)

1. Remove one screw (callout 1).

Figure 1-362 Remove one screw



2. At the right side of the printer, release the one boss (callout 1), and then release one tab (callout 2).

Figure 1-363 Release one boss and one tab

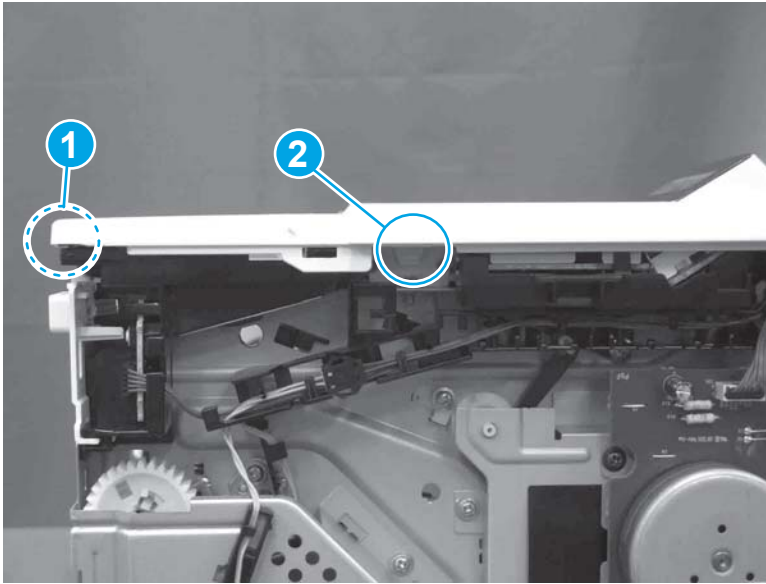

3. Release four tabs (callout 1), release four bosses (callout 2), and then remove the top cover (callout 3).



 **TIP:** Open the rear door to make releasing the bosses (callout 3) easier.

Figure 1-364 Remove the cover

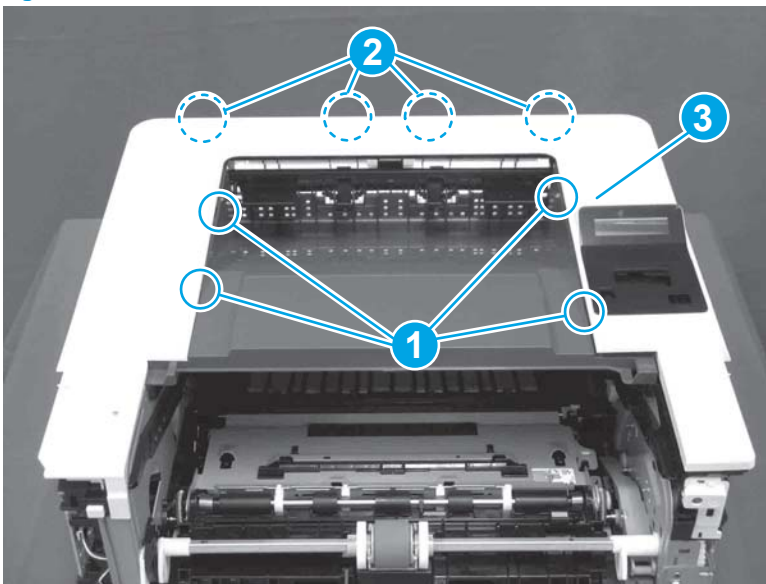

Step 10: Remove the paper delivery tray (output bin)

 **NOTE:** This procedure shows the M304/M305/M404/M405 model, however, the paper delivery tray (output bin) removal is similar for the M329/M428/M429 printer.

- ▲ Release two bosses (callout 1), release two tabs (callout 2), and then remove the paper delivery tray (output bin; callout 3).

Figure 1-365 Release two tabs

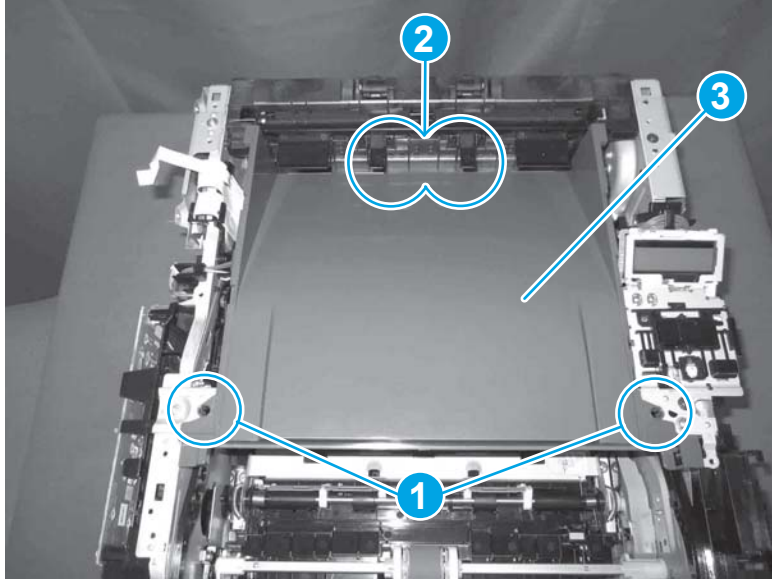

Step 11: Remove the fuser

1. Disconnect one connector (callout 1), and then release the wire harness from the guide (callout 2).

Figure 1-366 Disconnect one connector

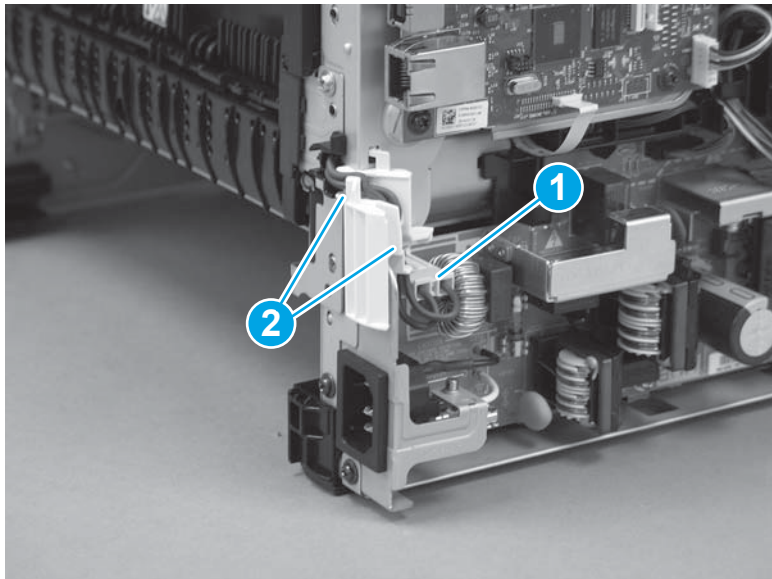

2. Pull the upper connector cover (callout 1) straight off of the printer to remove it.

Figure 1-367 Remove the cover

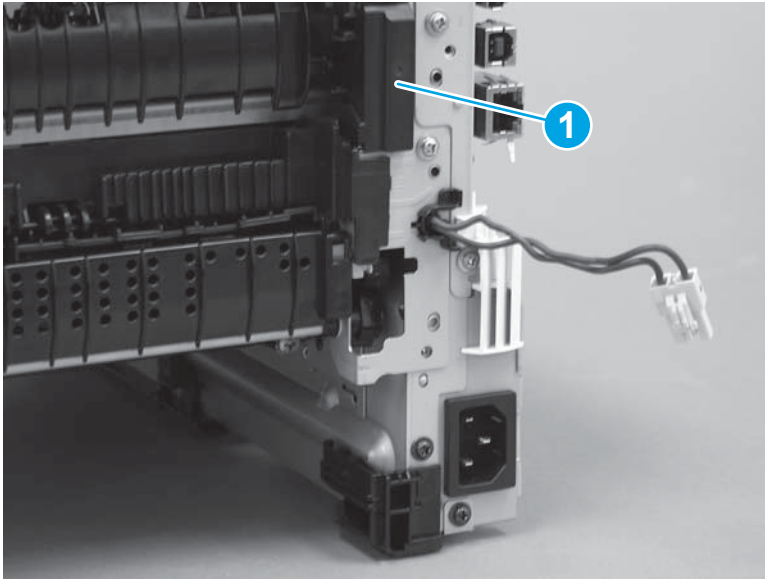

3. Disconnect two connectors (callout 1).

Figure 1-368 Disconnect two connectors

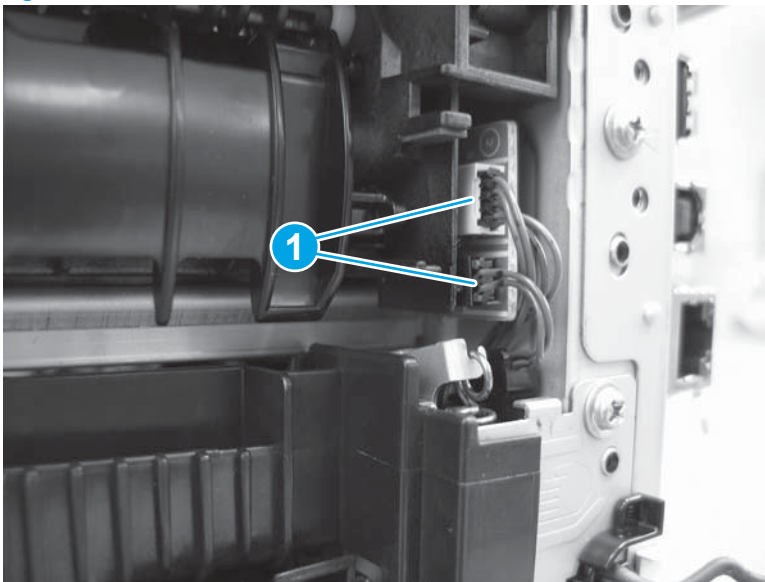

4. Remove four screws (callout 1).

Figure 1-369 Remove four screws

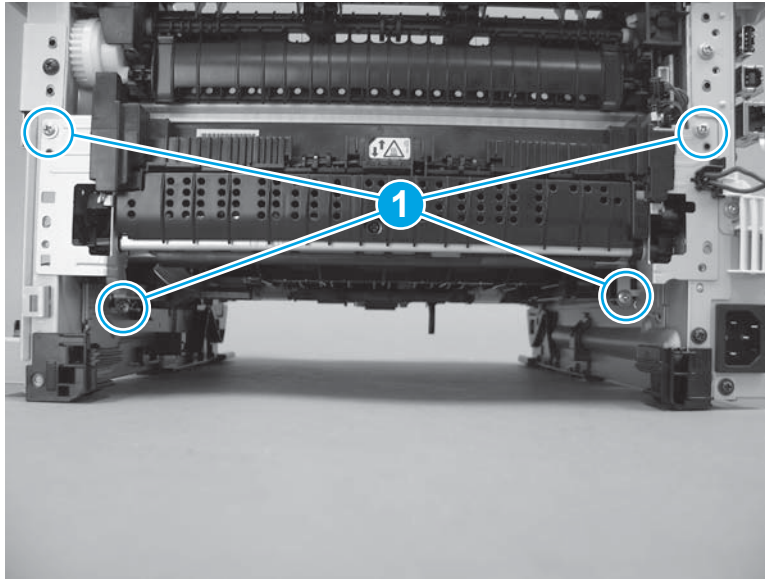

5. Pull the pressure-release link arm (callout 1) to release it from the fuser.

 **Reinstallation tip:** Make sure that the pressure-release arm is correctly connected to the fuser (callout 2).

Figure 1-370 Release the pressure-release arm

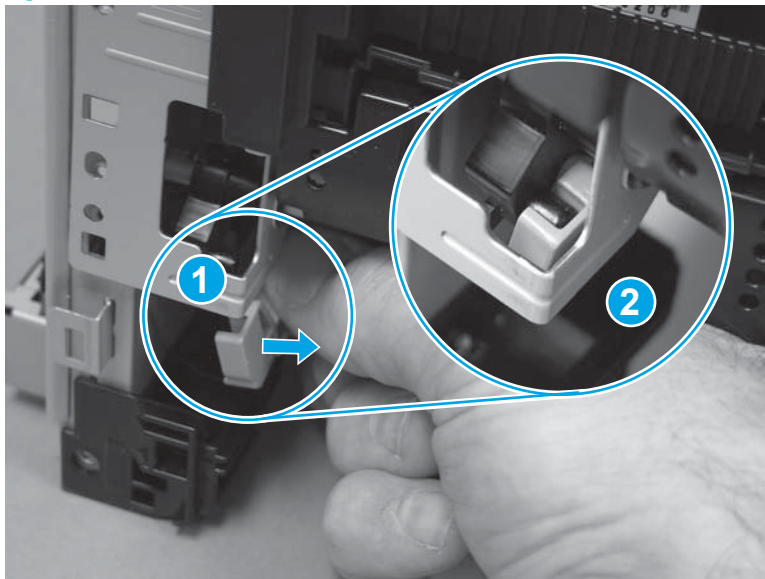

6. Slide the fuser straight out of the printer.

Figure 1-371 Remove the fuser

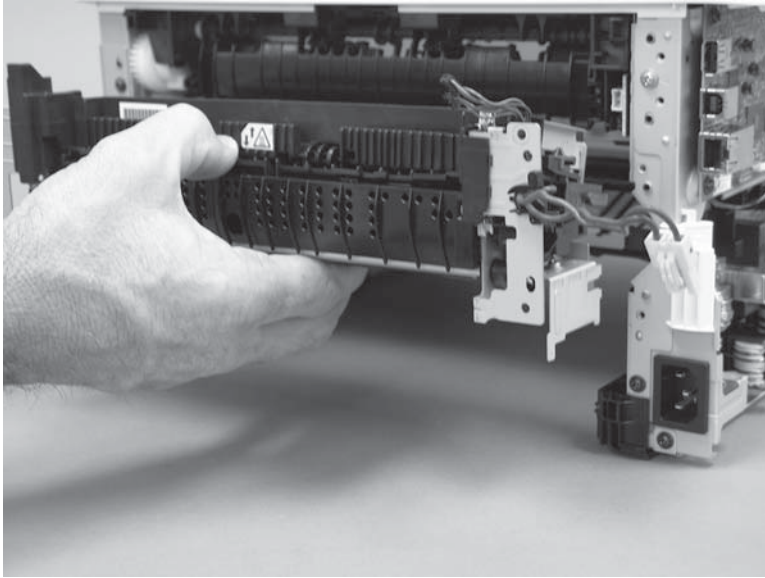

Step 12: Remove the registration assembly

1. Carefully rotate the printer backward until it rests on the rear side, bottom-side face forward.

Figure 1-372 Place the printer bottom-side face forward

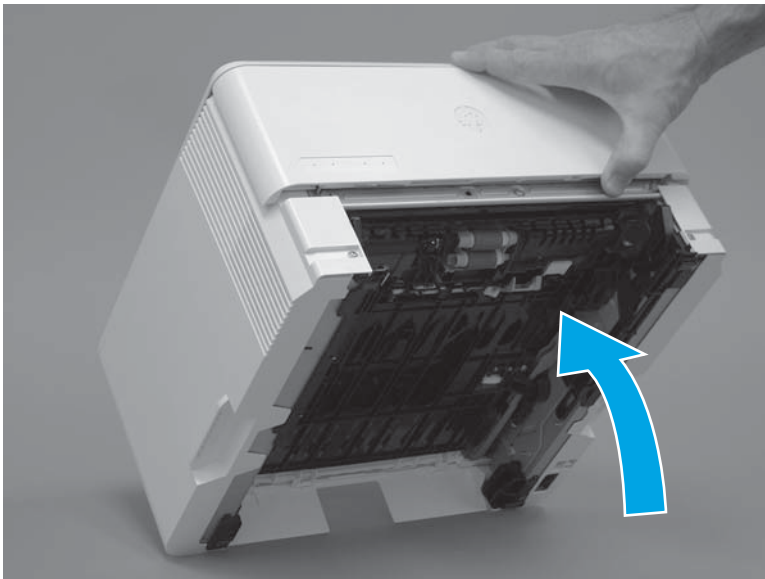

2. Remove one screw (callout 1), and then remove the guide (callout 2).

Figure 1-373 Remove one screw and the guide

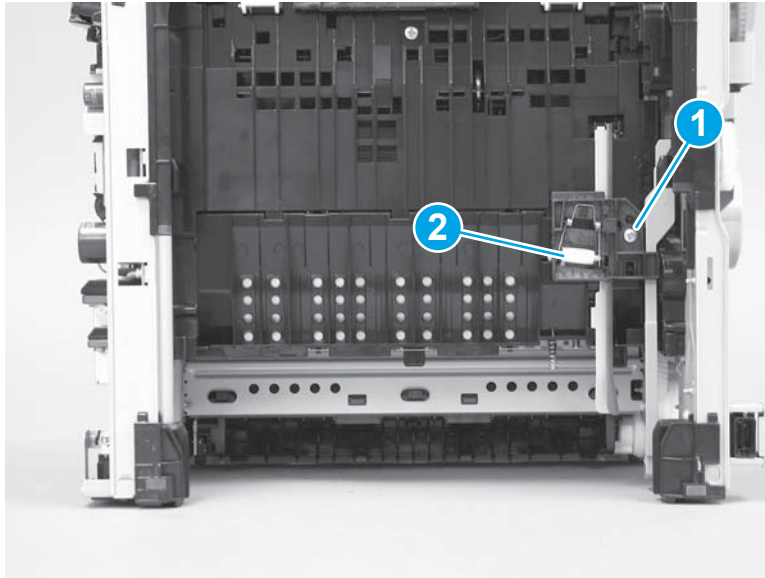

3. Move the end of pressure-release link arm out of the way.

 **NOTE:** Doing this makes the other end of the pressure-release arm easier to move out of the way of the later in this procedure.

Figure 1-374 Move the link arm out of the way

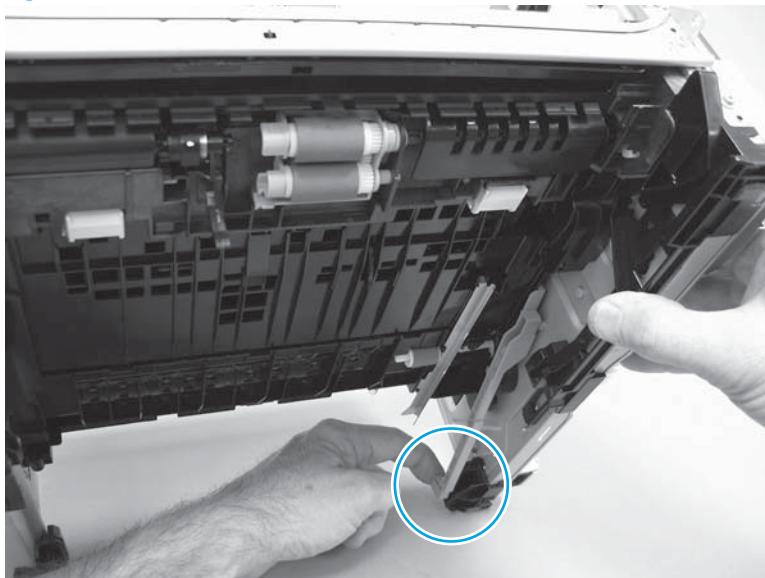

4. Place the printer with the bottom side down, look inside the toner-cartridge cavity, and then remove two screws (callout 1).

Figure 1-375 Remove two screws

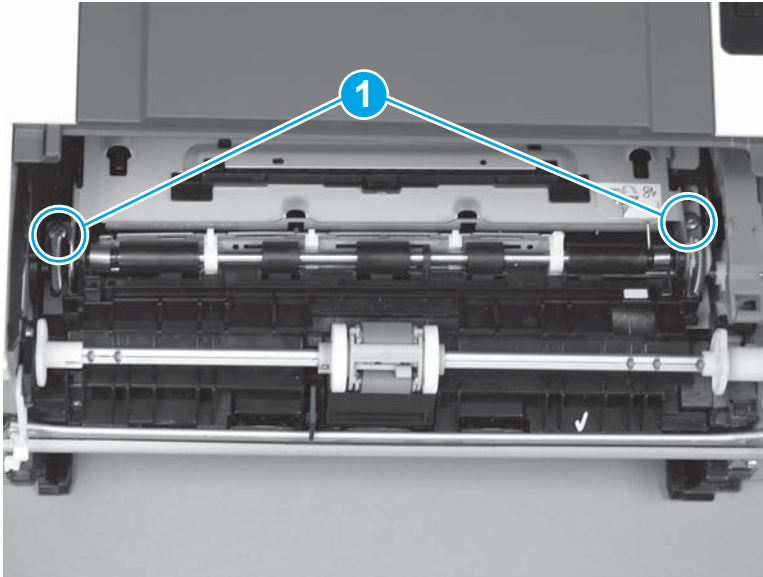

5. Move the end of pressure-release link arm (callout 1) out of the way.

Figure 1-376 Move the pressure-release arm out of the way

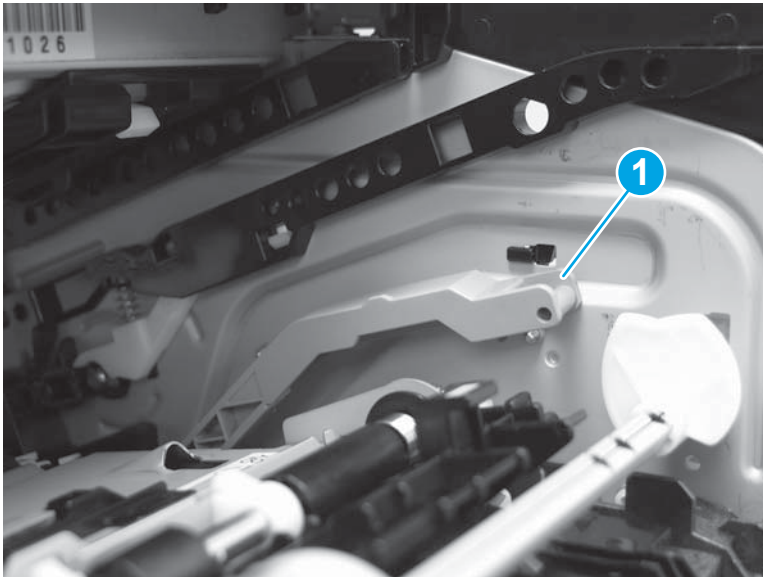

6. Rotate the left end of the registration up and out of the printer (callout 1), and then slide it to the left to release the gear end of the assembly (callout 2).

Figure 1-377 Release the assembly

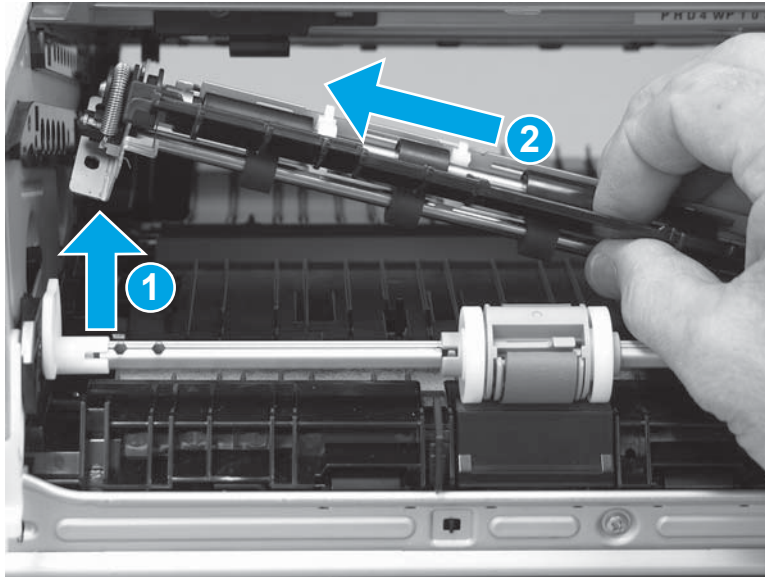

7. Remove the assembly.

Figure 1-378 Remove the assembly

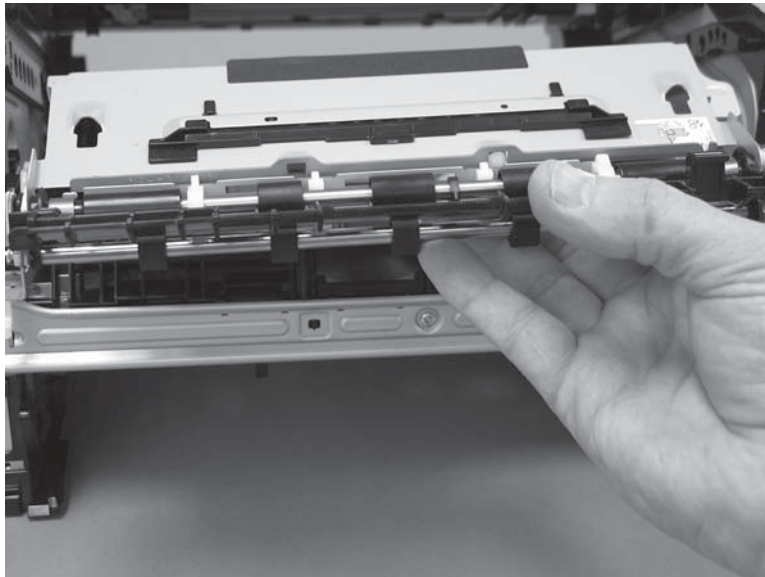



Step 13: Unpack the replacement assembly

1. Dispose of the defective part.

 **NOTE:** HP recommends responsible disposal of the defective part.

<http://www8.hp.com/us/en/hp-information/environment/product-recycling.html>

2. Unpack the replacement part from the packaging.

 **CAUTION:**  Some parts are sensitive to electrostatic discharge (ESD). Always perform service work at an ESD-protected workstation or mat. If an ESD workstation or mat is not available, touch the sheet-metal chassis to provide a static ground before touching an ESD-sensitive assembly. Protect the ESD-sensitive assemblies by placing them in ESD pouches when they are out of the printer.

If the replacement part is a roller or pad, avoid touching the spongy part of it. Skin oils on the roller or pad can cause paper pickup and/or print-quality problems. HP recommends using disposable gloves when handling rollers or pads or washing your hands before touching rollers or pads.

 **IMPORTANT:** Make sure that all of the shipping materials (for example shipping tape) are removed from the replacement part prior to installation.

3. To install an assembly, reverse the removal steps.

 **NOTE:** When applicable, special installation instructions are provided for an assembly at the end of the removal procedure. Always completely read the removal instructions and follow all special installation instructions.

Removal and replacement: Main motor (M1)

- [Introduction](#)
- [Step 1: Remove Tray 2](#)
- [Step 2: Remove the cartridge door assembly](#)
- [Step 3: Remove the right cover](#)
- [Step 4: Remove the main motor \(M1\)](#)
- [Step 5: Unpack the replacement assembly](#)

Introduction

This document provides the procedures to remove and replace the main motor (M1).

Before performing service

Turn the printer power off

- Disconnect the power cable.

 **WARNING!** To avoid damage to the printer, turn the printer off, wait 30 seconds, and then remove the power cable before attempting to service the printer.

Use the table below to identify the correct part number for your printer. To order the part, go to www.hp.com/buy/parts.

Main motor (M1) part number	
RM2-9531-000CN	Main motor (M1)

Required tools

- #2 Phillips screwdriver with a magnetic tip.

After performing service

Turn the printer power on

- Connect the power cable.
- Use the power switch to turn the power on.

Post service test

Make sure that the printer initializes to a **Ready** state.

Print a configuration page to make sure that the printer is functioning correctly.

Step 1: Remove Tray 2

- ▲ Pull the tray straight out of the printer to remove it.

Figure 1-379 Remove the tray



Step 2: Remove the cartridge door assembly

 **NOTE:** If the toner cartridge was not removed prior to servicing the printer, remove it now.

1. Release the support shaft (callout 1), and then slide it toward the center of the door (callout 2).

 **TIP:** It might be easier to release the support shaft by using a small flat-blade screwdriver.

Figure 1-380 Release the support shaft

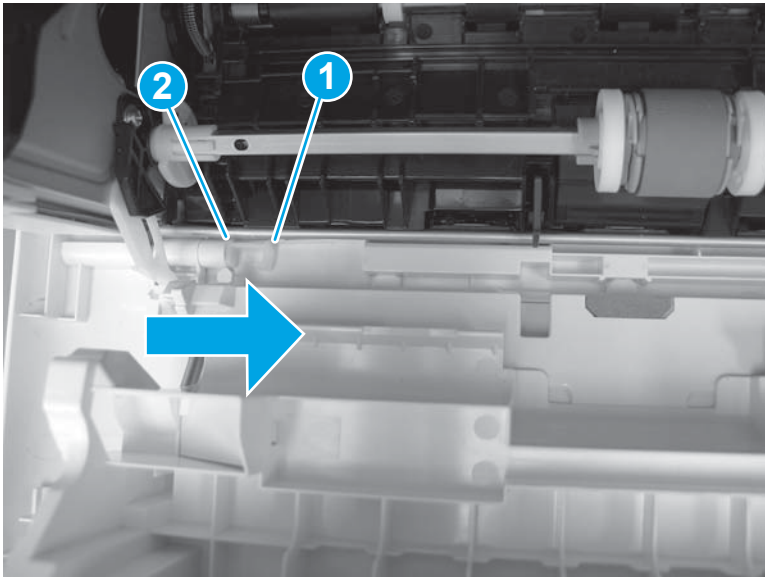

2. Remove the support shaft.

Figure 1-381 Remove the support shaft

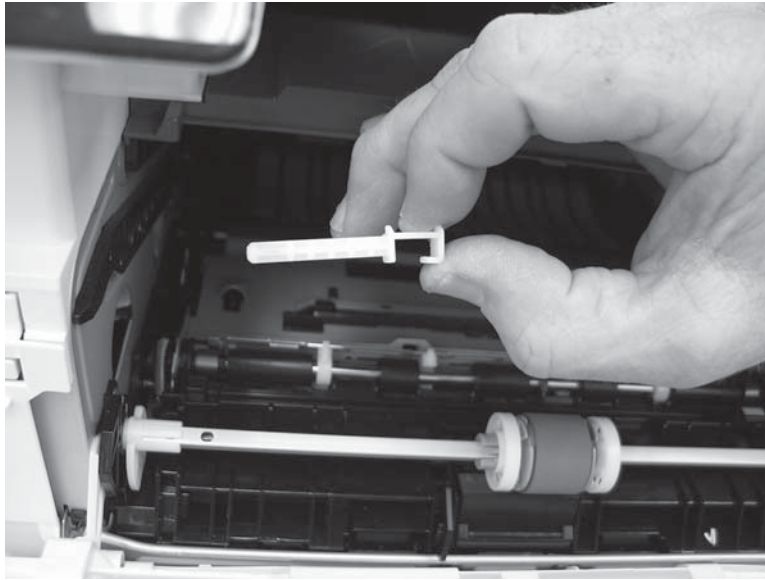

3. Release one tab (callout 1), and then slide the guide out of the printer (callout 2).

⚠ CAUTION: Be careful, the tab (callout 1) can be easily broken.

Figure 1-382 Remove the guide

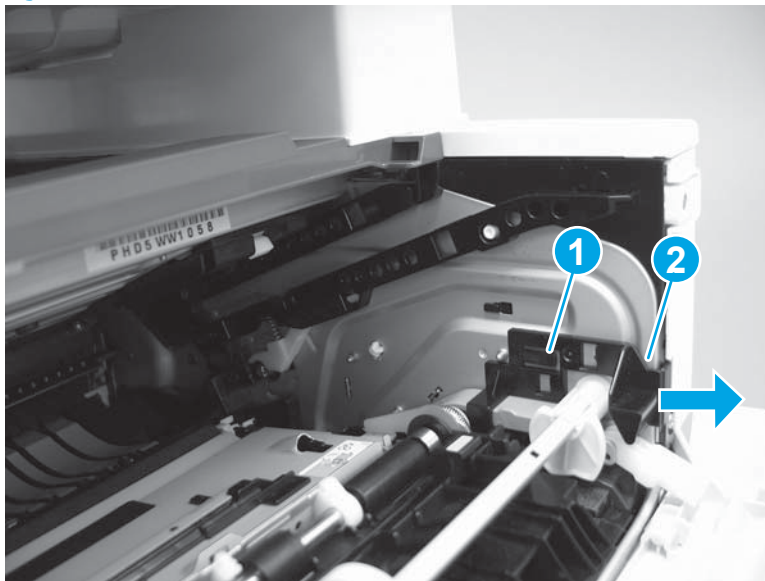

4. Use a small flat-blade screwdriver to gently pry the white-plastic door arm (callout 1) off of the gray-plastic pressure-release link (callout 2) to release the door arm.

Figure 1-383 Release the pressure-release link

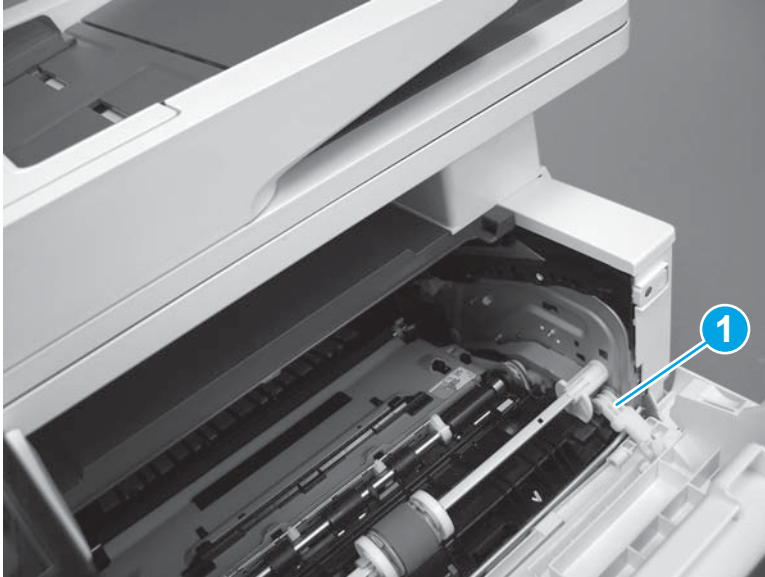

5. With the door in the partially closed position, slightly raise the left end (callout 1; raise it over the sheet-metal hinge boss), and then slide the door to the left (callout 2) to release the right hinge (callout 3).

CAUTION: The door is still attached to the printer by the left-side retainer arm. Do not attempt to completely remove the door.

Reinstallation tip: When reinstalling the door, there are two right-side hinge pins (not shown in callout 3). Keep a finger pressed on the left-side retainer arm so that it does not disengage from the door.

Figure 1-384 Release the door

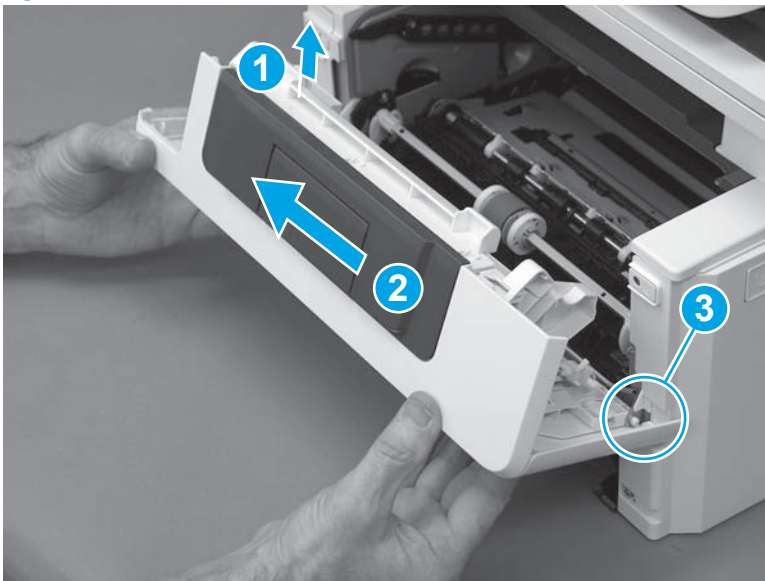

6. Rotate the door away from the printer until the keyed pin on the left-side retainer arm can disengage from the door.

Figure 1-385 Release the left-side retainer arm

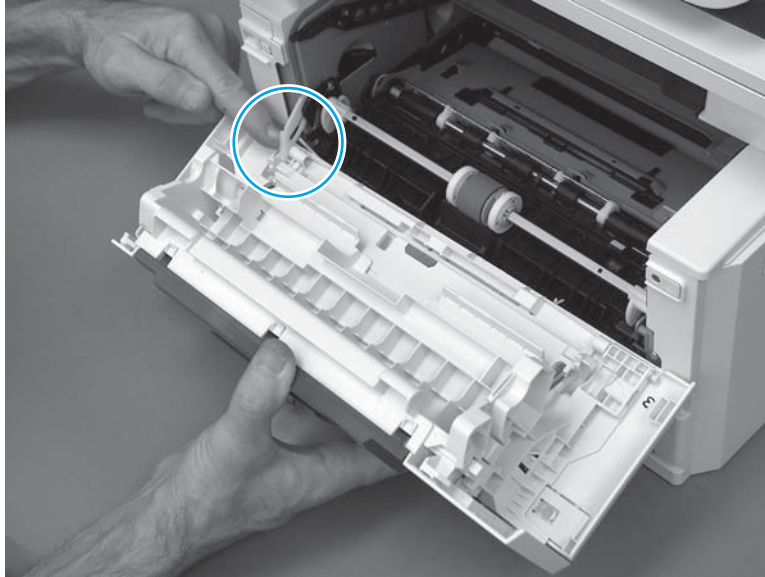

7. Remove the door.

Figure 1-386 Remove the door

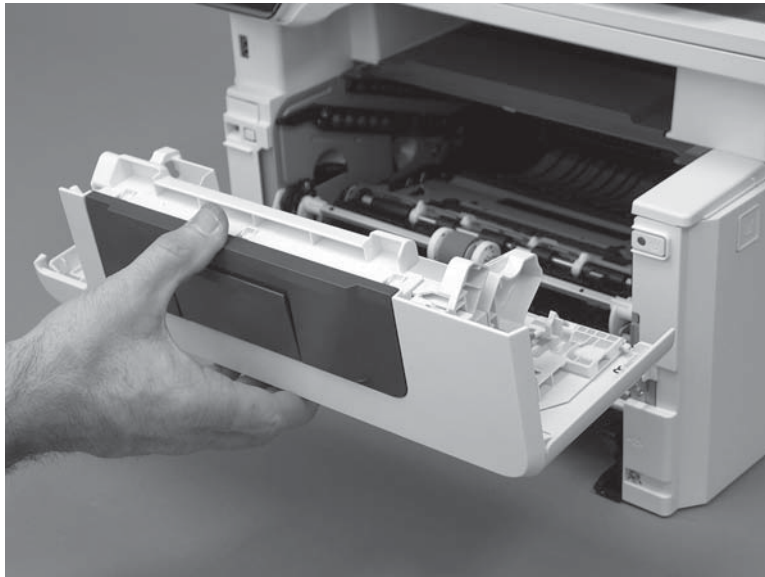

Step 3: Remove the right cover

1. At the front of the printer, release two bosses (callout 1), and then release three tabs (callout 2).

 **Reinstallation tip:** Remove, and then reinstall the cover if the switch or button does not correctly function.

Figure 1-387 Release two bosses and three tabs

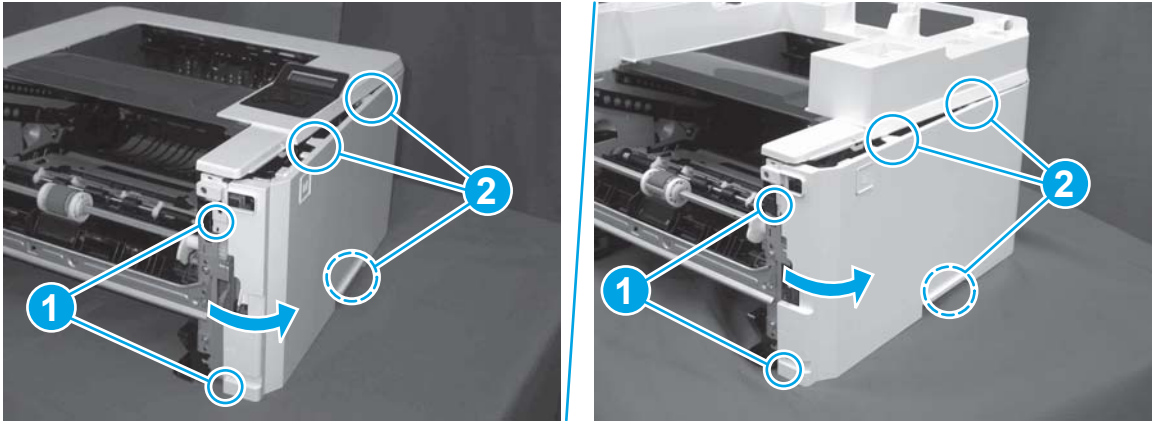

2. Open the rear door, release two bosses (callout 1), and then remove the cover (callout 2).

Figure 1-388 Remove the cover

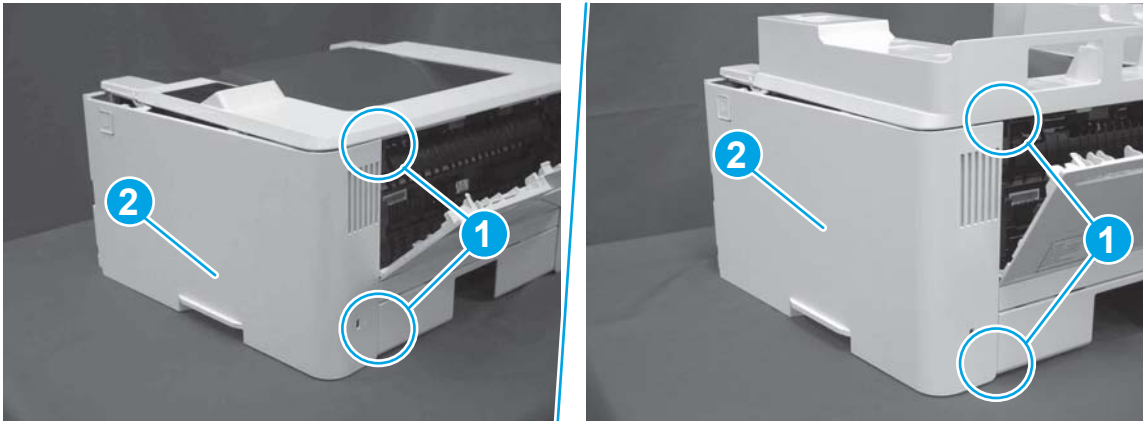

Step 4: Remove the main motor (M1)

- ▲ Disconnect one connector (callout 5), remove four screws (callout 1 to callout 4), and then remove the main motor (M1).

💡 **Reinstallation tip:** Make sure that the screws are installed in the order (callout 1 - 4).

Figure 1-389 Remove the motor

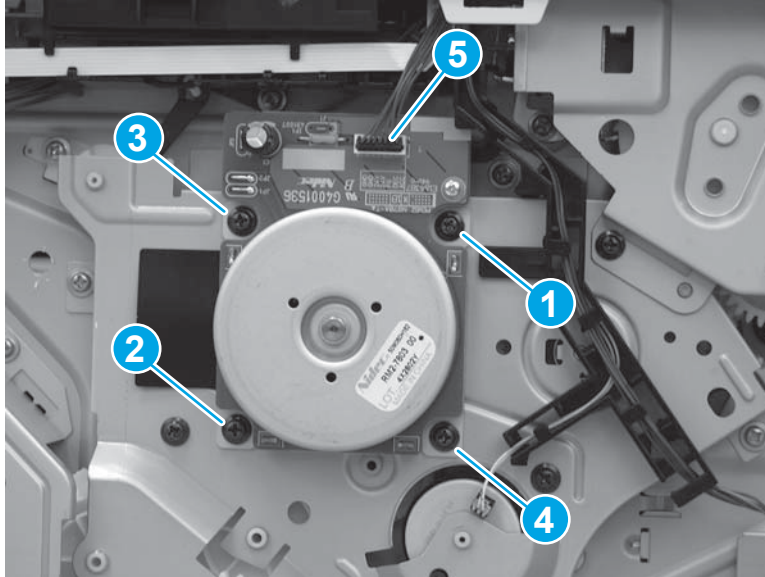



Step 5: Unpack the replacement assembly

1. Dispose of the defective part.

 **NOTE:** HP recommends responsible disposal of the defective part.

<http://www8.hp.com/us/en/hp-information/environment/product-recycling.html>

2. Unpack the replacement part from the packaging.

 **CAUTION:**  Some parts are sensitive to electrostatic discharge (ESD). Always perform service work at an ESD-protected workstation or mat. If an ESD workstation or mat is not available, touch the sheet-metal chassis to provide a static ground before touching an ESD-sensitive assembly. Protect the ESD-sensitive assemblies by placing them in ESD pouches when they are out of the printer.

If the replacement part is a roller or pad, avoid touching the spongy part of it. Skin oils on the roller or pad can cause paper pickup and/or print-quality problems. HP recommends using disposable gloves when handling rollers or pads or washing your hands before touching rollers or pads.

 **IMPORTANT:** Make sure that all of the shipping materials (for example shipping tape) are removed from the replacement part prior to installation.

3. To install an assembly, reverse the removal steps.

 **NOTE:** When applicable, special installation instructions are provided for an assembly at the end of the removal procedure. Always completely read the removal instructions and follow all special installation instructions.

Removal and replacement: Power switch printed circuit assembly

- [Introduction](#)
- [Step 1: Remove Tray 2](#)
- [Step 2: Remove the cartridge door assembly](#)
- [Step 3: Remove the right cover](#)
- [Step 4: Remove the power switch PCA](#)
- [Step 5: Unpack the replacement assembly](#)

Introduction

This document provides the procedures to remove and replace the power switch printed circuit assembly (PCA).

Before performing service

Turn the printer power off

- Disconnect the power cable.

⚠ WARNING! To avoid damage to the printer, turn the printer off, wait 30 seconds, and then remove the power cable before attempting to service the printer.

Use the table below to identify the correct part number for your printer. To order the part, go to www.hp.com/buy/parts.

Power switch PCA part number	
RM2-8506-000CN	Power switch PCA

Required tools

- #2 Phillips screwdriver with a magnetic tip.

After performing service

Turn the printer power on

- Connect the power cable.
- Use the power switch to turn the power on.

Post service test

Use the power switch to turn the printer on, and then off.

Step 1: Remove Tray 2

- ▲ Pull the tray straight out of the printer to remove it.

Figure 1-390 Remove the tray



Step 2: Remove the cartridge door assembly

 **NOTE:** If the toner cartridge was not removed prior to servicing the printer, remove it now.

1. Release the support shaft (callout 1), and then slide it toward the center of the door (callout 2).

 **TIP:** It might be easier to release the support shaft by using a small flat-blade screwdriver.

Figure 1-391 Release the support shaft

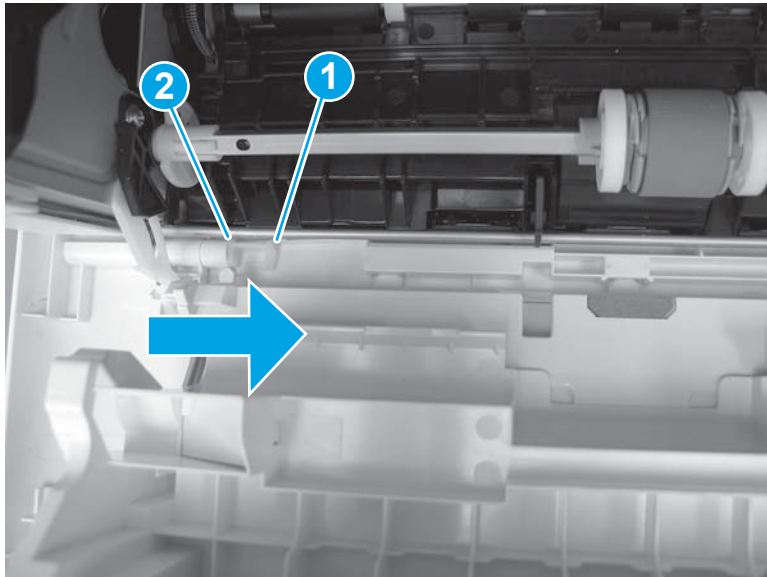

2. Remove the support shaft.

Figure 1-392 Remove the support shaft

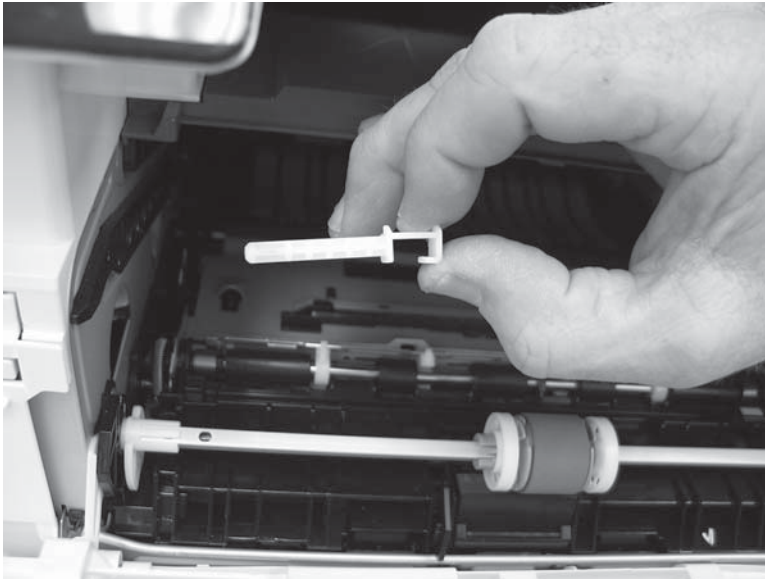

3. Release one tab (callout 1), and then slide the guide out of the printer (callout 2).

⚠ CAUTION: Be careful, the tab (callout 1) can be easily broken.

Figure 1-393 Remove the guide

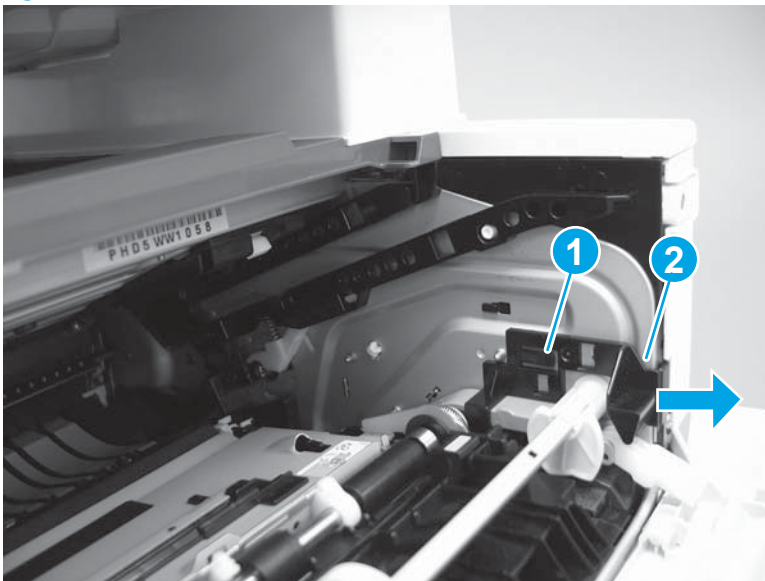

4. Use a small flat-blade screwdriver to gently pry the white-plastic door arm (callout 1) off of the gray-plastic pressure-release link (callout 2) to release the door arm.

Figure 1-394 Release the pressure-release link

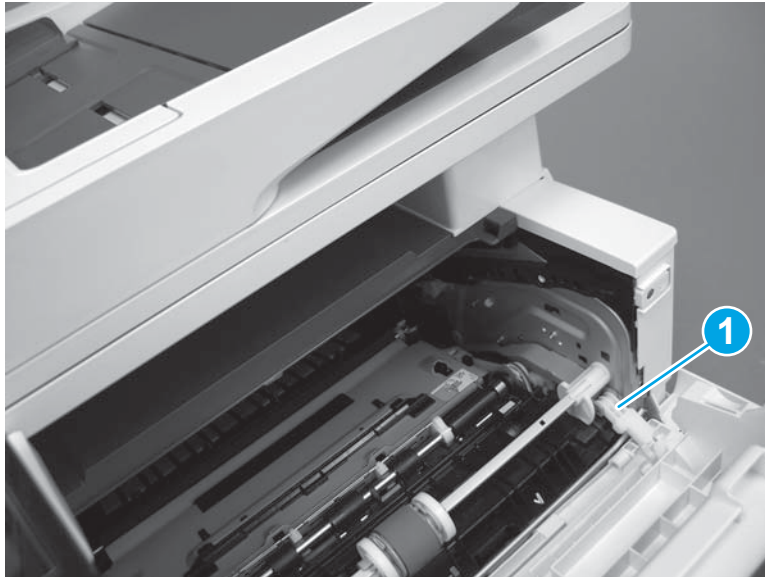

5. With the door in the partially closed position, slightly raise the left end (callout 1; raise it over the sheet-metal hinge boss), and then slide the door to the left (callout 2) to release the right hinge (callout 3).

⚠ CAUTION: The door is still attached to the printer by the left-side retainer arm. Do not attempt to completely remove the door.

💡 Reinstallation tip: When reinstalling the door, there are two right-side hinge pins (not shown in callout 3). Keep a finger pressed on the left-side retainer arm so that it does not disengage from the door.

Figure 1-395 Release the door

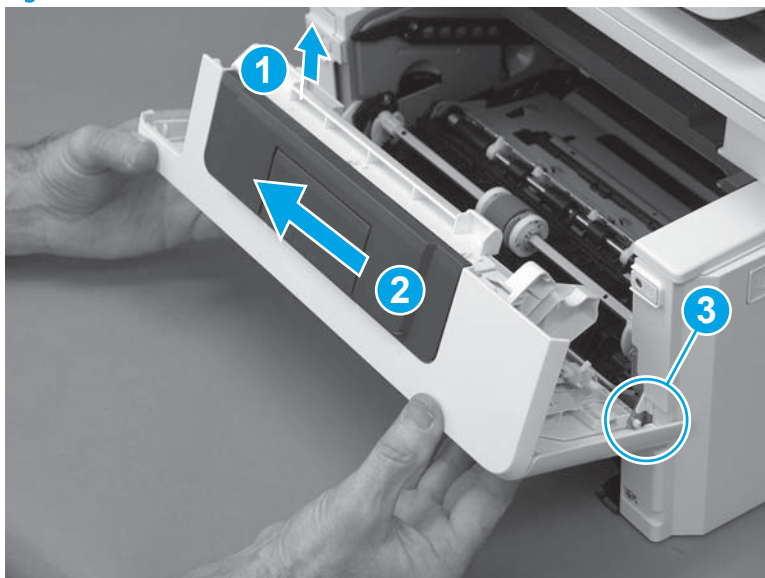

6. Rotate the door away from the printer until the keyed pin on the left-side retainer arm can disengage from the door.

Figure 1-396 Release the left-side retainer arm

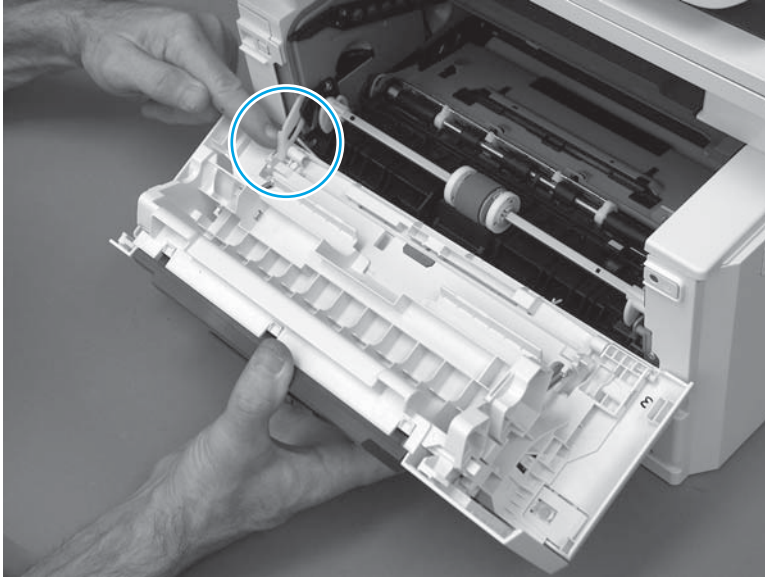

7. Remove the door.

Figure 1-397 Remove the door

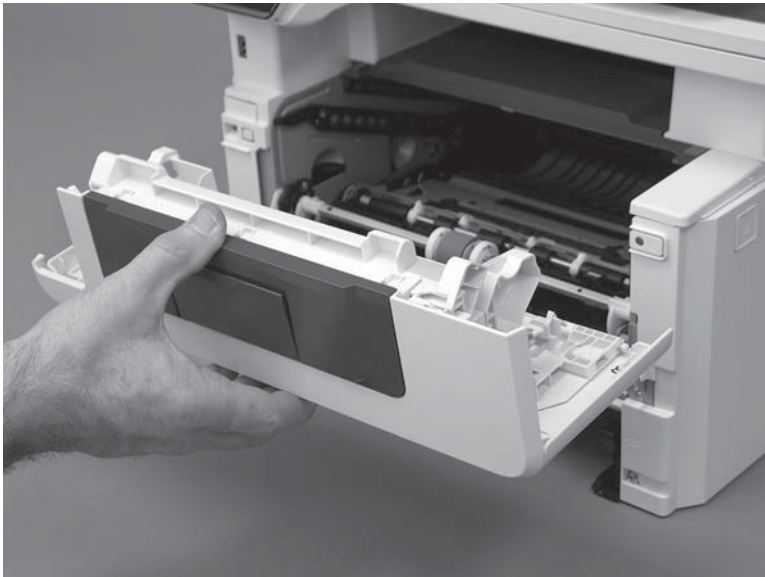

Step 3: Remove the right cover

1. At the front of the printer, release two bosses (callout 1), and then release three tabs (callout 2).

 **Reinstallation tip:** Remove, and then reinstall the cover if the switch or button does not correctly function.

Figure 1-398 Release two bosses and three tabs

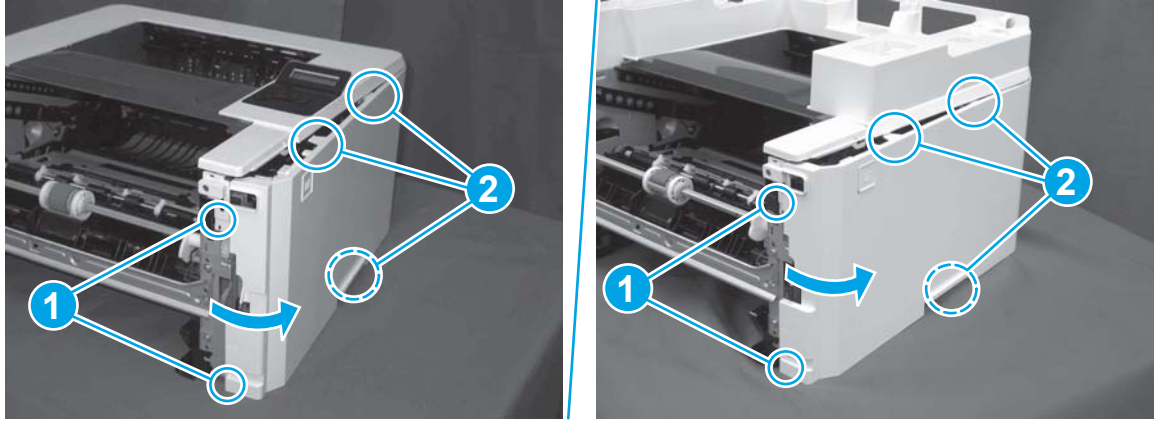

2. Open the rear door, release two bosses (callout 1), and then remove the cover (callout 2).

Figure 1-399 Remove the cover

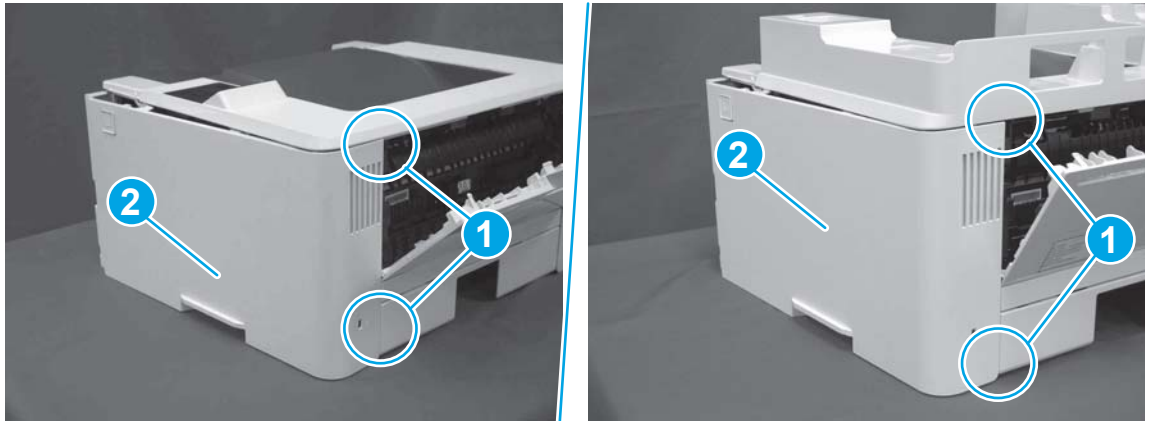

Step 4: Remove the power switch PCA

1. Release one tab (callout 1).

Figure 1-400 Release one tab

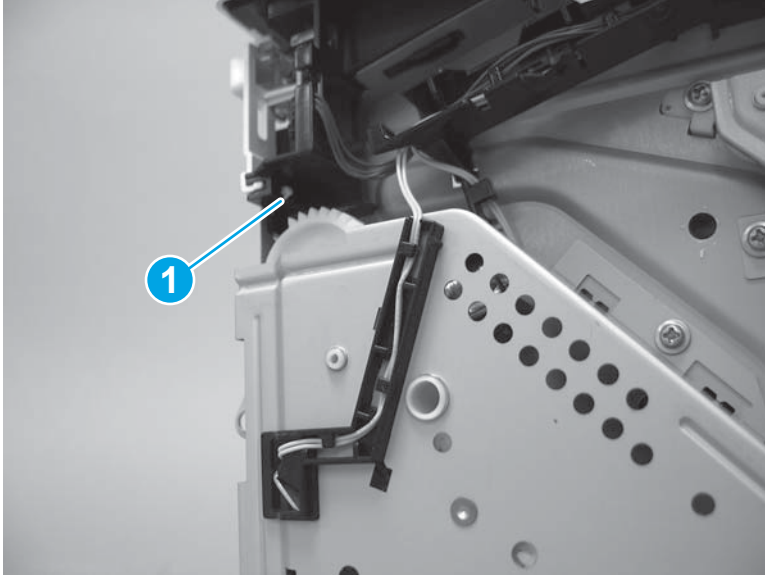

2. Remove the switch lever.

Figure 1-401 Remove the switch lever

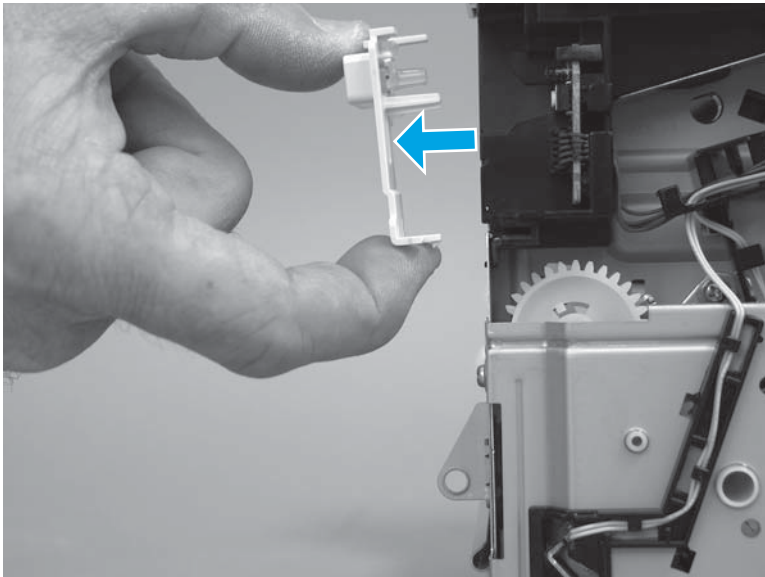

3. Release the wire harness from the guide (callout 1), and then disconnect one connector (callout 2).

Figure 1-402 Disconnect one connector

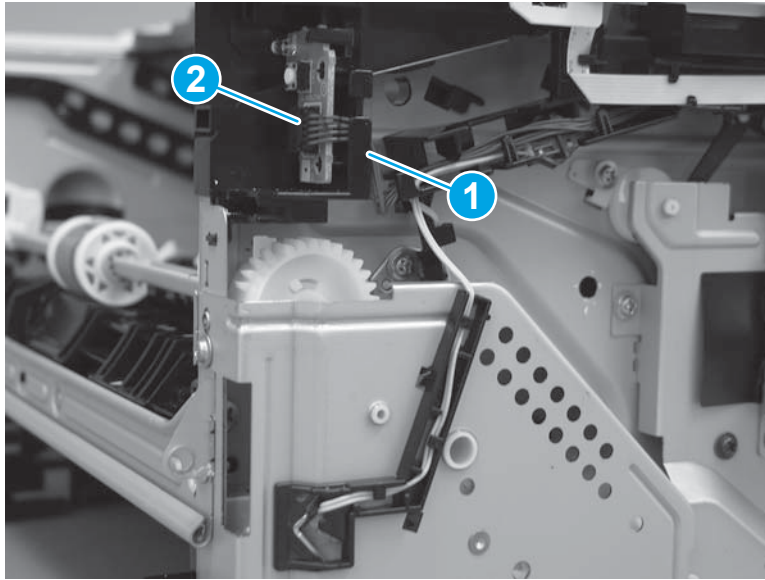

4. Release one tab (callout 1), and then remove the power switch PCA.

⚠ CAUTION: Do not damage the tab (callout 1) when releasing it. The tab must snap over the PCA when it is reinstalled.

💡 Reinstallation tip: The PCA must be securely installed in the holder. Make sure that the tab on the holder snaps in place over the edge of the PCA, and that the two alignment pins are installed in the holes on the PCA.

Figure 1-403 Release one tab and remove the PCA

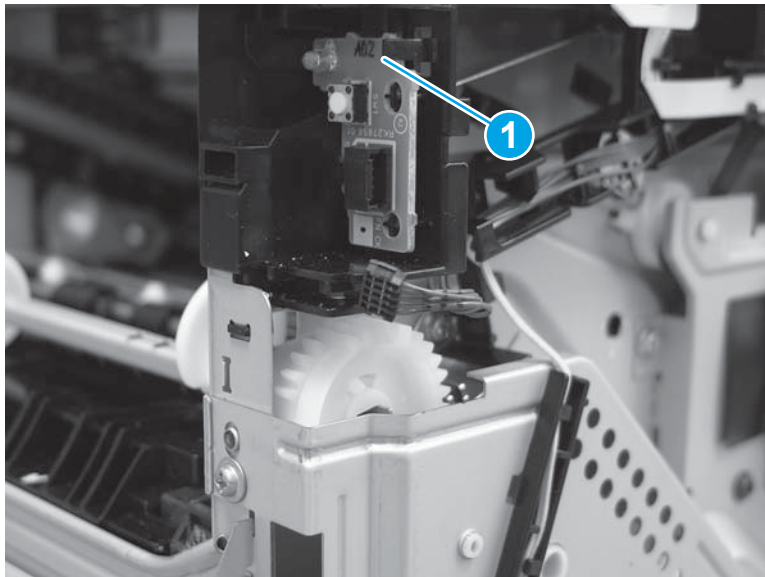



Step 5: Unpack the replacement assembly

1. Dispose of the defective part.

 **NOTE:** HP recommends responsible disposal of the defective part.

<http://www8.hp.com/us/en/hp-information/environment/product-recycling.html>

2. Unpack the replacement part from the packaging.

 **CAUTION:**  Some parts are sensitive to electrostatic discharge (ESD). Always perform service work at an ESD-protected workstation or mat. If an ESD workstation or mat is not available, touch the sheet-metal chassis to provide a static ground before touching an ESD-sensitive assembly. Protect the ESD-sensitive assemblies by placing them in ESD pouches when they are out of the printer.

If the replacement part is a roller or pad, avoid touching the spongy part of it. Skin oils on the roller or pad can cause paper pickup and/or print-quality problems. HP recommends using disposable gloves when handling rollers or pads or washing your hands before touching rollers or pads.

 **IMPORTANT:** Make sure that all of the shipping materials (for example shipping tape) are removed from the replacement part prior to installation.

3. To install an assembly, reverse the removal steps.

 **NOTE:** When applicable, special installation instructions are provided for an assembly at the end of the removal procedure. Always completely read the removal instructions and follow all special installation instructions.

Removal and replacement: Fax PCA (M329/M428/M429)



NOTE: Fax models only.

- [Introduction](#)
- [Step 1: Remove Tray 2](#)
- [Step 2: Remove the cartridge door assembly](#)
- [Step 3: Remove the left cover](#)
- [Step 4: Remove the fax PCA \(Fax models only\)](#)
- [Step 5: Unpack the replacement assembly](#)

Introduction

This document provides the procedures to remove and replace the fax printed circuit assembly (PCA).

Before performing service

Turn the printer power off

- Disconnect the power cable.



WARNING! To avoid damage to the printer, turn the printer off, wait 30 seconds, and then remove the power cable before attempting to service the printer.

Use the table below to identify the correct part number for your printer. To order the part, go to www.hp.com/buy/parts.

Fax PCA part number	
W1A78-67906	Fax PCA, crowdad (AP+AMS) ¹
W1A78-67907	Fax PCA, crowdad (EU) ¹
W1A78-67908	Fax PCA, crowdad (Brazil) ¹
W1A78-67909	Chepstow fax card for BBU ¹

¹ M329/M428/M429 fax models only.

Required tools

- #2 Phillips screwdriver with a magnetic tip.
- Small flat-blade screw driver

After performing service

Turn the printer power on

- Connect the power cable.
- Use the power switch to turn the power on.

Post service test

Make sure that the printer initializes to a **Ready** state.

If possible, send a fax to the printer.

Step 1: Remove Tray 2

- ▲ Pull the tray straight out of the printer to remove it.

Figure 1-404 Remove the tray

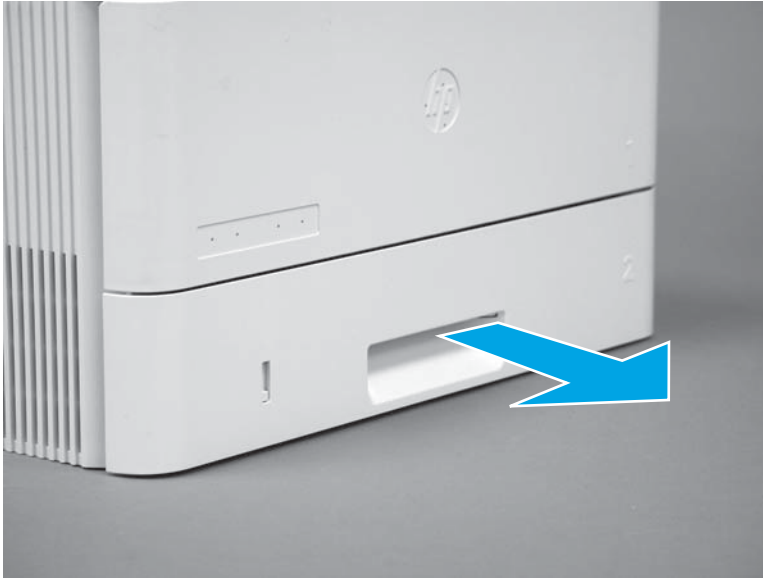

Step 2: Remove the cartridge door assembly

 **NOTE:** If the toner cartridge was not removed prior to servicing the printer, remove it now.

1. Release the support shaft (callout 1), and then slide it toward the center of the door (callout 2).

 **TIP:** It might be easier to release the support shaft by using a small flat-blade screwdriver.

Figure 1-405 Release the support shaft

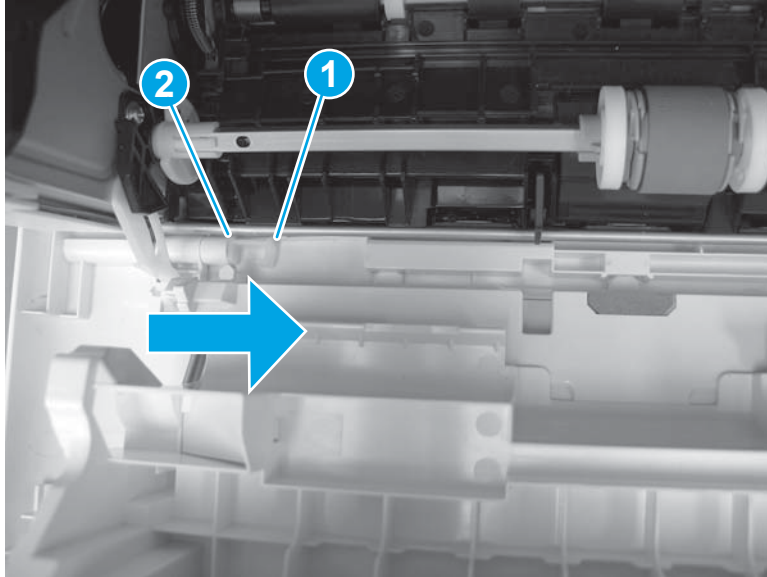

2. Remove the support shaft.

Figure 1-406 Remove the support shaft

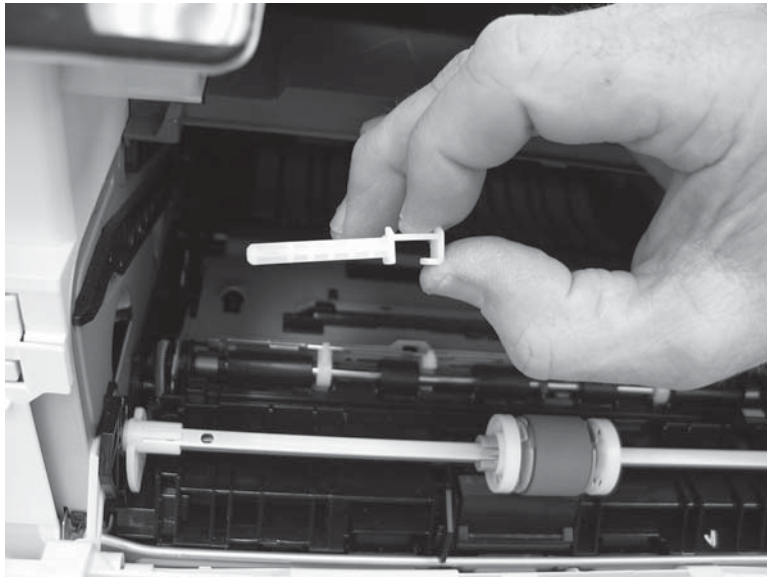

3. Release one tab (callout 1), and then slide the guide out of the printer (callout 2).

⚠ CAUTION: Be careful, the tab (callout 1) can be easily broken.

Figure 1-407 Remove the guide

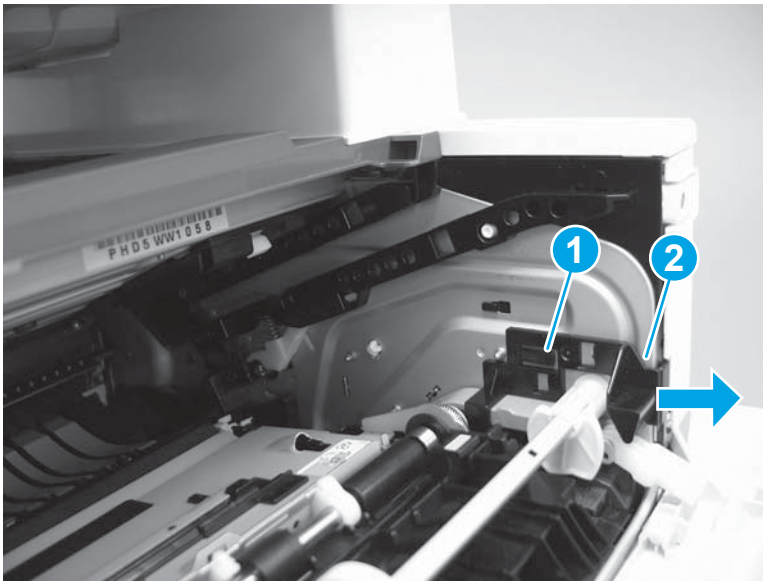

4. Use a small flat-blade screwdriver to gently pry the white-plastic door arm (callout 1) off of the gray-plastic pressure-release link (callout 2) to release the door arm.

Figure 1-408 Release the pressure-release link

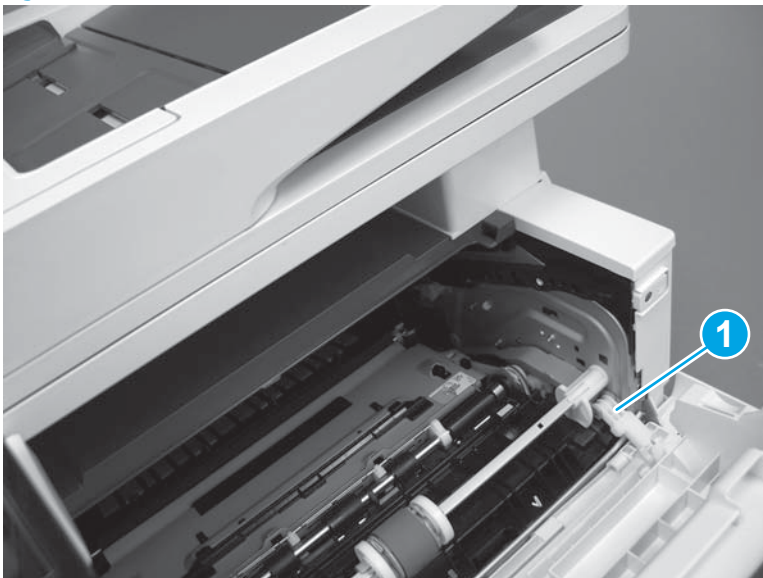

5. With the door in the partially closed position, slightly raise the left end (callout 1; raise it over the sheet-metal hinge boss), and then slide the door to the left (callout 2) to release the right hinge (callout 3).

⚠ CAUTION: The door is still attached to the printer by the left-side retainer arm. Do not attempt to completely remove the door.

💡 Reinstallation tip: When reinstalling the door, there are two right-side hinge pins (not shown in callout 3). Keep a finger pressed on the left-side retainer arm so that it does not disengage from the door.

Figure 1-409 Release the door

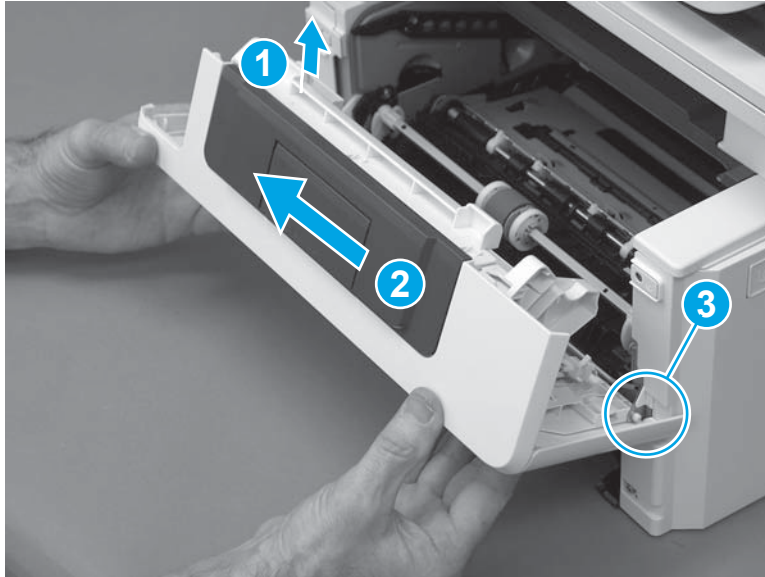

6. Rotate the door away from the printer until the keyed pin on the left-side retainer arm can disengage from the door.

Figure 1-410 Release the left-side retainer arm

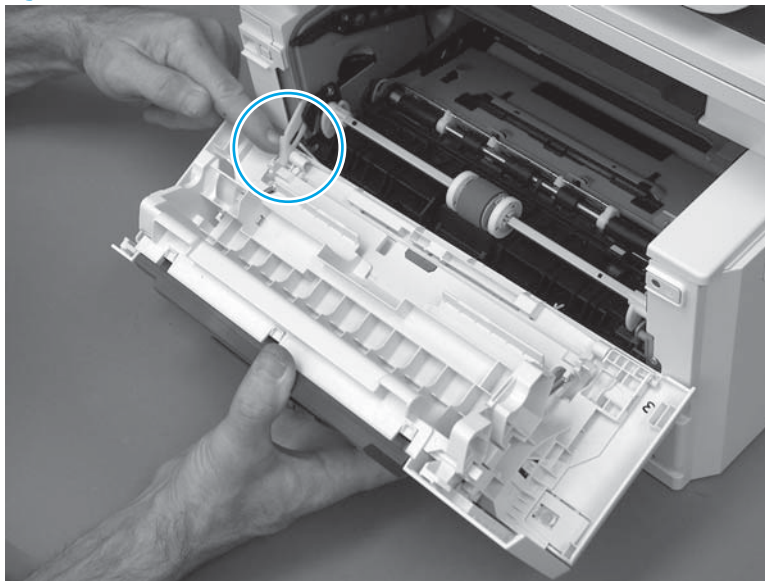

7. Remove the door.

Figure 1-411 Remove the door

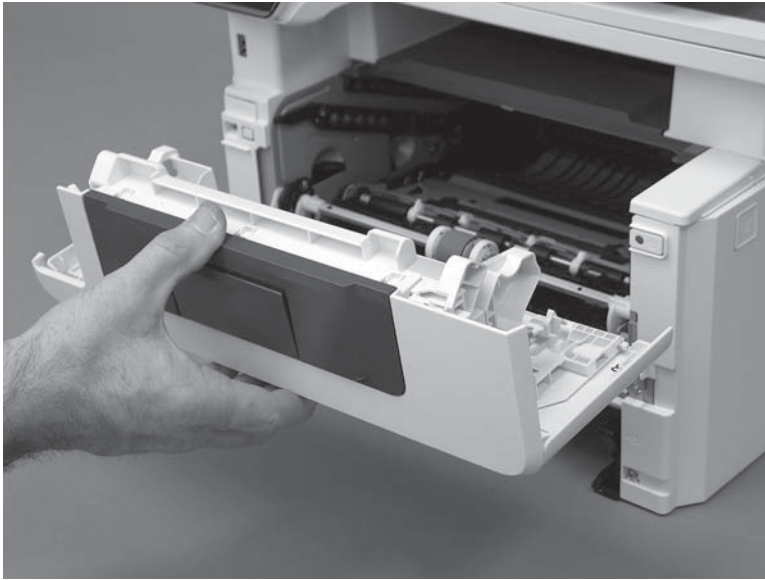

Step 3: Remove the left cover

1. Remove one screw (callout 1).

Figure 1-412 Remove one screw

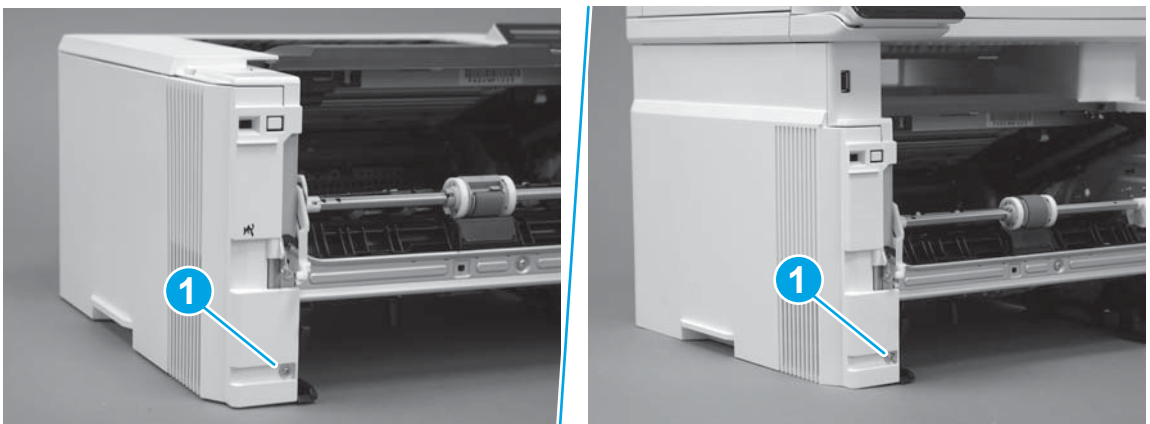

2. Open the rear door, release two bosses (callout 1), and then release three tabs (callout 2).

Figure 1-413 Release two bosses and three tabs

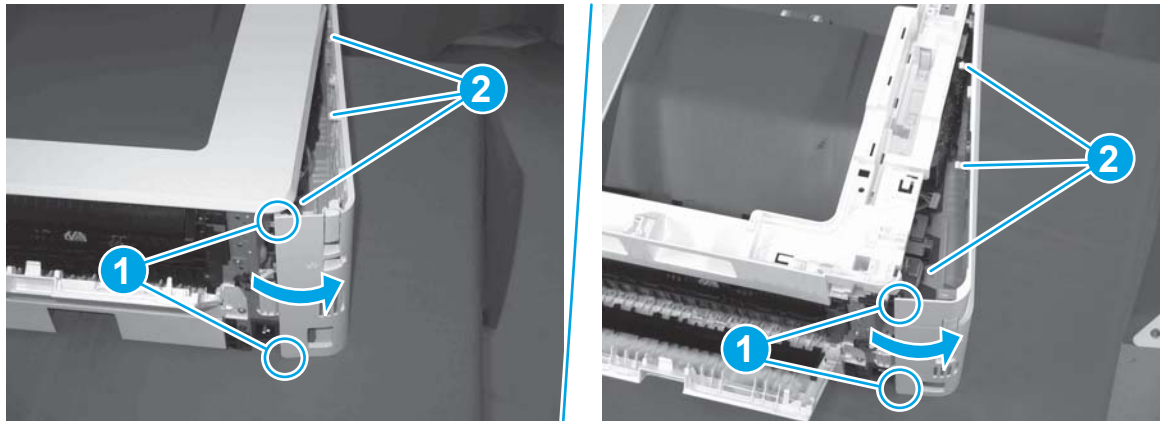

3. At the front of the printer, do one of the following:
 - **M304/M305/M404/M405:** Release two bosses (callout 1), and then remove the cover (callout 2).
 - **M329/M428/M429:** Release one tab (callout 3), two bosses (callout 4), and then remove the cover (callout 5).

CAUTION: Be careful when releasing the upper bosses on the M329/M428/M429 cover. One portion of the cover (callout 6) is fragile and is easily broken.

Figure 1-414 Remove the cover

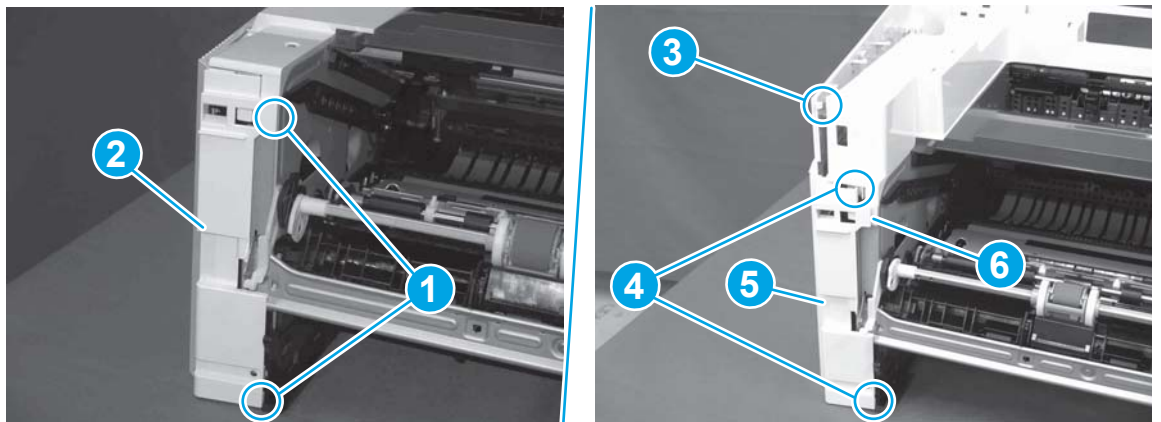

Step 4: Remove the fax PCA (Fax models only)

1. Remove three screws (callout 1).

Figure 1-415 Remove three screws

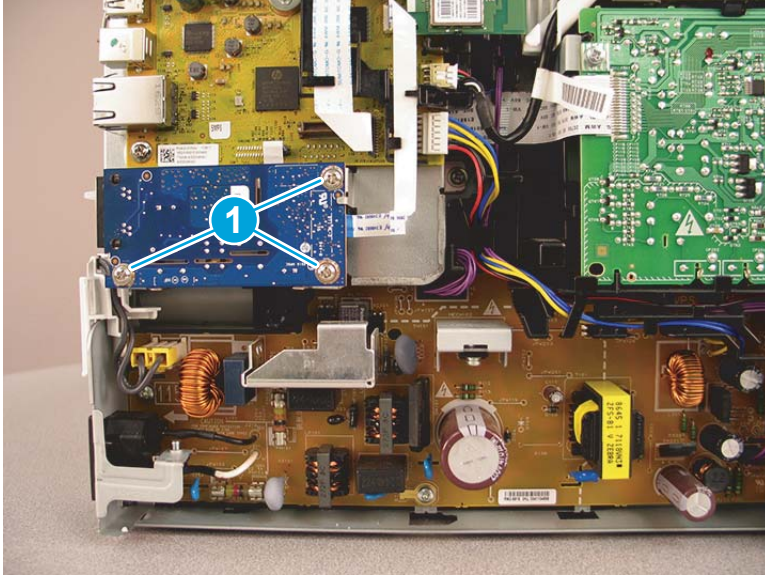

2. Disconnect one FFC (callout 1), and then remove the fax PCA.

Figure 1-416 Disconnect one connector and remove the PCA

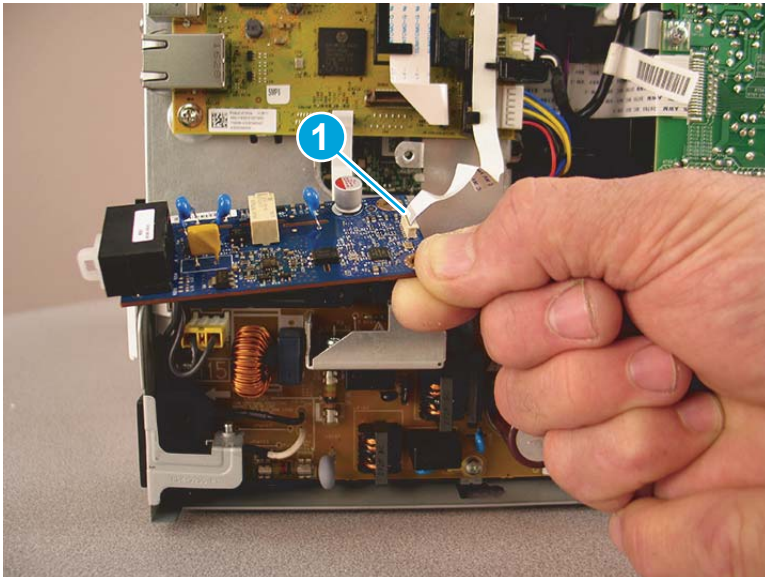



Step 5: Unpack the replacement assembly

1. Dispose of the defective part.

 **NOTE:** HP recommends responsible disposal of the defective part.

<http://www8.hp.com/us/en/hp-information/environment/product-recycling.html>

2. Unpack the replacement part from the packaging.

 **CAUTION:**  Some parts are sensitive to electrostatic discharge (ESD). Always perform service work at an ESD-protected workstation or mat. If an ESD workstation or mat is not available, touch the sheet-metal chassis to provide a static ground before touching an ESD-sensitive assembly. Protect the ESD-sensitive assemblies by placing them in ESD pouches when they are out of the printer.

If the replacement part is a roller or pad, avoid touching the spongy part of it. Skin oils on the roller or pad can cause paper pickup and/or print-quality problems. HP recommends using disposable gloves when handling rollers or pads or washing your hands before touching rollers or pads.

 **IMPORTANT:** Make sure that all of the shipping materials (for example shipping tape) are removed from the replacement part prior to installation.

3. To install an assembly, reverse the removal steps.

 **NOTE:** When applicable, special installation instructions are provided for an assembly at the end of the removal procedure. Always completely read the removal instructions and follow all special installation instructions.

Removal and replacement: Mute USB PCA (M329/M428/M429)

- [Introduction](#)
- [Step 1: Remove Tray 2](#)
- [Step 2: Remove the cartridge door assembly](#)
- [Step 3: Remove the left cover](#)
- [Step 4: Remove the Mute USB PCA \(M329/M428/M429\)](#)
- [Step 5: Unpack the replacement assembly](#)

Introduction

This document provides the procedures to remove and replace the Mute USB PCA.

Before performing service

Turn the printer power off

- Disconnect the power cable.

 **WARNING!** To avoid damage to the printer, turn the printer off, wait 30 seconds, and then remove the power cable before attempting to service the printer.

Use the table below to identify the correct part number for your printer. To order the part, go to www.hp.com/buy/parts.

Mute USB PCA part number	
5851-7008	Mute USB PCA ¹

¹ M329/M428/M429 only.

Required tools

- #2 Phillips screwdriver with a magnetic tip.

After performing service

Turn the printer power on

- Connect the power cable.
- Use the power switch to turn the power on.

Post service test

Make sure that the printer initializes to a **Ready** state.

Print a job from the walkup USB PCA.

Step 1: Remove Tray 2

- ▲ Pull the tray straight out of the printer to remove it.

Figure 1-417 Remove the tray



Step 2: Remove the cartridge door assembly

 **NOTE:** If the toner cartridge was not removed prior to servicing the printer, remove it now.

1. Release the support shaft (callout 1), and then slide it toward the center of the door (callout 2).

 **TIP:** It might be easier to release the support shaft by using a small flat-blade screwdriver.

Figure 1-418 Release the support shaft

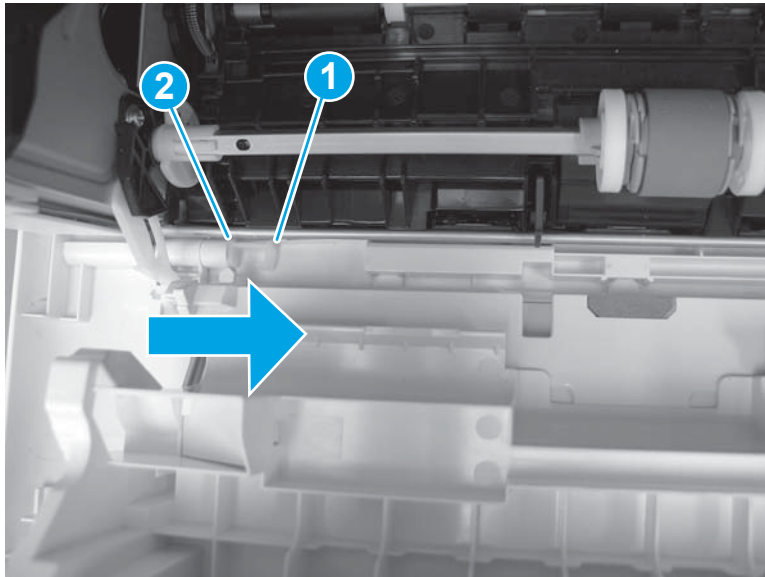

2. Remove the support shaft.

Figure 1-419 Remove the support shaft

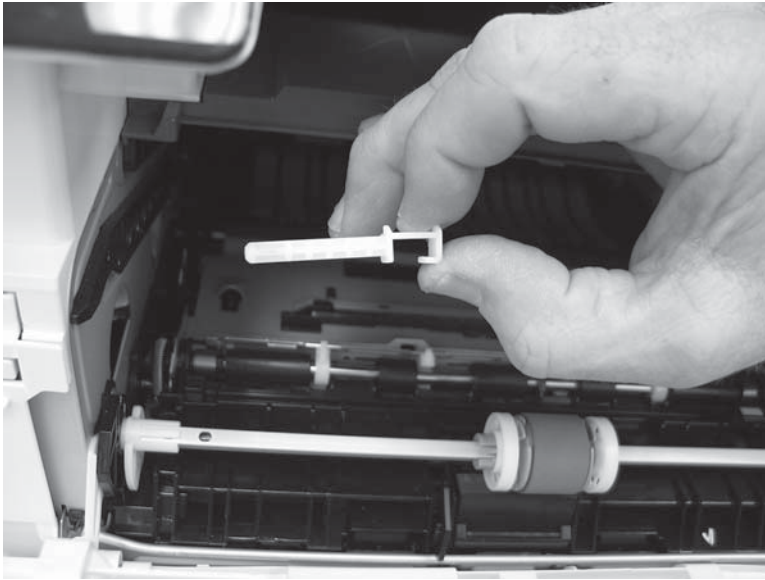

3. Release one tab (callout 1), and then slide the guide out of the printer (callout 2).

⚠ CAUTION: Be careful, the tab (callout 1) can be easily broken.

Figure 1-420 Remove the guide

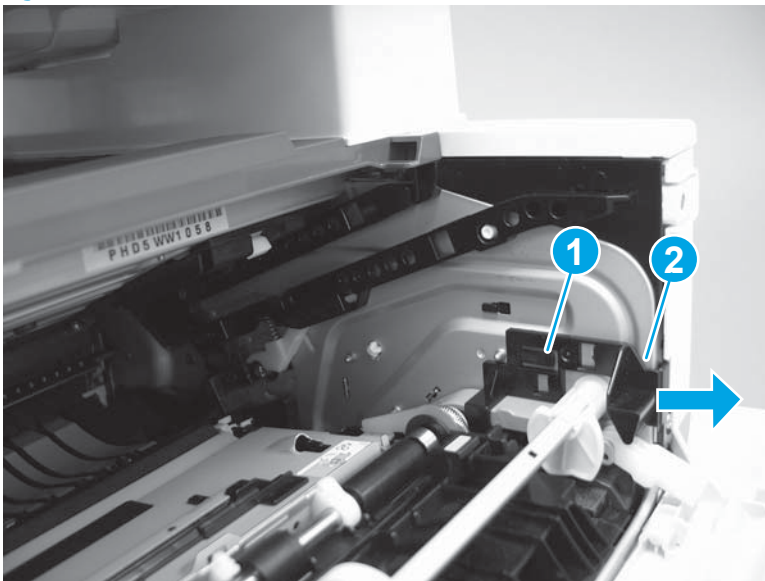

4. Use a small flat-blade screwdriver to gently pry the white-plastic door arm (callout 1) off of the gray-plastic pressure-release link (callout 2) to release the door arm.

Figure 1-421 Release the pressure-release link

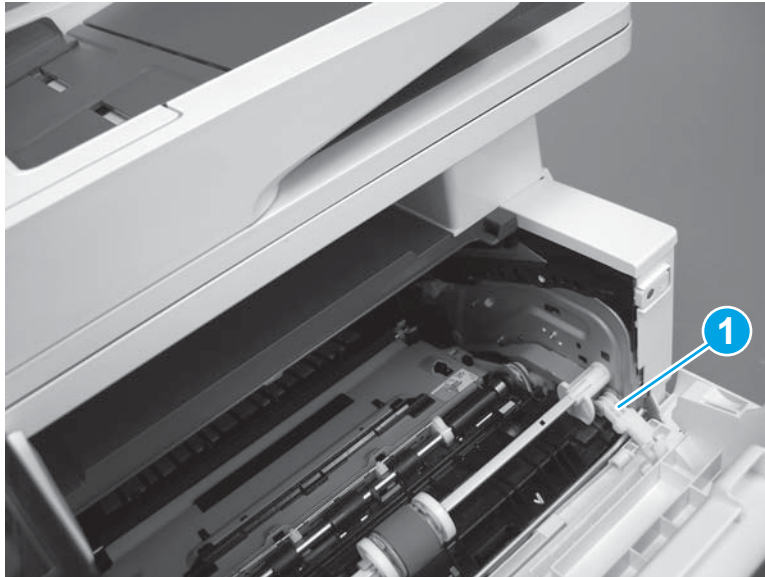

5. With the door in the partially closed position, slightly raise the left end (callout 1; raise it over the sheet-metal hinge boss), and then slide the door to the left (callout 2) to release the right hinge (callout 3).

⚠ CAUTION: The door is still attached to the printer by the left-side retainer arm. Do not attempt to completely remove the door.

💡 Reinstallation tip: When reinstalling the door, there are two right-side hinge pins (not shown in callout 3). Keep a finger pressed on the left-side retainer arm so that it does not disengage from the door.

Figure 1-422 Release the door

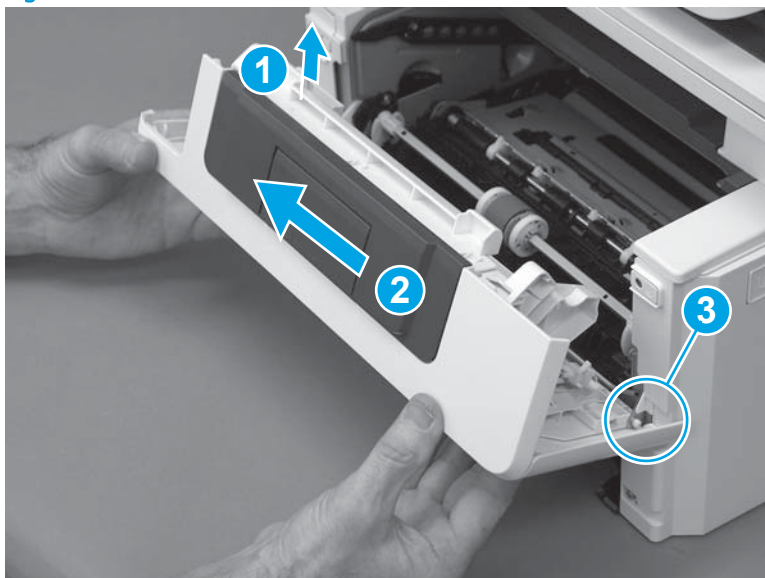

6. Rotate the door away from the printer until the keyed pin on the left-side retainer arm can disengage from the door.

Figure 1-423 Release the left-side retainer arm

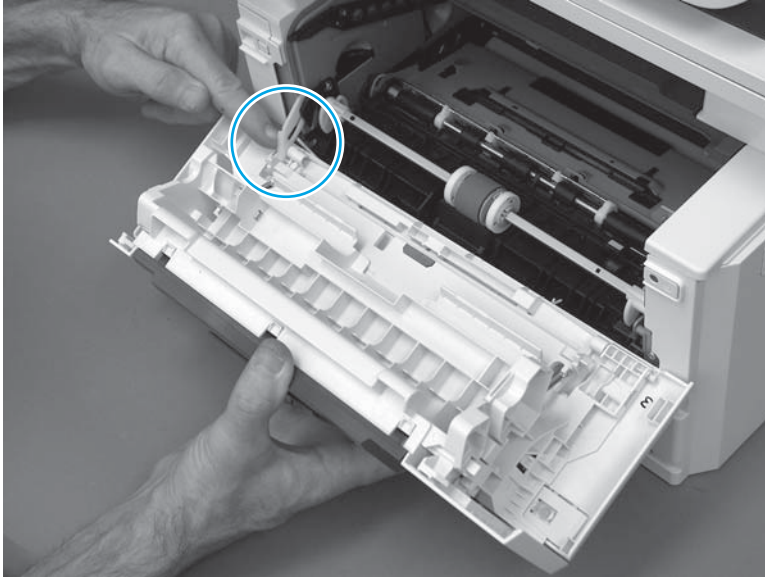

7. Remove the door.

Figure 1-424 Remove the door

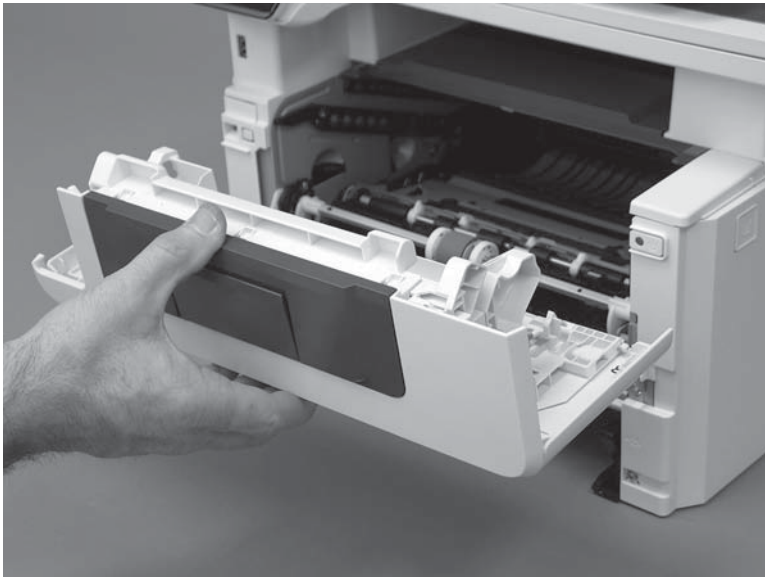

Step 3: Remove the left cover

1. Remove one screw (callout 1).

Figure 1-425 Remove one screw

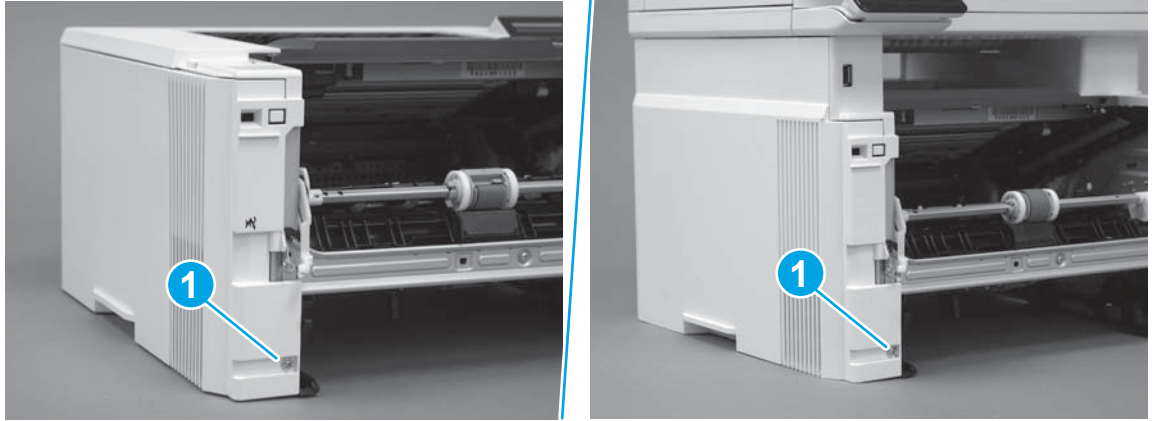

2. Open the rear door, release two bosses (callout 1), and then release three tabs (callout 2).

Figure 1-426 Release two bosses and three tabs

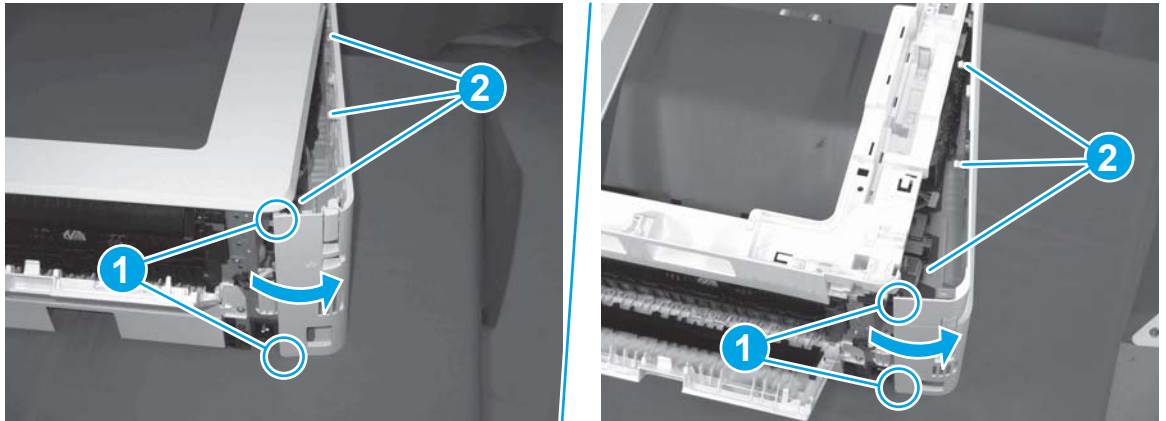

3. At the front of the printer, do one of the following:
 - **M304/M305/M404/M405:** Release two bosses (callout 1), and then remove the cover (callout 2).
 - **M329/M428/M429:** Release one tab (callout 3), two bosses (callout 4), and then remove the cover (callout 5).

⚠ CAUTION: Be careful when releasing the upper bosses on the M329/M428/M429 cover. One portion of the cover (callout 6) is fragile and is easily broken.

Figure 1-427 Remove the cover

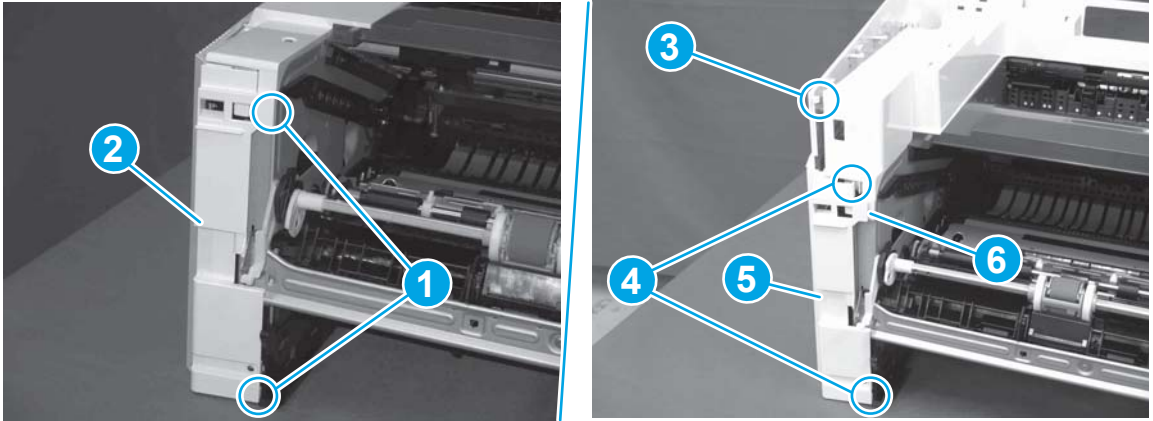

Step 4: Remove the Mute USB PCA (M329/M428/M429)

1. Disconnect one connector (callout 1), and then release the wire harness from the guide (callout 2).

Figure 1-428 Disconnect one connector

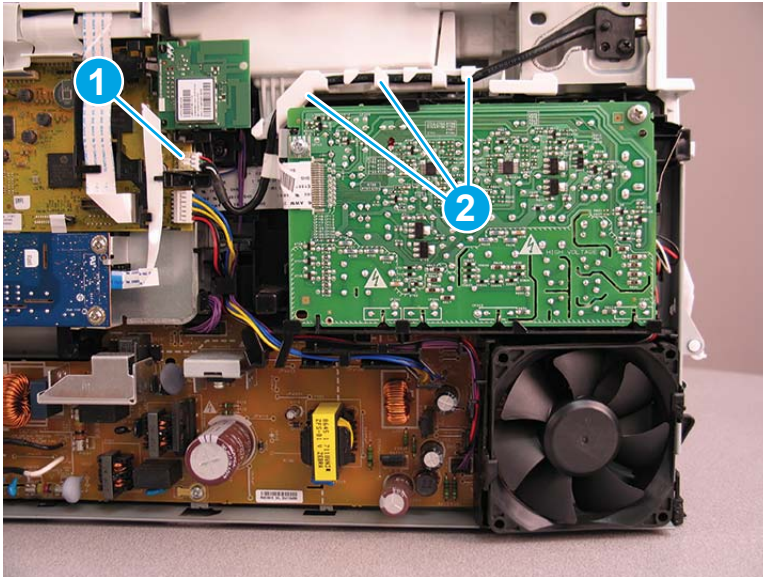

2. Remove one screw (callout 1).

Figure 1-429 Remove one screw

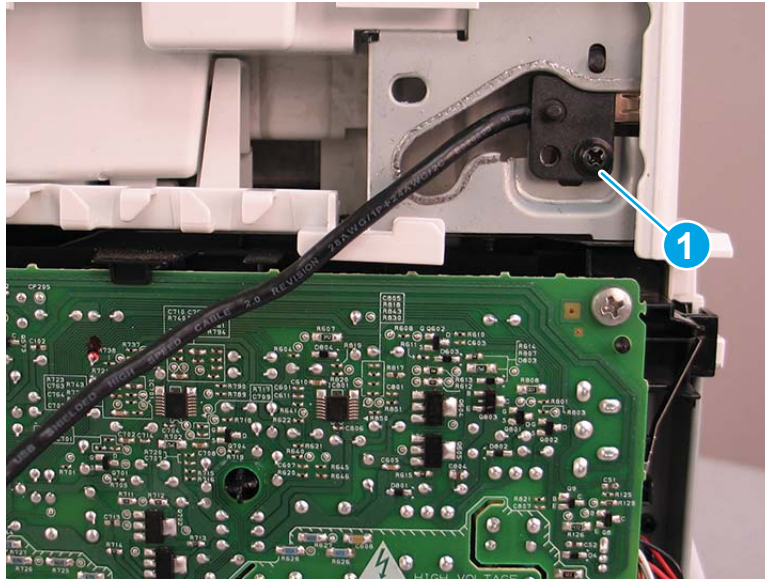

3. Remove the mute USB PCA.

Figure 1-430 Remove the mute USB PCA

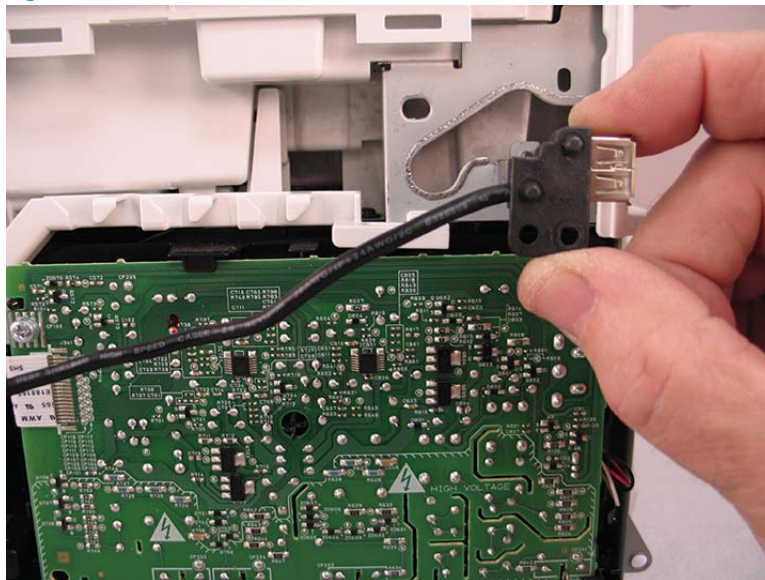



Step 5: Unpack the replacement assembly

1. Dispose of the defective part.

 **NOTE:** HP recommends responsible disposal of the defective part.

<http://www8.hp.com/us/en/hp-information/environment/product-recycling.html>

2. Unpack the replacement part from the packaging.

 **CAUTION:**  Some parts are sensitive to electrostatic discharge (ESD). Always perform service work at an ESD-protected workstation or mat. If an ESD workstation or mat is not available, touch the sheet-metal chassis to provide a static ground before touching an ESD-sensitive assembly. Protect the ESD-sensitive assemblies by placing them in ESD pouches when they are out of the printer.

If the replacement part is a roller or pad, avoid touching the spongy part of it. Skin oils on the roller or pad can cause paper pickup and/or print-quality problems. HP recommends using disposable gloves when handling rollers or pads or washing your hands before touching rollers or pads.

 **IMPORTANT:** Make sure that all of the shipping materials (for example shipping tape) are removed from the replacement part prior to installation.

3. To install an assembly, reverse the removal steps.

 **NOTE:** When applicable, special installation instructions are provided for an assembly at the end of the removal procedure. Always completely read the removal instructions and follow all special installation instructions.

Removal and replacement: Wireless PCA



NOTE: Wireless models only.

- [Introduction](#)
- [Step 1: Remove Tray 2](#)
- [Step 2: Remove the cartridge door assembly](#)
- [Step 3: Remove the left cover](#)
- [Step 4: Remove the wireless PCA](#)
- [Step 5: Unpack the replacement assembly](#)

Introduction

This document provides the procedures to remove and replace the wireless printed circuit assembly (PCA).

Before performing service

Turn the printer power off

- Disconnect the power cable.



WARNING! To avoid damage to the printer, turn the printer off, wait 30 seconds, and then remove the power cable before attempting to service the printer.

Use the table below to identify the correct part number for your printer. To order the part, go to www.hp.com/buy/parts.

Wireless PCA part number	
0960-4025	Wireless module (Ultra) ¹

¹ Wireless models only.

Required tools

- #2 Phillips screwdriver with a magnetic tip.

After performing service

Turn the printer power on

- Connect the power cable.
- Use the power switch to turn the power on.

Post service test

Make sure that the printer initializes to a **Ready** state.

If possible, send a wireless print job to the printer.

Step 1: Remove Tray 2

- ▲ Pull the tray straight out of the printer to remove it.

Figure 1-431 Remove the tray



Step 2: Remove the cartridge door assembly

 **NOTE:** If the toner cartridge was not removed prior to servicing the printer, remove it now.

1. Release the support shaft (callout 1), and then slide it toward the center of the door (callout 2).

 **TIP:** It might be easier to release the support shaft by using a small flat-blade screwdriver.

Figure 1-432 Release the support shaft

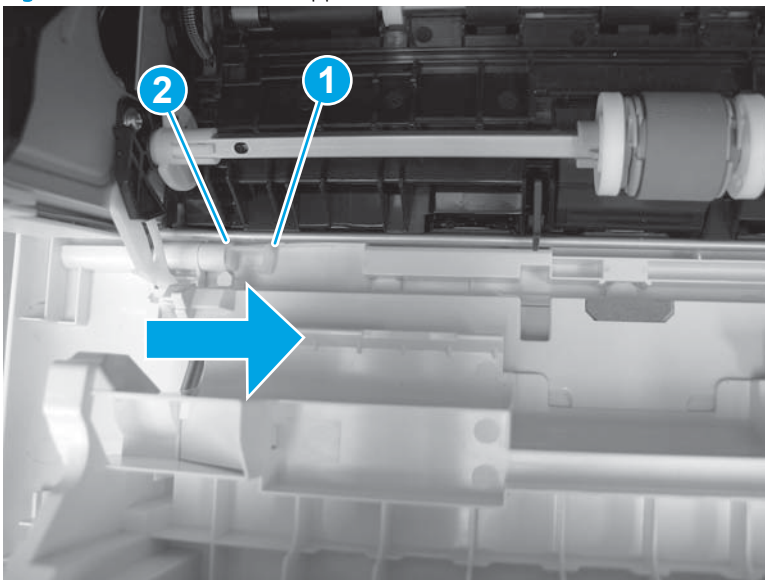

2. Remove the support shaft.

Figure 1-433 Remove the support shaft

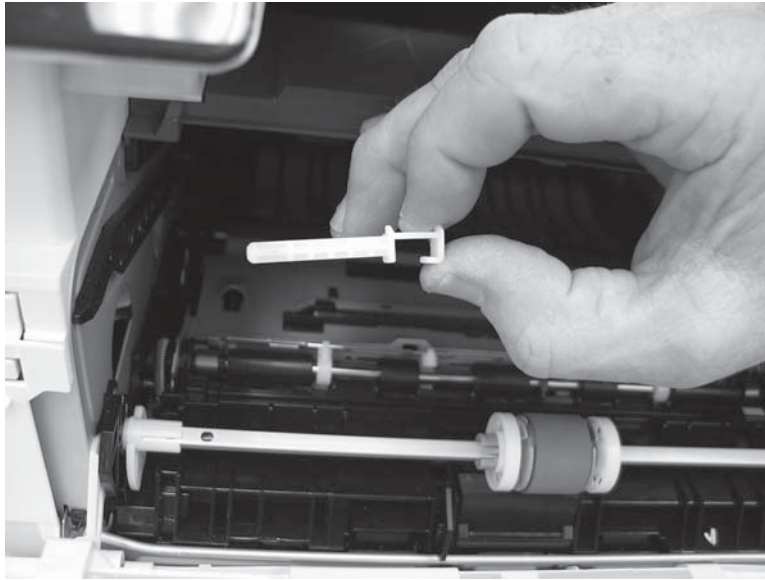

3. Release one tab (callout 1), and then slide the guide out of the printer (callout 2).

⚠ CAUTION: Be careful, the tab (callout 1) can be easily broken.

Figure 1-434 Remove the guide

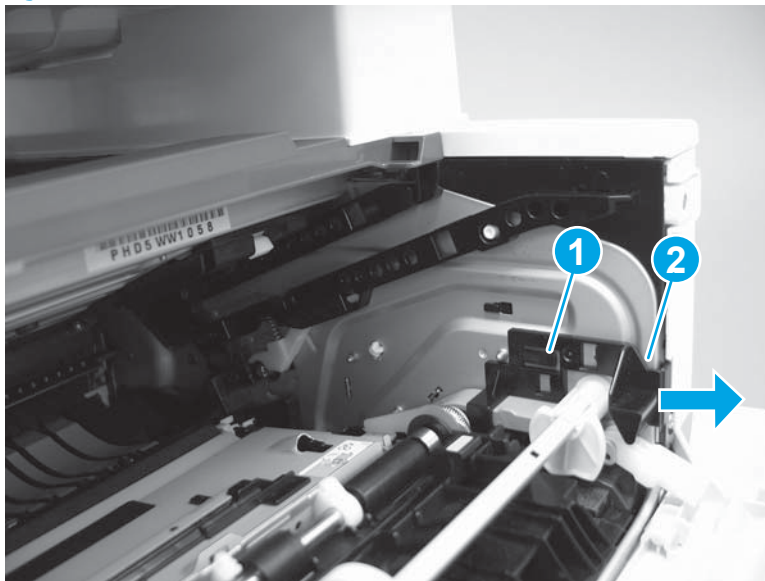

4. Use a small flat-blade screwdriver to gently pry the white-plastic door arm (callout 1) off of the gray-plastic pressure-release link (callout 2) to release the door arm.

Figure 1-435 Release the pressure-release link

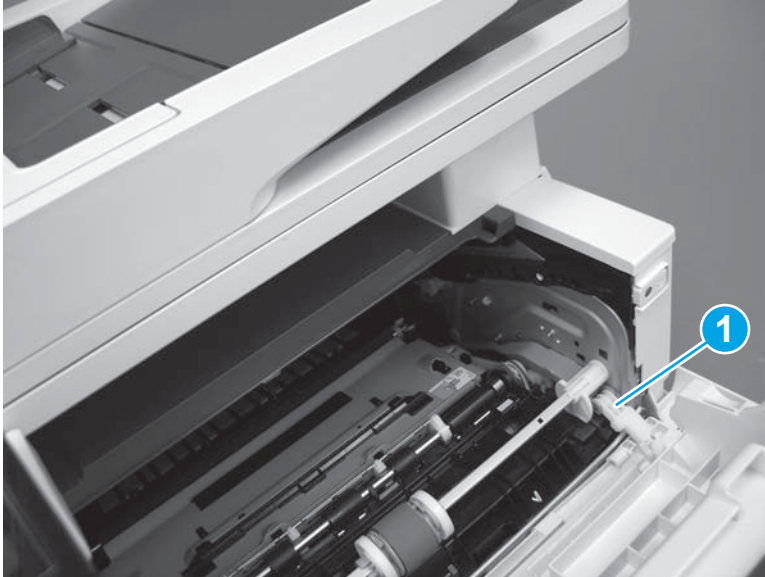

5. With the door in the partially closed position, slightly raise the left end (callout 1; raise it over the sheet-metal hinge boss), and then slide the door to the left (callout 2) to release the right hinge (callout 3).

⚠ CAUTION: The door is still attached to the printer by the left-side retainer arm. Do not attempt to completely remove the door.

💡 Reinstallation tip: When reinstalling the door, there are two right-side hinge pins (not shown in callout 3). Keep a finger pressed on the left-side retainer arm so that it does not disengage from the door.

Figure 1-436 Release the door

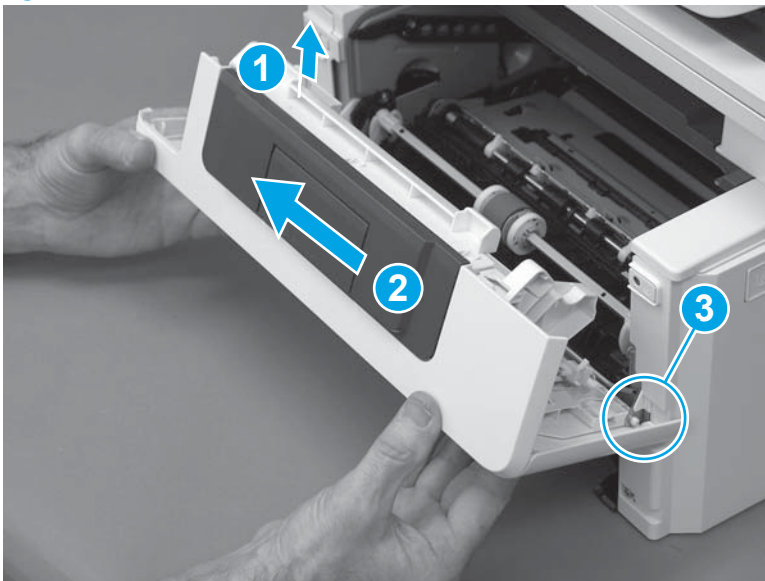

6. Rotate the door away from the printer until the keyed pin on the left-side retainer arm can disengage from the door.

Figure 1-437 Release the left-side retainer arm

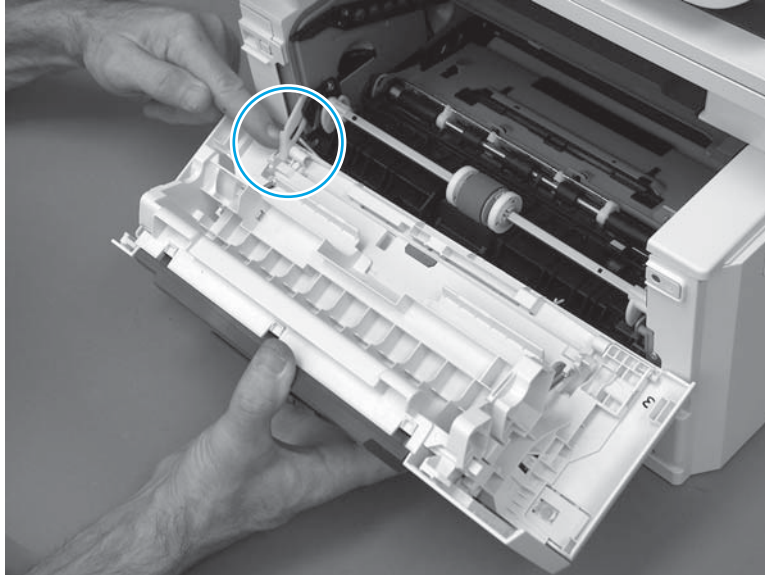

7. Remove the door.

Figure 1-438 Remove the door

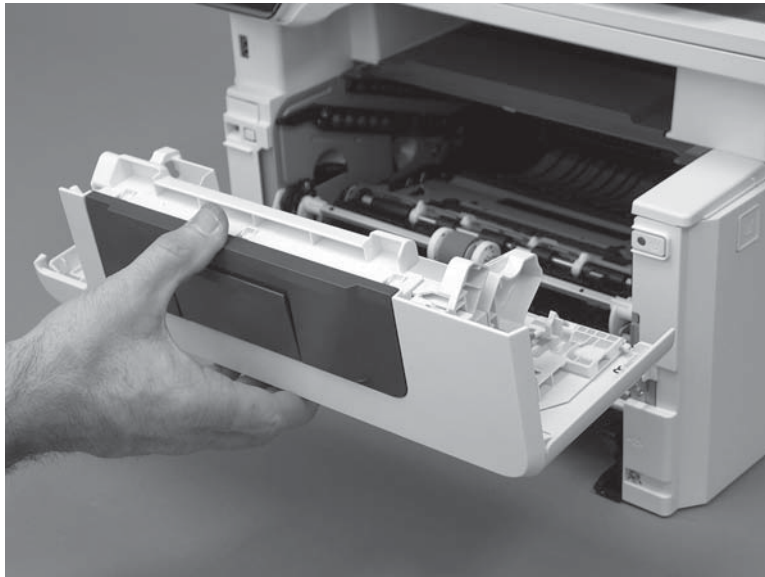

Step 3: Remove the left cover

1. Remove one screw (callout 1).

Figure 1-439 Remove one screw

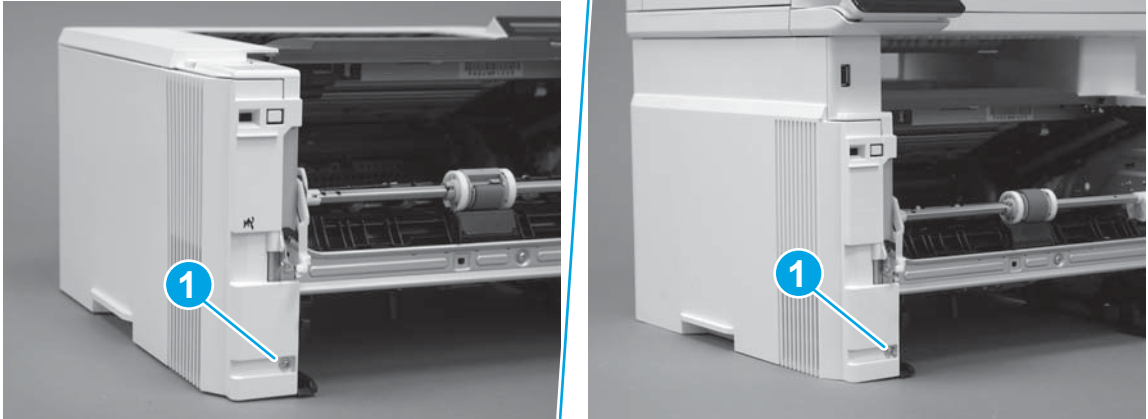

2. Open the rear door, release two bosses (callout 1), and then release three tabs (callout 2).

Figure 1-440 Release two bosses and three tabs

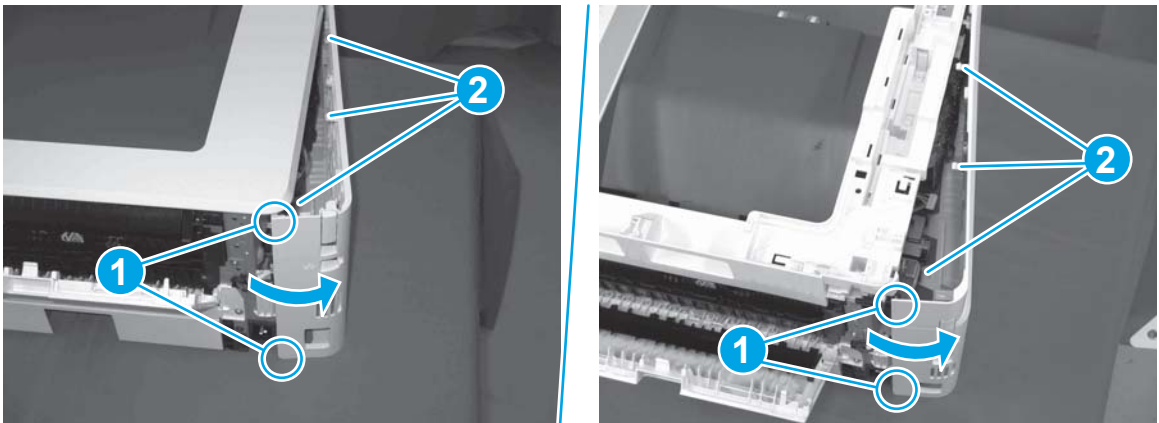

3. At the front of the printer, do one of the following:
 - **M304/M305/M404/M405:** Release two bosses (callout 1), and then remove the cover (callout 2).
 - **M329/M428/M429:** Release one tab (callout 3), two bosses (callout 4), and then remove the cover (callout 5).

CAUTION: Be careful when releasing the upper bosses on the M329/M428/M429 cover. One portion of the cover (callout 6) is fragile and is easily broken.

Figure 1-441 Remove the cover

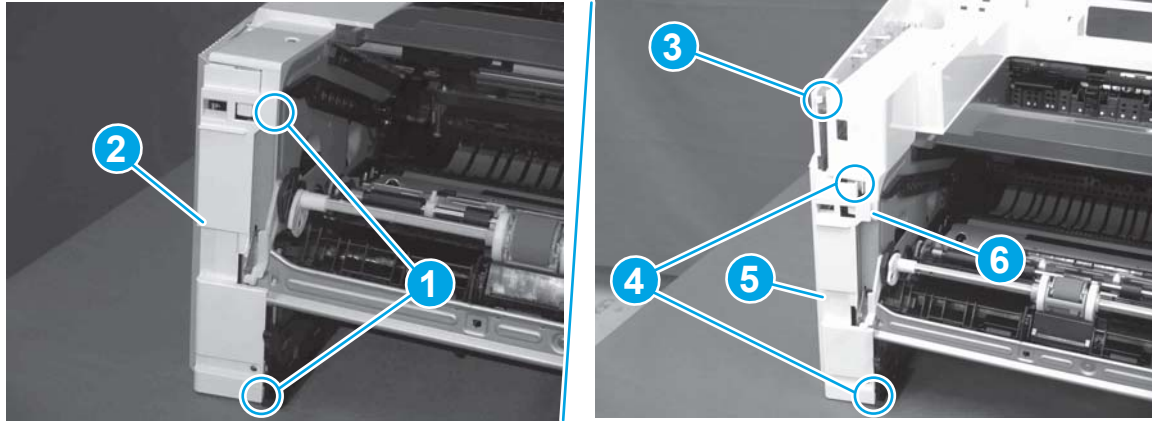

Step 4: Remove the wireless PCA

1. Do one of the following:

- **SFP only:** Release two tabs (callout 1).

 **NOTE:** Disconnect the WiFi antenna (callout 2) before releasing the tabs.

- **MFP only:** Release one tab (callout 3).

 **TIP:** Push the tab to the left to release it.

Figure 1-442 Release one or two tabs



2. Carefully pull the wireless PCA straight off of the formatter PCA to remove it.

Figure 1-443 Remove the wireless PCA

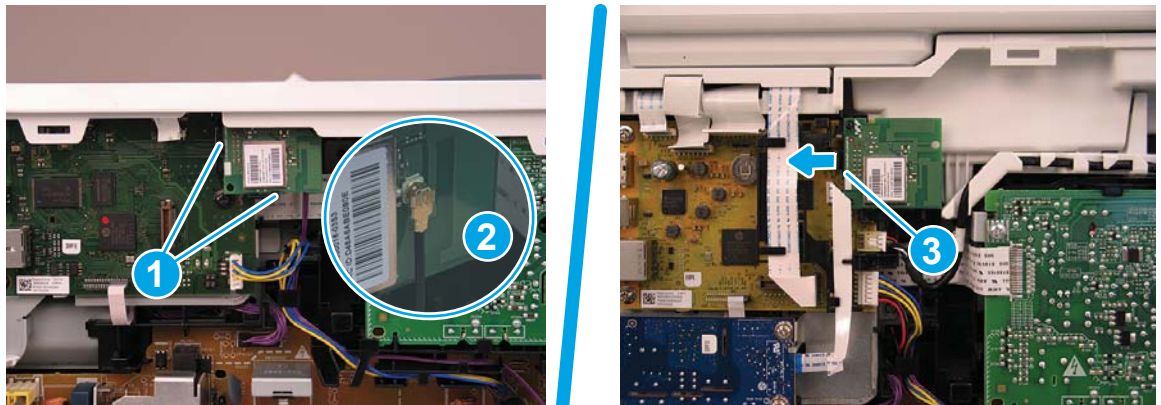
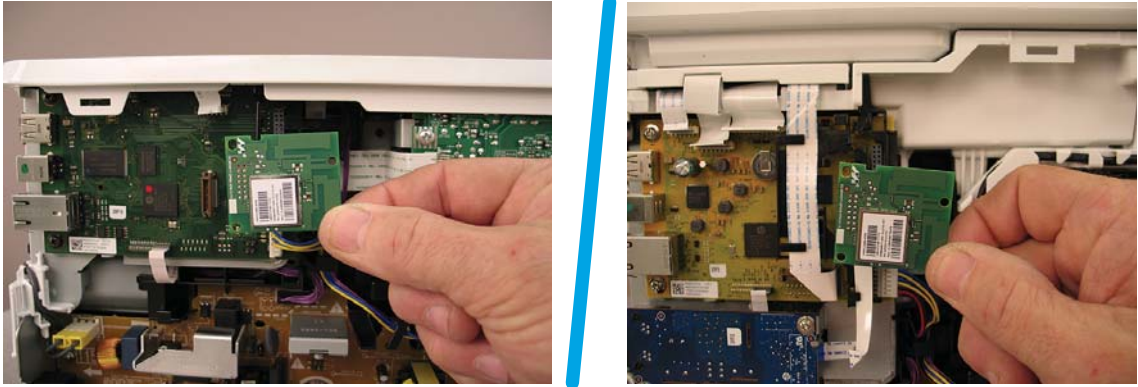



Step 5: Unpack the replacement assembly

1. Dispose of the defective part.

 **NOTE:** HP recommends responsible disposal of the defective part.

<http://www8.hp.com/us/en/hp-information/environment/product-recycling.html>

2. Unpack the replacement part from the packaging.

 **CAUTION:**  Some parts are sensitive to electrostatic discharge (ESD). Always perform service work at an ESD-protected workstation or mat. If an ESD workstation or mat is not available, touch the sheet-metal chassis to provide a static ground before touching an ESD-sensitive assembly. Protect the ESD-sensitive assemblies by placing them in ESD pouches when they are out of the printer.

If the replacement part is a roller or pad, avoid touching the spongy part of it. Skin oils on the roller or pad can cause paper pickup and/or print-quality problems. HP recommends using disposable gloves when handling rollers or pads or washing your hands before touching rollers or pads.

 **IMPORTANT:** Make sure that all of the shipping materials (for example shipping tape) are removed from the replacement part prior to installation.

3. To install an assembly, reverse the removal steps.

 **NOTE:** When applicable, special installation instructions are provided for an assembly at the end of the removal procedure. Always completely read the removal instructions and follow all special installation instructions.

Removal and replacement: Formatter PCA

- [Introduction](#)
- [Step 1: Remove Tray 2](#)
- [Step 2: Remove the cartridge door assembly](#)
- [Step 3: Remove the left cover](#)
- [Step 4: Remove the wireless PCA](#)
- [Step 5: Remove the formatter PCA](#)
- [Step 6: Unpack the replacement assembly](#)

Introduction

This document provides the procedures to remove and replace the formatter PCA.

Before performing service

Turn the printer power off

- Disconnect the power cable.

 **WARNING!** To avoid damage to the printer, turn the printer off, wait 30 seconds, and then remove the power cable before attempting to service the printer.

 **IMPORTANT:** Always replace the thermal transfer pad (5851-6550) when the formatter is replaced.

Formatter PCA part numbers (SFP)

W2Q08-60001	Formatter PCA (generic formatter for all d models)
W1A49-60001	Formatter PCA (M404d)
W1A58-60001	Formatter PCA (M405d; China/India)
W1A58-60002	Formatter PCA (M405d; China only)
W1A46-60001	Formatter PCA (M305d; China)
W1A66-60001	Formatter PCA (M304a; EMEA)
W2Q09-60001	Formatter PCA (generic formatter for all n/dn/dw models)
W1A52-60001	Formatter PCA (M404n)
W1A53-60001	Formatter PCA (M404dn)
W1A56-60001	Formatter PCA (M404dw)
W1A57-60002	Formatter PCA (M405n; China/India)
W1A57-60003	Formatter PCA (M405n; China only)
W1A59-60001	Formatter PCA (M405dn; China/India)
W1A59-60002	Formatter PCA (M405dn; China only)
W1A60-60001	Formatter PCA (M405dw; China/India)
W1A60-60002	Formatter PCA (M405dw; China only)
W1A47-60001	Formatter PCA (M305dn; China)

Formatter PCA part numbers (MFP)	
W2Q13-60001	Formatter PCA (generic formatter for all 4in1 models)
W2Q13-60003	Formatter PCA (M428fdn)
W1A30-60001	Formatter PCA (M428fdw)
W1A32-60001	Formatter PCA (M428fdn; Russia)
W1A34-60001	Formatter PCA (M429fdn)
W1A33-60001	Formatter PCA (M429fdw)
W1A34-60002	Formatter PCA (M429fdn; China only)
W1A35-60001	Formatter PCA (M429fdw; China only)
W1A23-60001	Formatter PCA (M329dn; China only)
W1A24-60001	Formatter PCA (M329dw; China only)
W2Q12-60001	Formatter PCA (generic formatter for all 3in1 models)
W1A28-60001	Formatter PCA (M428dw)
W1A28-60002	Formatter PCA (M428dw; Russia)
W1A33-60003	Formatter PCA (M429dw)
W1A33-60004	Formatter PCA (M429dw; China only)

Required tools

- #2 Phillips screwdriver with a magnetic tip.
- 5.5 mm (0.22 inch) socket screwdriver.

After performing service

Turn the printer power on

- Connect the power cable.
- Use the power switch to turn the power on.

Post service test

Make sure that the printer initializes to a **Ready** state.

Print a configuration page to make sure that the printer is functioning correctly.

Step 1: Remove Tray 2

- ▲ Pull the tray straight out of the printer to remove it.

Figure 1-444 Remove the tray



Step 2: Remove the cartridge door assembly

 **NOTE:** If the toner cartridge was not removed prior to servicing the printer, remove it now.

1. Release the support shaft (callout 1), and then slide it toward the center of the door (callout 2).

 **TIP:** It might be easier to release the support shaft by using a small flat-blade screwdriver.

Figure 1-445 Release the support shaft

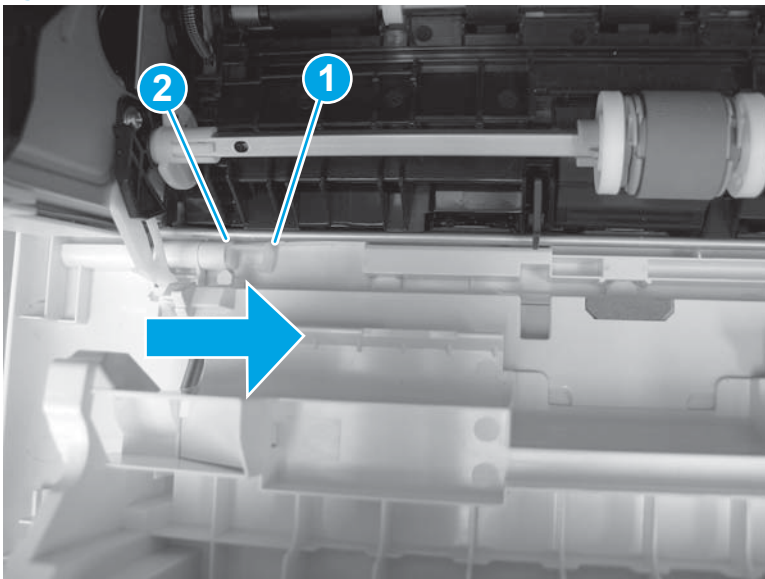

2. Remove the support shaft.

Figure 1-446 Remove the support shaft

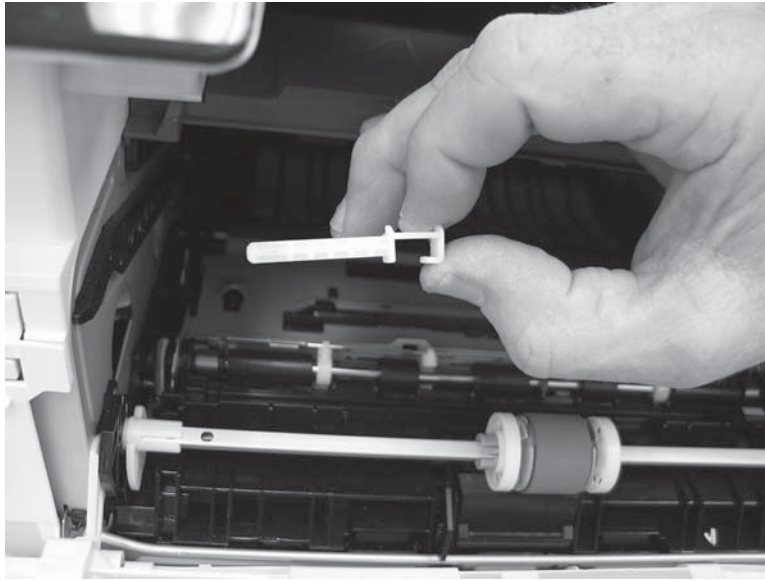

3. Release one tab (callout 1), and then slide the guide out of the printer (callout 2).

⚠ CAUTION: Be careful, the tab (callout 1) can be easily broken.

Figure 1-447 Remove the guide

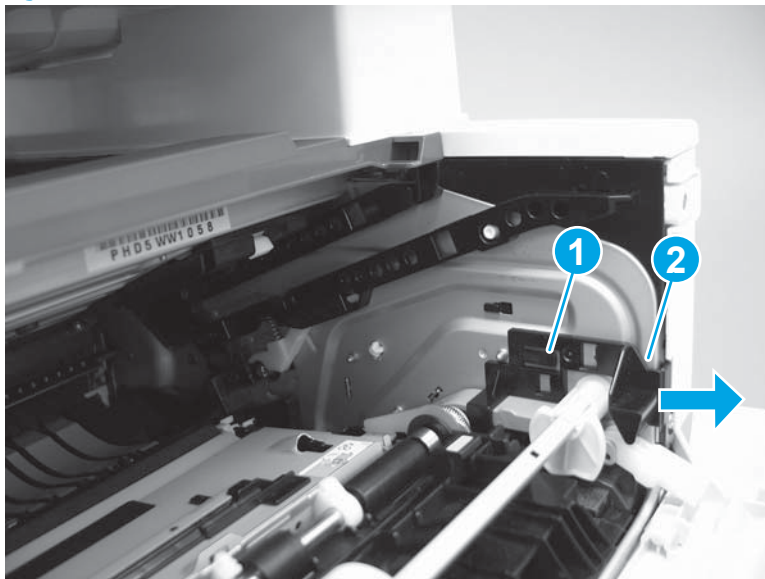

4. Use a small flat-blade screwdriver to gently pry the white-plastic door arm (callout 1) off of the gray-plastic pressure-release link (callout 2) to release the door arm.

Figure 1-448 Release the pressure-release link

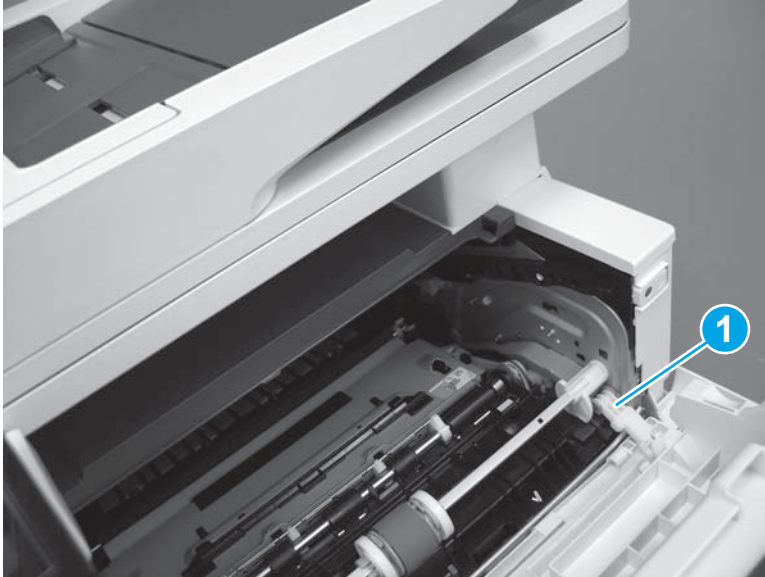

5. With the door in the partially closed position, slightly raise the left end (callout 1; raise it over the sheet-metal hinge boss), and then slide the door to the left (callout 2) to release the right hinge (callout 3).

⚠ CAUTION: The door is still attached to the printer by the left-side retainer arm. Do not attempt to completely remove the door.

💡 Reinstallation tip: When reinstalling the door, there are two right-side hinge pins (not shown in callout 3). Keep a finger pressed on the left-side retainer arm so that it does not disengage from the door.

Figure 1-449 Release the door

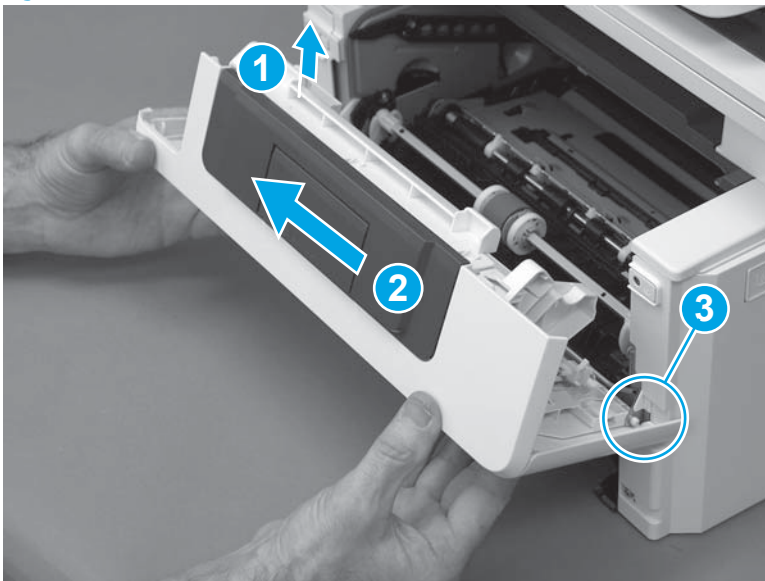

6. Rotate the door away from the printer until the keyed pin on the left-side retainer arm can disengage from the door.

Figure 1-450 Release the left-side retainer arm

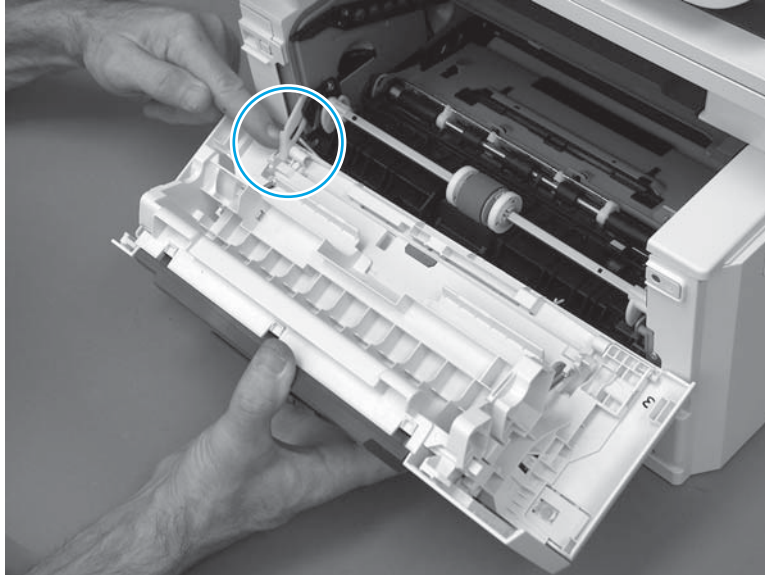

7. Remove the door.

Figure 1-451 Remove the door

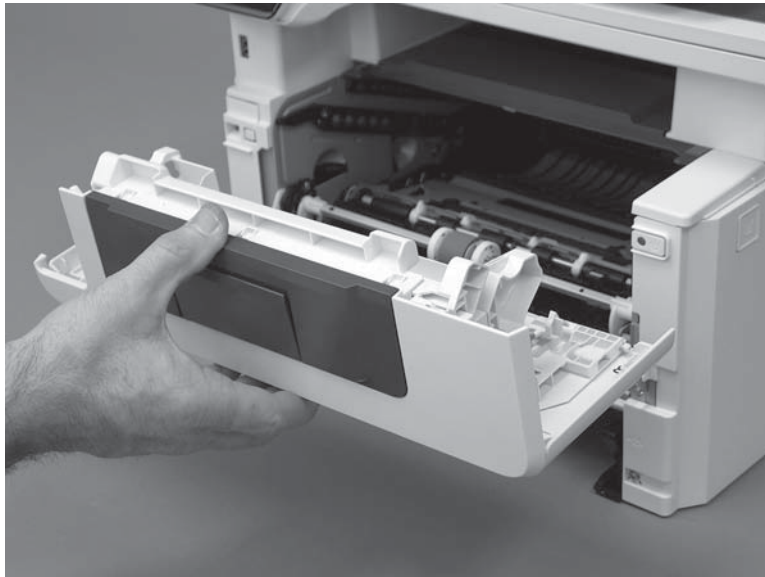

Step 3: Remove the left cover

1. Remove one screw (callout 1).

Figure 1-452 Remove one screw

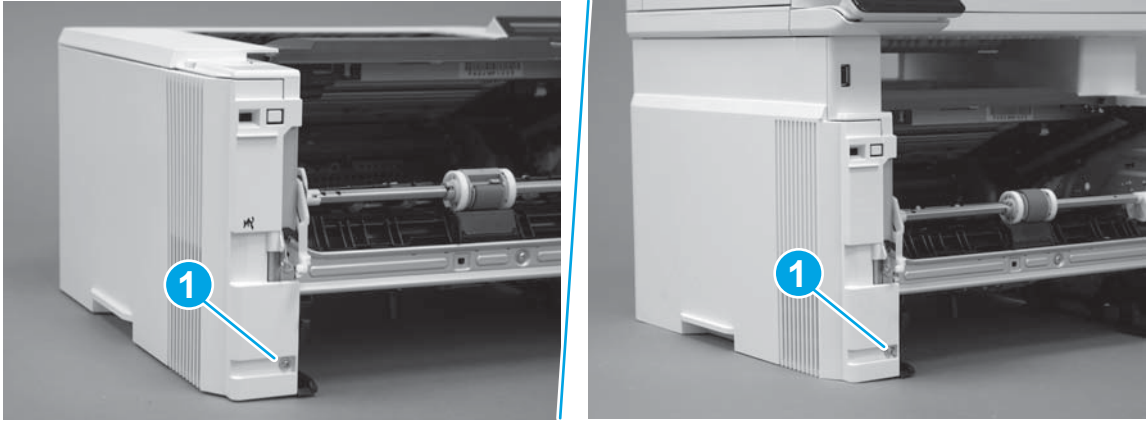

2. Open the rear door, release two bosses (callout 1), and then release three tabs (callout 2).

Figure 1-453 Release two bosses and three tabs

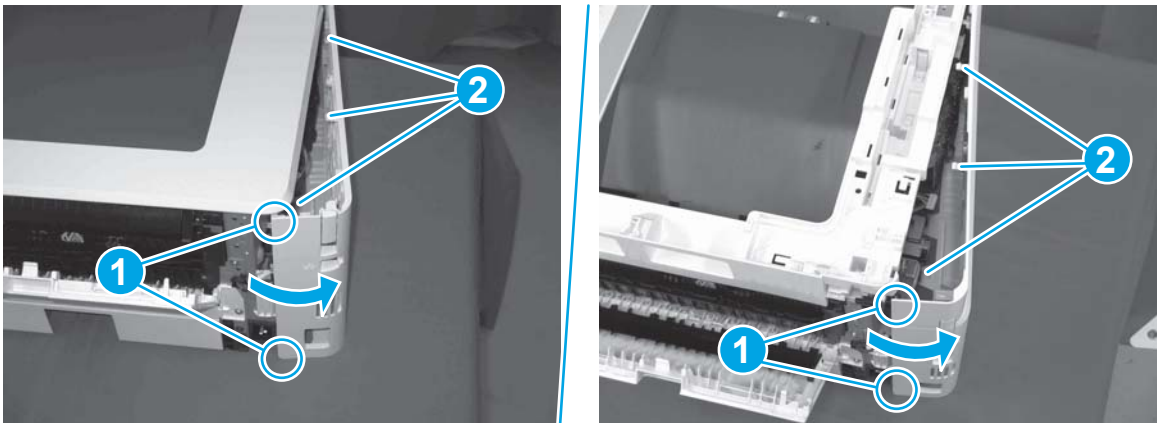

3. At the front of the printer, do one of the following:
 - **M304/M305/M404/M405:** Release two bosses (callout 1), and then remove the cover (callout 2).
 - **M329/M428/M429:** Release one tab (callout 3), two bosses (callout 4), and then remove the cover (callout 5).

CAUTION: Be careful when releasing the upper bosses on the M329/M428/M429 cover. One portion of the cover (callout 6) is fragile and is easily broken.

Figure 1-454 Remove the cover

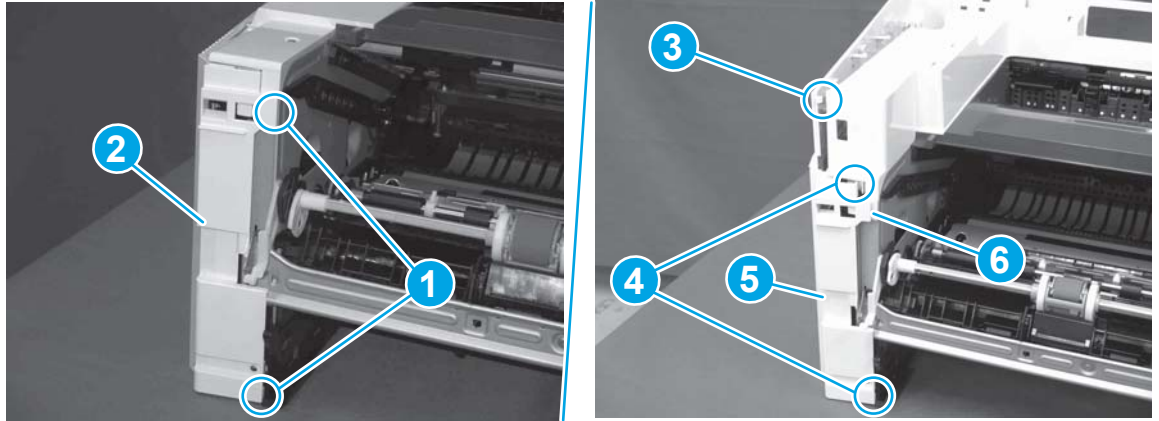

Step 4: Remove the wireless PCA

 **NOTE:** Wireless models only. For all other models, skip this step and go to [Step 5: Remove the formatter PCA on page 294](#).

1. Do one of the following:

- **SFP only:** Release two tabs (callout 1).

 **NOTE:** Disconnect the WiFi antenna (callout 2) before releasing the tabs.

- **MFP only:** Release one tab (callout 3).

 **TIP:** Push the tab to the left to release it.

Figure 1-455 Release one or two tabs



2. Carefully pull the wireless PCA straight off of the formatter PCA to remove it.

Figure 1-456 Remove the wireless PCA

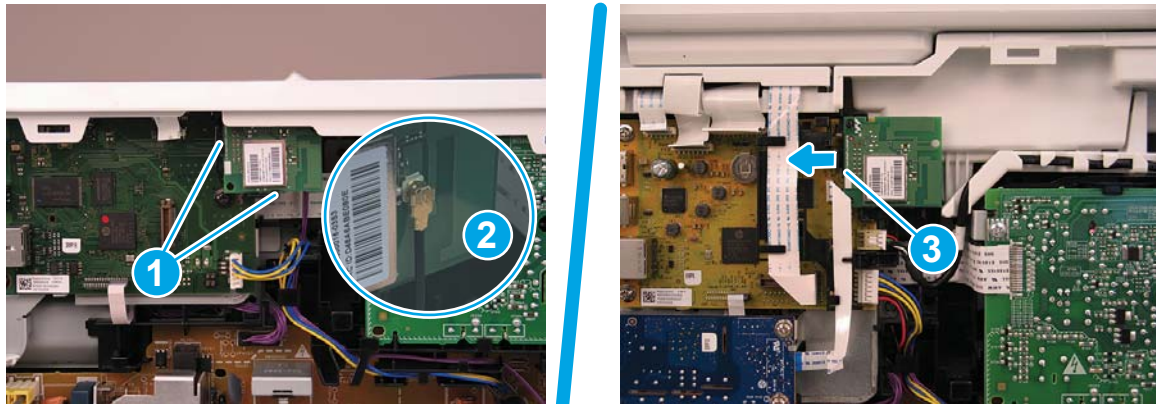
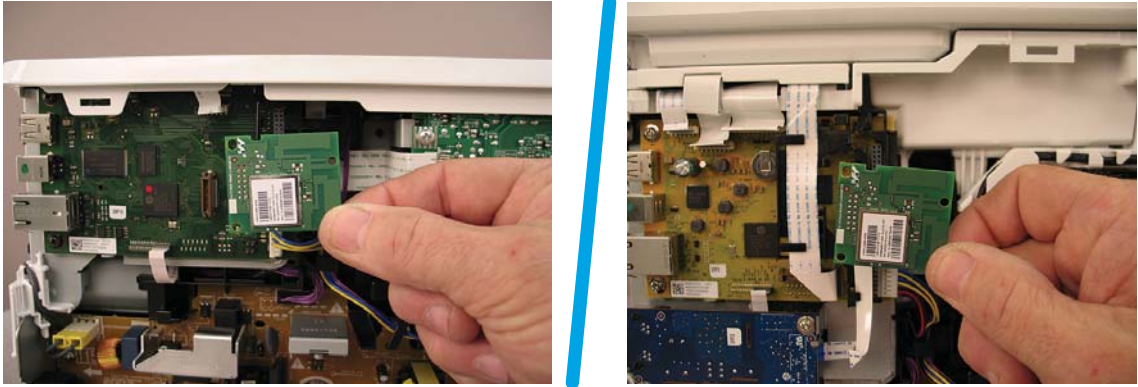

Step 5: Remove the formatter PCA

 **NOTE:** If the formatter PCA thermal pad on the back side of the PCA is broken or damaged, replace the pad (5851-6550).

1. Disconnect all of the connectors and FFCs.

 **IMPORTANT:** Take note of any empty connectors before removing the formatter PCA.

 **NOTE:** **MFP only:** Release two flat-flexible cables (FFCs) from the guides (callout 1).

Figure 1-457 Disconnect all of the connectors and FFCs



2. Remove three screws (callout 1), and then remove the formatter PCA.

 **Reinstallation tip:** If a replacement formatter is installed and the printer is a wireless model, make sure that the wireless PCA mounting holder (callout 2) is transferred to the replacement formatter.

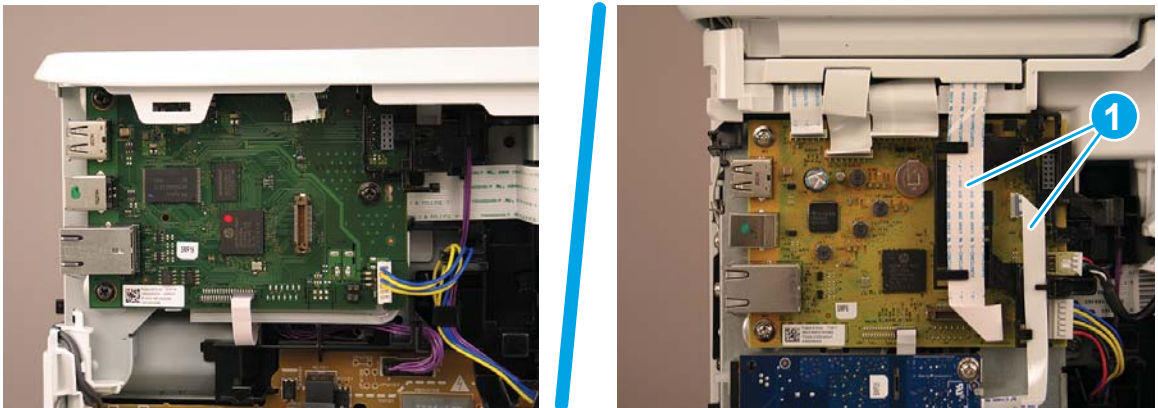
Figure 1-458 Remove the formatter PCA



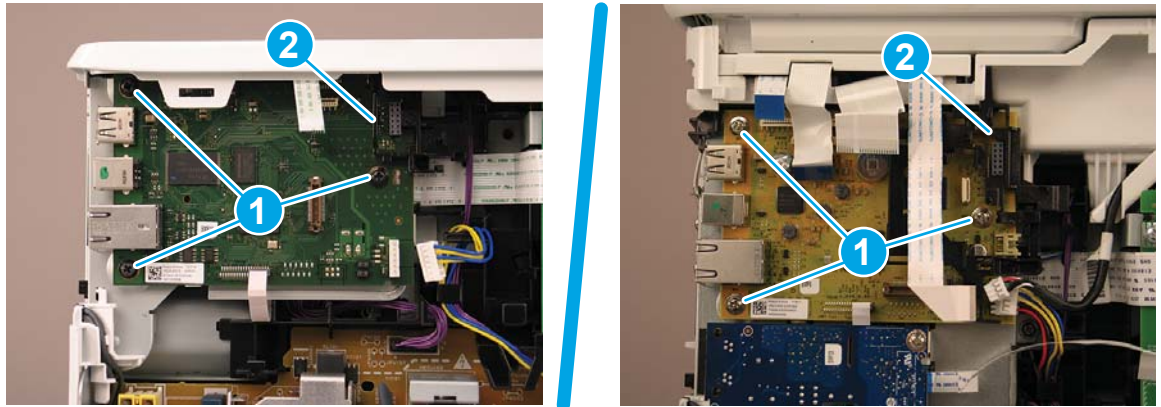

Step 6: Unpack the replacement assembly

1. Dispose of the defective part.

 **NOTE:** HP recommends responsible disposal of the defective part.

<http://www8.hp.com/us/en/hp-information/environment/product-recycling.html>

2. Unpack the replacement part from the packaging.

 **CAUTION:**  Some parts are sensitive to electrostatic discharge (ESD). Always perform service work at an ESD-protected workstation or mat. If an ESD workstation or mat is not available, touch the sheet-metal chassis to provide a static ground before touching an ESD-sensitive assembly. Protect the ESD-sensitive assemblies by placing them in ESD pouches when they are out of the printer.

If the replacement part is a roller or pad, avoid touching the spongy part of it. Skin oils on the roller or pad can cause paper pickup and/or print-quality problems. HP recommends using disposable gloves when handling rollers or pads or washing your hands before touching rollers or pads.

 **IMPORTANT:** Make sure that all of the shipping materials (for example shipping tape) are removed from the replacement part prior to installation.

3. To install an assembly, reverse the removal steps.

 **NOTE:** When applicable, special installation instructions are provided for an assembly at the end of the removal procedure. Always completely read the removal instructions and follow all special installation instructions.

Removal and replacement: Fan (FM1)

- [Introduction](#)
- [Step 1: Remove Tray 2](#)
- [Step 2: Remove the cartridge door assembly](#)
- [Step 3: Remove the left cover](#)
- [Step 4: Remove the fan \(FM1\)](#)
- [Step 5: Unpack the replacement assembly](#)

Introduction

This document provides the procedures to remove and replace the fan (FM1).

Before performing service

Turn the printer power off

- Disconnect the power cable.

 **WARNING!** To avoid damage to the printer, turn the printer off, wait 30 seconds, and then remove the power cable before attempting to service the printer.

Use the table below to identify the correct part number for your printer. To order the part, go to www.hp.com/buy/parts.

Fan (FM1) part number	
RK2-8068-000CN	Fan (FM1)

Required tools

- #2 Phillips screwdriver with a magnetic tip.

After performing service

Turn the printer power on

- Connect the power cable.
- Use the power switch to turn the power on.

Post service test

Listen for the fan to rotate when the printer power is turned on.

Step 1: Remove Tray 2

- ▲ Pull the tray straight out of the printer to remove it.

Figure 1-459 Remove the tray



Step 2: Remove the cartridge door assembly

 **NOTE:** If the toner cartridge was not removed prior to servicing the printer, remove it now.

1. Release the support shaft (callout 1), and then slide it toward the center of the door (callout 2).

 **TIP:** It might be easier to release the support shaft by using a small flat-blade screwdriver.

Figure 1-460 Release the support shaft

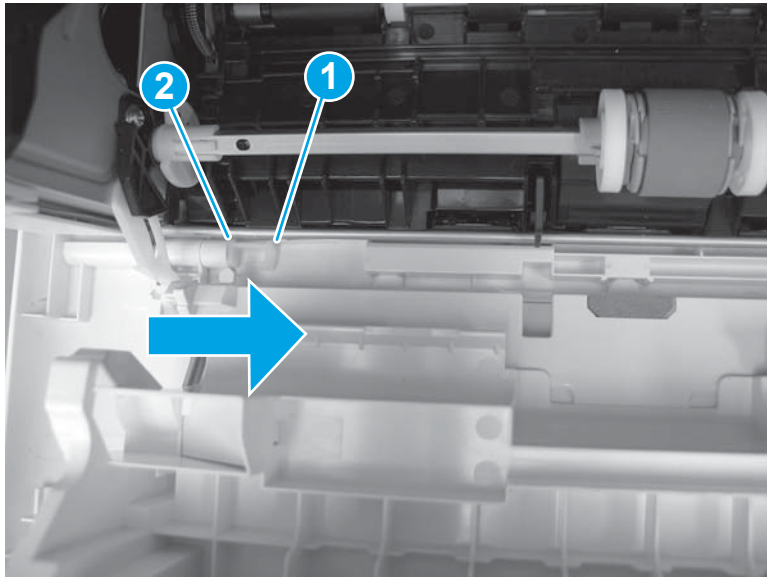

2. Remove the support shaft.

Figure 1-461 Remove the support shaft

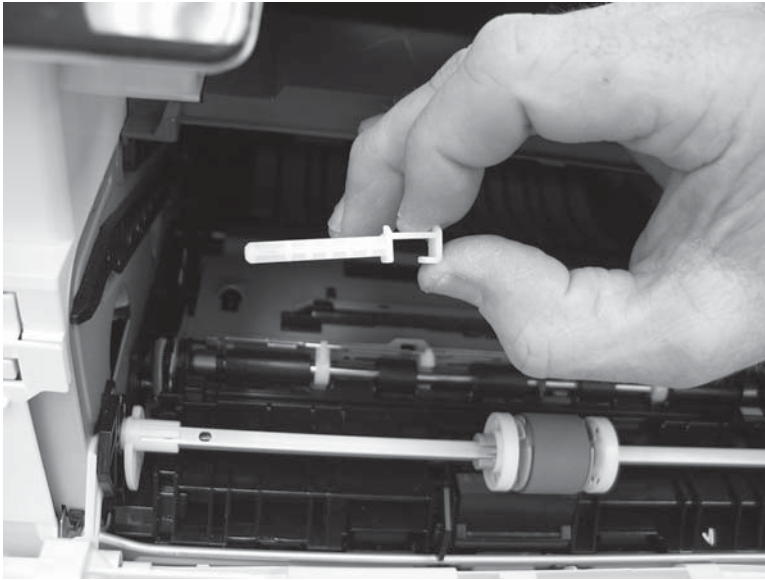

3. Release one tab (callout 1), and then slide the guide out of the printer (callout 2).

⚠ CAUTION: Be careful, the tab (callout 1) can be easily broken.

Figure 1-462 Remove the guide

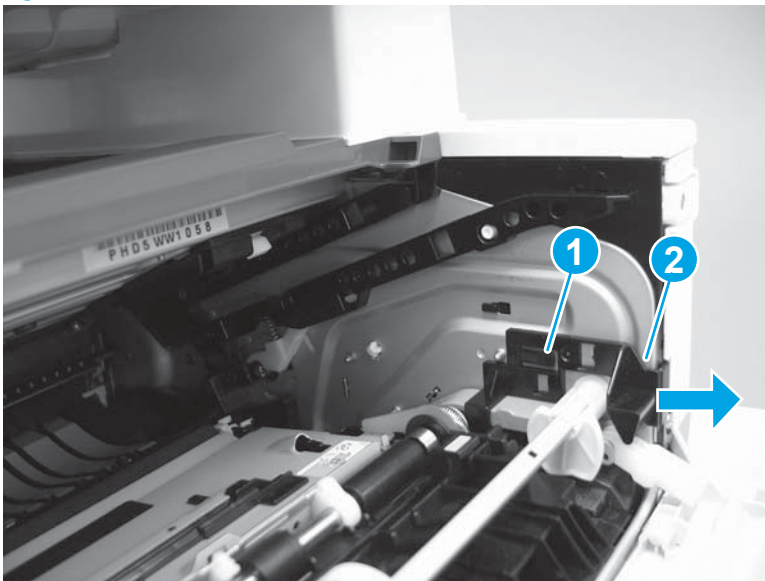

4. Use a small flat-blade screwdriver to gently pry the white-plastic door arm (callout 1) off of the gray-plastic pressure-release link (callout 2) to release the door arm.

Figure 1-463 Release the pressure-release link

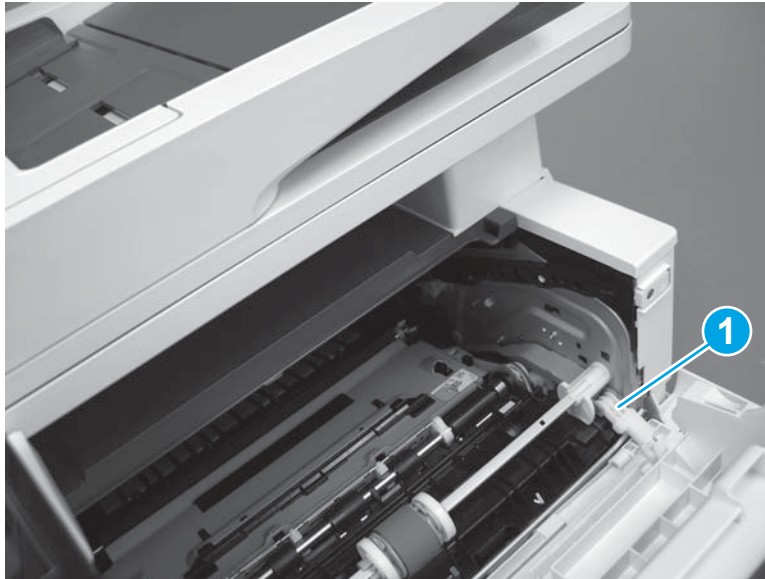

5. With the door in the partially closed position, slightly raise the left end (callout 1; raise it over the sheet-metal hinge boss), and then slide the door to the left (callout 2) to release the right hinge (callout 3).

⚠ CAUTION: The door is still attached to the printer by the left-side retainer arm. Do not attempt to completely remove the door.

💡 Reinstallation tip: When reinstalling the door, there are two right-side hinge pins (not shown in callout 3). Keep a finger pressed on the left-side retainer arm so that it does not disengage from the door.

Figure 1-464 Release the door

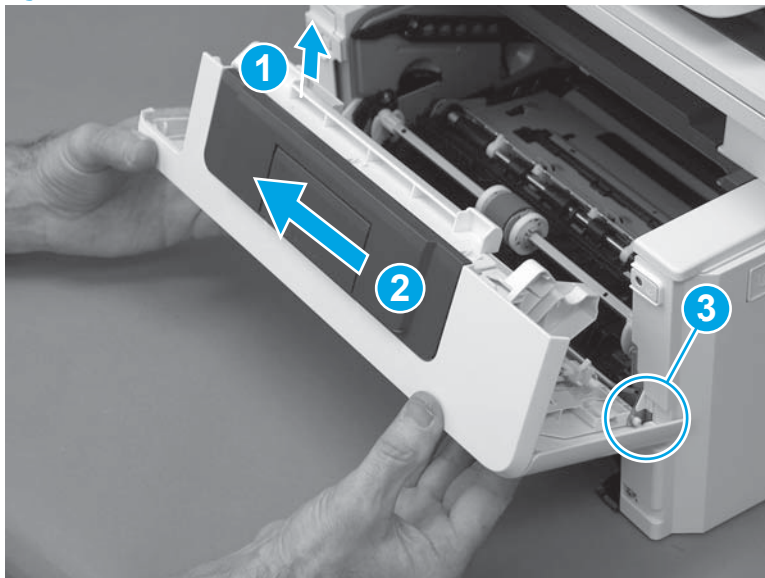

6. Rotate the door away from the printer until the keyed pin on the left-side retainer arm can disengage from the door.

Figure 1-465 Release the left-side retainer arm

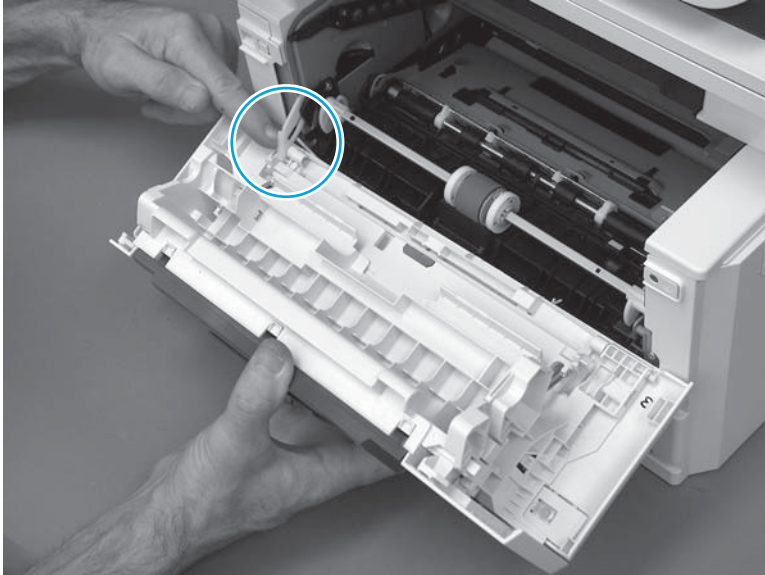

7. Remove the door.

Figure 1-466 Remove the door

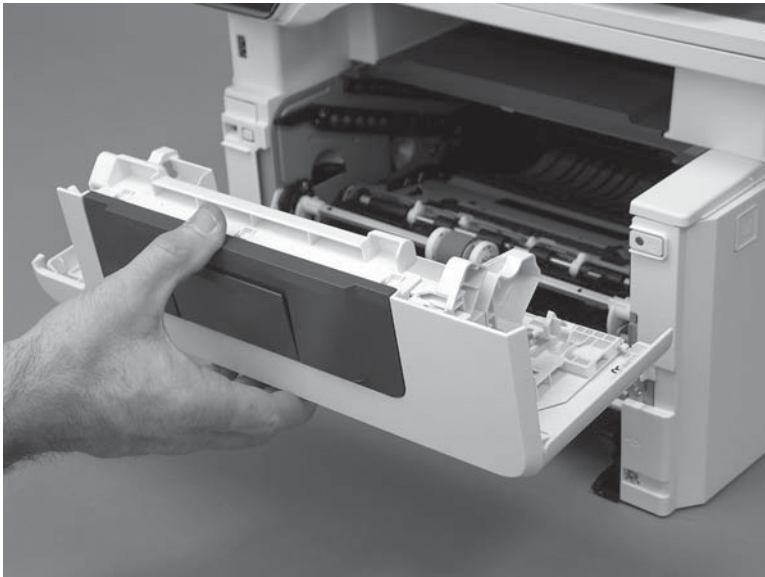

Step 3: Remove the left cover

1. Remove one screw (callout 1).

Figure 1-467 Remove one screw

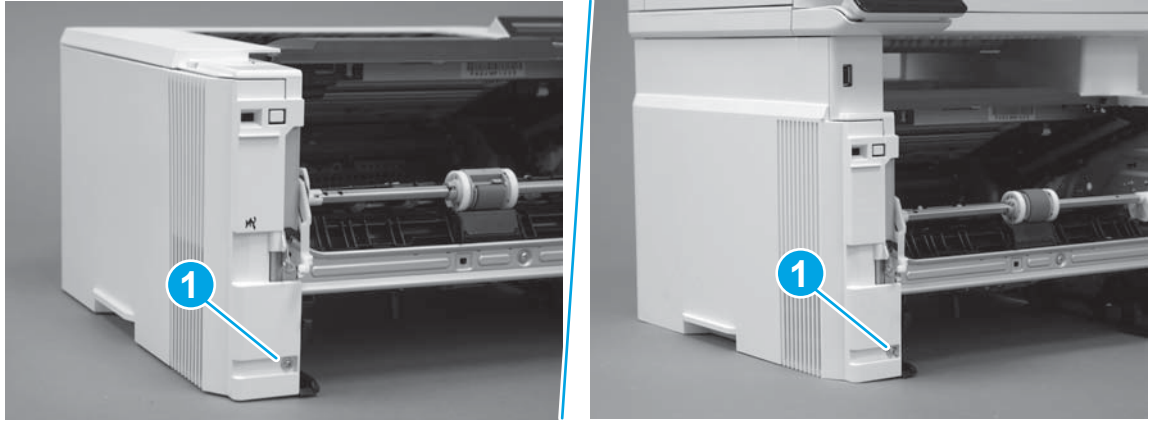

2. Open the rear door, release two bosses (callout 1), and then release three tabs (callout 2).

Figure 1-468 Release two bosses and three tabs

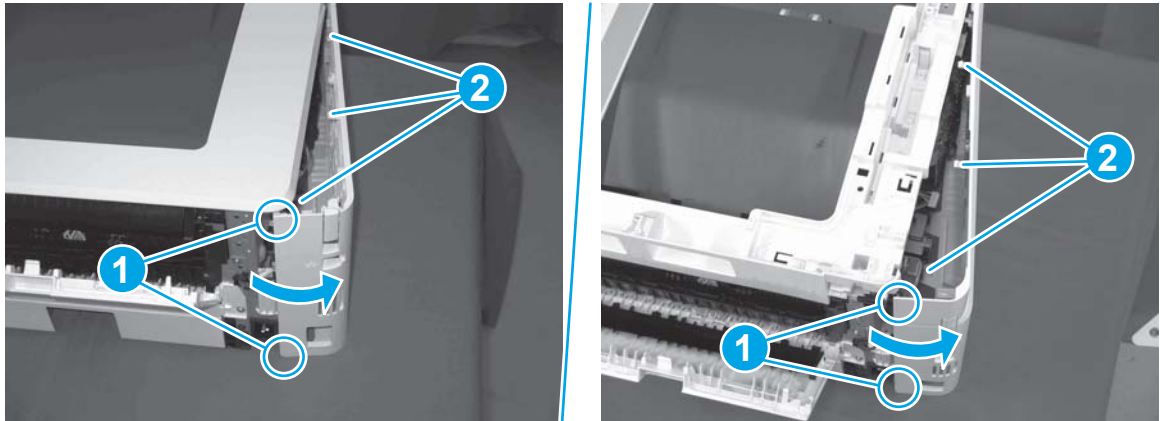

3. At the front of the printer, do one of the following:
 - **M304/M305/M404/M405:** Release two bosses (callout 1), and then remove the cover (callout 2).
 - **M329/M428/M429:** Release one tab (callout 3), two bosses (callout 4), and then remove the cover (callout 5).

⚠ CAUTION: Be careful when releasing the upper bosses on the M329/M428/M429 cover. One portion of the cover (callout 6) is fragile and is easily broken.

Figure 1-469 Remove the cover

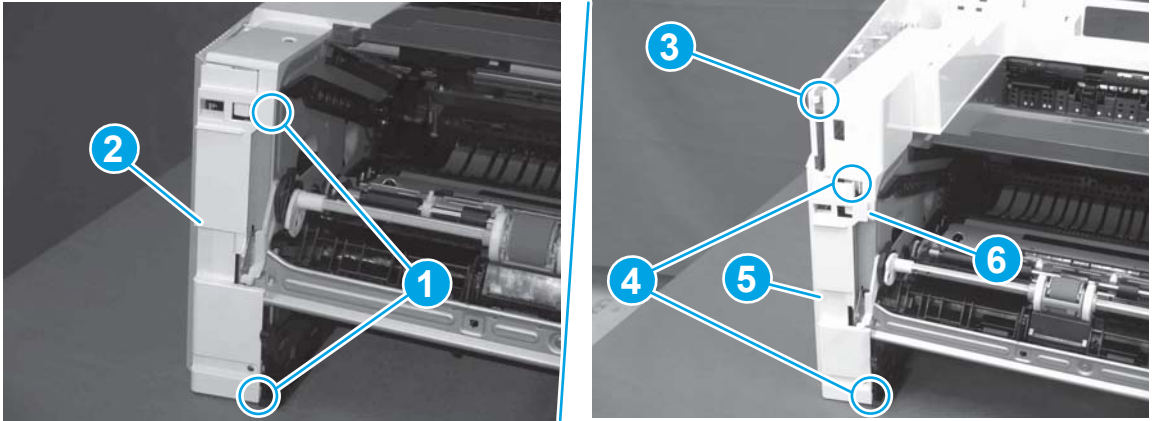

Step 4: Remove the fan (FM1)

1. Disconnect one connector (callout 1), and then release the wire harness from the retainer (callout 2).

Figure 1-470 Disconnect one connector

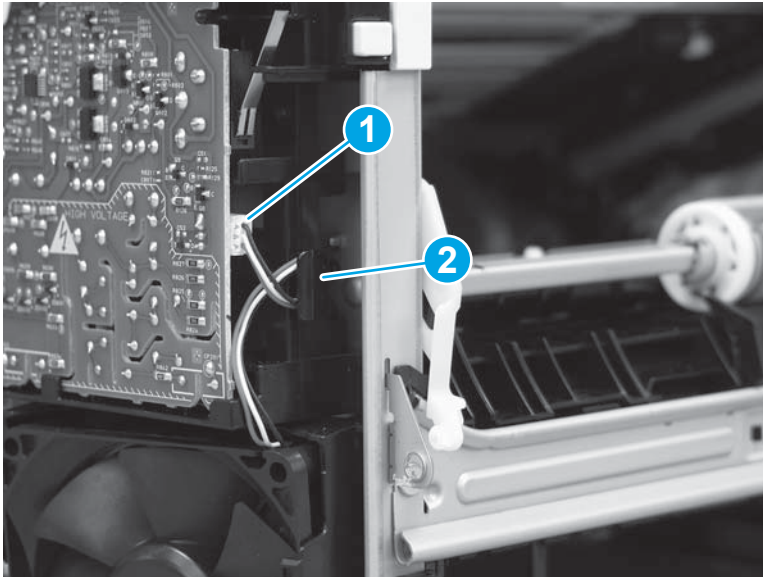

2. Release two tabs (callout 1).

Figure 1-471 Release two tabs

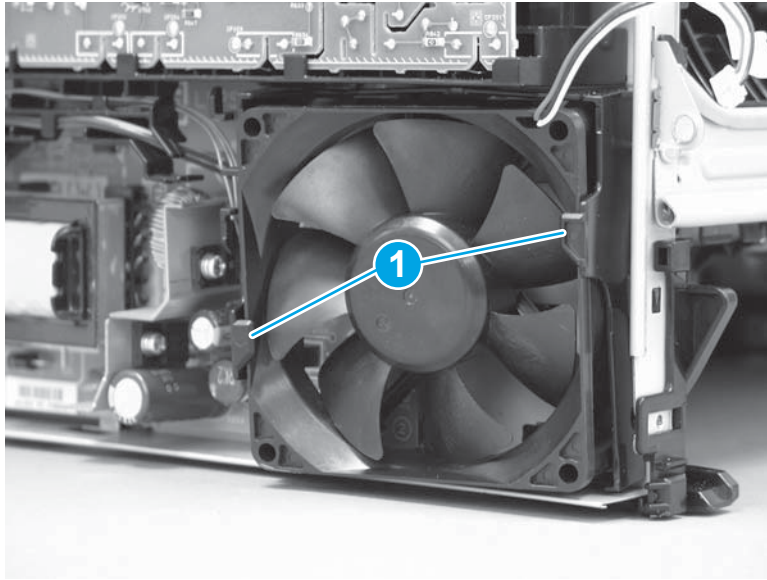

3. Remove the fan.



 **Reinstallation tip:** The fan must be correctly installed so that air is drawn into the printer. Make sure that the two arrows embossed on the right-side of the fan body—which indicate air flow direction—face upward and into the printer.

Figure 1-472 Remove the fan



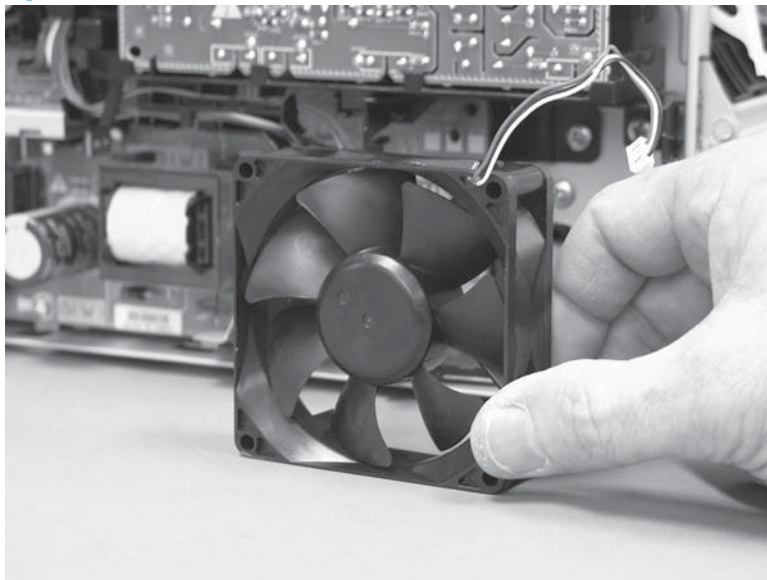

Step 5: Unpack the replacement assembly

1. Dispose of the defective part.

 **NOTE:** HP recommends responsible disposal of the defective part.

<http://www8.hp.com/us/en/hp-information/environment/product-recycling.html>

2. Unpack the replacement part from the packaging.

 **CAUTION:**  Some parts are sensitive to electrostatic discharge (ESD). Always perform service work at an ESD-protected workstation or mat. If an ESD workstation or mat is not available, touch the sheet-metal chassis to provide a static ground before touching an ESD-sensitive assembly. Protect the ESD-sensitive assemblies by placing them in ESD pouches when they are out of the printer.

If the replacement part is a roller or pad, avoid touching the spongy part of it. Skin oils on the roller or pad can cause paper pickup and/or print-quality problems. HP recommends using disposable gloves when handling rollers or pads or washing your hands before touching rollers or pads.

 **IMPORTANT:** Make sure that all of the shipping materials (for example shipping tape) are removed from the replacement part prior to installation.

3. To install an assembly, reverse the removal steps.

 **NOTE:** When applicable, special installation instructions are provided for an assembly at the end of the removal procedure. Always completely read the removal instructions and follow all special installation instructions.

Removal and replacement: Fan holder (FM1)

- [Introduction](#)
- [Step 1: Remove Tray 2](#)
- [Step 2: Remove the cartridge door assembly](#)
- [Step 3: Remove the left cover](#)
- [Step 4: Remove the fan \(FM1\)](#)
- [Step 5: Remove the fan holder \(FM1\)](#)
- [Step 6: Unpack the replacement assembly](#)

Introduction

This document provides the procedures to remove and replace the fan holder (FM1).

Before performing service

Turn the printer power off

- Disconnect the power cable.

 **WARNING!** To avoid damage to the printer, turn the printer off, wait 30 seconds, and then remove the power cable before attempting to service the printer.

Use the table below to identify the correct part number for your printer. To order the part, go to www.hp.com/buy/parts.

Fan holder (FM1) part number	
RC4-2891-000CN	Fan holder (FM1)

Required tools

- #2 Phillips screwdriver with a magnetic tip.

After performing service

Turn the printer power on

- Connect the power cable.
- Use the power switch to turn the power on.

Post service test

Listen for the fan to rotate when the printer power is turned on.

Step 1: Remove Tray 2

- ▲ Pull the tray straight out of the printer to remove it.

Figure 1-473 Remove the tray



Step 2: Remove the cartridge door assembly

 **NOTE:** If the toner cartridge was not removed prior to servicing the printer, remove it now.

1. Release the support shaft (callout 1), and then slide it toward the center of the door (callout 2).

 **TIP:** It might be easier to release the support shaft by using a small flat-blade screwdriver.

Figure 1-474 Release the support shaft

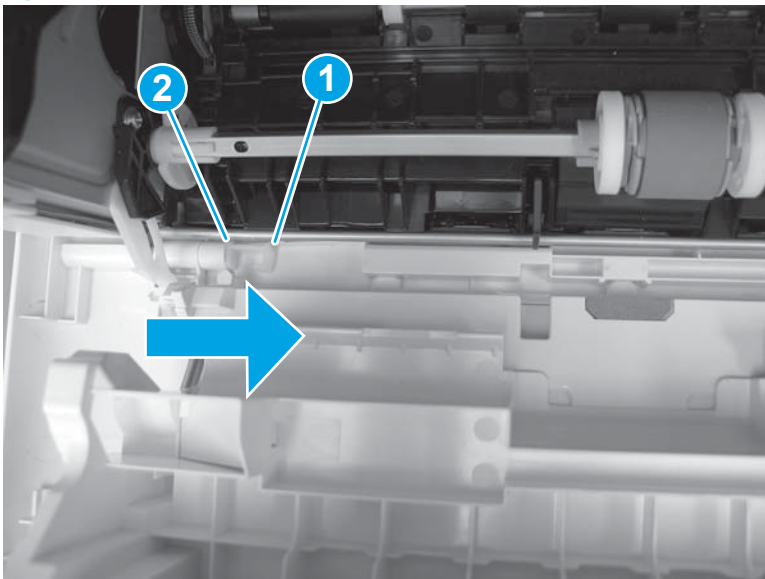

2. Remove the support shaft.

Figure 1-475 Remove the support shaft

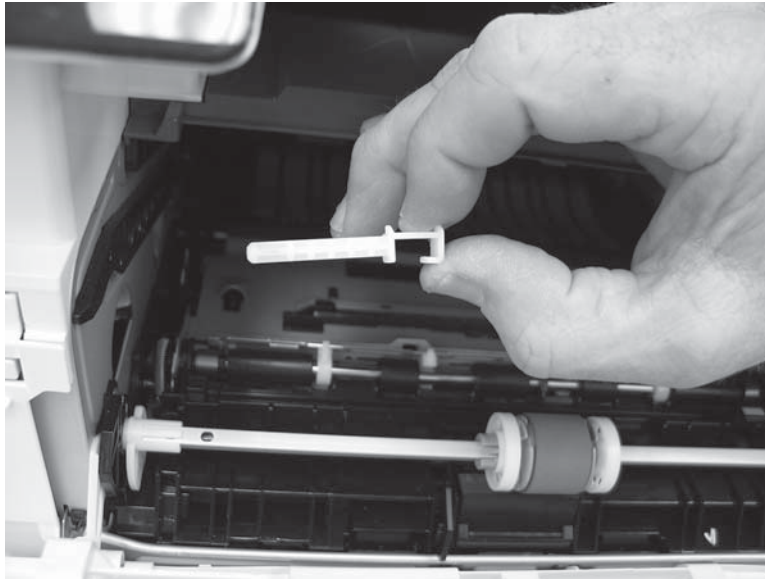

3. Release one tab (callout 1), and then slide the guide out of the printer (callout 2).

⚠ CAUTION: Be careful, the tab (callout 1) can be easily broken.

Figure 1-476 Remove the guide

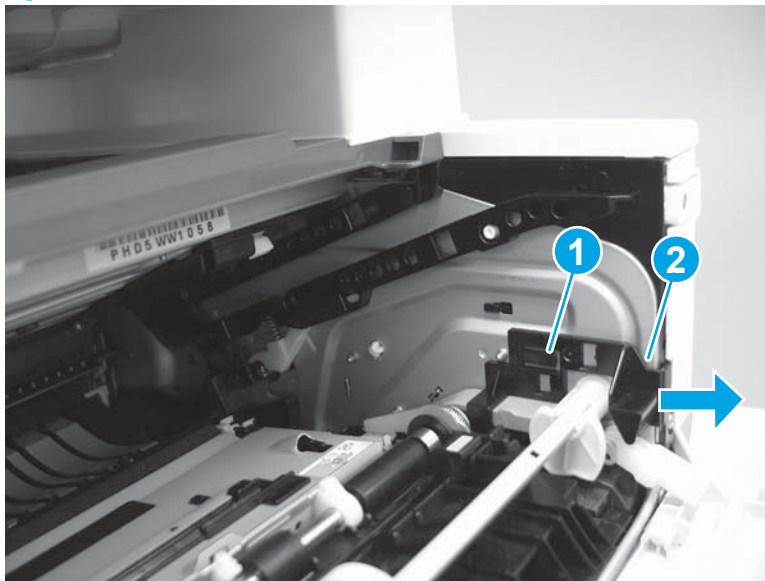

4. Use a small flat-blade screwdriver to gently pry the white-plastic door arm (callout 1) off of the gray-plastic pressure-release link (callout 2) to release the door arm.

Figure 1-477 Release the pressure-release link

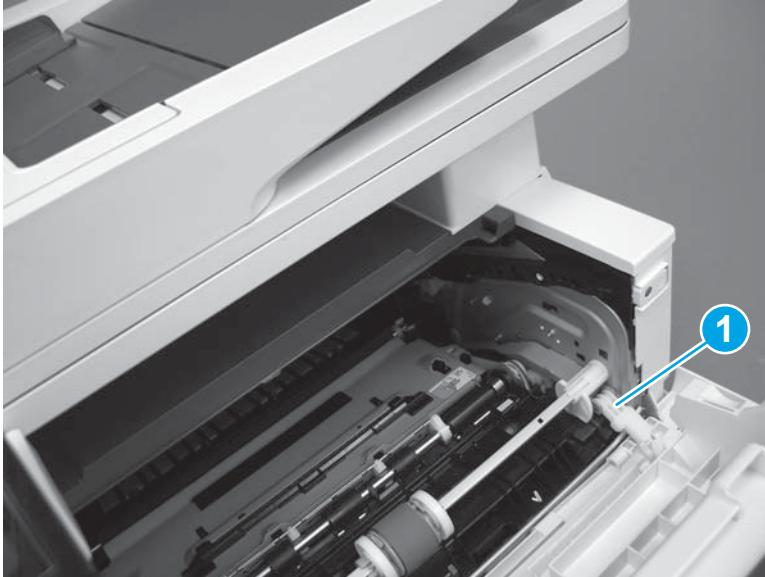

5. With the door in the partially closed position, slightly raise the left end (callout 1; raise it over the sheet-metal hinge boss), and then slide the door to the left (callout 2) to release the right hinge (callout 3).

CAUTION: The door is still attached to the printer by the left-side retainer arm. Do not attempt to completely remove the door.

Reinstallation tip: When reinstalling the door, there are two right-side hinge pins (not shown in callout 3). Keep a finger pressed on the left-side retainer arm so that it does not disengage from the door.

Figure 1-478 Release the door

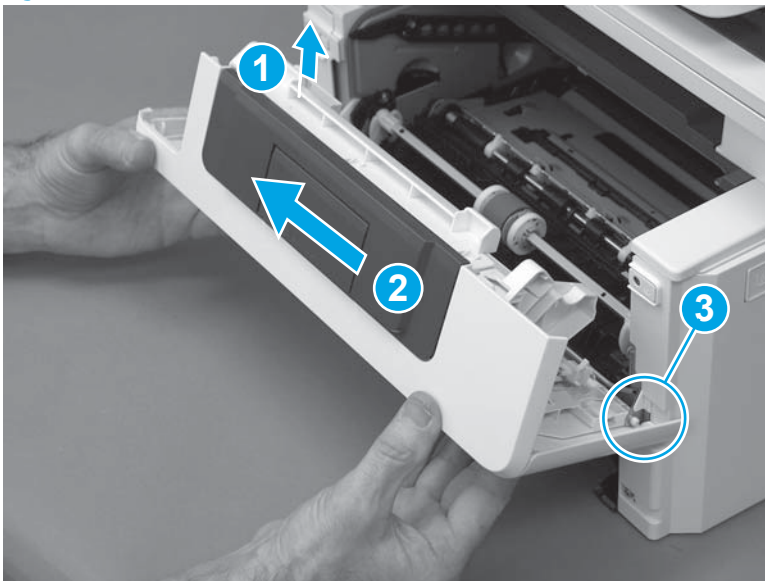

6. Rotate the door away from the printer until the keyed pin on the left-side retainer arm can disengage from the door.

Figure 1-479 Release the left-side retainer arm

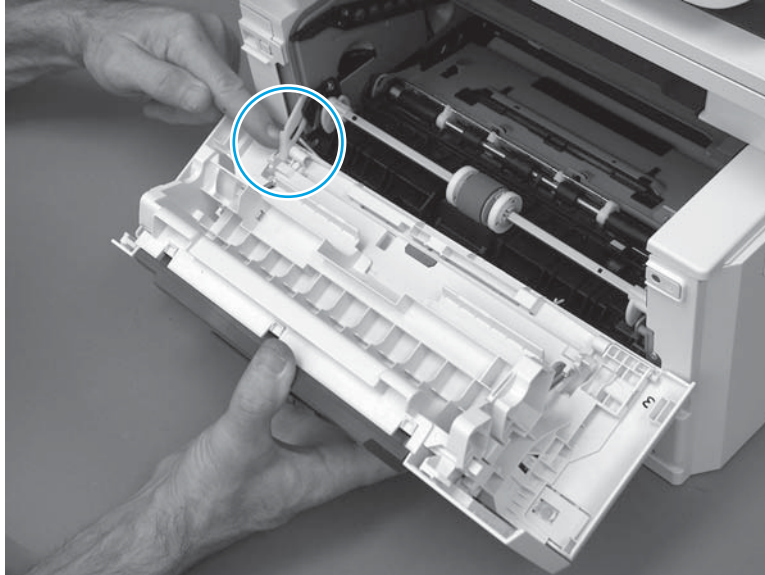

7. Remove the door.

Figure 1-480 Remove the door

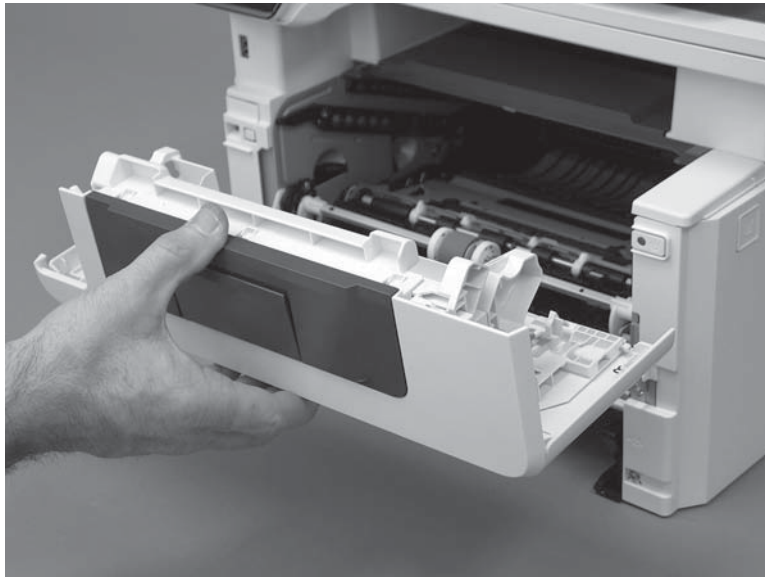

Step 3: Remove the left cover

1. Remove one screw (callout 1).

Figure 1-481 Remove one screw

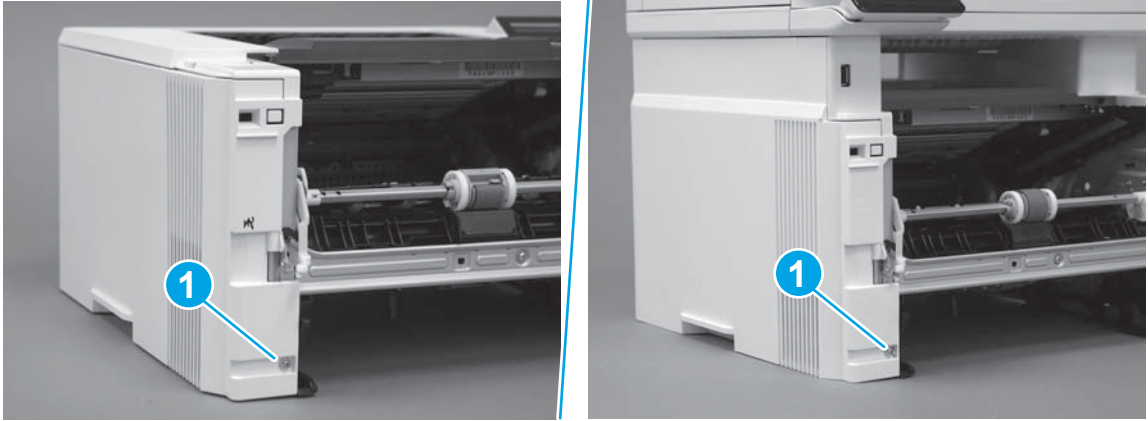

2. Open the rear door, release two bosses (callout 1), and then release three tabs (callout 2).

Figure 1-482 Release two bosses and three tabs

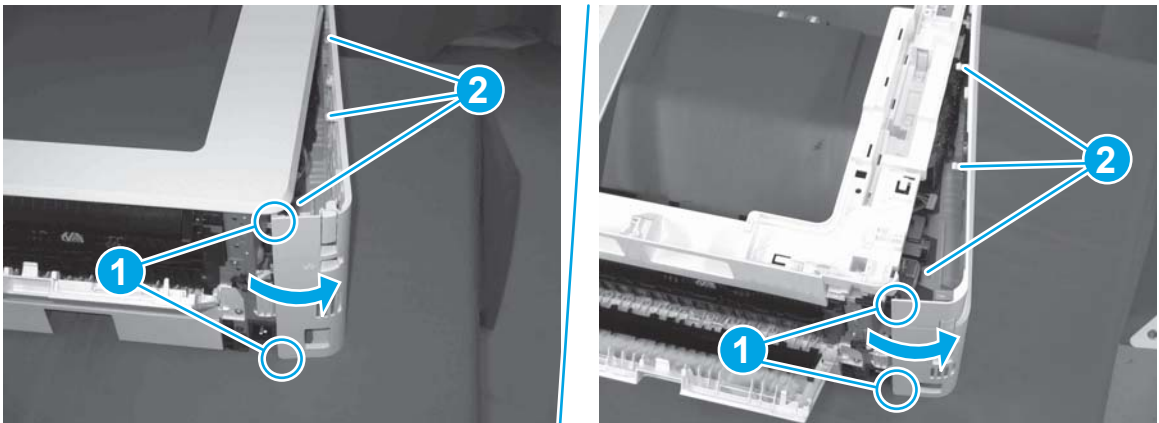

3. At the front of the printer, do one of the following:
 - **M304/M305/M404/M405:** Release two bosses (callout 1), and then remove the cover (callout 2).
 - **M329/M428/M429:** Release one tab (callout 3), two bosses (callout 4), and then remove the cover (callout 5).

CAUTION: Be careful when releasing the upper bosses on the M329/M428/M429 cover. One portion of the cover (callout 6) is fragile and is easily broken.

Figure 1-483 Remove the cover

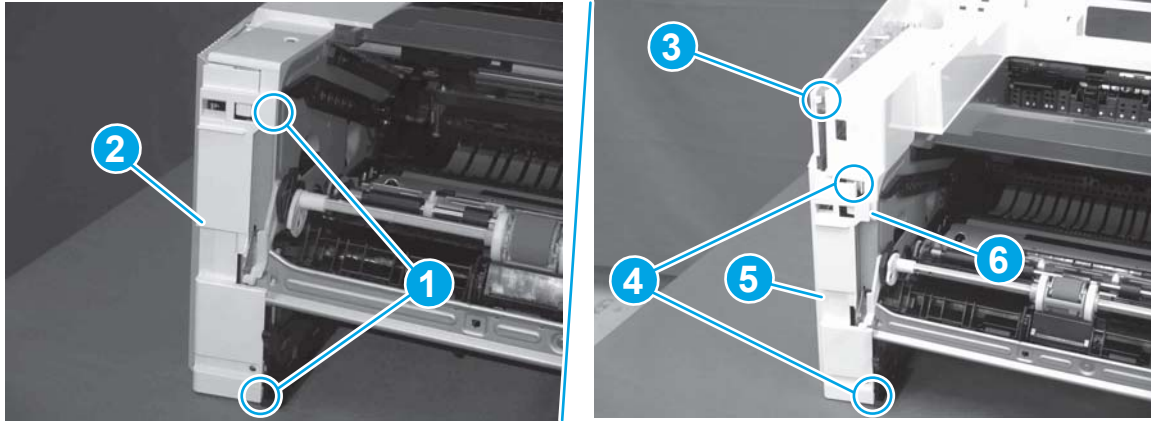

Step 4: Remove the fan (FM1)

1. Disconnect one connector (callout 1), and then release the wire harness from the retainer (callout 2).

Figure 1-484 Disconnect one connector

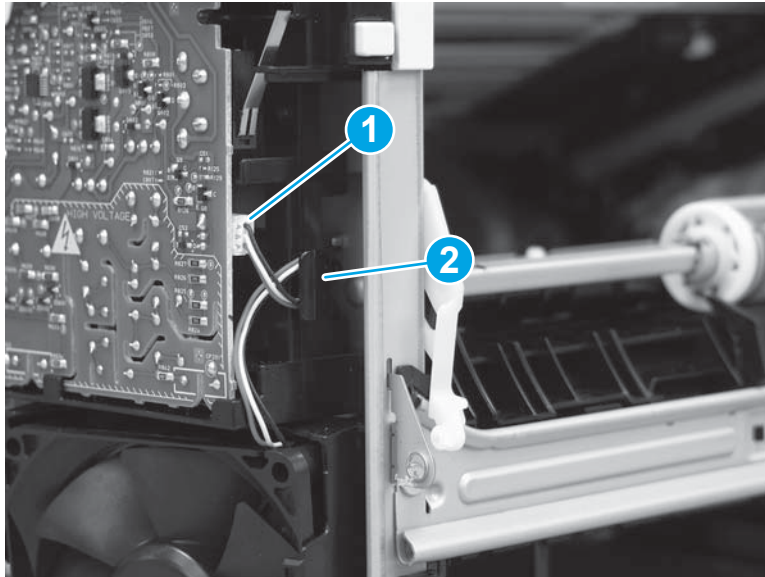

2. Release two tabs (callout 1).

Figure 1-485 Release two tabs

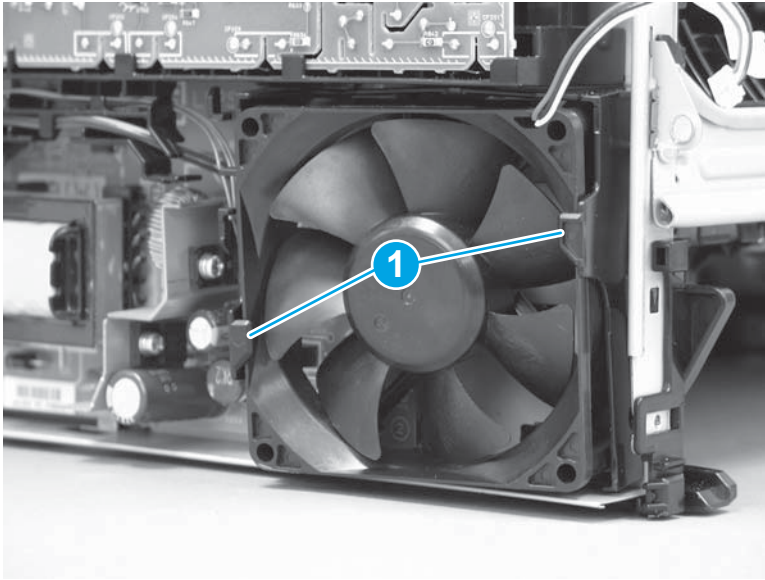

3. Remove the fan.



 **Reinstallation tip:** The fan must be correctly installed so that air is drawn into the printer. Make sure that the two arrows embossed on the right-side of the fan body—which indicate air flow direction—face upward and into the printer.

Figure 1-486 Remove the fan

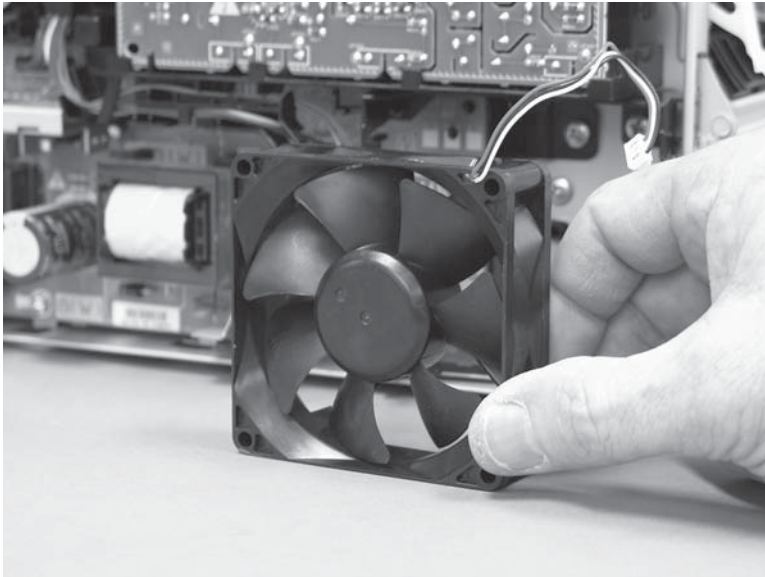

Step 5: Remove the fan holder (FM1)

1. Release one wire harness from the retainers (SFP shown; callout 1) on the fan holder.

 **NOTE:** The MFP has two wire harnesses in the retainers.

 **TIP:** It might be easier to release the wire harness by first disconnecting the connector.

Figure 1-487 Release the wire harness (SFP shown)

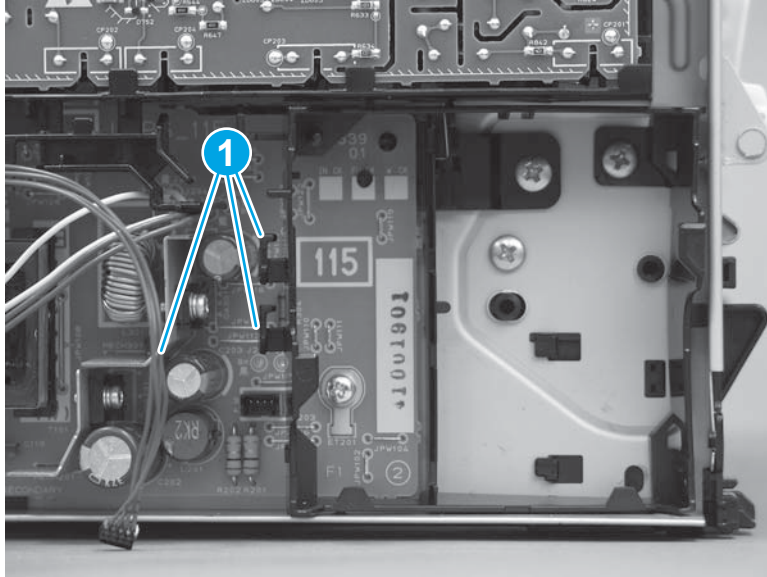

2. Remove one screw (callout 1).

Figure 1-488 Remove one screw

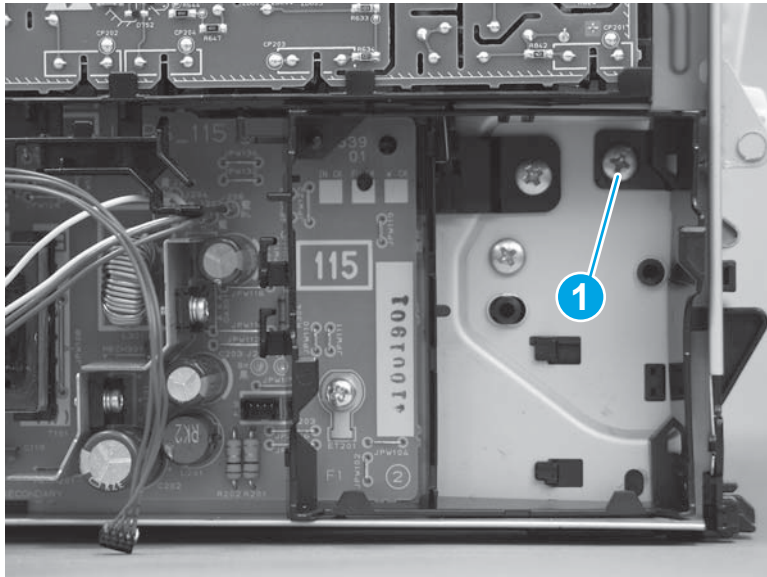

3. Release one tab at the top-left side of the fan holder (callout 1), and then rotate the top-left side corner of the holder away from the printer.

 **Reinstallation tip:** Use a flat-blade screwdriver to slightly flex the top of the holder down to make it easier to disengage this tab.

Figure 1-489 Release one tab

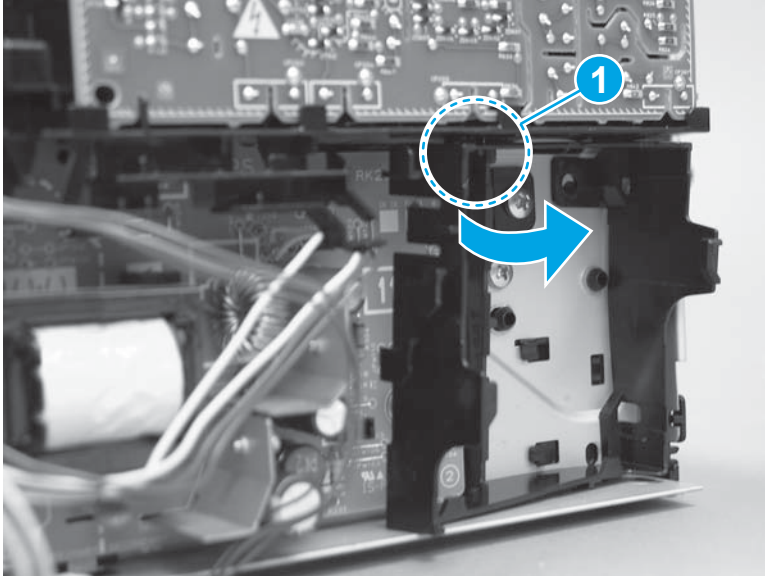

4. Slightly flex the right side of the holder to release one tab (callout 1), and then rotate the top of the holder away from the printer (callout 2).

Figure 1-490 Release one tab

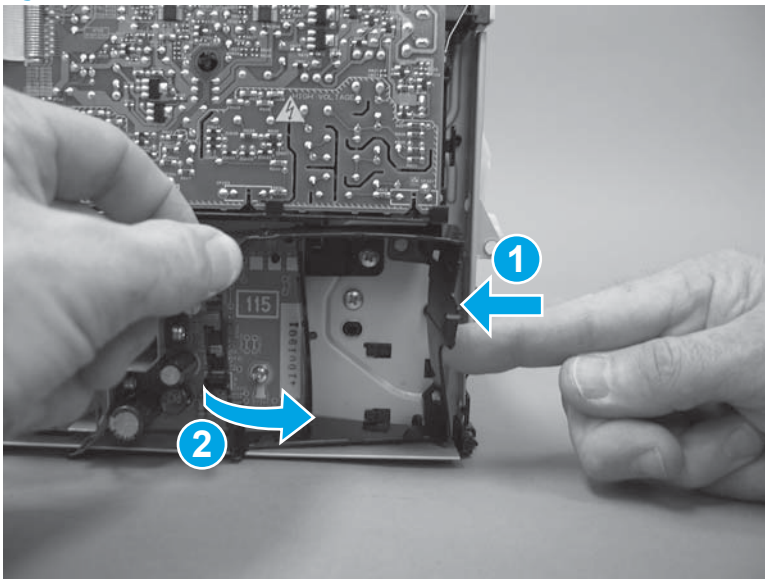

5. Lift the holder up to release two alignment tabs on the bottom of the holder, and then remove the holder.

Figure 1-491 Remove the holder

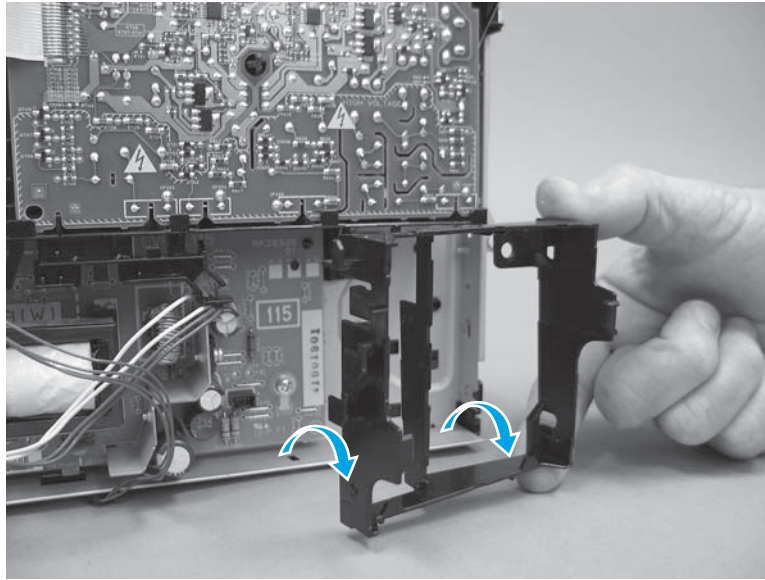



Step 6: Unpack the replacement assembly

1. Dispose of the defective part.

 **NOTE:** HP recommends responsible disposal of the defective part.

<http://www8.hp.com/us/en/hp-information/environment/product-recycling.html>

2. Unpack the replacement part from the packaging.

 **CAUTION:**  Some parts are sensitive to electrostatic discharge (ESD). Always perform service work at an ESD-protected workstation or mat. If an ESD workstation or mat is not available, touch the sheet-metal chassis to provide a static ground before touching an ESD-sensitive assembly. Protect the ESD-sensitive assemblies by placing them in ESD pouches when they are out of the printer.

If the replacement part is a roller or pad, avoid touching the spongy part of it. Skin oils on the roller or pad can cause paper pickup and/or print-quality problems. HP recommends using disposable gloves when handling rollers or pads or washing your hands before touching rollers or pads.

 **IMPORTANT:** Make sure that all of the shipping materials (for example shipping tape) are removed from the replacement part prior to installation.

3. To install an assembly, reverse the removal steps.

 **NOTE:** When applicable, special installation instructions are provided for an assembly at the end of the removal procedure. Always completely read the removal instructions and follow all special installation instructions.

Removal and replacement: Laser scanner assembly

- [Introduction](#)
- [Step 1: Remove Tray 2](#)
- [Step 2: Remove the cartridge door assembly](#)
- [Step 3: Remove the left cover](#)
- [Step 4: Remove the right cover](#)
- [Step 5: Remove the integrated scanner assembly \(M329/M428/M429\)](#)
- [Step 6: Remove the control panel \(M329/M428/M429\)](#)
- [Step 7: Remove the top cover \(M329/M428/M429\)](#)
- [Step 8: Remove the top cover \(M304/M305/M404/M405\)](#)
- [Step 9: Remove the paper delivery tray \(output bin\)](#)
- [Step 10: Remove the laser scanner assembly](#)
- [Step 11: Unpack the replacement assembly](#)

Introduction

This document provides the procedures to remove and replace the laser scanner assembly.

Before performing service

Turn the printer power off

- Disconnect the power cable.

 **WARNING!** To avoid damage to the printer, turn the printer off, wait 30 seconds, and then remove the power cable before attempting to service the printer.

Use the table below to identify the correct part number for your printer. To order the part, go to www.hp.com/buy/parts.

Laser scanner assembly part number

RM2-2891-000CNLaser scanner assembly

Required tools

- #2 Phillips screwdriver with a magnetic tip.

After performing service

Turn the printer power on

- Connect the power cable.
- Use the power switch to turn the power on.

Post service test

Make sure that the printer initializes to a **Ready** state.

Print a configuration page to make sure that the printer is functioning correctly.

Step 1: Remove Tray 2

- ▲ Pull the tray straight out of the printer to remove it.

Figure 1-492 Remove the tray



Step 2: Remove the cartridge door assembly

 **NOTE:** If the toner cartridge was not removed prior to servicing the printer, remove it now.

1. Release the support shaft (callout 1), and then slide it toward the center of the door (callout 2).

 **TIP:** It might be easier to release the support shaft by using a small flat-blade screwdriver.

Figure 1-493 Release the support shaft

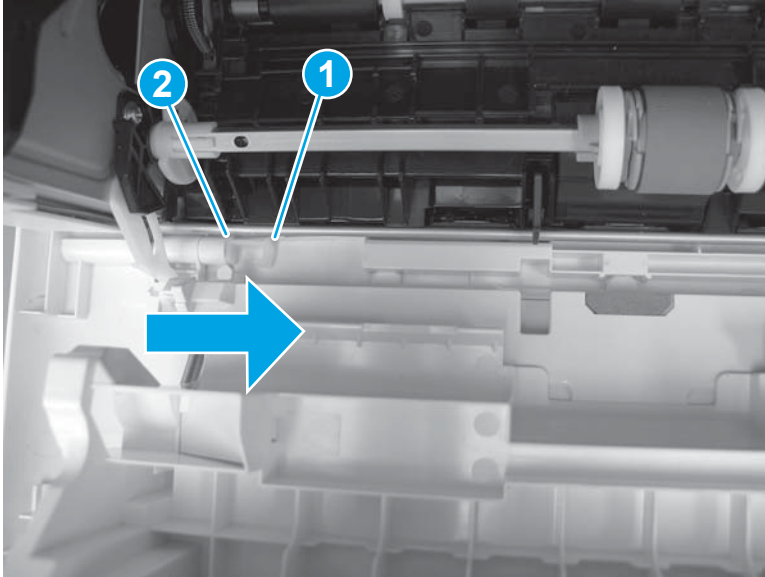

2. Remove the support shaft.

Figure 1-494 Remove the support shaft

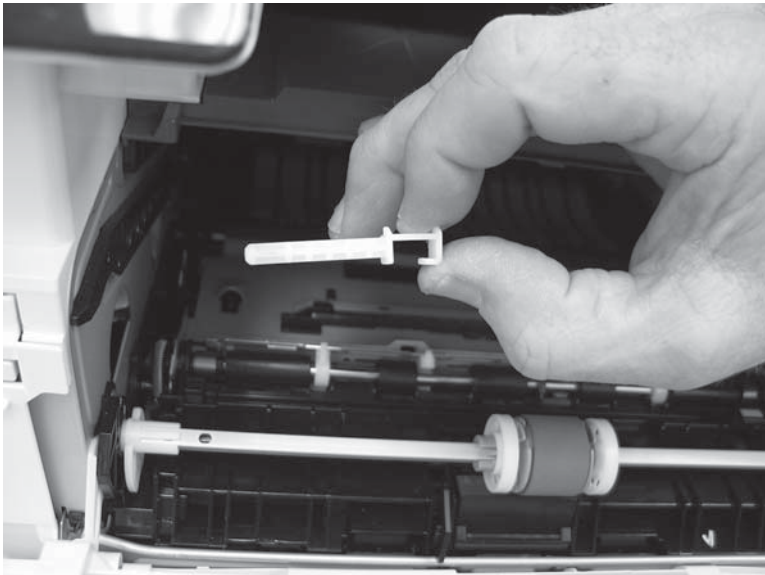

3. Release one tab (callout 1), and then slide the guide out of the printer (callout 2).

CAUTION: Be careful, the tab (callout 1) can be easily broken.

Figure 1-495 Remove the guide

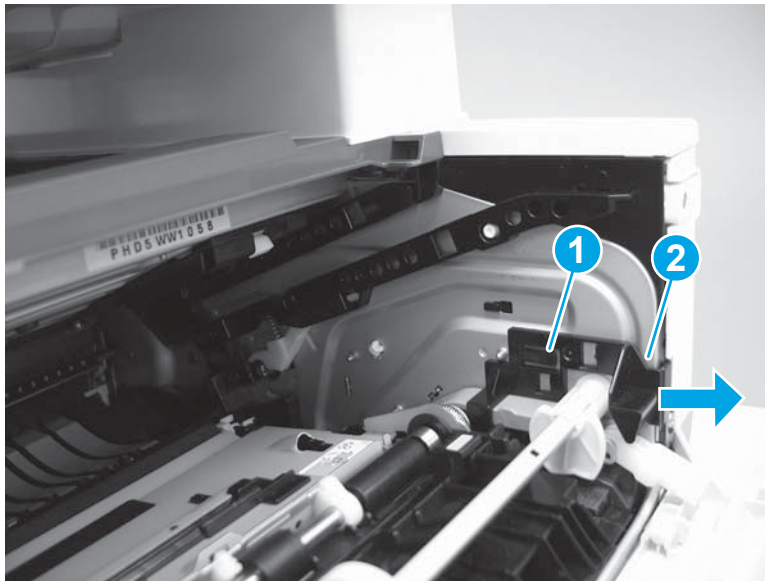

4. Use a small flat-blade screwdriver to gently pry the white-plastic door arm (callout 1) off of the gray-plastic pressure-release link (callout 2) to release the door arm.

Figure 1-496 Release the pressure-release link

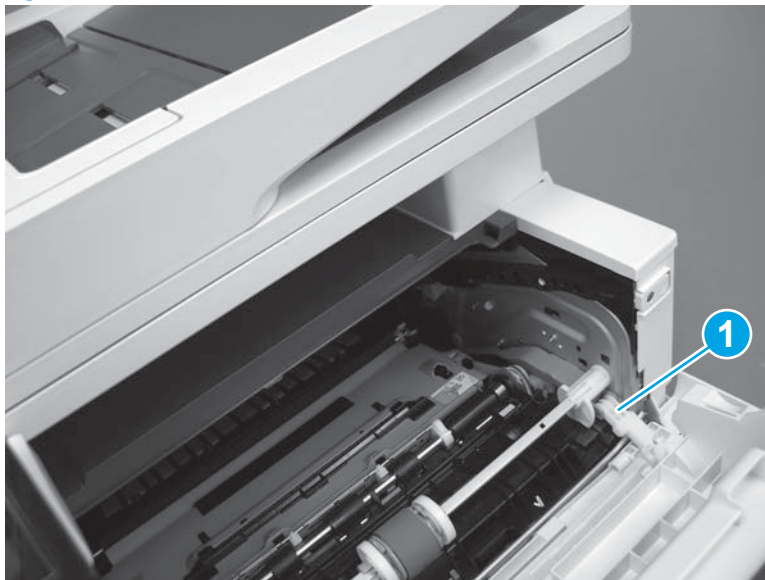

5. With the door in the partially closed position, slightly raise the left end (callout 1; raise it over the sheet-metal hinge boss), and then slide the door to the left (callout 2) to release the right hinge (callout 3).

⚠ CAUTION: The door is still attached to the printer by the left-side retainer arm. Do not attempt to completely remove the door.

💡 Reinstallation tip: When reinstalling the door, there are two right-side hinge pins (not shown in callout 3). Keep a finger pressed on the left-side retainer arm so that it does not disengage from the door.

Figure 1-497 Release the door

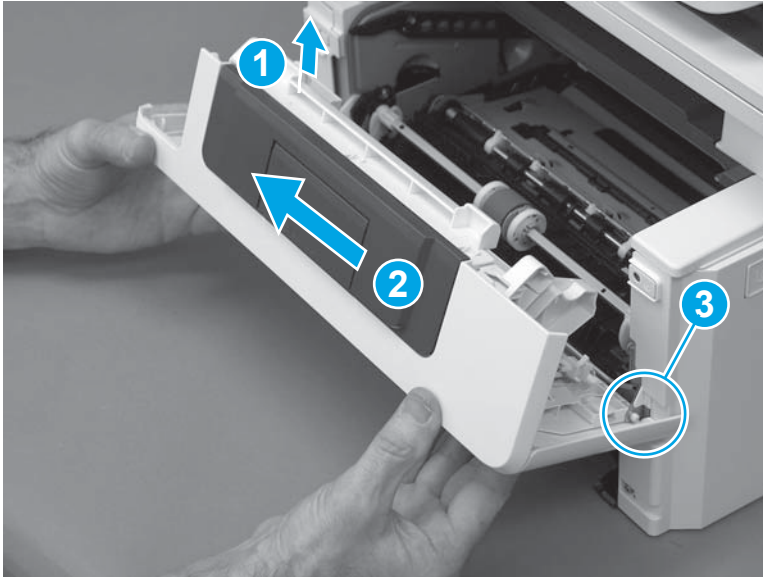

6. Rotate the door away from the printer until the keyed pin on the left-side retainer arm can disengage from the door.

Figure 1-498 Release the left-side retainer arm

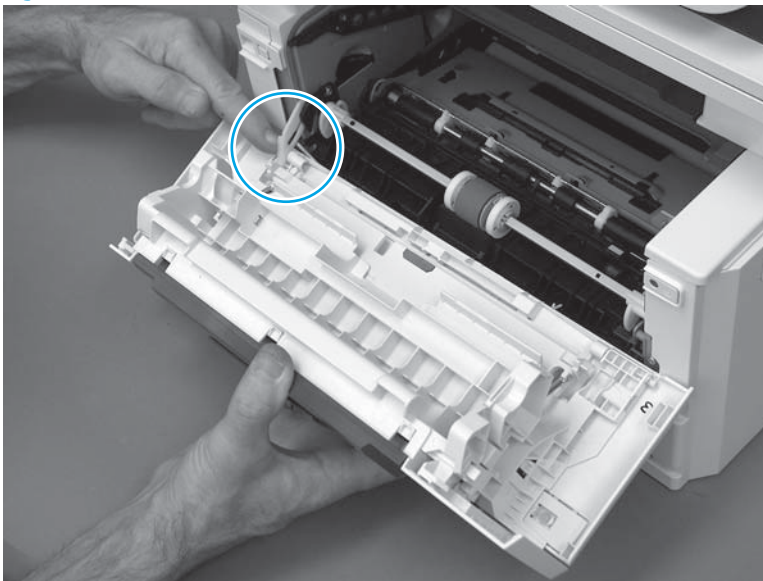

7. Remove the door.

Figure 1-499 Remove the door

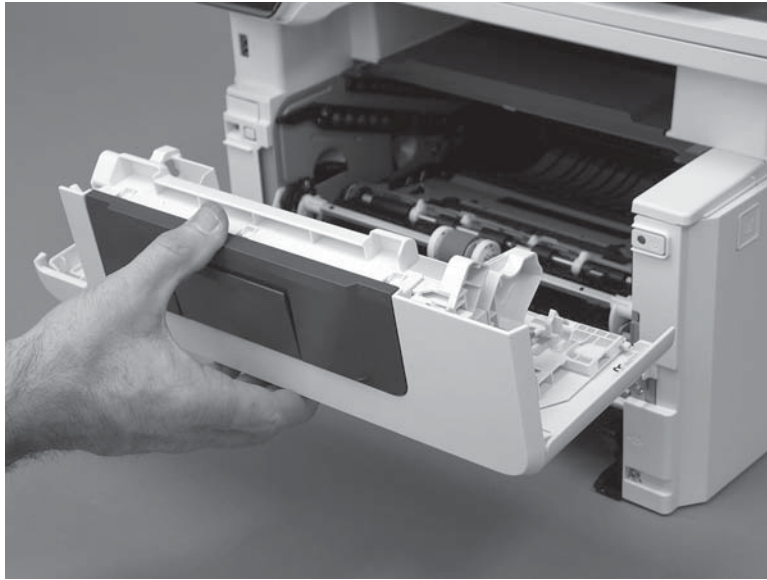

Step 3: Remove the left cover

1. Remove one screw (callout 1).

Figure 1-500 Remove one screw

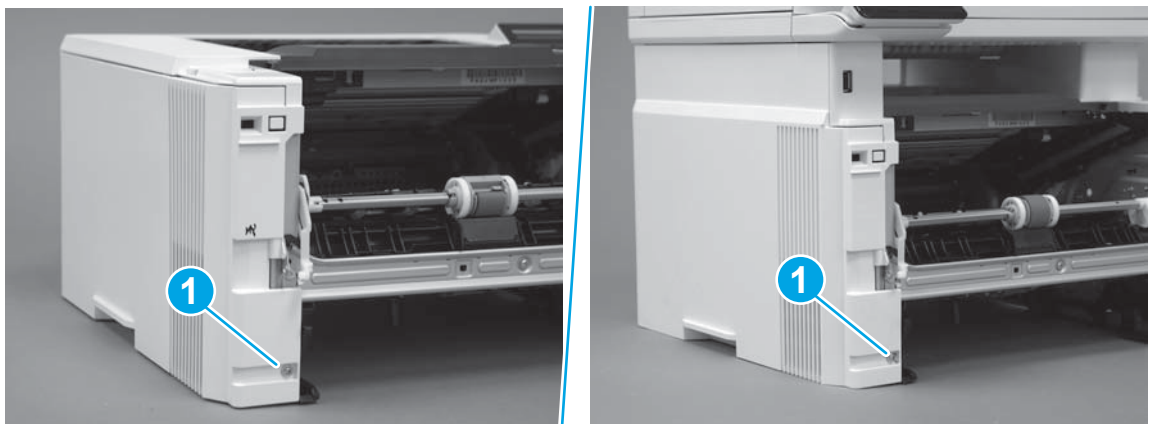

2. Open the rear door, release two bosses (callout 1), and then release three tabs (callout 2).

Figure 1-501 Release two bosses and three tabs

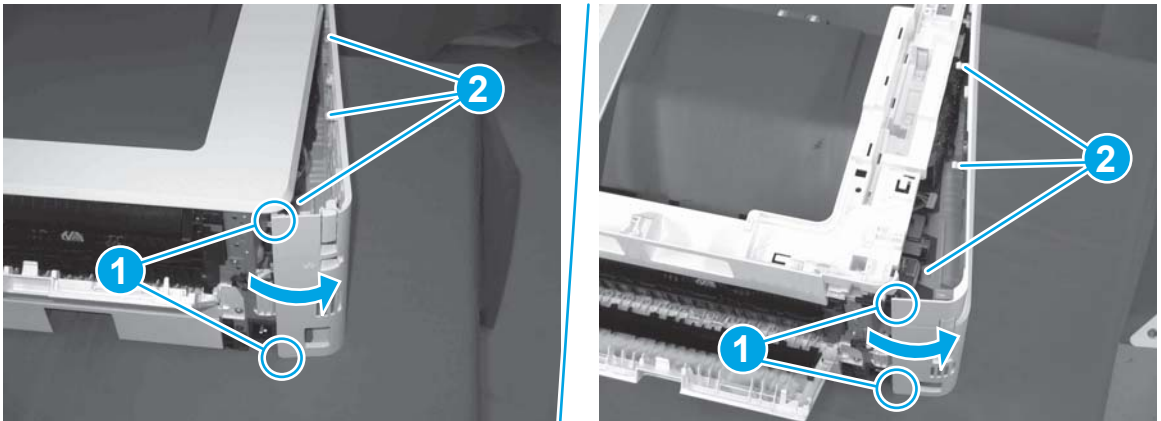

3. At the front of the printer, do one of the following:
 - **M304/M305/M404/M405:** Release two bosses (callout 1), and then remove the cover (callout 2).
 - **M329/M428/M429:** Release one tab (callout 3), two bosses (callout 4), and then remove the cover (callout 5).

CAUTION: Be careful when releasing the upper bosses on the M329/M428/M429 cover. One portion of the cover (callout 6) is fragile and is easily broken.

Figure 1-502 Remove the cover

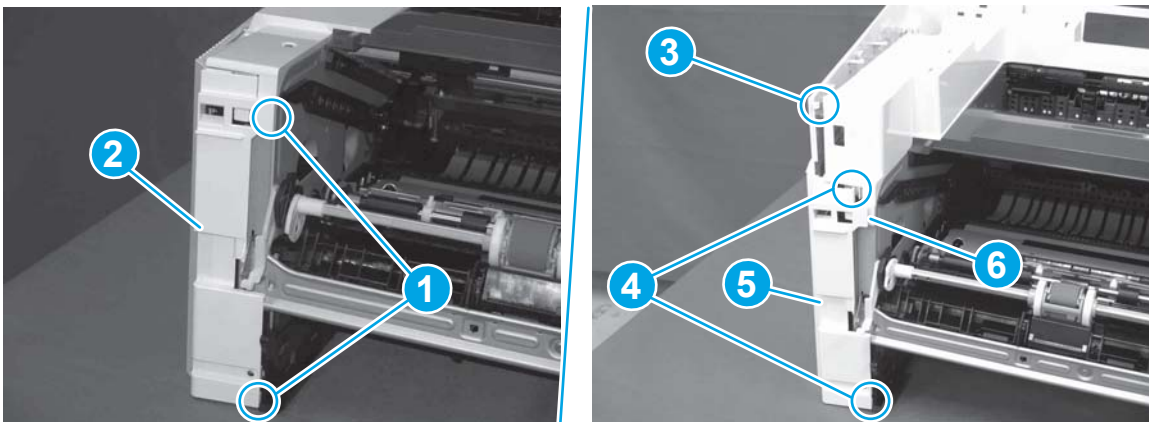

Step 4: Remove the right cover

1. At the front of the printer, release two bosses (callout 1), and then release three tabs (callout 2).

Reinstallation tip: Remove, and then reinstall the cover if the switch or button does not correctly function.

Figure 1-503 Release two bosses and three tabs

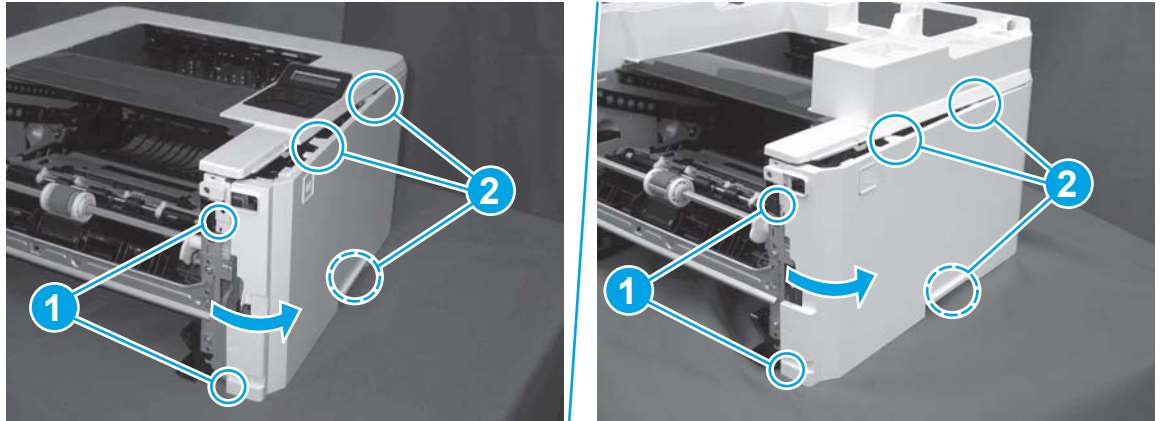

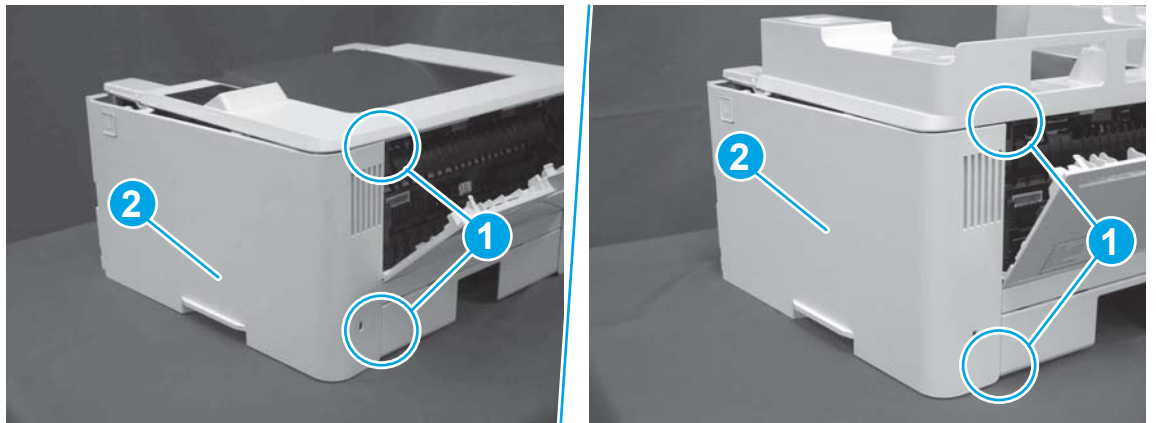

2. Open the rear door, release two bosses (callout 1), and then remove the cover (callout 2).

Figure 1-504 Remove the cover



Step 5: Remove the integrated scanner assembly (M329/M428/M429)

 **NOTE:** The step is for the M329/M428/M429 printer. For the M304/M305/M404/M405, skip this step and go to [Step 8: Remove the top cover \(M304/M305/M404/M405\) on page 334.](#)

 **NOTE:** M329/M428/M429 models only. The integrated scanner assembly (ISA) includes the sub-scanner assembly (SSA) and the automatic document feeder (ADF).

1. Raise the ISA.

Figure 1-505 Raise the ISA

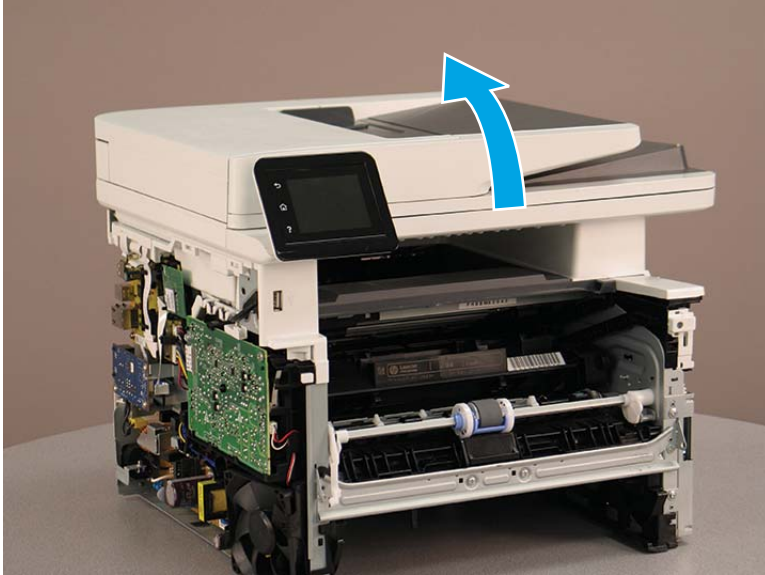

2. Release the ISA flat-flexible cable (FFC) cover (callout 1), and then remove it (callout 2).

Figure 1-506 Remove the ISA FFC cover

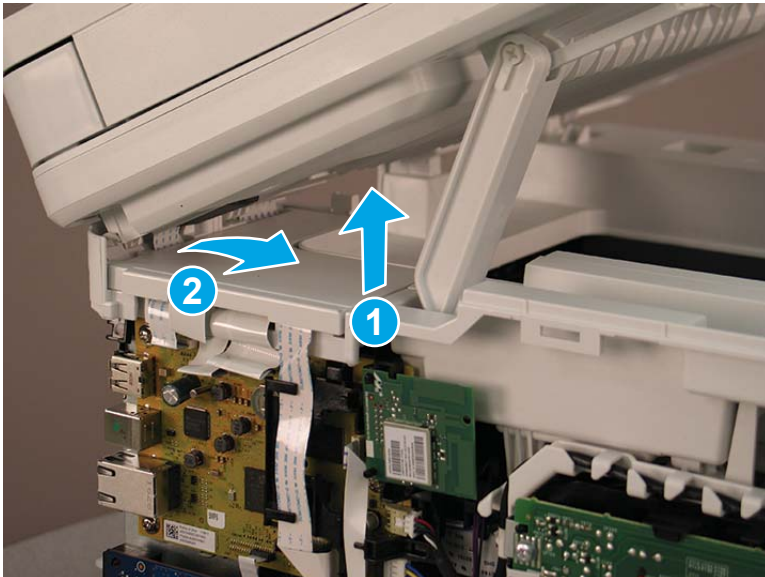

3. Disconnect three FFCs (callout 1), and then remove the ferrite (callout 2) from the holder.

CAUTION: The ferrite is not captive on the FFC. Do not lose the ferrite while handling the ISA.

Figure 1-507 Disconnect three FFCs

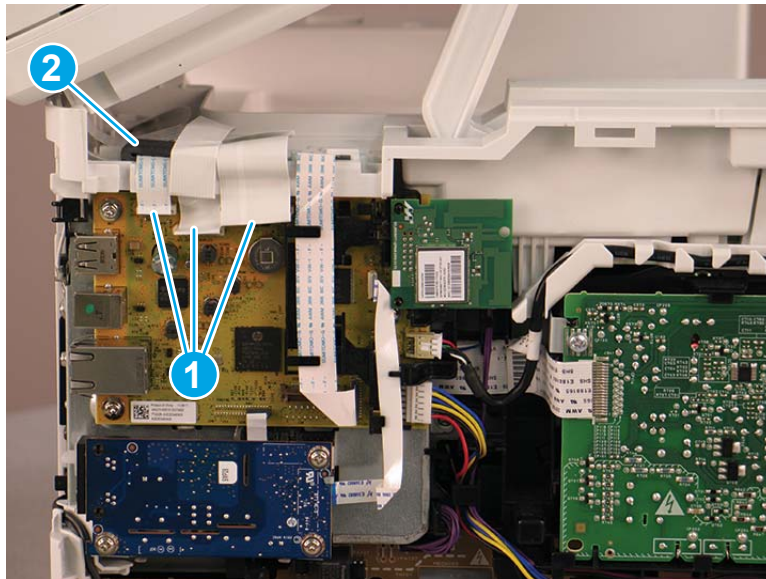

4. Remove one screw (callout 1).

Figure 1-508 Remove one screw

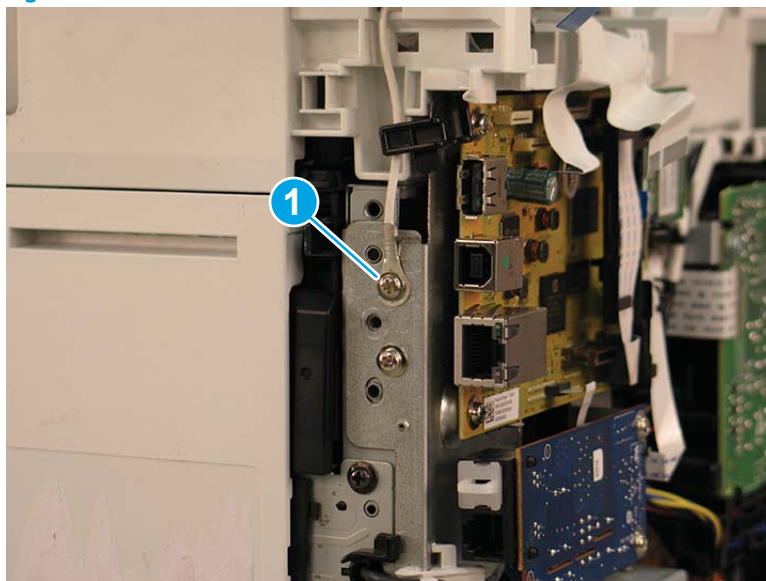

5. Pass the ground wire through the opening in the top cover.

Figure 1-509 Pass the wire through the opening

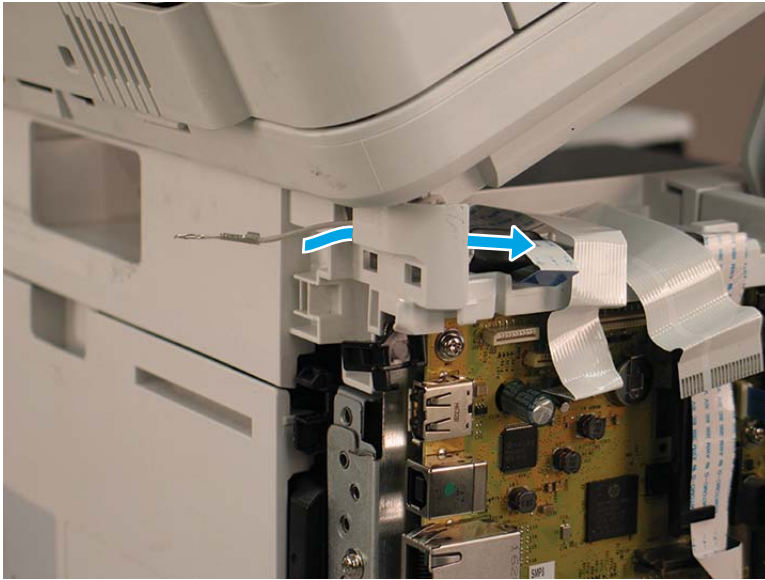

6. Release one tab (callout 1), and then rotate the ISA slider pin (callout 2) towards the front of the printer to release it.

Figure 1-510 Release one tab and rotate the slider pin

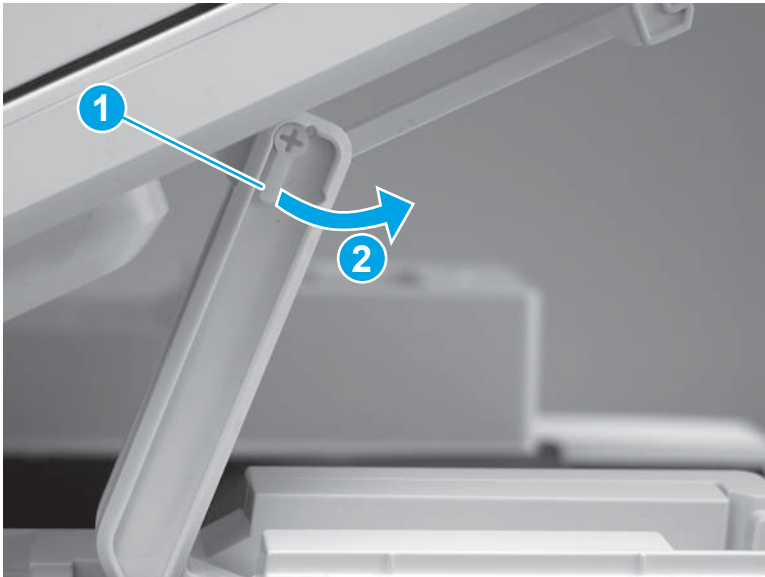

7. Remove the slider pin.

 **Reinstallation tip:** Align the keyed portion of the locking pin with the slot and hole in the support arm.

Figure 1-511 Remove the slider pin



8. Rotate the ISA towards the rear of the printer until it stops.

Figure 1-512 Rotate the ISA towards the rear of the printer

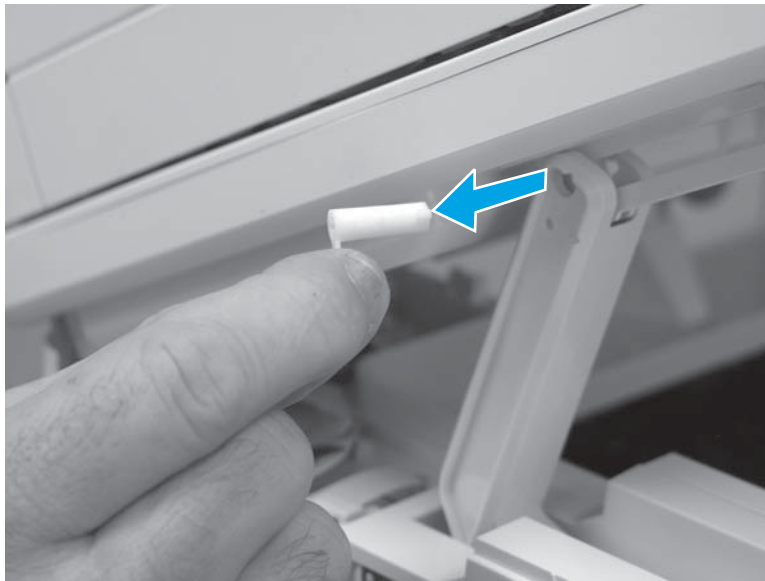
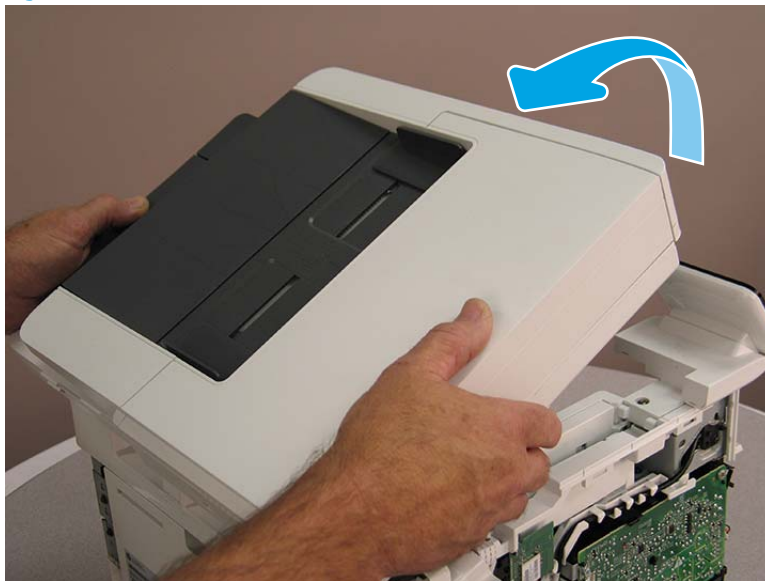

- Slide the ISA as shown to release it.

Figure 1-513 Release the ISA

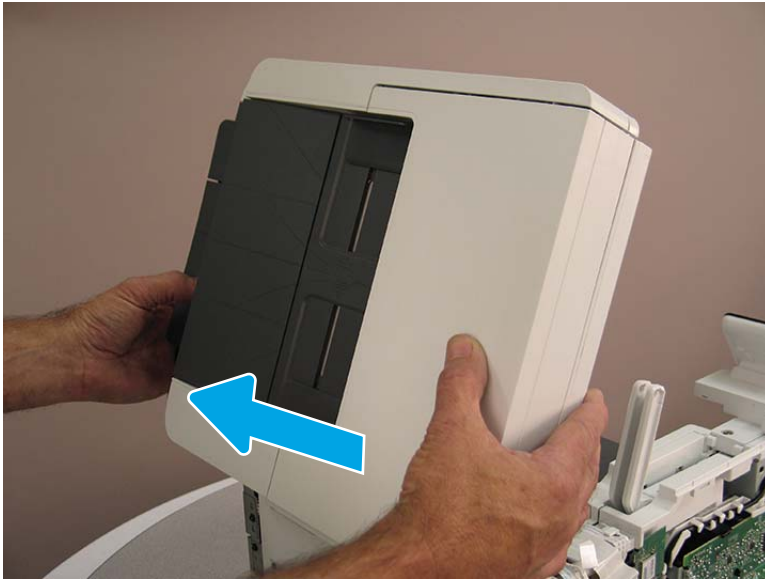

- Remove the ISA.

Figure 1-514 Remove the ISA

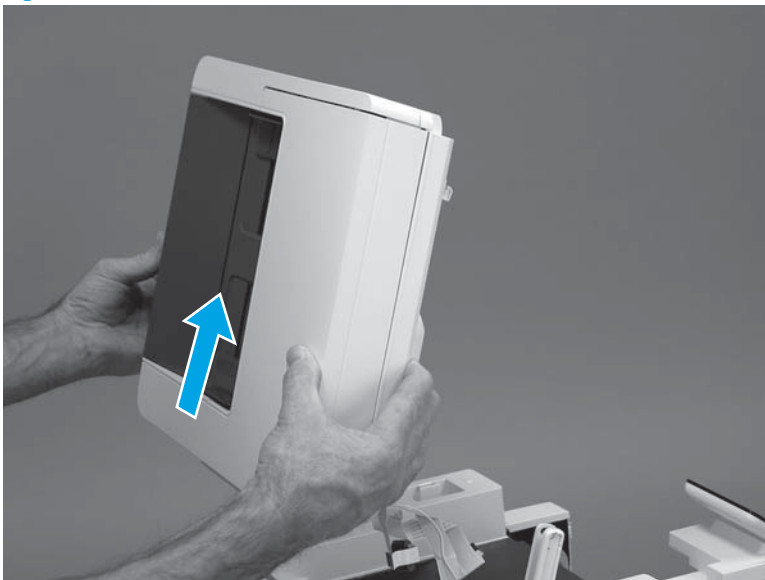

Step 6: Remove the control panel (M329/M428/M429)

 **NOTE:** The step is for the M329/M428/M429 printer. For the M304/M305/M404/M405, skip this step and go to [Step 8: Remove the top cover \(M304/M305/M404/M405\) on page 334](#).

- Disconnect one FFC (callout 1), and then release the FFC from the guide (callout 2).

Figure 1-515 Disconnect one connector

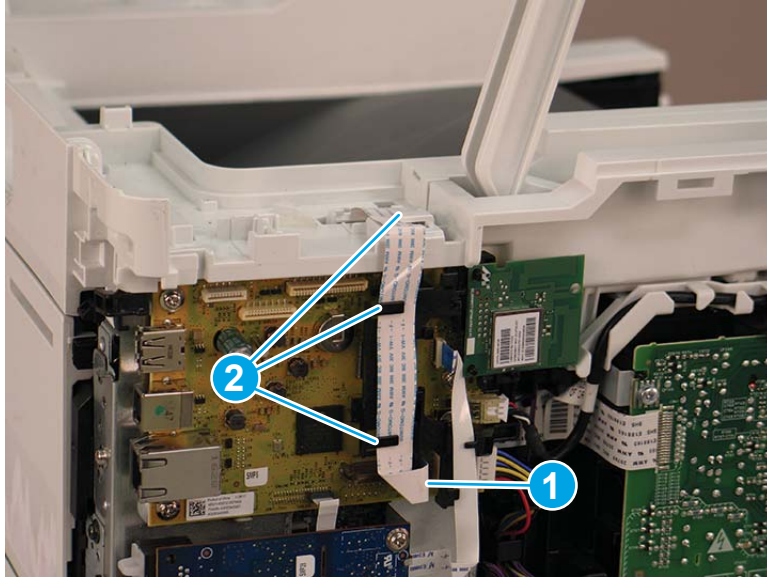

2. Remove one screw (callout 1).

Figure 1-516 Remove one screw

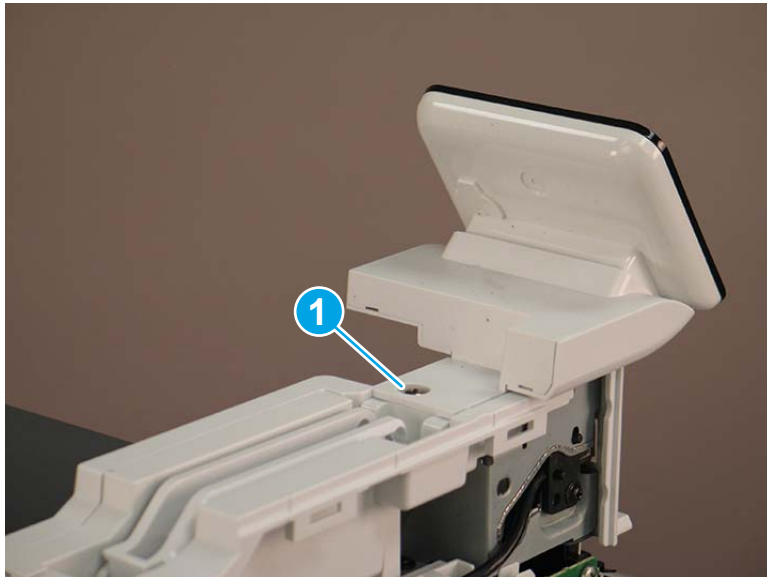

3. Use a small flat-blade screwdriver to release two tabs (callout 1) on the control-panel cable cover.

Figure 1-517 Release two tabs

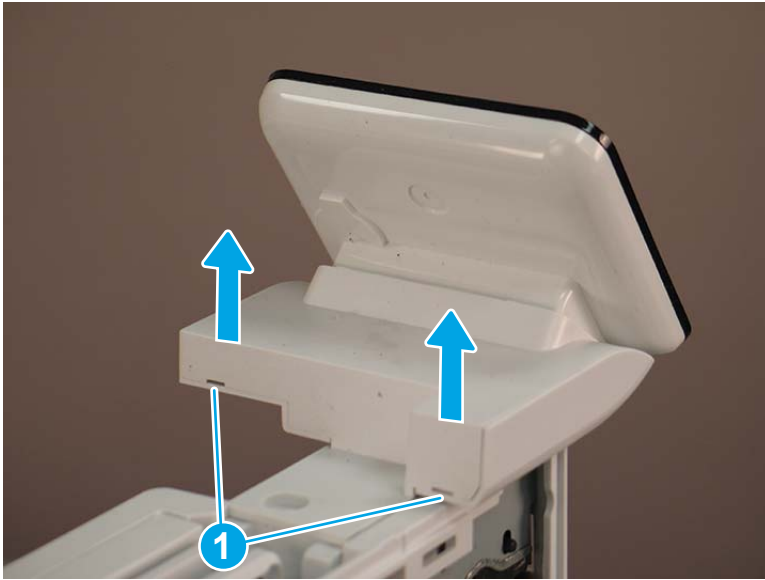

4. Remove the control-panel cable cover.

Figure 1-518 Remove the cover



5. Remove one grounding screw (callout 1), and then move the ground cable (callout 2) out of the way.

Figure 1-519 Remove one screw

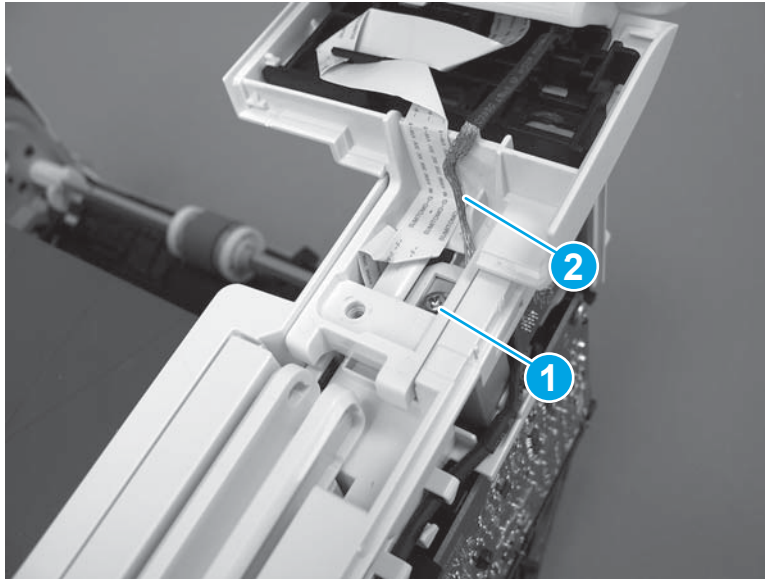

6. Move the FFC out of the way, and then remove two screws (callout 1).

Figure 1-520 Remove two screws



7. Slightly lift up the control-panel assembly to separate it from the top cover.

⚠ CAUTION: The control panel assembly is still connected to the printer by the FFC. Do not attempt to completely remove the assembly.

Figure 1-521 Lift up the control-panel assembly



8. Lift up the control-panel FFC cover to remove the control-panel assembly.

Figure 1-522 Remove the control-panel assembly

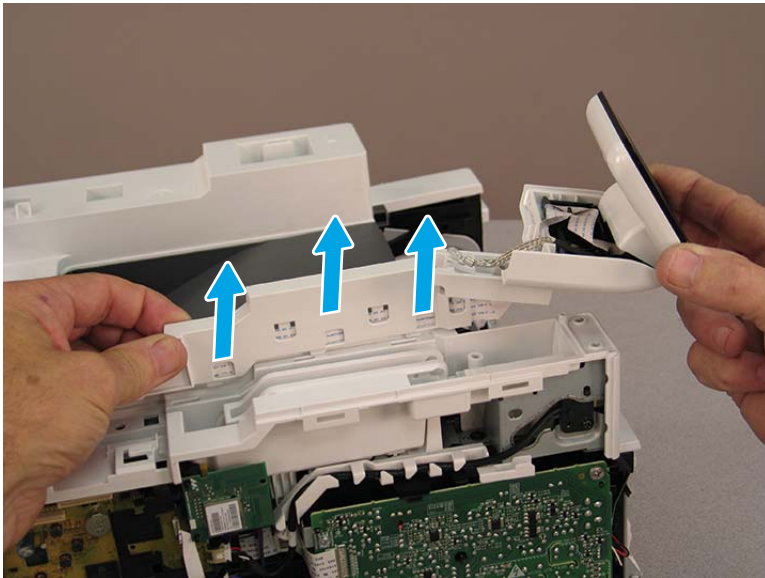

Step 7: Remove the top cover (M329/M428/M429)

📝 NOTE: The step is for the M329/M428/M429 printer. For the M304/M305/M404/M405, skip this step and go to [Step 8: Remove the top cover \(M304/M305/M404/M405\) on page 334](#).

1. Release the USB cable (callout 1) from the cable guide.

Figure 1-523 Remove the USB cable

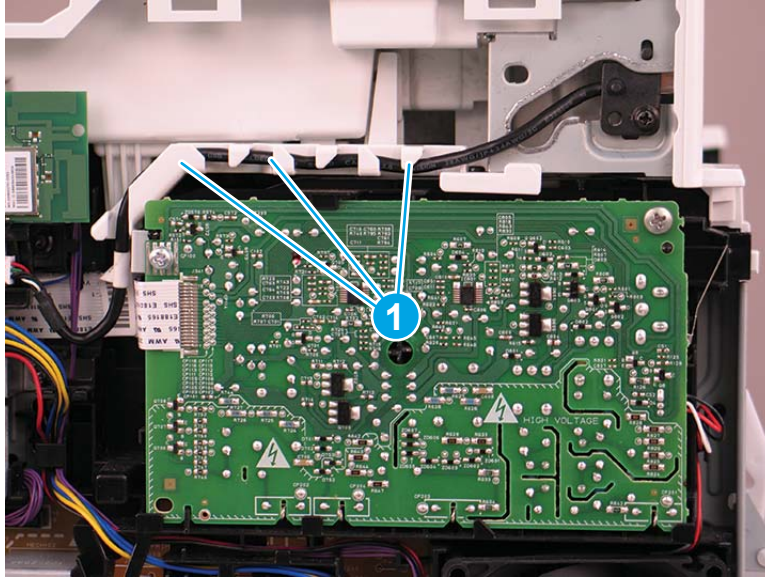

2. Remove one screw (callout 1), and then remove the support arm (callout 2).

⚠ CAUTION: The support arm is spring loaded and can unexpectedly spring into the open position. To avoid injury, do not place a finger in the screw well when the support arm is in the closed position.

Figure 1-524 Remove the support arm

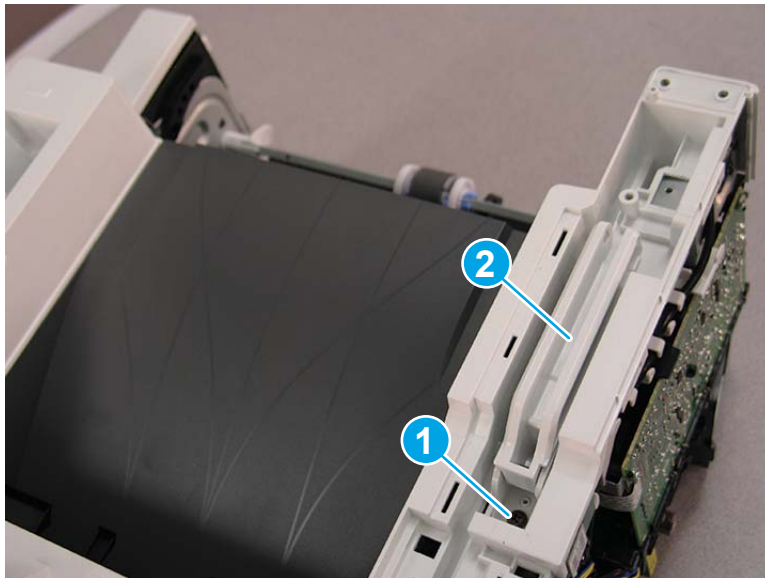

3. Remove five screws (callout 1), release four bosses (callout 2), and then remove the top cover (callout 3).

Figure 1-525 Remove the cover

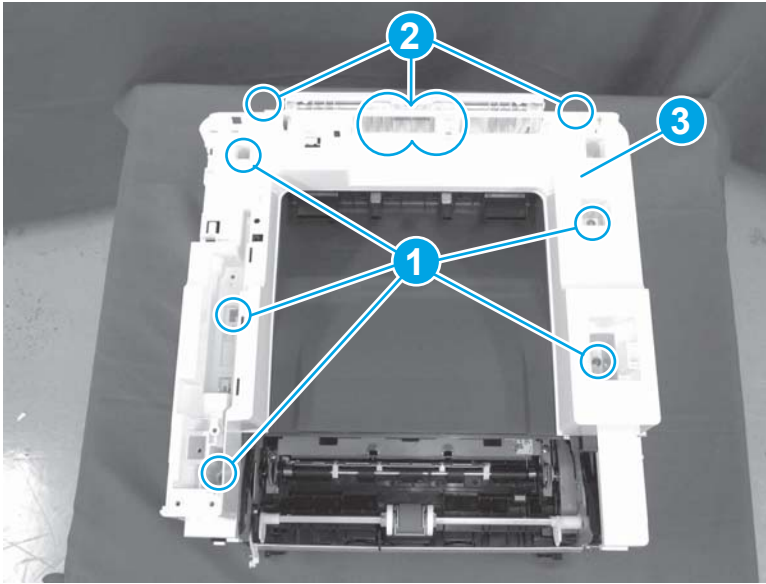

Step 8: Remove the top cover (M304/M305/M404/M405)

 **NOTE:** The step is for the M304/M305/M404/M405 printer. For the M329/M428/M429, skip this step and go to [Step 9: Remove the paper delivery tray \(output bin\) on page 335.](#)

1. Remove one screw (callout 1).

Figure 1-526 Remove one screw



2. At the right side of the printer, release the one boss (callout 1), and then release one tab (callout 2).

Figure 1-527 Release one boss and one tab

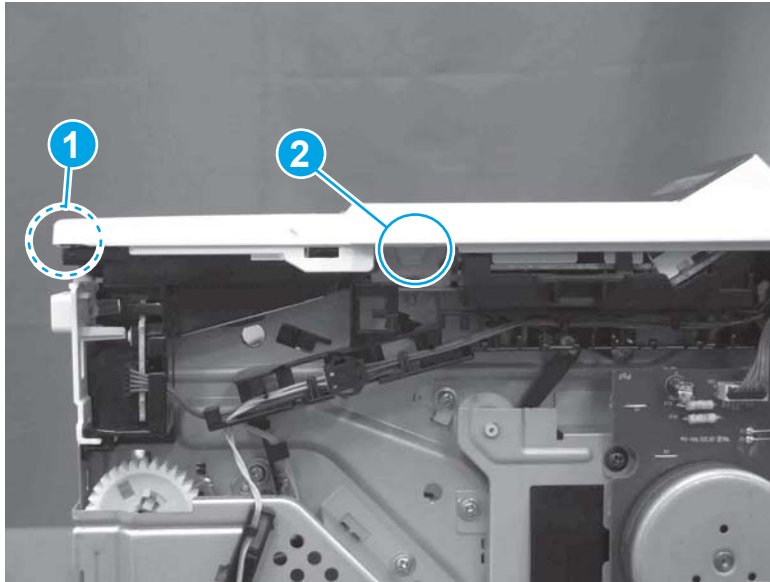

3. Release four tabs (callout 1), release four bosses (callout 2), and then remove the top cover (callout 3).

 **TIP:** Open the rear door to make releasing the bosses (callout 3) easier.

Figure 1-528 Remove the cover

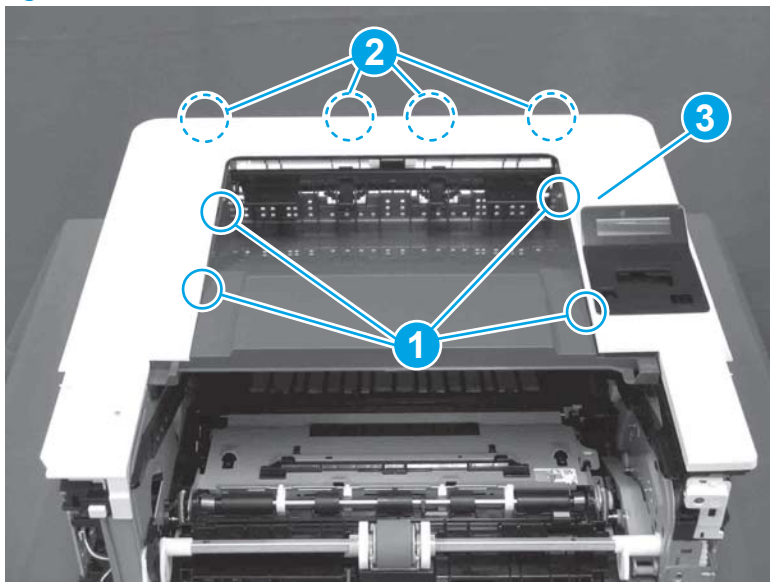

Step 9: Remove the paper delivery tray (output bin)

 **NOTE:** This procedure shows the M304/M305/M404/M405 model, however, the paper delivery tray (output bin) removal is similar for the M329/M428/M429 printer.

- ▲ Release two bosses (callout 1), release two tabs (callout 2), and then remove the paper delivery tray (output bin; callout 3).

Figure 1-529 Release two tabs

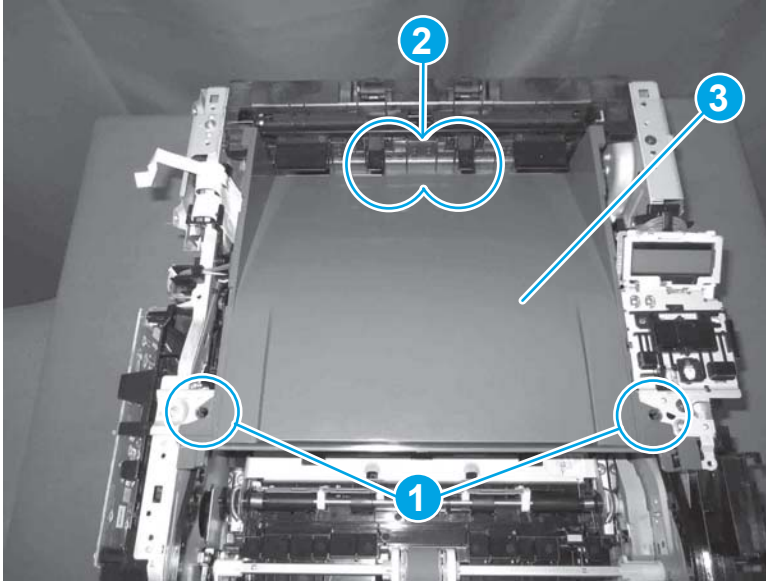

Step 10: Remove the laser scanner assembly

 **NOTE:** The M304/M305/M404/M405 product is shown in this procedure. However, the procedure is valid for the M329/M428/M429 laser scanner assembly.

1. Disconnect one flat-flexible cable (FFC) (callout 1), and one connector (callout 2).

 **Reinstallation tip:** Transfer the antistatic foam pad (callout 2) from the discarded laser/scanner assembly to the replacement assembly.

Figure 1-530 Disconnect one FFC and one connector



2. Remove four screws (callout 1), and then remove the laser scanner assembly.

Figure 1-531 Remove the laser scanner

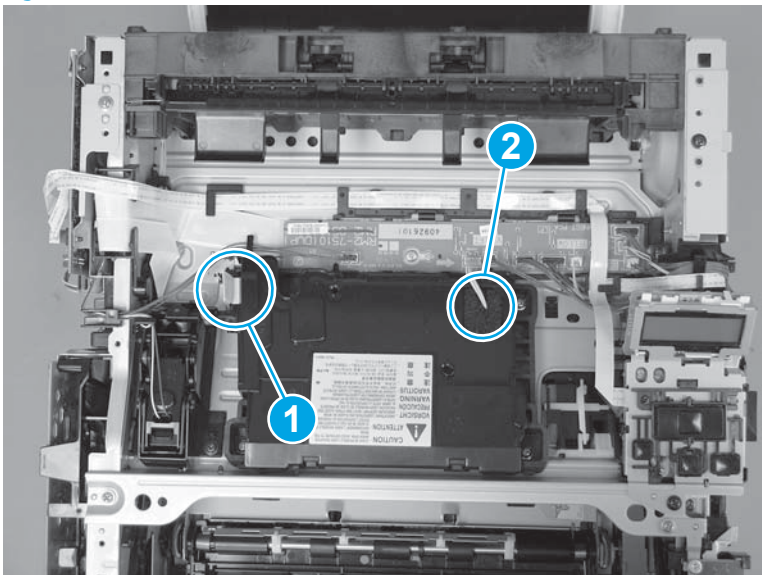
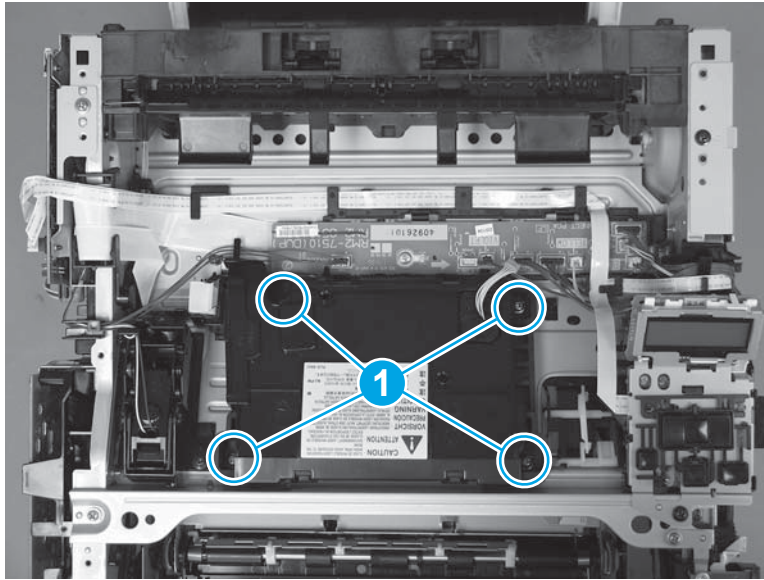

Step 11: Unpack the replacement assembly

1. Dispose of the defective part.



NOTE: HP recommends responsible disposal of the defective part.

<http://www8.hp.com/us/en/hp-information/environment/product-recycling.html>

2. Unpack the replacement part from the packaging.



CAUTION:  Some parts are sensitive to electrostatic discharge (ESD). Always perform service work at an ESD-protected workstation or mat. If an ESD workstation or mat is not available, touch the sheet-metal chassis to provide a static ground before touching an ESD-sensitive assembly. Protect the ESD-sensitive assemblies by placing them in ESD pouches when they are out of the printer.

If the replacement part is a roller or pad, avoid touching the spongy part of it. Skin oils on the roller or pad can cause paper pickup and/or print-quality problems. HP recommends using disposable gloves when handling rollers or pads or washing your hands before touching rollers or pads.



IMPORTANT: Make sure that all of the shipping materials (for example shipping tape) are removed from the replacement part prior to installation.

3. To install an assembly, reverse the removal steps.



NOTE: When applicable, special installation instructions are provided for an assembly at the end of the removal procedure. Always completely read the removal instructions and follow all special installation instructions.

Removal and replacement: Sheet-metal formatter bracket and formatter PCA

- [Step 1: Remove Tray 2](#)
- [Step 2: Remove the cartridge door assembly](#)
- [Step 3: Remove the left cover](#)
- [Step 4: Remove the right cover](#)
- [Step 5: Remove the integrated scanner assembly \(M329/M428/M429\)](#)
- [Step 6: Remove the control panel \(M329/M428/M429\)](#)
- [Step 7: Remove the top cover \(M329/M428/M429\)](#)
- [Step 8: Remove the top cover \(M304/M305/M404/M405\)](#)
- [Step 9: Remove the sheet-metal formatter bracket and formatter PCA](#)

Step 1: Remove Tray 2

- ▲ Pull the tray straight out of the printer to remove it.

Figure 1-532 Remove the tray



Step 2: Remove the cartridge door assembly

 **NOTE:** If the toner cartridge was not removed prior to servicing the printer, remove it now.

1. Release the support shaft (callout 1), and then slide it toward the center of the door (callout 2).

 **TIP:** It might be easier to release the support shaft by using a small flat-blade screwdriver.

Figure 1-533 Release the support shaft

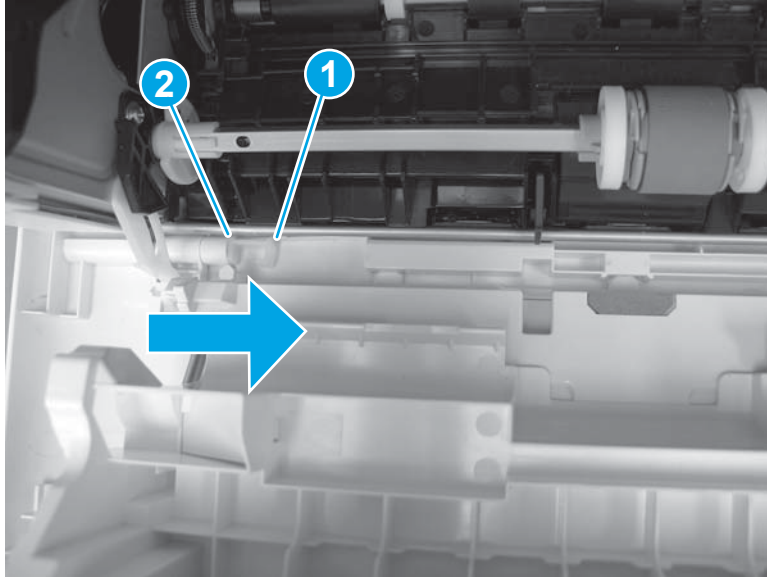

2. Remove the support shaft.

Figure 1-534 Remove the support shaft

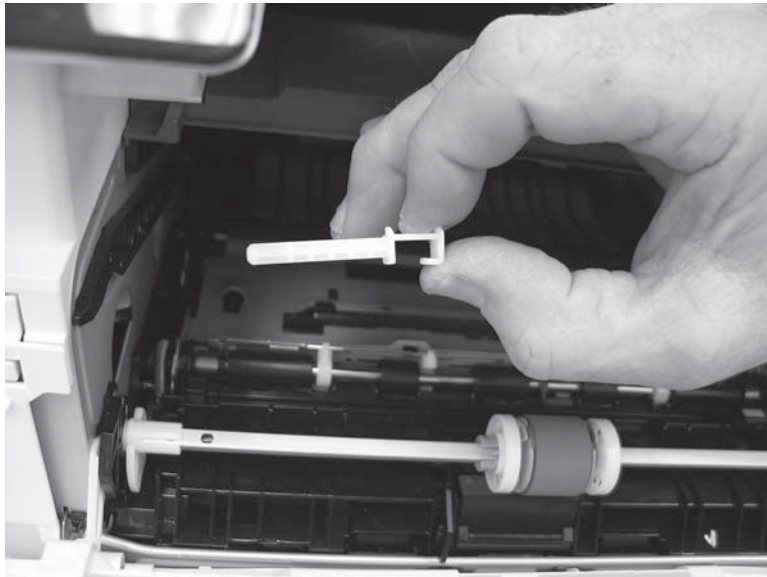

3. Release one tab (callout 1), and then slide the guide out of the printer (callout 2).

⚠ CAUTION: Be careful, the tab (callout 1) can be easily broken.

Figure 1-535 Remove the guide

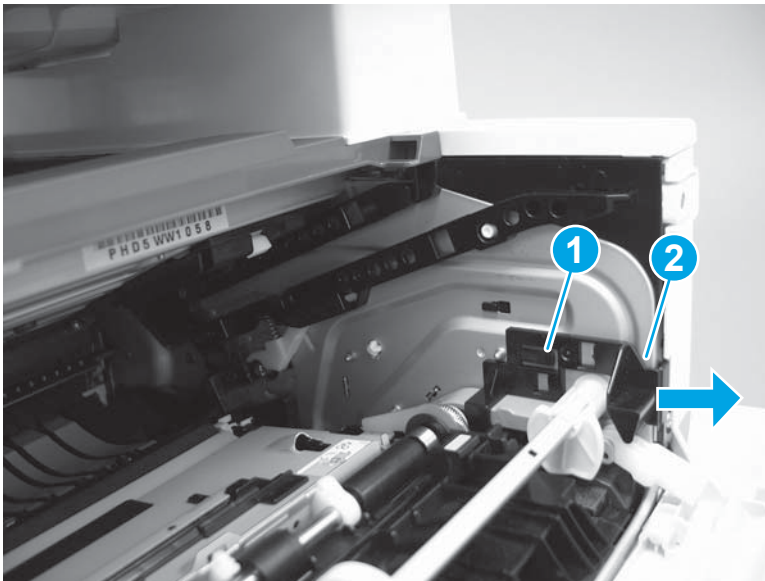

4. Use a small flat-blade screwdriver to gently pry the white-plastic door arm (callout 1) off of the gray-plastic pressure-release link (callout 2) to release the door arm.

Figure 1-536 Release the pressure-release link

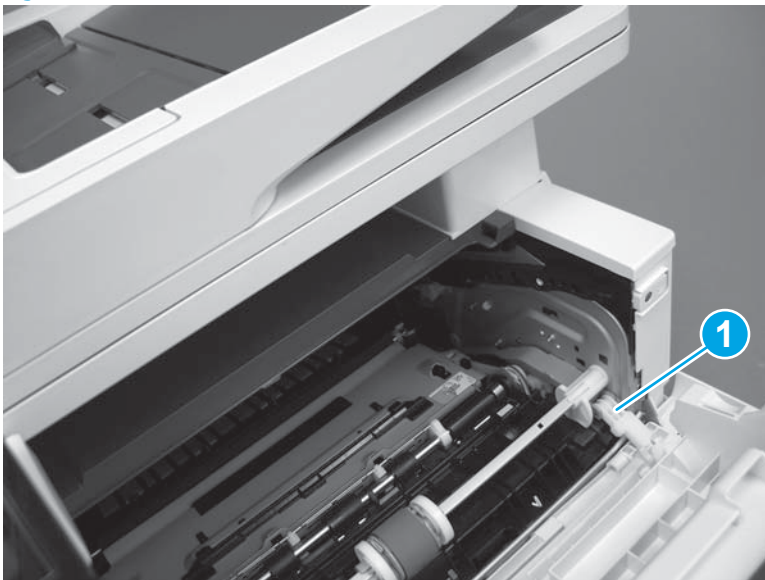

5. With the door in the partially closed position, slightly raise the left end (callout 1; raise it over the sheet-metal hinge boss), and then slide the door to the left (callout 2) to release the right hinge (callout 3).

⚠ CAUTION: The door is still attached to the printer by the left-side retainer arm. Do not attempt to completely remove the door.

💡 Reinstallation tip: When reinstalling the door, there are two right-side hinge pins (not shown in callout 3). Keep a finger pressed on the left-side retainer arm so that it does not disengage from the door.

Figure 1-537 Release the door

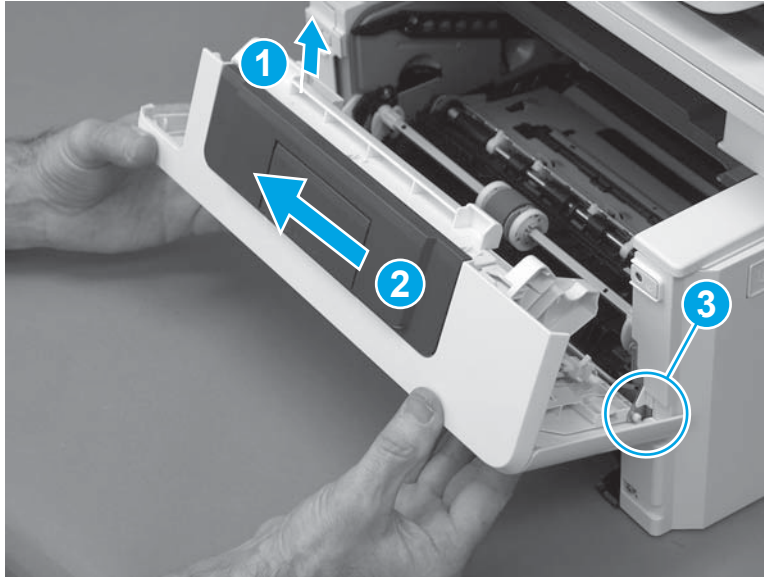

6. Rotate the door away from the printer until the keyed pin on the left-side retainer arm can disengage from the door.

Figure 1-538 Release the left-side retainer arm

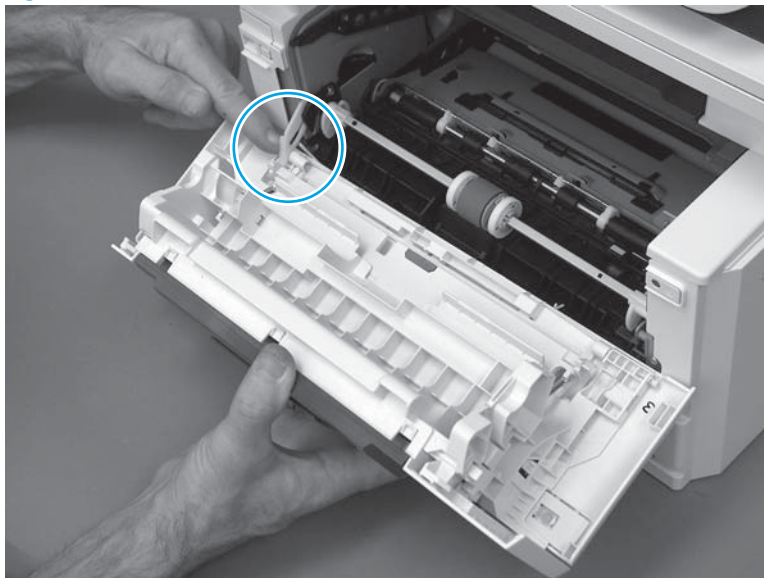

7. Remove the door.

Figure 1-539 Remove the door

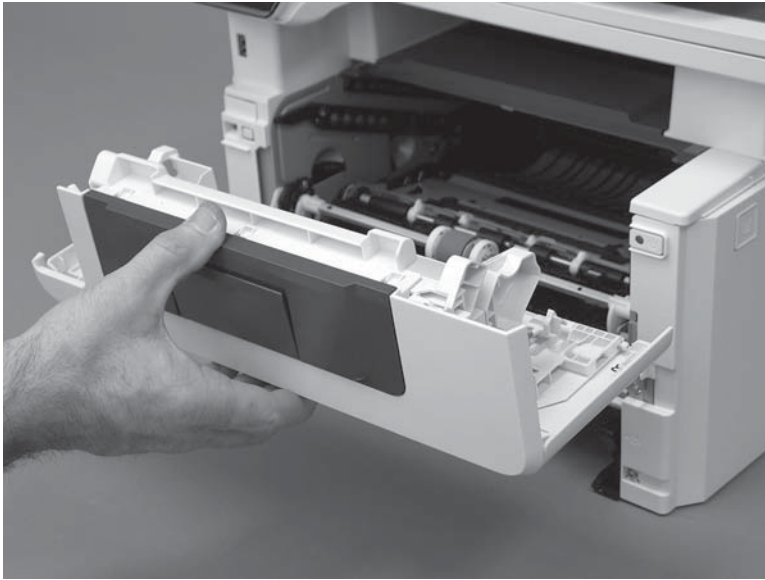

Step 3: Remove the left cover

1. Remove one screw (callout 1).

Figure 1-540 Remove one screw

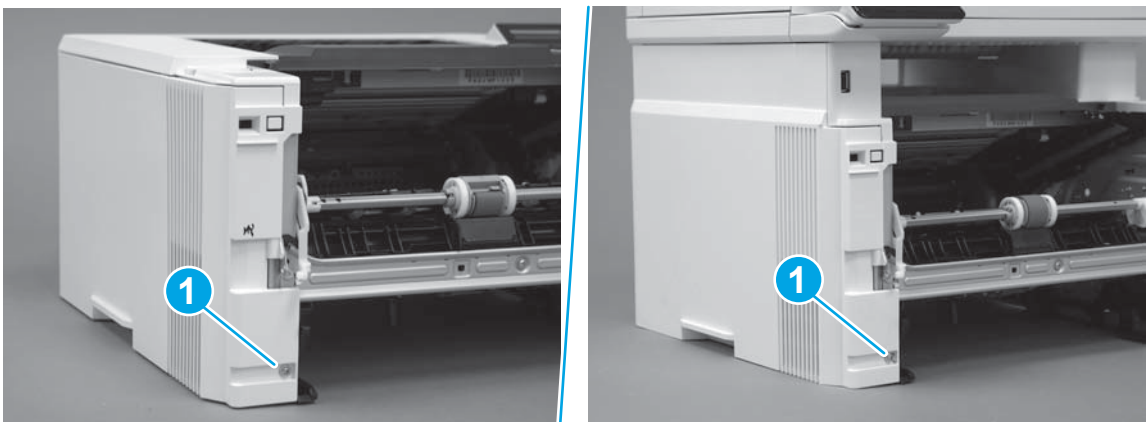

2. Open the rear door, release two bosses (callout 1), and then release three tabs (callout 2).

Figure 1-541 Release two bosses and three tabs

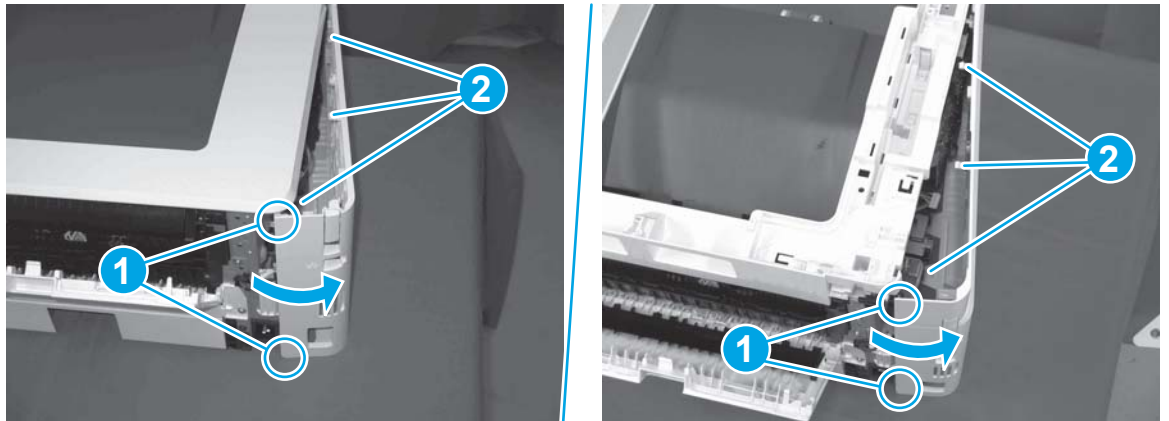

3. At the front of the printer, do one of the following:

- **M304/M305/M404/M405:** Release two bosses (callout 1), and then remove the cover (callout 2).
- **M329/M428/M429:** Release one tab (callout 3), two bosses (callout 4), and then remove the cover (callout 5).

⚠ CAUTION: Be careful when releasing the upper bosses on the M329/M428/M429 cover. One portion of the cover (callout 6) is fragile and is easily broken.

Figure 1-542 Remove the cover

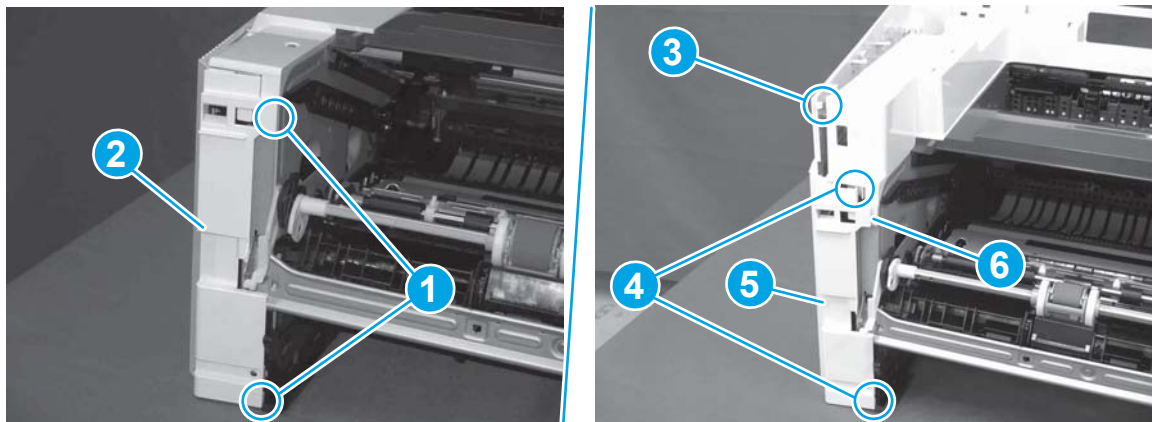

Step 4: Remove the right cover

1. At the front of the printer, release two bosses (callout 1), and then release three tabs (callout 2).

💡 Reinstallation tip: Remove, and then reinstall the cover if the switch or button does not correctly function.

Figure 1-543 Release two bosses and three tabs

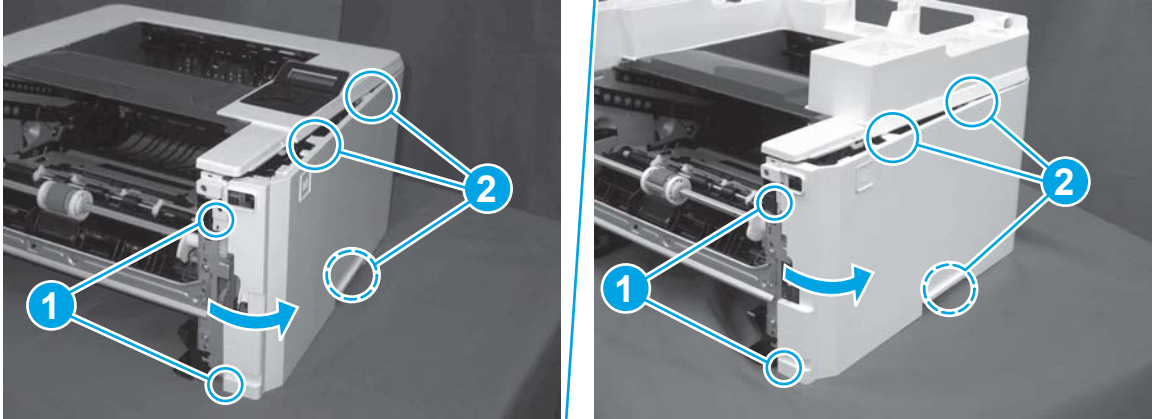

2. Open the rear door, release two bosses (callout 1), and then remove the cover (callout 2).

Figure 1-544 Remove the cover

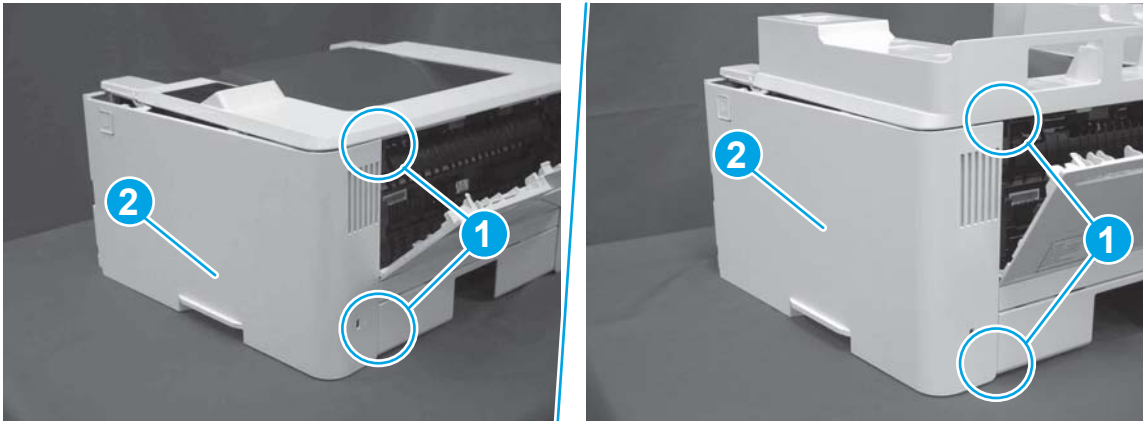

Step 5: Remove the integrated scanner assembly (M329/M428/M429)

 **NOTE:** The step is for the M329/M428/M429 printer. For the M304/M305/M404/M405, skip this step and go to [Step 8: Remove the top cover \(M304/M305/M404/M405\) on page 355.](#)

 **NOTE:** M329/M428/M429 models only. The integrated scanner assembly (ISA) includes the sub-scanner assembly (SSA) and the automatic document feeder (ADF).

1. Raise the ISA.

Figure 1-545 Raise the ISA

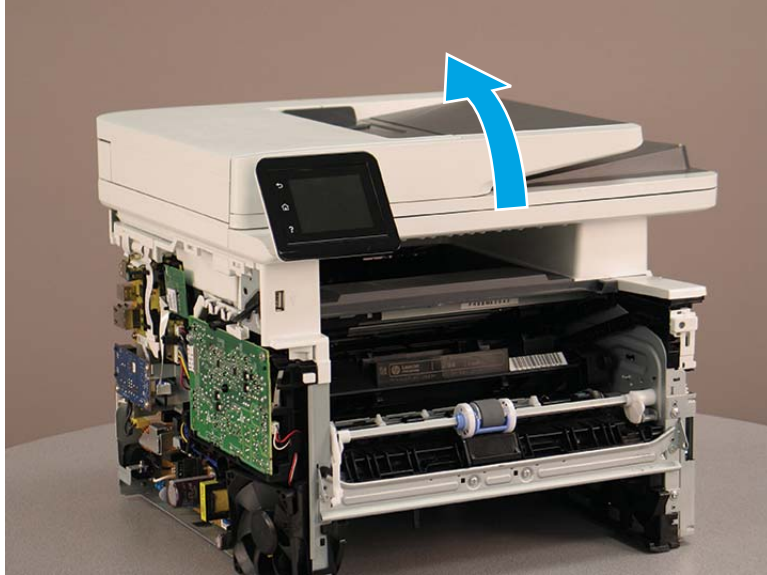

2. Release the ISA flat-flexible cable (FFC) cover (callout 1), and then remove it (callout 2).

Figure 1-546 Remove the ISA FFC cover

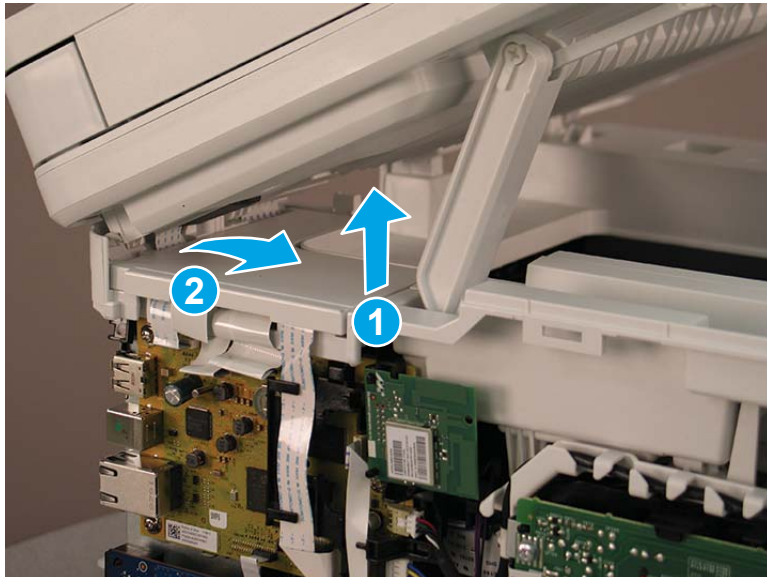

3. Disconnect three FFCs (callout 1), and then remove the ferrite (callout 2) from the holder.

⚠ CAUTION: The ferrite is not captive on the FFC. Do not lose the ferrite while handling the ISA.

Figure 1-547 Disconnect three FFCs

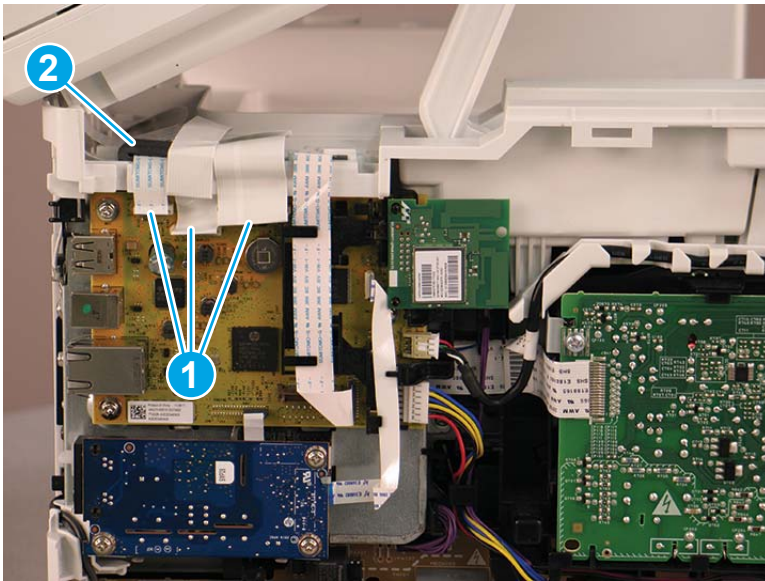

4. Remove one screw (callout 1).

Figure 1-548 Remove one screw

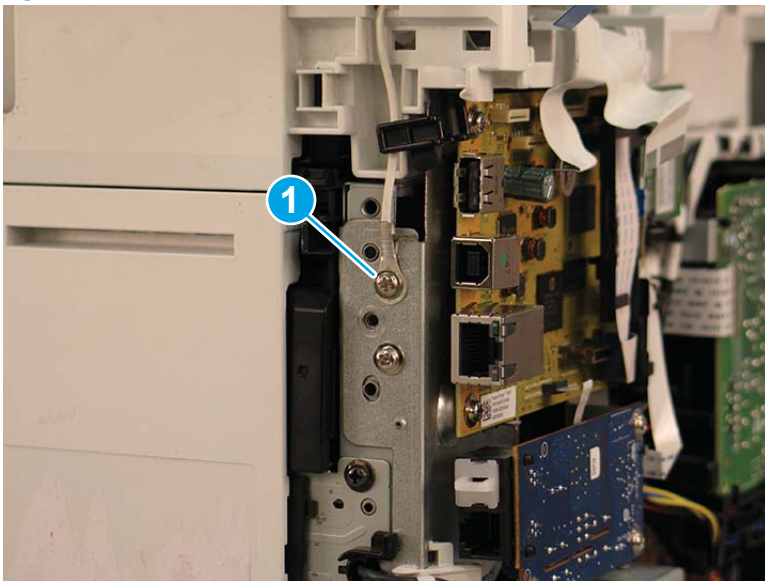

5. Pass the ground wire through the opening in the top cover.

Figure 1-549 Pass the wire through the opening

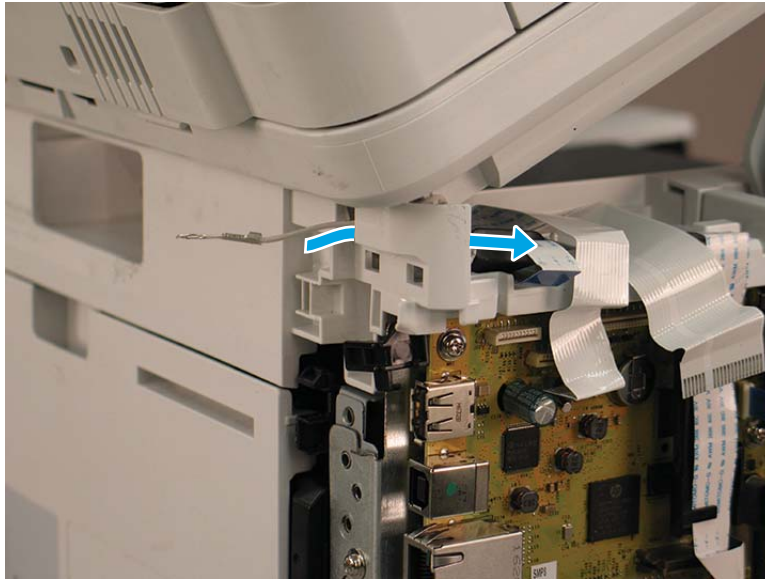

6. Release one tab (callout 1), and then rotate the ISA slider pin (callout 2) towards the front of the printer to release it.

Figure 1-550 Release one tab and rotate the slider pin

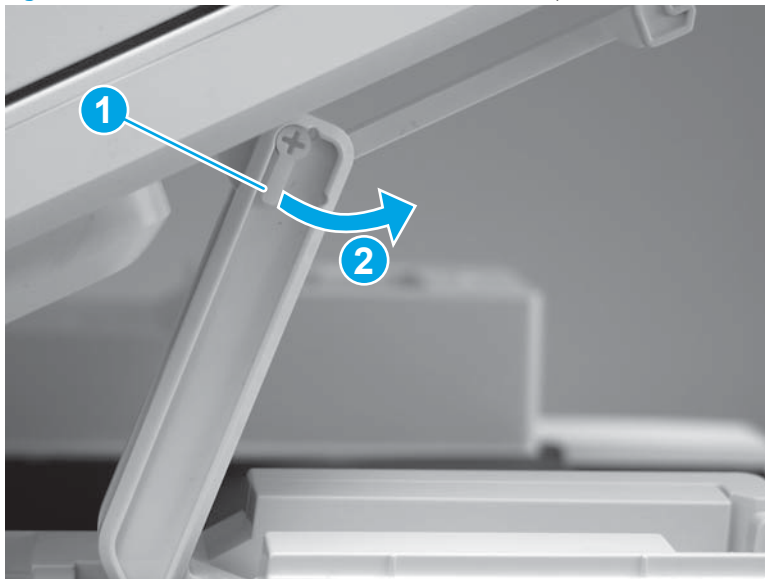

7. Remove the slider pin.

 **Reinstallation tip:** Align the keyed portion of the locking pin with the slot and hole in the support arm.

Figure 1-551 Remove the slider pin

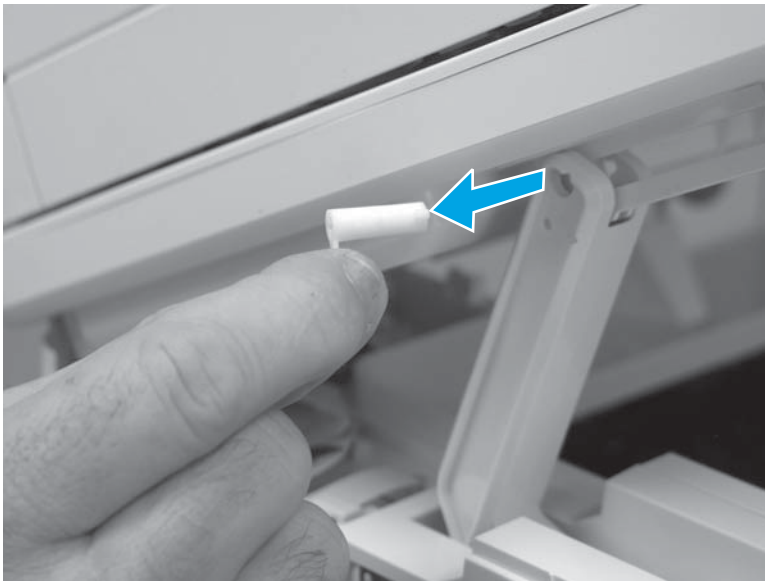

8. Rotate the ISA towards the rear of the printer until it stops.

Figure 1-552 Rotate the ISA towards the rear of the printer

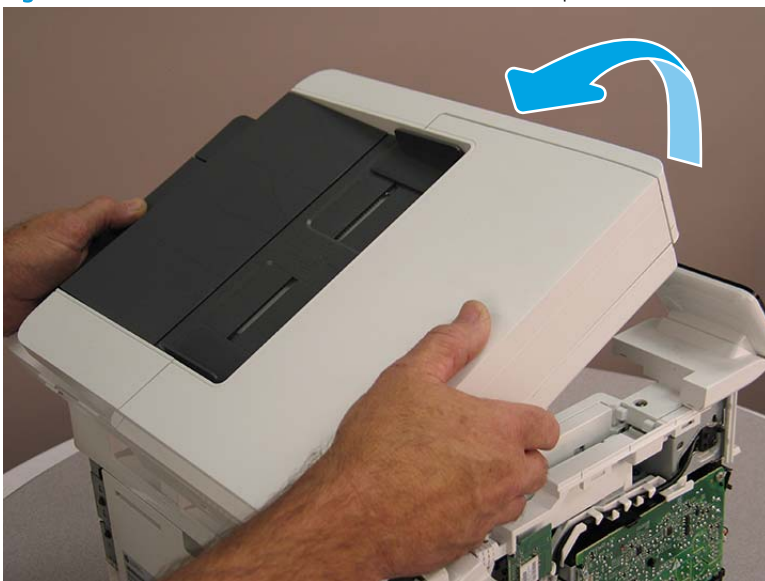

- Slide the ISA as shown to release it.

Figure 1-553 Release the ISA

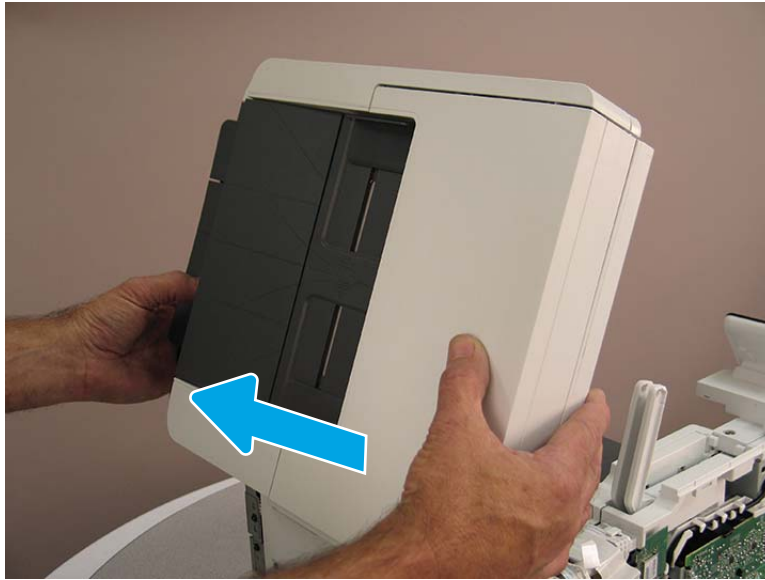

- Remove the ISA.

Figure 1-554 Remove the ISA

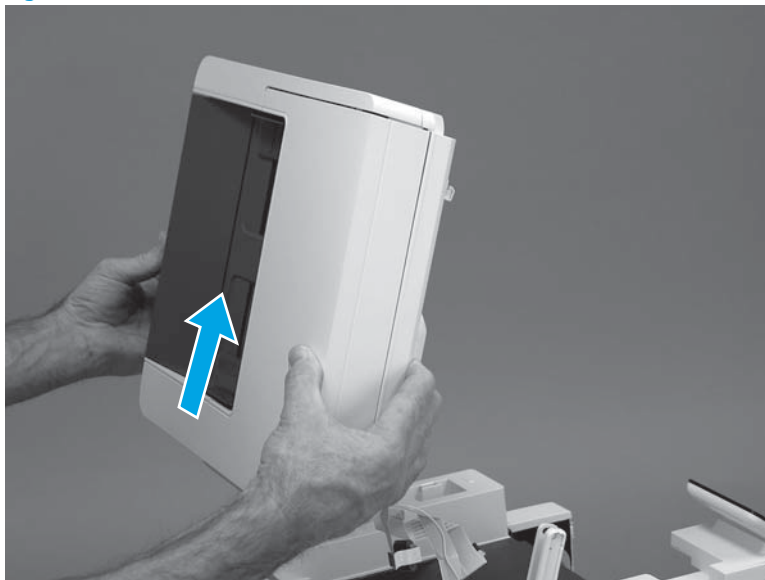

Step 6: Remove the control panel (M329/M428/M429)

 **NOTE:** The step is for the M329/M428/M429 printer. For the M304/M305/M404/M405, skip this step and go to [Step 8: Remove the top cover \(M304/M305/M404/M405\) on page 355](#).

- Disconnect one FFC (callout 1), and then release the FFC from the guide (callout 2).

Figure 1-555 Disconnect one connector

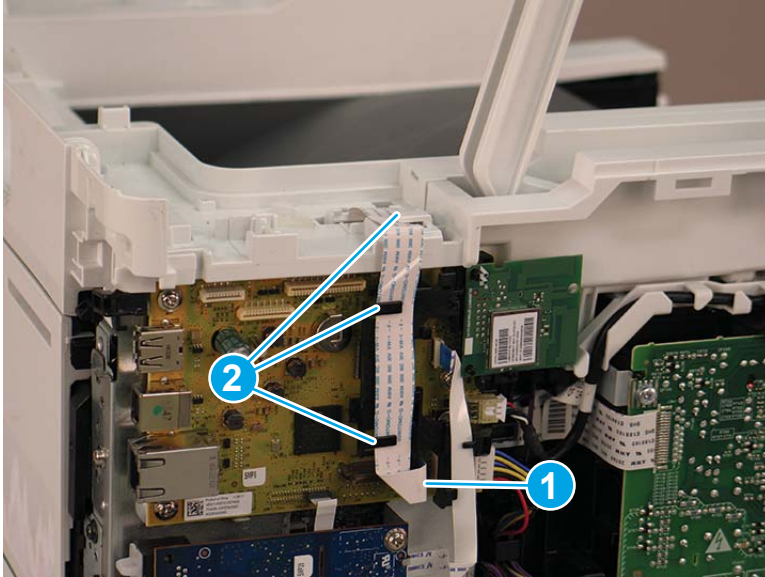

2. Remove one screw (callout 1).

Figure 1-556 Remove one screw

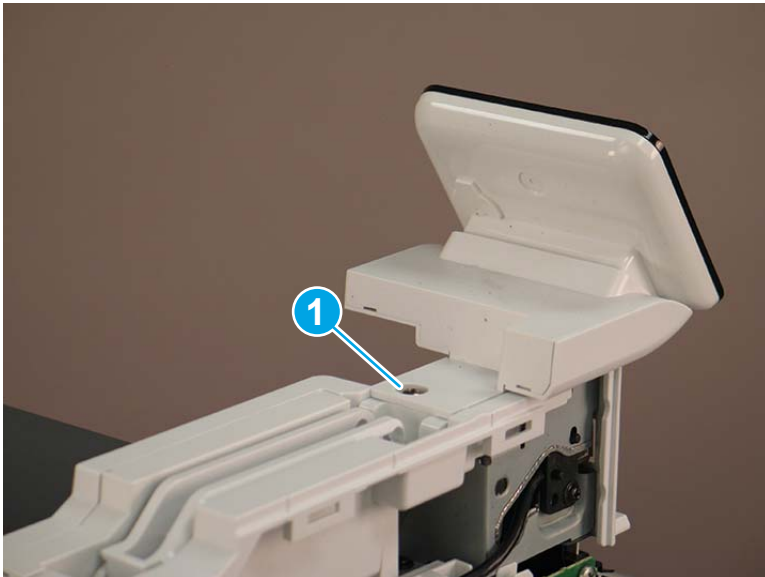

3. Use a small flat-blade screwdriver to release two tabs (callout 1) on the control-panel cable cover.

Figure 1-557 Release two tabs

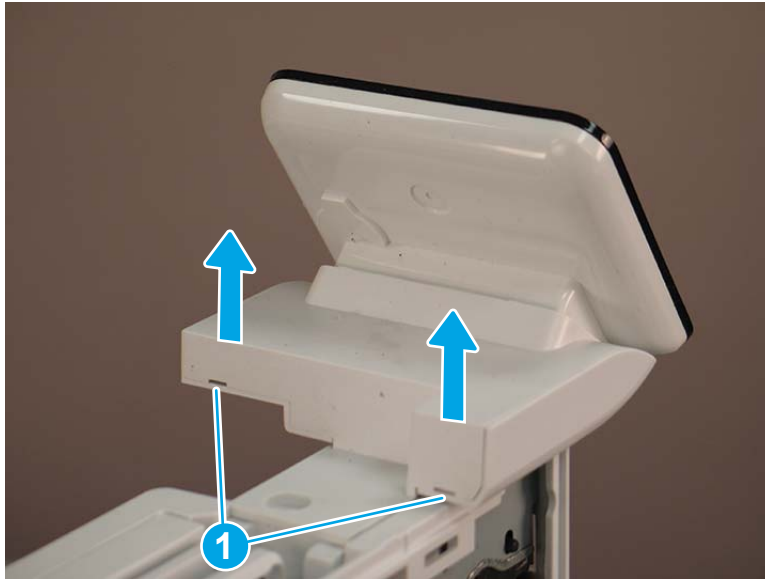

4. Remove the control-panel cable cover.

Figure 1-558 Remove the cover



5. Remove one grounding screw (callout 1), and then move the ground cable (callout 2) out of the way.

Figure 1-559 Remove one screw

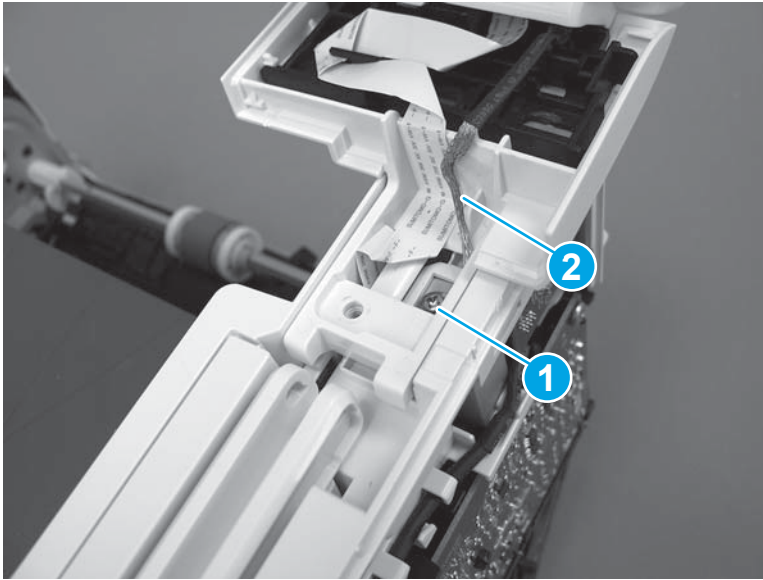

6. Move the FFC out of the way, and then remove two screws (callout 1).

Figure 1-560 Remove two screws

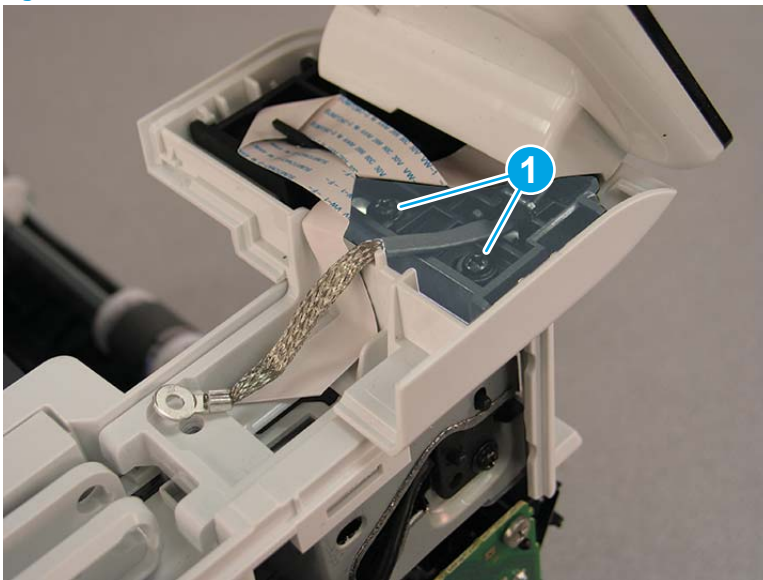

7. Slightly lift up the control-panel assembly to separate it from the top cover.

⚠ CAUTION: The control panel assembly is still connected to the printer by the FFC. Do not attempt to completely remove the assembly.

Figure 1-561 Lift up the control-panel assembly



8. Lift up the control-panel FFC cover to remove the control-panel assembly.

Figure 1-562 Remove the control-panel assembly

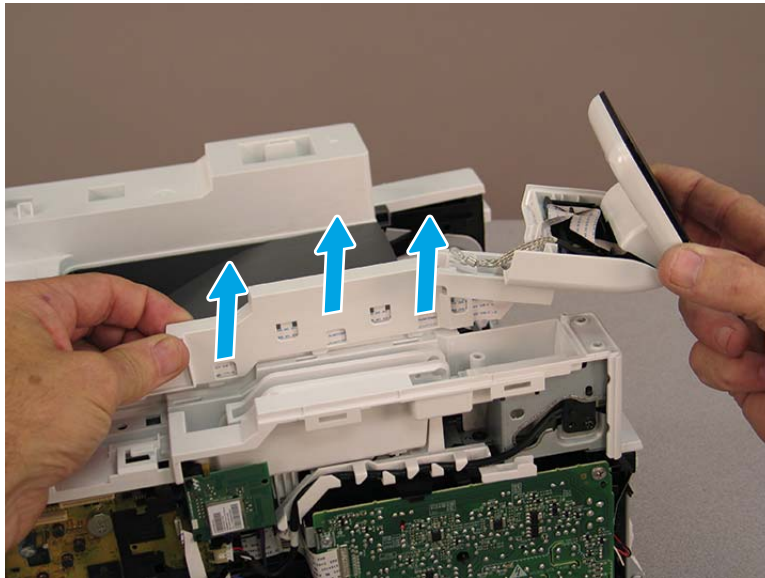

Step 7: Remove the top cover (M329/M428/M429)

📝 NOTE: The step is for the M329/M428/M429 printer. For the M304/M305/M404/M405, skip this step and go to [Step 8: Remove the top cover \(M304/M305/M404/M405\) on page 355](#).

1. Release the USB cable (callout 1) from the cable guide.

Figure 1-563 Remove the USB cable

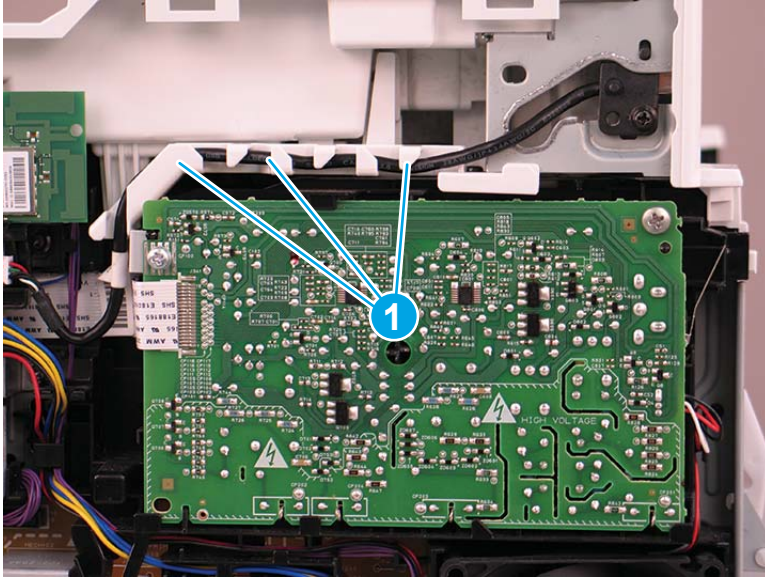

2. Remove one screw (callout 1), and then remove the support arm (callout 2).

⚠ CAUTION: The support arm is spring loaded and can unexpectedly spring into the open position. To avoid injury, do not place a finger in the screw well when the support arm is in the closed position.

Figure 1-564 Remove the support arm

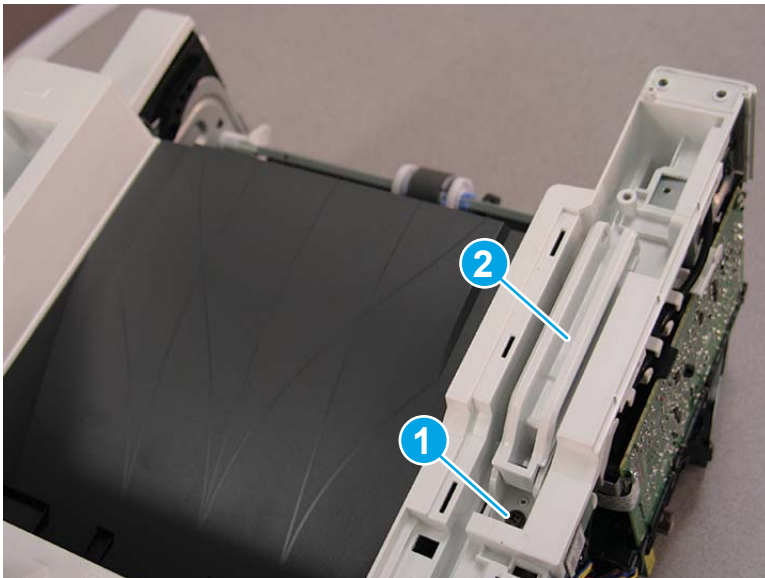

3. Remove five screws (callout 1), release four bosses (callout 2), and then remove the top cover (callout 3).

Figure 1-565 Remove the cover

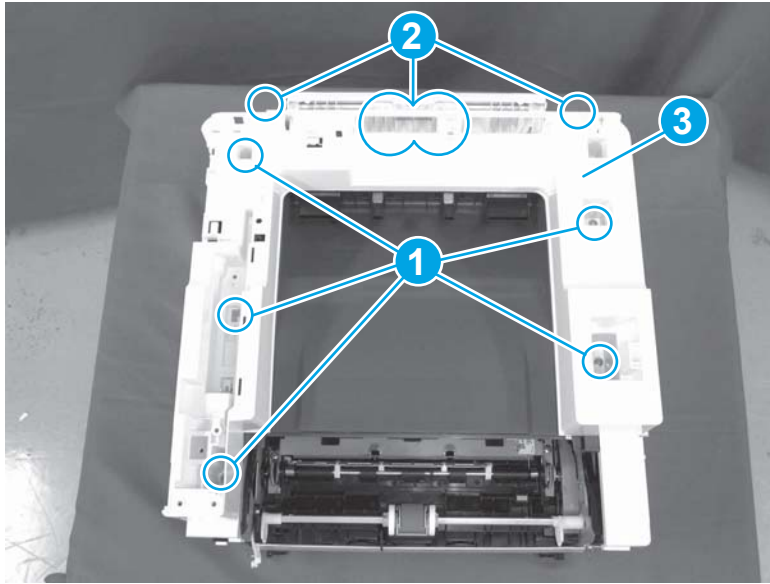

Step 8: Remove the top cover (M304/M305/M404/M405)

 **NOTE:** The step is for the M304/M305/M404/M405 printer. For the M329/M428/M429, skip this step and go to [Step 9: Remove the sheet-metal formatter bracket and formatter PCA on page 356.](#)

1. Remove one screw (callout 1).

Figure 1-566 Remove one screw



2. At the right side of the printer, release the one boss (callout 1), and then release one tab (callout 2).

Figure 1-567 Release one boss and one tab

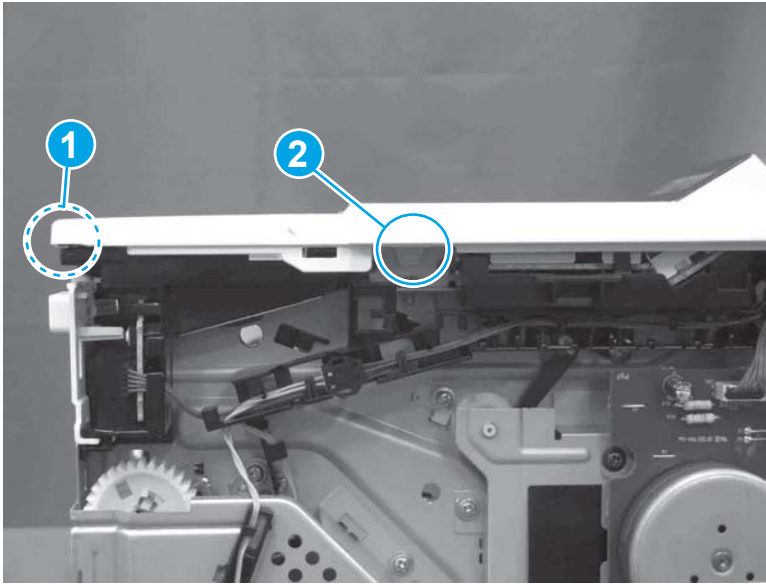

3. Release four tabs (callout 1), release four bosses (callout 2), and then remove the top cover (callout 3).

 **TIP:** Open the rear door to make releasing the bosses (callout 3) easier.

Figure 1-568 Remove the cover

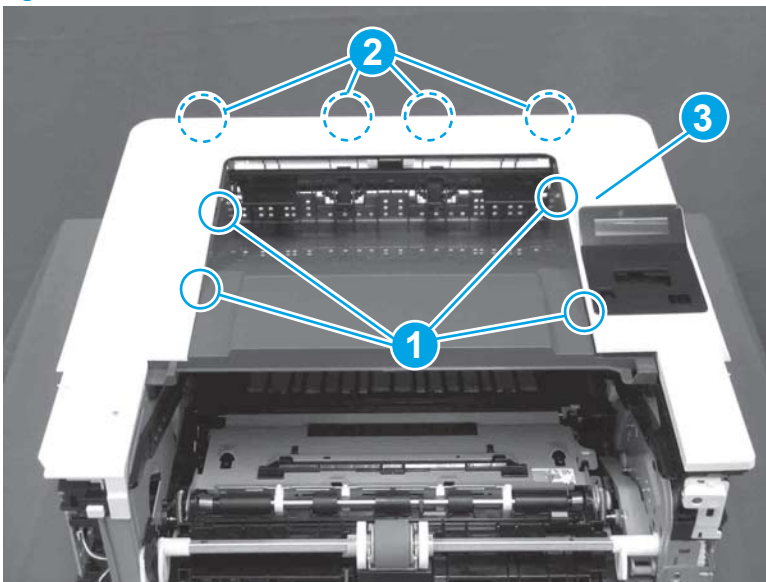

Step 9: Remove the sheet-metal formatter bracket and formatter PCA

1. Do one of the following:
 - **SFP only:** Release two tabs (callout 1), and then carefully pull the wireless PCA straight off of the formatter PCA to remove it.

 **NOTE:** Disconnect the WiFi antenna (callout 2) before releasing the tabs.

- **MFP only:** Release one tab (callout 3), and then carefully pull the wireless PCA straight off of the formatter PCA to remove it.

 **TIP:** Push the tab to the left to release it.

Figure 1-569 Remove the wireless PCA



2. Do one of the following:

- **SFP only:** Disconnect the connectors (callout 1), and then release one wire harness (callout 2) from the guide.
- **MFP only:** Disconnect the connectors (callout 1), and then release one wire harness and one FFC (callout 2) from the guides.

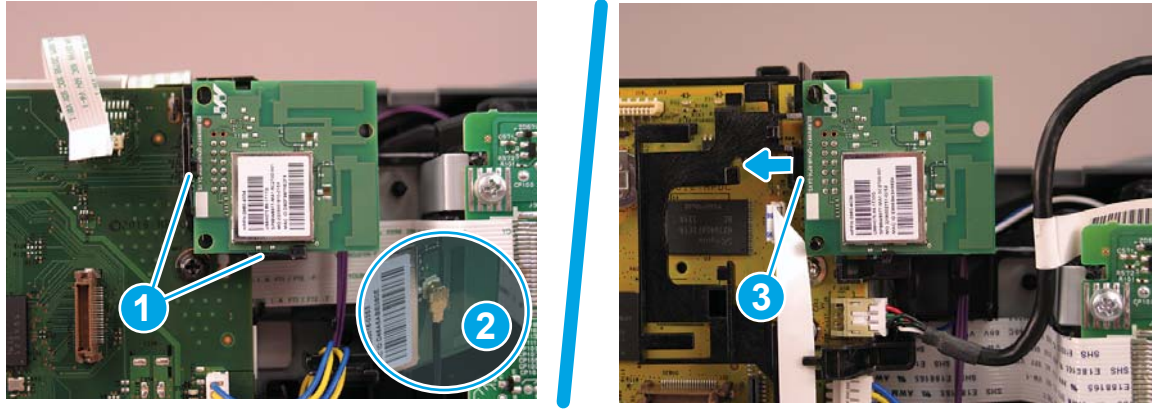
Figure 1-570 Disconnect the connectors

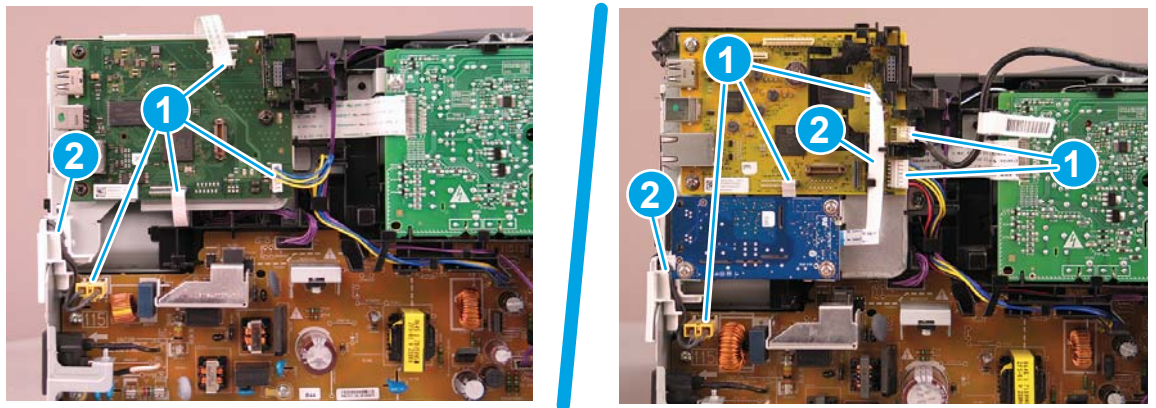

3. **MFP only:** Remove three screws (callout 1), and then remove the fax PCA.

Figure 1-571 Remove the fax PCA

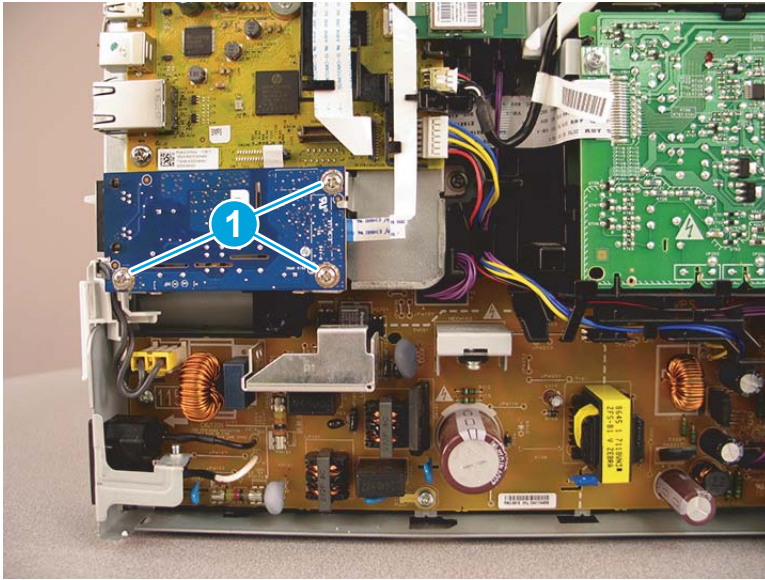

4. **MFP only:** Release the FFC from the guide (callout 1), release one tab (callout 2), and then remove the FFC guide (callout 3).

Figure 1-572 Remove the FFC guide

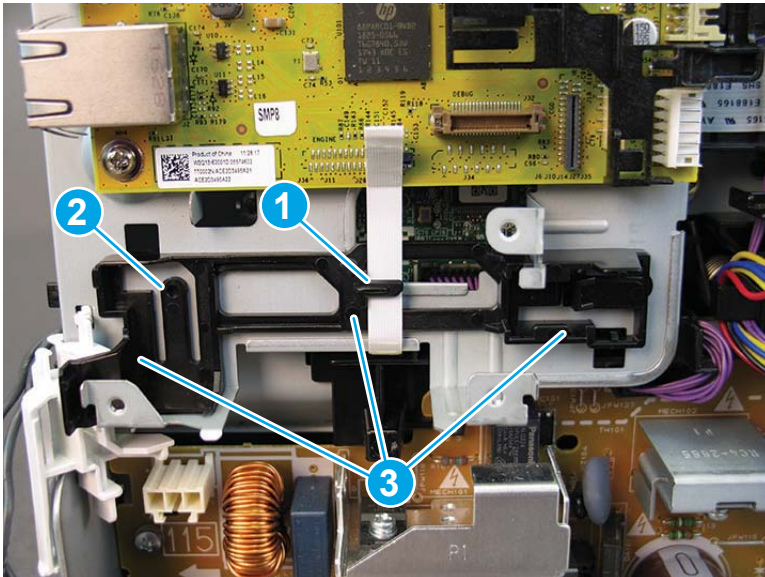

5. Remove one guide.

 **NOTE:** A SFP printer is shown in the figure. However, the guide is identical for an MFP printer.

Figure 1-573 Remove the guide



6. Remove two screws.

Figure 1-574 Remove two screws

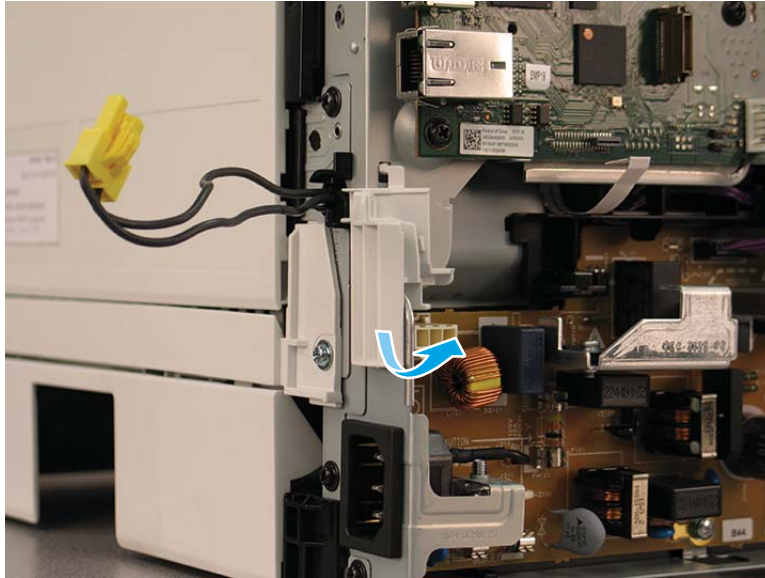

7. **MFP only:** Remove one screw.

Figure 1-575 Remove one screw

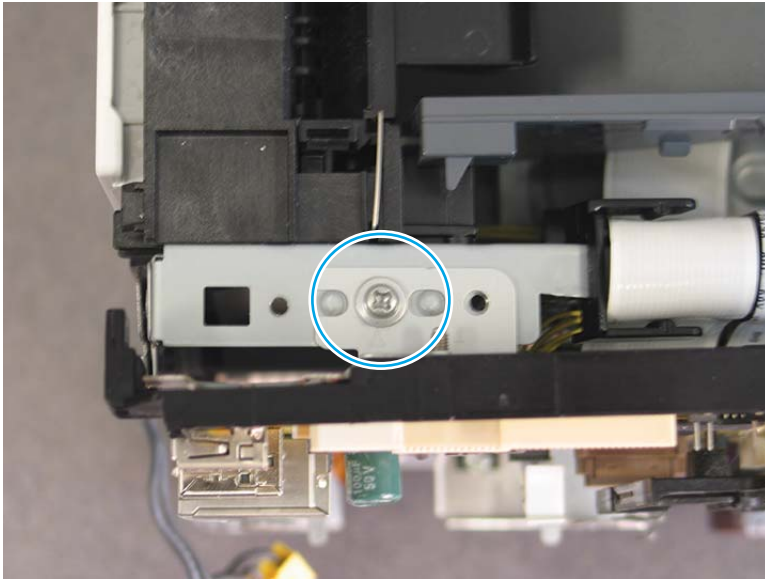

8. Support the formatter and bracket, and then remove two screws.

Figure 1-576 Remove two screws

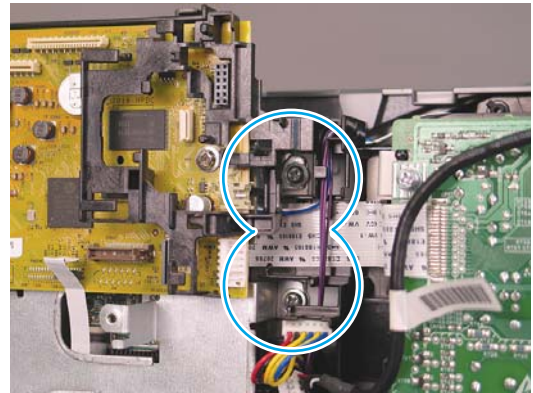
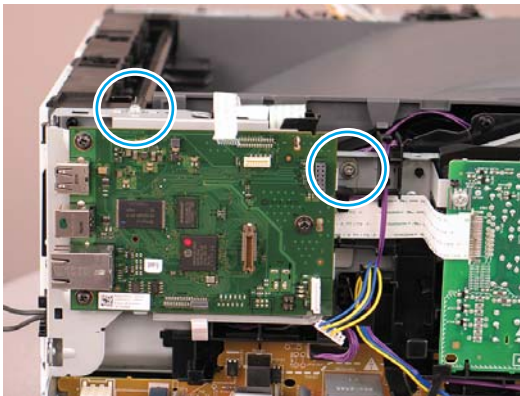

9. Remove the sheet-metal bracket and formatter PCA.

Figure 1-577 Remove the bracket

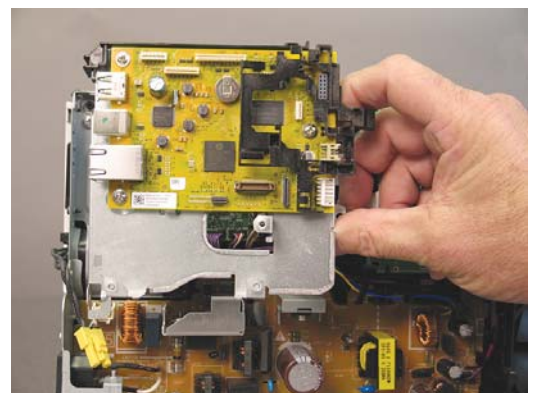
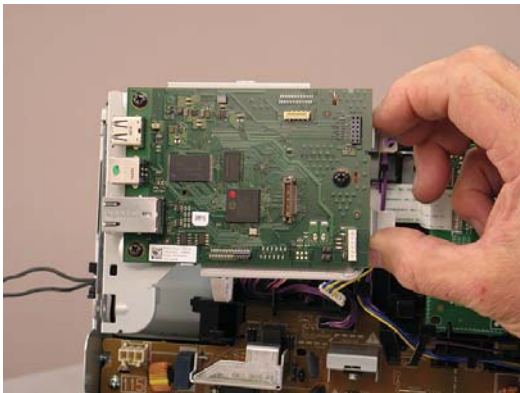

Removal and replacement: Control panel FFC, (M304/M305/M404/M405)

- [Introduction](#)
- [Step 1: Remove Tray 2](#)
- [Step 2: Remove the cartridge door assembly](#)
- [Step 3: Remove the left cover](#)
- [Step 4: Remove the right cover](#)
- [Step 5: Remove the top cover \(M304/M305/M404/M405\)](#)
- [Step 6: Remove the paper delivery tray \(output bin\)](#)
- [Step 7: Remove the control panel FFC](#)
- [Step 8: Unpack the replacement assembly](#)

Introduction

This document provides the procedures to remove and replace the control panel FFC (M304/M305/M404/M405 only).

Before performing service

Turn the printer power off

- Disconnect the power cable.

 **WARNING!** To avoid damage to the printer, turn the printer off, wait 30 seconds, and then remove the power cable before attempting to service the printer.

Use the table below to identify the correct part number for your printer. To order the part, go to www.hp.com/buy/parts.

Control panel FFC (M304/M305/M404/M405) part number	
RK2-6943-000CN	Control panel FFC (M304/M305/M404/M405)

Required tools

- #2 Phillips screwdriver with a magnetic tip.

After performing service

Turn the printer power on

- Connect the power cable.
- Use the power switch to turn the power on.

Post service test

Make sure that the printer initializes to a **Ready** state.

Print a configuration page to make sure that the printer is functioning correctly.

Step 1: Remove Tray 2

- ▲ Pull the tray straight out of the printer to remove it.

Figure 1-578 Remove the tray



Step 2: Remove the cartridge door assembly

 **NOTE:** If the toner cartridge was not removed prior to servicing the printer, remove it now.

1. Release the support shaft (callout 1), and then slide it toward the center of the door (callout 2).

 **TIP:** It might be easier to release the support shaft by using a small flat-blade screwdriver.

Figure 1-579 Release the support shaft

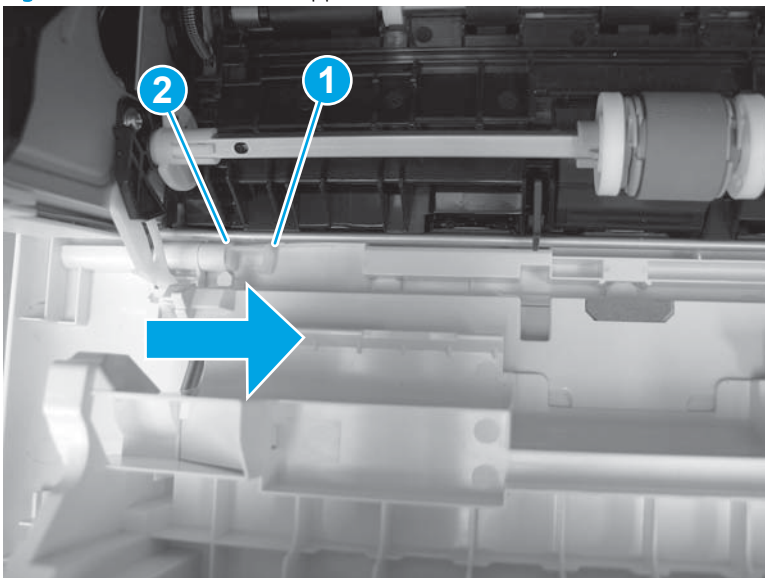

2. Remove the support shaft.

Figure 1-580 Remove the support shaft

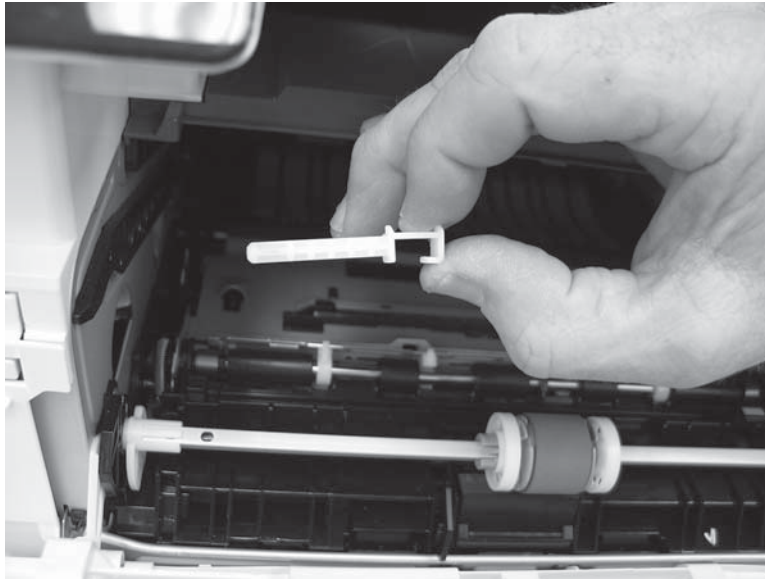

3. Release one tab (callout 1), and then slide the guide out of the printer (callout 2).

⚠ CAUTION: Be careful, the tab (callout 1) can be easily broken.

Figure 1-581 Remove the guide

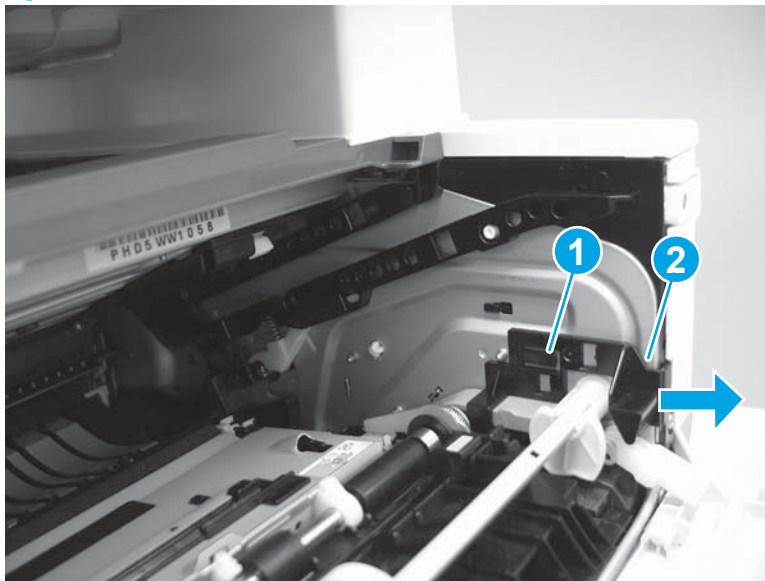

4. Use a small flat-blade screwdriver to gently pry the white-plastic door arm (callout 1) off of the gray-plastic pressure-release link (callout 2) to release the door arm.

Figure 1-582 Release the pressure-release link

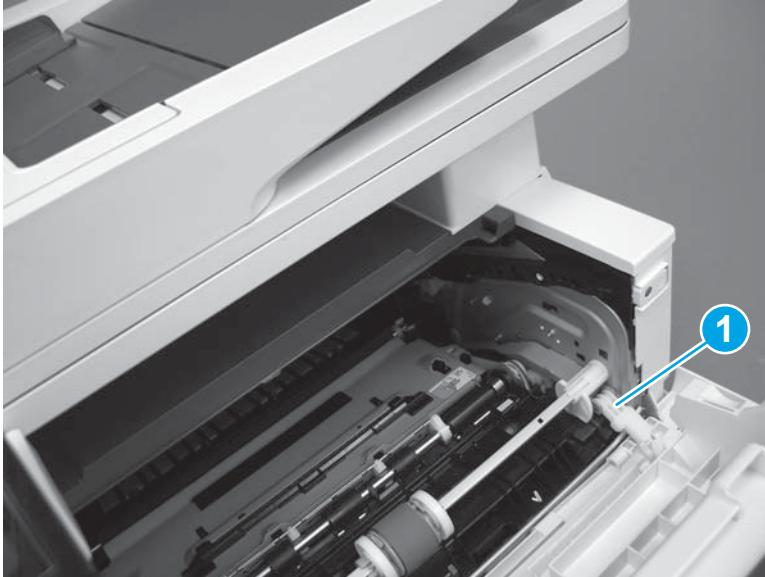

5. With the door in the partially closed position, slightly raise the left end (callout 1; raise it over the sheet-metal hinge boss), and then slide the door to the left (callout 2) to release the right hinge (callout 3).

CAUTION: The door is still attached to the printer by the left-side retainer arm. Do not attempt to completely remove the door.

Reinstallation tip: When reinstalling the door, there are two right-side hinge pins (not shown in callout 3). Keep a finger pressed on the left-side retainer arm so that it does not disengage from the door.

Figure 1-583 Release the door

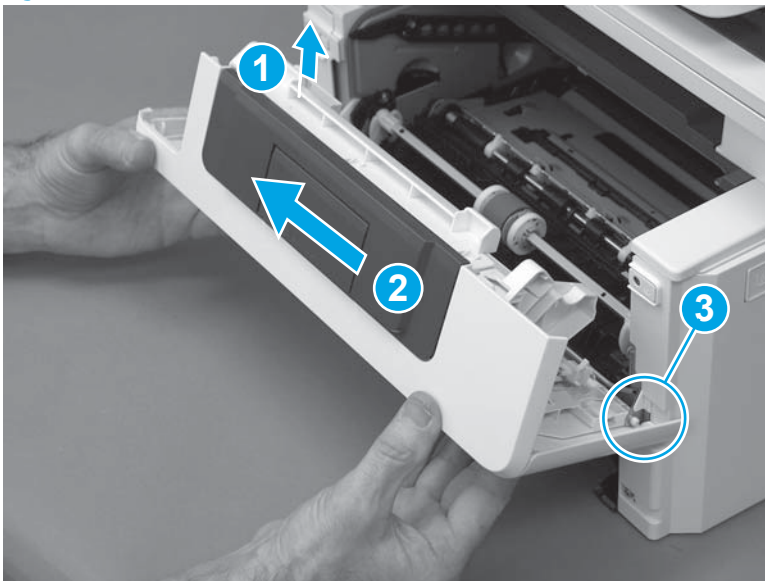

6. Rotate the door away from the printer until the keyed pin on the left-side retainer arm can disengage from the door.

Figure 1-584 Release the left-side retainer arm

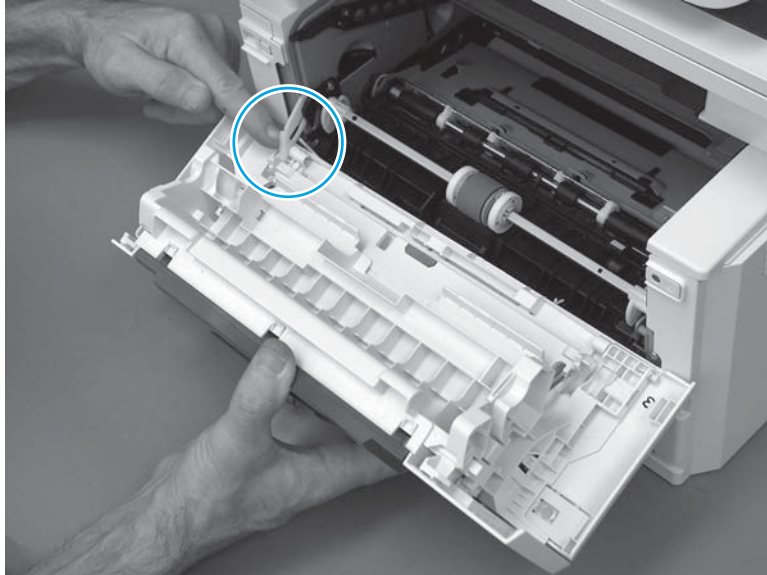

7. Remove the door.

Figure 1-585 Remove the door

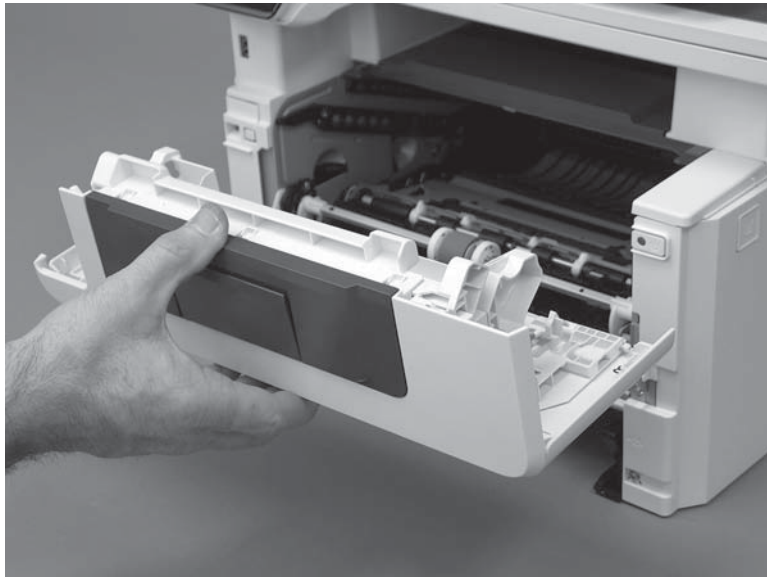

Step 3: Remove the left cover

1. Remove one screw (callout 1).

Figure 1-586 Remove one screw

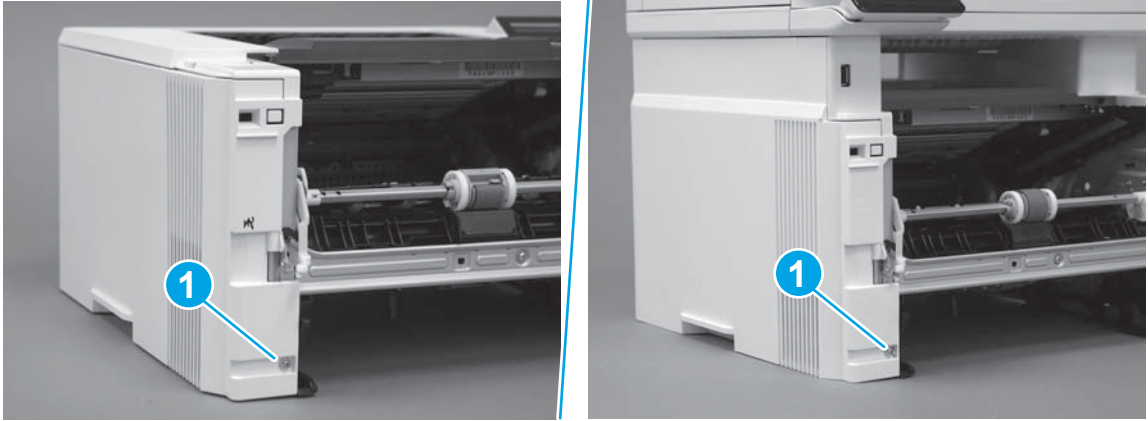

2. Open the rear door, release two bosses (callout 1), and then release three tabs (callout 2).

Figure 1-587 Release two bosses and three tabs

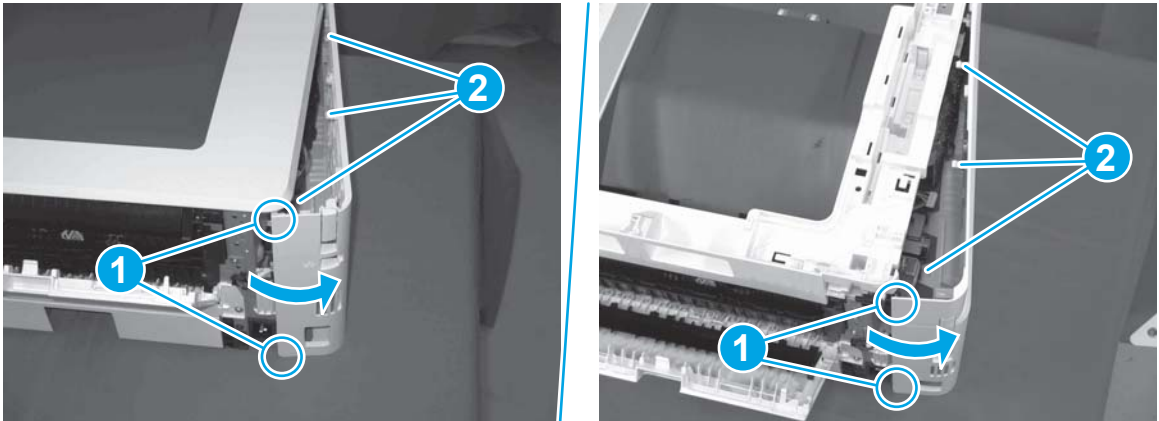

3. At the front of the printer, do one of the following:
 - **M304/M305/M404/M405:** Release two bosses (callout 1), and then remove the cover (callout 2).
 - **M329/M428/M429:** Release one tab (callout 3), two bosses (callout 4), and then remove the cover (callout 5).

CAUTION: Be careful when releasing the upper bosses on the M329/M428/M429 cover. One portion of the cover (callout 6) is fragile and is easily broken.

Figure 1-588 Remove the cover

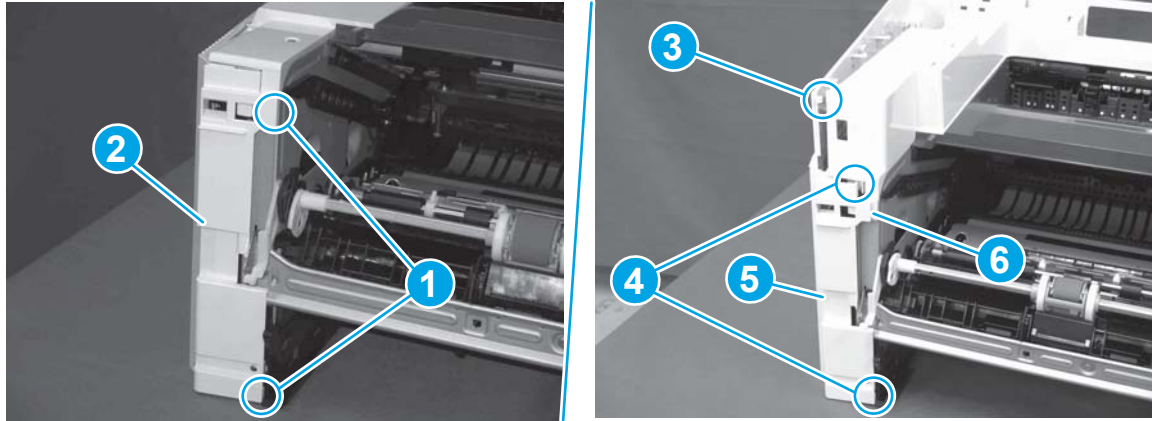

Step 4: Remove the right cover

1. At the front of the printer, release two bosses (callout 1), and then release three tabs (callout 2).

 **Reinstallation tip:** Remove, and then reinstall the cover if the switch or button does not correctly function.

Figure 1-589 Release two bosses and three tabs

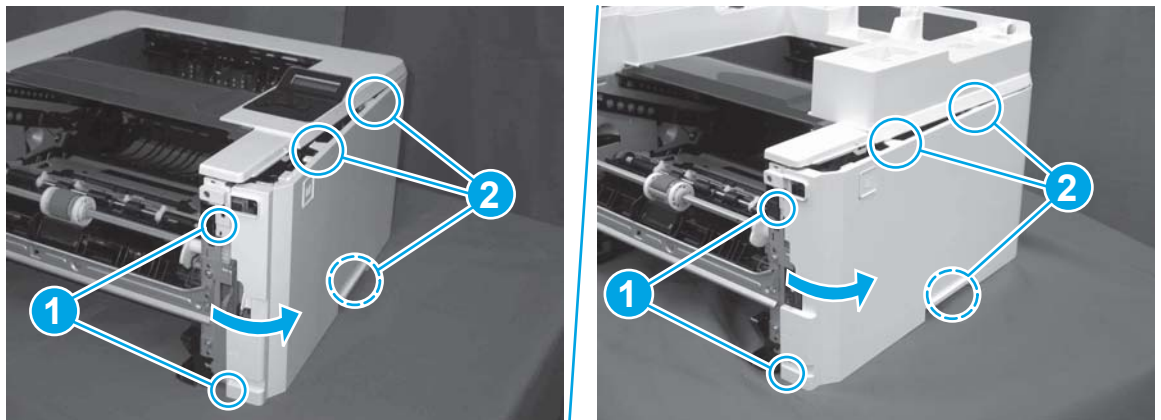

2. Open the rear door, release two bosses (callout 1), and then remove the cover (callout 2).

Figure 1-590 Remove the cover

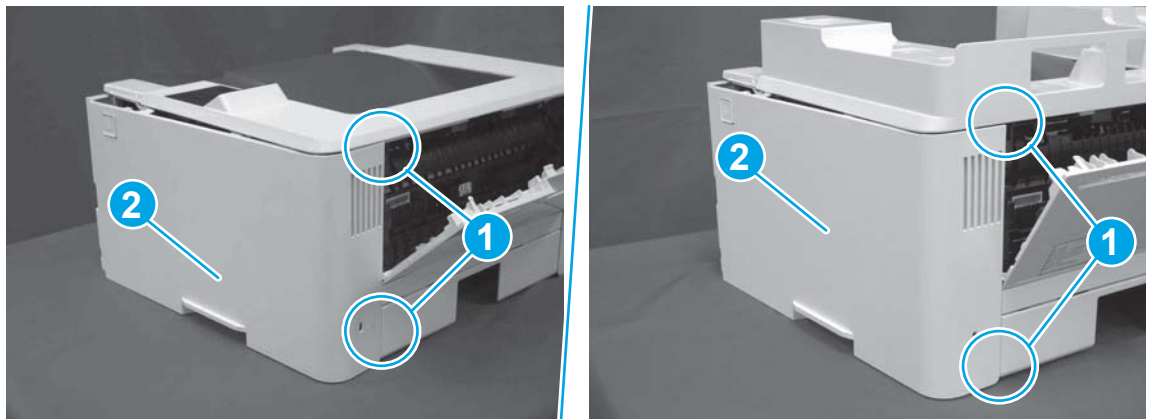

Step 5: Remove the top cover (M304/M305/M404/M405)

1. Remove one screw (callout 1).

Figure 1-591 Remove one screw



2. At the right side of the printer, release the one boss (callout 1), and then release one tab (callout 2).

Figure 1-592 Release one boss and one tab

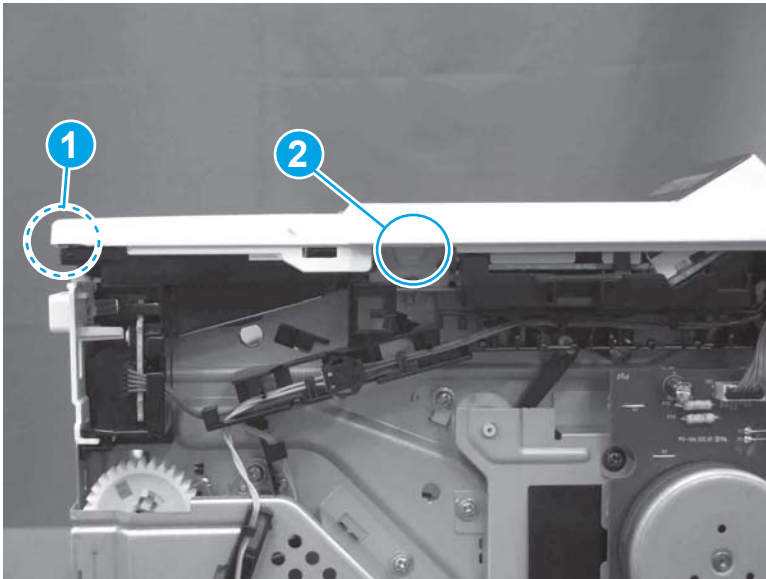

3. Release four tabs (callout 1), release four bosses (callout 2), and then remove the top cover (callout 3).



 **TIP:** Open the rear door to make releasing the bosses (callout 3) easier.

Figure 1-593 Remove the cover

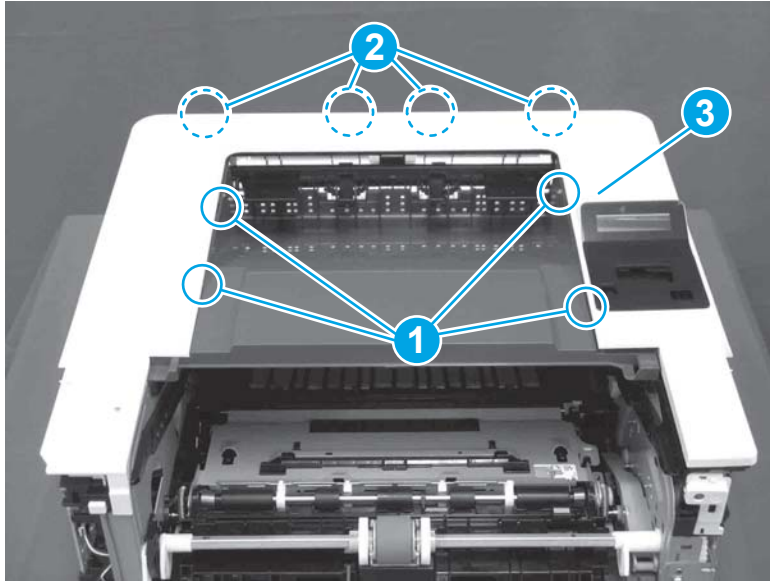

Step 6: Remove the paper delivery tray (output bin)

 **NOTE:** This procedure shows the M304/M305/M404/M405 model, however, the paper delivery tray (output bin) removal is similar for the M329/M428/M429 printer.

- ▲ Release two bosses (callout 1), release two tabs (callout 2), and then remove the paper delivery tray (output bin; callout 3).

Figure 1-594 Release two tabs

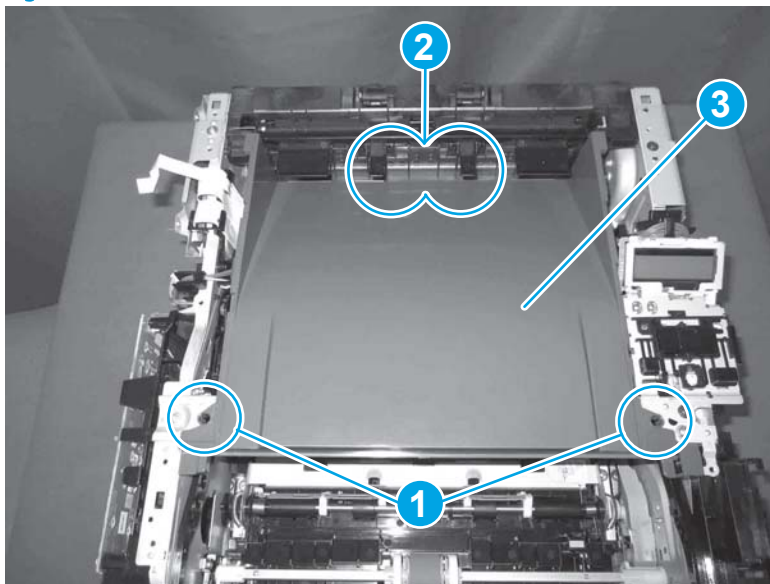

Step 7: Remove the control panel FFC

1. Disconnect the FFC from the control panel (callout 1).

Figure 1-595 Disconnect the FFC

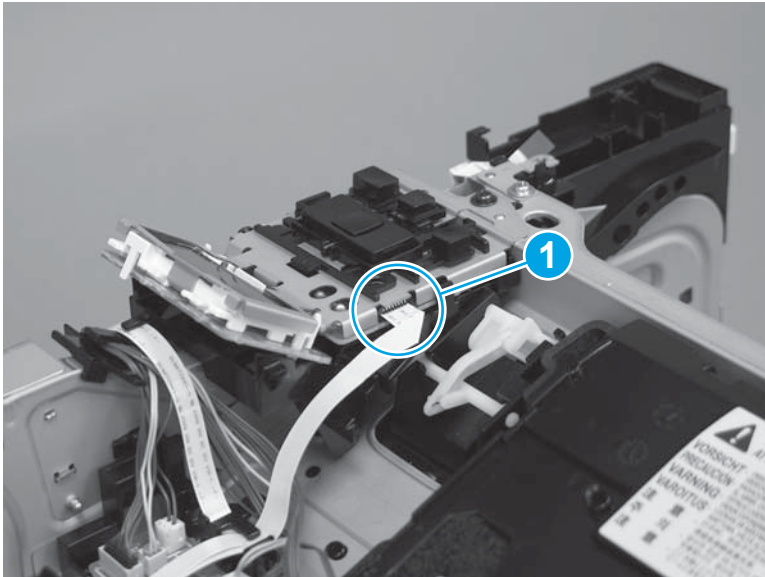

2. Release the FFC from the guide (callout 1).

Figure 1-596 Release the FFC from the guide

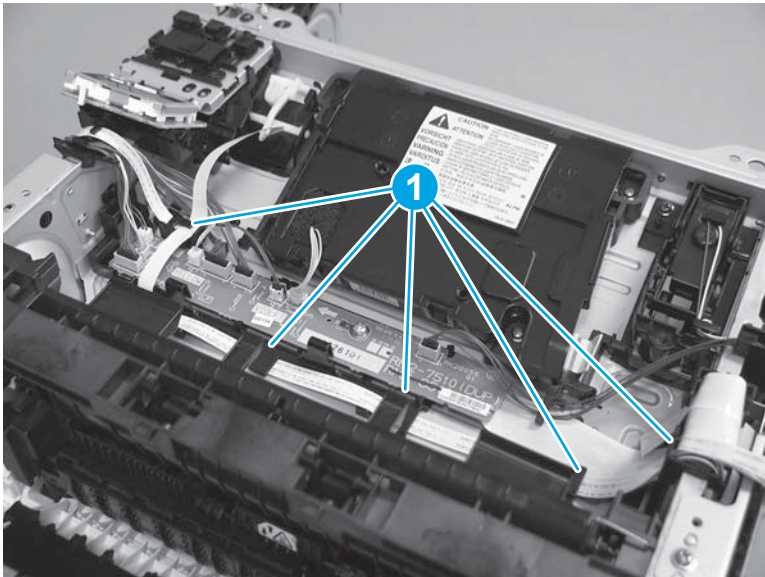

3. Disconnect one FFC (callout 1), and then remove the FFC.

Figure 1-597 Disconnect and remove the FFC

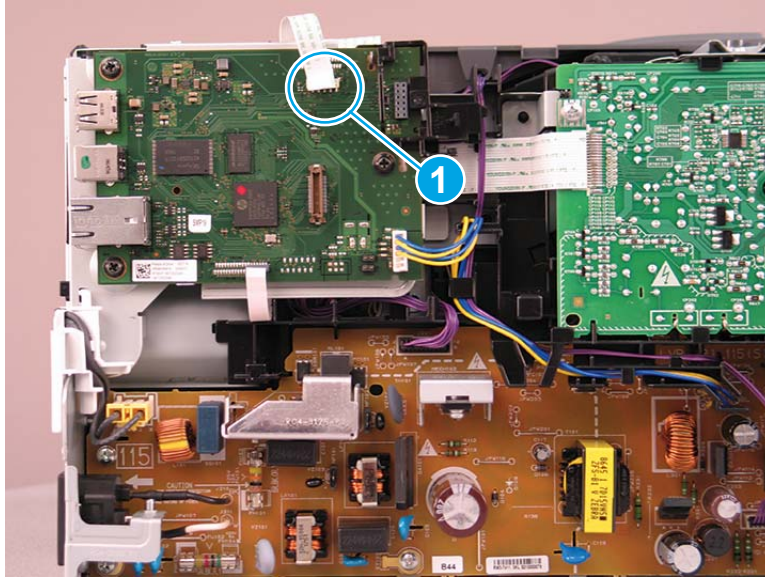

Step 8: Unpack the replacement assembly

1. Dispose of the defective part.



NOTE: HP recommends responsible disposal of the defective part.

<http://www8.hp.com/us/en/hp-information/environment/product-recycling.html>

2. Unpack the replacement part from the packaging.



CAUTION:  Some parts are sensitive to electrostatic discharge (ESD). Always perform service work at an ESD-protected workstation or mat. If an ESD workstation or mat is not available, touch the sheet-metal chassis to provide a static ground before touching an ESD-sensitive assembly. Protect the ESD-sensitive assemblies by placing them in ESD pouches when they are out of the printer.

If the replacement part is a roller or pad, avoid touching the spongy part of it. Skin oils on the roller or pad can cause paper pickup and/or print-quality problems. HP recommends using disposable gloves when handling rollers or pads or washing your hands before touching rollers or pads.



IMPORTANT: Make sure that all of the shipping materials (for example shipping tape) are removed from the replacement part prior to installation.

3. To install an assembly, reverse the removal steps.



NOTE: When applicable, special installation instructions are provided for an assembly at the end of the removal procedure. Always completely read the removal instructions and follow all special installation instructions.

Removal and replacement: Formatter FFC

- [Introduction](#)
- [Step 1: Remove Tray 2](#)
- [Step 2: Remove the cartridge door assembly](#)
- [Step 3: Remove the left cover](#)
- [Step 4: Remove the right cover](#)
- [Step 5: Remove the integrated scanner assembly \(M329/M428/M429\)](#)
- [Step 6: Remove the control panel \(M329/M428/M429\)](#)
- [Step 7: Remove the top cover \(M329/M428/M429\)](#)
- [Step 8: Remove the top cover \(M304/M305/M404/M405\)](#)
- [Step 9: Remove the sheet-metal formatter bracket and formatter PCA](#)
- [Step 10: Remove the formatter FFC](#)
- [Step 11: Unpack the replacement assembly](#)

Introduction

This document provides the procedures to remove and replace the formatter flat-flexible cable (FFC).

Before performing service

Turn the printer power off

- Disconnect the power cable.

 **WARNING!** To avoid damage to the printer, turn the printer off, wait 30 seconds, and then remove the power cable before attempting to service the printer.

Use the table below to identify the correct part number for your printer. To order the part, go to www.hp.com/buy/parts.

Formatter FFC part number	
RK2-6931-000CN	Formatter FFC (M329/M428/M429)
RK2-6920-000CN	Formatter FFC (M304/M305/M404/M405)

Required tools

- #2 Phillips screwdriver with a magnetic tip.
- 5.5 mm (0.22 inch) socket screwdriver.

After performing service

Turn the printer power on

- Connect the power cable.
- Use the power switch to turn the power on.

Post service test

Make sure that the printer initializes to a **Ready** state.

Print a configuration page to make sure that the printer is functioning correctly.

Step 1: Remove Tray 2

- ▲ Pull the tray straight out of the printer to remove it.

Figure 1-598 Remove the tray



Step 2: Remove the cartridge door assembly

 **NOTE:** If the toner cartridge was not removed prior to servicing the printer, remove it now.

1. Release the support shaft (callout 1), and then slide it toward the center of the door (callout 2).

 **TIP:** It might be easier to release the support shaft by using a small flat-blade screwdriver.

Figure 1-599 Release the support shaft

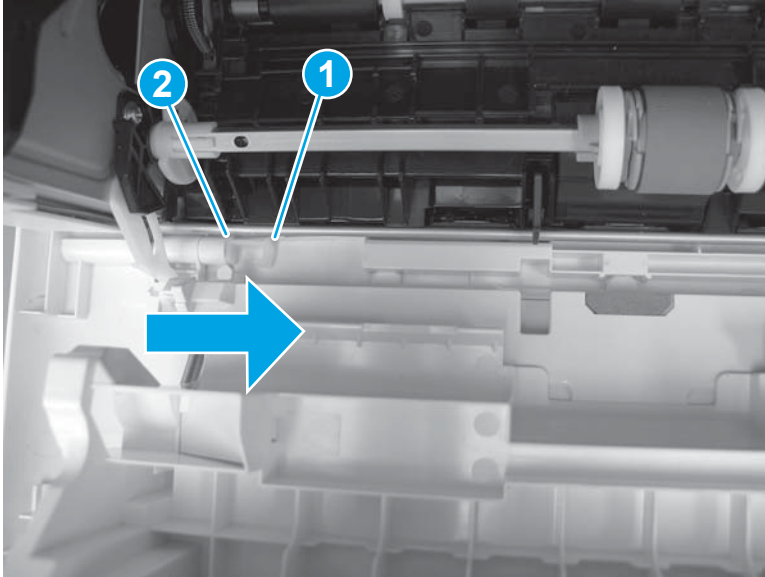

2. Remove the support shaft.

Figure 1-600 Remove the support shaft

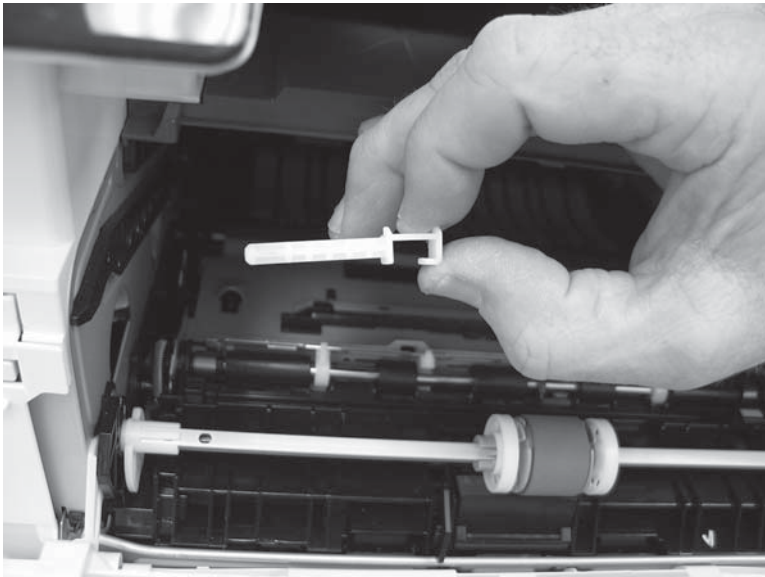

3. Release one tab (callout 1), and then slide the guide out of the printer (callout 2).

CAUTION: Be careful, the tab (callout 1) can be easily broken.

Figure 1-601 Remove the guide

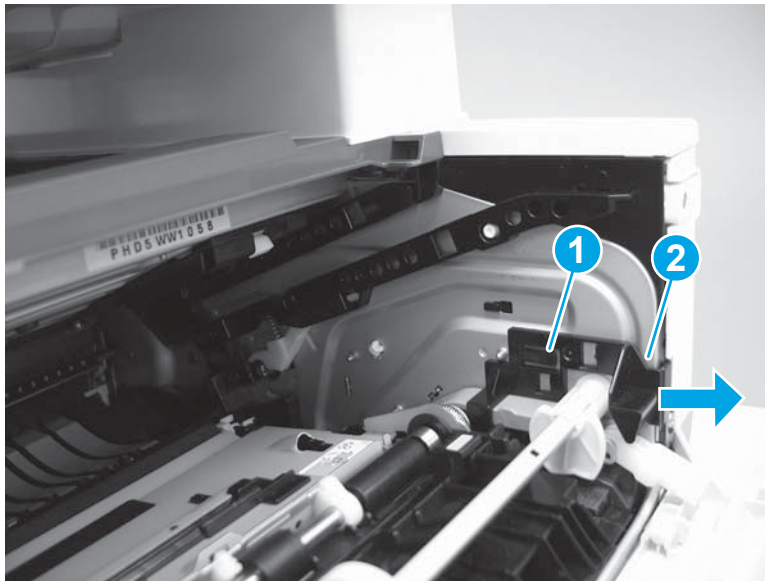

4. Use a small flat-blade screwdriver to gently pry the white-plastic door arm (callout 1) off of the gray-plastic pressure-release link (callout 2) to release the door arm.

Figure 1-602 Release the pressure-release link

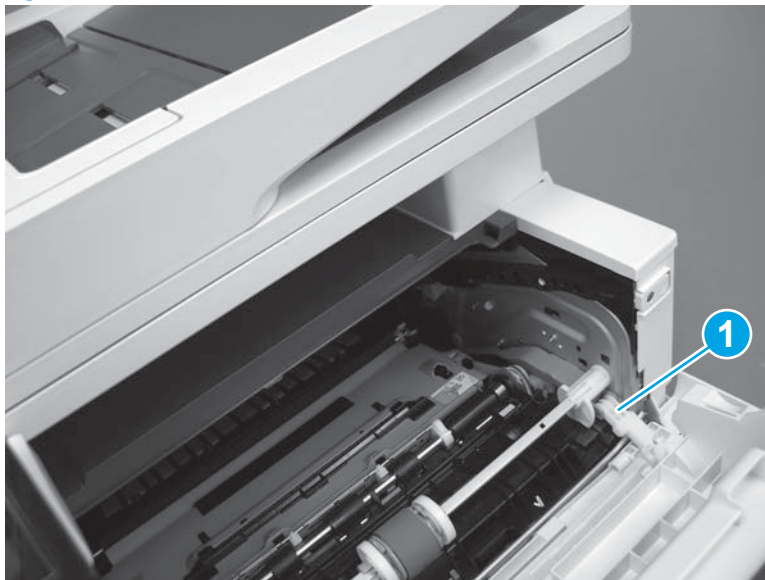

5. With the door in the partially closed position, slightly raise the left end (callout 1; raise it over the sheet-metal hinge boss), and then slide the door to the left (callout 2) to release the right hinge (callout 3).

⚠ CAUTION: The door is still attached to the printer by the left-side retainer arm. Do not attempt to completely remove the door.

💡 Reinstallation tip: When reinstalling the door, there are two right-side hinge pins (not shown in callout 3). Keep a finger pressed on the left-side retainer arm so that it does not disengage from the door.

Figure 1-603 Release the door

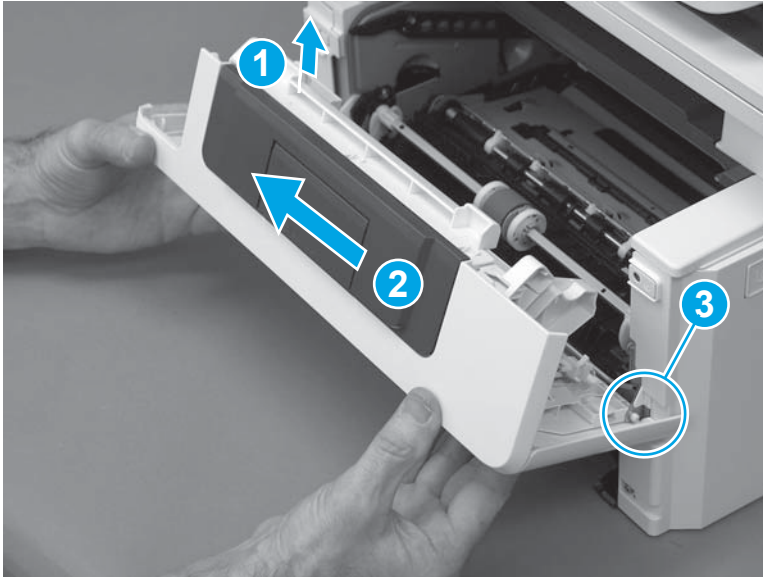

6. Rotate the door away from the printer until the keyed pin on the left-side retainer arm can disengage from the door.

Figure 1-604 Release the left-side retainer arm

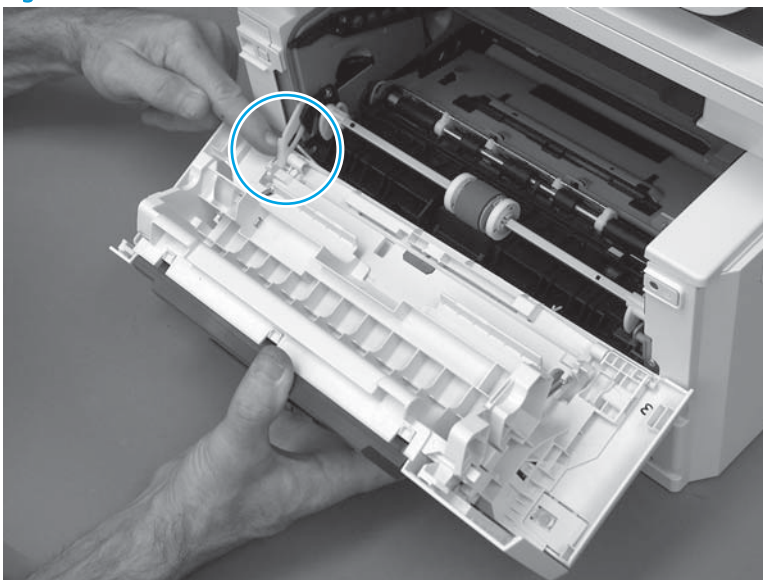

7. Remove the door.

Figure 1-605 Remove the door

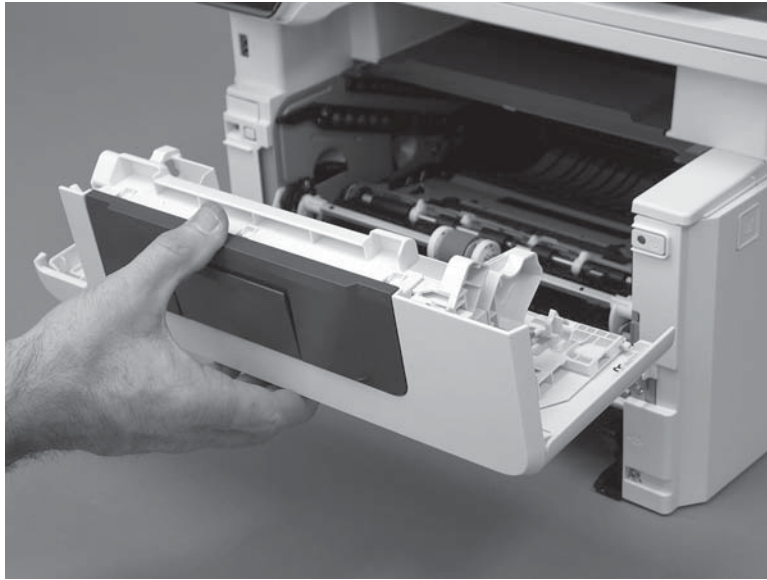

Step 3: Remove the left cover

1. Remove one screw (callout 1).

Figure 1-606 Remove one screw

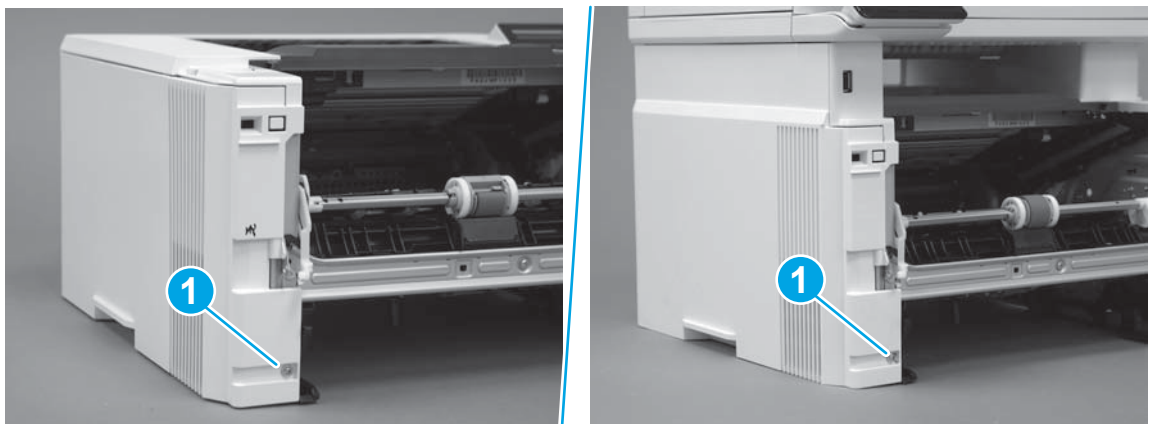

2. Open the rear door, release two bosses (callout 1), and then release three tabs (callout 2).

Figure 1-607 Release two bosses and three tabs

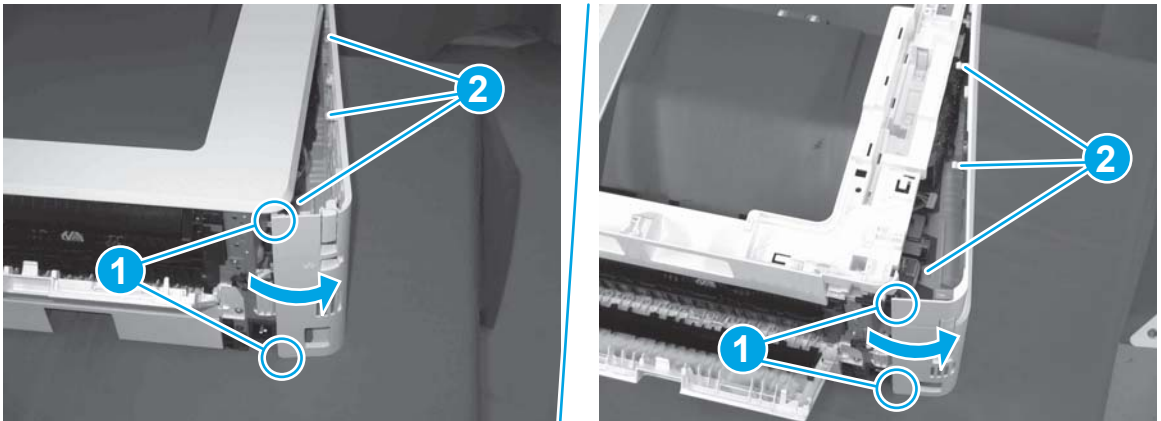

3. At the front of the printer, do one of the following:
 - **M304/M305/M404/M405:** Release two bosses (callout 1), and then remove the cover (callout 2).
 - **M329/M428/M429:** Release one tab (callout 3), two bosses (callout 4), and then remove the cover (callout 5).

CAUTION: Be careful when releasing the upper bosses on the M329/M428/M429 cover. One portion of the cover (callout 6) is fragile and is easily broken.

Figure 1-608 Remove the cover

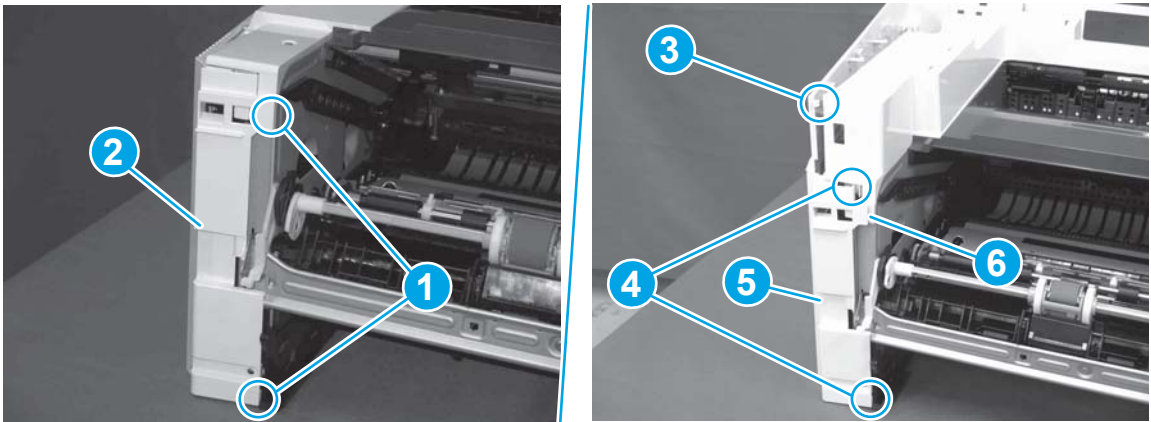

Step 4: Remove the right cover

1. At the front of the printer, release two bosses (callout 1), and then release three tabs (callout 2).

Reinstallation tip: Remove, and then reinstall the cover if the switch or button does not correctly function.

Figure 1-609 Release two bosses and three tabs

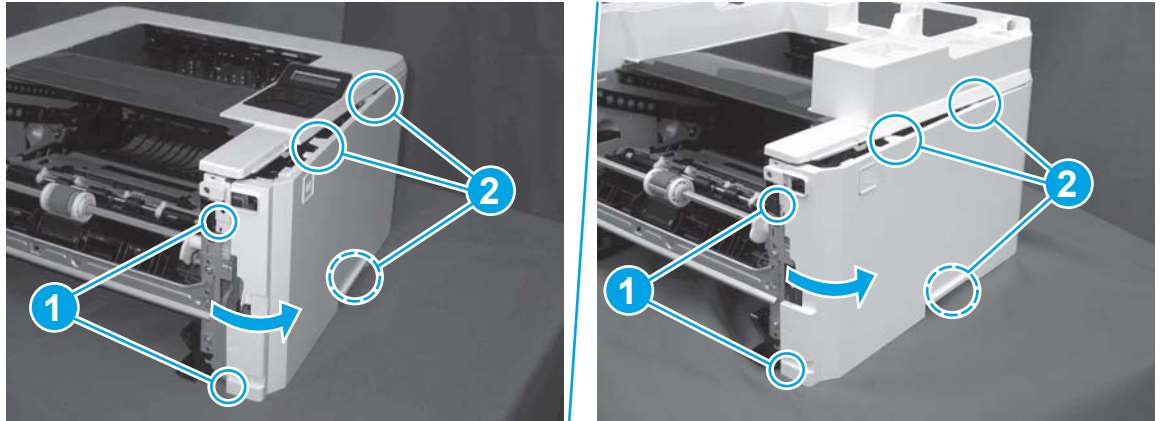

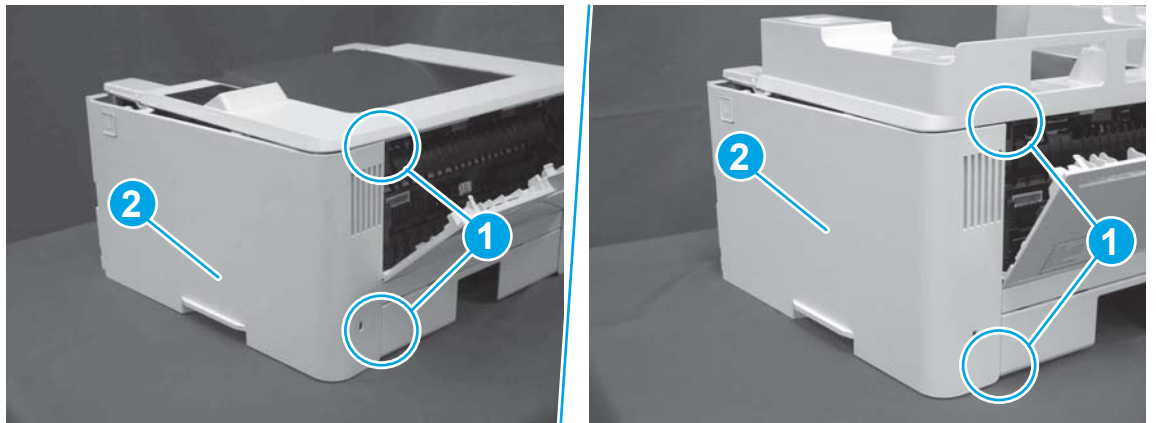

2. Open the rear door, release two bosses (callout 1), and then remove the cover (callout 2).

Figure 1-610 Remove the cover



Step 5: Remove the integrated scanner assembly (M329/M428/M429)

 **NOTE:** The step is for the M329/M428/M429 printer. For the M304/M305/M404/M405, skip this step and go to [Step 8: Remove the top cover \(M304/M305/M404/M405\) on page 390.](#)

 **NOTE:** M329/M428/M429 models only. The integrated scanner assembly (ISA) includes the sub-scanner assembly (SSA) and the automatic document feeder (ADF).

1. Raise the ISA.

Figure 1-611 Raise the ISA

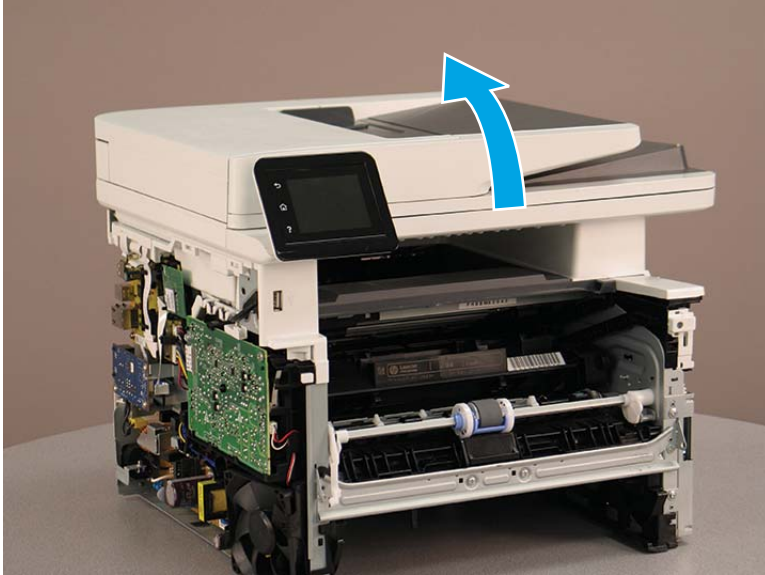

2. Release the ISA flat-flexible cable (FFC) cover (callout 1), and then remove it (callout 2).

Figure 1-612 Remove the ISA FFC cover

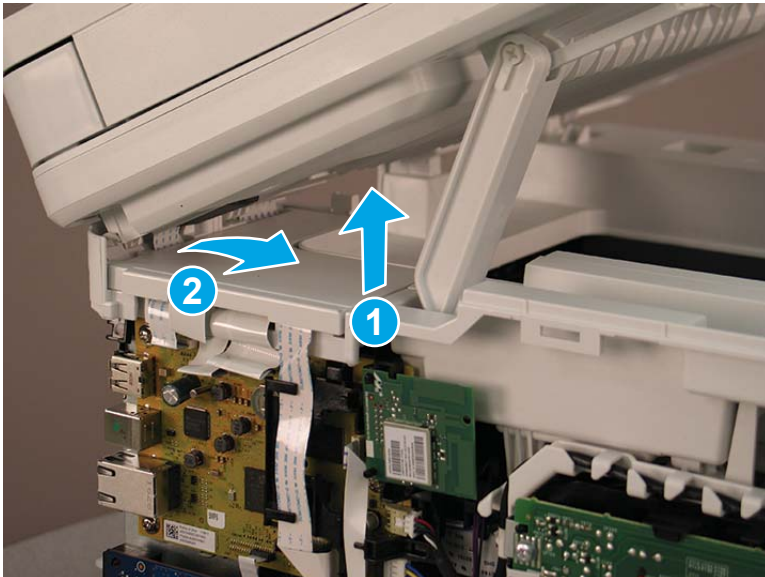

3. Disconnect three FFCs (callout 1), and then remove the ferrite (callout 2) from the holder.

CAUTION: The ferrite is not captive on the FFC. Do not lose the ferrite while handling the ISA.

Figure 1-613 Disconnect three FFCs

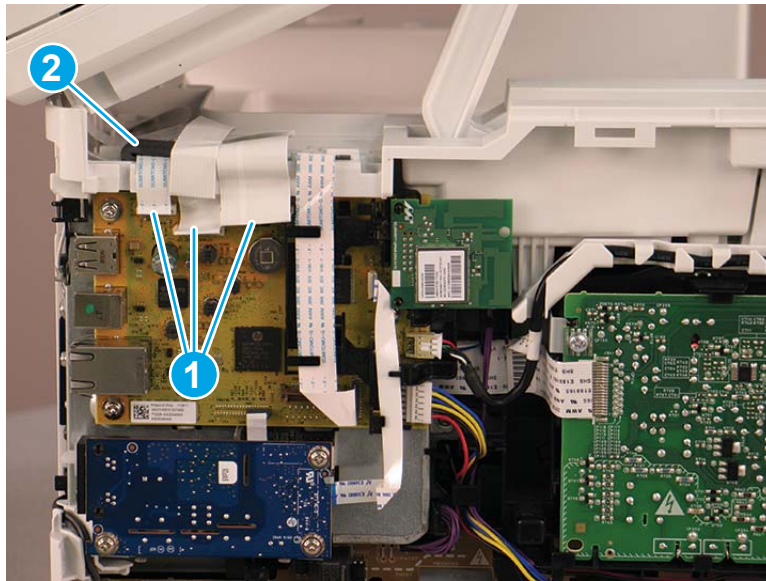

4. Remove one screw (callout 1).

Figure 1-614 Remove one screw

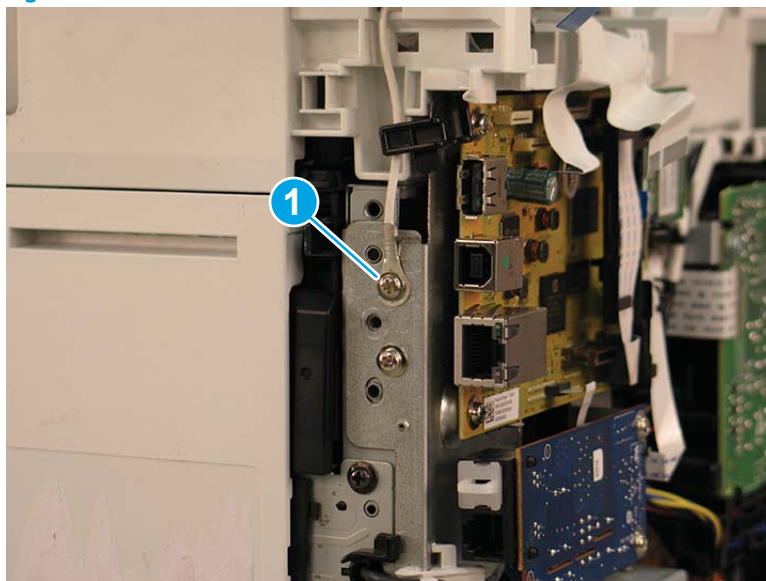

5. Pass the ground wire through the opening in the top cover.

Figure 1-615 Pass the wire through the opening

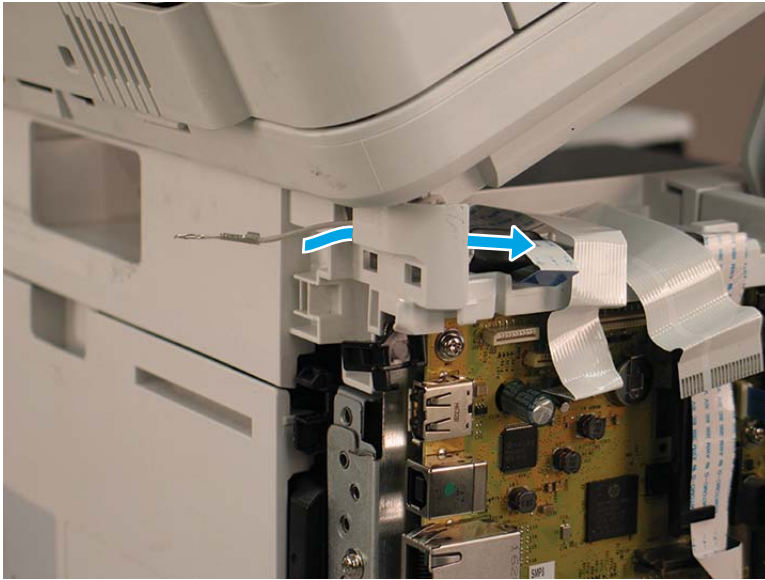

6. Release one tab (callout 1), and then rotate the ISA slider pin (callout 2) towards the front of the printer to release it.

Figure 1-616 Release one tab and rotate the slider pin

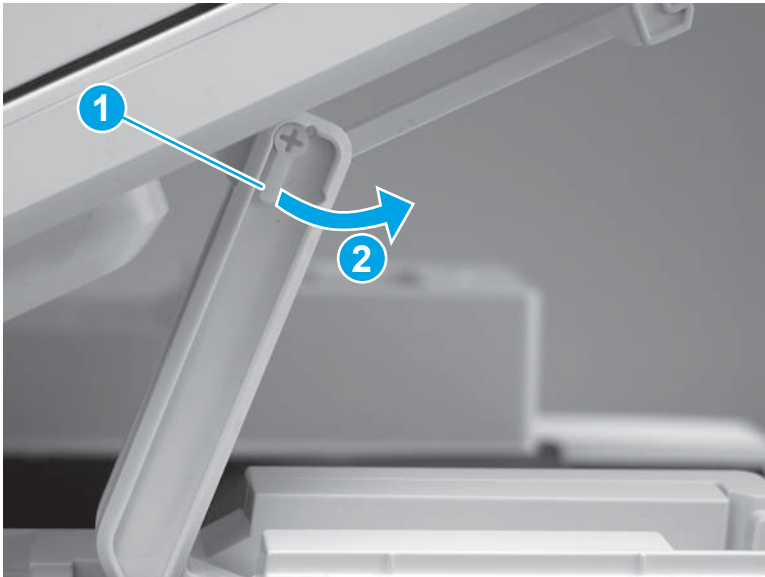

7. Remove the slider pin.

 **Reinstallation tip:** Align the keyed portion of the locking pin with the slot and hole in the support arm.

Figure 1-617 Remove the slider pin



8. Rotate the ISA towards the rear of the printer until it stops.

Figure 1-618 Rotate the ISA towards the rear of the printer

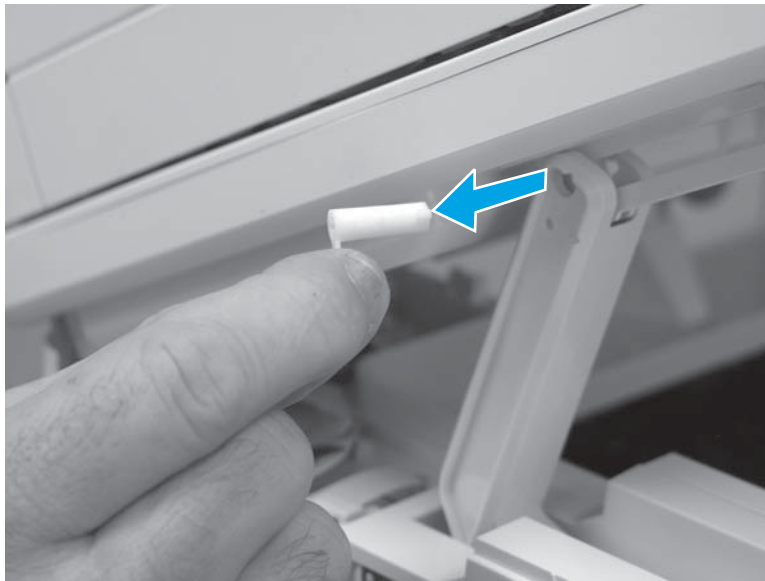
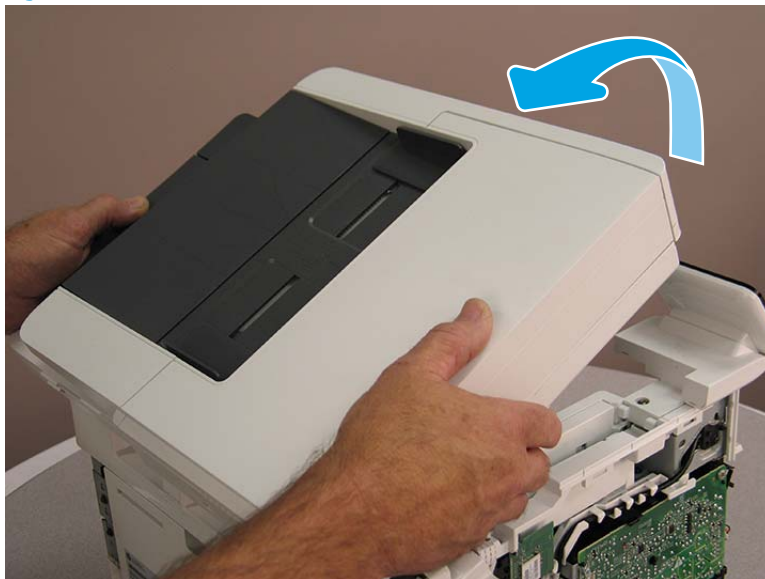

- Slide the ISA as shown to release it.

Figure 1-619 Release the ISA

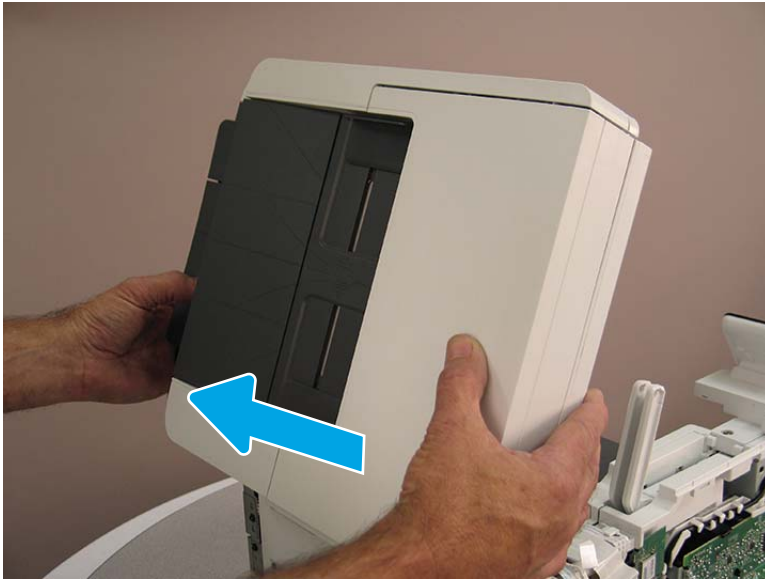

- Remove the ISA.

Figure 1-620 Remove the ISA

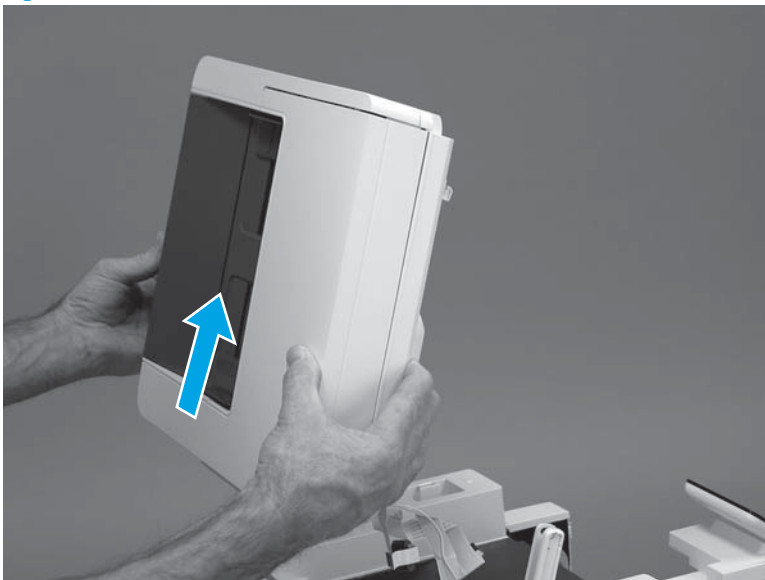

Step 6: Remove the control panel (M329/M428/M429)

 **NOTE:** The step is for the M329/M428/M429 printer. For the M304/M305/M404/M405, skip this step and go to [Step 8: Remove the top cover \(M304/M305/M404/M405\) on page 390.](#)

- Disconnect one FFC (callout 1), and then release the FFC from the guide (callout 2).

Figure 1-621 Disconnect one connector

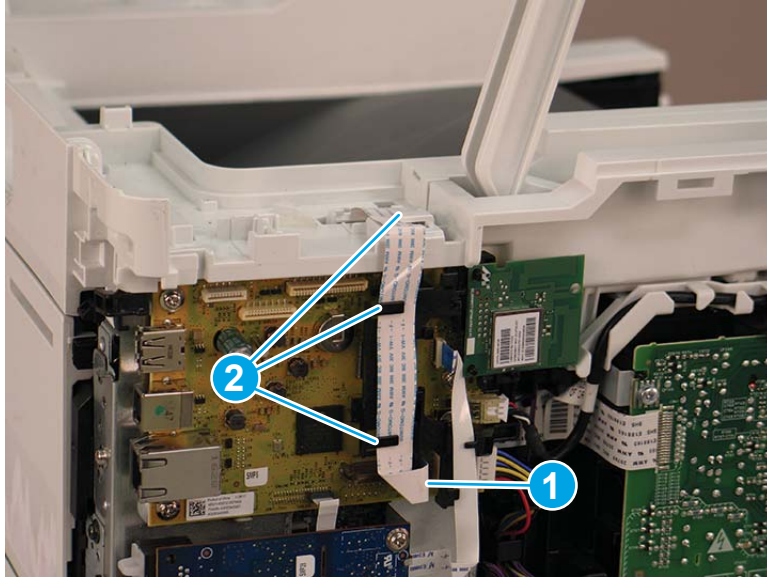

2. Remove one screw (callout 1).

Figure 1-622 Remove one screw

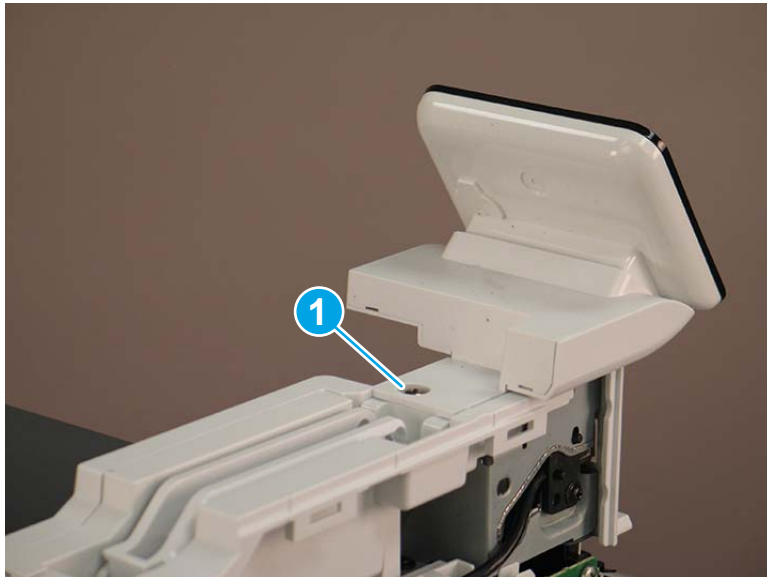

3. Use a small flat-blade screwdriver to release two tabs (callout 1) on the control-panel cable cover.

Figure 1-623 Release two tabs

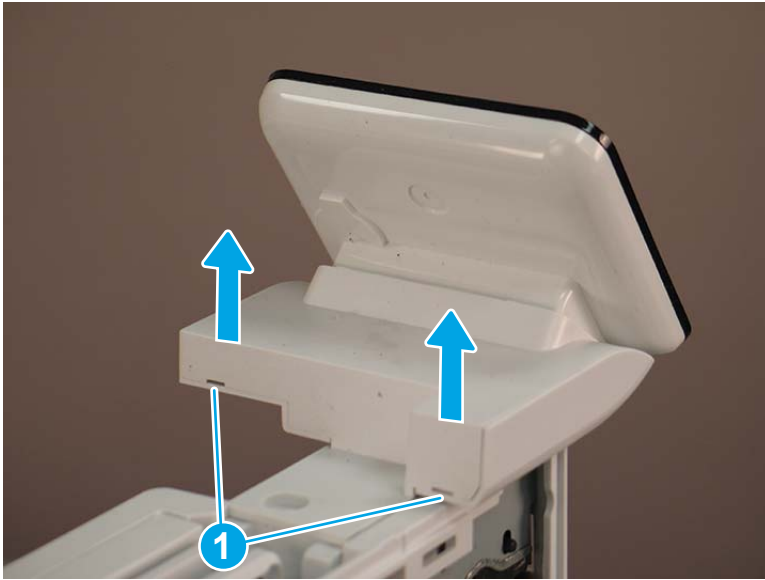

4. Remove the control-panel cable cover.

Figure 1-624 Remove the cover



5. Remove one grounding screw (callout 1), and then move the ground cable (callout 2) out of the way.

Figure 1-625 Remove one screw

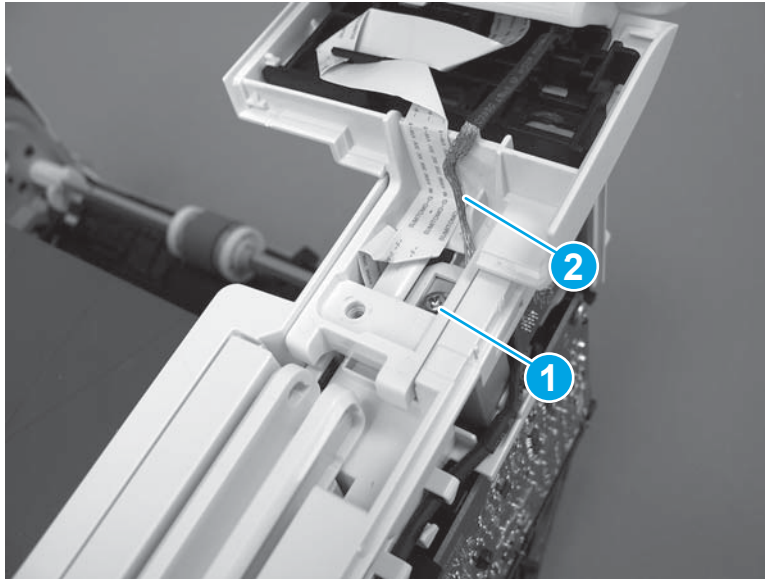

6. Move the FFC out of the way, and then remove two screws (callout 1).

Figure 1-626 Remove two screws



7. Slightly lift up the control-panel assembly to separate it from the top cover.

⚠ CAUTION: The control panel assembly is still connected to the printer by the FFC. Do not attempt to completely remove the assembly.

Figure 1-627 Lift up the control-panel assembly



8. Lift up the control-panel FFC cover to remove the control-panel assembly.

Figure 1-628 Remove the control-panel assembly

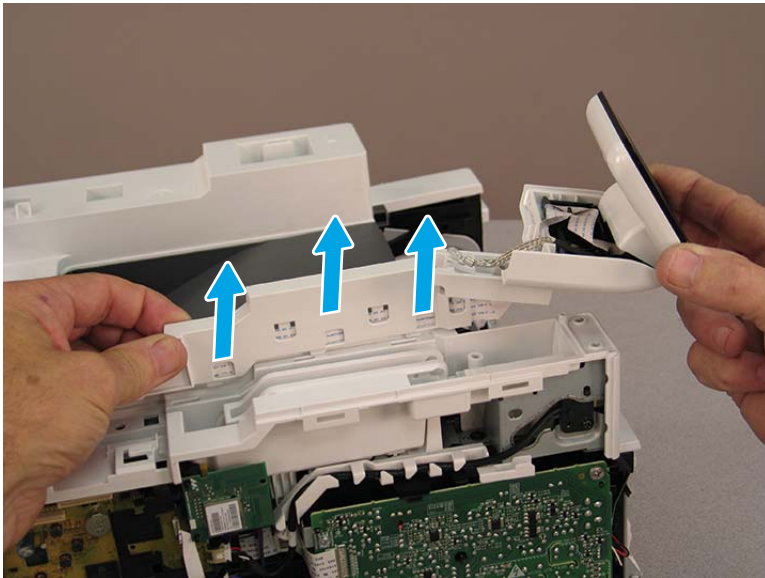

Step 7: Remove the top cover (M329/M428/M429)

📝 NOTE: The step is for the M329/M428/M429 printer. For the M304/M305/M404/M405, skip this step and go to [Step 8: Remove the top cover \(M304/M305/M404/M405\) on page 390](#).

1. Release the USB cable (callout 1) from the cable guide.

Figure 1-629 Remove the USB cable

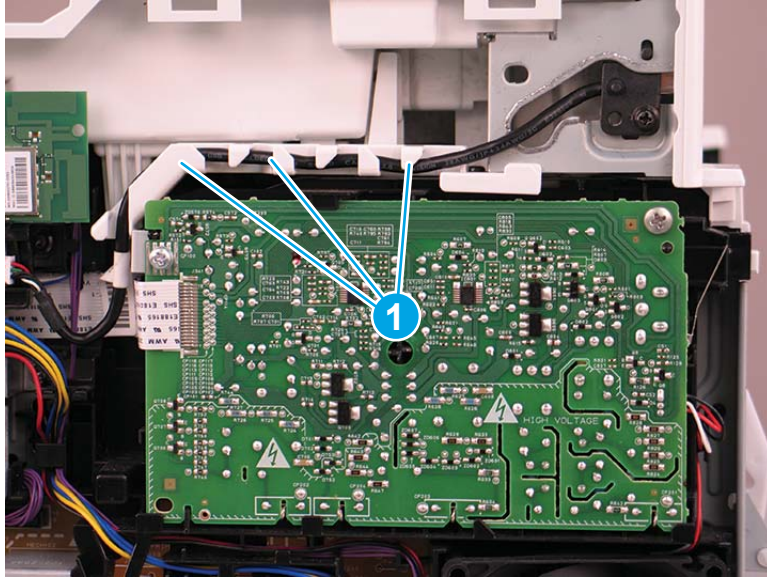

2. Remove one screw (callout 1), and then remove the support arm (callout 2).

⚠ CAUTION: The support arm is spring loaded and can unexpectedly spring into the open position. To avoid injury, do not place a finger in the screw well when the support arm is in the closed position.

Figure 1-630 Remove the support arm

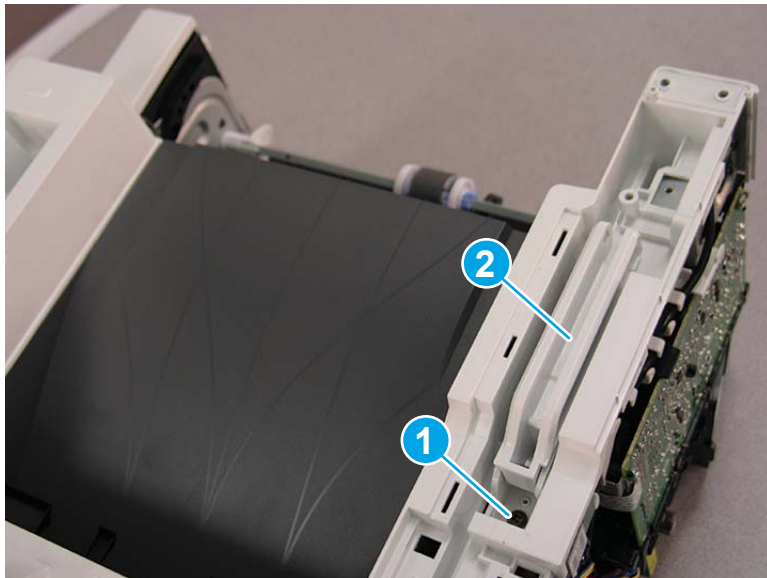

3. Remove five screws (callout 1), release four bosses (callout 2), and then remove the top cover (callout 3).

Figure 1-631 Remove the cover

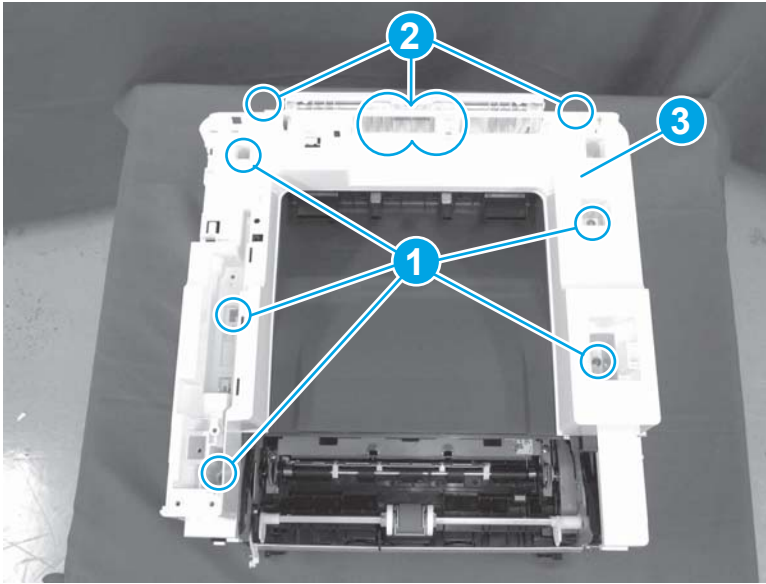

Step 8: Remove the top cover (M304/M305/M404/M405)

 **NOTE:** The step is for the M304/M305/M404/M405 printer. For the M329/M428/M429, skip this step and go to [Step 9: Remove the sheet-metal formatter bracket and formatter PCA on page 391.](#)

1. Remove one screw (callout 1).

Figure 1-632 Remove one screw



2. At the right side of the printer, release the one boss (callout 1), and then release one tab (callout 2).

Figure 1-633 Release one boss and one tab

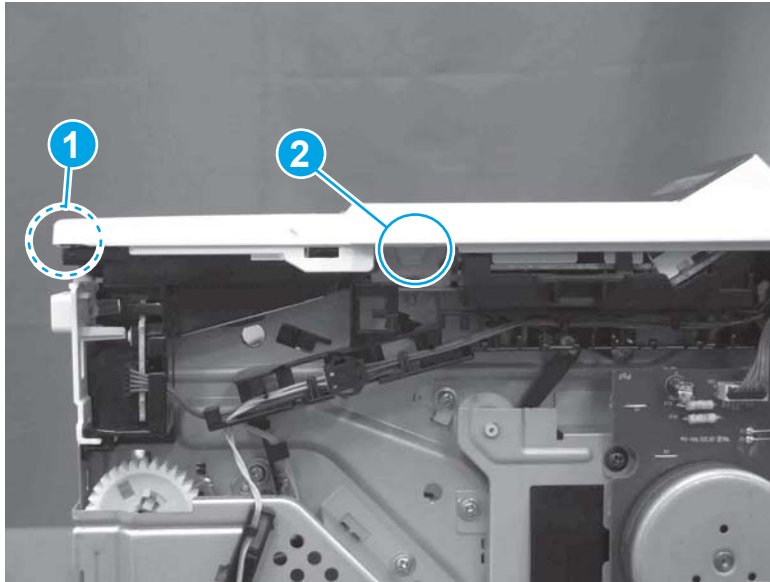

3. Release four tabs (callout 1), release four bosses (callout 2), and then remove the top cover (callout 3).

 **TIP:** Open the rear door to make releasing the bosses (callout 3) easier.

Figure 1-634 Remove the cover

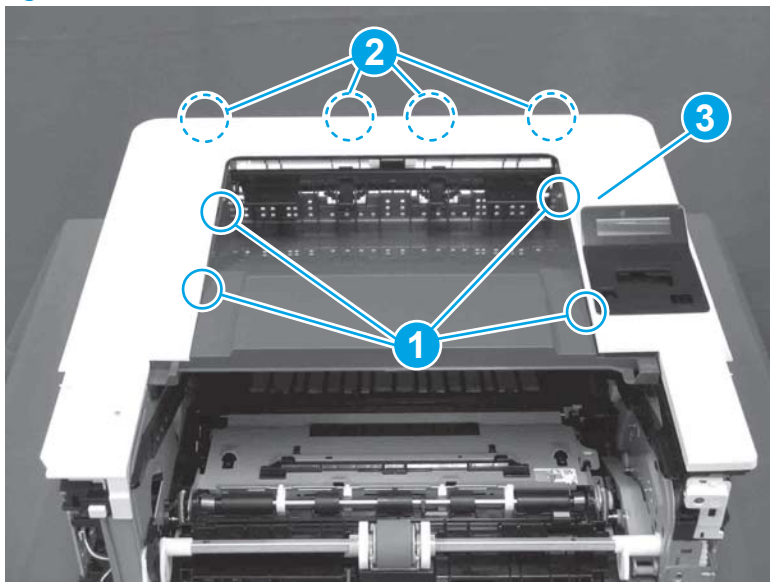

Step 9: Remove the sheet-metal formatter bracket and formatter PCA

1. Do one of the following:
 - **SFP only:** Release two tabs (callout 1), and then carefully pull the wireless PCA straight off of the formatter PCA to remove it.

 **NOTE:** Disconnect the WiFi antenna (callout 2) before releasing the tabs.

- **MFP only:** Release one tab (callout 3), and then carefully pull the wireless PCA straight off of the formatter PCA to remove it.

 **TIP:** Push the tab to the left to release it.

Figure 1-635 Remove the wireless PCA



2. Do one of the following:

- **SFP only:** Disconnect the connectors (callout 1), and then release one wire harness (callout 2) from the guide.
- **MFP only:** Disconnect the connectors (callout 1), and then release one wire harness and one FFC (callout 2) from the guides.

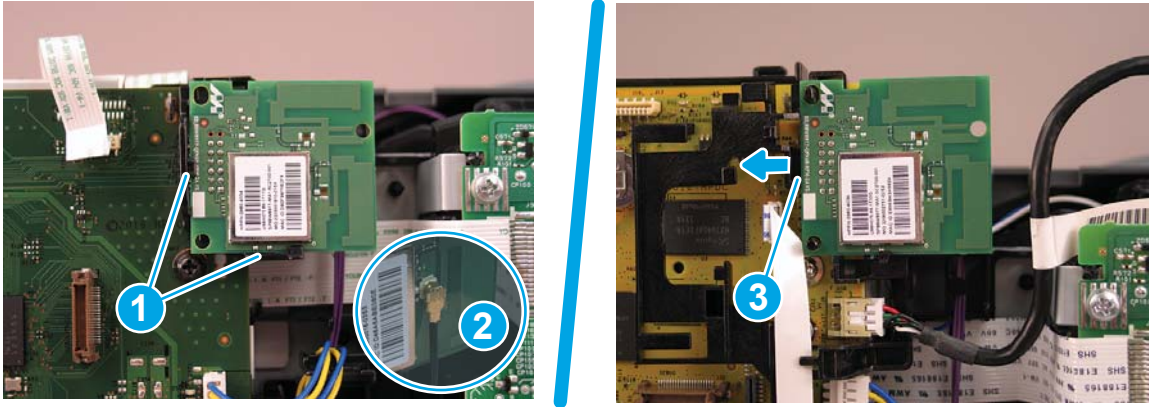
Figure 1-636 Disconnect the connectors

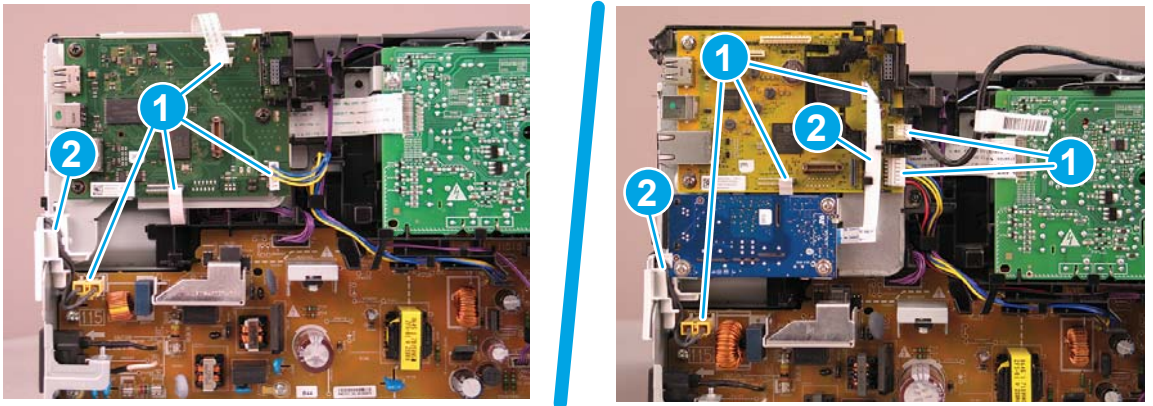

3. **MFP only:** Remove three screws (callout 1), and then remove the fax PCA.

Figure 1-637 Remove the fax PCA

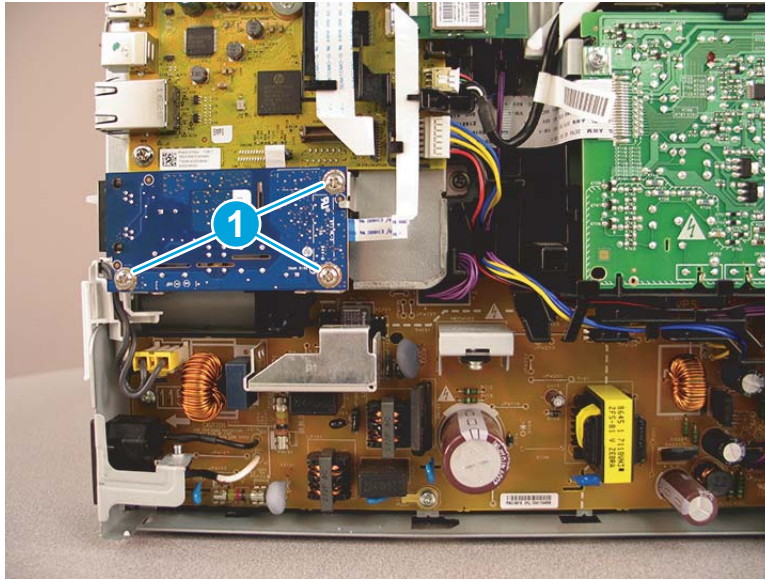

4. **MFP only:** Release the FFC from the guide (callout 1), release one tab (callout 2), and then remove the FFC guide (callout 3).

Figure 1-638 Remove the FFC guide

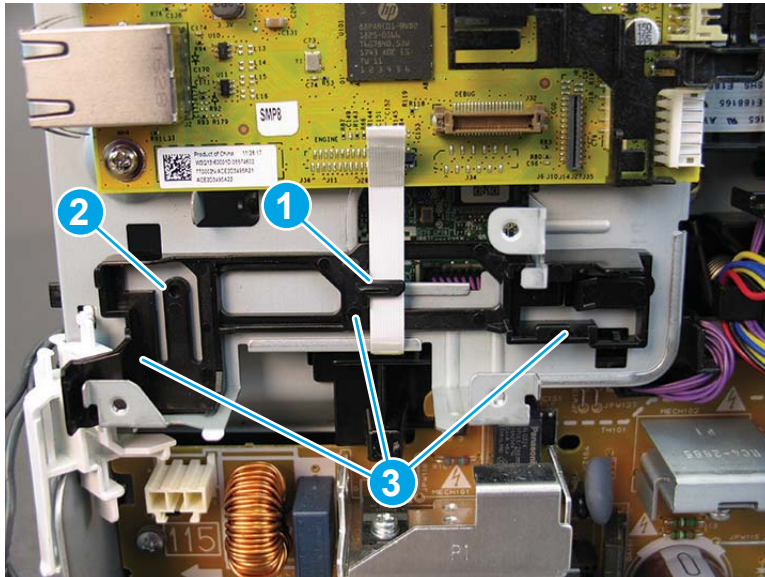

5. Remove one guide.

 **NOTE:** A SFP printer is shown in the figure. However, the guide is identical for an MFP printer.

Figure 1-639 Remove the guide



6. Remove two screws.

Figure 1-640 Remove two screws

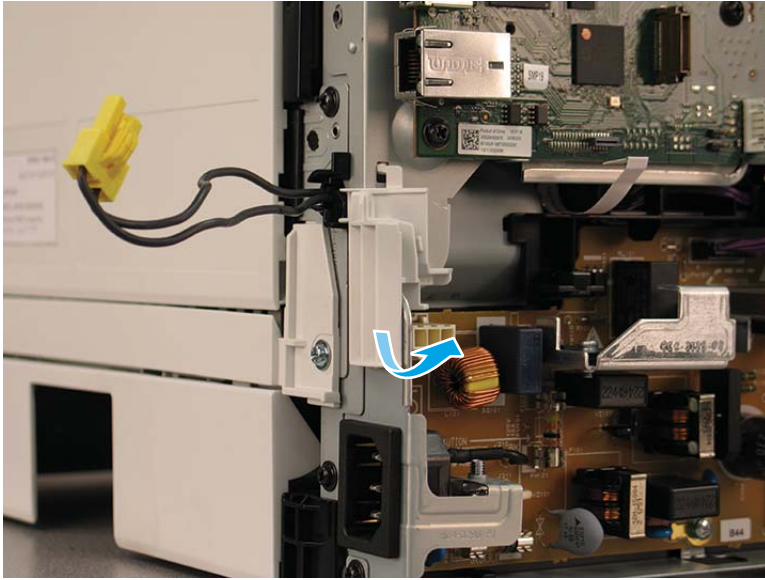

7. MFP only: Remove one screw.

Figure 1-641 Remove one screw

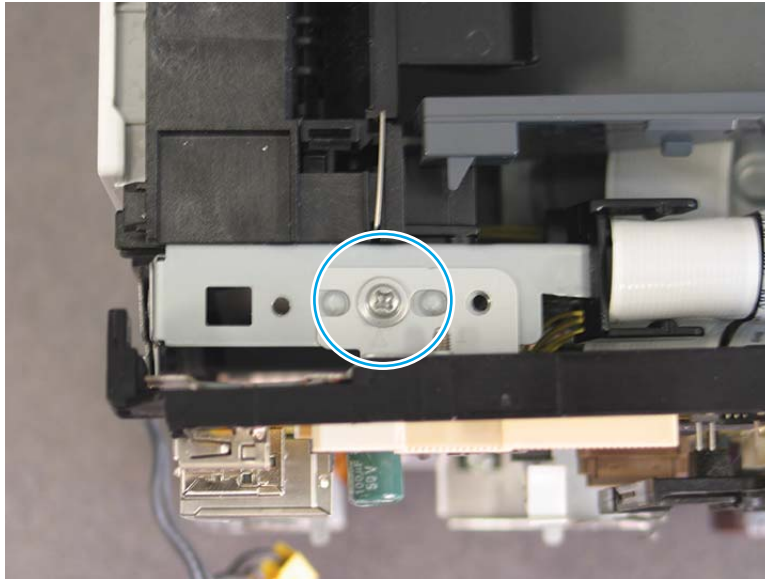

8. Support the formatter and bracket, and then remove two screws.

Figure 1-642 Remove two screws

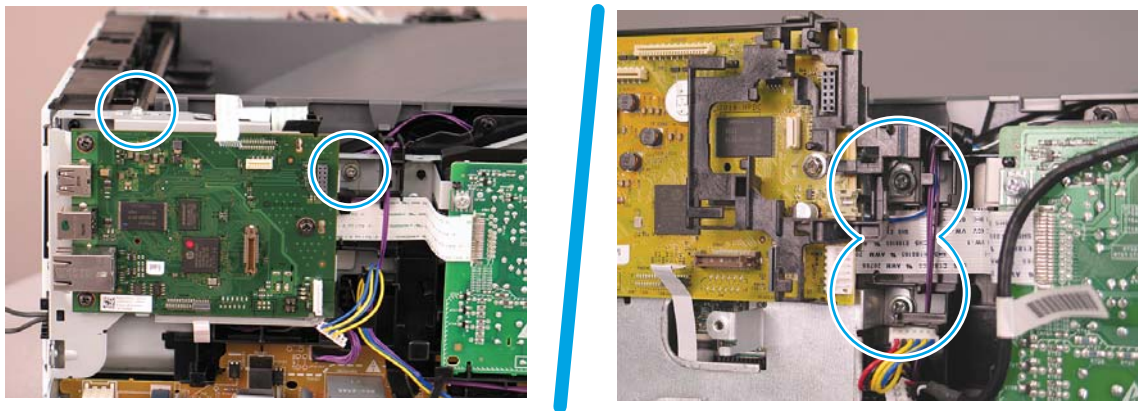

9. Remove the sheet-metal bracket and formatter PCA.

Figure 1-643 Remove the bracket

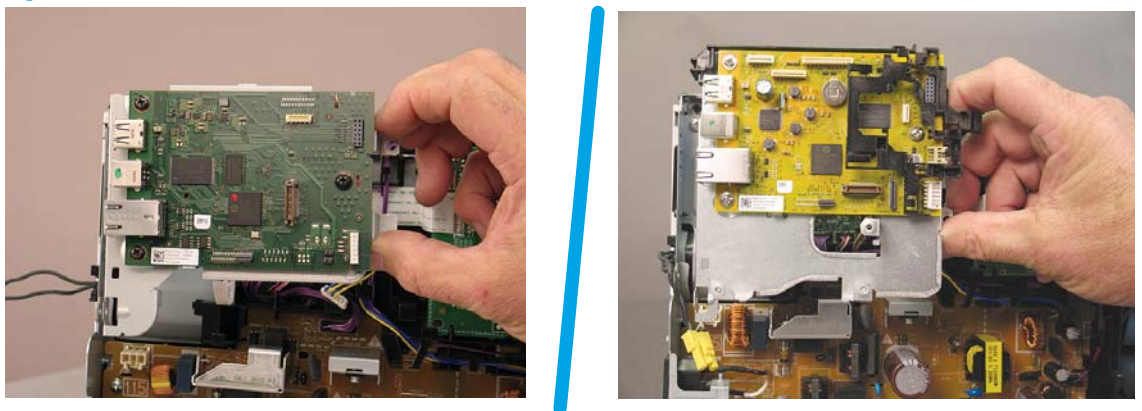

Step 10: Remove the formatter FFC

1. Carefully pull up on the FFC (callout 1) to release it from the guide—the FFC is attached to the guide with two-sided tape.

⚠ CAUTION: The FFC is still attached to the DC controller. Do not attempt to completely remove the FFC.

Figure 1-644 Release the FFC

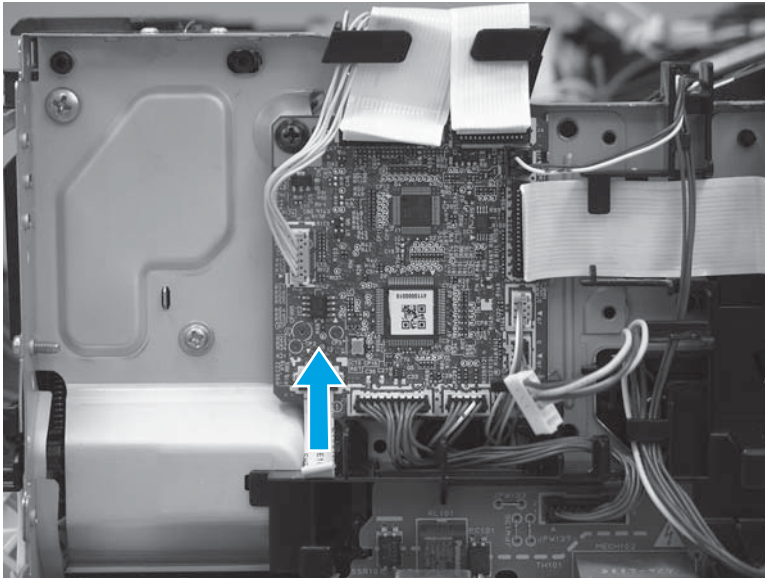

2. Disconnect the formatter FFC (callout 1).

📄 IMPORTANT: The FFC connector (callout 2) is a Zero Insertion Force (ZIF) connector that uses a hinged retainer to secure the FFC. The hinged retainer must be opened to release the FFC.

Figure 1-645 Disconnect the FFC

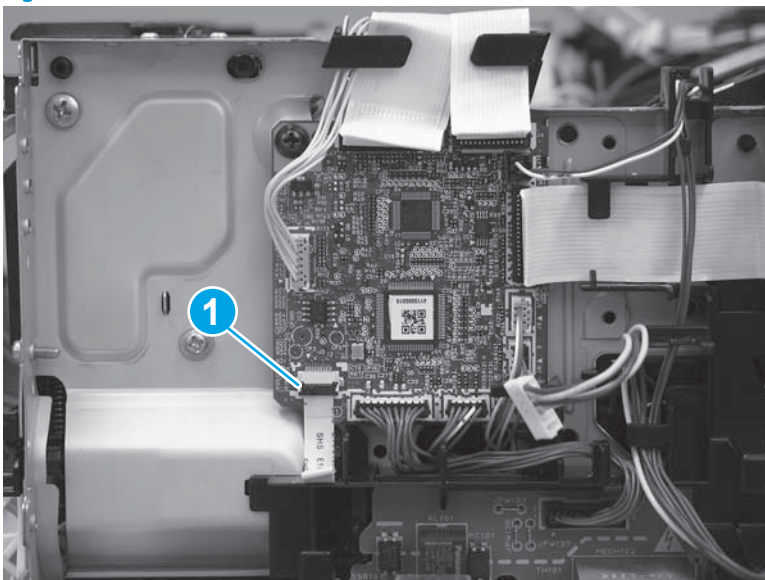



Step 11: Unpack the replacement assembly

1. Dispose of the defective part.

 **NOTE:** HP recommends responsible disposal of the defective part.

<http://www8.hp.com/us/en/hp-information/environment/product-recycling.html>

2. Unpack the replacement part from the packaging.

 **CAUTION:**  Some parts are sensitive to electrostatic discharge (ESD). Always perform service work at an ESD-protected workstation or mat. If an ESD workstation or mat is not available, touch the sheet-metal chassis to provide a static ground before touching an ESD-sensitive assembly. Protect the ESD-sensitive assemblies by placing them in ESD pouches when they are out of the printer.

If the replacement part is a roller or pad, avoid touching the spongy part of it. Skin oils on the roller or pad can cause paper pickup and/or print-quality problems. HP recommends using disposable gloves when handling rollers or pads or washing your hands before touching rollers or pads.

 **IMPORTANT:** Make sure that all of the shipping materials (for example shipping tape) are removed from the replacement part prior to installation.

3. To install an assembly, reverse the removal steps.

 **NOTE:** When applicable, special installation instructions are provided for an assembly at the end of the removal procedure. Always completely read the removal instructions and follow all special installation instructions.

Removal and replacement: DC controller

- [Introduction](#)
- [Step 1: Remove Tray 2](#)
- [Step 2: Remove the cartridge door assembly](#)
- [Step 3: Remove the left cover](#)
- [Step 4: Remove the right cover](#)
- [Step 5: Remove the rear door assembly](#)
- [Step 6: Remove the integrated scanner assembly \(M329/M428/M429\)](#)
- [Step 7: Remove the control panel \(M329/M428/M429\)](#)
- [Step 8: Remove the top cover \(M329/M428/M429\)](#)
- [Step 9: Remove the top cover \(M304/M305/M404/M405\)](#)
- [Step 10: Remove the paper delivery tray \(output bin\)](#)
- [Step 11: Remove the sheet-metal formatter bracket and formatter PCA](#)
- [Step 12: Remove the DC controller](#)
- [Step 13: Unpack the replacement assembly](#)

Introduction

This document provides the procedures to remove and replace the DC controller.

Before performing service

Turn the printer power off

- Disconnect the power cable.

 **WARNING!** To avoid damage to the printer, turn the printer off, wait 30 seconds, and then remove the power cable before attempting to service the printer.

Use the table below to identify the correct part number for your printer. To order the part, go to www.hp.com/buy/parts.

DC controller part number	
RM3-7580-000CN	DC controller

Required tools

- #2 Phillips screwdriver with a magnetic tip.

After performing service

Turn the printer power on

- Connect the power cable.
- Use the power switch to turn the power on.

Post service test

Make sure that the printer initializes to a **Ready** state.

Print a configuration page to make sure that the printer is functioning correctly.

Step 1: Remove Tray 2

- ▲ Pull the tray straight out of the printer to remove it.

Figure 1-646 Remove the tray



Step 2: Remove the cartridge door assembly

 **NOTE:** If the toner cartridge was not removed prior to servicing the printer, remove it now.

1. Release the support shaft (callout 1), and then slide it toward the center of the door (callout 2).

 **TIP:** It might be easier to release the support shaft by using a small flat-blade screwdriver.

Figure 1-647 Release the support shaft

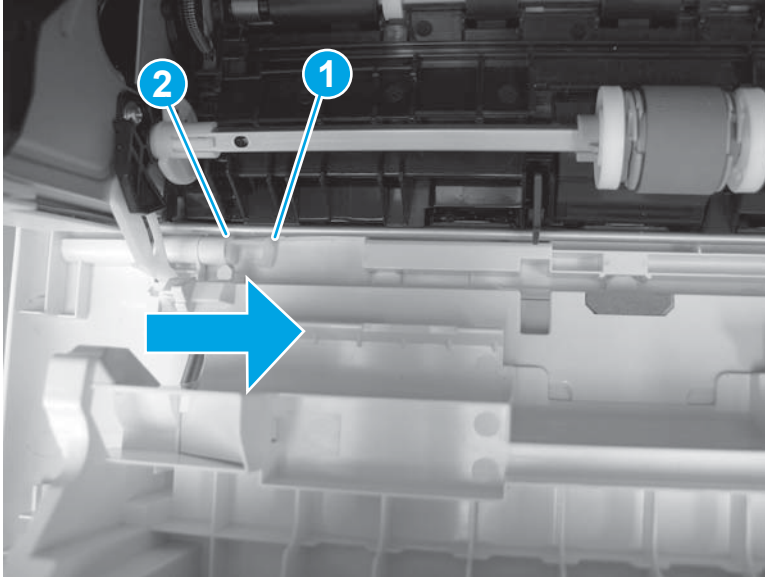

2. Remove the support shaft.

Figure 1-648 Remove the support shaft

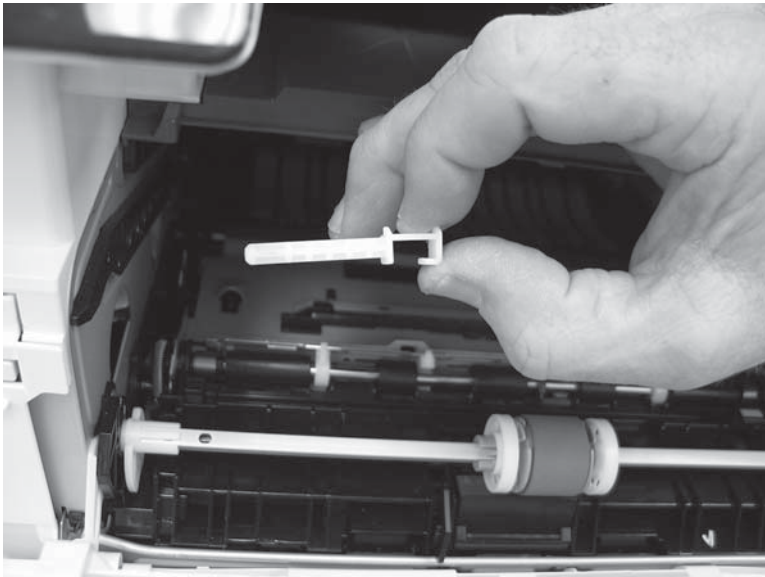

3. Release one tab (callout 1), and then slide the guide out of the printer (callout 2).

CAUTION: Be careful, the tab (callout 1) can be easily broken.

Figure 1-649 Remove the guide

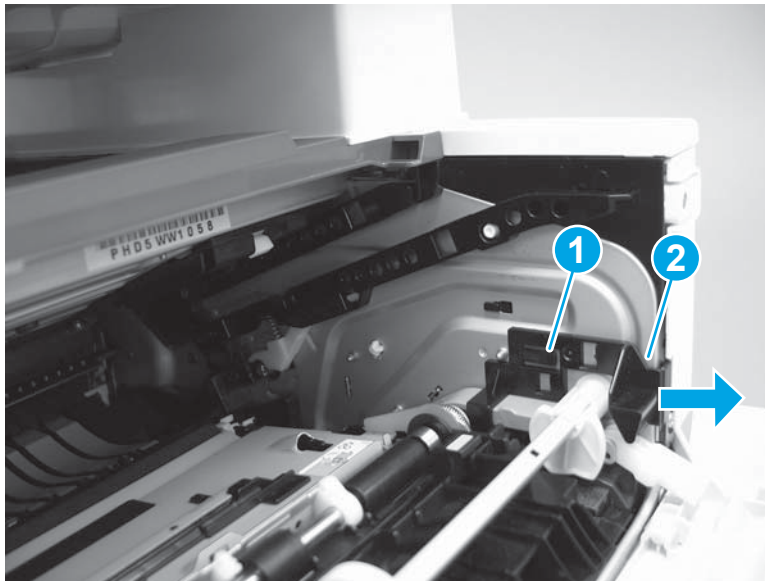

4. Use a small flat-blade screwdriver to gently pry the white-plastic door arm (callout 1) off of the gray-plastic pressure-release link (callout 2) to release the door arm.

Figure 1-650 Release the pressure-release link

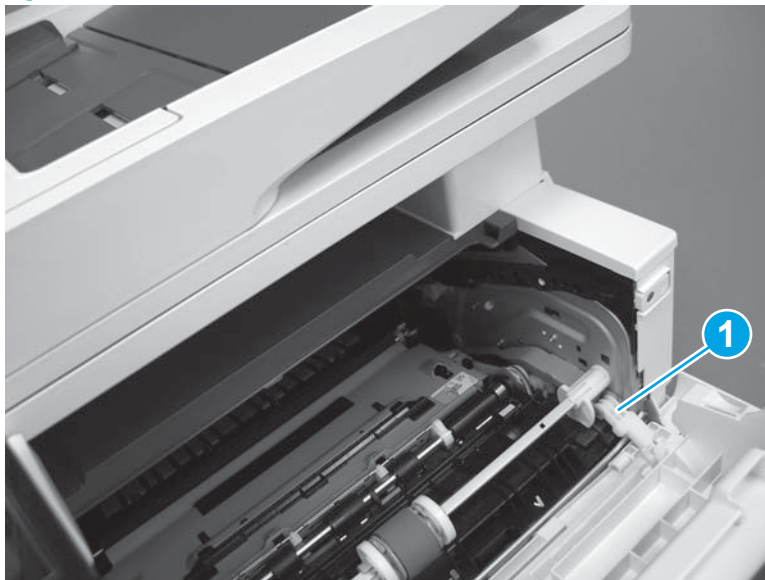

5. With the door in the partially closed position, slightly raise the left end (callout 1; raise it over the sheet-metal hinge boss), and then slide the door to the left (callout 2) to release the right hinge (callout 3).

⚠ CAUTION: The door is still attached to the printer by the left-side retainer arm. Do not attempt to completely remove the door.

💡 Reinstallation tip: When reinstalling the door, there are two right-side hinge pins (not shown in callout 3). Keep a finger pressed on the left-side retainer arm so that it does not disengage from the door.

Figure 1-651 Release the door

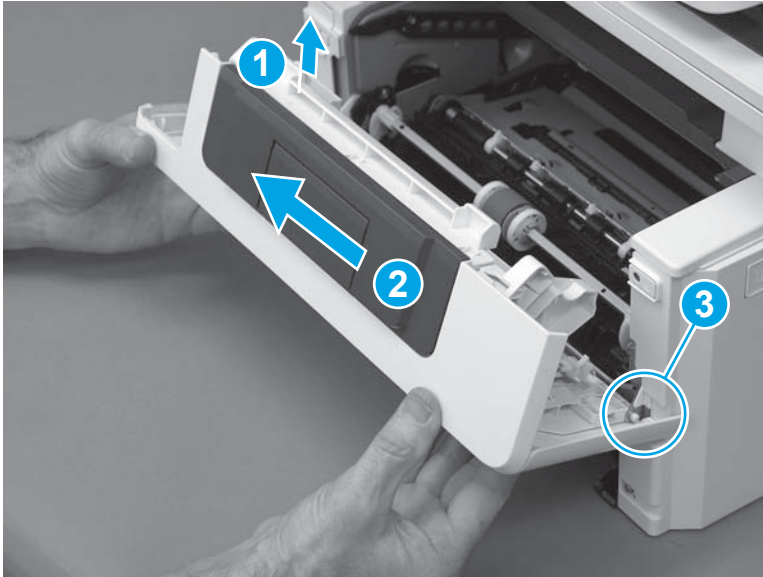

6. Rotate the door away from the printer until the keyed pin on the left-side retainer arm can disengage from the door.

Figure 1-652 Release the left-side retainer arm

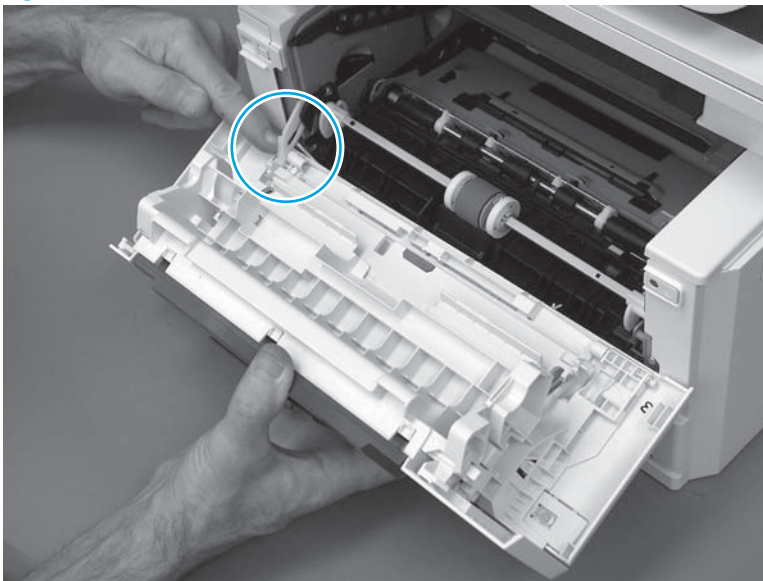

7. Remove the door.

Figure 1-653 Remove the door

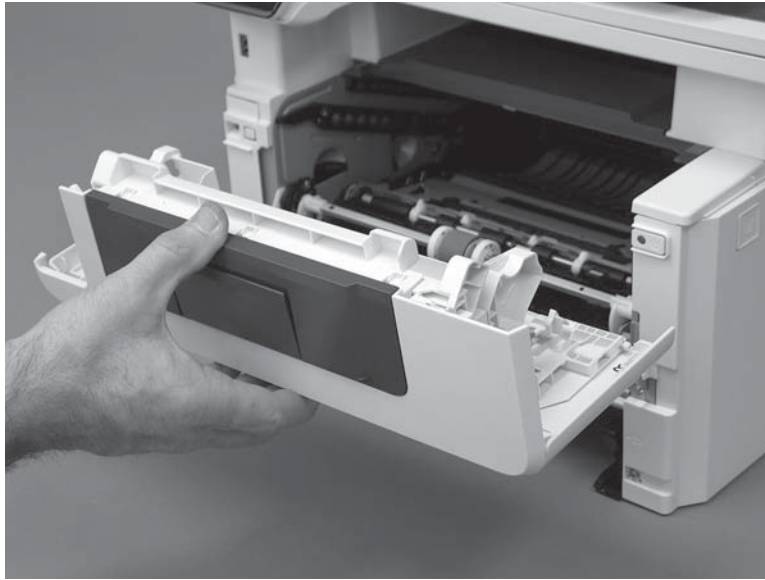

Step 3: Remove the left cover

1. Remove one screw (callout 1).

Figure 1-654 Remove one screw

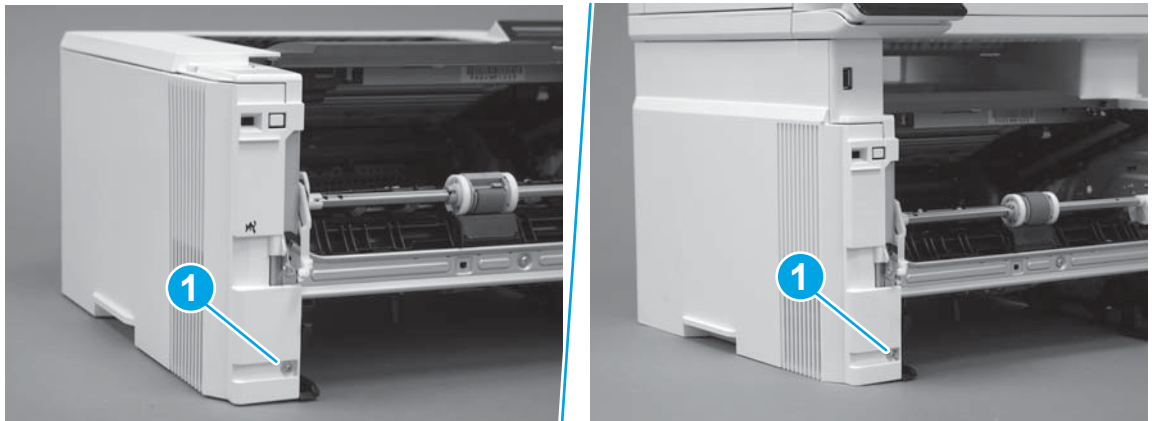

2. Open the rear door, release two bosses (callout 1), and then release three tabs (callout 2).

Figure 1-655 Release two bosses and three tabs

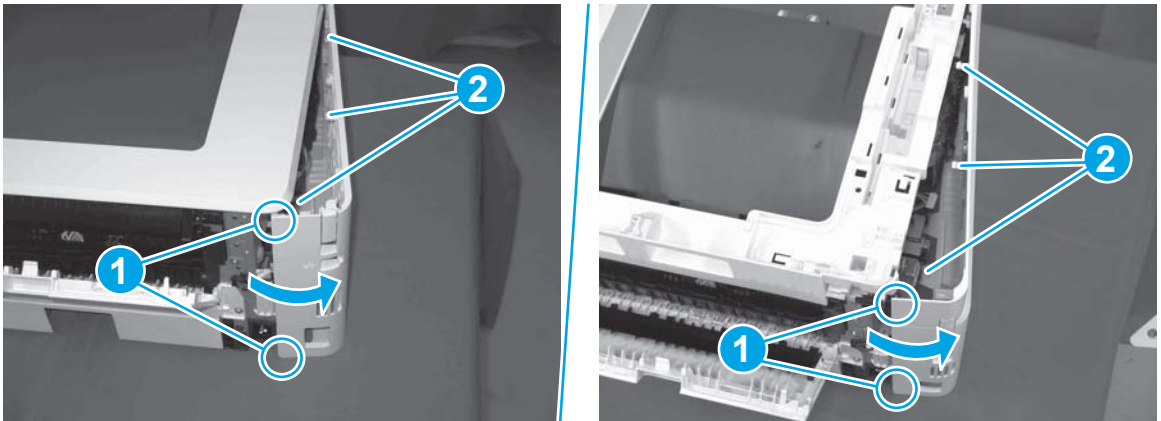

3. At the front of the printer, do one of the following:
 - **M304/M305/M404/M405:** Release two bosses (callout 1), and then remove the cover (callout 2).
 - **M329/M428/M429:** Release one tab (callout 3), two bosses (callout 4), and then remove the cover (callout 5).

CAUTION: Be careful when releasing the upper bosses on the M329/M428/M429 cover. One portion of the cover (callout 6) is fragile and is easily broken.

Figure 1-656 Remove the cover

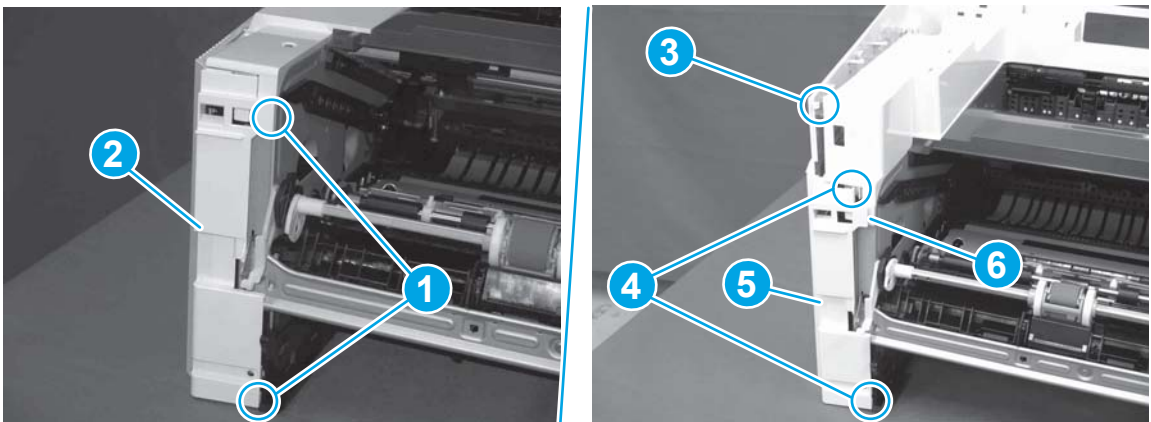

Step 4: Remove the right cover

1. At the front of the printer, release two bosses (callout 1), and then release three tabs (callout 2).

Reinstallation tip: Remove, and then reinstall the cover if the switch or button does not correctly function.

Figure 1-657 Release two bosses and three tabs

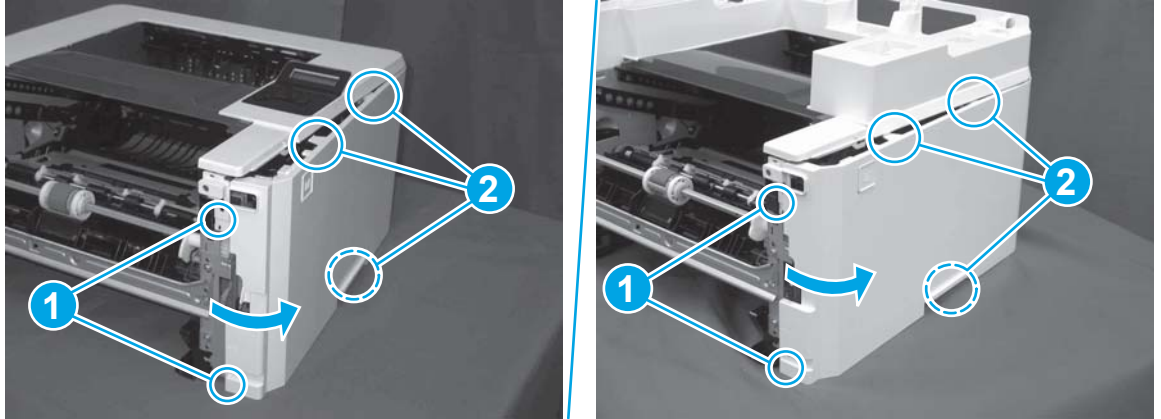

2. Open the rear door, release two bosses (callout 1), and then remove the cover (callout 2).

Figure 1-658 Remove the cover

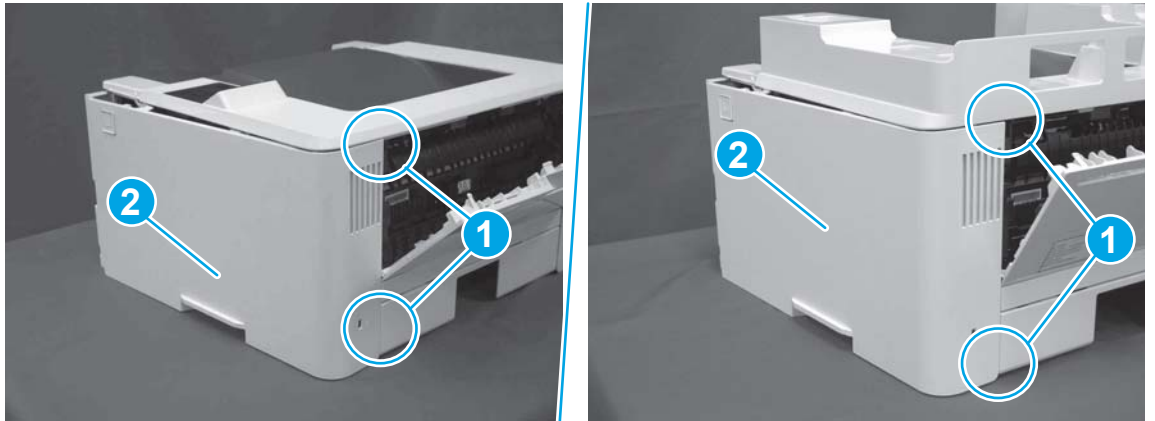

Step 5: Remove the rear door assembly

1. **Duplex models only:** Inside the Tray 2 cavity, press the green jam access lever (callout 1), and then lower the duplex feed assembly (callout 2).

Figure 1-659 Duplex models, lower the duplex feed assembly

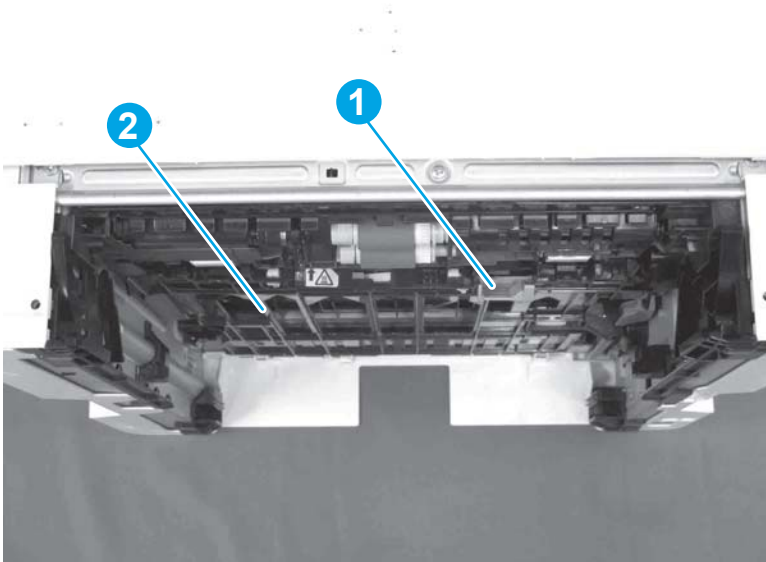

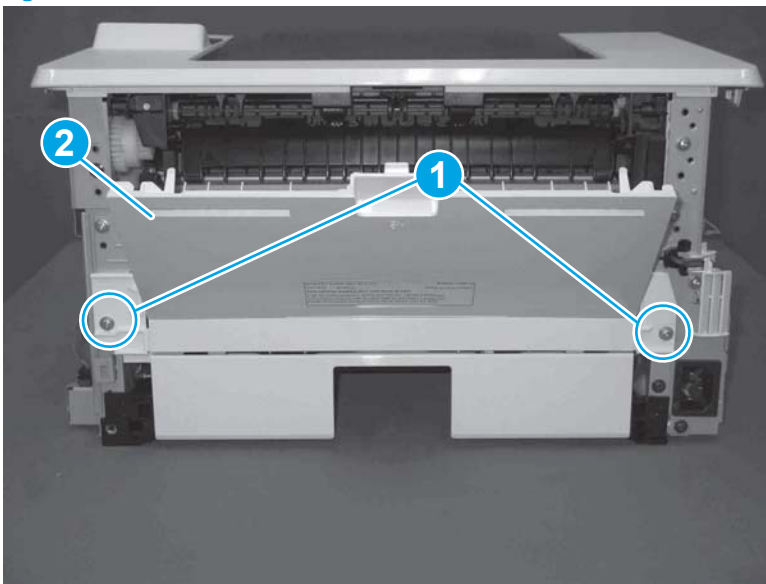

2. At the rear of the printer, remove two screws (callout 1), and then remove the rear door assembly (callout 2).

Figure 1-660 Remove two screws



Step 6: Remove the integrated scanner assembly (M329/M428/M429)

 **NOTE:** The step is for the M329/M428/M429 printer. For the M304/M305/M404/M405, skip this step and go to [Step 9: Remove the top cover \(M304/M305/M404/M405\) on page 417.](#)

 **NOTE:** M329/M428/M429 models only. The integrated scanner assembly (ISA) includes the sub-scanner assembly (SSA) and the automatic document feeder (ADF).

1. Raise the ISA.

Figure 1-661 Raise the ISA

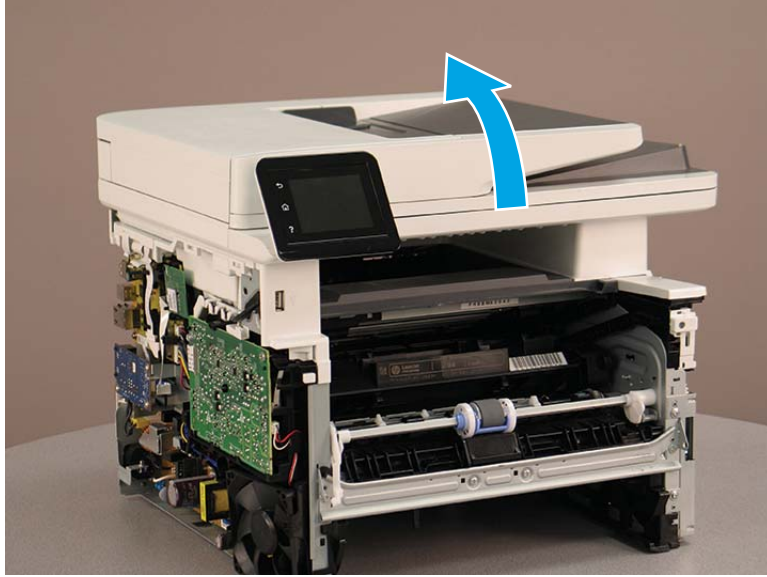

2. Release the ISA flat-flexible cable (FFC) cover (callout 1), and then remove it (callout 2).

Figure 1-662 Remove the ISA FFC cover

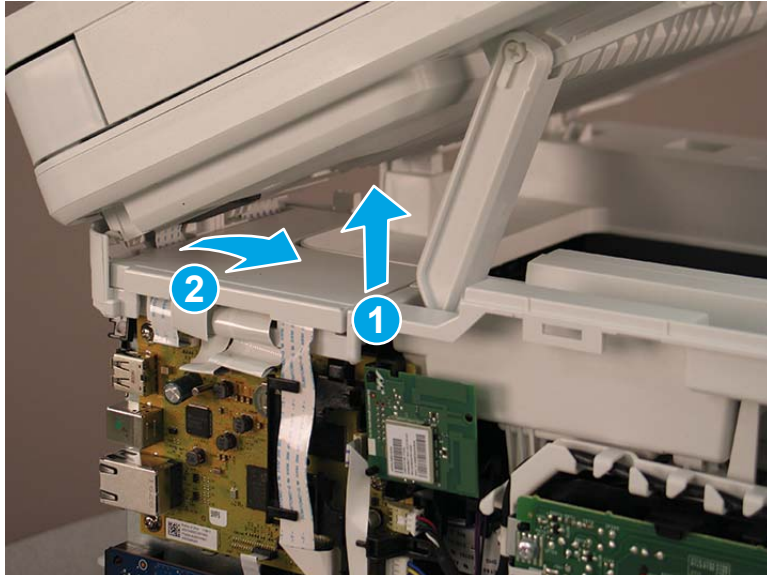

3. Disconnect three FFCs (callout 1), and then remove the ferrite (callout 2) from the holder.

⚠ CAUTION: The ferrite is not captive on the FFC. Do not lose the ferrite while handling the ISA.

Figure 1-663 Disconnect three FFCs

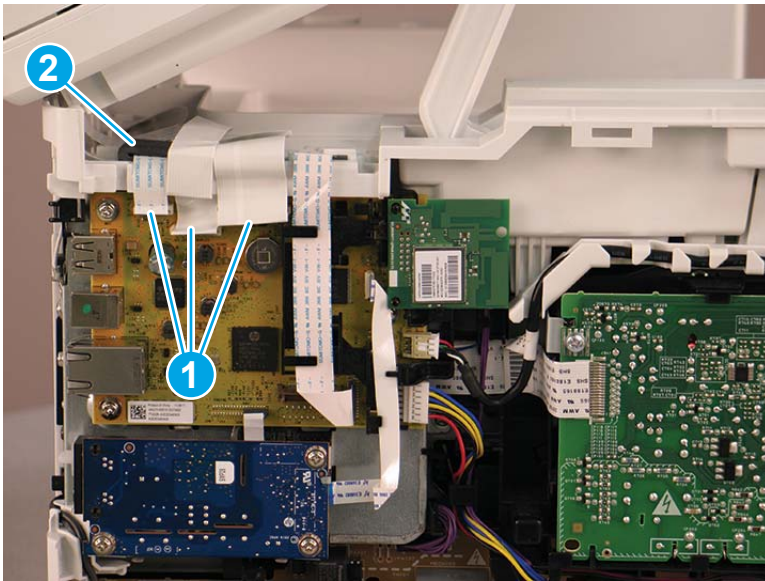

4. Remove one screw (callout 1).

Figure 1-664 Remove one screw

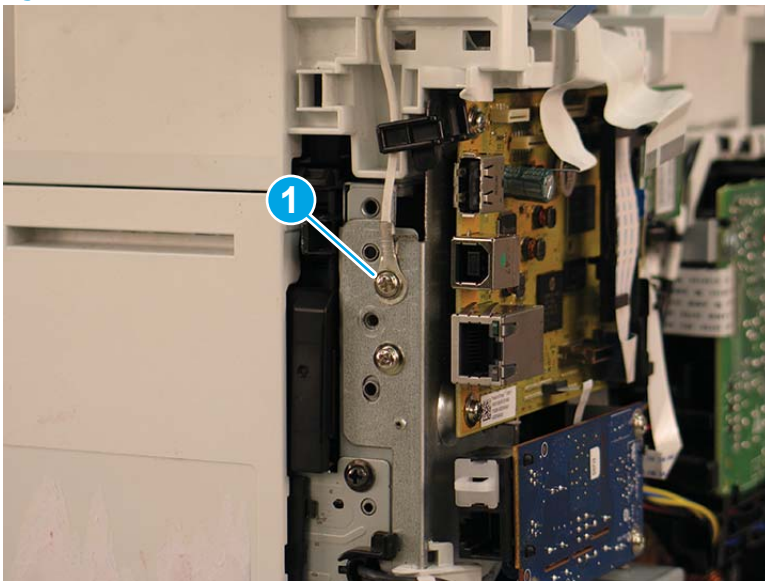

5. Pass the ground wire through the opening in the top cover.

Figure 1-665 Pass the wire through the opening



6. Release one tab (callout 1), and then rotate the ISA slider pin (callout 2) towards the front of the printer to release it.

Figure 1-666 Release one tab and rotate the slider pin

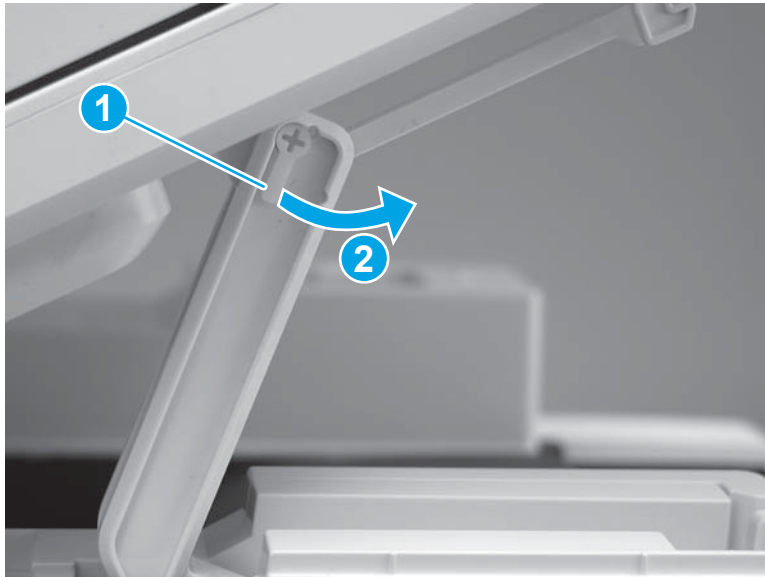

7. Remove the slider pin.

 **Reinstallation tip:** Align the keyed portion of the locking pin with the slot and hole in the support arm.

Figure 1-667 Remove the slider pin

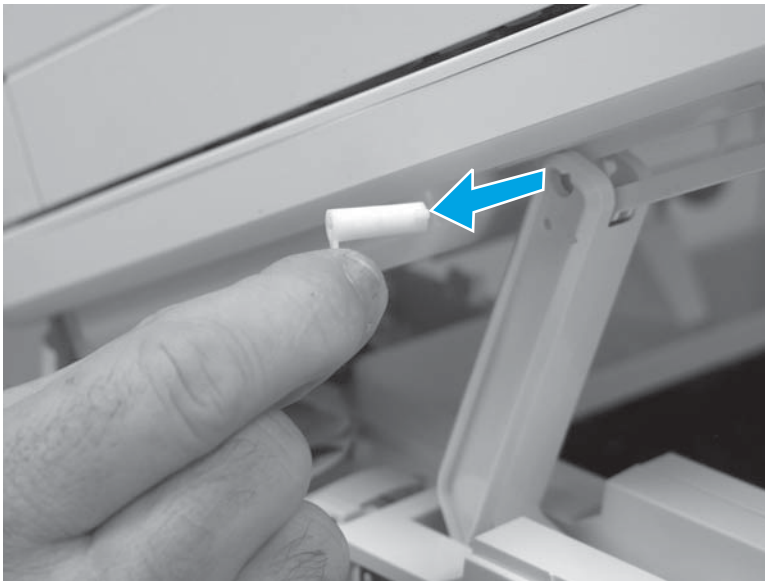

8. Rotate the ISA towards the rear of the printer until it stops.

Figure 1-668 Rotate the ISA towards the rear of the printer

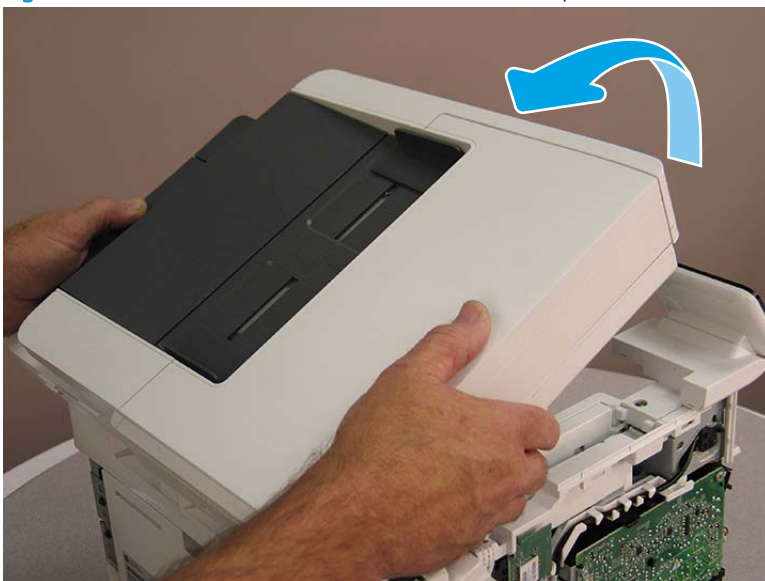

- Slide the ISA as shown to release it.

Figure 1-669 Release the ISA

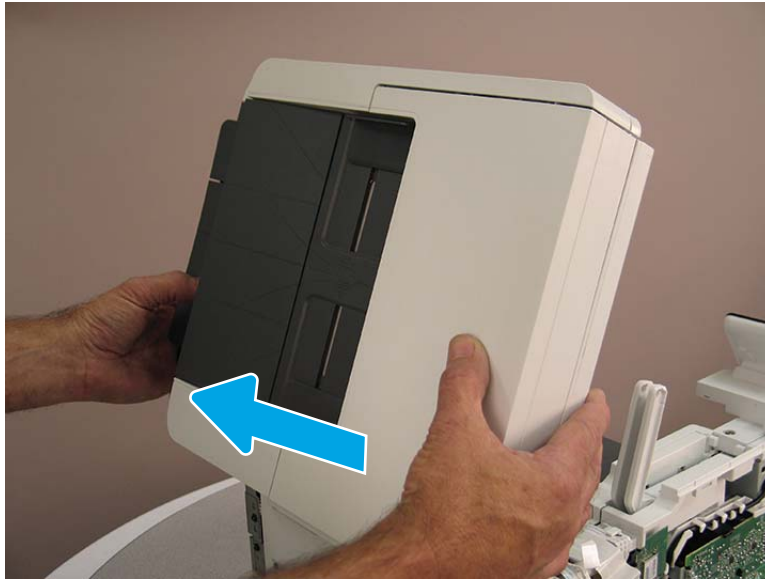

- Remove the ISA.

Figure 1-670 Remove the ISA

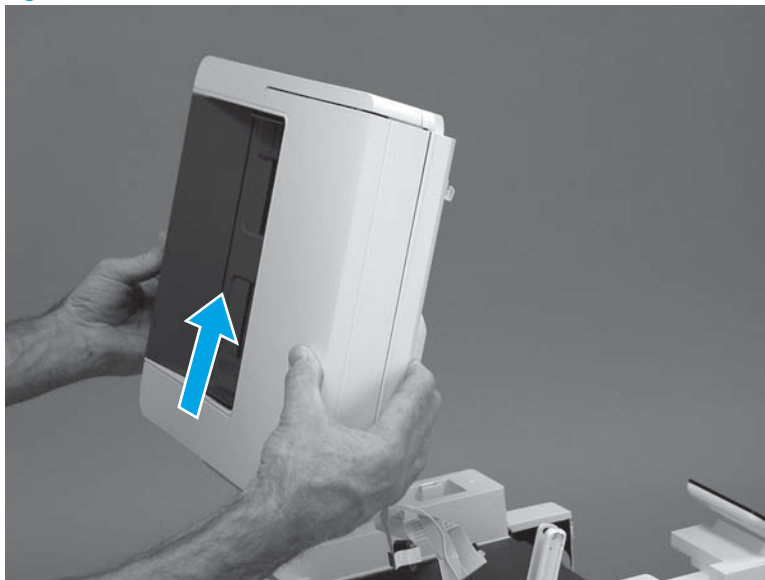

Step 7: Remove the control panel (M329/M428/M429)

 **NOTE:** The step is for the M329/M428/M429 printer. For the M304/M305/M404/M405, skip this step and go to [Step 9: Remove the top cover \(M304/M305/M404/M405\) on page 417.](#)

- Disconnect one FFC (callout 1), and then release the FFC from the guide (callout 2).

Figure 1-671 Disconnect one connector

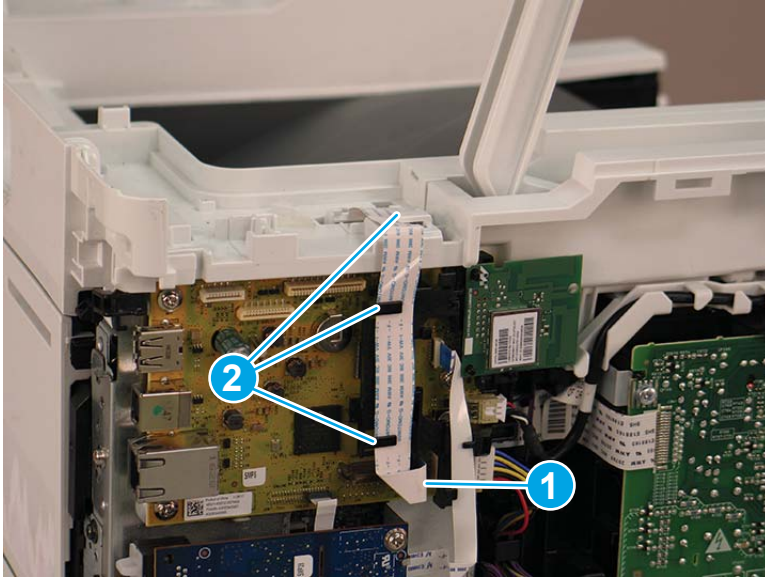

2. Remove one screw (callout 1).

Figure 1-672 Remove one screw

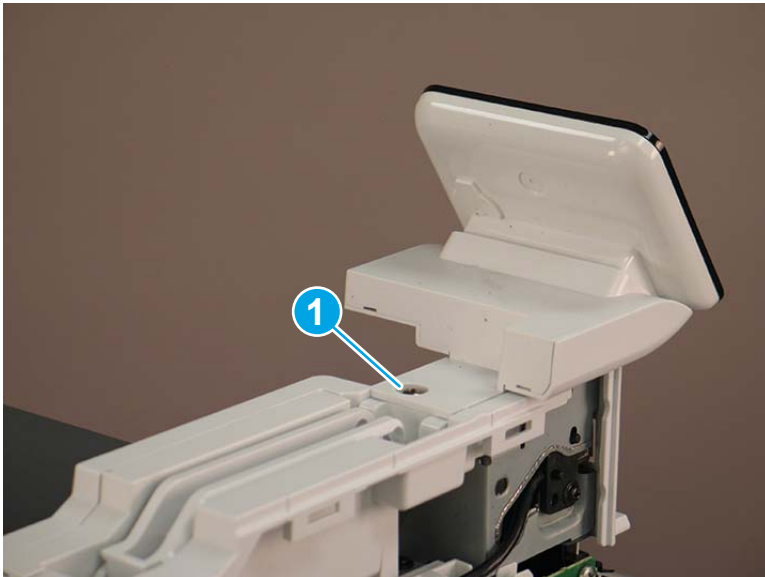

3. Use a small flat-blade screwdriver to release two tabs (callout 1) on the control-panel cable cover.

Figure 1-673 Release two tabs

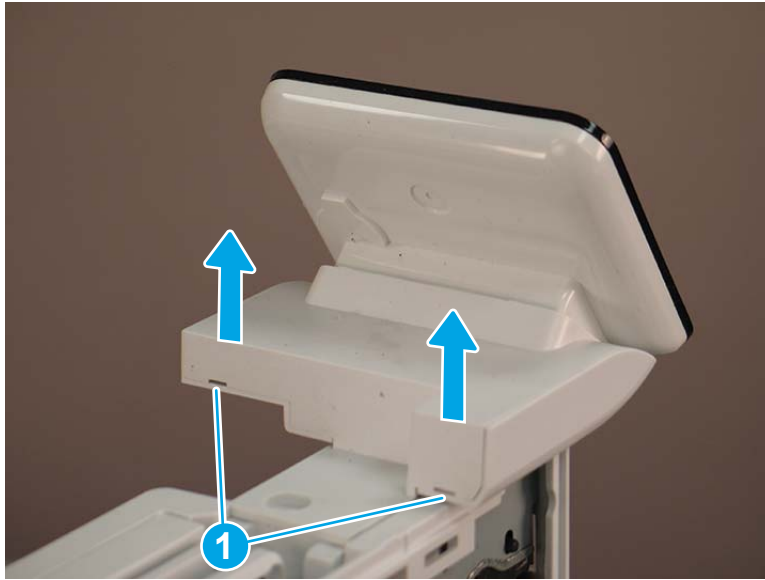

4. Remove the control-panel cable cover.

Figure 1-674 Remove the cover



5. Remove one grounding screw (callout 1), and then move the ground cable (callout 2) out of the way.

Figure 1-675 Remove one screw

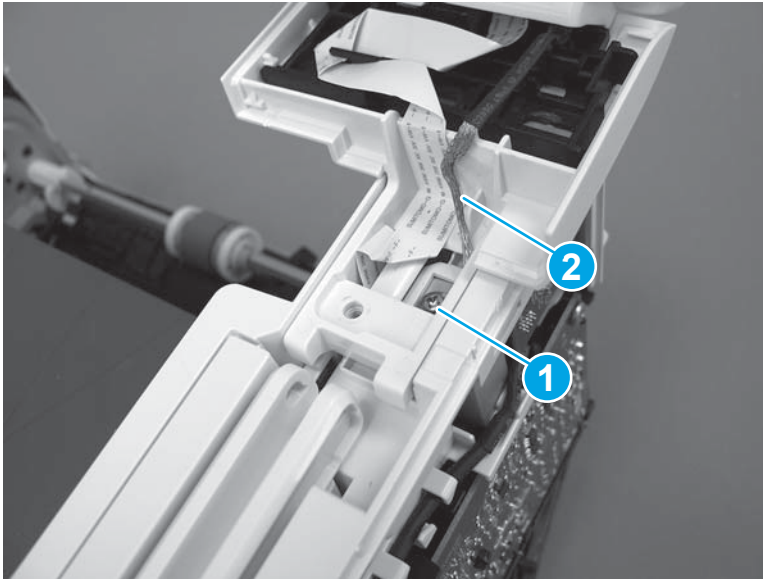

6. Move the FFC out of the way, and then remove two screws (callout 1).

Figure 1-676 Remove two screws



7. Slightly lift up the control-panel assembly to separate it from the top cover.

⚠ CAUTION: The control panel assembly is still connected to the printer by the FFC. Do not attempt to completely remove the assembly.

Figure 1-677 Lift up the control-panel assembly



8. Lift up the control-panel FFC cover to remove the control-panel assembly.

Figure 1-678 Remove the control-panel assembly

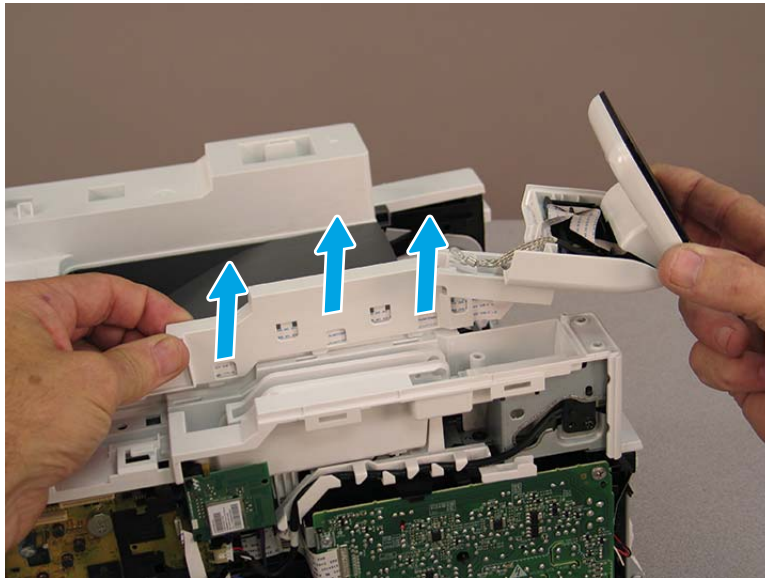

Step 8: Remove the top cover (M329/M428/M429)

📝 NOTE: The step is for the M329/M428/M429 printer. For the M304/M305/M404/M405, skip this step and go to [Step 9: Remove the top cover \(M304/M305/M404/M405\) on page 417](#).

1. Release the USB cable (callout 1) from the cable guide.

Figure 1-679 Remove the USB cable

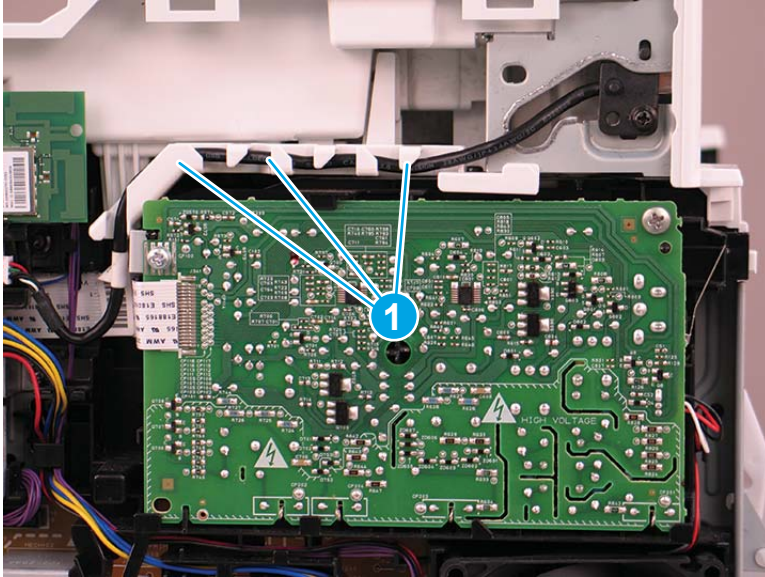

2. Remove one screw (callout 1), and then remove the support arm (callout 2).

⚠ CAUTION: The support arm is spring loaded and can unexpectedly spring into the open position. To avoid injury, do not place a finger in the screw well when the support arm is in the closed position.

Figure 1-680 Remove the support arm

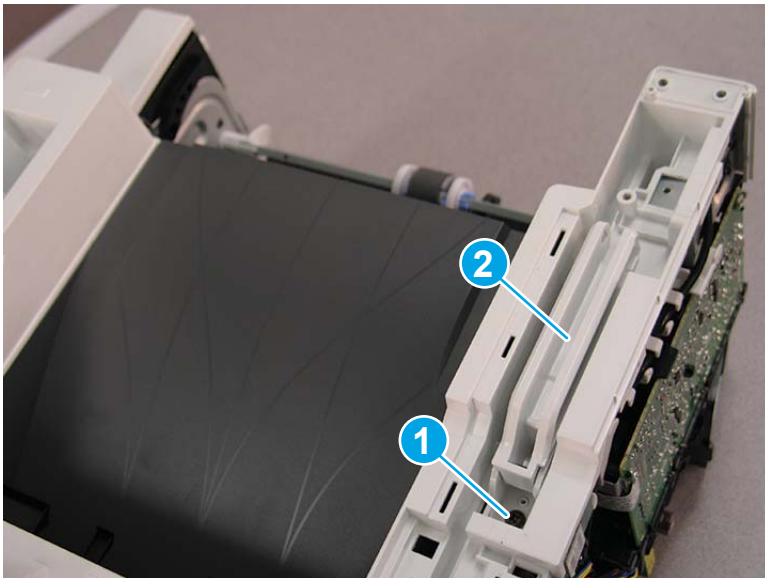

3. Remove five screws (callout 1), release four bosses (callout 2), and then remove the top cover (callout 3).

Figure 1-681 Remove the cover

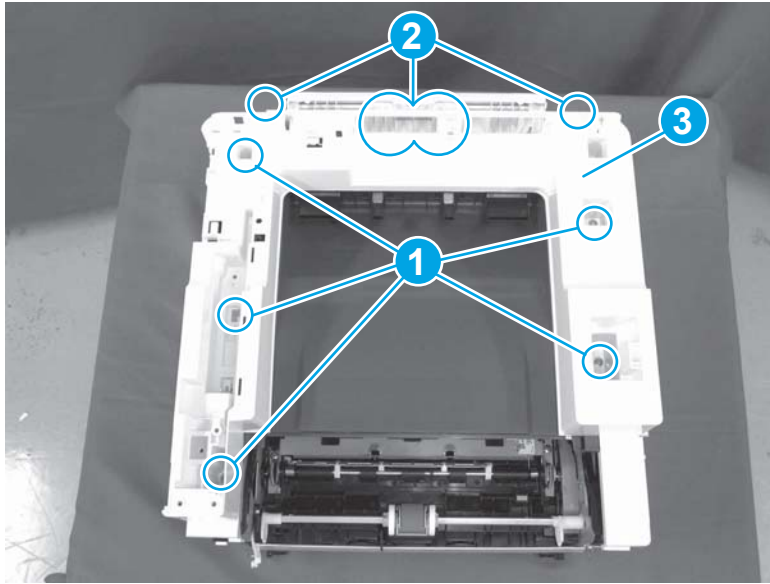

Step 9: Remove the top cover (M304/M305/M404/M405)

 **NOTE:** The step is for the M304/M305/M404/M405 printer. For the M329/M428/M429, skip this step and go to [Step 10: Remove the paper delivery tray \(output bin\) on page 418.](#)

1. Remove one screw (callout 1).

Figure 1-682 Remove one screw



2. At the right side of the printer, release the one boss (callout 1), and then release one tab (callout 2).

Figure 1-683 Release one boss and one tab

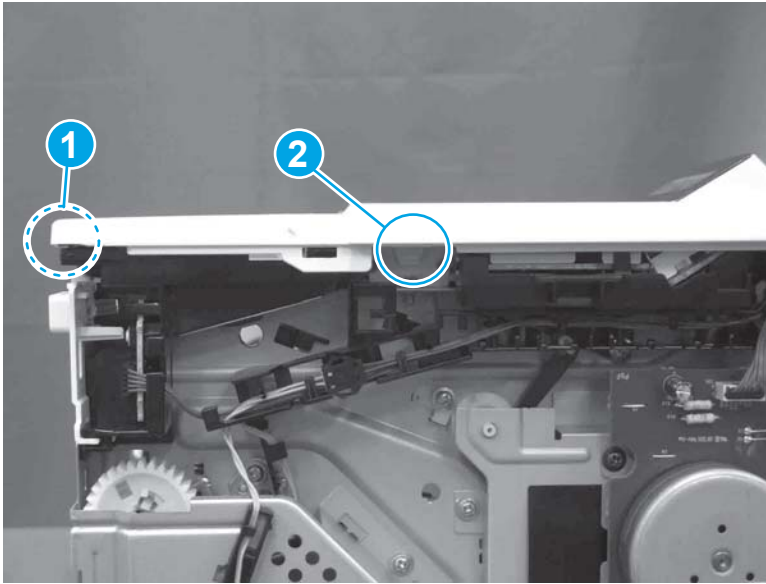

3. Release four tabs (callout 1), release four bosses (callout 2), and then remove the top cover (callout 3).



 **TIP:** Open the rear door to make releasing the bosses (callout 3) easier.

Figure 1-684 Remove the cover

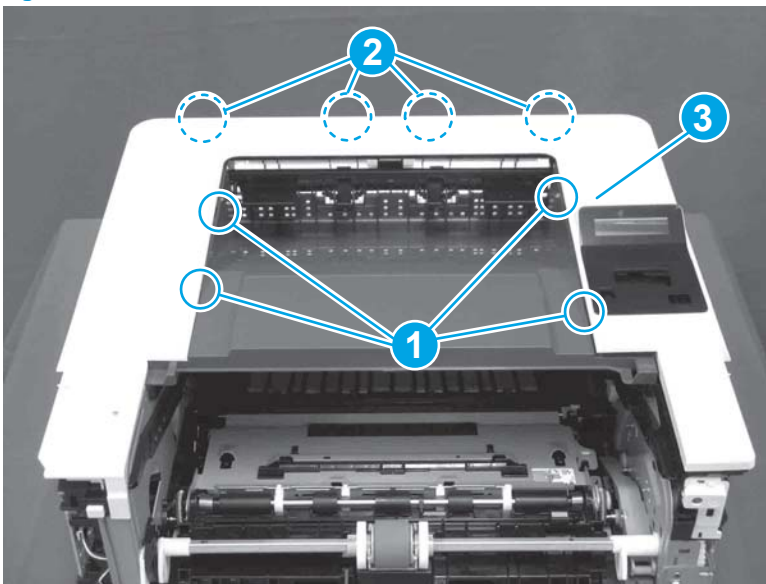

Step 10: Remove the paper delivery tray (output bin)

 **NOTE:** This procedure shows the M304/M305/M404/M405 model, however, the paper delivery tray (output bin) removal is similar for the M329/M428/M429 printer.

- ▲ Release two bosses (callout 1), release two tabs (callout 2), and then remove the paper delivery tray (output bin; callout 3).

Figure 1-685 Release two tabs

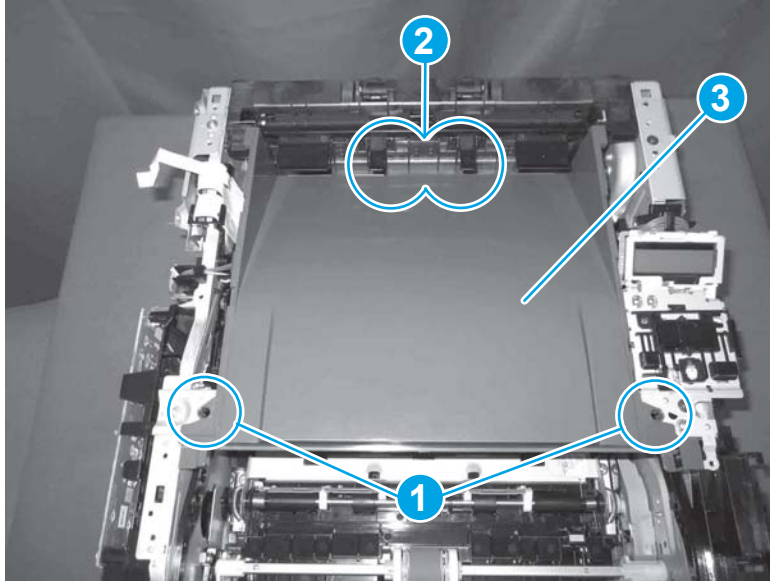

Step 11: Remove the sheet-metal formatter bracket and formatter PCA

1. Do one of the following:

- **SFP only:** Release two tabs (callout 1), and then carefully pull the wireless PCA straight off of the formatter PCA to remove it.

 **NOTE:** Disconnect the WiFi antenna (callout 2) before releasing the tabs.

- **MFP only:** Release one tab (callout 3), and then carefully pull the wireless PCA straight off of the formatter PCA to remove it.

 **TIP:** Push the tab to the left to release it.

Figure 1-686 Remove the wireless PCA



2. Do one of the following:

- **SFP only:** Disconnect the connectors (callout 1), and then release one wire harness (callout 2) from the guide.
- **MFP only:** Disconnect the connectors (callout 1), and then release one wire harness and one FFC (callout 2) from the guides.

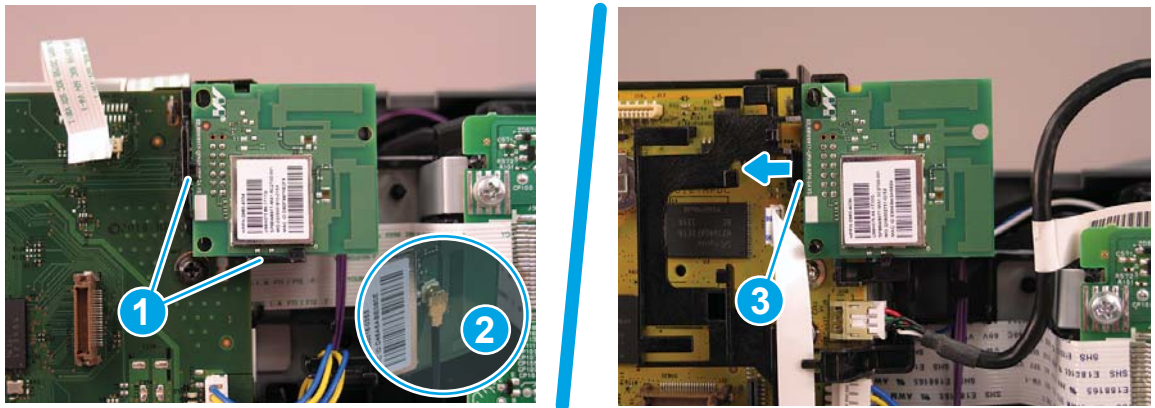
Figure 1-687 Disconnect the connectors

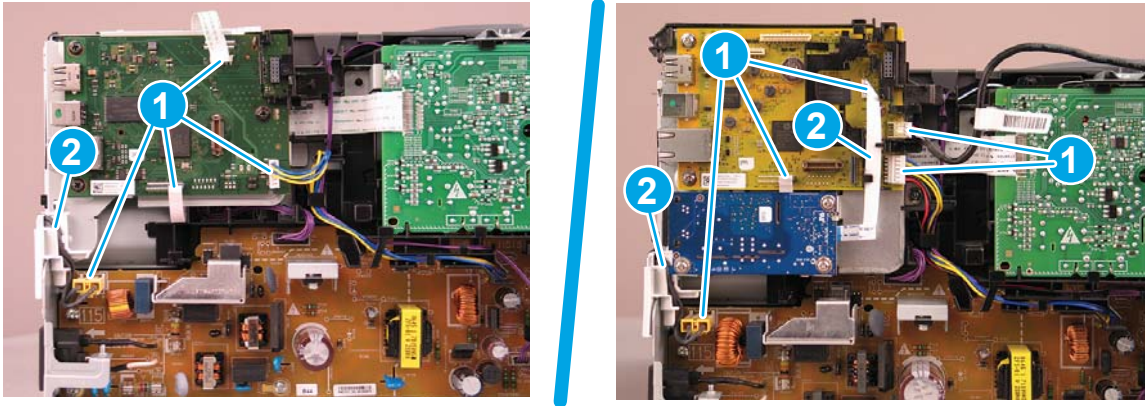

3. **MFP only:** Remove three screws (callout 1), and then remove the fax PCA.

Figure 1-688 Remove the fax PCA

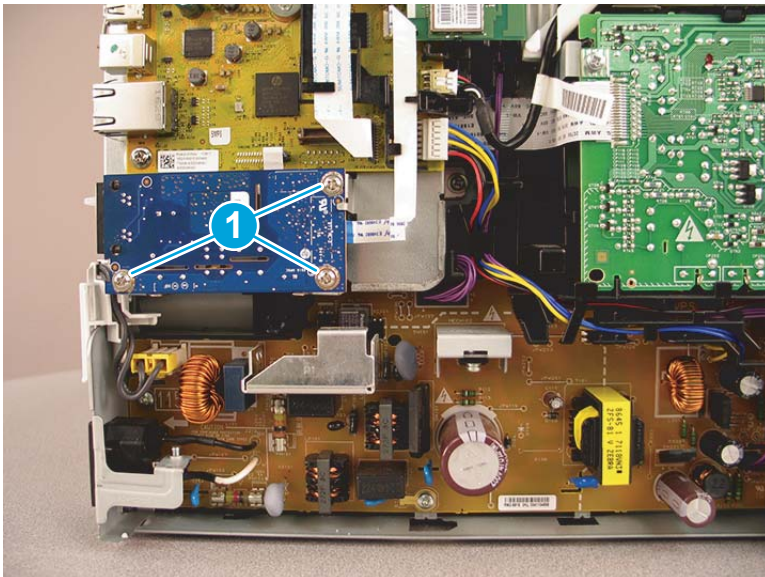

4. **MFP only:** Release the FFC from the guide (callout 1), release one tab (callout 2), and then remove the FFC guide (callout 3).

Figure 1-689 Remove the FFC guide

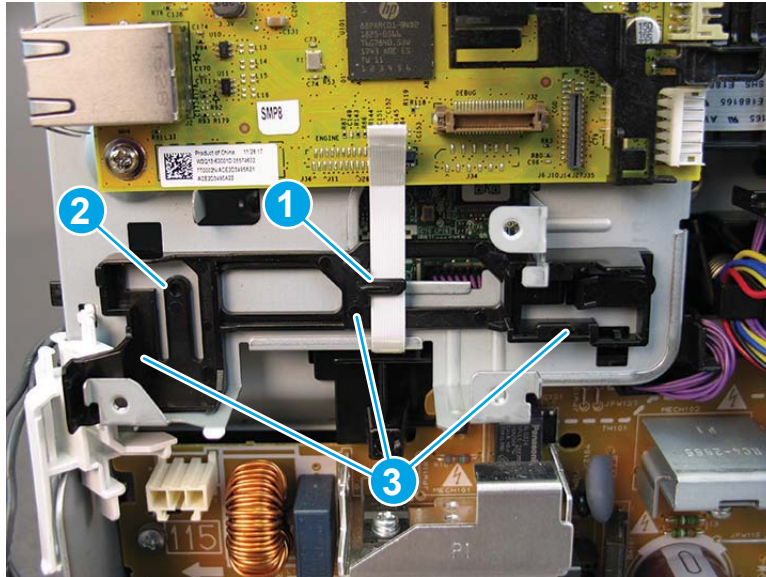

5. Remove one guide.

 **NOTE:** A SFP printer is shown in the figure. However, the guide is identical for an MFP printer.

Figure 1-690 Remove the guide



6. Remove two screws.

Figure 1-691 Remove two screws

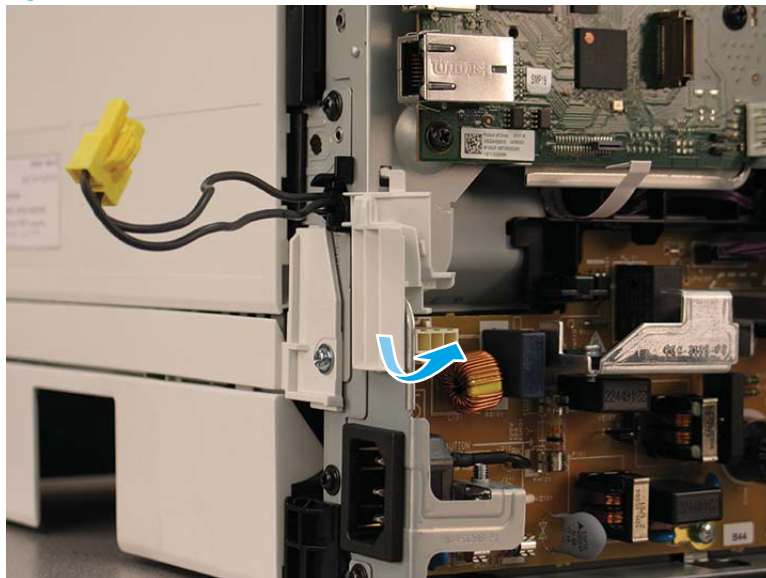

7. MFP only: Remove one screw.

Figure 1-692 Remove one screw

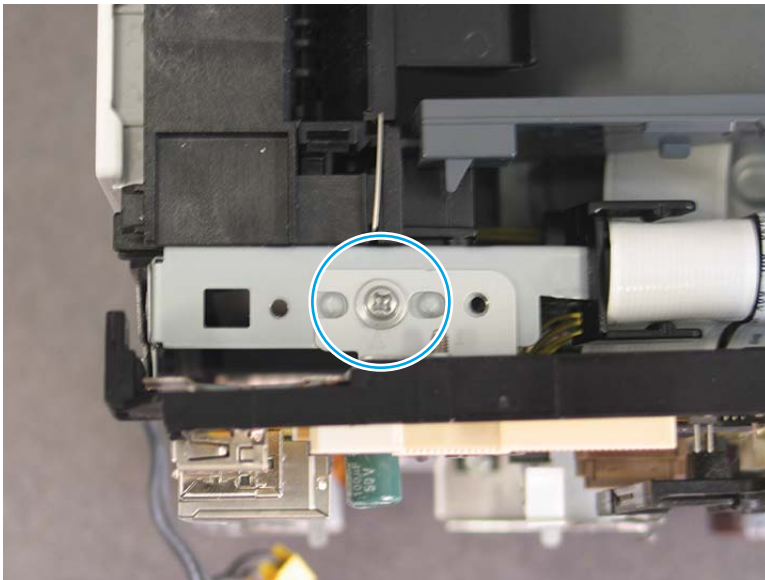

8. Support the formatter and bracket, and then remove two screws.

Figure 1-693 Remove two screws

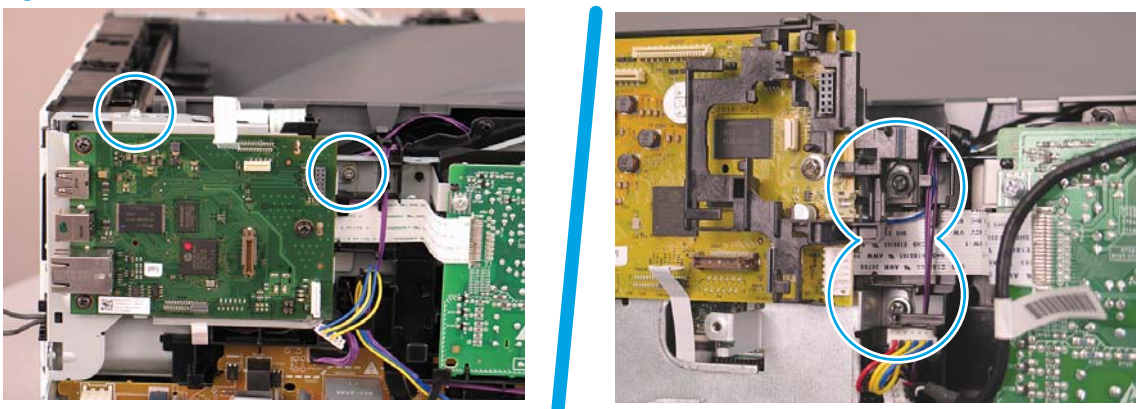

9. Remove the sheet-metal bracket and formatter PCA.

Figure 1-694 Remove the bracket

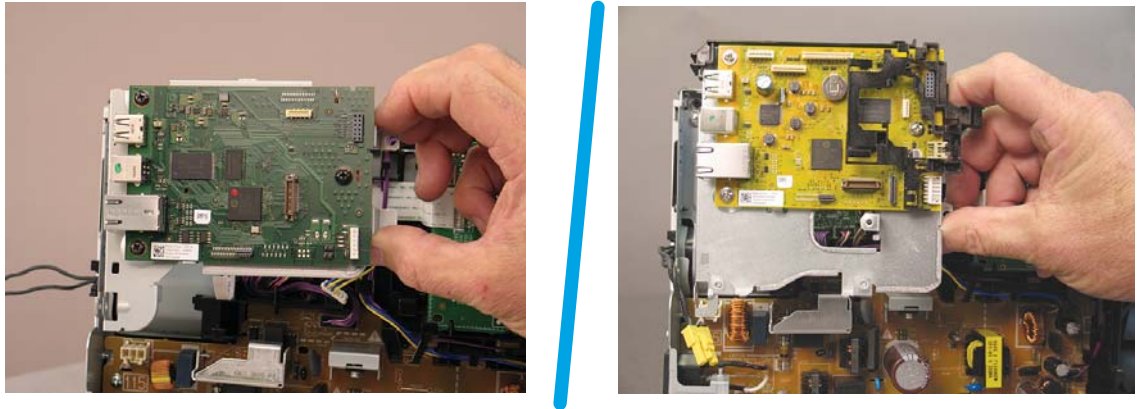

Step 12: Remove the DC controller

1. Disconnect three FFCs (callout 1), and six connectors (callout 2).

 **IMPORTANT:** One FFC (callout 3) is fastened to the guide with two sided tape. This FFC will be removed later in the procedure.

Figure 1-695 Disconnect three FFCs and six connectors



2. Remove two screws (callout 1).

Figure 1-696 Remove two screws

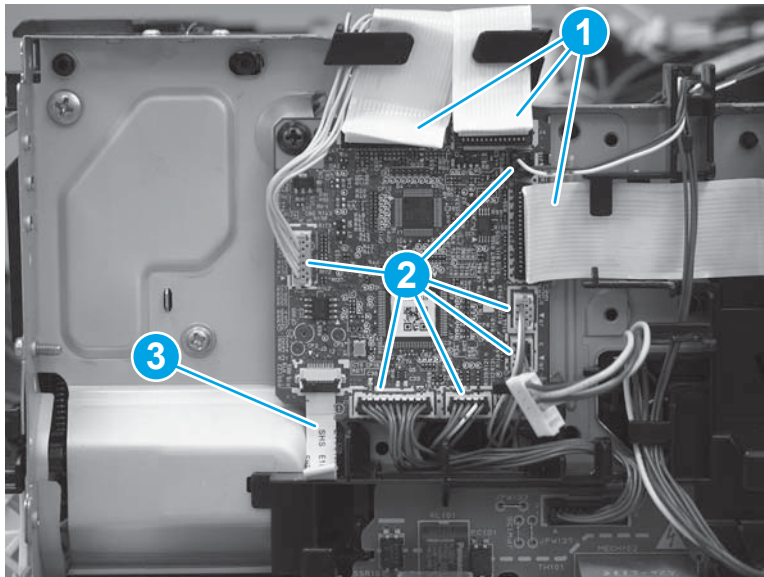
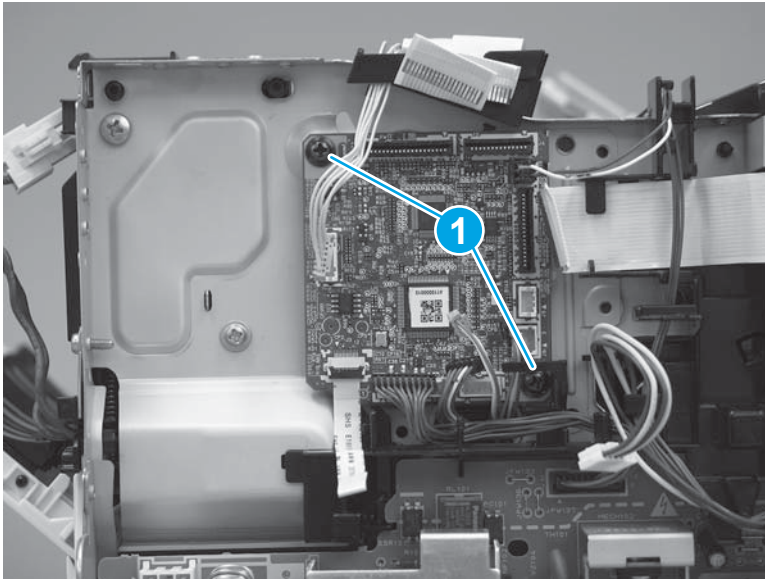

3. Separate the DC controller from the printer.

CAUTION: Carefully pull up on the FFC (callout 1) to release it from the guide, and then remove the DC controller.

Figure 1-697 Remove the DC controller

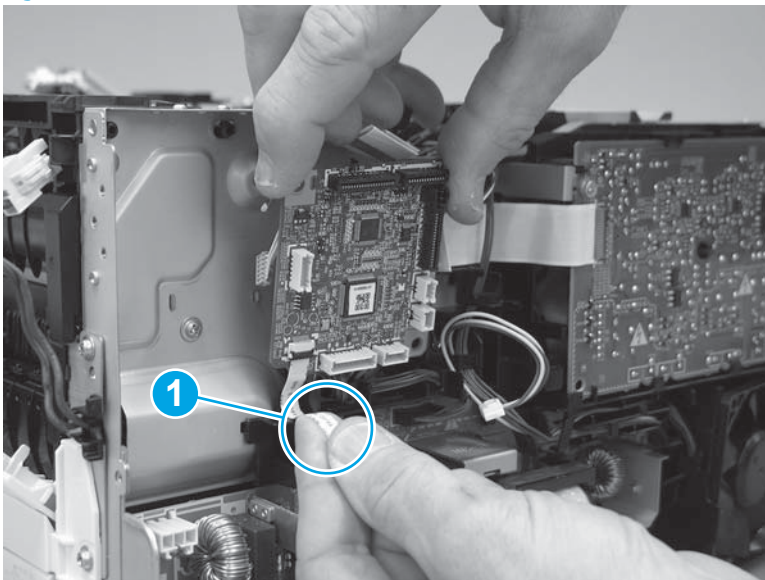

4. Disconnect one the FFC.

 **IMPORTANT:** The FFC connector is a Zero Insertion Force (ZIF) connector that uses a hinged retainer to secure the FFC. The hinged retainer must be opened to release the FFC.

Do not discard this FFC. It must be installed on the replacement DC controller

Figure 1-698 Disconnect one the FFC

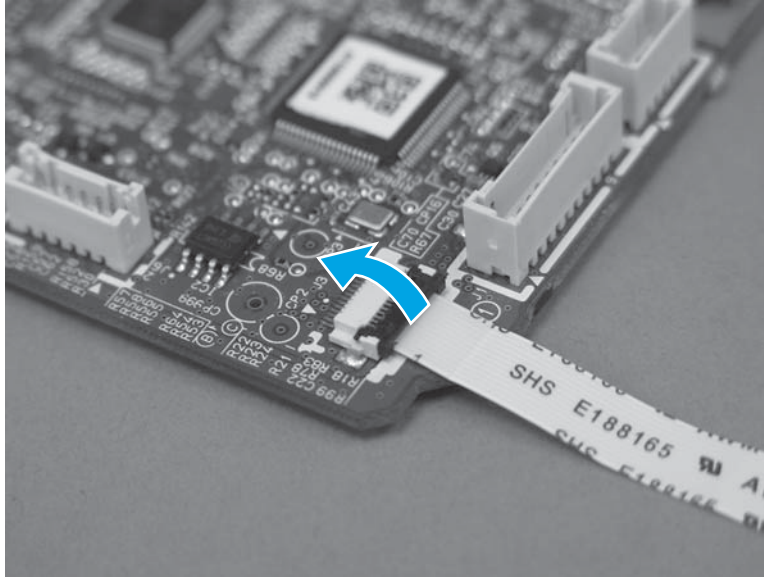



Step 13: Unpack the replacement assembly

1. Dispose of the defective part.

 **NOTE:** HP recommends responsible disposal of the defective part.

<http://www8.hp.com/us/en/hp-information/environment/product-recycling.html>

2. Unpack the replacement part from the packaging.

 **CAUTION:**  Some parts are sensitive to electrostatic discharge (ESD). Always perform service work at an ESD-protected workstation or mat. If an ESD workstation or mat is not available, touch the sheet-metal chassis to provide a static ground before touching an ESD-sensitive assembly. Protect the ESD-sensitive assemblies by placing them in ESD pouches when they are out of the printer.

If the replacement part is a roller or pad, avoid touching the spongy part of it. Skin oils on the roller or pad can cause paper pickup and/or print-quality problems. HP recommends using disposable gloves when handling rollers or pads or washing your hands before touching rollers or pads.

 **IMPORTANT:** Make sure that all of the shipping materials (for example shipping tape) are removed from the replacement part prior to installation.

3. To install an assembly, reverse the removal steps.

 **NOTE:** When applicable, special installation instructions are provided for an assembly at the end of the removal procedure. Always completely read the removal instructions and follow all special installation instructions.

Removal and replacement: Tag-cable assembly (toner-cartridge memory)

- [Introduction](#)
- [Step 1: Remove Tray 2](#)
- [Step 2: Remove the cartridge door assembly](#)
- [Step 3: Remove the left cover](#)
- [Step 4: Remove the right cover](#)
- [Step 5: Remove the integrated scanner assembly \(M329/M428/M429\)](#)
- [Step 6: Remove the control panel \(M329/M428/M429\)](#)
- [Step 7: Remove the top cover \(M329/M428/M429\)](#)
- [Step 8: Remove the top cover \(M304/M305/M404/M405\)](#)
- [Step 9: Remove the paper delivery tray \(output bin\)](#)
- [Step 10: Remove the sheet-metal formatter bracket and formatter PCA](#)
- [Step 11: Remove the tag-cable assembly \(toner-cartridge memory\)](#)
- [Step 12: Unpack the replacement assembly](#)

Introduction

This document provides the procedures to remove and replace the tag-cable assembly (toner-cartridge memory).

Before performing service

Turn the printer power off

- Disconnect the power cable.

 **WARNING!** To avoid damage to the printer, turn the printer off, wait 30 seconds, and then remove the power cable before attempting to service the printer.

Use the table below to identify the correct part number for your printer. To order the part, go to www.hp.com/buy/parts.

Tag-cable assembly (toner-cartridge memory) part number	
RM2-2556-000CN	Tag-cable assembly (toner-cartridge memory)

Required tools

- #2 Phillips screwdriver with a magnetic tip.
- 5.5 mm (0.22 inch) socket screwdriver.

After performing service

Turn the printer power on

- Connect the power cable.
- Use the power switch to turn the power on.

Post service test

Make sure that the printer initializes to a **Ready** state.

Print a configuration page to make sure that the printer is functioning correctly.

Step 1: Remove Tray 2

- ▲ Pull the tray straight out of the printer to remove it.

Figure 1-699 Remove the tray



Step 2: Remove the cartridge door assembly

 **NOTE:** If the toner cartridge was not removed prior to servicing the printer, remove it now.

1. Release the support shaft (callout 1), and then slide it toward the center of the door (callout 2).

 **TIP:** It might be easier to release the support shaft by using a small flat-blade screwdriver.

Figure 1-700 Release the support shaft

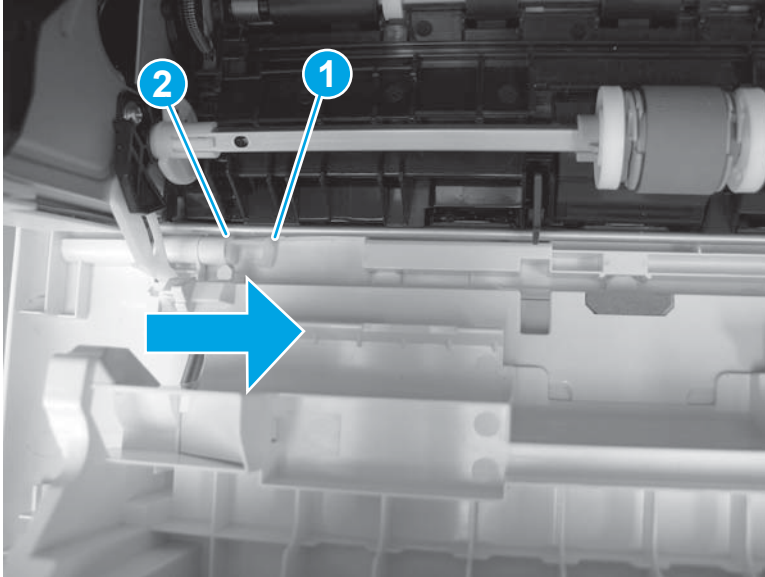

2. Remove the support shaft.

Figure 1-701 Remove the support shaft

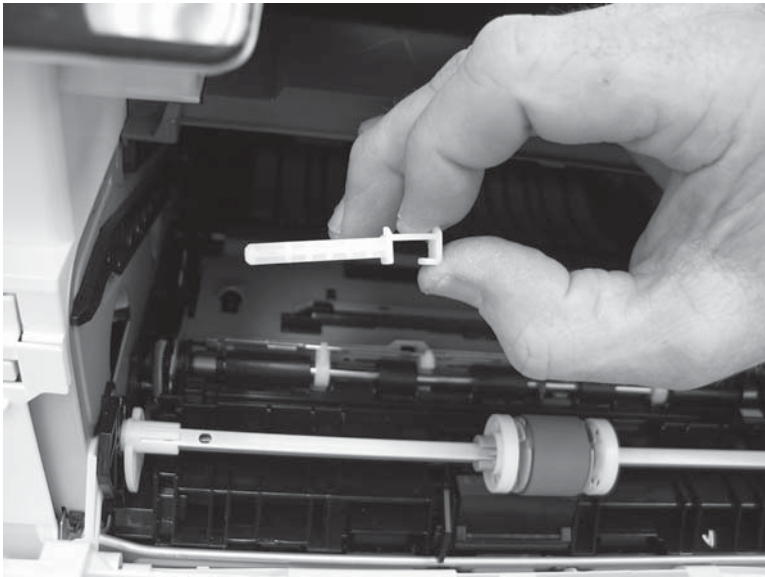

3. Release one tab (callout 1), and then slide the guide out of the printer (callout 2).

CAUTION: Be careful, the tab (callout 1) can be easily broken.

Figure 1-702 Remove the guide

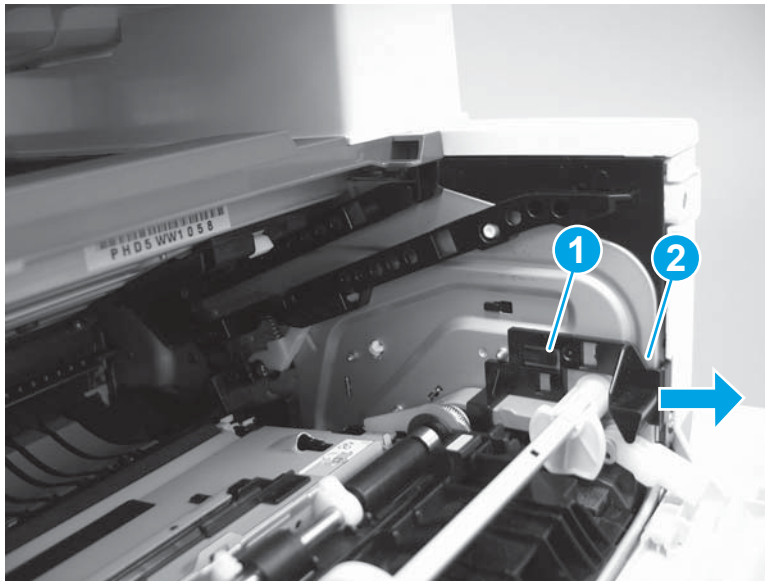

4. Use a small flat-blade screwdriver to gently pry the white-plastic door arm (callout 1) off of the gray-plastic pressure-release link (callout 2) to release the door arm.

Figure 1-703 Release the pressure-release link

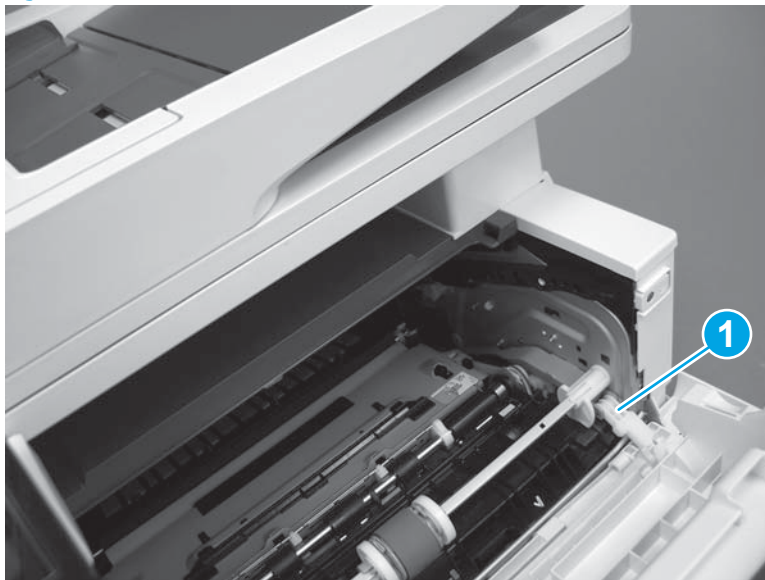

5. With the door in the partially closed position, slightly raise the left end (callout 1; raise it over the sheet-metal hinge boss), and then slide the door to the left (callout 2) to release the right hinge (callout 3).

⚠ CAUTION: The door is still attached to the printer by the left-side retainer arm. Do not attempt to completely remove the door.

💡 Reinstallation tip: When reinstalling the door, there are two right-side hinge pins (not shown in callout 3). Keep a finger pressed on the left-side retainer arm so that it does not disengage from the door.

Figure 1-704 Release the door

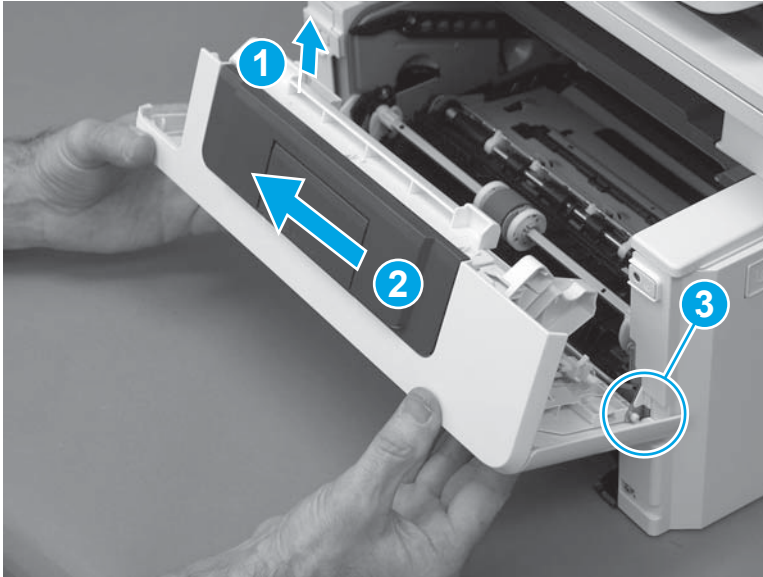

6. Rotate the door away from the printer until the keyed pin on the left-side retainer arm can disengage from the door.

Figure 1-705 Release the left-side retainer arm

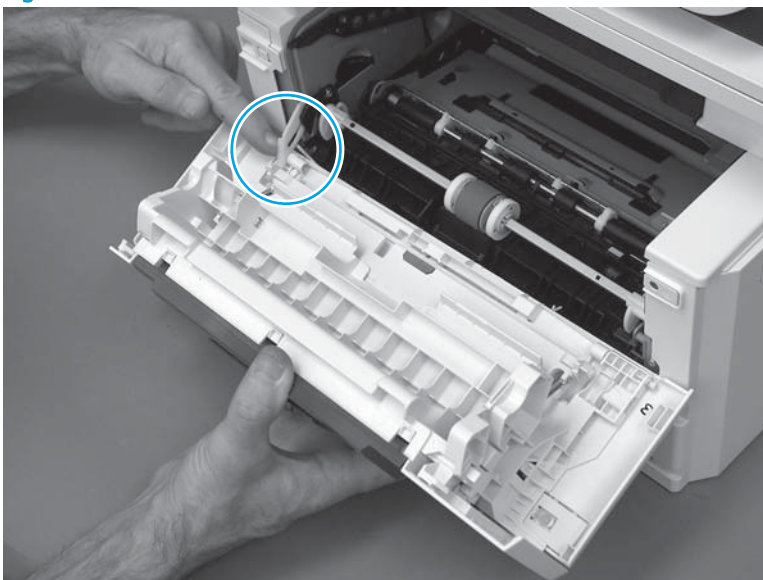

7. Remove the door.

Figure 1-706 Remove the door

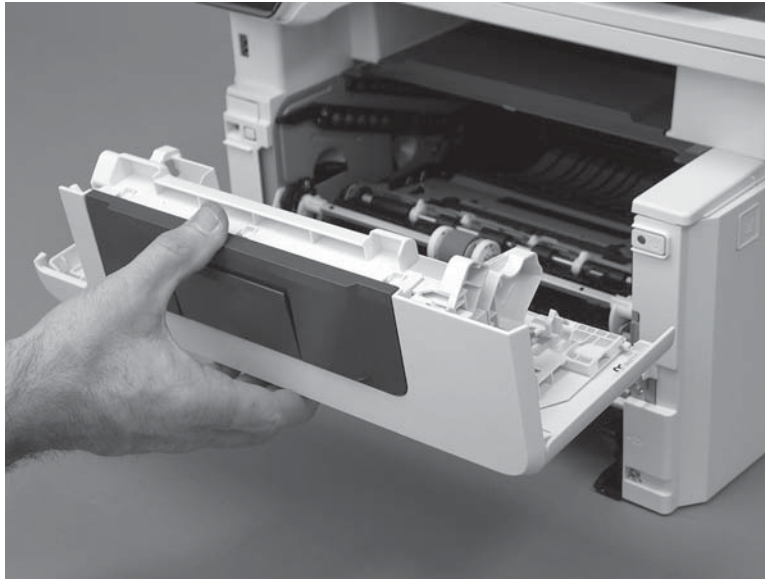

Step 3: Remove the left cover

1. Remove one screw (callout 1).

Figure 1-707 Remove one screw

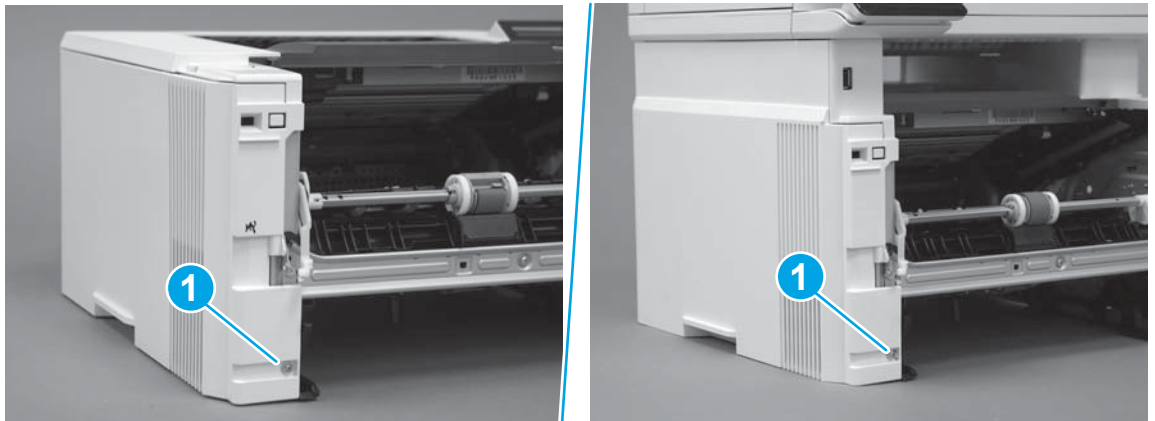

2. Open the rear door, release two bosses (callout 1), and then release three tabs (callout 2).

Figure 1-708 Release two bosses and three tabs

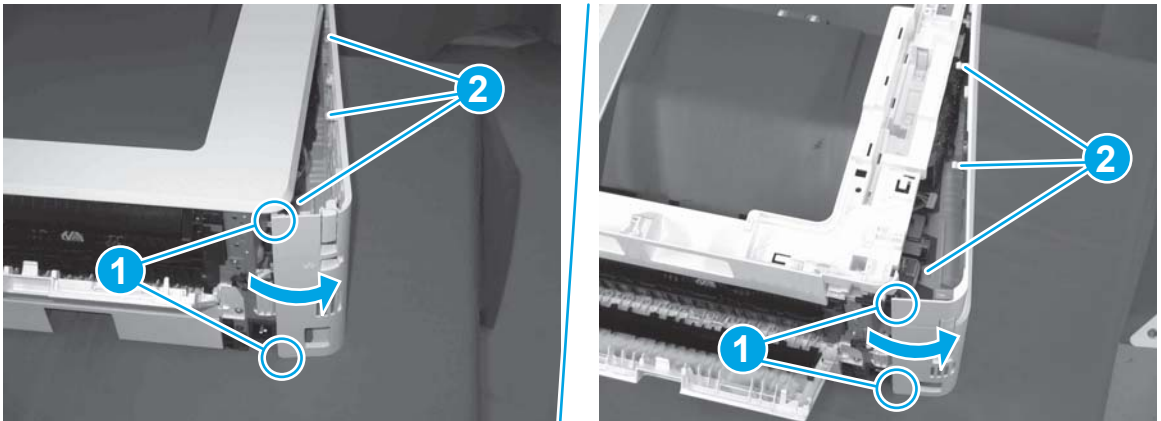

3. At the front of the printer, do one of the following:
 - **M304/M305/M404/M405:** Release two bosses (callout 1), and then remove the cover (callout 2).
 - **M329/M428/M429:** Release one tab (callout 3), two bosses (callout 4), and then remove the cover (callout 5).

CAUTION: Be careful when releasing the upper bosses on the M329/M428/M429 cover. One portion of the cover (callout 6) is fragile and is easily broken.

Figure 1-709 Remove the cover

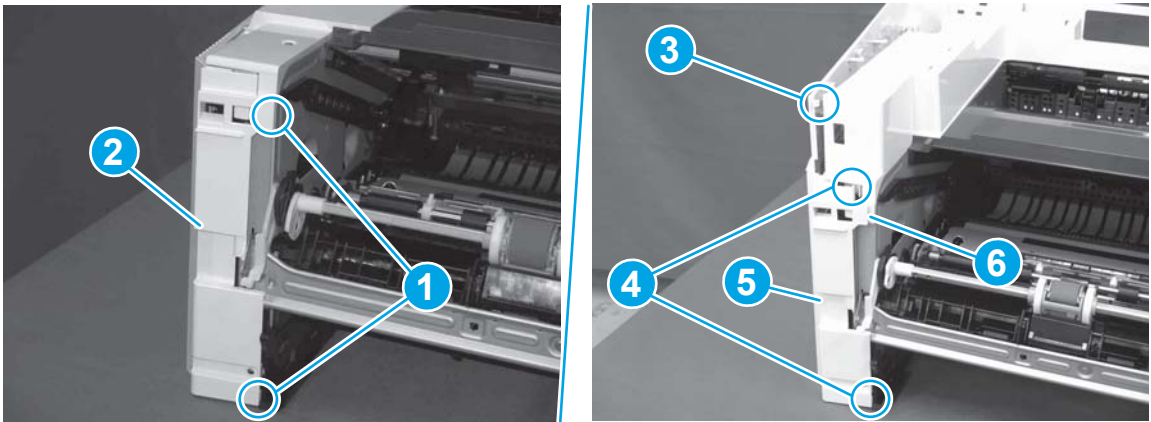

Step 4: Remove the right cover

1. At the front of the printer, release two bosses (callout 1), and then release three tabs (callout 2).

Reinstallation tip: Remove, and then reinstall the cover if the switch or button does not correctly function.

Figure 1-710 Release two bosses and three tabs

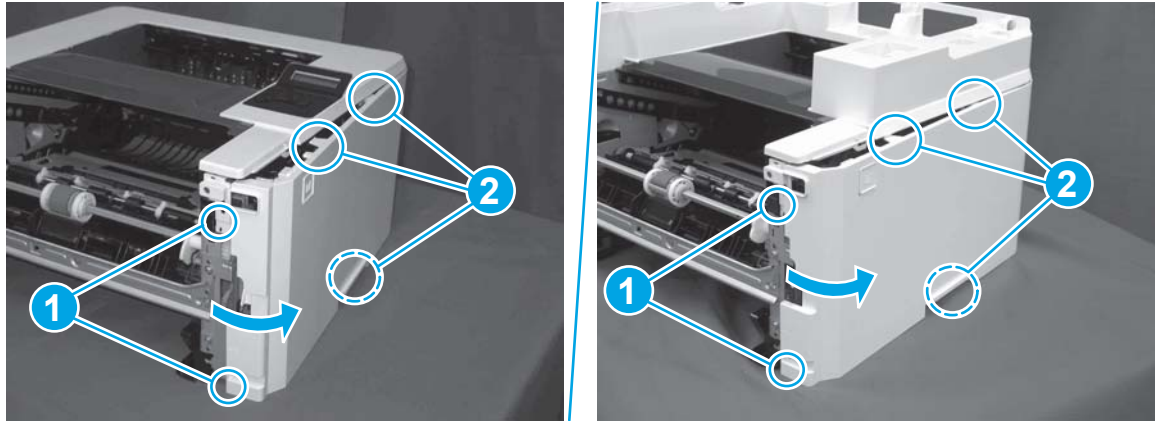

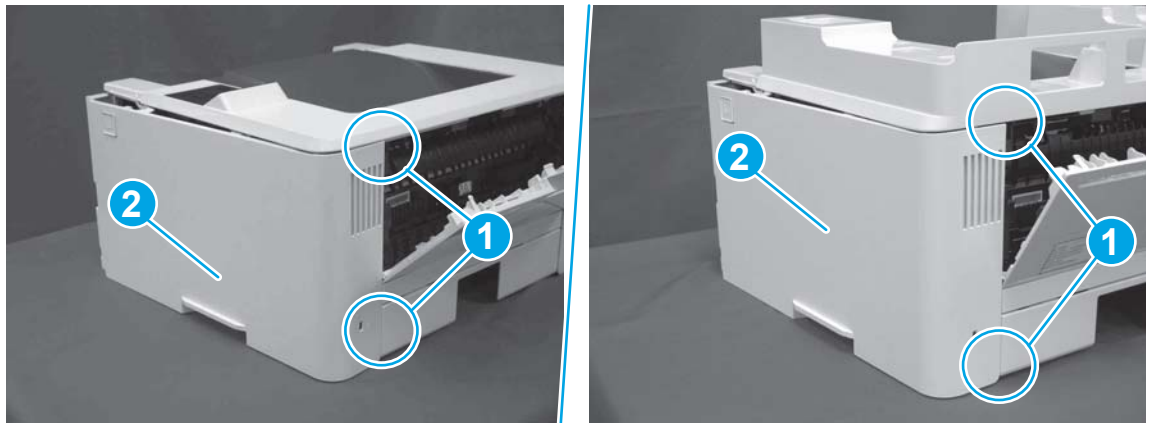

2. Open the rear door, release two bosses (callout 1), and then remove the cover (callout 2).

Figure 1-711 Remove the cover



Step 5: Remove the integrated scanner assembly (M329/M428/M429)

 **NOTE:** The step is for the M329/M428/M429 printer. For the M304/M305/M404/M405, skip this step and go to [Step 8: Remove the top cover \(M304/M305/M404/M405\) on page 444.](#)

 **NOTE:** M329/M428/M429 models only. The integrated scanner assembly (ISA) includes the sub-scanner assembly (SSA) and the automatic document feeder (ADF).

1. Raise the ISA.

Figure 1-712 Raise the ISA

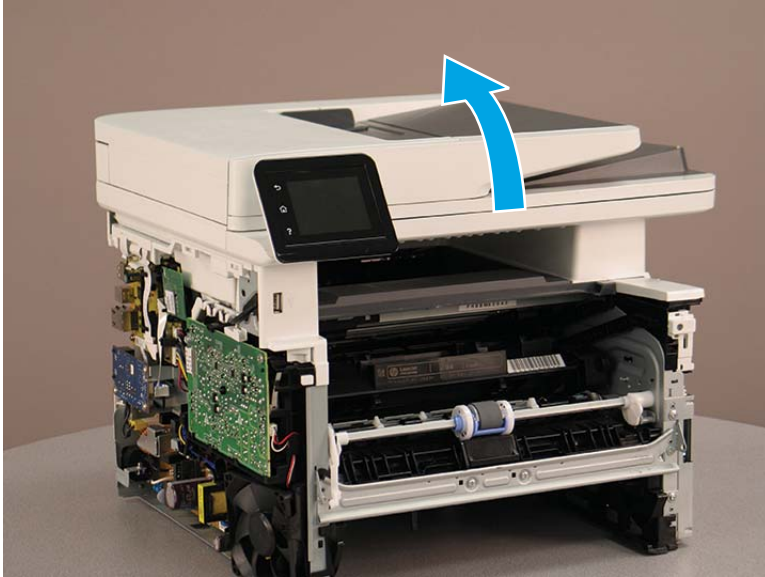

2. Release the ISA flat-flexible cable (FFC) cover (callout 1), and then remove it (callout 2).

Figure 1-713 Remove the ISA FFC cover

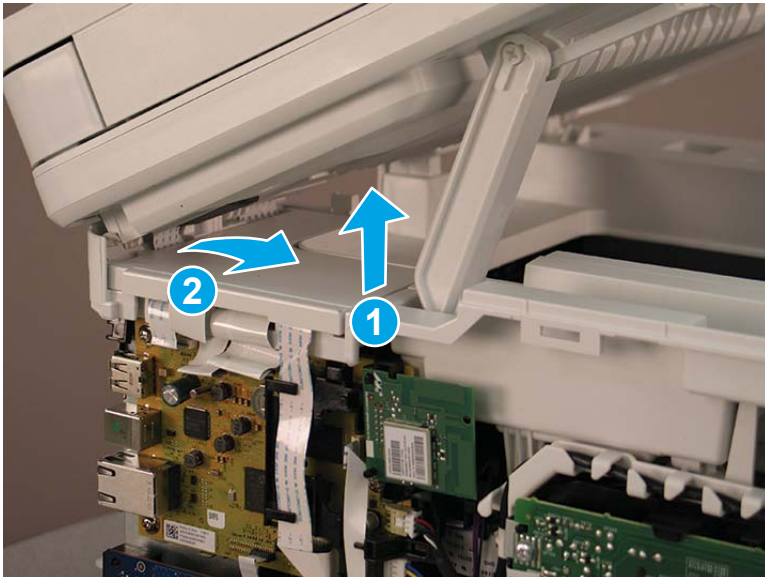

3. Disconnect three FFCs (callout 1), and then remove the ferrite (callout 2) from the holder.

CAUTION: The ferrite is not captive on the FFC. Do not lose the ferrite while handling the ISA.

Figure 1-714 Disconnect three FFCs

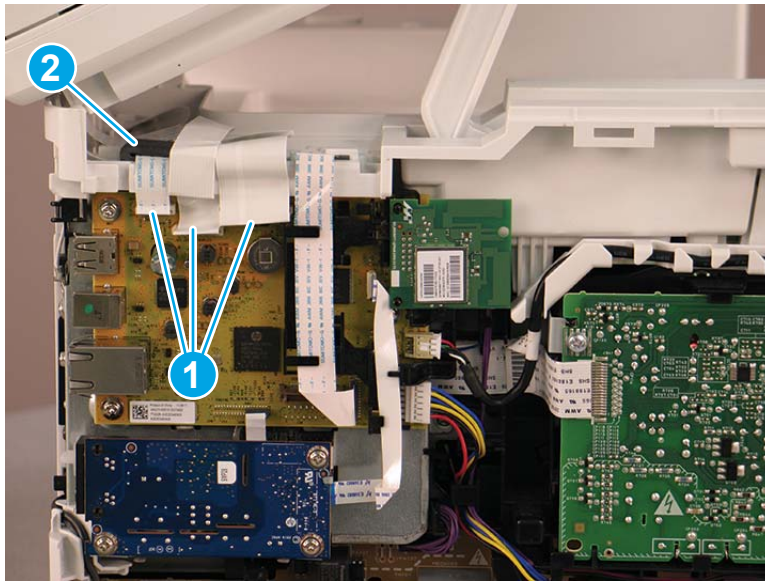

4. Remove one screw (callout 1).

Figure 1-715 Remove one screw

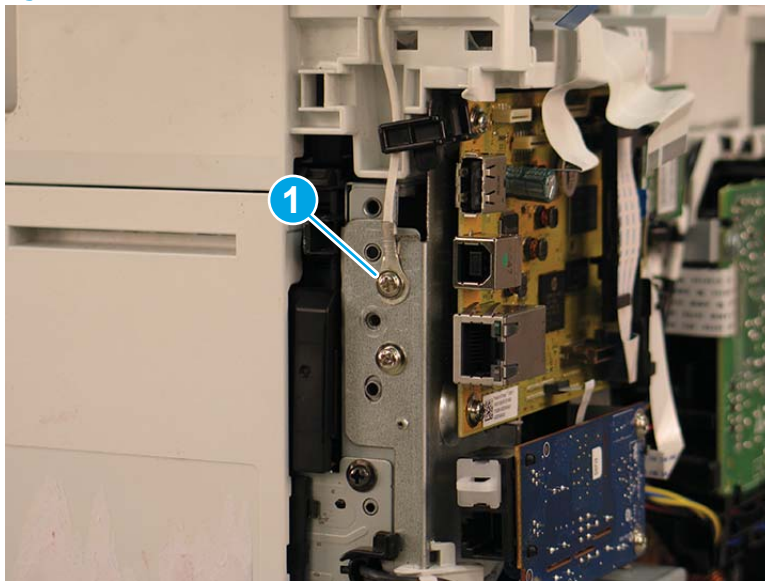

5. Pass the ground wire through the opening in the top cover.

Figure 1-716 Pass the wire through the opening

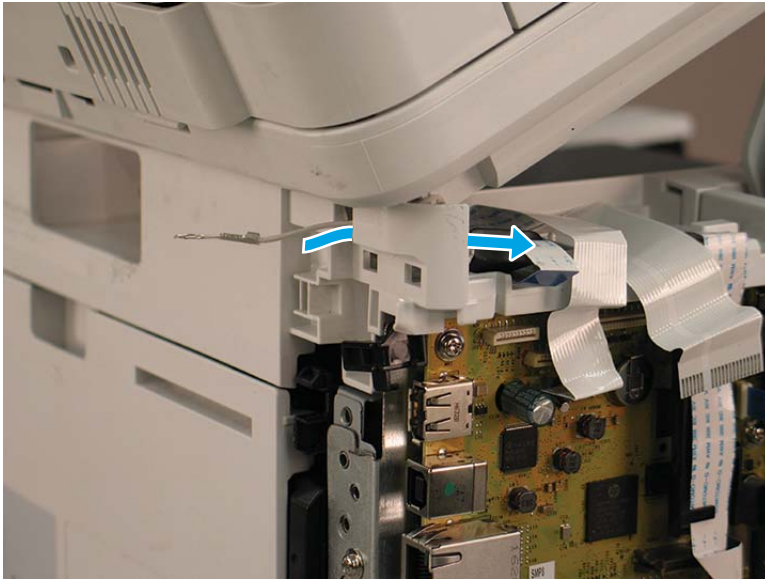

6. Release one tab (callout 1), and then rotate the ISA slider pin (callout 2) towards the front of the printer to release it.

Figure 1-717 Release one tab and rotate the slider pin

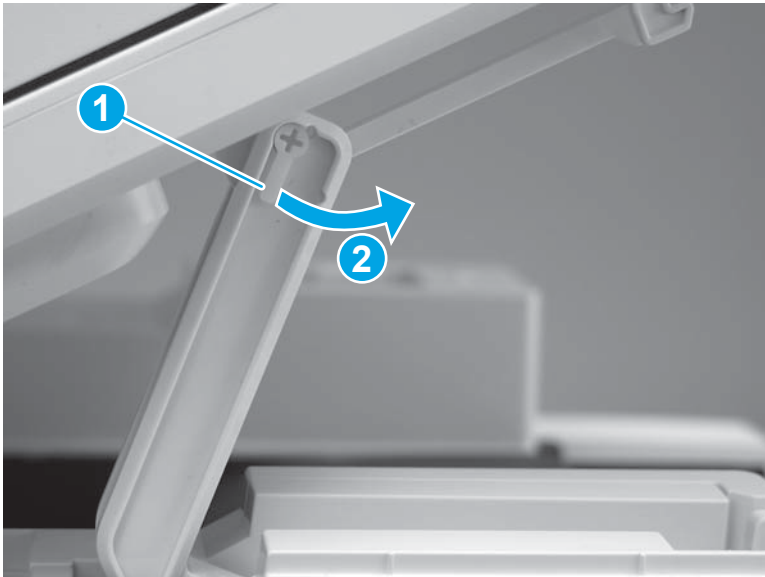

7. Remove the slider pin.

 **Reinstallation tip:** Align the keyed portion of the locking pin with the slot and hole in the support arm.

Figure 1-718 Remove the slider pin



8. Rotate the ISA towards the rear of the printer until it stops.

Figure 1-719 Rotate the ISA towards the rear of the printer

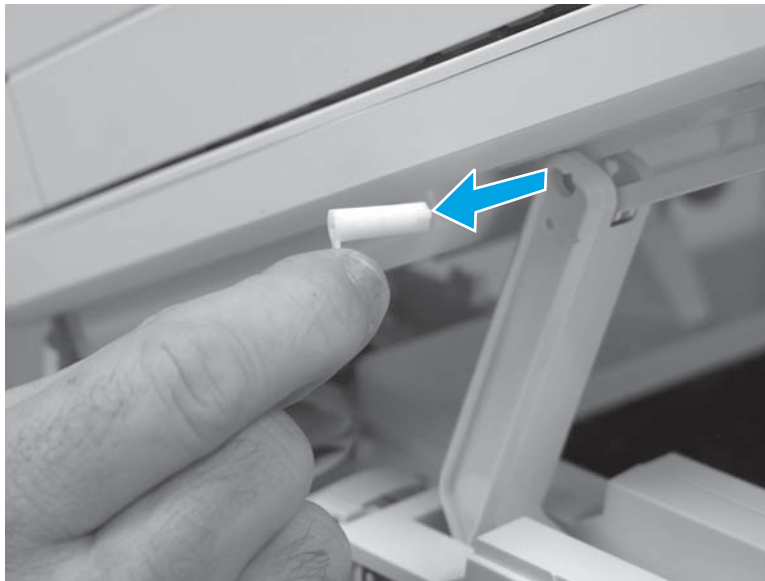
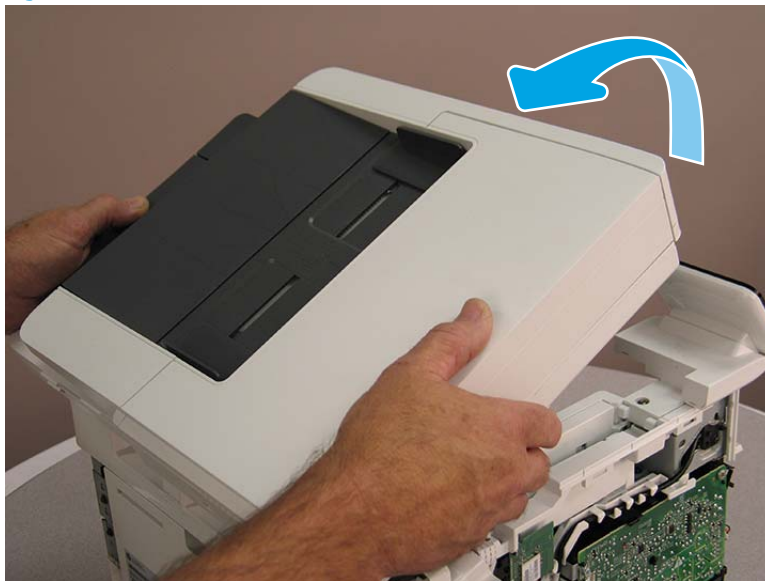

- Slide the ISA as shown to release it.

Figure 1-720 Release the ISA

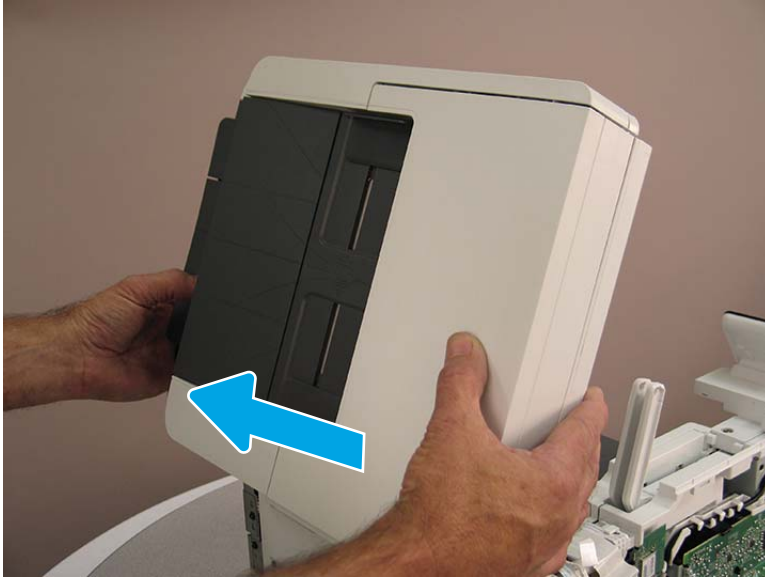

- Remove the ISA.

Figure 1-721 Remove the ISA

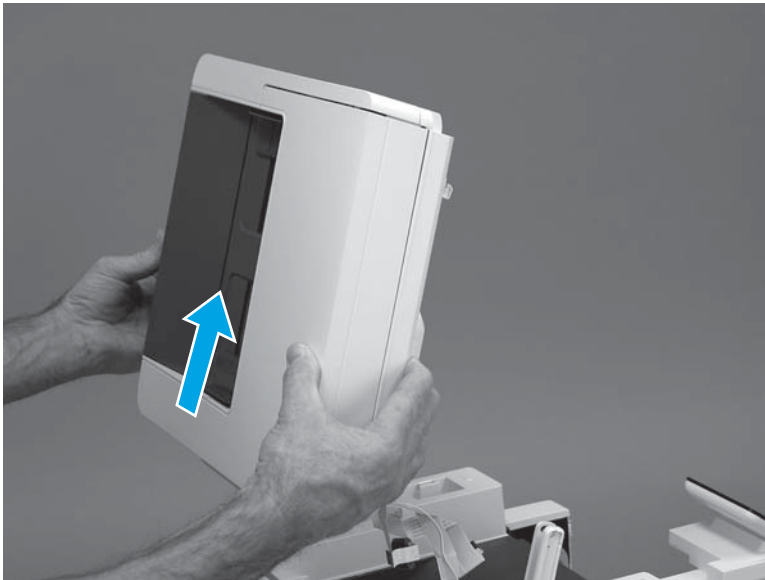

Step 6: Remove the control panel (M329/M428/M429)

 **NOTE:** The step is for the M329/M428/M429 printer. For the M304/M305/M404/M405, skip this step and go to [Step 8: Remove the top cover \(M304/M305/M404/M405\) on page 444.](#)

- Disconnect one FFC (callout 1), and then release the FFC from the guide (callout 2).

Figure 1-722 Disconnect one connector

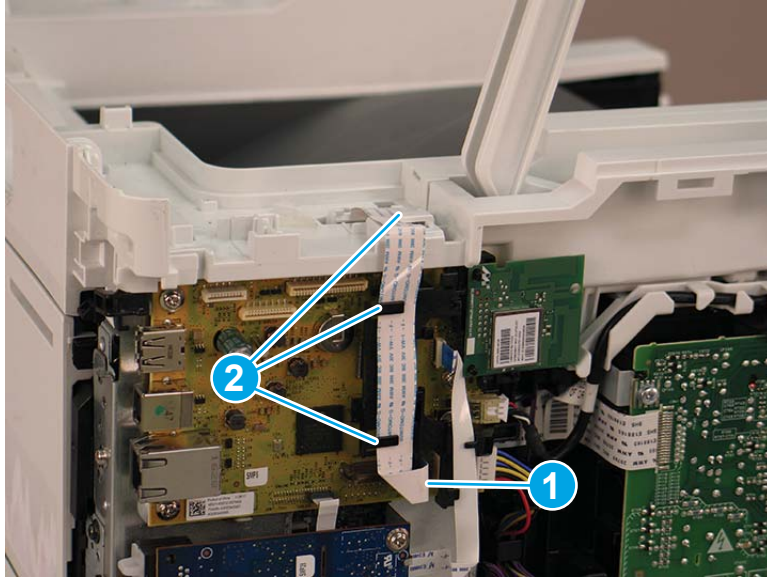

2. Remove one screw (callout 1).

Figure 1-723 Remove one screw

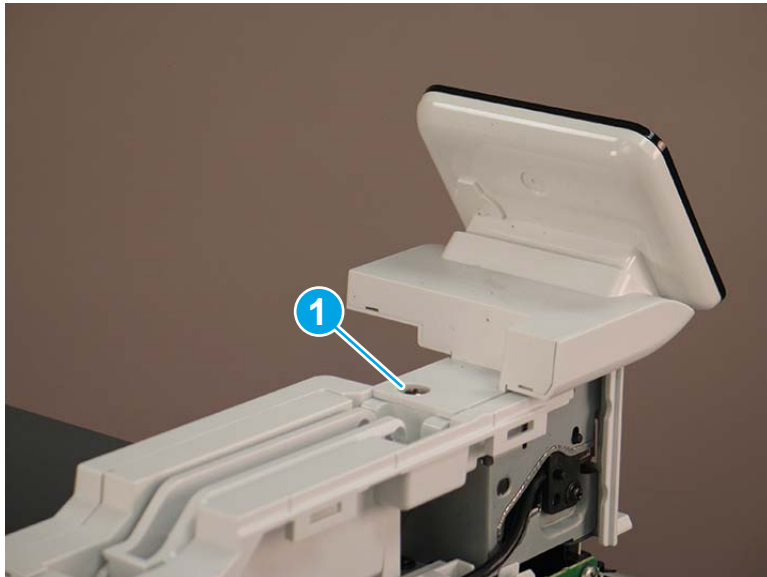

3. Use a small flat-blade screwdriver to release two tabs (callout 1) on the control-panel cable cover.

Figure 1-724 Release two tabs

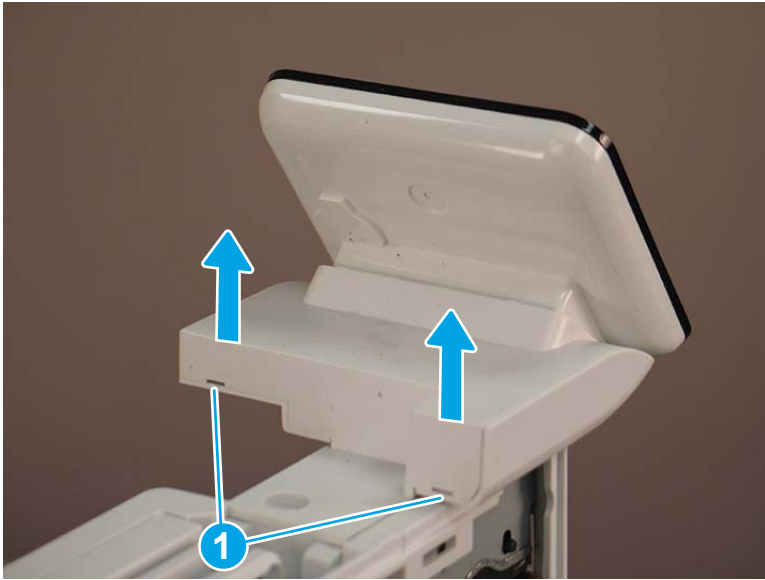

4. Remove the control-panel cable cover.

Figure 1-725 Remove the cover



5. Remove one grounding screw (callout 1), and then move the ground cable (callout 2) out of the way.

Figure 1-726 Remove one screw

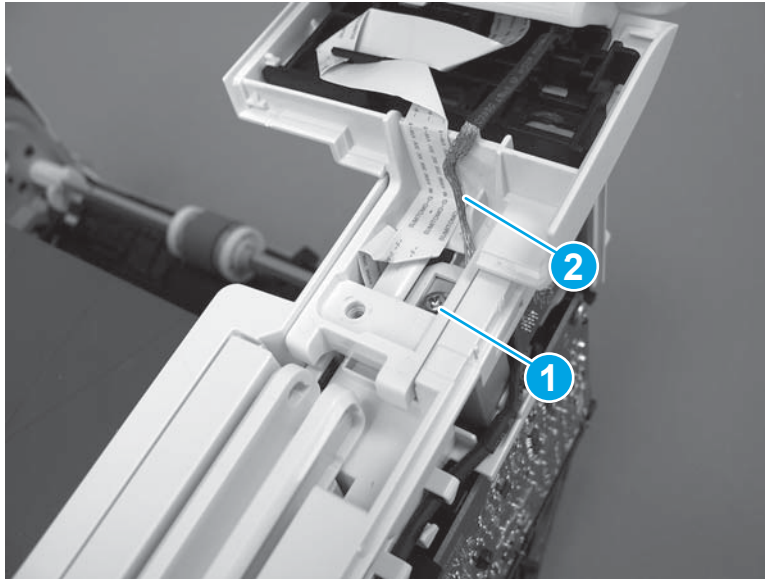

6. Move the FFC out of the way, and then remove two screws (callout 1).

Figure 1-727 Remove two screws

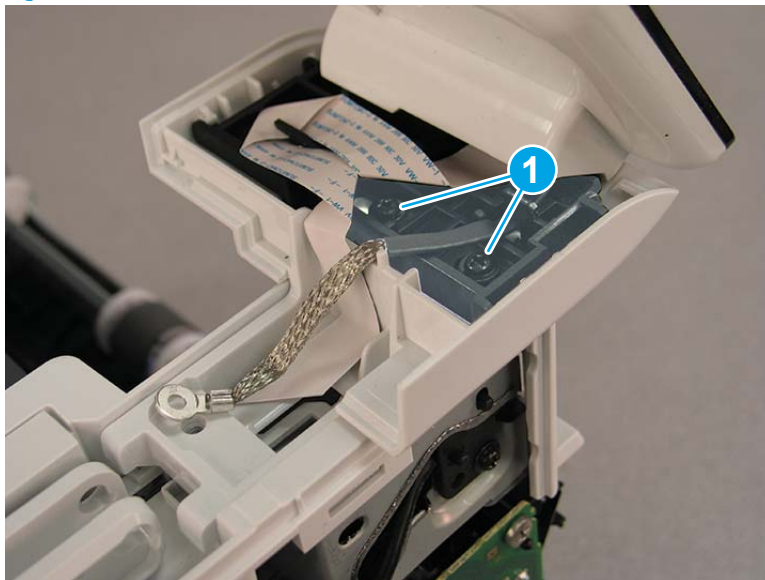

7. Slightly lift up the control-panel assembly to separate it from the top cover.

⚠ CAUTION: The control panel assembly is still connected to the printer by the FFC. Do not attempt to completely remove the assembly.

Figure 1-728 Lift up the control-panel assembly



8. Lift up the control-panel FFC cover to remove the control-panel assembly.

Figure 1-729 Remove the control-panel assembly

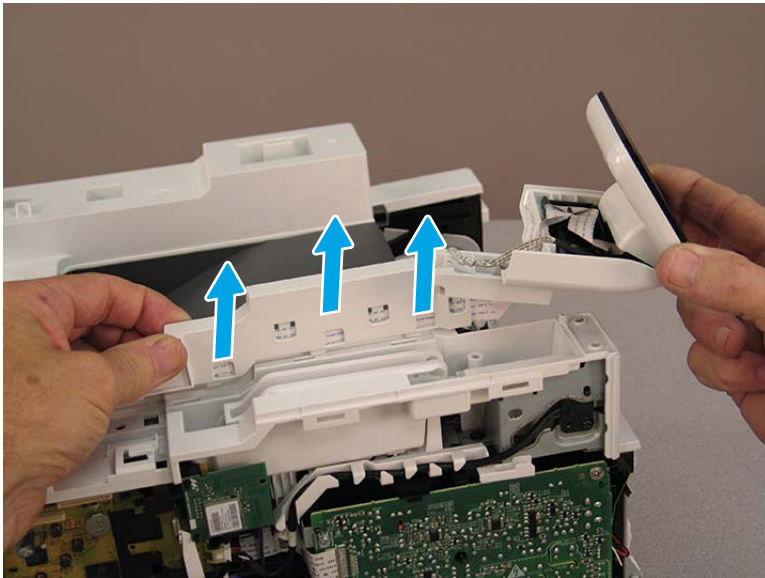

Step 7: Remove the top cover (M329/M428/M429)

📝 NOTE: The step is for the M329/M428/M429 printer. For the M304/M305/M404/M405, skip this step and go to [Step 8: Remove the top cover \(M304/M305/M404/M405\) on page 444](#).

1. Release the USB cable (callout 1) from the cable guide.

Figure 1-730 Remove the USB cable

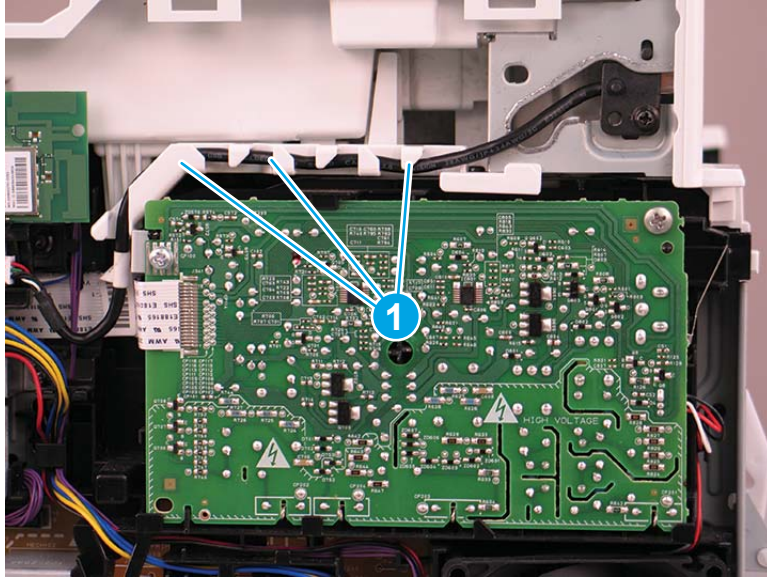

2. Remove one screw (callout 1), and then remove the support arm (callout 2).

⚠ CAUTION: The support arm is spring loaded and can unexpectedly spring into the open position. To avoid injury, do not place a finger in the screw well when the support arm is in the closed position.

Figure 1-731 Remove the support arm

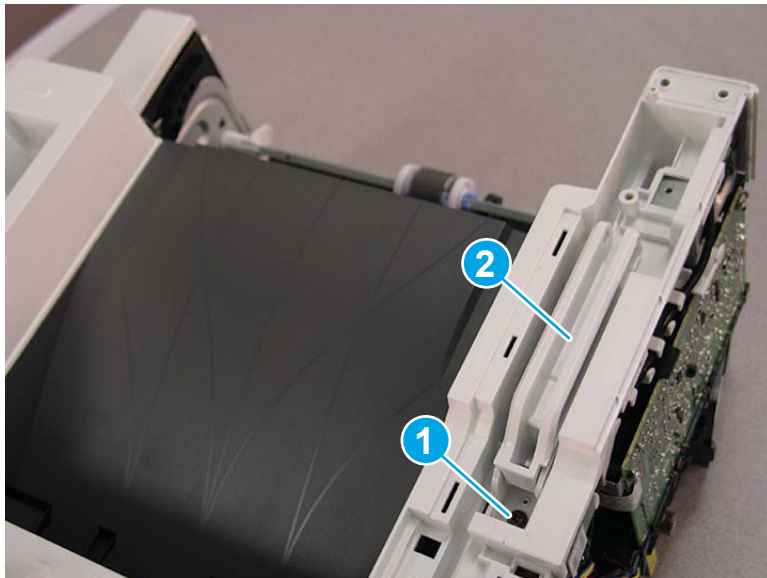

3. Remove five screws (callout 1), release four bosses (callout 2), and then remove the top cover (callout 3).

Figure 1-732 Remove the cover

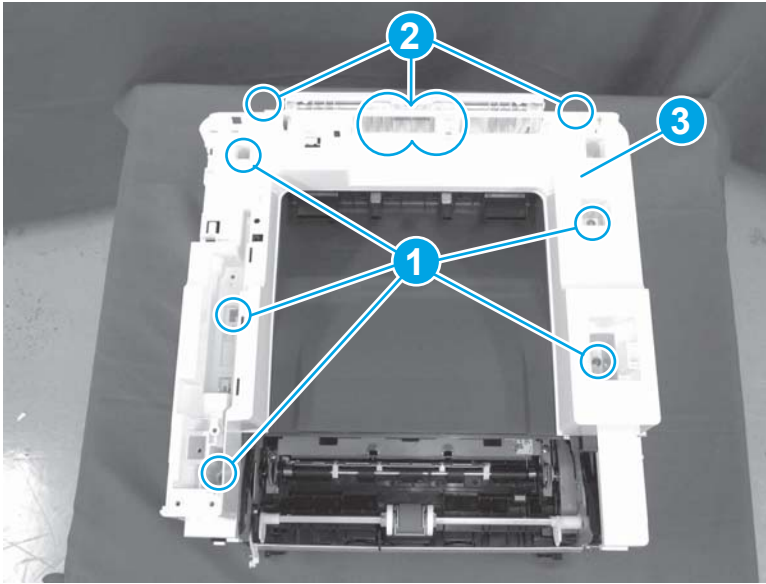

Step 8: Remove the top cover (M304/M305/M404/M405)

 **NOTE:** The step is for the M304/M305/M404/M405 printer. For the M329/M428/M429, skip this step and go to [Step 9: Remove the paper delivery tray \(output bin\) on page 445.](#)

1. Remove one screw (callout 1).

Figure 1-733 Remove one screw



2. At the right side of the printer, release the one boss (callout 1), and then release one tab (callout 2).

Figure 1-734 Release one boss and one tab

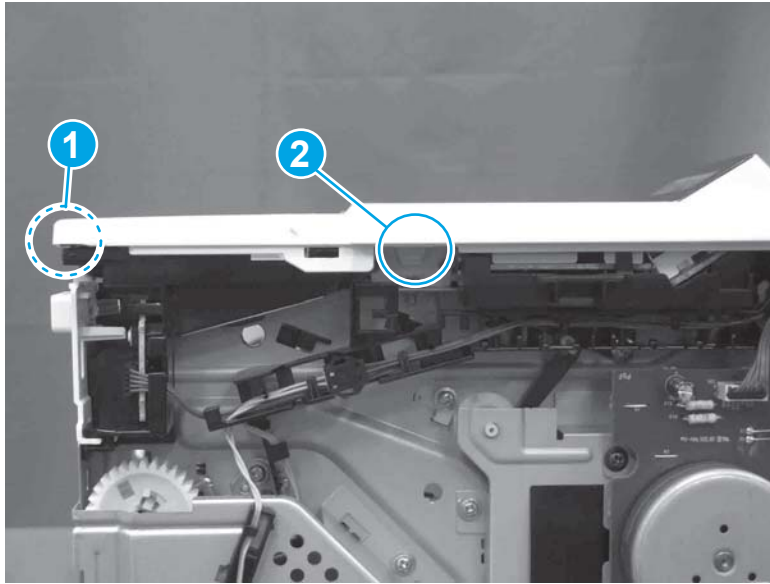

3. Release four tabs (callout 1), release four bosses (callout 2), and then remove the top cover (callout 3).

 **TIP:** Open the rear door to make releasing the bosses (callout 3) easier.

Figure 1-735 Remove the cover

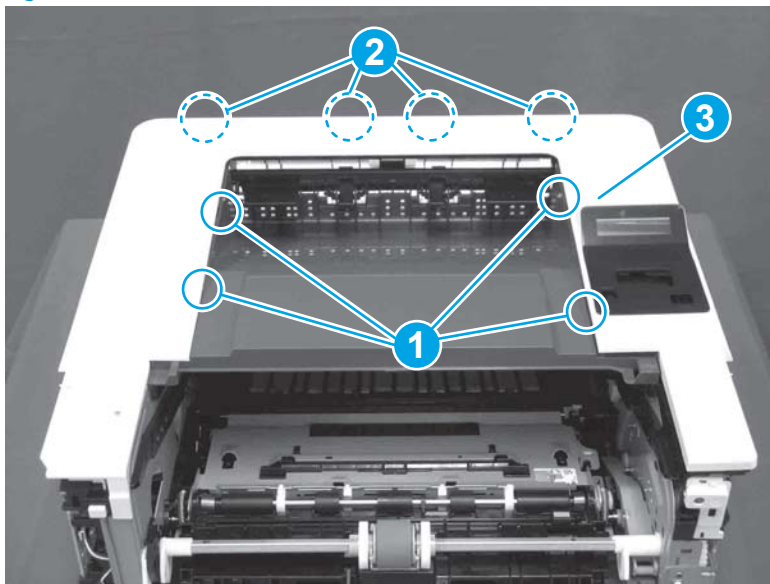

Step 9: Remove the paper delivery tray (output bin)

 **NOTE:** This procedure shows the M304/M305/M404/M405 model, however, the paper delivery tray (output bin) removal is similar for the M329/M428/M429 printer.

- ▲ Release two bosses (callout 1), release two tabs (callout 2), and then remove the paper delivery tray (output bin; callout 3).

Figure 1-736 Release two tabs

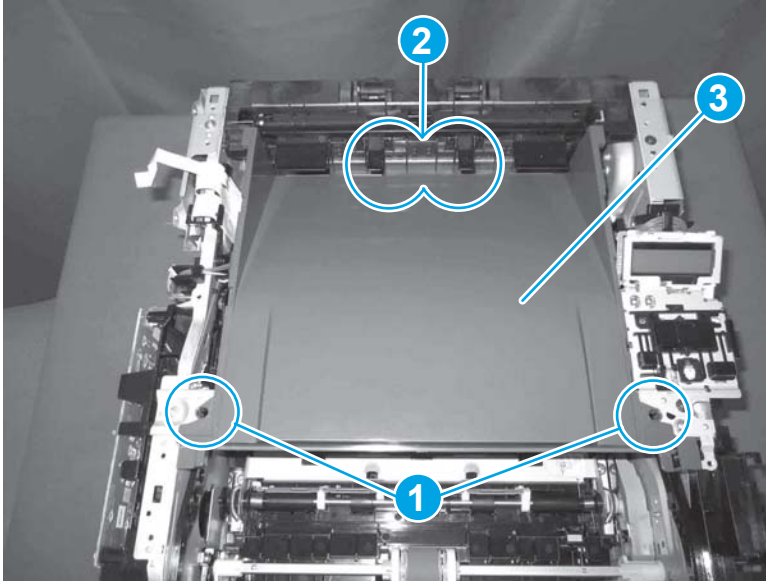

Step 10: Remove the sheet-metal formatter bracket and formatter PCA

1. Do one of the following:

- **SFP only:** Release two tabs (callout 1), and then carefully pull the wireless PCA straight off of the formatter PCA to remove it.

 **NOTE:** Disconnect the WiFi antenna (callout 2) before releasing the tabs.

- **MFP only:** Release one tab (callout 3), and then carefully pull the wireless PCA straight off of the formatter PCA to remove it.

 **TIP:** Push the tab to the left to release it.

Figure 1-737 Remove the wireless PCA



2. Do one of the following:

- **SFP only:** Disconnect the connectors (callout 1), and then release one wire harness (callout 2) from the guide.
- **MFP only:** Disconnect the connectors (callout 1), and then release one wire harness and one FFC (callout 2) from the guides.

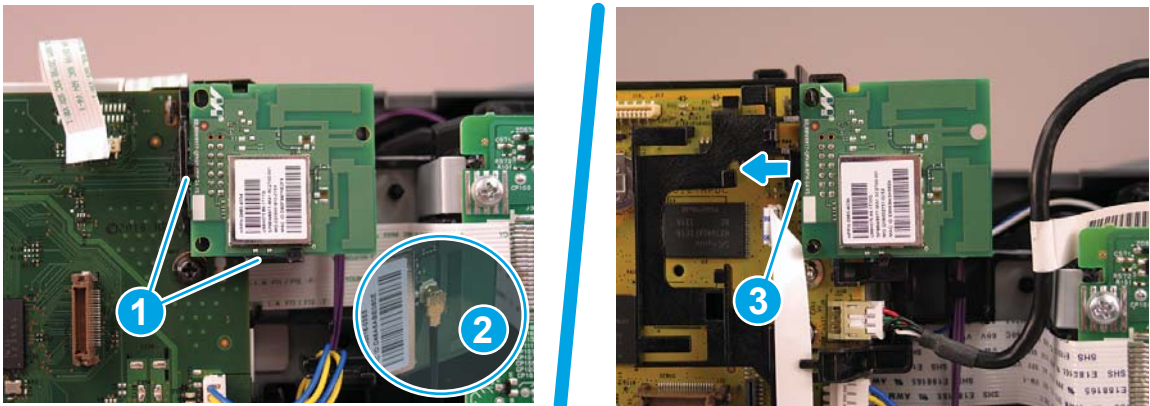
Figure 1-738 Disconnect the connectors

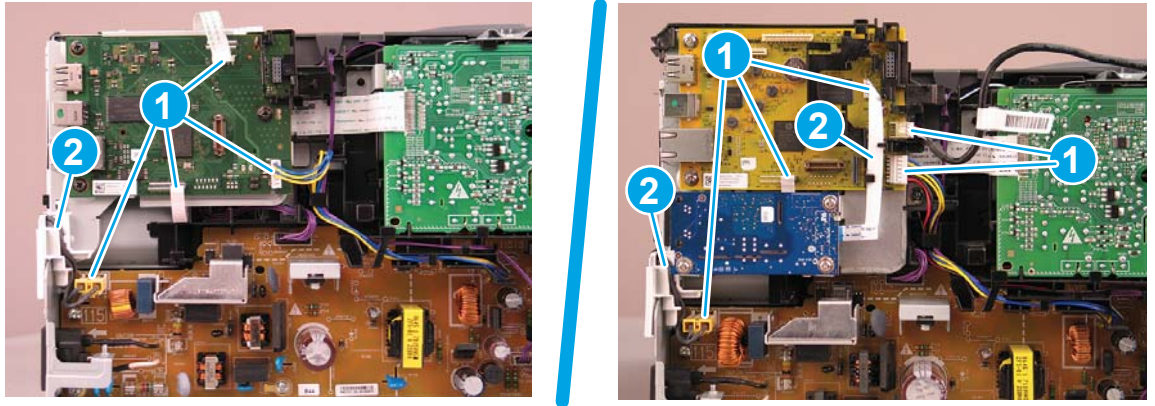

3. MFP only: Remove three screws (callout 1), and then remove the fax PCA.

Figure 1-739 Remove the fax PCA

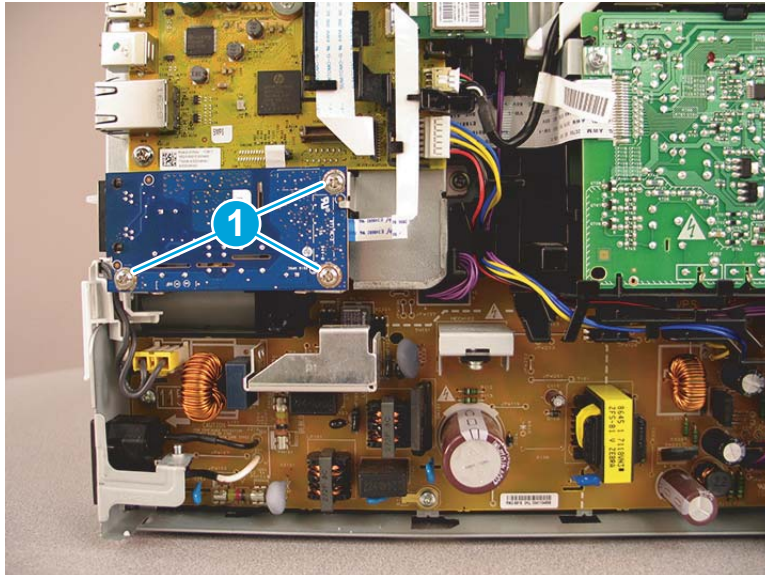

4. **MFP only:** Release the FFC from the guide (callout 1), release one tab (callout 2), and then remove the FFC guide (callout 3).

Figure 1-740 Remove the FFC guide

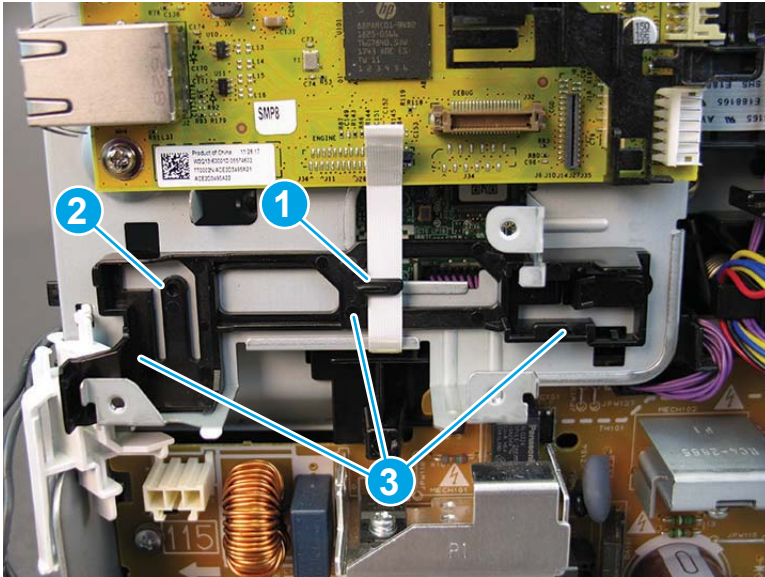

5. Remove one guide.

 **NOTE:** A SFP printer is shown in the figure. However, the guide is identical for an MFP printer.

Figure 1-741 Remove the guide



6. Remove two screws.

Figure 1-742 Remove two screws

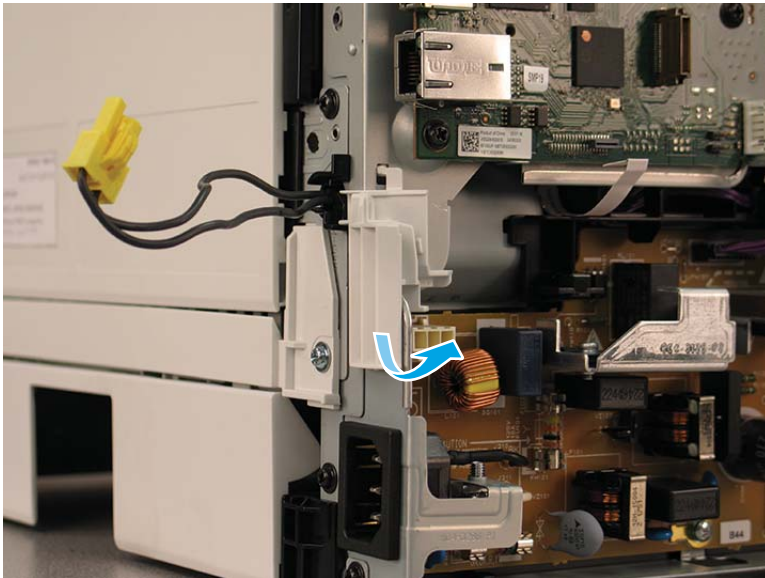

7. MFP only: Remove one screw.

Figure 1-743 Remove one screw

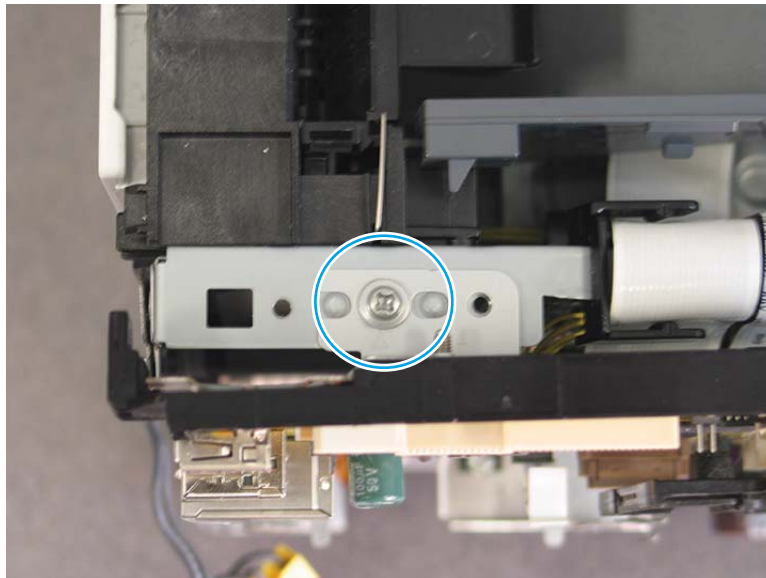

8. Support the formatter and bracket, and then remove two screws.

Figure 1-744 Remove two screws

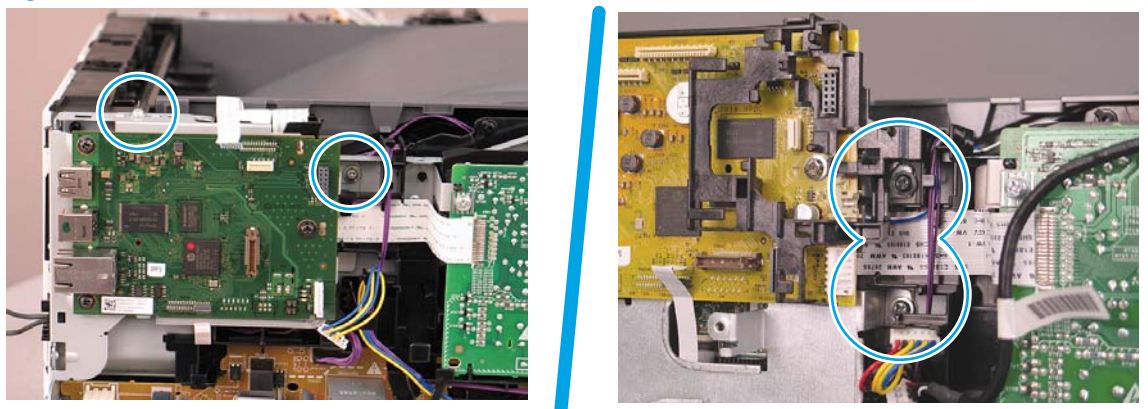

9. Remove the sheet-metal bracket and formatter PCA.

Figure 1-745 Remove the bracket

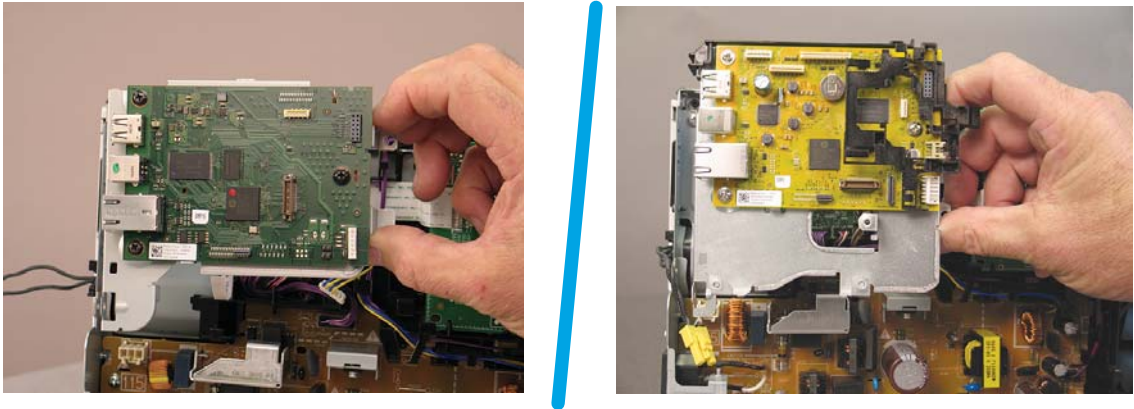

Step 11: Remove the tag-cable assembly (toner-cartridge memory)

1. Disconnect one connector (callout 1), and then release the wire harness from the guide (callout 2).

Figure 1-746 Disconnect one connector

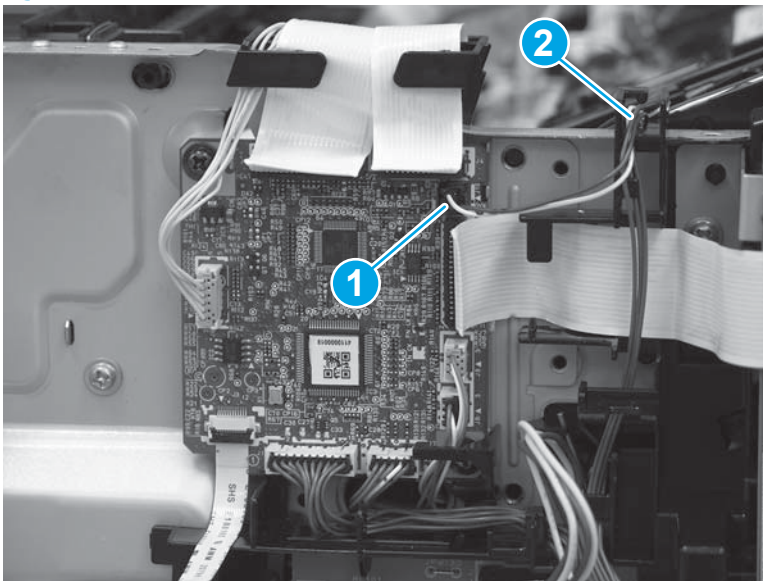

2. Remove one screw (callout 1).

Figure 1-747 Remove one screw

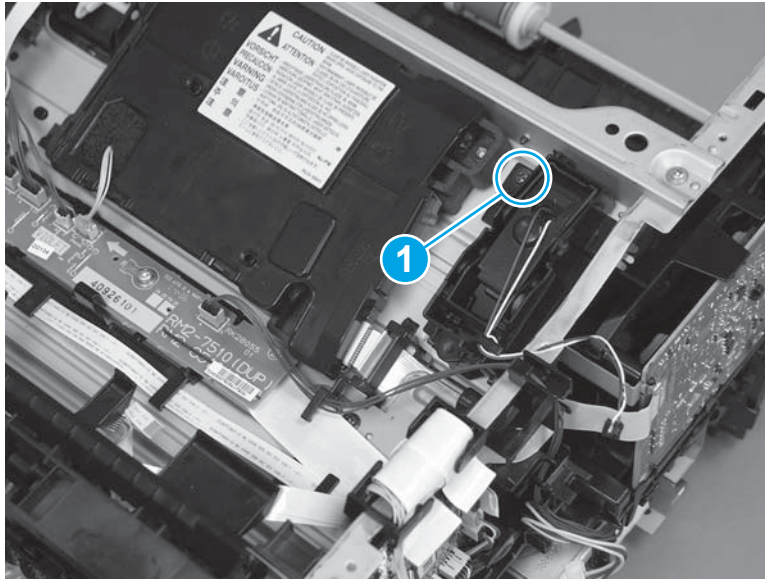

3. Remove the tag-cable assembly.



 **Reinstallation tip:** Make sure that the assembly is flat against the chassis. If the assembly is not correctly installed, it might not make proper contact with the toner cartridge.

Figure 1-748 Remove the tag-cable assembly



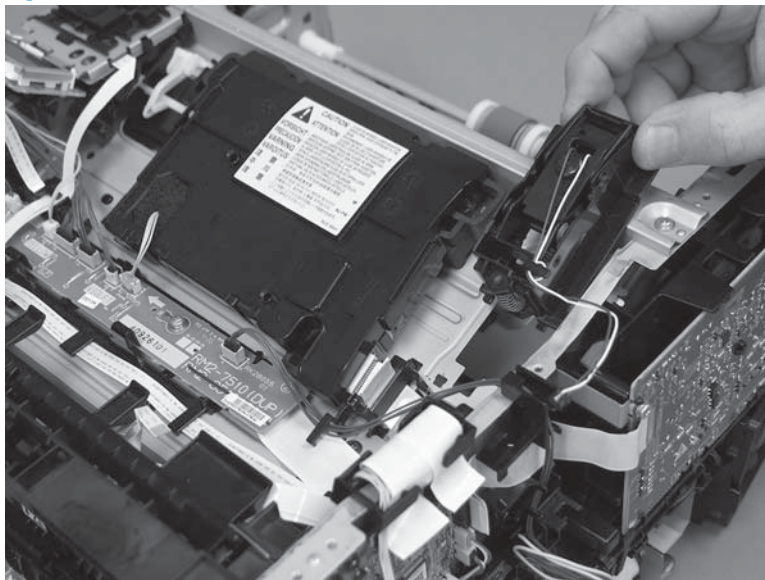

Step 12: Unpack the replacement assembly

1. Dispose of the defective part.

 **NOTE:** HP recommends responsible disposal of the defective part.

<http://www8.hp.com/us/en/hp-information/environment/product-recycling.html>

2. Unpack the replacement part from the packaging.

 **CAUTION:**  Some parts are sensitive to electrostatic discharge (ESD). Always perform service work at an ESD-protected workstation or mat. If an ESD workstation or mat is not available, touch the sheet-metal chassis to provide a static ground before touching an ESD-sensitive assembly. Protect the ESD-sensitive assemblies by placing them in ESD pouches when they are out of the printer.

If the replacement part is a roller or pad, avoid touching the spongy part of it. Skin oils on the roller or pad can cause paper pickup and/or print-quality problems. HP recommends using disposable gloves when handling rollers or pads or washing your hands before touching rollers or pads.

 **IMPORTANT:** Make sure that all of the shipping materials (for example shipping tape) are removed from the replacement part prior to installation.

3. To install an assembly, reverse the removal steps.

 **NOTE:** When applicable, special installation instructions are provided for an assembly at the end of the removal procedure. Always completely read the removal instructions and follow all special installation instructions.

Removal and replacement: Connecting PCA

- [Introduction](#)
- [Step 1: Remove Tray 2](#)
- [Step 2: Remove the cartridge door assembly](#)
- [Step 3: Remove the left cover](#)
- [Step 4: Remove the right cover](#)
- [Step 5: Remove the integrated scanner assembly \(M329/M428/M429\)](#)
- [Step 6: Remove the control panel \(M329/M428/M429\)](#)
- [Step 7: Remove the top cover \(M329/M428/M429\)](#)
- [Step 8: Remove the top cover \(M304/M305/M404/M405\)](#)
- [Step 9: Remove the paper delivery tray \(output bin\)](#)
- [Step 10: Remove the sheet-metal formatter bracket and formatter PCA](#)
- [Step 11: Remove the connecting PCA](#)
- [Step 12: Unpack the replacement assembly](#)

Introduction

This document provides the procedures to remove and replace the connecting printed circuit assembly (PCA).

Before performing service

Turn the printer power off

- Disconnect the power cable.

⚠ WARNING! To avoid damage to the printer, turn the printer off, wait 30 seconds, and then remove the power cable before attempting to service the printer.

Use the table below to identify the correct part number for your printer. To order the part, go to www.hp.com/buy/parts.

Connecting printed circuit assembly (PCA) part number	
RM2-7510-000CN	Connecting PCA (duplex models ¹)
RM2-8510-000CN	Connecting PCA (simplex models)

¹ All M329/M428/M429 printers are duplex models and use the RM2-7510-000CN connecting PCA.

Required tools

- #2 Phillips screwdriver with a magnetic tip.
- 5.5 mm (0.22 inch) socket screwdriver.

After performing service

Turn the printer power on

- Connect the power cable.
- Use the power switch to turn the power on.

Post service test

Make sure that the printer initializes to a **Ready** state.

Print a configuration page to make sure that the printer is functioning correctly.

Step 1: Remove Tray 2

- ▲ Pull the tray straight out of the printer to remove it.

Figure 1-749 Remove the tray



Step 2: Remove the cartridge door assembly

 **NOTE:** If the toner cartridge was not removed prior to servicing the printer, remove it now.

1. Release the support shaft (callout 1), and then slide it toward the center of the door (callout 2).

 **TIP:** It might be easier to release the support shaft by using a small flat-blade screwdriver.

Figure 1-750 Release the support shaft

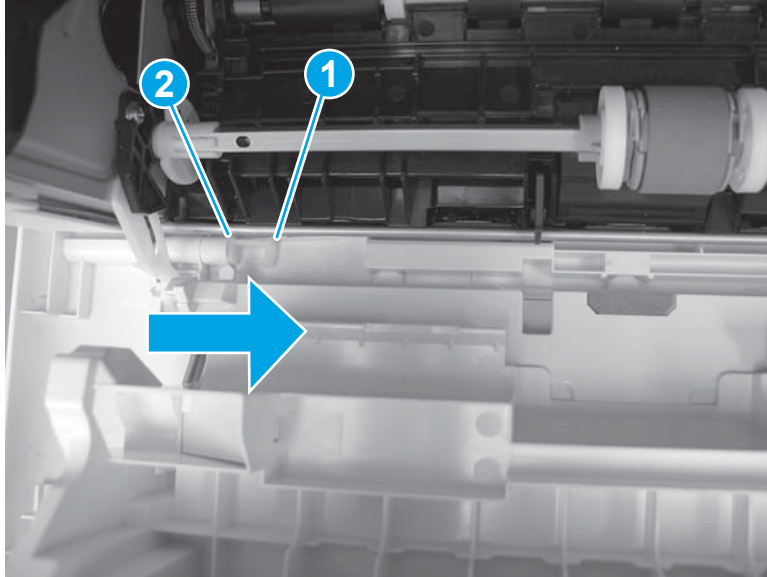

2. Remove the support shaft.

Figure 1-751 Remove the support shaft

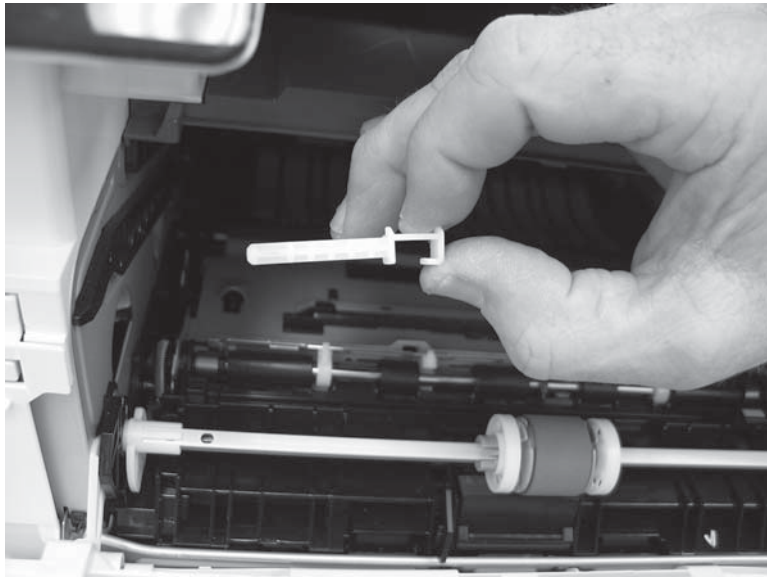

3. Release one tab (callout 1), and then slide the guide out of the printer (callout 2).

⚠ CAUTION: Be careful, the tab (callout 1) can be easily broken.

Figure 1-752 Remove the guide

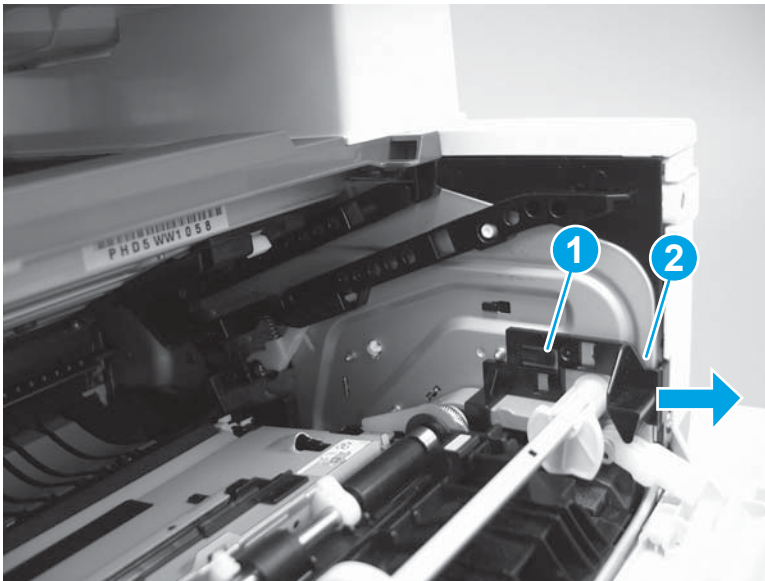

4. Use a small flat-blade screwdriver to gently pry the white-plastic door arm (callout 1) off of the gray-plastic pressure-release link (callout 2) to release the door arm.

Figure 1-753 Release the pressure-release link

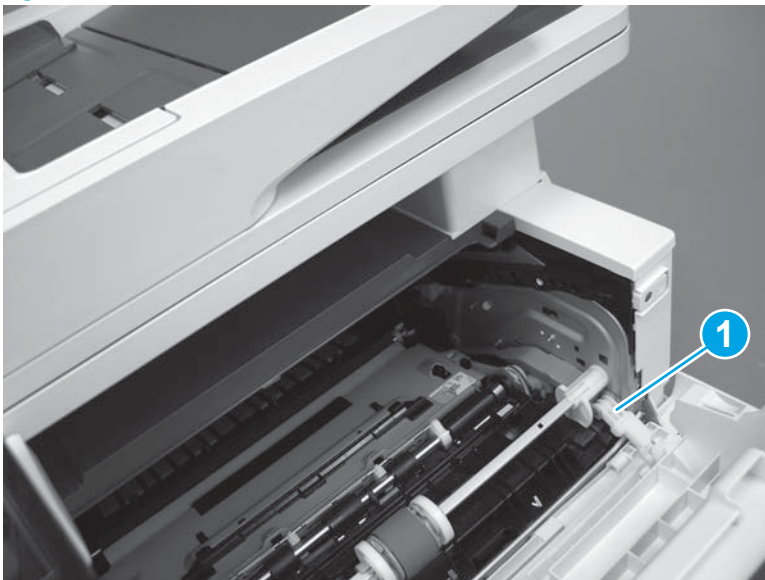

5. With the door in the partially closed position, slightly raise the left end (callout 1; raise it over the sheet-metal hinge boss), and then slide the door to the left (callout 2) to release the right hinge (callout 3).

⚠ CAUTION: The door is still attached to the printer by the left-side retainer arm. Do not attempt to completely remove the door.

💡 Reinstallation tip: When reinstalling the door, there are two right-side hinge pins (not shown in callout 3). Keep a finger pressed on the left-side retainer arm so that it does not disengage from the door.

Figure 1-754 Release the door

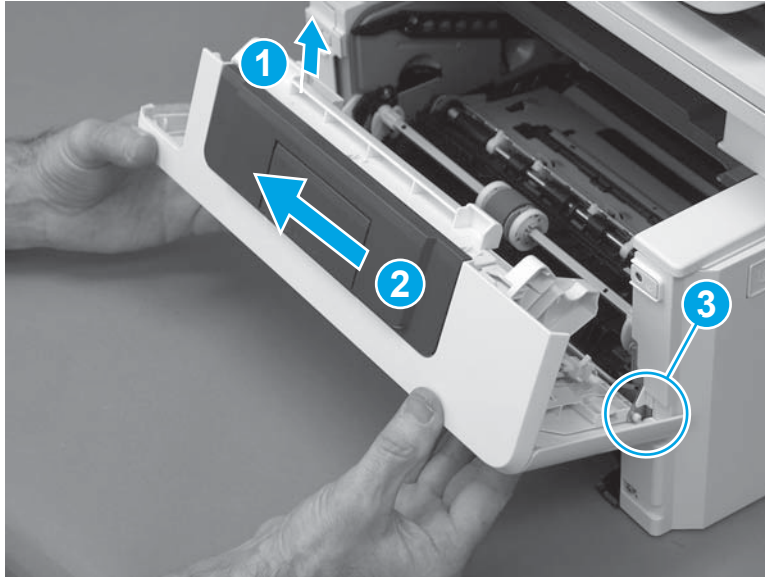

6. Rotate the door away from the printer until the keyed pin on the left-side retainer arm can disengage from the door.

Figure 1-755 Release the left-side retainer arm

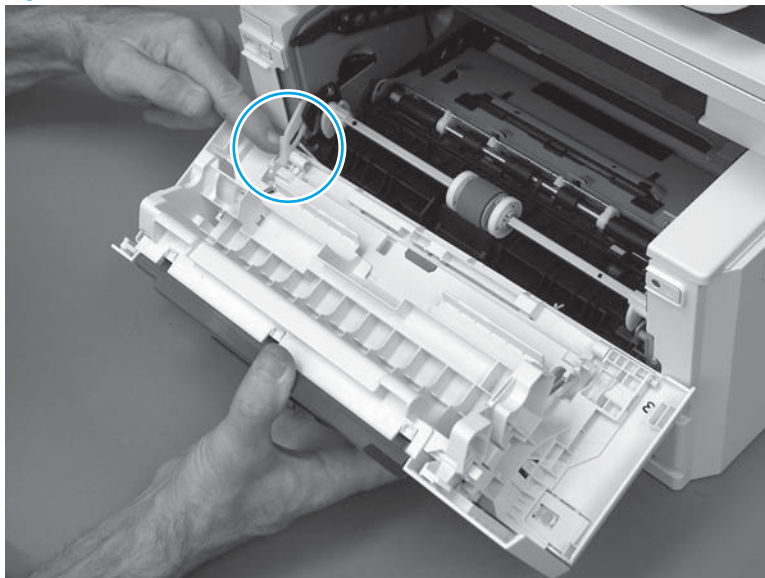

7. Remove the door.

Figure 1-756 Remove the door

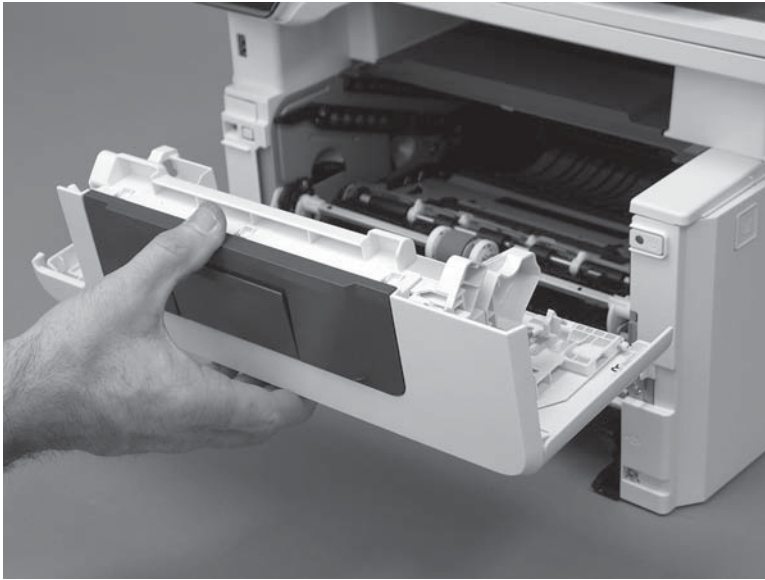

Step 3: Remove the left cover

1. Remove one screw (callout 1).

Figure 1-757 Remove one screw

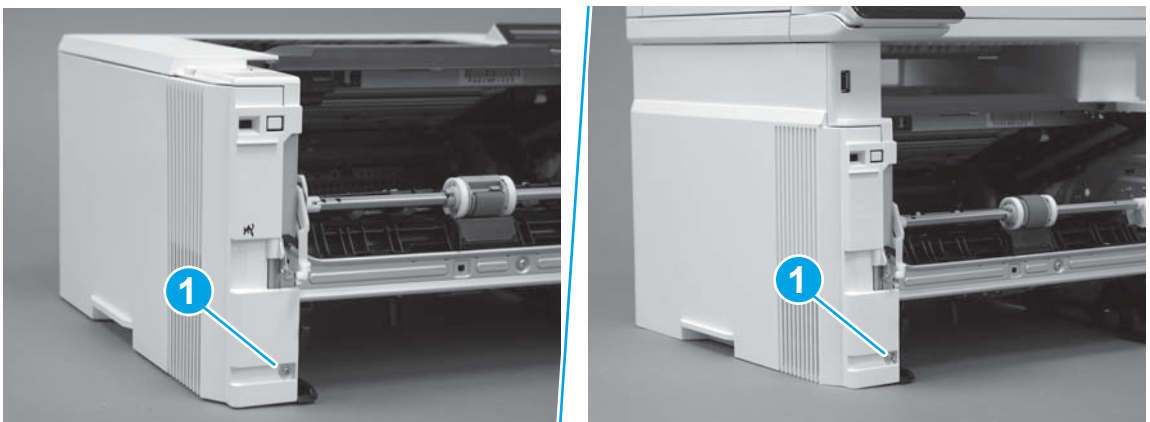

2. Open the rear door, release two bosses (callout 1), and then release three tabs (callout 2).

Figure 1-758 Release two bosses and three tabs

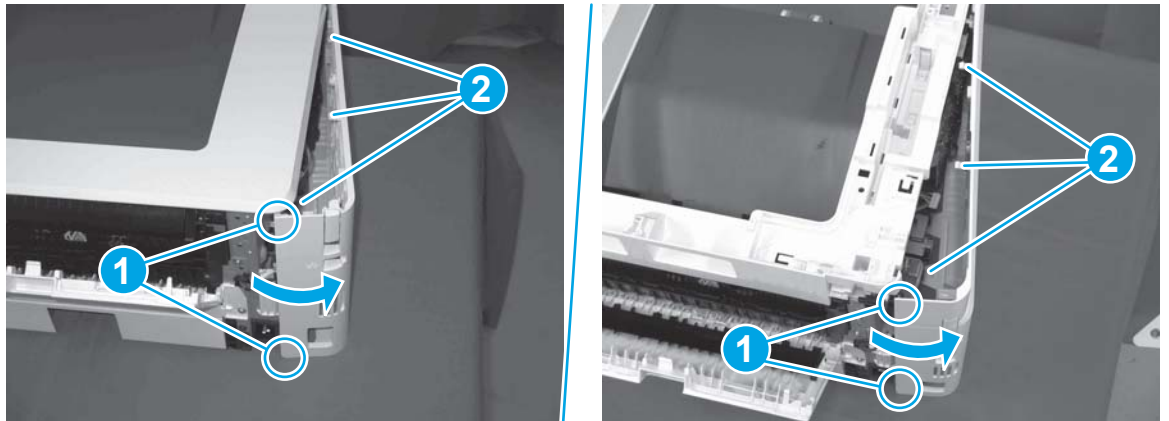

3. At the front of the printer, do one of the following:
 - **M304/M305/M404/M405:** Release two bosses (callout 1), and then remove the cover (callout 2).
 - **M329/M428/M429:** Release one tab (callout 3), two bosses (callout 4), and then remove the cover (callout 5).

⚠ CAUTION: Be careful when releasing the upper bosses on the M329/M428/M429 cover. One portion of the cover (callout 6) is fragile and is easily broken.

Figure 1-759 Remove the cover

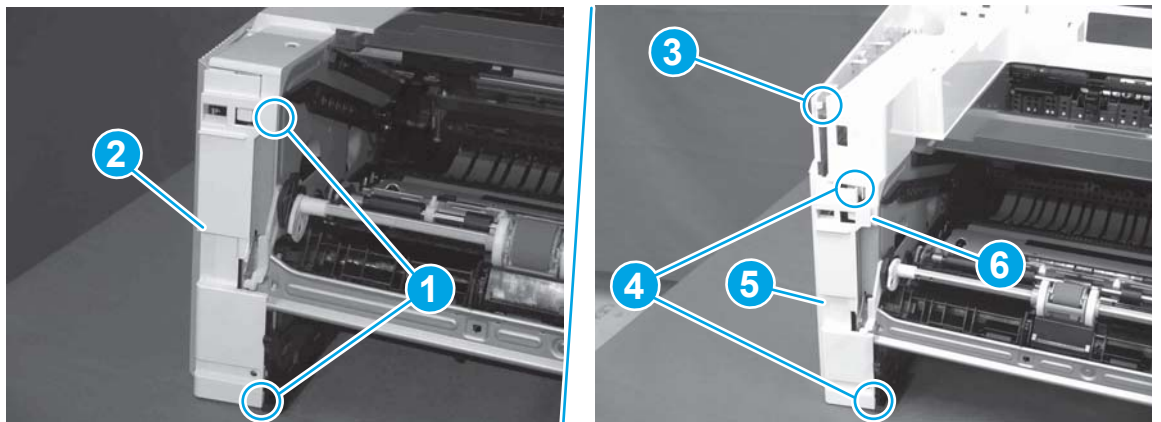

Step 4: Remove the right cover

1. At the front of the printer, release two bosses (callout 1), and then release three tabs (callout 2).

💡 Reinstallation tip: Remove, and then reinstall the cover if the switch or button does not correctly function.

Figure 1-760 Release two bosses and three tabs

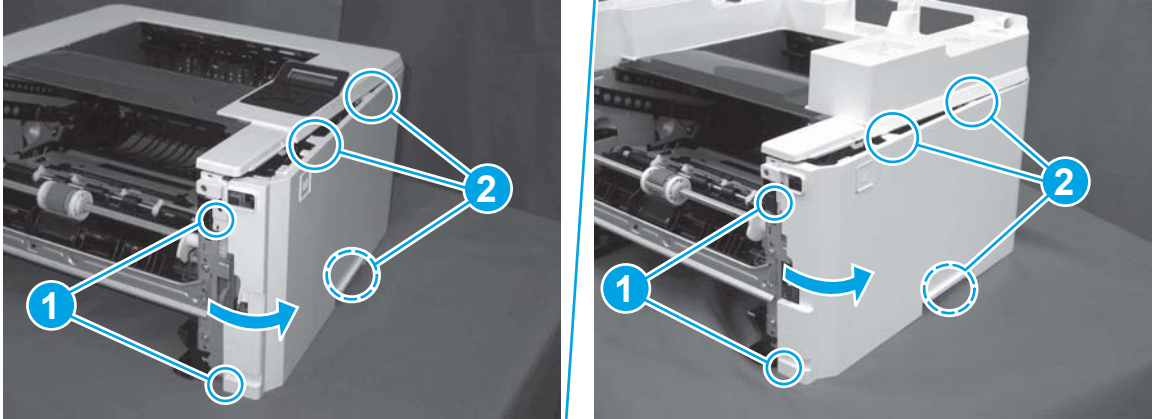

2. Open the rear door, release two bosses (callout 1), and then remove the cover (callout 2).

Figure 1-761 Remove the cover

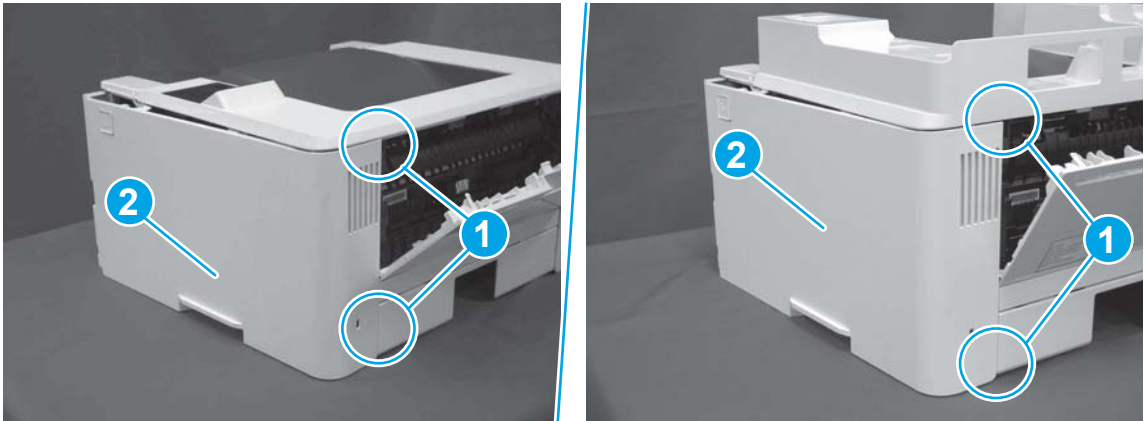

Step 5: Remove the integrated scanner assembly (M329/M428/M429)

 **NOTE:** The step is for the M329/M428/M429 printer. For the M304/M305/M404/M405, skip this step and go to [Step 8: Remove the top cover \(M304/M305/M404/M405\) on page 471.](#)

 **NOTE:** M329/M428/M429 models only. The integrated scanner assembly (ISA) includes the sub-scanner assembly (SSA) and the automatic document feeder (ADF).

1. Raise the ISA.

Figure 1-762 Raise the ISA

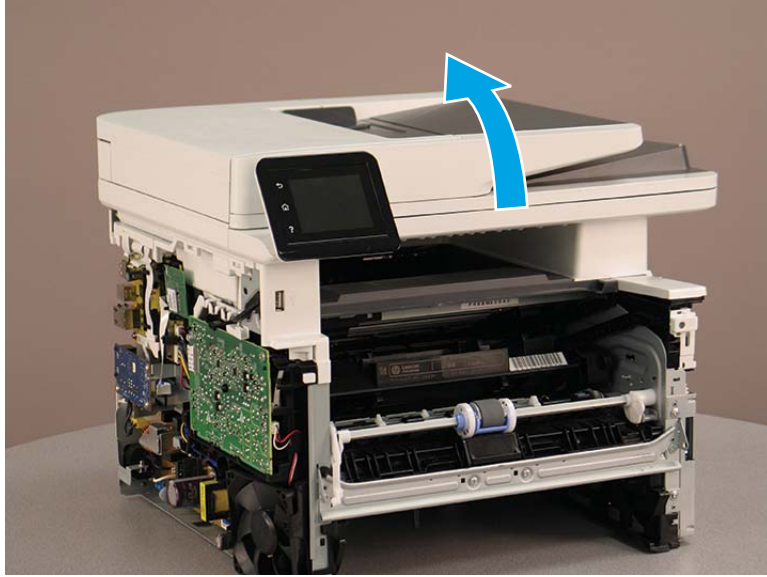

2. Release the ISA flat-flexible cable (FFC) cover (callout 1), and then remove it (callout 2).

Figure 1-763 Remove the ISA FFC cover

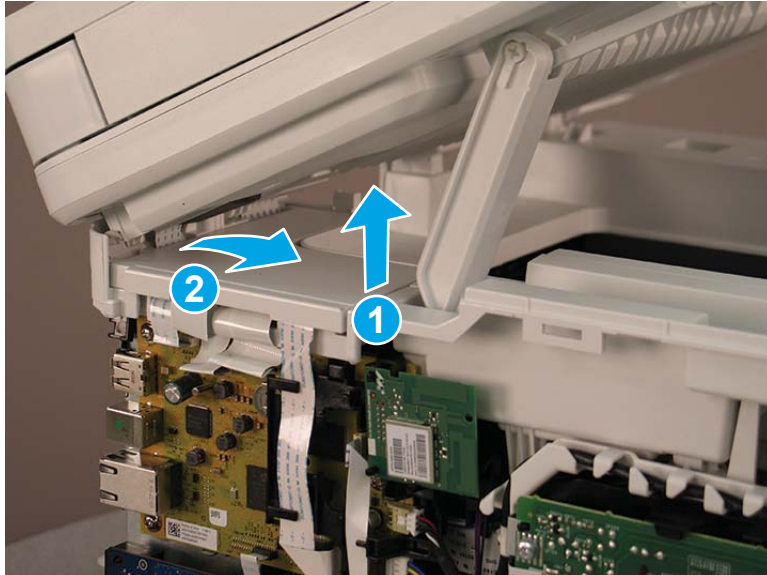

3. Disconnect three FFCs (callout 1), and then remove the ferrite (callout 2) from the holder.

⚠ CAUTION: The ferrite is not captive on the FFC. Do not lose the ferrite while handling the ISA.

Figure 1-764 Disconnect three FFCs

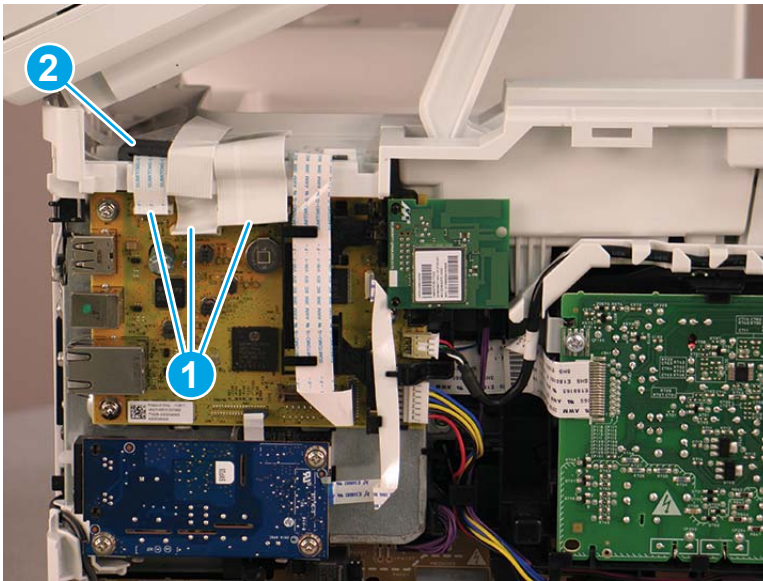

4. Remove one screw (callout 1).

Figure 1-765 Remove one screw

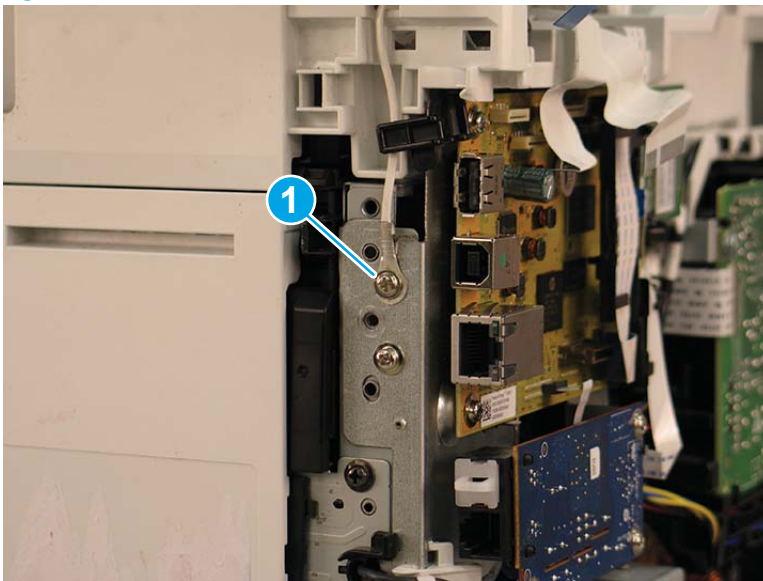

5. Pass the ground wire through the opening in the top cover.

Figure 1-766 Pass the wire through the opening

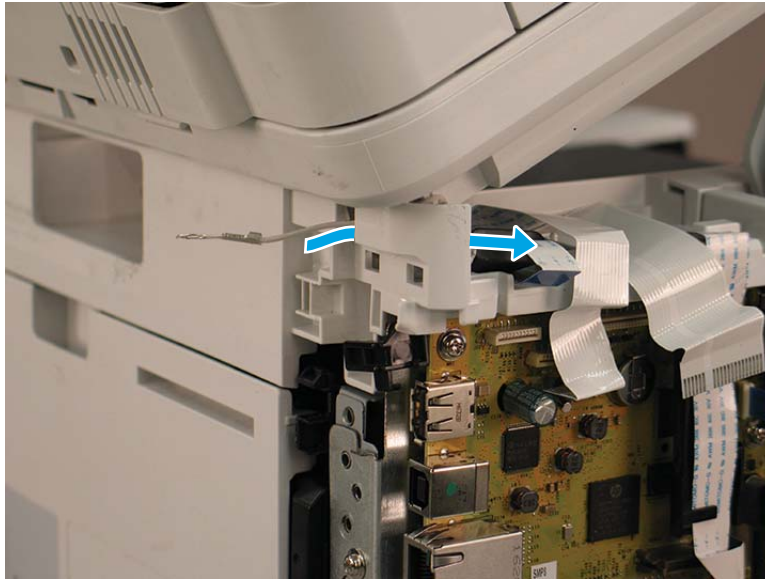

6. Release one tab (callout 1), and then rotate the ISA slider pin (callout 2) towards the front of the printer to release it.

Figure 1-767 Release one tab and rotate the slider pin

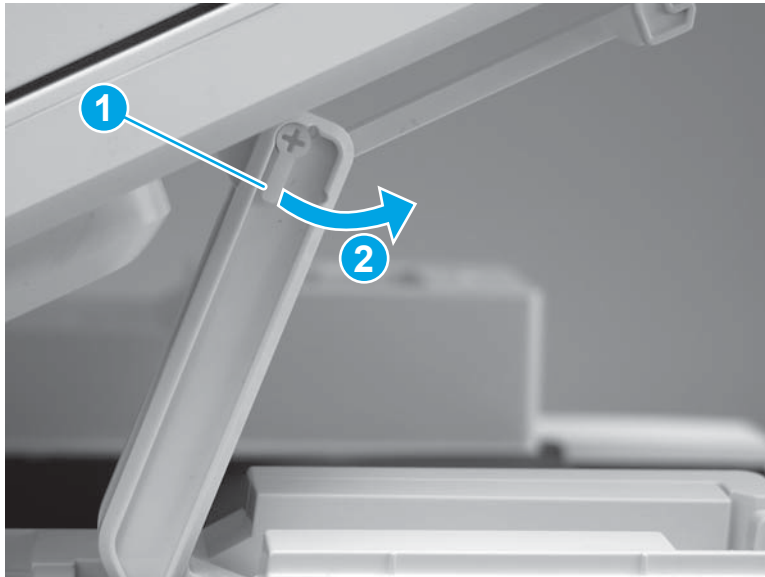

7. Remove the slider pin.

 **Reinstallation tip:** Align the keyed portion of the locking pin with the slot and hole in the support arm.

Figure 1-768 Remove the slider pin

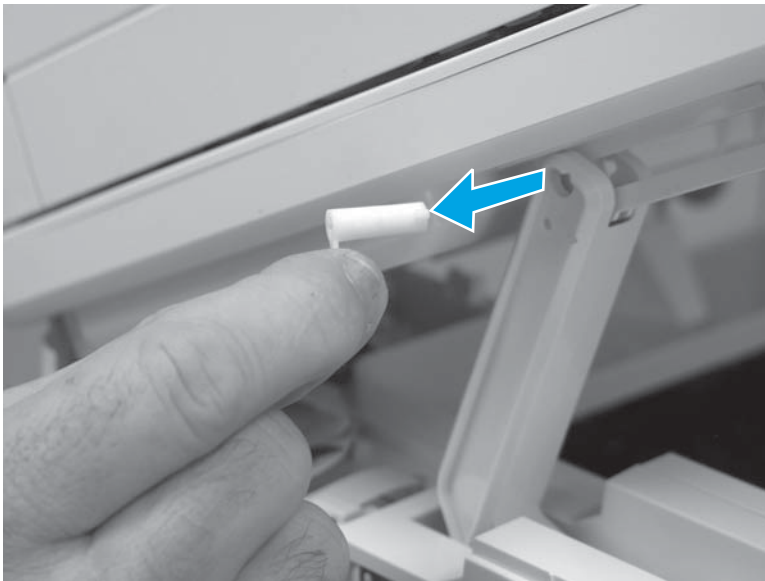

8. Rotate the ISA towards the rear of the printer until it stops.

Figure 1-769 Rotate the ISA towards the rear of the printer

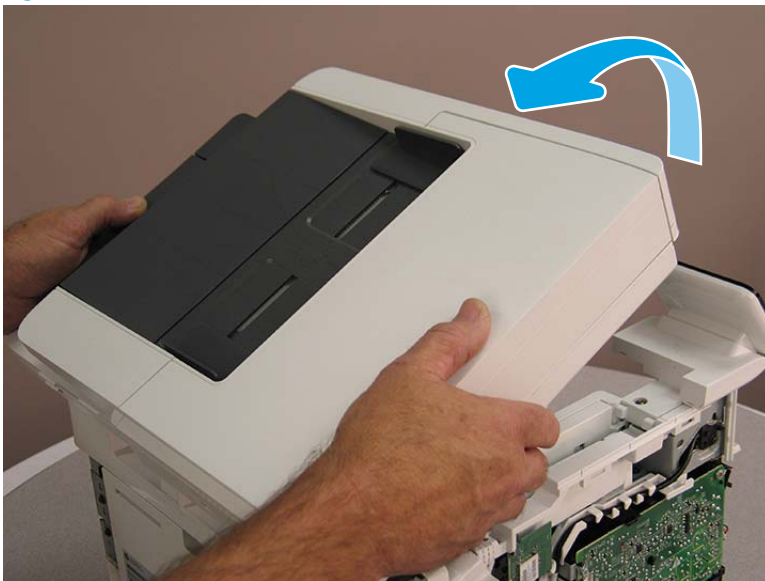

- Slide the ISA as shown to release it.

Figure 1-770 Release the ISA

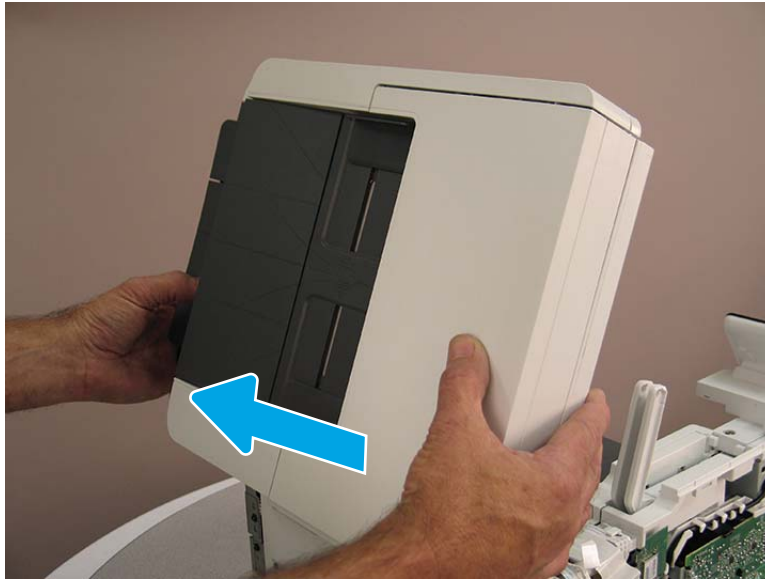

- Remove the ISA.

Figure 1-771 Remove the ISA

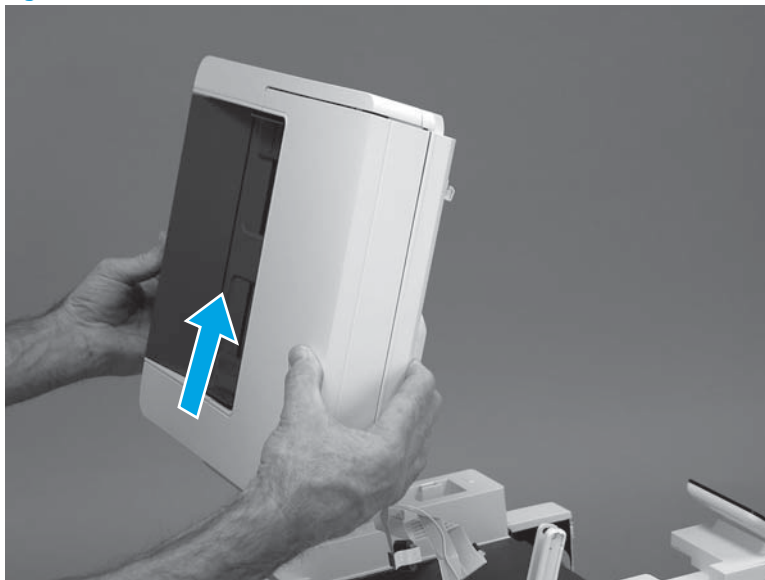

Step 6: Remove the control panel (M329/M428/M429)

 **NOTE:** The step is for the M329/M428/M429 printer. For the M304/M305/M404/M405, skip this step and go to [Step 8: Remove the top cover \(M304/M305/M404/M405\) on page 471.](#)

- Disconnect one FFC (callout 1), and then release the FFC from the guide (callout 2).

Figure 1-772 Disconnect one connector

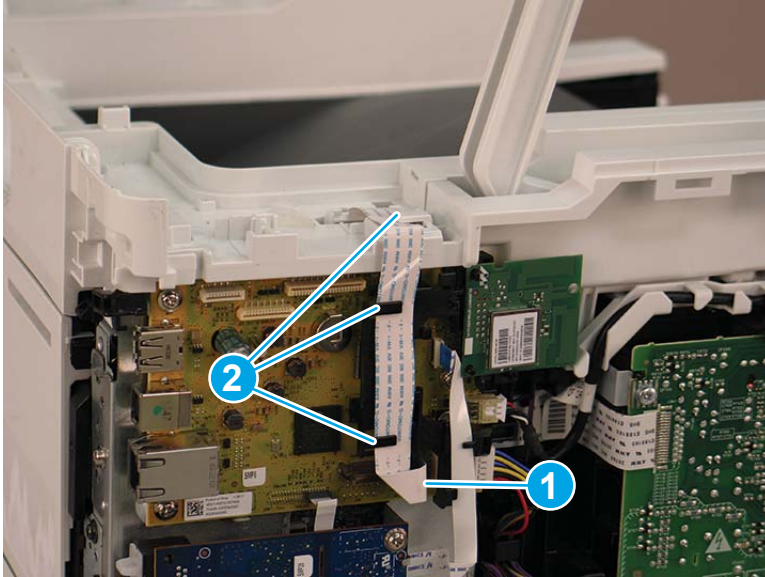

2. Remove one screw (callout 1).

Figure 1-773 Remove one screw

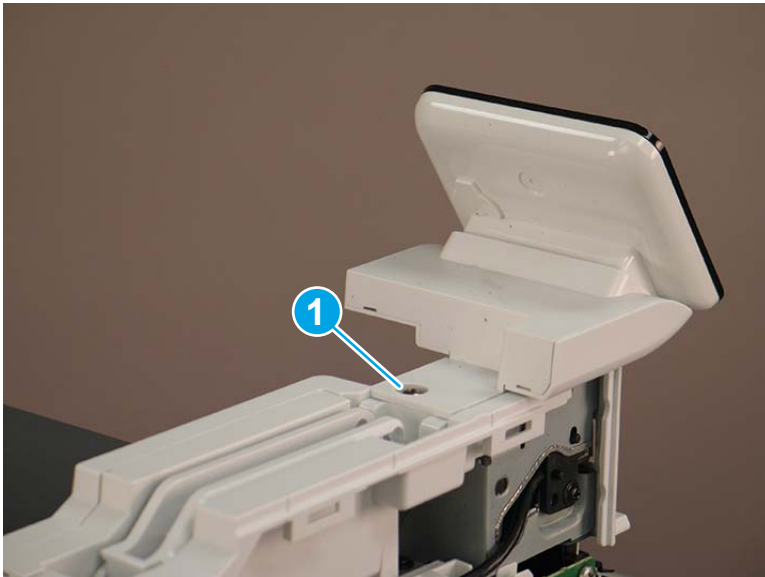

3. Use a small flat-blade screwdriver to release two tabs (callout 1) on the control-panel cable cover.

Figure 1-774 Release two tabs

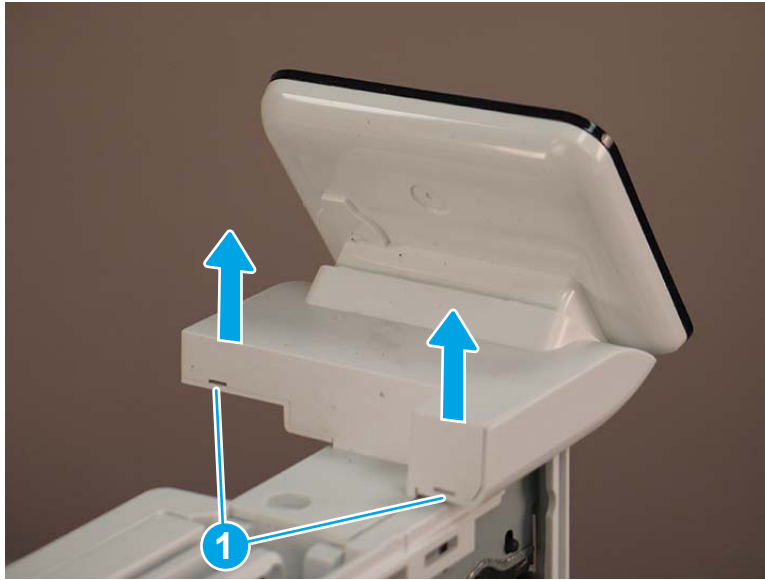

4. Remove the control-panel cable cover.

Figure 1-775 Remove the cover



5. Remove one grounding screw (callout 1), and then move the ground cable (callout 2) out of the way.

Figure 1-776 Remove one screw

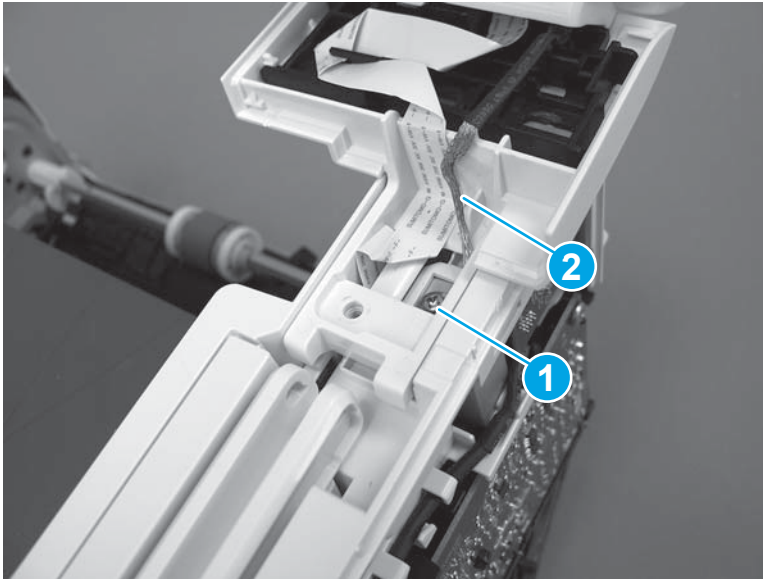

6. Move the FFC out of the way, and then remove two screws (callout 1).

Figure 1-777 Remove two screws



7. Slightly lift up the control-panel assembly to separate it from the top cover.

⚠ CAUTION: The control panel assembly is still connected to the printer by the FFC. Do not attempt to completely remove the assembly.

Figure 1-778 Lift up the control-panel assembly



8. Lift up the control-panel FFC cover to remove the control-panel assembly.

Figure 1-779 Remove the control-panel assembly

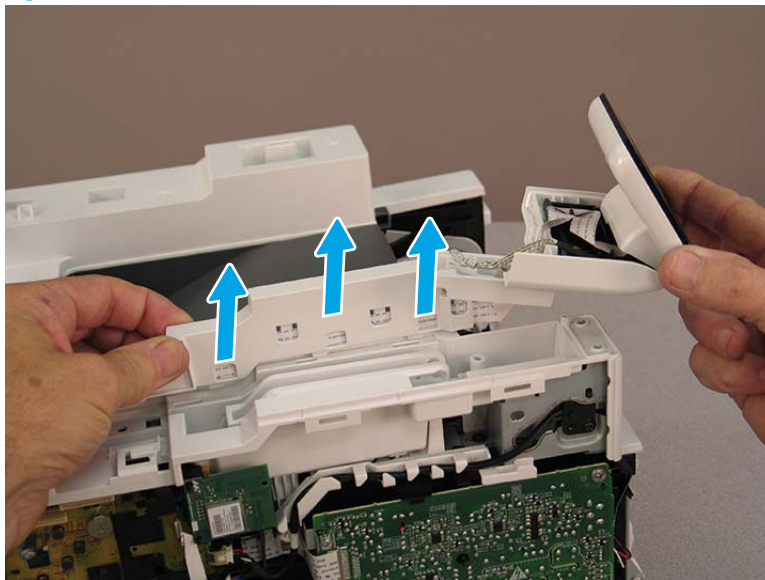

Step 7: Remove the top cover (M329/M428/M429)

📝 NOTE: The step is for the M329/M428/M429 printer. For the M304/M305/M404/M405, skip this step and go to [Step 8: Remove the top cover \(M304/M305/M404/M405\) on page 471](#).

1. Release the USB cable (callout 1) from the cable guide.

Figure 1-780 Remove the USB cable

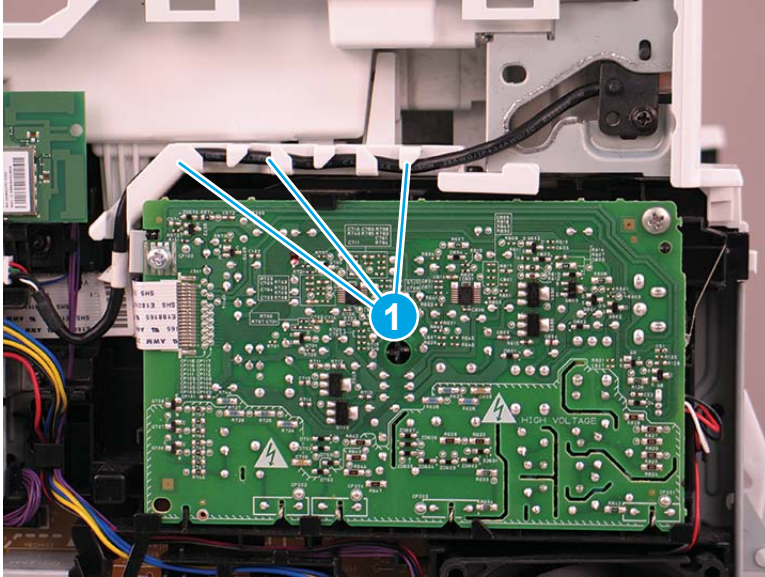

2. Remove one screw (callout 1), and then remove the support arm (callout 2).

⚠ CAUTION: The support arm is spring loaded and can unexpectedly spring into the open position. To avoid injury, do not place a finger in the screw well when the support arm is in the closed position.

Figure 1-781 Remove the support arm

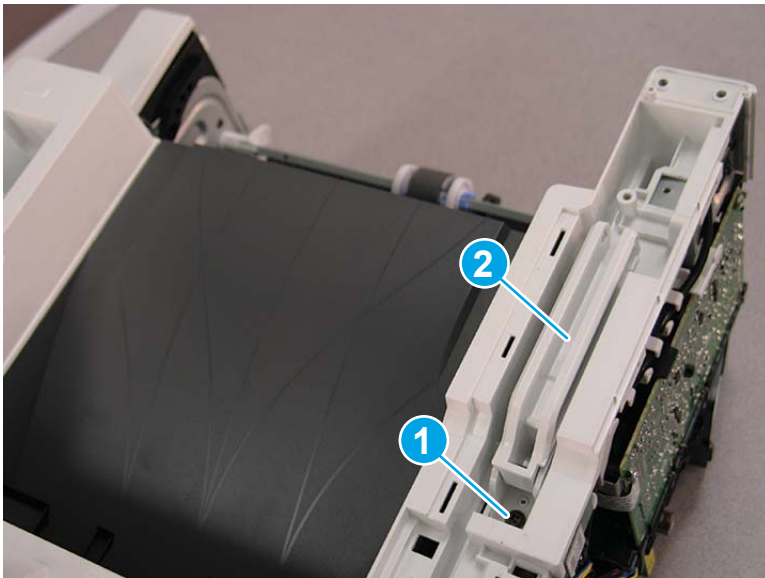

3. Remove five screws (callout 1), release four bosses (callout 2), and then remove the top cover (callout 3).

Figure 1-782 Remove the cover

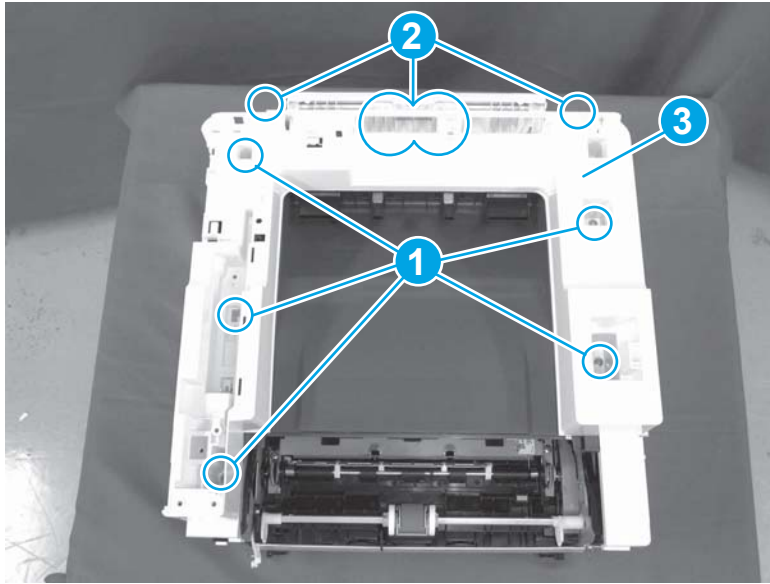

Step 8: Remove the top cover (M304/M305/M404/M405)

 **NOTE:** The step is for the M304/M305/M404/M405 printer. For the M329/M428/M429, skip this step and go to [Step 9: Remove the paper delivery tray \(output bin\) on page 472.](#)

1. Remove one screw (callout 1).

Figure 1-783 Remove one screw



2. At the right side of the printer, release the one boss (callout 1), and then release one tab (callout 2).

Figure 1-784 Release one boss and one tab

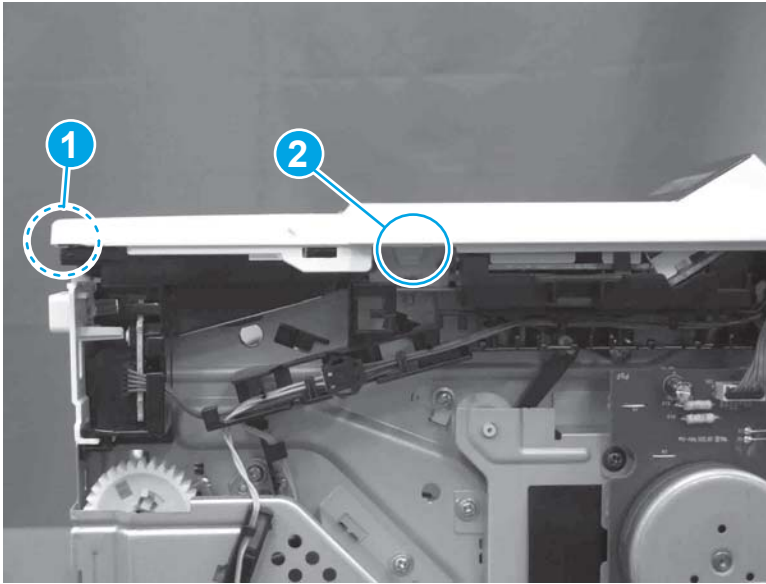

3. Release four tabs (callout 1), release four bosses (callout 2), and then remove the top cover (callout 3).



 **TIP:** Open the rear door to make releasing the bosses (callout 3) easier.

Figure 1-785 Remove the cover

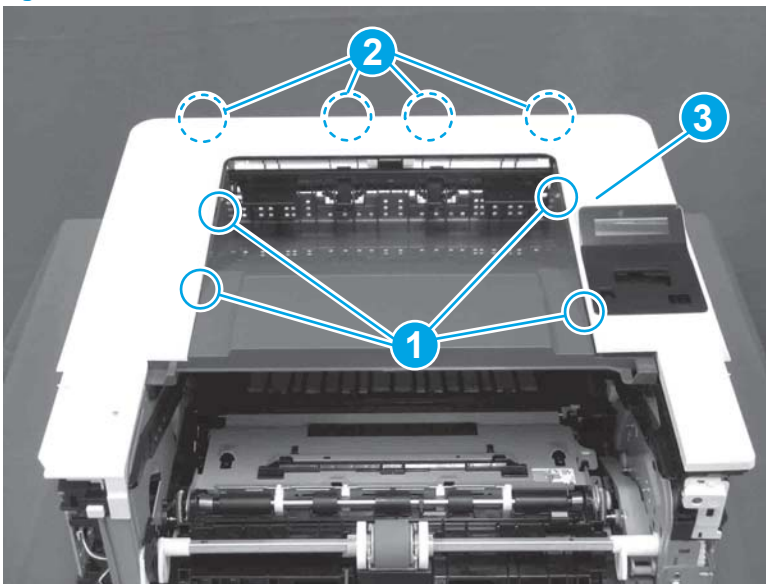

Step 9: Remove the paper delivery tray (output bin)

 **NOTE:** This procedure shows the M304/M305/M404/M405 model, however, the paper delivery tray (output bin) removal is similar for the M329/M428/M429 printer.

- ▲ Release two bosses (callout 1), release two tabs (callout 2), and then remove the paper delivery tray (output bin; callout 3).

Figure 1-786 Release two tabs

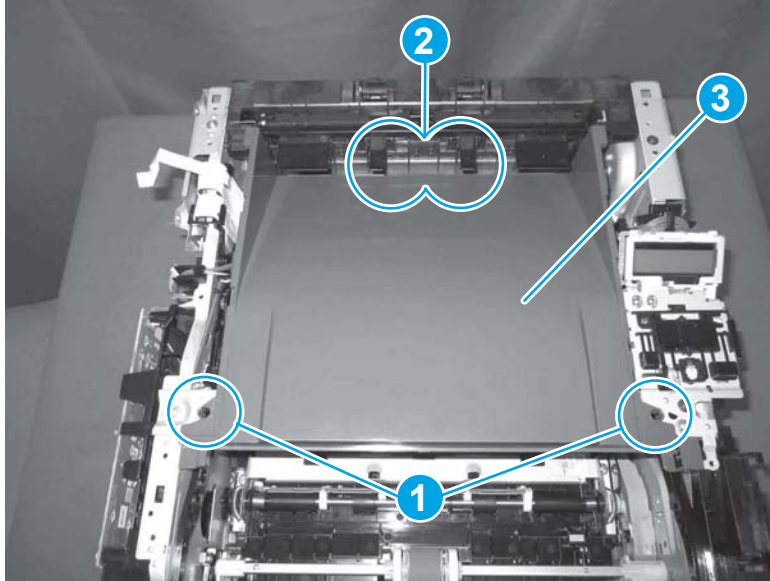

Step 10: Remove the sheet-metal formatter bracket and formatter PCA

1. Do one of the following:

- **SFP only:** Release two tabs (callout 1), and then carefully pull the wireless PCA straight off of the formatter PCA to remove it.



NOTE: Disconnect the WiFi antenna (callout 2) before releasing the tabs.

- **MFP only:** Release one tab (callout 3), and then carefully pull the wireless PCA straight off of the formatter PCA to remove it.



TIP: Push the tab to the left to release it.

Figure 1-787 Remove the wireless PCA

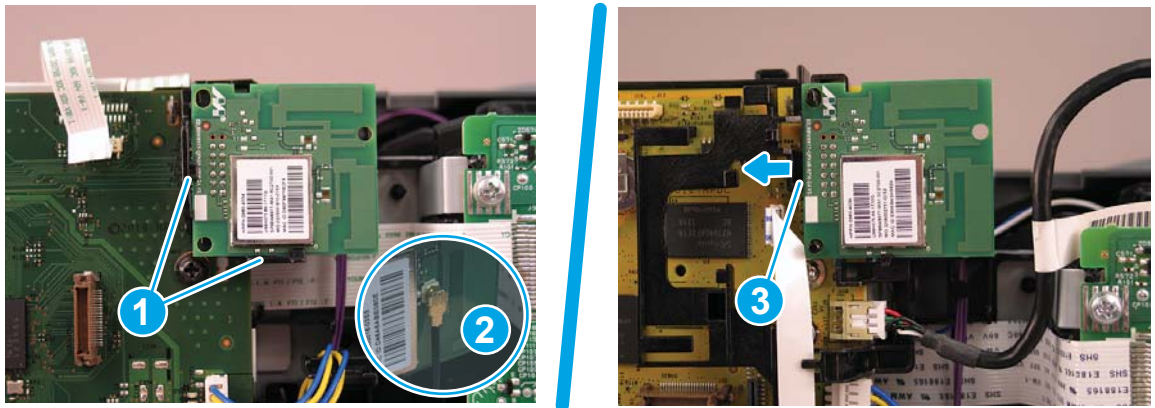

2. Do one of the following:

- **SFP only:** Disconnect the connectors (callout 1), and then release one wire harness (callout 2) from the guide.
- **MFP only:** Disconnect the connectors (callout 1), and then release one wire harness and one FFC (callout 2) from the guides.

Figure 1-788 Disconnect the connectors

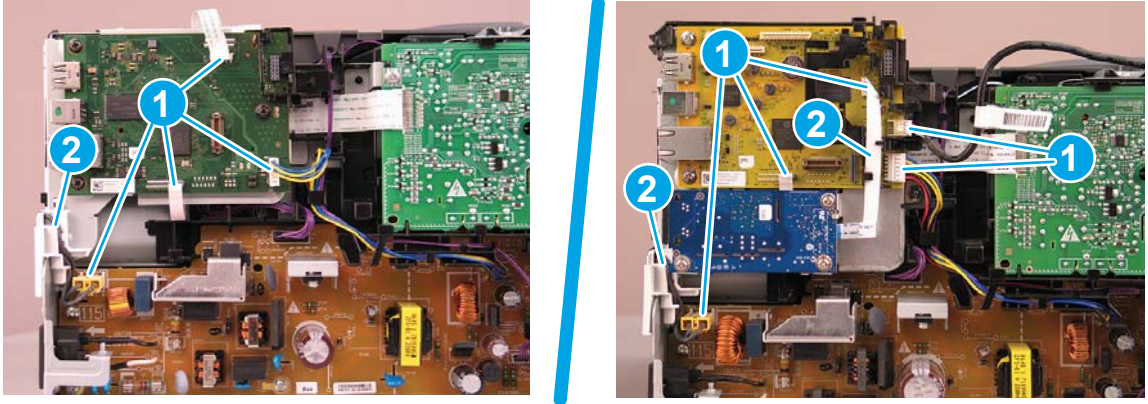

3. **MFP only:** Remove three screws (callout 1), and then remove the fax PCA.

Figure 1-789 Remove the fax PCA

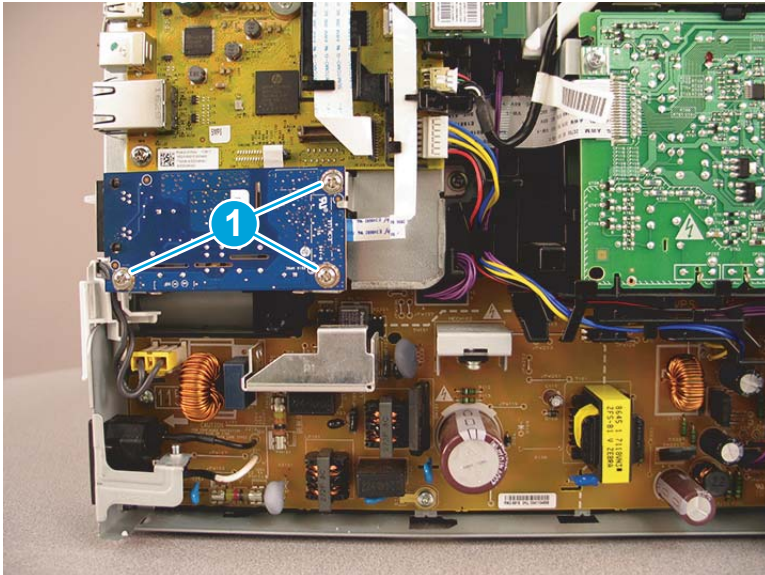

4. **MFP only:** Release the FFC from the guide (callout 1), release one tab (callout 2), and then remove the FFC guide (callout 3).

Figure 1-790 Remove the FFC guide

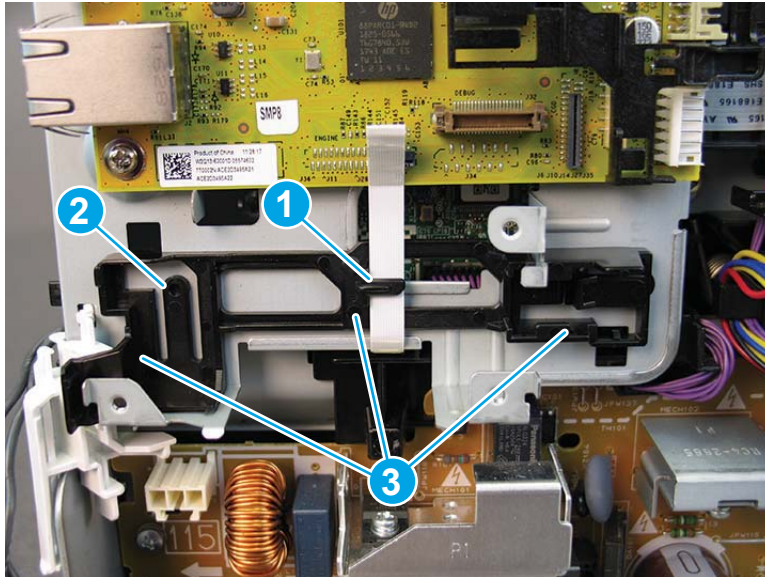

5. Remove one guide.

 **NOTE:** A SFP printer is shown in the figure. However, the guide is identical for an MFP printer.

Figure 1-791 Remove the guide



6. Remove two screws.

Figure 1-792 Remove two screws

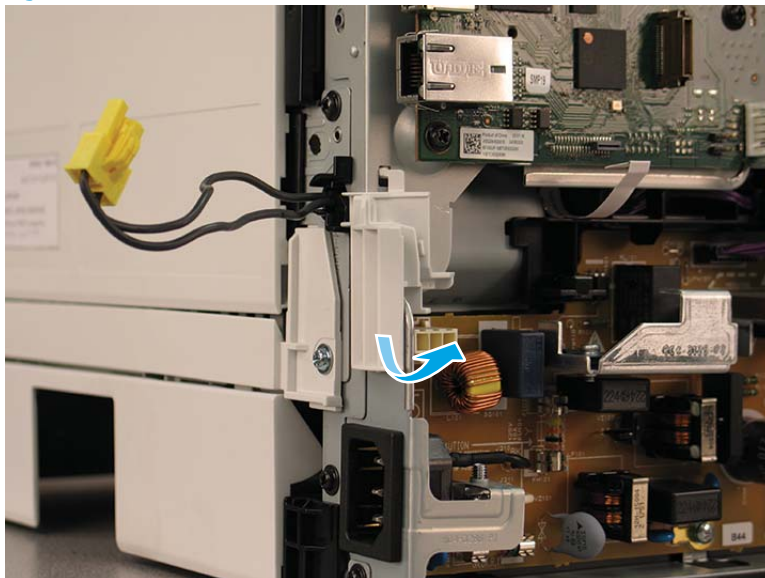

7. MFP only: Remove one screw.

Figure 1-793 Remove one screw

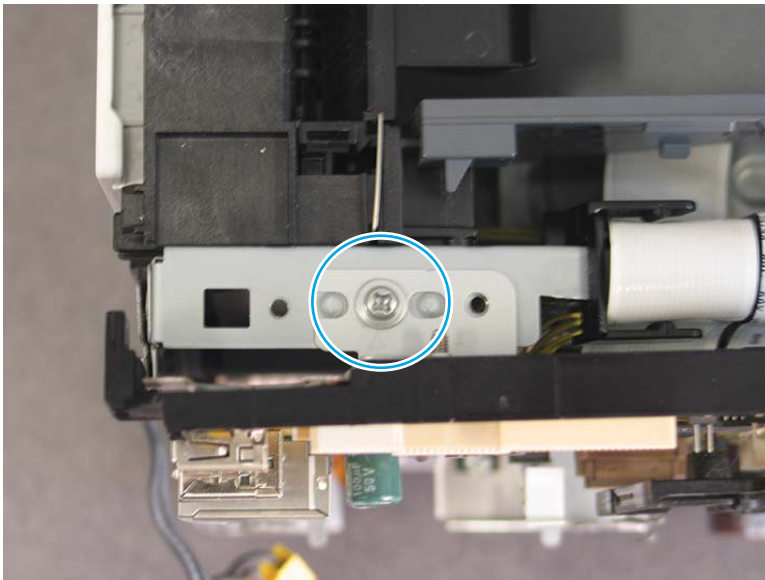

8. Support the formatter and bracket, and then remove two screws.

Figure 1-794 Remove two screws

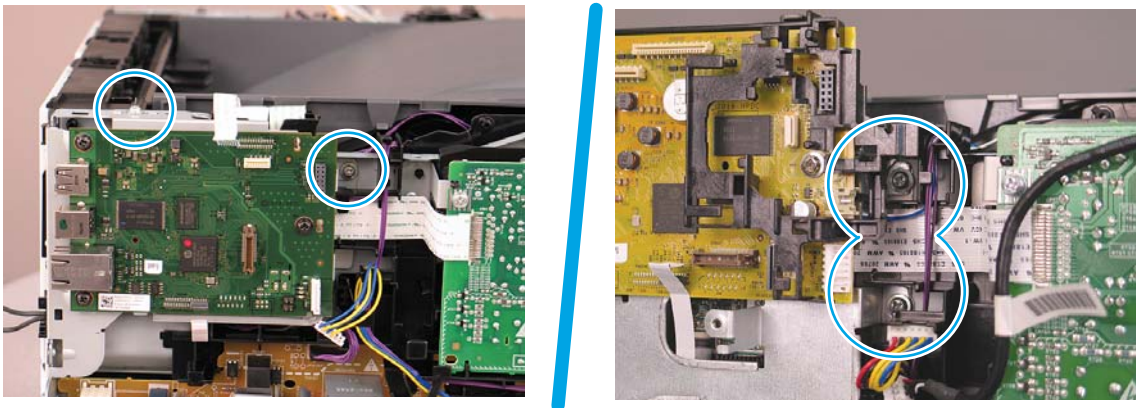

9. Remove the sheet-metal bracket and formatter PCA.

Figure 1-795 Remove the bracket

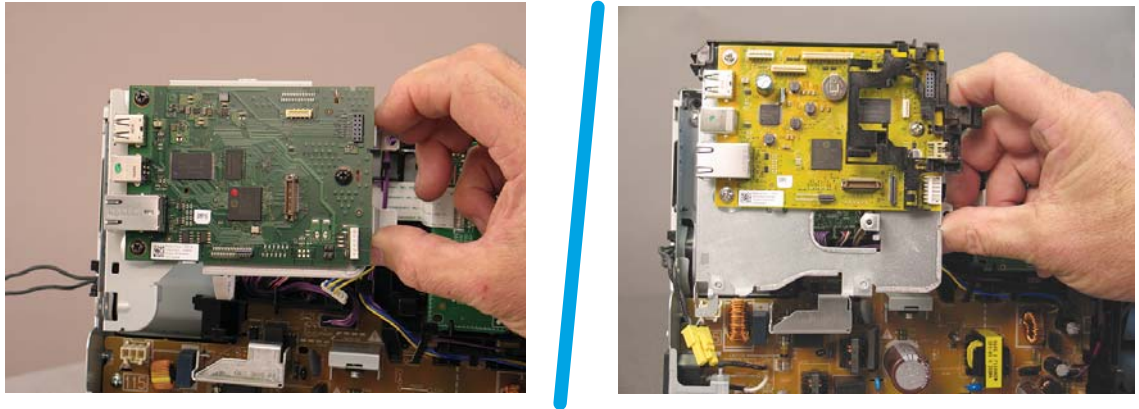

Step 11: Remove the connecting PCA

1. Disconnect nine connectors (callout 1).

 **TIP:** Some of these connectors might be easier to disconnect if the wire harnesses are removed from the guides.

Figure 1-796 Disconnect nine connectors



2. Remove one screw (callout 1).

Figure 1-797 Remove one screw

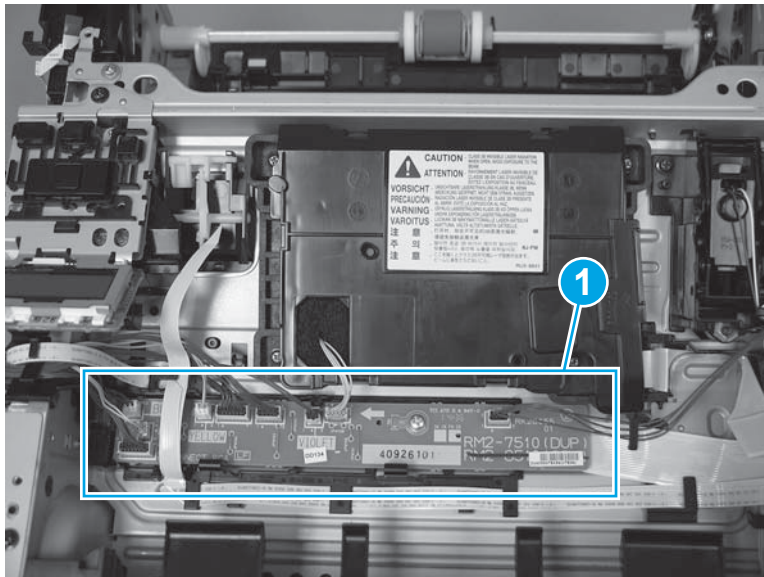
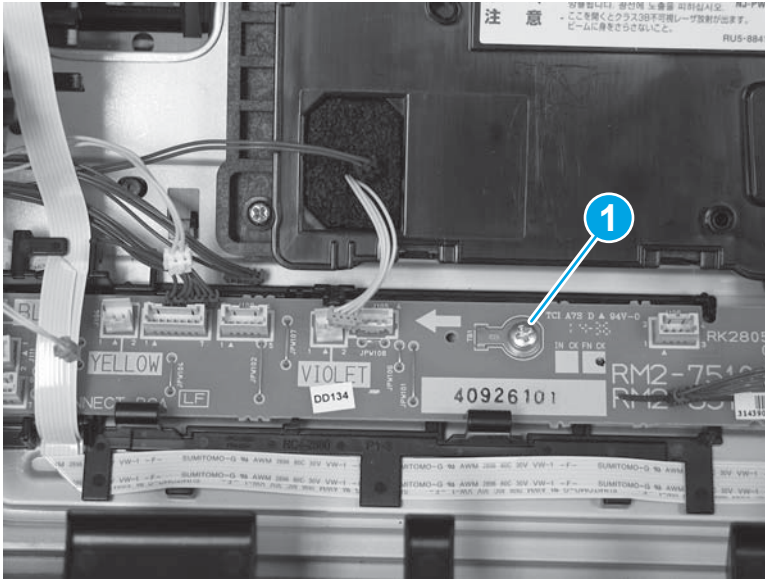

3. Release two holders (callout 1), and then remove the connecting PCA (callout 2).

Figure 1-798 Remove the connecting PCA

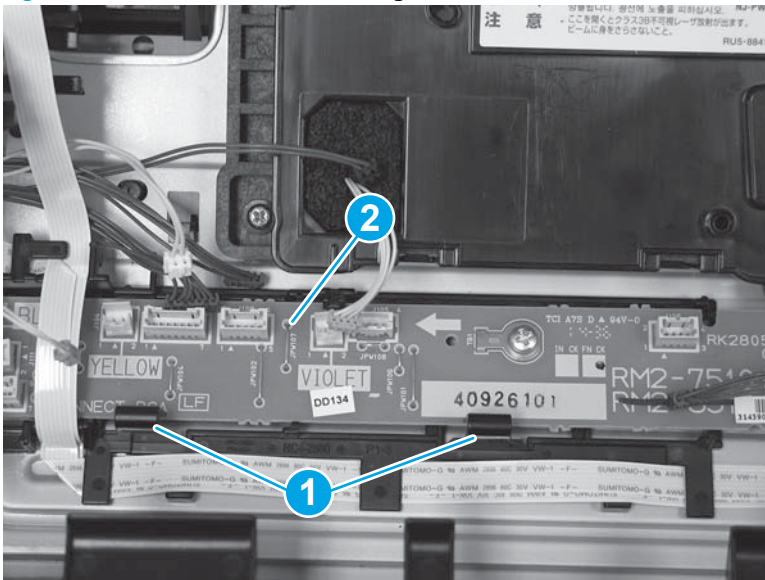



Step 12: Unpack the replacement assembly

1. Dispose of the defective part.

 **NOTE:** HP recommends responsible disposal of the defective part.

<http://www8.hp.com/us/en/hp-information/environment/product-recycling.html>

2. Unpack the replacement part from the packaging.

 **CAUTION:**  Some parts are sensitive to electrostatic discharge (ESD). Always perform service work at an ESD-protected workstation or mat. If an ESD workstation or mat is not available, touch the sheet-metal chassis to provide a static ground before touching an ESD-sensitive assembly. Protect the ESD-sensitive assemblies by placing them in ESD pouches when they are out of the printer.

If the replacement part is a roller or pad, avoid touching the spongy part of it. Skin oils on the roller or pad can cause paper pickup and/or print-quality problems. HP recommends using disposable gloves when handling rollers or pads or washing your hands before touching rollers or pads.

 **IMPORTANT:** Make sure that all of the shipping materials (for example shipping tape) are removed from the replacement part prior to installation.

3. To install an assembly, reverse the removal steps.

 **NOTE:** When applicable, special installation instructions are provided for an assembly at the end of the removal procedure. Always completely read the removal instructions and follow all special installation instructions.

Removal and replacement: Laser scanner FFC

- [Introduction](#)
- [Step 1: Remove Tray 2](#)
- [Step 2: Remove the cartridge door assembly](#)
- [Step 3: Remove the left cover](#)
- [Step 4: Remove the right cover](#)
- [Step 5: Remove the integrated scanner assembly \(M329/M428/M429\)](#)
- [Step 6: Remove the control panel \(M329/M428/M429\)](#)
- [Step 7: Remove the top cover \(M329/M428/M429\)](#)
- [Step 8: Remove the top cover \(M304/M305/M404/M405\)](#)
- [Step 9: Remove the paper delivery tray \(output bin\)](#)
- [Step 10: Remove the sheet-metal formatter bracket and formatter PCA](#)
- [Step 11: Remove the tag-cable assembly](#)
- [Step 12: Remove the laser scanner FFC](#)
- [Step 13: Unpack the replacement assembly](#)

Introduction

This document provides the procedures to remove and replace the laser scanner flat-flexible cable (FFC).

Before performing service

Turn the printer power off

- Disconnect the power cable.

 **WARNING!** To avoid damage to the printer, turn the printer off, wait 30 seconds, and then remove the power cable before attempting to service the printer.

Use the table below to identify the correct part number for your printer. To order the part, go to www.hp.com/buy/parts.

Laser scanner FFC part number	
RK2-6919-000CN	Laser scanner FFC

Required tools

- #2 Phillips screwdriver with a magnetic tip.
- 5.5 mm (0.22 inch) socket screwdriver.

After performing service

Turn the printer power on

- Connect the power cable.
- Use the power switch to turn the power on.

Post service test

Make sure that the printer initializes to a **Ready** state.

Print a configuration page to make sure that the printer is functioning correctly.

Step 1: Remove Tray 2

- ▲ Pull the tray straight out of the printer to remove it.

Figure 1-799 Remove the tray



Step 2: Remove the cartridge door assembly

 **NOTE:** If the toner cartridge was not removed prior to servicing the printer, remove it now.

1. Release the support shaft (callout 1), and then slide it toward the center of the door (callout 2).

 **TIP:** It might be easier to release the support shaft by using a small flat-blade screwdriver.

Figure 1-800 Release the support shaft

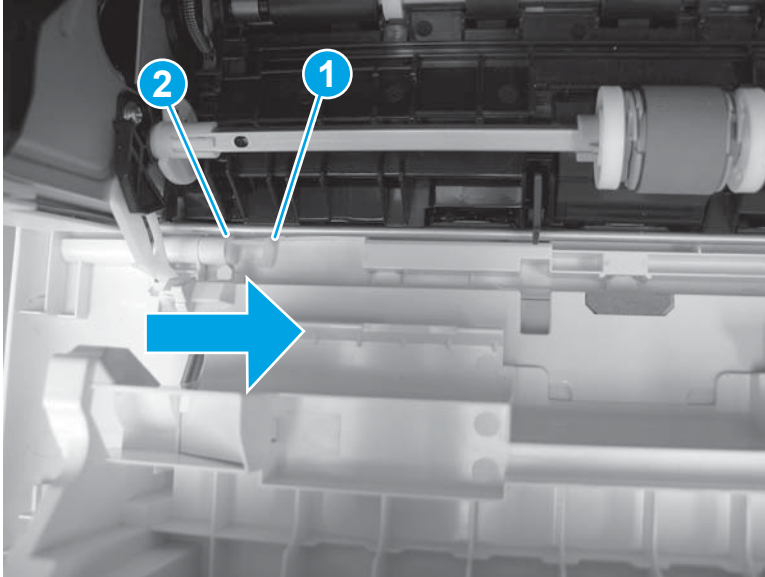

2. Remove the support shaft.

Figure 1-801 Remove the support shaft

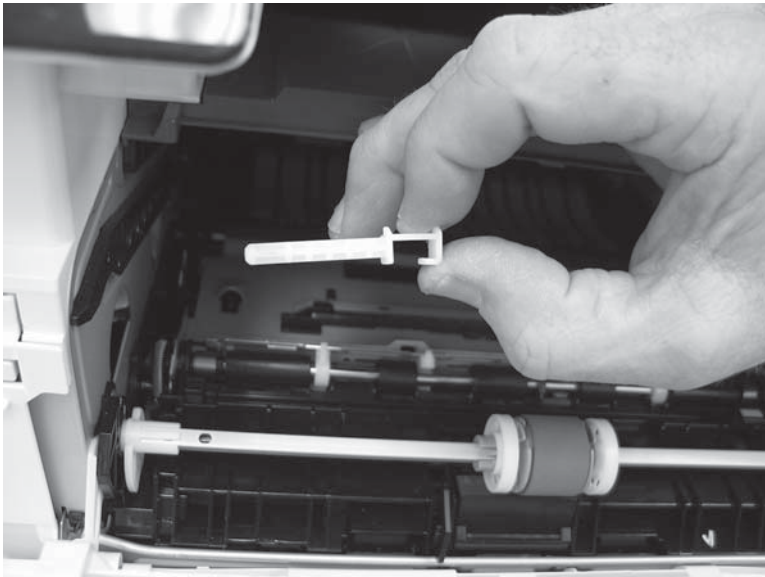

3. Release one tab (callout 1), and then slide the guide out of the printer (callout 2).

CAUTION: Be careful, the tab (callout 1) can be easily broken.

Figure 1-802 Remove the guide

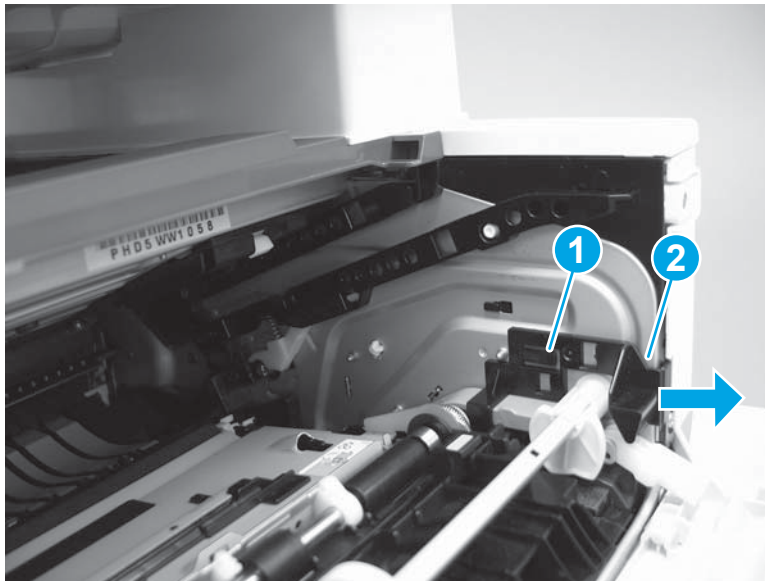

4. Use a small flat-blade screwdriver to gently pry the white-plastic door arm (callout 1) off of the gray-plastic pressure-release link (callout 2) to release the door arm.

Figure 1-803 Release the pressure-release link

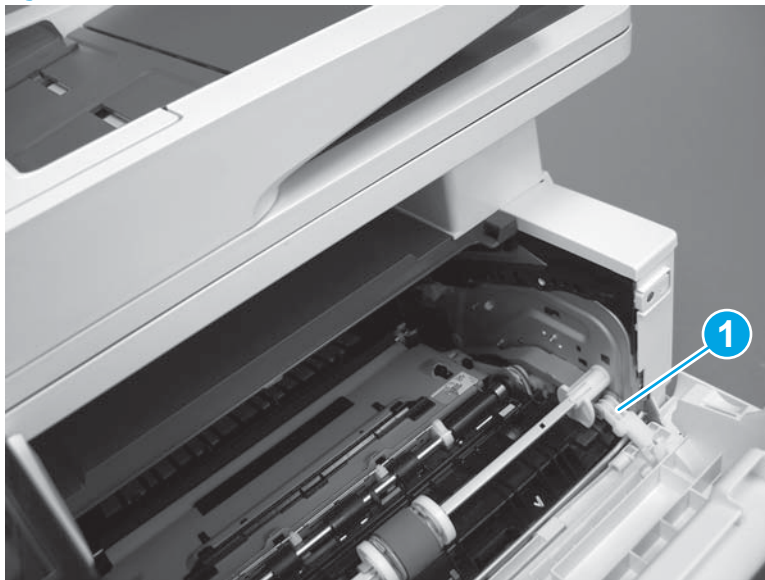

5. With the door in the partially closed position, slightly raise the left end (callout 1; raise it over the sheet-metal hinge boss), and then slide the door to the left (callout 2) to release the right hinge (callout 3).

⚠ CAUTION: The door is still attached to the printer by the left-side retainer arm. Do not attempt to completely remove the door.

💡 Reinstallation tip: When reinstalling the door, there are two right-side hinge pins (not shown in callout 3). Keep a finger pressed on the left-side retainer arm so that it does not disengage from the door.

Figure 1-804 Release the door

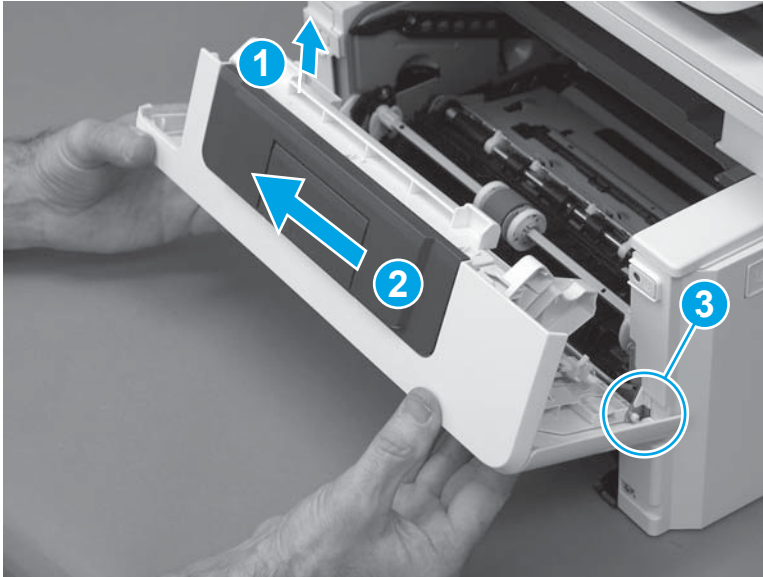

6. Rotate the door away from the printer until the keyed pin on the left-side retainer arm can disengage from the door.

Figure 1-805 Release the left-side retainer arm

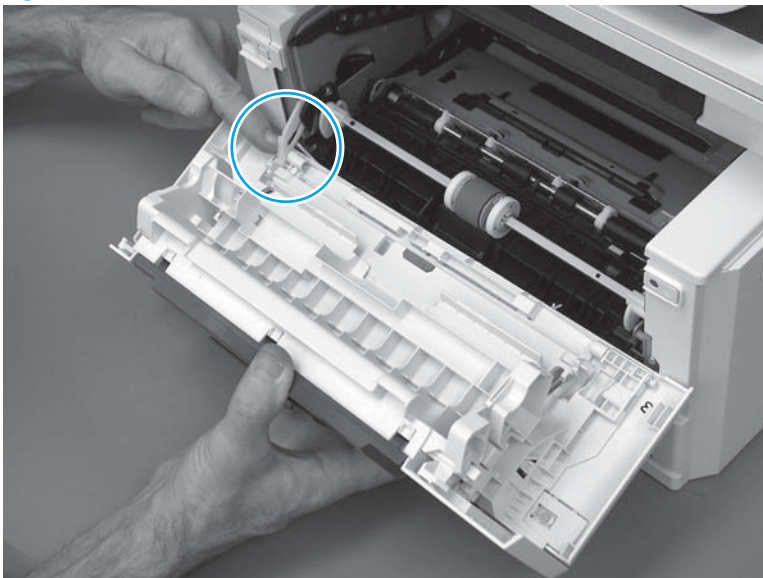

7. Remove the door.

Figure 1-806 Remove the door

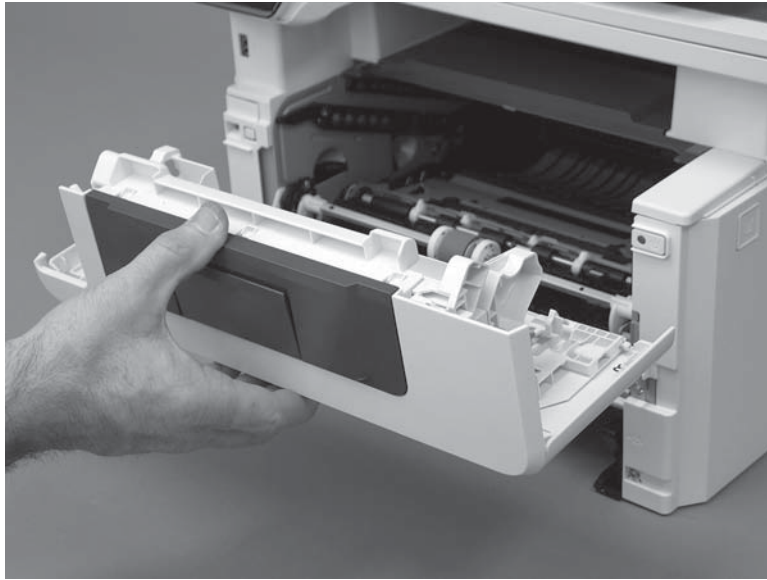

Step 3: Remove the left cover

1. Remove one screw (callout 1).

Figure 1-807 Remove one screw

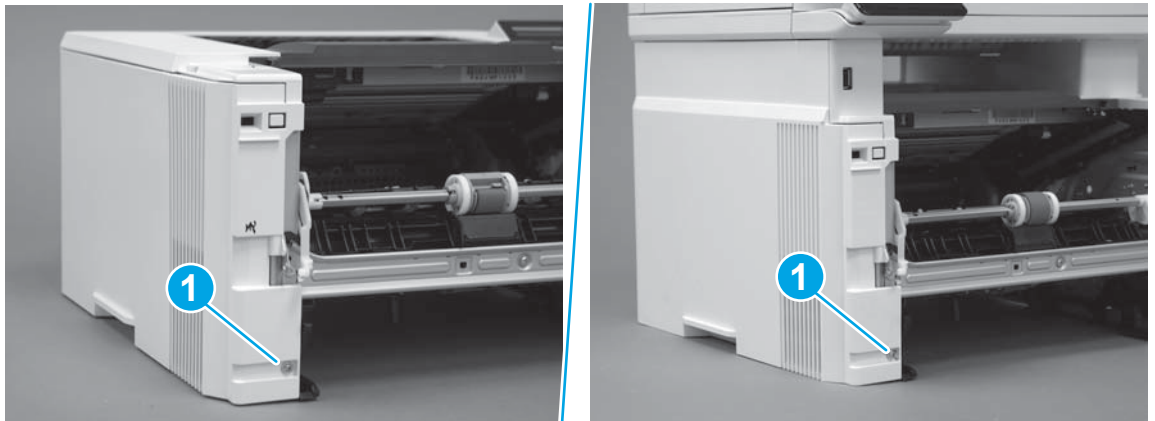

2. Open the rear door, release two bosses (callout 1), and then release three tabs (callout 2).

Figure 1-808 Release two bosses and three tabs

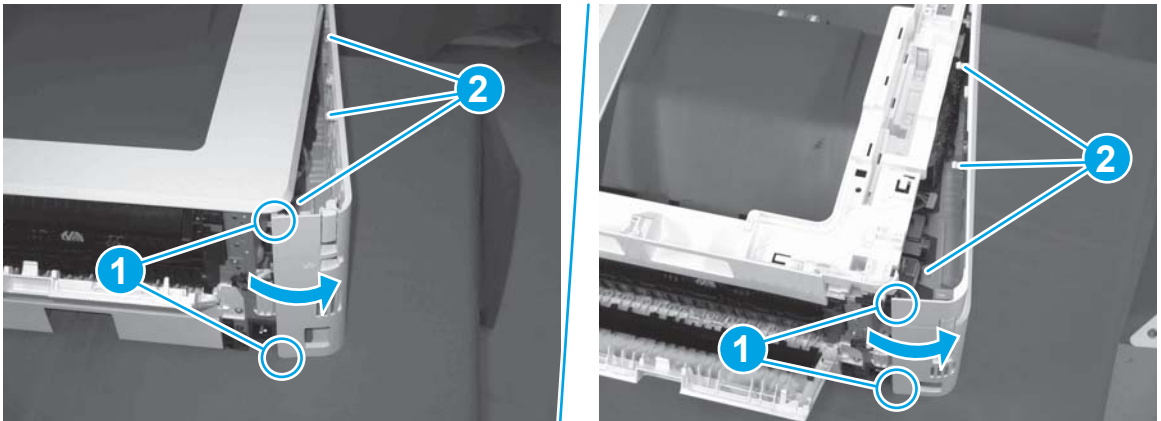

3. At the front of the printer, do one of the following:
 - **M304/M305/M404/M405:** Release two bosses (callout 1), and then remove the cover (callout 2).
 - **M329/M428/M429:** Release one tab (callout 3), two bosses (callout 4), and then remove the cover (callout 5).

CAUTION: Be careful when releasing the upper bosses on the M329/M428/M429 cover. One portion of the cover (callout 6) is fragile and is easily broken.

Figure 1-809 Remove the cover

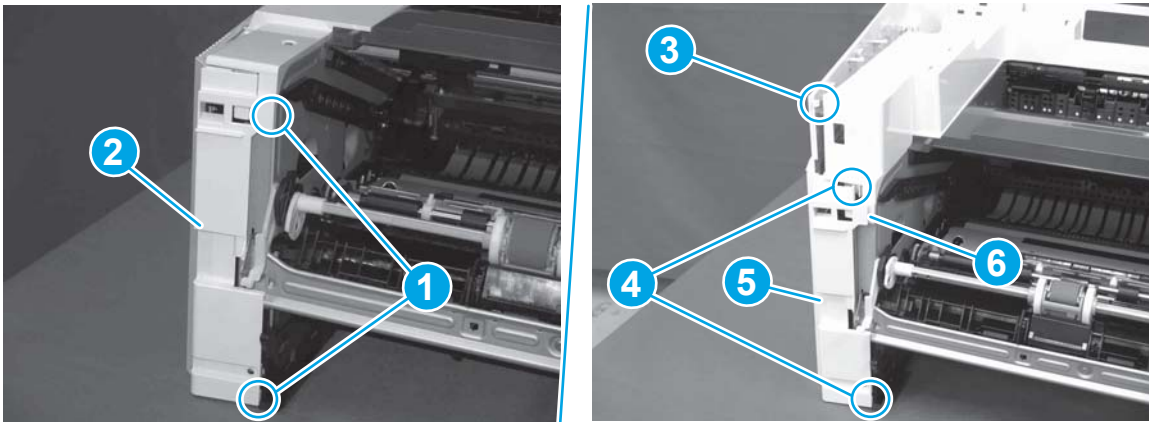

Step 4: Remove the right cover

1. At the front of the printer, release two bosses (callout 1), and then release three tabs (callout 2).

Reinstallation tip: Remove, and then reinstall the cover if the switch or button does not correctly function.

Figure 1-810 Release two bosses and three tabs

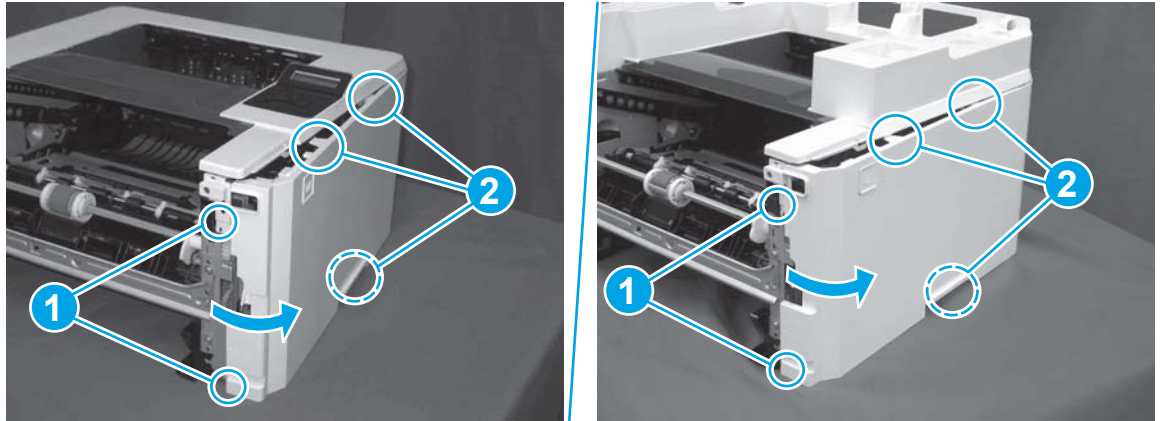

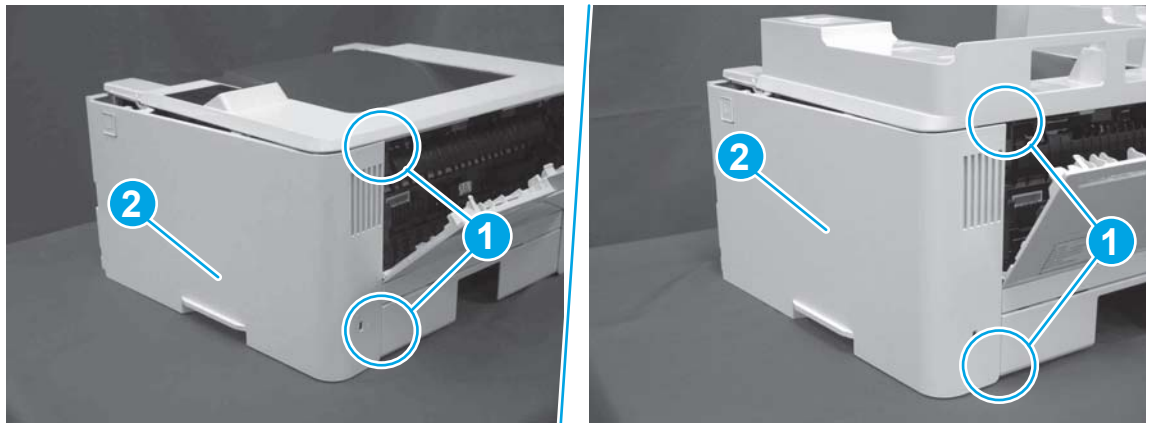

2. Open the rear door, release two bosses (callout 1), and then remove the cover (callout 2).

Figure 1-811 Remove the cover



Step 5: Remove the integrated scanner assembly (M329/M428/M429)

 **NOTE:** The step is for the M329/M428/M429 printer. For the M304/M305/M404/M405, skip this step and go to [Step 8: Remove the top cover \(M304/M305/M404/M405\) on page 498.](#)

 **NOTE:** M329/M428/M429 models only. The integrated scanner assembly (ISA) includes the sub-scanner assembly (SSA) and the automatic document feeder (ADF).

1. Raise the ISA.

Figure 1-812 Raise the ISA

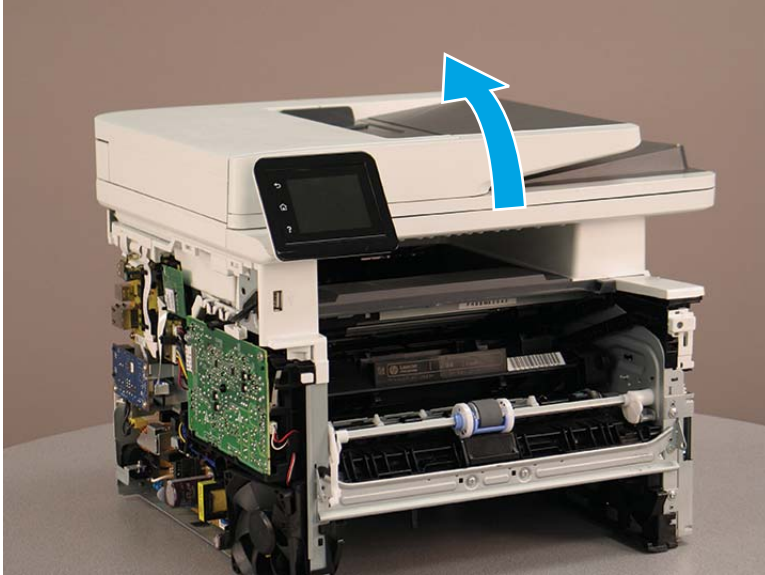

2. Release the ISA flat-flexible cable (FFC) cover (callout 1), and then remove it (callout 2).

Figure 1-813 Remove the ISA FFC cover

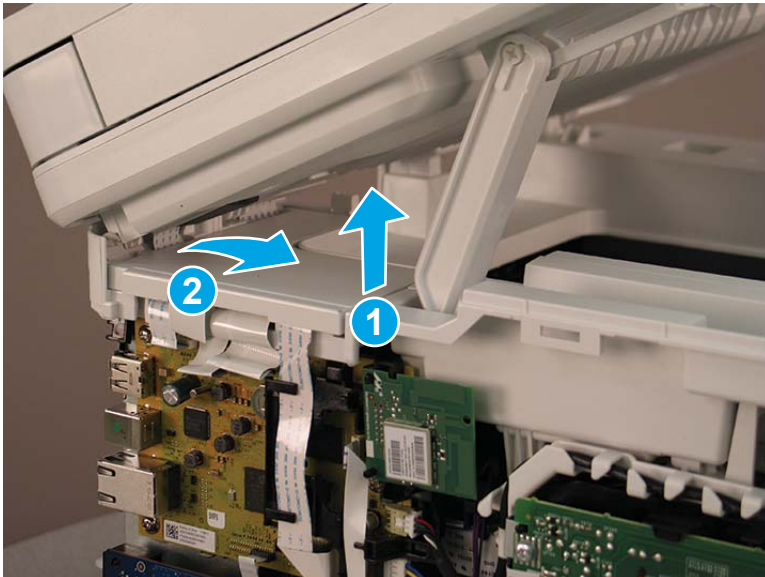

3. Disconnect three FFCs (callout 1), and then remove the ferrite (callout 2) from the holder.

CAUTION: The ferrite is not captive on the FFC. Do not lose the ferrite while handling the ISA.

Figure 1-814 Disconnect three FFCs

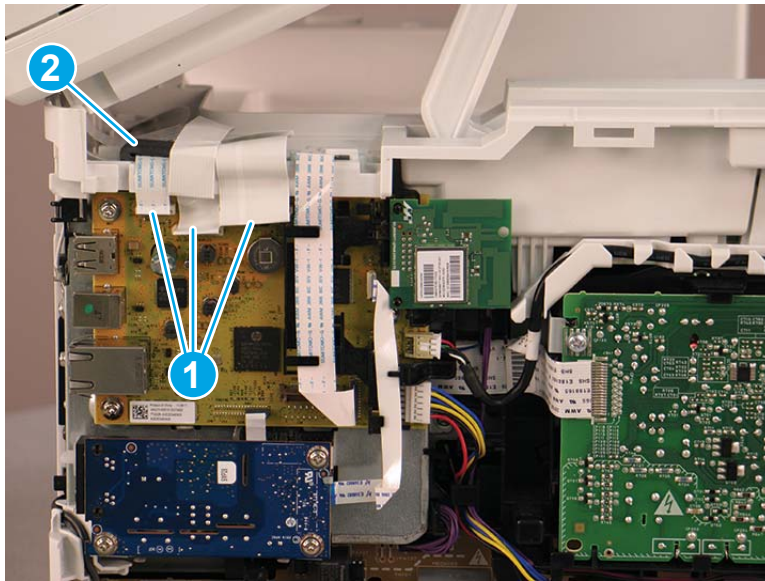

4. Remove one screw (callout 1).

Figure 1-815 Remove one screw

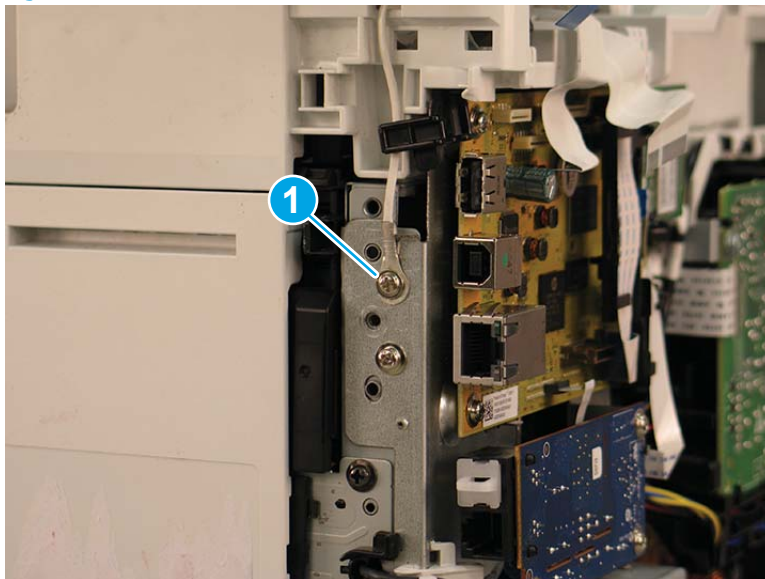

5. Pass the ground wire through the opening in the top cover.

Figure 1-816 Pass the wire through the opening

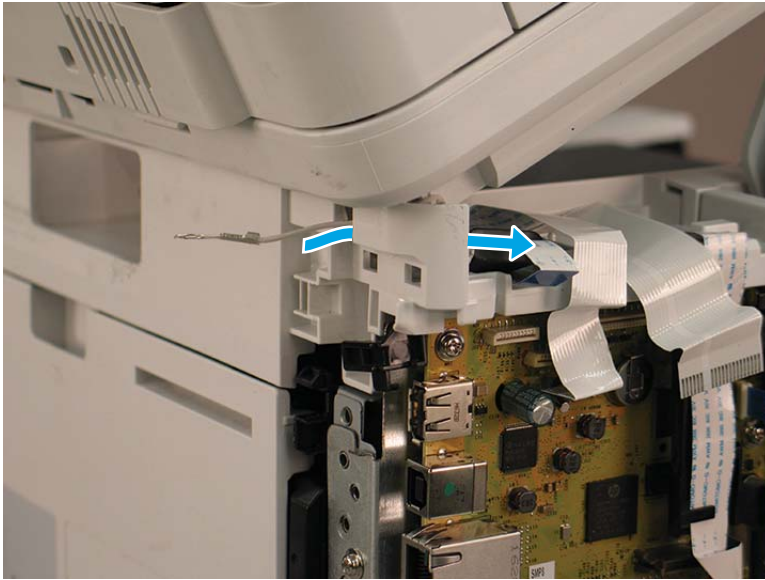

6. Release one tab (callout 1), and then rotate the ISA slider pin (callout 2) towards the front of the printer to release it.

Figure 1-817 Release one tab and rotate the slider pin

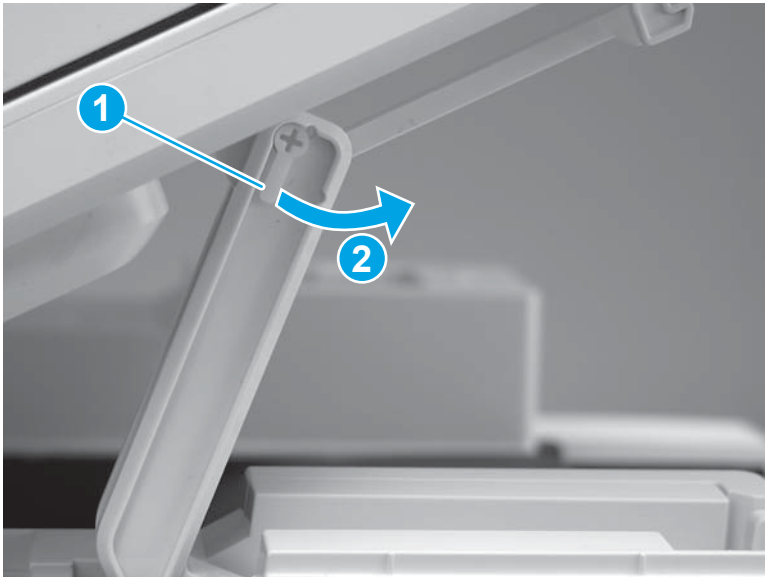

7. Remove the slider pin.

 **Reinstallation tip:** Align the keyed portion of the locking pin with the slot and hole in the support arm.

Figure 1-818 Remove the slider pin



8. Rotate the ISA towards the rear of the printer until it stops.

Figure 1-819 Rotate the ISA towards the rear of the printer

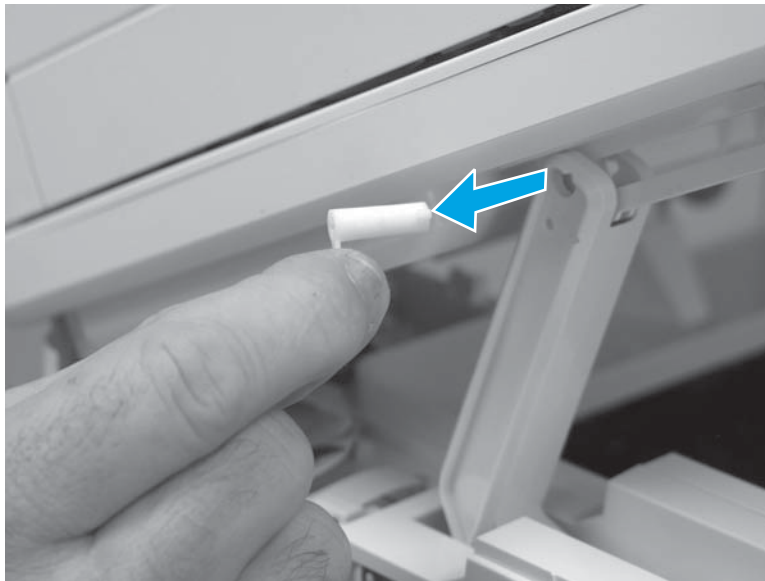
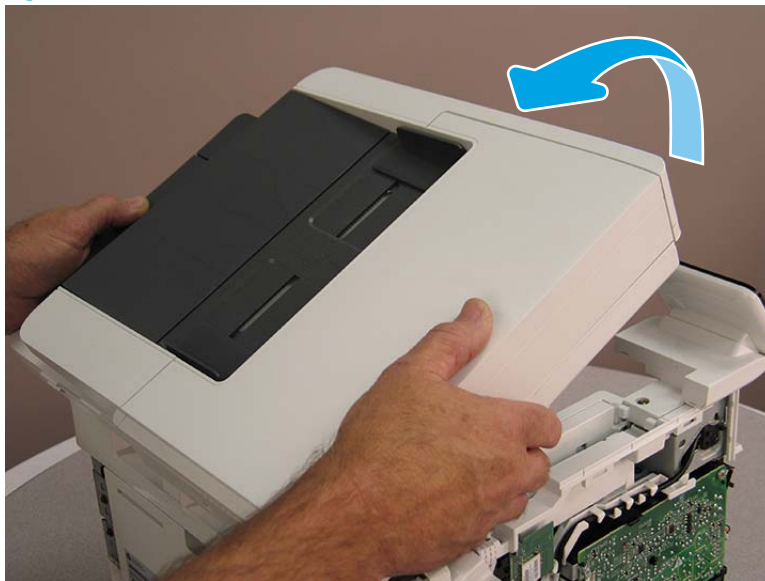

- Slide the ISA as shown to release it.

Figure 1-820 Release the ISA

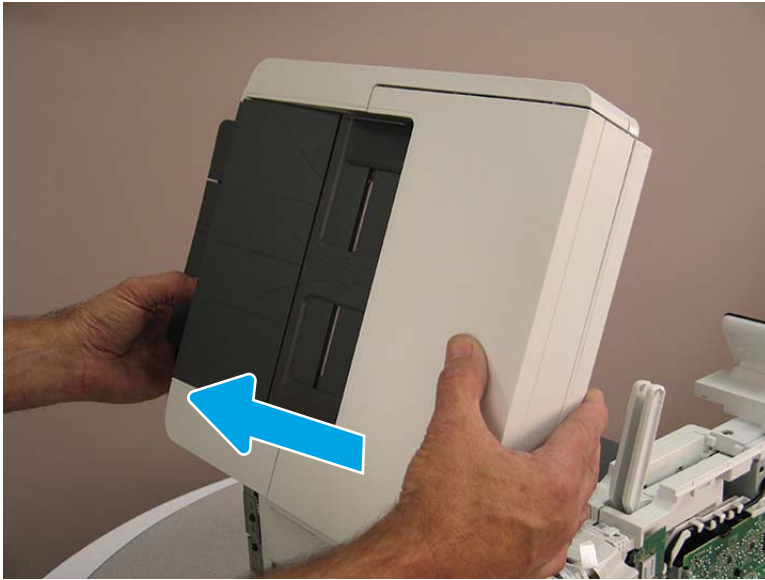

- Remove the ISA.

Figure 1-821 Remove the ISA

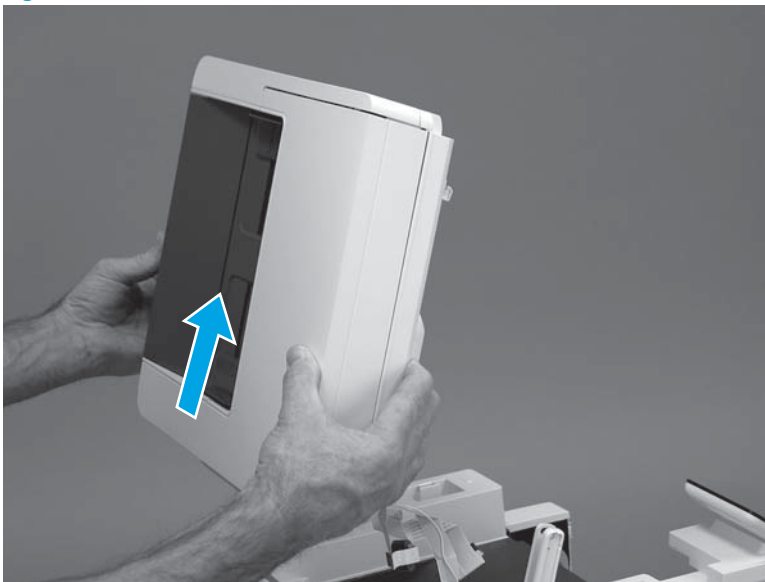

Step 6: Remove the control panel (M329/M428/M429)

 **NOTE:** The step is for the M329/M428/M429 printer. For the M304/M305/M404/M405, skip this step and go to [Step 8: Remove the top cover \(M304/M305/M404/M405\) on page 498.](#)

- Disconnect one FFC (callout 1), and then release the FFC from the guide (callout 2).

Figure 1-822 Disconnect one connector

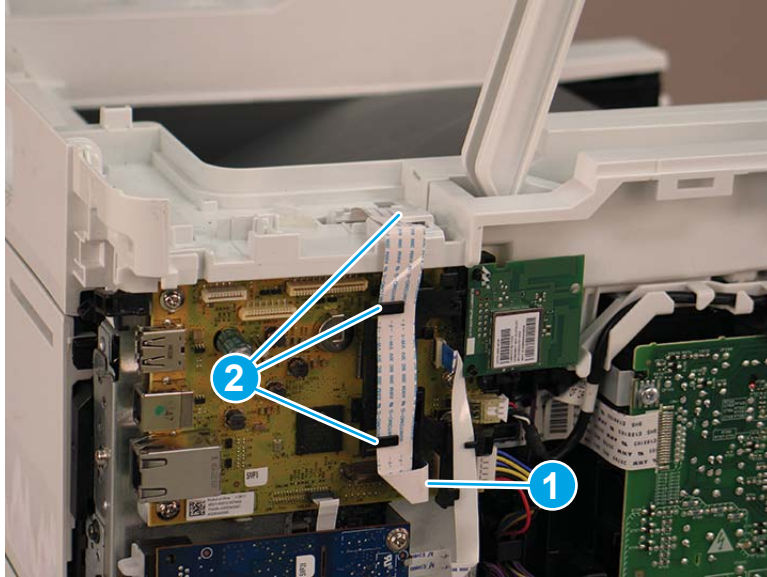

2. Remove one screw (callout 1).

Figure 1-823 Remove one screw

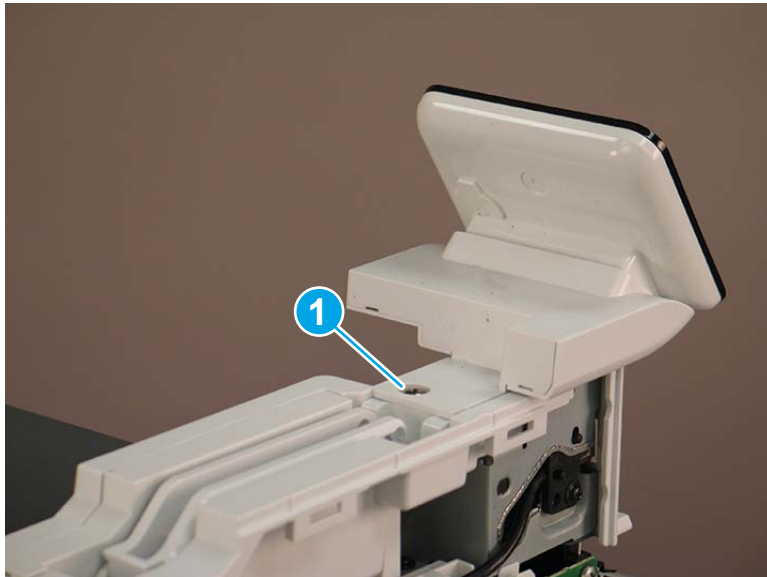

3. Use a small flat-blade screwdriver to release two tabs (callout 1) on the control-panel cable cover.

Figure 1-824 Release two tabs

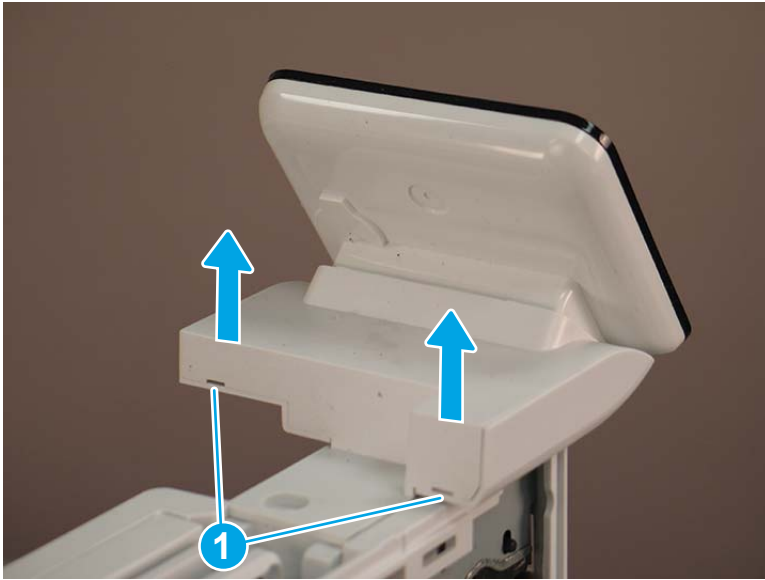

4. Remove the control-panel cable cover.

Figure 1-825 Remove the cover



5. Remove one grounding screw (callout 1), and then move the ground cable (callout 2) out of the way.

Figure 1-826 Remove one screw

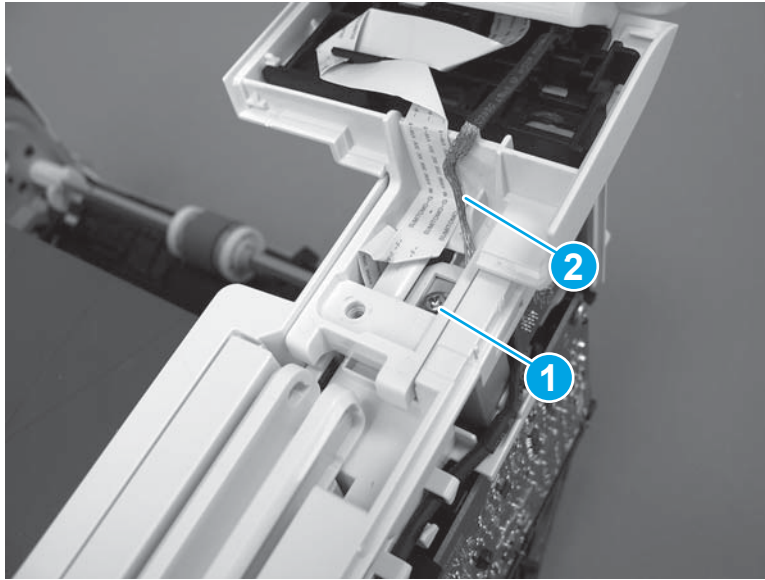

6. Move the FFC out of the way, and then remove two screws (callout 1).

Figure 1-827 Remove two screws

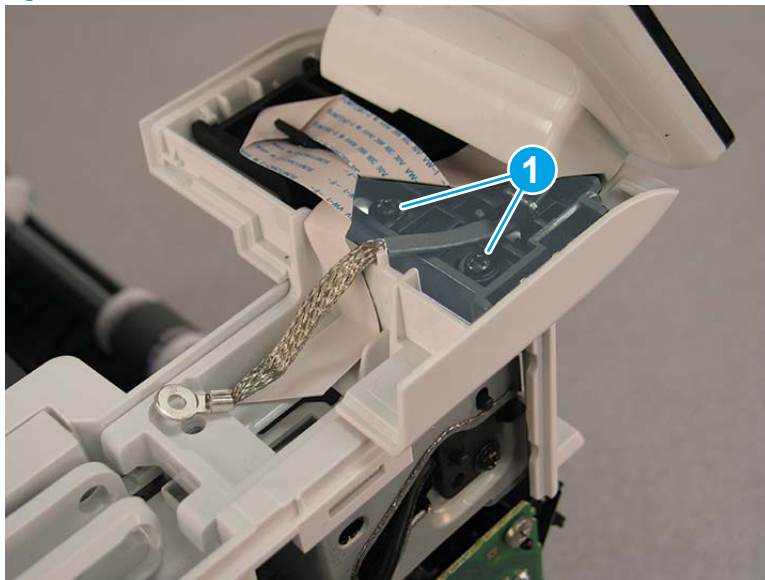

7. Slightly lift up the control-panel assembly to separate it from the top cover.

⚠ CAUTION: The control panel assembly is still connected to the printer by the FFC. Do not attempt to completely remove the assembly.

Figure 1-828 Lift up the control-panel assembly



8. Lift up the control-panel FFC cover to remove the control-panel assembly.

Figure 1-829 Remove the control-panel assembly

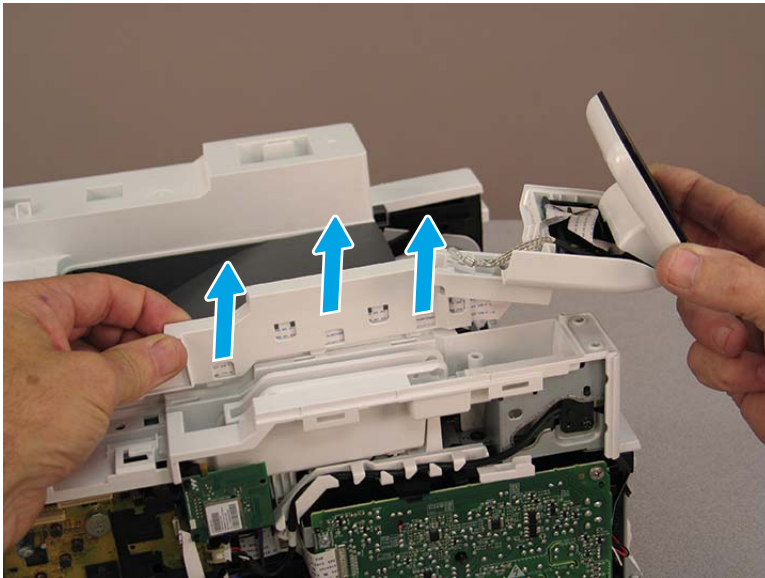

Step 7: Remove the top cover (M329/M428/M429)

📝 NOTE: The step is for the M329/M428/M429 printer. For the M304/M305/M404/M405, skip this step and go to [Step 8: Remove the top cover \(M304/M305/M404/M405\) on page 498](#).

1. Release the USB cable (callout 1) from the cable guide.

Figure 1-830 Remove the USB cable

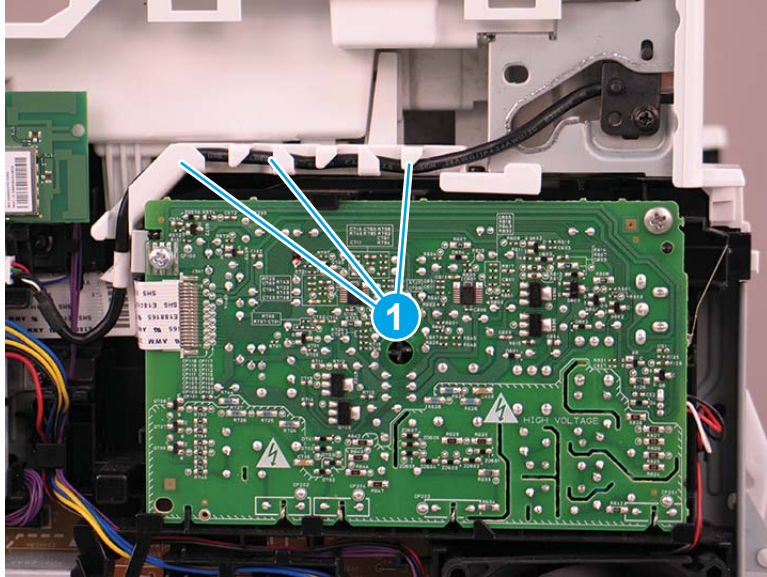

2. Remove one screw (callout 1), and then remove the support arm (callout 2).

⚠ CAUTION: The support arm is spring loaded and can unexpectedly spring into the open position. To avoid injury, do not place a finger in the screw well when the support arm is in the closed position.

Figure 1-831 Remove the support arm

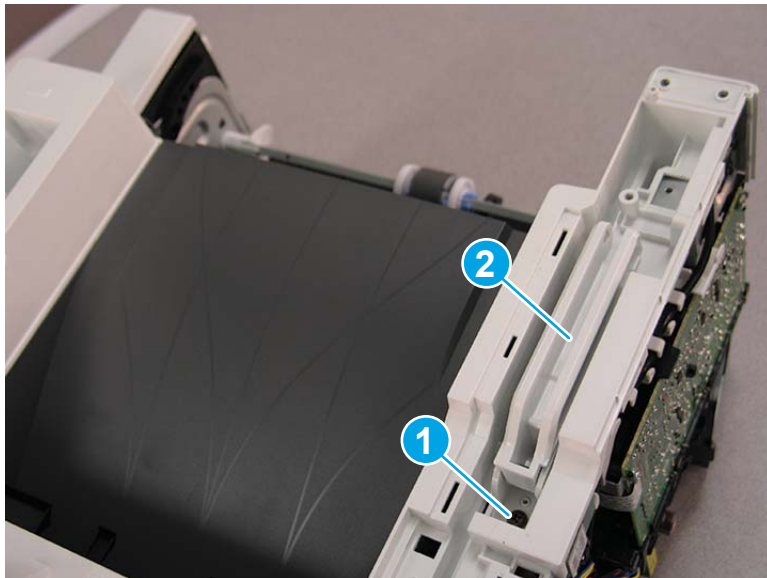

3. Remove five screws (callout 1), release four bosses (callout 2), and then remove the top cover (callout 3).

Figure 1-832 Remove the cover

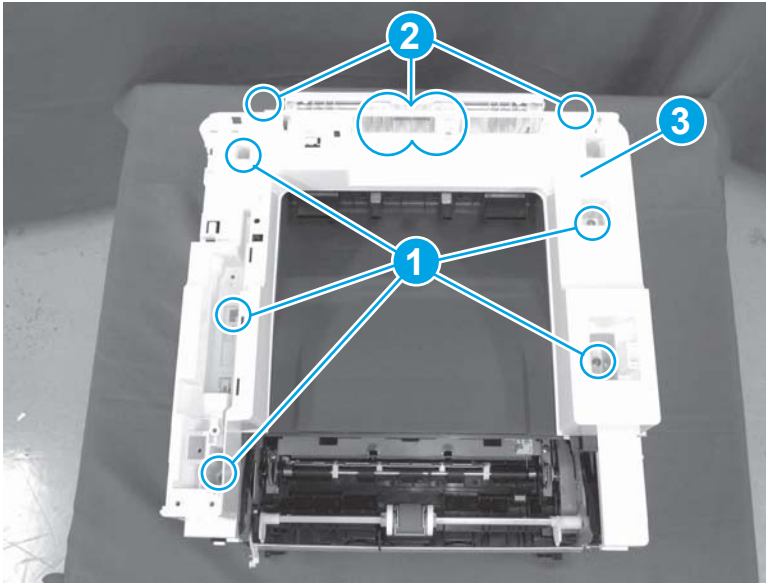

Step 8: Remove the top cover (M304/M305/M404/M405)

 **NOTE:** The step is for the M304/M305/M404/M405 printer. For the M329/M428/M429, skip this step and go to [Step 9: Remove the paper delivery tray \(output bin\) on page 499.](#)

1. Remove one screw (callout 1).

Figure 1-833 Remove one screw



2. At the right side of the printer, release the one boss (callout 1), and then release one tab (callout 2).

Figure 1-834 Release one boss and one tab

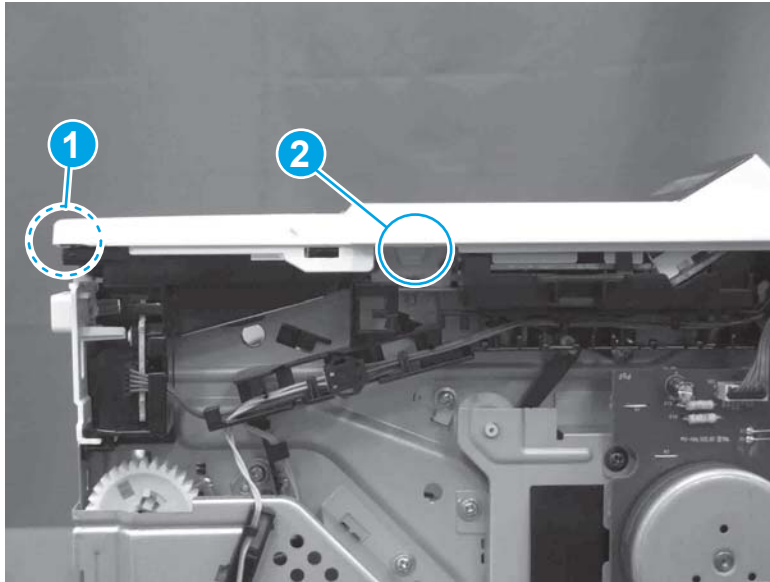

3. Release four tabs (callout 1), release four bosses (callout 2), and then remove the top cover (callout 3).

 **TIP:** Open the rear door to make releasing the bosses (callout 3) easier.

Figure 1-835 Remove the cover

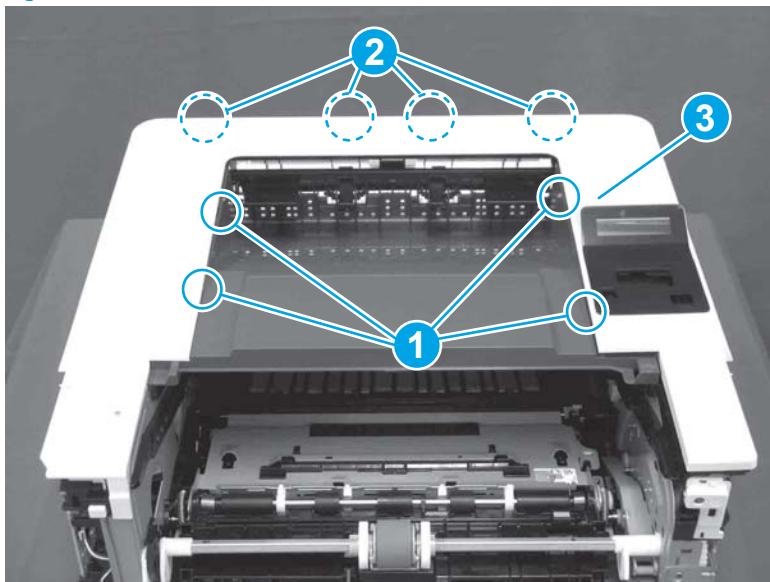

Step 9: Remove the paper delivery tray (output bin)

 **NOTE:** This procedure shows the M304/M305/M404/M405 model, however, the paper delivery tray (output bin) removal is similar for the M329/M428/M429 printer.

- ▲ Release two bosses (callout 1), release two tabs (callout 2), and then remove the paper delivery tray (output bin; callout 3).

Figure 1-836 Release two tabs

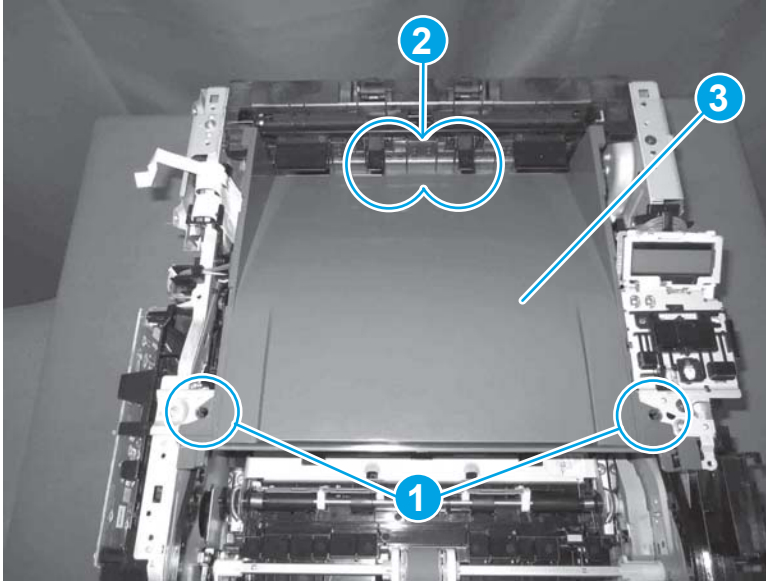

Step 10: Remove the sheet-metal formatter bracket and formatter PCA

1. Do one of the following:

- **SFP only:** Release two tabs (callout 1), and then carefully pull the wireless PCA straight off of the formatter PCA to remove it.

 **NOTE:** Disconnect the WiFi antenna (callout 2) before releasing the tabs.

- **MFP only:** Release one tab (callout 3), and then carefully pull the wireless PCA straight off of the formatter PCA to remove it.

 **TIP:** Push the tab to the left to release it.

Figure 1-837 Remove the wireless PCA



2. Do one of the following:

- **SFP only:** Disconnect the connectors (callout 1), and then release one wire harness (callout 2) from the guide.
- **MFP only:** Disconnect the connectors (callout 1), and then release one wire harness and one FFC (callout 2) from the guides.

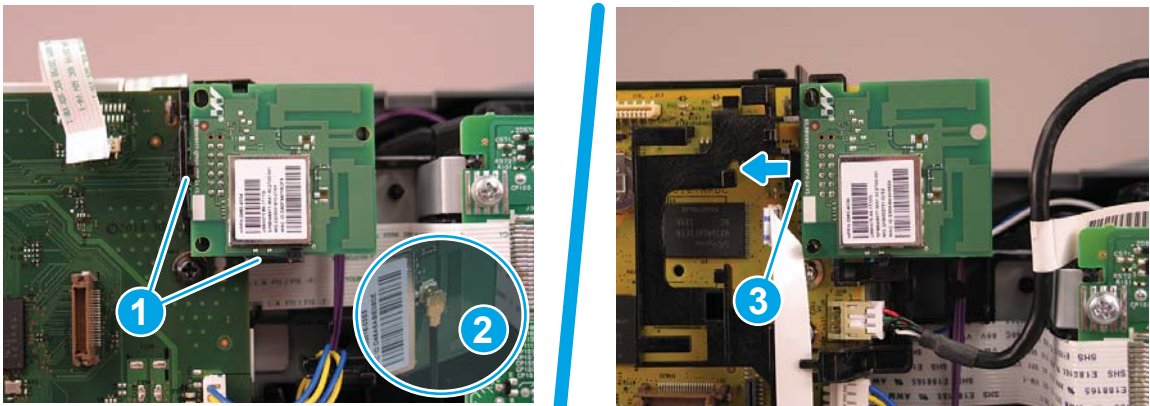
Figure 1-838 Disconnect the connectors

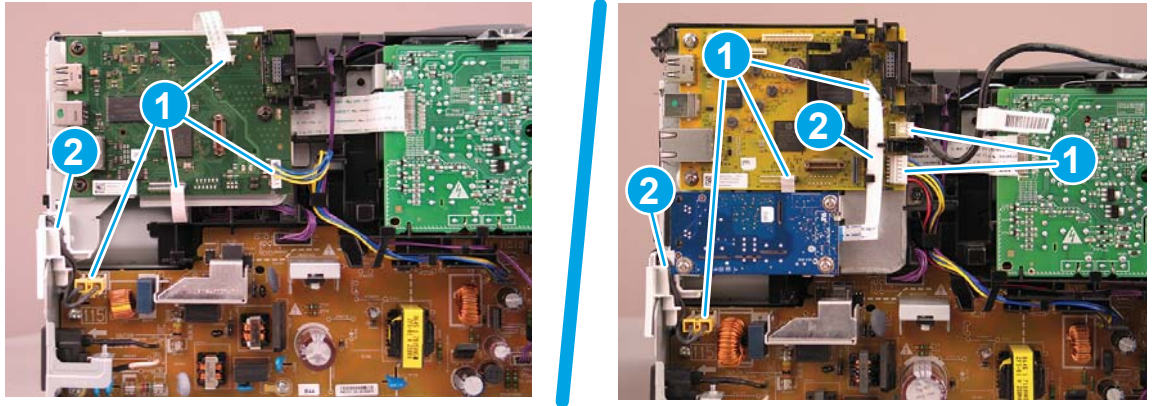

3. **MFP only:** Remove three screws (callout 1), and then remove the fax PCA.

Figure 1-839 Remove the fax PCA

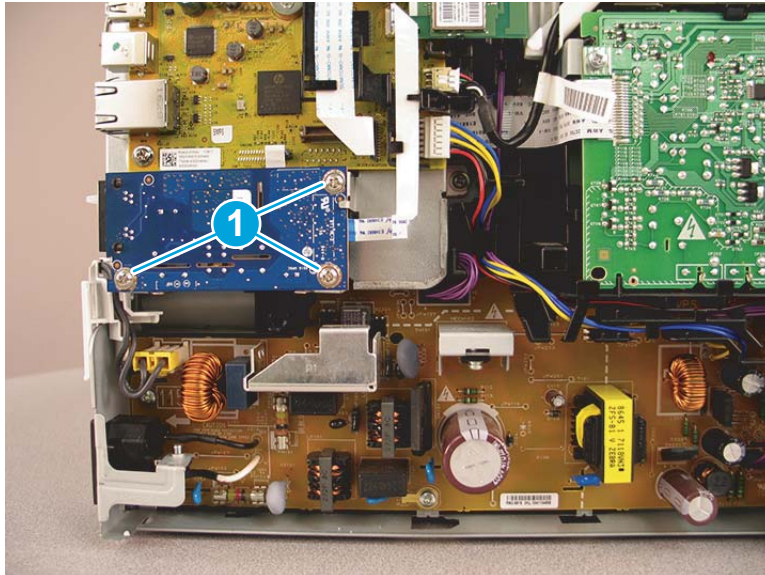

4. **MFP only:** Release the FFC from the guide (callout 1), release one tab (callout 2), and then remove the FFC guide (callout 3).

Figure 1-840 Remove the FFC guide

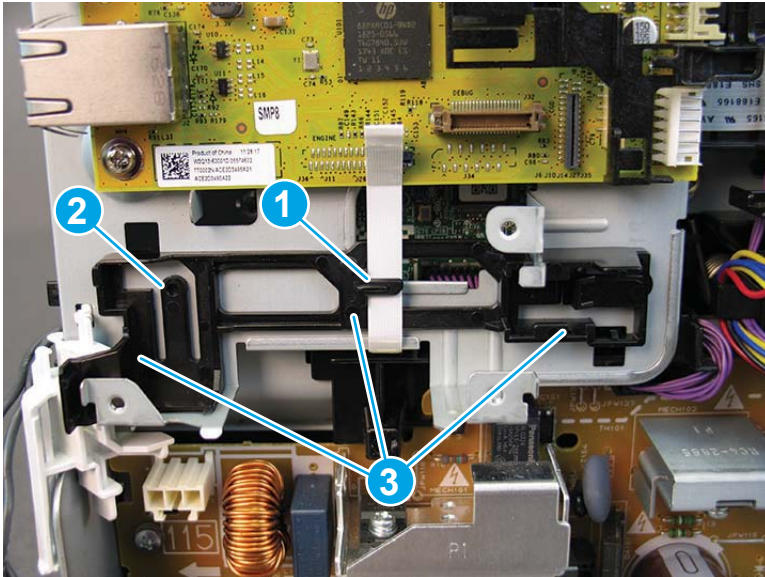

5. Remove one guide.

 **NOTE:** A SFP printer is shown in the figure. However, the guide is identical for an MFP printer.

Figure 1-841 Remove the guide



6. Remove two screws.

Figure 1-842 Remove two screws

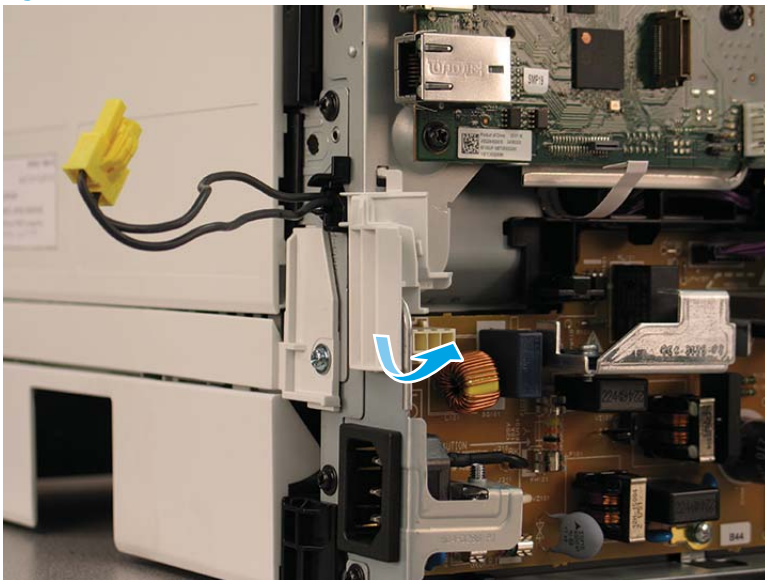

7. MFP only: Remove one screw.

Figure 1-843 Remove one screw

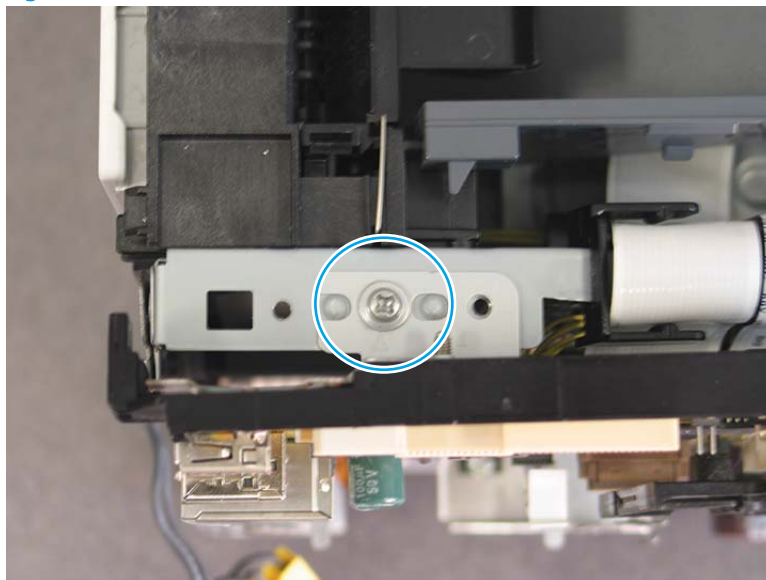

8. Support the formatter and bracket, and then remove two screws.

Figure 1-844 Remove two screws

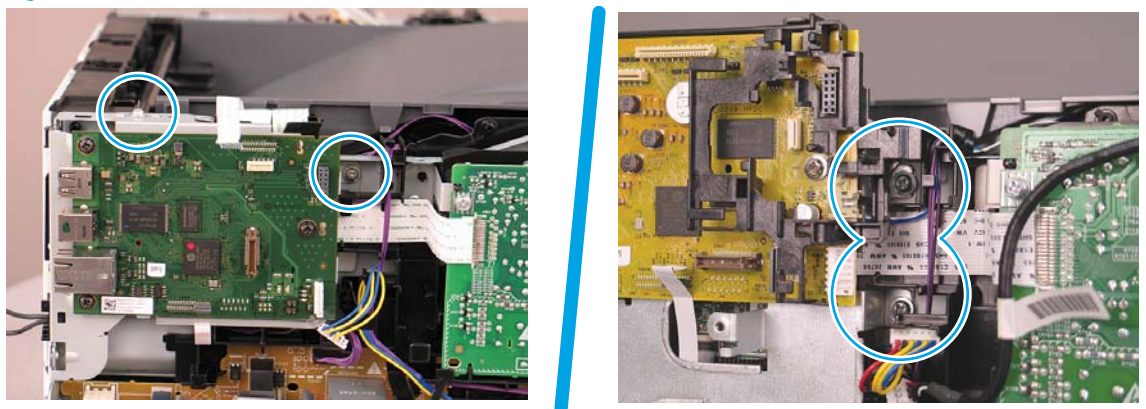

9. Remove the sheet-metal bracket and formatter PCA.

Figure 1-845 Remove the bracket

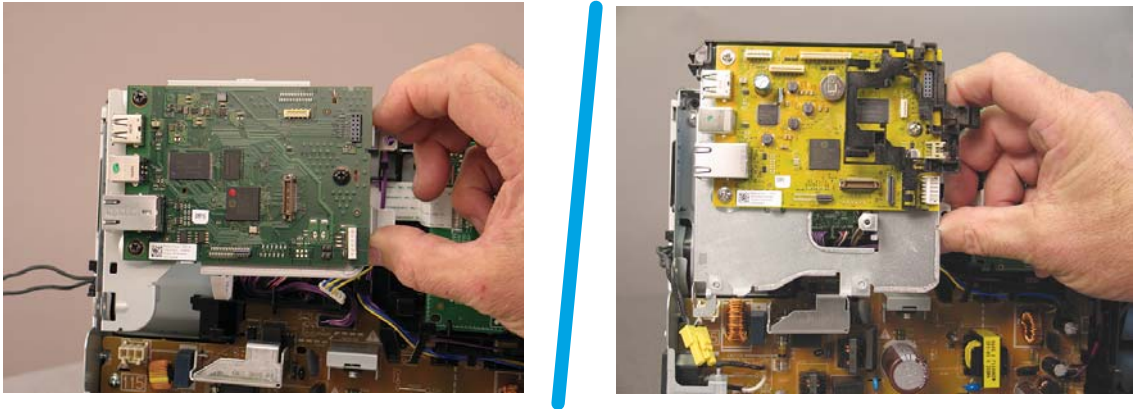

Step 11: Remove the tag-cable assembly

1. Disconnect one connector (callout 1), and then release the wire harness from the guide (callout 2).

Figure 1-846 Disconnect one connector

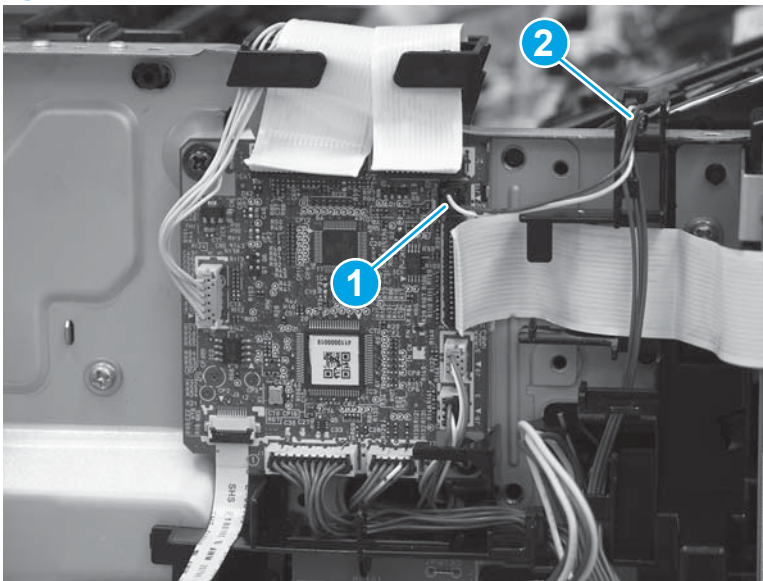

2. Remove one screw (callout 1).

Figure 1-847 Remove one screw

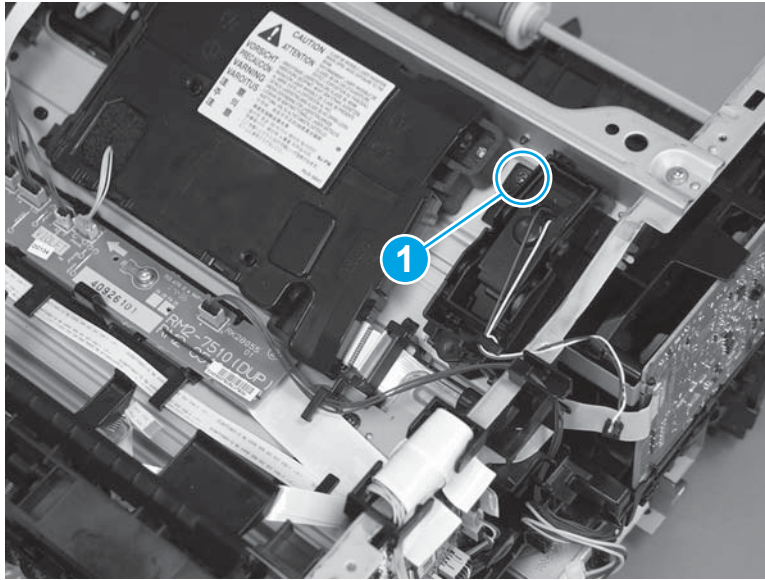

3. Remove the tag-cable assembly.

 **Reinstallation tip:** Make sure that the assembly is flat against the chassis. If the assembly is not correctly installed, it might not make proper contact with the toner cartridge.

Figure 1-848 Remove the tag-cable assembly



Step 12: Remove the laser scanner FFC

1. Disconnect one FFC (callout 1), and then release it from the guide (callout 2).

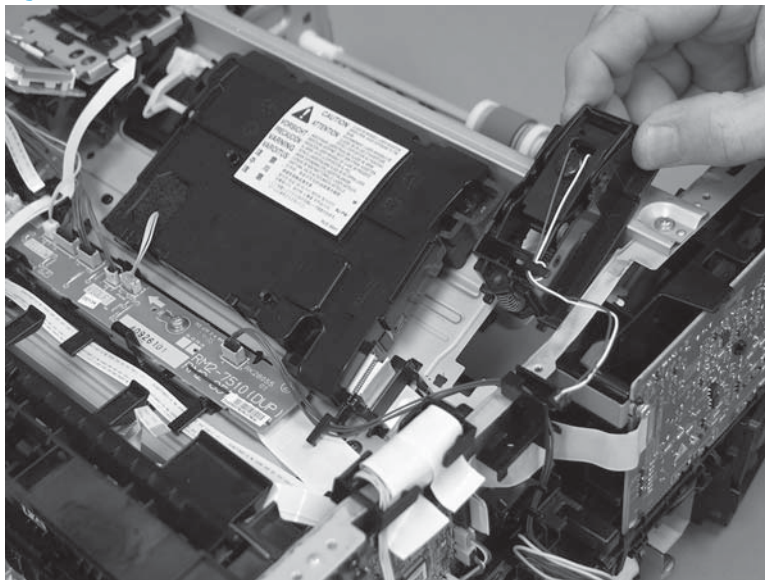
Figure 1-849 Disconnect one FFC

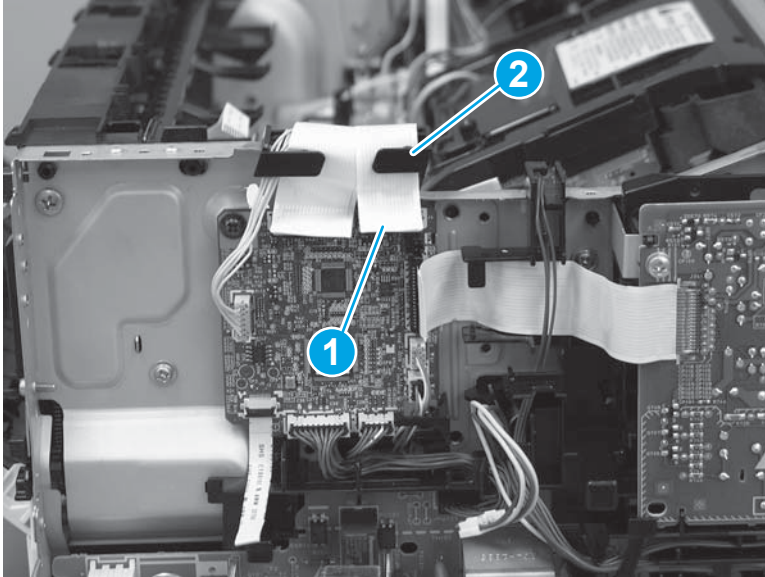

2. Remove one screw (callout 1), and then remove the sheet-metal plate (callout 2).

Figure 1-850 Remove one screw and the sheet-metal plate

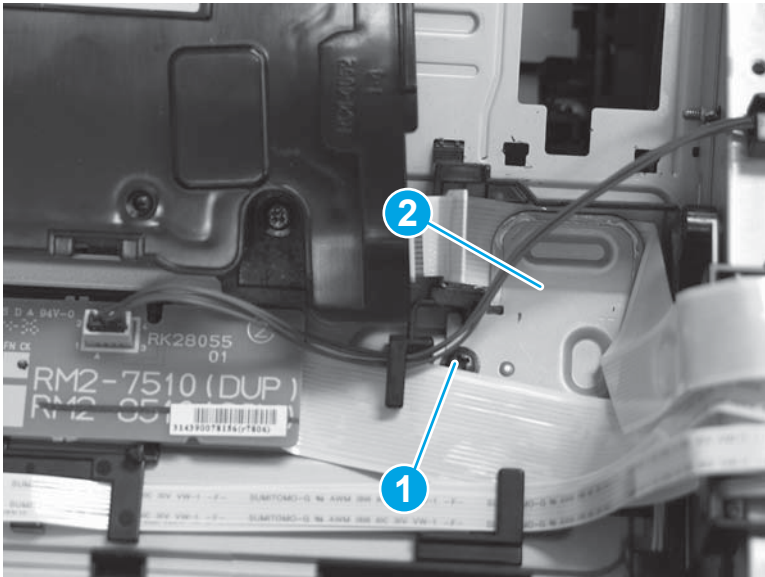

3. Disconnect one FFC (callout 1).

Figure 1-851 Disconnect one FFC

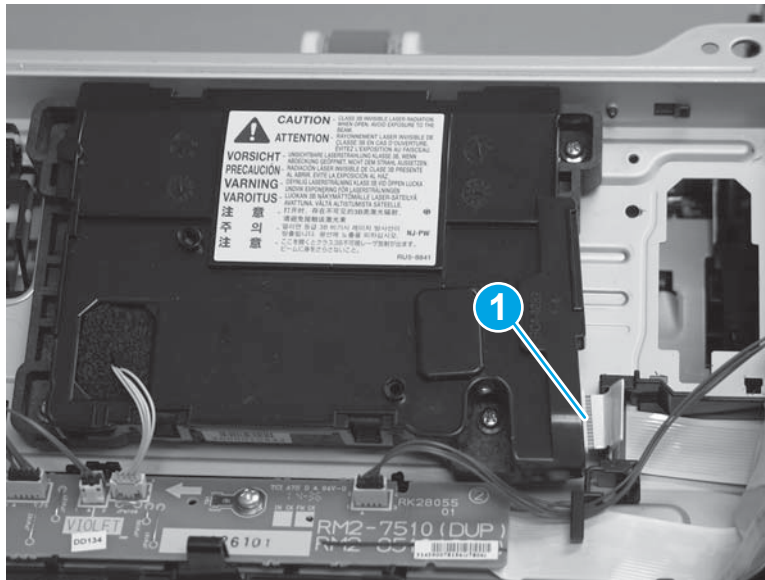

4. Slightly flex the holder (callout 1), and then release the FFC ferrite (callout 2).

 **Reinstallation tip:** Do not discard the ferrite. It will be installed on the replacement FFC.

Figure 1-852 Release the ferrite

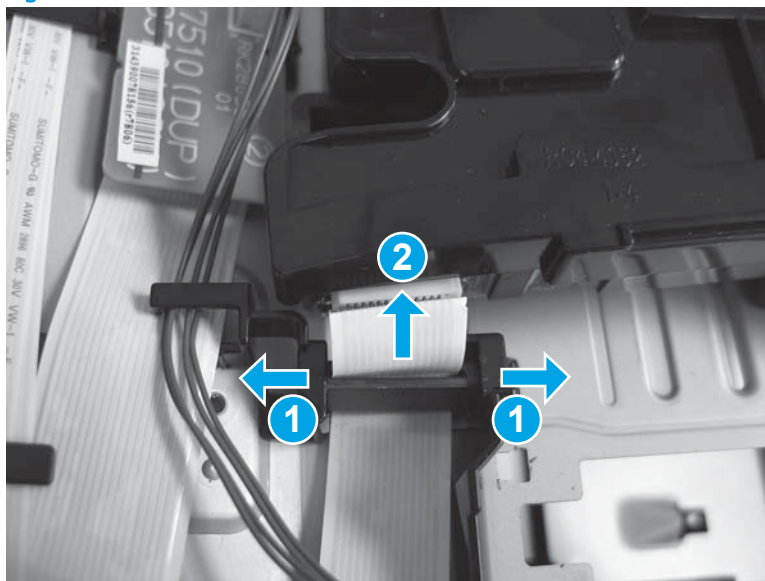

5. Remove the FFC.

 **TIP:** Install the ferrite on the replacement FFC.

Figure 1-853 Remove the FFC

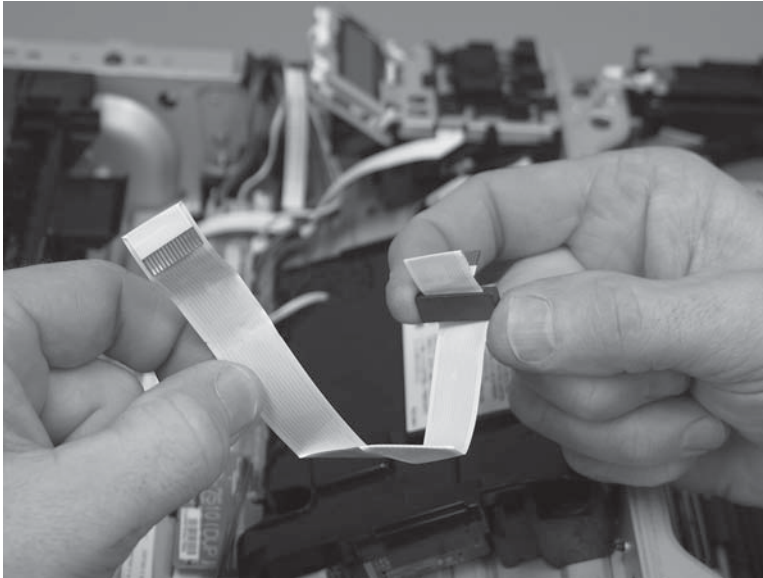



Step 13: Unpack the replacement assembly

1. Dispose of the defective part.

 **NOTE:** HP recommends responsible disposal of the defective part.

<http://www8.hp.com/us/en/hp-information/environment/product-recycling.html>

2. Unpack the replacement part from the packaging.

 **CAUTION:**  Some parts are sensitive to electrostatic discharge (ESD). Always perform service work at an ESD-protected workstation or mat. If an ESD workstation or mat is not available, touch the sheet-metal chassis to provide a static ground before touching an ESD-sensitive assembly. Protect the ESD-sensitive assemblies by placing them in ESD pouches when they are out of the printer.

If the replacement part is a roller or pad, avoid touching the spongy part of it. Skin oils on the roller or pad can cause paper pickup and/or print-quality problems. HP recommends using disposable gloves when handling rollers or pads or washing your hands before touching rollers or pads.

 **IMPORTANT:** Make sure that all of the shipping materials (for example shipping tape) are removed from the replacement part prior to installation.

3. To install an assembly, reverse the removal steps.

 **NOTE:** When applicable, special installation instructions are provided for an assembly at the end of the removal procedure. Always completely read the removal instructions and follow all special installation instructions.

Removal and replacement: High-voltage power supply

- [Introduction](#)
- [Step 1: Remove Tray 2](#)
- [Step 2: Remove the cartridge door assembly](#)
- [Step 3: Remove the left cover](#)
- [Step 4: Remove the right cover](#)
- [Step 5: Remove the integrated scanner assembly \(M329/M428/M429\)](#)
- [Step 6: Remove the control panel \(M329/M428/M429\)](#)
- [Step 7: Remove the top cover \(M329/M428/M429\)](#)
- [Step 8: Remove the top cover \(M304/M305/M404/M405\)](#)
- [Step 9: Remove the paper delivery tray \(output bin\)](#)
- [Step 10: Remove the sheet-metal formatter bracket and formatter PCA](#)
- [Step 11: Remove the HVPS](#)
- [Step 12: Unpack the replacement assembly](#)

Introduction

This document provides the procedures to remove and replace the high-voltage power supply (HVPS).

Before performing service

Turn the printer power off

- Disconnect the power cable.

⚠ WARNING! To avoid damage to the printer, turn the printer off, wait 30 seconds, and then remove the power cable before attempting to service the printer.

Use the table below to identify the correct part number for your printer. To order the part, go to www.hp.com/buy/parts.

High-voltage power supply (HVPS) part number	
RM2-7508-000CN	High-voltage power supply (HVPS)

Required tools

- #2 Phillips screwdriver with a magnetic tip.

After performing service

Turn the printer power on

- Connect the power cable.
- Use the power switch to turn the power on.

Post service test

Make sure that the printer initializes to a **Ready** state.

Print a configuration page to make sure that the printer is functioning correctly.

Step 1: Remove Tray 2

- ▲ Pull the tray straight out of the printer to remove it.

Figure 1-854 Remove the tray



Step 2: Remove the cartridge door assembly

 **NOTE:** If the toner cartridge was not removed prior to servicing the printer, remove it now.

1. Release the support shaft (callout 1), and then slide it toward the center of the door (callout 2).

 **TIP:** It might be easier to release the support shaft by using a small flat-blade screwdriver.

Figure 1-855 Release the support shaft

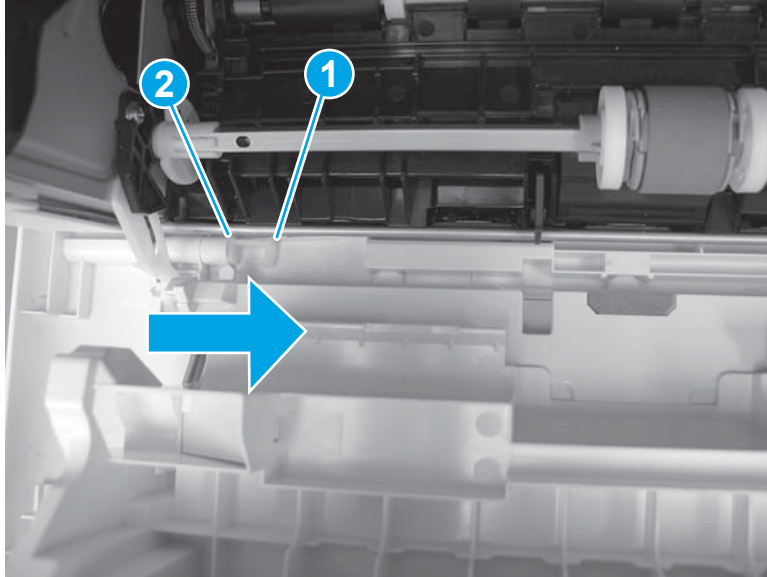

2. Remove the support shaft.

Figure 1-856 Remove the support shaft

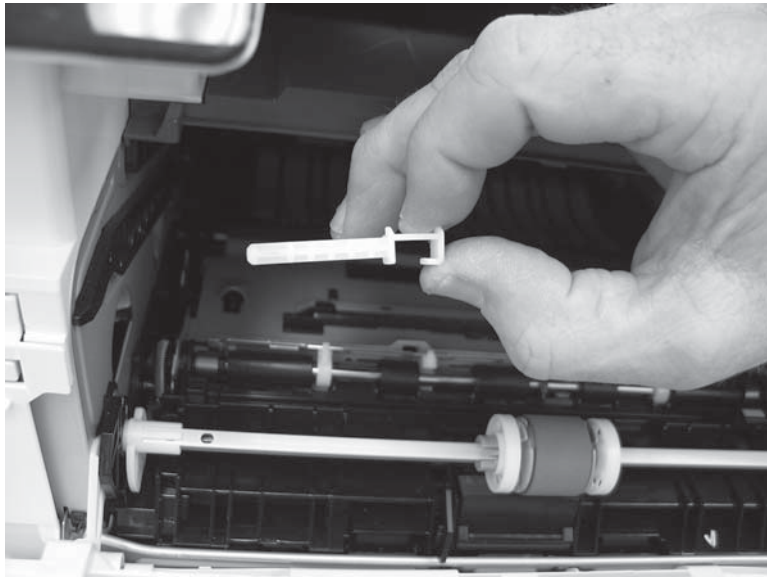

3. Release one tab (callout 1), and then slide the guide out of the printer (callout 2).

⚠ CAUTION: Be careful, the tab (callout 1) can be easily broken.

Figure 1-857 Remove the guide

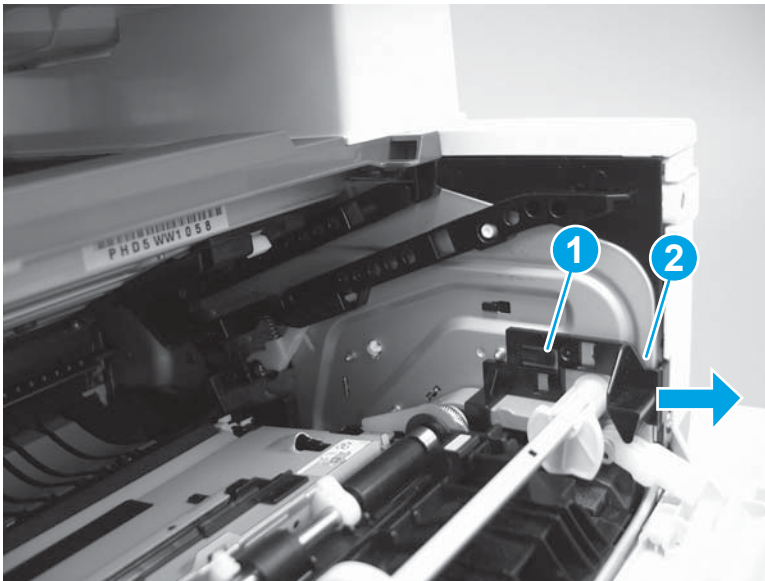

4. Use a small flat-blade screwdriver to gently pry the white-plastic door arm (callout 1) off of the gray-plastic pressure-release link (callout 2) to release the door arm.

Figure 1-858 Release the pressure-release link

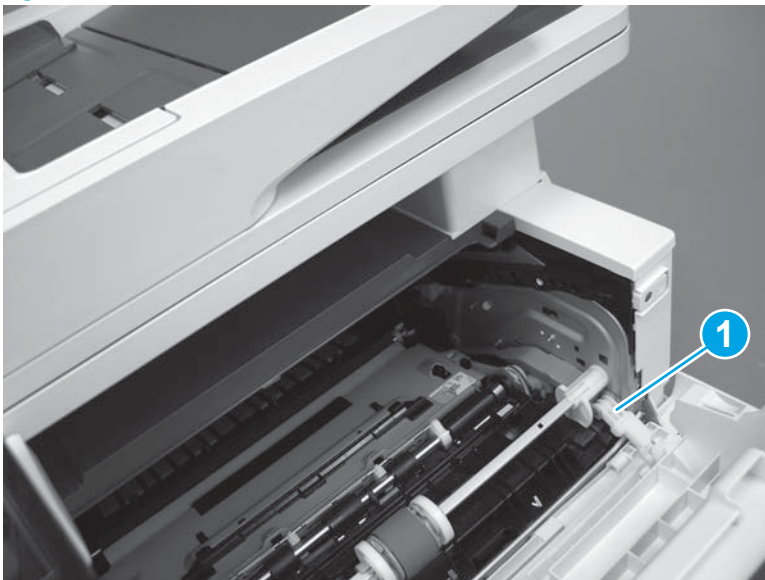

5. With the door in the partially closed position, slightly raise the left end (callout 1; raise it over the sheet-metal hinge boss), and then slide the door to the left (callout 2) to release the right hinge (callout 3).

⚠ CAUTION: The door is still attached to the printer by the left-side retainer arm. Do not attempt to completely remove the door.

💡 Reinstallation tip: When reinstalling the door, there are two right-side hinge pins (not shown in callout 3). Keep a finger pressed on the left-side retainer arm so that it does not disengage from the door.

Figure 1-859 Release the door

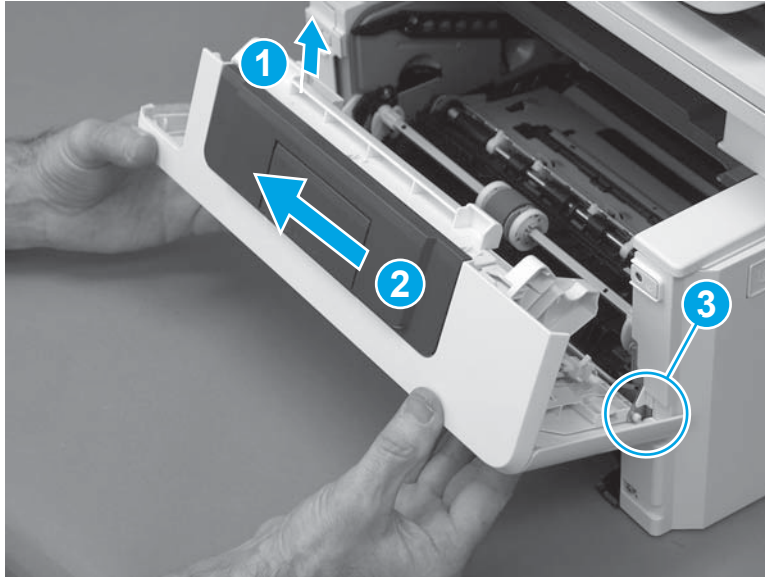

6. Rotate the door away from the printer until the keyed pin on the left-side retainer arm can disengage from the door.

Figure 1-860 Release the left-side retainer arm

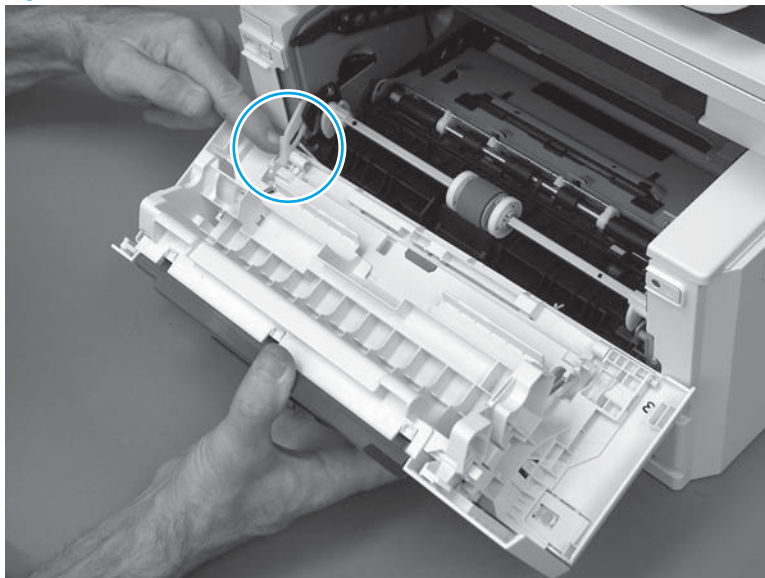

7. Remove the door.

Figure 1-861 Remove the door

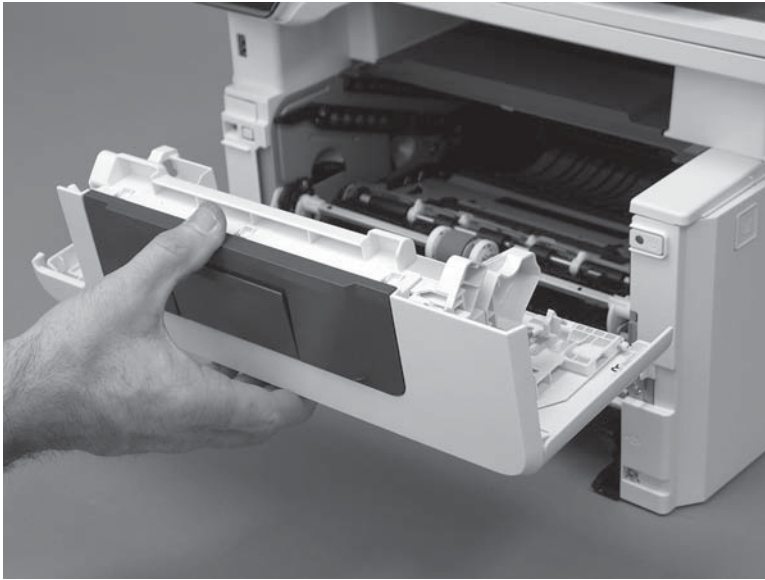

Step 3: Remove the left cover

1. Remove one screw (callout 1).

Figure 1-862 Remove one screw

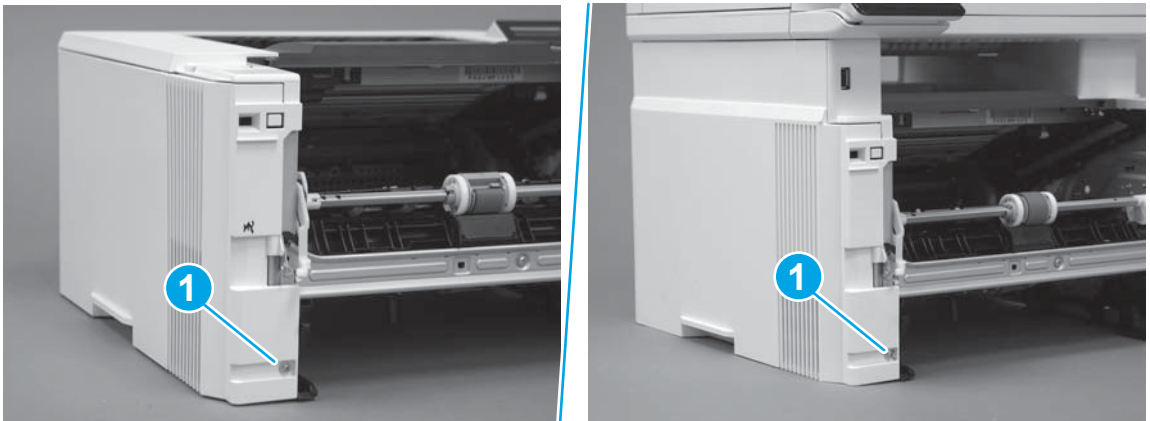

2. Open the rear door, release two bosses (callout 1), and then release three tabs (callout 2).

Figure 1-863 Release two bosses and three tabs

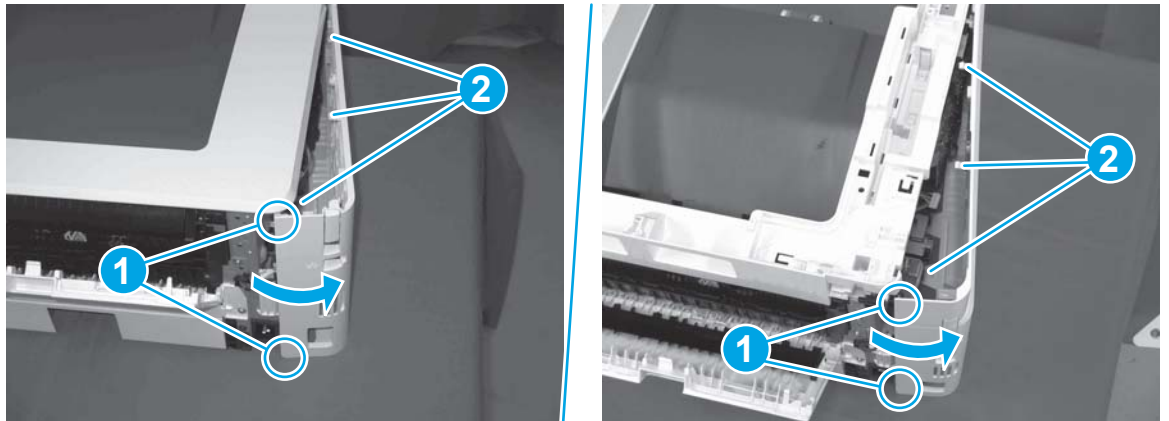

3. At the front of the printer, do one of the following:

- **M304/M305/M404/M405:** Release two bosses (callout 1), and then remove the cover (callout 2).
- **M329/M428/M429:** Release one tab (callout 3), two bosses (callout 4), and then remove the cover (callout 5).

CAUTION: Be careful when releasing the upper bosses on the M329/M428/M429 cover. One portion of the cover (callout 6) is fragile and is easily broken.

Figure 1-864 Remove the cover

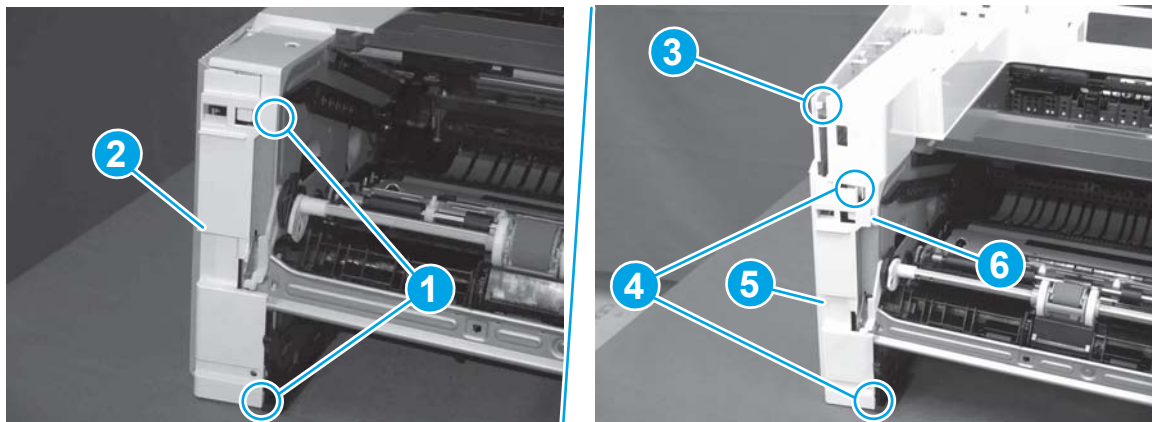

Step 4: Remove the right cover

1. At the front of the printer, release two bosses (callout 1), and then release three tabs (callout 2).

Reinstallation tip: Remove, and then reinstall the cover if the switch or button does not correctly function.

Figure 1-865 Release two bosses and three tabs

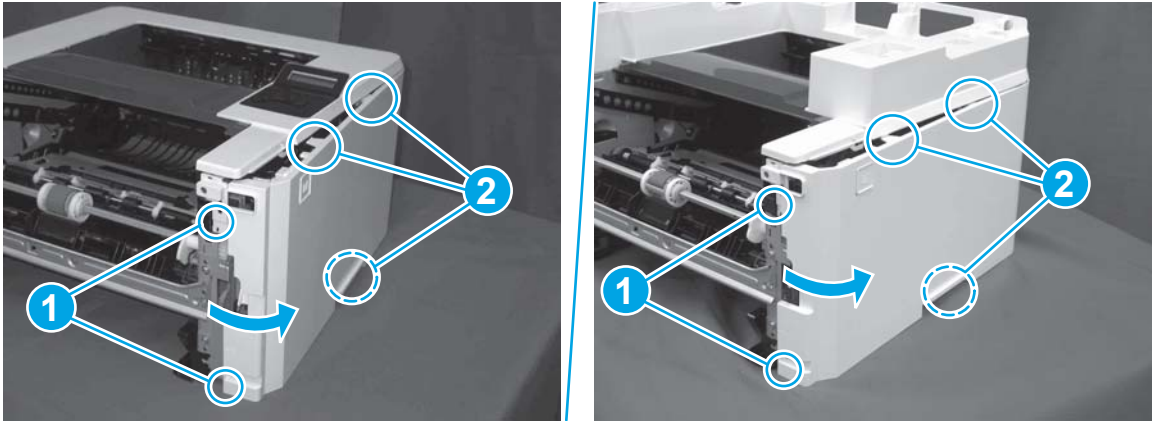

2. Open the rear door, release two bosses (callout 1), and then remove the cover (callout 2).

Figure 1-866 Remove the cover

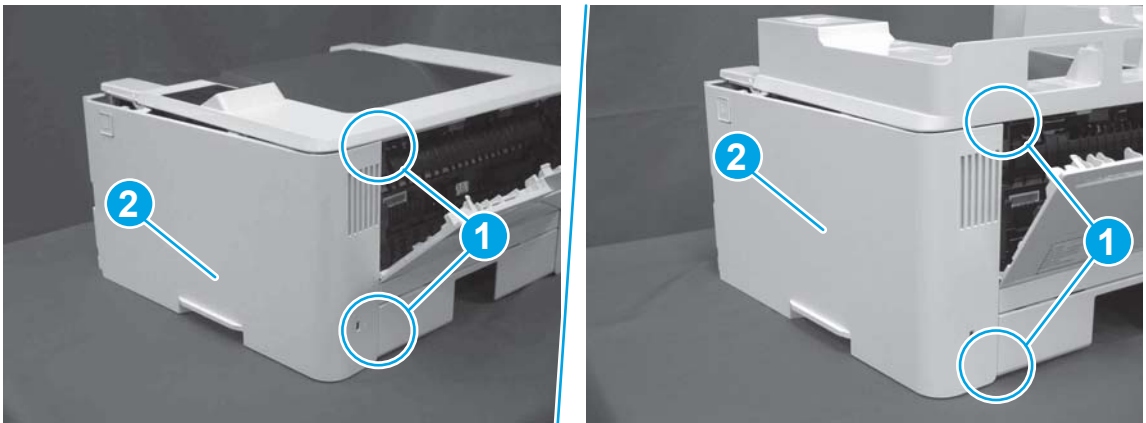

Step 5: Remove the integrated scanner assembly (M329/M428/M429)

 **NOTE:** The step is for the M329/M428/M429 printer. For the M304/M305/M404/M405, skip this step and go to [Step 8: Remove the top cover \(M304/M305/M404/M405\) on page 527](#).

 **NOTE:** M329/M428/M429 models only. The integrated scanner assembly (ISA) includes the sub-scanner assembly (SSA) and the automatic document feeder (ADF).

1. Raise the ISA.

Figure 1-867 Raise the ISA

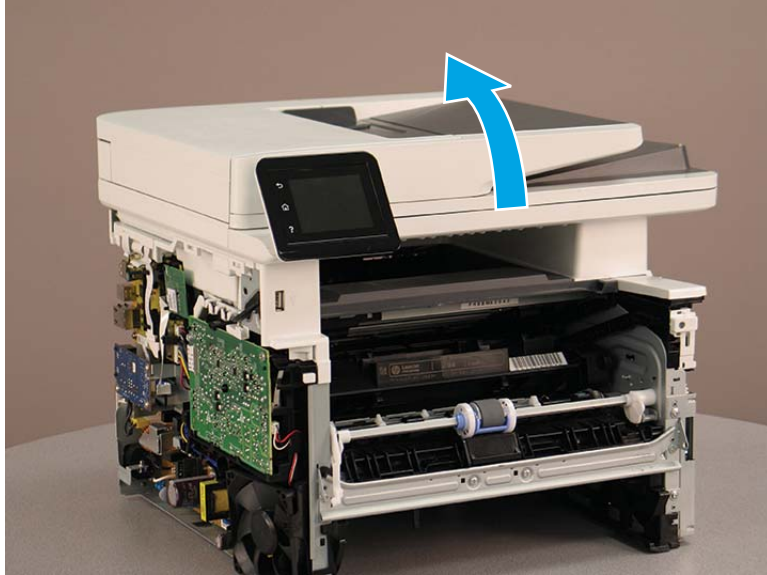

2. Release the ISA flat-flexible cable (FFC) cover (callout 1), and then remove it (callout 2).

Figure 1-868 Remove the ISA FFC cover

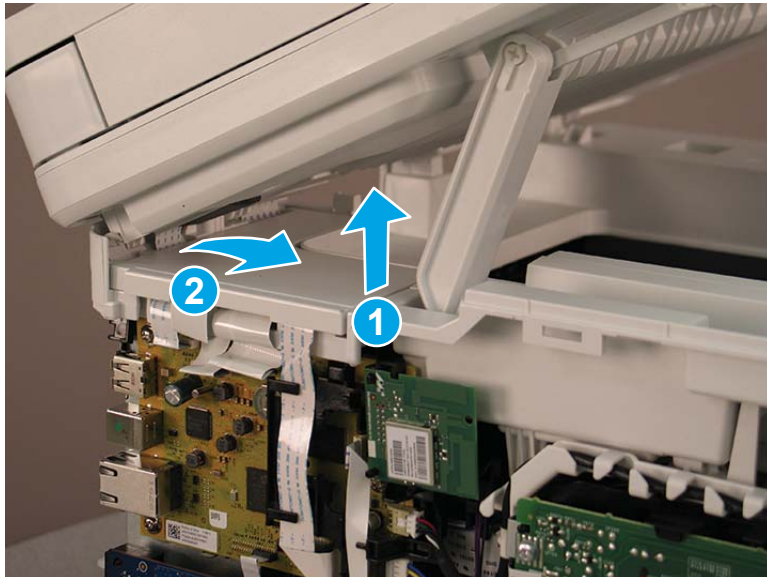

3. Disconnect three FFCs (callout 1), and then remove the ferrite (callout 2) from the holder.

⚠ CAUTION: The ferrite is not captive on the FFC. Do not lose the ferrite while handling the ISA.

Figure 1-869 Disconnect three FFCs

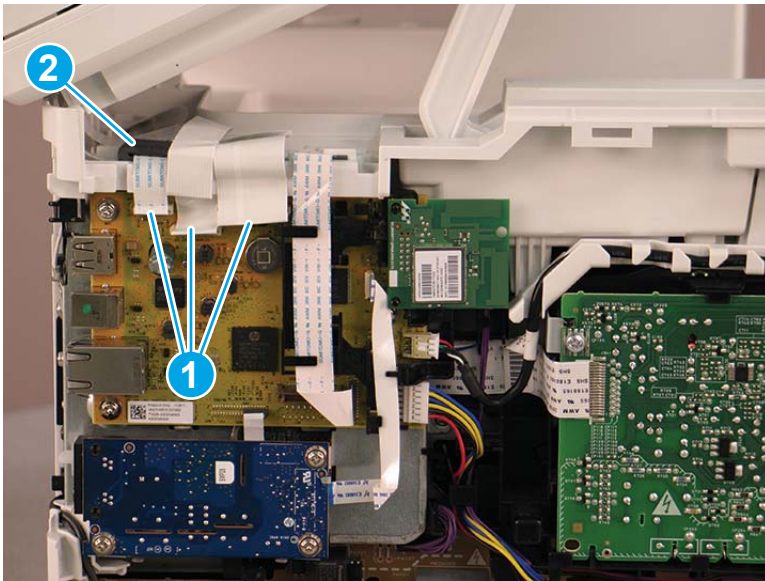

4. Remove one screw (callout 1).

Figure 1-870 Remove one screw

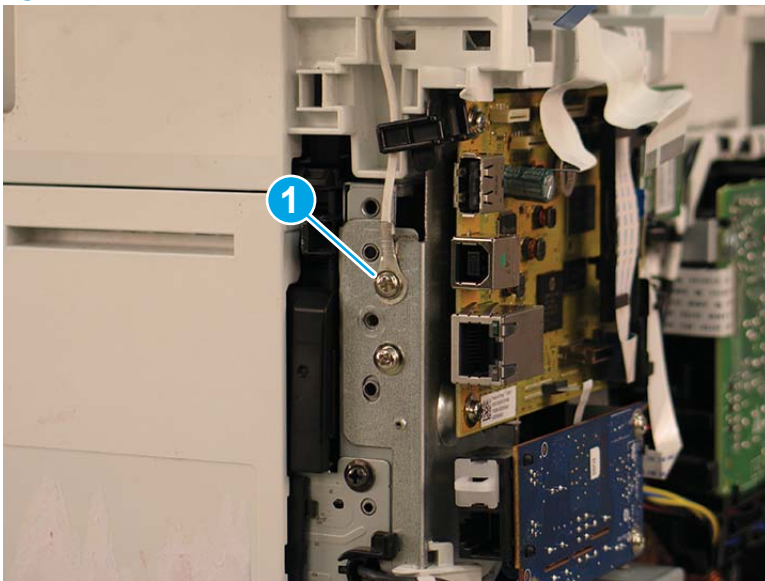

5. Pass the ground wire through the opening in the top cover.

Figure 1-871 Pass the wire through the opening

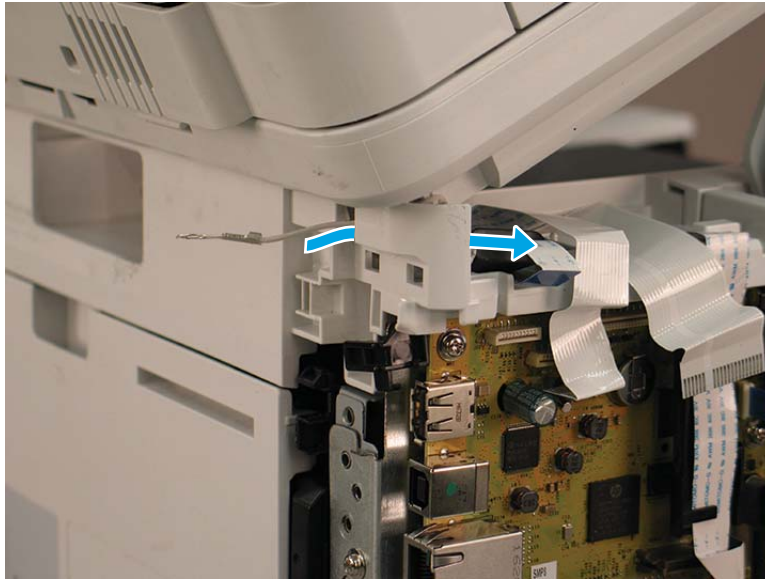

6. Release one tab (callout 1), and then rotate the ISA slider pin (callout 2) towards the front of the printer to release it.

Figure 1-872 Release one tab and rotate the slider pin

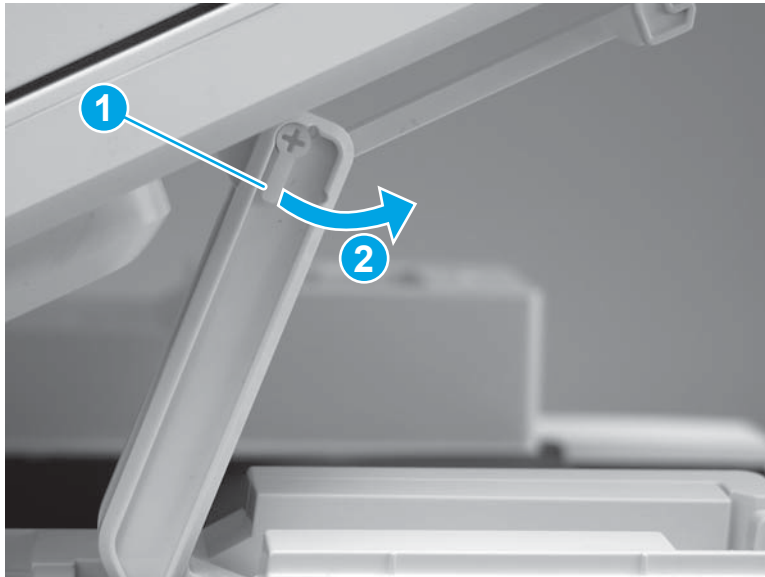

7. Remove the slider pin.

 **Reinstallation tip:** Align the keyed portion of the locking pin with the slot and hole in the support arm.

Figure 1-873 Remove the slider pin



8. Rotate the ISA towards the rear of the printer until it stops.

Figure 1-874 Rotate the ISA towards the rear of the printer

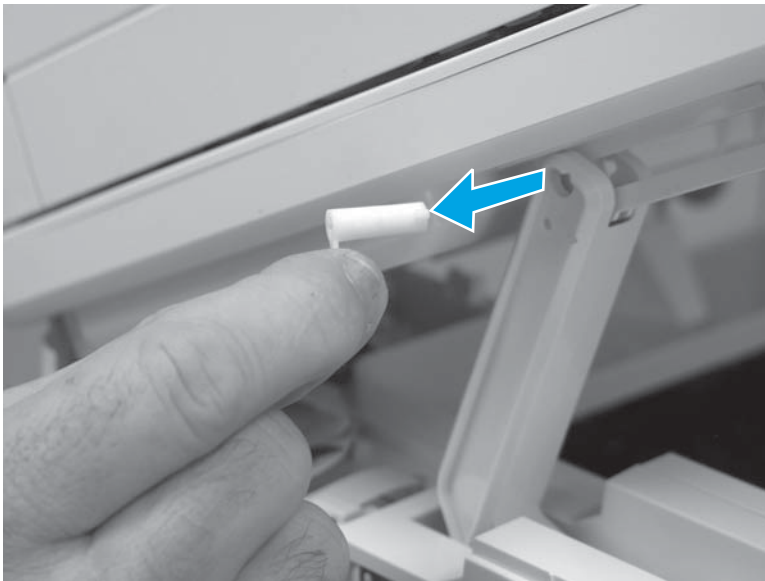
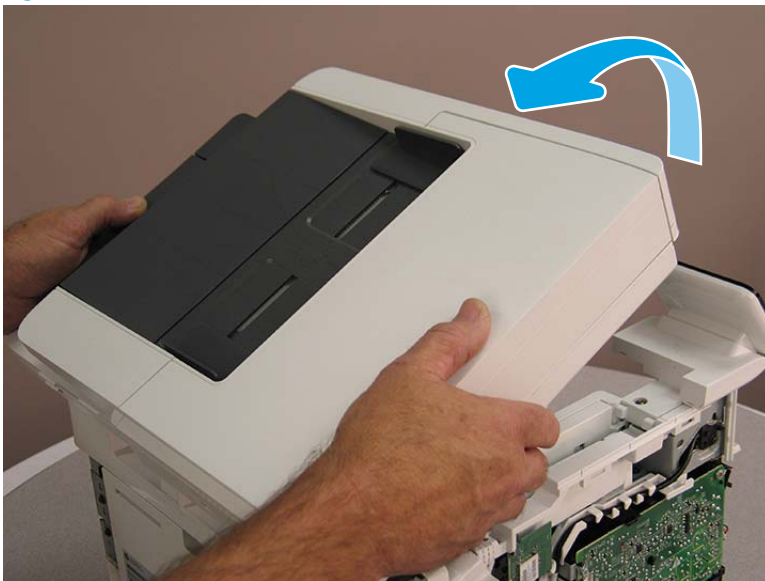

- Slide the ISA as shown to release it.

Figure 1-875 Release the ISA

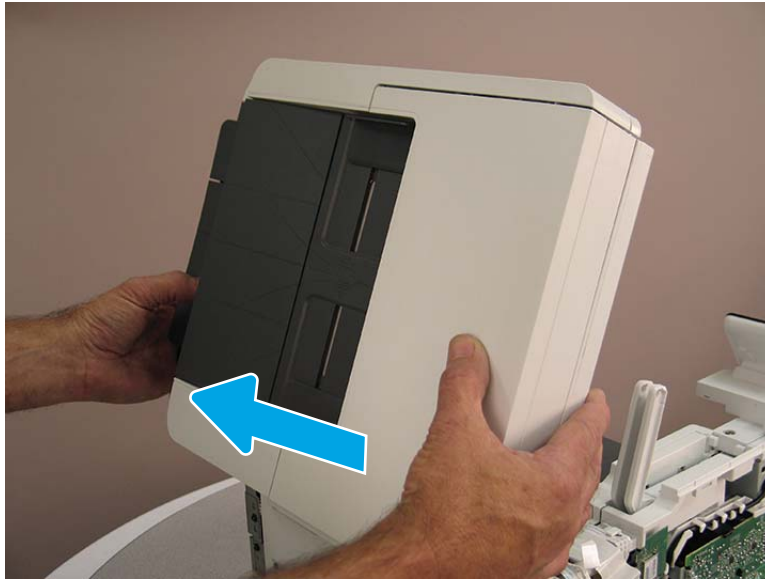

- Remove the ISA.

Figure 1-876 Remove the ISA

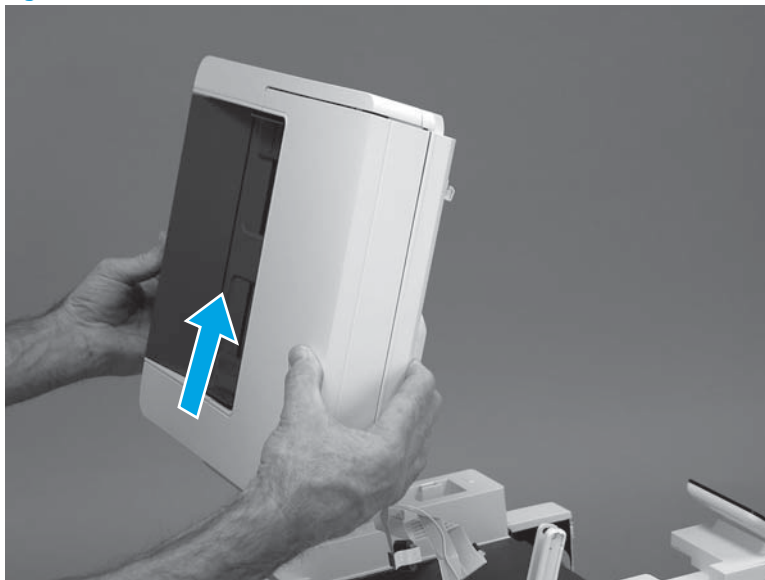

Step 6: Remove the control panel (M329/M428/M429)

 **NOTE:** The step is for the M329/M428/M429 printer. For the M304/M305/M404/M405, skip this step and go to [Step 8: Remove the top cover \(M304/M305/M404/M405\) on page 527](#).

- Disconnect one FFC (callout 1), and then release the FFC from the guide (callout 2).

Figure 1-877 Disconnect one connector

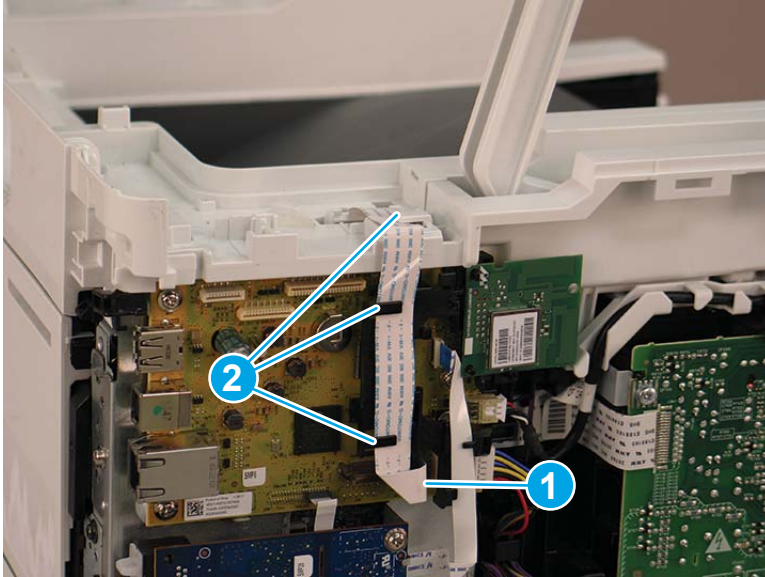

2. Remove one screw (callout 1).

Figure 1-878 Remove one screw

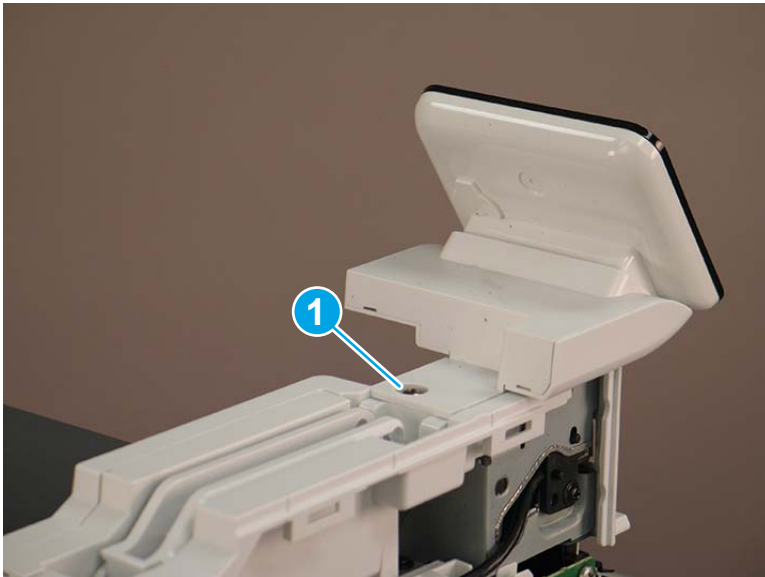

3. Use a small flat-blade screwdriver to release two tabs (callout 1) on the control-panel cable cover.

Figure 1-879 Release two tabs

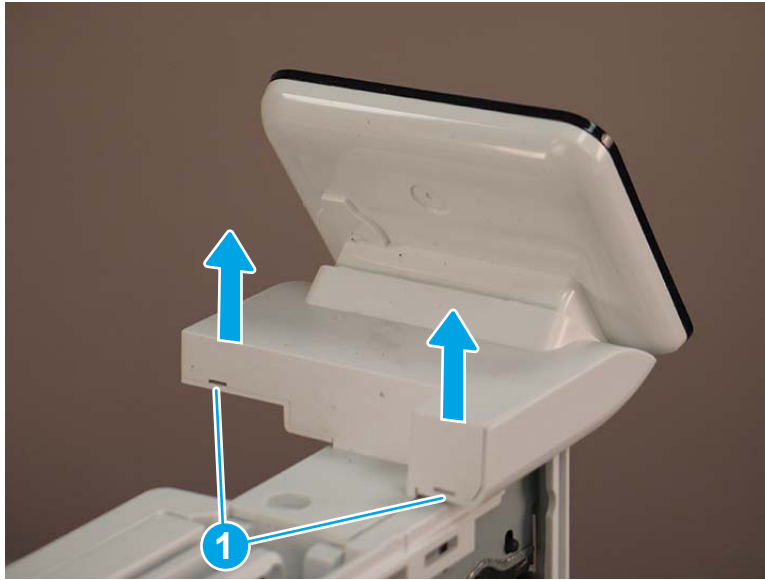

4. Remove the control-panel cable cover.

Figure 1-880 Remove the cover



5. Remove one grounding screw (callout 1), and then move the ground cable (callout 2) out of the way.

Figure 1-881 Remove one screw

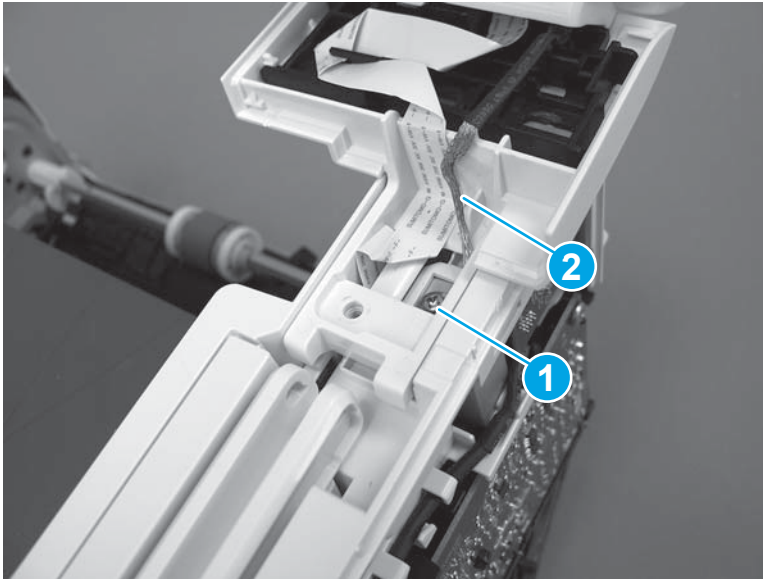

6. Move the FFC out of the way, and then remove two screws (callout 1).

Figure 1-882 Remove two screws



7. Slightly lift up the control-panel assembly to separate it from the top cover.

CAUTION: The control panel assembly is still connected to the printer by the FFC. Do not attempt to completely remove the assembly.

Figure 1-883 Lift up the control-panel assembly



8. Lift up the control-panel FFC cover to remove the control-panel assembly.

Figure 1-884 Remove the control-panel assembly

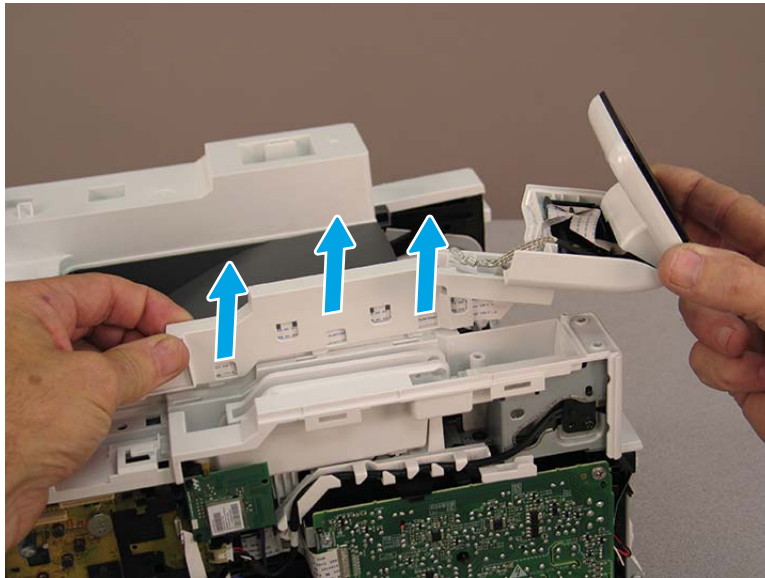

Step 7: Remove the top cover (M329/M428/M429)

NOTE: The step is for the M329/M428/M429 printer. For the M304/M305/M404/M405, skip this step and go to [Step 8: Remove the top cover \(M304/M305/M404/M405\) on page 527](#).

1. Release the USB cable (callout 1) from the cable guide.

Figure 1-885 Remove the USB cable

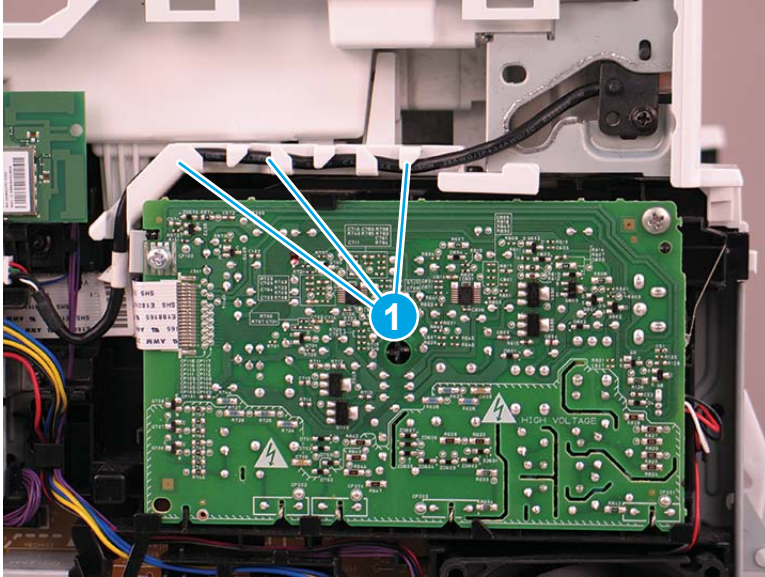

2. Remove one screw (callout 1), and then remove the support arm (callout 2).

⚠ CAUTION: The support arm is spring loaded and can unexpectedly spring into the open position. To avoid injury, do not place a finger in the screw well when the support arm is in the closed position.

Figure 1-886 Remove the support arm

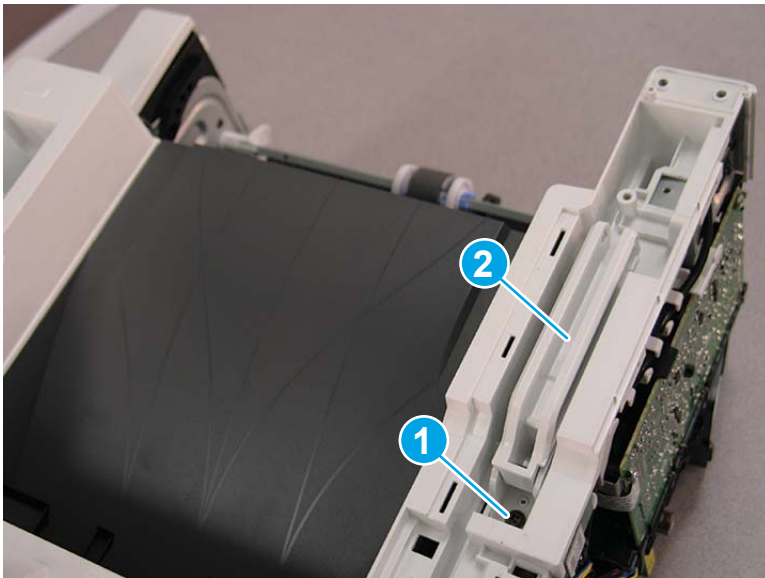

3. Remove five screws (callout 1), release four bosses (callout 2), and then remove the top cover (callout 3).

Figure 1-887 Remove the cover

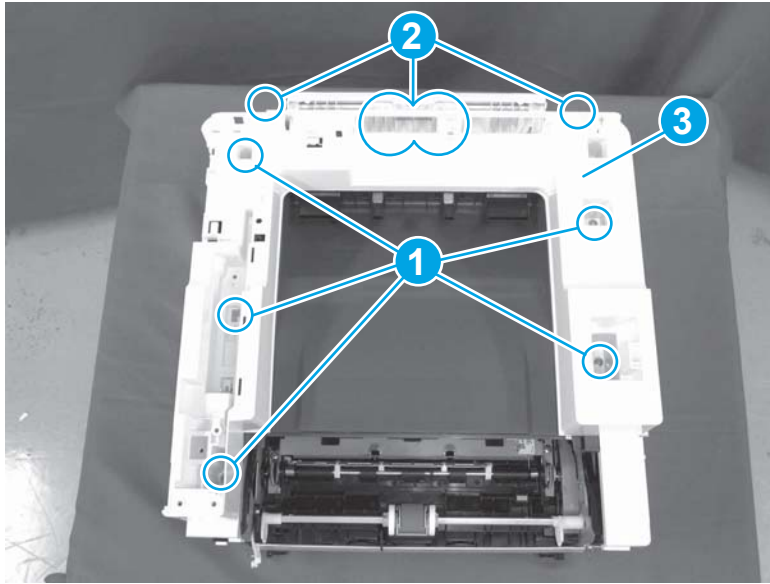

Step 8: Remove the top cover (M304/M305/M404/M405)

 **NOTE:** The step is for the M304/M305/M404/M405 printer. For the M329/M428/M429, skip this step and go to [Step 9: Remove the paper delivery tray \(output bin\) on page 528.](#)

1. Remove one screw (callout 1).

Figure 1-888 Remove one screw



2. At the right side of the printer, release the one boss (callout 1), and then release one tab (callout 2).

Figure 1-889 Release one boss and one tab

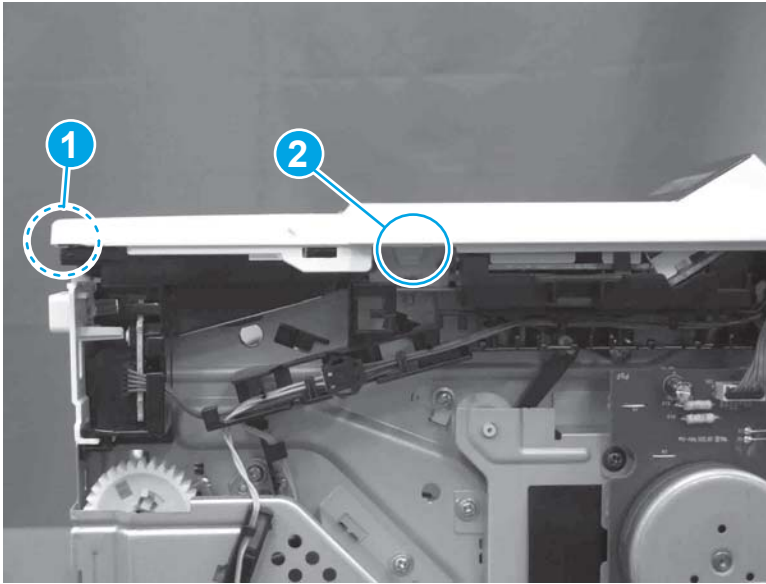

3. Release four tabs (callout 1), release four bosses (callout 2), and then remove the top cover (callout 3).



 **TIP:** Open the rear door to make releasing the bosses (callout 3) easier.

Figure 1-890 Remove the cover

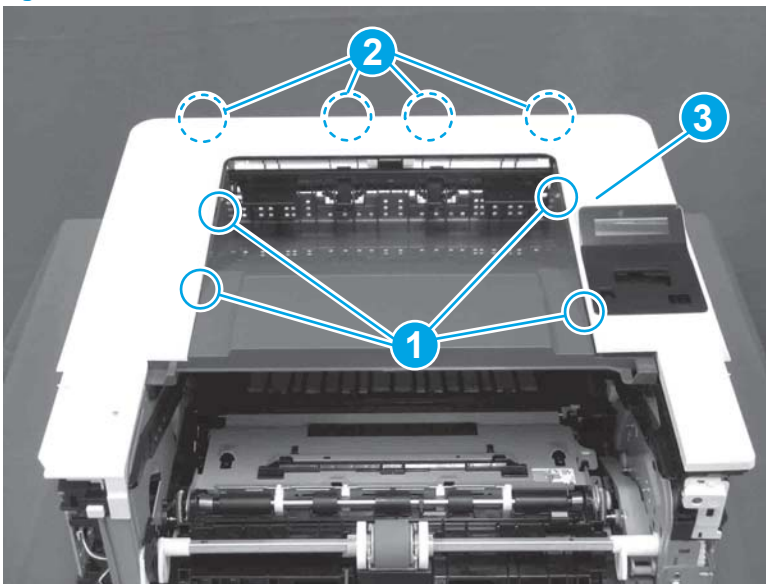

Step 9: Remove the paper delivery tray (output bin)

 **NOTE:** This procedure shows the M304/M305/M404/M405 model, however, the paper delivery tray (output bin) removal is similar for the M329/M428/M429 printer.

- ▲ Release two bosses (callout 1), release two tabs (callout 2), and then remove the paper delivery tray (output bin; callout 3).

Figure 1-891 Release two tabs

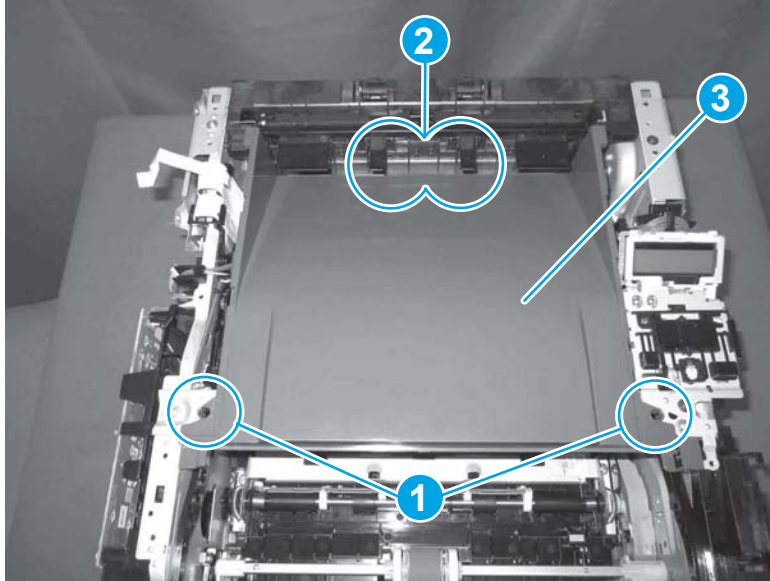

Step 10: Remove the sheet-metal formatter bracket and formatter PCA

1. Do one of the following:

- **SFP only:** Release two tabs (callout 1), and then carefully pull the wireless PCA straight off of the formatter PCA to remove it.

 **NOTE:** Disconnect the WiFi antenna (callout 2) before releasing the tabs.

- **MFP only:** Release one tab (callout 3), and then carefully pull the wireless PCA straight off of the formatter PCA to remove it.

 **TIP:** Push the tab to the left to release it.

Figure 1-892 Remove the wireless PCA



2. Do one of the following:

- **SFP only:** Disconnect the connectors (callout 1), and then release one wire harness (callout 2) from the guide.
- **MFP only:** Disconnect the connectors (callout 1), and then release one wire harness and one FFC (callout 2) from the guides.

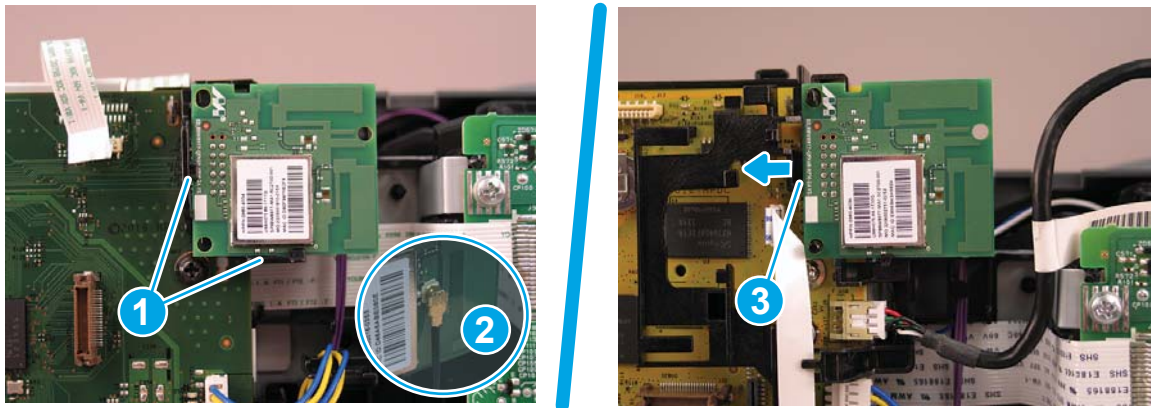
Figure 1-893 Disconnect the connectors

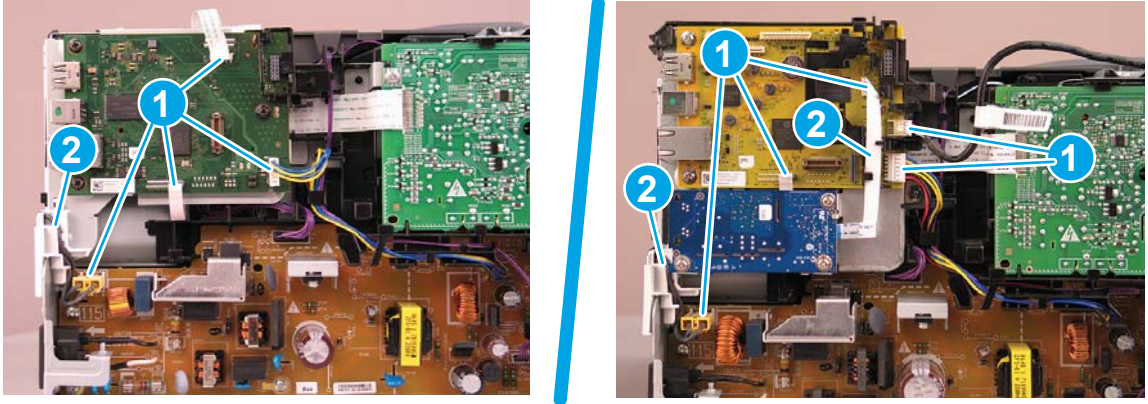

3. **MFP only:** Remove three screws (callout 1), and then remove the fax PCA.

Figure 1-894 Remove the fax PCA

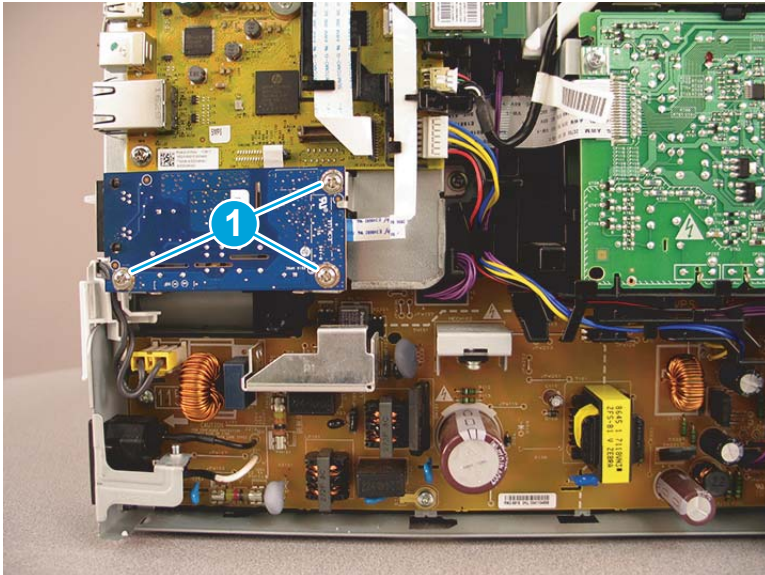

4. **MFP only:** Release the FFC from the guide (callout 1), release one tab (callout 2), and then remove the FFC guide (callout 3).

Figure 1-895 Remove the FFC guide

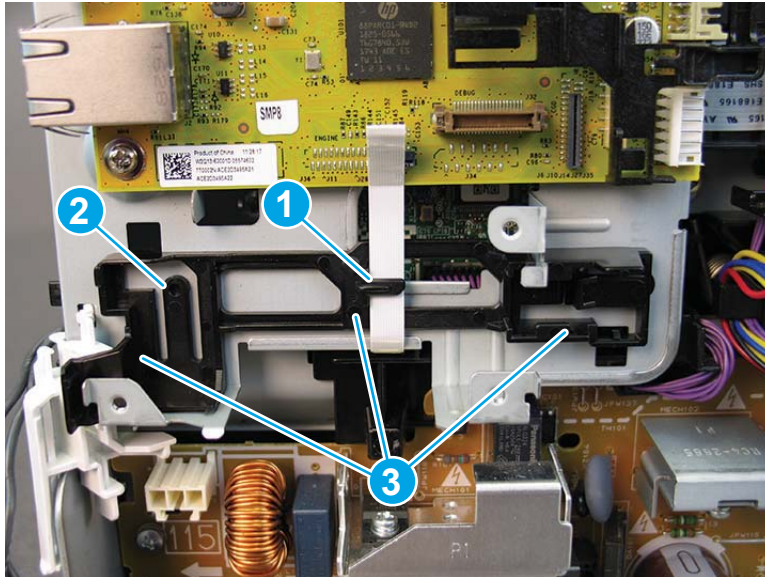

5. Remove one guide.

 **NOTE:** A SFP printer is shown in the figure. However, the guide is identical for an MFP printer.

Figure 1-896 Remove the guide



6. Remove two screws.

Figure 1-897 Remove two screws

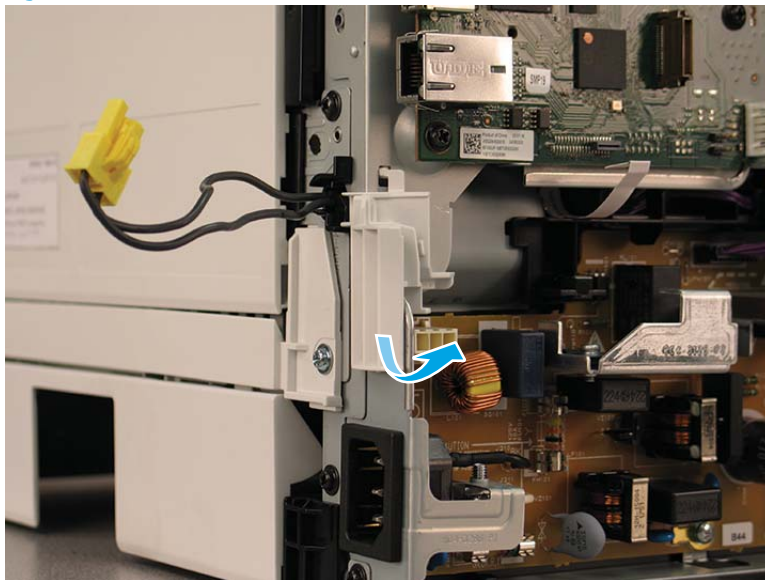

7. MFP only: Remove one screw.

Figure 1-898 Remove one screw

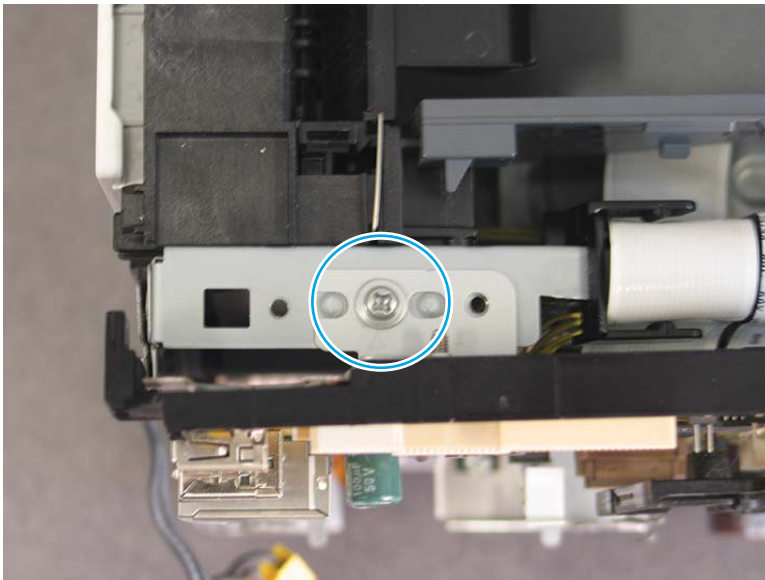

8. Support the formatter and bracket, and then remove two screws.

Figure 1-899 Remove two screws

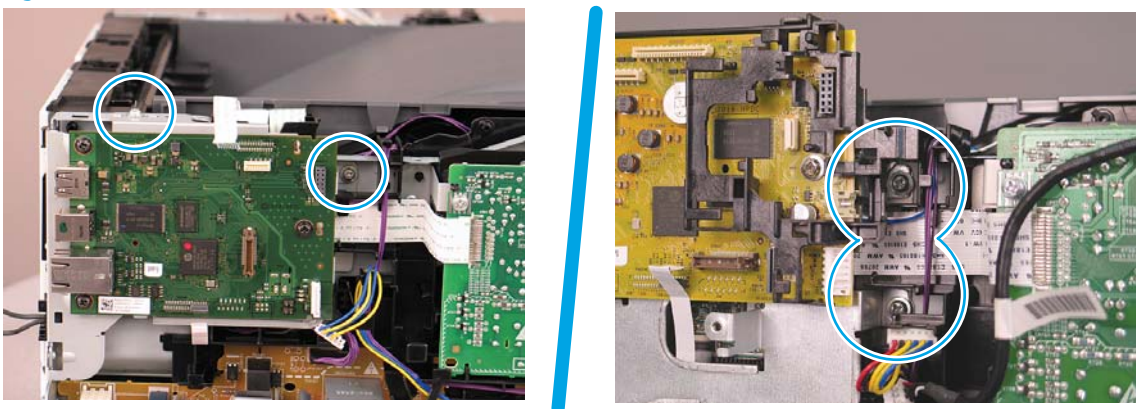

9. Remove the sheet-metal bracket and formatter PCA.

Figure 1-900 Remove the bracket

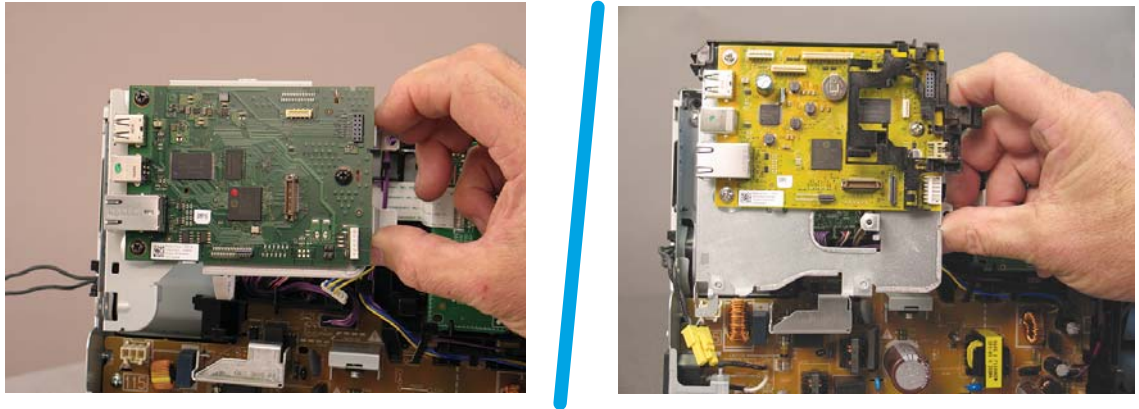

Step 11: Remove the HVPS

1. Disconnect one FFC (callout 1) on the DC controller, and then release it from the guide (callout 2).

Figure 1-901 Disconnect one FFC

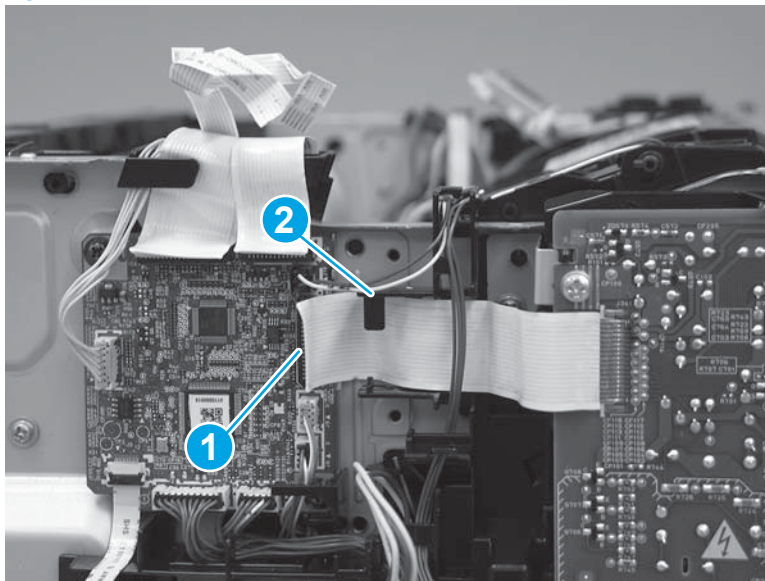

2. Disconnect one connector (callout 1).

Figure 1-902 Disconnect one connector

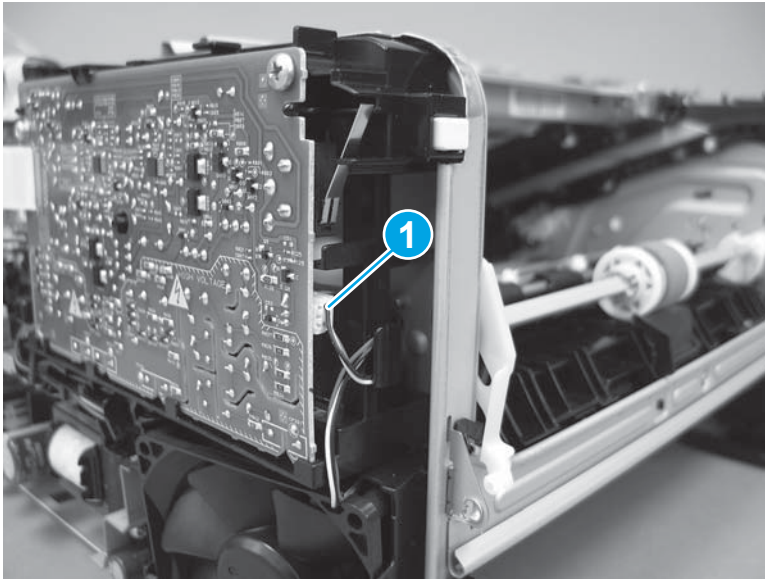

3. Remove two screws (callout 1).

Figure 1-903 Remove two screws

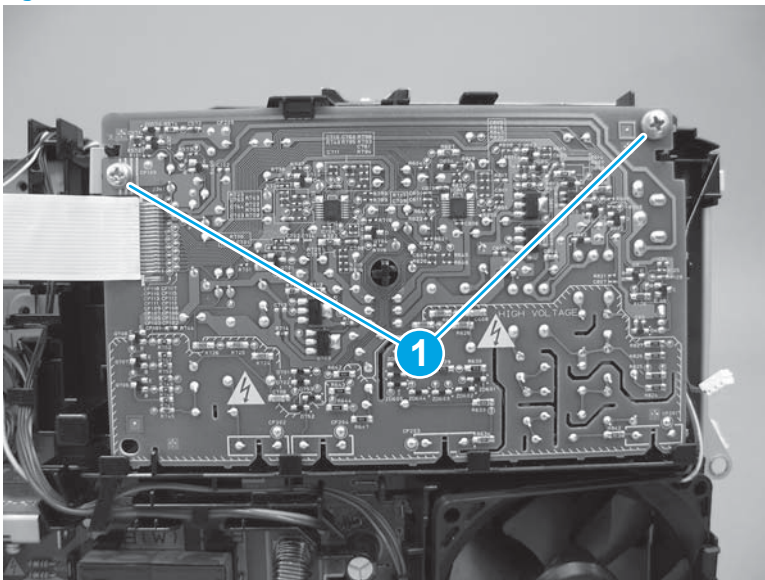

4. Release one tab (callout 1), and then rotate the top of the HVPS away from the printer.

Figure 1-904 Release one tab

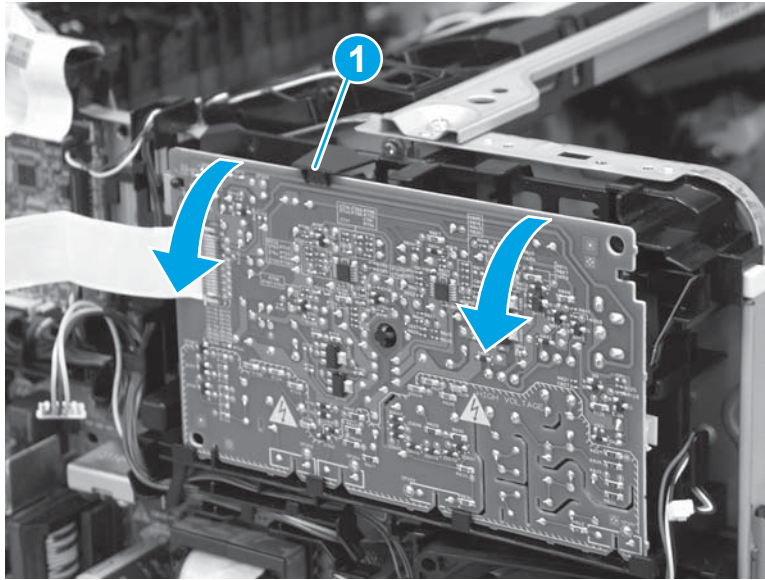

5. Slide the HVPS up and away from the holder to remove it.

Figure 1-905 Remove the HVPS

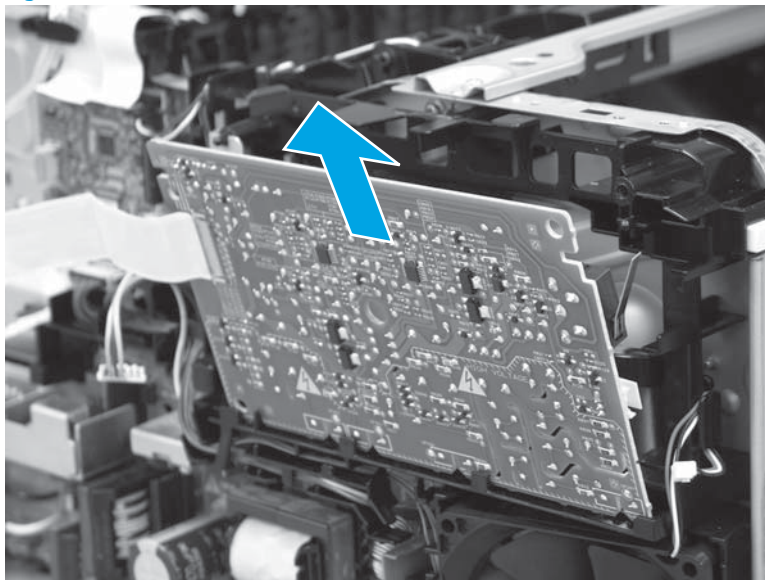



Step 12: Unpack the replacement assembly

1. Dispose of the defective part.

 **NOTE:** HP recommends responsible disposal of the defective part.

<http://www8.hp.com/us/en/hp-information/environment/product-recycling.html>

2. Unpack the replacement part from the packaging.

 **CAUTION:**  Some parts are sensitive to electrostatic discharge (ESD). Always perform service work at an ESD-protected workstation or mat. If an ESD workstation or mat is not available, touch the sheet-metal chassis to provide a static ground before touching an ESD-sensitive assembly. Protect the ESD-sensitive assemblies by placing them in ESD pouches when they are out of the printer.

If the replacement part is a roller or pad, avoid touching the spongy part of it. Skin oils on the roller or pad can cause paper pickup and/or print-quality problems. HP recommends using disposable gloves when handling rollers or pads or washing your hands before touching rollers or pads.

 **IMPORTANT:** Make sure that all of the shipping materials (for example shipping tape) are removed from the replacement part prior to installation.

3. To install an assembly, reverse the removal steps.

 **NOTE:** When applicable, special installation instructions are provided for an assembly at the end of the removal procedure. Always completely read the removal instructions and follow all special installation instructions.

Removal and replacement: Low-voltage power supply

- [Introduction](#)
- [Step 1: Remove Tray 2](#)
- [Step 2: Remove the cartridge door assembly](#)
- [Step 3: Remove the left cover](#)
- [Step 4: Remove the right cover](#)
- [Step 5: Remove the integrated scanner assembly \(M329/M428/M429\)](#)
- [Step 6: Remove the control panel \(M329/M428/M429\)](#)
- [Step 7: Remove the top cover \(M329/M428/M429\)](#)
- [Step 8: Remove the top cover \(M304/M305/M404/M405\)](#)
- [Step 9: Remove the paper delivery tray \(output bin\)](#)
- [Step 10: Remove the fan \(FM1\)](#)
- [Step 11: Remove the sheet-metal formatter bracket and formatter PCA](#)
- [Step 12: Remove the LVPS](#)
- [Step 13: Unpack the replacement assembly](#)

Introduction

This document provides the procedures to remove and replace the low-voltage power supply (LVPS).

Before performing service

Turn the printer power off

- Disconnect the power cable.

 **WARNING!** To avoid damage to the printer, turn the printer off, wait 30 seconds, and then remove the power cable before attempting to service the printer.

Use the table below to identify the correct part number for your printer. To order the part, go to www.hp.com/buy/parts.

Low-voltage power supply (LVPS) part number	
RM3-7413-000CN	Low-voltage power supply (M329/M428/M429; 110V-127V)
RM3-7414-000CN	Low-voltage power supply (M329/M428/M429; 220V-240V)
RM3-7411-000CN	Low-voltage power supply (M304/M305/M404/M405; 110V-127V)
RM3-7412-000CN	Low-voltage power supply (M304/M305/M404/M405; 220V-240V)

Required tools

- #2 Phillips screwdriver with a magnetic tip.

After performing service

Turn the printer power on

- Connect the power cable.
- Use the power switch to turn the power on.

Post service test

Make sure that the printer initializes to a **Ready** state.

Print a configuration page to make sure that the printer is functioning correctly.

Step 1: Remove Tray 2

- ▲ Pull the tray straight out of the printer to remove it.

Figure 1-906 Remove the tray



Step 2: Remove the cartridge door assembly

 **NOTE:** If the toner cartridge was not removed prior to servicing the printer, remove it now.

1. Release the support shaft (callout 1), and then slide it toward the center of the door (callout 2).

 **TIP:** It might be easier to release the support shaft by using a small flat-blade screwdriver.

Figure 1-907 Release the support shaft

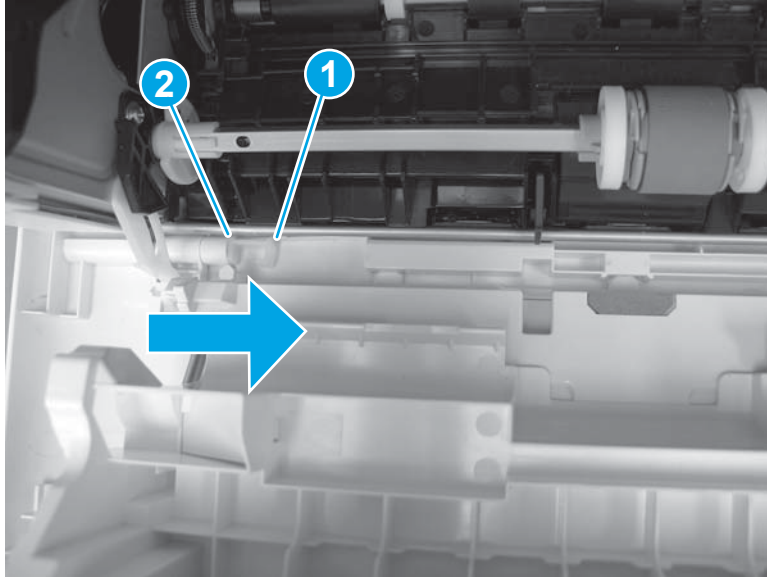

2. Remove the support shaft.

Figure 1-908 Remove the support shaft

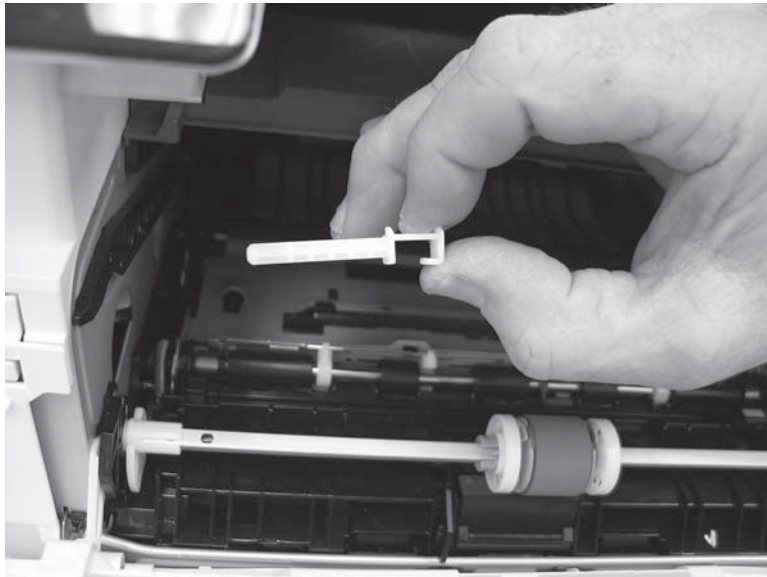

3. Release one tab (callout 1), and then slide the guide out of the printer (callout 2).

⚠ CAUTION: Be careful, the tab (callout 1) can be easily broken.

Figure 1-909 Remove the guide

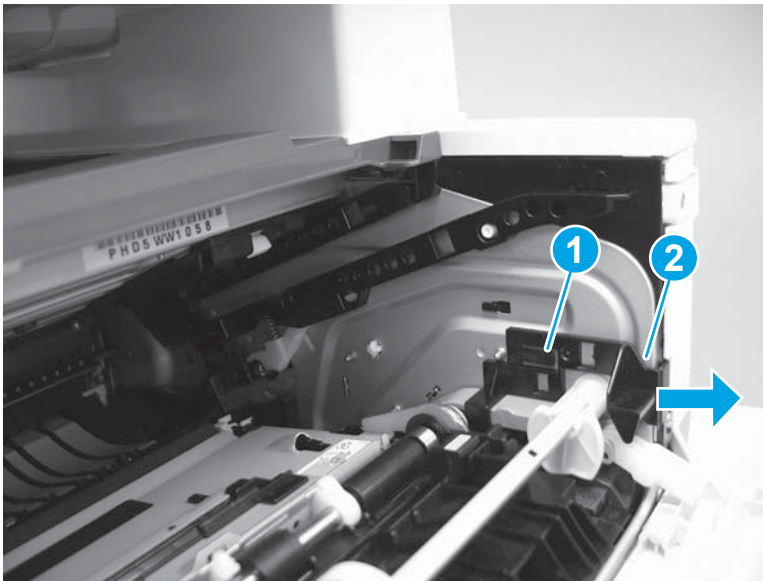

4. Use a small flat-blade screwdriver to gently pry the white-plastic door arm (callout 1) off of the gray-plastic pressure-release link (callout 2) to release the door arm.

Figure 1-910 Release the pressure-release link

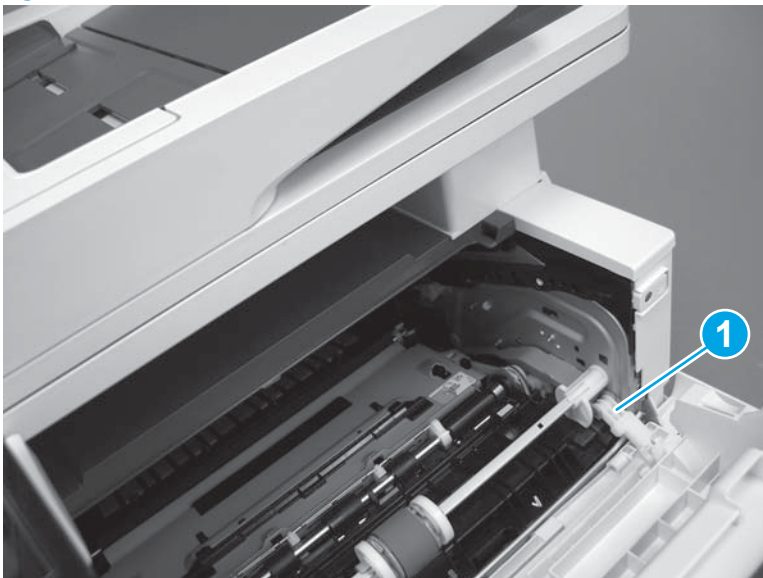

5. With the door in the partially closed position, slightly raise the left end (callout 1; raise it over the sheet-metal hinge boss), and then slide the door to the left (callout 2) to release the right hinge (callout 3).

⚠ CAUTION: The door is still attached to the printer by the left-side retainer arm. Do not attempt to completely remove the door.

💡 Reinstallation tip: When reinstalling the door, there are two right-side hinge pins (not shown in callout 3). Keep a finger pressed on the left-side retainer arm so that it does not disengage from the door.

Figure 1-911 Release the door

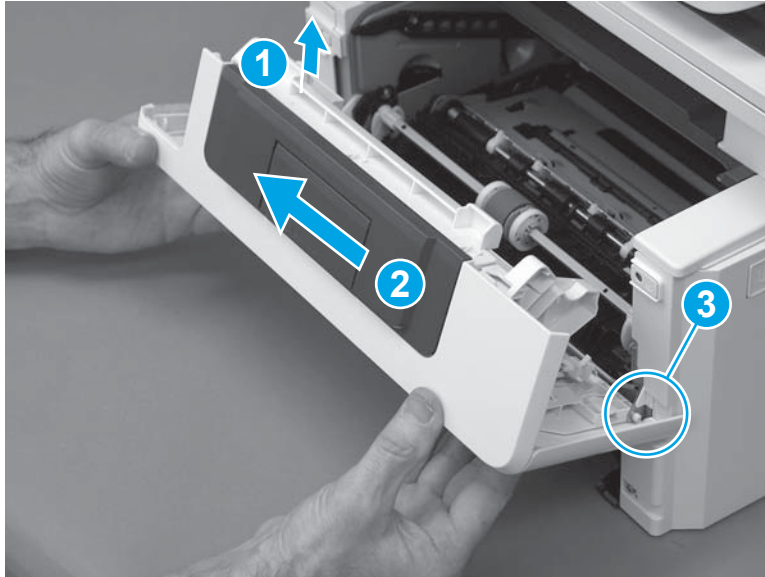

6. Rotate the door away from the printer until the keyed pin on the left-side retainer arm can disengage from the door.

Figure 1-912 Release the left-side retainer arm

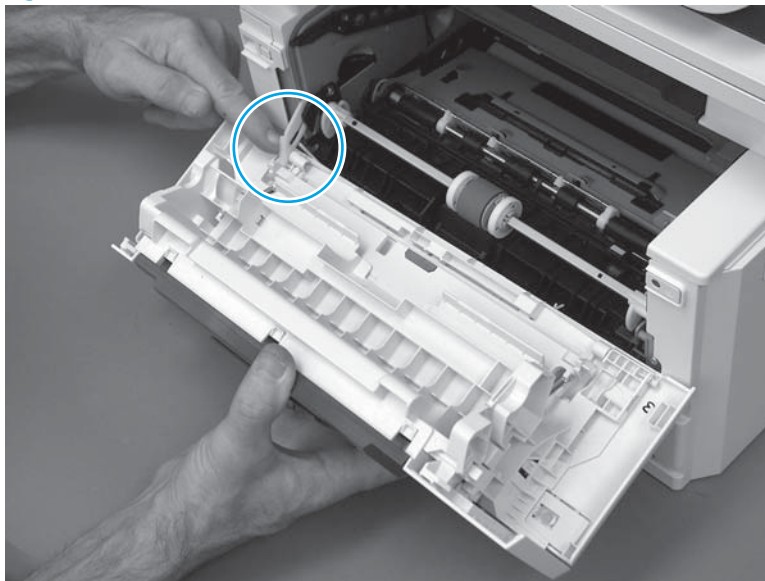

7. Remove the door.

Figure 1-913 Remove the door

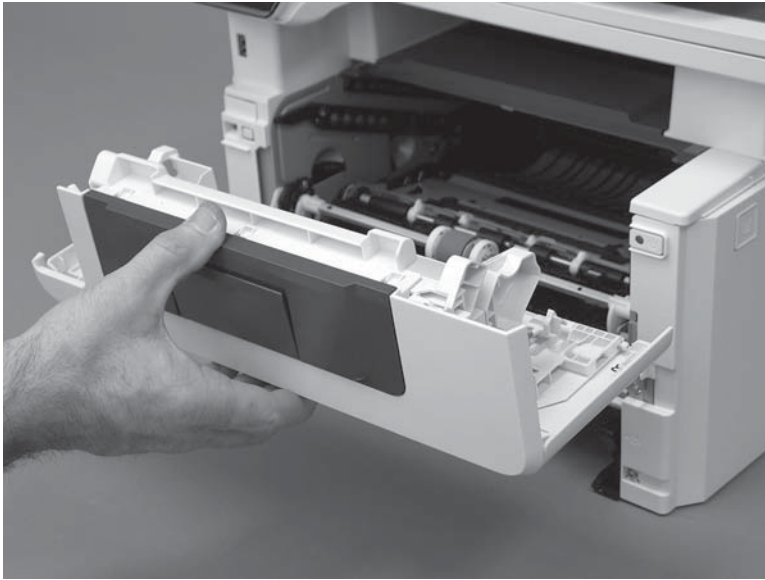

Step 3: Remove the left cover

1. Remove one screw (callout 1).

Figure 1-914 Remove one screw

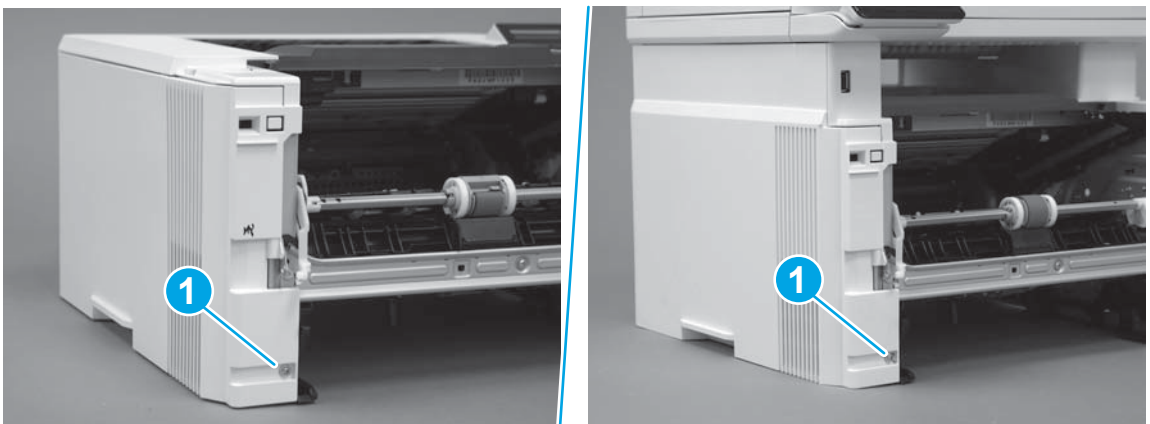

2. Open the rear door, release two bosses (callout 1), and then release three tabs (callout 2).

Figure 1-915 Release two bosses and three tabs

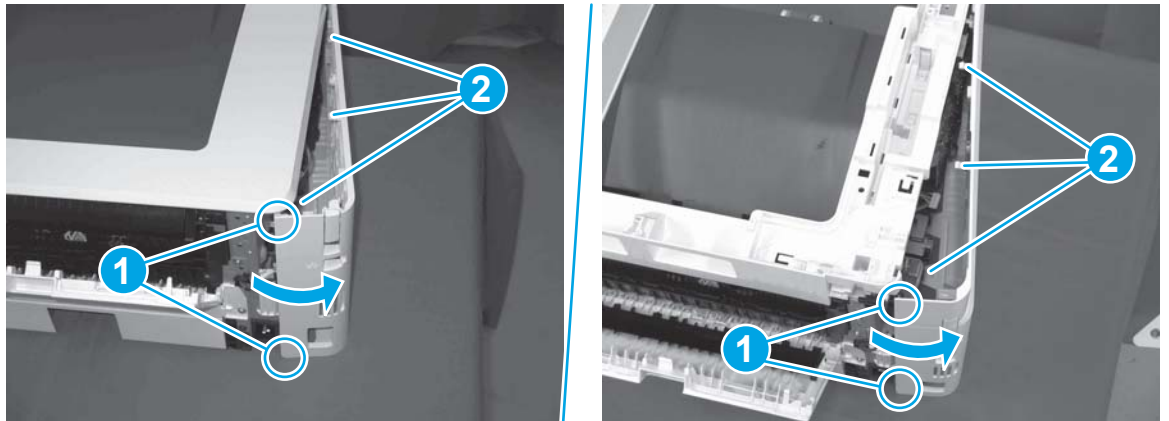

3. At the front of the printer, do one of the following:
 - **M304/M305/M404/M405:** Release two bosses (callout 1), and then remove the cover (callout 2).
 - **M329/M428/M429:** Release one tab (callout 3), two bosses (callout 4), and then remove the cover (callout 5).

⚠ CAUTION: Be careful when releasing the upper bosses on the M329/M428/M429 cover. One portion of the cover (callout 6) is fragile and is easily broken.

Figure 1-916 Remove the cover

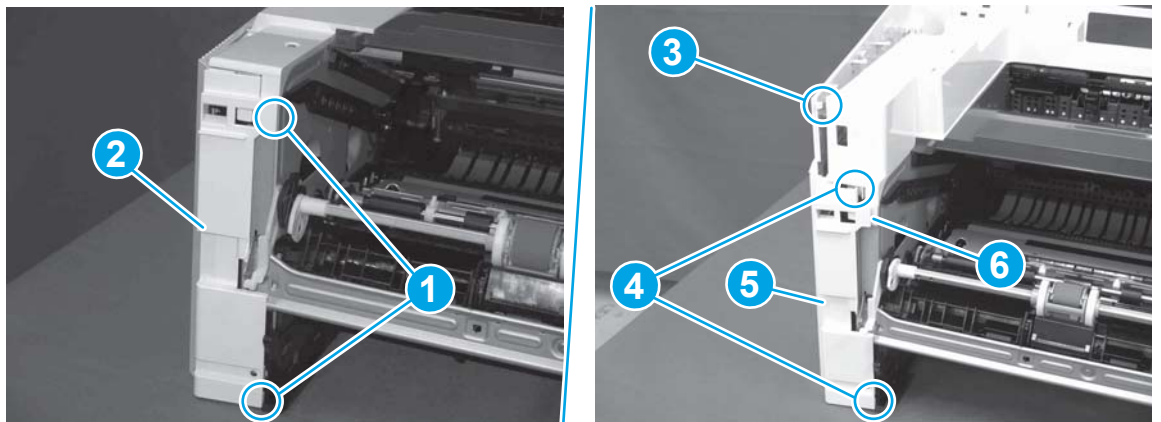

Step 4: Remove the right cover

1. At the front of the printer, release two bosses (callout 1), and then release three tabs (callout 2).

💡 Reinstallation tip: Remove, and then reinstall the cover if the switch or button does not correctly function.

Figure 1-917 Release two bosses and three tabs

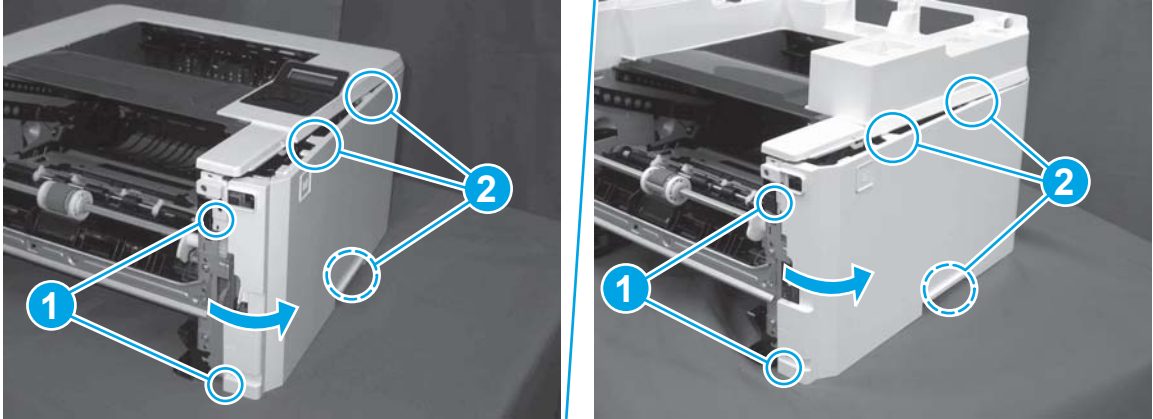

2. Open the rear door, release two bosses (callout 1), and then remove the cover (callout 2).

Figure 1-918 Remove the cover

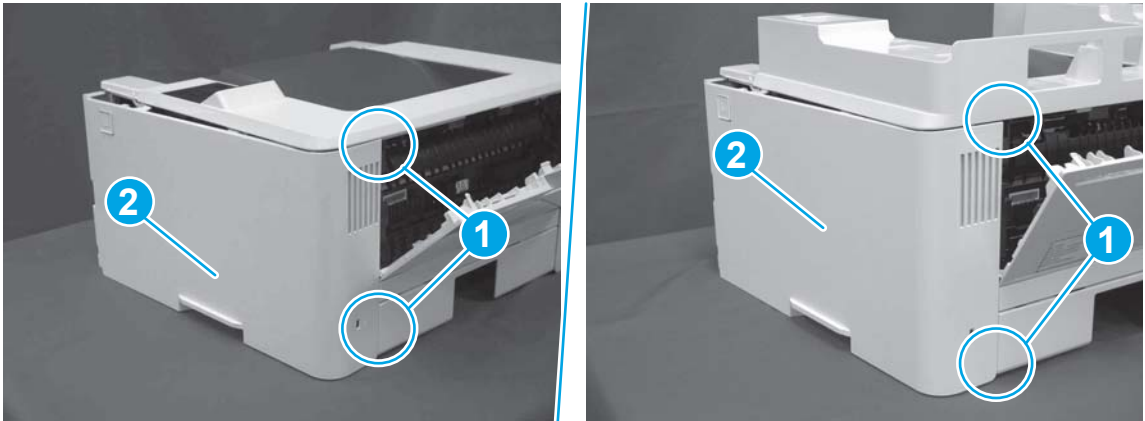

Step 5: Remove the integrated scanner assembly (M329/M428/M429)

 **NOTE:** The step is for the M329/M428/M429 printer. For the M304/M305/M404/M405, skip this step and go to [Step 8: Remove the top cover \(M304/M305/M404/M405\) on page 555.](#)

 **NOTE:** M329/M428/M429 models only. The integrated scanner assembly (ISA) includes the sub-scanner assembly (SSA) and the automatic document feeder (ADF).

1. Raise the ISA.

Figure 1-919 Raise the ISA

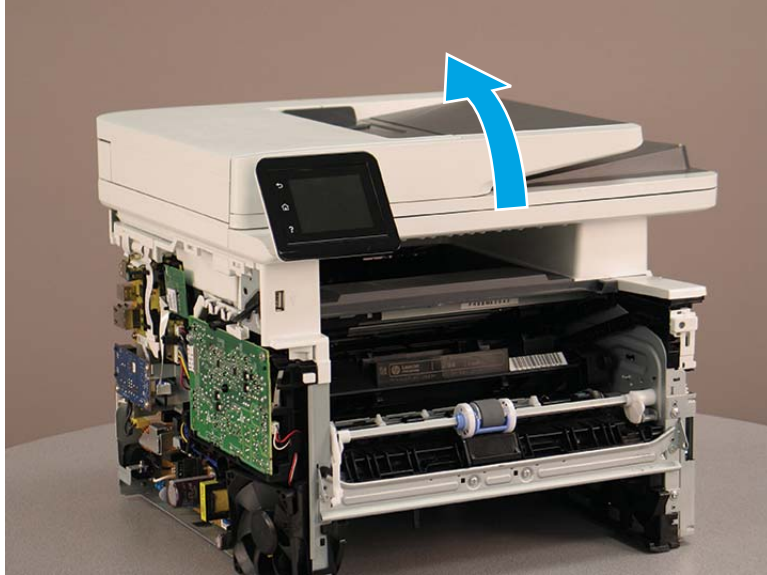

2. Release the ISA flat-flexible cable (FFC) cover (callout 1), and then remove it (callout 2).

Figure 1-920 Remove the ISA FFC cover

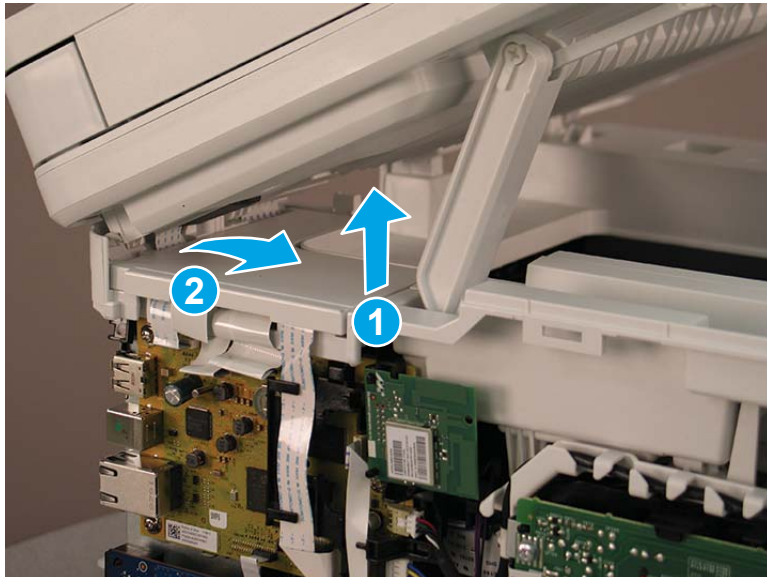

3. Disconnect three FFCs (callout 1), and then remove the ferrite (callout 2) from the holder.

⚠ CAUTION: The ferrite is not captive on the FFC. Do not lose the ferrite while handling the ISA.

Figure 1-921 Disconnect three FFCs

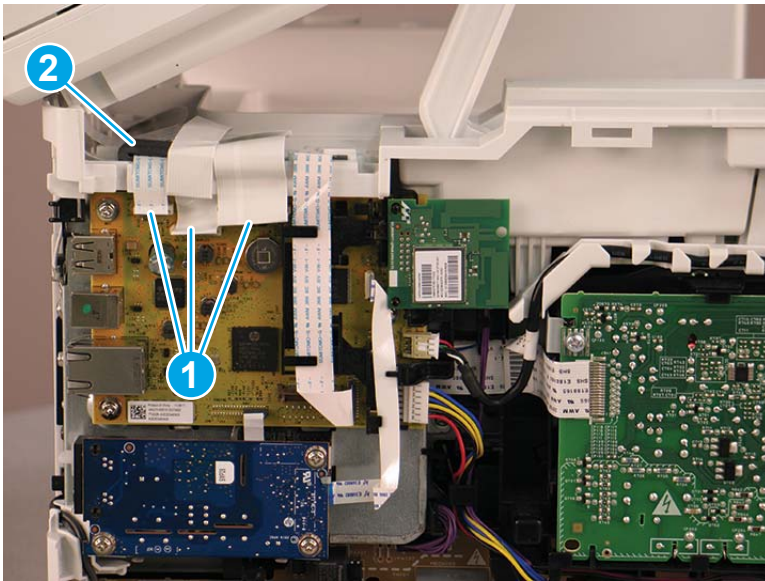

4. Remove one screw (callout 1).

Figure 1-922 Remove one screw

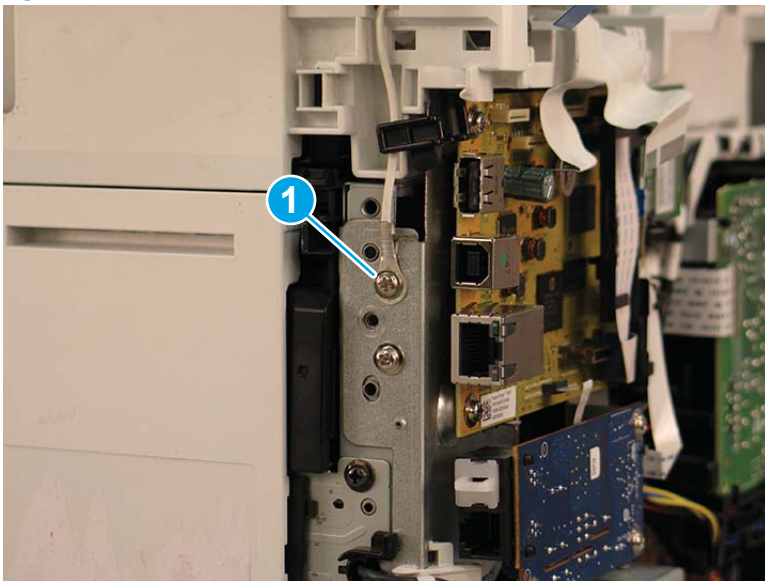

5. Pass the ground wire through the opening in the top cover.

Figure 1-923 Pass the wire through the opening

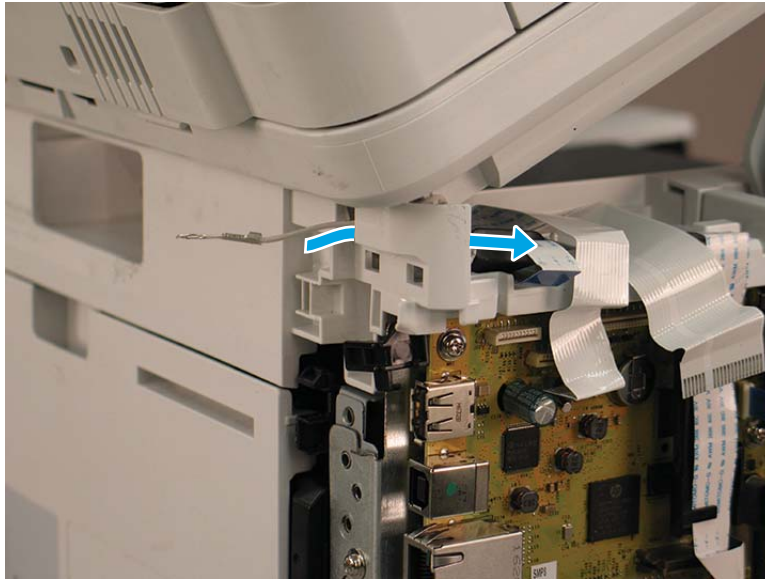

6. Release one tab (callout 1), and then rotate the ISA slider pin (callout 2) towards the front of the printer to release it.

Figure 1-924 Release one tab and rotate the slider pin

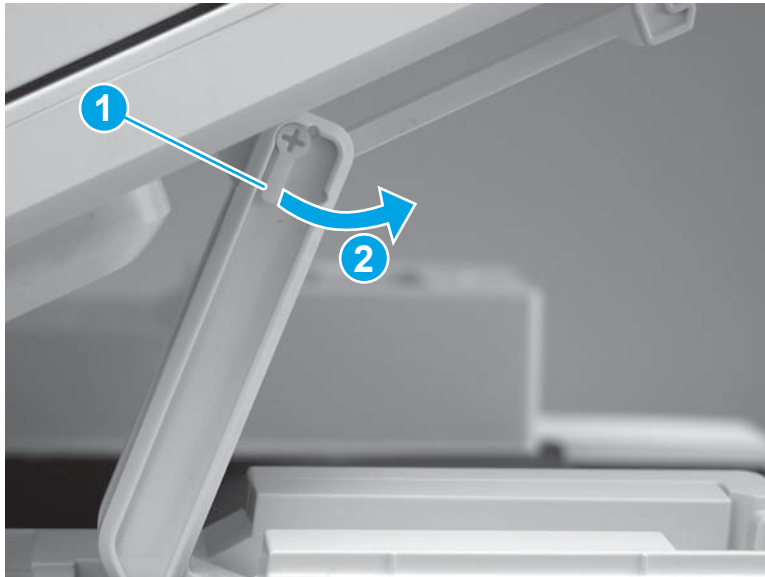

7. Remove the slider pin.

 **Reinstallation tip:** Align the keyed portion of the locking pin with the slot and hole in the support arm.

Figure 1-925 Remove the slider pin



8. Rotate the ISA towards the rear of the printer until it stops.

Figure 1-926 Rotate the ISA towards the rear of the printer

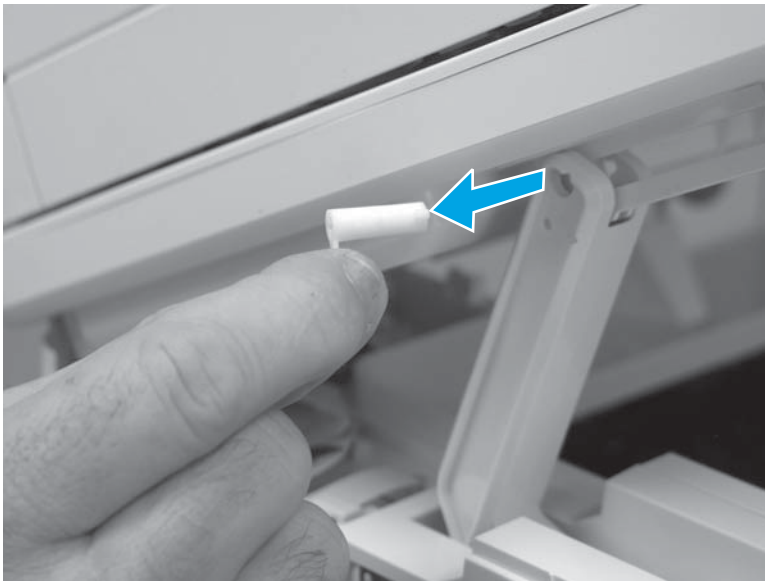
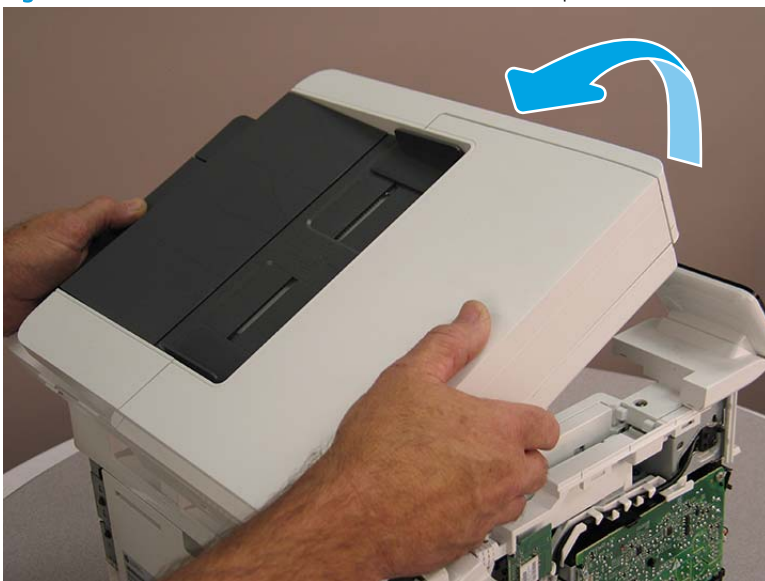

- Slide the ISA as shown to release it.

Figure 1-927 Release the ISA

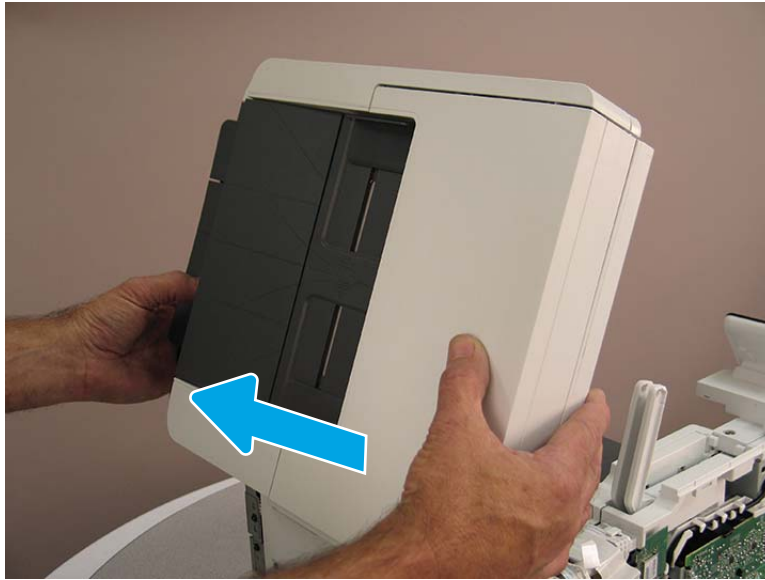

- Remove the ISA.

Figure 1-928 Remove the ISA

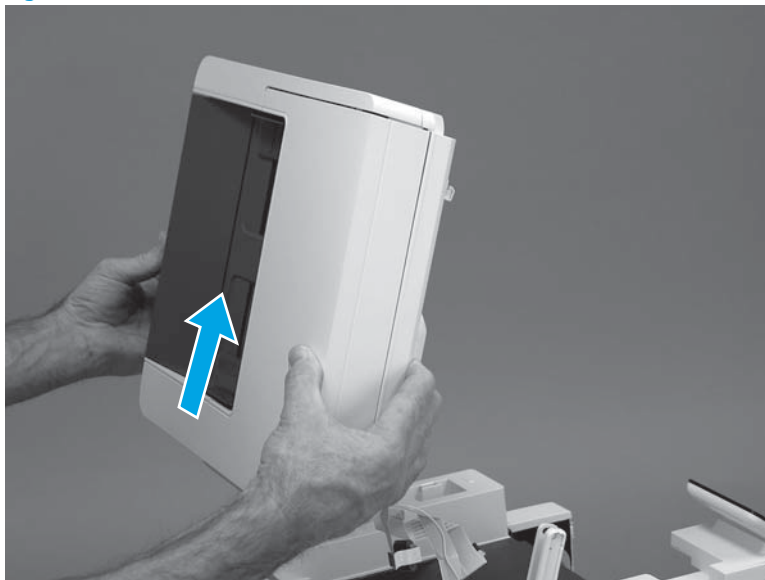

Step 6: Remove the control panel (M329/M428/M429)

 **NOTE:** The step is for the M329/M428/M429 printer. For the M304/M305/M404/M405, skip this step and go to [Step 8: Remove the top cover \(M304/M305/M404/M405\) on page 555](#).

- Disconnect one FFC (callout 1), and then release the FFC from the guide (callout 2).

Figure 1-929 Disconnect one connector

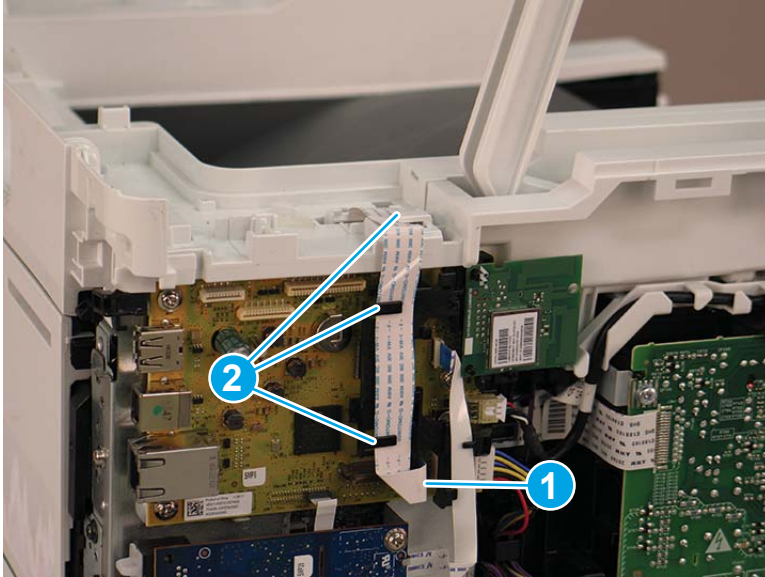

2. Remove one screw (callout 1).

Figure 1-930 Remove one screw

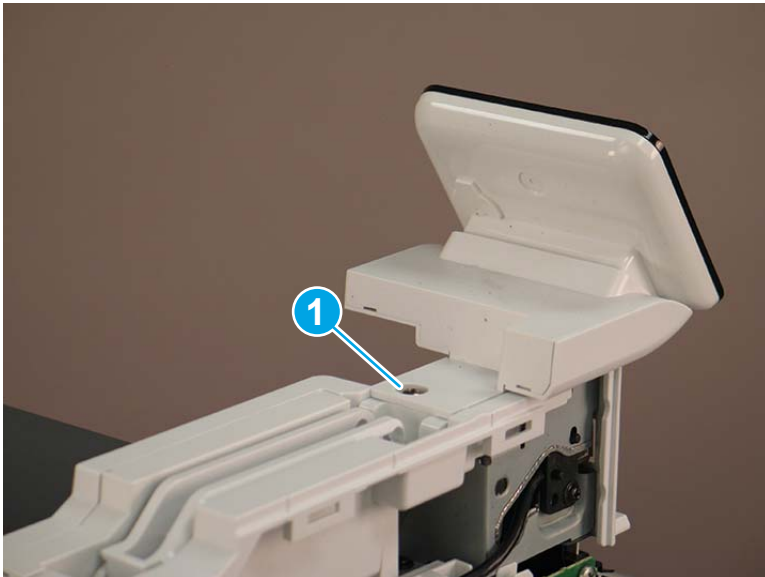

3. Use a small flat-blade screwdriver to release two tabs (callout 1) on the control-panel cable cover.

Figure 1-931 Release two tabs

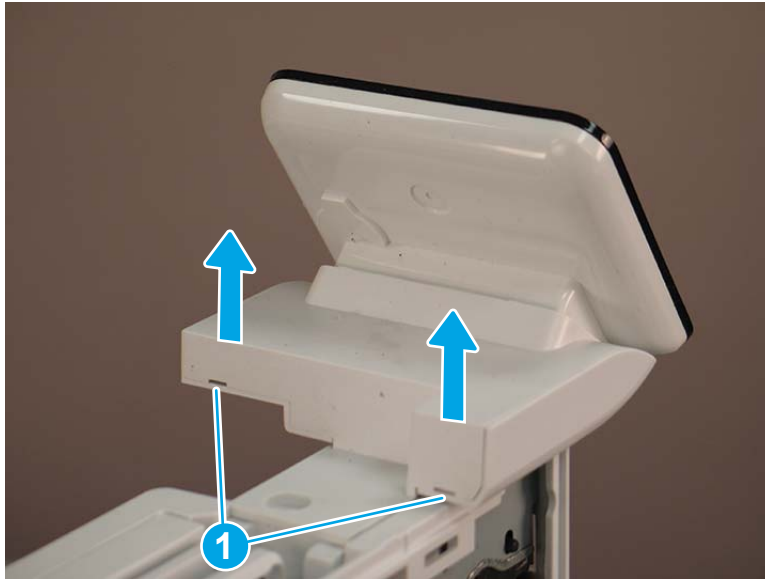

4. Remove the control-panel cable cover.

Figure 1-932 Remove the cover



5. Remove one grounding screw (callout 1), and then move the ground cable (callout 2) out of the way.

Figure 1-933 Remove one screw

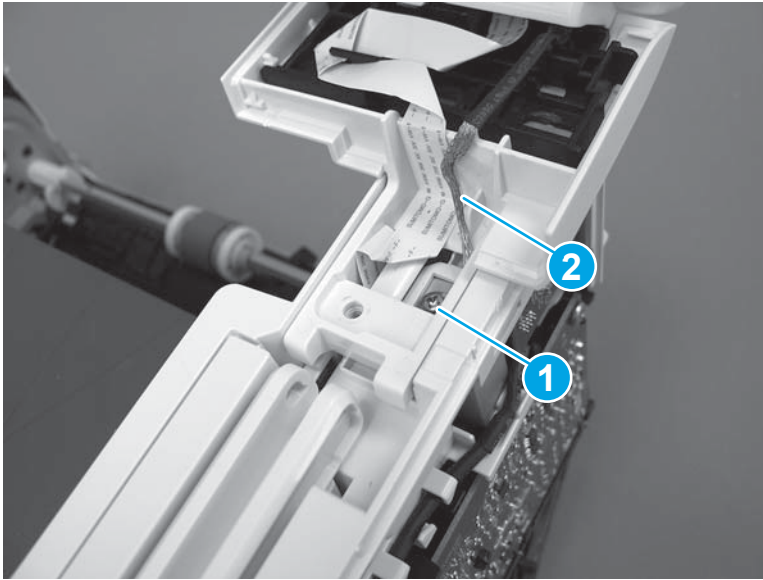

6. Move the FFC out of the way, and then remove two screws (callout 1).

Figure 1-934 Remove two screws

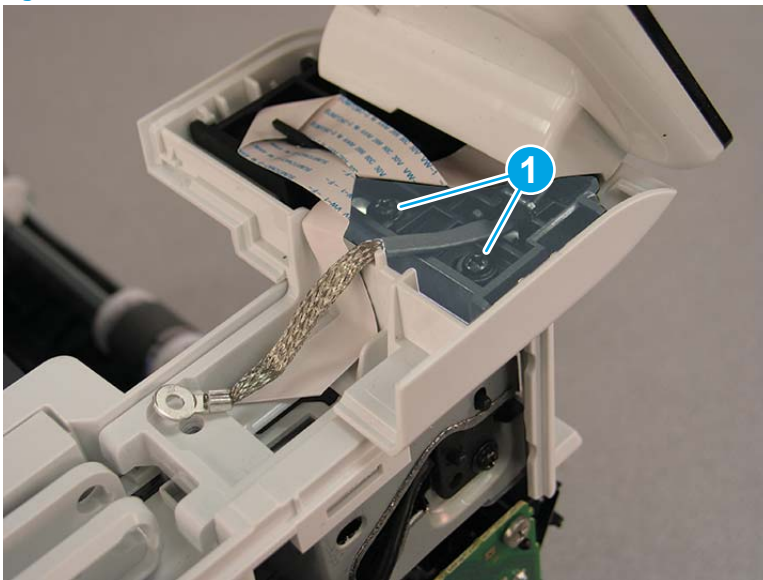

7. Slightly lift up the control-panel assembly to separate it from the top cover.

CAUTION: The control panel assembly is still connected to the printer by the FFC. Do not attempt to completely remove the assembly.

Figure 1-935 Lift up the control-panel assembly



8. Lift up the control-panel FFC cover to remove the control-panel assembly.

Figure 1-936 Remove the control-panel assembly

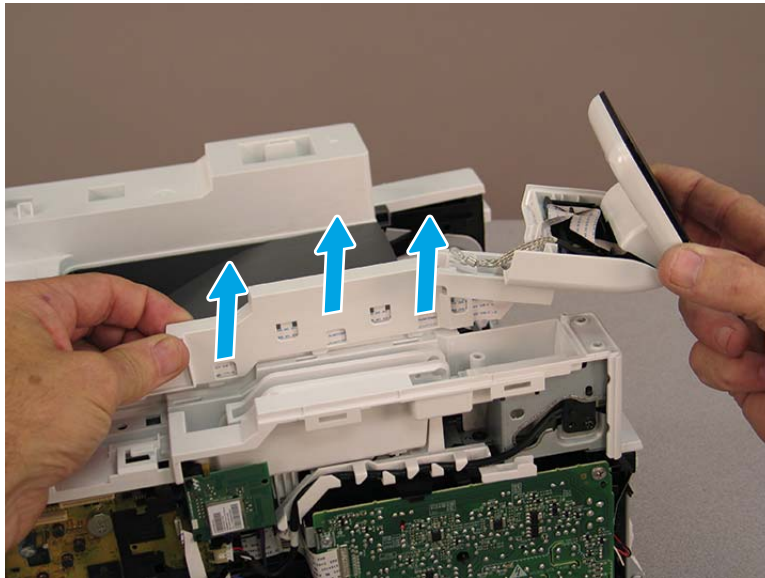

Step 7: Remove the top cover (M329/M428/M429)

NOTE: The step is for the M329/M428/M429 printer. For the M304/M305/M404/M405, skip this step and go to [Step 8: Remove the top cover \(M304/M305/M404/M405\) on page 555](#).

1. Release the USB cable (callout 1) from the cable guide.

Figure 1-937 Remove the USB cable

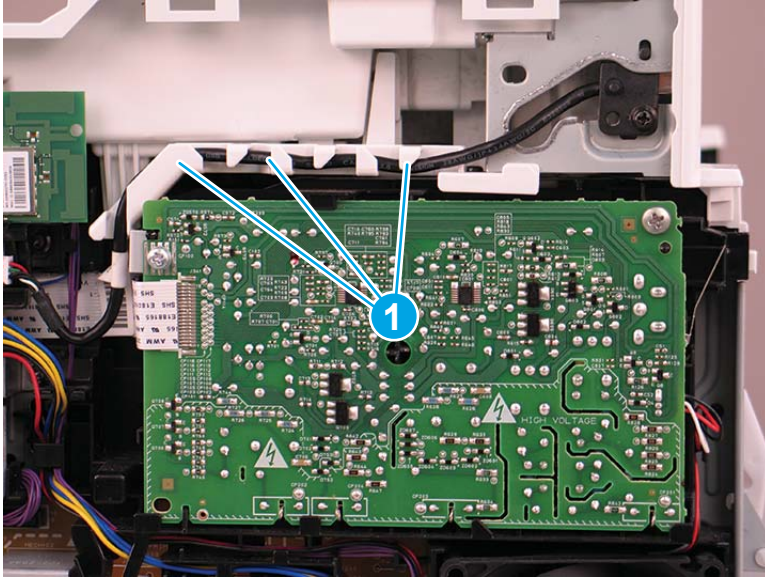

2. Remove one screw (callout 1), and then remove the support arm (callout 2).

⚠ CAUTION: The support arm is spring loaded and can unexpectedly spring into the open position. To avoid injury, do not place a finger in the screw well when the support arm is in the closed position.

Figure 1-938 Remove the support arm

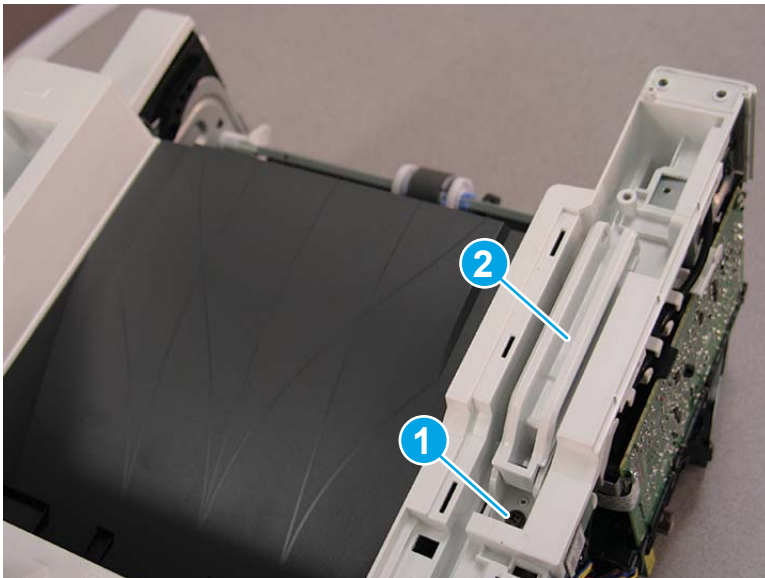

3. Remove five screws (callout 1), release four bosses (callout 2), and then remove the top cover (callout 3).

Figure 1-939 Remove the cover

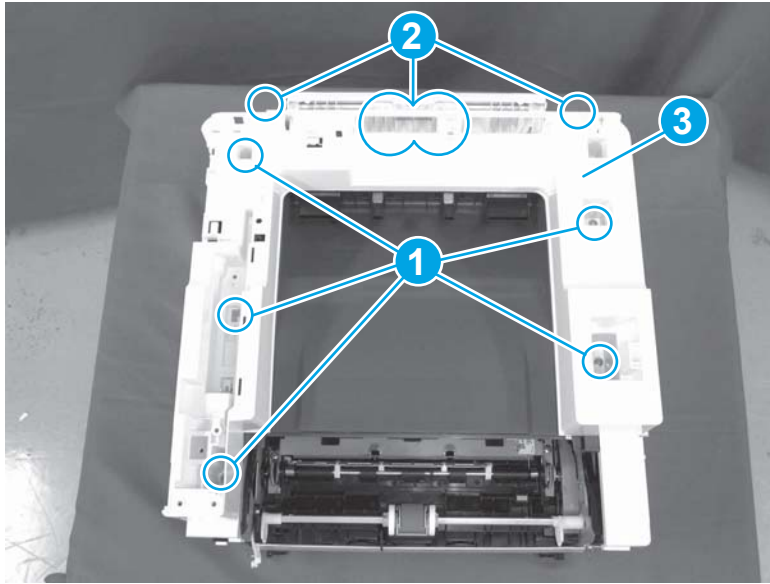

Step 8: Remove the top cover (M304/M305/M404/M405)

 **NOTE:** The step is for the M304/M305/M404/M405 printer. For the M329/M428/M429, skip this step and go to [Step 9: Remove the paper delivery tray \(output bin\) on page 556.](#)

1. Remove one screw (callout 1).

Figure 1-940 Remove one screw



2. At the right side of the printer, release the one boss (callout 1), and then release one tab (callout 2).

Figure 1-941 Release one boss and one tab

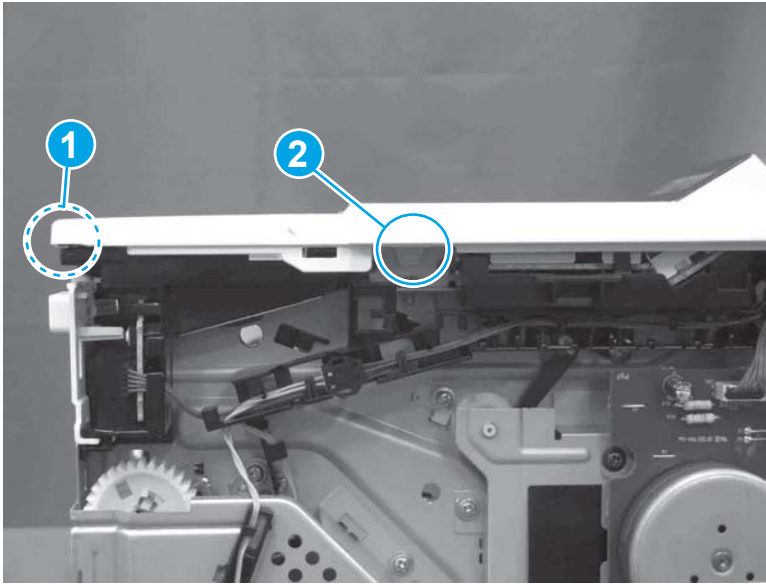

3. Release four tabs (callout 1), release four bosses (callout 2), and then remove the top cover (callout 3).



 **TIP:** Open the rear door to make releasing the bosses (callout 3) easier.

Figure 1-942 Remove the cover

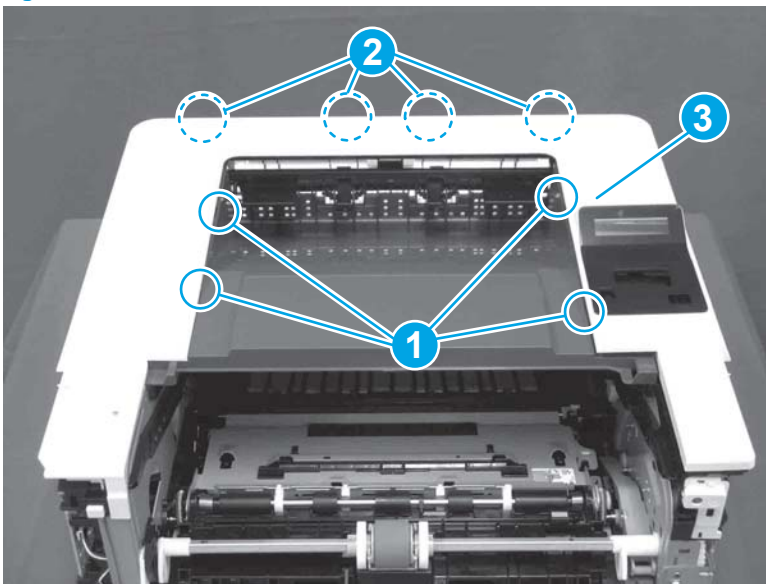

Step 9: Remove the paper delivery tray (output bin)

 **NOTE:** This procedure shows the M304/M305/M404/M405 model, however, the paper delivery tray (output bin) removal is similar for the M329/M428/M429 printer.

- ▲ Release two bosses (callout 1), release two tabs (callout 2), and then remove the paper delivery tray (output bin; callout 3).

Figure 1-943 Release two tabs

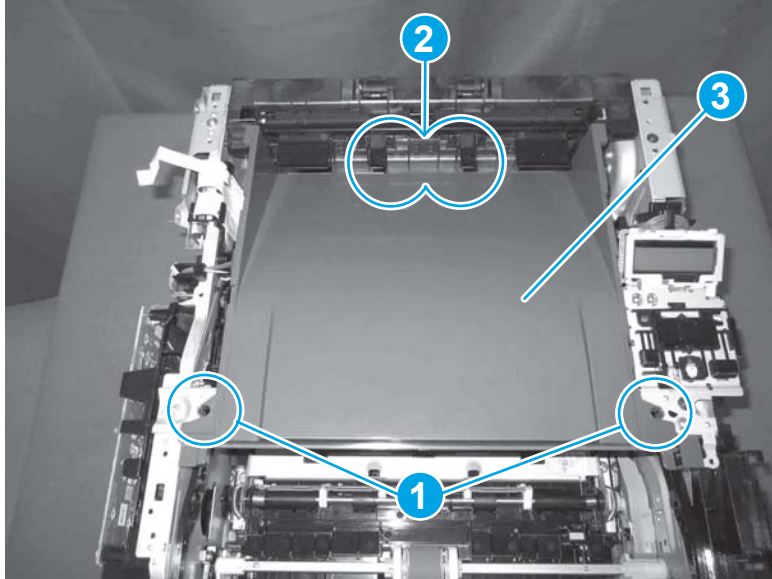

Step 10: Remove the fan (FM1)

1. Disconnect one connector (callout 1), and then release the wire harness from the retainer (callout 2).

Figure 1-944 Disconnect one connector

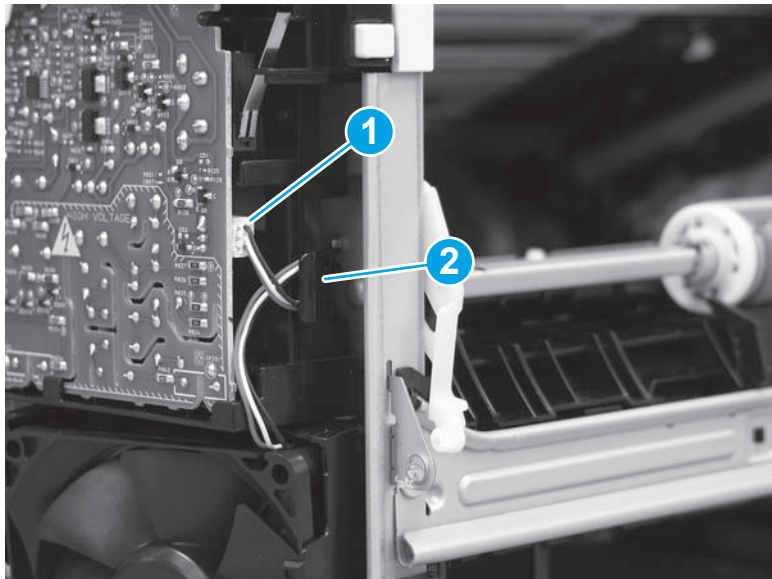

2. Release two tabs (callout 1).

Figure 1-945 Release two tabs

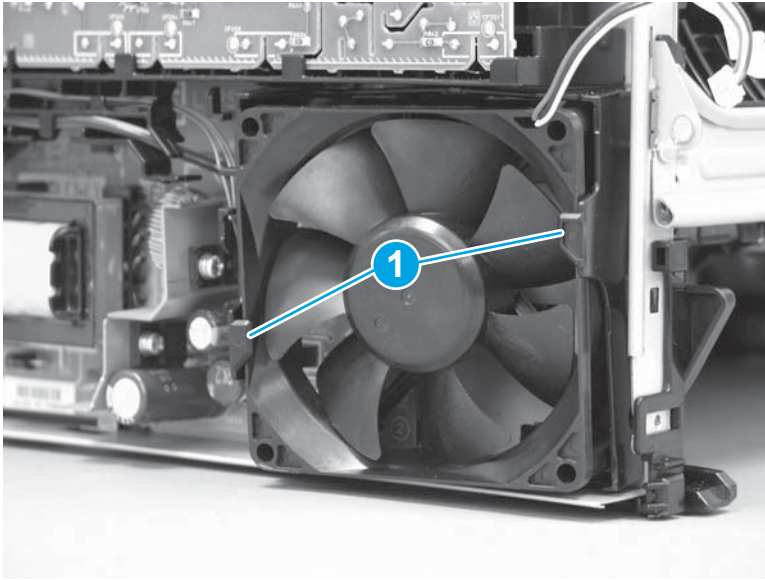

3. Remove the fan.

 **Reinstallation tip:** The fan must be correctly installed so that air is drawn into the printer. Make sure that the two arrows embossed on the right-side of the fan body—which indicate air flow direction—face upward and into the printer.

Figure 1-946 Remove the fan



Step 11: Remove the sheet-metal formatter bracket and formatter PCA

1. Do one of the following:
 - **SFP only:** Release two tabs (callout 1), and then carefully pull the wireless PCA straight off of the formatter PCA to remove it.

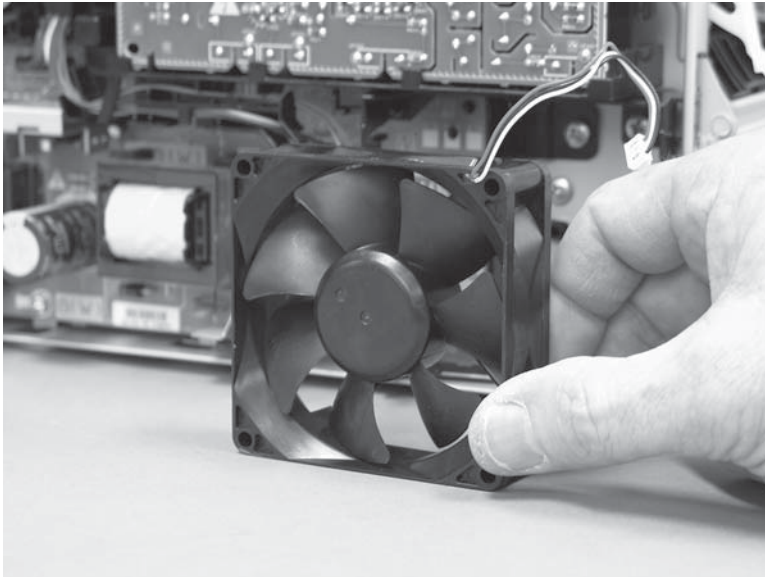
 **NOTE:** Disconnect the WiFi antenna (callout 2) before releasing the tabs.

- **MFP only:** Release one tab (callout 3), and then carefully pull the wireless PCA straight off of the formatter PCA to remove it.

 **TIP:** Push the tab to the left to release it.

Figure 1-947 Remove the wireless PCA



2. Do one of the following:

- **SFP only:** Disconnect the connectors (callout 1), and then release one wire harness (callout 2) from the guide.
- **MFP only:** Disconnect the connectors (callout 1), and then release one wire harness and one FFC (callout 2) from the guides.

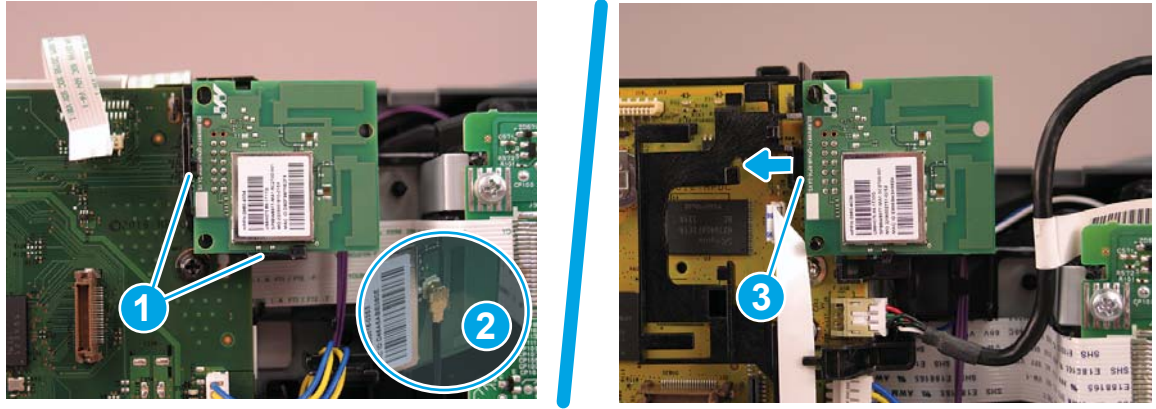
Figure 1-948 Disconnect the connectors

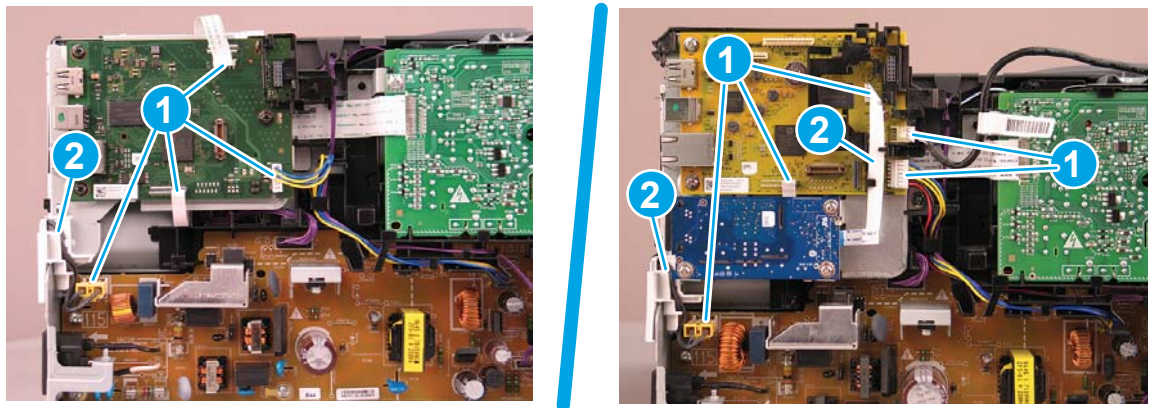

3. **MFP only:** Remove three screws (callout 1), and then remove the fax PCA.

Figure 1-949 Remove the fax PCA

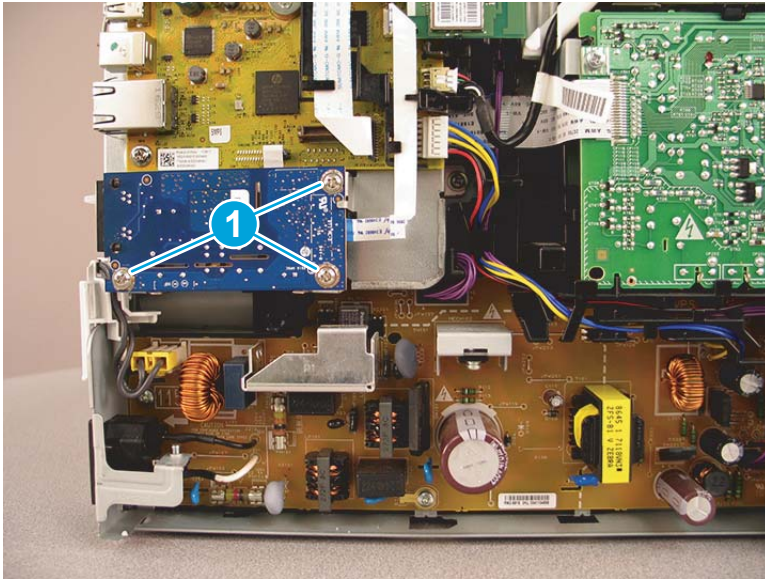

4. **MFP only:** Release the FFC from the guide (callout 1), release one tab (callout 2), and then remove the FFC guide (callout 3).

Figure 1-950 Remove the FFC guide

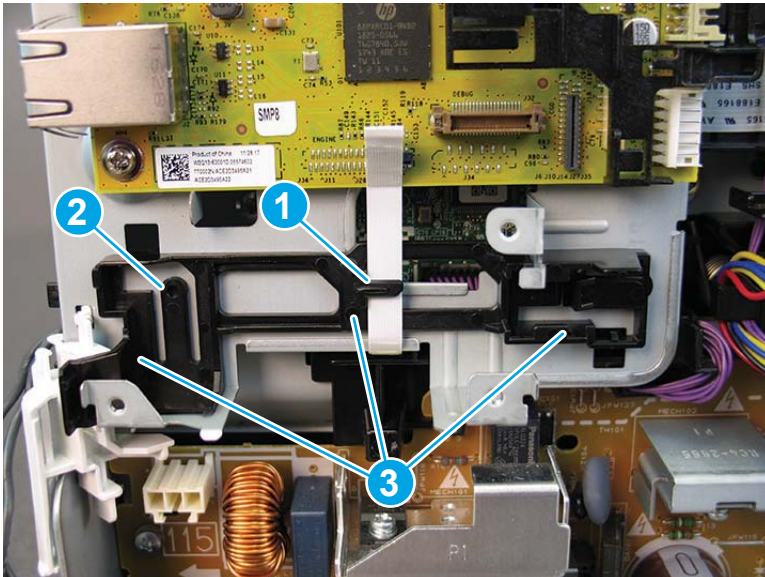

5. Remove one guide.

 **NOTE:** A SFP printer is shown in the figure. However, the guide is identical for an MFP printer.

Figure 1-951 Remove the guide



6. Remove two screws.

Figure 1-952 Remove two screws

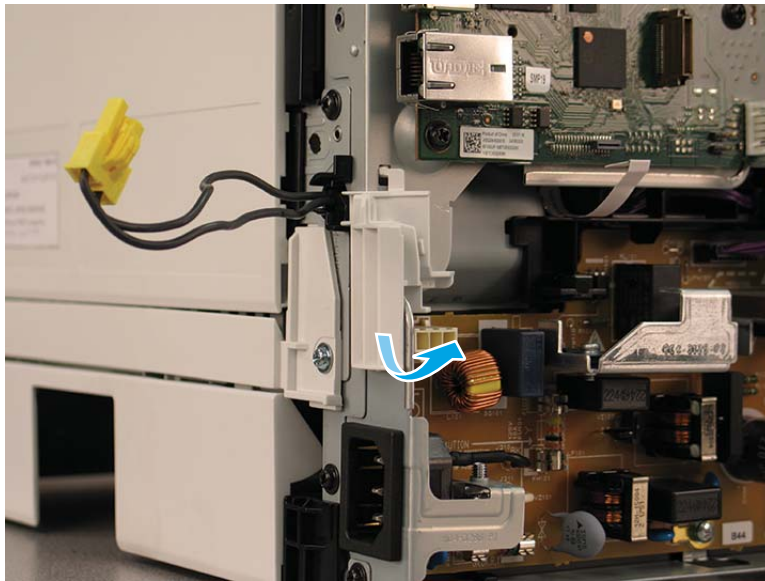

7. **MFP only:** Remove one screw.

Figure 1-953 Remove one screw

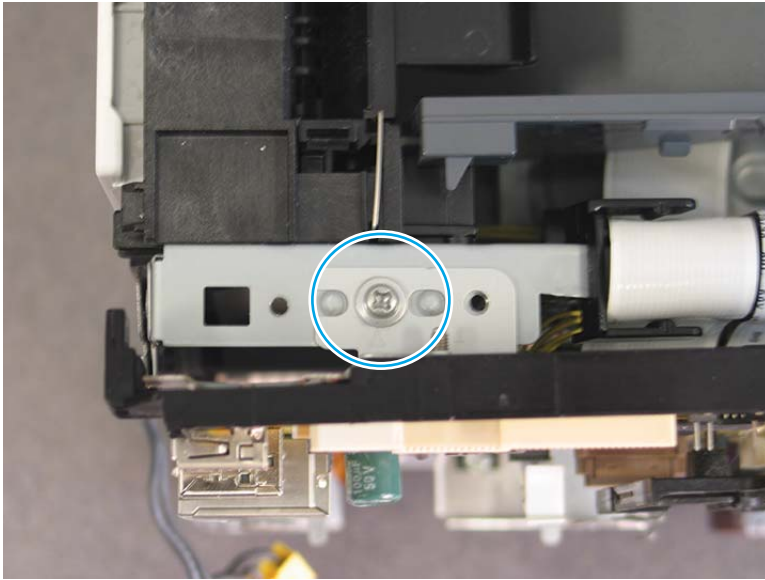

8. Support the formatter and bracket, and then remove two screws.

Figure 1-954 Remove two screws

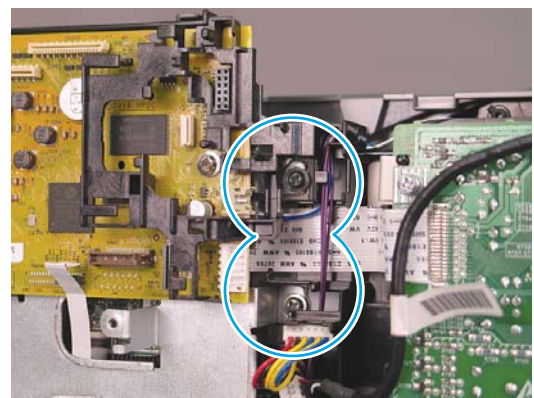
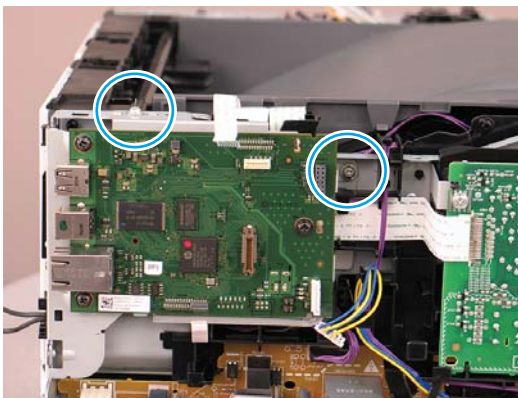

9. Remove the sheet-metal bracket and formatter PCA.

Figure 1-955 Remove the bracket

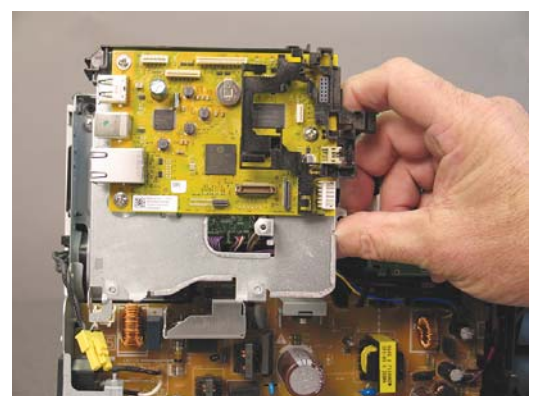
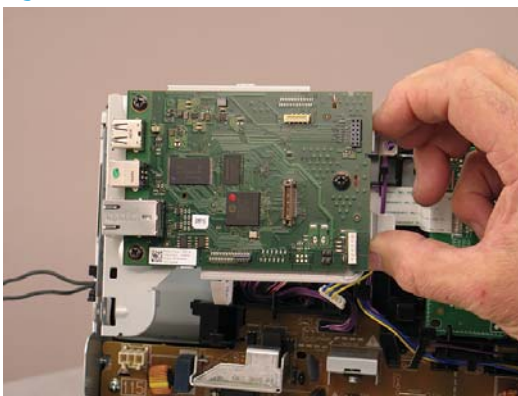

Step 12: Remove the LVPS

1. Disconnect two connectors (callout 1) on the LVPS, and then release the wire harnesses from the guides (callout 2).

Figure 1-956 Disconnect two connectors

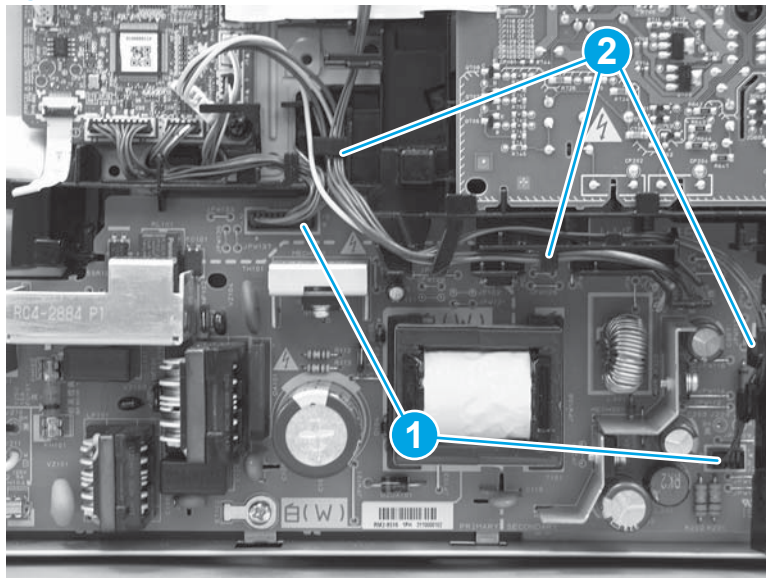

2. Remove one screw (callout 1).

Figure 1-957 Remove one screw

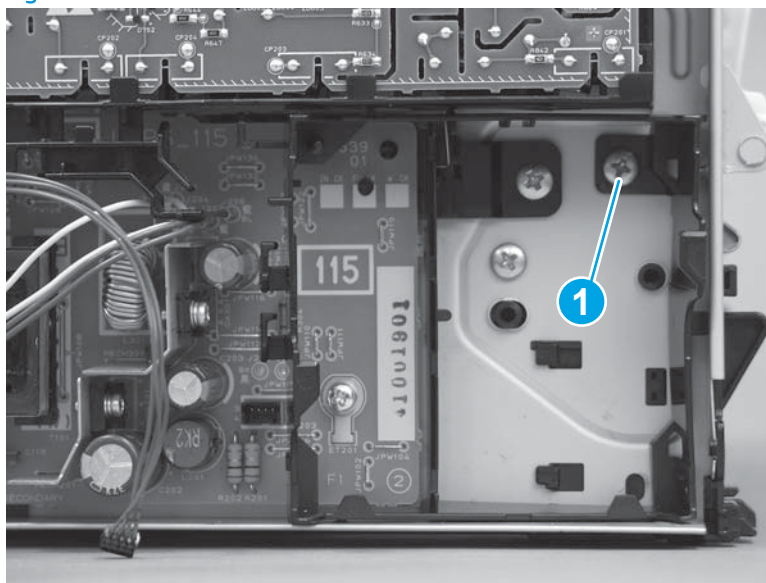

3. Release one tab at the top-left side of the fan holder (callout 1), and then rotate the top-left side corner of the holder away from the printer.

 **Reinstallation tip:** Use a flat-blade screwdriver to slightly flex the top of the holder down to make it easier to disengage this tab.

Figure 1-958 Release one tab

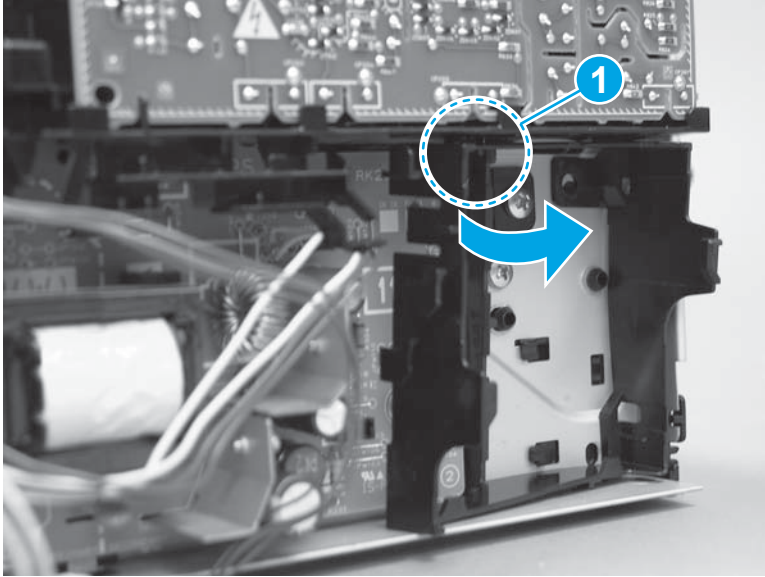

4. Slightly flex the right side of the holder to release one tab (callout 1), and then rotate the top of the holder away from the printer (callout 2).

Figure 1-959 Release one tab

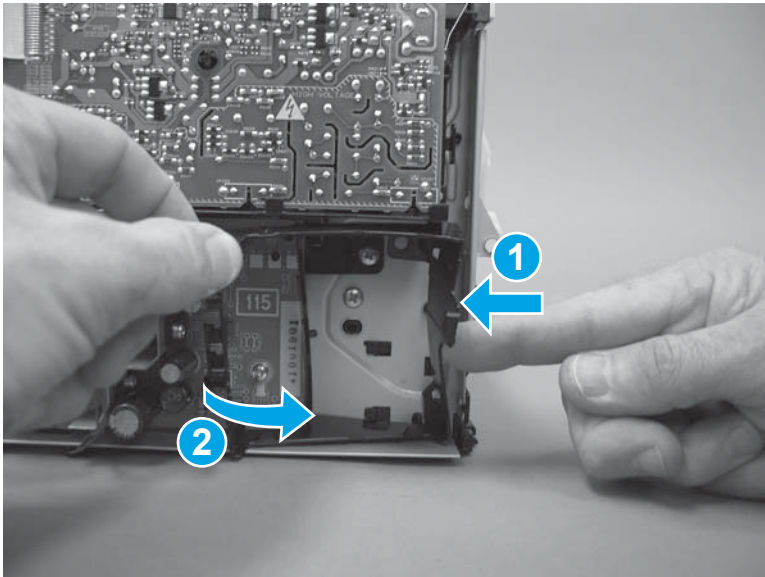

5. Lift the holder up to release two alignment tabs on the bottom of the holder, and then remove the holder.

Figure 1-960 Remove the holder

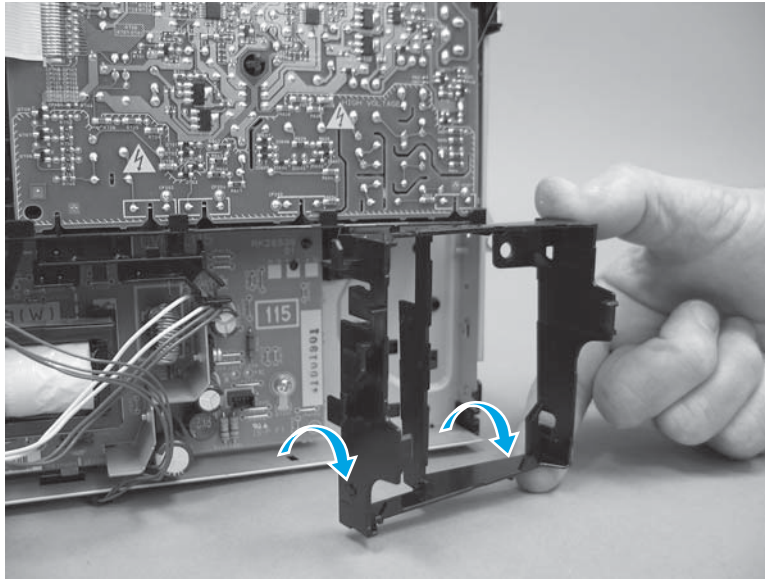

6. Remove two screws (callout 1).

Figure 1-961 Remove two screws

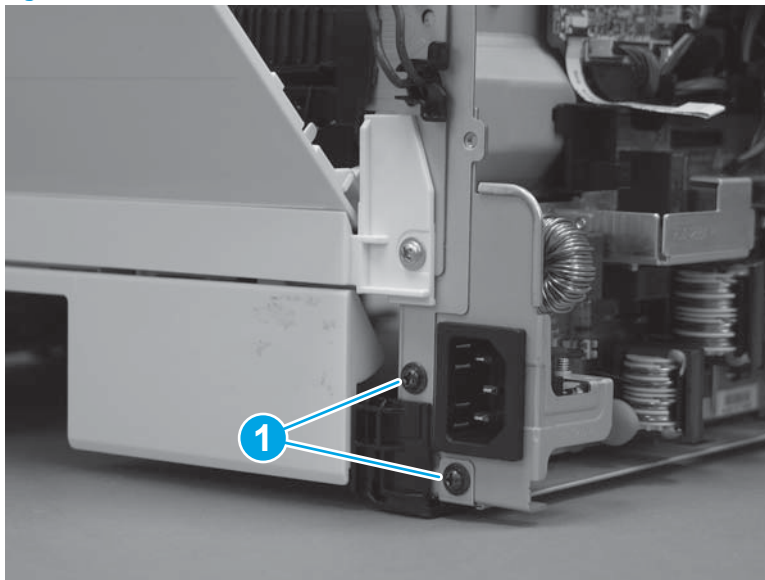

7. Remove three screws (callout 1).

Figure 1-962 Remove three screws

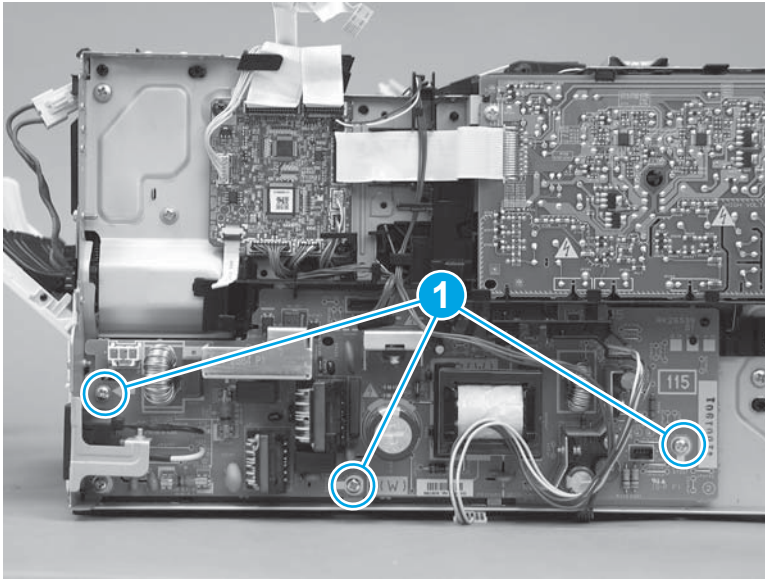

8. Rotate the bottom of the LVPS away from the printer, and then remove the LVPS.

Figure 1-963 Remove the LVPS

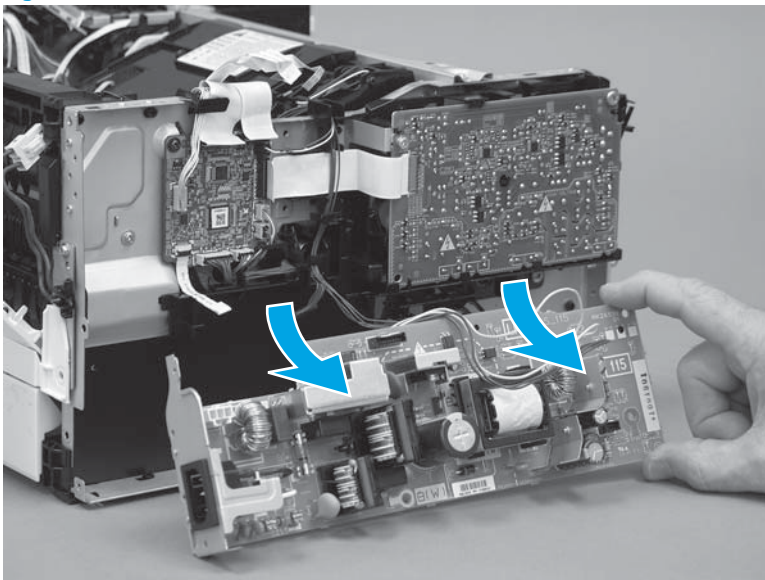



Step 13: Unpack the replacement assembly

1. Dispose of the defective part.

 **NOTE:** HP recommends responsible disposal of the defective part.

<http://www8.hp.com/us/en/hp-information/environment/product-recycling.html>

2. Unpack the replacement part from the packaging.

 **CAUTION:**  Some parts are sensitive to electrostatic discharge (ESD). Always perform service work at an ESD-protected workstation or mat. If an ESD workstation or mat is not available, touch the sheet-metal chassis to provide a static ground before touching an ESD-sensitive assembly. Protect the ESD-sensitive assemblies by placing them in ESD pouches when they are out of the printer.

If the replacement part is a roller or pad, avoid touching the spongy part of it. Skin oils on the roller or pad can cause paper pickup and/or print-quality problems. HP recommends using disposable gloves when handling rollers or pads or washing your hands before touching rollers or pads.

 **IMPORTANT:** Make sure that all of the shipping materials (for example shipping tape) are removed from the replacement part prior to installation.

3. To install an assembly, reverse the removal steps.

 **NOTE:** When applicable, special installation instructions are provided for an assembly at the end of the removal procedure. Always completely read the removal instructions and follow all special installation instructions.

Removal and replacement: Control-panel assembly (M304/M305/M404/M405)

- [Introduction](#)
- [Step 1: Remove Tray 2](#)
- [Step 2: Remove the cartridge door assembly](#)
- [Step 3: Remove the left cover](#)
- [Step 4: Remove the right cover](#)
- [Step 5: Remove the top cover \(M304/M305/M404/M405\)](#)
- [Step 6: Remove the paper delivery tray \(output bin\)](#)
- [Step 7: Remove the control-panel assembly \(M304/M305/M404/M405\)](#)
- [Step 8: Unpack the replacement assembly](#)

Introduction

This document provides the procedures to remove and replace the control-panel assembly (M304/M305/M404/M405).

Before performing service

Turn the printer power off

- Disconnect the power cable.

 **WARNING!** To avoid damage to the printer, turn the printer off, wait 30 seconds, and then remove the power cable before attempting to service the printer.

Use the table below to identify the correct part number for your printer. To order the part, go to www.hp.com/buy/parts.

Control-panel assembly (M304/M305/M404/M405) part number

RM2-5387-000CN	Control-panel assembly (M304/M305/M404/M405; non-wireless model)
RM2-5424-000CN	Control-panel assembly (M304/M305/M404/M405; wireless model)

Required tools

- #2 Phillips screwdriver with a magnetic tip.

After performing service

Turn the printer power on

- Connect the power cable.
- Use the power switch to turn the power on.

Post service test

Make sure that the printer initializes to a **Ready** state.

Print a configuration page to make sure that the printer is functioning correctly.

Step 1: Remove Tray 2

- ▲ Pull the tray straight out of the printer to remove it.

Figure 1-964 Remove the tray



Step 2: Remove the cartridge door assembly

 **NOTE:** If the toner cartridge was not removed prior to servicing the printer, remove it now.

1. Release the support shaft (callout 1), and then slide it toward the center of the door (callout 2).

 **TIP:** It might be easier to release the support shaft by using a small flat-blade screwdriver.

Figure 1-965 Release the support shaft

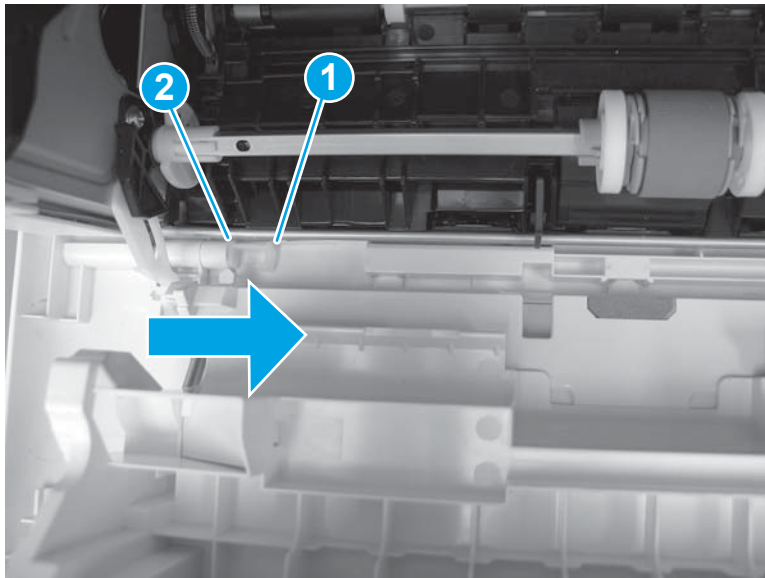

2. Remove the support shaft.

Figure 1-966 Remove the support shaft

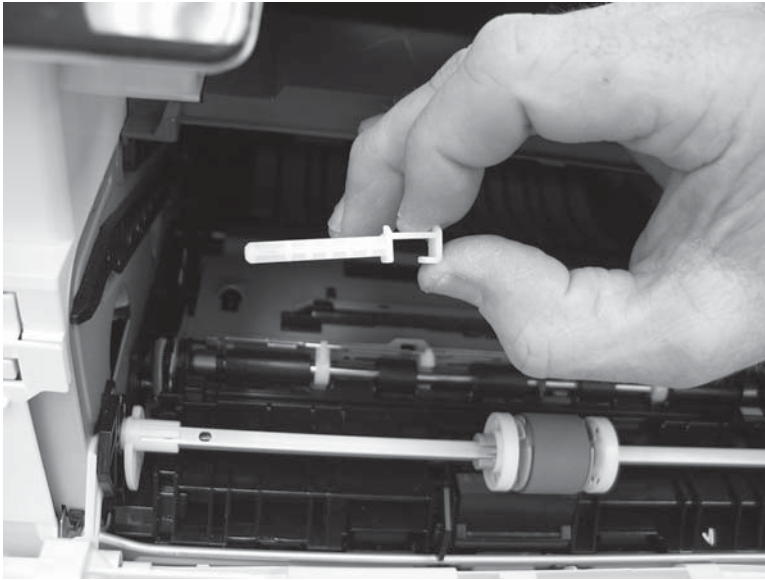

3. Release one tab (callout 1), and then slide the guide out of the printer (callout 2).

⚠ CAUTION: Be careful, the tab (callout 1) can be easily broken.

Figure 1-967 Remove the guide

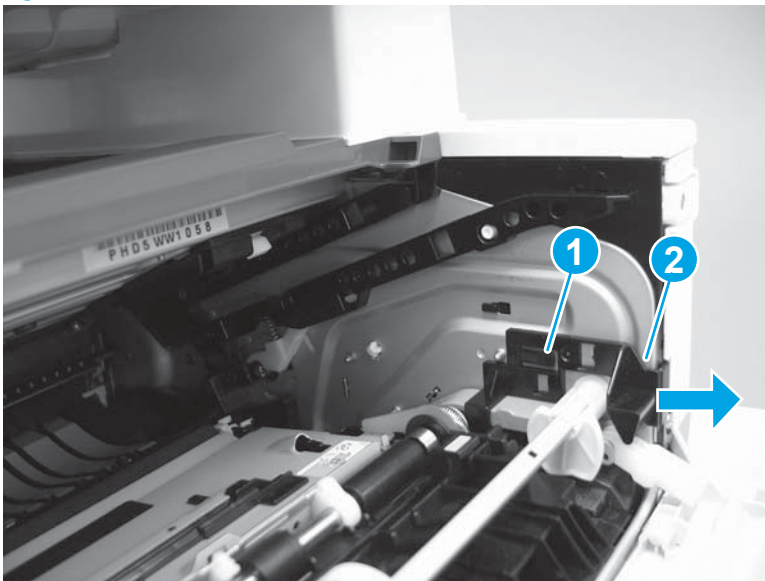

4. Use a small flat-blade screwdriver to gently pry the white-plastic door arm (callout 1) off of the gray-plastic pressure-release link (callout 2) to release the door arm.

Figure 1-968 Release the pressure-release link

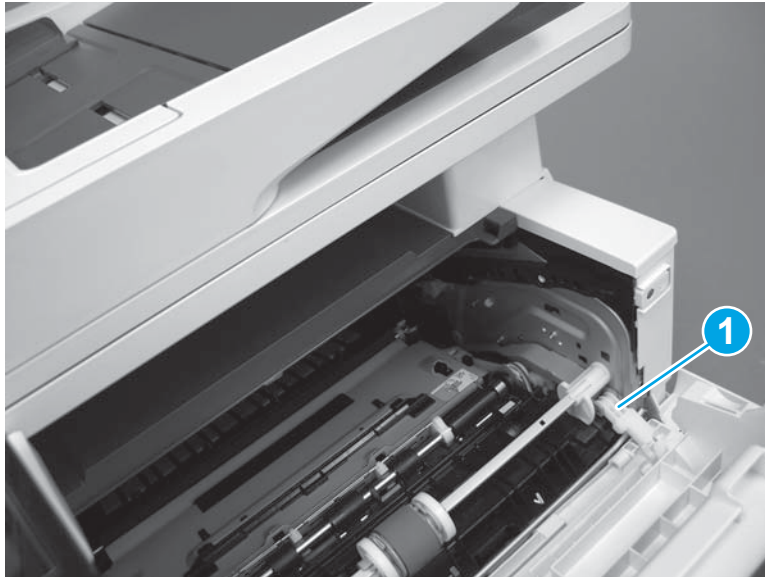

5. With the door in the partially closed position, slightly raise the left end (callout 1; raise it over the sheet-metal hinge boss), and then slide the door to the left (callout 2) to release the right hinge (callout 3).

⚠ CAUTION: The door is still attached to the printer by the left-side retainer arm. Do not attempt to completely remove the door.

💡 Reinstallation tip: When reinstalling the door, there are two right-side hinge pins (not shown in callout 3). Keep a finger pressed on the left-side retainer arm so that it does not disengage from the door.

Figure 1-969 Release the door

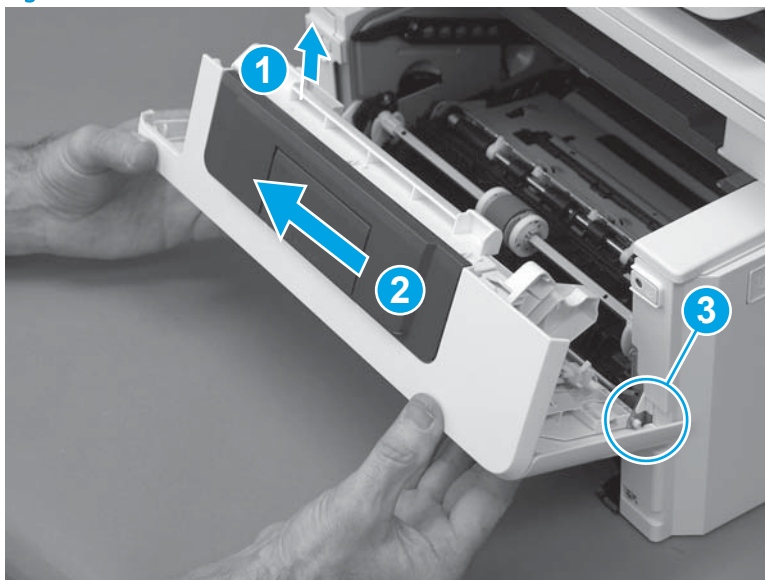

6. Rotate the door away from the printer until the keyed pin on the left-side retainer arm can disengage from the door.

Figure 1-970 Release the left-side retainer arm

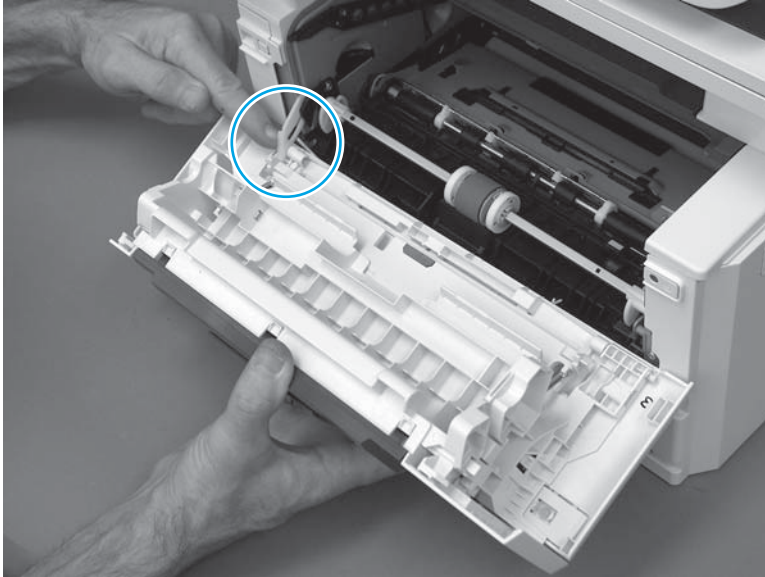

7. Remove the door.

Figure 1-971 Remove the door

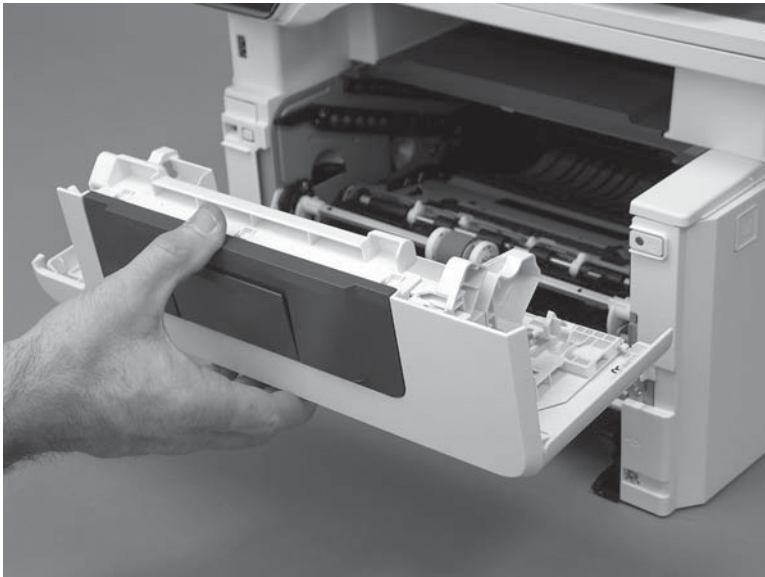

Step 3: Remove the left cover

1. Remove one screw (callout 1).

Figure 1-972 Remove one screw

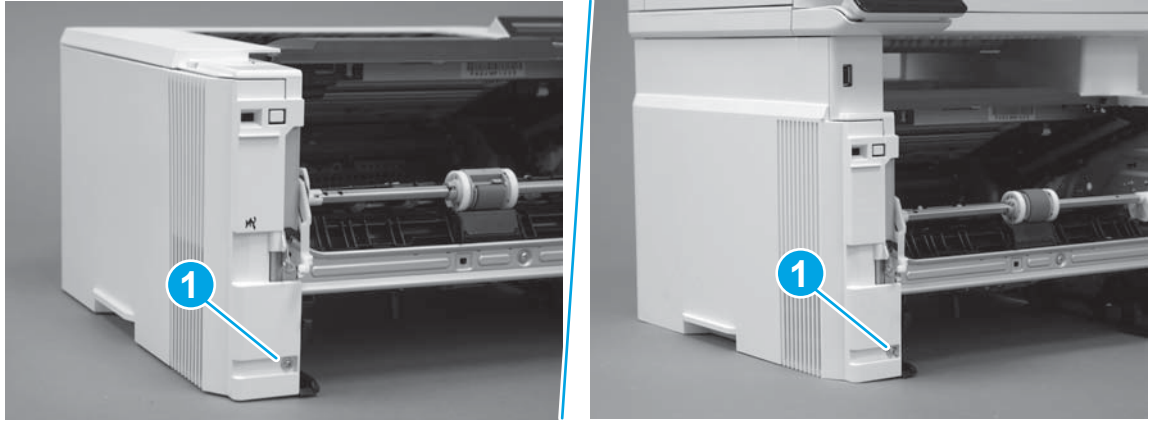

2. Open the rear door, release two bosses (callout 1), and then release three tabs (callout 2).

Figure 1-973 Release two bosses and three tabs

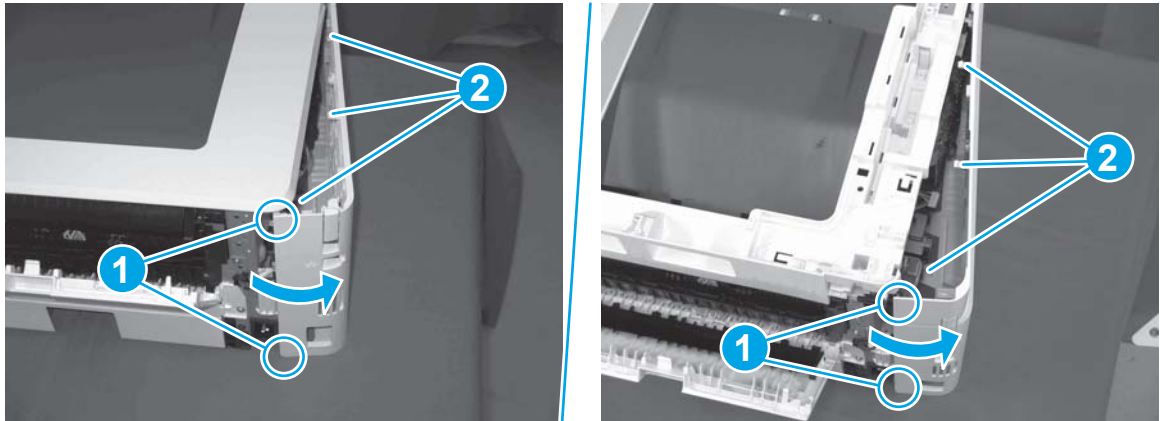

3. At the front of the printer, do one of the following:

- **M304/M305/M404/M405:** Release two bosses (callout 1), and then remove the cover (callout 2).
- **M329/M428/M429:** Release one tab (callout 3), two bosses (callout 4), and then remove the cover (callout 5).

⚠ CAUTION: Be careful when releasing the upper bosses on the M329/M428/M429 cover. One portion of the cover (callout 6) is fragile and is easily broken.

Figure 1-974 Remove the cover

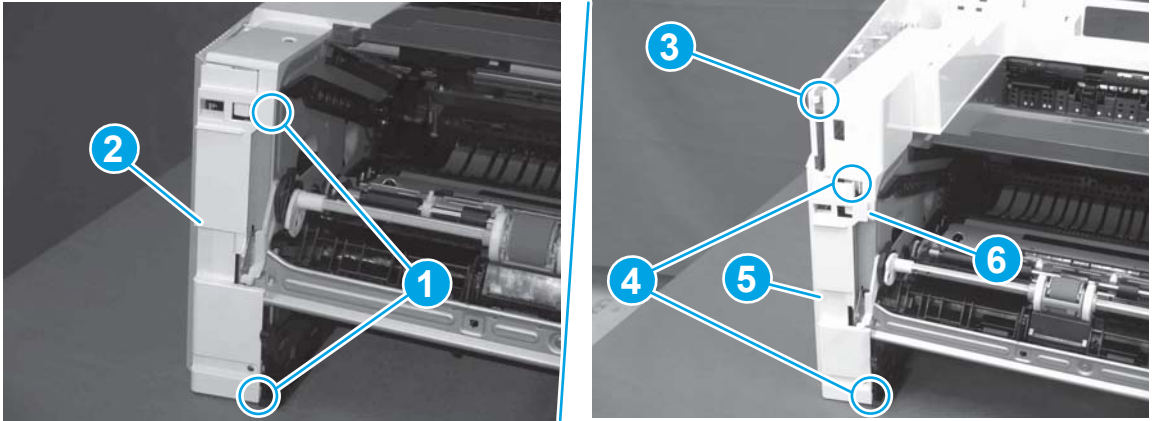

Step 4: Remove the right cover

1. At the front of the printer, release two bosses (callout 1), and then release three tabs (callout 2).

 **Reinstallation tip:** Remove, and then reinstall the cover if the switch or button does not correctly function.

Figure 1-975 Release two bosses and three tabs

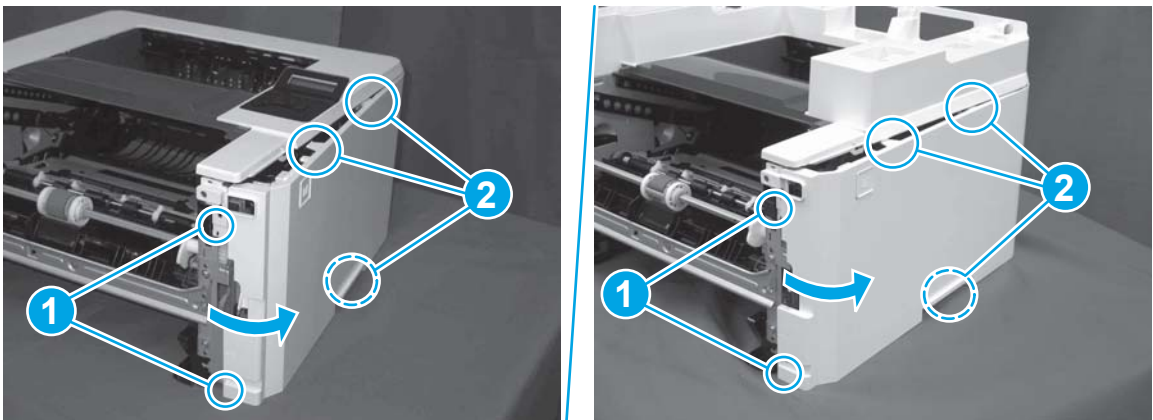

2. Open the rear door, release two bosses (callout 1), and then remove the cover (callout 2).

Figure 1-976 Remove the cover

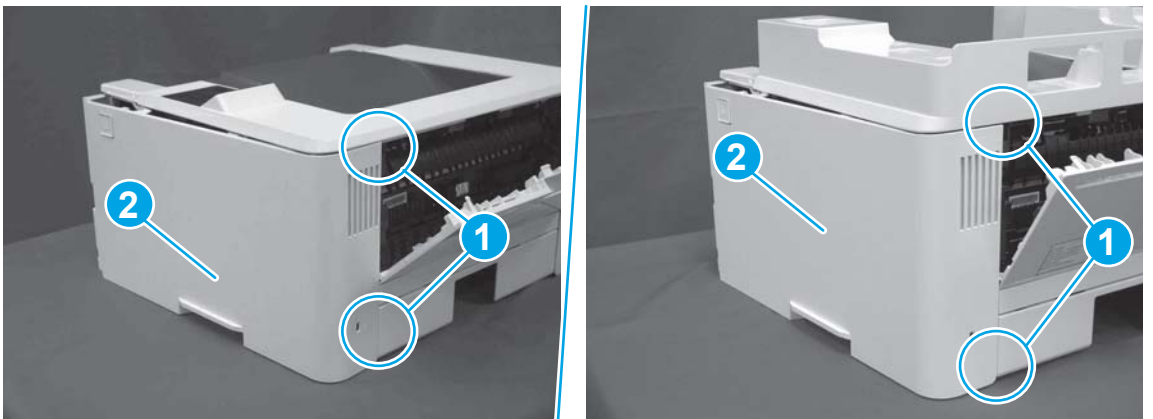

Step 5: Remove the top cover (M304/M305/M404/M405)

1. Remove one screw (callout 1).

Figure 1-977 Remove one screw



2. At the right side of the printer, release the one boss (callout 1), and then release one tab (callout 2).

Figure 1-978 Release one boss and one tab

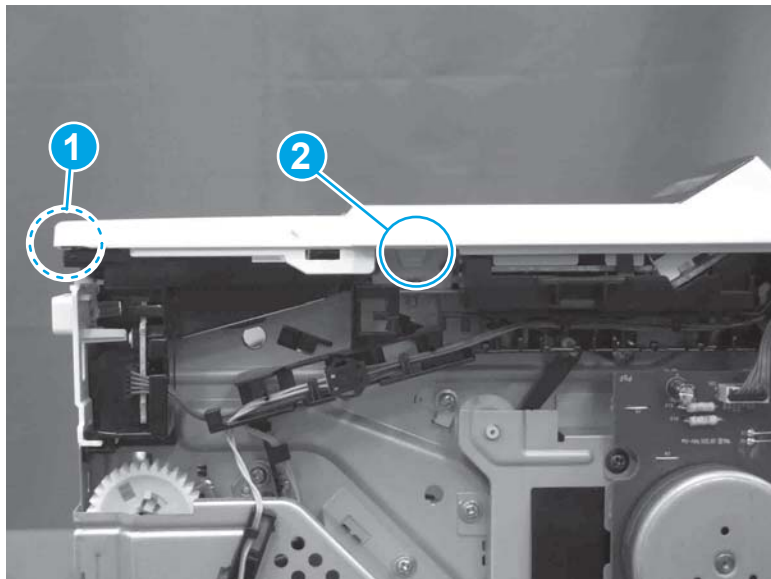

3. Release four tabs (callout 1), release four bosses (callout 2), and then remove the top cover (callout 3).



 **TIP:** Open the rear door to make releasing the bosses (callout 3) easier.

Figure 1-979 Remove the cover

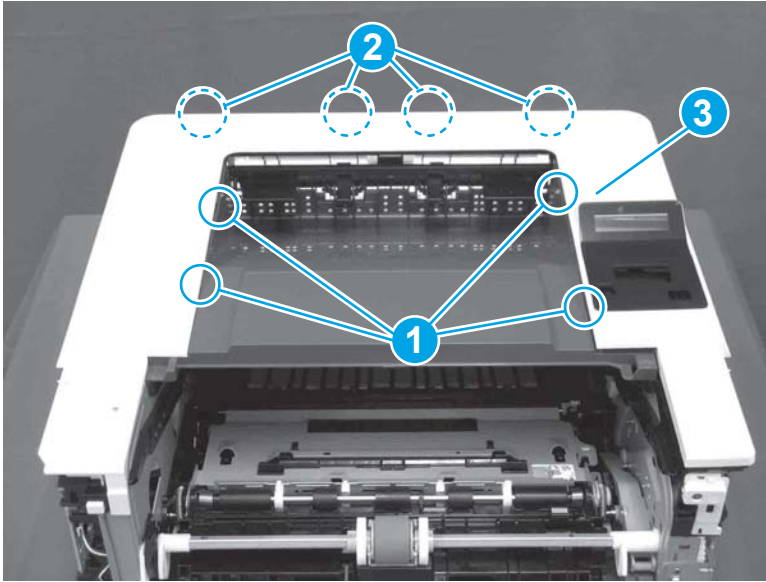

Step 6: Remove the paper delivery tray (output bin)

 **NOTE:** This procedure shows the M304/M305/M404/M405 model, however, the paper delivery tray (output bin) removal is similar for the M329/M428/M429 printer.

- ▲ Release two bosses (callout 1), release two tabs (callout 2), and then remove the paper delivery tray (output bin; callout 3).

Figure 1-980 Release two tabs

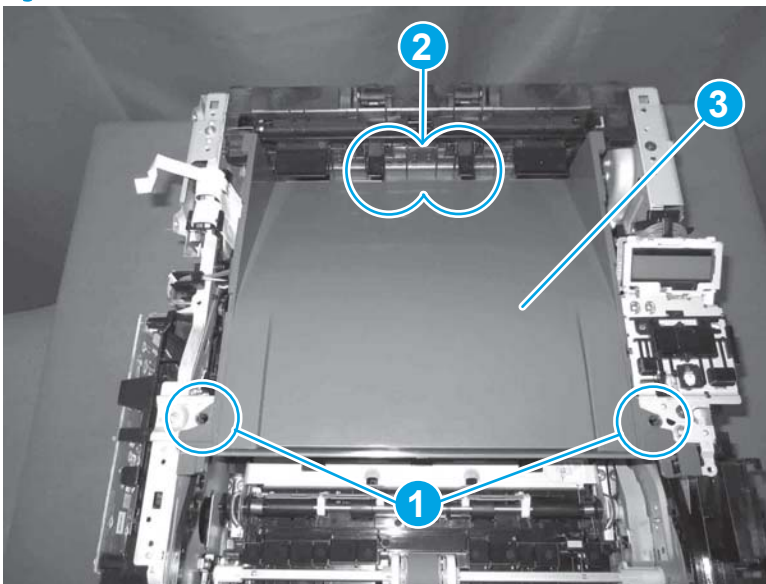

Step 7: Remove the control-panel assembly (M304/M305/M404/M405)

1. Disconnect one FFC (callout 1).

Figure 1-981 Disconnect one FFC

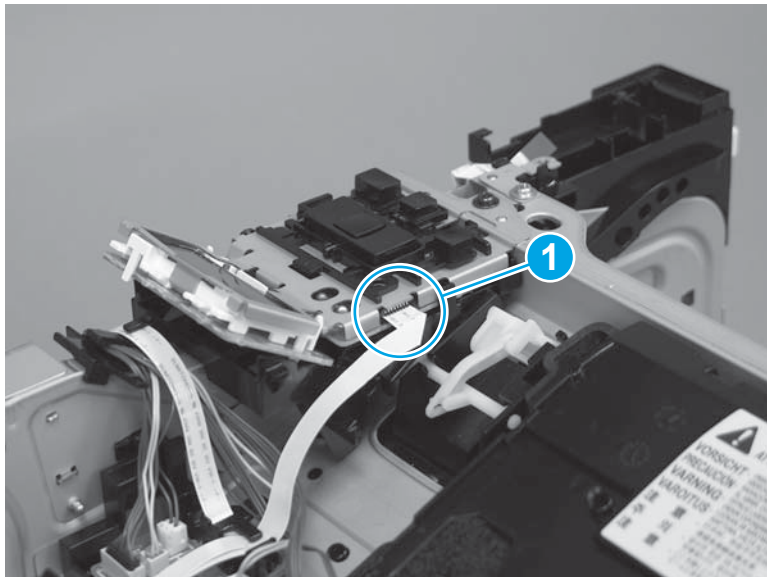

2. Remove one screw (callout 1), and then remove the control panel.

Figure 1-982 Remove one screw and the control panel

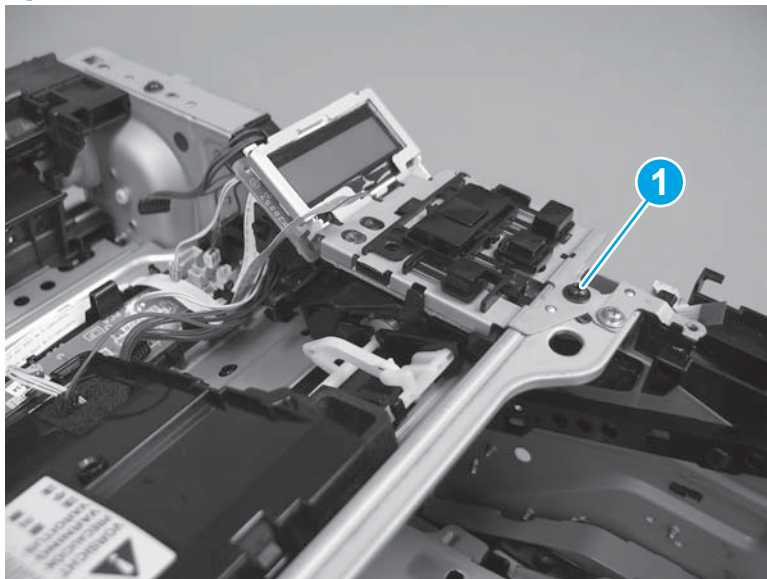



Step 8: Unpack the replacement assembly

1. Dispose of the defective part.

 **NOTE:** HP recommends responsible disposal of the defective part.

<http://www8.hp.com/us/en/hp-information/environment/product-recycling.html>

2. Unpack the replacement part from the packaging.

 **CAUTION:**  Some parts are sensitive to electrostatic discharge (ESD). Always perform service work at an ESD-protected workstation or mat. If an ESD workstation or mat is not available, touch the sheet-metal chassis to provide a static ground before touching an ESD-sensitive assembly. Protect the ESD-sensitive assemblies by placing them in ESD pouches when they are out of the printer.

If the replacement part is a roller or pad, avoid touching the spongy part of it. Skin oils on the roller or pad can cause paper pickup and/or print-quality problems. HP recommends using disposable gloves when handling rollers or pads or washing your hands before touching rollers or pads.

 **IMPORTANT:** Make sure that all of the shipping materials (for example shipping tape) are removed from the replacement part prior to installation.

3. To install an assembly, reverse the removal steps.

 **NOTE:** When applicable, special installation instructions are provided for an assembly at the end of the removal procedure. Always completely read the removal instructions and follow all special installation instructions.

Removal and replacement: Control panel (M329/M428/M429) and control panel sub assemblies

- [Introduction](#)
- [Step 1: Remove the control panel mount cover M329/M428/M429](#)
- [Step 2: Remove the control panel \(M329/M428/M429\)](#)
- [Step 3: Remove the control panel mount base \(M329/M428/M429\)](#)
- [Step 4: Remove the control panel mount chassis assembly \(M329/M448/M429\)](#)
- [Step 5: Remove Tray 2](#)
- [Step 6: Remove the cartridge door assembly](#)
- [Step 7: Remove the left cover](#)
- [Step 8: Remove the control panel 22-pin FFC \(M329/M428/M429\)](#)
- [Step 9: Unpack the replacement assembly](#)

Introduction

This document provides the procedures to remove and replace the M329/M428/M429 control panel, control panel mount cover, control panel base, control panel mount chassis assembly, and the control panel 22-pin flat flexible cable (FFC).

Before performing service

Turn the printer power off

- Disconnect the power cable.

 **WARNING!** To avoid damage to the printer, turn the printer off, wait 30 seconds, and then remove the power cable before attempting to service the printer.

Use the table below to identify the correct part number for your printer. To order the part, go to www.hp.com/buy/parts.

Control panel (M329/M428/M429) part numbers	
W2Q13-60103	Control panel (magic frame; 68.6 mm (2.7 in))
T6B80-40002	Cover, back control panel (68.6 mm (2.7 in))
B3Q10-60145	Control panel, mount chassis assembly
B3Q11-40001	Control panel, mount base
B3Q11-40002	Cover, control panel mount
W1A30-60101	Control panel FFC

NOTE: If the control panel is damaged, order the following parts and assemble them together.

- W2Q13-60103
- T6B80-40002

Required tools

- #2 Phillips screwdriver with a magnetic tip.

After performing service

Turn the printer power on

- Connect the power cable.
- Use the power switch to turn the power on.

Post service test

Make sure that the printer initializes to a **Ready** state.

Navigate the control-panel menus to make sure that the control panel is correctly functioning.

 **TIP:** If the control panel is not functioning, check the FFC connections at the formatter and control panel.

Step 1: Remove the control panel mount cover M329/M428/M429)

1. Open the integrated scanner assembly (ISA).

 **NOTE:** If the control panel is not fully tilted forward, tilt it forward now until it stops.

Figure 1-983 Open the ISA



2. Remove one screw (callout 1).

Figure 1-984 Remove one screw

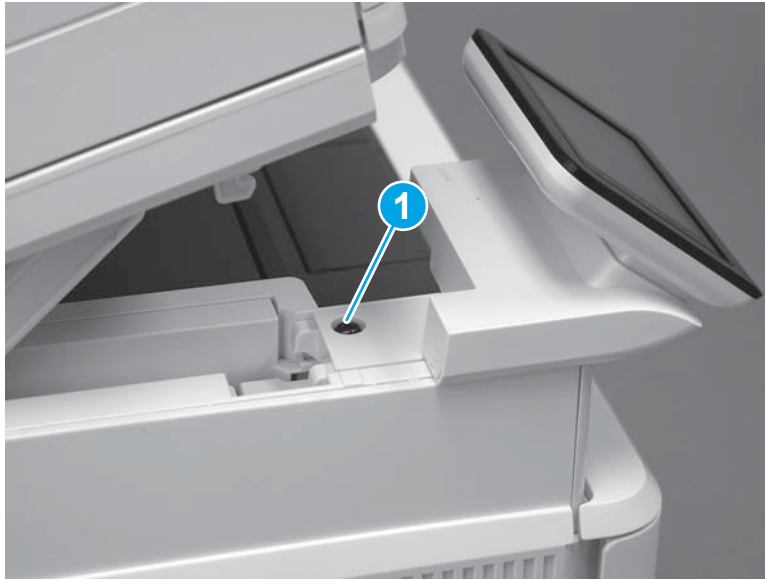

3. Use a small flat-blade screwdriver to release two tabs (callout 1) on the control-panel cable cover.

Figure 1-985 Release two tabs



4. Rotate the control-panel cable cover up towards the control panel to release it, and then remove the cover.

Figure 1-986 Remove the cover



Step 2: Remove the control panel (M329/M428/M429)

1. Disconnect one FFC (callout 1), and then release the FFC from the guide (callout 2).

Figure 1-987 Disconnect one connector

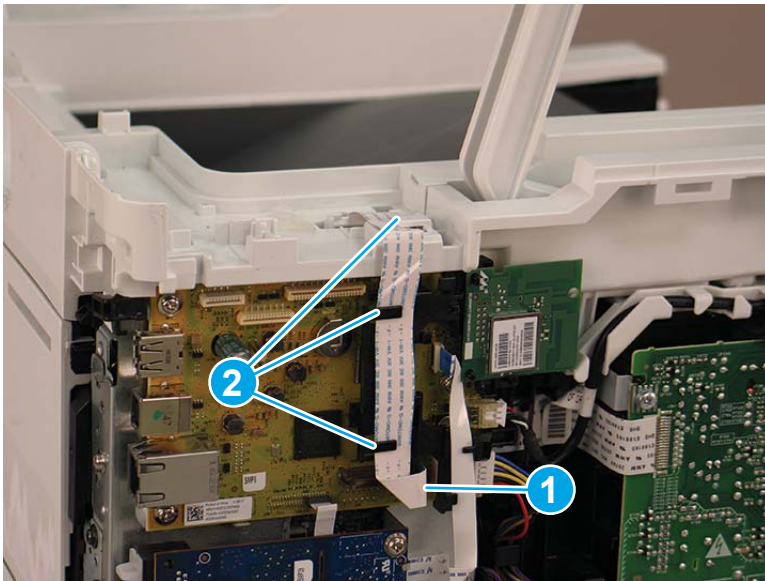

2. Remove one screw (callout 1).

Figure 1-988 Remove one screw

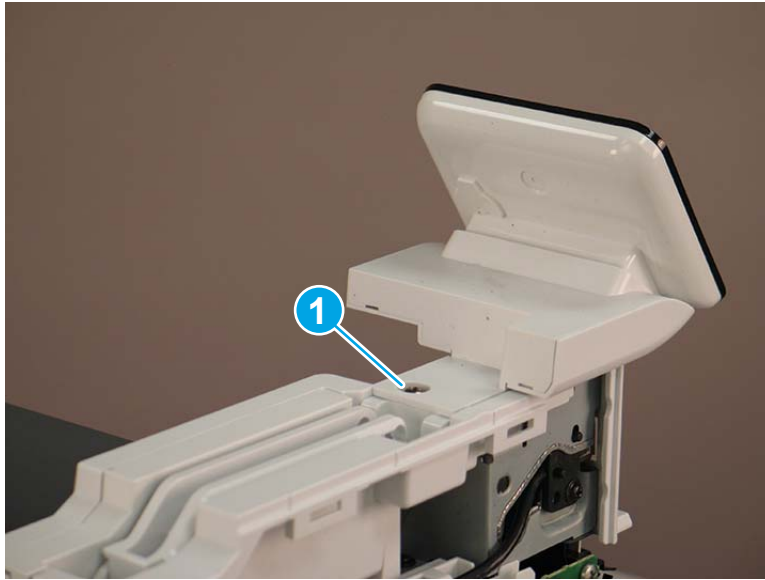

3. Use a small flat-blade screwdriver to release two tabs (callout 1) on the control-panel cable cover.

Figure 1-989 Release two tabs

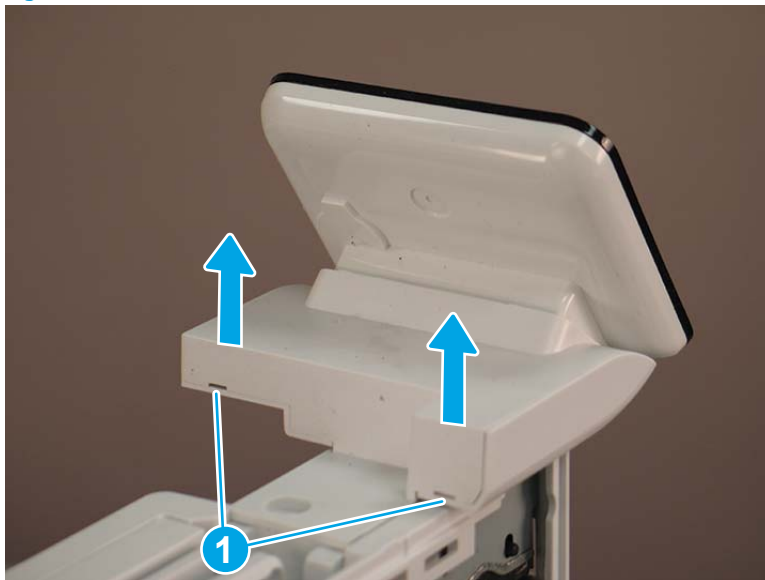

4. Remove the control-panel cable cover.

Figure 1-990 Remove the cover



5. Remove one grounding screw (callout 1), and then move the ground cable (callout 2) out of the way.

Figure 1-991 Remove one screw

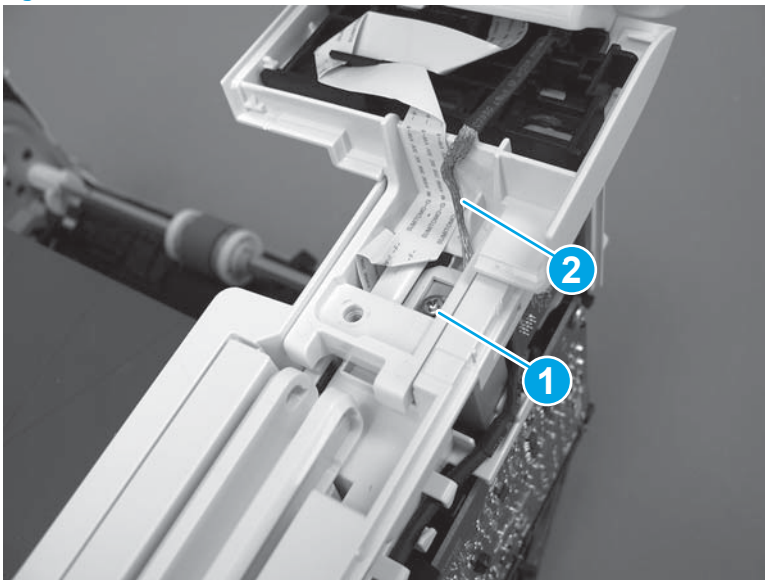

6. Move the FFC out of the way, and then remove two screws (callout 1).

Figure 1-992 Remove two screws



7. Slightly lift up the control-panel assembly to separate it from the top cover.

⚠ CAUTION: The control panel assembly is still connected to the printer by the FFC. Do not attempt to completely remove the assembly.

Figure 1-993 Lift up the control-panel assembly

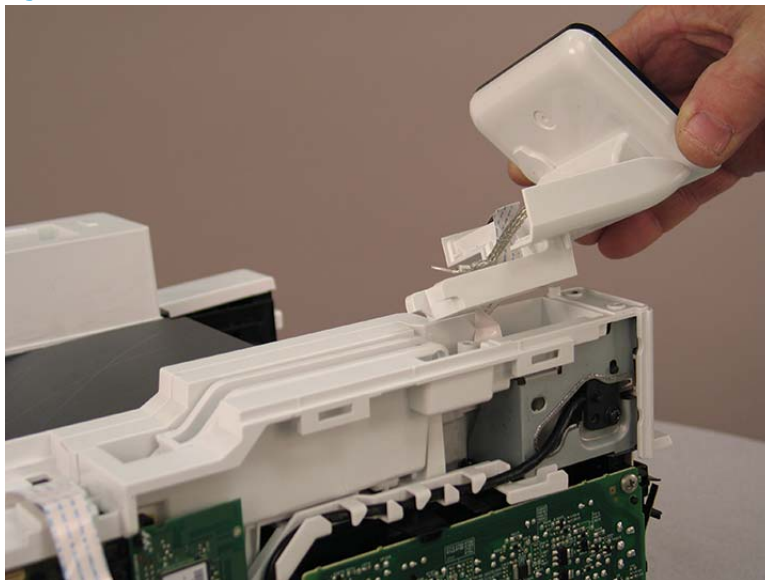

8. Lift up the control-panel FFC cover to remove the control-panel assembly.

Figure 1-994 Remove the control-panel assembly

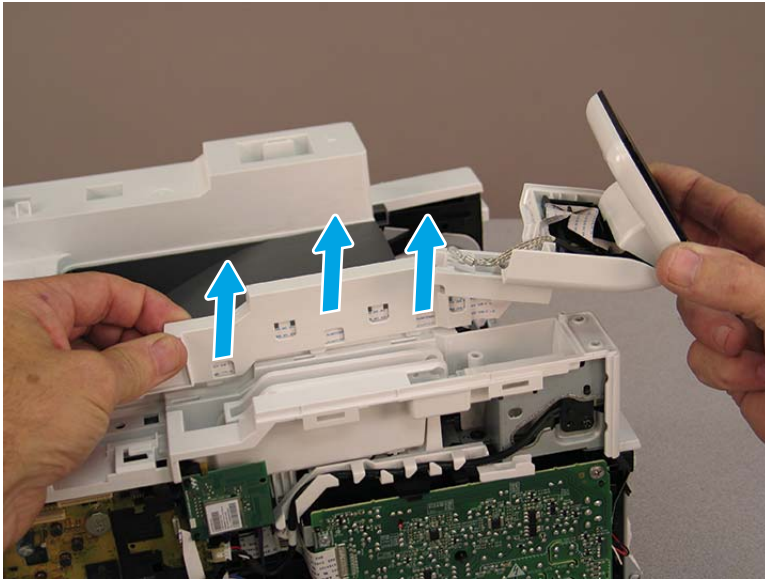

Step 3: Remove the control panel mount base (M329/M428/M429)

1. Remove two screws (callout 1).

Figure 1-995 Remove two screws

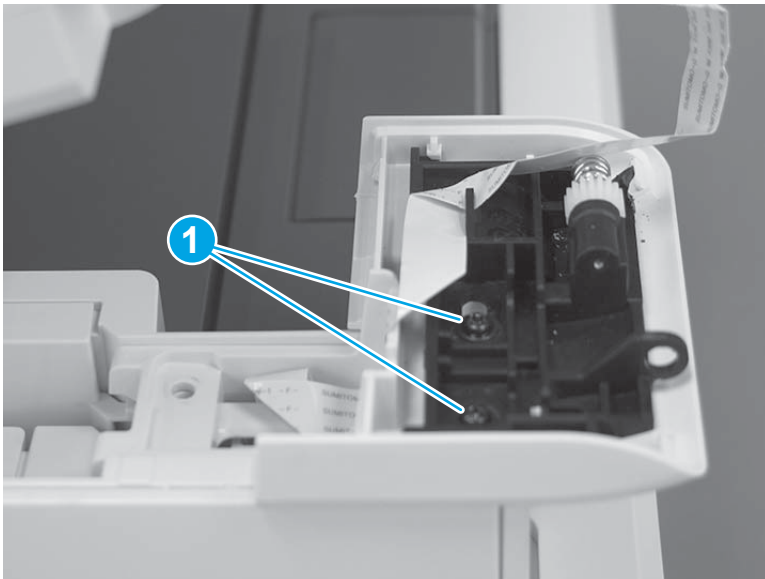

2. Release the FFC from the retainer (callout 1), and then gently remove the FFC from mount base (callout 2).

⚠ CAUTION: The FFC is adhered to the mount base with two-sided tape (callout 2). Do not damage the FFC when removing it from the mount base.

Figure 1-996 Remove the FFC

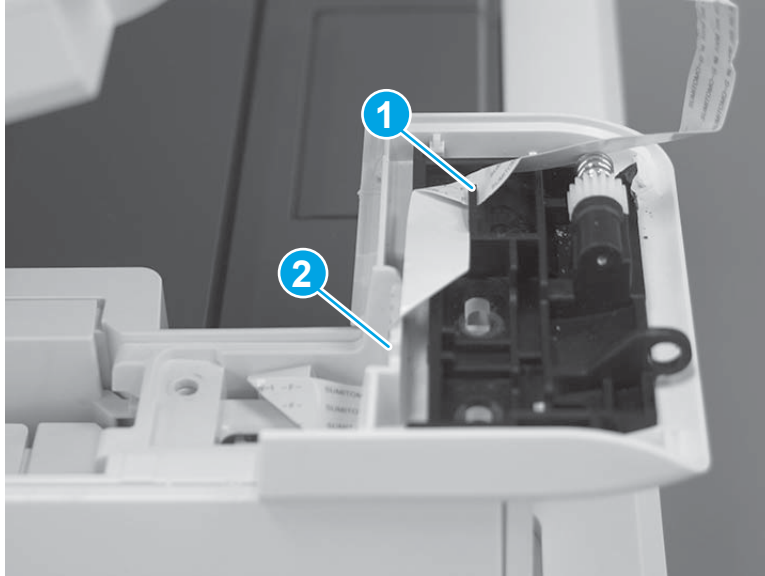

3. Remove the control panel mount base.

Figure 1-997 Release the control panel mount base



Step 4: Remove the control panel mount chassis assembly (M329/M448/M429)

1. Slide the mount chassis assembly as shown (callout 1) to release it from four bosses (callout 2).

Figure 1-998 Release the mount chassis assembly

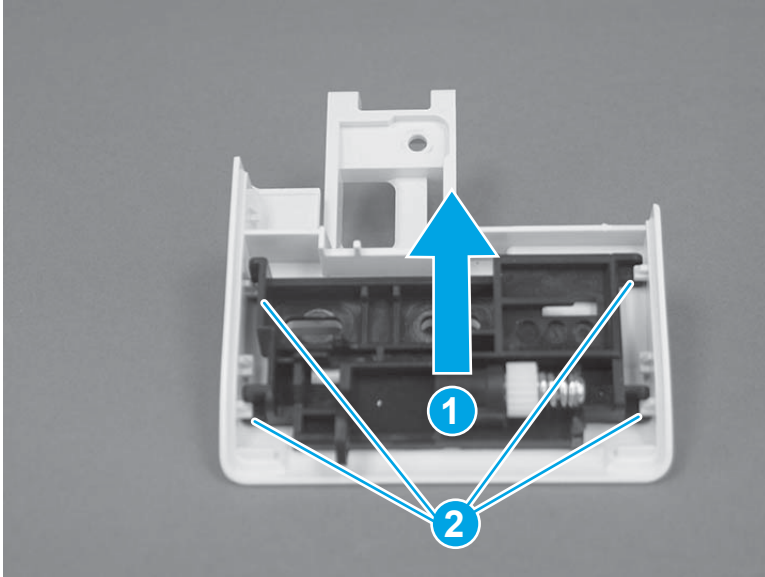

2. Separate the mount chassis assembly from the mount base.

Figure 1-999 Remove the mount chassis assembly

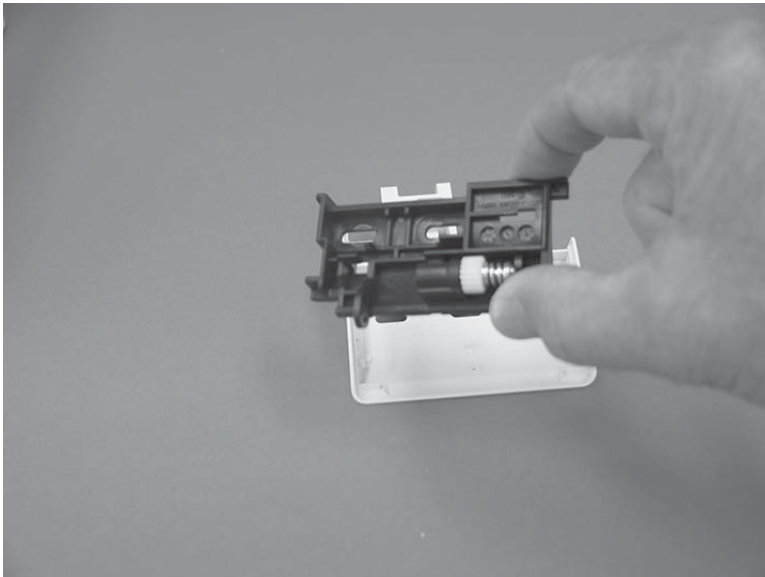

Step 5: Remove Tray 2

 **NOTE:** If the 22-pin control panel FFC does not need to be removed and replaced, skip this step and go to [Step 9: Unpack the replacement assembly on page 596](#).

- ▲ Pull the tray straight out of the printer to remove it.

Figure 1-1000 Remove the tray



Step 6: Remove the cartridge door assembly

 **NOTE:** If the toner cartridge was not removed prior to servicing the printer, remove it now.

1. Release the support shaft (callout 1), and then slide it toward the center of the door (callout 2).

 **TIP:** It might be easier to release the support shaft by using a small flat-blade screwdriver.

Figure 1-1001 Release the support shaft

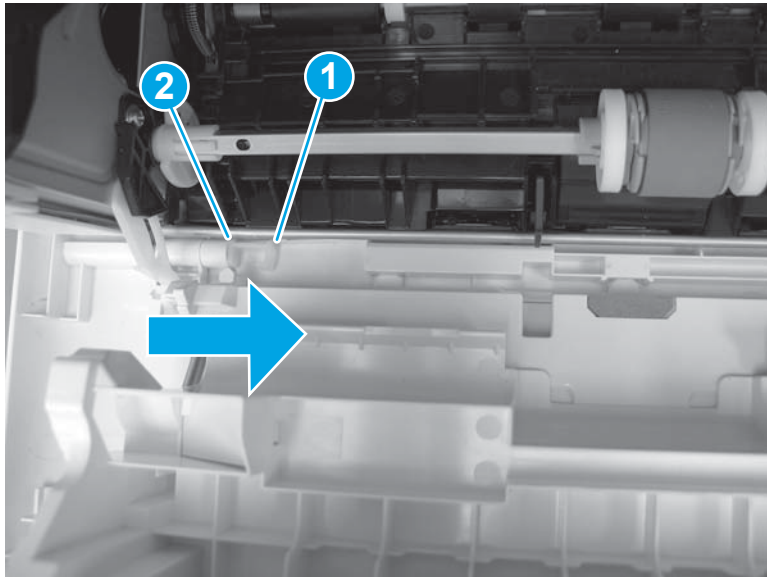

2. Remove the support shaft.

Figure 1-1002 Remove the support shaft

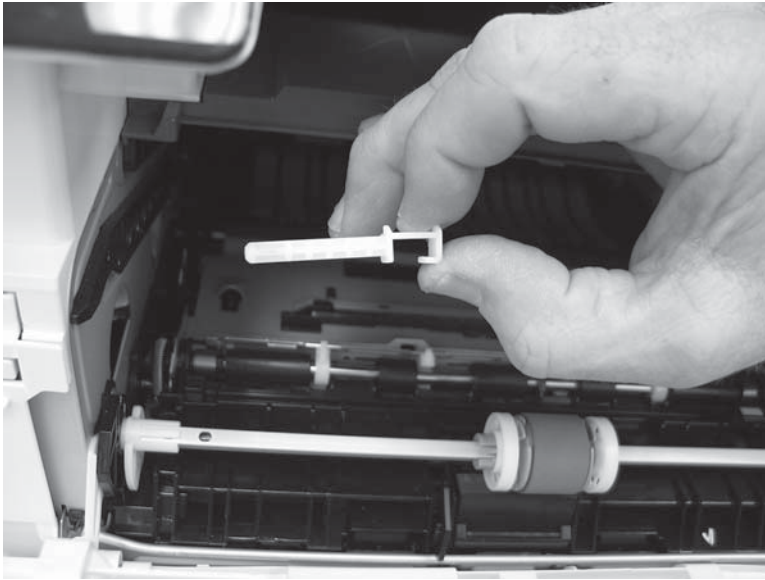

3. Release one tab (callout 1), and then slide the guide out of the printer (callout 2).

⚠ CAUTION: Be careful, the tab (callout 1) can be easily broken.

Figure 1-1003 Remove the guide

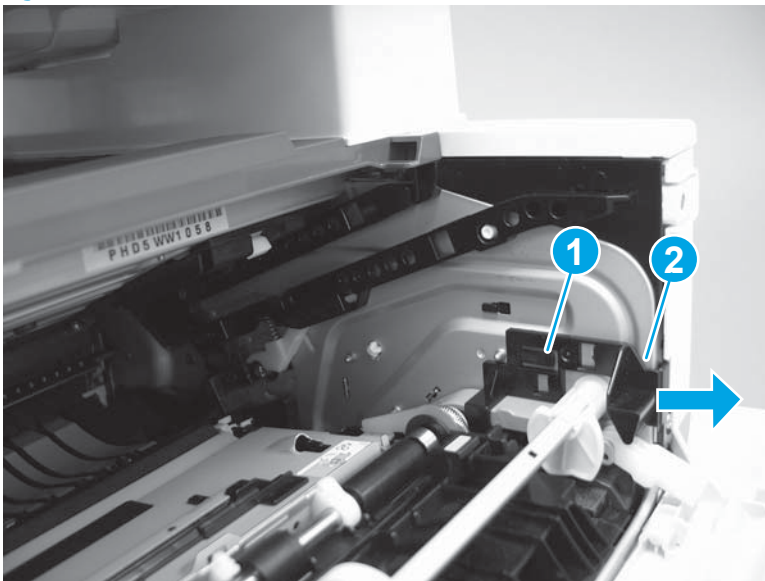

4. Use a small flat-blade screwdriver to gently pry the white-plastic door arm (callout 1) off of the gray-plastic pressure-release link (callout 2) to release the door arm.

Figure 1-1004 Release the pressure-release link

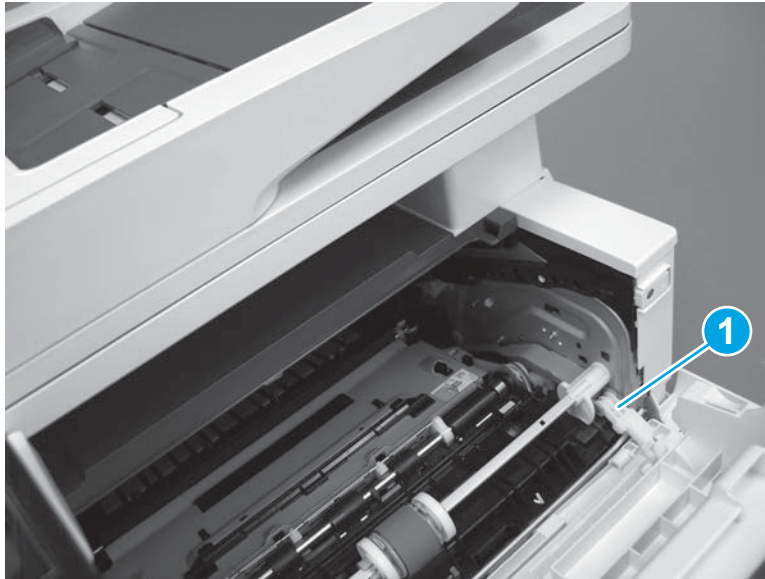

5. With the door in the partially closed position, slightly raise the left end (callout 1; raise it over the sheet-metal hinge boss), and then slide the door to the left (callout 2) to release the right hinge (callout 3).

⚠ CAUTION: The door is still attached to the printer by the left-side retainer arm. Do not attempt to completely remove the door.

💡 Reinstallation tip: When reinstalling the door, there are two right-side hinge pins (not shown in callout 3). Keep a finger pressed on the left-side retainer arm so that it does not disengage from the door.

Figure 1-1005 Release the door

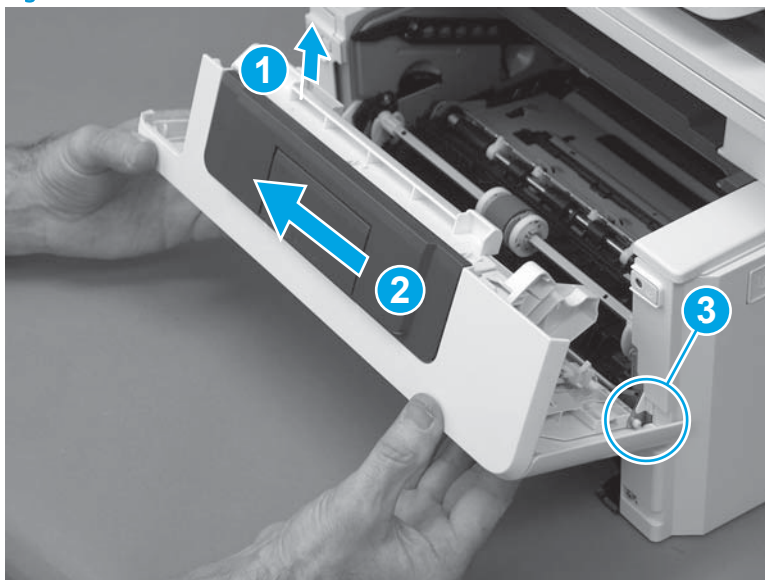

6. Rotate the door away from the printer until the keyed pin on the left-side retainer arm can disengage from the door.

Figure 1-1006 Release the left-side retainer arm

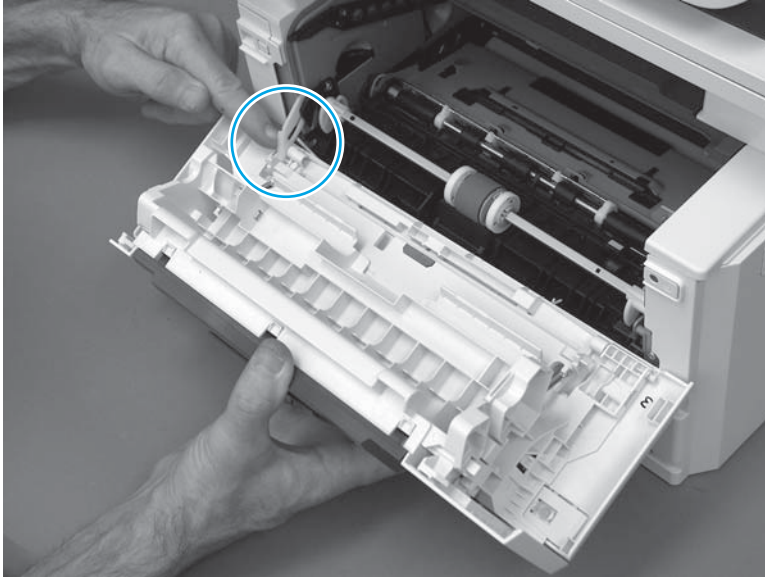

7. Remove the door.

Figure 1-1007 Remove the door

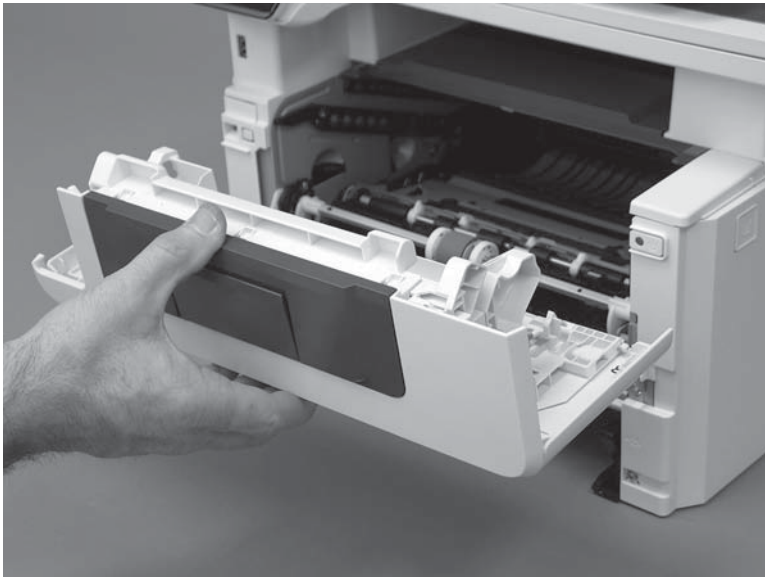

Step 7: Remove the left cover

 **NOTE:** If the 22-pin control panel FFC does not need to be removed and replaced, skip this step and go to [Step 9: Unpack the replacement assembly on page 596](#).

1. Remove one screw (callout 1).

Figure 1-1008 Remove one screw

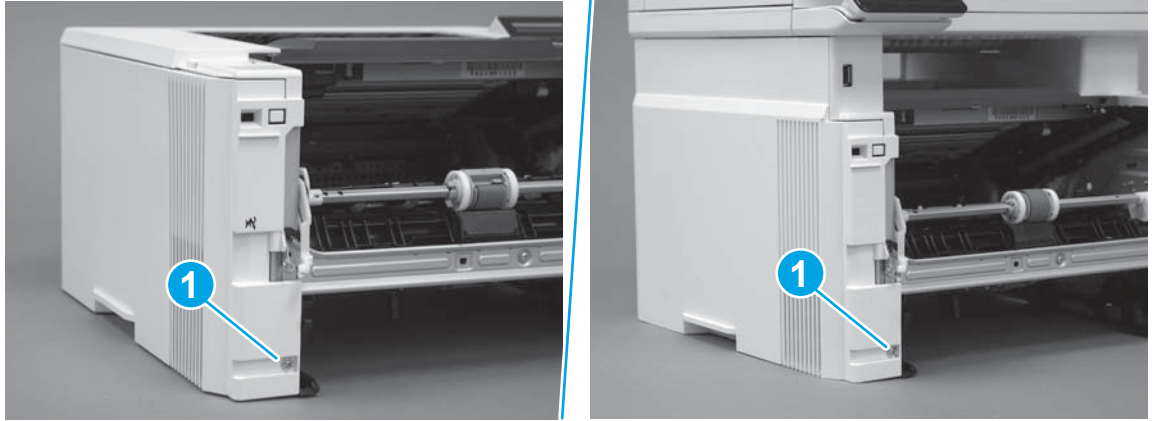

2. Open the rear door, release two bosses (callout 1), and then release three tabs (callout 2).

Figure 1-1009 Release two bosses and three tabs

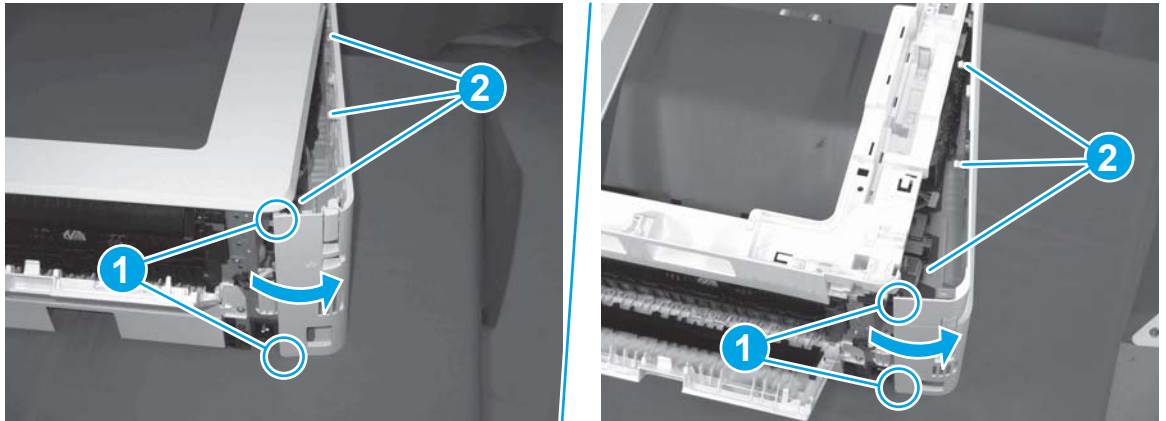

3. At the front of the printer, do one of the following:
 - **M304/M305/M404/M405:** Release two bosses (callout 1), and then remove the cover (callout 2).
 - **M329/M428/M429:** Release one tab (callout 3), two bosses (callout 4), and then remove the cover (callout 5).

⚠ CAUTION: Be careful when releasing the upper bosses on the M329/M428/M429 cover. One portion of the cover (callout 6) is fragile and is easily broken.

Figure 1-1010 Remove the cover

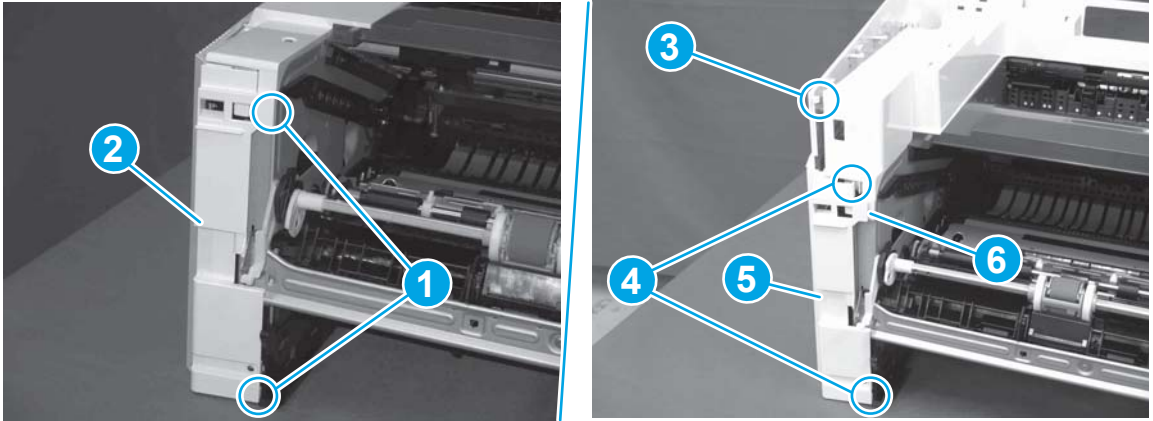

Step 8: Remove the control panel 22-pin FFC (M329/M428/M429)

 **NOTE:** If the 22-pin control panel FFC does not need to be removed and replaced, skip this step and go to [Step 9: Unpack the replacement assembly on page 596](#).

1. Release the ISA flat-flexible cable (FFC) cover (callout 1), and then remove it (callout 2).

Figure 1-1011 Remove the ISA FFC cover

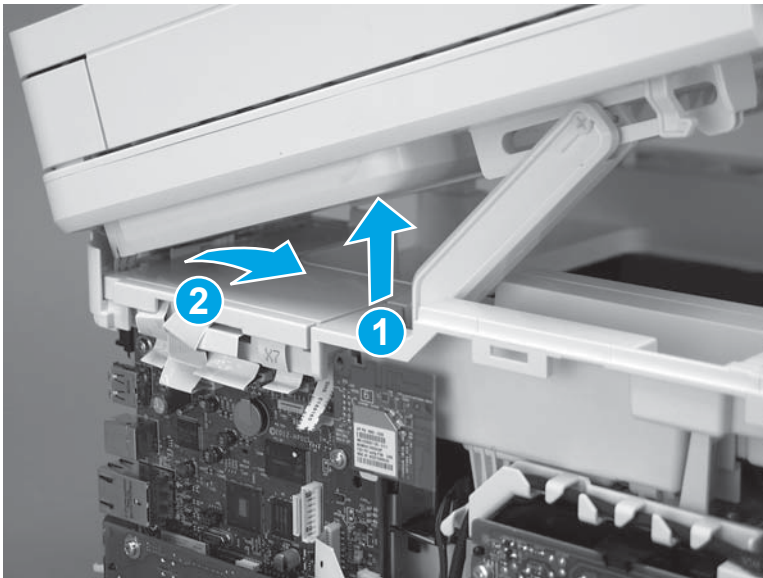

2. Disconnect one FFC (callout 1).

Figure 1-1012 Disconnect one FFC

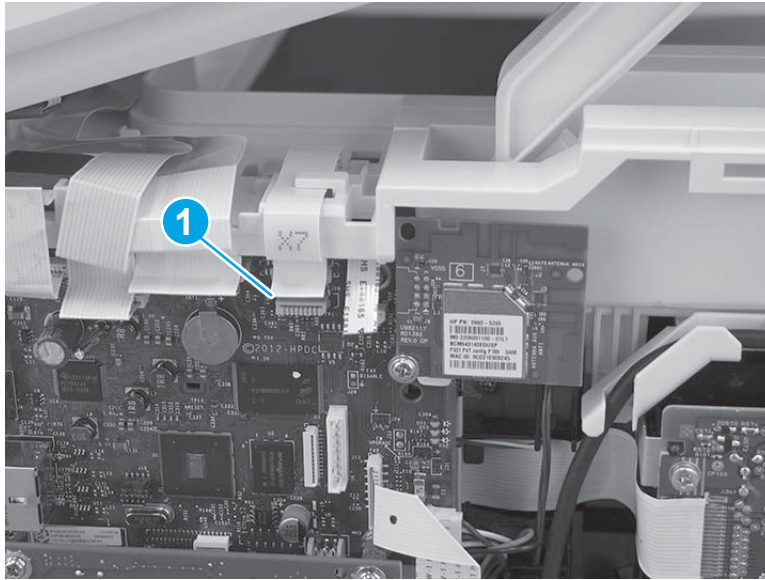

3. Lift up the control-panel FFC cover to release it.

Figure 1-1013 Release the control-panel FFC cover

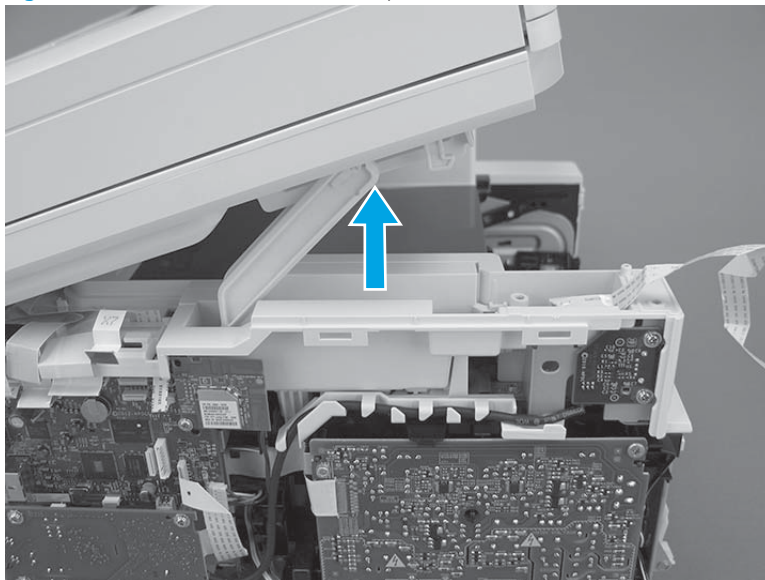

4. Remove the cover and FFC.

Figure 1-1014 Remove the cover and FFC

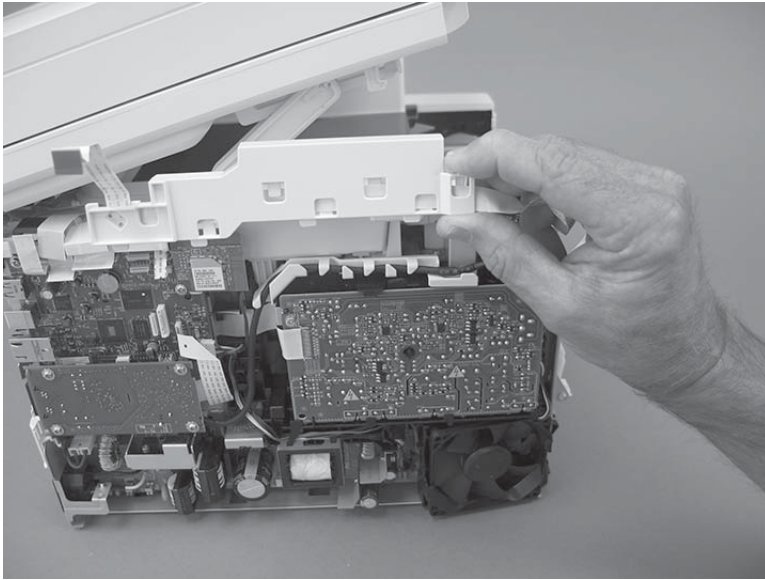

5. Release the FFC from the retainers (callout 1) on the cover to remove it.

 **Reinstallation tip:** Take note of how the FFC is installed on the cover. Make sure that the replacement FFC is installed with the pre-folds in the FFC correctly positioned to reach the formatter and the control panel.

Figure 1-1015 Remove the FFC

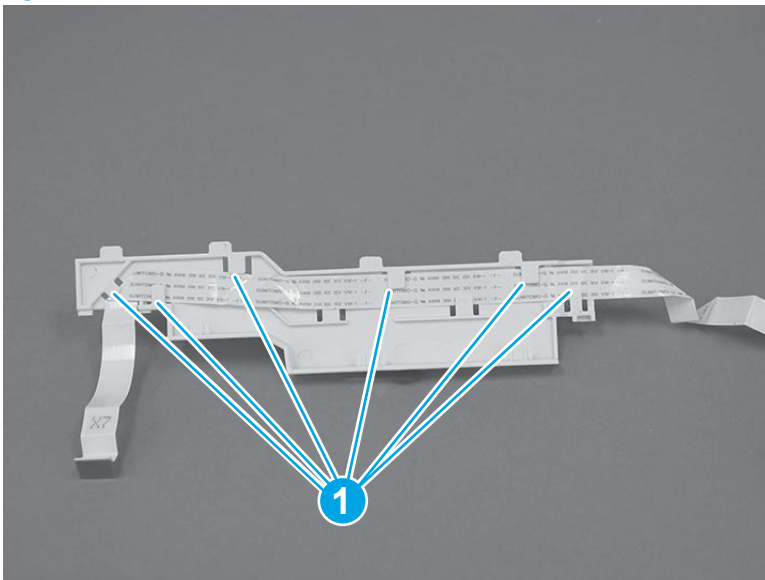



Step 9: Unpack the replacement assembly

1. Dispose of the defective part.

 **NOTE:** HP recommends responsible disposal of the defective part.

<http://www8.hp.com/us/en/hp-information/environment/product-recycling.html>

2. Unpack the replacement part from the packaging.

 **CAUTION:**  Some parts are sensitive to electrostatic discharge (ESD). Always perform service work at an ESD-protected workstation or mat. If an ESD workstation or mat is not available, touch the sheet-metal chassis to provide a static ground before touching an ESD-sensitive assembly. Protect the ESD-sensitive assemblies by placing them in ESD pouches when they are out of the printer.

If the replacement part is a roller or pad, avoid touching the spongy part of it. Skin oils on the roller or pad can cause paper pickup and/or print-quality problems. HP recommends using disposable gloves when handling rollers or pads or washing your hands before touching rollers or pads.

 **IMPORTANT:** Make sure that all of the shipping materials (for example shipping tape) are removed from the replacement part prior to installation.

3. To install an assembly, reverse the removal steps.

 **NOTE:** When applicable, special installation instructions are provided for an assembly at the end of the removal procedure. Always completely read the removal instructions and follow all special installation instructions.

Removal and replacement: Trays

- [Removal and replacement: Tray 2](#)

Removal and replacement: Tray 2

- [Removal and replacement: RM2-5392-010CN 250-sheet paper input tray](#)
- [Removal and replacement: RM2-5452-000CN Tray 2 paper pickup roller assembly](#)
- [Removal and replacement: RM2-5397-000CN Tray 2 separation roller assembly](#)
- [Removal and replacement:RM2-5375-000CN Tray 2 sensor assembly](#)

Removal and replacement: RM2-5392-010CN 250-sheet paper input tray

- [Introduction](#)
- [Step 1: Remove Tray 2](#)
- [Step 2: Unpack the replacement assembly](#)

Introduction

This document provides the procedures to remove and replace Tray 2.

Before performing service

Turn the printer power off

- Disconnect the power cable.

 **WARNING!** To avoid damage to the printer, turn the printer off, wait 30 seconds, and then remove the power cable before attempting to service the printer.

Use the table below to identify the correct part number for your printer. To order the part, go to www.hp.com/buy/parts.

Tray 2 part number	
RM2-5392-010CN	Cassette (Tray 2) assembly

Required tools

- No special tools are required to remove this part.

After performing service

Turn the printer power on

- Connect the power cable.
- Use the power switch to turn the power on.

Post service test

Make sure that the printer initializes to a **Ready** state.

Print a configuration page (from Tray 2) to make sure that the printer is functioning correctly.

Step 1: Remove Tray 2

- ▲ Pull the tray straight out of the printer to remove it.

Figure 1-1016 Remove the tray





Step 2: Unpack the replacement assembly

1. Dispose of the defective part.

 **NOTE:** HP recommends responsible disposal of the defective part.

<http://www8.hp.com/us/en/hp-information/environment/product-recycling.html>

2. Unpack the replacement part from the packaging.

 **CAUTION:**  Some parts are sensitive to electrostatic discharge (ESD). Always perform service work at an ESD-protected workstation or mat. If an ESD workstation or mat is not available, touch the sheet-metal chassis to provide a static ground before touching an ESD-sensitive assembly. Protect the ESD-sensitive assemblies by placing them in ESD pouches when they are out of the printer.

If the replacement part is a roller or pad, avoid touching the spongy part of it. Skin oils on the roller or pad can cause paper pickup and/or print-quality problems. HP recommends using disposable gloves when handling rollers or pads or washing your hands before touching rollers or pads.

 **IMPORTANT:** Make sure that all of the shipping materials (for example shipping tape) are removed from the replacement part prior to installation.

3. To install an assembly, reverse the removal steps.

 **NOTE:** When applicable, special installation instructions are provided for an assembly at the end of the removal procedure. Always completely read the removal instructions and follow all special installation instructions.

Removal and replacement: RM2-5452-000CN Tray 2 paper pickup roller assembly

- [Introduction](#)
- [Step 1: Remove Tray 2](#)
- [Step 2: Remove the pickup roller assembly \(Tray 2\)](#)
- [Step 3: Unpack the replacement assembly](#)

Introduction

This document provides the procedures to remove and replace the paper pickup roller assembly (Tray 2).

Before performing service

Turn the printer power off

- Disconnect the power cable.

⚠ WARNING! To avoid damage to the printer, turn the printer off, wait 30 seconds, and then remove the power cable before attempting to service the printer.

Use the table below to identify the correct part number for your printer. To order the part, go to www.hp.com/buy/parts.

Paper pickup roller assembly (Tray 2) part number	
RM2-5452-000CN	Paper pickup roller assembly (Tray 2)

Required tools

- No special tools are required to remove this part.

After performing service

Turn the printer power on

- Connect the power cable.
- Use the power switch to turn the power on.

Post service test

Make sure that the printer initializes to a **Ready** state.

Print a page from Tray 2 to make sure that the printer is functioning correctly.

Step 1: Remove Tray 2

- ▲ Pull the tray straight out of the printer to remove it.

Figure 1-1017 Remove the tray



Step 2: Remove the pickup roller assembly (Tray 2)

CAUTION: When handling the roller holder, do not touch the gray spongy portion of the rollers. Skin oils on the rollers can cause paper handling problems.

NOTE: The M304/M305/M404/M405 printer is shown in this procedure. However, the procedure is valid for the M329/M428/M429 printers.

1. Carefully rotate the printer backward.

CAUTION: To avoid damage to the rear cassette cover, keep it in the closed position.

Figure 1-1018 Tilt the printer backward

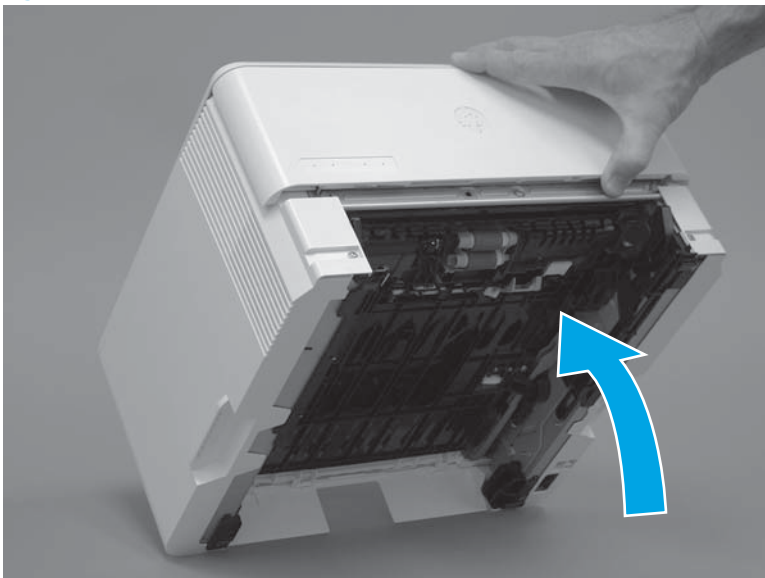

2. Continue rotate the printer backward until it rests on the rear cover, bottom-side face forward.

CAUTION: M329/M428/M429: The integrated scanner assembly (ISA) is not captive, and can unexpectedly open when the printer is tilted back.

Figure 1-1019 Place the printer bottom-side face forward

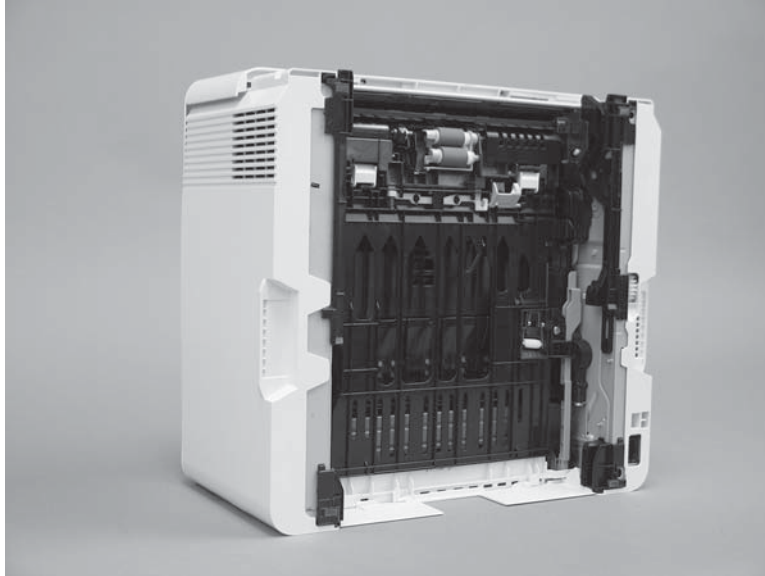

3. Release one tab (callout 1), and then slide the roller holder toward the left side of the printer to release it.

Reinstallation tip: When the assembly is reinstalled, make sure that the tab (callout 1) snaps into place.

Figure 1-1020 Release one tab

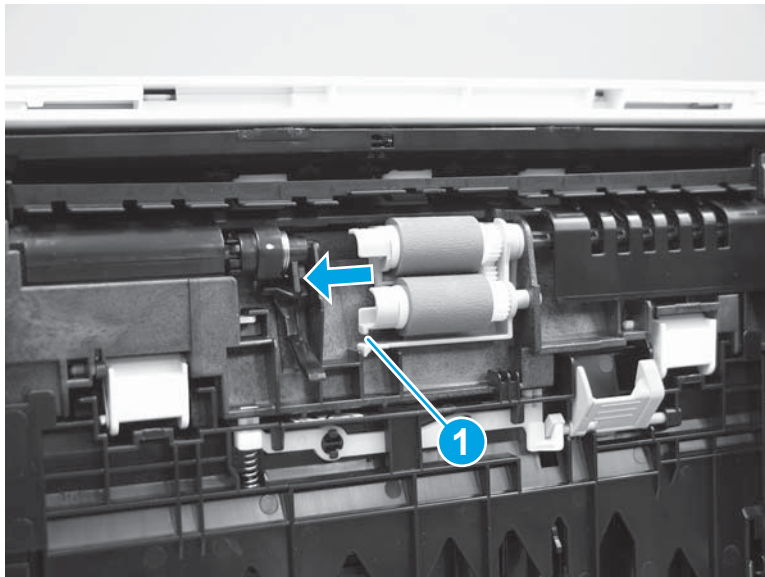

4. Remove the roller holder.

Figure 1-1021 Remove the roller holder

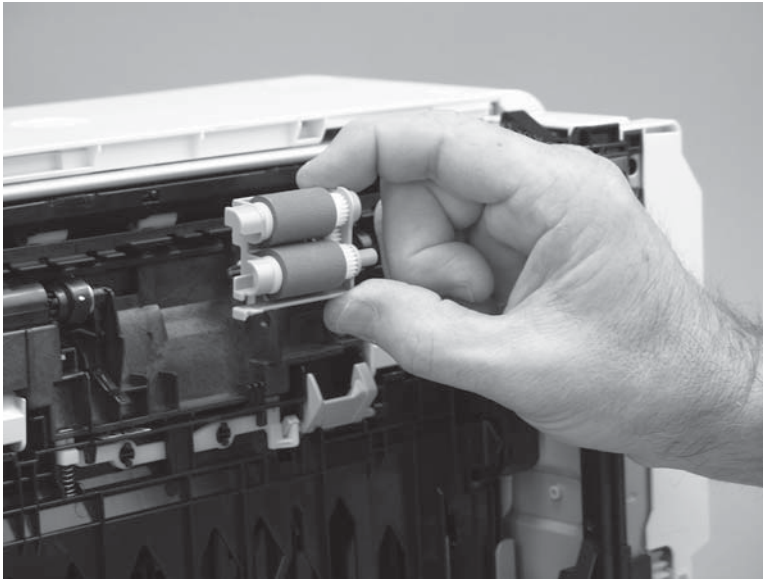



Step 3: Unpack the replacement assembly

1. Dispose of the defective part.

 **NOTE:** HP recommends responsible disposal of the defective part.

<http://www8.hp.com/us/en/hp-information/environment/product-recycling.html>

2. Unpack the replacement part from the packaging.

 **CAUTION:**  Some parts are sensitive to electrostatic discharge (ESD). Always perform service work at an ESD-protected workstation or mat. If an ESD workstation or mat is not available, touch the sheet-metal chassis to provide a static ground before touching an ESD-sensitive assembly. Protect the ESD-sensitive assemblies by placing them in ESD pouches when they are out of the printer.

If the replacement part is a roller or pad, avoid touching the spongy part of it. Skin oils on the roller or pad can cause paper pickup and/or print-quality problems. HP recommends using disposable gloves when handling rollers or pads or washing your hands before touching rollers or pads.

 **IMPORTANT:** Make sure that all of the shipping materials (for example shipping tape) are removed from the replacement part prior to installation.

3. To install an assembly, reverse the removal steps.

 **NOTE:** When applicable, special installation instructions are provided for an assembly at the end of the removal procedure. Always completely read the removal instructions and follow all special installation instructions.

Removal and replacement: RM2-5397-000CN Tray 2 separation roller assembly

- [Introduction](#)
- [Step 1: Remove Tray 2](#)
- [Step 2: Remove the separation pad roller assembly \(Tray 2\)](#)
- [Step 3: Unpack the replacement assembly](#)

Introduction

This document provides the procedures to remove and replace the separation roller assembly (Tray 2).

Before performing service

Turn the printer power off

- Disconnect the power cable.

⚠ WARNING! To avoid damage to the printer, turn the printer off, wait 30 seconds, and then remove the power cable before attempting to service the printer.

Use the table below to identify the correct part number for your printer. To order the part, go to www.hp.com/buy/parts.

Separation roller assembly (Tray 2) part number	
RM2-5397-000CN	Separation roller assembly (Tray 2)

Required tools

- No special tools are required to install this kit.

After performing service

Turn the printer power on

- Connect the power cable.
- Use the power switch to turn the power on.

Post service test

Make sure that the printer initializes to a **Ready** state.

Print a configuration page to make sure that the printer is functioning correctly.

Step 1: Remove Tray 2

- ▲ Pull the tray straight out of the printer to remove it.

Figure 1-1022 Remove the tray



Step 2: Remove the separation pad roller assembly (Tray 2)

1. Pull the separation pad assembly straight up to release it.

Figure 1-1023 Release the assembly

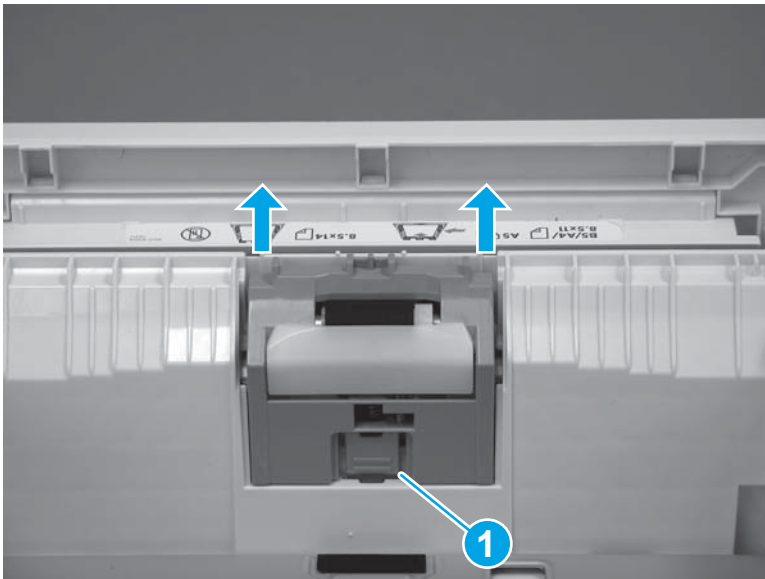

2. Remove the assembly.

Figure 1-1024 Remove the assembly

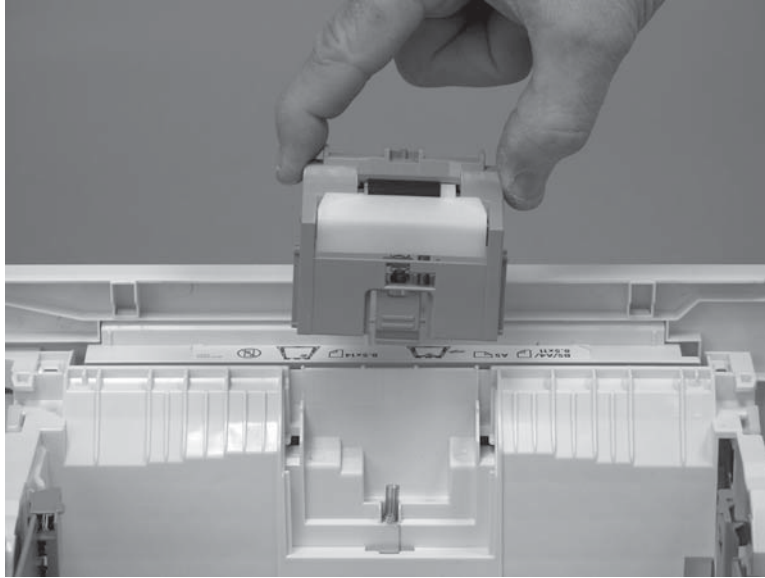

Step 3: Unpack the replacement assembly

1. Dispose of the defective part.



NOTE: HP recommends responsible disposal of the defective part.

<http://www8.hp.com/us/en/hp-information/environment/product-recycling.html>

2. Unpack the replacement part from the packaging.



CAUTION:  Some parts are sensitive to electrostatic discharge (ESD). Always perform service work at an ESD-protected workstation or mat. If an ESD workstation or mat is not available, touch the sheet-metal chassis to provide a static ground before touching an ESD-sensitive assembly. Protect the ESD-sensitive assemblies by placing them in ESD pouches when they are out of the printer.

If the replacement part is a roller or pad, avoid touching the spongy part of it. Skin oils on the roller or pad can cause paper pickup and/or print-quality problems. HP recommends using disposable gloves when handling rollers or pads or washing your hands before touching rollers or pads.



IMPORTANT: Make sure that all of the shipping materials (for example shipping tape) are removed from the replacement part prior to installation.

3. To install an assembly, reverse the removal steps.



NOTE: When applicable, special installation instructions are provided for an assembly at the end of the removal procedure. Always completely read the removal instructions and follow all special installation instructions.

Removal and replacement:RM2-5375-000CN Tray 2 sensor assembly

- [Introduction](#)
- [Step 1: Remove Tray 2](#)
- [Step 2: Remove the cartridge door assembly](#)
- [Step 3: Remove the left cover](#)
- [Step 4: Remove the right cover](#)
- [Step 5: Remove the Tray 2 sensor assembly](#)
- [Step 6: Unpack the replacement assembly](#)

Introduction

This document provides the procedures to remove and replace the Tray 2 sensor assembly.

Before performing service

Turn the printer power off

- Disconnect the power cable.

 **WARNING!** To avoid damage to the printer, turn the printer off, wait 30 seconds, and then remove the power cable before attempting to service the printer.

Use the table below to identify the correct part number for your printer. To order the part, go to www.hp.com/buy/parts.

Tray 2 sensor assembly part number	
RM2-5375-000CN	Tray 2 sensor assembly

Required tools

- #2 Phillips screwdriver with a magnetic tip.

After performing service

Turn the printer power on

- Connect the power cable.
- Use the power switch to turn the power on.

Post service test

Make sure that the printer initializes to a **Ready** state.

Step 1: Remove Tray 2

- ▲ Pull the tray straight out of the printer to remove it.

Figure 1-1025 Remove the tray



Step 2: Remove the cartridge door assembly

 **NOTE:** If the toner cartridge was not removed prior to servicing the printer, remove it now.

1. Release the support shaft (callout 1), and then slide it toward the center of the door (callout 2).

 **TIP:** It might be easier to release the support shaft by using a small flat-blade screwdriver.

Figure 1-1026 Release the support shaft

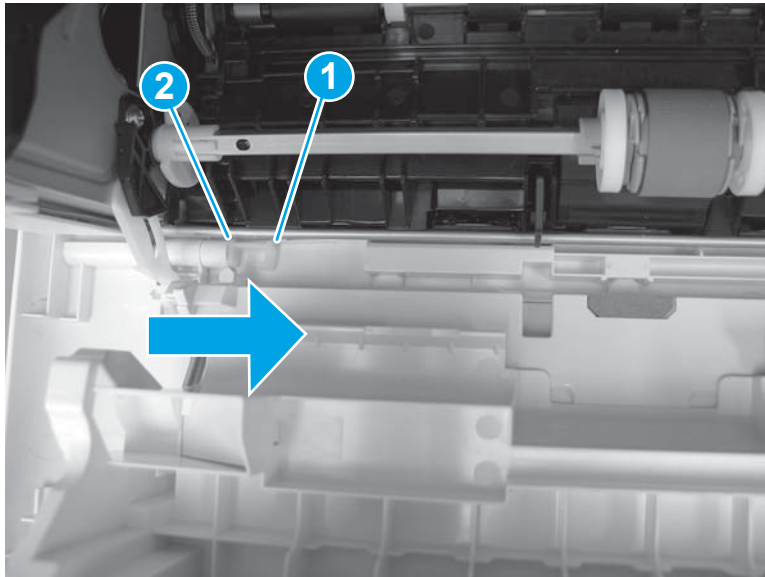

2. Remove the support shaft.

Figure 1-1027 Remove the support shaft

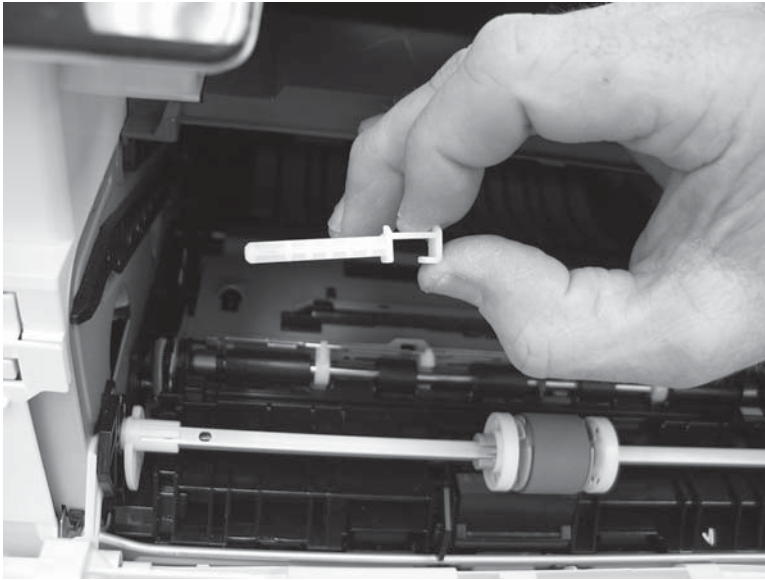

3. Release one tab (callout 1), and then slide the guide out of the printer (callout 2).

⚠ CAUTION: Be careful, the tab (callout 1) can be easily broken.

Figure 1-1028 Remove the guide

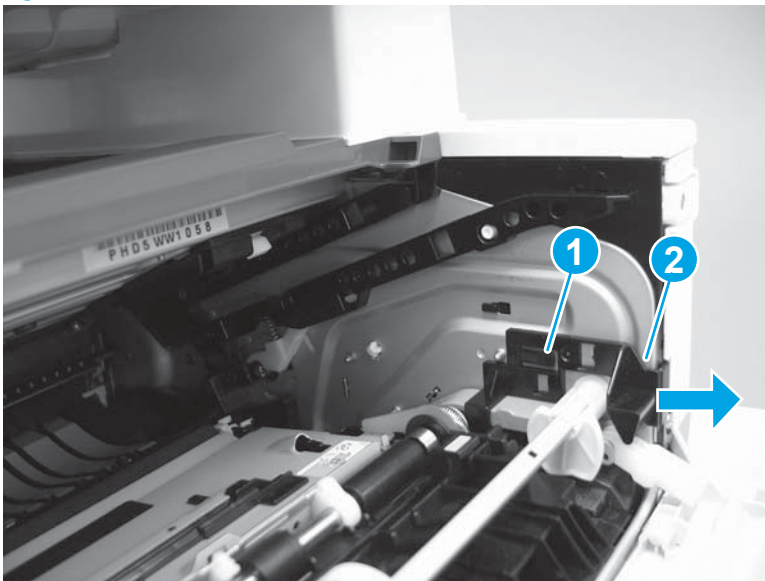

4. Use a small flat-blade screwdriver to gently pry the white-plastic door arm (callout 1) off of the gray-plastic pressure-release link (callout 2) to release the door arm.

Figure 1-1029 Release the pressure-release link

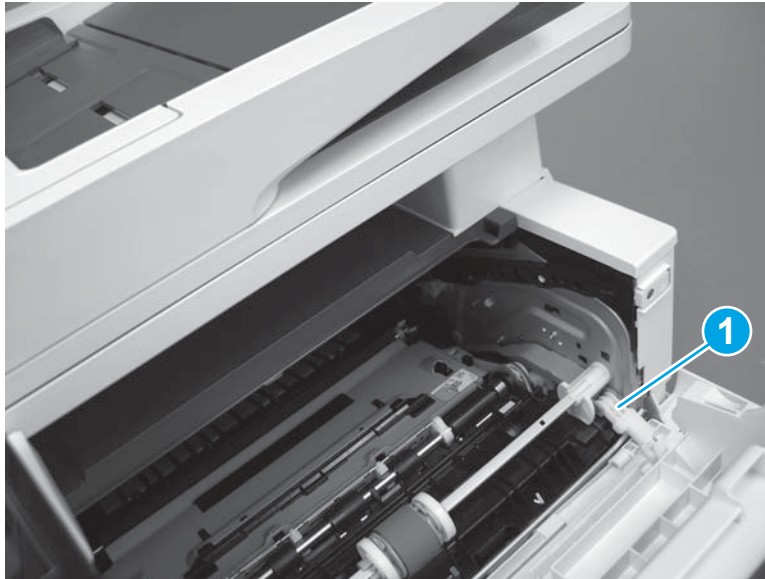

5. With the door in the partially closed position, slightly raise the left end (callout 1; raise it over the sheet-metal hinge boss), and then slide the door to the left (callout 2) to release the right hinge (callout 3).

⚠ CAUTION: The door is still attached to the printer by the left-side retainer arm. Do not attempt to completely remove the door.

💡 Reinstallation tip: When reinstalling the door, there are two right-side hinge pins (not shown in callout 3). Keep a finger pressed on the left-side retainer arm so that it does not disengage from the door.

Figure 1-1030 Release the door

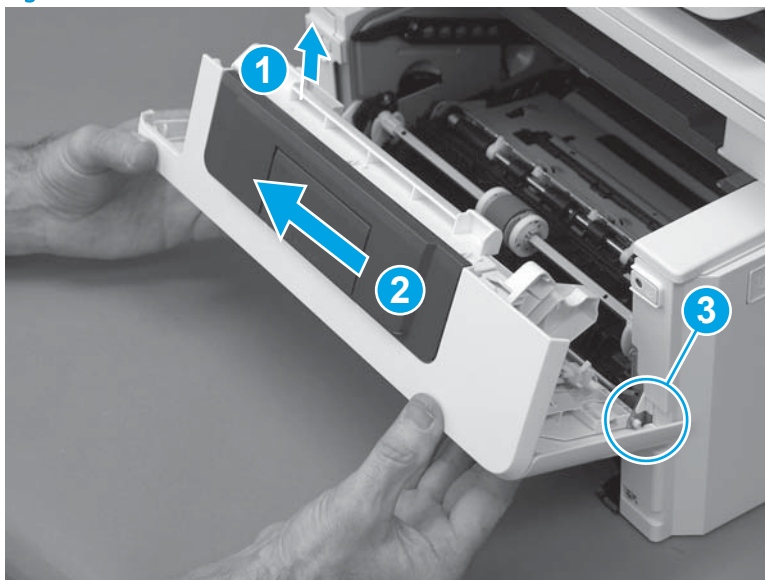

6. Rotate the door away from the printer until the keyed pin on the left-side retainer arm can disengage from the door.

Figure 1-1031 Release the left-side retainer arm

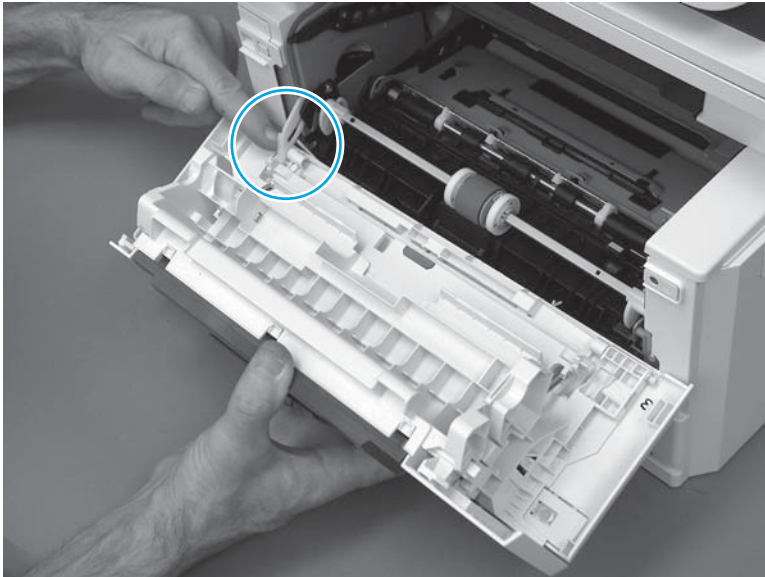

7. Remove the door.

Figure 1-1032 Remove the door

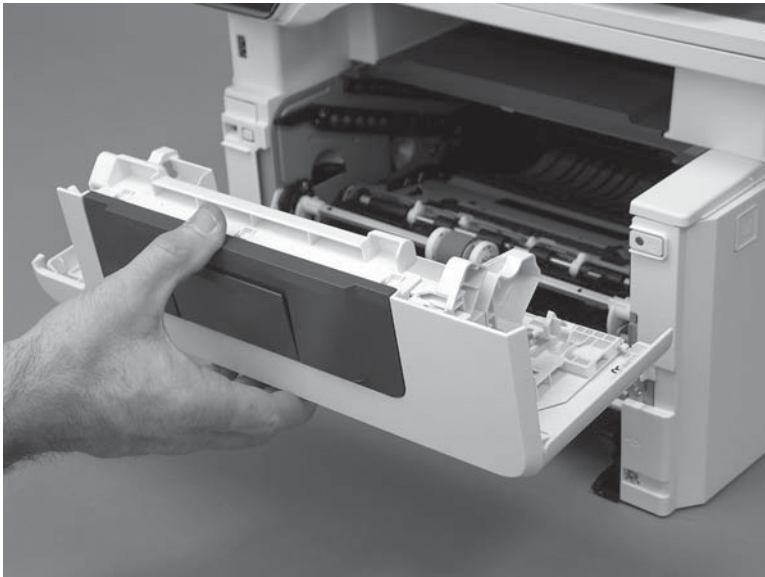

Step 3: Remove the left cover

1. Remove one screw (callout 1).

Figure 1-1033 Remove one screw

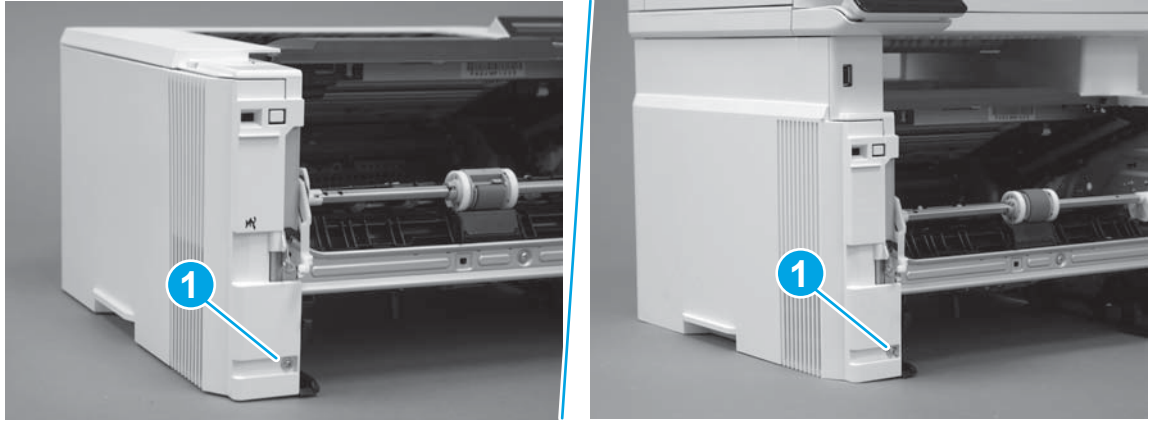

2. Open the rear door, release two bosses (callout 1), and then release three tabs (callout 2).

Figure 1-1034 Release two bosses and three tabs

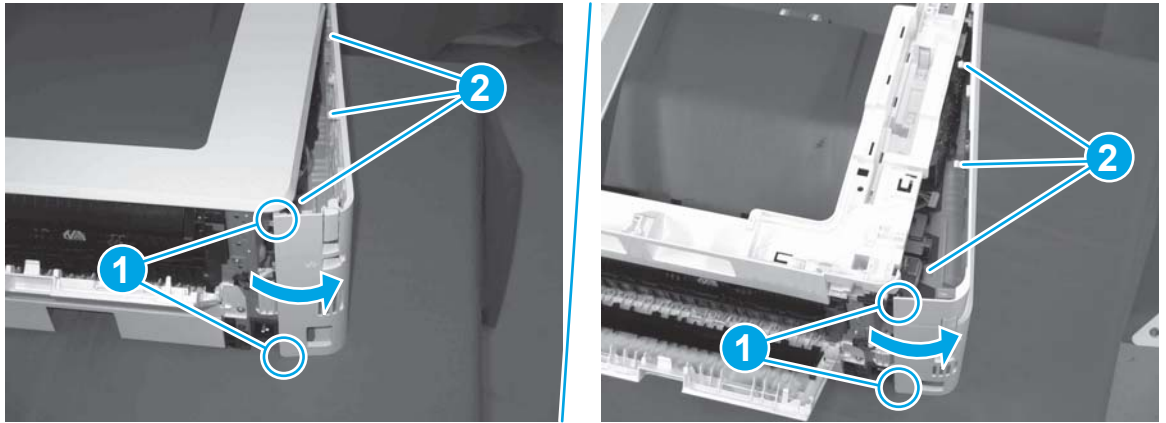

3. At the front of the printer, do one of the following:
 - **M304/M305/M404/M405:** Release two bosses (callout 1), and then remove the cover (callout 2).
 - **M329/M428/M429:** Release one tab (callout 3), two bosses (callout 4), and then remove the cover (callout 5).

⚠ CAUTION: Be careful when releasing the upper bosses on the M329/M428/M429 cover. One portion of the cover (callout 6) is fragile and is easily broken.

Figure 1-1035 Remove the cover

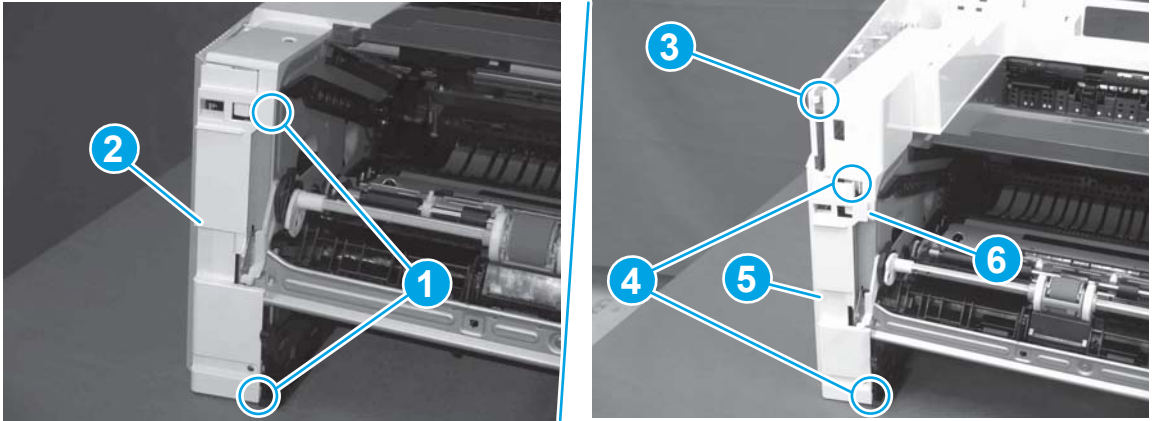

Step 4: Remove the right cover

1. At the front of the printer, release two bosses (callout 1), and then release three tabs (callout 2).

 **Reinstallation tip:** Remove, and then reinstall the cover if the switch or button does not correctly function.

Figure 1-1036 Release two bosses and three tabs

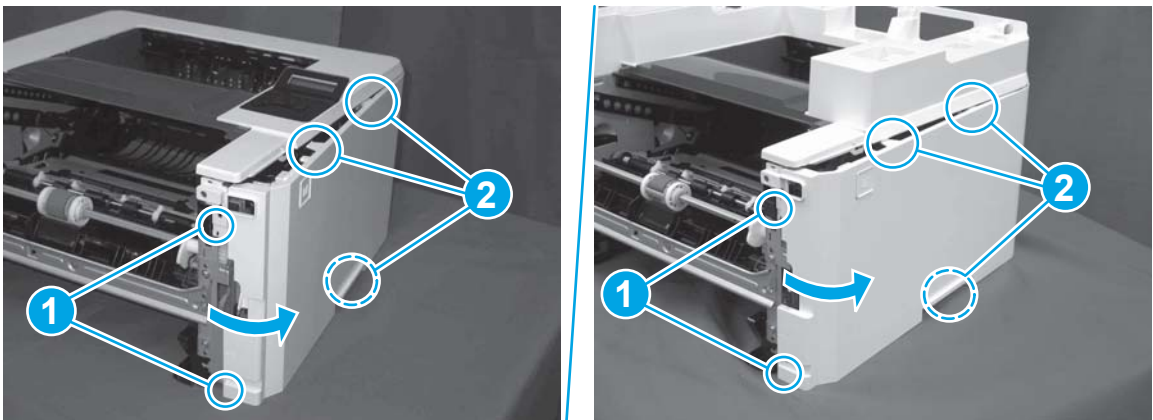

2. Open the rear door, release two bosses (callout 1), and then remove the cover (callout 2).

Figure 1-1037 Remove the cover

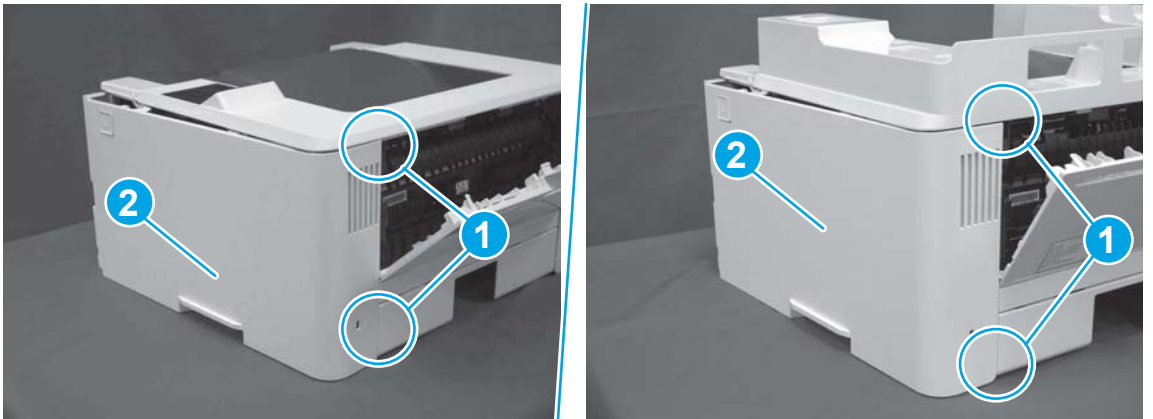

Step 5: Remove the Tray 2 sensor assembly

1. Grasp the white flanges on the Tray 1 pickup roller shaft, and then rotate the shaft clockwise (up to 90 degrees) to access the roller holder locking lever.

 **Reinstallation tip:** Take note of the original roller position. When the roller is reinstalled, make sure to return the roller to its original position.

Figure 1-1038 Rotate the Tray 1 pickup roller shaft



2. Raise the jam access door (callout 1), release one tab (callout 2), and then slide the roller and holder as shown (callout 3) to move it out of the way.

 **CAUTION:** Do not touch the gray spongy portion of the roller. Skin oils on the roller can cause paper handling problems.

Figure 1-1039 Slide the roller and holder out of the way



3. Remove the Tray 1 separation pad (callout 1).

Figure 1-1040 Remove the Tray 1 separation pad

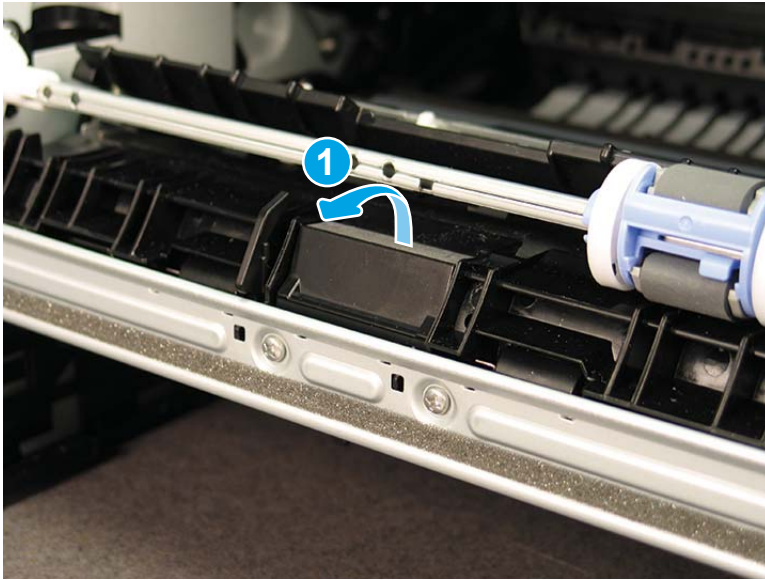

4. Do the following:

- a. Remove four screws (callout 1/2/3/4).

 **IMPORTANT:** When the stay is reinstalled, make sure that the screws are installed in the correct order (callout 1/2/3/4 in order).

- b. Release two hooks (callout 5), and then remove the front stay (callout 6).

 **Reinstallation tip:** When reinstalled, the bosses (callout 7) must engage the holes in the stay. Make sure that the stay is not positioned on top of the bosses.

Figure 1-1041 Remove the front stay



5. Rotate each spring (callout 1) down, and then unhook the springs from the hooks (callout 2).

Figure 1-1042 Remove the springs (1 of 2)

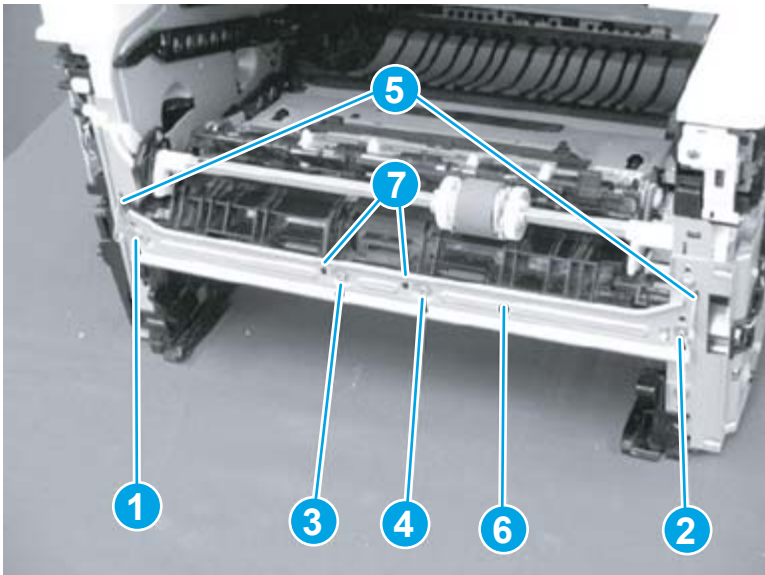
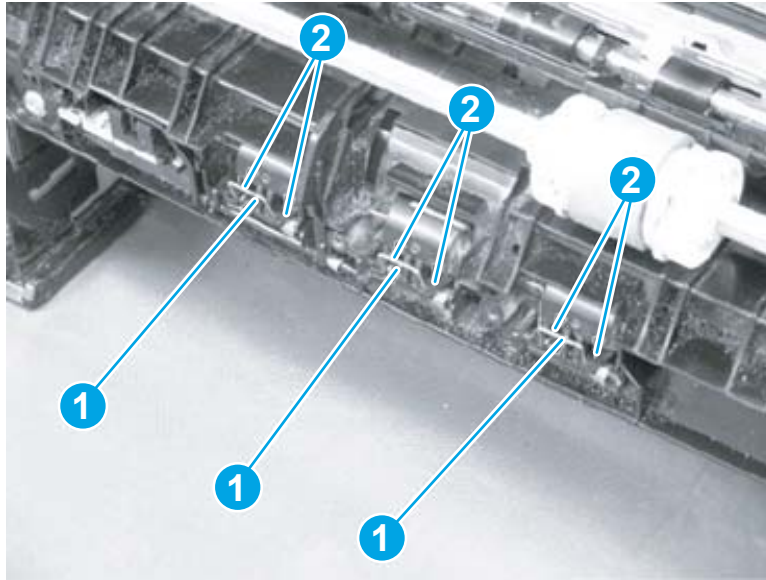
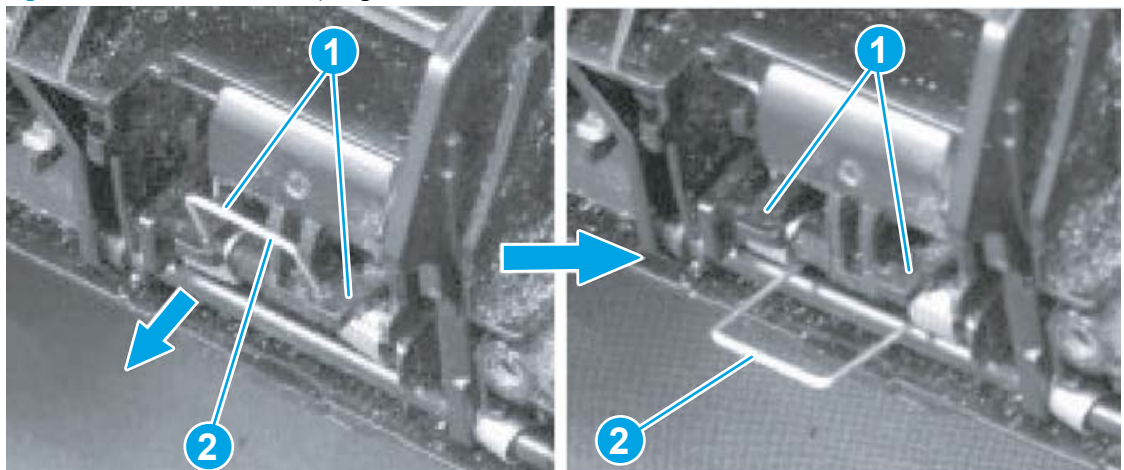
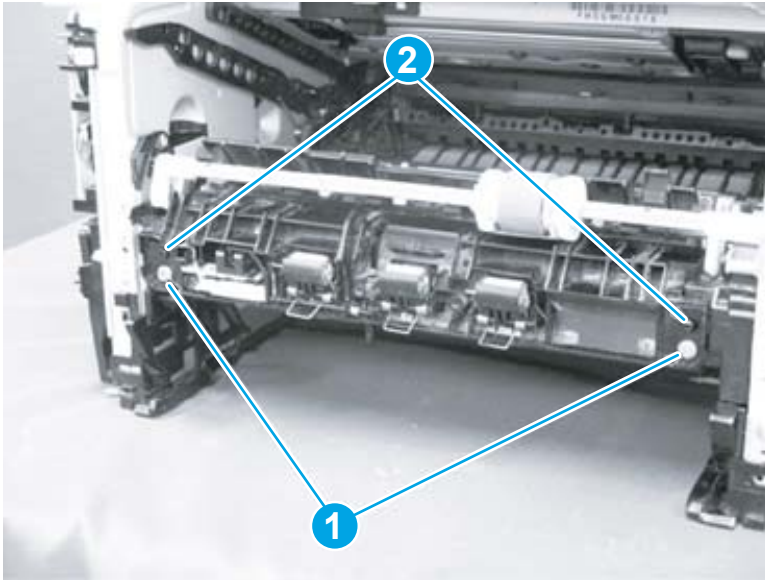

Figure 1-1043 Remove the springs (2 of 2)



6. Remove two screws (M4 tapping; callout 1), and then release two bosses (callout 2).

Figure 1-1044 Remove two screw and release two bosses



7. Separate the Tray 1 pickup assembly (callout 1) from the printer (as shown below).

⚠ CAUTION: Do not attempt to completely remove the assembly. The assembly is still connected to the printer by a wire harness (callout 2).

Figure 1-1045 Separate the Tray 1 pickup assembly from the printer

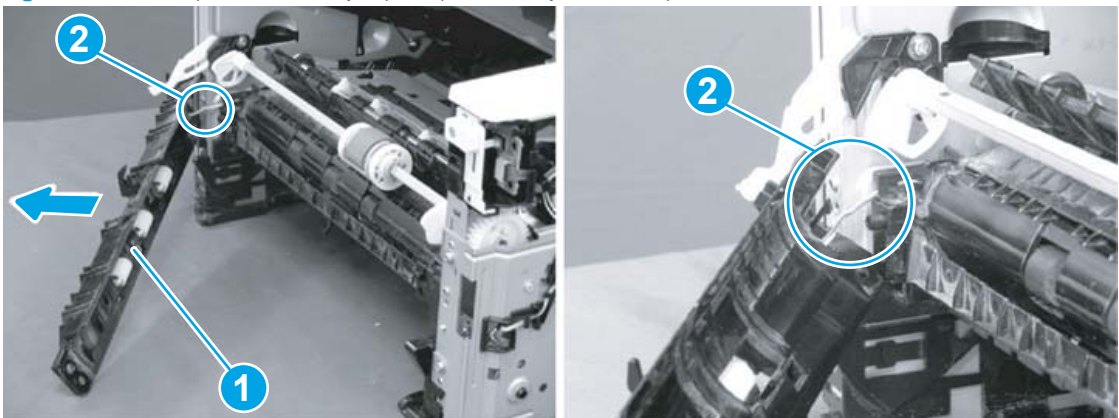

- Slightly flex the pickup guide (callout 1) to release the left-side and right side bosses (callout 2), and then remove the pickup guide.

Figure 1-1046 Remove the pickup guide

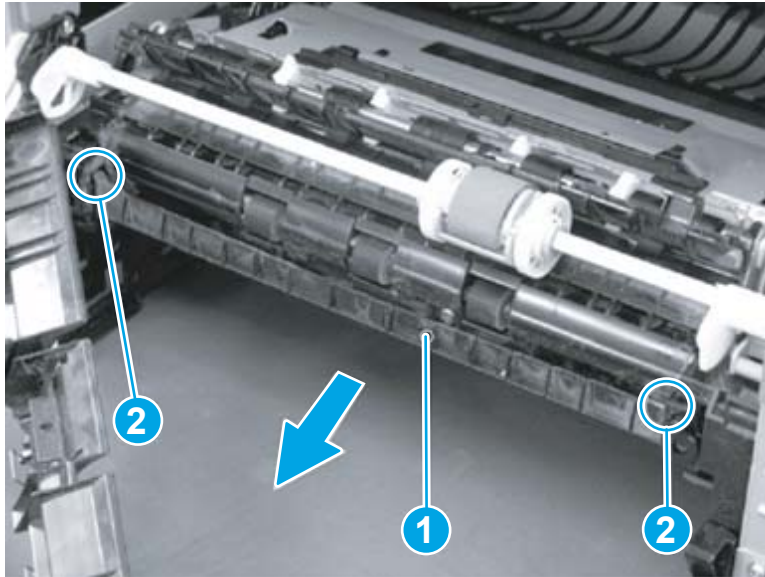

- Remove one screw (callout 1), release two bosses (callout 2), and then remove the guide and sensor lever (callout 2) assembly.

Figure 1-1047 Remove the guide and sensor lever assembly

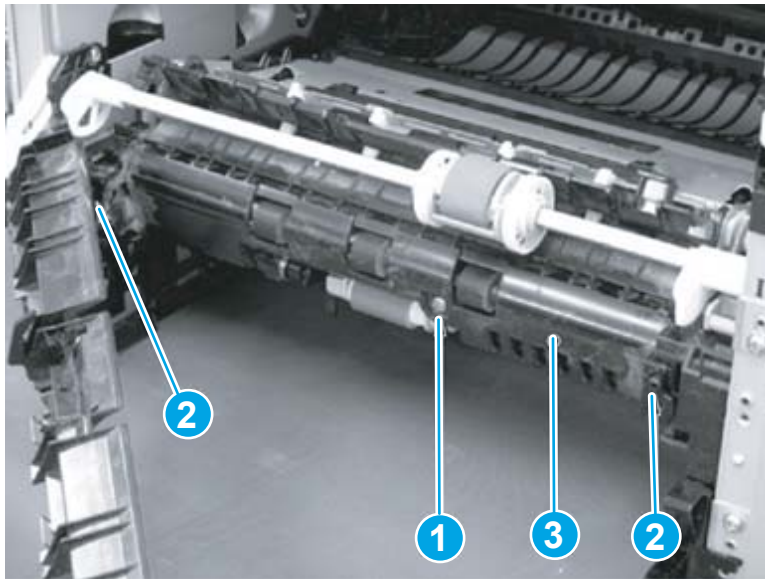

- Slide the sensor lever (callout 1) as shown, and then remove it from the guide (callout 2).

 **Reinstallation tip:** After reinstalling the guide and lever assembly on the printer, check the following:

- Verify that the sensor lever (callout 1) returns to the home position when the lever is manually moved to the forward position and released (sensor lever spring return; callout 3).
- Verify that the sensor lever (callout 1) returns to the home position when the lever is manually moved to the rear position and released (sensor lever weight return; callout 4).

If the sensor lever does not return to the home position, remove the guide and lever assembly, and then remove and reinstall the lever.

Figure 1-1048 Remove the sensor lever

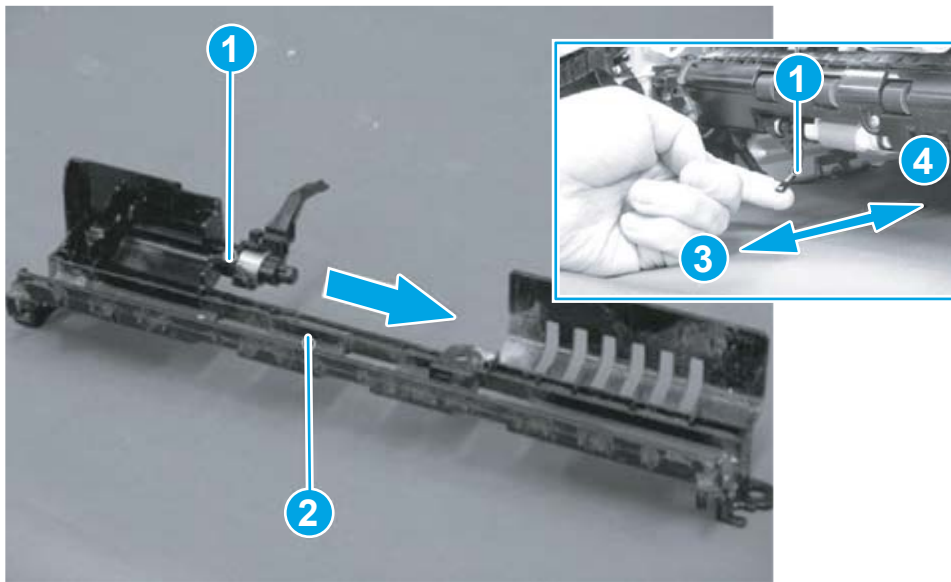



Step 6: Unpack the replacement assembly

1. Dispose of the defective part.

 **NOTE:** HP recommends responsible disposal of the defective part.

<http://www8.hp.com/us/en/hp-information/environment/product-recycling.html>

2. Unpack the replacement part from the packaging.

 **CAUTION:**  Some parts are sensitive to electrostatic discharge (ESD). Always perform service work at an ESD-protected workstation or mat. If an ESD workstation or mat is not available, touch the sheet-metal chassis to provide a static ground before touching an ESD-sensitive assembly. Protect the ESD-sensitive assemblies by placing them in ESD pouches when they are out of the printer.

If the replacement part is a roller or pad, avoid touching the spongy part of it. Skin oils on the roller or pad can cause paper pickup and/or print-quality problems. HP recommends using disposable gloves when handling rollers or pads or washing your hands before touching rollers or pads.

 **IMPORTANT:** Make sure that all of the shipping materials (for example shipping tape) are removed from the replacement part prior to installation.

3. To install an assembly, reverse the removal steps.

 **NOTE:** When applicable, special installation instructions are provided for an assembly at the end of the removal procedure. Always completely read the removal instructions and follow all special installation instructions.

Removal and replacement: Accessories

- [550-sheet paper feeder](#)

550-sheet paper feeder



NOTE: HP recommends removing the accessory from the product before servicing them.

- [Removal and replacement: D9P29-67018 optional 550-sheet paper feeder](#)
- [Removal and replacement: RM2-5413-000CN optional Tray 3 cassette](#)
- [Removal and replacement: RM2-5741-000CN optional Tray 3 paper pickup roller assembly](#)
- [Removal and replacement: RM2-5745-000CN optional Tray 3 separation roller assembly](#)

Removal and replacement: D9P29-67018 optional 550-sheet paper feeder

- [Introduction](#)
- [Step 1: Remove the optional 550-sheet feeder Tray 3](#)
- [Step 2: Unpack the replacement optional paper feeder](#)
- [Step 3: Install the optional 550-sheet feeder Tray 3](#)

Introduction

This document provides the procedures to remove and replace the optional 550-sheet paper feeder.

Before performing service

Turn the printer power off

- Disconnect the power cable.

⚠ WARNING! To avoid damage to the printer, turn the printer off, wait 30 seconds, and then remove the power cable before attempting to service the printer.

Use the table below to identify the correct part number for your printer. To order the part, go to www.hp.com/buy/parts.

Optional 550-sheet paper feeder part number	
D9P29-67018	Optional 550-sheet paper feeder (optional Tray 3 accessory)

Required tools

- No special tools are required to remove this part.

After performing service

Turn the printer power on

- Connect the power cable.
- Use the power switch to turn the power on.

Post service test

Make sure that the printer initializes to a **Ready** state.

Print a page from the optional Tray 3 to make sure that the paper feeder is functioning correctly.

Step 1: Remove the optional 550-sheet feeder Tray 3

- ▲ Carefully lift the printer off of the paper feeder assembly.

Figure 1-1049 Remove the printer

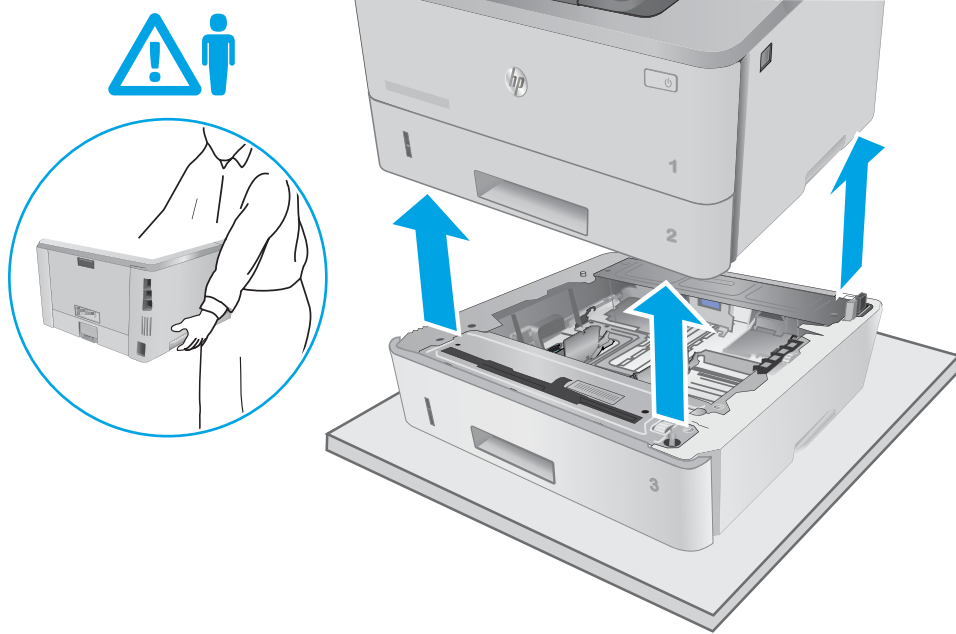

Step 2: Unpack the replacement optional paper feeder

Unpack the replacement part from the packaging.

<http://www8.hp.com/us/en/hp-information/environment/product-recycling.html>

 **NOTE:** HP recommends responsible disposal of the defective part.

Figure 1-1050 Recycle and unpack

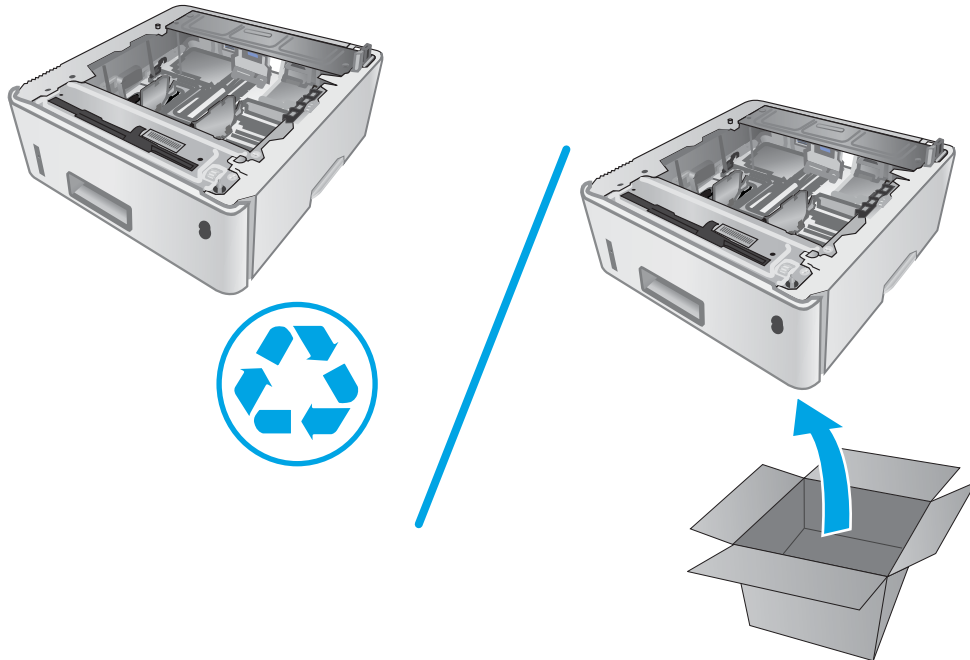

Step 3: Install the optional 550-sheet feeder Tray 3

1. Remove the orange shipping tape.

Figure 1-1051 Remove shipping tape

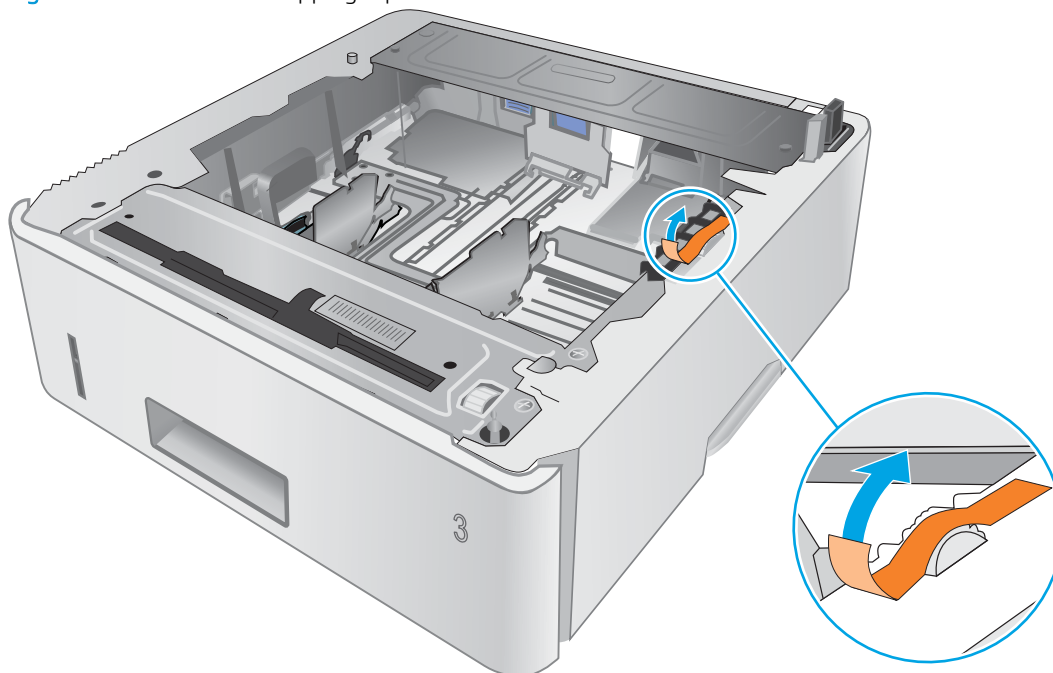

2. Carefully place the printer on the paper feeder assembly.

Figure 1-1052 Install the printer

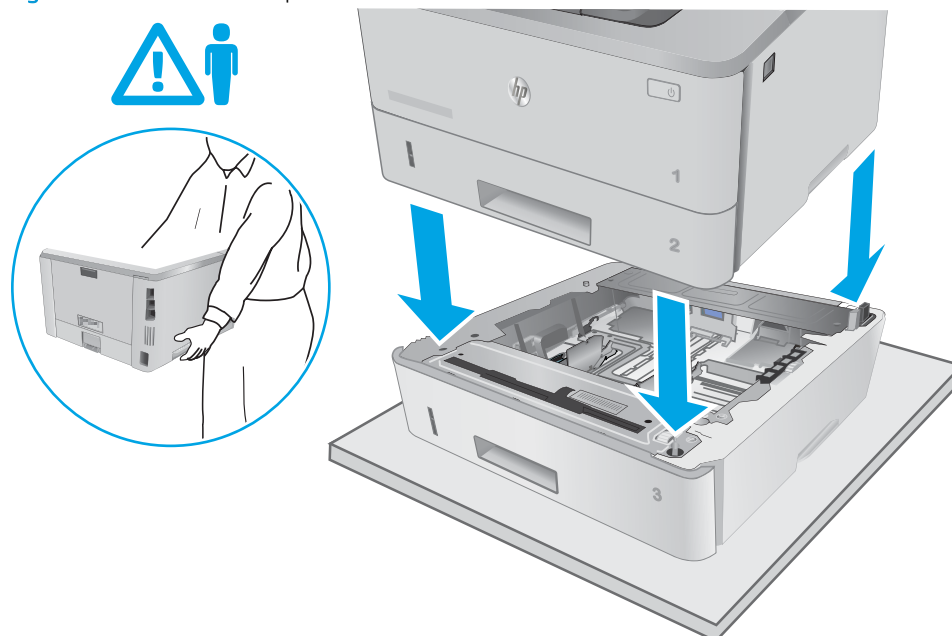

3. Pull Tray 3 out of the paper feeder assembly to remove it.

Figure 1-1053 Remove Tray 3

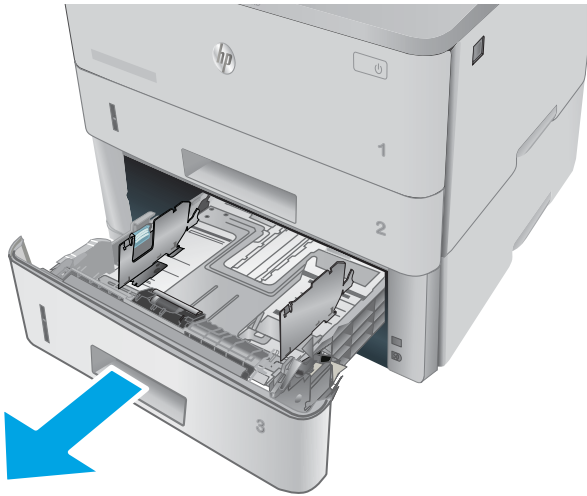

4. Adjust the Tray 3 sliding paper guides.

Figure 1-1054 Adjust the paper guides

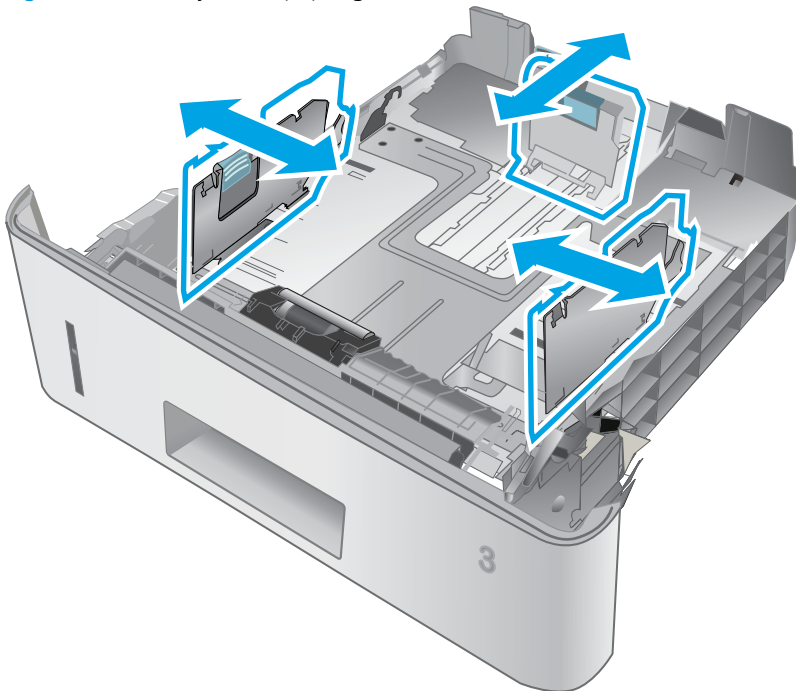

5. Load paper in Tray 3.

Figure 1-1055 Load paper

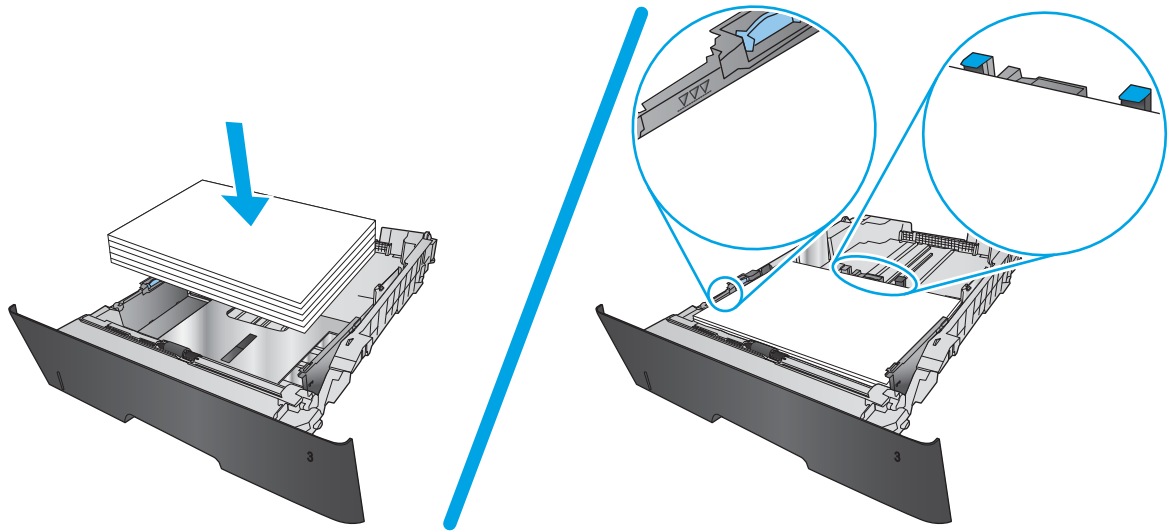

6. Slide Tray 3 into the paper feeder assembly to install it.

Figure 1-1056 Install



Removal and replacement: RM2-5413-000CN optional Tray 3 cassette

- [Introduction](#)
- [Step 1: Remove optional Tray 3](#)
- [Step 2: Unpack the replacement assembly](#)
- [Step 3: Install optional Tray 3](#)

Introduction

This document provides the procedures to remove and replace the optional Tray 3 cassette.

Before performing service

Turn the printer power off

- Disconnect the power cable.

 **WARNING!** To avoid damage to the printer, turn the printer off, wait 30 seconds, and then remove the power cable before attempting to service the printer.

Use the table below to identify the correct part number for your printer. To order the part, go to www.hp.com/buy/parts.

Tray 3 part number	
RM2-5413-000CN	550-sheet paper feeder cassette (optional Tray 3)

Required tools

- No special tools are required to remove this part.

After performing service

Turn the printer power on

- Connect the power cable.
- Use the power switch to turn the power on.

Post service test

Make sure that the printer initializes to a **Ready** state.

Print a page from Tray 3 to make sure that the paper feeder is functioning correctly.

Step 1: Remove optional Tray 3

1. Pull the tray straight out of the printer until it stops.

Figure 1-1057 Pull the tray out of the printer

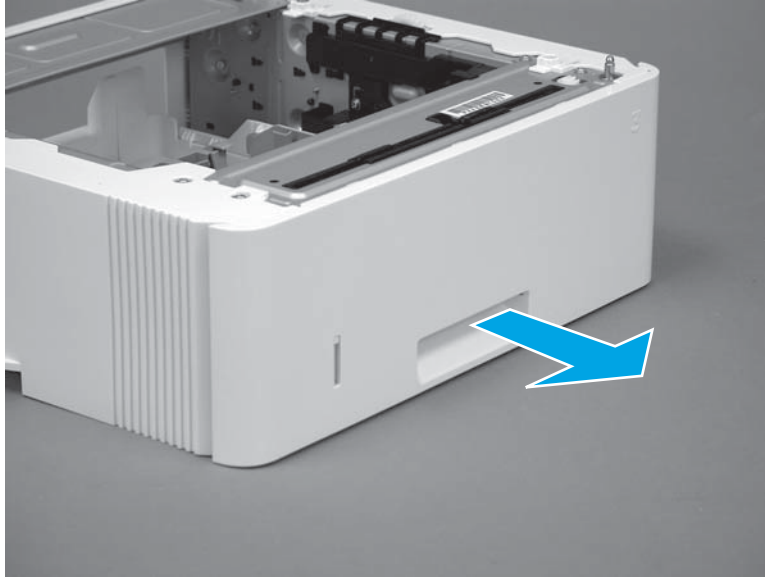

2. Slightly lift up on the front of the tray to release it, and then continue to pull the tray out of the accessory to remove it.

Figure 1-1058 Release and remove the tray

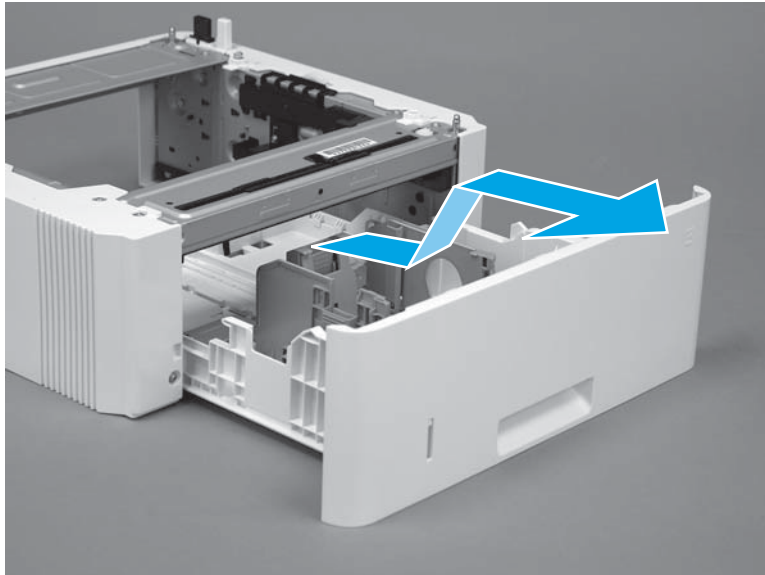

Step 2: Unpack the replacement assembly

Unpack the replacement part from the packaging.

<http://www8.hp.com/us/en/hp-information/environment/product-recycling.html>

 **NOTE:** HP recommends responsible disposal of the defective part.

Figure 1-1059 Recycle and unpack

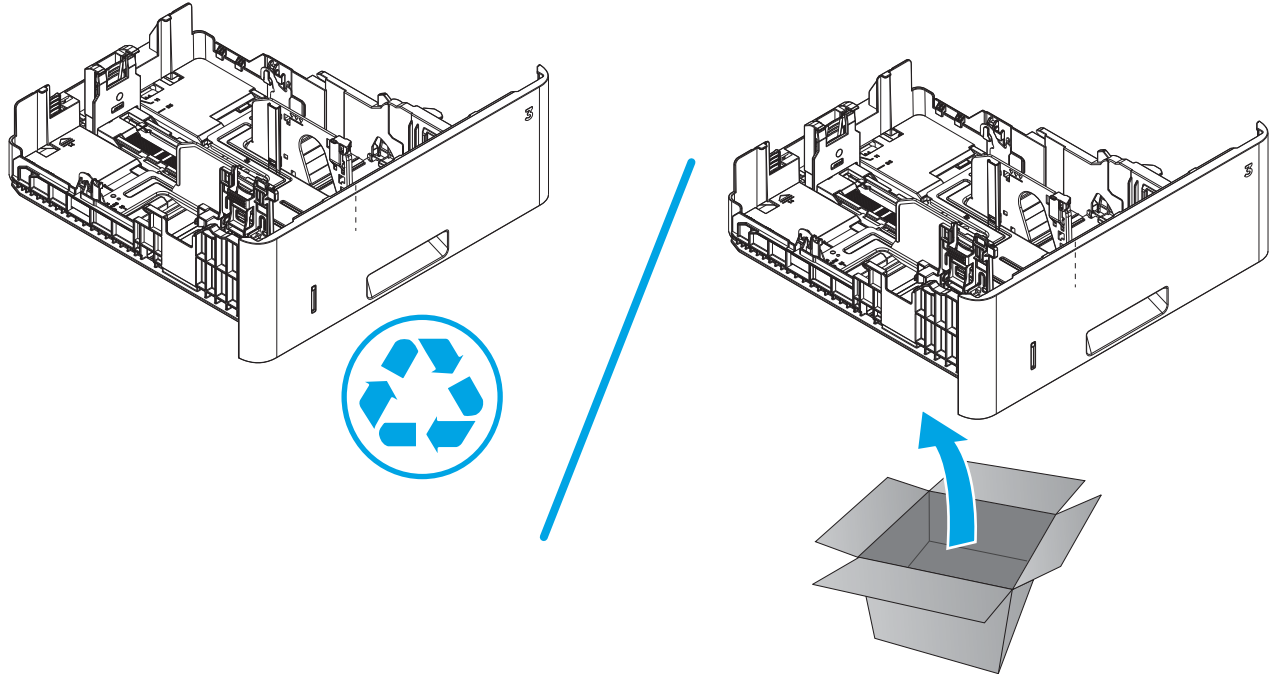

Step 3: Install optional Tray 3

1. With the tray at a slight angle, align the sides of the tray with the rails in the accessory, and then partially slide the tray into the accessory.

Figure 1-1060 Install the tray

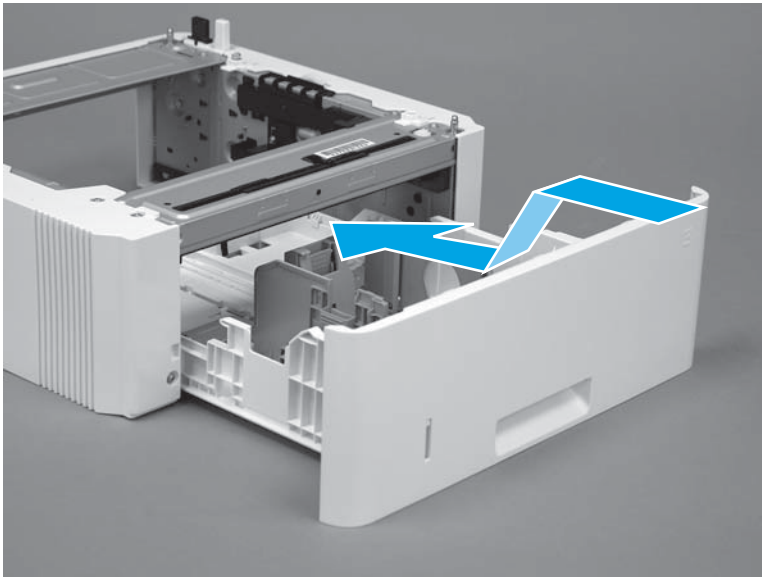

2. Push the tray straight into the accessory to close it.

Figure 1-1061 Close the tray

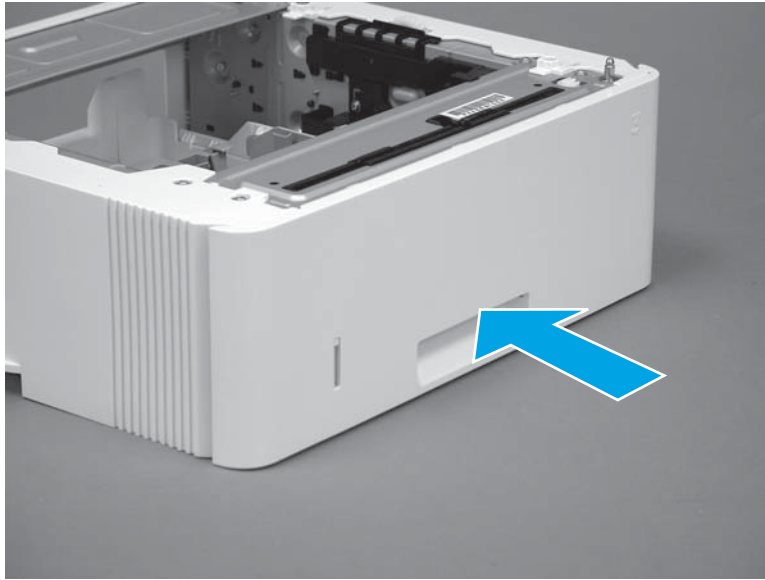

Removal and replacement: RM2-5741-000CN optional Tray 3 paper pickup roller assembly

- [Introduction](#)
- [Step 1: Remove optional Tray 3](#)
- [Step 2: Remove the paper pickup roller assembly \(Tray 3\)](#)
- [Step 3: Unpack the replacement assembly](#)
- [Step 4: Install the paper pickup roller assembly \(Tray 3\)](#)
- [Step 5: Install optional Tray 3](#)

Introduction

This document provides the procedures to remove and replace the paper pickup roller assembly (Tray 3).

Before performing service

Turn the printer power off

- Disconnect the power cable.

 **WARNING!** To avoid damage to the printer, turn the printer off, wait 30 seconds, and then remove the power cable before attempting to service the printer.

Use the table below to identify the correct part number for your printer. To order the part, go to www.hp.com/buy/parts.

Paper pickup roller assembly (Tray 3) part number	
---	--

RM2-5741-000N

Paper pickup roller assembly (Tray 3)

Required tools

- No special tools are required to remove this part.

After performing service

Turn the printer power on

- Connect the power cable.
- Use the power switch to turn the power on.

Post service test

Make sure that the printer initializes to a **Ready** state.

Print a page from the accessory to make sure that the printer is functioning correctly.

Step 1: Remove optional Tray 3

1. Pull the tray straight out of the printer until it stops.

Figure 1-1062 Pull the tray out of the printer

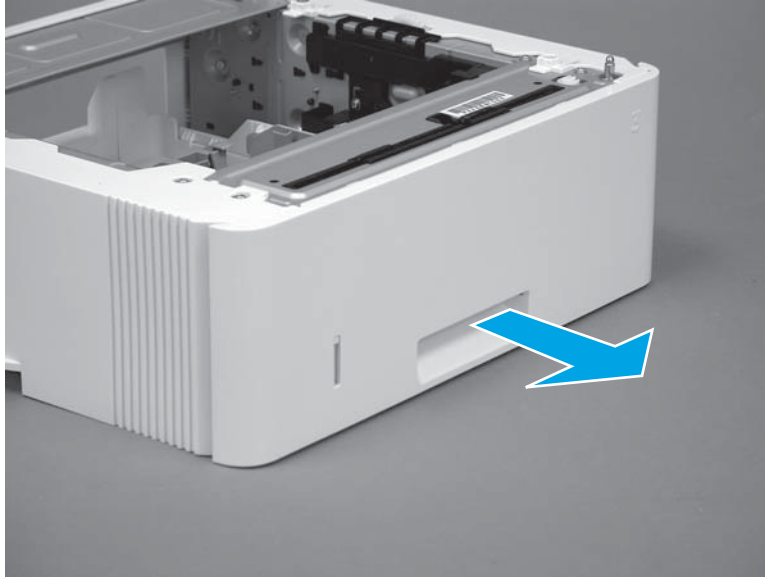

2. Slightly lift up on the front of the tray to release it, and then continue to pull the tray out of the accessory to remove it.

Figure 1-1063 Release and remove the tray

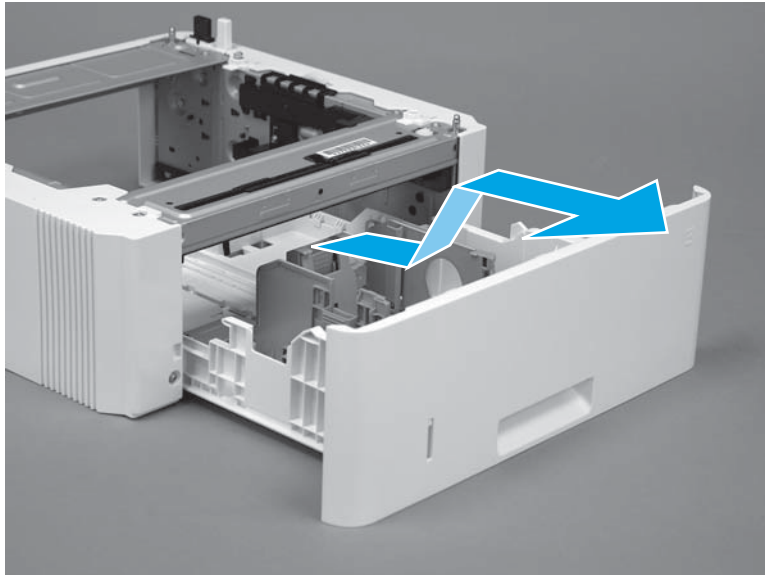

Step 2: Remove the paper pickup roller assembly (Tray 3)

⚠ CAUTION: When handling the roller holder, do not touch the gray spongy portion of the rollers. Skin oils on the rollers can cause paper handling problems.

1. Carefully turn the accessory over to expose the roller assembly.

Figure 1-1064 Turn the accessory over

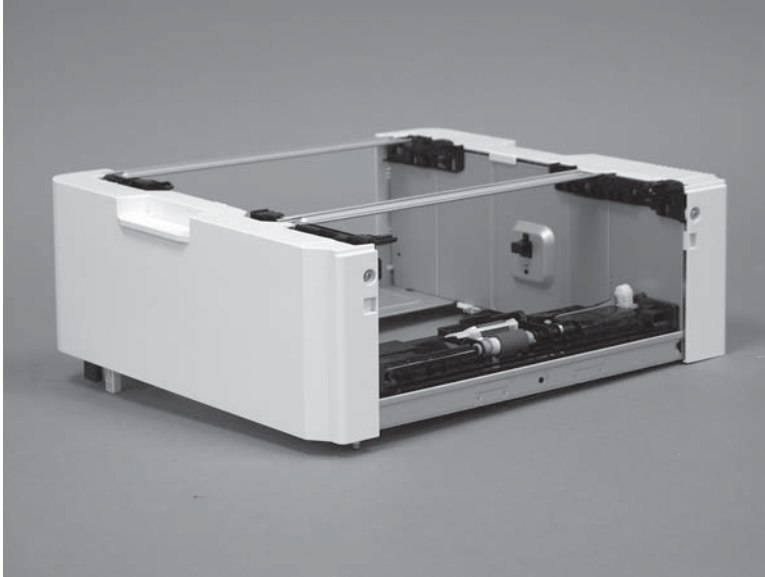

2. Slide the roller holder to the right to compress the spring-loaded shaft and release the assembly.

Figure 1-1065 Release the assembly

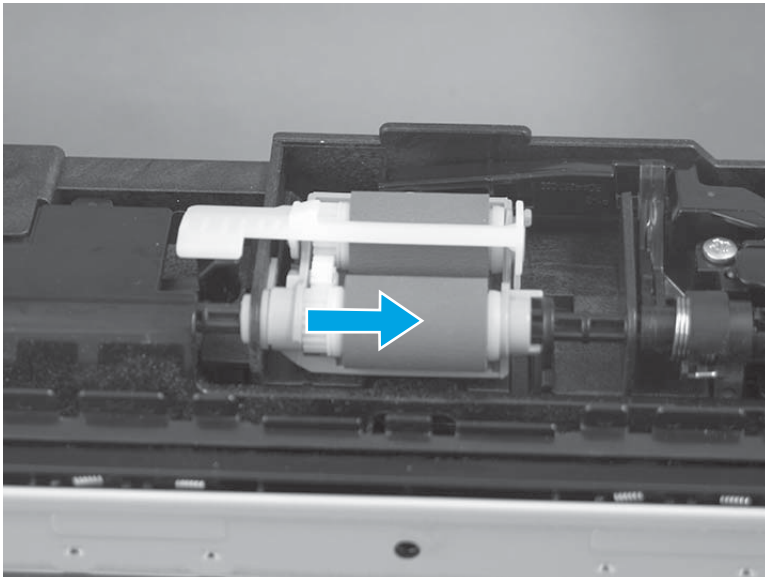

3. Rotate the end of the assembly up and away from the accessory.

Figure 1-1066 Rotate the assembly up

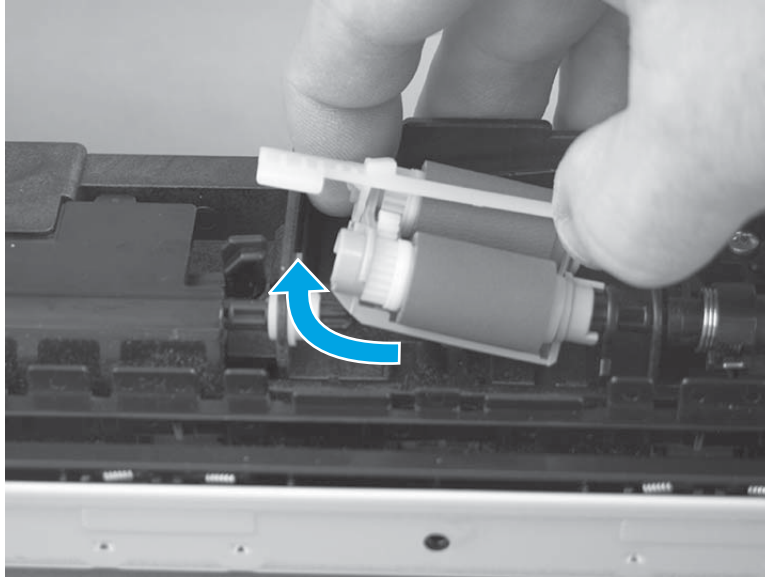

4. Remove the roller assembly.

Figure 1-1067 Remove the assembly

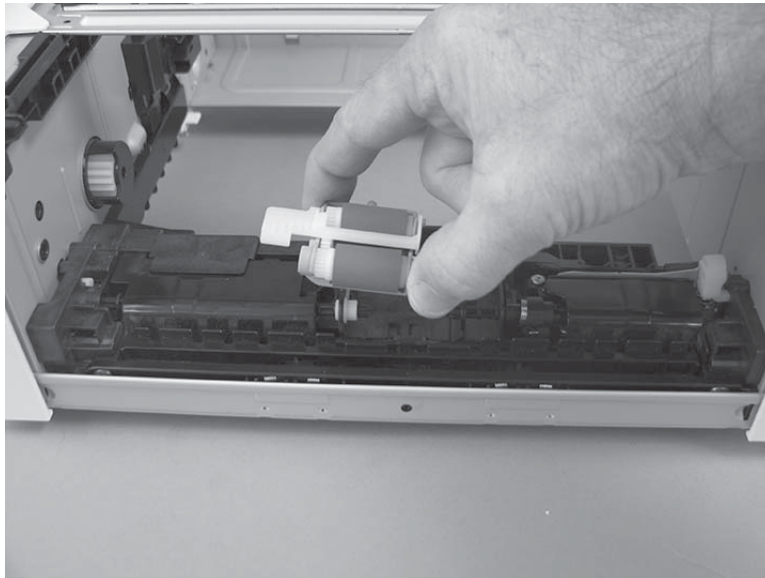

Step 3: Unpack the replacement assembly

Unpack the replacement part from the packaging.

<http://www8.hp.com/us/en/hp-information/environment/product-recycling.html>

CAUTION: When handling the roller holder, do not touch the gray spongy portion of the rollers. Skin oils on the rollers can cause paper handling problems.

NOTE: HP recommends responsible disposal of the defective part.

Figure 1-1068 Recycle and unpack

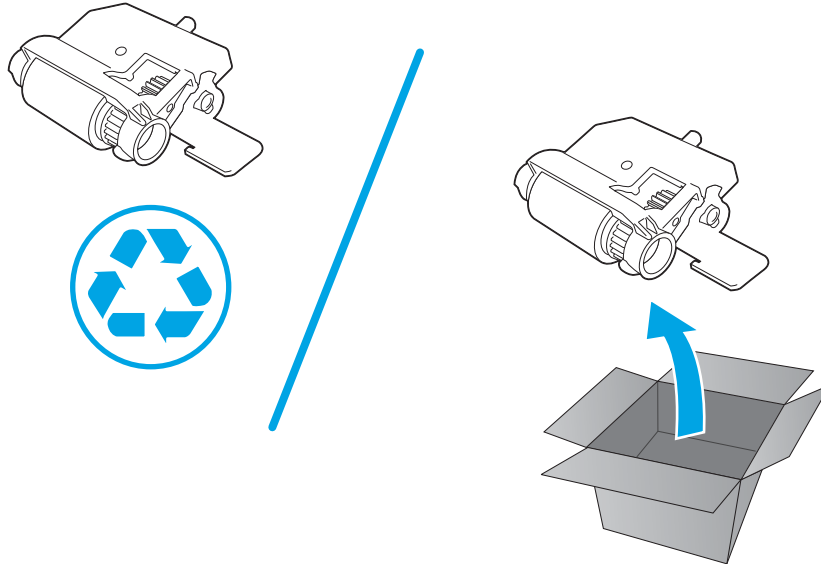

Step 4: Install the paper pickup roller assembly (Tray 3)

CAUTION: When handling the roller holder, do not touch the gray spongy portion of the rollers. Skin oils on the rollers can cause paper handling problems.

1. Install the right end of the assembly on the spring-loaded shaft (callout 1), and then slide it to the right to compress the shaft (callout 2).

IMPORTANT: Make sure that the pin on the back of the holder (callout 3) is inserted in the slot (callout 4) in the lever arm. If the pin is not correctly installed, the accessory will not pick paper.

Figure 1-1069 Install the roller assembly

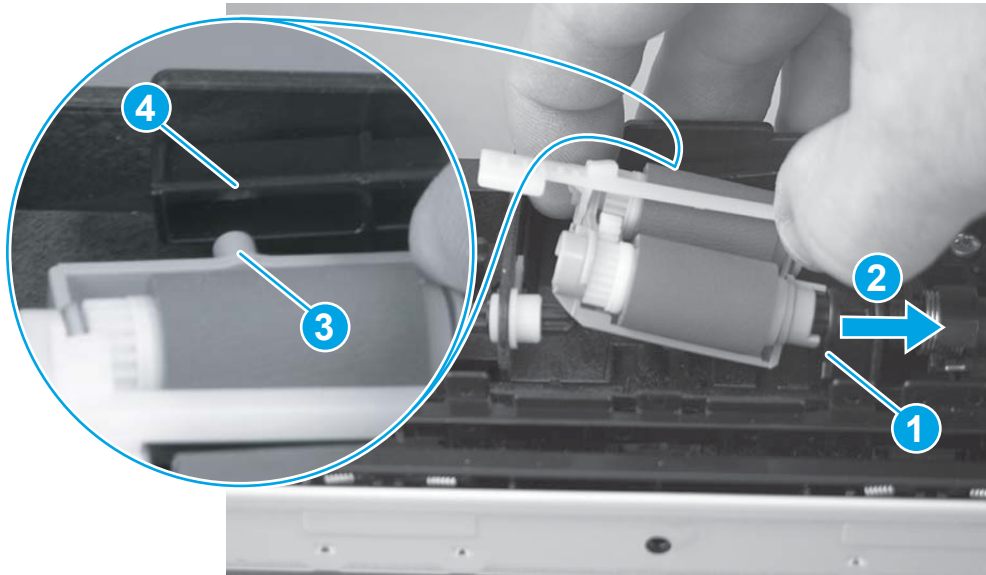

2. Rotate the left end of the assembly down and into place (callout 1), and then slide the assembly to the left (callout 2) to engage the drive end of the assembly with the drive shaft (callout 3).

Figure 1-1070 Release the assembly

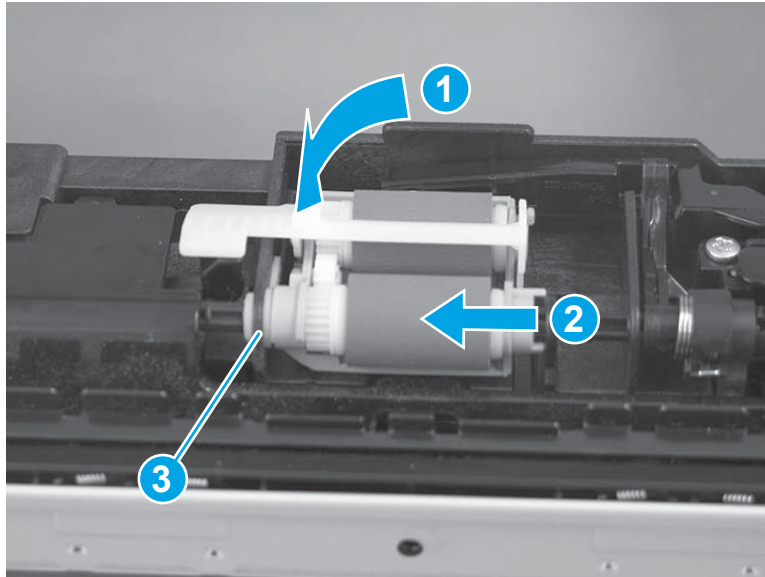

3. Push down and then release the tray-roller actuator (callout 1) and observe the roller assembly. It should move up and down (callout 2) in response to the actuator.

 **NOTE:** If it does not, remove the roller assembly and reinstall it making sure that the pin on the back of the assembly is in the lever arm. See [Figure 1-40 Install the roller assembly on page 38](#).

Figure 1-1071 Check the installation



Step 5: Install optional Tray 3

1. With the tray at a slight angle, align the sides of the tray with the rails in the accessory, and then partially slide the tray into the accessory.

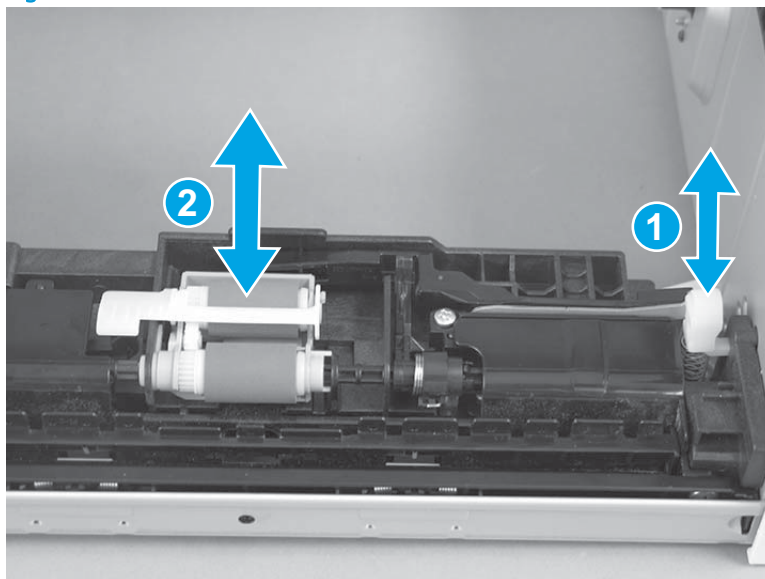
Figure 1-1072 Install the tray

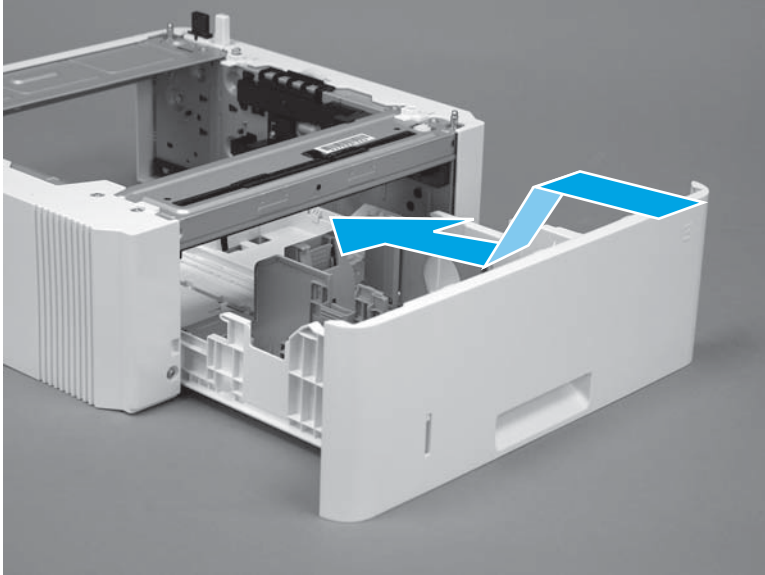

2. Push the tray straight into the accessory to close it.

Figure 1-1073 Close the tray

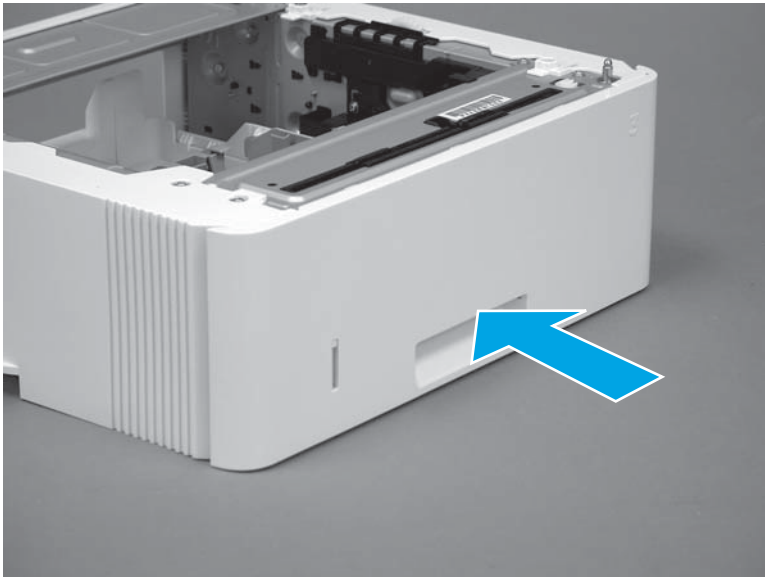

Removal and replacement: RM2-5745-000CN optional Tray 3 separation roller assembly

- [Introduction](#)
- [Step 1: Remove optional Tray 3](#)
- [Step 2: Remove the separation pad assembly \(550-sheet feeder\)](#)
- [Step 3: Unpack the replacement assembly](#)
- [Step 4: Install the separation pad assembly \(550-sheet feeder\)](#)
- [Step 5: Install optional Tray 3](#)

Introduction

This document provides the procedures to remove and replace the separation roller assembly (500-sheet feeder).

Before performing service

Turn the printer power off

- Disconnect the power cable.

⚠ WARNING! To avoid damage to the printer, turn the printer off, wait 30 seconds, and then remove the power cable before attempting to service the printer.

Use the table below to identify the correct part number for your printer. To order the part, go to www.hp.com/buy/parts.

Separation roller assembly (550-sheet feeder) part number	
RM2-5745-000CN	Separation roller assembly (550-sheet feeder)

Required tools

- No special tools are required to install this kit.

After performing service

Turn the printer power on

- Connect the power cable.
- Use the power switch to turn the power on.

Post service test

Make sure that the printer initializes to a **Ready** state.

Print a page from the accessory to make sure that the accessory is functioning correctly.

Step 1: Remove optional Tray 3

1. Pull the tray straight out of the printer until it stops.

Figure 1-1074 Pull the tray out of the printer

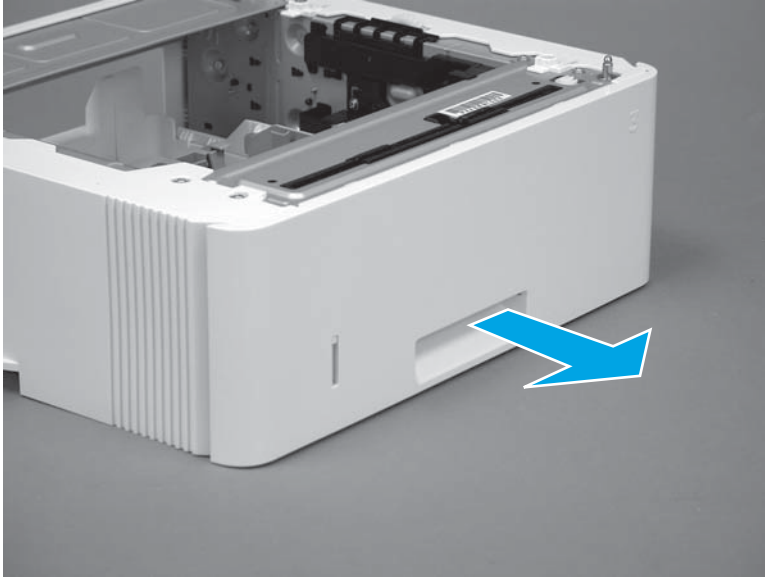

2. Slightly lift up on the front of the tray to release it, and then continue to pull the tray out of the accessory to remove it.

Figure 1-1075 Release and remove the tray

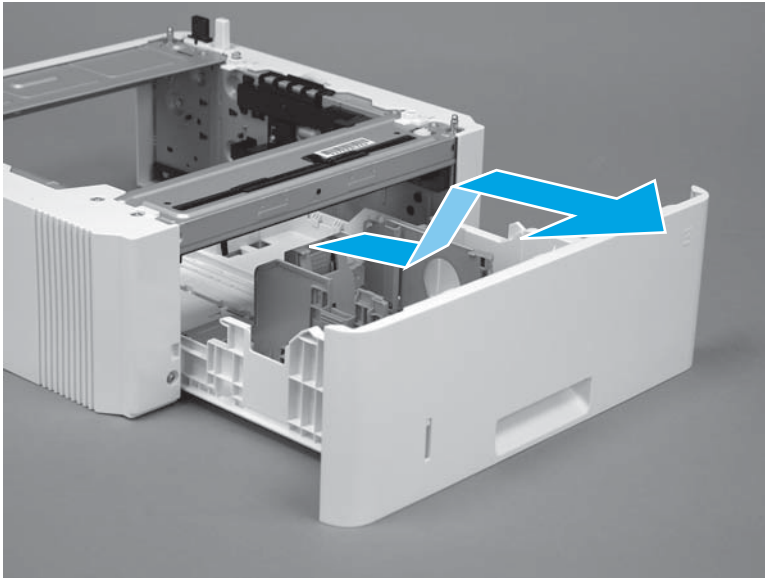

Step 2: Remove the separation pad assembly (550-sheet feeder)

1. Press the locking lever (callout 1), and then pull the separation roller assembly straight up to release it.

Figure 1-1076 Release the assembly

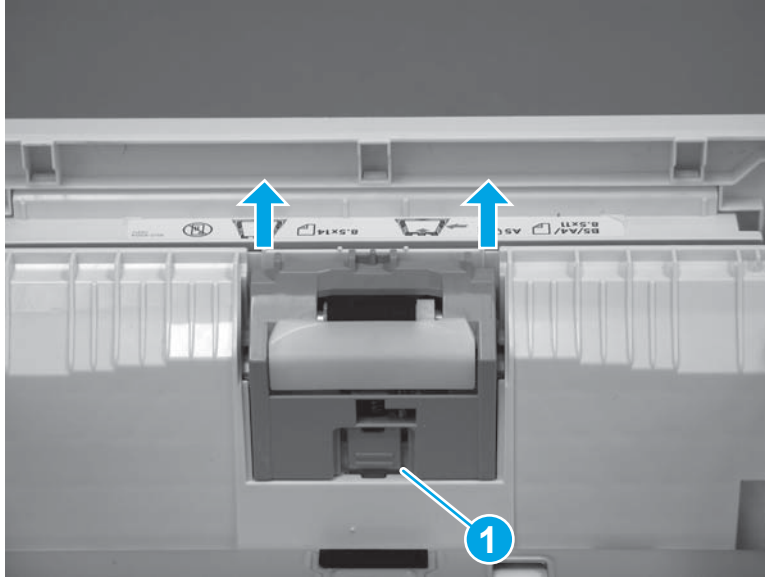

2. Remove the assembly.

Figure 1-1077 Remove the assembly

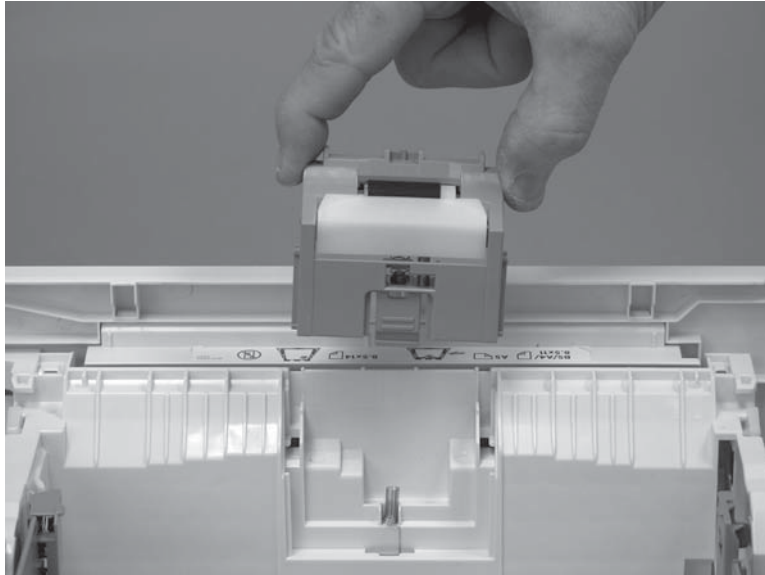

Step 3: Unpack the replacement assembly

Unpack the replacement part from the packaging.

<http://www8.hp.com/us/en/hp-information/environment/product-recycling.html>

 **NOTE:** HP recommends responsible disposal of the defective part.

Figure 1-1078 Recycle and unpack

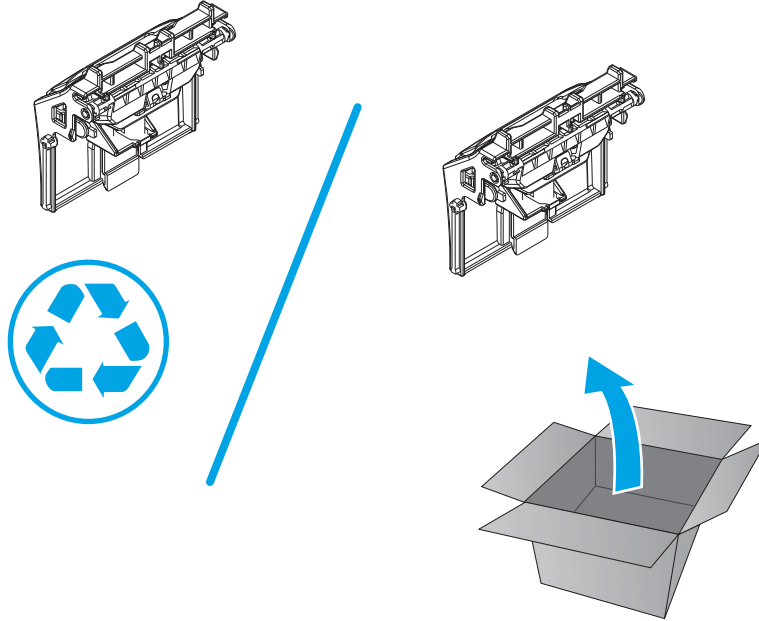

Step 4: Install the separation pad assembly (550-sheet feeder)

1. Install the assembly in the slots in the cassette.

Figure 1-1079 Install the assembly

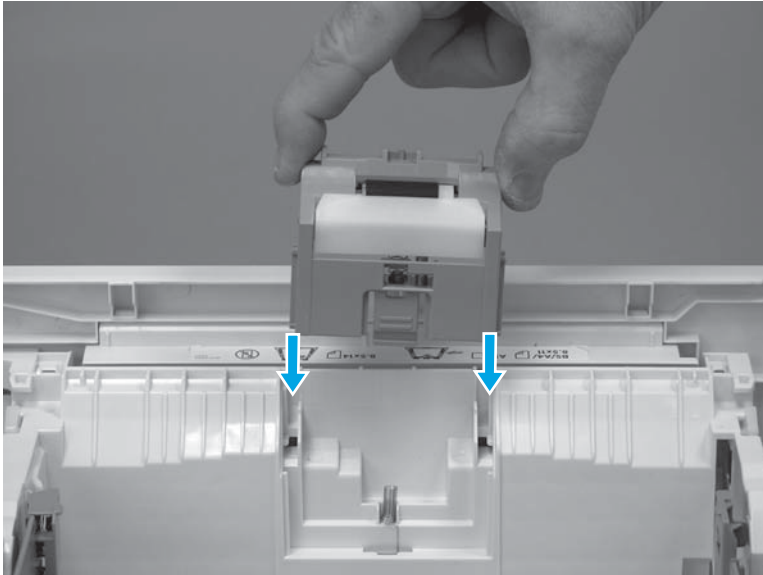

2. Push the separation roller assembly straight down until it snaps into place.

Figure 1-1080 Release the assembly

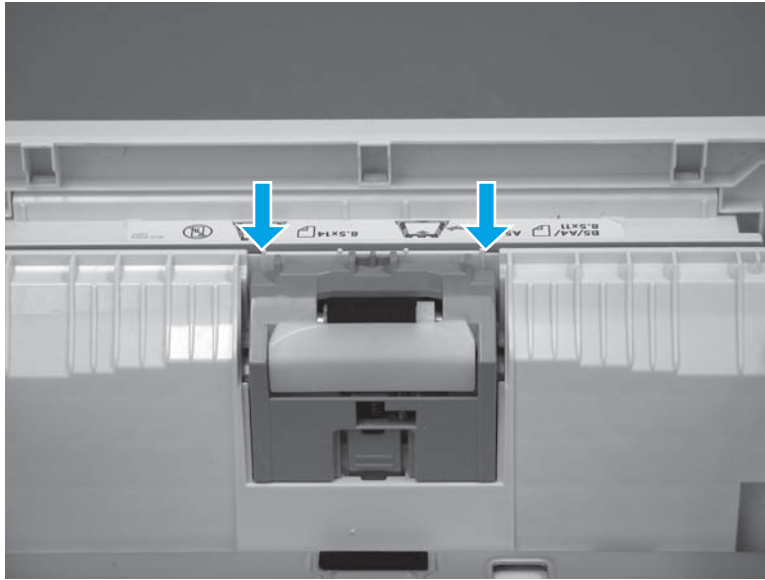

Step 5: Install optional Tray 3

1. With the tray at a slight angle, align the sides of the tray with the rails in the accessory, and then partially slide the tray into the accessory.

Figure 1-1081 Install the tray

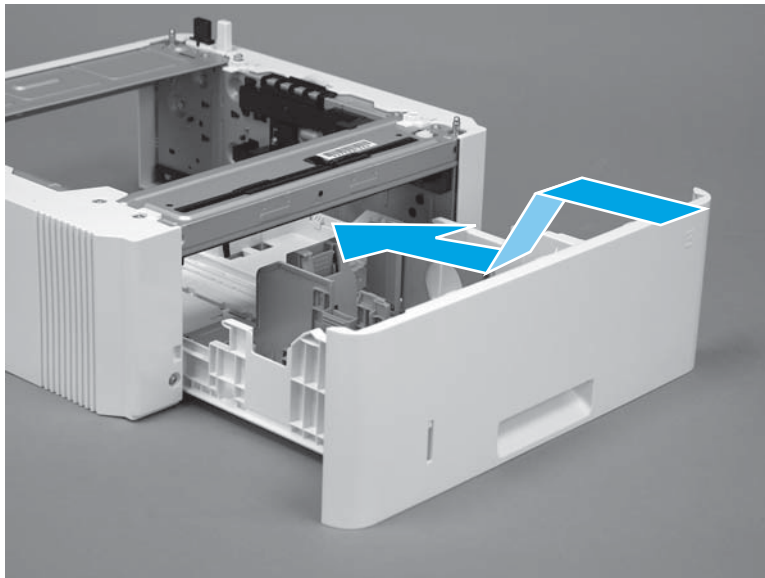

2. Push the tray straight into the accessory to close it.

Figure 1-1082 Close the tray

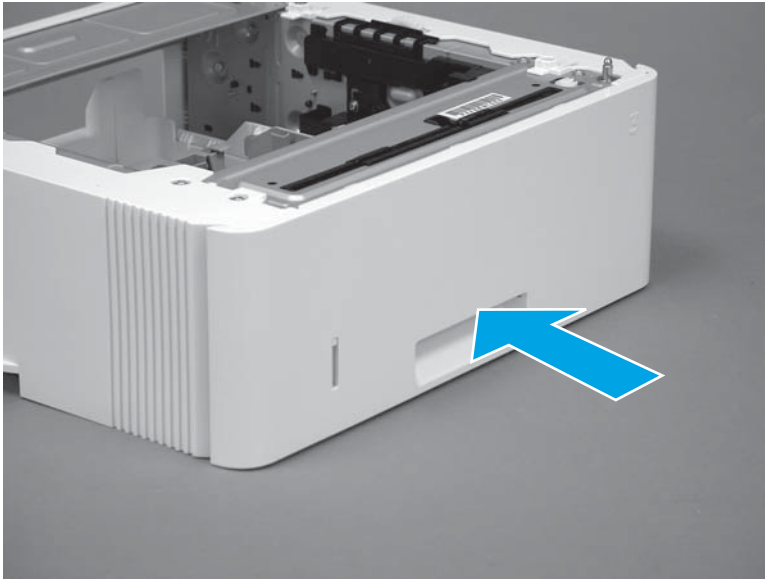

2 Parts and diagrams

- [HP service and support](#)
- [Order parts, accessories, and supplies](#)
- [Assembly locations](#)
- [How to use the parts lists and diagrams](#)
- [Document feeder and image scanner](#)
- [Covers, printer base](#)
- [Internal components, printer base](#)
- [550-sheet paper feeder](#)
- [Alphabetical parts list](#)
- [Numerical parts list](#)

HP service and support

Learn about HP access to additional service and support information.

Additional service and support for channel partners

Channel partners, go to partner.hp.com, and then use the steps below to access the HP Web-based Interactive Search Engine (WISE).

Access WISE for Channel partners

1. Select **Services & Support**, and then select **Services Delivery**.
2. Select **Technical Support**, and then select **Technical Documentation**.

Find information about the following topics

- Service manuals
- Service advisories
- Up-to-date control panel message (CPMD) troubleshooting
- Install and configure
- Printer specifications
- Solutions for printer issues and emerging issues
- Remove and replace part instructions and videos
- Warranty and regulatory information

Additional service and support for HP internal personnel

HP internal personnel, go to one of the following Web-based Interactive Search Engine (WISE) sites:

Americas (AMS)

- <https://support.hp.com/wise/home/ams-enWISE> - English
- <https://support.hp.com/wise/home/ams-esWISE> - Spanish
- <https://support.hp.com/wise/home/ams-ptWISE> - Portuguese
- <https://support.hp.com/wise/home/ams-frWISE> - French

Asia Pacific / Japan (APJ)

- <https://support.hp.com/wise/home/apj-enWISE> - English
- <https://support.hp.com/wise/home/apj-jaWISE> - Japanese
- <https://support.hp.com/wise/home/apj-koWISE> - Korean
- <https://support.hp.com/wise/home/apj-zh-HansWISE> - Chinese (simplified)

- [https://support.hp.com/wise/home/apj-zh-HantWISE - Chinese \(traditional\)](https://support.hp.com/wise/home/apj-zh-HantWISE - Chinese (traditional))
- <https://support.hp.com/wise/home/apj-thWISE - Thai>

Europe / Middle East / Africa (EMEA)

- <https://support.hp.com/wise/home/emea-enWISE - English>

Order parts, accessories, and supplies

Ordering

Order supplies and paper	www.hp.com/go/suresupply
Order genuine HP parts or accessories	www.hp.com/buy/parts or partsurfer.hp.com
Order through service or support providers	Contact an HP-authorized service or support provider.
Order using the HP Embedded Web Server (EWS)	To access, in a supported Web browser on your computer, enter the printer IP address or host name in the address/URL field. The EWS contains a link to the HP SureSupply Web site, which provides options for purchasing Original HP supplies.

Orderable parts

Not all of the parts shown in the diagrams in this chapter can be ordered. Refer to the table following the diagram or the parts lists at the end of this chapter to determine if a part is orderable.

Whole unit replacement (WUR)

Table 2-1 HP LaserJet Pro M304/M305/M404/M405

Part number	Printer
W1A51-69001	HP LaserJet Pro M404d; Prod-Exchange M404d 220V EMEA
W1A52-69001	HP LaserJet Pro M404n; Prod-Exchange M404n 220V AP(exclude CN)
W1A52-69002	HP LaserJet Pro M404n; Prod-Exchange M404n 110V Br
W1A52-69003	HP LaserJet Pro M404n; Prod-Exchange M404n 110V NAR/TW
W1A52-69004	HP LaserJet Pro M404n; Prod-Exchange M404n 220V EMEA
W1A53-69001	HP LaserJet Pro M404dn; Prod-Exchange M404dn 220V AP (exclude CN)
W1A53-69002	HP LaserJet Pro M404dn; Prod-Exchange M404dn 110V Br
W1A53-69003	HP LaserJet Pro M404dn; Prod-Exchange M404dn 110V NAR/TW
W1A53-69004	HP LaserJet Pro M404dn; Prod-Exchange M404dn 220V LAR
W1A53-69005	HP LaserJet Pro M404dn; Prod-Exchange M404dn 220V EMEA
W1A56-69001	HP LaserJet Pro M404dw; Prod-Exchange M404dw 220V AP(exclude CN)
W1A56-69002	HP LaserJet Pro M404dw; Prod-Exchange M404dw 110V NAR
W1A56-69003	HP LaserJet Pro M404dw; Prod-Exchange M404dw 220V EMEA
W1A57-69001	HP LaserJet Pro M405n; Prod-Replace New M405n 220V CN
W1A57-69002	HP LaserJet Pro M405n; Prod-Replace New M405n 220V India
W1A58-69001	HP LaserJet Pro M405d; Prod-Replace New M405d 220V CN
W1A58-69002	HP LaserJet Pro M405d; Prod-Replace New M405d 220V India

Table 2-1 HP LaserJet Pro M304/M305/M404/M405 (continued)

Part number	Printer
W1A58-69003	HP LaserJet Pro M405d; Prod-Replace New M405d 220V China Government SKU
W1A59-69001	HP LaserJet Pro M405dn; Prod-Replace New M405dn 220V India
W1A59-69002	HP LaserJet Pro M405dn; Prod-Replace New M405dn 220V China Government SKU
W1A60-69001	HP LaserJet Pro M405dw; Prod-Replace New M405dw 220V CN
W1A60-69002	HP LaserJet Pro M405dw; Prod-Replace New M405dw 220V India
W1A46-69001	Low PPM 300 Series; Prod-Replace New M305d 220V CN
W1A47-69001	Low PPM 300 Series; Prod-Replace New M305dn 220V China Government SKU
W1A66-69001	Low PPM 300 Series; Prod-Replace New M304a EMEA

Table 2-2 HP LaserJet Pro MFP M329/M428/M429

Part number	Printer
W1A28-69001	HP LaserJet Pro MFP M428dw; Prod-Exchange M428dw 110V NAR
W1A28-69002	HP LaserJet Pro MFP M428dw; Prod-Exchange M428dw 110V Brazil
W1A28-69003	HP LaserJet Pro MFP M428dw; Prod-Exchange M428dw 220V EMEA
W1A29-69001	HP LaserJet Pro MFP M428fdn; Prod-Exchange M428fdn 220V AP(exclude CN)
W1A29-69002	HP LaserJet Pro MFP M428fdn; Prod-Exchange M428fdn 110V NAR/TW
W1A29-69003	HP LaserJet Pro MFP M428fdn; Prod-Exchange M428fdn 220V EMEA
W1A30-69001	HP LaserJet Pro MFP M428fdw; Prod-Exchange M428fdw 220V AP(exclude CN)
W1A30-69002	HP LaserJet Pro MFP M428fdw; Prod-Exchange M428fdw 110V NAR/TW
W1A30-69003	HP LaserJet Pro MFP M428fdw; Prod-Exchange M428fdw 220V LAR
W1A30-69004	HP LaserJet Pro MFP M428fdw; Prod-Exchange M428fdw 110V Brazil
W1A30-69005	HP LaserJet Pro MFP M428fdw; Prod-Exchange M428fdw 220V EMEA
W1A31-69001	HP LaserJet Pro MFP M428dw (Russia); Prod-Exchange M428dw 220V Russia
W1A32-69001	HP LaserJet Pro MFP M428fdn (Russia); Prod-Exchange M428fdn 220V Russia
W1A33-69001	HP LaserJet Pro MFP M429dw; Prod-Replace New M429dw 220V CN
W1A33-69002	HP LaserJet Pro MFP M429dw; Prod-Replace New M429dw 220V India
W1A34-69001	HP LaserJet Pro MFP M429fdn; Prod-Replace New M429fdn 220V CN
W1A34-69002	HP LaserJet Pro MFP M429fdn; Prod-Replace New M429fdn 220V India
W1A35-69001	HP LaserJet Pro MFP M429fdw; Prod-Replace New M429fdw 220V CN
W1A35-69002	HP LaserJet Pro MFP M429fdw; Prod-Replace New M429fdw 220V India
W1A23-69001	Low PPM 300 Series; Prod-Replace New M329dn 220 CN
W1A24-69001	Low PPM 300 Series; Prod-Replace New M329dw 220 CN

Supplies

Following are the part numbers for the supplies available for the printers.

Table 2-3 Supplies

Item	Description	Cartridge number	Part number
Supplies			
Black toner cartridge	Standard-capacity toner cartridge (M404/M428/M304 EMEA)	59A	CF259-67901
Black toner cartridge	Standard-capacity toner cartridge (M404/M428 AMS)	58A	CF258-67901
Black toner cartridge	Standard-capacity toner cartridge (M404/M428 APJ)	76A	CF276-67901
Black toner cartridge	Standard-capacity toner cartridge (M405/M429/M305 CH/IN)	77A	CF277-67901
Black toner cartridge	High-capacity toner cartridge (M404/M428/M304 EMEA)	59X	CF259-67902
Black toner cartridge	High-capacity toner cartridge (M404/M428 AMS)	58X	CF258-67902
Black toner cartridge	High-capacity toner cartridge (M404/M428 APJ)	76X	CF276-67902
Black toner cartridge	High-capacity toner cartridge (M405/M429/M305 CH/IN)	77X	CF277-67902

Accessories

Following are the part numbers for the accessories available for the printer.

Table 2-4 Accessories

Item	Part number
550-sheet paper feeder (optional Tray 3)	D9P29A-69001

Customer self-repair parts

Customer Self-Repair (CSR) parts are available for many HP LaserJet printers to reduce repair time. More information about the CSR program and benefits can be found at www.hp.com/go/csr-support and www.hp.com/go/csr-faq.

Genuine HP replacement parts can be ordered at www.hp.com/buy/parts or by contacting an HP-authorized service or support provider. When ordering, one of the following will be needed: part number, serial number (found on back of printer), printer number, or printer name.

- Parts listed as **Mandatory** self-replacement are to be installed by customers, unless you are willing to pay HP service personnel to perform the repair. For these parts, on-site or return-to-depot support is not provided under the HP printer warranty.
- Parts listed as **Optional** self-replacement can be installed by HP service personnel at your request for no additional charge during the printer warranty period.

Item	Description	Self-replacement options	Part number
250-sheet paper input tray	Replacement cassette for Tray 2	Mandatory	RM2-5392-010CN
Optional 550-sheet accessory tray	Replacement cassette for Tray 3	Mandatory	RM2-5413-000CN
Tray 2 separation roller assembly	Tray 2 separation roller	Mandatory	RM2-5397-000CN
Optional Tray 3 separation roller assembly	Optional Tray 3 separation roller	Mandatory	RM2-5745-000CN
Multipurpose roller	Multipurpose roller	Mandatory	RL2-0656-000CN
Tray 2 paper pickup roller assembly	Tray 2 pickup roller	Mandatory	RM2-5452-000CN
Optional Tray 3 paper pickup roller assembly	Optional Tray 3 pickup roller	Mandatory	RM2-5741-000CN

Related documentation and software

HP service personnel, go to one of the following Web-based Interactive Search Engines (WISE) sites:

AMS

- <https://support.hp.com/wise/home/ams-en>
- <https://support.hp.com/wise/home/ams-es>
- <https://support.hp.com/wise/home/ams-pt>
- <https://support.hp.com/wise/home/ams-fr>

APJ

- <https://support.hp.com/wise/home/apj-en>
- <https://support.hp.com/wise/home/apj-ja>
- <https://support.hp.com/wise/home/apj-ko>
- <https://support.hp.com/wise/home/apj-zh-Hans>
- <https://support.hp.com/wise/home/apj-zh-Hant>
- <https://support.hp.com/wise/home/apj-th>

EMEA

- <https://support.hp.com/wise/home/emea-en>

Channel partners, go to partner.hp.com.

Channel partners, access training materials in the HP University and Partner Learning Center at <https://content.ext.hp.com/sites/LMS/HPU.page>.

Assembly locations

- [HP LaserJet Pro M304/M305/M404/M405](#)
- [HP LaserJet Pro MFP M329/M4284/M429](#)

HP LaserJet Pro M304/M305/M404/M405

Figure 2-1 Printer front view (SFP)

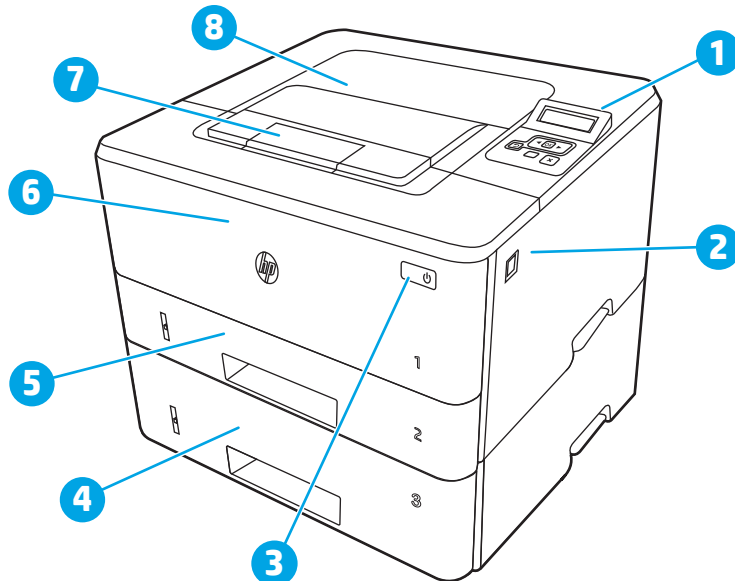

Table 2-5 Printer front view (SFP)

Item	Description
1	2-line backlit control panel
2	Front door release button (access to the toner cartridge)
3	Power on/off button
4	Tray 3 (optional)
5	Tray 2
6	Tray 1
7	Output bin extension
8	Output bin

Figure 2-2 Printer rear view (SFP)

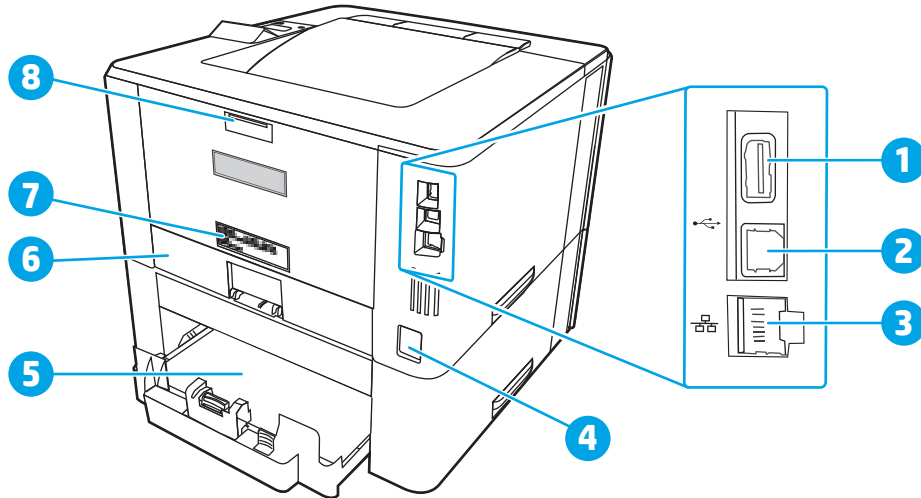

Table 2-6 Printer rear view (SFP)

Item	Description
1	USB port (for job storage and private printing) This port might be covered.
2	USB interface port
3	Ethernet port (network models only)
4	Power connection
5	Tray 3 (optional) Tray 3 extends when legal-size or A4-size paper is loaded.
6	Dust cover for Tray 2 Dust cover flips up when legal-size of A4-size paper is loaded.
7	Serial number and product number label
8	Rear door (access for clearing jams)

HP LaserJet Pro MFP M329/M4284/M429

Figure 2-3 Printer front view (MFP)

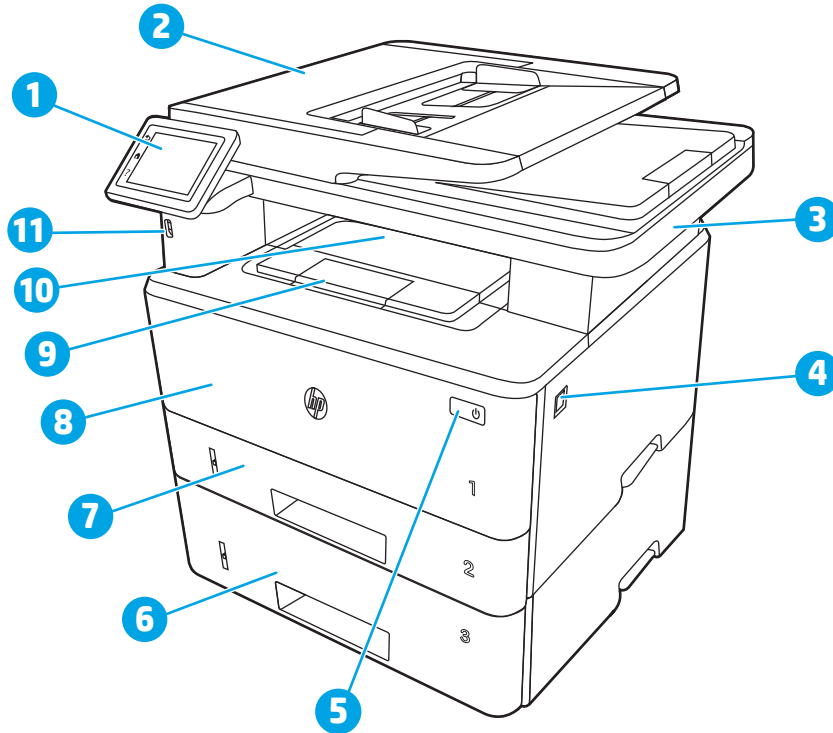

Table 2-7 Printer front view (MFP)

Item	Description
1	Control panel (tilts up for easier viewing)
2	Document feeder
3	Scanner
4	Front door release button (access to the toner cartridge)
5	Power on/off button
6	Tray 3 (optional)
7	Tray 2
8	Tray 1
9	Output bin extension
10	Output bin
11	Walk-up USB port (for printing and scanning without a computer)

Figure 2-4 Printer rear view (MFP)

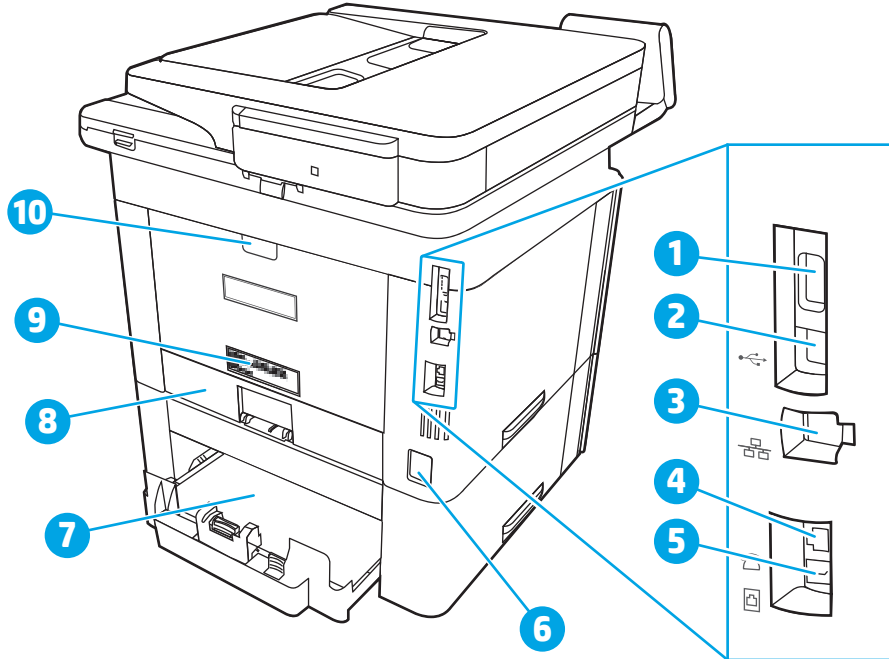



Table 2-8 Printer rear view (MFP)

Item	Description
1	USB port (for job storage and private printing) This port might be covered.
2	USB interface port
3	Ethernet port
4	Telephone "line out" port (for attaching an extension phone, answering machine, or other device)
5	Fax "line in" port (for attaching the fax line to the printer)
6	Power connection
7	Tray 3 (optional) Tray 3 extends when legal-size or A4-size paper is loaded.
8	Dust cover for Tray 2 Dust cover flips up when legal-size of A4-size paper is loaded.
9	Serial number and product number label
10	Rear door (access for clearing jams)

How to use the parts lists and diagrams

The figures in this chapter show the major subassemblies in the printer and their component parts. A parts list table follows each exploded view assembly diagram. Each table lists the item number, the associated part number, and the description of each part. If a part is not listed in the table, then it is not a field replacement unit (FRU).

 **CAUTION:** Be sure to order the correct part. When looking for part numbers for electrical components, pay careful attention to the voltage that is listed in the description column. Doing so will ensure that the part number selected is for the correct model.

 **NOTE:** In this manual, the abbreviation “PCA” stands for “printed circuit-board assembly.” Components described as a PCA might consist of a single circuit board or a circuit board plus other parts, such as cables and sensors.

Document feeder and image scanner

 **NOTE:** Parts listed in this section are for the M329, M428, and M429 printers.

Main assemblies

Figure 2-5 Main assembly (document feeder and image scanner)

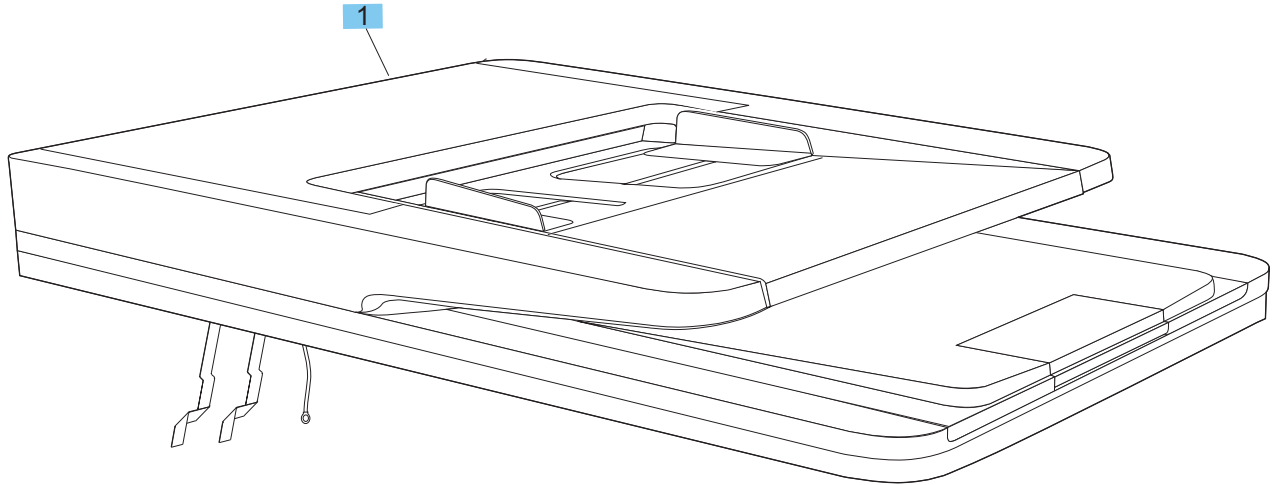

Table 2-9 Main assembly (document feeder and image scanner)

Ref	Description	Part number	Qty
1	Scanner/ADF-Pilderiver assembly (simplex models)	W1A73-60108	1
1	Scanner/ADF-Pilderiver assembly (duplex models)	W1A73-60109	1

Covers, printer base

Covers (M304/M305/M404/M405)

Figure 2-6 Covers (M304/M305/M404/M405)

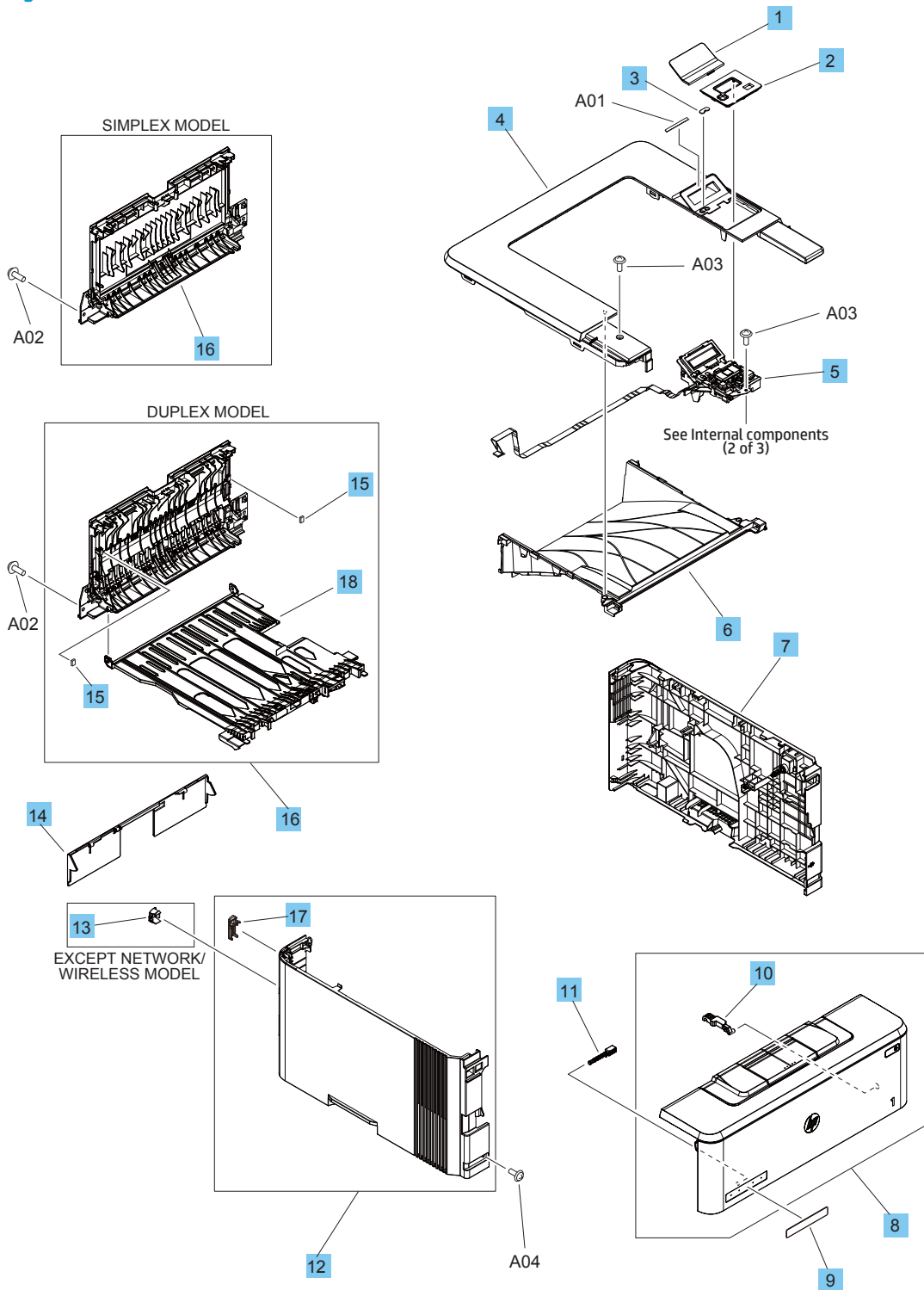

Table 2-10 Covers (M304/M305/M404/M405)

Ref	Description	Part number	Qty
1	Cover, indication	RL2-0675-000CN	1
2	Cover, operator (non-wireless models)	RC4-3312-000CN	1
2	Cover, operator (wireless models)	RC4-3322-000CN	1
3	Guide, led, light	RC4-3311-000CN	1
4	Cover, top	RC4-2956-000CN	1
5	Control panel assembly (non-wireless models)	RM2-5391-000CN	1
5	Control panel assembly (wireless models)	RM2-5424-000CN	1
6	Tray, paper delivery (non-wireless models)	RC4-3231-000CN	1
6	Tray, paper delivery (wireless models)	RM2-2581-000CN	1
7	Cover, right assembly	RM2-2578-000CN	1
8	Cartridge door assembly	RM2-2562-000CN	1
9	Label, name M404n	RC5-5038-000CN	1
9	Label, name M404d	RC5-5049-000CN	1
9	Label, name M404dn	RC5-5039-000CN	1
9	Label, name M404dw	RC5-5041-000CN	1
9	Label, name M405n	RC5-5042-000CN	1
9	Label, name M405d	RC5-5043-000CN	1
9	Label, name M405dn	RC5-5044-000CN	1
9	Label, name M405dw	RC5-5045-000CN	1
9	Label, name M305d	RC5-5046-000CN	1
9	Label, name M305dn	RC5-5047-000CN	1
9	Label, name M304a	RC5-5048-000CN	1
10	Link, pressure release	RC4-4479-000CN	1
11	Shaft, support	RC4-3002-000CN	1
12	Cover, left	RL2-3251-000CN	1
13	Cover, network (non-network/wireless models)	RC4-2907-000CN	1
14	Cover, cassette rear	RC4-3082-000CN	1
15	Sheet, damper (duplex models)	RC2-6075-000CN	2
16	Rear door assembly (simplex models)	RM2-5430-000CN	1
16	Rear door assembly (duplex models)	RM2-5405-000CN	1
17	Cover, I/O small	RC4-3298-000CN	1
18	Paper re-pickup assembly (duplex models)	RM2-5666-000CN	1
Not shown	HP logo jewel	7121-8686	1

Covers (M329/M428/M429)

Figure 2-7 Covers (M329/M428/M429)

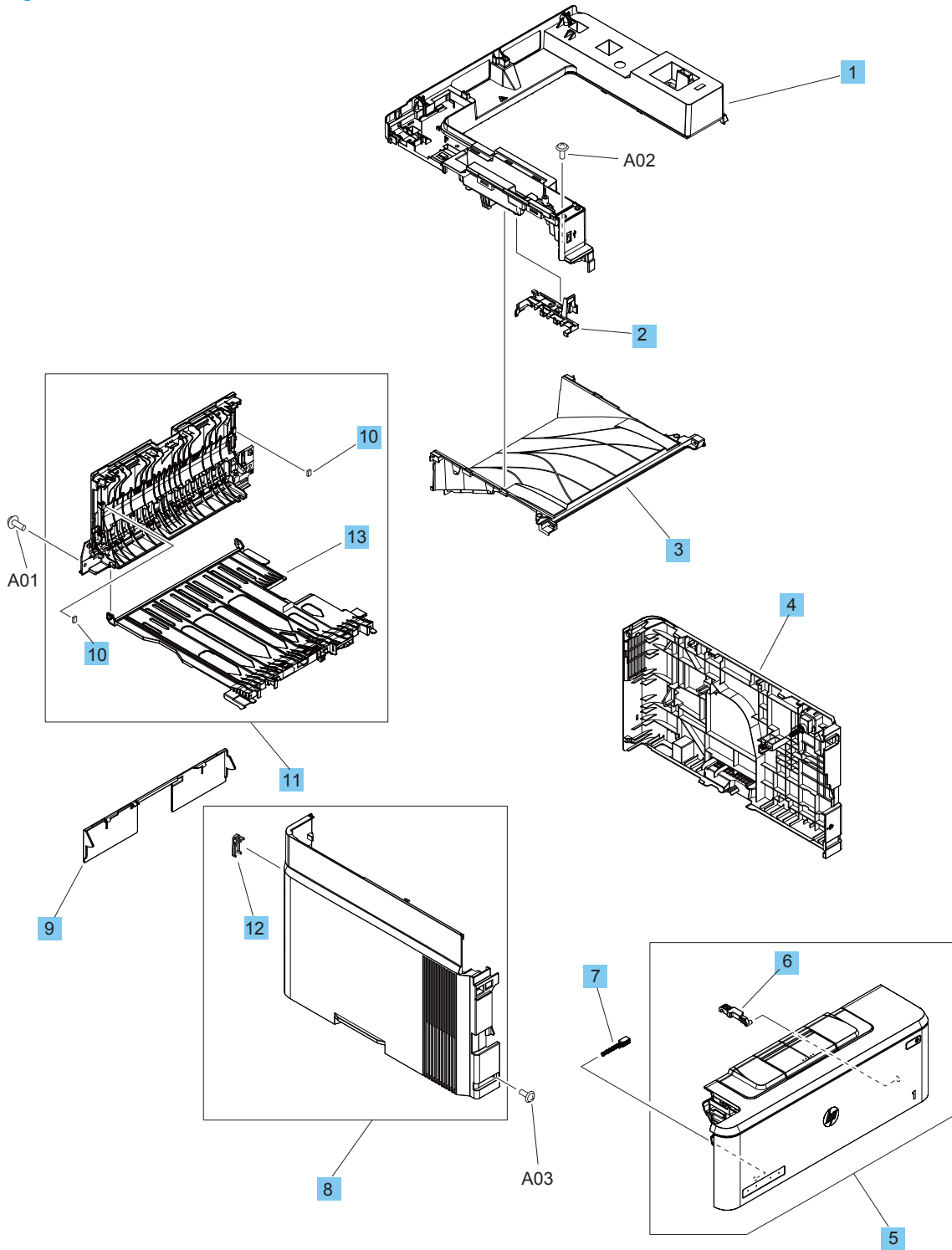

Table 2-11 Covers (M329/M428/M429)

Ref	Description	Part number	Qty
1	Cover, top	RC4-3207-000CN	1
2	Guide, cable	RC4-3217-000CN	1
3	Tray, paper delivery	RC4-3231-000CN	1
4	Right cover assembly	RM2-2578-000CN	1
5	Cartridge door assembly	RM2-2567-000CN	1
6	Link, pressure release	RC4-4479-000CN	1
7	Shaft, support	RC4-3002-000CN	1
8	Left cover assembly	RM2-2579-000CN	1
9	Cover, cassette rear	RC4-3082-000CN	1
10	Sheet, damper	RC2-6075-000CN	2
11	Rear door assembly	RM2-5405-000CN	1
12	Cover, I/O small	RC4-3299-000CN	1
13	Paper re-pickup assembly	RM2-5666-000CN	1
Not shown	HP logo jewel	7121-8686	1
Not shown	Nameplate, HP LaserJet Pro MFP M428dw	W1A28-00002	1
Not shown	Nameplate, HP LaserJet Pro MFP M428fdn	W1A29-00002	1
Not shown	Nameplate, HP LaserJet Pro MFP M428fdw	W1A30-00003	1
Not shown	Nameplate, HP LaserJet Pro MFP M429dw	W1A33-00001	1
Not shown	Nameplate, HP LaserJet Pro MFP M429fdn	W1A34-00001	1
Not shown	Nameplate, HP LaserJet Pro MFP M429fdw	W1A35-00001	1
Not shown	Nameplate, HP LaserJet Pro MFP M329dn	W1A23-00003	1
Not shown	Nameplate, HP LaserJet Pro MFP M329dw	W1A24-00003	1
Not shown	Control panel (MFP)	W2Q13-60103	1
Not shown	Control panel back cover	T6B80-40002	1
Not shown	Control panel mount cover	B3Q11-40002	1
Not shown	Control panel mount base	B3Q11-40001	1
Not shown	Control panel mount chassis assembly	B3Q10-60145	1
Not shown	Control panel FFC	W1A30-60101	1
Not shown	Cover, fax port (fax models)	C5F99-40003	1

Internal components, printer base

Internal components, printer base (1 of 3)

Figure 2-8 Internal components, printer base (1 of 3)
M329/M428/M429

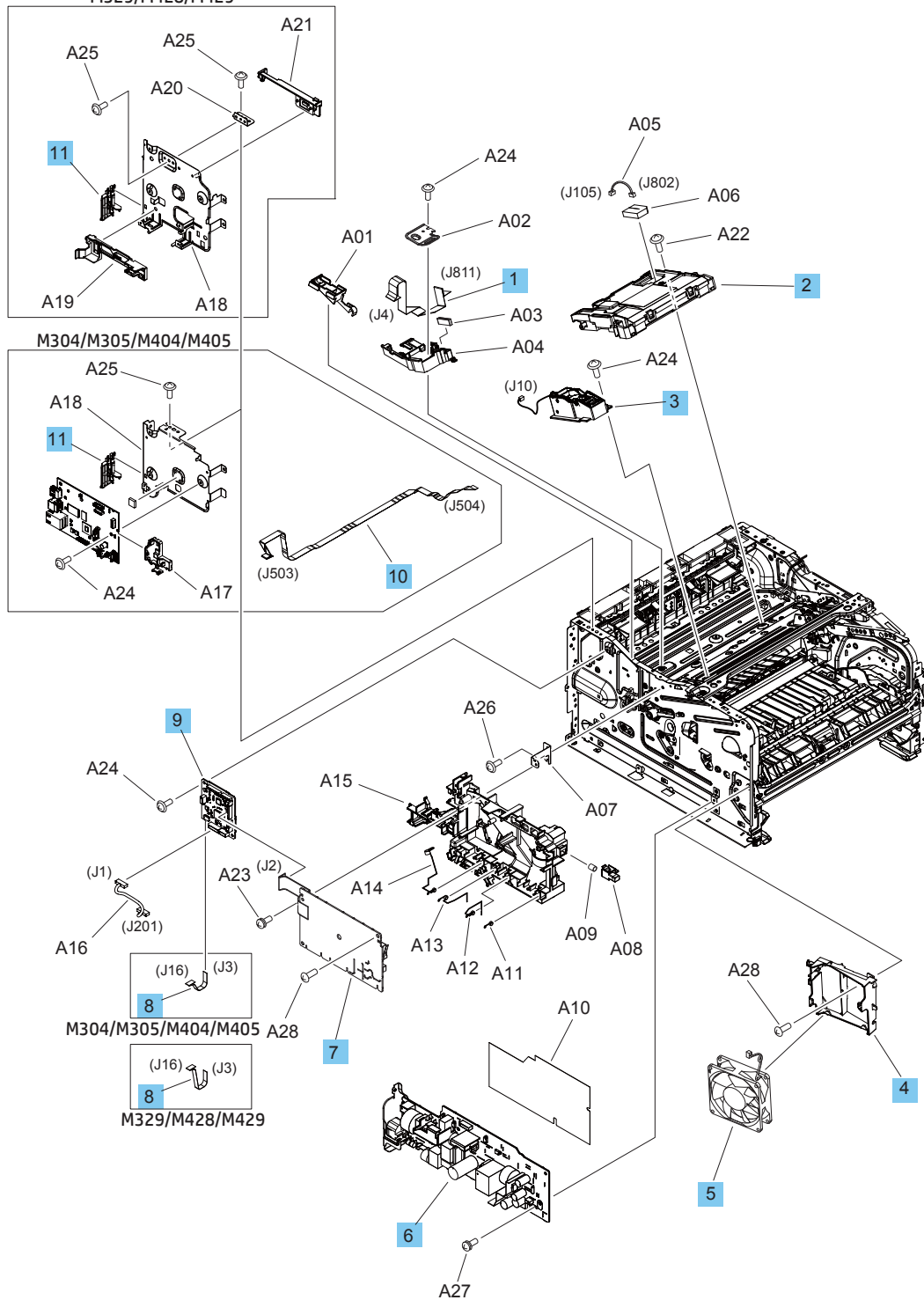

Table 2-12 Internal components, printer base (1 of 3)

Ref	Description	Part number	Qty
1	Cable, flexible flat laser	RK2-9901-000CN	1
2	Laser scanner assembly	RM2-2891-000CN	1
3	Tag cable assembly	RM2-2556-000CN	1
4	Duct, fan	RC4-2891-000CN	1
5	Fan	RK2-8068-000CN	1
6	Low voltage power supply PCA (MFP 110-127v)	RM3-7413-000CN	1
6	Low voltage power supply PCA (MFP 220-240v)	RM3-7414-000CN	1
6	Low voltage power supply PCA (SFP 220-240v)	RM3-7412-000CN	1
6	Low voltage power supply PCB assembly (SFP 110-127v)	RM3-7411-000CN	1
7	High voltage power supply PCA	RM2-7508-000CN	1
8	Cable, flexible flat formatter (MFP)	RK2-6931-000CN	1
8	Cable, flexible flat formatter (SFP)	RK2-6920-000CN	1
9	DC controller PCA	RM3-7580-000CN	1
10	Cable, flexible flat panel (SFP)	RK2-6942-000CN	1
11	Cover, inner left rear	RC4-3108-000CN	1
Not shown	Duplex release button	RC2-6075-000CN	1
Not shown	Fax PCA, crowdad (AP+AMS; fax models)	W1A78-67906	1
Not shown	Fax PCA, crowdad (EU; fax models)	W1A78-67907	1
Not shown	Fax PCA, crowdad (Brazil; fax models)	W1A78-67908	1
Not shown	Fax PCA, Chepstow fax card for BBU (fax models)	W1A78-67909	1
Not shown	Spacer, hexagonal fax (fax models)	C5F98-20001	1
Not shown	Wireless module (Ultra)	0960-4025	1
Not shown	Wireless holder	W1A30-40001	1
Not shown	FFC, laser scanner	RK2-6919-000CN	1

Internal components, printer base (2 of 3)

Figure 2-9 Internal components, printer base (2 of 3)

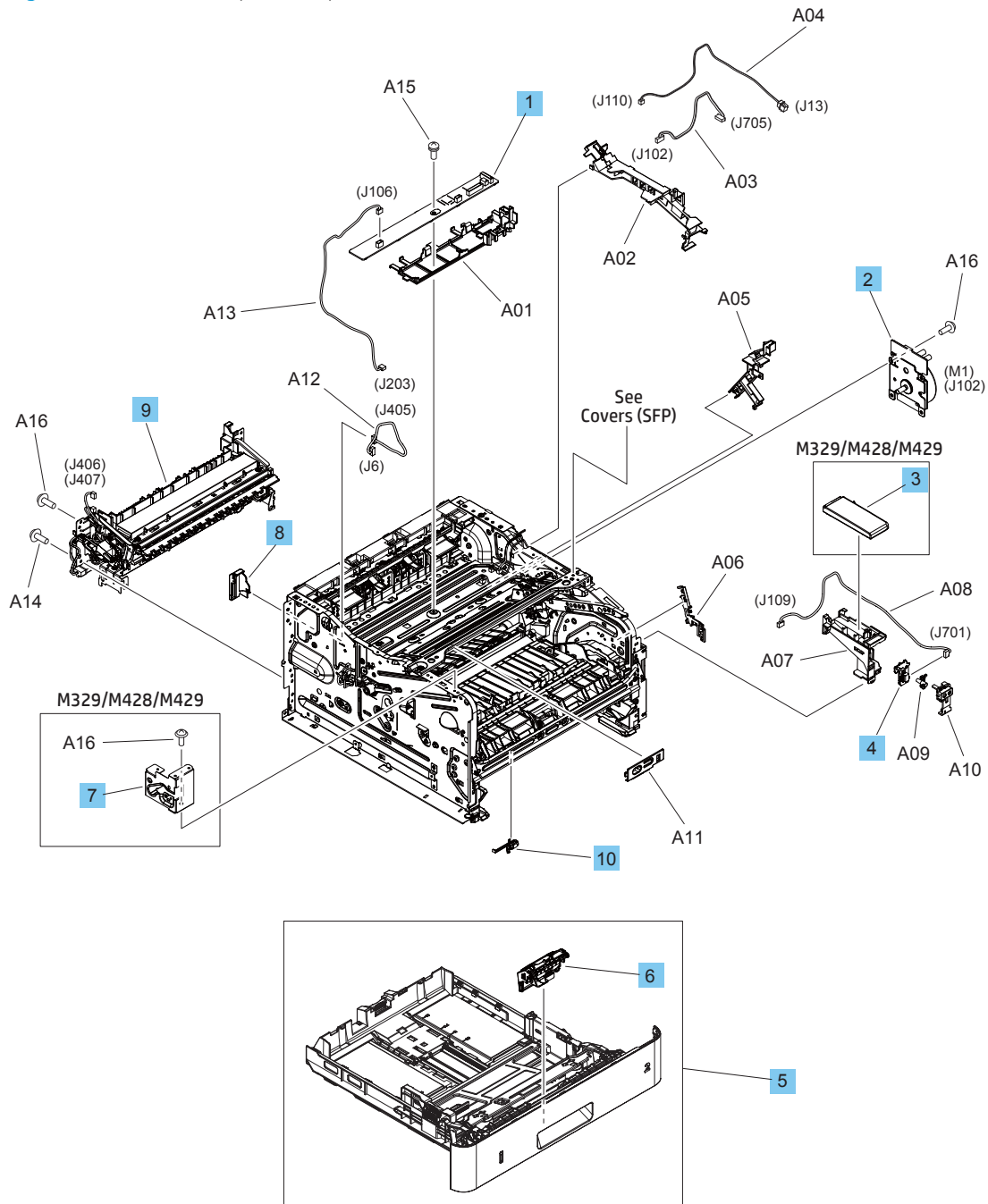

Table 2-13 Internal components, printer base (2 of 3)

Ref	Description	Part number	Qty
1	Connecting PCA (duplex model)	RM2-7510-000CN	1
1	Connecting PCA (simplex model)	RM2-8510-000CN	1
2	Main motor assembly	RM2-9531-000CN	1
3	Cover, NFC (MFP)	RC4-2961-000CN	1
4	Power switch PCA	RM2-8506-000CN	1
5	Cassette assembly	RM2-5392-010CN	1
6	Separation roller assembly	RM2-5397-000CN	1
7	Bracket, USB (MFP)	RC4-2938-000CN	1
8	Cover, full detect sensor	RC4-3219-000CN	1
9	Fixing (fuser) assembly (110-127v)	RM2-2554-000CN	1
9	Fixing (fuser) assembly (220-240v)	RM2-2555-000CN	1
10	Sensor, Tray 2 assembly	RM2-5375-000CN	1
Not shown	Ferrite, motor	9170-2659	1
Not shown	Mute USB PCA (MFP)	5851-7008	1

Internal components, printer base (3 of 3)

Figure 2-10 Internal components, printer base (3 of 3)

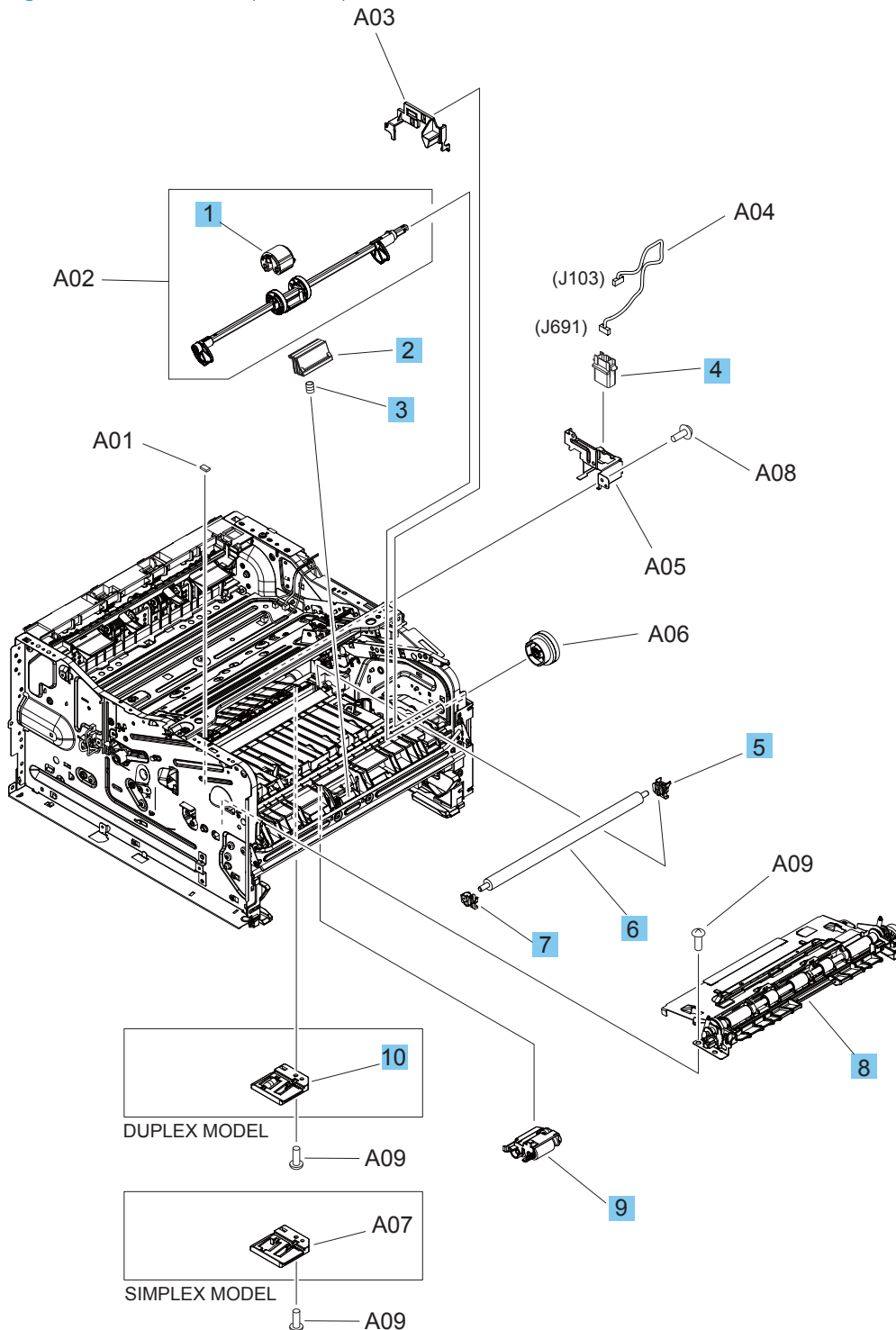

Table 2-14 Internal components, printer base (3 of 3)

Ref	Description	Part number	Qty
1	Roller, multi-purpose	RL2-0656-000CN	1
2	Roller, multi-purpose separation	RL2-0657-000CN	1
3	Spring, compression	RU8-2935-000CN	1
4	Connector, drawer	VS1-7258-007CN	1
5	Holder, transfer roller right	RC4-3133-000CN	1
6	Roller, transfer	RM1-4023-000CN	1
7	Holder, transfer roller left	RC4-3134-000CN	1
8	Registration assembly	RM2-2577-000CN	1
9	Paper pickup roller assembly	RM2-5452-000CN	1
10	Duplexing roller assembly (duplex models)	RM2-5454-000CN	1
Not shown	Sensor, Tray 2 assembly	RM2-5375-000CN	1
Not shown	Pad, thermal transfer	5851-6550	1
Not shown	Formatter PCA (SFP generic formatter for all d models)	W2Q08-60001	1
Not shown	Formatter PCA (M404d)	W1A49-60001	1
Not shown	Formatter PCA (M405d; China/India)	W1A58-60001	1
Not shown	Formatter PCA (M405d; China only)	W1A58-60002	1
Not shown	Formatter PCA (M305d; China)	W1A46-60001	1
Not shown	Formatter PCA (M304a; EMEA)	W1A66-60001	1
Not shown	Formatter PCA (SFP generic formatter for all n/dn/dw models)	W2Q09-60001	1
Not shown	Formatter PCA (M404n)	W1A52-60001	1
Not shown	Formatter PCA (M404dn)	W1A53-60001	1
Not shown	Formatter PCA (M404dw)	W1A56-60001	1
Not shown	Formatter PCA (M405n; China/India)	W1A57-60002	1
Not shown	Formatter PCA (M405n; China only)	W1A57-60003	1
Not shown	Formatter PCA (M405dn; China/India)	W1A59-60001	1
Not shown	Formatter PCA (M405dn; China only)	W1A59-60002	1
Not shown	Formatter PCA (M405dw; China/India)	W1A60-60001	1
Not shown	Formatter PCA (M405dw; China only)	W1A60-60002	1
Not shown	Formatter PCA (M305dn; China)	W1A47-60001	1
Not shown	Formatter PCA (MFP generic formatter for all 4in1 models)	W2Q13-60001	1
Not shown	Formatter PCA (M428fdn)	W2Q13-60003	1
Not shown	Formatter PCA (M428fdw)	W1A30-60001	1
Not shown	Formatter PCA (M428fdn; Russia)	W1A32-60001	1
Not shown	Formatter PCA (M429fdn)	W1A34-60001	1

Table 2-14 Internal components, printer base (3 of 3) (continued)

Ref	Description	Part number	Qty
Not shown	Formatter PCA (M429fdw)	W1A33-60001	1
Not shown	Formatter PCA (M429fdn; China only)	W1A34-60002	1
Not shown	Formatter PCA (M429fdw; China only)	W1A35-60001	1
Not shown	Formatter PCA (M329dn; China only)	W1A23-60001	1
Not shown	Formatter PCA (M329dw; China only)	W1A24-60001	1
Not shown	Formatter PCA (MFP generic formatter for all 3in1 models)	W2Q12-60001	1
Not shown	Formatter PCA (M428dw)	W1A28-60001	1
Not shown	Formatter PCA (M428dw; Russia)	W1A28-60002	1
Not shown	Formatter PCA (M429dw)	W1A33-60003	1
Not shown	Formatter PCA (M429dw; China only)	W1A33-60004	1

550-sheet paper feeder

Covers, 550-sheet paper feeder

Figure 2-11 Covers, 550-sheet paper feeder

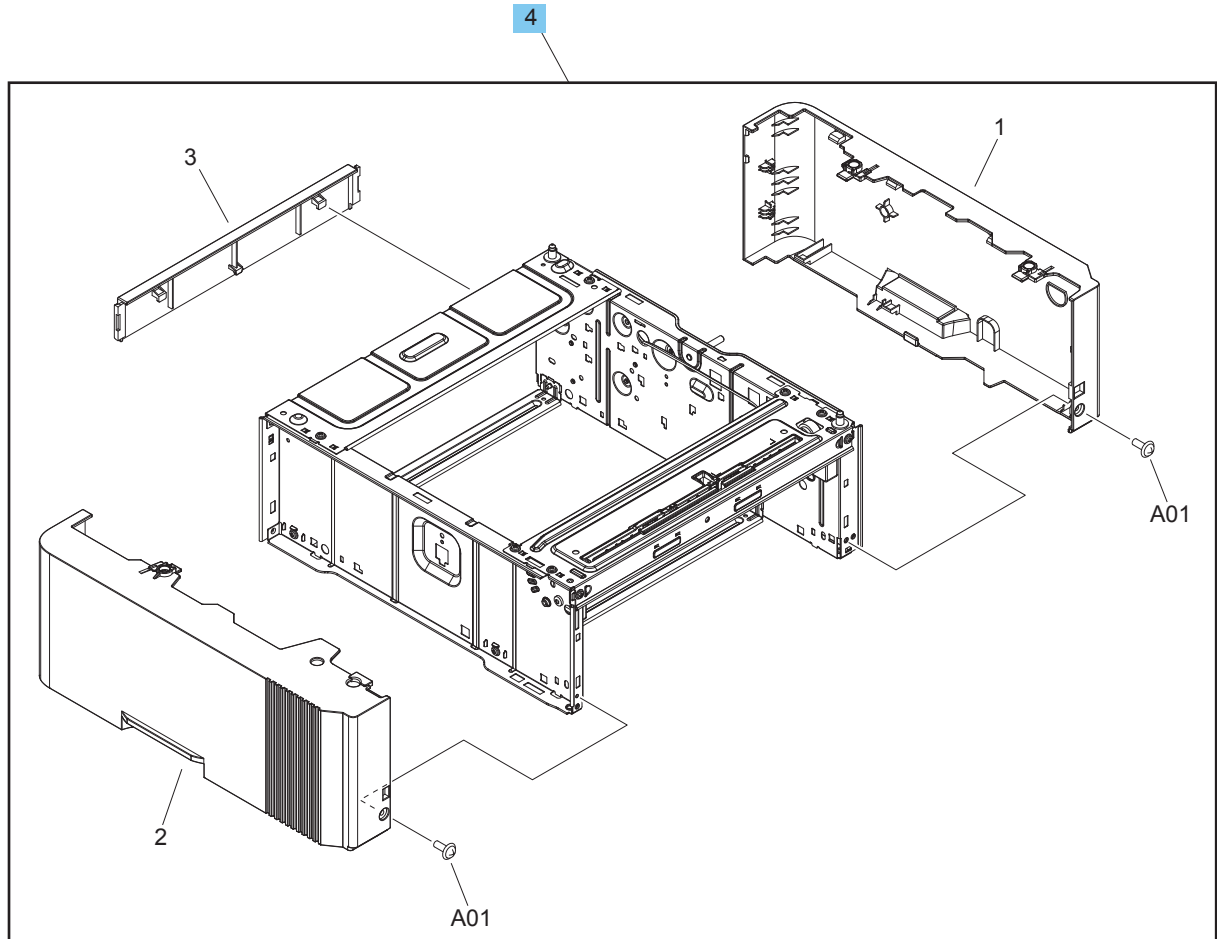

Table 2-15 Covers, 550-sheet paper feeder

Ref	Description	Part number	Qty
4	Paper feeder, 550-sheet assembly (whole unit)	D9P29A-69001	1

Main body, 550-sheet paper feeder

Figure 2-12 Main body, 550-sheet paper feeder

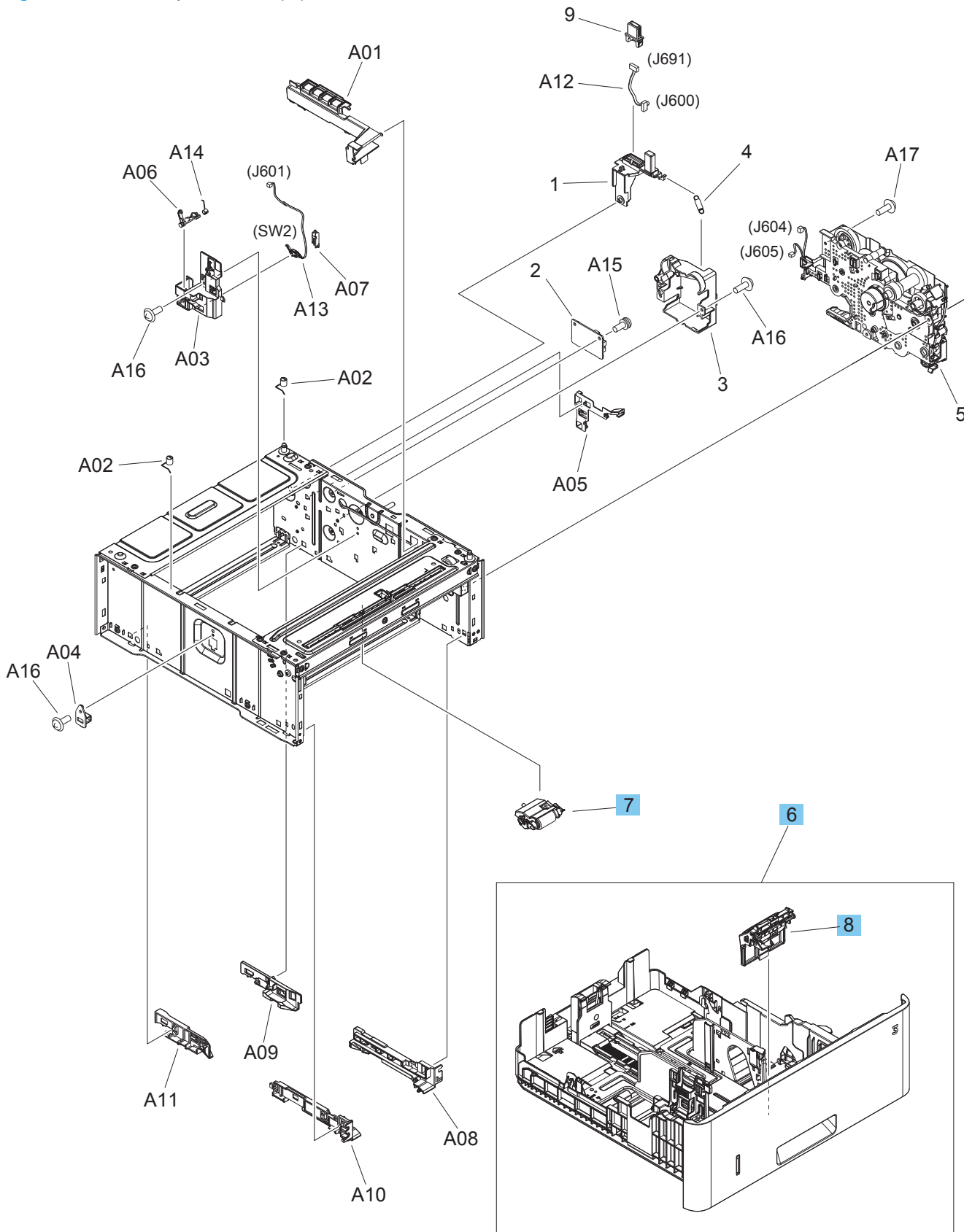

Table 2-16 Main body, 550-sheet paper feeder

Ref	Description	Part number	Qty
6	Cassette assembly (550-sheet feeder)	RM2-5413-000CN	1
7	Roller, paper pickup assembly (550-sheet feeder)	RM2-5741-000CN	1
8	Roller, separation assembly (550-sheet feeder)	RM2-5745-000CN	1

Alphabetical parts list

Table 2-17 Alphabetical parts list

Description	Part number	Table and page
Bracket, USB (MFP)	RC4-2938-000CN	Internal components, printer base (2 of 3) on page 667
Cable, flexible flat formatter (MFP)	RK2-6931-000CN	Internal components, printer base (1 of 3) on page 665
Cable, flexible flat formatter (SFP)	RK2-6920-000CN	Internal components, printer base (1 of 3) on page 665
Cable, flexible flat laser	RK2-9901-000CN	Internal components, printer base (1 of 3) on page 665
Cable, flexible flat panel (SFP)	RK2-6942-000CN	Internal components, printer base (1 of 3) on page 665
Cartridge door assembly	RM2-2562-000CN	Covers (M304/M305/M404/M405) on page 661
Cartridge door assembly	RM2-2567-000CN	Covers (M329/M428/M429) on page 663
Cassette assembly	RM2-5392-010CN	Internal components, printer base (2 of 3) on page 667
Cassette assembly (550-sheet feeder)	RM2-5413-000CN	Main body, 550-sheet paper feeder on page 675
Connecting PCA (duplex model)	RM2-7510-000CN	Internal components, printer base (2 of 3) on page 667
Connecting PCA (simplex model)	RM2-8510-000CN	Internal components, printer base (2 of 3) on page 667
Connector, drawer	VS1-7258-007CN	Internal components, printer base (3 of 3) on page 669
Control panel (MFP)	W2Q13-60103	Covers (M329/M428/M429) on page 663
Control panel assembly (non-wireless models)	RM2-5391-000CN	Covers (M304/M305/M404/M405) on page 661
Control panel assembly (wireless models)	RM2-5424-000CN	Covers (M304/M305/M404/M405) on page 661
Control panel back cover	T6B80-40002	Covers (M329/M428/M429) on page 663
Control panel FFC	W1A30-60101	Covers (M329/M428/M429) on page 663
Control panel mount base	B3Q11-40001	Covers (M329/M428/M429) on page 663
Control panel mount chassis assembly	B3Q10-60145	Covers (M329/M428/M429) on page 663
Control panel mount cover	B3Q11-40002	Covers (M329/M428/M429) on page 663

Table 2-17 Alphabetical parts list (continued)

Description	Part number	Table and page
Cover, cassette rear	RC4-3082-000CN	Covers (M304/M305/M404/M405) on page 661
Cover, cassette rear	RC4-3082-000CN	Covers (M329/M428/M429) on page 663
Cover, fax port (fax models)	C5F99-40003	Covers (M329/M428/M429) on page 663
Cover, full detect sensor	RC4-3219-000CN	Internal components, printer base (2 of 3) on page 667
Cover, I/O small	RC4-3298-000CN	Covers (M304/M305/M404/M405) on page 661
Cover, I/O small	RC4-3299-000CN	Covers (M329/M428/M429) on page 663
Cover, indication	RL2-0675-000CN	Covers (M304/M305/M404/M405) on page 661
Cover, inner left rear	RC4-3108-000CN	Internal components, printer base (1 of 3) on page 665
Cover, left	RL2-3251-000CN	Covers (M304/M305/M404/M405) on page 661
Cover, network (non-network/wireless models)	RC4-2907-000CN	Covers (M304/M305/M404/M405) on page 661
Cover, NFC (MFP)	RC4-2961-000CN	Internal components, printer base (2 of 3) on page 667
Cover, operator (non-wireless models)	RC4-3312-000CN	Covers (M304/M305/M404/M405) on page 661
Cover, operator (wireless models)	RC4-3322-000CN	Covers (M304/M305/M404/M405) on page 661
Cover, right assembly	RM2-2578-000CN	Covers (M304/M305/M404/M405) on page 661
Cover, top	RC4-2956-000CN	Covers (M304/M305/M404/M405) on page 661
Cover, top	RC4-3207-000CN	Covers (M329/M428/M429) on page 663
DC controller PCA	RM3-7580-000CN	Internal components, printer base (1 of 3) on page 665
Duct, fan	RC4-2891-000CN	Internal components, printer base (1 of 3) on page 665
Duplex release button	RC2-6075-000CN	Internal components, printer base (1 of 3) on page 665
Duplexing roller assembly (duplex models)	RM2-5454-000CN	Internal components, printer base (3 of 3) on page 669
Fan	RK2-8068-000CN	Internal components, printer base (1 of 3) on page 665

Table 2-17 Alphabetical parts list (continued)

Description	Part number	Table and page
Fax PCA, Chepstow fax card for BBU (fax models)	W1A78-67909	Internal components, printer base (1 of 3) on page 665
Fax PCA, crawdad (AP+AMS; fax models)	W1A78-67906	Internal components, printer base (1 of 3) on page 665
Fax PCA, crawdad (Brazil; fax models)	W1A78-67908	Internal components, printer base (1 of 3) on page 665
Fax PCA, crawdad (EU; fax models)	W1A78-67907	Internal components, printer base (1 of 3) on page 665
Ferrite, motor	9170-2659	Internal components, printer base (2 of 3) on page 667
FFC, laser scanner	RK2-6919-000CN	Internal components, printer base (1 of 3) on page 665
Fixing (fuser) assembly (110-127v)	RM2-2554-000CN	Internal components, printer base (2 of 3) on page 667
Fixing (fuser) assembly (220-240v)	RM2-2555-000CN	Internal components, printer base (2 of 3) on page 667
Formatter PCA (M304a; EMEA)	W1A66-60001	Internal components, printer base (3 of 3) on page 669
Formatter PCA (M305d; China)	W1A46-60001	Internal components, printer base (3 of 3) on page 669
Formatter PCA (M305dn; China)	W1A47-60001	Internal components, printer base (3 of 3) on page 669
Formatter PCA (M329dn; China only)	W1A23-60001	Internal components, printer base (3 of 3) on page 669
Formatter PCA (M329dw; China only)	W1A24-60001	Internal components, printer base (3 of 3) on page 669
Formatter PCA (M404d)	W1A49-60001	Internal components, printer base (3 of 3) on page 669
Formatter PCA (M404dn)	W1A53-60001	Internal components, printer base (3 of 3) on page 669
Formatter PCA (M404dw)	W1A56-60001	Internal components, printer base (3 of 3) on page 669
Formatter PCA (M404n)	W1A52-60001	Internal components, printer base (3 of 3) on page 669
Formatter PCA (M405d; China only)	W1A58-60002	Internal components, printer base (3 of 3) on page 669
Formatter PCA (M405d; China/India)	W1A58-60001	Internal components, printer base (3 of 3) on page 669
Formatter PCA (M405dn; China only)	W1A59-60002	Internal components, printer base (3 of 3) on page 669
Formatter PCA (M405dn; China/India)	W1A59-60001	Internal components, printer base (3 of 3) on page 669

Table 2-17 Alphabetical parts list (continued)

Description	Part number	Table and page
Formatter PCA (M405dw; China only)	W1A60-60002	Internal components, printer base (3 of 3) on page 669
Formatter PCA (M405dw; China/India)	W1A60-60001	Internal components, printer base (3 of 3) on page 669
Formatter PCA (M405n; China only)	W1A57-60003	Internal components, printer base (3 of 3) on page 669
Formatter PCA (M405n; China/India)	W1A57-60002	Internal components, printer base (3 of 3) on page 669
Formatter PCA (M428dw)	W1A28-60001	Internal components, printer base (3 of 3) on page 669
Formatter PCA (M428dw; Russia)	W1A28-60002	Internal components, printer base (3 of 3) on page 669
Formatter PCA (M428fdn)	W2Q13-60003	Internal components, printer base (3 of 3) on page 669
Formatter PCA (M428fdn; Russia)	W1A32-60001	Internal components, printer base (3 of 3) on page 669
Formatter PCA (M428fdw)	W1A30-60001	Internal components, printer base (3 of 3) on page 669
Formatter PCA (M429dw)	W1A33-60003	Internal components, printer base (3 of 3) on page 669
Formatter PCA (M429dw; China only)	W1A33-60004	Internal components, printer base (3 of 3) on page 669
Formatter PCA (M429fdn)	W1A34-60001	Internal components, printer base (3 of 3) on page 669
Formatter PCA (M429fdn; China only)	W1A34-60002	Internal components, printer base (3 of 3) on page 669
Formatter PCA (M429fdw)	W1A33-60001	Internal components, printer base (3 of 3) on page 669
Formatter PCA (M429fdw; China only)	W1A35-60001	Internal components, printer base (3 of 3) on page 669
Formatter PCA (MFP generic formatter for all 3in1 models)	W2Q12-60001	Internal components, printer base (3 of 3) on page 669
Formatter PCA (MFP generic formatter for all 4in1 models)	W2Q13-60001	Internal components, printer base (3 of 3) on page 669
Formatter PCA (SFP generic formatter for all d models)	W2Q08-60001	Internal components, printer base (3 of 3) on page 669
Formatter PCA (SFP generic formatter for all n/dn/dw models)	W2Q09-60001	Internal components, printer base (3 of 3) on page 669
Guide, cable	RC4-3217-000CN	Covers (M329/M428/M429) on page 663
Guide, led, light	RC4-3311-000CN	Covers (M304/M305/M404/M405) on page 661

Table 2-17 Alphabetical parts list (continued)

Description	Part number	Table and page
High voltage power supply PCA	RM2-7508-000CN	Internal components, printer base (1 of 3) on page 665
Holder, transfer roller left	RC4-3134-000CN	Internal components, printer base (3 of 3) on page 669
Holder, transfer roller right	RC4-3133-000CN	Internal components, printer base (3 of 3) on page 669
HP logo jewel	7121-8686	Covers (M304/M305/M404/M405) on page 661
HP logo jewel	7121-8686	Covers (M329/M428/M429) on page 663
Label, name M304a	RC5-5048-000CN	Covers (M304/M305/M404/M405) on page 661
Label, name M305d	RC5-5046-000CN	Covers (M304/M305/M404/M405) on page 661
Label, name M305dn	RC5-5047-000CN	Covers (M304/M305/M404/M405) on page 661
Label, name M404d	RC5-5049-000CN	Covers (M304/M305/M404/M405) on page 661
Label, name M404dn	RC5-5039-000CN	Covers (M304/M305/M404/M405) on page 661
Label, name M404dw	RC5-5041-000CN	Covers (M304/M305/M404/M405) on page 661
Label, name M404n	RC5-5038-000CN	Covers (M304/M305/M404/M405) on page 661
Label, name M405d	RC5-5043-000CN	Covers (M304/M305/M404/M405) on page 661
Label, name M405dn	RC5-5044-000CN	Covers (M304/M305/M404/M405) on page 661
Label, name M405dw	RC5-5045-000CN	Covers (M304/M305/M404/M405) on page 661
Label, name M405n	RC5-5042-000CN	Covers (M304/M305/M404/M405) on page 661
Laser scanner assembly	RM2-2891-000CN	Internal components, printer base (1 of 3) on page 665
Left cover assembly	RM2-2579-000CN	Covers (M329/M428/M429) on page 663
Link, pressure release	RC4-4479-000CN	Covers (M304/M305/M404/M405) on page 661
Link, pressure release	RC4-4479-000CN	Covers (M329/M428/M429) on page 663
Low voltage power supply PCA (MFP 220-240v)	RM3-7414-000CN	Internal components, printer base (1 of 3) on page 665

Table 2-17 Alphabetical parts list (continued)

Description	Part number	Table and page
Low voltage power supply PCA (SFP 220-240v)	RM3-7412-000CN	Internal components, printer base (1 of 3) on page 665
Low voltage power supply PCB assembly (SFP 110-127v)	RM3-7411-000CN	Internal components, printer base (1 of 3) on page 665
Low voltage, power supply PCA (MFP 110-127v)	RM3-7413-000CN	Internal components, printer base (1 of 3) on page 665
Main motor assembly	RM2-9531-000CN	Internal components, printer base (2 of 3) on page 667
Mute USB PCA (MFP)	5851-7008	Internal components, printer base (2 of 3) on page 667
Nameplate, HP LaserJet Pro MFP M329dn	W1A23-00003	Covers (M329/M428/M429) on page 663
Nameplate, HP LaserJet Pro MFP M329dw	W1A24-00003	Covers (M329/M428/M429) on page 663
Nameplate, HP LaserJet Pro MFP M428dw	W1A28-00002	Covers (M329/M428/M429) on page 663
Nameplate, HP LaserJet Pro MFP M428fdn	W1A29-00002	Covers (M329/M428/M429) on page 663
Nameplate, HP LaserJet Pro MFP M428fdw	W1A30-00003	Covers (M329/M428/M429) on page 663
Nameplate, HP LaserJet Pro MFP M429dw	W1A33-00001	Covers (M329/M428/M429) on page 663
Nameplate, HP LaserJet Pro MFP M429fdn	W1A34-00001	Covers (M329/M428/M429) on page 663
Nameplate, HP LaserJet Pro MFP M429fdw	W1A35-00001	Covers (M329/M428/M429) on page 663
Pad, thermal transfer	5851-6550	Internal components, printer base (3 of 3) on page 669
Paper feeder, 550-sheet assembly (whole unit)	D9P29A-69001	Covers, 550-sheet paper feeder on page 673
Paper pickup roller assembly	RM2-5452-000CN	Internal components, printer base (3 of 3) on page 669
Paper re-pickup assembly	RM2-5666-000CN	Covers (M329/M428/M429) on page 663
Paper re-pickup assembly (duplex models)	RM2-5666-000CN	Covers (M304/M305/M404/M405) on page 661
Power switch PCA	RM2-8506-000CN	Internal components, printer base (2 of 3) on page 667
Rear door assembly	RM2-5405-000CN	Covers (M329/M428/M429) on page 663
Rear door assembly (duplex models)	RM2-5405-000CN	Covers (M304/M305/M404/M405) on page 661

Table 2-17 Alphabetical parts list (continued)

Description	Part number	Table and page
Rear door assembly (simplex models)	RM2-5430-000CN	Covers (M304/M305/M404/M405) on page 661
Registration assembly	RM2-2577-000CN	Internal components, printer base (3 of 3) on page 669
Right cover assembly	RM2-2578-000CN	Covers (M329/M428/M429) on page 663
Roller, multi-purpose	RL2-0656-000CN	Internal components, printer base (3 of 3) on page 669
Roller, multi-purpose separation	RL2-0657-000CN	Internal components, printer base (3 of 3) on page 669
Roller, paper pickup assembly (550-sheet feeder)	RM2-5741-000CN	Main body, 550-sheet paper feeder on page 675
Roller, separation assembly (550-sheet feeder)	RM2-5745-000CN	Main body, 550-sheet paper feeder on page 675
Roller, transfer	RM1-4023-000CN	Internal components, printer base (3 of 3) on page 669
Scanner/ADF-Pilderiver assembly (duplex models)	W1A73-60102	Main assembly (document feeder and image scanner) on page 659
Scanner/ADF-Pilderiver assembly (simplex models)	W1A73-60101	Main assembly (document feeder and image scanner) on page 659
Sensor, Tray 2 assembly	RM2-5375-000CN	Internal components, printer base (2 of 3) on page 667
Sensor, Tray 2 assembly	RM2-5375-000CN	Internal components, printer base (3 of 3) on page 669
Separation roller assembly	RM2-5397-000CN	Internal components, printer base (2 of 3) on page 667
Shaft, support	RC4-3002-000CN	Covers (M304/M305/M404/M405) on page 661
Shaft, support	RC4-3002-000CN	Covers (M329/M428/M429) on page 663
Sheet, damper	RC2-6075-000CN	Covers (M329/M428/M429) on page 663
Sheet, damper (duplex models)	RC2-6075-000CN	Covers (M304/M305/M404/M405) on page 661
Spacer, hexagonal fax (fax models)	C5F98-20001	Internal components, printer base (1 of 3) on page 665
Spring, compression	RU8-2935-000CN	Internal components, printer base (3 of 3) on page 669
Tag cable assembly	RM2-2556-000CN	Internal components, printer base (1 of 3) on page 665
Tray, paper delivery	RC4-3231-000CN	Covers (M329/M428/M429) on page 663

Table 2-17 Alphabetical parts list (continued)

Description	Part number	Table and page
Tray, paper delivery (non-wireless models)	RC4-3231-000CN	Covers (M304/M305/M404/M405) on page 661
Tray, paper delivery (wireless models)	RM2-2581-000CN	Covers (M304/M305/M404/M405) on page 661
Wireless holder	W1A30-40001	Internal components, printer base (1 of 3) on page 665
Wireless module (Ultra)	0960-4025	Internal components, printer base (1 of 3) on page 665

Numerical parts list

Table 2-18 Numerical parts list

Part number	Description	Table and page
0960-4025	Wireless module (Ultra)	Internal components, printer base (1 of 3) on page 665
5851-6550	Pad, thermal transfer	Internal components, printer base (3 of 3) on page 669
5851-7008	Mute USB PCA (MFP)	Internal components, printer base (2 of 3) on page 667
7121-8686	HP logo jewel	Covers (M304/M305/M404/M405) on page 661
7121-8686	HP logo jewel	Covers (M329/M428/M429) on page 663
9170-2659	Ferrite, motor	Internal components, printer base (2 of 3) on page 667
B3Q10-60145	Control panel mount chassis assembly	Covers (M329/M428/M429) on page 663
B3Q11-40001	Control panel mount base	Covers (M329/M428/M429) on page 663
B3Q11-40002	Control panel mount cover	Covers (M329/M428/M429) on page 663
C5F98-20001	Spacer, hexagonal fax (fax models)	Internal components, printer base (1 of 3) on page 665
C5F99-40003	Cover, fax port (fax models)	Covers (M329/M428/M429) on page 663
D9P29A-69001	Paper feeder, 550-sheet assembly (whole unit)	Covers, 550-sheet paper feeder on page 673
W1A78-67906	Fax PCA, crawdad (AP+AMS; fax models)	Internal components, printer base (1 of 3) on page 665
W1A78-67907	Fax PCA, crawdad (EU; fax models)	Internal components, printer base (1 of 3) on page 665
W1A78-67908	Fax PCA, crawdad (Brazil; fax models)	Internal components, printer base (1 of 3) on page 665
W1A78-67909	Fax PCA, Chepstow fax card for BBU (fax models)	Internal components, printer base (1 of 3) on page 665
RC2-6075-000CN	Sheet, damper (duplex models)	Covers (M304/M305/M404/M405) on page 661
RC2-6075-000CN	Sheet, damper	Covers (M329/M428/M429) on page 663
RC2-6075-000CN	Duplex release button	Internal components, printer base (1 of 3) on page 665
RC4-2891-000CN	Duct, fan	Internal components, printer base (1 of 3) on page 665

Table 2-18 Numerical parts list (continued)

Part number	Description	Table and page
RC4-2907-000CN	Cover, network (non-network/wireless models)	Covers (M304/M305/M404/M405) on page 661
RC4-2938-000CN	Bracket, USB (MFP)	Internal components, printer base (2 of 3) on page 667
RC4-2956-000CN	Cover, top	Covers (M304/M305/M404/M405) on page 661
RC4-2961-000CN	Cover, NFC (MFP)	Internal components, printer base (2 of 3) on page 667
RC4-3002-000CN	Shaft, support	Covers (M304/M305/M404/M405) on page 661
RC4-3002-000CN	Shaft, support	Covers (M329/M428/M429) on page 663
RC4-3082-000CN	Cover, cassette rear	Covers (M304/M305/M404/M405) on page 661
RC4-3082-000CN	Cover, cassette rear	Covers (M329/M428/M429) on page 663
RC4-3108-000CN	Cover, inner left rear	Internal components, printer base (1 of 3) on page 665
RC4-3133-000CN	Holder, transfer roller right	Internal components, printer base (3 of 3) on page 669
RC4-3134-000CN	Holder, transfer roller left	Internal components, printer base (3 of 3) on page 669
RC4-3207-000CN	Cover, top	Covers (M329/M428/M429) on page 663
RC4-3217-000CN	Guide, cable	Covers (M329/M428/M429) on page 663
RC4-3219-000CN	Cover, full detect sensor	Internal components, printer base (2 of 3) on page 667
RC4-3231-000CN	Tray, paper delivery (non-wireless models)	Covers (M304/M305/M404/M405) on page 661
RC4-3231-000CN	Tray, paper delivery	Covers (M329/M428/M429) on page 663
RC4-3298-000CN	Cover, I/O small	Covers (M304/M305/M404/M405) on page 661
RC4-3299-000CN	Cover, I/O small	Covers (M329/M428/M429) on page 663
RC4-3311-000CN	Guide, led, light	Covers (M304/M305/M404/M405) on page 661
RC4-3312-000CN	Cover, operator (non-wireless models)	Covers (M304/M305/M404/M405) on page 661
RC4-3322-000CN	Cover, operator (wireless models)	Covers (M304/M305/M404/M405) on page 661

Table 2-18 Numerical parts list (continued)

Part number	Description	Table and page
RC4-4479-000CN	Link, pressure release	Covers (M304/M305/M404/M405) on page 661
RC4-4479-000CN	Link, pressure release	Covers (M329/M428/M429) on page 663
RC5-5038-000CN	Label, name M404n	Covers (M304/M305/M404/M405) on page 661
RC5-5039-000CN	Label, name M404dn	Covers (M304/M305/M404/M405) on page 661
RC5-5041-000CN	Label, name M404dw	Covers (M304/M305/M404/M405) on page 661
RC5-5042-000CN	Label, name M405n	Covers (M304/M305/M404/M405) on page 661
RC5-5043-000CN	Label, name M405d	Covers (M304/M305/M404/M405) on page 661
RC5-5044-000CN	Label, name M405dn	Covers (M304/M305/M404/M405) on page 661
RC5-5045-000CN	Label, name M405dw	Covers (M304/M305/M404/M405) on page 661
RC5-5046-000CN	Label, name M305d	Covers (M304/M305/M404/M405) on page 661
RC5-5047-000CN	Label, name M305dn	Covers (M304/M305/M404/M405) on page 661
RC5-5048-000CN	Label, name M304a	Covers (M304/M305/M404/M405) on page 661
RC5-5049-000CN	Label, name M404d	Covers (M304/M305/M404/M405) on page 661
RK2-6919-000CN	FFC, laser scanner	Internal components, printer base (1 of 3) on page 665
RK2-6920-000CN	Cable, flexible flat formatter (SFP)	Internal components, printer base (1 of 3) on page 665
RK2-6931-000CN	Cable, flexible flat formatter (MFP)	Internal components, printer base (1 of 3) on page 665
RK2-6942-000CN	Cable, flexible flat panel (SFP)	Internal components, printer base (1 of 3) on page 665
RK2-8068-000CN	Fan	Internal components, printer base (1 of 3) on page 665
RK2-9901-000CN	Cable, flexible flat laser	Internal components, printer base (1 of 3) on page 665
RL2-0656-000CN	Roller, multi-purpose	Internal components, printer base (3 of 3) on page 669
RL2-0657-000CN	Roller, multi-purpose separation	Internal components, printer base (3 of 3) on page 669

Table 2-18 Numerical parts list (continued)

Part number	Description	Table and page
RL2-0675-000CN	Cover, indication	Covers (M304/M305/M404/M405) on page 661
RL2-3251-000CN	Cover, left	Covers (M304/M305/M404/M405) on page 661
RM1-4023-000CN	Roller, transfer	Internal components, printer base (3 of 3) on page 669
RM2-2554-000CN	Fixing (fuser) assembly (110-127v)	Internal components, printer base (2 of 3) on page 667
RM2-2555-000CN	Fixing (fuser) assembly (220-240v)	Internal components, printer base (2 of 3) on page 667
RM2-2556-000CN	Tag cable assembly	Internal components, printer base (1 of 3) on page 665
RM2-2562-000CN	Cartridge door assembly	Covers (M304/M305/M404/M405) on page 661
RM2-2567-000CN	Cartridge door assembly	Covers (M329/M428/M429) on page 663
RM2-2577-000CN	Registration assembly	Internal components, printer base (3 of 3) on page 669
RM2-2578-000CN	Cover, right assembly	Covers (M304/M305/M404/M405) on page 661
RM2-2578-000CN	Right cover assembly	Covers (M329/M428/M429) on page 663
RM2-2579-000CN	Left cover assembly	Covers (M329/M428/M429) on page 663
RM2-2581-000CN	Tray, paper delivery (wireless models)	Covers (M304/M305/M404/M405) on page 661
RM2-2891-000CN	Laser scanner assembly	Internal components, printer base (1 of 3) on page 665
RM2-5375-000CN	Sensor, Tray 2 assembly	Internal components, printer base (2 of 3) on page 667
RM2-5375-000CN	Sensor, Tray 2 assembly	Internal components, printer base (3 of 3) on page 669
RM2-5391-000CN	Control panel assembly (non-wireless models)	Covers (M304/M305/M404/M405) on page 661
RM2-5392-010CN	Cassette assembly	Internal components, printer base (2 of 3) on page 667
RM2-5397-000CN	Separation roller assembly	Internal components, printer base (2 of 3) on page 667
RM2-5405-000CN	Rear door assembly (duplex models)	Covers (M304/M305/M404/M405) on page 661
RM2-5405-000CN	Rear door assembly	Covers (M329/M428/M429) on page 663

Table 2-18 Numerical parts list (continued)

Part number	Description	Table and page
RM2-5413-000CN	Cassette assembly (550-sheet feeder)	Main body, 550-sheet paper feeder on page 675
RM2-5424-000CN	Control panel assembly (wireless models)	Covers (M304/M305/M404/M405) on page 661
RM2-5430-000CN	Rear door assembly (simplex models)	Covers (M304/M305/M404/M405) on page 661
RM2-5452-000CN	Paper pickup roller assembly	Internal components, printer base (3 of 3) on page 669
RM2-5454-000CN	Duplexing roller assembly (duplex models)	Internal components, printer base (3 of 3) on page 669
RM2-5666-000CN	Paper re-pickup assembly (duplex models)	Covers (M304/M305/M404/M405) on page 661
RM2-5666-000CN	Paper re-pickup assembly	Covers (M329/M428/M429) on page 663
RM2-5741-000CN	Roller, paper pickup assembly (550-sheet feeder)	Main body, 550-sheet paper feeder on page 675
RM2-5745-000CN	Roller, separation assembly (550-sheet feeder)	Main body, 550-sheet paper feeder on page 675
RM2-7508-000CN	High voltage power supply PCA	Internal components, printer base (1 of 3) on page 665
RM2-7510-000CN	Connecting PCA (duplex model)	Internal components, printer base (2 of 3) on page 667
RM2-8506-000CN	Power switch PCA	Internal components, printer base (2 of 3) on page 667
RM2-8510-000CN	Connecting PCA (simplex model)	Internal components, printer base (2 of 3) on page 667
RM2-9531-000CN	Main motor assembly	Internal components, printer base (2 of 3) on page 667
RM3-7411-000CN	Low voltage power supply PCB assembly (SFP 110-127v)	Internal components, printer base (1 of 3) on page 665
RM3-7412-000CN	Low voltage power supply PCA (SFP 220-240v)	Internal components, printer base (1 of 3) on page 665
RM3-7413-000CN	Low voltage power supply PCA (MFP 110-127v)	Internal components, printer base (1 of 3) on page 665
RM3-7414-000CN	Low voltage power supply PCA (MFP 220-240v)	Internal components, printer base (1 of 3) on page 665
RM3-7580-000CN	DC controller PCA	Internal components, printer base (1 of 3) on page 665
RU8-2935-000CN	Spring, compression	Internal components, printer base (3 of 3) on page 669
T6B80-40002	Control panel back cover	Covers (M329/M428/M429) on page 663

Table 2-18 Numerical parts list (continued)

Part number	Description	Table and page
VS1-7258-007CN	Connector, drawer	Internal components, printer base (3 of 3) on page 669
W1A23-00003	Nameplate, HP LaserJet Pro MFP M329dn	Covers (M329/M428/M429) on page 663
W1A23-60001	Formatter PCA (M329dn; China only)	Internal components, printer base (3 of 3) on page 669
W1A24-00003	Nameplate, HP LaserJet Pro MFP M329dw	Covers (M329/M428/M429) on page 663
W1A24-60001	Formatter PCA (M329dw; China only)	Internal components, printer base (3 of 3) on page 669
W1A28-00002	Nameplate, HP LaserJet Pro MFP M428dw	Covers (M329/M428/M429) on page 663
W1A28-60001	Formatter PCA (M428dw)	Internal components, printer base (3 of 3) on page 669
W1A28-60002	Formatter PCA (M428dw; Russia)	Internal components, printer base (3 of 3) on page 669
W1A29-00002	Nameplate, HP LaserJet Pro MFP M428fdn	Covers (M329/M428/M429) on page 663
W1A30-00003	Nameplate, HP LaserJet Pro MFP M428fdw	Covers (M329/M428/M429) on page 663
W1A30-40001	Wireless holder	Internal components, printer base (1 of 3) on page 665
W1A30-60001	Formatter PCA (M428fdw)	Internal components, printer base (3 of 3) on page 669
W1A30-60101	Control panel FFC	Covers (M329/M428/M429) on page 663
W1A32-60001	Formatter PCA (M428fdn; Russia)	Internal components, printer base (3 of 3) on page 669
W1A33-00001	Nameplate, HP LaserJet Pro MFP M429dw	Covers (M329/M428/M429) on page 663
W1A33-60001	Formatter PCA (M429fdw)	Internal components, printer base (3 of 3) on page 669
W1A33-60003	Formatter PCA (M429dw)	Internal components, printer base (3 of 3) on page 669
W1A33-60004	Formatter PCA (M429dw; China only)	Internal components, printer base (3 of 3) on page 669
W1A34-00001	Nameplate, HP LaserJet Pro MFP M429fdn	Covers (M329/M428/M429) on page 663
W1A34-60001	Formatter PCA (M429fdn)	Internal components, printer base (3 of 3) on page 669
W1A34-60002	Formatter PCA (M429fdn; China only)	Internal components, printer base (3 of 3) on page 669

Table 2-18 Numerical parts list (continued)

Part number	Description	Table and page
W1A35-00001	Nameplate, HP LaserJet Pro MFP M429fdw	Covers (M329/M428/M429) on page 663
W1A35-60001	Formatter PCA (M429fdw; China only)	Internal components, printer base (3 of 3) on page 669
W1A46-60001	Formatter PCA (M305d; China)	Internal components, printer base (3 of 3) on page 669
W1A47-60001	Formatter PCA (M305dn; China)	Internal components, printer base (3 of 3) on page 669
W1A49-60001	Formatter PCA (M404d)	Internal components, printer base (3 of 3) on page 669
W1A52-60001	Formatter PCA (M404n)	Internal components, printer base (3 of 3) on page 669
W1A53-60001	Formatter PCA (M404dn)	Internal components, printer base (3 of 3) on page 669
W1A56-60001	Formatter PCA (M404dw)	Internal components, printer base (3 of 3) on page 669
W1A57-60002	Formatter PCA (M405n; China/India)	Internal components, printer base (3 of 3) on page 669
W1A57-60003	Formatter PCA (M405n; China only)	Internal components, printer base (3 of 3) on page 669
W1A58-60001	Formatter PCA (M405d; China/India)	Internal components, printer base (3 of 3) on page 669
W1A58-60002	Formatter PCA (M405d; China only)	Internal components, printer base (3 of 3) on page 669
W1A59-60001	Formatter PCA (M405dn; China/India)	Internal components, printer base (3 of 3) on page 669
W1A59-60002	Formatter PCA (M405dn; China only)	Internal components, printer base (3 of 3) on page 669
W1A60-60001	Formatter PCA (M405dw; China/India)	Internal components, printer base (3 of 3) on page 669
W1A60-60002	Formatter PCA (M405dw; China only)	Internal components, printer base (3 of 3) on page 669
W1A66-60001	Formatter PCA (M304a; EMEA)	Internal components, printer base (3 of 3) on page 669
W1A73-60108	Scanner/ADF-Pilddriver assembly (simplex models)	Main assembly (document feeder and image scanner) on page 659
W1A73-60109	Scanner/ADF-Pilddriver assembly (duplex models)	Main assembly (document feeder and image scanner) on page 659
W2Q08-60001	Formatter PCA (SFP generic formatter for all d models)	Internal components, printer base (3 of 3) on page 669
W2Q09-60001	Formatter PCA (SFP generic formatter for all n/dn/dw models)	Internal components, printer base (3 of 3) on page 669

Table 2-18 Numerical parts list (continued)

Part number	Description	Table and page
W2Q12-60001	Formatter PCA (MFP generic formatter for all 3in1 models)	Internal components, printer base (3 of 3) on page 669
W2Q13-60001	Formatter PCA (MFP generic formatter for all 4in1 models)	Internal components, printer base (3 of 3) on page 669
W2Q13-60003	Formatter PCA (M428fdn)	Internal components, printer base (3 of 3) on page 669
W2Q13-60103	Control panel (MFP)	Covers (M329/M428/M429) on page 663

Index

Symbols/Numerics

- 2-line LCD operator and indication covers (M304/M305/M404/M405) removing and replacing 151
- 2-line LCD operator and indication covers (M304/M305/M404/M405), removing and replacing 151
- 500-sheet feeder
 - parts lists and diagrams 672
- 550-sheet paper feeder
 - removing and replacing 623
- 550-sheet paper feeder, removing and replacing 623

A

- accessories
 - part numbers 651
- after-service checklist 8

C

- cable guide (M329/M428/M429) removing and replacing 121
- cable guide (M329/M428/M429), removing and replacing 121
- cartridge-door assembly
 - removing and replacing 57
- cartridge-door assembly, removing and replacing 57
- cartridges
 - ordering 650
 - part numbers 650
- cassette rear cover
 - removing and replacing 93
- cassette rear cover, removing and replacing 93
- cautions iii
- Channel partners support
 - HP Channel Services Network (CSN) v, 2, 646

- checklists
 - preservice 7
- connecting PCA
 - removing and replacing 453
- connecting PCA, removing and replacing 453
- control panel (M329/M428/M429) removing and replacing 579
- control panel 22-pin FFC (M329/M428/M429) removing and replacing 579
- control panel and control panel 22-pin FFC (M329/M428/M429), removing and replacing 579
- control panel and control panel sub assemblies (M329/M428/M429), removing and replacing 579
- control panel FFC (M304/M305/M404/M405) removing and replacing 361
- control panel FFC (M304/M305/M404/M405), removing and replacing 361
- control panel mount base (M329/M428/M429) removing and replacing 579
- control panel mount base (M329/M428/M429), removing and replacing 579
- control panel mount chassis assembly (M329/M428/M429) removing and replacing 579
- control panel mount chassis assembly (M329/M428/M429), removing and replacing 579
- control panel mount cover (M329/M428/M429) removing and replacing 579

- control panel mount cover (M329/M428/M429), removing and replacing 579
- conventions, document iii
- covers, printer base
 - parts lists and diagrams 660

D

- damper sheets
 - removing and replacing 49
- damper sheets, removing and replacing 49
- DC controller
 - removing and replacing 398
- DC controller, removing and replacing 398
- document conventions iii
- document feeder
 - parts lists and diagrams 658
- document feeder and image scanner
 - parts lists and diagrams 658
- document revisions vii

E

- electrostatic discharge (ESD) 5
- ESD electrostatic discharge (ESD) 5

F

- fan (FM1) removing and replacing 296
- fan (FM1), removing and replacing 296
- fan holder (FM1) removing and replacing 305
- fan holder (FM1), removing and replacing 305
- fax PCA
 - removing and replacing 259

- FFC control panel (M304/M305/M404/M405)
 - removing and replacing 361
 - FFC control panel (M304/M305/M404/M405), removing and replacing 361
 - FFC laser scanner
 - removing and replacing 480
 - FFC laser scanner, removing and replacing 480
 - FFC, formatter
 - removing and replacing 372
 - FFC, formatter, removing and replacing 372
 - field-replaceable units (FRUs)
 - replacing 4
 - flat-flexible cable, control panel (M304/M305/M404/M405)
 - removing and replacing 361
 - flat-flexible cable, control panel (M304/M305/M404/M405), removing and replacing 361
 - flat-flexible cable, formatter
 - removing and replacing 372
 - flat-flexible cable, formatter, removing and replacing 372
 - flat-flexible cable, laser scanner
 - removing and replacing 480
 - flat-flexible cable, laser scanner, removing and replacing 480
 - formatter FFC
 - removing and replacing 372
 - formatter FFC, removing and replacing 372
 - formatter PCA
 - removing and replacing 285
 - formatter PCA, removing and replacing 285
 - FRUs (field-replaceable units)
 - replacing 4
 - fuser
 - removing and replacing 201
 - fuser, removing and replacing 201
- H**
- high-voltage power supply
 - removing and replacing 509
 - high-voltage power supply, removing and replacing 509
 - history, revisions vii
- I**
- holder fan (FM1)
 - removing and replacing 305
 - holder fan (FM1), removing and replacing 305
 - HP Channel Services Network (CSN)
 - Channel partners support v, 2, 646
 - HVPS
 - removing and replacing 509
 - HVPS, removing and replacing 509
- I**
- I/O cover
 - removing and replacing 51
 - I/O cover, removing and replacing 51
 - image scanner
 - parts lists and diagrams 658
 - input/output cover
 - removing and replacing 51
 - input/output cover, removing and replacing 51
 - installation 6
 - screws 6
 - See also* replacing parts
 - integrated scanner assembly (M329/M428/M429)
 - removing and replacing 183
 - integrated scanner assembly (M329/M428/M429), removing and replacing 183
 - internal components, printer
 - parts lists and diagrams 664
 - ISA
 - removing and replacing 183
 - ISA (M329/M428/M429), removing and replacing 183
 - ISA lift assembly and slider pin
 - removing and replacing 195
 - ISA lift assembly and slider pin (M329/M428/M429)
 - removing and replacing 195
 - ISA lift assembly and slider pin (M329/M428/M429), removing and replacing 195
- L**
- laser scanner
 - warnings for servicing 4
 - laser scanner assembly
 - removing and replacing 316
 - laser scanner assembly, removing and replacing 316
 - laser scanner FFC
 - removing and replacing 480
 - laser scanner FFC, removing and replacing 480
 - left cover
 - removing and replacing 68
 - left cover, removing and replacing 68
 - low-voltage power supply
 - removing and replacing 537
 - low-voltage power supply, removing and replacing 537
 - LVPS
 - removing and replacing 537
 - LVPS, removing and replacing 537
- M**
- main motor (M1)
 - removing and replacing 243
 - main motor (M1), removing and replacing 243
 - maintenance kits
 - part numbers 651
 - multiple times
 - using toner cartridges multiple times: repair 7
 - multiple times, repair 7
 - multipurpose tray (Tray 1) roller
 - removing and replacing 11
 - multipurpose tray (Tray 1) roller, removing and replacing 11
 - mute USB PCA
 - removing and replacing 268
- N**
- notes iii
- O**
- optional Tray 3 paper pickup roller assembly (Tray 3), removing and replacing 34, 632
 - ordering
 - toner cartridges and accessories 650
 - output bin
 - removing and replacing 162
 - output bin, removing and replacing 162

P

- paper delivery tray (output bin)
 - removing and replacing 162
- paper delivery tray (output bin), removing and replacing 162
- paper pickup roller assembly (Tray 2)
 - removing and replacing 41, 601
- paper pickup roller assembly (Tray 2), removing and replacing 41, 601
- paper pickup roller assembly (Tray 3)
 - removing and replacing 34, 632
- paper pickup roller assembly (Tray 3), removing and replacing 34, 632
- part numbers
 - accessories 651
 - replacement parts 651
 - staple cartridges 651
 - supplies 651
 - toner cartridge 651
 - toner cartridges 650
- parts lists and diagrams 645
 - 500-sheet feeder 672
 - covers, printer base 660
 - document feeder and image scanner 658
 - internal components, printer 664
 - using 657
- PCA connecting
 - removing and replacing 453
- PCA connecting, removing and replacing 453
- PCA power switch
 - removing and replacing 250
- PCA power switch, removing and replacing 250
- post-service tests 8
- power switch printed circuit assembly
 - removing and replacing 250
- power switch printed circuit assembly, removing and replacing 250
- preservice checklist 7
- pressure-release link
 - removing and replacing 62
- pressure-release link, removing and replacing 62
- print quality
 - test 8

R

- rear door assembly
 - removing and replacing 84
- rear door assembly, removing and replacing 84
- registration assembly
 - removing and replacing 214
- registration assembly, removing and replacing 214
- removal strategy
 - removing and replacing 4
- removing and replacing
 - 2-line LCD operator and indication covers (M304/M305/M404/M405) 151
 - 550-sheet paper feeder 623
 - cable guide (M329/M428/M429) 121
 - cartridge-door assembly 57
 - cassette rear cover 93
 - connecting PCA 453
 - control panel and control panel sub assemblies (M329/M428/M429) 579
 - control panel FFC (M304/M305/M404/M405) 361
 - damper sheets 49
 - DC controller 398
 - fan (FM1) 296
 - fan holder (FM1) 305
 - fax PCA 259
 - FFC control panel (M304/M305/M404/M405) 361
 - FFC laser scanner 480
 - FFC, formatter 372
 - flat-flexible cable, control panel (M304/M305/M404/M405) 361
 - flat-flexible cable, formatter 372
 - flat-flexible cable, laser scanner 480
 - formatter FFC 372
 - formatter PCA 285
 - fuser 201
 - high-voltage power supply 509
 - HVPS 509
 - I/O cover 51
 - input/output cover 51
 - integrated scanner assembly (M329/M428/M429) 183
 - ISA (M329/M428/M429) 183

- ISA lift assembly and slider pin (M329/M428/M429) 195
- laser scanner assembly 316
- laser scanner FFC 480
- left cover 68
- low-voltage power supply 537
- LVPS 537
- main motor (M1) 243
- multipurpose tray (Tray 1) roller 11
- mute USB PCA 268
- output bin 162
- paper delivery tray (output bin) 162
- paper pickup roller assembly (Tray 2) 41, 601
- paper pickup roller assembly (Tray 3) 34, 632
- PCA connecting 453
- PCA power switch 250
- power switch printed circuit assembly 250
- pressure-release link 62
- rear door assembly 84
- registration assembly 214
- right cover 77
- roller MP tray (Tray 1) 11
- separation roller assembly (Tray 2) 23, 605
- separation roller assembly (Tray 3) 28, 639
- sheet-metal formatter bracket and formatter PCA 338
- support shaft 54
- tag-cable assembly (toner-cartridge memory) 426
- toner-cartridge memory (tag-cable assembly) 426
- top cover (M304/M305/M404/M405) 142
- top cover (M329/M428/M429) 103
- Tray 1 roller 11
- Tray 2 16, 598, 599
- Tray 2 paper pickup roller assembly 41, 601
- Tray 2 sensor assembly 608
- Tray 3 628
- Tray 3 cassette 19
- wireless PCA 277

- removing parts
 - after-service checklist 8
 - checklists 7
 - tools, required 5
 - repair mode 7
 - replacement parts
 - part numbers 651
 - replacing
 - parts 4
 - replacing parts
 - about 4
 - after-service checklist 8
 - screws 6
 - tools, required 5
 - revision history, document vii
 - right cover
 - removing and replacing 77
 - right cover, removing and replacing 77
 - roller MP tray (Tray 1)
 - removing and replacing 11
 - roller MP tray (Tray 1), removing and replacing 11
- S**
- screwdrivers, required 5
 - screws
 - installing 6
 - replacing 5
 - types of 6
 - separation roller assembly (Tray 2)
 - removing and replacing 23, 605
 - separation roller assembly (Tray 2), removing and replacing 23, 605
 - separation roller assembly (Tray 3)
 - removing and replacing 28, 639
 - separation roller assembly (Tray 3), removing and replacing 28, 639
 - service and support information 651
 - WISE and CSN v, 2, 646
 - service approach
 - removing and replacing 7
 - sheet-metal formatter bracket and formatter PCA, removing and replacing 338
 - sheet-metal formatter/fax bracket and formatter PCA
 - removing and replacing 338
 - staple cartridges
 - part numbers 651
 - static, precautions for 5
 - supplies
 - part numbers 651
 - support shaft
 - removing and replacing 54
 - support shaft, removing and replacing 54
- T**
- tag-cable assembly (toner-cartridge memory)
 - removing and replacing 426
 - tag-cable assembly (toner-cartridge memory), removing and replacing 426
 - tests
 - post-service 8
 - print-quality 8
 - tips iii
 - toner cartridge
 - part numbers 651
 - toner cartridges
 - ordering 650
 - part numbers 650
 - toner-cartridge memory (tag-cable assembly)
 - removing and replacing 426
 - toner-cartridge memory (tag-cable assembly), removing and replacing 426
 - tools, required 5
 - top cover (M304/M305/M404/M405)
 - removing and replacing 142
 - top cover (M304/M305/M404/M405), removing and replacing 142
 - top cover (M329/M428/M429)
 - removing and replacing 103
 - top cover (M329/M428/M429), removing and replacing 103
 - Tray 1 roller
 - removing and replacing 11
 - Tray 1 roller, removing and replacing 11
 - Tray 2
 - removing and replacing 16, 598, 599
 - Tray 2 paper pickup roller assembly
 - removing and replacing 41, 601
 - Tray 2 paper pickup roller assembly, removing and replacing 41, 601
 - Tray 2 sensor assembly
 - removing and replacing 608
 - Tray 2 sensor assembly, removing and replacing 608
 - Tray 2, removing and replacing 16, 598, 599
 - Tray 3
 - removing and replacing 628
 - Tray 3 cassette
 - removing and replacing 19
 - Tray 3 cassette, removing and replacing 19
 - Tray 3, removing and replacing 628
- U**
- using cartridges multiple times, repair 7
 - using toner cartridges multiple times 7
- W**
- warnings iii
 - Web-based Interactive Search Engine
 - WISE v, 2, 646
 - wireless PCA
 - removing and replacing 277
 - WISE
 - Web-based Interactive Search Engine v, 2, 646