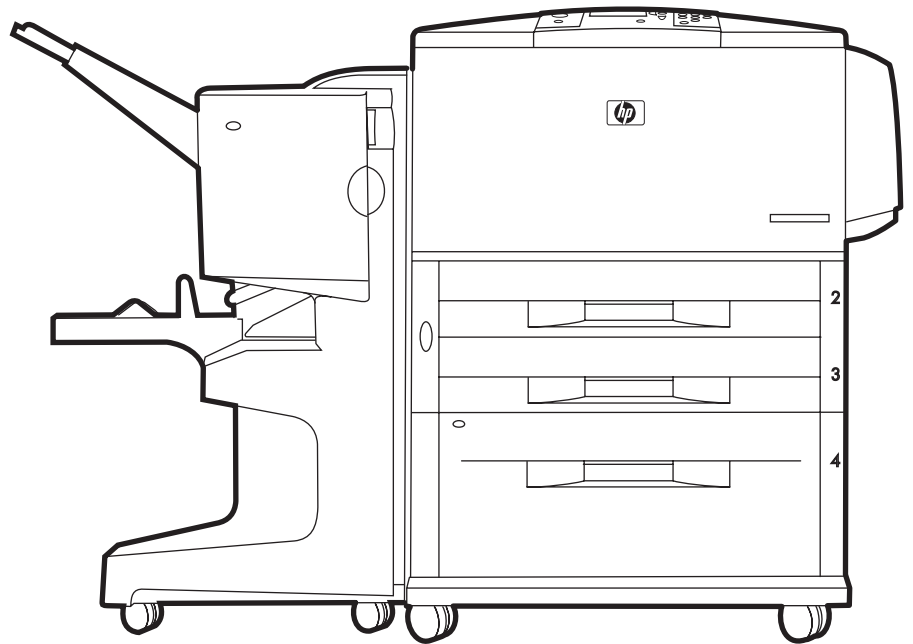


# HP LaserJet 9000/9040/9050 Service Manual





# HP LaserJet 9000, 9040, and 9050 Series printers

**Service** \_\_\_\_\_

## Copyright and License

© 2005 Copyright Hewlett-Packard Development Company, LP

Reproduction, adaptation or translation without prior written permission is prohibited, except as allowed under the copyright laws.

Part number: Q3721-90963

Edition 1, 4/2005

The information contained herein is subject to change without notice.

The only warranties for HP products and services are set forth in the express warranty statements accompanying such products and services. Nothing herein should be construed as constituting an additional warranty. HP shall not be liable for technical or editorial errors or omissions contained herein.

## Trademark Credits

Adobe® and PostScript® are trademarks of Adobe Systems Incorporated.

MS-DOS® is a U.S. registered trademark of Microsoft Corporation.

ENERGY STAR® is a U.S. registered service mark of the United States Environmental Protection Agency.





# Table of contents

## Table of contents

## List of tables

## List of figures

### 1 Product information

Product features of the HP LaserJet 9000 Series printers . . . . .	2
Product features of the HP LaserJet 9040/9050 Series printers . . . . .	4
Product specifications . . . . .	6
Product overview . . . . .	10
External view of the printer and accessories . . . . .	10
Interface connections . . . . .	11
Optional accessories. . . . .	12
Regulatory information . . . . .	13
Regulatory requirements. . . . .	13
FCC regulations . . . . .	13
Declaration of conformity . . . . .	13
Environmental product stewardship program . . . . .	13
Service approach . . . . .	14
Parts and supplies . . . . .	14
Warranty . . . . .	14
Limited warranty for print-cartridge life . . . . .	14

### 2 Product requirements

Site requirements . . . . .	16
Operating environment . . . . .	16
Space requirements . . . . .	17
Media specifications . . . . .	19
Guidelines for selecting print media . . . . .	19
Special media specifications. . . . .	19
Storing print media . . . . .	22
Media input/output options . . . . .	25
Trays, bins, and paper handling . . . . .	25
Supported sizes of paper for input and output . . . . .	26

### 3 Product configuration

Using the control panel . . . . .	30
Control-panel buttons . . . . .	31
Numeric keypad commands . . . . .	32
Settings and defaults. . . . .	33
Setting the display language. . . . .	33
Setting the tray registration . . . . .	33
Printer driver information. . . . .	36
Control-panel menus . . . . .	37
Using a menu map . . . . .	37

Retrieve job menu . . . . .	38
Information menu . . . . .	38
Paper-handling menu . . . . .	39
Configure device menu. . . . .	41
Printing submenu . . . . .	41
Print-quality submenu . . . . .	44
System setup submenu . . . . .	46
I/O submenu. . . . .	48
Resets submenu . . . . .	53
Diagnostics menu . . . . .	54
Service menu . . . . .	54
Remote firmware upgrade (RFU) . . . . .	55
Upgrading firmware to a single printer . . . . .	55

## 4 Product maintenance

Preventative maintenance . . . . .	60
Preventive maintenance kit contents . . . . .	60
Cleaning the printer and accessories . . . . .	61
General cleaning . . . . .	61
Internal cleaning. . . . .	62
Fuser cleaning . . . . .	65
Print cartridge information . . . . .	67
Storage. . . . .	67
Handling instructions . . . . .	67
Refilled print cartridges . . . . .	68
Print-cartridge weights . . . . .	68
Print-cartridge life expectancy . . . . .	68
Saving toner by using EconoMode . . . . .	68

## 5 Theory of operation

Basic operation. . . . .	70
Sequence of operation. . . . .	71
Power-on sequence . . . . .	73
Timing chart . . . . .	74
Engine control system . . . . .	75
DC controller PCA . . . . .	76
DC controller operations . . . . .	77
High-voltage power supply circuit . . . . .	78
Low-voltage power supply unit. . . . .	80
Formatter system . . . . .	81
Formatter hardware . . . . .	81
Laser/scanner system . . . . .	83
Image formation system . . . . .	84
The eight processes of image formation . . . . .	84
Print cartridge. . . . .	85
Pickup and feed system . . . . .	87
Media-size detection . . . . .	87
Media-level detection . . . . .	87
Multifeed prevention. . . . .	87
Overhead-transparency detection . . . . .	87
Fuser-wrapping-jam detection . . . . .	87
Jam detection . . . . .	88
Tray 1 . . . . .	93
Tray 1 driver PCA. . . . .	93
Power supply . . . . .	93
Sequence of operation. . . . .	93
Pickup and feed . . . . .	94
Jam detection . . . . .	94

Tray 4 . . . . .	95
Tray 4 driver PCA . . . . .	95
Power supply . . . . .	95
Sequence of operation . . . . .	95
Pickup and feed . . . . .	96
Media-level and media-size detection . . . . .	96
Jam detection . . . . .	96

## 6 Removal and replacement

Introduction . . . . .	99
Removal and replacement strategy . . . . .	99
Repair notices . . . . .	99
Electrostatic discharge (ESD) . . . . .	99
Required tools . . . . .	99
Orientation of the printer (with tray 4) . . . . .	100
Covers . . . . .	101
Right top cover . . . . .	101
Left top cover . . . . .	103
Front cover . . . . .	104
Right door . . . . .	105
Right lower cover . . . . .	106
Left door and diverter . . . . .	107
Left back cover . . . . .	108
Back cover . . . . .	109
Right and left rail covers . . . . .	110
Top assemblies . . . . .	111
Control panel . . . . .	111
Laser/scanner assembly . . . . .	112
Delivery assembly . . . . .	113
Delivery-fan assembly . . . . .	114
Delivery-assembly fans and face-down-bin fan (fans 3, 6, and 4) . . . . .	115
Delivery motor . . . . .	116
Cartridge release lever . . . . .	117
Front assemblies . . . . .	119
Print cartridge . . . . .	119
Transfer-roller assembly . . . . .	120
Tray 2 and tray 3 (interchangeable) . . . . .	121
Rollers (pickup, feed, or separation) . . . . .	122
Fuser-jam-removal knob . . . . .	123
Registration-jam-removal knob . . . . .	124
Right assemblies . . . . .	125
Tray 1 . . . . .	125
Paper-input unit (PIU) . . . . .	126
Registration assembly . . . . .	129
Transfer-guide assembly . . . . .	131
Left assemblies . . . . .	133
Duplexer . . . . .	133
Fuser assembly . . . . .	134
Back assemblies . . . . .	135
Formatter . . . . .	135
Low-voltage power supply . . . . .	136
High-voltage power supply . . . . .	137
DC controller . . . . .	138
Toner-sensor contact assembly . . . . .	140
Drum motor . . . . .	141
Feed-drive assembly . . . . .	142
Power-supply fan (fan 1) . . . . .	143
Cartridge fan (fan 5) . . . . .	144

Controller fan (fan 2) . . . . .	145
Jetlink connector . . . . .	146
Fuser-connector holder assembly . . . . .	147
Fuser delivery-drive assembly . . . . .	149
Tray 4 . . . . .	151
Orientation . . . . .	151
Left side cover . . . . .	151
Right side cover . . . . .	152
Back covers . . . . .	153
Tray 4 . . . . .	154
Rollers (pickup, feed, and separation) . . . . .	155
Registration assembly . . . . .	156
Drive motor . . . . .	157
Drive assembly . . . . .	158
Controller board . . . . .	159
Paper-size detection switch PCA . . . . .	160
Power supply . . . . .	161
Pickup assembly . . . . .	162
Paper-connecting unit . . . . .	163

## 7 Troubleshooting

Troubleshooting process . . . . .	167
Basic troubleshooting process flow . . . . .	168
Preliminary operating checks . . . . .	170
General troubleshooting information . . . . .	171
Abnormal noises are evident, such as grinding or chattering when the main motor is turned on . . . . .	171
Media does not feed from tray x when printing from a software program; the paper-path test is successful . . . . .	171
Media does not print from tray 4 . . . . .	171
The printer stops printing and hangs on certain jobs . . . . .	171
Envelopes are wrinkling . . . . .	172
Fusing is poor . . . . .	172
The printer feeds from an incorrect tray when different media is selected for the first page of the job . . . . .	172
Power-on . . . . .	174
Troubleshooting by using control-panel messages . . . . .	175
Event log page . . . . .	175
Control-panel messages . . . . .	178
Control-panel and event-log message format . . . . .	179
Printer-message tables . . . . .	179
Alphabetical error messages . . . . .	180
Numerical error messages . . . . .	188
User- and service-level diagnostics . . . . .	213
Paper-path test . . . . .	213
Service test . . . . .	213
Service-level diagnostics . . . . .	215
Engine test . . . . .	215
Service menu . . . . .	215
Diagnostics flowchart . . . . .	216
Other diagnostics for the HP LaserJet 9000, 9000mfp, and 9000Lmfp . . . . .	217
Cold reset . . . . .	217
Other diagnostics for the HP LaserJet 9040/9050, 9040mfp, and 9050mfp . . . . .	219
Cold reset . . . . .	219
Tray 4 diagnostics . . . . .	221
Diagnostics label . . . . .	221
Motor test . . . . .	221
Standalone running test . . . . .	222

Sensor test . . . . .	222
Light-pattern interpretation . . . . .	223
Jam troubleshooting . . . . .	224
Jams . . . . .	225
Customer print job. . . . .	225
Clearing jams . . . . .	225
Evaluate the information pages. . . . .	226
Configuration page . . . . .	226
Jetdirect page . . . . .	229
Supplies status page . . . . .	230
Usage page . . . . .	231
File directory page . . . . .	232
Image-formation troubleshooting . . . . .	233
Check the print cartridge. . . . .	234
EconoMode. . . . .	234
Skew . . . . .	234
Image-defect tables . . . . .	235
Repeating defect ruler . . . . .	243
Media troubleshooting . . . . .	244
Determine the problem source: media or printer . . . . .	244
Isolate a paper path . . . . .	244
Isolate a media brand . . . . .	245
Isolate a media type . . . . .	245
Communication troubleshooting . . . . .	246
Communications check. . . . .	246
Jetdirect configuration . . . . .	246
Embedded LAN troubleshooting (HP LaserJet 9040n/9050n, HP LaserJet 9040dn/9050dn, HP LaserJet 9050mfp, and HP LaserJet 9040mfp only). . . . .	247
Wiring diagrams . . . . .	251

## 8 Parts and diagrams

Introduction . . . . .	256
Ordering parts . . . . .	256
Consumables, supplies, accessories, FRUs, and documentation . . . . .	257
Common hardware . . . . .	261
Illustrations and parts lists . . . . .	262
External covers and panels. . . . .	262
Left door and diverter . . . . .	264
Right cover assembly . . . . .	265
Internal . . . . .	266
Internal components . . . . .	266
Drum feed drive assembly . . . . .	274
Fuser delivery drive assembly . . . . .	275
Cartridge lifter assembly . . . . .	276
500-sheet trays (tray 2 and tray 3) . . . . .	277
Paper input unit. . . . .	278
Registration assembly. . . . .	279
Transfer roller assembly . . . . .	280
Delivery assembly . . . . .	281
PCA assembly location . . . . .	283
Tray 4 . . . . .	284
Tray 4 main body . . . . .	284
Tray 4 drive assembly. . . . .	288
Tray 4 PCA location . . . . .	289
Tray 1 . . . . .	290
Alphabetical parts list . . . . .	291
Numerical parts list . . . . .	296

## Index

# List of tables

Table 1. Features of the HP LaserJet 9000 Series printers	2
Table 2. Features of the HP LaserJet 9040/9050 Series printers	4
Table 3. Configuration comparison	6
Table 4. Physical specifications	7
Table 5. Electrical specifications (HP LaserJet 9000)	7
Table 6. Electrical specifications (HP LaserJet 9040)	8
Table 7. Electrical specifications (HP LaserJet 9050)	8
Table 8. Environmental specifications	8
Table 9. Acoustical specifications	9
Table 10. Paper weight equivalence	23
Table 11. Control-panel button functions	31
Table 12. Printer state and numeric key effect	32
Table 13. Storing print cartridges	67
Table 14. Normal sequence of operation	71
Table 15. Failure sequence of operation	73
Table 16. Pickup-and-feed system sensors and switches	90
Table 17. Pickup-and-feed system motors and solenoids	92
Table 18. Primary steps for troubleshooting	167
Table 19. Power-on defects or a blank display	174
Table 20. Alphabetic error messages	180
Table 21. Numeric error messages	188
Table 22. Service test abnormality codes	213
Table 23. Service menu	215
Table 24. DIP switch settings	223
Table 25. Tray 4 light-pattern interpretation	223
Table 26. General jam troubleshooting questions	224
Table 27. Printer devices troubleshooting	228
Table 28. Image-quality checks	233
Table 29. Image defects	236
Table 30. Consumables, supplies, accessories, FRUs, and documentation	257
Table 31. Hardware table	261
Table 32. Common torque values	261
Table 33. Printer external covers and panels	263
Table 34. Left door and diverter	264
Table 35. Right cover assembly	265
Table 36. Internal components (1 of 4)	267
Table 37. Internal components (2 of 4)	269
Table 38. Internal components (3 of 4)	271
Table 39. Internal components (4 of 4)	273
Table 40. Drum feed drive assembly	274
Table 41. Fuser delivery drive assembly	275
Table 42. Cartridge lifter assembly	276
Table 43. 500-sheet trays (tray 2 and tray 3)	277
Table 44. Paper input unit	278
Table 45. Registration assembly	279
Table 46. Transfer roller assembly	280
Table 47. Delivery assembly	282
Table 48. PCA location	283
Table 49. Tray 4 main body (1 of 2)	285

Table 50. Tray 4 main body (2 of 2) .....	287
Table 51. Tray 4 drive assembly .....	288
Table 52. Tray 4 PCA location .....	289
Table 53. Tray 1 assembly .....	290
Table 54. Alphabetical parts list .....	291
Table 55. Numerical parts list .....	296



# List of figures

Figure 1. Sample identification label	6
Figure 2. External view of the printer and accessories	10
Figure 3. Interface connections (HP LaserJet 9040/9050 Series printer)	11
Figure 4. Interface connections (HP LaserJet 9000 Series printer)	11
Figure 5. Optional accessories	12
Figure 6. Space requirements for the base model	17
Figure 7. Space requirements with a finishing device (3,000-sheet stapler/stacker shown) and tray 4 installed	18
Figure 8. Sample seams	20
Figure 9. Adhesive labels	21
Figure 10. Media trays, bins, and paper handling	25
Figure 11. Control-panel layout	30
Figure 12. Registration page (1 of 2)	34
Figure 13. Registration page (2 of 2)	35
Figure 14. Turn off the printer and remove the power cords	62
Figure 15. Remove the print cartridge	62
Figure 16. Wipe any residue	63
Figure 17. Replace the print cartridge	63
Figure 18. Lock the print cartridge	63
Figure 19. Close the front cover	64
Figure 20. Sample cleaning page	65
Figure 21. Printer systems	70
Figure 22. Sequence-of-operation block diagram	71
Figure 23. Timing chart block diagram	74
Figure 24. Engine-control-system block diagram	75
Figure 25. DC controller PCA block diagram	76
Figure 26. High-voltage power supply block diagram	78
Figure 27. Power-supply-block diagram	80
Figure 28. Laser/scanner system	83
Figure 29. Image formation	84
Figure 30. Print cartridge	85
Figure 31. Pickup-and-feed system sensors and switches	89
Figure 32. Pickup-and-feed system motors and solenoids	91
Figure 33. Tray 1 block diagram	93
Figure 34. Tray 4 block diagram	95
Figure 35. View of front and right side	100
Figure 36. View of back and left side	100
Figure 37. Right top cover (1 of 2)	101
Figure 38. Right top cover (2 of 2)	102
Figure 39. Left top cover	103
Figure 40. Front cover (1 of 2)	104
Figure 41. Front cover (2 of 2)	104
Figure 42. Right door (1 of 2)	105
Figure 43. Right door (2 of 2)	105
Figure 44. Right lower cover	106
Figure 45. Left door	107
Figure 46. Left back cover	108
Figure 47. Back cover	109
Figure 48. Rail covers	110

Figure 49. Control panel . . . . .	111
Figure 50. Laser/scanner assembly . . . . .	112
Figure 51. Delivery assembly . . . . .	113
Figure 52. Delivery-fan assembly . . . . .	114
Figure 53. Delivery-assembly fans and face-down-bin fan (1 of 2) . . . . .	115
Figure 54. Delivery-assembly fans and face-down-bin fan (2 of 2) . . . . .	115
Figure 55. Delivery motor . . . . .	116
Figure 56. Cartridge release lever (1 of 3) . . . . .	117
Figure 57. Cartridge release lever (2 of 3) . . . . .	117
Figure 58. Cartridge release lever (3 of 3) . . . . .	118
Figure 59. Print cartridge . . . . .	119
Figure 60. Transfer-roller assembly . . . . .	120
Figure 61. Tray 2 or tray 3 . . . . .	121
Figure 62. Rollers (pickup, feed, or separation) . . . . .	122
Figure 63. Fuser-jam-removal knob . . . . .	123
Figure 64. Registration-jam-removal knob . . . . .	124
Figure 65. Tray 1 . . . . .	125
Figure 66. Paper-input unit (1 of 5) . . . . .	126
Figure 67. Paper-input unit (2 of 5) . . . . .	126
Figure 68. Paper-input unit (3 of 5) . . . . .	127
Figure 69. Paper-input unit (4 of 5) . . . . .	127
Figure 70. Paper-input unit (5 of 5) . . . . .	128
Figure 71. Registration assembly (1 of 2) . . . . .	129
Figure 72. Registration assembly (2 of 2) . . . . .	130
Figure 73. Transfer-guide assembly . . . . .	131
Figure 74. Reinstalling the transfer-guide assembly . . . . .	132
Figure 75. Duplexer (1 of 2) . . . . .	133
Figure 76. Duplexer (2 of 2) . . . . .	133
Figure 77. Fuser assembly (1 of 2) . . . . .	134
Figure 78. Fuser assembly (2 of 2) . . . . .	134
Figure 79. Formatter (HP LaserJet 9000 shown) . . . . .	135
Figure 80. Low-voltage power supply (1 of 2) . . . . .	136
Figure 81. Low-voltage power supply (2 of 2) . . . . .	136
Figure 82. High-voltage power supply (1 of 2) . . . . .	137
Figure 83. High-voltage power supply (2 of 2) . . . . .	137
Figure 84. DC controller (1 of 2) . . . . .	138
Figure 85. DC controller (2 of 2) . . . . .	139
Figure 86. Toner-sensor contact assembly . . . . .	140
Figure 87. Reinstalling the toner-sensor contact assembly . . . . .	140
Figure 88. Drum motor . . . . .	141
Figure 89. Feed-drive assembly . . . . .	142
Figure 90. Power-supply fan . . . . .	143
Figure 91. Cartridge fan (1 of 2) . . . . .	144
Figure 92. Cartridge fan (2 of 2) . . . . .	144
Figure 93. Controller fan . . . . .	145
Figure 94. Jetlink connector . . . . .	146
Figure 95. Fuser-connector holder assembly (1 of 3) . . . . .	147
Figure 96. Fuser-connector holder assembly (2 of 3) . . . . .	147
Figure 97. Fuser-connector holder assembly (3 of 3) . . . . .	148
Figure 98. Fuser delivery-drive assembly (1 of 3) . . . . .	149
Figure 99. Fuser delivery-drive assembly (2 of 3) . . . . .	149
Figure 100. Fuser delivery-drive assembly (3 of 3) . . . . .	150
Figure 101. Left side cover . . . . .	151
Figure 102. Right side cover . . . . .	152
Figure 103. Back covers . . . . .	153
Figure 104. Tray 4 . . . . .	154
Figure 105. Rollers . . . . .	155
Figure 106. Registration assembly (1 of 2) . . . . .	156
Figure 107. Registration assembly (2 of 2) . . . . .	156

Figure 108. Drive motor . . . . .	157
Figure 109. Drive assembly . . . . .	158
Figure 110. Controller board (1 of 2) . . . . .	159
Figure 111. Controller board (2 of 2) . . . . .	159
Figure 112. Paper-size switch PCA (1 of 2) . . . . .	160
Figure 113. Paper-size switch PCA (2 of 2) . . . . .	160
Figure 114. Power supply . . . . .	161
Figure 115. Pickup assembly (1 of 2) . . . . .	162
Figure 116. Pickup assembly (2 of 2) . . . . .	162
Figure 117. Paper-connecting unit . . . . .	163
Figure 118. Basic troubleshooting process flow (1 of 2) . . . . .	168
Figure 119. Basic troubleshooting process flow (2 of 2) . . . . .	169
Figure 120. Sample event log (HP LaserJet 9000 series printer page shown)	176
Figure 121. Example of events . . . . .	177
Figure 122. Diagnostics flowchart . . . . .	216
Figure 123. Tray 4 label . . . . .	221
Figure 124. Sample configuration page . . . . .	227
Figure 125. Sample Jetdirect configuration page . . . . .	229
Figure 126. Sample supplies status page . . . . .	230
Figure 127. Sample usage page . . . . .	231
Figure 128. Sample file directory page . . . . .	232
Figure 129. Image defect examples . . . . .	235
Figure 130. Repeating defect ruler . . . . .	243
Figure 131. Printer wiring diagram (HP LaserJet 9000 series printer) . . . . .	251
Figure 132. Printer wiring diagram (HP LaserJet 9040/9050 series printer) . . . . .	252
Figure 133. Tray 4 wiring diagram . . . . .	253
Figure 134. Printer external covers and panels . . . . .	262
Figure 135. Left door and diverter . . . . .	264
Figure 136. Right cover assembly . . . . .	265
Figure 137. Internal components (1 of 4) . . . . .	266
Figure 138. Internal components (2 of 4) . . . . .	268
Figure 139. Internal components (3 of 4) . . . . .	270
Figure 140. Internal components (4 of 4) . . . . .	272
Figure 141. Drum feed drive assembly . . . . .	274
Figure 142. Fuser delivery drive assembly . . . . .	275
Figure 143. Cartridge lifter assembly . . . . .	276
Figure 144. 500-sheet trays (tray 2 and tray 3) . . . . .	277
Figure 145. Paper input unit . . . . .	278
Figure 146. Registration assembly . . . . .	279
Figure 147. Transfer roller assembly . . . . .	280
Figure 148. Delivery assembly . . . . .	281
Figure 149. PCA assembly location . . . . .	283
Figure 150. Tray 4 main body (1 of 2) . . . . .	284
Figure 151. Tray 4 main body (2 of 2) . . . . .	286
Figure 152. Tray 4 drive assembly . . . . .	288
Figure 153. Tray 4 PCA location . . . . .	289
Figure 154. Tray 1 assembly . . . . .	290



# 1

# Product information

## Chapter contents

Product features of the HP LaserJet 9000 Series printers . . . . .	2
Product features of the HP LaserJet 9040/9050 Series printers . . . . .	4
Product specifications . . . . .	6
Product overview . . . . .	10
External view of the printer and accessories . . . . .	10
Interface connections . . . . .	11
Optional accessories . . . . .	12
Regulatory information . . . . .	13
Regulatory requirements . . . . .	13
FCC regulations . . . . .	13
Declaration of conformity . . . . .	13
Environmental product stewardship program . . . . .	13
Service approach . . . . .	14
Parts and supplies . . . . .	14
Warranty . . . . .	14
Limited warranty for print-cartridge life . . . . .	14
Limited warranty for print-cartridge life . . . . .	14

# Product features of the HP LaserJet 9000 Series printers



## HP LaserJet 9000 printer (C8519A)

The HP LaserJet 9000 printer comes standard with 64 MB RAM, wide-format printing, and two 500-sheet trays (tray 2 and tray 3).



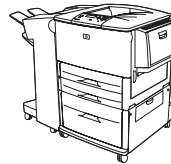
## HP LaserJet 9000n printer (C8520A)

The HP LaserJet 9000n printer comes standard with 64 MB RAM, wide-format printing, two 500-sheet trays (tray 2 and tray 3), a 100-sheet multipurpose tray (optional tray 1), and an embedded HP Jetdirect print server.



## HP LaserJet 9000dn printer (C8521A)

The HP LaserJet 9000dn printer comes standard with 64 MB RAM, wide-format printing, two 500-sheet trays (tray 2 and tray 3), a 100-sheet multipurpose tray (optional tray 1), an embedded HP Jetdirect print server, and an optional duplex printing accessory (duplexer) for printing on both sides of paper.



## HP LaserJet 9000hns printer (C8522A)

The HP LaserJet 9000hns printer contains the HP LaserJet 9000dn with a 2,000-sheet feeder (optional tray 4) and an optional 3,000-sheet stapler/stacker, an optional 3,000-sheet stacker, or an optional multifunction finisher.

**Table 1. Features of the HP LaserJet 9000 Series printers**

<b>Speed</b>	<ul style="list-style-type: none"> <li>50 pages per minute (ppm) for letter-size print media and A4-size media.</li> <li>First page out in less than 8 seconds.</li> <li>Transmit Once, Raster Image Processing (RIP) Once technology.</li> </ul>
<b>Resolution</b>	<ul style="list-style-type: none"> <li>600 dots per inch (dpi) with Resolution Enhancement technology (RET).</li> <li>HP FastRes 1200 (1200-dpi-like quality at up to 50 ppm letter and A4).</li> <li>Up to 256 levels of gray.</li> </ul>
<b>Toner</b>	<ul style="list-style-type: none"> <li>HP UltraPrecise print cartridge. The capacity is rated at an average 30,000 pages with 5% coverage.</li> <li>EconoMode capability.</li> </ul>
<b>PCL printer language and fonts</b>	<ul style="list-style-type: none"> <li>Fast printing performance, built-in Intellifont and TrueType scaling technologies, built-in HP-GL/2 vector graphics, and advanced imaging capabilities are benefits of the printer control language (PCL) 6 printer language. PCL 6 also includes 80 scalable TrueType fonts and one bitmapped Line Printer Font.</li> </ul>
<b>PS language</b>	<ul style="list-style-type: none"> <li>PostScript® 3 (PS) emulation.</li> </ul>
<b>Automatic language switching</b>	<ul style="list-style-type: none"> <li>The printer automatically determines and switches to the appropriate language for the print job.</li> </ul>
<b>Enhanced memory and memory expansion</b>	<ul style="list-style-type: none"> <li>The HP LaserJet 9000 Series printers come with 64 MB of memory and can be expanded to 384 MB.</li> </ul>

**Table 1. Features of the HP LaserJet 9000 Series printers (continued)**

<b>Expandability</b>	<p>All models accept the following accessories:</p> <ul style="list-style-type: none"><li>● Optional tray 1, a 100-sheet or 10-envelope multipurpose tray for automatic and manual feeding of envelopes, labels, transparencies, custom-sized media from 98 x 191 mm (3.8 x 7.5 inches) to 312 x 470 mm (12.3 x 18.5 in), and heavy paper.</li><li>● Optional tray 4, a 2,000-sheet feeder that supports letter, legal, B4, A4, 11 x 17 inches, A3, executive, B5, and custom 182 x 210 mm (7.2 x 8.3 inches) to 297 x 431.8 mm (11.7 x 17 inches) print media.</li><li>● Optional duplexer.</li><li>● Optional 3,000-sheet stapler/stacker, 3,000-sheet stacker, or multifunction finisher.</li><li>● Enhanced input/output (EIO) cards.</li><li>● Dual inline memory module (DIMM) slots for adding memory and fonts.</li><li>● Hard disk for RIP Once capability, job retention features, and font storage.</li></ul>
<b>Wireless printing</b>	<ul style="list-style-type: none"><li>● The printer supports wireless printing with the installation of a Fast InfraRed Connect pod.</li></ul>
<b>Interface connection</b>	<ul style="list-style-type: none"><li>● Bidirectional ECP type-C parallel port (IEEE-1284 compliant).</li><li>● Three EIO slots for hard-disk-accessory or print-server installation.</li><li>● Wireless Fast InfraRed port (IrDA compliant).</li><li>● Foreign interface connector.</li><li>● HP Jet-Link connector.</li></ul>
<b>Networking</b>	<ul style="list-style-type: none"><li>● Three EIO slots for hard-disk-accessory or print-server installation.</li><li>● An HP 610N Jetdirect print server is included with HP LaserJet 9000n, 9000dn, and 9000hns.</li></ul>
<b>Duty cycle</b>	<ul style="list-style-type: none"><li>● 300,000 images per month.</li></ul>

# Product features of the HP LaserJet 9040/9050 Series printers



## HP LaserJet 9040/9050 printer

The HP LaserJet 9040/9050 printer (product number Q7697A/Q3721A) comes standard with 64 MB RAM, wide-format printing, and two 500-sheet trays (tray 2 and tray 3).



## HP LaserJet 9040n/9050n printer

The HP LaserJet 9040n/9050n printer (product number Q7698A/Q3722A) comes standard with 128 MB RAM, wide-format printing, two 500-sheet trays (tray 2 and tray 3), a 100-sheet multipurpose tray (tray 1), and an embedded HP Jetdirect print server.



## HP LaserJet 9040dn/9050dn printer

The HP LaserJet 9040dn/9050dn printer (product number Q7699A/Q3723A) comes standard with 128 MB RAM, wide-format printing, two 500-sheet trays (tray 2 and tray 3), a 100-sheet multipurpose tray (tray 1), an embedded HP Jetdirect print server, and a duplex printing accessory (duplexer) for printing on both sides of paper.

**Table 2. Features of the HP LaserJet 9040/9050 Series printers**

Speed	<ul style="list-style-type: none"> <li>40 pages per minute (ppm) (HP LaserJet 9040 series printer) or 50 ppm (HP LaserJet 9050 series printer) on letter or ISO A4 paper.</li> <li>First page out in less than 8 seconds.</li> <li>Transmit Once, RIP Once technology.</li> </ul>
Resolution	<ul style="list-style-type: none"> <li>600 dpi with REt.</li> <li>FastRes 1200 provides 1200 dpi quality at full speed.</li> <li>Up to 256 levels of gray.</li> </ul>
Toner	<ul style="list-style-type: none"> <li>HP UltraPrecise print cartridge. The capacity is rated at an average 30,000 pages with 5% coverage.</li> <li>EconoMode capability.</li> </ul>
PCL printer language and fonts	<ul style="list-style-type: none"> <li>Fast printing performance, built-in Intellifont and TrueType scaling technologies, built-in HP-GL/2 vector graphics, and advanced imaging capabilities are benefits of the printer control language (PCL) 6 printer language. PCL 6 also includes 80 scalable TrueType fonts and one bitmapped Line Printer Font.</li> </ul>
PS language	<ul style="list-style-type: none"> <li>PostScript 3 (PS) emulation.</li> </ul>
Automatic language switching	<ul style="list-style-type: none"> <li>The printer automatically determines and switches to the appropriate language for the print job.</li> </ul>
Enhanced memory and memory expansion	<ul style="list-style-type: none"> <li>The HP LaserJet 9040/9050 Series printers come with 64 or 128 MB of memory and can be expanded to 512 MB.</li> </ul>



**Table 2. Features of the HP LaserJet 9040/9050 Series printers (continued)**

<b>Expandability</b>	<p>All models accept the following accessories:</p> <ul style="list-style-type: none"><li>● Optional tray 1, a 100-sheet or 10-envelope multipurpose tray for automatic and manual feeding of envelopes, labels, transparencies, custom-sized media from 98 x 191 mm (3.8 x 7.5 inches) to 312 x 470 mm (12.3 x 18.5 inches), and 64 to 216 g/m<sup>2</sup> (17- to 58-lb bond).</li><li>● Optional tray 4, a 2,000-sheet feeder that supports letter, legal, B4, A4, 11 x 17 inches, A3, executive, B5, and custom 76 x 127 mm (3 x 5 inches) to 297 x 431 mm (11.7 x 17 inches) print media.</li><li>● Optional duplexer.</li><li>● Optional 3,000-sheet stapler/stacker, 3,000-sheet stacker, multifunction finisher, or 8-bin mailbox.</li><li>● EIO cards.</li><li>● DIMM slots for adding memory.</li><li>● Hard disk for RIP Once capability, job retention features, and font storage.</li><li>● Compact Flash slots for printer firmware forms or fonts.</li></ul>
<b>Wireless printing</b>	<ul style="list-style-type: none"><li>● The printer supports wireless printing with the installation of a Fast InfraRed Connect pod.</li></ul>
<b>Interface connection</b>	<ul style="list-style-type: none"><li>● Bidirectional ECP type-B parallel port (IEEE-1284 compliant).</li><li>● Two EIO slots for accessory installation.</li><li>● HP Jet-Link connector.</li></ul>
<b>Networking</b>	<ul style="list-style-type: none"><li>● Two EIO slots for hard-disk-accessory or print server installation.</li><li>● A Jetdirect print server is included with HP LaserJet 9040n/9050n and 9040dn/9050dn.</li></ul>
<b>Duty cycle</b>	<ul style="list-style-type: none"><li>● 300,000 images per month.</li></ul>

# Product specifications

## Identification

The model number and printer serial number are listed on an identification label located in two places:

- on the rear cover
- on the chassis behind the right door

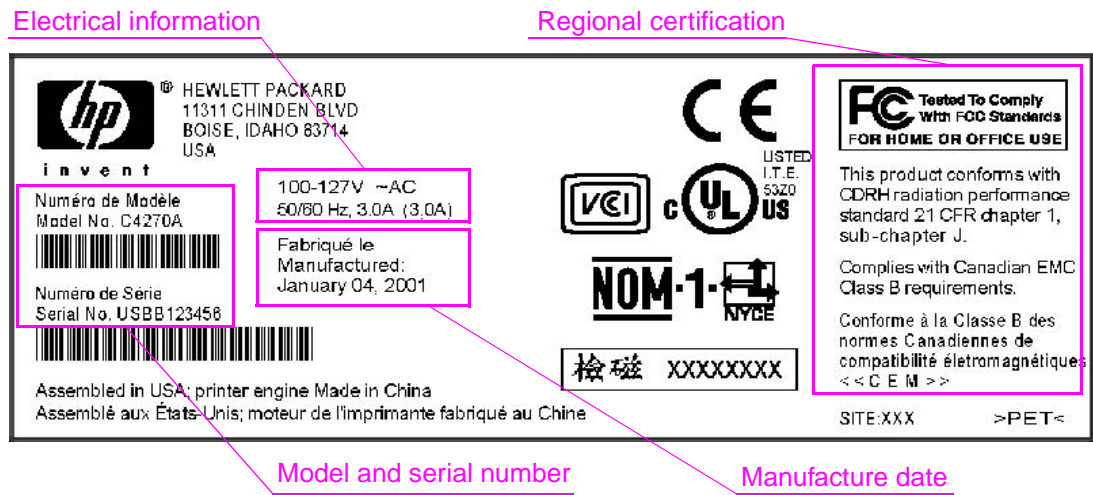
The model number is alphanumeric, such as C4270A.

The serial number contains information about the country/region of origin and the revision level, the production code, and production number of the printer. An example of a serial number is USBB123456.

The top label also contains power-rating and regulatory information. See figure 1.

**Note**

The power-rating and regulatory information varies by country/region.



**Figure 1. Sample identification label**

**Table 3. Configuration comparison**

	HP LaserJet 9000	HP LaserJet 9000n	HP LaserJet 9000dn	HP LaserJet 9000hns	HP LaserJet 9040/9050	HP LaserJet 9040n/9050n	HP LaserJet 9040dn/9050dn
Standard memory	64 MB	64 MB	64 MB	64 MB	64 MB	128 MB	128 MB
Maximum memory	384 MB	384 MB	384 MB	384 MB	512 MB	512 MB	512 MB
PS emulation	Standard	Standard	Standard	Standard	Standard	Standard	Standard
Jetdirect print server	Optional	Standard	Standard	Standard	Optional	Standard	Standard
Optional duplexer	Optional	Optional	Standard	Standard	Optional	Optional	Standard
Optional tray 1, 100-sheet multipurpose tray	Optional	Standard	Standard	Standard	Optional	Standard	Standard
Optional tray 4, 2,000-sheet feeder	Optional	Optional	Optional	Standard	Optional	Optional	Optional

**Table 3. Configuration comparison**

	HP LaserJet 9000	HP LaserJet 9000n	HP LaserJet 9000dn	HP LaserJet 9000hns	HP LaserJet 9040/9050	HP LaserJet 9040n/9050n	HP LaserJet 9040dn/9050dn
Optional 3,000-sheet stacker	Optional	Optional	Optional	Optional	Optional	Optional	Optional
Optional 3,000-sheet stapler/stacker	Optional	Optional	Optional	Standard	Optional	Optional	Optional
Optional multifunction finisher	Optional	Optional	Optional	Optional	Optional	Optional	Optional
Optional 8-bin mailbox	N/A	N/A	N/A	N/A	Optional	Optional	Optional
Optional hard disk	Optional	Optional	Optional	Optional	Optional	Optional	Optional

**Table 4. Physical specifications**

	HP LaserJet 9000, 9040, and 9050	HP LaserJet 9000n/9000dn, 9040n/9040dn, and 9050n/9050dn	HP LaserJet 9000hns
Height	600 mm (23.6 inches)	600 mm (23.6 inches)	1,036.4 mm (40.8 inches)
Width	990.8 mm (39.0 inches)	1,115.8 mm (44.4 inches)	1,788.2 mm (70.4 inches)
Depth	1,001 mm (42.7 inches)	1,001 mm (42.7 inches)	1,001 mm (42.7 inches)
Weight (without print cartridge)	63.5 kg (140 lb)	9000n/9040n/9050n: 69.4 kg (153 lb) 9000dn/9040dn/9050dn: 76.2 kg (168 lb)	76.2 kg (168 lb)

**Table 5. Electrical specifications (HP LaserJet 9000)**

Volts	Frequency	Amperes (A)	Watts (W) (typical)	Thermal units per hour (BTU/hr)
100-127 Vac ± 10%	50/60 Hz ± 2 Hz	Minimum recommended current capacity = 15 A dedicated circuit	printing = 1,040 W standby = 265 W PowerSave 1 = 40 W PowerSave 2 = 25 W off = 0 W	printing = 3,550.36 BTU/hr standby = 904.71 BTU/hr PowerSave 1 = 136.56 BTU/hr PowerSave 2 = 85.35 BTU/hr off = 0 BTU/hr
220-240 Vac ± 10%	50/60 Hz ± 2 Hz	Minimum recommended current capacity = 6.5 A dedicated circuit	printing = 995 W standby = 265 W PowerSave 1 = 40 W PowerSave 2 = 25 W off = 0.2 W	printing = 3,396.93 BTU/hr standby = 904.71 BTU/hr PowerSave 1 = 136.56 BTU/hr PowerSave 2 = 85.35 BTU/hr off = 0.69 BTU/hr

**Table 6. Electrical specifications (HP LaserJet 9040)**

Volts	Frequency	Ampres	Watts (W) (typical)	Thermal units per hour (BTu/hr)
100-127 Vac $\pm$ 10%	50/60 Hz $\pm$ 2 Hz	Minimum recommended current capacity = 12 A dedicated circuit	printing = 900 W standby = 200W PowerSave 1 = 158 W PowerSave 2 = 21 W off = 0.5 W	printing = 3,550.36 BTu/hr standby = 904.71 BTu/hr PowerSave 1 = 136.56 BTu/hr PowerSave 2 = 85.35 BTu/hr off = 0 BTu/hr
220-240 Vac $\pm$ 10%	50/60 Hz $\pm$ 2 Hz	Minimum recommended current capacity = 5.3 A dedicated circuit	printing = 900 W standby = 200 W PowerSave 1 = 40 W PowerSave 2 = 21 W off = 0.5 W	printing = 3,396.93 BTu/hr standby = 904.71 BTu/hr PowerSave 1 = 136.56 BTu/hr PowerSave 2 = 85.35 BTu/hr off = 0.69 BTu/hr

**Table 7. Electrical specifications (HP LaserJet 9050)**

Volts	Frequency	Ampres	Watts (W) (typical)	Thermal units per hour (BTu/hr)
100-127 Vac $\pm$ 10%	50/60 Hz $\pm$ 2 Hz	Minimum recommended current capacity = 12 A dedicated circuit	printing = 1,000 W standby = 200 W PowerSave 1 = 158 W PowerSave 2 = 21 W off = 0.5 W	printing = 3,550.36 BTu/hr standby = 904.71 BTu/hr PowerSave 1 = 136.56 BTu/hr PowerSave 2 = 85.35 BTu/hr off = 0 BTu/hr
220-240 Vac $\pm$ 10%	50/60 Hz $\pm$ 2 Hz	Minimum recommended current capacity = 6.5 A dedicated circuit	printing = 1,000 W standby = 200 W PowerSave 1 = 40 W PowerSave 2 = 21 W off = 0.5 W	printing = 3,396.93 BTu/hr standby = 904.71 BTu/hr PowerSave 1 = 136.56 BTu/hr PowerSave 2 = 85.35 BTu/hr off = 0.69 BTu/hr

**Note**

Electrical specifications might change. See [www.hp.com/go/lj9000](http://www.hp.com/go/lj9000) or [www.hp.com/go/lj9050\\_lj9040](http://www.hp.com/go/lj9050_lj9040) for the current information.

**WARNING!**

Power requirements are based on the country/region where the printer is sold. Do *not* convert operating voltages. This can damage the printer and void the product warranty.

**Table 8. Environmental specifications**

Operating temperature	10°C to 32.5°C (50°F to 91°F)
Relative humidity	10% to 80%
Storage temperature	-40°F to +60°F
Storage humidity	15% to 90%

**Table 9. Acoustical specifications**

Declared per ISO 9296		
Sound power level <sup>1</sup> HP LaserJet 9050	Printing (50 ppm)	$L_{WAd} = 7.2$ Bels (A) [72 dB(A)]
	Ready	$L_{WAd} = 5.6$ Bels (A) [56 dB(A)]
Sound power level <sup>2</sup> HP LaserJet 9040	Printing (40 ppm)	$L_{WAd} = 7.0$ Bels (A) [dB(A)]
	Ready	$L_{WAd} = 5.6$ Bels (A) [dB(A)]
Sound pressure level <sup>3</sup> (Bystander position) HP LaserJet 9050	Printing (50 ppm)	$L_{pAm} = 56$ dB(A)
	Ready	$L_{pAm} = 40$ dB(A)
Sound pressure level <sup>4</sup> (Bystander position) HP LaserJet 9040	Printing (40 ppm)	$L_{pAm} = 54$ dB(A)
	Ready	$L_{pAm} = 39$ dB(A)

1. Values current as of October 16, 2003. Values subject to change, see [www.hp.com/support/lj9050\\_lj9040](http://www.hp.com/support/lj9050_lj9040) for current information.

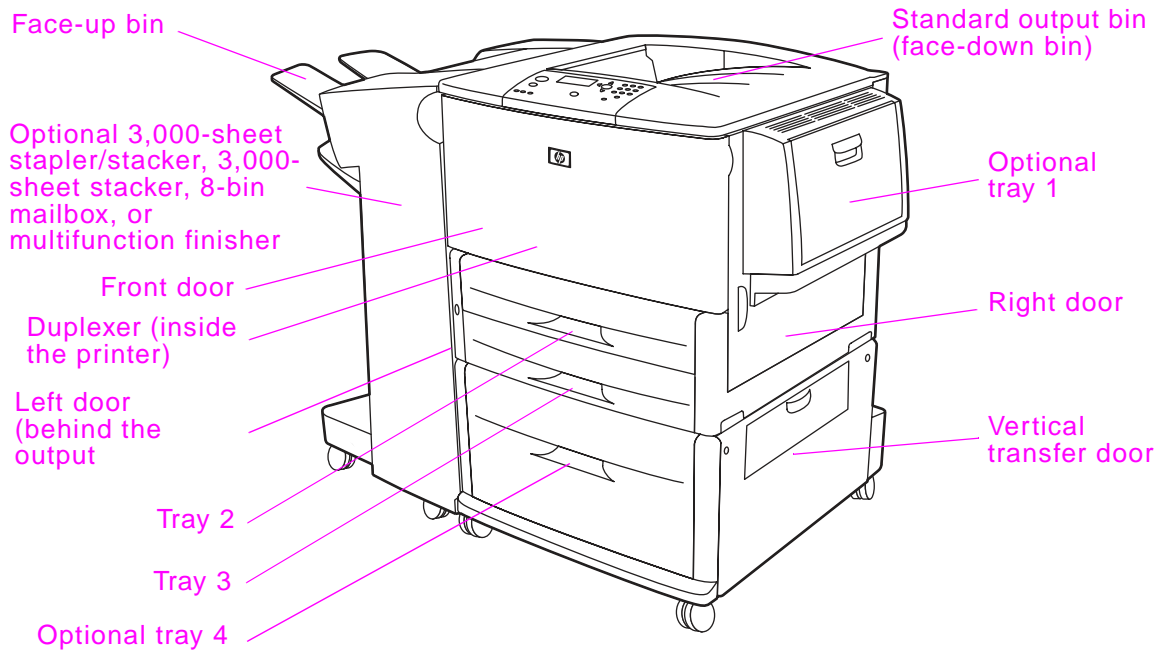
2. Values current as of October 24, 2004. Values subject to change, see [www.hp.com/support/lj9050\\_lj9040](http://www.hp.com/support/lj9050_lj9040) for current information.

3. Values current as of October 16, 2003. Values subject to change, see [www.hp.com/support/lj9050\\_lj9040](http://www.hp.com/support/lj9050_lj9040) for current information.

4. Values current as of October 24, 2004. Values subject to change, see [www.hp.com/support/lj9050\\_lj9040](http://www.hp.com/support/lj9050_lj9040) for current information.

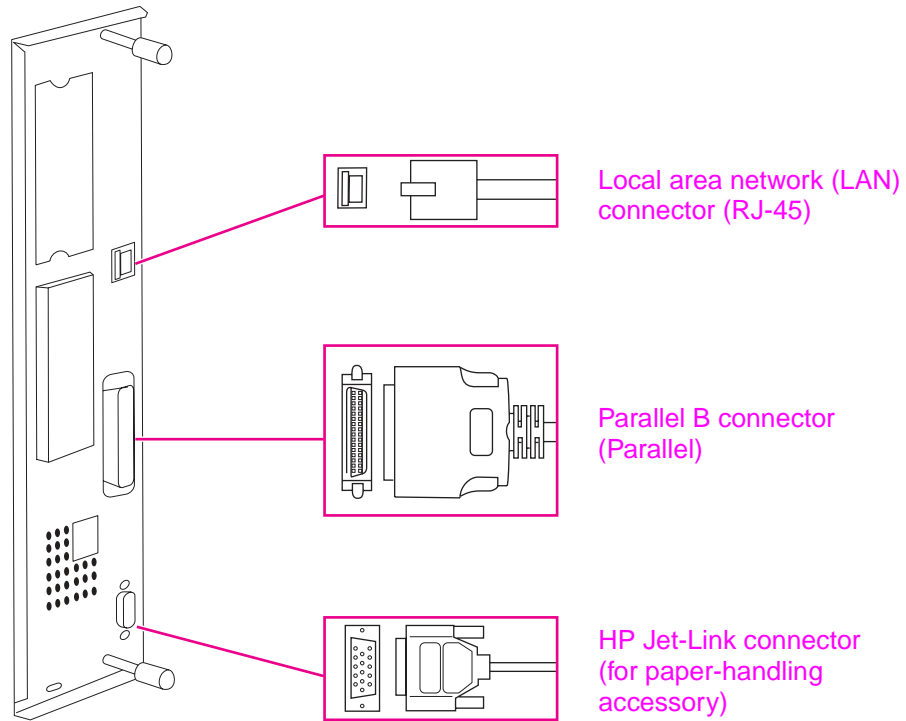
# Product overview

## External view of the printer and accessories

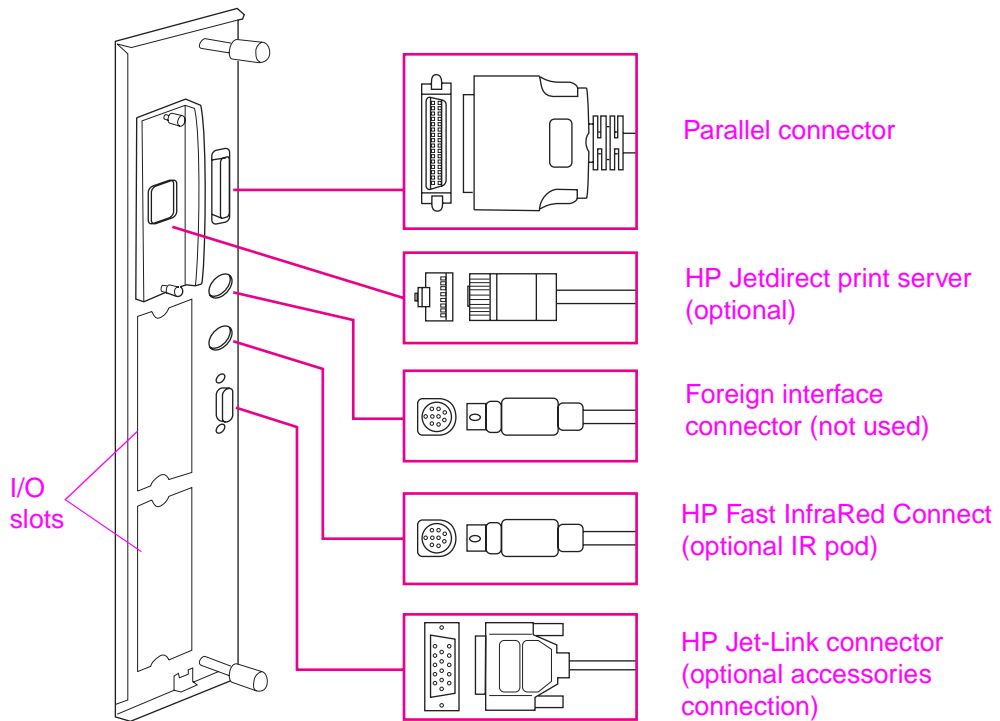


**Figure 2.** External view of the printer and accessories

## Interface connections



**Figure 3.** Interface connections (HP LaserJet 9040/9050 Series printer)



**Figure 4.** Interface connections (HP LaserJet 9000 Series printer)

## Optional accessories

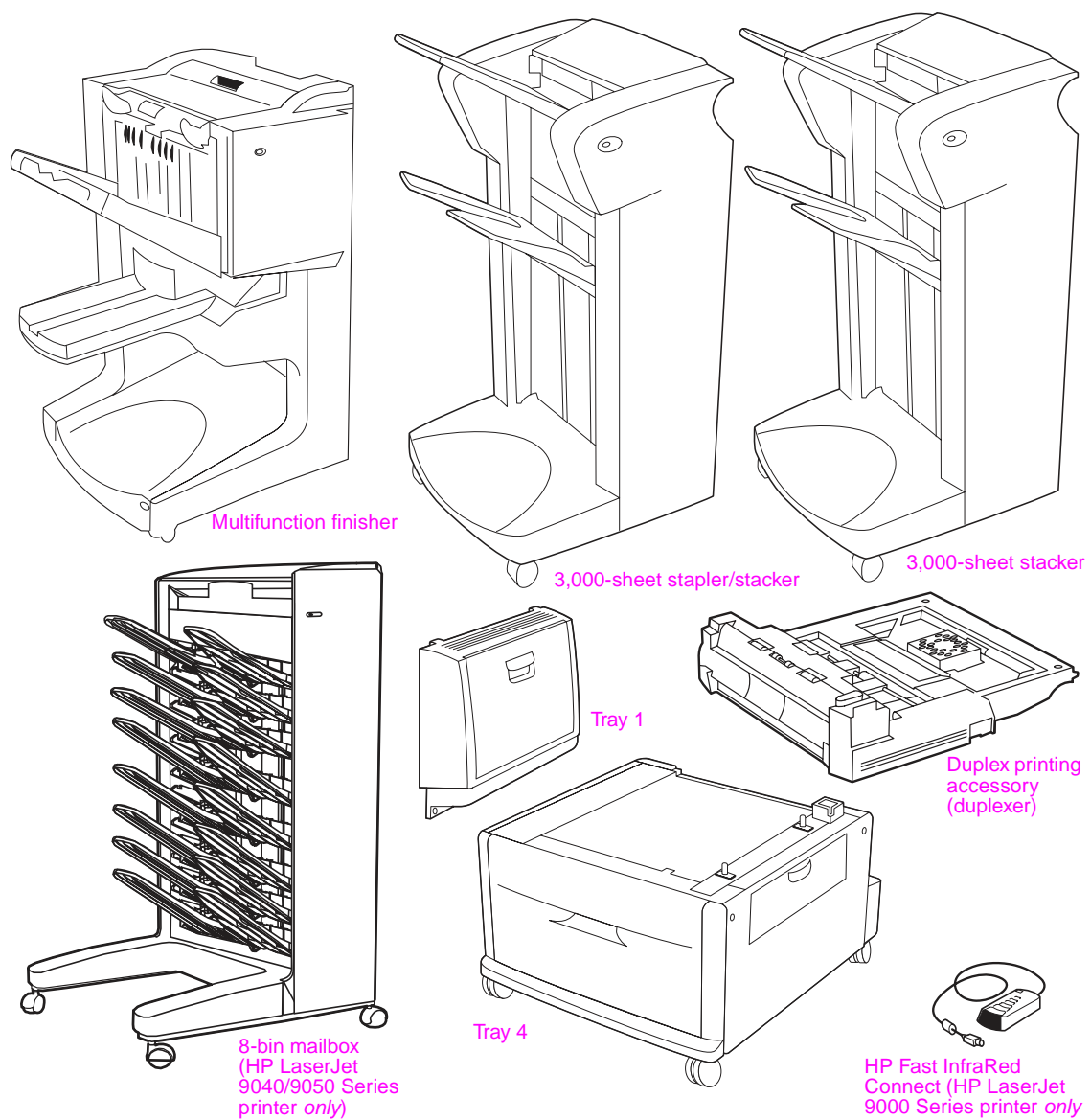


Figure 5. Optional accessories



# Regulatory information

## Regulatory requirements

For regulatory information and requirements, please see the *HP LaserJet 9000 Start Guide* or the *HP LaserJet 9040/9050 Start Guide*.

## FCC regulations

For FCC regulations, please see the *HP LaserJet 9000 Start Guide* or the *HP LaserJet 9040/9050 Start Guide*.

## Declaration of conformity

For declaration of conformity information, please see the *HP LaserJet 9000 Start Guide* or the *HP LaserJet 9040/9050 Start Guide*.

## Environmental product stewardship program

For environmental product stewardship program information, please see the *HP LaserJet 9000 Use Guide* or the *HP LaserJet 9040/9050 Use Guide*.

# Service approach

Repair of the printer normally begins with a three-step process:

- isolate the problem to the major system (the host computer, the network and/or server, or the printer system)
- determine whether the problem is located in one of the paper-handling devices or in the printer engine
- troubleshoot the problem using the procedures in chapter 7

When a faulty part is located, repair is usually accomplished by assembly-level replacement of field replaceable units (FRUs). Some mechanical assemblies can be repaired at the subassembly level. Hewlett-Packard does not support replacement of components on the printed circuit assemblies.

## Parts and supplies

The following information helps you locate parts and assistance.

### Ordering information

"Ordering parts" in chapter 8 of this manual contains FRUS and replacement part numbers. Replacement parts can be ordered from the HP Customer Services and Support Organization (HPS).

"Consumables, supplies, accessories, FRUs, and documentation" in chapter 8 of this manual contains information about accessories that are specifically designed for this printer. Order accessories from HPS.

### Phone listings

- HPS (for U.S.)  
(800) 752-0900
- HPS (for Canada)  
(800) 387-3867
- HPS (for Europe)  
(49 7031) 142253

### Exchange program

Hewlett-Packard offers remanufactured assemblies for some parts. These are identified in "Illustrations and parts lists" in chapter 8, and can be ordered through HPS.

### Consumables

The printer has two consumables: the print cartridge and the preventive maintenance kit. The stapler/stacker and the 8-bin mailbox have one consumable: the staple cartridge. These are identified in "Illustrations and parts lists" in chapter 8, and can be ordered through HPS.

### Warranty

For warranty information and requirements, please see the *HP LaserJet 9000 Start Guide* or the *HP LaserJet 9040/9050 Start Guide*.

### Limited warranty for print-cartridge life

For print-cartridge warranty information, please see the *HP LaserJet 9000 Start Guide* or the *HP LaserJet 9040/9050 Start Guide*.

# 2

## Product requirements

### Chapter contents

Site requirements . . . . .	16
Operating environment . . . . .	16
Space requirements . . . . .	17
Media specifications . . . . .	19
Guidelines for selecting print media . . . . .	19
Special media specifications . . . . .	19
Storing print media . . . . .	22
Media input/output options . . . . .	25
Trays, bins, and paper handling . . . . .	25

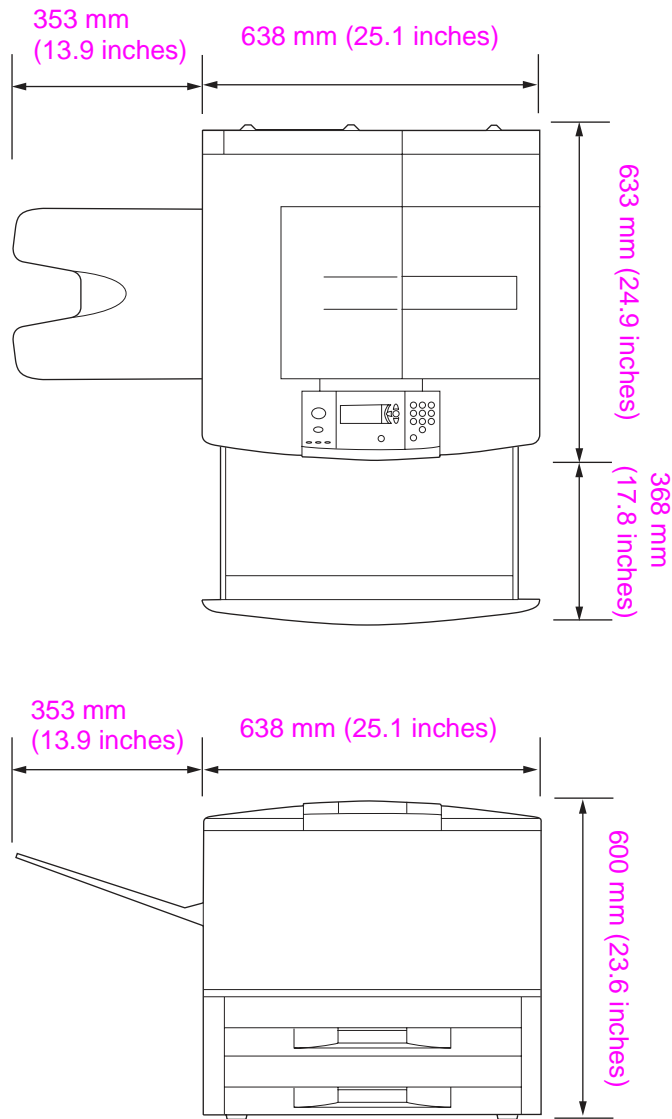
# Site requirements

## Operating environment

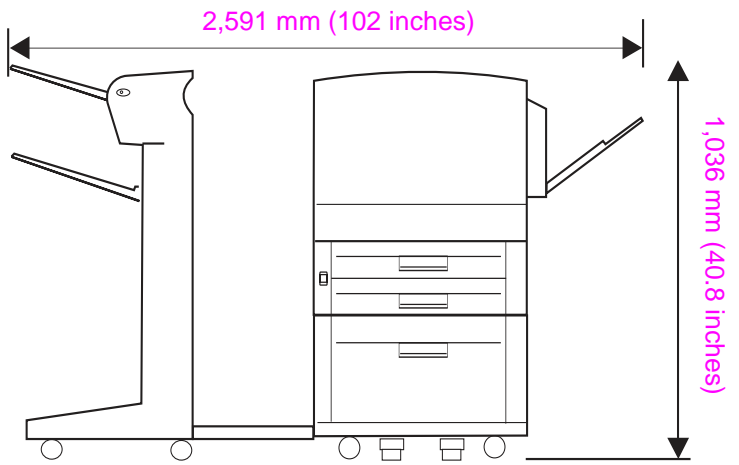
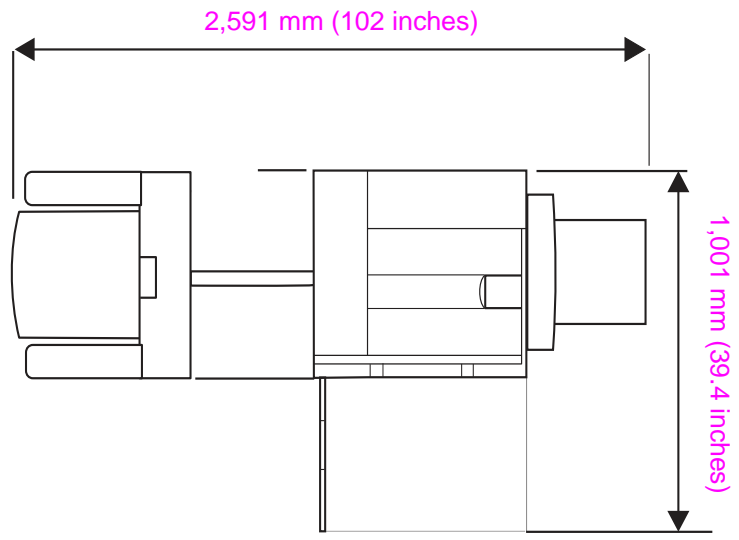
The electrical and environmental specifications must be maintained to ensure the proper operation of this printer. See "Product specifications" in chapter 1. Consider the following points before installing the printer:

- Install in a well-ventilated, dust-free area.
- Install on a level, flat surface that can support the printer size and weight. Make sure that all four printer feet are level. Do not install on carpet or on other soft surfaces.
- Make sure that an adequate power-supply circuitry is available. See "Product specifications" in chapter 1.
- Install where temperature and humidity are stable, and where no abrupt changes occur (away from water sources, humidifiers, air conditioners, refrigerators, or other major appliances). See "Product specifications" in chapter 1.
- Install away from direct sunlight, areas that experience vibration, open flames, ultrasonic heaters, ammonia fumes, or magnets and devices that emit a magnetic field. If the printer is placed near a window, make sure that the window has a curtain or blind to block direct sunlight.
- Maintain enough space around the printer for proper access and ventilation. See "Space requirements" on page 17.

## Space requirements



**Figure 6.** Space requirements for the base model



**Figure 7.** Space requirements with a finishing device (3,000-sheet stapler/stacker shown) and tray 4 installed

## Media specifications

Use the following information to help the user select and use print media.

---

### Note

Before purchasing large quantities of print media, make sure that it meets the requirements that are specified in this service manual and in the *HP LaserJet Printer Family Print Media Guide*. See "Media input/output options" on page 25. Always test print media before buying large quantities.

---

### Note

Hewlett-Packard neither warrants nor recommends the use of a particular brand of paper or print media. Media properties are subject to manufacturing changes, and HP has no control over such changes. Although testing media helps to characterize the manufacturer's performance and process quality, the customer assumes all responsibility for the quality and performance of media.

## Guidelines for selecting print media

For best results, use conventional 75-g/m<sup>2</sup> (20-lb) paper. Make sure that the paper is of good quality, and free of cuts, nicks, tears, spots, loose particles, dust, wrinkles, voids, and curled or bent edges.

---

### Note

Some print media might meet all of the guidelines in this manual and still not produce satisfactory results. This might be the result of improper handling, unacceptable temperature and humidity levels, or other variables over which HP has no control.

If you are unsure what type of paper you are loading (such as bond or recycled), check the label on the package of paper.

For information about measuring caliper, see "Media input/output options" on page 25.

---

### Hint

Do not purchase more media than can be easily used in a short time (about 3 months). Media that is stored for long periods experiences heat and moisture extremes that can be damaging. Planning is important to prevent damage to a large supply of media.

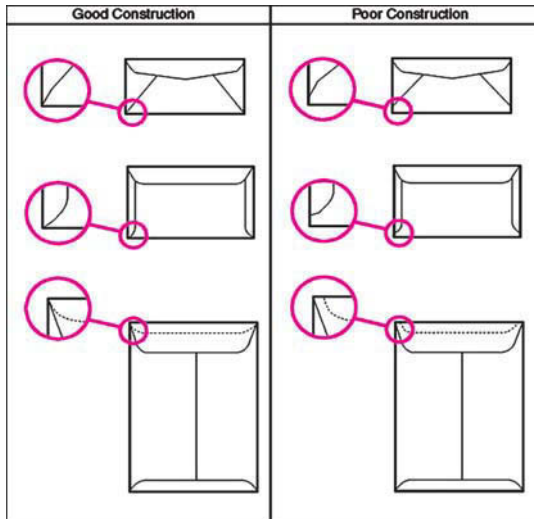
## Special media specifications

The following sections describe specifications for special media that can be used in these printers.

### Envelope specifications

Successful printing on envelopes depends upon the quality of the envelopes. Envelope fold lines can vary considerably, not only between manufacturers, but also within a box from the same manufacturer. When selecting envelopes, consider the following components:

- **Construction**—Prior to printing, envelopes should lie flat with less than 10 mm (0.39 inch) curl, and have well-constructed seams.
- **Condition**—Envelopes should not be wrinkled, nicked, or otherwise damaged.
- **Temperature**—Envelopes should be compatible with the heat and pressure produced by the printer.



**Figure 8.** Sample seams

**Note** Print envelopes from tray 1 *only*. Send envelopes straight through the printer, entering at tray 1 and exiting from the face-up bin.

**Note** For the best print quality, position margins no closer than 15 mm (0.6 inch) from the edges of the envelope. Avoid printing over the area where the envelope seams meet.

### Envelopes that have adhesive strips or flaps

Check to make sure that envelopes that have peel-off adhesive strips, or more than one flap that folds over to seal, use adhesives that are compatible with the heat and pressure in the printer. The extra flaps and strips might cause wrinkling, creasing, or jams, and can even damage the fuser.

### Label specifications

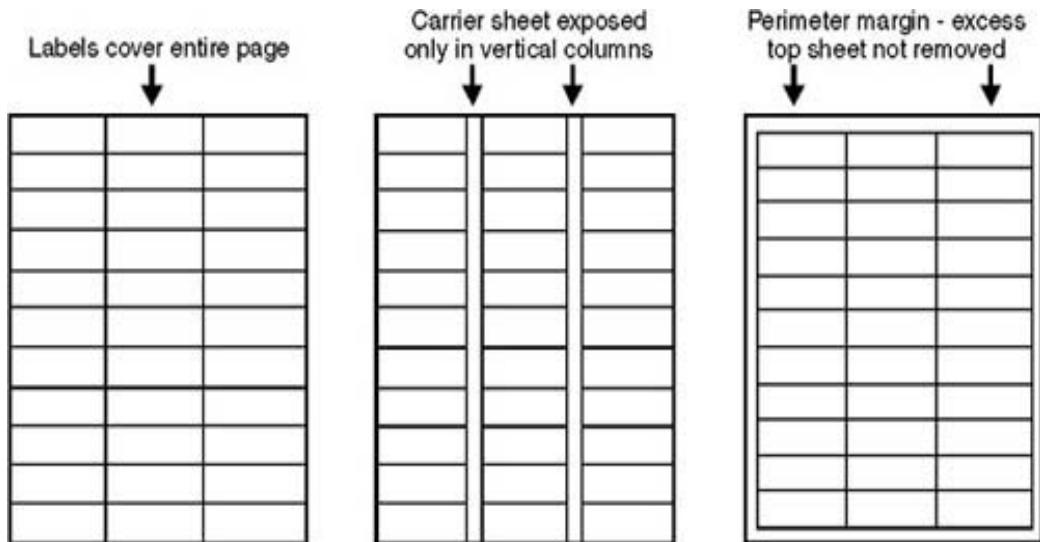
**CAUTION** To avoid damaging the printer, use only labels that are recommended for laser printers. Never print on the same sheet of labels more than once and never print on a partial sheet of labels.

When selecting labels, consider the quality of each component:

- **Adhesives**—The adhesive material should be stable at 190°C (374°F), which is the printer fusing temperature.
- **Arrangement**—Do not use labels that have exposed backing between them. Labels can peel off sheets with spaces between the labels, causing jams. See figure 9 for acceptable arrangement schemes.
- **Curl**—Prior to printing, labels must lie flat with no more than 10 mm (0.39 inch) of curl in any direction.
- **Condition**—Do not use labels that have wrinkles, bubbles, or other indications of separation.

**Note** Print labels from tray 1 *only*. Send labels straight through the printer, entering at tray 1 and exiting from the face-up bin.





**Figure 9.** Adhesive labels

### Transparency specifications

To avoid damaging the printer, use only transparencies that are recommended for use in laser printers.

- **Construction**—Prior to printing, transparencies should lie flat with less than 10 mm (0.39 inch) curl.
- **Condition**—Transparencies should not be wrinkled, nicked, or otherwise damaged.
- **Temperature**—Transparencies should be stable at 190°C (374°F), which is the printer fusing temperature.

---

**Note**

If problems occur while printing transparencies, use tray 1. Send transparencies straight through the printer, entering at tray 1 and exiting from the face-up bin.

---

**CAUTION**

Transparencies that are used in the printer must be able to withstand 190°C (374°F), the printer fusing temperature.

### Preprinted forms and special letterhead

Many preprinted forms and special letterhead papers perform well in HP LaserJet printers. However, these papers undergo processes that alter their original characteristics, and care must be taken to ensure that they conform to HP specifications. All special papers should be wrapped in moisture-proof wrapping when they are purchased from the paper converter or printing house.

Forms and letterhead must be printed with inks that conform to the following specifications:

- Only use ink that is heat-resistant, and that will not melt, scorch, or release hazardous emissions when subjected to 200°C (392°F) for 0.1 second.
- Inks must have resistance to silicon oils, and must not be affected by resin components in toner.
- Inks must not be flammable.
- Inks must not “offset” (transfer from the printed paper onto the printer, contaminating internal printer components). The principle cause of offset is ink that is not fully dried or that cannot withstand the printer fusing temperature.

---

**Note**

Do not use low-temperature inks (the kind that is used in thermography).

## Embossed media

Embossed media is not recommended for use in HP LaserJet printers. Media is embossed by stamping an image into the media by compressing the media fibers together at approximately 200°C (392°F), and sometimes by applying a thin metal foil to the surface. The printer fusing process can loosen the foil, and loose foil can interfere with the mechanical and electronic operation of the printer.

Embossed paper, with or without foil, can also cause multifeed jams. Multiple embossed print media sheets tend to stick to one another.

## Media that contains cutouts or perforations

Avoid media that contains cutouts or perforations for these reasons:

- Cut fibers absorb more moisture and can increase waviness and media curl. This decreases the print quality near the cutout or perforated area.
- Cutting knives leave a sharp edge on the cutout or perforation. If the sharp edge is facing the print cartridge drum during printing, it can scratch the drum surface.
- If printing occurs over a cutout hole, the transfer roller is contaminated with unused toner, creating light streaks on the paper.

## Chemically treated media

Coatings such as lacquers, polymers, laminations, or other chemicals protect the paper, but can cause problems in the fuser and transfer areas of HP LaserJet printers. The surface resistivity and moisture content can be greatly altered, resulting in print-quality problems. Hard surface coatings increase wear on the rollers and media guides. All chemically treated media must meet HP specifications for fusing compatibility.

## Synthetic media

Synthetic media (those manufactured from man-made fibers) do not perform as well as bond media in any printer, especially HP LaserJet printers. All synthetic media must meet HP specifications, especially for caliper and fusing compatibility.

## Coated media

Do not use coated media. Most coated media does not meet the specifications for fusing compatibility and other specifications for HP LaserJet printers.

## Other special media

- Odd sizes: check minimum and maximum supported sizes in chapter 2.
- Carbonless media: carbonless media (NCR) is not supported by HP LaserJet printers.
- Recycled media: choose recycled media that meets Hewlett-Packard specifications. Note that recycled media might not be as bright as indicated in the specifications. HP recommends that recycled media contain no more than 5% groundwood. See "Paper weight equivalence table" on page 23.

## Storing print media

Ideally, the printing and media storage environment should be at or near room temperature, and should not be too dry or too humid. Remember that paper is hygroscopic; it absorbs and loses moisture rapidly.

Heat works with humidity to damage paper. Heat causes the moisture in paper to evaporate, while cold causes it to condense on the sheets. Heating systems and air conditioners remove most of the humidity from a room. As a package is opened and used the paper is used, it loses moisture, causing

streaks and smudging. Humid weather or water coolers can cause the humidity in a room to increase. As a package of paper is opened and used, it absorbs any excess moisture, causing light print and dropouts. Also, as paper loses and gains moisture, it can distort. This can cause jams.

Therefore, print-media storage and handling are as important as the paper-making process itself. Media storage environmental conditions directly affect the feed operation.

Customers should not purchase more media than can easily be used in a short time (about three months). Media that is stored for long periods might experience heat and moisture extremes, which can cause damage. Planning is important to prevent damage to a large supply of media.

Unopened paper in sealed packages can remain stable for several months before use. Opened packages of paper have more potential for environmental damage, especially if they are not wrapped with a moisture-proof barrier.

The media storage environment should be properly maintained to ensure optimum printer performance. The required condition is 20°C to 24°C (68°F to 75°F), with a relative humidity of 45% to 55%. The following guidelines should be helpful when evaluating the paper-storage environment:

- Paper should be stored at or near room temperature.
- The air should not be too dry or too humid (because of the hygroscopic properties of paper).
- The best way to store an opened package of paper is to rewrap it tightly in its moisture-proof wrapping. If the printer environment is subject to extremes, unwrap only the amount of paper to be used during the day's operation to prevent unwanted moisture changes.

## Envelope storage

Proper storage of envelopes contributes to good print quality. Envelopes should be stored flat. If air is trapped in an envelope, and creates an air bubble, then the envelope might wrinkle during printing.

## Paper weight equivalence table

Use this table to determine approximate equivalent points in weight specifications other than U.S. bond weight. For example, to determine the equivalent of 20-lb U.S. bond-weight paper in U.S. cover-weight paper, locate the bond weight (in row 3, second column) and scan across the row to the cover weight (in the fourth column). The equivalent is 28 lb. Shaded areas indicate a standard weight for that grade.

**Table 10. Paper weight equivalence**

U.S. post-card thickness (mm)	U.S. bond weight (lb)	U.S. text/book weight (lb)	U.S. cover weight (lb)	U.S. bristol weight (lb)	U.S. index weight (lb)	U.S. tag weight (lb)	Europe metric weight (g/m <sup>2</sup> )	Japan metric weight (g/m <sup>2</sup> )
	17	43	24	29	35	39	64	64
	20	50	28	34	42	46	75	75
	21	54	30	36	44	49	80	80
	22	56	31	38	46	51	81	81
	24	60	33	41	50	55	90	90
	27	68	37	45	55	61	100	100
	28	70	39	49	58	65	105	105
	32	80	44	55	67	74	120	120
	34	86	47	58	71	79	128	128
	36	90	50	62	75	83	135	135
0.18	39	100	55	67	82	91	148	148
0.19	42	107	58	72	87	97	157	157
0.20	43	110	60	74	90	100	163	163

**Table 10. Paper weight equivalence**

U.S. post-card thickness (mm)	U.S. bond weight (lb)	U.S. text/book weight (lb)	U.S. cover weight (lb)	U.S. bristol weight (lb)	U.S. index weight (lb)	U.S. tag weight (lb)	Europe metric weight (g/m <sup>2</sup> )	Japan metric weight (g/m <sup>2</sup> )
0.23	47	119	65	80	97	108	176	176
	53	134	74	90	110	122	199	199
	54	137	75	93	113	125	203	203
	58	146	80	98	120	133	216	216
	65	165	90	111	135	150	244	244
	66	169	92	114	138	154	250	250
	67	171	94	115	140	155	253	253
	70	178	98	120	146	162	264	264
	72	183	100	123	150	166	271	271

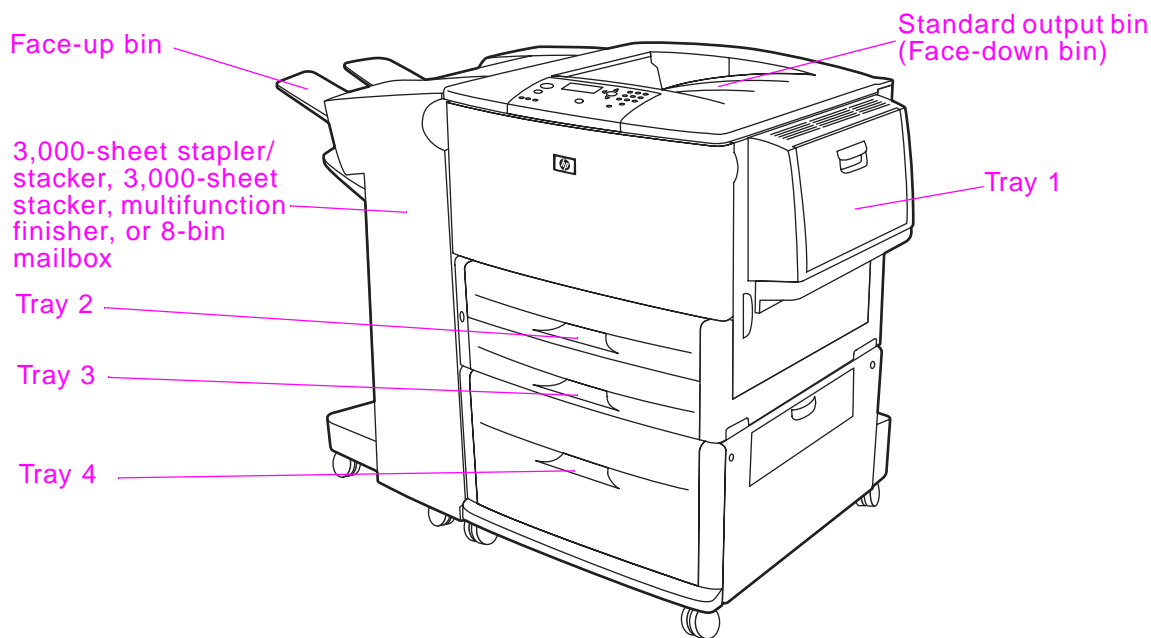
**Note**

The U.S. postcard measurements are approximate. Use for reference only.

# Media input/output options

## Trays, bins, and paper handling

The base-model printer comes with two built-in 500-sheet trays (tray 2 and tray 3). Tray 1 and tray 4 can be added to the printer. Special media (envelopes, labels) should only be loaded into tray 1. The printer comes with face-up and face-down bins, and a 3,000-sheet stapler/stacker, 3,000-sheet stacker, or multifunction finisher, or 8-bin mailbox for the HP LaserJet 9040/9050 Series printers, can be installed.



**Figure 10. Media trays, bins, and paper handling**

### CAUTION

Using print media that does not meet HP specifications might cause problems for the printer, requiring repair. Such repair is not covered by the Hewlett-Packard warranty or service agreements.

The HP LaserJet 9000 Series printers and HP LaserJet 9040/9050 Series printers accept a variety of media, such as cut-sheet paper (including up to 100% recycled fiber-content paper), envelopes, labels, transparencies, and custom-size paper. Properties such as weight, composition, grain, and moisture content are important factors affecting printer performance and output quality. Media that does not meet the guidelines outlined in this manual and in the print media guide can cause the following problems:

- poor print quality
- increased jams
- premature wear on the printer, requiring repair

## Supported sizes of paper for input and output

### Note

For more information on an optional HP output device, see the user guide that came with the product.

Tray or Bin	Capacity	Paper	Weight
Optional tray 1	Up to 100 sheets	Standard detectable sizes: Letter, Legal, Executive, ISO A3, ISO A4, ISO A5, 11 x 17, JIS B5, JIS B4, JPostD, Custom sizes: Minimum: 98 x 191 mm (3.9 x 7.5 inches) Maximum: 312 x 470 mm (12.3 x 18.4 inches)	64 to 216 g/m <sup>2</sup> (17- to 58-lb bond) Two-sided printing: 64 to 199 g/m <sup>2</sup> (1-7 to 53-lb bond)
	Up to 10 envelopes	Envelope sizes: Commercial #10, C5, DL, Monarch, B5	
	Maximum stack height for transparencies: 10 mm (0.4 inch)	Transparencies: 0.12 to 0.13 mm thick (4.7 to 5.5 mils thick) <b>Note</b> Print on envelopes, transparencies, and labels from optional tray 1 <i>only</i> .	
Trays 2 and 3	Up to 500 sheets	Standard detectable sizes: Letter, Letter-R, Legal, Executive, ISO A3, ISO A4-R, ISO A5, JIS B4, JIS B5, 11 x 17 Custom sizes: Minimum: 148 x 210 mm (5.8 x 8.3 inches) Maximum: 297 x 431 mm (11.7 x 17 inches)	64 to 199 g/m <sup>2</sup> (17- to 53-lb bond)
Optional tray 4	Up to 2,000 sheets	Standard detectable sizes: Letter, Legal, Executive, ISO A3, ISO A4, 11 x 17, JIS B4, JIS B5 Standard undetectable sizes: 8K, 16K, JIS Executive, 8.5 x 13 (215 x 330 mm) Custom sizes: Minimum: 182 x 210 mm (7.2 x 8.3 inches) Maximum: 297 x 431 mm (11.7 x 17 inches)	64 to 199 g/m <sup>2</sup> (17- to 53-lb bond)
Standard top bin	Up to 500 sheets	Standard sizes: Letter, Legal, Executive, ISO A3, ISO A4, ISO A5, 11 x 17, JIS B5, JIS B4, JPostD, Monarch, 8K, 16K Custom sizes Custom types: Transparencies	64 to 199 g/m <sup>2</sup> (17- to 53-lb bond)
	Up to 50 transparencies		

Tray or Bin	Capacity	Paper	Weight
Left output bin	Up to 100 sheets  Up to 10 transparencies	Standard sizes: Letter, Legal, Executive, ISO A3, ISO A4, ISO A5, 11 x 17, JIS B5, JIS B4, JPostD, Monarch, 8K, 16K Custom sizes Custom types: Envelopes, labels	64 to 216 g/m <sup>2</sup> (17- to 58-lb bond)
Duplex printing accessory		Standard detectable sizes: Letter, Letter-R, Legal, Executive, ISO A3, ISO A4, ISO A4-R, 11 x 17, JIS B4, JIS B5 Standard undetectable sizes: 8K, 16K Custom sizes Custom types: Duplexing is <i>not</i> supported for envelopes, labels, or transparencies.	64 to 199 g/m <sup>2</sup> (17- to 53-lb bond)
Optional 3,000-sheet stacker	Up to 3,000 sheets of Letter or A4  Up to 1,500 sheets of A3 or 11 x 17	Standard sizes for lower bin: Letter, Legal, Executive, ISO A3, ISO A4, ISO A5, 11 x 17, JIS B5, JIS B4, 8K, 16K  Standard sizes for upper bin: Letter, Legal, Executive, ISO A3, ISO A4, ISO A5, 11 x 17, JIS B5, JIS B4, JPostD, Monarch, 8K, 16K Custom sizes Custom types: Envelopes, labels, transparencies, heavy paper	64 to 199 g/m <sup>2</sup> (17- to 53-lb bond) in lower bin  64 to 216 g/m <sup>2</sup> (17- to 58-lb bond) in upper bin
Optional 3,000-sheet stacker/stapler	Up to 3,000 sheets of Letter or A4  Up to 1,500 sheets of A3 or 11 x 17  Up to 50 sheets stapled	Standard sizes for lower bin: Letter, Legal, Executive, ISO A3, ISO A4, ISO A5, 11 x 17, JIS B5, JIS B4, 8K, 16K  Standard sizes for upper bin: Letter, Legal, Executive, ISO A3, ISO A4, ISO A5, 11 x 17, JIS B5, JIS B4, JPostD, Monarch, 8K, 16K Custom sizes Custom types: Envelopes, labels, transparencies, heavy paper	64 to 199 g/m <sup>2</sup> (17 to 53 lb bond) in lower bin  64 to 216 g/m <sup>2</sup> (17- to 58-lb bond) in upper bin

Tray or Bin	Capacity	Paper	Weight
Optional multifunction finisher	Up to 1,000 sheets of stacked 20 lb bond for Letter and A4 (up to 50 sheets stapled), and 500 sheets of stacked 20-lb bond for A3 and 11 x 17 (up to 25 sheets stapled)  Up to 40 booklets of 5 sheets, stacked; or 20 booklets of 10, sheets stacked	Standard sizes: Letter, Legal, Executive, ISO A3, ISO A4, ISO A5, JIS B4, JIS B5, 11 x 17 Custom sizes: Minimum: 98 x 191 mm (3.9 x 7.5 inches) Maximum: 312 x 470 mm (12.3 x 18.5 inches) Custom types: Envelopes, labels, transparencies, heavy paper	64 to 199 g/m <sup>2</sup> (17- to 53-lb bond) in lower booklet bin 64 to 216 g/m <sup>2</sup> (17- to 58-lb bond) in upper bin
Optional 8-bin mailbox (HP LaserJet 9040/9050 Series printers <i>only</i> )	Up to 250 sheets of A4 or Letter in each output bin	Standard sizes for upper bin: Letter, Legal, Executive, ISO A3, ISO A4, ISO A5, JIS B4, JIS B5, 11 x 17 Custom sizes: Minimum: 148 x 210 mm (5.8 x 8.3 inches) Maximum: 297 x 432 mm (11.7 x 17 inches) Standard sizes for 8 mailbox bins: Letter, Legal, Executive, ISO A3, ISO A4, ISO A5, JIS B4, JIS B5, 11 x 17 Custom sizes: Minimum: 148 x 210 mm (5.8 x 8.3 inches) Maximum: 297 x 432 mm (11.7 x 17 inches)	60 to 135 g/m <sup>2</sup> (16- to 36-lb bond) in 8 mailbox bins  64 to 216 g/m <sup>2</sup> (18- to 58-lb bond) in upper bin



# 3

## Product configuration

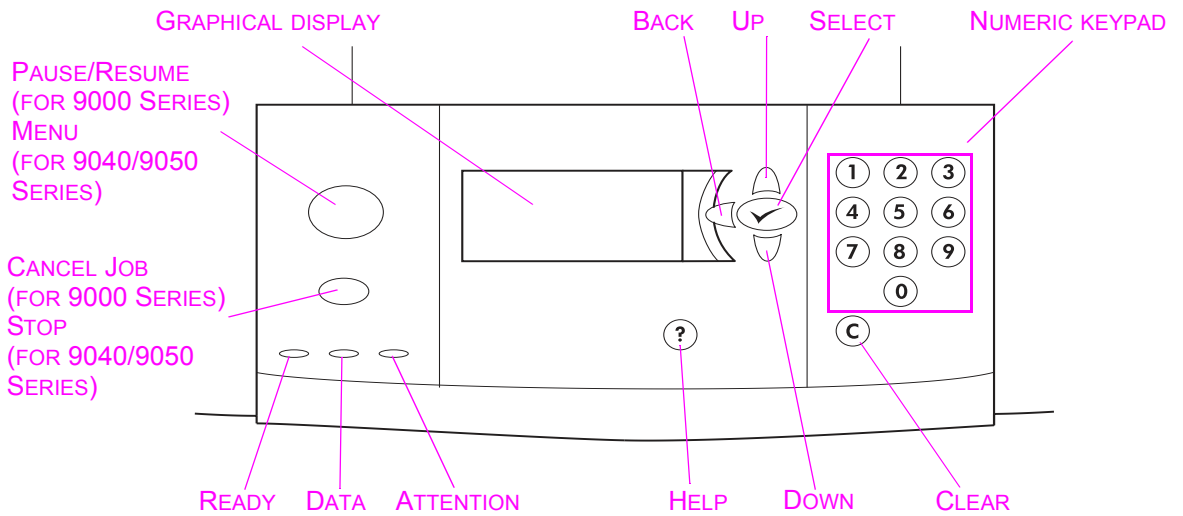
### Chapter contents

Using the control panel . . . . .	30
Control-panel buttons . . . . .	31
Numeric keypad commands . . . . .	32
Settings and defaults . . . . .	33
Setting the display language . . . . .	33
Setting the tray registration . . . . .	33
Printer driver information . . . . .	36
Control-panel menus . . . . .	37
Control-panel menus . . . . .	37
Using a menu map . . . . .	37
Retrieve job menu . . . . .	38
Information menu . . . . .	38
Paper-handling menu . . . . .	39
System setup submenu . . . . .	46
I/O submenu . . . . .	48
Resets submenu . . . . .	53
Diagnostics menu . . . . .	54
Service menu . . . . .	54
Remote firmware upgrade (RFU) . . . . .	55
Upgrading firmware to a single printer . . . . .	55
HP Web Jetadmin 6.1 for a single printer . . . . .	57

# Using the control panel

The control panel includes three LED indicator lights, four navigation buttons, a help button, a message-clear button, a pause/resume button (9000 Series) or a menu button (9040/9050 Series), a cancel-job button (9000 Series) or a stop button (9040/9050 Series), a numeric keypad, and a graphical display that can show up to four lines of text.

The control panel graphical display provides both status and error messages by using distinct text and codes.



**Figure 11.** Control-panel layout

## Control-panel buttons

Table 11. Control-panel button functions

Button	Function
◀ (BACK ARROW)	<ul style="list-style-type: none"> <li>Backs up one step from a selection or a 10-key entry.</li> </ul>
▲ (UP ARROW)	<ul style="list-style-type: none"> <li>Navigates to the previous item in the list.</li> </ul>
✓ (SELECT)	<ul style="list-style-type: none"> <li>Saves the selected value for that item. An asterisk ( * ) appears next to the selection, indicating that it is the new default. Default settings remain when the printer is switched off or is reset (unless you reset all factory defaults from the <b>Resets</b> menu).</li> <li>Prints one of the printer information pages from the control panel.</li> </ul>
C (CLEAR)	<ul style="list-style-type: none"> <li>Returns a numeric entry to its previous value.</li> </ul>
▼ (DOWN ARROW)	<ul style="list-style-type: none"> <li>Navigates to the next item in the list.</li> </ul>
? (HELP)	<ul style="list-style-type: none"> <li>Provides help on about the message that appears on the control-panel display.</li> </ul>
CANCEL JOB -OR- STOP	<ul style="list-style-type: none"> <li> <ul style="list-style-type: none"> <li>Cancel the current print job. The time it takes to cancel depends on the size of the print job. Press the button only once.</li> </ul> </li> <li> <ul style="list-style-type: none"> <li>Opens the <b>STOP</b> menu which contains the following options:                             <ul style="list-style-type: none"> <li>Cancel the current print job.</li> <li>Pause the printer.</li> <li>Resume printing if the printer was paused.</li> </ul> </li> </ul> </li> </ul>
PAUSE/RESUME -OR- MENU	<ul style="list-style-type: none"> <li> <ul style="list-style-type: none"> <li>Returns to the ready or busy state from menus or online help.</li> <li>Toggles between pause and resume.</li> </ul> </li> <li> <ul style="list-style-type: none"> <li>Opens or exits the menus.</li> </ul> </li> </ul>
NUMERIC KEYPAD	<ul style="list-style-type: none"> <li>Specifies numeric values.</li> </ul>

---

### Note

---

The HP LaserJet 9000 and the HP LaserJet 9040/9050 Series printers are similar products. The behavior or feature is common in both printers unless noted otherwise.

## Numeric keypad commands

The numeric keypad is used to specify numeric values. The numeric keypad provides a shortcut key to items in the menus if the device is in an idle state. Pressing the numbers that correspond with the position of the menu item opens that menu. For example, to print a configuration page, the customer can press 22. The first 2 represents the Information menu, which is the second menu. The second 2 represents the **Print configuration page** command, which is the second item in the Information-menu list.

The menus change dynamically. The **Configure device** menu has flexible menus that can be used to configure accessories depending on what accessories are available, so the number sequence might not be the same for all devices. Pressing a number should correspond to the same sequence that is used when navigating to that item in the list and pressing ✓.

The exception to this approach is when the display contains a list of values. In this case, typing the number moves to that item in the list but does not select the item. This is the same for continuous values that can be specified by using the numeric keypad. For example, to specify the number of copies, the customer presses the appropriate number and then presses ✓.

The following table outlines what happens in certain printer states when a button on the numeric keypad is pressed.

**Table 12. Printer state and numeric key effect**

<b>PowerSave</b>	<b>Idle/pause</b>	<b>Continuable error</b>	<b>Data</b>	<b>Processing job</b>	<b>In menus</b>	<b>In online information</b>
Exit the PowerSave mode.	Open a menu. Each menu has an assigned number.	No effect.	No effect.	No effect.	Specify the numeric value.	No effect.

## Settings and defaults

The printer bases most printing decisions on temporary settings or on factory (permanent) defaults.

### Note

Settings that you send from software programs override default settings.

**Temporary settings** are the values that are set through a software program for the current print job. Temporary settings remain in effect until the current print job is finished.

**Control-panel defaults** are the values that are specified by selecting a control-panel item and pressing ✓. An asterisk ( \* ) next to the item name indicates that it is now the default. The printer retains default settings even when power is turned off.

**Factory defaults** are preset at the factory and are the permanent default values for each menu item.

## Setting the display language

### Method 1

- 1 Press ✓ to open the menus.
- 2 Press ▼ or ▲ to scroll to `CONFIGURE DEVICE`, and then press ✓.
- 3 Press ▼ or ▲ to scroll to `SYSTEM SETUP`, and then press ✓.
- 4 Press ▼ or ▲ to scroll to `LANGUAGE`, and then press ✓.
- 5 Press ▼ or ▲ to scroll to the appropriate language, and then press ✓.

### Method 2

- 1 Press and hold ✓ while turning on the printer.
- 2 Hold ✓ until all three LED indicator lights are illuminated at the same time.
- 3 Press ▼ or ▲ to scroll to the desired language, and then press ✓.

### Note

For Japanese, Turkish, Czech, Russian, Hungarian, and Polish, the language selection changes the default symbol set for the specific language. For all other languages, the default symbol set is PC-8.

## Setting the tray registration

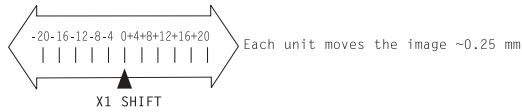
- 1 Press ✓ to open the menus.
- 2 Press ▼ or ▲ to scroll to `CONFIGURE DEVICE`, and then press ✓.
- 3 Press ▼ or ▲ to scroll to `PRINT QUALITY`, and then press ✓.
- 4 Press ▼ or ▲ to scroll to `SET REGISTRATION`, and then press ✓.

You can select a tray by specifying a `SOURCE`. The default `SOURCE` is tray 2. If you want to set the registration for tray 2, go to step 7. Otherwise, proceed to the next step.

- 5 Press ▼ or ▲ to scroll to `SOURCE`, and then press ✓.
- 6 Press ▼ or ▲ to select a tray, and then press ✓. After selecting a tray, the control-panel display returns to the `SET REGISTRATION` menu.
- 7 Press ▼ or ▲ to scroll to `PRINT TEST PAGE`, and then press ✓.
- 8 Follow the instructions on the printed page.

How to center all jobs from tray2:

- Step 1:
- A. Examine the borders on the top and bottom of this page.
  - B. Note the Y SHIFT value necessary to move the border in the desired direction.

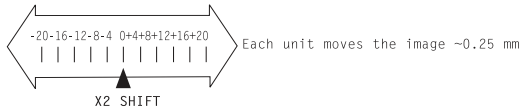


- Step 2:
- A. Examine the borders on the left and right of this page.
  - B. Note the X1 SHIFT value necessary to move the border in the desired direction.

- Step 3:
- A. Press the  key to enter the menus.
  - B. Use  and  to highlight **CONFIGURE DEVICE** and press  to select.
  - C. Use  and  to highlight **PRINT QUALITY** and press  to select.
  - D. Use  and  to highlight **SET REGISTRATION** and press  to select.
  - E. Use  and  to highlight **ADJUST TRAY2** and press  to select.
  - F. Use  and  to highlight **Y SHIFT** and press  to select.
  - G. Use  and  to locate the value you identified in step 1 and press  to select.
  - H. Use  and  to highlight **X1 SHIFT** and press  to select.
  - I. Use  and  to locate the value you identified in step 1 and press  to select.
  - J. Print another test page and repeat steps 1 & 2 to verify the border is properly centered.

Figure 12. Registration page (1 of 2)

Note: Y shift adjusts both sides.



Step 4:  
 A. Examine the borders on the left and right of this page.  
 B. Note the X2 SHIFT value necessary to move the border in the desired direction.

Step 5:  
 A. Press the  $\checkmark$  key to enter the menus.  
 B. Use  $\blacktriangle$  and  $\blacktriangledown$  to highlight CONFIGURE DEVICE and press  $\checkmark$  to select.  
 C. Use  $\blacktriangle$  and  $\blacktriangledown$  to highlight PRINT QUALITY and press  $\checkmark$  to select.  
 D. Use  $\blacktriangle$  and  $\blacktriangledown$  to highlight SET REGISTRATION and press  $\checkmark$  to select.  
 E. Use  $\blacktriangle$  and  $\blacktriangledown$  to highlight ADJUST TRAY 2 and press  $\checkmark$  to select.  
 F. Use  $\blacktriangle$  and  $\blacktriangledown$  to highlight X2 SHIFT and press  $\checkmark$  to select.  
 G. Use  $\blacktriangle$  and  $\blacktriangledown$  to locate the value you identified in step 4 and press  $\checkmark$  to select.  
 H. Print another test page and repeat step 4 to verify the front and back of the page align.

Figure 13. Registration page (2 of 2)

## **Printer driver information**

When you change a setting from the printer control panel, the new setting becomes the default value. You can override any control-panel setting from the printer driver and through most software programs.



## Control-panel menus

Press ▼ or ▲ to cycle through the control-panel menus. Each menu is described in a separate table in this section. Menu items appear only if their associated option is installed, or their functions are activated.

All menus and their associated items are available when the printer is online. In menu mode, if no buttons are pressed for approximately 30 seconds, the system automatically returns to the top level and displays either an existing error or one of the following messages:

- READY, if the printer is online
- OFFLINE, if the printer is offline

---

### Note

---

Items appear only when the associated optional accessory is installed or the associated function is activated. Printer-driver and software commands override the printer control-panel settings.

From the control panel, you can print a menu map that shows the current printer configuration. Additional menu items can appear on the control panel, depending on the optional accessories that are currently installed in the printer. The following is a list of menus that are available from the control panel, and where to find information about each menu.

- "Retrieve job menu" on page 38
- "Information menu" on page 38
- "Paper-handling menu" on page 39
- "System setup submenu" on page 46

## Using a menu map

To see the current settings for the menus and items that are available on the control panel, print a control-panel menu map. Values that appear with an ( \* ) next to them are the currently selected values for a setting. Many of these values can be overridden from the print driver or a software program. You might want to store the menu map near the printer for reference.

The contents of the menu map varies, depending on the optional accessories that are installed in the printer.



### Select an item from the menu map

- 1 Press ✓ to open the menus.
- 2 Press ▼ or ▲ to scroll to the required menu, and then press ✓ .
- 3 Press ▼ or ▲ to scroll to the page desired, and then press ✓ .

# Retrieve job menu

**Note**

If no private, stored, quick copy, or proof and hold jobs are stored on the printer hard disk or in RAM, the message NO STORED JOB appears when the menu is selected.

- 1 A list of user names appears.
- 2 Select a user name, and a list of jobs that are stored for that user appears.
- 3 Select a job name, and print or delete that job. If a job requires a PIN before it can be printed or deleted,  appears next to the PRINT or DELETE command and a PIN must be typed. If a job requires a PIN to delete,  appears next to the DELETE command and a PIN must be provided.
- 4 If you select PRINT, the printer prompts you to specify the number of copies to print (1 to 32,000).

# Information menu

To print an information page, scroll to the information page that you want and press .

Item	Explanation
PRINT MENU MAP	Generates a menu map that shows the layout and current settings of the control-menu items. The printer will back up one screen to SET FRONT TO BACK when the page is completed.
PRINT CONFIGURATION	Generates a page detailing the current configuration of the printer. The printer will return to the online READY state when the page is completed.
PRINT SUPPLIES STATUS PAGE	Generates a page that shows the number of pages remaining for each supply in the printer. The printer will return to the online READY state when the page is completed.
PRINT USAGE PAGE	Generates a page that contains information that could be used for cost accounting. This item is only available if a hard disk is installed. The printer will return to the online READY state when the page is completed.
PRINT FILE DIRECTORY	Generates a directory page containing information for all installed mass-storage devices. The printer will return to the online READY state when the page is completed.
PRINT PCL FONT LIST	Generates a typeface list of all PCL fonts that are available on the printer. The printer will return to the online READY state when the page is completed.
PRINT PS FONT LIST	Generates a typeface list of all PS fonts that are available on the printer. The printer will return to the online READY state when the page is completed.

## Paper-handling menu

When paper-handling settings are correctly configured through the control panel, you can print by selecting the type and size of paper from the printer driver or software program.

Some items in this menu (such as duplex and manual feed) are available from specific software programs, or from the printer driver (if the appropriate driver is installed). Printer-driver and software-program settings override control-panel settings.

Item	Values	Explanation
TRAY 1=FIRST (HP LaserJet 9000 only)	FIRST  CASSETTE	FIRST: The user can specify if media in the tray should be used.  CASSETTE: If set to CASSETTE, the tray must be configured with a size and type, but it then functions like all of the other trays.
TRAY <N> SIZE=LETTER	ANY SIZE LETTER LETTER-ROTATED LEGAL A4 A4-ROTATED EXECUTIVE EXECUTIVE(JIS) A3 A5 B4(JIS) B5(JIS) 8K 16K 8.5 X 13 11 X 17 CUSTOM ANY CUSTOM	The user can set the paper size for trays 2 and 3 and for optional tray 4 (if installed) when the custom switch is in the CUSTOM position. The size is detected if the switch is in the STANDARD position. Substitute the tray number for <N>.
TRAY <N> TYPE=PLAIN	ANY TYPE PLAIN PREPRINTED LETTERHEAD TRANSPARENCY PREPUNCHED LABELS BOND RECYCLED COLOR CARDSTOCK>163 ROUGH 90-105 G/M2 ENVELOPE *	The user can specify the type of media that is loaded in each tray. Substitute the tray number for <N>. *ENVELOPE appears for tray 1 only.

Item	Values	Explanation
FUSER MODES (HP LaserJet 9000 <i>only</i> )	List of print-media types	<p>Configure the fuser mode that is associated with each media type. The default value for each paper type is <b>AUTO</b>.</p> <p>The fuser mode can only be changed from this menu option on the control panel.</p> <p><b>AUTO</b>: Utilizes the optimum mode for that media type.</p> <p><b>NORMAL</b>: Normal temperature; prints at 50 pages per minute (ppm).</p> <p><b>LOW</b>: Low temperature; prints at 50 ppm.</p> <p><b>HIGH1</b>: Raises the temperature, prints at 50 ppm.</p> <p><b>HIGH2</b>: Raises the temperature; prints at 32 ppm.</p> <p><b>SPECIAL</b>: Use this mode to print at normal speeds with a 40-second delay added to the beginning of the next job. After each 400 pages are printed, the first page of that job is printed at a slower speed in order to clean the fuser. No defects should be noticeable on the printed page. This is <i>not</i> a preferred setting.</p> <p><b>CAUTION</b></p> <p>If you change the fuser mode to <b>HIGH1</b> or <b>HIGH2</b>, be sure to change it back to the default when you are done printing. Setting a paper type to <b>HIGH1</b> or <b>HIGH2</b> might shorten the life of some consumables, such as the fuser, and might cause other failures or jams.</p>

# Configure device menu

This menu contains all of the administrative functions.

## Printing submenu

Some items in this menu are available from a software program, or from the printer driver (if the appropriate driver is installed). Printer-driver and software-program settings override control-panel settings.

Item	Values	Explanation
COPIES=1	1 to 32,000	Set the default number of copies by selecting any number from 1 to 32,000. Use the numeric keypad to select the number of copies.  <b>Note</b> It is best to set the number of copies from the printer driver or software program. (Driver and software settings override control-panel settings.)
DEFAULT PAPER SIZE= LETTER	LETTER LEGAL A4 EXECUTIVE 11X17 A3 B4(JIS) B5(JIS) CUSTOM A5 LETTER ROTATED STATEMENT 8.5X13 12X18 A4 ROTATED RA3 EXECUTIVE(JIS) DPOSTCARDS(JIS) 8K 16k ENVELOPE #10 ENVELOPE MONARCH ENVELOPE C5 ENVELOPE DL ENVELOPE B5	Set the default image size for paper and envelopes. (The item name will change from paper to envelope as you scroll through the available sizes.)
DEFAULT CUSTOM PAPER SIZE	UNIT OF MEASURE X DIMENSION Y DIMENSION	Allows the user to set a custom paper size for any of the installed trays. Substitute the tray number for <N>. This menu only appears when the custom switch in the selected tray is in the custom size position. The user selects the X and Y dimensions of the custom paper size by using the ruler labels in the trays.
PAPER DESTINATION= STANDARD OUTPUT	STANDARD OUTPUT LEFT OUTPUT BIN STANDARD TOP BIN	Allows the user to configure the output bin destination. Only the installed bins appear on the menu.

Item	Values	Explanation
DUPLEX=OFF	OFF ON	This item appears only when an optional duplex printing accessory is installed. Set the value to <b>ON</b> to print on both sides (duplex) or <b>OFF</b> to print on one side (simplex) of a sheet of paper.  For more information, see the HP support flyer or go to <a href="http://www.hp.com/support/lj9050_lj9040">www.hp.com/support/lj9050_lj9040</a> or <a href="http://www.hp.com/support/lj9000">www.hp.com/support/lj9000</a> .
DUPLEX BINDING=LONG EDGE	LONG EDGE SHORT EDGE	Allows the user to change the binding edge for duplex printing. The menu item appears when a duplex printing accessory is installed in the printer and <b>DUPLEX=ON</b> .
OVERRIDE A4/ LETTER=NO	YES NO	This command is used to print on letter-size media when an A4 job is sent, but no A4-size media is loaded in the printer (or to print on A4-size media when a letter job is sent, but no letter media is loaded in the printer).
MANUAL FEED=OFF	OFF ON	Use this item to set the printer to feed the paper manually from optional tray 1, rather than automatically from a tray. When <b>MANUAL FEED=ON</b> and optional tray 1 is empty, the printer goes offline when it receives a print job. The message <b>MANUALLY FEED [PAPER SIZE]</b> appears on the control-panel display.
EDGE TO EDGE OVERRIDE=NO	NO YES	Turn the edge-to-edge mode on or off for all print jobs. This mode can be overridden inside a print job by using an edge-to-edge PCL variable.
COURIER FONT=REGULAR	REGULAR DARK	Select the version of Courier font to use: <b>REGULAR:</b> The internal Courier font that is available on the HP LaserJet 4 Series printers. <b>DARK:</b> The internal Courier font that is available on the HP LaserJet III Series printers. Both fonts are not available at the same time.
WIDE A4=NO	YES NO	The Wide A4 setting changes the number of characters that can be printed on a single line of A4 media. <b>YES:</b> Up to 80 10-pitch characters can be printed on one line. <b>NO:</b> Up to 78 10-pitch characters can be printed on one line.
PRINT PS ERRORS=OFF	ON OFF	Select <b>ON</b> to print the PS error page when PS errors occur.
PRINT PDF ERRORS= OFF	OFF ON	Select <b>ON</b> to print the PDF error page when PDF errors occur.

## PCL submenu

Items in the PCL submenu affect PCL tasks.

Item	Values	Explanation
FORM LENGTH=60	5 to 128	Sets vertical spacing from 5 to 128 lines for the default paper size. Specify the value by using the numeric keypad.
ORIENTATION= PORTRAIT	PORTRAIT LANDSCAPE	Allows the user to select the default page orientation.  <b>Note</b> It is best to set the page orientation from the printer driver or software program. (Driver and software settings override control-panel settings.)
FONT SOURCE=INTERNAL	INTERNAL CARD SLOT X	<b>INTERNAL:</b> Internal fonts. SLOT 1, 2, or 3: Fonts that are stored in one of the three DIMM slots.
FONT NUMBER=0	0-999	The printer assigns a number to each font and lists the numbers on the PCL Font List. The font number appears in the Font # column of the printout.
FONT PITCH=10.00	0.44 to 99.99	Using the numeric keypad or ▲ and ▼, specify a value. This item might not appear, depending on the font that you selected.
SYMBOL SET=PC-8	Variety of available symbol sets	Select any one of several available symbol sets from the printer control panel. A symbol set is a unique grouping of all of the characters in a font. PC-8 or PC-850 is recommended for line-draw characters.
APPEND CR TO LF=NO	YES NO	Select YES to append a carriage return to each line feed that is encountered in backward-compatible PCL jobs (pure text, no job control). Some environments, such as UNIX®, indicate a new line by using only the line-feed control code. This option allows the user to append the required carriage return to each line feed.
SUPRESS BLANK PAGES=NO	NO YES	When set to YES, form feeds are ignored if the page is blank.

## Print-quality submenu

Some items in this menu can be set with a software program, or from the driver (if the appropriate driver is installed). Driver and software settings override control-panel settings.

Item	Values	Explanation
SET REGISTRATION	PRINT TEST PAGE  SOURCE=TRAY 2  ADJUST TRAY <X>	Shift the margin alignment to center the image on the page from top to bottom, and from left to right. You can also align the image on the front with the image printed on the back.
FUSER MODES (HP LaserJet 9040/9050 only)	List of media types	<p>Configure the fuser mode that is associated with each print-media type.</p> <p>The fuser mode can only be changed from this menu option on the control panel. The default value for each paper type is <code>AUTO</code>.</p> <p><code>AUTO</code>: Utilizes the optimum mode for that media type.</p> <p><code>NORMAL</code>: Normal temperature; prints at 40/50 pages per minute (ppm).</p> <p><code>LOW</code>: Low temperature; prints at 40/50 ppm.</p> <p><code>HIGH1</code>: Raises the temperature; prints at 40/50 ppm.</p> <p><code>HIGH2</code>: Raises the temperature; prints at 32 ppm.</p> <p><code>SPECIAL</code>: Use this mode to print at normal speeds with a 40-second delay added to the beginning of the next job. After each 400 pages are printed, the first page of that job is printed at a slower speed in order to clean the fuser. No defects should be noticeable on the printed page. This is <i>not</i> a preferred setting.</p> <p><b>CAUTION</b></p> <p>If you change the fuser mode to <code>HIGH1</code> or <code>HIGH2</code>, be sure to change it back to the default when you are done printing. Setting a paper type to <code>HIGH1</code> or <code>HIGH2</code> might shorten the life of some consumables, such as the fuser, and might cause other failures or jams.</p>
RESOLUTION= FASTRES 1200	300 600 FASTRES 1200	<p>Select the resolution from the following values:</p> <p><code>300</code>: Produces draft print quality at maximum printer speed.</p> <p><code>300</code> dpi (dots per inch) is recommended for some bitmapped fonts and graphics, and for compatibility with the HP LaserJet III family of printers.</p> <p><code>600</code>: Produces high print quality at maximum product speed.</p> <p><code>FASTRES 1200</code>: Produces optimum print quality (comparable to 1200 dpi) at maximum product speed.</p> <p><b>Note</b></p> <p>It is best to change the resolution from the driver or software program. (Driver and software settings override control-panel settings.)</p>



Item	Values	Explanation
RET=MEDIUM	OFF LIGHT MEDIUM DARK	Use the printer Resolution Enhancement technology (REt) setting to produce print that contains smooth angles, curves, and edges. All print resolutions, including FastRes 1200, benefit from REt.  <b>Note</b> It is best to change the REt setting from the driver or software program. (Driver and software settings override control-panel settings.)
ECONOMODE	ON OFF	When set to "on", the printer prints by using a reduced amount of toner per page; however, the print quality of the page is drastically reduced.
TONER DENSITY=3	1 to 5	Lighten or darken the print on the page by changing the toner-density setting. The settings range from 1 (light) to 5 (dark), but the default setting of 3 usually produces the best results.  <b>Note</b> It is best to change the toner density from the driver or software program. (Driver and software settings override control-panel settings.)
SMALL PAPER MODE=NORMAL	NORMAL SLOW	When printing on narrow media, this setting slows down the printer which stabilizes the fuser temperature to minimize wrinkles.
CREATE CLEANING PAGE	No value to select	Press <input checked="" type="checkbox"/> to print a cleaning page (for cleaning excess toner from the paper path). In order for the cleaning page to work correctly, print the page on copier-grade paper (not bond or rough paper). Follow the instructions on the cleaning page. The progress bar shows the time remaining before the process is complete.
PROCESS CLEANING PAGE	No value to select	This item appears only after a cleaning page has been generated.  Press <input checked="" type="checkbox"/> to process the cleaning page. The progress bar shows the time remaining before the process is complete.

## System setup submenu

Items in this menu affect the printer function. Configure the printer according to your printing needs.

Item	Values	Explanation
DATE/TIME (HP LaserJet 9040/9050 <i>only</i> )	DATE DATE FORMAT TIME TIME FORMAT	Sets the date and time for the printer. The Real Time Clock is set to Greenwich Mean Time (GMT).
JOB STORAGE LIMIT=32	1 to 100	Specifies the number of jobs that can be stored on the printer hard-disk accessory.
JOB HELD TIMEOUT= OFF	OFF 1 HOUR 4 HOURS 1 DAY 1 WEEK	Sets the length of time that quick copy, proof and hold, private, and stored jobs are kept before being automatically deleted from the queue.
SHOW ADDRESS=OFF (HP LaserJet 9040/9050 <i>only</i> )	AUTO OFF	Sets whether or not the printer IP address appears with the Ready message. If this value is "on," the address of the EIO card in slot 1 is shown.
TRAY BEHAVIOR (HP LaserJet 9040/9050 <i>only</i> )	USE REQUESTED TRAY MANUAL FEED PROMPT PS DEFER MEDIA	Specifies the behavior of the tray by indicating which tray the printer should print from. USE REQUESTED TRAY sets the tray that the printer should print from for specified jobs. The values for this menu item are EXCLUSIVELY (default) and FIRST. MANUAL FEED PROMPT determines whether or not the product prompts the user when a job does not match a requested configured tray. The values for this menu item are ALWAYS (default) or UNLESS LOADED. PS DEFER MEDIA sets whether the paper-handling model is based on PostScript rules or HP rules. The values for this menu item are ENABLED (default) and DISABLED.
SLEEP DELAY=90 MINUTES  POWERSAVE TIME=1 HOUR (HP LaserJet 9000 <i>only</i> )	1 MINUTE 15 MINUTES 30 MINUTES 60 MINUTES 90 MINUTES 2 HOURS 4 HOURS	Set how long the printer remains idle before it enters Sleep mode. The Sleep mode minimizes the amount of power that the printer consumes when it is idle and reduces wear on the printer electronic components. When you send a print job, press a control-panel button, open a paper tray, or open the top cover, the printer automatically exits Sleep mode.
		<b>Note</b> Sleep turns off the backlight on the display, but the display is still readable.
WAKE TIME SUBMENU (HP LaserJet 9040/9050 <i>only</i> )	SETTING WAKE TIME	Sets the time that the printer automatically comes out of Sleep mode. This feature can be set for a different time for each day of the week.

Item	Values	Explanation
PERSONALITY=AUTO	AUTO PCL PS PDF XHTML MIME	Select the default printer language (personality). Possible values are determined by which valid languages are installed in the printer. Normally, you should not change the printer language (the default is <code>AUTO</code> ). If you change it to a specific printer language, the printer does not automatically switch from one language to another unless specific software commands are sent to the printer.
CLEARABLE WARNINGS=JOB	ON JOB	Set the amount of time that a clearable warning appears on the printer control panel. <code>ON</code> : Warning messages appear on the control panel until ✓ is pressed. <code>JOB</code> : Warning messages appear on the control panel until the end of the job from which they were generated.
AUTO CONTINUE=ON	ON OFF	Determine how the printer reacts to errors. <code>ON</code> : If an error prevents printing, the message appears, and the printer goes offline for 10 seconds before returning online. <code>OFF</code> : If an error prevents printing, the message remains on the display and the printer does not print until ✓ is pressed.  <b>Note</b> To stop printing when an installed optional stapler accessory is out of staples, set <code>AUTO CONTINUE=OFF</code> on the control-panel <b>System setup</b> menu.
CARTRIDGE LOW=CONTINUE	CONTINUE STOP	Determine how the printer functions when toner is low. The <code>CARTRIDGE LOW</code> message first appears when the print cartridge is almost out of toner. (About 2,400 pages can still be printed at 5% coverage.) <code>CONTINUE</code> : The printer continues to print while the <code>CARTRIDGE LOW</code> message appears. <code>STOP</code> : The printer goes offline and wait for attention.
CARTRIDGE OUT=CONTINUE (HP LaserJet 9040/9050 only)	STOP CONTINUE	Determine how the printer functions when toner is out.
JAM RECOVERY=AUTO	AUTO ON OFF	Determine how the printer functions when a jam occurs. <code>AUTO</code> : The printer automatically selects the best mode for printer jam recovery (usually <code>ON</code> ). This is the default setting. <code>ON</code> : The printer automatically reprints pages after a jam is cleared. <code>OFF</code> : The printer does not reprint pages following a jam. Printing performance might be increased with this setting.

Item	Values	Explanation
RAM DISK=AUTO (HP LaserJet 9000 only)	AUTO OFF	This item determines how the RAM disk is configured. This item appears only if no optional hard disk is installed and the printer has at least 8 MB of memory.  OFF: The RAM disk is disabled.  <b>Note</b> If the setting is changed from OFF to AUTO, the printer automatically reinitializes after it comes out of an idle period.
LANGUAGE=ENGLISH	List of available languages	Sets the language that is used on the control panel.

## I/O submenu

Items in the *I/O* (input/output) menu affect the communication between the printer and the computer.

### I/O timeout submenu

Item	Values	Explanation
I/O TIMEOUT=15	5 to 300	Select the <i>I/O</i> timeout period in seconds. ( <i>I/O</i> timeout refers to the time, measured in seconds, that the printer waits before ending a print job.) Use this setting to adjust timeout for best performance. If data from other ports appears in the middle of your print job, increase the timeout value.

### Parallel input submenu

Item	Values	Explanation
HIGH SPEED=YES	YES NO	The printer accepts the faster parallel communications that are used for connections with newer computers.
ADVANCED FUNCTIONS=ON	ON OFF	Turn the bidirectional parallel communication on or off. The default is set for a bidirectional parallel port (IEEE-1284). This setting allows the printer to send status readback messages to the computer. (Turning the parallel advanced functions on might slow language switching.)

## **EIO X Jetdirect submenu**

The EIO (enhanced input/output) submenu appears only when an EIO device is installed in an EIO slot on the printer (such as an HP Jetdirect print server). The items in the menu depend on the particular accessory product that is installed. If the printer contains an HP Jetdirect print server EIO card, you can configure basic networking parameters by using the EIO menu. These and other parameters can also be configured through HP Web Jetadmin or other network configuration tools (such as by using Telnet or browsing the embedded Web server).

For more information about the EIO submenu, see the documentation that came with the EIO Jetdirect card.

## Embedded Jetdirect submenu (HP LaserJet 9040n/9050n and 9040dn/9050dn only)

Item	Options	Values	Explanation
TCP/IP	ENABLE	ON	Enable the TCP/IP protocol.
		OFF	Disable the TCP/IP protocol.
	HOST NAME		An alphanumeric string, up to 32 characters, that identifies the device. This name is listed on the Jetdirect configuration page. The default host name is NPIxxxxxx, where xxxxxx is the last six digits of the LAN hardware (MAC) address.
	CONFIG METHOD	BOOTP	Use BootP (Bootstrap Protocol) for automatic configuration from a BootP server.
		DHCP	Use DHCP (Dynamic Host Configuration Protocol) for automatic configuration from a DHCP server. If selected and a DHCP lease exists, DHCP RELEASE and DHCP RENEW menus will be available to set DHCP lease options.
		AUTO IP	Use automatic link-local IP addressing. An address in the form 169.254.x.x will be automatically assigned.
		MANUAL	Use the MANUAL SETTINGS menu to configure TCP/IP parameters.
	DHCP RELEASE		The current DHCP lease along with the leased IP address are released.
	DHCP RENEW	NO (default)	The print server does not request to renew the DHCP lease.
		YES	The print server requests to renew the current DHCP lease.
	MANUAL SETTINGS	IP ADDRESS	The unique IP address of the printer.
		SUBNET MASK	The subnet mask for the printer.
		SYSLOG SERVER	The IP address of the syslog server that receives and logs syslog messages.
DEFAULT GATEWAY		The IP address of the gateway or router used for communications with other networks.	
IDLE TIMEOUT		The time period, in seconds, after which an idle TCP print data connection is closed (default is 270 seconds).	

Item	Options	Values	Explanation
TCP/IP	DEFAULT IP	AUTO IP LEGACY	A link-local IP address of 169.254.x.x is set.  The address 192.0.0.192 is set, consistent with older Jetdirect products.
	PRIMARY DNS		Specify the IP address (n.n.n.n) of the Primary Domain Name System (DNS) Server.
	SECONDARY DNS		Specify the IP address (n.n.n.n) of the Secondary Domain Name System (DNS) Server.
	PROXY SERVER		Specify the proxy server to be used by embedded applications in your printer. A proxy server is typically used by network clients for Internet access. It caches Web pages, and provides a degree of Internet security, for those clients. To specify a proxy server, type its IP address or fully-qualified domain name. The name can be up to 64 characters. For some networks, you might need to contact your Independent Service Provider (ISP) for the proxy server address.
	PROXY PORT		Type the port number that the proxy server uses for client support. The port number identifies the port that is reserved for proxy activity on your network, and can be a value from 0 to 65,535.
IPX/SPX	ENABLE	ON OFF	Enable the IPX/SPX protocol. Disable the IPX/SPX protocol.
	FRAME TYPE	AUTO  EN_8023 EN_II EN_8022 EN_SNAP	Select the frame type setting for your network. AUTO (default) automatically sets and limits the frame type to the first one detected.  These EN values are frame-type selections for Ethernet networks.
APPLETALK	ENABLE	ON OFF	Enable or disable the AppleTalk protocol.
DLC/LLC	ENABLE		Enable or disable the DLC/LLC protocol.
SECURE WEB	HTTPS REQUIRED		For secure, encrypted communications, only HTTPS access is accepted. The print server appears as a secure site.
	HTTPS OPTIONAL		Access is permitted to either HTTP or HTTPS.

Item	Options	Values	Explanation
DIAGNOSTICS	LOOPBACK TEST	YES	<p><b>CAUTION</b></p> <p>This test will erase your TCP/IP configuration.</p> <p>YES the loopback test will be initiated.</p> <p>NO the loopback test will not be initiated.</p>
		NO	
	PING TEST	DEST IP	Specify the IP address of the remote host. A valid IP address must be specified.
		PACKET SIZE	Specify the size of each packet, in bytes, to be sent to the remote host. The minimum is 64 (default) and the maximum is 2,048.
		TIMEOUT	Specify the length of time, in seconds, to wait for a response from the remote host. The default is 1 and the maximum is 100.
		COUNT	Specify the number of ping test packets to send for this test. Select a value from 1 to 100. To configure the test to run continuously, select 0.
		PRINT RESULTS	If the ping test was not set for continuous operation, you can choose to print the test results. Select YES to print results or NO.
		EXECUTE	Specify whether to initiate the ping test. Select YES to initiate the test or NO.
		PING RESULTS	PACKETS SENT
	PACKETS RECEIVED		Shows the number of packets (0-65,535) that have been received from the remote host since the most recent test was initiated or completed.
	PERCENT LOST		Shows the percent of ping test packets that were sent with no response from the remote host since the most recent test was initiated or completed.
	RTT MIN		Shows the minimum detected round-trip-time (RTT), from 0 to 4096 milliseconds, for packet transmission and response.
	RTT MAX		Shows the maximum detected RTT, from 0 to 4096 milliseconds, for packet transmission and response.
	RTT AVE		Shows the average detected RTT, from 0 to 4,096 milliseconds, for packet transmission and response.
	PING IN PROGRESS		Shows whether or not a ping test is in progress. YES indicates a test in progress and NO indicates that a test completed or was not run.
	REFRESH		Updates the ping test data with current results.



Item	Options	Values	Explanation
RESET SECURITY	NO YES	NO YES	Specifies whether the current security settings on the print server will be saved or reset to factory defaults. NO (default): The current security settings are maintained. YES: The security settings are reset to factory defaults.
LINK SPEED	AUTO  10T HALF  10T FULL  100TX HALF  100TX FULL		The print server automatically configures itself to match the network link speed and communication mode. If it fails, 100TX HALF is set.  10 Mbps, half-duplex operation  10 Mbps, full-duplex operation  100 Mbps, half-duplex operation  100 Mbps, full-duplex operation

## Resets submenu

### Note

Use this menu with caution. You can lose buffered page data or printer configuration settings when you select these items. Reset the product only under the following circumstances:

- You want to restore the printer default settings.
- Communication between the product and computer has been interrupted.
- You are having problems with a port.

The items in the **Resets** submenu clear all memory in the printer, while **RESET** clears only the current job.

## Diagnostics menu

Administrators can use this menu to troubleshoot jam and print-quality issues.

Item	Values	Explanation
PRINT EVENT LOG		Generates a localized LIFO (last in, first out) list of the 50 most recent entries in the error log. The printed event log shows error number, page count, error code, and description or personality.
SHOW EVENT LOG		Allows the user to scroll through the contents of the event log from the printer control panel, and shows the 50 most recent events. Use ▲ and ▼ to scroll through the event log contents.
PAPER PATH TEST	PRINT TEST PAGE	Generates a test page that is useful for testing the paper-handling features of the printer.
	SOURCE=TRAY 2	Specifies if paper from all of the trays or from a specific tray is used when the test is performed.
	DESTINATION=STANDARD OUTPUT	Specifies which paper paths are tested.
	DUPLEX=OFF	Specifies if the duplexer is included when the test is performed.
	COPIES=1	Specifies how many sheets of paper from the specified source are sent when the test is performed.
	SENSORS=OFF	Specifies if sensor information appears as the paper moves through the path or if only the status of the device is appears during the paper path test.
SERVICE TEST		The engine tests access portions of the printer internal diagnostics that occur when the printer is turned on. These diagnostics are available as tools to help isolate problems that the firmware does not report. See " <a href="#">Service test</a> " on page 213 for more information.

## Service menu

The Service menu is locked. A service technician must type a PIN to open the menu. See "[Service menu](#)" on page 215 for more information.

## Remote firmware upgrade (RFU)

The process for upgrading printer firmware remotely involves three steps:

- 1 Determine the current level of firmware installed on the printer.
- 2 Go to the [www.hp.com/go/lj9000\\_firmware](http://www.hp.com/go/lj9000_firmware), [www.hp.com/go/lj9040\\_firmware](http://www.hp.com/go/lj9040_firmware), or [www.hp.com/go/lj9050\\_firmware](http://www.hp.com/go/lj9050_firmware) Web site and download the latest firmware.
- 3 Download the new firmware to the printer.

---

### Note

In some instances, an upgrade might require about 10 minutes to complete.

## Upgrading firmware to a single printer

You can send an .RFU upgrade to a printer at any time; the printer waits for all input/output channels to become idle before turning power off and back on.

---

### Note

If the firmware upgrade involves a change in the format of NVRAM, the NVRAM settings are lost and must be set again by the customer.

The elapsed time for an upgrade depends on the I/O transfer time, in addition to the time that it takes for the printer to reinitialize. The I/O transfer time depends on several things, including the speed of the computer that is sending the upgrade and the I/O method (FIR, parallel, or network). The re-initialization time depends on the specific hardware configuration of the printer, such as the number of EIO devices that are installed, the presence of external paper-handling devices, and the amount of memory that is installed. Finally, any print jobs that are ahead of the .RFU job in the queue print before the .RFU upgrade processes.

---

### Note

The printer automatically restarts after processing the upgrade.

## Windows systems

If the printer is shared on the network, then the following command can be issued from a command prompt:

```
copy /b FILENAME \\SHARENAME\PRINTERNAME
```

where FILENAME is the name of the .RFU, SHARENAME is the name of the computer from which the printer is being shared, and PRINTERNAME is the printer share name.

If the printer is connected locally, then the .RFU can be sent directly to the printer with a COPY command from a command prompt or MS-DOS window:

```
copy /b FILENAME PORTNAME
```

where FILENAME is the name of the .RFU, and PORTNAME is the name of the appropriate printer port (such as LPT 1).

The following setting on the control panel might help if a timeout message appears on the computer during an upgrade.

### To change the timeout on the control panel

- 1 Press the **Menu** tab.
- 2 Press `CONFIGURE DEVICE`.
- 3 Press `I/O`.
- 4 Press `I/O TIMEOUT`.
- 5 Specify 300 seconds as the value.

6 Press **OK**.

7 Press **EXIT**.

The following command can be set on the computer to address a timeout message that appears on the computer screen during an upgrade. From a command prompt or MS-DOS window, type the command and press the enter key:

```
Mode lpt1:.,,p
```

If the printer is attached to a parallel port other than LPT1, substitute the correct LPT port number in the mode command. After this command is set, the file can be copied to the printer with the previously mentioned copy command.

---

**Note**

You can also send the file through a FIR port.

## FTP

If the HP LaserJet printer uses a direct network connection, file transfer protocol (FTP) can be used to update the HP LaserJet firmware following these steps:

1 See the TCP/IP address on the EIO X Jetdirect page (is the second page of the configuration page printout).

---

**Note**

See "[Evaluate the information pages](#)" on page 226 to print a configuration page.

---

**Note**

Before connecting to the printer, make sure that the printer is not in Powersave mode. Make sure that any error messages are cleared from the control panel.

2 Open a MS- DOS command window on the computer.

3 Type FTP <TCP/IP PRINTER ADDRESS> (for example, if the TCP/IP address is 192.168.0.90, type FTP 192.168.0.90).

4 Press **ENTER** on the computer keyboard.

5 When prompted for the user name and the password, press **ENTER** for each.

6 Type BIN at the >prompt.

7 Press **ENTER**.

8 Type:put <path> where <path> is the location where the .RFU was downloaded from the Web. For example, type: PUT C:\LJ9000\lj9000FW.RFU, C:\LJ9040\lj9040FW.RFU, or PUT C:\LJ9050\lj9050FW.RFU and then press enter.

9 When the download process starts and the firmware is updated on the printer, type BYE at the command prompt, and then press **ENTER** to exit the FTP session.

## HP Web Jetadmin 7.5/7.6 for single or multiple printers

1 Download the appropriate firmware upgrade file from [www.hp.com](http://www.hp.com) to a folder on the computer that is running HP Web Jetadmin.

2 Start Web Jetadmin 7.x.

3 From the navigation section on the screen, select **Device management** from the drop-down menu. This selection is located at the upper-left of the window.

4 Click the Tools folder, and then select **Printer Firmware Update** from the Multiple Firmware Update folder.

5 Click **Update a firmware image file**.

6 Click **Browse** and locate the correct firmware image.

7 Click **Upload** to place the firmware image file on the server.

- 8 Verify that the information that appears in **All Available Images**.
- 9 Click **Return to Device Firmware Update**.
- 10 Select the printer(s) to be upgraded.
- 11 Click **Update Firmware Now** to start the upgrade immediately, or enter an appropriate date and time, and then click **Schedule Update for Later** to perform the upgrade at another time.

---

**Note**

Do *not* turn the printer off during the upgrade. When the upgrade is complete, the printer automatically reboots.

---

**Note**

The status of the firmware upgrade can be monitored by selecting **View Printer Update Status** in the navigation section on the screen.

## HP Web Jetadmin 6.1 for a single printer

This procedure requires that Web Jetadmin version 6.1 be installed. Complete the following steps to upgrade a single printer through Web Jetadmin after downloading the .RFU file from the HP Web site.

- 1 Start HP Web Jetadmin 6.1.
- 2 Type the IP address or IP hostname of the printer in the **Quick Device Find** field, and then click **Go**. The printer Status window appears.
- 3 Click the right arrow on the toolbar to see the **Update** button.
- 4 Click **Update**.
- 5 When prompted for the type of update to perform, click **Update Printers**, and then click **Continue**.
- 6 Under **Upload new firmware image:**, click **Browse** to locate the .RFU file you that downloaded from the [www.hp.com/go/lj9000\\_firmware](http://www.hp.com/go/lj9000_firmware), [www.hp.com/go/lj9040\\_firmware](http://www.hp.com/go/lj9040_firmware), or the [www.hp.com/go/lj9050\\_firmware](http://www.hp.com/go/lj9050_firmware) Web site.
- 7 Click **Upload** to move the .RFU from your hard drive to the HP Web Jetadmin server.
- 8 Refresh the browser.
- 9 Select the .RFU from the **Select new firmware version:** drop-down menu.
- 10 Click **Update Firmware**. HP Web Jetadmin sends the selected .RFU to the printer.

Also, HP Web Jetadmin 6.1 can be used to perform multiple or unattended installations:

---

**Note**

In some instances, an upgrade might require about 10 minutes to complete.

- 1 Start HP Web Jetadmin.
- 2 Create a device group. The following is a simple way to do this:
  - a. Click **Devices** on the **Choose:** drop-down menu.
  - b. Click **Device Model** from the **Filter:** drop-down menu.
  - c. Type iy9000lw or iy9050lw in the **Criteria (Optional):** field.
  - d. Click **Go**.
- 3 In the **Device List**, select the printers that you want to include in the group, and then click **Create Group**.
- 4 When prompted, type a name for the new device group, and then click **OK**.
- 5 Click **Update**.

- 6 When prompted for the type of update to perform, click **Update Printers**, and then click **Continue**.
- 7 From the list of HP Devices, select the printers to be upgraded, or click **Select All**.
- 8 Click **Update** to install the new printer firmware.




# 4

## Product maintenance

### Chapter contents

Preventative maintenance . . . . .	60
Preventive maintenance kit contents . . . . .	60
Cleaning the printer and accessories . . . . .	61
General cleaning . . . . .	61
Internal cleaning . . . . .	62
Fuser cleaning . . . . .	65
Print cartridge information . . . . .	67
Storage . . . . .	67
Handling instructions . . . . .	67
Refilled print cartridges . . . . .	68
Print-cartridge weights . . . . .	68
Print-cartridge life expectancy . . . . .	68
Saving toner by using EconoMode . . . . .	68

## Preventative maintenance

To ensure optimum print quality, the printer prompts customers to perform printer maintenance every 350,000 pages. When the `PERFORM PRINTER MAINTENANCE` message appears on the control panel, the customer needs to purchase and install a preventative maintenance kit. After a new maintenance kit is installed, press and hold  until all three LEDs are solid. Press , and then press  to reset the maintenance counter.

---

### Note

The preventative maintenance kit is a consumable, and is not covered under warranty.

For more information about installing a preventative maintenance kit, see the installation guide that accompanies it.

### Preventive maintenance kit contents

The preventative maintenance kit, P/N C9152A (110 V) or C9153A (220 V), should be replaced after each 350,000 pages of use. The following parts are included in the preventative maintenance kit:

- Fuser assembly (1 assembly)
- Transfer roller assembly (1 assembly)
- Feed rollers (tray 2 and tray 3) (4 rollers)
- Pickup rollers (tray 2 and tray 3) (2 rollers)
- Tray 4 rollers (3 rollers)

Variables such as media, environment, and usage can cause premature wear of these parts. See "Media specifications" in chapter 2 or the *HP LaserJet Printer Family Print Media Guide* for information about suitable media, environment, and usage conditions.



## Cleaning the printer and accessories

To maintain superior print quality and performance, use the following procedures to clean the printer and the paper-handling accessories thoroughly every time you change the print cartridge or whenever print-quality problems occur.

### General cleaning

---

**WARNING!**

---

In order to avoid shock hazard, turn the printer and the paper-handling accessories off and unplug all of the power cords before you begin these steps.

---

**CAUTION**

---

Do not use ammonia-based cleaners on or around the products. While cleaning the printer, be careful not to touch the transfer roller (located underneath the print cartridge). Skin oils on the roller can cause print-quality problems.

To prevent damage, do not expose the print cartridge to direct light. Place a piece of paper over the print cartridge to shield it while it is out of the printer.

- Clean the outside of the products with a water-dampened cloth.
- Clean the inside of the products with a dry, lint-free cloth.

### Cleaning spilled toner

Defective print cartridges can develop leaks. After a jam has occurred, some toner might remain on the rollers and guides inside the printer. The pages that print immediately after the jam can pick up this toner.

---

**Note**

---

To clean skin and clothing of toner spills, remove as much toner as possible with a dry tissue, and then wash with cold water. Hot water causes toner to set permanently into clothing.

### Vacuum specifications

Do *not* use a conventional vacuum to vacuum the printer or any spilled toner. The toner particles that are used in this product might be too fine for effective vacuuming and could result in damage to the conventional vacuum cleaner.

A vacuum cleaner that is specifically designed for cleaning toner can be used if it is capable of filtering fine particles (5 microns in diameter).

Dispose of waste toner in accordance with local requirements. Do not discharge toner particles in drains.

### First aid measures

- **Ingestion**—If toner is ingested, rinse your mouth thoroughly with water and drink several glasses of water. If irritation occurs, consult a physician.
- **Inhalation**—If toner particles are inhaled, move to fresh air immediately. If irritation occurs, consult a physician.
- **Eye contact**—If toner comes in contact with the eyes, immediately flush them with plenty of water for at least 15 minutes. If irritation occurs, consult a physician.
- **Skin contact**—If toner spills on skin, remove as much toner as possible by using a dry tissue (more than one might be needed), and then wash the affected area of the skin with cold water. If irritation occurs, consult a physician.

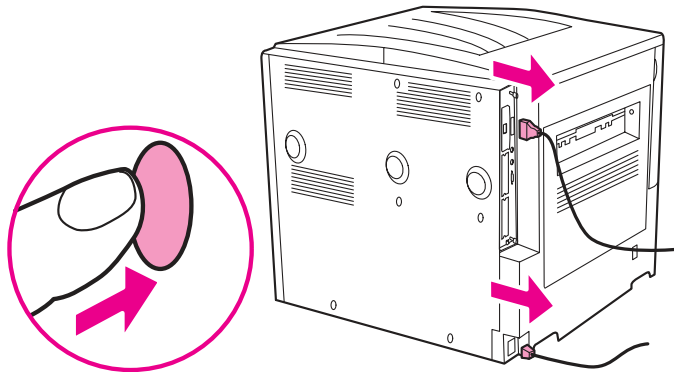
## Internal cleaning

During the printing process, paper, toner, and dust particles can accumulate inside the printer and the paper-handling accessories. Over time, this buildup can cause print-quality problems such as toner specks or smearing. Internal cleaning can assist in correcting and preventing these types of problems.

### CAUTION

Before you begin these steps, turn the printer off and unplug all of the power cords to avoid shock hazard.

- 1 Turn the printer off and unplug all of the power cords.

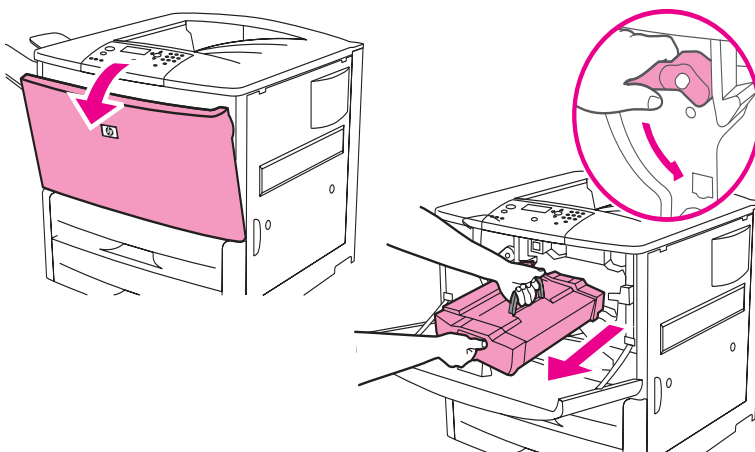


**Figure 14.** Turn off the printer and remove the power cords

### CAUTION

To prevent damage to the print cartridge, use two hands when removing it from the printer.

- 2 Open the front cover, turn the green lever counterclockwise to the unlocked position, and then slide the print cartridge out of the printer.

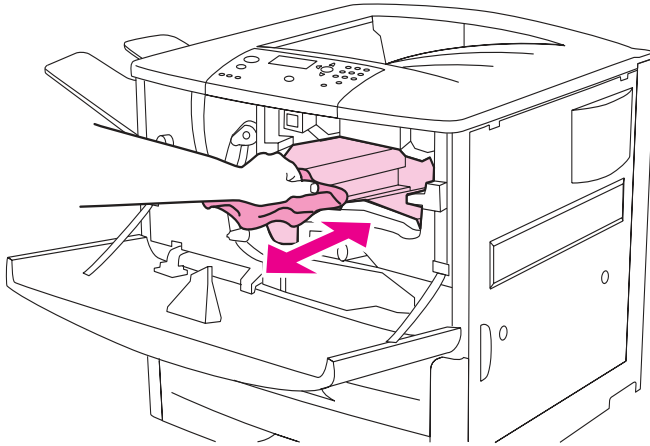


**Figure 15.** Remove the print cartridge

### CAUTION

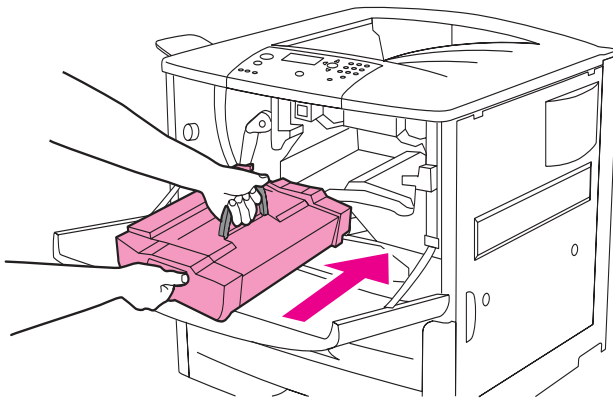
To prevent damage, do not expose the print cartridge to light. Place a piece of paper over the print cartridge to shield it while it is out of the printer.

- 3 Using a dry, lint-free cloth, wipe any residue from the paper-path area, the registration roller, and the print cartridge cavity.



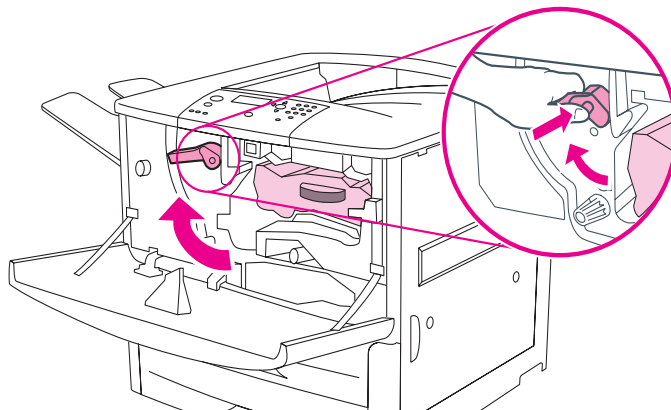
**Figure 16.** Wipe any residue

- 4 Replace the print cartridge.



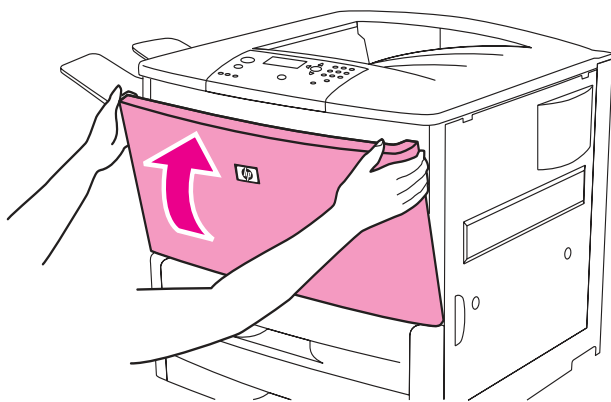
**Figure 17.** Replace the print cartridge

- 5 Press the button on the green lever, and then turn the lever clockwise to the locked position.



**Figure 18.** Lock the print cartridge

- 6 Close the front cover. Plug in all of the power cords, and then turn on the printer.



**Figure 19.** Close the front cover

## Fuser cleaning

To complete internal cleaning, create and process a cleaning page.











### Create a cleaning page

Generating a cleaning page cleans the excess toner off the pressure roller in the fuser. The page contains instructions that walk the customer through the process of inserting the page in a tray. If tray 1 is installed, the instructions indicate that the page should be placed face-down in tray 1. If tray 1 is not installed, the instructions indicate that the page be placed face-up in tray 2. The customer is then instructed to select the `PROCESS CLEANING PAGE` on the control panel. A sample cleaning page is shown below. While the cleaning page is printing, the display shows `CREATING CLEANING PAGE`.











#### Note

For best results, use copier-grade paper with a smooth surface and a weight of 64 to 90 g/m<sup>2</sup> (17 to 24 lb). Do *not* use bond or rough paper.

### Create/print a cleaning page

- 1 Press  to open the menus.
- 2 Press  or  to scroll to `CONFIGURE DEVICE`, and then press .
- 3 Press  or  to scroll to `PRINT QUALITY`, and then press .
- 4 Press  or  to scroll to `CREATE CLEANING PAGE`, and then press .
- 5 A cleaning page prints.

#### How to use this Cleaning Page

1. Load this sheet into Tray 1 before completing all steps
2. This side should be down with the arrow toward the printer
3. Press the  key to enter the menus
4. Use  and  to highlight `CONFIGURE DEVICE` and press 
5. Use  and  to highlight `PRINT QUALITY` and press 
6. Use  and  to highlight `PROCESS CLEANING PAGE` and press 

#### CAUTION

For best cleaning results:  
Use copier paper with smooth surface  
Weight: 64g/m<sup>2</sup> - 90g/m<sup>2</sup> (17 lb - 24 lb)

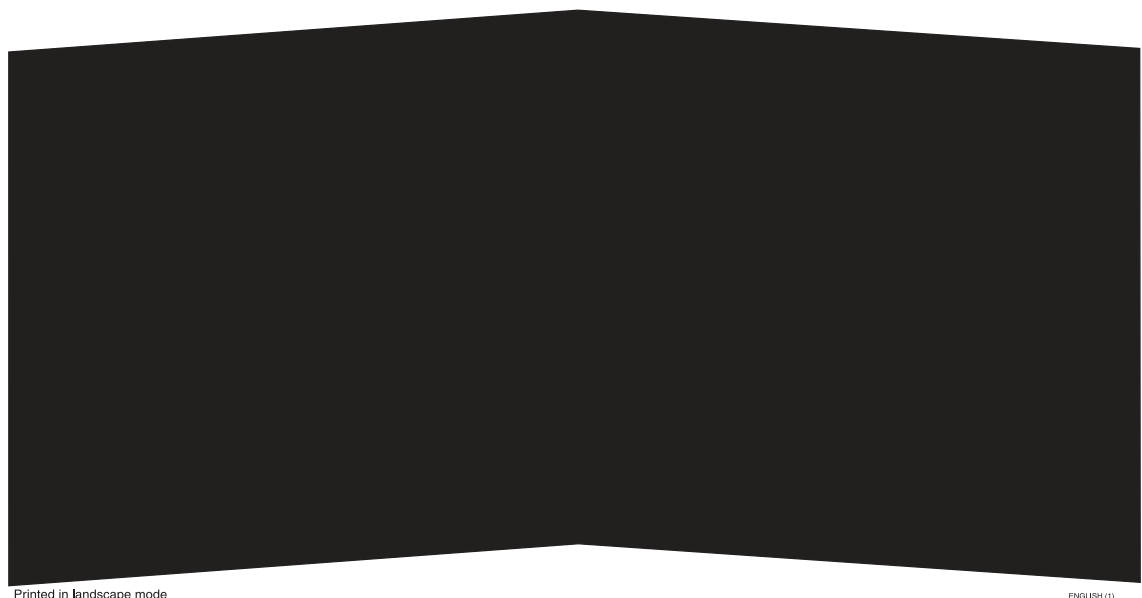


Figure 20.

### Sample cleaning page

## Process a cleaning page

Follow the instructions on the cleaning page to complete the cleaning process.

PROCESS CLEANING PAGE is only visible to the customer after a cleaning page is generated by using the CREATE CLEANING PAGE menu. When the customer generates the page and places it face-down in tray 1, or face-up in tray 2, the customer is instructed to select this menu item to complete the cleaning process. The device must check to make sure that letter or A4 paper is loaded so that the long edge feeds first. When the customer completes these steps, this menu item is not visible until another cleaning page is created. While the cleaning page is being processed, CLEANING appears on the display panel.

---

### Note

When toner is cleaned from inside the printer, shiny black spots appear on the black strip. If white spots appear on the black strip, print another cleaning page.

---

### Note

To ensure good print quality with certain types of paper, use the cleaning page every time the print cartridge is replaced. If the cleaning page is frequently needed, try a different type of paper for print jobs.

# Print cartridge information

Print cartridges contain components that are sensitive to light, temperature, and humidity. Make sure that the customer follows the recommendations in this section to ensure the highest quality and longest life of the print cartridge.

## Storage

The print cartridge (C8543X) should not be removed from its package until installation.

If cartridges are stored, the storage environment should meet the conditions listed in the following table.

**Table 13. Storing print cartridges**

Category	Temperature	Humidity
Storage	-20°C to 40°C (-4°F to 104°F)	10% to 90% RH

If the print cartridge must be removed from the printer, always store the cartridge in a situation that meets the following criteria:

- Inside the protective bag in which it was originally packaged

### Note

If original package is not available, cover the top opening of the print cartridge with paper.

- In a dark cabinet, away from direct sunlight
- With the correct side up and with the cartridge in a horizontal position (not standing on end)
- At a temperature listed in the preceding table
- Away from ammonia or other organic-solvent fumes

### CAUTION

Never ship the printer with a print cartridge installed. Excessive vibration during shipping can cause toner to leak, contaminating the printer.

Never expose the print cartridge to direct sunlight, or to room light. Bright light and direct sunlight can permanently damage a print cartridge.

## Handling instructions

- Do not touch the surface of the photosensitive drum in the cartridge. Protect the drum from light and contamination.
- Do not expose the cartridge to unnecessary vibrations or shock.
- Do not expose the photosensitive drum to strong light. Blurred areas on the page might indicate that the drum has been exposed to light for too long. This causes permanent damage to the photosensitive drum. If this occurs, replace the cartridge.
- Never manually rotate the drum, especially in the reverse direction. Manual rotation can cause internal damage and toner spills.

## Refilled print cartridges

### HP policy about non-HP print cartridges

Hewlett-Packard Company cannot recommend using new, refilled, or remanufactured, non-HP print cartridges. Because they are not HP products, HP cannot influence their design or control their quality.

While Hewlett-Packard Company does not prohibit the use of refilled print cartridges during the warranty period or while the printer is under a maintenance contract, we do not recommend their use for the following reasons:

- Hewlett-Packard has no ability to ensure that a refilled print cartridge functions at the high level or reliability of a new HP print cartridge. Hewlett-Packard also cannot predict the long-term effect of the various toner formulations found in refilled cartridges.
- Hewlett-Packard has no control over the print quality of a refilled print cartridge. The print quality of HP print cartridges influences customer perception of the printer.
- Repairs resulting from the use of refilled print cartridges are *not* be covered under the HP warranty or maintenance contract.
- Smart cartridge features (cartridge out/low) are not available.

### Print-cartridge weights

The approximate weight of a print cartridge when full and empty is as follows:

- Full: 4,220 grams (9.28 lb)
- Empty: 2,700 grams (5.94 lb)

### Print-cartridge life expectancy

The life of the print cartridge depends on the amount of toner used in each print job. When printing text at 5% coverage, an HP LaserJet 9000/9040/9050 print cartridge lasts an average of 30,000 images. This life expectancy is estimated with the default print density setting, and EconoMode off (default settings).

### Saving toner by using EconoMode

HP LaserJet 9000/9040/9050 print cartridge usage can be extended by using the printer EconoMode feature. EconoMode can be turned on or off through the driver or through HP LaserJet device configuration.

- Some software programs might refer to EconoMode as “draft mode.”
- EconoMode is only available if a genuine HP print cartridge is installed.

---

#### Note

HP does *not* recommend full-time use of EconoMode. If EconoMode is used full-time when the average toner coverage is significantly less than 5%, it is possible that the toner supply will outlast the mechanical parts in the print cartridge. If print quality begins to degrade under these circumstances, you will need to install a new print cartridge even if there is toner supply remaining in the cartridge.



# 5

## Theory of operation

### Chapter contents

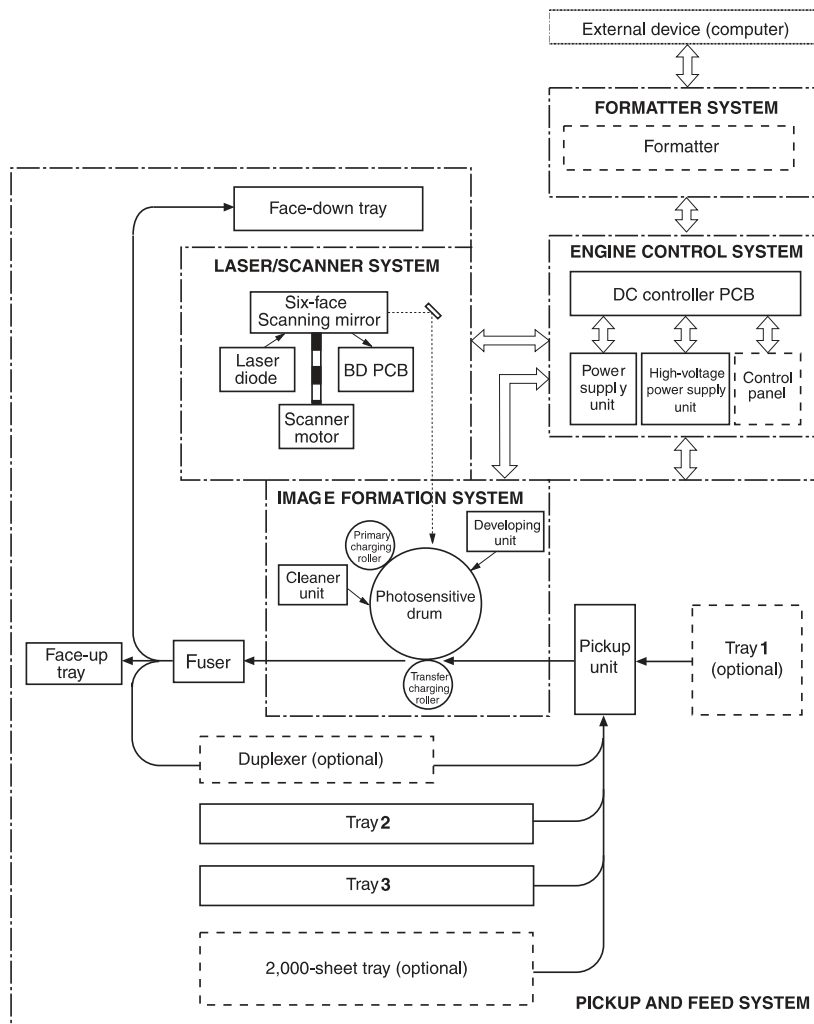
Basic operation . . . . .	70
Sequence of operation . . . . .	71
Power-on sequence . . . . .	73
Timing chart . . . . .	74
Engine control system . . . . .	75
DC controller PCA . . . . .	76
DC controller operations . . . . .	77
High-voltage power supply circuit . . . . .	78
Low-voltage power supply unit . . . . .	80
Formatter system . . . . .	81
Formatter hardware . . . . .	81
Laser/scanner system . . . . .	83
Image formation system . . . . .	84
The eight processes of image formation . . . . .	84
Print cartridge . . . . .	85
Pickup and feed system . . . . .	87
Media-size detection . . . . .	87
Media-level detection . . . . .	87
Multifeed prevention . . . . .	87
Overhead-transparency detection . . . . .	87
Fuser-wrapping-jam detection . . . . .	87
Jam detection . . . . .	88
Tray 1 . . . . .	93
Tray 1 driver PCA . . . . .	93
Power supply . . . . .	93
Sequence of operation . . . . .	93
Pickup and feed . . . . .	94
Jam detection . . . . .	94
Tray 4 . . . . .	95
Tray 4 driver PCA . . . . .	95
Power supply . . . . .	95
Sequence of operation . . . . .	95
Pickup and feed . . . . .	96
Media-level and media-size detection . . . . .	96
Jam detection . . . . .	96

# Basic operation

This chapter provides information about the following systems:

- Engine control
- Formatter
- Laser/scanner
- Image formation
- Pickup and feed

Relationships among the five systems are represented in figure 21.



**Figure 21. Printer systems**

## Sequence of operation

The engine control system controls operational sequences. Table 14 describes the sequences.

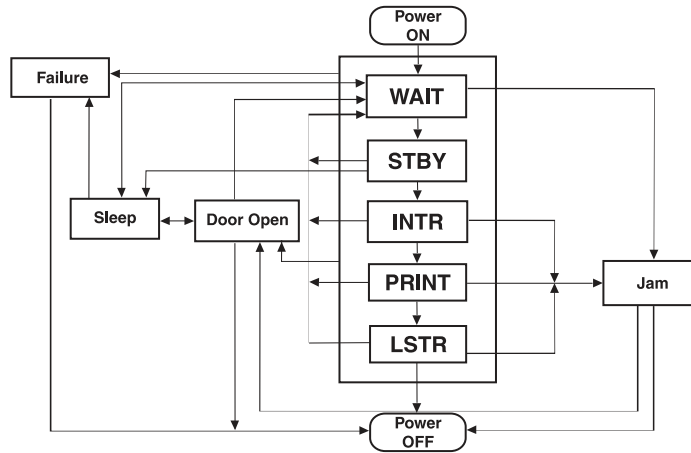


Figure 22. Sequence-of-operation block diagram

Table 14. Normal sequence of operation

State	Period	Operation
WAIT	From the time the power is switched on until the surface temperature of the fuser and pressure rollers reach their WAIT target value (four minutes or less)	<ul style="list-style-type: none"> <li>Power on: CPU and ASIC initialize</li> <li>Fan rotation (fans 1 through 6 for 30 seconds, duplexer fan for 3 seconds)</li> <li>Formatter interface communication starts</li> <li>Fuser heaters turn on</li> <li>Cartridge check</li> <li>Cartridge-memory check for toner level</li> <li>Optional interface communication (duplexer, tray 1, tray 4, paper handling)</li> <li>Cassette checks (lifting and loading status)</li> <li>Jam check (auto flush/eject)</li> <li>Fuser-wrapping-jam detect</li> <li>Door open/sleep check</li> <li>Fuser-roller temperature control and delivery motor</li> </ul>
STBY (standby)	From the end of the WAIT period to the input of a print reservation command from the formatter -or- From the end of the LSTR period until either a print reservation command is input from the formatter or until power is switched off	<ul style="list-style-type: none"> <li>Fuser control (fuser roller temperature—180°C [356°F]/ pressure roller 140°C [285°F])</li> <li>Print reservation command (awaits INTR sequence)</li> <li>Fan-motor drive control (fans 1 through 5 half-speed rotation; fan 6 is off)</li> <li>If the standby state lasts five minutes or more, the fuser/delivery motor is rotated for about 0.08 second to prevent the pressure roller from becoming deformed.</li> </ul>

**Table 14. Normal sequence of operation (continued)**

State	Period	Operation
INTR (initial rotation)	From the input of a print-reservation command from the formatter until the laser/scanner enters a ready state	<ul style="list-style-type: none"> <li>● scanner-motor rotation</li> <li>● fuser/delivery-motor rotation</li> <li>● drum-motor rotation</li> <li>● high-voltage control (negative bias to transfer roller)</li> <li>● receives print command</li> <li>● fan-motors 1 through 6 full-speed rotation</li> <li>● pickup operation starts</li> <li>● high-voltage control bias applied to primary charging roller, developing roller, and transfer roller)</li> <li>● fuser control (fuser roller to 190°C [374 °F], pressure roller 180°C [356°F])</li> <li>● initial rotation final check (high-voltage, scanner motor, pickup operation complete)</li> <li>● jam/door open/failure/sleep check</li> </ul>
PRINT	From the input of a print command until the primary dc bias is turned off	<ul style="list-style-type: none"> <li>● fuser/delivery, drum, scanner, and fan-motor rotations</li> <li>● fuser control (print temperature—fuser 190°C [374°F])</li> <li>● engine-to-formatter output signal</li> <li>● formatter-to-engine input signal</li> <li>● paper-feed control</li> <li>● image control</li> <li>● high-voltage control (toner level-output separation bias and pressure roller bias)</li> <li>● next-pickup control (calculates, from media size, the speed to send media through)</li> <li>● jam/door open/failure</li> </ul>
LSTR (last rotation)	From the time the primary charging roller is turned off until each of the motors stops	<ul style="list-style-type: none"> <li>● fuser/delivery, drum, scanner, and fan motor rotations</li> <li>● high-voltage control completion</li> <li>● fuser control (print to standby temperature—180°C [356°F])</li> <li>● fan motor control (fan 1 through 6 full-speed rotation)</li> <li>● fuser/delivery, drum, and scanner motor stop (writes in cartridge memory)</li> <li>● jam/door open/failure check</li> <li>● ready for next pickup</li> </ul>

**Table 15. Failure sequence of operation**

State	Period	Operation
JAM	From the time the power is switched on until the end of the LSTR period	<ul style="list-style-type: none"> <li>● sensor check</li> <li>● drive stop (scanner motor, high-voltage, fuser control, and fuser/delivery motor stop)</li> <li>● status setting (jam status set)</li> <li>● door open check</li> </ul>
DOOR OPEN	From the time the power is switched on until the end of the LSTR period	<ul style="list-style-type: none"> <li>● drive stop</li> <li>● status setting</li> <li>● door close (wait sequence)</li> </ul>
FAILURE	From the time the power is switched on until the end of the LSTR period	<ul style="list-style-type: none"> <li>● drive stop</li> <li>● status setting (set)</li> </ul>

**Table 15. Failure sequence of operation (continued)**

State	Period	Operation
SLEEP	From the time the power is switched on until the end of the LSTR period	<ul style="list-style-type: none"> <li>● drive stop (scanner motor, high-voltage control, fuser control, fuser/delivery motor, 24 V stop, 3.3 V sets PowerSave mode, fan motor stop)</li> <li>● status setting</li> <li>● door-open check</li> </ul>

## Power-on sequence

The sequence from the time the power is turned on until the printer enters the standby state is as follows:

- 1 The power is turned on.
- 2 The CPU and the ASIC are initialized.
- 3 Video interface communication begins (formatter).
- 4 All of the fans are turned on.
- 5 The printer flushes any residual paper from the paper path.
- 6 A cartridge-presence check occurs.
- 7 A cartridge-memory check occurs.
- 8 Any installed accessories are initialized.
- 9 The fuser and pressure-roller heaters are turned on.
- 10 The pickup-roller motor and the cassette-lifter motors are turned on.
- 11 The pickup-roller motor and the cassette-lifter motors are turned off.
- 12 The fuser motor, drum motor, and transfer negative bias are turned on.
- 13 The pressure bias and the jam detection lever drive solenoid (SL501) are turned on.
- 14 The developing ac bias is turned on (toner-level detection).
- 15 The fuser reaches its target temperature.
- 16 The fuser motor, drum motor, transfer negative bias, pressure bias, and SL501 are turned off.
- 17 Standby is initialized.

# Timing chart

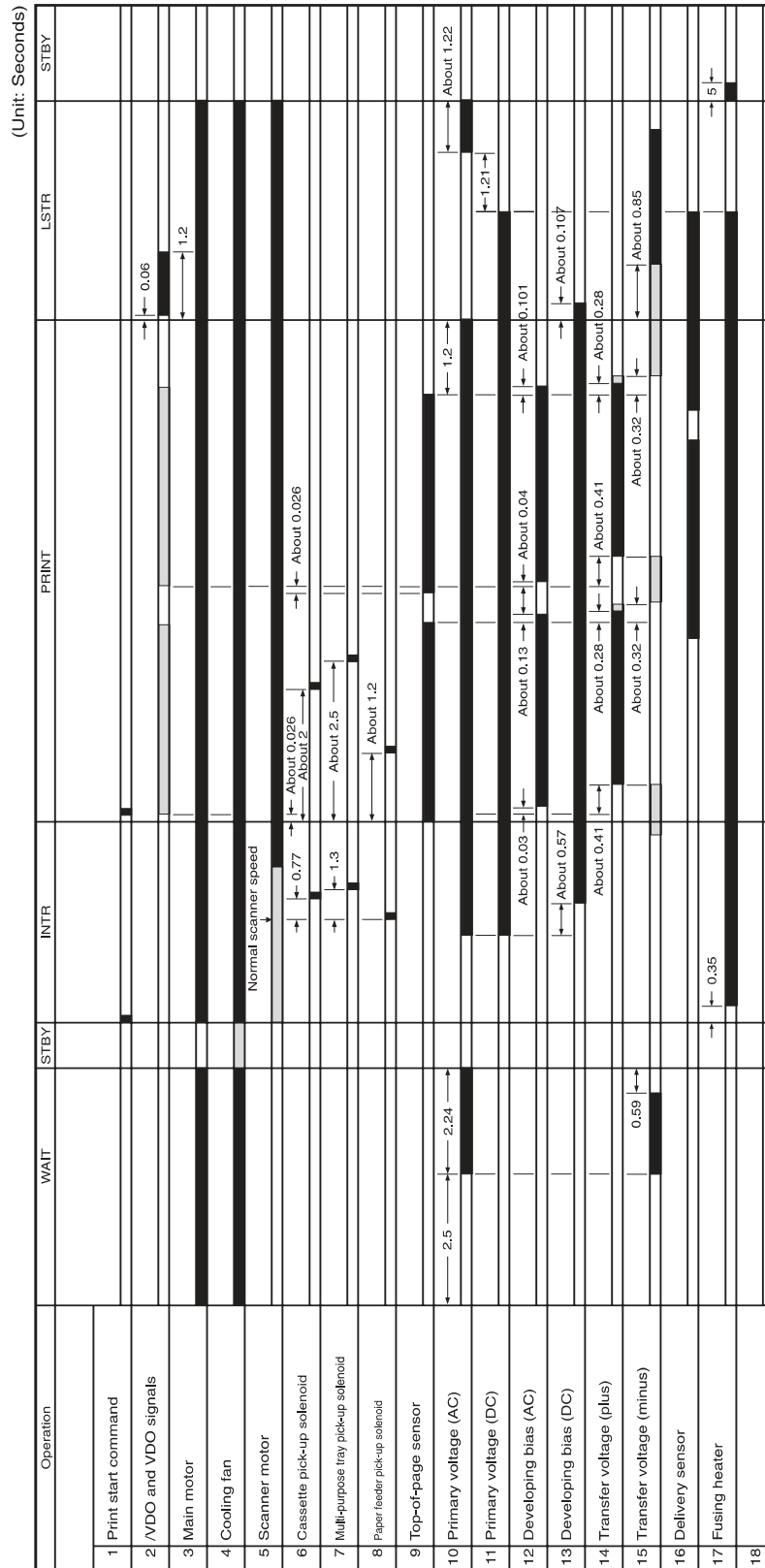
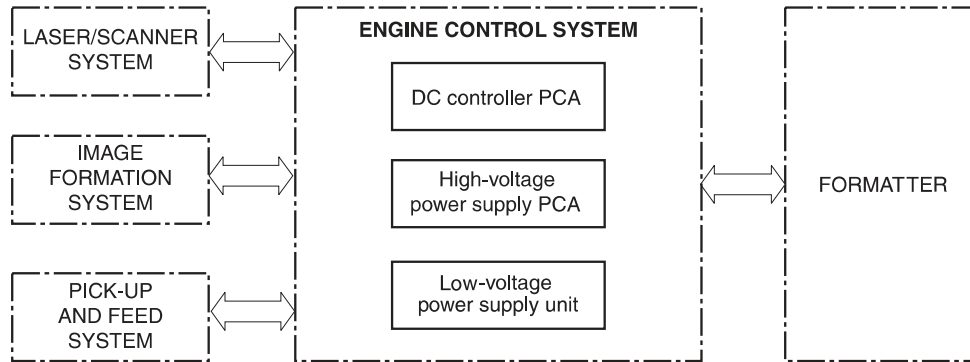


Figure 23. Timing chart block diagram

## Engine control system

The engine control system coordinates the laser/scanner, image formation, and pickup and feed systems according to the instructions it receives from the formatter. The engine control system consists of the DC controller PCA, the high-voltage power supply circuit, and the low-voltage power supply unit.

Figure 24 shows a block diagram of the engine control system.



**Figure 24.** Engine-control-system block diagram

# DC controller PCA

The DC controller circuit controls operational sequences of the printer.

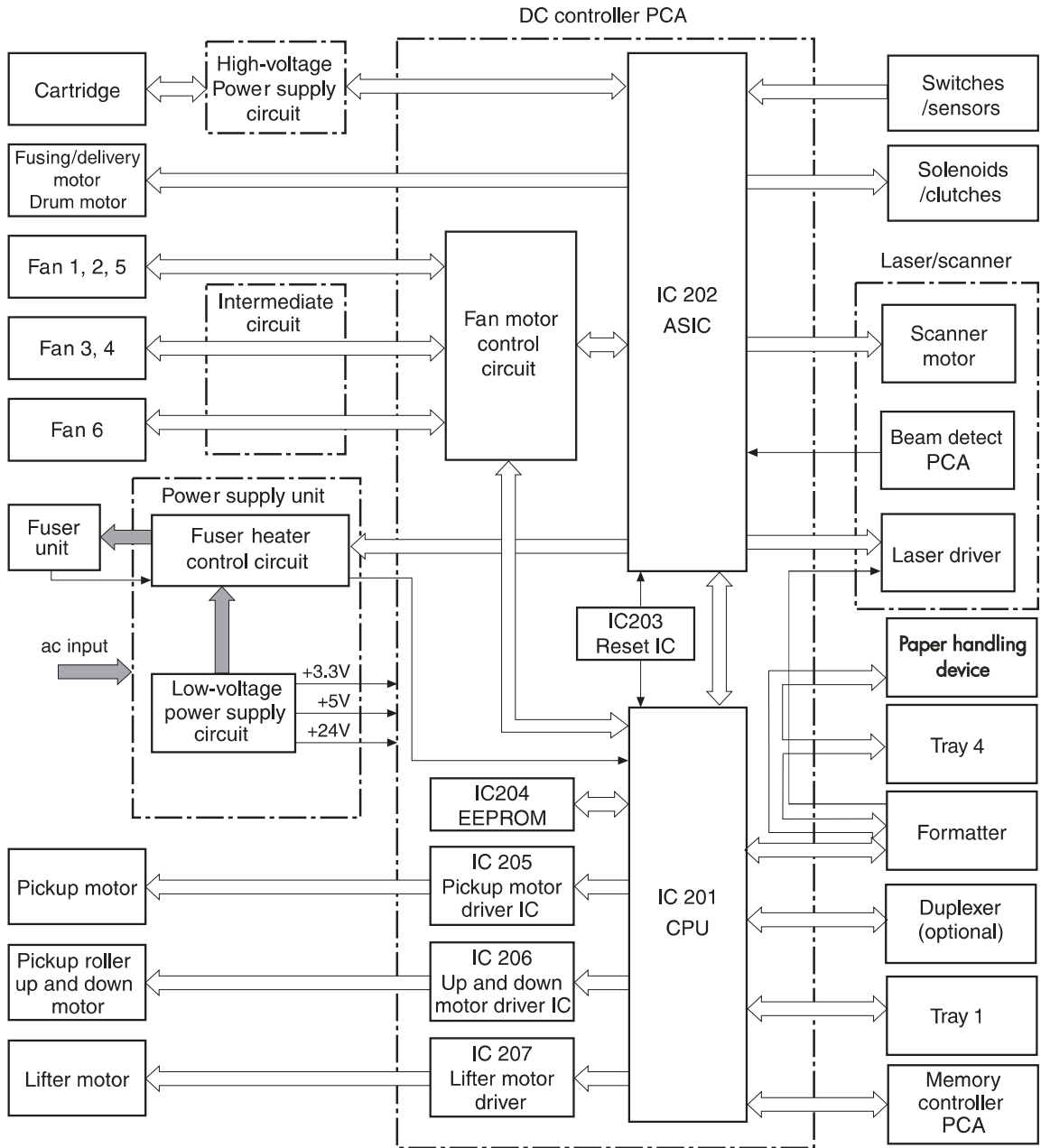


Figure 25. DC controller PCA block diagram



## DC controller operations

- The CPU (IC201) on the DC controller PCA controls the following printer operations:
  - Sequence of the printer
  - Communications with the formatter
  - High-voltage power supply circuit
  - Rotation of the pickup motor, lifter motor, pickup roller motor, and fan motor 6
  - Communication with the duplexer and tray 1, if installed
  - Fuser heater control circuit and fuser heater safety circuit
- The ASIC (IC202) on the DC controller PCA controls the following printer operations, according to instructions from the CPU:
  - laser/scanner
  - rotation of fuser/delivery motor and drum motor
  - sensors and switches
  - clutches and solenoids
  - rotation of fan motors 1 through 5
- The reset IC (IC203) monitors +3.3 V and resets the CPU and ASIC at power on.
- The EEPROM (IC204) stores backup data.
- The pickup motor driver IC (IC205) drives the pickup motor.
- The pickup roller up-and-down motor driver IC (IC206) drives the pickup roller up-and-down motor.
- The lifter motor driver IC (IC207) drives the lifter motor.
- The fan motor control circuit turns fans on and off.

# High-voltage power supply circuit

The high-voltage power supply circuit applies a high-voltage bias to the primary charging roller, the developing cylinder, the pre-transfer upper guide, the transfer charging roller, the separation static charge eliminator, and the pressure roller through the ASIC (IC 202), according to instructions it receives from the CPU (IC201) on the DC controller PCA. The high-voltage power supply circuit also detects the toner level.

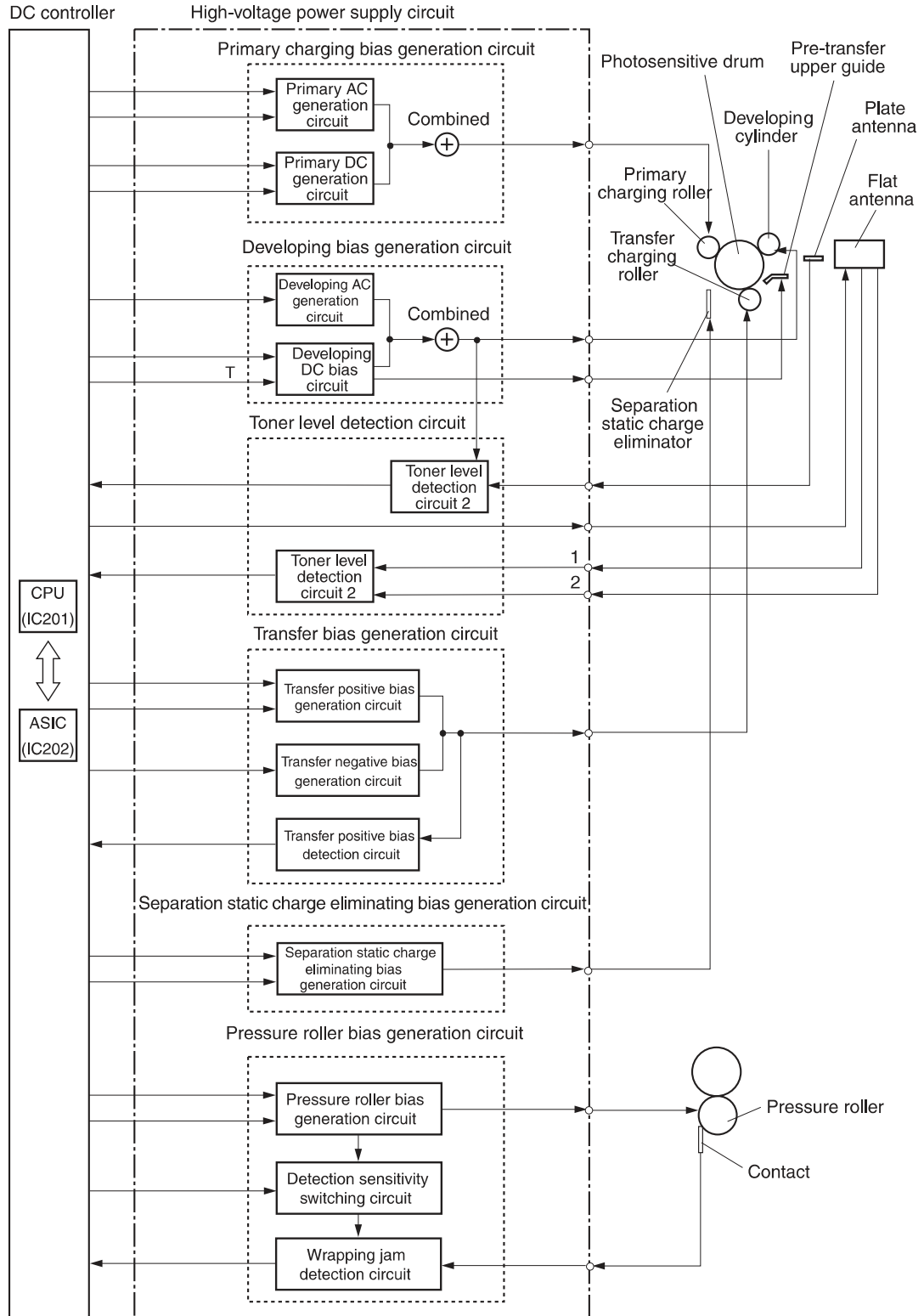


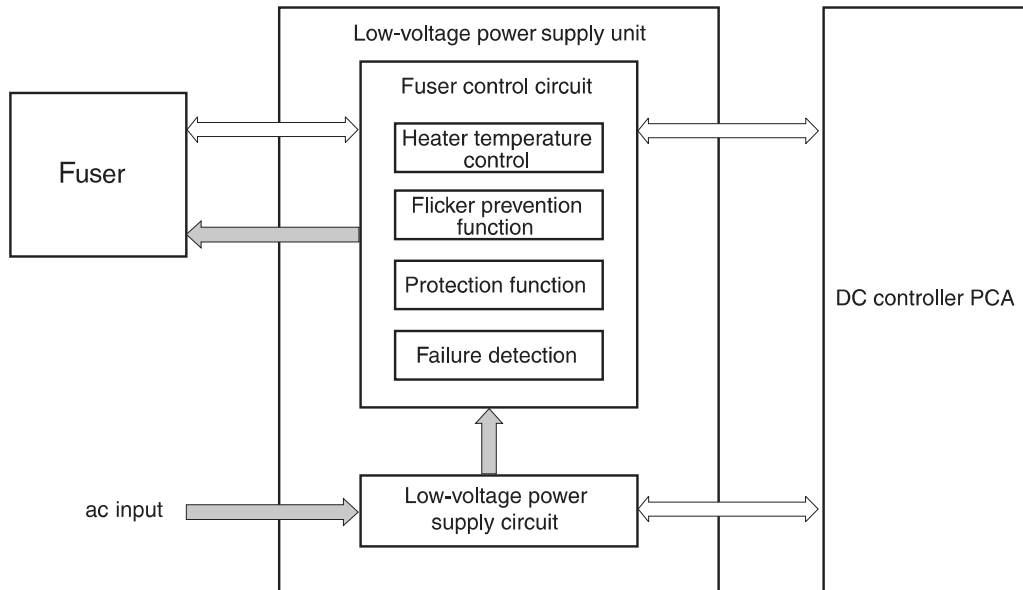
Figure 26. High-voltage power supply block diagram

Each of the bias generation circuits has a specific purpose:

- **Primary charging bias generation.** Applies bias to the primary charging roller to spread a uniform, negative charge on the photosensitive drum.
- **Developing bias generation.** Controls the amount of toner transferred onto latent images formed on the photosensitive drum.
- **Pre-transfer upper guide bias generation.** Prevents toner on the photosensitive drum from adhering to the pre-transfer upper guide.
- **Transfer bias generation.** Each of the three types of transfer bias (cleaning bias, between-page bias, and print bias) is applied to the transfer charging roller at specified intervals.
- **Cleaning bias.** Cleans the transfer charging roller by moving toner to the photosensitive drum.
- **Between-page bias.** Prevents residual toner on the photosensitive drum from adhering to the transfer charging roller between pages of a multi-page print job.
- **Print bias.** Transfers toner from the photosensitive drum to the print media.
- **Separation static charge eliminating bias.** Stabilizes media delivery.
- **Pressure roller bias generation.** Prevents toner from adhering to the fuser roller.
- **Toner level detection.** Monitors toner level through two antennae (plate antenna and flat antenna) in the print cartridge.

## Low-voltage power supply unit

The low-voltage power supply unit consists of the fuser control circuit and the low-voltage power-supply circuit.



**Figure 27.** Power-supply-block diagram

### Fuser control circuit

Three heaters heat the fuser roller and pressure roller. The main heater (H1) heats the center of the fuser roller, the sub-heater (H2) heats both ends of the fuser roller, and the lower heater (H3) heats the pressure roller.

Two thermistors monitor the surface temperature of the rollers. The upper thermistor (TH1) monitors the fuser roller surface temperature and the lower thermistor (TH2) monitors the pressure roller surface temperature.

Two thermal switches guard against overheating the three heaters by turning off power to the heaters when the temperature rises abnormally.

The printer is designed to prevent flicker. Lights attached to the same ac power source as the printer can flicker as a result of high-frequency noise. To control flicker, the printer gradually increases and decreases power to the heaters when they are turned on and off.

### Low-voltage power-supply circuit

The low-voltage power-supply circuit converts ac voltage from the power source to dc voltage when the printer is turned on. The ac power is converted as follows:

- +24 Vdc for motors, solenoids, clutches, and the high-voltage power supply circuit
- +5 Vdc for the laser/scanner PCA, the beam detect PCA, and the formatter
- +3.3 Vdc for the formatter, sensors, and the ICs on the DC controller PCA

## Formatter system

The formatter and DC controller exchange signals that allow the DC controller to begin the initial rotation period (INTR), turn on the registration roller drive clutch, and feed media into the printer. When media is positioned for printing, the formatter sends information through the DC controller to the laser/scanner, which then turns the laser diodes on and off. Laser beams that the laser diodes emit are reflected by the laser/scanner mirror, scanning across the photosensitive drum to form a latent image on the drum.

The formatter system is responsible for the following:

- Receiving and processing data from the various printer interfaces
- Monitoring control panel input and relaying printer status information (through the control panel and the I/O)
- Developing and coordinating data placement and timing with the print engine
- Storing font information and macros
- Communicating with the host computer

The formatter receives data from the I/O and converts it into a dot image. The formatter then sends a print signal to the engine controller assembly. The engine controller assembly synchronizes the image-formation system with the paper-feed system, and signals the formatter to send the print-image data. The formatter sends the print-image data (dots) in the form of a video signal, and the printing process begins.

## Formatter hardware

The formatter system includes the following components:

- **ROM**—Stores the dot patterns of internal character sets (fonts), in addition to storing microprocessor control programs.
- **RAM**—Stores printing and font information received from the host system, and can also serve to temporarily store a full page of print-image data before the data is sent to the print engine. Increasing the RAM increases graphic intense printing operations, but it will not increase the I/O buffer space or cause the printer to print more pages per minute.
- **NVRAM**—Stores information about the I/O and print environment configuration. The printer keeps the contents of NVRAM when the power is turned off or disconnected. (As in other HP LaserJet printers, downloaded fonts and macros are saved in conventional RAM and are lost when power is turned off.)
- **Interfaces**
  - **Parallel interface** (HP LaserJet 9040/9050 *only*)—Receives incoming data through its IEEE-1284 B interface connector. The IEEE-1284 B interface provides high-speed, two-way communication between the printer and the host, letting the customer change printer settings and monitor printer status from the host computer.
  - **Parallel interface** (HP LaserJet 9000 *only*)—Receives incoming data through its IEEE-1284 C interface connector. The IEEE-1284 C interface provides high-speed, two-way communication between the printer and the host, letting the customer change printer settings and monitor printer status from the host computer.
  - **EIO**—Supports a wide range of print servers and other add-on devices through PCI-based EIO slots. HP Jetdirect EIO cards provide high-speed communication for network printing over Ethernet, Ethernet and LocalTalk, Token Ring, or Fast Ethernet networks.
- **Flash memory card** (HP LaserJet 9040/9050 *only*)—The formatter has three flash memory card slots. One slot is dedicated to printer firmware. The printer supports Type 1 and Type 2 flash memory. Unlike standard printer memory, flash memory cards can be used to permanently store downloaded fonts, macros, and forms even when the printer is turned off.

---

**Note**

---

A flash memory card that is designed for use with a digital camera should *not* be inserted into the printer. The printer does not support photo printing directly from a flash memory card. If you install a camera-type flash memory card, a message asking if you want to reformat the flash memory card appears on the control-panel display. If you choose to reformat the card, all data on the card will be lost.

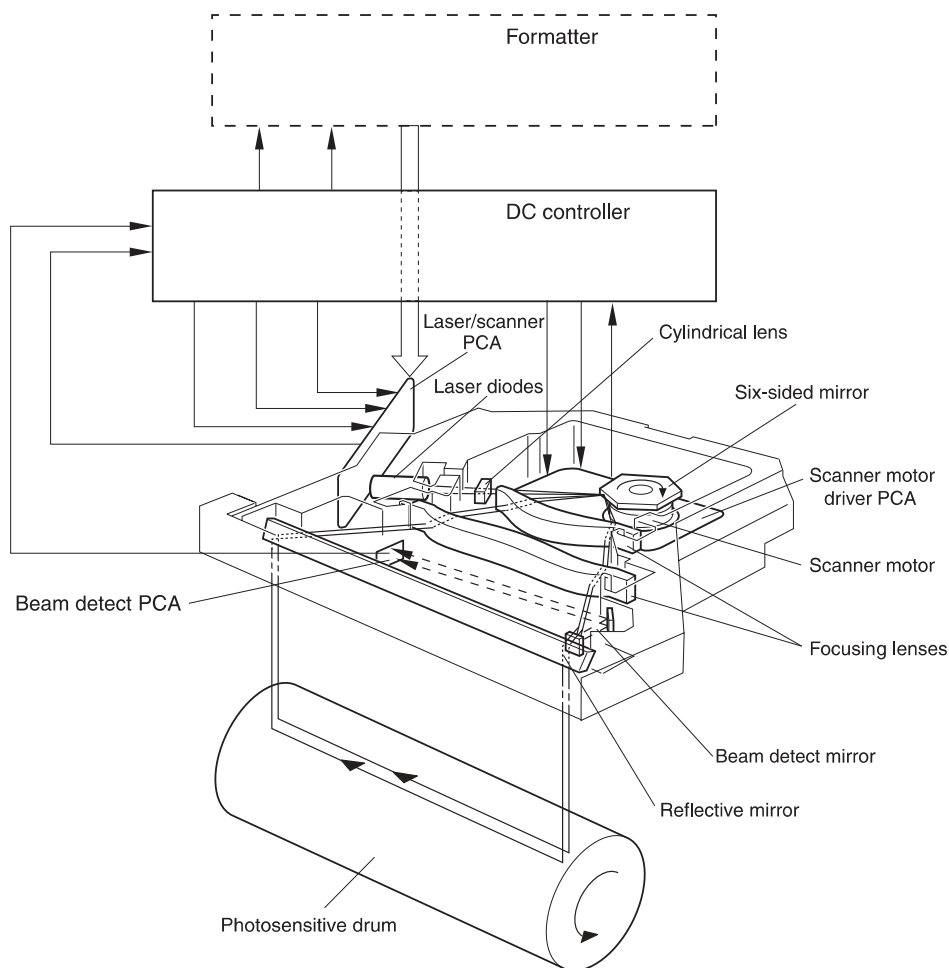
- **Real Time Clock** (HP LaserJet 9040/9050 *only*)—The user sets the date and time when the printer is turned on for the first time. This date and time is used for the Wake-up time feature. A battery supplies power when the printer is turned off.
- **HP Jetdirect Fast Ethernet embedded print server** (HP LaserJet 9040/9050 *only*)—The HP LaserJet 9040n/9050n and the HP LaserJet 9040dn/9050dn printers include an HP Jetdirect Fast Ethernet embedded print server on the formatter. This functions like other Jetdirect EIO products.

## Laser/scanner system

The laser/scanner unit of the HP LaserJet 9000 series printer and the HP LaserJet 9040/9050 series printer contains two laser diodes in its laser unit. The printer employs the “twin-beam method,” which scans two lines simultaneously.

Based on signals it receives from the DC controller and the formatter, the laser/scanner PCA causes the two laser diodes to emit laser beams. The beams strike a six-sided mirror that rotates at a constant speed. The beams reflect off the mirror, pass through a focusing lens and a reflective mirror, and focus on the photosensitive drum.

The scanning mirror rotating at a constant speed allows the laser beams to scan across the drum at a constant speed. Finally, a latent image is formed on the drum surface by constant-speed rotation of the photosensitive drum and constant-speed scanning of the laser beams.



**Figure 28.** Laser/scanner system

# Image formation system

The image formation system consists of the cartridge, transfer charging roller, and fuser.

When a print command is sent from the formatter, the engine controller drives the main motor to rotate the photosensitive drum, primary charging roller, developing cylinder, transfer charging roller, and pressure roller.

The primary charging roller applies a uniform negative charge to the photosensitive drum surface. Laser beams, modulated by the signals from the formatter, focus on the photosensitive drum surface to form a latent image on the photosensitive drum.

Toner on the developing cylinder develops the latent image formed on the photosensitive drum into a visible image, which is transferred onto media by the transfer charging roller. The toner transferred is changed to a permanent image by heat and pressure in the fuser. The cleaning blade scrapes residual toner from the photosensitive drum, and the primary charging roller applies a uniform negative charge to the photosensitive drum surface in preparation for the next latent image.

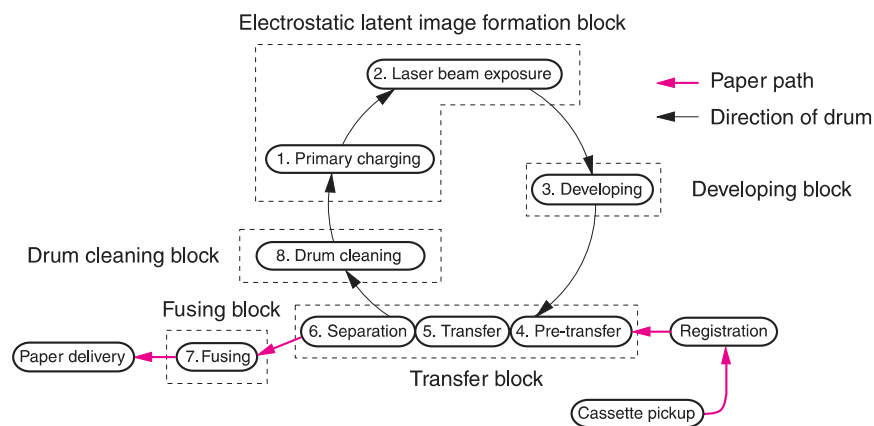


Figure 29. Image formation

## The eight processes of image formation

- 1 Conditioning (primary charging)**—Consists of the application of a uniform negative charge to the surface of the drum with the primary charging roller located in the print cartridge. The primary charging roller is made of conductive rubber. An ac bias is applied to the roller to erase any residual charges from any previous image. A negative dc bias is applied by the charging roller to create a uniform negative potential on the drum surface.
- 2 Writing (laser beam exposure)**—Two laser diodes project laser beams onto a rotating scanning mirror. As the mirror rotates, the beams reflect off the mirror, first through a set of focusing lenses, then off a mirror, and finally through a slot in the top of the print cartridge, and onto the photosensitive drum. The twin beams sweep the drum from left to right, discharging the negative potential wherever the beams strike the surface. This creates a latent electrostatic image, which later is developed into a visible image.
- 3 Developing**—At this stage of the process, the latent electrostatic image is present on the drum. The toner particles obtain a negative surface charge by rubbing against the developing cylinder which is connected to a negative dc supply. The negatively charged toner is attracted to the discharged (exposed, grounded) areas of the drum, and is repelled from the negatively charged (unexposed) areas.
- 4 Pre-transfer**—Applies bias to prevent toner on the photosensitive drum from adhering to the pre-transfer upper guide.



- 5 **Transfer**—During the transfer process, the toner image on the drum surface is transferred to the paper. The transfer charging roller applies a positive charge to the back of the paper and causes the negatively charged toner on the drum surface to be attracted to the paper. After separation, the drum is cleaned and conditioned for the next image.
- 6 **Separation**—During the separating process, the paper separates from the drum. To stabilize the feed system and to prevent dropouts on the printed image at low temperature and humidity, the charge on the back of the paper is reduced by the static charge eliminator.
- 7 **Fusing**—During the fusing process, the toner is fused to the paper by heat and pressure to produce a permanent image. The paper passes between a heated fuser element and a soft pressure roller. This melts the toner and presses it into the paper.
- 8 **Drum cleaning**—The cleaning blade is in contact with the surface of the drum at all times. As the drum rotates during printing, excess toner is scraped off and stored in the waste toner receptacle.

## Print cartridge

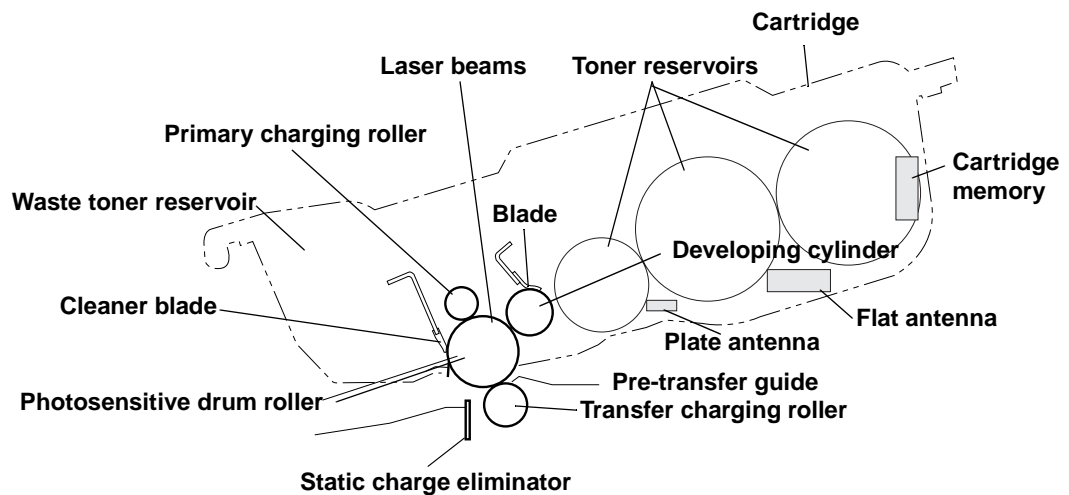


Figure 30. Print cartridge

### Cartridge design

The design of the print cartridge incorporates dramatic changes in the toner hopper geometry and stirrer design. The cartridge contains three main interconnecting toner reservoir areas, each with a cylindrical shape. A cylindrically shaped hopper effectively eliminates the packing and accumulation of toner in areas where it will not reach the development area. Another key improvement was realized in the design of the toner stirrer, where stirrers rotating within each of the hopper cylinders unpack the toner, allowing it to be displaced easily into the cartridge development area.

### No-shake toner

Shaking is not required at installation or at the end of cartridge life because the geometry of the hopper and stirrer design automatically redistributes and unpacks the toner. The overall design of the “no-shake” system is so efficient that when fading occurs for the first time, it is a sure indication that the cartridge is out of toner. Shaking the cartridge will not produce more toner for printing.

## Cartridge memory

The print cartridge comes with built-in RAM. The printer detects the cartridge condition by reading and writing to this memory. The read/write of the memory is performed by the memory controller after receiving instructions from the DC controller through the antenna unit.

The DC controller instructs the memory controller PCA to perform read/write at the following timing:

- Read
  - When the power is turned on
  - When the door cover is closed
  - When the DC controller receives a command from the formatter
- Write
  - When a print operation is complete
  - When the DC controller receives a command from the formatter

The DC controller also detects cartridge memory failures. If the DC controller fails in a read/write attempt two times, it reports the failure to the formatter as a cartridge memory abnormality.

## Toner seal

This print cartridge incorporates an automatic toner-seal roll-up. When a new print cartridge is installed, the DC controller detects a new cartridge and sends a signal to the drum motor to roll up the toner seal.

When a print cartridge is inserted, the power is turned on, or the door cover is closed, the DC controller monitors the toner seal opening detection signal and verifies whether or not the cartridge is new. If the cartridge is new, an open signal from the DC controller is sent to the drum motor. This reverses the drum motor rotation, which rolls up the toner seal. After a short period of time, the DC controller turns off the open signal, completing the roll up sequence.

The DC controller also monitors the printer for presence of a print cartridge. When a cartridge is inserted, the same signal that instructs the cartridge to roll up the seal is used as a detection signal.

## Toner-level detection

The print cartridge has built-in toner-level detection. The DC controller monitors the toner level using feedback signals received from two antennae (plate and flat) in the cartridge.

When the power is turned on, a door cover is closed, or a print operation is performed, the DC controller sets the developing bias signal, the developing ac bias circuit sends a signal to the toner level circuit 1 and the developing cylinder. This causes the plate antenna to feedback the output value to the toner level circuit 1. The toner level circuit 1 compares the two signals and sends the results to the DC controller as the toner level detection signal. At the same time, the DC controller turns on the frequency output signal to output the reference frequency to the flat antenna. This causes the flat antenna to feedback the output value to the toner level circuit 2. The toner level circuit 2 compares the two signals and sends the results to the DC controller as the toner level detection signal, toner level accuracy to within 1% from 0 to 100%, then reports the result to the formatter.

## Pickup and feed system

The pickup and feed system is divided into two blocks: pickup/feed and fuser/delivery. This printer contains two standard pickup sources (tray 2 and tray 3) and two delivery sources (face-up and face-down bins.)

The pickup unit picks up single sheets from tray 2 or tray 3. The feed unit transports each sheet to the fuser unit.

When the printer is turned on, the stack of print media is lifted by the lifter to where the paper pickup is enabled. When the DC controller receives a print command, the pickup roller starts rotating. This lowers the pickup roller to the paper surface. A sheet of paper is fed to the feed rollers and the pre-registration roller. The pre-registration roller corrects the skew.

After a short period of time, the sheet is transferred to the photosensitive drum. The image on the drum is transferred onto the sheet, which is then transported to the fuser.

### Media-size detection

Because the printer can contain custom-size media in all trays, the printer has a custom/standard switch and two size-detection switches. The DC controller reads information from the two size detection switches in the trays to determine media width and length. If the switches are set to the custom size setting, the “X” and “Y” dimensions must be set in the control panel. The width-detection switches also sense the presence of trays: if all of the width-detection switches are off, the DC controller assumes that a tray is missing.

### Media-level detection

The lifter that lifts the paper detects the media level in the trays. The lifter contains a lifter blocking plate. This plate shuts off two sensors in each tray, allowing the lifter position to be detected. This detected position determines the media level.

Media level is based on approximate number of sheets in the tray. Depending on the lifter position, the sensors determine paper levels as full (200 or more sheets), high (100 to 200 sheets), middle (50 to 100 sheets), or low (less than 50 sheets).

### Multifeed prevention

The printer utilizes the separation roller method for its multiple-feed-prevention mechanism. This method drives the feed rollers and separation roller in the reverse direction from each other. The separation roller contains a torque limiter. When a multifeed occurs, the torque limiter allows the top sheet to feed into the printer, but returns the additional sheet to the tray.

### Overhead-transparency detection

The overhead transparency sensor emits light through the media path and reads light that is reflected back from a prism. When plain paper passes through the media path, no light is reflected back, but when a transparency passes through the media path, the sensor can read the reflected light, indicating the presence of a transparency.

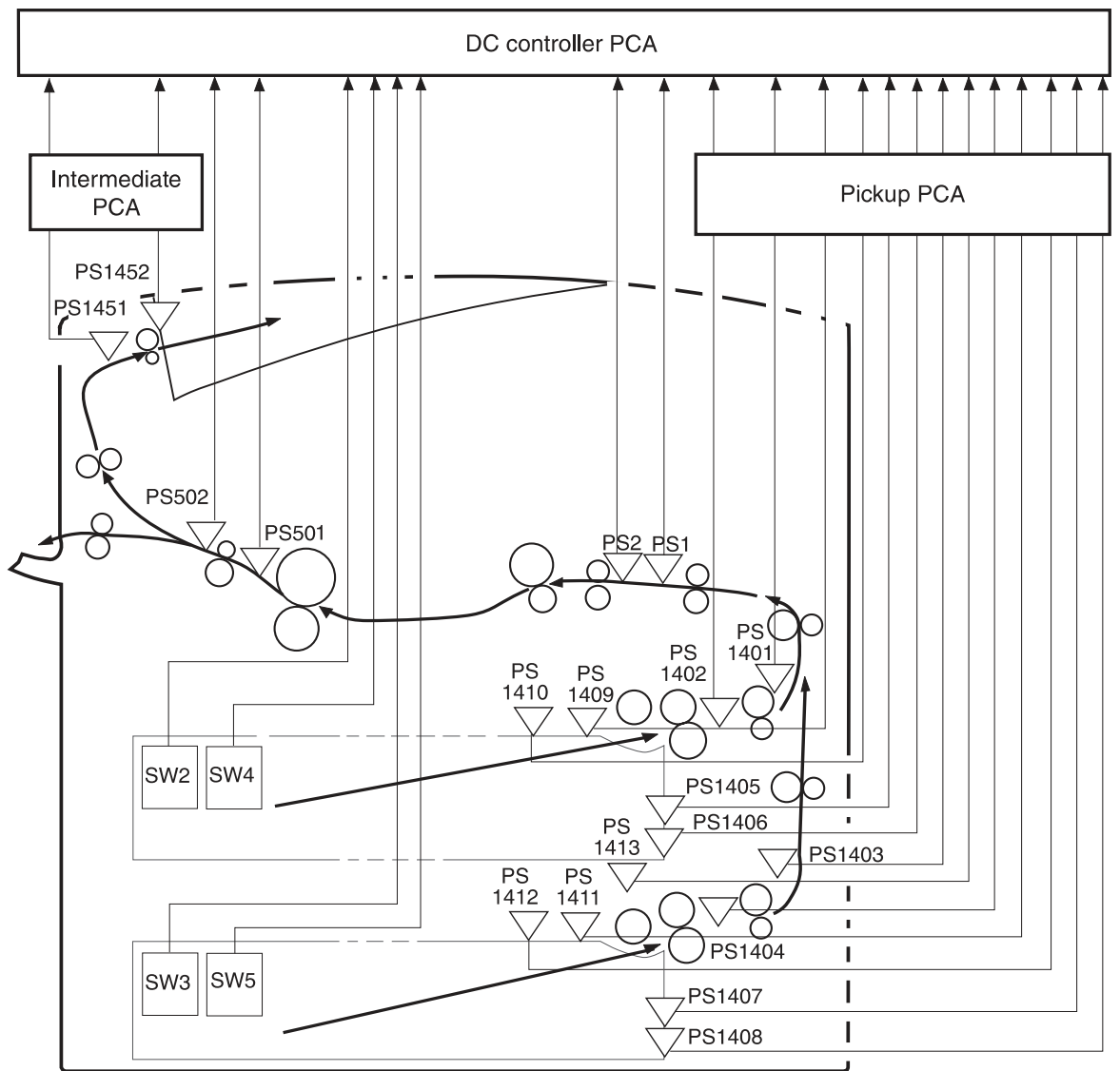
### Fuser-wrapping-jam detection

The printer contains a mechanism to detect wrapping jams in the fuser. The DC controller sends signals to the pressure roller bias generation circuit. The circuit applies the same bias values to the pressure roller and to the wrapping-jam-detection circuit. The jam-detection lever solenoid monitors the pressure roller bias through contact with the pressure roller. The wrapping-jam-detection circuit compares the monitored value to the applied value for differences in the values. When they differ, the circuit determines that a wrapping jam occurred, and signals the DC controller to stop the printer.

## Jam detection

The printer detects jams according to the following conditions:

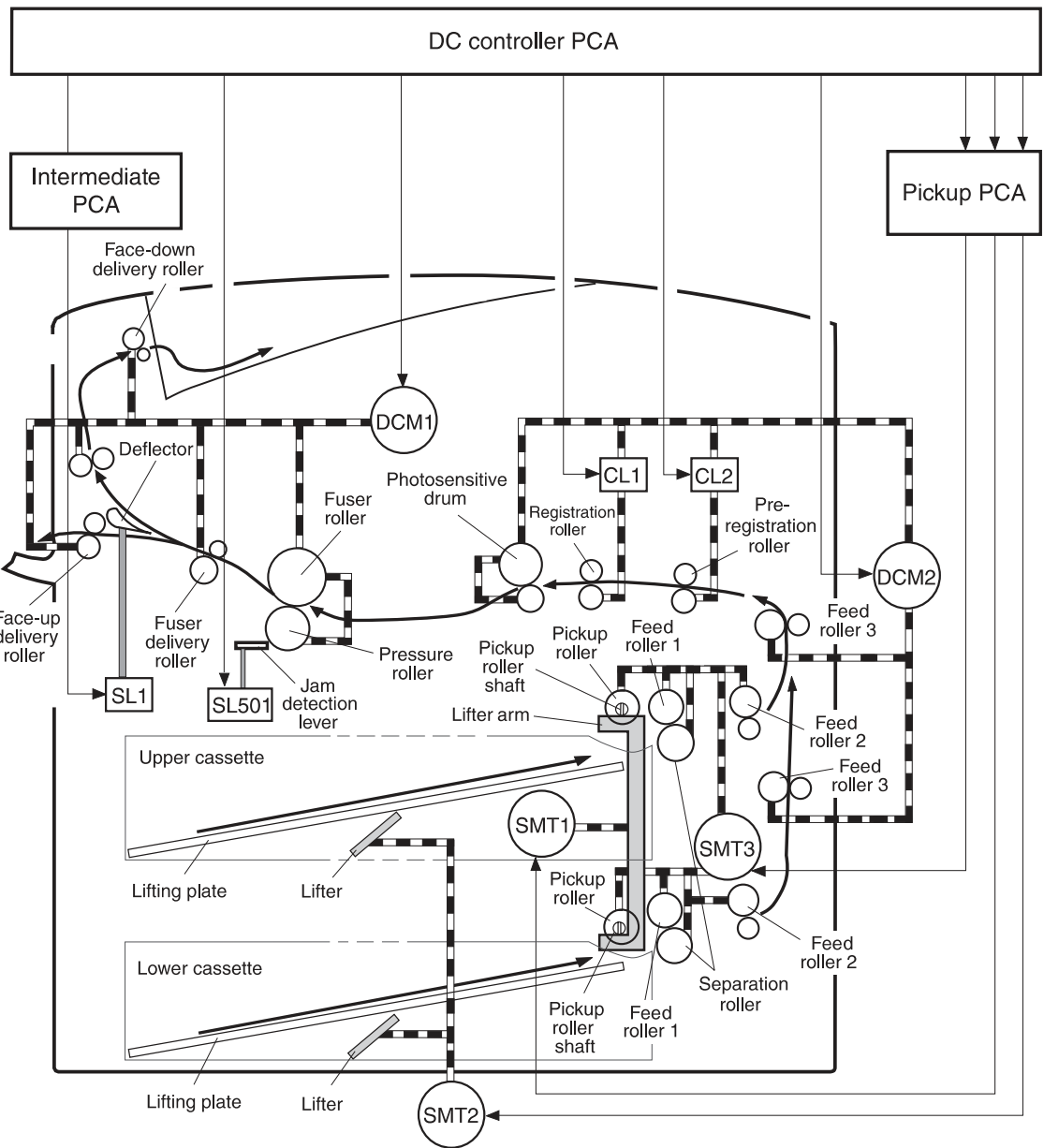
- **Pickup 1 delay jam.** Media does not reach the tray 2 feed sensor A (PS1402) or the tray 3 feed sensor A (PS1404) within 3.2 seconds after pickup begins.
- **Pickup 2 delay jam.**
  - Media does not reach the tray 2 feed sensor B (PS1401) or the tray 3 feed sensor B (PS1403) within 3.0 seconds after the tray 2 feed sensor A (PS1402) or the tray 3 feed sensor A (PS1404) detects the leading edge of the media.
  - Media does not reach the registration paper sensor (PS2) within 4.0 seconds after the tray 2 feed sensor B (PS1401) detected the leading edge of the media, or within 4.5 seconds after the tray 3 feed sensor B (PS1403) detected the leading edge of the media.
- **Fuser delivery 1 delay jam.** The leading edge of the media does not reach the fuser delivery sensor (PS502) within 1.4 seconds after the /VSYNC signal.
- **Fuser delivery 2 delay jam.** The leading edge of the media does not reach the fuser jam sensor (PS501) within 1.6 seconds after the /VSYNC signal.
- **Fuser delivery stationary jam.** The trailing edge of the media does not clear the fuser delivery sensor (PS502) within a specified time (3.4 seconds for A3 media, 2.5 seconds for A4 media) after the /VSYNC signal.
- **Face-down delivery delay jam.** The leading edge of the media does not reach the face-down bin delivery sensor (PS1451) within 2.4 seconds after the /VSYNC signal.
- **Face-down delivery stationary jam.** The leading edge of the media does not clear the face-down bin delivery sensor (PS1451) within a specified time (4.3 seconds for A3 media, 3.4 seconds for A4 media) after the /VSYNC signal.
- **Door open jam.** The following sensors can detect media when the door is opened or closed:
  - Registration paper sensor (PS2)
  - Fuser delivery sensor (PS501)
  - Fuser jam sensor (PS502)
  - Tray 2 feed sensor B (PS1401)
  - Tray 2 feed sensor A (PS1402)
  - Tray 3 feed sensor B (PS1403)
  - Tray 3 feed sensor A (PS1404)
  - Face-down bin delivery sensor (PS1451)
- **Residual jam.** The following conditions determine a residual jam:
  - The fuser delivery sensor (PS502) and the fuser jam sensor (PS501) detect media when the printer is turned on.
  - Three minutes have passed since a jam that should contain an automatic delivery command was cleared, but the CPU on the DC controller PCA did not receive the automatic delivery command.
  - A jam was cleared, jammed media was automatically delivered, the printer is on, and the fuser roller reached its target temperature, but at least one of the following sensors detects media:
    - Registration paper sensor (PS2)
    - Fuser delivery sensor (PS501)
    - Fuser jam sensor (PS502)
    - Tray 2 feed sensor B (PS1401)
    - Tray 3 feed sensor B (PS1403)
    - Face-down bin delivery sensor (PS1451)



**Figure 31.** Pickup-and-feed system sensors and switches

**Table 16. Pickup-and-feed system sensors and switches**

<b>Sensor/switch</b>	<b>Description</b>
PS1	Overhead transparency sensor
PS2	Registration paper sensor
PS501	Fuser delivery sensor
PS502	Fuser jam sensor
PS1401	Tray 2 feed sensor B
PS1402	Tray 2 feed sensor A
PS1403	Tray 3 feed sensor B
PS1404	Tray 3 feed sensor A
PS1405	Tray 2 media-level sensor 1
PS1406	Tray 2 media-level sensor 2
PS1407	Tray 3 media-level sensor 1
PS1408	Tray 3 media-level sensor 2
PS1409	Tray 2 media-surface sensor
PS1410	Tray 2 empty sensor
PS1411	Tray 3 media-surface sensor
PS1412	Tray 3 empty sensor
PS1413	Pickup shaft home-position sensor
PS1451	Face-down bin delivery sensor
PS1452	Face-down bin full sensor
SW2	Tray 2 media-length detection switch
SW3	Tray 3 media-length detection switch
SW4	Tray 2 media-width detection switch
SW5	Tray 3 media-width detection switch



**Figure 32. Pickup-and-feed system motors and solenoids**

**Table 17. Pickup-and-feed system motors and solenoids**

<b>Motor/solenoid</b>	<b>Description</b>
DCM1	Fuser/delivery motor
DCM2	Main/drum motor
SMT1	Pickup roller up and down motor
SMT2	Lifter motor
SMT3	Pickup motor
SL1	Face-up solenoid
SL501	Jam detection lever drive solenoid
CL1	Registration roller drive clutch
CL2	Pre-registration roller drive clutch



# Tray 1

Tray 1 is a multipurpose tray that picks up and feeds media into the printer.

## Tray 1 driver PCA

A driver PCA in the tray holds a four-bit microcomputer (CPU-IC2501) that controls its operational sequence and serial communications with the DC controller PCA. The CPU drives a motor, solenoid, and clutch according to commands sent from the DC controller PCA.

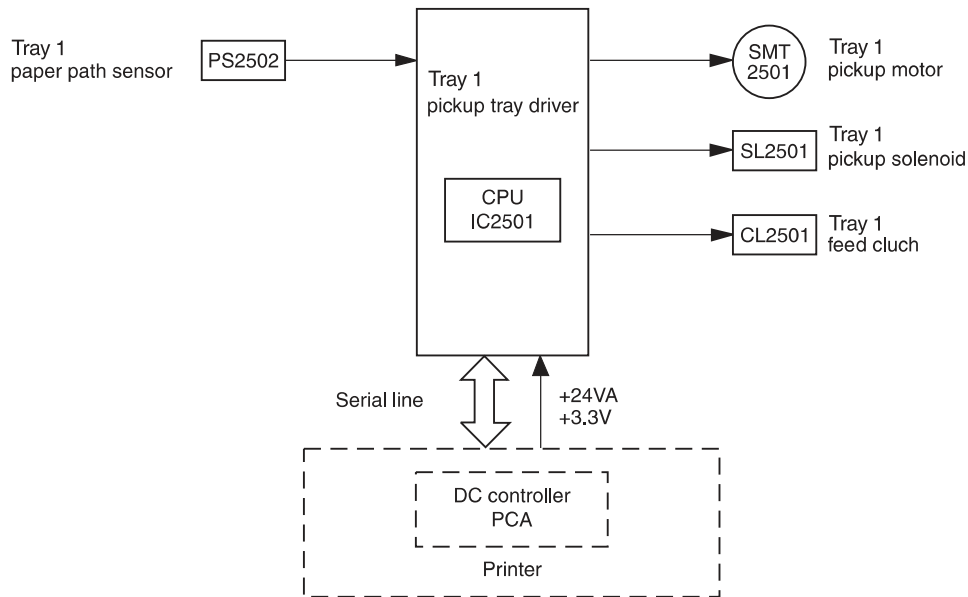


Figure 33. Tray 1 block diagram

## Power supply

The power supply is +24 Vdc that is supplied to drive the motor, solenoid, and clutch, and +3.3 Vdc for the IC and sensors.

## Sequence of operation

When tray 1 is installed, the door is closed, or the printer returns from sleep mode, and the paper path sensor (PS2502) does not detect the presence of media, the tray 1 driver PCA rotates the motor to bring the pickup roller to its initial position. The tray proceeds with the following pickup sequence:

- 1 Receives a pickup command
- 2 Turns on the pickup solenoid (SL2501), which brings the pickup roller in contact with the surface of the media
- 3 Turns on the feed clutch (CL2501) to rotate the pickup roller and feed roller, picking up the media
- 4 Feeds the media to the between-page adjustment position, turns off CL2501, and feeds media to the printer
- 5 Receives a feed-stop command, stops the motor, and returns to a standby state

## Pickup and feed

The tray 1 pickup unit picks up media by lowering the pickup roller onto the surface of the media that is loaded in the tray, and then separating the roller from the media surface the pickup cam lifts the pickup roller up and down. When the tray 1 pickup unit turns on the pickup solenoid, the stopper leaves the cam, allowing the cam to rotate. This shifts the pickup roller up and down. After completing one rotation, the cam contacts the stopper and is held in so the pickup roller is brought to its initial position.

Tray 1 utilizes the separation roller method for its multiple-feed-prevention mechanism. This method drives the feed rollers and separation roller in the reverse direction from each other. The separation roller contains a torque limiter. When a multifeed occurs, the torque limiter allows the top sheet to feed into the printer, but returns the additional sheet to the tray.

## Jam detection

The tray 1 paper path sensor (PS2502) determines whether or not media is transported correctly to the printer. If the paper path sensor does not detect the leading edge of media within the specified length of time after turning on the pickup solenoid, the CPU stops the pickup operation and notifies the DC controller of a jam occurrence.

The CPU in tray 1 detects the following jams:

- **Pickup retry.** If the paper path sensor does not detect the leading edge of media 1 second after turning on the pickup solenoid, the CPU stops the motor once, and then restarts it. The CPU turns on the pickup solenoid 0.7 seconds after the start of the second motor rotation.
- **Pickup delay jam.** The paper path sensor (PS2502) does not detect the leading edge of media within 3 seconds of turning on the pickup solenoid.
- **Residual jam.** There is power to tray 1, the top cover is closed (or when the tray returns from sleep mode), and the paper path sensor (PS2502) detects media.

## Tray 4

Tray 4 is a 2,000-sheet feeder that picks up and feeds media into the printer.

### Tray 4 driver PCA

A driver PCA in tray 4 holds a 16-bit microcomputer (IC1) that controls the tray 4 operational sequence and serial communications with the formatter. The driver PCA drives the motors and clutch according to commands that the formatter sends.

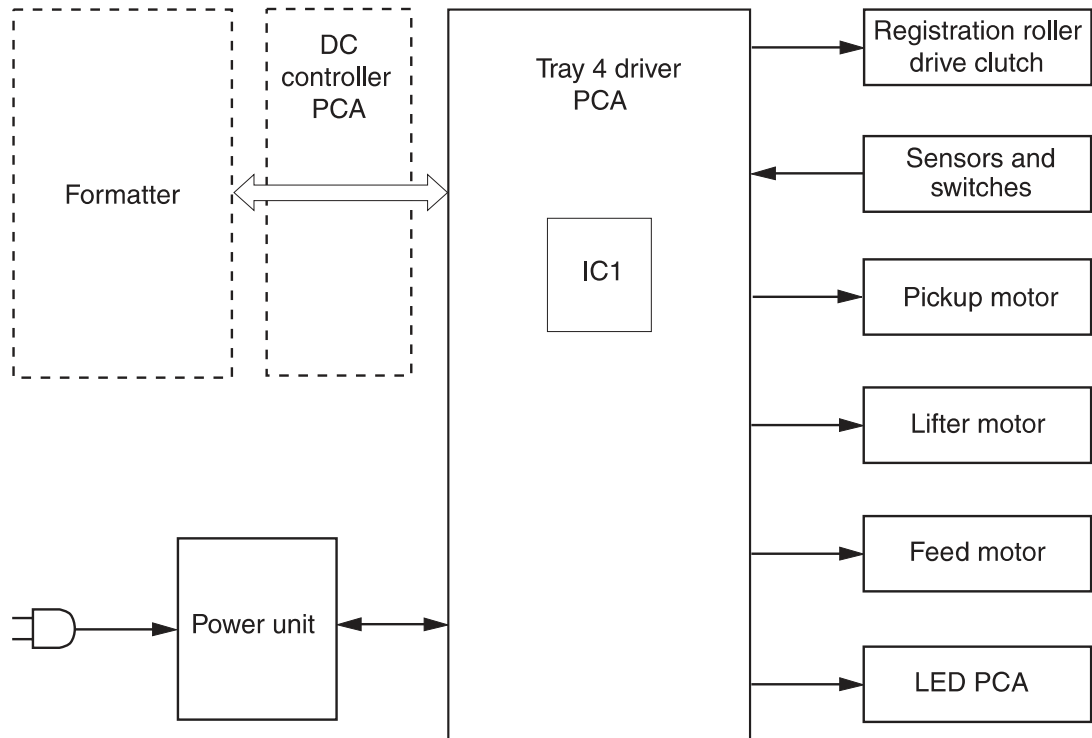


Figure 34. Tray 4 block diagram

### Power supply

Tray 4 employs a remote switch method for the power supply unit. The formatter sends a power-on signal to the power supply unit through the driver PCA. When the signal is received, the power supply unit supplies +24 Vdc and +5 Vdc to the driver PCA. +24V is then supplied to the lifter, feed, and pickup motors to drive them. The +5 V is supplied to the sensors and also to the ICs on the driver PCA.

The power unit utilizes a standalone switch so that tray 4 can be powered on without turning on the printer. This switch is used for standalone diagnostics. See "Tray 4 diagnostics" in chapter 7.

### Sequence of operation

When tray 4 is loaded with media and closed, the paper deck starts lifting the stack to the pickup position. When the formatter instructs tray 4 to deliver media, the drive rollers pick up a sheet and feed it to the registration assembly. The tray 4 registration assembly adjusts the skew and transports the sheet to the printer.

## Pickup and feed

The formatter sends a signal to the driver PCA to start driving the pickup and feed motors. Rotated by the rollers, the pickup roller picks up a sheet, the separation roller removes any excessive sheets, and the feed roller transports the sheet to the registration roller unit.

After the media enters the registration roller unit, the registration roller corrects the skew and the second feed roller feeds the media to the printer.

When the media reaches the merge-point in the printer, the driver PCA checks for a merge-point permission command sent from the formatter. If the signal is detected, tray 4 continues feeding to the printer. If the signal is not detected, tray 4 stops feeding until the signal is received.

## Media-level and media-size detection

The paper level is detected by the paper-level sensors (PS21 to 23) on the paper-level sensor PCA. The combination of these sensors determines the level of the print media loaded in tray 4.

The paper size is detected by the paper size detection switches (SW11 to 15) on the paper size detection switch PCA. The combination of these switches determines the paper size.

Tray 4 sends the size and level information to the printer formatter.

## Jam detection

Tray 4 determines a jam by monitoring the presence of media in the sensor areas at specific times that are stored in the CPU. If the CPU determines a jam under the following conditions, the tray stops feeding operations and notifies the formatter.

- **Residual jam.** The registration paper sensor (PS11) or jam sensor (PS103) detects media during the warm-up period.
- **Pickup delay jam.** The between page sensor (PS12) does not detect media after receiving a print command or the PS12 sensor detects media, but the registration paper sensor (PS11) does not.
- **Pickup stationary jam.** The edge does not clear the registration paper sensor (PS11) after the between-page sensor (PS12) detects the trailing edge of the media.
- **Feed delay jam.** The jam sensor (PS103) does not detect media after the start of the registration rollers.
- **Feed stationary jam.** The trailing edge of the media does not pass through the jam sensor (PS103) after the registration rollers are turned off.

# 6

# Removal and replacement

## Chapter contents

Introduction . . . . .	99
Removal and replacement strategy . . . . .	99
Repair notices . . . . .	99
Electrostatic discharge (ESD) . . . . .	99
Required tools . . . . .	99
Orientation of the printer (with tray 4) . . . . .	100
Covers . . . . .	101
Right top cover . . . . .	101
Left top cover . . . . .	103
Front cover . . . . .	104
Right door . . . . .	105
Right lower cover . . . . .	106
Left door and diverter . . . . .	107
Left back cover . . . . .	108
Back cover . . . . .	109
Right and left rail covers . . . . .	110
Top assemblies . . . . .	111
Control panel . . . . .	111
Laser/scanner assembly . . . . .	112
Delivery assembly . . . . .	113
Delivery-fan assembly . . . . .	114
Delivery-assembly fans and face-down-bin fan (fans 3, 6, and 4) . . . . .	115
Delivery motor . . . . .	116
Cartridge release lever . . . . .	117
Front assemblies . . . . .	119
Print cartridge . . . . .	119
Transfer-roller assembly . . . . .	120
Tray 2 and tray 3 (interchangeable) . . . . .	121
Rollers (pickup, feed, or separation) . . . . .	122
Fuser-jam-removal knob . . . . .	123
Registration-jam-removal knob . . . . .	124
Right assemblies . . . . .	125
Tray 1 . . . . .	125
Paper-input unit (PIU) . . . . .	126
Registration assembly . . . . .	129
Transfer-guide assembly . . . . .	131
Left assemblies . . . . .	133
Duplexer . . . . .	133
Fuser assembly . . . . .	134
Back assemblies . . . . .	135
Formatter . . . . .	135
Low-voltage power supply . . . . .	136
High-voltage power supply . . . . .	137

DC controller . . . . .	138
Toner-sensor contact assembly . . . . .	140
Drum motor . . . . .	141
Drum motor . . . . .	141
Feed-drive assembly . . . . .	142
Power-supply fan (fan 1) . . . . .	143
Cartridge fan (fan 5) . . . . .	144
Controller fan (fan 2) . . . . .	145
Jetlink connector . . . . .	146
Fuser-connector holder assembly . . . . .	147
Fuser delivery-drive assembly . . . . .	149
Tray 4 . . . . .	151
Orientation . . . . .	151
Left side cover . . . . .	151
Right side cover . . . . .	152
Back covers . . . . .	153
Tray 4 . . . . .	154
Rollers (pickup, feed, and separation) . . . . .	155
Registration assembly . . . . .	156
Drive motor . . . . .	157
Drive assembly . . . . .	158
Controller board . . . . .	159
Paper-size detection switch PCA . . . . .	160
Power supply . . . . .	161
Pickup assembly . . . . .	162
Paper-connecting unit . . . . .	163

# Introduction

## Removal and replacement strategy

This chapter documents removal and replacement of field replaceable units (FRUs) only.

Replace parts in the reverse order of their removal. Directions for difficult or critical replacement procedures are included.

## Repair notices

### WARNING!

The printer can have sharp sheet metal edges. Use caution when working on the printer.

### CAUTION

Always remove the print cartridge before removing or replacing assemblies and parts (see page 119). **IMPORTANT:** Put the print cartridge in its original print-cartridge bag, or, if the bag is not available, cover the print cartridge with a piece of paper. Light can damage the print cartridge.

To install a self-tapping screw, first turn it counterclockwise to align it with the existing thread pattern, then carefully turn it clockwise to tighten. Do not overtighten the screw. If a self-tapping screw-hole becomes stripped, repair the screw-hole or replace the affected assembly.

### Note

Note the lengths, diameters, and locations of screws. Be sure to return each screw to its original location during reassembly.

Incorrectly routed or loose wire harnesses can interfere with other internal components and can be damaged or broken. Frayed or pinched harness wires can be difficult to locate. When replacing wire harnesses, always use the provided wire loops, lance points, or wire-harness guides.

## Electrostatic discharge (ESD)

### CAUTION

The printer contains parts that are sensitive to electrostatic discharge (ESD). Always service the printer at an ESD-protected workstation, or use an ESD mat.



Watch for the ESD symbol (shown at left) to identify the parts that are sensitive to ESD. Protect these parts by using an ESD wrist strap and protective ESD pouches.

## Required tools

The following tools are needed to service the printer:

- #2 Phillips screwdriver with magnetic tip
- T-10 TORX screwdriver
- T-20 TORX screwdriver
- Small, flatblade screwdriver
- Small needle-nose pliers
- ESD mat
- Penlight

### CAUTION

A pozidrive screwdriver will damage screw-heads on the printer. Use a #2 Phillips screwdriver.

If you have a multi-speed screwdriver, use a torque limiter.

## Orientation of the printer (with tray 4)

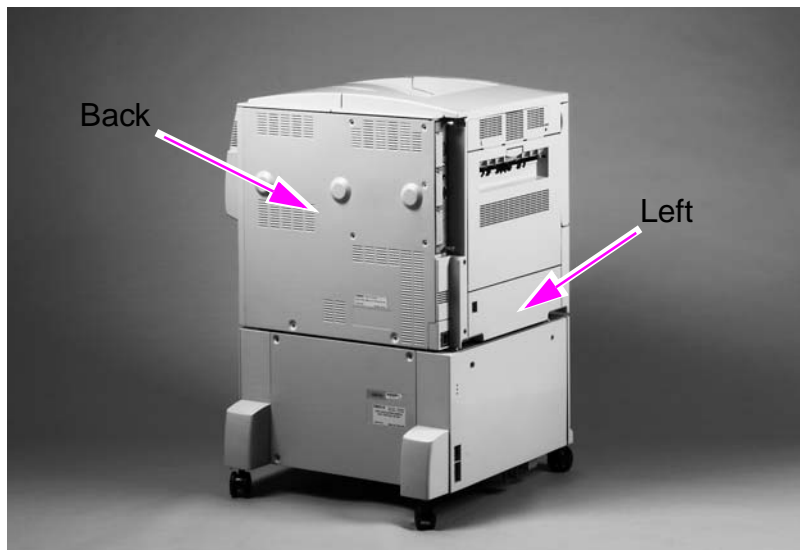
The printer is shown with tray 4 and tray 1.

### Front and right side orientation



**Figure 35.** View of front and right side

### Back and left side orientation



**Figure 36.** View of back and left side



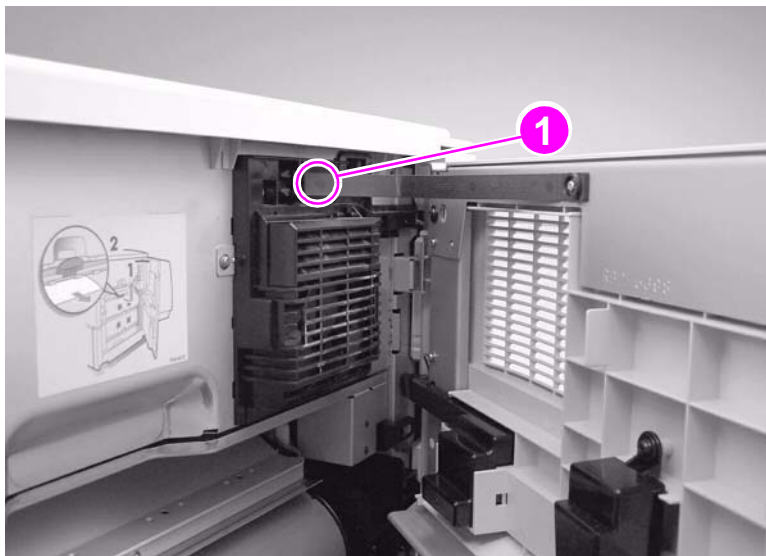
# Covers

The following covers can be removed from the printer:

- Right top cover
- Left top cover
- Front cover
- Right door
- Right lower cover
- Left door and diverter
- Left back cover
- Back cover
- Rail cover

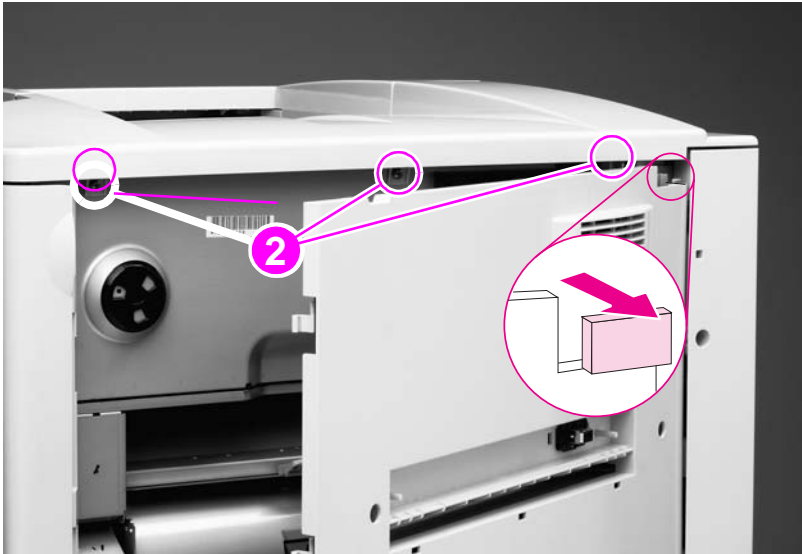
## Right top cover

- 1 Remove the control panel. See page 111.
- 2 Remove tray 1 if it is installed. See page 125.
- 3 Open the right door.
- 4 Release the door stop (callout 1).



**Figure 37.** Right top cover (1 of 2)

- 5 Remove three silver screws (callout 2).
- 6 Gently lift the right edge to release the tabs, and then lift the right top cover to the right.



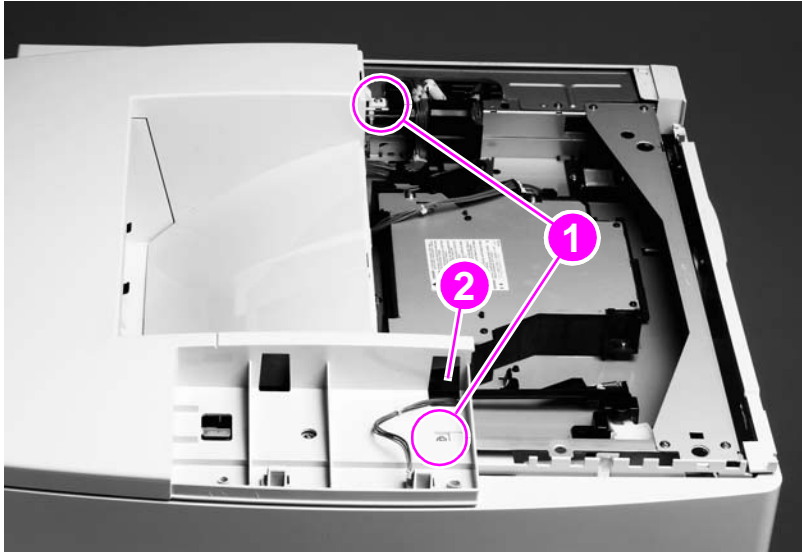
**Figure 38.** Right top cover (2 of 2)

### **To reinstall**

If the left top cover was removed (page 103), you must replace it before replacing the right top cover.

## Left top cover

- 1 Remove the control panel. See page 111.
- 2 Remove the right top cover. See page 101.
- 3 Remove two silver screws (callout 1).
- 4 Lift the left top cover up, and then pull it toward the right side of the printer to release two locating tabs (on the underside of the cover, at the left edge).



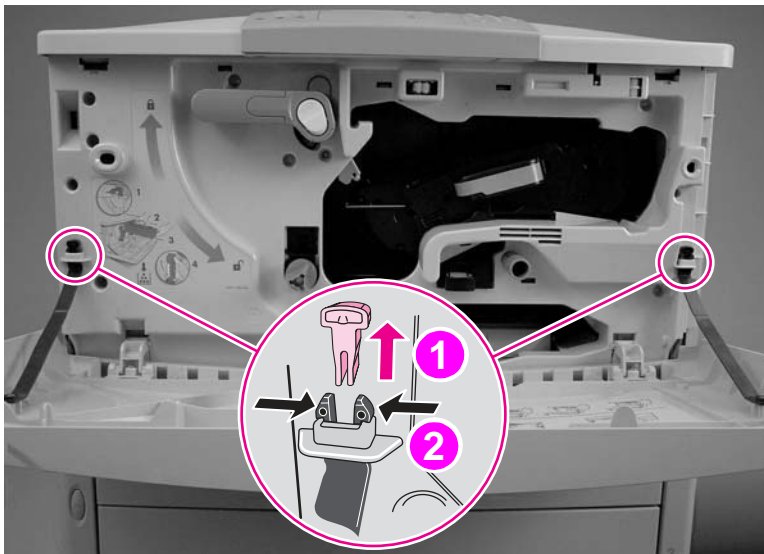
**Figure 39.** Left top cover

### To reinstall

- Be sure to feed the control-panel cable up and through the hole (callout 2) in the left top cover.
- Insert the three locating tabs (on the underside of the cover, at the left edge) into the locating holes on the top of the printer.

## Front cover

- 1 Remove two small, plastic retaining pins (callout 1).
- 2 Pinch and release two tabs (below the retaining cups, callout 2) on the end of each black retaining strap to release the strap ends.



**Figure 40.** Front cover (1 of 2)

- 3 Remove the front cover from the hinges (callout 3) by pulling up on the hinge tabs that are located below the front cover.

### Note

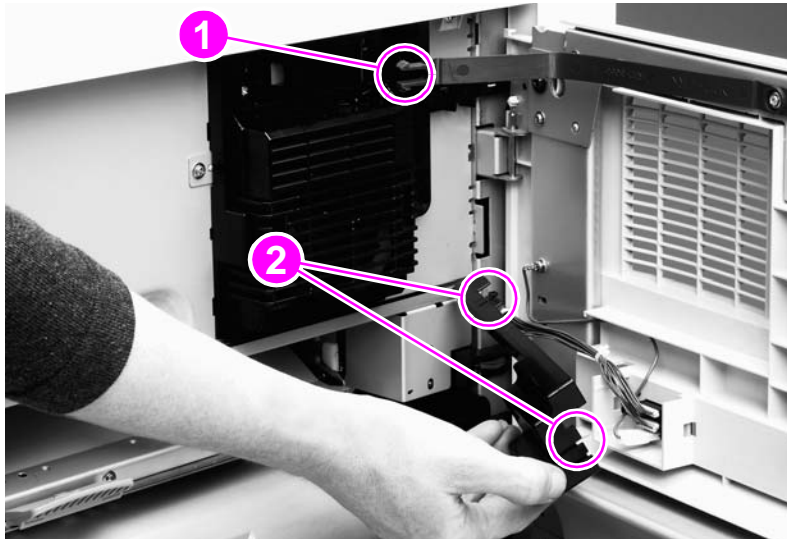
To gain access to the tabs, the front cover needs to be lifted away from the printer.



**Figure 41.** Front cover (2 of 2)

## Right door

- 1 Remove tray 1 if it is installed. See page 125.
- 2 Open the right door.
- 3 Pinch and then push the two tabs (callout 1) on the end of the black strap to release the strap ends. If you have difficulty, use needle-nose pliers.
- 4 Disconnect the four locator tabs (callout 2) on the cable cover, and then remove the cable cover.



**Figure 42.** Right door (1 of 2)

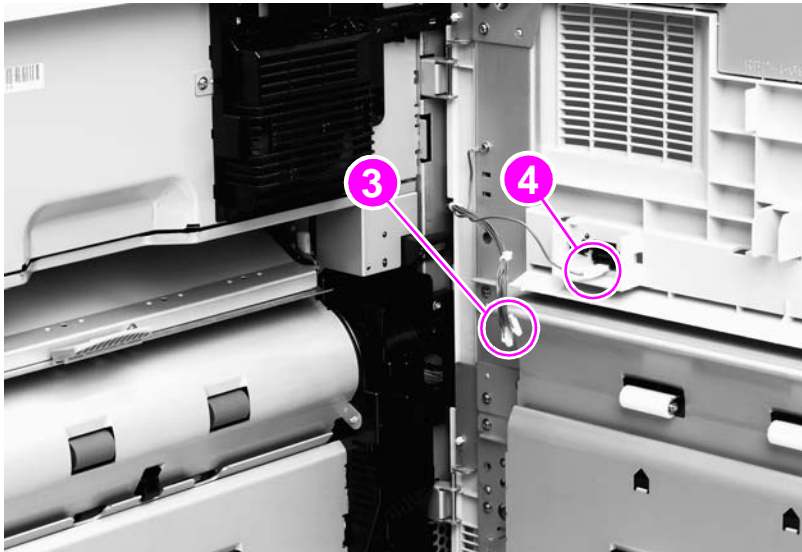
- 5 Unplug two multiple-wire cable connectors (callout 3).

---

### Note

Do not remove the single grounding cable (callout 4).

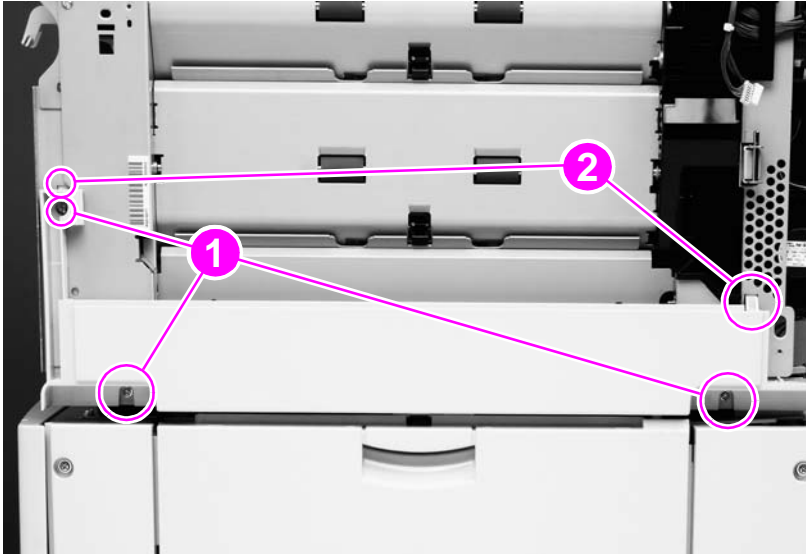
- 6 Lift the right door up and off of the two hinges, and remove it from the printer.



**Figure 43.** Right door (2 of 2)

## Right lower cover

- 1 Remove the following FRUs:
  - Right door. See page 105.
  - Back cover. See page 109.
  - Right and left rail covers. See page 110.
- 2 Remove three screws (callout 1).
- 3 Rotate the lower edge up to release two tabs (callout 2).
- 4 Remove the right lower cover.



**Figure 44.** Right lower cover

## Left door and diverter

### Note

If the 3,000-sheet stacker, 3,000-sheet stapler/stacker, or multifunction finisher is installed, move it away from the printer to gain access to the left door and diverter.

- 1 Open the left door.

### CAUTION

Make sure that you do not drop the pins (callout 1) that are on the end of each spring-loaded rod.

- 2 Grasp the two spring-loaded rods (callout 2), push them in toward the printer, and then pull them down and away from the printer.
- 3 Lift the left side of the door to a 45° angle and remove the left hinge (callout 3).
- 4 Slide the door toward the left and out of the right hinge (callout 4).

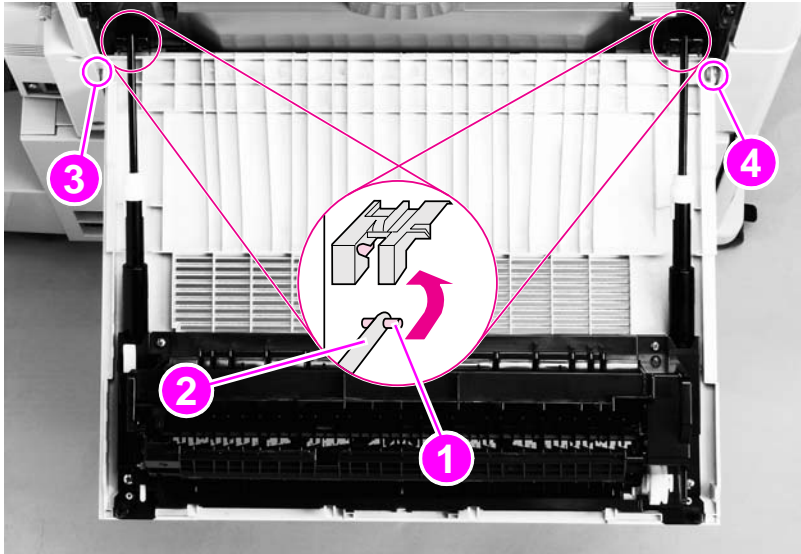


Figure 45.

Left door

## Left back cover

- 1 Remove the formatter. See page 135.
- 2 Remove three silver screws (not shown) from the left back cover.
- 3 Rotate the left back cover toward the back of the printer to release the three tabs (callout 1) on the left side of the cover and the two tabs (callout 2) on the right side of the cover.

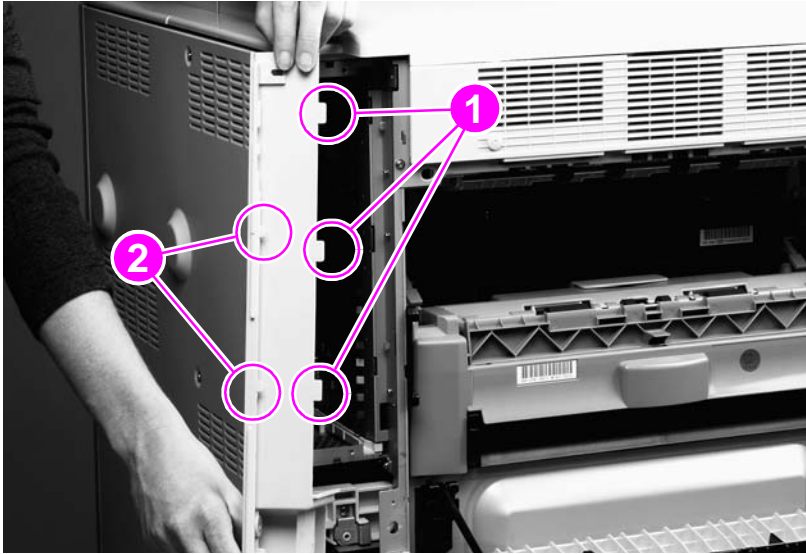


Figure 46.

Left back cover



## Back cover

- 1 Remove the power cord.
- 2 Remove two silver screws (callout 1) on the right back cover.
- 3 Remove seven gold screws (callout 2) on the back cover.
- 4 While facing the back of the printer, rotate the left edge out and then remove the back cover.

### CAUTION

Make sure that you do not damage the plastic that surrounds the power connection.

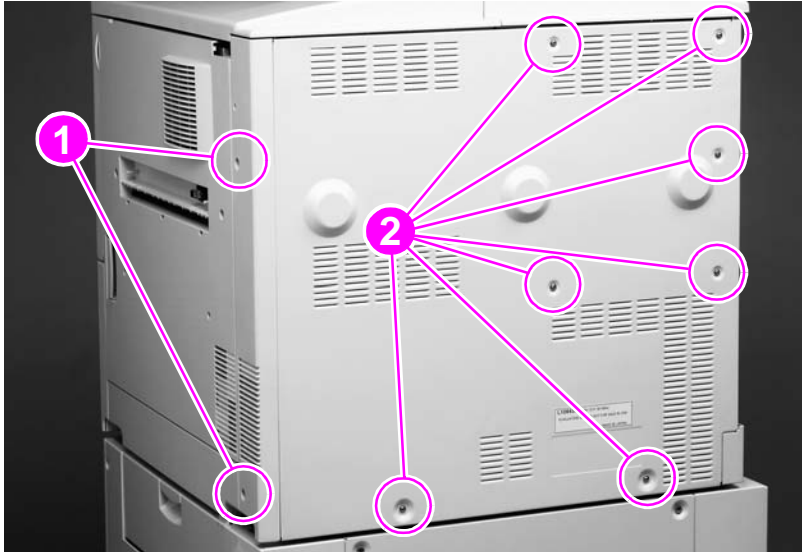


Figure 47.

Back cover

## Right and left rail covers

- 1 Remove trays 2 and 3. See page 121.
- 2 Remove two silver screws (callout 1) from the right rail cover.
- 3 Lift the upper tab (callout 2) to release it, and push the lower tab (callout 3) toward the right to release it.
- 4 Remove the right rail cover.
- 5 Remove the screw from the bottom left cover, and then remove the left rail cover.

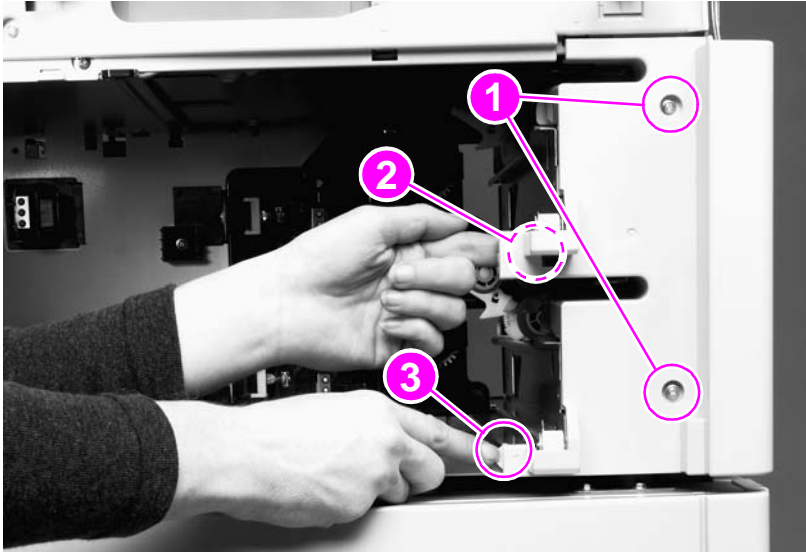


Figure 48.

Rail covers

## Top assemblies

Gain access to the following assemblies from the top of the printer:

- Control panel
- Laser/scanner assembly
- Delivery assembly
- Delivery-fan assembly
- Delivery-assembly fans and face-down-bin fan
- Delivery motor
- Cartridge release lever

### Control panel

- 1 Open the front cover.
- 2 Release the two tabs (callout 1) on the underside of the control panel by pulling them toward the front of the printer.
- 3 Tilt the front of the control panel up.
- 4 Unplug the cable connector on the underside of the control panel, and remove the control panel from the printer.

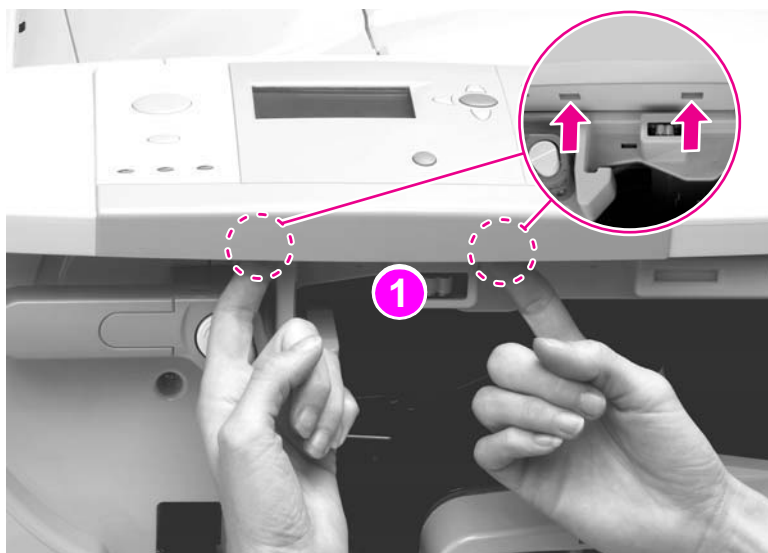
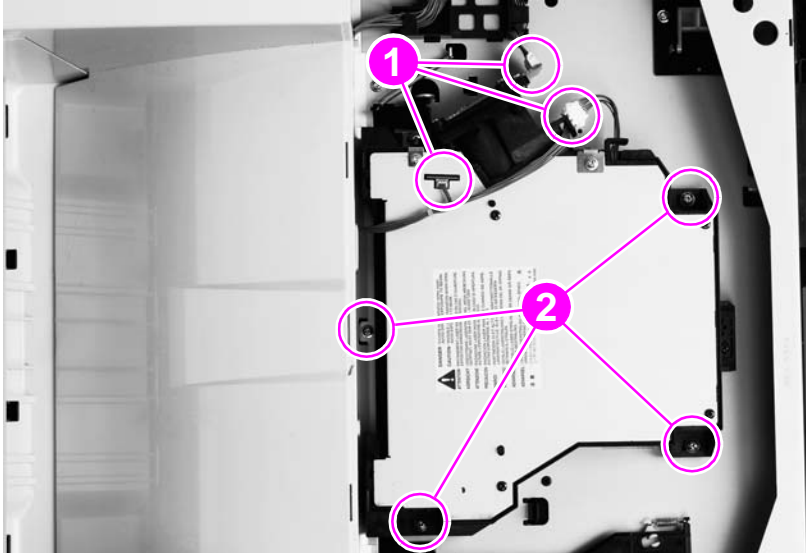


Figure 49.

Control panel

## Laser/scanner assembly

- 1 Remove the following FRUs:
  - Control panel. See page 111.
  - Right top cover. See page 101.
- 2 Unplug three cable connectors (callout 1).
- 3 Remove four long, gold screws (callout 2).
- 4 Lift the laser/scanner out of the printer.



**Figure 50.** Laser/scanner assembly

## Delivery assembly

- 1 Remove the following FRUs:
  - Right top cover. See page 101.
  - Left top cover. See page 103.
  - Left back cover. See page 108.
  - Control panel. See page 111.
- 2 Open the left door.
- 3 Face the top of the printer from the left side.
- 4 Unplug one cable connector (callout 1).
- 5 Remove four gold screws (callout 2) and two silver screws (callout 3).
- 6 Lift out the delivery assembly.

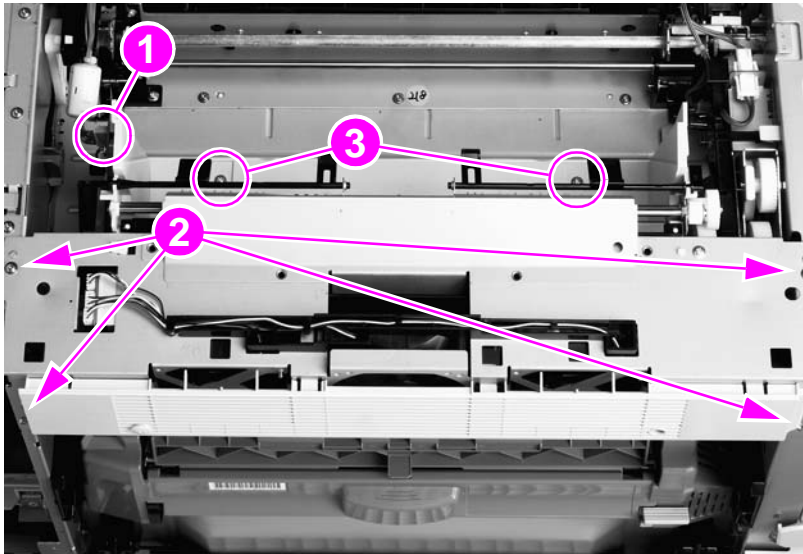


Figure 51.

Delivery assembly

## Delivery-fan assembly

- 1 Remove the delivery assembly. See page 113.
- 2 Gently remove the two sensor flags (callout 1) from the holders.
- 3 Unplug three cable connectors (callout 2).

### CAUTION

Make sure that you remove and replace the cable connectors carefully.

- 4 Remove one silver screw (callout 3).
- 5 Grasp the middle fan, lift the right side of the metal casing, and then slide the metal casing to the left to release the tab (callout 4).
- 6 Slide the fan assembly to the right, and gently separate the two parts.

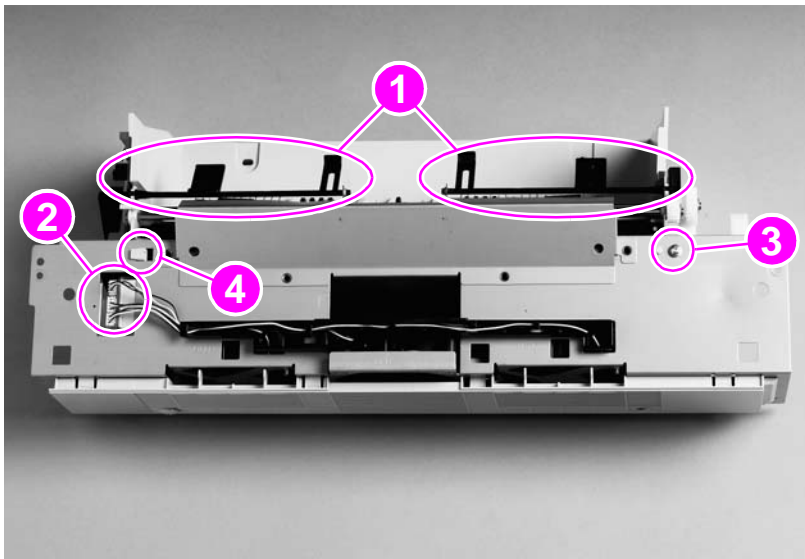


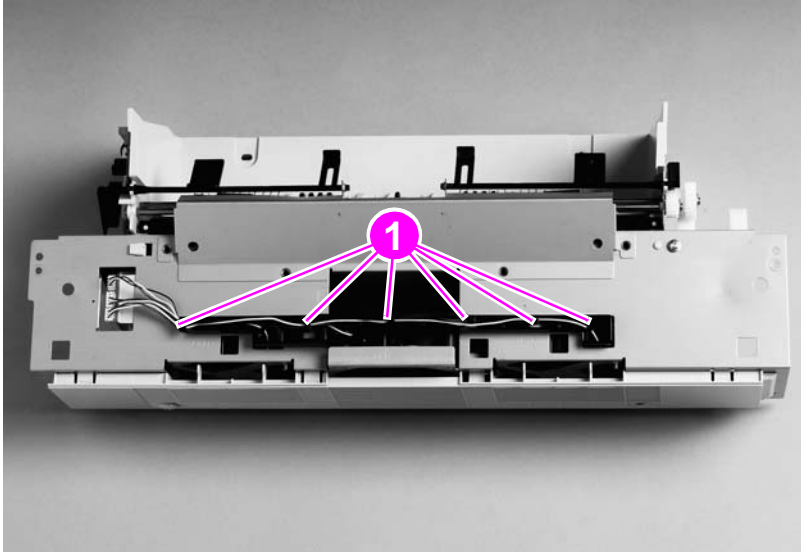
Figure 52. Delivery-fan assembly

### To reinstall

Make sure to install the sensor flags with the correct sides facing up.

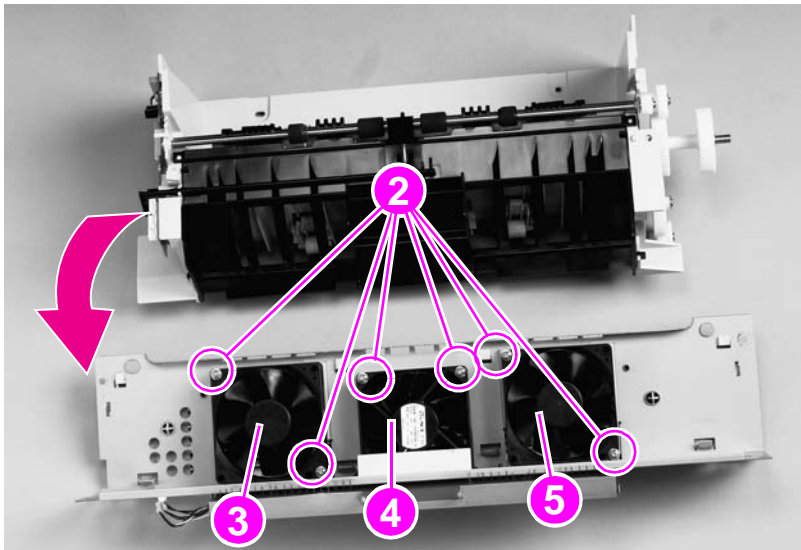
## Delivery-assembly fans and face-down-bin fan (fans 3, 6, and 4)

- 1 Remove the fan assembly. See page 114.
- 2 Carefully unwind the fan cables from the cable guides (callout 1).



**Figure 53.** Delivery-assembly fans and face-down-bin fan (1 of 2)

- 3 Remove six gold screws (callout 2).
- 4 Remove the three fans:
  - Fan 3: delivery-assembly back fan (callout 3)
  - Fan 6: face-down-bin fan (callout 4)
  - Fan 4: delivery-assembly front fan (callout 5)



**Figure 54.** Delivery-assembly fans and face-down-bin fan (2 of 2)

### To reinstall

Make sure to replace each fan in the correct airflow position.

## Delivery motor

- 1 Remove the following FRUs:
  - Right top cover. See page 101.
  - Left top cover. See page 103.
  - Control panel. See page 111.
  - Delivery assembly. See page 113.

### WARNING!

The PCA board is fragile. To prevent damage, hold the PCA board when you remove or plug in the connector.

- 2 Hold the PCA board, and unplug one cable connector (callout 1).
- 3 Remove four screws (callout 2).

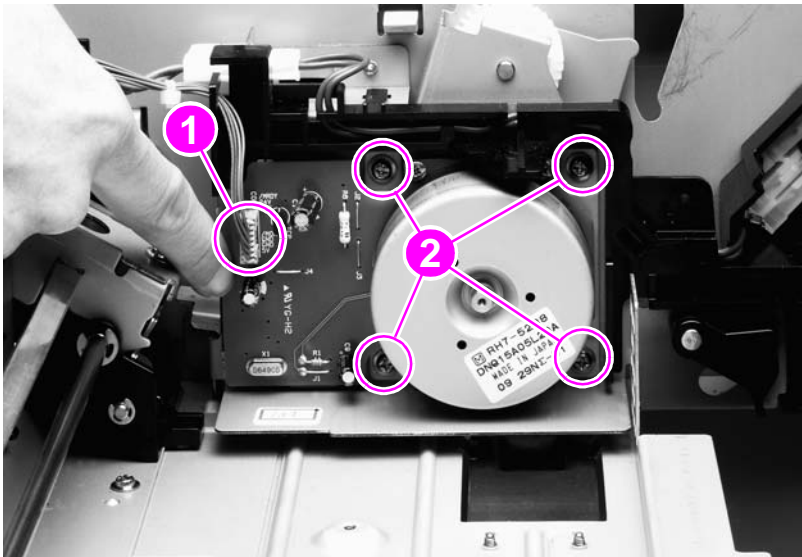


Figure 55.

Delivery motor



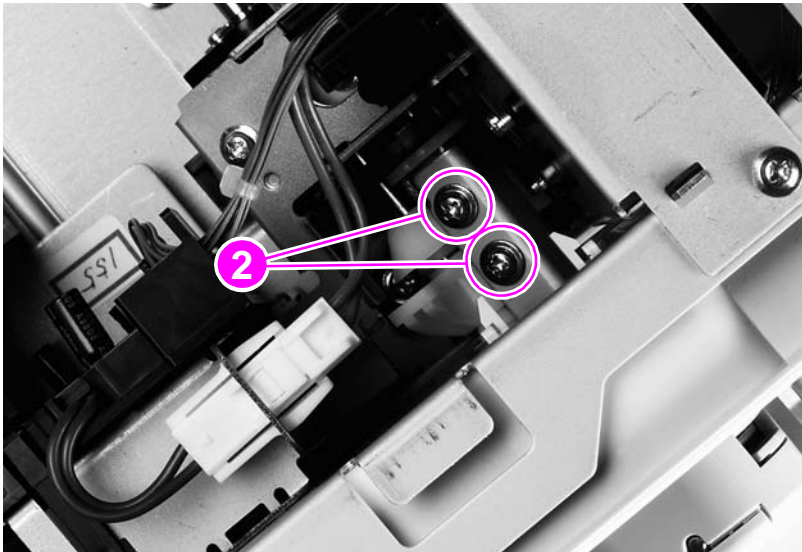
## Cartridge release lever

- 1 Remove the following FRUs:
  - Right top cover. See page 101.
  - Left top cover. See page 103.
  - Control panel. See page 111.
- 2 Open the front cover.
- 3 Rotate the cartridge release lever downward.



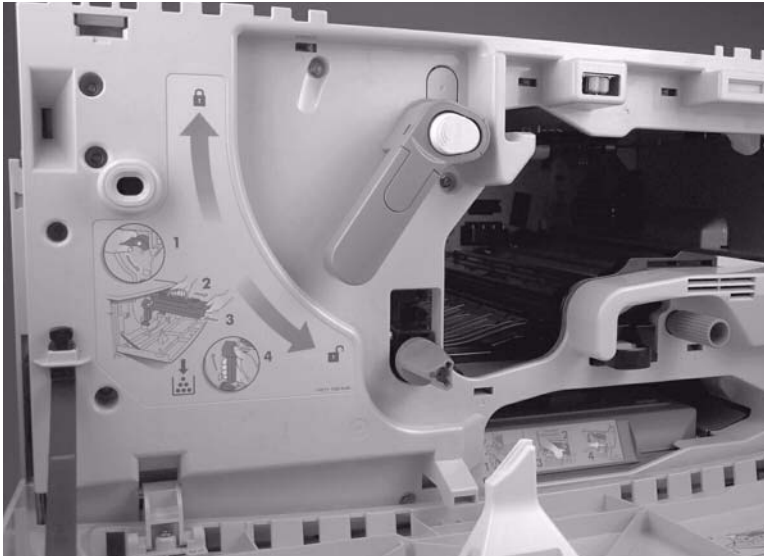
**Figure 56.** Cartridge release lever (1 of 3)

- 4 Remove the print cartridge. See page 119.
- 5 Rotate the cartridge release lever to a 45° angle.
- 6 Face the top of the printer, and remove two long screws (callout 2).



**Figure 57.** Cartridge release lever (2 of 3)

- 7 Rotate the cartridge release lever to the vertical, unlocked position.



**Figure 58.** Cartridge release lever (3 of 3)

- 8 Face the front of the printer, and slide the cartridge release handle away from the front of the printer.

## Front assemblies

Gain access to the following assemblies from the front of the printer:

- Print cartridge
- Transfer-roller assembly
- Tray 2 and tray 3
- Rollers (pickup, feed, and separation)
- Fuser-jam-removal knob
- Registration-jam-removal knob

### Print cartridge

#### WARNING!

To prevent damage, do not expose the print cartridge to light. Put it in its print cartridge bag, or, if the bag is not available, cover the print cartridge with a piece of paper.

- 1 Open the front cover of the printer.
- 2 Rotate the cartridge release lever (callout 1) downward.
- 3 Grasp the front handle (callout 2) with one hand, and pull the print cartridge out of the printer until the top handle (callout 3) is visible.
- 4 Grasp the top handle with your other hand, and continue pulling the print cartridge until it is out of the printer.

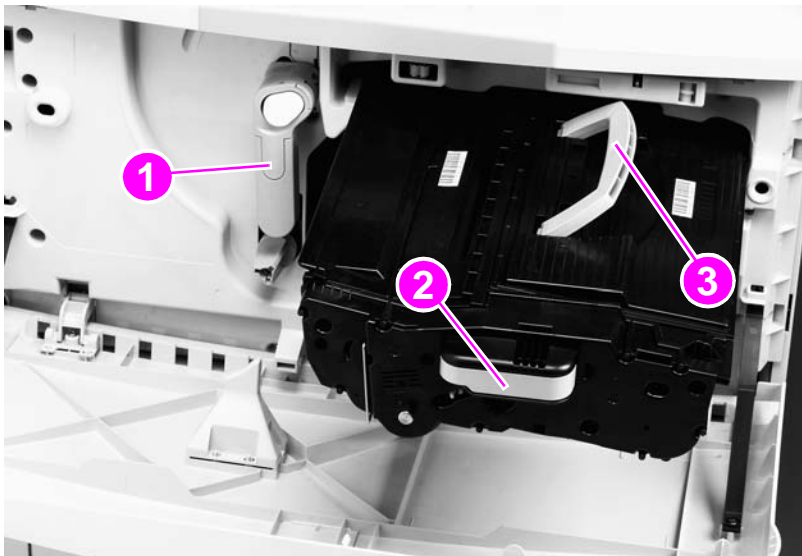


Figure 59. Print cartridge

#### To reinstall

- Make sure that the transfer roller assembly (page 120) is installed before you reinstall the print cartridge.
- Align the print cartridge with the print cartridge guides, and make sure that you insert it completely.
- Press and hold the white button (on the green lever), and rotate the green lever clockwise until it locks into place.

## Transfer-roller assembly

### CAUTION

Do *not* touch the black transfer roller. Skin oils can damage the roller.

- 1 Open the front cover.
- 2 Unlock the print cartridge by rotating the large, green lever (callout 1) downward.
- 3 Press the blue tab (callout 2), and slowly pull the transfer roller assembly out of the printer.
- 4 Lift the assembly upward to release the catch on the underside, and remove the assembly from the printer.

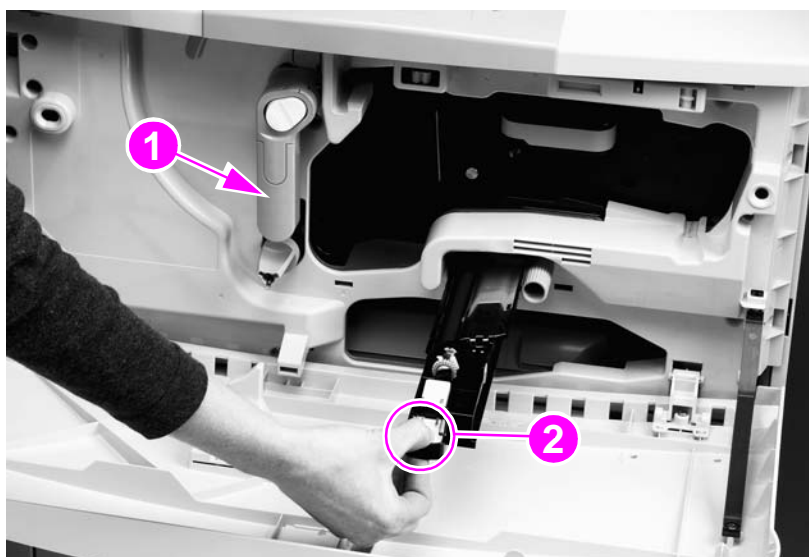


Figure 60. Transfer-roller assembly

### To reinstall

- Make sure that the transfer roller is completely inserted and latched.

## Tray 2 and tray 3 (interchangeable)

- 1 Slide the tray open until it stops.
- 2 Grasp the sides of the tray.
- 3 Lift the tray up and remove it.



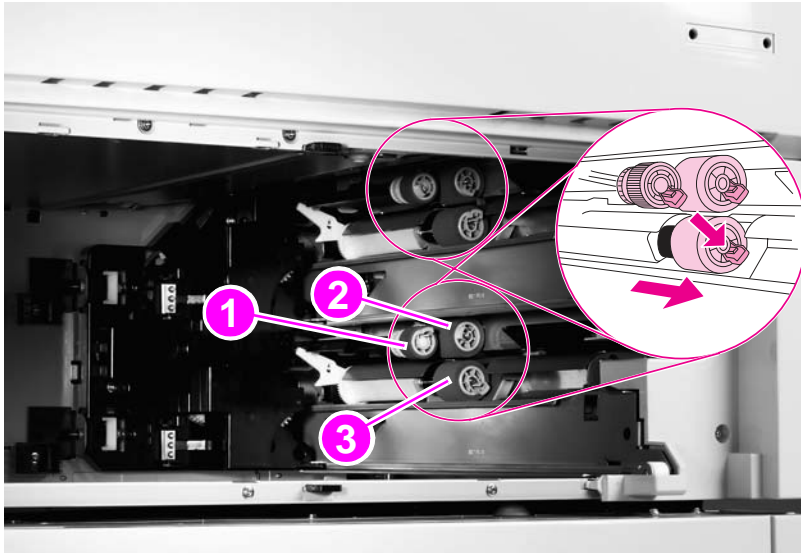
**Figure 61.** Tray 2 or tray 3

## Rollers (pickup, feed, or separation)

### CAUTION

Do not remove the torque limiter from behind the separation roller. If the black spacer comes off, return it to the shaft, metal-edge first.

- 1 Remove tray 2 or tray 3. See page 121.
- 2 Locate the appropriate roller on the upper-right side of the tray cavity. The pickup roller (callout 1) is a type 1 roller. The feed roller (callout 2) and the separation roller (callout 3) are type 2 rollers.
- 3 Pinch the tab on the end of each roller to release it.
- 4 Slide the roller off of the shaft.



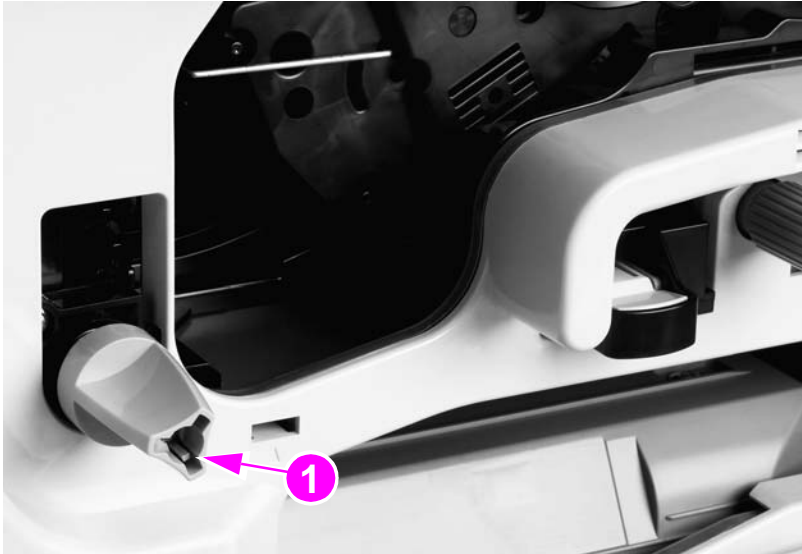
**Figure 62.** Rollers (pickup, feed, or separation)

## Fuser-jam-removal knob

### CAUTION

Make sure not to drop any of the internal parts from the fuser-jam-removal knob, and pay careful attention to the original location of the parts.

- 1 Open the front cover.
- 2 Release the tab (callout 1) with a small flatblade screwdriver.
- 3 Slowly remove the knob and internal parts (spring, pin, and bushing).



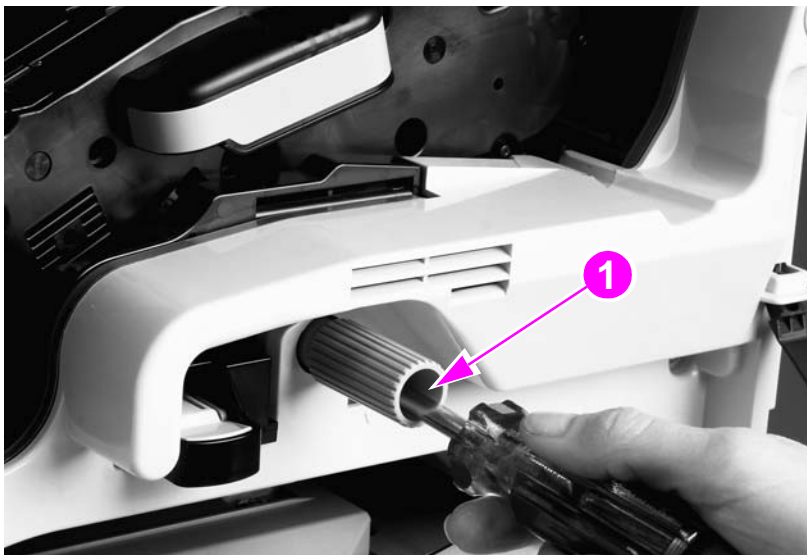
**Figure 63.** Fuser-jam-removal knob

### To reinstall

Reinstall any dropped parts in the following order: pin, spring (spring-side facing in), bushing, knob.

## Registration-jam-removal knob

- 1 Open the front cover.
- 2 Hold the registration-jam-removal knob firmly, and remove the silver screw inside the knob (callout 1).
- 3 Pull the knob off of the printer.



**Figure 64.** Registration-jam-removal knob

### To reinstall

Make sure that you align the knob with the notch on the post.



## Right assemblies

Gain access to the following assemblies from the right side of the printer:

- Multipurpose tray (tray 1)
- Paper-input unit (PIU)
- Registration assembly
- Transfer-guide assembly

### Tray 1

- 1 Unlock two locking pins (one shown, callout 1) at the bottom of tray 1.
- 2 Gently pull the bottom of the tray away from the printer.
- 3 Open the right door, and lift tray 1 off of the door.

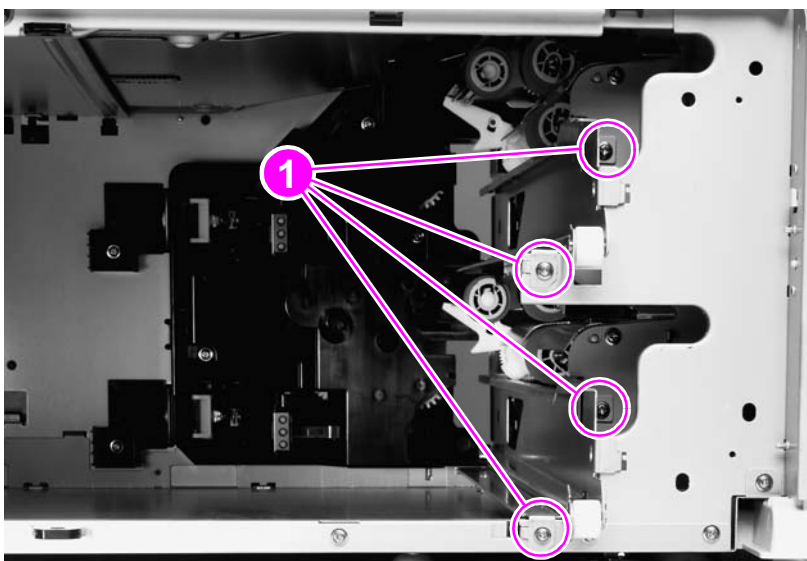


Figure 65.

Tray 1

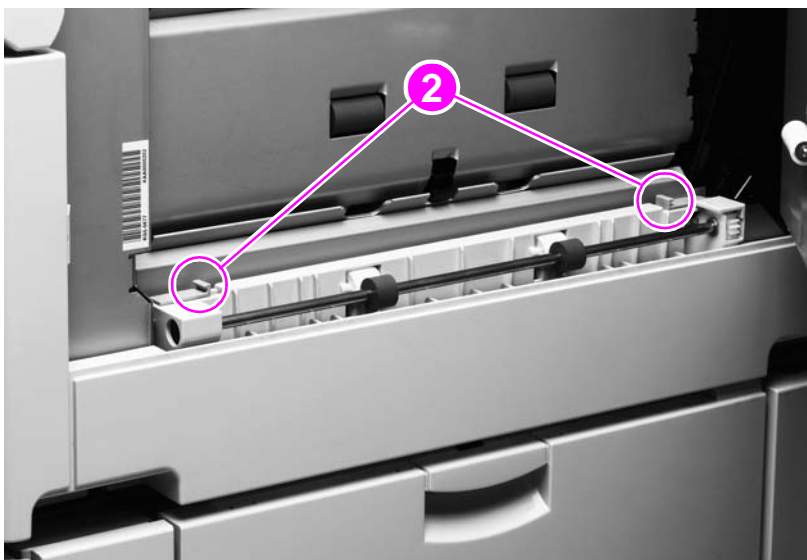
## Paper-input unit (PIU)

- 1 Remove the following FRUs:
  - Right door. See page 105.
  - Back cover. See page 109.
  - Right rail cover. See page 110.
  - Tray 2 and tray 3. See page 121.
- 2 Remove four gold screws (callout 1), two from each rail.
- 3 Pull the rails out from the front of the printer.



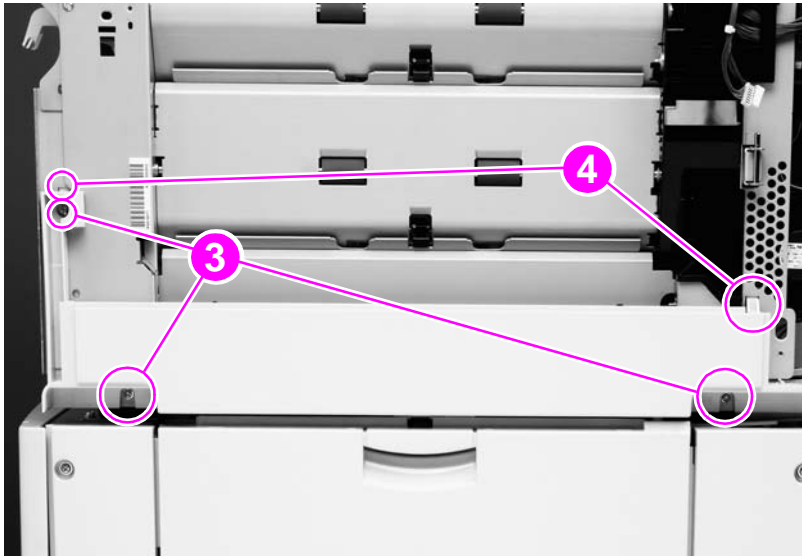
**Figure 66.** Paper-input unit (1 of 5)

- 4 Face the right side of the printer.
- 5 If tray 4 is installed, remove the paper-connecting unit by sliding two levers (callout 2) toward the center of the unit.



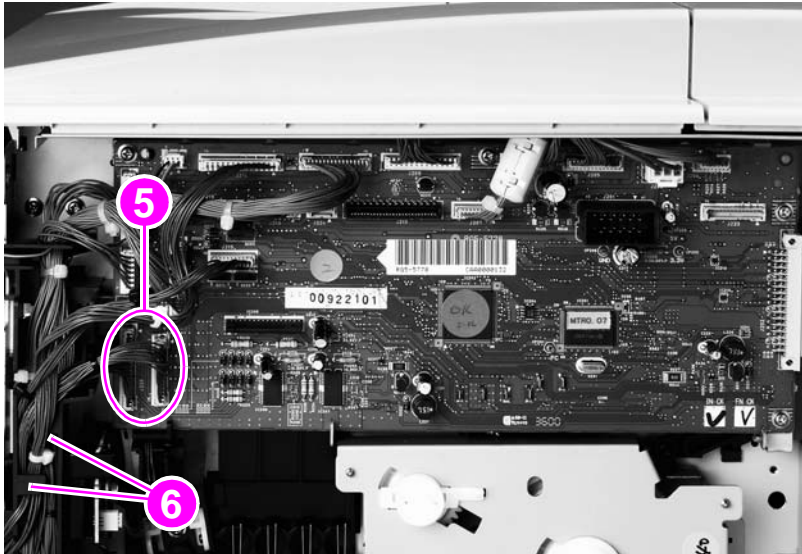
**Figure 67.** Paper-input unit (2 of 5)

- 6 Remove three screws (callout 3) from the right lower cover.
- 7 Rotate the lower edge up to release two tabs (callout 4).
- 8 Remove the right lower cover.



**Figure 68.** Paper-input unit (3 of 5)

- 9 Face the back of the printer.
- 10 Remove the J-220 and J-221 cable connectors (callout 5) from the DC controller, and carefully unwind the cables from the cable guides (callout 6).



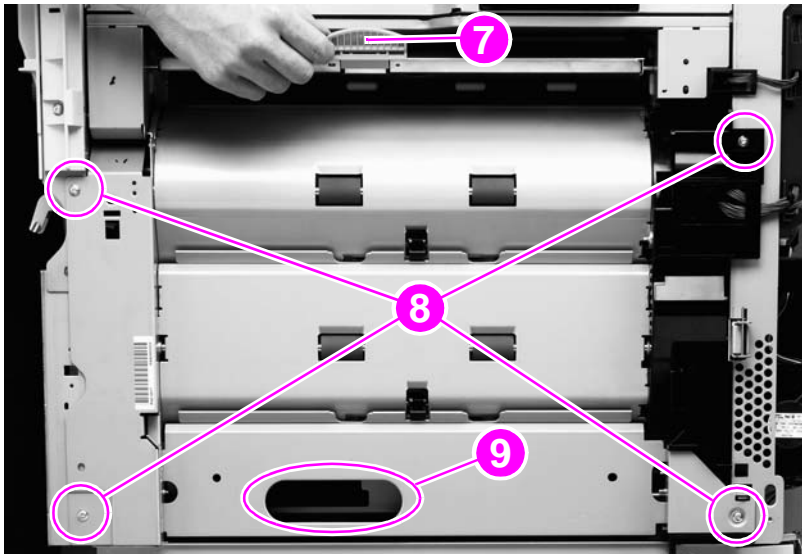
**Figure 69.** Paper-input unit (4 of 5)

- 11 Face the right side of the printer.
- 12 Push the green registration handle (callout 7) down slightly, and then pull it out to gain access to the PIU.
- 13 Remove four silver screws (callout 8).

**CAUTION**

The PIU is heavy.

- 14 Grasp the PIU handle (callout 9), and lift the PIU out.



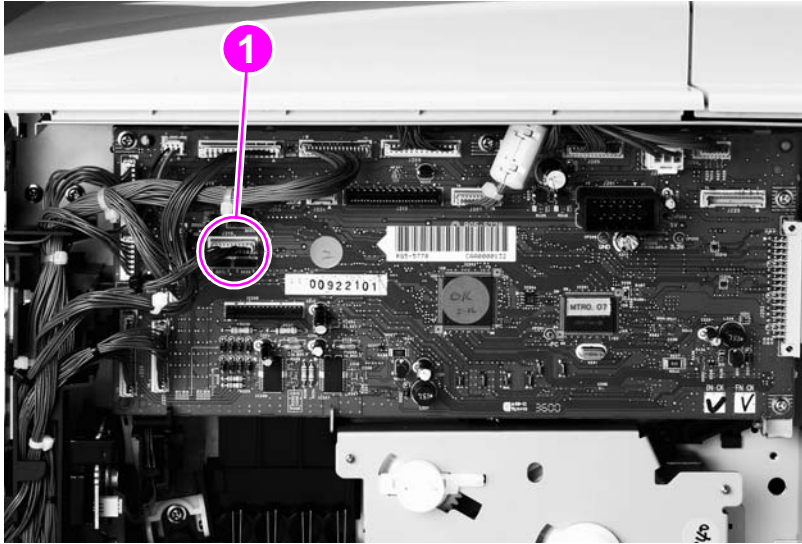
**Figure 70.** Paper-input unit (5 of 5)

**To reinstall**

- Make sure that the green handle on the registration assembly is up before reinstalling the PIU.
- Reinstall the right lower cover (figure 68 on page 127) before the right rail cover (figure 48 on page 110).

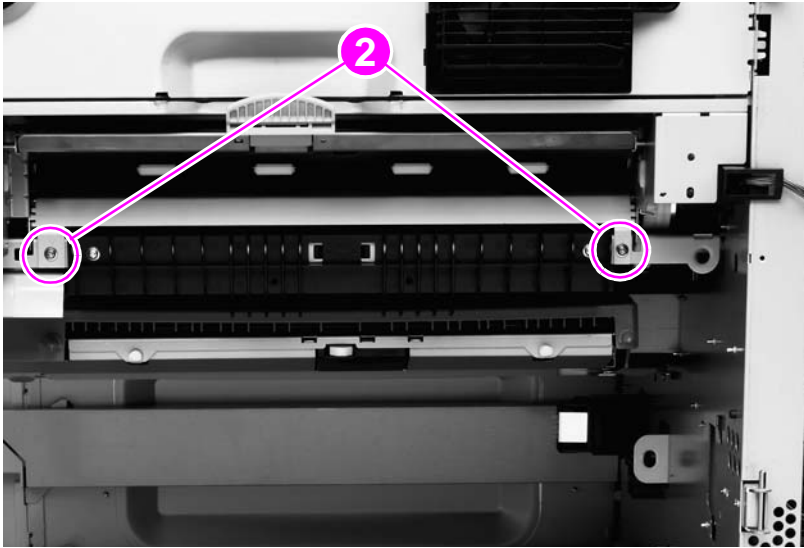
## Registration assembly

- 1 Remove the following FRUs:
  - Right door. See page 105.
  - Back cover. See page 109.
  - Print cartridge. See page 119.
  - Tray 2 and tray 3. See page 121.
  - Registration-jam-removal knob. See page 124.
  - PIU. See page 126.
- 2 Unplug the J-215 cable connector (callout 1) from the DC controller.



**Figure 71.** Registration assembly (1 of 2)

- 3 Remove two gold screws (callout 2) from the registration assembly.
- 4 Lift the registration assembly up slightly, and then rotate it downward until you can pull it from the chassis.



**Figure 72.** Registration assembly (2 of 2)

### To reinstall

**WARNING!**

Make sure not to scrape the top of the registration assembly against the chassis. Small, black, plastic pieces on top of the registration assembly can be damaged easily.

## Transfer-guide assembly

- 1 Remove the following FRUs:
  - Right door. See page 105.
  - Back cover. See page 109.
  - Transfer-roller assembly. See page 120.
  - Tray 2 and tray 3. See page 121.
  - PIU. See page 126.
  - Registration assembly. See page 129.
  - Fuser assembly. See page 134.
  - Feed-drive assembly. See page 142.

### Note

You do *not* need to remove the drum motor.

- 2 Remove two gold screws (callout 1) from the transfer-guide assembly.
- 3 Push in and release the two plastic tabs (callout 2) to the right of each screw.
- 4 Lift the transfer-guide assembly up, rotate it forward slightly, and then pull it out of the printer.

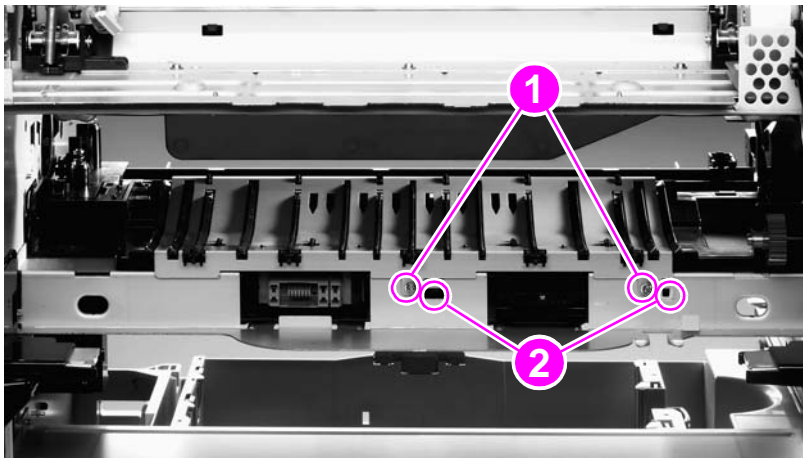


Figure 73. Transfer-guide assembly

## To reinstall

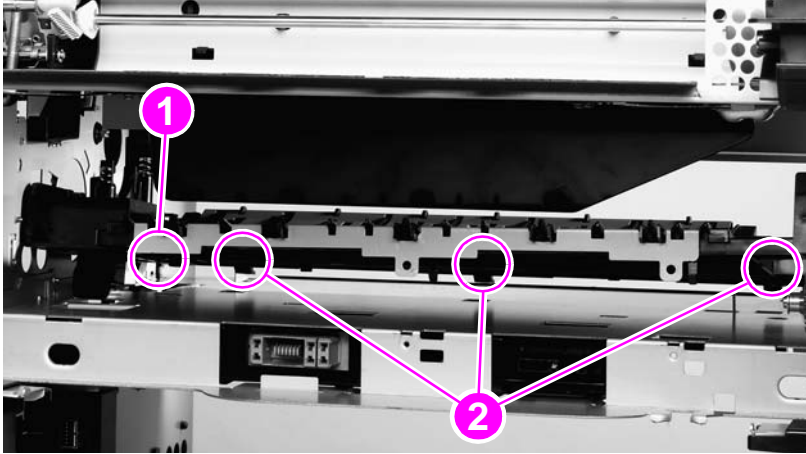
- 1 Face the right side of the printer, and reinsert the pin (callout 1) in the back, left corner.
- 2 Rotate the transfer guide assembly upward, and slide the three back tabs (callout 2) into place.

---

### CAUTION

---

You must confirm that the tabs are securely in place before proceeding. Face the left side of the printer, and check the tabs.



**Figure 74.** Reinstalling the transfer-guide assembly



## Left assemblies

### Note

If the 3,000-sheet stacker, 3,000-sheet stapler/stacker, multifunction finisher, or 8-bin mailbox is installed, move it away from the printer before beginning repairs to the left side of the printer.

Gain access to the following assemblies from the left side of the printer:

- Duplexer
- Fuser assembly

### Duplexer

- 1 Lift the left door handle, and then open the left door.
- 2 Push the green tab (callout 1) downward. This releases the duplexer and moves it forward slightly.
- 3 Pull the center handle (callout 2), and slide the duplexer from the printer until it locks.

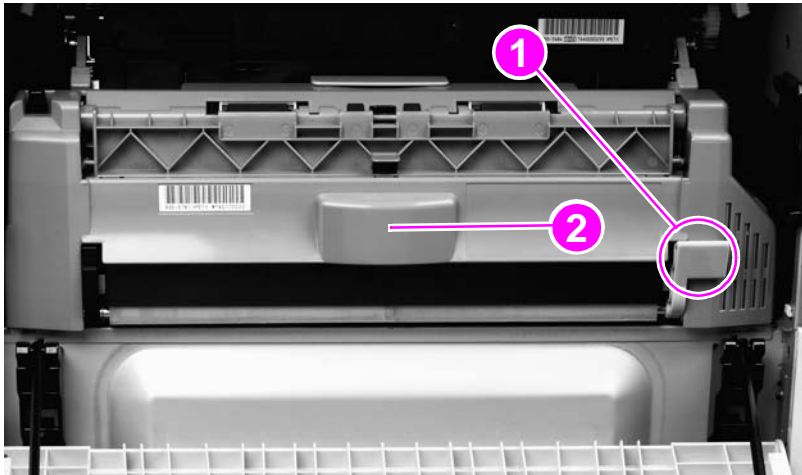


Figure 75.

### Duplexer (1 of 2)

- 4 Grasp the two handles that are on the sides of the duplexer.
- 5 Lift the duplexer up (to release two underside catches) and remove it.



Figure 76.

### Duplexer (2 of 2)

## Fuser assembly

### WARNING!

The fuser assembly can be hot. Use caution when removing it.

### Note

If an optional output accessory is installed, remove it.

If a duplexer is installed, remove it. See page 133.

- 1 Lift the left door handle, and then open the left door.
- 2 Rotate the two blue locking tabs (callout 1) toward each other and downward to release them.

### Note

Do not release the T-shaped envelope levers (callout 2).

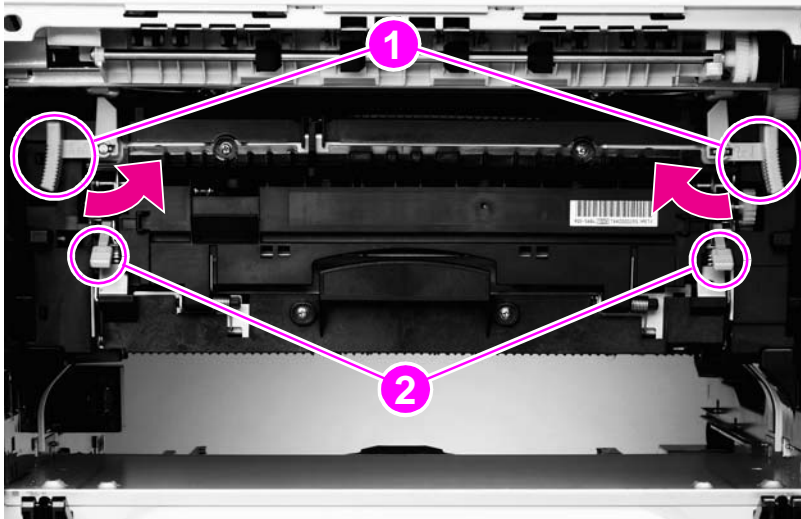


Figure 77. Fuser assembly (1 of 2)

- 3 Pull the center handle (callout 3) to rotate the fuser assembly upward slightly, and then slide the fuser assembly outward until it locks.

### WARNING!

The fuser assembly is heavy. Grasp the blue handle firmly before attempting to lift the fuser assembly.

- 4 Firmly grasp the blue handle (callout 4), and lift the fuser assembly up.

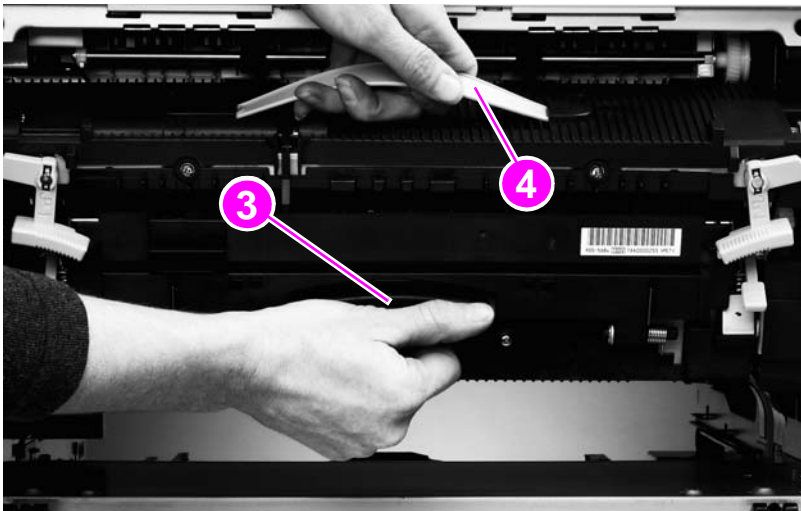


Figure 78. Fuser assembly (2 of 2)

## Back assemblies

Gain access to the following assemblies from the back of the printer:

- Formatter
- Low-voltage power supply (LVPS)
- High-voltage power supply (HVPS)
- DC controller
- Toner-sensor contact assembly
- Cartridge memory PCA
- Drum motor
- Feed-drive assembly
- Power-supply fan (fan 1)
- Cartridge fan (fan 5)
- Controller fan (fan 2)

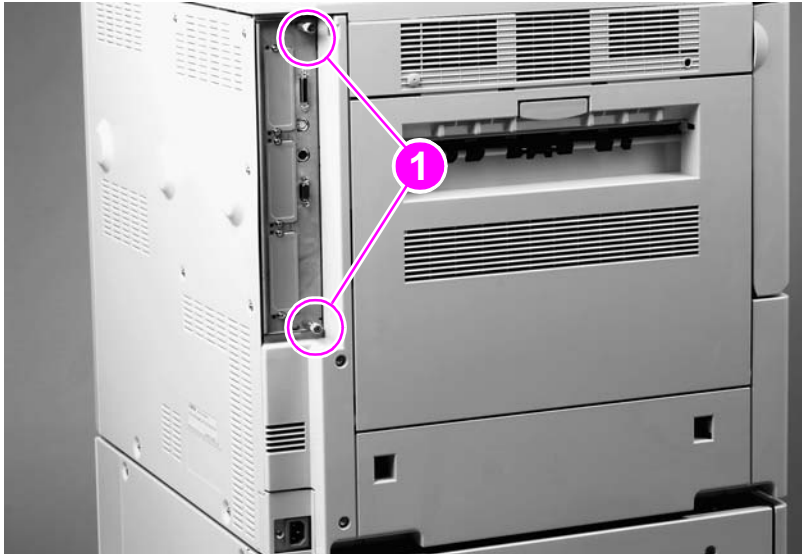
### Formatter

#### **WARNING!**

The formatter has sharp edges.



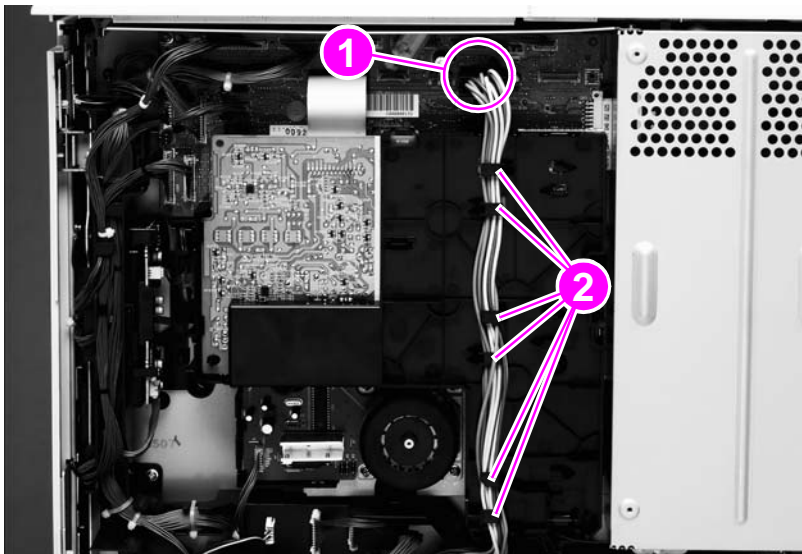
- 1 Turn the printer off.
- 2 Disconnect all cables from the formatter.
- 3 Loosen the two thumb screws (callout 1).
- 4 Grasp the thumb screws, and slide the formatter out of the printer.
- 5 Place the formatter on an ESD mat.



**Figure 79.** Formatter (HP LaserJet 9000 shown)

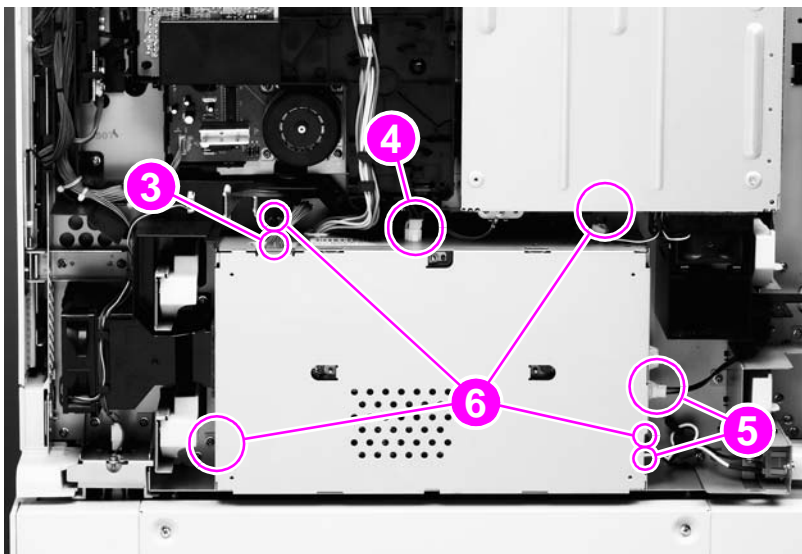
## Low-voltage power supply

- 1 Remove the back cover. See page 109.
- 2 Remove the large cable connector (callout 1) from the DC controller.
- 3 Unroute the cable from the cable guides (callout 2).



**Figure 80.** Low-voltage power supply (1 of 2)

- 4 Unplug one standard cable connector (callout 3) from the low-voltage power supply.
- 5 Unplug one molex cable connector (callout 4) by pulling and releasing the tab on the side of the connector.
- 6 Unplug two molex cable connectors (callout 5) by pressing and releasing the tabs on the side of the connectors.
- 7 Remove four gold screws (callout 6).
- 8 Remove the low-voltage power supply.



**Figure 81.** Low-voltage power supply (2 of 2)

## High-voltage power supply

- 1 Remove the back cover. See page 109.

### WARNING!

The flat ribbon cable is fragile. Do not bend or fold it.



- 2 Remove the flat ribbon cable connector (callout 1) from the DC controller.
- 3 Unplug the low-voltage power-supply cable connector (callout 2) from the DC controller, and unroute the cable from the cable guides (callout 3).

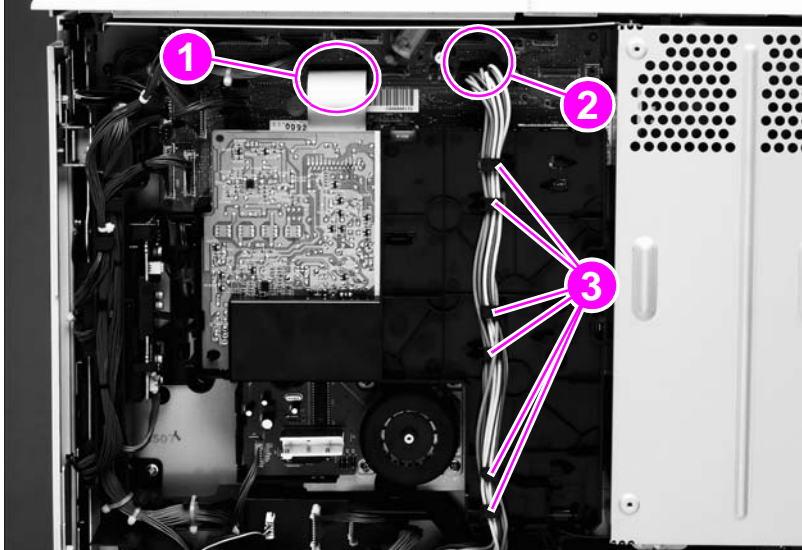


Figure 82. High-voltage power supply (1 of 2)

- 4 Remove three silver screws (callout 4).
- 5 Push the black locking tab (callout 5) away from the high-voltage power supply, and remove the high-voltage power supply.

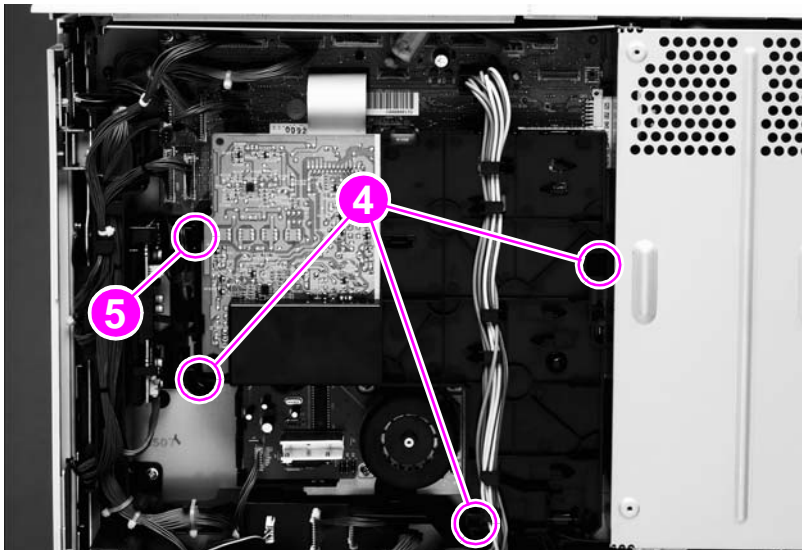


Figure 83. High-voltage power supply (2 of 2)



## DC controller

### CAUTION

The DC controller is sensitive to electrostatic discharge (ESD). Always perform service work at an ESD-protected workstation, or use an ESD mat. For further precautions, see page 99.

- 1 Remove the following FRUs:
  - Back cover. See page 109.
  - Formatter. See page 135.
  - High-voltage power supply. See page 137.

### CAUTION

Use caution when removing cable connectors J-215, J-219, and J-213. Do not bend or break the component that is adjacent to these cable connectors.

- 2 Remove 17 cable connectors (callout 1).

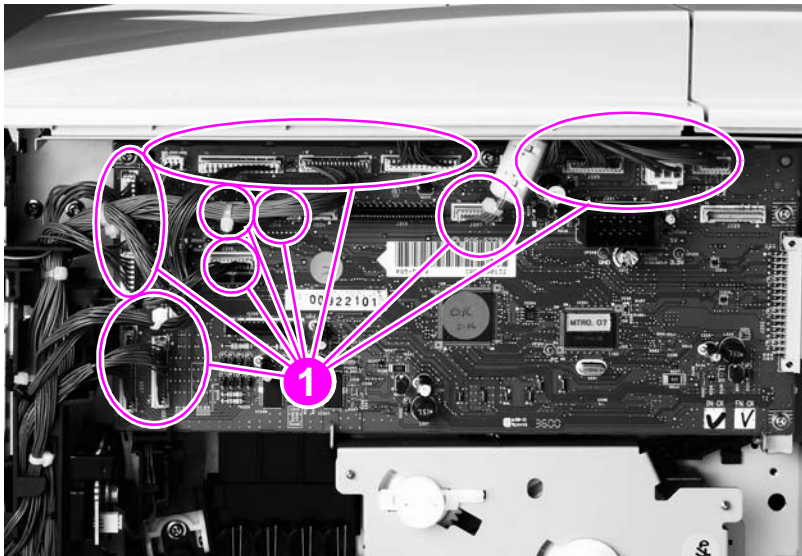
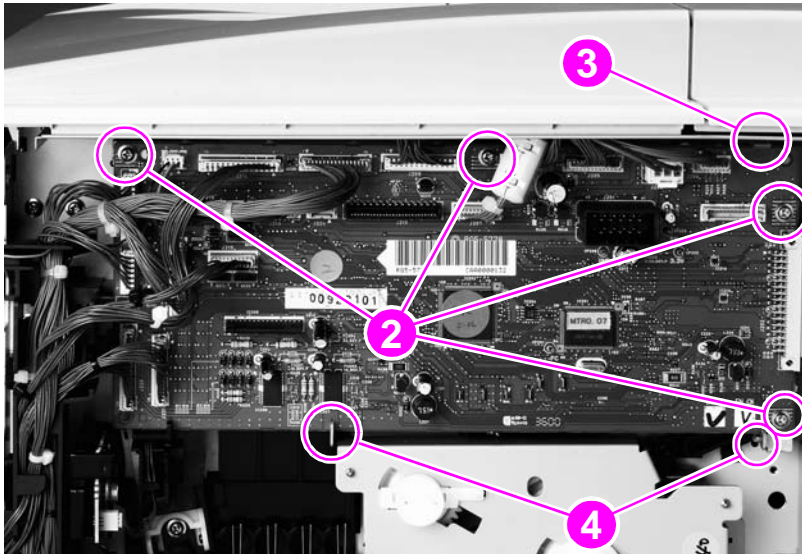


Figure 84.

DC controller (1 of 2)

- 3 Remove four gold screws (callout 2).
- 4 Release the small tab (callout 3), and rotate the top edge of the DC controller away from the printer.
- 5 Remove the DC controller from the two metal holders (callout 4).



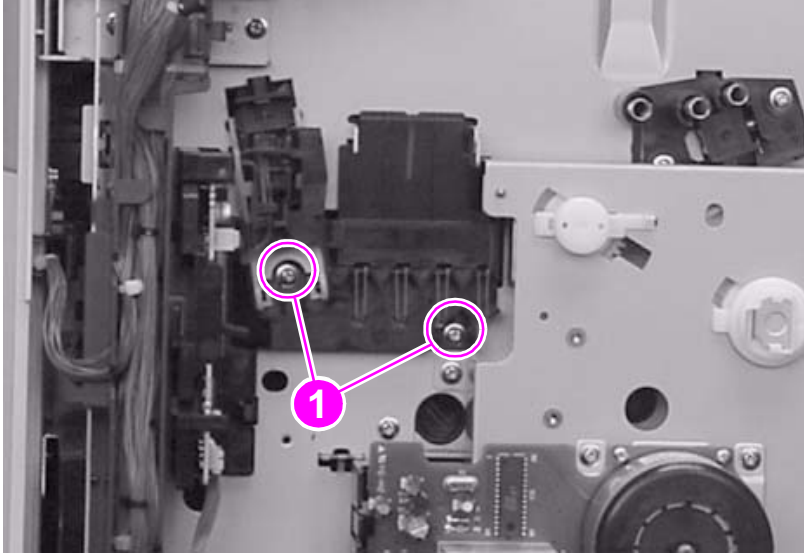
**Figure 85.**

**DC controller (2 of 2)**



## Toner-sensor contact assembly

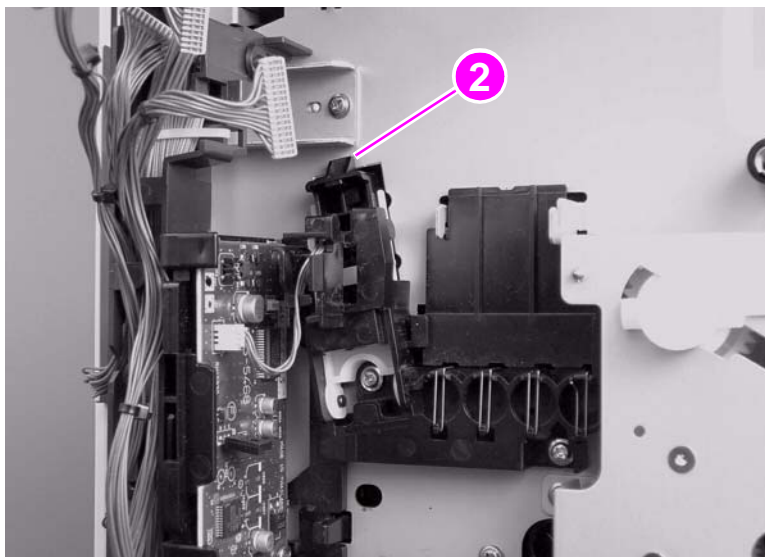
- 1 Remove the following FRUs:
  - Back cover. See page 109.
  - High-voltage power supply. See page 137.
  - DC controller. See page 138.
- 2 Remove two screws (callout 1).
- 3 Remove the toner-sensor contact assembly.



**Figure 86.** Toner-sensor contact assembly

### To reinstall

Make sure that the top tab (callout 2) is on the outside of the chassis.



**Figure 87.** Reinstalling the toner-sensor contact assembly



## Drum motor

- 1 Remove the back cover. See page 109.
- 2 Remove the HVPS. See page 137.
- 3 Unplug one cable connector (callout 1).
- 4 Remove four gold screws (callout 2).
- 5 Pull the drum motor away from the printer.

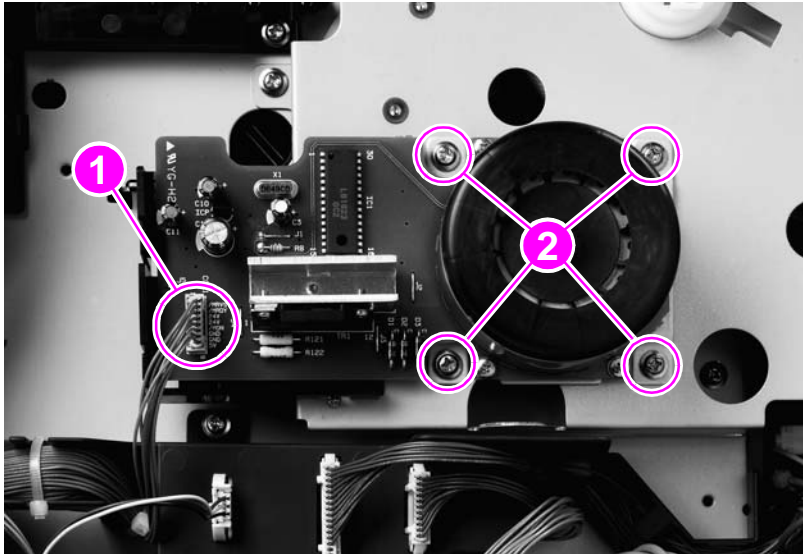
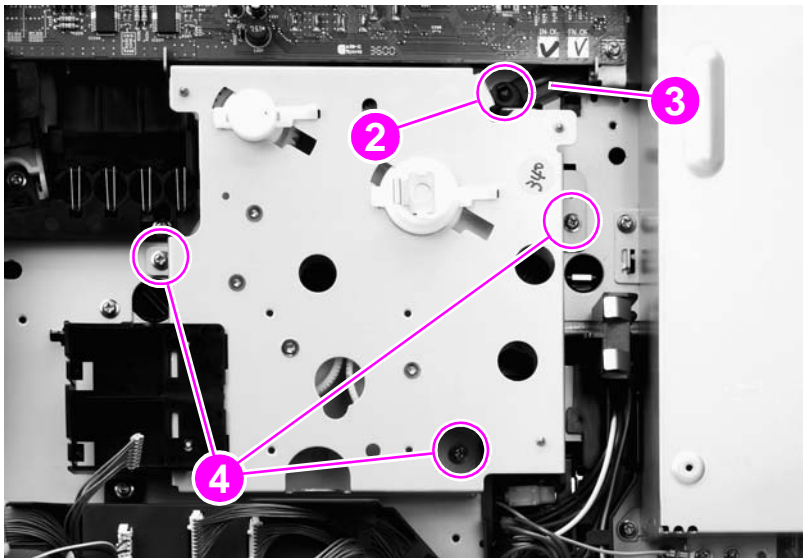


Figure 88.

Drum motor

## Feed-drive assembly

- 1 Remove the following FRUs:
  - Back cover. See page 109.
  - High-voltage power supply. See page 137.
  - DC controller. See page 138.
- 2 Disconnect the drum motor.
- 3 Open the front cover.
- 4 Press the white button on the cartridge release lever (callout 1, page 119), and then rotate the lever clockwise until it locks into place.
- 5 Face the back of the printer.
- 6 Pinch the two black tabs (callout 2) together with needle-nose pliers to release the activation lever (callout 3).
- 7 Remove three gold screws (callout 4).
- 8 Remove the feed-drive assembly.



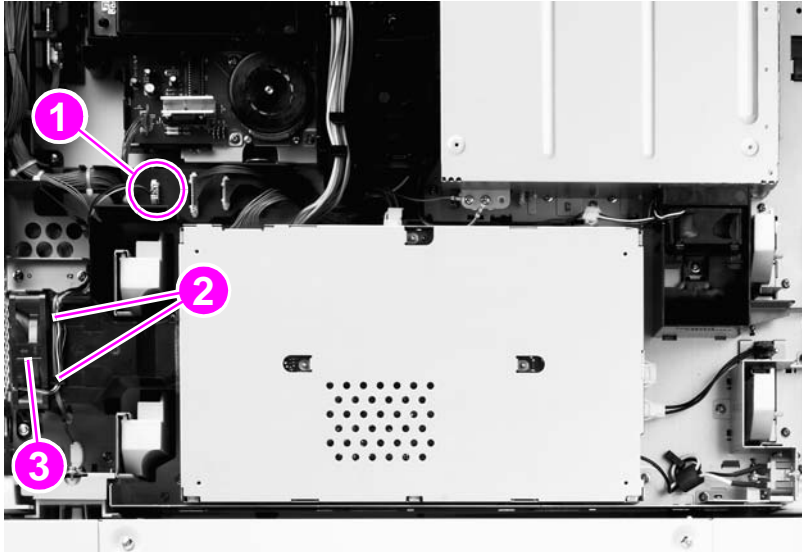
**Figure 89.** Feed-drive assembly

### To reinstall

**Note** Be sure to reconnect the activation lever.

## Power-supply fan (fan 1)

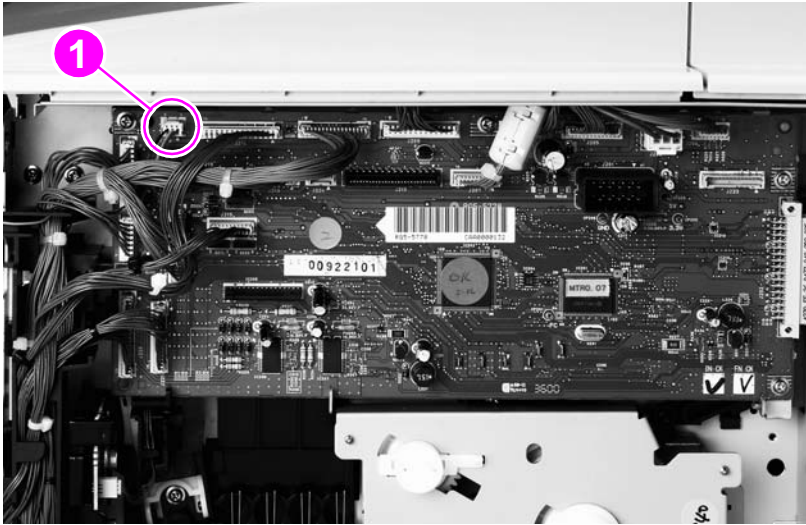
- 1 Remove the back cover. See page 109.
- 2 Unplug the fan cable connector (callout 1), and carefully unwind the fan cables from the cable guides (callout 2).
- 3 Slide the power supply fan (callout 3) out of the printer.



**Figure 90.** Power-supply fan

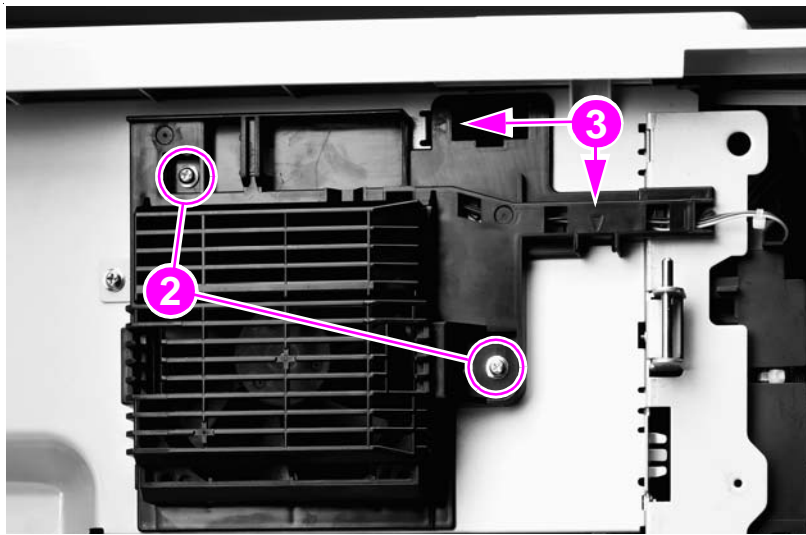
## Cartridge fan (fan 5)

- 1 Remove the back cover. See page 109.
- 2 Remove the J-216 cable connector (callout 1) from the DC controller.



**Figure 91.** Cartridge fan (1 of 2)

- 3 Remove tray 1 if it is installed. See page 125.
- 4 Open the right door.
- 5 Release the strap by pinching and then pushing the two tabs (page 105, callout 1) on the end of the black strap.
- 6 Remove two silver screws (callout 2) from the cartridge fan.
- 7 Locate the two arrow-marked tabs (callout 3), and then press the arrow-marked area in the direction that the arrow indicates.
- 8 Slide the cartridge fan to the right to remove it.



**Figure 92.** Cartridge fan (2 of 2)

### To reinstall

Slide the tabs into the printer before you snap the fan into place.

## Controller fan (fan 2)

- 1 Remove the back cover. See page 109.
- 2 Locate the controller fan below the formatter.
- 3 Unplug the fan cable connector (callout 1), and carefully unwind the fan cables from the cable guides (callout 2).
- 4 Release two black tabs (callout 3).
- 5 Slide the controller fan (callout 4) out of the printer.

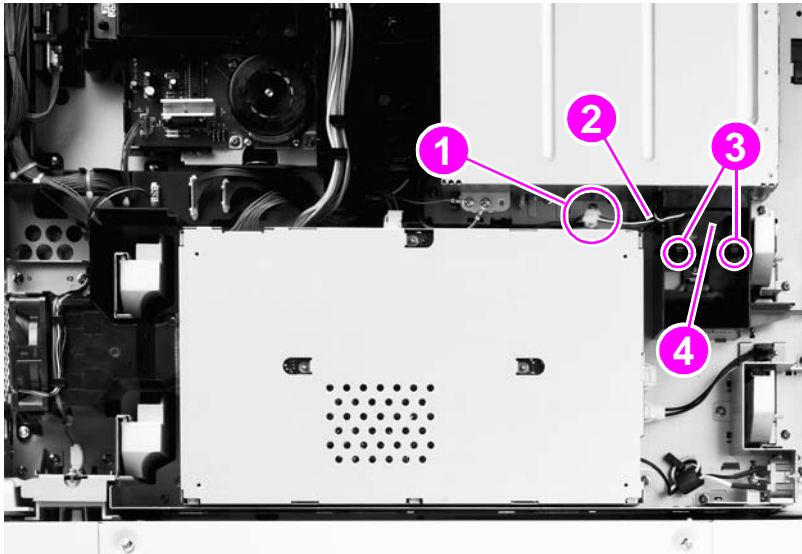
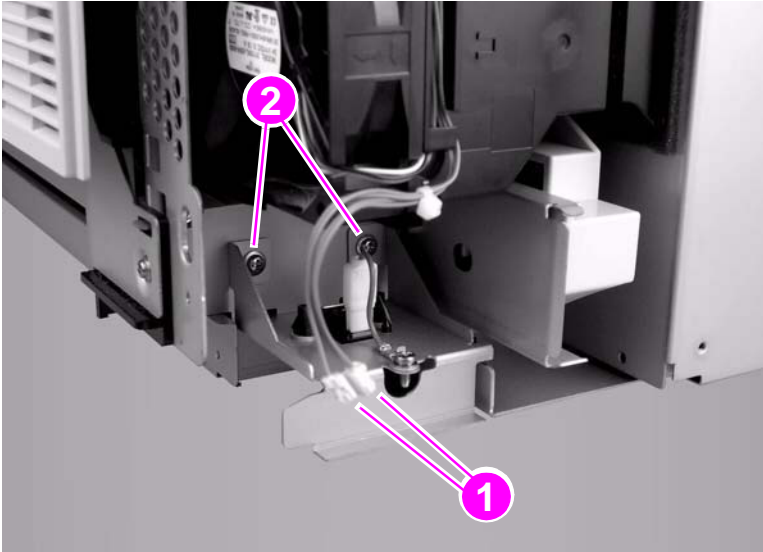


Figure 93.

Controller fan

## Jetlink connector

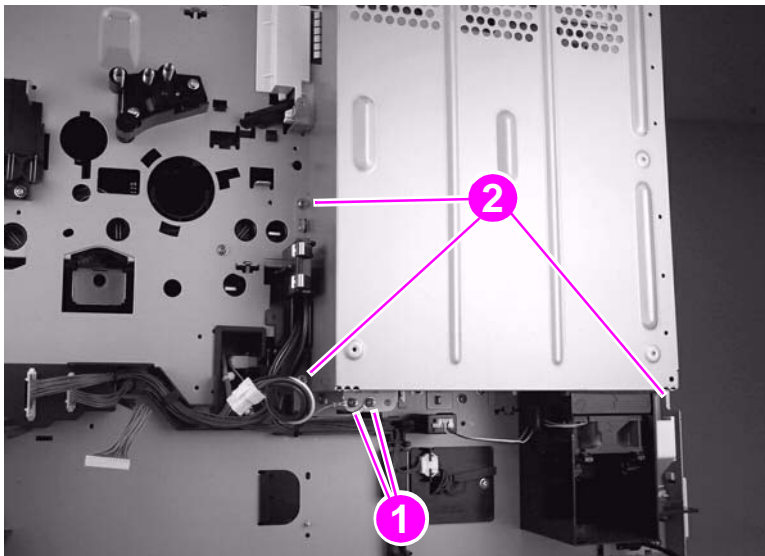
- 1 Remove the back cover. See page 109.
- 2 Disconnect two cables (callout 1) that are connected to the Jetlink connector (behind the white ground connector).
- 3 Remove two screws (callout 2).
- 4 Remove the Jetlink connector.



**Figure 94.** Jetlink connector

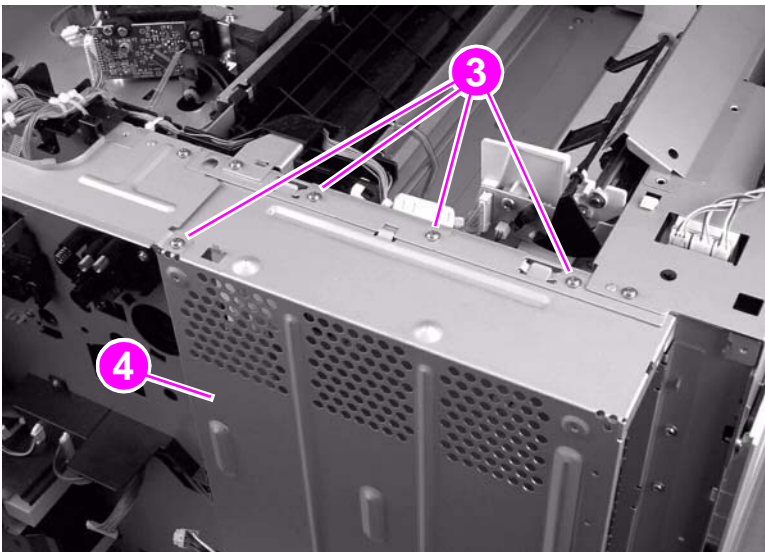
## Fuser-connector holder assembly

- 1 Remove the following FRUs:
  - Formatter. See page 135.
  - Back cover. See page 109.
  - Left top cover. See page 103.
  - Right top cover. See page 105.
  - Low-voltage power supply. See page 136.
  - High-voltage power supply. See page 137.
  - Feed-drive assembly. See page 142.
  - Duplexer (if installed). See page 133.
  - Fuser assembly. See page 134.
- 2 Remove two ground screws (callout 1) and three additional screws (callout 2).



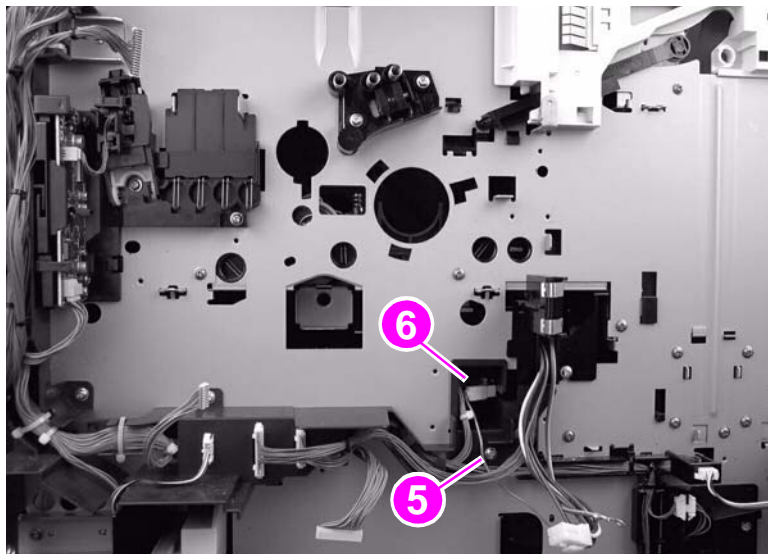
**Figure 95.** Fuser-connector holder assembly (1 of 3)

- 3 Remove four screws (callout 3) and then remove the formatter cage (callout 4).



**Figure 96.** Fuser-connector holder assembly (2 of 3)

- 4 Remove one screw (callout 5) and one cable connector (callout 6), and then pull the fuser-contractor holder assembly toward you.

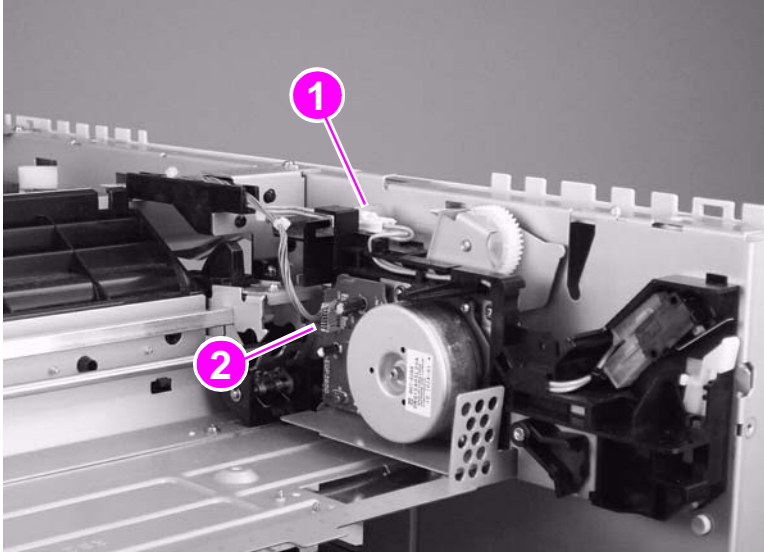


**Figure 97.** Fuser-contractor holder assembly (3 of 3)



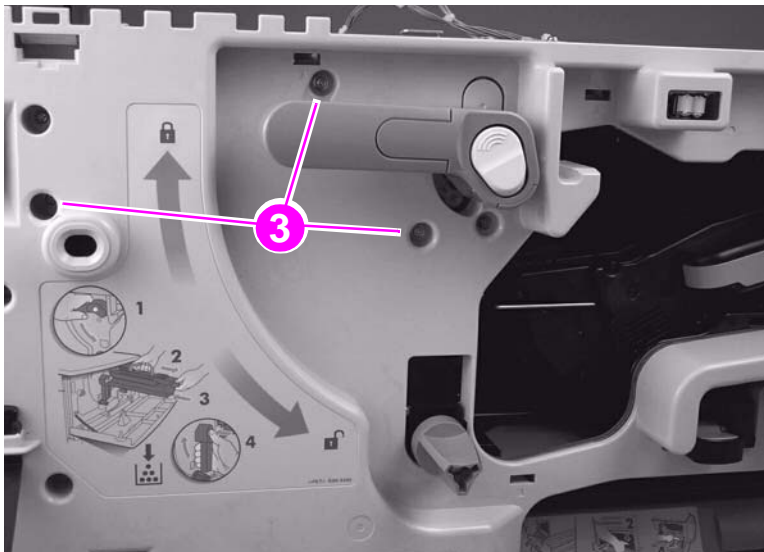
## Fuser delivery-drive assembly

- 1 Remove the following FRUs:
  - Left top cover. See page 103.
  - Right top cover. See page 105.
- 2 Open the left door.
- 3 Remove the delivery assembly. See page 113.
- 4 Disconnect one cable (callout 1) and one connector (callout 2).



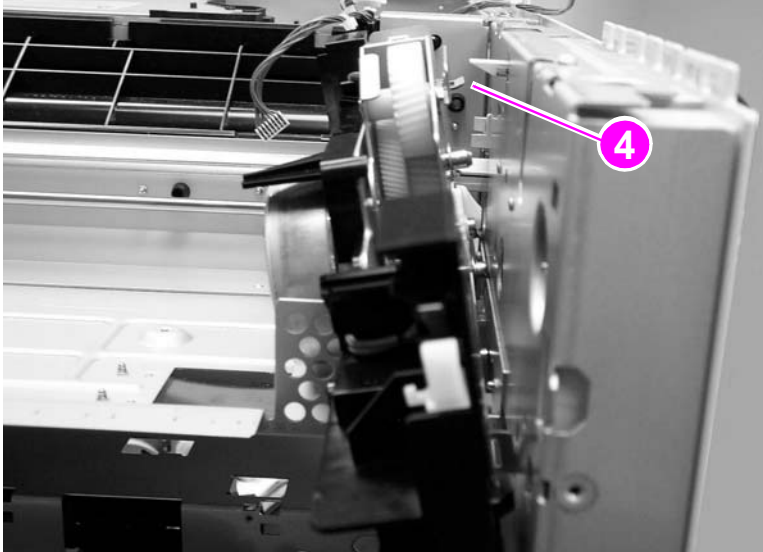
**Figure 98.** Fuser delivery-drive assembly (1 of 3)

- 5 Remove three screws (callout 3).



**Figure 99.** Fuser delivery-drive assembly (2 of 3)

- 6 From the left side of the printer, lift the back of the fuser delivery drive assembly to disengage the top tabs (callout 4).



**Figure 100.** Fuser delivery-drive assembly (3 of 3)

- 7 Pull the fuser delivery-drive assembly toward you to disengage the front tab, rotate the assembly to the left, and then lift it away from the chassis.

### **To reinstall**

Make sure that the green handle is in the locked position.

## Tray 4

The following covers and assemblies can be removed from tray 4:

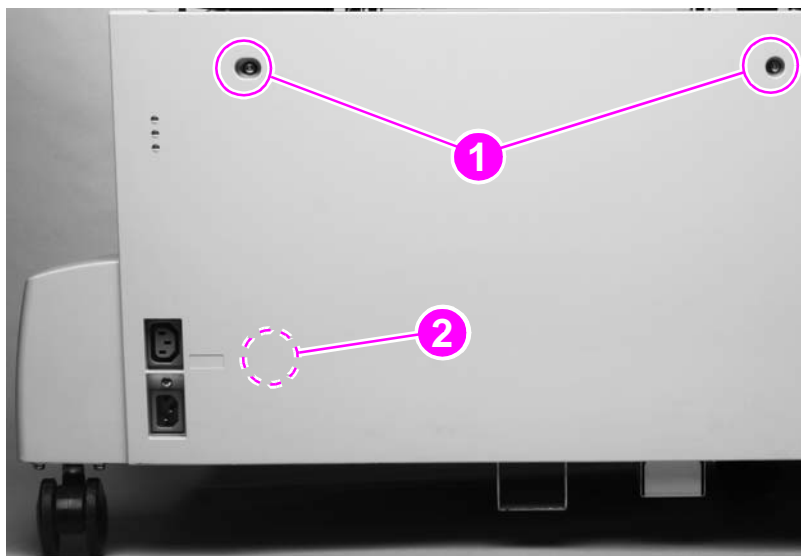
- Left side cover
- Right side cover
- Back covers
- Tray assembly
- Tray 4 rollers (pickup, feed, and separation)
- Registration assembly
- Drive motor
- Drive assembly
- Controller board
- Paper-size detection switch PCB
- Power supply
- Pickup assembly
- Paper connecting unit

### Orientation

See "Orientation of the printer (with tray 4)" on page 100.

### Left side cover

- 1 Remove two screws (callout 1) from the left side cover.
- 2 Pull the top edge of the cover outward.
- 3 Lift the left side cover up and outward to remove it from tray 4.



**Figure 101.** Left side cover

### To reinstall

Make sure that the hook (callout 2) on the inside of the cover connects correctly.

## Right side cover

- 1 Remove two screws (callout 1) from the right side cover.
- 2 Pull the top edge of the cover outward.
- 3 Lift the right side cover up and out to remove it from tray 4.

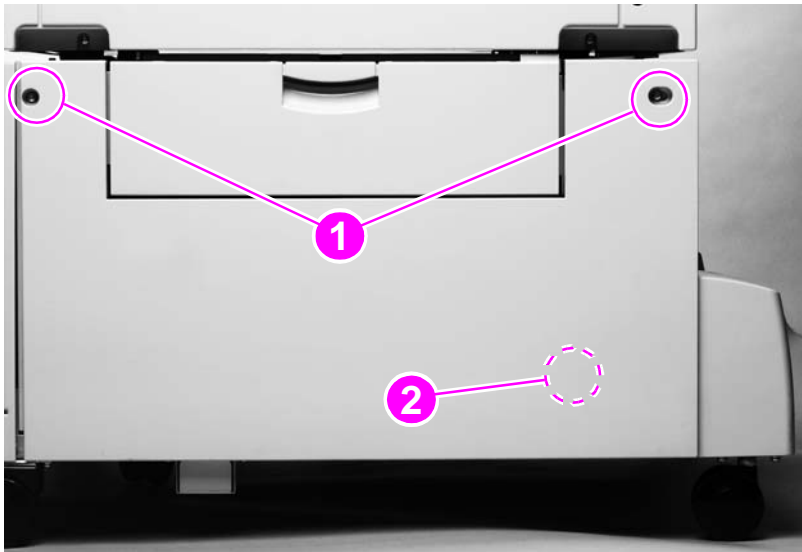


Figure 102. Right side cover

### To reinstall

Make sure that the hook (callout 2) on the inside of the cover connects correctly.

## Back covers

### Center back cover

- 1 Remove four screws (callout 1) from the center back cover.
- 2 Remove the center back cover.

### Right back cover

- 1 Remove the center back cover.
- 2 Slide the right back cover (callout 2) toward the center to release an interior tab.
- 3 Lift the right back cover straight up to release a second interior tab.

---

**Note**

Be sure to keep the right back cover vertically aligned with tray 4. Otherwise, the second interior tab will not release.

- 4 Pull the right back cover out to remove it.

### Left back cover

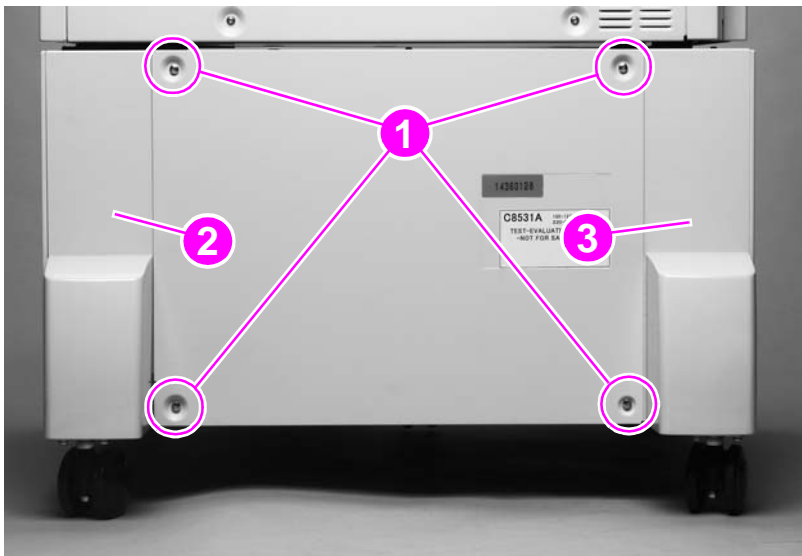
- 1 Remove the center back cover.
- 2 Slide the left back cover (callout 3) toward the center to release an interior tab.
- 3 Lift the left back cover straight up to release a second interior tab.

---

**Note**

Be sure to keep the left back cover vertically aligned with tray 4. Otherwise, the second interior tab will not release.

- 4 Pull the left back cover out to remove it.



**Figure 103.** Back covers

## Tray 4

### CAUTION

Tray 4 is heavy and can be damaged if dropped. Use both hands when removing tray 4.

- 1 Open tray 4 (the tray assembly), and remove all of the paper.
- 2 Pull the tray assembly out until it stops.
- 3 Press the release button (callout 1) on the right side of the tray and the release button (not shown) on the left side of the tray.
- 4 Continue to press the two release buttons while pulling the tray assembly out of the chassis.

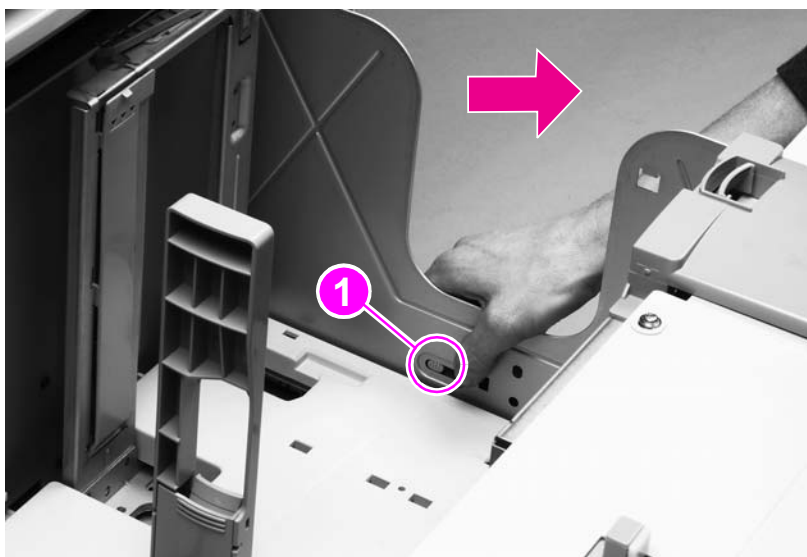


Figure 104. Tray 4

## Rollers (pickup, feed, and separation)

- 1 Remove tray 4. See page 154.
- 2 Locate the appropriate roller on the upper right side of the tray cavity. The pickup roller (callout 1), feed roller (callout 2), and separation roller (callout 3) are all type 2 rollers.

### Note

To gain access to the separation roller, slide the blue roller shield toward the back of tray 4 (as shown in figure 105).

- 3 Pinch the tab on the end of each roller to release it.
- 4 Slide the roller off of the shaft.

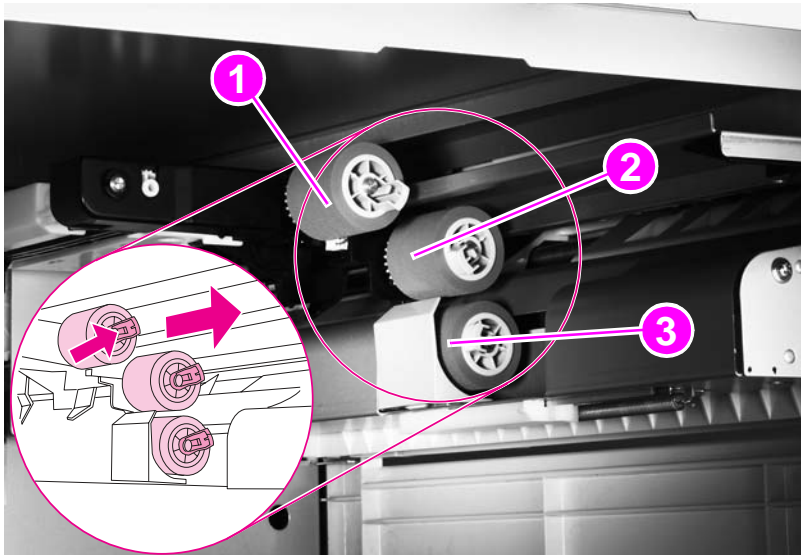


Figure 105. Rollers

### To reinstall

- You do not need to slide the blue shield back over the separation roller. It will reset automatically.
- Make sure that each roller is locked in place by attempting to remove it without first pinching the tab.

## Registration assembly

- 1 Remove the right side cover. See page 152.
- 2 Remove four screws (callout 1).

### CAUTION

Use care when following step 3. Three cables are connected to the registration assembly.

- 3 Gently lift the registration assembly off of tray 4, and unplug three connectors (callout 2) from the rear of the registration assembly.

### Note

If you cannot reach the three cable connectors, remove the center back cover (page 153), remove the right back cover (page 153), and unplug the connectors (figure 107, callout 3) from the back of tray 4.

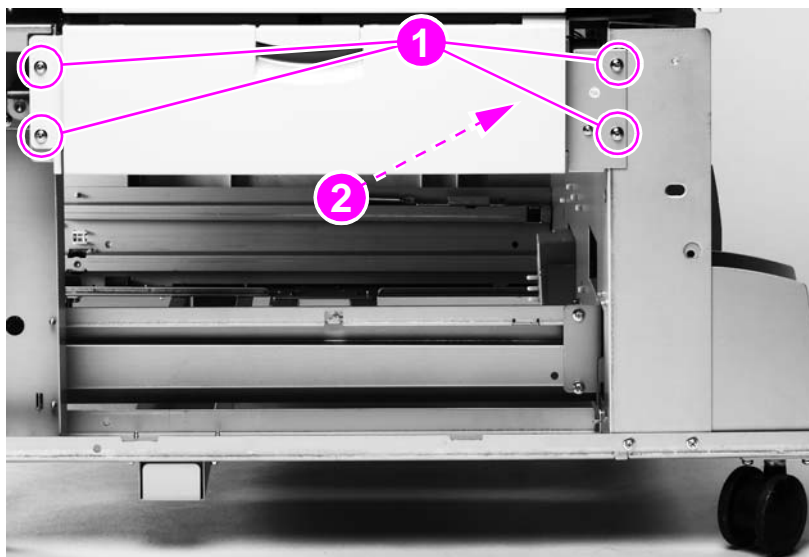


Figure 106. Registration assembly (1 of 2)

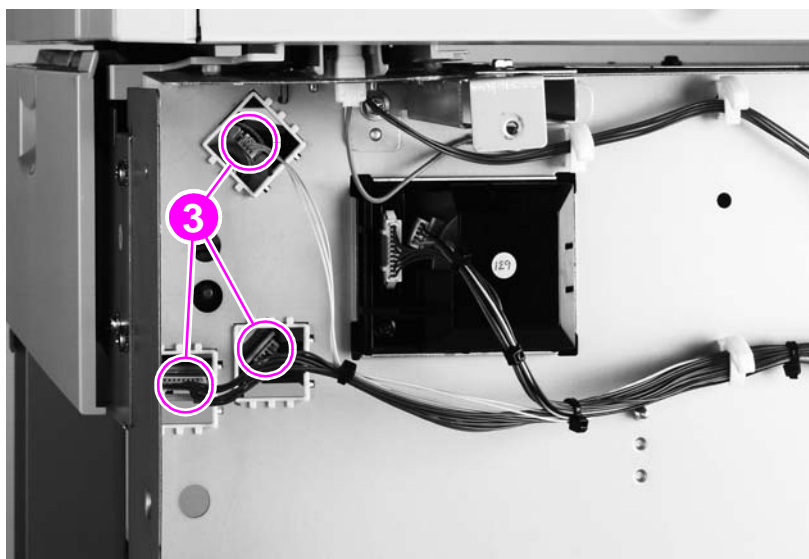
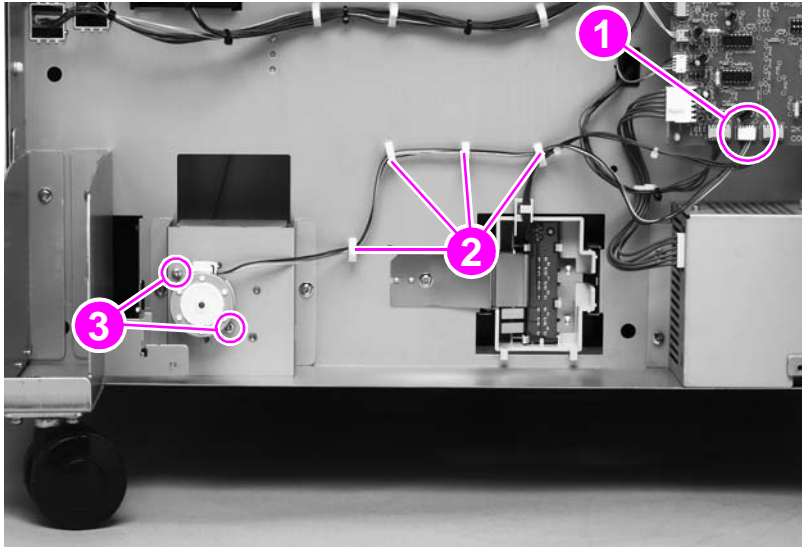


Figure 107. Registration assembly (2 of 2)



## Drive motor

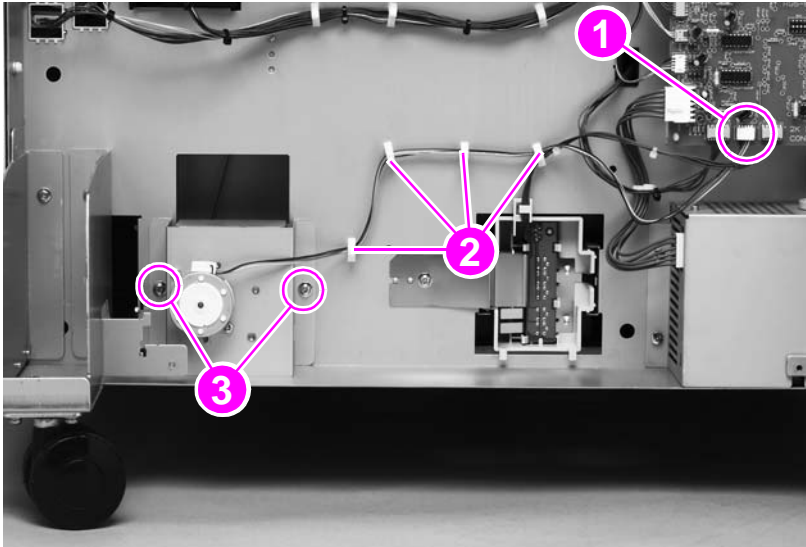
- 1 Remove the center back cover. See page 153.
- 2 Unplug the cable connector (callout 1) from the controller board.
- 3 Carefully unwind the cable from the cable guides (callout 2).
- 4 Remove two screws (callout 3).
- 5 Remove the drive motor from tray 4.



**Figure 108.** Drive motor

## Drive assembly

- 1 Remove the center back cover. See page 153.
- 2 Unplug the cable connector (callout 1) from the controller board.
- 3 Carefully unwind the cable from the cable guides (callout 2).
- 4 Remove two screws (callout 3).
- 5 Remove the drive assembly from tray 4.



**Figure 109.** Drive assembly

## Controller board

- 1 Remove the following FRUs:
  - Center back cover. See page 153.
  - Left back cover. See page 153.
- 2 Unplug eleven connectors (callout 1).

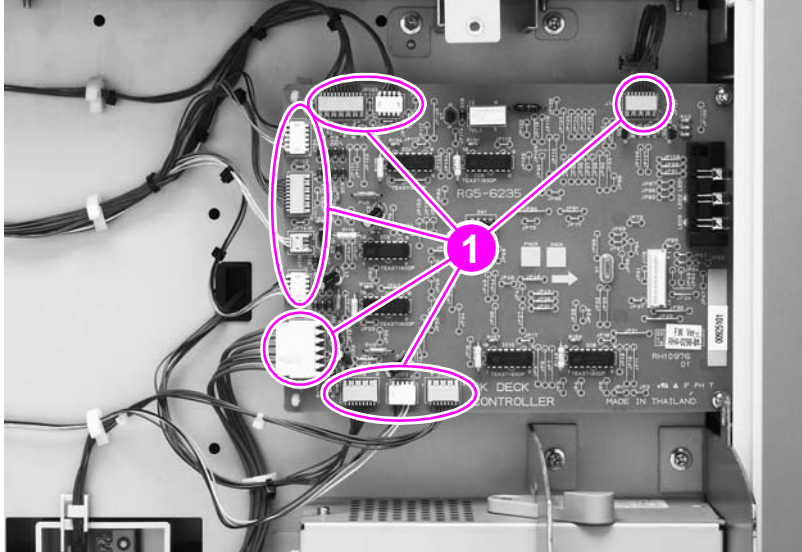


Figure 110.

Controller board (1 of 2)

- 3 Remove two screws (callout 2).
- 4 Release two holding pins (callout 3).
- 5 Remove the controller board from tray 4.

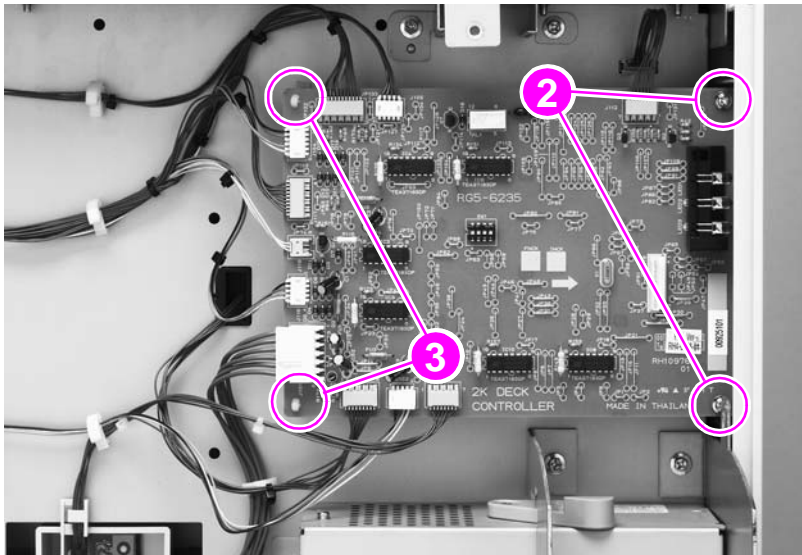
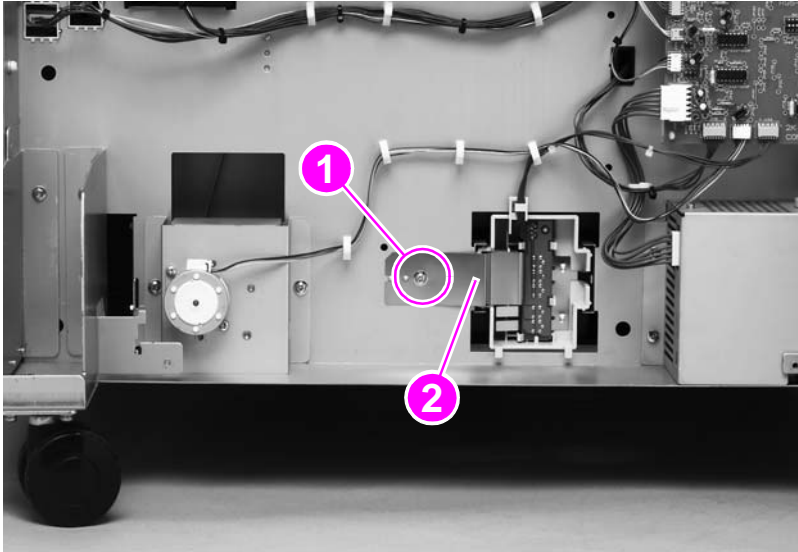


Figure 111.

Controller board (2 of 2)

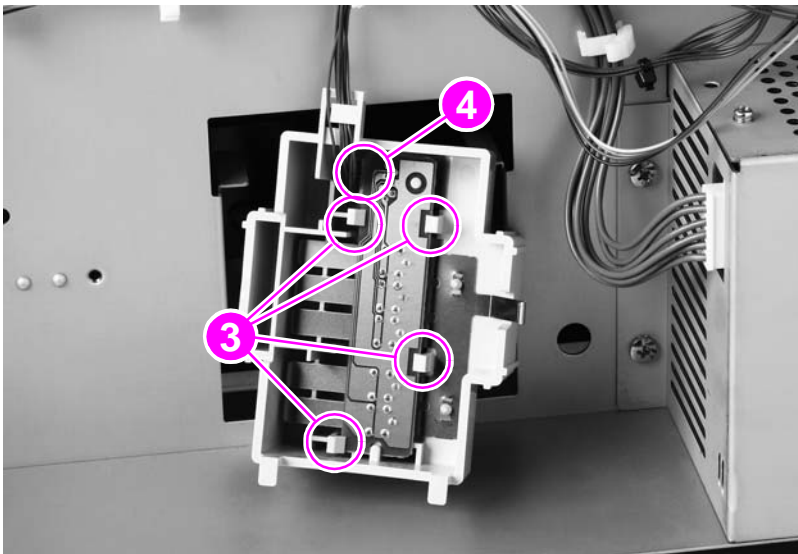
## Paper-size detection switch PCA

- 1 Remove the center back cover. See page 153.
- 2 Remove one screw (callout 1) to remove the leaf spring (callout 2).



**Figure 112.** Paper-size switch PCA (1 of 2)

- 3 Release four tabs (callout 3), and remove the PCA from the casing.
- 4 Unplug the cable connector (callout 4).



**Figure 113.** Paper-size switch PCA (2 of 2)

### To reinstall

Open tray 4 slightly so that it does not put pressure on the casing.



## Power supply

- 1 Remove the following FRUs:
  - Center back cover. See page 153.
  - Left back cover. See page 153.
- 2 Unplug one connector (callout 1).
- 3 Remove two screws (callout 2).
- 4 Slide the power supply to the left to remove it.

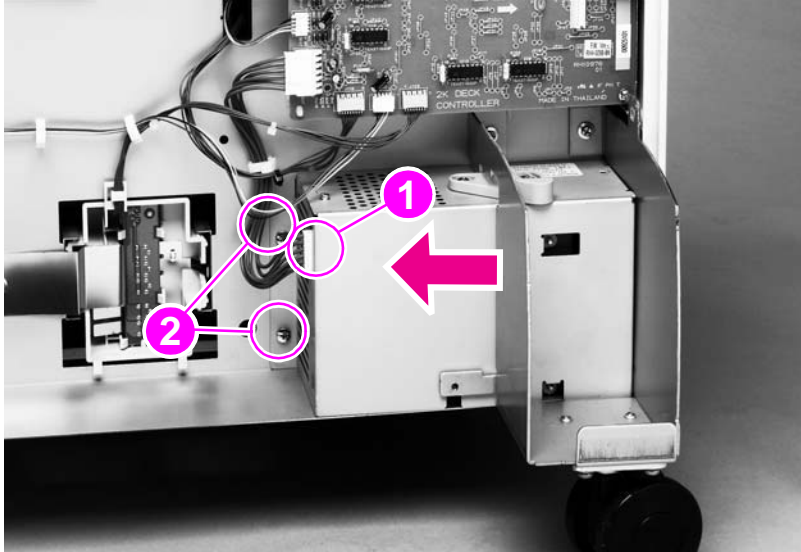
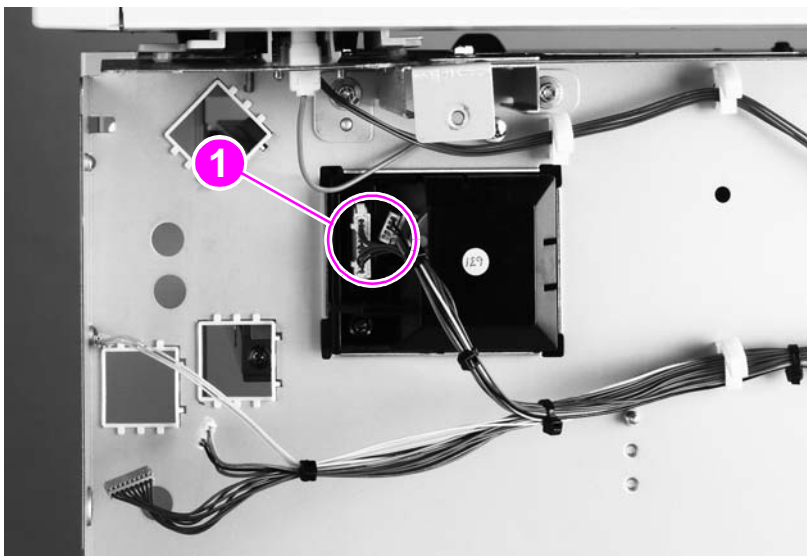


Figure 114. Power supply

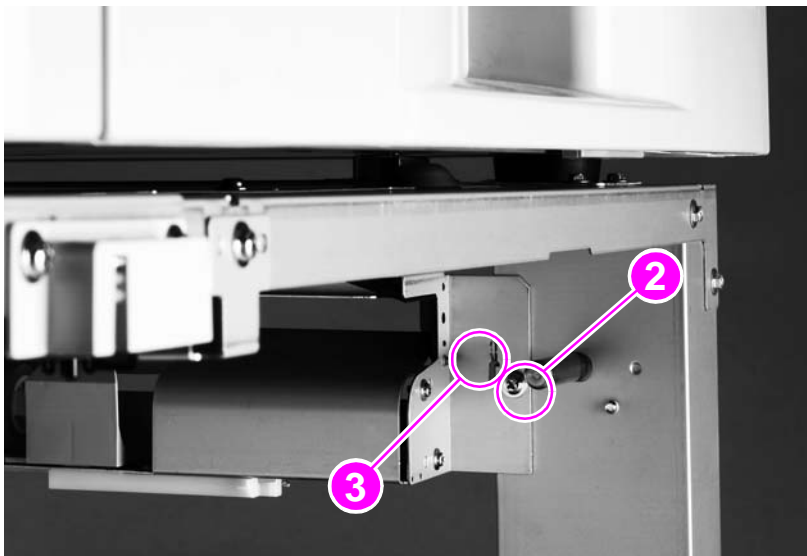
## Pickup assembly

- 1 Remove the following FRUs:
  - Right side cover. See page 152.
  - Center back cover. See page 153.
  - Right back cover. See page 153.
  - Tray assembly. See page 154.
  - Registration assembly. See page 156.
- 2 From the back of tray 4, unplug two connectors (callout 1).



**Figure 115.** Pickup assembly (1 of 2)

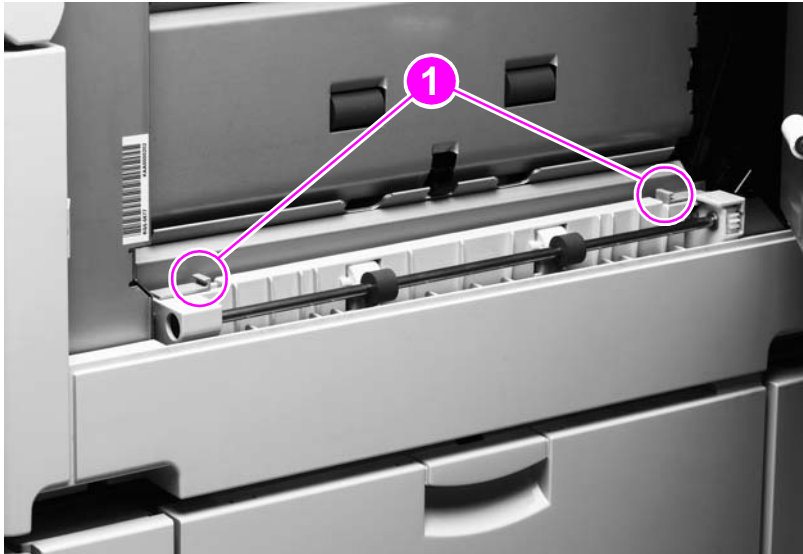
- 3 From the front of tray 4, remove one screw (callout 2).
- 4 Lift the pickup assembly off the hook (callout 3) to remove it from tray 4.



**Figure 116.** Pickup assembly (2 of 2)

## Paper-connecting unit

- 1 Release the two levers (callout 1) by pulling them toward the center of the paper connecting unit.
- 2 Lift the paper connecting unit straight up and remove it.



**Figure 117.** Paper-connecting unit





# 7

# Troubleshooting

## Chapter contents

Troubleshooting process . . . . .	167
Basic troubleshooting process flow . . . . .	168
Preliminary operating checks . . . . .	170
General troubleshooting information . . . . .	171
Power-on . . . . .	174
Troubleshooting by using control-panel messages . . . . .	175
Event log page . . . . .	175
Control-panel messages . . . . .	178
Control-panel and event-log message format . . . . .	179
Printer-message tables . . . . .	179
Alphabetical error messages . . . . .	180
Numerical error messages . . . . .	188
User- and service-level diagnostics . . . . .	213
Paper-path test . . . . .	213
Service test . . . . .	213
Service-level diagnostics . . . . .	215
Engine test . . . . .	215
Service menu . . . . .	215
Diagnostics flowchart . . . . .	216
Other diagnostics for the HP LaserJet 9000, 9000mfp, and 9000Lmfp . . . . .	217
Cold reset . . . . .	217
Other diagnostics for the HP LaserJet 9040/9050, 9040mfp, and 9050mfp . . . . .	219
Cold reset . . . . .	219
Tray 4 diagnostics . . . . .	221
Diagnostics label . . . . .	221
Motor test . . . . .	221
Standalone running test . . . . .	222
Sensor test . . . . .	222
Light-pattern interpretation . . . . .	223
Jam troubleshooting . . . . .	224
Jams . . . . .	225
Customer print job . . . . .	225
Clearing jams . . . . .	225
Evaluate the information pages . . . . .	226
Configuration page . . . . .	226
Jetdirect page . . . . .	229
Supplies status page . . . . .	230
Usage page . . . . .	231
File directory page . . . . .	232
Image-formation troubleshooting . . . . .	233
Check the print cartridge . . . . .	234
Image-defect tables . . . . .	235

Repeating defect ruler .....	243
Media troubleshooting .....	244
Determine the problem source: media or printer .....	244
Isolate a paper path .....	244
Isolate a media brand .....	245
Isolate a media type .....	245
Communication troubleshooting .....	246
Communications check .....	246
Jetdirect configuration .....	246
Embedded LAN troubleshooting (HP LaserJet 9040n/9050n, HP LaserJet 9040dn/9050dn, HP LaserJet 9050mfp, and HP LaserJet 9040mfp only) .....	247
Wiring diagrams .....	251

# Troubleshooting process

The troubleshooting process is a systematic approach that addresses the primary problems first, and then other problems, to discover the causes for printer malfunctions and errors. The "[Basic troubleshooting process flow](#)" on page 168 illustrates the primary steps for troubleshooting the printing system. Each heading depicts a primary troubleshooting step. A "yes" answer to the questions allows troubleshooting to proceed to the next primary step.

A "no" answer indicates that additional testing and correction is needed. Proceed to the referenced location in the chapter and follow the directions there. After completing the additional testing and correcting the problem, proceed to the next primary step.

---

## Note

---

It is important to always follow this process in sequence. Failure to do so can result in increased repair time, difficulty, and expense.

This list describes the basic questions to answer and the corresponding troubleshooting sections to help quickly define the problem(s).

**Table 18. Primary steps for troubleshooting**

<a href="#">"Power-on" on page 174</a>	Does the printer perform the initialization and power-on sequence?  This section contains the procedures for correcting power-supply problems.
<a href="#">"Printer-message tables" on page 179</a>	Does the control panel indicate an error condition?  This section contains the procedures for clearing control-panel messages.
<a href="#">"Paper-path test" on page 213</a>	Is it possible to perform a paper-path test?  This section contains information about troubleshooting paper-path and print-media problems.
<a href="#">"Evaluate the information pages" on page 226</a>	Is there information in the event log?  This section contains the procedures for printing the information pages and evaluating and correcting printer configuration.
<a href="#">"Image-formation troubleshooting" on page 233</a>	Does the print quality meet customer expectations?  This section contains print-cartridge checks, information about EconoMode, image-defect examples, and the repeating-defect ruler.
<a href="#">"Media troubleshooting" on page 244</a>	Is the media being used acceptable for this printer?  This section contains information about how to determine print-media problems and correct them.
<a href="#">"Communication troubleshooting" on page 246</a>	Can the customer print from the host system successfully?  This section describes how to determine whether the printer is communicating correctly with the host system.

## Basic troubleshooting process flow

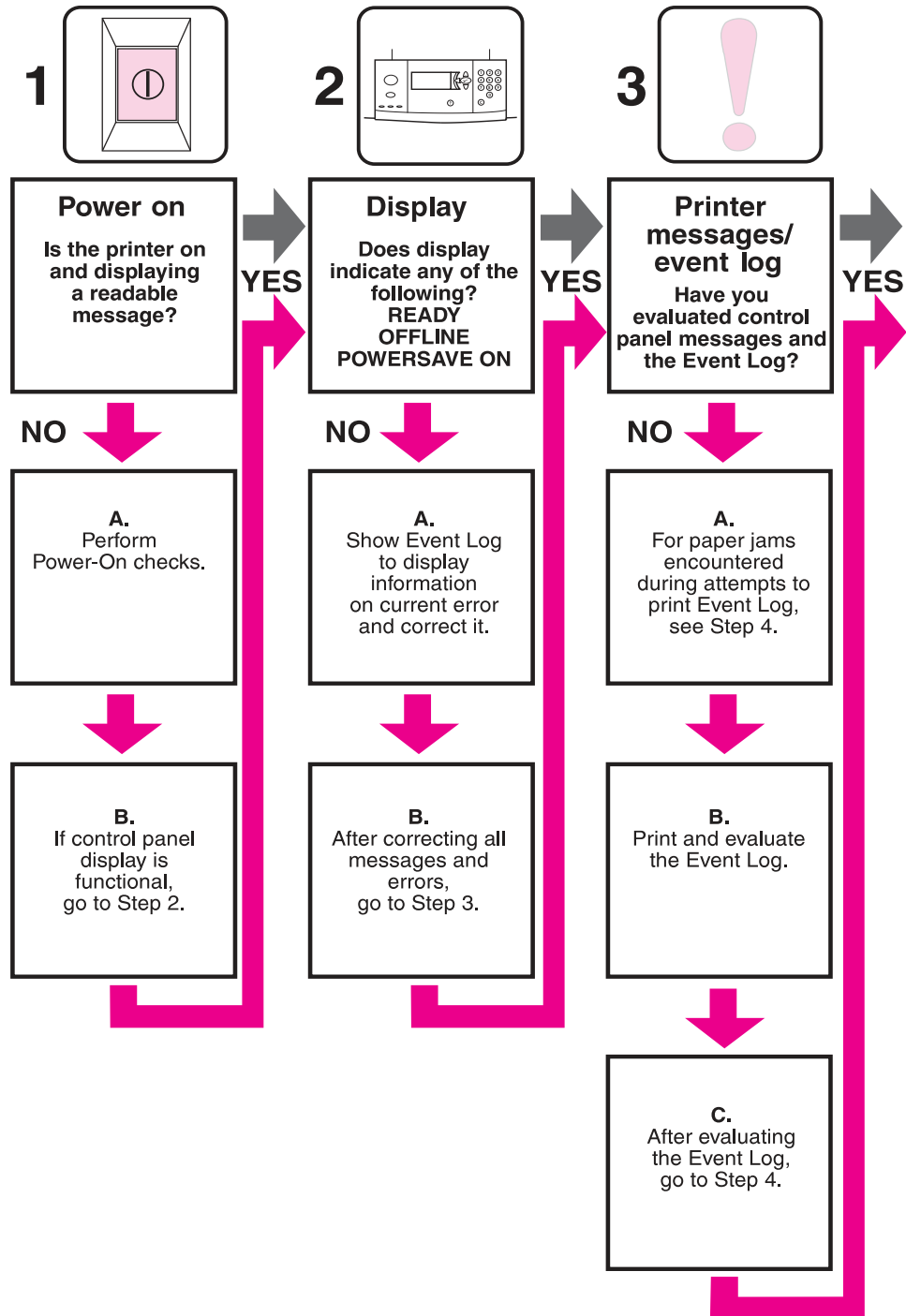


Figure 118. Basic troubleshooting process flow (1 of 2)

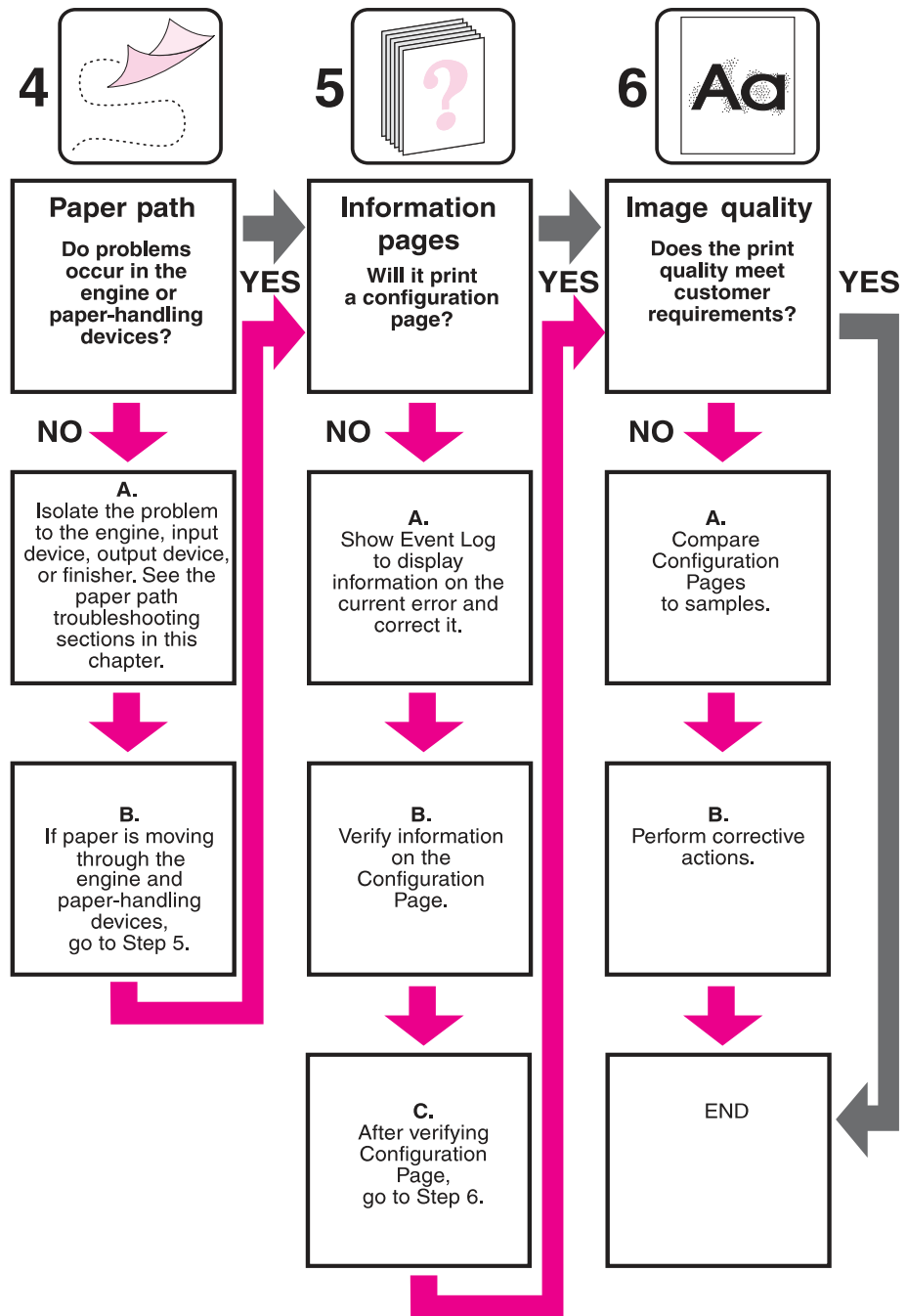


Figure 119. Basic troubleshooting process flow (2 of 2)

## Preliminary operating checks

Make sure that the following conditions are met before troubleshooting a specific printer problem:

- The printer is plugged in, and the specified power is being delivered.
- The selected tray contains media that is correctly loaded and adjusted.
- The print cartridge is installed correctly.
- The printer receives maintenance on a regular basis.
- Any I/O devices are installed correctly.
- The customer is using acceptable media
- The printer is positioned on a solid, level surface.
- The line voltage does not vary more than 10% from the nominal rated value that is specified on the power-rating label.
- The operating environment for the printer is within the temperature and humidity specifications.
- The printer is never exposed to ammonia fumes.
- The printer is not exposed to direct sunlight.
- Non-HP components (such as refilled print cartridges, font DIMMs, and memory DIMMs) are removed from the printer.

---

### Note

Sudden changes in printer environment can cause image defects and media-handling problems. Always make sure that the printer is not exposed to direct sunlight or to heating or cooling vents. Allow time for the printer and media to acclimate whenever changing environments (for example, moving from a cold environment to a warm one). Acclimation can take anywhere from 3 to 24 hours depending on the ambient conditions.

---

## General troubleshooting information

The following lists symptoms and typical solutions to miscellaneous problems.

### **Abnormal noises are evident, such as grinding or chattering when the main motor is turned on**

In the print cartridge area:

- If the print cartridge is new, automatic seal roll-up will cause noise until seal removal is complete.
- If it is not new, replace the print cartridge.

In the fuser area:

- Reseat the fuser.
- Remove and reinstall the fuser.

In tray 2 or 3:

- Verify that the media is loaded correctly with acceptable media.

If installed, from tray 4:

- Verify that the media is loaded correctly with acceptable media.
- Replace the tray 4 paper path connection unit (PPCU).
- Replace the tray 4 main-drive assembly.

### **Media does not feed from tray x when printing from a software program; the paper-path test is successful**

Verify that the correct media size is loaded:

- All trays: check from the control panel.
- Tray 2, 3, or 4: remove and reseal the paper guides in the correct position in the tray that fails.
- Verify the custom-size-switch setting.

### **Media does not print from tray 4**

- Make sure that power is being supplied to tray 4.
- Print a configuration page (make sure that tray 4 is listed in the paper-handling options section).
- Run a paper-path test from tray 4 (if the test is successful, the paper-size-detection switches might have failed or an incorrect size might be specified in the software program).
- Verify the custom-size-switch setting.

### **The printer stops printing and hangs on certain jobs**

- Remove any non-HP memory DIMMs and retry the print job.
- Resend the print job.
- Send a print job from a different software program.

## Envelopes are wrinkling

- Verify that the input tray is tray 1.
- Verify that the output destination is the face-up bin.
- Place the fuser levers in the up position and retry printing the envelopes.
- Try different envelopes (make sure that the envelopes are within specifications; see the *HP LaserJet Printer Family Print Media Guide*).

## Fusing is poor

- Make sure that the fuser levers are in the down position for cut-sheet media.
- Make sure that all packing spacers are removed from inside of the printer.
- Try different media (make sure that the media is within specifications; see the *HP LaserJet Printer Family Print Media Guide*).
- Make sure that the correct fusing mode for the media is set at the control panel.
- Make sure that the ac power does not fluctuate out of range during the print cycle.

## The printer feeds from an incorrect tray when different media is selected for the first page of the job











- Determine whether the problem is a hardware or a software issue (run a paper-path test from each paper tray to eliminate the hardware; see "[Paper-path test](#)" on page 213).
- If the paper-path test fails, troubleshoot the error message.
- Make sure that the most current printer driver is installed (click the **Print Quality** tab on the printer driver, and then click **About**).
- Verify the custom-size-switch setting.
- If the paper-path test works, the problem might be a software- or customer-related issue. Make sure to define the media types that are loaded in each paper tray. This can be done from HP Web Jetadmin if an HP Jetdirect print server is installed, or from the control panel. Use the appropriate procedure from the following choices.

*From HP Web Jetadmin:*

- 1 Click the **Trays** tab.
- 2 Select the correct media type for each tray that is listed.
- 3 Click **OK** to save your changes, and exit HP Web Jetadmin.

*From the control panel:*

### Tray 1

- 1 Press  to open the menus.
- 2 Use  or  to scroll to PAPER HANDLING, and then press .
- 3 Use  or  to scroll to TRAY 1 SIZE, and then press .
- 4 Use  or  to scroll to the size of media that is loaded, and then press .
- 5 Press **PAUSE/RESUME** or **MENU** to exit the menu.






















## Tray 2, tray 3, and tray 4

### Note

Standard sizes are automatically detected in these trays.

Use these steps to set the size for custom media in tray 2, tray 3, and tray 4:

- 1 Press  to open the menus.
- 2 Use  or  to scroll to PAPER HANDLING, and then press .
- 3 Use  or  to scroll to TRAY X SIZE, where X is the tray that you are setting, and then press .
- 4 Use  or  to scroll to CUSTOM, and then press .
- 5 Use  or  to select the unit of measure (MILLIMETERS or INCHES), and then press .
- 6 Use the keypad or the  or  to specify the X (front to back) dimension, and then press .
- 7 Use the keypad or the  or  to specify the Y (left to right) dimension, and then press .
- 8 Press PAUSE/RESUME or MENU to exit the menu.

# Power-on

The printer control panel should be functional as soon as possible in the troubleshooting process so that the printer diagnostics can assist in locating printing errors.

**Table 19. Power-on defects or a blank display**

Problem	Action
Is ac power available at the printer power receptacle?	Make sure that power is available. See "Electrical specifications (HP LaserJet 9000)" in Chapter 1.
Is the printer on/off switch set to on?	Push the switch to the on position.
Are the printer fans on?	<p>Press PAUSE/RESUME or MENU to put the printer in the ready state.</p> <p><b>Note</b></p> <p>The fan operation is significant, because all fans are controlled by the printer DC controller PCA. Fans 1 through 6 operate at full speed for 30 seconds during the WAIT period. Fans 1 through 5 slow to half-speed, and fan 6 stops during the STBY period and when the printer is in PowerSave mode. Make sure that the printer is not in PowerSave mode.</p> <p>Operational fans indicate that the following conditions are being met:</p> <ol style="list-style-type: none"> <li>1 The ac power is present in the printer.</li> <li>2 The DC power supply is functional (both 24 Vdc and 5 Vdc are generated).</li> <li>3 The DC controller PCA microprocessor is functional.</li> </ol>
NO	<p>If the fans are <i>not</i> working, turn off the printer and remove the printer formatter PCA. Disconnect all of the printer paper-handling options. Then, turn on the printer and check the fans again. If the fans are still not working, perform the following steps:</p> <ol style="list-style-type: none"> <li>1 Make sure that all of the fans are connected to the DC controller PCA.</li> <li>2 Perform an engine test.</li> </ol>
YES	<p>If the fans are working, but the printer control panel is blank, print an engine test. See "Service-level diagnostics" on page 215. If the engine test is successful, perform the following steps:</p> <ol style="list-style-type: none"> <li>1 Reseat or replace the cable from the control panel that is connected to the DC controller PCA.</li> <li>2 Replace the control-panel assembly.</li> <li>3 Make sure that the latest firmware is installed.</li> <li>4 Replace the printer formatter PCA.</li> </ol> <p>If the engine test is not successful, make sure that no media is in the paper path. Retry the engine test. If the engine test is still unsuccessful, perform the following steps:</p> <ol style="list-style-type: none"> <li>1 Make sure that the latest firmware is installed.</li> <li>2 Replace the DC controller PCA.</li> </ol>

# Troubleshooting by using control-panel messages

The control panel should show the message `READY`, `PAUSED`, or `POWERSAVE ON`. For information about error messages that appear, see the event log. If the display is blank, see ["Power-on" on page 174](#).

## Event log page

Use the event log to diagnose and troubleshoot printer errors and intermittent failures. You can either print the event log or view it on the control panel (select `PRINT EVENT LOG` or `SHOW EVENT LOG`).

The event log is a last in-first out (LIFO) ordered listing of the last 50 entries. The printed event log is printed in four columns that show the event number, page count, error code, and description or personality.

The description or personality provides detail about the error messages. The information is more useful for troubleshooting.

The following items should be logged in the event log:

- Critical errors
- Jams
- Sensors sensing out-of-range conditions
- Deleted jobs
- Unexpected media size
- Complex page
- Buffer overflow
- NVRAM changes
- Any diagnostics tests

## Print the event log

The printer internal event log stores the 50 most recent events, and can be printed at any time. Use these steps to print the event log:

- 1 Press `✓` to open the menus.
- 2 Use `▼` or `▲` to scroll to `CONFIGURE DEVICE`, and then press `✓`.
- 3 Use `▼` or `▲` to scroll to `DIAGNOSTICS`, and then press `✓`.
- 4 Use `▼` or `▲` to scroll to `PRINT EVENT LOG`, and then press `✓`.
- 5 The event log prints. The control panel shows the message `PRINTING EVENT LOG`.

## Interpret the event log

Each individual entry in the log is called an "error," while all errors that occur at the same page count are called an "event." See ["Printer-message tables" on page 179](#) for each error in an event to better understand the event. Events usually conclude with a time-out or no response from the device (error `66.XY` in the event log). Turn the printer off, and then turn the printer on.

Use the event log tables in this section to associate errors in the event log with the control-panel error message. Follow the recommended action listed in the event log table starting on [page 179](#) for each error or event.

- 1 Check the event log for specific error trends in the last 10,000 printed pages.
- 2 Ask the customer for any observed error trends (for example, if jams tend to occur in a specific area of the printer).
- 3 Record any specific error trends.
- 4 See "[Printer-message tables](#)" on page 179" and follow the recommended action.

## Sample event log

**HP LaserJet 9000 series printers**

Event Log Page 1

Current Page Count: 4      Serial Number: XXXXXXXXXXXX

Number	Error	Page Count	Description or Personality
2	55 0492	0	
1	55 0000	0	?.? PRINTER ERROR CYCLE POWER TO CONTINUE

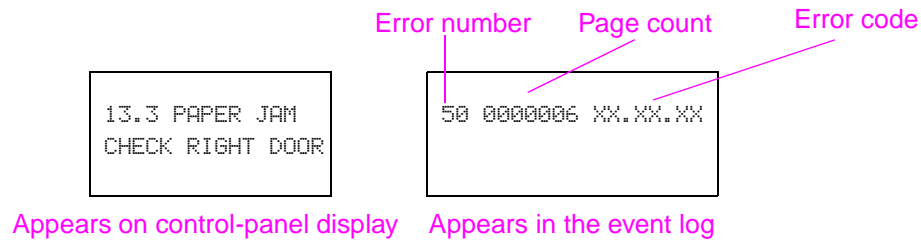
**Figure 120.** Sample event log (HP LaserJet 9000 series printer page shown)

## View the event log

Use the event log to scroll through the contents of the event log from the control panel. The 50 most recent events appear, with the most recent appearing first. Use ▼ or ▲ to scroll through the event-log contents. If the event log is empty, the control panel shows the message `EVENT LOG IS EMPTY`.

Follow these steps to view the event log:

- 1 Press ✓ to open the menus.
- 2 Use ▼ or ▲ to scroll to `CONFIGURE DEVICE`, and then press ✓.
- 3 Use ▼ or ▲ to scroll to `DIAGNOSTICS`, and then press ✓.
- 4 Use ▼ or ▲ to scroll to `SHOW EVENT LOG`, and then press ✓.
- 5 The event log appears.



**Figure 121.** Example of events

---

### Hint

Whenever a 13.?? appears on the control panel, clear the jammed media from the printer, press **PAUSE/RESUME** or **MENU** to stop printing, and print the event log. If you cannot print the event log, you can still view it on the control panel.

---

## Control-panel messages

Make sure to read the exact text of the control-panel message, including the error-message number and the text, in order to locate the error message in the tables. This control panel stores enhanced information.

Messages that appear on the control panel provide six categories of information. Each message category is assigned a priority. If more than one condition occurs at the same time, the highest priority message appears. When it is cleared, the next priority message appears, and so on. The following are the messages and their priorities:

- **Status messages**—Status messages communicate the current state of the printer to the operator. Whenever the printer is ready and online, the printer status message `READY` appears unless warning messages are pending. When the printer is performing a task, such as a reset or a test, the associated printer-status message appears. When the task is complete, the message returns to `READY` or `PAUSED`, depending on the current state of the printer.
- **Warning messages**—Warning messages are messages that are important enough that the customer must acknowledge them, but not serious enough to cause the printer to stop the printing process. They are usually transient in nature but they can affect the output, so a record of their occurrence is important. Warnings generally alternate with the `READY` (or `PAUSED`) status message and remain on the control panel until the customer presses `✓`. Warnings appear in most-recent order (LIFO) with duplicates removed.
- **Error messages**—Error messages communicate to the customer that some action must be performed, such as adding media or clearing a jam. Some errors are considered auto-continuable, because the error message appears on the control panel for 10 seconds, and then the printer clears the message and continues normal operation. Pressing a control-panel button during the 10-second period cancels the auto-continue feature and indicates the function of the button that was pressed. Unlike status and warning messages, error messages stop the printing process. The customer has to either fix the problem or give the printer a different command. If the customer can continue past some error conditions without actually fixing the problem, then the customer should be able to perform the task by pressing `✓`. If only one option is available when the customer presses `✓`, printing should continue by applying the option shown. If more than one option is available when the customer presses `✓`, the options are listed with the most logical option listed first and highlighted.
- **Critical error messages**—Critical error messages communicate printer failures to the customer. Generally, turning power off and then on is required in order for the printer to resume normal operation. If the critical error persists, the printer might require service and the customer must request a service call. Critical errors are not auto-continuable.
- **Output device warning messages**—These messages are similar to the warning messages that were described previously, except that they relate to the output device. By default only, the message appears if the output device does not provide any additional help. The prompt at the bottom of the control panel does *not* appear.
- **Output device error messages**—These messages are similar to the error messages that are described previously, except that they relate to the output device. By default only, the message appears if the output device does not provide any additional help. The prompt at the bottom of the control panel does *not* appear.

## Control-panel and event-log message format

The control-panel messages are in the following format:

- 13.XY.ZZ JAM INSIDE DUPLEXER
- WAITING FOR TRAY XX TO LIFT
- 40 EIO X BAD TRANSMISSION

The event-log messages are in the following format:

- 3 13.xy.zz 0 JAM INSIDE DUPLEXER
- 2 00.00.00 0 WAITING FOR TRAY XX TO LIFT
- 1 40.00.00 0 EIO X BAD TRANSMISSION

---

### Note

Print a configuration page to identify the input or output device that is configured. Notice that the error format only identifies the Jetlink device number and the device type; it does not identify the input or output device.

---

## Printer-message tables

Printer messages appear on the printer control-panel display to relay the normal status of the printer (such as PROCESSING JOB), or an error condition (such as CLOSE RIGHT DOOR) that needs attention. "Alphabetical error messages" on page 180 and "Numerical error messages" on page 188 list messages that require attention, or that might raise questions. Messages are listed in alphabetical. Not all messages are listed, because some (such as READY) are self-explanatory.

---

### Note

Some printer messages are affected by the AUTO CONTINUE and CLEARABLE WARNINGS settings on the **Configure Device** menu, on the **System Setup** submenu, or on the printer control panel (see "System setup submenu" on page 46).

---

## Alphabetical error messages

Table 20. Alphabetic error messages

Message	Event-log error message	Description or explanation	Recommended action
[F5] DEVICE FAILURE To enter menus Press ✓ alternates with READY To enter menus Press ✓		The printer detected a device failure on the specified device. [F5] is: <ul style="list-style-type: none"> <li>• DISK</li> <li>• FLASH</li> <li>• ROM DISK</li> <li>• RAM DISK</li> </ul>	<ol style="list-style-type: none"> <li>1 Turn off the printer, and then turn the printer on again.</li> <li>2 Reseat the specified device.</li> <li>3 Replace the specified device.</li> </ol>
[F5] FILE OPERATION FAILED To enter menus Press ✓ alternates with READY To enter menus Press ✓		A PJL file system command attempted to perform an illogical operation. [F5] is: <ul style="list-style-type: none"> <li>• DISK</li> <li>• FLASH</li> <li>• ROM DISK</li> <li>• RAM DISK</li> </ul>	Verify the PJL command.
[F5] FILE SYSTEM IS FULL To enter menus Press ✓ alternates with READY To enter menus Press ✓		A PJL file-system command could not store something on the file system. [F5] is: <ul style="list-style-type: none"> <li>• DISK</li> <li>• FLASH</li> <li>• ROM DISK</li> <li>• RAM DISK</li> </ul>	<ol style="list-style-type: none"> <li>1 Clear the file system.</li> <li>2 Check with the system administrator.</li> </ol>
[F5] IS WRITE PROTECTED To enter menus Press ✓ alternates with READY To enter menus Press ✓		The file-system device is protected, and no new files can be written to it. [F5] is: <ul style="list-style-type: none"> <li>• DISK</li> <li>• FLASH</li> <li>• ROM DISK</li> <li>• RAM DISK</li> </ul>	<ol style="list-style-type: none"> <li>1 Remove the file system protection.</li> <li>2 Check with the network administrator.</li> </ol>
<BINNAME> FULL REMOVE ALL PAPER FROM BIN		The specified output bin is full.	<ol style="list-style-type: none"> <li>1 Empty the specified output bin.</li> <li>2 Make sure that the flag moves smoothly.</li> <li>3 If the error persists, perform the service test.</li> </ol>
ACCESS DENIED MENUS LOCKED		Security mechanism is enabled.	<ul style="list-style-type: none"> <li>• Check with the network administrator.</li> </ul>
BLOWN LAMP FUSER			
BLOWN MOTOR FUSER			
CANCELING		The printer is canceling a job.	No action is necessary.



**Table 20. Alphabetic error messages (continued)**

Message	Event-log error message	Description or explanation	Recommended action
CARTRIDGE FAILURE For help press <b>?</b> alternates with RETURN FOR REPLACEMENT For help press <b>?</b>		<ul style="list-style-type: none"> <li>• The print cartridge is defective.</li> <li>• The toner-sensor contact assembly is defective.</li> <li>• The high-voltage power supply is defective.</li> </ul>	<ol style="list-style-type: none"> <li>1 Remove and reinstall the print cartridge</li> <li>2 Replace the cartridge.</li> <li>3 Replace the toner-sensor contact assembly.</li> <li>4 Replace the high-voltage power supply.</li> </ol>
CARTRIDGE LOW-XXXX PAGES ESTIMATED For help press <b>?</b> alternates with TO CONTINUE PRESS ✓		<ul style="list-style-type: none"> <li>• A low-toner situation occurred and the cartridge low setting is set to "stop."</li> <li>• The XXXX starts at 8% toner capacity remaining.</li> <li>• When the estimated pages reaches 0, the message REPLACE CARTRIDGE appears.</li> </ul>	<ol style="list-style-type: none"> <li>1 To continue press ✓ .</li> <li>2 Replace the print cartridge.</li> <li>3 Replace the toner-sensor contact assembly.</li> <li>4 Replace the high-voltage power supply.</li> <li>5 Replace the DC controller.</li> </ol>
CARTRIDGE OUT REPLACE CARTRIDGE For help press <b>?</b> alternates with READY To enter menus press ✓		<ul style="list-style-type: none"> <li>• The toner in the cartridge reached 0%.</li> <li>• The printer continues printing until the drum life reaches 0%.</li> </ul>	Replace the print cartridge.
CHECK CABLES		The printer cables might be loose.	Make sure that the printer cables are secured tightly.
CHECK COPY CONNECT CARD		The copy connect card might not be installed correctly.	Install the copy connect card.
CHECKING PRINTER		The engine is doing an internal test.	No action is necessary.
CHOSEN PERSONALITY NOT AVAILABLE For help press <b>?</b> alternates with READY To enter menus press ✓		<ul style="list-style-type: none"> <li>• The PJI encountered a request for a personality that does not exist in the printer.</li> <li>• The job is aborted, and no pages are printed.</li> </ul>	<ol style="list-style-type: none"> <li>1 Change the font request.</li> <li>2 Install additional fonts.</li> </ol>
CLEANING		A cleaning page is processing.	No action is necessary.
CLEARING EVENT LOG		An event log is clearing.	No action is necessary.
CLEARING PAPER FROM PRINTER		Media is detected in the paper path (the printer will attempt to eject the media).	<ol style="list-style-type: none"> <li>1 No action is necessary.</li> <li>2 If the jam does not clear, remove the media.</li> </ol>
CLOSE FRONT DOOR For help press <b>?</b>		The front door is open.	<ol style="list-style-type: none"> <li>1 Close the front door.</li> <li>2 If the error persists, perform a service test.</li> </ol>

**Table 20. Alphabetic error messages (continued)**

Message	Event-log error message	Description or explanation	Recommended action
DATA RECEIVED PRESS ✓ TO CONTINUE alternates with READY To enter menus press ✓		The printer has received data.	Press ✓ to print the last page.
DELETING		The printer is deleting the stored job.	No action is necessary.
DETECTABLE SIZE IN TRAY XX For help press ? alternates with DETECTABLE SIZE IN TRAY XX MOVE SWITCH TO STANDARD		Standard-size media is loaded in tray XX, but the switch is set to custom.	Set the switch to standard.
DIFFERENT PAPER SIZES IN JOB		The current job has different media sizes.	No action is necessary.
DIGITAL SEND COMMUNICATION		The MFP cannot communicate with the server.	Check with the system administrator.
EIO DISK X NOT FUNCTIONAL For help press ?		The hard disk in the EIO slot X is not working correctly.	<ol style="list-style-type: none"> <li>1 Reseat the hard disk.</li> <li>2 Replace the hard disk.</li> </ol>
EIO X DISK INITIALIZING		The EIO hard disk in slot X is initializing.	No action is necessary.
EIO X DISK SPINNING UP		The EIO hard disk in slot X is spinning up its plater.	No action is necessary.
ERROR EXITING DIGITAL SEND JOB		The digital-send job failed.	Resend the digital-send job.
EXTERNAL DEVICE INITIALIZING To enter menus press ✓		The printer has just been turned on, or is coming out of the PowerSave mode.	No action is necessary.
FINISHER ALIGN ERROR		An alignment error occurred in the output device.	The job will not be completed.
FLASH DISK X INITIALIZING		A new flash DIMM is installed and is initializing.	<ol style="list-style-type: none"> <li>1 No action is necessary.</li> <li>2 Do not turn the power off during the initialization.</li> </ol>
HARD DISK NOT INSTALLED		The hard disk is not installed on the MFP.	Install the hard disk.
INCORRECT PIN		<ul style="list-style-type: none"> <li>• The wrong PIN is typed.</li> <li>• This message appears for 2 seconds and then returns to the previous screen so that the customer can retype the PIN.</li> </ul>	Retype the PIN.

**Table 20. Alphabetic error messages (continued)**

Message	Event-log error message	Description or explanation	Recommended action
INITIALIZING PERMANENT STORAGE		<ul style="list-style-type: none"> <li>• The printer has just been turned on.</li> <li>• Permanent storage is initializing.</li> </ul>	No action is necessary.
INPUT PAPER PATH OPEN		The paper-path between the printer and the external paper-handling input device is open.	Close the input device paper path.
INSTALL CONNECTION UNIT For help press ?		The paper path connection unit was not installed in the right access door.	<ol style="list-style-type: none"> <li>1 Locate and install the paper-path connection unit.</li> <li>2 Reinstall the paper-path connection unit.</li> <li>3 Replace the paper path connection unit.</li> </ol>
INTERNAL DISK NOT FOUND		The internal disk is not found	Make sure that the internal disk is installed correctly.
INTERNAL DISK NOT FUNCTIONAL		The internal disk is not functioning correctly.	Turn off the printer, and then turn the printer on again.
INTERNAL DISK NOT INITIALIZED		The internal disk has not been initialized.	Initialize the disk or check with the system administrator.
LOAD TRAY XX [TYPE] [SIZE] For help press ? alternates with TO USE ANOTHER TRAY PRESS ✓		Tray XX is configured for a specific type and size for a job that has been sent, but the tray is empty.	<ol style="list-style-type: none"> <li>1 Insert media into tray XX.</li> <li>2 Select a different tray by pressing ✓.</li> <li>3 Verify the program settings.</li> </ol>
LOADING PROGRAM XX DO NOT POWER OFF		Programs or fonts are loading into RAM (the length of the process depends on the size of the entity).	No action is necessary (do <i>not</i> turn power off during this process).
MANUAL FEED [TYPE] [SIZE] For help press ? alternates with TO USE ANOTHER TRAY PRESS ✓		A job is sent to the printer, but the specified media size is not available.	<ol style="list-style-type: none"> <li>1 Insert the correct media into tray 1.</li> <li>2 Select a different tray.</li> </ol>
MECHANICAL ERROR			
MEMORY FULL STORED DATA LOST		<ul style="list-style-type: none"> <li>• No memory is available in the printer.</li> <li>• The current job might not print correctly, and some resources (downloaded fonts) might be lost.</li> </ul>	<ol style="list-style-type: none"> <li>1 Simplify the job.</li> <li>2 Install additional memory.</li> </ol>
MEMORY SETTINGS CHANGED		The resource-saving or I/O buffering settings had to be changed by the printer (memory is insufficient for the previous settings).	<ol style="list-style-type: none"> <li>1 Verify the program settings.</li> <li>2 Simplify the job.</li> <li>3 Install additional memory.</li> </ol>

**Table 20. Alphabetic error messages (continued)**

Message	Event-log error message	Description or explanation	Recommended action
MEMORY SHORTAGE JOB CLEARED For help press ? alternates with READY To enter menus press ✓		The printer ran out of memory (the remainder of the job is canceled).	<ol style="list-style-type: none"> <li>1 Add additional memory.</li> <li>2 Add a hard disk.</li> <li>3 Verify the job and program settings.</li> <li>4 Simplify the job.</li> </ol>
MEMORY SHORTAGE PAGE SIMPLIFIED For help press ? alternates with READY To enter menus press ✓		The printer adaptive data compression had to fit the raster graphics in the available memory.	<ol style="list-style-type: none"> <li>1 Simplify the job.</li> <li>2 Add additional memory.</li> <li>3 Add a hard disk.</li> </ol>
NON HP CARTRIDGE DETECTED For help press ?		A non-HP print cartridge is installed.	<p>No action is necessary.</p> <hr/> <p><b>Note</b> This message appears for 30 seconds, and then the printer returns to the READY state.</p> <hr/> <p><b>Note</b> A cartridge-low/out message does not appear with non-HP print cartridges.</p>
OPTIONAL BIN 1 FULL REMOVE ALL PAPER FROM BIN		The face-up bin is full. More than 125 pages are in the face-up bin.	Remove all media from the face-up bin.
OPTIONAL BIN 2 FULL REMOVE ALL PAPER FROM BIN		The stapler bin is full. More than 3,000 sheets of letter or A4 media are in the stapler bin.	Remove all media from the stapler bin.
OUTPUT PAPER PATH OPEN		The paper path between the printer and the output-device is open.	Close the output-device paper path.
PAUSED  To return to ready press RESUME key		PAUSE/RESUME has been pressed. Printing stopped, but the job might be received.	Press PAUSE/RESUME to return the printer to READY.
PERFORM PRINTER MAINTENANCE For help press ?		The printer reached its prescribed printed page threshold of 350,000 pages between maintenance periods.	Perform printer maintenance.
PLEASE WAIT		The printer is deleting data so it can stop receiving I/O.	No action is necessary.
POWERSAVE ON		The printer is in the PowerSave mode.	<p>No action is necessary.</p> <hr/> <p><b>Note</b> Press any key on the control panel to return the device to ready.</p>

**Table 20. Alphabetic error messages (continued)**

Message	Event-log error message	Description or explanation	Recommended action
PRINTING CONFIGURATION		A configuration page is printing.	No action is necessary.
PRINTING EVENT LOG		An event log is printing.	No action is necessary.
PRINTING FILE DIRECTORY		A file directory page is printing.	No action is necessary.
PRINTING FONT LIST		A PCL or PS personality typeface list is printing.	No action is necessary.
PRINTING MENU MAP		A menu map is printing.	No action is necessary.
PRINTING PAPER PATH TEST		A paper-path test is printing.	No action is necessary.
PRINTING REGISTRATION PAGE		A registration page is printing.	No action is necessary.
PRINTING SUPPLIES STATUS		A supplies-status page is printing.	No action is necessary.
PRINTING USAGE PAGE		A usage page is printing.	No action is necessary.
PROCESSING		The printer is processing the current job, but has not yet begun to pick up pages.	No action is necessary.
PROCESSING COPY X OF Y		The printer is processing or printing collated copies (X of Y indicates copies is processing).	No action is necessary.
PROCESSING FROM TRAY X		The printer is processing the current job.	No action is necessary.
READY To enter menus Press ✓		The printer is ready and online, waiting for data.	No action is necessary.
RESEND UPGRADE		The firmware upgrade is not complete.	Resend the upgrade (do not turn power off during the upgrade).
RESETTING FACTORY SETTINGS		<ul style="list-style-type: none"> <li>● “Restore factory settings” is selected.</li> <li>● A cold reset has occurred.</li> </ul>	Reset the configurations.
ROTATE PAPER IN TRAY XX For help Press ?		A job requires booklet printing, but none of the trays has letter or A4 media loaded in the correct orientation.	<ol style="list-style-type: none"> <li>1 Rotate the media in the tray.</li> <li>2 Verify the program settings.</li> </ol>
ROTATE PAPER IN TRAY XX For help Press ? alternates with READY To enter menus Press ✓		Tray XX is loaded with letter or A4 media in the portrait orientation, but the job that used the tray did not specify portrait.	<ol style="list-style-type: none"> <li>1 Verify the program settings.</li> <li>2 Verify the tray settings.</li> </ol> <p><b>Note</b> To improve performance, rotate the media.</p>

**Table 20. Alphabetic error messages (continued)**

Message	Event-log error message	Description or explanation	Recommended action
SCAN CARRIAGE LOCKED		The scan carriage is locked.	Unlock the scan carriage.
SCAN FAILURE		A scanning job failed.	Turn off the printer, and then turn the printer on again.
SETTING SAVED		A value is saved.	No action is necessary.
SIZE MISMATCH TRAY XX = [SIZE] For help press ?		The media loaded in the tray is longer or shorter in the feed direction than the size that the tray is configured for.	<ol style="list-style-type: none"> <li>1 Verify the tray settings.</li> <li>2 Set the tray switch to standard (if custom-size media is used, set the X and Y values in the custom setting of the control panel).</li> </ol>
STAPLER ALIGN ERROR		The media in the stapling device is unaligned (this error message might appear when different media sizes are used for the same print job).	Clean the rollers at the accumulator.
STAPLER JAM For help press ?		The stapler is jammed.	Clear the jammed staples.
STAPLER OUT OF STAPLES For help press ?		The stapler is out of staples.	Replace the staple cartridge.
STAPLING INTERRUPTION		An obstruction in the stapler must be removed before stapling can continue.	Remove the obstruction.
TOO MANY PAGES IN JOB TO STAPLE For help press ?		The output device received too many pages to perform the stapling process.	The pages are ejected without being finished.
TRAY XX CONTAINS UNKNOWN MEDIA		The media type in the specified tray cannot be determined.	<ol style="list-style-type: none"> <li>1 Verify the tray settings.</li> <li>2 Make the media settings more specific.</li> </ol>
TRAY XX EMPTY [TYPE] [SIZE] To enter menus press ✓ alternates with READY To enter menus press ✓		The specified tray is empty, but the current job does not require this tray to print correctly.	Load additional media into the tray.
TRAY XX OPEN For help press ? alternates with READY To enter menus press ✓		The specified tray is open, but the current job does not require this tray to print.	Close the tray.

**Table 20. Alphabetic error messages (continued)**

Message	Event-log error message	Description or explanation	Recommended action
TRAY XX SIZE= *DETECTED SIZE For help press ? alternates with TRAY X SIZE= *DETECTED SIZE To change, move switch in tray x		The custom switch is in the "Standard" position, and the customer selects a value from the menu.	<ol style="list-style-type: none"> <li>1 Verify the tray settings.</li> <li>2 Verify the program settings.</li> <li>3 Set the tray switch to "Custom," or do not select a value from the menu.</li> </ol>
TRAY XX [TYPE] [SIZE] DETECTED SIZE		The media size in tray XX when the tray is closed and the custom switch is not changed.	If custom size media is installed, change the custom switch to the correct position.
TYPE MISMATCH TRAY XX= [TYPE] For help press ?		The system detects a transparency in the paper path coming from tray XX.	<ol style="list-style-type: none"> <li>1 Reconfigure the tray for transparencies.</li> <li>2 If no transparencies are installed, replace the OHT sensor (PS1).</li> </ol>
UNABLE TO STORE JOB		A memory, disk, or configuration problem prevents the job from being stored.	Check the control panel for additional messages.
UNSUPPORTED SIZE IN TRAY XX		A job requires a specified size media that is not supported by the printer.	<ol style="list-style-type: none"> <li>1 Reformat the print job to use a supported size.</li> <li>2 Cancel the job.</li> </ol>
USE [TYPE] [SIZE] FROM TRAY N INSTEAD		The requested media size or type is not available (the printer asks if it should use another media size or type instead).	<ol style="list-style-type: none"> <li>1 Select a different type, size, or tray to use. Use ▲ and ▼ to view the available media in the printer and press ✓ to select the highlighted tray.</li> <li>2 Verify the program settings.</li> </ol>
WAIT FOR PRINTER TO REINITIALIZE		A RAM-disk setting changed (the printer is automatically restarting). An output-device setting changed (the printer is automatically restarting).	No action is necessary (do not turn the power off during initialization).
WAITING FOR TRAY XX TO LIFT		The tray number XX is lifting the media to the top of the tray for correct feeding.	No action is necessary.
WARMING UP		The printer was turned on or is coming out of PowerSave mode.	No action is necessary.

## Numerical error messages

Table 21. Numeric error messages

Control panel message	Event-log error message	Description	Recommended action
13.01.00 JAM IN TRAY 1 For help press ?	13.01.00	A page is jammed in the paper path at the tray 1 feed area.	<ol style="list-style-type: none"> <li>1 Clear the jam in the indicated area.</li> <li>2 Close the door so that the printer attempts to clear the paper path.</li> <li>3 Perform a service test. <a href="#">See page 213.</a></li> <li>4 If the error persists, replace the paper-input unit.</li> <li>5 Replace the tray 1 pickup rollers.</li> <li>6 Replace tray 1.</li> </ol>
13.01.00 JAM IN TRAY X For help press ?	13.01.00	<p>A page is jammed in the paper path at tray X feed area.</p> <ul style="list-style-type: none"> <li>• Tray 2: The media did not reach the tray 2 feed sensor (PS1402) within the specified time.</li> <li>• Tray 3: The media did not reach the tray 3 feed sensor (PS1404) within the specified time.</li> </ul>	<ol style="list-style-type: none"> <li>1 Clear the jam in the indicated area.</li> <li>2 Closing the door so that the printer attempts to clear the paper path.</li> <li>3 Make sure that the pickup roller is installed in tray 2 and/or tray 3.</li> <li>4 Replace the pickup rollers.</li> <li>5 If the errors persists, replace the paper-input unit.</li> </ol>
13.01.00 JAM INSIDE RIGHT DOOR For help press ?	13.01.00	A page is jammed in the paper path at the feed area.	<ol style="list-style-type: none"> <li>1 Clear the jam in the indicated area.</li> <li>2 Close the door so that the printer attempts to clear the paper path.</li> <li>3 Perform a service test. <a href="#">See page 213.</a></li> <li>4 If the error persists, replace the paper input unit.</li> <li>5 Replace the tray 1 pickup rollers.</li> <li>6 Replace tray 1.</li> </ol>



**Table 21. Numeric error messages (continued)**

Control panel message	Event-log error message	Description	Recommended action
13.03.00 JAM IN TRAY 1 For help press ?	13.03.00	<ul style="list-style-type: none"> <li>● A page is jammed in the paper path at the tray 1 feed area.</li> <li>● The media did not reach the registration sensor (PS2) within the specified time.</li> </ul>	<ol style="list-style-type: none"> <li>1 Clear the jam in the indicated area.</li> <li>2 Close the door so that the printer attempts to clear the paper path.</li> <li>3 Perform a service test. <a href="#">See page 213.</a></li> <li>4 If the error persists when feeding, replace the tray 1 pickup rollers and replace tray 1.</li> </ol>
13.03.00 JAM IN TRAY X For help press ?	13.03.00	<ul style="list-style-type: none"> <li>● A page is jammed in the paper path at tray X feed area.</li> <li>● The media did not reach the registration sensor (PS2) within the specified time.</li> </ul>	<ol style="list-style-type: none"> <li>1 Clear the jam in the indicated area.</li> <li>2 Close the door so that the printer attempts to clear the paper path.</li> <li>3 Perform a service test. <a href="#">See page 213.</a></li> <li>4 If the error persists when feeding from tray 2 or tray 3, replace the paper input unit.</li> </ol>
13.03.00 JAM INSIDE RIGHT DOOR For help press ?	13.03.00	A page is jammed in the paper path at the feed area.	<ol style="list-style-type: none"> <li>1 Clear the jam in the indicated area.</li> <li>2 Close the door so that the printer attempts to clear the paper path.</li> <li>3 Perform a service test. <a href="#">See page 213.</a></li> <li>4 If the error persists, replace the paper-input unit.</li> <li>5 Replace the tray 1 pickup rollers.</li> <li>6 Replace tray 1.</li> </ol>
13.05.00 JAM INSIDE FRONT DOOR For help press ?	13.05.00	<ul style="list-style-type: none"> <li>● A page is jammed in the paper path at the fuser area.</li> <li>● The leading edge of the media did not reach the fuser delivery sensor (PS502) within the specified time.</li> </ul>	<ol style="list-style-type: none"> <li>1 Clear the jam in the indicated area.</li> <li>2 Close the door so that the printer attempts to clear the paper path.</li> <li>3 If the error persists, replace the print cartridge.</li> <li>4 Replace the transfer roller assembly.</li> <li>5 Replace the fuser.</li> </ol>

**Table 21. Numeric error messages (continued)**

Control panel message	Event-log error message	Description	Recommended action
13.05.00 JAM INSIDE RIGHT DOOR For help press ?	13.05.00	<ul style="list-style-type: none"> <li>● A page is jammed in the paper path at the fuser area.</li> <li>● The leading edge of the media did not reach the fuser delivery sensor (PS502) within the specified time.</li> </ul>	<ol style="list-style-type: none"> <li>1 Clear the jam in the indicated area.</li> <li>2 Close the door so that the printer attempts to clear the paper path.</li> <li>3 If the error persists, replace the print cartridge.</li> <li>4 Replace the transfer roller assembly.</li> <li>5 Replace the fuser.</li> </ol>
13.06.00 JAM INSIDE FRONT DOOR For help press ?	13.06.00	A page is jammed in the paper path at the fuser area.	<ol style="list-style-type: none"> <li>1 Clear the jam in the indicated area.</li> <li>2 Close the door so that the printer attempts to clear the paper path.</li> <li>3 If the error persists, replace the fuser.</li> </ol>
13.06.00 JAM INSIDE LEFT DOOR For help press ?	13.06.00	A page is jammed in the paper path at the fuser area.	<ol style="list-style-type: none"> <li>1 Clear the jam in the indicated area.</li> <li>2 Close the door so that the printer attempts to clear the paper path.</li> <li>3 If the error persists, replace the fuser.</li> </ol>
13.09.00 JAM INSIDE FRONT DOOR For help press ?	13.09.00	<ul style="list-style-type: none"> <li>● A page is jammed in the paper path at the face-down bin.</li> <li>● The leading edge of the media did not reach the face-down bin delivery sensor (PS1451) within the specified time.</li> </ul>	<ol style="list-style-type: none"> <li>1 Clear the jam in the indicated area.</li> <li>2 Close the door so that the printer attempts to clear the paper path.</li> <li>3 Reseat the connections to the DC controller.</li> <li>4 Make sure the delivery flags move smoothly.</li> <li>5 Perform a service test. <a href="#">See page 213.</a></li> <li>6 If the error persists, replace the delivery unit.</li> <li>7 Replace the DC controller.</li> </ol>

**Table 21. Numeric error messages (continued)**

Control panel message	Event-log error message	Description	Recommended action
13.09.00 JAM INSIDE LEFT DOOR For help Press ?	13.09.00	<ul style="list-style-type: none"> <li>● A page is jammed in the paper path at the face-down bin.</li> <li>● The leading edge of the media did not reach the face-down bin delivery sensor (PS1451) within the specified time.</li> </ul>	<ol style="list-style-type: none"> <li>1 Clear the jam in the indicated area.</li> <li>2 Close the door so that the printer attempts to clear the paper path.</li> <li>3 Reseat the connections to the DC controller.</li> <li>4 Make sure the delivery flags move smoothly.</li> <li>5 Perform a service test. <a href="#">See page 213.</a></li> <li>6 If the error persists, replace the delivery unit.</li> <li>7 Replace the DC controller.</li> </ol>
13.0A.00 JAM INSIDE LEFT DOOR For help Press ?	13.0A.00	<ul style="list-style-type: none"> <li>● A page is jammed in the paper path. Access through the left door.</li> <li>● The trailing edge of the media did not leave the face-down bin delivery sensor (PS1451) within the specified time.</li> </ul>	<ol style="list-style-type: none"> <li>1 Clear the jam in the indicated area.</li> <li>2 Close the door so that the printer attempts to clear the paper path.</li> <li>3 If the error persists, replace the delivery unit.</li> <li>4 Replace the diverter.</li> </ol>
13.0A.00 JAM IN TOP OUTPUT BIN For help Press ?	13.0A.00	<ul style="list-style-type: none"> <li>● A page is jammed in the paper path at the face-down bin.</li> <li>● The trailing edge of the media did not leave the face-down bin delivery sensor (PS1451) within the specified time.</li> </ul>	<ol style="list-style-type: none"> <li>1 Clear the jam in the indicated area.</li> <li>2 Close the door so that the printer attempts to clear the paper path.</li> <li>3 If the error persists, replace the delivery unit.</li> <li>4 Replace the diverter.</li> </ol>
13.10.00 JAM INSIDE DUPLEXER DOOR For help Press ?	13.10.00	<ul style="list-style-type: none"> <li>● A page is jammed in the paper path at the reversing area.</li> <li>● The leading edge of the media did not reach the reversed paper sensor (PS2002) in the duplexer within the specified time.</li> </ul>	<ol style="list-style-type: none"> <li>1 Clear the jam in the indicated area.</li> <li>2 Close the door so that the printer attempts to clear the paper path.</li> <li>3 Reseat the connections to the DC controller.</li> <li>4 If the error persists, replace the duplexer.</li> </ol>
13.10.00 JAM INSIDE LEFT DOOR For help Press ?	13.10.00	<ul style="list-style-type: none"> <li>● A page is jammed in the paper path at the reversing area.</li> <li>● The leading edge of the media did not reach the reversed paper sensor (PS2002) in the duplexer within the specified time.</li> </ul>	<ol style="list-style-type: none"> <li>1 Clear the jam in the indicated area.</li> <li>2 Close the door so that the printer attempts to clear the paper path.</li> <li>3 Reseat the connections to the DC controller.</li> <li>4 If the error persists, replace the duplexer.</li> </ol>

**Table 21. Numeric error messages (continued)**

Control panel message	Event-log error message	Description	Recommended action
13.11.00 JAM INSIDE DUPLXER DOOR For help press ?	13.11.00	<ul style="list-style-type: none"> <li>● A page is jammed in the paper path at the reversing area.</li> <li>● The trailing edge of the media did not leave the reversed paper sensor (PS2002) in the duplexer within the specified time.</li> </ul>	<ol style="list-style-type: none"> <li>1 Clear the jam in the indicated area.</li> <li>2 Close the door so that the printer attempts to clear the paper path.</li> <li>3 Reseat the connections to the DC controller.</li> <li>4 If the error persists, replace the duplexer.</li> </ol>
13.11.00 JAM INSIDE LEFT DOOR For help press ?	13.11.00	<ul style="list-style-type: none"> <li>● A page is jammed in the paper path at the reversing area.</li> <li>● The trailing edge of the media did not leave the reversed paper sensor (PS2002) in the duplexer within the specified time.</li> </ul>	<ol style="list-style-type: none"> <li>1 Clear the jam in the indicated area.</li> <li>2 Close the door so that the printer attempts to clear the paper path.</li> <li>3 Reseat the connections to the DC controller.</li> <li>4 If the error persists, replace the duplexer.</li> </ol>
13.11.05 JAM IN INPUT ACCESSORY For help press ?	13.11.05	<ul style="list-style-type: none"> <li>● A page is jammed in the paper path at the registration area.</li> <li>● A pickup delay jam has occurred.</li> </ul>	<ol style="list-style-type: none"> <li>1 Clear the jam in the indicated area.</li> <li>2 Close the door so that the printer attempts to clear the paper path.</li> <li>3 Perform a paper-path test. <a href="#">See page 213.</a></li> <li>4 If the error persists, replace the paper-pickup assembly.</li> </ol>
13.11.06 PICKUP STATIONARY JAM For help press ?	13.11.06	A page is jammed in the pickup area of the input accessory.	<ol style="list-style-type: none"> <li>1 Clear the jam in the indicated area of the input device.</li> <li>2 Remove the media from the right door of the printer engine.</li> </ol>
13.11.07 JAM IN INPUT ACCESSORY For help press ?	13.11.07	<ul style="list-style-type: none"> <li>● A page is jammed in the right door area.</li> <li>● A page stopped in the registration area.</li> </ul>	<ol style="list-style-type: none"> <li>1 Clear the jam in the indicated area.</li> <li>2 Close the door so that the printer attempts to clear the paper path.</li> <li>3 If the error persists, replace the vertical transfer unit.</li> </ol>

**Table 21. Numeric error messages (continued)**

Control panel message	Event-log error message	Description	Recommended action
13.11.08 JAM IN INPUT ACCESSORY For help press ?	13.11.08	<ul style="list-style-type: none"> <li>● A page is jammed in the paper path at the vertical transfer unit registration area.</li> <li>● A paper-delivery delay jam occurred.</li> </ul>	<ol style="list-style-type: none"> <li>1 Clear the jam in the indicated area.</li> <li>2 Close the door so that the printer attempts to clear the paper path.</li> <li>3 Make sure that the vertical transfer sensor is functional.</li> <li>4 If the error persists, replace the vertical transfer sensor.</li> <li>5 Replace the vertical transfer unit.</li> </ol>
13.11.09 JAM IN INPUT ACCESSORY For help press ?	13.11.09	<ul style="list-style-type: none"> <li>● A page is jammed in the paper path at the right door area.</li> <li>● A paper-delivery stationary jam occurred.</li> </ul>	<ol style="list-style-type: none"> <li>1 Clear the jam in the indicated area.</li> <li>2 Close the door so that the printer attempts to clear the paper path.</li> <li>3 Replace the paper path connection unit.</li> <li>4 Replace the vertical registration assembly.</li> <li>5 If the error persists, replace the diverter.</li> </ol>
13.11.10 RESIDUAL JAM IN DELIVERY AREA For help press ?	13.11.10	A page is jammed in the delivery area when the power is turned on or when the front door is closed.	<ol style="list-style-type: none"> <li>1 Clear the jam.</li> <li>2 Turn off the printer, and then turn the printer on again.</li> <li>3 Replace the paper path connection unit.</li> <li>4 Replace the VRA.</li> </ol>
13.11.0A JAM IN INPUT DEVICE For help press ?	13.11.0A	A page is jammed in the input device when the power is turned on.	<ol style="list-style-type: none"> <li>1 Clear the jam in the indicated area.</li> <li>2 Turn off the printer, and then turn the printer on again.</li> </ol>
13.12.00 JAM INSIDE DUPLEXER DOOR For help press ?	13.12.00	<ul style="list-style-type: none"> <li>● A page is jammed in the paper path at the duplexer.</li> <li>● The leading edge of the media did not reach the duplexer paper sensor (PS2004) within the specified time.</li> </ul>	<ol style="list-style-type: none"> <li>1 Clear the jam in the indicated area.</li> <li>2 Close the door so that the printer attempts to clear the paper path.</li> <li>3 Perform a paper-path test. <a href="#">See page 213.</a></li> <li>4 If the error persists, replace the fuser.</li> <li>5 Replace the duplexer.</li> <li>6 Replace the diverter.</li> </ol>

**Table 21. Numeric error messages (continued)**

Control panel message	Event-log error message	Description	Recommended action
13.12.00 JAM INSIDE LEFT DOOR For help press ?	13.12.00	<ul style="list-style-type: none"> <li>● A page is jammed in the paper path at the duplexer.</li> <li>● The leading edge of the media did not reach the duplexer paper sensor (PS2004) within the specified time.</li> </ul>	<ol style="list-style-type: none"> <li>1 Clear the jam in the indicated area.</li> <li>2 Close the door so that the printer attempts to clear the paper path.</li> <li>3 Perform a paper-path test. <a href="#">See page 213.</a></li> <li>4 If the error persists, replace the fuser.</li> <li>5 Replace the duplexer.</li> <li>6 Replace the diverter.</li> </ol>
13.12.01 JAM IN LEFT ACCESSORY For help press ?	13.12.01	<ul style="list-style-type: none"> <li>● Media is present in the flipper when power is turned on.</li> <li>● An auto-flush operation is not possible.</li> </ul>	<ol style="list-style-type: none"> <li>1 Clear the jam.</li> <li>2 Turn off the printer, and then turn the printer on again.</li> <li>3 Send two pages through for a paper-path test.</li> <li>4 Replace the flipper assembly.</li> </ol>
13.12.02 JAM IN LEFT ACCESSORY For help press ?	13.12.02	Media never reached the flipper input area.	<ol style="list-style-type: none"> <li>1 Clear the jam.</li> <li>2 Turn off the printer, and then turn the printer on again.</li> <li>3 Send two pages through for a paper-path test.</li> <li>4 Replace the flipper assembly.</li> </ol>
13.12.03 JAM IN LEFT ACCESSORY For help press ?	13.12.03	Media is jammed in the flipper entry area.	<ol style="list-style-type: none"> <li>1 Clear the jam.</li> <li>2 Turn off the printer, and then turn the printer on again.</li> <li>3 Send two pages through for a paper-path test to test the top face-down bin and the left face-up bin.</li> <li>4 Replace the flipper assembly.</li> </ol>
13.12.04 JAM IN LEFT ACCESSORY For help press ?	13.12.04	Media is jammed in the flipper internal area.	<ol style="list-style-type: none"> <li>1 Clear the jam.</li> <li>2 Turn off the printer, and then turn the printer on again.</li> <li>3 Send two pages through for a paper-path test.</li> <li>4 Replace the delivery assembly.</li> <li>5 Replace the flipper assembly.</li> </ol>

**Table 21. Numeric error messages (continued)**

Control panel message	Event-log error message	Description	Recommended action
<p>13.12.10 JAM IN LEFT ACCESSORY For help press ?</p>	<p>13.12.0A</p>	<p>Media was present in the paper path when power was turned on.</p>	<ol style="list-style-type: none"> <li>1 Clear the jam.</li> <li>2 Check for mechanical interference in the flipper and paper-path rollers.</li> <li>3 Turn off the printer, and then turn the printer on again.</li> <li>4 Send two pages through for a paper-path test.</li> <li>5 Replace the paper-path assembly.</li> </ol>
<p>13.12.11 JAM IN LEFT ACCESSORY For help press ?</p>	<p>13.12.0B</p>	<ul style="list-style-type: none"> <li>● Media stopped while it was flipping.</li> <li>● Media never reached the FLEXIT sensor.</li> </ul>	<ol style="list-style-type: none"> <li>1 Clear the jam.</li> <li>2 Check for mechanical interference in the flipper and paper-path rollers.</li> <li>3 Turn off the printer, and then turn the printer on again.</li> <li>4 Send two pages through for a paper-path test.</li> <li>5 Replace the paper-path assembly.</li> </ol>
<p>13.12.12 JAM IN LEFT ACCESSORY For help press ?</p>	<p>13.12.0C</p>	<p>Media stopped in the paper path.</p>	<ol style="list-style-type: none"> <li>1 Clear the jam.</li> <li>2 Check for mechanical interference in the flipper and paper-path rollers.</li> <li>3 Turn off the printer, and then turn the printer on again.</li> <li>4 Send two pages through for a paper-path test.</li> <li>5 Replace the paper-path assembly.</li> </ol>
<p>13.12.13 JAM IN LEFT ACCESSORY For help press ?</p>	<p>13.12.0D</p>	<ul style="list-style-type: none"> <li>● Media stopped in the paper path.</li> <li>● Media jammed entering the accumulator or offset module.</li> </ul>	<ol style="list-style-type: none"> <li>1 Clear the jam.</li> <li>2 Check for mechanical interference in the flipper and paper-path rollers.</li> <li>3 Check for jams at the accumulator or the offset module.</li> <li>4 Turn off the printer, and then turn the printer on again.</li> <li>5 Send two pages through for a paper-path test.</li> <li>6 Replace the paper-path assembly.</li> </ol>

**Table 21. Numeric error messages (continued)**

Control panel message	Event-log error message	Description	Recommended action
13.12.20 JAM IN LEFT ACCESSORY For help press ?	13.12.14	<ul style="list-style-type: none"> <li>● Media is present in the accumulator when the printer is turned on.</li> <li>● Media is activating the exit sensor when the printer is turned on.</li> </ul>	<ol style="list-style-type: none"> <li>1 Clear the jam.</li> <li>2 Turn off the printer, and then turn the printer on again.</li> <li>3 Send two pages through for a paper-path test.</li> <li>4 Replace the accumulator assembly.</li> </ol>
13.12.21 JAM IN LEFT ACCESSORY For help press ?	13.12.15	Media is jammed in the accumulator entry area.	<ol style="list-style-type: none"> <li>1 Clear the jam.</li> <li>2 Turn off the printer, and then turn the printer on again.</li> <li>3 Send two pages through for a paper-path test.</li> <li>4 Replace the accumulator assembly.</li> </ol>
13.12.22 JAM IN LEFT ACCESSORY For help press ?	13.12.16	<p>The GW sensor never activated.</p> <hr style="width: 10%; margin-left: 0;"/> <p><b>Note</b> This jam might be a hardware malfunction if the failure persists consistently.</p>	<ol style="list-style-type: none"> <li>1 Clear the jam.</li> <li>2 Turn off the printer, and then turn the printer on again.</li> <li>3 Send two pages through for a paper-path test.</li> <li>4 Replace the accumulator assembly.</li> </ol>
13.12.23 JAM IN LEFT ACCESSORY For help press ?	13.12.17	Media is jammed in the accumulator exit area.	<ol style="list-style-type: none"> <li>1 Clear the jam.</li> <li>2 Turn off the printer, and then turn the printer on again.</li> <li>3 Send two pages through for a paper-path test.</li> <li>4 Replace the accumulator assembly.</li> </ol>
13.12.24 JAM IN LEFT ACCESSORY For help press ?	13.12.18	<p>The retainer sensor does not activate.</p> <hr style="width: 10%; margin-left: 0;"/> <p><b>Note</b> This jam might be a hardware malfunction if the error persists.</p>	<ol style="list-style-type: none"> <li>1 Clear the jam.</li> <li>2 Turn off the printer, and then turn the printer on again.</li> <li>3 Send two pages through for a paper-path test.</li> <li>4 Replace the accumulator assembly.</li> </ol>
13.12.30 JAM IN LEFT ACCESSORY For help press ?	13.12.1E	<ul style="list-style-type: none"> <li>● The carriage hit the media.</li> <li>● Media is jammed between the carriage and the stack of paper in the stapling area.</li> <li>● The carriage motor does not detect movement; it should be finding the home position.</li> </ul>	<ol style="list-style-type: none"> <li>1 Clear the jam.</li> <li>2 Perform a staple-position calibration.</li> <li>3 Send a staple job to the stapler.</li> <li>4 Turn off the printer, and then turn the printer on again.</li> <li>5 Replace the carriage assembly.</li> <li>6 Replace the stapler unit.</li> </ol>



**Table 21. Numeric error messages (continued)**

Control panel message	Event-log error message	Description	Recommended action
13.12.31 JAM IN LEFT ACCESSORY For help press ?	13.12.1F	Media is jammed in the stapler unit.	<ol style="list-style-type: none"> <li>1 Clear the jam.</li> <li>2 Turn off the printer, and then turn the printer on again.</li> <li>3 Send a staple job to the stapler.</li> <li>4 Replace the stapler unit.</li> <li>5 Replace the carriage assembly.</li> </ol>
13.12.40 JAM IN LEFT ACCESSORY For help press ?	13.12.28	Media is present in the offset module when power is turned on.	<ol style="list-style-type: none"> <li>1 Clear the jam.</li> <li>2 Turn off the printer, and then turn the printer on again.</li> <li>3 Send two pages through for a test job.</li> <li>4 Replace the offset assembly.</li> </ol>
13.12.41 JAM IN LEFT ACCESSORY For help press ?	13.12.29	<p>The offset module did not reach its target position.</p> <p><b>Note</b> This jam might be a hardware malfunction if the failure repeats five consecutive times.</p>	<ol style="list-style-type: none"> <li>1 Clear the jam.</li> <li>2 Turn off the printer, and then turn the printer on again.</li> <li>3 Send two pages through for a test job.</li> <li>4 Replace the offset assembly.</li> </ol>
13.12.42 JAM IN LEFT ACCESSORY For help press ?	13.12.2A	Media is jammed in the offset module exit area.	<ol style="list-style-type: none"> <li>1 Clear the jam.</li> <li>2 Turn off the printer, and then turn the printer on again.</li> <li>3 Send two pages through for a test job.</li> <li>4 Replace the offset assembly.</li> </ol>
13.13.00 JAM INSIDE DUPLER DOOR For help press ?	13.13.00	<ul style="list-style-type: none"> <li>● A page is jammed in the paper path at the duplexer.</li> <li>● The trailing edge of the media did not leave the duplexer paper sensor (PS2004) within a specified time.</li> </ul>	<ol style="list-style-type: none"> <li>1 Clear the jam in the indicated area.</li> <li>2 Close the door so that the printer attempts to clear the paper path.</li> <li>3 If the error persists, replace the duplexer.</li> </ol>
13.13.00 JAM INSIDE LEFT DOOR For help press ?	13.13.00	<ul style="list-style-type: none"> <li>● A page is jammed in the paper path at the duplexer.</li> <li>● The trailing edge of the media did not leave the duplexer paper sensor (PS2004) within a specified time.</li> </ul>	<ol style="list-style-type: none"> <li>1 Clear the jam in the indicated area.</li> <li>2 Close the door so the printer attempts to clear the paper path.</li> <li>3 If the error persists, replace the duplexer.</li> </ol>

**Table 21. Numeric error messages (continued)**

Control panel message	Event-log error message	Description	Recommended action
<p>13.20.00 JAM INSIDE FRONT DOOR For help press ?</p>	<p>13.20.00</p>	<ul style="list-style-type: none"> <li>● A page is jammed in the paper path.</li> <li>● Media is present in the printer.</li> </ul> <p><b>Note</b></p> <p>Media is detected in the paper path when the printer is turned on, or media is detected after opening and closing any door:</p> <ul style="list-style-type: none"> <li>• Registration sensor (PS2)</li> <li>• Fusing-unit jam sensor (PS501)</li> <li>• Fusing-unit delivery sensor (PS502)</li> <li>• Tray 2 paper-feed sensor (PS1402)</li> <li>• Tray 3 paper-feed sensor (PS1403)</li> <li>• Face-down-bin delivery sensor (PS1451)</li> </ul> <ul style="list-style-type: none"> <li>● The duplexer residual paper sensor (PS2005) detects media.</li> </ul>	<ol style="list-style-type: none"> <li><b>1</b> Clear the jam in the indicated area.</li> <li><b>2</b> Close the door so that the printer attempts to clear the paper path.</li> <li><b>3</b> Perform a paper-path test. <a href="#">See page 213.</a></li> <li><b>4</b> Verify correct seating of the leaf springs under the high-voltage power supply.</li> <li><b>5</b> Remove the duplexer and make sure that all of the media is removed from the paper path.</li> <li><b>6</b> Verify the correct movement of the duplexer residual-paper sensor.</li> <li><b>7</b> If the error persists, replace the fuser.</li> </ol>
<p>13.20.00 JAM INSIDE LEFT DOOR For help press ?</p>	<p>13.20.00</p>	<ul style="list-style-type: none"> <li>● A page is jammed in the paper path.</li> <li>● Media is present in the printer.</li> </ul>	<ol style="list-style-type: none"> <li><b>1</b> Clear the jam in the indicated area.</li> <li><b>2</b> Close the door so the printer attempts to clear the paper path.</li> <li><b>3</b> Perform a paper-path test. <a href="#">See page 213.</a></li> <li><b>4</b> Verify the correct seating of the leaf springs under the high-voltage power supply.</li> <li><b>5</b> If the error persists, replace the fuser.</li> </ol>
<p>13.21.00 JAM INSIDE FRONT DOOR For help press ?</p>	<p>13.21.00</p>	<p>A door is open.</p>	<ol style="list-style-type: none"> <li><b>1</b> Close the door so that the printer attempts to clear the paper path.</li> <li><b>2</b> Clear the jam in the indicated area.</li> <li><b>3</b> Perform a paper-path test. <a href="#">See page 213.</a></li> <li><b>4</b> Perform a service test. <a href="#">See page 213.</a></li> <li><b>5</b> Verify that the interlock switches are working correctly.</li> <li><b>6</b> If the error persists, replace the front door.</li> </ol>

**Table 21. Numeric error messages (continued)**

Control panel message	Event-log error message	Description	Recommended action
<p>13.21.00 JAM INSIDE LEFT DOOR For help Press ?</p>	<p>13.21.00</p>	<p>A door is open.</p>	<ol style="list-style-type: none"> <li><b>1</b> Close the door so that the printer attempts to clear the paper path.</li> <li><b>2</b> Clear the jam in the indicated area.</li> <li><b>3</b> Perform a paper-path test. <a href="#">See page 213.</a></li> <li><b>4</b> Perform a service test. <a href="#">See page 213.</a></li> <li><b>5</b> Verify that the interlock switches are working correctly.</li> <li><b>6</b> If the error persists, replace the left door.</li> </ol>
<p>13.30.00 JAM IN TRAY 1 For help Press ?</p>	<p>13.30.00</p>	<p>A page is jammed in the pickup area of tray 1.</p>	<ol style="list-style-type: none"> <li><b>1</b> Clear the jam in the indicated area.</li> <li><b>2</b> Close the door so that the printer attempts to clear the paper path.</li> <li><b>3</b> Perform a service test. <a href="#">See page 213.</a></li> <li><b>4</b> If the error persists, replace the paper input unit.</li> <li><b>5</b> Replace the tray 1 pickup rollers.</li> <li><b>6</b> Replace tray 1.</li> </ol>
<p>13.30.00 JAM IN TRAY X For help Press ?</p>	<p>13.30.00</p>	<p>A page is jammed in the pickup area of tray X.</p>	<ol style="list-style-type: none"> <li><b>1</b> Clear the jam in the indicated area.</li> <li><b>2</b> Close the door so that the printer attempts to clear the paper path.</li> <li><b>3</b> Perform a service test. <a href="#">See page 213.</a></li> <li><b>4</b> If the error persists, replace the paper input unit.</li> <li><b>5</b> Replace the tray X pickup rollers.</li> <li><b>6</b> Replace tray X.</li> </ol>

**Table 21. Numeric error messages (continued)**

Control panel message	Event-log error message	Description	Recommended action
13.30.00 JAM INSIDE RIGHT DOOR For help press ?	13.30.00	A page is jammed in the pickup area of tray 1.	<ol style="list-style-type: none"> <li>1 Clear the jam in the indicated area.</li> <li>2 Close the door so that the printer attempts to clear the paper path.</li> <li>3 Perform a service test. <a href="#">See page 213.</a></li> <li>4 If the error persists, replace the paper-input unit.</li> <li>5 Replace the tray 1 pickup rollers.</li> <li>6 Replace tray 1.</li> </ol>
13.31.00 JAM INSIDE FRONT DOOR For help press ?	13.31.00	<ul style="list-style-type: none"> <li>● A page is jammed in the paper path at the fuser area.</li> <li>● The leading edge of the media reached the fuser delivery sensor (PS502) within the specified time, but the trailing edge of the media did not reach the fuser-jam sensor (PS501) within the specified time.</li> </ul>	<ol style="list-style-type: none"> <li>1 Clear the jam in the indicated area.</li> <li>2 Close the door so that the printer attempts to clear the paper path.</li> <li>3 If the error persists, replace the fuser.</li> </ol>
13.31.00 JAM INSIDE LEFT DOOR For help press ?	13.31.00	<ul style="list-style-type: none"> <li>● A page is jammed in the paper path at the fuser area.</li> <li>● The leading edge of the media reached the fuser delivery sensor (PS502) within the specified time, but the trailing edge of the media did not reach the fuser-jam sensor (PS501) within the specified time.</li> </ul>	<ol style="list-style-type: none"> <li>1 Clear the jam in the indicated area.</li> <li>2 Close the door so that the printer attempts to clear the paper path.</li> <li>3 If the error persists, replace the fuser.</li> </ol>
13.32.00 JAM INSIDE RIGHT DOOR For help press ?	13.32.00	<ul style="list-style-type: none"> <li>● A page is jammed in the paper path at the feed area.</li> <li>● The media did not leave the registration sensor (PS2) within the specified time.</li> </ul>	<ol style="list-style-type: none"> <li>1 Clear the jam in the indicated area.</li> <li>2 Close the door so that the printer attempts to clear the paper path.</li> <li>3 Replace the registration assembly.</li> <li>4 If the error persists, replace the paper-input unit.</li> </ol>
13.XX.YZ JAM INSIDE TOP OUTPUT BIN	13.0A.00	A delivery stay jam has occurred, and the media did not clear PS1451 within the specified time.	<ol style="list-style-type: none"> <li>1 Clear the jam in the indicated area.</li> <li>2 Close the door so that the printer attempts to clear the paper path.</li> <li>3 Make sure that PS1451 is functioning correctly.</li> <li>4 Perform a sensor test.</li> <li>5 Perform a paper-path test.</li> </ol>

**Table 21. Numeric error messages (continued)**

Control panel message	Event-log error message	Description	Recommended action
13.XX.YZ JAM IN TRAY N	13.01.00 -or- 13.01.00 -or- 13.30.00	<ul style="list-style-type: none"> <li>● A tray 2 pickup jam has occurred (N = 2) (PS1402).</li> <li>● A tray 3 pickup jam has occurred (N = 3) (PS1404).</li> <li>● A tray 1 pickup jam has occurred (N = 1).</li> </ul>	<ol style="list-style-type: none"> <li>1 Clear the jam in the indicated area.</li> <li>2 Close the door so that the printer attempts to clear the paper path.</li> <li>3 Make sure that the indicated sensor is functioning correctly.</li> <li>4 Perform a sensor test.</li> <li>5 Perform a paper-path test.</li> </ol>
13.XX.YZ JAM INSIDE FRONT DOOR	13.05.00 -or- 13.31.00	<ul style="list-style-type: none"> <li>● A fuser delivery delay jam has occurred, and the media did not clear PS501 within the specified time.</li> <li>● A fuser delivery delay jam has occurred, and the media did not clear PS502 within the specified time.</li> </ul>	<ol style="list-style-type: none"> <li>1 Clear the jam in the indicated area.</li> <li>2 Close the door so that the printer attempts to clear the paper path.</li> <li>3 Make sure that the PS501 sensor flag or the PS502 flag is functioning correctly.</li> <li>4 Perform a sensor test.</li> <li>5 Perform a paper-path test.</li> </ol>
13.XX.YZ JAM INSIDE LEFT DOOR	13.06.00	A fuser delivery stay jam has occurred, and the media did not clear PS501 within the specified time.	<ol style="list-style-type: none"> <li>1 Clear the jam in the indicated area.</li> <li>2 Close the door so that the printer attempts to clear the paper path.</li> <li>3 Make sure that the PS501 sensor flag is functioning correctly.</li> <li>4 Perform a sensor test.</li> <li>5 Perform a paper-path test.</li> </ol>
13.XX.YZ JAM INSIDE LEFT DOOR	13.09.00	A delivery delay jam has occurred, and the media did not clear PS1451 within the specified time.	<ol style="list-style-type: none"> <li>1 Clear the jam in the indicated area.</li> <li>2 Close the door so that the printer attempts to clear the paper path.</li> <li>3 Make sure that PS1451 is functioning correctly.</li> <li>4 Perform a sensor test.</li> <li>5 Perform a paper-path test.</li> </ol>
13.XX.YZ JAM INSIDE LEFT DOOR	13.10.00 -or- 13.11.00	<ul style="list-style-type: none"> <li>● A reversing delay jam has occurred.</li> <li>● A reversing stay jam has occurred.</li> </ul>	<ol style="list-style-type: none"> <li>1 Clear the jam in the indicated area.</li> <li>2 Close the door so that the printer attempts to clear the paper path.</li> <li>3 Perform a sensor test.</li> <li>4 Perform a paper-path test.</li> </ol>

**Table 21. Numeric error messages (continued)**

Control panel message	Event-log error message	Description	Recommended action
13.XX.YZ JAM INSIDE DUPLEXER	13.12.00 -or- 13.13.00	<ul style="list-style-type: none"> <li>● A duplexing delay jam has occurred.</li> <li>● A duplexing stay jam has occurred.</li> </ul>	<ol style="list-style-type: none"> <li>1 Clear the jam in the indicated area.</li> <li>2 Close the door so that the printer attempts to clear the paper path.</li> <li>3 Perform a sensor test.</li> <li>4 Perform a paper-path test.</li> </ol>
13.XX.YZ JAM INSIDE RIGHT DORR	13.32.00	<ul style="list-style-type: none"> <li>● A media stay jam has occurred in the paper path.</li> <li>● The media did not reach PS1401 or PS1403 after reaching PS1402 or PS1404.</li> </ul>	<ol style="list-style-type: none"> <li>1 Clear the jam in the indicated area.</li> <li>2 Close the door so that the printer attempts to clear the paper path.</li> <li>3 Perform a sensor test.</li> <li>4 Perform a paper-path test.</li> </ol>
14.X	14.X	<ul style="list-style-type: none"> <li>● X = 2 for tray 2</li> <li>● X = 3 for tray 3</li> </ul>	<ol style="list-style-type: none"> <li>1 Check the media for premature wear of the feed rollers.</li> <li>2 Clean the feed rollers with a lightly dampened cloth.</li> <li>3 Replace the feed rollers.</li> </ol>
21 PAGE TOO COMPLEX For help press ? alternates with 21 PAGE TOO COMPLEX To continue press ✓	21	The page formatting process is too complex.	<ol style="list-style-type: none"> <li>1 To continue printing, press ✓ (some data will be lost).</li> <li>2 Simplify the print job.</li> <li>3 To print the job without losing data, set PAGE PROTECT=ON in the configuration menu. Do not leave the PAGE PROTECT=ON or the print performance will degrade. The normal setting is PAGE PROTECT=AUTO.</li> <li>4 Add memory.</li> </ol>
22 EIO X BUFFER OVERFLOW To continue press ✓	22	The printer EIO card in slot X overflowed the I/O buffer during a busy state.	<ol style="list-style-type: none"> <li>1 To continue printing, press ✓ (some data will be lost).</li> <li>2 Turn off the printer, and then turn the printer on again.</li> <li>3 Move the EIO card to a different slot.</li> <li>4 Replace the EIO card.</li> </ol>

**Table 21. Numeric error messages (continued)**

Control panel message	Event-log error message	Description	Recommended action
22 EMBEDDED I/O BUFFER OVERFLOW	22	The printer embedded I/O buffer overflowed during a busy state.	<ol style="list-style-type: none"> <li>1 To continue printing, press ✓ (some data will be lost).</li> <li>2 Turn off the printer, and then turn the printer on again.</li> <li>3 See "Embedded LAN troubleshooting (HP LaserJet 9040n/9050n, HP LaserJet 9040dn/9050dn, HP LaserJet 9050mfp, and HP LaserJet 9040mfp only)" on page 247 for more information.</li> </ol>
22 PARALLEL I/O BUFFER OVERFLOW For help press ? alternates with 22 PARALLEL I/O BUFFER OVERFLOW To continue press ✓	22	The printer parallel buffer overflowed during a busy state.	<ol style="list-style-type: none"> <li>1 To continue printing, press ✓ (some data will be lost).</li> <li>2 Turn off the printer, and then turn the printer on again.</li> <li>3 Reseat the parallel cable.</li> <li>4 Replace the parallel cable.</li> <li>5 Replace the formatter.</li> </ol>
22 SERIAL I/O BUFFER OVERFLOW To continue press ✓	22	The printer serial buffer overflowed during a busy state.	<ol style="list-style-type: none"> <li>1 To continue printing, press ✓ (some data lost).</li> <li>2 Turn off the printer, and then turn the printer on again.</li> <li>3 Reseat the serial cable.</li> <li>4 Replace the serial cable.</li> <li>5 Move the EIO card to a different slot.</li> <li>6 Replace the EIO card.</li> </ol>
40 BAD SERIAL TRANSMISSION To continue press ✓	40	A serial data error (parity, framing, or line overrun) occurred while data was being received.	<ol style="list-style-type: none"> <li>1 To continue printing, press ✓ (some data will be lost).</li> <li>2 Turn off the printer, and then turn the printer on again.</li> <li>3 Reseat the serial cable.</li> <li>4 Replace the serial cable.</li> <li>5 Move the EIO card to a different slot.</li> <li>6 Replace the EIO card.</li> </ol>

**Table 21. Numeric error messages (continued)**

Control panel message	Event-log error message	Description	Recommended action
<p>40 EIO X BAD TRANSMISSION To continue Press ✓</p>	<p>40</p>	<p>A connection with the EIO card in slot X has been abnormally interrupted.</p>	<ol style="list-style-type: none"> <li>1 To continue printing, press ✓ (some will be lost).</li> <li>2 Turn off the printer, and then turn the printer on again.</li> <li>3 Reseat the serial cable.</li> <li>4 Replace the serial cable.</li> <li>5 Move the EIO card to a different slot.</li> <li>6 Verify the program settings.</li> <li>7 Replace the EIO card.</li> </ol>
<p>40 EMBEDDED I/O BAD TRANSMISSION</p>	<p>40</p>	<p>A connection with the embedded I/O card has been abnormally interrupted.</p>	<ol style="list-style-type: none"> <li>1 To continue printing, press ✓ (some will be lost).</li> <li>2 Turn off the printer, and then turn the printer on again.</li> <li>3 See <a href="#">"Embedded LAN troubleshooting (HP LaserJet 9040n/9050n, HP LaserJet 9040dn/9050dn, HP LaserJet 9050mfp, and HP LaserJet 9040mfp only)"</a> on page 247 for more information.</li> </ol>
<p>41.3 UNEXPECTED SIZE TRAY XX For help press ? alternates with LOAD TRAY XX [TYPE] [SIZE] To change size press ✓</p>	<p>41.3</p>	<p>Tray XX is loaded with media that is longer or shorter in the feed direction than the size that is configured for the tray.</p>	<ol style="list-style-type: none"> <li>1 Replace the media with the correct size or reconfigure the tray to use the current size.</li> <li>2 Press ✓ to select another tray.</li> <li>3 Verify the position of the standard/custom switch.</li> <li>4 Verify the program settings.</li> </ol>
<p>41.5 UNEXPECTED TYPE TRAY XX For help press ? alternates with LOAD TRAY XX [TYPE] [SIZE] To change type press ✓</p>	<p>41.5</p>	<p>Tray XX is loaded with a media type (transparencies, envelopes) that is different from what the tray is configured to use.</p>	<ol style="list-style-type: none"> <li>1 Replace the media with the correct size or reconfigure the tray to use the current size.</li> <li>2 Press ✓ to select another tray.</li> <li>3 Verify the program settings.</li> </ol>



**Table 21. Numeric error messages (continued)**

Control panel message	Event-log error message	Description	Recommended action
<p>41.X PRINTER ERROR For help press ? alternates with To continue press ✓</p>	<p>41.X</p>	<p>A printer error occurred, and X corresponds to the following issue:</p> <ul style="list-style-type: none"> <li>• 1 = Unknown misprint error</li> <li>• 2 = Beam detect error</li> <li>• 4 = No video sync</li> </ul>	<ol style="list-style-type: none"> <li>1 To continue printing, press ✓.</li> <li>2 Turn off the printer, and then turn the printer on to continue.</li> <li>3 Resend the print job.</li> <li>4 Reseat connections to the laser/scanner and DC controller.</li> <li>5 If error persists, replace the laser/scanner.</li> <li>6 Replace the upper cable guide assembly.</li> <li>7 Replace the DC controller.</li> </ol>
<p>49.X PRINTER ERROR To continue cycle power</p>	<p>49.X</p>	<p>A critical firmware error occurred.</p>	<ol style="list-style-type: none"> <li>1 Turn off the printer, and then turn the printer on to continue.</li> <li>2 Resend the print job.</li> <li>3 Update the firmware to the latest version.</li> </ol>
<p>50.X FUSER ERROR For help press ?</p>	<p>50.X</p>	<p>A fuser error occurred, and X corresponds to the following issue:</p> <ol style="list-style-type: none"> <li>1 Low fuser temperature</li> <li>2 Fuser warm up service</li> <li>3 High fuser temperature</li> <li>4 Faulty fuser</li> <li>5 Inconsistent fuser</li> <li>6 Faulty fuser</li> </ol>	<ol style="list-style-type: none"> <li>1 Turn off the printer, and then turn the printer on to continue.</li> <li>2 Reseat connections to the fuser and the DC controller.</li> <li>3 Reseat the fuser.</li> <li>4 If error persists, replace the fuser.</li> <li>5 Replace the upper cable-guide assembly.</li> <li>6 Replace the low-voltage power supply.</li> <li>7 Replace the DC controller.</li> </ol>
<p>51.X PRINTER ERROR For help press ? alternates with To continue cycle power</p>	<p>51.X</p>	<p>A printer error occurred, and X corresponds to the following issue:</p> <ol style="list-style-type: none"> <li>1 Beam detect error</li> <li>2 Laser error</li> </ol>	<ol style="list-style-type: none"> <li>1 Turn off the printer, and then turn the printer on to continue.</li> <li>2 Reseat connections to the laser/scanner and DC controller.</li> <li>3 If error persists, replace the laser/scanner.</li> <li>4 Replace the upper cable-guide assembly.</li> <li>5 Replace the DC controller.</li> </ol>

**Table 21. Numeric error messages (continued)**

Control panel message	Event-log error message	Description	Recommended action
<p>52.X PRINTER ERROR For help press ? alternates with To continue cycle power</p>	<p>52.X</p>	<p>A printer error occurred, and X corresponds to the following issue:</p> <ul style="list-style-type: none"> <li>0 Scanner error</li> <li>1 Scanner startup error</li> <li>2 Scanner rotation error</li> </ul>	<ul style="list-style-type: none"> <li>1 Turn off the printer, and then turn the printer on to continue.</li> <li>2 Reseat connections to the laser/scanner and DC controller.</li> <li>3 If error persists, replace the laser/scanner.</li> <li>4 Replace the upper cable-guide assembly.</li> <li>5 Replace the DC controller.</li> </ul>
<p>53.XY.ZZ PRINTER ERROR For help press ?</p>	<p>53.XY.ZZ</p>	<p>A DIMM error occurred, and X, Y, and Z corresponds to the following issues:</p> <p>X = DIMM type</p> <ul style="list-style-type: none"> <li>0 ROM</li> <li>1 RAM</li> </ul> <p>Y = Device location</p> <ul style="list-style-type: none"> <li>0 On board RAM/ROM</li> <li>1 DIMM slot 1</li> <li>2 DIMM slot 2</li> <li>3 DIMM slot 3</li> <li>4 DIMM slot 4</li> </ul> <p>ZZ = Error number</p> <ul style="list-style-type: none"> <li>1 Unsupported memory</li> <li>2 Recognized memory</li> <li>3 Less than minimum memory</li> <li>4 Exceeds maximum memory</li> </ul>	<ul style="list-style-type: none"> <li>1 Turn off the printer, and then turn the printer on to continue.</li> <li>2 Reseat the specified DIMM.</li> <li>3 Move DIMM to a different slot.</li> <li>4 If the error persists, replace the specified DIMM.</li> <li>5 Replace the formatter.</li> </ul>
<p>55.X PRINTER ERROR For help press ? alternates with To continue press ✓</p>	<p>55.X</p>	<p>A temporary printer error occurred.</p>	<ul style="list-style-type: none"> <li>1 To clear the error, press ✓.</li> <li>2 Turn off the printer, and then turn the printer on again.</li> <li>3 Make sure that the maintenance kit is not due for replacement.</li> <li>4 Reseat the formatter, DIMMs, and EIO cards.</li> <li>5 Perform an engine test. <a href="#">See page 215.</a></li> <li>6 Perform a service test. <a href="#">See page 213.</a></li> <li>7 Replace the DC controller</li> <li>8 Replace the formatter.</li> </ul>
<p>56.XX PRINTER ERROR For help press ? alternates with To continue cycle power</p>	<p>56.X</p>	<p>A printer error occurred, and X corresponds to the following issue:</p> <ul style="list-style-type: none"> <li>1 Illegal input selection</li> <li>2 Duplexer was removed while power is on</li> </ul>	<ul style="list-style-type: none"> <li>1 Turn off the printer, and then turn the printer on again to continue.</li> <li>2 Check the printer configuration.</li> <li>3 Check the program settings.</li> <li>4 Turn the printer off and reinstall the duplexer.</li> </ul>

**Table 21. Numeric error messages (continued)**

Control panel message	Event-log error message	Description	Recommended action
<p>57.XX PRINTER ERROR For help press ? alternates with To continue cycle power</p>	<p>57.X</p>	<p>A printer error occurred, and X corresponds to the following issue:</p> <ol style="list-style-type: none"> <li>1 Cartridge fan error (fan #5)</li> <li>2 (not used)</li> <li>3 Power-supply-fan error (fan #1)</li> <li>4 Formatter- (controller-) fan error (fan #2)</li> <li>5 Delivery-fan (front) error (fan #4)</li> <li>6 Face-down tray error</li> <li>7 Delivery-fan (back) error (fan #3)</li> <li>8 Duplexer-fan error</li> </ol>	<ol style="list-style-type: none"> <li>1 Turn off the printer, and then turn the printer on again to continue.</li> <li>2 Reseat connections to the specified fan and DC controller.</li> <li>3 If the error persists, replace the specified fan.</li> <li>4 Replace the DC controller.</li> </ol>
<p>58.XX PRINTER ERROR For help press ? alternates with To continue cycle power</p>	<p>58.X</p>	<p>A printer error occurred. XX = 04 (power supply) XX = 03 (CPU)</p>	<ol style="list-style-type: none"> <li>1 Turn off the printer, and then turn the printer on again to continue.</li> <li>2 Check the printer configuration.</li> <li>3 Replace the print cartridge.</li> <li>4 Replace the toner sensor contact assembly.</li> <li>5 Replace the DC controller.</li> </ol>
<p>59.X PRINTER ERROR For help press ? alternates with To continue cycle power</p>	<p>59.X</p>	<p>A printer error occurred, and X corresponds to the following issue:</p> <ol style="list-style-type: none"> <li>0 Main motor error</li> <li>1 Main motor startup error</li> <li>2 Main motor rotation error</li> </ol>	<ol style="list-style-type: none"> <li>1 Turn off the printer, and then turn the printer on again to continue.</li> <li>2 Reseat connections to the DC controller.</li> <li>3 Replace the print cartridge.</li> <li>4 Perform a service test. <a href="#">See page 213.</a></li> <li>5 Replace the main motor.</li> <li>6 Replace the DC controller.</li> </ol>
<p>59.X PRINTER ERROR For help press ? alternates with To continue cycle power</p>	<p>59.X</p>	<p>A printer error occurred, and X corresponds to the following issue:</p> <ol style="list-style-type: none"> <li>3 Abnormal fuser motor start</li> <li>4 Fuser motor rotation error</li> </ol>	<ol style="list-style-type: none"> <li>1 Check the cables connections at the fuser motor, and reseat them as necessary.</li> <li>2 Reseat the fuser.</li> <li>3 Replace the fuser motor.</li> <li>4 Replace the fuser assembly.</li> </ol>

**Table 21. Numeric error messages (continued)**

Control panel message	Event-log error message	Description	Recommended action
<p>60.X PRINTER ERROR For help press ?</p>	<p>60.X</p>	<p>Tray X is lifting the media to the top of the tray for correct feeding, but something is preventing the lift process.</p> <p>2 Error in tray 2 3 Error in tray 3</p>	<ol style="list-style-type: none"> <li>1 Open tray X.</li> <li>2 Check tray X for obstructions.</li> <li>3 Remove and reseal tray X.</li> <li>4 Perform a service test. <a href="#">See page 213.</a></li> <li>5 Switch tray X with the other tray.</li> <li>6 If the error changes, the tray might be defective.</li> <li>7 If the error persists, replace the paper input unit.</li> </ol>
<p>62.X PRINTER ERROR To continue cycle Power</p>	<p>62.X</p>	<p>A printer error occurred, and X corresponds to the following issue:</p> <p>1 memory in DIMM slot 1 2 memory in DIMM slot 2 3 memory in DIMM slot 3 4 memory in DIMM slot 4</p>	<ol style="list-style-type: none"> <li>1 Turn off the printer, and then turn the printer on to continue.</li> <li>2 Reseat the DIMM.</li> <li>3 Move the DIMM to a different slot.</li> <li>4 Replace the DIMM.</li> </ol>
<p>64 PRINTER ERROR For help press ? alternates with To continue cycle Power</p>	<p>64</p>	<p>A scan buffer error occurred.</p>	<ol style="list-style-type: none"> <li>1 Turn off the printer, and then turn the printer on to continue.</li> <li>2 Update the firmware to the latest version.</li> <li>3 Reseat connections to the laser/scanner and DC controller.</li> <li>4 If the error persists, replace the laser/scanner.</li> <li>5 Replace the DC controller.</li> <li>6 Make sure that the side of the tray is empty.</li> </ol>
<p>66.11.00 INPUT DEVICE FAILURE For help press ?</p>	<p>66.11.00</p>	<ul style="list-style-type: none"> <li>● A failure in an external input device occurred.</li> <li>● A lifting operation is not completed in the correct amount of time.</li> </ul>	<ol style="list-style-type: none"> <li>1 Make sure that the tray on the left side of the lift deck is empty.</li> <li>2 Make sure that the paper-path connection unit is installed in the right side of the engine.</li> <li>3 Check the connections.</li> <li>4 Turn off the printer, and then turn the printer on to continue.</li> <li>5 Send two pages through for a paper-path test.</li> <li>6 Reseat the input device.</li> <li>7 Replace the input device.</li> </ol>

**Table 21. Numeric error messages (continued)**

Control panel message	Event-log error message	Description	Recommended action
66.11.01 For help press ?	66.11.01	The paper path connection unit is not installed.	Install the paper-path connection unit.
66.12.20 OUTPUT DEVICE FAILURE For help press ?	66.12.14	<ul style="list-style-type: none"> <li>● The retainer sensor was not activated.</li> <li>● The retainer DC motor, located in the accumulator, is damaged.</li> <li>● The printer cannot finish a power-on sequence.</li> </ul>	<ol style="list-style-type: none"> <li>1 Check the cables.</li> <li>2 Turn off the printer, and then turn the printer on to continue.</li> <li>3 Send two pages through for a paper-path test.</li> <li>4 Replace the accumulator assembly.</li> <li>5 Replace the output device controller PCA.</li> </ol>
66.12.21 OUTPUT DEVICE FAILURE For help press ? alternates with CHECK CABLES AND CYCLE POWER	66.12.21	<ul style="list-style-type: none"> <li>● The bearing bracket is damaged.</li> <li>● The accumulator-wheel sensor is damaged.</li> <li>● The printer cannot finish a power-on sequence.</li> </ul>	<ol style="list-style-type: none"> <li>1 Check the cables.</li> <li>2 Turn off the printer, and then turn the printer on to continue.</li> <li>3 Send two pages through for a paper-path test.</li> <li>4 Replace the accumulator assembly.</li> <li>5 Replace the output device controller PCA.</li> </ol>
66.12.40 OUTPUT DEVICE FAILURE For help press ? alternates with CHECK CABLES AND CYCLE POWER	66.12.28	<ul style="list-style-type: none"> <li>● The offset module did not reach the offset position.</li> <li>● The printer firmware detected five consecutive jams.</li> </ul>	<ol style="list-style-type: none"> <li>1 Check the cables.</li> <li>2 Turn off the printer, and then turn the printer on to continue.</li> <li>3 Send two pages through for a paper-path test.</li> <li>4 Replace the offset assembly.</li> <li>5 Replace the output device controller PCA.</li> </ol>
66.12.60 OUTPUT DEVICE FAILURE For help press ? alternates with CHECK CABLES AND CYCLE POWER	66.12.3C	<ul style="list-style-type: none"> <li>● An EEPROM error occurred.</li> <li>● The EEPROM on the controller PCA is damaged.</li> </ul>	<ol style="list-style-type: none"> <li>1 Check the cables.</li> <li>2 Turn off the printer, and then turn the printer on to continue.</li> <li>3 Send two pages through for a paper-path test.</li> <li>4 Replace the output device controller PCA.</li> </ol>
66.12.70 OUTPUT DEVICE FAILURE For help press ? alternates with CHECK CABLES AND CYCLE POWER	66.12.46	<ul style="list-style-type: none"> <li>● An EEPROM error occurred.</li> <li>● The EEPROM on the controller PCA is damaged.</li> </ul>	<ol style="list-style-type: none"> <li>1 Check the cables.</li> <li>2 Turn off the printer, and then turn the printer on to continue.</li> <li>3 Send two pages through for a paper-path test.</li> <li>4 Replace the output device controller PCA.</li> </ol>

**Table 21. Numeric error messages (continued)**

Control panel message	Event-log error message	Description	Recommended action
67.X		The output device is not attached when the printer is turned on.	<ol style="list-style-type: none"> <li>1 At power-on, make sure that the output device is attached correctly.</li> <li>2 Make sure that the JetLink connector is installed correctly.</li> </ol>
68.X PERMANENT STORAGE WRITE FAIL For help press ? alternates with 68.X PERMANENT STORAGE WRITE FAIL To continue press ✓	68.X	<ul style="list-style-type: none"> <li>● The printer NVRAM or hard disk is failing to write.</li> <li>● Printing can continue but there might be unexpected responses because an error occurred in permanent storage.</li> </ul>	<ol style="list-style-type: none"> <li>1 To clear the error, press ✓ .</li> <li>2 Check the printer configuration.</li> <li>3 Turn off the printer, and then turn the printer on to continue.</li> <li>4 Reseat the hard disk.</li> <li>5 Reinitialize the hard disk.</li> <li>6 Replace the hard disk.</li> </ol>
68.0 PERMANENT STORAGE ERROR For help press ? alternates with To continue press ✓	68.0	<ul style="list-style-type: none"> <li>● One or more of the printer settings that were saved in the NVRAM or hard disk is invalid and is reset to the factory default.</li> <li>● Printing can continue, but unexpected responses might occur because an error occurred in permanent storage.</li> </ul>	<ol style="list-style-type: none"> <li>1 To clear the error, press ✓ .</li> <li>2 Check the printer configuration.</li> <li>3 Turn off the printer, and then turn the printer on to continue.</li> <li>4 Print a configuration page.</li> <li>5 Resend the firmware.</li> <li>6 Perform a NVRAM initialization, and re-enter the configuration information.</li> <li>7 Replace the formatter.</li> </ol>
68.1 PERMANENT STORAGE FULL For help press ? alternates with To continue press ✓	68.1	<ul style="list-style-type: none"> <li>● The printer NVRAM or hard disk is full.</li> <li>● Printing can continue, but unexpected responses might occur because an error occurred in permanent storage.</li> </ul>	<ol style="list-style-type: none"> <li>1 To clear the error, press ✓ .</li> <li>2 Check the printer configuration.</li> <li>3 Turn off the printer, and then turn the printer on to continue.</li> <li>4 Reseat the hard disk.</li> <li>5 Reinitialize the hard disk.</li> <li>6 Replace the hard disk.</li> </ol>

**Table 21. Numeric error messages (continued)**

Control panel message	Event-log error message	Description	Recommended action
<p>69.X PRINTER ERROR To continue cycle power</p>	<p>69.X</p>	<p>A printer error occurred where X is detailed below. 0 The duplex mechanism failed 1 The duplex side-adjust failed</p>	<ol style="list-style-type: none"> <li><b>1</b> Turn off the printer, and then turn the printer on to continue.</li> <li><b>2</b> Reseat the duplexer (make sure that the printer is turned off).</li> <li><b>3</b> Perform a service test. <a href="#">See page 213.</a></li> <li><b>4</b> Perform a paper-path test. <a href="#">See page 213.</a></li> <li><b>5</b> If the error persists, replace the duplexer (make sure that the printer is turned off).</li> </ol>
<p>79.XXXX PRINTER ERROR To continue cycle power</p>	<p>79.XXXX</p>	<p>A critical hardware error occurred.</p>	<ol style="list-style-type: none"> <li><b>1</b> Turn off the printer, and then turn the printer on to continue.</li> <li><b>2</b> Try printing a job from a different software program. If the job prints, go back to the first program and try printing a different file. (If the message only appears with a certain software program or print job, contact the software vendor for assistance.)</li> <li><b>3</b> If the error persists, try the following: <ul style="list-style-type: none"> <li>• Turn off the printer, and then turn the printer on again.</li> <li>• Reseat or replace the interface cable.</li> <li>• Remove the DIMMs one at a time, turn the printer off, and then turn the printer on again.</li> <li>• Try using the parallel interface.</li> <li>• Upgrade to the latest firmware.</li> <li>• Remove the EIO cards and perform a cold reset.</li> <li>• Remove the hard disk, turn the printer off, and then turn the printer on again.</li> <li>• If the error persists, replace the formatter.</li> </ul> </li> </ol>

**Table 21. Numeric error messages (continued)**

Control panel message	Event-log error message	Description	Recommended action
80.XXXX EIO ERROR	80.XXXX	The EIO accessory card in slot X encountered a critical error.	<ol style="list-style-type: none"> <li><b>1</b> Turn off the printer, and then turn the printer on again.</li> <li><b>2</b> Reseat the EIO card.</li> <li><b>3</b> Move the EIO card to a different slot.</li> <li><b>4</b> If the error persists, replace the EIO card.</li> </ol>
80.XXX EMBEDDED JETDIRECT ERROR	80	An embedded Jetdirect error occurred.	<ol style="list-style-type: none"> <li><b>1</b> Turn off the printer, and then turn the printer on again.</li> <li><b>2</b> See "Embedded LAN troubleshooting (HP LaserJet 9040n/9050n, HP LaserJet 9040dn/9050dn, HP LaserJet 9050mfp, and HP LaserJet 9040mfp only)" on page 247 for more information.</li> </ol>
81 SERVICE For help press ?	81	A temporary error occurred while testing the printer.	<ol style="list-style-type: none"> <li><b>1</b> Turn off the printer, and then turn the printer on again.</li> <li><b>2</b> If the error persists, replace the formatter.</li> </ol>
	88.XXXX	A service test has been initialized.	<ul style="list-style-type: none"> <li>● See Table 22, "Service test abnormality codes," on page 213.</li> </ul> <hr style="width: 20%; margin-left: 0;"/> <p><b>Note</b> 0000 denotes that the service test passed.</p>
99 SERVICE For help press ?	99	A firmware flash-failure occurred.	<ol style="list-style-type: none"> <li><b>1</b> Resend the flash upgrade.</li> <li><b>2</b> Replace the flash DIMM.</li> </ol>


















# User- and service-level diagnostics

The following sections describe diagnostics for the printer.

## Paper-path test

The paper-path test can be used to verify that various paper paths are working correctly or to troubleshoot problems with tray configuration.











### To print a paper-path test

- 1 Press  to open the menus.
- 2 Use  or  to scroll to `CONFIGURE DEVICE`, and then press .
- 3 Use  or  to scroll to `DIAGNOSTICS`, and then press .
- 4 Use  or  to scroll to `SET PAPER PATH TEST`, and then press .
- 5 Use  or  to select the input tray that you want to test, the output bin, the duplex printing accessory (if available), and the number of copies.
- 6 Use  or  to scroll to `PRINT TEST PAGE`, and then press  to start the paper-path test.

## Service test

The service test verifies that the print engine is functioning correctly. This test is very useful for isolating printer problems. The test can be performed with that paper-handling accessories attached, but it will not activate any of the accessory motors, switches, or sensors.

### To perform a service test

- 1 Turn off the printer.
- 2 Make sure that the paper path of the printer is clear of all media, and that the left, front, and right doors are closed.
- 3 Open tray 2 and tray 3.
- 4 Turn on the printer, and when the printer is ready press  to open the menus.
- 5 Use  or  to scroll to `CONFIGURE DEVICE`, and then press .
- 6 Use  or  to scroll to `DIAGNOSTICS`, and then press .
- 7 Use  or  to scroll to `SERVICE TEST`, and then press . The service test can take up to two minutes to complete. The message `PERFORMING SERVICE TEST` appears on the control panel.
- 8 When the test is complete, the message `SERVICE TEST PASSED` appears on the control panel, or up to five sets of four-digit numbers appear on the control panel. If no abnormalities were noted, `(0000 0000 0000 0000 0000)` appears. If abnormalities were noted, the four-digit code or codes appear in parentheses `(0101 0111 0132 0000 0000)`. Write down these codes and match them to the descriptions and FRUs that are listed in table 21.
- 9 Close tray 2 and tray 3.

**Table 22. Service test abnormality codes**

Code	Description	FRU
0101	Cassette pickup-rod motor	Paper-input unit
0102	Cassette feed motor	Paper-input unit
0103	Cassette lifter motor	Paper-input unit

**Table 22. Service test abnormality codes (continued)**

<b>Code</b>	<b>Description</b>	<b>FRU</b>
0104	Tray 1 feed motor	Tray 1
0105	Switchback motor	Duplexer
0106	Duplex feed motor	Duplexer
0107	Duplex feed motor 2	Duplexer
0108	Side registration motor	Duplexer
0109	Pre-registration roller clutch	Registration assembly
0110	Registration roller clutch	Registration assembly
0111	Tray 1 feed roller clutch	Tray 1
0112	Coil jam sensor solenoid	Fuser assembly
0113	Face-up flapper solenoid	Delivery assembly
0114	Tray 1 pickup solenoid	Tray 1
0115	Duplex deflector solenoid	Duplexer
0116	Duplex flapper solenoid	Duplexer
0117	Upper cassette paper out solenoid	Paper-input unit
0118	Upper cassette lifter position sensor	Paper-input unit
0119	Upper cassette paper level sensor A	Paper-input unit
0120	Upper cassette paper level sensor B	Paper-input unit
0121	Upper cassette feed sensor A	Paper-input unit
0122	Upper cassette feed sensor B	Paper-input unit
0123	Lower cassette paper out sensor	Paper-input unit
0124	Lower cassette lifter position sensor	Paper-input unit
0125	Lower cassette paper level sensor A	Paper-input unit
0126	Lower cassette paper level sensor B	Paper-input unit
0127	Lower cassette feed sensor A	Paper-input unit
0128	Lower cassette feed sensor B	Paper-input unit
0129	Registration paper sensor	Registration assembly
0130	Pickup rod home position sensor	Paper-input unit
0131	Fusing unit delivery sensor A	Fuser assembly
0132	Fusing unit delivery sensor B	Fuser assembly
0133	Face-down bin delivery sensor	Delivery assembly
0135	Tray feed sensor	Tray 1
0136	Switchback sensor	Duplexer
0137	Duplex feed sensor	Duplexer
0138	Duplexer reaming paper sensor	Duplexer
0139	Face-down bin paper-full sensor	Delivery assembly
0140	Right door sensor	Paper input unit
0141	Duplex feed roller 1 home-position sensor	Duplexer
0142	Side registration guide home-position sensor	Duplexer
0143	OHT sensor	Registration assembly
0144	Coil jam sensor	Fuser assembly

# Service-level diagnostics

## Engine test

The engine test verifies that the print engine is functioning correctly. Because the formatter is completely bypassed during an engine test, this test is very useful for isolating printer problems. The engine test prints a full page of horizontal lines across the entire printable area.

### Note

Media can be picked up from tray 2 or tray 3 if the formatter is installed. If the formatter is removed, the tray that you do *not* want to print from must be open. Also, make sure that the print cartridge is installed in the printer.

## Service menu

The service menu printer commands should be used only by authorized service personnel. The service menu can only be opened by using the PIN code 00900001 for the HP LaserJet 9000 series printers, 04904005 for the HP LaserJet 9040 series printers, or 09905004 for the HP LaserJet 9050 series printers. While in the service menu, you can perform the following tasks:

- Clear the event log
- Verify and set the page count and serial number (these appear on the configuration page)
- Change the maintenance intervals
- Set the cold-reset media size

If a stapler/stacker is installed you can also perform these tasks:

- Calibrate the staple position
- Review and edit the serial number of the output device
- Review and edit the page count of the output device

**Table 23. Service menu**

Item	Explanation
Clear event log	Clear the event log after maintenance or repairs are complete.
Total page count	Reset the total page count.
Maintenance count	Reset the pages since the last maintenance count.
Maintenance interval	Change or reset the maintenance interval.
Serial number	Reset the printer serial number.
Cold reset paper	Set the cold-reset the media size.
Stapler/stacker	Perform a staple position calibration.

## Diagnostics flowchart

Use this flowchart to help identify the cause of high-level printer problems for the HP LaserJet 9000, HP LaserJet 9000mfp, HP LaserJet 9000Lmfp, HP LaserJet 9040/9050, and HP LaserJet 9040mfp/9050mfp. These problems are indicated by abnormalities in the printer power-on sequence. The LED that the flowchart refers to is on the formatter.

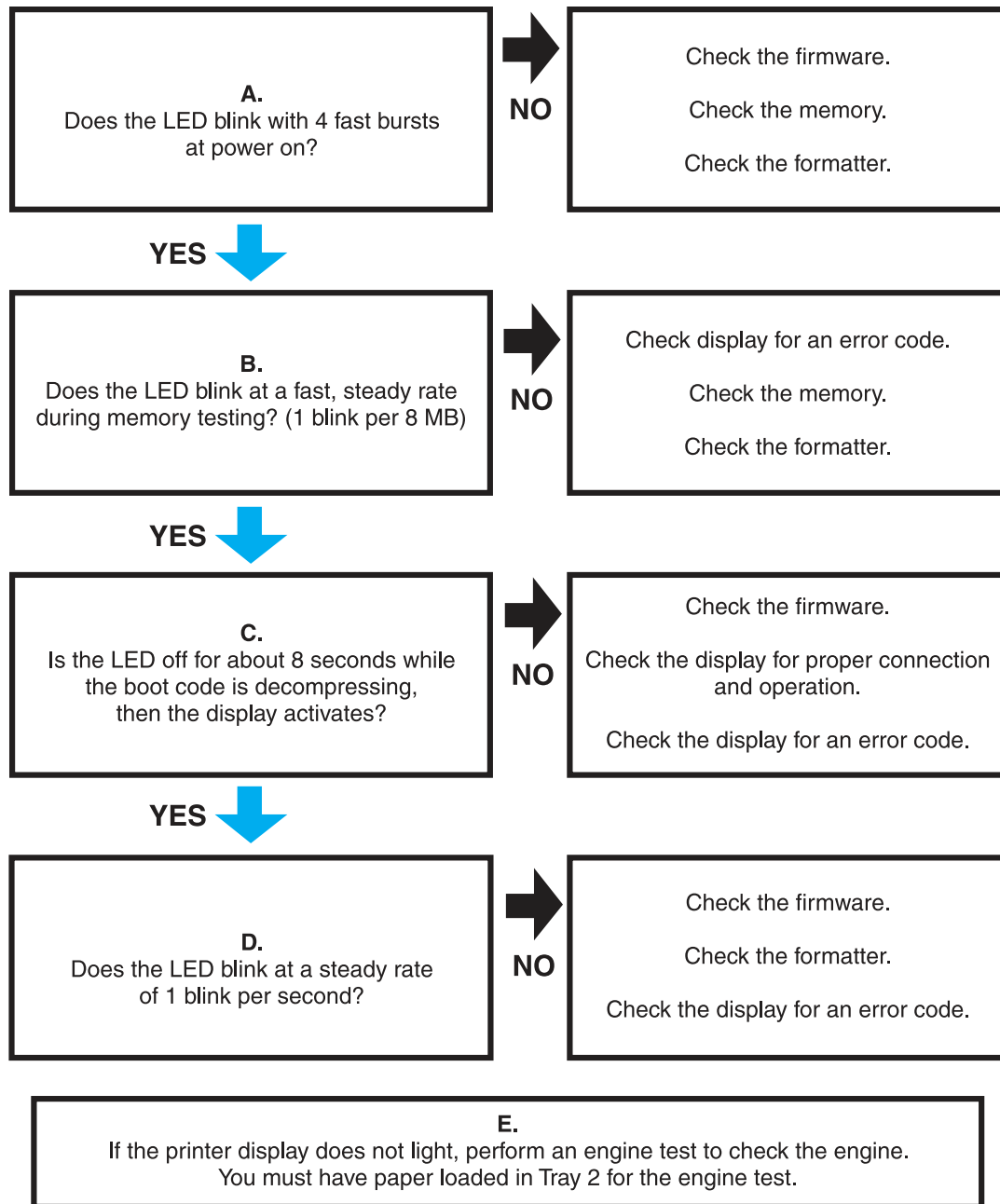


Figure 122. Diagnostics flowchart

# Other diagnostics for the HP LaserJet 9000, 9000mfp, and 9000Lmfp

## Cold reset

Performing a cold reset clears all data from the printer memory and returns all of the default settings to the factory settings.

---

### CAUTION

Performing a cold reset resets the Jetdirect configuration. To avoid making changes to your network configuration, remove the HP Jetdirect print server before performing a cold reset.

---

### Note

If possible, print a configuration page and menu map before performing a cold reset. This documents current settings for later reference.

## To perform a cold reset, set the display language, or reset the maintenance kit

- 1 Turn off the printer.
- 2 Press and hold ✓ (the 6 button on MFPs).
- 3 Turn on the printer.
- 4 Continue to hold ✓ until all three control panel lights illuminate, and then release ✓ (the 6 button on MFPs).
- 5 Use ▼ (the 9 button on MFPs) or ▲ (the 3 button on MFPs) to scroll to the appropriate selection (COLD RESET, SELECT LANGUAGE, or NEW MAINTENANCE KIT).

---

### Note

Other functions are available in this menu, but are not applicable.

- 6 Press ✓ (the 6 button on MFPs).

The printer boot sequence is complete when READY appears on the control-panel display.

## To initialize (format) a hard disk

---

### Note

Initializing a hard disk erases all of the data on the installed mass-storage devices.

- 1 Turn off the printer.
- 2 Press and hold PAUSE/RESUME (START on MFPs).
- 3 Turn on the printer.
- 4 Hold PAUSE/RESUME or START down until all three error lights illuminate.
- 5 Release the PAUSE/RESUME or START key.
- 6 Press ◀ (the 5 button on MFPs) until INITIALIZE DISKS appears on the control-panel display.
- 7 Press ✓ (the 6 button on MFPs).

The printer boot sequence is complete when READY appears on the control-panel display.

## To initialize NVRAM or perform a skip disk

---

### Note

---

The model number, the serial number, the usage data, and the error event log information is retained when performing a disk initialization.

- 1 Turn off the printer.
- 2 Press and hold ▼ (the 9 button on MFPs).
- 3 Turn on the printer.
- 4 Release ▼ (the 9 button on MFPs).
- 5 Press ▲ (the 3 button on MFPs).
- 6 Press **PAUSE/RESUME** (**START** on MFPs).
- 7 Use ▼ (the 9 button on MFPs) or ▲ (the 3 button on MFPs) to scroll to the appropriate selection (**NVRAM INIT** or **SKIP DISK**).

---

### Note

---

Other functions are available in this menu, but are not applicable.

- 8 Press ✓ (the 6 button on MFPs).

The printer boot sequence is complete when **READY** appears on the control-panel display.

# Other diagnostics for the HP LaserJet 9040/9050, 9040mfp, and 9050mfp

## Cold reset

Performing a cold reset clears all data from the printer memory and returns all of the default settings to the factory settings.






### CAUTION

Performing a cold reset resets the Jetdirect configuration. To avoid making changes to your network configuration, remove the HP Jetdirect print server before performing a cold reset.

### Note


If possible, print a configuration page and menu map before performing a cold reset. This documents current settings for later reference.

## To perform a cold reset, set the display language, reset the maintenance kit, enable or disable embedded LAN

- 1 Turn off the printer.
- 2 Turn on the printer.
- 3 Wait until the printer begins counting memory.
- 4 Press and hold  (the 6 button on MFPs).
- 5 Continue to hold  until all three control panel lights illuminate, and then release  (the 6 button on MFPs).
- 6 Use  (the 9 button on MFPs) or  (the 3 button on MFPs) to scroll to the appropriate selection (COLD RESET, SELECT LANGUAGE, NEW MAINTENANCE KIT, or ENABLE/DISABLE EMBEDDED LAN).

### Note

Other functions are available in this menu, but are not applicable.



- 7 Press  (the 6 button on MFPs).

The printer boot sequence is complete when READY appears on the control-panel display.

## To initialize (format) a hard disk

### Note

Initializing a hard disk erases all of the data on the installed mass-storage devices.

- 1 Turn off the printer.
- 2 Turn on the printer.
- 3 Wait until the printer begins counting memory.
- 4 Press and hold **MENU** (**START** on MFPs).
- 5 Hold **PAUSE/RESUME** or **START** down until all three error lights illuminate.
- 6 Release the **MENU** or **START** key.
- 7 Press  (the 5 button on MFPs) until INITIALIZE DISKS appears on the control-panel display.
- 8 Press  (the 6 button on MFPs).

The printer boot sequence is complete when READY appears on the control-panel display.

## To initialize NVRAM or perform a skip disk

### Note

The model number, the serial number, the usage data, and the error event log information is retained when performing a disk initialization.

- 1 Turn off the printer.
- 2 Turn on the printer.
- 3 Wait until the printer begins counting memory.
- 4 Press and hold ▼ (the 9 button on MFPs) until all three error lights illuminate.
- 5 Release ▼ (the 9 button on MFPs).
- 6 Press ▲ (the 3 button on MFPs).
- 7 Press **MENU** (**START** on MFPs).
- 8 Use ▼ (the 9 button on MFPs) or ▲ (the 3 button on MFPs) to scroll to the appropriate selection (**NVRAM INIT** or **SKIP DISK**).

### Note

Additional functions are available in this menu but they are not applicable.

- 9 Press ✓ (the 6 button on MFPs).

The printer boot sequence is complete when **READY** appears on the control-panel display.

## Drum-rotation functional check

The photosensitive drum in the print cartridge must rotate in order for the print process to work. The photosensitive drum receives its drive from the main drive assembly. Use this procedure to test whether the drum is rotating:

- 1 Open the front cover.
- 2 Remove the print cartridge.
- 3 Mark the cartridge drive gear with a felt-tipped marker. Note the position of the mark.
- 4 Install the print cartridge, and close the front cover. The start-up sequence should rotate the drum enough to move the mark.
- 5 Open the printer, and inspect the gear that was marked in step 3. Verify that the mark moved. If the mark did not move, inspect the main drive assembly to make sure that it is meshing with the print cartridge gears. If the drive gears appear functional, and the drum does not move, replace the print cartridge.

### Note

This test is especially important if refilled print cartridges are being used.

## High-voltage power-supply check

The high-voltage power-supply PCA provides the necessary voltages for the electrophotographic processes. Use the following procedures to verify the operation of the high-voltage system.

### Print cartridge connection points

Visually inspect the four connection points on the inside, right end of the print cartridge. If they are dirty or corroded, clean the connections. If they are damaged, replace the print cartridge.

### High-voltage contacts

The high-voltage contact springs are mounted on the high-voltage power-supply PCA and protrude through the print cartridge cavity to contact the print cartridge. Verify that the contacts are not dirty or corroded and that the spring action is functional. If they are damaged, replace the high-voltage power-supply PCA.



# Tray 4 diagnostics

Tray 4 can run standalone diagnostics to test the device motors, functionality, and sensors. You need one power cord, one #2 Phillips screwdriver, and a small flatblade screwdriver for the DIP switches.

## Diagnostics label

The following label is on the inside of the tray 4 back cover.

**C8531A 2000-Sheet Input Tray Service Diagnostics**  
Turn off power and set all DIP switches to the off position when finished.

**Motor test** This test verifies the functionality of the three motors on the unit.

- Open tray 4 and the VTU .
- Set the DIP switches for the desired motor test. (See table 1 for switch settings.)
- Turn on the unit power switch.
  - If working properly, the motors will start rotating .
  - If the rotation does not occur , replace the corresponding motor: paper pickup unit, paper delivery unit (VTU), or tray lifting motor.
- To stop the test, turn off the unit power switch and set all DIP switches to the off position.

**Standalone running test** This test checks for proper unit operation. See table 2 to diagnose problems with the unit.


- Ensure there is paper in the tray
- Set the DIP switches for the desired standalone running mode. (See table 1 for switch settings).

Feed only 6 to 8 pages to prevent excessive paper jams when performing this test.

- Turn on the unit power switch.
  - If working properly, the unit pulls paper from the tray and ejects it, and the bottom green service LED lights.
  - If the unit is not working , then there is no paper movement and the service LEDs flash in red or yellow patterns that indicate the problem. (See table 2 for an explanation of the number of LED flashes).
- To stop the test, turn off the unit power switch and set all DIP switches to the off position. Open the VTU and remove any media from the paper path.

**Sensor test** This test checks the sensors for proper operation.

- Set the DIP switches for sensor test. (See table 1 for switch settings).
- Open tray 4 and the VTU .
- Turn on the unit power switch and manually actuate the sensor to be tested.
  - When the paper level sensing lever is activated (lifted), all the service LEDs (red, yellow and green) light. When the lever is in the normal position, all LEDs are off .
  - When the two sensors on the paper input unit are actuated, the red and green LEDs light. When the sensor levers are in the normal position, the LEDs are off .
  - When each of the other sensors are actuated, the green service LED lights. When the sensor levers are in the normal position, the LED is off .
  - If each service LED does not light, the corresponding sensor is faulty . Replace the sensor .
- To stop the test, turn off the unit power switch and set all DIP switches to the off position.



If you want to select another test or change DIP switch settings, turn off the unit power switch, reset DIP switches, then turn the unit power switch on to enable the new settings.

Table 1. DIP switch settings for troubleshooting test procedures

DIP switch	Normal settings	Standalone running test 1	Standalone running test 2	Standalone running test 3	Motor test 1	Motor test 2	Motor test 3	Sensor tests
1	Off	On	On	On	On	On	On	Off
2	Off	Off	Off	Off	On	On	On	Off
3	Off	Off	Off	Off	Off	Off	On	On
4	Off	Off	On	Off	Off	On	Off	On

If working properly , the unit pulls paper from the tray and ejects it, and the green service LED flashes regularly every 0.5 seconds.

Table 2. Patterns of LED flashing

LED	Number of LED flashes	Abnormality	Recommended action
Green	(Always on)	Device OK	
	1	Paper size inconsistency	Set correct paper size and STD/Custom (dip switch) properly.
	2	Tray open	Close tray
	3	Tray is paper empty	Load paper
	4	Tray is lifting paper	Wait until paper finishes lifting
	5	VTU door open	Close VTU door
Yellow	6	Under mechanical initialization	Wait until initialization is completed
	1	Registration sensor delay jam	Remove jammed paper from VTU door and tray
	2	Registration sensor stay jam	
	3	Registration sensor initial jam	
	4	VTU sensor delay jam	
	5	VTU sensor stay jam	
6	VTU sensor initial jam		
Red	1	Lifter malfunction	Verify motor 1 and lifter mechanism in tray
	2	Connection unit not installed	Properly install Connection Unit inside printer
	3	Communication error	Verify connectors in controller board
	4	EEPROM error	Replace controller board

R56-8435 >PET<

Figure 123. Tray 4 label

## Motor test

This test verifies that the three motors on tray 4 are functioning correctly.

- Identify the back cover (opposite from the tray door). Remove the four screws in the back cover. Remove the back cover.
- Pull open the tray.
- Set the DIP switches on the controller PCA to the motor-test mode.
- To turn the power-supply switch to the diagnostic mode, pull out on the blue handle.
  - If the motors are working correctly, you will hear them as they rotate continuously.
  - If the motors do not rotate, replace the corresponding FRU: either the paper pickup assembly or the paper-deck drive assembly.
- To stop the test, return the power switch to the operational mode (push it in), and reset the DIP switches on the controller PCA to the off position.

Tray 4 diagnostics 221

## Standalone running test

This test verifies that tray 4 is functioning correctly. For this test, use the LED that is located on the controller PCA on tray 4.

---

### Note

---

If tray 4 is mounted underneath the printer, jams might occur because the printer will not pick up the media. To prevent excessive jams during this test, feed only six to eight pages.

- 1 Make sure that media is in the tray.
- 2 Set the DIP switches on the controller PCA for the standalone running mode.
- 3 To set the power-supply switch to diagnostic mode, pull the blue power-supply switch outward. The motors start. Media should be lifted from the tray.

If the unit does not work correctly, the lower service LED on the controller PCA flashes in a pattern that indicates the problem. (See table 25 on page 223 for an interpretation of the LED patterns.)

- 4 To stop the test, return the power-supply switch to the operational mode, and set the DIP switches on the controller PCA to the off position (see table 24). Open tray 4, and remove any media from the paper path.

## Sensor test

This test manually activates the sensors on tray 4 to test whether they are working correctly.

- 1 Set the DIP switches on the controller PCA for the sensor-test mode.
- 2 For each paper sensor, perform the following actions:
  - Pull open the paper tray.
  - Remove the metal spring that holds the sensor unit in place (secured by one screw).
  - Pull out the sensor unit.
- 3 To set the power-supply switch to the diagnostic mode, pull the blue power-supply switch outward.
- 4 To manually activate each sensor, press it in.
  - When you activate the sensor, the bottom service LED on the controller PCA illuminates. When you release the sensor, the LED turns off.
  - If the LED does not come on, a problem exists with the sensor. Replace the corresponding FRU.
- 5 To stop the test, return the power-supply switch to the operational mode, and set the DIP switches on the controller PCA to the off position (see table 24).

**Table 24. DIP switch settings**

DIP switch	Normal	Motor test	Stand-alone running test	Sensor test
1	Off	On	On	Off
2	Off	On	Off	Off
3	Off	Off	Off	On
4	Off	On	On	On

**Note**

Make sure that you turn the power supply off and set all the DIP switches to the off position (normal settings) when you finish the diagnostics, or the unit will not work correctly. Then, replace the back cover.

**Light-pattern interpretation**

If tray 4 is working correctly, it picks up media from the tray and feeds it to the printer, and the bottom service light flashes regularly every 0.5 seconds.

**Table 25. Tray 4 light-pattern interpretation**

Long (1 sec.)	Short (0.03 sec.)	Error number and meaning	Recommended action
3	1	66.11.01 lifter malfunction	Lift the tray by hand to make sure that it lifts smoothly. Make sure that the paper-size plates are correctly installed (in the same corresponding slots) and are not bent. If neither of these is the problem, replace tray 4.
2	1	13.11.11 registration-sensor delay jam	If the media does not reach the sensor, open the door and remove the media. Replace the paper pickup assembly.
2	2	13.11.3B registration-sensor station jam/initial jam	Open the door, and remove the media. Check the sensors, and replace the corresponding FRU.
2	3	13.11.31 jam-sensor delay jam	If the media did not reach the sensor, open the door and remove the media. Replace the paper pickup assembly.
2	4	13.11.21 13.11.2B jam-sensor stationary jam/initial jam	Open the door and remove the media.
1	1	paper-path door open	Close the door.
1	2	tray open	Close the tray.
		wrong size of media loaded	Load the correct size of media, or check the sensors.
1	3	no media in tray	Load the media, or check the sensors.

**Note**

If the LED does not illuminate, replace the paper-deck PCA or the universal-power-supply assembly.

## Jam troubleshooting

Jams occur either when media does not reach or does not clear a photosensor along the printer paper path in a specific amount of time. If a media jam occurs, a 13.xx PAPER JAM message appears on the printer control panel. The following table lists general questions that you should ask and topics that you should explore before troubleshooting.

**Table 26. General jam troubleshooting questions**

Problem	Action
What is the frequency of the jams (continuous, one jam per 100 pages, one jam per 1,000 pages, or some other interval)?	Verify the frequency of the jam with the customer. Print or view the event log to determine the jam history. See "Event log page" on page 175.
Do jams only occur when the media is fed from a particular input source (tray 1, tray 2, tray 3, or tray 4)?	See "Jams" on page 225 and "Paper-path test" on page 213 to isolate the problem.
Do jams only occur when media is delivered to a specific output bin (for example, the face-down bin, face-up bin, duplexer, stapler)?	See "Jams" on page 225 and "Paper-path test" on page 213 to isolate the problem.
Do jams occur with a specific type of media?	Try media that is known to perform well. See the <i>HP LaserJet Printer Family Print Media Guide</i> .
Where does the leading edge of the first sheet of media in the printer paper path stop when a jam occurs? Are any sheets of media physically damaged or torn?	Attempt to duplicate the problem. See "Paper-path test" on page 213. Inspect the paper path and all mechanical assemblies in the path in advance of the leading jam.
Is the customer loading the trays correctly?	Observe the customer loading the media. See correct paper-handling procedures in the <i>HP LaserJet Printer Family Print Media Guide</i> .
Is the customer overfilling the trays?	Make sure that the media level is <i>not</i> above the maximum fill marks in the paper trays. Observe the customer loading media in the trays.
Are the tray guides set correctly?	Make sure that the tray 2 and tray 3 paper guides are set correctly both at the front and rear of the tray. Make sure that the front fence is locked into the correct position. For tray 4, make sure that all adjustments are set correctly: front, back, and side at the top and bottom of the tray.
Does the printer need cleaning?	Inspect the paper path and paper-path rollers. See "Internal cleaning" on page 62.
When was the user maintenance performed on the printer?	From the configuration page, determine the number of pages since the last maintenance. The preventive maintenance kit should be installed every 350,000 images.
Is the custom-size switch set correctly?	Make sure that the switch is set correctly for the media that is selected.

## Jams

Jams occur most often when the following conditions exist:

- Trays are not correctly loaded (the media does not meet the specifications listed in the *HP LaserJet Printer Family Print Media Guide*)
- The media is in poor condition
- The printer needs cleaning

If a jam occurs, a 13.x PAPER JAM message appears on the control panel. See "[Printer-message tables](#)" on page 179 for detailed descriptions of the 13.x messages and the recommended actions to resolve the errors.

## Customer print job

Ask the customer to send a print job from the problem source(s) to the problem destination(s). Try to recreate the jam errors by having the customer perform a paper-path test. See "[Paper-path test](#)" on page 213.

When verifying print jobs, make sure that all of the settings are selected according to the customer's preference. Keep in mind that program settings take priority over driver settings, which take priority over the printer control-panel settings. If a single setting is not present in the program, but is set in the driver, it overrides the control-panel settings.

---

### Note

HP Web Jetadmin can override media types and sizes in certain conditions. See the *HP LaserJet 9000 Use Guide* or the *HP LaserJet 9040/9050 Use Guide* for more information.

## Clearing jams

---

### Note

Open and close all of the printer covers to clear the jam message. After removing a sheet of media, you might need to check other areas for the presence of other media.

All portions of a jammed piece of media must be removed, or you might experience repeated jams.

If the jam persists, try the following remedies:

- If PostScript is installed, use the JAM RECOVERY=ON menu item under the PostScript Menu (the printer attempts to automatically recover from jams).
- Perform a form feed from the computer or the printer control panel (a form feed might flush any media or envelopes that remain in the printer).
- Make sure you have located and removed all scraps of media from inside the printer.

## Clearing repeated jams

- 1 Check to see that media is correctly loaded in trays and that all width guides are correctly set (not skewed).
- 2 Try turning over the stack of media in the tray. If you are using letterhead media, try printing from a different tray.
- 3 Do not use previously printed media or torn, worn, or irregular media.
- 4 Check the media specifications. If media is outside of the recommended specifications, problems might occur. See the *HP LaserJet Printer Family Print Media Guide*.
- 5 The printer might be dirty. See "[Internal cleaning](#)" in chapter 4.








## Evaluate the information pages

From the printer control panel, print pages that give details about the printer and its current configuration. The following information pages are available:

- Configuration page
  - If JetDirect card is installed, a Jetdirect page is also generated.
- File directory page
- Usage page
- File directory page

For a complete list of the printer information pages, print a menu map.

To select and print items from the information menu:

- 1 Press  to open the menus.
- 2 Use  or  to scroll to INFORMATION, and then press .
- 3 Use  or  to scroll to the appropriate information page, and then press .

### Configuration page

Use the configuration page to view current printer settings, to help troubleshoot printer problems, or to verify installation of accessories, such as memory (DIMMs), input and output paper-handling devices, and printer languages.

The content of the configuration page varies, depending on the options currently installed in the printer.

If any of the installed devices are not shown on the configuration page, verify that the Jet-Link cabling is correctly connected and functional and that DC power is available to the paper-handling devices. Check and reseat suspect cable connections. If any of the cables are replaced, you must cycle the power to have the printer recognize the device again.

### Configuration page elements

- A Printer information
- B Event log
- C Installed personalities and options
- D Memory
- E Security
- F Paper trays and options

# HP LaserJet 9000 series printers



## configuration page

1

### Printer Information **A**

Product Name: HP LaserJet 9000 Series  
Printer Name: HP LaserJet 9000 Series  
Printer Number: 4  
Formatter Number: S46XXXXXXXXX  
Printer Serial Number: XXXXXXXXXX  
Firmware Datecode: 20010409 01.032.4  
PS Wait Time-out: 300 seconds  
Page Count: 24  
Preventive Maintenance Interval: 350000  
Pages Since Last Maintenance: 22

### Memory **D**

Total Memory: 64 MB  
DWS: 20.87  
Automatic Resource Saving Enabled

### Event Log **B**

Number of Entries in Use: 3  
Maximum Number of Entries: 50  
Last Three Entries:

Number	Error	Page Count
3	88 0000	2
2	55 0492	0
1	55 0000	0

### Security **E**

Control Panel Lock: NONE  
Control Panel Password: DISABLED  
Write Protect: DISABLED

### Installed Personalities and Options **C**

PCL (20010402)  
PS (20010402)  
PCLXL (20010402)  
DIMM Slot 1: Side 1: 8 MB FLASH  
Side 2: 8 MB FLASH  
DIMM Slot 2: Side 1: 32 MB SDRAM  
Side 2: 32 MB SDRAM  
DIMM Slot 3: Empty  
DIMM Slot 4: Empty  
EIO 1: HP JetDirect J4169A  
EIO 2: Empty  
EIO 3: Empty  
RAM DISK Storage: 70 MB Capacity

### Paper Trays and Options **F**

Default Paper Size: LETTER  
Tray 2 (LETTER)  
Tray 3 (LETTER)  
Duplex Unit  
Device 1:  
HEWLETT-PACKARD  
2000 SHEETS INPUT TRAY [03.22] C8531A  
Input Trays:  
1: TRAY 4, 2000 Sheets  
Device 2:  
HEWLETT-PACKARD  
HP 3000-SHEET STAPLER STACKER [010406] C8085A  
Output Bins:  
1: OPTIONAL BIN 1, 125 Sheets, Face Up  
2: OPTIONAL BIN 2, 3000 Sheets, Face Down

ENGLISH(1)

**Figure 124.** Sample configuration page

#### Note

If an HP Jetdirect EIO card is installed, an HP Jetdirect configuration page also prints out.

## Verify installed options

In the installed personalities and options section on the configuration page, look for options such as hard disk information, DIMM types (RAM or ROM), and DIMM sizes.

Make sure that the options installed in the printer are reflected in the configuration page. If an installed device is not shown on the configuration page, see [table 27](#) for recommended actions.

The paper tray and options section of the configuration page identifies two types of paper-handling devices that communicate or interact with the printer:

- Engine DC controller-driven devices
  - Duplexer
  - Tray 1
- Communication link devices (Jet-Link protocol)
  - Input devices: Tray 4
  - Output devices: Multifunction finisher, 3,000-sheet stapler/stacker, or 3,000-sheet stacker

While the engine DC controller-driven devices draw power (24 VDC) and control signals from the engine, the Jet-Link devices have their own power supply and controller board.

The information from the paper handling controller is carried by the Jet-Link cables that connect the controller board of all the Jet-Link protocol supported devices. The Jet-Link protocol supports up to 64 devices connected to the paper handling. Each device controller has an input or output port that provides flexible connections in different configurations.

**Table 27. Printer devices troubleshooting**

Device	Action if installed and undetected
Duplexer	<p>Print a configuration page to verify device installation.</p> <p>Turn the power off, reseal the duplexer, verify that the connector is not broken, and turn the printer on.</p> <p>If the connector is broken or if turning the printer on and off does not work, then replace the duplex cable and/or duplexer.</p>
Device 1 and 2	<p>Verify that ac power is present.</p> <p>Verify that the Jet-Link cables are installed correctly.</p> <p>Remove all Jet-Link connections, and visually inspect for connector damage on the cable pins and connector ends. Try using a different cable to connect the problem device directly to the paper handling controller. All Jet-Link cables are wired the same, but are different lengths.</p> <p>If a device is not recognized, replace the device controller or defective Jet-Link cable.</p>




## Jetdirect page

Use the Jetdirect page to view current network settings, to help troubleshoot printer problems, or to verify network statistics or protocol information.

### Jetdirect page elements

- A HP Jetdirect configuration
- B Network statistics
- C Protocol information

  
invent

## HP LaserJet 9000 series printers

**EIO 1 - JetDirect page** 1

**HP JetDirect Configuration** A

Status: I/O Card Not Ready	Port Config: Disconnected
LAN ERROR - LOSS OF CARRIER	Auto Negotiation: On
Model Number: J4169A	Manufacturing ID: 41004100902007
Hardware Address: 0001E627932EB4642	Date Manufactured: 01/2001
Firmware Version: L.20.24	SNMP Set Cmty Name: Not Specified
Port Select: None	

**Network Statistics** B

Total Packets Received: 0	Total Packets Transmitted: 0
Unicast Packets Received: 0	Unsendable Packets: 0
Bad Packets Received: 0	Transmit Collisions: 0
Framing Errors Received: 0	Transmit Late Collisions: 0

**Protocol Information** C

TCP/IP	Novell/Netware
Status: Initializing	Status: NOT CONFIGURED 16
Host Name: Not Specified	Node Name: NPI27932E
IP Address: 0.0.0.0	Netware Mode: Queue Server
Subnet Mask: 0.0.0.0	NDS Tree Name:
Default Gateway: 0.0.0.0	NDS Context:
Config By: Not Configured	Attached Server:
BOOTP/DHCP Server: 0.0.0.0	Queue Poll Interval: 2 sec
TFTP Server: 0.0.0.0	SAP Interval: 60 sec
Config File: Not Specified	
Domain Name: Not Specified	
DNS Server: Not Specified	
WINS Server: Not Specified	
Syslog Server: Not Specified	
Idle Timeout: 90 sec	
SLP: Enabled	
Access List: Not Specified	
Web JetAdmin URL: Not Specified	

IPX/SPX	AppleTalk
Status: Ready	Status: Initializing
Primary Frame Type: Auto Select	Name: *
Network Frame Type: Rcvd	Zone: HP LaserJet LaserWriter
	Type 1: 0
	Type 2: 0
	Network Number: 0
	Node Number: 0

DLC/LLC
Status: Ready


Figure 125. Sample Jetdirect configuration page

## Supplies status page

Use the supplies status page to view current printer supply status, to help troubleshoot printer problems, or to verify printer information.

### Supplies status page elements

- A Supplies ordering information
- B Cartridge information
- C Other supplies information
- D Printer information

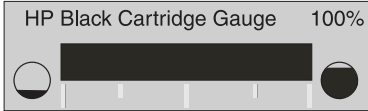
  
invent

## HP LaserJet 9000 series printers

supplies status page1

Hewlett-Packard Supplies can be ordered on the internet at <https://www.hp.com/go/ordersupplies> (A) or by calling Hewlett-Packard. (Please refer to your printer User Manual for the telephone number).  
For highest print quality always use genuine Hewlett-Packard LaserJet supplies.

### Cartridge Information (B)



HP Black Cartridge Gauge 100%

HP Part Number:	C8543X
Cartridge Low Reached:	NO
Cartridge Out Reached:	NO
Estimated Pages Remaining:	30000


Total Pages Printed:	470
Page count by Paper Size:	
A3/Ledger:	0
Legal:	0
A4/Letter:	446
B5/Executive:	0
Envelope:	0
Custom/Other:	24
Number of Jobs Processed:	127

Cartridge Manufacture Date:	20001017
Cartridge Serial Number:	39
Marked as Reordered:	NO

Please return your used HP cartridge to Hewlett-Packard. For more information see <http://www.hp.com/go/recycle>

### Other Supplies Information (C)



HP Maintenance Kit 100%

HP Part Numbers:	
110V	C9152A
220V	C9153A

### Printer Information (D)

Total Printer Page Count:	71
Preventive Maintenance Interval:	350000
Pages Until Next Maintenance:	349940
Printer Serial Number:	XXXXXXXXXX

ENGLISH(1)

**Figure 126.** Sample supplies status page

## Usage page

The usage page is designed to fit into a pay-per-page (PPP) model. A reseller can configure the usage page with instructions for a customer to send the information back to the reseller in order to prepare bills.

Print a usage page from the printer control panel (or gain access to the information remotely from HP Web Jetadmin) to determine how many simplex or duplex pages of each media size are scanned on the copy module and printed on the printer. Average toner coverage is approximated by counting pixels. Jams are not counted. The data cannot be reset manually, and values such as total print and scan impressions, toner coverage, serial number, default language, and default media size are backed up between the printer NVRAM and hard disk.

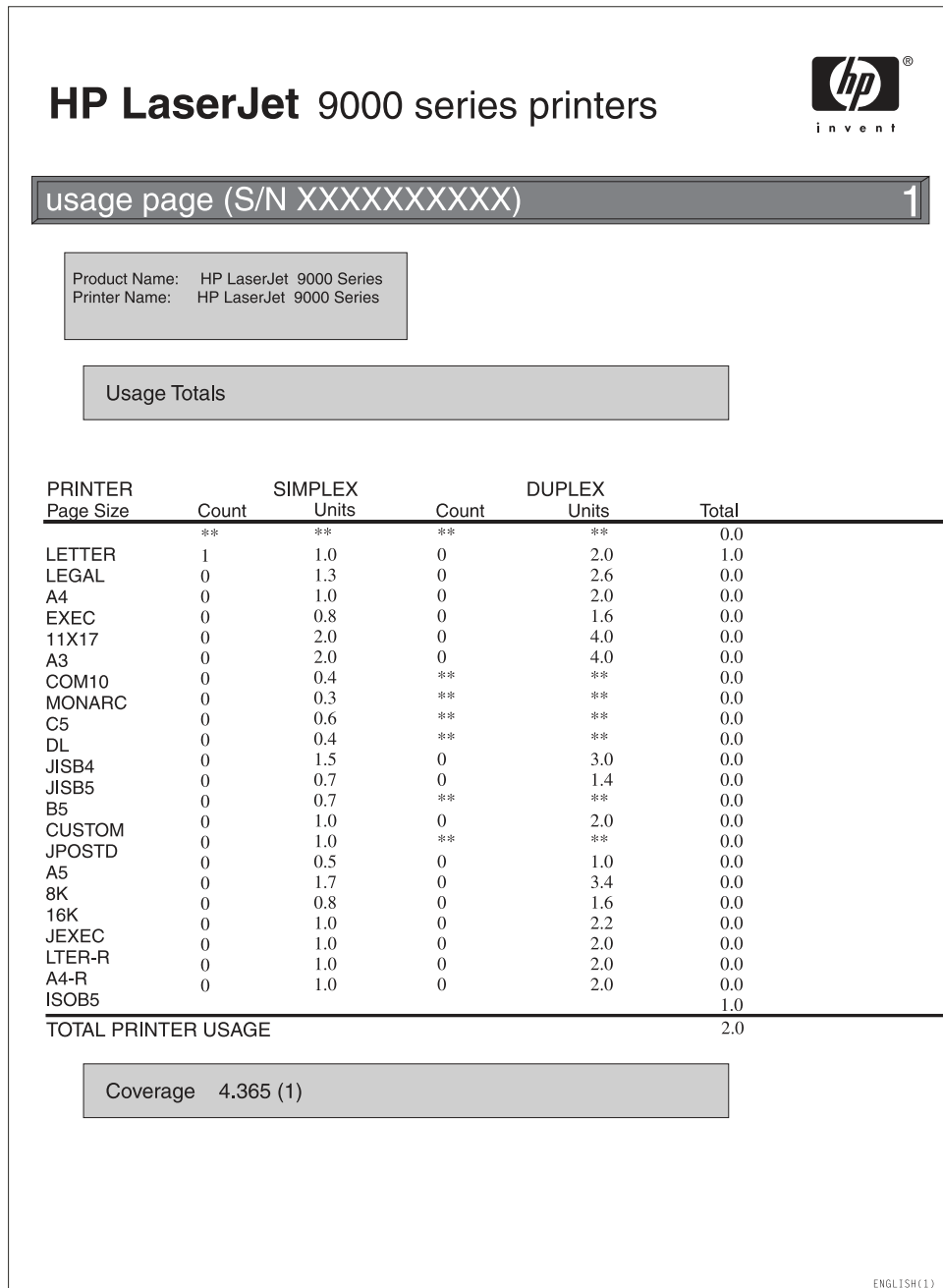


Figure 127. Sample usage page

## File directory page

Use the file directory page to view current directory structures, to help troubleshoot printer problems, or to verify storage capabilities.

### File directory page elements

#### A Directory information

**HP LaserJet 9000 series printers**

file directory page 1

Device Type: RAM DISK  
Device Capacity: 64 MB  
Free Space: 60 MB  
Write Protect: DISABLED

Permissions	Owner	File Size	Directory/File Name
drwxrwxrwx	0	Directory	0:
drwxrwxrwx	0	Directory	0:\PostScript
drwxrwxrwx	0	Directory	0:\PIL

**Figure 128.** Sample file directory page

## Image-formation troubleshooting

When working with customers, obtain a print sample before troubleshooting the printer. Ask the customer to describe the quality expected from the printer. The print sample also helps clarify the customer's description of the problem.

Often an image-formation problem is linked to media that is outside the specifications Hewlett-Packard establishes for optimum printer performance. See "[Media troubleshooting](#)" on page 244 for help with persistent image-formation problems.

**Table 28. Image-quality checks**

Image-quality checks	Action
Does the problem repeat on the page?	Use the " <a href="#">Repeating defect ruler</a> " on page 243.
Is the print cartridge full and is it manufactured by HP?	See " <a href="#">Check the print cartridge</a> " on page 234.
Is the customer using media that meets all HP specifications?	See " <a href="#">Trays, bins, and paper handling</a> " in chapter 2.
Is the print sample similar to those in the image defect tables?	Compare the sample to the tables and perform the actions recommended in the " <a href="#">Image-defect tables</a> " on page 235.
Is the problem on the print cartridge or the transfer charging roller?	If a dark and distinct toner image is present on the drum surface, assume that the first four functions of the electrophotographic process are functioning (cleaning, conditioning, writing, and developing—See " <a href="#">Image formation system</a> " in chapter 5), and troubleshoot the failure as a transfer or fusing problem.
Does the media meet HP standards?	See " <a href="#">Media troubleshooting</a> " on page 244.

## Check the print cartridge

Image-formation defects often result from problems with the print cartridge. Use the following list to verify that the print cartridge is operating correctly.

Perform all of the following checks before replacing the print cartridge.

- Make sure that the print cartridge contains toner.
  - The full print cartridge weight is approximately 4,220 grams (9.28 lb).
  - The empty weight is approximately 2,700 grams (5.94 lb).
- Check the print cartridge to see if it is disassembled or refilled.
- Make sure that the print cartridge is seated correctly in the printer cavity.
- Inspect the cartridge for toner leaking through worn seals (manual rotation of the drum can cause internal damage and toner spills).

---

### Note

---

The print cartridge is rated for 30,000 images at 5% coverage for two-page jobs. Check the surface of the photosensitive drum in the cartridge to see if it is damaged or scratched. Touching the drum contaminates the photosensitive surface and might cause spotting and defects during printing.

- White areas on the page might indicate that the drum was exposed to light for too long. If white areas appear, stop the printer and wait a few minutes. This should eliminate most defective images. If not, the print cartridge might be placed in a dark environment for several days, which might restore some life to the drum.

## EconoMode

EconoMode creates draft-quality printing by reducing the amount of toner on the printed page by up to 50%. Advise the customer to turn EconoMode on or off, either from the printer driver or a software program.

## Skew

Use the following information to gauge skew specifications.

- 2 mm over 260 mm (simplex and duplex)
- Leading edge plus or minus 2.5 mm (cut sheet media)
- Plus or minus 4.5 mm (envelopes)
- Left margin plus or minus 2.5 mm (cut sheet)

## Image-defect tables




The printer output quality is subject to customer judgment. This section helps define print-quality defects and the factors that affect print quality.

The print samples shown illustrate some print-quality defects. Keep copies of print-quality defects that you encounter in the field, and an explanation of their causes, to use for future reference.



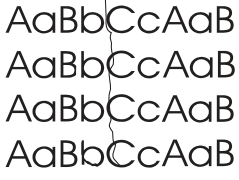
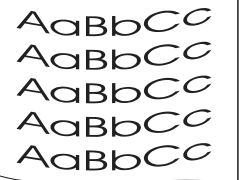
Figure 129. Image defect examples

**Table 29. Image defects**

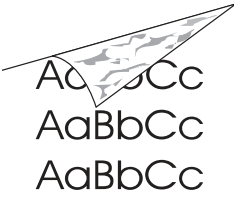


Problem	Cause	Solution
<p>Black page</p> 	<p>The high-voltage power supply connections are contaminated.</p> <p>The high-voltage power supply is installed incorrectly.</p> <p><b>Note</b> If the high-voltage power supply was removed and replaced, it might not be seated correctly.</p> <p>Defective primary charging roller.</p> <p>The laser drive circuitry is damaged on the DC controller board so that the laser is always on.</p>	<ul style="list-style-type: none"> <li>● Clean the high-voltage power supply terminals.</li> <li>● Clean the high-voltage springs where they contact the print cartridge.</li> <li>● Remove the high-voltage power supply and check the connectors and ribbon cable for damage.</li> <li>● Reseat the high-voltage power supply, and make sure to fully seat the connectors and ribbon cable correctly.</li> <li>● Replace the print cartridge.</li> <li>● Replace the laser/scanner assembly and DC controller board, and the formatter, if necessary.</li> </ul>
<p>White page</p> 	<p>The print cartridge is out of toner.</p> <p>The laser shutter is defective.</p> <p>Transfer charging roller voltage does not exist.</p> <p>Developing bias does not exist.</p> <p>The laser/scanner cable assembly is defective.</p>	<ul style="list-style-type: none"> <li>● Replace the print cartridge.</li> <li>● Check the laser shutter for correct operation when closing the front door with the print cartridge installed.</li> <li>● Replace the transfer roller assembly if necessary.</li> <li>● Clean the high-voltage power supply contacts.</li> <li>● Replace the high-voltage power supply.</li> <li>● Replace the laser/scanner cable assembly.</li> </ul>
<p>Blank spots</p>  <p>Also see "Dropouts" on page 238.</p>	<p>The media does not meet printer specifications or is stored incorrectly.</p> <p>The transfer charging roller is contaminated or deformed.</p> <p>The print cartridge is defective.</p>	<ul style="list-style-type: none"> <li>● Print a few more pages to see if the problem corrects itself.</li> <li>● Turn over the stack of media in the tray. Also try rotating the media 180°.</li> <li>● If the media does not meet HP specifications, replace the media.</li> <li>● Replace the transfer charging roller.</li> <li>● Replace the print cartridge.</li> </ul>








**Table 29. Image defects (continued)**

Problem	Cause	Solution
<p data-bbox="320 191 533 216">Wrinkles or creases</p> 	<p data-bbox="588 191 991 247">The media does not meet printer specifications or is stored incorrectly.</p>	<ul data-bbox="1000 191 1492 373" style="list-style-type: none"> <li>● Print a few more pages to see if the problem corrects itself.</li> <li>● Turn over the stack of media in the tray. Also try rotating the media 180°.</li> <li>● If the media does not meet HP specifications, replace the media.</li> </ul>
	<p data-bbox="588 390 991 447">The printer operating environment does not meet specifications.</p>	<ul data-bbox="1000 390 1492 447" style="list-style-type: none"> <li>● Make sure that the printer operating environment meets specifications.</li> </ul>
	<p data-bbox="588 464 927 491">The media is loaded incorrectly.</p>	<ul data-bbox="1000 464 1492 548" style="list-style-type: none"> <li>● Make sure that the media is loaded correctly, and that the guides fit correctly against the stack of media.</li> </ul>
	<p data-bbox="588 569 991 625">The media is printing from the wrong tray.</p>	<ul data-bbox="1000 569 1492 596" style="list-style-type: none"> <li>● Print from a different tray (such as tray 1).</li> </ul>
	<p data-bbox="588 642 991 699">The wrong output bin for the media type is being used.</p>	<ul data-bbox="1000 642 1492 699" style="list-style-type: none"> <li>● Print to a different output bin (face-up or face-down bin).</li> </ul>
	<p data-bbox="588 716 991 772">An obstruction in the paper path exists.</p>	<ul data-bbox="1000 716 1492 800" style="list-style-type: none"> <li>● Check the paper path for media debris.</li> <li>● Check for damaged components that could be creasing the media.</li> </ul>
	<p data-bbox="588 821 991 877">The fuser levers are not in the correct position.</p>	<ul data-bbox="1000 821 1492 940" style="list-style-type: none"> <li>● The levers should be in the down position for all media except envelopes.</li> <li>● The levers should be in the up position for envelopes.</li> </ul>
<p data-bbox="320 961 453 987">Curl or wave</p>  <p data-bbox="320 1245 571 1302">Also see "Dropouts" on page 238.</p>	<p data-bbox="588 961 991 1018">The media does not meet printer specifications or is stored incorrectly.</p>	<ul data-bbox="1000 961 1492 1144" style="list-style-type: none"> <li>● Print a few more pages to see if the problem corrects itself.</li> <li>● Turn over the stack of media in the tray. Also try rotating the media 180°.</li> <li>● If the media does not meet HP specifications, replace the media.</li> </ul>
	<p data-bbox="588 1167 991 1224">The printer operating environment does not meet specifications.</p>	<ul data-bbox="1000 1167 1492 1215" style="list-style-type: none"> <li>● Make sure that the printer operating environment meets specifications.</li> </ul>
	<p data-bbox="588 1241 991 1297">The media is printing to the wrong output bin.</p>	<ul data-bbox="1000 1241 1492 1289" style="list-style-type: none"> <li>● Print to a different output bin (face-up or face-down bin).</li> </ul>
	<p data-bbox="588 1314 991 1371">The wrong fuser setting is used for the media type.</p>	<ul data-bbox="1000 1314 1492 1423" style="list-style-type: none"> <li>● From the paper-handling menu on the control panel, change the fuser mode setting or select another media type from the printer driver.</li> </ul>


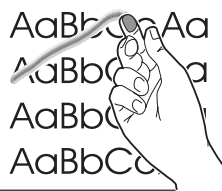

**Table 29. Image defects (continued)**

Problem	Cause	Solution
<p><b>Contamination on back</b></p> 	<p>Contamination inside printer (for example, tray separation roller, feed roller, transfer charging roller, fuser, print cartridge) exists.</p>	<ul style="list-style-type: none"> <li>● Print at least 10 pages to see if the problem goes away.</li> <li>● Print a cleaning page. See "Create a cleaning page" in chapter 4.</li> <li>● Identify and clean the contaminated part according to the "Repeating defect ruler" on page 243. If contamination cannot be removed, replace the contaminated part.</li> <li>● Check for toner leaks.</li> </ul>
	<p>The media does not meet printer specifications or is stored incorrectly.</p>	<ul style="list-style-type: none"> <li>● Print a few more pages to see if the problem corrects itself.</li> <li>● Turn over the stack of media in the tray. Also try rotating the media 180°.</li> <li>● If the media does not meet HP specifications, replace the media.</li> </ul>
	<p>The printer requires a preventive maintenance kit.</p>	<ul style="list-style-type: none"> <li>● When the printer reaches 350,000 pages printed, install the preventive maintenance kit.</li> </ul>
<p><b>Distorted images</b></p> 	<p>The media does not meet printer specifications or is stored incorrectly.</p>	<ul style="list-style-type: none"> <li>● Print a few more pages to see if the problem corrects itself.</li> <li>● Turn over the stack of media in the tray. Also try rotating the media 180°.</li> <li>● If the media does not meet HP specifications, replace the media.</li> </ul>
	<p>The printer operating environment does not meet specifications.</p>	<ul style="list-style-type: none"> <li>● Make sure the printer operating environment meets specifications.</li> </ul>
	<p>Media is not moving through the paper path correctly.</p>	<ul style="list-style-type: none"> <li>● Check all rollers and motors for correct operation.</li> </ul>
	<p>Poor connection of cables to the laser/scanner exists.</p>	<ul style="list-style-type: none"> <li>● Reseat the cables connected to the laser/scanner.</li> </ul>
	<p>Poor connection of cables to the DC controller board exists.</p>	<ul style="list-style-type: none"> <li>● Reseat the cables connected to the DC controller PCA.</li> </ul>
	<p>A defective laser/scanner exists.</p>	<ul style="list-style-type: none"> <li>● Replace the laser/scanner.</li> </ul>
<p><b>Dropouts</b></p>  <p>Also see "Blank spots" on page 236.</p>	<p>The media might be too smooth.</p>	<ul style="list-style-type: none"> <li>● Check the media type and quality.</li> </ul>
	<p>The printer operating environment does not meet specifications.</p>	<ul style="list-style-type: none"> <li>● Make sure the printer operating environment meets specifications.</li> </ul>
	<p>The toner density setting is incorrect.</p>	<ul style="list-style-type: none"> <li>● From the configure device menu on the control panel, adjust the toner density setting (make sure EconoMode is off).</li> </ul>
	<p>The fuser setting for the type of media is incorrect.</p>	<ul style="list-style-type: none"> <li>● From the paper-handling menu on the control panel, change the fuser mode setting or select another media type from the printer driver.</li> </ul>
	<p>Maintenance is due.</p>	<ul style="list-style-type: none"> <li>● When the printer reaches 350,000 pages printed, install the preventive maintenance kit.</li> </ul>




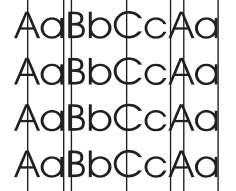
**Table 29. Image defects (continued)**

Problem	Cause	Solution
<p><b>Bubbles</b></p> 	<p>A drum ground path does not exist.</p>	<ul style="list-style-type: none"> <li>● Check the drum ground spring and reconnect it, if necessary.</li> <li>● Replace the high-voltage power supply.</li> </ul> <p><b>Note</b> With no ground path, the drum cannot discharge. The negative charge on the drum repels toner and leaves the page with bubble print.</p>
<p><b>Gray background</b></p> 	<p>The media does not meet printer specifications or is stored incorrectly.</p> <p>The printer operating environment does not meet specifications.</p> <p>The toner density setting is incorrect.</p> <p>The print cartridge is faulty.</p>	<ul style="list-style-type: none"> <li>● Print a few more pages to see if the problem corrects itself.</li> <li>● Turn over the stack of media in the tray. Also try rotating the media 180°.</li> <li>● If the media does not meet HP specifications, replace the media.</li> <li>● Make sure that the printer operating environment meets specifications.</li> <li>● From the configure device menu on the control panel, adjust the toner density setting (make sure EconoMode is off).</li> <li>● Replace the print cartridge.</li> </ul>
<p><b>Horizontal black lines</b></p> 	<p>The print cartridge, laser/scanner assembly, or DC controller PCA is defective.</p>	<ul style="list-style-type: none"> <li>● See the "Repeating defect ruler" on page 243.</li> <li>● Replace the print cartridge.</li> <li>● Reseat the connectors on the laser/scanner and DC controller PCA.</li> <li>● Replace the laser/scanner assembly and the DC controller PCA, if necessary.</li> </ul>
<p><b>Horizontal smudges</b></p> 	<p>The paper path is contaminated or damaged.</p>	<ul style="list-style-type: none"> <li>● See the "Repeating defect ruler" on page 243.</li> <li>● Replace the print cartridge.</li> <li>● Check the print cartridge and replace it, if necessary.</li> <li>● Check the fuser and replace it, if necessary.</li> </ul>
<p><b>Horizontal white lines</b></p> 		<ul style="list-style-type: none"> <li>● Check the print cartridge and replace it, if necessary.</li> <li>● Check the fuser and replace it, if necessary.</li> <li>● Replace the laser/scanner assembly and the DC controller PCA, if necessary.</li> </ul>



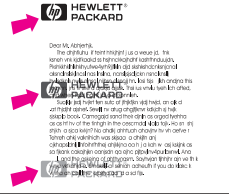
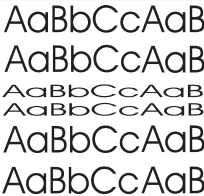
**Table 29. Image defects (continued)**

Problem	Cause	Solution
<p>Light print, dark print, or fade</p>  <p>Also see "Bubbles" on page 239.</p>	<p>The toner density setting is incorrect.</p> <p>The transfer charging roller is defective.</p> <p>The media does not meet printer specifications or is stored incorrectly.</p> <p>Poor contact to the high-voltage power supply exists.</p> <p>The laser/scanner assembly is defective.</p> <p>The DC controller PCA is defective.</p> <p>The laser shutter is defective.</p>	<ul style="list-style-type: none"> <li>● From the configure device menu on the control panel, adjust the toner density setting (make sure EconoMode is off).</li> <li>● Replace the transfer charging roller.</li> <li>● Print a few more pages to see if the problem corrects itself.</li> <li>● Turn over the stack of media in the tray. Also try rotating the media 180°.</li> <li>● If the media does not meet HP specifications, replace the media.</li> <li>● Make sure that the drum ground spring is connected correctly to the high-voltage power supply.</li> <li>● Clean the contacts if they are contaminated. If the problem persists after cleaning, or if parts are damaged or deformed, replace them.</li> <li>● Replace the high-voltage power supply, if necessary.</li> <li>● Replace the laser/scanner assembly.</li> <li>● Replace the DC controller PCA.</li> <li>● Check the laser shutter for correct operation when installing the print cartridge.</li> </ul>
<p>Loose toner</p> 	<p>Contamination in the printer exists.</p> <p>The print cartridge is defective.</p> <p>The media might be too smooth.</p> <p>The fuser setting is incorrect for the media type.</p> <p>The fuser is defective.</p> <p>The envelope levers are set incorrectly.</p>	<ul style="list-style-type: none"> <li>● Print a few more pages to see if the problem corrects itself.</li> <li>● Clean the inside of the printer or use the printer cleaning page.</li> <li>● Replace the print cartridge.</li> <li>● Check the media type and quality.</li> <li>● From the paper-handling menu on the control panel, change the fuser mode setting or select another media type from the printer driver.</li> <li>● Maintenance might be due. Check this by printing a copy of the supplies status page. If maintenance is due, order and install the preventive maintenance kit.</li> <li>● Replace the fuser.</li> <li>● Make sure that the envelope levers are set to the specified media.</li> </ul>
<p>Repeating defects</p> 	<p>A roller is contaminated or defective.</p>	<ul style="list-style-type: none"> <li>● See the "Repeating defect ruler" on page 243.</li> </ul>

**Table 29. Image defects (continued)**

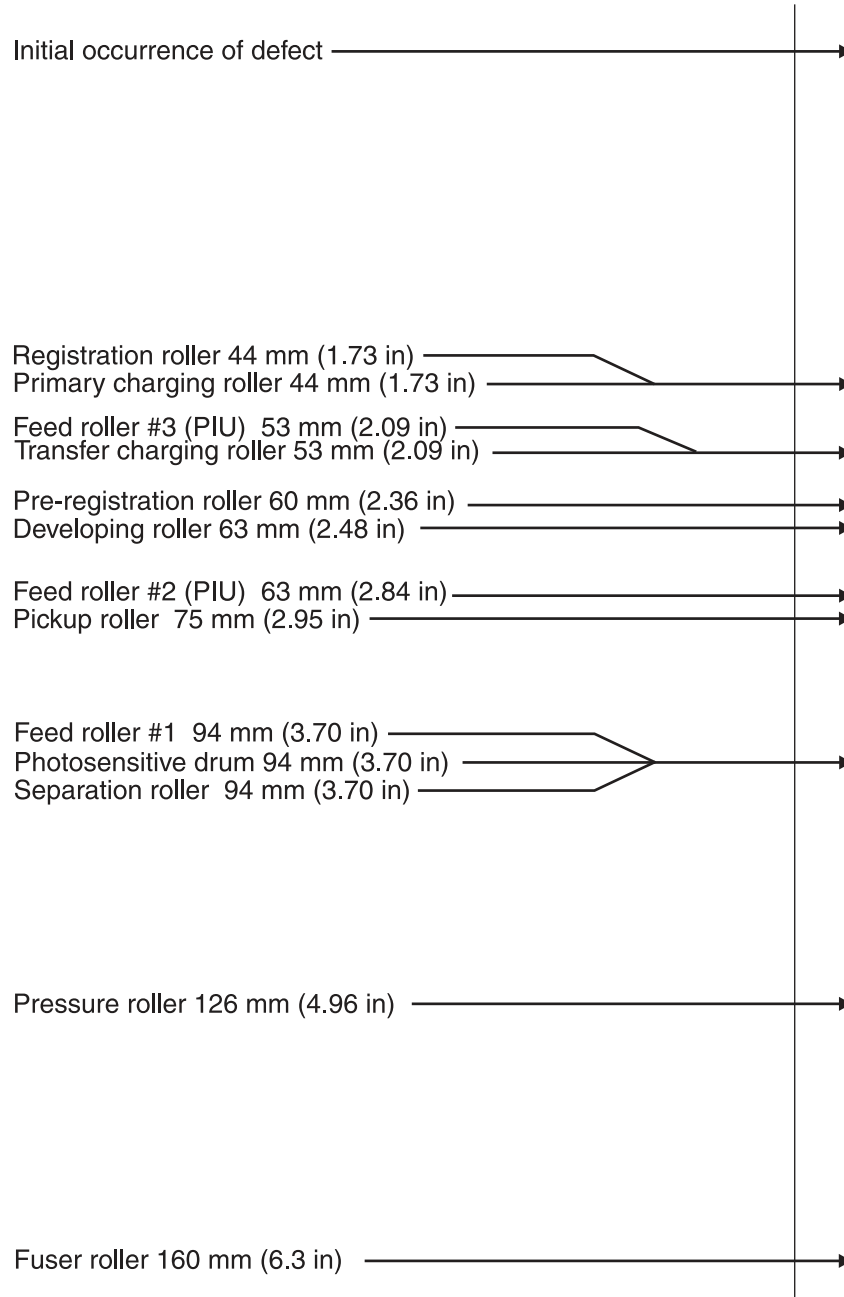
Problem	Cause	Solution
<p><b>Page skew</b></p> 	The media does not meet printer specifications or is stored incorrectly.	<ul style="list-style-type: none"> <li>Print a few more pages to see if the problem corrects itself.</li> <li>Turn over the stack of media in the tray. Also try rotating the media 180°.</li> <li>If the media does not meet HP specifications, replace the media.</li> </ul>
	The media is not loaded correctly or trays are not adjusted correctly.	<ul style="list-style-type: none"> <li>Make sure that the media is loaded correctly and that the guides fit correctly against the stack of media.</li> </ul>
	The registration assembly is installed incorrectly.	<ul style="list-style-type: none"> <li>Make sure that the registration assembly is installed correctly.</li> </ul>
<p><b>Toner smears</b></p> 	Contamination in the printer exists.	<ul style="list-style-type: none"> <li>Print a few more pages to see if the problem corrects itself.</li> <li>Clean the inside of the printer or use the printer cleaning page.</li> </ul>
	The media might be too smooth.	<ul style="list-style-type: none"> <li>Check the media type and quality.</li> </ul>
	The print cartridge is defective.	<ul style="list-style-type: none"> <li>Replace the print cartridge.</li> </ul>
	The fuser setting for the media type is incorrect.	<ul style="list-style-type: none"> <li>From the paper-handling menu on the control panel, change the fuser mode setting or select another media type from the printer driver.</li> </ul>
<p><b>Toner specks</b></p> 	Contamination in the printer exists.	<ul style="list-style-type: none"> <li>Print a few more pages to see if the problem corrects itself.</li> <li>Clean the inside of the printer. See "Internal cleaning" in chapter 4.</li> <li>Print a cleaning page. See "Create a cleaning page" in chapter 4.</li> </ul>
	The media does not meet printer specifications or is stored incorrectly.	<ul style="list-style-type: none"> <li>Print a few more pages to see if the problem corrects itself.</li> <li>Turn over the stack of media in the tray. Also try rotating the media 180°.</li> <li>If the media does not meet HP specifications, replace the media.</li> </ul>
	The customer is alternating small and standard media (such as envelopes and letterhead).	<ul style="list-style-type: none"> <li>To alternate small and standard media, from the paper-handling menu on the control panel, set SMALL PAPER SPEED=SLOW.</li> </ul>
<p><b>Vertical black lines</b></p> 	The print cartridge is defective.	<ul style="list-style-type: none"> <li>Replace the print cartridge.</li> </ul>
	The fuser entrance guide is contaminated.	<ul style="list-style-type: none"> <li>Clean the guide.</li> </ul>
	Scratches on the fuser exist.	<ul style="list-style-type: none"> <li>Replace the fuser.</li> </ul>
	The fuser film is worn.	<ul style="list-style-type: none"> <li>Set the fuser to a lower temperature mode.</li> <li>Replace the fuser.</li> </ul>

**Table 29. Image defects (continued)**

Problem	Cause	Solution
<p><b>Vertical dots</b></p> 	<p>The static charge eliminator teeth are contaminated.</p> <p>Poor contact exists between the static charge eliminator and the high-voltage power supply.</p> <p>The transfer charging roller is deformed or deteriorated.</p> <p>The high-voltage power supply is defective.</p>	<ul style="list-style-type: none"> <li>● Clean the static charge eliminator.</li> <li>● Clean the contacts, if contaminated. If the problem persists after cleaning, or parts are damaged or deformed, replace them.</li> <li>● Replace the transfer charging roller.</li> <li>● Replace the high-voltage power supply.</li> </ul>
<p><b>Vertical white lines</b></p> 	<p>The print cartridge faulty.</p> <p>Contamination in the laser path exists.</p> <p>The fuser is defective.</p>	<ul style="list-style-type: none"> <li>● Replace the print cartridge.</li> <li>● Clean the laser path (remove the laser/scanner assembly and clean the lens).</li> <li>● Replace the laser/scanner assembly.</li> <li>● Replace the fuser assembly.</li> </ul>
<p><b>Repeating images</b></p> 	<p>This type of defect might occur when using preprinted forms, a large quantity of narrow media, or a fuser mode that is set too high for the media.</p> <p>Maintenance is due.</p>	<ul style="list-style-type: none"> <li>● Print a few more pages and see if the problem corrects itself.</li> <li>● Make sure that the media type and quality meet HP specifications.</li> <li>● If you observe that this type of defect occurs on wide media (such as letter or A4) just after printing on narrow media (such as envelopes), you can set <b>SMALL PAPER SPEED</b> on the paper-handling menu to <b>SLOW</b>. This slows down printing.</li> <li>● Check your fuser mode.</li> <li>● Print a copy of the supplies status page. If maintenance is due, order and install the preventive maintenance kit.</li> </ul>
<p><b>Misformed characters</b></p> 	<p>The printer operating environment does not meet specifications.</p> <p>Maintenance is due.</p>	<ul style="list-style-type: none"> <li>● Make sure that the printer operating environment meets specifications.</li> <li>● Print a copy of the supplies status page. If maintenance is due, order and install the preventive maintenance kit.</li> </ul>

## Repeating defect ruler

Repetitive print defects are usually caused by a specific roller in the printer or the print cartridge. Use the following figure to isolate the cause of repetitive print defects. Align the first occurrence of the defect with the top of the “ruler” (at the top or bottom of the misprinted page), and measure to the next occurrence of the defect to determine which roller is causing the defect. When the defect pattern matches the pattern of the ruler, replace the indicated roller.



**Figure 130.** Repeating defect ruler

# Media troubleshooting

Media defects can cause jams and image defects. If the previously described conditions are corrected and do not eliminate the printing problem, continue to investigate the media as the source of the defect.

Problems with media are sometimes difficult to detect. Follow a standard troubleshooting procedure to help isolate media-related problems. The following are the steps to follow:

- "Determine the problem source: media or printer" on page 244.
- "Isolate a paper path" on page 244.
- "Isolate a media brand" on page 245.
- "Isolate a media type" on page 245.
- "Operating environment" in chapter 2.
- "Paper-path test" on page 213.

## Determine the problem source: media or printer

When determining the cause of a printer failure, a distinction must be made between problems that relate to the printer itself and those that involve media. Often a problem that seems to be related to the printer is actually a matter of poor print-media selection or handling. To determine whether a problem is caused by the printer or by the media, try a few simple steps to remedy the situation:

- Turn the media over in the tray to print on the reverse side.
- Rotate the sheets 180° (end to end) to feed with a different leading edge.

If the symptoms cease, or change in some way, assume that the problems are caused by the media.

## Isolate a paper path

### Try using the straightest paper path

Some problems can be avoided by using the straightest available paper path. Usually this means media feeds from the upper paper tray or tray 1, and exits into the face-up bin. This path is recommended for envelopes and labels.

### Determine if the problem is caused by the duplexing process

Media that has just made a pass through the printer can show increased media curl. Media curl increases image dropout, and creates pickup and stacking problems. When the second pass is made, media might not meet the specifications for moisture and curl. Dry media can hold static charges that affect print quality and stacking of the duplexed page. Media shrinkage resulting from a second pass through the printer can cause image misalignment on the duplexed page.

### Isolate the source of the jam

Define the source of the media that jams.

### Determine where media jams occur

Check where media stops when a jam occurs.



## Determine whether the printer is experiencing misfeeds or multifeed jams

The following are some possible causes of misfeeds or multifeed jams:

- The media might be too heavy. Check basis weight and measure caliper. See "Media input/output options" in chapter 2.
- The media might be too smooth. Check the finish.
- The media might be too heavy or too light. Check basis weight.
- The customer might be attempting to print embossed media, pre-printed forms, or perforated media that does not meet HP specifications. See "Media specifications" in chapter 2.
- The media might be loaded incorrectly. Turn over the sheets in the media tray to determine if in-ream curl is causing misfeeds.
- The customer might be fanning media before loading it into the tray.
- The customer might be adding media in small amounts. Do not add small amounts of media or mix types of media in the tray.
- The printer or media storage environment might be too humid or too dry. See "Storing print media" in chapter 2.

## Isolate a media brand

If the printer jams with only one brand of media:

- Try switching media brands.
- If the media ream in use appears to be old, open a fresh ream of the same media and load it correctly into the printer. If the problem disappears, investigate storage and handling conditions.

## Isolate a media type

When jams and other problems occur frequently, it is often because the customer is using a special media. Customers must only use media that conforms to all Hewlett-Packard specifications, and should always test media before purchasing large quantities. Media should be tested before storage to verify quality printing results. Then, if problems occur, storage or handling conditions can isolate the most likely cause. Some types of media that might cause problems are:

- Adhesive labels
- Envelopes
- Transparencies
- Preprinted forms and letterhead
- Embossed media
- Perforated media
- Chemically treated media
- Synthetic media
- Coated media
- Other special media

See "Media specifications" in chapter 2 for further information concerning these types of media.

# Communication troubleshooting

## Communications check

---

### Note

---

Communication problems are normally the customer's responsibility. Time spent attempting to resolve these problems might not be covered by the Hewlett-Packard warranty. Refer the customer to the network administrator for assistance in troubleshooting network problems.

### Test message

After the printer is installed, verify communications between the printer and the IBM-compatible computer. Type the following information at the MS-DOS prompt:

C:\>DIR>LPT1 then press **ENTER** to print to parallel port #1.

The printer should print a directory listing of the C:\ directory.

### EIO troubleshooting

The Jetdirect configuration page shown in figure 125 on page 229 contains valuable information about the current status of the EIO accessories. Before attempting to troubleshoot a network problem or notifying your network consultant of a problem, always print a configuration page. If an EIO accessory is installed, the Jetdirect configuration page also prints.

See the *HP Jetdirect Network Interface Configuration Guide* for detailed explanations of network issues.

### Jetdirect configuration

- If the EIO Jetdirect print server has successfully turned on and completed its internal diagnostics, the `I/O CARD READY` message will appear. If communication is lost, an `I/O NOT READY` message appears followed by a two digit error code. Consult the *HP Jetdirect Network Interface Configuration Guide* for further details and recommended action.
- The "Network Statistics" column indicates the status of network activity. Bad packets, framing errors, un-sendable packets, and collisions should be minimal. If a high percentage (greater than 1%) of these occur, contact the network administrator. All of the statistics are set to zero when the printer is powered off.
- A "Novell Status" block should state the Novell printer server name to which the printer is connected. If the Node Name reads "NPIxxxxxx" (xxxxxx = last six digits of the EIO LAN address), the EIO card has not been configured for a Novell server. This could indicate that the card is operating under an IPX protocol other than Novell. Consult with the network administrator if the Node Name is not present.
- In the TCP/IP protocol block, the default IP address is "192.0.0.192." It is acceptable to operate the printer with this default address. The error message `ARP DUPLICATE IP ADDRESS` might appear in this block. This is also an acceptable error code if the TCP/IP protocol is not being used. Please check with the network administrator to determine the correct IP address for the printer.

## Embedded LAN troubleshooting (HP LaserJet 9040n/9050n, HP LaserJet 9040dn/9050dn, HP LaserJet 9050mfp, and HP LaserJet 9040mfp only)

Although networking is integrated, the embedded LAN has additional features to assist in troubleshooting. These include the following features:

- The ability to turn on and turn off the embedded networking.
- An internal diagnostic to check the networking hardware.
- The ability to initiate communication from the printer to other network devices to check communication paths.
- The ability to upgrade the embedded LAN separately from the printer firmware.
- Procedures to upgrade the embedded LAN by installing new printer firmware (through the parallel port and the networking port).
- A Save + Restore capability for formatter exchanges.

### Error codes

Some embedded LAN error codes are the same as those for an EIO card. In these cases, the embedded LAN is identified as EIO 4. In other cases, because the embedded LAN is part of the printer firmware, the LAN error codes are within the 49.X series. See ["Numerical error messages" on page 188](#) for more information.

If the printer cannot print a configuration page, click the **Configure Device** menu and then click the **I/O** menu. If **Embedded Jetdirect Menu** does not appear or if the JDI is disabled or is not installed, do *not* look at the LEDs on the back of the printer next to the RJ-45 connector (10/100 LEDs). These LEDs are controlled by hardware and are active regardless of the state of the embedded LAN (enabled or disabled).

### LAN diagnostics

Two diagnostic menus are available on the control-panel display. One of the menus is unique to the printer diagnostics and the other is unique to the embedded LAN in the **I/O** submenu. The diagnostics menu item in the **I/O** submenu is described as follows.

The following are the embedded LAN diagnostics:

- Loopback test
- Ping test
- Ping-test results

#### Loopback test

Perform a loopback test to check for hardware errors in the embedded LAN. The loopback test is designed to operate for a few hours, overnight, or during the weekend. When it is operating, the printer cannot accept network traffic such as print jobs.

Use the loopback test to help detect printer problems and embedded LAN problems that might be caused by hardware or basic firmware problem. This is done by eliminating the network as a variable in the troubleshooting process.

If a loopback test fails, printer and/or embedded LAN updates might be required or the formatter might need to be replaced.

---

#### Note

If the printer fails before you open the **Loopback** menu, remove the LAN cable, perform a cold reset on the printer, and then perform a loopback test.

## Ping test

Perform a ping test to check for network connectivity.

A ping test is designed to troubleshoot TCP/IP network connectivity issues by taking key parts of the functionality from the ping utility on Microsoft Windows systems. All Jetdirect products can respond to ping requests, but the embedded LAN can initiate ping requests. All TCP/IP implementations, such as ICMP Echo Response, are required to respond to ping requests.

The following are the ping-test parameters:

- **Destination IP address:** the IP address that you want to contact
- **Packet size:** how many octets of data to send
- **Count:** the number of packets to send
- **Timeout:** the number of seconds to wait for a response
- **Print results:** a printed page of the results

The following are the recommended settings for a ping test:

- **Destination IP address:** use the local router and then use the remote nodes
- **Packet Size:** 64 bytes and then 1,460
- **Count:** 4
- **Timeout:** 1 second (more time if using a WAN connection)
- **Print results:** yes (to have a record of what succeeded and what failed)

## Ping-test results

The following information is available from the ping test:

- **Packets Sent:** The total number of ICMP packets that were sent to the remote host during the test (or during the most recent test)
- **Packets Received:** The total number of ICMP packets that were received from the remote host during the test (or during the most recent test)
- **Percent Lost:** The percentage of ICMP packets that were sent but not received from the remote host during the test (or during the most recent test)
- **RTT Min:** The minimum time (in milliseconds) from when an ICMP packet is sent until it is returned from the remote host
- **RTT Max:** The maximum time (in milliseconds) from when an ICMP packet is sent until it is returned from the remote host
- **RTT Average:** The average time (in milliseconds) from when an ICMP packet is sent until it is returned from the remote host (total time/number of packets).

The **View Ping Results** menu indicates whether a ping-test is in progress. If a ping test is in progress, the user has a menu item to “refresh” the ping results. The results are not dynamically updated in most cases.

---

### Note

HP recommends printing a page with the ping-test results when working on network connectivity issues.

## To enable or disable the embedded LAN

- 1 Turn off the printer.
- 2 Turn on the printer.
- 3 Wait until the printer begins counting memory.
- 4 Press and hold ✓ (the 6 button on MFPs).
- 5 When all three LEDs are illuminated, release ✓ (the 6 button on MFPs).

- 6 Use ▼ (the 9 button on MFPs) or ▲ (the 3 button on MFPs) to scroll to the appropriate selection (COLD RESET, SELECT LANGUAGE, NEW MAINTENANCE KIT, or ENABLE/DISABLE EMBEDDED LAN).

---

**Note**

Other functions are available in this menu, but are not applicable to the LAN.

- 7 Press ✓ (6 key on MFPs). The printer continues the boot sequence.

## Hard-failure troubleshooting for the embedded LAN

If a 49, 79, or 8X error or equivalent occurs, determine if the environment outside of the printer is causing the problem or if the problem is in the printer.

---

**Note**

HP recommends printing a network configuration page to use if you lose the network configuration.

- 1 Turn off the printer.
- 2 Remove the network cable.
- 3 Turn on the printer and disable the embedded LAN. (If the test fails, a hardware problem exists. If the test succeeds, go to step 4.)
- 4 Turn off the printer.
- 5 Turn on the printer and enable the embedded LAN. (If the test fails, go to step 6. If the test succeeds, go to step 8).
- 6 Turn off the printer.
- 7 Turn on the printer and perform a cold reset. (If the test fails, a hardware problem exists. If the test succeeds, go to step 8.)
- 8 Click the **Embedded Network** menu.
- 9 On the **Diagnostics** menu, click **Loopback Test**.
- 10 On the **Loopback Test** menu, click **Execute**. This begins a continuous diagnostic that is only stopped by using a power-cycle. A failure is reported on a diagnostic page or with an error message. (If the test fails, a hardware problem exists. If the test succeeds, go to step 11).
- 11 Turn off the printer.
- 12 Install the network cable.
- 13 Turn on the printer.
- 14 Restore the network configuration (if necessary).

If the test succeeds, the problem has not been diagnosed. If the test fails, the problem might be a network firmware issue. Perform a standard Jetdirect firmware troubleshooting procedure, and disable all of the unused network protocols and services.

If the printer fails when the embedded LAN is enabled and the network cable is unplugged, disable the embedded LAN and upgrade the printer by installing the .RFU file and the parallel port. Sending the .RFU file by using the printer results in the embedded LAN firmware being reprogrammed.

When enabled, the embedded LAN supports the traditional methods of upgrading a Jetdirect device (FTP, HTTP, HP Download Manager, and Web Jetadmin). In addition, .RFU upgrades when the embedded LAN is enabled or disabled.

## Connectivity problems

Use the following procedure if the printer and the network configuration page are correct, but the network printer connectivity is not working.

- 1 Print a network configuration page.
- 2 Click **Embedded Networking**.
- 3 On the **Diagnostics** menu, click **Loopback Test**.
- 4 On the **Loopback Test** menu, click **Execute**. This begins a continuous diagnostic that can only be stopped by using a power-cycle. A failure is reported on a diagnostic page or with an error message. (If the test fails, a hardware problem exists. If the test succeeds, go to step 5.)
- 5 Turn off the printer.
- 6 Turn on the printer.
- 7 Reenter the network information.
- 8 Click **Embedded Jetdirect**.
- 9 On the **Diagnostics** menu, click **Ping**.
- 10 Specify the destination IP (the default is 127.0.0.1).
- 11 Specify the packet size (64 to 2,048, with a default of 64).
- 12 Specify the timeout (1 to 100 seconds, with a default of 1).
- 13 Specify the count (0 to 100, with a default of 4).

---

### Note

Use different IP addresses to test the network connectivity. Results are obtained by opening the **Ping Results** menu and selecting the individual keys, or by configuring the printer to print the results at the end of the test. Click the **Diagnostics** menu and then click the **View Ping Results** sub-menu for more information.

---

---

### Note

The embedded Jetdirect and EIO cards can work together simultaneously (just like two EIO cards in the same printer). Or, if necessary as a part of troubleshooting, the embedded Jetdirect can be disabled and an EIO card can be installed.

---

## Save + Restore

---

### CAUTION

Do *not* replace the formatter, Compact Flash firmware, and/or the DC controller at the same time. The product will not work if the formatter, Compact Flash firmware, and/or the DC controller are replaced at the same time. After you replace the formatter, Compact Flash firmware, and/or the DC controller leave the product in the READY state for at least 10 minutes so that the formatter, Compact Flash firmware, and/or the DC controller update each other.

Do *not* perform a cold reset.

---

---

### WARNING!

The formatter has sharp edges.

---

# Wiring diagrams

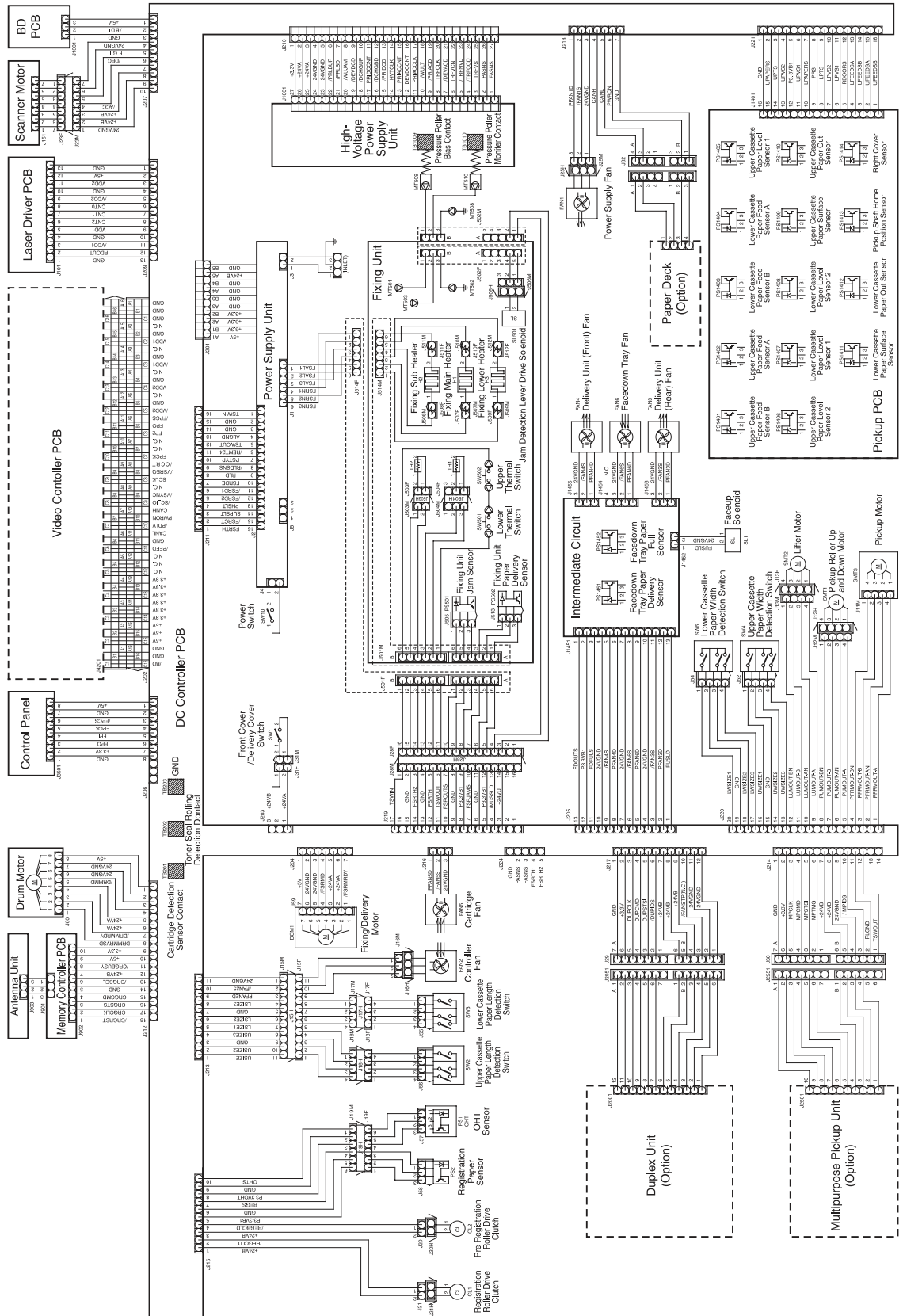


Figure 131. Printer wiring diagram (HP LaserJet 9000 series printer)

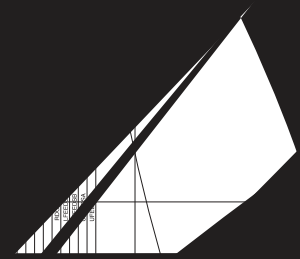
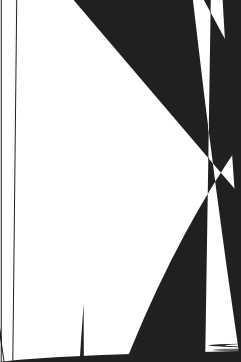
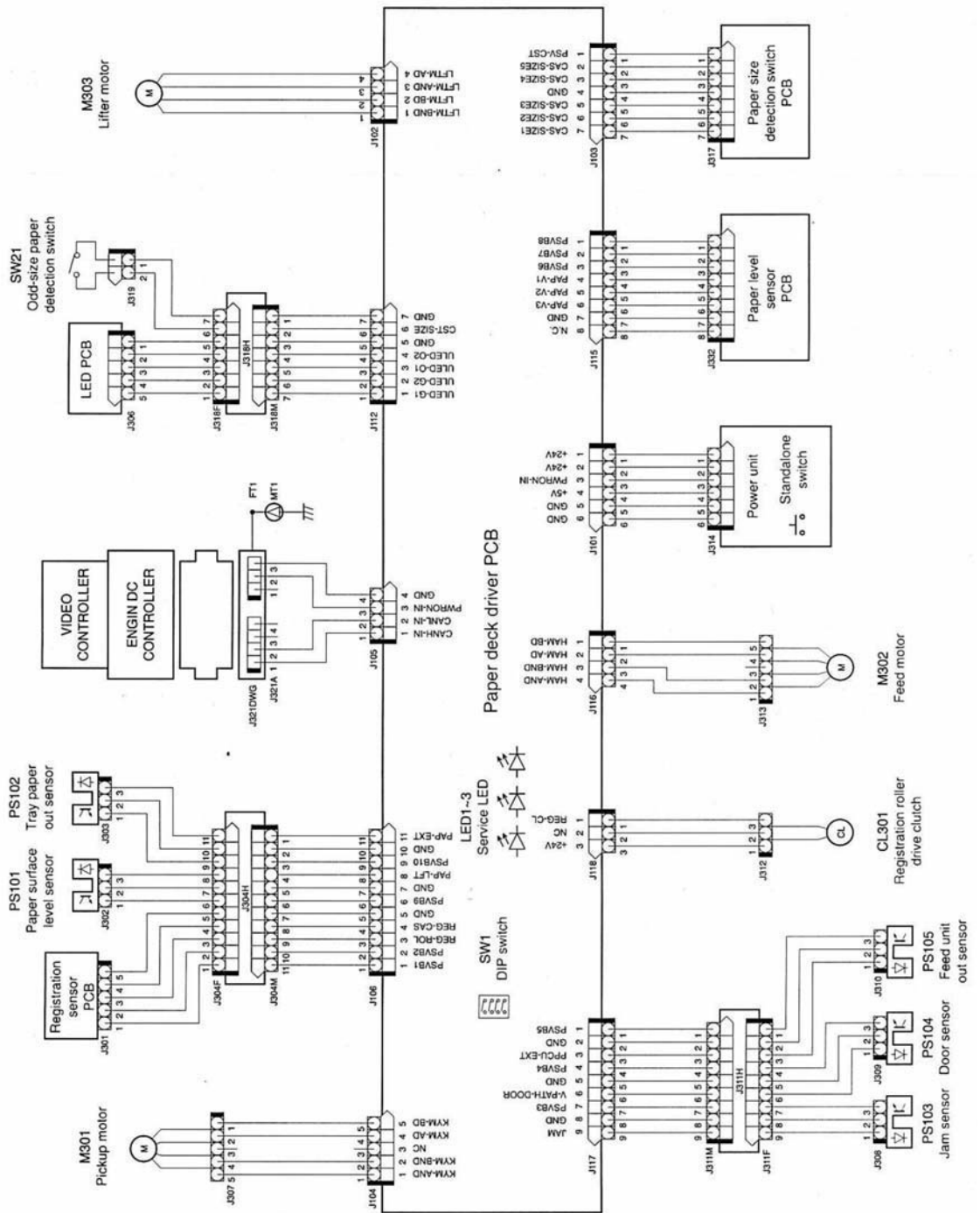




Figure 133. Tray 4 wiring diagram





# 8

## Parts and diagrams

### Chapter contents

Introduction . . . . .	256
Ordering parts . . . . .	256
Consumables, supplies, accessories, FRUs, and documentation . . . . .	257
Common hardware . . . . .	261
Illustrations and parts lists . . . . .	262
External covers and panels . . . . .	262
Left door and diverter . . . . .	264
Right cover assembly . . . . .	265
Internal . . . . .	266
Internal components . . . . .	266
Drum feed drive assembly . . . . .	274
Fuser delivery drive assembly . . . . .	275
Cartridge lifter assembly . . . . .	276
500-sheet trays (tray 2 and tray 3) . . . . .	277
Paper input unit . . . . .	278
Registration assembly . . . . .	279
Transfer roller assembly . . . . .	280
Delivery assembly . . . . .	281
PCA assembly location . . . . .	283
Tray 4 . . . . .	284
Tray 4 main body . . . . .	284
Tray 4 drive assembly . . . . .	288
Tray 4 PCA location . . . . .	289
Tray 1 . . . . .	290
Alphabetical parts list . . . . .	291
Numerical parts list . . . . .	296

# Introduction

The figures in this chapter illustrate the major subassemblies in the printer and their component parts. A table accompanies each exploded-view diagram. Each table lists the item number for the replaceable part, the associated part number for the item, the quantity, and a description of the part.

---

**Note**

---

When looking for a part number, pay careful attention to the voltage listed in the description column to make sure that the part number selected is for the correct printer model.

## Ordering parts

All standard part numbers listed are stocked and can be ordered from HP's Customer Services and Support Organization (CCSO). See "Parts and supplies" in chapter 1.

Consumables and accessories like those listed in table 30 can be ordered from Hewlett-Packard. See "Parts and supplies" in chapter 1.

## Consumables, supplies, accessories, FRUs, and documentation

**Table 30. Consumables, supplies, accessories, FRUs, and documentation**

Product number	Service number	Exchange number	Description	Printer
<b>Consumables</b>				
C8543X		C8519-69009	Print cartridge	
C8091A	C8085-60541		Staple cartridge (3,000-sheet stapler/stacker)	
C8088B	C8088-60541		Staple cartridge (multifunction finisher)	
<b>Supplies</b>				
C9152A	C9152-67904	C9152-69004	PM kit/110 V	
C9153A	C9153-67904	C9153-69004	PM kit/220 V	
<b>FRUs</b>				
C7860A	C8519-67901	C8519-69001	Formatter assembly	HP LaserJet 9000
	Q3721-67901	Q3721-69001	Formatter assembly <b>(Note: Do not</b> replace the formatter and the Compact Flash firmware at the same time)	HP LaserJet 9040/9050 base
	Q3722-67901	Q3722-69001	Formatter assembly <b>(Note: Do not</b> replace the formatter and the Compact Flash firmware at the same time)	HP LaserJet 9040n/9050n and 9040dn/9050dn
	Q3726-67905	Q3726-69005	Formatter assembly <b>(Note: Do not</b> replace the formatter and the Compact Flash firmware at the same time)	HP LaserJet 9040mfp and 9050mfp
RG5-5750-210CN		C8519-69031	Fuser assembly, 110 V	
RG5-5751-210CN		C8519-69032	Fuser assembly, 220 V	
RG5-5681-030CN			Paper input unit (PIU)	
RG5-5778-120CN		C8519-69028	DC controller	HP LaserJet 9000
RG5-7780-000CN			DC controller	HP LaserJet 9040/9050
RG5-5728-050CN		C8519-69015	High-voltage power supply	
RG5-5730-000CN		C8519-69007	Low-voltage power supply, 110 V	HP LaserJet 9000
RG5-7778-000CN			Low-voltage power supply, 110 V	HP LaserJet 9040/9050
RG5-5731-000CN			Low-voltage power supply, 220 V	HP LaserJet 9000
RG5-7779-000CN			Low-voltage power supply, 220 V	HP LaserJet 9040/9050
RG5-5734-020	Q3721-67902		Control panel assembly	HP LaserJet 9040/9050
	Q2635-67912		Firmware Compact Flash <b>(Note: Do not</b> replace the formatter and the Compact Flash firmware at the same time)	HP LaserJet 9040/9050

**Table 30. Consumables, supplies, accessories, FRUs, and documentation (continued)**

Product number	Service number	Exchange number	Description	Printer
	Q2635-67903		Firmware Compact Flash ( <b>Note:</b> Do <i>not</i> replace the formatter and the Compact Flash firmware at the same time)	HP LaserJet 9040mfp and HP LaserJet 9050mfp
RG5-5663-000CN			Registration assembly	
<b>Accessories</b>				
			Blank 16MB flash DIMM	
C9147A	C9147-67908	C9147-69019	16 MB flash firmware DIMM	HP LaserJet 9000
C7843A	C7843-67901		16 MB DIMM	HP LaserJet 9000
C7845A	C7845-67901		32 MB DIMM	HP LaserJet 9000
Q1887A	C7846-67901		64 MB DIMM	HP LaserJet 9000
C9121A	C9121-67901		128 MB DIMM	HP LaserJet 9000
	Q3982-67951		32MB DDR DIMM	HP LaserJet 9040/9050 series only
	Q2625-67951		64MB DDR DIMM	HP LaserJet 9040/9050 series only
	Q2626-67951		128MB DDR DIMM	HP LaserJet 9040/9050 series only
	Q2627-67951		256MB DDR DIMM	HP LaserJet 9040/9050 series only
Q2628A	Q2628-67951		512MB DDR DIMM	HP LaserJet 9040/9050 series only
C4103A	C4103-67901		HP Fast InfraRed Connect pod	HP LaserJet 9000
C4293A			Font DIMM—simplified Chinese	HP LaserJet 9000
C4292A			Font DIMM—traditional Chinese	HP LaserJet 9000
J6054B	J6054-61031	J6054-69031	Hard disk	HP LaserJet 9000
J6073A	J6073-61011	J6073-69011	Hard disk	HP LaserJet 9040/9050
J4169A	J4169-61001	J4169-69001	HP Jetdirect 610N Fast Ethernet (10/100 Base-TX)	
J4135A	J4135-61001		HP Jetdirect Connectivity (USB)	
C8568A	C8568-67902		Tray 1	
C8531A	C8531-67902		2,000-sheet feeder (tray 4)	
RG5-6212-300CN			2,000-sheet feeder (tray 4) cassette only	
RG5-6225-050CN			Vertical transfer assembly	
RG5-6228-040CN			Paper deck drive assembly	
RG5-6208-150CN		C8531-69013	Paper pickup assembly	
C8085A			3,000-sheet stapler/stacker	
C8088B			Multifunction finisher	
Q8532A			8-bin mailbox	HP LaserJet 9040/9050 series only
C8532A	C8532-67902		Duplexer	

**Table 30. Consumables, supplies, accessories, FRUs, and documentation (continued)**

Product number	Service number	Exchange number	Description	Printer
<b>Documentation</b>				
	Q3721-90963		Service manual bundle for the HP LaserJet 9040mfp and the HP LaserJet 9050mfp	HP LaserJet 9040mfp, HP LaserJet 9050mfp, and the HP LaserJet 9000mfp
	5963-7863		<i>HP LaserJet Printer Family Print Media Guide</i>	
	5969-6818		<i>HP Jetdirect Print Server Administrator's Guide</i>	
	5969-3412		<i>HP Jetdirect Print Server Jetadmin Setup Guide</i>	
	Q5693-90002		<i>Paper Handling Accessories Service Addendum</i>	
	C8519-90901		<i>HP LaserJet 9000 Start Guide—U.S.</i>	
	C8519-90902		<i>HP LaserJet 9000 Start Guide—Americas</i>	
	C8519-90903		<i>HP LaserJet 9000 Start Guide—West Europe</i>	
	C8519-90904		<i>HP LaserJet 9000 Start Guide—North Europe</i>	
	C8519-90905		<i>HP LaserJet 9000 Start Guide—East Europe</i>	
	C8519-90906		<i>HP LaserJet 9000 Start Guide—Asia</i>	
URL: <a href="http://www.hp.com/support/lj9000">www.hp.com/support/lj9000</a>			<i>HP LaserJet 9000 Use Guide</i>	
	Q3721-90906		<i>HP LaserJet 9040/9050 Use Guide</i>	
	Q3721-90934		<i>HP LaserJet 9000 and 9040/9050 Series printers Service Guide</i>	
	C8532-90901		<i>HP Duplexer Install Guide</i>	
	C8568-90901		<i>HP Tray 1 Install Guide</i>	
	C8531-90901		<i>HP 2,000-sheet feeder Install Guide</i>	
	C8084-90900		<i>HP Stapler/stacker and Stacker Install Guide</i>	
	C8088-90903		<i>HP Multifunction Finisher Install Guide</i>	
	C8088-90902		<i>HP Multifunction Finisher Service Guide</i>	
	C8088-90901		<i>HP Multifunction Finisher Use Guide</i>	
	C8519-60102		<i>HP LaserJet 9000 Series Printer Software CD-ROM—Americas</i>	

**Table 30. Consumables, supplies, accessories, FRUs, and documentation (continued)**

<b>Product number</b>	<b>Service number</b>	<b>Exchange number</b>	<b>Description</b>	<b>Printer</b>
	C8519-60104		<i>HP LaserJet 9000 Series Printer Software CD-ROM—Europe</i>	
	C8519-60105		<i>HP LaserJet 9000 Series Printer Software CD-ROM—Asia</i>	
	C8519-60106		<i>HP LaserJet 9000 Series Printer Service CD-ROM (English version)</i>	
	C9152-90901		PM kit installation guide	



## Common hardware

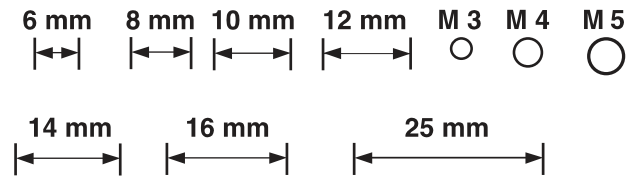


Table 31. Hardware table

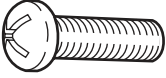

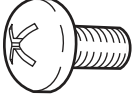
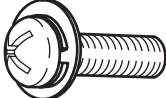

Example	Description	Sizes	Uses
	Screw	M3 by 6 mm M3 by 8 mm M4 by 8 mm M4 by 10 mm	Various
	Screw, tapping	M3 by 6 mm M3 by 8 mm M3 by 30 mm M4 by 6 mm M4 by 12 mm	To hold plastic to metal (excluding the control panel)
	Screw, pan head	M3 by 6 mm	To hold plastic to plastic
	Screw, w/washer	M3 by 6 mm M3 by 8 mm M3 by 7 mm M4 by 6 mm M4 by 12 mm	To hold plastic to metal (excluding the covers)
	E-ring	XD9-0136-000CN XD9-0134-000CN	To hold gears in place

Table 32. Common torque values

Material	HP recommended torque value
Plastic to metal	5.5 lb-in
Metal to metal	10 lb-in
PCBA	5.5 lb-in
Plastic to plastic	5.5 lb-in

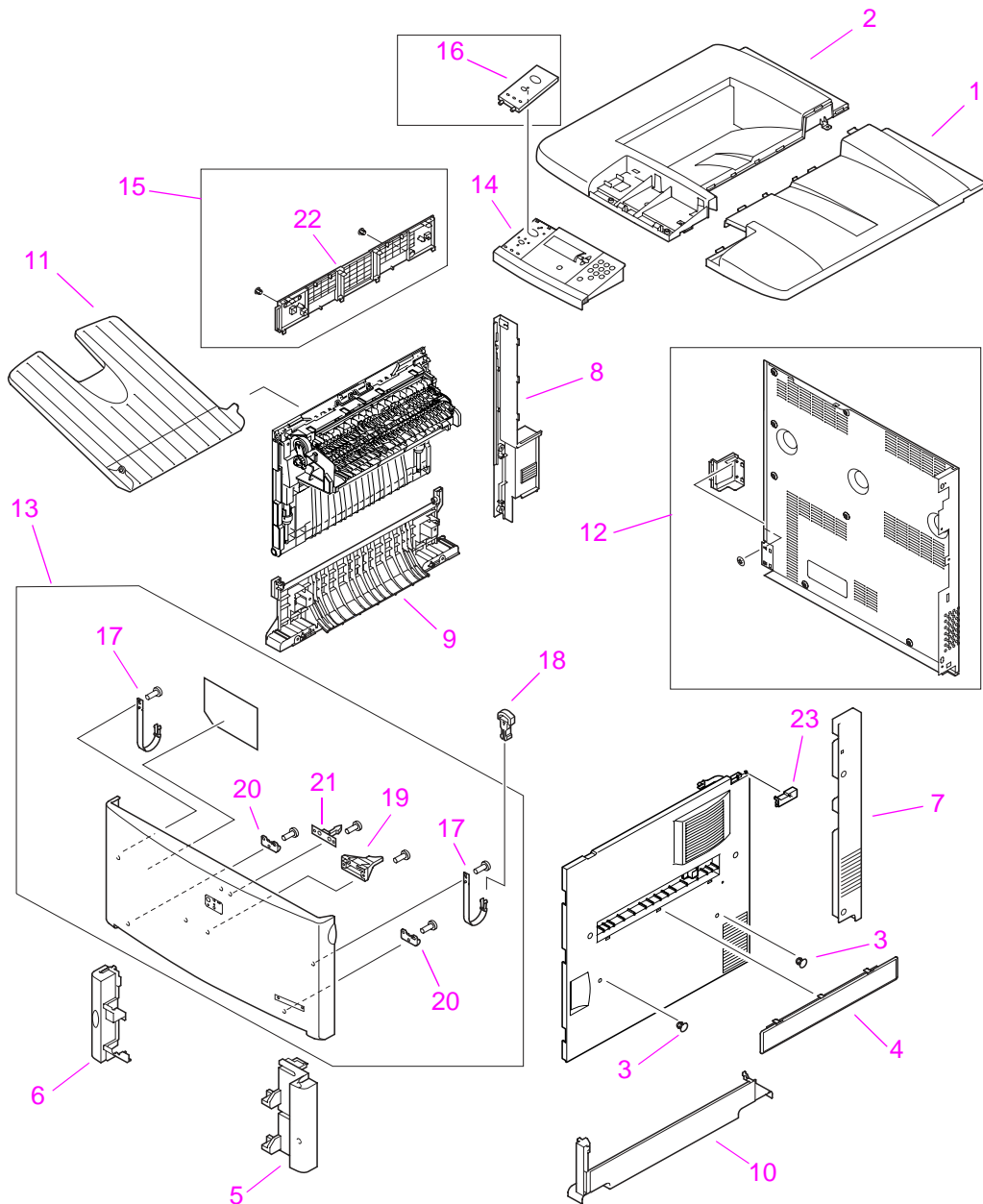
# Illustrations and parts lists

The following illustrations and parts tables list the field replaceable units (FRUs) for this printer. Two tables at the end of this chapter list all of the parts shown in this chapter: table 54, "Alphabetical parts list," on page 291 lists the parts in alphabetical order, and table 55, "Numerical parts list," on page 296 lists the parts in numerical order by part number. Both tables list the appropriate figure in this chapter that shows the part.

**Note**

Parts that have no item number or part number listed are not FRUs and cannot be ordered.

## External covers and panels



**Figure 134.** Printer external covers and panels

**Table 33. Printer external covers and panels**

Ref	Description	9000 part number	9040/9050 part number (if different)	Qty
1	Cover, right top	RB2-5659-000CN		1
2	Cover, left top	RB2-5660-000CN		1
3	Cap, right cover	RB2-5675-000CN		2
4	Cover, tray 1 blanking	RB2-5676-000CN		1
5	Cover, right rail	RB2-5682-000CN		1
6	Cover, left rail	RB2-5683-000CN		1
7	Cover, right back	RB2-5684-000CN		1
8	Cover, left back	RB2-5685-000CN		1
9	Cover, left lower	RB2-5687-000CN		1
10	Cover, right lower	RB2-5689-000CN		1
11	Tray, face-up	RB2-5690-000CN		1
12	Back cover assembly	RG5-5701-000CN		1
13	Front cover assembly	RG5-5702-000CN		1
14	Control panel assembly	RG5-5703-060CN		1
15	Left upper cover assembly	RG5-5705-000CN		1
16	Cover, operation panel, 110 V	RB2-5701-000CN		1
16	Cover, operation panel, 220 V	RB2-5703-000CN		1
17	Tape, cover (retaining strap)	RB2-5653-000CN		2
18	Strap, rock block, retaining clip	RB2-5655-000CN		2
19	Pin	RB2-5656-000CN		1
20	Bushing	RB2-5652-000CN		2
21	Latch, roller-action	RB2-5700-000CN		1
22	Cover, left upper	RB2-6491-000CN		1
23	Plate, lock, right side	RB2-5679-000CN		1

## Left door and diverter

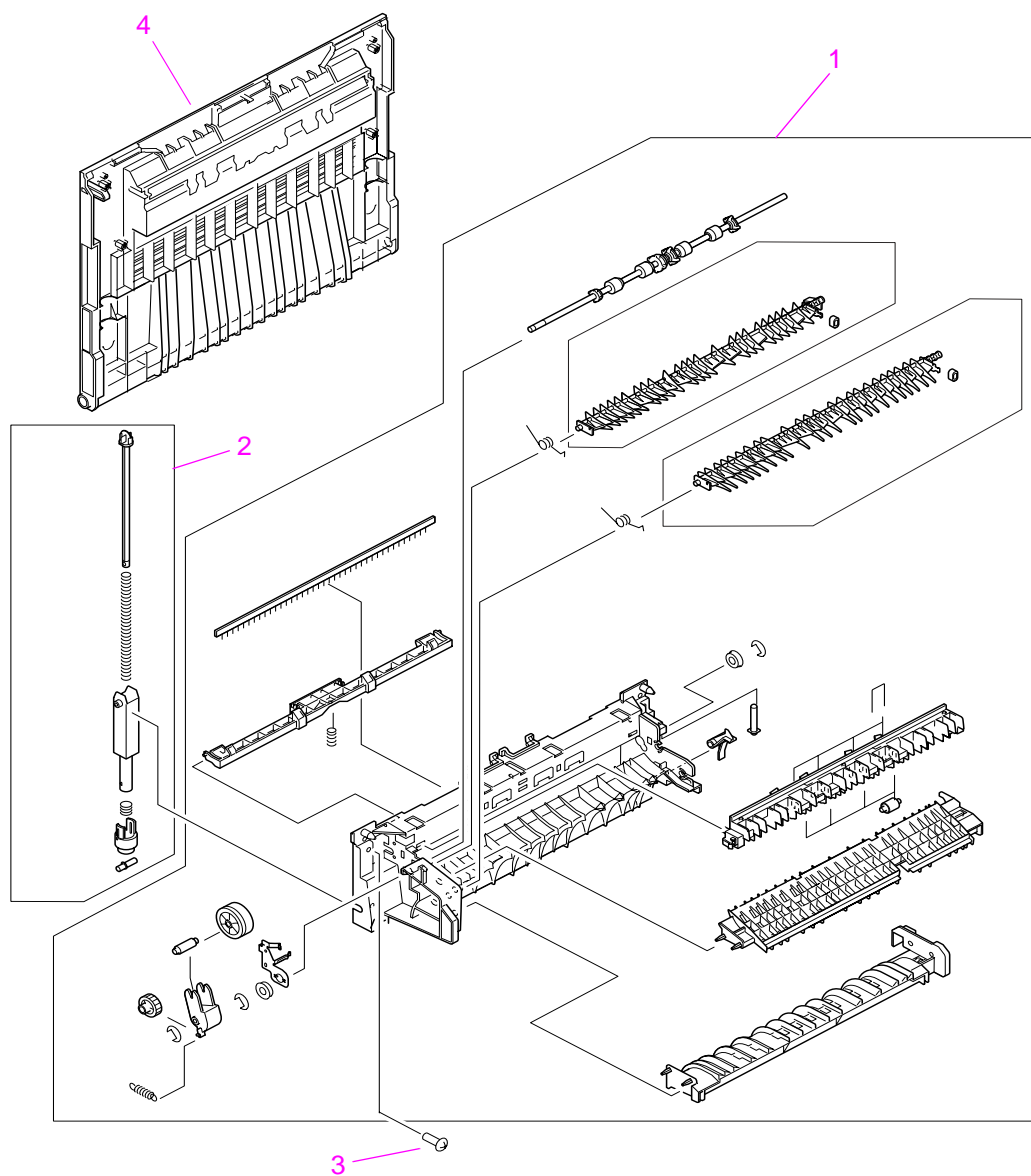
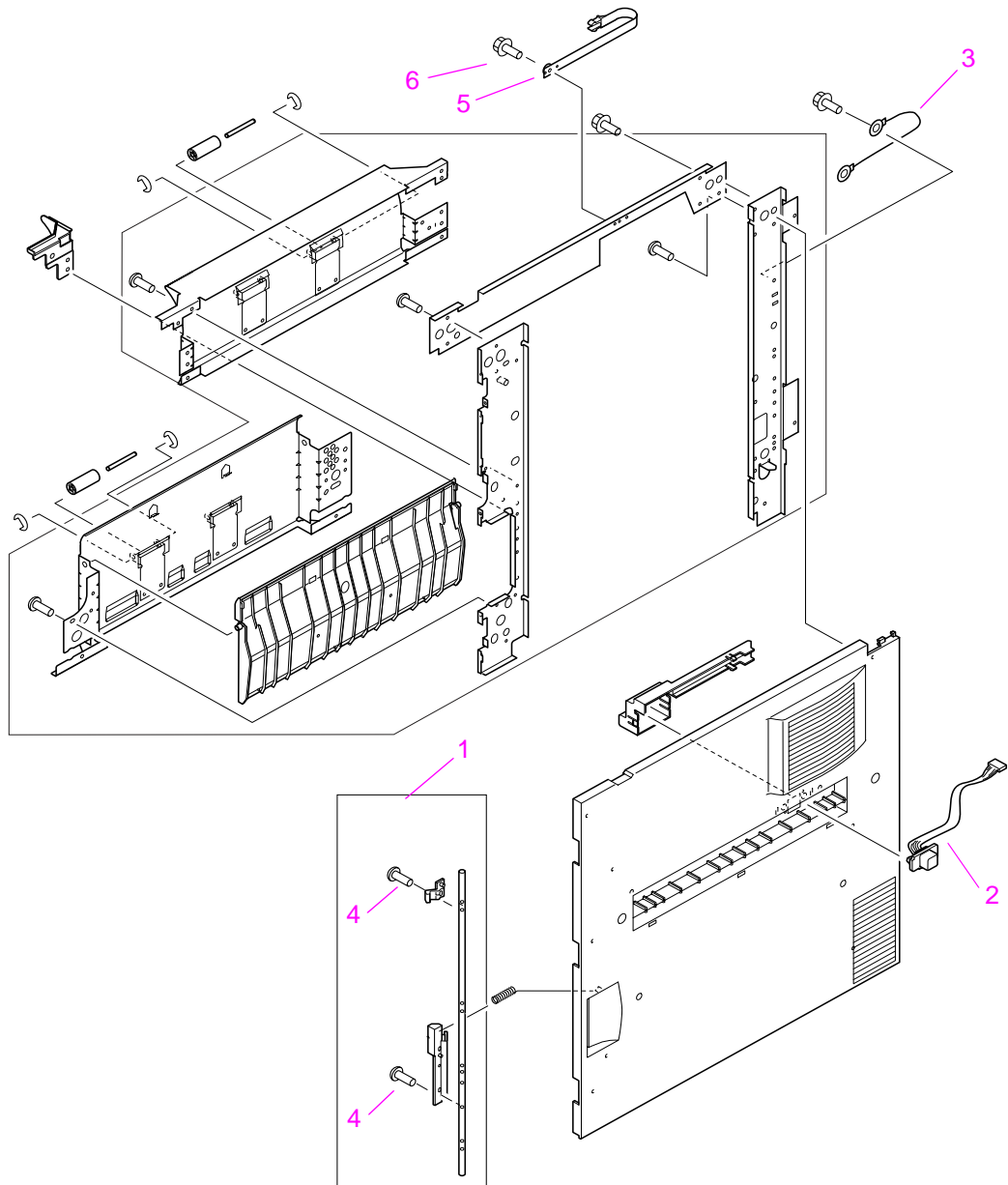


Figure 135. Left door and diverter

Table 34. Left door and diverter

Ref	Description	9000 part number	9040/9050 part number (if different)	Qty
	Left door and diverter	RG5-5646-050CN		1
1	Diverter assembly	RG5-5647-050CN		1
2	Damper assembly	RG5-5648-000CN		2
3	Screw, M4 by 10	XA9-1189-000CN		
4	Cover, left (left door)	RB2-6007-000CN		1

## Right cover assembly



**Figure 136.** Right cover assembly

**Table 35.** Right cover assembly

Ref	Description	9000 part number	9040/9050 part number (if different)	Qty
	Right cover assembly	RG5-5737-000CN		1
1	Right cover knob assembly	RG5-5740-000CN		1
2	Cable, tray 1	RG5-5763-000CN		1
3	Grounding cable, tray 1	RG5-5764-000CN		1
4	Screw, M3 by 8	XA9-1200-000CN		
5	Tape, cover (restraining strap)	RB2-5653-000CN		1
6	Screw, M3 by 8, RS	XA9-1276-000CN		

# Internal

## Internal components

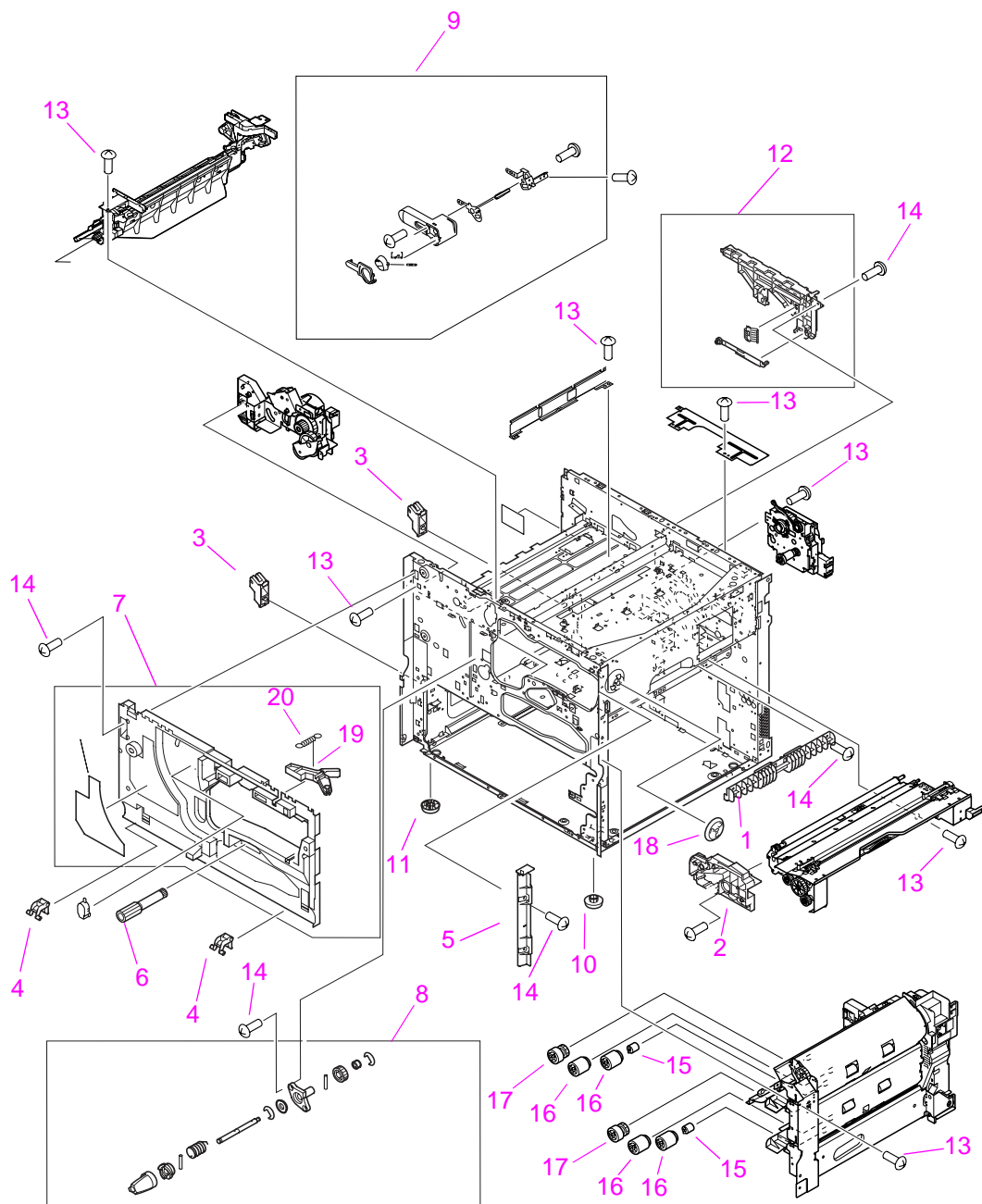
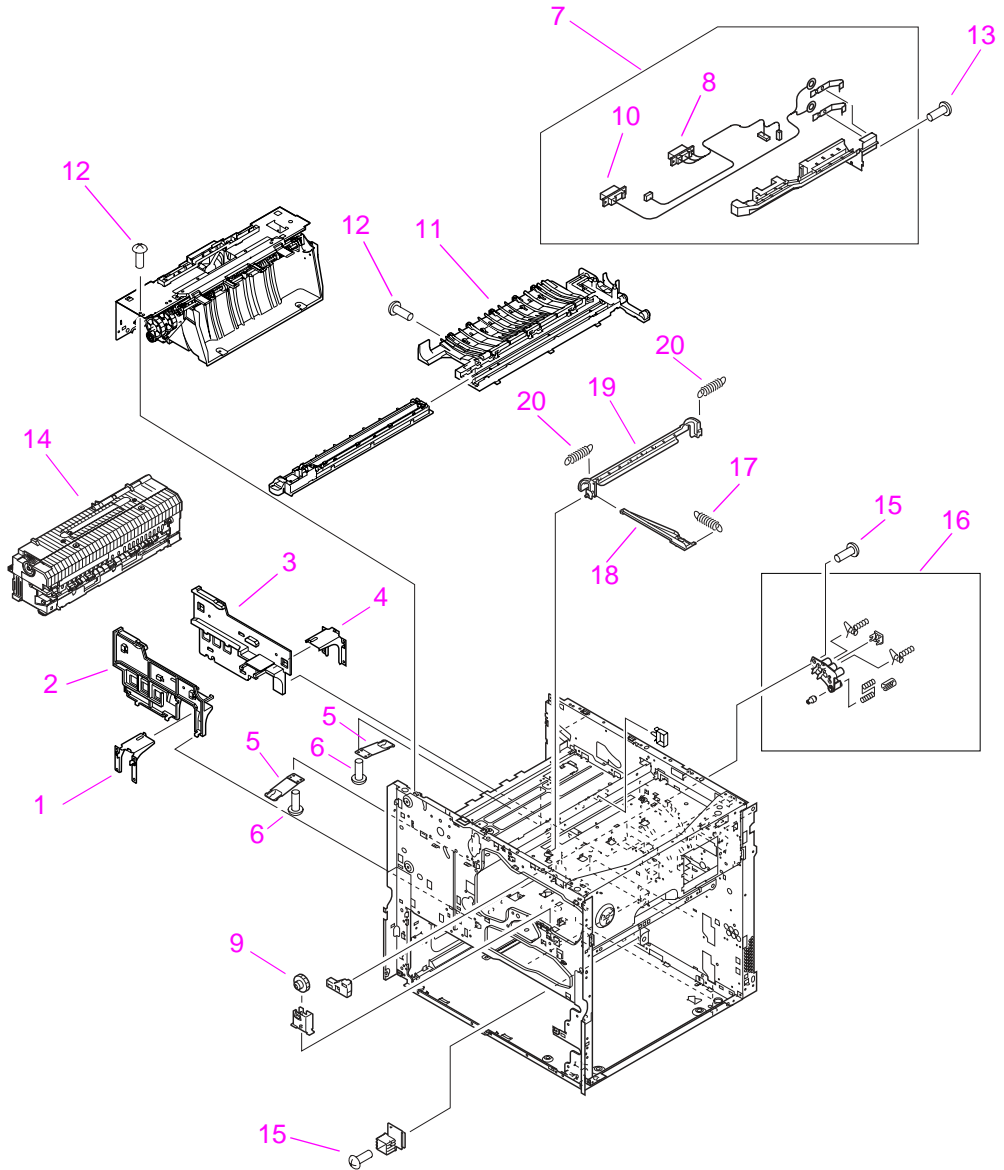


Figure 137. Internal components (1 of 4)

**Table 36. Internal components (1 of 4)**

Ref	Description	9000 part number	9040/9050 part number (if different)	Qty
1	Guide, pickup	RB2-5522-000CN		1
2	Guide, cartridge	RB2-5526-000CN		1
3	Hinge mount, damper	RB2-5570-020CN		2
4	Hinge arm, front cover	RB2-5654-000CN		2
5	Cover, right door, inside	RB2-5697-000CN		1
6	Knob, registration, jam removal	RB2-5845-000CN		1
7	Front inside cover assembly	RG5-5721-000CN		1
8	Jam clearing assembly, fuser	RG5-5700-000CN		1
9	Lever assembly, cartridge release	RG5-5746-000CN		1
10	Foot, right side	RB1-6421-000CN		2
11	Foot, left side	RB2-5529-000CN		2
12	Guide rail, cartridge	RG5-5718-000CN		1
13	Screw, M3 by 6, RS	XA9-1275-000CN		
14	Screw, M3 by 8, RS	XA9-1276-000CN		
15	Torque limiter, spacer	RB2-5759-000CN		2
16	Roller, feed/separation	RF5-3338-000CN		4
17	Roller, PICK	RF5-3340-000CN		2
18	Collar	RB2-5547-000CN		1
19	Link, connect	RB2-5528-000CN		1
20	Spring, tension	RS6-2285-000CN		1

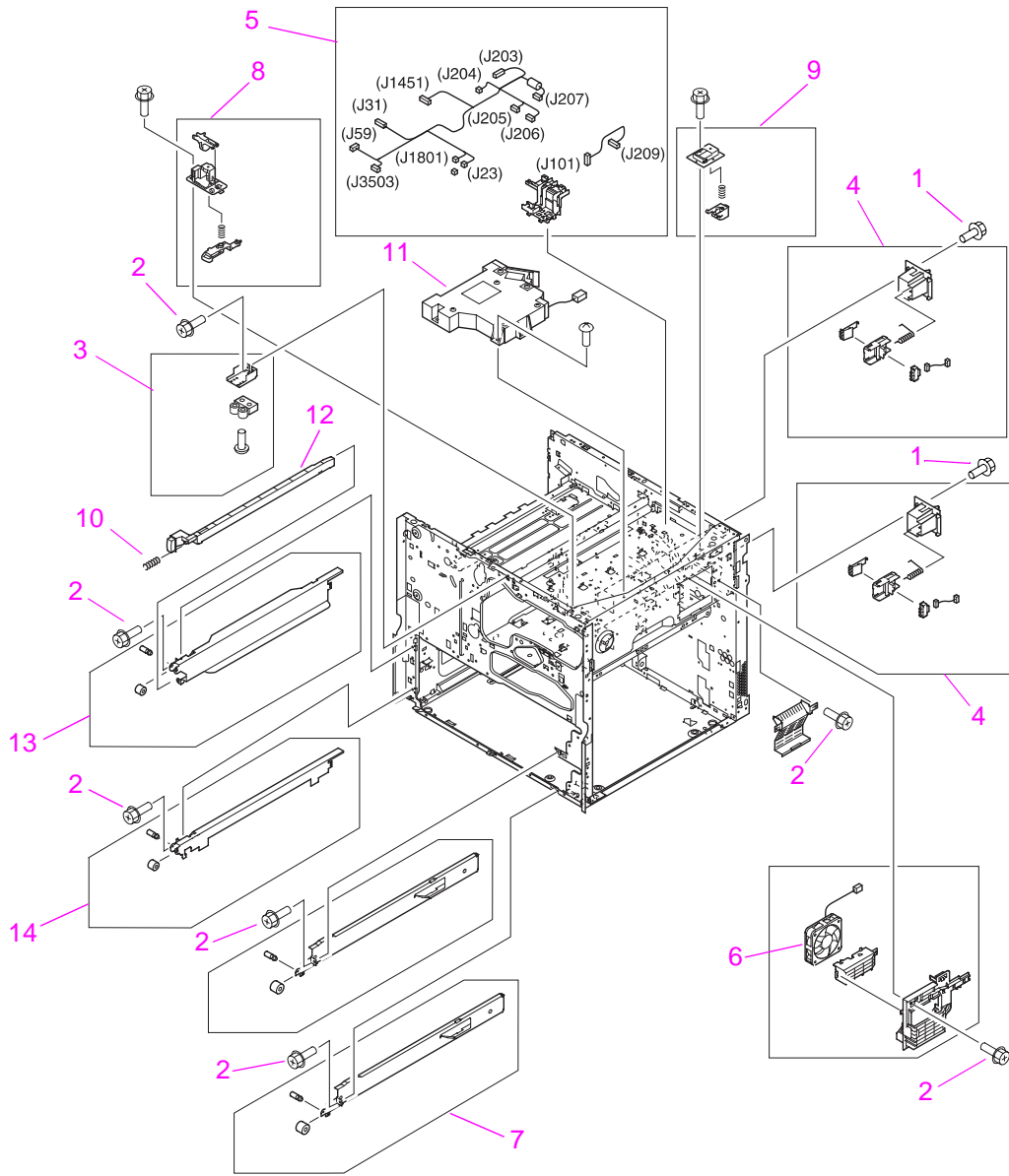


**Figure 138.** Internal components (2 of 4)



**Table 37. Internal components (2 of 4)**

Ref	Description	9000 part number	9040/9050 part number (if different)	Qty
1	Front fusing mount	RB2-5517-000CN		1
2	Front fusing rail	RB2-5515-000CN		1
3	Back fusing rail	RB2-5516-000CN		1
4	Back fusing mount	RB2-5518-000CN		1
5	Spring, leaf	RB2-5523-000CN		2
6	Screw, M3 by 6	XA9-1275-000CN		
7	Fuser connector holder assembly	RG5-5724-020CN		1
8	Fuser power cable	RG5-5771-000CN		1
9	Gear, 21T	RS5-0708-000CN		1
10	Fuser high-voltage cable	RG5-5772-000CN		1
11	Feed guide, transfer	RG5-5651-000CN		1
12	Screw, M3 by 6, RS	XA9-1275-000CN		
13	Screw, M3 by 8, RS	XA9-1276-000CN		
14	Fuser assembly, 110 V	RG5-5750-170CN		1
14	Fuser assembly, 220 V	RG5-5751-170CN		1
15	Screw, M3 by 8	XA9-1276-000CN		
16	Toner contact assembly	RG5-5717-000CN		1
17	Spring, tension	RS6-2299-000CN		
18	Arm, shutter	RB2-5639-000CN		1
19	Shutter, laser	RB2-5640-000CN		1
20	Spring, tension	RS6-2296-000CN		2



**Figure 139. Internal components (3 of 4)**

**Table 38. Internal components (3 of 4)**

Ref	Description	9000 part number	9040/9050 part number (if different)	Qty
1	Screw, M3 by 6, RS	XA9-1275-000CN		
2	Screw, M3 by 8, RS	XA9-1276-000CN		
3	Latch mount assembly	RG5-5704-000CN		1
4	End paper sensor assembly	RG5-5699-000CN		2
5	Upper cable guide assembly	RG5-7787-000CN		1
6	Fan, #5, cartridge fan	RH7-5306-000CN	RG5-5729-000CN	1
7	Right rail assembly	RG5-5715-000CN		2
8	Cartridge, front pressure assembly	RG5-5709-000CN		1
9	Cartridge, back pressure assembly	RG5-5710-000CN		1
10	Spring, compression	RS6-2302-000CN		
11	Laser/scanner assembly	RG5-5826-000CN		1
12	Rod, switch, ON/OFF	RB2-5661-000CN		1
13	Left rail, upper	RG5-5713-000CN		1
14	Left rail, lower	RG5-5714-000CN		1

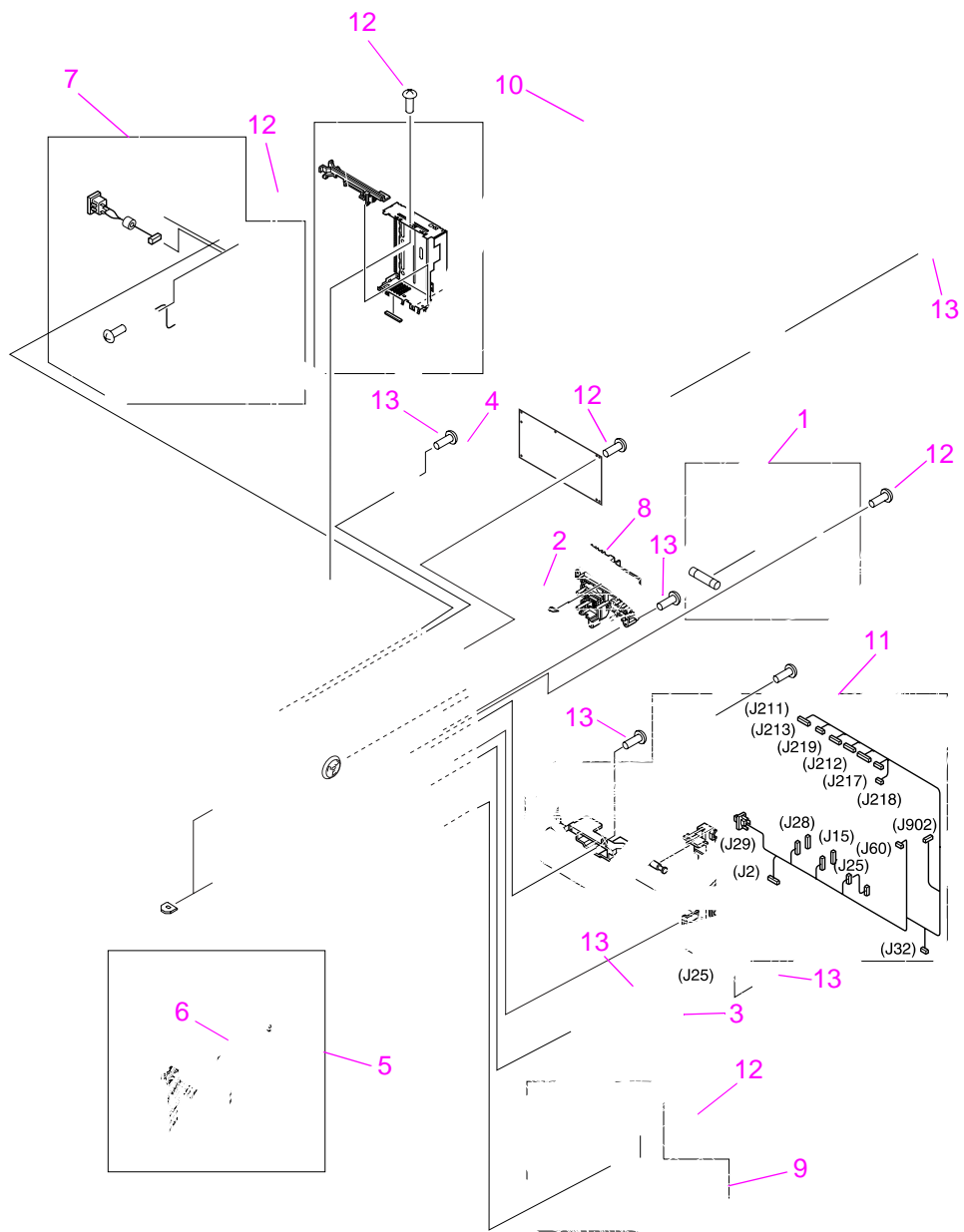
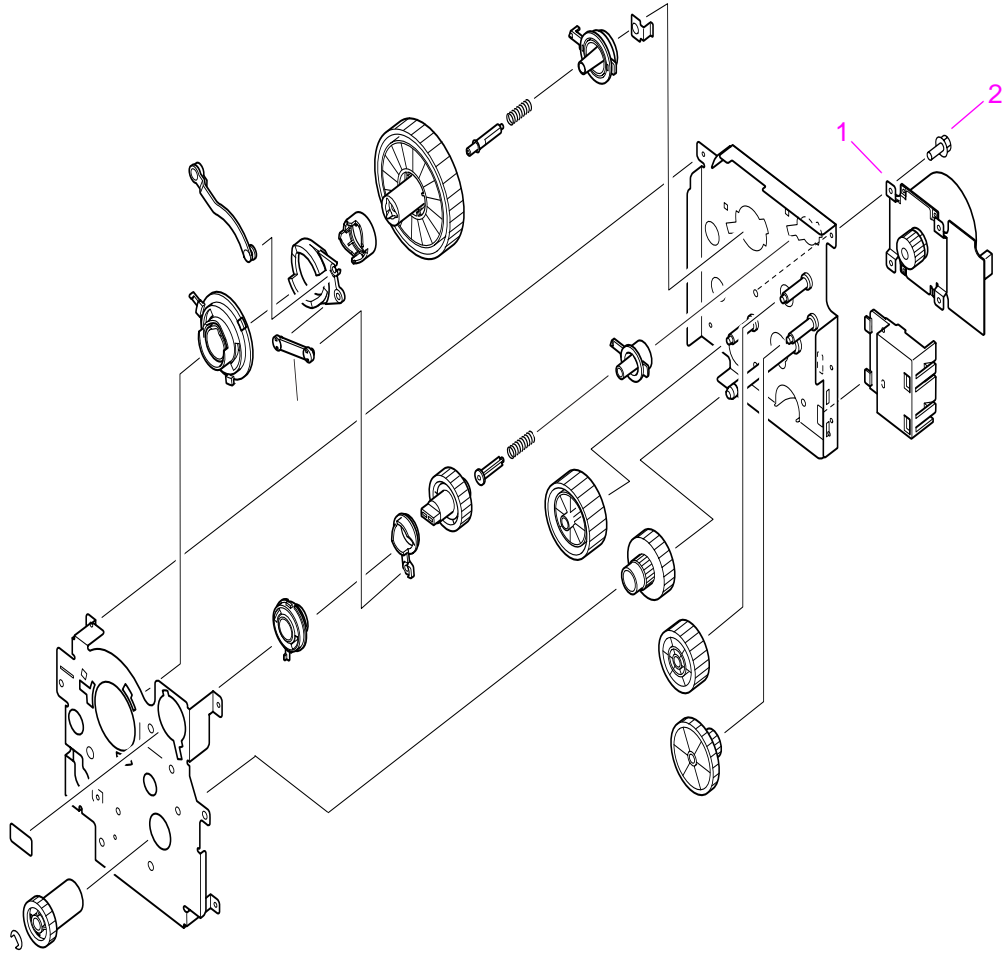


Figure 8-10 Internal Structure of

**Table 39. Internal components (4 of 4)**

Ref	Description	9000 part number	9040/9050 part number (if different)	Qty
1	Low voltage power supply assembly 110 V	RG5-5730-000CN	RG5-7778-000CN	1
1	Low voltage power supply assembly 220 V	RG5-5731-000CN	RG5-7779-000CN	1
2	Cable, HVPS flat ribbon	RH2-5445-000CN		1
3	Fan, #1, power supply	RH7-5294-000CN		1
4	Fan, #2, controller	RH7-5295-000CN	RH7-1623-000CN	1
5	Back cable holder assembly	RG5-5725-030CN	RG5-7786-000CN	1
6	Fan connecting cable	RG5-5759-000CN	RG5-7783-000CN	1
7	Inlet assembly (Power SW 10)	RG5-5727-000CN		1
8	High voltage power supply (HVPS)	RG5-5728-050CN		1
9	Connector assembly	RG5-5779-000CN		1
10	Toner sensor contact with memory (antenna)	RG5-5719-000CN		1
11	Main cable harness assembly	RG5-5722-000CN		1
12	Screw, M3 by 6, RS	XA9-1275-000CN		
13	Screw, M3 by 8, RS	XA9-1276-000CN		

## Drum feed drive assembly

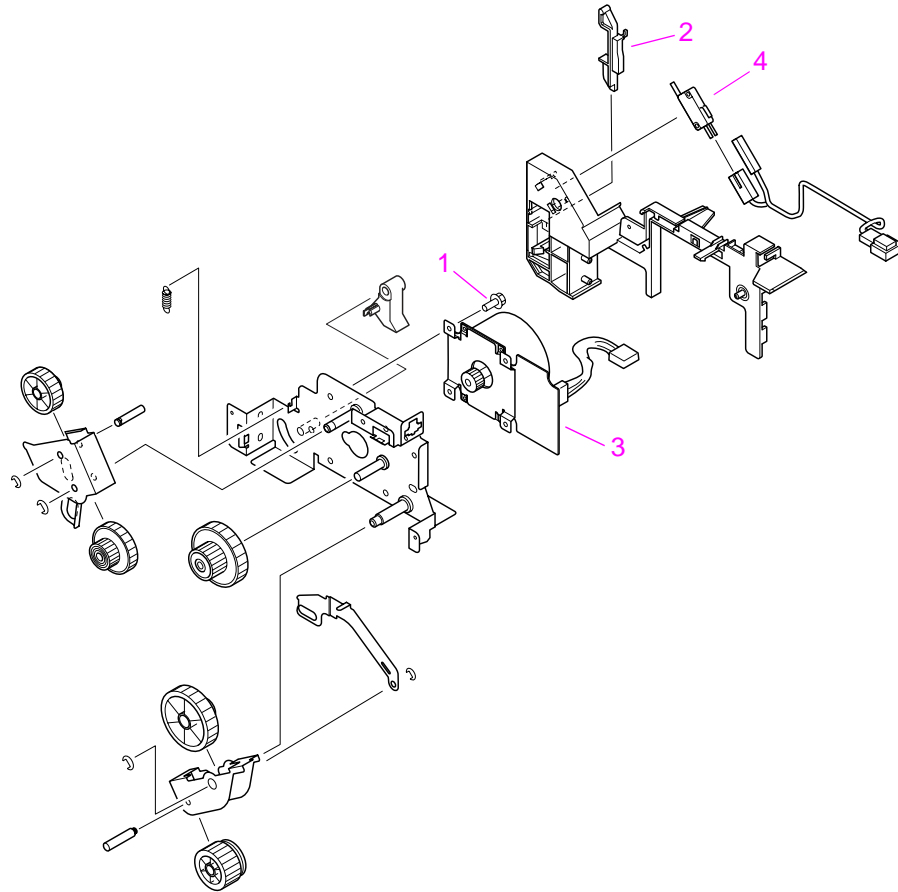


**Figure 141.** Drum feed drive assembly

**Table 40.** Drum feed drive assembly

Ref	Description	9000 part number	9040/9050 part number (if different)	Qty
	Drum feed drive assembly	RG5-5656-060CN		1
1	Main motor (M2)	RH7-5287-000CN		1
2	Screw, M3 by 6	XA9-1275-000CN		

## Fuser delivery drive assembly

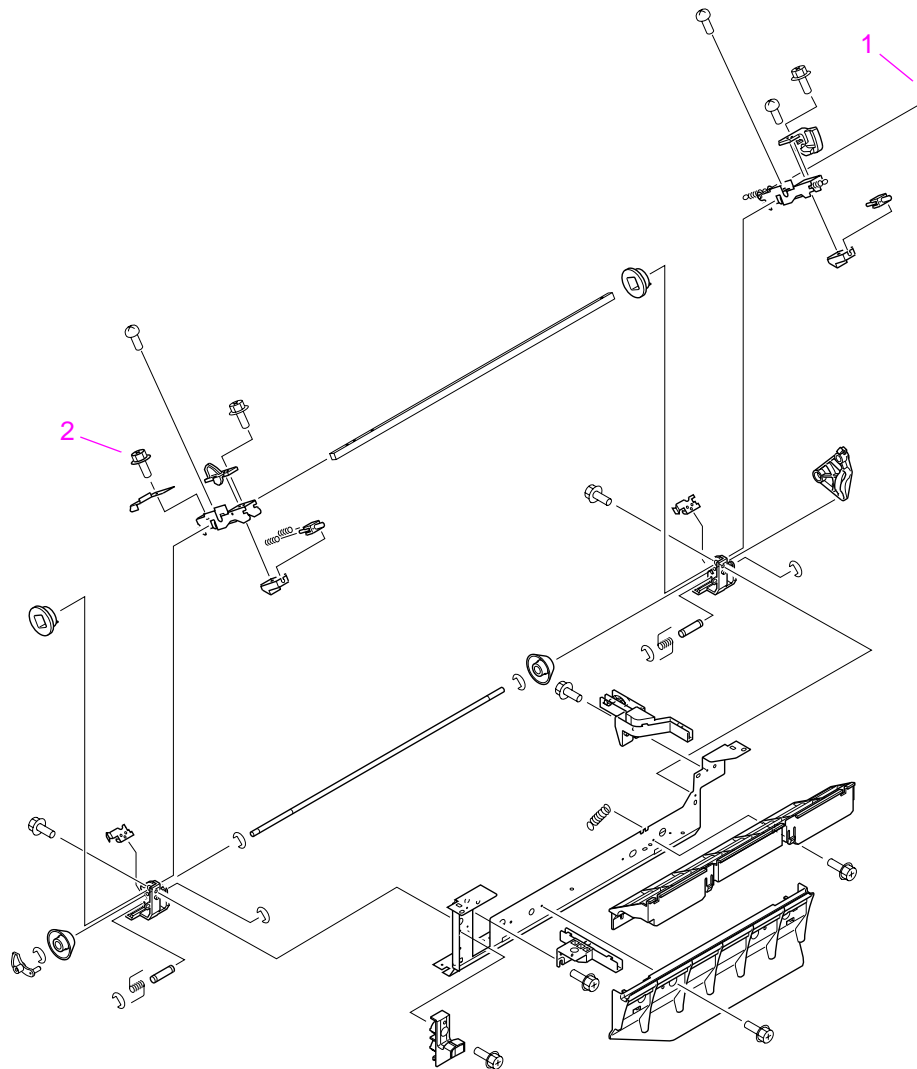


**Figure 142.** Fuser delivery drive assembly

**Table 41. Fuser delivery drive assembly**

Ref	Description	9000 part number	9040/9050 part number (if different)	Qty
	Fuser delivery drive assembly	RG5-5659-000CN	RG5-7789-000CN	1
1	Screw, M3 by 6, RS	XA9-1275-000CN		
2	Lever, switch	RB2-6077-000CN		1
3	Motor, DC, 24V (M1)	RG5-5288-000CN	RH7-1622-000CN	1
4	Microswitch (SW1)	WC4-5171-000CN		1

## Cartridge lifter assembly



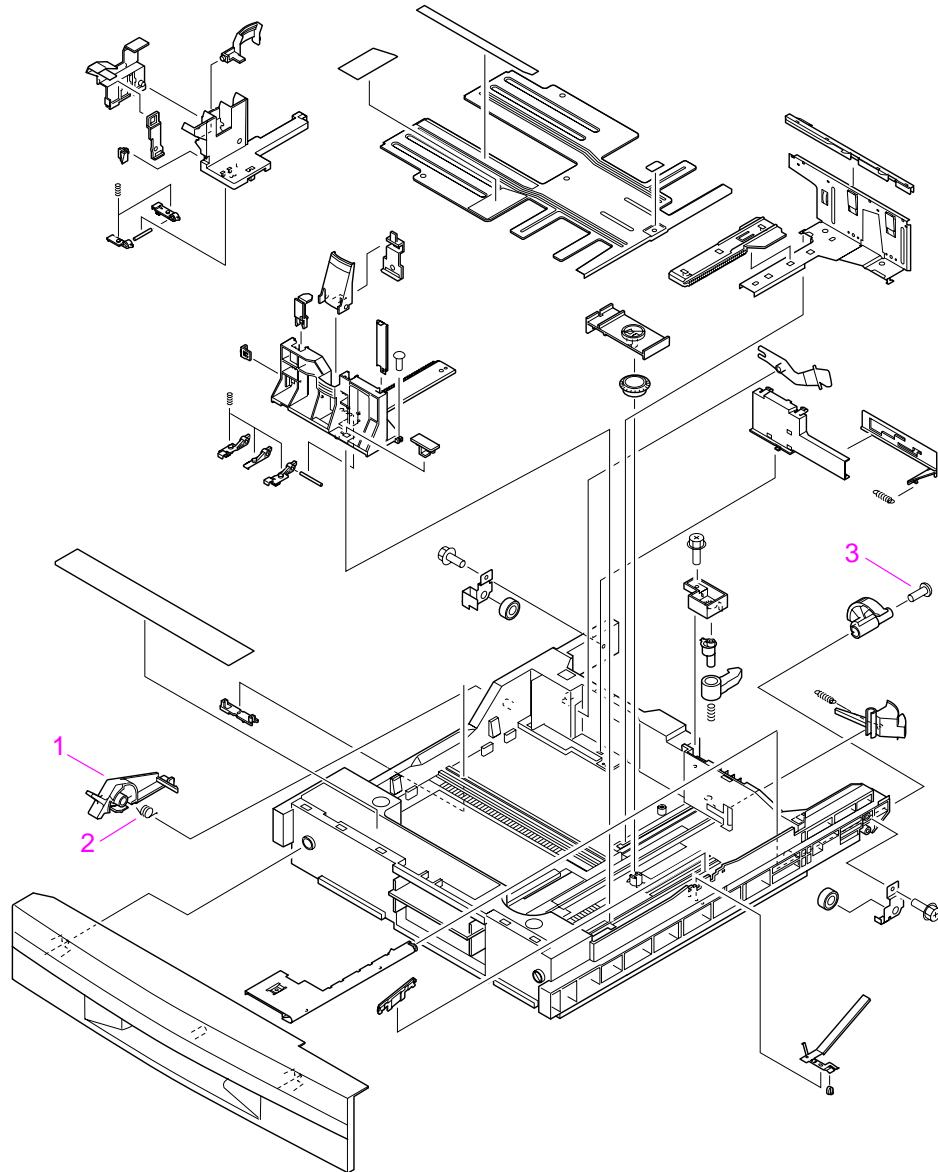
**Figure 143.** Cartridge lifter assembly

**Table 42.** Cartridge lifter assembly

Ref	Description	9000 part number	9040/9050 part number (if different)	Qty
	Cartridge lifter assembly	RG5-5741-020CN		1
1	Spring, tension	RS6-2298-020CN		1
2	Screw, M3 by 6	XA9-1275-000CN		



## 500-sheet trays (tray 2 and tray 3)



**Figure 144.** 500-sheet trays (tray 2 and tray 3)

**Table 43.** 500-sheet trays (tray 2 and tray 3)

Ref	Description	9000 part number	9040/9050 part number (if different)	Qty
	500-sheet trays	RG5-5635-080CN		1
1	Custom/standard switch	RB2-5813-000CN		1
2	Spring, torsion	RB2-5816-000CN		1
3	Screw, W/W, M3 by 29.5	XA9-0668-000CN		

## Paper input unit

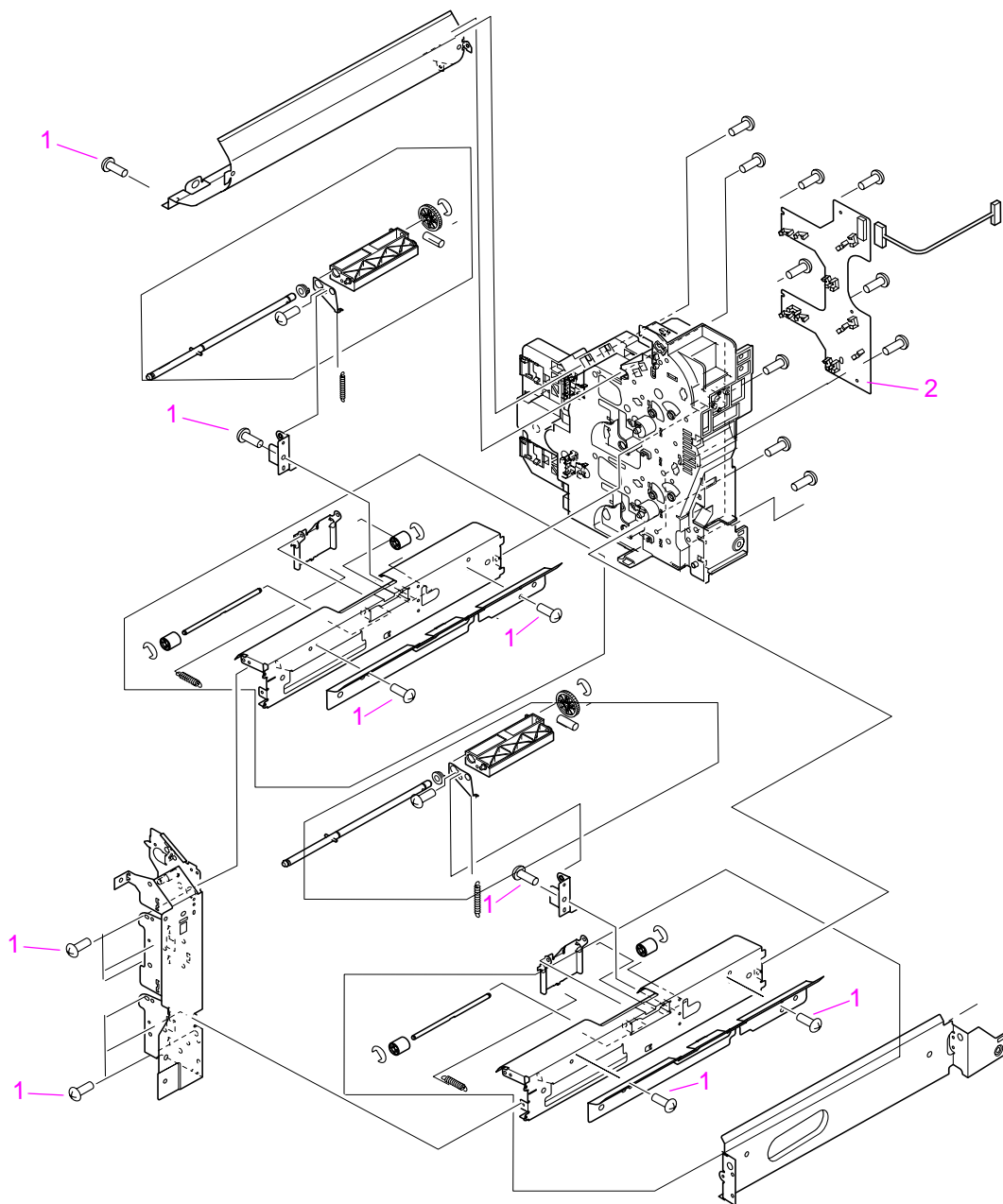
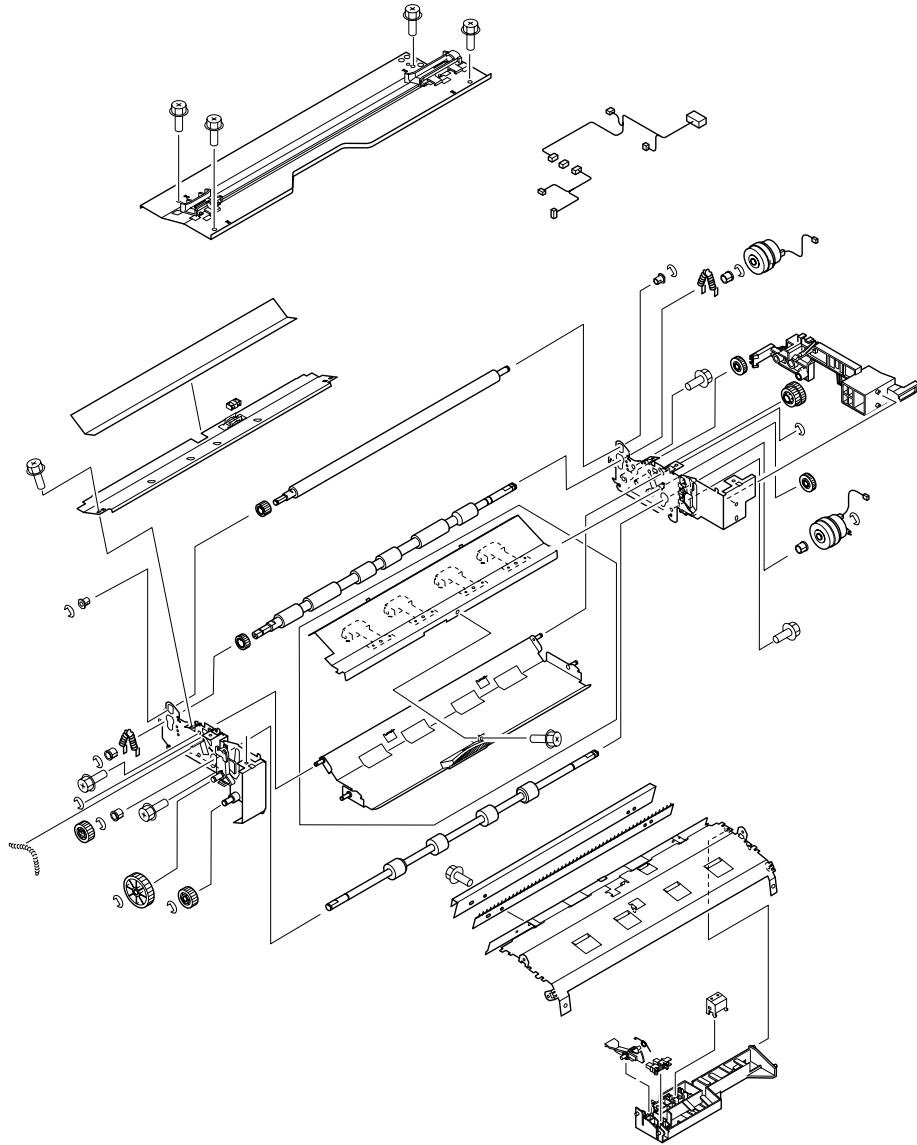


Figure 145. Paper input unit

Table 44. Paper input unit

Ref	Description	9000 part number	9040/9050 part number (if different)	Qty
	Paper input unit	RG5-5681-030CN		1
1	Screw, M3 by 6, RS	XA9-1275-000CN		
2	Paper pickup PCA	RG5-5678-000CN		1

# Registration assembly

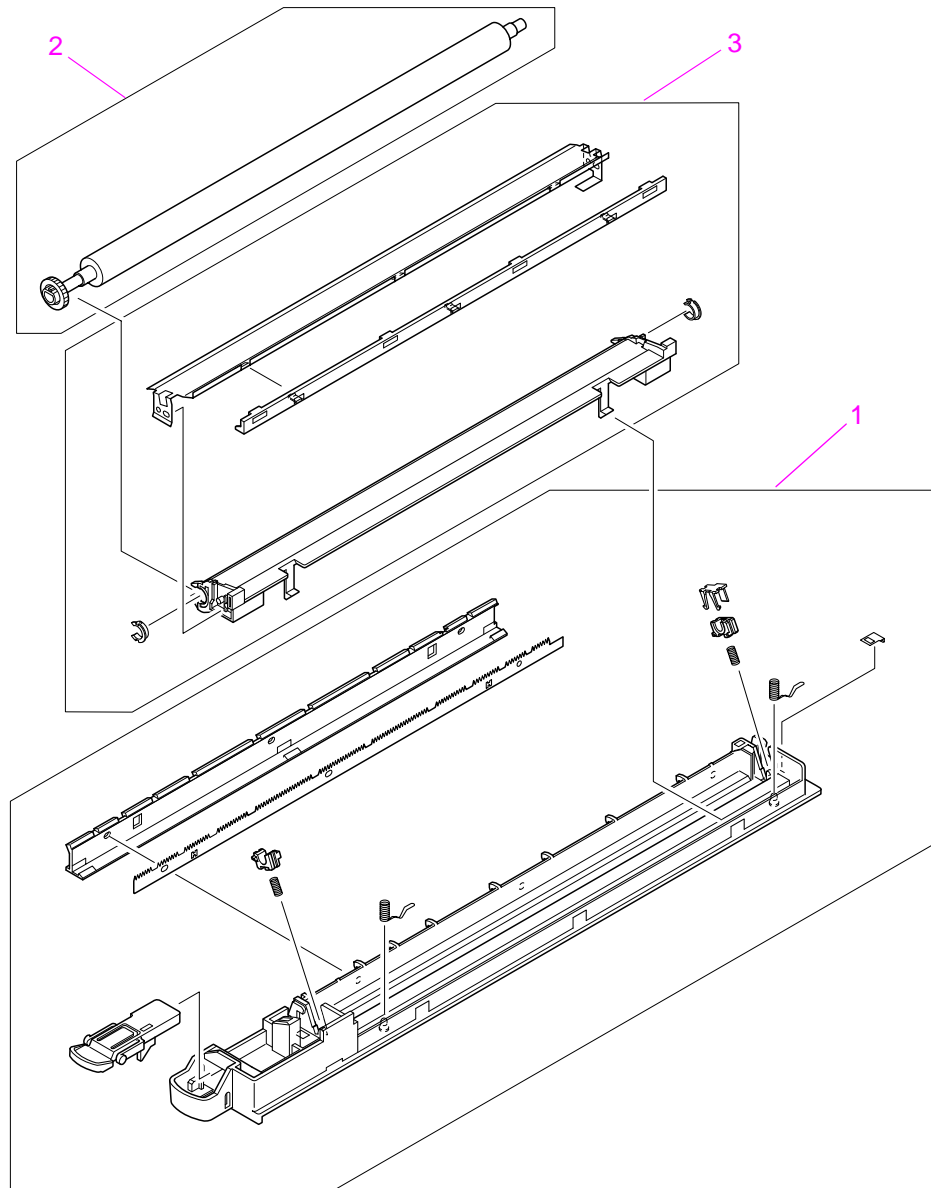


**Figure 146.** Registration assembly

**Table 45.** Registration assembly

Ref	Description	9000 part number	9040/9050 part number (if different)	Qty
	Registration assembly	RG5-5663-000CN		1

## Transfer roller assembly

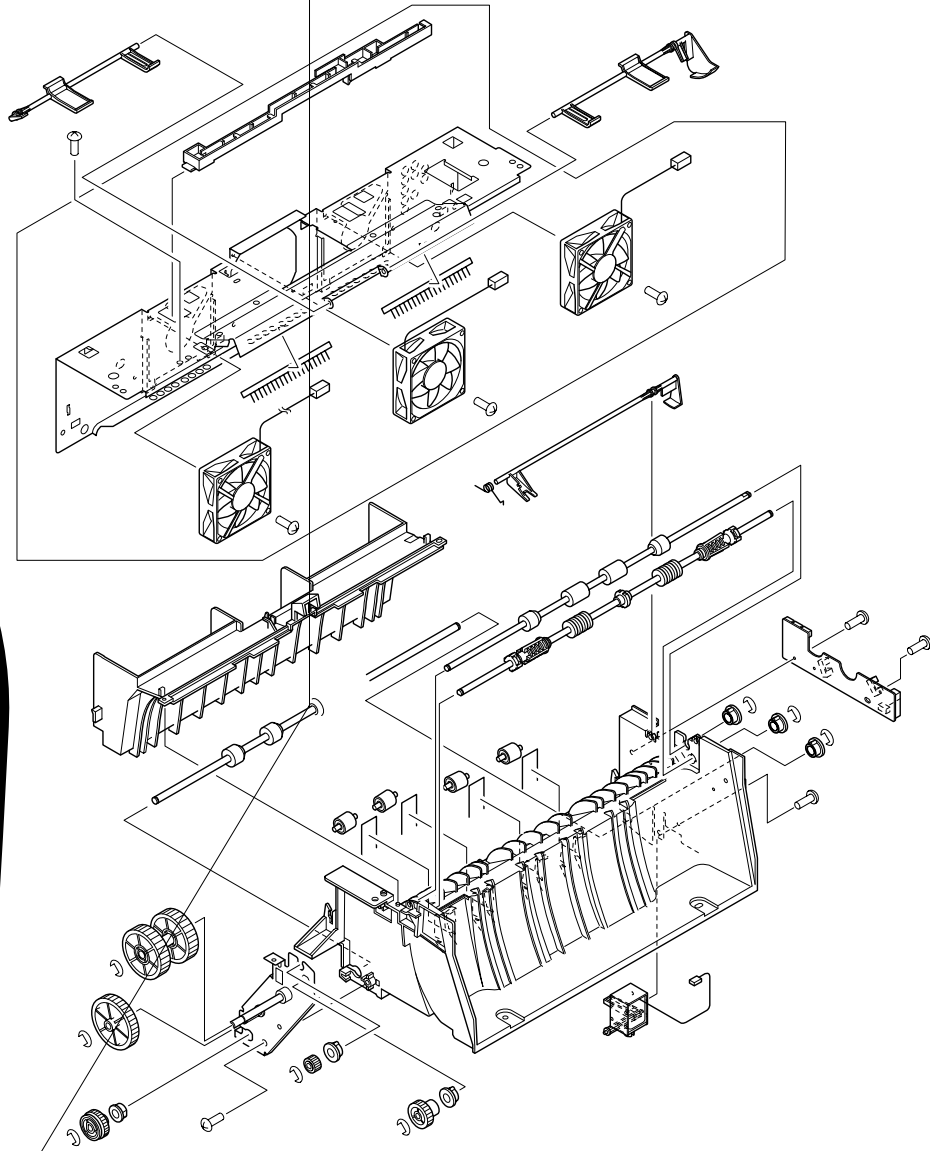


**Figure 147.** Transfer roller assembly

**Table 46.** Transfer roller assembly

Ref	Description	9000 part number	9040/9050 part number (if different)	Qty
	Transfer roller assembly	RG5-5662-000CN		1
1	Holder, transfer	RG5-5653-000CN		1
2	Roller, transfer	RF5-3319-000CN		1
3	Guide, transfer/pre-transfer	RG5-5654-000CN		1

livery assembly

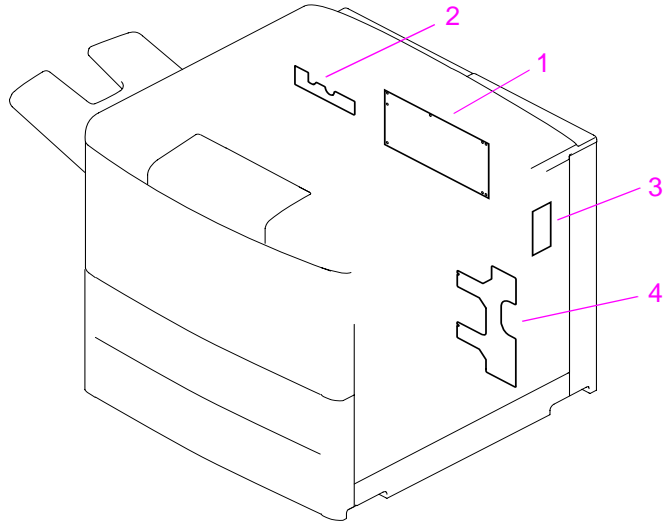


livery assembly

**Table 47. Delivery assembly**

<b>Ref</b>	<b>Description</b>	<b>9000 part number</b>	<b>9040/9050 part number (if different)</b>	<b>Qty</b>
	Delivery assembly	RG5-5643-030CN		1
1	Delivery cross member assembly	RG5-5645-000CN		1
2	Delivery PCA	RG5-5649-000CN		1
3	Flag, sensor	RB2-6037-000CN		1
4	Lever, sensor	RB2-6035-000CN		1
5	Screw, M3 by 8	XA9-1276-000CN		1
6	Fan, #3, rear delivery	RH7-5296-000CN		1
7	Fan, #4, front delivery	RH7-5297-000CN		1
8	Fan, #6, face down tray	RH7-5302-000CN		1
9	Lever, sensor	RB2-6036-000CN		1
10	Spring, tension	RB2-6042-000CN		1

## PCA assembly location



**Figure 149.** PCA assembly location

**Table 48.** PCA location

Ref	Description	9000 part number	9040/9050 part number (if different)	Qty
1	DC controller PCA	RG5-5778-120CN	RG5-7780-000CN	1
2	Delivery PCA	RG5-5649-000CN		1
3	Print cartridge memory controller PCA	RG5-6996-000CN		1
4	Paper pickup (PIU) PCA	RG5-5678-000CN		1

# Tray 4

## Tray 4 main body

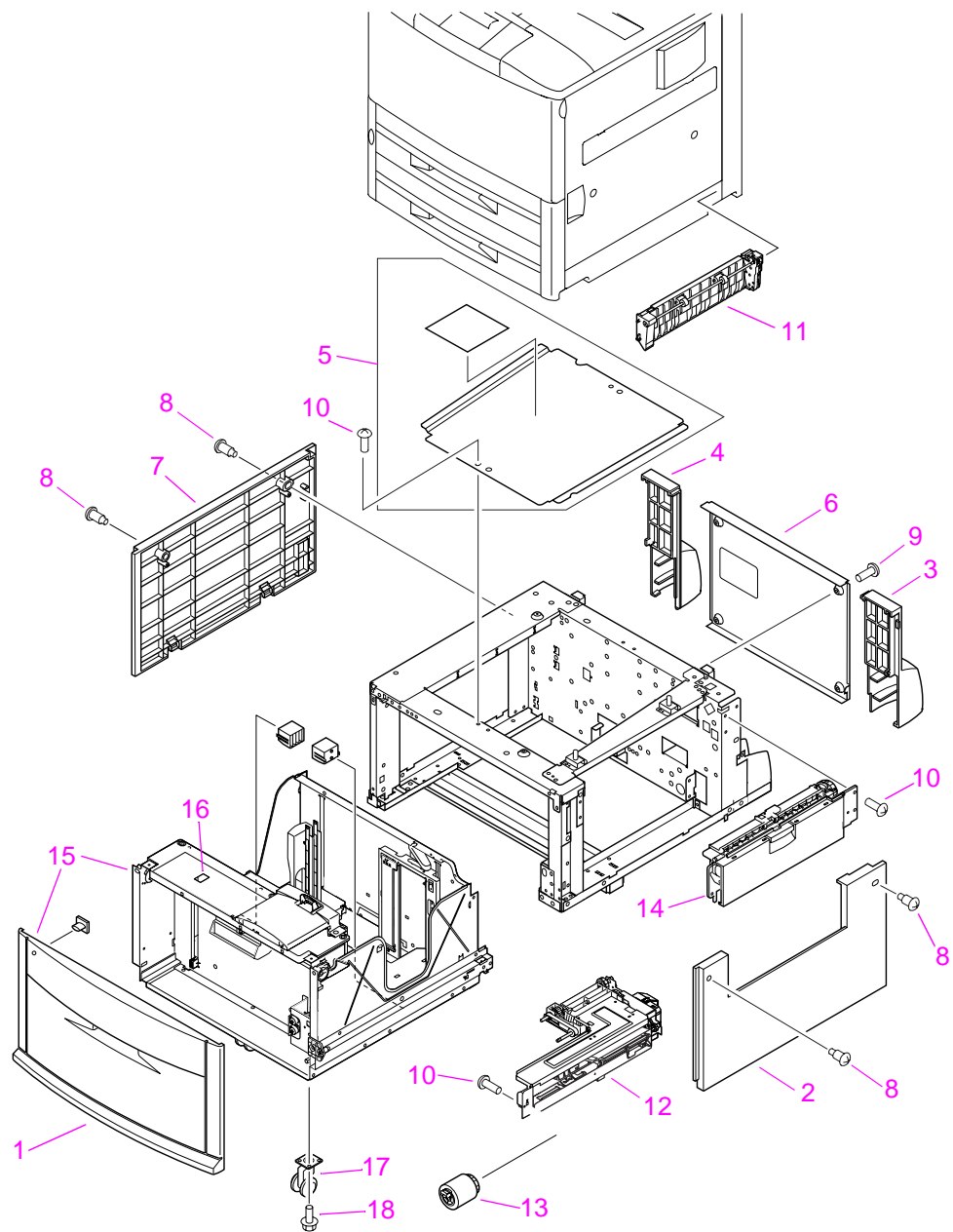
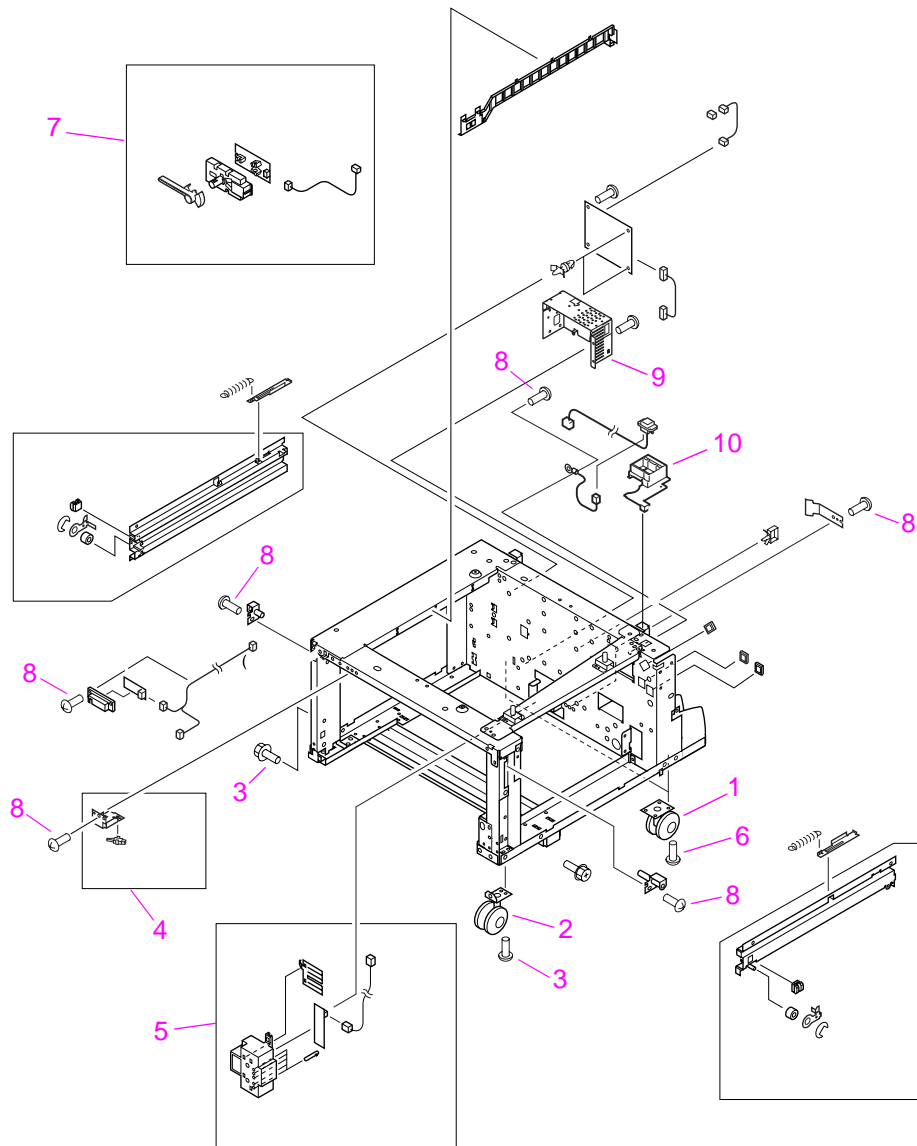


Figure 150. Tray 4 main body (1 of 2)



**Table 49. Tray 4 main body (1 of 2)**

Ref	Description	9000 part number	9040/9050 part number (if different)	Qty
1	Cover, front	RB2-7648-040CN		1
2	Cover, right	RB2-7649-000CN		1
3	Cover, right back	RB2-7650-000CN		1
4	Cover, left back	RB2-7651-000CN		1
5	Cover, center	RB2-7652-000CN		1
6	Cover, back	RF5-3644-000CN		1
7	Cover, left	RF5-3645-000CN		1
8	Screw, stepped	RS5-9099-000CN		6
9	Screw, W/W, M4 by 6	XA9-0994-000CN		7
10	Screw, M4 by 6	XB6-7400-000CN		
11	Paper path connection unit (PPCU)	RG5-6227-000CN		1
12	Paper input unit (PIU)	RG5-6208-150CN		1
13	Feed/separation rollers	RF5-3338-000CN		3
14	Tray 4 vertical registration assembly (VTU/VRA)	RG5-6225-050CN		1
15	Tray 4	RG5-6212-300CN		1
16	Lever, standard/custom	RB2-7762-020CN		1
17	Caster	RB2-7709-000CN		2
18	Screw, M4 by 8	XA9-0732-000CN		7
Not shown	Tray 4-to-engine stabilizing screws	0515-4318		2

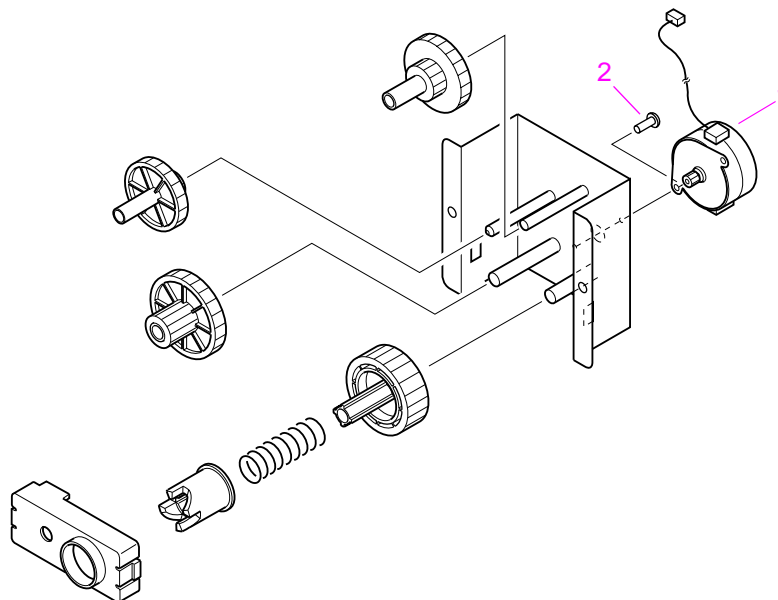


**Figure 151.** Tray 4 main body (2 of 2)

**Table 50. Tray 4 main body (2 of 2)**

Ref	Description	9000 part number	9040/9050 part number (if different)	Qty
1	Caster, back	RB2-7678-020CN		2
2	Caster, front swivel	RB3-0304-040CN		2
3	Screw, M5 by 12	XA9-0912-000CN		14
4	Switch assembly (SW21)	RG5-6206-020CN		1
5	Paper size sensing assembly	RG5-6207-040CN		1
6	Screw, M4 by 8, RS	XA9-0732-000CN		4
7	Paper volume sensing assembly	RG5-6229-030CN		1
8	Screw, M4 by 6	XA9-0994-000CN		12
9	Power supply	RG5-6250-000CN		1
10	Jet-Link cable holder assembly (see 10a, 10b, and 10c)			
10a	Holder	RB2-7662-000CN		
10b	Cable assembly	RG5-6240-000CN		
10c	Grounding cable	RG5-6249-000CN		

## Tray 4 drive assembly

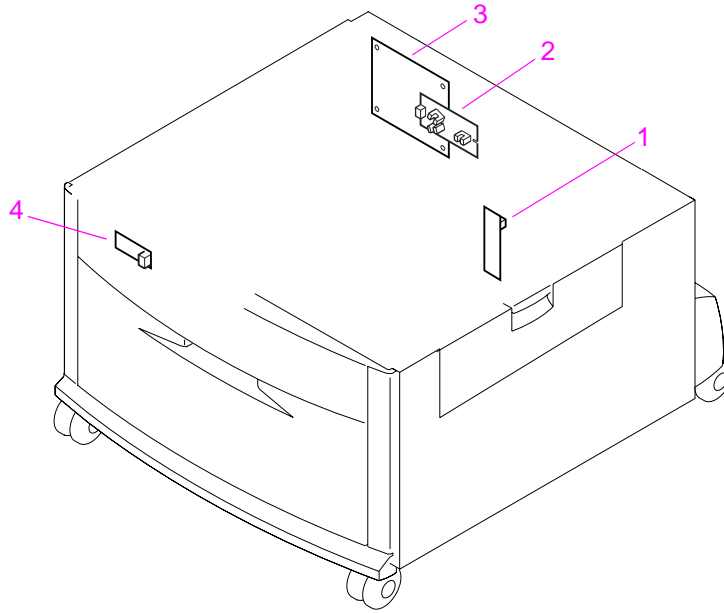


**Figure 152.** Tray 4 drive assembly

**Table 51.** Tray 4 drive assembly

Ref	Description	9000 part number	9040/9050 part number (if different)	Qty
	Tray 4 deck drive assembly	RG5-6228-040CN		1
1	Motor	RH7-1481-000CN		1
2	Screw, M3 by 6 with washer	XB2-6300-607CN		2

## Tray 4 PCA location

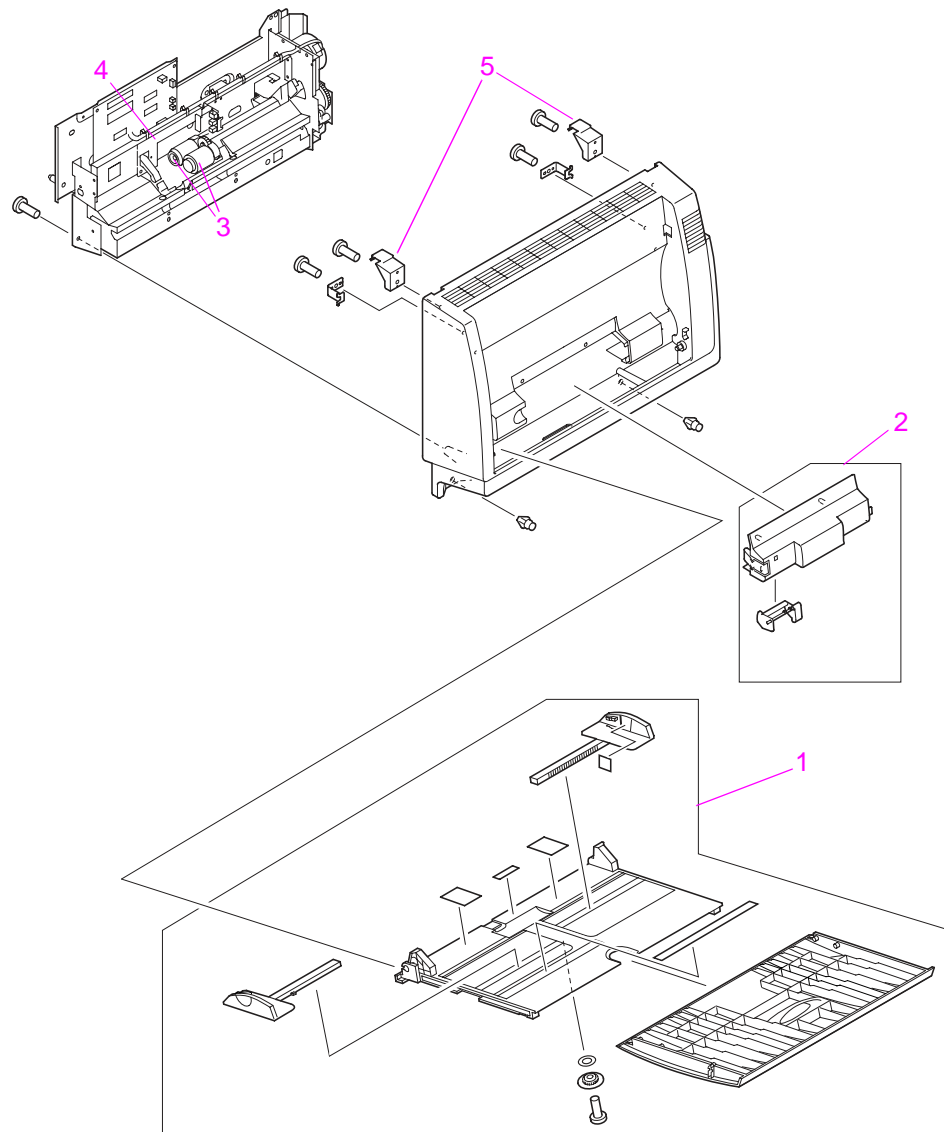


**Figure 153.** Tray 4 PCA location

**Table 52.** Tray 4 PCA location

Ref	Description	9000 part number	9040/9050 part number (if different)	Qty
1	Paper size PCA	RG5-6238-000CN		1
2	Paper volume PCA	RG5-6237-000CN		1
3	Deck controller PCA	RG5-6235-120CN		1
4	LED PCA	RG5-6239-000CN		1

# Tray 1



**Figure 154.** Tray 1 assembly

**Table 53.** Tray 1 assembly

Ref	Description	9000 part number	9040/9050 part number (if different)	Qty
	Tray 1	C8568-67902		1
1	Tray assembly	RG5-5809-000CN		
2	Service cover assembly	RG5-5811-040CN		1
3	Roller, pickup	RF5-3403-000CN		1
4	Roller, separation	RF5-3404-000CN		2
5	Cover hooks	RB2-6537-000CN		2

## Alphabetical parts list

**Table 54. Alphabetical parts list**

<b>Description</b>	<b>Part number</b>	<b>Figure and page</b>
Arm, front cover	RB2-5654-000CN	Figure 137 on page 266
Arm, shutter	RB2-5639-000CN	Figure 138 on page 268
Back cable holder assembly (HP LaserJet 9040/9050)	RG5-7786-000CN	Figure 140 on page 272
Back cable holder assembly (HP LaserJet 9000)	RG5-5725-030CN	Figure 140 on page 272
Back cover assembly	RG5-5701-000CN	Figure 134 on page 262
Bushing	RB2-5652-000CN	Figure 134 on page 262
Cable, flat	RH2-5445-000CN	Figure 140 on page 272
Cap, left cover	RB2-5675-000CN	Figure 134 on page 262
Cartridge back pressure assembly	RG5-5710-000CN	Figure 139 on page 270
Cartridge front pressure assembly	RG5-5709-000CN	Figure 139 on page 270
Cartridge lifter assembly	RG5-5741-020CN	Figure 143 on page 276
Caster, back	RB2-7678-020CN	Figure 151 on page 286
Caster, front swivel	RB3-0304-040CN	Figure 151 on page 286
Collar	RB2-5547-000CN	Figure 137 on page 266
Connector assembly	RG5-5779-000CN	Figure 140 on page 272
Control lever assembly	RG5-5746-000CN	Figure 137 on page 266
Control panel assembly	RG5-5703-060CN	Figure 134 on page 262
Control panel overlay	RB2-5703-000CN	Figure 134 on page 262
Cover, back	RF5-3644-000CN	Figure 150 on page 284
Cover, back left	RB2-7651-000CN	Figure 150 on page 284
Cover, back right	RB2-7650-000CN	Figure 150 on page 284
Cover, front	RB2-7648-040CN	Figure 150 on page 284
Cover hooks	RB2-6537-000CN	Figure 154 on page 290
Cover, left (left door)	RB2-6007-000CN	Figure 135 on page 264
Cover, left (tray 4)	RF5-3645-000CN	Figure 150 on page 284
Cover, left back	RB2-5685-000CN	Figure 134 on page 262
Cover, left lower	RB2-5687-000CN	Figure 134 on page 262
Cover, left rail	RB2-5683-000CN	Figure 134 on page 262
Cover, left, top	RB2-5660-000CN	Figure 134 on page 262
Cover, left upper	RB2-6491-000CN	Figure 134 on page 262
Cover, multipurpose blanking	RB2-5676-000CN	Figure 134 on page 262
Cover, operation panel, 100 to 127 V	RB2-5701-000CN	Figure 134 on page 262
Cover, right	RB2-5662-000CN	Figure 136 on page 265
Cover, right (tray 4)	RB2-7649-000CN	Figure 150 on page 284
Cover, right back	RB2-5684-000CN	Figure 134 on page 262
Cover, right door	RB2-5697-000CN	Figure 137 on page 266

**Table 54. Alphabetical parts list (continued)**

<b>Description</b>	<b>Part number</b>	<b>Figure and page</b>
Cover, right lower	RB2-5689-000CN	Figure 134 on page 262
Cover, right rail	RB2-5682-000CN	Figure 134 on page 262
Cover, right top	RB2-5659-000CN	Figure 134 on page 262
Cover, upper	RB2-7652-000CN	Figure 150 on page 284
Damper assembly	RG5-5648-000CN	Figure 135 on page 264
DC controller PCA	RG5-7780-120CN	Figure 149 on page 283
Deck controller PCA	RG5-6235-120CN	Figure 153 on page 289
Delivery cross member assembly	RG5-5645-000CN	Figure 148 on page 281
Delivery feed assembly	RG5-5643-030CN	Figure 148 on page 281
Delivery PCA	RG5-5649-000CN	Figure 148 on page 281
Delivery PCA	RG5-5649-000CN	Figure 149 on page 283
Diverter assembly	RG5-5647-050CN	Figure 135 on page 264
Drum feed drive assembly	RG5-5656-050CN	Figure 141 on page 274
E ring	XD9-0136-000CN	Figure 143 on page 276
E ring	XD9-0134-000CN	Figure 143 on page 276
End paper sensor assembly	RG5-5699-000CN	Figure 139 on page 270
Fan, #1, power supply	RH7-5294-000CN	Figure 140 on page 272
Fan, #2, controller (HP LaserJet 9040/9050)	RH7-1623-000CN	Figure 140 on page 272
Fan, #2, controller (HP LaserJet 9000)	RH7-5295-000CN	Figure 140 on page 272
Fan, #3	RH7-5296-000CN	Figure 148 on page 281
Fan, #4	RH7-5297-000CN	Figure 148 on page 281
Fan, #5 (HP LaserJet 9040/9050)	RH7-5306-000CN	Figure 139 on page 270
Fan, #5 (HP LaserJet 9000)	RG5-5729-000CN	Figure 139 on page 270
Fan, #6	RH7-5302-000CN	Figure 148 on page 281
Fan connecting cable (HP LaserJet 9040/9050)	RG5-7783-000CN	Figure 140 on page 272
Fan connecting cable (HP LaserJet 9000)	RG5-5759-000CN	Figure 140 on page 272
Feed PCA	RG5-5678-000CN	Figure 145 on page 278
Feed PCA	RG5-5678-000CN	Figure 149 on page 283
Flag, sensor	RB2-6037-000CN	Figure 148 on page 281
Foot, left side	RB2-5529-000CN	Figure 137 on page 266
Foot, right side	RB1-6421-000CN	Figure 137 on page 266
Frame, delivery	RB2-6006-000CN	Figure 135 on page 264
Front cover assembly	RG5-5702-000CN	Figure 134 on page 262
Front inside cover assembly	RG5-5721-000CN	Figure 137 on page 266
Fuser assembly 110 V	RG5-5750-170CN	Figure 138 on page 268
Fuser assembly 220 V	RG5-5751-170CN	Figure 138 on page 268
Fuser delivery drive assembly (HP LaserJet 9040/9050)	RG5-7789-000CN	Figure 142 on page 275
Fuser delivery drive assembly (HP LaserJet 9000)	RG5-5659-000CN	Figure 142 on page 275
Fuser high-voltage cable	RG5-5772-000CN	Figure 138 on page 268
Fusing connector holder assembly	RG5-5724-000CN	Figure 138 on page 268



**Table 54. Alphabetical parts list (continued)**

<b>Description</b>	<b>Part number</b>	<b>Figure and page</b>
Fusing jam clearing assembly	RG5-5700-000CN	Figure 137 on page 266
Fusing power cable	RG5-5771-000CN	Figure 138 on page 268
Gear, 21T	RS5-0708-000CN	Figure 138 on page 268
Guide, cartridge	RB2-5526-000CN	Figure 137 on page 266
Guide, pickup	RB2-5522-000CN	Figure 137 on page 266
Guide rail, cartridge	RG5-5718-000CN	Figure 137 on page 266
Guide, transfer/pre-transfer	RG5-5654-000CN	Figure 147 on page 280
High voltage power supply (HVPS)	RG5-5728-050CN	Figure 140 on page 272
Hinge arm, front cover	RB2-5654-000CN	Figure 137 on page 266
Hinge mount, damper	RB2-5570-020CN	Figure 137 on page 266
Holder, transfer	RG5-5653-000CN	Figure 147 on page 280
Inlet assembly (Power SW10)	RG5-5727-000CN	Figure 140 on page 272
Jet-Link cable assembly	RG5-6240-000CN	Figure 151 on page 286
Jet-Link grounding cable	RG5-6249-000CN	Figure 151 on page 286
Jet-Link holder	RB2-7662-000CN	Figure 151 on page 286
Knob, cassette	RB2-5813-000CN	Figure 144 on page 277
Knob, jam removal	RB2-5845-000CN	Figure 137 on page 266
Label, custom/standard switch	5851-1391	Figure 144 on page 277
Laser/scanner assembly	RG5-5826-000CN	Figure 139 on page 270
Latch mount assembly	RG5-5704-000CN	Figure 139 on page 270
Latch, roller-action	RB2-5700-000CN	Figure 134 on page 262
LED PCA	RG5-6239-000CN	Figure 153 on page 289
Left door and diverter	RG5-5646-050CN	Figure 135 on page 264
Left upper cover assembly	RG5-5705-000CN	Figure 134 on page 262
Lever, custom	RB2-7762-020CN	Figure 150 on page 284
Lever, sensor	RB2-6035-000CN	Figure 148 on page 281
Lever, switch	RB2-6077-000CN	Figure 142 on page 275
Link, connect	RB2-5528-000CN	Figure 137 on page 266
Low voltage power supply assembly 110 V (HP LaserJet 9040/9050)	RG5-7778-000CN	Figure 140 on page 272
Low voltage power supply assembly 110 V (HP LaserJet 9000)	RG5-5730-000CN	Figure 140 on page 272
Low voltage power supply assembly 220 V (HP LaserJet 9040/9050)	RG5-7779-000CN	Figure 140 on page 272
Low voltage power supply assembly 220 V (HP LaserJet 9000)	RG5-5731-000CN	Figure 140 on page 272
Main cable harness holder assembly	RG5-5722-000CN	Figure 140 on page 272
Main motor (M2)	RH7-5287-000CN	Figure 141 on page 274
Microswitch (SW1)	WC4-5171-000CN	Figure 142 on page 275
Motor	RH7-1481-000CN	Figure 152 on page 288
Motor, DC, 24V (M1) (HP LaserJet 9040/9050)	RH7-1622-000CN	Figure 142 on page 275

**Table 54. Alphabetical parts list (continued)**

<b>Description</b>	<b>Part number</b>	<b>Figure and page</b>
Motor, DC, 24V (M1) (HP LaserJet 9000)	RG5-5288-00CN	Figure 142 on page 275
Mount, back fusing	RB2-5518-000CN	Figure 138 on page 268
Mount, damper	RB2-5570-000CN	Figure 137 on page 266
Mount, front fusing	RB2-5517-000CN	Figure 138 on page 268
Multi-purpose cable	RG5-5763-000CN	Figure 136 on page 265
Multi-purpose grounding cable	RG5-5764-000CN	Figure 136 on page 265
Paper input unit (PIU) (engine)	RG5-5681-030CN	Figure 145 on page 278
Paper input unit (PIU)	RG5-6208-150CN	Figure 150 on page 284
Paper path connection assembly (PPCU)	RG5-6227-000CN	Figure 151 on page 286
Paper size PCA	RG5-6238-000CN	Figure 153 on page 289
Paper-size sensing assembly	RG5-6207-040CN	Figure 151 on page 286
Paper volume PCA	RG5-6237-000CN	Figure 153 on page 289
Paper volume sensing assembly	RG5-6229-030CN	Figure 151 on page 286
Pin, fusing shutter	RB2-5656-000CN	Figure 134 on page 262
Print cartridge memory controller PCA	RG5-6996-000CN	Figure 149 on page 283
Rail, back fusing	RB2-5516-000CN	Figure 138 on page 268
Rail, front fusing	RB2-5515-020CN	Figure 138 on page 268
Registration assembly	RG5-5663-000CN	Figure 146 on page 279
Right cover assembly	RG5-5737-000CN	Figure 136 on page 265
Right cover knob assembly	RG5-5740-000CN	Figure 136 on page 265
Right rail assembly	RG5-5715-000CN	Figure 139 on page 270
Rod, switch	RB2-5661-000CN	Figure 139 on page 270
Roller, feed retard	RF5-3338-000CN	Figure 137 on page 266
Roller, feed retard	RF5-3338-000CN	Figure 151 on page 286
Roller, PIC	RF5-3340-000CN	Figure 137 on page 266
Roller, transfer	RF5-3319-000CN	Figure 147 on page 280
Screw, M3 by 6	XA9-1275-000CN	Figure 138 on page 268
Screw, M3 by 6	XA9-1275-000CN	Figure 141 on page 274
Screw, M3 by 6	XA9-1275-000CN	Figure 143 on page 276
Screw, M3 by 6, RS	XA9-1275-000CN	Figure 137 on page 266
Screw, M3 by 6, RS	XA9-1275-000CN	Figure 138 on page 268
Screw, M3 by 6, RS	XA9-1275-000CN	Figure 139 on page 270
Screw, M3 by 6, RS	XA9-1275-000CN	Figure 140 on page 272
Screw, M3 by 6, RS	XA9-1275-000CN	Figure 142 on page 275
Screw, M3 by 6, RS	XA9-1275-000CN	Figure 145 on page 278
Screw, M3 by 8	XA9-1200-000CN	Figure 136 on page 265
Screw, M3 by 8	XA9-1276-000CN	Figure 138 on page 268
Screw, M3 by 8	XA9-1276-000CN	Figure 148 on page 281
Screw, M3 by 8, RS	XA9-1276-000CN	Figure 136 on page 265
Screw, M3 by 8, RS	XA9-1276-000CN	Figure 137 on page 266

**Table 54. Alphabetical parts list (continued)**

<b>Description</b>	<b>Part number</b>	<b>Figure and page</b>
Screw, M3 by 8, RS	XA9-1276-000CN	Figure 138 on page 268
Screw, M3 by 8, RS	XA9-1276-000CN	Figure 139 on page 270
Screw, M3 by 8, RS	XA9-1276-000CN	Figure 140 on page 272
Screw, M4 by 6	XA9-0994-000CN	Figure 151 on page 286
Screw, M4 by 10	XA9-1189-000CN	Figure 135 on page 264
Screw, M4 by 8, RS	XA9-0732-000CN	Figure 151 on page 286
Screw, stepped	RS5-9099-000CN	Figure 150 on page 284
Screw, TP, M4 by 6	XB6-7400-000CN	Figure 150 on page 284
Screw, W/W, M3 by 6	XB2-6300-607CN	Figure 152 on page 288
Screw, W/W, M3 by 29.5	XA9-0668-000CN	Figure 144 on page 277
Screw, W/W, M4 by 6	XA-0994-000CN	Figure 150 on page 284
Screw, W/W, M5 by 12	XA9-0912-000CN	Figure 151 on page 286
Service cover assembly	RG5-5811-040CN	Figure 154 on page 290
Shutter, laser	RB2-5640-000CN	Figure 138 on page 268
Spring, compression	RS6-2302-000CN	Figure 139 on page 270
Spring, leaf	RB2-5523-000CN	Figure 138 on page 268
Spring, tension	RS6-2285-000CN	Figure 137 on page 266
Spring, tension	RS6-2296-000CN	Figure 138 on page 268
Spring, tension	RS6-2299-000CN	Figure 138 on page 268
Spring, tension	RS6-2298-020CN	Figure 143 on page 276
Spring, torsion	RB2-5816-000CN	Figure 144 on page 277
Strap, rock block	RB2-5655-000CN	Figure 134 on page 262
Switch assembly (SW21)	RG5-6206-020CN	Figure 151 on page 286
Tape, cover (retaining strap)	RB2-5653-000CN	Figure 134 on page 262
Tape, cover (retaining strap)	RB2-5653-000CN	Figure 136 on page 265
Toner contact assembly	RB2-5717-000CN	Figure 138 on page 268
Toner sensor contact with memory (antenna)	RG5-5719-000CN	Figure 140 on page 272
Torque, limiter	RB2-5759-000CN	Figure 137 on page 266
Transfer guide assembly	RG5-5651-000CN	Figure 138 on page 268
Transfer roller assembly	RG5-5662-000CN	Figure 147 on page 280
Tray 1 assembly	RG5-5809-000CN	Figure 154 on page 290
Tray, face-up	RB2-5690-000CN	Figure 134 on page 262
Tray, 500-sheet	RG5-5635-080CN	Figure 144 on page 277
Tray 4	RG5-6212-300CN	Figure 150 on page 284
Tray 4 deck drive assembly	RG5-6228-040CN	Figure 152 on page 288
Tray 4-to-engine stabilizing screws	0515-4318	Figure 150 on page 284
Tray 4 vertical registration assembly (VTU/VRA)	RG5-6225-050CN	Figure 150 on page 284
Upper cable guide assembly	RG5-7787-000CN	Figure 139 on page 270
Vertical transfer assembly	RG5-6225-000CN	Figure 150 on page 284

## Numerical parts list

**Table 55. Numerical parts list**

<b>Part number</b>	<b>Description</b>	<b>Figure and page</b>
0515-4318	Tray 4-to-engine stabilizing screws	Figure 150 on page 284
5851-1391	Label, custom/standard switch	Figure 144 on page 277
RB1-6421-000CN	Foot, right side	Figure 137 on page 266
RB2-5515-020CN	Rail, front fusing	Figure 138 on page 268
RB2-5516-000CN	Rail, back fusing	Figure 138 on page 268
RB2-5517-000CN	Mount, front fusing	Figure 138 on page 268
RB2-5518-000CN	Mount, back fusing	Figure 138 on page 268
RB2-5522-000CN	Guide, pickup	Figure 137 on page 266
RB2-5523-000CN	Spring, leaf	Figure 138 on page 268
RB2-5526-000CN	Guide, cartridge	Figure 137 on page 266
RB2-5528-000CN	Link, connect	Figure 137 on page 266
RB2-5529-000CN	Foot, left side	Figure 137 on page 266
RB2-5547-000CN	Collar	Figure 137 on page 266
RB2-5570-020CN	Hinge mount, damper	Figure 137 on page 266
RB2-5639-000CN	Arm, shutter	Figure 138 on page 268
RB2-5640-000CN	Shutter, laser	Figure 138 on page 268
RB2-5652-000CN	Bushing	Figure 134 on page 262
RB2-5653-000CN	Tape, cover (retaining strap)	Figure 134 on page 262
RB2-5653-000CN	Tape, cover (retaining strap)	Figure 136 on page 265
RB2-5654-000CN	Arm, front cover	Figure 137 on page 266
RB2-5654-000CN	Hinge arm, front cover	Figure 137 on page 266
RB2-5655-000CN	Strap, rock block	Figure 134 on page 262
RB2-5656-000CN	Pin, fusing shutter	Figure 134 on page 262
RB2-5659-000CN	Cover, right, top	Figure 134 on page 262
RB2-5660-000CN	Cover, left, top	Figure 134 on page 262
RB2-5661-000CN	Rod, switch	Figure 139 on page 270
RB2-5662-000CN	Cover, right	Figure 136 on page 265
RB2-5675-000CN	Cap, left cover	Figure 134 on page 262
RB2-5676-000CN	Cover, multipurpose blanking	Figure 134 on page 262
RB2-5682-000CN	Cover, right rail	Figure 134 on page 262
RB2-5683-000CN	Cover, left rail	Figure 134 on page 262
RB2-5684-000CN	Cover, right back	Figure 134 on page 262
RB2-5685-000CN	Cover, left back	Figure 134 on page 262
RB2-5687-000CN	Cover, left lower	Figure 134 on page 262
RB2-5689-000CN	Cover, right lower	Figure 134 on page 262
RB2-5690-000CN	Tray, face-up	Figure 134 on page 262

**Table 55. Numerical parts list (continued)**

<b>Part number</b>	<b>Description</b>	<b>Figure and page</b>
RB2-5697-000CN	Cover, right door	Figure 137 on page 266
RB2-5700-000CN	Latch, roller-action	Figure 134 on page 262
RB2-5701-000CN	Cover, operation panel, 100 to 127 V	Figure 134 on page 262
RB2-5703-000CN	Control panel overlay	Figure 134 on page 262
RB2-5717-000CN	Toner contact assembly	Figure 138 on page 268
RB2-5759-000CN	Torque, limiter	Figure 137 on page 266
RB2-5813-000CN	Knob, cassette	Figure 144 on page 277
RB2-5816-000CN	Spring, torsion	Figure 144 on page 277
RB2-5845-000CN	Knob, jam removal	Figure 137 on page 266
RB2-6006-000CN	Frame, delivery	Figure 135 on page 264
RB2-6035-000CN	Lever, sensor	Figure 148 on page 281
RB2-6037-000CN	Flag, sensor	Figure 148 on page 281
RB2-6007-000CN	Cover, left (left door)	Figure 135 on page 264
RB2-6077-000CN	Lever, switch	Figure 142 on page 275
RB2-6491-000CN	Cover, left upper	Figure 134 on page 262
RB2-6537-000CN	Cover hooks	Figure 154 on page 290
RB2-7648-040CN	Cover, front	Figure 150 on page 284
RB2-7649-000CN	Cover, right (tray 4)	Figure 150 on page 284
RB2-7650-000CN	Cover, back right	Figure 150 on page 284
RB2-7651-000CN	Cover, back left	Figure 150 on page 284
RB2-7652-000CN	Cover, upper	Figure 150 on page 284
RB2-7662-000CN	Jet-Link holder	Figure 151 on page 286
RB2-7678-020CN	Caster, back	Figure 151 on page 286
RB2-7762-020CN	Lever, custom	Figure 150 on page 284
RB3-0304-040CN	Caster, front swivel	Figure 151 on page 286
RF5-3319-000CN	Roller, transfer	Figure 147 on page 280
RF5-3338-000CN	Roller, feed retard	Figure 137 on page 266
RF5-3338-000CN	Roller, feed retard	Figure 151 on page 286
RF5-3340-000CN	Roller, PIC	Figure 137 on page 266
RF5-3644-000CN	Cover, back	Figure 150 on page 284
RF5-3645-000CN	Cover, left (tray 4)	Figure 150 on page 284
RG5-5288-000CN	Motor, DC, 24V (M1) (HP LaserJet 9000)	Figure 142 on page 275
RG5-5635-080CN	Tray, 500-sheet	Figure 144 on page 277
RG5-5643-030CN	Delivery feed assembly	Figure 148 on page 281
RG5-5645-000CN	Delivery cross member assembly	Figure 148 on page 281
RG5-5646-050CN	Left door and diverter	Figure 135 on page 264
RG5-5647-050CN	Diverter assembly	Figure 135 on page 264
RG5-5648-000CN	Damper assembly	Figure 135 on page 264
RG5-5649-000CN	Delivery PCA	Figure 148 on page 281
RG5-5649-000CN	Delivery PCA	Figure 149 on page 283

**Table 55. Numerical parts list (continued)**

<b>Part number</b>	<b>Description</b>	<b>Figure and page</b>
RG5-5651-000CN	Transfer guide assembly	Figure 138 on page 268
RG5-5653-000CN	Holder, transfer	Figure 147 on page 280
RG5-5654-000CN	Guide, transfer/pre-transfer	Figure 147 on page 280
RG5-5656-050CN	Drum feed drive assembly	Figure 141 on page 274
RG5-5659-000CN	Fuser delivery drive assembly (HP LaserJet 9000)	Figure 142 on page 275
RG5-5662-000CN	Transfer roller assembly	Figure 147 on page 280
RG5-5663-000CN	Registration assembly	Figure 146 on page 279
RG5-5678-000CN	Feed PCA	Figure 145 on page 278
RG5-5678-000CN	Feed PCA	Figure 149 on page 283
RG5-5681-000CN	Paper input unit (PIU), engine	Figure 145 on page 278
RG5-5699-000CN	End paper sensor assembly	Figure 139 on page 270
RG5-5700-000CN	Fusing jam clearing assembly	Figure 137 on page 266
RG5-5701-000CN	Back cover assembly	Figure 134 on page 262
RG5-5702-000CN	Front cover assembly	Figure 134 on page 262
RG5-5703-060CN	Control panel assembly	Figure 134 on page 262
RG5-5704-000CN	Latch mount assembly	Figure 139 on page 270
RG5-5705-000CN	Left upper cover assembly	Figure 134 on page 262
RG5-5709-000CN	Cartridge front pressure assembly	Figure 139 on page 270
RG5-5710-000CN	Cartridge back pressure assembly	Figure 139 on page 270
RG5-5715-000CN	Right rail assembly	Figure 139 on page 270
RG5-5718-000CN	Guide rail, cartridge	Figure 137 on page 266
RG5-5719-000CN	Toner sensor contact with memory (antenna)	Figure 140 on page 272
RG5-5721-000CN	Front inside cover assembly	Figure 137 on page 266
RG5-5722-000CN	Main cable harness holder assembly	Figure 140 on page 272
RG5-5724-000CN	Fusing connector holder assembly	Figure 138 on page 268
RG5-5725-000CN	Back cable holder assembly (HP LaserJet 9000)	Figure 140 on page 272
RG5-5727-000CN	Inlet assembly (Power SW 10)	Figure 140 on page 272
RG5-5728-050CN	High voltage power supply (HVPS)	Figure 140 on page 272
RG5-5730-000CN	Low voltage power supply assembly 110 V (HP LaserJet 9000)	Figure 140 on page 272
RG5-5731-000CN	Low voltage power supply assembly 220 V (HP LaserJet 9040/9050)	Figure 140 on page 272
RG5-5737-000CN	Right cover assembly	Figure 136 on page 265
RG5-5740-000CN	Right cover knob assembly	Figure 136 on page 265
RG5-5741-020CN	Cartridge lifter assembly	Figure 143 on page 276
RG5-5746-000CN	Control lever assembly	Figure 137 on page 266
RG5-5750-170CN	Fuser assembly 110 V	Figure 138 on page 268
RG5-5751-170CN	Fuser assembly 220 V	Figure 138 on page 268
RG5-5759-000CN	Fan connecting cable (HP LaserJet 9040/9050)	Figure 140 on page 272
RG5-5763-000CN	Multi-purpose cable	Figure 136 on page 265

**Table 55. Numerical parts list (continued)**

<b>Part number</b>	<b>Description</b>	<b>Figure and page</b>
RG5-5764-000CN	Multi-purpose grounding cable	Figure 136 on page 265
RG5-5771-000CN	Fusing power cable	Figure 138 on page 268
RG5-5772-000CN	Fuser high-voltage cable	Figure 138 on page 268
RG5-5779-000CN	Connector assembly	Figure 140 on page 272
RG5-5809-000CN	Tray 1 assembly	Figure 154 on page 290
RG5-5811-040CN	Service cover assembly	Figure 154 on page 290
RG5-5826-000CN	Laser/scanner assembly	Figure 139 on page 270
RG5-6206-020CN	Switch assembly (SW21)	Figure 151 on page 286
RG5-6207-040CN	Paper-size sensing assembly	Figure 151 on page 286
RG5-6208-150CN	Paper input unit (PIU)	Figure 150 on page 284
RG5-6212-300CN	Tray 4	Figure 150 on page 284
RG5-6225-000CN	Vertical transfer assembly	Figure 150 on page 284
RG5-6225-050CN	Tray 4 vertical registration assembly (VTU/VRA)	Figure 150 on page 284
RG5-6227-000CN	Paper path connection assembly (PPCU)	Figure 151 on page 286
RG5-6228-040CN	Tray 4 deck drive assembly	Figure 152 on page 288
RG5-6229-030CN	Paper volume sensing assembly	Figure 151 on page 286
RG5-6235-120CN	Deck controller PCA	Figure 153 on page 289
RG5-6237-000CN	Paper volume PCA	Figure 153 on page 289
RG5-6238-000CN	Paper size PCA	Figure 153 on page 289
RG5-6239-000CN	LED PCA	Figure 153 on page 289
RG5-6240-000CN	Jet-Link cable assembly	Figure 151 on page 286
RG5-6249-000CN	Jet-Link grounding cable	Figure 151 on page 286
RG5-6996-000CN	Print cartridge memory controller PCA	Figure 149 on page 283
RG5-7778-000CN	Low voltage power supply assembly 110 V (HP LaserJet 9040/9050)	Figure 140 on page 272
RG5-7779-000CN	Low voltage power supply assembly 220 V (HP LaserJet 9040/9050)	Figure 140 on page 272
RG5-7780-120CN	DC controller PCA	Figure 149 on page 283
RG5-7783-000CN	Fan connecting cable (HP LaserJet 9040/9050)	Figure 140 on page 272
RG5-7786-000CN	Back cable holder assembly (HP LaserJet 9040/9050)	Figure 140 on page 272
RG5-7787-000CN	Upper cable guide assembly	Figure 139 on page 270
RG5-7789-000CN	Fuser delivery drive assembly (HP LaserJet 9040/9050)	Figure 142 on page 275
RH2-5445-000CN	Cable, flat	Figure 140 on page 272
RH7-1481-000CN	Motor	Figure 152 on page 288
RH7-1622-000CN	Motor, DC, 24V (M1) (HP LaserJet 9040/9050)	Figure 142 on page 275
RH7-1623-000CN	Fan, #2, controller (HP LaserJet 9040/9050)	Figure 140 on page 272
RH7-5287-000CN	Main motor (M2)	Figure 141 on page 274
RH7-5294-000CN	Fan, #1, power supply	Figure 140 on page 272
RH7-5295-000CN	Fan, #2, controller (HP LaserJet 9000)	Figure 140 on page 272
RH7-5296-000CN	Fan, #3, rear delivery	Figure 148 on page 281

**Table 55. Numerical parts list (continued)**

<b>Part number</b>	<b>Description</b>	<b>Figure and page</b>
RH7-5297-000CN	Fan, #4, front delivery	Figure 148 on page 281
RH7-5302-000CN	Fan, #6, face down tray	Figure 148 on page 281
RG7-5306-000CN	Fan, #5, cartridge fan	Figure 139 on page 270
RS5-0708-000CN	Gear, 21T	Figure 138 on page 268
RS5-9099-000CN	Screw, stepped	Figure 150 on page 284
RS6-2285-000CN	Spring, tension	Figure 137 on page 266
RS6-2296-000CN	Spring, tension	Figure 138 on page 268
RS6-2298-020CN	Spring, tension	Figure 143 on page 276
RS6-2299-000CN	Spring, tension	Figure 138 on page 268
RS6-2302-000CN	Spring, compression	Figure 139 on page 270
WC4-5171-000CN	Microswitch (SW1)	Figure 142 on page 275
XA9-0668-000CN	Screw, W/W, M3 by 29.5	Figure 144 on page 277
XA9-0732-000CN	Screw, M4 by 8, RS	Figure 151 on page 286
XA9-0912-000CN	Screw, W/W, M5 by 12	Figure 151 on page 286
XA9-0994-000CN	Screw, M4 by 6	Figure 151 on page 286
XA9-1189-000CN	Screw, M4 by 10	Figure 135 on page 264
XA9-1200-000CN	Screw, M3 by 8	Figure 136 on page 265
XA9-1275-000CN	Screw, M3 by 6	Figure 138 on page 268
XA9-1275-000CN	Screw, M3 by 6	Figure 141 on page 274
XA9-1275-000CN	Screw, M3 by 6	Figure 143 on page 276
XA9-1275-000CN	Screw, M3 by 6, RS	Figure 137 on page 266
XA9-1275-000CN	Screw, M3 by 6, RS	Figure 138 on page 268
XA9-1275-000CN	Screw, M3 by 6, RS	Figure 139 on page 270
XA9-1275-000CN	Screw, M3 by 6, RS	Figure 140 on page 272
XA9-1275-000CN	Screw, M3 by 6, RS	Figure 142 on page 275
XA9-1275-000CN	Screw, M3 by 6, RS	Figure 145 on page 278
XA9-1276-000CN	Screw, M3 by 8	Figure 138 on page 268
XA9-1276-000CN	Screw, M3 by 8	Figure 148 on page 281
XA9-1276-000CN	Screw, M3 by 8, RS	Figure 136 on page 265
XA9-1276-000CN	Screw, M3 by 8, RS	Figure 137 on page 266
XA9-1276-000CN	Screw, M3 by 8, RS	Figure 138 on page 268
XA9-1276-000CN	Screw, M3 by 8, RS	Figure 139 on page 270
XA9-1276-000CN	Screw, M3 by 8, RS	Figure 140 on page 272
XB2-6300-607CN	Screw, W/W, M3 by 6	Figure 152 on page 288
XB6-7400-000CN	Screw, TP, M4 by 6	Figure 150 on page 284
XD9-0134-000CN	E ring	Figure 143 on page 276
XD9-0136-000CN	E ring	Figure 143 on page 276



# Index

## Symbols

\* (asterisk), next to control panel selections 31

## Numerics

2,000-sheet input tray. See tray 4

3,000-sheet stacker

communications, troubleshooting 228

Install guide 259

locating 10, 12

models including 7

paper sizes supported 27

3,000-sheet stapler/stacker

communications, troubleshooting 228

error messages 186

Install guide 259

locating 10, 12

models including 7

paper sizes supported 27

space requirements 18

500-sheet trays. See tray 2 or 3

8-bin mailbox

locating 10

models supported 7

paper sizes supported 28

part number 258

## A

A4 paper

override settings 42

Wide A4 settings 42

AC voltage operations 80

access denied, menus locked 180

accessories

available 3, 5

diagrams 12

ordering 14

part numbers 257

acclimating printer 170

accounting information 231

address, IP 46

adhesive labels

fuser mode 44

output path 244

specifications 20

alignment, tray registration 44

alphabetical lists

error messages 180

part numbers 291

Appletalk settings 51

applications, changing settings from 33

arrow keys, control panel 31

assemblies

diagrams and part numbers 256

ordering 14

removing and replacing 99

service approach 14

asterisk (\*), next to control panel selections 31

Attention light, locating 30

auto continue, settings 47

## B

Back arrow, control panel 31

back assemblies, removing 135

back covers, removing

left 108

printer 109

tray 4 153

back of page contamination, troubleshooting 238

back view, diagrams 100

background, gray 239

base memory 6

BD PCB, voltage 80

beams, operations 83, 84

between-page bias 79

bias generation circuits, operations 79

bidirectional communication

operations 81

settings 48

troubleshooting 246

billing, usage page information 231

binding edge, settings 42

bins, output

event log error messages 179

fan, removing 115

full, error messages 180, 184

jam detection operations 88

jams, error messages 191

locating 10

paper sizes supported 26

selecting 41

sensors 88, 90

straight paper path, using 244

black lines, troubleshooting

horizontal 239

vertical 241

black pages, troubleshooting 236

blank pages

suppressing 43

troubleshooting 236

blank spots, troubleshooting 236

blown lamp or motor error message 180

bond paper, weight equivalence table 23

both sides, printing on 42

bubbles, troubleshooting 239

buffer overflow, error messages 202

buttons, control panel 30

## C

Cancel Job button, control panel 31

capacities

print cartridges 2, 4

trays and bins 3, 5, 26

carbonless media 22

cardstock

fuser mode 44

sizes supported 26

carriage returns, settings 43

cartridge fan, removing 144

cartridge lifter assembly, diagrams and part numbers 276

cartridge release lever, removing 117

- cartridges
  - capacity 2, 4
  - checking 234
  - components, operations 85
  - EconoMode 45, 68
  - error messages 181
  - handling 67
  - image formation operations 84
  - level detection operations 79, 86
  - low 47
  - noise, troubleshooting 171
  - non-HP 68
  - ordering 14
  - out, settings 47
  - part numbers 257
  - refilled 68, 220
  - removing 62, 119
  - ROM, memory operations 86
  - seals, automatic roll-up 86
  - storing 67
  - supplies status page information 230
  - weight 68
- CD-ROMs, part numbers 260
- center back cover (tray 4), removing 153
- characters, troubleshooting
  - dropouts 238
  - misformed 242
- chemically treated media 22
- circuit capacity, specifications 7
- cleaning
  - bias, operations 79
  - blade, operations 84, 85
  - page, creating 65
  - precautions 61
  - procedures 62
- Clear key, control panel 31
- clearable warnings, settings 47
- clearing jams 225
- clearing memory 217, 219
- clock, setting 46
- clothing, toner on 61
- clutches
  - pickup and feed system 92
  - tray 1 93
  - voltage 80
- coated media 22
- codes, service test errors 214
- cold reset 250
- cold resets, performing 217, 219
- communications
  - operations 77, 81
  - settings 48
  - troubleshooting 246
- Compact Flash 250
- complex pages, error messages 202
- components, internal 266
- conditioning process, image formation operations 84
- configuration page
  - HP Jetdirect 229
  - printing 38
  - using 226
- Configure device menu 41
- connectivity, troubleshooting 250
- connectors, locating 11
- consumables
  - ordering 14
  - part numbers 257
- contamination, troubleshooting 238
- control panel
  - blank, troubleshooting 174
  - Configure device menu 41
  - configuring trays 172
  - Diagnostics menu 54
  - EIO menu 49
  - error messages, alphabetical list 180
  - error messages, numerical list 188
  - event log, displaying 177
  - I/O menu 48
  - Information menu 38
  - keys 30
  - language, selecting 33, 48, 217, 219
  - LED indicator lights 30
  - locating 10
  - menu map 37
  - menu map, printing 38
  - menus, using 37
  - messages, interpreting 178
  - numeric keypad 32
  - operations 81
  - Paper handling menu 39
  - Parallel input submenu 48
  - part numbers 257
  - PCL menu 42
  - Print quality menu 44
  - Printing submenu 41
  - removing 111
  - Resets 53
  - Retrieve job menu 38
  - Service menu 215
  - settings 33
  - System setup submenu 46
- controller board (tray 4), removing 159
- controller fan, removing 145
- copies, number of 41
- cost accounting information 231
- country of origin 6
- counts, page 231
- Courier font settings 42
- covers
  - back, removing 109
  - diagrams 262
  - front, removing 104
  - left back, removing 108
  - left, removing 103
  - locating 10
  - part numbers 263
  - rail, removing 110
  - right lower, removing 106
  - right top, removing 101
  - tray 4, removing 151
- CPU
  - DC controller PCB 77
  - tray 1 driver PCB 93
  - tray 4 96
- creases, troubleshooting 237
- critical error messages 178
- CSSO (Customer Services and Support Organization) 14
- curl, troubleshooting 237, 244
- current capacity, specifications 7
- custom media
  - detectable size message 182
  - jams, troubleshooting 224
  - sizes supported 26
  - tray settings 41
- Customer Services and Support Organization (CSSO) 14
- cutouts, avoiding media with 22

## D

- dark pages, troubleshooting 236, 240
- dark setting, toner density 45
- data communication operations 81
- Data light, locating 30
- data transmission settings 48
- date, setting 46
- DC controller
  - cartridge memory failures, detection 86
  - diagrams and part numbers 283
  - formatter operations 81
  - media-size detection 87
  - operations 76
  - part numbers 257
  - removing 138
  - tray 1 feeding operations 93
  - troubleshooting 174
  - voltage 80
- DC voltage, conversion 80
- declaration of conformity 13
- default settings
  - restoring 53, 217, 219
  - selecting 31, 33
- defect ruler 243
- defect tables 235
- delay jams
  - tray 1 94
  - tray 2 or 3 88
  - tray 4 96
- delivery assembly
  - diagrams and part numbers 281
  - fans, removing 114, 115
  - removing 113
- delivery motor, removing 116
- density settings 45
- depth, printer
  - space requirements 17
  - specifications 7
- developing bias generation 79
- developing cylinder, operations 84
- developing process, image formation operations 84
- diagnostics
  - communications 246
  - drum rotation 220
  - engine 174, 215
  - flowchart 216
  - high-voltage power supply 220
  - LAN 247
  - loopback 247, 249
  - paper path 213
  - ping 248
  - print cartridges 234
  - service test 213
  - tray 4 221
  - troubleshooting, preliminary 170
- Diagnostics menu 54
- different media for first page, troubleshooting 172
- digital camera memory cards 82
- DIMMs
  - error messages 206
  - installed personalities and options 228
  - part numbers 258
- DIP switches, tray 4 223
- directory, file 38, 232
- disks. *See* hard disks
- distorted images, troubleshooting 238
- diverter, left door 107, 264
- DLC/LLC settings 51
- documentation, part numbers 259

- door open jams 88
- DOOR OPEN sequence of operations 73
- doors, removing
  - left 107, 264
  - right 105
- DOS prompt, communications test 246
- dots per inch (dpi)
  - features 2, 4
  - settings 44
- dots, vertical 242
- double-sided printing 42
- Down arrow, control panel 31
- dpi (dots per inch)
  - features 2, 4
  - settings 44
- draft printing 45, 68
- drive assembly (tray 4), removing 158
- drive motor (tray 4), removing 157
- drivers, changing settings from 36
- dropouts, troubleshooting 238
- drum
  - bias generation 79
  - cleaning process, image formation operations 85
  - feed drive assembly, diagrams and part numbers 274
  - ground path, troubleshooting 239
  - image defects, troubleshooting 234
  - image formation operations 84
  - rotation check 220
- drum motor (DCM2)
  - block diagram 92
  - removing 141
- duplexer
  - communications 77, 228
  - failure, error messages 211
  - Install guide 259
  - jams, error messages 191, 197, 202
  - locating 10, 12
  - models including 2, 6
  - paper sizes supported 27
  - part number 259
  - removing 133
  - settings 42
  - troubleshooting 244
- duty cycle 3, 5

## E

- EconoMode 45, 68
- edge-to-edge printing 42
- EEPROM operations 77
- EIO cards
  - critical error messages 212
  - slots 81
  - supported 3, 5
- EIO menu 49
- electrical specifications 7
- electrostatic discharge (ESD), precautions for 99
- embedded LAN
  - disabling 248
  - formatter replacement 250
  - ping test 248
  - troubleshooting 247, 249
- embossed media, specifications 22
- engine control system
  - block diagram 75
  - formatter operations 81
- engine test
  - performing 215
  - troubleshooting 174

- envelopes
  - default image size, setting 41
  - fuser lever positioning 237
  - output path 244
  - sizes supported 26
  - specifications 19
  - storing 23
  - wrinkled, troubleshooting 172
- environmental product stewardship program 13
- environmental specifications
  - acclimating to changes 170
  - print cartridges, storing 67
  - printer 8, 16
  - storing media 22
- equivalence table, paper weight 23
- e-rings 261
- error messages
  - alphabetical list 180
  - event log 175
  - numerical list 188
  - priority 178
  - settings 47
- ESD (electrostatic discharge), precautions for 99
- Ethernet MAC addresses 250
- event log
  - configuration page 226
  - message format 179
  - printing 175
  - using 175
  - viewing 54, 177
- exchange program 14
- expansion, memory 6
- external paper handling device messages 178
- eye contact, toner 61

**F**

- face-down bin
  - delivery sensor (PS1451) 88, 90
  - fan, removing 115
  - full sensor (PS1452) 90
  - jam detection operations 88
  - jams, error messages 191
  - locating 10
- face-up bin
  - locating 10
  - using 244
- face-up solenoid (SL1) 92
- factory default settings, restoring 53, 217, 219
- faded print, troubleshooting 240
- FAILURE sequence of operations 73
- fans
  - cartridge, removing (fan 5) 144
  - controller, removing (fan 2) 145
  - delivery, removing 114
  - error messages 207
  - face-down bin, removing (fans 3, 6, and 4) 115
  - operations, troubleshooting 174
  - power supply, removing (fan 1) 143
- Fast InfraRed Connect
  - locating 11, 12
  - part number 258
- fasteners, types of 261
- FastRes 44
- FCC regulations 13
- features, product 2, 4, 6
- feed clutch, tray 1 (CL2501) 93
- feed delay jams, tray 4 96
- feed-drive assembly, removing 142
- feed rollers
  - image defects, troubleshooting 238
  - included in printer maintenance kit 60
  - removing 122
  - tray 1 93, 94
  - tray 4 96, 155
- feed sensors, tray 2 or 3 90
- feed stationary jams, tray 4 96
- feed system
  - motors, solenoids, and clutches 92
  - operations 87
  - sensors and switches 89
  - tray 1 93
  - tray 4 95
- field replaceable units (FRUs)
  - part numbers 262
  - removing and replacing 99
  - service approach 14
- file directory 38, 232
- file warning messages 180
- firmware
  - error messages 205
  - flash failures 212
  - part numbers 257
  - upgrading 55
- first aid procedures, toner 61
- first page out, specifications 2, 4
- first page, troubleshooting 172
- flash disks, error messages 180, 182
- flash memory
  - cards, digital camera 82
- flat ribbon cables 137
- flickering, prevention operations 80
- flowcharts
  - diagnostics 216
  - troubleshooting process 168
- focusing lenses, operations 83, 84
- font DIMMs, part numbers 258
- fonts
  - Courier settings 42
  - downloaded, storage operations 81
  - included 2
  - lists, printing 38
  - PCL settings 43
- foreign interface connector, locating 11
- form lines, settings 43
- formatter
  - bypassing 215
  - operations 81
  - removing 135
  - replacing 250
  - tray 4 feeding operations 95
  - voltage 80
- forms, preprinted 21
- frequent jams, troubleshooting 224, 225
- front assemblies, removing 119
- front cover
  - locating 10
  - removing 104
- front door error messages
  - jams 189, 198
  - open 181
- front view, diagrams 100
- FRUs (field replaceable units)
  - part numbers 262
  - removing and replacing 99
  - service approach 14
- FTP, remote firmware upgrades 56

- fuser
    - assembly 60
    - assembly, removing 134
    - cleaning 65
    - connector holder assembly, removing 147
    - contamination, troubleshooting 238
    - control circuit operations 80
    - delivery drive assembly, diagrams and part numbers 275
    - delivery jams 88
    - delivery sensor (PS502) 88, 90
    - delivery-drive assembly, removing 149
    - error messages 205
    - image defects, troubleshooting 240, 241, 242
    - image formation operations 85
    - jam removal knob, removing 123
    - jam sensor (PS501) 88, 90
    - levers 237
    - media compatibility 20
    - noise, troubleshooting 171
    - operations 77
    - part numbers 257
    - poor adhesion, troubleshooting 172
    - roller 79, 80
    - wrapping jam detection operations 87
  - fuser modes 40, 44
  - fuser/delivery motor (DCM1) 92
- G**
- gray background, troubleshooting 239
  - ground path, drum 239
- H**
- hard disks
    - critical error messages 212
    - error messages 180, 182
    - file directory page 232
    - file directory, printing 38
    - initializing 217, 219
    - installed personalities and options 228
    - job retention 46
    - models including 7
    - part numbers 258
    - skip disk function 218, 220
    - supported 3, 5
  - harnesses, replacing 99
  - heating operations, fuser 80
  - heavy paper
    - fuser mode 44
    - types supported 26
  - height, printer
    - space requirements 17
    - specifications 7
  - Help key, control panel 31
  - high-voltage power supply
    - checking 220
    - image defects, troubleshooting 236, 240, 242
    - operations 78
    - part numbers 257
    - removing 137
    - voltage 80
  - hoppers, printer cartridge 85
  - horizontal defects, troubleshooting 239
  - HP Customer Services and Support Organization (CSSO) 14
  - HP Fast InfraRed Connect
    - locating 11, 12
    - part number 258
  - HP Jetdirect configuration page 229
  - HP Jetdirect print servers
    - EIO menu 49
    - models including 6
    - networks supported 81
    - part numbers 258
    - troubleshooting 246, 250
  - HP Jet-Link
    - cabling, troubleshooting 226
    - connector, locating 11
    - connector, removing 146
  - HP LaserJet 9000 Series Printer software CD-ROM 260
  - HP Web JetAdmin
    - configuring trays from 172
    - upgrading firmware with 56, 57
  - HTTPS settings 51
  - humidity
    - environmental specifications, printer 8
    - storing media 22
    - storing print cartridges 67
- I**
- I/O buffer overflow, error messages 202
  - I/O communication operations 81
  - I/O menu 48
  - I/O slots, locating 11
  - image defect tables 235
  - image formation operations 84
  - image quality
    - cleaning page, creating 65
    - settings 44
    - troubleshooting 233
  - image size, setting default 41
  - Information menu 38
  - information pages
    - configuration 226
    - file directory 232
    - Jetdirect 229
    - printing 38, 226
    - supplies status 230
    - usage 231
  - ingestion, toner 61
  - inhalation, toner 61
  - inks, preprinted media specifications 21
  - input trays
    - capacities 26
    - configuration page information 228
    - detectable size error messages 182
    - feeding, troubleshooting 171, 172
    - included 2
    - jams, error messages 188, 199
    - jams, troubleshooting 224
    - Jet-Link device error messages 179
    - media error messages 186, 187
    - paper path test 213
    - paper sizes, supported 26
    - part numbers 259
    - registration 33, 44
    - selecting 46, 172
    - unexpected size, error messages 204
  - installed personalities and options 228
  - installing printer 16
  - Intellifont 2, 4
  - interfaces
    - connections, locating 11
    - operations 81
  - internal components, diagrams and part numbers 266
  - INTR (initial rotation) sequence 72
  - IP address 46, 246
  - IPX/SPX settings 51

## J

- jam detection lever driver solenoid (SL501) 92
- jam removal knobs, removing 123
- JAM sequence of operations 73
- jams
  - causes of 225
  - cleaning spilled toner after 61
  - clearing 225
  - error messages 188
  - multifeeds, troubleshooting 245
  - recovery settings 47
  - tray 1 detection operations 94
  - tray 2 or 3 detection operations 88
  - tray 4 detection operations 96
  - troubleshooting 224
- JetAdmin
  - configuring trays from 172
  - upgrading firmware with 56, 57
- Jetdirect configuration page 229
- Jetdirect print servers
  - EIO menu 49
  - models including 6
  - networks supported 81
  - part numbers 258
  - troubleshooting 246, 250
- Jet-Link
  - cabling, troubleshooting 226
  - connector, locating 11
  - connector, removing 146
  - devices, troubleshooting 228
- job retention
  - job storage limit, setting 46
  - Retrieve job menu 38
  - timeout settings 46

## K

- keypad, numeric 32
- keys, control panel 30
- kits, maintenance
  - installation guides 260
  - part numbers 257
  - replacing 60
- knobs, removing 124

## L

- labels
  - fuser mode 44
  - output path 244
  - specifications 20
- lamp error messages 180
- LAN
  - disabling 248
  - formatter replacement 250
  - ping test 248
  - troubleshooting 247, 249
- landscape orientation, setting as default 43
- language, control panel 33, 48, 217, 219
- languages, printer
  - default, setting 47
  - error messages 181
  - included 2, 4
- laser shutter, troubleshooting 236
- laser/scanner
  - operations 83
  - removing 112
  - voltage 80
- LaserJet 9000 Series Printer software CD-ROM 260
- latent image formation 84

- leading edge, detection operations
  - tray 1 94
  - tray 2 or 3 88
- LEDs
  - control panel 30
  - flickering, prevention operations 80
  - tray 4 223
- left assemblies, removing 133
- left back cover (printer), removing 108
- left back cover (tray 4), removing 153
- left door
  - diagrams and part numbers 264
  - jams, error messages 190, 191, 198
  - part numbers 264
  - removing 107
- left output bin, paper sizes supported 27
- left rail cover, removing 110
- left side cover (tray 4), removing 151
- left side view, diagrams 100
- left top cover, removing 103
- lenses, operations 83, 84
- letterhead
  - fuser mode 44
  - specifications 21
- level, media detection operations
  - tray 2 or 3 87
  - tray 4 96
- level, toner 79, 86
- levers, fuser 237
- life expectancies, print cartridges 2, 4
- lifter motor (SMT2) 92
- lifter position, media-level detection operations
  - tray 2 or 3 87
  - tray 4 95
- light print
  - setting, toner density 45
  - troubleshooting 240
- line feed settings 43
- line spacing settings 43
- lines, troubleshooting
  - horizontal 239
  - vertical 241
- locked menus, control panel 180
- long edge binding, settings 42
- loopback test 247, 249
- loose toner, troubleshooting 240
- low print cartridges, settings 47
- lower heater (H3), operations 80
- low-voltage power supply
  - operations 80
  - part numbers 257
  - removing 136
- LSTR (last rotation) sequence 72

## M

- MAC addresses 250
- Macintosh, Appletalk settings 51
- macros, downloaded 81
- mailbox
  - locating 10
  - models supported 7
  - paper sizes supported 28
  - part number 258
- main heater (H1), operations 80
- main motor, operations 84
- maintenance kits
  - installation guide 260
  - part numbers 257
  - replacing 60

- manual feed
  - control panel settings 42
  - error messages 183
- manuals, part numbers 259
- map, control panel menus 37
- map, menu 38
- margins, settings 44
- media
  - coated 22
  - configuring trays 172
  - default image size, setting 41
  - detection operations 87, 96
  - error messages 185, 204
  - fuser modes 40, 44
  - level detection operations 87, 96
  - preprinted 21
  - selecting 19, 25
  - sizes, supported 26
  - small, mode for 45
  - storing 22
  - troubleshooting 244
  - weight equivalence table 23
- media-level sensors 90
- memory
  - clearing 217, 219
  - configuration page information 226
  - data loss, error message 183
  - DIMMs, error messages 208
  - expansion features 6
  - flash cards 82
  - formatter system 81
  - part numbers 258
  - print cartridges 86
  - settings changed, error message 183
- memory controller PCB assembly, diagrams and part numbers 283
- Menu button, control panel 31
- menu map, control panel 37
- menus, control panel
  - Configure device 41
  - Diagnostics 54
  - EIO 49
  - I/O 48
  - Information 38
  - locked 180
  - map 37
  - map, printing 38
  - numeric keypad, navigating with 32
  - Paper handling 39
  - Parallel input 48
  - PCL 42
  - Print quality 44
  - Printing 41
  - Resets 53
  - Retrieve job 38
  - Service 215
  - System setup 46
  - using 37
- messages
  - alphabetical list 180
  - event log codes 175
  - numerical list 188
  - settings 47
  - types of 178
- metal, screws for 261
- metric weight equivalence table, paper 23
- Microsoft Windows, remote firmware upgrades 55
- mirrors, operations 83, 84
- misfeeds, troubleshooting 245
- misformed characters, troubleshooting 242
- model number 6
- models, printer 2, 4, 6
- modes
  - fuser 40, 44
  - Sleep 46
- moisture
  - environmental specifications, printer 8
  - storing media 22
  - storing print cartridges 67
- molex cable connectors, unplugging 136
- monthly duty cycle 3, 5
- motors
  - delivery, removing 116
  - drum 92, 141
  - error messages 180, 207
  - main, operations 84
  - noise, troubleshooting 171
  - pickup and feed system 92
  - tray 4 drive, removing 157
  - tray 4, testing 221
  - voltage 80
- MS-DOS prompt, communications test 246
- multifeeds
  - prevention operations 87
  - troubleshooting 245
- multifunction finisher
  - documentation 259
  - locating 10
  - models including 7
  - paper sizes supported 28
  - part number 258
- multipurpose tray. *See* tray 1

**N**

- narrow media settings 45
- navigation, control panel
  - keys 30
  - menus 37
  - numeric keypad 32
- networking features 3, 5
- networks
  - connectivity, troubleshooting 250
  - disabling embedded LAN 248
  - embedded LAN, troubleshooting 247
  - formatter, replacing 250
  - Jetdirect configuration page 229
  - Jetdirect print servers, part numbers 258
  - ping tests 248
  - speed settings 53
- noise
  - troubleshooting 171
- non-HP cartridges 68, 184
- Novell Status information 246
- number of copies 41
- numeric keypad, control panel 32
- numerical lists
  - error messages 188
  - part numbers 296
- NVRAM
  - errors 210
  - initializing 218, 220
  - operations 81

**O**

- offline message 37
- on/off switch, locating 10



- operating environment
    - acclimating to 170
    - print cartridges 67
    - printer, specifications 8, 16
  - operations
    - bias generation circuits 79
    - DC controller 76
    - engine control system 75
    - formatter 81
    - high-voltage power supply circuit 78
    - image formation 84
    - laser/scanner system 83
    - low-voltage power supply 80
    - pickup and feed system 87
    - power-on 73
    - sequences 71
    - systems overview 70
    - tray 1 93
    - tray 4 95
  - ordering parts 14
  - orientation
    - default 43
    - error messages 185
  - output bins
    - event log error messages 179
    - fan, removing 115
    - full, error messages 180, 184
    - jam detection operations 88
    - jams, error messages 191
    - locating 10
    - paper sizes supported 26
    - selecting 41
    - sensors 88, 90
    - straight paper path, using 244
  - output quality
    - cleaning page, creating 65
    - settings 44
    - specifications 2, 4
    - troubleshooting 233
  - overhead transparencies
    - sensor (PS1) 87, 90
    - specifications 21
  - overheating, thermistor operations 80
  - override A4/letter 42
- P**
- page counts 231
  - page orientation
    - default 43
    - error messages 185
  - page skew
    - adjustment operations, tray 4 95
    - specifications 234
    - troubleshooting 241
  - pages per minute (ppm) 2, 4
  - pages per month 3, 5
  - pan head screws 261
  - paper
    - coated 22
    - configuring trays 172
    - default image size, setting 41
    - detection operations 87, 96
    - error messages 185, 204
    - fuser modes 40, 44
    - level detection operations 87, 96
    - preprinted 21
    - selecting 19, 25
    - sizes, supported 26
    - small, mode for 45
    - storing 22
    - troubleshooting 244
    - weight equivalence table 23
  - paper deck drive assembly, part numbers 258
  - Paper handling menu 39
  - paper input unit (PIU)
    - diagrams and part numbers 278
    - part numbers 257
    - reinstalling 128
    - removing 126
  - paper jams. *See* jams
  - paper path
    - cleaning 63
    - straight 244
    - test, printing 213
    - test, settings 54
    - tray 1 sensor (PS2502) 93, 94
  - paper pickup assembly, part numbers 258
  - paper-size detection switch PCB (tray 4), removing 160
  - parallel communication operations 81
  - parallel connector, locating 11
  - Parallel input submenu 48
  - parallel port, supported 3, 5
  - part numbers
    - alphabetical list 291
    - consumables, accessories, and documentation 257
    - numerical list 296
    - voltage 256
  - parts
    - ordering 14
    - removing and replacing 99
  - Pause/Resume key, control panel 31
  - pay-per-page 231
  - PCB assemblies, diagrams and part numbers
    - printer 283
    - tray 4 289
  - PCBA, screws for 261
  - PCI slots 81
  - PCL font list, printing 38
  - PCL language, features 2, 4
  - PCL menu 42
  - PDF error page 42
  - perforated media, avoiding 22
  - Perform Printer Maintenance message 60
  - periods
    - image formation 84
    - operations 71
    - power-on 73
  - personalities
    - default, setting 47
    - error messages 181
    - included 2, 4
  - phases
    - image formation 84
    - operations 71
    - power-on 73
  - phone numbers, ordering parts 14



- photosensitive drum
  - bias generation 79
  - cleaning process, image formation operations 85
  - feed drive assembly, diagrams and part numbers 274
  - ground path, troubleshooting 239
  - image defects, troubleshooting 234
  - image formation operations 84
  - rotation check 220
- physical specifications 7
- pickup and feed system
  - feed-drive assembly, removing 142
  - motors, solenoids, and clutches 92
  - operations 87
  - sensors and switches 89
  - tray 1 93
  - tray 4 95
- pickup assembly (tray 4), removing 162
- pickup delay jams
  - tray 1 94
  - tray 2 or 3 88
  - tray 4 96
- pickup feed guide (tray 4), removing 163
- pickup motor (SMT3) 92
- pickup roller up and down motor (SMT1) 92
- pickup rollers
  - included in printer maintenance kit 60
  - printer, removing 122
  - tray 1 93, 94
  - tray 4 96, 155
- pickup shaft home-position sensor (PS1413) 90
- pickup solenoid, tray 1 (SL2501) 93, 94
- ping tests 248
- PINs
  - error messages 182
  - Service menu 215
- PIU (paper input unit)
  - diagrams and part numbers 278
  - part numbers 257
  - reinstalling 128
  - removing 126
- plastic, screws for 261
- portrait orientation
  - error messages 185
  - setting as default 43
- ports, supported 3, 5
- PostScript error pages 42
- PostScript font list, printing 38
- PostScript Level 3 emulation 2, 6
- power
  - consumption, specifications 7
  - switch, locating 10
  - troubleshooting 174
- power supplies
  - fan, removing 143
  - high-voltage, removing 137
  - low-voltage 80
  - low-voltage, removing 136
  - part numbers 257
  - tray 1 93
  - tray 4, operations 95
  - tray 4, removing 161
- power-on sequence 73
- PowerSave
  - energy consumption 7
  - fan operation during 174
  - settings 32, 46
- ppm (pages per minute) 2, 4
- preliminary operating checks, troubleshooting 170
- preprinted media specifications 21
- preprinted paper, fuser mode 44
- prepunched paper, fuser mode 44
- pre-registration roller drive clutch (CL2) 92
- pressure roller
  - bias generation 79
  - cleaning 65
  - fuser wrapping jam detection operations 87
  - heating operations 80
  - image formation operations 84, 85
- pre-transfer process, image formation operations 84
- pre-transfer upper guide bias generation 79
- primary charging roller
  - bias generation 79
  - image defects, troubleshooting 236
  - image formation operations 84
- print bias, operations 79
- print cartridges
  - capacity 2, 4
  - checking 234
  - components, operations 85
  - EconoMode 45, 68
  - error messages 181
  - fan, removing 144
  - handling 67
  - image formation operations 84
  - level detection operations 79, 86
  - lifter assembly, diagrams and part numbers 276
  - low 47
  - noise, troubleshooting 171
  - non-HP 68
  - ordering 14
  - out, settings 47
  - part numbers 257
  - refilled 68, 220
  - release lever, removing 117
  - removing 62, 119
  - ROM, memory operations 86
  - seals, automatic roll-up 86
  - storing 67
  - supplies status page information 230
  - weight 68
- print quality
  - cleaning page, creating 65
  - settings 44
  - troubleshooting 233
- Print quality menu 44
- PRINT sequence 72
- print servers
  - EIO menu 49
  - models including 6
  - networks supported 81
  - troubleshooting 246, 250
- print servers, part numbers 258
- printer drivers, changing settings from 36
- printer languages
  - default, setting 47
  - error messages 181
  - included 2, 4
- printer maintenance kits
  - installation guide 260
  - part numbers 257
  - replacing 60
- printer messages
  - alphabetical list 180
  - event log codes 175
  - numerical list 188
  - types of 178
- Printing submenu 41
- priorities, messages 178

- private jobs
    - control panel settings 38
    - timeout settings 46
  - production code, locating 6
  - programs, changing settings from 33
  - proof and hold jobs
    - control panel settings 38
    - timeout settings 46
  - protocols, network
    - Jetdirect page information 229
    - settings 50
    - troubleshooting 246
  - PS error pages 42
  - PS fonts
    - included 2
    - list, printing 38
  - PS Level 3 emulation 6
- Q**
- quality
    - cleaning page, creating 65
    - settings 44
    - specifications 2, 4
    - troubleshooting 233
  - QuickCopy jobs
    - control panel settings 38
    - timeout settings 46
- R**
- rail covers, removing 110
  - RAM disk
    - error messages 180
    - operations 81
    - settings 48
  - RAM, print cartridges 86
  - Ready light, locating 30
  - Ready message 37
  - Real Time Clock operations 82
  - recovery, jam 47
  - recycled media, specifications 22
  - refilled print cartridges 68, 220
  - registration assembly
    - diagrams and part numbers 279
    - image defects, troubleshooting 241
    - part numbers 258
    - removing 129
    - tray 4 95, 156
  - registration jam removal knob, removing 124
  - registration paper sensor (PS2) 88, 90
  - registration roller drive clutch (CL1) 92
  - registration roller, cleaning 63
  - registration, tray settings 33, 44
  - regulatory information 13
  - relative humidity
    - specifications, printer 8
    - storing media 22
    - storing print cartridges 67
  - remanufactured assemblies 14
  - remote firmware upgrade (RFU) 55
  - removing parts 99
  - repair process 14
  - repeating defects, troubleshooting 240, 243
  - repeating images, troubleshooting 242
  - repetitive defect ruler 243
  - replacement intervals
    - print cartridges 68
    - printer maintenance kit 60
  - replacement parts
    - ordering 14
    - removing and replacing 99
  - replacing
    - parts 99
    - printer maintenance kit 60
  - reports
    - configuration 226
    - file directory 232
    - Jetdirect 229
    - printing 38, 226
    - supplies status 230
    - usage 231
  - reset, cold 250
  - Resets menu 53
  - resets, cold 217, 219
  - residual jams, detection operations
    - tray 1 94
    - tray 2 or 3 88
    - tray 4 96
  - resolution
    - features 2, 4
    - settings 44
  - Resolution Enhancement technology (REt) 45
  - restoring factory default settings 53, 217, 219
  - REt (Resolution Enhancement technology) 45
  - Retrieve job menu 38
  - revision level 6
  - RFU (remote firmware upgrade) 55
  - ribbon cables 137
  - right assemblies, removing 125
  - right back cover (tray 4), removing 153
  - right door
    - assembly, diagrams 265
    - jams, error messages 188, 200
    - locating 10
    - part numbers 265
    - removing 105
  - right lower cover, removing 106
  - right rail cover, removing 110
  - right side cover (tray 4), removing 152
  - right side view, diagrams 100
  - right top cover, removing 101
  - RIP Once technology 2, 4
  - rollers
    - cleaning 61
    - image defects, troubleshooting 238
    - included in printer maintenance kit 60
    - printer, removing 122
    - repeating defects, troubleshooting 240, 243
    - tray 1 operations 94
    - tray 4 operations 96
    - tray 4, removing 155
  - ROM
    - disk, error messages 180
    - formatter operations 81
  - rotate paper message 185
  - rotation check, drum 220
  - ruler, repeating defects 243
- S**
- Save + Restore 250
  - scan buffer errors 208
  - scan error messages 186
  - scanning mirror, operations 84
  - screwdrivers, required 99
  - screws
    - self-tapping, installing 99
    - types of 261

- seal, toner 86
- security
  - configuration page information 226
  - settings 53
  - Web sites, settings 51
- Select key, control panel 31
- self-tapping screws 99, 261
- sensors
  - pickup and feed system 89
  - tray 1 93
  - tray 4 222
  - voltage 80
- separation process, image formation operations 85
- separation rollers
  - image defects, troubleshooting 238
  - printer, removing 122
  - tray 1 94
  - tray 4, operations 96
  - tray 4, removing 155
- separation static charge eliminating bias, operations 79
- sequences
  - image formation 84
  - operations 71
  - power-on 73
- serial error messages 203
- serial number 6
- service approach 14
- Service menu 215
- service tests 213
- Set Registration 44
- setting up printer 16
- settings
  - control panel, selecting 31
  - image quality 44
  - restoring defaults 53, 217, 219
  - types of 33
- shipping printer 67
- short edge binding, settings 42
- shutter, troubleshooting 236
- site requirements 16
- size, printer
  - space requirements 17
  - specifications 7
- sizes, media
  - configuring trays 172
  - detection operations 87, 96
  - envelopes 19
  - error messages 185, 204
  - mismatch error message 186
  - supported 26
- sizes, screws 261
- skew
  - adjustment operations, tray 4 95
  - specifications 234
  - troubleshooting 241
- skin contact, toner 61
- skip disk 218, 220
- Sleep mode settings 46
- SLEEP sequence of operations 73
- small paper
  - mode 45
  - troubleshooting 241
- smears, troubleshooting 241
- smudges, horizontal 239
- software
  - HP LaserJet 9000 Series Printer CD-ROM 260
  - settings 33
- solenoids
  - pickup and feed system 92
  - tray 1 93, 94
  - voltage 80
- space requirements 17
- spare parts, ordering 14
- special media
  - coated 22
  - embossed 22
  - envelope specifications 19
  - fuser lever positioning 237
  - label specifications 20
  - loading 25
  - output path 244
  - perforated 22
  - storing 22
  - transparency specifications 21
- specifications
  - print cartridges, storing 67
  - printer 7
  - skew 234
  - speed 2, 4
- specks, troubleshooting 241
- speed
  - data transmission settings 48
  - network settings 53
  - printer, specifications 2, 4
  - resolution settings 44
- spilled toner, cleaning 61
- stacker
  - communications, troubleshooting 228
  - Install guide 259
  - locating 10, 12
  - models including 7
  - paper sizes supported 27
- stages
  - image formation 84
  - operations 71
  - power-on 73
- standard memory 6
- standard top bin, paper sizes supported 26
- staple cartridges
  - ordering 14
  - part numbers 257
- stapler/stacker
  - communications, troubleshooting 228
  - error messages 186
  - Install guide 259
  - locating 10, 12
  - models including 7
  - paper sizes supported 27
  - space requirements 18
- Start guide 259
- static charge eliminating bias, operations 79
- static eliminator
  - image defects, troubleshooting 242
  - operations 85
- static, precautions for 99
- stationary jams
  - tray 2 or 3 88
  - tray 4 96
- status messages 47, 178
- status, supplies information page
  - printing 38
  - using 230
- STBY (standby) sequence 71
- Stop button, control panel 31
- stopped printing, troubleshooting 171

- stored jobs
  - control panel settings 38
  - timeout settings 46
- storing
  - envelopes 23
  - media 22
  - print cartridges 67
  - printer 8
- straight paper path, using 244
- stripped screw holes 99
- subassemblies, service approach 14
- sub-heater (H2), operations 80
- supplies
  - ordering 14
  - part numbers 257
- supplies status page
  - printing 38
  - using 230
- surface coatings, media 22
- switches
  - engine test 215
  - media-length detection (SW2-SW5) 90
  - paper-size detection (tray 4), removing 160
  - pickup and feed system 89
  - tray 4 223
- symbol sets 43
- synthetic media 22
- System setup submenu 46
- systems, operations overview 70

**T**

- tapping screws 261
- TCP/IP settings 50, 52, 246
- telephone numbers, ordering parts 14
- temperature
  - environmental specifications, printer 8
  - fuser heating operations 80
  - label specifications 20
  - print cartridges, storing 67
  - storing media 22
- temporary settings 33
- tests
  - communications 246
  - diagnostics flowchart 216
  - drum rotation 220
  - engine 174, 215
  - high-voltage power supply 220
  - LAN 247
  - loopback 247, 249
  - paper path 213
  - ping 248
  - print cartridge 234
  - service 213
  - tray 4 221
  - troubleshooting, preliminary 170
- text, troubleshooting
  - dropouts 238
  - misformed 242
- thermistors, fuser control circuit 80
- time, setting 46
- timeout settings
  - held jobs 46
  - I/O 48
  - Sleep mode 46
- timing chart, printer operations 74
- toner
  - bubbles, troubleshooting 239
  - cleaning spilled 61
  - coverage, usage page information 231
  - density settings 45
  - first aid measures 61
  - image formation operations 84
  - level detection operations 79
  - loose, troubleshooting 240
  - no-shake cartridge design 85
  - seal 86
  - smears, troubleshooting 241
  - specks, troubleshooting 241
- toner-sensor contact assembly, removing 140
- tools, required 99
- top assemblies, removing 111
- top covers
  - left, removing 103
  - right, removing 101
- torque limiter, operations 87
- torque values, screws 261
- trailing edge, detection operations
  - tray 2 or 3 88
  - tray 4 96
- transfer bias generation 79
- transfer charging roller
  - cleaning operations 79
  - image formation operations 84
  - operations 85
- transfer guide assembly, removing 131
- transfer process, image formation operations 85
- transfer roller
  - assembly, removing 120
  - cleaning 61
  - contamination, troubleshooting 238
  - diagrams and part numbers 280
  - image defects, troubleshooting 236, 240
  - included in printer maintenance kit 60
- Transmit Once technology 2, 4
- transparencies
  - detection sensor (PS1) 87, 90
  - fuser mode 44
  - specifications 21
- tray 1
  - See also trays*
  - assembly, diagrams and part numbers 290
  - communications 77, 228
  - configuring 172
  - feeding operations 93
  - feeding, troubleshooting 171
  - Install guide 259
  - jam detection operations 94
  - jams, error messages 188, 199
  - loading special media 25
  - locating 10, 12
  - models including 6
  - paper sizes supported 26
  - part number 258
  - registration 33
  - removing 125

## tray 2 or 3

- See *also* trays
- configuring 173
- diagrams and part numbers 277
- feeding, troubleshooting 171
- guides, adjusting 224
- jam detection operations 88
- locating 10
- media detection operations 87
- media-length detection switches 90
- noise, troubleshooting 171
- paper sizes supported 26
- pickup and feed operations 87
- registration 33
- removing 121
- sensors 90
- settings 39

## tray 4

- See *also* trays
- back covers, removing 153
- communications, troubleshooting 228
- configuring 173
- controller board, removing 159
- diagnostics 221
- drive assembly, diagrams and part numbers 288
- drive assembly, removing 158
- drive motor, removing 157
- feeding operations 95
- feeding, troubleshooting 171
- guides, adjusting 224
- Install guide 259
- jam detection operations 96
- left side cover, removing 151
- lights, interpreting 223
- locating 10, 12
- main body, diagrams and part numbers 284
- models including 6
- motors, testing 221
- noise, troubleshooting 171
- paper sizes supported 26
- paper-size detection switch PCB, removing 160
- part number 258
- PCB, diagrams and part numbers 289
- pickup assembly, removing 162
- pickup feed guide, removing 163
- power supply, operations 95
- power supply, removing 161
- printing, troubleshooting 171
- registration assembly, removing 156
- registration settings 33
- removing covers and assemblies 151
- removing from printer 154
- right side cover, removing 152
- rollers included in printer maintenance kit 60
- rollers, removing 155
- sensors, testing 222
- settings 39
- space requirements 18
- stand-alone running test 222

## trays

- capacities 26
- configuration page information 228
- detectable size error messages 182
- feeding, troubleshooting 171, 172
- included 2
- jams, error messages 188, 199
- jams, troubleshooting 224
- Jet-Link device error messages 179
- media error messages 186, 187
- paper path test 213
- paper sizes, supported 26
- part numbers 259
- registration 33, 44
- selecting 46, 172
- unexpected size, error messages 204

## troubleshooting

- about 167
- blank pages 236
- blurry images 238
- bubbles 239
- communications 246
- connectivity 250
- diagnostics flowchart 216
- dropouts 238
- embedded LAN 247
- formatter replacement 250
- gray background 239
- hard disk 217, 218, 219, 220
- horizontal lines 239
- HP Jetdirect print servers 246
- image quality 233
- light print 240
- loose toner 240
- media 244
- misformed characters 242
- noise 171
- power 174
- preliminary operating checks 170
- process flow 168
- repeating defect ruler 243
- repeating defects 240
- repeating images 242
- skewed pages 241
- smeared toner 241
- specks, toner 241
- tray 4, stand-alone diagnostics 221
- vertical lines 241
- wiring diagram 251
- wrinkled pages 237

## TrueType fonts, features 2, 4

## two-sided printing 42

## types, paper

- fuser modes 44
- tray settings 39

## U

- unexpected size, error messages 204
- universal serial bus (USB) communication operations 81
- UNIX, carriage return settings 43
- Up arrow, control panel 31
- upgrading firmware 55
- usage page 38, 231
- USB communication operations 81
- Use guide 259

## V

- vacuuming spilled toner 61

- vertical dots, troubleshooting 242
- vertical line spacing settings 43
- vertical lines, troubleshooting
  - black 241
  - white 242
- vertical transfer assembly, part numbers 258
- vertical transfer door, locating 10
- viewing event log 177
- voltage
  - AC 80
  - high-voltage power supply check 220
  - part numbers 256
  - specifications 7
  - tray 1 power supply 93
  - tray 4 power supply 95
  - variations, allowable 170

## W

- WAIT sequence 71
- wake time, setting 46
- warning messages 178
- warranty 14
- washers, types of 261
- washing off toner 61
- waste toner, cleaning operations 85
- Web JetAdmin
  - configuring trays from 172
  - upgrading firmware with 56, 57
- Web sites
  - documentation 259
  - firmware upgrades 55
  - security settings 51
- weight
  - envelopes 19
  - equivalence table, paper 23
  - paper, supported 26
  - print cartridges 68
  - printer 7
- white lines, troubleshooting
  - horizontal 239
  - vertical 242
- white pages, troubleshooting 236
- Wide A4 setting 42
- wide-format printing 2
- width, printer
  - space requirements 17
  - specifications 7
- Windows, remote firmware upgrades 55
- wire harnesses, replacing 99
- wireless printing 3
- wiring diagrams 251
- wrapping jams, detection operations 87
- wrinkles, troubleshooting
  - envelopes 172
  - pages 237
- writing process, image formation operations 84



© 2005 Hewlett-Packard Development Company, L.P.

[www.hp.com](http://www.hp.com)



Q3721-90963