

HP

LaserJet

1100A

Service Manual



HP LaserJet 1100A

Service Manual _____

© Copyright
Hewlett-Packard Company 1998

All Rights Reserved. Reproduction, adaptation, or translation without prior written permission is prohibited, except as allowed under the copyright laws.

Publication number
C4224-90962

First edition, October 1998

Trademark Credits

Adobe and PostScript are trademarks of Adobe Systems Incorporated which may be registered in certain jurisdictions.

Windows is a U.S. registered trademark of Microsoft Corporation.

Warranty

The information contained in this document is subject to change without notice.

Hewlett-Packard makes no warranty of any kind with regard to this material, including, but not limited to, the implied warranties or merchantability and fitness for a particular purpose.

Hewlett-Packard shall not be liable for errors contained herein or for incidental or consequential damages in connection with the furnishing, performance, or use of this material.

WARNING

Electrical Shock Hazard

To avoid electrical shock, use only supplied power cords and connect only to properly grounded wall outlets.

Conventions

This manual uses the following conventions:

The names of major printer parts and assemblies are Capitalized.

Color is used to emphasize items which are important to the material under discussion.

Bold is used for emphasis, particularly in situations where *italic* type would be confusing.

Italic type is used to indicate related documents or emphasis.

NOTE:

Notes contain important information set off from the text.

CAUTION:

Caution messages alert you to the possibility of damage to equipment or loss of data.

WARNING!

Warning messages alert you to the possibility of personal injury.

Chapter Descriptions

1 Printer Specifications

Contains printer features and product overview, printer specifications, and required safety and compliance statements.

2 Product Operation

Contains descriptions of the Control Panel, printer key functionality, scanner Control Panel, paper handling, toner cartridge, and warranty statement.

3 Functional Overview

Contains details about basic functions, printer functions, Engine Control Unit (ECU) and power system, formatter system, image formation system, printer paper feed system, optional document scanner system, and basic sequence of operation.

4 Removal and Replacement

Contains step-by-step procedures for replacing field replaceable units (FRUs) in the printer.

5 Troubleshooting/Maintenance

Contains details basic troubleshooting steps, fatal errors and accessory errors, image formation troubleshooting steps, solving image quality problems, cleaning procedures, functional checks, ServiceMode functions, and troubleshooting tools.

6 Parts and diagrams

Contains exploded view drawings and part number listings for all replaceable parts in the printer.

Contains two replaceable parts tables: one sorted alphabetically by part name and one sorted numerically by part number. Both tables are cross referenced to the diagrams in the chapter.

Index

Contains an alphabetical, cross referenced listing of information found in the main body of the manual.

Contents

1 Printer Specifications

Printer description	10
Hardware description	11
Firmware description	12
Specifications	13
FCC compliance	16
Environmental Product Stewardship Program	17
Protecting the Environment.	17
Material safety data sheet	19
Additional product stewardship	20
Environmental conformity	20
Regulatory statements	21
Laser safety statement	22
Canadian DOC regulations.	23
Korean EMI statement	23
Laser statement for Finland	24

2 Product Operation

HP LaserJet 1100 Printer control panel	26
Printer key functionality	29
Scanner control panel	31
Printer paper handling	35
Toner cartridge information	38
Warranty statement	39

3 Functional Overview

Basic functions	42
Printer functions	43
Engine Control Unit (ECU)/power system	44
Printer engine control system	45
Power system on ECU	46
Formatter system	48
Control panel.	49
Draft mode	49
Memory Enhancement technology (MEt)	49
Enhanced I/O	49
Page Protect	49
PJL Overview	50
Image formation system	51
Toner cartridge	51
Printer paper feed system	53
Paper jam detection	54
Solenoid, photosensors, and switches	55
Document scanner system (optional)	56
Basic sequence of operation (formatter to printer)	58

4 Removal and Replacement

Removal and replacement strategy	62
Required tools	63
External assemblies and covers	64
Paper guides removal	64
Document scanner removal	65
Document scanner opening	66
Contact image sensor removal	67
Printer door removal	70
Pod removal	76
Back cover removal	77
Internal paper guide removal	79
Front cover removal	80
Stabilizer bars removal	82
Printer laser/scanner cover removal	83
Internal assemblies	84
Scanner assembly removal	84
Output roller removal	85
Delivery assembly removal	87
Paper exit sensor flag removal	89
Fusing element removal	90
Fusing element removal	91
Gear train motor and solenoid removal	95
Solenoid removal	98
Pressure roller removal	99
Transfer roller removal	101
Pickup roller removal	102
Paper pick-up assembly removal	103
Kick plate removal	105
Separation pad removal	106
Bottom assemblies	108
Formatter pan removal	108
Document scanner cable removal	110
Hinge mechanism removal	112
ECU pan removal	113
Paper feed assembly removal	115

5 Troubleshooting/Maintenance

Basic troubleshooting	120
Fatal errors/accessory errors	122
Image formation troubleshooting	125
Checking the toner cartridge	125
Solving image quality problems	126
Solving paper feed problems	134
Cleaning procedures	137
Cleaning the toner cartridge area	137
Cleaning the printer paper path	137
Cleaning the pickup roller	137
Cleaning the scanner	138
Functional checks	140
Engine test	140
Self test page	141
Half-self test functional check	142
Drum rotation functional check	143
Heating element check	143
High-voltage power supply check	146
Paper curl	147
Paper path check	147
ServiceMode functions (PJL Software Commands)	149
Troubleshooting tools	152
Printer paper path	152
Document paper path	153
Repetitive image defect ruler	154
Main wiring	155

6 Parts and diagrams

How to use the parts lists and diagrams	158
Parts and supplies	159
Ordering Information	159
Consumables and accessories	160
Ordering consumables	161
Common hardware	162
External covers and panels	163
Document scanner parts	164
Internal components	165
Feeder assembly	172
Engine controller assembly	174
Formatter pan	176
Parts list sorted by part number	177
Parts list sorted by part name	180

1

Printer Specifications

Chapter contents

Printer description	10
Hardware description	11
Firmware description	12
Specifications	13
FCC compliance	16
Environmental Product Stewardship Program	17
Material safety data sheet	19
Regulatory statements	21

Printer description

The HP LaserJet 1100 Printer is the next generation low-cost HP LaserJet printer. It provides 600 dots-per-inch (dpi) LaserJet features and add-on scanner capabilities at the lowest possible price. The scanner is 300 dpi/8 bits per pixel (bpp) and contains an automatic document feed (ADF) holding up to 20 pages.

The HP LaserJet 1100 Printer prints eight pages-per-minute (ppm). It provides an excellent Windows printing solution, ease of use, and higher performance. With 600 dpi resolution, the HP LaserJet 1100 Printer has exceptional text and graphics print quality. The simplified Control Panel and improved paper handling make this product very simple to use. The HP LaserJet 1100 Printer also provides modular scanner capability.

This product is sold in three configurations:

1. Printer Only:

- C4224AHP LaserJet 1100 Printer
- C4225AHP LaserJet 1100 xi Printer (U.S.)
- C4226AHP LaserJet 1100 si Printer (U.S.)

2. Printer and Scanner:

- C4218A HP LaserJet 1100A Printer-Copier-Scanner
- C4219A HP LaserJet 1100A xi Printer-Copier-Scanner (U.S.)
- C4220AHP LaserJet 1100A se Printer-Copier-Scanner (U.S.)

3. Scanner Only:

- C4221A Copier-Scanner for HP LaserJet 1100 Printer

Hardware description

The HP LaserJet 1100 Printer engine prints eight pages per minute. The HP LaserJet 1100 Printer has a compact design with vertical paper trays.

There is one main Paper Input Bin with a 125-sheet capacity for continuous, multiple-page printing. Manual, single-sheet printing is possible through the Single Sheet Input Slot. Both trays are center justified for all supported paper sizes. The output tray holds up to 100 sheets.

The HP LaserJet 1100 Printer has a very fast first-page-out, at less than twenty seconds. It has a Control Panel containing two LEDs. A third LED is located on the Go Key. The formatter board contains 4 MB of ROM, 2 MB of RAM, and a 32-bit MCF5202 chip. There is one slot available for DIMM Memory Expansion (supporting a 4 MB, 8 MB, or 16 MB DIMM). The HP LaserJet 1100 Printer engine has a 7,000 pager-per-month duty cycle and has no fan. The toner life for the HP LaserJet 1100 Printer is 2,500 pages. The attachable scanner has two Control Panel buttons and up to 20-page ADF.

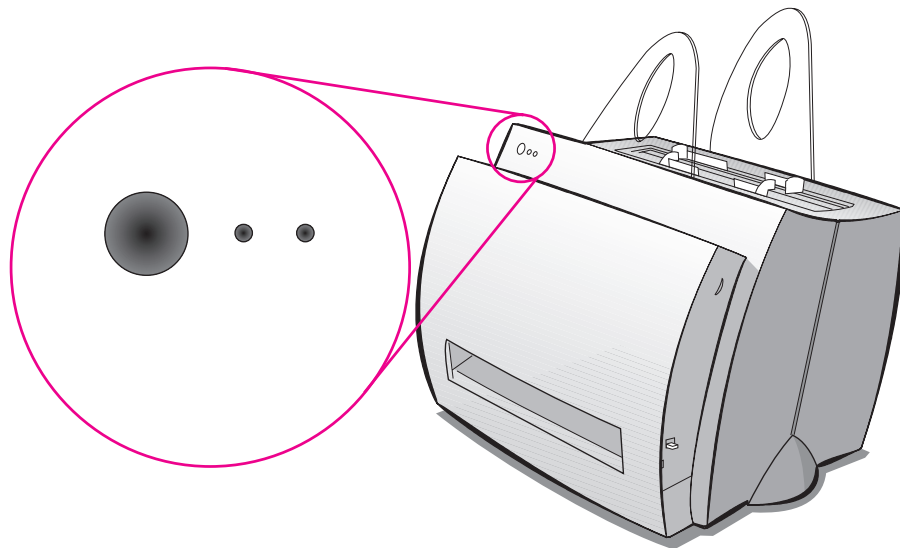

Figure 1-1 Control panel

Firmware description

The firmware in the HP LaserJet 1100 Printer includes:

- Enhanced PCL 5 with Status Readback
- 26 scalable Intellifont Fonts
- Full page 600 dpi bitmap
- 600 dpi
- Pixel Placement, Mosaic Characters
- Memory Enhancement technology (MEt) with Hardware Compression/Decompression

The HP LaserJet 1100 Printer firmware also has REt and EconoMode functionality. Scan capability for the scanner attachment includes 300 dpi and 256 levels of gray (8 bpp).

Specifications

Table 1-1. Printer specifications

Environmental specifications

Operating environment	Printer plugged into an AC outlet: <ul style="list-style-type: none">• Temperature: 10° C to 32.5° C (50° F to 90.5° F)• Humidity: 20% to 80% (no condensation)
Storage environment	Printer unplugged from an AC outlet: <ul style="list-style-type: none">• Temperature: 0° C to 40° C (32° F to 104° F)• Humidity: 10% to 90% (no condensation)

Acoustics

Noise level	During printing: <ul style="list-style-type: none">• 6.1 Bels sound power level (per ISO 9296) (HP LaserJet 1100 Printer tested at 8 ppm)• Sound pressure level (bystander position): 47 dB• Sound pressure level (operator position): 55 dB• Silent during standby and sleep mode
-------------	---

Electrical specifications

Power requirements	<ul style="list-style-type: none">• 100-120v (+/-10%), 50/60 Hz (+/-2); 127v, 60Hz NOM <p>or</p> <ul style="list-style-type: none">• 220v (+/-10%), 50/60 Hz (+/-2 Hz)• 220-240v (+/-10%), 50 Hz (+/-2 Hz)
Power consumption	<ul style="list-style-type: none">• During printing: 200 watts (average)• During standby and power save: 6 watts
Minimum recommended circuit capacity	4.5A @ 115v; 2.5A @ 230v

Table 1-1. Printer specifications (continued)

Physical specifications

Dimensions (1100)	<ul style="list-style-type: none">• Width: 367 mm (14.5 inches)• Depth: 306 mm (12.8 inches)• Height: 266 mm (14.9 inches)
Weight (cartridge installed)	<ul style="list-style-type: none">• 7.2 kg (16.1 lb)
1100A	<ul style="list-style-type: none">• Width: 367 mm (14.5 inches)• Depth: 402 mm (15.8 inches)• Height: 378 mm (14.9 inches)
Weight	<ul style="list-style-type: none">• 8.7 kg (19.2 lb)

Printer capacities and ratings

Print speed	8 pages per minute (Letter size paper)
Paper input bin capacity	125 sheets of regular weight 20 lb (75 g/m ²) paper or up to 10 envelopes
Paper output bin capacity	100 sheets of regular weight 20 lb (75 g/m ²) paper
Minimum paper size	76 x 127 mm (3 x 5 inches)
Maximum paper size	216 x 356 mm (8.5 x 14 inches)
Base memory	4 MB of ROM and 2 MB of RAM
Upgrade memory expansion	One DIMM slot available for a 4 MB, 8 MB, or 16 MB RAM DIMM
Print resolution	600 dots per inch (dpi)
Duty cycle	7,000 single-sided pages per month

Scanning Capacities and Ratings

Table 1-1. Printer specifications (continued)

Scan Speed	Up to 8 pages per minute (Letter size paper)
Input Capacity	Up to 20 pages of regular weight 20 lb (75 g/m ²) paper
Minimum Paper Size	51 x 89 mm (2 x 3.5 inches)
Maximum Paper Size	216 x 762 mm (8.5 x 30 inches)
Scan Resolution	300 dots per inch 256 levels of gray
Duty Cycle	2,500 pages per month

FCC compliance

This equipment has been tested and found to comply with the limits for a Class B digital device, pursuant to Part 15 of the FCC rules. These limits are designed to provide reasonable protection against harmful interference in a residential installation. This equipment generates, uses, and can radiate radio frequency energy. If it is not installed and used in accordance with the instructions, it may cause harmful interference to radio communications. However, there is no guarantee that interference will not occur in a particular installation. If this equipment does cause harmful interference to radio or television reception, which can be determined by turning the equipment off and on, the user is encouraged to try to correct the interference by one or more of the following measures:

- Reorient or relocate the receiving antenna.
- Increase separation between equipment and receiver.
- Connect equipment to an outlet on a circuit different from that to which the receiver is located.
- Consult your dealer or an experienced radio/TV technician.

NOTE:

Any changes or modifications to the printer that are not expressly approved by HP could void the user's authority to operate this equipment.

Use of a shielded interface cable is required to comply with the Class B limits of Part 15 of FCC rules.

Environmental Product Stewardship Program

Protecting the Environment

Hewlett-Packard Company is committed to providing quality products in an environmentally sound manner. This HP LaserJet printer has been designed with several attributes to minimize impacts on our environment.

This HP LaserJet printer eliminates:

Ozone production

The printer uses charging rollers in the electrophotographic process and therefore generates no appreciable ozone gas (O₃).

This HP LaserJet printer design reduces:

Energy consumption

Energy usage drops to as little as 6 W while in low-power (PowerSave) mode. Not only does this save natural resources, but it also saves money without affecting the high performance of this printer. This product qualifies for ENERGY STAR. ENERGY STAR is a voluntary program established to encourage the development of energy-efficient office products. ENERGY STAR is a U.S. registered service mark of the U.S. EPA.



As an ENERGY STAR partner, Hewlett-Packard Company has determined that this product meets ENERGY STAR Guidelines for energy efficiency.

Toner consumption

EconoMode uses significantly less toner, which may extend the life of the toner cartridge.

Paper use

Depending on the type of software program in use, you can request for a number of pages of your document to be printed on one page of paper. This N-up printing practice and the printer's manual duplexing feature, which provides two-sided printing, can reduce paper usage and the resulting demands on natural resources.

The design of this HP LaserJet printer facilitates the recycling of:

Plastics

Plastic housing parts have markings according to international standards that enhance the ability to identify plastics for recycling purposes at the end of the printer's life.

HP LaserJet printing supplies

In many countries, this product's printing supplies (e.g., toner cartridge, drum, fuser) can be returned to HP through the HP Planet Partners Printing Supplies Environmental Program. An easy-to-use takeback component of the program is available in over 20 countries. Multi-lingual program information and instructions are included in every new HP LaserJet Toner Cartridge and Consumables box.

HP Planet Partners printing supplies environmental program information

Since 1990, the HP LaserJet Toner Cartridge Recycling Program has collected more than 12 million used HP LaserJet toner cartridges that otherwise may have been discarded in the world's landfills. The HP LaserJet toner cartridges go to a collection center and are bulk shipped to our recycling partners who disassemble the cartridge parts for recycling. After a thorough quality inspection, minor parts such as nuts, screws, and clips are reclaimed for use in new cartridges. Remaining materials are separated and converted into raw materials for use by other industries to make a variety of useful products. For more information in the U.S., call 1-800-340-2445 or visit the HP LaserJet Supplies website at:

Asia Pacific: <http://www.hp.com/sg/asiapacific/planp1.htm>

U.S.: <http://www.ljsupplies.com/planetpartners/>

Europe: http://www.hp.com/pays/eur_supplies/english/planetpartners

Non-U.S. customers should call the local HP Sales and Service Office for further information regarding availability of the HP Planet Partners LaserJet Toner Cartridge and Consumables Recycling Program.

Paper

This printer is suited for the use of recycled papers when the paper meets the guidelines outlined in the *HP LaserJet Printer Family Paper Specifications Guide*. See "Accessories and Ordering Information" in the *HP LaserJet Printer Family Paper Specifications Guide* for ordering information. This printer is suitable for the use of recycled paper according to DIN 19 309.

Material safety data sheet

The Toner Cartridge/Drum MSDS can be obtained by contacting the HP LaserJet Supplies website at <http://www.ljsupplies.com/planetpartners/datasheets.html>. If you do not have access to the Internet, try calling the U.S. HP FIRST (fax-on-demand service) at 1-800-231-9300. Use Index number 7 for a listing of the Toner Cartridge/Drum Material/Chemical Safety Data Sheets. Non-US customers should refer to the front of this manual for appropriate phone numbers and information.

Additional product stewardship

Environmental conformity

The design of this HP LaserJet printer facilitates the recycling of:

Printer and parts

Design for recycling has been incorporated into this printer and its accessories. The number of materials has been kept to a minimum while ensuring proper functionality and high product reliability. Dissimilar materials have been designed to separate easily. Fasteners and other connections are easy to locate, access, and remove with common tools. High priority parts have been designed to be accessed quickly for efficient disassembly and repair. Plastic parts have been primarily designed in two colors to enhance recycling options. A few small parts are colored specifically to highlight customer access points. The plastics used in the printer housing and chassis are technically recyclable.

HP provides a product return system for customers in Germany. Many of the functional parts are recovered, tested, and reused as fully warranted service parts. Used parts are not placed into new products. Remaining product parts are recycled, if possible. For product return information, contact the address below:

Hewlett-Packard GmbH
Wertstoffzentrum
Fronackerstr.30
71063 Sindelfingen

To ensure longevity of your HP LaserJet printer, HP provides the following:

Extended warranty

HP SupportPack provides coverage for the HP hardware product and all HP-supplied internal components. The hardware maintenance warranty covers a three-year period from date of the HP product purchase. The customer must purchase HP SupportPack within 90 days of the HP product purchase. Information on HP SupportPack is available in a fax format by calling HP FIRST (Fax Information Retrieval Service Technology). The document number is 9036. Customers can contact the nearest HP dealer about this service.

Spare parts and consumables availability

Spare parts and consumable supplies for this product will be made available for at least five years after production has stopped.

Regulatory statements

Declaration of Conformity according to ISO/IEC Guide 22 and EN45014	
Manufacturer's Name:	Hewlett-Packard Company
Manufacturer's Address:	11311 Chinden Boulevard Boise, Idaho 83714-1021, USA
declares that the product	
Product Name:	HP LaserJet 1100 Printer
Model Number:	C4224A
Product Options:	ALL
conforms to the following Product Specifications:	
Safety:	IEC 950:1991+A1+A2+A3+A4 / EN 60950:1992+A1+A2+A3+A4 IEC 825-1:1993 / EN 60825-1:1994 Class 1 (Laser/LED)
EMC:	CISPR 22:1993+A1 / EN 55022:1994 Class B ¹ EN 50082-1:1992 IEC 801-2:1991 / prEN 55024-2:1992 - 4 kV CD, 8 kV AD IEC 801-3:1984 / prEN 55024-3:1991 - 3 V/m IEC 801-4:1988 / prEN 55024-4:1992 - 0.5 kV Signal Lines 1.0 kV Power Lines IEC 1000-3-2:1995 / EN61000-3-2:1995 IEC 1000-3-3:1994 / EN61000-3.3:1995 FCC Title 47 CFR, Part 15 Class B ²⁾ / ICES-003, Issue 2 / VCCI-2 ¹⁾ AS / NZS 3548:1992 / CISPR 22:1993 Class B ¹⁾
Supplementary Information:	
The product herewith complies with the requirements of the following Directives and carries the CE-marking accordingly: the EMC directive 89/336/EEC the Low-Voltage Directive 73/23/EEC The product was tested in a typical configuration with Hewlett-Packard Personal Computer Systems. This Device complies with Part 15 of the FCC Rules. Operation is subject to the following two conditions: (1) this device may not cause harmful interference, and (2) this device must accept any interference received, including interference that may cause undesired operation.	
For Compliance Information ONLY, contact:	
Australia Contact:	Product Regulations Manager, Hewlett-Packard Australia Ltd., 31-41 Joseph Street, Blackburn, Victoria 3130, Australia
European Contact:	Your Local Hewlett-Packard Sales and Service Office or Hewlett-Packard GmbH, Department HQ-TRE / Standards Europe, Herrenberger Straße 130, D-71034 Böblingen (FAX: +49-7031-14-3143)
USA Contact:	Product Regulations Manager, Hewlett-Packard Company, PO Box 15 Mail Stop 160, Boise, ID 83707-0015 (Phone: 208-396-6000)

Laser safety statement

The Center for Devices and Radiological Health (CDRH) of the U.S. Food and Drug Administration has implemented regulations for laser products manufactured since August 1, 1976. Compliance is mandatory for products marketed in the United States. The printer is certified as a "Class 1" laser product under the U.S. Department of Health and Human Services (DHHS) Radiation Performance Standard according to the Radiation Control for Health and Safety Act of 1968.

Since radiation emitted inside the printer is completely confined within protective housings and external covers, the laser beam cannot escape during any phase of normal user operation.

WARNING!

Using controls, making adjustments, or performing procedures other than those specified in this user's guide may result in exposure to hazardous radiation.

Canadian DOC regulations

Complies with Canadian EMC Class B requirements.

«Conforme á la classe B des normes canadiennes de compatibilité électromagnétiques.
«CEM».»

Korean EMI statement

사용자 안내문 (B급 기기)

이 기기는 비업무용으로 전자파장해검정을 받은 기기로서, 주거지역에서는 물론 모든 지역에서 사용할 수 있습니다.

Laser statement for Finland

LASERTURVALLISUUS

LUOKAN 1 LASERLAITE

KLASS 1 LASER APPARAT

HP LaserJet 1100 Printer -laserkirjoitin on käyttäjän kannalta turvallinen luokan 1 laserlaite. Normaalisissa käytössä kirjoittimen suojakoteloointi estää lasersäteiden pääsyn laitteen ulkopuolelle.

Laitteen turvallisuusluokka on määritetty standardin EN 60825-1 (1993) mukaisesti.

VAROITUS!

Laitteen käyttäminen muulla kuin käyttöohjeessa mainitulla tavalla saattaa altistaa käyttäjän turvallisuusluokan 1 ylittävälle näkymättömälle lasersäteilylle.

WARNING!

Om apparaten används på annat sätt än i bruksanvisning specificerats, kan användaren utsättas för osynlig laserstrålning, som överskrider gränsen för laserklass 1.

HUOLTO

HP LaserJet 1100 Printer -kirjoittimen sisällä ei ole käyttäjän huollettavissa olevia kohteita. Laitteen saa avata ja huoltaa ainoastaan sen huoltamiseen koulutettu henkilö. Tällaiseksi huoltotoimenpiteeksi ei katsota väriainekasetin vaihtamista, paperiradan puhdistusta tai muita käyttäjän käsikirjassa lueteltuja, käyttäjän tehtäväksi tarkoitettuja ylläpitotoimia, jotka voidaan suorittaa ilman erikoistyökaluja.

VARO!

Mikäli kirjoittimen suojakotelo avataan, olet alttiina näkymättömälle lasersäteilylle laitteen ollessa toiminnassa. Älä katso säteeseen.

WARNING!

Om laserprinterns skyddshölje öppnas då apparaten är i funktion, utsättas användaren för osynlig laserstrålning. Betrakta ej strålen.

Tiedot laitteessa käytettävän laserdiodin säteilyominaisuuksista:

Aallonpituus 770-795 nm

Teho 5 mW

Luokan 3B laser

2 Product Operation

Chapter contents

HP LaserJet 1100 Printer control panel	26
Printer key functionality	29
Scanner control panel	31
Printer paper handling	35
Toner cartridge information	38
Warranty statement	39

HP LaserJet 1100 Printer control panel

Hardware overview

The HP LaserJet 1100 Printer's Control Panel consists of two LEDs and a Go key containing a third LED. There is one amber LED (the Attention LED), and two green LEDs (the Ready LED and the Go LED). The green LEDs are contained in the Go key. If the scanner is attached, there are two additional buttons. Scanner modes are not shown on the printer LEDs and scan keys have no effect on printer functionality.

Go key

The HP LaserJet 1100 Printer Control Panel's single Go key will be the only means the user has of interacting with the printer, except through software. Therefore, the Go key must perform all actions the user needs. The Go key performs ten functions. These functions are explained in the table below. See "Scanner control panel" on page 31.

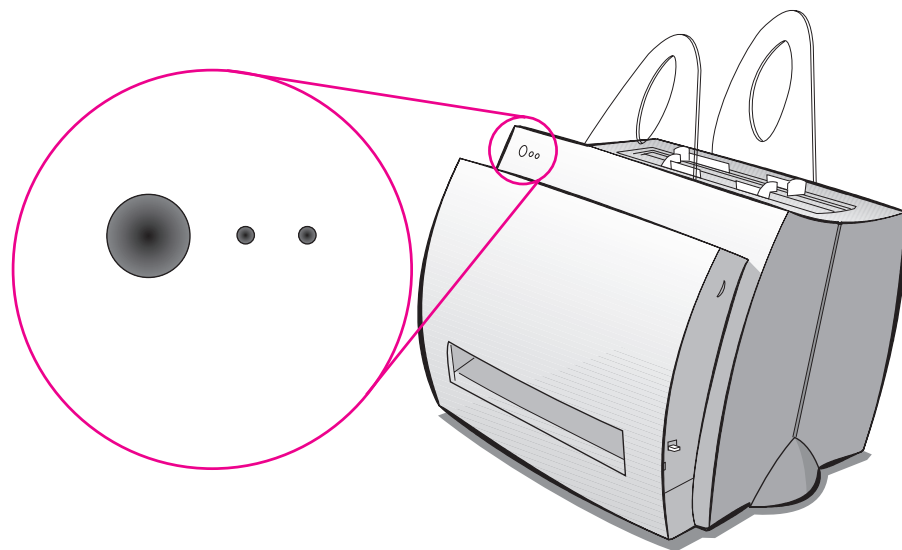

Figure 2-1 Printer light patterns

Light status legend



-  Symbol for "light off"
-  Symbol for "light on"
-  Symbol for "light blinking"

Table 2-1. Control panel light messages











Light status	Condition of the printer	Action
	<p>PowerSave mode (or the printer is off)</p> <p>The printer uses PowerSave mode to conserve energy.</p>	<p>Low power consumption mode. Pressing the Go key on the printer control panel or printing will awaken the printer from PowerSave mode. Check the power cord if the above actions do not generate a response (and the power switch if your printer is powered with 220-240 volts).</p>
	<p>Ready</p> <p>The printer is ready to print.</p>	<p>No action is necessary; however, if you press and release the Go key on the printer control panel, a self-test page will print.</p>
	<p>Processing Self test page Form Feed</p> <p>The printer is receiving or processing data.</p>	<p>Wait for the job to print.</p>
	<p>Buffered data</p> <p>The printer memory is retaining unprinted data. A file has been sent to the printer that does not contain a form feed at the end.</p>	<p>Press and release the Go key on the printer control panel to print the remaining data.</p>
	<p>Manual feed</p> <p>The printer is in manual feed mode. The printer is waiting for a different size sheet of paper to be placed in the Single Sheet Input Slot or Paper Input Bin.</p>	<p>Check that you have loaded the correct paper, then press and release the Go key on the printer's Control Panel to print. Manual feed is controlled by the software. If you do not want to be in manual feed mode, change the setting in your printer properties.</p>
	<p>Door open, no Toner Cartridge, or paper jam</p> <p>The printer is in an error state.</p>	<p>Check the following:</p> <ul style="list-style-type: none"> ● The printer door is closed. ● The Toner Cartridge is correctly installed in the printer. ● There are no paper jams.
	<p>Paper out</p> <p>The printer is out of paper.</p>	<p>Load paper into the printer.</p>

Table 2-1. Control panel light messages (continued)

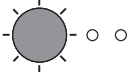
Light status	Condition of the printer	Action
	<p>Memory out</p> <p>The printer ran out of memory in the middle of a print job.</p>	<p>The page being printed may have been too complex for the memory capacity of the printer.</p> <ul style="list-style-type: none">● See “Memory (DIMMs)” in the HP LaserJet 1100 Printer User Guide to add memory.● Press and release the Go key to print.
	<p>Reset/Printer initialization</p> <p>The printer memory is being reset and all previously sent print jobs are being purged. Or, a printer initialization is taking place. All lights blink for 1/2 of a second or longer if initializing.</p>	<p>No action is necessary. However, you can reset the printer if you press and hold the Go key for five seconds.</p>
	<p>Fatal error</p> <p>All lights are on.</p>	<ul style="list-style-type: none">● Turn the printer off and then back on.● Press the Go key to see the secondary light pattern.● See Chapter 5, “Troubleshooting/Maintenance” for details on fatal light patterns.

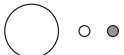
Printer key functionality

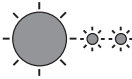
The following table contains each printer mode and the result from a short press (when the **Go key** is pressed for less than five seconds), and the results from a long press (when the **Go key** is pressed for five or more seconds). Scanner keys have no effect on printer functionality other than the sharing of power resources, which may slow down either function.

Table 2-2. Printer key functionality

Printer mode	Short press (less than five seconds)	Long press (greater than five seconds)
Power on / Initialization	No action	Performs NVRAM Initialization if Go key is pressed during power up and held for twenty seconds Prints continuous Self Test if pressed during RAM/ROM check and held for 15 seconds
Sleep mode	Printer transitions to Ready mode or Paper Out mode	Printer transitions to Ready mode or Paper Out mode
Ready	Print the Self Test Page	Printer Reset if held for five seconds Cleaning Page if held for 20 seconds
Processing data	No Action/Form Feed the current page	
Self Test	No action	Printer Reset
Form Feeding	No action	Printer Reset
Buffered Data in printer	Printer performs a form feed	Printer Reset
Manual Feed request	Printer prints the page	Printer Reset
Door open / no toner	No action	Printer Reset
Paper Out	No action	Printer Reset
Paper Jam	Attempts to reset jam condition	Printer Reset
Continuable error (Memory Out/Page Punt)	Continue to print	Printer Reset
Resetting	No action	No action
Fatal Error	Shows LED error pattern as long as the Go key is held down	Shows LED error pattern as long as the Go key is held down
Continuous Self Test Page	Printer resets and transitions to Ready mode	Printer resets and transitions to Ready mode

A form feed may occur when the LEDs on the Control Panel are showing a processing mode. This could occur if the computer sends only part of the page to the printer because the computer has not completed processing the entire page. When the Go key is pressed

while data is in the printer, a form feed pending will occur. Once the data the printer has received is completely formatted and no more data is in the I/O, the partial page will be ejected due to the form feed pending.

Normal printer operation

When power is supplied to the printer, all LEDs go on and then off. The LEDs will sequence on and off, one after the other, from the first LED (Go key/LED) to the last LED (Attention LED). If an error is detected or if paper is out, the printer will enter that error mode.

When data is downloaded to the printer (during Ready mode), the Ready LED will blink. When the printer stops receiving data, the Ready LED may continue to blink while the printer formats the data.

If an error occurs, the printer will enter that error mode and display the error on the Control Panel.

Error priority

The highest priority error will be displayed if multiple errors occur simultaneously. The priority of errors, from highest priority (most important) to lowest, is:

- 1 Fatal Errors
- 2 Door Open/No Toner Cartridge
- 3 Paper Jam
- 4 Paper Out
- 5 Memory Error

While in any of the errors except Fatal Error, a reset may be performed by pressing and holding the **Go key** for five or more seconds, or unplug to reset. When the reset completes it will return to the error condition. If the error was cleared by the reset (such as a Memory Error), the printer will return to Ready mode.

Scanner control panel

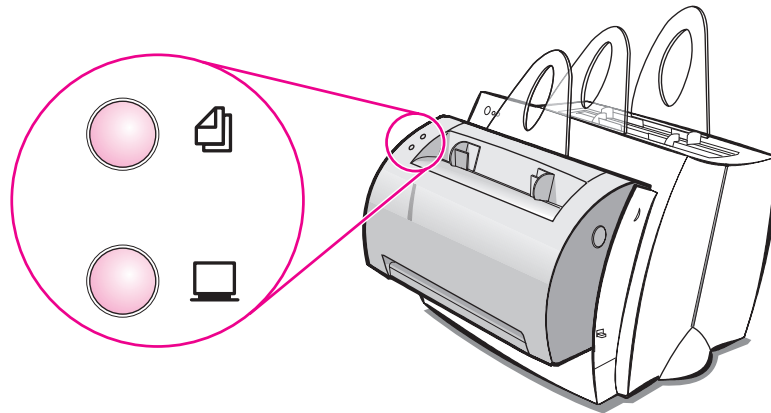

Figure 2-2 Scanner control panel

The scanner Control Panel consists of two keys; a scan key and a copy key. These keys have no effect on the printer other than contention for resources.

Scan

Pressing the scan key sends a message to the computer that opens the appropriate software application to start the scan or starts a scan depending on how the computer software is configured. If the scan is initiated with no paper in the ADF, an error message will appear on the computer.

Quick copy

Pressing the copy button initiates a scan that is sent directly to the printer without using the computer software. If there is no paper in the ADF, the scanner will still attempt to pick up a sheet of paper. The Quick Copy function will work even if the unit is not attached to a computer.

NOTE:

Scan Abort: Pressing both copy and scan keys within one half second of each other causes the scanner to abort the current scan. If there is paper in the scanner, the scan engine will be in a jam mode, and the paper will have to be removed manually. This decreases the chance of documents being damaged by the scanner.

Scanner key functionality based on printer status

The following table contains scanner and printer modes and the result of pressing the scan and/or copy keys. The scanner key has no effect on printer functionality other than some print functionality will be held off due to contention for resources. The only print key press that will affect a scan job, other than contention for resources, is a printer Control Panel reset.

Table 2-3. Scanner key functionality based on printer status

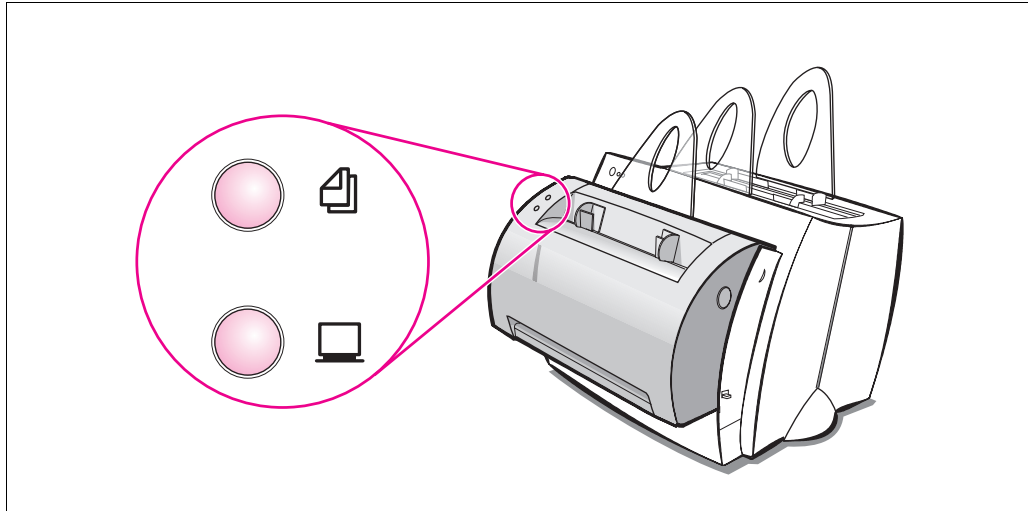

Scanner mode	Scan key press	Scan and copy key pressed together	Copy key press	Printer reset
Power on / Initialization	No action	No action	No action	No action
Sleep mode	Starts scan	No action	Starts copy if paper is in the printer tray	Resets the printer
Ready	Starts scan	No action	Starts copy	Resets the printer
Processing data	Starts scan if scan manager can get the required resources	No action	Starts copy if copy manager can get the required resources	Resets the printer
Self Test	Starts scan if scan manager can get the required resources	No action	Starts copy if copy manager can get the required resources	Resets the printer
Form Feeding	Starts scan if scan manager can get the required resources	No action	Starts copy if copy manager can get the required resources	Resets the printer
Buffered Data in printer	Starts scan if scan manager can get the required resources	No action	Starts copy if copy manager can get the required resources	Resets the printer
Manual Feed request	Starts scan if scan manager can get the required resources	No action	Starts scanning copy, but will wait until the printer is ready	Resets the printer
Door open / no toner	Starts scan if scan manager can get the required resources	No action	Starts scanning copy, but will wait until the printer is ready	Resets the printer
Paper Out	Starts scan if scan manager can get the required resources	No action	Starts scanning copy, but will wait until the printer is ready	Resets the printer

Table 2-3. Scanner key functionality based on printer status (continued)

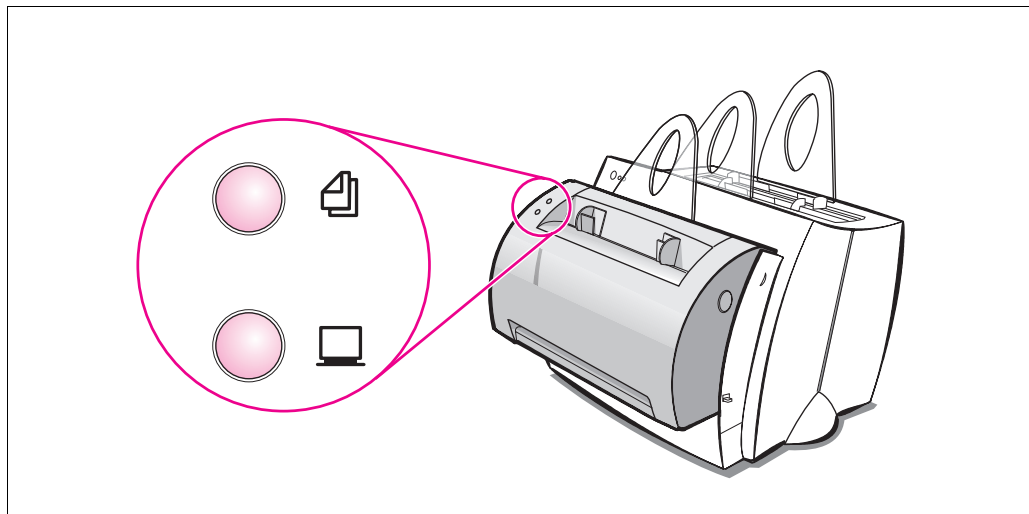

Scanner mode	Scan key press	Scan and copy key pressed together	Copy key press	Printer reset
Printer Paper Jam	Starts scan if scan manager can get the required resources	No action	Starts scanning copy, but will wait until the printer is ready	Resets the printer
Continuable error (Memory Out/Page Punt)	Starts scan if scan manager can get the required resources	No action	Starts scanning copy, but will wait until the printer is ready	Resets the printer
Resetting	No action	No action	No action	No action
Fatal Error	No action	No action	No action	No action
Continuous Self Test Page	Starts scan if scan manager can get the required resources	No action	Starts copy if copy manager can get the required resources	Resets the printer
Scanner jam	No action	No action	No action	Resets the printer, scanner is still jammed
Scanner door open	No action	No action	No action	Resets the printer
Scanning	No action	Scan Abort, if paper is in the scanner results in a scanner jam	No action	Resets the printer, scanner may be in a jammed mode
Quick Copying	After scan attempts to pick, but fails because ADF is empty	If scan is still processing, scan is aborted. What was scanned is still printed. If paper is still in the scanner, results in a paper jam.	No action	Resets the printer, scanner may be in a jammed mode
Scan Abort	No action	No action	No action	Resets the printer, scanner may be in a jammed mode

Normal scanner operation

At power up or after a Control Panel reset, the scan motor rotates to verify it is ready for operation. Scan functionality is only available through computer software. A scan can be initiated two ways: from the computer or from the scanner Control Panel.

When the scan key is pressed on the scanner, it sends a signal to the computer to let it know the firmware is ready to scan. The computer will either prompt the user to start the scan from the computer, or automatically start it, depending on how the Document Assistant is configured. When a scan job is initiated the scanner will pick up a page from the automatic document feeder (ADF), and then wait for the necessary resources to be acquired.

The copy key functionality is always available, even when the printer is disconnected from the computer. When the copy key is pressed it starts the scan of the document from the ADF. If the scanner cannot get the resources it needs, it still picks the first page from the ADF to give the user feedback. When the resources needed to continue are acquired, the scan is started. This scan is passed directly to the printer as print data and printed. This is called a Quick Copy. As much as .75 inches may be clipped (discarded) depending on available memory. If memory resources are limited or the copy original exceeds the printer media by more than .75 inches, the remaining copy data will be printed to a second page with no data lost.

At any time during a scan or Quick Copy the user can press both the scan and copy keys to abort the scan. If there is still a sheet of paper inside the scanner, it will enter the jam mode and the sheet of paper will have to be removed manually. If a Quick Copy occurs, the printer will still print any data it has received

Printer paper handling

There are two vertical input paper trays: the Paper Input Bin and the Single Sheet Input Slot. With the vertical open trays, it is easier for the user to know exactly what paper is in the printer and when the printer is out of paper. There are two paper output paths: the vertical Paper Output Bin and the Front Output Slot in the front of the printer. The user may wish to use the Front Output Slot occasionally since it provides a straighter path and reduces curl.

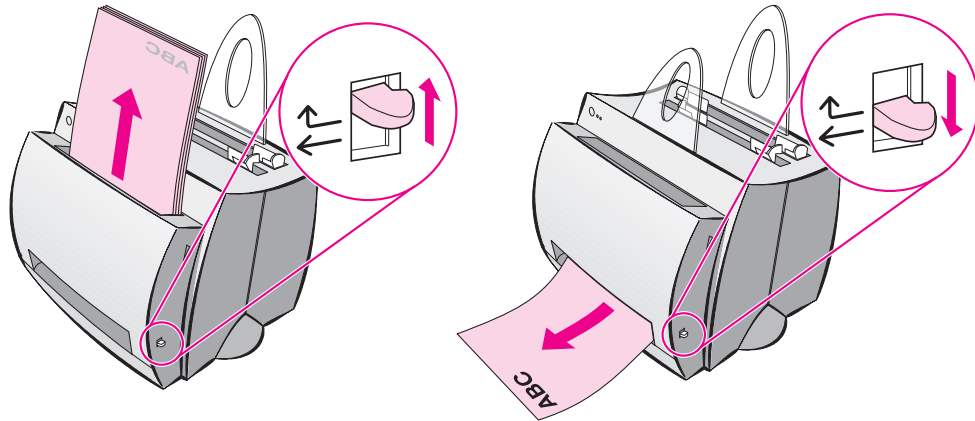

The Paper Path Lever is located on the side of the printer. When the lever is pushed down, it allows the paper to exit through the Front Output Slot. If the lever is pushed up, the paper exits the printer to the Paper Output Bin.

Manual feed

Since the HP LaserJet 1100 Printer has only one paper input sensor, it cannot sense which input tray/slot the paper is in. Therefore, when manual feed has been selected, the printer pauses, waiting for the user to insert the correct paper into the printer (either in the Paper Input Bin or the Single Sheet Input Slot) and press the **Go key**. When the Go key is pressed, the paper is pulled from the Single Sheet Input Slot if paper is loaded there; otherwise, paper is pulled from the Paper Input Bin.

Manual paper feed is normally set by a user's software application. A user can create a Manual Feed request by either sending the PCL Media Source escape sequence or setting the PCL MANUALFEED command. The printer's current PCL setting takes effect if the user has not overridden it with a PCL escape sequence. Otherwise the setting by the PCL escape sequence is used.

When Manual Feed is selected, there may not be any immediate indication on the Control Panel. When the manual feed page has been processed and is ready to be printed, the Go key/LED will begin blinking and the Ready LED will turn off, indicating that the printer is requesting the user to place the correct paper in either the Single Sheet Input Slot or the Paper Input Bin and press the **Go key**.

If the HP LaserJet 1100 Printer has no paper it will show the Paper Out mode (Attention LED on). When paper is loaded it will automatically pick the next page without the user having to press the Go key. If the printer is in a manual feed mode and the user unloads and then reloads paper, the HP LaserJet 1100 Printer will automatically pick the next page as well.

Legal timing

Legal timing refers to the time between the first page picked and the second page picked. Legal timing is the time it takes for a Legal page to go through the engine's paper path.

The HP LaserJet 1100 Printer may run at legal timing if manual feed is selected. If the first manual feed page is followed by a second manual feed page, the first manual feed page will run at legal timing. If a manual feed page is followed by a non-manual feed page, the manual feed page will run at engine speed.

Paper size change

The paper tray is merely a source for paper; it cannot detect the size of the paper. Therefore, the user must inform the printer what size paper is being used. This is normally done automatically by the user's software application. However, this can be done on a job-by-job basis by sending the PCL Page Size escape sequence or setting the PJP PAPER variable. The PCL escape sequence for paper size takes precedence over the PJP PAPER setting.

The user may load a new size of paper and not modify the PJP or PCL variable. Therefore, the paper size may be too large or too small for the formatted page. The image that has been formatted will be placed on the sheet of paper and fed through the printer.

Scanner paper handling

The scanner can handle a slightly wider range of paper sizes than the print engine. It will have a single automatic document feeder (ADF) that supplies a single straight paper path. The ADF has no paper sensor, so the scanner will attempt a paper pickup to determine if the bin is empty or not. Therefore, when a job is started, it attempts to pick a page to make sure a page is available in the ADF. Once a job is started, the scanner continues to pick pages until the ADF is empty. The ADF has no ability to tell how wide the source page is, so page scan width has to be set from the computer.

Main input tray (ADF)

A center justified, vertical Paper Input Bin with a 20-sheet capacity adjustable to all supported paper and envelope sizes.

Output tray

None

Straight through paper path

Paper is output through the Front Output Slot in face-up, reverse order.

Priority feed

None

Supported paper and envelope sizes

Scan: Minimum 2 x 3.5 inches

Maximum 8.5 x 30 inches

Copy: Letter, Legal, A4, Executive

Envelopes - Commercial 10, Monarch, C5, DL, B5, no custom

Paper Input Sensor(s)

None

Paper size change

As with the printer, the scanner has to receive paper size information on a job-by-job basis. There is an unchangeable default, but the scan width can be adjusted by the job. The scan length is determined by the media. Quick Copy paper sizes are set from the computer, except in an NVRAM initialization or initial power up when paper size is set to a factory default NVRAM value. This value is the same as the printer factory default paper size. If the media is larger than the Quick Copy page size or the print page size, clipping might occur.

Toner cartridge information

The Toner Cartridge is designed to simplify replacement of the major “consumable” parts. The Toner Cartridge contains the printing mechanism and a supply of toner.

At 5% page coverage, a Toner Cartridge will print approximately 10,000 pages. However, a Toner Cartridge should print more pages if regularly printing pages with less coverage, such as short memos. The cartridge may print fewer pages if heavy or bold print is used.

NOTE:

For best results, always use a Toner Cartridge before the expiration date stamped on the Toner Cartridge’s box.

Refilled toner cartridges

While Hewlett-Packard does not prohibit the use of refilled Toner Cartridges during the warranty period or while the printer is under a maintenance contract, it is not recommended for the following reasons:

- Repairs resulting from the use of refilled Toner Cartridges are not covered under Hewlett-Packard warranty or maintenance contracts.
- Hewlett-Packard has no control or process to ensure that a refilled Toner Cartridge functions at the high level of reliability of a new HP LaserJet Toner Cartridge. Hewlett-Packard also cannot predict what the long term reliability effect on the printer is from using different toner formulations found in refilled cartridges.
- The print quality of HP LaserJet Toner Cartridges influences the customer’s perception of the printer. Hewlett-Packard has no control over the actual print quality of a refilled Toner Cartridge.

Recycling toner cartridges

In order to reduce waste, Hewlett-Packard offers a recycling program, called HP Planet Partners, for used Toner Cartridges. Cartridge components that do not wear out are recycled. Plastics and other materials are recycled. HP pays the shipping costs from the user to the recycling plant. To join this recycling effort, follow the instructions inside the Toner Cartridge’s box.

Warranty statement

This warranty gives specific legal rights. There may also be other rights which vary from area to area. See the user guide for further warranty information or see the warranty card included with the printer.

3

Functional Overview

Chapter contents

Basic functions	42
Printer functions	43
Engine Control Unit (ECU)/power system	44
Formatter system	48
Image formation system	51
Printer paper feed system	53
Document scanner system (optional)	56
Basic sequence of operation (formatter to printer)	58

Basic functions

This chapter presents a functional overview of the HP LaserJet 1100 Printer's processes. The following systems are discussed:

- engine controller unit (ECU) system/power system
- formatter system
- image formation system
- paper feed system (printer) and document feed system (optional document scanner)
- document scanner system (optional)
- optical system (located in the optional document scanner)

The HP LaserJet 1100 Printer consists of the printer and the document scanner (HP LaserJet 1100A Printer-Copier-Scanner). Operation sequences of the printer are controlled by the ECU. Operation sequences of the document scanner are controlled by the video controller.

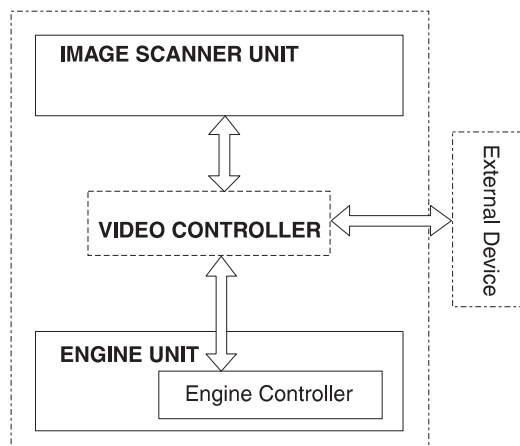

Figure 3-1 Basic configuration

Printer functions

Printer functions are divided into six groups:

- 1 ECU/power system
- 2 formatter system
- 3 image formation system
- 4 printer paper feed system
- 5 document scanner system
- 6 basic sequence of operation (formatter to printer)

The following figure is a block diagram of the printer unit:

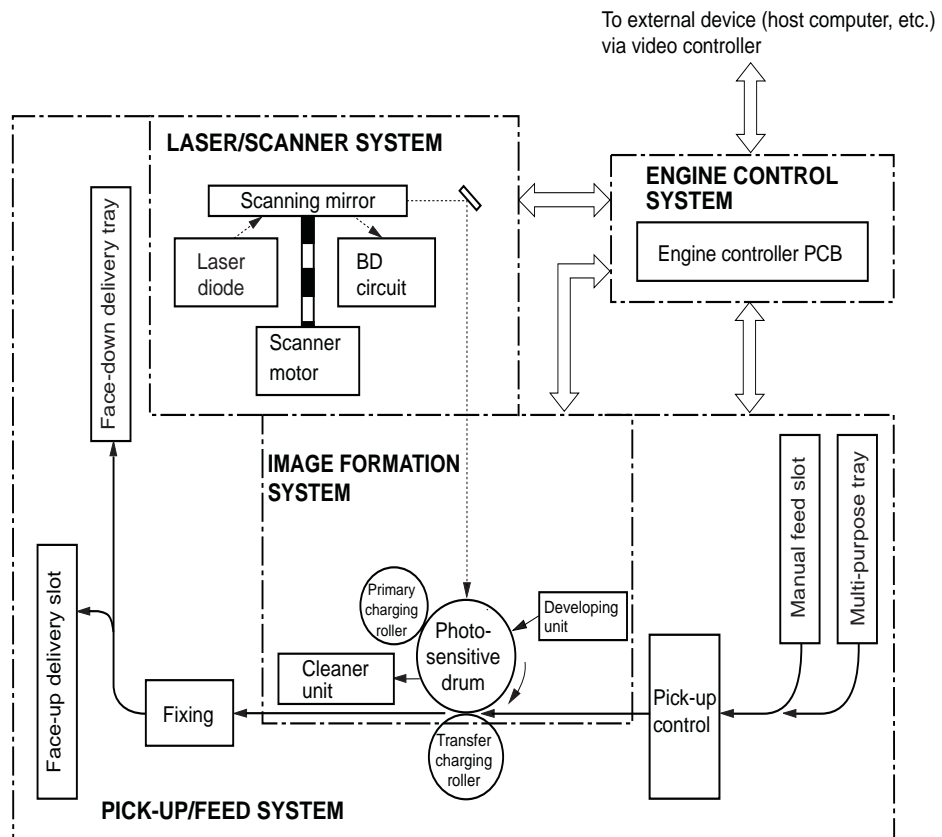

Figure 3-2 Printer unit functional block diagram

Engine Control Unit (ECU)/power system

The Engine Control Unit (ECU) coordinates all print engine activities, drives the laser, and coordinates print data from the formatter with the image formation process. The ECU also includes power supply and distribution circuitry. The ECU controls the following systems and functions:

- **Printer engine control**
 - printer laser/scanner drive
 - paper motion monitoring and control
 - motor
- **Power system**
 - AC power distribution
 - DC power distribution
 - overvoltage/undervoltage protection
 - high-voltage power distribution

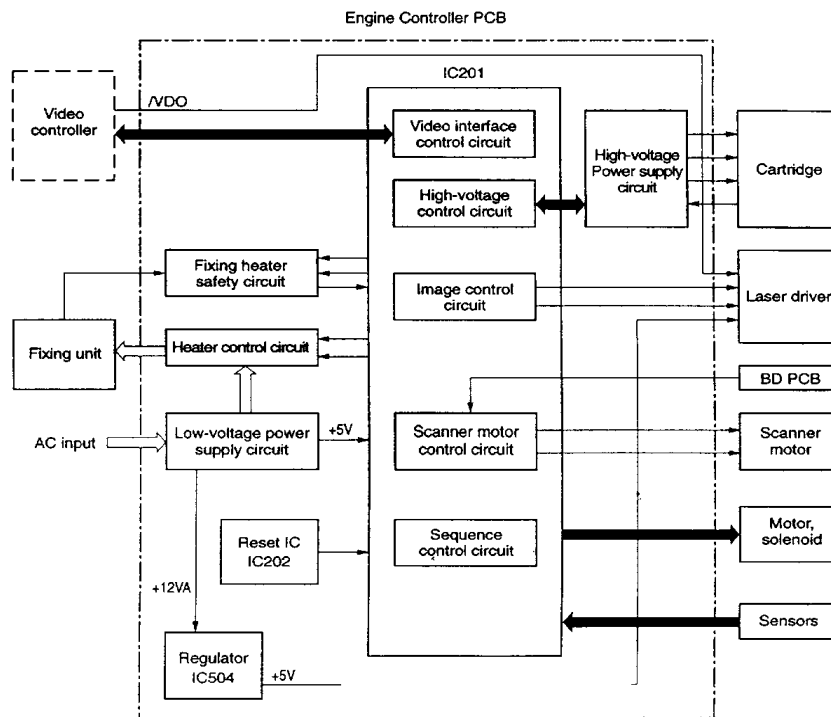

Figure 3-3 ECU loads

Printer engine control system

Printer laser/scanner drive

Based on information received from the formatter, the ECU sends signals to the laser/scanner assembly to modulate the laser diode “on” and “off” and to drive the laser/scanner motor. For more information, see “Image formation system” later in this chapter.

Paper motion monitoring and control

The ECU controls paper motion by continuously monitoring the various paper sensors and coordinating the timing with the other print processes.

For a detailed explanation of paper movement, and the interaction of photosensors and solenoid with the paper movement process, see “Printer paper feed system.”

Motor

The motor is controlled by the ECU. The motor provides all of the printer's paper movement.

Power system on ECU

The AC, DC, and high-voltage power supply circuits are all contained within the ECU.

AC power distribution

The AC power circuitry supplies AC voltage whenever the power cord is connected to the AC power source. AC voltage is distributed to the DC power supply circuitry and to the AC driver circuitry, which controls AC voltage to the fusing assembly's heating element.

DC power distribution

The DC power distribution circuitry, located on the ECU, distributes +3.3 V DC, +5 V DC and +24 V DC as follows:

Table 3-1. DC power distribution

+3.3 V DC	Formatter Laser/Beam Detect Circuitry ECU
+5 V DC:	Formatter Photosensors ECU Laser/Beam Detect Circuitry
+24 V DC:	Motor Laser Scanner Motor Document Scanner Motor Solenoid Formatter
+24VA DC:	High Voltage Power Supply

Overcurrent/overvoltage

There are two overvoltage devices in this printer:

- Fuse F101 provides overcurrent protection for the fusing system circuitry. To check or replace the fuse requires the removal of the ECU. Fuse F102 (found only on 110V units) provides overcurrent protection to the printer DC power supply circuitry.
- In addition, the +24V DC, +3.3 V DC, and +5V DC power circuitry contains an overcurrent protection circuit which automatically shuts off the output voltage when an overcurrent condition occurs due to a short or abnormal voltage on the load side.

High-voltage power distribution

The high-voltage power supply PCA applies an overlap of DC and AC voltage to the primary charging roller and the developing roller. This circuit also applies a positive or negative DC voltage to the transfer roller according to the instructions from the ECU.

This circuit also controls the image density by changing the primary AC voltage and the developing AC bias according to the print density setting.

High voltage is disabled when the printer door is open.

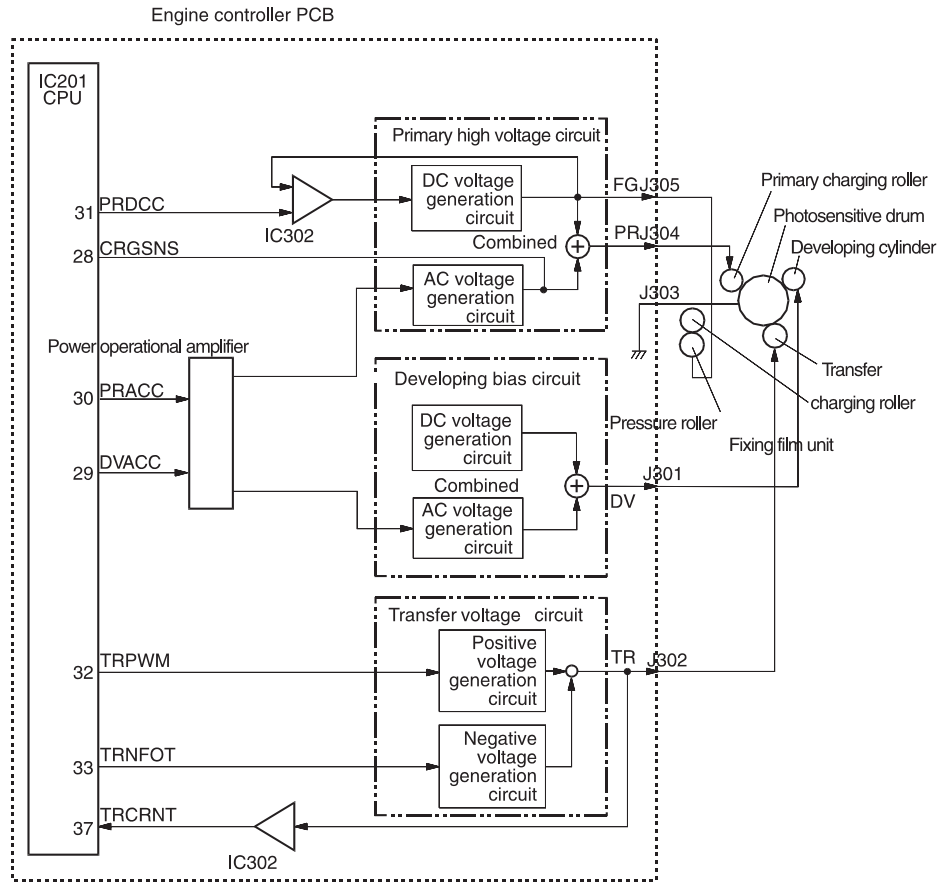

Figure 3-4 High-voltage power supply circuit

Formatter system

The formatter is responsible for the following:

- controlling the optional document scanner
- formatting and controlling copies
- receiving and processing print data from the printer interface
- monitoring the control panel and relaying printer status information
- developing and coordinating data placement and timing with the print engine
- communicating with the host computer through the bidirectional interface

The formatter receives print data from the bidirectional Extended Capabilities Port (ECP) mode interface and converts it into a dot image. The ECU synchronizes the image formation system with the paper feed system and signals the formatter to send the print image data. The formatter sends the print image data (dots) in the form of a video signal and the printing process begins.

Central processing unit

The formatter incorporates an MCF5202 custom microprocessor operating at 35 megahertz (MHz).

Random-access memory (RAM)

- One bank of Non-Volatile RAM (NVRAM) stores parameters
- DRAM (Dynamic RAM) provides temporary storage of copy, scan, and print data

Parallel interface

The formatter receives incoming data through its ECP interface. This interface provides high speed and two-way communication between the printer and the host, allowing the user to change printer settings and monitor printer status from the host computer.

Control panel

- Three front panel status lights (one contained in the Go key)
- **Go** key

Draft mode

Depending on which printer driver is used, selecting “draft” or EconoMode from the printer driver allows the HP LaserJet 1100 Printer to use approximately 50% less toner, extending the life of the toner cartridge.

Memory Enhancement technology (MEt)

The Hewlett-Packard Memory Enhancement technology (MEt) effectively doubles the standard memory through a variety of font and data compression methods.

Enhanced I/O

The Enhanced I/O feature allows printer memory to be used for storing data received from the host computer. When Enhanced I/O is enabled, you can send more data to the printer in shorter amounts of time, which allows you to return to your application sooner. Enhanced I/O has the following options:

- **Auto** - Allows the printer to use Enhanced I/O memory allocating to increase the speed of data transfer from the host computer to the printer, if necessary.
- **Off** - Uses the minimum amount of printer memory for storing data sent from the host computer.

Page Protect

Page complexity (rules, complex graphics, or dense text) may exceed the printer's ability to create the page image fast enough to keep pace with the Image Formation process. If Page Protect is disabled and a page is too complex, the page may print in parts (for example, the top half on one page and the bottom half on the next page). Some print data loss is likely in these instances, and the printer will display an error message.

Page Protect allows the Formatter to create the entire page image in page buffer memory before physically moving the paper through the printer. This process ensures that the entire page will be printed. The default setting is Auto.

PJL Overview

Printer Job Language (PJL) is an integral part of configuration, in addition to the standard Printer Command Language (PCL). With standard ECP cabling, PJL allows the printer to perform functions such as:

- **Two-way communication** with the host computer through a bidirectional Parallel connection. The printer can tell the host such things as the control panel status.
- **Isolation of print environment settings** from one print job to the next. For example, if a print job is sent to the printer in landscape mode, the subsequent print jobs print in landscape only if they are formatted for landscape printing.

Image formation system

Laser printing requires the interaction of several different technologies including electronics, optics, and electrophotographics to provide a printed page. Each process functions independently and must be coordinated with the other printer processes. Image formation consists of six processes:

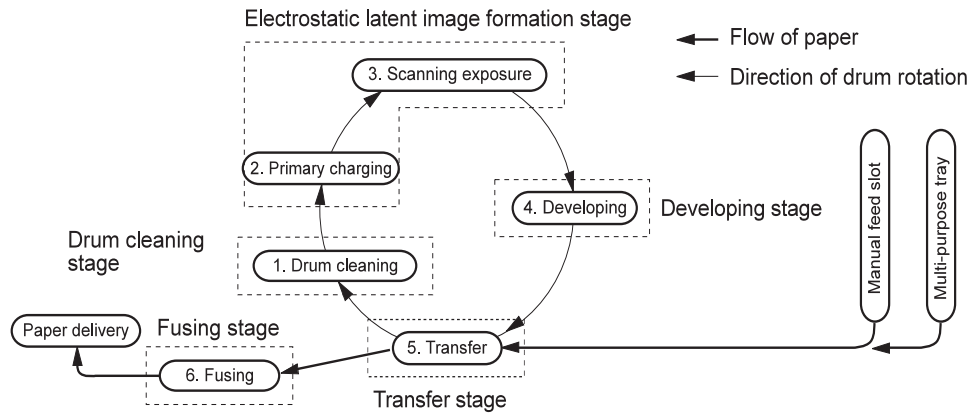

Figure 3-5 Image formation block diagram

Toner cartridge

As the heart of the image formation system, the Toner Cartridge houses the cleaning, conditioning, and developing steps of the process. The Toner Cartridge contains the photosensitive primary charging roller, developing station, toner cavity, and cleaning station. Including these components (which wear, degrade, or are consumed) in the replaceable Toner Cartridge eliminates the need for a service call when replacement is required. The special photosensitive properties of the drum allow an image to be formed on the drum surface and then transferred to paper.

CAUTION:

The printer's Toner Cartridge does not include a light-blocking shutter. Be careful to avoid exposing the drum to light, which can permanently damage the drum. Protect the Toner Cartridge whenever removing it from the printer.

Step 1 Cleaning stage. The cleaning blade is in contact with the surface of the drum at all times. As the drum rotates during printing, excess toner is wiped off and stored in the waste toner receptacle.

Step 2 Conditioning stage. This process consists of applying a uniform negative charge to the surface of the drum with the primary charging roller located in the Toner Cartridge. The primary charging roller is coated with conductive rubber. An AC bias is applied to the roller to erase any residual charges from any previous image. In addition, a negative DC bias is applied by the charging roller to create a uniform negative potential on the drum surface. The amount of DC voltage is modified by the print density setting.

Step 3 Writing stage. During this process, a modulated laser diode projects the beam onto a rotating scanning mirror. As the mirror rotates, the beam reflects off the mirror, first through a set of focusing lenses, then off a mirror, and finally through a slot in the top of the Toner Cartridge, and onto the photosensitive drum. The beam sweeps the drum from left to right, discharging the negative potential wherever the beam strikes the surface. This creates a latent electrostatic image, which later is developed into a visible image.

Because the beam is sweeping the entire length of the drum and the drum is rotating, the entire surface area of the drum can be covered. At the end of each sweep, the beam strikes the beam detect lens, generating the beam detect signal (BD signal). The BD signal is sent to the ECU where it is converted to an electrical signal used to synchronize the output of the next scan line of data.

Step 4 Developing stage. At this stage of the process, the latent electrostatic image is present on the drum. The toner particles obtain a negative surface charge by rubbing against the developing cylinder which is connected to a negative DC supply. The negatively charged toner is attracted to the discharged (exposed, grounded) areas of the drum, and repelled from the negatively charged (unexposed) areas.

Step 5 Transferring stage. During the transferring process, the toner image on the drum surface is transferred to the paper. A positive charge applied to the back of the paper by the transfer roller causes the negatively charged toner on the drum surface to be attracted to the paper. After separation, the drum is cleaned and conditioned for the next image.

During the separating process, the paper separates from the drum. To stabilize the feed system and prevent dropouts on the printed image at low temperature and humidity, the charge on the back of the paper is reduced by the static charge eliminator.

Step 6 Fusing stage. During the fusing process, the toner is fused into the paper by heat and pressure to produce a permanent image. The paper passes between a heated fusing element and a soft pressure roller. This melts the toner and presses it into the paper.

Printer paper feed system

The paper input bin and the single-sheet input slot merge into one, main input area. Paper placed in either of these areas enables the paper-out sensor (PS001), which informs the ECU that paper is present. The following steps occur when the printer receives a print job:

- Step 1** The ECU enables the laser/scanner assembly and the motor. Paper motion begins when the ECU energizes the solenoid (SL001).
- Step 2** The paper pickup roller rotates once. The paper kick plate pushes the paper against the pickup roller.
- Step 3** The pickup roller grabs the top sheet and advances it to the feed assembly drive rollers. To ensure that only one sheet is fed, a main separation pad and two subpads hold the remainder of the stack in place.
- Step 4** The feed assembly drive rollers advance the paper to the paper top photosensor (PS002). This sensor informs the ECU of the exact location of the paper's leading edge, so that the image being written on the photosensitive drum can be precisely positioned on the page.
- Step 5** The feed assembly drive rollers then advance the paper to the transfer area where the toner image on the photosensitive drum is transferred to paper.
- Step 6** After the image is transferred, the paper enters the fusing assembly where heat from the fuser and pressure from the pressure roller permanently bond the toner image to paper. The paper exit sensor (PS201) determines that paper has successfully moved out of the fusing area.
- Step 7** The fusing assembly exit rollers deliver paper to either the paper output bin or the front paper output slot, depending upon the position of the face-up/face-down lever.

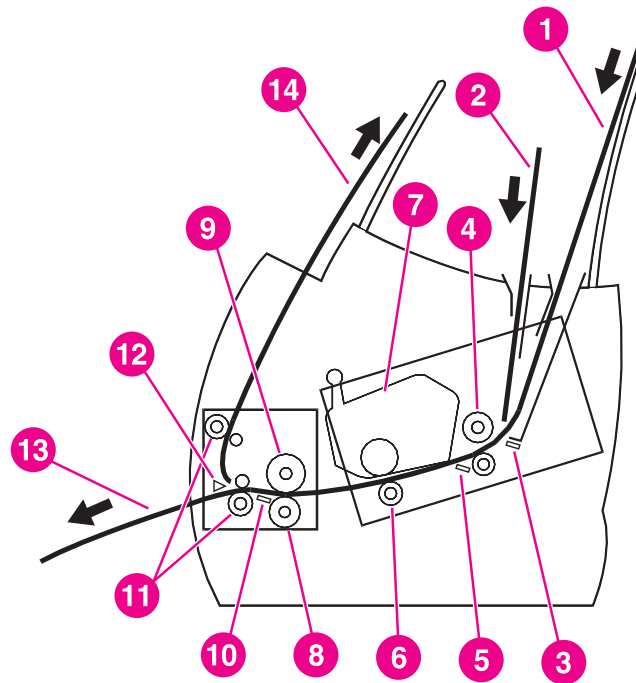

Figure 3-6 Simplified paper path

- 1 Paper input bin
- 2 Single sheet input slot

- 3 Paper sensor (PS001)
- 4 Pickup roller
- 5 Paper sensor (PS002)
- 6 Transfer roller
- 7 Toner cartridge
- 8 Pressure roller
- 9 Fusing unit
- 10 Paper exit sensor
- 11 Delivery rollers
- 12 Face-up/Face-down deflector
- 13 Face-down output path
- 14 Face-up output path

Paper jam detection

The paper out sensor (PS001), paper registration sensor (PS002), and the paper exit sensor (PS201) detect paper moving through the HP LaserJet 1100 Printer. If a paper jam is detected, the ECU immediately stops the printing process and displays a paper jam message on the control panel.

A paper jam can be detected under any of the following conditions:

- Power-on jams. Paper is present under either (PS201) or (SL001) at power on.
- Pickup jams. Paper does not reach and clear photosensor (SL001) within a specified period of time. The time period begins when the Paper Pickup Solenoid (SL001) is energized.
- Delay jams. Paper does not reach or clear the photosensor (PS201) within a specified period of time.
- Wrapping Jam Photosensor (PS201) detects the trailing edge of the paper within a specified period of time after photosensor (SL001) detects the trailing edge.

Solenoid, photosensors, and switches

The following figure shows the locations of the solenoid, photosensors, and switches.

Table 3-2. Solenoid, photosensors, and switches

1	Pickup solenoid (SL001)	Enables the pickup roller.
2	Paper top sensor (SL001)	Detects the leading and trailing edges of the paper. Synchronizes the photosensitive drum and the top of the paper.
3	Door open sensor (SW301)	Detects whether or not the printer door is closed and the Toner Cartridge is present. Printing cannot continue until the printer door is closed and the Toner Cartridge is in its correct position.
4	Paper out sensor (PS001)	If the sensor does not sense paper in the Paper Input Bin or the Single Sheet Input Slot, the Control Panel displays the paper-out message. Paper must be loaded before printing can resume.
5	Document sensor (PS1)	Detects the presence and leading edge of a document in the document feed path.
7	Paper exit sensor (PS201)	Senses when paper has successfully moved out of the fusing area.
8	Engine test switch (SW201)	See "Troubleshooting" in this chapter for information about engine tests.
9	Power Switch (SW101)	Turns power to printer on and off (220V units only).

Document scanner system (optional)

The document scanner system consists of the optical system and document pickup and feed systems.

The optical system, also known as the contact image sensor, contains the following:

- light-emitting diode (LED) array
- contact glass
- rod lens array
- phototransistor array

The LED array, which emits light from two LEDs, is controlled by the formatter. Light reflected from documents passes through the rod lens array and focuses on the phototransistor array.

The phototransistor array consists of 2,574 phototransistors: 11 driver chips amplify the light reception output in units of 234 phototransistors. The image data is converted and sent from the driver circuits to the formatter.

The document pickup and feed systems contain a pickup roller and CIS roller, both of which are driven by the document scanner motor.

The following figure shows a simplified Document Scanner document path.

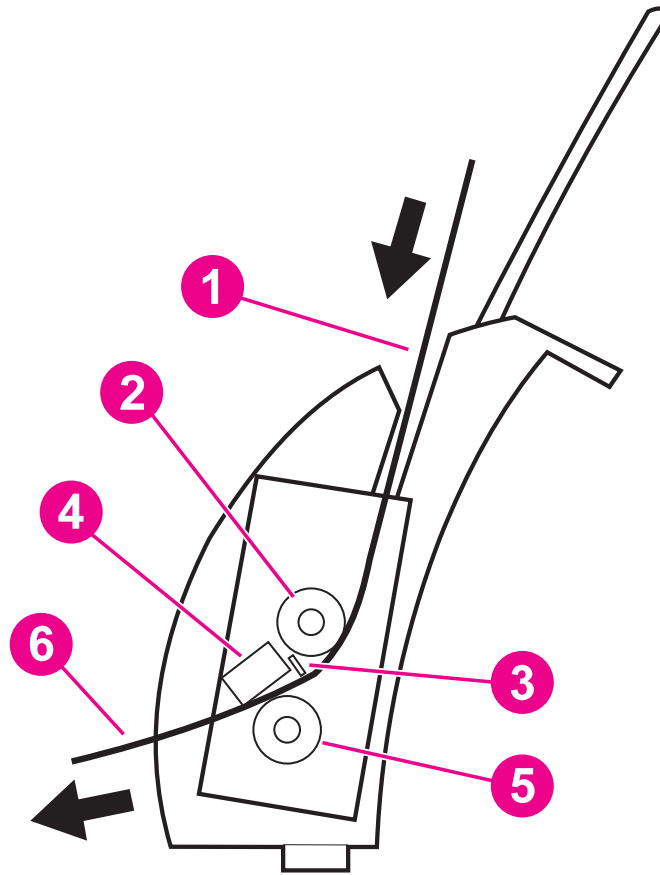

Figure 3-7 Simplified scanner document path

- 1 Input path
- 2 Document pickup roller
- 3 Document sensor
- 4 Contact image sensor (CIS)
- 5 CIS roller
- 6 Output path

Basic sequence of operation (formatter to printer)

The formatter and the ECU share information during printer operation. The ECU-to-formatter connector (J201) forms a link that operates as a serial data bus. This allows printer status, command information, and dot-image data to be passed between the two. The following events take place during normal printer operation:

Period	Purpose	Remarks
WAIT From the power-ON until the end of the main motor initial rotation.	To clear the drum surface of potential and to clean the transfer charging roller.	Detects whether the cartridge is installed or not.
STBY (Standby) From the end of the WAIT period or the LSTR period until the pick-up command is input from the video controller. Or, from the end of the LSTR period until power-OFF.	To keep the printer ready to print.	
INTR Initial Rotation Period After the pick-up command has been input from the video controller until the paper reaches the paper top sensor.	To stabilize the photosensitive drum sensitivity in preparation for printing. Also to clean the transfer charging roller.	
PRINT (Print) From the end of the initial rotation until the primary voltage goes OFF.	To form images on the photosensitive drum based on the VIDEO signals (/VDO, VDO) input from the video controller and to transfer the toner image onto the paper.	
LSTR (Last Rotation Period) After the primary voltage goes OFF until the main motor stops rotating.	To delivery the last page. Also to clean the transfer charging roller.	When the pick-up command is input from the video controller, the printer enters the INTR period immediately after the end of the LSTR period.

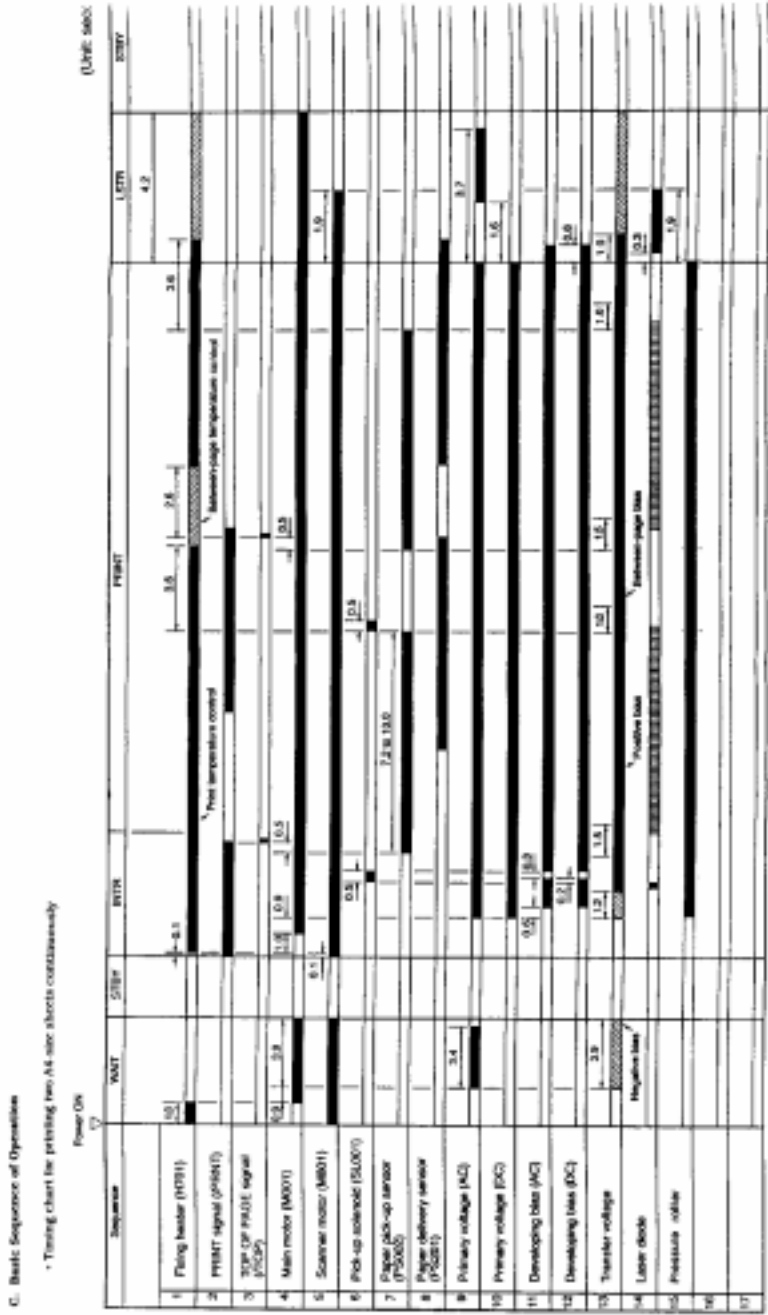

Figure 3-8 General timing diagram

4 Removal and Replacement

Chapter contents

Removal and replacement strategy	62
Required tools	63
External assemblies and covers	64
Document scanner removal	65
Contact image sensor removal	67
Pod removal	76
Printer door removal	70
Back cover removal	77
Internal paper guide removal	79
Front cover removal	80
Printer laser/scanner cover removal	83
Internal assemblies	84
Output roller removal	85
Delivery assembly removal	87
Paper exit sensor flag removal	89
Fusing element removal	90
Gear train motor and solenoid removal	95
Pressure roller removal	99
Transfer roller removal	101
Paper pick-up assembly removal	103
Kick plate removal	105
Separation pad removal	106
Bottom assemblies	108
Formatter pan removal	108
Document scanner cable removal	110
Hinge mechanism removal	112
ECU pan removal	113
Paper feed assembly removal	115

Removal and replacement strategy

This chapter documents removal and replacement of field replaceable units (FRUs) only.

Replacement is generally the reverse of removal. Occasionally, notes are included to provide direction for difficult or critical replacement procedures.

WARNING!

Unplug the power cord from the power outlet before attempting to service the HP LaserJet 1100 Printer. If this warning is not followed, severe injury can result. Certain functional checks must be performed during troubleshooting with power supplied to the product. However, the power supply should be disconnected during removal.

Never operate or service the HP LaserJet 1100 Printer with the protective cover removed from the laser/scanner assembly. The reflected beam, although invisible, can damage your eyes.

The sheet metal edges of the HP LaserJet 1100 Printer can be sharp. Use caution when working on the HP LaserJet 1100 Printer.

CAUTION:

The HP LaserJet 1100 Printer contains parts that are electrostatic discharge (ESD) sensitive. Always perform servicing at an ESD-protected workstation.

NOTE:

To install a self-tapping screw, first turn it counterclockwise to align it with the existing thread pattern, then carefully turn clockwise to tighten. Do not overtighten. If a self-tapping screw-hole becomes stripped, repair the screw-hole or replace the affected assembly.

Always remove the Toner Cartridge before removing or replacing parts.

Required tools

- #1 Phillips screwdriver with magnetic tip
- #2 Phillips screwdriver with magnetic tip
- Small flat-blade screwdriver
- Needle nose pliers
- ESD mat
- Pod removal tool (optional, part number BZ99-R72-8010-4)

CAUTION:

A Posidrive screwdriver will damage screw heads on the HP LaserJet 1100 Printer. Use Phillips screwdriver only.

External assemblies and covers

Paper guides removal



Figure 4-1 Removing the paper guides

- 1 Remove the clear plastic paper guides from the paper output trays and the scanner.

Document scanner removal

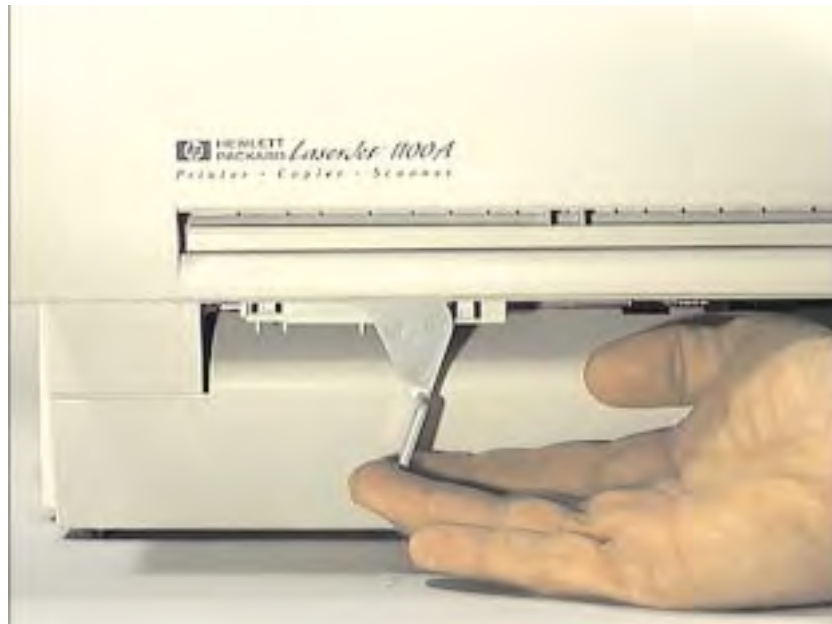

Figure 4-2 Removing the optional scanner unit

- 1 Rotate the document scanner latch down and to the right to the “open” position.
- 2 Pull out on the bottom of the document scanner unit, then push it up slowly to clear the connector at the top of the scanner.
- 3 Lift the scanner off.
- 4 Move the scanner latch back to the “closed” position.

Document scanner opening



Figure 4-3 Opening the scanner unit

NOTE:

The only serviceable part inside the scanner unit is the Contact Image Sensor (CIS).

- 1 Open the scanner unit by pressing the round button on the end of the unit.

Contact image sensor removal



Figure 4-4 Removing the Contact Image Sensor (continued on next page)

- 1 Remove the black rounded cable cover by pressing down on the small catch at the top of the cover and then sliding the cover down and back.

Contact image sensor removal (continued)



Figure 4-5 Removing the Contact Image Sensor (continued)

- 2 Gently pry open the snap connectors on each end of the Contact Image Sensor with a small flat-blade screwdriver.
- 3 Rotate the unit up, grasp the CIS on each end, pry the end pin out of the plastic frame, and slowly lift it out.

NOTE:

Be careful with the CIS when you lift it out; it has two springs and a small cable connected to it.

Contact image sensor removal (continued)



Figure 4-6 Disconnecting the CIS wire connector

- 4 Gently pull the connector from the slot in the metal casing.

Printer door removal



Figure 4-7 Opening the printer door

Prior to this step: Remove the Document Scanner.

The printer door is hinged at the bottom.

- 1 Pull out on the top of the printer door.
- 2 The printer door will then swing open until two plastic stabilizer bars on each side of the cover are fully extended.

Printer door removal (continued)



Figure 4-8 Disconnecting the stabilizer bars

To disconnect the two stabilizer bars from the front cover:

- 3** Move the printer door slightly back toward the “closed” position to ease tension on the stabilizer bar connection.
- 4** Using a small, flat-blade screwdriver, press down on the plastic connecting snaps underneath the end of the stabilizer bar (callout 1).
- 5** Push up on the end of the stabilizer bar, and slide the connector out of the bracket (callout 2).

Printer door removal (continued)

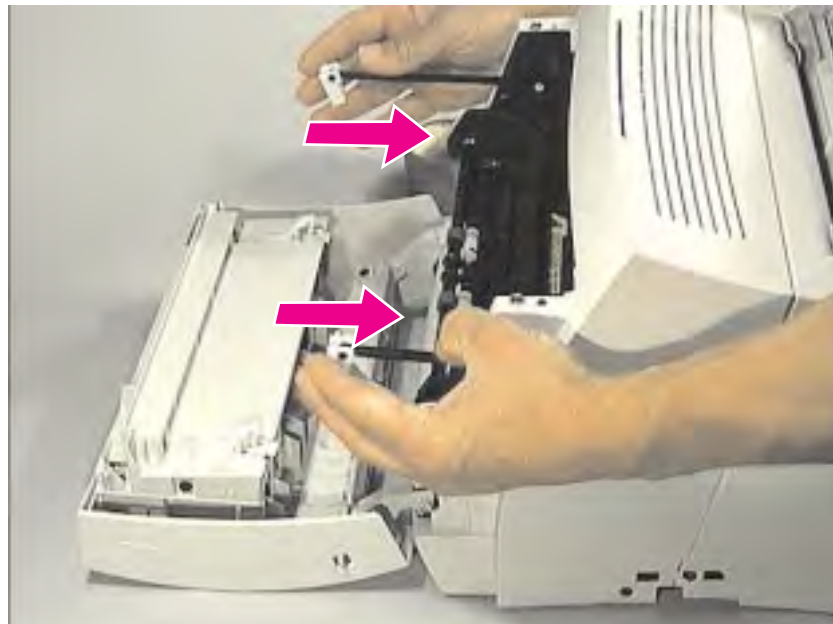

Figure 4-9 Storing the stabilizer bars

CAUTION:

Stabilizer bars can break if they are not inserted back into their slots.

- 6 Slide the stabilizer bars back into their slots.

Printer door removal (continued)

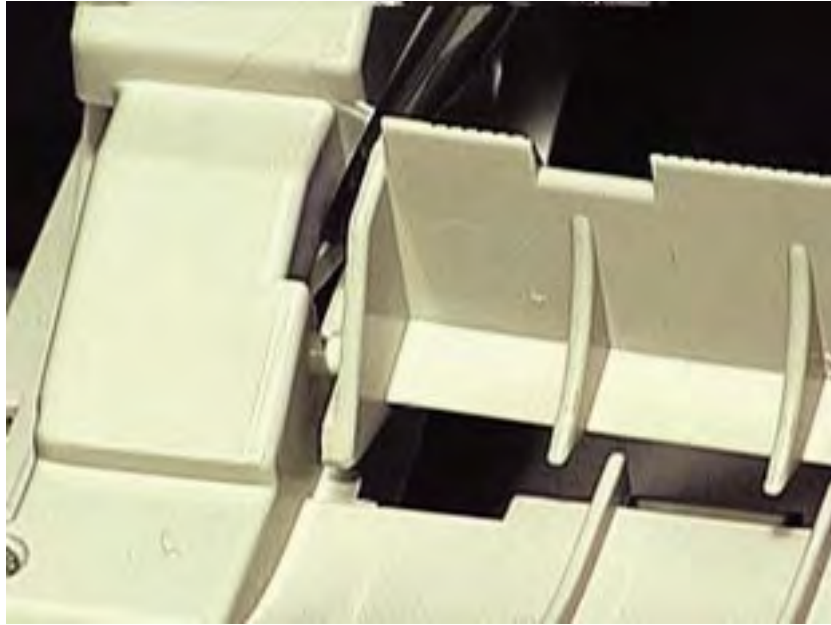
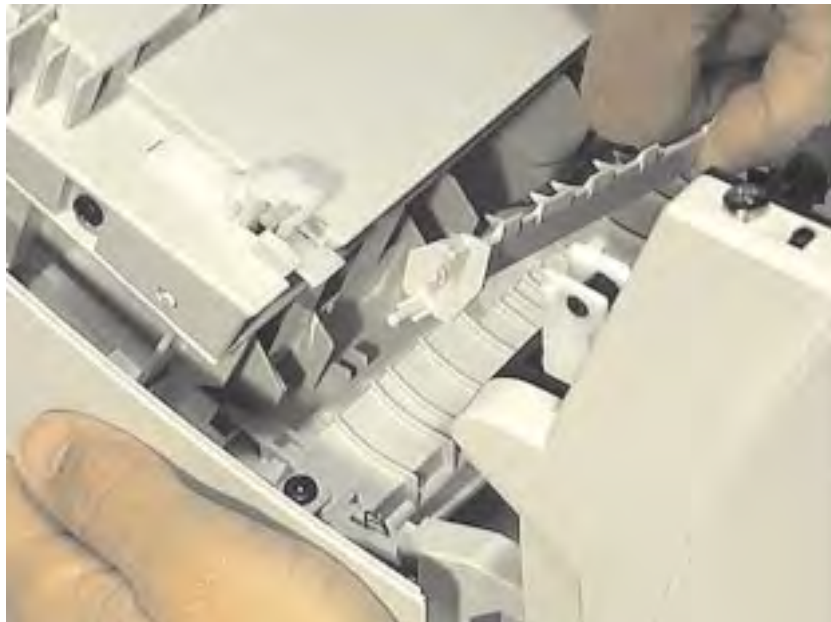

Figure 4-10 Removing the paper deflector

- 7 Deflect the plastic spring on the left end of the deflector using a small flat-blade screwdriver.
- 8 Lift the paper deflector, pivoting on the right side.



Printer door removal (continued)

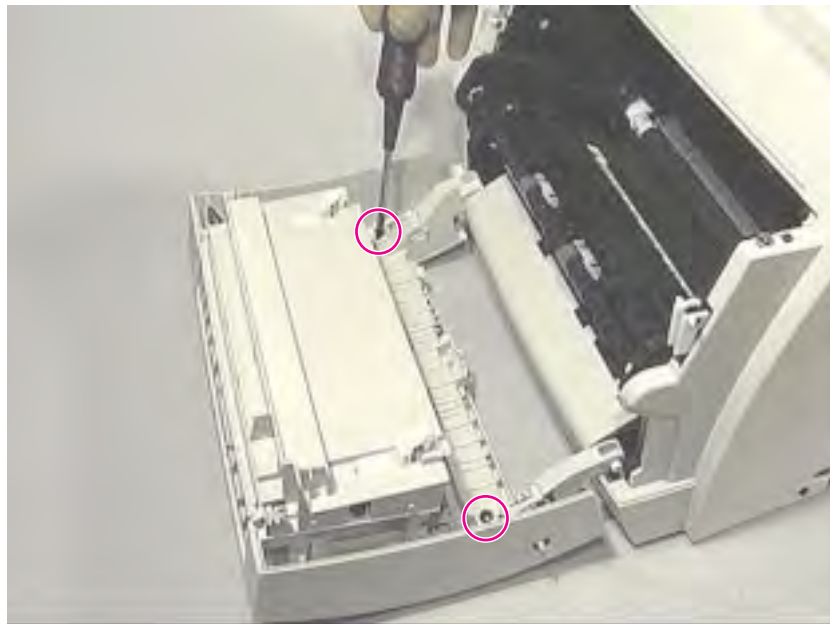

Figure 4-11 Removing the door from the hinge mechanism (continued on next page)

- 9 Remove the two screws connecting the door to the hinge mechanism.

Printer door removal (continued)

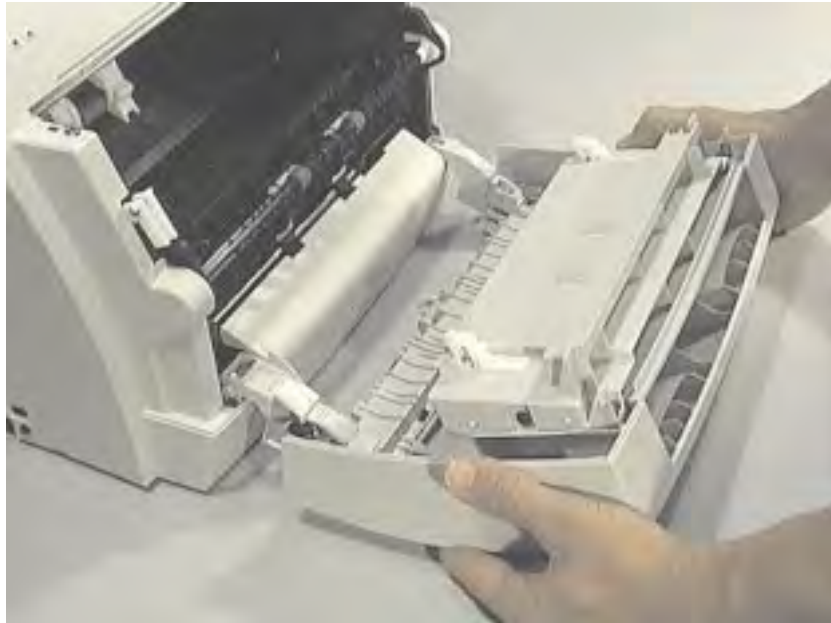

Figure 4-12 Removing the cover from the hinge mechanism (continued)

- 10** Pull firmly on the cover to slide it off of the hinge mechanism, disconnecting the plastic tabs on each side.

Pod removal

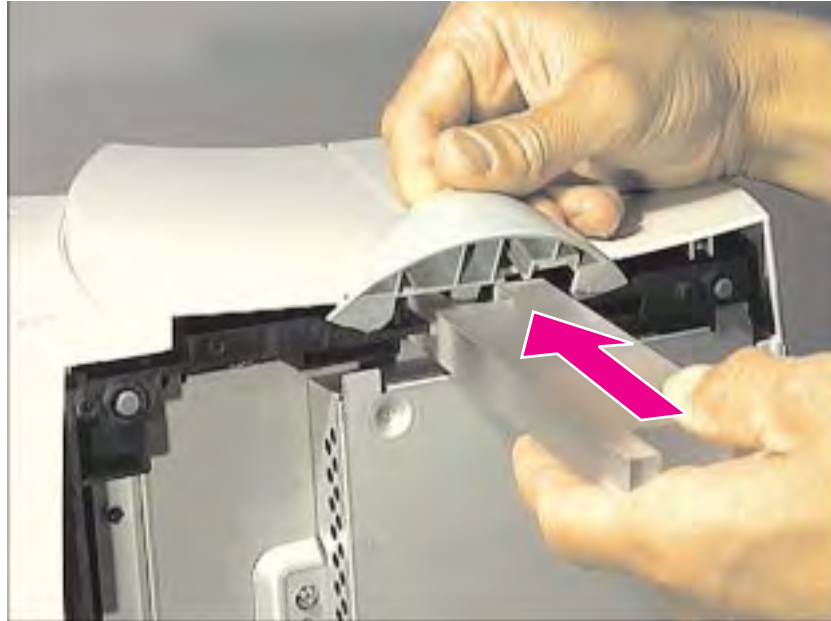

Figure 4-13 Removing the stabilizing pods

The pods connected to the bottom of the printer must be removed before the covers of the printer can be taken off. The end of the pod removal tool marked “L” removes the left pod; the end of the tool marked “R” removes the right. To release the pods:

- 1 Insert the pod removal tool into the slot below the corresponding pod, and press firmly.
- 2 Lift the pods from the frame.

Alternate procedure:

- 1 Using a small, flat-blade screwdriver, pry the plastic snaps open.
- 2 Lift the pods from the frame.

Back cover removal

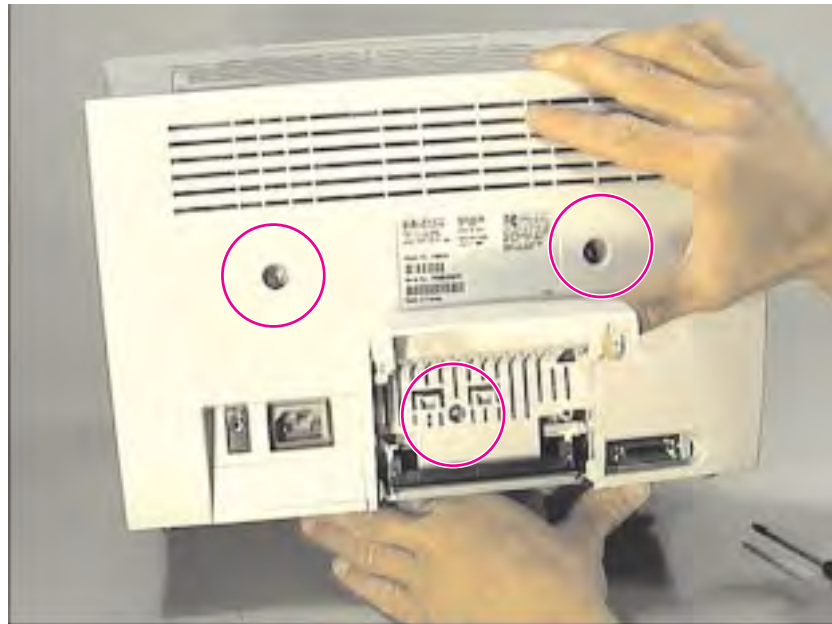

Figure 4-14 Removing the screws on the back cover

Prior to this step: Remove the memory card (if applicable) and pods.

To Remove the back cover:

- 1 Remove the two screws inside the deep holes in the back cover.
- 2 Remove the third screw underneath the small cover over the memory door.

Back cover removal (continued)

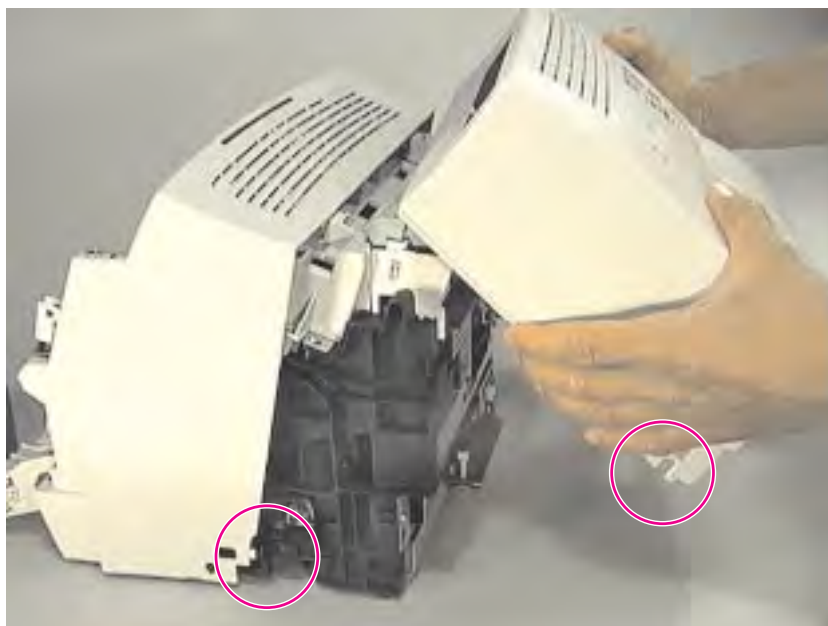

Figure 4-15 Removing the back cover

- 3 Release the plastic tabs on the bottom left and right side of the printer.
- 4 Pull out on the bottom of the cover and lift it clear of the printer.

Internal paper guide removal

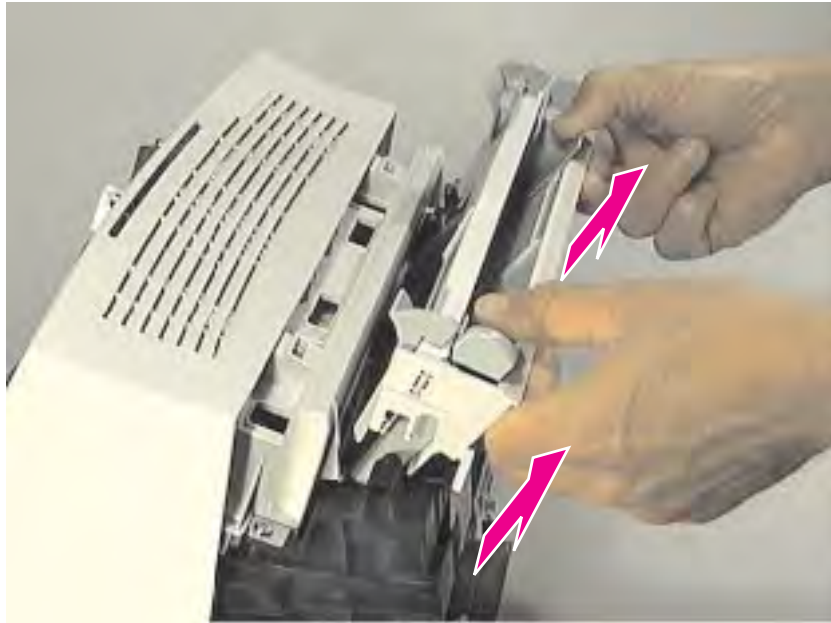

Figure 4-16 Removing the paper guide

Prior to this step: Remove the memory card (if applicable), pods, and back cover.

- 1 There are no screws securing the paper guide. Remove it by pulling it up and out (two small snaps will release as you pull on the paper guide).

Front cover removal

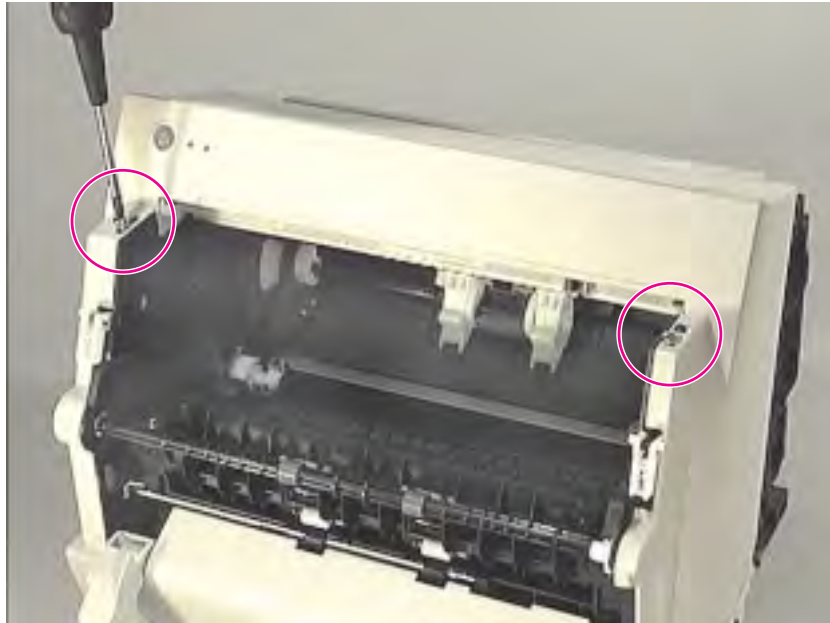

Figure 4-17 Removing the front cover (continued on next page)

Prior to this step: Remove the pods, front door, and scanner.

NOTE:

The hinge mechanism cannot be easily removed until the formatter is removed, due to the presence of the flat flexible cable.

- 1 Remove the two screws on the top of the front cover.
- 2 Slightly extend the stabilizer bars and close the door hinge mechanism against the printer frame.

Front cover removal (continued)

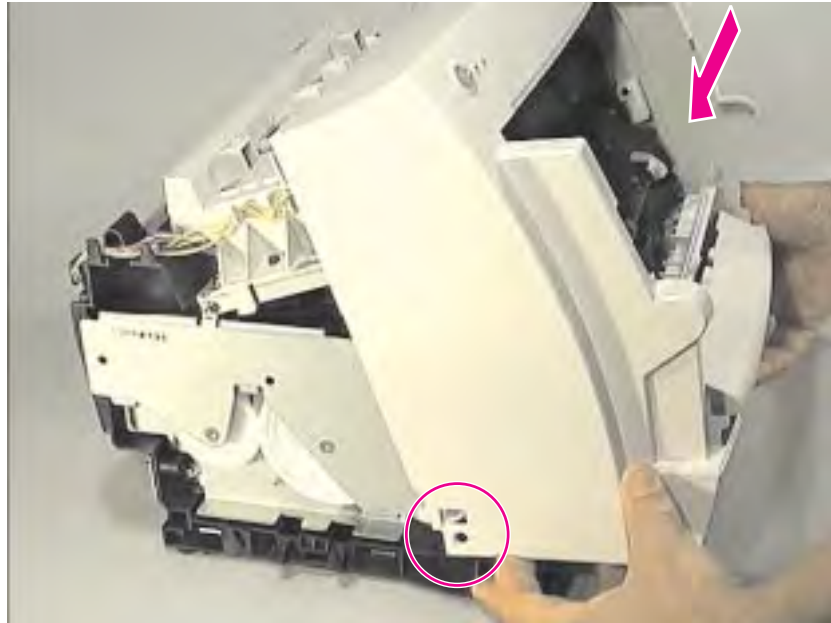

Figure 4-18 Removing the front cover (continued)

- 3 Pop the plastic snaps open on the bottom left and right of the cover.
- 4 Pull the bottom of the cover out and lift the cover up and away from the printer.

NOTE:

During reassembly, you must realign small tongue-in-groove tabs on the left and right side of the front cover.

Stabilizer bars removal

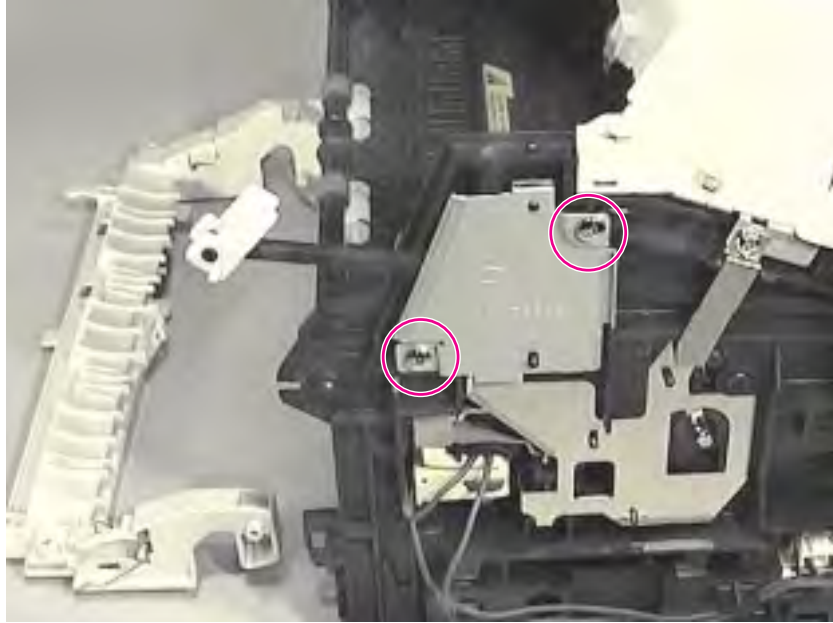

Figure 4-19 Stabilizer bars

The stabilizer bars are secured by metal plates on each end of the printer chassis.

- 1 Remove the two screws holding the metal plate at the right end of the printer chassis.
- 2 Remove the remaining screw holding the metal plate at the left end of the printer.

Printer laser/scanner cover removal

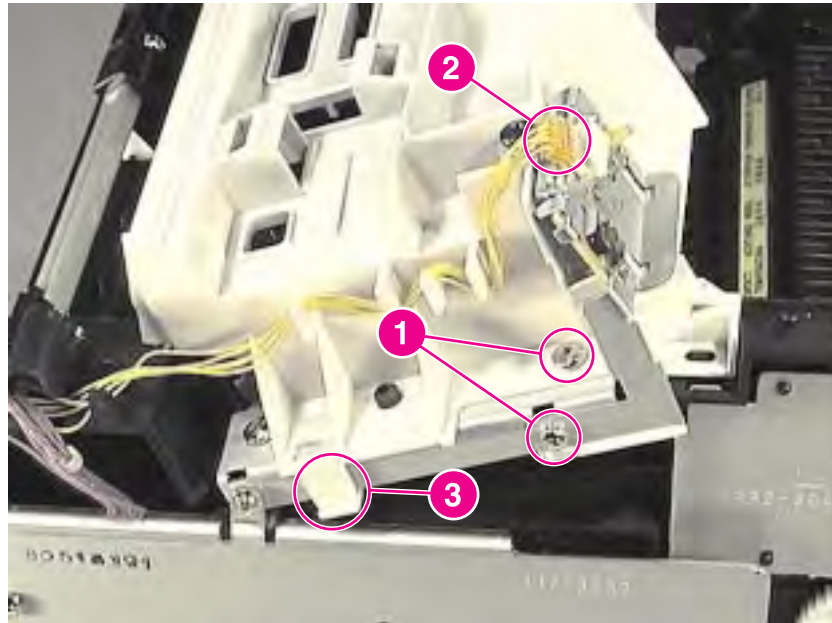

Figure 4-20 Removing the printer laser/scanner cover

Prior to this step: Remove the memory card (if applicable), pods, back cover, front door, front cover, scanner, and paper guides.

- 1 Remove the three screws fastening the Printer Laser/Scanner Cover. Two of the screws are shown in the photo above (callout 1). The remaining screw at the right end of the scanner cover is not shown in the above photo.
- 2 Disconnect the cable from the Control Panel (callout 2).

NOTE:

If the Control Panel needs to be replaced, it can be disconnected from the Printer Laser/Scanner Cover by removing the remaining screw.

- 3 Using a small flat-blade screwdriver, release the plastic snaps on the left and right ends of the Printer Laser/Scanner Cover (callout 3).

Internal assemblies

Scanner assembly removal

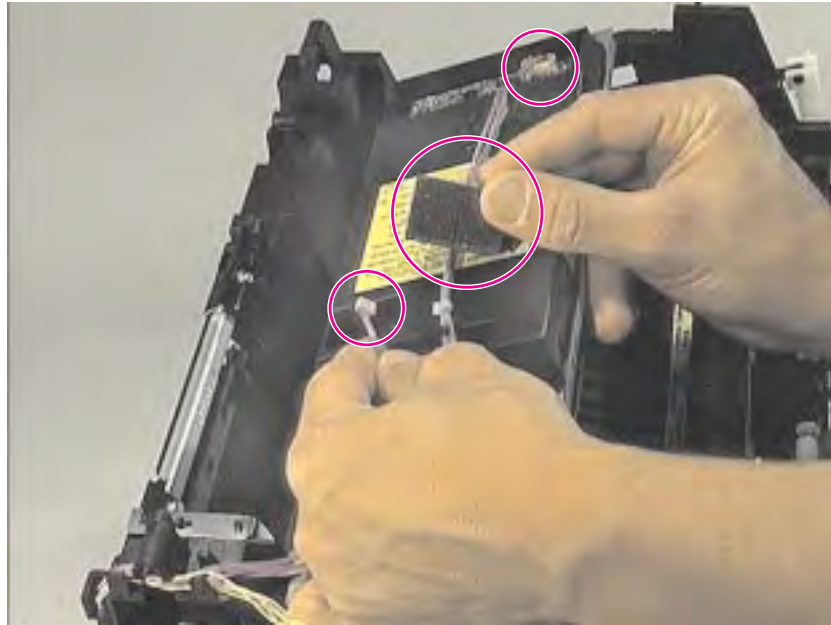

Figure 4-21 Disconnecting the scanner assembly cables

Prior to this step: Remove the memory card (if applicable), pods, back cover, front door, front cover, scanner, and paper guides.

- 1 Remove the small foam cover over the small cable connector.
- 2 Disconnect both cable connections, and remove the cable from the routing.
- 3 Remove the four screws holding the assembly in place, and lift it free of the printer.

Output roller removal

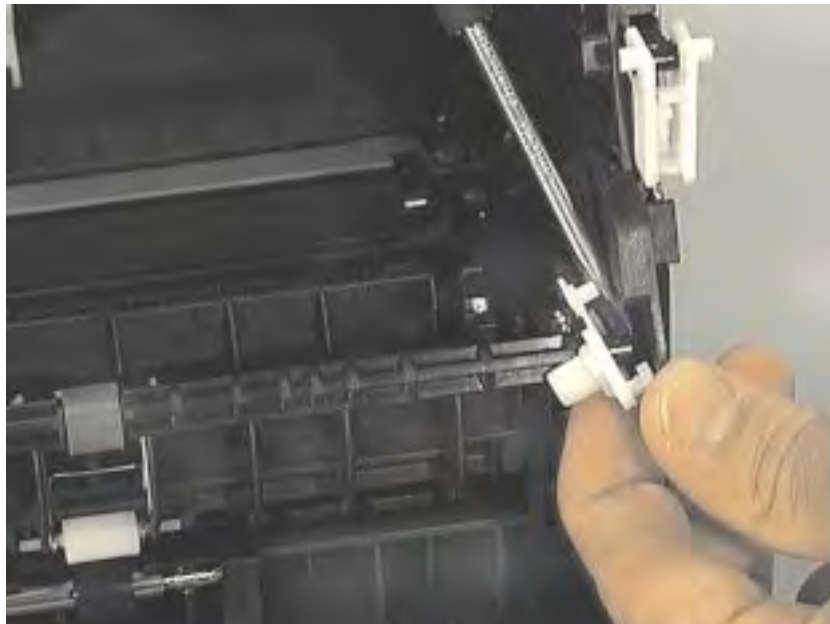

Figure 4-22 Releasing the output roller (continued on next page)

NOTE:

This part can be removed without disassembling any other printer parts.

- 1 Using a small flat-blade screwdriver, release the plastic snap on the right end of the output roller.

Output roller removal (continued)

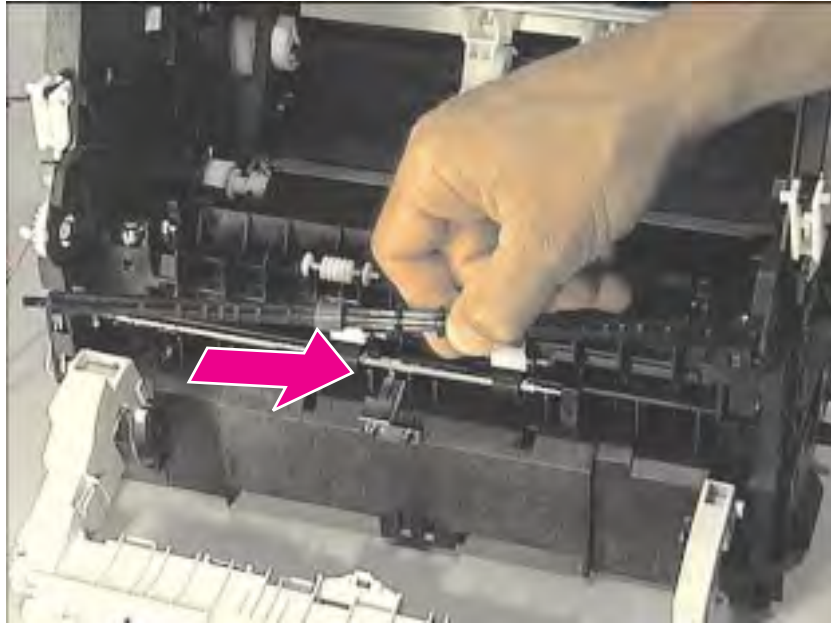

Figure 4-23 Releasing the output roller snaps

- 2 Slide the roller to the right, releasing it from the gear on the left.
- 3 Lift the roller out of the printer.

Delivery assembly removal

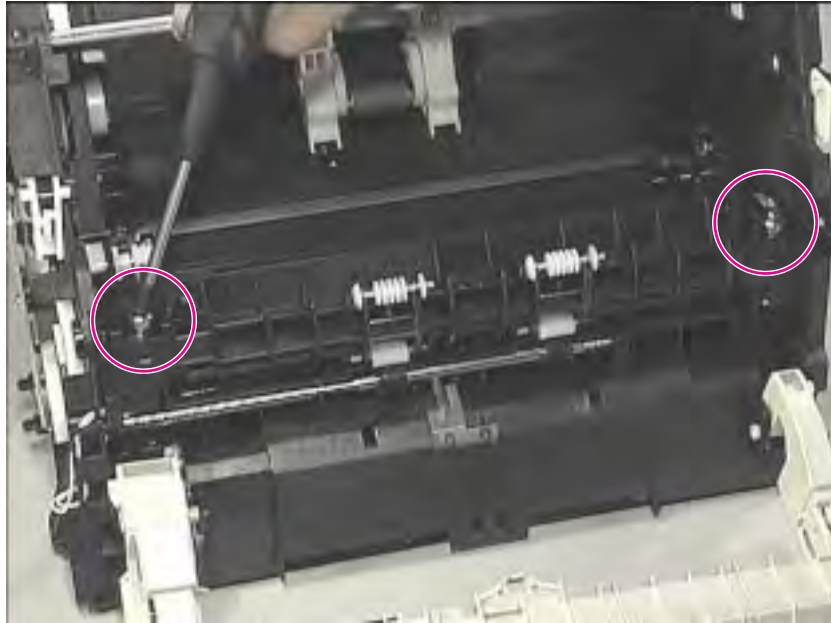

Figure 4-24 Removing the torsion screws on the delivery assembly

Prior to this step: Remove the output roller.

NOTE:

The springs underneath the torsion screws are not attached and may come loose during removal.

- 1 Remove the two screws in the front of the assembly.

Delivery assembly removal (continued)

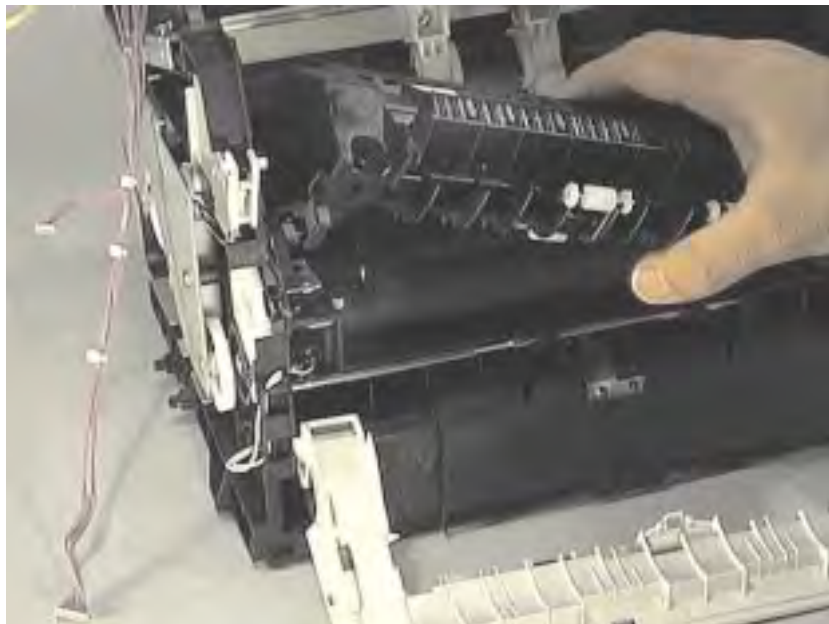

Figure 4-25 Removing the delivery assembly

- 2 Gently slide the assembly to the right, and lift it out of the printer.

Paper exit sensor flag removal

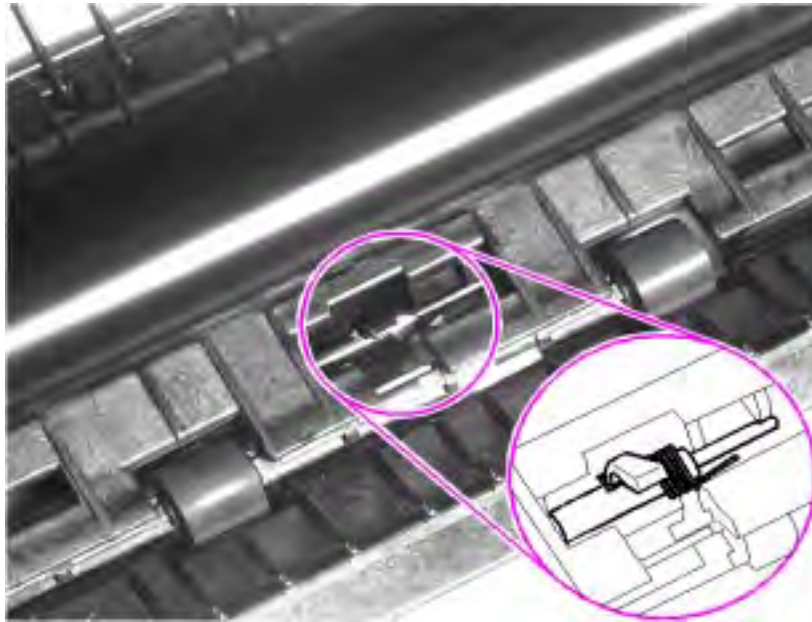

Figure 4-26 Paper Exit Sensor Flag

Prior to this step: Remove the output roller and delivery assembly.

NOTE:

Before proceeding, examine the paper exit sensor flag. It is important to note the position of the spring mechanism on the flag. The spring must be reinstalled to exactly this position, because installing it incorrectly will cause a control panel error message.

- 1 Remove the paper exit sensor flag by pressing down on the left side and pulling up on the right side.

To reinstall

Place the left side of the flag in the correct position first, then slide the right side into place, making certain the spring is on top of the flag. If the spring exerts no pressure on the flag, it may require respringing by giving the spring an extra turn before reinstalling. The flag should fit snugly in place.

Fusing element removal

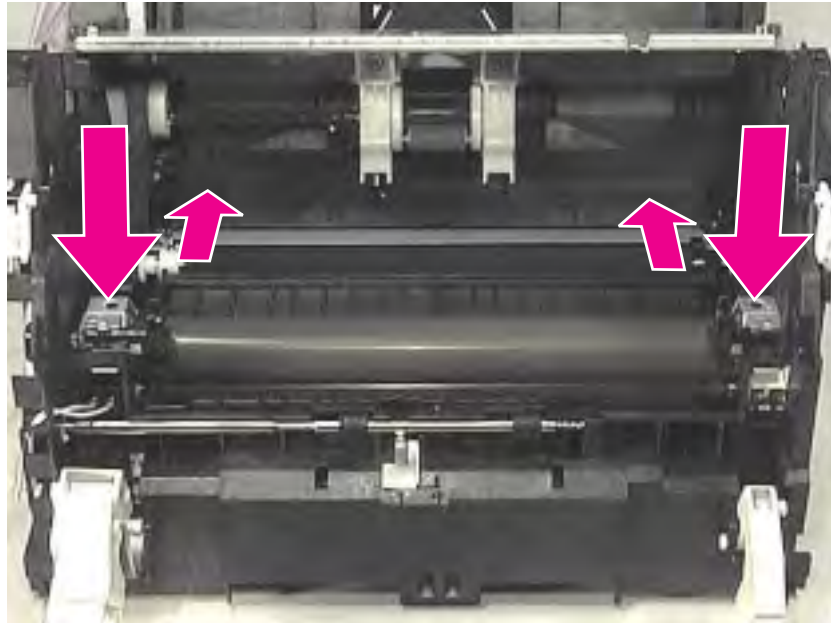

Figure 4-27 Metal Clips Holding Fusing Element

Prior to this step: Remove the scanner, pods, printer door, front cover, memory card (if applicable), output roller, and delivery assembly.

NOTE:

Pay special attention to the way these metal clips are attached to the printer chassis before you remove them. This will make reassembly easier.

The Fusing Element is held in place on each end by two metal spring-loaded clips. Each clip has a small black lever next to it. These levers must be in the “up” position.

- 1 Push each clip down and back, releasing it from the printer chassis.

Fusing element removal

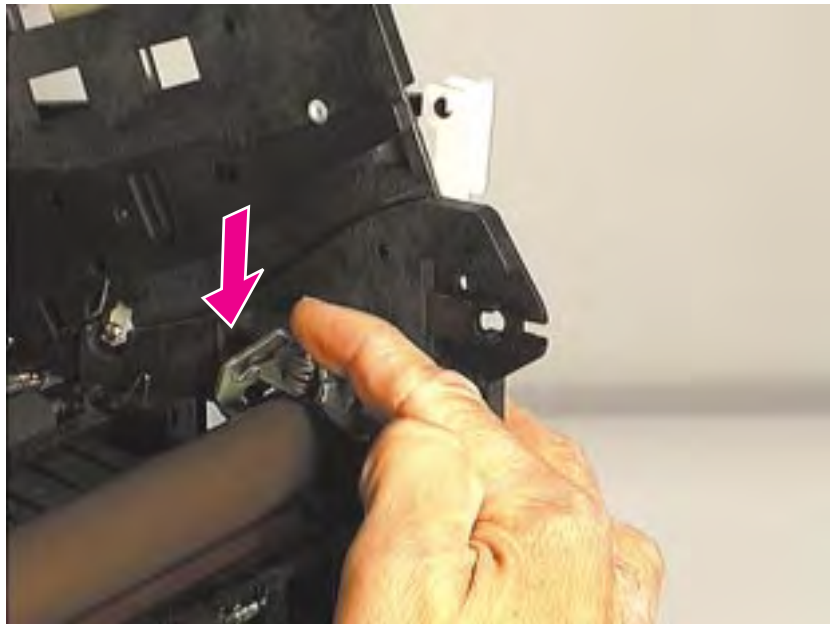

Figure 4-28 Reassembly of fusing element clips

NOTE:

During reassembly, make sure the metal clips are seated properly.

The front of the metal clip has a small threaded hole. There is a corresponding hole on the printer chassis.

Slide the front of the metal clip underneath the threaded tab on the printer chassis so that the two holes line up.

Push down on the metal clip (you will feel the tension springs pushing against the clip) until the small metal tab on the back of the clip snaps into place.

Fusing element removal (continued)

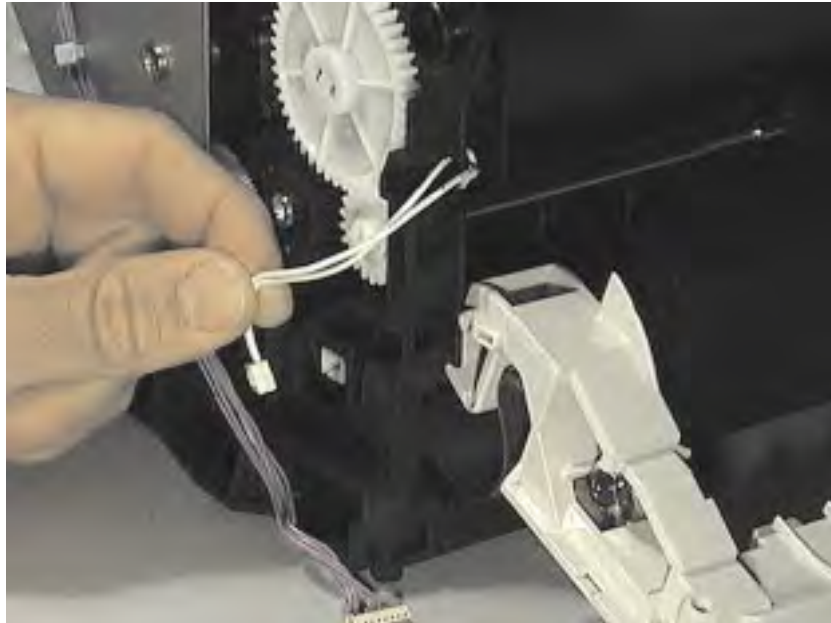

Figure 4-29 Releasing the fusing element cable connection, left side

The Fusing Element has electronic cable connections on both the left and right ends, outside the printer.

- 2 Disconnect the small cable on the left by gently pulling the connection apart.

Fusing element removal (continued)

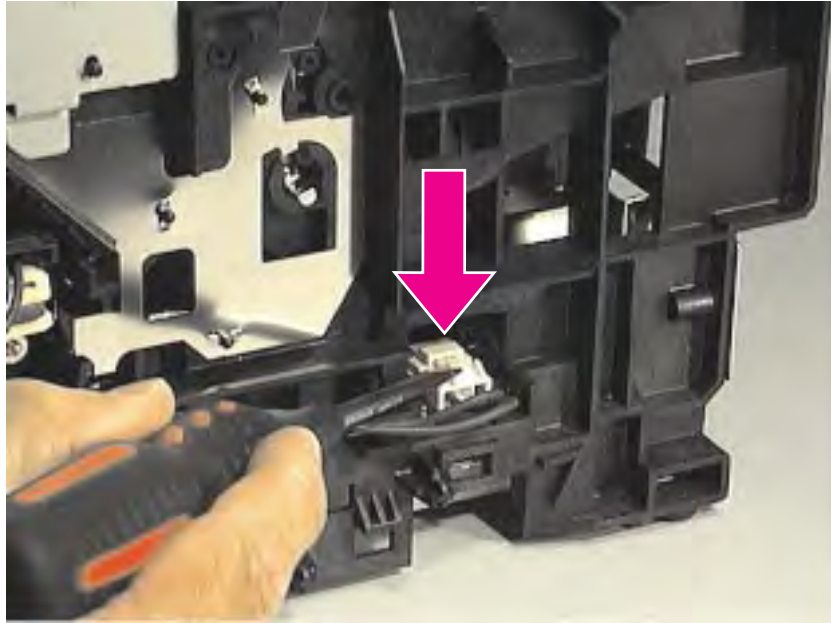

Figure 4-30 Releasing the fusing element cable connection, right side

The larger double cable on the right end is held in place by a plastic snap.

- 3 Press down on the top of the plastic snap with a flat-blade screwdriver.
- 4 Unwind the cable from the cable guides along the side of the printer.

Fusing element removal (continued)



Figure 4-31 Removing the fusing element

- 5 After the two cables are disconnected from the right and left sides of the printer, lift the element gently out of the printer.

Gear train motor and solenoid removal

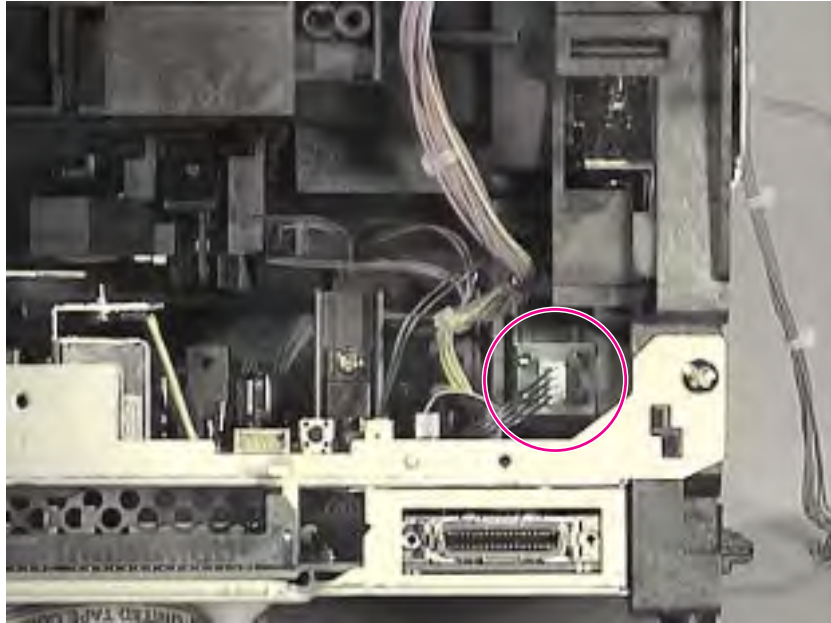

Figure 4-32 Removing the motor cable connection to the gear train cover

Prior to this step: Remove the pods, memory card (if applicable), scanner, back cover, printer door, paper guides, and front cover.

The Gear Train, located behind the metal plate (Gear Train Cover) on the left side of the printer, must be removed to access the Pressure Roller.

- 1 Disconnect the motor cable connection at the back of the printer.

Gear train motor and solenoid removal (continued)

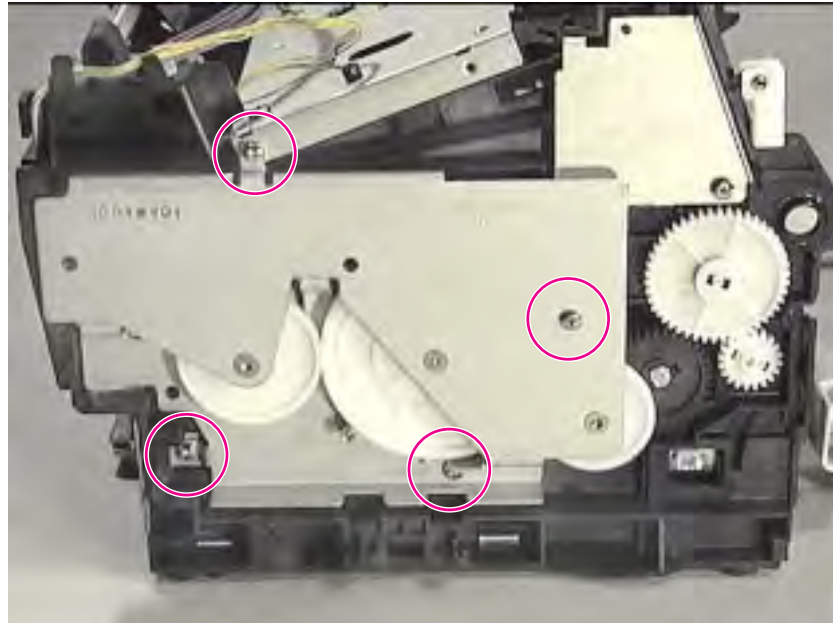

Figure 4-33 Removing the gear train cover

- 2 Remove the four screws securing the metal plate over the Gear Train, and very gently release it.

Gear train motor and solenoid removal (continued)

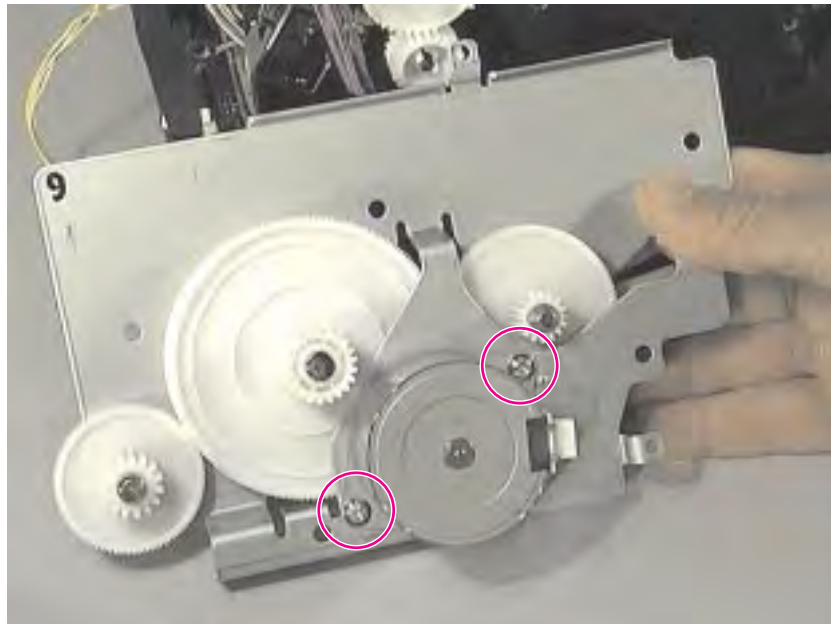

Figure 4-34 Removing the gear train motor

NOTE:

Some gears are not all held in place and may come apart during removal.

- 3 Remove the two screws holding the Gear Motor to the Gear Plate Cover.
- 4 Pull the Gear Motor out of the Gear Plate Cover.

Solenoid removal

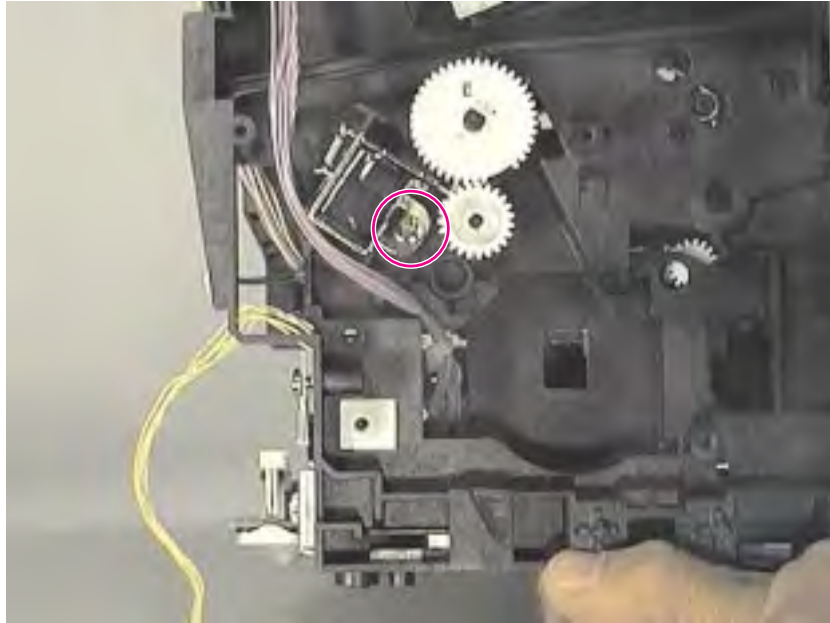

Figure 4-35 Removing the solenoid

- 5 Remove the single screw securing the solenoid to the printer chassis.
- 6 Release the solenoid.

NOTE:

During reassembly, rotate the clutch so that the flat spot on the clutch allows the feed roller (gear) to turn freely.

Pressure roller removal

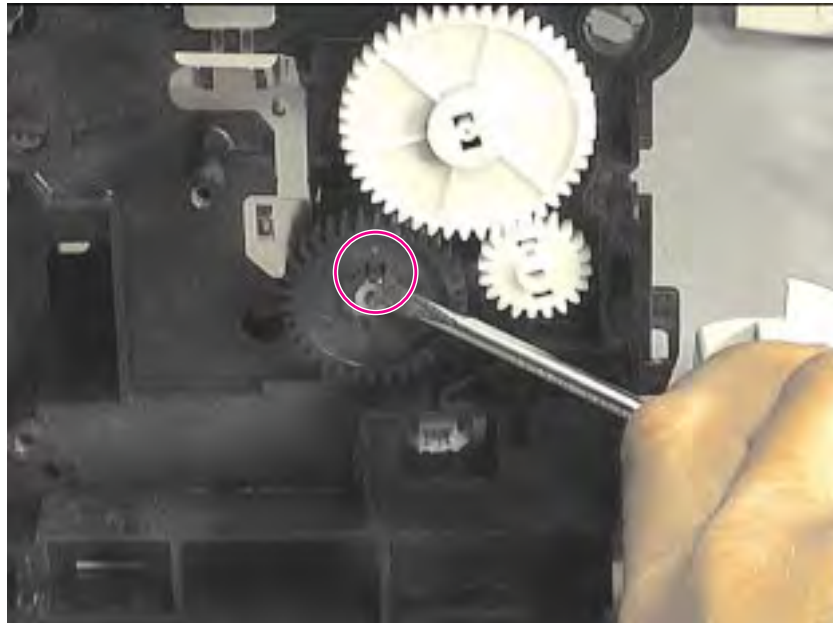

Figure 4-36 Removing the pressure roller (continued on next page)

Prior to this step: Remove the scanner, pods, printer door, memory card (if applicable), paper guide, front cover, back cover, output roller, delivery assembly, fuser assembly, and gear train.

- 1 Using a flat-blade screwdriver, remove the gear from the end of the Pressure Roller by gently prying the small plastic tab up from the slot in the end of the roller axles.
- 2 Slide the gear off the end of the roller.

Pressure roller removal (continued)

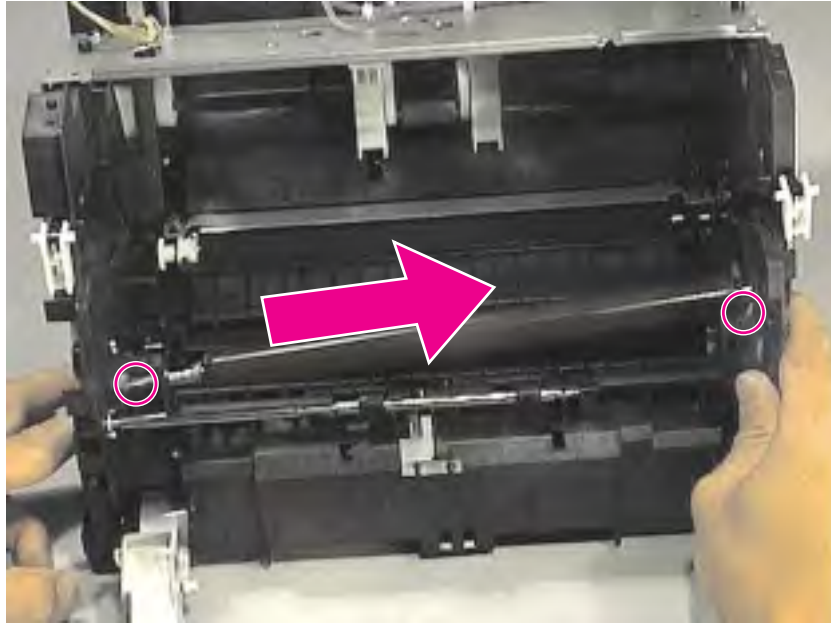

Figure 4-37 Removing the pressure roller

CAUTION:

This Pressure Roller is covered with light contact grease. Do not get it on your clothes. See Chapter 6, "Parts and diagrams," for information about ordering pressure roller grease.

NOTE:

The half bushing on the right of the assembly or the full bushing on the left end of the assembly are not connected to the printer chassis and may come loose during removal.

- 3 Loosen the two screws in the fusing guide (see callouts).
- 4 Lift the right end of the Pressure Roller out of the half bushing and slowly move the roller to the right, pulling the left end of the roller axle out of the opening on the left side of the printer.

Transfer roller removal

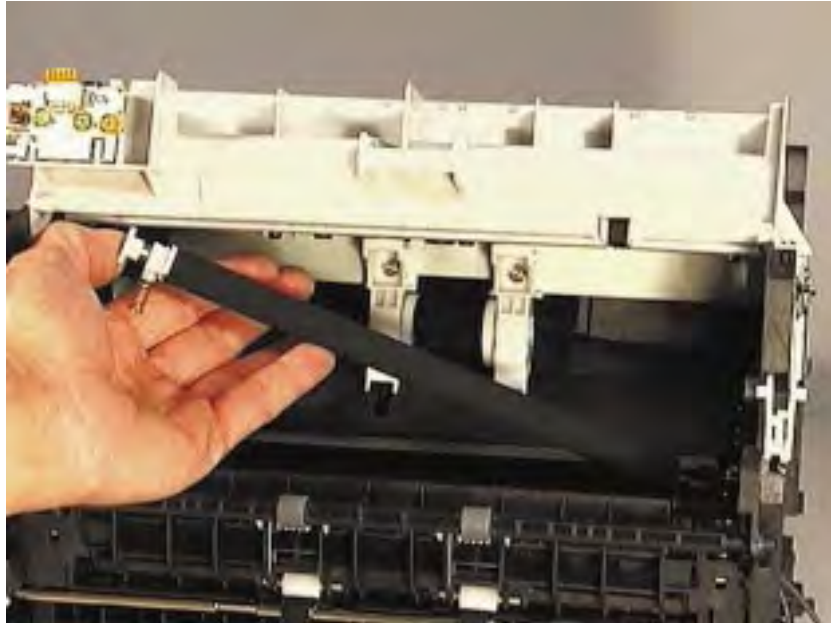

NOTE:

The Transfer Roller can be removed without disassembling any other printer parts.

CAUTION:

Do not touch the black portion of the Transfer Roller.

NOTE:

A grounding spring is attached to the bottom of the left end of the Transfer Roller. This spring may come loose during assembly or removal.

- 1 Using needle nose pliers, release the Transfer Roller by gently squeezing the small plastic snaps on the left end of the roller.
- 2 Lift the Transfer Roller up and out.

Pickup roller removal



Figure 4-38 Changing the pickup roller

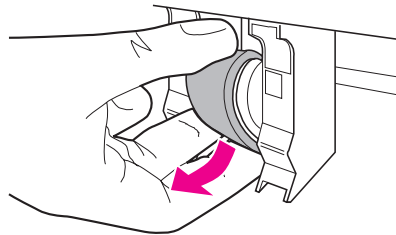

- 1 Rotate the bottom of the pickup roller towards the front of the printer.

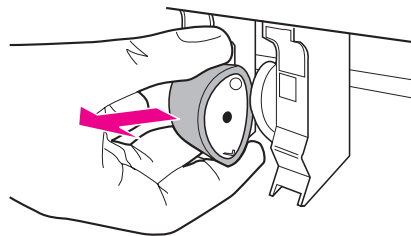

- 2 Gently pull the pickup roller straight out.

Paper pick-up assembly removal

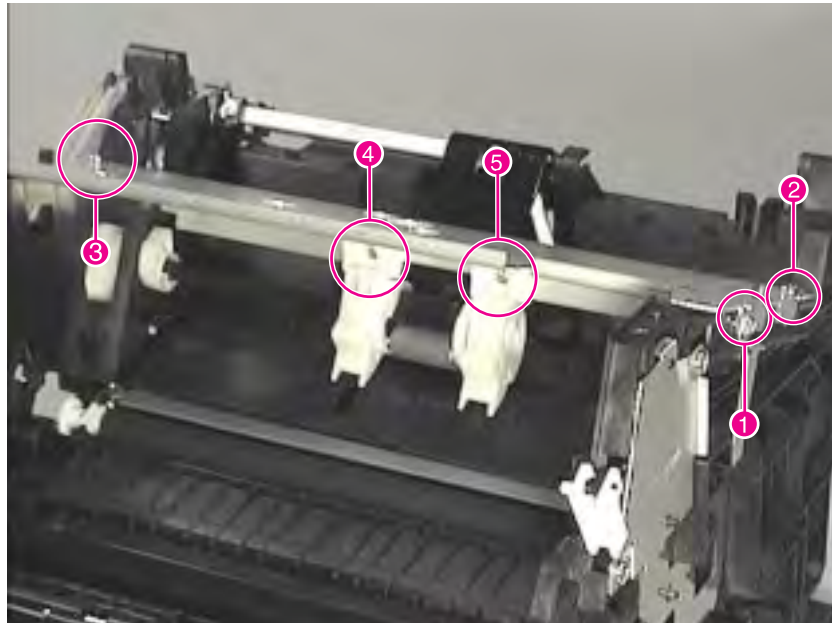

Figure 4-39 Accessing the paper pick-up assembly area

Prior to this step: Remove the memory card (if applicable), scanner, pods, front door, front cover, back cover, paper guide, top cover; and disconnect the laser/scanner.

- 1 Remove the screw attached to a bracket at the right end of the cover plate (callout 1).
- 2 Remove the two top screws attached to the right and left of the plate (callouts 2 and 3).
- 3 Remove the two screws located underneath the plate, securing it to the Paper Pick-up Assembly (callouts 4 and 5).

Paper pick-up assembly removal (continued)

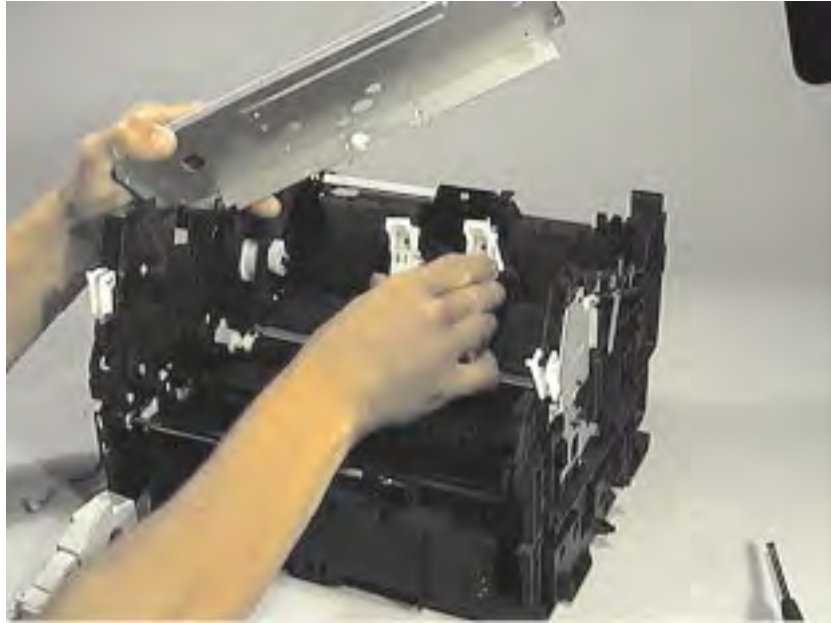

Figure 4-40 Removing the paper pick-up assembly cover

NOTE:

The Pickup Assembly is in several pieces; these pieces should be kept together. Pay close attention to how the Assembly is aligned before removing it (see Reassembly Note on this page).

- 4 Lift the metal plate clear of the printer.
- 5 Remove the Paper Pickup Assembly.

NOTE:

Reassembly Note:

When reassembling this part, you must correctly align and attach the section of the clutch without the teeth with the gear.

Kick plate removal

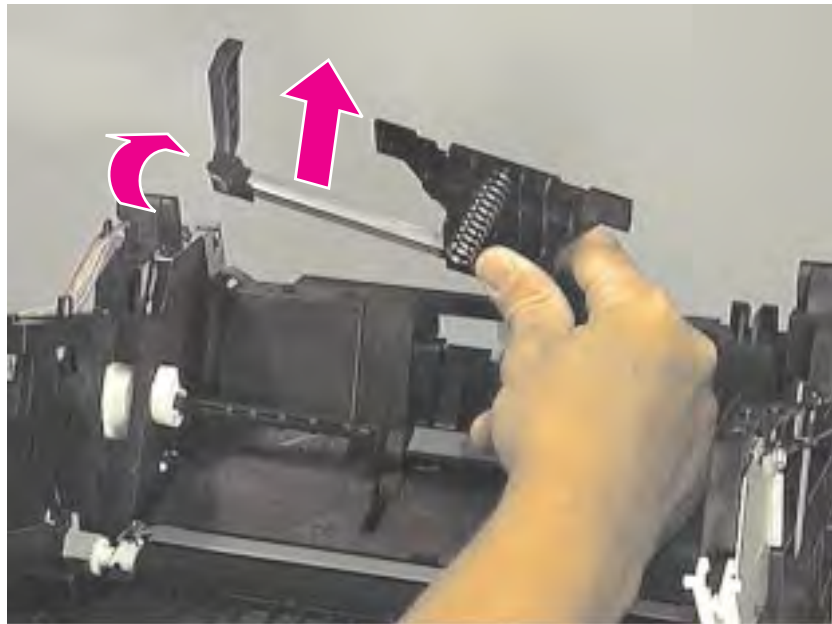

Figure 4-41 Removing the kick plate

Prior to this step: Remove the memory card (if applicable), scanner, pods, front door, front cover, back cover, paper guide, top cover; and disconnect the laser/scanner.

- 1 Rotate the cam to free the Kick Plate.
- 2 Rotate the Kick Plate arm up approximately 45 degrees and lift the left end up and out of the collar shaft securing it.

Separation pad removal

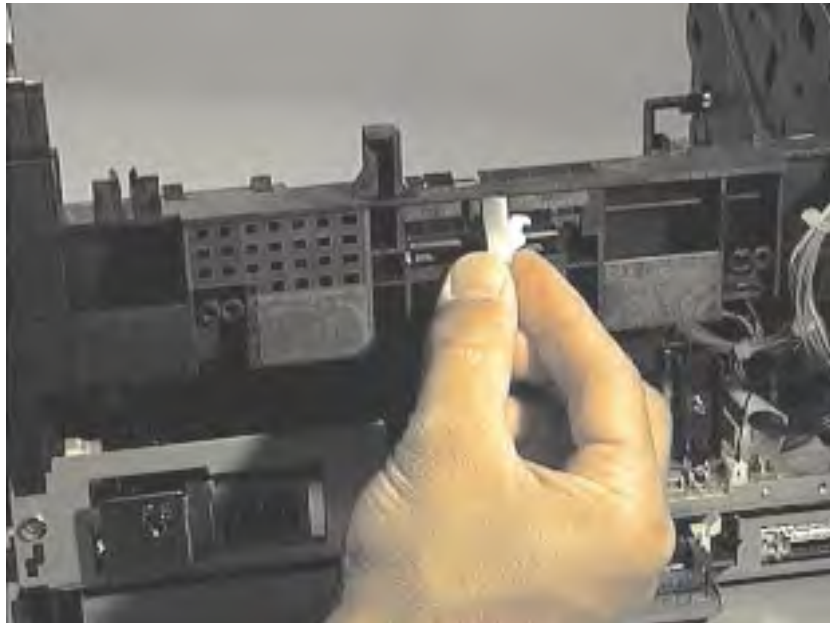

Figure 4-42 Removing the snap holding the separation pad

Prior to this step: Remove the memory card (if applicable), scanner, pods, front door, front cover, back cover, paper guide, top cover, kick plate; and disconnect the laser/scanner.

- 1 Remove the plastic snap on the opposite side of the printer from the Kick Plate.

Separation pad removal (continued)



Figure 4-43 Removing the separation pad

- 2 Slide the Separation Pad out through the brackets securing it.

Bottom assemblies

Formatter pan removal

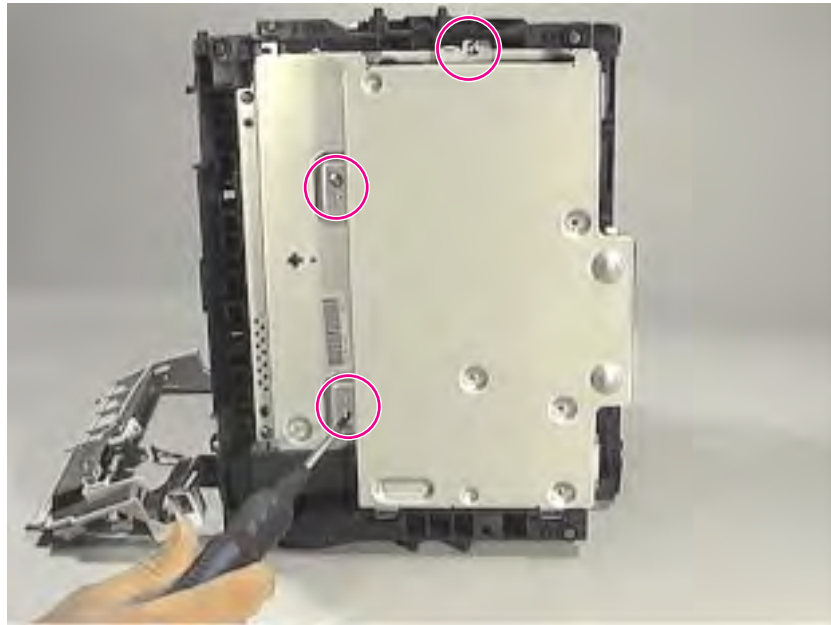

Figure 4-44 The formatter pan (continued on next page)

- 1 Remove the three screws holding the Formatter Pan to the bottom of the printer chassis. The third screw is located on a bracket at the end of the pan.

Formatter pan removal (continued)

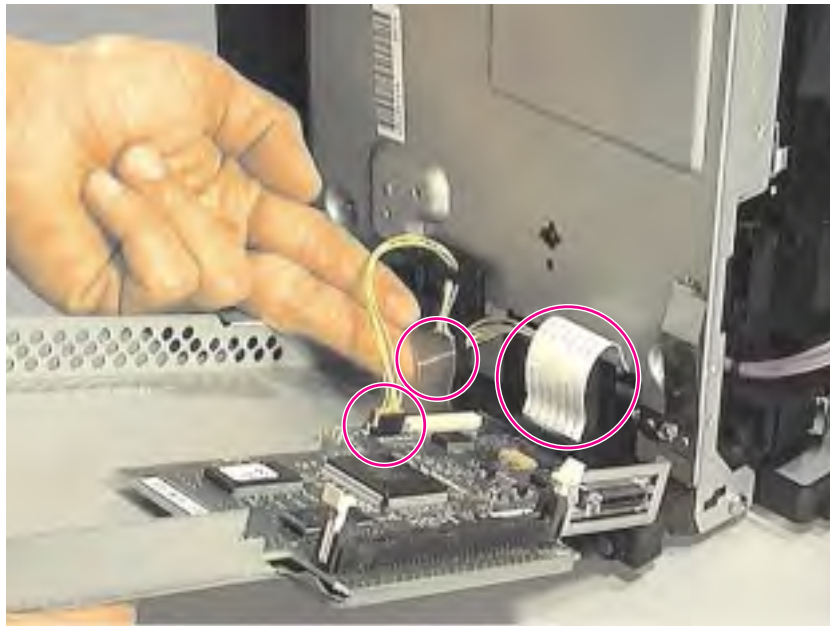

Figure 4-45 Removing the formatter pan (continued)

NOTE:

Be careful not to damage or break the electronic cables and connections underneath the formatter pan.

- 2 Slowly rotate the Formatter Pan away from the chassis.
- 3 Unplug the small connector cable and two flat flexible cables.
- 4 Slide the Formatter Pan free of the metal brackets.
- 5 To remove the Formatter from the Formatter Pan, remove the four screws securing the Formatter.

NOTE:

During reassembly, make sure the pan is resealed in the brackets.

Document scanner cable removal

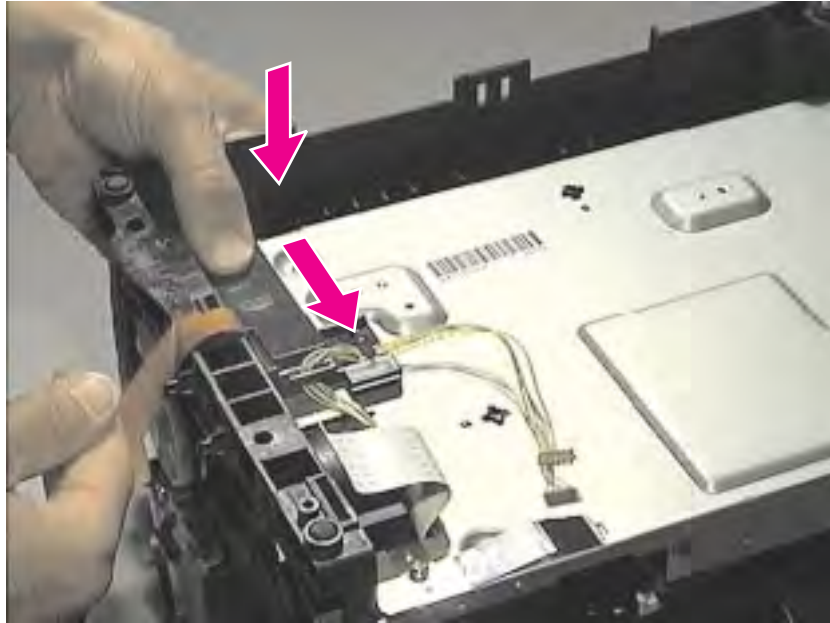

Figure 4-46 Removing the ECU pan cable cover

Prior to this step: Remove the scanner, pods, doors, back cover, front cover, and formatter.

- 1 Push down and back on the plastic cable cover on the bottom of the ECU Pan (the cable cover is marked with raised directional arrows).
- 2 Remove the cover, exposing the cable underneath.

Document scanner cable removal (continued)

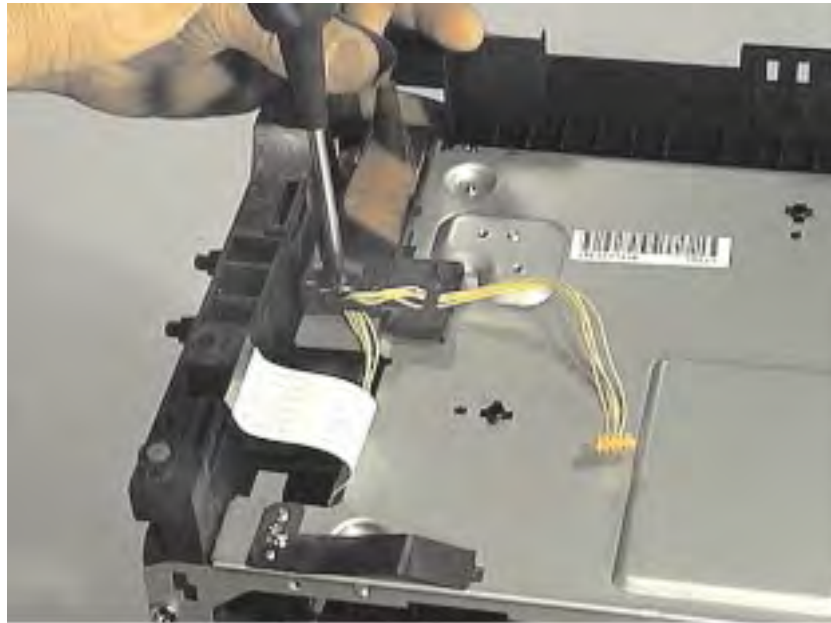

Figure 4-47 Removing ECU pan flat flexible cable

- 3** Remove the screw from the cable guide.
- 4** Slide the flat cable and attached grounding slip out from under the holding tabs.
- 5** Carefully slide the cable and grounding slip out through the opening in the printer chassis.

Hinge mechanism removal

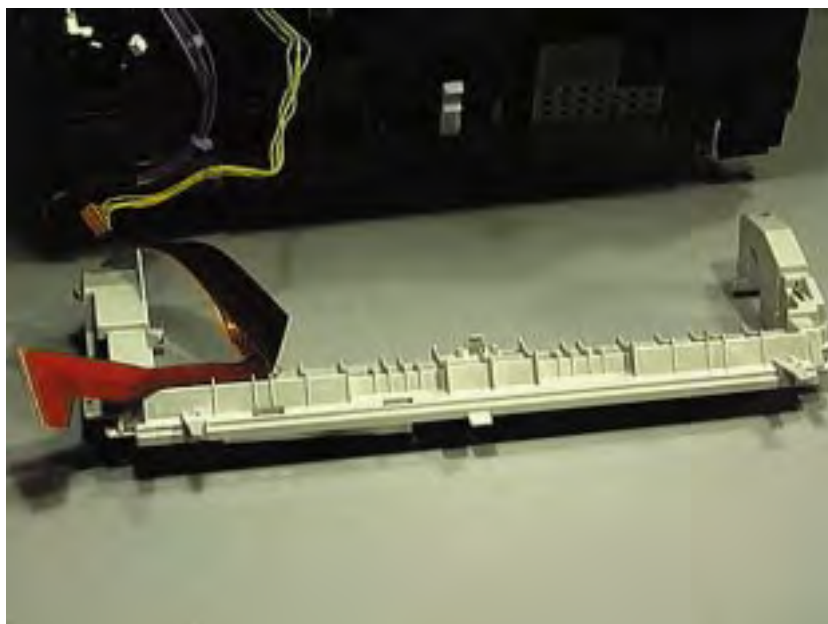

Figure 4-48 Removing the hinge mechanism

- 1 Slide the hinge mechanism and attached cables out of the chassis.

ECU pan removal

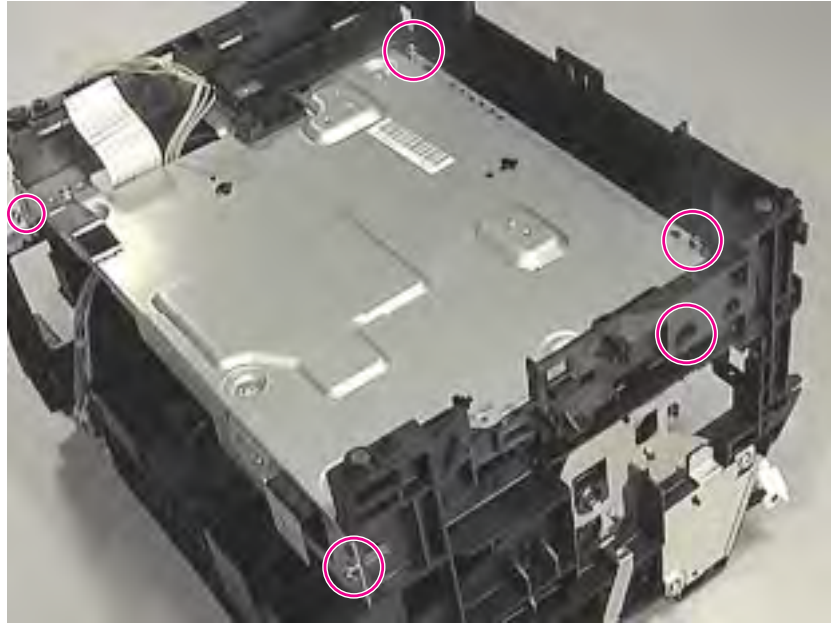

Figure 4-49 Removing the ECU pan

Prior to this step: Remove the scanner, pods, doors, back cover, front cover, formatter; and disconnect the ECU cable.

NOTE:

If the fuser cables are connected, disconnect them before removing the ECU pan.

- 1 Remove the two screws fastened to the brackets on the sides of the pan.
- 2 Remove the two screws accessed through openings in the side of the black plastic printer chassis.
- 3 Disconnect the small solenoid connection from the back of the ECU.

ECU pan removal (continued)



Figure 4-50 Removing the ECU pan (continued on next page)

- 4 Slowly lift the ECU plate away from the printer chassis.

CAUTION:

Be very careful not to damage or break the connectors underneath the ECU plate as you lift it from the printer chassis.

- 5 Reach between the plate and the chassis and unwind the cables from their cable guides until there is enough slack in the cables to allow access to the bottom of the ECU plate.
- 6 Unwind and disconnect all cables until the ECU board is separated from the chassis.

NOTE:

The entire ECU Board can be replaced as a single unit (cables do not ship with the replacement board; if cables are damaged during removal, you will need to purchase new ones).

Paper feed assembly removal

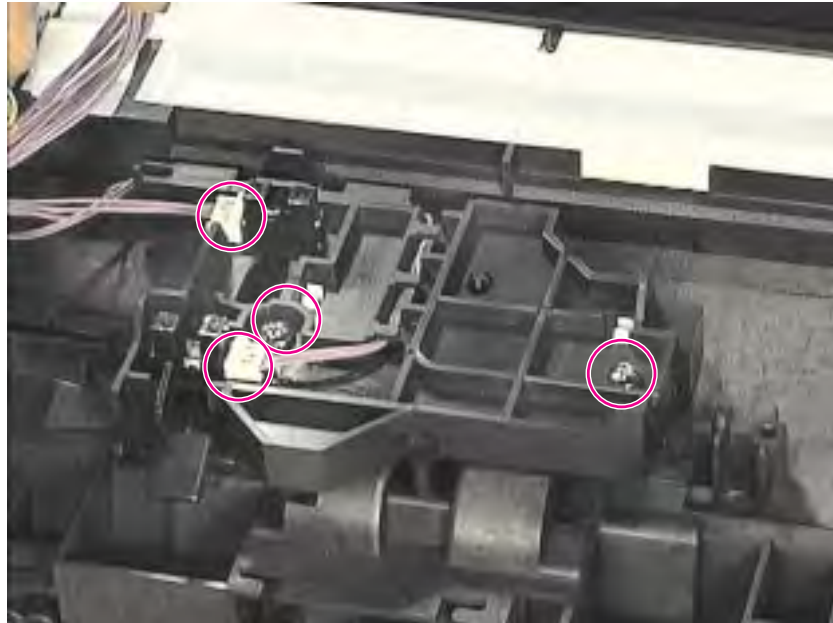

Figure 4-51 Removing the paper feed assembly (continued on next page)

Prior to this step: Remove the scanner, pods, doors, back cover, front cover, formatter; disconnect the ECU cable; and remove the ECU pan.

- 1 Disconnect the two cable connections.
- 2 Partially unwind the cables from their cable guides.
- 3 Remove the two screws securing the assembly to the printer chassis.
- 4 Lift paper feed frame away from chassis, being careful not to damage sensor flags.

NOTE:

Reassembly note: Be sure to seat the tab into the frame.

Paper feed assembly removal (continued)



Figure 4-52 Removing the paper feed assembly (continued)

- 5 Release the snap catches inside the gear on the left end of the Paper Feed Roller Shaft.

Paper feed assembly removal (continued)

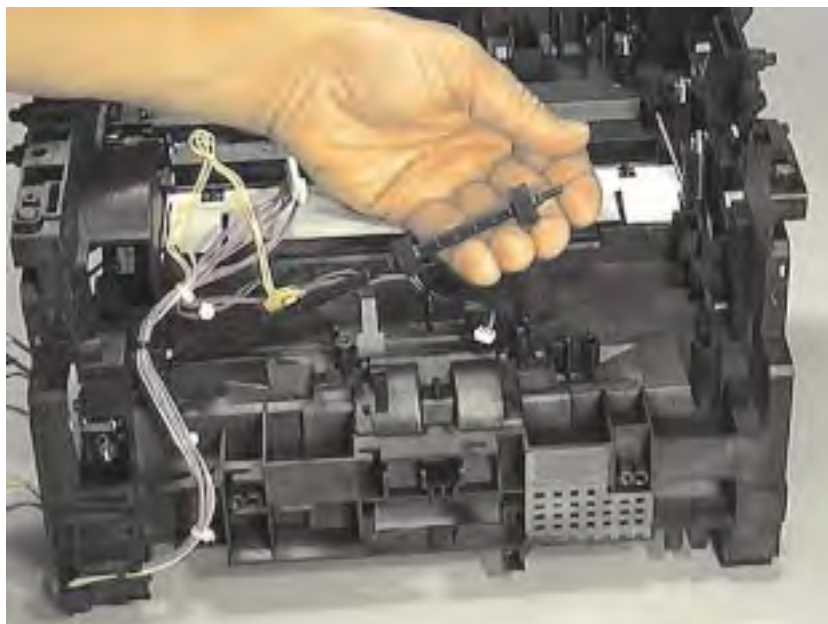

Figure 4-53 Removing the paper feed assembly (continued)

- 6 Slide the Paper Feed Roller to the right, and remove it from the printer chassis.

5 Troubleshooting/ Maintenance

Chapter contents

Basic troubleshooting	120
Fatal errors/accessory errors	122
Image formation troubleshooting	125
Solving image quality problems	126
Cleaning procedures	137
Functional checks	140
ServiceMode functions (PJM Software Commands)	149
Troubleshooting tools	152

Basic troubleshooting

Table 5-1. Basic troubleshooting

Verification steps	Possible problems	Solutions
Is Power On successful? When the product is connected to a grounded power source, the printer motor should rotate for approximately six seconds and the document scanner motor should rotate for approximately two seconds.	No power.	<ol style="list-style-type: none"> 1. Verify that the product is plugged in. 2. Verify that the power cable is functional and that the power switch is on (220v only). 3. Verify that FU102 on the ECU is not open. 4. If all of these conditions are correct, replace the ECU.
	Printer motor does not rotate.	<ol style="list-style-type: none"> 1. Verify that the toner cartridge is present. 2. Verify that the printer door is closed. 3. Verify that paper is loaded in the paper input bin. 4. Verify that printer path paper sensors are functional. 5. Verify that the motor connector J1 is seated into the ECU. 6. Verify that the motor is correctly mounted to the printer chassis. 7. If all of these conditions are correct, replace the ECU. 8. If, after replacing the ECU, the printer motor still does not rotate, replace the motor.
	Document scanner motor does not rotate.	<ol style="list-style-type: none"> 1. Verify that the document scanner connector is seated in the printer door. 2. Verify that the document scanner is correctly mounted on the printer. 3. If these conditions are met, replace the document scanner. 4. If, after replacing the scanner, the document scanner motor still does not rotate, replace the formatter. 5. If, after replacing the formatter, the document scanner motor still does not rotate, replace the ECU.
Is the product ready?	Control panel displays an error light pattern.	Consult the list of common messages later in this chapter to correct the error.
The control panel should function without error messages.	Control panel is not functional.	Verify that the control panel cable is seated into both the control panel and the formatter board. If the cable is connected correctly, replace the control panel.
Do engine tests and self tests print?	Engine test is not successful.	Replace the ECU.

Table 5-1. Basic troubleshooting

Verification steps	Possible problems	Solutions
Print an engine test, which is discussed later in this chapter. The engine test should print without paper feed problems or print quality problems. Also print self test (follow the instructions under "Printing self test" later in this chapter).	Control panel displays an error light.	Consult the list of common messages in Chapter 2, or "Fatal errors" in this chapter to correct the error.
	Self test does not print.	If the engine test is successful, but the self test does not print, replace the formatter.
	Paper does not move smoothly through the printer paper path.	Isolate printer paper path problems by performing a paper path check, which is discussed later in this chapter.
	Poor print quality.	See "Solving image defects" later in this chapter.
Is the copy function operational?	Poor copy quality.	If the print quality from the self test and engine test was acceptable, but the print quality of the copies is not, clean the contact image sensor and the white roller, and then recalibrate the document scanner. If, after performing the maintenance, the problem persists, replace the contact image sensor or document scanner.
Place the self test into the document scanner input bin and copy it to the printer. Self test should feed smoothly through the document scanner path and copies should print without print quality problems.	Paper does not move smoothly through the document scanner path.	Clear the document scanner path of obstructions. Check photosensor to make sure that it operates correctly. If the problem persists, replace the document scanner.
Is the software installed correctly?	Software is not installed or an error occurred during software installation.	Uninstall the software. Reload the product's software. Make sure you use an ECP port setting.
Does the product print from the computer?	The parallel cable is not connected.	Connect the cable.
Connect the parallel cable to the product and the computer. Use a word processing application to send a print job to the printer.	An incorrect printer driver is selected.	Reset the printer driver.
	Other devices are connected to the parallel port.	Disconnect the other devices and try again to print.
	There is an LPT port driver problem in Windows 95/NT.	Reset the computer's port settings. Formatter failure - replace formatter.
Does the product scan to the computer?	Other devices are connected to the parallel port.	Disconnect the other devices and try again to scan.
Initiate a scan from either the computer's basic desktop software or from the product.	The computer's parallel port hardware is not bidirectional.	Check hardware documentation to see if the port configuration can be changed.
	The BIOS settings for the parallel port are set incorrectly.	Reset the computer's port settings. If the problem persists, reset the BIOS settings in CMOS.
	Polling is turned off in Document Assistant or Document Assistant is not running.	Start Document Assistant, turn on polling.

Fatal errors/accessory errors

The printer may encounter a severe error, one that inhibits further operation. All LEDs will turn on or, in the case of an Accessory Error, all LEDs will start flashing. During this mode, pressing and holding the Go key down will reveal a pattern on the LEDs. Some LEDs might be on and some might be off, but it will be a non-changing pattern as long as the Go key is held down. This pattern can be used to identify what type of fatal error it was. For example, if all LEDs turn on, holding the Go key down might turn off all of the LEDs except for the Attention LED. This pattern would indicate that there is an Engine Error. For most of the errors listed here, turning the printer off for a short while will not clear the error (it is more serious than that), but it is recommended as a last resort. Remember, the error pattern will only be displayed as long as the Go key is held down.

Light status legend

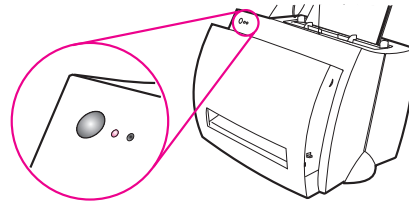
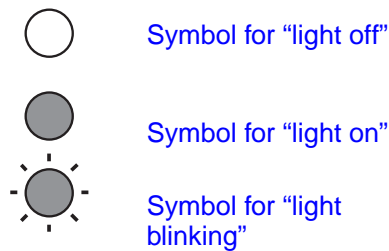

Table 5-2. Service and error messages

Light status	Description	Recommended action
	<p>ROM/RAM Error. An error was found with the ROM or RAM. The printer believes that the ROM is corrupted or an error has been found in the RAM.</p>	<ol style="list-style-type: none"> 1. Power cycle the printer by unplugging the printer and plugging it back in. If this does not clear the error, go to step 2. 2. Unplug the printer, remove any optional memory, then power the printer back on. If the message clears, replace the memory card. 3. Replace the Formatter PCA.
	<p>Fuser Error. This indicates a fusing assembly malfunction.</p> <p>NOTE: Chronic fuser failures, fuser overheating, or both are indicators of an uninterruptible power supply or battery backup being used with the printer. Uninterruptible power supplies (UPSs) should not be used with the printer.</p>	<ol style="list-style-type: none"> 1. Unplug the printer for 10 minutes or more. 2. Verify that the fuser connector is firmly seated in the ECU and that the thermistor connector (left of fusing assembly) is seated into both the printer chassis and the ECU. 3. Perform heating element resistance check. 4. If the resistance readings are correct yet the error persists, replace the ECU.

Table 5-2. Service and error messages





Light status	Description	Recommended action
	<p>Beam Error. There are a number of causes for this error, and some of the causes may disappear.</p>	<ol style="list-style-type: none"> 1. Power cycle the printer by unplugging the printer and plugging it back in. 2. Make certain the Laser/Scanner Assembly is correctly seated on the printer chassis. 3. Replace the Laser/Scanner cable. 4. Replace the Laser/Scanner Assembly. 5. Replace the ECU.
	<p>Print Engine Error. The formatter and engine are not communicating.</p>	<ol style="list-style-type: none"> 1. Power cycle the printer by unplugging the printer and plugging it back in. 2. Reseat Formatter to ECU cable. 3. Replace the Formatter PCA. 4. Replace the ECU.
	<p>Printer Laser/Scanner Error. Caused by a laser scanner malfunction.</p>	<ol style="list-style-type: none"> 1. Power cycle the printer by unplugging the printer and plugging it back in. If this does not clear the error, go to step 2. 2. Ensure condensation caused by moving the printer from a cold to a warm environment hasn't occurred. Allow the printer to acclimate to the warmer room. 3. Verify the two Laser/Scanner Assembly connectors are firmly seated. 4. Replace the scanner cable on the ECU. 5. Replace the Laser/Scanner Assembly. 6. Replace the ECU.
	<p>Firmware Error.</p> <p>Note the LED patterns on the BiTronics error code. Contact HP technical support with this information as well as a description of what data was sent, the errors encountered prior to the firmware error, the condition of the printer prior to the error, and any other information that may help isolate the error.</p>	<ol style="list-style-type: none"> 1. Power cycle the printer by unplugging the printer and plugging it back in. 2. Disconnect the parallel I/O cable and try running a printer self test. Reconnect the parallel cable if the self test is successful and try host/printer communications again. 3. If the error persists, replace the Formatter PCA.

Table 5-2. Service and error messages



Light status	Description	Recommended action
	Incompatible DIMM Error (Accessory Error).	Remove DIMM and power cycle. If error persists, replace formatter.
	Document Scan Engine Error.	1. Unplug the printer, remove and reattach the laser scanner, and then replug the printer. 2. Replace the document scanner unit.
	Document Scan Engine NVRAM Error.	1. Unplug the printer, remove and reattach the laser scanner, and then replug the printer. 2. Replace the laser scanner unit.

Image formation troubleshooting

Checking the toner cartridge

Image formation defects are many times the result of toner cartridge problems. If there is any doubt, always replace the toner cartridge before troubleshooting image defects.

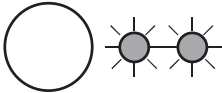
Use the following checklist to ensure that the toner cartridge is still operable.

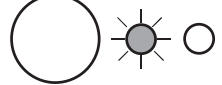
- ❑ Ensure that the toner cartridge is seated properly.
- ❑ Inspect the toner cartridge for remaining toner.
- ❑ Check the expiration date stamped on the toner cartridge box.
- ❑ Check the toner cartridge to see if it has been disassembled or refilled.
- ❑ Inspect the cartridge to see if toner is leaking through worn seals.
- ❑ Check the surface of the photosensitive drum in the cartridge to see if it has been damaged or scratched. Touching the drum contaminates the photosensitive surface and can cause spotting and image defects.
- ❑ Blurred areas on printed pages indicate that the photosensitive drum in the cartridge has been overexposed to light. Because overexposure to light causes permanent damage to the photosensitive drum, the cartridge should be replaced.

NOTE:

A toner cartridge weighs 702 grams (24.7 ounces) when it is full and 594 grams (20.9 ounces) when it is empty.

To redistribute toner in the cartridge

Before installing a new cartridge or when toner begins to run low, redistribute the toner by rotating the cartridge back and forth five or six times.

Solving image quality problems

Use the following table to help solve problems with printed pages. See “Solving paper feed problems” in this chapter.

Table 5-3. Solving image quality problems



Problem	Cause	Solution
Parts of the page around the edges aren't printing.	The HP LaserJet 1100 Printer cannot print to the edge of the paper. The HP LaserJet 1100 Printer has minimum margins on each edge of 0.25 in (6.4 mm).	To get the image to fit into this printable area, slightly reduce the size of the image.
	If printing or copying, the reduction setting is set incorrectly.	For printing, check the reduction setting in the “Print” or “Setup” window from within the program you are using. Copies will clip if original has image too close to edge.
Images will not print.	The HP LaserJet 1100 Printer is not plugged in.	Make sure that the HP LaserJet 1100 Printer is plugged into a live wall outlet or power strip.
	The parallel cable is loose.	Check that the parallel cable is securely connected between the HP LaserJet 1100 Printer and the computer.
Copies or scanned images are too light or too dark.	The contrast is not set correctly.	Adjust the contrast and resolution settings from the Document Assistant.
	The HP LaserJet 1100 Printer needs to be recalibrated.	Recalibrate the product.
	The original image is very light or very dark.	Adjust the resolution and/or contrast setting(s) from the tool box on the Document Assistant.
	The scanned image is too light or too dark because the original was on a colored paper.	If the original was on a colored paper, including brown recycled paper, the text may not be clear. Adjust the resolution, contrast, and/or brightness settings from the tool box on the Document Assistant.

Table 5-3. Solving image quality problems

Problem	Cause	Solution
Print is faded or you notice a block of vertically aligned white streaks,	The toner cartridge is getting low on toner.	Redistribute the toner or replace the toner cartridge.
	The HP LaserJet 1100 Printer needs to be cleaned.	See "Cleaning procedures" in this chapter.
or print is not faded, but vertical white stripes appear on the page.	The paper you are using does not meet HP's paper specifications (for example, it is too moist or too rough).	Make sure that the media meets specifications detailed in HP's media specifications guide.
	Toner density setting is not adjusted correctly.	Adjust the setting from the control panel.
	A part of the HP LaserJet 1100 Printer is damaged.	Follow the steps in "Basic troubleshooting" to isolate the problem.
	The internal mirror or optics are damaged.	Clean the mirror by blowing air through the laser/scanner to remove any dust particles.
	The laser/scanner is damaged.	Replace the laser/scanner.
	There is a problem in the contact image sensor.	Follow the instructions in this chapter to recalibrate the document scanner.
	The document scanner needs to be recalibrated.	Replace the contact image sensor.
	There is a problem in the formatter.	Replace the formatter.
Stains or smudges appear as small, round, black dots on the front or back of a page. Sometimes inconsistent stains appear.	The paper you are using does not meet HP's paper specifications (for example, it is too moist or too rough).	Make sure that the media meets specifications detailed in HP's media specifications guide.
	You are printing on the wrong side of the paper.	Remove the paper from the paper input bin and turn it over. (The wrapper on many reams of paper has an arrow indicating the print side.)
	The HP LaserJet 1100 Printer needs to be cleaned.	See "Cleaning procedures" in this chapter for instructions on cleaning the product and using a cleaning page.
	The toner cartridge is damaged.	Replace the toner cartridge if maintenance procedures do not improve print quality.

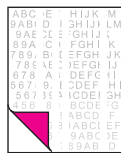

Table 5-3. Solving image quality problems

Problem	Cause	Solution
Vertically-aligned black streaks or smears appear on successive pages.	The HP LaserJet 1100 Printer needs to be cleaned.	See "Cleaning procedures" in this chapter.
	The toner cartridge is damaged.	Replace the toner cartridge if maintenance procedures do not improve print quality.
	There is a problem in the heating element.	Perform the "Heating element check," which is discussed later in this chapter.
	If scanned images have unwanted lines through them:	
	There is ink, glue, white-out, or some other substance on the contact image sensor.	See "Cleaning procedures" in this chapter.
	Slick paper caused the document scanner trouble in scanning.	Use a carrier sheet to send the item.
	The HP LaserJet 1100 Printer needs to be recalibrated.	Recalibrate the product.

Table 5-3. Solving image quality problems

Problem	Cause	Solution
Horizontally aligned black streaks or smears appear.	The toner cartridge was improperly installed.	Make sure you removed the entire length of the sealing tape from the toner cartridge before you installed it.
	The toner cartridge is defective.	Replace the toner cartridge.
	The HP LaserJet 1100 Printer needs to be cleaned.	See "Cleaning procedures" in this chapter.
	There is a problem in the heating element.	Perform the "Heating element check," which is discussed later in this chapter.
	A gear is damaged.	Perform the "Drum rotation functional check," which is discussed later in this chapter.
	There is a problem in the laser/scanner.	Replace the laser/scanner.
	The HP LaserJet 1100 Printer needs to be cleaned.	See "Cleaning procedures" in this chapter.
	There is a problem in the contact image sensor.	Replace the contact image sensor.
	A roller is damaged.	Use the "Repetitive image defect ruler" later in this chapter to determine which roller is damaged. Replace the roller.
	The HP LaserJet 1100 Printer needs to be cleaned.	See "Cleaning procedures" in this chapter.
	If you are using transparencies, they do not meet HP's specifications.	Make sure that the media meets specifications detailed in HP's media specifications guide.
The paper's texture is too coarse.	Try changing to a paper with a smoother finish.	
The toner cartridge is damaged, causing a repetitive black flaw on every printout.	Replace the toner cartridge.	
The toner cartridge's photosensitive drum has been overexposed to bright light, causing repetitive defects (usually a fuzzy black area).	Replace the toner cartridge.	

Table 5-3. Solving image quality problems



Problem	Cause	Solution
Character voids appear (white areas within the parts of characters that should be solid black).	The paper or transparencies do not meet HP's specifications.	Make sure that the media meets specifications detailed in HP's media specifications guide.
	You are printing on the wrong surface of the paper.	Remove the paper and turn it around. (The wrapper on many reams of paper has an arrow indicating the print side.)
	Poor fusing.	Check for wrap jam in fuser.
	Background scatter results from bits of toner distributed on the front or back of a printed page. Background scatter often is isolated to a specific area of the page.	Try changing the print density setting. If that doesn't work, change the paper type, weight, or surface finish. If background scatter occurs on an envelope, try moving the text to an area with no seams. Printing on seams can cause this problem.
	Toner has spilled inside the product.	See "Cleaning procedures" in this chapter.
	The pickup roller is dirty.	See "Cleaning procedures" in this chapter.
The page is completely black.	The toner cartridge was improperly installed.	Remove the cartridge and reinstall it.
	The toner cartridge is defective.	Replace the toner cartridge.
	Discontinuity exists in the high-voltage contact points.	Perform the "High-voltage power supply check," which is discussed later in this chapter.
	There is a problem in the ECU or the laser/scanner.	Follow the steps in "Basic troubleshooting" to isolate the problem. Replace the ECU or the laser/scanner, as needed.

Table 5-3. Solving image quality problems



Problem	Cause	Solution
<p>Characters are only partially printed (also referred to as dropouts).</p> 	A single sheet of paper is defective.	Try reprinting the job.
	The print density needs to be adjusted.	Adjust the print density from the control panel.
	The moisture content of the paper is inconsistent or the paper has moist or wet spots on the surface.	Make sure that the media meets specifications detailed in HP's media specifications guide.
	The paper was damaged by inconsistent manufacturing processes.	Make sure that the media meets specifications detailed in HP's media specifications guide.
	A "draft mode" or "economy mode" is selected in the software.	Try a "normal" or "best" setting.
	<hr/>	
<p>The bottom of the printed page is blank or part of a graphic's image is cut off.</p> 	The page is too complex. (There is not enough memory to process the page.)	Set the resolution to 300 dpi through your software or printer driver. See the online help for printer driver issues.
<p>Blank pages print occasionally.</p> 	Page length and margins are not set correctly for the paper size.	If you are printing on small paper and your page is blank, try printing on larger paper to see where the image is printing. Adjust the margins accordingly.
	Your HP LaserJet 1100 Printer is feeding two or more sheets of paper at a time because the paper is difficult to separate.	Remove the paper from the paper input bin and align the edges of the paper. "Break" the ream of paper by curving it into an upside-down u-shape. Try turning the paper around to feed the other end first, or use a different type of paper.
		Clean the pickup roller and the separation pad. If the problem persists, replace the separation pad or subpads.
	Your software application is sending an extra page-eject command.	Check your software's printing configuration information. If you are using a word-processing program, check for a natural page break and a forced page break that are close to each other.

Table 5-3. Solving image quality problems



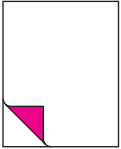

Problem	Cause	Solution
<p>Blank pages are always printing.</p> 	The toner cartridge was improperly installed.	Make sure you removed the entire length of the sealing tape from the toner cartridge before you installed it.
	The toner cartridge is completely out of toner.	Replace the toner cartridge.
	Discontinuity exists in the high-voltage contact points.	Perform the "High-voltage power supply check," which is discussed later in this chapter.
	There is a problem in a part of the product.	Print a self-test page. If the page is blank, follow the steps in "Basic troubleshooting" to isolate the problem. Replace the laser/scanner or the ECU as needed.
<p>Print is misaligned on the page (skewed pages).</p> 	The paper input bin is overfilled.	Remove some of the paper.
	The guides are adjusted improperly.	Be sure to center the paper with the paper guides. Also, verify that the paper guides are not adjusted too tightly or too loosely against the paper.
	The paper's weight or surface finish does not meet HP's specifications.	Make sure that the media meets specifications detailed in HP's media specifications guide.
<p>Scanned images have black dots or streaks in top and bottom margins.</p> 	There is ink, glue, white-out, or some other substance on the contact image sensor.	See "Cleaning procedures" in this chapter.
	There is a problem in the contact image sensor.	Replace the contact image sensor.

Table 5-3. Solving image quality problems

Problem	Cause	Solution
Scanned text is not clear.	The contrast, resolution, or brightness needs to be adjusted before scanning.	Adjust the resolution, contrast and/or brightness setting(s) from the tool box on the Document Assistant.
	The original is on colored paper.	If the original was on colored paper, including brown recycled paper, the text may not be clear. Try adjusting the resolution, contrast, and/or brightness settings from the tool box on the Document Assistant.
	There is a problem in the contact image sensor.	Replace the contact image sensor.

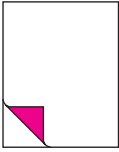
Solving paper feed problems

Use the following table to solve problems related to moving paper or documents through the HP LaserJet 1100 Printer.

Table 5-4. Solving paper feed problems

Problem	Cause	Solution
Pages are coming out curled or wrinkled from the HP LaserJet 1100 Printer.	Paper is curled or wrinkled when using the paper output bin.	Use the front paper output slot by pushing the paper path lever to the lower position.
	Paper is not stored properly.	Whenever possible, store paper in its sealed ream at room temperature.
Long pages stop feeding through the document scanner.	The document feeder tray guides are not set correctly, are broken, or are missing.	Check for broken or missing document feeder tray guides and replace as necessary.
	The maximum scannable page length is 30 inches (991 mm). If the page is longer, scanning stops at 30 inches (991 mm).	Do not try to pull the page out because you may damage the document scanner. To remove the page, open the document release door and remove the jammed media.
Print is misaligned on the page (skewed pages).	The paper input bin is overfilled.	Remove some of the paper.
	The paper guides are not set correctly, are broken, or are missing.	Be sure to center the paper with the guides. Verify that the guides are not adjusted too tightly or too loosely against the paper. Check for broken or missing paper guides and replace scanner as necessary.
	The paper's weight or surface finish does not meet HP's specifications.	Make sure that the media meets specifications detailed in HP's media specifications guide.
Scanned items are crooked.	The document feeder tray guides are not adjusted properly.	Be sure to center the paper with the guides. Also, verify that the guides are not adjusted too tightly or too loosely against the paper. Check for broken or missing document feeder tray guides and replace scanner as necessary.

Table 5-4. Solving paper feed problems

Problem	Cause	Solution
The HP LaserJet 1100 Printer is feeding multiple sheets or jams frequently from the paper input bin or single-sheet input slot.	Paper guides are not adjusted properly.	Slide the guides against the sides of the stack in the paper input bin or against the single sheet in the single-sheet input slot to center the paper. Make sure the guides are not adjusted too tightly.
	Paper was not removed from the paper input bin before filling the bin.	Always remove paper from the paper input bin before refilling the bin.
	The paper input bin is overfilled.	Remove some of the sheets. The paper input bin can hold up to 125 sheets of 20-lb. (75g/m ²) bond weight paper (less for heavier paper) or from 7 to 10 envelopes.
	More than one sheet was placed in the single-sheet input slot.	Place only one sheet at a time in the single-sheet input slot.
	The paper was poorly cut by the manufacturer and is sticking together.	“Break” the ream of paper by curving it into an upside-down u-shape; this may effectively decrease multifeeds. Also try turning the paper around to feed the opposite end first, or use a different type of paper.
	The paper does not meet HP’s specifications for print media.	Make sure that the media meets specifications detailed in HP’s media specifications guide.
	The output capacity was exceeded in the paper output bin or front paper output slot.	Do not allow more than 100 sheets of 20-lb (75g/m ²) bond weight paper (less for heavier paper) to fill the paper output bin.
	The pickup roller is dirty.	See “Cleaning procedures” in this chapter.
	The pickup roller is damaged.	Replace the pickup roller.
	The separation pad is dirty.	Clean the separation pad.
The separation pad is damaged.	Replace the separation pad.	
A sensor is not operating properly.	Check the sensors to make sure that none of them are jammed. If a sensor cannot be “unjammed,” replace the sensor.	
There is a problem in the paper path.	Perform the “Paper path check,” which is discussed later in this chapter, to determine which parts should be replaced.	

Table 5-4. Solving paper feed problems

Problem	Cause	Solution
The HP LaserJet 1100 Printer is feeding multiple sheets or jams frequently from the document feeder tray.	Guides are not adjusted properly.	Remove the document from the document feeder tray. Straighten the item, then reinsert it. Slide the guides against the sides of the item to center it. Make sure the guides are not adjusted too tightly.
	The document feeder tray is overfilled.	Remove some of the sheets. The document feeder tray can hold up to 10 pages, depending on the thickness of the pages.
	The item was too thick, too slick, or otherwise did not meet specifications.	Make sure that the media meets specifications detailed in HP's media specifications guide.
	The document scanner pickup roller or separation pad is dirty and cannot feed the document.	See "Cleaning procedures" in this chapter.
	The document scanner pickup roller or separation pad is damaged or worn.	Replace the scanner.
	The sensor is not operating properly.	Check the sensor to make sure it is not jammed. If a sensor cannot be "unjammed," replace the scanner.
	There is a problem in the document scanner path.	Check the path for obstructions. Readjust as necessary or replace the scanner.
Items loaded in the document feeder tray fall forward out of the tray.	The item is on a very lightweight media.	Do not try to pull the page out because you may damage the document scanner. Open the document release door and remove the jammed media. Then, curl or roll the item in the direction of the printed side, unroll it, and reload the item.

Cleaning procedures

Cleaning the toner cartridge area

With a dry, lint-free cloth, wipe any residue from the paper path area and the toner cartridge cavity.

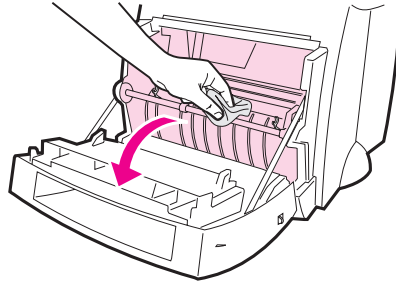

NOTE:

Cleaning the toner cartridge area is not necessary on a regular basis. Before cleaning, look for excessive toner in the compartment.

Cleaning the printer paper path

This process uses copier-grade paper to remove dust and toner from the paper path. Do not use bond or rough paper. Use this process if you are experiencing toner specks or dots on printouts. This process will produce a page with toner debris, which should be discarded.

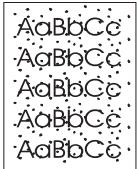

- 1 Ensure the printer is loaded with paper.
- 2 Ensure the printer is in the Ready state.
- 3 Press and hold the **GO** key for 20 seconds (if released before 20 seconds the printer will perform a reset). Paper will feed through the printer.

NOTE:

After holding the **GO** key for 20 seconds, each of the three printer lights will blink until the cleaning process is complete.

Cleaning the pickup roller

To clean the pickup roller rather than replace it, follow the instructions below:

- 1 Remove the pickup roller as described in “Changing the pickup roller.”
- 2 Dab a lint-free cloth in isopropyl alcohol, and then scrub the roller.

WARNING!

Alcohol is flammable. Keep the alcohol and cloth away from open flame. Allow alcohol to dry completely before closing the printer and plugging in the power cord.

- 3 Using a dry, lint-free cloth, wipe the pickup roller to remove loosened dirt.

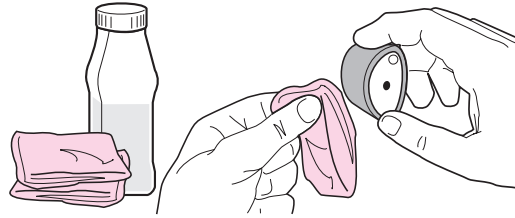

- 4 Allow the pickup roller to completely dry before reinstalling it in the printer.

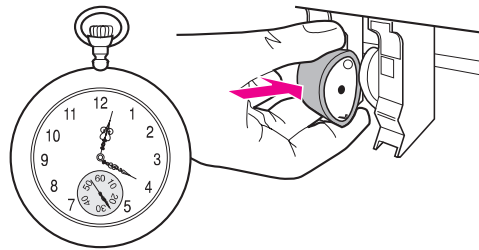

Cleaning the scanner

You may need to clean the scanner after scanning or copying items that have ink which smudges or that have excessive amounts of dirt or dust.

To clean the scanner, follow the instructions below:

- 1 Unplug the printer to turn the power off, and then wait for the scanner to cool.

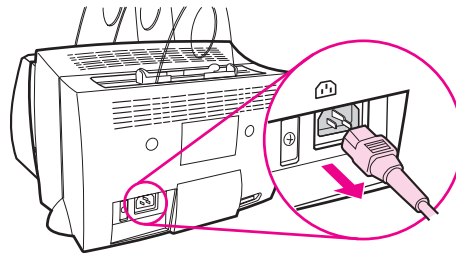

- 2 Open the scanner door.

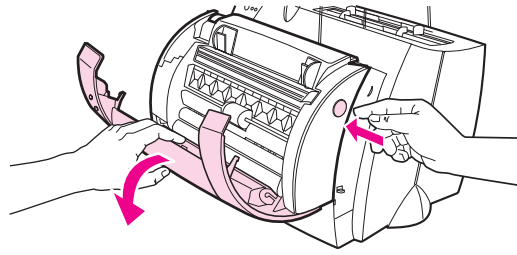

- 3 Dampen a clean, cotton cloth with rubbing alcohol (pH7 or neutral pH) or glass cleaner. Gently rub back and forth on the white CIS roller with the damp cloth while slowly turning the CIS roller.

WARNING!

Alcohol is flammable. Keep the alcohol and cloth away from open flame. Allow alcohol to dry completely before plugging in the power cord.

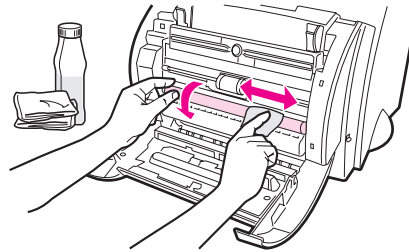

- 4 Spray **glass cleaner** on another piece of clean, cotton cloth and carefully clean the glass on the image sensor.

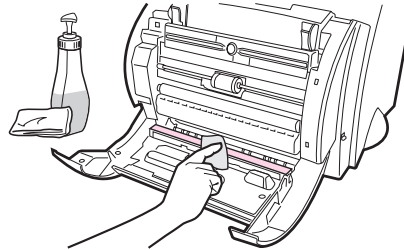

WARNING!

Ensure the scanner is completely dry before plugging in the printer power cord.

Functional checks

Engine test

The engine test is used to verify that the print engine is functioning correctly. The formatter is bypassed during an engine test, so the engine test is useful for isolating printer problems. The engine test prints vertical lines down the entire printable area of a page and is also useful for checking and adjusting registration.

Engine test button location

The engine test switch is accessible without removing the covers. It is located on the back of the HP LaserJet 1100 Printer under the memory door.

New picture here: now behind memory door on back of printer

Printing an engine test

To print an engine test, lift the memory door on the back of the printer and depress the engine test switch (Figure 5-1). A single test page will print.



Figure 5-1 Engine Test Switch

Self test page

The Self Test Page (Figure 5-2) printout provides both a means of testing the printer and a way of displaying the printer's configuration. The Self Test Page Printout does not run a diagnostic Self Test (unlike previous printers) but it still tests the functionality of the printer by being able to format data and place it accurately on the page.

To print a Self Test Page, press the Go key when the printer is in a ready state.

Some graphic images are available to make the page more visually pleasing. The configuration is printed next. This configuration is the PCL configuration that PCL will use. This includes such items as PaperSize, Orientation and Copies, etc.

HP LaserJet 1100A

Copy/Scan Option
 - Easy to attach
 - Quick copy, scan, OCR

Upgrades
 - Maximum 18Mb RAM
 - Network via HP JetDirect

8 Pages Per Minute
 8 ppm

True Laser Output
 600dpi

Windows & DOS

Configuration Settings

Scanner Installed	YES	Quick Copy Page Count	100	Quick Copy Image Type	TEXT
Scanner Page Count	120	Quick Copy Paper Size	LETTER	Quick Copy Copies	10
Print Page Count	1000	Paper Size	LETTER	Symbol Set	PC8
Total Memory	2 MByte	Orientation	PORTRAIT	Default Typeface	Courier
Printer Resolution	600	Copies	1	Font Number	0
Resolution Enhancement	ON	Lines Off Page	00	Font Size	1
Economy Mode	OFF	Toner Density	3	Font Height	12.0
Minimum Font	OFF	Image Magnify	ALTO	Font Pitch	18.00
Page Fraction	ALTO	Image Magnify Used	NO	Fluorescent Datecode	1890180

**hp HEWLETT®
PACKARD**
Expanding Possibilities

Figure 5-2 Self Test Page

If there are any downloaded “permanent” fonts (not “temporary” fonts), other pages are printed out showing these fonts. Each font will provide a sample of the font, the font ID, the typeface, the style, the stroke weight, the size (not applicable if the font is a scalable), and whether it is Fixed pitch or Proportional spacing.

If the memory is too low, a reduced Self Test Page is printed which contains only the printer configurations and a message "Reduced Self Test Printed - Memory Too Low." In a low-memory condition the font printout attempts to print all downloaded permanent fonts, but if the memory is too low a message "Font Test Aborted" is printed. In some low-memory situations a reduced Self Test Page may be printed, but the font printout may have enough memory to print all downloaded permanent fonts.

Half-self test functional check

The electrophotographic process can be subdivided into the following stages:

- Image formation stage (charges the drum and writes a latent image to the drum with the laser)
- Development stage (forms a toner image on the drum)
- Transfer stage (transfers the image to paper)
- Cleaning stage (removes excess toner from the drum)
- Fixing stage (applies heat and pressure to make the image on paper permanent)

The purpose of the half-self test check is to determine which process is malfunctioning. Perform the test as follows:

- 1 Initiate a self test.
- 2 Open the printer door after the paper advances half-way through the printer (about 8 seconds after the motor begins rotation). The leading edge of the paper should have advanced past the toner cartridge.
- 3 Remove the toner cartridge.
- 4 Open the toner cartridge drum shield to view the drum surface. If a dark and distinct toner image is present on the drum surface, assume that the first two functions of the electrophotographic process are functioning (image formation and development). Troubleshoot the failure as a transfer or fixing problem.

If there is no image on the photosensitive drum, perform the following functional checks:

- 1 Make sure you have removed the entire length of the sealing tape from the toner cartridge before you installed the cartridge.
- 2 Perform a drum rotation functional check.
- 3 Perform a high-voltage power supply check.

Drum rotation functional check

The photosensitive drum, located in the toner cartridge, must rotate for the print process to work. The photosensitive drum receives its drive from the main drive assembly. To verify that the drum is rotating:

- 1 Open the printer door.
- 2 Remove the toner cartridge.
- 3 Mark the drive gear on the cartridge with a felt-tipped marker. Note the position of the mark.
- 4 Install the toner cartridge and close the printer door. The start-up sequence should rotate the drum enough to move the mark.
- 5 Open the printer and inspect the gear that was marked in step 3. Verify that the mark moved.

If the mark did not move, inspect the main drive assembly to make sure that it is meshing with the toner cartridge gears. If the drive gears appear functional and the drum does not move, replace the toner cartridge.

NOTE:

This test is especially important if refilled toner cartridges have been used.

Heating element check

Paper passes between the heating element and a soft pressure roller to fuse toner to the paper. To verify that the heating element is functioning correctly:

- 1 Unplug the HP LaserJet 1100 Printer for at least ten minutes.
- 2 Verify that the thermistor connector (Figure 5-3) is seated into both the printer chassis and the ECU (for printer disassembly instructions, see Chapter 4, "Removal and replacement").

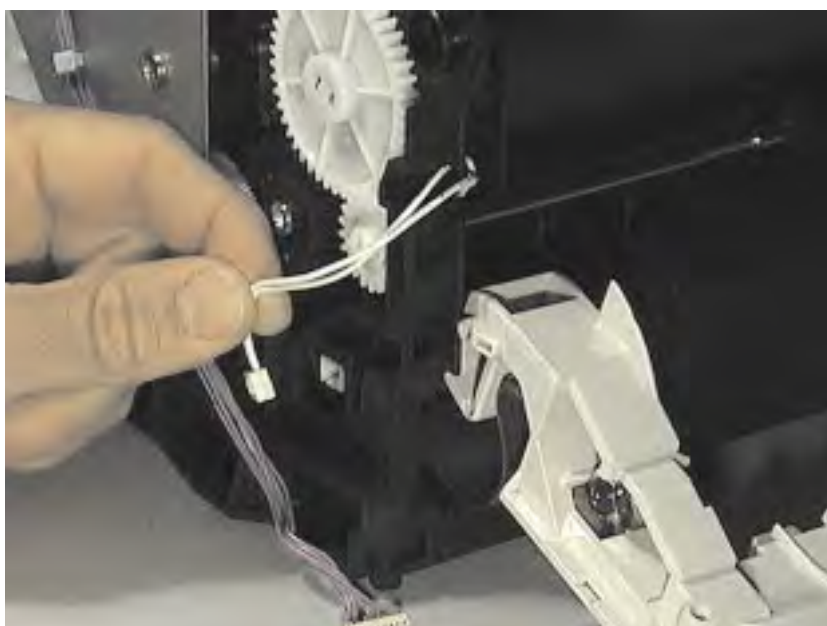

Figure 5-3 Thermistor Connector

- 3 Remove the heating element connector (Figure 5-4) from the ECU. To measure the continuity of the heating element, measure the resistance between the two pins at the end of the cable.

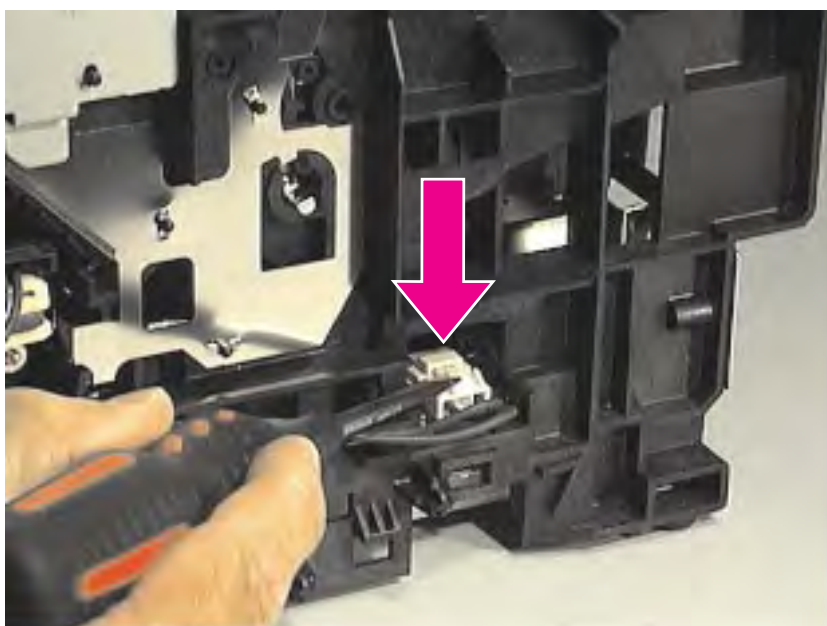

Figure 5-4 Heating Element Connector

NOTE:

Normal resistance is 30 ohms +/- 10 ohms.

- 4 If no resistance is measured, replace the heating element.

- 5 Remove the thermistor connector (Figure 5-3) and measure the resistance between pins one and two.

NOTE:

Normal resistance is 440K ohms +/- 30K ohms at 68° F (20° C).

- 6 If no resistance is measured, replace the heating element.

High-voltage power supply check

The high-voltage power supply PCA provides the necessary voltages for the electrophotographic processes.

Checking the toner cartridge connection points

Visually inspect the three connection points on the underside, right end of the toner cartridge: charging (callout 1), drum ground (callout 2), and developing roller (callout 3). If they are dirty or corroded, clean the connections, or, if they are damaged, replace the toner cartridge.

NOTE:

Use only alcohol to clean the connections.

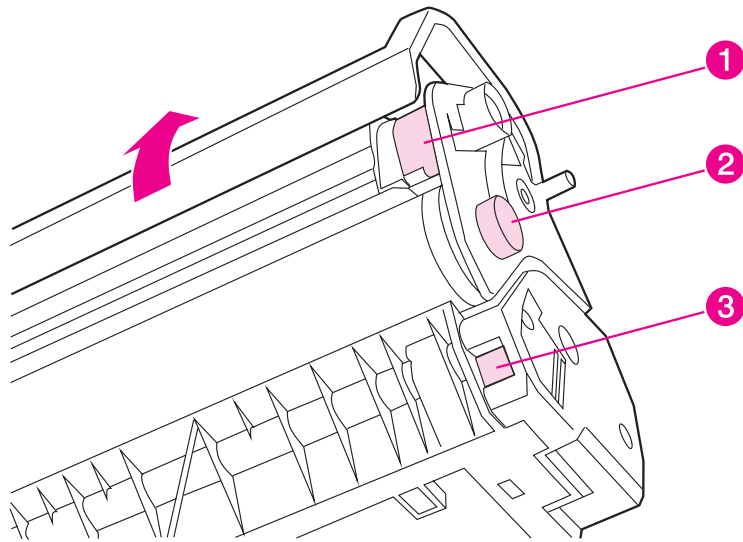

Figure 5-5 Toner cartridge high-voltage connection points

Checking the high-voltage connector assembly

The assembly uses three spring-loaded pins to contact the toner cartridge: charging (callout 1), drum ground (callout 2), and developing roller (callout 3). Verify that the pins are not dirty or corroded and that the spring-loading action is functional. If the pins are dirty, clean them using alcohol only. If they are damaged, replace the high voltage connector assembly.

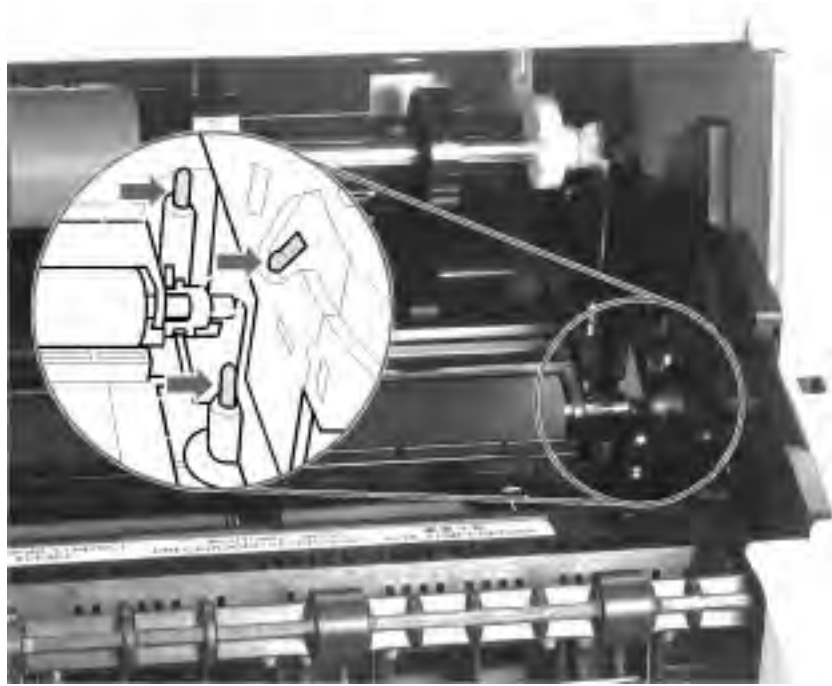

Figure 5-6 High-voltage connector assembly

Paper curl

Paper curl is inherent to the laser printing processes, and occurs when paper is subjected to heat. Paper curl tends to relax as the paper cools while resting on a flat surface. The specification for maximum paper curl when the paper is lying flat before print is 0.2 inches (5 mm).

Paper path check

If paper is not being picked up or is not moving through the paper path, you may want to observe all of the paper motion activities. Overriding SW301 allows you to observe:

- Motor rotation
- Solenoid action
- Kick plate motion
- Paper pickup roller motion
- Drive roller, transfer roller, fuser roller and gear, and delivery roller motion

To override SW301

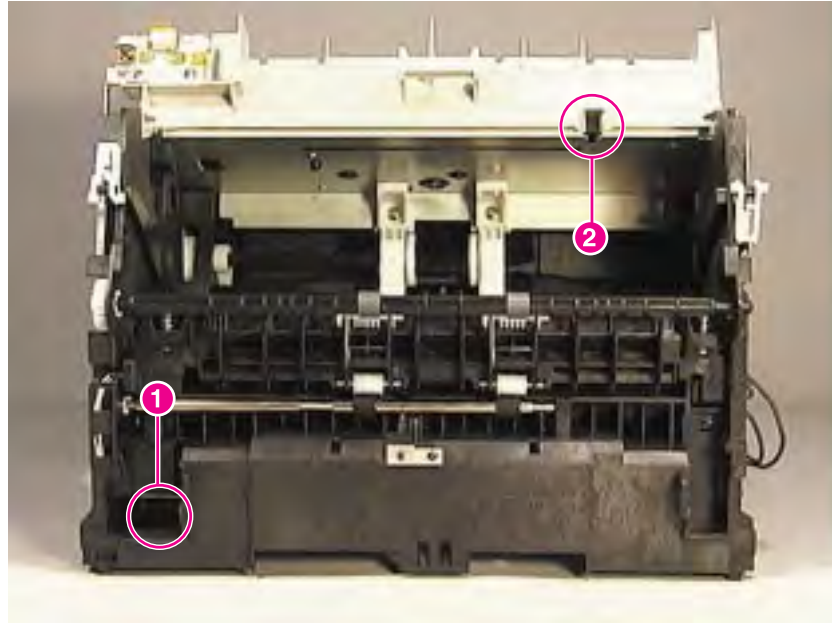

Figure 5-7 Overriding SW301

- 1 Remove the printer covers
- 2 Install the toner cartridge.
- 3 Make sure the fuser levers on the Delivery Assembly are closed.
- 4 Press SW301- front door interlock (callout 1).
- 5 Press Laser/Scanner Interlock Switch on Laser/Scanner (callout 2)
- 6 While SW301 and Laser/Scanner Interlock is engaged, perform an Engine Test to observe paper motion. (See procedures earlier in this chapter.)

ServiceMode functions (PJL Software Commands)

To set the following NVRAM variables:

Factory printer DEFAULT PAPER, scanner factory default paper size will be set to the same value automatically if one is attached.

Factory printer DEFAULT LPARM:PCL SYMSET.

Factory DEFAULT OEM bit.

Factory DEFAULT PRINTPAGECOUNT.

Factory DEFAULT SCANPAGECOUNT if scanner is attached.

Factory DEFAULT COPYPAGECOUNT if scanner is attached.

NOTE: Default quick copy paper size is also stored in scanner NVRAM but is changed only with software or set back to factory default with a NVRAMINIT. Quick copy image type, and contrast only have a default value stored in NVRAM, and can only be changed with the software or by NVRAMINIT, which returns them to a ROM default value.

NVRAMINIT, sets all default variables stored in NVRAM back to factory default values, or a default ROM value depending on the variable, and performs a system reset. This can be done also be done manually by turning off the printer, hold down the GO key, turn on the printer. You will see the all the LED's flash once, then turn off. Keep the Go key held down until you see the LED's cycle once then release it. This will cause the LED's to cycle twice as fast after the RAM/ROM checks than normal and the NVRAM variables will be set back to the factory defaults.

NOTE:

NVRAMINIT will not clear page counts

Figure 5-8 provides a more detailed description of the NVRAM PJL factory variables and commands and how they are used.

NVRAM PJL Variable or Command	Possible settings
DEFAULT PAPER	"LETTER", "LEGAL", "A4", "EXECUTIVE", "COM10", "MONARCH", "DL", "C5", "B5", "CUSTOM"
DEFAULT LPARM:PCL SYMSET	"ROMAN8", "ISOL1", "ISOL2", "ISOL5", "PC8", "PC8DN", "PC850", "PC852", "PC8TK", "WINL1", "WINL2", "WINL5", "DESKTOP", "PSTEXT", "VNINTL", "VNUS", "MSPUBL", "MATH8", "PSMATH", "VNMATH", "PIFONT", "LEGAL", "ISO4", "ISO6", "ISO11", "ISO15", "ISO17", "ISO21", "ISO60", "ISO69", "WIN30"
DEFAULT OEM	"ON", "OFF"
DEFAULT PRINTPAGECOUNT	0-2147483647
DEFAULT SCANPAGECOUNT	0-2147483647
DEFAULT COPYPAGECOUNT	0-2147483647
CLEARNVRAM	None - Command
NVRAMINIT	None - Command

Figure 5-8 NVRAM PJL Factory Variables

To use these commands you need some method of sending PJL commands to the printer, either with a software tool or by copying down a binary file containing the commands from the host using a DOS box. For example from the DOS prompt:

```
copy /b filename lpt1
```

Here is an example file that uses one of the commands:

```
ESC%-12345X@PJL SET SERVICEMODE=HPBOISEID
@PJL `command`
@PJL RESET
```

Here is an of using the NVRAMINIT command:

```
ESC%-12345X@PJL SET SERVICEMODE=HPBOISEID
@PJL NVRAMINIT
@PJL RESET
```

NOTE:

Remember to set `SERVICEMODE` before trying to set the variable or you will not get the desired result. The PjL reset is also necessary to be sure the `SERVICEMODE` status is cleared.

To create these files you will need an editor that can insert the ESC character, or be able to copy it in from a existing file. If a software tool is used, just send down the same strings, in the same order as given for the example files.

Printer paper path

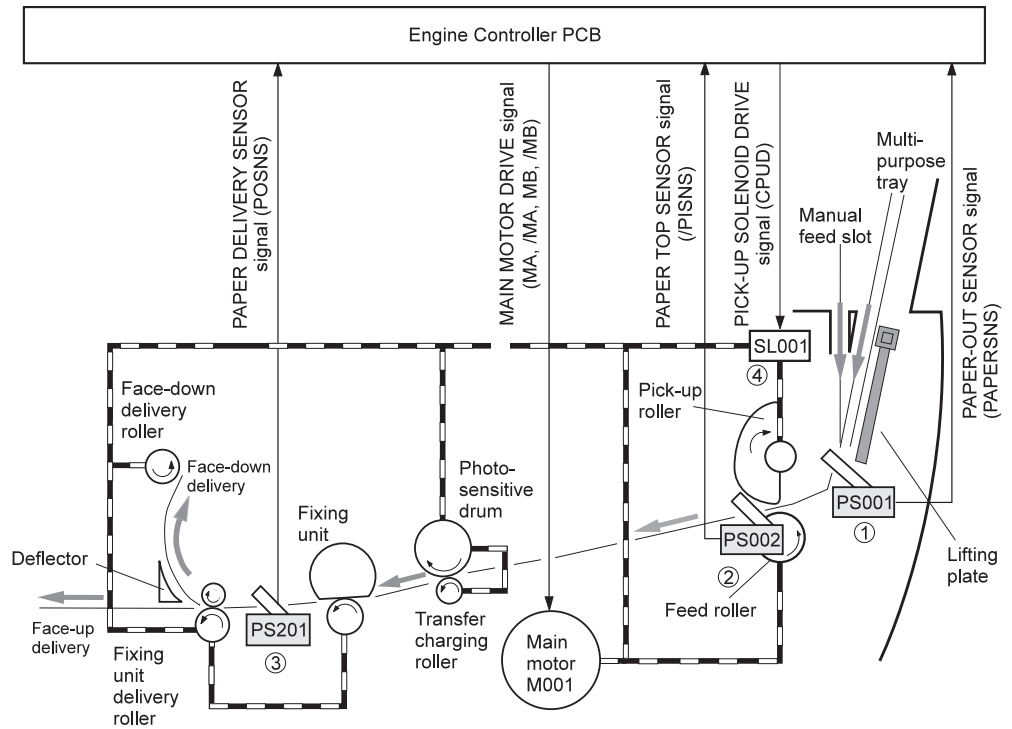

Figure 5-9 Paper path and components

Document paper path

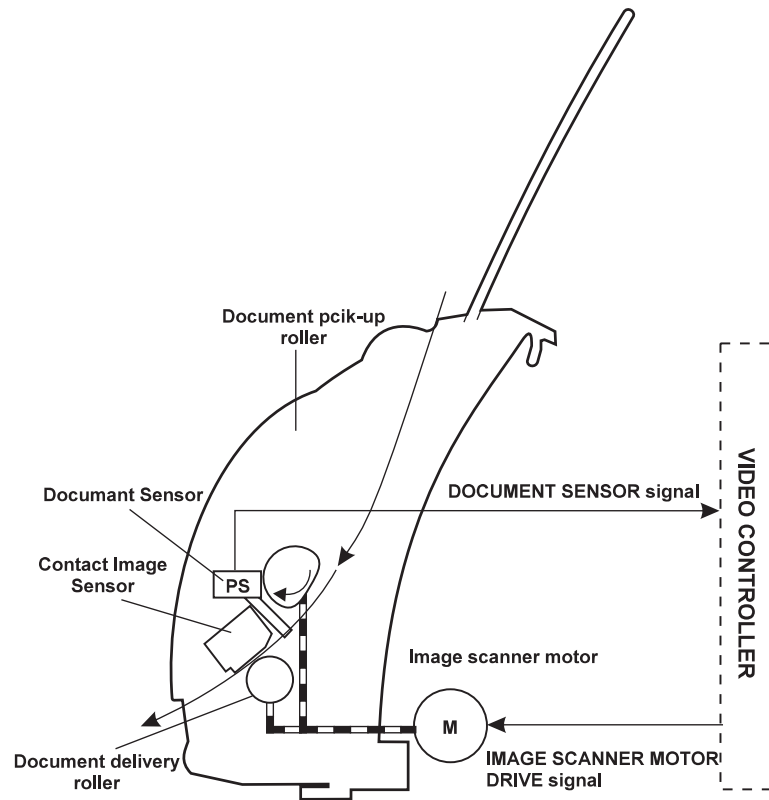

Figure 5-10 Document path and components

Repetitive image defect ruler

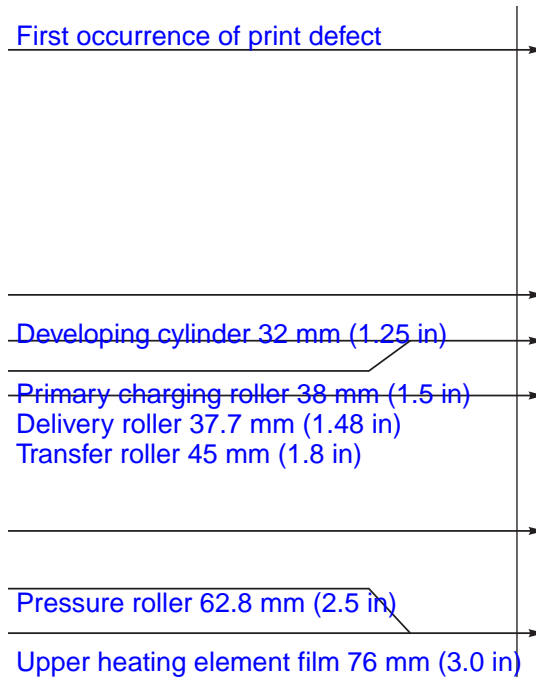
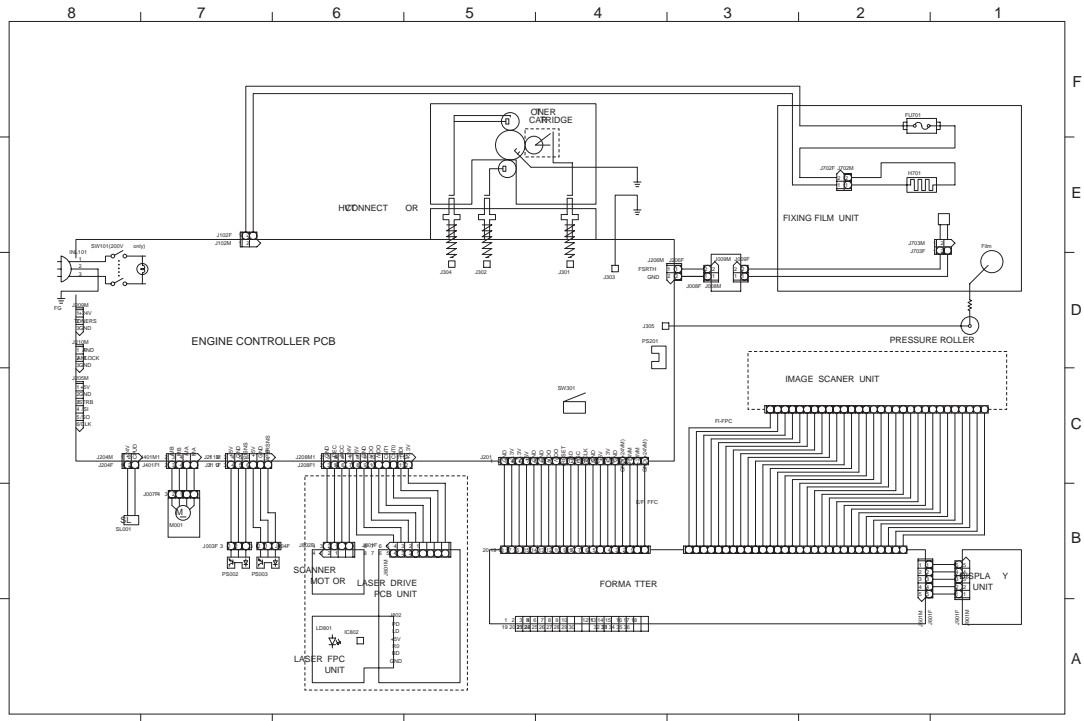

Figure 5-11 Repetitive image defect ruler

Main wiring

II. GENERAL CIRCUIT DIAGRAM



A-2

Figure 5-12 Main wiring

6 Parts and diagrams

Chapter contents

How to use the parts lists and diagrams	158
Parts and supplies	159
Ordering Information	159
Consumables and accessories	160

How to use the parts lists and diagrams

The figures in this chapter illustrate the major subassemblies in the printer and their component parts. A table (material list) follows each exploded assembly diagram. Each table lists the reference designator, the associated part number for the item, and a description of the part.

While looking for a part number, pay careful attention to the voltage listed in the description column to make sure that the part number selected is for the correct model of printer.

Parts and supplies

Ordering parts

Replacement parts may be ordered from HP's Support Materials Organization (SMO) or Support Materials Europe (SME).

Use only accessories specifically designed for this printer. Accessories can be ordered from an authorized service or support provider.

All standard part numbers listed are stocked and may be ordered from HP's Support Materials Organization (SMO), or Support Materials, Europe (SME).

- Hewlett-Packard Co.
Support Materials Organization
8050 Foothills Blvd.
Roseville, CA 95678
Parts Direct Ordering: (800) 227-8164 (U.S. Only)
- Hewlett-Packard Co.
Support Materials, Europe
Wolf-Hirth Strasse 33
D-7030 Boblingen, Germany
(49 7031) 14-2253

You can also contact Hewlett-Packard at (916) 783-0804 to find out part numbers for the HP LaserJet 3100 product. Contact a local HP Parts Coordinator for other local phone numbers.

Ordering Information

You can increase the capabilities of the printer with optional accessories and supplies. Use accessories and supplies specifically designed for the HP LaserJet 1100 Printer and the HP LaserJet 1100A Printer-Copier-Scanner to ensure optimum performance.

Consumables and accessories

The following items are available through a local authorized HP dealer. To find a dealer near you (or if your dealer is temporarily out of stock), call the HP Customer Information Center at (800) 752-0900.

DESCRIPTION	PART #	EST. LIFE (PAGES)	REMARKS
Toner cartridge (user replaceable)	C4092A	2,500	When print becomes faint, redistribute toner in the cartridge.
Printer transfer roller	RG5 4594-000CN	50,000	Can affect print quality and/or paper movement
Printer pickup roller assembly	RB2-3929-000CN	50,000	Look for glazing and/or cracks.
Printer separation pad	RF5-2832-000CN	50,000	Can affect paper movement
Printer separation sub-pads	RY7-5050-000CN	50,000	Can affect paper movement
Heating element (110 volts)	RG5-4589-000CN	50,000	Can affect paper quality and/or paper movement
Heating element (220 volts)	RG5-4890-000CN	50,000	Can affect paper quality and/or paper movement
Pressure roller	RF5-2823-000CN	50,000	Look for marks on pressure roller or upper Teflon sleeve.

Accessory ordering information

DESCRIPTION	ITEM	ORDER NUMBER	REMARKS
Printer memory	Dual in-line memory module (DIMM)	C4135A C4136A C4137A	4 MB 8 MB 16 MB
Cables and interface accessories	Parallel cables Copier/Scanner for the HP LaserJet 1100 Printer	8120-8668 C2946A C4221A	2 Meter IEEE-1284 cable 3 Meter IEEE-1284 cable Attachable scanner exclusively for the HP LaserJet 1100 Printer.
Network	JetDirect Ex	170x 300x 500x	

Ordering consumables

The consumables and accessories listed in the above table may be ordered from Hewlett-Packard.

The phone numbers are:

- U.S.: (800) 538-8787
- Canada: (800) 387-3154 (Toronto: (516) 671-8383)
- United Kingdom: 0734-441212
- Germany: 0130-3322
- SMO (Support Material Organization)
(800) 227-8164 (U.S. only)
- SME (Support Materials Europe)
(49 7031) 142253

Contact a local HP Parts Coordinator for other local phone numbers.

Parts that have no reference designator or part number are not field replacement parts and cannot be ordered through SMO.

Common hardware

Table 6-1. Common fasteners

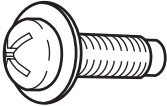
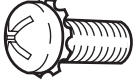
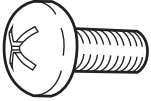
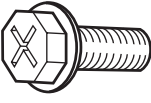
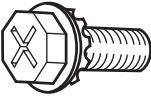
Example	Description
	Screw, machine, truss head
	Screw, star
	Screw, self-tapping
	Screw, hex-head
	Screw, hex-head, star

External covers and panels

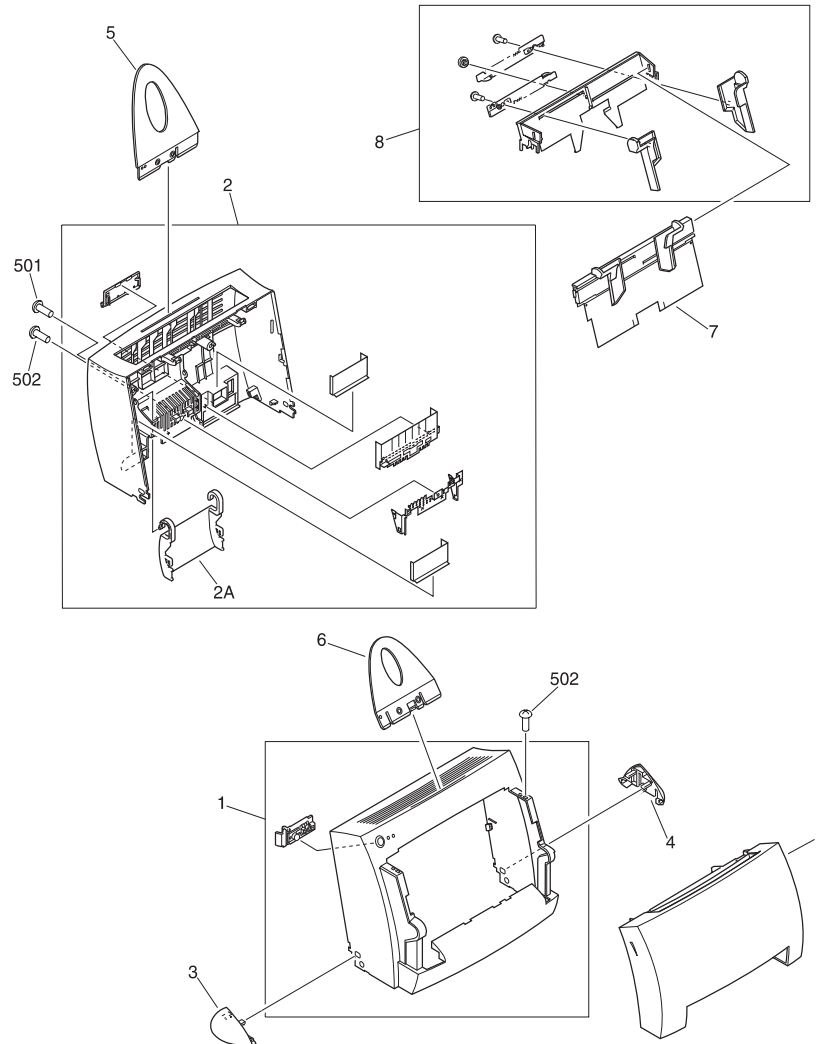

Figure 6-1 External covers, panels, etc.

Table 6-2. External covers, panels, etc.

KEY #	PART #	QTY	DESCRIPTION
1	RF5-2827-000CN	1	COVER, FRONT
2	RF5-2828-000CN	1	COVER, REAR
2A	RB2-4014-000CN	1	MEMORY DOOR
3	RB2-4018-000CN	1	POD, LEFT
4	RB2-4019-000CN	1	POD, RIGHT
5	RB2-4020-000CN	1	INPUT PAPER SUPPORT
6	RB2-4021-000CN	1	OUTPUT/SCANNER PAPER SUPPORT
7	RG5-4601-000CN	1	SINGLE SHEET BIN
8	RG5-4602-000CN	1	INPUT PAPER BIN
9	RG5-4604-000CN	1	PRINTER DOOR
501	XB2-7300-607CN	1	SCREW, M3X6
502	XB4-7401-007CN	4	SCREW, M4X10
	RZ4-0690-000CN	2	SHIPPING BLOCK

Document scanner parts

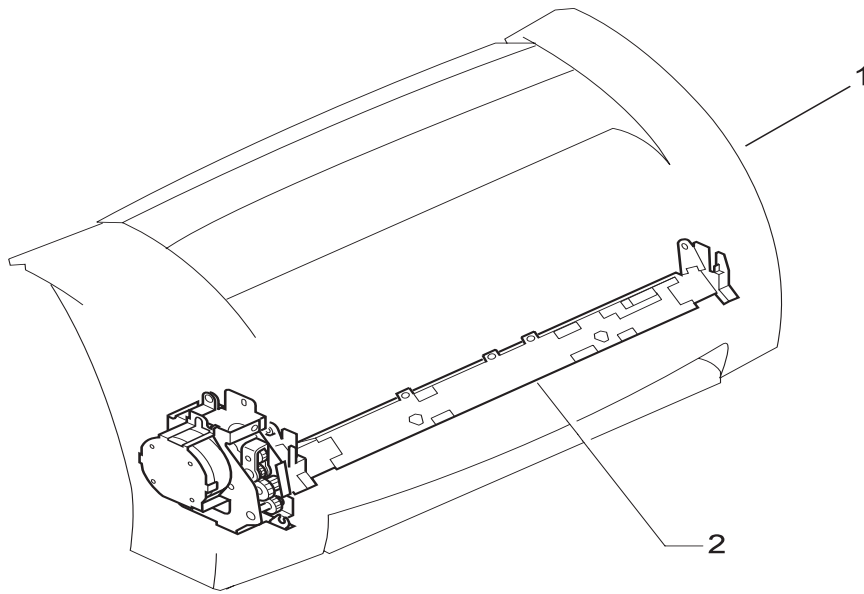

Figure 6-2 Document Scanner

Table 6-3. Document Scanner

KEY #	PART #	QTY	DESCRIPTION
1	R37-5000-000CN	1	SCANNER ASS'Y
2	RG5-4561-000CN	1	CONTACT IMAGE SENSOR

Internal components

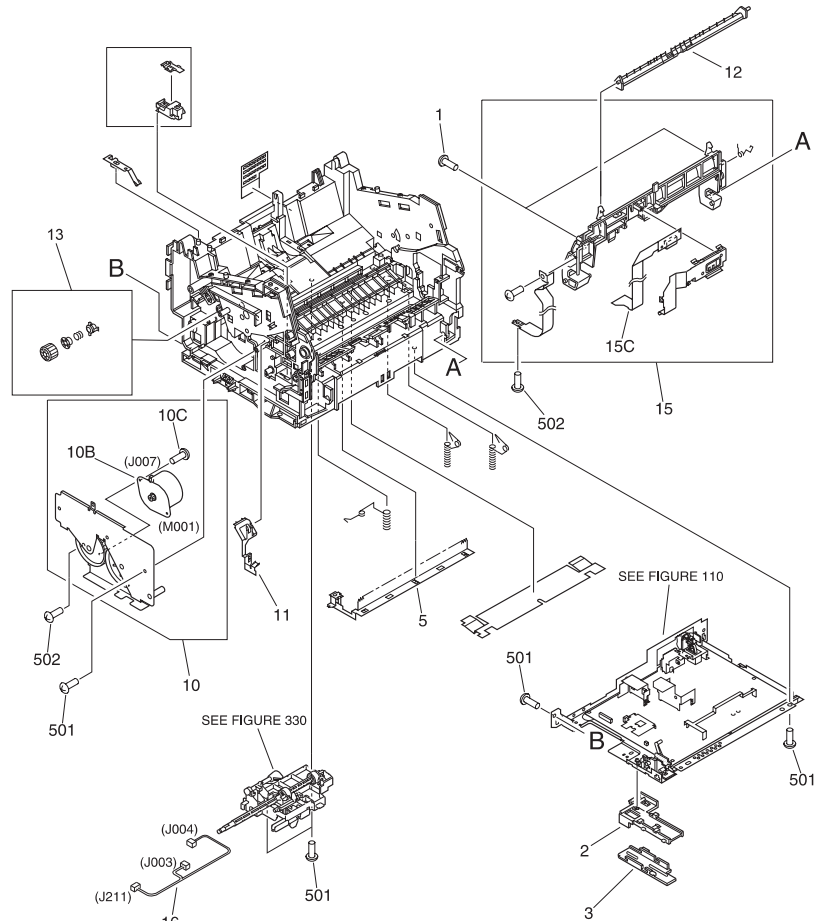

Figure 6-3 Internal components, 1 of 4

Table 6-4. Internal components, 1 of 4

KEY #	PART #	QTY	DESCRIPTION
1	XA9-0605-000CN	2	SCREW, M4X8
2	RB2-4017-000CN	1	HOLDER, FLAT CABLE
3	RB2-4030-000CN	1	COVER, HOLDER
5	RB2-3951-000CN	1	ELIMINATOR, STATIC CHARGE
10	RG5-4586-000CN	1	DRIVE ASS'Y
10B	RH7-1404-000CN	1	MAIN MOTOR
10C	XB6-7300-609CN	2	SCREW, M3X6
11	RB2-3959-000CN	1	SPRING, LEAF, LEFT
12	RB2-4006-000CN	1	GUIDE, FACE DOWN DELIVERY
13	RY7-5051-000CN	1	CLUTCH KIT
15	RG5-4653-000CN	1	CONNECTOR HOLDER ASS'Y
15C	RH2-5379-000CN	1	FLAT CABLE
16	RG5-4617-000CN	1	SENSOR CABLE (J211, J003, J004)
501	XB4-7401-007CN	8	SCREW, TAPPING, PAN HEAD, M4X10
502	XB2-7300-607CN	3	SCREW, W/WASHER, M3X6

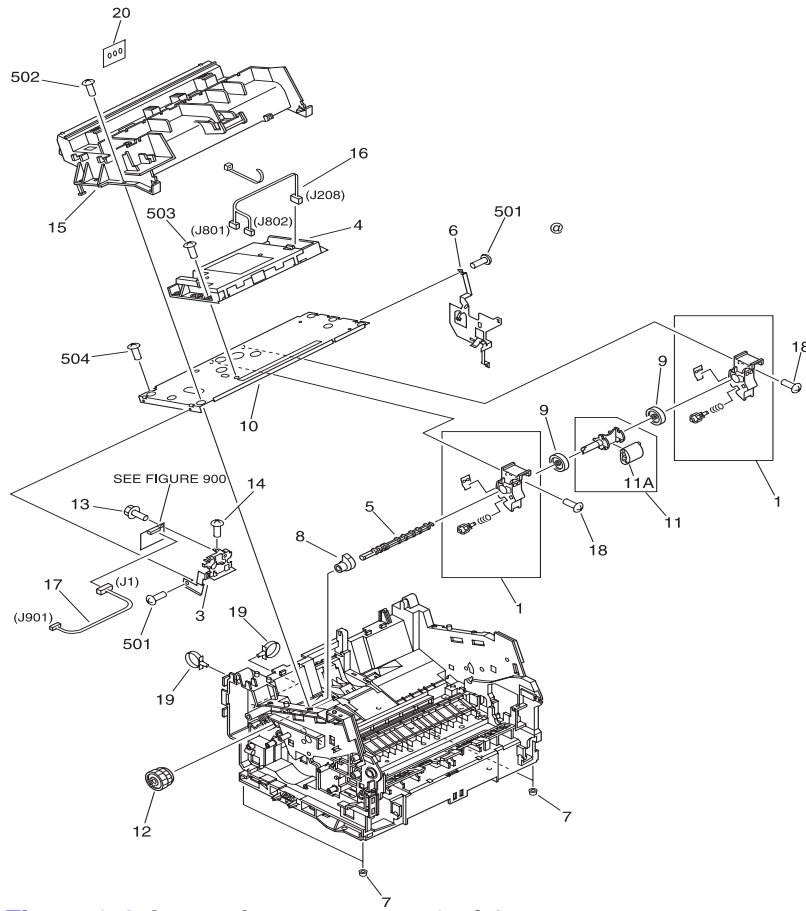

Figure 6-4 Internal components, 2 of 4

Table 6-5. Internal components, 2 of 4

KEY #	PART #	QTY	DESCRIPTION
1	RG5-4584-000CN	2	ROLLER HOLDER ASS'Y
3	RB2-4001-000CN	1	MOUNT, DISPLAY PCB
4	RG5-4570-000CN	1	LASER/SCANNER ASS'Y
5	RB2-3943-000CN	1	SHAFT
6	RB2-3944-000CN	1	SPRING, LEAF
7	RB2-3945-000CN	4	FOOT
8	RB2-3949-000CN	1	CAM
9	RB2-3931-000CN	2	ROLLER
10	RB2-3932-000CN	1	PLATE, SCANNER
11	RB2-3930-000CN	1	ROLLER SHAFT
11A	RB2-4026-000CN	1	ROLLER, PAPER PICK-UP
12	RG5-4585-000CN	1	GEAR ASS'Y
13	XA9-0686-000CN	1	SCREW, M3X6
14	XA9-0605-000CN	1	SCREW, M4X8
15	RB2-3999-000CN	1	DUCT, 2
16	RG5-4616-000CN	1	SCANNER CABLE (J208, J801, J802)
17	RG5-4620-000CN	1	DISPLAY CABLE (J1, J901)
18	XA9-0267-000CN	2	SCREW, TP, M3X6
19	WT2-5041-000CN	2	TIE, CABLE
20	RG5-4608-000CN	1	DISPLAY PCB ASS'Y
501	XB2-7300-607 CN	3	SCREW, M3X6
502	XB4-7401-209 CN	2	SCREW, M4X12
503	XB6-7300-807 CN	4	SCREW, M3X8
504	XB4-7401-007 CN	2	SCREW, M4X10

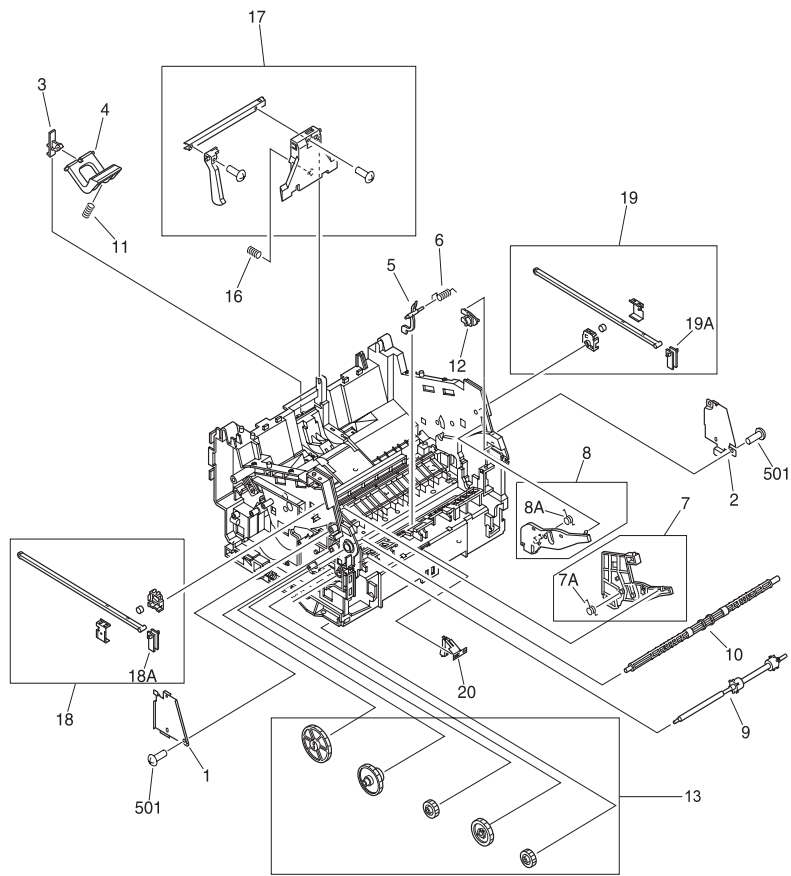

Figure 6-5 Internal components, 3 of 4

Table 6-6. Internal components, 3 of 4

KEY #	PART #	QTY	DESCRIPTION
1	RB2-3941-000CN	1	GUIDE, ARM, LEFT
2	RB2-3942-000CN	1	GUIDE, ARM, RIGHT
3	RB2-3947-000CN	1	HOLDER, PAD
4	RF5-2832-000CN	1	ARM, PAD
5	RB2-3960-000CN	1	FLAG, SENSOR
6	RB2-3961-000CN	1	TORSION SPRING
7	RF5-2818-000CN	1	GUIDE, CARTRIDGE, LEFT
8	RF5-2819-000CN	1	GUIDE, CARTRIDGE, RIGHT
9	RF5-2822-000CN	1	ROLLER, FACE-UP
10	RF5-2830-000CN	1	ROLLER, FACE-DOWN
11	RS5-2502-000CN	1	SPRING, COMPRESSION
12	RB2-4016-000CN	1	STOP, SLIDE
13	RY7-5049-000CN	1	GEAR KIT
16	RS6-2122-000CN	1	SPRING, COMPRESSION
17	RG5-4582-000CN	1	PAPER GUIDE PLATE ASS'Y
18	RG5-4587-000CN	1	ARM HOLDER ASS'Y LEFT
18A	RB2-4034-000CN	1	MOUNT, ARM
19	RG5-4588-000CN	1	ARM HOLDER ASS'Y RIGHT
19A	RB2-4034-000CN	1	MOUNT, ARM
20	RB2-4219-000CN	1	PLATE, GROUNDING
501	XB4-7401-007CN	3	SCREW, TAPPING, PAN HEAD, M4X10

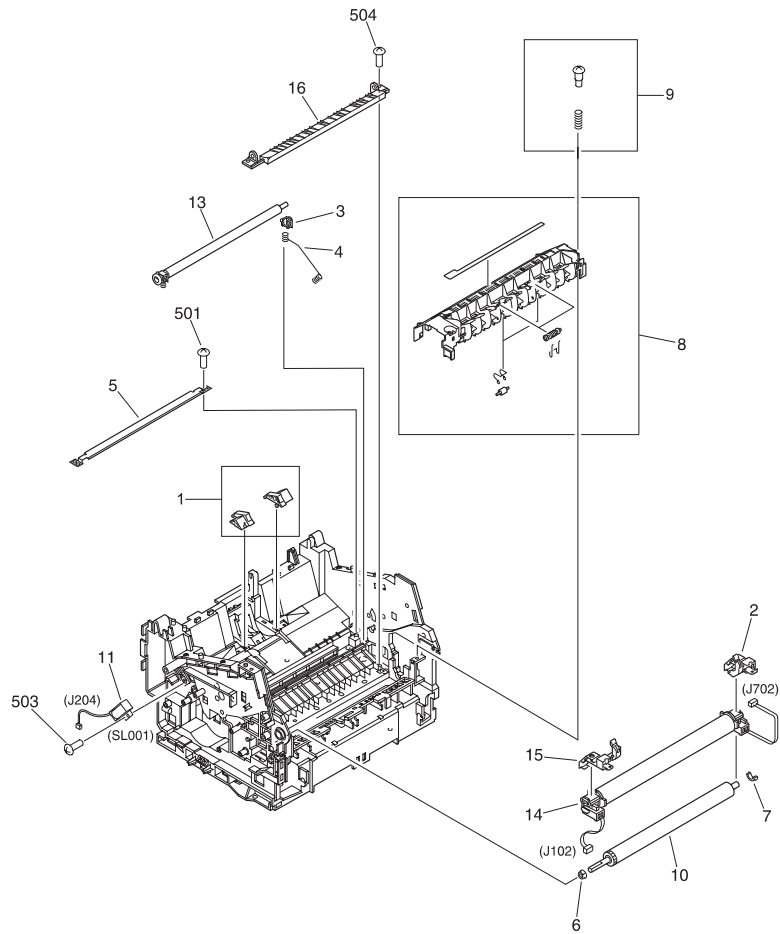

Figure 6-6 Internal components, 4 of 4

Table 6-7. Internal components, 4 of 4

KEY #	PART #	QTY	DESCRIPTION
1	RY7-5050-000CN	1	SUBPAD KIT
2	RG5-4592-000CN	1	FIXING PRESSURE ASS'Y, RIGHT
3	RB2-3939-000CN	1	BUSHING, RIGHT
4	RB2-3940-000CN	1	SPRING, COMPRESSION
5	RB2-3950-000CN	1	GUIDE, TRANSFER
6	RB2-3956-000CN	1	BUSHING, LEFT
7	RB2-3957-000CN	1	BUSHING, RIGHT
8	RG5-4593-000CN	1	DELIVERY ASS'Y
9	RY7-5060-000CN	1	DEVELOPER FASTENER KIT
10	RF5-2823-000CN	1	ROLLER, PRESSURE
11	RH7-5227-000CN	1	SOLENOID (SL001, J204)
13	RG5-4594-000CN	1	TRANSFER ASS'Y
14	RG5-4589-000CN	1	FIXING FILM ASS'Y - 100-127V (J102, J702)
14	RG5-4590-000CN	1	FIXING FILM ASS'Y - 220-240V
15	RG5-4591-000CN	1	FIXING PRESSURE ASS'Y, LEFT
16	RB2-3958-000CN	1	GUIDE, FIXING
501	XB4-7400-805	2	SCREW, M4X8
503	XB4-7401-007	1	SCREW, M4X10
504	XB4-7401-209	2	SCREW, M4X12
	CK-8006		PRESSURE ROLLER GREASE

Feeder assembly

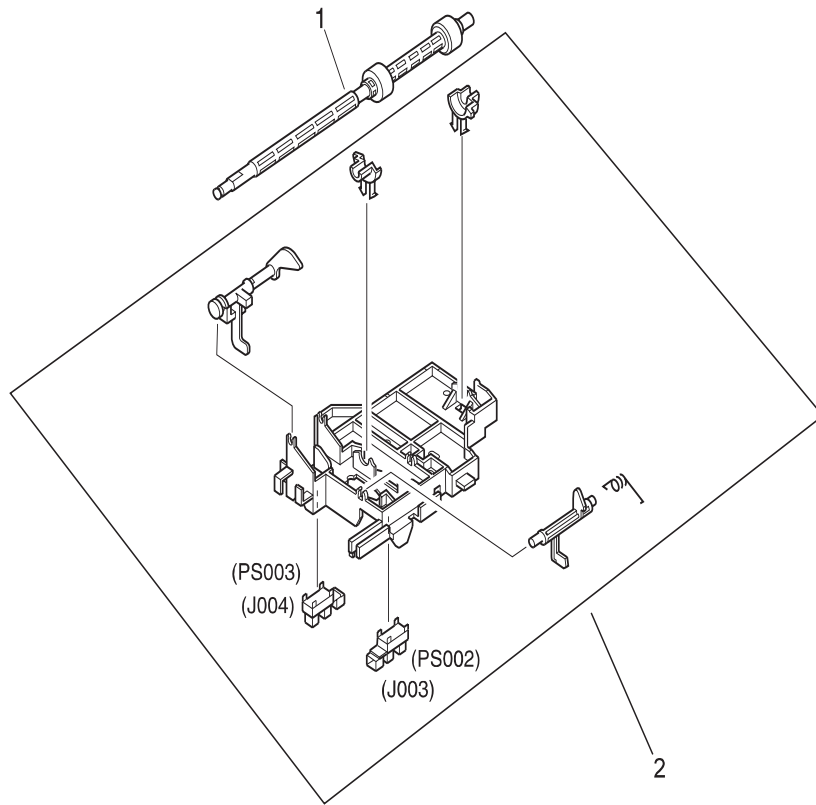

Figure 6-7 Feeder assembly

Table 6-8. Feeder assembly

KEY #	PART #	QTY	DESCRIPTION
1	RB2-3912-000CN	1	FEED ROLLER
2	RG5-4581-000CN	1	FEEDER ASS'Y

Engine controller assembly

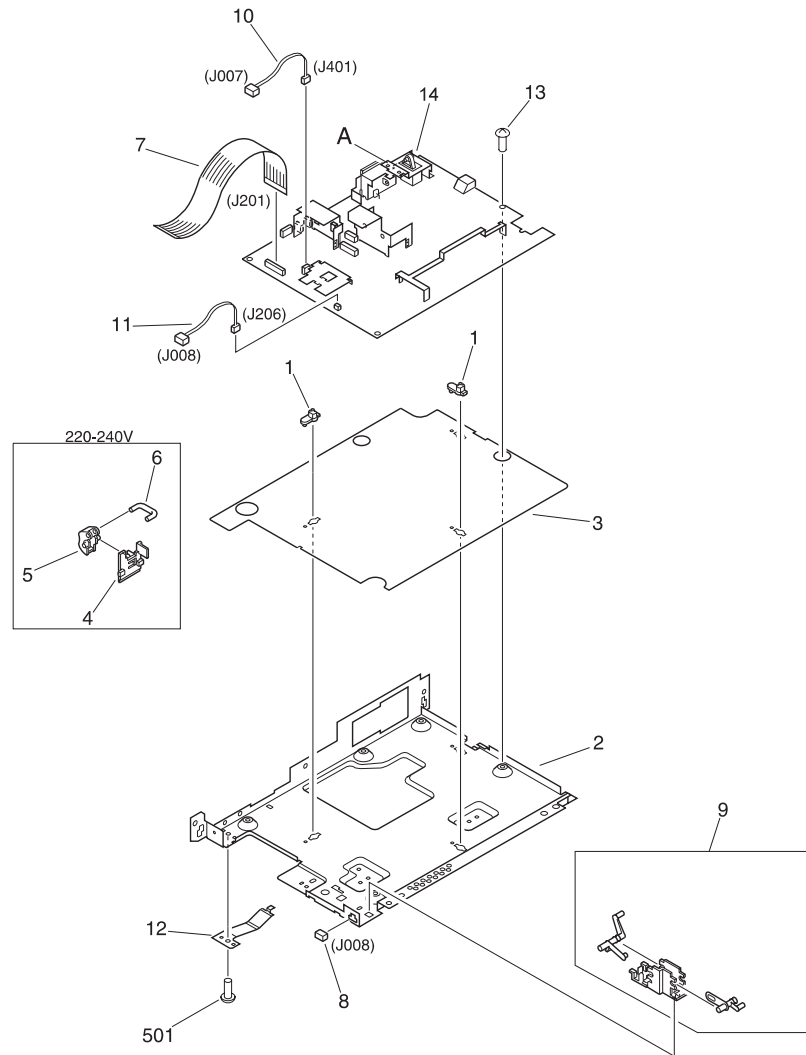

Figure 6-8 Engine controller assembly

Table 6-9. Engine controller assembly

KEY #	PART #	QTY	DESCRIPTION
1	RB1-7303-000CN	3	SPACER, PCB
2	RB2-3984-000CN	1	CASE, PRINTER CONTROLLER
3	RB2-3985-000CN	1	SHEET, INSULATING
4	RB2-3986-000CN	1	HOLDER, POWER SWITCH LEVER
5	RB2-3987-000CN	1	LEVER, POWER SWITCH
6	RB2-3988-000CN	1	ROD, SWITCH
7	RH2-5381-000CN	1	FLAT CABLE, (J201)
8	VS1-5057-002 CN	1	CONNECTOR, 2P (J008)
9	RG5-4599-000CN	1	DOOR SENSOR ASS'Y
10	RG5-4618-000CN	1	MOTOR CABLE,(J007, J401)
11	RG5-4619-000CN	1	THERMISTOR CABLE (J008, J206)
12	RB2-4049-000CN	1	PLATE, GROUNDING
13	XA9-0956-000CN	6	SCREW, M3X6
14	RG5-4605-000CN	1	ECU PCB ASS'Y
14	RG5-4606-000CN	1	ECU PCB ASS'Y
501	XB2-7300-607 CN	1	SCREW, M3X6

Formatter pan

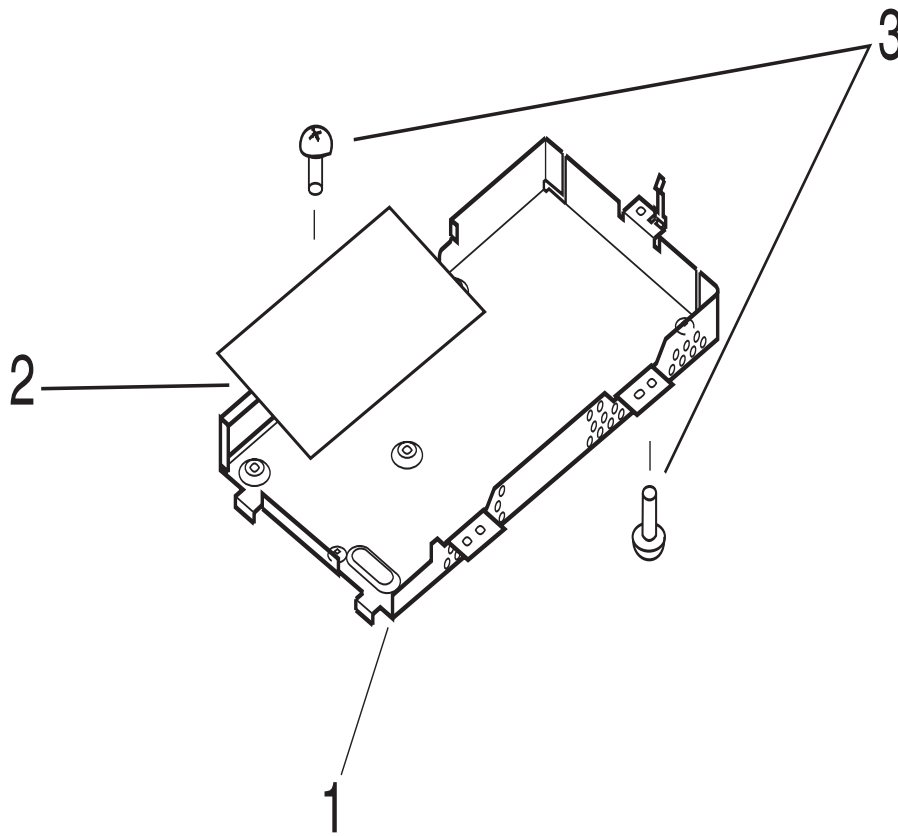

Figure 6-9 Formatter pan

Table 6-10. Formatter pan

KEY #	PART #	Q'TY	DESCRIPTION
1	RB2-3992-000CN	1	FORMATTER PLATE
2	C4146-60001	1	FORMATTER
3	0515-2672	7	FORMATTER SCREWS

Parts list sorted by part number

Table 6-11. Parts list sorted by part number

Part Number	Qty	Part Name	Table #	Key #
0515-2672	7	FORMATTER SCREWS	6-9	3
C4146-60001	1	FORMATTER	6-9	2
CK-8006		PRESSURE ROLLER GREASE	6-6	
R37-5000-000CN	1	SCANNER ASSÆY	6-2	1
RB1-7303-000CN	3	SPACER, PCB	6-8	1
RB2-3940-000CN	1	SPRING, COMPRESSION	6-6	4
RB2-3957-000CN	1	BUSHING, RIGHT	6-6	7
RB2-3956-000CN	1	BUSHING, LEFT	6-6	6
RB2-3949-000CN	1	CAM	6-4	8
RB2-3959-000CN	1	SPRING, LEAF, LEFT	6-3	11
RB2-4219-000CN	1	PLATE, GROUNDING	6-5	20
RB2-4018-000CN	1	POD, LEFT	6-1	3
RB2-3984-000CN	1	CASE, PRINTER CONTROLLER	6-8	2
RB2-4030-000CN	1	COVER, HOLDER	6-3	3
RB2-3944-000CN	1	SPRING, LEAF	6-4	6
RB2-3943-000CN	1	SHAFT	6-4	5
RB2-4026-000CN	1	ROLLER, PAPER PICK-UP	6-4	11A
RB2-3951-000CN	1	ELIMINATOR, STATIC CHARGE	6-3	5
RB2-3999-000CN	1	DUCT, 2	6-4	15
RB2-3961-000CN	1	TORSION SPRING	6-5	6
RB2-3912-000CN	1	FEED ROLLER	6-7	1
RB2-3930-000CN	1	ROLLER SHAFT	6-4	11
RB2-4016-000CN	1	STOP, SLIDE	6-5	12
RB2-3987-000CN	1	LEVER, POWER SWITCH	6-8	5
RB2-3985-000CN	1	SHEET, INSULATING	6-8	3
RB2-3939-000CN	1	BUSHING, RIGHT	6-6	3
RB2-4017-000CN	1	HOLDER, FLAT CABLE	6-3	2
RB2-3950-000CN	1	GUIDE, TRANSFER	6-6	5
RB2-4019-000CN	1	POD, RIGHT	6-1	4
RB2-3988-000CN	1	ROD, SWITCH	6-8	6
RB2-4006-000CN	1	GUIDE, FACE DOWN DELIVERY	6-3	12
RB2-3941-000CN	1	GUIDE, ARM, LEFT	6-5	1
RB2-3947-000CN	1	HOLDER, PAD	6-5	3
RB2-3960-000CN	1	FLAG, SENSOR	6-5	5
RB2-3958-000CN	1	GUIDE, FIXING	6-6	16
RB2-3942-000CN	1	GUIDE, ARM, RIGHT	6-5	2
RB2-3992-000CN	1	FORMATTER PLATE	6-9	1
RB2-3945-000CN	4	FOOT	6-4	7
RB2-4034-000CN	1	MOUNT, ARM	6-5	19A
RB2-4014-000CN	1	MEMORY DOOR	6-1	2A
RB2-4020-000CN	1	INPUT PAPER SUPPORT	6-1	5
RB2-3986-000CN	1	HOLDER, POWER SWITCH LEVER	6-8	4
RB2-4049-000CN	1	PLATE, GROUNDING	6-8	12

Table 6-11. Parts list sorted by part number

Part Number	Qty	Part Name	Table #	Key #
0515-2672	7	FORMATTER SCREWS	6-9	3
RB2-3931-000CN	2	ROLLER	6-4	9
RB2-4001-000CN	1	MOUNT, DISPLAY PCB	6-4	3
RB2-3932-000CN	1	PLATE, SCANNER	6-4	10
RB2-4034-000CN	1	MOUNT, ARM	6-5	18A
RB2-4021-000CN	1	OUTPUT/SCANNER PAPER SUPPORT	6-1	6
RF5-2819-000CN	1	GUIDE, CARTRIDGE, RIGHT	6-5	8
RF5-2832-000CN	1	ARM, PAD	6-5	4
RF5-2827-000CN	1	COVER, FRONT	6-1	1
RF5-2818-000CN	1	GUIDE, CARTRIDGE, LEFT	6-5	7
RF5-2823-000CN	1	ROLLER, PRESSURE	6-6	10
RF5-2830-000CN	1	ROLLER, FACE-DOWN	6-5	10
RF5-2822-000CN	1	ROLLER, FACE-UP	6-5	9
RF5-2828-000CN	1	COVER, REAR	6-1	2
RG5-4581-000CN	1	FEEDER ASS'Y	6-7	2
RG5-4561-000CN	1	CONTACT IMAGE SENSOR	6-2	2
RG5-4588-000CN	1	ARM HOLDER ASS'Y RIGHT	6-5	19
RG5-4585-000CN	1	GEAR ASS'Y	6-4	12
RG5-4582-000CN	1	PAPER GUIDE PLATE ASS'Y	6-5	17
RG5-4587-000CN	1	ARM HOLDER ASS'Y LEFT	6-5	18
RG5-4653-000CN	1	CONNECTOR HOLDER ASS'Y	6-3	15
RG5-4593-000CN	1	DELIVERY ASS'Y	6-6	8
RG5-4589-000CN	1	FIXING FILM ASS'Y - 100-127V (J102, J702)	6-6	14
RG5-4591-000CN	1	FIXING PRESSURE ASS'Y, LEFT	6-6	15
RG5-4570-000CN	1	LASER/SCANNER ASS'Y	6-4	4
RG5-4602-000CN	1	INPUT PAPER BIN	6-1	8
RG5-4590-000CN	1	FIXING FILM ASS'Y - 220-240V	6-6	14
RG5-4592-000CN	1	FIXING PRESSURE ASS'Y, RIGHT	6-6	2
RG5-4584-000CN	2	ROLLER HOLDER ASS'Y	6-4	1
RG5-4604-000CN	1	PRINTER DOOR	6-1	9
RG5-4601-000CN	1	SINGLE SHEET BIN	6-1	7
RG5-4616-000CN	1	SCANNER CABLE (J208, J801, J802)	6-4	16
RG5-4594-000CN	1	TRANSFER ASS'Y	6-6	13
RG5-4620-000CN	1	DISPLAY CABLE (J1, J901)	6-4	17
RG5-4619-000CN	1	THERMISTOR CABLE (J008, J206)	6-8	11
RG5-4617-000CN	1	SENSOR CABLE (J211, J003, J004)	6-3	16
RG5-4605-000CN	1	ECU PCB ASS'Y	6-8	14
RG5-4618-000CN	1	MOTOR CABLE,(J007, J401)	6-8	10
RG5-4586-000CN	1	DRIVE ASS'Y	6-3	10
RG5-4606-000CN	1	ECU PCB ASS'Y	6-8	14
RG5-4608-000CN	1	DISPLAY PCB ASS'Y	6-4	20
RG5-4599-000CN	1	DOOR SENSOR ASS'Y	6-8	9
RH2-5379-000CN	1	FLAT CABLE	6-3	15C
RH2-5381-000CN	1	FLAT CABLE, (J201)	6-8	7
RH7-1404-000CN	1	MAIN MOTOR	6-3	10B
RH7-5227-000CN	1	SOLENOID (SL001, J204)	6-6	11

Table 6-11. Parts list sorted by part number

Part Number	Qty	Part Name	Table #	Key #
0515-2672	7	FORMATTER SCREWS	6-9	3
RS5-2502-000CN	1	SPRING, COMPRESSION	6-5	11
RS6-2122-000CN	1	SPRING, COMPRESSION	6-5	16
RY7-5051-000CN	1	CLUTCH KIT	6-3	13
RY7-5049-000CN	1	GEAR KIT	6-5	13
RY7-5060-000CN	1	DEVELOPER FASTENER KIT	6-6	9
RY7-5050-000CN	1	SUBPAD KIT	6-6	1
RZ4-0690-000CN	2	SHIPPING BLOCK	6-1	
VS1-5057-002 CN	1	CONNECTOR, 2P (J008)	6-8	8
WT2-5041-000CN	2	TIE, CABLE	6-4	19
XA9-0267-000CN	2	SCREW, TP, M3X6	6-4	18
XA9-0605-000CN	2	SCREW, M4X8	6-3	1
XA9-0686-000CN	1	SCREW, M3X6	6-4	13
XA9-0956-000CN	6	SCREW, M3X6	6-8	13
XA9-0605-000CN	1	SCREW, M4X8	6-4	14
XB2-7300-607 CN	1	SCREW, M3X6	6-8	501
XB2-7300-607CN	1	SCREW, M3X6	6-1	501
XB2-7300-607CN	3	SCREW, W/WASHER, M3X6	6-3	502
XB2-7300-607 CN	3	SCREW, M3X6	6-4	501
XB4-7401-007	1	SCREW, M4X10	6-6	503
XB4-7401-007 CN	2	SCREW, M4X10	6-4	504
XB4-7401-209	2	SCREW, M4X12	6-6	504
XB4-7401-007CN	3	SCREW, TAPPING, PAN HEAD, M4X10	6-5	501
XB4-7400-805	2	SCREW, M4X8	6-6	501
XB4-7401-007CN	4	SCREW, M4X10	6-1	502
XB4-7401-007CN	8	SCREW, TAPPING, PAN HEAD, M4X10	6-3	501
XB4-7401-209 CN	2	SCREW, M4X12	6-4	502
XB6-7300-609CN	2	SCREW, M3X6	6-3	10C
XB6-7300-807 CN	4	SCREW, M3X8	6-4	503

Parts list sorted by part name

Table 6-12. Parts list sorted by part name

Part Name	Qty	Part #	Table #	Key #
ARM HOLDER ASS'Y RIGHT	1	RG5-4588-000CN	6-5	19
ARM HOLDER ASS'Y LEFT	1	RG5-4587-000CN	6-5	18
ARM, PAD	1	RF5-2832-000CN	6-5	4
BUSHING, LEFT	1	RB2-3956-000CN	6-6	6
BUSHING, RIGHT	1	RB2-3939-000CN	6-6	3
BUSHING, RIGHT	1	RB2-3957-000CN	6-6	7
CAM	1	RB2-3949-000CN	6-4	8
CASE, PRINTER CONTROLLER	1	RB2-3984-000CN	6-8	2
CLUTCH KIT	1	RY7-5051-000CN	6-3	13
CONNECTOR HOLDER ASS'Y	1	RG5-4653-000CN	6-3	15
CONNECTOR, 2P (J008)	1	VS1-5057-002 CN	6-8	8
CONTACT IMAGE SENSOR	1	RG5-4561-000CN	6-2	2
COVER, HOLDER	1	RB2-4030-000CN	6-3	3
COVER, REAR	1	RF5-2828-000CN	6-1	2
COVER, FRONT	1	RF5-2827-000CN	6-1	1
DELIVERY ASS'Y	1	RG5-4593-000CN	6-6	8
DEVELOPER FASTENER KIT	1	RY7-5060-000CN	6-6	9
DISPLAY CABLE (J1, J901)	1	RG5-4620-000CN	6-4	17
DISPLAY PCB ASS'Y	1	RG5-4608-000CN	6-4	20
DOOR SENSOR ASS'Y	1	RG5-4599-000CN	6-8	9
DRIVE ASS'Y	1	RG5-4586-000CN	6-3	10
DUCT, 2	1	RB2-3999-000CN	6-4	15
ECU PCB ASS'Y	1	RG5-4605-000CN	6-8	14
ECU PCB ASS'Y	1	RG5-4606-000CN	6-8	14
ELIMINATOR, STATIC CHARGE	1	RB2-3951-000CN	6-3	5
FEED ROLLER	1	RB2-3912-000CN	6-7	1
FEEDER ASS'Y	1	RG5-4581-000CN	6-7	2
FIXING PRESSURE ASS'Y, LEFT	1	RG5-4591-000CN	6-6	15
FIXING FILM ASS'Y - 100-127V (J102, J702)	1	RG5-4589-000CN	6-6	14
FIXING FILM ASS'Y - 220-240V	1	RG5-4590-000CN	6-6	14
FIXING PRESSURE ASS'Y, RIGHT	1	RG5-4592-000CN	6-6	2
FLAG, SENSOR	1	RB2-3960-000CN	6-5	5
FLAT CABLE, (J201)	1	RH2-5381-000CN	6-8	7
FLAT CABLE	1	RH2-5379-000CN	6-3	15C
FOOT	4	RB2-3945-000CN	6-4	7
FORMATTER	1	C4146-60001	6-9	2
FORMATTER PLATE	1	RB2-3992-000CN	6-9	1
FORMATTER SCREWS	7	0515-2672	6-9	3
GEAR ASS'Y	1	RG5-4585-000CN	6-4	12
GEAR KIT	1	RY7-5049-000CN	6-5	13
GUIDE, FACE DOWN DELIVERY	1	RB2-4006-000CN	6-3	12
GUIDE, TRANSFER	1	RB2-3950-000CN	6-6	5
GUIDE, ARM, LEFT	1	RB2-3941-000CN	6-5	1

Table 6-12. Parts list sorted by part name

GUIDE, FIXING	1	RB2-3958-000CN	6-6	16
GUIDE, ARM, RIGHT	1	RB2-3942-000CN	6-5	2
GUIDE, CARTRIDGE, LEFT	1	RF5-2818-000CN	6-5	7
GUIDE, CARTRIDGE, RIGHT	1	RF5-2819-000CN	6-5	8
HOLDER, PAD	1	RB2-3947-000CN	6-5	3
HOLDER, FLAT CABLE	1	RB2-4017-000CN	6-3	2
HOLDER, POWER SWITCH LEVER	1	RB2-3986-000CN	6-8	4
INPUT PAPER SUPPORT	1	RB2-4020-000CN	6-1	5
INPUT PAPER BIN	1	RG5-4602-000CN	6-1	8
LASER/SCANNER ASS'Y	1	RG5-4570-000CN	6-4	4
LEVER, POWER SWITCH	1	RB2-3987-000CN	6-8	5
MAIN MOTOR	1	RH7-1404-000CN	6-3	10B
MEMORY DOOR	1	RB2-4014-000CN	6-1	2A
MOTOR CABLE,(J007, J401)	1	RG5-4618-000CN	6-8	10
MOUNT, ARM	1	RB2-4034-000CN	6-5	19A
MOUNT, ARM	1	RB2-4034-000CN	6-5	18A
MOUNT, DISPLAY PCB	1	RB2-4001-000CN	6-4	3
OUTPUT/SCANNER PAPER SUPPORT	1	RB2-4021-000CN	6-1	6
PAPER GUIDE PLATE ASS'Y	1	RG5-4582-000CN	6-5	17
PLATE, GROUNDING	1	RB2-4219-000CN	6-5	20
PLATE, GROUNDING	1	RB2-4049-000CN	6-8	12
PLATE, SCANNER	1	RB2-3932-000CN	6-4	10
POD, LEFT	1	RB2-4018-000CN	6-1	3
POD, RIGHT	1	RB2-4019-000CN	6-1	4
PRESSURE ROLLER GREASE		CK-8006	6-6	
PRINTER DOOR	1	RG5-4604-000CN	6-1	9
ROD, SWITCH	1	RB2-3988-000CN	6-8	6
ROLLER, FACE-DOWN	1	RF5-2830-000CN	6-5	10
ROLLER, PRESSURE	1	RF5-2823-000CN	6-6	10
ROLLER HOLDER ASS'Y	2	RG5-4584-000CN	6-4	1
ROLLER	2	RB2-3931-000CN	6-4	9
ROLLER, PAPER PICK-UP	1	RB2-4026-000CN	6-4	11A
ROLLER SHAFT	1	RB2-3930-000CN	6-4	11
ROLLER, FACE-UP	1	RF5-2822-000CN	6-5	9
SCANNER ASS'Y	1	R37-5000-000CN	6-2	1
SCANNER CABLE (J208, J801, J802)	1	RG5-4616-000CN	6-4	16
SCREW, M4X8	2	XB4-7400-805	6-6	501
SCREW, M3X6	1	XA9-0686-000CN	6-4	13
SCREW, M3X6	1	XB2-7300-607 CN	6-8	501
SCREW, M4X8	1	XA9-0605-000CN	6-4	14
SCREW, M4X12	2	XB4-7401-209	6-6	504
SCREW, M3X6	1	XB2-7300-607CN	6-1	501
SCREW, M4X10	4	XB4-7401-007CN	6-1	502
SCREW, TP, M3X6	2	XA9-0267-000CN	6-4	18
SCREW, M4X10	1	XB4-7401-007	6-6	503
SCREW, M3X6	6	XA9-0956-000CN	6-8	13
SCREW, M4X12	2	XB4-7401-209 CN	6-4	502

Table 6-12. Parts list sorted by part name

SCREW, TAPPING, PAN HEAD, M4X10	8	XB4-7401-007CN	6-3	501
SCREW, M3X8	4	XB6-7300-807 CN	6-4	503
SCREW, M4X8	2	XA9-0605-000CN	6-3	1
SCREW, TAPPING, PAN HEAD, M4X10	3	XB4-7401-007CN	6-5	501
SCREW, M4X10	2	XB4-7401-007 CN	6-4	504
SCREW, M3X6	3	XB2-7300-607 CN	6-4	501
SCREW, M3X6	2	XB6-7300-609CN	6-3	10C
SCREW, W/WASHER, M3X6	3	XB2-7300-607CN	6-3	502
SENSOR CABLE (J211, J003, J004)	1	RG5-4617-000CN	6-3	16
SHAFT	1	RB2-3943-000CN	6-4	5
SHEET, INSULATING	1	RB2-3985-000CN	6-8	3
SHIPPING BLOCK	2	RZ4-0690-000CN	6-1	
SINGLE SHEET BIN	1	RG5-4601-000CN	6-1	7
SOLENOID (SL001, J204)	1	RH7-5227-000CN	6-6	11
SPACER, PCB	3	RB1-7303-000CN	6-8	1
SPRING, COMPRESSION	1	RS6-2122-000CN	6-5	16
SPRING, COMPRESSION	1	RS5-2502-000CN	6-5	11
SPRING, LEAF	1	RB2-3944-000CN	6-4	6
SPRING, COMPRESSION	1	RB2-3940-000CN	6-6	4
SPRING, LEAF, LEFT	1	RB2-3959-000CN	6-3	11
STOP, SLIDE	1	RB2-4016-000CN	6-5	12
SUBPAD KIT	1	RY7-5050-000CN	6-6	1
THERMISTOR CABLE (J008, J206)	1	RG5-4619-000CN	6-8	11
TIE, CABLE	2	WT2-5041-000CN	6-4	19
TORSION SPRING	1	RB2-3961-000CN	6-5	6
TRANSFER ASS'Y	1	RG5-4594-000CN		13

List of Figures

Control panel	11
Printer light patterns	26
Scanner control panel	31
Basic configuration	42
Printer unit functional block diagram	43
ECU loads	44
High-voltage power supply circuit	47
Image formation block diagram	51
Simplified paper path	53
Simplified scanner document path	57
General timing diagram	59
Removing the paper guides	64
Removing the optional scanner unit	65
Opening the scanner unit	66
Removing the Contact Image Sensor (continued on next page)	67
Removing the Contact Image Sensor (continued)	68
Disconnecting the CIS wire connector	69
Opening the printer door	70
Disconnecting the stabilizer bars	71
Storing the stabilizer bars	72
Removing the paper deflector	73
Removing the door from the hinge mechanism (continued on next page)	74
Removing the cover from the hinge mechanism (continued)	75
Removing the stabilizing pods	76
Removing the screws on the back cover	77
Removing the back cover	78
Removing the paper guide	79
Removing the front cover (continued on next page)	80
Removing the front cover (continued)	81
Stabilizer bars	82
Removing the printer laser/scanner cover	83
Disconnecting the scanner assembly cables	84
Releasing the output roller (continued on next page)	85
Releasing the output roller snaps	86
Removing the torsion screws on the delivery assembly	87
Removing the delivery assembly	88
Paper Exit Sensor Flag	89
Metal Clips Holding Fusing Element	90
Reassembly of fusing element clips	91
Releasing the fusing element cable connection, left side	92
Releasing the fusing element cable connection, right side	93
Removing the fusing element	94
Removing the motor cable connection to the gear train cover	95
Removing the gear train cover	96
Removing the gear train motor	97
Removing the solenoid	98
Removing the pressure roller (continued on next page)	99
Removing the pressure roller	100
Changing the pickup roller	102
Accessing the paper pick-up assembly area	103
Removing the paper pick-up assembly cover	104

Removing the kick plate	105
Removing the snap holding the separation pad	106
Removing the separation pad	107
The formatter pan (continued on next page)	108
Removing the formatter pan (continued)	109
Removing the ECU pan cable cover	110
Removing ECU pan flat flexible cable	111
Removing the hinge mechanism	112
Removing the ECU pan	113
Removing the ECU pan (continued on next page)	114
Removing the paper feed assembly (continued on next page)	115
Removing the paper feed assembly (continued)	116
Removing the paper feed assembly (continued)	117
Engine Test Switch	140
Self Test Page	141
Thermistor Connector	144
Heating Element Connector	144
Toner cartridge high-voltage connection points	146
High-voltage connector assembly	147
Overriding SW301	148
NVRAM PjL Factory Variables	150
Paper path and components	152
Document path and components	153
Repetitive image defect ruler	154
Main wiring	155
External covers, panels, etc.	163
Document Scanner	164
Internal components, 1 of 4	165
Internal components, 2 of 4	166
Internal components, 3 of 4	168
Internal components, 4 of 4	170
Feeder assembly	172
Engine controller assembly	174
Formatter pan	176

List of Tables

- Printer specifications13
- Control panel light messages27
- Printer key functionality29
- Scanner key functionality based on printer status32
- DC power distribution46
- Solenoid, photosensors, and switches55
- Basic troubleshooting120
- Service and error messages122
- Solving image quality problems126
- Solving paper feed problems134
- Common fasteners162
- External covers, panels, ets.163
- Document Scanner164
- Internal components, 1 of 4165
- Internal components, 2 of 4167
- Internal components, 3 of 4169
- Internal components, 4 of 4171
- Feeder assembly173
- Engine controller assembly175
- Formatter pan176
- Parts list sorted by part number177
- Parts list sorted by part name180

Index

A

- AC power distribution 46
- accessories and consumables
 - ordering 161
- adjusting registration 140
- assemblies
 - fusing 53
 - high-voltage connector 147
- assembly diagrams 158

B

- bidirectional
 - ECP interface 48
- black
 - dots on pages 127
 - dots on scanned images 132
 - pages 130
 - streaks on page 128
- blank
 - areas on page 130
 - bottom of page or graphic 131
 - pages 131
- bottom of page or graphic cut off 131

C

- cartridge sensor (SW101) 55
- characters partially printed 131
- charging the drum 52
- checking registration 140
- checks
 - drum rotation 143
 - half-self test 142

- high-voltage power supply 146
- circuit
 - driver 56
- circuitry
 - high-voltage 47
 - power 46
- cleaning
 - photosensitive drum process 51
 - printer 137
 - printer paper path 137
 - toner cartridge connection points 146
- components, internal
 - illustrations 165, 168, 172, 174, 176
- connection points for toner cartridge 146
- conserving toner 49
- consumables and accessories
 - ordering 161
- contact image sensor 56
- control panel
 - description 49
- control, paper motion 45
- crooked pages 134
- curled
 - pages 134
 - paper 147
- customer support
 - ordering parts 159
 - Support Materials Europe (SME) 159
 - Support Materials Organization (SMO) 159

D

- dark
 - faxes 126
 - scanned images 126
- date/time

- toner cartridge expiration 125
- DC power distribution 46
- delivery roller
 - motion 147
- developing process 52
- diagrams
 - assembly 158
 - timing 59
- distribution of power 46
- document sensor (PS801) 55
- documents
 - fall out of feeder tray 136
- door open sensor (SW101) 55
- dots
 - on pages 127
 - on scanned images 132
- draft mode 49
- DRAM (dynamic random-access memory) 48
- driver
 - circuits 56
 - roller motion 147
- dropouts in characters 131
- drum rotation functional check 143
- drum, photosensitive
 - charging 52
 - cleaning process 51
 - troubleshooting 125
- dynamic random-access memory (DRAM) 48
- E**
- ECP interface 48
- ECU (engine controller unit)
 - description 44
 - loads 44
- edge of paper, not printing to 126

electrophotographic process 142

engine control function 43

engine test 140

engine test switch (SW201) 55

error messages

printer

light patterns 11, 26

ESD (electrostatic discharge)

caution 62

mat 63

exit rollers 53

expiration date of toner cartridges 125

F

faded print 127

fasteners, common 162

faxes

light or dark 126

feed assembly drive rollers 53

feed functions 43

feeding problems 135, 136

fixing

process 52

formatter 48

functional checks

drum rotation 143

fuser

gear motion 147

roller motion 147

fuses 46

fusing

assembly 53

element 52

G

graphic, bottom cut off 131

H

half-self test 142

hardware

common 162

high-voltage

connector assembly 147

power distribution 46

power supply check 146

I

image fixing process 52

image formation

function 43

system 51

troubleshooting 125

images

lines on page 128

too light or dark 126

installing self-tapping screws 62

K

kick plate

motion 53, 147

L

LED (light-emitting diode) array 56

light

faxes 126

printing 127

scanned images 126

light patterns

printer 11, 26

light-emitting diode (LED) array 56

lines

on scanned images 128

M

memory

 DRAM (dynamic random-access memory) 48

 RAM (random-access memory) 48

misaligned print 132

missing bottom of page or graphic 131

mode, draft 49

monitoring paper motion 45

motion control 45

motor

 description 45

 rotation 147

multiple pages feeding 135, 136

O

optical system 56

ordering

 accessories and consumables 161

overcurrent 46

overview of processes 42

overvoltage 46

P

pads

 separation 53

 sub 53

page

 engine test 140

pages

 blank print 131

 bottom cut off 131

 completely black 130

 crooked 134

 curled or wrinkled 134

 long stop feeding 134

 multiple feeding 135, 136

- skewed 132, 134
- paper
 - curl 147
 - feed problems 134
 - motion 53
 - not being picked up 147
 - not moving through path 147
 - not printing to edge 126
- paper exit sensor (PS201) 53, 54, 55
- paper jams 135, 136
- paper motion control 45
- paper out sensor (PS202) 54, 55
- paper path
 - check 147
- paper registration sensor (PS203) 53, 54, 55
- partially printed characters 131
- parts
 - lists 158
- path
 - scanner 56
- path, paper
 - check 147
- photosensitive drum
 - charging 52
 - cleaning process 51
 - troubleshooting 125
- phototransistor array 56
- pickup roller assembly
 - motion 147
- pickup/feed functions 43
- plates
 - kick 53, 147
- pliers required for servicing 63
- power

- AC distribution 46
- DC distribution 46
- high-voltage distribution 46
- shutoff switch 45
- supply check 146
- system description 44, 46

primary charging 52

print

- misaligned 134

- skewed 134

print engine control system 45

printer

- functions 43

- isolating problems 140

- laser/scanner functions 43

- light patterns 11, 26

- specifications 13– 14

printing

- engine test page 140

- faded 127

- misaligned 132

- to edge of paper 126

- won't print 126

product

- block diagram 43

- overview of processes 42

protection, overcurrent 46

R

RAM (random-access memory) 48

random-access memory (RAM) 48

recycling toner cartridges 38

registration checking and adjusting 140

rod lens array 56

rollers

- exit 53
- feed assembly drive 53
- motion 147
- rotation, drum 143

S

- scan
 - process 142
- scanned images
 - lines on page 128
 - too light or dark 126
- scanned text unclear 133
- scanner
 - path 56
 - system 56
- scattered toner on page 130
- screwdrivers required for servicing 63
- screws
 - common 162
 - installing 62
 - self-tapping 62
- self-tapping screws, installing 62
- sensors
 - contact image 56
 - document 55
 - door open 55
 - location and function 55
 - paper exit 55
 - paper exit (PS201) 53, 54
 - paper out (PS202) 54, 55
 - paper registration (PS203) 53, 54, 55
 - toner cartridge 55
- separating process 52
- separation pads
 - description 53

- service and support
 - ordering parts 159
 - Support Materials Europe (SME) 159
 - Support Materials Organization (SMO) 159
- shutoff switch 45
- skewed
 - pages 134
 - print 132
- smears on page 128
- smudges on page 127
- solenoid 55
- solenoid assembly 147
- specifications
 - printer 13– 14
- stains on page 127
- streaks
 - on pages 128
 - on scanned images 132
- stripes on page, white 127
- subassembly diagrams 158
- subpads
 - description 53
- summary of processes 42
- support and service
 - ordering parts 159
- Support Materials Europe (SME) 159
- switches
 - engine test (SW201) 55
 - location and function 55
 - power shutoff 45

T

- test
 - engine switch (SW201) 55
 - page for engine 140

- tests
 - engine 140
 - half-self 142
- text, scanned, unclear 133
- timing diagram 59
- toner
 - draft mode for conserving 49
 - scattered on page 130
- toner cartridge 38
 - recycling 38
 - refilled 38
- toner cartridges
 - checking 125
 - checking and cleaning connection points 146
 - description 51
 - expiration date 125
 - photosensitive drum 125
 - sensor 55
 - weight when full and empty 125
- tools
 - servicing 63
 - troubleshooting 147
- transfer process 142
- transfer roller
 - motion 147
- trays
 - documents fall out 136
- troubleshooting
 - drum rotation 143
 - image formation 125
 - paper feed problems 134
- printer
 - light patterns 11, 26
 - process malfunctions 142

tools 147

V

video controller 56

void areas on page 130

voltage

distribution 46

high 46

over 46

power supply check 146

protection 46

W

warranty statement 39

weight

toner cartridge when full and empty 125

white

areas on page 130

stripes on page 127

wrinkled pages 134



HEWLETT®
PACKARD

Expanding Possibilities

Copyright© 1998
Hewlett-Packard Co.
Printed in USA

Manual Part No.
C4224-90962



C4224-90962



Printed on at least
50% Total Recycled Fiber with
at least 10% Post-Consumer Paper