



HP DesignJet ColorPro CAD HP DesignJet ColorPro GA



Service Manual

For HP Internal Use Only

©Copyright Hewlett-Packard Company 1999

This document contains proprietary information that is protected by copyright. All rights are reserved. No part of this document may be photocopied, reproduced, or translated to another language without the prior written consent of Hewlett-Packard Company.

First Edition, September 1999

Warranty

The information contained in this document is subject to change without notice.

Hewlett-Packard makes no warranty of any kind with regard to this material, including, but not limited to, the implied warranties of merchantability and fitness for a particular purpose.

Hewlett-Packard shall not be liable for errors contained herein or for incidental or consequential damages in connection with the furnishing, performance, or use of this material.

WARNING

The procedures described in this manual are to be performed by HP-qualified service personnel only.

Electrical Shock Hazard

Serious shock hazard leading to death or injury may result if you do not take the following precautions:

- Ensure that the ac power outlet (mains) has a protective earth (ground) terminal.
- Disconnect the Printer from the power source prior to performing any maintenance.
- Prevent water or any other liquids from running onto electrical components or circuits, or through openings in the enclosure.

Electrostatic Discharge

Refer to the beginning of Chapter 10 of this manual, for precautions you should take to prevent damage to the Printer circuits from electrostatic discharge.

WARNING

The Warning symbol calls attention to a procedure, practice, or the like, which, if not correctly performed or adhered to, could result in personal injury. Do not proceed beyond a Warning symbol until the indicated conditions are fully understood and met.

CAUTION

The Caution symbol calls attention to an operating procedure, practice, or the like, which, if not correctly performed or adhered to, could result in damage to or destruction of part or all of the product. Do not proceed beyond a Caution symbol until the indicated conditions are fully understood and met.

Technical Marketing,
Barcelona Division,
Hewlett-Packard Espanola, S.A.
Avda. Graells, 501
08190 Sant Cugat del Valles
Spain

HP DesignJet ColorPro CAD
HP DesignJet ColorPro GA



Service Manual

Using this Manual

Purpose

This Service Manual contains information necessary to test, calibrate and service:

- HP DesignJet ColorPro CAD Printer (Model C7777A)
- HP DesignJet ColorPro GA Printer (Model C7778A)

For information about using these printers, refer to the corresponding User and Quick Reference Guides.

Readership

The procedures described in this Service Manual are to be performed by HP Certified service personnel only.

Part Numbers

Part Numbers for Printer options, accessories and service parts are located in Chapter 9.

Table of Contents

Chapter 1 - Product Information

Chapter 2 - Operating Overview

Chapter 3 - Loading Paper and paper Behaviour

Chapter 4 - Install/Uninstall printer Software

Chapter 5 - Maintenance and Ink

Chapter 6 - Functional Overview

Chapter 7 - Removal & Replacement w/o Calibration

Chapter 8 - Troubleshooting

Chapter 9 - Parts & Diagrams

Chapter 10 - Removal & Replacement with Calibration

Chapter 11 - Calibration

Table of Contents

Chapter 1 Product Information

Technology Update

Modular Ink Delivery System

A modular ink delivery system is the separation of ink cartridges and printheads into individual, single-color components. Traditional inkjet printers use one black and one tri-color ink cartridge, each with integrated printheads. HP's modular ink delivery system features four separate ink cartridges--one for each primary printing color--and four corresponding long-life printheads, with tubes connecting the components. Including the standard and high-capacity black ink cartridges, there are actually nine consumables, with only eight used in the printer at one time.



Technology Update

How It Works

By separating the ink cartridge from the printheads, a modular ink delivery system allows the ink supply to remain in a permanent, fixed position. The printheads remain attached to the carriage and move back and forth, delivering ink to the page as the paper advances through the printer. Each printhead and ink cartridge is embedded with a tiny memory device called a smart chip that recognizes and stores the unique operating characteristics of the component to create a totally integrated printing system that ensures consistent, high-quality printing at the lowest cost available.

A unique pressurization system maintains a constant supply of ink to the printheads. Smart chips monitor the amount of ink used by counting every drop that passes through each printhead. When the smart chips sense more ink is needed to maintain continuous printing, a plunger in each cartridge temporarily pressurizes the cartridges to deliver more ink to the printheads. With the modular ink delivery system, ink supply is instantly replenished, even at top speeds.

The new, individually replaceable printheads are designed for long life and each should print 12,000 pages in black, 24,000 pages in color. As a result, you'll go through many ink cartridges before the corresponding printhead will need replacement. With their modular design, ink cartridges contain twice the ink supply of current HP cartridges, so you'll also get longer lasting cartridges. When a component approaches the end of its print life, the smart chip notifies the user through on-screen messages so a replacement can be purchased prior to the part expiring.

By separating the printheads and ink cartridges, you only replace the component that is no longer usable. Printheads can be replaced one at a time without the need for costly or extensive servicing and aren't discarded when the ink is expended. HP printheads also use a wet wiping system to eliminate nozzle clogging that plagues other permanent printhead designs. Component replacement is easy. Simply pull out the used part and snap in a replacement.

Technology Update

The Benefits

Cuts up to 30 percent off the printing costs of other methods

- Modular design means only the component that is no longer useful is replaced.
- Longer-life printheads and higher-capacity ink cartridges means less frequent replacement.

Achieves color laser speed in a personal desktop printer

- Each Printhead has 304 nozzles (1,216 total, the most in the industry) resulting in faster print speeds.
- Prints in 1/2-inch swath as opposed to the 1/5- or 1/3-inch swaths of integrated print cartridges.
- Ink cartridge pressurization system keeps constant flow of ink to printhead. Smart chips store component information and alert user to low-ink, ink-out and printhead failure status.

Specifications

Data Sheet

Print Method	Plain paper drop on-demand thermal inkjet printing.		
Print Speed ¹ Black	Black Text Econofast Mode Normal Mode Best Mode	Letter / A4 11.0 ppm 9.0 ppm 7.5 ppm	11x17 / A3 7.0 ppm 5.0 ppm 4.5 ppm
Print Speed ¹ Color	Color Highlights Econofast Mode Normal Mode Best Mode Mixed Text & Graphics Econofast Mode Normal Mode Best Mode Full Page Color Econofast Mode Normal Mode Best Mode	Letter / A4 9.0 ppm 6.5 ppm 5.5 ppm Letter / A4 9.0 ppm 3.0 ppm 1.5 ppm Letter / A4 2.5 ppm 1.2 ppm 0.4 ppm	11x17 / A3 5.5 ppm 3.5 ppm 2.5 ppm 11x17 / A3 6.0 ppm 2.0 ppm 1.0 ppm 11x17 / A3 1.7 ppm 0.7 ppm 0.3 ppm
	¹ Approximate figures. Exact speed dependent on the system configuration, software program, and document complexity		
Black Resolution	Up to 600x600 dpi		
Color Resolution	PhotoREt II for photo quality		
Printhead Nozzles	304 black, 912 color (304 per color printhead)		
Printer Command Language	HP PCL 3 enhanced Adobe PostScript 3 (With HP 2500CM only)		
Font Capability	HP FontSmart v2.5 (110 TrueType fonts for windows) HP FontSmart software provides easy-to-use font management capabilities 136 PostScript fonts with Adobe PostScript 3		
Memory	HP DesignJet ColorPro CAD 4 Mbytes standard RAM HP DesignJet ColorPro GA 20 Mbytes standard RAM Two 72-pin SIMM slots for additional memory (EDO, 60ns) expansion up to a total of 76 Mbytes		

<p>Connectivity /Network Management</p>	<p>HP DesignJet ColorPro CAD Network-capable printer for DOS and Windows environments Enhanced HP PCL 3e Windows Driver Support for Windows NT 4.0, Windows 3.1x/95/98 Centronics parallel, IEEE 1284 compliant One network interface slot accepts optional HP MIO Print Servers with support for Novell Netware, Microsoft LAN Manager, Windows for Workgroups, Windows for NT, IBM LAN Server, Unix environment and Apple Talk (Ether Talk)</p> <p>HP DesignJet ColorPro GA Network-ready printer for DOS, Windows and Macintosh environments Enhanced HP PCL 3e Windows Driver Support for Windows NT 4.0, Windows 3.1x/95/98 Centronics parallel, IEEE 1284 compliant HP MIO 10/100Base-TX print server with support for Novell Netware, Microsoft LAN Manager, Windows for Workgroups, Windows NT, IBM LAN Server, Unix environment and AppleTalk (EtherTalk) Supports networking protocols IPX/SPX, TCP/IP, DLC/LLC, AppleTalk and NetBEUI Adobe PostScript 3 drivers for Windows and Macintosh QuickDraw</p> <p>Automatic switching between languages and ports. HP JetAdmin printer management software provides easy printer setup and configuration. Latest versions available from HP's web site (http://www.hp.com/go/jetadmin) HP WebJetAdmin printer management software available from HP's web site (http://www.hp.com/go/webjetadmin) for simple installations and configuration from a common web browser.</p>
<p>Paper Handling</p>	<p>Standard input capacity of 400 sheets through two trays (Tray 2 & 3) of 150 sheet and 250 sheet capacity. Standard output capacity of 150 sheets (face-up) Rear Manual feed – single sheet only Tray 1 (Input / Output Tray) – Sheets: up to 10, Cards: up to 4 Tray 2 (Upper Tray) – Sheets: up to 150, Cards: up to 60 Tray 3 (Lower Tray) – Sheets: up to 250 All input paths handle standard media sizes (as listed below) up to 13 in.x19 in. (Supper A3) Additionally, Tray 1 and the rear manual feed support all media sizes as small as 4 in.x6 in. (101.6mmx152.4mm) Built-in media size sensors prevents printing on the wrong size of media</p>

Paper Size Handling	Minimum Width: 76.2 mm (4in.) x 127.0 mm (6 in.) Maximum Width: 330.2 mm (13in.) x 482.6 mm (19 in.)
Maximum Print Width	320 mm (12.61 in.) x 470 mm (18.49 in.) on 13 in. x 19 in. media
Recommended Media Weight	All input paths handle the following paper weights with the rear straight-through paper path handling up to 0.3 mm thickness of paper Paper / Labels: 60 to 135 g/m ² (16 to 36 lb. Bond) Cards: 110 to 200 g/m ² (110 lb. Index) Straight-through path: up to 0.3 mm thickness (0.012 in.) or approx. 200 g/m ² (110 lb. Index)
Smart Software Features	Built-in printer driver features: HP ZoomSmart scaling technology, Billboard, Handout (N-up printing), Mirror, Watermark, Print Preview, Quick Sets, LaserJet Margin Emulation
Media Size / Type	Paper: Super B 13 x 19 in., U.S. Tabloid 11 x 17 in., U.S. Legal 8.5 x 14 in., U.S. Letter 8.5 x 11 in., European A3 297 x 420 mm, European A4 210 x 297 mm, European B4 257 x 364 mm Transparencies: U.S. Letter 8.5 x 11 in., European A4 210 x 297mm Cards: U.S. Index card 4 x 6 in., Index card 5 x 8 in., European A5 card 105 x 148.5 mm, Postcard 100 x 148 mm Labels: U.S. Labels, 8.5 x 11 in.; European A4 Labels, 210 x 297mm
Control Panel	Intuitive operation and complete, easy-to-understand messages Two-line 32 character LCD display and 2 LEDs Buttons:  (Go), Job Cancel, Menu, Item, Value, Select Indicators: Attention, Ready Messages can be displayed in 14 languages: English, French, Italian, German, Spanish, Portuguese, Dutch, Norwegian, Finnish, Swedish, Danish, Polish, Czech and Russian
Operating Environment	Operating temperature: 5° to 40°C (41° to 104°F) Recommended operating conditions: 15° to 35°C (59° to 95°F) Storage temperature: -40° to 60°C (-40° to 140°F) Relative Humidity: 20 to 80% RH non-condensing Noise levels per ISO 9614-1: Sound Pressure, LwAm 62 dB(A)
Power Supply	Built-in Universal Power Supply
Power Requirements	Input Voltage 100 – 240 AC (±10%), 50/60 Hz (±3 Hz)
Power Consumption	Less than 2 watts when off, 8 watts maximum non-printing, 35 watts average printing, 65 watts maximum printing

Dimensions	<p>With paper tray closed 685 mm (26.97in.) W x 610 mm (24.02in.) D x 337 mm (13.27in.) H</p> <p>With paper tray fully extended 685 mm (26.97in.) W x 745 mm (29.33in.) D x 337 mm (13.27in.) H</p> <p>Desk Space Required 685 mm (26.97 in.) W x 532 mm (20.94 in.) D</p>
Weight	<p>26.5 kg (58.48 lb.) without printheads and ink cartridges 27.0 kg (59.52 lb.) with printheads and ink cartridges</p>
Reliability & Estimated Usage	<p>Up to 12,000 pages / month</p>
System Requirements	<p>Minimum: Windows 3.1x: 486DX-66, 8Mb RAM Windows 95/98: 486DX-100, 8Mb RAM Windows NT 4.0: 486DX-100, 16Mb RAM Macintosh System 7.5.3: 68040 – 8Mb RAM</p> <p>Recommended: Windows 3.1x: Pentium 150/166, 16Mb RAM Windows 95/98: Pentium 150/166, 16Mb RAM Windows NT 4.0: Pentium 150/166, 32 Mb RAM Macintosh System 8 or later: Power PC – 16 Mb</p> <p>50 Mb Free HardDisk space for 11 x 17 or A3 size printing. Graphics intensive files may require more disk space.</p>
Warranty	<p>1 year on site warranty</p>
Product Certifications	<p>Safety Certifications: CCIB (China), CSA (Canada), PSB (Singapore), UL (USA), NOMi(Mexico), TUV-GS (Germany), SABS (South Africa), JUN (Korea)</p> <p>EMI Certifications: FCC Part 15B Class B when used with a Class B computing device (USA), FCC Part 15B Class A when connected to Local Area Network (LAN) Devices, CTICK (Australia & New Zealand), VCCI (Japan), CE (European Union), B mark (Poland), Gost (Russia), BCIQ (Taiwan), RRL (Korea)</p>

Brands and product names listed are trademarks or registered trademarks of their respective companies.

Information in this document is subject to change without notice – for more information or the latest updates, please go to the HP DesignJet web site located at <http://www.designjet-online.hp.com/>

Specifications

Cable Specifications

1284-B Connector Pin Assignments

The pin numbers and their assigned signal names for the 1284-B connectors are given below.

Note

The abbreviations used in the "Source" column:

H = host; P = printer; Bi-Di = bi-directional

PIN#	SOURCE	COMPATIBLE	NIBBLE	BYTE	ECP	EPP
1	H	nStrobe	HostClk	HostClk	HostClk	nWrite
2	Bi-Di*	Data 1 (Least Significant Bit)				AD1
3	Bi-Di*	Data 2				AD2
4	Bi-Di*	Data 3				AD3
5	Bi-Di*	Data 4				AD4
6	Bi-Di*	Data 5				AD5
7	Bi-Di*	Data 6				AD6
8	Bi-Di*	Data 7				AD7
9	Bi-Di*	Data 8 (Most Significant Bit)				AD8
10	P	nAck	PtrClk	PtrClk	PeriphClk	Intr
11	P	Busy	PtrBusy	PtrBusy	PeriphAck	nWait
12	P	PError	AckDataReq	AckDataReq	nAckReverse	User Defined 1
13	P	Select	Xflag	Xflag	Xflag	User Defined 3
14	H	nAutoFd	HostBusy	HostBusy	HostAck	nDStrb
15		Not Defined				
16		Logic Gnd				
17		Chassis Gnd				
18	P	Peripheral Logic High				
19		Signal Ground (nStrobe)				
20		Signal Ground (Data 1)				
21		Signal Ground (Data 2)				
22		Signal Ground (Data 3)				
23		Signal Ground (Data 4)				
24		Signal Ground (Data 5)				
25		Signal Ground (Data 6)				
26		Signal Ground (Data 7)				
27		Signal Ground (Data 8)				
28		Signal Ground (PError, Select, nAck)				
29		Signal Ground (Busy, nFault)				

30		Signal Ground (nAutoFd, nSelectIn, nInit)				
31	H	nInit	nInit	nInit	nReverseRequest	nInit
32	P	nFault	nDataAvail	nDataAvail	nPeriphRequest	User Defined 2
33		Not Defined				
34		Not Defined				
35		Not Defined				
36	H	nSelectIn	1284 Active	1284 Active	1284 Active	nAStrb

* Data signals will be driven by some but not all peripheral devices.

* Pins not defined by this spec are used by manufacturers at their own risk.

Specifications

Centronics Parallel Pinout Information

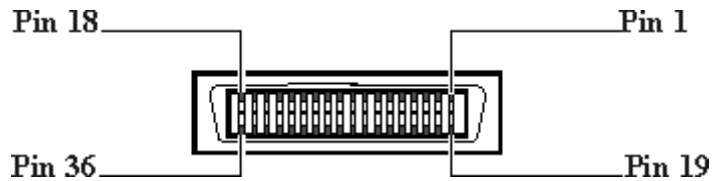

PIN NUMBER	PIN ID	DESCRIPTION
1	Strobe ¹	A low pulse causes the printer to read one byte of data
2 - 9	Data 0 - Data 7	These pins are the data lines. Data 0 is the least significant bit (LSB)
10	Acknowledge	The printer sends a low pulse to indicate that it has accepted a byte of data and is ready for more data.
11	Busy	The printer sends a high logic level to indicate to the computer that it cannot receive data due to data entry, a full buffer or error status.
12	Paper Error	The printer sends a high logic level to indicate to the computer that it is out of paper.
13	Ready	The printer sends a high logic level to indicate to the computer that it is in an online condition. The printer sends a low logic level to indicate that it is offline or that the input buffer is full.
16	Signal Ground	Signal interface ground.
17	Chassis Ground	Chassis ground.
18	+5 V	The printer outputs a +5 volt high logic level through a 2.2K ohm resistor.
19 - 30	Ground	These pins are tied to signal ground
31	Reset/Input Clear ¹	A low pulse sent by the computer resets the printer and clears the print buffer. The reset occurs on the trailing edge of the pulse
32	Error ¹	The printer sends a low logic level to the computer to indicate that it is in an error state.

¹ Active low

Specifications

The Centronics Parallel Cable has only 8 data lines, 5 status lines, 4 ground lines and ground connections between the host PC and the peripheral. Each of the signal lines has a corresponding bit position in a memory address (register) in the host where data is read or written. Sending data to the printer follows the sequence below:

- Host places data in Data Out register
- Host sends pulse on Strobe line
- Printer sends pulse on Busy in response to pulse on Strobe
- Printer reads data on Data Out lines
- Printer sends pulse on ACK (Acknowledge) line after data is read

This method of data transfer is also known as the Compatibility mode and the transfer rate of data is slow. The printer while operating in compatibility mode is capable of indicating limited printer error feedback to the host computer. Such feedback includes:

- Paper jam
- Out of paper
- Printer on or off line
- Time out

Specifications

IEEE 1284 Pinout Information

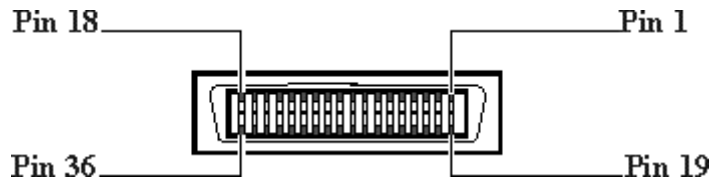

Any standard IEEE 1284 compliant printer cable will work with the printer. The customer can order the HP IEEE 124 Compliant Parallel Interface Cable C2950A (2 meters) or C2951A (3 meters).

PIN NUMBER	PIN ID	DESCRIPTION
1	HostClk	Used in a closed-loop handshake with PeriphAck to transfer data or address information from the host to the peripheral device.
2 - 9	AD1 - AD8	Host to peripheral device or peripheral device to host address or data. Data 1 is the least significant bit (bit 0).
10	PeriphClk	Used in a closed-loop handshake with HostAck (nAutoFd) to transfer data from the peripheral device to host.
11	PeriphAck	The peripheral uses this signal for flow control in the forward direction. PheriphAck also provides a ninth data bit to determine whether command or data information is present on the data signals in the reverse direction.
12	nAckReverse	The peripheral drives this signal low to acknowledge nReverseRequest. The host relies upon nAckReverse to determine when it is permitted to drive the data signals.
13	Xflag	This is used by the peripheral device to reply to the requested extensibility byte during the negotiation phase.
14	HostAck	The host drives this signal for flow control in the reverse direction. It is used in an interlocked handshake with PeriphClk. Host Ack also provides a ninth data bit used to determine whether command or data information is present on the data signals in the forward direction.
16	Logic Ground	Logic board ground.
17	Chassis Ground	Chassis Ground.
18	Peripheral Logic High	This signal is used to provide +5V high logic.
19-30	Ground	These pins are tied to signal ground
31	nReverseRequest	This signal is driven low to place the channel in the reverse direction. While in ECP mode, the peripheral is only allowed to driver the bi-directional data signals when nReverseRequest is low and 1284 Active is high.

32	nPeriphRequest	During ECP mode the peripheral may drive this pin low to request communications with the host. This request merely "hints" to the host; the host has ultimate control over the transfer direction. This signal provides a mechanism for peer-to-peer communication. This signal is valid in the forward and reverse directions.
36	1284 Active	Driven high by host while in ECP mode. Set low by the host to terminate ECP mode and return the link to the Centronics (uni-directional) mode

The 1284 compliant cable supports the ECP (Extended Capabilities Port) mode in the transfer of data. The ECP protocol includes a series of protocols that differ from standard Centronics parallel port operation. These additional signaling methods allow the host and peripheral to negotiate any of faster transfer modes (e.g. DMA, FIFO and RLE decompression). The protocol is hardware driven and the performance is limited by the ISA bus bandwidth. The primary advantage is that once data transfer is negotiated, data can flow without the need of an acknowledge or a return status signal. This can result in a transfer rate of up to 10 times faster than that of the compatibility mode that the Centronics parallel cable supports.

To transfer data, the host first goes through a negotiation phase, which allows the host and peripheral to select a mutually-supported communications mode. During the negotiation phase, the host indicates which communication mode and options it would like to use via the Extensibility Request Value. If the peripheral device does not support the requested mode or options, it sets the Extensibility Flag low and the interface returns to Compatibility Mode.

Specifications

Reliability Specifications

Category	Specifications
Printer Usage	Up to 12,000 pages / month
Mechanism Life	150,000 A size pages / 5 years

Specifications

Interface Specifications

Category	Specifications
Interface Specification	<ul style="list-style-type: none"><li data-bbox="740 566 1193 674">▪ Centronics parallel, IEEE 1284 Compliant with 1284-B receptacle (ECP)<li data-bbox="740 730 1007 763">▪ 64KB buffer size

Specifications

Physical Dimensions

With paper tray closed (W x D x H)	27.0 x 24.0 x 13.3 inches 685 x 610 x 337 mm
With paper tray fully extended (W x D x H)	27.0 x 29.3 x 13.3 inches 685 x 745 x 337 mm
Weight	26.5 kg (58.48 lb.) without printheads and ink cartridges 27.0 kg (59.52 lb.) with printheads and ink cartridges
Desk space needed (W x D)	27.0 x 21.0 inches 685 x 532 mm

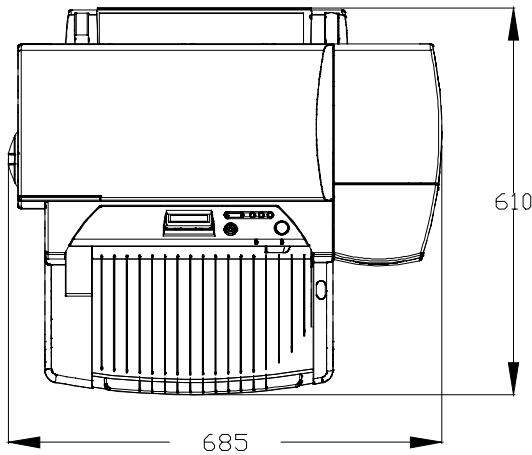

Printer with paper tray closed

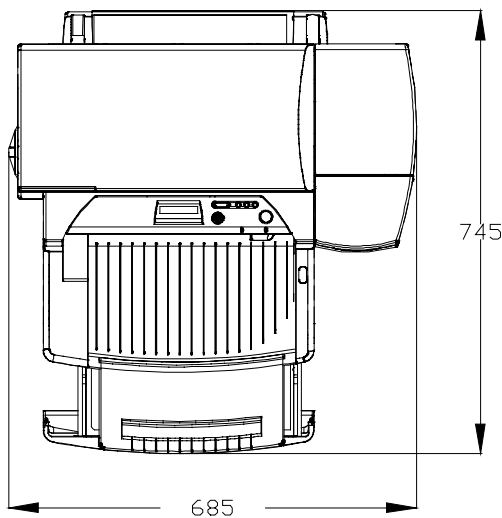
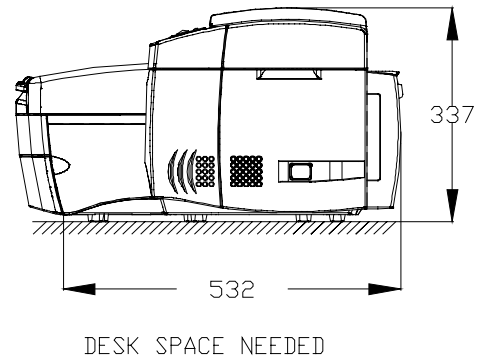

Printer with paper tray fully extended

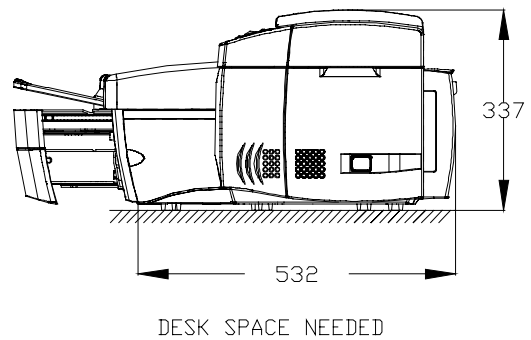

Specifications

Packaging Dimensions Specifications

792 mm (31.3 in.) W x 731 mm (28.8 in.) D x 457 mm (18.0 in.) H

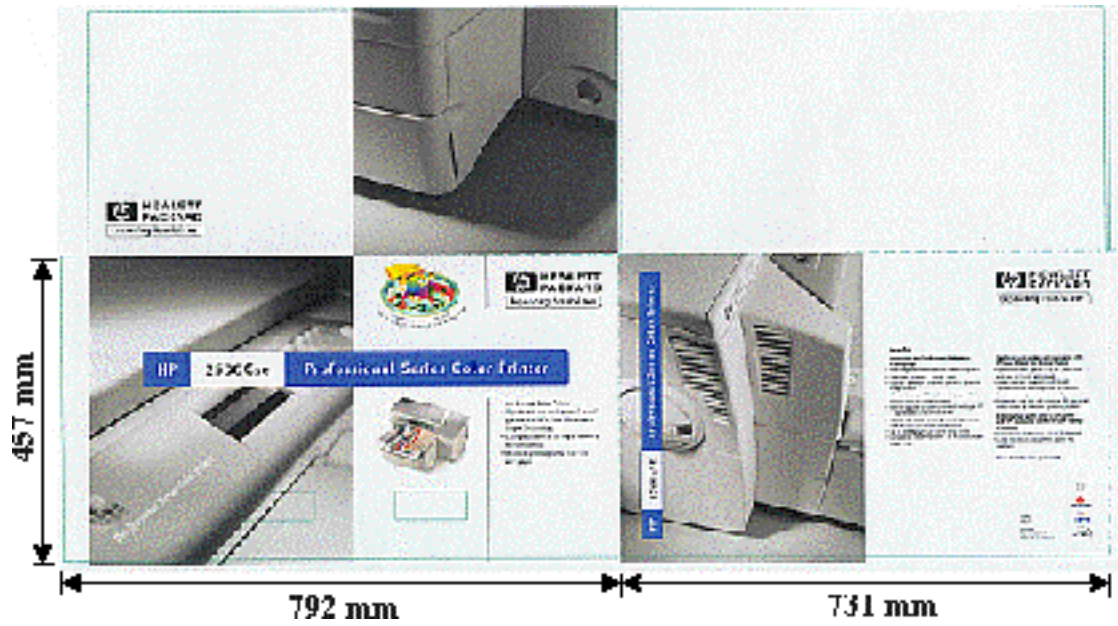

Specifications

Electrical Specifications

Category	Specification
Input Voltage	100 to 240 Vac ($\pm 10\%$)
Frequency	50/60 Hz (± 3 Hz)
Interface Specification	Centronics parallel, IEEE 1284 Compliant with 1284-B receptacle (ECP)
Power Consumption	
▪ Idle	4.4 watts
▪ Printing	35 watts max.
Transient Spike Immunity	
▪ Amplitude	1 kV
▪ Pulse width	50 μ seconds
▪ Rise time	1.2 μ seconds

Specifications

Environmental Specifications

Category	Specifications
Temperature	
<ul style="list-style-type: none"> ▪ Operating ▪ Storage condition ▪ Recommended operating 	5 °C to 40 °C (41 °F to 104 °F) -40 °C to 60 °C (-40 °F to 140 °F) 15 °C to 35 °C (59 °F to 95 °F)
Humidity	
<ul style="list-style-type: none"> ▪ Operating ▪ Storage condition ▪ Recommended operating 	10%-80% RH non-condensing 10%-80% RH non-condensing 20%-80% RH non-condensing
Altitude	
<ul style="list-style-type: none"> ▪ Operating ▪ Non-operating 	0 to 3100 meters 0 to 4600 meters
Mechanical Vibration	
<ul style="list-style-type: none"> ▪ Frequency range ▪ Operating (Random) ▪ Non-operating (Random) ▪ Swept Sine 	5 to 500 Hz Approximately 0.21 G rms Approximately 2.09 G rms 0.5 (0 to peak)
Noise Levels per ISO 9296	
<ul style="list-style-type: none"> ▪ Sound power L_{pAm} 	49 dB(A) (By-stander position)

Specifications

Product Certifications

Safety Certifications	EMI Certifications
CCIB (China)	C TICK (Australia and New Zealand)
CSA (Canada)	VCCI (Japan)
NOM1 (Mexico)	CE (European Union)
PSB (Singapore)	GOST (Russia)
TUV-GS (Germany)	B mark (Poland)
UL (USA)	GOST (Russia)
SABS (South Africa)	BCIQ (Taiwan)
JUN (Korea)	RRL (Korea)
EMI	FCC Class B when used with a Class B computing device (USA)

Specifications

Media Sizes Supported

The following are the media sizes supported by the printer.

General type	Sizes (mm)	Sizes (inch)	Remarks
Tray 1 (Input / Output Tray)			
Post Card	100x148	3.94x5.83	Minimum Size
Including all media sizes in Tray 2 (Upper Tray) / Tray 3 (Lower Tray)			
Tray 2 (Upper Tray) / Tray 3 (Lower Tray)			
ISO-A4	210x297	8.27x11.7	
US-Letter	215.9x279.4	8.5x11	
US-Legal	215.9x355.6	8.5x14	
JIS-B4	257x364	10.11x14.33	
US-B (Ledger)	279.4x431.8	11x17	
ISO-A3	297x420	11.69x16.53	
Super B	330.2x482.6	13x19	Maximum Size

Note

1. There are sensors mounted on Tray 2 (Upper Tray) and Tray 3 (Lower Tray) of the printer to detect the sizes of paper in use on each tray.
2. The printer is capable of printing on custom-sized media provided that its dimensions conform to the minimum and maximum size definition.
3. Envelopes are not supported on the HP DesignJet ColorPro CAD/GA Printer.

Specifications

Recommended Media Weight

Paper	60 to 135 g/m ² (16 to 36 lb. Bond)
Cardstock	110 to 200 g/m ² (110 lb. Index) (up to 0.012 in. or 0.3 mm thickness for straight paper path)

Specifications

Paper Handling

Media Type	Capacity (Pages)
Tray 1 (Input / Output Tray)	
Sheets	10
Cards	4
Tray 2 (Upper Tray)	
Sheets	150
Cards	60
Tray 2 (Upper Tray)	
Sheets	250
Rear Manual Feed	
All media sizes from 4x6 inches (101.6x152.4mm) to 13x19 inches (330.2x482.6mm) and maximum thickness of 0.3mm (0.012 inches)	1
Output Tray	
Sheets (face-up)	150

Note

1. There is a sensor mounted on the bypass paper feed to indicate whether it is in use.

Specifications

Printable Area

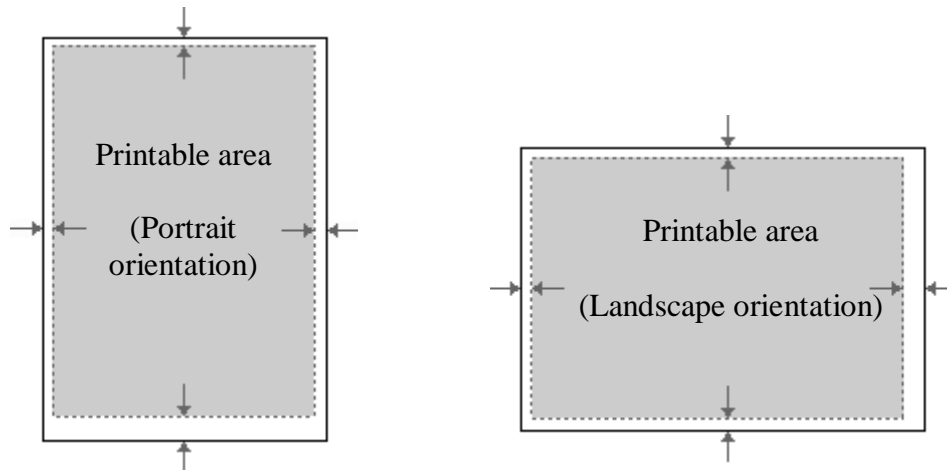

The table as follows will show the minimum margin of each media type (portrait orientation) for the HP DesignJet ColorPro Series Printer.

Please note that the printable area is smaller than that of HP LaserJets. However in the HP DesignJet ColorPro printer driver software there is a new utility that can automatically adjust the margins of LaserJet formatted documents so that they can be printed without the loss of any formatting.

Specifications

Media Margins (in portrait orientation)

Media Type	Margins				Comments
	Left	Right	Top	Bottom	
US Letter 8.5 x 11 in. 215.9 x 279.4 mm	0.25 in. 6.4 mm.	0.25 in. 6.4 mm.	0.12 in. 3.0 mm.	0.50 in. 12.7 mm.	
Tabloid / Ledger 11 x 17 in. 279.4 x 431.8 mm	0.20 in. 5.1 mm.	0.20 in. 5.1 mm.	0.12 in. 3.0 mm.	0.50 in. 12.7 mm.	
A4 8.27 x 11.69 in. 210.00 x 296.9 mm	0.13 in. 3.4 mm.	0.13 in. 3.4 mm.	0.12 in. 3.0 mm.	0.50 in. 12.7 mm.	
A3 11.69 x 16.53 in. 296.9 x 419.9 mm	0.20 in. 5.1 mm.	0.20 in. 5.1 mm.	0.12 in. 3.0 mm.	0.50 in. 12.7 mm.	
B4 10.12 x 14.33 in. 257.0 x 364.0 mm	0.20 in. 5.1 mm.	0.20 in. 5.1 mm.	0.12 in. 3.0 mm.	0.50 in. 12.7 mm.	
Legal 8.5 x 14 in. 215.9 x 355.6 mm	0.25 in. 6.4 mm.	0.25 in. 6.4 mm.	0.12 in. 3.0 mm.	0.50 in. 12.7 mm.	
Executive 7.25 x 10.50 in. 184.2 x 266.7 mm	0.25 in. 6.4 mm.	0.25 in. 6.4 mm.	0.12 in. 3.0 mm.	0.50 in. 12.7 mm.	
A5 5.83 x 8.27 in. 148.0 x 210.0 mm	0.12 in. 3.1 mm.	0.12 in. 3.1 mm.	0.12 in. 3.0 mm.	0.50 in. 12.7 mm.	
B5 7.16 x 10.12 in. 181.9 x 257.0 mm	0.12 in. 3.1 mm.	0.12 in. 3.1 mm.	0.12 in. 3.0 mm.	0.50 in. 12.7 mm.	Landscape Orientation
4x6 Index Card 4.00 x 6.00 101.6 x 152.4	0.12 in. 3.1 mm.	0.12 in. 3.1 mm.	0.12 in. 3.0 mm.	0.50 in. 12.7 mm.	
5x8 Index Card 5.00 x 8.00 127.0 x 203.2	0.12 in. 3.1 mm.	0.12 in. 3.1 mm.	0.12 in. 3.0 mm.	0.50 in. 12.7 mm.	

A6 Card 4.13 x 5.83 105.0 x 148.0	0.12 in. 3.1 mm.	0.12 in. 3.1 mm.	0.12 in. 3.0 mm.	0.50 in. 12.7 mm.	
Hagaki Card 3.94 x 5.83 100.0 x 148.0	0.12 in. 3.1 mm.	0.12 in. 3.1 mm.	0.12 in. 3.0 mm.	0.50 in. 12.7 mm.	
Super B 13.00 x 19.00 330.2 x 482.6	0.20 in. 5.1 mm.	0.20 in. 5.1 mm.	0.12 in. 3.0 mm.	0.50 in. 12.7 mm.	
Statement 5.50 x 8.50 139.7 x 215.9	0.20 in. 5.1 mm.	0.20 in. 5.1 mm.	0.12 in. 3.0 mm.	0.50 in. 12.7 mm.	
C Size 17.00 x 22.00 431.8 x 558.8	0.50 in. 12.7 mm.	0.50 in. 12.7 mm.	0.40 in. 10.2 mm.	0.40 in. 10.2 mm.	
A2 16.53 x 23.38 419.9 x 593.9	0.50 in. 12.7 mm.	0.50 in. 12.7 mm.	0.40 in. 10.2 mm.	0.40 in. 10.2 mm.	
Hagaki 7.87 x 5.83 200.0 x 148.0	0.12 in. 3.1 mm.	0.12 in. 3.1 mm.	0.12 in. 3.0 mm.	0.51 in. 13.0 mm.	*NEC only
A3 Nobi 13.00 x 19.00 330.2 x 482.6	0.20 in. 5.1 mm.	0.20 in. 5.1 mm.	0.12 in. 3.0 mm.	0.51 in. 13.0 mm.	*NEC only
Custom 3.94 to 13.00 x 5.83 to 19.00 100 to 330 x 148 to 482	0.20 in. 5.1 mm.	0.20 in. 5.1 mm.	0.12 in. 3.0 mm.	0.50 in. 12.7 mm.	

Note

For the printable regions of landscape orientation, just reverse the matrix on the table above. For example, the matrix for US Letter size in portrait is 8.5 x 11 inches, so in landscape the matrix is 11 x 8.5 inches.

Specifications

Hewlett-Packard Ink Cartridge Specifications

Category	Specification		
Type	Plain paper drop on-demand thermal inkjet printing		
Printhead Nozzles	304 black, 912 color (304 per color printhead)		
Black Resolution	Up to 600x600 dpi		
Color Resolution	PhotoREt II for photo quality		
Ink Drop Volume	35ng black, 8ng color drop volume for high resolution printing		
Print Speed¹ Black	Black Text	Letter / A4	11x17 / A3
	Econofast Mode	9 ppm	5 ppm
	Normal Mode	7 ppm	3 ppm
	Best Mode	7 ppm	3 ppm
Print Speed¹ Color	Color Highlights	Letter / A4	11x17 / A3
	Econofast Mode	9 ppm	5 ppm
	Normal Mode	6 ppm	3 ppm
	Best Mode	5 ppm	2 ppm
	Mixed Text & Graphics	Letter / A4	11x17 / A3
	Econofast Mode	7 ppm	4 ppm
	Normal Mode	3.5 ppm	2 ppm
	Best Mode	1.2 ppm	0.5 ppm
	Full Page Color Highlights	Letter / A4	11x17 / A3
	Econofast Mode	3.5 ppm	1 ppm
	Normal Mode	1.8 ppm	0.8 ppm
	Best Mode	0.4 ppm	0.2 ppm
	¹ Approximate figures. The exact speed is dependent on the system configuration, software program and document complexity.		

Specifications

System Requirement

The following CPUs and memory are required :

Minimum: Windows 3.1x: 486DX-66, 8 Mb RAM
 Windows 95/98: 486DX-100, 8 Mb RAM
 Windows NT 4.0/5.0: 486DX-66, 16 Mb RAM
 Macintosh System 7.5.3 or later: 68040 – 8 Mb RAM

Recommended: Windows 3.1x: Pentium 150/166, 16 Mb RAM
 Windows 95/98: Pentium 150/166, 16 Mb RAM
 Windows NT 4.0/5.0: Pentium 150/166, 32 Mb RAM
 Macintosh System 8 or later: Power PC – 16 Mb RAM

50 Mb free hard disk space for 11x17 or A3 size printing.
Graphics intensive files may require more disk space.

Product Overview

Printer External View

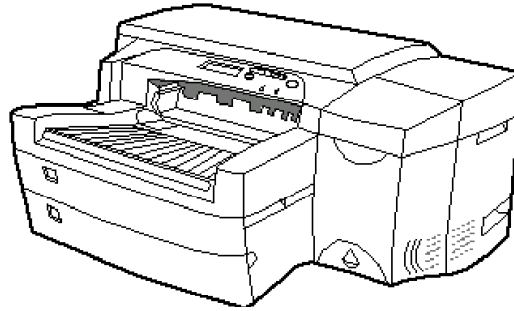

Model and Serial Number

The serial number of the HP DesignJet ColorPro Series Printers can be found on the labels at the back of each printer and at the top of the main case (concealed by the top cover). The figure below shows how the serial number is interpreted.

Serial Number = CCYMDVL###

CC (Country)	The country show where the printer was manufactured.
Y (Year)	The year the printer was manufactured.
M (Month)	The month the printer was manufactured.
D (Day)	The day the printer was manufactured.
V (Version)	The printer model version 1 indicates HP DesignJet ColorPro, other version numbers will be assigned as needed. Contact a technical support engineer if you need to know which version a new number refers to.
L (Line)	The factory assembly line which manufactured this printer.
###	These three digits allow a maximum of 27,000 unique serial numbers per line per day. This unit number is in base 30.

Supplies and Accessories

Product Structure

The following items will be shipped in the box:

	Basics
	Printer
	Extended Tray Cover (a)
	Driver Kit
	Starter CD (b)
	HP JetDirect CD (HP DesignJet ColorPro GA printer only)(b)
	User's Guide (d)
	Hardcopy Kit
	Setup Poster (c)
	Getting Started Guide (Not available in U.S.)
	Quick Reference Guide (e)
	User's Guide (Available in U.S. only)
	Accessory Kit
	Power Cord (f)
Four HP No. 10 Ink Cartridges (h) (Black, Cyan, Magenta and Yellow)	
Four HP No. 10 Printheads (g) (Black, Cyan, Magenta and Yellow)	

Supplies and Accessories

Power Cord

US	8120-6805	#ABB, #ABM, #AC4, #AKY, #A2L, #ABA
Europe	8120-6802	#ABS, #AKB, #ACB, #ABT, #AKC, #ACT, #AB7, #ABB, #ARG, #ARP, #AKY
Australia	8120-6803	#ABG, #AKY
Singapore / Malaysia	8120-6809	#AB4
SA	8120-6808	#ACQ
UK	8120-6801	#ABU

Supplies and Accessories

Network Interface

The following cards have been tested with the HP DesignJet ColorPro Series Printers.

JetDirect MIO print server card (Bundled with HP HP DesignJet ColorPro GA)	J4100A	Ethernet RJ-45 (10/100 base-TX) BNC
JetDirect MIO print server card	J2556B	Ethernet RJ-45 (10/100 base-TX)
	J2550B	Ethernet RJ-45 (10 Base-T)
	J2552B	Ethernet BNC (Thin Coax) RJ-45 (10 Base-T) LocalTalk System 7
	J2555B	Token Ring DB9, RJ-45
300X Print Server	J3263A	Ethernet RJ-45 (10/100 base-TX) Parallel Port

Supplies and Accessories

Print Cartridge

No. 10 Cyan Ink Cartridge	C4841A
No. 10 Magenta Ink Cartridge	C4842A
No. 10 Yellow Ink Cartridge	C4843A
No. 10 Hi Capacity Black Ink Cartridge	C4844A
No. 10 Cyan Pen	C4801A
No. 10 Magenta Pen	C4802A
No. 10 Yellow Pen	C4803A
No. 10 Black Pen	C4800A

Note

The HP DesignJet ColorPro Series Printers are shipped with a Low Capacity Black Ink Cartridge (C4840A).

Supplies and Accessories

Media

HP Bright White Paper (500 / A size)	C1824A
HP Bright White Paper (500 / A4 size)	C1825A
HP Bright White Paper (200 / 11x17 size)	C1857A
HP Bright White Paper (200 / A3 size)	C1858A
HP Premium InkJet Coated Paper (200 / A)	51634Y
HP Premium InkJet Coated Paper (200 / A4)	51634Z
HP Premium InkJet Coated Paper (100 / 11x17)	C1855A
HP Premium InkJet Coated Paper (100 / A3)	C1856A
HP Premium InkJet Heavyweight Paper (100 / A)	C1852A
HP Premium InkJet Heavyweight Paper (100 / A4)	C1853A
HP Premium Photo Paper (20 / 11x17)	C6058A
HP Premium Photo Paper (20 / A3)	C6059A
HP Premium Photo Paper (15 / A)	C6039A
HP Premium Photo Paper (15 / A4) – European	C6040A
HP Premium Photo Paper (15 / A4) – Asian	C6043A
HP Premium InkJet Transparency Film (20 / A)	C3828A
HP Premium InkJet Transparency Film (20 / A4)	C3832A
HP Premium InkJet Transparency Film (50 / A)	C3834A
HP Premium InkJet Transparency Film (50 / A4)	C3835A
HP Premium InkJet Rapid-Dry Transparency Film (A)	C6051A
HP Premium InkJet Rapid-Dry Transparency Film (A4)	C6053A
HP Iron-On T-Shirt Transfers (10 / A)	C6049A
HP Iron-On T-Shirt Transfers (10 / A4)	C6050A
HP Greeting Card Paper	C1812A
HP Greeting Card Paper (Europe Only)	C6042A
HP White Labels 1"x2.5/8" Addressing Labels	92296A
HP White Labels 1.1/3"x4" Addressing Labels	92296B
HP White Labels 1"x4" Addressing Labels	92296C
HP White Labels 2"x4" Shipping Labels	92296D
HP White Labels 3.1/3"x4" Shipping Labels	92296E
HP White Labels 1/2"x1.3/4" Return Address Labels	92296F
HP White Labels 8.1/2"x11" White Full Sheet Labels	92296K
HP White Labels 99.1x38.1mm Addressing Labels	92296L
HP White Labels 99.1x38.8mm Addressing Labels	92296M
HP White Labels 63.5x38.1mm Addressing Labels	92296N
HP White Labels 100x51mm Addressing Labels	92296P
HP White Labels 199.6x289mm Full Sheet Labels	92296R
HP White Labels 99.1x67.7mm Parcel Labels	C4296A
HP White Labels 63.5x46.6mm Addressing Labels	C4297A

Supplies and Accessories

Other Accessories

HP 64MB (2x32MB) 60ns EDO SIMM	D4543A
HP 32MB (2x16MB) 60ns EDO SIMM	D3648B
HP 16MB (2x8MB) 60ns EDO SIMM	D3647B
HP DesignJet ColorPro CAD Postscript 3 Upgrade Kit	C3289A

Customer Replaceable Parts

Note

The following parts are customer replaceable parts. Replacing these parts require no technical expertise. These parts can be sent directly to the customer by the Customer Care Centers after qualification. This process is based on the premise that customers agree to replace the parts themselves.

The exceptions to this process are the PCA Logic and Service Station. These two parts require some technical capability and will only be sent to customers that have the capabilities to replace these two modules.

PCA-Logic	C2684-60200
CAD NamePlate (ColorPro CAD Printer)	C7777-40001
GA NamePlate (ColorPro GA Printer)	C7778-40001
Cover Main PCA	C2684-60206
Side Cover Service Station	C2684-60210
Assembly Secondary Access Door	C2684-60212
Assembly Output Tray	C2684-60214
Removable Trough	C2684-60215
Assembly Dual Bin Tray	C2684-60224
Adjuster Width Dual Bin	C2684-60225
Adjuster Length Dual Bin	C2684-60226
Media Plate	C2684-60227
Adjuster Length I/O	C2684-60232
Adjuster Width I/O	C2684-60233
Tray Cover	C2684-60108
CAD Front Cover (ColorPro CAD Printer)	C7777-40002
GA Front Cover (ColorPro GA Printer)	C7778-40002
Service Station	C2684-60273
Plate Media 2	C2684-60274
Foot	C2684-60275

Warranty and Support

The warranty for HP DesignJet ColorPro Series Printers varies depending on the product, the date and the country of purchase.

For products returned under warranty, Hewlett-Packard may :

- Provide on-site repair,
- Replace the product with a remanufactured unit,
- Replace the product with a product of equal or greater functionality or
- Refund the purchased price.

Warranty and Support

Hewlett-Packard Limited Warranty Statement

HP Product	Duration of Limited Warranty
Software	1 year
Print Cartridges	90 days
Printer	1 year
Printheads	1 year

Extent of Limited Warranty

1. Hewlett-Packard (HP) warrants to the end user customer that HP products will be free from defects in materials and workmanship, for a specified time after the date of purchase by the customer. The duration of this limited warranty is stated above. Certain additional conditions and limitations of HP's warranty are stated in the user's guide. Those conditions and limitations include:
 - a. For software products, the warranty applies only to the media upon which the product is recorded; and
 - b. HP does not warrant the operation of any product to be uninterrupted or error free.
2. HP's limited warranty covers only those defects which arise as a result of normal use of the product, and do not apply to any:
 - a. Improper or inadequate maintenance;
 - b. Software or interfacing not supplied by HP;
 - c. Unauthorized modification or misuse;
 - d. Operation outside the product's environment specifications, including duty cycle abuse or use of a mechanical switch-box without a designated surge protector;
 - e. Use of non-supported printing media or memory boards; or
 - f. Improper site preparation or maintenance.
3. For HP printer products, the use of a non-HP print cartridge or a refilled print cartridge does not affect either the warranty to the customer or any HP support contract with the customer; print cartridge includes both toner cartridges and ink cartridges. However, if printer failure or damage is attributable to the use of a non-HP or refilled print cartridge, HP will charge its standard time and materials charges to service the printer for the particular failure or damage.
4. If any software media product or print cartridge product proves defective during the applicable warranty period, and if the product is covered by HP's warranty, the customer shall return the product for replacement.

5. If HP receives, during the applicable warranty period, notice of a defect in a hardware product which is covered by HP's warranty, HP shall either repair or replace the product, at its option. Any replacement product may be either new or like-new, provided that it has functionality at least equal to that of the product being replaced.
6. If HP is unable to repair or replace, as applicable, a defective product which is covered by HP's warranty, HP shall within a reasonable time after being notified of the defect, refund the purchase price for the product, provided the customer returns the product.
7. The warranty is valid in any country where this product is distributed by Hewlett-Packard. Contracts for additional services such as on-site service are available from any authorized HP service facility in countries where this product is distributed by HP or an authorized importer.
8. This limited Warranty Statement gives the customer specific legal rights. The customer may also have other legal rights which vary from state to state in the United States, from province to province in Canada, and from country to country elsewhere in the world.

Limitations of Warranty

1. NEITHER HP NOR ANY OF ITS THIRD PARTY SUPPLIERS MAKES ANY OTHER WARRANTY OF ANY KIND, WHETHER EXPRESS OR IMPLIED, WITH RESPECT TO HP PRODUCTS. HP AND ITS THIRD PARTY SUPPLIES SPECIFICALLY DISCLAIM THE IMPLIED WARRANTIES OF MERCHANTABILITY AND FITNESS FOR A PARTICULAR PURPOSE.
2. To the extent that this Limited Warranty Statement is inconsistent with the law of the locality where the customer uses the HP product, this Limited Warranty Statement shall be deemed modified to be consistent with such local law. Under such local law, certain limitations of this Limited Warranty Statement may not apply to the customer. For example, some states in the United States, as well as some governments outside the United States (including provinces in Canada), may:
 - a. Preclude the disclaimers and limitations in this Warranty Statement from limiting the statutory rights of a customer (e.g. Australia and the United Kingdom);
 - b. Otherwise restrict the ability of a manufacturer to make such disclaimers or impose such limitations; or
 - c. Grant the customer additional warranty rights, specify the duration of implied warranties which the manufacturer cannot disclaim, or not allow limitations on how long an implied warranty lasts.
3. To the extent allowed by local law, the remedies provided in this Warranty Statement are the customer's sole and exclusive remedies.

Limitations of Liability

1. EXCEPT FOR THE OBLIGATIONS SPECIFICALLY SET FORTH IN THIS WARRANTY STATEMENT, IN NO EVENT SHALL HP BE LIABLE FOR ANY DIRECT, INCIRECT, SPECIAL, INCIDENTAL, OR CONSEQUENTIAL DAMAGES, WHETHER BASED ON CONTRACT, TORT, OR ANY OTHER LEGAL THEORY AND WHETHER ADVISED OF THE POSSIBILITY OF SUCH DAMAGES.

Warranty and Support

Obtaining Printer Drivers

The HP DesignJet ColorPro Series Printer Driver Software is updated periodically. The latest versions can be obtained from authorized Hewlett-Packard dealers or any of the sources listed below.

24-hour Modem Access

Internet

HP DesignJet ColorPro Series Printer drivers and product support information can be obtained through the World Wide Web at:

<http://www.designjet-online.hp.com>

HP BBS Library

The HP DesignJet ColorPro Series Printer drivers can also be obtained at HP's electronic bulletin board library service. Refer to **HP BBS Library under Service and Support Resources** for the list of phone numbers.

Set modem communications software to: no parity, 8 bits, and 1 stop bit.

Warranty and Support

Service Support Contracts

In the U.S.

HP SupportPack

The HP SupportPack is an enhancement to the customer's original one-year warranty repair service. The HP SupportPack provides next business day on-site support for the duration of an additional two years of warranty. This service enhancement provides customers with a cost-effective and timely way to achieve quality support. The HP SupportPack (ordered like any other HP product) is sold exclusively through resellers and is not available directly from Hewlett-Packard. Customers **MUST** purchase this service enhancement within 30 days of purchasing the printer. The HP SupportPack is not transferable from one piece of equipment to another. Additional information on HP SupportPack and the prices for the service upgrade are available through HPNN and the In-Touch newsletter.

Non-U.S.

HP SupportPack

The HP SupportPack enhances the service offering during the warranty period by upgrading warranty repair service to a next day exchange service. This service enhancement provides customers with a cost-effective and timely way to achieve quality support. HP SupportPack is sold exclusively through resellers (ordered like any other HP product) and is not available directly from Hewlett-Packard. Additional information on HP SupportPack and the prices for the service upgrade is available through HPNN.

For other service and support contracts, contact the Hewlett-Packard office or Response Center for that country.

Warranty and Support

Service and Support Resources

Hewlett-Packard News Network (HPNN)

HPNN is an electronic bulletin board service available only to HP authorized resellers. This service provides the following information:

- Presales Information
- Printer Drivers
- HP SupportPack Information
- Software Notes
- Postsales Information

For more information, call 1 (408) 553-7303.

HP Customer Information Center

The HP Customer Information Center provides presales product information. This service is available for resellers and end-users.

For more information, call 1 (800) 752-0900, Monday – Friday, 6:00 AM – 5:00 PM U.S. Pacific Time.

HP Reseller Response Line

The HP Reseller Response Line provides pre-sales and post-sales technical support for HP authorized resellers.

For more information, call 1 (800) 544-9976, Monday – Friday, 8:00 AM – 4:00 PM U.S. Pacific Time.

Warranty and Support

HP BBS Library

The HP electronic bulletin board library service, which is available 24 hours a day, 7 days a week, contains drivers and support information which can be downloaded to your PC via modem.

Country	Number	Baud Rates
Austria	+ 43 (222)251658	2400 to 28800 or ISDN
Belgium	+ 32 (2) 778-3819	1200 to 28800
Denmark	+ 45 (45) 991905	300 to 28800
Finland	(9600) 7280	2400 to 28800
France	3616 HP MICRO	1200 to 28800 (Service Minitel)
Italy	+ 39 (2) 9210-4244	Up to 28800
Netherlands	+ 31 (20) 647-5433	2400 to 28800
Norway	+ 47 (2) 273-5697	2400 to 28800
Sweden	+ 46 (8) 750-6262	2400 to 28800
Switzerland	+ 41 (64) 560200	Up to 28800 or ISDN
United Kingdom	+ 44 (1344) 361891	Up to 28800
Worldwide	Int Code + 1 (208) 344-1691	300 to 28800

Set the modem for no parity, 8 data bits and 1 stop bit (N,8,1).

Warranty and Support

HP FAXback on Demand – HP FIRST

You can use this service to select documents, such as product descriptions and technical information. To access this service, use the handset on your fax machine and dial the appropriate number from the table in this section.

Use the following steps to use HP FIRST:

1. Call the system. You will need to use a touch-tone telephone or the phone set of your fax machine. A voice prompt will welcome you and guide you to the information you need. You will also need to give the phone number of the fax machine where you wish to receive the documents you select.
2. We suggest you initially request the index which lists all available documents.
3. Once you receive the HP FIRST index, choose the documents you need.
4. Call HP FIRST again. A voice prompt will ask you for the index number of the documents you have selected and would like to have faxed to you.
5. Selected documents will be sent immediately to the fax number you have specified.

Note

To obtain documents in English from outside the UK, dial your international access code and then (31) 20 681 5792 (international toll rates applicable).

Warranty and Support

HP FIRST Telephone Numbers

Country	Telephone Number
For US and Canada	(800) 333-1917
For Customers in Europe:	
U.K.	0800 96 02 71
For service in English outside U.K.	+ 31 20 681 5792
Austria	0600 8128
Belgium (Dutch)	0800 11906
Belgium (French)	0800 17043
Denmark	800 10453
Finland	800 13134
France	0800 905900
Germany	0130 810061
Italy	1678 59020
Norway	800 11 319
Portugal	05 05 31 33 42
Spain	900 993123
Sweden	020 795743
Switzerland (French)	0800 551 526
Switzerland (German)	0800 551 527
Netherlands	0800 022 2420
For Customers in Asia-Pacific:	
Australia	613 9272 2627
China	86 10 6564 5735
Hong Kong	2506 2422
India	9111 622 6420
Indonesia	21-352 2044
Korea	822 769 0543
Malaysia	03 298 2478
New Zealand	64 09 356 6642
Philippines	(65) 275 7251
Singapore	275 7251
Taiwan	(02) 719 5589
Thailand	662 661 3511

Warranty and Support

HP Telephone Support

Technical Phone Support for Customers

The HP Customer Support Center provides free technical assistance for peripherals within the hardware warranty period.

For the product under warranty, call (208) 323-2551.

For the product out of warranty, call :

- 1 (900) 555-1500 at \$2.50 per minute, or
- 1 (800) 999-1148 at \$25.00 per call using VISA / MasterCard.

(The above prices are subjected to change without notice)

To ensure the call is dealt with quickly, have the following information ready:

- The product model number and serial number.
- The operating system version and the configuration.
- A description of the software installed and the accessories used.

HP North American Customer Support Center

Assistance from the Hewlett-Packard North American Customer Support Center is available Monday to Friday, 7:00 AM to 6:00 PM Mountain Time, except Wednesday, (7:00 AM to 4:00 PM).

- 1 (303) 635-1000

HP European Customer Support Center

Assistance from the Hewlett-Packard European Customer Support Center is available in English, Monday to Friday, 8:30 AM to 6:00 PM Central European time, except Wednesday, (8:30 AM to 4:00 PM).

- Int Code + 31 (20) 682-8291

HP provides free telephone support during the warranty period. After the warranty has expired, support is available through the same telephone number for a fee. The fee is charged on a per incident basis. When calling HP, please have the following information ready:

- The product model number and serial number.
- The operating system version and the configuration.
- A description of the software installed and the accessories used.

Warranty and Support

Warranty and Out-of-Warranty Support Telephone Numbers

Country (Language)	Telephone Number
Austria (German)	0660-6386
Belgium (Dutch)	02 626 8806
Belgium (French)	02 626 8807
Denmark (Danish)	3929 4099
Finland (Finnish)	0203 47288
France (French)	04 50 43 9853
Ireland	01 622 5525
Germany (German)	0180 5 25 81 43
Italy (Italian)	02 26410350
Netherlands (Dutch)	020 606 8751
Norway (Norwegian)	22 11 6299
Portugal	01 441 7199
Spain (Spanish)	902-321 123
Sweden (Swedish)	08 619 2170
Switzerland (French)	0848 80 11 11
Switzerland (German)	0848 80 11 11
UK	0171 512 5202
English language support for other European countries	+44 171 512 5202

Warranty and Support

Contacting Hewlett-Packard

To contact HP, check your local telephone directory for the HP Sales and Service Office near you. If you cannot find an HP office, contact one of the major HP Sales and Service Offices or one of the following Worldwide Marketing Headquarters.

Asia	Far East Sales Region Headquarters Hewlett-Packard Asia Ltd. 22/F Peregrine Tower Lippo Centre 89 Queensway, Central Hong Kong
Canada	Hewlett-Packard Ltd. 6877 Goreway Drive Mississauga Ontario L4V 1M8, Canada
Europe	European Operations Headquarters Hewlett-Packard S.A. 150, route du Nant-d'Avril PO Box 1217 Meyrin 2/Geneva, Switzerland
Latin America	Hewlett-Packard Latin Am. Headquarters Monte Pelvoux 111 Lomas de Chapultepec 11000 Mexico D.F.
Middle East / Asia	Middle East / Central Africa Sales Headquarters Hewlett-Packard S.A. Rue de Veyrot 39 CH-1217 Meyrin 1/Geneva, Switzerland
U.S.	Intercon Operations Headquarters Hewlett-Packard Company 3495 Deer Creek Road PO Box 10495 Palo Alto, CA 94303-0896, USA

Warranty and Support

Worldwide Customer Support Numbers

Customer Support Centers provide technical information via telephone directly with online agents who are trained to assist with setup, configuration, startup and troubleshooting of HP products.

Customer Support Center assistance can be obtained by calling one of the following country-specific telephone numbers:

Note

Check the world wide web at <http://www.designjet-online.hp.com> for the most up-to-date customer support telephone numbers.

Country	Telephone Number
For U.S.	(208) 323-2551
For Latin America	
Argentina	(541) 787 4061/69
Brazil	55 11 709 1444
Chile	562 800 360999
Mexico City	01-800-22147000/1-800-9052900
Mexico Guadalajara	(525) 264 2075
Mexico Monterey	91800 22147
Venezuela	582 239 5664

For Europe	
Africa/Middle East	41 22/780 71 11
Austria	0660 6386
Belgium (Dutch)	02 6268806
Belgium (French)	02 6268807
Czech Republic	42 (2) 471 7327
Denmark	3929 4099
Finland	203 47288
France	01 43 62 34 34
Germany	180 5258 143
Greece	0168 96 411
Hungary	36 (1) 252 4505
Ireland	01662 5525
Italy	02 264 10350
Norway	22 11 6299
Poland	48 22 37 50 65
Portugal	01 441 7199
Russia	7095 923 50 01
Spain	902 321 123
Sweden	08 619 2170
Switzerland	0848 80 11 11
Netherlands	020 606 8751
Turkey	90 1 224 59 25
United Kingdom	0171 512 5202

For Asia-Pacific	
Australia	(61-3) 9272-8000
China	86 10 6564 5959
Hong Kong	800 96 7729
India	9111 682 6035
Indonesia	21 350 3408
Korea	(82-2) 3270-0700
Malaysia	03 295 2566
New Zealand	09 356-6640
Philippines	2 867 3551
Singapore	272 5300
Taiwan	866-2-7170055
Thailand	02 661 4011
Vietnam	8823 4530

Chapter 2 Operating Overview

Using the Control Panel

The Control Panel allows you to perform most major tasks with the printer, including controlling print status, resetting from recoverable errors and changing the printer's default settings.

Control Panel Layout

The Control Panel on the front of the printer consists of six buttons on the panel, two LEDs and a LCD multi-function display panel:

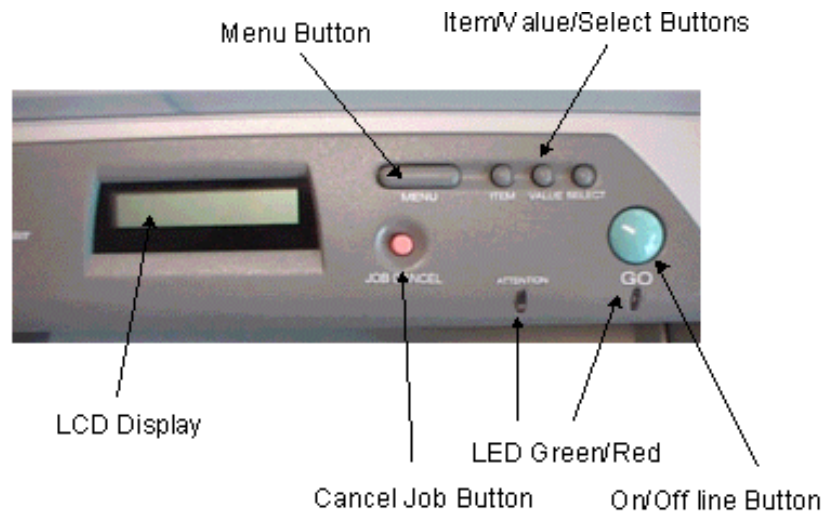

Using the Control Panel

The functions of each of the buttons are as follows :

Control Panel Key	Function
[ GO]	<ul style="list-style-type: none"> ▪ Puts the printer either online or offline. ▪ Allows the printer to resume printing after going offline. Also clears most printer messages and puts the printer online. ▪ Allows the printer to continue printing after a non-critical warning message such as UNEXPECTED PAPER SIZE or TRAY x LOAD [TYPE] [SIZE]. ▪ Exits the control panel menus. (To save the control panel selection, press the [Select] button first.) ▪ Displays unrecoverable error codes.
[Cancel Job]	Press this only once to cancel the print job that the printer is processing. The duration required to cancel the job will depend on the size of the print job. Pressing the Cancel Job button repeatedly will not cancel the next job on the print queue.
[Menu]	Press this to cycle through the control panel menus. To print a menu map from the control panel : <ol style="list-style-type: none"> 1. Press [Menu] until SELF TEST MENU appears. 2. Press [Item] until PRINT MENU MAP appears. 3. Press [Select] to print the menu map. For more information on each menu item, see Control Panel Menus (Chapter 2) .
[Item]	Press this to cycle through selected menu items.
[Value]	Press this to cycle through selected menu item's values.
[Select]	<ul style="list-style-type: none"> ▪ Saves the value for the selected item. An asterisk (*) will appear next to the value, indicating that it is the new default. Default settings will remain when the printer is powered off, or until reset when you choose to reset factory defaults from the [RESETS] menu. ▪ Prints the selected printer information page from the control panel.

Using the Control Panel

Indicator Lights

There are two LEDs (lights) on the printer :

LED Indicators	Color	Function
Ready LED	Green	Lit up when the printer is printing OR in normal state OR when it is online.
Attention LED	Red	Blinks when the printer is in an error state OR requires attention.
Error LED	Green + Red blinking rapidly	Both LEDs blink when the printer detects an error. Power cycle the printer to correct. If the error persists, push the on-line button once to see the error message.

Using the Control Panel

Settings and Defaults

These are the various possible menu settings. The factory defaults, where applicable, are indicated in **bold**. Other additional menu items may also appear, depending on which hardware modules have been installed in the printer.

For more information on these settings, refer to **Control Panel Menus (Chapter 2)**.

Paper Handling Menu	
TRAY 2 TYPE =	PLAIN HP INKJET/HEAVY HP PHOTO TRANSPRNCY/IRON RAPID TRANSPRNCY
TRAY 3 TYPE =	PLAIN HP INKJET/HEAVY HP PHOTO TRANSPRNCY/IRON RAPID TRANSPRNCY

Diagnostics Menu
ALIGN PRNT -HD
CLEAN PRNT -HD LEVEL 1
CLEAN PRNT -HD LEVEL 2
CLEAN PRNT -HD LEVEL 3
PERFORM TRAY2 PAPER PATH TEST
PERFORM TRAY3 PAPER PATH TEST
PERFORM TRAY1 PAPER PATH TEST

Information Menu
BASE FW VER
PS FW VER (Available if PS installed)
MIO FW VER (Available if MIO installed)
CHECK TOTAL RAM SIZE
CHECK INK LEVELS
SERVICE ID

Self Test Menu	
PRINT MENU MAP	
PRINT PS FONT LIST (Available if PS installed)	
PRINT MARKETING DEMO (Available if Demo DIMM installed)	
PRINT DIAGNOSTIC PAGE	
PERFORM TRAY2 PAPER PATH TEST	
PERFORM TRAY3 PAPER PATH TEST	
PERFORM TRAY1 PAPER PATH TEST	

Print Quality Menu	
PRINT QUALITY =	NORMAL ECONOFAST BEST

Printing Menu	
PAPER =	LETTER LEGAL 13X19 A4 A3 11X17 JISB4
ORIENTATION =	PORTRAIT LANDSCAPE
APPEND CR TO LF =	NO YES

I/O Menu	
IN JOB TIMEOUT =	45 (5 - 300 secs)
OUT JOB TIMEOUT =	0 (0 - 300 secs)
I/O CHANNEL TIMEOUT =	0 (0 - 300 secs)

Resets Menu	
RESET TO FACTORY SETTINGS	
RESET ACTIVE I/O CHANNEL	
RESET ALL I/O CHANNELS	
RESET MIO TO FACTORY SETTINGS (Available if MIO installed)	

Configuration Menu (Available if DIMM installed)	
PERSONALITY =	AUTO PCL PS (Available if PS installed)

MIO Menu (Available if MIO installed)	
CONFIGURE	
MIO	
(The remaining options will appear depending on the type of MIO card installed.)	

Postscript Menu (Available if PS installed)	
PRINT PS ERRORS =	OFF ON
JAM RECOVERY =	AUTO ON OFF
COPIES =	1 (1 – 99 pages)

Using the Control Panel

Restoring Factory Defaults

To restore the default factory settings, press [MENU] till the **Resets Menu** appears. Then press [ITEM] until RESET TO FACTORY SETTINGS is shown in the LCD display. Press [SELECT] to restore the factory defaults. This action will also clear the input buffer for the active I/O channel.

Using the Control Panel

Control Panel Menus

The following is a summary diagram of all the menus available in the HP DesignJet ColorPro Series Printer :

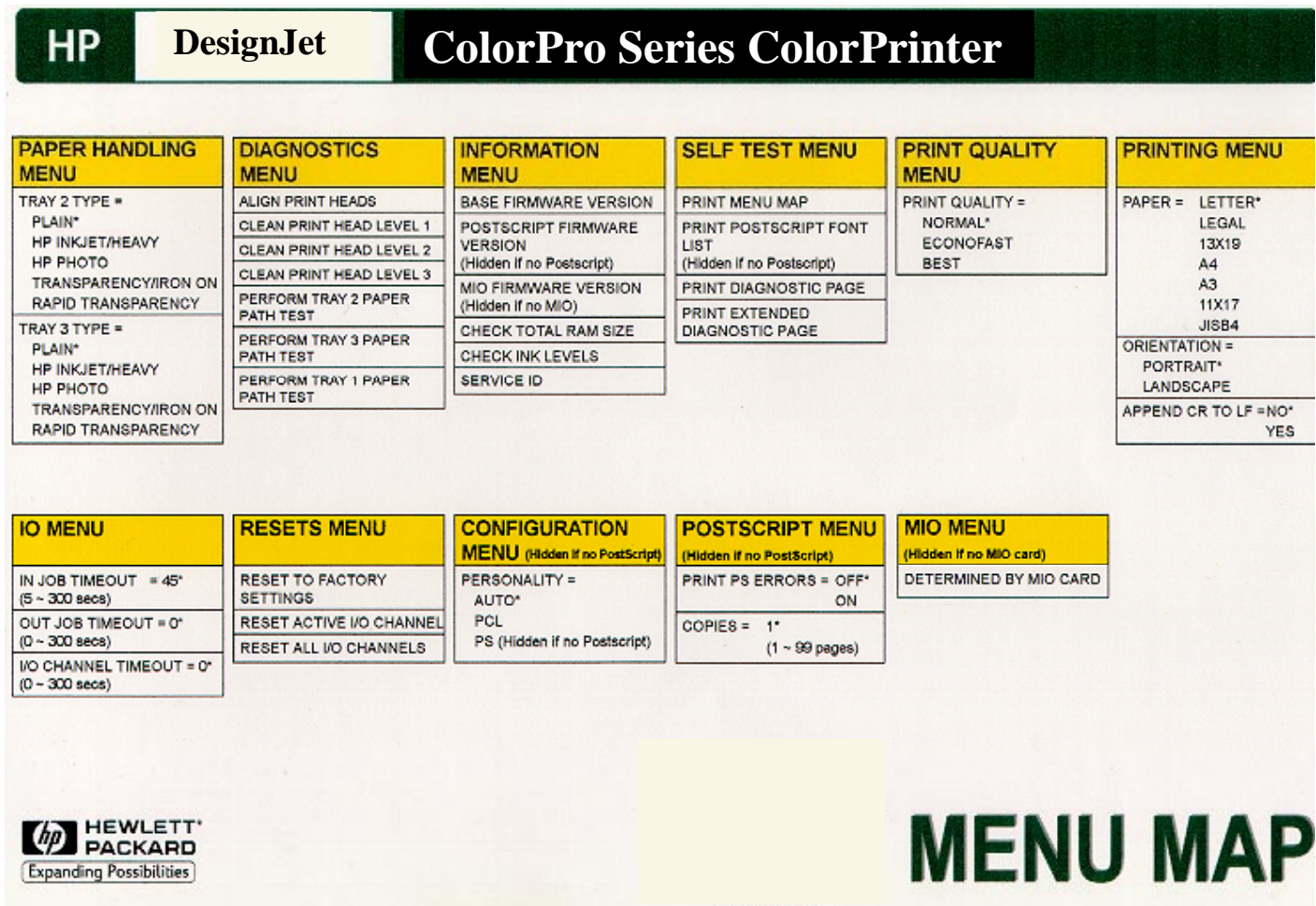

Using the Control Panel

Paper Handling Menu

Item	Value	Explanation
TRAY 2 TYPE=PLAIN	PLAIN HP INKJET/HEAVY HP PHOTO TRANSPRNCY/IRON RAPID TRANSPRNCY	<p>Set this value to correspond with the paper type currently loaded in Tray 2.</p> <p>PLAIN: Plain paper</p> <p>HP INKJET/HEAVY: HP Premium Inkjet Paper or HP Premium Inkjet Heavyweight Paper</p> <p>HP PHOTO: HP Premium Photo Paper</p> <p>TRANSPRNCY/IRON: HP Premium Transparency Film or HP Iron-on T-Shirt Transfer</p> <p>RAPID TRANSPRNCY: HP Premium Inkjet Rapid-Dry Transparencies.</p> <p>Note: It is not advisable to load the following combination of paper types in Tray 2 and Tray 3 at the same time:</p> <ul style="list-style-type: none"> ▪ HP Premium Inkjet Paper and HP Premium Inkjet Heavyweight Paper ▪ HP Premium Transparency Film and HP Iron-on T-Shirt Transfer
TRAY 3 TYPE=PLAIN	PLAIN HP INKJET/HEAVY HP PHOTO TRANSPRNCY/IRON RAPID TRANSPRNCY	<p>Set this value to correspond with the paper type currently loaded in Tray 3.</p> <p>PLAIN: Plain paper</p> <p>HP INKJET/HEAVY: HP Premium Inkjet Paper or HP Premium Inkjet Heavyweight Paper</p> <p>HP PHOTO: HP Premium Photo Paper</p> <p>TRANSPRNCY/IRON: HP Premium</p>

		<p>Transparency Film or HP Iron-on T-Shirt Transfer</p> <p>RAPID TRNSPRNCY: HP Premium Inkjet Rapid-Dry Transparencies.</p> <p>Note: It is not advisable to load the following combination of paper types in Tray 2 and Tray 3 at the same time:</p> <ul style="list-style-type: none">▪ HP Premium Inkjet Paper and HP Premium Inkjet Heavyweight Paper▪ HP Premium Transparency Film and HP Iron-on T-Shirt Transfer
--	--	--

Using the Control Panel

Diagnostics Menu

Item	Explanation
ALIGN PRNT-HDS	This item aligns the printheads to ensure printout of the best possible print quality.
CLEAN PRNT-HD: LEVEL 1	This item cleans the printheads. Level 1 is the basic level and should be performed first. This option will cause the printer to perform a dry wipe and spitting.
CLEAN PRNT-HD: LEVEL 2	This item cleans the printheads. Level 2 is more thorough than Level 1, but it should be performed only when Level 1 cleaning does not solve the print quality problem. This option will cause the printer to perform a wet wipe, followed by a dry wipe and spitting.
CLEAN PRNT-HD: LEVEL 3	This item cleans the printheads. Level 3 is most thorough, but it should be performed only when Levels 1 and 2 cleaning do not solve the print quality problem, as it uses the most ink. This option will cause the printer to perform 3 wet wipes followed by dry wipes and spitting. The maximum amount of ink used is less than 0.1 cc.
PERFORM TRAY 2 PAPER PATH TEST	This item performs a paper path test on Tray 2. When this is selected, the printer will pick paper from Tray 2 until all the paper has been ejected.
PERFORM TRAY 3 PAPER PATH TEST	This item performs a paper path test on Tray 3. When this is selected, the printer will pick paper from Tray 3 until all the paper has been ejected.
PERFORM TRAY 1 PAPER PATH TEST	This item performs a paper path test on Tray 1. When this is selected, the printer will pick paper from Tray 1 until all the paper has been ejected.

Note

1. The "PRNT-HD NOT ALIGNED" message will appear if the Secondary Access Door has been opened even though the print heads have not been changed.

Using the Control Panel

Information Menu

Item	Explanation
CHECK INK LEVEL	<p>This item displays the amount of ink remaining in each ink cartridge. The following screen appears on the LCD:</p> <p style="text-align: center;">B C M Y 60% 80% 80% 80%</p> <p>B, C, M and Y represent the black, cyan, magenta and yellow cartridges respectively. The corresponding percentage under each letter indicates the amount of ink left (from 0% to 99%).</p>
BASE FW VER	<p>This item displays the firmware version of the printer. Example:</p> <p style="text-align: center;">VERSION=5.10</p>
PS FW VER	<p>This item displays the PostScript firmware version of the printer. Example:</p> <p style="text-align: center;">FIRMWARE VERSION=5.10</p>
MIO FW VER	<p>This item displays the MIO print server firmware version. Example:</p> <p style="text-align: center;">MIO VERSION=3.10</p>
CHECK TOTAL RAM SIZE	<p>This item displays the total amount of RAM available in the printer. Example:</p> <p style="text-align: center;">TOTAL RAM SIZE=6118K</p>
SERVICE ID	<p>This item displays the Service Identification Number of the printer. This number is used by HP Customer Care Centers for support. The format taken is:</p> <p style="text-align: center;">SERVICE ID=YYDDD</p> <p>Where YY indicates the last two digits of the year of manufacture and DDD indicates the number of days since the printer was first used by the customer.</p>

Using the Control Panel

Self-Test Menu

Item	Explanation
PRINT MENU MAP	The Menu Map shows the layout of the Control Panel menu items.
PRINT PS FONT LIST	The PS Font List shows all the PS fonts currently available to the printer. This option is activated only if PS Personality module has been installed.
PRINT DIAGNOSTIC PAGE	The Diagnostic Page shows general printer information and current network parameters. See Diagnostic Page (Chapter 2) .
PRINT EXT DIAGNOSTIC PAGE	The Extended Diagnostic Page shows printer information which is used for troubleshooting. See Extended Diagnostic Page (Chapter 2) .

Using the Control Panel

Print Quality Menu

Item	Value	Explanation
PRINT QUALITY= NORMAL	NORMAL ECONOFAST BEST	<p>NORMAL: Normal mode delivers high quality output and is the recommended setting for speed and quality. Normal mode is the default setting for most paper types.</p> <p>ECONOFAST: Draft quality printing. EconoFast mode prints faster than Normal mode and delivers comparable output.</p> <p>Using EconoFast will also cut down on the frequency of replacing your ink cartridges because it uses less ink. EconoFast printing is available only when you select plain paper or transparency as the paper type.</p> <p>BEST: High quality printing. Best mode produces the highest print quality for all paper types and eliminates the banding effect that sometimes occurs in solid areas. However, Best mode prints more slowly than Normal mode for most documents.</p>

Note

2. When printing in either Normal or Econofast mode, the printer will print bi-directionally (that is, from left to right and right to left).
- 3.
4. However in when printing in Best mode, the printer will print uni-directionally (that is, only from right to left). Printing in Best mode will result in slower printing, but this can solve banding problems.

Using the Control Panel

Printing Menu

Item	Value	Explanation
PAPER= LETTER	LETTER LEGAL 13X19 A4 A3 11X17 JISB4	Sets the paper size.
ORIENTATION= PORTRAIT	PORTRAIT LANDSCAPE	Determine the default orientation of print on the page. Note: It is best to set the page orientation from the printer driver or software application.
APPEND CR TO LF= NO	NO YES	Select YES to append a carriage return to each line feed (LF) encountered in backward-compatible PCL jobs (pure text, no job control). Some environments indicate a new line using only the line feed control code. This option allows the user to append the required carriage return to each line feed.

Using the Control Panel

I/O Menu

Item	Value	Explanation
IN JOB TIMEOUT= 15	5 to 300	<p>Selects the amount of time (in seconds) that the printer will wait within a print job before ending it.</p> <p>When the data from a print job is not completely sent to the printer, the printer will wait for this specified number of seconds. After that, it will abort the job and carry on to process the next print job.</p> <p>Press [Value] once to change the setting by increments of 1 or hold down [Value] to scroll through the settings.</p>
OUT JOB TIMEOUT= 15	0 to 300	<p>Selects the amount of time (in seconds) that the printer will wait for the next print job before switching to another port.</p> <p>This is useful especially when your printer is connected to two different ports, such as the parallel port and the network port.</p> <p>Press [Value] once to change the setting by increments of 1 or hold down [Value] to scroll through the settings.</p>
I/O CHANNEL TIMEOUT= 120	0 to 300	<p>Selects the amount of time (in seconds) that the printer will receive data from a port before switching to the next port.</p> <p>When the printer is connected to different ports with simultaneous data being sent from these ports, the printer will be able to toggle between ports so that jobs sent through all ports will be given equal priority.</p> <p>Press [Value] once to change the setting by increments of 1 or hold down [Value] to scroll through the settings.</p>

Using the Control Panel

Resets Menu

Item	Explanation
RESET TO FACTORY SETTINGS	This item performs a simple reset and restores most of the factory (default) settings. This item also clears the input buffer for the active I/O.
RESET ACTIVE I/O CHANNEL	This item performs a simple reset and clears the input and output buffers (for the active I/O channels only).
RESET ALL I/O CHANNELS	This item performs a simple reset and clears the input and output buffers for all I/O channels.
RESET MIO TO FACTORY SETTINGS	This item resets the MIO print server and restores most of the factory (default) settings.

Configuration Menu

Item	Value	Explanation
PERSONALITY=AUTO	AUTO PCL PS	<p>Selects the default printer language (personality).</p> <p>Possible values are determined by valid languages which are installed in the printer ; for example, if you have the PS module installed, you will be able to select between AUTO, PCL or PS.</p> <p>Normally, you should not change the printer language (the default is AUTO). If you change it to a specific printer language, the printer will not automatically switch from one language to another unless specific software commands are sent to the printer.</p>

Using the Control Panel

MIO Menu

This menu is available only if the MIO card is installed. It is controlled by the MIO print server which has been installed on the printer and thus varies accordingly. Please refer to the documentation that comes with the print server for more information.

PostScript Menu (for HP DesignJet ColorPro GA printer or with PostScript Upgrade Kit installed only)

Item	Value	Explanation
PRINT PS ERRORS= OFF	OFF ON	Select ON to print the PS error page when a PS error occurs.
JAM RECOVERY= AUTO	AUTO ON OFF	Determines how the printer behaves when a paper jam occurs. AUTO: The printer automatically selects the best mode for printer jam recovery (usually ON). This is the default setting. ON: The printer automatically reprints pages after a paper jam is cleared. OFF: The printer does not reprint pages following a paper jam. Printing performance might be increased with this setting.
COPIES=1	1 to 99	Sets the default number of copies by selecting any number from 1 to 99. Press [Value] once to change the setting by increments of 1 or hold down [Value] to scroll through the settings.

Using the Control Panel

Aligning Printheads

To align the printheads from the LCD :

1. Press the [Menu] button until “Diagnostic Menu”.
2. Press the [Item] button until “Align Printheads”.
3. Press the [Select] button.
4. LCD message “Printing Pattern Page”.
5. Printer prints alignment page with horizontal and vertical alignment patterns.
6. The following screen appears on the LCD:

A	B	C	D	E
3	3	3	3	3

7. The value “3” at A is flashing.
8. By pressing value change the value at A that matches the corresponding straight line on the test page.
9. When the value for A is correct press the [Item] button to skip to B.
10. When all values are set press the [Select] button.
11. The printer will display signs of activity. LCD message “Printing Confirm Page”.
12. The printer prints two squares and a cross. If the printed lines are straight, the printhead alignment procedure is complete.

All pens Missing

When the message “ALL PENS MISSING” appears on the LCD one of two possible situations apply. Either all print heads are missing from the carriage or at least one of the print heads is experiencing an ink short.

Following the message:

- A. The printer will go automatically into Ink Head Diagnostic Process “Prt-Hd Diag” appears
- B. The user has to press “select” to start the Ink Head Diagnostic Process

The diagnostic program will ask to insert the black print head only, after which the printer will check the print head. Subsequently the user will be asked to add one print head at the time and the diagnostic program will perform checks on each print head added.

Note

1. The printer has only one data-line to check for shorts. It is possible that the original error message will refer to a different print head as the one that is actually having the ink short. The Ink Head Diagnostic Process will help you identify the print head having the problem.
2. Not all cases of ink shorts can be diagnosed by the Printhead Diagnostic Process. If the diagnostic program is not able to diagnose correctly, replace the printheads one after another to identify the faulty printhead.

The Printhead Diagnostic Process in steps:

1. "PRNT-HD DIAG" appears on LCD
2. Press GO
3. Open the Print Head Access Cover and remove C, M and Y Printheads
4. Close Printhead Access Cover
5. LCD will display "Detecting"
6. If B Print Head faulty LCD shows "B PRNT-HD FAULTY"
7. Press GO
8. LCD displays "REPLACE B PRNT-HD"
9. User replaces Black Printhead
10. LCD shows "DETECTING"

Error Codes





Recoverable Error Codes





A recoverable error is one that is defined as an anomaly that will cause the printer to pause until the user resolves the error.

The other two types of errors are: warning errors, which will highlight a potential problem to the user but does not cause the printer to stop operation, and unrecoverable errors, which are generally irresolvable by the user and will cause the printer to stop functioning altogether.

Also note that if the printer is in the Menu state, error messages will not be displayed until the printer is back in the Ready state.

Note: Brackets [] in the Message column indicate variables.

MESSAGE	EXPLANATION	SOLUTION
OFFLINE	The printer is offline.	Press  to set the printer online.
CANCELING JOB	The printer is canceling current print job.	
[COLOR] INK OUT, REPLACE CART	One of the ink cartridges (Black, Cyan, Magenta or Yellow) is out of ink.	Replace the appropriate cartridge.
[COLOR] CART FAULTY, REPLACE	One of the ink cartridges (Black, Cyan, Magenta or Yellow) is faulty.	Replace the appropriate cartridge.
[COLOR] CART MISSING, INSERT	One of the ink cartridges (Black, Cyan, Magenta or Yellow) is missing.	Insert the appropriate cartridge.
[COLOR] PRNT-HD FAULTY, REPLACE	One of the printheads (Black, Cyan, Magenta or Yellow) is faulty.	Replace the appropriate printhead.
[COLOR] PRNT-HD MISSING, INSERT	One of the printheads (Black, Cyan, Magenta or Yellow) is missing.	Insert the appropriate printhead
PRNT-HD ACCESS COVER OPEN	The Printhead Access Cover is open.	Close the cover to resume printing.
TOP COVER OPEN	The Top Cover is open.	Close the cover and press  to resume printing.
PAPER JAM, OPEN TOP COVER	There is paper jammed in the printer.	Open the Top Cover to remove paper. When finished, close the Top Cover and press  to resume printing.
CARRIAGE JAM, OPEN TOP COVER	The Carriage is jammed.	Open the Top Cover to clear obstruction. When finished, close the Top Cover and press  to resume printing.
CARRIAGE JAM, OPEN ACC COVER	The Carriage is jammed.	Open the Printhead Access Cover to remove obstruction. When finished, close the Printhead Access Cover and align printheads.
LEFT BACK PANEL OUT	The left side of the Back Panel has not been inserted properly.	Open the Rear Access Cover and ensure that the left side of the panel is properly installed.
RIGHT BACK PANEL OUT	The right side of the Back Panel has not been inserted properly.	Open the Rear Access Cover and ensure that the right side of the panel is properly installed.
TRAY 2 PAPER GUIDE REMOVED	One of the Paper Guides in Tray 2 has been removed.	Insert the Paper Guide back into Tray 2.
TRAY 3 OPEN OR GUIDE REMOVED	Tray 3 is either open or one of its Paper Guides has been removed.	Ensure that both the Paper Guides are properly installed and that Tray 3 is inserted into the printer.
MNL FEED LOAD [TYPE] [SIZE]	You have chosen to print through Tray 1.	Load the paper type and size as specified in the LCD Panel and press  to continue printing.

TRAY [NUMBER] EMPTY, LOAD & PRESS 	The specified tray is empty.	<i>Load the paper size and type which this tray has been set up for</i>
PRESS  TO CONTINUE	<i>To continue your present task, press the  button.</i>	
MEDIA IN TRAY 1, REMOVE	There is media in Tray 1 which may not be the type or size that is specified in your current print job.	<i>Remove the media in Tray 1 and press the  button to resume printing. If you wish to print through Tray 1, set your driver to pick from Tray 1 and send the print job before putting media in Tray 1.</i>
WRONG MEDIA TYPE, [ACTION]	The media type which the printer has detected is not the type specified in your print settings.	<i>You may wish to either load in the right media, or choose to print on existing media. You may also cancel the current print job by pressing the [Cancel Print] button.</i>
UNEXPECTED PAPER SIZE	The specified paper size is different from the paper size in the selected input tray. The output was truncated to fit the paper in the printer. Some output may have been lost.	<i>Reload the correct media into the tray and print again.</i>
PRNT-HDS NOT ALIGNED	The printheads have not been aligned. For best print quality, align the printheads before the next print job.	<i>Align the printheads. For instructions, see Align Printheads.</i>
NON HP [COLOR] CART	A non-HP color cartridge has been detected. HP does not guarantee non-HP cartridges. The use of incompatible cartridges may disrupt the intricate printing system, potentially resulting in reduced print quality and even printer damage.	<i>Use original HP ink cartridges instead.</i>
[COLOR] CART NEAR EXPIRY	One of the ink cartridges (Black, Cyan, Magenta or Yellow) is near expiry. To obtain optimum print quality, it is recommended that you do not use expired ink cartridges.	<i>Be prepared to replace the mentioned color ink cartridge.</i>
[COLOR] INK LOW	One of the ink cartridges (Black, Cyan, Magenta or Yellow) is low on ink. You may still continue to print with this cartridge until the ink has totally run out.	<i>Be prepared to replace the mentioned color ink cartridge.</i>

Error Codes

Unrecoverable Error Codes

Display error code on LCD: “ERROR CODE: XXXX-XXXX”

The unrecoverable error codes are coded and refer to the printer module that is experiencing a failure. Some of the codes in the list below have a comment “Not Used”. These codes are only for development purposes and should no longer be triggered by the firmware. We do supply the full list of unrecoverable codes because experience told us that under some unique circumstances some of the development codes will still be displayed.

Error No	Error Message	Comments	Error Meaning
111	RED_NO_ERROR		
112	NONSPECIFIC_ERROR		Standard error trap (no additional information).
	System/Selftest Errors		
121	ASSERT_ERROR		Assert will display additional information: the first extended code displayed (after the “121”) is the file number that represents one of the source modules in the system. File numbers are enumerated in <i>AssertFilesPub.h</i> . The next one or two extended codes represent the line number within the file that holds the assert() statement that failed. One addition extended code is used if the line number is 999 or less, and two extended codes if the line number is 1000 or greater.
122	SAMPLE_ROM_TEST_FAIL	Problem with ROM on Main PCA –CRC Test failed	Two types of ROM tests.
123	FULL_ROM_TEST_FAIL	Problem with ROM on Main PCA –CRC Test failed	
124	FRONT_PANEL_ERROR_TRAP	Not used	User asked for an error-trap.
125	STACK_SIZE_TOO_SMALL	Stack Overflow => program error –reset printer otherwise replace PCA	Emulator : p/s offendingTask.
126	RAM_ADDRESS_TEST_FAIL	PCA error	Ram address line test.
127	DEMO_MSG_Q_CREATE	Program error - resources are not available –printer could be working on other tasks - reset or replace PCA	Couldn't create qSelfTest queue.
128	PROCESSOR_FAULT	Program errors affecting main CPU – reset or replace PCA	i960 processor fault.
129	UNUSED_INTERRUPT_HIT	Design of interrupt is wrong – service routine is not recognized	Interrupt with no vector assigned.

		(Development error)	
131	INK_LEAK_ERR_K	ISS error – Not used	Pump detected OOI before level down.
132	INK_LEAK_ERR_C	ISS error – Not used	Pump detected OOI before level down.
133	INK_LEAK_ERR_M	ISS error – Not used	Pump detected OOI before level down.
134	INK_LEAK_ERR_Y	ISS error – Not used	Pump detected OOI before level down.

139	DEFERRED_ERROR_TRAP	Error happened during power up but printer recovered	Printer error-trapped in a previous lifetime.
141	NVM_ERR_NOT_INIT	Not used	Attempt to read/write before init.
142	NVM_ERR_GENERIC	Not used	Non-specific NVM error.
143	NVM_ERR_DEVICE_ABSENT	NVM errors Reset printer =>Replace logic PCA	Requested memory device did not respond.
144	NVM_ERR_WRITE	NVM errors Reset printer =>Replace logic PCA	Protocol error on write operation to NVM.
145	NVM_ERR_READ	NVM errors Reset printer =>Replace logic PCA	Protocol error on read operation to NVM.
146	NVM_ERR_READBACK	NVM errors Reset printer =>Replace logic PCA	Failed readback/verify after write.
147	NVM_ERR_DATA_NOT_VALID	NVM errors Reset printer =>Replace logic PCA	Device works OK.
148	NVM_ERR_UNKNOWN_TAG	NVM errors Reset printer =>Replace logic PCA	Data tag invalid.
149	NVM_ERR_UNKNOWN_FORMAT	NVM errors Reset printer =>Replace logic PCA	Chip functions but has invalid format.
151	NVM_ERR_BAD_CHIP_TAG	Penhead and cartridge errors –Not used	Acumen's chip tag unrecognized.
152	NVM_ERR_BAD_FAMILY	Penhead and cartridge errors –Not used	Acumen's family ID unrecognized.
153	NVM_ERR_BAD_COLOR	Penhead and cartridge errors –Not used	Acumen's color code did not match device ID.
154	NVM_ERR_TSR_VALUE	Penhead and cartridge errors –Not used	Acumen TSR value = 0.
155	NVM_ERR_DROP_VALUE	Penhead and cartridge errors –Not used	Acumen drop volume = 0.
156	NVM_ERR_BAD_TOKEN	Penhead and cartridge errors –Not used	Token area failed zero-write self test.
157	NVM_ERR_BAD_WRITE_PROT	Penhead and cartridge errors –Not used	Write-protect area failed self test.
158	NVM_ERR_BAD_MODEL_NUM	Penhead and cartridge errors –Not used	Acumen Model Number field out of range.
159	NVM_ERR_INCOMPAT_INK	Penhead and cartridge errors –Not used	Non-approved bit and "JETSERIES".
161	NVM_ERR_BAD_MFG_WEEK	Penhead and cartridge errors –Not used	Mfg week > 51.
162	NVM_ERR_SPARE	Penhead and cartridge errors –Not used	Previously was Gas Gauge Gap.
163	NVM_ERR_POOL_ALLOC_FAIL	System resources – Reset printer	No memory to allocate pool from.
164	NVM_ERR_ACU_BAD_SIZE	Penhead and cartridge errors –Not used	Token Write-protected or Scratchpad size = 0.
165	NVM_ERR_DUPLICATE_TAG	Penhead and cartridge errors –Not used	Two identical tags were found in an Acumen chip.
166	NVM_ERR_TOKEN_MISLOC	Penhead and cartridge errors –Not used	Status superfield not located in token area.
167	NVM_ERR_I2C_CONF_FAIL	Bus used for connecting devices on the PCA experiences error. Reset Printer => Replace PCA	A failure was detected on the serial bus used to access NVM devices (I2C bus). The following extended error codes apply : 001 = STUCK_LO_SDA 002 = STUCK_HI_SDA 004 = STUCK_LO_SCL 005 = STUCK_LO_SCL + STUCK_LO_SDA 006 = STUCK_LO_SCL + STUCK_HI_SDA 008 = STUCK_HI_SCL 009 = STUCK_HI_SCL + STUCK_LO_SDA 010 = STUCK_HI_SCL + STUCK_HI_SDA
Memory Manager			
171	MM_PROC_WAITING	Not used	Memory Manager error traps.
172	MM_SIGNAL_ERR	Not used	
173	MM_MAX_WAIT_ERR	Not used	MM debug = 0.

Critical Task WatchDog Timeouts			
181	CRIT_TASK_WD_TASK_1	Not used All are PCA timing issues	Critical task 1 watchdog timeout.
182	CRIT_TASK_WD_TASK_2	Not used	Critical task 2 watchdog timeout.
183	CRIT_TASK_WD_TASK_3	Not used	Critical task 3 watchdog timeout.
184	CRIT_TASK_WD_TASK_4	Not used	Critical task 4 watchdog timeout.
185	CRIT_TASK_WD_TASK_5	Not used	Critical task 5 watchdog timeout.
186	CRIT_TASK_WD_TASK_6	Not used	Critical task 6 watchdog timeout.
187	CRIT_TASK_WD_TASK_7	Not used	Critical task 7 watchdog timeout.
188	CRIT_TASK_WD_TASK_8	Not used	Critical task 8 watchdog timeout.
189	CRIT_TASK_WD_TASK_9	Not used	Critical task 9 watchdog timeout.
Pens and Darwin Errors			
211	SB_ERR_FORCE_RESET	Not used	Failed to perform serial bus reset.
221	SB_ERR_BAD_XFER_CMD	Not used	Darwin Bus: bad transfer command format.
222	SB_ERR_NO_SLAVE_ADDR	Not used	Darwin Bus: no slave address found.
223	SB_ERR_MISSING_ACK	Not used	Darwin Bus: missing data acknowledge pulse.
224	SB_ERR_HARDWARE_FAULT	Not used	Darwin Bus: wrote 0, read 1.
225	SB_ERR_UNEX_STOP_BIT	Not used	Darwin Bus: unexpected stop bit.
226	SB_ERR_UNEX_START_BIT	Not used	Darwin Bus: unexpected start bit.
227	SB_ERR_DATA_ERROR	Not used	Darwin Bus: wrote 1, read 0.
228	SB_ERR_MISSING_STOP	Not used	Darwin Bus: missing stop bit.
229	SB_ERR_MISSING_START	Not used	Darwin Bus: missing start bit.
241	SB_ERR_RETRIGGER_FAIL	Power down to clear SRAM –information remained after reset-Potentially PCA problem	Exceeded maximum bus transaction retries.
242	SB_ERR_FORCE_RESET_FAIL	Power down to clear SRAM –information remained after reset-Potentially PCA problem	Bus failed to execute forced reset.
Personality			
311	RED_DM_ERR_PAGE_DIR_RANGE	PCL generic errors	Page directory overflow.
312	RED_DM_ERR_NO_SCALER	PCL generic errors	No font scaler present.
313	RED_DM_ERR_BAD_HANDLE	PCL generic errors	Page index out of range.
314	RED_DM_ERR_BAD_SYMBOLSET	PCL generic errors	Requested symbol set doesn't match font headers.
315	RED_DM_ERR_FONT_TYPE	PCL generic errors	Unknown or bad font type.
316	RED_DM_ERR_NO_ALT_WIDTHS	PCL generic errors	Needed alt width table and none exists.
317	RED_DM_ERR_NO_CACHE_FONT	PCL generic errors	Couldn't allocate CACHE_FONT structure.
318	RED_DM_ERR_CACHE_INIT	PCL generic errors	Cache already initialized.
319	RED_DM_ERR_CACHE_ALLOC	PCL generic errors	Cache memory allocation failed.
321	RED_DM_ERR_BAD_CALLER	PCL generic errors	Invalid caller number.
322	RED_DM_ERR_BAD_METRICS	PCL generic errors	Invalid FM_METRICS data.
323	RED_DM_ERR_NO_SS_ENTITY	PCL generic errors	No symbol set entity for unbound font.
324	RED_DM_ERR_MEM_ALLOC	PCL generic errors	malloc() failure.

325	RED_DM_ERR_INVALID_HDR	PCL generic errors	Font header not on available.
326	RED_DM_ERR_DELETE_FONT	PCL generic errors	Can't delete font from list.
327	RED_DM_ERR_MODIFY_FONT	PCL generic errors	Can't make internal font permanent or temporary.
328	RED_DM_FONT_SELECTMODE_ERROR	PCL generic errors	
329	RED_DM_FONT_FORMAT_ERROR	PCL generic errors	
331	RED_DM_FONT_WEIGHT_ERROR	PCL generic errors	
332	RED_DM_FMTR_INVALID_CHANNEL	PCL generic errors	Miscellaneous formatter error.
333	RED_DM_FMTR_CANNOT_SUBMIT_INPUT	PCL generic errors	
334	RED_DM_FMTR_CANNOT_ALLOC_MEM	PCL generic errors	
335	RED_DM_PCL_ERROR	PCL generic errors	PCL subsystem.
336	RED_DM_PCL_INVALID_ORIENTATION	PCL generic errors	
337	RED_DM_PCL_INVALID_POSITION	PCL generic errors	
338	RED_DM_PCL_INVALID_CHARACTER	PCL generic errors	
339	RED_DM_PCL_UNDERLINE_ERROR	PCL generic errors	
341	RED_DM_PMGR_ERROR	PCL generic errors	Page Manager subsystem.
342	RED_DM_DL_WRITE_BUFF_ERROR	PCL generic errors	
343	RED_DM_DL_BAD_OPCODE	PCL generic errors	
344	RED_DM_DL_READ_BUFF_ERROR	PCL generic errors	
345	RED_DM_DL_BAD_TEXT_REC_POS	PCL generic errors	
346	RED_DM_DL_BAD_FMGR_CALL	PCL generic errors	
347	RED_DM_DL_BAD_BYTE_COUNT	PCL generic errors	
348	RED_DM_DL_BAD_CHAR_CALL	PCL generic errors	
349	RED_DM_DL_BAD_ORIENTATION	PCL generic errors	
351	RED_DM_DL_BAD_SWATH_POS	PCL generic errors	
352	RED_DM_DL_BAD_RENDER_POS	PCL generic errors	
353	RED_DM_PMGR_NO_PAGE_OPEN	PCL generic errors	
354	RED_DM_PMGR_NO_MEM	PCL generic errors	
355	RED_DM_PMGR_ED_PAGE_ERROR	PCL generic errors	
356	RED_DM_PMGR_NO_RENDER_RES	PCL generic errors	
357	RED_DM_PMGR_BAD_RENDER_RES	PCL generic errors	
358	RED_DM_PMGR_REVISIT_RASTER	PCL generic errors	
359	RED_DM_FOX_DETECT_SYSTEM_DEAD	PCL generic errors	FOX Download subsystem.
361	RED_DM_FOX_DELETE_FONT_ERROR	PCL generic errors	
362	RED_DM_IO_BAD_MEM_BLOCK	PCL generic errors	I/O buffer management failure.
363	RED_DM_IO_NO_MEMORY	Memory management or not enough memory error	malloc failure.
364	RED_DM_IO_WD_CREATE_FAIL	I/O problems –firmware problem => reset printer or PCA replacement	WD timer creation failed.
365	RED_DM_IO_GIVE_SEM_FAIL	I/O problems –firmware problem => reset printer or PCA replacement	Give semaphore failed.
366	RED_DM_IO_EXPECTED_TAG	I/O problems –firmware problem => reset printer or PCA replacement	BAD ReadCtrl tag.
367	RED_DM_IO_SEM_FAIL	I/O problems –firmware problem => reset printer or PCA replacement	Delete or create semaphore fail.

368	RED_DM_IO_ECP_UNSUPPORTED_CHANNEL	I/O problems –firmware problem => reset printer or PCA replacement	Data received on unsupported channel.
369	RED_DM_IO_UNSUPPORTED_SOCKET	I/O problems –firmware problem => reset printer or PCA replacement	
371	RED_DM_MLC_CREDIT_GONE_BAD	I/O problems –firmware problem => reset printer or PCA replacement	
372	RED_DM_MLC_CREDIT_GONE_BAD2	I/O problems –firmware problem => reset printer or PCA replacement	
373	RED_DM_MLC_INSUFFICIENT_MEM	I/O problems –firmware problem => reset printer or PCA replacement I/O problems –firmware problem => reset printer or PCA replacement	
374	RED_DM_MLC_COULDNT_ALLOC_OUTPUT	I/O problems –firmware problem => reset printer or PCA replacement	
375	RED_DM_MLC_UNKNOWN_DATA_CONTROL	I/O problems –firmware problem => reset printer or PCA replacement	
376	RED_DM_MLC_GET_INPUT_FAILED	I/O problems –firmware problem => reset printer or PCA replacement	
377	RED_DM_MLC_DEFAULT_CONFIG_FAIL	I/O problems –firmware problem => reset printer or PCA replacement	
378	RED_DM_MLC_MIDPACKET_CHANNEL	I/O problems –firmware problem => reset printer or PCA replacement	
379	RED_DM_MLC_READ_STOPPED_ERROR	I/O problems –firmware problem => reset printer or PCA replacement	
381	RED_DM_SOCKET_MULTIPLE_READS	I/O problems –firmware problem => reset printer or PCA replacement	
382	RED_DM_SOCKET_ILLEGAL_TAG	I/O problems –firmware problem => reset printer or PCA replacement	
397	RED_DM_SYS_PARAMETER_ERR	Not used	
398	RED_DM_INVALID_PEN	Not used	
399	RED_DM_NONSPEC_ERROR	Not used	Generic error trap (no additional information).
Mechanism Code Errors			
411	MECH_BAD_MECHWARE	Not supported Mechware command	
412	MECH_BAD_RESOLUTION	Print resolution not supported	Someone asked for an unsupported resolution.
413	MECH_BAD_INIT	Firmware code error – subsystem failed	TaskSpawn.
414	MECH_THERMAL_SHORT	Not used	Pen temperature went over 95 degrees.
415	MECH_CARRIAGE_JAM	Carriage blocked – Encoder strip/ carriage motor/ carriage PCA/ Harness/ Logic PCA error	Carriage servo failure detected.
416	MECH_NO_MEMORY	Firmware error or not enough memory – reset printer	
417	MECH_FAIL_ADC_CAL	Not used	Failed the internal ADC CAL.
418	MECH_ADC_RAIL	Not used	The ADC was at the rails (was 423).
419	MECH_VREF_PROB	Not used	The ADC was probably overdriven.

421	MECH_BAD_BLACK_PEN	Not used – pen/ flexcable/ Carriage PCA/ Logic PCA error	Black pen had bad ID or TSR.
422	MECH_BAD_CYAN_PEN	Not used – pen/ flexcable/ Carriage PCA/ Logic PCA error	Cyan pen had bad ID or TSR.
423	MECH_BAD_MAGENTA_PEN	Not used – pen/ flexcable/ Carriage PCA/ Logic PCA error	Magenta pen had bad ID TSR.
424	MECH_BAD_YELLOW_PEN	Not used – pen/ flexcable/ Carriage PCA/ Logic PCA error	Yellow pen had bad ID TSR.
425	MECH_BLACK_OOI	Not used – ISS/ Harness/ Logic PCA error	Black out of ink trap.
426	MECH_CYAN_OOI	Not used – ISS/ Harness/ Logic PCA error	Cyan out of ink trap.
427	MECH_MAGENTA_OOI	Not used – ISS/ Harness/ Logic PCA error	Magenta out of ink trap.
428	MECH_YELLOW_OOI	Not used – ISS/ Harness/ Logic PCA error	Yellow out of ink trap.
429	MECH_UDV_PROB	Not used	12V supply was out of spec (was 424).
431	MECH_PEN_E_5_SHORT	Pen failed	Electrical short test on 5 V failed.
432	MECH_SS_FAILURE	Service Station/ harness / Logic PCA error	SS jammed or SS OPTO failure.
433	MECH_NO_RAMP_MEMORY	Not used	Downloadable ramp allocation memory failed.
434	MECH_BAD_SPIT_FREQ	Not used - Logic PCA/ bad pen	Spit Frequency or Spit Count out of range.
435	MECH_PEN_VP1_SHORT	Pen / Logic PCA/ carriage base/ Flexcable connection error	Electrical short test on VP1 failed.
436	MECH_PEN_VP2_SHORT	Pen / Logic PCA/ carriage base/ Flexcable connection error	Electrical short test on VP2 failed.
437	MECH_PEN_E_12_SHORT	Pen / Logic PCA/ carriage base/ Flexcable connection error	Electrical short test on 12 V failed.
438	MECH_ALL_PENS_BAD	Not used – pen issue/ Logic PCA/ Carriage base	All 4 pens have a bad ID. This error could be caused by a short on one of the pens, which cannot be specifically identified.
439	MECH_CARRIAGE_LATCH_ERROR	Not used – Recoverable error	The carriage latch is open. This error should become something more benign.
441	MECH_PUMP_JAM	ISS pump motor jam – ISS/ Logic PCA / Harness	Pump could not move to desired position.
442	MECH_STALLED_MOTOR_ENCODER	Encoder wheel / Linefeed PCA / Logic PCA error	Motor stall: paper encoder signal.
443	MECH_STALLED_MOTOR_EMF	Not used	Motor stall: EMF signal.
444	MECH_PAPER_ENCODER	Encoder wheel / linefeed PCA / Logic PCA error	Thrown when quadrature calibration fails.
445	MECH_NUDGE_ERROR	Not used	Nudge position error outside limits.
446	MECH_PAPER_JAM_ERROR	Not able to feed out media / Linefeed motor / Linefeed PCA error	Paper jam while ejecting.
451	MECH_PEN_SHORT_OVER	Pen issue / Logic PCA / carriage base error	Pen Short Test failed (voltage increase).
452	MECH_DARWIN_OVERTEMP	Darwin Senior Failed – PCA	Darwin over temperature.
453	MECH_DARWIN_JR_OVERTEMP	Darwin Junior Failed – PCA	Darwin Jr over temperature.
454	MECH_RESISTOR_TEST_FAIL	Not used - pen issue/ flex cable/ carriage base/ logic PCA	Resistor test > 100 nozzle failure.
455	MECH_SS_OUTOFLIMITS	Service Station / Logic PCA	SS could not be homed within reasonable limit.
456	MECH_SS_DIRTYPON1	Service Station / Logic PCA	SS could not be freed from carriage - case 1.
457	MECH_SS_DIRTYPON2	Service Station / Logic PCA	SS could not be freed from carriage - case 2.
458	MECH_SS_DIRTYPON3	Service Station / Logic PCA	SS could not be freed from carriage - case 3.
459	MECH_SS_DIRTYPON4	Service Station / Logic PCA	SS could not be freed from carriage - case 4.
461	MECH_SHORT_TIMER	Pen short detected – pen issue	The short test was not completed within required time.
462	MECH_SS_REHOMING_ERROR	Service Station/ Logic PCA	Error while rehomng service station.
463	MECH_SPIT_POSITION_ERROR	Firmware error – Encoder strip / SS / carriage base/ Logic PCA	Error in spit position.
464	MECH_PAPERMOTOR_NO_INDEX	Not used	Thrown when index mark is not found.

465	MECH PAPER MOTOR STALL	Linefeed motor stall – Linefeed motor/ Linefeed PCA/ encoder wheel/ Logic PCA	Thrown when linefeed move is bad.
466	MECH PAPER MOTOR SLOW MOVE	Linefeed motor stall – Linefeed motor/ Linefeed PCA/ encoder wheel/ Logic PCA	Thrown when paper motor moves too slowly.
	I/O Manager		
511	IO_BAD_TIMER	All errors point to I/O problem Host error/ Logic PCA/ Connector	
512	P1284_DOUBLE_READ	All errors point to I/O problem Host error/ Logic PCA/ Connector	
513	P1284_ISR_INVALID_STATE	All errors point to I/O problem Host error/ Logic PCA/ Connector	
514	P1284_BAD_TIMER	All errors point to I/O problem Host error/ Logic PCA/ Connector	
515	P1284_ISR_UNRECOGNIZED	All errors point to I/O problem Host error/ Logic PCA/ Connector	
516	P1284_BAD_DMA_SIZE	All errors point to I/O problem Host error/ Logic PCA/ Connector	
517	P1284_NO_READ	All errors point to I/O problem Host error/ Logic PCA/ Connector	
518	P1284_DMA_NOT_OFF	All errors point to I/O problem Host error/ Logic PCA/ Connector	
519	P1284_DOUBLE_WRITE	All errors point to I/O problem Host error/ Logic PCA/ Connector	
521	P1284_NO_WRITE	All errors point to I/O problem Host error/ Logic PCA/ Connector	
522	P1284_CORRUPTED_DMA_BUF	All errors point to I/O problem Host error/ Logic PCA/ Connector	
523	P1284_ECP2_AUTOHS_NOT_OFF	All errors point to I/O problem Host error/ Logic PCA/ Connector	
549	PLL_EXPECTED_INTS_OFF	Parallel port error – Host error/ Logic PCA or connector	
551	PLL_INTERRUPTS_NEGATIVE	Parallel port error – Host error/ Logic PCA or connector	
552	PLL_OUT_OF_TRIGGERS	Parallel port error – Host error/ Logic PCA or connector	
553	PLL_NO_TRIGGERS	Parallel port error – Host error/ Logic PCA or connector	
554	PLL_BAD_ECP_COMMAND	Parallel port error – Host error/ Logic PCA or connector	
555	PLL_EXPECTED_BUFFER	Parallel port error – Host error/ Logic PCA or connector	
556	PLL_NO_COMPLETION_SET	Parallel port error – Host error/ Logic PCA or connector	
557	PLL_INPUT_ARG_ERROR	Parallel port error – Host error/ Logic PCA or connector	
558	PLL_INPUT_ENABLE_ERROR	Parallel port error – Host error/ Logic PCA or connector	
559	PLL_INPUT_NOT_DISABLED	Parallel port error – Host error/ Logic PCA or connector	
561	PLL_TOO_MANY_COMPLETIONS	Parallel port error – Host error/ Logic PCA or connector	
	Flash Memory		
611	FLASH_ERR_FILE_SIG	Error can only occur when flashing firmware	
612	FLASH_ERR_MACH_TYPE	Error can only occur when flashing firmware	
613	FLASH_ERR_CHECKSUM	Error can only occur when flashing firmware	
614	FLASH_ERR_BLOCKSIZE	Error can only occur when flashing firmware	
621	FLASH_ERR_UNKNOWN_STATE	Error can only occur when flashing firmware	Impossible internal state.
622	FLASH_ERR_BUF_COUNT	Error can only occur when flashing firmware	
623	FLASH_ERR_UNK_LAMP	Error can only occur when flashing firmware	
624	FLASH_ERR_UNK_BUTTON	Error can only occur when flashing firmware	
625	FLASH_ERR_UNK_SUBSTATE	Error can only occur when flashing firmware	
626	FLASH_ERR_WP_UNIMPL	Error can only occur when flashing firmware	

631	FLASH_ERR_ERASE_CMD	Error can only occur when flashing firmware	Flash chip failure.
632	FLASH_ERR_ERASE_FAILED	Error can only occur when flashing firmware	
633	FLASH_ERR_TIME_ES_INIT	Error can only occur when flashing firmware	
634	FLASH_ERR_TIME_SUSPEND	Error can only occur when flashing firmware	
635	FLASH_ERR_TIME_PAGEBUF	Error can only occur when flashing firmware	
636	FLASH_ERR_TIME_QUEUE	Error can only occur when flashing firmware	
637	FLASH_ERR_TIME_CMD	Error can only occur when flashing firmware	
38	FLASH_ERR_VPP_BAD	Error can only occur when flashing firmware	
641	FLASH_ERR_WRITE_START	Error can only occur when flashing firmware	
642	FLASH_ERR_WRITE_FAILED	Error can only occur when flashing firmware	
643	FLASH_ERR_DATA_BAD	Error can only occur when flashing firmware	Read-after-write failed.
651	FLASH_ERR_2MANY_ERASE	Error can only occur when flashing firmware	Excessive erase attempts.
661	FLASH_ERR_2MANY_WRITE	Error can only occur when flashing firmware	Excessive write attempts.
671	FLASH_ERR_BUF_DATA_BAD	Error can only occur when flashing firmware	Chip's page buffer write failed.
672	FLASH_ERR_ENCODING	Error can only occur when flashing firmware	Block's encoding method unknown.
	Personality (cont'd)		
711	RED_DM_PML_ERROR	PCA problem can also be caused by MIO card	PML subsystem (general).
712	RED_DM_PML_OPEN_SOCKET_ERROR	PCA problem can also be caused by MIO card	Could not open PML socket.
713	RED_DM_PML_IO_NOTIFY_ERROR	PCA problem can also be caused by MIO card	Could not set up callback.
714	RED_DM_PML_MEMPOOL_ERROR	PCA problem can also be caused by MIO card	Could not allocate PML pool.
715	RED_DM_PML_IO_READ_ERROR	PCA problem can also be caused by MIO card	Could not read from PML socket.
721	RED_DM_PM_INSUFFICIENT_MEM	PCA problem can also be caused by MIO card	PM could not get its structure.
	Swath Manager		
811	SM_PRINTING_OFF	Firmware issue – reset printer	Printing has been cancelled.
812	SM_NON_10X_ADVANCE	Firmware issue - reset printer	Non-x10 advance performed in a shingled mode.
813	SM_SWING_BUF_NON_ZERO	All data received=0 – reset printer	Used in AssertSwingBuffersAllZero().
820	SM_NO_MEMORY_FOR_LOG	Not enough memory available – reset printer	No memory for print logging.
	User Interface		
911	UI_MSG_Q_CREATE	Not used	Could not create the message queue.
912	UI_BUTTON_WD	Not used	Could not create button-reading watchdog.
913	UI_INDICATOR_WD	Not used	Could not create indicator-flashing watchdog.
914	UI_RESET_WD	Not used	Could not create reset button watchdog.
915	UI_UNKNOWN_IND_STATE	Not used	Unknown indicator state: state machine confused.
	Device Manager		
921	DEV_MGR_IDLE_INIT_ERR	Reset printer	Failed to start idle loop.
922	DEV_MGR_WD_START_ERR	Reset printer	Failed to create watchdog.
923	DM_MSGQ_CREATION_ERROR	Reset printer	Failed to create a message queue.
924	DM_UNSUPPORTED_MESSAGE	Reset printer	Received an unrecognized DM message.

925	DM_MESSAGE_SEND_FAILED	Reset printer	Failed to send message to dmEventMsgQ.
926	DM_MESSAGE_RECV_FAILED	Reset printer	Failed to receive device mgr message
	I/O Switcher		
971	FMT_SEM_CREATE_ERROR	Firmware error managing auto I/O switching – Reset Printer	
972	SWI_SEM_TAKE_ERROR	Firmware error managing auto I/O switching – Reset Printer	

Printer Diagnostic Pages

The HP DesignJet ColorPro Series Printer can test-print up to two self-diagnostic pages: the diagnostic page and extended diagnostic page. A PostScript (PS) configuration page may also be printed if the PS Personality Module has been installed.

Please note that the default pick for diagnostic pages is determined by the firmware version of the printer and can not be changed. Diagnostic pages will by default always pick from Tray 2 or Tray 3 (depending on firmware rev.).

Diagnostic Page

The various fields on the page are as follows:

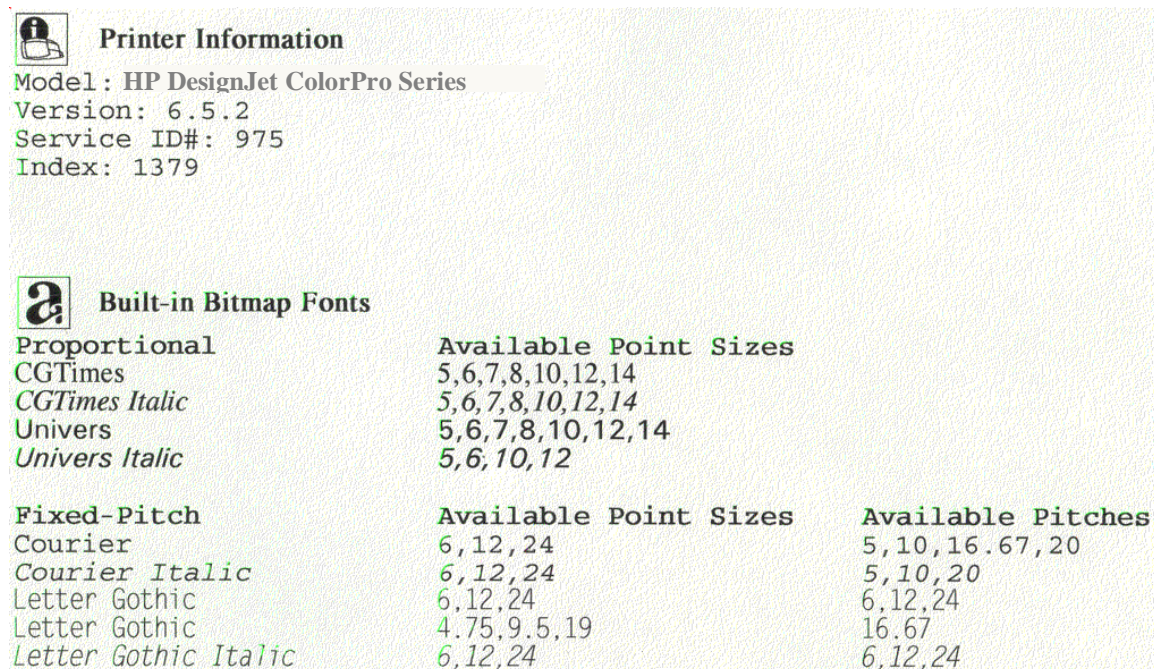

Printer Information

Model: HP DesignJet ColorPro Series
Version: 6.5.2
Service ID#: 975
Index: 1379

Built-in Bitmap Fonts

Proportional	Available Point Sizes
CGTimes	5,6,7,8,10,12,14
<i>CGTimes Italic</i>	5,6,7,8,10,12,14
Univers	5,6,7,8,10,12,14
<i>Univers Italic</i>	5,6,10,12

Fixed-Pitch	Available Point Sizes	Available Pitches
Courier	6,12,24	5,10,16,67,20
<i>Courier Italic</i>	6,12,24	5,10,20
Letter Gothic	6,12,24	6,12,24
Letter Gothic	4,7.5,9.5,19	16,67
<i>Letter Gothic Italic</i>	6,12,24	6,12,24

- Version: firmware version of the printer.
- Service ID#: born-on-date, which takes the format YYDDD, where YY indicates the year and DDD indicates the ordinal number of days in the year when the printer was first used by the customer.
- Index: number of pages printed.
- Built-in Bitmap Fonts: the PCL fonts that reside in the printer.

Printer Diagnostic Pages

Printhead Info

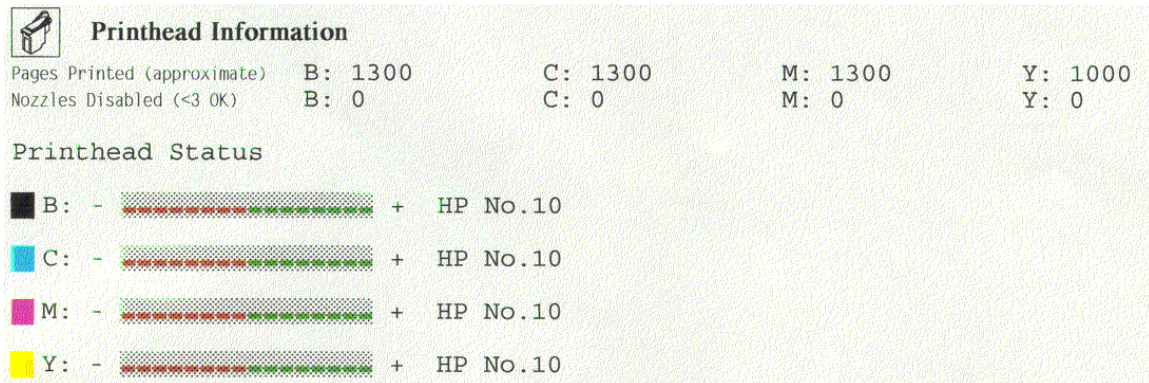

- Pages Printed (approximate): this takes the format B C M Y, and shows how many pages have been printed by each individual printhead.
- Nozzles Disabled (<3 OK): this shows, if any, the number of printhead nozzles that are not functioning properly. If any of the nozzles are disabled, the problem may be rectified by trying any of the cleaning procedures. Disabled nozzles may also indicate printhead end-of-life.
- Printhead Status: this shows the condition of each printhead. When the indicating line moves into the red zone, it means that the printhead has reached the end of its useful service life.

Cartridge

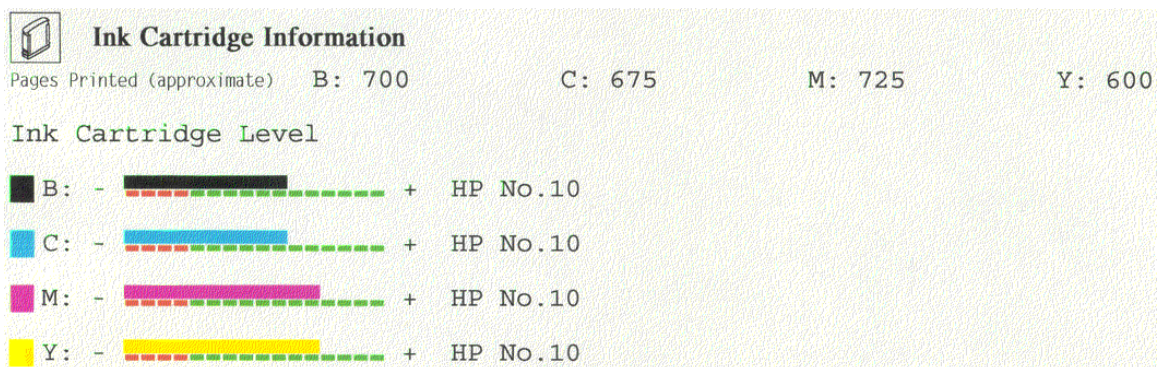

- Pages Printed (approximate): this takes the format B C M Y, and shows how many pages have been printed by each individual cartridge.
- Ink Cartridge Level: this shows the amount of ink in each cartridge. When the indicating line moves into the red zone, it means that the ink in the cartridge is going to finish soon.

Printer Diagnostic Pages

Extended Diagnostic Page

The extended diagnostic page is used by manufacturing to show the NVRAM values for the printheads, cartridges and PCA.

HP ColorPro Series Extended Diagnostic Test

Printer Information
Model: HP 2500C Series
Version: 6.5.2
Service ID#: 975

Printhead Information
Left ID: B: 0X67079 C: 0X67079 M: 0X67079 Y: 0X67079
Right ID: B: 0X88383 C: 0X68383 M: 0X68383 Y: 0X68383

Ink Cartridge Information
Ink Cartridge Level
B: - + HP No.10
C: - + HP No.10
M: - + HP No.10
Y: - + HP No.10

Technical Information
Nvm:
01: 0 02: 1 03: 0 04: 1221 05: 201 06: 242825 07: 1 08: 0
09: 807 10: 0 11: 0 12: 0 13: 0 14: 0 15: 0 16: 0
17: 0 18: 3 19: 3 20: 3 21: 2 22: 3 23: 1 24: 4
25: 3 26: 4 27: 64095522 28: 39244216 29: 121 30: 0 31: 0 32: 0
33: 248 34: 109 35: 49 36: 3 37: 5 38: 1 39: 975

Pen B:
01: 0 02: 22 03: 1023 04: 2 05: 0 06: 20 07: 1023 08: 1
09: 29 10: 2 11: 1 12: 0 13: 13 14: 0 15: 0 16: 0
17: 0 18: 0 19: 35 20: 32 21: 332 22: 132 23: 352 24: 7

Pen C:
01: 0 02: 0 03: 1023 04: 2 05: 0 06: 0 07: 1023 08: 1
09: 29 10: 2 11: 1 12: 0 13: 13 14: 0 15: 0 16: 0
17: 0 18: 0 19: 36 20: 30 21: 312 22: 131 23: 99 24: 9

Pen M:
01: 0 02: 0 03: 1023 04: 2 05: 0 06: 0 07: 1023 08: 1
09: 15 10: 2 11: 1 12: 0 13: 10 14: 0 15: 0 16: 0
17: 0 18: 0 19: 33 20: 35 21: 270 22: 132 23: 89 24: 10

Pen Y:
01: 0 02: 0 03: 1023 04: 1 05: 0 06: 0 07: 1023 08: 1
09: 30 10: 2 11: 1 12: 0 13: 10 14: 0 15: 0 16: 0
17: 0 18: 0 19: 32 20: 30 21: 338 22: 131 23: 101 24: 9

Ink B:
01: 0 02: 0 03: 1023 04: 1 05: 1 06: 0 07: 1023 08: 0
09: 8 10: 2 11: 1 12: 1 13: 28 14: JETSERIES 15: 0 16: 3
17: 0

Ink C:
01: 0 02: 0 03: 1023 04: 1 05: 1 06: 0 07: 1023 08: 1
09: 4 10: 2 11: 6 12: 1 13: 27 14: JETSERIES 15: 0 16: 3
17: 0

Ink M:
01: 0 02: 0 03: 1023 04: 1 05: 1 06: 0 07: 1023 08: 1
09: 44 10: 1 11: 6 12: 1 13: 29 14: JETSERIES 15: 0 16: 4
17: 0

Ink Y:
01: 0 02: 0 03: 1023 04: 1 05: 1 06: 0 07: 1023 08: 1
09: 11 10: 2 11: 6 12: 1 13: 24 14: JETSERIES 15: 0 16: 2
17: 0

PS Configuration Page

Available only be printed if the PS Personality Module has been installed. It prints all the PS fonts which are available on the module.

Chapter 3 Loading Paper and Paper Behavior

Loading the Trays

Overview

The HP DesignJet ColorPro Series Printer has 3 paper trays and 1 Rear Manual Feed.

Tray 1 - This tray is used as a bypass tray, and holds up to 10 sheets of paper. This tray should be used for media types and sizes that are seldom used.

Tray 2 - This tray holds up to 150 sheets of paper. It is recommended that you use this tray to hold commonly-used paper.

Tray 3 - This tray holds up to 250 sheets of paper. It is recommended that you use this tray to hold commonly-used paper.

Rear Manual Feed - The Rear Manual Feed is designed to provide a straight paper path for printing on thicker media (up to 0.3mm), such as card stock or labels, without bending. This paper path will only allow you to print on 1 sheet at a time.

Loading Commonly-Used Media in Tray 2

Tray 2 is designed to hold up to 150 sheets of paper, and can accommodate the paper sizes : Letter, A4, Legal, B4, A3, 11"x17", 13"x19" and 330x483mm.

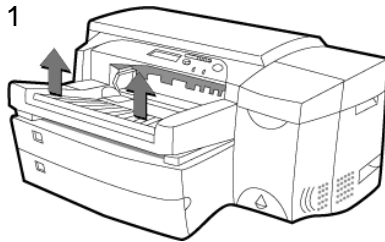

1. Remove Tray 1.
2. If you wish to change the paper size setting that has been set for the tray, go to step 3. If you wish to load paper using the existing tray setting, go to step 5.

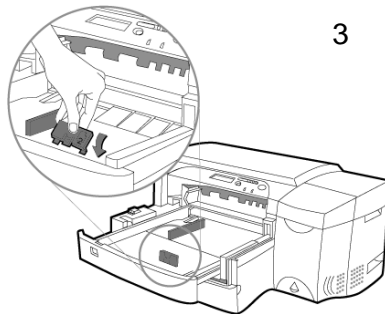

3. Adjust the Paper Length and Paper Width guides to the correct slots. Respective paper size markings are indicated beside each slot.

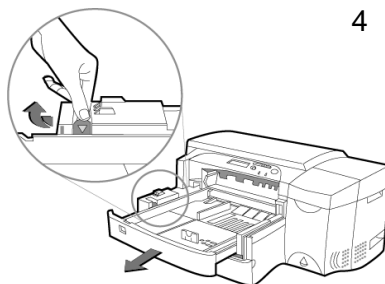
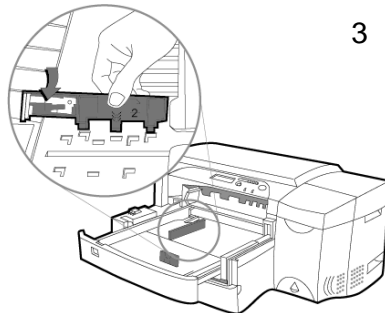

4. If you are loading paper sizes : B4, A3, 11"x17", 13"x19" and 330x483mm, unlatch the tray lock, extend the tray and relatch the tray lock. If you are loading paper sizes : Letter, A4 and Legal, check that the tray is not extended. If it is, unlatch the tray lock, push in the tray and re-latch the tray lock.

Loading Commonly-Used Media in Tray 2

5

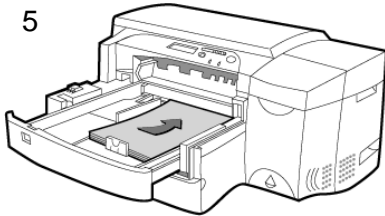

5. Insert the paper, print side down, into the printer.
6. Tap the left side of the stack of paper to ensure that it is flush with the right side of the tray.

7

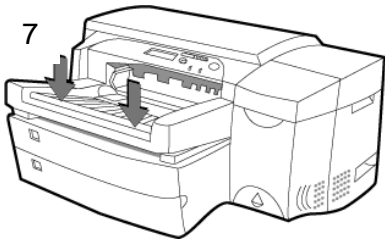

7. Replace Tray 1.

8

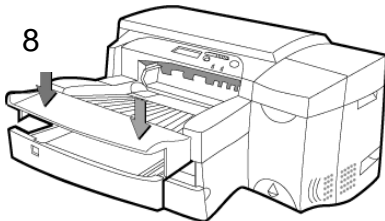

8. If Tray 2 is extended, place the Extended Tray Cover over the tray.
9. If you are loading a different type of media, press [Menu] on the Control Panel until PAPER HANDLING MENU appears.
10. Press [Item] to select TRAY 2 TYPE= .
11. Press [Value] to select the media type you have loaded into the tray and press [Select].

Loading Commonly-Used Media in Tray 3

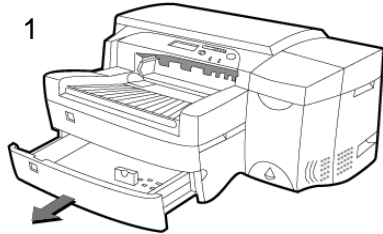

1. Grasp the sides of Tray 3 and pull it out of the printer.
2. If you wish to change the paper size setting that has been set for the tray, go to step 3. If you wish to load paper using the existing tray setting, go to step 5.

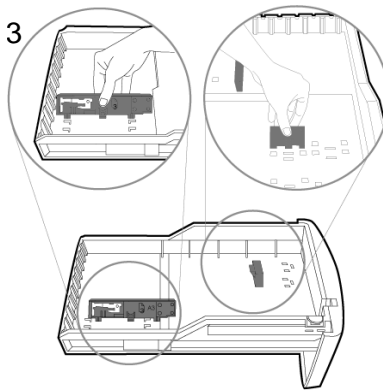

3. Adjust the Paper Length and Paper Width guides to the correct slots. Respective paper size markings are indicated beside each slot.

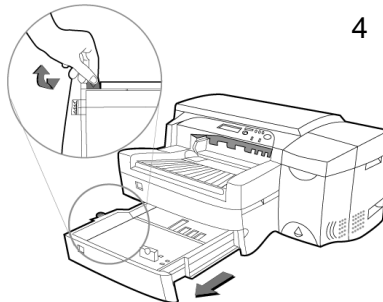

4. If you are loading paper sizes : B4, A3, 11"x17", 13"x19" and 330x483mm, unlatch the tray lock, extend the tray and relatch the tray lock. If you are loading paper sizes : Letter, A4 and Legal, check that the tray is not extended. If it is, unlatch the tray lock, push in the tray and re-latch the tray lock.

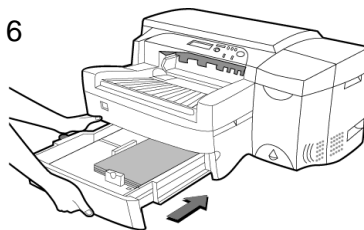

5. Load the paper, print side down, by aligning the paper edge to the Paper Length guide first. Tap the other end of the paper stack to ensure that the paper stack is loaded correctly.
6. Re-insert Tray 3 into the printer.

Loading Commonly-Used Media in Tray 3

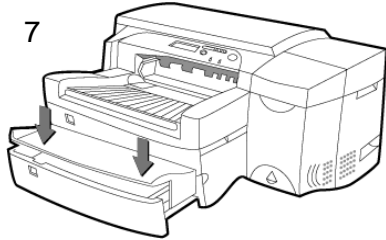

7. If Tray 3 is extended, place the Extended Tray Cover over the tray.
8. If you are loading a different type of media, press [Menu] on the Control Panel until PAPER HANDLING MENU appears.
9. Press [Item] to select TRAY 3 TYPE= .
10. Press [Value] to select the media type you have loaded into the tray and press [Select].

Loading Paper in Tray 1

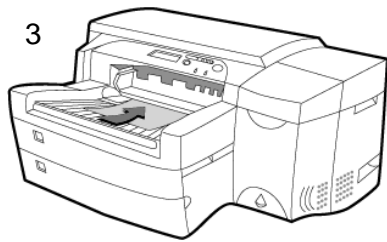

1. Set your driver to pick paper from Tray 1 and print your document (i.e. send the print job to the printer).
2. After sending the print job, the LCD Panel will display the message "TRAY 1 LOAD [TYPE] [SIZE]" where [TYPE] and [SIZE] is the media type and size as specified in your printer driver respectively.
3. Slide the paper width guide to its outermost position.
4. Insert up to 10 sheets of paper along the right side of Tray 1, print side down, until it stops.
5. Slide the paper width guide in until it stops at the edge of the paper.
6. Press the  button to print.

Loading Paper through the Rear Manual Feed

1. Set your driver to pick paper from Tray 1 and print your document (i.e. send the print job to the printer).
2. After sending the print job, the LCD Panel will display the message "MNL FEED LOAD [TYPE] [SIZE]" where [TYPE] and [SIZE] is the media type and size as specified in your printer driver respectively.
3. Insert the paper media into the Rear Manual Feed at the back of the printer, making sure that the edge of the sheet is aligned with the alignment mark on the left side of the slot. Wait for the printer to grip the media before releasing it.

Paper Behavior

The HP DesignJet ColorPro Series Printer has an automatic paper size sensing capability. However, paper type cannot be automatically detected and has to be manually set via the LCD menu. (The driver selections for paper tray can be: Tray1, Tray2, Tray3, Autoselect or Manual Feed.)

If PAPER SIZE or TYPE as specified in a print job does not match the LCD setting or current paper size settings, the printer will respond in different manners. The following are the various cases which may be encountered :

Print Job Selected Tray 2

1. The printer will check if Tray 2 has the correct Size and Type.
2. If the Type and Size are correct but there is paper media in Tray 1, the printer will prompt to remove the media from Tray 1.
3. If Tray 1 paper is not removed, all the paper from Tray 1 will be picked and ejected, followed by a load from Tray 2.
4. If the Tray 2 Size and Type of the media does not match the print job selection:
 - i. The printer will check Size and Type settings for Tray 3.
 - ii. If the Tray 3 settings match the print job selection, the printer will load from Tray 3.
 - iii. If the Tray 3 settings do not match, the printer will ask the user to load the correct media Size and Type in Tray 1.
5. If Tray 2 is Out of Paper :
 - i. The printer will check Size and Type settings for Tray 3
 - ii. If the Tray 3 settings match the print job selection, the printer will load from Tray 3.
 - iii. If the Tray 3 settings do not match the printer will ask to load the correct media Size and Type in Tray 1.

The same procedure applies to **print jobs selecting Tray 3.**

Paper Behavior

Print Job selected Autoselect

1. The printer will check if Tray 3 has the correct Size and Type.
2. The printer will check if Tray 2 has the correct Size and Type.
3. The printer prompts the user to load correct Size and Type in Tray 1.
4. After the user presses the  button, the printer will load from Tray 1.

Print Job selected Manual Feed

- The printer prompts the user to load correct Size and Type in rear feed slot.
- When either paper is sensed at the OOPS sensor or the user presses , the printer will load.

Unexpected Paper Size

- The OOPS sensor warns the user when the paper is shorter than the page to be printed.
- When the user presses the  button, the printer loads the next sheet of paper and prints the remainder of the print job on the next page.

Printer is Idle

- This condition occurs when the user opens Tray 3 or removes the paper guide.
- After the user puts back Tray 3 and/or the paper guide, the printer will return to ready status.

Printer is Printing from Tray 1 or Tray 2

- This condition occurs when the user opens Tray 3 and/or removes the paper guide while the printer is printing from tray 1 or tray 2.
- The printer stops printing and caps the pens, until the user replaces Tray 3 and/or the paper guide.

Paper Behavior

Printer is Printing from Tray 3

- This condition occurs when the user opens Tray 3 and/or removes the paper guide while the printer is printing from tray 3.
- The printer stops printing, caps the pens and ejects the current page (which can be a blank page).
- When the user puts back Tray 3 and/or the paper guide, the printer loads a new page and resumes printing the remaining page.

Paper Jam at Output Bin During Paper Loading

To rectify this problem,

1. Open the Top Cover.
2. The LCD will display: "Front Door Opened".
3. The printer caps the pens and deactivates the linefeed motor.
4. After the user manually clears the jam and closes the Top Cover, the LCD will display: "Ready".
5. The printer will initialize the linefeed motor, load new paper and resume printing.

Paper Jam at Output Bin During Printing

To rectify this problem,

1. Open the Top Cover.
2. The LCD will display: "Front Door Opened".
3. The printer deactivates **all motors** immediately.
4. The user has to push the carriage to the extreme left.
5. After the user manually clears the jam and closes the Top Cover, the LCD will display: "Ready".
6. The printer will initialize the motors, load new paper and resume printing.

Paper Behavior

Paper Jam Internal During Paper Loading

To rectify this problem,

1. Open the Back Door.
2. The printer shuts down immediately.
3. After the user clears the jam and closes the Back Door, the user also has to manually power up the printer.

Chapter 4 Install / Uninstall

Installing Printer Software from CD

To install the printer software, you will need at least 8 MB of RAM if Microsoft Windows 3.1x, Windows 95 or 98 is installed as the operating system. For Windows NT 4.0 systems, you will need a minimum of 16 MB of RAM.

For Macintosh, to install the PostScript printer software, you need at least a 68040 computer with OS 7.53 installed. This printer software is only available for HP DesignJet ColorPro GA printer or the PostScript Upgrade Kit.

System requirements for the printer software may vary in different countries; please refer to **System Requirements (Chapter 1)** for minimum and recommended system requirements .

The HP DesignJet ColorPro Series printer software is available in the Starter CD.

Note for Windows 95 users

If you see the message, "**New Hardware Found**", before or during installation, select **Do not install a driver (Windows will not prompt you again)**, and click **OK**. Then follow the instructions below to install the printer software.

If you see the **Update Device Driver** box, click **Next**, then **Finish**. Follow the instructions below to install the printer software.

Installing Printer Software from CD

Installing the PCL Printer Software from the Starter CD for Windows 3.1x, Windows 95, Windows 98 and Windows NT 4.0

1. Start **Microsoft Windows**. Make sure no other **Windows** applications are active.
2. Insert the **Starter CD** into the computer's CD-ROM drive. The installation program will run automatically.
3. Click the **Printer Driver** option in the menu that appears to install your printer software. If the installation program does not run, follow the instructions below.

If the installation program does not run automatically

1. Start **Microsoft Windows**. Make sure no other **Windows** applications are running.
2. Insert the **Starter CD** into your computer's CD-ROM drive.
3. For Windows 3.1x, select **File**, then **Run** ; for Windows 95 / 98 / NT 4.0, select **Start**, then **Run**.
4. At the **Command Line** box, enter the letter of the computer's CD-ROM drive, followed by `:\INSTALL` (for example, `D:\INSTALL`).
5. Follow the instructions that appear on the screen to complete installation.

Installing Printer Software from CD

Installing Printer Software from Floppy Diskettes in Windows 3.1x, Windows 95, Windows 98 and Windows NT 4.0

1. Close all other applications, including anti-virus programs.
2. Put **Disk 1** into the computer's floppy drive.
3. Select **File, Run** for Windows 3.1 or select **Start, then Run** in Windows 95/98/NT 4.0.
4. At the **Command Line** box, type the letter of your floppy drive followed by **:\SETUP** (for example, **A:\SETUP**).
5. Click the **OK** button. Follow the instructions that appear on the screen to complete installation of the printer software.

Installing Printer Software from CD

Installing the PostScript Printer Software on a Macintosh computer (for HP DesignJet ColorPro printer and PostScript Upgrade kit only)

1. Insert the PostScript CD into the computer's CD-ROM drive.
2. Click on the CD icon on the Desktop.
3. Click the **Install** icon in the folder to install the printer software.

Installing the PostScript Printer Software in Windows 3.1x, Windows 95, Windows 98 and Windows NT 4.0 (for HP DesignJet ColorPro printer and PostScript Upgrade kit only)

1. Insert the PostScript CD into the computer's CD-ROM drive. The program will run automatically.
2. Double click the **Install** icon in the folder to install the PostScript printer software.

If the PostScript Printer Software does not run automatically

1. Start **Microsoft Windows**. Make sure no other **Windows** applications are running.
2. Insert the **PostScript CD** into your computer's CD-ROM drive.
3. For Windows 3.1x, select **File**, then **Run** ; for Windows 95 / 98 / NT 4.0, select **Start**, then **Run**.
4. At the **Command Line** box, enter the letter of the computer's CD-ROM drive, followed by `:\INSTALL` (for example, `D:\INSTALL`).
5. Follow the instructions that appear on the screen to complete installation.

Uninstalling Printer Software

For Windows 3.1x

1. Click **File** in the **Program Manager** window.
2. Click **Run**.
3. Type **hpw4st1 /u** in the command line box. Click **OK**.

For Windows 95/ 98 / NT 4.0

1. Go to the **HP DesignJet ColorPro Series Printer** folder and double click on the **HP DesignJet ColorPro Uninstaller** icon.
2. Follow the instructions that appear on the screen to complete uninstallation.

Copy HP DesignJet ColorPro Printer Software from Starter CD to Floppy Diskettes or Network Server

The **Starter CD** includes a utility which copies the HP DesignJet ColorPro Printer software onto 3.5 inch, high-density diskettes or to a network server. Installing the driver on a network server allows client machines to install driver, especially useful if client machines do not have a CD-ROM. This utility can be found in the **Printer Driver** menu in the **Starter CD**.

Chapter 5 Maintenance and Print Cartridge Safety

Cleaning the Printer and Accessories

Cleaning Spilled Ink

The HP DesignJet ColorPro Series Printer has automatic media size sensors. Media type has to be specified in the LCD menu. These measures have been implemented to prevent printing on the platen or rollers when there is no paper in the printer. If the main OOPS sensor does not detect any paper the printer will not print.

However, if ink has spilled on any parts of the printer, it can be removed with a damp cloth.

Cleaning the Printer and Accessories

Print Head

There are 3 levels of cleaning for the “Cleaning Printhead” utility. It is recommended to proceed from Level 1 to Level 3.

Note

Level 3 uses the most ink and takes the longest time to clean.

1. Press the **Menu** button on the **Control Panel** until **DIAGNOSTICS MENU** appears.
2. Press **Item** button until **CLEAN PRNT-HDS LEVEL 1, 2 or 3**.
3. Press **Select** button to start the cleaning process.

Ink Cartridge Safety

Ink used in the ink cartridge does not pose a health hazard to customers. During the development of ink formulas, all the ingredients are researched for known potential health related issues. Only those chemicals that meet or exceed worldwide safety and regulatory requirements are used in HP inks.

For HP No. 10 Color / Black Ink Cartridges

Potential Health Effects

Primary Routes of Exposures	Skin, eye, oral and inhalation.
Acute Health Hazards	
Skin	Ink may cause slight skin irritation characterized by redness and swelling after prolonged contact. Indications of skin irritation may be covered by color of ink.
Eye	Ink may cause mild irritation to eye.
Oral	Color Accidental ingestion of nitrates will cause respiratory depression. The primary indicators of prolonged exposure include shortness of breath, headaches, dizziness and cyanosis (bluish skin and lips). Black Accidental ingestion of ink may cause stomach upset.
Inhalation	Intentional prolonged inhalation may result in primary irritation to the respiratory tract.
Chronic Toxicity	None.
Carcinogenicity	No component is a listed carcinogen in the National Toxicology Program (NTP) Annual Report or found to be carcinogenic by International Agency for Research on Cancer (IARC) or OSHA.

Ink Cartridge Safety

First Aid Measures

If ink is ingested accidentally, contact the HP Health Line 1 (800) 457-4209 in North America or 1 (503) 494-7199 for all other international locations. This health line is operational 24 hours a day.

Skin	Wash affected areas thoroughly with soap and water.
Eye	Immediately flush with large amount of clean, lukewarm water (low pressure) for at least 15 minutes.
Oral	<p>Color</p> <p>Seek medical attention for accidental ingestion of nitrates.</p> <p>Note to Medical Professionals: Treat symptomatically for nitrate related toxicity (methemoglobinemia). The technical literature indicates administration of 1 to 2 mg/kg of 1% methylene blue slowly by IV if the patient is cyanotic and symptomatic or the methemoglobin level is greater than 30% in an asymptomatic patient. Additional doses may be required.</p> <p>Black</p> <p>Wash affected areas thoroughly with soap and water.</p>
Inhalation	Remove to fresh air.

Seek medical attention if the skin irritation, eye irritation or stomach upset persists. For more information, please refer to the **MSDS (Chapter 7)**.

Ink Cartridge Safety

For Service Station Assembly

Polyethylene Glycol is found in the service station and is used to clean the printheads. This substance is commonly used as food additive.

Action To Take For Spills Or Leaks

Do not leave the substance on the floor as it makes the floor slippery. Soak it with absorbent material and scoop into drums.

Disposal Method

Salvage or burn in an approved incinerator in accordance with all federal, state and local requirements.

Ink Cartridge Safety

Potential Health Effects

Primary Routes of Exposures	Skin, eye, oral and inhalation
Acute Health Hazards	
Skin Contact	Prolonged or repeated exposure to polyethylene glycol is not likely to cause severe skin irritation. Severe response may be caused if the skin is scratched or cut. If material is encountered at higher temperature, more intense effects as well as thermal burns are possible.
Skin Absorption	The material is not likely to be absorbed through the skin in harmful amount during a single prolonged exposure. There is some indication that prolonged or repeated exposure of damaged skin to polyethylene glycol may result in absorption of toxic amounts.
Eye	Polyethylene glycol may cause slight temporary eye irritation.
Oral	The toxicity for a single dose is low. No hazards anticipated from ingestion incidental to industrial exposure.
Inhalation	Vapors are unlikely at room temperature due to the properties of polyethylene glycol.
Systemic and other effects	Based on the data available, repeated exposures are not likely to cause any severe adverse effects. Findings of kidney failure and death in burn patients, as well as some studies using animal burn models, suggest that polyethylene glycol may have been a factor. The use of tropical applications containing polyethylene glycol may not be appropriate in severely burned patients of individuals with impaired renal function. Polyethylene glycol did not cause cancer in long term animal studies.

Ink Cartridge Safety

First Aid Measures

If ink is ingested accidentally, contact the HP Health Line 1 (800) 457-4209 in North America or 1 (503) 494-7199 for all other international locations. This health line is operational 24 hours a day.

Skin	Wash off in flowing water or shower.
Eye	Immediately flush with water for at least 5 minutes.
Oral	No adverse effects anticipated by this route of exposure incidental to proper industrial handling.
Inhalation	No adverse effects anticipated by this route of exposure.

Note To Physician

There is no specific antidote. Treatment is based on the judgement of the physician in response to the reactions of the patient.

Handling Precautions

Exposure guideline(s)	American Industrial Hygiene Association workplace environmental exposure level is 10 mg/m ³ for polyethylene glycol.
Ventilation	Good general ventilation should be sufficient for most conditions.
Respiratory protection	If respiratory irritation is experienced, use an approved air-purifying respirator.
Skin protection	No precautions other than clean body-covering clothing should be needed. Protective clothing may be necessary when individual skin is abraded.
Eye protection	Use safety glasses.

Ink Cartridge Safety

Additional Information

- Observe reasonable care and cleanliness when handling and storage.
- Trace quantities of ethylene oxide (EO) may be present in this product. Although these trace quantities could accumulate in headspace areas of storage and transport vessels, they are not expected to cause a condition which will result in EO concentrations greater than 0.5 ppm (8 hour TWA) in the breathing zone of the workplace for appropriate applications.
- OSHA has established a permissible exposure limit of 1.0 ppm 8 hr TWA for EO. (Code of Federal Regulations Part 1910.1047 of Title 29).
- This product may decompose at high temperatures generating vapors which could cause irritation. For uses at elevated temperatures, adequate ventilation or exhaust is recommended.

Material Safety Data Sheet (MSDS)

Material Safety Data Sheet (MSDS) are available for the ink used in ink cartridges and the polyethylene glycol used in the service station. These MSDS data sheets include product identification, characteristics of the ink, etc. and precautions for handling and use. You can request an MSDS at the following address:

Hewlett-Packard Customer Information Center
Department MSDS
19310 Pruneridge Avenue
Cupertino, CA 95014
Mailstop 49AS

Telephone 1 (800) 752-0900
Ask for Department MSDS (6 am to 5 pm Pacific Time)

Material Safety Data Sheets are also available from the following sources:

- HP Forums of Electronic Bulletin Board Services
- HP FIRST
- Customer Support Centers

Refer to **Service and Support Resources (Chapter 1)** for access to the above resources.

Chapter 6 Functional Overview

Writing System

Introduction

The ink transport system for the HP DesignJet ColorPro Series Printer consists of four sub-systems as follows:

- Supply Station (where the ink supply is stored)
- Ink Delivery System (which transports the ink from the supply station to the printheads)
- Carriage Assembly (which moves the printheads from the service station across the paper)
- Service Station (which maintains the printheads between print jobs)

The ink, stored in the supply station in replaceable ink cartridges, is carried by the ink delivery system to the carriage assembly and stops in the printheads.

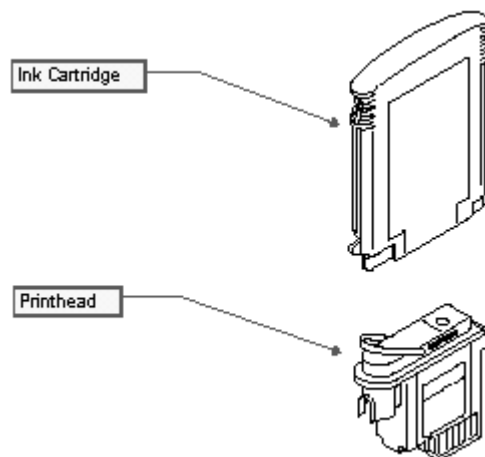

The service station cleans the printheads and collects excess ink expelled by the printheads as they are readied for use at the beginning of each printing session, and when cleaning routines are selected from the Service menu. The Service Station also caps and stores the printheads between printing sessions to prevent the printhead's nozzles from drying out.

Writing System

Part Numbers

Printhead and Ink cartridge ordering information

	Description	HP Part Reorder Number
HP No. 10 Printheads	HP No. 10 Black Printhead	C4800A Black
	HP No. 10 Cyan Printhead	C4801A Cyan
	HP No. 10 Magenta Printhead	C4802A Magenta
	HP No. 10 Yellow Printhead	C4803A Yellow
HP No. 10 Ink Cartridges	HP No. 10 Black Ink Cartridge (28 ml)	C4840A Black
	HP No. 10 High-capacity black Ink Cartridge (74 ml)	C4844A
	HP No. 10 Cyan Ink Cartridge	C4841A Cyan
	HP No. 10 Magenta Ink Cartridge	C4843A Magenta
	HP No. 10 Yellow Ink Cartridge	C4842A Yellow

Writing System

Ink Cartridge and Printhead Specifications

The printing type described here is plain paper drop-on-demand Thermal InkJet printing. The specifications listed here assume the printer is being used for general home or office applications. It is further assumed that the printer is being stored and operated at ordinary room temperature and humidity.

Ink Cartridge Specifications

Ink Cartridge	Ink Base	Page Life	Ink Capacity
HP No. 10 Black	Pigment-based ink	500 pages ¹	27 ml
HP No. 10 Black	Hi-capacity Pigment-based ink	1400 pages ¹	74 ml
HP No. 10 Cyan	Dye-based ink	1240 pages ²	29 ml
HP No. 10 Magenta	Dye-based ink	1240 pages ²	29 ml
HP No. 10 Yellow	Dye-based ink	1240 pages ²	29 ml

Note

1. The black ink cartridge life is based on an 8 in. x 10 in. printable area with a 5% printing density.
2. The color ink cartridge life is based on an 8 in. x 10 in. printable area with a 15% printing density. The printing consists of 10% composite black and 15% of the following colors: cyan, magenta, yellow, green, red and blue

Printhead Specifications

Printhead	Approximate Life	Nozzles	Speed
HP No. 10 Black	12,000 pages min.	300	12 kHz
HP No. 10 Cyan	15,000 pages min.	300	12 kHz
HP No. 10 Magenta	15,000 pages min.	300	12 kHz
HP No. 10 Yellow	15,000 pages min.	300	12 kHz

Writing System

Thermal InkJet Technology

The HP printer family uses Thermal InkJet II (TIJ II) technology. The basic principle of TIJ II is to apply heat to a tiny amount of ink until it expands and is propelled through a nozzle.

The first step in the process is to fill a small reservoir, known as the firing chamber, with ink.

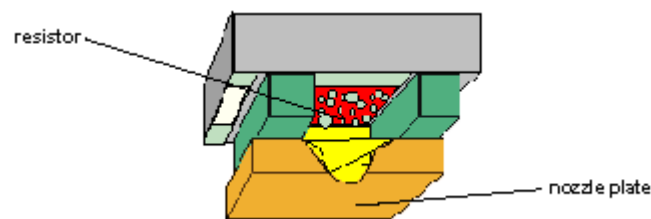

The next step is to heat the ink with a thin-film resistor layered above the firing chamber. As the ink heats up, it expands to form a bubble.

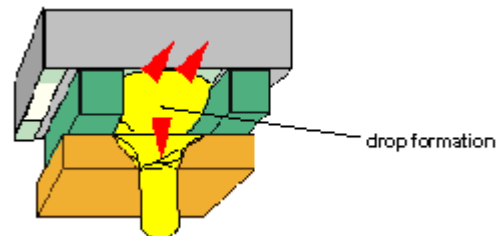

The bubble continues to expand and finally "bursts". At the instant when the bubble bursts, the ink is forced through the nozzle located below the firing chamber and out onto the paper.

Writing System

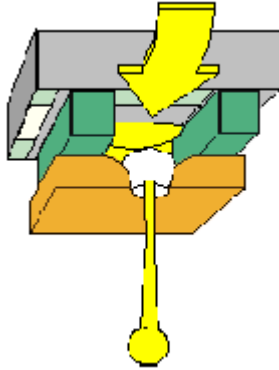

Bubble collapse begins refill.

As the bubble collapses, the ink in the orifices retracts, breaking off the ejected drop of ink and drawing the meniscus into the orifice. The surface tension in the deformation of the meniscus produces the suction to draw in fresh ink to refill the chamber.

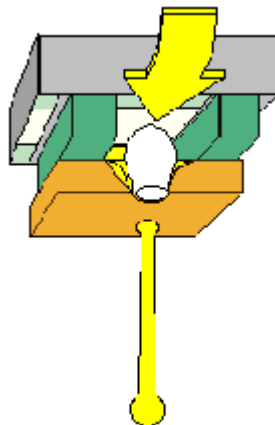

Meniscus settles to complete refill.

This process repeats up to 12,000 times a second and creates residual heat in the resistor. A layer of silicon is placed above the resistor to cool it by conducting away the residual heat.

Paper Paths and Components

Chassis

The chassis structure consists of two high strength polymeric supports held together by two sheet metal tie bars (see figure below). The two tie bars are placed a distance apart to yield a high moment of inertia. This results in a structure of high rigidity in torsion and bending. Besides structural purposes, the lower tie bar is used to mount the paper trough and the higher tie bar to hold the upper paper guides.

An open structure like this can accommodate flexibility in designing for removable trough from the back. Moreover, the modularity allows ease of assembly at the top level; the carriage system is mounted at the top and the dual bin is mounted at the bottom on the two supports.

The primary datum of the system is on the supports, thus minimizing the tolerance stack-up on critical subsystems like the drive, input and carriage. Polymeric material of the supports allows flexibility in complex designs to support these subsystems.

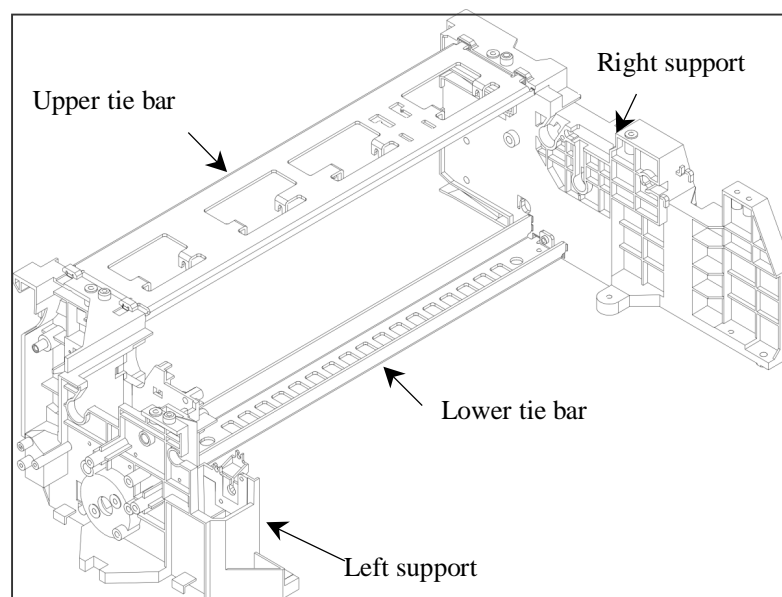

Chassis Structure

Paper Paths and Components

Output Management

Output Mechanism Schematic

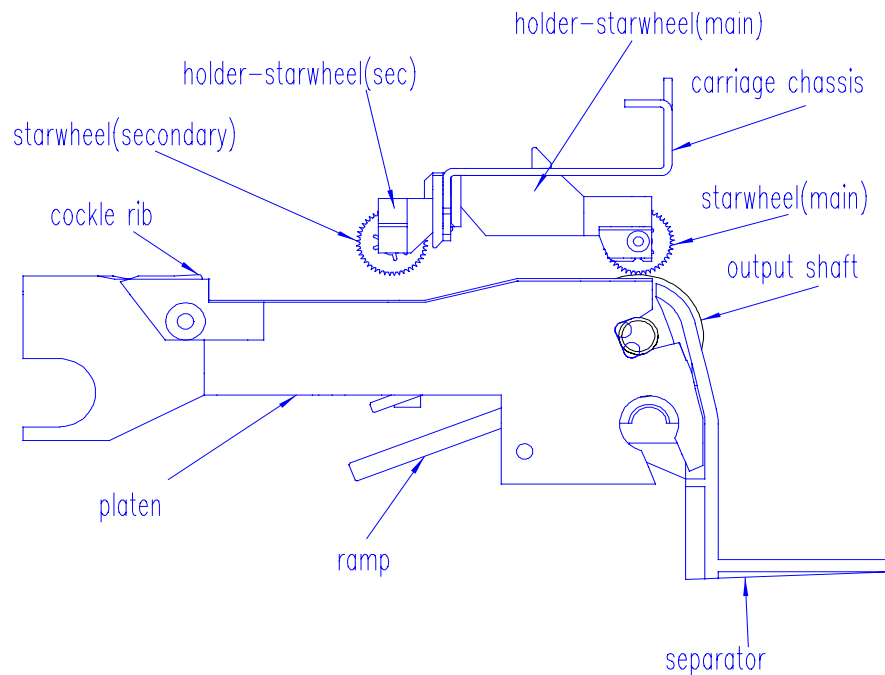

Star-wheels

There are two rows of star-wheels, main and secondary. The main row contains ten sets of active starwheels (each set consists of 2 starwheels) and two passive starwheels . Active starwheels are preloaded by starwheel springs and are driven by output roller. The linear speed of starwheels is 2 % greater than that of drive roller thus creating paper stiffness to maintain the critical parameter *pps* distance. Also, once the media leaves the outpinch rollers, these starwheels become the only driving force to eject the media to the output tray. Two passive starwheels (not shown in figure) are provided to control A/A4 media shape such a way that the bow shape created by ramp does not propagate into the print zone. There are four sets of secondary starwheels in between the main row starwheels and cockle ribs. Locating the outer profile of these starwheels at the tangential line connecting the main row active starwheels and cockle rib tip make sure that media is not lifted above the tangential line and also the media does not touch the chassis once it leaves outpinch roller after printing.

Paper Paths and Components

Star-wheel Spring

It is a coil spring type loaded transversely. The objective is that the spring force is high enough to eject all the media supported and is low enough not to produce any star-wheel track marks or minimum marks within the acceptable level.

Spring force (@ span 14.2 mm and deflection 1.5 mm) : 19 gm

Deflection in assembled condition : 1.5 mm

Allows additional deflection to accommodate paper thickness and other unusual operation (example: paper jam removal) : 1.2 mm

Output Mechanism

Output Ramps

Four sets of ramps are used to support different media from Post Cards to Super B-size media during printing. This creates a bow-shape especially for media sizes B5,A, Letter, Legal by stressing the media thereby increasing the drying time to avoid smearing on the previous printed media.

Ramp Profile

The ramp has a slope in two stages with respect to horizontal or paper axis to increase the resistance gradually.

1st stage angle :21°

2nd stage angle :30°

Ramp also has slope in front direction which helps media to form bow-shape. Ramp edges have been curved to reduce friction with mating platen surface.

Paper Paths and Components

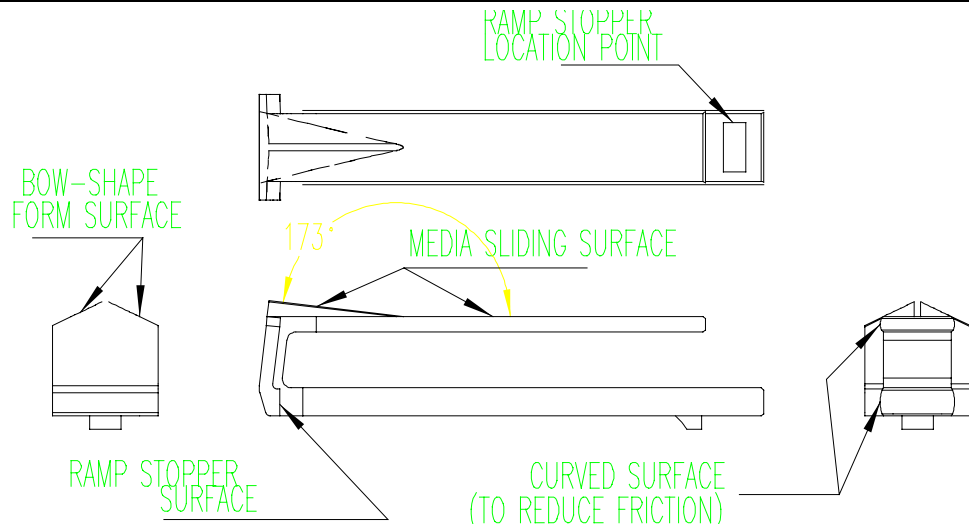

RAMP - SHAPE

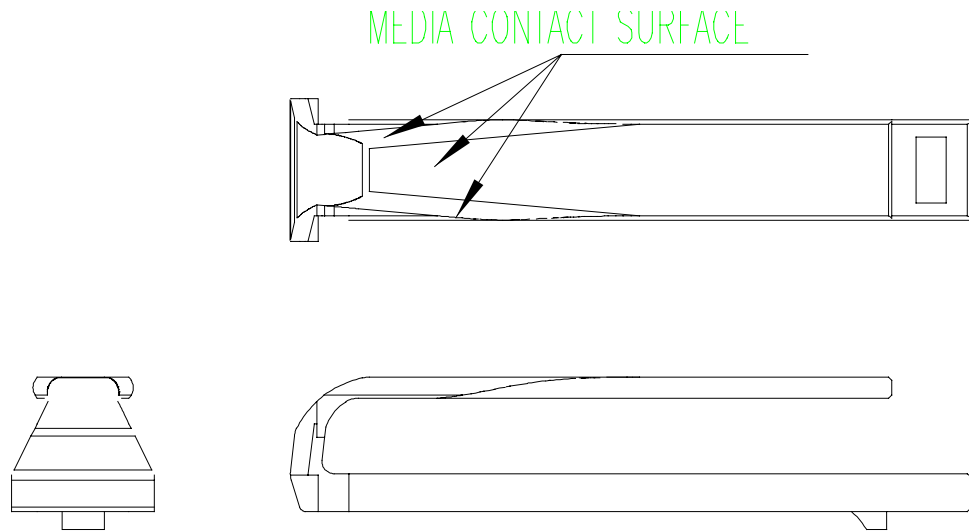

RAMP CURVED

To effectively hold the B size media for a longer distance, the ramp at the second position (Ramp2) is curved in such a way that A size media holding is not affected but at the same time B size media will rest directly on Ramp1 and Ramp3 to create an effective bow shape.

Paper Paths and Components

Ramp Drive

Ramps are driven by Stepper motor (Bi-polar) through gear train. Each ramp has rack tooth profile and individual pinion fitted in a shaft engages with rack tooth. The ramps can be moved in both directions (extended and withdrawn). Ramps are stopped in both directions mechanically by Platen surfaces. In the forward direction, ramps are stopped by stopper (snapped to it) hitting the Platen surface. In the reverse direction, projection in the ramp hits the Platen surface.

In reverse direction, projection in the ramp hits the Platen surface.

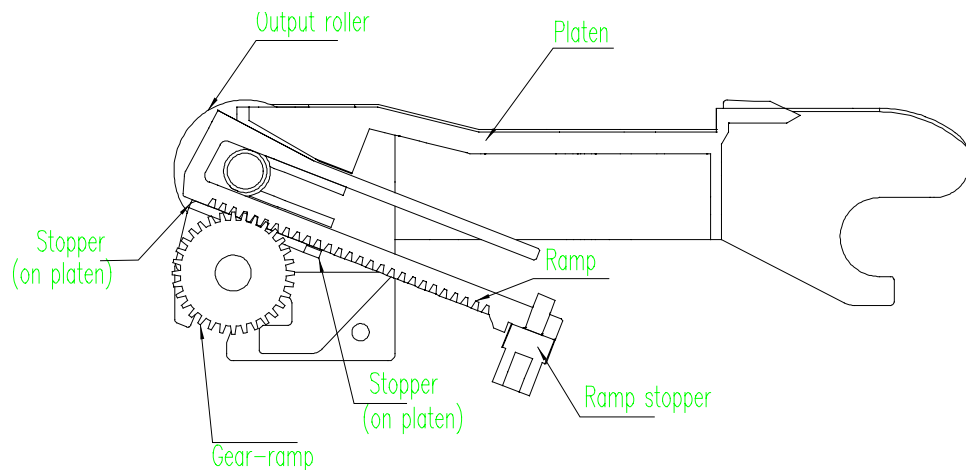

Ramp slipping mechanism

Slipping arrangement is provided for the ramps. During Printer initialization as well as during resetting after Elec. Power disruption we need to bring the ramps back to their home position (withdrawn condition) as we will not know their current position. To achieve this ramps have to be overrun but at the same time the drive to the ramps should be cut-off once they have reached their home position. Axially loaded compression spring provides frictional force (400gm) to the slip-gear which transmits motion from the drive shaft to the ramp-gear.

In case the resistance force from the ramps increases (due to stoppage) more than 400 gms, the spring compresses further and thereby slip-gear starts slipping.

Force required to stall/ hold the ramp for slipping : 175-275 gm
(measured on the face of the ramp i.e;
opposite to the direction of ramp movement)

Paper Paths and Components

Output Reverse Control

Primary bin media pick is initiated by reverse motion of LF motor for a specified (small) angle. As our output drive is connected directly to LF motor, star wheels tend to rotate in reverse direction. This pulls back the media which is to be ejected to the print zone which may cause jamming. (Note: Media ejection is done simultaneously along with Pick to increase throughput). Hence we need a mechanism which should be able to disengage output star wheel drive during the reversal of LF motor. This is taken care by introducing Rocking gear as a part of the output drive. Rock gear engages with its mating gear only when LF motor rotates in forward direction and disengages in reverse direction. Rock gear is mounted on the arm-rocker which is stopped in defined positions in both directions by Left-support wall. Arm-rocker disengagement angle is 20° .

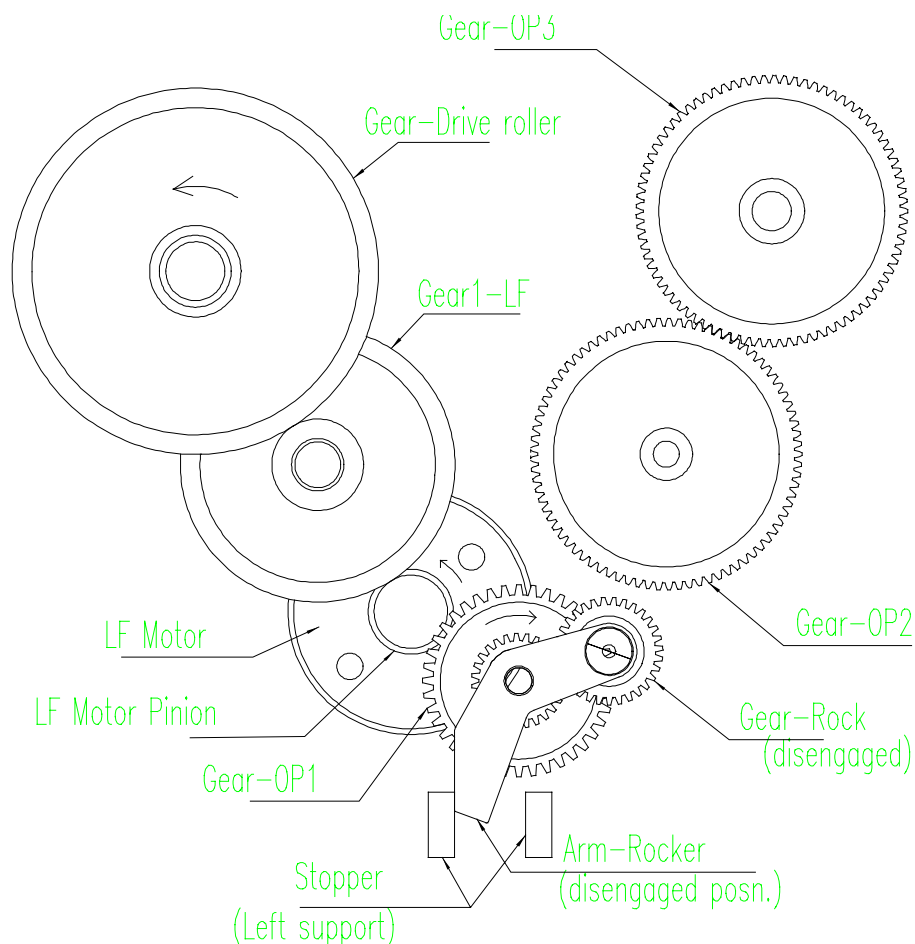

Paper Paths and Components

Output Transmission

Function	S/No	Gear Name	Number Of Teeth	
			Big	Small
Line feed Transmission	(1)	Gear-Drive roller	80	
	(2)	Gear 1-LF	60	20
	(3)	LF Motor Pinion	16	
Output Transmission	(4)	Gear-OP 1	40	27
	(5)	Gear-Rock	31	
	(6)	Gear-OP2	81	
	(7)	Gear-OP 3	81	

Diameter of drive roller = 38.808 mm

Diameter of output roller = 19.800mm

Gear ratio of Gear-OP3/LF Motor Pinion = $(40/16) * (81/27) = 7.5$

Gear ratio of Gear-Drive roller/LF Motor Pinion = $(60/16)*(80/20) = 15$

Gear ratio of Line feed/Output wrt. LF motor = $15/7.5$

Linear velocity of output roller/ Linear velocity of drive roller

= $(15/7.5) *(19.8/38.808) = 1.02$

Hence the linear velocity of output roller is 2% faster than drive roller.

Paper Paths and Components

Bypass Paper Feed

Output tray assembly together with separator offers bypass paper feed path. The media entering from the out tray member is further guided by separator. The entry angle with respect to pickup roller outer profile is 2.2 degrees.

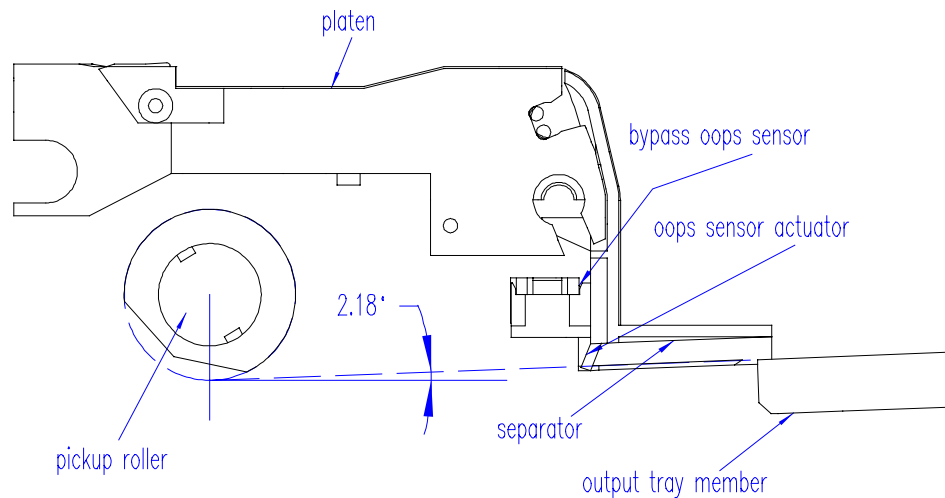

Oops sensor to detect the bypass entry is mounted at 45 degree with respect to paper path. The actuator lever is designed to rotate about 21.9 degrees for single sheet entry and about 53.8 degrees for full stack entry (The sensor is actuated by 10 degrees rotation of the actuator lever).

Paper Paths and Components

Output Tray Assembly

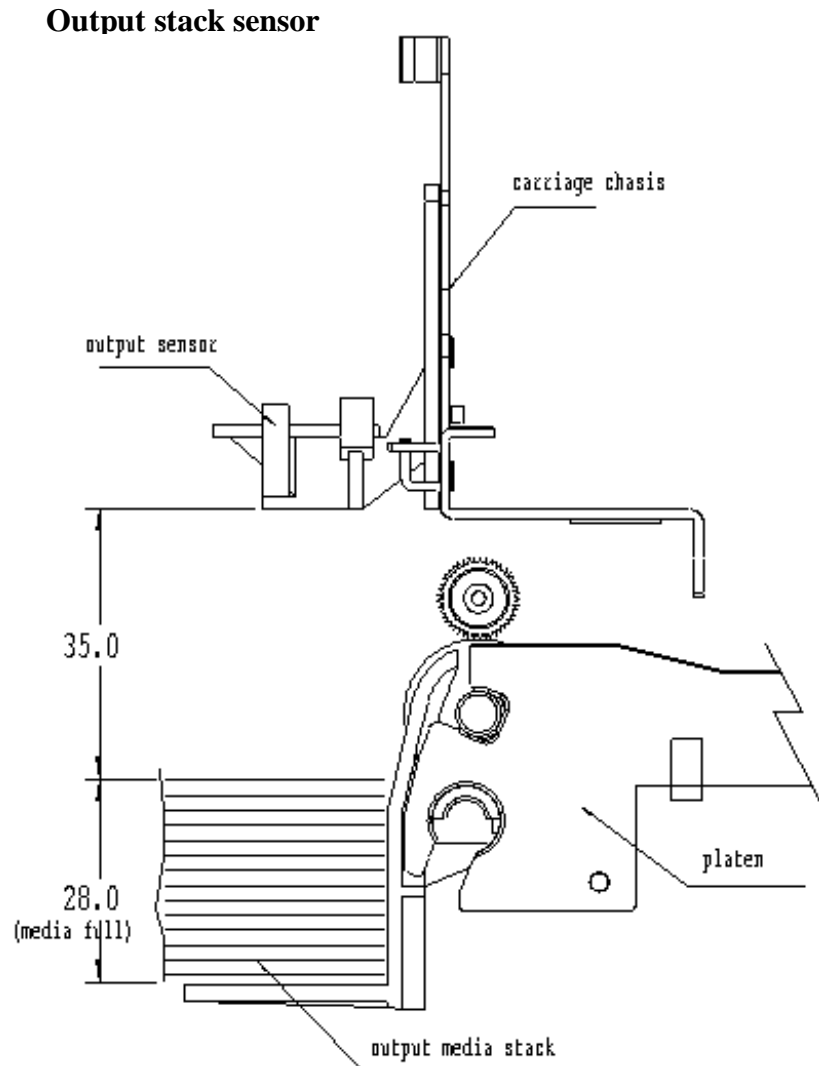

Output stack height has to be sensed to indicate the user that output tray is full so that user can clear the printed media. Moreover, if the output stack height reaches beyond certain limit (31mm from the separator base to the ramp front side bottom end) it may affect the ramp extension which in turn will disturb output media drying time / holding distance.

Paper Paths and Components

Output stack sensing is based on fixed field proximity sensing using two LEDs side by side. These LEDs have both light source emitters as well as receivers. In short, it is based on the concept of fixed distance sensing and ignoring any objects that lie beyond their sensing range regardless of object surface reflectivity e.g. plain paper vs. glossy paper. (But Transparencies will affect the sensing distance, they are detected earlier by 8mm) Sensor is mounted on the carriage wall directly on top of the BOF of media (which is approx. 10mm). As BOF is the non-printed area, this is used as the reflecting surface for the light so that the variation in colour/text content of the output media does not have any influence. Fixed field sensors compare the amount of reflected light that is seen by two differently aimed receiver optical elements. A target is recognised as long as the amount of light reaching receiver seen by one receiver is greater than other.

Distance of sensing(from the bottom of the sensor to paper full level) = 35mm

Paper Paths and Components

Linefeed Accuracy

A closed loop drive system was used to ensure good positional accuracy of the transmission system. This involved the use of a rotary encoder disc mounted on the drive roller shaft in conjunction with a three gears gear-train design. The mounting of the encoder disc directly on the drive shaft helps to eliminate gear and motor errors and at the same time offer direct feedback on the position of the drive roller shaft. However, errors due to encoder disc eccentricity, drive roller run-out and media-roller interface will still be present.

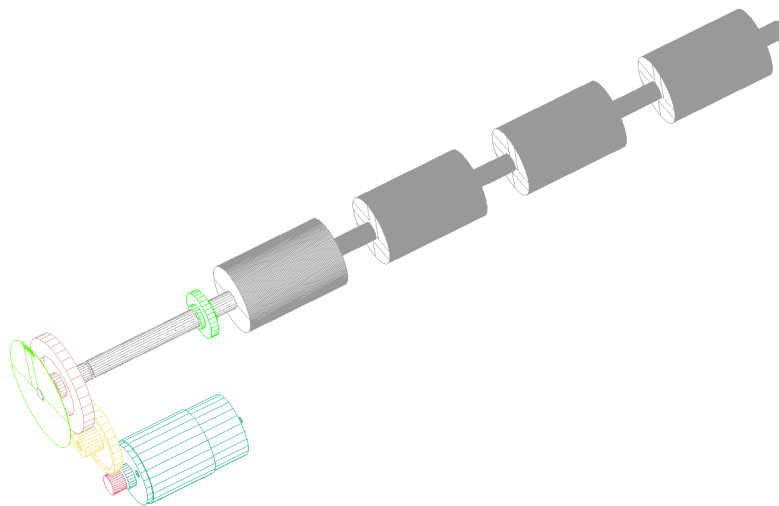

The encoder disc is a rotary disc made from Kodak LPF7 film. A total of 1440 counts were printed on the disc at an optical diameter of 58.2125 mm. The count to count spacing is 200 LPI. This spacing translate into a linear movement of 1/300 inch on the circumference of the $\text{Ø}38.808$ mm drive roller.

Paper Paths and Components

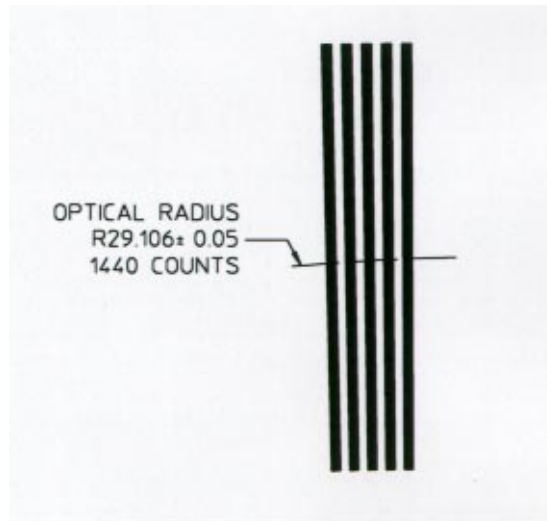

To achieve linefeed of less than 1/300 inch, the spacing between counts will have to be extrapolated with the help of the HP HEDS 9730 series incremental encoder module. With this combination, the smallest linefeed increment of 1/2400 inch will be possible.

Due to torque and throughput consideration, a gear ratio of 15 : 1 is used. This is achieved in two stages of 3.75 and 4. Spur gears with AGMA quality standard 10 were selected to ensure good accuracy and to help minimize servo-control problems. Also, pressure angle of 14.5° was used to reduce transmission noise.

Paper Paths and Components

Swivel PCA

Description

The intent to have a swivel PCA is to allow the trough of the printer to be removed in the event of paper jammed in the paper path of the printer which the user are not able to clear it from the front of the printer. This design will clear the back of the printer for the user to removed any media that are jammed inside the printer (For details on removable trough, refer to **Replacement of Paper Trough (Chapter 9)**)

The PCA will always be in the upright position, as shown in figure A . When there is a paper jam and need to remove the media from the back of the printer, then the user will need to unlock the locking lever and lower the PCA. The PCA will swing down 90° and lie flat as shown in figure B.

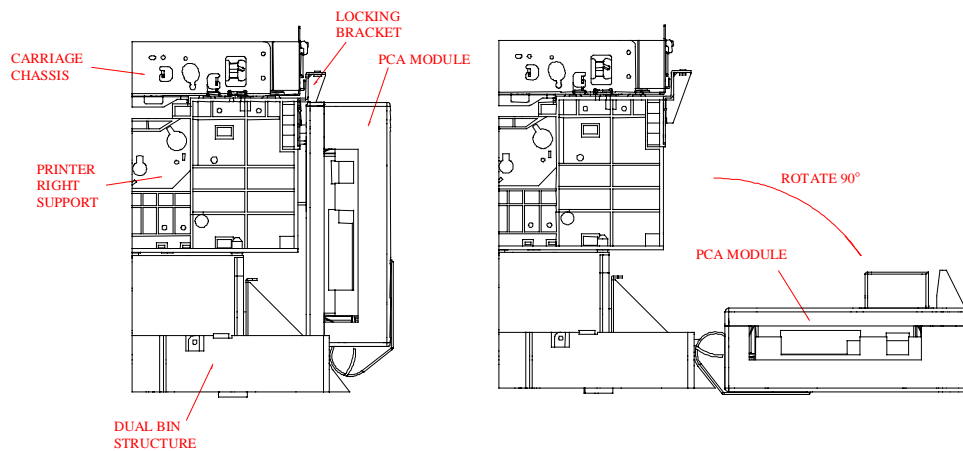

Figure A

Figure B

Paper Paths and Components

Modular PCA

The PCA is mounted on a metal ground plate and is cased up with plastic case as shown in figure C. This allowed it to ship separately from the printer itself and assemble at the DC. By doing this, the printer can be configured differently to suit the market demand by connecting the printer with different type of PCA module. The overall size of this module is 185mm x 470mm x 95mm. Brackets are provided on the printer to mount the PCA module. The module is fastened to the bracket with 4xM3 screws as shown in figure D.

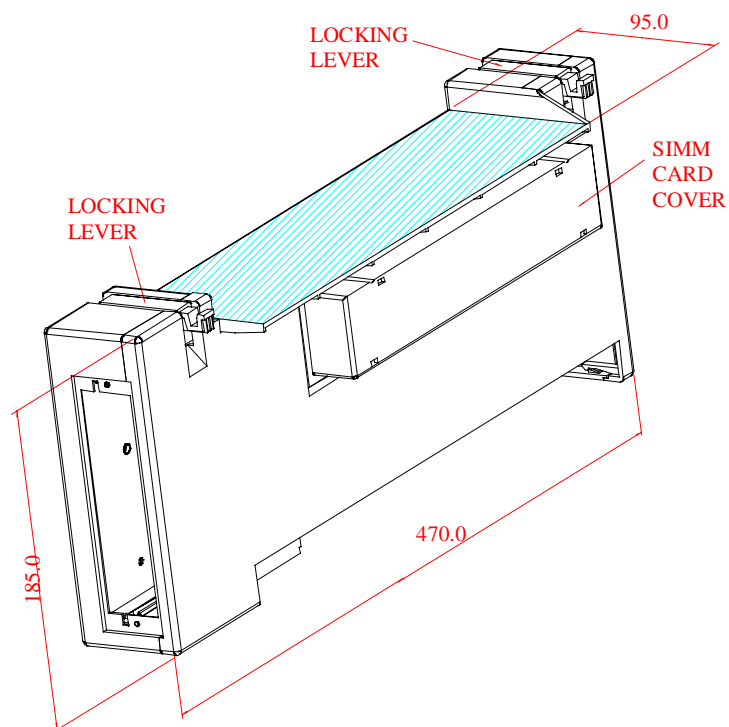

Figure C

Paper Paths and Components

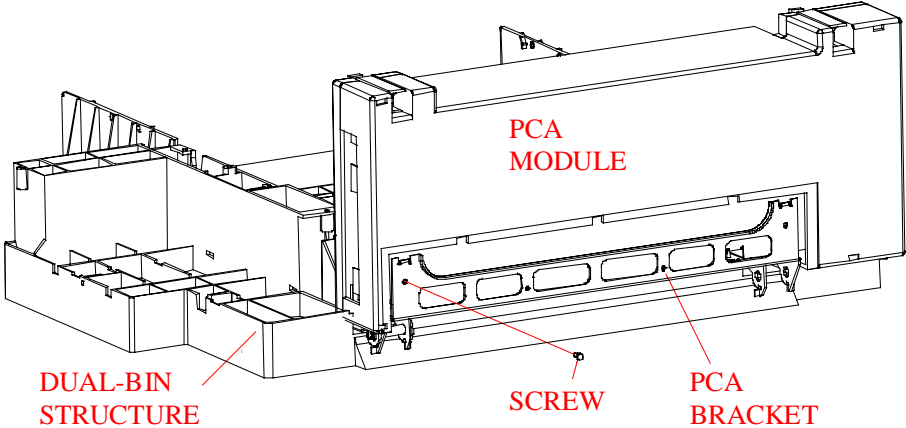

Figure D

Paper Paths and Components

Dual Bin Pick And Feed Mechanism

Pick And Feed Schematic

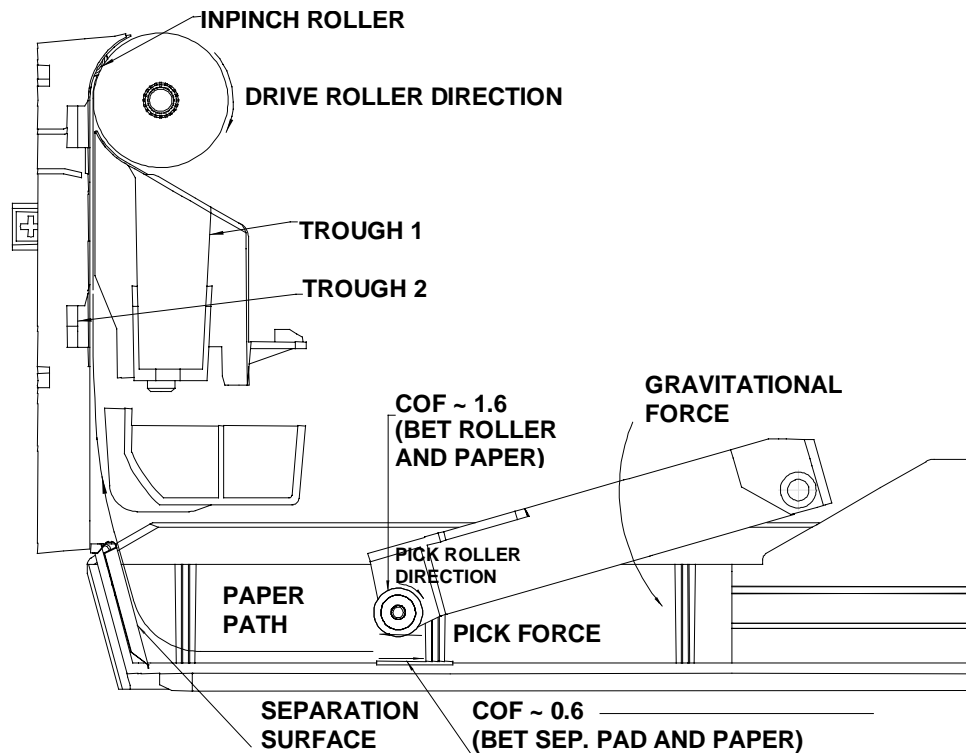

Figure E

The Dual Bin Pick And Feed

The pick roller is mounted to a pivot arm such that when the paper tray is pushed into its position, the pick roller and the pivot arm will fall on the paper surface, as shown in Figure E. A DC motor is used to supply power to provide the pick force (μN , $N=mg$) to drive the top media sheet(s) against the separation surface in front of the tray. The angle of the separation surface with respect to the horizontal is in such that it ensures only one sheet of media is fed through. The media is fed continuously until it reaches the set of pinch rollers at the drive roller, before the drive roller takes over the driving force.

Paper Paths and Components

Dual Bin Skew Correction Method

The TOF skew for media from dual bin is bettered by the dual bin skew correction to its required specifications. The media from the dual bin tray is fed by the dual bin pick roller until it hits the first roll of in-pinch rollers, which is stationary at that moment. The over feeding of the media will cause the media top edge to align perpendicularly to the pinch rollers and corrects itself. The drive roller takes over the drive the media into the print zone.

Paper Paths and Components

Dual Bin Structure

Schematic

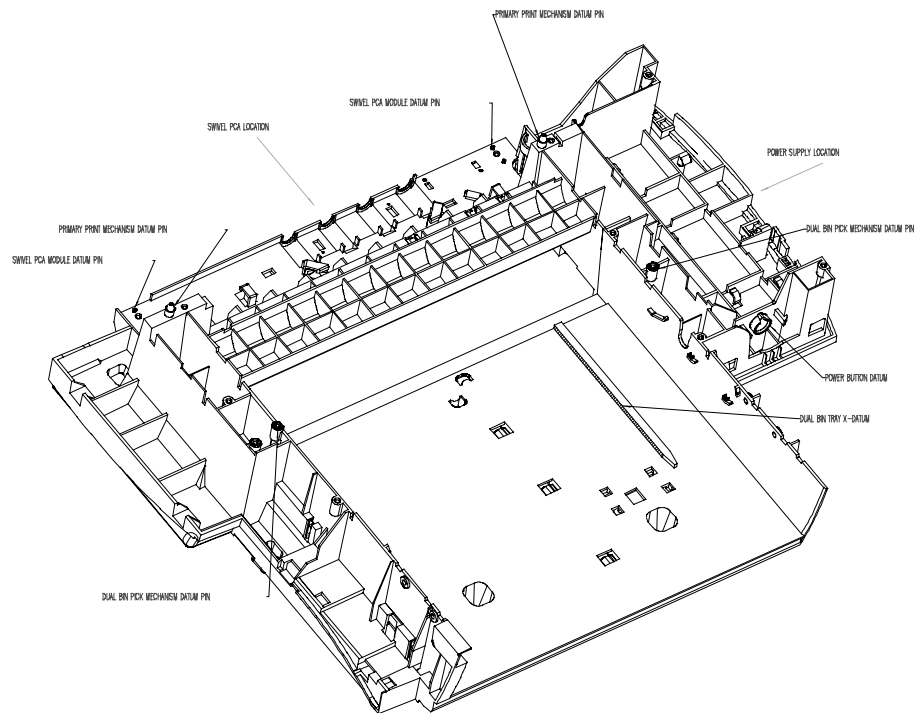

The dual bin structure is molded in one piece to reduce feature to feature tolerance stack up. It supports the whole weight of the primary paper path mechanism and writing system from the top, provide mounting for the swivel PCA from the back, encapsulates the 100V power supply on the right, and provides sliding surface and datum surface for the dual bin tray at the middle. The x-y datum for the primary print mechanism on top is provided by two datum pins at the structure and its z datum is given by the height of the dual bin structure. The dual bin structure also provides datum pins for the swivel PCA and the power supply. There are two bias springs which pushes the dual bin tray to the right against the datum rail. This will determine the right margin for the media printed. Two screw bosses which provides mounting location for the primary print units also serve as the datum pins for the dual bin pick and feed mechanism, the dual bin pivot arm module, which is mounted underneath the sheet metal dual bin beam top. The material requirement for the dual bin structure has to meet grade V5 (Noryl) or better as it encapsulates the high voltage power supply module.

Electronics

PCA Overview

The following is a block diagram of the PCA electronics:

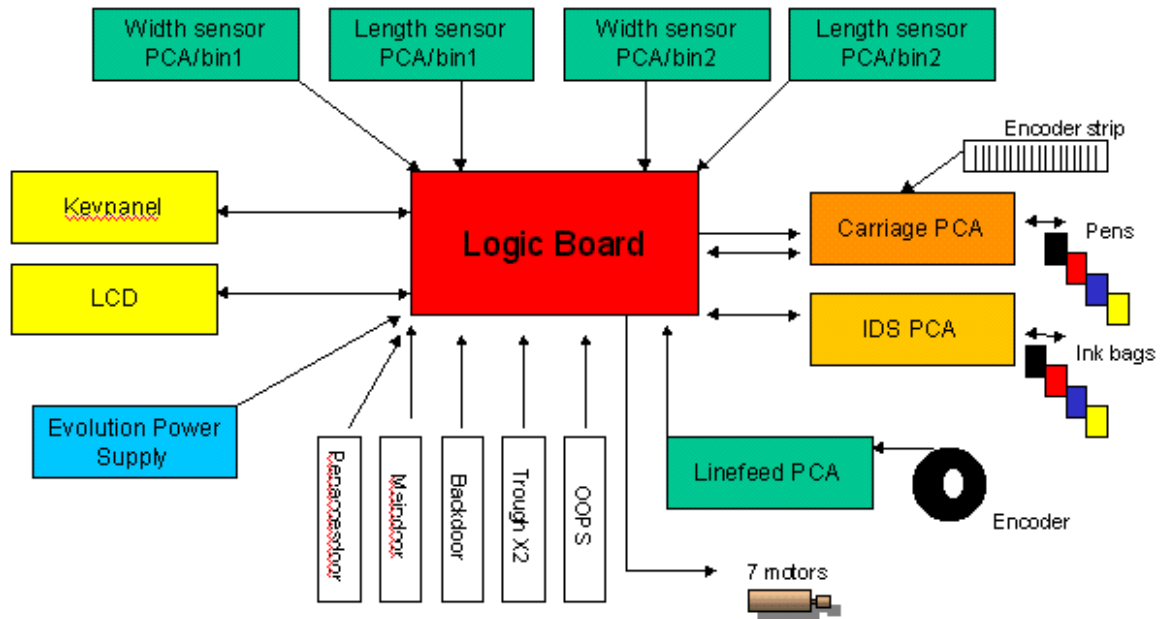

Electronics

Motor Control Overview

There are four main motors in the printer : the Carriage Motor, the IDS Motor, the Line Feed motor and the Dual Bin motor. Additionally, there are two Service Station Motors and one Output Ramp Motor. The following diagram shows the control hierarchy of the motors in the Printer:

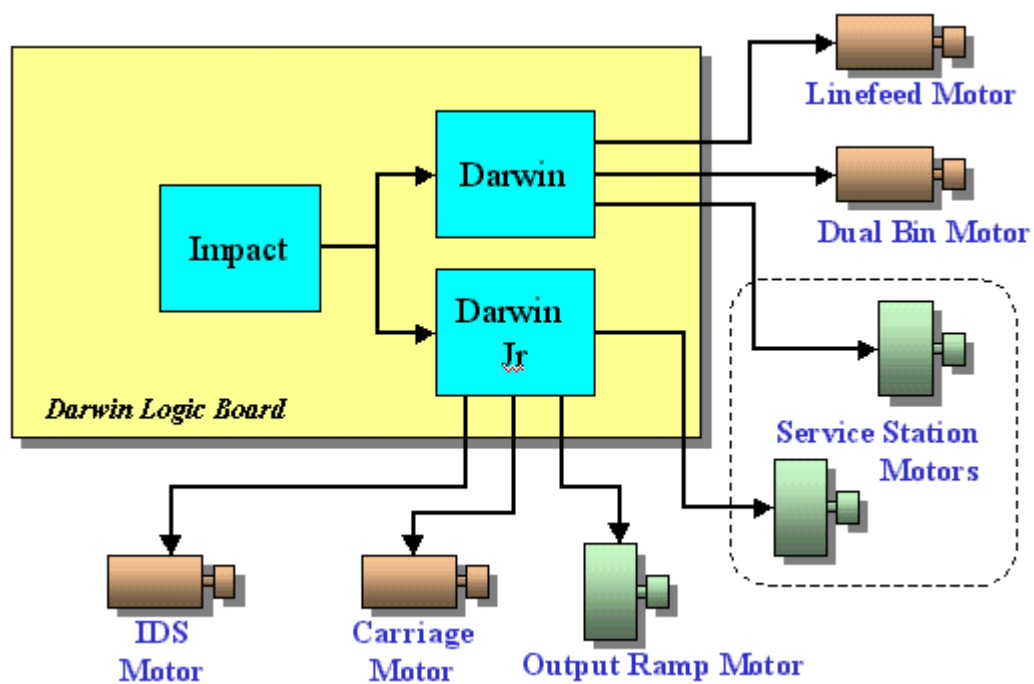

Firmware

Firmware is the collective medium comprising of the computer, the printer mechanism and the key panel that enables all three components to communicate and interact. The printer by itself does not independent capability to process printing data (such as print mode and byte stream), obtaining this data from the software-driven printer driver.

The printer is thus dependent on the host for the processing and sending of job data. The Printer, however, supports full duplex (bi-directional) printing and is able to give extensive feedback on print status to the host computer.

This is an overview of the firmware, summarizing the flow of data:

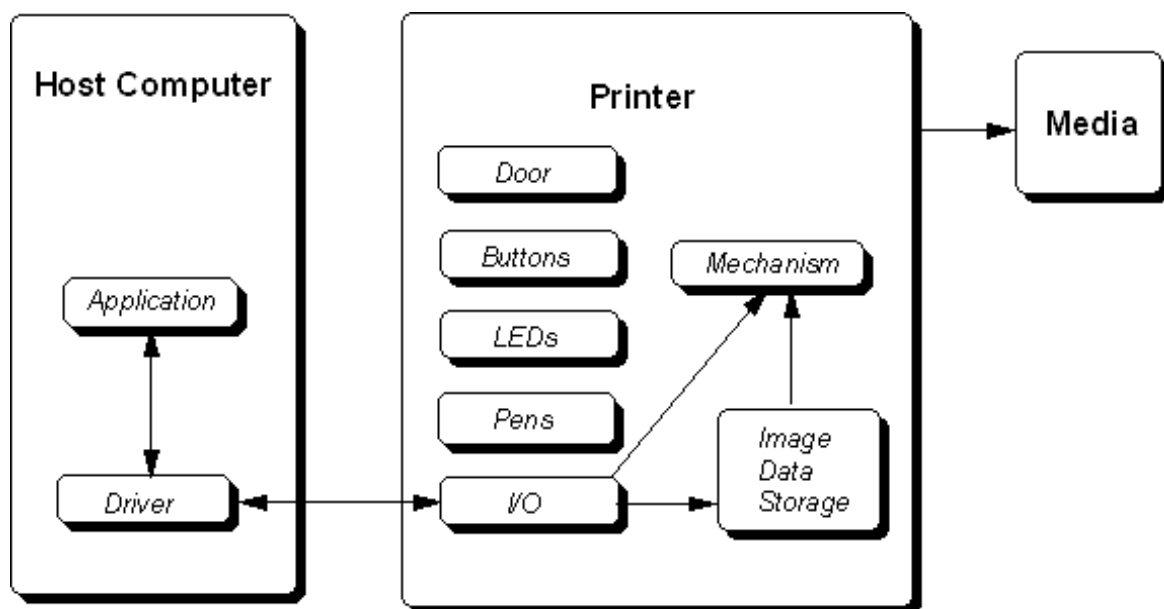

(firmware data flow diagram)

The firmware operates on three layers: the physical layer, the data link layer and the application layer.

Firmware

Physical Layer

On the physical layer, the firmware performs the following functions :

- It supports IEEE 1284 (bi-directional) compatibility in Forward mode.
- It is able to return extended status reports to the host computer in Nibble mode.
- It identifies the Device ID.
- It negotiates between various modes.

Data Link Layer

On the data link layer, the firmware will perform :

- Support channeling of commands, pacing, status, device ID and print data to their respective destination devices.
- Perform limited frame checking and recovery.

Application Layer

On the application layer, the firmware's function is to :

- Control the printing, media and pen.
- Configure communication status.
- Provide synchronized or asynchronous status reports.
- Perform limited print mechanism error recovery.
- Perform low-level device commands (e.g. change ID).

Firmware

Interface with mechanism

The following diagram shows the interface between the firmware and the hardware :

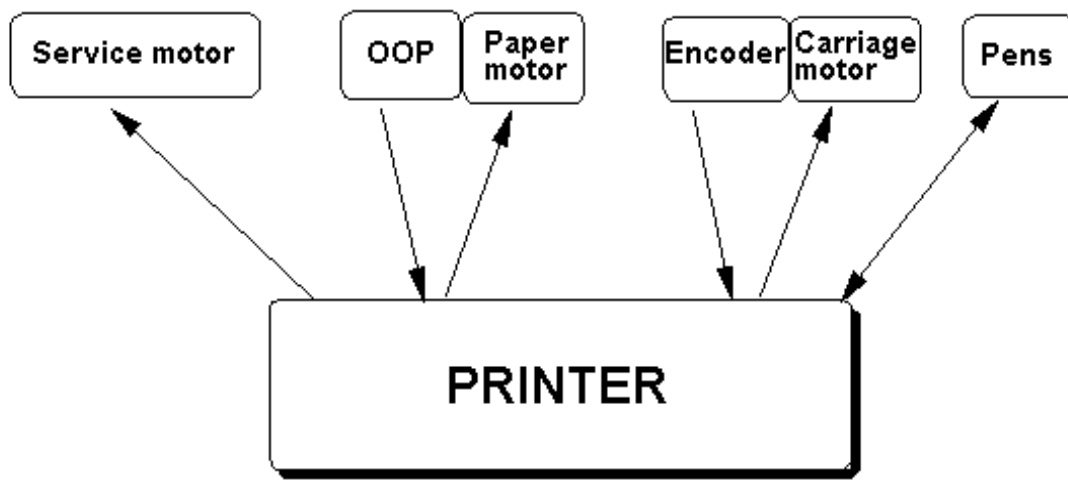

(hardware-firmware interface diagram)

- Paper Motor control is an open-looped control. The firmware does not know the exact position or the size of the paper and relies on the OOPs flag to confirm the presence of paper.
- Service Station control is also an open-looped control. There is no feedback to the firmware from the Service Station.
- Carriage Control is a closed-loop control. The Carriage PCA is enabled by the encoder strip to read and send data back to the firmware.
- Pen information is also controlled by a closed loop. The firmware is therefore able to receives printing data such as pen firing parameters, pen ID and pen temperature from the active pen.

Firmware

Interface with Key Panel

The Key Panel consists of 3 buttons and 2 LEDs. The buttons allows you to perform some rudimentary interactions with the firmware. The indication of the LEDs allows you to troubleshoot any printer problems. (See **Indicator Lights (Chapter 2)** for more information on the LEDs).

The firmware is running if there is AC power supply to the printer even if the printer LEDs are off. The LEDs will light up when data is sent to the printer or when the Power button is pressed.

Chapter 7 Removal and Replacement of Parts (without Calibration)

This chapter describes how the printer can be disassembled for repair and maintenance. This section covers the removal of parts that can be reassembled without calibration. To reassemble the printer, reverse the order of the procedure. Where required, additional explanation will also be provided for any special adjustments or procedure steps (such as instances where reassembly differs from disassembly).

You should also take note that it may not be necessary to disassemble the printer to service certain components.

Removal and Replacement Tools

To disassemble the printer, you will need the following tools :

1. A TORX[®] screwdriver with T-10 and T-20 screw bits.
2. Needle nose pliers.
3. Straight tweezers.
4. A flat-blade screw driver (Philips no.1 or flathead no.5).
5. Instruction manual.

It is strongly recommended that proper tools (including screws) be used for the job.

Before You Begin

Check the following before you begin disassembly :

1. The printer is turned off and the power cable has been disconnected from the socket.
2. Paper has been removed from the tray.
3. Ink cartridges and pens are removed from the printer.

Caution

- Your body may discharge static current which may damage the fragile PCAs. Before disassembly please ensure that the proper precautions to prevent damage by electrostatic discharge (ESD) to ESD-sensitive printer components have been taken with ESD heel or wrist straps. Ensure also that the work area is similarly free of static current.
- When disassembling the printer, ensure that the capacitors are fully discharged before you handle power supply components. As a precaution, switch off the printer before disconnecting it from the power socket, and wait five seconds before commencing disassembly.

Important Notes about Printer Components and Disassembly

The printer has been built to a modular architecture which uses one-way snap-fit technology – that is, parts are designed so that they will only fit with each other in one direction. Please exercise care and apply only the force required to remove each component, as excessive force could damage the parts.

When reassembling the printer, remember to use the correct screw type when putting the components together.

Replacement of Parts

Replacement of PCA

You will be removing the PCA from the printer and installing a new PCA.

Removing the PCA

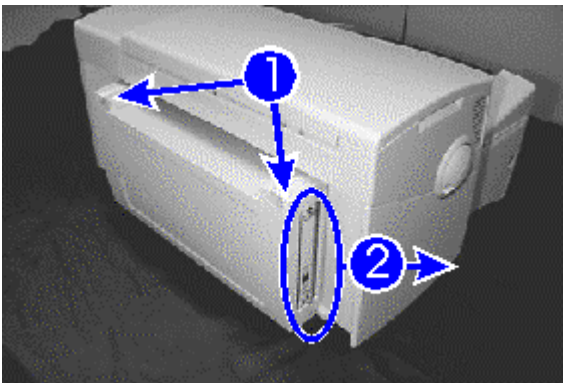

Step 1. Lift the two latches on both the right top and left top corners of the rear access door to unlatch it.

Step 2. If you have any peripheral accessory (e.g. MIO network card), remove it by loosening the two screws on the card and slide it out from the right side of the rear access door. Set the card aside.

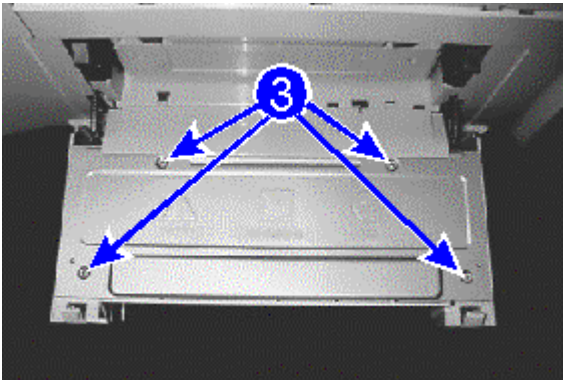

Step 3. Unscrew the four screws on the metal PCA cover and set them aside. Remove the PCA cover.

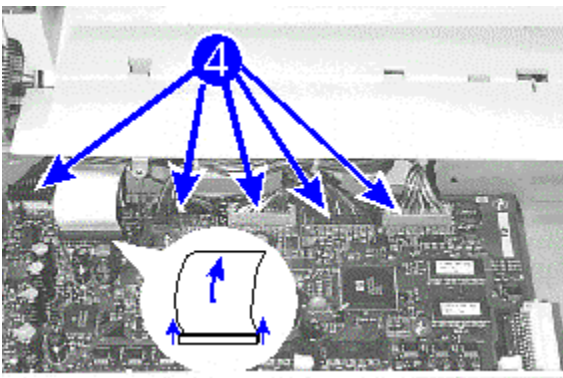

Step 4. Unplug all connectors (two in black and two in grey) and the power connector (blue) from the main PCA.

Step 5. Carefully remove the two flex cables from the main PCA by lifting the black plastic fastener at both ends and sliding the flex out.

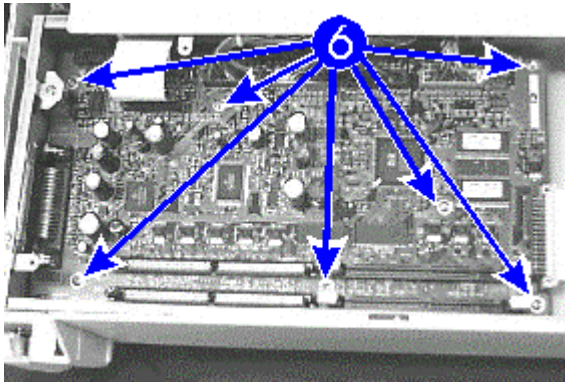

Step 6. Remove all the seven screws securing the PCA to the chassis.

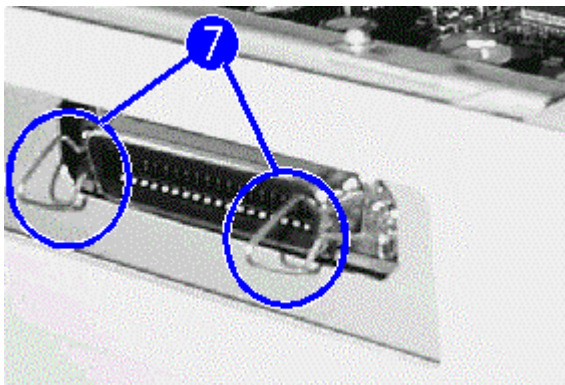

Step 7. Check that the clips on the parallel port cable plug do not impede the PCA removal ; position them to stand straight out from the plug. Make sure that all cables and connectors are moved out of the way. Remove the PCA.

Replacement of Parts

Installing the PCA

- Step 1. Attach the new PCA board, ensuring that the clips on the parallel port cable plug and the various connector cables do not cause any obstruction.
- Step 2. Replace the seven screws back to secure the PCA to the chassis.
- Step 3. Reattach the flex connectors carefully, gently pushing both ends of the black plastic fastener till they are seated firmly in the slots. Also reattach the power connector and the four connectors, ensuring that the black connectors are connected to the black slots, and the grey connectors to the grey slots respectively.
- Step 4. Place the metal PCA cover over the PCA card and ensure that the screw holes are aligned properly. Replace the four screws to fasten the cover plate to the rear access door.
- Step 5. If you have any peripheral accessory (e.g. MIO network card), reconnect it by sliding it in on the right side of the rear access door and tightening the two screws on the card to attach it firmly.
- Step 6. Close the rear access door. Plug in the power cord and turn on the printer.

Replacement of Parts

Replacement of Service Station

You will be removing the Service Station from the printer and installing a new Service Station.

Removing the Service Station

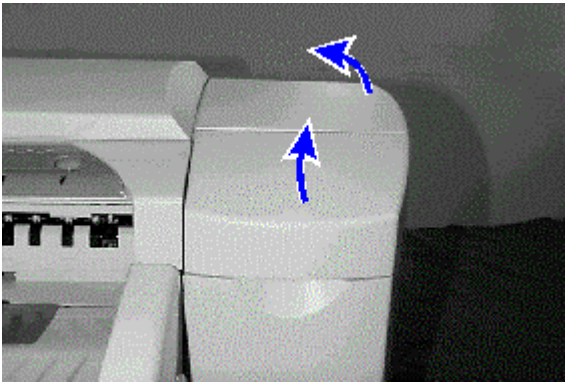

Step 1. Remove the printhead access cover by opening the ink cartridge door and tilting the access cover to the side.

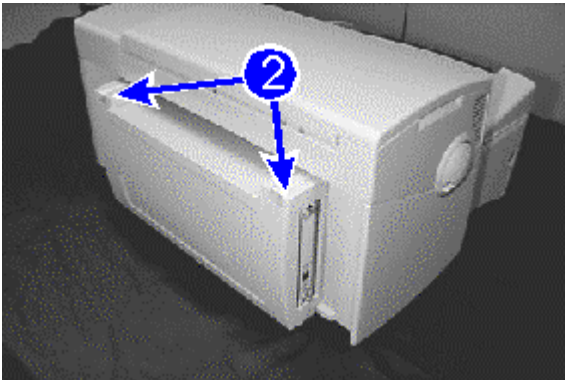

Step 2. Lift the two latches on both the right top and left top corners of the rear access door to unlatch it.

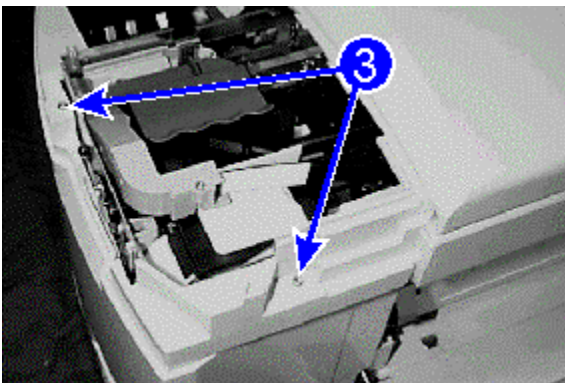

Step 3. Remove the service station side cover by unscrewing the two screws securing it and lifting it up.

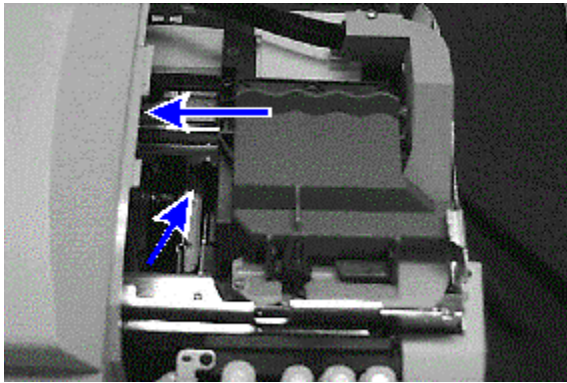

Step 4. Slide the ink carriage mechanism along the carriage rod to the left under the top cover. This will expose three screws, previously concealed under the ink carriage mechanism, that secure the service station.

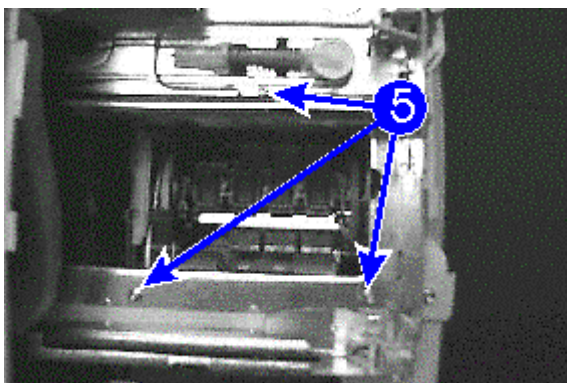

Step 5. Unscrew the three screws in the order shown on the chassis.

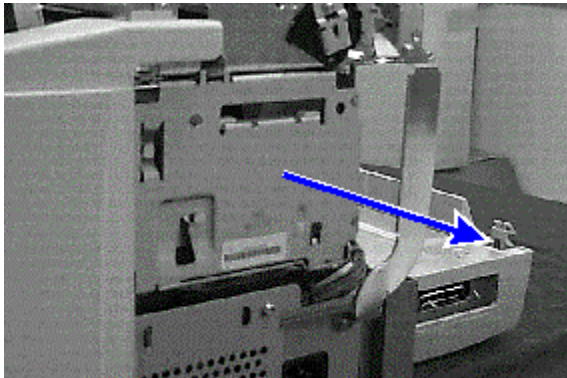

Step 6. Remove the service station by sliding it out. Be careful of connecting cables when removing the service station.

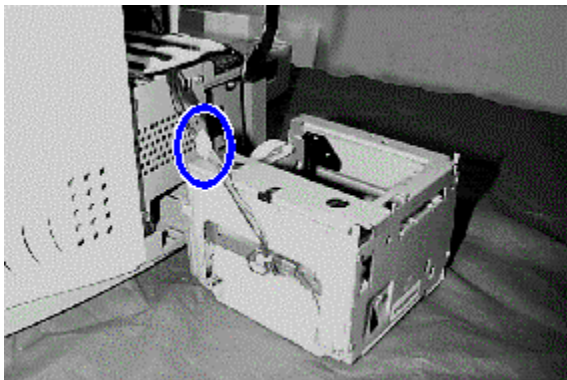

Step 7. Disconnect the service station connector.

Replacement of Parts

Installing the Service Station

- Step 1. Gently slide the new service station into the printer until the screw holes are aligned.
- Step 2. Reconnect the service station connector. Ensure that it is properly plugged in.
- Step 3. Replace the three screws at the top of the service station in order (that is, replace number one, followed by two and then three).
- Step 4. Put back the service station side cover.
- Step 5. Replace the two screws for the service station side cover.
- Step 6. Close the rear access door.
- Step 7. Place the printhead access door by fitting the left tab under the top cover.
- Step 8. Plug in the power cord and turn on the printer.

Note

To ensure that the alignment of the Service Station with the Printheads is correct, replace the Service Station screws in the correct order when installing the Service Station.

Replacement of Parts

Replacement of LED PCA

You will be removing the LED PCA from the printer and installing a new LED PCA.

Removing the LED Panel

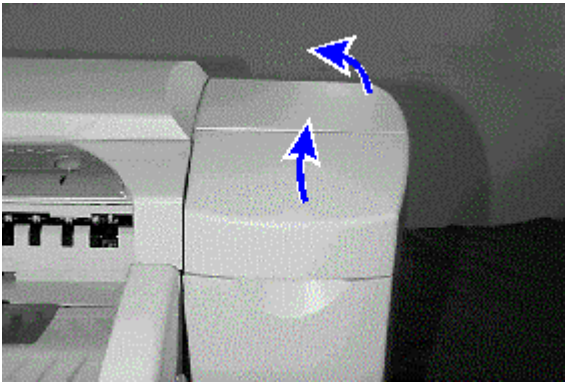

Step 1. Remove the printhead access cover by opening the ink cartridge door and tilting the access cover to the side.

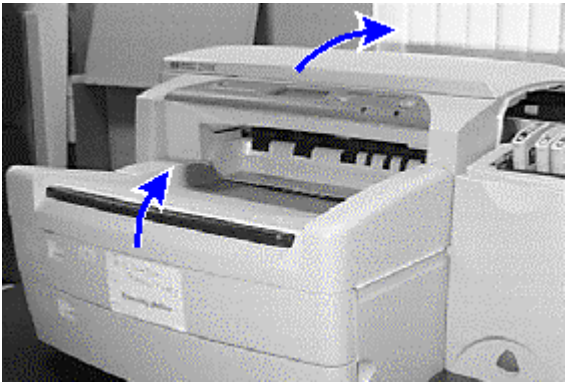

Step 2. Remove the output tray (Tray 1).

Step 3. Open the top cover of the printer.

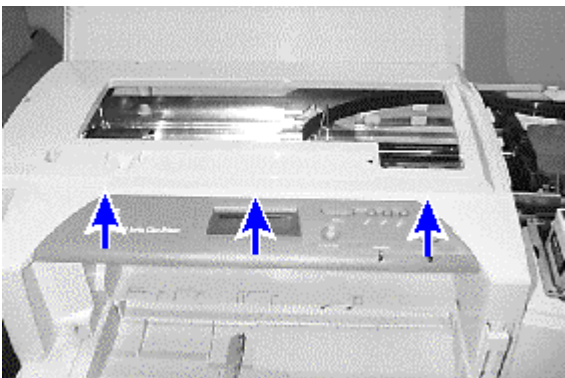

Step 4. Remove the LCD cover by unsnapping three catches, pushing it upward from the left side first, then the right. Set the cover aside.

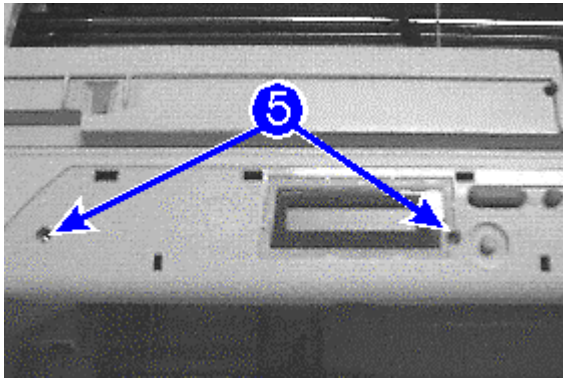

Step 5. Remove the two screws on the chassis and set them aside.

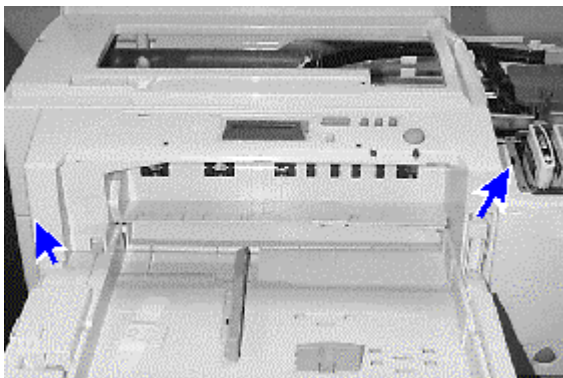

Step 6. Release the latches from left first, then the right. Unlatch the one on the right with a screw driver. Set the panel aside.

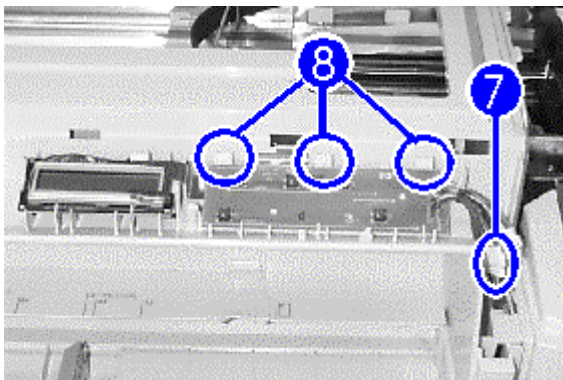

Step 7. Locate and disconnect the LED PCA connectors.

Step 8. Remove the LED PCA by pushing back on the hooks securing it and lifting it up.

Replacement of Parts

Installing the LED PCA

Step 1. Install the new LED PCA by fitting it in from the bottom first before pushing it down till it snaps into place. Ensure that the plastic holders secure the LED panel properly.

Step 2. Reconnect the LED PCA connector.

Caution!

Please note that the colors of the LCD connector wiring are different from that of the LED connector wiring. When attaching both connectors, check that the sequences of the colors of the connectors correspond on both ends.

Step 3. Reinstall the key panel by latching the four rear hinges to the chassis first.

Step 4. Snap the panel into the latches from the right side first towards the left side.

Step 5. Replace the two screws at the top of the panel.

Step 6. Reinstall the LCD cover by fitting in the hinges at the back first before pushing it down from the right first, then the left.

Step 7. Close the top cover of the printer.

Step 8. Reinstall the output tray (Tray 1) into place.

Step 9. Reinstall the printhead access door.

Step 10. Plug in the power cord and turn on the printer.

Replacement of Parts

Replacement of LCD Assembly

You will be removing the LCD assembly from the printer and installing a new LCD assembly.

Removing the LCD Assembly

Step 1. Remove the **LED PCA** (refer to the procedure in **Replacement of LED PCA**).

Step 2. Remove the LCD harness by removing one screw (as indicated in callout **2**) and lifting it up from the LCD.

Step 3. Remove the LCD by unlatching its wiring from under the plastic hooks and unsnapping the LCD from under the plastic holders.

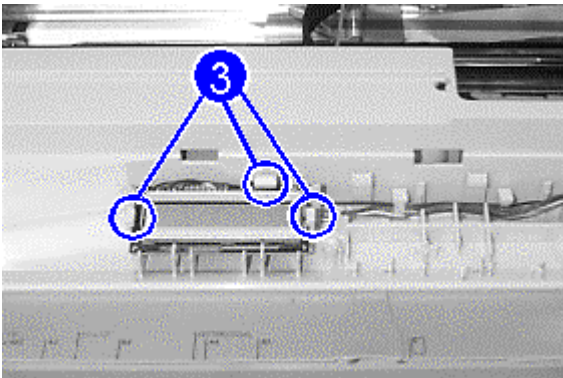
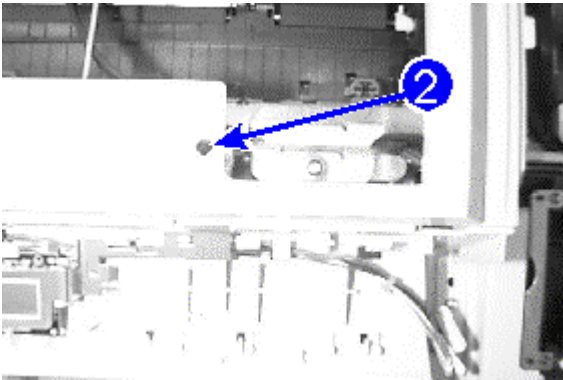

Replacement of Parts

Installing the LCD Panel

- Step 1. Install the new LCD panel by fitting it in from the bottom first before pushing it down till it snaps into place. Make sure the plastic holders secure the LCD panel properly.
- Step 2. Latch the wiring back in the plastic hooks neatly.
- Step 3. Reinstall the LCD harness and replace the screw securing it.
- Step 4. Reconnect both the LCD and LED connectors. Make sure the connectors are correctly secured.

Caution!

Please note that the colors of the wiring of the LCD connector are different from that of the LED connector. When connecting, please check that the sequences of the colors of the connectors match on both ends.

- Step 5. Replace the remaining components for the LED PCA (refer to the procedures in **Installing the LED PCA** from **Replacement of LED PCA**).

Replacement of Parts

Replacement of Power Knob

You will be removing the power knob from the printer and installing a new power knob.

Removing the Power Knob

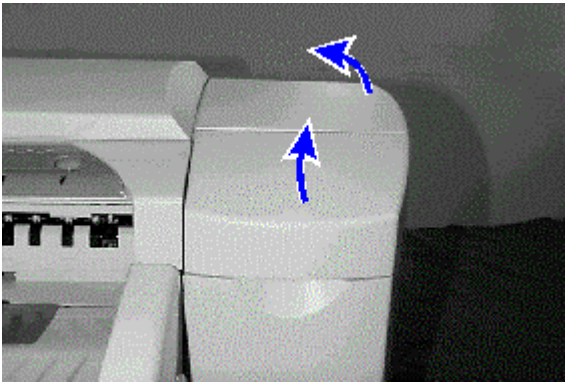

Step 1. Remove the printhead access cover by opening the ink cartridge door and tilting the access cover to the side.

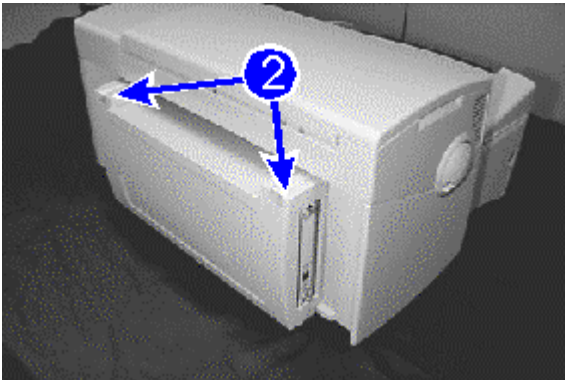

Step 2. Lift the two latches on both the right top and left top corners of the rear access door to unlatch it.

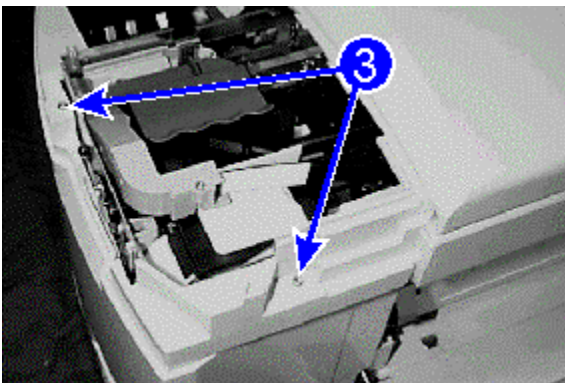

Step 3. Remove the service station side cover by unscrewing the two screws securing it and lifting it up. Set the screws and cover aside.

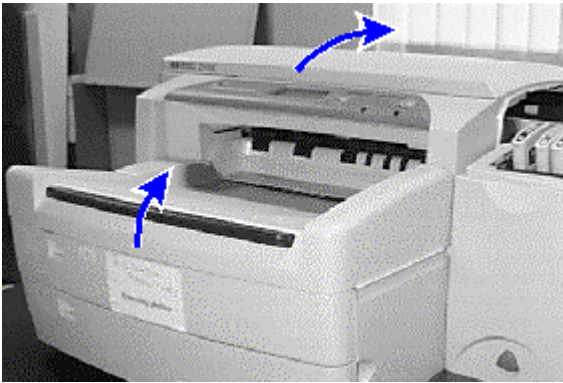

Step 4. Remove the output tray (Tray 1) by lifting it up. Set it aside.

Step 5. Open the top cover of the printer.

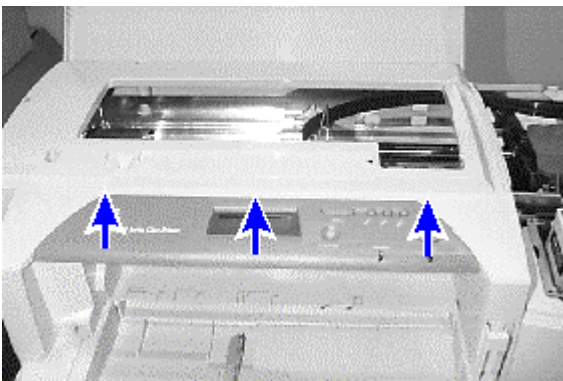

Step 6. Remove the LCD cover by unsnapping it with your thumbs pushing it upward from the left side first, then the right (facing the printer). Set the cover aside.

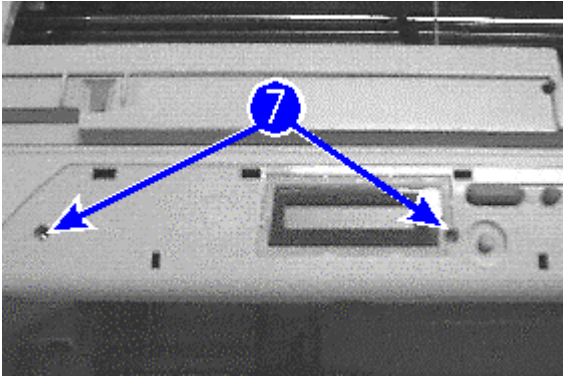

Step 7. Unscrew the two screws and set them aside.

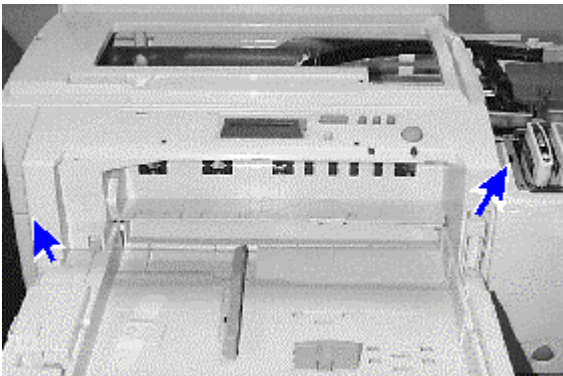

Step 8. Unhook the latches from left first, then the right. Unlatch the one on the right with the help of a screw driver if necessary. Be careful not to break the latches. Set the panel aside.

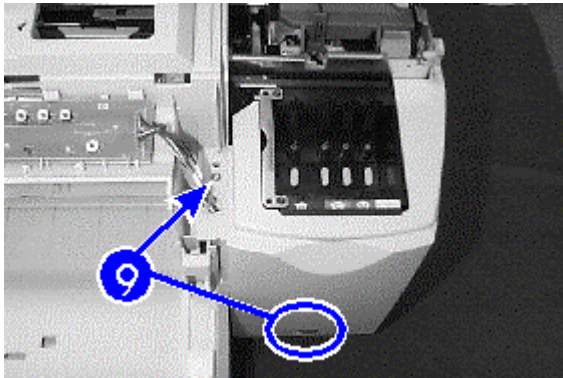

Step 9. Remove the ink supply station cover by unscrewing the screw near LCD and LED connectors. Then lift up the cover. Set the cover aside.

Note

There is an additional screw hole available for the ISS cover.

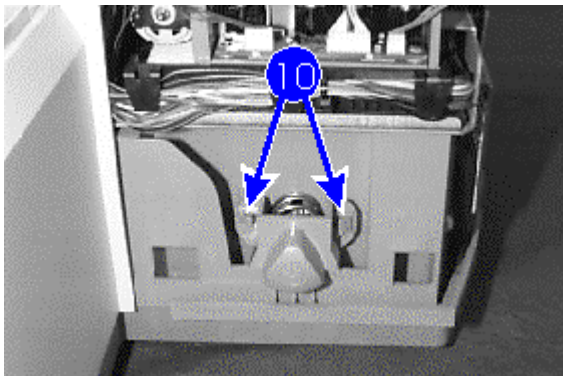

Step 10. Locate the power knob and unlatch both sides of the knob. Be careful not to break the latches !

Replacement of Parts

Installing the Power Knob

- Step 1. Fit the latches on the printer to the holes on both sides of the new knob. Make sure the knob is secured properly.
- Step 2. Reinstall the ink supply station cover.
- Step 3. Replace the screw in any of the two screw holes given near the LCD and LED connectors.
- Step 4. Reinstall the key panel by latching the hinges behind first.
- Step 5. Snap the panel into the latches from the right side first towards the left side. Make sure the connectors are properly covered.
- Step 6. Replace the two screws at the top of the panel.
- Step 7. Reinstall the LCD cover by fitting in the hinges at the back first before pushing it down from the right first, then the left. Make sure the cover snaps into place.
- Step 8. Close the top cover of the printer.
- Step 9. Reinstall the output tray (Tray 1) into place.
- Step 10. Cover the service station with the side cover. Make sure it is fitted in properly.
- Step 11. Replace the two screws for the service station side cover.
- Step 12. Close the rear access door.
- Step 13. Reinstall the printhead access door by fitting in the tabs on the left of it to the top cover and unfold downwards. Flip the ink cartridge down.
- Step 14. Plug in the power cord and turn on the printer.

Replacement of Parts

Replacement of Power Supply

You will be removing the power supply from the printer and installing a new power supply.

Removing the Power Supply

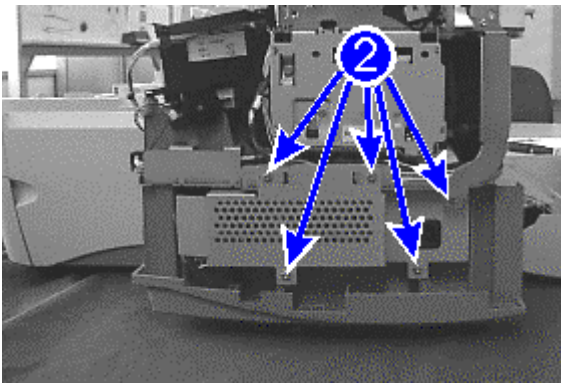

Step 1. Follow **Steps 1-9 of Removing the Power Knob** from **Replacement of Power Knob**.

Step 2. Locate the side of the power supply and unscrew five screws (one of which is attached to the ESD strap). Set the screws aside.

Step 3. Lift up the cover of the power supply. Be careful of the ESD clip.

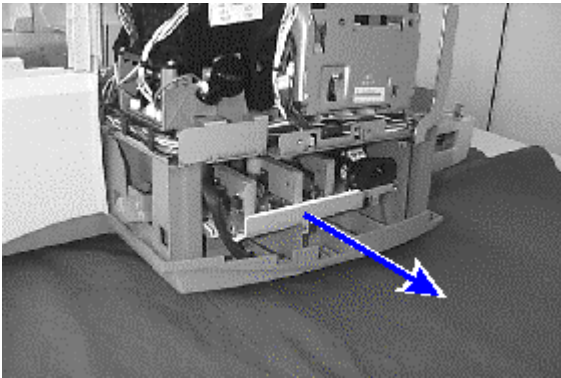

Step 4. Slide the power supply out. Be careful of any cable or wire.

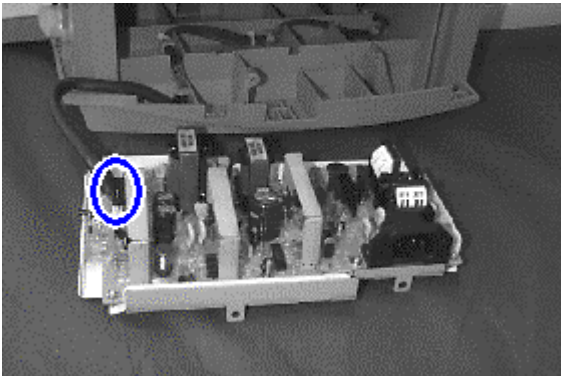

Step 5. Disconnect the power supply connector.

Replacement of Parts

Installing the Power Supply

- Step 1. Slide in the new power supply.
- Step 2. Reconnect the power supply connector. Make sure the connector is secured properly.
- Step 3. Reinstall the power supply cover. Make sure the ESD clip is on the outside of the cover and the screw holes are aligned.
- Step 4. Replace the five screws. Do not over-tighten the plastic screws (the two at the bottom of the cover).
- Step 5. Replace the remaining components for the power supply (refer to **Steps 3-14** of **Installing the Power Knob** from **Replacement of Power Knob.**)

Replacement of Parts

Replacement of Modular Ink Delivery System (MIDS)

You will be removing the Modular Ink Delivery System (MIDS) from the printer and installing a new MIDS.

Removing the MIDS

Step 1. Follow **Steps 1-9** of **Removing the Power Knob** from **Replacement of Power Knob**.

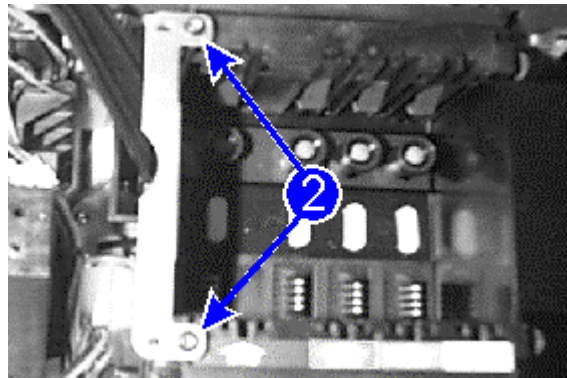

Step 2. Remove both screws from the ink supply station, then remove the pump section.

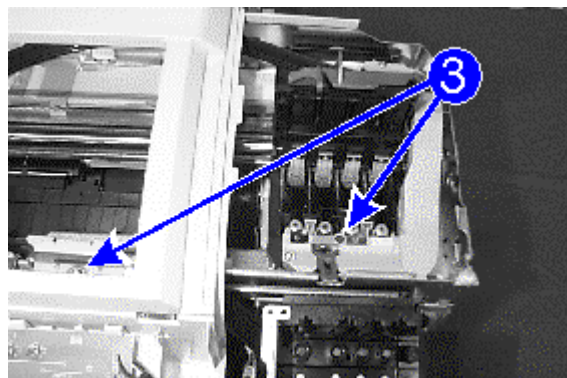

Step 3. Detach the MIDS by removing the retainer clip from the carriage assembly and the center screw between the letters **C** and **M** on the print carriage. Keep the retainer clip aside as it will be used when the new MIDS is installed.

Replacement of Parts

Installing the MIDS

- Step 1. Attach the retainer clip to the tubes and to fasten them in place to the chassis with the screw.
- Step 2. Fasten the screw between “C” and “M”.
- Step 3. Replace the pump section, tilting it an angle such that the catch next to the yellow nozzle is latched first, and replace the screws.
- Step 4. Replace the remaining components for the MIDS (refer to **Steps 3-14 of Installing the Power Knob** from **Replacement of Power Knob.**)

Replacement of Parts

Replacement of Ink Supply Station

You will be removing the ink supply station from the printer and installing a new ink supply station.

Removing the Ink Supply Station

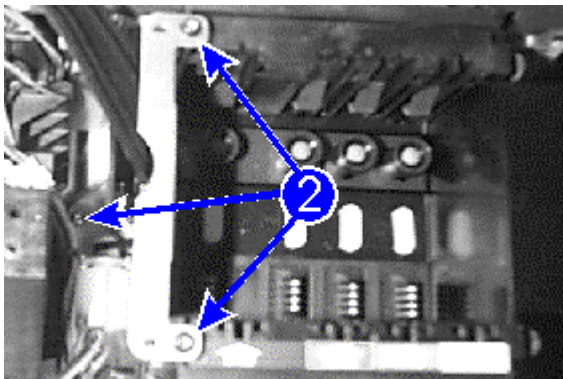

Step 1. Follow **Steps 1-9** of **Removing the Power Knob** from **Replacement of Power Knob**.

Step 2. Locate the three screws securing the ink supply station and unscrew them. Two of the screws are at the top right of the ink supply station. The third one is at the base of the ink supply station which require long screw driver to unscrew. Set them aside.

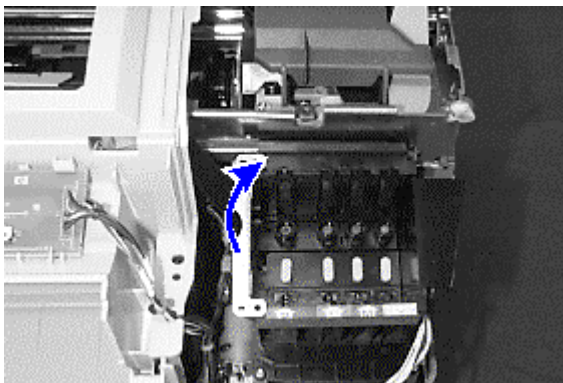

Step 3. Remove the ink delivery system by lifting the unit up and folding towards the right.

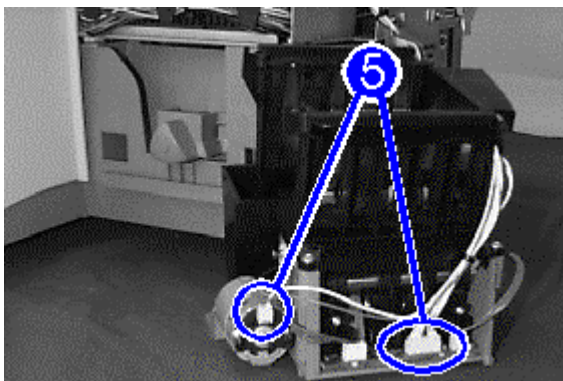

Step 4. Remove the ink supply station by sliding from the right (facing the printer). Be careful of the loose wires.

Step 5. Locate two connectors that connect to the ISS motor and the PCB. Unhook and disconnect them.

Replacement of Parts

Installing the Ink Supply Station

- Step 1. Install the new ink supply station. Make sure the screws are put in first.
- Step 2. Reinstall the ink delivery system by looping in the hinge on the right first, then place it down.
- Step 3. Latch the wires back into the hooks and reconnect the ink supply station motor and PCB connectors. Make sure the connectors are secured properly.
- Step 4. Replace the two screws at the right side of the ink delivery system.
- Step 5. Replace the remaining components for the ink supply station (refer to **Steps 3-14** of **Installing the Power Knob** from **Replacement of Power Knob**.)

Replacement of Parts

Replacement of Main Case

You will be removing the main case from the printer and installing a new main case.

Removing the Main Case

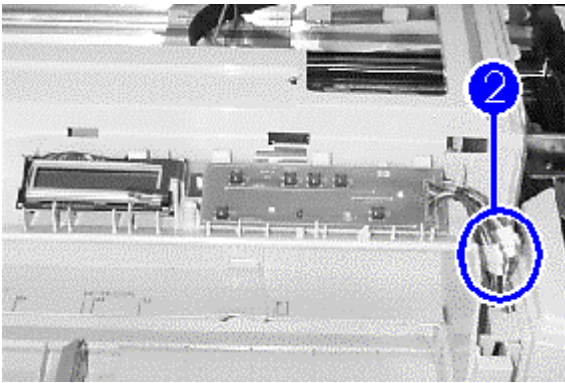

Step 1. Follow **Steps 1-9** of **Removing the Power Knob** from **Replacement of Power Knob**.

Step 2. Disconnect the LCD and LED connectors.

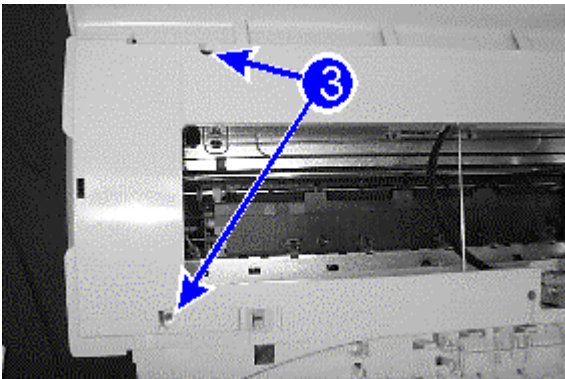

Step 3. Unscrew the two screws at the top of the main case and set them aside.

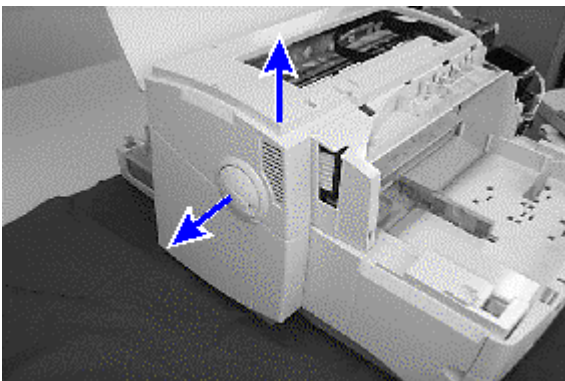

Step 4. Pull out the paper knob a little and lift up the main case.

Replacement of Parts

Installing the Main Case

Step 1. Pull the paper knob out and place the new main case down.

Step 2. Replace the two screws at the top of the main case.

Step 3. Reconnect the LCD and LED connectors.

Caution!

Please note that the colors of the wiring of the LCD connector are different from that of the LED connector. When connecting, please check that the sequences of the colors of the connectors match on both ends.

Step 4. Replace the remaining components for the **Power Knob** (refer to **Steps 3-14** of **Installing the Power Knob** from **Replacement of Power Knob**.)

Replacement of Parts

Replacement of Paper Knob

You will be removing the paper knob from the printer and installing a new paper knob.

Removing the Paper Knob

Step 1. Remove the **Main Case** (refer to the procedures in **Removing the Main Case** from **Replacement of Main Case**).

Step 2. Locate and unscrew the screw securing the paper knob. Set it aside.

Step 3. Remove the paper knob.

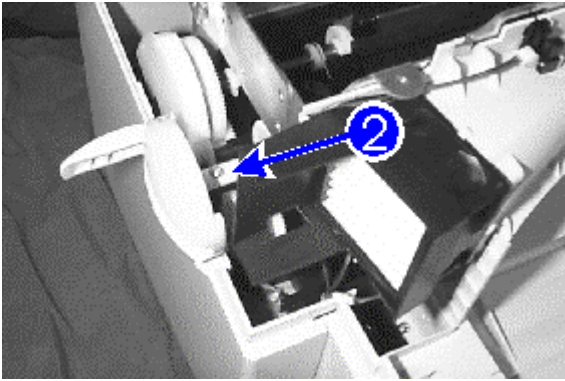

Replacement of Parts

Installing the Paper Knob

Step 1. Put in the paper knob and replace the screw.

Step 2. Replace the remaining components for the **Main Case** (refer to the procedures in **Installing the Main Case** from **Replacement of Main Case**).

Replacement of Parts

Replacement of Fan

You will be removing the fan case from the printer and installing a new fan.

Removing the Fan

Step 1. Remove the **Main Case** (refer to the procedures in **Removing the Main Case** from **Replacement of Main Case**).

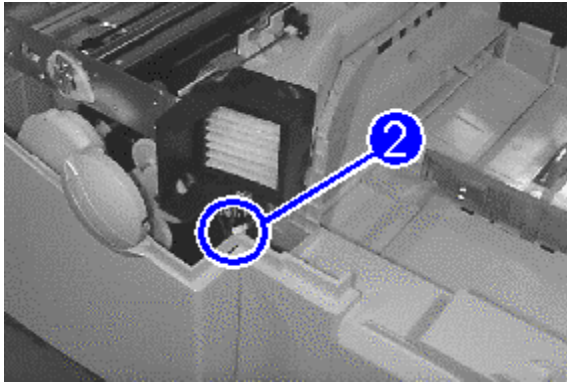

Step 2. Disconnect the connector of the fan to the motor as well as the connector of the main access door sensor.

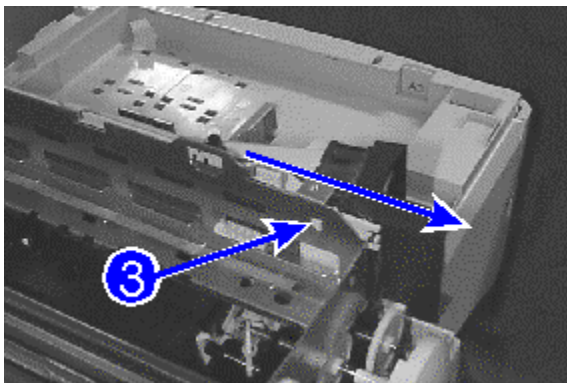

Step 3. Remove the fan by unlatching the catch securing the fan and sliding it out. Be careful of wires and connectors.

Replacement of Parts

Installing the Fan

- Step 1. Slide in the new fan until it is secured with a click. Make sure the wires or connectors are not in the way.
- Step 2. Reconnect the main access door sensor connector.
- Step 3. Reconnect the connector of the fan motor.
- Step 4. Replace the remaining components for the **Main Case** (refer to the procedures in **Installing the Main Case** from **Replacement of Main Case**).

Replacement of Parts

Replacement of Carriage Motor

You will be removing the carriage motor from the printer and installing a new carriage motor.

Removing the Carriage Motor

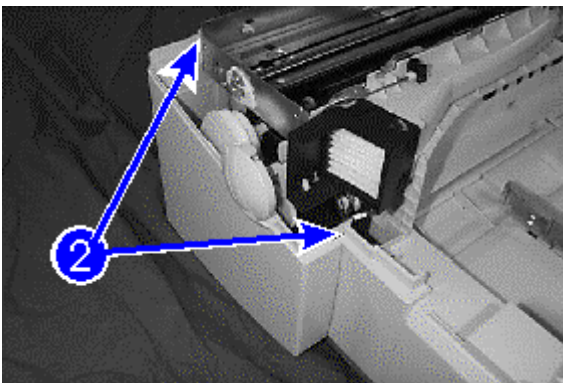

Step 1. Remove the **Paper Knob** (refer to the procedures in **Removing the Paper Knob** from **Replacement of Paper Knob**).

Step 2. Unlatch the catches under the fan and remove casing. Set the cover aside.

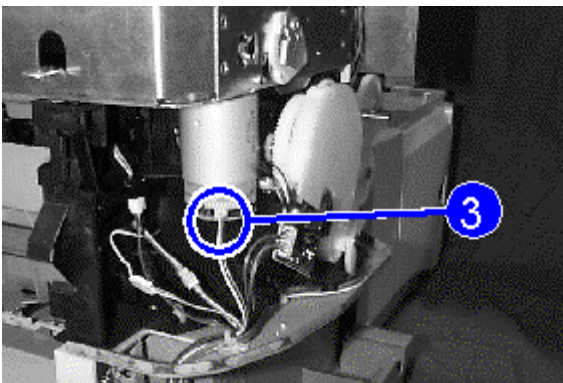

Step 3. Disconnect the connector leading to the carriage motor.

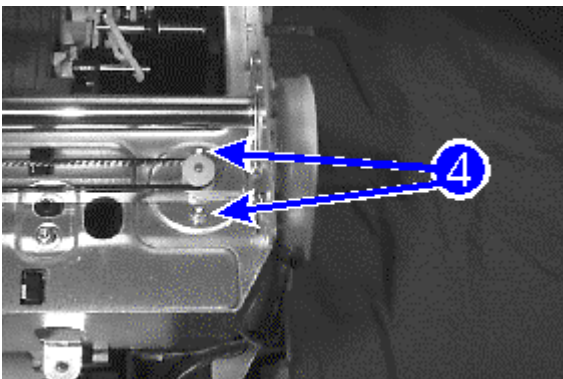

Step 4. Remove the screws on top of the carriage motor. Holding on to the motor because of the tension created by the drive belt.

Step 5. Unattach the drive belt from the carriage motor.

Replacement of Parts

Installing the Carriage Motor

- Step 1. Reinstall the new carriage motor by putting one screw loosely into the screw hole, reattach the drive belt and secure the screws back in.
- Step 2. Reconnect the wiring of the carriage motor.
- Step 3. Slot the cover back to place. Make sure it is properly secured.
- Step 4. Replace the remaining components for the **Paper Knob** (refer to the procedures in **Installing the Paper Knob** from **Replacement of Paper Knob**).

Replacement of Parts

Replacement of Assembly Harness Cover

You will be removing the assembly harness cover from the printer and installing a new assembly harness cover.

Removing the Assembly Harness Cover

Step 1. Remove the **Main Case** (refer to the procedures in **Removing the Main Case** from **Replacement of Main Case**).

Step 2. Remove the two springs attached on both sides of the rear door.

Step 3. Remove the back panel by pulling both the handles and sliding it out of the printer.

Step 4. Push in the flaps of the assembly harness cover on both the right and the left.

Step 5. The assembly harness cover pops out by giving it a pull.

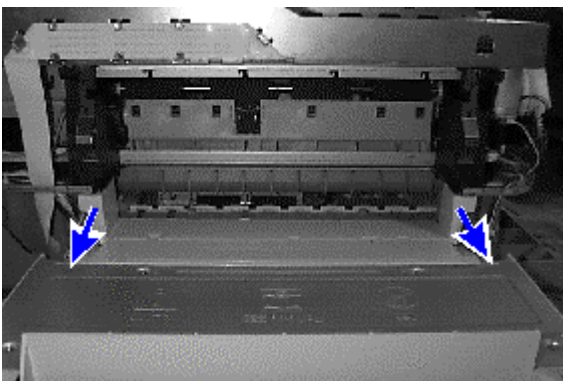
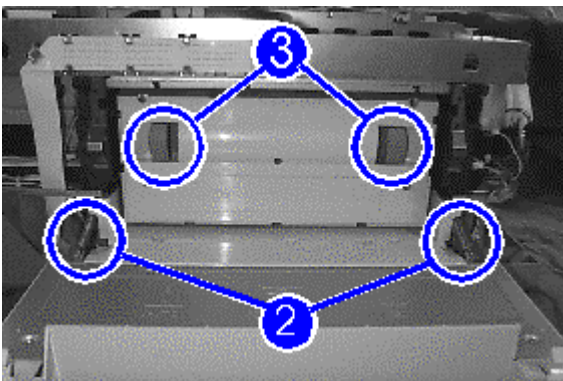

Replacement of Parts

Installing the Assembly Harness Cover

- Step 1. Latch the hinges of the assembly harness cover first.
- Step 2. Push in both flaps of the assembly harness cover. Make sure the cover is secured properly.
- Step 3. Reattach the springs on both sides of the rear door.
- Step 4. Close the rear door.
- Step 5. Replace the remaining components for the **Main Case** (refer to the procedures in **Installing the Main Case** from **Replacement of Main Case**).

Replacement of Parts

Replacement of Rear Door

You will be removing the rear door from the printer and installing a new rear door.

Removing the Rear Door

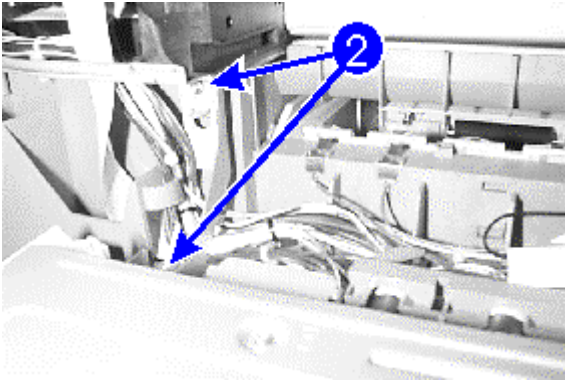

- Step 1. Remove the **Assembly Harness Cover** (refer to the procedures in **Removing the Assembly Harness Cover** from **Replacement of Assembly Harness Cover**).
- Step 2. Remove the four screws connecting the rear door to the main panel and set them aside.
- Step 3. Detach the rear door from the printer.

Replacement of Parts

Installing the Rear Door

- Step 1. Reinstall the rear door to the main panel by realigning the screw holes.
- Step 2. Replace the four screws. Do not over tighten.
- Step 3. Replace the remaining components for the **Assembly Harness Cover** (refer to the procedures in **Installing the Assembly Harness Cover** from **Replacement of Assembly Harness Cover**).

Replacement of Parts

Replacement of Encoder Strip

You will be removing the encoder strip from the printer and installing a new encoder strip.

Removing the Encoder Strip

Step 1. Remove the **Paper Knob** (refer to the procedures in **Removing the Paper Knob** from **Replacement of Paper Knob**).

Step 2. Unlatch the catch under the fan and remove casing. Set the cover aside.

Step 3. Unlatch the encoder strip from both ends.

Step 4. Slide the encoder strip out through the carriage.

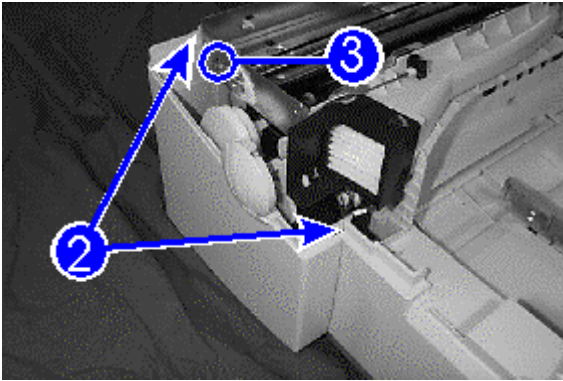

Replacement of Parts

Installing the Encoder Strip

- Step 1. Slide a new encoder strip through the carriage.
- Step 2. Latch the encoder strip on both ends. Be careful not to touch the middle portion of the strip.
- Step 3. Slot the cover back to place. Make sure it is properly secured.
- Step 4. Replace the remaining components for the **Paper Knob** (refer to the procedures in **Installing the Paper Knob** from **Replacement of Paper Knob**).

Replacement of Parts

Replacement of Primary Star Wheel

You will be removing the primary star wheel from the printer and installing a primary new star wheel.

Removing the Primary Star Wheel

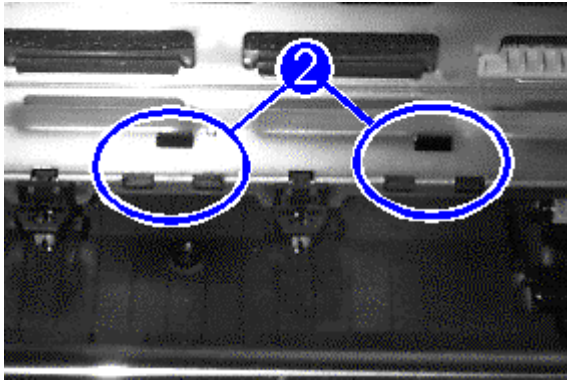

- Step 1. Remove the **Main Case** (refer to the procedures in **Removing the Main Case** from **Replacement of Main Case**).
- Step 2. Push the main latch of the primary star wheel downwards from the top of the printer.
- Step 3. Slide the star wheel out easily from the front of the printer.

Replacement of Parts

Installing the Primary Star Wheel

- Step 1. Snap the two small latches of the primary star wheel from the front of the printer.
- Step 2. Push the star wheel upwards till the main latch snaps in place. Use a screw driver if required.
- Step 3. Replace the remaining components for the **Main Case** (refer to the procedures in **Installing the Main Case** from **Replacement of Main Case**).

Replacement of Parts

Replacement of Secondary Star Wheel

You will be removing the secondary star wheel from the printer and installing a secondary new star wheel.

Removing the Secondary Star Wheel

Step 1. Remove the **Main Case** (refer to the procedures in **Removing the Main Case** from **Replacement of Main Case**).

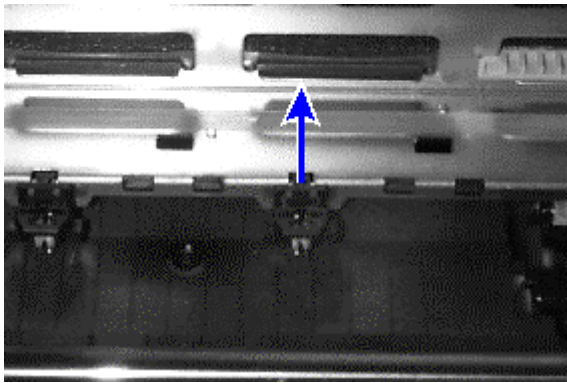

Step 2. From the front of the printer, push the two small latches of the secondary star wheel in and the main latch upwards. Use a screw driver if required.

Step 3. Slide the star wheel up from the top of the printer.

Replacement of Parts

Installing the Secondary Star Wheel

- Step 1. Push the new secondary star wheel downwards from the top of the printer till it snaps in place.
- Step 2. Replace the remaining components for the **Main Case** (refer to the procedures in **Installing the Main Case** from **Replacement of Main Case**).

Replacement of Parts

Replacement of Rubber Foot

You will be removing the rubber foot from the printer and installing a new rubber foot.

Removing the Rubber Foot

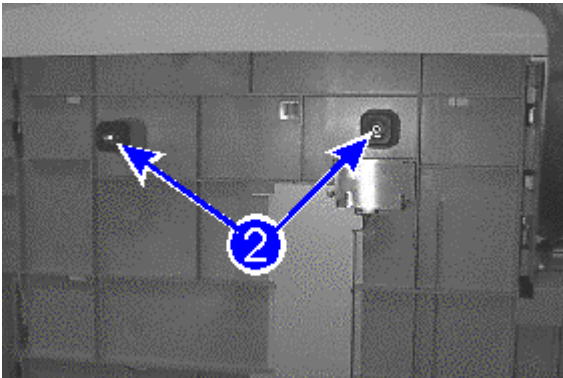

Step 1. Sit the printer on its back gently.

Step 2. Remove the rubber foot by unscrewing the screw attaching it to the printer.

Replacement of Parts

Installing the Rubber Foot

Step 1. Align the screw hole of the new rubber foot to that of the printer.

Step 2. Replace the screw. Make sure the rubber foot is secured properly.

Replacement of Parts

Replacement of Absorbers

You will be removing the absorbers from the printer and installing new absorbers.

Removing the Absorbers

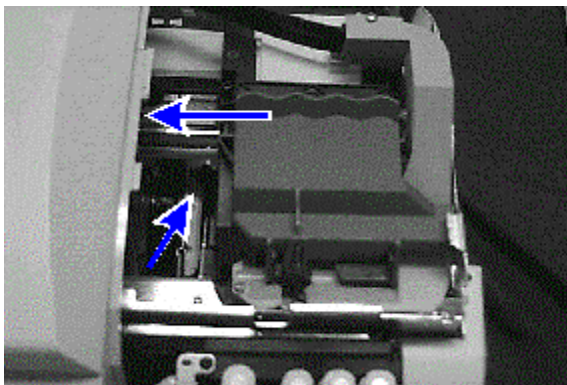

Step 1. Remove the **Ink Supply Station** (refer to procedures in **Removing the Ink Supply Station** from **Replace of Ink Supply Station**).

Step 2. Slide the ink carriage mechanism along the carriage rod to the left under the top cover. This will expose three screws, previously concealed under the ink carriage mechanism, that secure the service station.

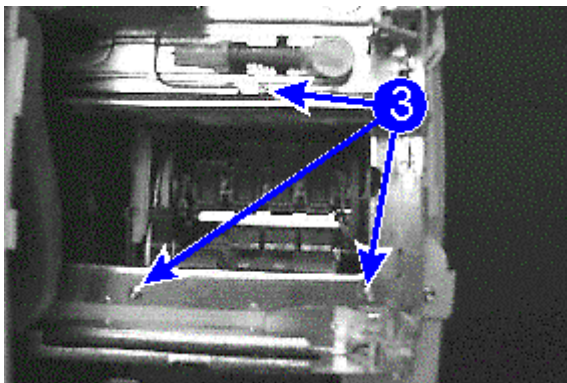

Step 3. Unscrew the three screws in the order shown on the chassis.

Step 4. Remove the service station by sliding it out. Be careful of connecting cables when removing the service station.

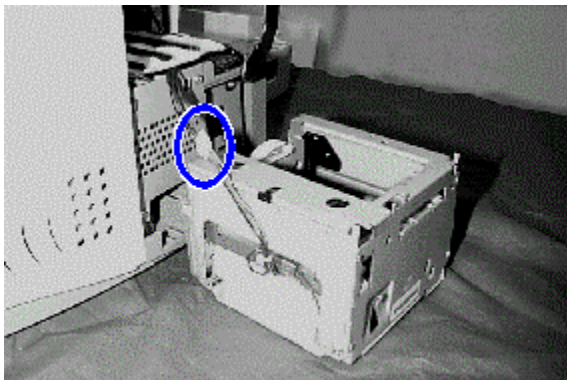

Step 5. Disconnect the service station connector.

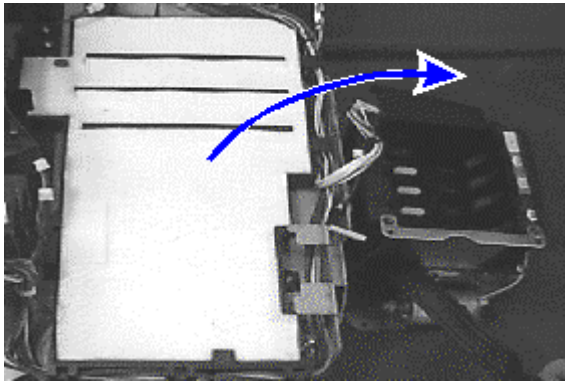

Step 6. Remove the absorbers.

Replacement of Parts

Installing the Absorber

- Step 1. Replace the absorbers into position.
- Step 2. Gently slide the new service station into the printer until the screw holes are aligned.
- Step 3. Replace the service station connector. Ensure that it is properly plugged in.
- Step 4. Replace the three screws at the top of the service station in order (that is, replace number one, followed by two and then three).
- Step 5. Replace the remaining components for the **Ink Supply Station** (refer to the procedures in **Installing the Ink Supply Station** from **Replacement of Ink Supply Station**).

7-48 Removal and Replacement of Parts (without Calibration)

Chapter 8 Troubleshooting

Troubleshooting Concepts

If there is a problem with the printer, there are several steps that can be taken to trace and resolve the problem.

If you get a message on the computer screen, follow the on-screen instructions. If you did not receive an error message but suspect that something may be wrong with the printer, you can check the HP Toolbox by clicking on the Troubleshooting tab, then select the appropriate section and perform any printer diagnostics as required.

If the printer is not printing, examine the following for signs of abnormal operation :

- key panel LEDs
- printer operation
- assembly operation

For each symptom, there may be more than one solution possible. Using your own experience and the information provided in this chapter, you should be able to trace the problem to its source and carry out the appropriate repairs. The design of the printer, which allows you to replace and test one component at a time, should be helpful in resolving any problems.

LED

The LEDs on the printer will light up when it is not functioning properly. See **Indicator Lights (Chapter 2)** for more information on the LED.

Standard Procedures

There are several symptoms which may be observed when the printer malfunctions :

- No power.
- The printer can be powered but there is no LED/LCD activity.
- An error message (Recoverable or Unrecoverable) is displayed.
- No error message is displayed but a problem exists: paper is not picked or is picked up multiply, problems in print quality, broken or loose parts.

Do the following checks and preparations before going into further troubleshooting.

1. Check that the ink cartridges, the printheads and power cord are properly installed.
2. Check that the top cover and the rear door are properly closed.
3. Switch off the printer. Disconnect the printer cable and remove the MIO card (if available). Then switch on the printer again.
4. If the printer LCD panel displays a error message, refer to **Error Codes (Chapter 2)** for the interpretation of the error message.

No Power

If the printer does not power up, do the following checks:

1. Make sure the power cord is connected firmly to the printer and to a working outlet.
2. Ensure that the printer is turned on.

Possible Hardware Causes

If the printer is still not functioning, there may be several hardware causes:

- Bad logic PCA
- Bad power supply
- Back door sensor failure
- Wiring or connectors faulty or loose

Parts Needed for Repair

- Power supply
- PCA
- Mechanism

Symptoms on Login PCA

There are some symptoms if the fault lies with the logic PCA:

- There is no power but the LCD displays squares.
- When customer has installed memory, personality module or MIO into the printer just before the failure.

No Power

Known Issues

The main issues known for causing No Power is:

- Logic PCA failure
- Harness being cut
- Power supply on/off switch is broken
- Faulty back door sensor

LED or LCD

The printer is not functioning properly when the key panel LED has no lights (red or green) or when the LCD has no display or wrong display.

Possible Hardware Causes

- Bad Key Panel PCA or LCD PCA
- Bad PCA
- Wiring or connectors faulty or loose

Both LEDs (red and green) blink at a very fast speed if there is a mechanism error or bad PCA. Verify the problem by powering off the printer and us

Parts Required for Repair

- Key Panel PCA or LCD PCA
- PCA
- Mechanism

LED or LCD

Blinking LED

Both the red and green LED lights blink at a very fast rate if there is a bad Logic PCA. Verify the problem by:

1. Powering off the printer and powering it up again to see if the error persists.
2. If error persists, press the on-line button once to read the error code.

Note

Error 143 – Replace Logic PCA. This is an NVM reset error.

Possible Hardware Causes

- Mechanism error
- Bad PCA

Parts Required for Repair

- PCA
- Mechanism

LED or LCD

Sensor Error

The sensor has a problem if it activates continuously.

Possible Hardware Causes

- Sensor problem
- Bad PCA
- Wiring or connector problem

Parts Required for Repair

- PCA
- Mechanism

Note

Whenever the back panel has been removed, make sure it snaps back into place properly on putting back.

Unrecoverable Error Messages

The printer LCD panel displays recoverable or non-recoverable error messages. Printer displays recoverable error message if the problem can be easily solved by customers and it displays non-recoverable error message if there is a hardware problem.

Bad PCA is indicated by:

- 100 series errors
- Error 241 and 242
- 300 series errors
- 500 series errors
- 700 series errors

Note

1. Some 700 series errors are caused by the MIO.
2. 400 series errors are Mechanism code errors but can be caused by PCA problems too.

Bad Service Station is indicated by:

- Errors 455 – 459
- Error 462
- Error 463

Parts Required for Repair

- Service Station
- PCA

Unrecoverable Error Messages

Bad Ink Supply Station is indicated by:

- Errors 425 – 428
- Error 441

Parts Required for Repair

- Ink Supply Station
- PCA

Known Issue

Leakage from ink cartridge can damage Ink Supply Station. Therefore, the solution to this issue is to replace the Ink Supply Station and the absorbers in the printer.

Print Quality

Smearing

Smearing can occur, especially on special media. This problem is caused by incorrect Pen to Paper Calibration.

Solution

The solution to this problem is to replace the printer mechanism.

Bad Print Quality

The jittering of the Encoder Strip can cause irregular banding, unexpected waves or missing patches while printing.

Solution

The solution to this problem is to replace the printer mechanism.

Broken or Missing Parts

Parts of the printer might be broken or missing during the warranty period which cause the printer not to function at all or properly.

Solution

If the part is a customer replaceable part, a new part will be sent to the customer. The customer will replace the broken or missing part with guiding instructions.

No Pick or Multiple Pick or Other Mechanism Problems

The printer might not function well because paper is not picked or more than one pieces of paper are picked. Sometimes, it might not be able to function due to mechanism problems.

Solution

The solution to these problems of paper picking and other mechanism is a mechanism SWAP.

Troubleshooting Tools

There are two sets of diagnostics provided by the HP DesignJet ColorPro Series Printers which you can use to troubleshoot the printer :

- Diagnostic Test Page
- Extended Diagnostic Test Page

More details on these two test pages can be found in **Diagnostic Page (Chapter 2)** and **Extended Diagnostic Page (Chapter 2)**.

You will also need to provide the additional tools to perform troubleshooting :

- multimeter
- cotton swabs
- rigid paper, card stock
- clean and soft cloth
- tweezers
- a TORX[®] screwdriver with either a T-10 or a T-20 screw bit

As you may be handling delicate electronic components in the printer, it is also strongly recommended that you use an ESD heel or wrist straps to dissipate body static electricity which may damage PCAs inside the printer.

Chapter 9 Parts and Diagrams

The parts and diagrams for the HP DesignJet ColorPro Series Printer are categorized according to the replacement level of the parts.

- Parts orderable for ASP and Self Maintainers (1 and 2)
- HP Internal parts (3, calibration required)
(Note: A special calibration tool is required for HP Serviceable parts. This tool is not available.)

The table below lists the replaceable parts of the printer. The Remarks column indicates the replacement level/category. To view a diagram of a part, locate it on the diagram using the “No.” as a reference.

Note: The parts indicated with ** are composite parts and contain several service assemblies (They are not shown in the drawings separately).

Parts List

No.	HP Part Number	Description	Remarks
1	C2684-60200	PCA-Logic Service (New)	1
	C2684-69200	PCA-Logic Service (Repaired)	1
2	C2684-60201	Assembly Mechanism Service (New) (* *)	2
	C2684-69201	Assembly Mechanism Service (Repaired) (* *)	2
3	C2684-60202	Assembly RIDS Service	2
4	C7777-40001	CAD Name Plate (for HP DesignJet ColorPro CAD)	1
	C7778-40001	GA Name Plate (for HP DesignJet ColorPro GA)	1
5	C2684-60204	Assembly Power Supply Service	2
6	C2684-60205	Assembly Swivel PCA Service	2
7	C2684-60206	Cover Main PCA Service	1
8	C2684-60207	Assembly Aerosol Management System Service	2
9	C2684-60208	Strip Encoder Service	2
10	C2684-60209	Side Cover IDS (IDS Cover Service Station) Service	1
11	C2684-60210	Side Cover Service Station Service	1
12	C2684-60211	Main Case Service	2
13	C2684-60212	Assembly Secondary Access Door	1
14	C2684-60213	Lower Main Case Service	2
15	C2684-60214	Assembly Output Tray Service	1
16	C2684-60215	Removable Trough Service	1
17	C2684-60216	Assembly Knob Service	2
23	C2684-60222	Assembly Power Button Service	2
24	C2684-60223	Ground Plate Service	2
25	C2684-60224	Assembly Dual Bin Tray Service	1
26	C2684-60225	Adjuster Width Dual Bin Service	1
27	C2684-60226	Adjuster Length Dual Bin Service	1
28	C2684-60227	Media Plate Service	1

33	C2684-60232	Adjuster Length I/O Service	1
34	C2684-60233	Adjuster Width I/O Service	1
35	C2684-60234	Endcap Left Service	1
36	C2684-60235	Endcap Right Service	1
37	C2684-60280	Tray Cover Service	1
38	C2684-60237	Keypanel Service	2
39	C2684-60238	LCD Service	2
40	C7777-40002	CAD Front Cover (for HP DesinJet ColorPro CAD)	1
	C7778-40002	GA Front Cover (for HP DesinJet ColorPro GA)	1
41	C2684-60240	Assembly Main Door Access Service	1
44	C2684-60243	ESD Clip Left Service	2
45	C2684-60244	ESD Clip Right Service	2
46	C2684-60245	PCA Linefeed Service	2
48	C2684-60247	Assembly Harness Cover Service	2
49	C2684-60248	Holder Ferrite Harness Service	2
55	C2684-60254	Holder Ferrite Service	2
56	C2684-60255	Holder Flex Service	2
62	C2684-60261	Assembly Starwheel Main 1 Service	1
63	C2684-60262	Assembly Starwheel Main 2 Service	1
64	C2684-60263	Assembly Starwheel Main 3 Service	1
65	C2684-60264	Assembly Starwheel Secondary Service	1
67	C2684-60266	Assembly Keypanel Cover Service	1
68	C2684-60267	Assembly Removable Trough Sensor Service	2
69	C2684-60268	Swivel PCA Actuator Sensor Service	2
74	C2684-60273	Service Station Service	1
75	C2684-60274	Plate Media 2 Service	1
76	C2684-60275	Foot Service	1
77	C2684-60276	Hanger RIDS Service	2
78	C2684-60277	Assembly Ink Supply Station Service	2
79	C2684-60278	Assembly DC Motor Carriage Service	2
-	C6071-60153	Carriage Interconnect Wiper	1
-	C3390-60001	PCL-5 SIMM ((for HP DesinJet ColorPro CAD)	1
-	D3648-63001	HP 32 MB (2x16MB) 60ns EDO SIMM (for HP DesinJet ColorPro CAD)	1
-	J4100-60002	MIO JetDirect Card (for HP DesinJet ColorPro GA)	1

Parts Leveraged from HP2000C (C4530A)

No	HP Part Number	Description	Remarks
1	C4530-40290	Encoder Snubber	2
6	C4530-00113	Spring Carriage Z Bias	2
7	C4530-60130	Assembly Sensor Carriage Access Door	2
8	C4530-40260	Housing Carriage Access Door Sensor	2
9	C4530-40261	Trigger Carriage Housing	2
10	C4530-60090	Assembly Pen Latch	1

Exploded Parts Views

Case Part

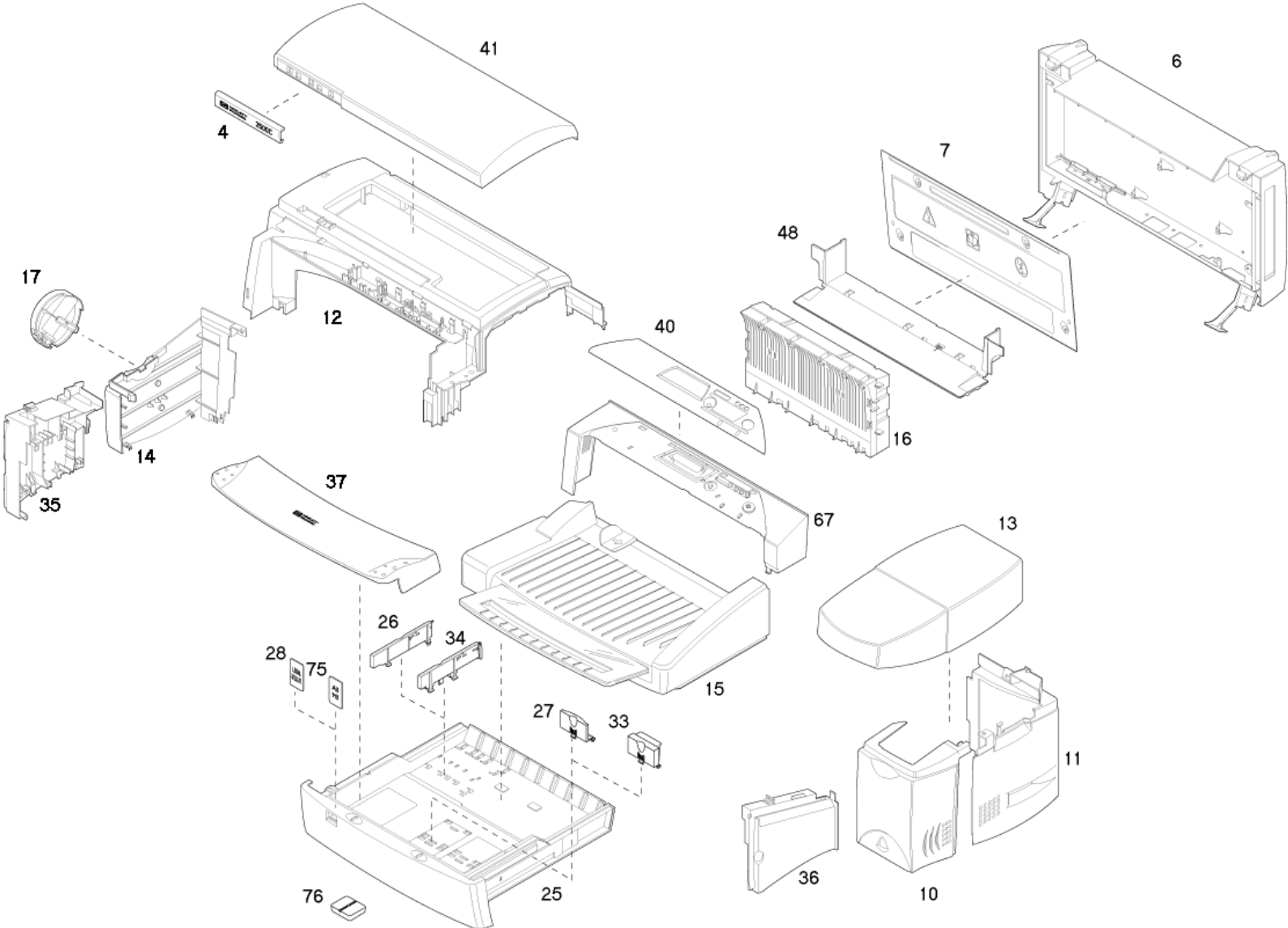

Exploded Parts Views

Other Removable Assemblies

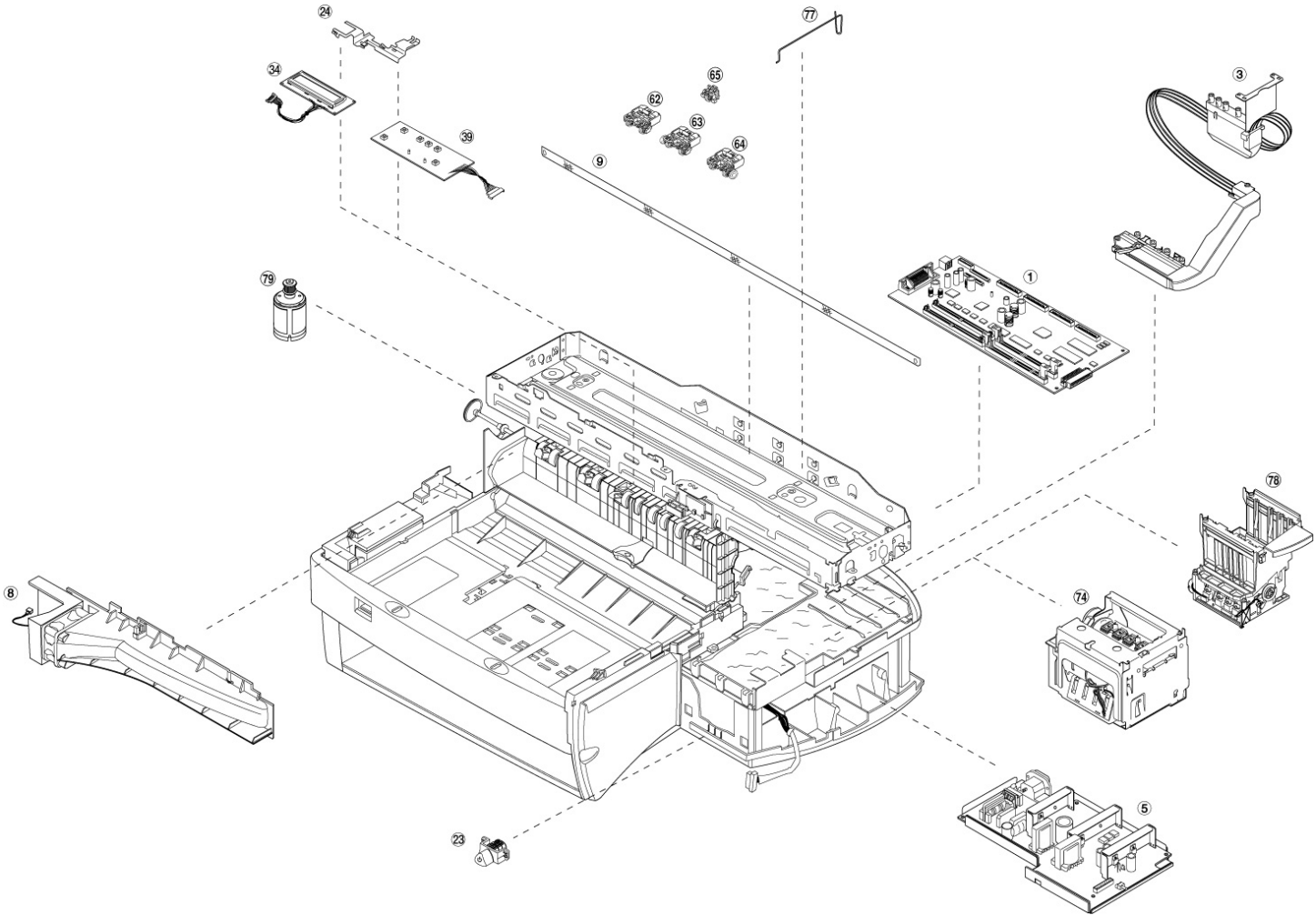

Exploded Parts Views

Mechanism

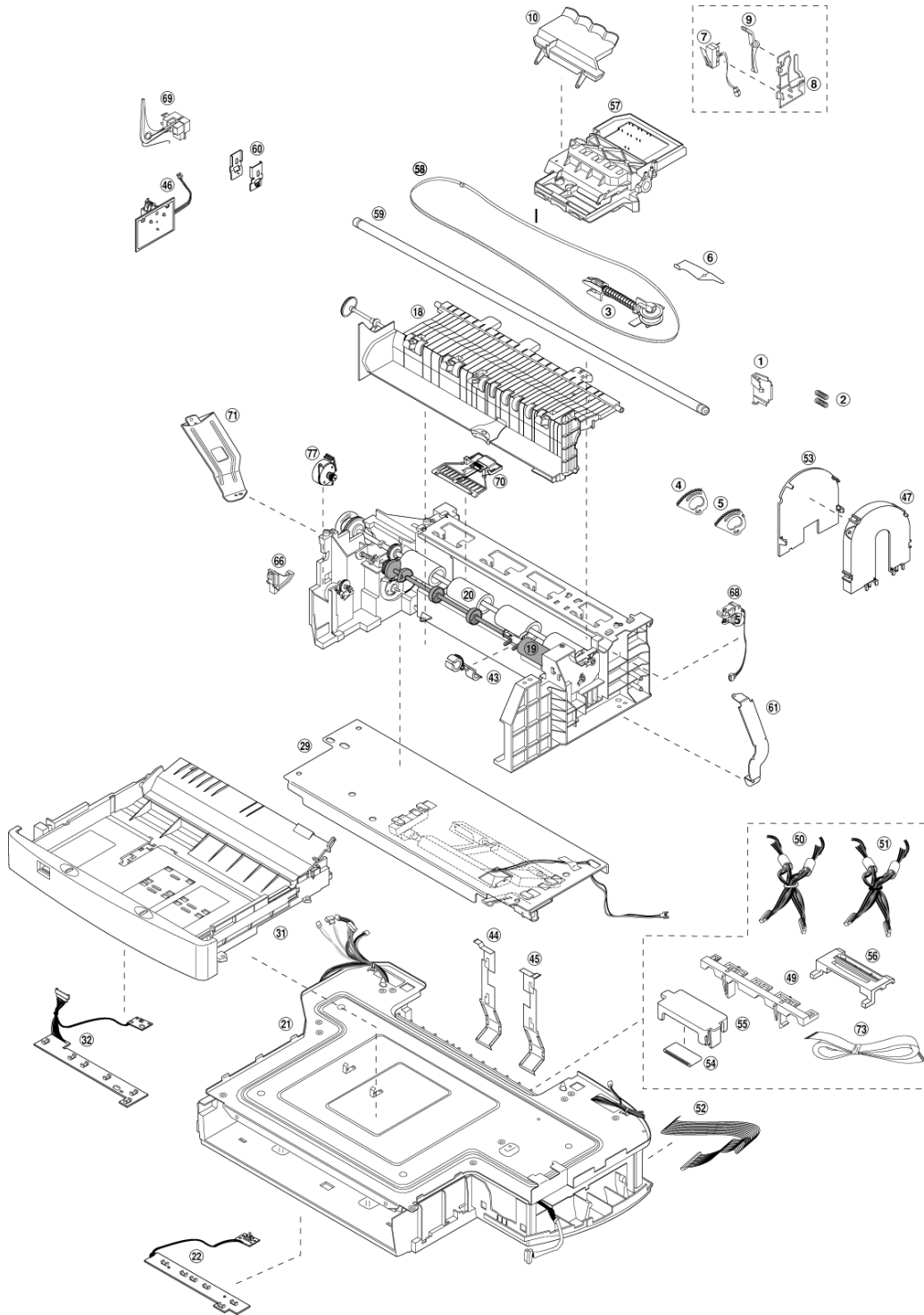

Chapter 10 Removal and Replacement of Parts (with Calibration)

This chapter describes how the printer can be disassembled for repair and maintenance.. This section covers the removal of parts that require calibration upon assembly. To reassemble the printer, reverse the order of the procedure. Where required, additional explanation will also be provided for any special adjustments or procedure steps (such as instances where reassembly differs from disassembly).

You should also take note that it may not be necessary to disassemble the printer to service certain components.

Removal and Replacement Tools

To disassemble the printer, you will need the following tools :

1. A TORX[®] screwdriver with T-10 and T-20 screw bits.
2. Needle nose pliers.
3. Straight tweezers.
4. A flat-blade screw driver (Philips no.1 or flathead no.5).
5. Instruction manual.

It is strongly recommended that proper tools (including screws) be used for the job.

Before You Begin

Check the following before you begin disassembly :

1. The printer is turned off and the power cable has been disconnected from the socket.
2. Paper has been removed from the tray.
3. Ink cartridges and pens are removed from the printer.

Caution

- Your body may discharge static current which may damage the fragile PCAs. Before disassembly please ensure that the proper precautions to prevent damage by electrostatic discharge (ESD) to ESD-sensitive printer components have been taken with ESD heel or wrist straps. Ensure also that the work area is similarly free of static current.
- When disassembling the printer, ensure that the capacitors are fully discharged before you handle power supply components. As a precaution, switch off the printer before disconnecting it from the power socket, and wait five seconds before commencing disassembly.

Important Notes about Printer Components and Disassembly

The printer has been built to a modular architecture which uses one-way snap-fit technology – that is, parts are designed so that they will only fit with each other in one direction. Please exercise care and apply only the force required to remove each component, as excessive force could damage the parts.

When reassembling the printer, remember to use the correct screw type when putting the components together.

Replacement of Parts

Replacement of Assembly Platen

You will be removing the assembly platen from the printer and installing a new assembly platen.

Removing the Assembly Platen

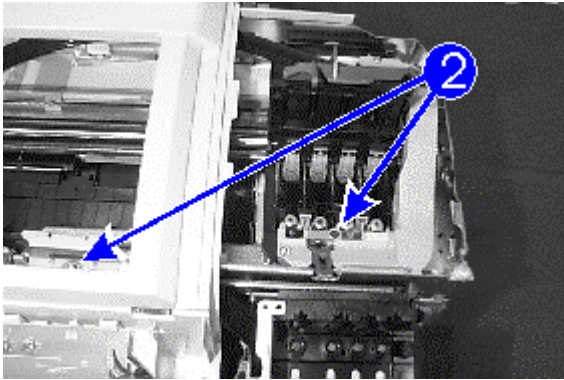

Step 1. Remove the **Main Case** (refer to the procedures in **Removing the Main Case** from **Replacement of Main Case**).

Step 2. Detach the MIDS by removing the MIDS tube clip from the carriage assembly and the center screw between the letters **C** and **M** on the print carriage.

Step 3. Move the delivery tube hook clear of the chassis.

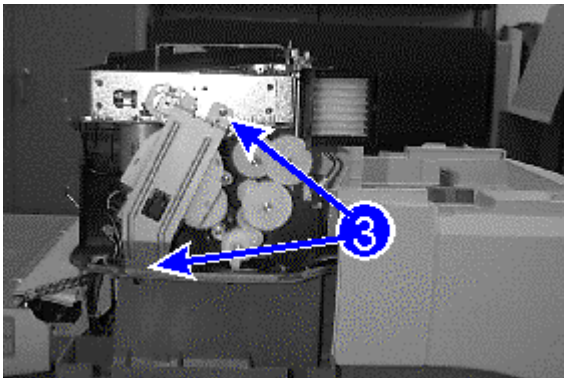

Step 4. Remove the top and bottom screws from the bracket encoder.

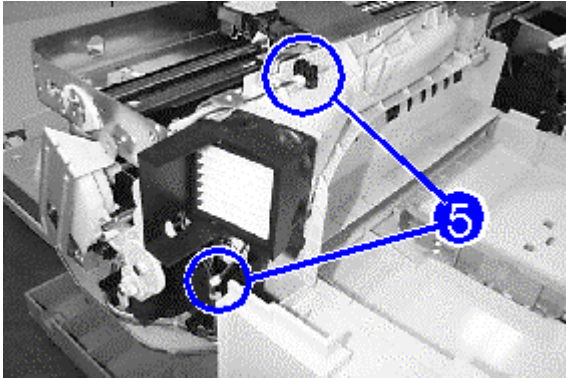

Step 5. Unplug the top cover sensor, fan motor connector and sensor assembly harness connector.

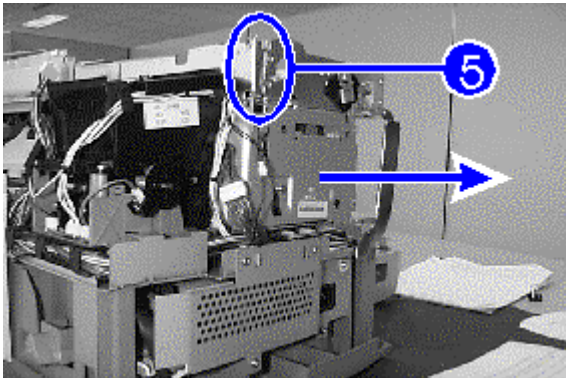

Step 6. Remove the service station.

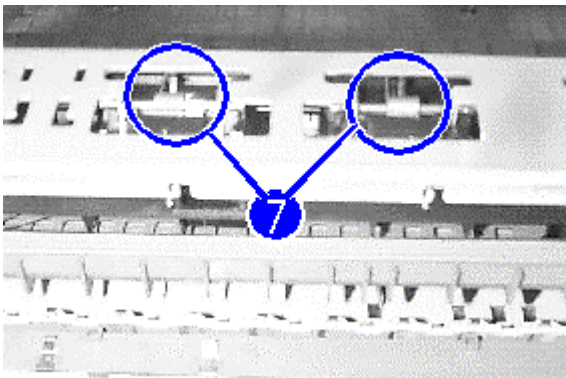

Step 7. Remove the upper feed guides by unlatching the spring from the upper tie bar.



Step 8. Remove the right plastic bearing, and slide the left plastic bearing out.

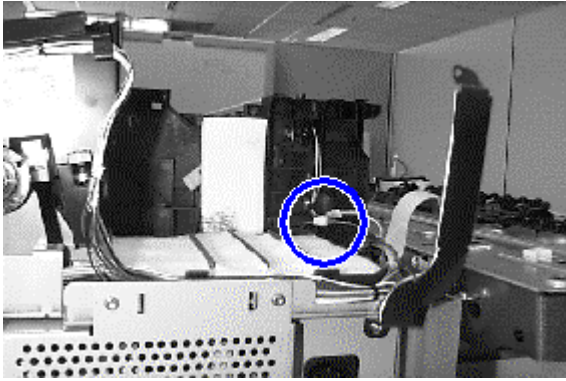

Step 9. Disconnect two connectors on the right.

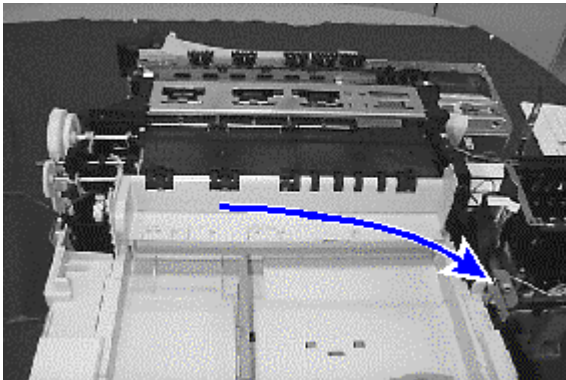

Step 10. Remove assembly platen by sliding it out from the right. Watch out that the right retaining tab does not get entangled.

Replacement of Parts

Installing the Assembly Platen

- Step 1. Install the assembly platen by sliding it inwards from the right.
- Step 2. Reconnect the two connectors on the right.
- Step 3. Slide the left plastic bearing in and snap it into position ; replace the right bearing.
- Step 4. Replace the upper feed guides.
- Step 5. Replace the service station.
- Step 6. Replace the sensor assembly harness connector, fan motor connector and top cover sensor.
- Step 7. Reattach the bracket encoder and fasten it with two screws.
- Step 8. Reattach MIDS by refastening the MIDS tube clip to the carriage chassis assembly and replacing the center screw between the letters **C** and **M** on the print carriage.
- Step 9. Replace the remaining components for the **Main Case** (refer to the procedures in **Installing the Main Case** from **Replacement of Main Case**).

Replacement of Parts

Replacement of Drive Roller

You will be removing the drive roller from the printer and installing a new drive roller.

Removing the Drive Roller

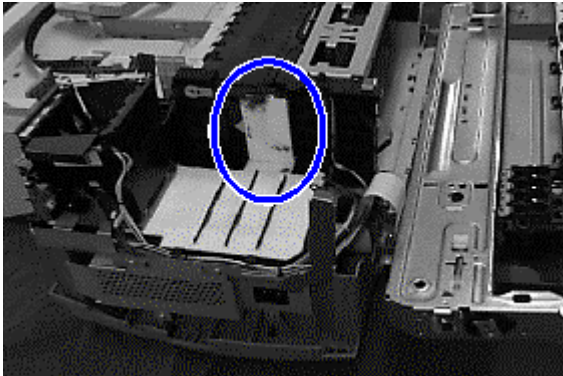

Step 1. Remove the **Assembly Platen** (refer to the procedures in **Removing the Assembly Platen** from **Replacement of Assembly Platen**).

Step 2. Remove the absorber chimney.

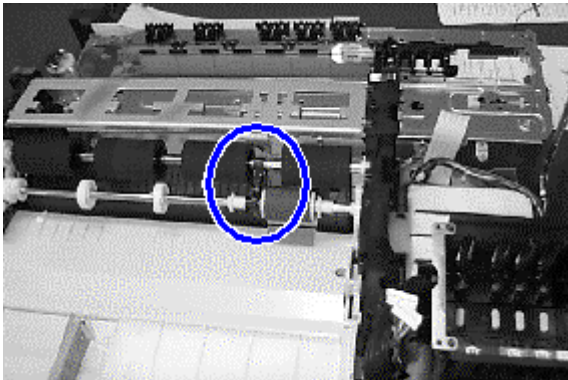

Step 3. Unsnap the kicker assembly from the drive roller and set it aside. This component will be used again when installing the new drive roller.

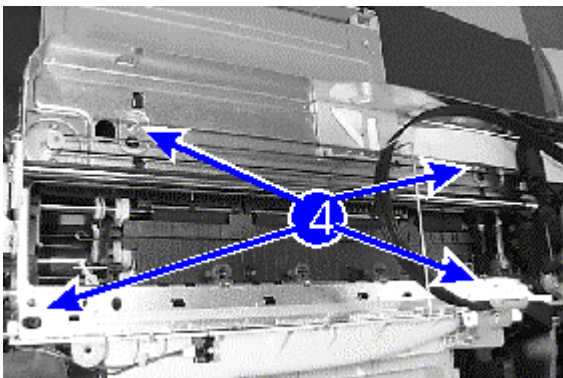

Step 4. Unscrew four screws on the frame of the carriage chassis assembly and remove the unit.

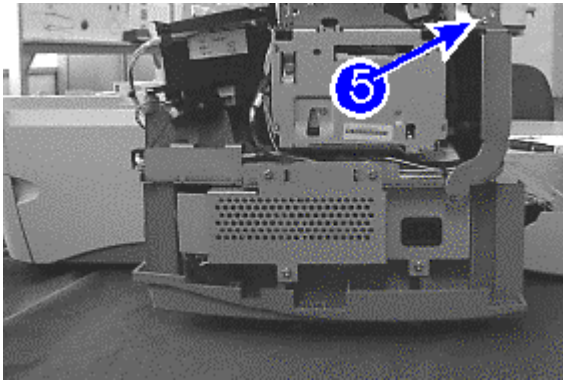

Step 5. Detach the ESD clip on the right by removing the screw.

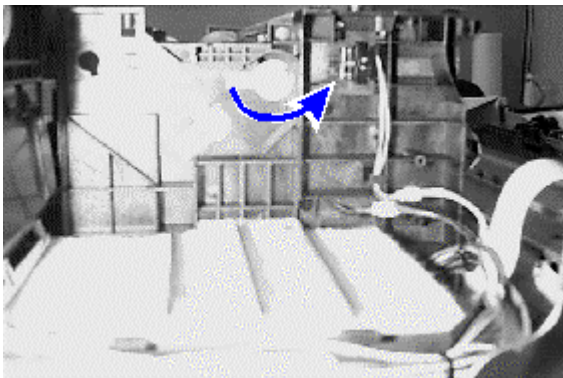

Step 6. Remove the white plastic bearing on the left of the print mechanism by unsnapping and rotating it anticlockwise until it can be pulled out.

Step 7. Repeat the above step for the bearing on the right, but in a clockwise direction.

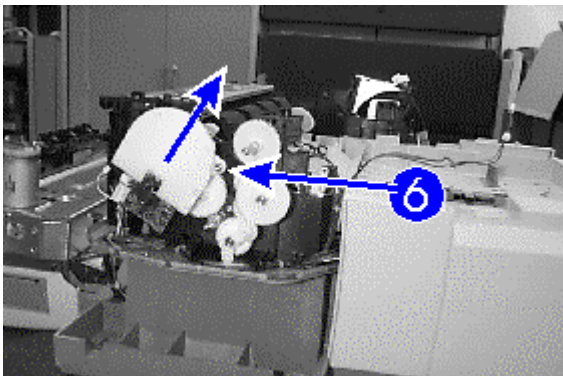

Step 6. Remove the shroud cover screw, then remove the shroud cover by unfastening the two retaining tabs. Then unlatch the six alternating retaining snaps and remove the shroud by sliding it upwards.

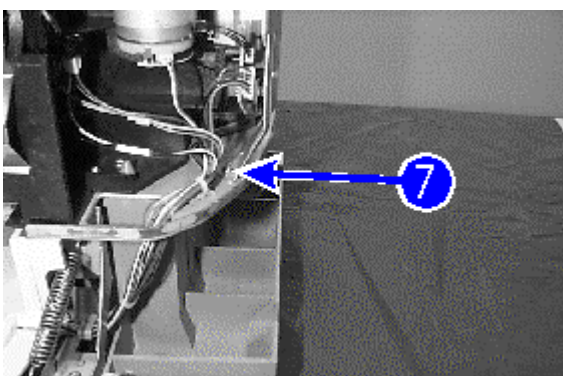

Step 7. Detach the bracket encoder on the left from the chassis by removing the screw at the base of the bracket.

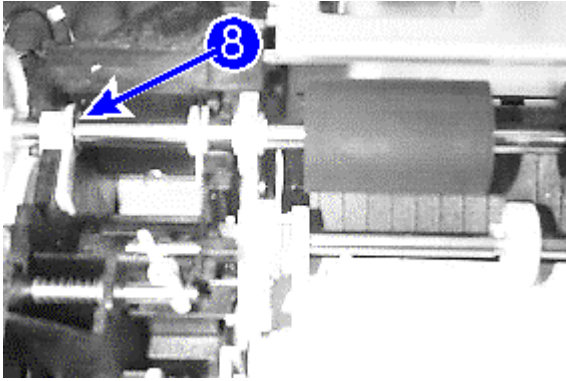

Step 8. On the inside of the inner mechanism, unsnap the retaining E-clip.

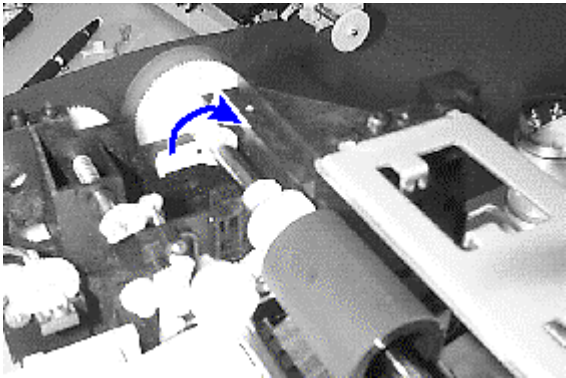

Step 9. Remove the inner left bearing drive by unsnapping it upwards, rotating it clockwise till it is free of the fastening seat and sliding it outwards along the drive roller bar.

Step 10. Unsnap the picker from the drive roller.

Step 11. Remove the drive roller from the chassis by sliding it out from the left side till it is clear of the chassis.

Replacement of Parts

Installing the Drive Roller

- Step 1. Slide the drive roller into the print mechanism. Ensure that the encoder wheel sits correctly in place on the wonder bracket of the line feed PCA.
- Step 2. Snap the picker onto the drive roller.
- Step 3. Attach the left bearing drive by sliding it back along the drive bar, then rotating it anticlockwise till it snaps into place.
- Step 4. Attach the E-clip by snapping it into position just next to the left bearing drive.
- Step 5. Slide the protective shroud back till the retaining tabs latch onto the line feed PCA. Replace the shroud cover.
- Step 6. Reattach the bracket encoder.
- Step 7. Attach the drive bearings on the left and right of the print mechanism by pushing them onto the axle of the drive roller, then rotating till they snap into position.
- Step 8. Reattach the carriage chassis assembly to the main chassis by fastening four screws.
- Step 9. Snap the kicker assembly back onto the drive roller.
- Step 10. Replace the absorber chimney.
- Step 11. Replace the remaining components for the **Drive Roller** (refer to **Steps 2-9** of **Installing the Assembly Platen** from **Replacement of Assembly Platen**).

Replacement of Parts

Replacement of Pick Roller

You will be removing the pick roller from the printer and installing a new pick roller.

Removing the Pick Roller

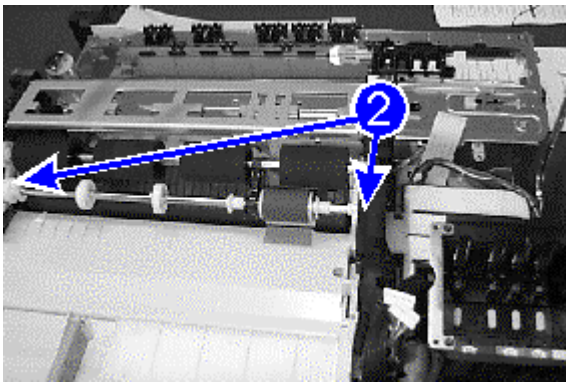

- Step 1. Remove the **Drive Roller** (refer to the procedures in **Removing the Drive Roller** from **Replacement of Drive Roller**).
- Step 2. Remove the two pick roller bearings on the left and right of the print mechanism.
- Step 3. Slide the pick roller out from the left, then detach it from the main chassis. Ensure that the clutch spring gear is not shaken loose.

Replacement of Parts

Installing the Pick Roller

- Step 1. Slide the new pick roller into the print chassis from the right, then lower it down into position.
- Step 2. Reattach both pick roller bearings on the left and right of the print mechanism.
- Step 3. Replace the remaining components for the **Drive Roller** (refer to the procedures in **Installing the Drive Roller** from **Replacement of Drive Roller**).

Replacement of Parts

Replacement of Paper Tray 2

You will be removing paper tray 2 from the printer and installing a new paper tray.

Removing the Paper Tray

Step 1. Remove the **Pick Roller** (refer to the procedures in **Removing the Pick Roller** from **Replacement of Pick Roller**).

Step 2. Remove the four screws on the pressure plate.

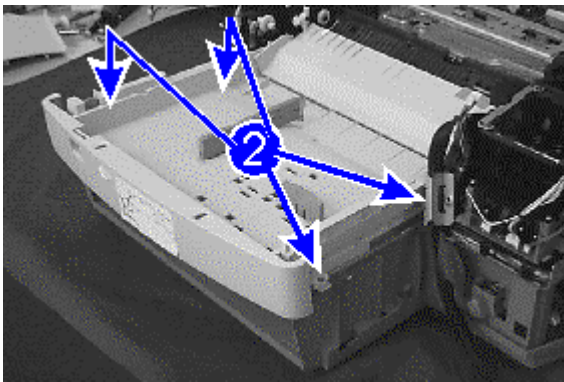

Step 3. Remove both end-caps (left and right) by unlatching the retaining tabs from the underside of the printer with a screwdriver.

Step 4. Remove two additional screws previously concealed by the end-caps.

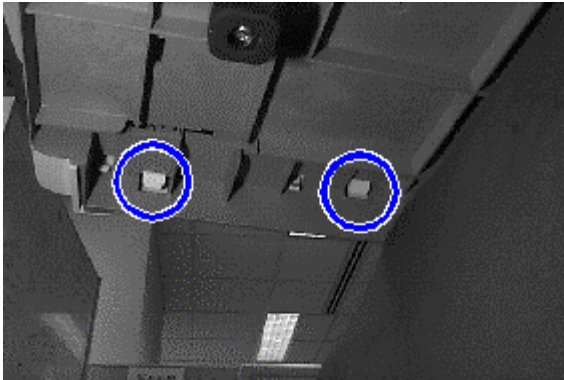

Step 5. Detach the connector on the left of the tray.

Step 6. Tilt tray 1 upwards and slide it out.

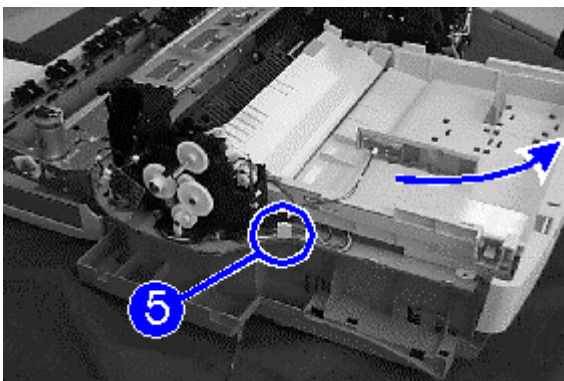

Replacement of Parts

Installing the Paper Tray

- Step 1. Slide tray 1 into the printer, ensuring that the positioning tabs on the underside are properly seated into position.
- Step 2. Reattach the connector on the left.
- Step 3. Replace all six screws to fasten the tray in position.
- Step 4. Reattach the left and right end-caps, ensuring that the retaining tabs snap properly into place.
- Step 5. Replace the remaining components for the **Pick Roller** (refer to the procedures in **Installing the Pick Roller** from **Replacement of Pick Roller**).

Replacement of Parts

Replacement of Trough Sensor (Left)

You will be removing the trough sensor (left) from the printer and installing a new sensor.

Removing the Trough Sensor (Left)

Step 1. Remove the **Assembly Platen** (refer to the procedures in **Removing the Assembly Platen** from **Replacement of Assembly Platen**).

Step 2. Remove the absorber chimney.

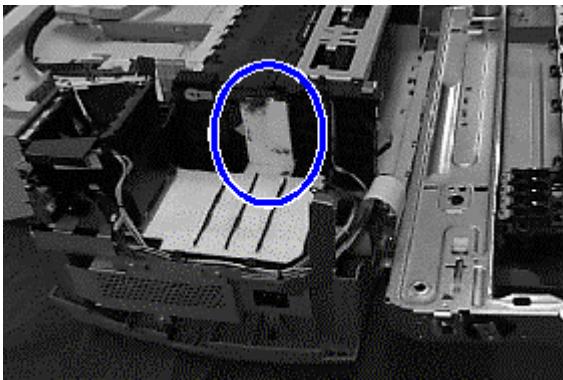

Step 3. Unscrew four screws on the frame of the carriage chassis assembly and remove the unit.

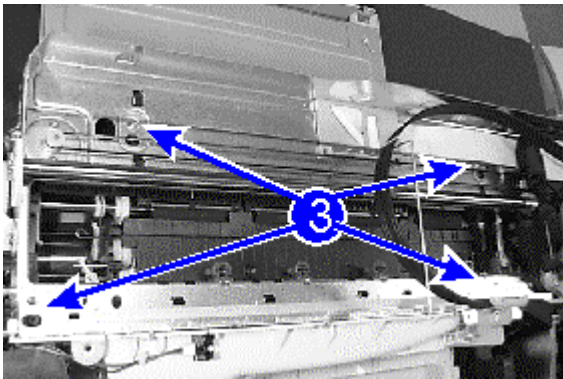

Step 4. Unlatch the left trough sensor by unclipping it from the top with a pair of tweezers, then disconnect the connector.

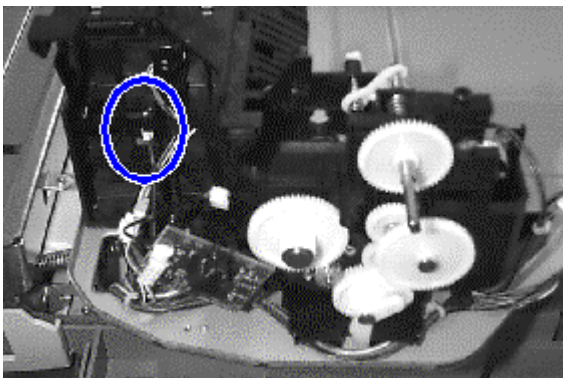

Replacement of Parts

Installing the Trough Sensor (Left)

- Step 1. Reattach the sensor to the connector, then clip it into place on the chassis.
- Step 2. Reattach the carriage chassis assembly to the main chassis by fastening four screws.
- Step 3. Replace the absorber chimney.
- Step 5. Replace the remaining components for the **Assembly Platen** (refer to the procedures in **Installing the Assembly Platen** from **Replacement of Assembly Platen**).

Replacement of Parts

Replacement of Trough Sensor (Right)

You will be removing the trough sensor (right) from the printer and installing a new sensor.

Removing the Trough Sensor (Right)

Step 1. Remove the **Assembly Platen** (refer to the procedures in **Removing the Assembly Platen** from **Replacement of Assembly Platen**).

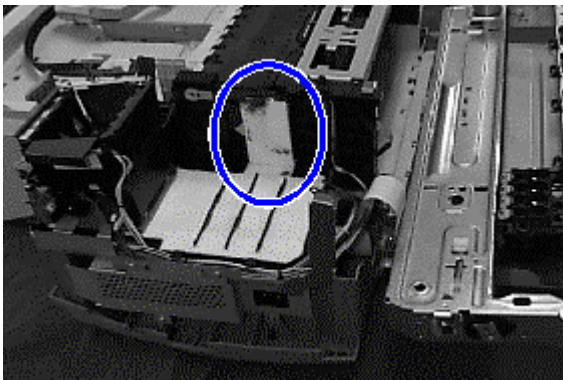

Step 2. Remove the absorber chimney.

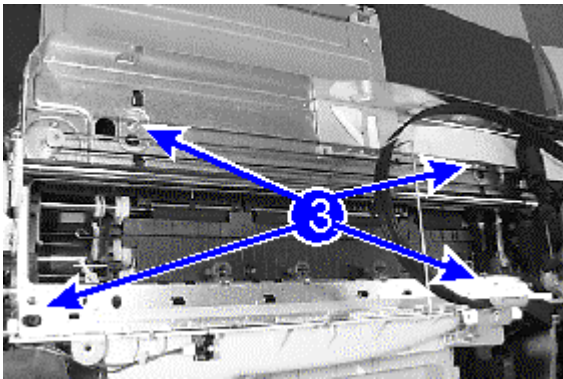

Step 3. Unscrew four screws on the frame of the carriage chassis assembly and remove the unit.

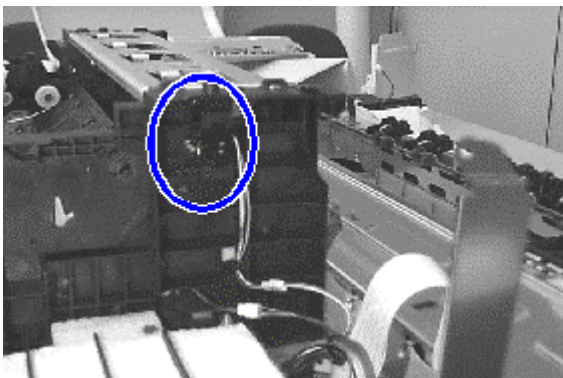

Step 4. Unlatch the right trough sensor by unclipping it from the inside with a pair of tweezers, then disconnect the connector.

Replacement of Parts

Installing the Trough Sensor (Right)

- Step 1. Reattach the sensor to the connector, then clip it into place on the chassis.
- Step 2. Reattach the carriage chassis assembly to the main chassis by fastening four screws.
- Step 3. Replace the absorber chimney.
- Step 4. Replace the remaining components for the **Assembly Platen** (refer to the procedures in **Installing the Assembly Platen** from **Replacement of Assembly Platen**).

Replacement of Parts

Replacement of Back Door Sensor

You will be removing the back door sensor from the printer and installing a new back door sensor.

Removing the Back Door Sensor

Step 1. Remove the **Assembly Platen** (refer to the procedures in **Removing the Assembly Platen** from **Replacement of Assembly Platen**).

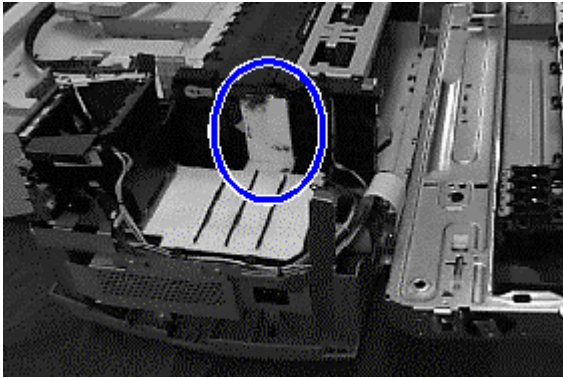

Step 2. Remove the absorber chimney.

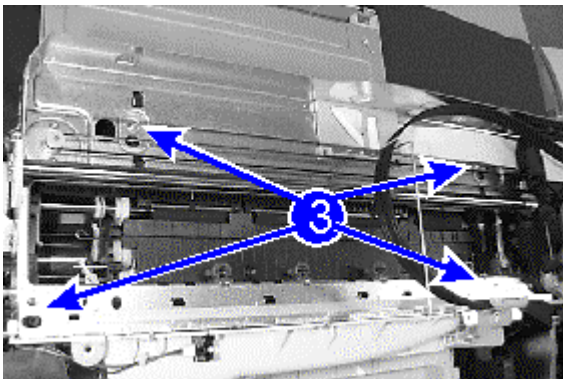

Step 3. Unscrew four screws on the frame of the carriage chassis assembly and remove the unit.

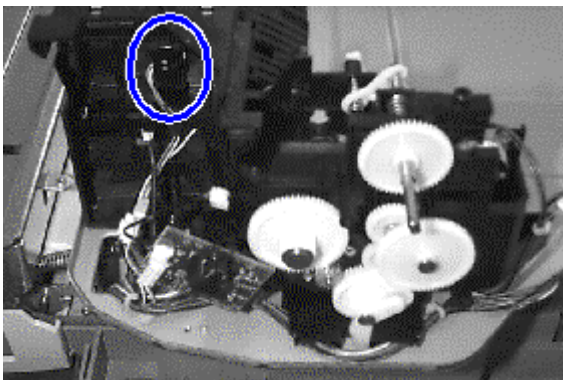

Step 4. With a pair of tweezers, unlatch the sensor by prying it loose from the outer side of the print mechanism, then detach the connector and remove the sensor.

Replacement of Parts

Installing the Back Door Sensor

- Step 1. Reattach the sensor to the connector, then snap it into place on the print mechanism.
- Step 2. Reattach the carriage chassis assembly to the main chassis by fastening four screws.
- Step 3. Replace the absorber chimney.
- Step 4. Replace the remaining components for the **Assembly Platen** (refer to the procedures in **Installing the Assembly Platen** from **Replacement of Assembly Platen**).

Replacement of Parts

Replacement of Line Feed Motor

You will be removing the line feed motor from the printer and installing a new motor.

Removing the Line Feed Motor

Step 1. Remove the **Pick Roller** (refer to the procedures in **Removing the Pick Roller** from **Replacement of Pick Roller**).

Step 2. Remove the two screws fastening the line feed motor to the print mechanism.

Step 3. Disconnect the black and white connector from the motor, and slide the motor unit out.

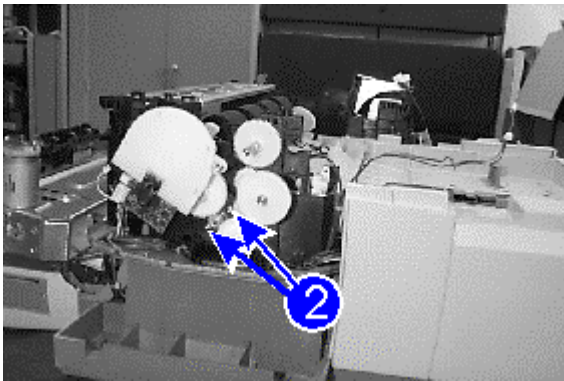

Replacement of Parts

Installing the Line Feed Motor

- Step 1. Slide the new left motor into position, then reattach the black/white connectors.
- Step 2. Fasten the motor in position with the two holding screws.
- Step 3. Replace the remaining components for the **Pick Roller** (refer to the procedures in **Installing the Pick Roller** from **Replacement of Pick Roller**).

Replacement of Parts

Replacement of Paper Trough

You will be removing the paper trough from the printer and installing a new paper trough.

Removing the Paper Trough

Step 1. Remove **Paper Tray 2** (refer to the procedures in **Removing the Paper Tray** from **Replacement of Paper Tray**).

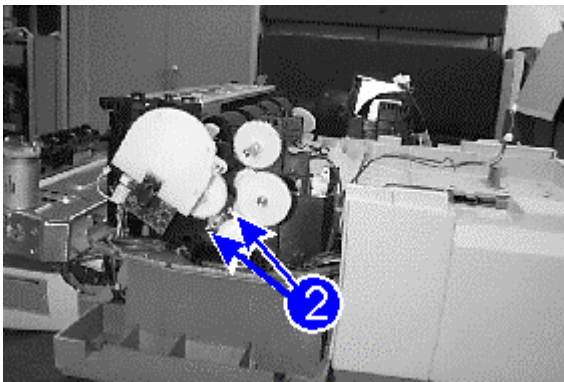

Step 2. Remove the two screws fastening the line feed motor to the print mechanism.

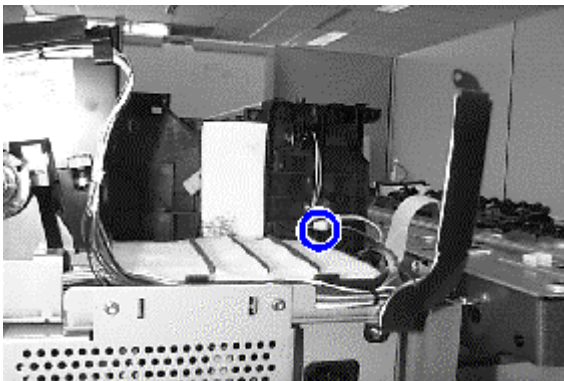

Step 3. Disconnect the red/blue connector that loops through the right wall.

Step 4. Remove the paper trough.

Replacement of Parts

Installing the Paper Trough

Step 1. Replace the paper trough.

Step 2. Reattach the connector that loops through the right wall.

Step 3. Fasten the motor in position with the two holding screws.

Step 4. Replace the remaining components for the **Paper Tray** (refer to the procedures in **Installing the Paper Tray** from **Replacement of Paper Tray 1**).

Replacement of Parts

Replacement of Sensor Assembly Housing

You will be removing the sensor assembly housing from the printer and installing a new sensor assembly housing.

Removing the Sensor Assembly Housing

Step 1. Follow **Steps 1-4** of **Removing the Drive Roller** from **Replacement of Drive Roller**.

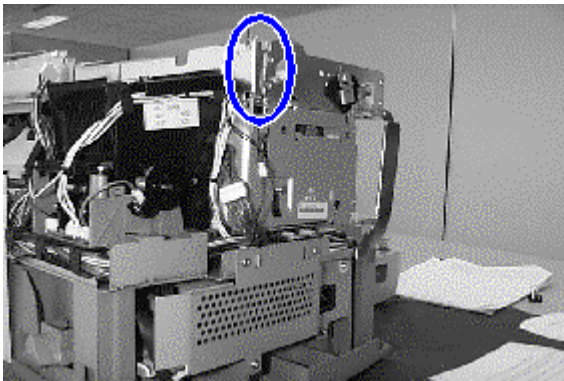

Step 2. Remove the sensor assembly housing from the carriage chassis assembly by using the pair of tweezers, pushing the retaining catch while prying upwards simultaneously so that it unsnaps loose.

Replacement of Parts

Installing the Sensor Assembly Housing

- Step 1. Attach the new sensor assembly housing to the chassis assembly by sliding it into position.
- Step 2. Replace the remaining components for the **Drive Roller** (refer to **Steps 8-11** of **Installing the Drive Roller** from **Replacement of Drive Roller**).

Replacement of Parts

Replacement of Belt Drive

You will be removing the belt drive from the printer and installing a new belt drive.

Removing the Belt Drive

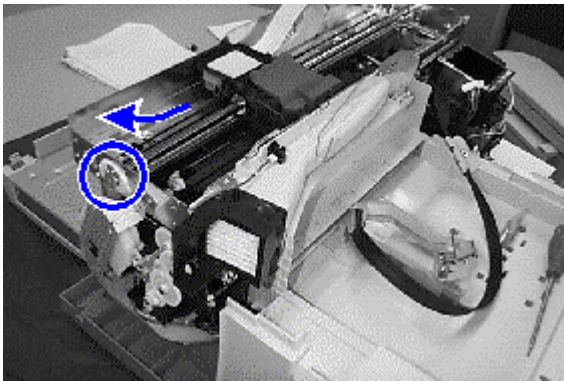

Step 1. Remove the **Sensor Assembly Housing** (refer to the procedures in **Removing the Sensor Assembly Housing** from **Replacement of Sensor Assembly Housing**).

Step 2. Remove the stopper shaft on the left of the carriage chassis assembly by turning it anticlockwise until it is inverted and can be removed.

Step 3. Remove the stopper shaft on the right in a similar manner, turning it clockwise.

Step 4. Remove the stopper spring.

Step 5. Remove the encoder strip by gently pulling it to the left until the left end can be unhooked, then unhook the right end from the encoder snub and carefully slide the encoder strip free.

Step 6. Unslacken tension in the drive belt by pushing inwards on the idler assembly till the belt comes loose.

Step 7. Remove the flex clamp by unlatching the retaining tabs from underneath.

Step 8. Slide the carriage shaft out.

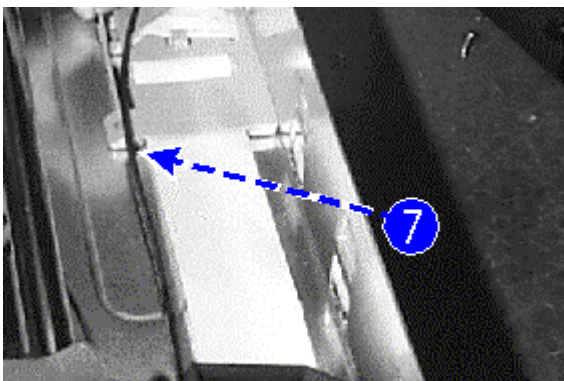
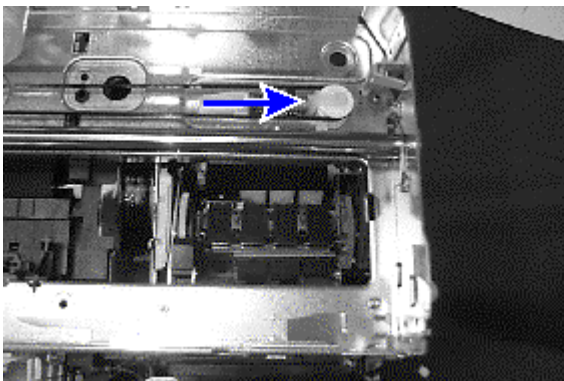

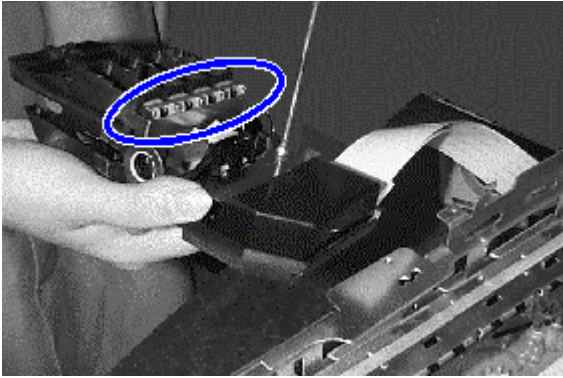

Step 9. Remove the belt retainer by unlatching the four retaining tabs on the print carriage.

Step 10. Remove the belt drive, along with the securing springs. Keep the springs for the new belt drive.

Replacement of Parts

Installing the Belt Drive

- Step 1. Place the belt drive into the print carriage, aligning the indicator tab correctly. Carefully place the securing springs.
- Step 2. Replace belt retainer, ensuring that all four retaining tabs snap into position.
- Step 3. Slide the carriage shaft back onto the carriage chassis assembly.
- Step 4. Reattach the flex clamp.
- Step 5. Replace the drive belt by first looping the belt drive on the right around the drive motor axle, then tighten the slack on the right by sliding the idler assembly inwards till the belt loops around it.
- Step 6. Replace the encoder strip, taking care not to touch the encoded portion of the strip itself, by hooking it on the right encoder snub, then carefully sliding it through the print carriage mechanism and latching it taut on the left.
- Step 7. Reattach the stopper spring.
- Step 8. Replace the left stopper shaft by placing it into the socket inverted, then rotating it clockwise till it snaps into position.
- Step 9. Repeat the same for the right stopper shaft, rotating it anticlockwise into position.
- Step 10. Replace the remaining components for the **Sensor Assembly Housing** (refer to the procedures in **Installing the Sensor Assembly Housing** from **Replacement of Sensor Assembly Housing**).

Replacement of Parts

Replacement of Idler Assembly

You will be removing the idler assembly from the printer and installing a new idler assembly.

Removing the Idler Assembly

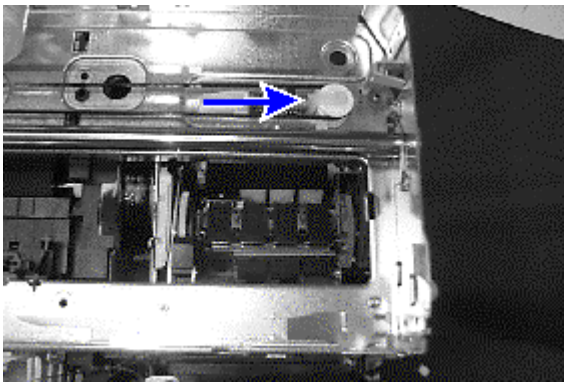

- Step 1. Remove the **Main Case** (refer to the procedures in **Removing the Main Case** from **Replacement of Main Case**).
- Step 2. Slacken the tension on the drive belt by pushing the idler assembly inwards till the belt comes loose.
- Step 3. Remove the idler assembly by pushing the lever inwards from the left and slide the idler assembly out.

Replacement of Parts

Installing the Idler Assembly

- Step 1. Replace the new idler assembly by sliding the unit into the groove from the left, then push the right lever inwards till it springs into position.
- Step 2. Replace the drive belt by first looping the belt drive on the right around the drive motor axle, then tighten the slack on the right by sliding the idler assembly lever inwards till the belt loops around it.
- Step 3. Replace the remaining components for the **Main Case** (refer to the procedures in **Installing the Main Case** from **Replacement of Main Case**).

Replacement of Parts

Replacement of Upper Paper Guide

You will be removing the upper paper guide from the printer and installing a new upper paper guide.

Removing the Upper Paper Guide

Step 1. Remove the **Main Case** (refer to the procedures in **Removing the Main Case** from **Replacement of Main Case**).

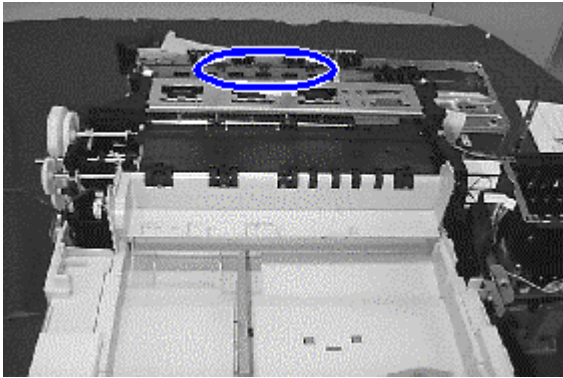

Step 2. From the front of the printer, push the latches of the upper paper guide in and the main latch upwards. Use a screw driver if required.

Step 3. Slide the paper guide up from the top of the printer.

Replacement of Parts

Installing the Upper Paper Guide

- Step 1. Push the new upper paper guide downwards from the top of the printer till it snaps in place.
- Step 2. Replace the remaining components for the **Main Case** (refer to the procedures in **Installing the Main Case** from **Replacement of Main Case**).

Replacement of Parts

Replacement of Print Carriage Flex Cable

You will be removing the print carriage flex cable from the printer and installing a new flex cable.

Removing the Print Carriage Flex Cable

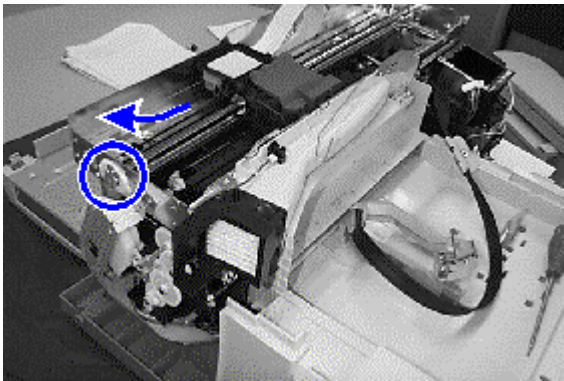

Step 1. Remove the **Sensor Housing Assembly** (refer to the procedures in **Removing the Sensor Housing Assembly** from **Replacement of Sensor Assembly Housing**).

Step 2. Remove the stopper shaft on the left of the carriage chassis assembly by turning it anticlockwise until it is inverted and can be removed.

Step 3. Remove the stopper shaft on the right in a similar manner, turning it clockwise.

Step 4. Remove the stopper spring.

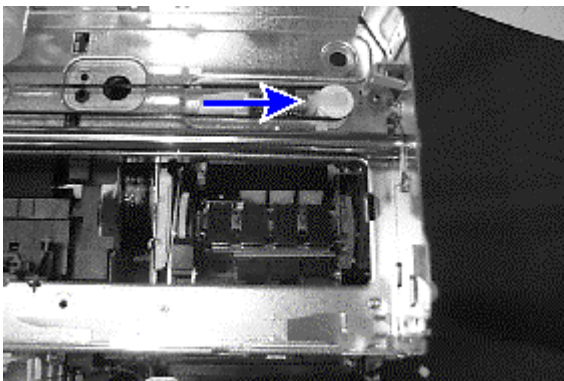

Step 5. Remove the encoder strip by gently pulling it to the left until the left end can be unhooked, then unhook the right end from the encoder snub and carefully slide the encoder strip free.

Step 6. Slacken tension in the drive belt by pushing inwards on the idler assembly till the belt comes loose.

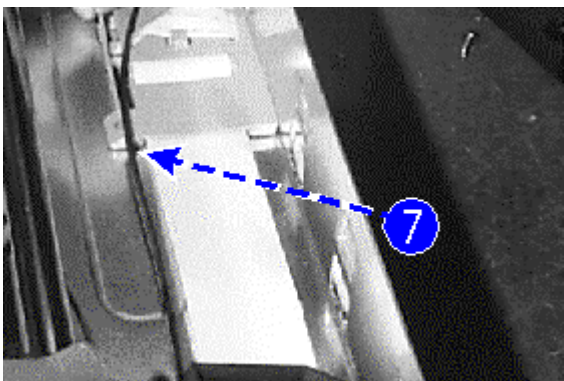

Step 7. Remove the flex clamp by unlatching the retaining tabs from underneath.

Step 8. Slide the carriage shaft out and separate the print carriage from the rest of the other components.

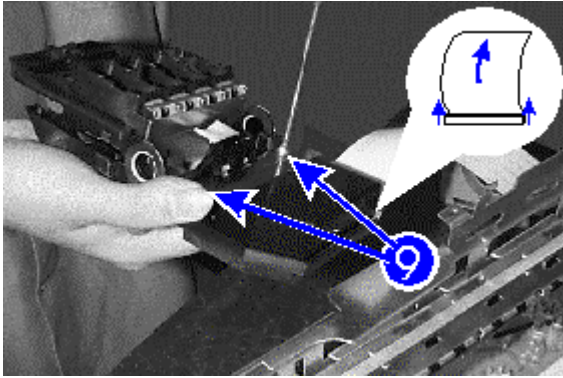

Step 9. Remove two screws from the top of the print carriage. The top of the carriage folds open backwards.

Step 10. Carefully remove the two flex connectors from the PCA by lifting the black plastic fastener at both ends and sliding the connectors out. If required, unfasten the plastic retainer gently using a pair of tweezers.

Step 11. Slide the flex cable out through the slots on the carriage chassis assembly and detach from the printer.

Replacement of Parts

Installing the Print Carriage Flex Cable

- Step 1. Reattach the double flex connectors to the print carriage, gently pushing both ends of the black plastic fastener till they are seated firmly in the slots. Snap the plastic retainer into position, with tweezers if necessary.
- Step 2. Slide the remainder of the flex cable through the slots on the carriage chassis assembly, folding the flex cable as shown (require pictures to show how they are folded). Ensure that the folds are made within the insulated area to prevent abrasive damage to the cable.
- Step 3. Attach the other end of the flex cable to the printer.
- Step 4. Slide the carriage shaft back onto the carriage chassis assembly, mounting the print carriage mechanism.
- Step 5. Reattach the flex clamp.
- Step 6. Replace the drive belt by first looping the belt drive on the right around the drive motor axle, then tighten the slack on the right by sliding the idler assembly inwards till the belt loops around it.
- Step 7. Replace the encoder strip, taking care not to touch the encoded portion of the strip itself, by hooking it on the right encoder snub, then carefully sliding it through the print carriage mechanism and latching it taut on the left.
- Step 8. Reattach the stopper spring.
- Step 9. Replace the left stopper shaft by placing it into the socket inverted, then rotating it clockwise till it snaps into position.
- Step 10. Repeat the same for the right stopper shaft, rotating it anticlockwise into position.
- Step 11. Replace the remaining components for the **Sensor Assembly Housing** (refer to the procedures in **Installing the Sensor Assembly Housing** from **Replacement of Sensor Assembly Housing**).

Replacement of Parts

Replacement of Carriage Chassis Assembly

You will be removing the carriage chassis assembly from the printer and installing a new carriage chassis assembly.

Removing the Carriage Chassis Assembly

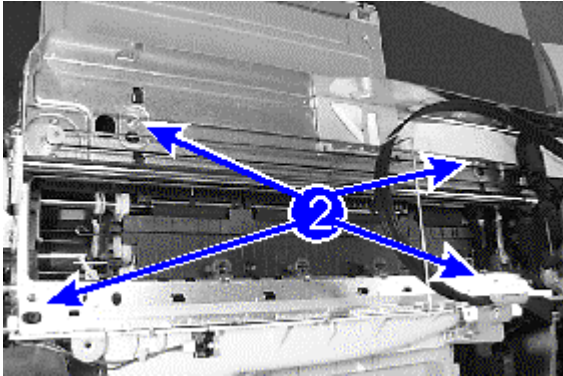

Step 1. Follow **Steps 1-5** of **Removing the Assembly Platen** from **Replacement of Assembly Platen**.

Step 2. Unscrew four screws on the frame of the carriage chassis assembly and remove the unit.

Replacement of Parts

Installing the Carriage Chassis Assembly

- Step 1. Reattach the carriage chassis assembly to the main chassis by fastening four screws.
- Step 2. Replace the remaining components for the **Assembly Platen** (refer to **Steps 6-9** of **Installing the Assembly Platen** from **Replacement of Assembly Platen**).

Chapter 11 Calibration

Pen-to-Paper Calibration (PPC)

Pre-requisites and Tools Required

Note

The PPC equipment and procedures are similar for HP DesignJet ColorPro Series Printer and HP 2000C/2500C Printer. The PPC technology is based on the Zaphod pen and applies to these platforms.

1. A Pentium or 486 PC installed with Windows 95. The PC must have one ISA slot free for inserting the Data Acquisition Card. A desk top model is preferred.
2. Install the Data Acquisition Card in the PC's ISA slot and tighten the screws to secure. Make sure the printer is off when the card is added.
3. HP DesignJet ColorPro Series Printer driver version 1 should be installed in the PC.

If it is not, HP DesignJet ColorPro Series Printer driver is available from the web, [http:// www.designjet-online.hp.com](http://www.designjet-online.hp.com). At the web page, go to drivers download and select the driver for Windows 95.

4. The tools required are:
 - i) PPC Zaphod sensor pen.
 - ii) Calibration Stand
 - iii) PPC special media.

Pen-to-Paper Calibration (PPC)

Installation of PPC software

Step 1. Install the PPC software by running the set up file. Please accept all the default settings. The software is self installing without much help.

Step 2. Using Windows Explorer, go to c:\ppc. Create a shortcut to file, ppc.exe, at the desk top.

Step 3. Double click on the 'ppc icon'. A login menu will appear and give the following details.

Login :- hp2000
Password :- rogue1

Step 4. Click the OK button when the software screen appears.

Step 5. Go to the 'set up' menu at the top of the screen. Select 'Calibration stand'. A detailed menu on Calibration stand appears. Key in all the details as per the Calibration stand supplied along with the serial number. Press OK.

Step 6. Go to 'set up' menu. Select 'Spec limits' then 'adjust' menu. Change the specifications as follows.

Min specification :- 1.1938
Nominal :- 1.3716
Max specification :- 1.5494

Let the other details remain unchanged as we will not be using the other details for the measurement process. Press OK to continue.

Step 7. Click the left most button 'CALIBRATION'. Put in the sensor serial number and the calibration block serial number. Follow the menu to calibrate. There are two sections for calibration. After the first stage, it will once again verify the calibration.

Step 8. Press the big 'MEASURE' button on the right side of the screen. You can see that the tool is ready for calibration.

Pen-to-Paper Calibration (PPC)

Measurement

- Step 1. Put the Zaphod sensor pen in the carriage of HP DesignJet ColorPro Series Printer. Use the slot for the black pen.
- Step 2. Pick the paper using Paper Jam Removal Knob and drive it until 20 mm ahead of Cockle Rib ends.

Note
1. Use special PPC media supplied. Do not use any other paper.
2. Media should be inserted in Landscape mode.

Step 3. Move the carriage to the left side of the paper. Give around 10 mm margin from the end of paper to the sensor.

Step 4. Check the reading. Adjust the carriage to make the paper angle between LSL and USL, that is, the red floating line is between two blue lines.

Step 5. Tighten the carriage adjustor.

Step 6. Move the carriage to the right position of the paper.

Step 7. Adjust the carriage.

Step 8. Tighten the carriage adjustor.

Step 9. Scan move the carriage across the media to check whether any region is out of specification. If an area is out of specification, adjust the carriage to rectify the error.

Step 10. Torque tighten the adjustor screws to $10\text{Kgfc} \pm 0.5\text{Kgfc}$. If this adjustment cannot ensure the product to be within specification, change the Upper Paper Guide until the specification is met.

This document and all future updates are available in the web site, <http://gul61198.sgp.hp.com/ppcinstall.htm>. This is part of the Intranet and will be available only inside HP.

About this Edition

This is the 1st edition of this Service Manual

1st edition, titled

HP C7777A/C7778A DesignJet ColorPro CAD and ColorPro GA Service Manual



What's in this Service Manual

This manual contains information necessary to test, calibrate and service:

- HP DesignJet ColorPro CAD (model C7777A)
- HP DesignJet ColorPro GA (model C7778A)

For information about using these printers, refer to the corresponding User and Quick Reference Guides.

The procedures described in this manual are to be performed by HP-qualified Service Personnel only.